

Engineering

- Land/Site Development
- Municipal Infrastructure
- Environmental/Water Resources
- Traffic/Transportation
- Recreational

Planning

- Land/Site Development
- Planning Application Management
- Municipal Planning
- Urban Design
- Expert Witness (LPAT)
- Wireless Industry

Landscape Architecture

- Streetscapes & Public Amenities
- Open Space, Parks & Recreation
- Community & Residential
- Commercial & Institutional
- Environmental Restoration



Proposed Residential Development 5331 Fernbank Road Transportation Impact Assessment

Proposed Residential Development
5331 Fernbank Road
Transportation Impact Assessment

Prepared By:

NOVATECH
Suite 200, 240 Michael Cowpland Drive
Ottawa, Ontario
K2M 1P6

June 3, 2021
Revised November 8, 2021

Novatech File: 121011
Ref: R-2021-081



November 8, 2021

City of Ottawa
Planning and Growth Management Department
110 Laurier Ave. W., 4th Floor,
Ottawa, Ontario K1P 1J1

Attention: Ms. Josiane Gervais
Project Manager, Infrastructure Approvals

Dear Ms. Gervais:

Reference: 5331 Fernbank Road
Transportation Impact Assessment
Novatech File No. 121011

We are pleased to submit the following Transportation Impact Assessment (TIA) in support of a Site Plan Control application for 5331 Fernbank Road. The structure and format of this report is in accordance with the City of Ottawa Transportation Impact Assessment Guidelines (June 2017).

If you have any questions or comments regarding this report, please feel free to contact the undersigned.

Yours truly,

NOVATECH

A handwritten signature in blue ink that reads "B. Byvelds".

Brad Byvelds, P. Eng.
Project Coordinator | Transportation/Traffic



TIA Plan Reports

On 14 June 2017, the Council of the City of Ottawa adopted new Transportation Impact Assessment (TIA) Guidelines. In adopting the guidelines, Council established a requirement for those preparing and delivering transportation impact assessments and reports to sign a letter of certification.

Individuals submitting TIA reports will be responsible for all aspects of development-related transportation assessment and reporting, and undertaking such work, in accordance and compliance with the City of Ottawa's Official Plan, the Transportation Master Plan and the Transportation Impact Assessment (2017) Guidelines.

By submitting the attached TIA report (and any associated documents) and signing this document, the individual acknowledges that s/he meets the four criteria listed below.

CERTIFICATION

1. I have reviewed and have a sound understanding of the objectives, needs and requirements of the City of Ottawa's Official Plan, Transportation Master Plan and the Transportation Impact Assessment (2017) Guidelines;
2. I have a sound knowledge of industry standard practice with respect to the preparation of transportation impact assessment reports, including multi modal level of service review;
3. I have substantial experience (more than 5 years) in undertaking and delivering transportation impact studies (analysis, reporting and geometric design) with strong background knowledge in transportation planning, engineering or traffic operations; and
4. I am either a licensed¹ or registered² professional in good standing, whose field of expertise [check appropriate field(s)] is either transportation engineering or transportation planning .

1,2 License of registration body that oversees the profession is required to have a code of conduct and ethics guidelines that will ensure appropriate conduct and representation for transportation planning and/or transportation engineering works.

City Of Ottawa
Infrastructure Services and Community
Sustainability
Planning and Growth Management
110 Laurier Avenue West, 4th fl.
Ottawa, ON K1P 1J1
Tel. : 613-580-2424
Fax: 613-560-6006

Ville d'Ottawa
Services d'infrastructure et Viabilité des
collectivités
Urbanisme et Gestion de la croissance
110, avenue Laurier Ouest
Ottawa (Ontario) K1P 1J1
Tél. : 613-580-2424
Télécopieur: 613-560-6006

Dated at Ottawa this 8 day of November, 2021 .
(City)

Name: Brad Byvelds
(Please Print)

Professional Title: P. Eng. - Project Coordinator

B. Byvelds

Signature of Individual certifier that s/he meets the above four criteria

Office Contact Information (Please Print)	
Address:	240 Michael Cowpland Drive
City / Postal Code:	Ottawa, ON K2M 1P6
Telephone / Extension:	613-254-9643 ext. 286
E-Mail Address:	b.byvelds@novaetch-eng.com

TABLE OF CONTENTS

1.0	SCREENING	1
1.1	Introduction.....	1
1.2	Proposed Development	2
1.3	Screening Form	2
2.0	SCOPING	2
2.1	Existing Conditions	2
2.1.1	<i>Roadways</i>	2
2.1.2	<i>Intersections</i>	4
2.1.3	<i>Driveways</i>	4
2.1.4	<i>Pedestrian and Cycling Facilities</i>	5
2.1.5	<i>Transit</i>	5
2.1.6	<i>Existing Area Traffic Management Measures</i>	6
2.1.7	<i>Existing Traffic Volumes</i>	7
2.1.8	<i>Collision Records</i>	8
2.2	Planned Conditions.....	9
2.3	Study Area and Time Periods	10
2.4	Exemptions Review	10
3.0	FORECASTING	11
3.1	Development-Generated Traffic.....	11
3.1.1	<i>Trip Generation</i>	11
3.1.2	<i>Trip Distribution</i>	13
3.2	Background Traffic.....	13
3.2.1	<i>General Background Growth Rate</i>	13
3.2.2	<i>Other Area Development</i>	14
3.3	Demand Rationalization.....	20
3.3.1	<i>Existing Traffic</i>	21
3.3.2	<i>2023 Background Traffic</i>	21
3.3.3	<i>2028 Background Traffic</i>	22
4.0	ANALYSIS	23
4.1	Development Design.....	23
4.1.1	<i>Design for Sustainable Modes</i>	23
4.1.2	<i>Circulation and Access</i>	24
4.2	Parking	24

4.3 Boundary Streets27

4.4 Access Intersections Design28

4.5 Transportation Demand Management.....38

 4.5.1 Context for TDM38

 4.5.2 Need and Opportunity.....38

 4.5.3 TDM Program38

4.6 Neighbourhood Traffic Management38

4.7 Transit.....39

4.8 Network Concept39

4.9 Network Intersections40

 4.9.1 Existing Intersection MMLOS Analysis.....40

 4.9.2 2023 Total Intersection Operations41

 4.9.3 2028 Total Intersection Operations41

5.0 CONCLUSIONS AND RECOMMENDATIONS42

Figures

Figure 1: View of the Subject Lands..... 1

Figure 2: Roadway Network..... 3

Figure 3: OC Transpo Bus Stop Locations 6

Figure 4: Existing Traffic Volumes..... 7

Figure 5: Site Generated Traffic14

Figure 6: 2023 Other Area Development Traffic.....15

Figure 7: 2028 Other Area Development Traffic.....16

Figure 8: 2023 Background Traffic17

Figure 9: 2028 Background Traffic18

Figure 10: 2023 Total Traffic19

Figure 11: 2028 Total Traffic20

Figure 12: Garbage Turning Movements.....25

Figure 13: Garbage Turning Movements.....26

Figure 14: Terry Fox Drive Access – Turning Movements29

Figure 15: Terry Fox Drive Access – Turning Movements30

Figure 16: Stopping Sight Distance – Cope Drive32

Figure 17: Stopping Sight Distance – Cope Drive33

Figure 18: Turning Sight Distance – Cope Drive34

Figure 19: Turning Sight Distance – Cope Drive35

Figure 20: Stopping Sight Distance – Terry Fox Drive.....36

Figure 21: Turning Sight Distance – Terry Fox Drive.....37

Tables

Table 1: OC Transpo Route Information	6
Table 2: Reported Collisions	8
Table 3: TIA Exemptions	11
Table 4: Peak Period Person Trip Generation	12
Table 5: Peak Period Person Trips by Modal Share	12
Table 6: Peak Hour Person Trips by Mode Share	12
Table 7: Existing Traffic.....	21
Table 8: 2023 Background Traffic	21
Table 9: 2028 Background Traffic	22
Table 10: Parking Requirements.....	24
Table 11: Segment MMLOS Summary.....	27
Table 12: Access Intersection Operations	31
Table 13: Neighbourhood Traffic Impacts.....	38
Table 14: Projected Transit Utilization.....	39
Table 15: Intersection MMLOS Summary.....	40
Table 16: 2023 Total Traffic	41
Table 17: 2028 Total Traffic	42

Appendices

Appendix A: Proposed Site Plan
Appendix B: TIA Screening Form
Appendix C: OC Transpo System Information
Appendix D: Traffic Count and Signal Timing Data
Appendix E: Collision Records
Appendix F: Relevant Traffic Study Excerpts
Appendix G: Synchro Analysis Reports – Existing/Background Traffic
Appendix H: Transportation Demand Management Checklists
Appendix I: Multi-Modal Level of Service Analysis
Appendix J: MTO Left Turn Lane Warrants
Appendix K: Functional Design of Left Turn Lane on Cope Drive
Appendix L: Synchro Analysis Reports – Future Traffic

EXECUTIVE SUMMARY

Novatech has been retained by Claridge Homes to prepare a Transportation Impact Assessment (TIA) in support of a Site Plan Control application to allow for the development of the lands known as 5331 Fernbank Road.

The subject site is currently zoned General Mixed-Use (GM[2411]) in Zoning By-law 2008-250 and permits the proposed development. The development consists of 192 residential two-bedroom condominium units and 268 parking spaces. Two accesses to the subject site will be provided and are described as follows:

- Full movement access along Cope Drive opposite the future Street 1 to the residential subdivision at 5331 Fernbank Road and 1039 Terry Fox Drive north of Cope Drive (City File Number: D07-16-18-0027), approximately 140m east of Terry Fox Drive and 80m west of Northgraves Crescent
- Right-in/right-out access along Terry Fox Drive, approximately 145m north of Fernbank Road and 210m south of Cope Drive

The proposed development will be constructed in one phase, with an estimated completion date of 2023.

The conclusions and recommendations of this TIA can be summarized as follows:

Development Design

- A sidewalk will be provided on both sides of the main drive-aisles, connecting to the existing sidewalks along Cope Drive and Fernbank Road.
- A north-south pathway will also be provided on the eastern portion of the site, connecting from Cope Drive to Fernbank Road. An east-west pathway will be provided between buildings G and F, connecting to an existing pathway leading to Patriot Place.
- Bicycle parking will be in accordance with the minimum requirements of the City's Zoning By-law. Bicycle parking racks will be located near the entrances for each building.
- All required TDM-supportive design and infrastructure measures in the TDM checklist are met.
- Garbage collection will be conducted on-site. Earth bins will be located on the west side of the main drive aisle opposite Building G, and in a garbage area south of Building Q.

Parking

- A total of 268 vehicle parking spaces (230 resident, 38 visitor) and 96 bicycle parking spaces are proposed, meeting the minimum requirements of the City's Zoning By-law.

Boundary Street Design

- Cope Drive meets the target PLOS but does not meet the target BLOS for the general urban area. Either a reduction in operating speed combined with bike lanes or a separated cycling facility are required to achieve the target BLOS B. This is identified for the City's consideration.
- Fernbank Road meets the target TkLOS for the general urban area. However, it does not meet a target PLOS C and BLOS C. A boulevard width of 0.5m or greater between the sidewalk and the roadway is required on the north side of the road. A reduction in the operating speed is required to achieve the target PLOS C on the south side of the road.

Either a reduction in operating speed or a separated cycling facility are required to achieve the target BLOS C. This is identified for the City's consideration.

- Terry Fox Drive meets the target TkLOS. However, it does not meet the target PLOS and BLOS. Opportunities to improve the PLOS and BLOS should be explored by the City through the future widening of Terry Fox Drive, as identified in the City's 2013 TMP network concept. At that time, consideration should be given by the City to providing a 2m sidewalk with a boulevard to improve the PLOS. A review of the OTM Book 18 Cycling Nomograph suggests consideration should be given to implementing a separated cycling facility along Terry Fox Drive as part of the future widening project.

Access Intersections Design

- One new all movement access is proposed on Cope Drive, opposite the future Street 1 connection to the subdivision north of Cope Drive, and a right-in right-out access to Terry Fox Drive. The sidewalk along Cope Drive will be depressed and continuous through the proposed accesses, per City of Ottawa Specification 7.1.
- The width of the Cope Drive access conforms to the requirements of the City's Private Approach By-law and Zoning By-law.
- As the width of the Terry Fox Drive access is required to accommodate the proposed pork chop right-in right-out island, a waiver to Section 25 (c) of the Private Approach By-law is requested.
- The location of both accesses meet the requirements of the Private Approach By-law.
- A maximum grade of 2% is proposed for a distance of 9m within the private property at both accesses, conforming to the requirements of the Private Approach By-law.
- Based on the projected northbound right turn volumes at the Terry Fox Drive access, a right turn lane is not recommended. A pork chop island will be provided to restrict this access to right-in right-out.
- Based on the projected eastbound right turn volumes at the Cope Drive access, a right turn lane is not recommended.
- To provide improved access operations and safety, a westbound left turn lane will be painted in lieu of the previously proposed gore area runout taper as part of the left turn lane for the subdivision opposite the proposed development.
- The required Stopping Sight Distance and Intersection Sight Distance at both accesses meet TAC requirements.
- Side street stop control is recommended at the proposed accesses along Cope Drive and Terry Fox Drive.

Transportation Demand Management

- The proposed development conforms to the City's TDM initiatives by providing easy access to local pedestrian, bicycle, and transit systems.
- The following additional TDM measures will be implemented within the proposed development:
 - Unbundle parking from purchase price, and
 - Provide multimodal travel option information package to new residents.

Neighbourhood Traffic Management

- The proposed development is anticipated to generate 7-11 vehicle trips (two-way) along Cope Drive east of the access during the weekday AM and PM peak hours. This equates to one vehicle every 5.5-8.5 minutes during peak hours.

- As there is sufficient capacity along Cope Drive to accommodate traffic generated by the development, no mitigation measures are recommended to offset the impacts of the development generated traffic.

Transit

- The existing routes 161, 164, and 252 have capacity to accommodate the projected transit trips generated by the proposed development.

MMLOS Analysis

- Terry Fox Drive/Cope Drive
 - The Terry Fox Drive/Cope Drive intersection currently does not meet the target PLOS or BLOS for the General Urban Area. As this intersection is not located along a rapid transit or transit priority network, there is no target TLOS.
 - A reduction in the crossing distance on all legs of the intersection would have the greatest improvement on the PETS I score and the Pedestrian Delay.
 - Due to the high operational speed along Terry Fox Drive, a BLOS B is unachievable on the north and south approaches. The target BLOS can be achieved on the east and west approaches by implementing two-stage left-turn bike boxes. This is identified for the City's consideration.
- Terry Fox Drive/Fernbank Road
 - The Terry Fox Drive/Fernbank Road intersection currently does not meet the target PLOS, BLOS, or Auto LOS for the General Urban Area. As this intersection is not located along a rapid transit or transit priority network, there is no target TLOS.
 - A reduction in the crossing distance on all legs of the intersection would have the greatest improvement on the PETS I score and the Pedestrian Delay.
 - Due to the high operational speed along Terry Fox Drive and Fernbank Road, a BLOS B is unachievable at this intersection. A reduction in the length of the southbound, eastbound, and westbound right turn lanes, and a reduction in the operating speed along both Terry Fox Drive and Fernbank Road are required to meet the target BLOS at this intersection.
 - Critical movements at the Terry Fox Drive/Fernbank Road intersection are currently operating with an Auto LOS C during the AM peak hour and an Auto LOS F during the PM peak hour.
 - PM peak hour traffic signalization with an increased cycle length of 120 seconds is anticipated to improve operations to a LOS D, meeting the area target. The increased cycle length is not anticipated to have a significant impact to the PLOS delay score at this intersection.

Background Intersection Operations

- Critical movements at the Terry Fox Drive/Cope Drive intersection are anticipated to operate with a LOS D or better during the weekday AM and PM peak hours.
- Critical movements at the Terry Fox Drive/Fernbank Road intersection are anticipated to operate with a LOS C during the AM peak hour and a LOS F during the PM peak hour.
- PM peak hour traffic signalization with an increased cycle length of 120 seconds is anticipated to improve operations to a LOS D, meeting the area target. The increased cycle length is not anticipated to have a significant impact to the PLOS delay score at this intersection.

Total Intersection Operations

- Traffic generated by the proposed development is anticipated to have marginal operational effects within the study area. The discussion of over-capacity movements and queue lengths are generally consistent with those described in the background traffic analysis.
- Under 2028 total traffic conditions, the v/c ratio associated with the eastbound left turn movement at the Terry Fox Drive/Cope Drive intersection is anticipated to increase from 0.90 to 0.91 during the PM peak hour, increasing to a LOS E. Minor optimization to the existing traffic signal plan is anticipated to improve operations to a LOS D, achieving the area target.
- Under 2028 total traffic conditions, the maximum northbound through queue along Terry Fox Drive is anticipated to be approximately 195m during the AM peak hour and 200m during the PM peak hour. This queue is anticipated to extend approximately to the Terry Fox Drive right-in right-out access during the peak hours, and drivers exiting north onto Terry Fox Drive may periodically rely on courtesy of other drivers.

1.0 SCREENING

1.1 Introduction

Novatech has been retained by Claridge Homes to prepare a Transportation Impact Assessment (TIA) in support of a Site Plan Control application to allow for the development of the lands known as 5331 Fernbank Road. The subject site is surrounded by the following:

- Cope Drive and future residential development to the north;
- Existing residential development to the east;
- New residential rental apartments under construction to the east on south side of Cope Drive;
- Fernbank Road and existing residential development to the south; and
- Terry Fox Drive and existing commercial retail development in the Fernbank Community Design Plan lands to the west.

A view of the subject lands is provided in **Figure 1**.

Figure 1: View of the Subject Lands

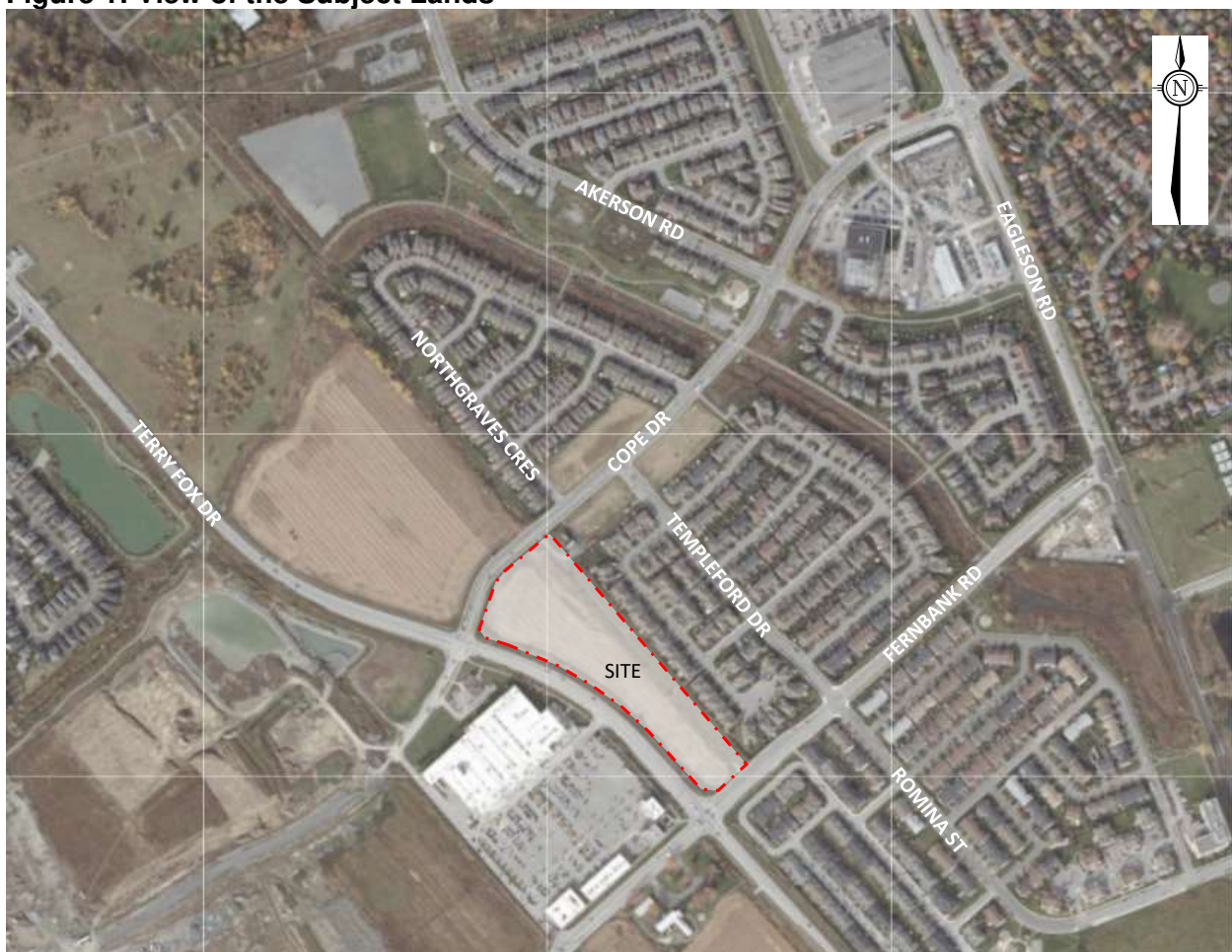

1.2 Proposed Development

The subject site is currently zoned General Mixed-Use (GM[2411]) in Zoning By-law 2008-250 and permits the proposed development. The development consists of 192 residential two-bedroom condominium units and 268 parking spaces. Two accesses to the subject site will be provided and are described as follows:

- Full movement access along Cope Drive opposite the future Street 1 to the residential subdivision at 5331 Fernbank Road and 1039 Terry Fox Drive north of Cope Drive (City File Number: D07-16-18-0027), approximately 140m east of Terry Fox Drive and 80m west of Northgraves Crescent
- Right-in/right-out access along Terry Fox Drive, approximately 145m north of Fernbank Road and 210m south of Cope Drive

The proposed development will be constructed in one phase, with an estimated completion date of 2023. A copy of the site plan is included in **Appendix A**.

1.3 Screening Form

The City's 2017 TIA Guidelines identify three triggers for completing a TIA report, including trip generation, location, and safety. The criteria for each trigger are outlined in the City's TIA Screening Form. A copy of the TIA Screening Form is included in **Appendix B**.

Based on the TIA Screening Form, the proposed development satisfies all three triggers for completing a TIA.

2.0 SCOPING

2.1 Existing Conditions

2.1.1 Roadways

The roadway network of the greater area surrounding the subject site is illustrated in **Figure 2**.

Figure 2: Roadway Network



Terry Fox Drive is an arterial roadway that generally runs on a north-south alignment within the study area. Near the subject lands, Terry Fox Drive has a two-lane undivided rural cross section. Terry Fox Drive is designated as a truck route with a posted speed limit of 80 km/hr within the study area. The City of Ottawa Official Plan (OP) identifies a 44.5m right-of-way (ROW) to be protected along Terry Fox Drive between Eagleson Road and the Great Trail (Trans-Canada Trail) located north of the site.

Fernbank Road runs on an east-west alignment between Dwyer Hill Road to Eagleson Road. It is classified as an arterial roadway in proximity of the subject site. Fernbank Road has a two-lane undivided urban cross section with a posted speed limit of 60km/hr between Eagleson Road and Terry Fox Drive. West of Terry Fox Drive, it transitions into a two-lane undivided rural cross section with a posted speed limit of 80km/hr. The City of Ottawa OP identifies a 30m ROW to be protected along Fernbank Road between Terry Fox Drive and Eagleson Road.

Cope Drive generally runs on an east-west alignment between Eagleson Road and west of Robert Grant Avenue. It is classified as a collector roadway between Eagleson Road and Terry Fox Drive. West of Terry Fox Drive, it is classified as a major collector roadway through the Fernbank Community Design Plan (CDP) lands. Cope Drive has a two-lane undivided urban cross section with a posted speed limit of 50km/hr. The City of Ottawa OP identifies a 24m ROW to be protected along the entire length of Cope Drive.

2.1.2 Intersections

Terry Fox Drive/Cope Drive

- Signalized intersection
- Northbound: one left turn lane and one shared through/right turn lane
- Southbound: one left turn lane, one through turn lane and one right turn lane
- Eastbound/Westbound: one left turn lane and one shared through/right turn lane
- Standard crosswalks are provided on all four legs
- A pocket bike lane is provided on the southbound approach



Terry Fox Drive/Fernbank Road

- Signalized intersection
- Northbound: one left turn lane and one shared through/right turn lane
- Southbound: one left turn lane, one through turn lane and one right turn lane
- Eastbound: one left turn lane, one through lane, and one right turn lane
- Westbound: one left turn lane, one through lane, and one channelized right turn lane
- Standard crosswalks are provided on all four legs
- Pocket bike lanes are provided on the eastbound, westbound, and southbound approaches



2.1.3 Driveways

In accordance with the City's 2017 TIA guidelines, a review of adjacent driveways along the boundary roads are provided as follows:

Terry Fox Drive, East Side:

- No other driveways

Terry Fox Drive, West Side:

- One right-in right-out driveway to commercial retail development at 5357 Fernbank Road
- One right-in driveway to an LCBO at 1150 Terry Fox Drive

Cope Drive, North Side:

- Future subdivision street 1 connection opposite proposed access
- No other driveways

Cope Drive, South Side:

- No other driveways

Fernbank Road, North Side:

- No other driveways

Fernbank Road, South Side:

- No other driveways

2.1.4 Pedestrian and Cycling Facilities

Terry Fox Drive is classified as a spine cycling route and currently contains paved shoulders.

Cope Drive is classified as a local cycling route between Terry Fox Drive and Eagleson Road, and a spine cycling route west of Terry Fox Drive. It has concrete sidewalks on both sides and mixed-use travel lanes east of Terry Fox Drive. It will have a concrete sidewalk on the south side and multi-use pathway on the north side west of Terry Fox Drive.

Fernbank Road is classified as a spine cycling route. It has concrete sidewalks on both sides and bike lanes east of Terry Fox Drive. It has paved shoulders west of Terry Fox Drive.

2.1.5 Transit

OC Transpo bus stops within a walking distance of 400m, or a five-minute walk, of the subject site are summarized as follows:

- Stop #4031 (Cope Drive/Northgraves Crescent) – Serves Route 161 and 252
- Stop #1919 (Cope Drive/Templeford Avenue) – Serves Route 161 and 164
- Stop #6933 (Cope Drive/Templeford Avenue) – Serves Route 164, 168, and 252
- Stop #1930 (Terry Fox Drive/Fernbank Road) – Serves Route 161 and 168
- Stop #1933 (Terry Fox Drive/Fernbank Road) – Serves Route 161

The location of the bus stops with respect to the subject site are shown in **Figure 3**.

Descriptions of the transit routes in proximity of the subject site are provided in the following table. Route maps and existing bus stop utilization data are included in **Appendix C**.

Figure 3: OC Transpo Bus Stop Locations

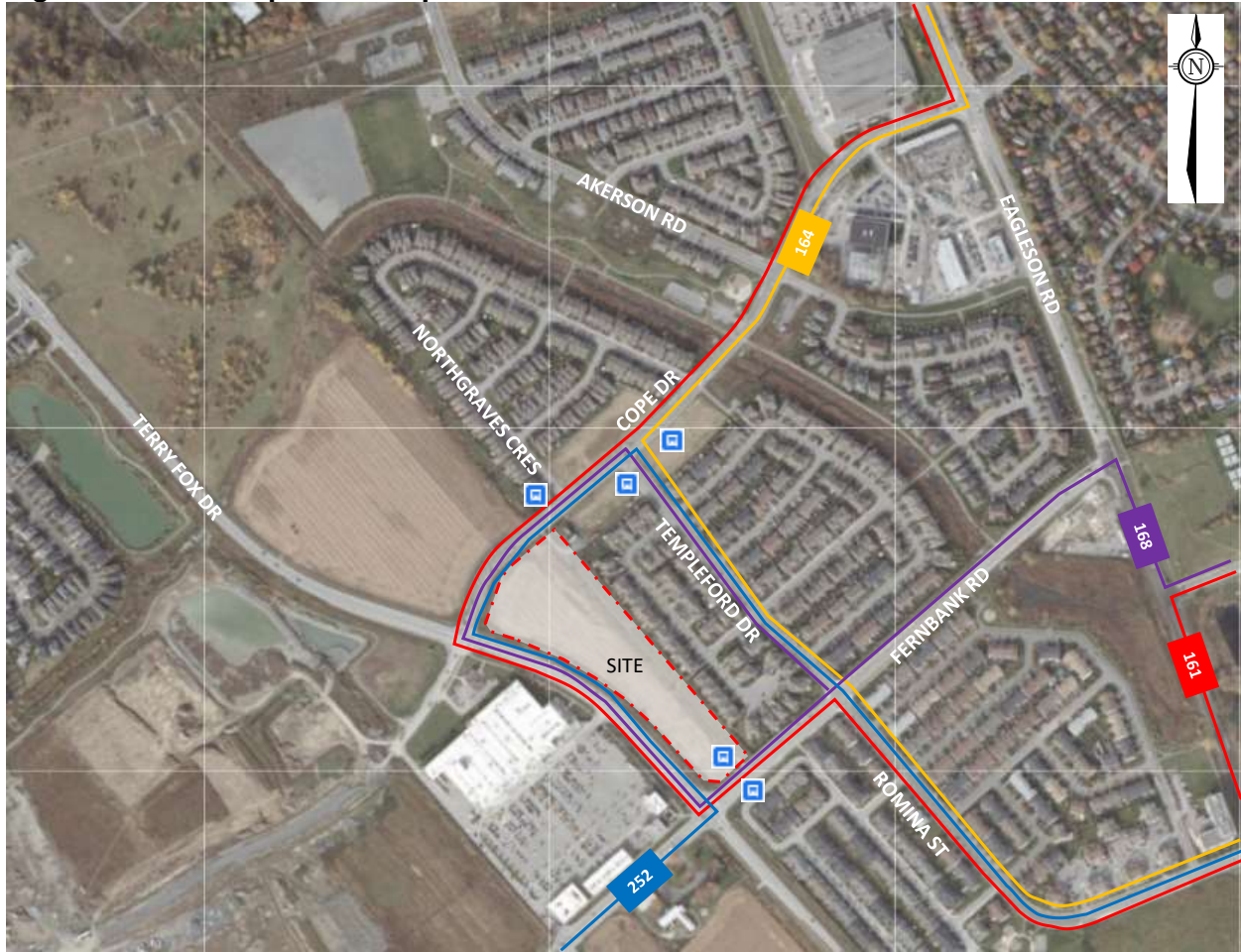

Table 1: OC Transpo Route Information

Route	Description	Schedule		
		Days	Service	Headways
161	Travels between Terry Fox Transit Station and Bridewood	Weekdays	All Day	Morning/Evening: 30 min Mid-Day/Night: 60 min
164	Travels between Terry Fox Transit Station and Hope Side Road	Weekdays	Peak Periods	Morning/Evening: 30 min
168	Travels between Terry Fox Transit Station and Cope Drive	7 Days/Week	All Day	All Day: 30 min
252	Travels between Mackenzie King Transit Station and Cope Drive	Weekdays	Peak Periods	Morning/Evening: 15-20 min

2.1.6 Existing Area Traffic Management Measures

Unit paver crosswalks are provided at the Cope Drive intersections with Northgraves Crescent, Templeford Avenue, and Akerson Road/Carronbridge Circle. There are currently no area traffic management measures in place along any other study area roadways.

2.1.7 Existing Traffic Volumes

Weekday traffic counts were obtained from the City of Ottawa at the study area intersections to determine the existing pedestrian, cyclist, and vehicular traffic volumes. The traffic counts were completed on the following dates:

- Terry Fox Drive/Cope Drive August 8, 2019
- Terry Fox Drive/Fernbank Road April 11, 2018

Existing traffic volumes along the study area roadways are shown in **Figure 4**. Peak hour summary sheets of the above traffic counts are included in **Appendix D**.

Figure 4: Existing Traffic Volumes

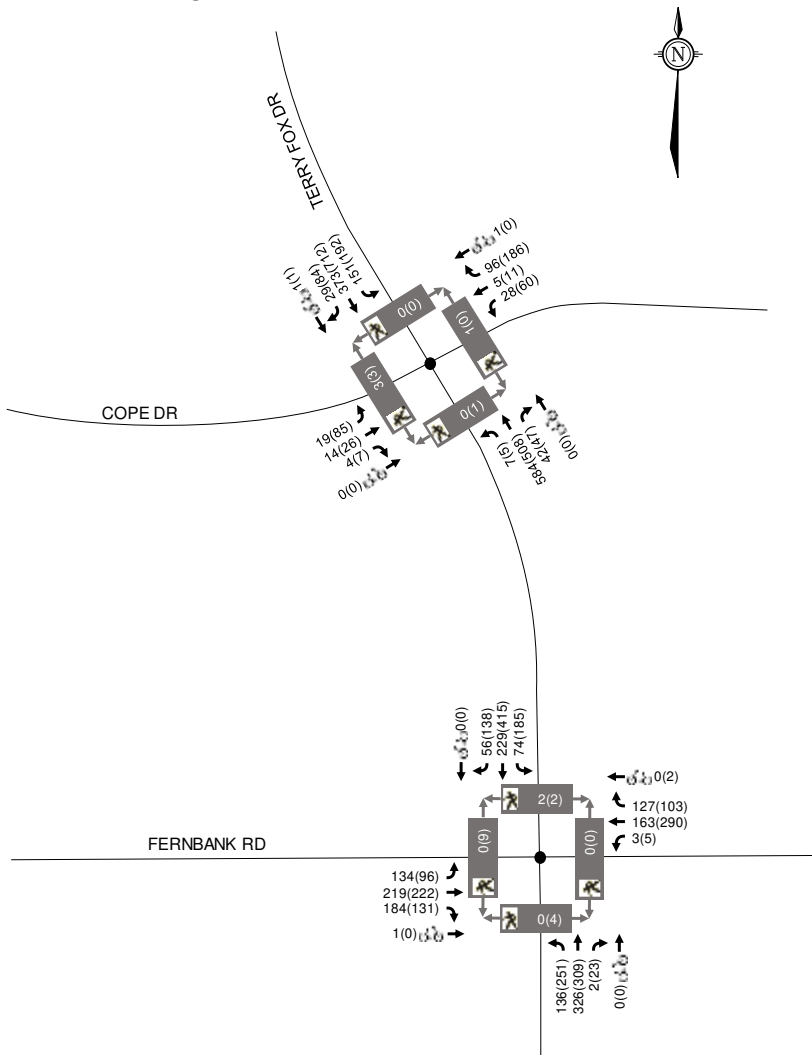

2.1.8 Collision Records

Historical collision data from the last five years was obtained from the City’s Public Works and Service Department for the study area intersection. Copies of the collision summary report are included in **Appendix E**.

The collision data has been evaluated to determine if there are any identifiable collision patterns, defined in the 2017 TIA Guidelines as ‘more than six collisions in five years’ for any one movement. The following summarizes the number of collisions at each intersection from January 1, 2015 to December 31, 2019.

Table 2: Reported Collisions

Intersection	Impact Types					Total Number of Collisions
	Angle	Sideswipe	Rear End	Turning Movement	SMV ¹ / Other	
Terry Fox Drive/ Cope Drive	2	1	8	13	3	27
Terry Fox Drive/ Fernbank Road	6	6	10	5	2	29

1. SMV = Single Motor Vehicle

Terry Fox Drive/Cope Drive

A total of 29 collisions were reported at the Terry Fox Drive/Cope Drive intersection over the last five years. Thirteen of the collisions were turning movement impacts, eight were rear-end impacts, three were single motor vehicle/other impacts, two were angle impacts and one was a sideswipe. Seven of the collisions resulted in personal injuries, however none resulted in a fatality. Twelve of the collisions occurred under poor driving conditions. None of the collisions involved pedestrians or cyclists.

Eight of the turning movement impacts involved southbound left turning vehicles, three involved northbound left turning vehicles, one involved a northbound right turning vehicle, and one involved an eastbound left turning vehicle. Two of the impacts involving southbound left turning vehicles occurred on weekends, two occurred during the weekday AM peak period, two occurred during the weekday PM peak period, and two occurred during weekday off-peak hours. Based on the existing signal timing plan, a permitted and protected southbound left turn phasing is provided during the PM peak hour only. Consideration could be given by the City to implementing the permitted and protected southbound left turn phase during all periods to mitigate turning movement impacts associated southbound left turning vehicles.

Three of the rear-end impacts involved northbound vehicles, three involved southbound vehicles, and two involved westbound vehicles. One of the rear-end collisions resulted in personal injuries. Four of the rear-end collisions occurred under poor driving conditions.

Terry Fox Drive/Fernbank Road

A total of 29 collisions were reported at the Terry Fox Drive/Fernbank Road intersection over the last five years. Ten of the collisions were rear-end impacts, six were angle impacts, six were sideswipe impacts, five were turning movement impacts, and two were single motor vehicle/other impacts. Six of the collisions resulted in personal injuries, however none resulted in a fatality. Ten of the collisions occurred under poor driving conditions.

Four of the rear-end impacts involved westbound vehicles, three involved southbound vehicles, two involved northbound vehicles, and one involved eastbound vehicles. All of the rear-end impacts resulted in property damage only. Four of the rear-end impacts occurred under poor driving conditions.

Two of the angle impacts involved eastbound and northbound vehicles (one involved a cyclist), two involved southbound and eastbound vehicles, and two involved southbound and westbound vehicles. Two of the angle impacts resulted in personal injuries. One of the angle impacts occurred under poor driving conditions.

Three of the sideswipe impacts involved eastbound vehicles, two involved northbound vehicles, and one involved southbound vehicles. One of the sideswipe impacts resulted in personal injuries. Three of the sideswipe impacts occurred under poor driving conditions.

2.2 Planned Conditions

The City of Ottawa's 2013 Transportation Master Plan (TMP) identifies a widening from two to four lanes along Eagleson Road between Cadence Gate and Hope Side Road. This widening will provide capacity for additional travel demands from new development areas and provide continuity from the four-lane Eagleson Road to the north. The widening of Eagleson Road is identified as a Phase 2 project with implementation between 2020 and 2025.

The City of Ottawa's 2013 TMP identifies a widening from two to four lanes along Hope Side Road between Eagleson Road and Richmond Road. This widening will provide capacity and network continuity for growth areas in Kanata. The widening of Hope Side Road is identified as a Phase 3 project in the affordable plan with implementation between 2026 and 2031.

The City of Ottawa's 2013 TMP identifies a widening from two to four lanes along Terry Fox Drive between Winchester Drive and Eagleson Road. This project is part of the City's Road Network Concept which will not be complete by 2031.

City staff advised that the Cope Drive/Templeford Road intersection has been approved to be converted into a mini roundabout.

A Transportation Impact Assessment dated October 2018 and revised in March 2019, and Addendum dated October 2020 were prepared in support of a Draft Plan of Subdivision application for 5331 Fernbank Road and 1039 Terry Fox Drive. The proposed development consists of 47 single detached units and 161 semi-detached/townhouse units.

A Transportation Impact Assessment dated January 2019 and revised in May 2019 was prepared in support of a Draft Plan of Subdivision application for 866, 898 Eagleson Road and 1335, 1365 Terry Fox Drive (City File Number: D02-02-19-0004 & D07-16-19-000). The proposed development consists of 347 townhouse units and 47 single-detached units.

A Transportation Impact Study dated May 2017 and Addendum dated February 2018 were prepared in support of a Draft Plan of Subdivision application for 5505 Fernbank Road (Blackstone Phases 4-8 City File Number: D07-16-17-0014) within the Fernbank Community. The proposed development consists of 241 single detached units, 219 townhouse units, and 156 condominium units. This subdivision has recently constructed Cope Drive between the Fernbank Community Design Plan lands and Terry Fox Drive.

A Site Plan Control application was submitted to the City of Ottawa in June 2018, in support of a six storey 143-unit apartment building at 800 Eagleson Road. No TIA has been submitted as part of this application. This building is currently under construction and nearing completion.

A Transportation Impact Study was prepared in support of a Zoning By-law Amendment and Site Plan Control application in July 2015 for a proposed residential development at 80, 110, 140, 151 and 180 Cope Drive (City File Number: D07-12-15-0163). The proposed residential development consists of 260 residential units.

A TIA was prepared in support of a Site Plan Control application in August 2018 for a proposed commercial development at 10 Cope Drive (City File Number: D07-12-18-0074). The proposed commercial development consists of a 3,620m² grocery store and 1,982m² of commercial. This development is now complete. The grocery store is now open and some of the other commercial units are occupied.

2.3 Study Area and Time Periods

A boundary street review will be conducted for Fernbank Road, Cope Drive, and Terry Fox Drive. The study area intersections are summarized as follows:

- Terry Fox Drive/Cope Drive
- Terry Fox Drive/Fernbank Road

It is noted that the Eagleson Road/Fernbank Road and Eagleson Road/Cope Drive intersections are also located within a 1km radius of the subject site. As Terry Fox will provide a reduced travel distance to/from the south, traffic generated by the site is not anticipated to use the Eagleson Road/Fernbank Road intersection. As such, this intersection has been excluded from the study area.

Based on a December 2017 traffic count, the overall Eagleson Road/Cope Drive intersection volumes equate to approximately 1850 vehicles during the AM peak hour and 2500 vehicles during the PM peak hour. The additional vehicles generated by the site (based on the distribution presented in Section 3.0) equate to approximately 0.5% of the existing intersection volumes. As the Eagleson Road/Cope Drive intersection is approximately 800-850m east of the site access and traffic generated by the proposed development is anticipated to be negligible compared to the existing traffic volumes, the Eagleson Road/Cope Drive intersection has been excluded from the study area.

The selected time periods for the analysis are the weekday AM and PM peak hours, as they represent the 'worst case' combination of site generated traffic and adjacent street traffic. Analysis will be completed for the 2023 build-out year and 2028 horizon year.

2.4 Exemptions Review

This module reviews possible exemptions from the final TIA, as outlined in the TIA Guidelines. The applicable exemptions for this site are shown in **Table 3**.

Table 3: TIA Exemptions

Module	Element	Exemption Criteria	Exemption Applies
Design Review Component			
4.1 Development Design	4.1.2 Circulation and Access	<ul style="list-style-type: none"> Only required for site plans 	Not Exempt
	4.1.3 New Street Networks	<ul style="list-style-type: none"> Only required for plans of subdivision 	Exempt
4.2 Parking	4.2.1 Parking Supply	<ul style="list-style-type: none"> Only required for site plans 	Not Exempt
	4.2.2 Spillover Parking	<ul style="list-style-type: none"> Only required for site plans where parking supply is 15% below unconstrained demand 	Exempt
Network Impact Component			
4.5 Transportation Demand Management	<i>All elements</i>	<ul style="list-style-type: none"> Not required for non-residential site plans expected to have fewer than 60 employees and/or students on location at any given time 	Not Exempt
4.6 Neighbourhood Traffic Management	4.6.1 Adjacent Neighbourhoods	<ul style="list-style-type: none"> Only required when the development relies on local or collector streets for access and total volumes exceed ATM capacity thresholds 	Not Exempt
4.8 Network Concept	<i>All elements</i>	<ul style="list-style-type: none"> Only required when proposed development generates more than 200 person-trips during the peak hour in excess of the equivalent volume permitted by the established zoning 	Exempt

As the proposed parking is anticipated to meet the requirements of the Zoning By-law, and the development is permitted under the current zoning the Spillover Parking and Network Concept Modules are exempt.

Based on the foregoing, the following modules will be included in the TIA report:

- Module 4.1: Development Design
- Module 4.2: Parking
- Module 4.3: Boundary Streets
- Module 4.4: Access Design
- Module 4.5: Transportation Demand Management
- Module 4.6: Neighbourhood Traffic Management
- Module 4.7: Transit
- Module 4.9: Intersection Design

3.0 FORECASTING

3.1 Development-Generated Traffic

3.1.1 Trip Generation

Trips generated by the proposed development during the weekday AM and PM peak period have been estimated based on relevant rates presented in the City's 2020 TRANS Trip Generation

Manual Summary Report. Peak period person trips, based on the Multi-Unit (High-Rise – 3+ Storey) rates in Table 3 of the TRANS report, are summarized in the following table.

Table 4: Peak Period Person Trip Generation

Land Use	TRANS Rate	Units	AM Peak Period (ppp ⁽¹⁾)			PM Peak Period (ppp)		
			IN	OUT	TOT	IN	OUT	TOT
High-Rise Multifamily Housing	AM: 0.80 PM: 0.90	192	48	106	154	100	73	173

1. ppp: Person Trips per Peak Period

Table 8 of the TRANS report includes data to estimate the mode shares for high-rise (3+ storey) multifamily housing for the AM and PM peak periods based on district. Based on the TRANS report, the mode shares for the Kanata-Stittsville district are summarized as follows:

- Auto Driver: 43% AM, 55% PM
- Auto Passenger: 26% AM, 19% PM
- Transit: 28% AM, 21% PM
- Cyclist: 0% AM, 0% PM
- Pedestrian: 4% AM, 5% PM

A breakdown of the peak period person trips by modal share is shown in **Table 5**.

Table 5: Peak Period Person Trips by Modal Share

Travel Mode	Mode Share		AM Peak Period			PM Peak Period		
	AM	PM	IN	OUT	TOT	IN	OUT	TOT
Peak Period Person Trips			48	106	154	100	73	173
Auto Driver	43%	55%	20	45	65	55	40	95
Auto Passenger	26%	19%	12	28	40	19	14	33
Transit	28%	21%	13	30	43	21	15	36
Cyclist	0%	0%	0	0	0	0	0	0
Pedestrian	4%	5%	2	4	6	5	4	9

Table 4 of the TRANS report includes adjustment factors to convert the estimated number of trips generated for each mode from peak period to peak hour. A breakdown of the peak hour trips by mode is shown in **Table 6**.

Table 6: Peak Hour Person Trips by Mode Share

Travel Mode	Adj. Factor		AM Peak Hour			PM Peak Hour		
	AM	PM	IN	OUT	TOT	IN	OUT	TOT
Auto Driver	0.48	0.44	10	21	31	24	18	42
Auto Passenger	0.48	0.44	6	13	19	9	6	15
Transit	0.55	0.47	7	17	24	10	7	17
Cyclist	0.58	0.48	0	0	0	0	0	0
Pedestrian	0.58	0.52	1	2	3	3	2	5
Peak Hour Person Trips			24	53	77	46	33	79

From the previous table, the proposed development is estimated to generate 77 person trips (including 31 vehicle trips) during the AM peak hour and 79 person trips (including 42 vehicle trips) during the PM peak hour.

3.1.2 Trip Distribution

The distribution of traffic generated by the proposed development has been estimated based on area traffic patterns, the principles of logical trip routing, and a review of distributions for other area developments. The distribution of traffic to the area road network is summarized as follows:

- 40% to/from the north via Terry Fox Drive
- 25% to/from the east via Cope Drive
- 20% to/from the south via Terry Fox Drive
- 15% to/from the west via Fernbank Road and Cope Drive

The assignment of trips to the proposed accesses is summarized as follows:

Cope Drive Access

- 60% of trips to the north via Terry Fox Drive
- All trips from the north via Terry Fox Drive
- All trips to/from the east via Cope Drive
- All trips to the south via Terry Fox Drive
- All trips to the west via Fernbank Road
- All trips to/from the west via Cope Drive

Terry Fox Access

- 40% of trips to the north via Terry Fox Drive
- All trips from the south via Terry Fox Drive
- All trips from the west via Fernbank Road

Site generated traffic volumes are shown in **Figure 5**.

3.2 Background Traffic

3.2.1 General Background Growth Rate

Background traffic growth along the area roadways has been developed based on a review of historic traffic counts and a review of other area developments.

Based on 2010 and 2018 traffic counts at the Terry Fox Drive/Fernbank Road intersection, the intersection Average Annual Daily Traffic (AADT) volumes increased by approximately 2% per annum. Based on 2014 and 2019 traffic counts at the Terry Fox Drive/Cope Drive intersection, the intersection AADT volumes increased by approximately 4% per annum.

A summary of background growth assumptions utilized in other area developments is provided below.

- 1039 Terry Fox Drive, TIA dated March 2019: 2% growth to Cope Drive and Terry Fox Drive
- 866 Eagleson Road, TIA dated May 2019: 2% growth to Terry Fox Drive, No growth to Fernbank Road
- 10 Cope Drive, TIA dated August 2018: 2% growth to Cope Drive and Fernbank Road
- 5505 Fernbank Road, TIS dated May 2017: 2% growth rate to Fernbank Road
- 80-180 Cope Drive, TIS dated July 2015: 2% growth to Cope Drive and Terry Fox Drive

Based on the foregoing, a 2% per annum growth rate has been applied to through traffic along Terry Fox Drive, Fernbank Road, and Cope Drive.

Figure 5: Site Generated Traffic

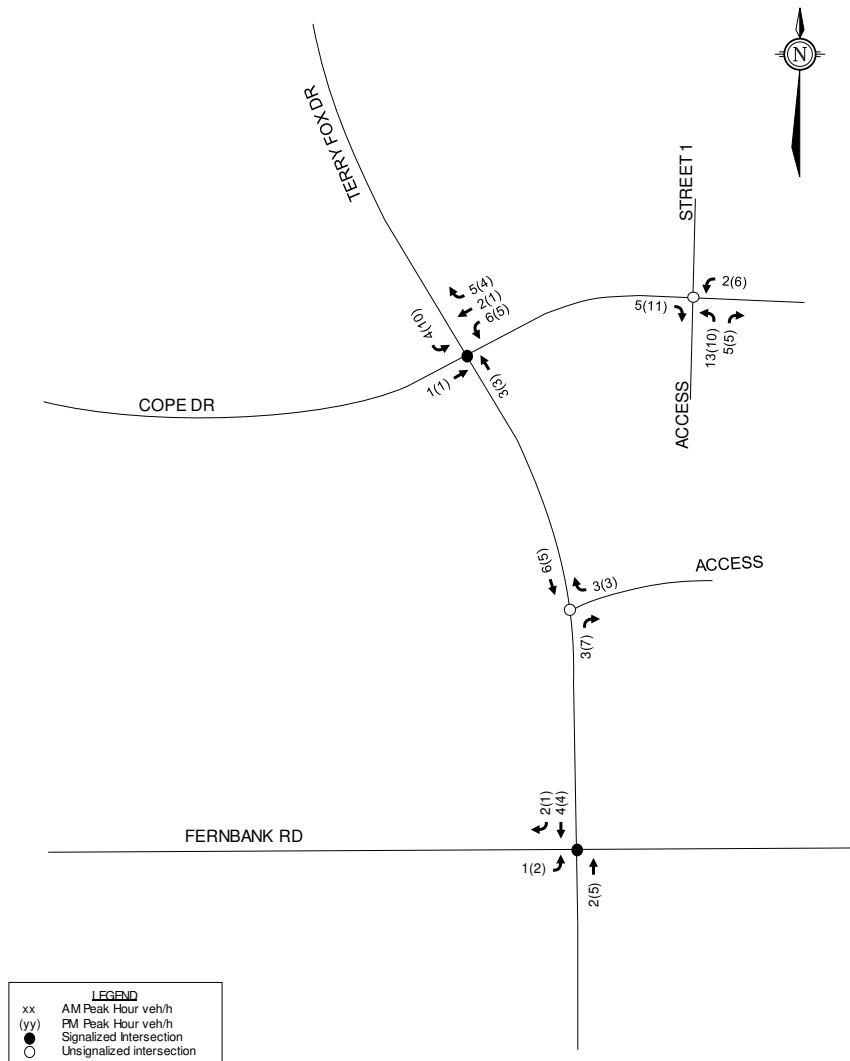

3.2.2 Other Area Development

A description of other study area developments is included in Section 2.2. The following other area developments have been added to the background traffic volumes:

- 1039 Terry Fox Drive: 100% built-out by 2023
- 866 Eagleson Road: 50% built-out by 2023, 100% built-out by 2028
- 5505 Fernbank Road: 50% built-out by 2023, 100% built-out by 2028
- 80-180 Cope Drive: 100% built-out by 2023
- 10 Cope Drive: 100% built-out by 2023

Relevant excerpts from these studies are included in **Appendix F**.

Traffic generated by other area developments for the 2023 build-out and 2028 horizon years are shown in **Figure 6** and **7**. Background traffic volumes for the 2023 build-out and 2028 horizon years are shown in **Figures 8** and **9**. Total traffic volumes for the 2023 build-out and 2028 horizon years are shown in **Figures 10** and **11**.

Figure 6: 2023 Other Area Development Traffic

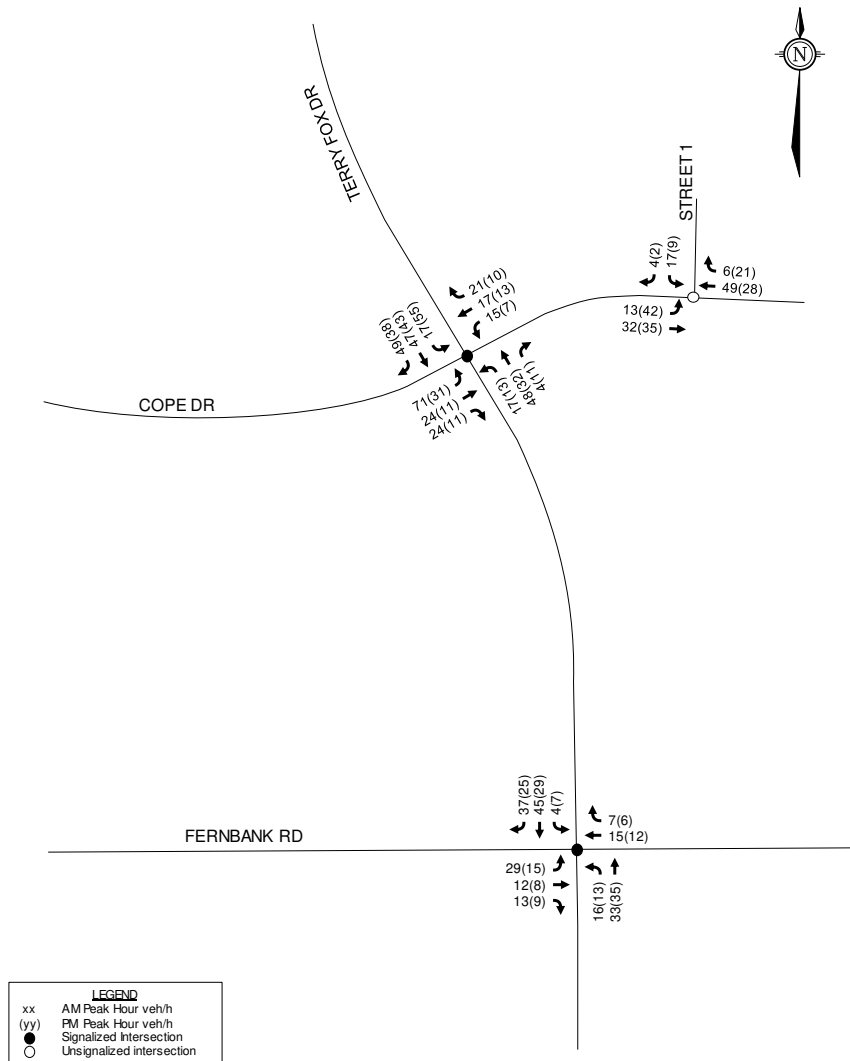

Figure 7: 2028 Other Area Development Traffic

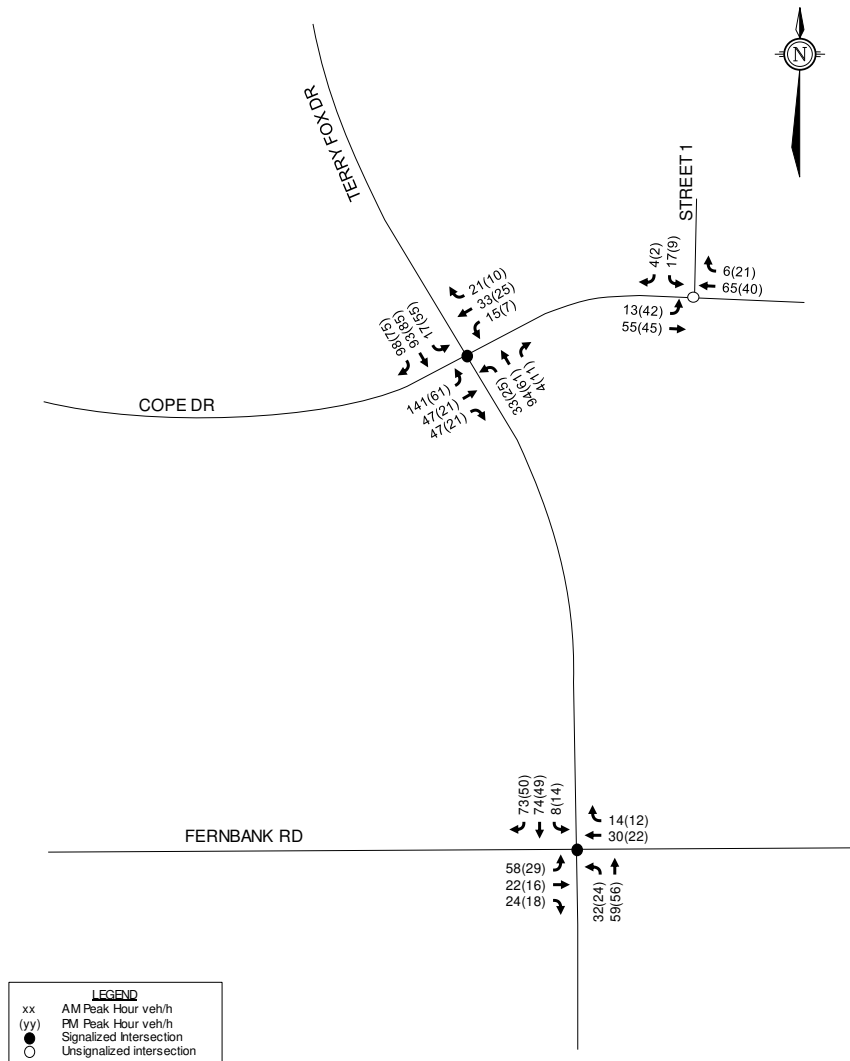

Figure 8: 2023 Background Traffic

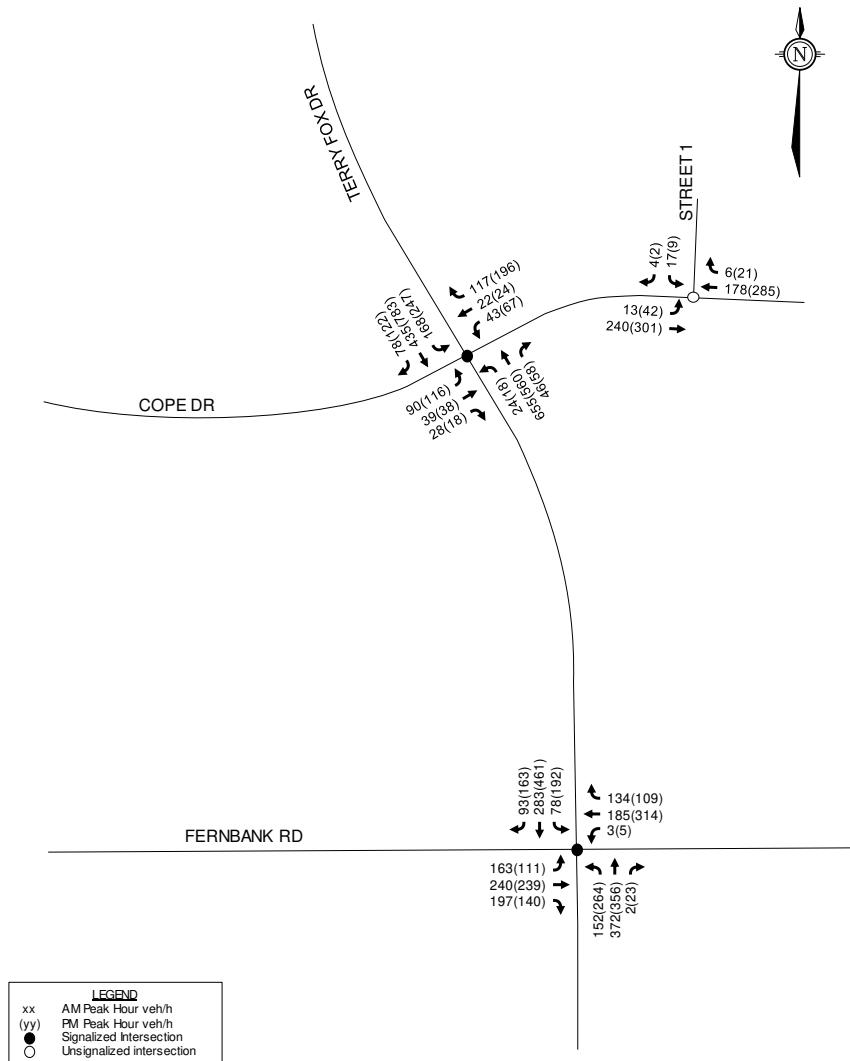

Figure 9: 2028 Background Traffic

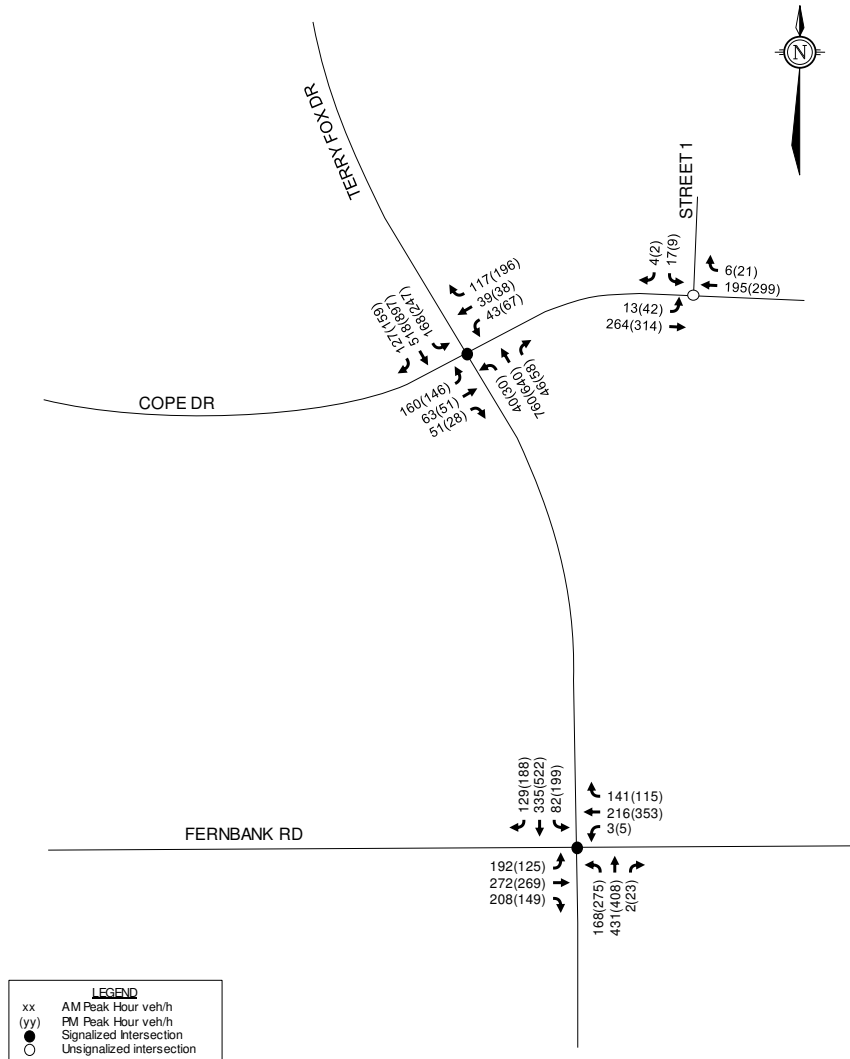

Figure 10: 2023 Total Traffic

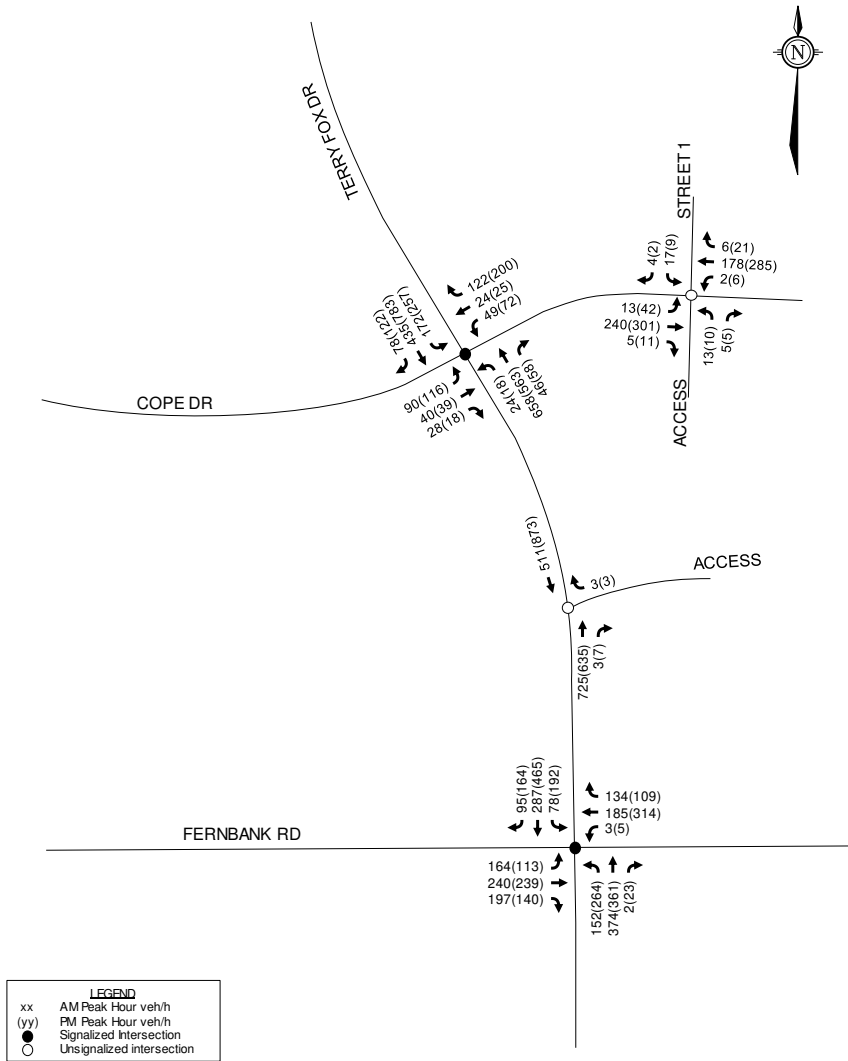
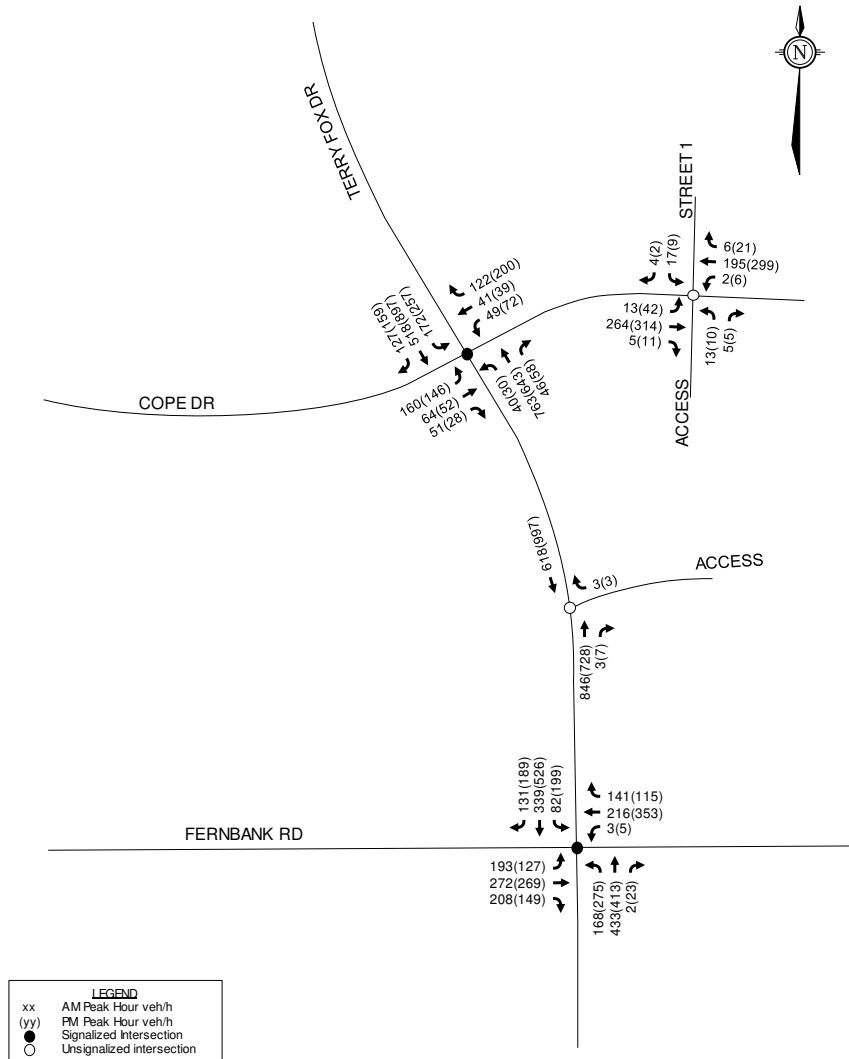

Figure 11: 2028 Total Traffic



3.3 Demand Rationalization

A review of the existing and background intersection operations has been conducted to determine if and when the projected background traffic will exceed the capacity within the study area. The intersection parameters used in the analysis are consistent with the City of Ottawa’s TIA guidelines (saturated flow rate: 1800 vphpl, PHF: 0.9 for existing conditions and 1.0 for future conditions).

Intersection lane arrangements are consistent with the existing conditions described in Section 4.1. Intersection signal timing plans were obtained from the City, and are included in **Appendix D**.

3.3.1 Existing Traffic

Intersection capacity analysis has been completed for the existing traffic conditions. The results of the analysis are summarized in the following table for the weekday AM and PM peak hours. Detailed reports are included in **Appendix G**.

Table 7: Existing Traffic

Intersection	AM Peak			PM Peak		
	Max V/C or Delay	LOS	Mvmt	Max V/C or Delay	LOS	Mvmt
Terry Fox Drive/ Cope Drive ¹	0.56	A	NBT/R	0.80	C	EBL
Terry Fox Drive/ Fernbank Road ¹	0.78	C	NBT/R	1.12	F	NBL

1. Signalized Intersection

Critical movements at the Terry Fox Drive/Cope Drive intersection are currently operating with a LOS C or better during the weekday AM and PM peak hours. The maximum (95th percentile) queue length for all auxiliary lanes does not exceed the existing storage length during the AM and PM peak hours. However, the maximum northbound (AM and PM peak) and southbound (PM peak) through queues along Terry Fox Drive extend past and block access to the adjacent auxiliary left turn lanes.

Critical movements at the Terry Fox Drive/Fernbank Road intersection are currently operating with a LOS C during the AM peak hour and a LOS F during the PM peak hour. The maximum queue length for all auxiliary lanes does not exceed the existing storage length during the AM and PM peak hours. However, the southbound through queue along Terry Fox Drive extends past and block access to the adjacent auxiliary left and right turn lanes during the PM peak hour. PM peak hour traffic signalization with an increased cycle length of 120 seconds is anticipated to improve operations to a LOS D, meeting the area target.

3.3.2 2023 Background Traffic

Intersection capacity analysis has been completed for the 2023 background traffic conditions. The results of the analysis are summarized in the following table for the weekday AM and PM peak hours. Detailed reports are included in **Appendix G**.

Table 8: 2023 Background Traffic

Intersection	AM Peak			PM Peak		
	Max V/C or Delay	LOS	Mvmt	Max V/C or Delay	LOS	Mvmt
Terry Fox Drive/ Cope Drive ¹	0.61	B	NBT/R	0.86	D	EBL
Terry Fox Drive/ Fernbank Road ¹	0.79	C	NBT/R	1.06	F	NBL
Cope Drive/ Street 1 ²	11 sec	B	SB	13 sec	B	SB

1. Signalized Intersection
 2. Unsignalized Intersection

Critical movements at the Terry Fox Drive/Cope Drive intersection are anticipated to operate with a LOS D or better during the weekday AM and PM peak hours. The maximum queue length for all auxiliary lanes does not exceed the existing storage length during the AM and PM peak hours. Consistent with the existing traffic condition, the maximum northbound (AM and PM peak) and southbound (PM peak) through queues along Terry Fox Drive extend past and block access to the adjacent auxiliary left turn lanes.

Critical movements at the Terry Fox Drive/Fernbank Road intersection are anticipated to operate with a LOS C during the AM peak hour and a LOS F during the PM peak hour. The maximum queue length for all auxiliary lanes does not exceed the existing storage length during the AM and PM peak hours. Consistent with the existing traffic condition, the maximum southbound through queue along Terry Fox Drive extends past and block access to the adjacent auxiliary left and right turn lanes during the PM peak hour. PM peak hour traffic signalization with an increased cycle length of 120 seconds is anticipated to improve operations to a LOS D, meeting the area target. The increased cycle length is not anticipated to have a significant impact to the PLOS delay score at this intersection.

3.3.3 2028 Background Traffic

Intersection capacity analysis has been completed for the 2028 background traffic conditions. The results of the analysis are summarized in the following table for the weekday AM and PM peak hours. Detailed reports are included in **Appendix G**.

Table 9: 2028 Background Traffic

Intersection	AM Peak			PM Peak		
	Max V/C or Delay	LOS	Mvmt	Max V/C or Delay	LOS	Mvmt
Terry Fox Drive/Cope Drive ¹	0.75	C	NBT/R	0.90	D	EBL
Terry Fox Drive/Fernbank Road ¹	0.83	D	NBT/R	1.22	F	NBL
				0.93	E	SBT
Cope Drive/Street 1 ²	12 sec	B	SB	14 sec	B	SB

- 1. Signalized Intersection
- 2. Unsignalized Intersection

Critical movements at the Terry Fox Drive/Cope Drive intersection are anticipated to operate with a LOS D or better during the weekday AM and PM peak hours. The maximum queue length for the southbound left turn movement is anticipated to be 55m to 65m during the weekday AM and PM peak hours respectively, exceeding the existing storage by approximately 5m to 15m. The maximum queue length for all other auxiliary lanes does not exceed the existing storage length during the AM and PM peak hours. Consistent with the 2023 background traffic condition, the maximum northbound (AM and PM peak) and southbound (PM peak) through queues along Terry Fox Drive extend past and block access to the adjacent auxiliary left turn lanes.

It is noted that the TIA dated March 2019 in support of the 5331 Fernbank Road and 1039 Terry Fox Drive subdivision recommended the City consider the implementation of a westbound right turn lane at the Terry Fox Drive/Cope Drive intersection to improve operations of the eastbound left turn movement during the PM peak hour. Although more recent traffic counts suggest the eastbound left turn movement is anticipated to meet the target LOS D during the PM peak hour,

the implementation of a westbound right turn lane would improve the eastbound left turn operations to a LOS B (v/c ratio 0.65). This is identified for the City's consideration as funding permits.

Critical movements at the Terry Fox Drive/Fernbank Road intersection are anticipated to operate with a LOS D during the AM peak hour and a LOS F during the PM peak hour. The maximum queue length for the northbound left turn movement is anticipated to be 95m during the weekday PM peak hour, exceeding the existing storage by approximately 5m. The maximum queue length for all other auxiliary lanes does not exceed the existing storage length during the AM and PM peak hours. Consistent with the 2023 background traffic condition, the southbound through queue along Terry Fox Drive extends past and block access to the adjacent auxiliary left and right turn lanes during the PM peak hour. PM peak hour traffic signalization with an increased cycle length of 120 seconds is anticipated to improve operations to a LOS E (v/c ratio of 0.91), slightly exceeding the area target. The increased cycle length is not anticipated to have a significant impact to the PLOS delay score at this intersection.

4.0 ANALYSIS

4.1 Development Design

4.1.1 Design for Sustainable Modes

A sidewalk will be provided on both sides of the main drive-aisles, connecting to the existing sidewalks along Cope Drive and Fernbank Road. A north-south pathway will also be provided on the eastern portion of the site, connecting from Cope Drive to Fernbank Road. An east-west pathway will be provided between buildings G and F, connecting to an existing pathway leading to Patriot Place.

Bicycle parking will be in accordance with the minimum requirements of the City's Zoning By-law. Bicycle parking racks will be located near the entrances for each building.

The closest OC Transpo bus stops to the subject site are #4031, #1919, and #6933 along Cope Drive, and #1930 and #1933 along Fernbank Road. These bus stops serve OC Transpo Routes 161, 164, 168, and 252, and can be accessed via the proposed pedestrian connections to Cope Drive and Fernbank Road.

A review of the City's Transportation Demand Management (TDM) – Supportive Development Design and Infrastructure Checklist has been conducted. A copy of the TDM checklist is included in **Appendix H**. All required TDM-supportive design and infrastructure measures in the TDM checklist are met. In addition to the required measures, the proposed development also meets the following 'basic' or 'better' measures as defined in the TDM-supported design and infrastructure measures checklist:

- Locate building entrances in order to minimize walking distances to sidewalks and transit stops/stations
- Locate building doors and windows to ensure visibility of pedestrians from the building, for their security and comfort
- Provide safe, direct and attractive walking routes from building entrances to nearby transit stops

- Ensure that walking routes to transit stops are secure, visible, lighted, shaded and wind-protected wherever possible

4.1.2 Circulation and Access

The main drive aisle will function as the fire route for the development, as shown on the Site Plan in **Appendix A**.

Garbage collection will be conducted on-site. Earth bins will be located on the west side of the main drive aisle opposite Building G, and in a garbage area south of Building Q. The turning movements of a Medium Single Unit Truck, which is representative of a garbage truck, accessing the earth bins are included in **Figure 12** and **13**.

4.2 Parking

The subject site is located in Area C on Schedule 1 and 1A of the City of Ottawa’s Zoning By-Law. Minimum vehicular and bicycle parking rates for the proposed development are identified in the Zoning By-law and are summarized in the following table.

Table 10: Parking Requirements

Land Use	Minimum Parking Rate	Units	Required
<i>Vehicle Parking</i>			
Apartment	1.2 spaces per unit (Resident)	192	230
	0.2 spaces per unit (Visitor)		38
Total			268
<i>Bicycle Parking</i>			
Apartment	0.5 spaces per unit	192	96
Total			96

A total of 268 vehicle parking spaces (230 resident, 38 visitor) and 96 bicycle parking spaces are proposed, meeting the minimum requirements of the City’s Zoning By-law.

M:\2021\121011\CAD\Design\Figures\Traffic\121011-TM.dwg, FIG.12, Nov.05, 2021 - 2:29pm, bbyvelds

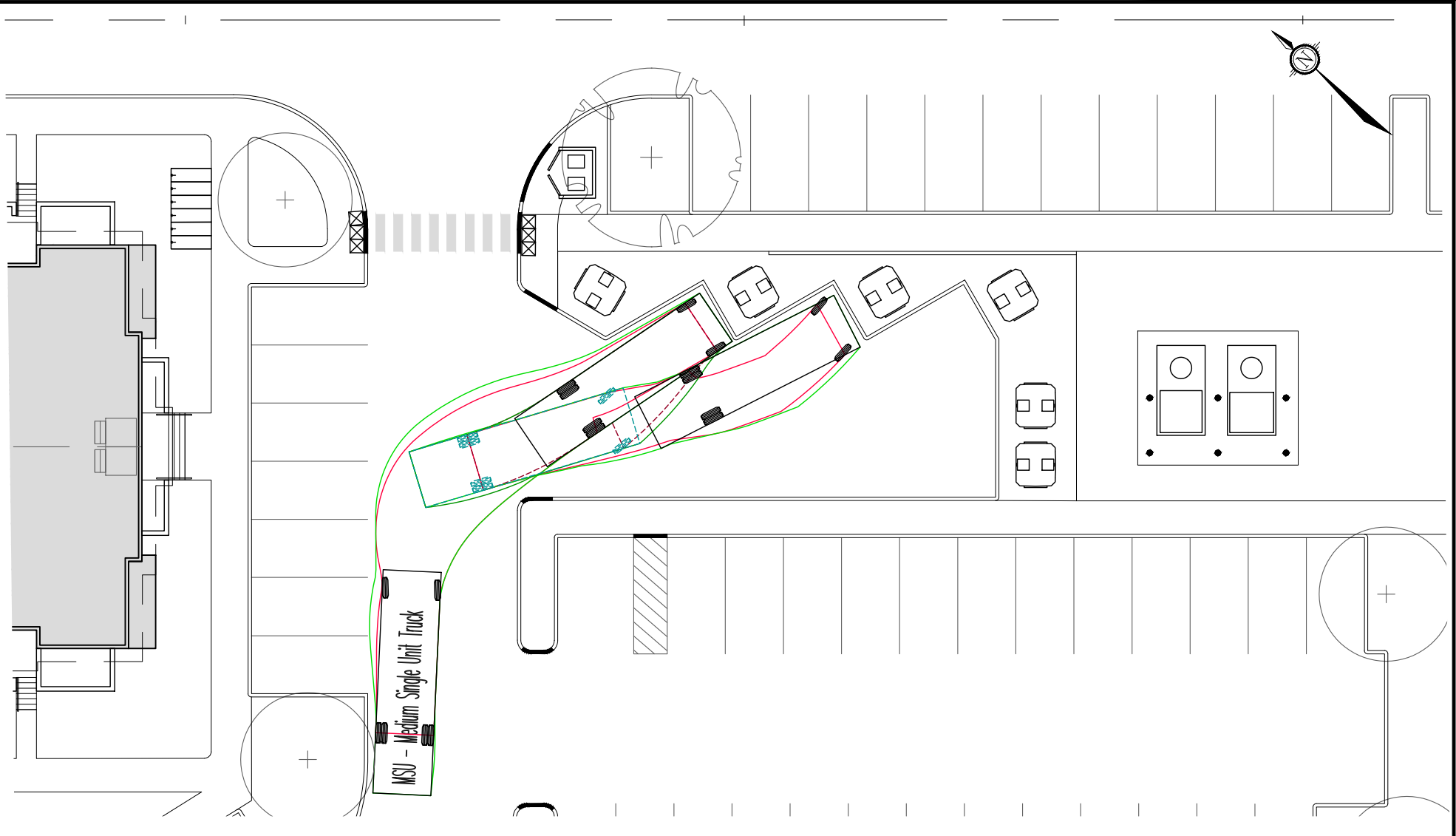

Engineers, Planners & Landscape Architects
 Suite 200, 240 Michael Cowpland Drive
 Ottawa, Ontario, Canada K2M 1P6

Telephone (613) 254-9643
 Facsimile (613) 254-5867
 Website www.novatech-eng.com

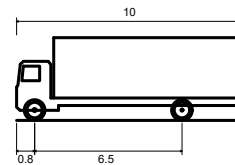

MSU - Medium Single Unit Truck

Overall Length	10.000m
Overall Width	2.600m
Overall Body Height	3.650m
Min Body Ground Clearance	0.445m
Track Width	2.600m
Lock-to-lock time	4.00s
Curb to Curb Turning Radius	11.100m

5331 FERNBANK ROAD

TURNING MOVEMENTS
 (MSU / GARBAGE TRUCK)



DATE NOV 2021	JOB 121011	FIGURE FIGURE 12
------------------	---------------	---------------------

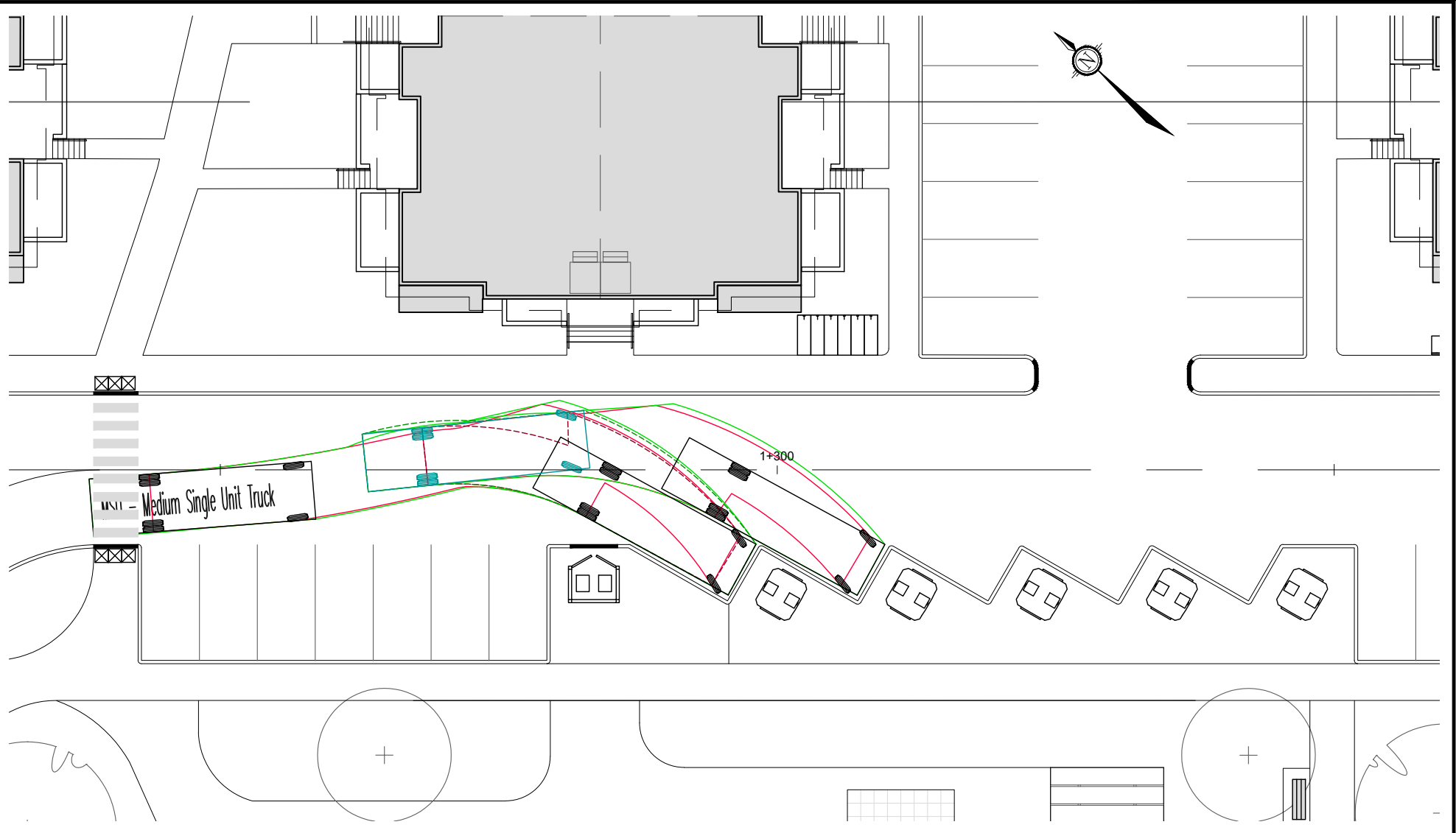

M:\2021\121011\CAD\Design\Figures\Traffic\121011-TM.dwg, FIG13, Nov 05, 2021 - 2:29pm, bbyveldis



Engineers, Planners & Landscape Architects
 Suite 200, 240 Michael Cowpland Drive
 Ottawa, Ontario, Canada K2M 1P6

Telephone (613) 254-9643
 Facsimile (613) 254-5867
 Website www.novatech-eng.com

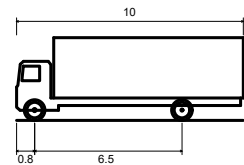

MSU - Medium Single Unit Truck

Overall Length	10.000m
Overall Width	2.600m
Overall Body Height	3.650m
Min Body Ground Clearance	0.445m
Track Width	2.600m
Lock-to-lock time	4.00s
Curb to Curb Turning Radius	11.100m

5331 FERNBANK ROAD

TURNING MOVEMENTS
 (MSU / GARBAGE TRUCK)

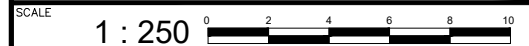

DATE NOV 2021	JOB 121011	FIGURE FIGURE 13
------------------	---------------	---------------------

4.3 Boundary Streets

This section provides a review of the boundary streets using complete streets principles. The Multi-Modal Level of Service (MMLOS) guidelines produced by IBI Group in 2015 were used to evaluate the LOS of the boundary roadways for each mode of transportation. Schedule 'B' of the City of Ottawa's Official Plan indicates that Cope Drive, Fernbank Road, and Terry Fox Drive are located within the General Urban Area.

A summary of the results of the segment MMLOS analysis for the boundary roadways is provided in the following table. Detailed segment MMLOS calculations can be found in **Appendix I**.

Table 11: Segment MMLOS Summary

Segment	PLOS	BLOS	TLOS	TkLOS
Cope Drive	A	F	D	B
Target	C	B	-	-
Fernbank Road	F	E	D	C
Target	C	C	-	E
Terry Fox Drive	F	E	D	C
Target	C	B	-	D

Cope Drive meets the target PLOS but does not meet the target BLOS for the general urban area. Based on the criteria in Exhibit 11 of the MMLOS Guidelines, either a reduction in operating speed combined with bike lanes or a separated cycling facility are required to achieve the target BLOS B. This is identified for the City's consideration.

Fernbank Road meets the target TkLOS for the general urban area. However, it does not meet a target PLOS C and BLOS C. Based on Exhibit 4 of the MMLOS Guidelines, a boulevard width of 0.5m or greater between the sidewalk and the roadway is required on the north side of the road. A reduction in the operating speed is required to achieve the target PLOS C on the south side of the road. Based on the criteria in Exhibit 11 of the MMLOS Guidelines, either a reduction in operating speed or a separated cycling facility are required to achieve the target BLOS C. This is identified for the City's consideration.

Terry Fox Drive meets the target TkLOS. However, it does not meet the target PLOS and BLOS. Terry Fox Drive currently has a two-lane undivided rural cross-section adjacent to the subject site. The City of Ottawa's 2013 TMP does not identify any roadway projects along this stretch of Terry Fox Drive in its affordable plan, however it does identify a widening from two to four lanes between Winchester Drive and Eagleson Road in its network concept.

Opportunities to improve the PLOS and BLOS should be explored by the City through the future widening of Terry Fox Drive, as identified in the City's 2013 TMP network concept. At that time, consideration should be given by the City to providing a 2m sidewalk with a boulevard to improve the PLOS. A review of the OTM Book 18 Cycling Nomograph suggests consideration should be

given to implementing a separated cycling facility along Terry Fox Drive as part of the future widening project.

4.4 Access Intersections Design

One new all movement access is proposed on Cope Drive, opposite the future Street 1 connection to the subdivision north of Cope Drive, and a right-in right-out access to Terry Fox Drive. The sidewalk along Cope Drive will be depressed and continuous through the proposed access, per City of Ottawa Specification 7.1.

The Cope Drive access is located approximately 40m from the east property line and 120m from the Terry Fox Drive right-of-way limit. The Terry Fox Drive access is located approximately 210m from the Cope Drive right-of-way limit and 145m from the Fernbank Road right-of-way limit. The Cope Drive access will have a width of 6.7m, while the Terry Fox Drive access will have a width of 10m measured at the property line.

Section 25 (c) of the City of Ottawa's Private Approach By-law identifies that no private approach intended for two-way vehicular traffic shall exceed 9m in width at the street line. Section 107 (1)(a) of the City's Zoning By-law identifies a driveway serving a parking lot must have a minimum width of 6.7m for a double traffic lane. The width of the Cope Drive access conforms to the requirements of the City's Private Approach By-law and Zoning By-law. As the width of the Terry Fox Drive access is required to accommodate the proposed pork chop right-in right-out island, a waiver to Section 25 (c) of the Private Approach By-law is requested.

Section 25 (m) of the City's Private Approach By-law identifies that the access to residential parking lots with 200-299 parking spaces, where the site abuts an arterial roadway, must be a minimum of 60m from the nearest intersecting streetline. Section 25 (p) of the Private Approach By-law identifies that the access must be a minimum of 3m from the nearest property line. The location of both accesses meet the requirements of the Private Approach By-law.

Section 25 (u) of the City's Private Approach By-law identifies a maximum access grade of 2% for a distance of 9m within the property, where the access leads to 50 or more parking spaces. A maximum grade of 2% is proposed for a distance of 9m within the private property at both accesses, conforming to the requirements of the Private Approach By-law.

Based on the projected northbound right turn volumes at the Terry Fox Drive access, a right turn lane is not recommended. A pork chop island will be provided to restrict this access to right-in right-out. The design of the pork chop island will be in accordance with Transportation Association of Canada (TAC) Geometric Design Guidelines standards and will accommodate the turning movements of a Fire Truck. Fire Truck turning movements at the Terry Fox Drive access are shown in **Figures 14** and **15**.

Based on the projected eastbound right turn volumes at the Cope Drive access, a right turn lane is not recommended. The Ministry of Transportation of Ontario (MTO) left turn lane warrants were reviewed at the Cope Drive access. Based on the MTO graph included in **Appendix J**, a westbound left turn lane is not required. It is noted that an eastbound left turn lane will be provided for the Street 1 subdivision access opposite the Cope Drive access, as depicted in the functional design included in **Appendix K**. To provide improved access operations and safety, a westbound left turn lane will be painted in lieu of the previously proposed gore area runoff taper. A revised functional design is included in **Appendix K**.

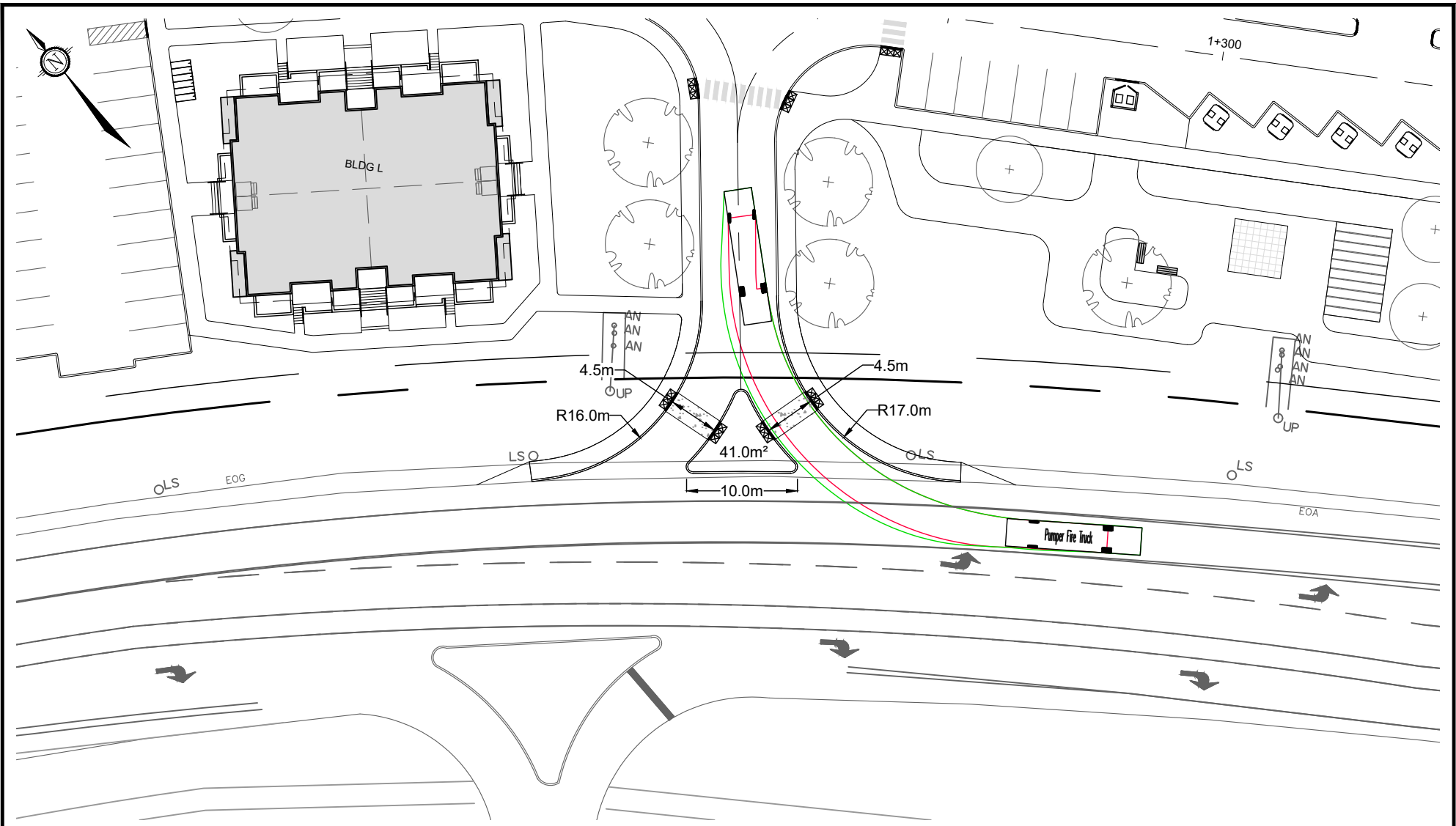

M:\2021\121011\CAD\Design\Figures\Traffic\121011-TM.dwg, FIG14, Nov 05, 2021 - 2:29pm, bbyvelds



Engineers, Planners & Landscape Architects
 Suite 200, 240 Michael Cowpland Drive
 Ottawa, Ontario, Canada K2M 1P6

Telephone (613) 254-9643
 Facsimile (613) 254-5867
 Website www.novatech-eng.com

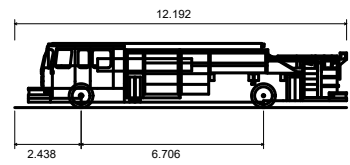

Pumper Fire Truck

Overall Length	12.192m
Overall Width	2.489m
Overall Body Height	2.361m
Min Body Ground Clearance	0.200m
Track Width	2.489m
Lock-to-lock time	5.00s
Max Wheel Angle	45.00°

5331 FERNBANK ROAD

**TURNING MOVEMENTS
(FIRE TRUCK)**



DATE NOV 2021	JOB 121011	FIGURE FIGURE 14
------------------	---------------	---------------------

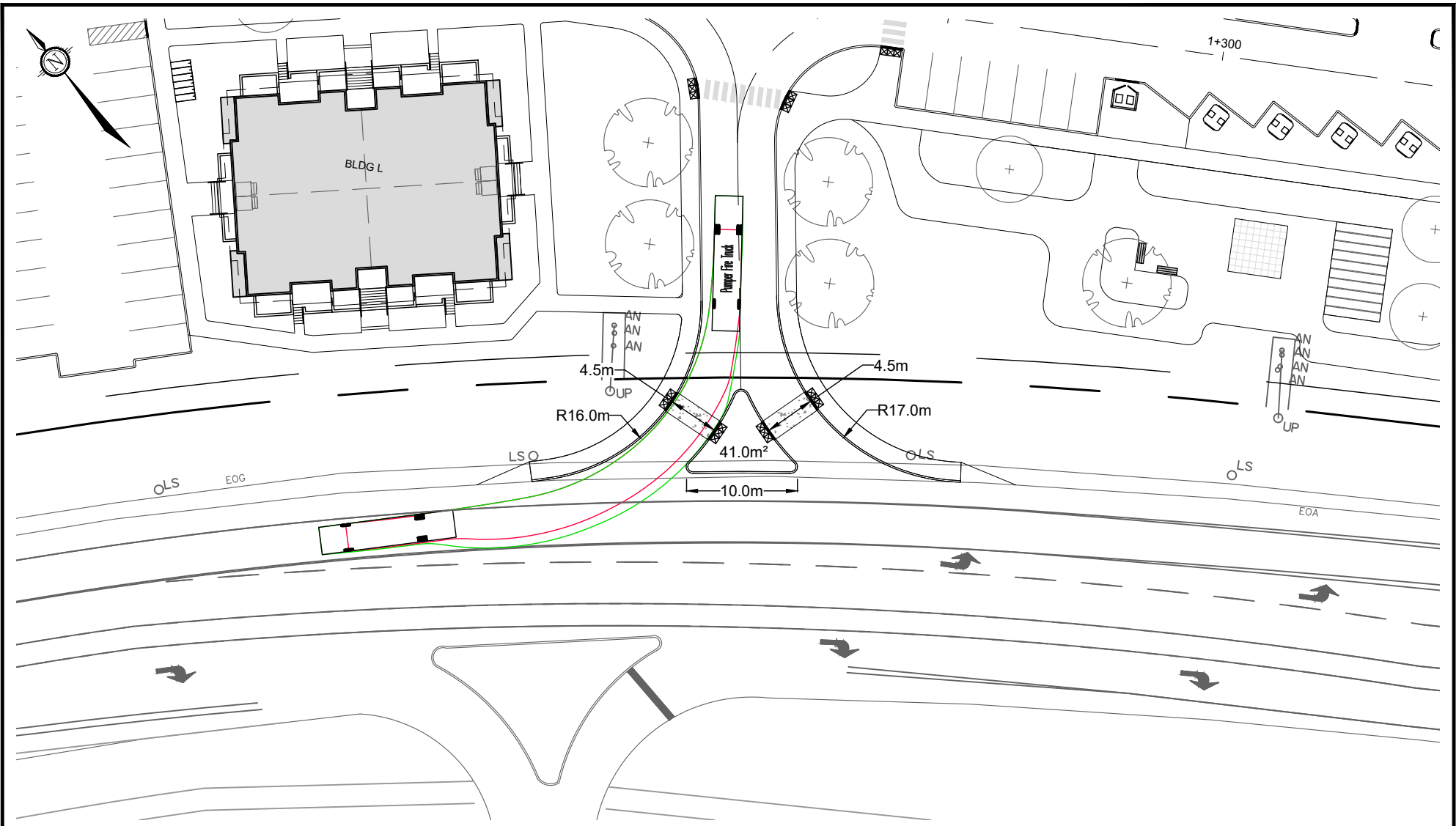

M:\2021\12101\CAD\Design\Figures\Traffic\121011-TM.dwg, FIG15, Nov 05, 2021 - 2:29pm, bbyvelds



Engineers, Planners & Landscape Architects
 Suite 200, 240 Michael Cowpland Drive
 Ottawa, Ontario, Canada K2M 1P6

Telephone (613) 254-9643
 Facsimile (613) 254-5867
 Website www.novatech-eng.com

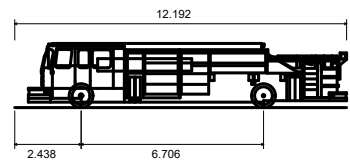

Pumper Fire Truck

Overall Length	12.192m
Overall Width	2.489m
Overall Body Height	2.361m
Min Body Ground Clearance	0.200m
Track Width	2.489m
Lock-to-lock time	5.00s
Max Wheel Angle	45.00°

5331 FERNBANK ROAD

**TURNING MOVEMENTS
(FIRE TRUCK)**



DATE NOV 2021	JOB 121011	FIGURE FIGURE 15
------------------	---------------	---------------------

A review of stopping sight distance (SSD) and Intersection Sight Distance (ISD) at both accesses has been conducted in accordance with Transportation Association of Canada (TAC) Geometric Design Guidelines. For design purposes, TAC recommends a driver eye height of 1.08m. TAC identifies the following SSD and ISD requirements for the Cope Drive access, based on a design speed of 60km/hr, and the Terry Fox Drive access, based on a design speed of 90km/hr.

Cope Drive

- 85m SSD
- ISD:
 - 130m looking right, to turn left
 - 110m looking left, to turn right

Terry Fox Drive

- 160m SSD
- ISD:
 - 165m looking left, to turn right

Based on the landscape plan, three Japanese Lilac trees and two Makamik Crabapple trees are proposed within the right-of-way east and west of the proposed Cope Drive access. The proposed street trees will have a high canopy and will not represent an obstruction to sightlines.

The required SSD and ISD at the Cope Drive access meets TAC requirements and is depicted in **Figures 16 to 19**.

The required SSD and ISD at the Terry Fox Drive access meets TAC requirements and is depicted in **Figures 20 and 21**.

A review of the intersection operations at the proposed accesses was conducted for the 2023 and 2028 total traffic conditions. The following table provides a summary of the access intersection operations, assuming side street stop control. Detailed summary sheets are provided in **Appendix L**.

Table 12: Access Intersection Operations

Intersection	AM Peak			PM Peak		
	Delay	LOS	Mvmt	Delay	LOS	Mvmt
<i>2023 Total</i>						
Terry Fox Drive Access	13 sec	B	WB	12 sec	B	WB
Cope Drive Access	12 sec	B	SB	15 sec	B	SB
<i>2028 Total</i>						
Terry Fox Drive Access	15 sec	B	WB	13 sec	B	WB
Cope Drive Access	12 sec	B	SB	15 sec	B	SB

The proposed accesses are anticipated to operate with a LOS B or better during the weekday AM and PM peak hours under the 2023 and 2028 total traffic conditions. Based on the foregoing, side street stop control is recommended at the proposed accesses along Cope Drive and Terry Fox Drive.

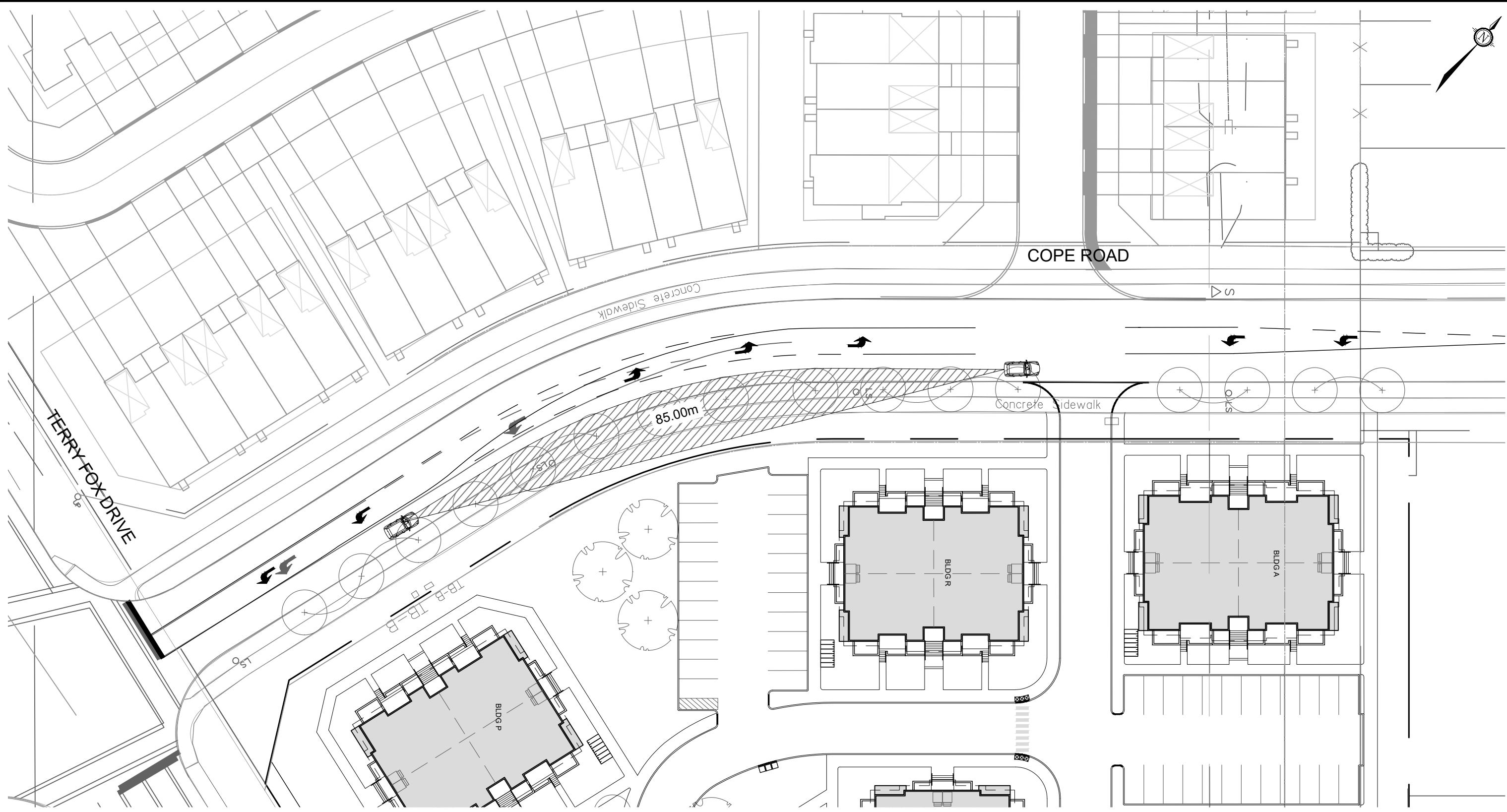

M:\2021\121011\CAD\Design\Figures\Traffic\121011-SD.dwg, FIG.16, Sep 29, 2021 - 1:38pm, rhillier

<p>NOVATECH Engineers, Planners & Landscape Architects Suite 200, 240 Michael Cowpland Drive Ottawa, Ontario, Canada K2M 1P6</p> <p>Telephone (613) 254-9643 Facsimile (613) 254-5867 Website www.novatech-eng.com</p>	<p>5331 FERNBANK ROAD</p>	
	<p>STOPPING SIGHT DISTANCE COPE DRIVE</p>	
<p>SCALE 1 : 500</p>		<p>DATE NOV 2021</p>
<p>FIGURE 16</p>		<p>JOB 121011</p>

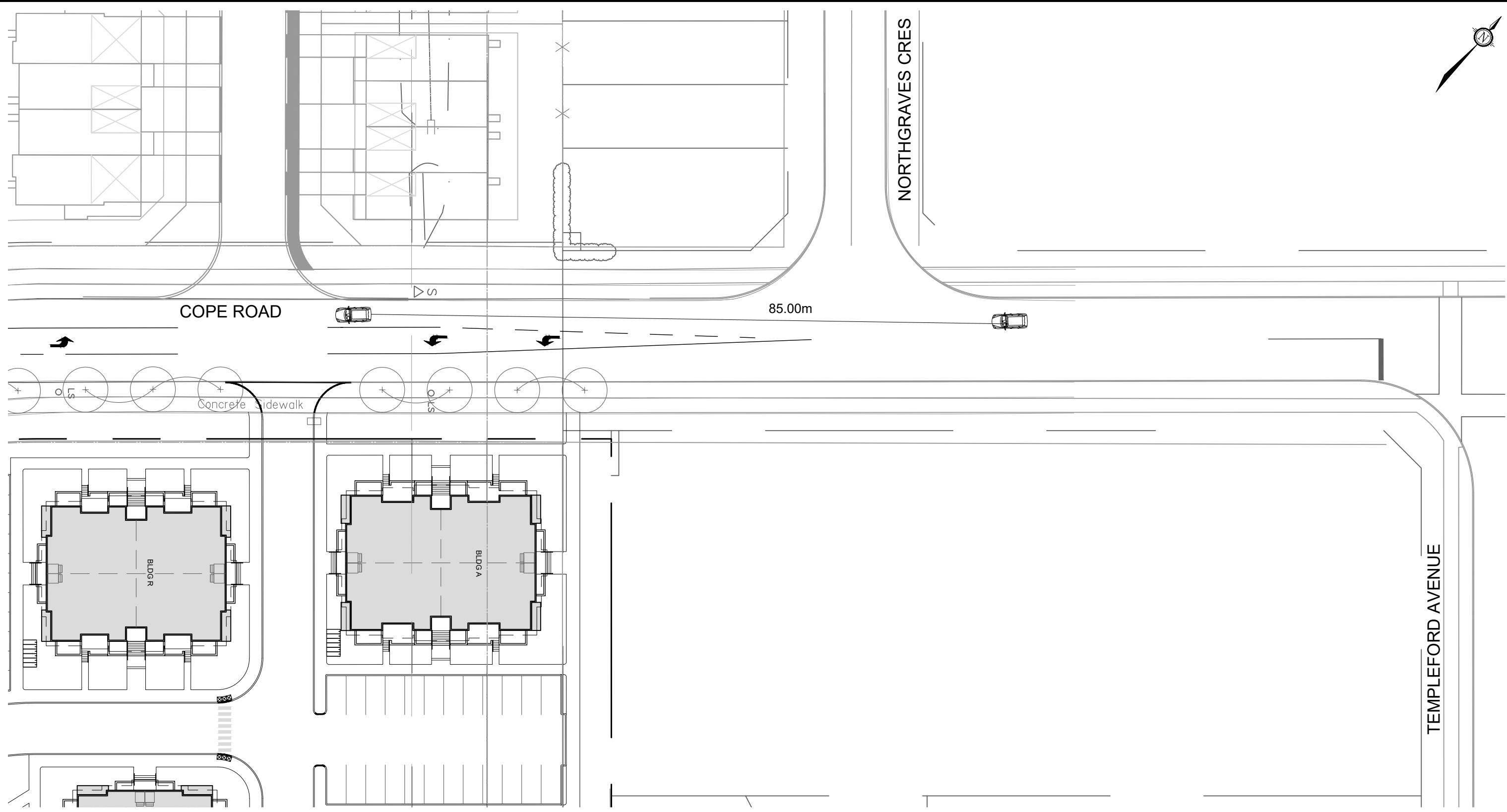

M:\2021\121011\CAD\Design\Figures\Traffic\121011-SD.dwg, FIG17, Sep 29, 2021 - 1:38pm, rhillier

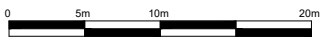
 Engineers, Planners & Landscape Architects Suite 200, 240 Michael Cowpland Drive Ottawa, Ontario, Canada K2M 1P6 Telephone (613) 254-9643 Facsimile (613) 254-5867 Website www.novatech-eng.com	5331 FERNBANK ROAD	
	STOPPING SIGHT DISTANCE COPE DRIVE	
	SCALE 1 : 500	
DATE NOV 2021	JOB 121011	FIGURE FIGURE 17

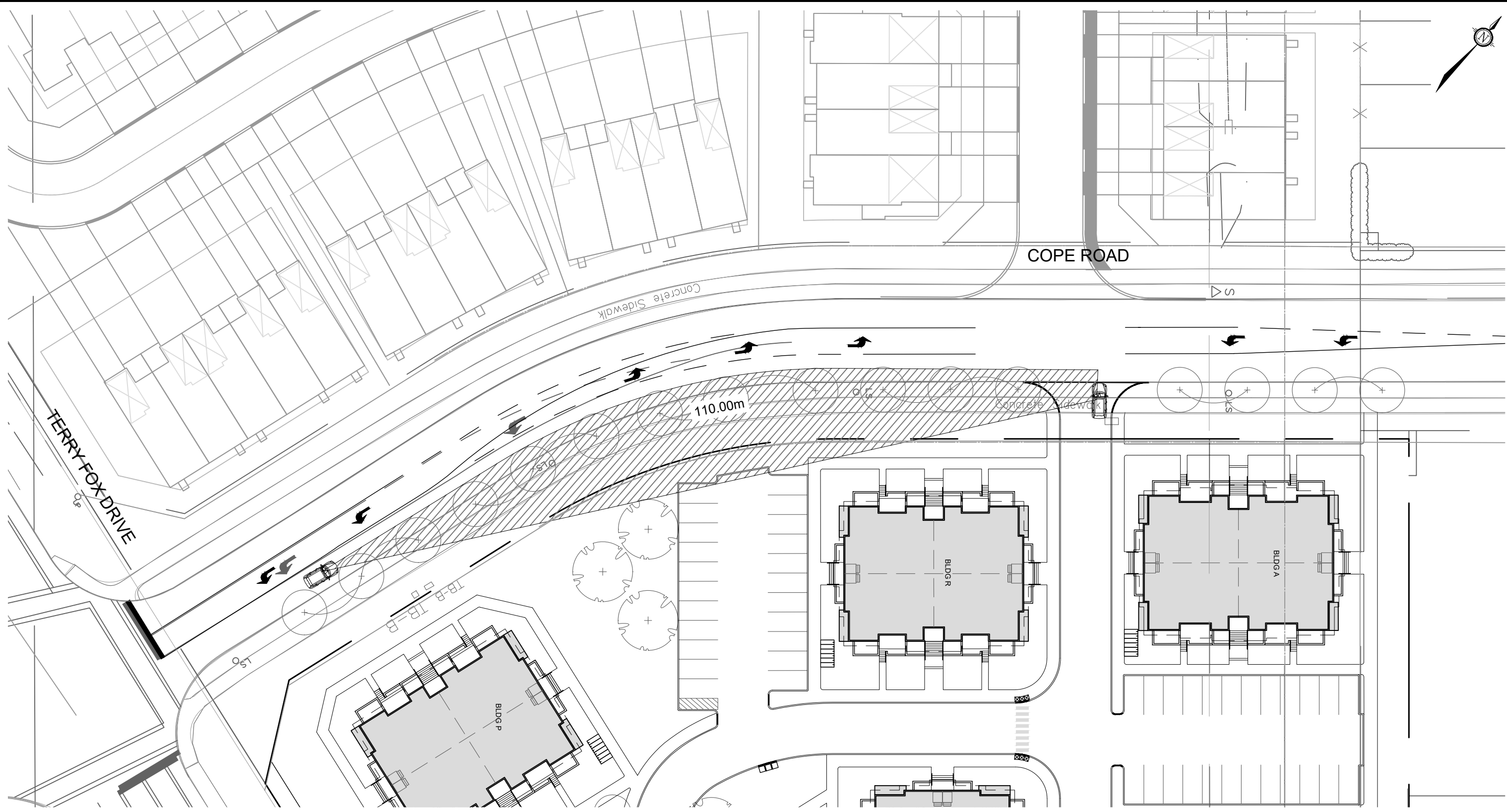

M:\2021\121011\CAD\Design\Figures\Traffic\121011-SD.dwg, FIG18, Sep 29, 2021 - 1:38pm, rhillier

<p>NOVATECH Engineers, Planners & Landscape Architects Suite 200, 240 Michael Cowpland Drive Ottawa, Ontario, Canada K2M 1P6</p> <p>Telephone (613) 254-9643 Facsimile (613) 254-5867 Website www.novatech-eng.com</p>	<p>5331 FERNBANK ROAD</p>	
	<p>INTERSECTION SIGHT DISTANCE COPE DRIVE</p>	
	<p>SCALE 1 : 500</p>	<p>DATE NOV 2021</p>
		<p>FIGURE 18</p>

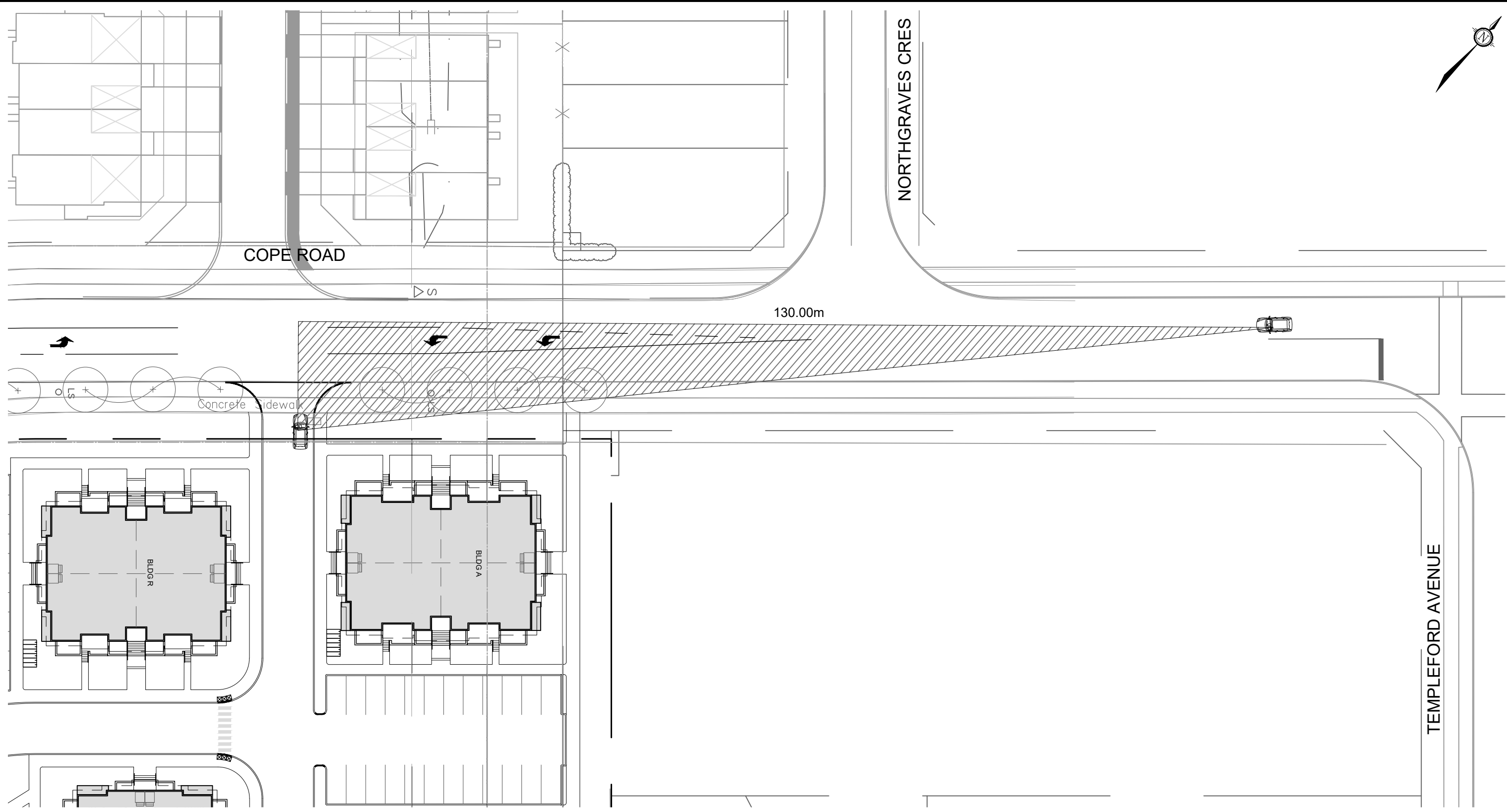

M:\2021\121011\CAD\Design\Figures\Traffic\121011-SD.dwg, FIG19, Sep 29, 2021 - 1:38pm, rhillier

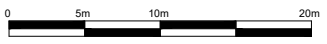
 Engineers, Planners & Landscape Architects Suite 200, 240 Michael Cowpland Drive Ottawa, Ontario, Canada K2M 1P6 Telephone (613) 254-9643 Facsimile (613) 254-5867 Website www.novatech-eng.com	5331 FERNBANK ROAD	
	INTERSECTION SIGHT DISTANCE COPE DRIVE	
	SCALE 1 : 500	
DATE NOV 2021	JOB 121011	FIGURE FIGURE 19

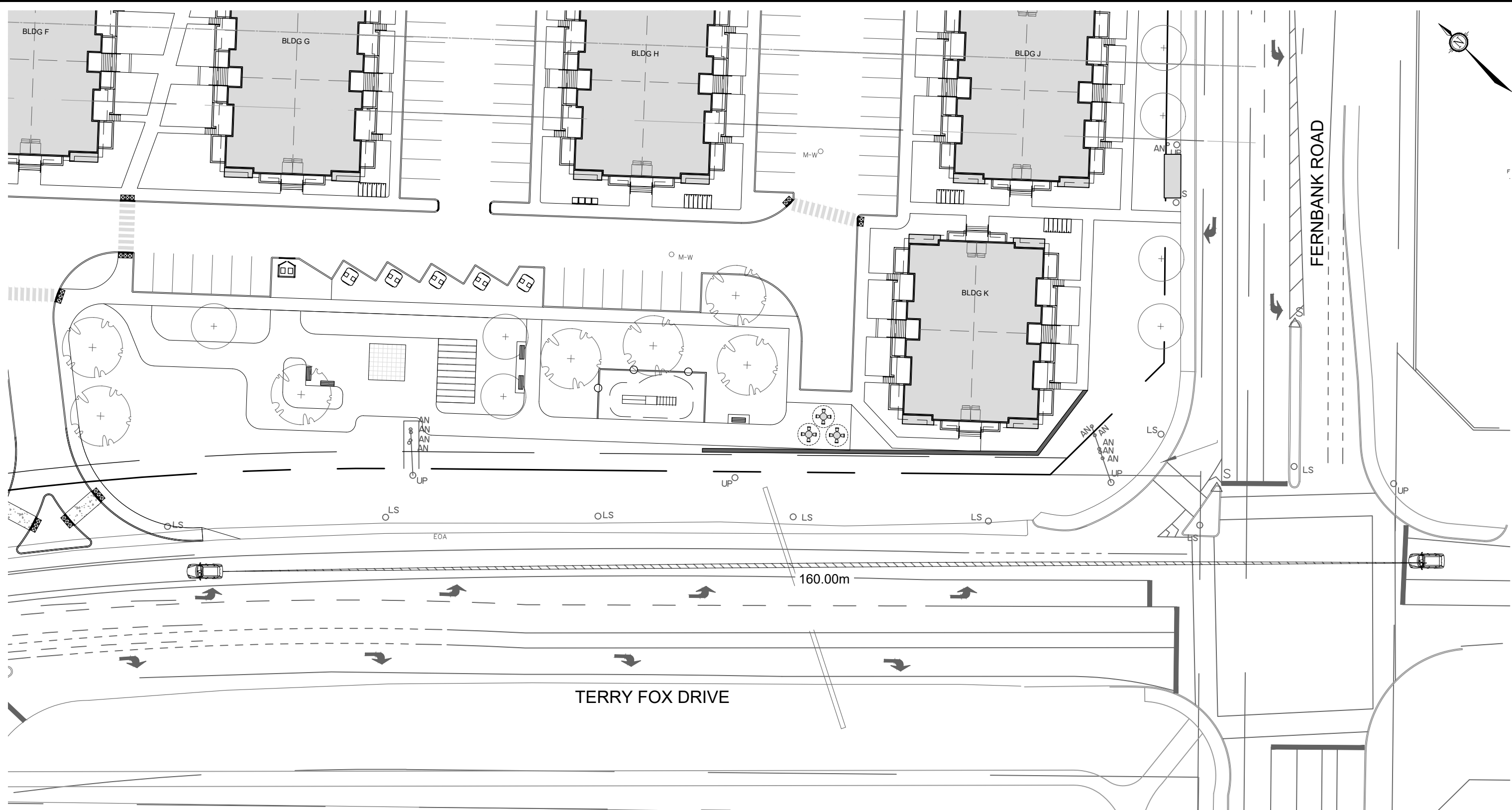

M:\2021\121011\CAD\Design\Figures\Traffic\121011-SD.dwg, FIG20, Sep 29, 2021 - 1:38pm, rhillier

<p>NOVATECH Engineers, Planners & Landscape Architects Suite 200, 240 Michael Cowpland Drive Ottawa, Ontario, Canada K2M 1P6</p> <p>Telephone (613) 254-9643 Facsimile (613) 254-5867 Website www.novatech-eng.com</p>	<p>5331 FERNBANK ROAD</p>	
	<p>STOPPING SIGHT DISTANCE TERRY FOX DRIVE</p>	
	<p>SCALE 1 : 500</p>	
	<p>DATE NOV 2021</p>	<p>JOB 121011</p>

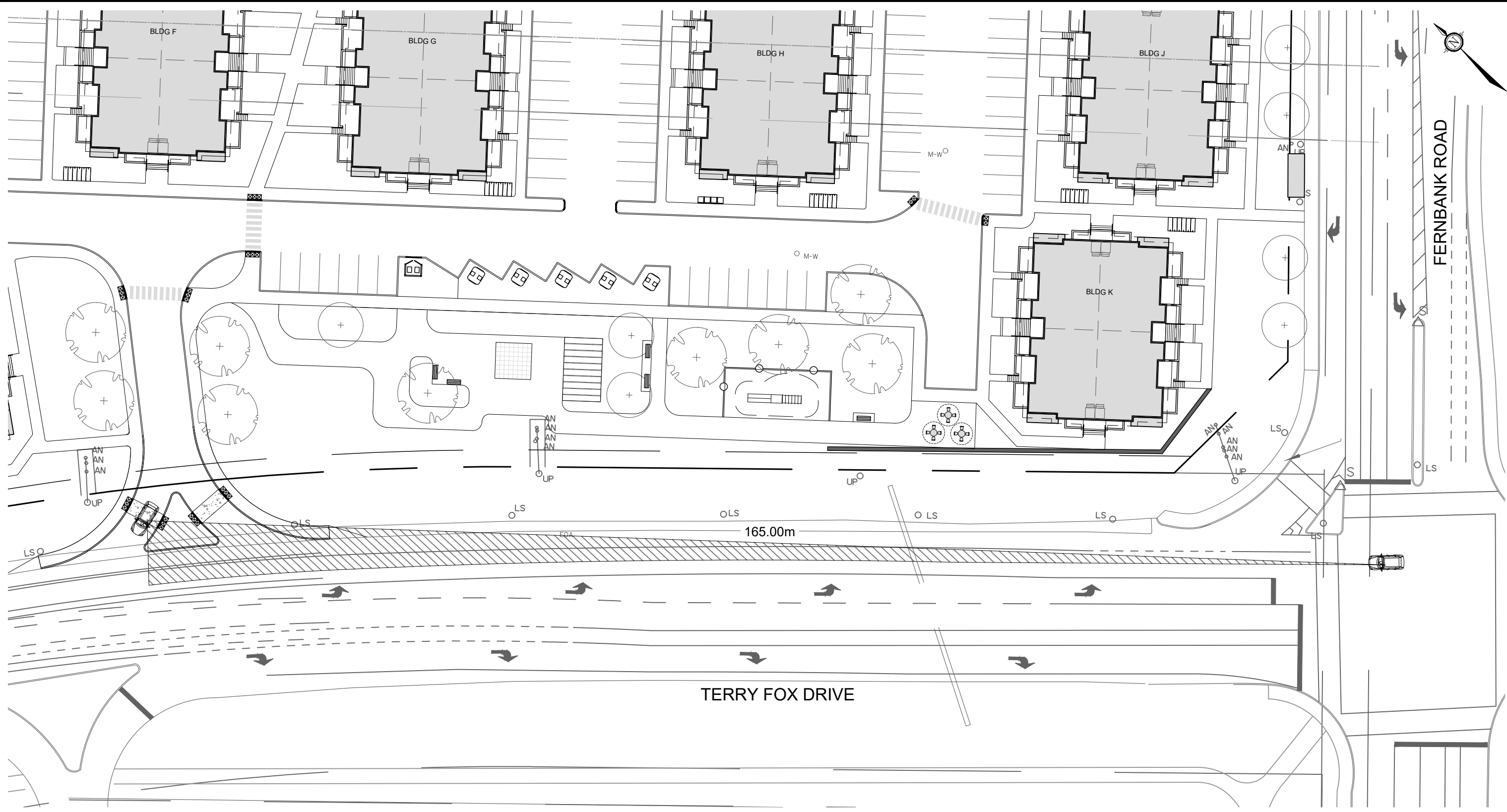

M:\2021\121011\CAD\Design\Figures\Traffic\121011-SD.dwg, FIG21, Sep 29, 2021 - 1:38pm, rhillier

<p>NOVATECH Engineers, Planners & Landscape Architects Suite 200, 240 Michael Cowpland Drive Ottawa, Ontario, Canada K2M 1P6</p> <p>Telephone (613) 254-9643 Facsimile (613) 254-5867 Website www.novatech-eng.com</p>	<p>5331 FERNBANK ROAD</p>	
	<p>INTERSECTION SIGHT DISTANCE TERRY FOX DRIVE</p>	
	<p>SCALE 1 : 500</p>	<p>DATE NOV 2021</p>
		<p>FIGURE 21</p>

4.5 Transportation Demand Management

4.5.1 Context for TDM

The proposed development will contain 192 two-bedroom residential units.

4.5.2 Need and Opportunity

The assumed modal shares for the development are consistent with the existing modal shares associated with high-rise (3+ storey) residential developments in the Kanata/Stittsville district. Based on this, the proposed development is anticipated to meet the assumed modal shares.

4.5.3 TDM Program

The proposed development conforms to the City’s TDM initiatives by providing easy access to local pedestrian, bicycle, and transit systems as outlined in **Section 4.1**. A review of the TDM – Measures Checklist has been conducted and is included in **Appendix H**. The following measures will be implemented within the proposed development:

- Unbundle parking from purchase price, and
- Provide multimodal travel option information package to new residents.

4.6 Neighbourhood Traffic Management

Cope Drive is classified as collector roadway adjacent to the subject site. The following table summarizes the 2028 background traffic, proposed additional traffic, and total traffic along Cope Drive.

Table 13: Neighbourhood Traffic Impacts

Roadway	AM Peak			PM Peak		
	2028 Bkgd	Site	2028 Total	2028 Bkgd	Site	2028 Total
Cope Dr east of access						
Eastbound	281	5	286	323	5	328
Westbound	201	2	203	320	6	326

The City of Ottawa Area Traffic Management (ATM) guidelines identify a maximum threshold of 2,500 vehicles per day, or 300 vehicles during the peak hour for collector roadways. The 2028 background and total traffic volumes along Cope Drive exceed the ATM threshold. However, it is noted that the overall capacity of a collector roadway is estimated at 600 vehicles per hour per lane based on the City’s TRANS Long Range Transportation Model. Total peak hour, peak directional traffic volumes along Cope Drive equate to a volume to capacity (v/c) ratio of 0.48 (LOS A) during the AM peak hour and 0.55 (LOS A) during the PM peak hour.

The proposed development is anticipated to generate 7-11 vehicle trips (two-way) along Cope Drive east of the access during the weekday AM and PM peak hours. This equates to one vehicle every 5.5-8.5 minutes during peak hours. As there is sufficient capacity along Cope Drive to accommodate traffic generated by the development, no mitigation measures are recommended to offset the impacts of the development generated traffic.

4.7 Transit

Based on the trip generation presented in Section 3.1, the proposed development is anticipated to generate an additional 24 transit trips (17 boarding, 7 alighting) during the AM peak hour and 17 transit trips (7 boarding, 10 alighting) during the PM peak hour.

The distribution of transit trips to/from the development has been estimated based on origin-destination data from the 2011 TRANS O-D Survey Report. The destinations of trips from the Kanata/Stittsville Area to all TRANS O-D districts during the AM peak period were used to develop the following transit distribution:

AM Peak

- 45% board Route 161 northbound
- 35% board Route 164 northbound
- 20% board Route 252 northbound

- 100% alight Route 161 southbound

PM Peak

- 100% board Route 161 northbound

- 45% alight Route 161 southbound
- 35% alight Route 164 southbound
- 20% alight Route 252 southbound

The projected transit route load at arrival and departure of the study area is summarized in the following table.

Table 14: Projected Transit Utilization

Route		Existing Load at Arrival to Study Area	Site Trips Alighting ⁽¹⁾	Future Load at Arrival to Study Area	Existing Load at Departure of Study Area	Site Trips Boarding ⁽¹⁾	Future Load at Departure of Study Area
AM Peak							
161	NB	3	0	3	3	8	11
	SB	2	7	9	1	0	1
164	NB	2	0	2	2	6	8
	SB	-	-	-	-	-	-
252	NB	3	0	3	3	3	6
	SB	-	-	-	-	-	-
PM Peak							
161	NB	3	0	3	3	7	10
	SB	5	5	10	4	0	4
164	NB	-	-	-	-	-	-
	SB	6	3	9	4	0	4
252	NB	-	-	-	-	-	-
	SB	7	2	9	3	0	3

1. Conservatively assumes all site trips board/alight one bus. However based on existing headways, a minimum of two buses service route 161, 164, and 252 during peak hours

Based on the foregoing, the existing routes 161, 164, and 252 have capacity to accommodate the projected transit trips generated by the proposed development.

4.8 Network Concept

Per Section 2.4, this module is exempt from the analysis.

4.9 Network Intersections

4.9.1 Existing Intersection MMLOS Analysis

This section provides a review of the signalized study area intersections using complete streets principles. The MMLOS guidelines produced by IBI Group in October 2015 were used to evaluate the LOS of all study area intersections for each mode of transportation. Schedule 'B' of the City of Ottawa's Official Plan indicates the Terry Fox Drive/Cope Drive and Terry Fox Drive/Fernbank Road intersections are located in the General Urban Area. Aerial photo of these intersections are provided in Section 2.1.2.

The following table summarizes the findings of the MMLOS intersection analysis. Detailed intersection MMLOS calculations are included in **Appendix I**.

Table 15: Intersection MMLOS Summary

Segment	PLOS	BLOS	TLOS	TkLOS	Auto LOS
Terry Fox Drive/ Cope Drive	F	E	E	C	C
Target	C	B	-	D	D
Terry Fox Drive/ Fernbank Road	F	E	F	C	F
Target	C	B	-	D	D

Terry Fox Drive/Cope Drive

The Terry Fox Drive/Cope Drive intersection currently does not meet the target PLOS or BLOS for the General Urban Area. As this intersection is not located along a rapid transit or transit priority network, there is no target TLOS.

Based on the Pedestrian Exposure to Traffic (PETS) score, the Terry Fox Drive/Cope Drive intersection is operating with a PLOS F. Based on the Pedestrian Delay Evaluation Table, this intersection is operating with a PLOS D. A reduction in the crossing distance on all legs of the intersection would have the greatest improvement on the PETS score and the Pedestrian Delay.

All approaches do not meet the target BLOS B based on the left turn characteristics, and the north approach does not meet the target BLOS B based on the right turn characteristics. Due to the high operational speed along Terry Fox Drive, a BLOS B is unachievable on the north and south approaches. Based on Exhibit 12 of the MMLOS Guidelines, the target BLOS can be achieved on the east and west approaches by implementing two-stage left-turn bike boxes. This is identified for the City's consideration.

Terry Fox Drive/Fernbank Road

The Terry Fox Drive/Fernbank Road intersection currently does not meet the target PLOS, BLOS, or Auto LOS for the General Urban Area. As this intersection is not located along a rapid transit or transit priority network, there is no target TLOS.

Based on the Pedestrian Exposure to Traffic (PETS) score, the Terry Fox Drive/Fernbank Road intersection is operating with a PLOS F. Based on the Pedestrian Delay Evaluation Table, this

intersection is operating with a PLOS E. A reduction in the crossing distance on all legs of the intersection would have the greatest improvement on the PETS I score and the Pedestrian Delay.

All approaches do not meet the target BLOS B based on the left turn characteristics, and the north, east and west approaches do not meet the target BLOS B based on the right turn characteristics. Due to the high operational speed along Terry Fox Drive and Fernbank Road, a BLOS B is unachievable at this intersection. A reduction in the length of the southbound, eastbound, and westbound right turn lanes, and a reduction in the operating speed along both Terry Fox Drive and Fernbank Road are required to meet the target BLOS at this intersection.

Critical movements at the Terry Fox Drive/Fernbank Road intersection are currently operating with a LOS C during the AM peak hour and a LOS F during the PM peak hour. The 95th percentile queue length for all auxiliary lanes does not exceed the existing storage length during the AM and PM peak hours. PM peak hour traffic signalization with an increased cycle length of 120 seconds is anticipated to improve operations to a LOS D, meeting the area target. The increased cycle length is not anticipated to have a significant impact to the PLOS delay score at this intersection.

4.9.2 2023 Total Intersection Operations

Intersection capacity analysis has been completed for the 2023 total traffic conditions. The results of the analysis are summarized in the following table for the weekday AM and PM peak hours. Detailed reports are included in **Appendix L**.

Table 16: 2023 Total Traffic

Intersection	AM Peak			PM Peak		
	Max V/C	LOS	Mvmt	Max V/C	LOS	Mvmt
Terry Fox Drive/ Cope Drive	0.62	B	NBT/R	0.88	D	EBL
Terry Fox Drive/ Fernbank Road	0.79	C	NBT/R	1.06	F	NBL

Comparing the previous tables and the 2023 background traffic conditions, traffic generated by the proposed development is anticipated to have marginal operational effects within the study area. The discussion of over-capacity movements and queue lengths are generally consistent with those described in Section 3.3.2.

The maximum northbound through queue along Terry Fox Drive is anticipated to be approximately 150m during the AM peak hour and 165m during the PM peak hour. This queue is not anticipated to block the Terry Fox Drive right-in right-out access.

4.9.3 2028 Total Intersection Operations

Intersection capacity analysis has been completed for the 2028 total traffic conditions. The results of the analysis are summarized in the following table for the weekday AM and PM peak hours. Detailed reports are included in **Appendix L**.

Table 17: 2028 Total Traffic

Intersection	AM Peak			PM Peak		
	Max V/C	LOS	Mvmt	Max V/C	LOS	Mvmt
Terry Fox Drive/ Cope Drive	0.75	C	NBT/R	0.91	E	EBL
Terry Fox Drive/ Fernbank Road	0.83	D	NBT/R	1.23	F	NBL
				0.93	E	SBT

Comparing the previous tables and the 2028 background traffic conditions, traffic generated by the proposed development is anticipated to have marginal operational effects within the study area. The discussion of over-capacity movements and queue lengths are generally consistent with those described in Section 3.3.3.

It is noted that the v/c ratio associated with the eastbound left turn movement at the Terry Fox Drive/Cope Drive intersection is anticipated to increase from 0.90 to 0.91 during the PM peak hour, increasing to a LOS E. Minor optimization to the existing traffic signal plan is anticipated to improve operations to a LOS D, achieving the area target.

The maximum northbound through queue along Terry Fox Drive is anticipated to be approximately 195m during the AM peak hour and 200m during the PM peak hour. This queue is anticipated to extend approximately to the Terry Fox Drive right-in right-out access during the peak hours, and drivers exiting north onto Terry Fox Drive may periodically rely on courtesy of other drivers.

5.0 CONCLUSIONS AND RECOMMENDATIONS

Based on the foregoing, the conclusions and recommendations of this TIA can be summarized as follows:

Development Design

- A sidewalk will be provided on both sides of the main drive-aisles, connecting to the existing sidewalks along Cope Drive and Fernbank Road.
- A north-south pathway will also be provided on the eastern portion of the site, connecting from Cope Drive to Fernbank Road. An east-west pathway will be provided between buildings G and F, connecting to an existing pathway leading to Patriot Place.
- Bicycle parking will be in accordance with the minimum requirements of the City’s Zoning By-law. Bicycle parking racks will be located near the entrances for each building.
- All required TDM-supportive design and infrastructure measures in the TDM checklist are met.
- Garbage collection will be conducted on-site. Earth bins will be located on the west side of the main drive aisle opposite Building G, and in a garbage area south of Building Q.

Parking

- A total of 268 vehicle parking spaces (230 resident, 38 visitor) and 96 bicycle parking spaces are proposed, meeting the minimum requirements of the City’s Zoning By-law.

Boundary Street Design

- Cope Drive meets the target PLOS but does not meet the target BLOS for the general urban area. Either a reduction in operating speed combined with bike lanes or a separated

cycling facility are required to achieve the target BLOS B. This is identified for the City's consideration.

- Fernbank Road meets the target TkLOS for the general urban area. However, it does not meet a target PLOS C and BLOS C. A boulevard width of 0.5m or greater between the sidewalk and the roadway is required on the north side of the road. A reduction in the operating speed is required to achieve the target PLOS C on the south side of the road. Either a reduction in operating speed or a separated cycling facility are required to achieve the target BLOS C. This is identified for the City's consideration.
- Terry Fox Drive meets the target TkLOS. However, it does not meet the target PLOS and BLOS. Opportunities to improve the PLOS and BLOS should be explored by the City through the future widening of Terry Fox Drive, as identified in the City's 2013 TMP network concept. At that time, consideration should be given by the City to providing a 2m sidewalk with a boulevard to improve the PLOS. A review of the OTM Book 18 Cycling Nomograph suggests consideration should be given to implementing a separated cycling facility along Terry Fox Drive as part of the future widening project.

Access Intersections Design

- One new all movement access is proposed on Cope Drive, opposite the future Street 1 connection to the subdivision north of Cope Drive, and a right-in right-out access to Terry Fox Drive. The sidewalk along Cope Drive will be depressed and continuous through the proposed accesses, per City of Ottawa Specification 7.1.
- The width of the Cope Drive access conforms to the requirements of the City's Private Approach By-law and Zoning By-law.
- As the width of the Terry Fox Drive access is required to accommodate the proposed pork chop right-in right-out island, a waiver to Section 25 (c) of the Private Approach By-law is requested.
- The location of both accesses meet the requirements of the Private Approach By-law.
- A maximum grade of 2% is proposed for a distance of 9m within the private property at both accesses, conforming to the requirements of the Private Approach By-law.
- Based on the projected northbound right turn volumes at the Terry Fox Drive access, a right turn lane is not recommended. A pork chop island will be provided to restrict this access to right-in right-out.
- Based on the projected eastbound right turn volumes at the Cope Drive access, a right turn lane is not recommended.
- To provide improved access operations and safety, a westbound left turn lane will be painted in lieu of the previously proposed gore area runout taper as part of the left turn lane for the subdivision opposite the proposed development.
- The required Stopping Sight Distance and Intersection Sight Distance at both accesses meet TAC requirements.
- Side street stop control is recommended at the proposed accesses along Cope Drive and Terry Fox Drive.

Transportation Demand Management

- The proposed development conforms to the City's TDM initiatives by providing easy access to local pedestrian, bicycle, and transit systems.
- The following additional TDM measures will be implemented within the proposed development:
 - Unbundle parking from purchase price, and
 - Provide multimodal travel option information package to new residents.

Neighbourhood Traffic Management

- The proposed development is anticipated to generate 7-11 vehicle trips (two-way) along Cope Drive east of the access during the weekday AM and PM peak hours. This equates to one vehicle every 5.5-8.5 minutes during peak hours.
- As there is sufficient capacity along Cope Drive to accommodate traffic generated by the development, no mitigation measures are recommended to offset the impacts of the development generated traffic.

Transit

- The existing routes 161, 164, and 252 have capacity to accommodate the projected transit trips generated by the proposed development.

MMLOS Analysis

- Terry Fox Drive/Cope Drive
 - The Terry Fox Drive/Cope Drive intersection currently does not meet the target PLOS or BLOS for the General Urban Area. As this intersection is not located along a rapid transit or transit priority network, there is no target TLOS.
 - A reduction in the crossing distance on all legs of the intersection would have the greatest improvement on the PETS I score and the Pedestrian Delay.
 - Due to the high operational speed along Terry Fox Drive, a BLOS B is unachievable on the north and south approaches. The target BLOS can be achieved on the east and west approaches by implementing two-stage left-turn bike boxes. This is identified for the City's consideration.
- Terry Fox Drive/Fernbank Road
 - The Terry Fox Drive/Fernbank Road intersection currently does not meet the target PLOS, BLOS, or Auto LOS for the General Urban Area. As this intersection is not located along a rapid transit or transit priority network, there is no target TLOS.
 - A reduction in the crossing distance on all legs of the intersection would have the greatest improvement on the PETS I score and the Pedestrian Delay.
 - Due to the high operational speed along Terry Fox Drive and Fernbank Road, a BLOS B is unachievable at this intersection. A reduction in the length of the southbound, eastbound, and westbound right turn lanes, and a reduction in the operating speed along both Terry Fox Drive and Fernbank Road are required to meet the target BLOS at this intersection.
 - Critical movements at the Terry Fox Drive/Fernbank Road intersection are currently operating with an Auto LOS C during the AM peak hour and an Auto LOS F during the PM peak hour.
 - PM peak hour traffic signalization with an increased cycle length of 120 seconds is anticipated to improve operations to a LOS D, meeting the area target. The increased cycle length is not anticipated to have a significant impact to the PLOS delay score at this intersection.

Background Intersection Operations

- Critical movements at the Terry Fox Drive/Cope Drive intersection are anticipated to operate with a LOS D or better during the weekday AM and PM peak hours.
- Critical movements at the Terry Fox Drive/Fernbank Road intersection are anticipated to operate with a LOS C during the AM peak hour and a LOS F during the PM peak hour.
- PM peak hour traffic signalization with an increased cycle length of 120 seconds is anticipated to improve operations to a LOS D, meeting the area target. The increased

cycle length is not anticipated to have a significant impact to the PLOS delay score at this intersection.

Total Intersection Operations

- Traffic generated by the proposed development is anticipated to have marginal operational effects within the study area. The discussion of over-capacity movements and queue lengths are generally consistent with those described in the background traffic analysis.
- Under 2028 total traffic conditions, the v/c ratio associated with the eastbound left turn movement at the Terry Fox Drive/Cope Drive intersection is anticipated to increase from 0.90 to 0.91 during the PM peak hour, increasing to a LOS E. Minor optimization to the existing traffic signal plan is anticipated to improve operations to a LOS D, achieving the area target.
- Under 2028 total traffic conditions, the maximum northbound through queue along Terry Fox Drive is anticipated to be approximately 195m during the AM peak hour and 200m during the PM peak hour. This queue is anticipated to extend approximately to the Terry Fox Drive right-in right-out access during the peak hours, and drivers exiting north onto Terry Fox Drive may periodically rely on courtesy of other drivers.

NOVATECH

Prepared by:



Brad ByvelDs, P. Eng.
Project Coordinator | Transportation/Traffic

APPENDIX A

Proposed Site Plan

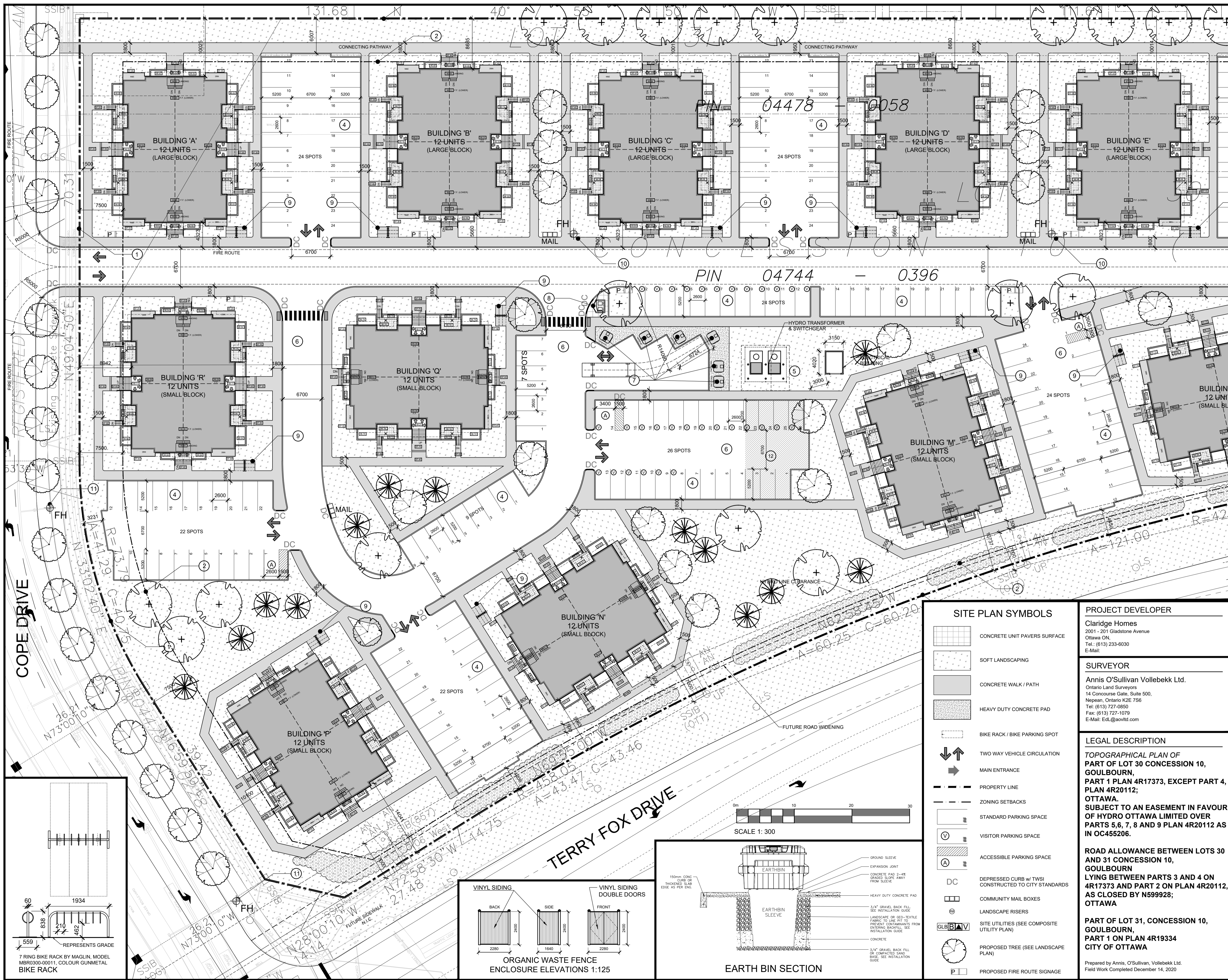

IT IS THE RESPONSIBILITY OF THE APPROPRIATE CONTRACTOR TO CHECK AND VERIFY ALL DIMENSIONS ON SITE AND TO REPORT ALL ERRORS AND/OR OMISSIONS TO THE ARCHITECT. ALL CONTRACTORS MUST COMPLY WITH ALL PERTINENT CODES AND BY-LAWS. THIS DRAWING MAY NOT BE USED FOR CONSTRUCTION UNTIL SIGNED BY THE ARCHITECT. DO NOT SCALE DRAWINGS.

- NOTATION SYMBOLS:**
- (00) INDICATES DRAWING NOTES, LISTED ON EACH SHEET.
 - (A) INDICATES ASSEMBLY TYPE, REFER TO TYPICAL ASSEMBLIES SCHEDULE.
 - (W) INDICATES WINDOW TYPE, REFER TO WINDOW ELEVATIONS AND DETAILS ON A900 SERIES.
 - (D) INDICATES DOOR TYPE, REFER TO DOOR SCHEDULE AND DETAILS ON A900 SERIES.
 - DETAIL NUMBER
 - TITLE SCALE
 - DETAIL REFERENCE PAGE

No.	DESCRIPTION	DATE
7	SITE PLAN COMMENT RESPONSE	2021-11-04
6	REVISED CONSULTANT COORDINATION	2021-07-12
5	REVISED CONSULTANT COORDINATION	2021-06-03
4	FOR COORDINATION	2021-04-30
3	REVISED CONSULTANT COORDINATION	2021-04-07
2	REVISED PRELIMINARY COMMENTS	2021-02-25
1	ISSUED FOR COORDINATION	2021-02-03

ARCHITECT SEAL: **RODERICK LOHEY ARCHITECTS** (Professional Seal)
 CLIENT: **CLARIDGE HOMES**
 SEAL DATE: STAMP DATE

CLARIDGE HOMES
 PROJECT DEVELOPER
 Claridge Homes
 2001 - 201 Gladstone Avenue
 Ottawa ON, Tel: (613) 233-6030
 E-Mail:

rla / architecture
 roderick lohey architect inc.
 56 beech street, ottawa, ontario K1S 3J6
 t.613.724.9932 f.613.724.1209 rlaarchitecture.ca

PROJECT TITLE: **TERRY FOX ZEN**
 5331 FERNBANK STREET
 OTTAWA ONTARIO

SHEET TITLE: **SITE PLAN (NORTH-WEST)**

DRAWN: BIO	CHECKED: CM
SCALE: 1:300	SHEET No. SP-1
PROJECT No. 2101	

- SITE PLAN SYMBOLS**
- [Grid Pattern] CONCRETE UNIT PAVERS SURFACE
 - [Dotted Pattern] SOFT LANDSCAPING
 - [Solid Grey] CONCRETE WALK / PATH
 - [Stippled] HEAVY DUTY CONCRETE PAD
 - [Dashed Line] BIKE RACK / BIKE PARKING SPOT
 - [Double Arrow] TWO WAY VEHICLE CIRCULATION
 - [Single Arrow] MAIN ENTRANCE
 - [Dashed Line] PROPERTY LINE
 - [Dashed Line] ZONING SETBACKS
 - [Empty Box] STANDARD PARKING SPACE
 - [Circle with V] VISITOR PARKING SPACE
 - [Circle with A] ACCESSIBLE PARKING SPACE
 - [DC] DEPRESSED CURB w/ TWSI CONSTRUCTED TO CITY STANDARDS
 - [Box with M] COMMUNITY MAIL BOXES
 - [Circle with R] LANDSCAPE RISERS
 - [GLB|A|V] SITE UTILITIES (SEE COMPOSITE UTILITY PLAN)
 - [Circle with P] PROPOSED TREE (SEE LANDSCAPE PLAN)
 - [Square with P] PROPOSED FIRE ROUTE SIGNAGE

SURVEYOR
 Annis O'Sullivan Vollebek Ltd.
 Ontario Land Surveyors
 14 Concourse Gate, Suite 500,
 Nepean, Ontario K2E 7S6
 Tel: (613) 727-0850
 Fax: (613) 727-1079
 E-Mail: Edl@aovltd.com

LEGAL DESCRIPTION
 TOPOGRAPHICAL PLAN OF PART OF LOT 30 CONCESSION 10, GOULBOURN, PART 1 PLAN 4R17373, EXCEPT PART 4, PLAN 4R20112; OTTAWA. SUBJECT TO AN EASEMENT IN FAVOUR OF HYDRO OTTAWA LIMITED OVER PARTS 5, 6, 7, 8 AND 9 PLAN 4R20112 AS IN OC455206.

ROAD ALLOWANCE BETWEEN LOTS 30 AND 31 CONCESSION 10, GOULBOURN LYING BETWEEN PARTS 3 AND 4 ON 4R17373 AND PART 2 ON PLAN 4R20112, AS CLOSED BY N599928; OTTAWA

PART OF LOT 31, CONCESSION 10, GOULBOURN, PART 1 ON PLAN 4R19334 CITY OF OTTAWA

Prepared by Annis, O'Sullivan, Vollebek Ltd.
 Field Work Completed December 14, 2020

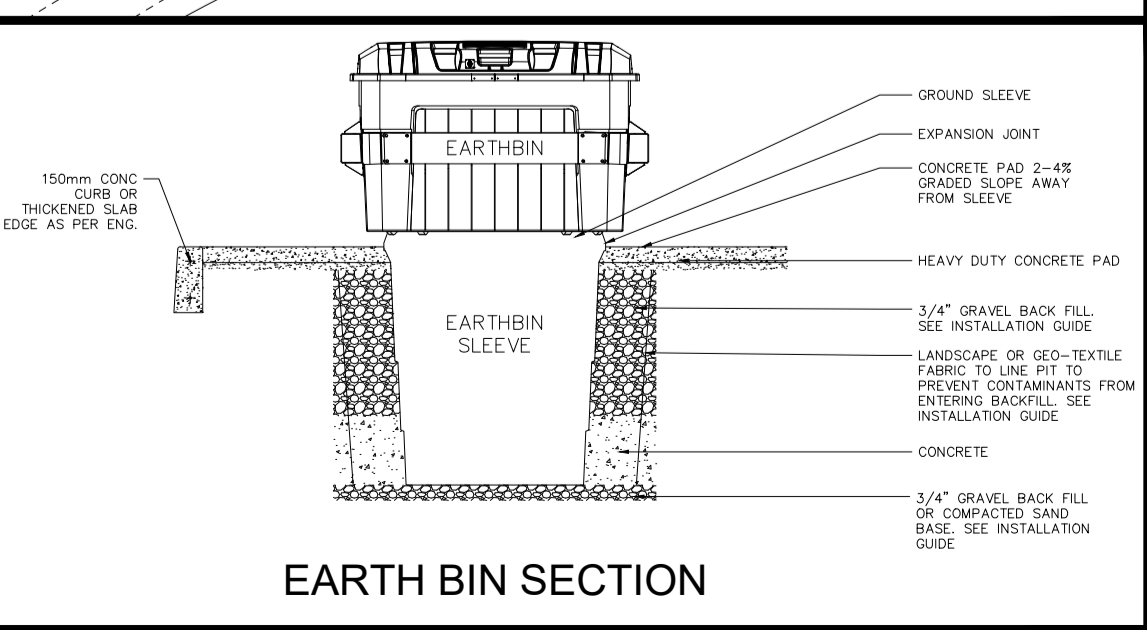
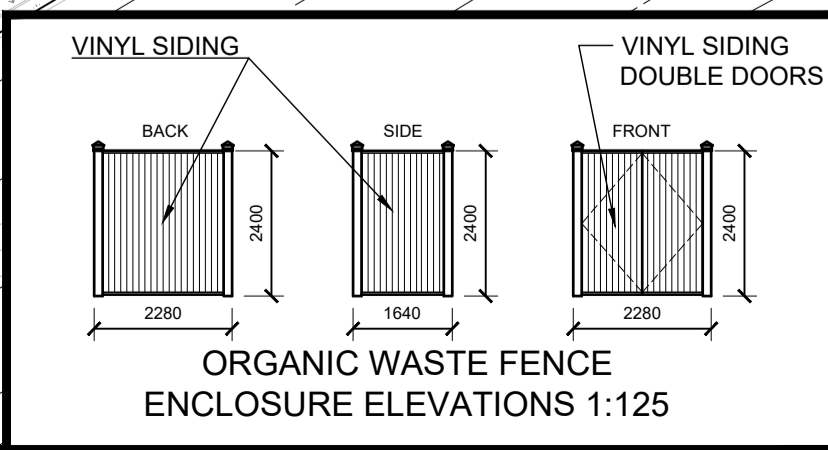
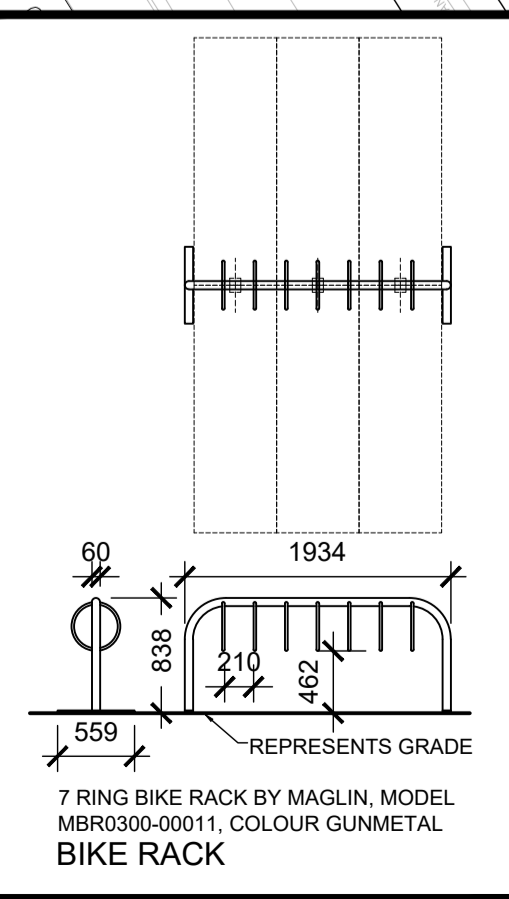

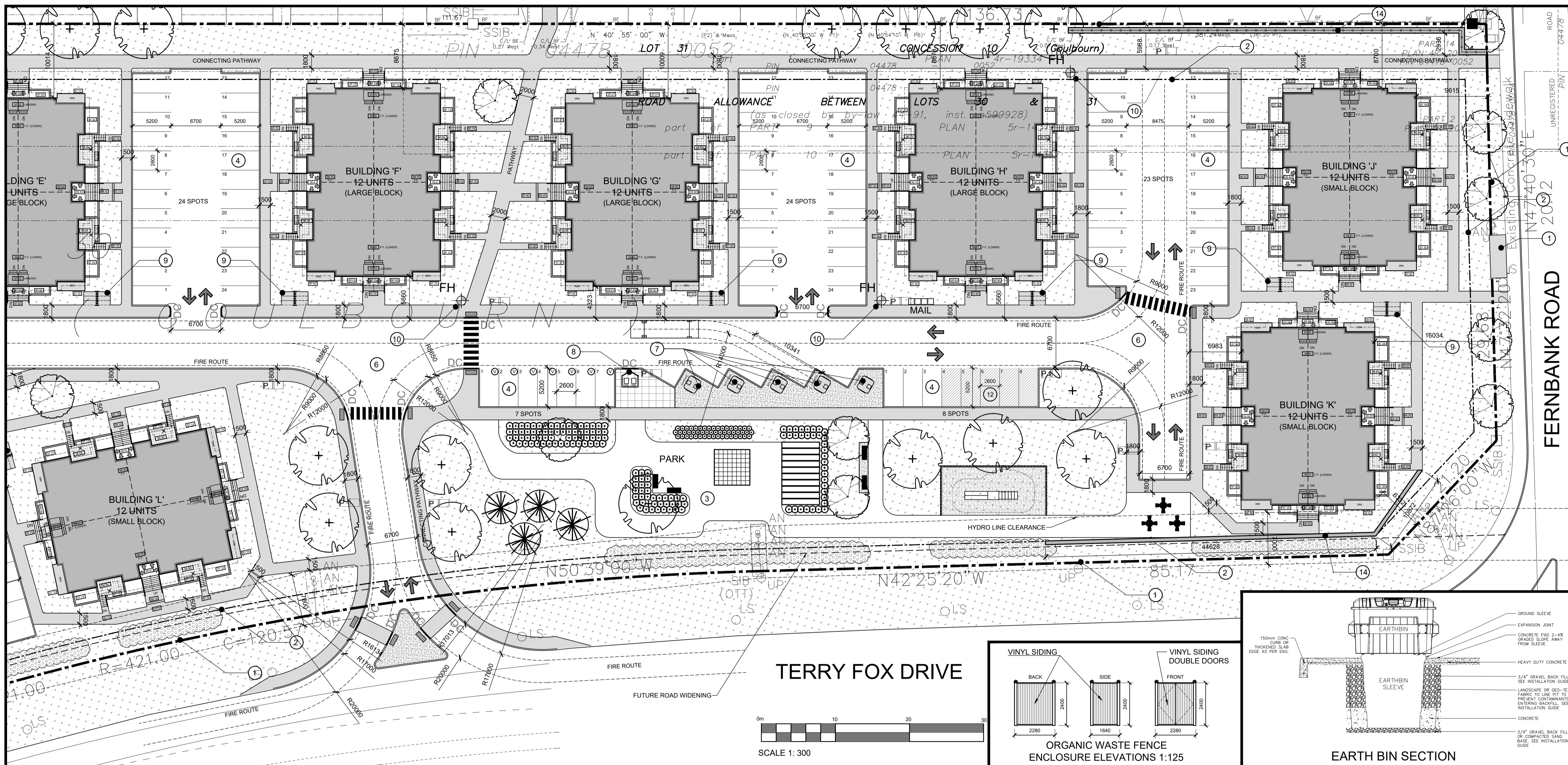

IT IS THE RESPONSIBILITY OF THE APPROPRIATE CONTRACTOR TO CHECK AND VERIFY ALL DIMENSIONS ON SITE AND TO REPORT ALL ERRORS AND/OR OMISSIONS TO THE ARCHITECT. ALL CONTRACTORS MUST COMPLY WITH ALL PERTINENT CODES AND BY-LAWS. THIS DRAWING MAY NOT BE USED FOR CONSTRUCTION UNTIL SIGNED BY THE ARCHITECT. DO NOT SCALE DRAWINGS.

NOTATION SYMBOLS:

- ① INDICATES DRAWING NOTES, LISTED ON EACH SHEET.
- ⬡ INDICATES ASSEMBLY TYPE; REFER TO TYPICAL ASSEMBLIES SCHEDULE.
- ⊕ INDICATES WINDOW TYPE; REFER TO WINDOW ELEVATIONS AND DETAILS ON A900 SERIES.
- ⊙ INDICATES DOOR TYPE; REFER TO DOOR SCHEDULE AND DETAILS ON A900 SERIES.
- ①-⑩ DETAIL NUMBER
- ①-⑩ TITLE SCALE
- ①-⑩ DETAIL REFERENCE PAGE

No.	REVISIONS	DATE
7	SITE PLAN COMMENT RESPONSE	2021-11-04
6	REVISED CONSULTANT COORDINATION	2021-07-12
5	REVISED CONSULTANT COORDINATION	2021-06-03
4	FOR COORDINATION	2021-04-30
3	REVISED CONSULTANT COORDINATION	2021-04-07
2	REVISED PRELIMINARY COMMENTS	2021-02-25
1	ISSUED FOR COORDINATION	2021-02-03
No.	DESCRIPTION	DATE

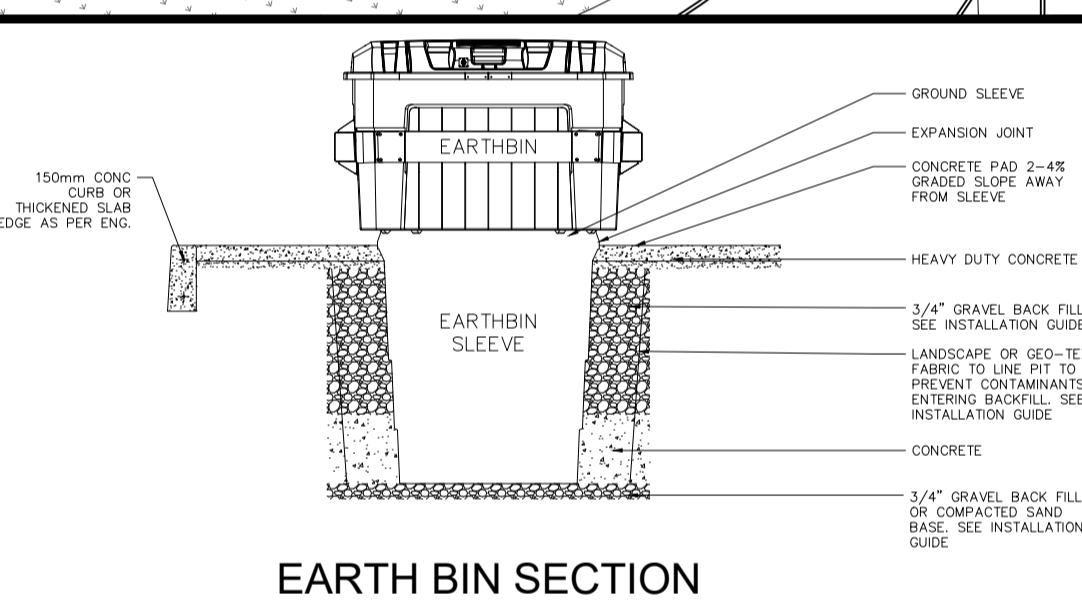
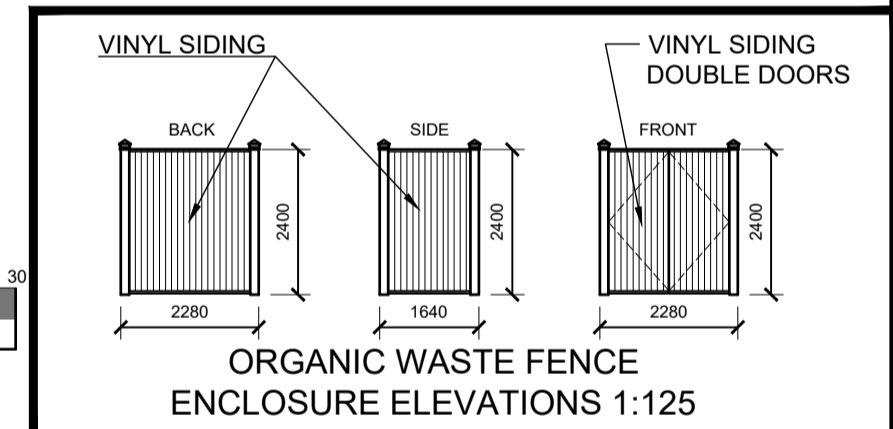

1 SITE PLAN
SP-2 SCALE = 1 : 300

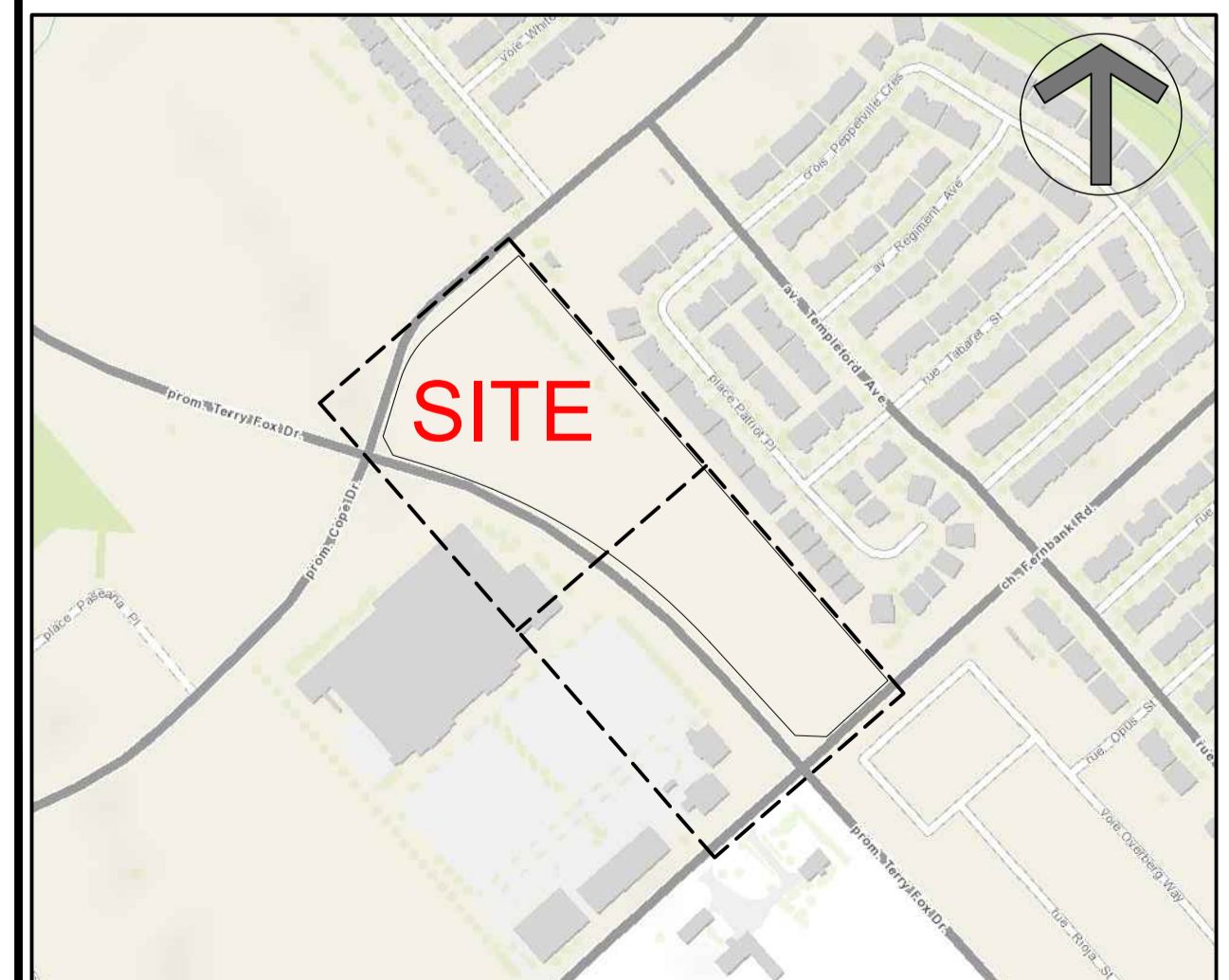

- DRAWING NOTES**
- PROPERTY LINE
 - BUILDING SETBACKS
 - REQUIRED AMENITY AREA
 - PARKING SPACE: STANDARD SIZE 2.6 x 5.2 METRES
 - PROPOSED HYDRO TRANSFORMER
 - ASPHALT DRIVING SURFACE
 - EARTH BINS
 - ORGANIC WASTE SHED
 - BICYCLE PARKING SPACES
 - PROPOSED HYDRANT
 - EXISTING FIRE HYDRANT
 - TEMPORARY SNOW STORAGE
 - EXISTING BELL BOXES
 - RETAINING WALL, SEE CIVIL
 - PROPOSED CONCRETE BUS PAD

- SITE PLAN SYMBOLS**
- CONCRETE UNIT PAVERS SURFACE
 - SOFT LANDSCAPING
 - CONCRETE WALK / PATH
 - HEAVY DUTY CONCRETE PAD
 - BIKE RACK / BIKE PARKING SPOT
 - TWO WAY VEHICLE CIRCULATION
 - MAIN ENTRANCE
 - PROPERTY LINE
 - ZONING SETBACKS
 - STANDARD PARKING SPACE
 - VISITOR PARKING SPACE
 - ACCESSIBLE PARKING SPACE
 - DEPRESSED CURB w/ TWSI CONSTRUCTED TO CITY STANDARDS
 - COMMUNITY MAIL BOXES
 - LANDSCAPE RISERS
 - SITE UTILITIES (SEE COMPOSITE UTILITY PLAN)
 - PROPOSED TREE (SEE LANDSCAPE PLAN)
 - PROPOSED FIRE ROUTE SIGNAGE

PROJECT DEVELOPER
Claridge Homes
2001 - 201 Gladstone Avenue
Ottawa, ON.
Tel.: (613) 233-6030
E-Mail:

SURVEYOR
Annis O'Sullivan Vollebek Ltd.
Ontario Land Surveyors
14 Concourse Gate, Suite 500,
Nepean, Ontario K2E 7S6
Tel: (613) 727-0850
Fax: (613) 727-1079
E-Mail: EdL@aovltd.com

LEGAL DESCRIPTION
TOPOGRAPHICAL PLAN OF PART OF LOT 30 CONCESSION 10, GOULBOURN, PART 1 PLAN 4R17373, EXCEPT PART 4, PLAN 4R20112; OTTAWA. SUBJECT TO AN EASEMENT IN FAVOUR OF HYDRO OTTAWA LIMITED OVER PARTS 5, 6, 7, 8 AND 9 PLAN 4R20112 AS IN OC455206.

ROAD ALLOWANCE BETWEEN LOTS 30 AND 31 CONCESSION 10, GOULBOURN LYING BETWEEN PARTS 3 AND 4 ON 4R17373 AND PART 2 ON PLAN 4R20112, AS CLOSED BY N599928; OTTAWA

PART OF LOT 31, CONCESSION 10, GOULBOURN, PART 1 ON PLAN 4R19334 CITY OF OTTAWA

Prepared by Annis O'Sullivan, Vollebek Ltd.
Field Work Completed December 14, 2020

WASTE COLLECTION

GUIDELINES

GARBAGE	- 0.231 CUBIC YARDS / UNIT	45 YARDS ³
RECYCLING (GMP)	- 0.018 CUBIC YARDS / UNIT	4 YARDS ³
RECYCLING (FIBRE)	- 0.062 CUBIC YARDS / UNIT	12 YARDS ³
ORGANICS	- 240L CONTAINER /50 UNITS	4x 240L

GARBAGE	7 EARTH BINS	7 EARTH BINS
RECYCLING (GMP)	1 EARTH BINS	2 EARTH BINS
RECYCLING (FIBRE)	2 EARTH BINS	2 EARTH BINS
ORGANICS	4x 240L BINS	4x 240L BINS

*EARTH BINS= (6.5 YARDS³)

SNOW STORAGE
TEMPORARILY STORED AND TRUCKED OFF SITE

PROJECT INFORMATION

CURRENT ZONING GM(2411)
USE PLANNED UNIT DEVELOPMENT

SITE AREA 36,789 sq. m. (395,995) sq. ft.

BUILDING HEIGHT 18.0 m.

AMENITY AREA PER DWELLING UNIT 6.0 sq. m.

FRONT YARD SETBACK 3.0 M

REAR YARD SETBACK 3.0 M

INTERIOR SIDE YARD SETBACK 7.5 M

PROJECT STATISTICS

BUILDING HEIGHT	11.0 M
REQUIRED AMENITY SPACE	6 SQ. M. PER UNIT= 288 sq. m. (13,130) sq. ft.
50% COMMUNAL AMENITY AREA =	144 sq. m. (13,130) sq. ft.
PROVIDED AMENITY SPACE	PRIVATE BALCONY / PATIOS = 361 sq. m. (13,130) sq. ft.
COMMUNAL EXTERIOR AREA=	200 sq. m. (13,130) sq. ft.
TOTAL =	100.0% 6,768.95 sq. m.

SITE COVERAGE

BUILDING FOOTPRINT =	33.6% 2,278.43 sq. m.
DRIVING SURFACE =	25.9% 1,751.40 sq. m.
LANDSCAPE AREA =	40.5% 2,739.12 sq. m.
TOTAL =	100.0% 6,768.95 sq. m.

CAR PARKING REQUIRED by ZONING BY-LAW

RESIDENCE	- 1.2 PER UNIT (192 UNITS)	230
VISITOR	- 0.2 PER DWELLING UNIT	38
TOTAL		268

PROVIDED

RESIDENCE	- 1.2 PER UNIT (192 UNITS)	230
VISITOR	- 0.2 PER DWELLING UNIT	38
TOTAL		268

BICYCLE PARKING

REQUIRED	- 0.5 PER UNIT (192 UNITS)	96
PROVIDED		96

GROSS BUILDING - AREAS
(CITY OF OTTAWA'S DEFINITION)

PROPOSED BUILDING 'A'	1,290.5 sq. m. (13,890) sq. ft.
PROPOSED BUILDING 'B'	1,290.5 sq. m. (13,890) sq. ft.
PROPOSED BUILDING 'C'	1,290.5 sq. m. (13,890) sq. ft.
PROPOSED BUILDING 'D'	1,290.5 sq. m. (13,890) sq. ft.
PROPOSED BUILDING 'E'	1,290.5 sq. m. (13,890) sq. ft.
PROPOSED BUILDING 'F'	1,290.5 sq. m. (13,890) sq. ft.
PROPOSED BUILDING 'G'	1,290.5 sq. m. (13,890) sq. ft.
PROPOSED BUILDING 'H'	1,290.5 sq. m. (13,890) sq. ft.
PROPOSED BUILDING 'J'	1,220.0 sq. m. (13,130) sq. ft.
PROPOSED BUILDING 'K'	1,220.0 sq. m. (13,130) sq. ft.
PROPOSED BUILDING 'L'	1,220.0 sq. m. (13,130) sq. ft.
PROPOSED BUILDING 'M'	1,220.0 sq. m. (13,130) sq. ft.
PROPOSED BUILDING 'N'	1,220.0 sq. m. (13,130) sq. ft.
PROPOSED BUILDING 'P'	1,220.0 sq. m. (13,130) sq. ft.
PROPOSED BUILDING 'Q'	1,220.0 sq. m. (13,130) sq. ft.
PROPOSED BUILDING 'R'	1,220.0 sq. m. (13,130) sq. ft.
TOTAL PROPOSED AREA	20,084.0 sq. m. (216,182) sq. ft.

UNIT STATISTICS

2 BEDROOM UNIT	192
----------------	-----

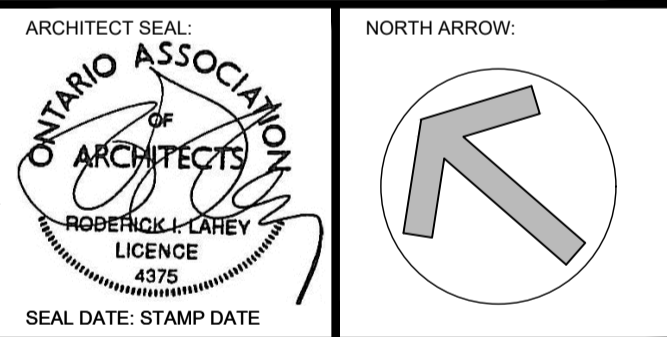

TERRY FOX ZEN
5331 FERNBANK STREET
OTTAWA ONTARIO

SITE PLAN (SOUTH-EAST)

DRAWN:	BIO	CHECKED:	CM
SCALE:	1:300	SHEET No.	SP-2
PROJECT No.	2101		

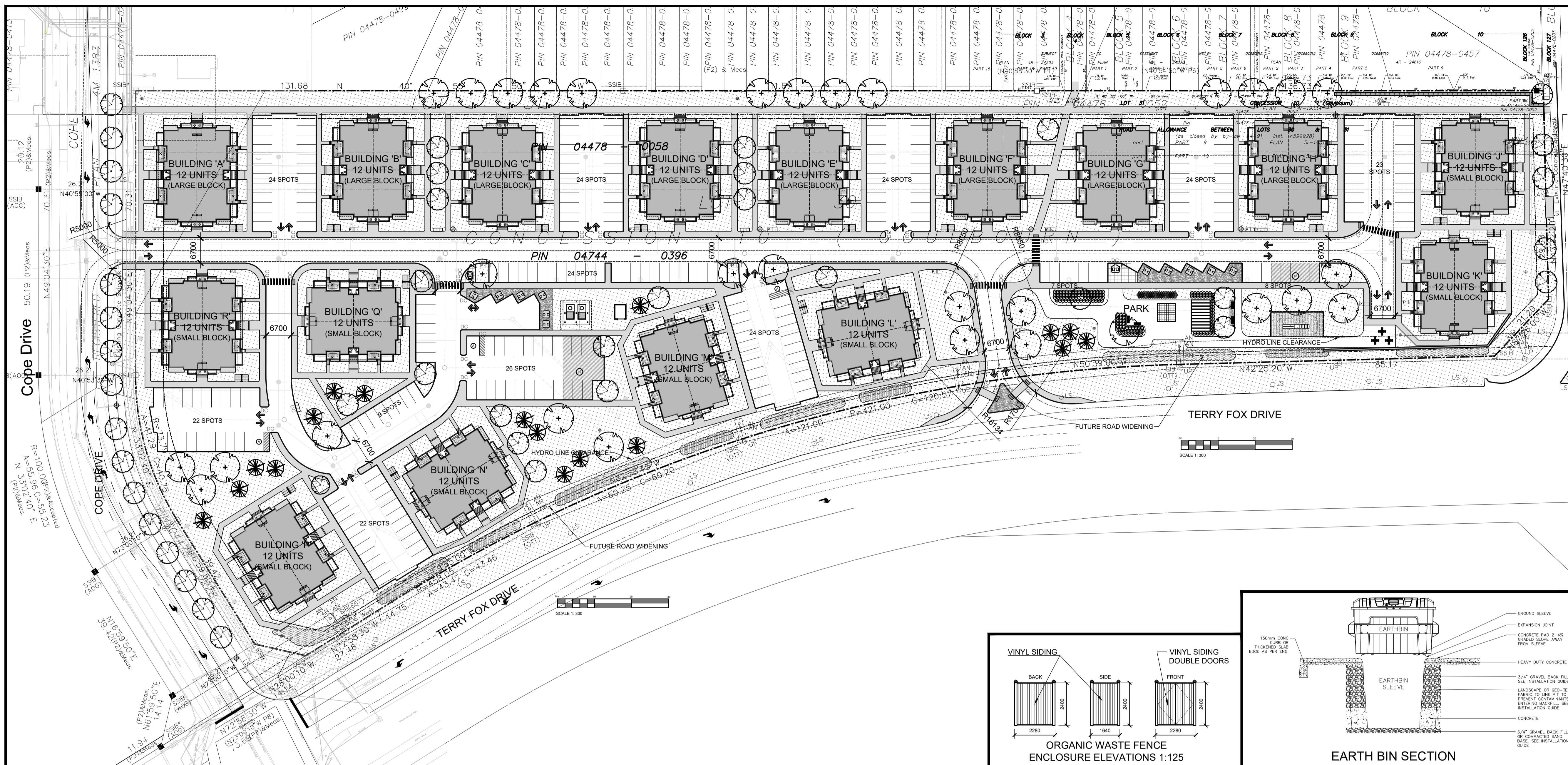

IT IS THE RESPONSIBILITY OF THE APPROPRIATE CONTRACTOR TO CHECK AND VERIFY ALL DIMENSIONS ON SITE AND TO REPORT ALL ERRORS AND/OR OMISSIONS TO THE ARCHITECT. ALL CONTRACTORS MUST COMPLY WITH ALL PERTINENT CODES AND BY-LAWS. THIS DRAWING MAY NOT BE USED FOR CONSTRUCTION UNLESS SIGNED BY THE ARCHITECT. DO NOT SCALE DRAWINGS.

NOTATION SYMBOLS:

- Ⓢ INDICATES DRAWING NOTES, LISTED ON EACH SHEET.
- Ⓛ INDICATES ASSEMBLY TYPE, REFER TO TYPICAL ASSEMBLIES SCHEDULED.
- Ⓜ INDICATES WINDOW TYPE, REFER TO WINDOW ELEVATIONS AND DETAILS ON A900 SERIES.
- Ⓝ INDICATES DOOR TYPE, REFER TO DOOR SCHEDULE AND DETAILS ON A900 SERIES.
- ①-⑩ DETAIL NUMBER
- Ⓢ/Ⓛ TITLE SCALE
- ①-⑩ DETAIL REFERENCE PAGE

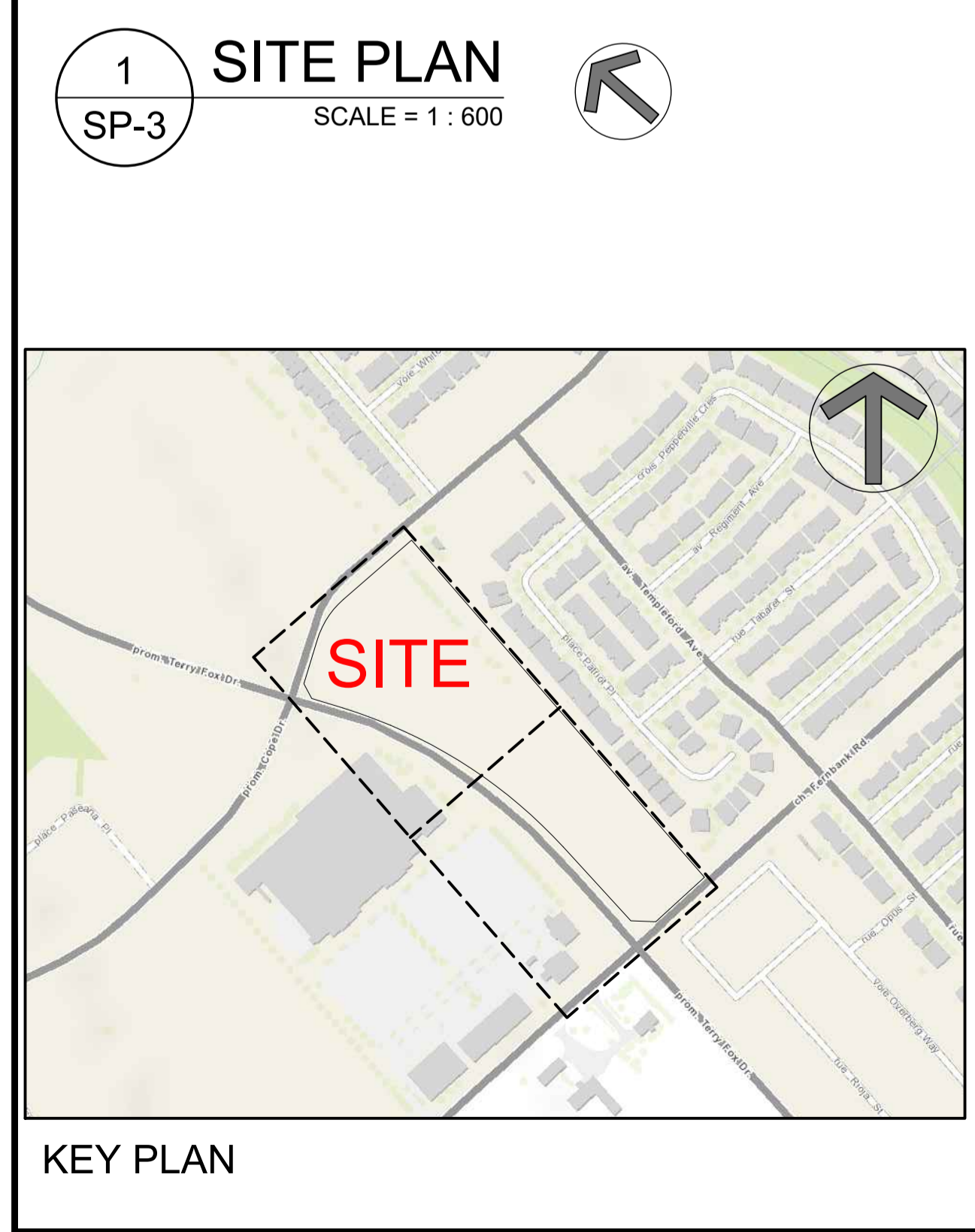

- 1 SITE PLAN**
SCALE = 1 : 600
- DRAWING NOTES**
- PROPERTY LINE
 - BUILDING SETBACKS
 - REQUIRED AMENITY AREA
 - PARKING SPACE: STANDARD SIZE 2.6 x 5.2 METRES
 - PROPOSED HYDRO TRANSFORMER
 - ASPHALT DRIVING SURFACE
 - EARTH BINS
 - ORGANIC WASTE SHED
 - BICYCLE PARKING SPACES
 - PROPOSED HYDRANT
 - EXISTING FIRE HYDRANT
 - TEMPORARY SNOW STORAGE
 - EXISTING BELL BOXES
 - RETAINING WALL, SEE CIVIL
 - PROPOSED CONCRETE BUS PAD

- SITE PLAN SYMBOLS**
- CONCRETE UNIT PAVERS SURFACE
 - SOFT LANDSCAPING
 - CONCRETE WALK / PATH
 - HEAVY DUTY CONCRETE PAD
 - BIKE RACK / BIKE PARKING SPOT
 - TWO WAY VEHICLE CIRCULATION
 - MAIN ENTRANCE
 - PROPERTY LINE
 - ZONING SETBACKS
 - STANDARD PARKING SPACE
 - VISITOR PARKING SPACE
 - ACCESSIBLE PARKING SPACE
 - DEPRESSED CURB w/ TWSI CONSTRUCTED TO CITY STANDARDS
 - COMMUNITY MAIL BOXES
 - LANDSCAPE RISERS
 - SITE UTILITIES (SEE COMPOSITE UTILITY PLAN)
 - PROPOSED TREE (SEE LANDSCAPE PLAN)
 - PROPOSED FIRE ROUTE SIGNAGE

PROJECT DEVELOPER
Claridge Homes
2001 - 201 Gladstone Avenue
Ottawa ON,
Tel: (613) 233-6030
E-Mail:

SURVEYOR
Annis O'Sullivan Vollebek Ltd.
Ontario Land Surveyors
14 Concourse Gate, Suite 500,
Nepean, Ontario K2E 7S6
Tel: (613) 727-0850
Fax: (613) 727-1079
E-Mail: Edl@aovltd.com

LEGAL DESCRIPTION
TOPOGRAPHICAL PLAN OF PART OF LOT 30 CONCESSION 10, GOULBOURN, PART 1 PLAN 4R17373, EXCEPT PART 4, PLAN 4R20112; OTTAWA. SUBJECT TO AN EASEMENT IN FAVOUR OF HYDRO OTTAWA LIMITED OVER PARTS 5, 6, 7, 8 AND 9 PLAN 4R20112 AS IN OC455206.

ROAD ALLOWANCE BETWEEN LOTS 30 AND 31 CONCESSION 10, GOULBOURN LYING BETWEEN PARTS 3 AND 4 ON 4R17373 AND PART 2 ON PLAN 4R20112, AS CLOSED BY N599928; OTTAWA

PART OF LOT 31, CONCESSION 10, GOULBOURN, PART 1 ON PLAN 4R19334 CITY OF OTTAWA

Prepared by Annis O'Sullivan, Vollebek Ltd.
Field Work Completed December 14, 2020

WASTE COLLECTION

GUIDELINES

GARBAGE	- 0.231 CUBIC YARDS / UNIT	45 YARDS ³
RECYCLING (GMP)	- 0.018 CUBIC YARDS / UNIT	4 YARDS ³
RECYCLING (FIBRE)	- 0.062 CUBIC YARDS / UNIT	12 YARDS ³
ORGANICS	- 240L CONTAINER /50 UNITS	4x 240L

GARBAGE	7 EARTH BINS	7 EARTH BINS
RECYCLING (GMP)	1 EARTH BINS	2 EARTH BINS
RECYCLING (FIBRE)	2 EARTH BINS	2 EARTH BINS
ORGANICS	4x 240L BINS	4x 240L BINS

*EARTH BINS= (6.5 YARDS³)

SNOW STORAGE
TEMPORARILY STORED AND TRUCKED OFF SITE

PROJECT INFORMATION

CURRENT ZONING
USE: GM(2411)
PLANNED UNIT DEVELOPMENT

SITE AREA
36,789 sq. m. (395,995) sq. ft.

BUILDING HEIGHT
18.0 m

AMENITY AREA PER DWELLING UNIT
6.0 sq. m

FRONT YARD SETBACK
3.0 M

REAR YARD SETBACK
3.0 M

INTERIOR SIDE YARD SETBACK
7.5 M

PROJECT STATISTICS

BUILDING HEIGHT	11.0 M
REQUIRED AMENITY SPACE	6 SQ. M. PER UNIT= 288 sq. m. (13,130) sq. ft.
50% COMMUNAL AMENITY AREA =	144 sq. m. (13,130) sq. ft.
PROVIDED AMENITY SPACE	PRIVATE BALCONY / PATIOS = 361 sq. m. (13,130) sq. ft.
COMMUNAL EXTERIOR AREA=	200 sq. m. (13,130) sq. ft.
TOTAL =	561 sq. m. (13,130) sq. ft.

SITE COVERAGE

BUILDING FOOTPRINT =	33.6%	2,278.43 sq. m.
DRIVING SURFACE =	25.9%	1,751.40 sq. m.
LANDSCAPE AREA =	40.5%	2,739.12 sq. m.
TOTAL =	100.0%	6,768.95 sq. m.

CAR PARKING REQUIRED by ZONING BY-LAW

RESIDENCE	- 1.2 PER UNIT (192 UNITS)	230
VISITOR	- 0.2 PER DWELLING UNIT	38
TOTAL		268
PROVIDED		
RESIDENCE	- 1.2 PER UNIT (192 UNITS)	230
VISITOR	- 0.2 PER DWELLING UNIT	38
TOTAL		268

BICYCLE PARKING

REQUIRED		
RESIDENCE	- 0.5 PER UNIT (192 UNITS)	96
PROVIDED		
EXTERIOR		96

GROSS BUILDING - AREAS
(CITY OF OTTAWA'S DEFINITION)

PROPOSED BUILDING 'A'	1,290.5 sq. m. (13,890) sq. ft.
PROPOSED BUILDING 'B'	1,290.5 sq. m. (13,890) sq. ft.
PROPOSED BUILDING 'C'	1,290.5 sq. m. (13,890) sq. ft.
PROPOSED BUILDING 'D'	1,290.5 sq. m. (13,890) sq. ft.
PROPOSED BUILDING 'E'	1,290.5 sq. m. (13,890) sq. ft.
PROPOSED BUILDING 'F'	1,290.5 sq. m. (13,890) sq. ft.
PROPOSED BUILDING 'G'	1,290.5 sq. m. (13,890) sq. ft.
PROPOSED BUILDING 'H'	1,290.5 sq. m. (13,890) sq. ft.
PROPOSED BUILDING 'J'	1,220.0 sq. m. (13,130) sq. ft.
PROPOSED BUILDING 'K'	1,220.0 sq. m. (13,130) sq. ft.
PROPOSED BUILDING 'L'	1,220.0 sq. m. (13,130) sq. ft.
PROPOSED BUILDING 'M'	1,220.0 sq. m. (13,130) sq. ft.
PROPOSED BUILDING 'N'	1,220.0 sq. m. (13,130) sq. ft.
PROPOSED BUILDING 'P'	1,220.0 sq. m. (13,130) sq. ft.
PROPOSED BUILDING 'Q'	1,220.0 sq. m. (13,130) sq. ft.
PROPOSED BUILDING 'R'	1,220.0 sq. m. (13,130) sq. ft.
TOTAL PROPOSED AREA	20,084.0 sq. m. (216,182) sq. ft.

UNIT STATISTICS

2 BEDROOM UNIT	192
----------------	-----

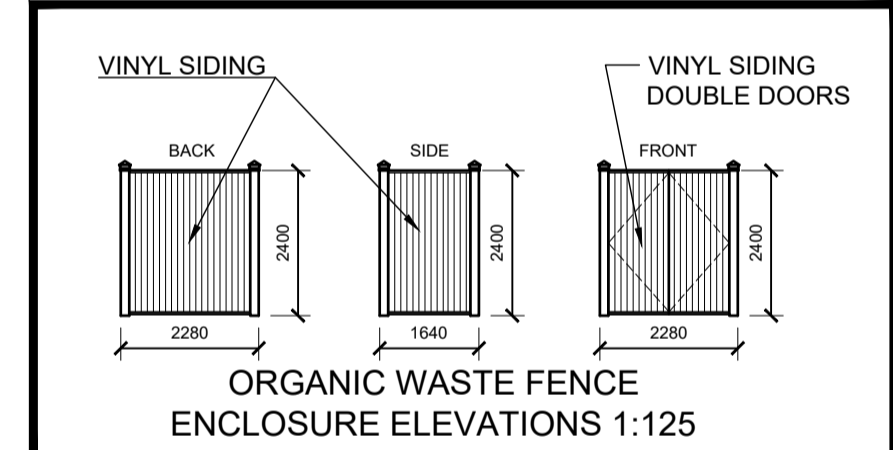
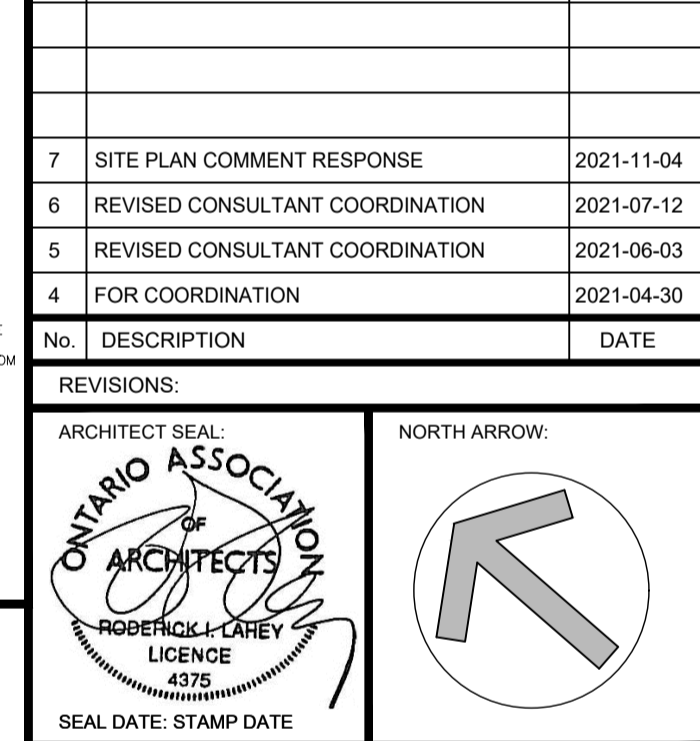

ARCHITECT SEAL:
ONTARIO ASSOCIATION OF ARCHITECTS
RODERICK LAHEY
LICENCE 4375
SEAL DATE: STAMP DATE

CLIENT:
CLARIDGE HOMES

ARCHITECT:
rla / architecture
roderick lahey architect inc.
56 beech street, ottawa, ontario K1S 3J6
t.613.724.9932 f.613.724.1209 rlaarchitecture.ca

PROJECT TITLE:
TERRY FOX ZEN
5331 FERNBANK STREET
OTTAWA ONTARIO

SHEET TITLE:
SITE PLAN (OVERALL)

DRAWN: BIO
CHECKED: CM

SCALE: 1:600
SHEET No: SP-3

PROJECT No: 2101

APPENDIX B

TIA Screening Form

City of Ottawa 2017 TIA Guidelines Screening Form

1. Description of Proposed Development

Municipal Address	5331 Fernbank Road
Description of Location	East side of Terry Fox Drive, between Fernbank Road and Cope Drive
Land Use Classification	Residential
Development Size (units)	192 Units
Development Size (m ²)	
Number of Accesses and Locations	One all movement to Cope Drive One Right-in Right-out to Terry Fox Drive
Phase of Development	One
Buildout Year	

If available, please attach a sketch of the development or site plan to this form.

2. Trip Generation Trigger

Considering the Development's Land Use type and Size (as filled out in the previous section), please refer to the Trip Generation Trigger checks below.

Land Use Type	Minimum Development Size
Single-family homes	40 units
Townhomes or apartments	90 units
Office	3,500 m ²
Industrial	5,000 m ²
Fast-food restaurant or coffee shop	100 m ²
Destination retail	1,000 m ²
Gas station or convenience market	75 m ²

** If the development has a land use type other than what is presented in the table above, estimates of person-trip generation may be made based on average trip generation characteristics represented in the current edition of the Institute of Transportation Engineers (ITE) Trip Generation Manual.*

If the proposed development size is greater than the sizes identified above, the Trip Generation Trigger is satisfied.

3. Location Triggers

	Yes	No
Does the development propose a new driveway to a boundary street that is designated as part of the City's Transit Priority, Rapid Transit or Spine Bicycle Networks?	✓	
Is the development in a Design Priority Area (DPA) or Transit-oriented Development (TOD) zone?*		x

*DPA and TOD are identified in the City of Ottawa Official Plan (DPA in Section 2.5.1 and Schedules A and B; TOD in Annex 6). See Chapter 4 for a list of City of Ottawa Planning and Engineering documents that support the completion of TIA).

If any of the above questions were answered with 'Yes,' the Location Trigger is satisfied.

4. Safety Triggers

	Yes	No
Are posted speed limits on a boundary street are 80 km/hr or greater?	✓	
Are there any horizontal/vertical curvatures on a boundary street limits sight lines at a proposed driveway?		x
Is the proposed driveway within the area of influence of an adjacent traffic signal or roundabout (i.e. within 300 m of intersection in rural conditions, or within 150 m of intersection in urban/ suburban conditions)?	✓	
Is the proposed driveway within auxiliary lanes of an intersection?	✓	
Does the proposed driveway make use of an existing median break that serves an existing site?		x
Is there is a documented history of traffic operations or safety concerns on the boundary streets within 500 m of the development?		x
Does the development include a drive-thru facility?		x

If any of the above questions were answered with 'Yes,' the Safety Trigger is satisfied.

5. Summary

	Yes	No
Does the development satisfy the Trip Generation Trigger?	✓	
Does the development satisfy the Location Trigger?	✓	
Does the development satisfy the Safety Trigger?	✓	

If none of the triggers are satisfied, the TIA Study is complete. If one or more of the triggers is satisfied, the TIA Study must continue into the next stage (Screening and Scoping).

APPENDIX C

OC Transpo System Information

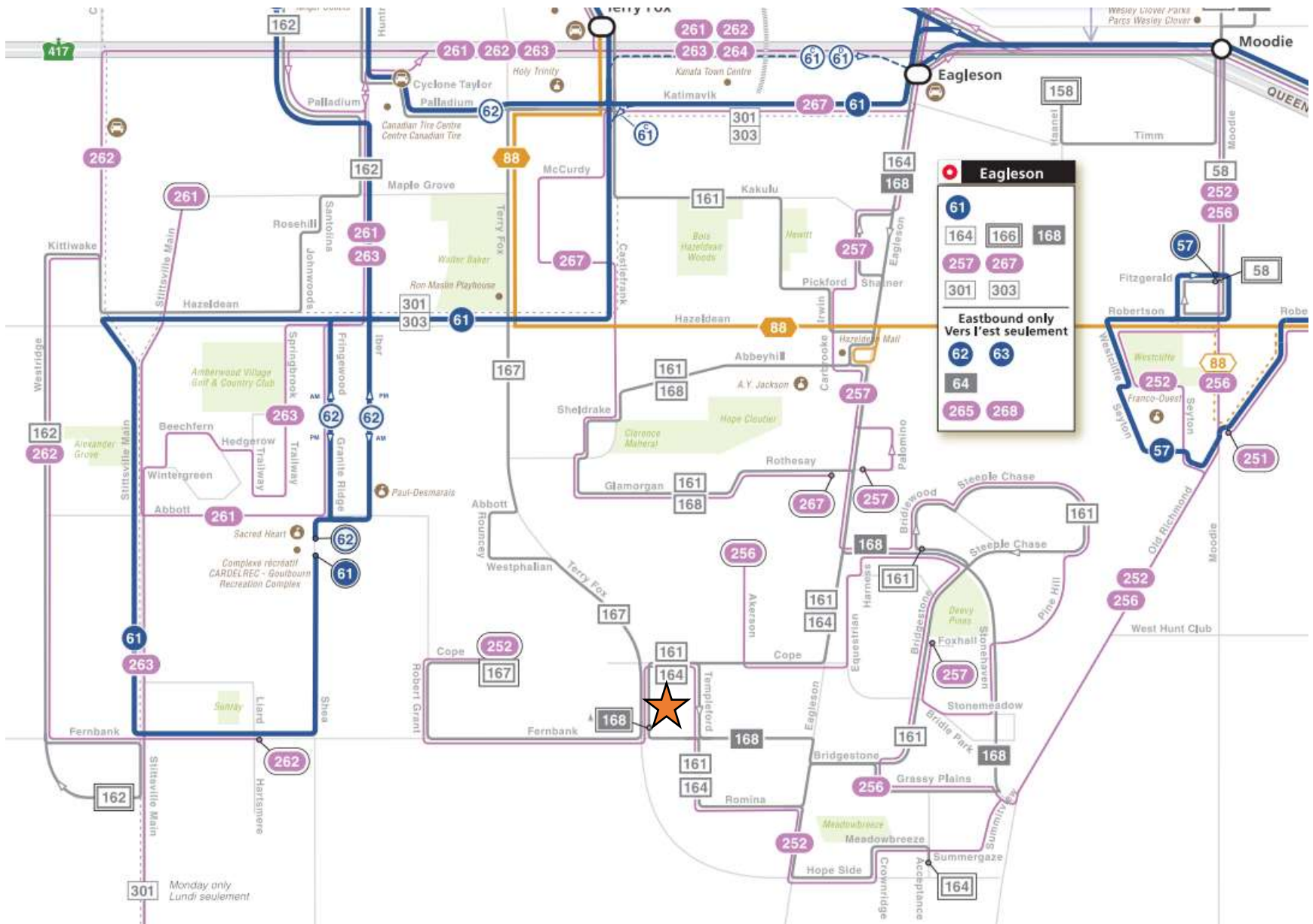

SUBJECT SITE



161

TERRY FOX BRIDLEWOOD

Local

Monday to Friday/ Lundi au vendredi

All day service. No weekend service

Service toute la journée.

Aucun service les fins de semaine

TERRY FOX

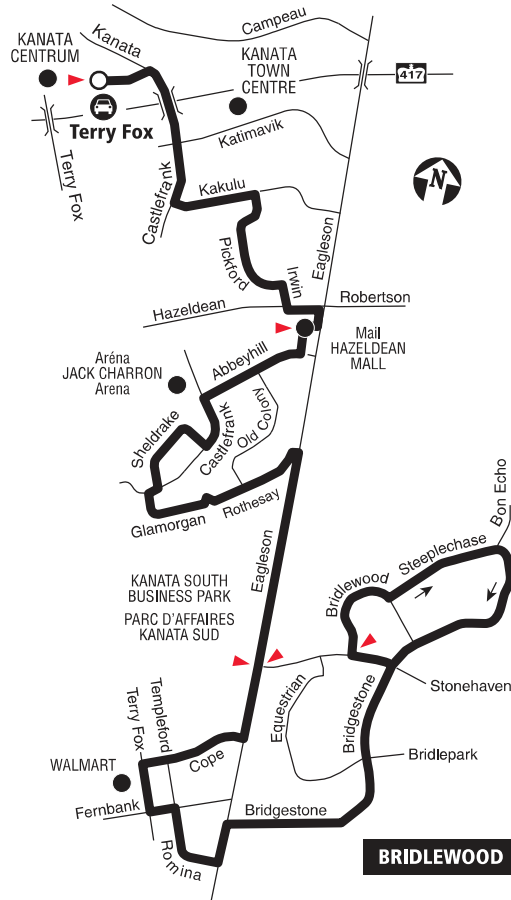

2019.06



Schedule / Horaire..... 613-560-1000

Text / Texto560560

plus your four digit bus stop number / plus votre numéro d'arrêt à quatre chiffres

Customer Service
Service à la clientèle **613-741-4390**

Lost and Found / Objets perdus..... **613-563-4011**

Security / Sécurité **613-741-2478**

Effective June 29, 2015

En vigueur 29 juin 2015



INFO 613-741-4390
octranspo.com



164

TERRY FOX HOPE SIDE

Local

Monday to Friday/ Lundi au vendredi

Peak periods only
Périodes de pointe seulement

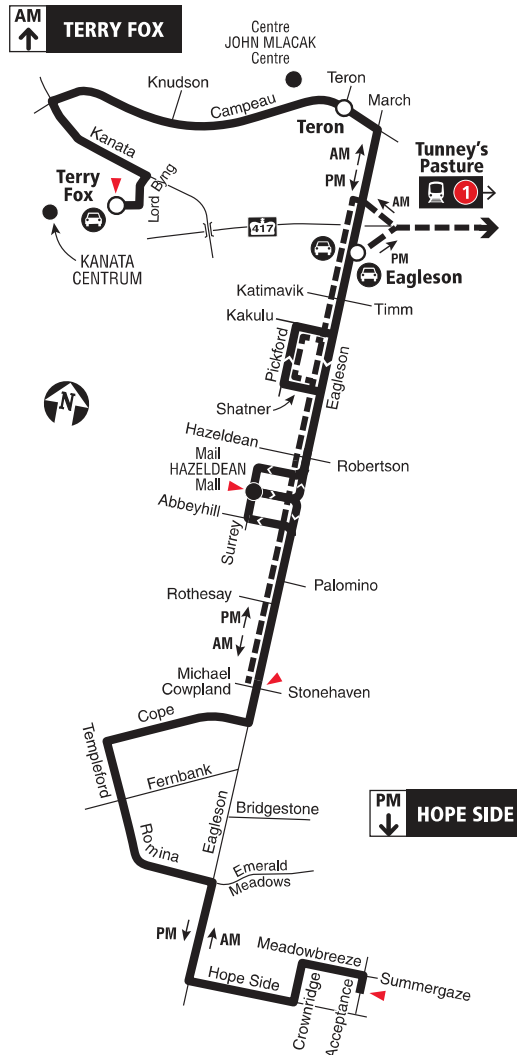

- Transitway Station / Station du Transitway
- Peak Periods Only / Périodes de pointe seulement
Some trips to / from Tunney's Pasture
Quelques trajets de / vers Tunney's Pasture
- Park & Ride / Parc-o-bus
- Timepoint / Heures de passage

2020.12



Schedule / Horaire.....613-560-1000

Text / Texto560560

plus your four digit bus stop number / plus votre numéro d'arrêt à quatre chiffres

Customer Service
Service à la clientèle 613-741-4390

Lost and Found / Objets perdus..... 613-563-4011

Security / Sécurité..... 613-741-2478

Effective December 21, 2020

En vigueur 21 décembre 2020



INFO 613-741-4390
octranspo.com



168

TERRY FOX BRIDLEWOOD

Local

7 days a week / 7 jours par semaine
All day service
Service toute la journée

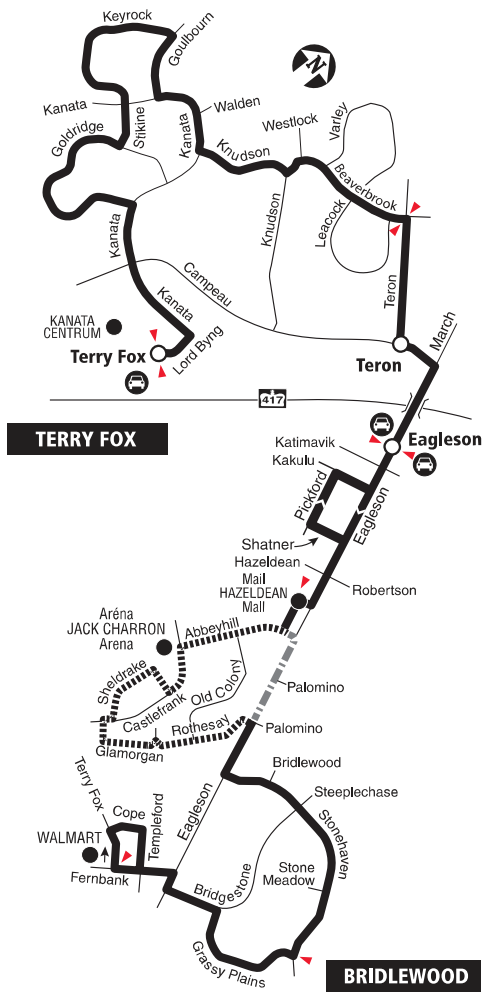

- Transitway Station / Station du Transitway
- Saturday and Sunday only
Samedi et dimanche seulement
- No weekend service
Aucun service la fin de semaine
- Park & Ride / Parc-o-bus
- Timepoint / Heures de passage

2019.06

Schedule / Horaire..... 613-560-1000
Text / Texto560560
plus your four digit bus stop number / plus votre numéro d'arrêt à quatre chiffres

Customer Service
 Service à la clientèle **613-741-4390**
 Lost and Found / Objets perdus..... **613-563-4011**
 Security / Sécurité **613-741-2478**

Effective December 24, 2017
En vigueur 24 décembre 2017



252

FERNBANK TUNNEY'S PASTURE

Connexion

Monday to Friday / Lundi au vendredi

Peak periods only

Périodes de pointe seulement

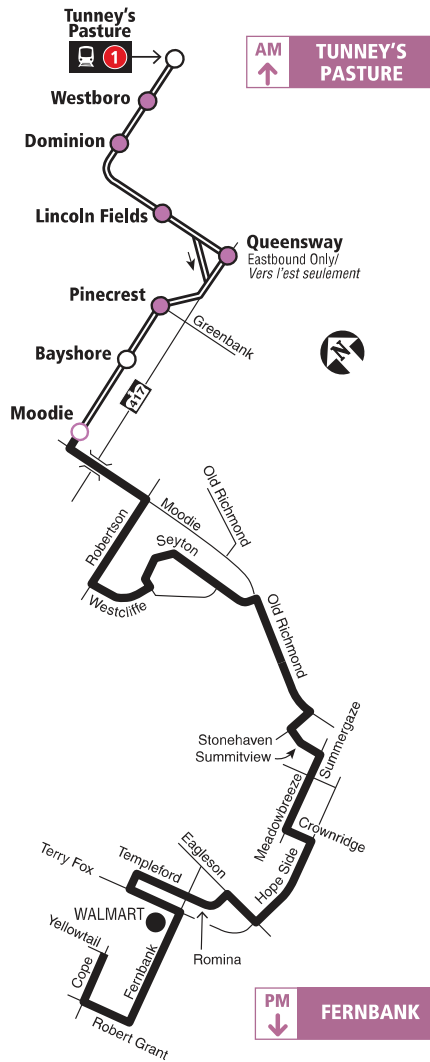

2019.07



Future route after O-Train Line 1 is open
Trajet du circuit après l'ouverture
de la Ligne 1 de l'O-Train

Lost and Found / Objets perdus..... 613-563-4011

Security / Sécurité..... 613-741-2478



INFO 613-741-4390
octranspo.com

Brad Byvelds

From: Rathwell, Graham <graham.rathwell@ottawa.ca>
Sent: Thursday, April 15, 2021 1:44 PM
To: Brad Byvelds
Subject: RE: Request for Transit Information - Terry Fox and Fernbank

Follow Up Flag: Follow up
Flag Status: Flagged

Hi Brad,

The requested data is provided in the table below. Data was sampled from January 5 to March 7 2020, which is the last period of 'normal' ridership before the pandemic began. Cells with a dash (-) indicate that the bus stop in question is not served by the corresponding route in the given time period and direction. Also note that Route 681 is a specialized school route with limited trips to/from Bell High School to meet the school bell times. While these trips are available to anyone, in practice only high school students use them so they are generally not considered part of the regular transit service and are not shown on the transit system map.

Winter 2020 (5 Jan 2020 - 7 Mar 2020)

Stop No.	Location	Route	Direction	AM (6:00-9:00)			PM (15:00-18:00)			24-HR		
				Boardings	Alightings	Avg Load at Departure	Boardings	Alightings	Avg Load at Departure	Boardings	Alightings	Avg Load at Departure
6993	TEMPLEFORD / COPE	164	SB	-	-	-	0	2	4	0	4	3
		168	NB	1	2	1	2	0	1	5	4	1
1919	COPE / TEMPLEFORD	252	IB	10	0	3	-	-	-	11	0	2
		161	NB	2	2	3	0	0	3	3	2	3
		164	NB	4	0	2	-	-	-	4	0	3
4031	COPE / NORTHGRAVES	681	EB	0	0	4	-	-	-	0	0	4
		161	SB	0	0	2	0	0	5	0	0	3
		252	OB	-	-	-	0	4	3	0	6	2
1930	FERNBANK / TERRY FOX	681	WB	-	-	-	0	0	16	0	0	16
		161	NB	0	0	3	1	0	3	2	0	2
		168	SB	0	2	0	0	10	0	0	38	0
1933	FERNBANK / TERRY FOX	168	NB	4	0	1	7	0	1	31	0	1
		681	EB	0	0	4	-	-	-	0	0	4
		161	SB	0	3	1	0	3	4	0	8	3
		681	WB	-	-	-	0	1	15	0	1	15

Please let me know if there are any questions, or if there is any additional information you require.

Best,

Graham Rathwell

Transit Planner, Network Service Design
 Service Planning Branch
 Transportation Services Department
 OC Transpo | City of Ottawa



From: Rathwell, Graham
Sent: April 06, 2021 3:52 PM
To: Brad Byvelds <B.Byvelds@novatech-eng.com>
Subject: RE: Request for Transit Information

Good afternoon Brad,

Your request has been received and I will follow-up once the data is prepared.

In the meantime, I drafted a quick map of the area with the stops in question and the patterns of the routes that serve them: please see below and attached. Note that Route 167 also currently operates through this area (via Fernbank and Terry Fox) however it does not serve any stops shown within these map extents so it was left off the map. Also note that there are additional bus stops within the map extents (shown with a light grey symbol): these are shown for context only, as I assume the data for the requested stops will be sufficient to meet your needs.



Please let me know if there are any questions about the above or if any additional data is required. I will follow-up as soon as the ridership data is prepared.

Best,

Graham Rathwell

Transit Planner, Network Service Design
Service Planning Branch
Transportation Services Department
OC Transpo | City of Ottawa



From: Brad Byvelds <B.Byvelds@novatech-eng.com>
Sent: March 31, 2021 1:33 PM
To: Rathwell, Graham <graham.rathwell@ottawa.ca>
Subject: Request for Transit Information

Hello Graham,

Can you please provide me with OC Transpo boarding/alighting/load information for the following bus stops:

- #1930
- #1933
- #4031
- #6933
- #1919

Thanks,

Brad Byvelds, P.Eng., Project Coordinator | Transportation/Traffic

NOVATECH Engineers, Planners & Landscape Architects

240 Michael Cowpland Drive, Suite 200, Ottawa, ON, K2M 1P6 | Tel: 613.254.9643 x 286 | Fax: 613.254.5867

The information contained in this email message is confidential and is for exclusive use of the addressee.

,

This e-mail originates from the City of Ottawa e-mail system. Any distribution, use or copying of this e-mail or the information it contains by other than the intended recipient(s) is unauthorized. Thank you.

Le présent courriel a été expédié par le système de courriels de la Ville d'Ottawa. Toute distribution, utilisation ou reproduction du courriel ou des renseignements qui s'y trouvent par une personne autre que son destinataire prévu est interdite. Je vous remercie de votre collaboration.

,

APPENDIX D

Traffic Count and Signal Timing Data

Turning Movement Count - Peak Hour Diagram

COPE DR @ TERRY FOX

Survey Date: Thursday, August 08, 2019

Start Time: 07:00

WO No: 38638

Device: Miovision

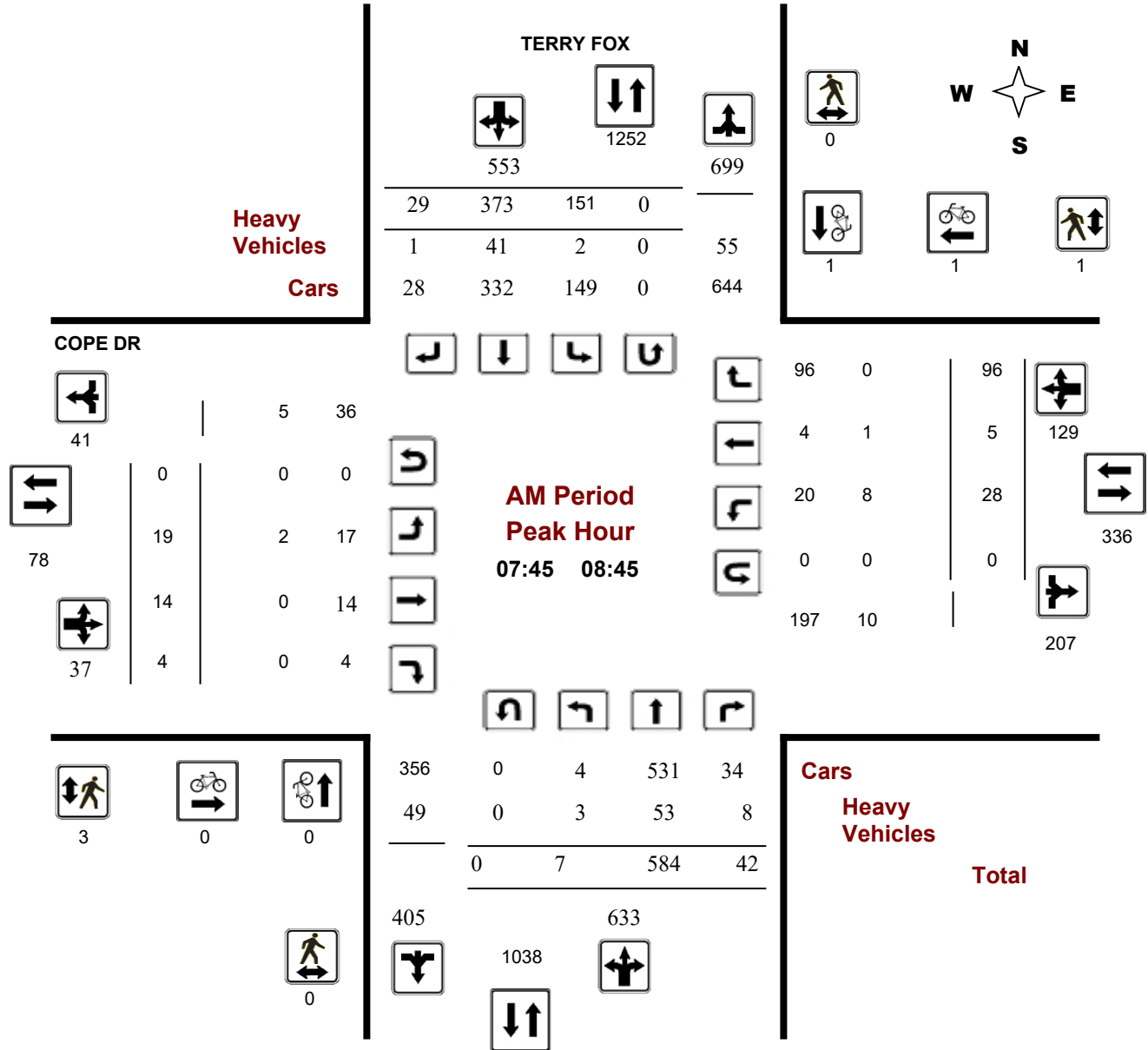

Turning Movement Count - Peak Hour Diagram

COPE DR @ TERRY FOX

Survey Date: Thursday, August 08, 2019

Start Time: 07:00

WO No: 38638

Device: Miovision

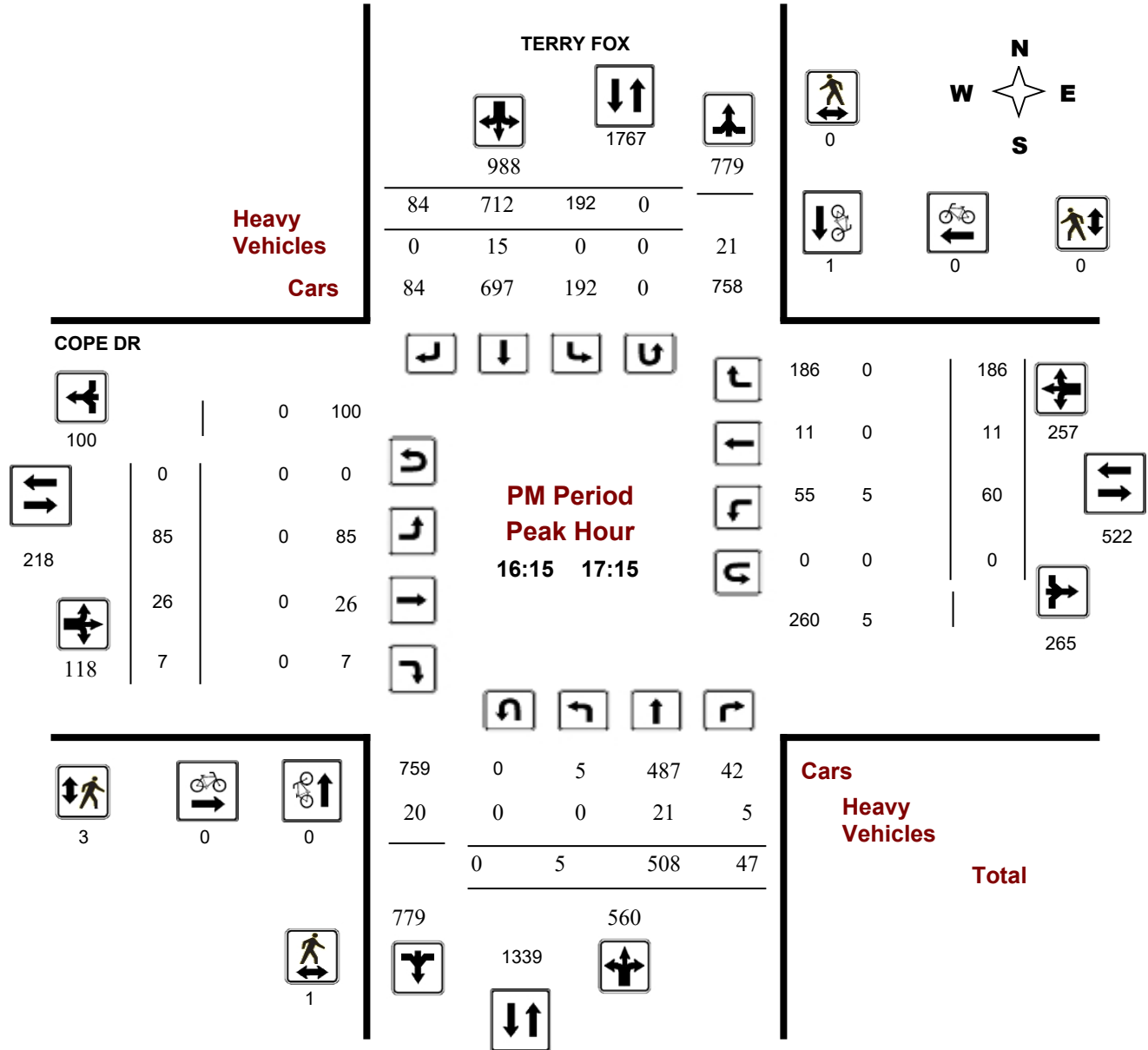



Transportation Services - Traffic Services

Turning Movement Count - Study Results

COPE DR @ TERRY FOX

Survey Date: Thursday, August 08, 2019

WO No: 38638

Start Time: 07:00

Device: Miovision

Full Study Summary (8 HR Standard)

Survey Date: Thursday, August 08, 2019

Total Observed U-Turns
 Northbound: 1 Southbound: 0
 Eastbound: 0 Westbound: 0

AADT Factor
 .90

Period	TERRY FOX										COPE DR										
	Northbound					Southbound					Eastbound					Westbound					
	LT	ST	RT	NB TOT	STR TOT	LT	ST	RT	SB TOT	STR TOT	LT	ST	RT	EB TOT	STR TOT	LT	ST	RT	WB TOT	STR TOT	Grand Total
07:00 08:00	6	477	33	516	988	100	353	19	472	988	16	11	2	29	988	23	8	59	90	119	1107
08:00 09:00	4	541	48	593	1145	151	360	41	552	1145	28	12	3	43	1145	35	8	111	154	197	1342
09:00 10:00	12	457	30	499	984	96	333	56	485	984	53	18	2	73	984	38	17	97	152	225	1209
11:30 12:30	6	464	25	495	1197	138	477	87	702	1197	104	40	5	149	1197	54	17	136	207	356	1553
12:30 13:30	11	443	37	491	1160	147	448	74	669	1160	99	46	10	155	1160	45	16	89	150	305	1465
15:00 16:00	14	455	35	504	1314	139	599	72	810	1314	96	34	8	138	1314	37	16	117	170	308	1622
16:00 17:00	5	515	40	560	1533	176	720	77	973	1533	91	31	7	129	1533	58	14	164	236	365	1898
17:00 18:00	8	500	39	547	1436	179	628	82	889	1436	99	31	5	135	1436	52	15	172	239	374	1810
Sub Total	66	3852	287	4205	9757	1126	3918	508	5552	9757	586	223	42	851	9757	342	111	945	1398	2249	12006
U Turns	1			1	1	0			0	1	0			0	0	0			0	0	1
Total	67	3852	287	4206	9758	1126	3918	508	5552	9758	586	223	42	851	9758	342	111	945	1398	2249	12007
EQ 12Hr	93	5354	399	5846	13563	1565	5446	706	7717	13563	815	310	58	1183	13563	475	154	1314	1943	3126	16689
Note: These values are calculated by multiplying the totals by the appropriate expansion factor.																1.39					
AVG 12Hr	84	4819	359	5262	12206	1408	4901	635	6944	12206	734	279	52	1065	12206	428	139	1183	1750	2815	15021
Note: These volumes are calculated by multiplying the Equivalent 12 hr. totals by the AADT factor.																.90					
AVG 24Hr	110	6313	470	6893	15989	1844	6420	832	9096	15989	962	365	68	1395	15989	561	182	1550	2293	3688	19677
Note: These volumes are calculated by multiplying the Average Daily 12 hr. totals by 12 to 24 expansion factor.																1.31					
Note: U-Turns provided for approach totals. Refer to 'U-Turn' Report for specific breakdown.																					

Turning Movement Count - Peak Hour Diagram

TERRY FOX DR @ FERNBANK RD

Survey Date: Wednesday, April 11, 2018

Start Time: 07:00

WO No: 37725

Device: Miovision

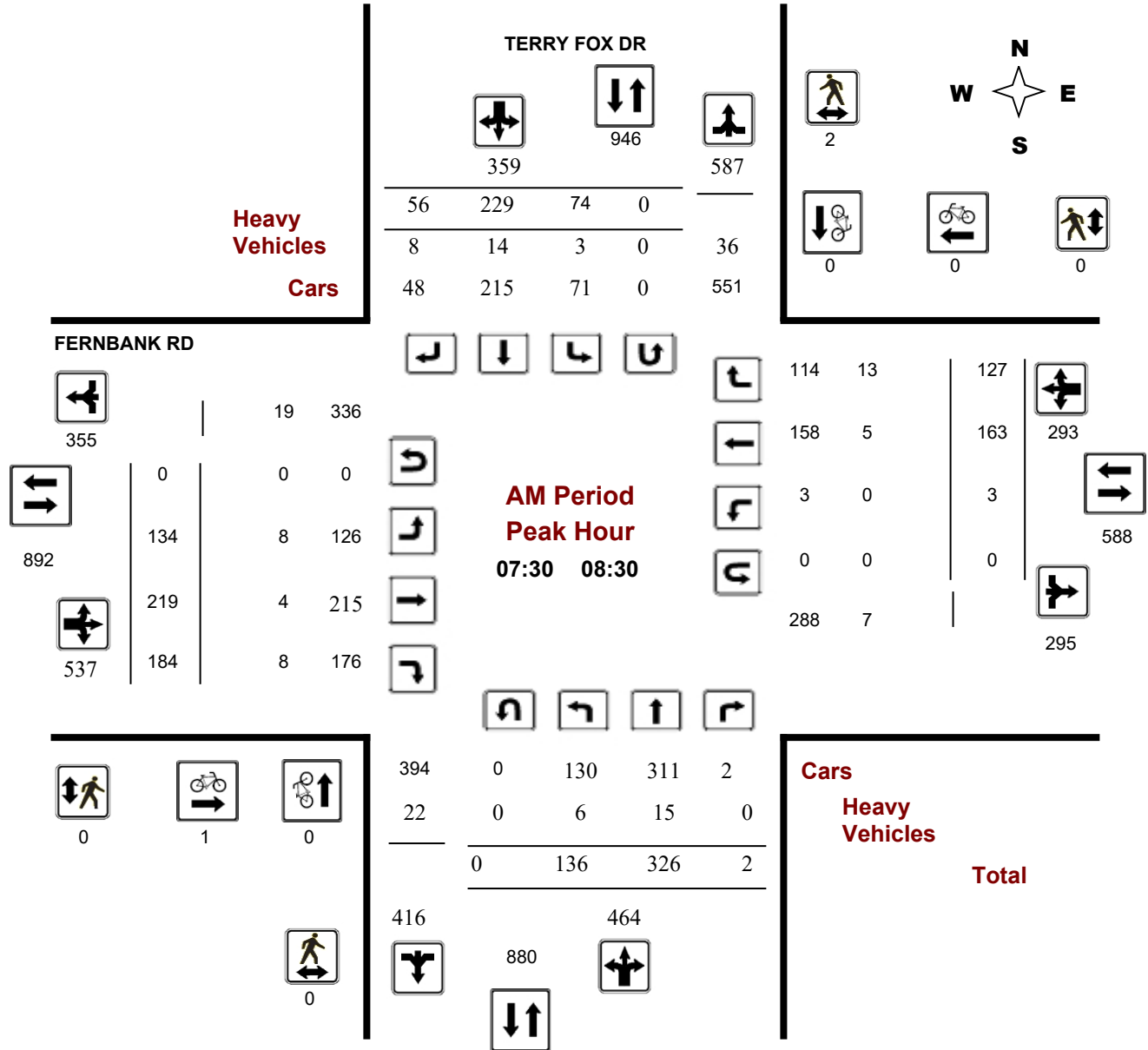

Turning Movement Count - Peak Hour Diagram

TERRY FOX DR @ FERNBANK RD

Survey Date: Wednesday, April 11, 2018

Start Time: 07:00

WO No: 37725

Device: Miovision

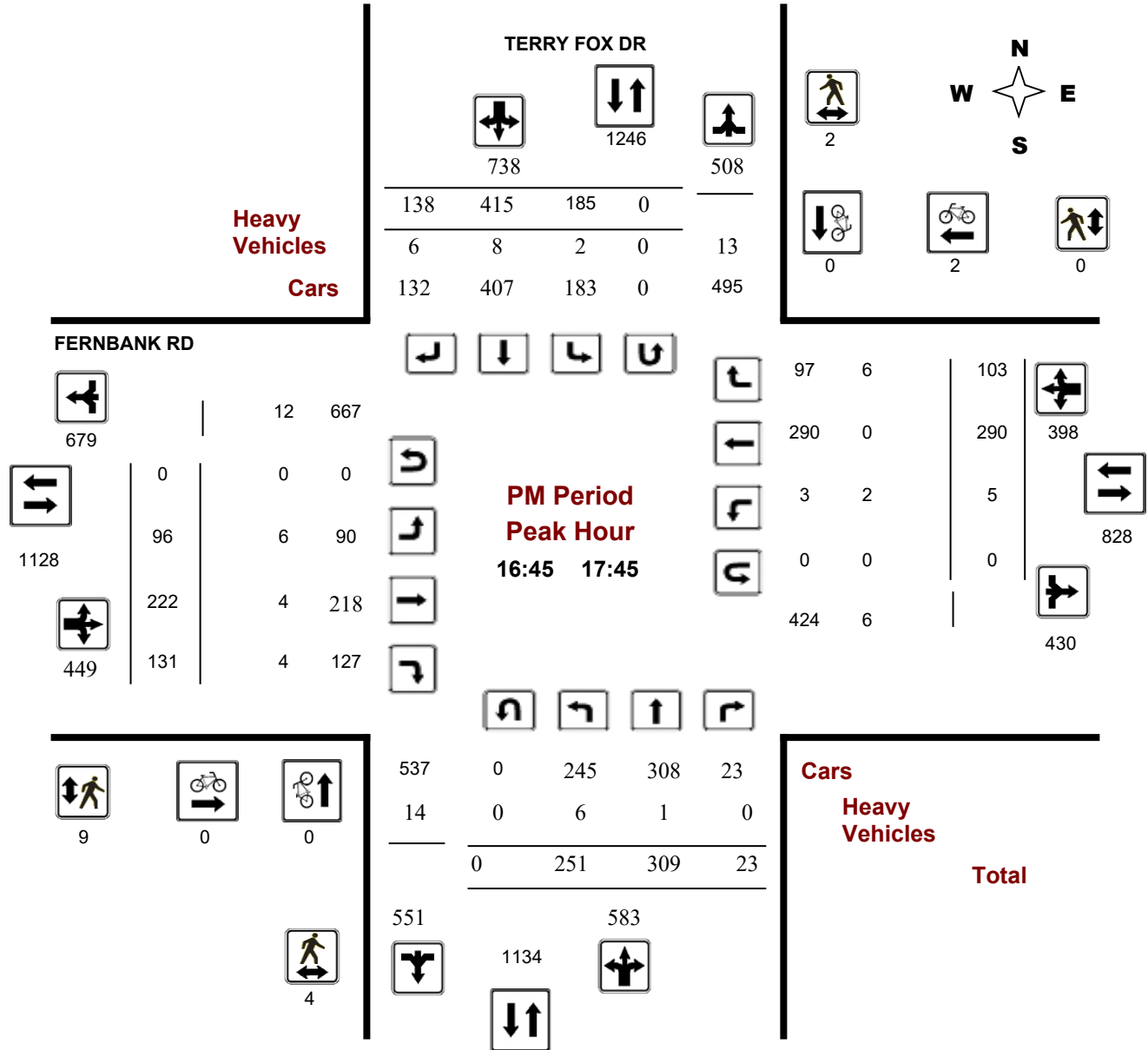



Transportation Services - Traffic Services

Turning Movement Count - Study Results

TERRY FOX DR @ FERNBANK RD

Survey Date: Wednesday, April 11, 2018

WO No: 37725

Start Time: 07:00

Device: Miovision

Full Study Summary (8 HR Standard)

Survey Date: Wednesday, April 11, 2018

Total Observed U-Turns
 Northbound: 0 Southbound: 0
 Eastbound: 0 Westbound: 3

AADT Factor
 .90

TERRY FOX DR

FERNBANK RD

Period	TERRY FOX DR Northbound					TERRY FOX DR Southbound					FERNBANK RD Eastbound					FERNBANK RD Westbound					Grand Total
	LT	ST	RT	NB TOT	STR TOT	LT	ST	RT	SB TOT	STR TOT	LT	ST	RT	EB TOT	STR TOT	LT	ST	RT	WB TOT	STR TOT	
07:00 08:00	128	313	4	445	776	54	222	55	331	776	93	221	172	486	761	3	143	129	275	761	1537
08:00 09:00	132	325	3	460	828	99	202	67	368	828	141	206	152	499	796	2	159	136	297	796	1624
09:00 10:00	118	245	3	366	651	68	170	47	285	651	119	147	110	376	629	2	142	109	253	629	1280
11:30 12:30	108	217	3	328	705	83	216	78	377	705	78	144	118	340	575	5	152	78	235	575	1280
12:30 13:30	126	163	7	296	700	92	244	68	404	700	75	138	116	329	539	1	146	63	210	539	1239
15:00 16:00	239	217	2	458	1005	142	312	93	547	1005	115	183	145	443	758	7	220	88	315	758	1763
16:00 17:00	248	327	7	582	1219	135	382	120	637	1219	96	172	154	422	829	4	292	111	407	829	2048
17:00 18:00	233	298	18	549	1247	188	379	131	698	1247	99	234	125	458	854	3	281	112	396	854	2101
Sub Total	1332	2105	47	3484	7131	861	2127	659	3647	7131	816	1445	1092	3353	5741	27	1535	826	2388	5741	12872
U Turns	0			0	0	0			0	0	0			0	3				3	3	3
Total	1332	2105	47	3484	7131	861	2127	659	3647	7131	816	1445	1092	3353	5744	30	1535	826	2391	5744	12875
EQ 12Hr	1851	2926	65	4842	9912	1197	2957	916	5070	9912	1134	2009	1518	4661	7985	42	2134	1148	3324	7985	17897

Note: These values are calculated by multiplying the totals by the appropriate expansion factor. **1.39**

AVG 12Hr 1666 2633 58 4357 1077 2661 824 4562 8919 1021 1808 1366 4195 38 1921 1033 2992 7187 16106

Note: These volumes are calculated by multiplying the Equivalent 12 hr. totals by the AADT factor. **.90**

AVG 24Hr 2182 3449 76 5707 1411 3486 1079 5976 11683 1338 2368 1789 5495 50 2517 1353 3920 9415 21098

Note: These volumes are calculated by multiplying the Average Daily 12 hr. totals by 12 to 24 expansion factor. **1.31**

Note: U-Turns provided for approach totals. Refer to 'U-Turn' Report for specific breakdown.

Survey Date: Thursday, December 21, 2017

Start Time: 07:00

WO No: 37390

Device: Miovision

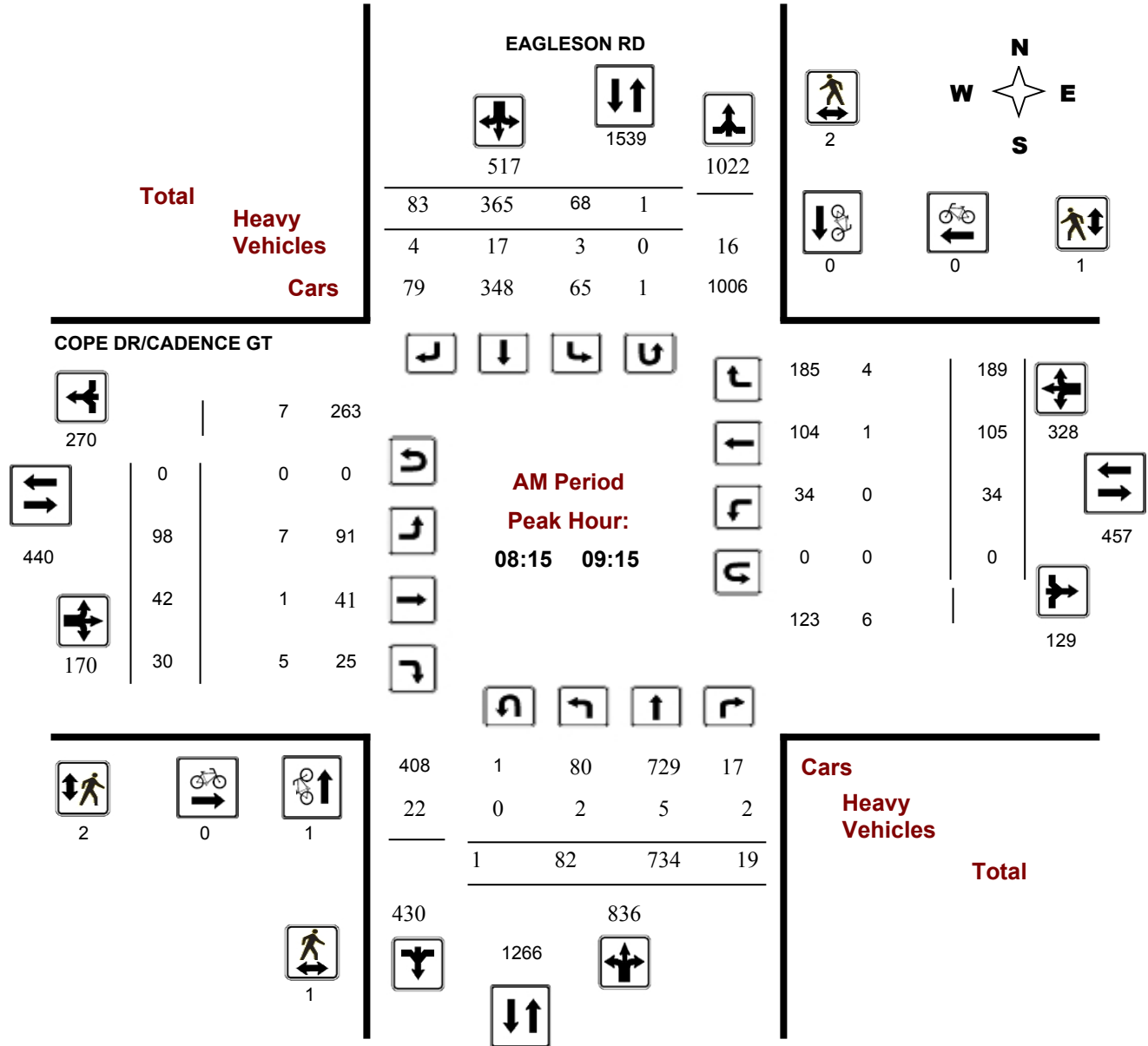

Survey Date: Thursday, December 21, 2017

Start Time: 07:00

WO No: 37390

Device: Miovision

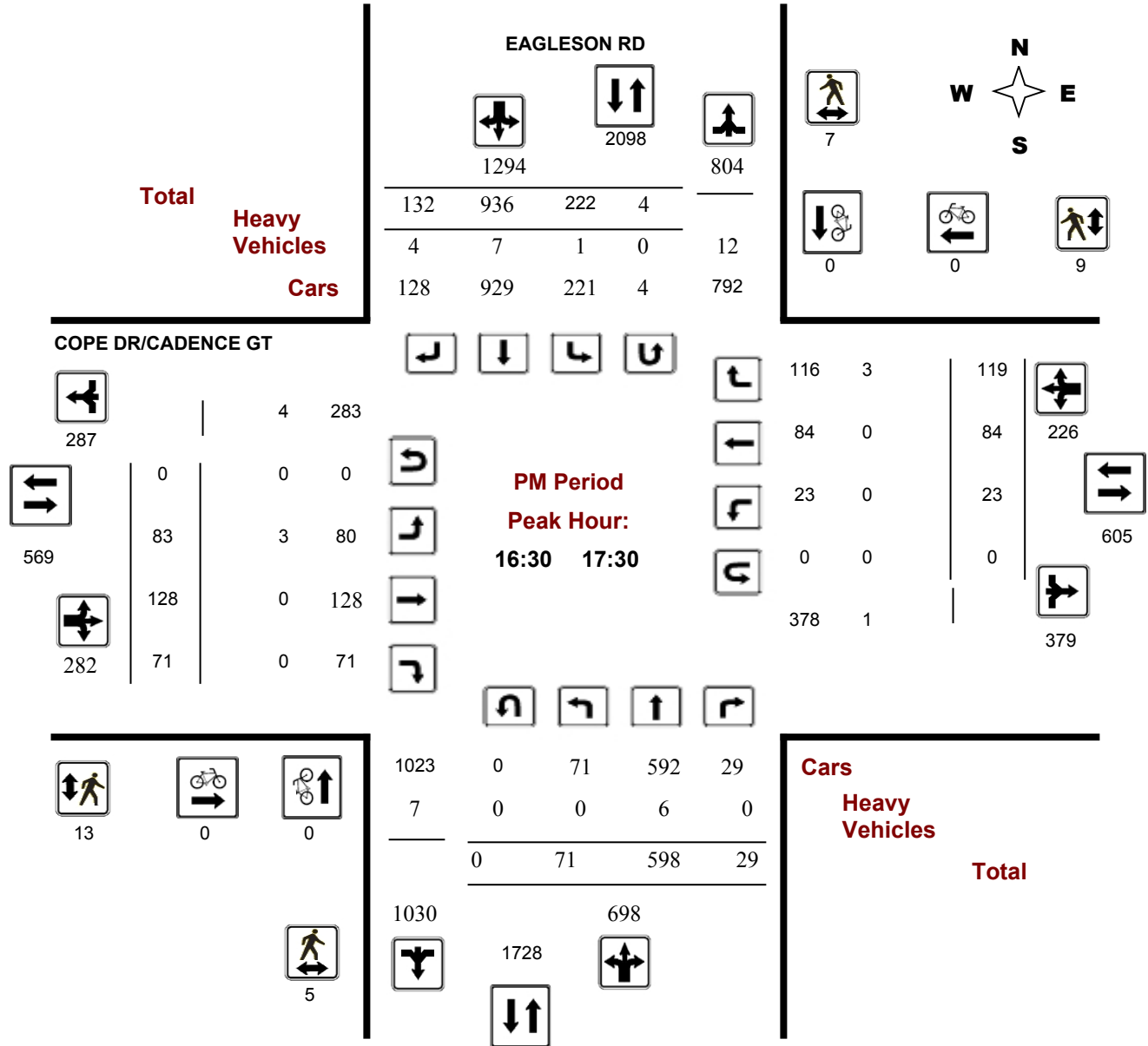

Traffic Signal Timing

City of Ottawa, Transportation Services Department

Traffic Signal Operations Unit

Intersection:	Main: Fernbank	Side: Terry Fox
Controller:	ATC 3	TSD: 6577
Author:	Matthew Anderson	Date: 01-Apr-2021

Existing Timing Plans[†]

	Plan					Ped Minimum Time		
	AM Peak 1	Off Peak 2	PM Peak 3	Night 4	Saturday 5	Walk	DW	A+R
Cycle	90	80	100	65	120			
Offset	9	0	91	X	X			
NB Thru	38	40	54	30	45	7	16	4.6+1.6
SB Thru	38	40	39	30	45	7	16	4.6+1.6
EB Left	17	-	12	-	20	-	-	3.7+2.4
EB Thru	52	40	46	35	35	7	20	3.7+2.5
WB Thru	35	40	34	35	35	7	20	3.7+2.5
NB Left	-	-	15	-	20	-	-	4.6+1.9

Phasing Sequence[‡]

Plan: 1

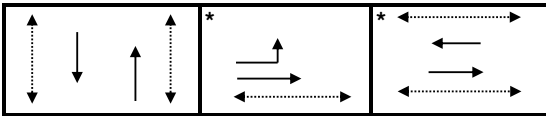

Plan: 2 and 4

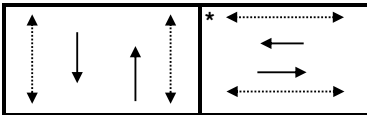

Plan: 3 and 5

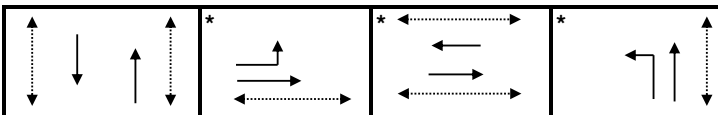

Schedule

Weekday

Time	Plan
0:10	4
6:20	1
9:30	2
15:00	3
19:00	2
23:00	4

Saturday

Time	Plan
0:10	4
9:00	2
11:30	5
21:30	2
22:30	4

Sunday

Time	Plan
0:10	4
8:00	2
11:00	3
21:30	2
22:30	4

Notes

†: Time for each direction includes amber and all red intervals

‡: Start of first phase should be used as reference point for offset

Asterisk (*) Indicates actuated phase

(fp): Fully Protected Left Turn

←.....→ Pedestrian signal

Cost is \$59.96 (\$53.06 + HST)

Traffic Signal Timing

City of Ottawa, Transportation Services Department

Traffic Signal Operations Unit

Intersection:	Main: Terry Fox	Side: Cope
Controller:	MS-3200	TSD: 6578
Author:	Matthew Anderson	Date: 01-Apr-2021

Existing Timing Plans†

	Plan					Ped Minimum Time		
	AM Peak 1	Off Peak 2	PM Peak 3	Night 4	Weekend 5	Walk	DW	A+R
Cycle	90	80	100	65	85			
Offset	55	0	69	X	0			
NB Thru	53	41	51	33	46	7	15	4.6+1.8
SB Thru	53	41	63	33	46	7	15	4.6+1.8
EB Thru	37	39	37	32	39	7	19	3.3+2.9
WB Thru	37	39	37	32	39	7	19	3.3+2.9
SB Left	-	-	12	-	-	-	-	4.6+1.8

Terry Fox is considered to be the NS street

Phasing Sequence‡

Plan: 1,2,4,5

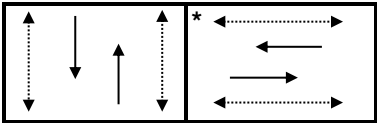

Plan: 3

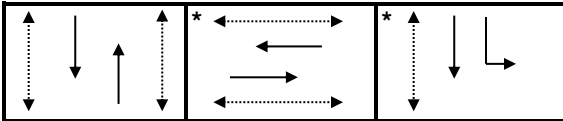

Schedule

Weekday		Saturday		Sunday	
Time	Plan	Time	Plan	Time	Plan
0:10	4	0:10	4	0:10	4
6:20	1	9:00	2	8:00	2
9:30	2	11:30	5	11:00	3
15:00	3	21:30	2	21:30	2
19:00	2	22:30	4	22:30	4
23:00	4				

Notes

†: Time for each direction includes amber and all red intervals

‡: Start of first phase should be used as reference point for offset

Asterisk (*) Indicates actuated phase

(fp): Fully Protected Left Turn

◄.....► Pedestrian signal

Cost is \$59.96 (\$53.06 + HST)

APPENDIX E

Collision Records



Transportation Services - Traffic Services

Collision Details Report - Public Version

From: January 1, 2015 To: December 31, 2019

Location: COPE DR @ TERRY FOX

Traffic Control: Traffic signal

Total Collisions: 27

Date/Day/Time	Environment	Impact Type	Classification	Surface Cond'n	Veh. Dir	Vehicle Manoeuver	Vehicle type	First Event	No. Ped
2015-Feb-26, Thu,11:48	Clear	Turning movement	P.D. only	Wet	North	Turning left	Automobile, station wagon	Other motor vehicle	0
					South	Going ahead	Automobile, station wagon	Other motor vehicle	
2015-Sep-09, Wed,07:25	Clear	Turning movement	P.D. only	Dry	South	Turning left	Pick-up truck	Other motor vehicle	0
					North	Going ahead	Pick-up truck	Other motor vehicle	
2016-Jan-22, Fri,19:12	Clear	Angle	P.D. only	Dry	East	Turning left	Automobile, station wagon	Other motor vehicle	0
					South	Going ahead	Pick-up truck	Other motor vehicle	
2016-Feb-22, Mon,16:09	Clear	Turning movement	P.D. only	Dry	North	Turning left	Pick-up truck	Other motor vehicle	0
					South	Going ahead	Automobile, station wagon	Other motor vehicle	
2016-Apr-06, Wed,17:52	Snow	Rear end	P.D. only	Loose snow	North	Slowing or stopping	Pick-up truck	Other motor vehicle	0
					North	Stopped	Automobile, station wagon	Other motor vehicle	
2016-May-01, Sun,15:35	Clear	Rear end	P.D. only	Wet	North	Going ahead	Automobile, station wagon	Other motor vehicle	0
					North	Stopped	Automobile, station wagon	Other motor vehicle	
2016-May-03, Tue,19:43	Clear	Rear end	P.D. only	Dry	West	Slowing or stopping	Automobile, station wagon	Other motor vehicle	0
					West	Stopped	Automobile, station wagon	Other motor vehicle	
2016-Oct-04, Tue,03:47	Clear	SMV other	P.D. only	Dry	West	Going ahead	Automobile, station wagon	Curb	0
2016-Oct-17, Mon,08:04	Clear	Angle	Non-fatal injury	Wet	North	Going ahead	Automobile, station wagon	Other motor vehicle	0
					West	Going ahead	Pick-up truck	Other motor vehicle	
2016-Oct-18, Tue,19:06	Clear	Rear end	P.D. only	Dry	North	Slowing or stopping	Automobile, station wagon	Other motor vehicle	0
					North	Stopped	Municipal transit bus	Other motor vehicle	
2016-Nov-12, Sat,15:27	Clear	Rear end	Non-fatal injury	Dry	South	Turning left	Pick-up truck	Other motor vehicle	0
					South	Turning left	Automobile, station wagon	Other motor vehicle	
2016-Dec-09, Fri,17:51	Snow	Rear end	P.D. only	Ice	South	Going ahead	Pick-up truck	Other motor vehicle	0
					South	Stopped	Automobile, station wagon	Other motor vehicle	



Transportation Services - Traffic Services

Collision Details Report - Public Version

From: January 1, 2015 To: December 31, 2019

Location: COPE DR @ TERRY FOX

Traffic Control: Traffic signal

Total Collisions: 27

Date/Day/Time	Environment	Impact Type	Classification	Surface Cond'n	Veh. Dir	Vehicle Manoeuvre	Vehicle type	First Event	No. Ped
2017-Feb-19, Sun,12:15	Clear	Turning movement	Non-fatal injury	Wet	South	Turning left	Automobile, station wagon	Other motor vehicle	0
					North	Going ahead	Passenger van	Other motor vehicle	
2017-Mar-05, Sun,10:33	Clear	Turning movement	Non-fatal injury	Dry	South	Turning left	Automobile, station wagon	Other motor vehicle	0
					North	Going ahead	Automobile, station wagon	Other motor vehicle	
2017-Jun-30, Fri,20:42	Clear	Turning movement	P.D. only	Dry	South	Turning left	Automobile, station wagon	Other motor vehicle	0
					North	Going ahead	Pick-up truck	Other motor vehicle	
2017-Jul-06, Thu,15:16	Clear	Rear end	P.D. only	Dry	South	Turning left	Passenger van	Other motor vehicle	0
					South	Turning left	Automobile, station wagon	Other motor vehicle	
2017-Aug-25, Fri,18:36	Clear	Turning movement	P.D. only	Dry	South	Turning left	Automobile, station wagon	Other motor vehicle	0
					North	Going ahead	Automobile, station wagon	Other motor vehicle	
2017-Nov-05, Sun,12:24	Rain	Turning movement	P.D. only	Wet	East	Turning left	Passenger van	Other motor vehicle	0
					West	Going ahead	Automobile, station wagon	Other motor vehicle	
2017-Nov-28, Tue,17:21	Rain	Turning movement	P.D. only	Wet	North	Turning right	Automobile, station wagon	Other motor vehicle	0
					North	Going ahead	Automobile, station wagon	Other motor vehicle	
2018-Feb-03, Sat,19:00	Clear	Turning movement	P.D. only	Dry	North	Turning left	Automobile, station wagon	Other motor vehicle	0
					South	Going ahead	Automobile, station wagon	Other motor vehicle	
2018-Mar-16, Fri,10:15	Clear	Rear end	P.D. only	Ice	West	Slowing or stopping	Automobile, station wagon	Skidding/sliding	0
					West	Turning right	Automobile, station wagon	Other motor vehicle	
2018-Jun-12, Tue,16:05	Clear	Turning movement	Non-fatal injury	Dry	South	Turning left	Automobile, station wagon	Other motor vehicle	0
					North	Going ahead	Automobile, station wagon	Other motor vehicle	
2019-Mar-18, Mon,17:45	Clear	Turning movement	P.D. only	Dry	South	Turning left	Automobile, station wagon	Other motor vehicle	0
					North	Going ahead	Automobile, station wagon	Other motor vehicle	
					West	Stopped	Automobile, station wagon	Other motor vehicle	



Transportation Services - Traffic Services

Collision Details Report - Public Version

From: January 1, 2015 To: December 31, 2019

Location: COPE DR @ TERRY FOX

Traffic Control: Traffic signal

Total Collisions: 27

Date/Day/Time	Environment	Impact Type	Classification	Surface Cond'n	Veh. Dir	Vehicle Manoeuver	Vehicle type	First Event	No. Ped
2019-Apr-19, Fri,09:43	Rain	Turning movement	P.D. only	Wet	South	Turning left	Automobile, station wagon	Other motor vehicle	0
					North	Going ahead	Automobile, station wagon	Other motor vehicle	
2019-Jun-24, Mon,08:00	Clear	Other	P.D. only	Dry	South	Going ahead	Automobile, station wagon	Debris falling off vehicle	0
					North	Unknown	Unknown	Other	
2019-Jul-12, Fri,13:54	Clear	SMV other	Non-fatal injury	Dry	West	Turning left	Automobile, station wagon	Ditch	0
2019-Dec-23, Mon,18:57	Clear	Sideswipe	Non-fatal injury	Wet	South	Changing lanes	Automobile, station wagon	Other motor vehicle	0
					South	Going ahead	Automobile, station wagon	Other motor vehicle	

Location: TERRY FOX DR @ FERNBANK RD

Traffic Control: Traffic signal

Total Collisions: 29

Date/Day/Time	Environment	Impact Type	Classification	Surface Cond'n	Veh. Dir	Vehicle Manoeuver	Vehicle type	First Event	No. Ped
2015-Mar-03, Tue,18:31	Snow	Rear end	P.D. only	Loose snow	North	Slowing or stopping	Automobile, station wagon	Other motor vehicle	0
					North	Slowing or stopping	Pick-up truck	Other motor vehicle	
2015-May-06, Wed,19:38	Clear	Angle	Non-fatal injury	Dry	East	Going ahead	Bicycle	Other motor vehicle	0
					North	Going ahead	Automobile, station wagon	Cyclist	
2015-Aug-26, Wed,17:32	Rain	Rear end	P.D. only	Wet	West	Going ahead	Automobile, station wagon	Other motor vehicle	0
					West	Stopped	Automobile, station wagon	Other motor vehicle	
2015-Sep-13, Sun,16:48	Clear	Angle	Non-fatal injury	Dry	South	Going ahead	Automobile, station wagon	Other motor vehicle	0
					East	Going ahead	Pick-up truck	Other motor vehicle	
2015-Nov-19, Thu,19:52	Clear	Sideswipe	P.D. only	Dry	South	Changing lanes	Automobile, station wagon	Other motor vehicle	0
					South	Overtaking	Automobile, station wagon	Other motor vehicle	
2015-Nov-25, Wed,13:51	Clear	Sideswipe	P.D. only	Dry	East	Turning right	Automobile, station wagon	Other motor vehicle	0
					East	Turning right	Truck and trailer	Other motor vehicle	



Transportation Services - Traffic Services

Collision Details Report - Public Version

From: January 1, 2015 To: December 31, 2019

Location: TERRY FOX DR @ FERNBANK RD

Traffic Control: Traffic signal

Total Collisions: 29

Date/Day/Time	Environment	Impact Type	Classification	Surface Cond'n	Veh. Dir	Vehicle Manoeuvre	Vehicle type	First Event	No. Ped
2016-May-23, Mon,18:34	Clear	SMV other	Non-fatal injury	Dry	North	Pulling onto shoulder or toward curb	Automobile, station wagon	Curb	1
2016-Jul-14, Thu,11:00	Rain	Angle	P.D. only	Wet	South East	Turning right Stopped	Automobile, station wagon Pick-up truck	Other motor vehicle Other motor vehicle	0
2016-Jul-28, Thu,19:10	Clear	Turning movement	P.D. only	Dry	North South	Turning left Going ahead	Automobile, station wagon Pick-up truck	Other motor vehicle Other motor vehicle	0
2016-Aug-07, Sun,20:15	Clear	Rear end	P.D. only	Dry	South South	Slowing or stopping Stopped	Automobile, station wagon Passenger van	Other motor vehicle Other motor vehicle	0
2017-Jan-13, Fri,18:16	Clear	Turning movement	P.D. only	Dry	South North	Turning left Going ahead	Automobile, station wagon Automobile, station wagon	Other motor vehicle Other motor vehicle	0
2017-Jun-17, Sat,07:59	Clear	Angle	P.D. only	Dry	West South	Going ahead Going ahead	Automobile, station wagon Pick-up truck	Other motor vehicle Other motor vehicle	0
2017-Jun-30, Fri,11:34	Rain	Sideswipe	P.D. only	Wet	North North	Changing lanes Turning left	Automobile, station wagon Pick-up truck	Other motor vehicle Other motor vehicle	0
2017-Sep-08, Fri,12:53	Clear	Rear end	P.D. only	Dry	West West	Slowing or stopping Turning right	Automobile, station wagon Automobile, station wagon	Other motor vehicle Other motor vehicle	0
2017-Nov-18, Sat,10:15	Clear	Other	P.D. only	Dry	South South	Going ahead Going ahead	Pick-up truck Unknown	Debris falling off vehicle Other	0
2018-Mar-05, Mon,16:15	Clear	Turning movement	P.D. only	Dry	East West	Turning left Going ahead	Passenger van Automobile, station wagon	Other motor vehicle Other motor vehicle	0
2018-Aug-12, Sun,11:39	Clear	Sideswipe	Non-fatal injury	Dry	North North	Slowing or stopping Stopped	Motorcycle Automobile, station wagon	Skidding/sliding Other motor vehicle	0
2018-Oct-16, Tue,13:17	Clear	Sideswipe	P.D. only	Dry	East East	Turning right Turning right	Automobile, station wagon Truck and trailer	Other motor vehicle Other motor vehicle	0



Transportation Services - Traffic Services

Collision Details Report - Public Version

From: January 1, 2015 To: December 31, 2019

Location: TERRY FOX DR @ FERNBANK RD

Traffic Control: Traffic signal

Total Collisions: 29

Date/Day/Time	Environment	Impact Type	Classification	Surface Cond'n	Veh. Dir	Vehicle Manoeuver	Vehicle type	First Event	No. Ped
2018-Dec-10, Mon,13:10	Clear	Rear end	P.D. only	Dry	South	Turning right	Automobile, station wagon	Other motor vehicle	0
					South	Turning right	Automobile, station wagon	Other motor vehicle	
2018-Dec-25, Tue,12:01	Clear	Rear end	P.D. only	Dry	South	Slowing or stopping	Pick-up truck	Other motor vehicle	0
					South	Stopped	Automobile, station wagon	Other motor vehicle	
2019-Jan-19, Sat,23:25	Snow	Rear end	P.D. only	Ice	West	Going ahead	Automobile, station wagon	Other motor vehicle	0
					West	Going ahead	Automobile, station wagon	Other motor vehicle	
2019-Jan-22, Tue,15:10	Clear	Rear end	P.D. only	Packed snow	East	Turning right	Automobile, station wagon	Other motor vehicle	0
					East	Turning right	Pick-up truck	Other motor vehicle	
2019-Mar-07, Thu,13:26	Clear	Angle	Non-fatal injury	Dry	West	Going ahead	Automobile, station wagon	Other motor vehicle	0
					South	Going ahead	Automobile, station wagon	Other motor vehicle	
2019-Jun-10, Mon,17:35	Rain	Sideswipe	P.D. only	Wet	East	Changing lanes	Automobile, station wagon	Other motor vehicle	0
					East	Turning left	Automobile, station wagon	Other motor vehicle	
2019-Jun-12, Wed,18:52	Clear	Turning movement	P.D. only	Dry	North	Turning left	Pick-up truck	Other motor vehicle	0
					South	Going ahead	Automobile, station wagon	Other motor vehicle	
2019-Jun-18, Tue,13:28	Clear	Angle	Non-fatal injury	Dry	East	Going ahead	Automobile, station wagon	Other motor vehicle	0
					North	Going ahead	Automobile, station wagon	Other motor vehicle	
2019-Oct-03, Thu,20:44	Rain	Turning movement	P.D. only	Wet	North	Turning left	Automobile, station wagon	Other motor vehicle	0
					South	Going ahead	Automobile, station wagon	Other motor vehicle	
2019-Oct-11, Fri,14:38	Clear	Rear end	P.D. only	Dry	North	Going ahead	Automobile, station wagon	Other motor vehicle	0
					North	Stopped	Automobile, station wagon	Other motor vehicle	
2019-Dec-11, Wed,12:43	Clear	Rear end	P.D. only	Dry	West	Stopped	Passenger van	Other motor vehicle	0
					West	Turning right	Municipal transit bus	Other motor vehicle	

APPENDIX F

Relevant Traffic Study Excerpts

10 Cope Drive

Figure 6: 'New' Site-Generated Traffic

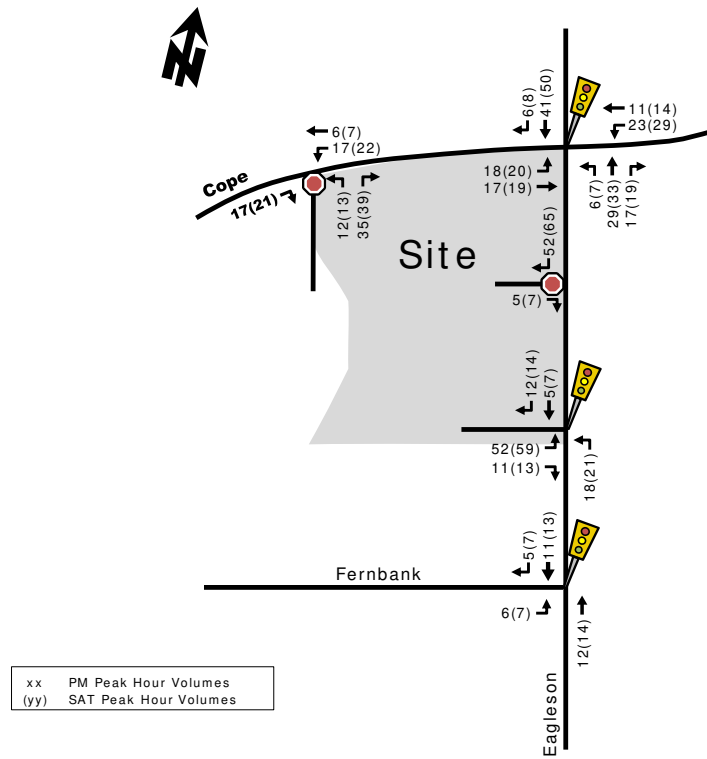
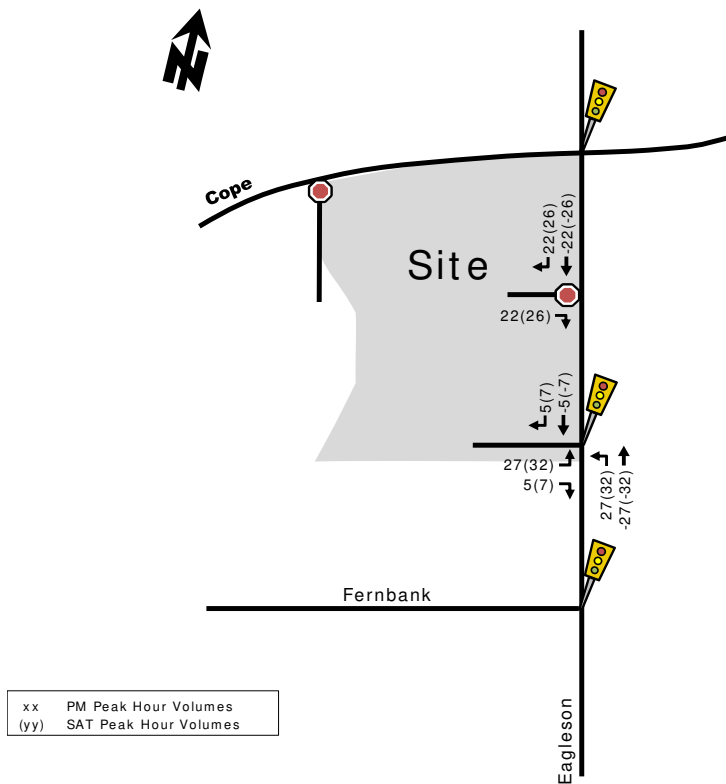
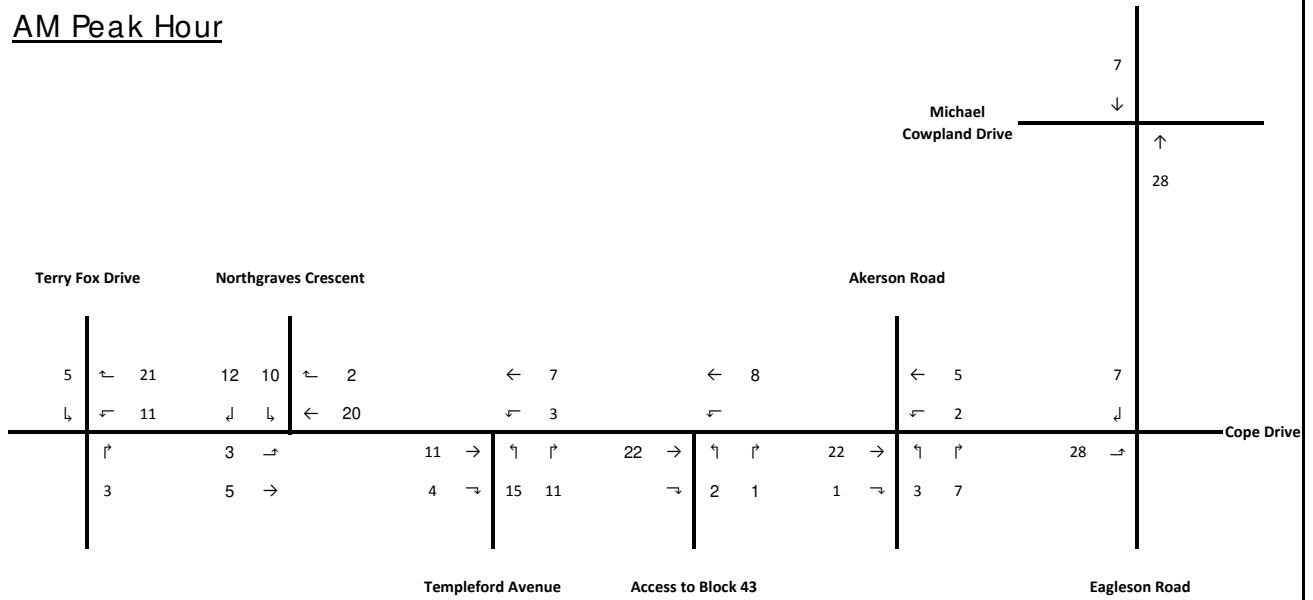

Figure 7: 'Pass-by' Site-Generated Traffic



80-180 Cope Drive

AM Peak Hour



AM Peak Hour

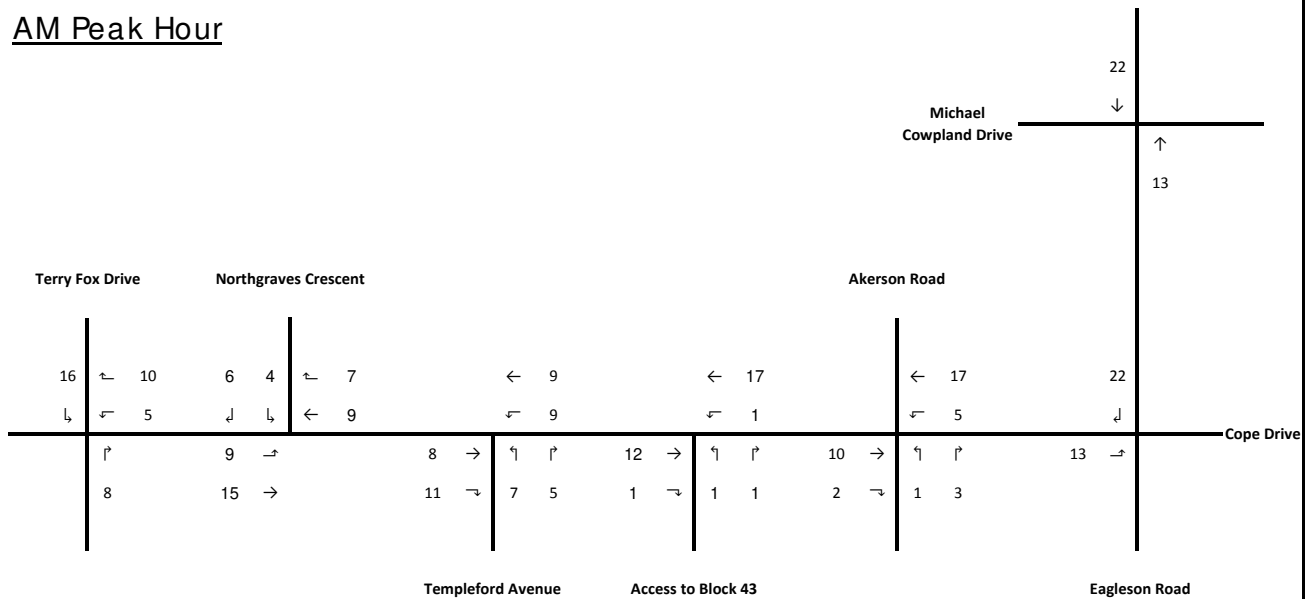

Stantec Consulting Ltd.
 1331 Clyde Avenue, Suite 400
 Ottawa, ON, Canada K2C 3G4
 Tel: (613) 722-4420
 www.stantec.com



Thomas Cavanagh Construction Ltd.
 Cope Drive Lands TIS
 Figure 8
 Total Development Site Trips

5505 Fernbank Road

Figure 7: Future Background Traffic (2030)

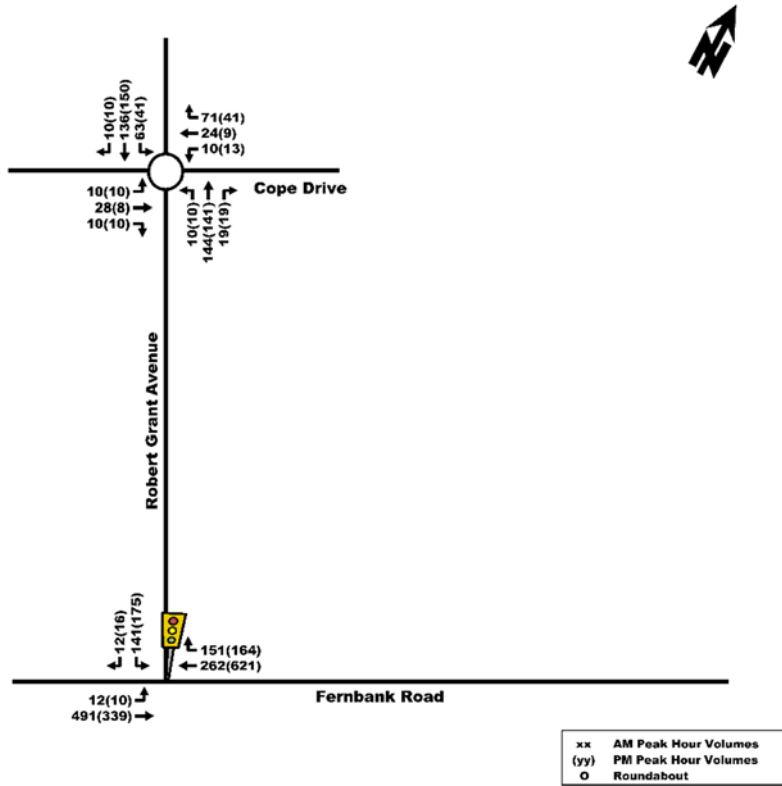

Figure 8: Site Generated Traffic Volumes (Full Build-Out)

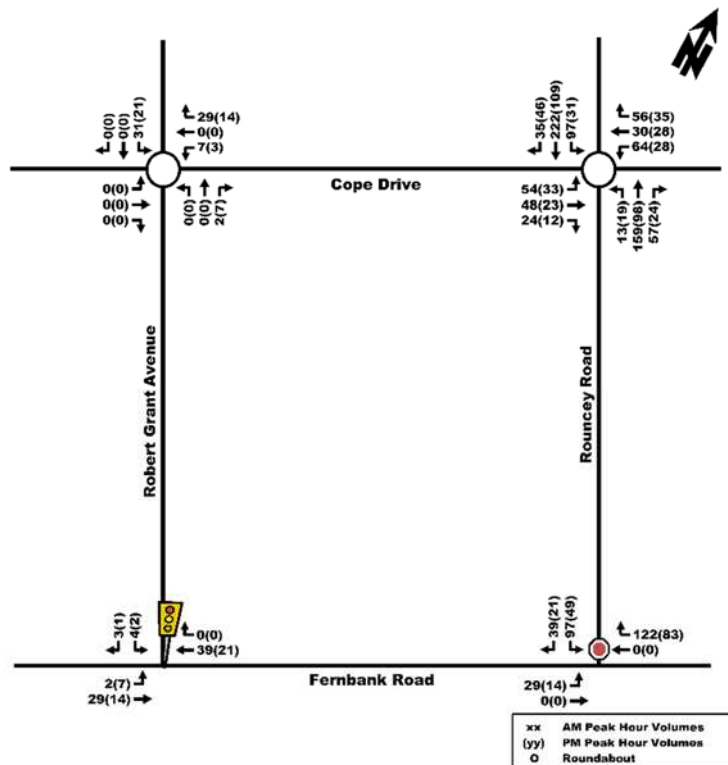

Table 2: Total Site Trip Generation (Original TIS)

Travel Mode	Mode Share	AM Peak (Person Trips/hr)			PM Peak (Person Trips/hr)		
		In	Out	Total	In	Out	Total
Auto Driver	60%	59	214	273	217	122	339
Auto Passenger	15%	15	54	69	54	30	84
Transit	10%	10	35	45	36	20	56
Non-motorized	15%	14	53	67	54	30	84
Total Person Trips	100%	98	356	454	361	202	563
Total 'New' Auto Trips		59	214	273	217	122	339

2.2. REVISED SITE PLAN

The Blackstone development draft plan was revised in December 2017 to satisfy City comments received during the application process and with the new properties along Fernbank Road. The subsequent unit count totals 609 units, with a breakdown of 214 single family homes, 239 townhomes, and 156 condo units. The revised trip generation results in a total of 438 two-way person trips (92 inbound, 346 outbound) during the AM peak hour and 544 two-way person trips (350 inbound, 194 outbound) during the PM peak hour. The assumed modal split of 60% auto driver meant a total of 264 two-way auto trips (56 inbound, 208 outbound) during the AM peak hour and 327 two-way auto trips (210 inbound, 117 outbound) during the PM peak hour.

The modified person trip generation is summarized below in Table 3, and the modal split is summarized in Table 4 [Table 2](#).

Table 3: Modified Person Trip Generation (Revised Draft Plan)

Land Use	Data Source	Units	AM Peak (Person Trips/hr)			PM Peak (Person Trips/hr)		
			In	Out	Total	In	Out	Total
			17%	83%		67%	33%	
Townhome	ITE 230	239 du	22	113	135	107	53	160
			25%	75%		63%	37%	
Single Family Home	ITE 210	214 du	51	156	207	170	101	271
			20%	80%		65%	35%	
Condo Block	ITE 220	156 du	19	77	96	73	40	113
Total			92	346	438	350	194	544

Table 4: Total Site Trip Generation (Revised Draft Plan)

Travel Mode	Mode Share	AM Peak (Person Trips/hr)			PM Peak (Person Trips/hr)		
		In	Out	Total	In	Out	Total
Auto Driver	60%	56	208	264	210	117	327
Auto Passenger	15%	14	52	66	53	29	82
Transit	10%	9	35	44	35	19	54
Non-motorized	15%	13	51	64	52	29	81
Total Person Trips	100%	92	346	438	350	194	544
Total 'New' Auto Trips		56	208	264	210	117	327

3. CONCLUSIONS

Table 5 summarizes the changes in trip generation from the original TIS and the Revised Draft Plan, broken into total person trips and both auto and transit modal shares.

Table 5: Net Change in Trip Generation and Trips by Mode

Peak Period	Mode Type	Original TIA		Revised Draft Plan		Net Difference	
		Inbound	Outbound	Inbound	Outbound	Inbound	Outbound
AM	Person	98	356	92	346	-6	-10
	Total	454		438		-16	
	Auto	59	214	56	208	-3	-6
	Total	273		264		-9	
PM	Person	361	202	350	194	-11	-8
	Total	563		544		-19	
	Auto	217	122	210	117	-7	-5
	Total	339		327		-12	

The net change in the original TIS trip generation and the Revised Draft Plan is a reduction of 16 total person trips (or 9 auto trips) during the AM peak hour and a reduction of 19 total person trips (or 12 auto trips) during the PM peak hour.

The overall reduction in the trip generation for the Mattamy Blackstone lands is a combination of revised unit count which is 5 units lower than previously submitted, and increase in townhomes over single family homes that typically generate more trips during the peak hours.

Therefore, the reduction in the overall trip generation is considered negligible and the conclusions/recommendations of the May 2017 TIS remain valid. No further trip generation analysis is required to support the December 14, 2017 Revised Draft Plan.

Prepared By



Andrew Harte, P.Eng.
Senior Transportation Engineer

5331 Fernbank Road and 1039 Terry Fox Drive

Figure 5: Site Generated Traffic

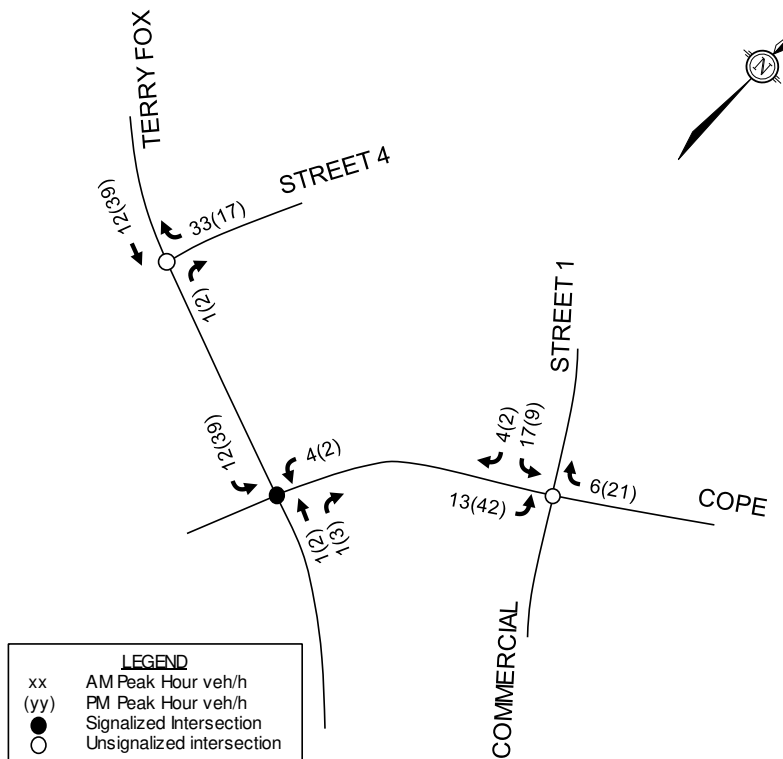

4.2 Background Traffic

4.2.1 General Background Growth Rate

The addendum to the Van Gaal Lands CTS applied a 2% background growth rate to the traffic volumes along Terry Fox Drive and Cope Drive. In the interest of maintaining consistency with the addendum, a 2% per annum growth rate has been carried forward for this analysis.

4.2.2 Other Area Development Traffic

As identified above, Site Plan Control or Zoning By-law Amendment applications have been filed for the following lands in the vicinity of the subject site:

- 800 Eagleson Road and 5264 Fernbank Road
- 80, 110, 140, 151 and 180 Cope Drive
- 10 Cope Drive
- 5331 Fernbank Road

The 2022 and 2027 background traffic projections include traffic generated by the developments along Cope Drive, as well as the 5331 Fernbank Road commercial development. As a TIA was not submitted in support of the 800 Eagleson Road site, and the site is located in the southwest corner of the Eagleson Road/Fernbank Road intersection where minimal traffic is anticipated to travel through the study area, this development has not been accounted for in the background traffic projections. Relevant excerpts from other area developments are included in **Appendix E**.

Table 1: Person Trip Generation

Land Use	Units	AM Peak			PM Peak		
		IN	OUT	TOTAL	IN	OUT	TOTAL
Previous TIA							
Single Family Detached Housing	55	16	40	56	51	22	73
Multifamily Housing (Low-Rise)	129	20	58	78	67	28	95
Total		36	98	134	118	50	168
Revised Development							
Single Family Detached Housing	47	12	37	49	40	23	63
Multifamily Housing (Low-Rise)	161	22	74	96	72	43	115
Total		34	111	145	112	66	178
Difference		-2	+13	+11	-6	+16	+10

Based on the foregoing, the revised Draft Plan is anticipated to result in a net increase of 11 person trips during the AM peak hour and 10 person trips during the PM peak hour. The modal shares for the proposed development are consistent with the previous TIA. A full breakdown of the person trips by modal share are summarized in the following table.

Travel Mode	Modal Share	AM Peak			PM Peak		
		IN	OUT	TOTAL	IN	OUT	TOTAL
Previous TIA							
Total Person Trips		36	98	134	118	50	168
Auto Driver	55%	20	54	74	65	27	92
Auto Passenger	15%	5	15	20	18	7	25
Transit	20%	7	20	27	24	10	34
Non-Auto	10%	4	9	13	11	5	17
Revised Development							
Total Person Trips		34	111	145	112	66	178
Auto Driver	55%	19	60	79	62	35	97
Auto Passenger	15%	5	17	22	17	10	27
Transit	20%	7	22	29	22	14	36
Non-Auto	10%	3	12	15	11	7	18
Auto Driver (Difference)		-1	6	5	-3	8	5
Auto Passenger (Difference)		0	2	2	-1	3	2
Transit (Difference)		0	2	2	-2	4	2
Non-Auto (Difference)		-1	3	2	0	2	1

Based on the foregoing, the proposed development is only anticipated to generate an additional five vehicle trips during the AM and PM peak hours, compared to the previously proposed development. The additional vehicle trips generated by the revised development are not anticipated to have a significant impact on the intersection operations presented in the original report.





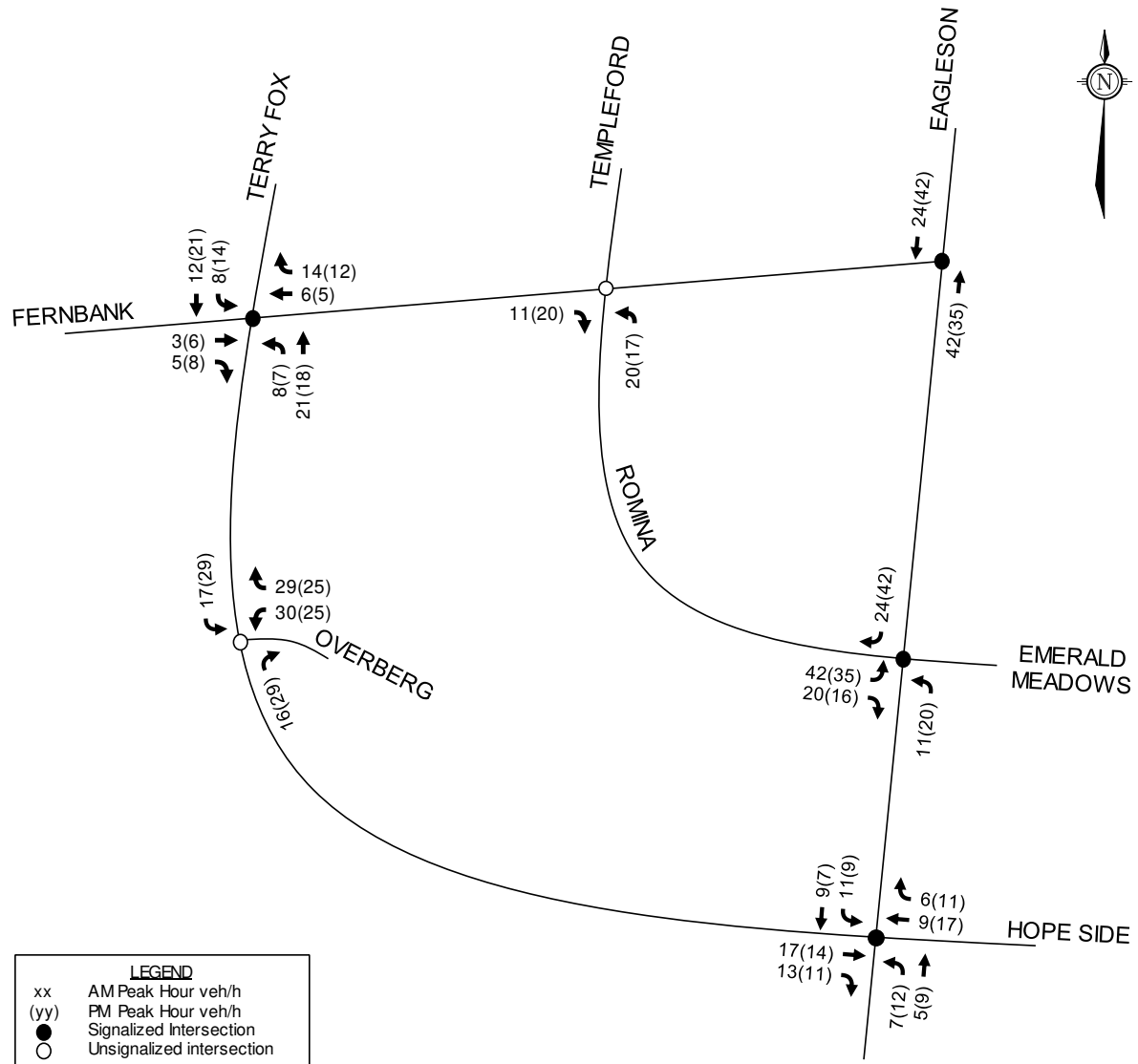















866, 898 Eagleson Road and
1335, 1365 Terry Fox Drive

Figure 4: Site Generated Traffic Volumes



APPENDIX G

Synchro Analysis Reports – Existing/Background Traffic

												
Lane Group	EBL	EBT	EBR	WBL	WBT	WBR	NBL	NBT	NBR	SBL	SBT	SBR
Lane Configurations												
Traffic Volume (vph)	19	14	4	25	5	96	7	584	42	151	373	29
Future Volume (vph)	19	14	4	25	5	96	7	584	42	151	373	29
Ideal Flow (vphpl)	1800	1800	1800	1800	1800	1800	1800	1800	1800	1800	1800	1800
Storage Length (m)	30.0		0.0	30.0		0.0	35.0		0.0	50.0		140.0
Storage Lanes	1		0	1		0	1		0	1		1
Taper Length (m)	55.0			55.0			80.0			80.0		
Lane Util. Factor	1.00	1.00	1.00	1.00	1.00	1.00	1.00	1.00	1.00	1.00	1.00	1.00
Ped Bike Factor					0.98		1.00	1.00		1.00		0.97
Fr t		0.970			0.858			0.990				0.850
Flt Protected	0.950			0.950			0.950			0.950		
Satd. Flow (prot)	1558	1731	0	1340	1486	0	1209	1640	0	1695	1640	1502
Flt Permitted	0.684			0.744			0.514			0.348		
Satd. Flow (perm)	1122	1731	0	1050	1486	0	652	1640	0	621	1640	1462
Right Turn on Red			Yes			Yes			Yes			Yes
Satd. Flow (RTOR)		4			107			6				39
Link Speed (k/h)		50			50			80				80
Link Distance (m)		302.1			142.5			210.5				515.9
Travel Time (s)		21.8			10.3			9.5				23.2
Confl. Peds. (#/hr)							3		1	1		3
Confl. Bikes (#/hr)						1						1
Peak Hour Factor	0.90	0.90	0.90	0.90	0.90	0.90	0.90	0.90	0.90	0.90	0.90	0.90
Heavy Vehicles (%)	11%	2%	2%	29%	20%	2%	43%	9%	19%	2%	11%	3%
Adj. Flow (vph)	21	16	4	28	6	107	8	649	47	168	414	32
Shared Lane Traffic (%)												
Lane Group Flow (vph)	21	20	0	28	113	0	8	696	0	168	414	32
Enter Blocked Intersection	No	No	No	No	No	No	No	No	No	No	No	No
Lane Alignment	Left	Left	Right	Left	Left	Right	Left	Left	Right	Left	Left	Right
Median Width(m)		3.7			3.7			3.7				3.7
Link Offset(m)		0.0			0.0			0.0				0.0
Crosswalk Width(m)		4.9			4.9			4.9				4.9
Two way Left Turn Lane												
Headway Factor	1.06	1.06	1.06	1.06	1.06	1.06	1.06	1.06	1.06	1.06	1.06	1.06
Turning Speed (k/h)	24		14	24		14	24		14	24		14
Number of Detectors	1	2		1	2		1	2		1	2	1
Detector Template	Left	Thru		Left	Thru		Left	Thru		Left	Thru	Right
Leading Detector (m)	6.1	30.5		6.1	30.5		6.1	30.5		6.1	30.5	6.1
Trailing Detector (m)	0.0	0.0		0.0	0.0		0.0	0.0		0.0	0.0	0.0
Detector 1 Position(m)	0.0	0.0		0.0	0.0		0.0	0.0		0.0	0.0	0.0
Detector 1 Size(m)	6.1	1.8		6.1	1.8		6.1	1.8		6.1	1.8	6.1
Detector 1 Type	Cl+Ex	Cl+Ex		Cl+Ex	Cl+Ex		Cl+Ex	Cl+Ex		Cl+Ex	Cl+Ex	Cl+Ex
Detector 1 Channel												
Detector 1 Extend (s)	0.0	0.0		0.0	0.0		0.0	0.0		0.0	0.0	0.0
Detector 1 Queue (s)	0.0	0.0		0.0	0.0		0.0	0.0		0.0	0.0	0.0
Detector 1 Delay (s)	0.0	0.0		0.0	0.0		0.0	0.0		0.0	0.0	0.0
Detector 2 Position(m)		28.7			28.7			28.7				28.7
Detector 2 Size(m)		1.8			1.8			1.8				1.8
Detector 2 Type		Cl+Ex			Cl+Ex			Cl+Ex				Cl+Ex
Detector 2 Channel												
Detector 2 Extend (s)		0.0			0.0			0.0				0.0
Turn Type	Perm	NA		Perm	NA		Perm	NA		Perm	NA	Perm
Protected Phases		4			8			2			6	
Permitted Phases	4			8			2			6		6
Detector Phase	4	4		8	8		2	2		6	6	6
Switch Phase												
Minimum Initial (s)	10.0	10.0		10.0	10.0		10.0	10.0		10.0	10.0	10.0
Minimum Split (s)	32.2	32.2		32.2	32.2		28.4	28.4		28.4	28.4	28.4
Total Split (s)	37.0	37.0		37.0	37.0		53.0	53.0		53.0	53.0	53.0
Total Split (%)	41.1%	41.1%		41.1%	41.1%		58.9%	58.9%		58.9%	58.9%	58.9%
Maximum Green (s)	30.8	30.8		30.8	30.8		46.6	46.6		46.6	46.6	46.6
Yellow Time (s)	3.3	3.3		3.3	3.3		4.6	4.6		4.6	4.6	4.6



Lane Group	EBL	EBT	EBR	WBL	WBT	WBR	NBL	NBT	NBR	SBL	SBT	SBR
All-Red Time (s)	2.9	2.9		2.9	2.9		1.8	1.8		1.8	1.8	1.8
Lost Time Adjust (s)	0.0	0.0		0.0	0.0		0.0	0.0		0.0	0.0	0.0
Total Lost Time (s)	6.2	6.2		6.2	6.2		6.4	6.4		6.4	6.4	6.4
Lead/Lag												
Lead-Lag Optimize?												
Vehicle Extension (s)	3.0	3.0		3.0	3.0		3.0	3.0		3.0	3.0	3.0
Recall Mode	None	None		None	None		C-Max	C-Max		C-Max	C-Max	C-Max
Walk Time (s)	7.0	7.0		7.0	7.0		7.0	7.0		7.0	7.0	7.0
Flash Dont Walk (s)	19.0	19.0		19.0	19.0		15.0	15.0		15.0	15.0	15.0
Pedestrian Calls (#/hr)	5	5		5	5		5	5		5	5	5
Act Effct Green (s)	13.2	13.2		13.2	13.2		68.7	68.7		68.7	68.7	68.7
Actuated g/C Ratio	0.15	0.15		0.15	0.15		0.76	0.76		0.76	0.76	0.76
v/c Ratio	0.13	0.08		0.18	0.37		0.02	0.56		0.35	0.33	0.03
Control Delay	32.1	26.0		33.7	10.3		5.0	7.2		9.2	6.6	2.1
Queue Delay	0.0	0.0		0.0	0.0		0.0	0.0		0.0	0.0	0.0
Total Delay	32.1	26.0		33.7	10.3		5.0	7.2		9.2	6.6	2.1
LOS	C	C		C	B		A	A		A	A	A
Approach Delay		29.1			15.0			7.2				7.1
Approach LOS		C			B			A				A
Queue Length 50th (m)	3.4	2.5		4.5	1.0		0.2	14.7		8.1	19.4	0.0
Queue Length 95th (m)	8.1	7.1		9.9	12.4		m1.3	149.4		33.5	59.0	3.1
Internal Link Dist (m)		278.1			118.5			186.5			491.9	
Turn Bay Length (m)	30.0			30.0			35.0			50.0		140.0
Base Capacity (vph)	383	595		359	578		498	1253		474	1252	1125
Starvation Cap Reductn	0	0		0	0		0	0		0	0	0
Spillback Cap Reductn	0	0		0	0		0	0		0	0	0
Storage Cap Reductn	0	0		0	0		0	0		0	0	0
Reduced v/c Ratio	0.05	0.03		0.08	0.20		0.02	0.56		0.35	0.33	0.03

Intersection Summary

Area Type: Other
 Cycle Length: 90
 Actuated Cycle Length: 90
 Offset: 55 (61%), Referenced to phase 2:NBTL and 6:SBTL, Start of Green
 Natural Cycle: 80
 Control Type: Actuated-Coordinated
 Maximum v/c Ratio: 0.56
 Intersection Signal Delay: 8.5
 Intersection LOS: A
 Intersection Capacity Utilization 68.1%
 ICU Level of Service C
 Analysis Period (min) 15
 m Volume for 95th percentile queue is metered by upstream signal.

Splits and Phases: 2: Terry Fox & Cope

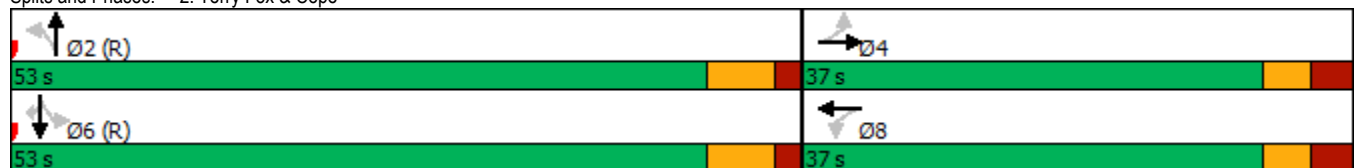

Lane Group	EBL	EBT	EBR	WBL	WBT	WBR	NBL	NBT	NBR	SBL	SBT	SBR
Lane Configurations												
Traffic Volume (vph)	134	219	184	3	163	127	136	326	2	74	229	56
Future Volume (vph)	134	219	184	3	163	127	136	326	2	74	229	56
Ideal Flow (vphpl)	1800	1800	1800	1800	1800	1800	1800	1800	1800	1800	1800	1800
Storage Length (m)	75.0		75.0	95.0		115.0	90.0		0.0	90.0		95.0
Storage Lanes	1		1	1		1	1		0	1		1
Taper Length (m)	100.0			60.0			70.0			100.0		
Lane Util. Factor	1.00	1.00	1.00	1.00	1.00	1.00	1.00	1.00	1.00	1.00	1.00	1.00
Ped Bike Factor	1.00		0.98			0.98						
Fr t			0.850			0.850		0.999				0.850
Fit Protected	0.950			0.950			0.950			0.950		
Satd. Flow (prot)	1631	1784	1488	1695	1767	1406	1662	1732	0	1662	1717	1357
Fit Permitted	0.555			0.608			0.488			0.310		
Satd. Flow (perm)	951	1784	1457	1085	1767	1374	854	1732	0	542	1717	1357
Right Turn on Red			Yes			Yes			Yes			Yes
Satd. Flow (RTOR)			204			141						113
Link Speed (k/h)					60			80				80
Link Distance (m)		274.4			222.4			294.7				171.1
Travel Time (s)		16.5			13.3			13.3				7.7
Confl. Peds. (#/hr)	2					2						
Confl. Bikes (#/hr)			1									
Peak Hour Factor	0.90	0.90	0.90	0.90	0.90	0.90	0.90	0.90	0.90	0.90	0.90	0.90
Heavy Vehicles (%)	6%	2%	4%	2%	3%	10%	4%	5%	2%	4%	6%	14%
Adj. Flow (vph)	149	243	204	3	181	141	151	362	2	82	254	62
Shared Lane Traffic (%)												
Lane Group Flow (vph)	149	243	204	3	181	141	151	364	0	82	254	62
Enter Blocked Intersection	No	No	No	No	No	No	No	No	No	No	No	No
Lane Alignment	Left	Left	Right	Left	Left	Right	Left	Left	Right	Left	Left	Right
Median Width(m)		3.7			3.7			3.7				3.7
Link Offset(m)		0.0			0.0			0.0				0.0
Crosswalk Width(m)		4.9			4.9			4.9				4.9
Two way Left Turn Lane												
Headway Factor	1.06	1.06	1.06	1.06	1.06	1.06	1.06	1.06	1.06	1.06	1.06	1.06
Turning Speed (k/h)	24		14	24		14	24		14	24		14
Number of Detectors	1	2	1	1	2	1	1	2		1	2	1
Detector Template	Left	Thru	Right	Left	Thru	Right	Left	Thru		Left	Thru	Right
Leading Detector (m)	6.1	30.5	6.1	6.1	30.5	6.1	6.1	30.5		6.1	30.5	6.1
Trailing Detector (m)	0.0	0.0	0.0	0.0	0.0	0.0	0.0	0.0		0.0	0.0	0.0
Detector 1 Position(m)	0.0	0.0	0.0	0.0	0.0	0.0	0.0	0.0		0.0	0.0	0.0
Detector 1 Size(m)	6.1	1.8	6.1	6.1	1.8	6.1	6.1	1.8		6.1	1.8	6.1
Detector 1 Type	CI+Ex	CI+Ex	CI+Ex	CI+Ex	CI+Ex	CI+Ex	CI+Ex	CI+Ex		CI+Ex	CI+Ex	CI+Ex
Detector 1 Channel												
Detector 1 Extend (s)	0.0	0.0	0.0	0.0	0.0	0.0	0.0	0.0		0.0	0.0	0.0
Detector 1 Queue (s)	0.0	0.0	0.0	0.0	0.0	0.0	0.0	0.0		0.0	0.0	0.0
Detector 1 Delay (s)	0.0	0.0	0.0	0.0	0.0	0.0	0.0	0.0		0.0	0.0	0.0
Detector 2 Position(m)		28.7			28.7			28.7				28.7
Detector 2 Size(m)		1.8			1.8			1.8				1.8
Detector 2 Type		CI+Ex			CI+Ex			CI+Ex				CI+Ex
Detector 2 Channel												
Detector 2 Extend (s)		0.0			0.0			0.0				0.0
Turn Type	pm+pt	NA	Perm	Perm	NA	Perm	Perm	NA		Perm	NA	Perm
Protected Phases	5	2			6			8				4
Permitted Phases	2		2	6		6	8			4		4
Detector Phase	5	2	2	6	6	6	8	8		4	4	4
Switch Phase												
Minimum Initial (s)	5.0	10.0	10.0	10.0	10.0	10.0	10.0	10.0		10.0	10.0	10.0
Minimum Split (s)	11.2	33.2	33.2	33.2	33.2	33.2	29.2	29.2		29.2	29.2	29.2
Total Split (s)	17.0	52.0	52.0	35.0	35.0	35.0	38.0	38.0		38.0	38.0	38.0
Total Split (%)	18.9%	57.8%	57.8%	38.9%	38.9%	38.9%	42.2%	42.2%		42.2%	42.2%	42.2%
Maximum Green (s)	10.9	45.8	45.8	28.8	28.8	28.8	31.8	31.8		31.8	31.8	31.8
Yellow Time (s)	3.7	3.7	3.7	3.7	3.7	3.7	4.6	4.6		4.6	4.6	4.6



Lane Group	EBL	EBT	EBR	WBL	WBT	WBR	NBL	NBT	NBR	SBL	SBT	SBR
All-Red Time (s)	2.4	2.5	2.5	2.5	2.5	2.5	1.6	1.6		1.6	1.6	1.6
Lost Time Adjust (s)	0.0	0.0	0.0	0.0	0.0	0.0	0.0	0.0		0.0	0.0	0.0
Total Lost Time (s)	6.1	6.2	6.2	6.2	6.2	6.2	6.2	6.2		6.2	6.2	6.2
Lead/Lag	Lead			Lag			Lag					
Lead-Lag Optimize?	Yes			Yes			Yes					
Vehicle Extension (s)	3.0	3.0	3.0	3.0	3.0	3.0	3.0	3.0		3.0	3.0	3.0
Recall Mode	None	C-Max	C-Max	C-Max	C-Max	C-Max	None	None		None	None	None
Walk Time (s)		7.0	7.0	7.0	7.0	7.0	7.0	7.0		7.0	7.0	7.0
Flash Dont Walk (s)		20.0	20.0	20.0	20.0	20.0	16.0	16.0		16.0	16.0	16.0
Pedestrian Calls (#/hr)		5	5	5	5	5	5	5		5	5	5
Act Effct Green (s)	53.4	53.3	53.3	38.2	38.2	38.2	24.3	24.3		24.3	24.3	24.3
Actuated g/C Ratio	0.59	0.59	0.59	0.42	0.42	0.42	0.27	0.27		0.27	0.27	0.27
v/c Ratio	0.24	0.23	0.22	0.01	0.24	0.21	0.66	0.78		0.56	0.55	0.14
Control Delay	10.6	10.6	2.3	19.7	20.1	4.8	42.0	41.7		42.9	32.4	5.6
Queue Delay	0.0	0.0	0.0	0.0	0.0	0.0	0.0	0.0		0.0	0.0	0.0
Total Delay	10.6	10.6	2.3	19.7	20.1	4.8	42.0	41.7		42.9	32.4	5.6
LOS	B	B	A	B	C	A	D	D		D	C	A
Approach Delay		7.8			13.5			41.8			30.4	
Approach LOS		A			B			D			C	
Queue Length 50th (m)	10.6	18.2	0.0	0.3	19.5	0.0	23.1	58.1		9.3	28.6	0.2
Queue Length 95th (m)	23.5	37.0	10.0	2.3	40.2	12.3	39.2	78.8		22.5	53.6	6.6
Internal Link Dist (m)		250.4			198.4			270.7			147.1	
Turn Bay Length (m)	75.0		75.0	95.0		115.0	90.0		90.0		95.0	
Base Capacity (vph)	646	1056	946	460	750	664	301	611		191	606	552
Starvation Cap Reductn	0	0	0	0	0	0	0	0		0	0	0
Spillback Cap Reductn	0	0	0	0	0	0	0	0		0	0	0
Storage Cap Reductn	0	0	0	0	0	0	0	0		0	0	0
Reduced v/c Ratio	0.23	0.23	0.22	0.01	0.24	0.21	0.50	0.60		0.43	0.42	0.11

Intersection Summary

Area Type:	Other
Cycle Length:	90
Actuated Cycle Length:	90
Offset:	9 (10%), Referenced to phase 2:EBTL and 6:WBTL, Start of Green
Natural Cycle:	75
Control Type:	Actuated-Coordinated
Maximum v/c Ratio:	0.78
Intersection Signal Delay:	23.2
Intersection LOS:	C
Intersection Capacity Utilization:	77.5%
ICU Level of Service:	D
Analysis Period (min):	15

Splits and Phases: 5: Terry Fox & Fernbank





Lane Group	EBL	EBT	EBR	WBL	WBT	WBR	NBL	NBT	NBR	SBL	SBT	SBR
Lane Configurations												
Traffic Volume (vph)	85	26	7	60	11	186	5	508	47	192	712	84
Future Volume (vph)	85	26	7	60	11	186	5	508	47	192	712	84
Ideal Flow (vphpl)	1800	1800	1800	1800	1800	1800	1800	1800	1800	1800	1800	1800
Storage Length (m)	30.0		0.0	30.0		0.0	35.0		0.0	50.0		140.0
Storage Lanes	1		0	1		0	1		0	1		1
Taper Length (m)	55.0			55.0			80.0			80.0		
Lane Util. Factor	1.00	1.00	1.00	1.00	1.00	1.00	1.00	1.00	1.00	1.00	1.00	1.00
Ped Bike Factor		1.00		1.00			1.00					0.97
Fr _t		0.968			0.858			0.987				0.850
Flt Protected	0.950			0.950			0.950			0.950		
Satd. Flow (prot)	1695	1719	0	1601	1531	0	1695	1717	0	1695	1784	1517
Flt Permitted	0.412			0.733			0.366			0.266		
Satd. Flow (perm)	735	1719	0	1233	1531	0	652	1717	0	475	1784	1475
Right Turn on Red			Yes			Yes			Yes			Yes
Satd. Flow (RTOR)		8			207			6				93
Link Speed (k/h)		50			50			80				80
Link Distance (m)		302.1			142.5			210.5				515.9
Travel Time (s)		21.8			10.3			9.5				23.2
Confl. Peds. (#/hr)			1	1			3					3
Confl. Bikes (#/hr)												1
Peak Hour Factor	0.90	0.90	0.90	0.90	0.90	0.90	0.90	0.90	0.90	0.90	0.90	0.90
Heavy Vehicles (%)	2%	2%	2%	8%	2%	2%	2%	4%	11%	2%	2%	2%
Adj. Flow (vph)	94	29	8	67	12	207	6	564	52	213	791	93
Shared Lane Traffic (%)												
Lane Group Flow (vph)	94	37	0	67	219	0	6	616	0	213	791	93
Enter Blocked Intersection	No	No	No	No	No	No	No	No	No	No	No	No
Lane Alignment	Left	Left	Right	Left	Left	Right	Left	Left	Right	Left	Left	Right
Median Width(m)		3.7			3.7			3.7				3.7
Link Offset(m)		0.0			0.0			0.0				0.0
Crosswalk Width(m)		4.9			4.9			4.9				4.9
Two way Left Turn Lane												
Headway Factor	1.06	1.06	1.06	1.06	1.06	1.06	1.06	1.06	1.06	1.06	1.06	1.06
Turning Speed (k/h)	24		14	24		14	24		14	24		14
Number of Detectors	1	2		1	2		1	2		1	2	1
Detector Template	Left	Thru		Left	Thru		Left	Thru		Left	Thru	Right
Leading Detector (m)	6.1	30.5		6.1	30.5		6.1	30.5		6.1	30.5	6.1
Trailing Detector (m)	0.0	0.0		0.0	0.0		0.0	0.0		0.0	0.0	0.0
Detector 1 Position(m)	0.0	0.0		0.0	0.0		0.0	0.0		0.0	0.0	0.0
Detector 1 Size(m)	6.1	1.8		6.1	1.8		6.1	1.8		6.1	1.8	6.1
Detector 1 Type	Cl+Ex	Cl+Ex		Cl+Ex	Cl+Ex		Cl+Ex	Cl+Ex		Cl+Ex	Cl+Ex	Cl+Ex
Detector 1 Channel												
Detector 1 Extend (s)	0.0	0.0		0.0	0.0		0.0	0.0		0.0	0.0	0.0
Detector 1 Queue (s)	0.0	0.0		0.0	0.0		0.0	0.0		0.0	0.0	0.0
Detector 1 Delay (s)	0.0	0.0		0.0	0.0		0.0	0.0		0.0	0.0	0.0
Detector 2 Position(m)		28.7			28.7			28.7				28.7
Detector 2 Size(m)		1.8			1.8			1.8				1.8
Detector 2 Type		Cl+Ex			Cl+Ex			Cl+Ex				Cl+Ex
Detector 2 Channel												
Detector 2 Extend (s)		0.0			0.0			0.0				0.0
Turn Type	Perm	NA		Perm	NA		Perm	NA		pm+pt	NA	Perm
Protected Phases		4			8			2		1		6
Permitted Phases	4			8			2			6		6
Detector Phase	4	4		8	8		2	2		1	6	6
Switch Phase												
Minimum Initial (s)	10.0	10.0		10.0	10.0		10.0	10.0		5.0	10.0	10.0
Minimum Split (s)	32.2	32.2		32.2	32.2		28.4	28.4		11.4	28.4	28.4
Total Split (s)	37.0	37.0		37.0	37.0		51.0	51.0		12.0	63.0	63.0
Total Split (%)	37.0%	37.0%		37.0%	37.0%		51.0%	51.0%		12.0%	63.0%	63.0%
Maximum Green (s)	30.8	30.8		30.8	30.8		44.6	44.6		5.6	56.6	56.6
Yellow Time (s)	3.3	3.3		3.3	3.3		4.6	4.6		4.6	4.6	4.6



Lane Group	EBL	EBT	EBR	WBL	WBT	WBR	NBL	NBT	NBR	SBL	SBT	SBR
All-Red Time (s)	2.9	2.9		2.9	2.9		1.8	1.8		1.8	1.8	1.8
Lost Time Adjust (s)	0.0	0.0		0.0	0.0		0.0	0.0		0.0	0.0	0.0
Total Lost Time (s)	6.2	6.2		6.2	6.2		6.4	6.4		6.4	6.4	6.4
Lead/Lag							Lag	Lag		Lead		
Lead-Lag Optimize?							Yes	Yes		Yes		
Vehicle Extension (s)	3.0	3.0		3.0	3.0		3.0	3.0		3.0	3.0	3.0
Recall Mode	None	None		None	None		C-Max	C-Max		None	C-Max	C-Max
Walk Time (s)	7.0	7.0		7.0	7.0		7.0	7.0		7.0	7.0	7.0
Flash Dont Walk (s)	19.0	19.0		19.0	19.0		15.0	15.0		15.0	15.0	15.0
Pedestrian Calls (#/hr)	5	5		5	5		5	5		5	5	5
Act Effct Green (s)	16.1	16.1		16.1	16.1		54.8	54.8		71.3	71.3	71.3
Actuated g/C Ratio	0.16	0.16		0.16	0.16		0.55	0.55		0.71	0.71	0.71
v/c Ratio	0.80	0.13		0.34	0.52		0.02	0.65		0.46	0.62	0.09
Control Delay	80.4	28.1		39.6	10.3		11.6	20.9		9.1	11.5	1.7
Queue Delay	0.0	0.0		0.0	0.0		0.0	0.0		0.0	0.0	0.0
Total Delay	80.4	28.1		39.6	10.3		11.6	20.9		9.1	11.5	1.7
LOS	F	C		D	B		B	C		A	B	A
Approach Delay		65.7			17.2			20.8			10.2	
Approach LOS		E			B			C			B	
Queue Length 50th (m)	18.0	4.9		11.8	2.0		0.6	89.3		11.1	64.7	0.0
Queue Length 95th (m)	32.0	11.9		21.4	19.1		m2.4	#153.3		27.3	143.9	5.5
Internal Link Dist (m)		278.1			118.5			186.5			491.9	
Turn Bay Length (m)	30.0			30.0			35.0			50.0		140.0
Base Capacity (vph)	226	534		379	614		357	943		461	1271	1078
Starvation Cap Reductn	0	0		0	0		0	0		0	0	0
Spillback Cap Reductn	0	0		0	0		0	0		0	0	0
Storage Cap Reductn	0	0		0	0		0	0		0	0	0
Reduced v/c Ratio	0.42	0.07		0.18	0.36		0.02	0.65		0.46	0.62	0.09

Intersection Summary

Area Type: Other
 Cycle Length: 100
 Actuated Cycle Length: 100
 Offset: 69 (69%), Referenced to phase 2:NBTL and 6:SBTL, Start of Green
 Natural Cycle: 90
 Control Type: Actuated-Coordinated
 Maximum v/c Ratio: 0.80
 Intersection Signal Delay: 17.6
 Intersection LOS: B
 Intersection Capacity Utilization 90.0%
 ICU Level of Service E
 Analysis Period (min) 15
 # 95th percentile volume exceeds capacity, queue may be longer.
 Queue shown is maximum after two cycles.
 m Volume for 95th percentile queue is metered by upstream signal.

Splits and Phases: 2: Terry Fox & Cope

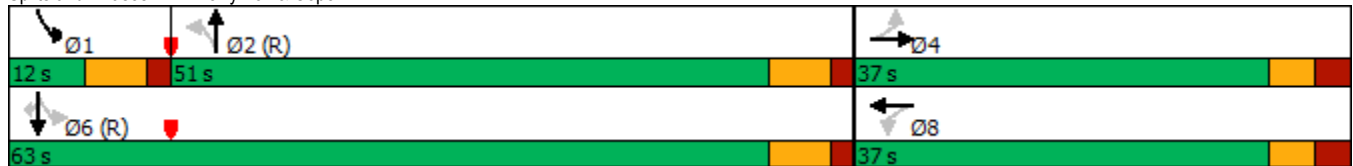

Lane Group	EBL	EBT	EBR	WBL	WBT	WBR	NBL	NBT	NBR	SBL	SBT	SBR
Lane Configurations												
Traffic Volume (vph)	96	222	131	5	290	103	251	309	23	185	415	138
Future Volume (vph)	96	222	131	5	290	103	251	309	23	185	415	138
Ideal Flow (vphpl)	1800	1800	1800	1800	1800	1800	1800	1800	1800	1800	1800	1800
Storage Length (m)	75.0		75.0	95.0		115.0	90.0		0.0	90.0		95.0
Storage Lanes	1		1	1		1	1		0	1		1
Taper Length (m)	100.0			60.0			70.0			100.0		
Lane Util. Factor	1.00	1.00	1.00	1.00	1.00	1.00	1.00	1.00	1.00	1.00	1.00	1.00
Ped Bike Factor	1.00		0.97	0.99		0.97						0.96
Fr t			0.850			0.850		0.989				0.850
Fit Protected	0.950			0.950			0.950			0.950		
Satd. Flow (prot)	1631	1784	1502	1235	1784	1459	1695	1765	0	1695	1784	1488
Fit Permitted	0.305			0.606			0.164			0.542		
Satd. Flow (perm)	523	1784	1461	784	1784	1421	293	1765	0	967	1784	1429
Right Turn on Red			Yes			Yes			Yes			Yes
Satd. Flow (RTOR)			146			172		5				172
Link Speed (k/h)		60			60			80			80	
Link Distance (m)		274.4			222.4			294.7			171.1	
Travel Time (s)		16.5			13.3			13.3			7.7	
Confl. Peds. (#/hr)	2		4	4		2	9					9
Confl. Bikes (#/hr)						2						
Peak Hour Factor	0.90	0.90	0.90	0.90	0.90	0.90	0.90	0.90	0.90	0.90	0.90	0.90
Heavy Vehicles (%)	6%	2%	3%	40%	2%	6%	2%	2%	2%	2%	2%	4%
Adj. Flow (vph)	107	247	146	6	322	114	279	343	26	206	461	153
Shared Lane Traffic (%)												
Lane Group Flow (vph)	107	247	146	6	322	114	279	369	0	206	461	153
Enter Blocked Intersection	No	No	No	No	No	No	No	No	No	No	No	No
Lane Alignment	Left	Left	Right	Left	Left	Right	Left	Left	Right	Left	Left	Right
Median Width(m)		3.7			3.7			3.7			3.7	
Link Offset(m)		0.0			0.0			0.0			0.0	
Crosswalk Width(m)		4.9			4.9			4.9			4.9	
Two way Left Turn Lane												
Headway Factor	1.06	1.06	1.06	1.06	1.06	1.06	1.06	1.06	1.06	1.06	1.06	1.06
Turning Speed (k/h)	24		14	24		14	24		14	24		14
Number of Detectors	1	2	1	1	2	1	1	2		1	2	1
Detector Template	Left	Thru	Right	Left	Thru	Right	Left	Thru		Left	Thru	Right
Leading Detector (m)	6.1	30.5	6.1	6.1	30.5	6.1	6.1	30.5		6.1	30.5	6.1
Trailing Detector (m)	0.0	0.0	0.0	0.0	0.0	0.0	0.0	0.0		0.0	0.0	0.0
Detector 1 Position(m)	0.0	0.0	0.0	0.0	0.0	0.0	0.0	0.0		0.0	0.0	0.0
Detector 1 Size(m)	6.1	1.8	6.1	6.1	1.8	6.1	6.1	1.8		6.1	1.8	6.1
Detector 1 Type	Cl+Ex	Cl+Ex	Cl+Ex	Cl+Ex	Cl+Ex	Cl+Ex	Cl+Ex	Cl+Ex		Cl+Ex	Cl+Ex	Cl+Ex
Detector 1 Channel												
Detector 1 Extend (s)	0.0	0.0	0.0	0.0	0.0	0.0	0.0	0.0		0.0	0.0	0.0
Detector 1 Queue (s)	0.0	0.0	0.0	0.0	0.0	0.0	0.0	0.0		0.0	0.0	0.0
Detector 1 Delay (s)	0.0	0.0	0.0	0.0	0.0	0.0	0.0	0.0		0.0	0.0	0.0
Detector 2 Position(m)		28.7			28.7			28.7			28.7	
Detector 2 Size(m)		1.8			1.8			1.8			1.8	
Detector 2 Type		Cl+Ex			Cl+Ex			Cl+Ex			Cl+Ex	
Detector 2 Channel												
Detector 2 Extend (s)		0.0			0.0			0.0			0.0	
Turn Type	pm+pt	NA	Perm	Perm	NA	Perm	pm+pt	NA		Perm	NA	Perm
Protected Phases	5	2			6		3	8			4	
Permitted Phases	2		2	6		6	8		4			4
Detector Phase	5	2	2	6	6	6	3	8		4	4	4
Switch Phase												
Minimum Initial (s)	5.0	10.0	10.0	10.0	10.0	10.0	5.0	10.0		10.0	10.0	10.0
Minimum Split (s)	11.2	33.2	33.2	33.2	33.2	33.2	11.5	29.2		29.2	29.2	29.2
Total Split (s)	12.0	46.0	46.0	34.0	34.0	34.0	15.0	54.0		39.0	39.0	39.0
Total Split (%)	12.0%	46.0%	46.0%	34.0%	34.0%	34.0%	15.0%	54.0%		39.0%	39.0%	39.0%
Maximum Green (s)	5.9	39.8	39.8	27.8	27.8	27.8	8.5	47.8		32.8	32.8	32.8
Yellow Time (s)	3.7	3.7	3.7	3.7	3.7	3.7	4.6	4.6		4.6	4.6	4.6



Lane Group	EBL	EBT	EBR	WBL	WBT	WBR	NBL	NBT	NBR	SBL	SBT	SBR
All-Red Time (s)	2.4	2.5	2.5	2.5	2.5	2.5	1.9	1.6		1.6	1.6	1.6
Lost Time Adjust (s)	0.0	0.0	0.0	0.0	0.0	0.0	0.0	0.0		0.0	0.0	0.0
Total Lost Time (s)	6.1	6.2	6.2	6.2	6.2	6.2	6.5	6.2		6.2	6.2	6.2
Lead/Lag	Lead			Lag			Lead			Lag		
Lead-Lag Optimize?	Yes			Yes			Yes			Yes		
Vehicle Extension (s)	3.0	3.0	3.0	3.0	3.0	3.0	3.0	3.0		3.0	3.0	3.0
Recall Mode	C-Max	C-Max	C-Max	Max	Max	Max	None	None		None	None	None
Walk Time (s)		7.0	7.0	7.0	7.0	7.0		7.0		7.0	7.0	7.0
Flash Dont Walk (s)		20.0	20.0	20.0	20.0	20.0		16.0		16.0	16.0	16.0
Pedestrian Calls (#/hr)		5	5	5	5	5		5		5	5	5
Act Effct Green (s)	42.8	42.7	42.7	27.8	27.8	27.8	44.6	44.9		29.9	29.9	29.9
Actuated g/C Ratio	0.43	0.43	0.43	0.28	0.28	0.28	0.45	0.45		0.30	0.30	0.30
v/c Ratio	0.33	0.32	0.21	0.03	0.65	0.22	1.12	0.46		0.72	0.87	0.28
Control Delay	21.9	21.5	4.1	27.0	39.0	2.1	115.7	20.6		50.0	53.1	10.8
Queue Delay	0.0	0.0	0.0	0.0	0.0	0.0	0.0	0.0		0.0	0.0	0.0
Total Delay	21.9	21.5	4.1	27.0	39.0	2.1	115.7	20.6		50.0	53.1	10.8
LOS	C	C	A	C	D	A	F	C		D	D	B
Approach Delay		16.5			29.3			61.5			44.4	
Approach LOS		B			C			E			D	
Queue Length 50th (m)	13.1	32.7	0.0	0.9	55.0	0.0	~36.8	45.0		30.5	68.7	0.6
Queue Length 95th (m)	24.3	52.0	11.4	3.9	83.9	3.6	#86.9	67.9		62.5	#126.1	m23.8
Internal Link Dist (m)		250.4			198.4			270.7			147.1	
Turn Bay Length (m)	75.0		75.0	95.0		115.0	90.0		90.0			95.0
Base Capacity (vph)	322	762	708	217	495	519	249	846		317	585	584
Starvation Cap Reductn	0	0	0	0	0	0	0	0		0	0	0
Spillback Cap Reductn	0	0	0	0	0	0	0	0		0	0	0
Storage Cap Reductn	0	0	0	0	0	0	0	0		0	0	0
Reduced v/c Ratio	0.33	0.32	0.21	0.03	0.65	0.22	1.12	0.44		0.65	0.79	0.26

Intersection Summary

Area Type: Other
 Cycle Length: 100
 Actuated Cycle Length: 100
 Offset: 79 (79%), Referenced to phase 2:EBTL and 5:EBL, Start of Green
 Natural Cycle: 90
 Control Type: Actuated-Coordinated
 Maximum v/c Ratio: 1.12
 Intersection Signal Delay: 40.5
 Intersection LOS: D
 Intersection Capacity Utilization 89.5%
 ICU Level of Service E
 Analysis Period (min) 15
 ~ Volume exceeds capacity, queue is theoretically infinite.
 Queue shown is maximum after two cycles.
 # 95th percentile volume exceeds capacity, queue may be longer.
 Queue shown is maximum after two cycles.
 m Volume for 95th percentile queue is metered by upstream signal.

Splits and Phases: 5: Terry Fox & Fernbank

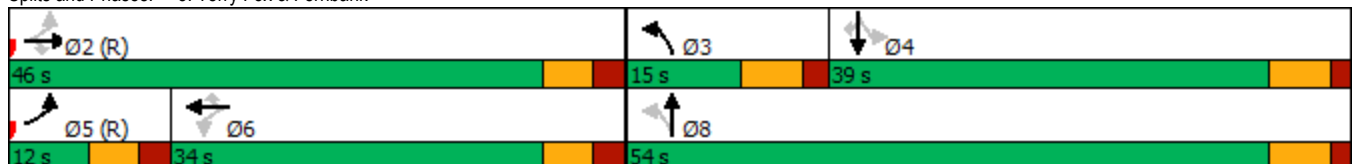

5331 Fernbank Road
Existing Traffic (Optimized)

5: Terry Fox & Fernbank
Timing Plan: PM Peak



Lane Group	EBL	EBT	EBR	WBL	WBT	WBR	NBL	NBT	NBR	SBL	SBT	SBR
Lane Configurations												
Traffic Volume (vph)	96	222	131	5	290	103	251	309	23	185	415	138
Future Volume (vph)	96	222	131	5	290	103	251	309	23	185	415	138
Ideal Flow (vphpl)	1800	1800	1800	1800	1800	1800	1800	1800	1800	1800	1800	1800
Storage Length (m)	75.0		75.0	95.0		115.0	90.0		0.0	90.0		95.0
Storage Lanes	1		1	1		1	1		0	1		1
Taper Length (m)	100.0			60.0			70.0			100.0		
Lane Util. Factor	1.00	1.00	1.00	1.00	1.00	1.00	1.00	1.00	1.00	1.00	1.00	1.00
Ped Bike Factor	1.00		0.97	0.99		0.97						0.96
Frt			0.850			0.850		0.989				0.850
Flt Protected	0.950			0.950			0.950			0.950		
Satd. Flow (prot)	1631	1784	1502	1235	1784	1459	1695	1765	0	1695	1784	1488
Flt Permitted	0.245			0.606			0.146			0.542		
Satd. Flow (perm)	420	1784	1459	783	1784	1419	261	1765	0	967	1784	1424
Right Turn on Red			Yes			Yes			Yes			Yes
Satd. Flow (RTOR)			146			144		5				153
Link Speed (k/h)		60			60			80			80	
Link Distance (m)		274.4			222.4			294.7			171.1	
Travel Time (s)		16.5			13.3			13.3			7.7	
Confl. Peds. (#/hr)	2		4	4		2	9					9
Confl. Bikes (#/hr)						2						
Peak Hour Factor	0.90	0.90	0.90	0.90	0.90	0.90	0.90	0.90	0.90	0.90	0.90	0.90
Heavy Vehicles (%)	6%	2%	3%	40%	2%	6%	2%	2%	2%	2%	2%	4%
Adj. Flow (vph)	107	247	146	6	322	114	279	343	26	206	461	153
Shared Lane Traffic (%)												
Lane Group Flow (vph)	107	247	146	6	322	114	279	369	0	206	461	153
Enter Blocked Intersection	No	No	No	No	No	No	No	No	No	No	No	No
Lane Alignment	Left	Left	Right	Left	Left	Right	Left	Left	Right	Left	Left	Right
Median Width(m)		3.7			3.7			3.7			3.7	
Link Offset(m)		0.0			0.0			0.0			0.0	
Crosswalk Width(m)		4.9			4.9			4.9			4.9	
Two way Left Turn Lane												
Headway Factor	1.06	1.06	1.06	1.06	1.06	1.06	1.06	1.06	1.06	1.06	1.06	1.06
Turning Speed (k/h)	24		14	24		14	24		14	24		14
Number of Detectors	1	2	1	1	2	1	1	2		1	2	1
Detector Template	Left	Thru	Right	Left	Thru	Right	Left	Thru		Left	Thru	Right
Leading Detector (m)	6.1	30.5	6.1	6.1	30.5	6.1	6.1	30.5		6.1	30.5	6.1
Trailing Detector (m)	0.0	0.0	0.0	0.0	0.0	0.0	0.0	0.0		0.0	0.0	0.0
Detector 1 Position(m)	0.0	0.0	0.0	0.0	0.0	0.0	0.0	0.0		0.0	0.0	0.0
Detector 1 Size(m)	6.1	1.8	6.1	6.1	1.8	6.1	6.1	1.8		6.1	1.8	6.1
Detector 1 Type	Cl+Ex	Cl+Ex	Cl+Ex	Cl+Ex	Cl+Ex	Cl+Ex	Cl+Ex	Cl+Ex		Cl+Ex	Cl+Ex	Cl+Ex
Detector 1 Channel												
Detector 1 Extend (s)	0.0	0.0	0.0	0.0	0.0	0.0	0.0	0.0		0.0	0.0	0.0
Detector 1 Queue (s)	0.0	0.0	0.0	0.0	0.0	0.0	0.0	0.0		0.0	0.0	0.0
Detector 1 Delay (s)	0.0	0.0	0.0	0.0	0.0	0.0	0.0	0.0		0.0	0.0	0.0
Detector 2 Position(m)		28.7			28.7			28.7			28.7	
Detector 2 Size(m)		1.8			1.8			1.8			1.8	
Detector 2 Type		Cl+Ex			Cl+Ex			Cl+Ex			Cl+Ex	
Detector 2 Channel												
Detector 2 Extend (s)		0.0			0.0			0.0			0.0	
Turn Type	pm+pt	NA	Perm	Perm	NA	Perm	pm+pt	NA		Perm	NA	Perm
Protected Phases	5	2			6		3	8			4	
Permitted Phases	2		2	6		6	8			4		4
Detector Phase	5	2	2	6	6	6	3	8		4	4	4
Switch Phase												
Minimum Initial (s)	5.0	10.0	10.0	10.0	10.0	10.0	5.0	10.0		10.0	10.0	10.0
Minimum Split (s)	11.2	33.2	33.2	33.2	33.2	33.2	11.5	29.2		29.2	29.2	29.2
Total Split (s)	16.0	51.0	51.0	35.0	35.0	35.0	24.0	69.0		45.0	45.0	45.0
Total Split (%)	13.3%	42.5%	42.5%	29.2%	29.2%	29.2%	20.0%	57.5%		37.5%	37.5%	37.5%
Maximum Green (s)	9.9	44.8	44.8	28.8	28.8	28.8	17.5	62.8		38.8	38.8	38.8
Yellow Time (s)	3.7	3.7	3.7	3.7	3.7	3.7	4.6	4.6		4.6	4.6	4.6

5331 Fernbank Road
Existing Traffic (Optimized)

5: Terry Fox & Fernbank
Timing Plan: PM Peak



Lane Group	EBL	EBT	EBR	WBL	WBT	WBR	NBL	NBT	NBR	SBL	SBT	SBR	
All-Red Time (s)	2.4	2.5	2.5	2.5	2.5	2.5	1.9	1.6		1.6	1.6	1.6	
Lost Time Adjust (s)	0.0	0.0	0.0	0.0	0.0	0.0	0.0	0.0		0.0	0.0	0.0	
Total Lost Time (s)	6.1	6.2	6.2	6.2	6.2	6.2	6.5	6.2		6.2	6.2	6.2	
Lead/Lag	Lead			Lag			Lead			Lag			
Lead-Lag Optimize?	Yes			Yes			Yes			Yes			
Vehicle Extension (s)	3.0	3.0	3.0	3.0	3.0	3.0	3.0	3.0		3.0	3.0	3.0	
Recall Mode	C-Max	C-Max	C-Max	Max	Max	Max	None	None		None	None	None	
Walk Time (s)	7.0	7.0	7.0	7.0	7.0	7.0	7.0	7.0		7.0	7.0	7.0	
Flash Dont Walk (s)		20.0	20.0	20.0	20.0	20.0		16.0		16.0	16.0	16.0	
Pedestrian Calls (#/hr)		5	5	5	5	5		5		5	5	5	
Act Effct Green (s)	49.4	49.3	49.3	28.8	28.8	28.8	58.0	58.3		35.2	35.2	35.2	
Actuated g/C Ratio	0.41	0.41	0.41	0.24	0.24	0.24	0.48	0.49		0.29	0.29	0.29	
v/c Ratio	0.34	0.34	0.21	0.03	0.75	0.25	0.86	0.43		0.73	0.88	0.29	
Control Delay	27.2	27.2	4.8	35.8	54.6	4.3	48.5	20.8		53.3	59.3	6.1	
Queue Delay	0.0	0.0	0.0	0.0	0.0	0.0	0.0	0.0		0.0	0.0	0.0	
Total Delay	27.2	27.2	4.8	35.8	54.6	4.3	48.5	20.8		53.3	59.3	6.1	
LOS	C	C	A	D	D	A	D	C		D	E	A	
Approach Delay		20.7			41.4			32.7			47.9		
Approach LOS		C			D			C			D		
Queue Length 50th (m)	16.5	41.3	0.0	1.1	70.7	0.0	38.9	50.5		42.1	99.9	0.0	
Queue Length 95th (m)	29.6	63.6	13.0	4.7	#108.7	8.4	#80.2	72.1		69.7	#147.3	14.4	
Internal Link Dist (m)		250.4			198.4			270.7			147.1		
Turn Bay Length (m)	75.0		75.0	95.0		115.0	90.0		90.0		95.0	95.0	
Base Capacity (vph)	317	732	685	187	428	450	335	926		312	576	563	
Starvation Cap Reductn	0	0	0	0	0	0	0	0		0	0	0	
Spillback Cap Reductn	0	0	0	0	0	0	0	0		0	0	0	
Storage Cap Reductn	0	0	0	0	0	0	0	0		0	0	0	
Reduced v/c Ratio	0.34	0.34	0.21	0.03	0.75	0.25	0.83	0.40		0.66	0.80	0.27	

Intersection Summary





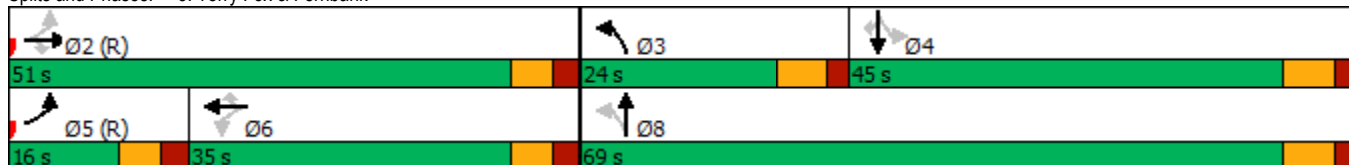















Area Type: Other
 Cycle Length: 120
 Actuated Cycle Length: 120
 Offset: 0 (0%), Referenced to phase 2:EBTL and 5:EBL, Start of Green
 Natural Cycle: 90
 Control Type: Actuated-Coordinated
 Maximum v/c Ratio: 0.88
 Intersection Signal Delay: 37.0
 Intersection LOS: D
 Intersection Capacity Utilization 89.5%
 ICU Level of Service E
 Analysis Period (min) 15
 # 95th percentile volume exceeds capacity, queue may be longer.
 Queue shown is maximum after two cycles.

Splits and Phases: 5: Terry Fox & Fernbank



5331 Fernbank Road
2023 Background Traffic

2: Terry Fox & Cope
Timing Plan: AM Peak

												
Lane Group	EBL	EBT	EBR	WBL	WBT	WBR	NBL	NBT	NBR	SBL	SBT	SBR
Lane Configurations												
Traffic Volume (vph)	90	39	28	43	22	117	24	655	46	168	435	78
Future Volume (vph)	90	39	28	43	22	117	24	655	46	168	435	78
Ideal Flow (vphpl)	1800	1800	1800	1800	1800	1800	1800	1800	1800	1800	1800	1800
Storage Length (m)	30.0		0.0	30.0		0.0	35.0		0.0	50.0		140.0
Storage Lanes	1		0	1		0	1		0	1		1
Taper Length (m)	55.0			55.0			80.0			80.0		
Lane Util. Factor	1.00	1.00	1.00	1.00	1.00	1.00	1.00	1.00	1.00	1.00	1.00	1.00
Ped Bike Factor					0.98		1.00	1.00		1.00		0.97
Fr t		0.937			0.874			0.990				0.850
Flt Protected	0.950			0.950			0.950			0.950		
Satd. Flow (prot)	1558	1672	0	1340	1490	0	1209	1641	0	1695	1640	1502
Flt Permitted	0.664			0.713			0.491			0.328		
Satd. Flow (perm)	1089	1672	0	1006	1490	0	623	1641	0	585	1640	1462
Right Turn on Red			Yes			Yes			Yes			Yes
Satd. Flow (RTOR)		28			117			6				78
Link Speed (k/h)		50			50			80				80
Link Distance (m)		302.1			142.5			210.5				515.9
Travel Time (s)		21.8			10.3			9.5				23.2
Confl. Peds. (#/hr)							3		1	1		3
Confl. Bikes (#/hr)						1						1
Peak Hour Factor	1.00	1.00	1.00	1.00	1.00	1.00	1.00	1.00	1.00	1.00	1.00	1.00
Heavy Vehicles (%)	11%	2%	2%	29%	20%	2%	43%	9%	19%	2%	11%	3%
Adj. Flow (vph)	90	39	28	43	22	117	24	655	46	168	435	78
Shared Lane Traffic (%)												
Lane Group Flow (vph)	90	67	0	43	139	0	24	701	0	168	435	78
Enter Blocked Intersection	No	No	No	No	No	No	No	No	No	No	No	No
Lane Alignment	Left	Left	Right	Left	Left	Right	Left	Left	Right	Left	Left	Right
Median Width(m)		3.7			3.7			3.7				3.7
Link Offset(m)		0.0			0.0			0.0				0.0
Crosswalk Width(m)		4.9			4.9			4.9				4.9
Two way Left Turn Lane												
Headway Factor	1.06	1.06	1.06	1.06	1.06	1.06	1.06	1.06	1.06	1.06	1.06	1.06
Turning Speed (k/h)	24		14	24		14	24		14	24		14
Number of Detectors	1	2		1	2		1	2		1	2	1
Detector Template	Left	Thru		Left	Thru		Left	Thru		Left	Thru	Right
Leading Detector (m)	6.1	30.5		6.1	30.5		6.1	30.5		6.1	30.5	6.1
Trailing Detector (m)	0.0	0.0		0.0	0.0		0.0	0.0		0.0	0.0	0.0
Detector 1 Position(m)	0.0	0.0		0.0	0.0		0.0	0.0		0.0	0.0	0.0
Detector 1 Size(m)	6.1	1.8		6.1	1.8		6.1	1.8		6.1	1.8	6.1
Detector 1 Type	Cl+Ex	Cl+Ex		Cl+Ex	Cl+Ex		Cl+Ex	Cl+Ex		Cl+Ex	Cl+Ex	Cl+Ex
Detector 1 Channel												
Detector 1 Extend (s)	0.0	0.0		0.0	0.0		0.0	0.0		0.0	0.0	0.0
Detector 1 Queue (s)	0.0	0.0		0.0	0.0		0.0	0.0		0.0	0.0	0.0
Detector 1 Delay (s)	0.0	0.0		0.0	0.0		0.0	0.0		0.0	0.0	0.0
Detector 2 Position(m)		28.7			28.7			28.7				28.7
Detector 2 Size(m)		1.8			1.8			1.8				1.8
Detector 2 Type		Cl+Ex			Cl+Ex			Cl+Ex				Cl+Ex
Detector 2 Channel												
Detector 2 Extend (s)		0.0			0.0			0.0				0.0
Turn Type	Perm	NA		Perm	NA		Perm	NA		Perm	NA	Perm
Protected Phases		4			8			2			6	
Permitted Phases	4			8			2			6		6
Detector Phase	4	4		8	8		2	2		6	6	6
Switch Phase												
Minimum Initial (s)	10.0	10.0		10.0	10.0		10.0	10.0		10.0	10.0	10.0
Minimum Split (s)	32.2	32.2		32.2	32.2		28.4	28.4		28.4	28.4	28.4
Total Split (s)	37.0	37.0		37.0	37.0		53.0	53.0		53.0	53.0	53.0
Total Split (%)	41.1%	41.1%		41.1%	41.1%		58.9%	58.9%		58.9%	58.9%	58.9%
Maximum Green (s)	30.8	30.8		30.8	30.8		46.6	46.6		46.6	46.6	46.6
Yellow Time (s)	3.3	3.3		3.3	3.3		4.6	4.6		4.6	4.6	4.6

5331 Fernbank Road
2023 Background Traffic

2: Terry Fox & Cope
Timing Plan: AM Peak



Lane Group	EBL	EBT	EBR	WBL	WBT	WBR	NBL	NBT	NBR	SBL	SBT	SBR
All-Red Time (s)	2.9	2.9		2.9	2.9		1.8	1.8		1.8	1.8	1.8
Lost Time Adjust (s)	0.0	0.0		0.0	0.0		0.0	0.0		0.0	0.0	0.0
Total Lost Time (s)	6.2	6.2		6.2	6.2		6.4	6.4		6.4	6.4	6.4
Lead/Lag												
Lead-Lag Optimize?												
Vehicle Extension (s)	3.0	3.0		3.0	3.0		3.0	3.0		3.0	3.0	3.0
Recall Mode	None	None		None	None		C-Max	C-Max		C-Max	C-Max	C-Max
Walk Time (s)	7.0	7.0		7.0	7.0		7.0	7.0		7.0	7.0	7.0
Flash Dont Walk (s)	19.0	19.0		19.0	19.0		15.0	15.0		15.0	15.0	15.0
Pedestrian Calls (#/hr)	5	5		5	5		5	5		5	5	5
Act Effct Green (s)	14.8	14.8		14.8	14.8		62.6	62.6		62.6	62.6	62.6
Actuated g/C Ratio	0.16	0.16		0.16	0.16		0.70	0.70		0.70	0.70	0.70
v/c Ratio	0.50	0.22		0.26	0.41		0.06	0.61		0.41	0.38	0.07
Control Delay	42.3	21.0		34.1	11.7		5.2	8.5		11.6	8.1	2.1
Queue Delay	0.0	0.0		0.0	0.0		0.0	0.0		0.0	0.0	0.0
Total Delay	42.3	21.0		34.1	11.7		5.2	8.5		11.6	8.1	2.1
LOS	D	C		C	B		A	A		B	A	A
Approach Delay		33.2			17.0			8.3			8.2	
Approach LOS		C			B			A			A	
Queue Length 50th (m)	14.8	6.0		6.8	3.4		0.5	17.3		9.6	24.2	0.0
Queue Length 95th (m)	24.7	14.3		13.6	15.9		m3.1	150.6		35.2	63.0	5.5
Internal Link Dist (m)		278.1			118.5			186.5			491.9	
Turn Bay Length (m)	30.0			30.0			35.0			50.0		140.0
Base Capacity (vph)	372	590		344	586		432	1142		406	1140	1040
Starvation Cap Reductn	0	0		0	0		0	0		0	0	0
Spillback Cap Reductn	0	0		0	0		0	0		0	0	0
Storage Cap Reductn	0	0		0	0		0	0		0	0	0
Reduced v/c Ratio	0.24	0.11		0.13	0.24		0.06	0.61		0.41	0.38	0.07

Intersection Summary

Area Type: Other
 Cycle Length: 90
 Actuated Cycle Length: 90
 Offset: 55 (61%), Referenced to phase 2:NBTL and 6:SBTL, Start of Green
 Natural Cycle: 80
 Control Type: Actuated-Coordinated
 Maximum v/c Ratio: 0.61
 Intersection Signal Delay: 11.4 Intersection LOS: B
 Intersection Capacity Utilization 87.3% ICU Level of Service E
 Analysis Period (min) 15
 m Volume for 95th percentile queue is metered by upstream signal.

Splits and Phases: 2: Terry Fox & Cope

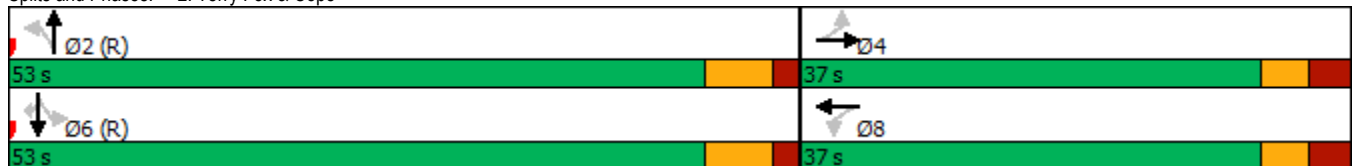

5331 Fernbank Road
2023 Background Traffic

5: Terry Fox & Fernbank
Timing Plan: AM Peak

Lane Group	EBL	EBT	EBR	WBL	WBT	WBR	NBL	NBT	NBR	SBL	SBT	SBR
Lane Configurations												
Traffic Volume (vph)	163	240	197	3	185	134	152	372	2	78	283	93
Future Volume (vph)	163	240	197	3	185	134	152	372	2	78	283	93
Ideal Flow (vphpl)	1800	1800	1800	1800	1800	1800	1800	1800	1800	1800	1800	1800
Storage Length (m)	75.0		75.0	95.0		115.0	90.0		0.0	90.0		95.0
Storage Lanes	1		1	1		1	1		0	1		1
Taper Length (m)	100.0			60.0			70.0			100.0		
Lane Util. Factor	1.00	1.00	1.00	1.00	1.00	1.00	1.00	1.00	1.00	1.00	1.00	1.00
Ped Bike Factor	1.00		0.98			0.98						
Fr t			0.850			0.850		0.999				0.850
Fit Protected	0.950			0.950			0.950			0.950		
Satd. Flow (prot)	1631	1784	1488	1695	1767	1406	1662	1732	0	1662	1717	1357
Fit Permitted	0.551			0.610			0.444			0.301		
Satd. Flow (perm)	944	1784	1457	1088	1767	1374	777	1732	0	527	1717	1357
Right Turn on Red			Yes			Yes			Yes			Yes
Satd. Flow (RTOR)			197			134						113
Link Speed (k/h)		60			60			80				80
Link Distance (m)		274.4			222.4			294.7				171.1
Travel Time (s)		16.5			13.3			13.3				7.7
Confl. Peds. (#/hr)	2					2						
Confl. Bikes (#/hr)			1									
Peak Hour Factor	1.00	1.00	1.00	1.00	1.00	1.00	1.00	1.00	1.00	1.00	1.00	1.00
Heavy Vehicles (%)	6%	2%	4%	2%	3%	10%	4%	5%	2%	4%	6%	14%
Adj. Flow (vph)	163	240	197	3	185	134	152	372	2	78	283	93
Shared Lane Traffic (%)												
Lane Group Flow (vph)	163	240	197	3	185	134	152	374	0	78	283	93
Enter Blocked Intersection	No	No	No	No	No	No	No	No	No	No	No	No
Lane Alignment	Left	Left	Right	Left	Left	Right	Left	Left	Right	Left	Left	Right
Median Width(m)		3.7			3.7			3.7				3.7
Link Offset(m)		0.0			0.0			0.0				0.0
Crosswalk Width(m)		4.9			4.9			4.9				4.9
Two way Left Turn Lane												
Headway Factor	1.06	1.06	1.06	1.06	1.06	1.06	1.06	1.06	1.06	1.06	1.06	1.06
Turning Speed (k/h)	24		14	24		14	24		14	24		14
Number of Detectors	1	2	1	1	2	1	1	2		1	2	1
Detector Template	Left	Thru	Right	Left	Thru	Right	Left	Thru		Left	Thru	Right
Leading Detector (m)	6.1	30.5	6.1	6.1	30.5	6.1	6.1	30.5		6.1	30.5	6.1
Trailing Detector (m)	0.0	0.0	0.0	0.0	0.0	0.0	0.0	0.0		0.0	0.0	0.0
Detector 1 Position(m)	0.0	0.0	0.0	0.0	0.0	0.0	0.0	0.0		0.0	0.0	0.0
Detector 1 Size(m)	6.1	1.8	6.1	6.1	1.8	6.1	6.1	1.8		6.1	1.8	6.1
Detector 1 Type	Cl+Ex	Cl+Ex	Cl+Ex	Cl+Ex	Cl+Ex	Cl+Ex	Cl+Ex	Cl+Ex		Cl+Ex	Cl+Ex	Cl+Ex
Detector 1 Channel												
Detector 1 Extend (s)	0.0	0.0	0.0	0.0	0.0	0.0	0.0	0.0		0.0	0.0	0.0
Detector 1 Queue (s)	0.0	0.0	0.0	0.0	0.0	0.0	0.0	0.0		0.0	0.0	0.0
Detector 1 Delay (s)	0.0	0.0	0.0	0.0	0.0	0.0	0.0	0.0		0.0	0.0	0.0
Detector 2 Position(m)		28.7			28.7			28.7				28.7
Detector 2 Size(m)		1.8			1.8			1.8				1.8
Detector 2 Type		Cl+Ex			Cl+Ex			Cl+Ex				Cl+Ex
Detector 2 Channel												
Detector 2 Extend (s)		0.0			0.0			0.0				0.0
Turn Type	pm+pt	NA	Perm	Perm	NA	Perm	Perm	NA		Perm	NA	Perm
Protected Phases	5	2			6			8				4
Permitted Phases	2		2	6		6	8			4		4
Detector Phase	5	2	2	6	6	6	8	8		4	4	4
Switch Phase												
Minimum Initial (s)	5.0	10.0	10.0	10.0	10.0	10.0	10.0	10.0		10.0	10.0	10.0
Minimum Split (s)	11.2	33.2	33.2	33.2	33.2	33.2	29.2	29.2		29.2	29.2	29.2
Total Split (s)	17.0	52.0	52.0	35.0	35.0	35.0	38.0	38.0		38.0	38.0	38.0
Total Split (%)	18.9%	57.8%	57.8%	38.9%	38.9%	38.9%	42.2%	42.2%		42.2%	42.2%	42.2%
Maximum Green (s)	10.9	45.8	45.8	28.8	28.8	28.8	31.8	31.8		31.8	31.8	31.8
Yellow Time (s)	3.7	3.7	3.7	3.7	3.7	3.7	4.6	4.6		4.6	4.6	4.6

5331 Fernbank Road
2023 Background Traffic

5: Terry Fox & Fernbank
Timing Plan: AM Peak



Lane Group	EBL	EBT	EBR	WBL	WBT	WBR	NBL	NBT	NBR	SBL	SBT	SBR
All-Red Time (s)	2.4	2.5	2.5	2.5	2.5	2.5	1.6	1.6		1.6	1.6	1.6
Lost Time Adjust (s)	0.0	0.0	0.0	0.0	0.0	0.0	0.0	0.0		0.0	0.0	0.0
Total Lost Time (s)	6.1	6.2	6.2	6.2	6.2	6.2	6.2	6.2		6.2	6.2	6.2
Lead/Lag	Lead			Lag			Lag					
Lead-Lag Optimize?	Yes			Yes			Yes					
Vehicle Extension (s)	3.0	3.0	3.0	3.0	3.0	3.0	3.0	3.0		3.0	3.0	3.0
Recall Mode	None	C-Max	C-Max	C-Max	C-Max	C-Max	None	None		None	None	None
Walk Time (s)		7.0	7.0	7.0	7.0	7.0	7.0	7.0		7.0	7.0	7.0
Flash Dont Walk (s)		20.0	20.0	20.0	20.0	20.0	16.0	16.0		16.0	16.0	16.0
Pedestrian Calls (#/hr)		5	5	5	5	5	5	5		5	5	5
Act Effct Green (s)	53.0	52.9	52.9	37.5	37.5	37.5	24.7	24.7		24.7	24.7	24.7
Actuated g/C Ratio	0.59	0.59	0.59	0.42	0.42	0.42	0.27	0.27		0.27	0.27	0.27
v/c Ratio	0.26	0.23	0.21	0.01	0.25	0.21	0.71	0.79		0.54	0.60	0.20
Control Delay	11.0	10.7	2.4	20.0	20.6	5.0	47.3	42.0		40.8	32.5	7.0
Queue Delay	0.0	0.0	0.0	0.0	0.0	0.0	0.0	0.0		0.0	0.0	0.0
Total Delay	11.0	10.7	2.4	20.0	20.6	5.0	47.3	42.0		40.8	32.5	7.0
LOS	B	B	A	B	C	A	D	D		D	C	A
Approach Delay		8.1			14.1			43.5			28.7	
Approach LOS		A			B			D			C	
Queue Length 50th (m)	11.9	18.3	0.0	0.3	20.4	0.0	23.6	59.7		9.1	33.1	0.0
Queue Length 95th (m)	25.5	36.6	9.8	2.3	41.1	11.9	41.2	81.5		22.7	60.4	11.4
Internal Link Dist (m)		250.4			198.4			270.7			147.1	
Turn Bay Length (m)	75.0		75.0	95.0		115.0	90.0			90.0		95.0
Base Capacity (vph)	640	1049	938	453	736	650	274	611		186	606	552
Starvation Cap Reductn	0	0	0	0	0	0	0	0		0	0	0
Spillback Cap Reductn	0	0	0	0	0	0	0	0		0	0	0
Storage Cap Reductn	0	0	0	0	0	0	0	0		0	0	0
Reduced v/c Ratio	0.25	0.23	0.21	0.01	0.25	0.21	0.55	0.61		0.42	0.47	0.17

Intersection Summary

Area Type:	Other
Cycle Length:	90
Actuated Cycle Length:	90
Offset:	9 (10%), Referenced to phase 2:EBTL and 6:WBTL, Start of Green
Natural Cycle:	75
Control Type:	Actuated-Coordinated
Maximum v/c Ratio:	0.79
Intersection Signal Delay:	23.8
Intersection LOS:	C
Intersection Capacity Utilization:	81.7%
ICU Level of Service:	D
Analysis Period (min):	15

Splits and Phases: 5: Terry Fox & Fernbank



5331 Fernbank Road
2023 Background Traffic

1: Cope & Street 1
Timing Plan: AM Peak



Movement	EBL	EBT	WBT	WBR	SBL	SBR
Lane Configurations						
Traffic Volume (veh/h)	13	240	178	6	17	4
Future Volume (Veh/h)	13	240	178	6	17	4
Sign Control		Free	Free		Stop	
Grade		0%	0%		0%	
Peak Hour Factor	1.00	1.00	1.00	1.00	1.00	1.00
Hourly flow rate (vph)	13	240	178	6	17	4
Pedestrians						
Lane Width (m)						
Walking Speed (m/s)						
Percent Blockage						
Right turn flare (veh)						
Median type		None	None			
Median storage veh						
Upstream signal (m)		143				
pX, platoon unblocked						
vC, conflicting volume	184				447	181
vC1, stage 1 conf vol						
vC2, stage 2 conf vol						
vCu, unblocked vol	184				447	181
tC, single (s)	4.1				6.4	6.2
tC, 2 stage (s)						
tF (s)	2.2				3.5	3.3
p0 queue free %	99				97	100
cM capacity (veh/h)	1391				564	862
Direction, Lane #	EB 1	EB 2	WB 1	SB 1		
Volume Total	13	240	184	21		
Volume Left	13	0	0	17		
Volume Right	0	0	6	4		
cSH	1391	1700	1700	604		
Volume to Capacity	0.01	0.14	0.11	0.03		
Queue Length 95th (m)	0.2	0.0	0.0	0.8		
Control Delay (s)	7.6	0.0	0.0	11.2		
Lane LOS	A			B		
Approach Delay (s)	0.4			11.2		
Approach LOS				B		
Intersection Summary						
Average Delay			0.7			
Intersection Capacity Utilization			23.3%	ICU Level of Service	A	
Analysis Period (min)			15			

5331 Fernbank Road
2023 Background Traffic

2: Terry Fox & Cope
Timing Plan: PM Peak

Lane Group	EBL	EBT	EBR	WBL	WBT	WBR	NBL	NBT	NBR	SBL	SBT	SBR
Lane Configurations												
Traffic Volume (vph)	116	38	18	67	24	196	18	560	58	247	783	122
Future Volume (vph)	116	38	18	67	24	196	18	560	58	247	783	122
Ideal Flow (vphpl)	1800	1800	1800	1800	1800	1800	1800	1800	1800	1800	1800	1800
Storage Length (m)	30.0		0.0	30.0		0.0	35.0		0.0	50.0		140.0
Storage Lanes	1		0	1		0	1		0	1		1
Taper Length (m)	55.0			55.0			80.0			80.0		
Lane Util. Factor	1.00	1.00	1.00	1.00	1.00	1.00	1.00	1.00	1.00	1.00	1.00	1.00
Ped Bike Factor		0.99		1.00			1.00					0.97
Fr _t		0.952			0.866			0.986				0.850
Flt Protected	0.950			0.950			0.950			0.950		
Satd. Flow (prot)	1695	1687	0	1601	1545	0	1695	1715	0	1695	1784	1517
Flt Permitted	0.433			0.720			0.369			0.238		
Satd. Flow (perm)	773	1687	0	1211	1545	0	657	1715	0	425	1784	1475
Right Turn on Red			Yes			Yes			Yes			Yes
Satd. Flow (RTOR)		18			196			7				122
Link Speed (k/h)		50			50			80				80
Link Distance (m)		302.1			142.5			210.5				515.9
Travel Time (s)		21.8			10.3			9.5				23.2
Confl. Peds. (#/hr)			1	1			3					3
Confl. Bikes (#/hr)												1
Peak Hour Factor	1.00	1.00	1.00	1.00	1.00	1.00	1.00	1.00	1.00	1.00	1.00	1.00
Heavy Vehicles (%)	2%	2%	2%	8%	2%	2%	2%	4%	11%	2%	2%	2%
Adj. Flow (vph)	116	38	18	67	24	196	18	560	58	247	783	122
Shared Lane Traffic (%)												
Lane Group Flow (vph)	116	56	0	67	220	0	18	618	0	247	783	122
Enter Blocked Intersection	No	No	No	No	No	No	No	No	No	No	No	No
Lane Alignment	Left	Left	Right	Left	Left	Right	Left	Left	Right	Left	Left	Right
Median Width(m)		3.7			3.7			3.7				3.7
Link Offset(m)		0.0			0.0			0.0				0.0
Crosswalk Width(m)		4.9			4.9			4.9				4.9
Two way Left Turn Lane												
Headway Factor	1.06	1.06	1.06	1.06	1.06	1.06	1.06	1.06	1.06	1.06	1.06	1.06
Turning Speed (k/h)	24		14	24		14	24		14	24		14
Number of Detectors	1	2		1	2		1	2		1	2	1
Detector Template	Left	Thru		Left	Thru		Left	Thru		Left	Thru	Right
Leading Detector (m)	6.1	30.5		6.1	30.5		6.1	30.5		6.1	30.5	6.1
Trailing Detector (m)	0.0	0.0		0.0	0.0		0.0	0.0		0.0	0.0	0.0
Detector 1 Position(m)	0.0	0.0		0.0	0.0		0.0	0.0		0.0	0.0	0.0
Detector 1 Size(m)	6.1	1.8		6.1	1.8		6.1	1.8		6.1	1.8	6.1
Detector 1 Type	Cl+Ex	Cl+Ex		Cl+Ex	Cl+Ex		Cl+Ex	Cl+Ex		Cl+Ex	Cl+Ex	Cl+Ex
Detector 1 Channel												
Detector 1 Extend (s)	0.0	0.0		0.0	0.0		0.0	0.0		0.0	0.0	0.0
Detector 1 Queue (s)	0.0	0.0		0.0	0.0		0.0	0.0		0.0	0.0	0.0
Detector 1 Delay (s)	0.0	0.0		0.0	0.0		0.0	0.0		0.0	0.0	0.0
Detector 2 Position(m)		28.7			28.7			28.7			28.7	
Detector 2 Size(m)		1.8			1.8			1.8			1.8	
Detector 2 Type		Cl+Ex			Cl+Ex			Cl+Ex			Cl+Ex	
Detector 2 Channel												
Detector 2 Extend (s)		0.0			0.0			0.0			0.0	
Turn Type	Perm	NA		Perm	NA		Perm	NA		pm+pt	NA	Perm
Protected Phases		4			8			2		1	6	
Permitted Phases	4			8			2		6			6
Detector Phase	4	4		8	8		2	2		1	6	6
Switch Phase												
Minimum Initial (s)	10.0	10.0		10.0	10.0		10.0	10.0		5.0	10.0	10.0
Minimum Split (s)	32.2	32.2		32.2	32.2		28.4	28.4		11.4	28.4	28.4
Total Split (s)	37.0	37.0		37.0	37.0		51.0	51.0		12.0	63.0	63.0
Total Split (%)	37.0%	37.0%		37.0%	37.0%		51.0%	51.0%		12.0%	63.0%	63.0%
Maximum Green (s)	30.8	30.8		30.8	30.8		44.6	44.6		5.6	56.6	56.6
Yellow Time (s)	3.3	3.3		3.3	3.3		4.6	4.6		4.6	4.6	4.6

5331 Fernbank Road
2023 Background Traffic

2: Terry Fox & Cope
Timing Plan: PM Peak

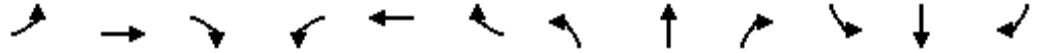

Lane Group	EBL	EBT	EBR	WBL	WBT	WBR	NBL	NBT	NBR	SBL	SBT	SBR
All-Red Time (s)	2.9	2.9		2.9	2.9		1.8	1.8		1.8	1.8	1.8
Lost Time Adjust (s)	0.0	0.0		0.0	0.0		0.0	0.0		0.0	0.0	0.0
Total Lost Time (s)	6.2	6.2		6.2	6.2		6.4	6.4		6.4	6.4	6.4
Lead/Lag							Lag	Lag		Lead		
Lead-Lag Optimize?							Yes	Yes		Yes		
Vehicle Extension (s)	3.0	3.0		3.0	3.0		3.0	3.0		3.0	3.0	3.0
Recall Mode	None	None		None	None		C-Max	C-Max		None	C-Max	C-Max
Walk Time (s)	7.0	7.0		7.0	7.0		7.0	7.0		7.0	7.0	7.0
Flash Dont Walk (s)	19.0	19.0		19.0	19.0		15.0	15.0		15.0	15.0	15.0
Pedestrian Calls (#/hr)	5	5		5	5		5	5		5	5	5
Act Effct Green (s)	17.5	17.5		17.5	17.5		51.0	51.0		69.9	69.9	69.9
Actuated g/C Ratio	0.18	0.18		0.18	0.18		0.51	0.51		0.70	0.70	0.70
v/c Ratio	0.86	0.18		0.32	0.51		0.05	0.70		0.54	0.63	0.11
Control Delay	86.5	25.0		37.7	11.0		13.4	24.9		11.0	12.2	1.6
Queue Delay	0.0	0.0		0.0	0.0		0.0	0.0		0.0	0.0	0.0
Total Delay	86.5	25.0		37.7	11.0		13.4	24.9		11.0	12.2	1.6
LOS	F	C		D	B		B	C		B	B	A
Approach Delay		66.5			17.3			24.6				10.8
Approach LOS		E			B			C				B
Queue Length 50th (m)	22.2	6.3		11.5	4.0		2.1	98.2		14.5	70.0	0.0
Queue Length 95th (m)	38.7	15.1		21.5	21.1		m5.8	#161.9		31.8	140.9	6.3
Internal Link Dist (m)		278.1			118.5			186.5			491.9	
Turn Bay Length (m)	30.0			30.0			35.0			50.0		140.0
Base Capacity (vph)	238	532		372	611		335	878		455	1247	1068
Starvation Cap Reductn	0	0		0	0		0	0		0	0	0
Spillback Cap Reductn	0	0		0	0		0	0		0	0	0
Storage Cap Reductn	0	0		0	0		0	0		0	0	0
Reduced v/c Ratio	0.49	0.11		0.18	0.36		0.05	0.70		0.54	0.63	0.11

Intersection Summary

Area Type: Other
 Cycle Length: 100
 Actuated Cycle Length: 100
 Offset: 69 (69%), Referenced to phase 2:NBTL and 6:SBTL, Start of Green
 Natural Cycle: 90
 Control Type: Actuated-Coordinated
 Maximum v/c Ratio: 0.86
 Intersection Signal Delay: 19.8
 Intersection LOS: B
 Intersection Capacity Utilization 95.3%
 ICU Level of Service F
 Analysis Period (min) 15
 # 95th percentile volume exceeds capacity, queue may be longer.
 Queue shown is maximum after two cycles.
 m Volume for 95th percentile queue is metered by upstream signal.

Splits and Phases: 2: Terry Fox & Cope



5331 Fernbank Road
2023 Background Traffic

5: Terry Fox & Fernbank
Timing Plan: PM Peak

Lane Group	EBL	EBT	EBR	WBL	WBT	WBR	NBL	NBT	NBR	SBL	SBT	SBR
Lane Configurations												
Traffic Volume (vph)	111	239	140	5	314	109	264	356	23	192	461	163
Future Volume (vph)	111	239	140	5	314	109	264	356	23	192	461	163
Ideal Flow (vphpl)	1800	1800	1800	1800	1800	1800	1800	1800	1800	1800	1800	1800
Storage Length (m)	75.0		75.0	95.0		115.0	90.0		0.0	90.0		95.0
Storage Lanes	1		1	1		1	1		0	1		1
Taper Length (m)	100.0			60.0			70.0			100.0		
Lane Util. Factor	1.00	1.00	1.00	1.00	1.00	1.00	1.00	1.00	1.00	1.00	1.00	1.00
Ped Bike Factor	1.00		0.97	0.99		0.97				1.00		0.96
Fr t			0.850			0.850		0.991				0.850
Fit Protected	0.950			0.950			0.950			0.950		
Satd. Flow (prot)	1631	1784	1502	1235	1784	1459	1695	1768	0	1695	1784	1488
Fit Permitted	0.315			0.610			0.164			0.537		
Satd. Flow (perm)	540	1784	1461	789	1784	1421	293	1768	0	954	1784	1429
Right Turn on Red			Yes			Yes			Yes			Yes
Satd. Flow (RTOR)			140			172		4				172
Link Speed (k/h)		60			60			80			80	
Link Distance (m)		274.4			222.4			294.7			171.1	
Travel Time (s)		16.5			13.3			13.3			7.7	
Confl. Peds. (#/hr)	2		4	4		2	9			3		9
Confl. Bikes (#/hr)						2						
Peak Hour Factor	1.00	1.00	1.00	1.00	1.00	1.00	1.00	1.00	1.00	1.00	1.00	1.00
Heavy Vehicles (%)	6%	2%	3%	40%	2%	6%	2%	2%	2%	2%	2%	4%
Adj. Flow (vph)	111	239	140	5	314	109	264	356	23	192	461	163
Shared Lane Traffic (%)												
Lane Group Flow (vph)	111	239	140	5	314	109	264	379	0	192	461	163
Enter Blocked Intersection	No	No	No	No	No	No	No	No	No	No	No	No
Lane Alignment	Left	Left	Right	Left	Left	Right	Left	Left	Right	Left	Left	Right
Median Width(m)		3.7			3.7			3.7			3.7	
Link Offset(m)		0.0			0.0			0.0			0.0	
Crosswalk Width(m)		4.9			4.9			4.9			4.9	
Two way Left Turn Lane												
Headway Factor	1.06	1.06	1.06	1.06	1.06	1.06	1.06	1.06	1.06	1.06	1.06	1.06
Turning Speed (k/h)	24		14	24		14	24		14	24		14
Number of Detectors	1	2	1	1	2	1	1	2		1	2	1
Detector Template	Left	Thru	Right	Left	Thru	Right	Left	Thru		Left	Thru	Right
Leading Detector (m)	6.1	30.5	6.1	6.1	30.5	6.1	6.1	30.5		6.1	30.5	6.1
Trailing Detector (m)	0.0	0.0	0.0	0.0	0.0	0.0	0.0	0.0		0.0	0.0	0.0
Detector 1 Position(m)	0.0	0.0	0.0	0.0	0.0	0.0	0.0	0.0		0.0	0.0	0.0
Detector 1 Size(m)	6.1	1.8	6.1	6.1	1.8	6.1	6.1	1.8		6.1	1.8	6.1
Detector 1 Type	Cl+Ex	Cl+Ex	Cl+Ex	Cl+Ex	Cl+Ex	Cl+Ex	Cl+Ex	Cl+Ex		Cl+Ex	Cl+Ex	Cl+Ex
Detector 1 Channel												
Detector 1 Extend (s)	0.0	0.0	0.0	0.0	0.0	0.0	0.0	0.0		0.0	0.0	0.0
Detector 1 Queue (s)	0.0	0.0	0.0	0.0	0.0	0.0	0.0	0.0		0.0	0.0	0.0
Detector 1 Delay (s)	0.0	0.0	0.0	0.0	0.0	0.0	0.0	0.0		0.0	0.0	0.0
Detector 2 Position(m)		28.7			28.7			28.7			28.7	
Detector 2 Size(m)		1.8			1.8			1.8			1.8	
Detector 2 Type		Cl+Ex			Cl+Ex			Cl+Ex			Cl+Ex	
Detector 2 Channel												
Detector 2 Extend (s)		0.0			0.0			0.0			0.0	
Turn Type	pm+pt	NA	Perm	Perm	NA	Perm	pm+pt	NA		Perm	NA	Perm
Protected Phases	5	2			6		3	8			4	
Permitted Phases	2		2	6		6	8		4			4
Detector Phase	5	2	2	6	6	6	3	8		4	4	4
Switch Phase												
Minimum Initial (s)	5.0	10.0	10.0	10.0	10.0	10.0	5.0	10.0		10.0	10.0	10.0
Minimum Split (s)	11.2	33.2	33.2	33.2	33.2	33.2	11.5	29.2		29.2	29.2	29.2
Total Split (s)	12.0	46.0	46.0	34.0	34.0	34.0	15.0	54.0		39.0	39.0	39.0
Total Split (%)	12.0%	46.0%	46.0%	34.0%	34.0%	34.0%	15.0%	54.0%		39.0%	39.0%	39.0%
Maximum Green (s)	5.9	39.8	39.8	27.8	27.8	27.8	8.5	47.8		32.8	32.8	32.8
Yellow Time (s)	3.7	3.7	3.7	3.7	3.7	3.7	4.6	4.6		4.6	4.6	4.6

5331 Fernbank Road
2023 Background Traffic

5: Terry Fox & Fernbank
Timing Plan: PM Peak



Lane Group	EBL	EBT	EBR	WBL	WBT	WBR	NBL	NBT	NBR	SBL	SBT	SBR
All-Red Time (s)	2.4	2.5	2.5	2.5	2.5	2.5	1.9	1.6		1.6	1.6	1.6
Lost Time Adjust (s)	0.0	0.0	0.0	0.0	0.0	0.0	0.0	0.0		0.0	0.0	0.0
Total Lost Time (s)	6.1	6.2	6.2	6.2	6.2	6.2	6.5	6.2		6.2	6.2	6.2
Lead/Lag	Lead			Lag			Lead			Lag		Lag
Lead-Lag Optimize?	Yes			Yes			Yes			Yes		Yes
Vehicle Extension (s)	3.0	3.0	3.0	3.0	3.0	3.0	3.0	3.0		3.0	3.0	3.0
Recall Mode	C-Max	C-Max	C-Max	Max	Max	Max	None	None		None	None	None
Walk Time (s)	7.0	7.0	7.0	7.0	7.0	7.0	7.0	7.0		7.0	7.0	7.0
Flash Dont Walk (s)		20.0	20.0	20.0	20.0	20.0		16.0		16.0	16.0	16.0
Pedestrian Calls (#/hr)		5	5	5	5	5		5		5	5	5
Act Effct Green (s)	42.8	42.7	42.7	27.8	27.8	27.8	44.6	44.9		29.9	29.9	29.9
Actuated g/C Ratio	0.43	0.43	0.43	0.28	0.28	0.28	0.45	0.45		0.30	0.30	0.30
v/c Ratio	0.34	0.31	0.20	0.02	0.63	0.21	1.06	0.48		0.68	0.87	0.30
Control Delay	22.0	21.3	4.1	26.8	38.4	1.7	96.4	20.9		49.6	54.8	12.4
Queue Delay	0.0	0.0	0.0	0.0	0.0	0.0	0.0	0.0		0.0	0.0	0.0
Total Delay	22.0	21.3	4.1	26.8	38.4	1.7	96.4	20.9		49.6	54.8	12.4
LOS	C	C	A	C	D	A	F	C		D	D	B
Approach Delay		16.6			28.9			51.9			45.1	
Approach LOS		B			C			D			D	
Queue Length 50th (m)	13.6	31.5	0.0	0.7	53.3	0.0	~32.2	46.7		30.1	73.0	2.0
Queue Length 95th (m)	25.2	50.4	11.1	3.5	81.7	2.7	#79.5	70.1		59.1	#126.2	m25.4
Internal Link Dist (m)		250.4			198.4			270.7			147.1	
Turn Bay Length (m)	75.0		75.0	95.0		115.0	90.0			90.0		95.0
Base Capacity (vph)	327	762	704	219	495	519	249	847		312	585	584
Starvation Cap Reductn	0	0	0	0	0	0	0	0		0	0	0
Spillback Cap Reductn	0	0	0	0	0	0	0	0		0	0	0
Storage Cap Reductn	0	0	0	0	0	0	0	0		0	0	0
Reduced v/c Ratio	0.34	0.31	0.20	0.02	0.63	0.21	1.06	0.45		0.62	0.79	0.28

Intersection Summary

Area Type: Other
 Cycle Length: 100
 Actuated Cycle Length: 100
 Offset: 79 (79%), Referenced to phase 2:EBTL and 5:EBL, Start of Green
 Natural Cycle: 90
 Control Type: Actuated-Coordinated
 Maximum v/c Ratio: 1.06
 Intersection Signal Delay: 38.1
 Intersection LOS: D
 Intersection Capacity Utilization 92.8%
 ICU Level of Service F
 Analysis Period (min) 15
 ~ Volume exceeds capacity, queue is theoretically infinite.
 Queue shown is maximum after two cycles.
 # 95th percentile volume exceeds capacity, queue may be longer.
 Queue shown is maximum after two cycles.
 m Volume for 95th percentile queue is metered by upstream signal.

Splits and Phases: 5: Terry Fox & Fernbank

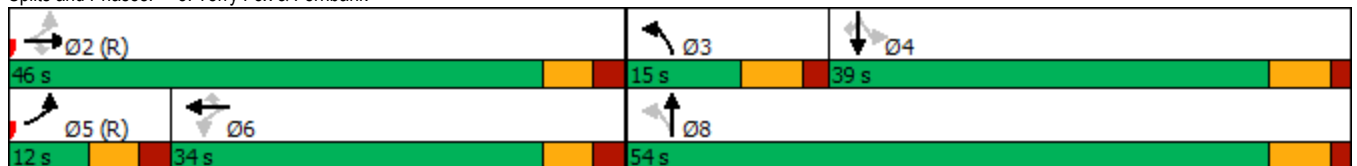

5331 Fernbank Road
2023 Background Traffic

1: Cope & Street 1
Timing Plan: PM Peak

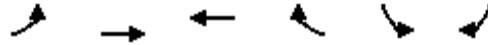

Movement	EBL	EBT	WBT	WBR	SBL	SBR
Lane Configurations						
Traffic Volume (veh/h)	42	301	285	21	9	2
Future Volume (Veh/h)	42	301	285	21	9	2
Sign Control		Free	Free		Stop	
Grade		0%	0%		0%	
Peak Hour Factor	1.00	1.00	1.00	1.00	1.00	1.00
Hourly flow rate (vph)	42	301	285	21	9	2
Pedestrians						
Lane Width (m)						
Walking Speed (m/s)						
Percent Blockage						
Right turn flare (veh)						
Median type		None	None			
Median storage (veh)						
Upstream signal (m)		143				
pX, platoon unblocked					0.98	
vC, conflicting volume	306				680	296
vC1, stage 1 conf vol						
vC2, stage 2 conf vol						
vCu, unblocked vol	306				664	296
tC, single (s)	4.1				6.4	6.2
tC, 2 stage (s)						
tF (s)	2.2				3.5	3.3
p0 queue free %	97				98	100
cM capacity (veh/h)	1255				403	744
Direction, Lane #	EB 1	EB 2	WB 1	SB 1		
Volume Total	42	301	306	11		
Volume Left	42	0	0	9		
Volume Right	0	0	21	2		
cSH	1255	1700	1700	440		
Volume to Capacity	0.03	0.18	0.18	0.03		
Queue Length 95th (m)	0.8	0.0	0.0	0.6		
Control Delay (s)	8.0	0.0	0.0	13.4		
Lane LOS	A			B		
Approach Delay (s)	1.0		0.0	13.4		
Approach LOS				B		
Intersection Summary						
Average Delay			0.7			
Intersection Capacity Utilization			33.8%		ICU Level of Service	A
Analysis Period (min)			15			

5331 Fernbank Road
2023 Background Traffic (Optimized)

5: Terry Fox & Fernbank
Timing Plan: PM Peak



Lane Group	EBL	EBT	EBR	WBL	WBT	WBR	NBL	NBT	NBR	SBL	SBT	SBR
Lane Configurations												
Traffic Volume (vph)	111	239	140	5	314	109	264	356	23	192	461	163
Future Volume (vph)	111	239	140	5	314	109	264	356	23	192	461	163
Ideal Flow (vphpl)	1800	1800	1800	1800	1800	1800	1800	1800	1800	1800	1800	1800
Storage Length (m)	75.0		75.0	95.0		115.0	90.0		0.0	90.0		95.0
Storage Lanes	1		1	1		1	1		0	1		1
Taper Length (m)	100.0			60.0			70.0			100.0		
Lane Util. Factor	1.00	1.00	1.00	1.00	1.00	1.00	1.00	1.00	1.00	1.00	1.00	1.00
Ped Bike Factor	1.00		0.97	0.99		0.97				1.00		0.96
Fr t			0.850			0.850		0.991				0.850
Fit Protected	0.950			0.950			0.950			0.950		
Satd. Flow (prot)	1631	1784	1502	1235	1784	1459	1695	1768	0	1695	1784	1488
Fit Permitted	0.257			0.610			0.149			0.537		
Satd. Flow (perm)	440	1784	1459	788	1784	1419	266	1768	0	954	1784	1424
Right Turn on Red			Yes			Yes			Yes			Yes
Satd. Flow (RTOR)			140			144		4				163
Link Speed (k/h)		60			60			80			80	
Link Distance (m)		274.4			222.4			294.7			171.1	
Travel Time (s)		16.5			13.3			13.3			7.7	
Confl. Peds. (#/hr)	2		4	4		2	9			3		9
Confl. Bikes (#/hr)						2						
Peak Hour Factor	1.00	1.00	1.00	1.00	1.00	1.00	1.00	1.00	1.00	1.00	1.00	1.00
Heavy Vehicles (%)	6%	2%	3%	40%	2%	6%	2%	2%	2%	2%	2%	4%
Adj. Flow (vph)	111	239	140	5	314	109	264	356	23	192	461	163
Shared Lane Traffic (%)												
Lane Group Flow (vph)	111	239	140	5	314	109	264	379	0	192	461	163
Enter Blocked Intersection	No	No	No	No	No	No	No	No	No	No	No	No
Lane Alignment	Left	Left	Right	Left	Left	Right	Left	Left	Right	Left	Left	Right
Median Width(m)		3.7			3.7			3.7			3.7	
Link Offset(m)		0.0			0.0			0.0			0.0	
Crosswalk Width(m)		4.9			4.9			4.9			4.9	
Two way Left Turn Lane												
Headway Factor	1.06	1.06	1.06	1.06	1.06	1.06	1.06	1.06	1.06	1.06	1.06	1.06
Turning Speed (k/h)	24		14	24		14	24		14	24		14
Number of Detectors	1	2	1	1	2	1	1	2		1	2	1
Detector Template	Left	Thru	Right	Left	Thru	Right	Left	Thru		Left	Thru	Right
Leading Detector (m)	6.1	30.5	6.1	6.1	30.5	6.1	6.1	30.5		6.1	30.5	6.1
Trailing Detector (m)	0.0	0.0	0.0	0.0	0.0	0.0	0.0	0.0		0.0	0.0	0.0
Detector 1 Position(m)	0.0	0.0	0.0	0.0	0.0	0.0	0.0	0.0		0.0	0.0	0.0
Detector 1 Size(m)	6.1	1.8	6.1	6.1	1.8	6.1	6.1	1.8		6.1	1.8	6.1
Detector 1 Type	Cl+Ex	Cl+Ex	Cl+Ex	Cl+Ex	Cl+Ex	Cl+Ex	Cl+Ex	Cl+Ex		Cl+Ex	Cl+Ex	Cl+Ex
Detector 1 Channel												
Detector 1 Extend (s)	0.0	0.0	0.0	0.0	0.0	0.0	0.0	0.0		0.0	0.0	0.0
Detector 1 Queue (s)	0.0	0.0	0.0	0.0	0.0	0.0	0.0	0.0		0.0	0.0	0.0
Detector 1 Delay (s)	0.0	0.0	0.0	0.0	0.0	0.0	0.0	0.0		0.0	0.0	0.0
Detector 2 Position(m)		28.7			28.7			28.7			28.7	
Detector 2 Size(m)		1.8			1.8			1.8			1.8	
Detector 2 Type		Cl+Ex			Cl+Ex			Cl+Ex			Cl+Ex	
Detector 2 Channel												
Detector 2 Extend (s)		0.0			0.0			0.0			0.0	
Turn Type	pm+pt	NA	Perm	Perm	NA	Perm	pm+pt	NA		Perm	NA	Perm
Protected Phases	5	2			6		3	8			4	
Permitted Phases	2		2	6		6	8		4		4	4
Detector Phase	5	2	2	6	6	6	3	8		4	4	4
Switch Phase												
Minimum Initial (s)	5.0	10.0	10.0	10.0	10.0	10.0	5.0	10.0		10.0	10.0	10.0
Minimum Split (s)	11.2	33.2	33.2	33.2	33.2	33.2	11.5	29.2		29.2	29.2	29.2
Total Split (s)	17.0	52.0	52.0	35.0	35.0	35.0	22.0	68.0		46.0	46.0	46.0
Total Split (%)	14.2%	43.3%	43.3%	29.2%	29.2%	29.2%	18.3%	56.7%		38.3%	38.3%	38.3%
Maximum Green (s)	10.9	45.8	45.8	28.8	28.8	28.8	15.5	61.8		39.8	39.8	39.8
Yellow Time (s)	3.7	3.7	3.7	3.7	3.7	3.7	4.6	4.6		4.6	4.6	4.6

5331 Fernbank Road
2023 Background Traffic (Optimized)

5: Terry Fox & Fernbank
Timing Plan: PM Peak



Lane Group	EBL	EBT	EBR	WBL	WBT	WBR	NBL	NBT	NBR	SBL	SBT	SBR
All-Red Time (s)	2.4	2.5	2.5	2.5	2.5	2.5	1.9	1.6		1.6	1.6	1.6
Lost Time Adjust (s)	0.0	0.0	0.0	0.0	0.0	0.0	0.0	0.0		0.0	0.0	0.0
Total Lost Time (s)	6.1	6.2	6.2	6.2	6.2	6.2	6.5	6.2		6.2	6.2	6.2
Lead/Lag	Lead			Lag			Lead			Lag		Lag
Lead-Lag Optimize?	Yes			Yes			Yes			Yes		Yes
Vehicle Extension (s)	3.0	3.0	3.0	3.0	3.0	3.0	3.0	3.0		3.0	3.0	3.0
Recall Mode	C-Max	C-Max	C-Max	Max	Max	Max	None	None		None	None	None
Walk Time (s)		7.0	7.0	7.0	7.0	7.0		7.0		7.0	7.0	7.0
Flash Dont Walk (s)		20.0	20.0	20.0	20.0	20.0		16.0		16.0	16.0	16.0
Pedestrian Calls (#/hr)		5	5	5	5	5		5		5	5	5
Act Effct Green (s)	50.6	50.5	50.5	28.8	28.8	28.8	56.8	57.1		35.5	35.5	35.5
Actuated g/C Ratio	0.42	0.42	0.42	0.24	0.24	0.24	0.47	0.48		0.30	0.30	0.30
v/c Ratio	0.33	0.32	0.20	0.03	0.73	0.24	0.87	0.45		0.68	0.87	0.30
Control Delay	26.1	26.1	4.7	35.6	53.5	3.8	49.8	22.0		49.6	57.9	5.9
Queue Delay	0.0	0.0	0.0	0.0	0.0	0.0	0.0	0.0		0.0	0.0	0.0
Total Delay	26.1	26.1	4.7	35.6	53.5	3.8	49.8	22.0		49.6	57.9	5.9
LOS	C	C	A	D	D	A	D	C		D	E	A
Approach Delay		20.0			40.6			33.4			45.6	
Approach LOS		B			D			C			D	
Queue Length 50th (m)	16.6	38.6	0.0	0.9	68.5	0.0	36.0	54.6		38.7	100.0	0.0
Queue Length 95th (m)	30.0	60.5	12.5	4.3	100.9	7.2	#76.8	76.1		63.7	137.8	14.5
Internal Link Dist (m)		250.4			198.4			270.7			147.1	
Turn Bay Length (m)	75.0		75.0	95.0		115.0	90.0			90.0		95.0
Base Capacity (vph)	340	750	694	189	428	450	310	912		316	591	581
Starvation Cap Reductn	0	0	0	0	0	0	0	0		0	0	0
Spillback Cap Reductn	0	0	0	0	0	0	0	0		0	0	0
Storage Cap Reductn	0	0	0	0	0	0	0	0		0	0	0
Reduced v/c Ratio	0.33	0.32	0.20	0.03	0.73	0.24	0.85	0.42		0.61	0.78	0.28

Intersection Summary

Area Type: Other
 Cycle Length: 120
 Actuated Cycle Length: 120
 Offset: 0 (0%), Referenced to phase 2:EBTL and 5:EBL, Start of Green
 Natural Cycle: 90
 Control Type: Actuated-Coordinated
 Maximum v/c Ratio: 0.87
 Intersection Signal Delay: 36.1
 Intersection LOS: D
 Intersection Capacity Utilization 92.8%
 ICU Level of Service F
 Analysis Period (min) 15
 # 95th percentile volume exceeds capacity, queue may be longer.
 Queue shown is maximum after two cycles.

Splits and Phases: 5: Terry Fox & Fernbank

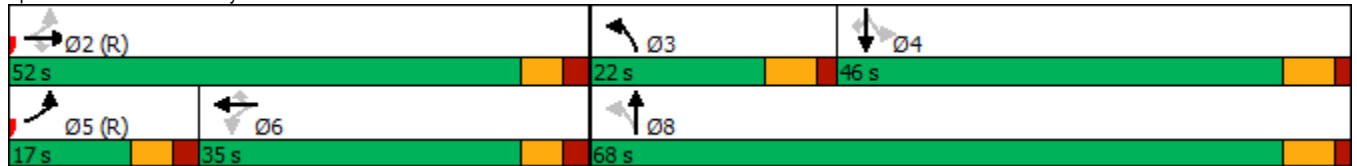

5331 Fernbank Road
2028 Background Traffic

2: Terry Fox & Cope
Timing Plan: AM Peak

Lane Group	EBL	EBT	EBR	WBL	WBT	WBR	NBL	NBT	NBR	SBL	SBT	SBR
Lane Configurations												
Traffic Volume (vph)	160	63	51	43	39	117	40	760	46	168	518	127
Future Volume (vph)	160	63	51	43	39	117	40	760	46	168	518	127
Ideal Flow (vphpl)	1800	1800	1800	1800	1800	1800	1800	1800	1800	1800	1800	1800
Storage Length (m)	30.0		0.0	30.0		0.0	35.0		0.0	50.0		140.0
Storage Lanes	1		0	1		0	1		0	1		1
Taper Length (m)	55.0			55.0			80.0			80.0		
Lane Util. Factor	1.00	1.00	1.00	1.00	1.00	1.00	1.00	1.00	1.00	1.00	1.00	1.00
Ped Bike Factor					0.98		1.00	1.00				0.97
Fr t		0.933			0.887			0.991				0.850
Flt Protected	0.950			0.950			0.950			0.950		
Satd. Flow (prot)	1558	1665	0	1340	1492	0	1209	1644	0	1695	1640	1502
Flt Permitted	0.638			0.684			0.422			0.245		
Satd. Flow (perm)	1046	1665	0	965	1492	0	536	1644	0	437	1640	1462
Right Turn on Red			Yes			Yes			Yes			Yes
Satd. Flow (RTOR)		49			117			5				127
Link Speed (k/h)		50			50			80				80
Link Distance (m)		302.1			142.5			210.5				515.9
Travel Time (s)		21.8			10.3			9.5				23.2
Confl. Peds. (#/hr)							3		1	1		3
Confl. Bikes (#/hr)						1						1
Peak Hour Factor	1.00	1.00	1.00	1.00	1.00	1.00	1.00	1.00	1.00	1.00	1.00	1.00
Heavy Vehicles (%)	11%	2%	2%	29%	20%	2%	43%	9%	19%	2%	11%	3%
Adj. Flow (vph)	160	63	51	43	39	117	40	760	46	168	518	127
Shared Lane Traffic (%)												
Lane Group Flow (vph)	160	114	0	43	156	0	40	806	0	168	518	127
Enter Blocked Intersection	No	No	No	No	No	No	No	No	No	No	No	No
Lane Alignment	Left	Left	Right	Left	Left	Right	Left	Left	Right	Left	Left	Right
Median Width(m)		3.7			3.7			3.7				3.7
Link Offset(m)		0.0			0.0			0.0				0.0
Crosswalk Width(m)		4.9			4.9			4.9				4.9
Two way Left Turn Lane												
Headway Factor	1.06	1.06	1.06	1.06	1.06	1.06	1.06	1.06	1.06	1.06	1.06	1.06
Turning Speed (k/h)	24		14	24		14	24		14	24		14
Number of Detectors	1	2		1	2		1	2		1	2	1
Detector Template	Left	Thru		Left	Thru		Left	Thru		Left	Thru	Right
Leading Detector (m)	6.1	30.5		6.1	30.5		6.1	30.5		6.1	30.5	6.1
Trailing Detector (m)	0.0	0.0		0.0	0.0		0.0	0.0		0.0	0.0	0.0
Detector 1 Position(m)	0.0	0.0		0.0	0.0		0.0	0.0		0.0	0.0	0.0
Detector 1 Size(m)	6.1	1.8		6.1	1.8		6.1	1.8		6.1	1.8	6.1
Detector 1 Type	Cl+Ex	Cl+Ex		Cl+Ex	Cl+Ex		Cl+Ex	Cl+Ex		Cl+Ex	Cl+Ex	Cl+Ex
Detector 1 Channel												
Detector 1 Extend (s)	0.0	0.0		0.0	0.0		0.0	0.0		0.0	0.0	0.0
Detector 1 Queue (s)	0.0	0.0		0.0	0.0		0.0	0.0		0.0	0.0	0.0
Detector 1 Delay (s)	0.0	0.0		0.0	0.0		0.0	0.0		0.0	0.0	0.0
Detector 2 Position(m)		28.7			28.7			28.7			28.7	
Detector 2 Size(m)		1.8			1.8			1.8			1.8	
Detector 2 Type		Cl+Ex			Cl+Ex			Cl+Ex			Cl+Ex	
Detector 2 Channel												
Detector 2 Extend (s)		0.0			0.0			0.0			0.0	
Turn Type	Perm	NA		Perm	NA		Perm	NA		Perm	NA	Perm
Protected Phases		4			8			2			6	
Permitted Phases	4			8			2			6		6
Detector Phase	4	4		8	8		2	2		6	6	6
Switch Phase												
Minimum Initial (s)	10.0	10.0		10.0	10.0		10.0	10.0		10.0	10.0	10.0
Minimum Split (s)	32.2	32.2		32.2	32.2		28.4	28.4		28.4	28.4	28.4
Total Split (s)	37.0	37.0		37.0	37.0		53.0	53.0		53.0	53.0	53.0
Total Split (%)	41.1%	41.1%		41.1%	41.1%		58.9%	58.9%		58.9%	58.9%	58.9%
Maximum Green (s)	30.8	30.8		30.8	30.8		46.6	46.6		46.6	46.6	46.6
Yellow Time (s)	3.3	3.3		3.3	3.3		4.6	4.6		4.6	4.6	4.6

5331 Fernbank Road
2028 Background Traffic

2: Terry Fox & Cope
Timing Plan: AM Peak



Lane Group	EBL	EBT	EBR	WBL	WBT	WBR	NBL	NBT	NBR	SBL	SBT	SBR
All-Red Time (s)	2.9	2.9		2.9	2.9		1.8	1.8		1.8	1.8	1.8
Lost Time Adjust (s)	0.0	0.0		0.0	0.0		0.0	0.0		0.0	0.0	0.0
Total Lost Time (s)	6.2	6.2		6.2	6.2		6.4	6.4		6.4	6.4	6.4
Lead/Lag												
Lead-Lag Optimize?												
Vehicle Extension (s)	3.0	3.0		3.0	3.0		3.0	3.0		3.0	3.0	3.0
Recall Mode	None	None		None	None		C-Max	C-Max		C-Max	C-Max	C-Max
Walk Time (s)	7.0	7.0		7.0	7.0		7.0	7.0		7.0	7.0	7.0
Flash Dont Walk (s)	19.0	19.0		19.0	19.0		15.0	15.0		15.0	15.0	15.0
Pedestrian Calls (#/hr)	5	5		5	5		5	5		5	5	5
Act Effct Green (s)	18.6	18.6		18.6	18.6		58.8	58.8		58.8	58.8	58.8
Actuated g/C Ratio	0.21	0.21		0.21	0.21		0.65	0.65		0.65	0.65	0.65
v/c Ratio	0.74	0.30		0.22	0.39		0.11	0.75		0.59	0.48	0.13
Control Delay	52.5	18.3		29.4	11.5		7.0	13.7		22.6	11.1	2.0
Queue Delay	0.0	0.0		0.0	0.0		0.0	0.0		0.0	0.0	0.0
Total Delay	52.5	18.3		29.4	11.5		7.0	13.7		22.6	11.1	2.0
LOS	D	B		C	B		A	B		C	B	A
Approach Delay		38.3			15.4			13.4				12.1
Approach LOS		D			B			B				B
Queue Length 50th (m)	26.0	9.3		6.2	5.5		1.1	28.0		14.6	40.5	0.0
Queue Length 95th (m)	42.3	20.5		13.4	18.6		m4.7	#193.5		#54.7	82.2	7.0
Internal Link Dist (m)		278.1			118.5			186.5			491.9	
Turn Bay Length (m)	30.0			30.0			35.0			50.0		140.0
Base Capacity (vph)	357	602		330	587		349	1075		285	1071	998
Starvation Cap Reductn	0	0		0	0		0	0		0	0	0
Spillback Cap Reductn	0	0		0	0		0	0		0	0	0
Storage Cap Reductn	0	0		0	0		0	0		0	0	0
Reduced v/c Ratio	0.45	0.19		0.13	0.27		0.11	0.75		0.59	0.48	0.13

Intersection Summary

Area Type: Other
 Cycle Length: 90
 Actuated Cycle Length: 90
 Offset: 55 (61%), Referenced to phase 2:NBTL and 6:SBTL, Start of Green
 Natural Cycle: 90
 Control Type: Actuated-Coordinated
 Maximum v/c Ratio: 0.75
 Intersection Signal Delay: 16.3
 Intersection LOS: B
 Intersection Capacity Utilization 95.1%
 ICU Level of Service F
 Analysis Period (min) 15
 # 95th percentile volume exceeds capacity, queue may be longer.
 Queue shown is maximum after two cycles.
 m Volume for 95th percentile queue is metered by upstream signal.

Splits and Phases: 2: Terry Fox & Cope

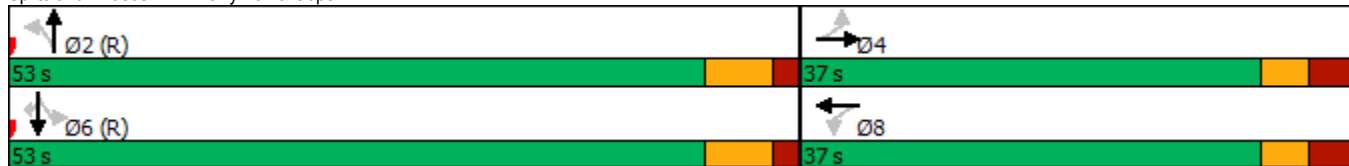

5331 Fernbank Road
2028 Background Traffic

5: Terry Fox & Fernbank
Timing Plan: AM Peak

Lane Group	EBL	EBT	EBR	WBL	WBT	WBR	NBL	NBT	NBR	SBL	SBT	SBR
Lane Configurations												
Traffic Volume (vph)	192	272	208	3	216	141	168	431	2	82	335	129
Future Volume (vph)	192	272	208	3	216	141	168	431	2	82	335	129
Ideal Flow (vphpl)	1800	1800	1800	1800	1800	1800	1800	1800	1800	1800	1800	1800
Storage Length (m)	75.0		75.0	95.0		115.0	90.0		0.0	90.0		95.0
Storage Lanes	1		1	1		1	1		0	1		1
Taper Length (m)	100.0			60.0			70.0			100.0		
Lane Util. Factor	1.00	1.00	1.00	1.00	1.00	1.00	1.00	1.00	1.00	1.00	1.00	1.00
Ped Bike Factor	1.00		0.98			0.98						
Fr t			0.850			0.850		0.999				0.850
Fit Protected	0.950			0.950			0.950			0.950		
Satd. Flow (prot)	1631	1784	1488	1695	1767	1406	1662	1732	0	1662	1717	1357
Fit Permitted	0.509			0.592			0.389			0.251		
Satd. Flow (perm)	872	1784	1457	1056	1767	1374	681	1732	0	439	1717	1357
Right Turn on Red			Yes			Yes			Yes			Yes
Satd. Flow (RTOR)			208			141						129
Link Speed (k/h)		60			60			80				80
Link Distance (m)		274.4			222.4			294.7				171.1
Travel Time (s)		16.5			13.3			13.3				7.7
Confl. Peds. (#/hr)	2					2						
Confl. Bikes (#/hr)			1									
Peak Hour Factor	1.00	1.00	1.00	1.00	1.00	1.00	1.00	1.00	1.00	1.00	1.00	1.00
Heavy Vehicles (%)	6%	2%	4%	2%	3%	10%	4%	5%	2%	4%	6%	14%
Adj. Flow (vph)	192	272	208	3	216	141	168	431	2	82	335	129
Shared Lane Traffic (%)												
Lane Group Flow (vph)	192	272	208	3	216	141	168	433	0	82	335	129
Enter Blocked Intersection	No	No	No	No	No	No	No	No	No	No	No	No
Lane Alignment	Left	Left	Right	Left	Left	Right	Left	Left	Right	Left	Left	Right
Median Width(m)		3.7			3.7			3.7				3.7
Link Offset(m)		0.0			0.0			0.0				0.0
Crosswalk Width(m)		4.9			4.9			4.9				4.9
Two way Left Turn Lane												
Headway Factor	1.06	1.06	1.06	1.06	1.06	1.06	1.06	1.06	1.06	1.06	1.06	1.06
Turning Speed (k/h)	24		14	24		14	24		14	24		14
Number of Detectors	1	2	1	1	2	1	1	2		1	2	1
Detector Template	Left	Thru	Right	Left	Thru	Right	Left	Thru		Left	Thru	Right
Leading Detector (m)	6.1	30.5	6.1	6.1	30.5	6.1	6.1	30.5		6.1	30.5	6.1
Trailing Detector (m)	0.0	0.0	0.0	0.0	0.0	0.0	0.0	0.0		0.0	0.0	0.0
Detector 1 Position(m)	0.0	0.0	0.0	0.0	0.0	0.0	0.0	0.0		0.0	0.0	0.0
Detector 1 Size(m)	6.1	1.8	6.1	6.1	1.8	6.1	6.1	1.8		6.1	1.8	6.1
Detector 1 Type	Cl+Ex	Cl+Ex	Cl+Ex	Cl+Ex	Cl+Ex	Cl+Ex	Cl+Ex	Cl+Ex		Cl+Ex	Cl+Ex	Cl+Ex
Detector 1 Channel												
Detector 1 Extend (s)	0.0	0.0	0.0	0.0	0.0	0.0	0.0	0.0		0.0	0.0	0.0
Detector 1 Queue (s)	0.0	0.0	0.0	0.0	0.0	0.0	0.0	0.0		0.0	0.0	0.0
Detector 1 Delay (s)	0.0	0.0	0.0	0.0	0.0	0.0	0.0	0.0		0.0	0.0	0.0
Detector 2 Position(m)		28.7			28.7			28.7				28.7
Detector 2 Size(m)		1.8			1.8			1.8				1.8
Detector 2 Type		Cl+Ex			Cl+Ex			Cl+Ex				Cl+Ex
Detector 2 Channel												
Detector 2 Extend (s)		0.0			0.0			0.0				0.0
Turn Type	pm+pt	NA	Perm	Perm	NA	Perm	Perm	NA		Perm	NA	Perm
Protected Phases	5	2			6			8				4
Permitted Phases	2		2	6		6	8			4		4
Detector Phase	5	2	2	6	6	6	8	8		4	4	4
Switch Phase												
Minimum Initial (s)	5.0	10.0	10.0	10.0	10.0	10.0	10.0	10.0		10.0	10.0	10.0
Minimum Split (s)	11.2	33.2	33.2	33.2	33.2	33.2	29.2	29.2		29.2	29.2	29.2
Total Split (s)	17.0	52.0	52.0	35.0	35.0	35.0	38.0	38.0		38.0	38.0	38.0
Total Split (%)	18.9%	57.8%	57.8%	38.9%	38.9%	38.9%	42.2%	42.2%		42.2%	42.2%	42.2%
Maximum Green (s)	10.9	45.8	45.8	28.8	28.8	28.8	31.8	31.8		31.8	31.8	31.8
Yellow Time (s)	3.7	3.7	3.7	3.7	3.7	3.7	4.6	4.6		4.6	4.6	4.6

5331 Fernbank Road
2028 Background Traffic

5: Terry Fox & Fernbank
Timing Plan: AM Peak



Lane Group	EBL	EBT	EBR	WBL	WBT	WBR	NBL	NBT	NBR	SBL	SBT	SBR
All-Red Time (s)	2.4	2.5	2.5	2.5	2.5	2.5	1.6	1.6		1.6	1.6	1.6
Lost Time Adjust (s)	0.0	0.0	0.0	0.0	0.0	0.0	0.0	0.0		0.0	0.0	0.0
Total Lost Time (s)	6.1	6.2	6.2	6.2	6.2	6.2	6.2	6.2		6.2	6.2	6.2
Lead/Lag	Lead			Lag			Lag					
Lead-Lag Optimize?	Yes			Yes			Yes					
Vehicle Extension (s)	3.0	3.0	3.0	3.0	3.0	3.0	3.0	3.0		3.0	3.0	3.0
Recall Mode	None	C-Max	C-Max	C-Max	C-Max	C-Max	None	None		None	None	None
Walk Time (s)		7.0	7.0	7.0	7.0	7.0	7.0	7.0		7.0	7.0	7.0
Flash Dont Walk (s)		20.0	20.0	20.0	20.0	20.0	16.0	16.0		16.0	16.0	16.0
Pedestrian Calls (#/hr)		5	5	5	5	5	5	5		5	5	5
Act Effct Green (s)	50.7	50.6	50.6	34.7	34.7	34.7	27.0	27.0		27.0	27.0	27.0
Actuated g/C Ratio	0.56	0.56	0.56	0.39	0.39	0.39	0.30	0.30		0.30	0.30	0.30
v/c Ratio	0.34	0.27	0.23	0.01	0.32	0.23	0.82	0.83		0.63	0.65	0.26
Control Delay	12.7	12.2	2.4	21.0	23.0	5.1	59.9	43.5		50.2	35.2	10.3
Queue Delay	0.0	0.0	0.0	0.0	0.0	0.0	0.0	0.0		0.0	0.0	0.0
Total Delay	12.7	12.2	2.4	21.0	23.0	5.1	59.9	43.5		50.2	35.2	10.3
LOS	B	B	A	C	C	A	E	D		D	D	B
Approach Delay		9.3			16.0			48.1			31.5	
Approach LOS		A			B			D			C	
Queue Length 50th (m)	16.0	23.6	0.0	0.3	26.9	0.0	26.2	67.8		9.7	39.4	0.0
Queue Length 95th (m)	29.9	41.6	10.0	2.3	47.6	12.3	#55.5	97.2		#25.5	74.2	18.4
Internal Link Dist (m)		250.4			198.4			270.7			147.1	
Turn Bay Length (m)	75.0		75.0	95.0		115.0	90.0		90.0			95.0
Base Capacity (vph)	583	1002	909	406	680	615	240	611		155	606	562
Starvation Cap Reductn	0	0	0	0	0	0	0	0		0	0	0
Spillback Cap Reductn	0	0	0	0	0	0	0	0		0	0	0
Storage Cap Reductn	0	0	0	0	0	0	0	0		0	0	0
Reduced v/c Ratio	0.33	0.27	0.23	0.01	0.32	0.23	0.70	0.71		0.53	0.55	0.23

Intersection Summary

Area Type: Other
 Cycle Length: 90
 Actuated Cycle Length: 90
 Offset: 9 (10%), Referenced to phase 2:EBTL and 6:WBTL, Start of Green
 Natural Cycle: 75
 Control Type: Actuated-Coordinated
 Maximum v/c Ratio: 0.83
 Intersection Signal Delay: 26.7
 Intersection LOS: C
 Intersection Capacity Utilization 86.7%
 ICU Level of Service E
 Analysis Period (min) 15
 # 95th percentile volume exceeds capacity, queue may be longer.
 Queue shown is maximum after two cycles.

Splits and Phases: 5: Terry Fox & Fernbank

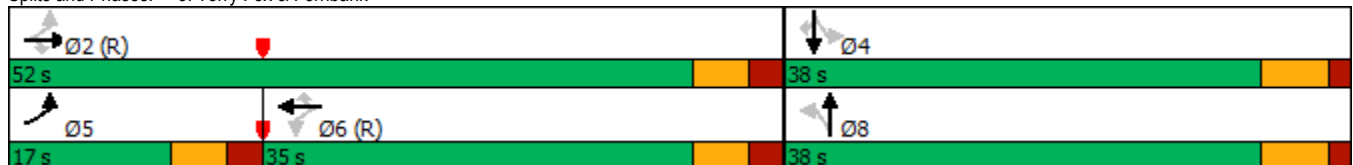

5331 Fernbank Road
2028 Background Traffic

1: Cope & Street 1
Timing Plan: AM Peak

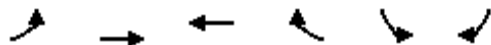

Movement	EBL	EBT	WBT	WBR	SBL	SBR
Lane Configurations						
Traffic Volume (veh/h)	13	264	195	6	17	4
Future Volume (Veh/h)	13	264	195	6	17	4
Sign Control		Free	Free		Stop	
Grade		0%	0%		0%	
Peak Hour Factor	1.00	1.00	1.00	1.00	1.00	1.00
Hourly flow rate (vph)	13	264	195	6	17	4
Pedestrians						
Lane Width (m)						
Walking Speed (m/s)						
Percent Blockage						
Right turn flare (veh)						
Median type		None	None			
Median storage (veh)						
Upstream signal (m)		143				
pX, platoon unblocked					1.00	
vC, conflicting volume	201				488	198
vC1, stage 1 conf vol						
vC2, stage 2 conf vol						
vCu, unblocked vol	201				485	198
tC, single (s)	4.1				6.4	6.2
tC, 2 stage (s)						
tF (s)	2.2				3.5	3.3
p0 queue free %	99				97	100
cM capacity (veh/h)	1371				534	843
Direction, Lane #	EB 1	EB 2	WB 1	SB 1		
Volume Total	13	264	201	21		
Volume Left	13	0	0	17		
Volume Right	0	0	6	4		
cSH	1371	1700	1700	574		
Volume to Capacity	0.01	0.16	0.12	0.04		
Queue Length 95th (m)	0.2	0.0	0.0	0.9		
Control Delay (s)	7.7	0.0	0.0	11.5		
Lane LOS	A			B		
Approach Delay (s)	0.4			11.5		
Approach LOS				B		
Intersection Summary						
Average Delay			0.7			
Intersection Capacity Utilization			24.7%	ICU Level of Service	A	
Analysis Period (min)			15			

5331 Fernbank Road
2028 Background Traffic

2: Terry Fox & Cope
Timing Plan: PM Peak

Lane Group	EBL	EBT	EBR	WBL	WBT	WBR	NBL	NBT	NBR	SBL	SBT	SBR
Lane Configurations												
Traffic Volume (vph)	146	51	28	67	38	196	30	640	58	247	897	159
Future Volume (vph)	146	51	28	67	38	196	30	640	58	247	897	159
Ideal Flow (vphpl)	1800	1800	1800	1800	1800	1800	1800	1800	1800	1800	1800	1800
Storage Length (m)	30.0		0.0	30.0		0.0	35.0		0.0	50.0		140.0
Storage Lanes	1		0	1		0	1		0	1		1
Taper Length (m)	55.0			55.0			80.0			80.0		
Lane Util. Factor	1.00	1.00	1.00	1.00	1.00	1.00	1.00	1.00	1.00	1.00	1.00	1.00
Ped Bike Factor		0.99		1.00								0.97
Fr t		0.947			0.874			0.988				0.850
Flt Protected	0.950			0.950			0.950			0.950		
Satd. Flow (prot)	1695	1677	0	1601	1559	0	1695	1719	0	1695	1784	1517
Flt Permitted	0.444			0.706			0.297			0.128		
Satd. Flow (perm)	792	1677	0	1188	1559	0	530	1719	0	228	1784	1475
Right Turn on Red			Yes			Yes			Yes			Yes
Satd. Flow (RTOR)		28			196			6				159
Link Speed (k/h)		50			50			80				80
Link Distance (m)		302.1			142.5			210.5				515.9
Travel Time (s)		21.8			10.3			9.5				23.2
Confl. Peds. (#/hr)			1	1			3					3
Confl. Bikes (#/hr)												1
Peak Hour Factor	1.00	1.00	1.00	1.00	1.00	1.00	1.00	1.00	1.00	1.00	1.00	1.00
Heavy Vehicles (%)	2%	2%	2%	8%	2%	2%	2%	4%	11%	2%	2%	2%
Adj. Flow (vph)	146	51	28	67	38	196	30	640	58	247	897	159
Shared Lane Traffic (%)												
Lane Group Flow (vph)	146	79	0	67	234	0	30	698	0	247	897	159
Enter Blocked Intersection	No	No	No	No	No	No	No	No	No	No	No	No
Lane Alignment	Left	Left	Right	Left	Left	Right	Left	Left	Right	Left	Left	Right
Median Width(m)		3.7			3.7			3.7				3.7
Link Offset(m)		0.0			0.0			0.0				0.0
Crosswalk Width(m)		4.9			4.9			4.9				4.9
Two way Left Turn Lane												
Headway Factor	1.06	1.06	1.06	1.06	1.06	1.06	1.06	1.06	1.06	1.06	1.06	1.06
Turning Speed (k/h)	24		14	24		14	24		14	24		14
Number of Detectors	1	2		1	2		1	2		1	2	1
Detector Template	Left	Thru		Left	Thru		Left	Thru		Left	Thru	Right
Leading Detector (m)	6.1	30.5		6.1	30.5		6.1	30.5		6.1	30.5	6.1
Trailing Detector (m)	0.0	0.0		0.0	0.0		0.0	0.0		0.0	0.0	0.0
Detector 1 Position(m)	0.0	0.0		0.0	0.0		0.0	0.0		0.0	0.0	0.0
Detector 1 Size(m)	6.1	1.8		6.1	1.8		6.1	1.8		6.1	1.8	6.1
Detector 1 Type	Cl+Ex	Cl+Ex		Cl+Ex	Cl+Ex		Cl+Ex	Cl+Ex		Cl+Ex	Cl+Ex	Cl+Ex
Detector 1 Channel												
Detector 1 Extend (s)	0.0	0.0		0.0	0.0		0.0	0.0		0.0	0.0	0.0
Detector 1 Queue (s)	0.0	0.0		0.0	0.0		0.0	0.0		0.0	0.0	0.0
Detector 1 Delay (s)	0.0	0.0		0.0	0.0		0.0	0.0		0.0	0.0	0.0
Detector 2 Position(m)		28.7			28.7			28.7				28.7
Detector 2 Size(m)		1.8			1.8			1.8				1.8
Detector 2 Type		Cl+Ex			Cl+Ex			Cl+Ex				Cl+Ex
Detector 2 Channel												
Detector 2 Extend (s)		0.0			0.0			0.0				0.0
Turn Type	Perm	NA		Perm	NA		Perm	NA		pm+pt	NA	Perm
Protected Phases		4			8			2		1	6	
Permitted Phases	4			8			2		6			6
Detector Phase	4	4		8	8		2	2		1	6	6
Switch Phase												
Minimum Initial (s)	10.0	10.0		10.0	10.0		10.0	10.0		5.0	10.0	10.0
Minimum Split (s)	32.2	32.2		32.2	32.2		28.4	28.4		11.4	28.4	28.4
Total Split (s)	37.0	37.0		37.0	37.0		51.0	51.0		12.0	63.0	63.0
Total Split (%)	37.0%	37.0%		37.0%	37.0%		51.0%	51.0%		12.0%	63.0%	63.0%
Maximum Green (s)	30.8	30.8		30.8	30.8		44.6	44.6		5.6	56.6	56.6
Yellow Time (s)	3.3	3.3		3.3	3.3		4.6	4.6		4.6	4.6	4.6

5331 Fernbank Road
2028 Background Traffic

2: Terry Fox & Cope
Timing Plan: PM Peak



Lane Group	EBL	EBT	EBR	WBL	WBT	WBR	NBL	NBT	NBR	SBL	SBT	SBR
All-Red Time (s)	2.9	2.9		2.9	2.9		1.8	1.8		1.8	1.8	1.8
Lost Time Adjust (s)	0.0	0.0		0.0	0.0		0.0	0.0		0.0	0.0	0.0
Total Lost Time (s)	6.2	6.2		6.2	6.2		6.4	6.4		6.4	6.4	6.4
Lead/Lag							Lag	Lag		Lead		
Lead-Lag Optimize?							Yes	Yes		Yes		
Vehicle Extension (s)	3.0	3.0		3.0	3.0		3.0	3.0		3.0	3.0	3.0
Recall Mode	None	None		None	None		C-Max	C-Max		None	C-Max	C-Max
Walk Time (s)	7.0	7.0		7.0	7.0		7.0	7.0		7.0	7.0	7.0
Flash Dont Walk (s)	19.0	19.0		19.0	19.0		15.0	15.0		15.0	15.0	15.0
Pedestrian Calls (#/hr)	5	5		5	5		5	5		5	5	5
Act Effct Green (s)	20.6	20.6		20.6	20.6		44.8	44.8		66.8	66.8	66.8
Actuated g/C Ratio	0.21	0.21		0.21	0.21		0.45	0.45		0.67	0.67	0.67
v/c Ratio	0.90	0.21		0.27	0.49		0.13	0.90		0.65	0.75	0.15
Control Delay	84.8	21.5		33.4	10.5		16.0	41.4		24.3	18.4	1.9
Queue Delay	0.0	0.0		0.0	0.0		0.0	0.0		0.0	0.0	0.0
Total Delay	84.8	21.5		33.4	10.5		16.0	41.4		24.3	18.4	1.9
LOS	F	C		C	B		B	D		C	B	A
Approach Delay		62.5			15.6			40.3				17.5
Approach LOS		E			B			D				B
Queue Length 50th (m)	27.7	8.1		11.0	6.0		3.8	138.8		19.1	104.5	0.0
Queue Length 95th (m)	#46.7	17.8		20.3	23.1		m8.8	#197.1		#67.2	#227.9	7.9
Internal Link Dist (m)		278.1			118.5			186.5			491.9	
Turn Bay Length (m)	30.0			30.0			35.0			50.0		140.0
Base Capacity (vph)	243	535		365	615		237	773		379	1191	1037
Starvation Cap Reductn	0	0		0	0		0	0		0	0	0
Spillback Cap Reductn	0	0		0	0		0	0		0	0	0
Storage Cap Reductn	0	0		0	0		0	0		0	0	0
Reduced v/c Ratio	0.60	0.15		0.18	0.38		0.13	0.90		0.65	0.75	0.15

Intersection Summary

Area Type: Other
 Cycle Length: 100
 Actuated Cycle Length: 100
 Offset: 69 (69%), Referenced to phase 2:NBTL and 6:SBTL, Start of Green
 Natural Cycle: 90
 Control Type: Actuated-Coordinated
 Maximum v/c Ratio: 0.90
 Intersection Signal Delay: 27.8 Intersection LOS: C
 Intersection Capacity Utilization 102.6% ICU Level of Service G
 Analysis Period (min) 15
 # 95th percentile volume exceeds capacity, queue may be longer.
 Queue shown is maximum after two cycles.
 m Volume for 95th percentile queue is metered by upstream signal.

Splits and Phases: 2: Terry Fox & Cope



5331 Fernbank Road
2028 Background Traffic

5: Terry Fox & Fernbank
Timing Plan: PM Peak

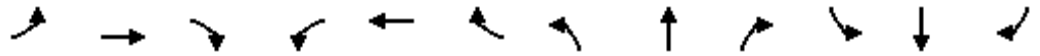

Lane Group	EBL	EBT	EBR	WBL	WBT	WBR	NBL	NBT	NBR	SBL	SBT	SBR
Lane Configurations												
Traffic Volume (vph)	125	269	149	5	353	115	275	408	23	199	522	188
Future Volume (vph)	125	269	149	5	353	115	275	408	23	199	522	188
Ideal Flow (vphpl)	1800	1800	1800	1800	1800	1800	1800	1800	1800	1800	1800	1800
Storage Length (m)	75.0		75.0	95.0		115.0	90.0		0.0	90.0		95.0
Storage Lanes	1		1	1		1	1		0	1		1
Taper Length (m)	100.0			60.0			70.0			100.0		
Lane Util. Factor	1.00	1.00	1.00	1.00	1.00	1.00	1.00	1.00	1.00	1.00	1.00	1.00
Ped Bike Factor	1.00		0.97	0.99		0.97				1.00		0.96
Fr t			0.850			0.850		0.992				0.850
Fit Protected	0.950			0.950			0.950			0.950		
Satd. Flow (prot)	1631	1784	1502	1235	1784	1459	1695	1770	0	1695	1784	1488
Fit Permitted	0.266			0.594			0.122			0.512		
Satd. Flow (perm)	456	1784	1461	768	1784	1421	218	1770	0	910	1784	1429
Right Turn on Red			Yes			Yes			Yes			Yes
Satd. Flow (RTOR)			149			172		4				188
Link Speed (k/h)		60			60			80			80	
Link Distance (m)		274.4			222.4			294.7			171.1	
Travel Time (s)		16.5			13.3			13.3			7.7	
Confl. Peds. (#/hr)	2		4	4		2	9			3		9
Confl. Bikes (#/hr)						2						
Peak Hour Factor	1.00	1.00	1.00	1.00	1.00	1.00	1.00	1.00	1.00	1.00	1.00	1.00
Heavy Vehicles (%)	6%	2%	3%	40%	2%	6%	2%	2%	2%	2%	2%	4%
Adj. Flow (vph)	125	269	149	5	353	115	275	408	23	199	522	188
Shared Lane Traffic (%)												
Lane Group Flow (vph)	125	269	149	5	353	115	275	431	0	199	522	188
Enter Blocked Intersection	No	No	No	No	No	No	No	No	No	No	No	No
Lane Alignment	Left	Left	Right	Left	Left	Right	Left	Left	Right	Left	Left	Right
Median Width(m)		3.7			3.7			3.7			3.7	
Link Offset(m)		0.0			0.0			0.0			0.0	
Crosswalk Width(m)		4.9			4.9			4.9			4.9	
Two way Left Turn Lane												
Headway Factor	1.06	1.06	1.06	1.06	1.06	1.06	1.06	1.06	1.06	1.06	1.06	1.06
Turning Speed (k/h)	24		14	24		14	24		14	24		14
Number of Detectors	1	2	1	1	2	1	1	2		1	2	1
Detector Template	Left	Thru	Right	Left	Thru	Right	Left	Thru		Left	Thru	Right
Leading Detector (m)	6.1	30.5	6.1	6.1	30.5	6.1	6.1	30.5		6.1	30.5	6.1
Trailing Detector (m)	0.0	0.0	0.0	0.0	0.0	0.0	0.0	0.0		0.0	0.0	0.0
Detector 1 Position(m)	0.0	0.0	0.0	0.0	0.0	0.0	0.0	0.0		0.0	0.0	0.0
Detector 1 Size(m)	6.1	1.8	6.1	6.1	1.8	6.1	6.1	1.8		6.1	1.8	6.1
Detector 1 Type	Cl+Ex	Cl+Ex	Cl+Ex	Cl+Ex	Cl+Ex	Cl+Ex	Cl+Ex	Cl+Ex		Cl+Ex	Cl+Ex	Cl+Ex
Detector 1 Channel												
Detector 1 Extend (s)	0.0	0.0	0.0	0.0	0.0	0.0	0.0	0.0		0.0	0.0	0.0
Detector 1 Queue (s)	0.0	0.0	0.0	0.0	0.0	0.0	0.0	0.0		0.0	0.0	0.0
Detector 1 Delay (s)	0.0	0.0	0.0	0.0	0.0	0.0	0.0	0.0		0.0	0.0	0.0
Detector 2 Position(m)		28.7			28.7			28.7			28.7	
Detector 2 Size(m)		1.8			1.8			1.8			1.8	
Detector 2 Type		Cl+Ex			Cl+Ex			Cl+Ex			Cl+Ex	
Detector 2 Channel												
Detector 2 Extend (s)		0.0			0.0			0.0			0.0	
Turn Type	pm+pt	NA	Perm	Perm	NA	Perm	pm+pt	NA		Perm	NA	Perm
Protected Phases	5	2			6		3	8			4	
Permitted Phases	2		2	6		6	8			4		4
Detector Phase	5	2	2	6	6	6	3	8		4	4	4
Switch Phase												
Minimum Initial (s)	5.0	10.0	10.0	10.0	10.0	10.0	5.0	10.0		10.0	10.0	10.0
Minimum Split (s)	11.2	33.2	33.2	33.2	33.2	33.2	11.5	29.2		29.2	29.2	29.2
Total Split (s)	12.0	46.0	46.0	34.0	34.0	34.0	15.0	54.0		39.0	39.0	39.0
Total Split (%)	12.0%	46.0%	46.0%	34.0%	34.0%	34.0%	15.0%	54.0%		39.0%	39.0%	39.0%
Maximum Green (s)	5.9	39.8	39.8	27.8	27.8	27.8	8.5	47.8		32.8	32.8	32.8
Yellow Time (s)	3.7	3.7	3.7	3.7	3.7	3.7	4.6	4.6		4.6	4.6	4.6

5331 Fernbank Road
2028 Background Traffic

5: Terry Fox & Fernbank
Timing Plan: PM Peak



Lane Group	EBL	EBT	EBR	WBL	WBT	WBR	NBL	NBT	NBR	SBL	SBT	SBR
All-Red Time (s)	2.4	2.5	2.5	2.5	2.5	2.5	1.9	1.6		1.6	1.6	1.6
Lost Time Adjust (s)	0.0	0.0	0.0	0.0	0.0	0.0	0.0	0.0		0.0	0.0	0.0
Total Lost Time (s)	6.1	6.2	6.2	6.2	6.2	6.2	6.5	6.2		6.2	6.2	6.2
Lead/Lag	Lead			Lag			Lead			Lag		
Lead-Lag Optimize?	Yes			Yes			Yes			Yes		
Vehicle Extension (s)	3.0	3.0	3.0	3.0	3.0	3.0	3.0	3.0		3.0	3.0	3.0
Recall Mode	C-Max	C-Max	C-Max	Max	Max	Max	None	None		None	None	None
Walk Time (s)		7.0	7.0	7.0	7.0	7.0		7.0		7.0	7.0	7.0
Flash Dont Walk (s)		20.0	20.0	20.0	20.0	20.0		16.0		16.0	16.0	16.0
Pedestrian Calls (#/hr)		5	5	5	5	5		5		5	5	5
Act Effct Green (s)	41.1	41.0	41.0	27.8	27.8	27.8	46.3	46.6		31.6	31.6	31.6
Actuated g/C Ratio	0.41	0.41	0.41	0.28	0.28	0.28	0.46	0.47		0.32	0.32	0.32
v/c Ratio	0.46	0.37	0.22	0.02	0.71	0.22	1.22	0.52		0.69	0.93	0.32
Control Delay	25.8	22.8	4.1	26.8	41.8	2.1	152.5	21.1		51.9	61.7	14.7
Queue Delay	0.0	0.0	0.0	0.0	0.0	0.0	0.0	0.0		0.0	0.0	0.0
Total Delay	25.8	22.8	4.1	26.8	41.8	2.1	152.5	21.1		51.9	61.7	14.7
LOS	C	C	A	C	D	A	F	C		D	E	B
Approach Delay		18.4			32.0			72.3			49.9	
Approach LOS		B			C			E			D	
Queue Length 50th (m)	15.5	36.3	0.0	0.7	61.5	0.0	~47.5	55.0		35.3	93.1	6.9
Queue Length 95th (m)	27.8	56.7	11.4	3.5	92.8	3.9	#97.2	81.9		m0.0	#160.8	m25.9
Internal Link Dist (m)		250.4			198.4			270.7			147.1	
Turn Bay Length (m)	75.0		75.0	95.0		115.0	90.0			90.0		95.0
Base Capacity (vph)	270	731	686	213	495	519	226	848		298	585	595
Starvation Cap Reductn	0	0	0	0	0	0	0	0		0	0	0
Spillback Cap Reductn	0	0	0	0	0	0	0	0		0	0	0
Storage Cap Reductn	0	0	0	0	0	0	0	0		0	0	0
Reduced v/c Ratio	0.46	0.37	0.22	0.02	0.71	0.22	1.22	0.51		0.67	0.89	0.32

Intersection Summary

Area Type: Other
 Cycle Length: 100
 Actuated Cycle Length: 100
 Offset: 79 (79%), Referenced to phase 2:EBTL and 5:EBL, Start of Green
 Natural Cycle: 100
 Control Type: Actuated-Coordinated
 Maximum v/c Ratio: 1.22
 Intersection Signal Delay: 46.2
 Intersection LOS: D
 Intersection Capacity Utilization 96.8%
 ICU Level of Service F
 Analysis Period (min) 15
 ~ Volume exceeds capacity, queue is theoretically infinite.
 Queue shown is maximum after two cycles.
 # 95th percentile volume exceeds capacity, queue may be longer.
 Queue shown is maximum after two cycles.
 m Volume for 95th percentile queue is metered by upstream signal.

Splits and Phases: 5: Terry Fox & Fernbank

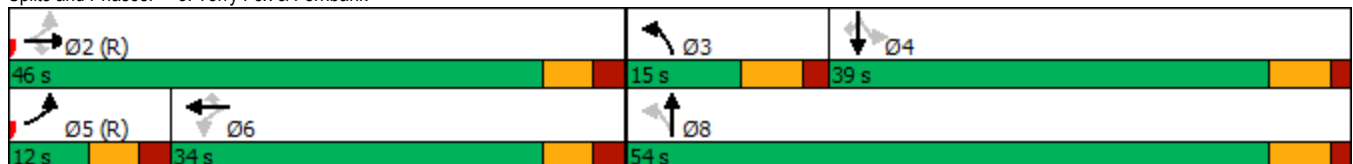

5331 Fernbank Road
2028 Background Traffic

1: Cope & Street 1
Timing Plan: PM Peak



Movement	EBL	EBT	WBT	WBR	SBL	SBR
Lane Configurations						
Traffic Volume (veh/h)	42	314	299	21	9	2
Future Volume (Veh/h)	42	314	299	21	9	2
Sign Control		Free	Free		Stop	
Grade		0%	0%		0%	
Peak Hour Factor	1.00	1.00	1.00	1.00	1.00	1.00
Hourly flow rate (vph)	42	314	299	21	9	2
Pedestrians						
Lane Width (m)						
Walking Speed (m/s)						
Percent Blockage						
Right turn flare (veh)						
Median type		None	None			
Median storage veh						
Upstream signal (m)		143				
pX, platoon unblocked					0.97	
vC, conflicting volume	320				708	310
vC1, stage 1 conf vol						
vC2, stage 2 conf vol						
vCu, unblocked vol	320				686	310
tC, single (s)	4.1				6.4	6.2
tC, 2 stage (s)						
tF (s)	2.2				3.5	3.3
p0 queue free %	97				98	100
cM capacity (veh/h)	1240				389	731
Direction, Lane #	EB 1	EB 2	WB 1	SB 1		
Volume Total	42	314	320	11		
Volume Left	42	0	0	9		
Volume Right	0	0	21	2		
cSH	1240	1700	1700	425		
Volume to Capacity	0.03	0.18	0.19	0.03		
Queue Length 95th (m)	0.8	0.0	0.0	0.6		
Control Delay (s)	8.0	0.0	0.0	13.7		
Lane LOS	A			B		
Approach Delay (s)	0.9			13.7		
Approach LOS				B		
Intersection Summary						
Average Delay			0.7			
Intersection Capacity Utilization			34.6%	ICU Level of Service	A	
Analysis Period (min)			15			

5331 Fernbank Road
2028 Background Traffic

2: Terry Fox & Cope
Timing Plan: PM Peak

Lane Group	EBL	EBT	EBR	WBL	WBT	WBR	NBL	NBT	NBR	SBL	SBT	SBR
Lane Configurations												
Traffic Volume (vph)	146	51	28	67	38	196	30	640	58	247	897	159
Future Volume (vph)	146	51	28	67	38	196	30	640	58	247	897	159
Ideal Flow (vphpl)	1800	1800	1800	1800	1800	1800	1800	1800	1800	1800	1800	1800
Storage Length (m)	30.0		0.0	30.0		30.0	35.0		0.0	50.0		140.0
Storage Lanes	1		0	1		1	1		0	1		1
Taper Length (m)	55.0			55.0			80.0			80.0		
Lane Util. Factor	1.00	1.00	1.00	1.00	1.00	1.00	1.00	1.00	1.00	1.00	1.00	1.00
Ped Bike Factor		0.99		1.00								0.97
Fr t		0.947				0.850		0.988				0.850
Flt Protected	0.950			0.950			0.950			0.950		
Satd. Flow (prot)	1695	1677	0	1601	1784	1517	1695	1719	0	1695	1784	1517
Flt Permitted	0.732			0.706			0.332			0.142		
Satd. Flow (perm)	1306	1677	0	1188	1784	1517	592	1719	0	253	1784	1475
Right Turn on Red			Yes			Yes			Yes			Yes
Satd. Flow (RTOR)		28				196		6				159
Link Speed (k/h)		50			50			80			80	
Link Distance (m)		302.1			142.5			210.5			515.9	
Travel Time (s)		21.8			10.3			9.5			23.2	
Confl. Peds. (#/hr)			1	1			3					3
Confl. Bikes (#/hr)												1
Peak Hour Factor	1.00	1.00	1.00	1.00	1.00	1.00	1.00	1.00	1.00	1.00	1.00	1.00
Heavy Vehicles (%)	2%	2%	2%	8%	2%	2%	2%	4%	11%	2%	2%	2%
Adj. Flow (vph)	146	51	28	67	38	196	30	640	58	247	897	159
Shared Lane Traffic (%)												
Lane Group Flow (vph)	146	79	0	67	38	196	30	698	0	247	897	159
Enter Blocked Intersection	No	No	No	No	No	No	No	No	No	No	No	No
Lane Alignment	Left	Left	Right	Left	Left	Right	Left	Left	Right	Left	Left	Right
Median Width(m)		3.7			3.7			3.7			3.7	
Link Offset(m)		0.0			0.0			0.0			0.0	
Crosswalk Width(m)		4.9			4.9			4.9			4.9	
Two way Left Turn Lane												
Headway Factor	1.06	1.06	1.06	1.06	1.06	1.06	1.06	1.06	1.06	1.06	1.06	1.06
Turning Speed (k/h)	24		14	24		14	24		14	24		14
Number of Detectors	1	2		1	2	1	1	2		1	2	1
Detector Template	Left	Thru		Left	Thru	Right	Left	Thru		Left	Thru	Right
Leading Detector (m)	6.1	30.5		6.1	30.5	6.1	6.1	30.5		6.1	30.5	6.1
Trailing Detector (m)	0.0	0.0		0.0	0.0	0.0	0.0	0.0		0.0	0.0	0.0
Detector 1 Position(m)	0.0	0.0		0.0	0.0	0.0	0.0	0.0		0.0	0.0	0.0
Detector 1 Size(m)	6.1	1.8		6.1	1.8	6.1	6.1	1.8		6.1	1.8	6.1
Detector 1 Type	Cl+Ex	Cl+Ex		Cl+Ex	Cl+Ex	Cl+Ex	Cl+Ex	Cl+Ex		Cl+Ex	Cl+Ex	Cl+Ex
Detector 1 Channel												
Detector 1 Extend (s)	0.0	0.0		0.0	0.0	0.0	0.0	0.0		0.0	0.0	0.0
Detector 1 Queue (s)	0.0	0.0		0.0	0.0	0.0	0.0	0.0		0.0	0.0	0.0
Detector 1 Delay (s)	0.0	0.0		0.0	0.0	0.0	0.0	0.0		0.0	0.0	0.0
Detector 2 Position(m)		28.7			28.7			28.7			28.7	
Detector 2 Size(m)		1.8			1.8			1.8			1.8	
Detector 2 Type		Cl+Ex			Cl+Ex			Cl+Ex			Cl+Ex	
Detector 2 Channel												
Detector 2 Extend (s)		0.0			0.0			0.0			0.0	
Turn Type	Perm	NA		Perm	NA	Perm	Perm	NA		pm+pt	NA	Perm
Protected Phases		4			8			2		1	6	
Permitted Phases	4			8		8	2			6		6
Detector Phase	4	4		8	8	8	2	2		1	6	6
Switch Phase												
Minimum Initial (s)	10.0	10.0		10.0	10.0	10.0	10.0	10.0		5.0	10.0	10.0
Minimum Split (s)	32.2	32.2		32.2	32.2	32.2	28.4	28.4		11.4	28.4	28.4
Total Split (s)	37.0	37.0		37.0	37.0	37.0	51.0	51.0		12.0	63.0	63.0
Total Split (%)	37.0%	37.0%		37.0%	37.0%	37.0%	51.0%	51.0%		12.0%	63.0%	63.0%
Maximum Green (s)	30.8	30.8		30.8	30.8	30.8	44.6	44.6		5.6	56.6	56.6
Yellow Time (s)	3.3	3.3		3.3	3.3	3.3	4.6	4.6		4.6	4.6	4.6

5331 Fernbank Road
2028 Background Traffic

2: Terry Fox & Cope
Timing Plan: PM Peak

Lane Group	EBL	EBT	EBR	WBL	WBT	WBR	NBL	NBT	NBR	SBL	SBT	SBR
All-Red Time (s)	2.9	2.9		2.9	2.9	2.9	1.8	1.8		1.8	1.8	1.8
Lost Time Adjust (s)	0.0	0.0		0.0	0.0	0.0	0.0	0.0		0.0	0.0	0.0
Total Lost Time (s)	6.2	6.2		6.2	6.2	6.2	6.4	6.4		6.4	6.4	6.4
Lead/Lag							Lag	Lag		Lead		
Lead-Lag Optimize?							Yes	Yes		Yes		
Vehicle Extension (s)	3.0	3.0		3.0	3.0	3.0	3.0	3.0		3.0	3.0	3.0
Recall Mode	None	None		None	None	None	C-Max	C-Max		None	C-Max	C-Max
Walk Time (s)	7.0	7.0		7.0	7.0	7.0	7.0	7.0		7.0	7.0	7.0
Flash Dont Walk (s)	19.0	19.0		19.0	19.0	19.0	15.0	15.0		15.0	15.0	15.0
Pedestrian Calls (#/hr)	5	5		5	5	5	5	5		5	5	5
Act Effct Green (s)	17.1	17.1		17.1	17.1	17.1	46.3	46.3		70.3	70.3	70.3
Actuated g/C Ratio	0.17	0.17		0.17	0.17	0.17	0.46	0.46		0.70	0.70	0.70
v/c Ratio	0.65	0.26		0.33	0.12	0.47	0.11	0.87		0.57	0.72	0.15
Control Delay	51.5	24.5		38.6	33.1	8.4	17.1	38.2		16.9	14.6	1.5
Queue Delay	0.0	0.0		0.0	0.0	0.0	0.0	0.0		0.0	0.0	0.0
Total Delay	51.5	24.5		38.6	33.1	8.4	17.1	38.2		16.9	14.6	1.5
LOS	D	C		D	C	A	B	D		B	B	A
Approach Delay		42.0			18.3			37.4			13.5	
Approach LOS		D			B			D			B	
Queue Length 50th (m)	26.9	8.6		11.6	6.4	0.0	3.1	114.2		14.1	88.0	0.0
Queue Length 95th (m)	42.0	18.9		21.5	13.5	16.2	9.1	#193.9		#58.2	185.8	7.1
Internal Link Dist (m)		278.1			118.5			186.5			491.9	
Turn Bay Length (m)	30.0			30.0		30.0	35.0			50.0		140.0
Base Capacity (vph)	402	535		365	549	602	274	799		431	1254	1084
Starvation Cap Reductn	0	0		0	0	0	0	0		0	0	0
Spillback Cap Reductn	0	0		0	0	0	0	0		0	0	0
Storage Cap Reductn	0	0		0	0	0	0	0		0	0	0
Reduced v/c Ratio	0.36	0.15		0.18	0.07	0.33	0.11	0.87		0.57	0.72	0.15

Intersection Summary

Area Type: Other

Cycle Length: 100

Actuated Cycle Length: 100

Offset: 69 (69%), Referenced to phase 2:NBTL and 6:SBTL, Start of Green

Natural Cycle: 90

Control Type: Actuated-Coordinated

Maximum v/c Ratio: 0.87

Intersection Signal Delay: 23.3 Intersection LOS: C

Intersection Capacity Utilization 89.4% ICU Level of Service E

Analysis Period (min) 15

95th percentile volume exceeds capacity, queue may be longer.
Queue shown is maximum after two cycles.

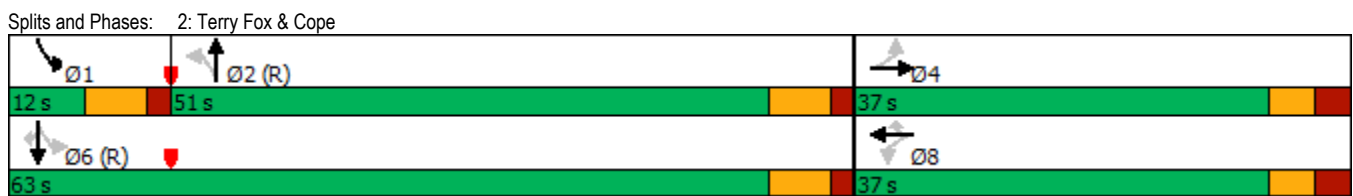

5331 Fernbank Road
2028 Background Traffic

5: Terry Fox & Fernbank
Timing Plan: PM Peak

Lane Group	EBL	EBT	EBR	WBL	WBT	WBR	NBL	NBT	NBR	SBL	SBT	SBR
Lane Configurations												
Traffic Volume (vph)	125	269	149	5	353	115	275	408	23	199	522	188
Future Volume (vph)	125	269	149	5	353	115	275	408	23	199	522	188
Ideal Flow (vphpl)	1800	1800	1800	1800	1800	1800	1800	1800	1800	1800	1800	1800
Storage Length (m)	75.0		75.0	95.0		115.0	90.0		0.0	90.0		95.0
Storage Lanes	1		1	1		1	1		0	1		1
Taper Length (m)	100.0			60.0			70.0			100.0		
Lane Util. Factor	1.00	1.00	1.00	1.00	1.00	1.00	1.00	1.00	1.00	1.00	1.00	1.00
Ped Bike Factor	1.00		0.97	0.99		0.97				1.00		0.96
Fr t			0.850			0.850		0.992				0.850
Fit Protected	0.950			0.950			0.950			0.950		
Satd. Flow (prot)	1631	1784	1502	1235	1784	1459	1695	1770	0	1695	1784	1488
Fit Permitted	0.204			0.594			0.119			0.512		
Satd. Flow (perm)	350	1784	1459	767	1784	1419	212	1770	0	910	1784	1424
Right Turn on Red			Yes			Yes			Yes			Yes
Satd. Flow (RTOR)			149			144		4				188
Link Speed (k/h)		60			60			80			80	
Link Distance (m)		274.4			222.4			294.7			171.1	
Travel Time (s)		16.5			13.3			13.3			7.7	
Confl. Peds. (#/hr)	2		4	4		2	9			3		9
Confl. Bikes (#/hr)						2						
Peak Hour Factor	1.00	1.00	1.00	1.00	1.00	1.00	1.00	1.00	1.00	1.00	1.00	1.00
Heavy Vehicles (%)	6%	2%	3%	40%	2%	6%	2%	2%	2%	2%	2%	4%
Adj. Flow (vph)	125	269	149	5	353	115	275	408	23	199	522	188
Shared Lane Traffic (%)												
Lane Group Flow (vph)	125	269	149	5	353	115	275	431	0	199	522	188
Enter Blocked Intersection	No	No	No	No	No	No	No	No	No	No	No	No
Lane Alignment	Left	Left	Right	Left	Left	Right	Left	Left	Right	Left	Left	Right
Median Width(m)		3.7			3.7			3.7			3.7	
Link Offset(m)		0.0			0.0			0.0			0.0	
Crosswalk Width(m)		4.9			4.9			4.9			4.9	
Two way Left Turn Lane												
Headway Factor	1.06	1.06	1.06	1.06	1.06	1.06	1.06	1.06	1.06	1.06	1.06	1.06
Turning Speed (k/h)	24		14	24		14	24		14	24		14
Number of Detectors	1	2	1	1	2	1	1	2		1	2	1
Detector Template	Left	Thru	Right	Left	Thru	Right	Left	Thru		Left	Thru	Right
Leading Detector (m)	6.1	30.5	6.1	6.1	30.5	6.1	6.1	30.5		6.1	30.5	6.1
Trailing Detector (m)	0.0	0.0	0.0	0.0	0.0	0.0	0.0	0.0		0.0	0.0	0.0
Detector 1 Position(m)	0.0	0.0	0.0	0.0	0.0	0.0	0.0	0.0		0.0	0.0	0.0
Detector 1 Size(m)	6.1	1.8	6.1	6.1	1.8	6.1	6.1	1.8		6.1	1.8	6.1
Detector 1 Type	Cl+Ex	Cl+Ex	Cl+Ex	Cl+Ex	Cl+Ex	Cl+Ex	Cl+Ex	Cl+Ex		Cl+Ex	Cl+Ex	Cl+Ex
Detector 1 Channel												
Detector 1 Extend (s)	0.0	0.0	0.0	0.0	0.0	0.0	0.0	0.0		0.0	0.0	0.0
Detector 1 Queue (s)	0.0	0.0	0.0	0.0	0.0	0.0	0.0	0.0		0.0	0.0	0.0
Detector 1 Delay (s)	0.0	0.0	0.0	0.0	0.0	0.0	0.0	0.0		0.0	0.0	0.0
Detector 2 Position(m)		28.7			28.7			28.7			28.7	
Detector 2 Size(m)		1.8			1.8			1.8			1.8	
Detector 2 Type		Cl+Ex			Cl+Ex			Cl+Ex			Cl+Ex	
Detector 2 Channel												
Detector 2 Extend (s)		0.0			0.0			0.0			0.0	
Turn Type	pm+pt	NA	Perm	Perm	NA	Perm	pm+pt	NA		Perm	NA	Perm
Protected Phases	5	2			6		3	8			4	
Permitted Phases	2		2	6		6	8		4			4
Detector Phase	5	2	2	6	6	6	3	8		4	4	4
Switch Phase												
Minimum Initial (s)	5.0	10.0	10.0	10.0	10.0	10.0	5.0	10.0		10.0	10.0	10.0
Minimum Split (s)	11.2	33.2	33.2	33.2	33.2	33.2	11.5	29.2		29.2	29.2	29.2
Total Split (s)	14.0	49.2	49.2	35.2	35.2	35.2	23.4	70.8		47.4	47.4	47.4
Total Split (%)	11.7%	41.0%	41.0%	29.3%	29.3%	29.3%	19.5%	59.0%		39.5%	39.5%	39.5%
Maximum Green (s)	7.9	43.0	43.0	29.0	29.0	29.0	16.9	64.6		41.2	41.2	41.2
Yellow Time (s)	3.7	3.7	3.7	3.7	3.7	3.7	4.6	4.6		4.6	4.6	4.6

5331 Fernbank Road
2028 Background Traffic

5: Terry Fox & Fernbank
Timing Plan: PM Peak



Lane Group	EBL	EBT	EBR	WBL	WBT	WBR	NBL	NBT	NBR	SBL	SBT	SBR
All-Red Time (s)	2.4	2.5	2.5	2.5	2.5	2.5	1.9	1.6		1.6	1.6	1.6
Lost Time Adjust (s)	0.0	0.0	0.0	0.0	0.0	0.0	0.0	0.0		0.0	0.0	0.0
Total Lost Time (s)	6.1	6.2	6.2	6.2	6.2	6.2	6.5	6.2		6.2	6.2	6.2
Lead/Lag	Lead			Lag			Lead			Lag		
Lead-Lag Optimize?	Yes			Yes			Yes			Yes		
Vehicle Extension (s)	3.0	3.0	3.0	3.0	3.0	3.0	3.0	3.0		3.0	3.0	3.0
Recall Mode	C-Max	C-Max	C-Max	Max	Max	Max	None	None		None	None	None
Walk Time (s)		7.0	7.0	7.0	7.0	7.0		7.0		7.0	7.0	7.0
Flash Dont Walk (s)		20.0	20.0	20.0	20.0	20.0		16.0		16.0	16.0	16.0
Pedestrian Calls (#/hr)		5	5	5	5	5		5		5	5	5
Act Effct Green (s)	46.5	46.4	46.4	29.0	29.0	29.0	60.9	61.2		38.5	38.5	38.5
Actuated g/C Ratio	0.39	0.39	0.39	0.24	0.24	0.24	0.51	0.51		0.32	0.32	0.32
v/c Ratio	0.49	0.39	0.23	0.03	0.82	0.25	0.90	0.48		0.68	0.91	0.32
Control Delay	33.4	29.8	5.0	35.4	59.6	4.3	57.6	20.4		48.0	60.5	5.4
Queue Delay	0.0	0.0	0.0	0.0	0.0	0.0	0.0	0.0		0.0	0.0	0.0
Total Delay	33.4	29.8	5.0	35.4	59.6	4.3	57.6	20.4		48.0	60.5	5.4
LOS	C	C	A	D	E	A	E	C		D	E	A
Approach Delay		23.8			45.9			34.9			46.4	
Approach LOS		C			D			C			D	
Queue Length 50th (m)	20.3	47.5	0.0	0.9	79.0	0.0	42.0	58.8		39.1	113.3	0.0
Queue Length 95th (m)	34.7	71.1	13.4	4.3	#124.7	8.7	#87.5	83.9		66.5	#170.9	15.3
Internal Link Dist (m)		250.4			198.4			270.7			147.1	
Turn Bay Length (m)	75.0		75.0	95.0		115.0	90.0		90.0		95.0	95.0
Base Capacity (vph)	257	690	656	185	431	452	316	954		312	612	612
Starvation Cap Reductn	0	0	0	0	0	0	0	0		0	0	0
Spillback Cap Reductn	0	0	0	0	0	0	0	0		0	0	0
Storage Cap Reductn	0	0	0	0	0	0	0	0		0	0	0
Reduced v/c Ratio	0.49	0.39	0.23	0.03	0.82	0.25	0.87	0.45		0.64	0.85	0.31

Intersection Summary

Area Type: Other
 Cycle Length: 120
 Actuated Cycle Length: 120
 Offset: 0 (0%), Referenced to phase 2:EBTL and 5:EBL, Start of Green
 Natural Cycle: 100
 Control Type: Actuated-Coordinated
 Maximum v/c Ratio: 0.91
 Intersection Signal Delay: 38.6
 Intersection LOS: D
 Intersection Capacity Utilization 96.8%
 ICU Level of Service F
 Analysis Period (min) 15
 # 95th percentile volume exceeds capacity, queue may be longer.
 Queue shown is maximum after two cycles.

Splits and Phases: 5: Terry Fox & Fernbank

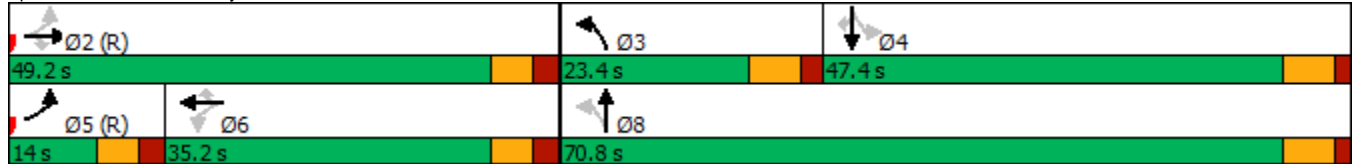

APPENDIX H

Transportation Demand Management Checklists

TDM-Supportive Development Design and Infrastructure Checklist: *Residential Developments (multi-family or condominium)*

Legend	
REQUIRED	The Official Plan or Zoning By-law provides related guidance that must be followed
BASIC	The measure is generally feasible and effective, and in most cases would benefit the development and its users
BETTER	The measure could maximize support for users of sustainable modes, and optimize development performance

TDM-supportive design & infrastructure measures: <i>Residential developments</i>		Check if completed & add descriptions, explanations or plan/drawing references
1. WALKING & CYCLING: ROUTES		
1.1 Building location & access points		
BASIC	1.1.1 Locate building close to the street, and do not locate parking areas between the street and building entrances	<input type="checkbox"/>
BASIC	1.1.2 Locate building entrances in order to minimize walking distances to sidewalks and transit stops/stations	<input checked="" type="checkbox"/>
BASIC	1.1.3 Locate building doors and windows to ensure visibility of pedestrians from the building, for their security and comfort	<input checked="" type="checkbox"/>
1.2 Facilities for walking & cycling		
REQUIRED	1.2.1 Provide convenient, direct access to stations or major stops along rapid transit routes within 600 metres; minimize walking distances from buildings to rapid transit; provide pedestrian-friendly, weather-protected (where possible) environment between rapid transit accesses and building entrances; ensure quality linkages from sidewalks through building entrances to integrated stops/stations <i>(see Official Plan policy 4.3.3)</i>	<input checked="" type="checkbox"/>
REQUIRED	1.2.2 Provide safe, direct and attractive pedestrian access from public sidewalks to building entrances through such measures as: reducing distances between public sidewalks and major building entrances; providing walkways from public streets to major building entrances; within a site, providing walkways along the front of adjoining buildings, between adjacent buildings, and connecting areas where people may congregate, such as courtyards and transit stops; and providing weather protection through canopies, colonnades, and other design elements wherever possible <i>(see Official Plan policy 4.3.12)</i>	<input checked="" type="checkbox"/>

TDM-supportive design & infrastructure measures: <i>Residential developments</i>		Check if completed & add descriptions, explanations or plan/drawing references
REQUIRED	1.2.3 Provide sidewalks of smooth, well-drained walking surfaces of contrasting materials or treatments to differentiate pedestrian areas from vehicle areas, and provide marked pedestrian crosswalks at intersection sidewalks (<i>see Official Plan policy 4.3.10</i>)	<input checked="" type="checkbox"/>
REQUIRED	1.2.4 Make sidewalks and open space areas easily accessible through features such as gradual grade transition, depressed curbs at street corners and convenient access to extra-wide parking spaces and ramps (<i>see Official Plan policy 4.3.10</i>)	<input checked="" type="checkbox"/>
REQUIRED	1.2.5 Include adequately spaced inter-block/street cycling and pedestrian connections to facilitate travel by active transportation. Provide links to the existing or planned network of public sidewalks, multi-use pathways and on-road cycle routes. Where public sidewalks and multi-use pathways intersect with roads, consider providing traffic control devices to give priority to cyclists and pedestrians (<i>see Official Plan policy 4.3.11</i>)	<input checked="" type="checkbox"/>
BASIC	1.2.6 Provide safe, direct and attractive walking routes from building entrances to nearby transit stops	<input checked="" type="checkbox"/>
BASIC	1.2.7 Ensure that walking routes to transit stops are secure, visible, lighted, shaded and wind-protected wherever possible	<input checked="" type="checkbox"/>
BASIC	1.2.8 Design roads used for access or circulation by cyclists using a target operating speed of no more than 30 km/h, or provide a separated cycling facility	<input type="checkbox"/>
1.3 Amenities for walking & cycling		
BASIC	1.3.1 Provide lighting, landscaping and benches along walking and cycling routes between building entrances and streets, sidewalks and trails	<input type="checkbox"/>
BASIC	1.3.2 Provide wayfinding signage for site access (where required, e.g. when multiple buildings or entrances exist) and egress (where warranted, such as when directions to reach transit stops/stations, trails or other common destinations are not obvious)	<input type="checkbox"/>

TDM-supportive design & infrastructure measures: <i>Residential developments</i>		Check if completed & add descriptions, explanations or plan/drawing references
2. WALKING & CYCLING: END-OF-TRIP FACILITIES		
2.1 Bicycle parking		
REQUIRED	2.1.1 Provide bicycle parking in highly visible and lighted areas, sheltered from the weather wherever possible (see <i>Official Plan policy 4.3.6</i>)	<input checked="" type="checkbox"/>
REQUIRED	2.1.2 Provide the number of bicycle parking spaces specified for various land uses in different parts of Ottawa; provide convenient access to main entrances or well-used areas (see <i>Zoning By-law Section 111</i>)	<input checked="" type="checkbox"/>
REQUIRED	2.1.3 Ensure that bicycle parking spaces and access aisles meet minimum dimensions; that no more than 50% of spaces are vertical spaces; and that parking racks are securely anchored (see <i>Zoning By-law Section 111</i>)	<input checked="" type="checkbox"/>
BASIC	2.1.4 Provide bicycle parking spaces equivalent to the expected number of resident-owned bicycles, plus the expected peak number of visitor cyclists	<input type="checkbox"/>
2.2 Secure bicycle parking		
REQUIRED	2.2.1 Where more than 50 bicycle parking spaces are provided for a single residential building, locate at least 25% of spaces within a building/structure, a secure area (e.g. supervised parking lot or enclosure) or bicycle lockers (see <i>Zoning By-law Section 111</i>)	<input type="checkbox"/> Not Applicable
BETTER	2.2.2 Provide secure bicycle parking spaces equivalent to at least the number of units at condominiums or multi-family residential developments	<input type="checkbox"/>
2.3 Bicycle repair station		
BETTER	2.3.1 Provide a permanent bike repair station, with commonly used tools and an air pump, adjacent to the main bicycle parking area (or secure bicycle parking area, if provided)	<input type="checkbox"/>
3. TRANSIT		
3.1 Customer amenities		
BASIC	3.1.1 Provide shelters, lighting and benches at any on-site transit stops	<input type="checkbox"/>
BASIC	3.1.2 Where the site abuts an off-site transit stop and insufficient space exists for a transit shelter in the public right-of-way, protect land for a shelter and/or install a shelter	<input type="checkbox"/>
BETTER	3.1.3 Provide a secure and comfortable interior waiting area by integrating any on-site transit stops into the building	<input type="checkbox"/>

TDM-supportive design & infrastructure measures: <i>Residential developments</i>		Check if completed & add descriptions, explanations or plan/drawing references
4. RIDESHARING		
4.1 Pick-up & drop-off facilities		
BASIC	4.1.1 Provide a designated area for carpool drivers (plus taxis and ride-hailing services) to drop off or pick up passengers without using fire lanes or other no-stopping zones	<input type="checkbox"/>
5. CARSHARING & BIKESHARING		
5.1 Carshare parking spaces		
BETTER	5.1.1 Provide up to three carshare parking spaces in an R3, R4 or R5 Zone for specified residential uses (see <i>Zoning By-law Section 94</i>)	<input type="checkbox"/>
5.2 Bikeshare station location		
BETTER	5.2.1 Provide a designated bikeshare station area near a major building entrance, preferably lighted and sheltered with a direct walkway connection	<input type="checkbox"/>
6. PARKING		
6.1 Number of parking spaces		
REQUIRED	6.1.1 Do not provide more parking than permitted by zoning, nor less than required by zoning, unless a variance is being applied for	<input checked="" type="checkbox"/>
BASIC	6.1.2 Provide parking for long-term and short-term users that is consistent with mode share targets, considering the potential for visitors to use off-site public parking	<input type="checkbox"/>
BASIC	6.1.3 Where a site features more than one use, provide shared parking and reduce the cumulative number of parking spaces accordingly (see <i>Zoning By-law Section 104</i>)	<input type="checkbox"/>
BETTER	6.1.4 Reduce the minimum number of parking spaces required by zoning by one space for each 13 square metres of gross floor area provided as shower rooms, change rooms, locker rooms and other facilities for cyclists in conjunction with bicycle parking (see <i>Zoning By-law Section 111</i>)	<input type="checkbox"/>
6.2 Separate long-term & short-term parking areas		
BETTER	6.2.1 Provide separate areas for short-term and long-term parking (using signage or physical barriers) to permit access controls and simplify enforcement (i.e. to discourage residents from parking in visitor spaces, and vice versa)	<input type="checkbox"/>

TDM Measures Checklist:
Residential Developments (multi-family, condominium or subdivision)

Legend	
BASIC	The measure is generally feasible and effective, and in most cases would benefit the development and its users
BETTER	The measure could maximize support for users of sustainable modes, and optimize development performance
★	The measure is one of the most dependably effective tools to encourage the use of sustainable modes

TDM measures: <i>Residential developments</i>		Check if proposed & add descriptions
1. TDM PROGRAM MANAGEMENT		
1.1 Program coordinator		
BASIC	★	1.1.1 Designate an internal coordinator, or contract with an external coordinator <input type="checkbox"/>
1.2 Travel surveys		
BETTER		1.2.1 Conduct periodic surveys to identify travel-related behaviours, attitudes, challenges and solutions, and to track progress <input type="checkbox"/>
2. WALKING AND CYCLING		
2.1 Information on walking/cycling routes & destinations		
BASIC		2.1.1 Display local area maps with walking/cycling access routes and key destinations at major entrances (<i>multi-family, condominium</i>) <input type="checkbox"/>
2.2 Bicycle skills training		
BETTER		2.2.1 Offer on-site cycling courses for residents, or subsidize off-site courses <input type="checkbox"/>

TDM measures: <i>Residential developments</i>		Check if proposed & add descriptions
3. TRANSIT		
3.1 Transit information		
BASIC	3.1.1 Display relevant transit schedules and route maps at entrances (<i>multi-family, condominium</i>)	<input type="checkbox"/>
BETTER	3.1.2 Provide real-time arrival information display at entrances (<i>multi-family, condominium</i>)	<input type="checkbox"/>
3.2 Transit fare incentives		
BASIC ★	3.2.1 Offer PRESTO cards preloaded with one monthly transit pass on residence purchase/move-in, to encourage residents to use transit	<input type="checkbox"/>
BETTER	3.2.2 Offer at least one year of free monthly transit passes on residence purchase/move-in	<input type="checkbox"/>
3.3 Enhanced public transit service		
BETTER ★	3.3.1 Contract with OC Transpo to provide early transit services until regular services are warranted by occupancy levels (<i>subdivision</i>)	<input type="checkbox"/>
3.4 Private transit service		
BETTER	3.4.1 Provide shuttle service for seniors homes or lifestyle communities (e.g. scheduled mall or supermarket runs)	<input type="checkbox"/>
4. CARSHARING & BIKESHARING		
4.1 Bikeshare stations & memberships		
BETTER	4.1.1 Contract with provider to install on-site bikeshare station (<i>multi-family</i>)	<input type="checkbox"/>
BETTER	4.1.2 Provide residents with bikeshare memberships, either free or subsidized (<i>multi-family</i>)	<input type="checkbox"/>
4.2 Carshare vehicles & memberships		
BETTER	4.2.1 Contract with provider to install on-site carshare vehicles and promote their use by residents	<input type="checkbox"/>
BETTER	4.2.2 Provide residents with carshare memberships, either free or subsidized	<input type="checkbox"/>
5. PARKING		
5.1 Priced parking		
BASIC ★	5.1.1 Unbundle parking cost from purchase price (<i>condominium</i>)	<input checked="" type="checkbox"/>
BASIC ★	5.1.2 Unbundle parking cost from monthly rent (<i>multi-family</i>)	<input type="checkbox"/>

TDM measures: <i>Residential developments</i>		Check if proposed & add descriptions
6. TDM MARKETING & COMMUNICATIONS		
6.1 Multimodal travel information		
BASIC ★	6.1.1 Provide a multimodal travel option information package to new residents	<input checked="" type="checkbox"/>
6.2 Personalized trip planning		
BETTER ★	6.2.1 Offer personalized trip planning to new residents	<input type="checkbox"/>

APPENDIX I

Multi-Modal Level of Service Analysis

Pedestrian Level of Service (PLOS)

Sidewalk Width	Boulevard Width	Avg. Daily Curb Lane Traffic Volume	Presence of On-Street Parking	Operating Speed ⁽¹⁾	Segment PLOS
Cope Drive (Both Sides)					
2.0m	>2.0m	<3,000 vpd	N/A	60 km/hr	A
Fernbank Road (North Side)					
2.0m	0m	<3,000 vpd ⁽²⁾	N/A	70 km/hr	D
Fernbank Road (South Side)					
2.0m	0m	>3,000 vpd	No	70 km/hr	F
Terry Fox Drive (East Side) ⁽³⁾					
2.0m	None	>3,000 vpd	No	90 km/hr	F
Terry Fox Drive (West Side)					
2.0m	>2.0m	>3,000 vpd	No	90 km/hr	D

1. Operating speed based on 10km/hr above posted speed limit
2. AADT based on westbound right turning volumes
3. Paved Shoulder, Adjusted downward for rural conditions

Bicycle Level of Service (BLOS)

Road Class	Bike Route	Type of Bikeway	Travel Lanes ⁽¹⁾	Centerline Markings	Operating Speed	Segment BLOS
Cope Drive						
Collector	Local	Mixed Traffic	1	N/A	60 km/hr	F
Fernbank Road						
Arterial	Spine	Bike Lane	1	N/A	70 km/hr	E
Terry Fox Drive						
Arterial	Spine	Bike Lane/ Paved Shoulder	1	N/A	90 km/hr	E

1. Travel lanes in each direction

Transit Level of Service (TLOS)

Facility Type	Level/Exposure to Congestion Delay, Friction and Incidents			Segment TLOS
	Congestion	Friction	Incident Potential	
Cope Drive				
Mixed Traffic	Yes	Low	Medium	D
Fernbank Road				
Mixed Traffic	Yes	Low	Medium	D
Terry Fox Drive				
Mixed Traffic	Yes	Low	Medium	D

Truck Level of Service (TkLOS)

Curb Lane Width	Number of Travel Lanes (Per Direction)	Segment TkLOS
Cope Drive		
>3.7m	1	B
Fernbank Road		
≤3.5m	1	C
Terry Fox Drive		
≤3.5m	1	C

Pedestrian Level of Service (PLOS)

Criteria	North Approach		South Approach		East Approach		West Approach	
Terry Fox Drive/Cope Drive								
PETSI SCORE								
<i>CROSSING DISTANCE CONDITIONS</i>								
Median > 2.4m in Width	No	39	No	39	No	55	No	55
Lanes Crossed (3.5m Lane Width)	7		7		6		6	
<i>SIGNAL PHASING AND TIMING</i>								
Left Turn Conflict	Permissive	-8	Permissive	-8	Perm + Prot	-8	Permissive	-8
Right Turn Conflict	Permissive or Yield	-5	Permissive or Yield	-5	Permissive or Yield	-5	Permissive or Yield	-5
Right Turn on Red	RTOR Allowed	-3	RTOR Allowed	-3	RTOR Allowed	-3	RTOR Allowed	-3
Leading Pedestrian Interval	No	-2	No	-2	No	-2	No	-2
<i>CORNER RADIUS</i>								
Parallel Radius	> 10m to 15m	-6	> 15m to 25m	-8	> 10m to 15m	-6	> 15m to 25m	-8
Parallel Right Turn Channel	No Right Turn Channel	-4	No Right Turn Channel	-4	No Right Turn Channel	-4	No Right Turn Channel	-4
Perpendicular Radius	N/A	0	N/A	0	N/A	0	N/A	0
Perpendicular Right Turn Channel	N/A	0	N/A	0	N/A	0	N/A	0
<i>CROSSING TREATMENT</i>								
Treatment	Standard	-7	Standard	-7	Standard	-7	Standard	-7
	PETSI SCORE	4		2		20		18
	LOS	F		F		F		F
DELAY SCORE								
Cycle Length		100		100		100		90
Pedestrian Walk Time		11.8		11.8		29.6		31.6
	DELAY SCORE	38.9		38.9		24.8		18.9
	LOS	D		D		C		B
	OVERALL	F		F		F		F

Criteria	North Approach		South Approach		East Approach		West Approach	
Terry Fox Drive/Fernbank Road								
PETSI SCORE								
<i>CROSSING DISTANCE CONDITIONS</i>								
Median > 2.4m in Width	No	23	No	39	No	23	No	55
Lanes Crossed (3.5m Lane Width)	8		7		8		6	
<i>SIGNAL PHASING AND TIMING</i>								
Left Turn Conflict	Perm + Prot	-8	Permissive	-8	Permissive	-8	Perm + Prot	-8
Right Turn Conflict	Permissive or Yield	-5	Permissive or Yield	-5	Permissive or Yield	-5	Permissive or Yield	-5
Right Turn on Red	RTOR Allowed	-3	RTOR Allowed	-3	RTOR Allowed	-3	RTOR Allowed	-3
Leading Pedestrian Interval	No	-2	No	-2	No	-2	No	-2
<i>CORNER RADIUS</i>								
Parallel Radius	> 15m to 25m	-8	> 10m to 15m	-6	> 10m to 15m	-6	> 10m to 15m	-6
Parallel Right Turn Channel	Smart Channel	2	No Right Turn Channel	-4	No Right Turn Channel	-4	No Right Turn Channel	-4
Perpendicular Radius	N/A	0	N/A	0	> 15m to 25m	-8	N/A	0
Perpendicular Right Turn Channel	N/A	0	N/A	0	Smart Channel	2	N/A	0
<i>CROSSING TREATMENT</i>								
Treatment	Standard	-7	Standard	-7	Standard	-7	Standard	-7
PETSI SCORE		-8		4		-18		20
LOS		F		F		F		F
DELAY SCORE								
Cycle Length		100		100		90		100
Pedestrian Walk Time		7.8		19.8		15.8		16.8
DELAY SCORE		42.5		32.2		30.6		34.6
LOS		E		D		D		D
OVERALL		F		F		F		F

Criteria	North Approach		South Approach		East Approach		West Approach	
Terry Fox Drive/Fernbank Road (Optimized)								
PETSI SCORE								
<i>CROSSING DISTANCE CONDITIONS</i>								
Median > 2.4m in Width	No	23	No	39	No	23	No	55
Lanes Crossed (3.5m Lane Width)	8		7		8		6	
<i>SIGNAL PHASING AND TIMING</i>								
Left Turn Conflict	Perm + Prot	-8	Permissive	-8	Permissive	-8	Perm + Prot	-8
Right Turn Conflict	Permissive or Yield	-5	Permissive or Yield	-5	Permissive or Yield	-5	Permissive or Yield	-5
Right Turn on Red	RTOR Allowed	-3	RTOR Allowed	-3	RTOR Allowed	-3	RTOR Allowed	-3
Leading Pedestrian Interval	No	-2	No	-2	No	-2	No	-2
<i>CORNER RADIUS</i>								
Parallel Radius	> 15m to 25m	-8	> 10m to 15m	-6	> 10m to 15m	-6	> 10m to 15m	-6
Parallel Right Turn Channel	Smart Channel	2	No Right Turn Channel	-4	No Right Turn Channel	-4	No Right Turn Channel	-4
Perpendicular Radius	N/A	0	N/A	0	> 15m to 25m	-8	N/A	0
Perpendicular Right Turn Channel	N/A	0	N/A	0	Smart Channel	2	N/A	0
<i>CROSSING TREATMENT</i>								
Treatment	Standard	-7	Standard	-7	Standard	-7	Standard	-7
PETSI SCORE		-8		4		-18		20
LOS		F		F		F		F
DELAY SCORE								
Cycle Length		120		120		120		120
Pedestrian Walk Time		8.8		24.8		46.8		22.8
DELAY SCORE		51.5		37.8		22.3		39.4
LOS		E		D		C		D
OVERALL		F		F		F		F

Bicycle Level of Service (BLOS)

Approach	Bikeway Facility Type	Criteria	Travel Lanes and/or Speed	BLOS
Terry Fox Drive/Cope Drive				
North Approach	Pocket Bike Lane	Right Turn Lane Characteristics	Right turn lane >50m long	D
		Left Turn Accommodation	One lane crossed, >60km/hr	E
South Approach	Paved Shoulder	Right Turn Lane Characteristics	No impact to LTS	A
		Left Turn Accommodation	One lane crossed, >60km/hr	E
East Approach	Mixed Traffic	Right Turn Lane Characteristics	No impact to LTS	A
		Left Turn Accommodation	One lane crossed, 50km/hr	D
West Approach	Mixed Traffic	Right Turn Lane Characteristics	No impact to LTS	A
		Left Turn Accommodation	One lane crossed, 50km/hr	D
Terry Fox Drive/Fernbank Road				
North Approach	Pocket Bike Lane	Right Turn Lane Characteristics	Right-turn lane >50m long	D
		Left Turn Accommodation	One lane crossed, >60km/hr	E
South Approach	Paved Shoulder	Right Turn Lane Characteristics	No impact to LTS	A
		Left Turn Accommodation	One lane crossed, >60km/hr	E
East Approach	Pocket Bike Lane	Right Turn Lane Characteristics	Right-turn lane >50m long	D
		Left Turn Accommodation	One lane crossed, 60km/hr	E
West Approach	Pocket Bike Lane	Right Turn Lane Characteristics	Bike lane shifts to the left of right-turn lane	D
		Left Turn Accommodation	One lane crossed, 60km/hr	E

Transit Level of Service (TLOS)

Approach	Facility Type	Delay ¹ AM (PM)	Movement	TLOS
Terry Fox Drive/Cope Drive²				
North Approach	Mixed Traffic (No TSP)	7 sec (12 sec)	SBT	C
South Approach	Mixed Traffic (No TSP)	7 sec (21 sec)	NBT/R	D
East Approach	Mixed Traffic (No TSP)	34 sec (40 sec)	WBL	E
West Approach	Mixed Traffic (No TSP)	-	-	-
Terry Fox Drive/Fernbank Road²				
North Approach	Mixed Traffic (No TSP)	43 sec (50 sec)	SBL	F
South Approach	Mixed Traffic (No TSP)	-	-	-
East Approach	Mixed Traffic (No TSP)	5 sec (2 sec)	WBR	B
West Approach	Mixed Traffic (No TSP)	11 sec (22 sec)	EBL	D

1. Mixed traffic delay based on the critical approach delay in Synchro analysis

2. No OC Transpo Service on Terry Fox Drive south of Fernbank Road, and on Cope Drive west of Terry Fox Drive

Truck Level of Service (TkLOS)

Approach	Effective Corner Radius	Number of Receiving Lanes on Departure from Intersection	LOS
Terry Fox Drive/Cope Drive			
North Approach	> 15m	One	C
South Approach	> 15m	One	C
East Approach	> 15m	One	C
West Approach	> 15m	One	C
Terry Fox Drive/Fernbank Road			
North Approach	> 15m	One	C
South Approach	> 15m	One	C
East Approach	> 15m	One	C
West Approach	> 15m	One	C

STEP 1 of 3 Desirable Cycling Facility Pre-selection Nomograph

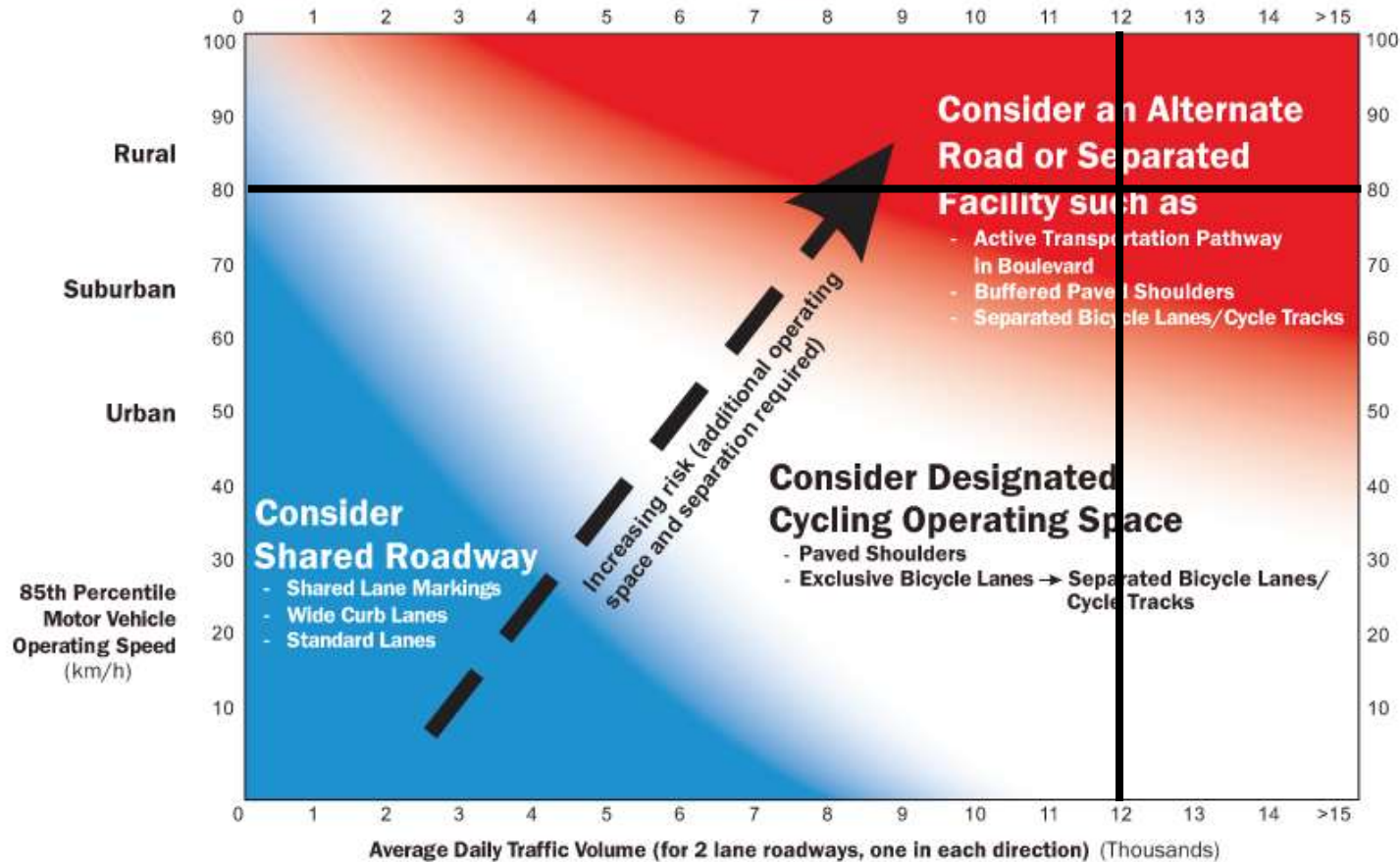

Figure 3.3 – Desirable Bicycle Facility Pre-Selection Nomograph

Footnotes: - This nomograph is the first of a three step bicycle facility selection process, and should not be used by itself as the justification for facility selection (see Steps 2 and 3). The nomograph simply helps practitioners pre-select a desirable cycling facility type, however the context of the situation governs the final decision.

- The nomograph has been adapted for the North American context and is based on international examples and research for two lane roadways. It is, however, still applicable for multi-lane roadways. For these situations, designers should consider the operating speed, total combined traffic volume and traffic mix of the vehicles travelling in the lanes immediately adjacent to the cycling facilities.

- Consider a Separated Facility or an Alternate Road for roadways with an AADT greater than 15,000 vehicles and an operating speed of greater than 50 km/h.

- For rural and suburban locations this nomograph assumes good sightlines are provided for all road users. In urban areas, there are typically more frequent conflict points at driveways, midblock crossings and intersections (especially on multi-lane roads), as well as on road segments with on-street parking. This needs to be considered when assessing risk exposure in urban environments since it will influence the selection of a suitable facility type.

APPENDIX J

MTO Left Turn Lane Warrants

Cope Drive/Access
2028 Total Traffic

Exhibit 9A-6

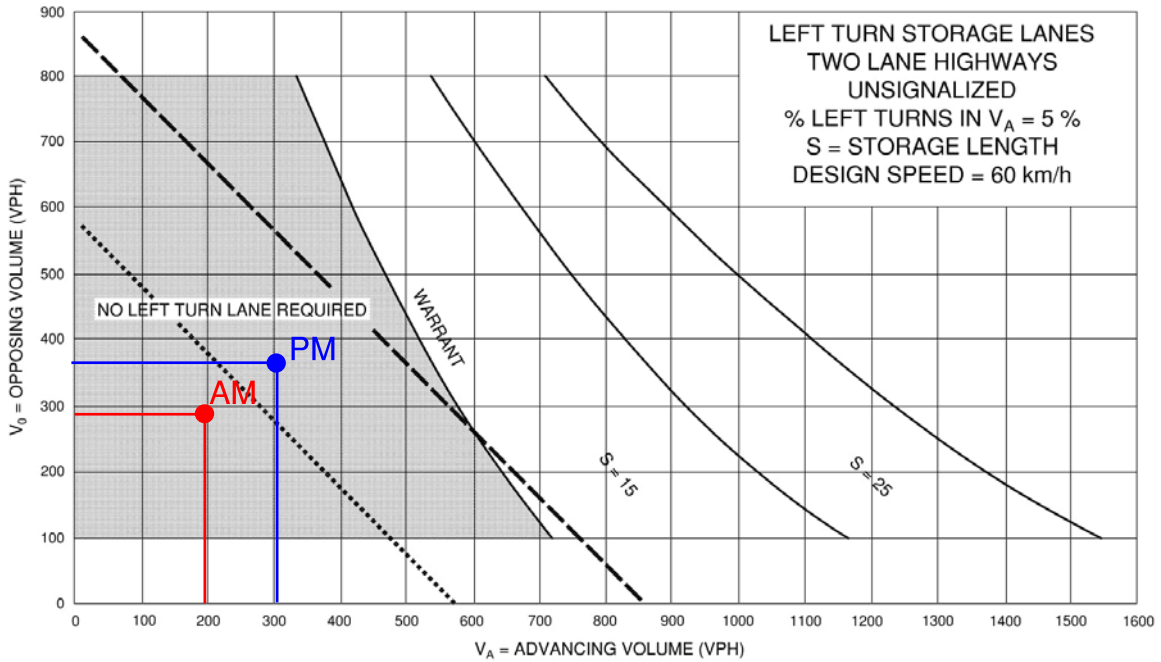

- TRAFFIC SIGNALS MAY BE WARRANTED IN RURAL AREAS OR URBAN AREAS WITH RESTRICTED FLOW
- TRAFFIC SIGNALS MAY BE WARRANTED IN "FREE FLOW" URBAN AREAS

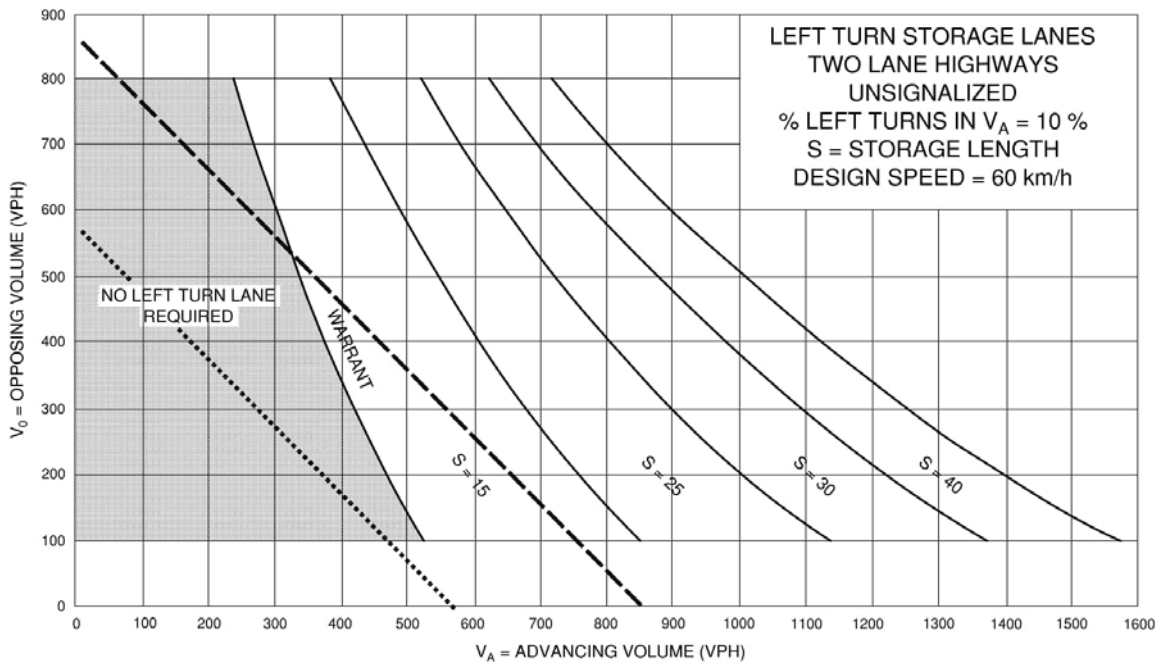

APPENDIX K

Functional Design of Turn Lane on Cope Drive

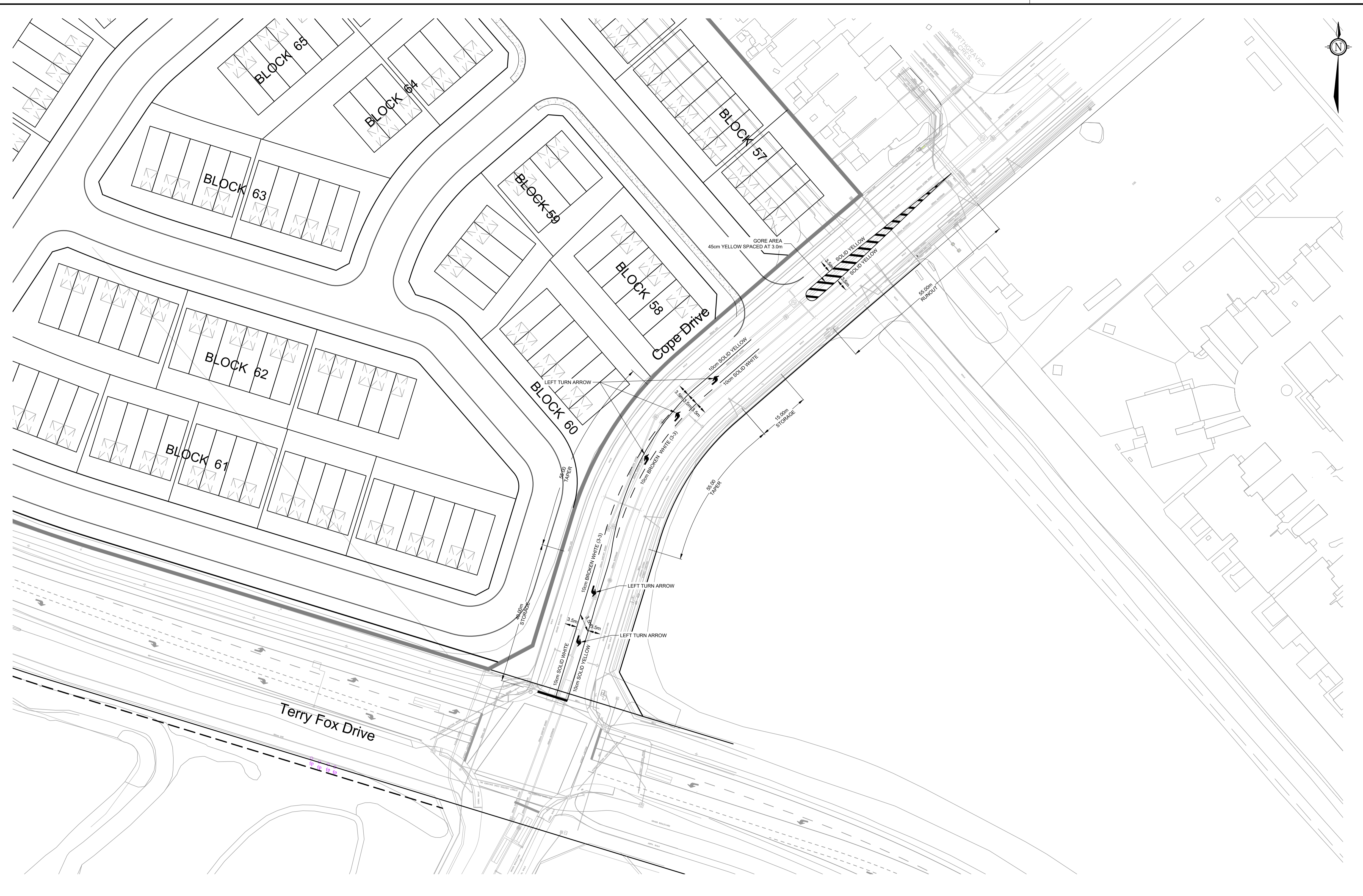
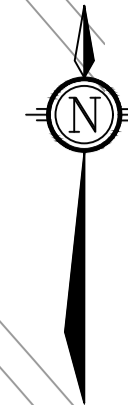

NOTE:
 THE POSITION OF ALL POLE LINES, CONDUITS,
 WATERMANS, SEWERS AND OTHER
 UNDERGROUND AND OVERGROUND UTILITIES AND
 STRUCTURES IS NOT NECESSARILY SHOWN ON
 THE CONTRACT DRAWINGS, AND WHERE SHOWN,
 THE ACCURACY OF THE POSITION OF SUCH
 UTILITIES AND STRUCTURES IS NOT GUARANTEED.
 BEFORE STARTING WORK, DETERMINE THE EXACT
 LOCATION OF ALL SUCH UTILITIES AND
 STRUCTURES AND ASSUME ALL LIABILITY FOR
 DAMAGE TO THEM.

No.	REVISION	DATE	BY
1.	ISSUED FOR CITY REVIEW	NOV 06/18	BJB

SCALE	
1:500	

DESIGN	RCH
CHECKED	BJB
DRAWN	RCH
CHECKED	BJB
APPROVED	JLL

FOR REVIEW ONLY

NOVATECH
 Engineers, Planners & Landscape Architects
 Suite 200, 240 Michael Cowpland Drive
 Ottawa, Ontario, Canada K2M 1P6
 Telephone (613) 254-9643
 Facsimile (613) 254-5867
 Website www.novatech-eng.com

LOCATION CITY OF OTTAWA 5331 FERNBANK ROAD AND 1039 TERRY FOX DRIVE	
DRAWING NAME	PROJECT No.
FUNCTIONAL DESIGN	117198
	REV # 1
DRAWING No.	117198-FD

M:\2017\117198\CAD\Design\Figures\Traffic\117198-FD.dwg, 117198-FD, Mar. 14, 2019 - 5:41pm, rthillier

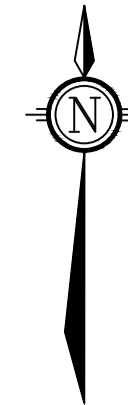

NOTE:
 THE POSITION OF ALL POLE LINES, CONDUITS, WATERMANS, SEWERS AND OTHER UNDERGROUND AND OVERGROUND UTILITIES AND STRUCTURES IS NOT NECESSARILY SHOWN ON THE CONTRACT DRAWINGS, AND WHERE SHOWN, THE ACCURACY OF THE POSITION OF SUCH UTILITIES AND STRUCTURES IS NOT GUARANTEED. BEFORE STARTING WORK, DETERMINE THE EXACT LOCATION OF ALL SUCH UTILITIES AND STRUCTURES AND ASSUME ALL LIABILITY FOR DAMAGE TO THEM.

No.	REVISION	DATE	BY
1.	ISSUED FOR CITY REVIEW	SEP 29/21	BJB

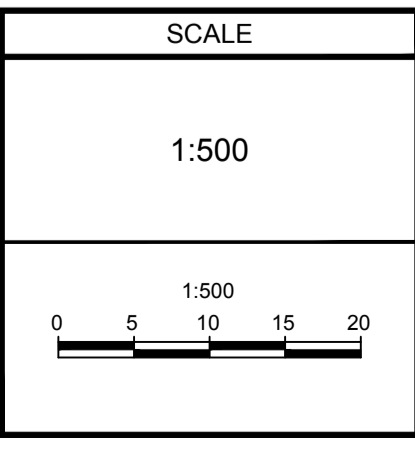

DESIGN	RCH
CHECKED	BJB
DRAWN	RCH
CHECKED	BJB
APPROVED	JLL

FOR REVIEW ONLY

NOVATECH
 Engineers, Planners & Landscape Architects
 Suite 200, 240 Michael Cowpland Drive
 Ottawa, Ontario, Canada K2M 1P6

Telephone (613) 254-9643
 Facsimile (613) 254-5867
 Website www.novatech-eng.com

LOCATION CITY OF OTTAWA 5331 FERNBANK ROAD	PROJECT No. 117198
DRAWING NAME FUNCTIONAL DESIGN	REV REV # 1
	DRAWING No. 121011-FD

C:\temp\AcPublish_21532\121011-FD.dwg, 12/10/11-FD, Sep 29, 2021, 1:39pm, millier

APPENDIX L

Synchro Analysis Reports – Future Traffic

Lane Group	EBL	EBT	EBR	WBL	WBT	WBR	NBL	NBT	NBR	SBL	SBT	SBR
Lane Configurations												
Traffic Volume (vph)	90	40	28	49	24	122	24	658	46	172	435	78
Future Volume (vph)	90	40	28	49	24	122	24	658	46	172	435	78
Ideal Flow (vphpl)	1800	1800	1800	1800	1800	1800	1800	1800	1800	1800	1800	1800
Storage Length (m)	30.0		0.0	30.0		0.0	35.0		0.0	50.0		140.0
Storage Lanes	1		0	1		0	1		0	1		1
Taper Length (m)	55.0			55.0			80.0			80.0		
Lane Util. Factor	1.00	1.00	1.00	1.00	1.00	1.00	1.00	1.00	1.00	1.00	1.00	1.00
Ped Bike Factor					0.98		1.00	1.00		1.00		0.97
Fr t		0.938			0.875			0.990				0.850
Flt Protected	0.950			0.950			0.950			0.950		
Satd. Flow (prot)	1558	1674	0	1340	1491	0	1209	1641	0	1695	1640	1502
Flt Permitted	0.645			0.713			0.491			0.326		
Satd. Flow (perm)	1058	1674	0	1006	1491	0	623	1641	0	581	1640	1462
Right Turn on Red			Yes			Yes			Yes			Yes
Satd. Flow (RTOR)		28			122			6				78
Link Speed (k/h)		50			50			80				80
Link Distance (m)		302.1			142.5			210.5				515.9
Travel Time (s)		21.8			10.3			9.5				23.2
Confl. Peds. (#/hr)							3		1	1		3
Confl. Bikes (#/hr)						1						1
Peak Hour Factor	1.00	1.00	1.00	1.00	1.00	1.00	1.00	1.00	1.00	1.00	1.00	1.00
Heavy Vehicles (%)	11%	2%	2%	29%	20%	2%	43%	9%	19%	2%	11%	3%
Adj. Flow (vph)	90	40	28	49	24	122	24	658	46	172	435	78
Shared Lane Traffic (%)												
Lane Group Flow (vph)	90	68	0	49	146	0	24	704	0	172	435	78
Enter Blocked Intersection	No	No	No	No	No	No	No	No	No	No	No	No
Lane Alignment	Left	Left	Right	Left	Left	Right	Left	Left	Right	Left	Left	Right
Median Width(m)		3.7			3.7			3.7				3.7
Link Offset(m)		0.0			0.0			0.0				0.0
Crosswalk Width(m)		4.9			4.9			4.9				4.9
Two way Left Turn Lane												
Headway Factor	1.06	1.06	1.06	1.06	1.06	1.06	1.06	1.06	1.06	1.06	1.06	1.06
Turning Speed (k/h)	24		14	24		14	24		14	24		14
Number of Detectors	1	2		1	2		1	2		1	2	1
Detector Template	Left	Thru		Left	Thru		Left	Thru		Left	Thru	Right
Leading Detector (m)	6.1	30.5		6.1	30.5		6.1	30.5		6.1	30.5	6.1
Trailing Detector (m)	0.0	0.0		0.0	0.0		0.0	0.0		0.0	0.0	0.0
Detector 1 Position(m)	0.0	0.0		0.0	0.0		0.0	0.0		0.0	0.0	0.0
Detector 1 Size(m)	6.1	1.8		6.1	1.8		6.1	1.8		6.1	1.8	6.1
Detector 1 Type	Cl+Ex	Cl+Ex		Cl+Ex	Cl+Ex		Cl+Ex	Cl+Ex		Cl+Ex	Cl+Ex	Cl+Ex
Detector 1 Channel												
Detector 1 Extend (s)	0.0	0.0		0.0	0.0		0.0	0.0		0.0	0.0	0.0
Detector 1 Queue (s)	0.0	0.0		0.0	0.0		0.0	0.0		0.0	0.0	0.0
Detector 1 Delay (s)	0.0	0.0		0.0	0.0		0.0	0.0		0.0	0.0	0.0
Detector 2 Position(m)		28.7			28.7			28.7				28.7
Detector 2 Size(m)		1.8			1.8			1.8				1.8
Detector 2 Type		Cl+Ex			Cl+Ex			Cl+Ex				Cl+Ex
Detector 2 Channel												
Detector 2 Extend (s)		0.0			0.0			0.0				0.0
Turn Type	Perm	NA		Perm	NA		Perm	NA		Perm	NA	Perm
Protected Phases		4			8			2			6	
Permitted Phases	4			8			2			6		6
Detector Phase	4	4		8	8		2	2		6	6	6
Switch Phase												
Minimum Initial (s)	10.0	10.0		10.0	10.0		10.0	10.0		10.0	10.0	10.0
Minimum Split (s)	32.2	32.2		32.2	32.2		28.4	28.4		28.4	28.4	28.4
Total Split (s)	37.0	37.0		37.0	37.0		53.0	53.0		53.0	53.0	53.0
Total Split (%)	41.1%	41.1%		41.1%	41.1%		58.9%	58.9%		58.9%	58.9%	58.9%
Maximum Green (s)	30.8	30.8		30.8	30.8		46.6	46.6		46.6	46.6	46.6
Yellow Time (s)	3.3	3.3		3.3	3.3		4.6	4.6		4.6	4.6	4.6



Lane Group	EBL	EBT	EBR	WBL	WBT	WBR	NBL	NBT	NBR	SBL	SBT	SBR
All-Red Time (s)	2.9	2.9		2.9	2.9		1.8	1.8		1.8	1.8	1.8
Lost Time Adjust (s)	0.0	0.0		0.0	0.0		0.0	0.0		0.0	0.0	0.0
Total Lost Time (s)	6.2	6.2		6.2	6.2		6.4	6.4		6.4	6.4	6.4
Lead/Lag												
Lead-Lag Optimize?												
Vehicle Extension (s)	3.0	3.0		3.0	3.0		3.0	3.0		3.0	3.0	3.0
Recall Mode	None	None		None	None		C-Max	C-Max		C-Max	C-Max	C-Max
Walk Time (s)	7.0	7.0		7.0	7.0		7.0	7.0		7.0	7.0	7.0
Flash Dont Walk (s)	19.0	19.0		19.0	19.0		15.0	15.0		15.0	15.0	15.0
Pedestrian Calls (#/hr)	5	5		5	5		5	5		5	5	5
Act Effct Green (s)	14.9	14.9		14.9	14.9		62.5	62.5		62.5	62.5	62.5
Actuated g/C Ratio	0.17	0.17		0.17	0.17		0.69	0.69		0.69	0.69	0.69
v/c Ratio	0.52	0.23		0.30	0.42		0.06	0.62		0.43	0.38	0.08
Control Delay	43.1	21.1		35.1	11.8		5.3	8.5		12.0	8.1	2.1
Queue Delay	0.0	0.0		0.0	0.0		0.0	0.0		0.0	0.0	0.0
Total Delay	43.1	21.1		35.1	11.8		5.3	8.5		12.0	8.1	2.1
LOS	D	C		D	B		A	A		B	A	A
Approach Delay		33.6			17.7			8.4			8.4	
Approach LOS		C			B			A			A	
Queue Length 50th (m)	14.8	6.2		7.8	3.7		0.5	17.5		10.0	24.3	0.0
Queue Length 95th (m)	24.8	14.6		15.1	16.4		m3.1	151.4		36.5	63.0	5.5
Internal Link Dist (m)		278.1			118.5			186.5			491.9	
Turn Bay Length (m)	30.0			30.0			35.0			50.0		140.0
Base Capacity (vph)	362	591		344	590		432	1141		403	1139	1039
Starvation Cap Reductn	0	0		0	0		0	0		0	0	0
Spillback Cap Reductn	0	0		0	0		0	0		0	0	0
Storage Cap Reductn	0	0		0	0		0	0		0	0	0
Reduced v/c Ratio	0.25	0.12		0.14	0.25		0.06	0.62		0.43	0.38	0.08

Intersection Summary

Area Type: Other
 Cycle Length: 90
 Actuated Cycle Length: 90
 Offset: 55 (61%), Referenced to phase 2:NBTL and 6:SBTL, Start of Green
 Natural Cycle: 80
 Control Type: Actuated-Coordinated
 Maximum v/c Ratio: 0.62
 Intersection Signal Delay: 11.7
 Intersection LOS: B
 Intersection Capacity Utilization 88.2%
 ICU Level of Service E
 Analysis Period (min) 15
 m Volume for 95th percentile queue is metered by upstream signal.

Splits and Phases: 2: Terry Fox & Cope

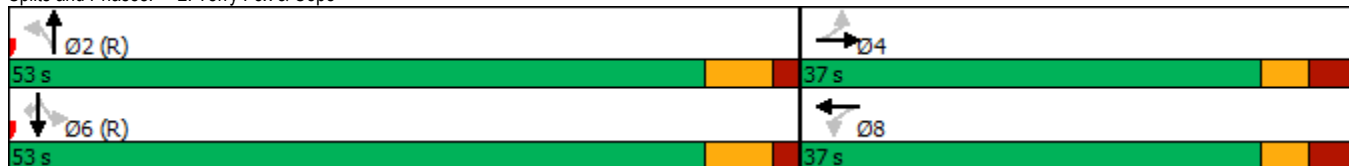

Lane Group	EBL	EBT	EBR	WBL	WBT	WBR	NBL	NBT	NBR	SBL	SBT	SBR
Lane Configurations												
Traffic Volume (vph)	164	240	197	3	185	134	152	374	2	78	287	95
Future Volume (vph)	164	240	197	3	185	134	152	374	2	78	287	95
Ideal Flow (vphpl)	1800	1800	1800	1800	1800	1800	1800	1800	1800	1800	1800	1800
Storage Length (m)	75.0		75.0	95.0		115.0	90.0		0.0	90.0		95.0
Storage Lanes	1		1	1		1	1		0	1		1
Taper Length (m)	100.0			60.0			70.0			100.0		
Lane Util. Factor	1.00	1.00	1.00	1.00	1.00	1.00	1.00	1.00	1.00	1.00	1.00	1.00
Ped Bike Factor	1.00		0.98			0.98						
Fr t			0.850			0.850		0.999				0.850
Fit Protected	0.950			0.950			0.950			0.950		
Satd. Flow (prot)	1631	1784	1488	1695	1767	1406	1662	1732	0	1662	1717	1357
Fit Permitted	0.551			0.610			0.439			0.299		
Satd. Flow (perm)	944	1784	1457	1088	1767	1374	768	1732	0	523	1717	1357
Right Turn on Red			Yes			Yes			Yes			Yes
Satd. Flow (RTOR)			197			134						113
Link Speed (k/h)					60			80				80
Link Distance (m)		274.4			222.4			294.7				171.1
Travel Time (s)		16.5			13.3			13.3				7.7
Confl. Peds. (#/hr)	2					2						
Confl. Bikes (#/hr)			1									
Peak Hour Factor	1.00	1.00	1.00	1.00	1.00	1.00	1.00	1.00	1.00	1.00	1.00	1.00
Heavy Vehicles (%)	6%	2%	4%	2%	3%	10%	4%	5%	2%	4%	6%	14%
Adj. Flow (vph)	164	240	197	3	185	134	152	374	2	78	287	95
Shared Lane Traffic (%)												
Lane Group Flow (vph)	164	240	197	3	185	134	152	376	0	78	287	95
Enter Blocked Intersection	No	No	No	No	No	No	No	No	No	No	No	No
Lane Alignment	Left	Left	Right	Left	Left	Right	Left	Left	Right	Left	Left	Right
Median Width(m)		3.7			3.7			3.7				3.7
Link Offset(m)		0.0			0.0			0.0				0.0
Crosswalk Width(m)		4.9			4.9			4.9				4.9
Two way Left Turn Lane												
Headway Factor	1.06	1.06	1.06	1.06	1.06	1.06	1.06	1.06	1.06	1.06	1.06	1.06
Turning Speed (k/h)	24		14	24		14	24		14	24		14
Number of Detectors	1	2	1	1	2	1	1	2		1	2	1
Detector Template	Left	Thru	Right	Left	Thru	Right	Left	Thru		Left	Thru	Right
Leading Detector (m)	6.1	30.5	6.1	6.1	30.5	6.1	6.1	30.5		6.1	30.5	6.1
Trailing Detector (m)	0.0	0.0	0.0	0.0	0.0	0.0	0.0	0.0		0.0	0.0	0.0
Detector 1 Position(m)	0.0	0.0	0.0	0.0	0.0	0.0	0.0	0.0		0.0	0.0	0.0
Detector 1 Size(m)	6.1	1.8	6.1	6.1	1.8	6.1	6.1	1.8		6.1	1.8	6.1
Detector 1 Type	Cl+Ex	Cl+Ex	Cl+Ex	Cl+Ex	Cl+Ex	Cl+Ex	Cl+Ex	Cl+Ex		Cl+Ex	Cl+Ex	Cl+Ex
Detector 1 Channel												
Detector 1 Extend (s)	0.0	0.0	0.0	0.0	0.0	0.0	0.0	0.0		0.0	0.0	0.0
Detector 1 Queue (s)	0.0	0.0	0.0	0.0	0.0	0.0	0.0	0.0		0.0	0.0	0.0
Detector 1 Delay (s)	0.0	0.0	0.0	0.0	0.0	0.0	0.0	0.0		0.0	0.0	0.0
Detector 2 Position(m)		28.7			28.7			28.7				28.7
Detector 2 Size(m)		1.8			1.8			1.8				1.8
Detector 2 Type		Cl+Ex			Cl+Ex			Cl+Ex				Cl+Ex
Detector 2 Channel												
Detector 2 Extend (s)		0.0			0.0			0.0				0.0
Turn Type	pm+pt	NA	Perm	Perm	NA	Perm	Perm	NA		Perm	NA	Perm
Protected Phases	5	2			6			8				4
Permitted Phases	2		2	6		6	8			4		4
Detector Phase	5	2	2	6	6	6	8	8		4	4	4
Switch Phase												
Minimum Initial (s)	5.0	10.0	10.0	10.0	10.0	10.0	10.0	10.0		10.0	10.0	10.0
Minimum Split (s)	11.2	33.2	33.2	33.2	33.2	33.2	29.2	29.2		29.2	29.2	29.2
Total Split (s)	17.0	52.0	52.0	35.0	35.0	35.0	38.0	38.0		38.0	38.0	38.0
Total Split (%)	18.9%	57.8%	57.8%	38.9%	38.9%	38.9%	42.2%	42.2%		42.2%	42.2%	42.2%
Maximum Green (s)	10.9	45.8	45.8	28.8	28.8	28.8	31.8	31.8		31.8	31.8	31.8
Yellow Time (s)	3.7	3.7	3.7	3.7	3.7	3.7	4.6	4.6		4.6	4.6	4.6



Lane Group	EBL	EBT	EBR	WBL	WBT	WBR	NBL	NBT	NBR	SBL	SBT	SBR
All-Red Time (s)	2.4	2.5	2.5	2.5	2.5	2.5	1.6	1.6		1.6	1.6	1.6
Lost Time Adjust (s)	0.0	0.0	0.0	0.0	0.0	0.0	0.0	0.0		0.0	0.0	0.0
Total Lost Time (s)	6.1	6.2	6.2	6.2	6.2	6.2	6.2	6.2		6.2	6.2	6.2
Lead/Lag	Lead			Lag			Lag					
Lead-Lag Optimize?	Yes			Yes			Yes					
Vehicle Extension (s)	3.0	3.0	3.0	3.0	3.0	3.0	3.0	3.0		3.0	3.0	3.0
Recall Mode	None	C-Max	C-Max	C-Max	C-Max	C-Max	None	None		None	None	None
Walk Time (s)		7.0	7.0	7.0	7.0	7.0	7.0	7.0		7.0	7.0	7.0
Flash Dont Walk (s)		20.0	20.0	20.0	20.0	20.0	16.0	16.0		16.0	16.0	16.0
Pedestrian Calls (#/hr)		5	5	5	5	5	5	5		5	5	5
Act Effct Green (s)	52.9	52.8	52.8	37.4	37.4	37.4	24.8	24.8		24.8	24.8	24.8
Actuated g/C Ratio	0.59	0.59	0.59	0.42	0.42	0.42	0.28	0.28		0.28	0.28	0.28
v/c Ratio	0.26	0.23	0.21	0.01	0.25	0.21	0.72	0.79		0.55	0.61	0.21
Control Delay	11.0	10.8	2.4	20.0	20.7	5.0	48.0	42.0		41.0	32.4	7.0
Queue Delay	0.0	0.0	0.0	0.0	0.0	0.0	0.0	0.0		0.0	0.0	0.0
Total Delay	11.0	10.8	2.4	20.0	20.7	5.0	48.0	42.0		41.0	32.4	7.0
LOS	B	B	A	B	C	A	D	D		D	C	A
Approach Delay		8.1			14.1			43.7			28.6	
Approach LOS		A			B			D			C	
Queue Length 50th (m)	12.0	18.3	0.0	0.3	20.5	0.0	23.6	60.0		9.1	33.7	0.0
Queue Length 95th (m)	25.7	36.6	9.8	2.3	41.1	11.9	41.4	82.0		22.7	61.4	11.5
Internal Link Dist (m)		250.4			198.4			270.7			147.1	
Turn Bay Length (m)	75.0		75.0	95.0		115.0	90.0		90.0		95.0	95.0
Base Capacity (vph)	639	1047	936	452	734	649	271	611		184	606	552
Starvation Cap Reductn	0	0	0	0	0	0	0	0		0	0	0
Spillback Cap Reductn	0	0	0	0	0	0	0	0		0	0	0
Storage Cap Reductn	0	0	0	0	0	0	0	0		0	0	0
Reduced v/c Ratio	0.26	0.23	0.21	0.01	0.25	0.21	0.56	0.62		0.42	0.47	0.17

Intersection Summary

















Area Type: Other
 Cycle Length: 90
 Actuated Cycle Length: 90
 Offset: 9 (10%), Referenced to phase 2:EBTL and 6:WBTL, Start of Green
 Natural Cycle: 75
 Control Type: Actuated-Coordinated
 Maximum v/c Ratio: 0.79
 Intersection Signal Delay: 23.9
 Intersection LOS: C
 Intersection Capacity Utilization 81.9%
 ICU Level of Service D
 Analysis Period (min) 15

Splits and Phases: 5: Terry Fox & Fernbank



5331 Fernbank Road
2023 Total Traffic

1: Access/Street 1 & Cope
Timing Plan: AM Peak

												
Movement	EBL	EBT	EBR	WBL	WBT	WBR	NBL	NBT	NBR	SBL	SBT	SBR
Lane Configurations												
Traffic Volume (veh/h)	13	240	5	2	178	6	13	0	5	17	0	4
Future Volume (Veh/h)	13	240	5	2	178	6	13	0	5	17	0	4
Sign Control		Free			Free			Stop			Stop	
Grade		0%			0%			0%			0%	
Peak Hour Factor	1.00	1.00	1.00	1.00	1.00	1.00	1.00	1.00	1.00	1.00	1.00	1.00
Hourly flow rate (vph)	13	240	5	2	178	6	13	0	5	17	0	4
Pedestrians												
Lane Width (m)												
Walking Speed (m/s)												
Percent Blockage												
Right turn flare (veh)												
Median type												
Median storage (veh)												
Upstream signal (m)												
pX, platoon unblocked												
vC, conflicting volume	184			245			458	456	242	456	456	181
vC1, stage 1 conf vol												
vC2, stage 2 conf vol												
vCu, unblocked vol	184			245			458	456	242	456	456	181
tC, single (s)	4.1			4.1			7.1	6.5	6.2	7.1	6.5	6.2
tC, 2 stage (s)												
tF (s)	2.2			2.2			3.5	4.0	3.3	3.5	4.0	3.3
p0 queue free %	99			100			97	100	99	97	100	100
cM capacity (veh/h)	1391			1321			507	495	796	507	495	862
Direction, Lane #	EB 1	EB 2	WB 1	NB 1	SB 1							
Volume Total	13	245	186	18	21							
Volume Left	13	0	2	13	17							
Volume Right	0	5	6	5	4							
cSH	1391	1700	1321	564	550							
Volume to Capacity	0.01	0.14	0.00	0.03	0.04							
Queue Length 95th (m)	0.2	0.0	0.0	0.8	0.9							
Control Delay (s)	7.6	0.0	0.1	11.6	11.8							
Lane LOS	A		A	B	B							
Approach Delay (s)	0.4		0.1	11.6	11.8							
Approach LOS				B	B							
Intersection Summary												
Average Delay			1.2									
Intersection Capacity Utilization			23.7%		ICU Level of Service				A			
Analysis Period (min)			15									

Lane Group	EBL	EBT	EBR	WBL	WBT	WBR	NBL	NBT	NBR	SBL	SBT	SBR
Lane Configurations												
Traffic Volume (vph)	116	39	18	72	25	200	18	563	58	257	783	122
Future Volume (vph)	116	39	18	72	25	200	18	563	58	257	783	122
Ideal Flow (vphpl)	1800	1800	1800	1800	1800	1800	1800	1800	1800	1800	1800	1800
Storage Length (m)	30.0		0.0	30.0		0.0	35.0		0.0	50.0		140.0
Storage Lanes	1		0	1		0	1		0	1		1
Taper Length (m)	55.0			55.0			80.0			80.0		
Lane Util. Factor	1.00	1.00	1.00	1.00	1.00	1.00	1.00	1.00	1.00	1.00	1.00	1.00
Ped Bike Factor		0.99		1.00			1.00					0.97
Fr _t		0.953			0.867			0.986				0.850
Flt Protected	0.950			0.950			0.950			0.950		
Satd. Flow (prot)	1695	1689	0	1601	1547	0	1695	1715	0	1695	1784	1517
Flt Permitted	0.422			0.720			0.369			0.227		
Satd. Flow (perm)	753	1689	0	1211	1547	0	657	1715	0	405	1784	1475
Right Turn on Red			Yes			Yes			Yes			Yes
Satd. Flow (RTOR)		18			200			7				122
Link Speed (k/h)		50			50			80				80
Link Distance (m)		302.1			142.5			210.5				515.9
Travel Time (s)		21.8			10.3			9.5				23.2
Confl. Peds. (#/hr)			1	1			3					3
Confl. Bikes (#/hr)												1
Peak Hour Factor	1.00	1.00	1.00	1.00	1.00	1.00	1.00	1.00	1.00	1.00	1.00	1.00
Heavy Vehicles (%)	2%	2%	2%	8%	2%	2%	2%	4%	11%	2%	2%	2%
Adj. Flow (vph)	116	39	18	72	25	200	18	563	58	257	783	122
Shared Lane Traffic (%)												
Lane Group Flow (vph)	116	57	0	72	225	0	18	621	0	257	783	122
Enter Blocked Intersection	No	No	No	No	No	No	No	No	No	No	No	No
Lane Alignment	Left	Left	Right	Left	Left	Right	Left	Left	Right	Left	Left	Right
Median Width(m)		3.7			3.7			3.7				3.7
Link Offset(m)		0.0			0.0			0.0				0.0
Crosswalk Width(m)		4.9			4.9			4.9				4.9
Two way Left Turn Lane												
Headway Factor	1.06	1.06	1.06	1.06	1.06	1.06	1.06	1.06	1.06	1.06	1.06	1.06
Turning Speed (k/h)	24		14	24		14	24		14	24		14
Number of Detectors	1	2		1	2		1	2		1	2	1
Detector Template	Left	Thru		Left	Thru		Left	Thru		Left	Thru	Right
Leading Detector (m)	6.1	30.5		6.1	30.5		6.1	30.5		6.1	30.5	6.1
Trailing Detector (m)	0.0	0.0		0.0	0.0		0.0	0.0		0.0	0.0	0.0
Detector 1 Position(m)	0.0	0.0		0.0	0.0		0.0	0.0		0.0	0.0	0.0
Detector 1 Size(m)	6.1	1.8		6.1	1.8		6.1	1.8		6.1	1.8	6.1
Detector 1 Type	Cl+Ex	Cl+Ex		Cl+Ex	Cl+Ex		Cl+Ex	Cl+Ex		Cl+Ex	Cl+Ex	Cl+Ex
Detector 1 Channel												
Detector 1 Extend (s)	0.0	0.0		0.0	0.0		0.0	0.0		0.0	0.0	0.0
Detector 1 Queue (s)	0.0	0.0		0.0	0.0		0.0	0.0		0.0	0.0	0.0
Detector 1 Delay (s)	0.0	0.0		0.0	0.0		0.0	0.0		0.0	0.0	0.0
Detector 2 Position(m)		28.7			28.7			28.7				28.7
Detector 2 Size(m)		1.8			1.8			1.8				1.8
Detector 2 Type		Cl+Ex			Cl+Ex			Cl+Ex				Cl+Ex
Detector 2 Channel												
Detector 2 Extend (s)		0.0			0.0			0.0				0.0
Turn Type	Perm	NA		Perm	NA		Perm	NA		pm+pt	NA	Perm
Protected Phases		4			8			2		1		6
Permitted Phases	4			8			2			6		6
Detector Phase	4	4		8	8		2	2		1	6	6
Switch Phase												
Minimum Initial (s)	10.0	10.0		10.0	10.0		10.0	10.0		5.0	10.0	10.0
Minimum Split (s)	32.2	32.2		32.2	32.2		28.4	28.4		11.4	28.4	28.4
Total Split (s)	37.0	37.0		37.0	37.0		51.0	51.0		12.0	63.0	63.0
Total Split (%)	37.0%	37.0%		37.0%	37.0%		51.0%	51.0%		12.0%	63.0%	63.0%
Maximum Green (s)	30.8	30.8		30.8	30.8		44.6	44.6		5.6	56.6	56.6
Yellow Time (s)	3.3	3.3		3.3	3.3		4.6	4.6		4.6	4.6	4.6



Lane Group	EBL	EBT	EBR	WBL	WBT	WBR	NBL	NBT	NBR	SBL	SBT	SBR
All-Red Time (s)	2.9	2.9		2.9	2.9		1.8	1.8		1.8	1.8	1.8
Lost Time Adjust (s)	0.0	0.0		0.0	0.0		0.0	0.0		0.0	0.0	0.0
Total Lost Time (s)	6.2	6.2		6.2	6.2		6.4	6.4		6.4	6.4	6.4
Lead/Lag							Lag	Lag		Lead		
Lead-Lag Optimize?							Yes	Yes		Yes		
Vehicle Extension (s)	3.0	3.0		3.0	3.0		3.0	3.0		3.0	3.0	3.0
Recall Mode	None	None		None	None		C-Max	C-Max		None	C-Max	C-Max
Walk Time (s)	7.0	7.0		7.0	7.0		7.0	7.0		7.0	7.0	7.0
Flash Dont Walk (s)	19.0	19.0		19.0	19.0		15.0	15.0		15.0	15.0	15.0
Pedestrian Calls (#/hr)	5	5		5	5		5	5		5	5	5
Act Effct Green (s)	17.6	17.6		17.6	17.6		49.7	49.7		69.8	69.8	69.8
Actuated g/C Ratio	0.18	0.18		0.18	0.18		0.50	0.50		0.70	0.70	0.70
v/c Ratio	0.88	0.18		0.34	0.52		0.06	0.73		0.56	0.63	0.11
Control Delay	90.7	25.1		38.3	11.0		13.6	26.3		11.5	12.3	1.6
Queue Delay	0.0	0.0		0.0	0.0		0.0	0.0		0.0	0.0	0.0
Total Delay	90.7	25.1		38.3	11.0		13.6	26.3		11.5	12.3	1.6
LOS	F	C		D	B		B	C		B	B	A
Approach Delay		69.1			17.6			26.0				11.0
Approach LOS		E			B			C				B
Queue Length 50th (m)	22.2	6.5		12.4	4.1		2.1	100.5		15.3	70.5	0.0
Queue Length 95th (m)	#40.3	15.4		22.7	21.8		m5.7	#162.8		33.0	140.9	6.3
Internal Link Dist (m)		278.1			118.5			186.5			491.9	
Turn Bay Length (m)	30.0			30.0			35.0			50.0		140.0
Base Capacity (vph)	231	532		372	614		326	856		459	1245	1066
Starvation Cap Reductn	0	0		0	0		0	0		0	0	0
Spillback Cap Reductn	0	0		0	0		0	0		0	0	0
Storage Cap Reductn	0	0		0	0		0	0		0	0	0
Reduced v/c Ratio	0.50	0.11		0.19	0.37		0.06	0.73		0.56	0.63	0.11

Intersection Summary

Area Type: Other
 Cycle Length: 100
 Actuated Cycle Length: 100
 Offset: 69 (69%), Referenced to phase 2:NBTL and 6:SBTL, Start of Green
 Natural Cycle: 90
 Control Type: Actuated-Coordinated
 Maximum v/c Ratio: 0.88
 Intersection Signal Delay: 20.5
 Intersection LOS: C
 Intersection Capacity Utilization 95.6%
 ICU Level of Service F
 Analysis Period (min) 15
 # 95th percentile volume exceeds capacity, queue may be longer.
 Queue shown is maximum after two cycles.
 m Volume for 95th percentile queue is metered by upstream signal.

Splits and Phases: 2: Terry Fox & Cope



Lane Group	EBL	EBT	EBR	WBL	WBT	WBR	NBL	NBT	NBR	SBL	SBT	SBR
Lane Configurations												
Traffic Volume (vph)	113	239	140	5	314	109	264	361	23	192	465	164
Future Volume (vph)	113	239	140	5	314	109	264	361	23	192	465	164
Ideal Flow (vphpl)	1800	1800	1800	1800	1800	1800	1800	1800	1800	1800	1800	1800
Storage Length (m)	75.0		75.0	95.0		115.0	90.0		0.0	90.0		95.0
Storage Lanes	1		1	1		1	1		0	1		1
Taper Length (m)	100.0			60.0			70.0			100.0		
Lane Util. Factor	1.00	1.00	1.00	1.00	1.00	1.00	1.00	1.00	1.00	1.00	1.00	1.00
Ped Bike Factor	1.00		0.97	0.99		0.97				1.00		0.96
Fr t			0.850			0.850		0.991				0.850
Fit Protected	0.950			0.950			0.950			0.950		
Satd. Flow (prot)	1631	1784	1502	1235	1784	1459	1695	1768	0	1695	1784	1488
Fit Permitted	0.315			0.610			0.161			0.534		
Satd. Flow (perm)	540	1784	1461	789	1784	1421	287	1768	0	949	1784	1429
Right Turn on Red			Yes			Yes			Yes			Yes
Satd. Flow (RTOR)			140			172		4				172
Link Speed (k/h)		60			60			80			80	
Link Distance (m)		274.4			222.4			294.7			171.1	
Travel Time (s)		16.5			13.3			13.3			7.7	
Confl. Peds. (#/hr)	2		4	4		2	9			3		9
Confl. Bikes (#/hr)						2						
Peak Hour Factor	1.00	1.00	1.00	1.00	1.00	1.00	1.00	1.00	1.00	1.00	1.00	1.00
Heavy Vehicles (%)	6%	2%	3%	40%	2%	6%	2%	2%	2%	2%	2%	4%
Adj. Flow (vph)	113	239	140	5	314	109	264	361	23	192	465	164
Shared Lane Traffic (%)												
Lane Group Flow (vph)	113	239	140	5	314	109	264	384	0	192	465	164
Enter Blocked Intersection	No	No	No	No	No	No	No	No	No	No	No	No
Lane Alignment	Left	Left	Right	Left	Left	Right	Left	Left	Right	Left	Left	Right
Median Width(m)		3.7			3.7			3.7			3.7	
Link Offset(m)		0.0			0.0			0.0			0.0	
Crosswalk Width(m)		4.9			4.9			4.9			4.9	
Two way Left Turn Lane												
Headway Factor	1.06	1.06	1.06	1.06	1.06	1.06	1.06	1.06	1.06	1.06	1.06	1.06
Turning Speed (k/h)	24		14	24		14	24		14	24		14
Number of Detectors	1	2	1	1	2	1	1	2		1	2	1
Detector Template	Left	Thru	Right	Left	Thru	Right	Left	Thru		Left	Thru	Right
Leading Detector (m)	6.1	30.5	6.1	6.1	30.5	6.1	6.1	30.5		6.1	30.5	6.1
Trailing Detector (m)	0.0	0.0	0.0	0.0	0.0	0.0	0.0	0.0		0.0	0.0	0.0
Detector 1 Position(m)	0.0	0.0	0.0	0.0	0.0	0.0	0.0	0.0		0.0	0.0	0.0
Detector 1 Size(m)	6.1	1.8	6.1	6.1	1.8	6.1	6.1	1.8		6.1	1.8	6.1
Detector 1 Type	Cl+Ex	Cl+Ex	Cl+Ex	Cl+Ex	Cl+Ex	Cl+Ex	Cl+Ex	Cl+Ex		Cl+Ex	Cl+Ex	Cl+Ex
Detector 1 Channel												
Detector 1 Extend (s)	0.0	0.0	0.0	0.0	0.0	0.0	0.0	0.0		0.0	0.0	0.0
Detector 1 Queue (s)	0.0	0.0	0.0	0.0	0.0	0.0	0.0	0.0		0.0	0.0	0.0
Detector 1 Delay (s)	0.0	0.0	0.0	0.0	0.0	0.0	0.0	0.0		0.0	0.0	0.0
Detector 2 Position(m)		28.7			28.7			28.7			28.7	
Detector 2 Size(m)		1.8			1.8			1.8			1.8	
Detector 2 Type		Cl+Ex			Cl+Ex			Cl+Ex			Cl+Ex	
Detector 2 Channel												
Detector 2 Extend (s)		0.0			0.0			0.0			0.0	
Turn Type	pm+pt	NA	Perm	Perm	NA	Perm	pm+pt	NA		Perm	NA	Perm
Protected Phases	5	2			6		3	8			4	
Permitted Phases	2		2	6		6	8		4			4
Detector Phase	5	2	2	6	6	6	3	8	4	4		4
Switch Phase												
Minimum Initial (s)	5.0	10.0	10.0	10.0	10.0	10.0	5.0	10.0		10.0	10.0	10.0
Minimum Split (s)	11.2	33.2	33.2	33.2	33.2	33.2	11.5	29.2		29.2	29.2	29.2
Total Split (s)	12.0	46.0	46.0	34.0	34.0	34.0	15.0	54.0		39.0	39.0	39.0
Total Split (%)	12.0%	46.0%	46.0%	34.0%	34.0%	34.0%	15.0%	54.0%		39.0%	39.0%	39.0%
Maximum Green (s)	5.9	39.8	39.8	27.8	27.8	27.8	8.5	47.8		32.8	32.8	32.8
Yellow Time (s)	3.7	3.7	3.7	3.7	3.7	3.7	4.6	4.6		4.6	4.6	4.6



Lane Group	EBL	EBT	EBR	WBL	WBT	WBR	NBL	NBT	NBR	SBL	SBT	SBR
All-Red Time (s)	2.4	2.5	2.5	2.5	2.5	2.5	1.9	1.6		1.6	1.6	1.6
Lost Time Adjust (s)	0.0	0.0	0.0	0.0	0.0	0.0	0.0	0.0		0.0	0.0	0.0
Total Lost Time (s)	6.1	6.2	6.2	6.2	6.2	6.2	6.5	6.2		6.2	6.2	6.2
Lead/Lag	Lead			Lag	Lag	Lag	Lead			Lag	Lag	Lag
Lead-Lag Optimize?	Yes			Yes	Yes	Yes	Yes			Yes	Yes	Yes
Vehicle Extension (s)	3.0	3.0	3.0	3.0	3.0	3.0	3.0	3.0		3.0	3.0	3.0
Recall Mode	C-Max	C-Max	C-Max	Max	Max	Max	None	None		None	None	None
Walk Time (s)		7.0	7.0	7.0	7.0	7.0		7.0		7.0	7.0	7.0
Flash Dont Walk (s)		20.0	20.0	20.0	20.0	20.0		16.0		16.0	16.0	16.0
Pedestrian Calls (#/hr)		5	5	5	5	5		5		5	5	5
Act Effct Green (s)	42.7	42.6	42.6	27.8	27.8	27.8	44.7	45.0		30.0	30.0	30.0
Actuated g/C Ratio	0.43	0.43	0.43	0.28	0.28	0.28	0.45	0.45		0.30	0.30	0.30
v/c Ratio	0.35	0.31	0.20	0.02	0.63	0.21	1.06	0.48		0.68	0.87	0.30
Control Delay	22.3	21.4	4.2	26.8	38.4	1.7	98.3	20.9		49.5	54.9	12.4
Queue Delay	0.0	0.0	0.0	0.0	0.0	0.0	0.0	0.0		0.0	0.0	0.0
Total Delay	22.3	21.4	4.2	26.8	38.4	1.7	98.3	20.9		49.5	54.9	12.4
LOS	C	C	A	C	D	A	F	C		D	D	B
Approach Delay		16.7			28.9			52.4				45.2
Approach LOS		B			C			D				D
Queue Length 50th (m)	13.9	31.6	0.0	0.7	53.3	0.0	~32.5	47.4		30.2	73.8	2.1
Queue Length 95th (m)	25.5	50.4	11.1	3.5	81.7	2.7	#80.4	71.1		58.9	#127.4	25.5
Internal Link Dist (m)		250.4			198.4			270.7			147.1	
Turn Bay Length (m)	75.0		75.0	95.0		115.0	90.0			90.0		95.0
Base Capacity (vph)	325	760	702	219	495	519	248	847		311	585	584
Starvation Cap Reductn	0	0	0	0	0	0	0	0		0	0	0
Spillback Cap Reductn	0	0	0	0	0	0	0	0		0	0	0
Storage Cap Reductn	0	0	0	0	0	0	0	0		0	0	0
Reduced v/c Ratio	0.35	0.31	0.20	0.02	0.63	0.21	1.06	0.45		0.62	0.79	0.28

Intersection Summary





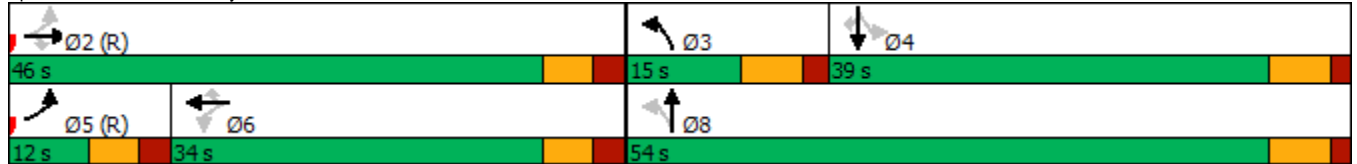











Area Type: Other
 Cycle Length: 100
 Actuated Cycle Length: 100
 Offset: 79 (79%), Referenced to phase 2:EBTL and 5:EBL, Start of Green
 Natural Cycle: 90
 Control Type: Actuated-Coordinated
 Maximum v/c Ratio: 1.06
 Intersection Signal Delay: 38.4
 Intersection LOS: D
 Intersection Capacity Utilization 93.0%
 ICU Level of Service F
 Analysis Period (min) 15
 ~ Volume exceeds capacity, queue is theoretically infinite.
 Queue shown is maximum after two cycles.
 # 95th percentile volume exceeds capacity, queue may be longer.
 Queue shown is maximum after two cycles.

Splits and Phases: 5: Terry Fox & Fernbank



5331 Fernbank Road
2023 Total Traffic

1: Access/Street 1 & Cope
Timing Plan: PM Peak

												
Movement	EBL	EBT	EBR	WBL	WBT	WBR	NBL	NBT	NBR	SBL	SBT	SBR
Lane Configurations												
Traffic Volume (veh/h)	42	301	11	6	285	21	10	0	5	9	0	2
Future Volume (Veh/h)	42	301	11	6	285	21	10	0	5	9	0	2
Sign Control		Free			Free			Stop			Stop	
Grade		0%			0%			0%			0%	
Peak Hour Factor	1.00	1.00	1.00	1.00	1.00	1.00	1.00	1.00	1.00	1.00	1.00	1.00
Hourly flow rate (vph)	42	301	11	6	285	21	10	0	5	9	0	2
Pedestrians												
Lane Width (m)												
Walking Speed (m/s)												
Percent Blockage												
Right turn flare (veh)												
Median type		None			None							
Median storage (veh)												
Upstream signal (m)		143										
pX, platoon unblocked				0.98			0.98	0.98	0.98	0.98	0.98	
vC, conflicting volume	306			312			700	708	306	698	704	296
vC1, stage 1 conf vol												
vC2, stage 2 conf vol												
vCu, unblocked vol	306			283			681	689	278	678	684	296
tC, single (s)	4.1			4.1			7.1	6.5	6.2	7.1	6.5	6.2
tC, 2 stage (s)												
tF (s)	2.2			2.2			3.5	4.0	3.3	3.5	4.0	3.3
p0 queue free %	97			100			97	100	99	97	100	100
cM capacity (veh/h)	1255			1249			345	346	743	345	348	744
Direction, Lane #	EB 1	EB 2	WB 1	NB 1	SB 1							
Volume Total	42	312	312	15	11							
Volume Left	42	0	6	10	9							
Volume Right	0	11	21	5	2							
cSH	1255	1700	1249	420	382							
Volume to Capacity	0.03	0.18	0.00	0.04	0.03							
Queue Length 95th (m)	0.8	0.0	0.1	0.8	0.7							
Control Delay (s)	8.0	0.0	0.2	13.9	14.7							
Lane LOS	A		A	B	B							
Approach Delay (s)	0.9		0.2	13.9	14.7							
Approach LOS				B	B							
Intersection Summary												
Average Delay			1.1									
Intersection Capacity Utilization			38.6%		ICU Level of Service				A			
Analysis Period (min)			15									

5331 Fernbank Road
2023 Total Traffic (Optimized)

5: Terry Fox & Fernbank
Timing Plan: PM Peak



Lane Group	EBL	EBT	EBR	WBL	WBT	WBR	NBL	NBT	NBR	SBL	SBT	SBR
Lane Configurations												
Traffic Volume (vph)	113	239	140	5	314	109	264	361	23	192	465	164
Future Volume (vph)	113	239	140	5	314	109	264	361	23	192	465	164
Ideal Flow (vphpl)	1800	1800	1800	1800	1800	1800	1800	1800	1800	1800	1800	1800
Storage Length (m)	75.0		75.0	95.0		115.0	90.0		0.0	90.0		95.0
Storage Lanes	1		1	1		1	1		0	1		1
Taper Length (m)	100.0			60.0			70.0			100.0		
Lane Util. Factor	1.00	1.00	1.00	1.00	1.00	1.00	1.00	1.00	1.00	1.00	1.00	1.00
Ped Bike Factor	1.00		0.97	0.99		0.97				1.00		0.96
Fr t			0.850			0.850		0.991				0.850
Fit Protected	0.950			0.950			0.950			0.950		
Satd. Flow (prot)	1631	1784	1502	1235	1784	1459	1695	1768	0	1695	1784	1488
Fit Permitted	0.257			0.610			0.147			0.534		
Satd. Flow (perm)	440	1784	1459	788	1784	1419	262	1768	0	948	1784	1424
Right Turn on Red			Yes			Yes			Yes			Yes
Satd. Flow (RTOR)			140			144		4				164
Link Speed (k/h)		60			60			80			80	
Link Distance (m)		274.4			222.4			294.7			171.1	
Travel Time (s)		16.5			13.3			13.3			7.7	
Confl. Peds. (#/hr)	2		4	4		2	9			3		9
Confl. Bikes (#/hr)						2						
Peak Hour Factor	1.00	1.00	1.00	1.00	1.00	1.00	1.00	1.00	1.00	1.00	1.00	1.00
Heavy Vehicles (%)	6%	2%	3%	40%	2%	6%	2%	2%	2%	2%	2%	4%
Adj. Flow (vph)	113	239	140	5	314	109	264	361	23	192	465	164
Shared Lane Traffic (%)												
Lane Group Flow (vph)	113	239	140	5	314	109	264	384	0	192	465	164
Enter Blocked Intersection	No	No	No	No	No	No	No	No	No	No	No	No
Lane Alignment	Left	Left	Right	Left	Left	Right	Left	Left	Right	Left	Left	Right
Median Width(m)		3.7			3.7			3.7			3.7	
Link Offset(m)		0.0			0.0			0.0			0.0	
Crosswalk Width(m)		4.9			4.9			4.9			4.9	
Two way Left Turn Lane												
Headway Factor	1.06	1.06	1.06	1.06	1.06	1.06	1.06	1.06	1.06	1.06	1.06	1.06
Turning Speed (k/h)	24		14	24		14	24		14	24		14
Number of Detectors	1	2	1	1	2	1	1	2		1	2	1
Detector Template	Left	Thru	Right	Left	Thru	Right	Left	Thru		Left	Thru	Right
Leading Detector (m)	6.1	30.5	6.1	6.1	30.5	6.1	6.1	30.5		6.1	30.5	6.1
Trailing Detector (m)	0.0	0.0	0.0	0.0	0.0	0.0	0.0	0.0		0.0	0.0	0.0
Detector 1 Position(m)	0.0	0.0	0.0	0.0	0.0	0.0	0.0	0.0		0.0	0.0	0.0
Detector 1 Size(m)	6.1	1.8	6.1	6.1	1.8	6.1	6.1	1.8		6.1	1.8	6.1
Detector 1 Type	Cl+Ex	Cl+Ex	Cl+Ex	Cl+Ex	Cl+Ex	Cl+Ex	Cl+Ex	Cl+Ex		Cl+Ex	Cl+Ex	Cl+Ex
Detector 1 Channel												
Detector 1 Extend (s)	0.0	0.0	0.0	0.0	0.0	0.0	0.0	0.0		0.0	0.0	0.0
Detector 1 Queue (s)	0.0	0.0	0.0	0.0	0.0	0.0	0.0	0.0		0.0	0.0	0.0
Detector 1 Delay (s)	0.0	0.0	0.0	0.0	0.0	0.0	0.0	0.0		0.0	0.0	0.0
Detector 2 Position(m)		28.7			28.7			28.7			28.7	
Detector 2 Size(m)		1.8			1.8			1.8			1.8	
Detector 2 Type		Cl+Ex			Cl+Ex			Cl+Ex			Cl+Ex	
Detector 2 Channel												
Detector 2 Extend (s)		0.0			0.0			0.0			0.0	
Turn Type	pm+pt	NA	Perm	Perm	NA	Perm	pm+pt	NA		Perm	NA	Perm
Protected Phases	5	2			6		3	8			4	
Permitted Phases	2		2	6		6	8			4		4
Detector Phase	5	2	2	6	6	6	3	8		4	4	4
Switch Phase												
Minimum Initial (s)	5.0	10.0	10.0	10.0	10.0	10.0	5.0	10.0		10.0	10.0	10.0
Minimum Split (s)	11.2	33.2	33.2	33.2	33.2	33.2	11.5	29.2		29.2	29.2	29.2
Total Split (s)	17.0	52.0	52.0	35.0	35.0	35.0	22.0	68.0		46.0	46.0	46.0
Total Split (%)	14.2%	43.3%	43.3%	29.2%	29.2%	29.2%	18.3%	56.7%		38.3%	38.3%	38.3%
Maximum Green (s)	10.9	45.8	45.8	28.8	28.8	28.8	15.5	61.8		39.8	39.8	39.8
Yellow Time (s)	3.7	3.7	3.7	3.7	3.7	3.7	4.6	4.6		4.6	4.6	4.6











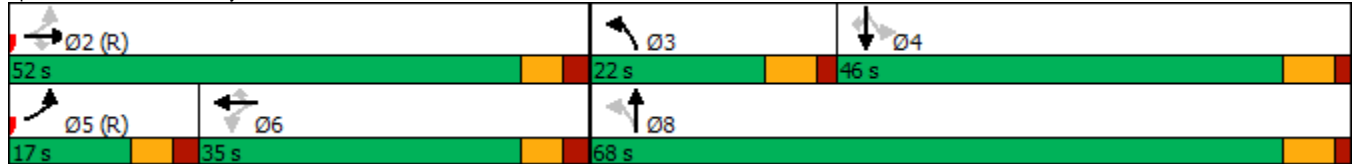













Lane Group	EBL	EBT	EBR	WBL	WBT	WBR	NBL	NBT	NBR	SBL	SBT	SBR
All-Red Time (s)	2.4	2.5	2.5	2.5	2.5	2.5	1.9	1.6		1.6	1.6	1.6
Lost Time Adjust (s)	0.0	0.0	0.0	0.0	0.0	0.0	0.0	0.0		0.0	0.0	0.0
Total Lost Time (s)	6.1	6.2	6.2	6.2	6.2	6.2	6.5	6.2		6.2	6.2	6.2
Lead/Lag	Lead			Lag			Lead			Lag		Lag
Lead-Lag Optimize?	Yes			Yes			Yes			Yes		Yes
Vehicle Extension (s)	3.0	3.0	3.0	3.0	3.0	3.0	3.0	3.0		3.0	3.0	3.0
Recall Mode	C-Max	C-Max	C-Max	Max	Max	Max	None	None		None	None	None
Walk Time (s)		7.0	7.0	7.0	7.0	7.0		7.0		7.0	7.0	7.0
Flash Dont Walk (s)		20.0	20.0	20.0	20.0	20.0		16.0		16.0	16.0	16.0
Pedestrian Calls (#/hr)		5	5	5	5	5		5		5	5	5
Act Effct Green (s)	50.4	50.3	50.3	28.8	28.8	28.8	57.0	57.3		35.7	35.7	35.7
Actuated g/C Ratio	0.42	0.42	0.42	0.24	0.24	0.24	0.48	0.48		0.30	0.30	0.30
v/c Ratio	0.34	0.32	0.20	0.03	0.73	0.24	0.87	0.45		0.68	0.88	0.30
Control Delay	26.3	26.2	4.7	35.6	53.5	3.8	50.3	21.9		49.6	58.1	5.9
Queue Delay	0.0	0.0	0.0	0.0	0.0	0.0	0.0	0.0		0.0	0.0	0.0
Total Delay	26.3	26.2	4.7	35.6	53.5	3.8	50.3	21.9		49.6	58.1	5.9
LOS	C	C	A	D	D	A	D	C		D	E	A
Approach Delay		20.1			40.6			33.5			45.6	
Approach LOS		C			D			C			D	
Queue Length 50th (m)	17.0	38.8	0.0	0.9	68.5	0.0	36.0	55.2		38.6	100.8	0.0
Queue Length 95th (m)	30.6	60.5	12.5	4.3	100.9	7.2	#77.5	77.2		63.9	#139.7	14.5
Internal Link Dist (m)		250.4			198.4			270.7			147.1	
Turn Bay Length (m)	75.0		75.0	95.0		115.0	90.0			90.0		95.0
Base Capacity (vph)	337	747	692	189	428	450	309	912		314	591	581
Starvation Cap Reductn	0	0	0	0	0	0	0	0		0	0	0
Spillback Cap Reductn	0	0	0	0	0	0	0	0		0	0	0
Storage Cap Reductn	0	0	0	0	0	0	0	0		0	0	0
Reduced v/c Ratio	0.34	0.32	0.20	0.03	0.73	0.24	0.85	0.42		0.61	0.79	0.28

Intersection Summary

Area Type: Other
 Cycle Length: 120
 Actuated Cycle Length: 120
 Offset: 0 (0%), Referenced to phase 2:EBTL and 5:EBL, Start of Green
 Natural Cycle: 90
 Control Type: Actuated-Coordinated
 Maximum v/c Ratio: 0.88
 Intersection Signal Delay: 36.2
 Intersection LOS: D
 Intersection Capacity Utilization 93.0%
 ICU Level of Service F
 Analysis Period (min) 15
 # 95th percentile volume exceeds capacity, queue may be longer.
 Queue shown is maximum after two cycles.

Splits and Phases: 5: Terry Fox & Fernbank



												
Lane Group	EBL	EBT	EBR	WBL	WBT	WBR	NBL	NBT	NBR	SBL	SBT	SBR
Lane Configurations												
Traffic Volume (vph)	160	64	51	49	41	122	40	763	46	172	518	127
Future Volume (vph)	160	64	51	49	41	122	40	763	46	172	518	127
Ideal Flow (vphpl)	1800	1800	1800	1800	1800	1800	1800	1800	1800	1800	1800	1800
Storage Length (m)	30.0		0.0	30.0		0.0	35.0		0.0	50.0		140.0
Storage Lanes	1		0	1		0	1		0	1		1
Taper Length (m)	55.0			55.0			80.0			80.0		
Lane Util. Factor	1.00	1.00	1.00	1.00	1.00	1.00	1.00	1.00	1.00	1.00	1.00	1.00
Ped Bike Factor					0.98		1.00	1.00				0.97
Fr t		0.933			0.888			0.991				0.850
Flt Protected	0.950			0.950			0.950			0.950		
Satd. Flow (prot)	1558	1665	0	1340	1493	0	1209	1644	0	1695	1640	1502
Flt Permitted	0.622			0.683			0.422			0.243		
Satd. Flow (perm)	1020	1665	0	964	1493	0	536	1644	0	434	1640	1462
Right Turn on Red			Yes			Yes			Yes			Yes
Satd. Flow (RTOR)		48			122			5				127
Link Speed (k/h)		50			50			80				80
Link Distance (m)		302.1			142.5			210.5				515.9
Travel Time (s)		21.8			10.3			9.5				23.2
Confl. Peds. (#/hr)							3		1	1		3
Confl. Bikes (#/hr)						1						1
Peak Hour Factor	1.00	1.00	1.00	1.00	1.00	1.00	1.00	1.00	1.00	1.00	1.00	1.00
Heavy Vehicles (%)	11%	2%	2%	29%	20%	2%	43%	9%	19%	2%	11%	3%
Adj. Flow (vph)	160	64	51	49	41	122	40	763	46	172	518	127
Shared Lane Traffic (%)												
Lane Group Flow (vph)	160	115	0	49	163	0	40	809	0	172	518	127
Enter Blocked Intersection	No	No	No	No	No	No	No	No	No	No	No	No
Lane Alignment	Left	Left	Right	Left	Left	Right	Left	Left	Right	Left	Left	Right
Median Width(m)		3.7			3.7			3.7				3.7
Link Offset(m)		0.0			0.0			0.0				0.0
Crosswalk Width(m)		4.9			4.9			4.9				4.9
Two way Left Turn Lane												
Headway Factor	1.06	1.06	1.06	1.06	1.06	1.06	1.06	1.06	1.06	1.06	1.06	1.06
Turning Speed (k/h)	24		14	24		14	24		14	24		14
Number of Detectors	1	2		1	2		1	2		1	2	1
Detector Template	Left	Thru		Left	Thru		Left	Thru		Left	Thru	Right
Leading Detector (m)	6.1	30.5		6.1	30.5		6.1	30.5		6.1	30.5	6.1
Trailing Detector (m)	0.0	0.0		0.0	0.0		0.0	0.0		0.0	0.0	0.0
Detector 1 Position(m)	0.0	0.0		0.0	0.0		0.0	0.0		0.0	0.0	0.0
Detector 1 Size(m)	6.1	1.8		6.1	1.8		6.1	1.8		6.1	1.8	6.1
Detector 1 Type	Cl+Ex	Cl+Ex		Cl+Ex	Cl+Ex		Cl+Ex	Cl+Ex		Cl+Ex	Cl+Ex	Cl+Ex
Detector 1 Channel												
Detector 1 Extend (s)	0.0	0.0		0.0	0.0		0.0	0.0		0.0	0.0	0.0
Detector 1 Queue (s)	0.0	0.0		0.0	0.0		0.0	0.0		0.0	0.0	0.0
Detector 1 Delay (s)	0.0	0.0		0.0	0.0		0.0	0.0		0.0	0.0	0.0
Detector 2 Position(m)		28.7			28.7			28.7			28.7	
Detector 2 Size(m)		1.8			1.8			1.8			1.8	
Detector 2 Type		Cl+Ex			Cl+Ex			Cl+Ex			Cl+Ex	
Detector 2 Channel												
Detector 2 Extend (s)		0.0			0.0			0.0			0.0	
Turn Type	Perm	NA		Perm	NA		Perm	NA		Perm	NA	Perm
Protected Phases		4			8			2			6	
Permitted Phases	4			8			2			6		6
Detector Phase	4	4		8	8		2	2		6	6	6
Switch Phase												
Minimum Initial (s)	10.0	10.0		10.0	10.0		10.0	10.0		10.0	10.0	10.0
Minimum Split (s)	32.2	32.2		32.2	32.2		28.4	28.4		28.4	28.4	28.4
Total Split (s)	37.0	37.0		37.0	37.0		53.0	53.0		53.0	53.0	53.0
Total Split (%)	41.1%	41.1%		41.1%	41.1%		58.9%	58.9%		58.9%	58.9%	58.9%
Maximum Green (s)	30.8	30.8		30.8	30.8		46.6	46.6		46.6	46.6	46.6
Yellow Time (s)	3.3	3.3		3.3	3.3		4.6	4.6		4.6	4.6	4.6

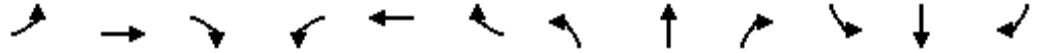

























Lane Group	EBL	EBT	EBR	WBL	WBT	WBR	NBL	NBT	NBR	SBL	SBT	SBR
All-Red Time (s)	2.9	2.9		2.9	2.9		1.8	1.8		1.8	1.8	1.8
Lost Time Adjust (s)	0.0	0.0		0.0	0.0		0.0	0.0		0.0	0.0	0.0
Total Lost Time (s)	6.2	6.2		6.2	6.2		6.4	6.4		6.4	6.4	6.4
Lead/Lag												
Lead-Lag Optimize?												
Vehicle Extension (s)	3.0	3.0		3.0	3.0		3.0	3.0		3.0	3.0	3.0
Recall Mode	None	None		None	None		C-Max	C-Max		C-Max	C-Max	C-Max
Walk Time (s)	7.0	7.0		7.0	7.0		7.0	7.0		7.0	7.0	7.0
Flash Dont Walk (s)	19.0	19.0		19.0	19.0		15.0	15.0		15.0	15.0	15.0
Pedestrian Calls (#/hr)	5	5		5	5		5	5		5	5	5
Act Effct Green (s)	18.7	18.7		18.7	18.7		58.7	58.7		58.7	58.7	58.7
Actuated g/C Ratio	0.21	0.21		0.21	0.21		0.65	0.65		0.65	0.65	0.65
v/c Ratio	0.75	0.30		0.24	0.40		0.11	0.75		0.61	0.48	0.13
Control Delay	54.2	18.5		30.1	11.5		7.1	13.9		23.9	11.2	2.0
Queue Delay	0.0	0.0		0.0	0.0		0.0	0.0		0.0	0.0	0.0
Total Delay	54.2	18.5		30.1	11.5		7.1	13.9		23.9	11.2	2.0
LOS	D	B		C	B		A	B		C	B	A
Approach Delay		39.2			15.8			13.6			12.5	
Approach LOS		D			B			B			B	
Queue Length 50th (m)	26.1	9.6		7.1	5.8		1.1	28.9		15.3	40.6	0.0
Queue Length 95th (m)	42.6	20.7		14.9	19.2		m4.8	#195.1		#56.6	82.8	7.1
Internal Link Dist (m)		278.1			118.5			186.5			491.9	
Turn Bay Length (m)	30.0			30.0			35.0			50.0		140.0
Base Capacity (vph)	349	601		329	591		349	1073		282	1069	997
Starvation Cap Reductn	0	0		0	0		0	0		0	0	0
Spillback Cap Reductn	0	0		0	0		0	0		0	0	0
Storage Cap Reductn	0	0		0	0		0	0		0	0	0
Reduced v/c Ratio	0.46	0.19		0.15	0.28		0.11	0.75		0.61	0.48	0.13

Intersection Summary

Area Type: Other
 Cycle Length: 90
 Actuated Cycle Length: 90
 Offset: 55 (61%), Referenced to phase 2:NBTL and 6:SBTL, Start of Green
 Natural Cycle: 90
 Control Type: Actuated-Coordinated
 Maximum v/c Ratio: 0.75
 Intersection Signal Delay: 16.7
 Intersection LOS: B
 Intersection Capacity Utilization 96.0%
 ICU Level of Service F
 Analysis Period (min) 15
 # 95th percentile volume exceeds capacity, queue may be longer.
 Queue shown is maximum after two cycles.
 m Volume for 95th percentile queue is metered by upstream signal.

Splits and Phases: 2: Terry Fox & Cope



												
Lane Group	EBL	EBT	EBR	WBL	WBT	WBR	NBL	NBT	NBR	SBL	SBT	SBR
Lane Configurations												
Traffic Volume (vph)	193	272	208	3	216	141	168	433	2	82	339	131
Future Volume (vph)	193	272	208	3	216	141	168	433	2	82	339	131
Ideal Flow (vphpl)	1800	1800	1800	1800	1800	1800	1800	1800	1800	1800	1800	1800
Storage Length (m)	75.0		75.0	95.0		115.0	90.0		0.0	90.0		95.0
Storage Lanes	1		1	1		1	1		0	1		1
Taper Length (m)	100.0			60.0			70.0			100.0		
Lane Util. Factor	1.00	1.00	1.00	1.00	1.00	1.00	1.00	1.00	1.00	1.00	1.00	1.00
Ped Bike Factor	1.00		0.98			0.98						
Fr t			0.850			0.850		0.999				0.850
Fit Protected	0.950			0.950			0.950			0.950		
Satd. Flow (prot)	1631	1784	1488	1695	1767	1406	1662	1732	0	1662	1717	1357
Fit Permitted	0.509			0.592			0.384			0.249		
Satd. Flow (perm)	872	1784	1457	1056	1767	1374	672	1732	0	436	1717	1357
Right Turn on Red			Yes			Yes			Yes			Yes
Satd. Flow (RTOR)			208			141						131
Link Speed (k/h)		60			60			80				80
Link Distance (m)		274.4			222.4			294.7				171.1
Travel Time (s)		16.5			13.3			13.3				7.7
Confl. Peds. (#/hr)	2					2						
Confl. Bikes (#/hr)			1									
Peak Hour Factor	1.00	1.00	1.00	1.00	1.00	1.00	1.00	1.00	1.00	1.00	1.00	1.00
Heavy Vehicles (%)	6%	2%	4%	2%	3%	10%	4%	5%	2%	4%	6%	14%
Adj. Flow (vph)	193	272	208	3	216	141	168	433	2	82	339	131
Shared Lane Traffic (%)												
Lane Group Flow (vph)	193	272	208	3	216	141	168	435	0	82	339	131
Enter Blocked Intersection	No	No	No	No	No	No	No	No	No	No	No	No
Lane Alignment	Left	Left	Right	Left	Left	Right	Left	Left	Right	Left	Left	Right
Median Width(m)		3.7			3.7			3.7				3.7
Link Offset(m)		0.0			0.0			0.0				0.0
Crosswalk Width(m)		4.9			4.9			4.9				4.9
Two way Left Turn Lane												
Headway Factor	1.06	1.06	1.06	1.06	1.06	1.06	1.06	1.06	1.06	1.06	1.06	1.06
Turning Speed (k/h)	24		14	24		14	24		14	24		14
Number of Detectors	1	2	1	1	2	1	1	2		1	2	1
Detector Template	Left	Thru	Right	Left	Thru	Right	Left	Thru		Left	Thru	Right
Leading Detector (m)	6.1	30.5	6.1	6.1	30.5	6.1	6.1	30.5		6.1	30.5	6.1
Trailing Detector (m)	0.0	0.0	0.0	0.0	0.0	0.0	0.0	0.0		0.0	0.0	0.0
Detector 1 Position(m)	0.0	0.0	0.0	0.0	0.0	0.0	0.0	0.0		0.0	0.0	0.0
Detector 1 Size(m)	6.1	1.8	6.1	6.1	1.8	6.1	6.1	1.8		6.1	1.8	6.1
Detector 1 Type	Cl+Ex	Cl+Ex	Cl+Ex	Cl+Ex	Cl+Ex	Cl+Ex	Cl+Ex	Cl+Ex		Cl+Ex	Cl+Ex	Cl+Ex
Detector 1 Channel												
Detector 1 Extend (s)	0.0	0.0	0.0	0.0	0.0	0.0	0.0	0.0		0.0	0.0	0.0
Detector 1 Queue (s)	0.0	0.0	0.0	0.0	0.0	0.0	0.0	0.0		0.0	0.0	0.0
Detector 1 Delay (s)	0.0	0.0	0.0	0.0	0.0	0.0	0.0	0.0		0.0	0.0	0.0
Detector 2 Position(m)		28.7			28.7			28.7				28.7
Detector 2 Size(m)		1.8			1.8			1.8				1.8
Detector 2 Type		Cl+Ex			Cl+Ex			Cl+Ex				Cl+Ex
Detector 2 Channel												
Detector 2 Extend (s)		0.0			0.0			0.0				0.0
Turn Type	pm+pt	NA	Perm	Perm	NA	Perm	Perm	NA		Perm	NA	Perm
Protected Phases	5	2			6			8				4
Permitted Phases	2		2	6		6	8			4		4
Detector Phase	5	2	2	6	6	6	8	8		4	4	4
Switch Phase												
Minimum Initial (s)	5.0	10.0	10.0	10.0	10.0	10.0	10.0	10.0		10.0	10.0	10.0
Minimum Split (s)	11.2	33.2	33.2	33.2	33.2	33.2	29.2	29.2		29.2	29.2	29.2
Total Split (s)	17.0	52.0	52.0	35.0	35.0	35.0	38.0	38.0		38.0	38.0	38.0
Total Split (%)	18.9%	57.8%	57.8%	38.9%	38.9%	38.9%	42.2%	42.2%		42.2%	42.2%	42.2%
Maximum Green (s)	10.9	45.8	45.8	28.8	28.8	28.8	31.8	31.8		31.8	31.8	31.8
Yellow Time (s)	3.7	3.7	3.7	3.7	3.7	3.7	4.6	4.6		4.6	4.6	4.6



Lane Group	EBL	EBT	EBR	WBL	WBT	WBR	NBL	NBT	NBR	SBL	SBT	SBR
All-Red Time (s)	2.4	2.5	2.5	2.5	2.5	2.5	1.6	1.6		1.6	1.6	1.6
Lost Time Adjust (s)	0.0	0.0	0.0	0.0	0.0	0.0	0.0	0.0		0.0	0.0	0.0
Total Lost Time (s)	6.1	6.2	6.2	6.2	6.2	6.2	6.2	6.2		6.2	6.2	6.2
Lead/Lag	Lead			Lag			Lag					
Lead-Lag Optimize?	Yes			Yes			Yes					
Vehicle Extension (s)	3.0	3.0	3.0	3.0	3.0	3.0	3.0	3.0		3.0	3.0	3.0
Recall Mode	None	C-Max	C-Max	C-Max	C-Max	C-Max	None	None		None	None	None
Walk Time (s)		7.0	7.0	7.0	7.0	7.0	7.0	7.0		7.0	7.0	7.0
Flash Dont Walk (s)		20.0	20.0	20.0	20.0	20.0	16.0	16.0		16.0	16.0	16.0
Pedestrian Calls (#/hr)		5	5	5	5	5	5	5		5	5	5
Act Effct Green (s)	50.6	50.5	50.5	34.6	34.6	34.6	27.1	27.1		27.1	27.1	27.1
Actuated g/C Ratio	0.56	0.56	0.56	0.38	0.38	0.38	0.30	0.30		0.30	0.30	0.30
v/c Ratio	0.34	0.27	0.23	0.01	0.32	0.23	0.83	0.83		0.63	0.66	0.26
Control Delay	12.7	12.2	2.4	21.0	23.1	5.1	61.3	43.6		50.3	35.3	10.2
Queue Delay	0.0	0.0	0.0	0.0	0.0	0.0	0.0	0.0		0.0	0.0	0.0
Total Delay	12.7	12.2	2.4	21.0	23.1	5.1	61.3	43.6		50.3	35.3	10.2
LOS	B	B	A	C	C	A	E	D		D	D	B
Approach Delay		9.3			16.0			48.6			31.6	
Approach LOS		A			B			D			C	
Queue Length 50th (m)	16.1	23.6	0.0	0.3	27.0	0.0	26.3	68.1		9.7	40.1	0.0
Queue Length 95th (m)	30.1	41.6	10.0	2.3	47.6	12.3	#56.1	97.8		#26.0	75.6	18.8
Internal Link Dist (m)		250.4			198.4			270.7			147.1	
Turn Bay Length (m)	75.0		75.0	95.0		115.0	90.0		90.0			95.0
Base Capacity (vph)	582	1001	909	405	679	614	237	611		154	606	564
Starvation Cap Reductn	0	0	0	0	0	0	0	0		0	0	0
Spillback Cap Reductn	0	0	0	0	0	0	0	0		0	0	0
Storage Cap Reductn	0	0	0	0	0	0	0	0		0	0	0
Reduced v/c Ratio	0.33	0.27	0.23	0.01	0.32	0.23	0.71	0.71		0.53	0.56	0.23

Intersection Summary

Area Type: Other
 Cycle Length: 90
 Actuated Cycle Length: 90
 Offset: 9 (10%), Referenced to phase 2:EBTL and 6:WBTL, Start of Green
 Natural Cycle: 75
 Control Type: Actuated-Coordinated
 Maximum v/c Ratio: 0.83
 Intersection Signal Delay: 26.9
 Intersection LOS: C
 Intersection Capacity Utilization 86.9%
 ICU Level of Service E
 Analysis Period (min) 15
 # 95th percentile volume exceeds capacity, queue may be longer.
 Queue shown is maximum after two cycles.

Splits and Phases: 5: Terry Fox & Fernbank



5331 Fernbank Road
2028 Total Traffic

1: Access/Street 1 & Cope
Timing Plan: AM Peak



Movement	EBL	EBT	EBR	WBL	WBT	WBR	NBL	NBT	NBR	SBL	SBT	SBR
Lane Configurations												
Traffic Volume (veh/h)	13	264	5	2	195	6	13	0	5	17	0	4
Future Volume (Veh/h)	13	264	5	2	195	6	13	0	5	17	0	4
Sign Control		Free			Free			Stop			Stop	
Grade		0%			0%			0%			0%	
Peak Hour Factor	1.00	1.00	1.00	1.00	1.00	1.00	1.00	1.00	1.00	1.00	1.00	1.00
Hourly flow rate (vph)	13	264	5	2	195	6	13	0	5	17	0	4
Pedestrians												
Lane Width (m)												
Walking Speed (m/s)												
Percent Blockage												
Right turn flare (veh)												
Median type												
Median storage veh												
Upstream signal (m)												
pX, platoon unblocked												
vC, conflicting volume												
vC1, stage 1 conf vol												
vC2, stage 2 conf vol												
vCu, unblocked vol												
tC, single (s)												
tC, 2 stage (s)												
tF (s)												
p0 queue free %												
cM capacity (veh/h)												
Direction, Lane #	EB 1	EB 2	WB 1	NB 1	SB 1							
Volume Total	13	269	203	18	21							
Volume Left	13	0	2	13	17							
Volume Right	0	5	6	5	4							
cSH	1371	1700	1295	534	520							
Volume to Capacity	0.01	0.16	0.00	0.03	0.04							
Queue Length 95th (m)	0.2	0.0	0.0	0.8	1.0							
Control Delay (s)	7.7	0.0	0.1	12.0	12.2							
Lane LOS	A		A	B	B							
Approach Delay (s)	0.4		0.1	12.0	12.2							
Approach LOS				B	B							
Intersection Summary												
Average Delay			1.1									
Intersection Capacity Utilization			25.0%	ICU Level of Service	A							
Analysis Period (min)			15									

Lane Group	EBL	EBT	EBR	WBL	WBT	WBR	NBL	NBT	NBR	SBL	SBT	SBR
Lane Configurations												
Traffic Volume (vph)	146	52	28	72	39	200	30	643	58	257	897	159
Future Volume (vph)	146	52	28	72	39	200	30	643	58	257	897	159
Ideal Flow (vphpl)	1800	1800	1800	1800	1800	1800	1800	1800	1800	1800	1800	1800
Storage Length (m)	30.0		0.0	30.0		0.0	35.0		0.0	50.0		140.0
Storage Lanes	1		0	1		0	1		0	1		1
Taper Length (m)	55.0			55.0			80.0			80.0		
Lane Util. Factor	1.00	1.00	1.00	1.00	1.00	1.00	1.00	1.00	1.00	1.00	1.00	1.00
Ped Bike Factor		0.99		1.00								0.97
Fr t		0.947			0.874			0.988				0.850
Flt Protected	0.950			0.950			0.950			0.950		
Satd. Flow (prot)	1695	1677	0	1601	1559	0	1695	1719	0	1695	1784	1517
Flt Permitted	0.438			0.705			0.295			0.122		
Satd. Flow (perm)	782	1677	0	1186	1559	0	526	1719	0	218	1784	1475
Right Turn on Red			Yes			Yes			Yes			Yes
Satd. Flow (RTOR)		28			200			6				159
Link Speed (k/h)		50			50			80				80
Link Distance (m)		302.1			142.5			210.5			515.9	
Travel Time (s)		21.8			10.3			9.5			23.2	
Confl. Peds. (#/hr)			1	1			3					3
Confl. Bikes (#/hr)												1
Peak Hour Factor	1.00	1.00	1.00	1.00	1.00	1.00	1.00	1.00	1.00	1.00	1.00	1.00
Heavy Vehicles (%)	2%	2%	2%	8%	2%	2%	2%	4%	11%	2%	2%	2%
Adj. Flow (vph)	146	52	28	72	39	200	30	643	58	257	897	159
Shared Lane Traffic (%)												
Lane Group Flow (vph)	146	80	0	72	239	0	30	701	0	257	897	159
Enter Blocked Intersection	No	No	No	No	No	No	No	No	No	No	No	No
Lane Alignment	Left	Left	Right	Left	Left	Right	Left	Left	Right	Left	Left	Right
Median Width(m)		3.7			3.7			3.7			3.7	
Link Offset(m)		0.0			0.0			0.0			0.0	
Crosswalk Width(m)		4.9			4.9			4.9			4.9	
Two way Left Turn Lane												
Headway Factor	1.06	1.06	1.06	1.06	1.06	1.06	1.06	1.06	1.06	1.06	1.06	1.06
Turning Speed (k/h)	24		14	24		14	24		14	24		14
Number of Detectors	1	2		1	2		1	2		1	2	1
Detector Template	Left	Thru		Left	Thru		Left	Thru		Left	Thru	Right
Leading Detector (m)	6.1	30.5		6.1	30.5		6.1	30.5		6.1	30.5	6.1
Trailing Detector (m)	0.0	0.0		0.0	0.0		0.0	0.0		0.0	0.0	0.0
Detector 1 Position(m)	0.0	0.0		0.0	0.0		0.0	0.0		0.0	0.0	0.0
Detector 1 Size(m)	6.1	1.8		6.1	1.8		6.1	1.8		6.1	1.8	6.1
Detector 1 Type	Cl+Ex	Cl+Ex		Cl+Ex	Cl+Ex		Cl+Ex	Cl+Ex		Cl+Ex	Cl+Ex	Cl+Ex
Detector 1 Channel												
Detector 1 Extend (s)	0.0	0.0		0.0	0.0		0.0	0.0		0.0	0.0	0.0
Detector 1 Queue (s)	0.0	0.0		0.0	0.0		0.0	0.0		0.0	0.0	0.0
Detector 1 Delay (s)	0.0	0.0		0.0	0.0		0.0	0.0		0.0	0.0	0.0
Detector 2 Position(m)		28.7			28.7			28.7			28.7	
Detector 2 Size(m)		1.8			1.8			1.8			1.8	
Detector 2 Type		Cl+Ex			Cl+Ex			Cl+Ex			Cl+Ex	
Detector 2 Channel												
Detector 2 Extend (s)		0.0			0.0			0.0			0.0	
Turn Type	Perm	NA		Perm	NA		Perm	NA		pm+pt	NA	Perm
Protected Phases		4			8			2		1	6	
Permitted Phases	4			8			2		6			6
Detector Phase	4	4		8	8		2	2		1	6	6
Switch Phase												
Minimum Initial (s)	10.0	10.0		10.0	10.0		10.0	10.0		5.0	10.0	10.0
Minimum Split (s)	32.2	32.2		32.2	32.2		28.4	28.4		11.4	28.4	28.4
Total Split (s)	37.0	37.0		37.0	37.0		51.0	51.0		12.0	63.0	63.0
Total Split (%)	37.0%	37.0%		37.0%	37.0%		51.0%	51.0%		12.0%	63.0%	63.0%
Maximum Green (s)	30.8	30.8		30.8	30.8		44.6	44.6		5.6	56.6	56.6
Yellow Time (s)	3.3	3.3		3.3	3.3		4.6	4.6		4.6	4.6	4.6



Lane Group	EBL	EBT	EBR	WBL	WBT	WBR	NBL	NBT	NBR	SBL	SBT	SBR
All-Red Time (s)	2.9	2.9		2.9	2.9		1.8	1.8		1.8	1.8	1.8
Lost Time Adjust (s)	0.0	0.0		0.0	0.0		0.0	0.0		0.0	0.0	0.0
Total Lost Time (s)	6.2	6.2		6.2	6.2		6.4	6.4		6.4	6.4	6.4
Lead/Lag							Lag	Lag		Lead		
Lead-Lag Optimize?							Yes	Yes		Yes		
Vehicle Extension (s)	3.0	3.0		3.0	3.0		3.0	3.0		3.0	3.0	3.0
Recall Mode	None	None		None	None		C-Max	C-Max		None	C-Max	C-Max
Walk Time (s)	7.0	7.0		7.0	7.0		7.0	7.0		7.0	7.0	7.0
Flash Dont Walk (s)	19.0	19.0		19.0	19.0		15.0	15.0		15.0	15.0	15.0
Pedestrian Calls (#/hr)	5	5		5	5		5	5		5	5	5
Act Effct Green (s)	20.9	20.9		20.9	20.9		44.6	44.6		66.5	66.5	66.5
Actuated g/C Ratio	0.21	0.21		0.21	0.21		0.45	0.45		0.66	0.66	0.66
v/c Ratio	0.90	0.22		0.29	0.49		0.13	0.91		0.69	0.76	0.15
Control Delay	84.9	21.4		33.7	10.5		16.1	42.7		27.6	18.7	1.9
Queue Delay	0.0	0.0		0.0	0.0		0.0	0.0		0.0	0.0	0.0
Total Delay	84.9	21.4		33.7	10.5		16.1	42.7		27.6	18.7	1.9
LOS	F	C		C	B		B	D		C	B	A
Approach Delay		62.4			15.9			41.6			18.4	
Approach LOS		E			B			D			B	
Queue Length 50th (m)	27.7	8.3		11.8	6.2		3.8	139.7		22.6	105.2	0.0
Queue Length 95th (m)	#46.6	17.8		21.3	23.3		m8.9	#198.0		#75.1	#229.4	8.0
Internal Link Dist (m)		278.1			118.5			186.5			491.9	
Turn Bay Length (m)	30.0			30.0			35.0			50.0		140.0
Base Capacity (vph)	240	535		365	618		234	769		374	1186	1034
Starvation Cap Reductn	0	0		0	0		0	0		0	0	0
Spillback Cap Reductn	0	0		0	0		0	0		0	0	0
Storage Cap Reductn	0	0		0	0		0	0		0	0	0
Reduced v/c Ratio	0.61	0.15		0.20	0.39		0.13	0.91		0.69	0.76	0.15

Intersection Summary

Area Type: Other
 Cycle Length: 100
 Actuated Cycle Length: 100
 Offset: 69 (69%), Referenced to phase 2:NBTL and 6:SBTL, Start of Green
 Natural Cycle: 90
 Control Type: Actuated-Coordinated
 Maximum v/c Ratio: 0.91
 Intersection Signal Delay: 28.5 Intersection LOS: C
 Intersection Capacity Utilization 102.9% ICU Level of Service G
 Analysis Period (min) 15
 # 95th percentile volume exceeds capacity, queue may be longer.
 Queue shown is maximum after two cycles.
 m Volume for 95th percentile queue is metered by upstream signal.

Splits and Phases: 2: Terry Fox & Cope



Lane Group	EBL	EBT	EBR	WBL	WBT	WBR	NBL	NBT	NBR	SBL	SBT	SBR
Lane Configurations												
Traffic Volume (vph)	127	269	149	5	353	115	275	413	23	199	526	189
Future Volume (vph)	127	269	149	5	353	115	275	413	23	199	526	189
Ideal Flow (vphpl)	1800	1800	1800	1800	1800	1800	1800	1800	1800	1800	1800	1800
Storage Length (m)	75.0		75.0	95.0		115.0	90.0		0.0	90.0		95.0
Storage Lanes	1		1	1		1	1		0	1		1
Taper Length (m)	100.0			60.0			70.0			100.0		
Lane Util. Factor	1.00	1.00	1.00	1.00	1.00	1.00	1.00	1.00	1.00	1.00	1.00	1.00
Ped Bike Factor	1.00		0.97	0.99		0.97				1.00		0.96
Fr t			0.850			0.850		0.992				0.850
Flt Protected	0.950			0.950			0.950			0.950		
Satd. Flow (prot)	1631	1784	1502	1235	1784	1459	1695	1770	0	1695	1784	1488
Flt Permitted	0.266			0.594			0.119			0.509		
Satd. Flow (perm)	456	1784	1461	768	1784	1421	212	1770	0	905	1784	1429
Right Turn on Red			Yes			Yes			Yes			Yes
Satd. Flow (RTOR)			149			172		4				189
Link Speed (k/h)		60			60			80			80	
Link Distance (m)		274.4			222.4			294.7			171.1	
Travel Time (s)		16.5			13.3			13.3			7.7	
Confl. Peds. (#/hr)	2		4	4		2	9			3		9
Confl. Bikes (#/hr)						2						
Peak Hour Factor	1.00	1.00	1.00	1.00	1.00	1.00	1.00	1.00	1.00	1.00	1.00	1.00
Heavy Vehicles (%)	6%	2%	3%	40%	2%	6%	2%	2%	2%	2%	2%	4%
Adj. Flow (vph)	127	269	149	5	353	115	275	413	23	199	526	189
Shared Lane Traffic (%)												
Lane Group Flow (vph)	127	269	149	5	353	115	275	436	0	199	526	189
Enter Blocked Intersection	No	No	No	No	No	No	No	No	No	No	No	No
Lane Alignment	Left	Left	Right	Left	Left	Right	Left	Left	Right	Left	Left	Right
Median Width(m)		3.7			3.7			3.7			3.7	
Link Offset(m)		0.0			0.0			0.0			0.0	
Crosswalk Width(m)		4.9			4.9			4.9			4.9	
Two way Left Turn Lane												
Headway Factor	1.06	1.06	1.06	1.06	1.06	1.06	1.06	1.06	1.06	1.06	1.06	1.06
Turning Speed (k/h)	24		14	24		14	24		14	24		14
Number of Detectors	1	2	1	1	2	1	1	2		1	2	1
Detector Template	Left	Thru	Right	Left	Thru	Right	Left	Thru		Left	Thru	Right
Leading Detector (m)	6.1	30.5	6.1	6.1	30.5	6.1	6.1	30.5		6.1	30.5	6.1
Trailing Detector (m)	0.0	0.0	0.0	0.0	0.0	0.0	0.0	0.0		0.0	0.0	0.0
Detector 1 Position(m)	0.0	0.0	0.0	0.0	0.0	0.0	0.0	0.0		0.0	0.0	0.0
Detector 1 Size(m)	6.1	1.8	6.1	6.1	1.8	6.1	6.1	1.8		6.1	1.8	6.1
Detector 1 Type	Cl+Ex	Cl+Ex	Cl+Ex	Cl+Ex	Cl+Ex	Cl+Ex	Cl+Ex	Cl+Ex		Cl+Ex	Cl+Ex	Cl+Ex
Detector 1 Channel												
Detector 1 Extend (s)	0.0	0.0	0.0	0.0	0.0	0.0	0.0	0.0		0.0	0.0	0.0
Detector 1 Queue (s)	0.0	0.0	0.0	0.0	0.0	0.0	0.0	0.0		0.0	0.0	0.0
Detector 1 Delay (s)	0.0	0.0	0.0	0.0	0.0	0.0	0.0	0.0		0.0	0.0	0.0
Detector 2 Position(m)		28.7			28.7			28.7			28.7	
Detector 2 Size(m)		1.8			1.8			1.8			1.8	
Detector 2 Type		Cl+Ex			Cl+Ex			Cl+Ex			Cl+Ex	
Detector 2 Channel												
Detector 2 Extend (s)		0.0			0.0			0.0			0.0	
Turn Type	pm+pt	NA	Perm	Perm	NA	Perm	pm+pt	NA		Perm	NA	Perm
Protected Phases	5	2			6		3	8			4	
Permitted Phases	2		2	6		6	8		4			4
Detector Phase	5	2	2	6	6	6	3	8		4	4	4
Switch Phase												
Minimum Initial (s)	5.0	10.0	10.0	10.0	10.0	10.0	5.0	10.0		10.0	10.0	10.0
Minimum Split (s)	11.2	33.2	33.2	33.2	33.2	33.2	11.5	29.2		29.2	29.2	29.2
Total Split (s)	12.0	46.0	46.0	34.0	34.0	34.0	15.0	54.0		39.0	39.0	39.0
Total Split (%)	12.0%	46.0%	46.0%	34.0%	34.0%	34.0%	15.0%	54.0%		39.0%	39.0%	39.0%
Maximum Green (s)	5.9	39.8	39.8	27.8	27.8	27.8	8.5	47.8		32.8	32.8	32.8
Yellow Time (s)	3.7	3.7	3.7	3.7	3.7	3.7	4.6	4.6		4.6	4.6	4.6



Lane Group	EBL	EBT	EBR	WBL	WBT	WBR	NBL	NBT	NBR	SBL	SBT	SBR
All-Red Time (s)	2.4	2.5	2.5	2.5	2.5	2.5	1.9	1.6		1.6	1.6	1.6
Lost Time Adjust (s)	0.0	0.0	0.0	0.0	0.0	0.0	0.0	0.0		0.0	0.0	0.0
Total Lost Time (s)	6.1	6.2	6.2	6.2	6.2	6.2	6.5	6.2		6.2	6.2	6.2
Lead/Lag	Lead			Lag			Lead			Lag		
Lead-Lag Optimize?	Yes			Yes			Yes			Yes		
Vehicle Extension (s)	3.0	3.0	3.0	3.0	3.0	3.0	3.0	3.0		3.0	3.0	3.0
Recall Mode	C-Max	C-Max	C-Max	Max	Max	Max	None	None		None	None	None
Walk Time (s)	7.0	7.0	7.0	7.0	7.0	7.0	7.0	7.0		7.0	7.0	7.0
Flash Dont Walk (s)		20.0	20.0	20.0	20.0	20.0		16.0		16.0	16.0	16.0
Pedestrian Calls (#/hr)		5	5	5	5	5		5		5	5	5
Act Effct Green (s)	41.0	40.9	40.9	27.8	27.8	27.8	46.4	46.7		31.7	31.7	31.7
Actuated g/C Ratio	0.41	0.41	0.41	0.28	0.28	0.28	0.46	0.47		0.32	0.32	0.32
v/c Ratio	0.47	0.37	0.22	0.02	0.71	0.22	1.23	0.53		0.70	0.93	0.33
Control Delay	26.2	22.9	4.1	26.8	41.8	2.1	158.4	21.2		51.9	62.2	14.7
Queue Delay	0.0	0.0	0.0	0.0	0.0	0.0	0.0	0.0		0.0	0.0	0.0
Total Delay	26.2	22.9	4.1	26.8	41.8	2.1	158.4	21.2		51.9	62.2	14.7
LOS	C	C	A	C	D	A	F	C		D	E	B
Approach Delay		18.5			32.0			74.3			50.1	
Approach LOS		B			C			E			D	
Queue Length 50th (m)	15.7	36.3	0.0	0.7	61.5	0.0	~48.5	55.9		35.4	94.3	7.0
Queue Length 95th (m)	28.1	56.7	11.4	3.5	92.8	3.9	#98.2	83.1		m56.3	#162.8	m25.6
Internal Link Dist (m)		250.4			198.4			270.7			147.1	
Turn Bay Length (m)	75.0		75.0	95.0		115.0	90.0		90.0			95.0
Base Capacity (vph)	269	730	685	213	495	519	224	848		296	585	595
Starvation Cap Reductn	0	0	0	0	0	0	0	0		0	0	0
Spillback Cap Reductn	0	0	0	0	0	0	0	0		0	0	0
Storage Cap Reductn	0	0	0	0	0	0	0	0		0	0	0
Reduced v/c Ratio	0.47	0.37	0.22	0.02	0.71	0.22	1.23	0.51		0.67	0.90	0.32

Intersection Summary





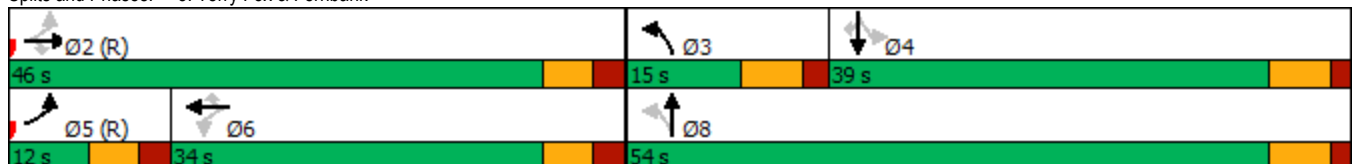











Area Type: Other
 Cycle Length: 100
 Actuated Cycle Length: 100
 Offset: 79 (79%), Referenced to phase 2:EBTL and 5:EBL, Start of Green
 Natural Cycle: 100
 Control Type: Actuated-Coordinated
 Maximum v/c Ratio: 1.23
 Intersection Signal Delay: 46.9
 Intersection LOS: D
 Intersection Capacity Utilization 97.1%
 ICU Level of Service F
 Analysis Period (min) 15
 ~ Volume exceeds capacity, queue is theoretically infinite.
 Queue shown is maximum after two cycles.
 # 95th percentile volume exceeds capacity, queue may be longer.
 Queue shown is maximum after two cycles.
 m Volume for 95th percentile queue is metered by upstream signal.

Splits and Phases: 5: Terry Fox & Fernbank



5331 Fernbank Road
2028 Total Traffic

1: Access/Street 1 & Cope
Timing Plan: PM Peak

												
Movement	EBL	EBT	EBR	WBL	WBT	WBR	NBL	NBT	NBR	SBL	SBT	SBR
Lane Configurations												
Traffic Volume (veh/h)	42	314	11	6	299	21	10	0	5	9	0	2
Future Volume (Veh/h)	42	314	11	6	299	21	10	0	5	9	0	2
Sign Control		Free			Free			Stop			Stop	
Grade		0%			0%			0%			0%	
Peak Hour Factor	1.00	1.00	1.00	1.00	1.00	1.00	1.00	1.00	1.00	1.00	1.00	1.00
Hourly flow rate (vph)	42	314	11	6	299	21	10	0	5	9	0	2
Pedestrians												
Lane Width (m)												
Walking Speed (m/s)												
Percent Blockage												
Right turn flare (veh)												
Median type	None					None						
Median storage (veh)												
Upstream signal (m)	143											
pX, platoon unblocked				0.97			0.97			0.97		
vC, conflicting volume	320			325			727			736		
vC1, stage 1 conf vol												
vC2, stage 2 conf vol												
vCu, unblocked vol	320			287			702			711		
tC, single (s)	4.1			4.1			7.1			6.5		
tC, 2 stage (s)												
tF (s)	2.2			2.2			3.5			4.0		
p0 queue free %	97			100			97			100		
cM capacity (veh/h)	1240			1235			331			334		
Direction, Lane #	EB 1	EB 2	WB 1	NB 1	SB 1							
Volume Total	42	325	326	15	11							
Volume Left	42	0	6	10	9							
Volume Right	0	11	21	5	2							
cSH	1240	1700	1235	405	367							
Volume to Capacity	0.03	0.19	0.00	0.04	0.03							
Queue Length 95th (m)	0.8	0.0	0.1	0.9	0.7							
Control Delay (s)	8.0	0.0	0.2	14.2	15.1							
Lane LOS	A		A	B	C							
Approach Delay (s)	0.9		0.2		14.2		15.1					
Approach LOS					B		C					
Intersection Summary												
Average Delay			1.1									
Intersection Capacity Utilization			38.9%		ICU Level of Service				A			
Analysis Period (min)	15											

5331 Fernbank Road
2028 Total Traffic (Optimized)

2: Terry Fox & Cope
Timing Plan: PM Peak

Lane Group	EBL	EBT	EBR	WBL	WBT	WBR	NBL	NBT	NBR	SBL	SBT	SBR
Lane Configurations												
Traffic Volume (vph)	146	52	28	72	39	200	30	643	58	257	897	159
Future Volume (vph)	146	52	28	72	39	200	30	643	58	257	897	159
Ideal Flow (vphpl)	1800	1800	1800	1800	1800	1800	1800	1800	1800	1800	1800	1800
Storage Length (m)	30.0		0.0	30.0		30.0	35.0		0.0	50.0		140.0
Storage Lanes	1		0	1		0	1		0	1		1
Taper Length (m)	55.0			55.0			80.0			80.0		
Lane Util. Factor	1.00	1.00	1.00	1.00	1.00	1.00	1.00	1.00	1.00	1.00	1.00	1.00
Ped Bike Factor		0.99		1.00								0.97
Fr t		0.947			0.874			0.988				0.850
Flt Protected	0.950			0.950			0.950			0.950		
Satd. Flow (prot)	1695	1677	0	1601	1559	0	1695	1719	0	1695	1784	1517
Flt Permitted	0.436			0.705			0.290			0.133		
Satd. Flow (perm)	778	1677	0	1186	1559	0	517	1719	0	237	1784	1475
Right Turn on Red			Yes			Yes			Yes			Yes
Satd. Flow (RTOR)		28			200			6				159
Link Speed (k/h)		50			50			80				80
Link Distance (m)		302.1			142.5			210.5				515.9
Travel Time (s)		21.8			10.3			9.5				23.2
Confl. Peds. (#/hr)			1	1			3					3
Confl. Bikes (#/hr)												1
Peak Hour Factor	1.00	1.00	1.00	1.00	1.00	1.00	1.00	1.00	1.00	1.00	1.00	1.00
Heavy Vehicles (%)	2%	2%	2%	8%	2%	2%	2%	4%	11%	2%	2%	2%
Adj. Flow (vph)	146	52	28	72	39	200	30	643	58	257	897	159
Shared Lane Traffic (%)												
Lane Group Flow (vph)	146	80	0	72	239	0	30	701	0	257	897	159
Enter Blocked Intersection	No	No	No	No	No	No	No	No	No	No	No	No
Lane Alignment	Left	Left	Right	Left	Left	Right	Left	Left	Right	Left	Left	Right
Median Width(m)		3.7			3.7			3.7				3.7
Link Offset(m)		0.0			0.0			0.0				0.0
Crosswalk Width(m)		4.9			4.9			4.9				4.9
Two way Left Turn Lane												
Headway Factor	1.06	1.06	1.06	1.06	1.06	1.06	1.06	1.06	1.06	1.06	1.06	1.06
Turning Speed (k/h)	24		14	24		14	24		14	24		14
Number of Detectors	1	2		1	2		1	2		1	2	1
Detector Template	Left	Thru		Left	Thru		Left	Thru		Left	Thru	Right
Leading Detector (m)	6.1	30.5		6.1	30.5		6.1	30.5		6.1	30.5	6.1
Trailing Detector (m)	0.0	0.0		0.0	0.0		0.0	0.0		0.0	0.0	0.0
Detector 1 Position(m)	0.0	0.0		0.0	0.0		0.0	0.0		0.0	0.0	0.0
Detector 1 Size(m)	6.1	1.8		6.1	1.8		6.1	1.8		6.1	1.8	6.1
Detector 1 Type	Cl+Ex	Cl+Ex		Cl+Ex	Cl+Ex		Cl+Ex	Cl+Ex		Cl+Ex	Cl+Ex	Cl+Ex
Detector 1 Channel												
Detector 1 Extend (s)	0.0	0.0		0.0	0.0		0.0	0.0		0.0	0.0	0.0
Detector 1 Queue (s)	0.0	0.0		0.0	0.0		0.0	0.0		0.0	0.0	0.0
Detector 1 Delay (s)	0.0	0.0		0.0	0.0		0.0	0.0		0.0	0.0	0.0
Detector 2 Position(m)		28.7			28.7			28.7				28.7
Detector 2 Size(m)		1.8			1.8			1.8				1.8
Detector 2 Type		Cl+Ex			Cl+Ex			Cl+Ex				Cl+Ex
Detector 2 Channel												
Detector 2 Extend (s)		0.0			0.0			0.0				0.0
Turn Type	Perm	NA		Perm	NA		Perm	NA		pm+pt	NA	Perm
Protected Phases		4			8			2		1		6
Permitted Phases	4			8			2		6			6
Detector Phase	4	4		8	8		2	2		1	6	6
Switch Phase												
Minimum Initial (s)	10.0	10.0		10.0	10.0		10.0	10.0		5.0	10.0	10.0
Minimum Split (s)	32.2	32.2		32.2	32.2		28.4	28.4		11.4	28.4	28.4
Total Split (s)	36.0	36.0		36.0	36.0		52.0	52.0		12.0	64.0	64.0
Total Split (%)	36.0%	36.0%		36.0%	36.0%		52.0%	52.0%		12.0%	64.0%	64.0%
Maximum Green (s)	29.8	29.8		29.8	29.8		45.6	45.6		5.6	57.6	57.6
Yellow Time (s)	3.3	3.3		3.3	3.3		4.6	4.6		4.6	4.6	4.6

5331 Fernbank Road
2028 Total Traffic (Optimized)

2: Terry Fox & Cope
Timing Plan: PM Peak



Lane Group	EBL	EBT	EBR	WBL	WBT	WBR	NBL	NBT	NBR	SBL	SBT	SBR
All-Red Time (s)	2.9	2.9		2.9	2.9		1.8	1.8		1.8	1.8	1.8
Lost Time Adjust (s)	0.0	0.0		0.0	0.0		0.0	0.0		0.0	0.0	0.0
Total Lost Time (s)	6.2	6.2		6.2	6.2		6.4	6.4		6.4	6.4	6.4
Lead/Lag							Lag	Lag		Lead		
Lead-Lag Optimize?							Yes	Yes		Yes		
Vehicle Extension (s)	3.0	3.0		3.0	3.0		3.0	3.0		3.0	3.0	3.0
Recall Mode	None	None		None	None		C-Max	C-Max		None	C-Max	C-Max
Walk Time (s)	7.0	7.0		7.0	7.0		7.0	7.0		7.0	7.0	7.0
Flash Dont Walk (s)	19.0	19.0		19.0	19.0		15.0	15.0		15.0	15.0	15.0
Pedestrian Calls (#/hr)	5	5		5	5		5	5		5	5	5
Act Effct Green (s)	20.8	20.8		20.8	20.8		45.6	45.6		66.6	66.6	66.6
Actuated g/C Ratio	0.21	0.21		0.21	0.21		0.46	0.46		0.67	0.67	0.67
v/c Ratio	0.90	0.22		0.29	0.50		0.13	0.89		0.69	0.76	0.15
Control Delay	86.6	21.5		33.9	10.5		17.6	40.4		27.0	18.6	1.9
Queue Delay	0.0	0.0		0.0	0.0		0.0	0.0		0.0	0.0	0.0
Total Delay	86.6	21.5		33.9	10.5		17.6	40.4		27.0	18.6	1.9
LOS	F	C		C	B		B	D		C	B	A
Approach Delay		63.6			15.9			39.4				18.2
Approach LOS		E			B			D				B
Queue Length 50th (m)	27.7	8.3		11.8	6.2		3.3	119.9		20.3	105.6	0.0
Queue Length 95th (m)	#49.9	18.0		21.5	23.6		9.1	#191.6		#73.3	#227.2	7.9
Internal Link Dist (m)		278.1			118.5			186.5			491.9	
Turn Bay Length (m)	30.0			30.0			35.0			50.0		140.0
Base Capacity (vph)	231	519		353	604		235	787		370	1187	1035
Starvation Cap Reductn	0	0		0	0		0	0		0	0	0
Spillback Cap Reductn	0	0		0	0		0	0		0	0	0
Storage Cap Reductn	0	0		0	0		0	0		0	0	0
Reduced v/c Ratio	0.63	0.15		0.20	0.40		0.13	0.89		0.69	0.76	0.15

Intersection Summary

Area Type: Other
 Cycle Length: 100
 Actuated Cycle Length: 100
 Offset: 69 (69%), Referenced to phase 2:NBTL and 6:SBTL, Start of Green
 Natural Cycle: 90
 Control Type: Actuated-Coordinated
 Maximum v/c Ratio: 0.90
 Intersection Signal Delay: 27.9
 Intersection LOS: C
 Intersection Capacity Utilization 102.9%
 ICU Level of Service G
 Analysis Period (min) 15
 # 95th percentile volume exceeds capacity, queue may be longer.
 Queue shown is maximum after two cycles.

Splits and Phases: 2: Terry Fox & Cope



5331 Fernbank Road
2028 Total Traffic (Optimized)

5: Terry Fox & Fernbank
Timing Plan: PM Peak



Lane Group	EBL	EBT	EBR	WBL	WBT	WBR	NBL	NBT	NBR	SBL	SBT	SBR
Lane Configurations												
Traffic Volume (vph)	127	269	149	5	353	115	275	413	23	199	526	189
Future Volume (vph)	127	269	149	5	353	115	275	413	23	199	526	189
Ideal Flow (vphpl)	1800	1800	1800	1800	1800	1800	1800	1800	1800	1800	1800	1800
Storage Length (m)	75.0		75.0	95.0		115.0	90.0		0.0	90.0		95.0
Storage Lanes	1		1	1		1	1		0	1		1
Taper Length (m)	100.0			60.0			70.0			100.0		
Lane Util. Factor	1.00	1.00	1.00	1.00	1.00	1.00	1.00	1.00	1.00	1.00	1.00	1.00
Ped Bike Factor	1.00		0.97	0.99		0.97				1.00		0.96
Fr			0.850			0.850		0.992				0.850
Flt Protected	0.950			0.950			0.950			0.950		
Satd. Flow (prot)	1631	1784	1502	1235	1784	1459	1695	1770	0	1695	1784	1488
Flt Permitted	0.204			0.594			0.116			0.509		
Satd. Flow (perm)	350	1784	1459	767	1784	1419	207	1770	0	904	1784	1424
Right Turn on Red			Yes			Yes			Yes			Yes
Satd. Flow (RTOR)			149			144		4				189
Link Speed (k/h)		60			60			80			80	
Link Distance (m)		274.4			222.4			294.7			171.1	
Travel Time (s)		16.5			13.3			13.3			7.7	
Confl. Peds. (#/hr)	2		4	4		2	9			3		9
Confl. Bikes (#/hr)						2						
Peak Hour Factor	1.00	1.00	1.00	1.00	1.00	1.00	1.00	1.00	1.00	1.00	1.00	1.00
Heavy Vehicles (%)	6%	2%	3%	40%	2%	6%	2%	2%	2%	2%	2%	4%
Adj. Flow (vph)	127	269	149	5	353	115	275	413	23	199	526	189
Shared Lane Traffic (%)												
Lane Group Flow (vph)	127	269	149	5	353	115	275	436	0	199	526	189
Enter Blocked Intersection	No	No	No	No	No	No	No	No	No	No	No	No
Lane Alignment	Left	Left	Right	Left	Left	Right	Left	Left	Right	Left	Left	Right
Median Width(m)		3.7			3.7			3.7			3.7	
Link Offset(m)		0.0			0.0			0.0			0.0	
Crosswalk Width(m)		4.9			4.9			4.9			4.9	
Two way Left Turn Lane												
Headway Factor	1.06	1.06	1.06	1.06	1.06	1.06	1.06	1.06	1.06	1.06	1.06	1.06
Turning Speed (k/h)	24		14	24		14	24		14	24		14
Number of Detectors	1	2	1	1	2	1	1	2		1	2	1
Detector Template	Left	Thru	Right	Left	Thru	Right	Left	Thru		Left	Thru	Right
Leading Detector (m)	6.1	30.5	6.1	6.1	30.5	6.1	6.1	30.5		6.1	30.5	6.1
Trailing Detector (m)	0.0	0.0	0.0	0.0	0.0	0.0	0.0	0.0		0.0	0.0	0.0
Detector 1 Position(m)	0.0	0.0	0.0	0.0	0.0	0.0	0.0	0.0		0.0	0.0	0.0
Detector 1 Size(m)	6.1	1.8	6.1	6.1	1.8	6.1	6.1	1.8		6.1	1.8	6.1
Detector 1 Type	Cl+Ex	Cl+Ex	Cl+Ex	Cl+Ex	Cl+Ex	Cl+Ex	Cl+Ex	Cl+Ex		Cl+Ex	Cl+Ex	Cl+Ex
Detector 1 Channel												
Detector 1 Extend (s)	0.0	0.0	0.0	0.0	0.0	0.0	0.0	0.0		0.0	0.0	0.0
Detector 1 Queue (s)	0.0	0.0	0.0	0.0	0.0	0.0	0.0	0.0		0.0	0.0	0.0
Detector 1 Delay (s)	0.0	0.0	0.0	0.0	0.0	0.0	0.0	0.0		0.0	0.0	0.0
Detector 2 Position(m)		28.7			28.7			28.7			28.7	
Detector 2 Size(m)		1.8			1.8			1.8			1.8	
Detector 2 Type		Cl+Ex			Cl+Ex			Cl+Ex			Cl+Ex	
Detector 2 Channel												
Detector 2 Extend (s)		0.0			0.0			0.0			0.0	
Turn Type	pm+pt	NA	Perm	Perm	NA	Perm	pm+pt	NA		Perm	NA	Perm
Protected Phases	5	2			6		3	8			4	
Permitted Phases	2		2	6		6	8			4		4
Detector Phase	5	2	2	6	6	6	3	8		4	4	4
Switch Phase												
Minimum Initial (s)	5.0	10.0	10.0	10.0	10.0	10.0	5.0	10.0		10.0	10.0	10.0
Minimum Split (s)	11.2	33.2	33.2	33.2	33.2	33.2	11.5	29.2		29.2	29.2	29.2
Total Split (s)	14.0	49.2	49.2	35.2	35.2	35.2	23.4	70.8		47.4	47.4	47.4
Total Split (%)	11.7%	41.0%	41.0%	29.3%	29.3%	29.3%	19.5%	59.0%		39.5%	39.5%	39.5%
Maximum Green (s)	7.9	43.0	43.0	29.0	29.0	29.0	16.9	64.6		41.2	41.2	41.2
Yellow Time (s)	3.7	3.7	3.7	3.7	3.7	3.7	4.6	4.6		4.6	4.6	4.6



Lane Group	EBL	EBT	EBR	WBL	WBT	WBR	NBL	NBT	NBR	SBL	SBT	SBR
All-Red Time (s)	2.4	2.5	2.5	2.5	2.5	2.5	1.9	1.6		1.6	1.6	1.6
Lost Time Adjust (s)	0.0	0.0	0.0	0.0	0.0	0.0	0.0	0.0		0.0	0.0	0.0
Total Lost Time (s)	6.1	6.2	6.2	6.2	6.2	6.2	6.5	6.2		6.2	6.2	6.2
Lead/Lag	Lead			Lag			Lead			Lag		Lag
Lead-Lag Optimize?	Yes			Yes			Yes			Yes		Yes
Vehicle Extension (s)	3.0	3.0	3.0	3.0	3.0	3.0	3.0	3.0		3.0	3.0	3.0
Recall Mode	C-Max	C-Max	C-Max	Max	Max	Max	None	None		None	None	None
Walk Time (s)		7.0	7.0	7.0	7.0	7.0		7.0		7.0	7.0	7.0
Flash Dont Walk (s)		20.0	20.0	20.0	20.0	20.0		16.0		16.0	16.0	16.0
Pedestrian Calls (#/hr)		5	5	5	5	5		5		5	5	5
Act Effct Green (s)	46.4	46.3	46.3	29.0	29.0	29.0	61.0	61.3		38.6	38.6	38.6
Actuated g/C Ratio	0.39	0.39	0.39	0.24	0.24	0.24	0.51	0.51		0.32	0.32	0.32
v/c Ratio	0.50	0.39	0.23	0.03	0.82	0.25	0.90	0.48		0.68	0.92	0.32
Control Delay	33.9	29.9	5.1	35.4	59.6	4.3	58.8	20.4		48.1	61.1	5.5
Queue Delay	0.0	0.0	0.0	0.0	0.0	0.0	0.0	0.0		0.0	0.0	0.0
Total Delay	33.9	29.9	5.1	35.4	59.6	4.3	58.8	20.4		48.1	61.1	5.5
LOS	C	C	A	D	E	A	E	C		D	E	A
Approach Delay		24.0			45.9			35.2			46.8	
Approach LOS		C			D			D			D	
Queue Length 50th (m)	20.6	47.5	0.0	0.9	79.0	0.0	42.6	59.8		39.2	114.7	0.0
Queue Length 95th (m)	35.3	71.1	13.4	4.3	#124.7	8.7	#88.5	85.1		66.7	#173.3	15.3
Internal Link Dist (m)		250.4			198.4			270.7			147.1	
Turn Bay Length (m)	75.0		75.0	95.0		115.0	90.0			90.0		95.0
Base Capacity (vph)	255	688	654	185	431	452	314	954		310	612	613
Starvation Cap Reductn	0	0	0	0	0	0	0	0		0	0	0
Spillback Cap Reductn	0	0	0	0	0	0	0	0		0	0	0
Storage Cap Reductn	0	0	0	0	0	0	0	0		0	0	0
Reduced v/c Ratio	0.50	0.39	0.23	0.03	0.82	0.25	0.88	0.46		0.64	0.86	0.31

Intersection Summary

Area Type: Other
 Cycle Length: 120
 Actuated Cycle Length: 120
 Offset: 0 (0%), Referenced to phase 2:EBTL and 5:EBL, Start of Green
 Natural Cycle: 100
 Control Type: Actuated-Coordinated
 Maximum v/c Ratio: 0.92
 Intersection Signal Delay: 38.8
 Intersection LOS: D
 Intersection Capacity Utilization 97.1%
 ICU Level of Service F
 Analysis Period (min) 15
 # 95th percentile volume exceeds capacity, queue may be longer.
 Queue shown is maximum after two cycles.

Splits and Phases: 5: Terry Fox & Fernbank

