

SERVICING AND STORMWATER MANAGEMENT REPORT

KANATA AVENUE – THE WOODS



Perspective Prepared by S.J. Lawrence Architect Incorporated

MP Project No.: CCO-21-3764
City File No.: D07-12-21-0098

Prepared for:
Kanata Woods
1600 Laperriere Avenue
Ottawa, ON
K1Z 8P5

Prepared by:
McIntosh Perry
115 Walgreen Road
Carp, ON
K0A 1L0

May 6th, 2022

McINTOSH PERRY

TABLE OF CONTENTS

1.0	PROJECT DESCRIPTION	1
1.1	<i>Purpose</i>	1
1.2	<i>Site Description.....</i>	1
1.3	<i>Existing Conditions and Infrastructures</i>	2
1.4	<i>Approvals</i>	2
2.0	BACKGROUND STUDIES.....	3
2.1	<i>Applicable Guidelines and Standards.....</i>	3
3.0	PRE-CONSULTATION SUMMARY	5
4.0	SERVICING PLAN.....	6
4.1	<i>Proposed Servicing Overview</i>	6
4.2	<i>Proposed Water Design</i>	6
4.3	<i>Proposed Sanitary Design</i>	8
4.4	<i>Proposed Storm Design.....</i>	9
5.0	PROPOSED STORMWATER MANAGEMENT	10
5.1	<i>Design Criteria and Methodology.....</i>	10
5.2	<i>Runoff Calculations.....</i>	11
5.3	<i>Pre-Development Drainage.....</i>	11
5.4	<i>Post-Development Drainage</i>	12
5.5	<i>Quantity Control.....</i>	13
5.6	<i>Quality Control</i>	14
6.0	SEDIMENT EROSION CONTROL.....	16
6.1	<i>Temporary Measures.....</i>	16
6.2	<i>Permanent Measures.....</i>	16
7.0	SUMMARY.....	17
8.0	RECOMMENDATIONS.....	18
9.0	STATEMENT OF LIMITATIONS.....	19

LIST OF TABLES

Table 1: Water Supply Design Criteria and Water Demands	6
Table 2: Boundary Conditions Results	7
Table 3: Fire Protection Confirmation.....	7
Table 4: Sanitary Design Criteria.....	8
Table 5: Summary of Estimated Sanitary Flow	8
Table 6: Pre-Development Runoff Summary.....	11
Table 7: Post-Development Runoff Summary	12
Table 8: Allowable Release Rate.....	13
Table 9: Post-Development Restricted Runoff	13
Table 10: Storage Summary	14

APPENDICES

Appendix A: Key Plan	
Appendix B: Background Documents	
Appendix C: Watermain Calculations	
Appendix D: Sanitary Calculations	
Appendix E: Pre-Development Drainage Plan	
Appendix F: Post-Development Drainage Plan	
Appendix G: Stormwater Management Calculations	
Appendix H: City of Ottawa Design Checklist	

1.0 PROJECT DESCRIPTION

1.1 Purpose

McIntosh Perry (MP) has been retained by Kanata Woods Inc. to prepare this Servicing and Stormwater Management Report in support of the Site Plan Control process for the proposed mixed-use building consisting of residential and commercial uses located at 180 Kanata Avenue within the City of Ottawa.

The main purpose of this report is to present a servicing design for the development in accordance with the recommendations and guidelines provided by the City of Ottawa (City), the Mississippi Valley Conservation Authority (MVCA), and the Ministry of the Environment, Conservation and Parks (MECP). This report will address the water, sanitary and storm sewer servicing for the development, ensuring that existing and available services will adequately service the proposed development.

This report should be read in conjunction with the following drawings:

- CCO-21-3764, C101 – Lot Grading and Drainage Plan,
- CCO-21-3764, C102 – Site Servicing Plan,
- CCO-21-3764, C103 – Erosion and Sediment Control Plan,
- CCO-21-3764, PRE – Pre-Development Drainage Plan, and
- CCO-21-3764, POST – Post Development Drainage Plan.

1.2 Site Description

The property is located at 180 Kanata Avenue, within the City of Ottawa. It is described as Part of Lot 3, Concession 2, Geographic Township of March, City of Ottawa. The developable land in question covers approximately **1.11 ha** (property limits only) and is located on the north side of Kanata Avenue between Earl Grey Drive and Maritime Way. The existing site is currently undeveloped with vegetation throughout the entire site area.

Adjacent to the property on all sides is undeveloped land except for the southern property line which is fronting onto Kanata Avenue.

The proposed development consists of a six-storey building with commercial on the ground floor. The total building area is 5,043 m² and there will be two levels of underground parking. The remainder of the site will consist of landscaped areas and amenity space. A new road will be extended from Kanata Avenue to provide vehicular access to the site. The new road will be located directly across from the entrance to the parking area for the Kanata Centrum. Another development located to the east will make use of this new road. Detailed design documents have been provided by others and can be found under separate cover.

A site location plan has been provided in **Appendix A** for reference.

1.3 Existing Conditions and Infrastructures

The site is currently undeveloped.

Sewer and watermain mapping collected from the City of Ottawa indicate that the following services exist across the property frontages within the adjacent municipal rights-of-way(s):

- ❖ Kanata Avenue
 - 610 mm backbone watermain and 305 mm watermain (stubbed at property line)
 - 750 mm trunk sanitary sewer main and 250 mm sanitary main (stubbed at property line)
 - 450-, 525-, and a 675-mm storm sewer main

The 305 mm watermain and 250 mm sanitary main have been stubbed at the location for the new road extension. These services will be extended north in order to service future development. In addition to the services within the roadway, there is also fire hydrants along the north side of Kanata Avenue that are available for fire protection.

1.4 Approvals

The proposed development is subject to the City of Ottawa site plan control approval process. Site plan control requires the City to review, provide concurrence and approve the engineering design package. Permits to construct can be requested once the City has issued a site plan agreement.

An Environmental Compliance Approval (**ECA**) through the Ministry of Environment, Conservation and Parks (**MECP**) is not required for the development since the development will be serviced from Kanata Avenue via service laterals. The development does not propose connections to a combined sewershed and does not propose industrial uses. As a result, the stormwater management system meets the exemption requirements under O.Reg 525/90.

2.0 BACKGROUND STUDIES

Background studies that have been completed for the site include a review of the City of Ottawa as-built drawings, master servicing studies, a topographical survey of the site, an Environmental Impact Study, a geotechnical report and a Phase I Environmental Site Assessment (ESA).

As-built drawings of the existing services within the vicinity of the site were reviewed in order to determine proper servicing and stormwater management schemes for the site.

Master servicing reports for the area have been previously completed for the area and identify stormwater management criteria. The reviewed reports were:

- Kanata Town Centre, Central Business District, Stormwater Management Report (J.L. Richards, January 1999) (*KTC SWM*)
- Servicing Brief (Revised) – Kanata Town Centre Central Business District Subdivision, Technical Memorandum (J.L. Richards, June 13, 2012).

A topographic survey of the site was completed by Farley, Smith & Denis Surveying Ltd. dated May 3rd, 2021 and can be found under separate cover.

The following reports have been completed for the development and are available under separate cover:

- Geotechnical Investigation completed by Paterson Group dated April 21, 2021.
- Phase I ESA completed by EXP. dated June 30, 2021.
- Traffic Impact Study completed by McIntosh Perry Consulting Engineers Ltd.

2.1 Applicable Guidelines and Standards

City of Ottawa:

- ◆ Ottawa Sewer Design Guidelines, City of Ottawa, SDG002, October 2012. (*Ottawa Sewer Guidelines*)
 - Technical Bulletin ISTB-2014-01 City of Ottawa, February 2014. (*ISTB-2014-01*)
 - Technical Bulletin PIEDTB-2016-01 City of Ottawa, September 2016. (*PIEDTB-2016-01*)
 - Technical Bulletin ISTB-2018-01 City of Ottawa, January 2018. (*ISTB-2018-01*)
 - Technical Bulletin ISTB-2018-03 City of Ottawa, March 2018. (*ISTB-2018-03*)
 - Technical Bulletin ISTB-2019-01 City of Ottawa, January 2019. (*ISTB-2019-01*)
 - Technical Bulletin ISTB-2019-02 City of Ottawa, February 2019. (*ISTB-2019-02*)

- ◆ Ottawa Design Guidelines – Water Distribution City of Ottawa, July 2010. (***Ottawa Water Guidelines***)
 - Technical Bulletin ISD-2010-2 City of Ottawa, December 15, 2010. (***ISD-2010-2***)
 - Technical Bulletin ISDTB-2014-02 City of Ottawa, May 2014. (***ISDTB-2014-02***)
 - Technical Bulletin ISTB-2018-03 City of Ottawa, March 2018. (***ISTB-2018-03***)

Ministry of Environment, Conservation and Parks:

- ◆ Stormwater Planning and Design Manual, Ministry of the Environment, March 2003. (***MECP Stormwater Design Manual***)
- ◆ Design Guidelines for Sewage Works, Ministry of the Environment, 2008. (***MECP Sewer Design Guidelines***)

3.0 PRE-CONSULTATION SUMMARY

City of Ottawa Staff have been pre-consulted regarding this proposed development. Specific design parameters to be incorporated within this design include the following:

- Stormwater management to be in compliance with the master servicing studies for the area;
- Flows to the storm sewer in excess of the allowable release rate, up to and including the 100-year storm event, must be detained on-site;
- New sanitary and water pipes are to be extended from stubs within Kanata Avenue within the new road;
- Storm service connections can be made to Kanata Avenue;
- Quality control of storm runoff must be confirmed with MVCA; and
- Sanitary capacity will need to be demonstrated.

Pre-Consultation notes from the City can be found in **Appendix B**.

4.0 SERVICING PLAN

4.1 Proposed Servicing Overview

The overall servicing will be provided via connections to the existing sewers within Kanata Avenue and the new roadway. The water service will be serviced by the 305 mm watermain within the new roadway. The sanitary service will be connected to the 750 mm sanitary main within Kanata Avenue. The storm service will be connected to the 525 mm storm main within Kanata Avenue.

Details pertaining to the final proposed servicing locations have been reviewed and are shown on the proposed Site Servicing Plan (C102) included within the submission package.

4.2 Proposed Water Design

Dual water services (200 mm PVC) will be extended into the building from the 305 mm PVC watermain within the new roadway, complete with a water valve located at the property line. The water services and new 305 mm watermain has been designed to provide a minimum of 2.4 m of cover.

The Fire Underwriters Survey 1999 (FUS) method was utilized to estimate the required fire flow for the site. Fire flow requirements were calculated per City of Ottawa Technical Bulletin *ISTB-2018-03*. The following parameters were coordinated with the architect.

- ❖ Type of construction – Ordinary Construction
- ❖ Occupancy Type – Limited Combustibility
- ❖ Sprinkler Protection – Supervised Sprinkler System

The results of the calculations yielded a required fire flow of **19,000 L/min** (316.7 L/s). The detailed calculations for the FUS can be found in **Appendix C**.

The water demands for the proposed building have been calculated to adhere to the **Ottawa Water Guidelines** and can be found in **Appendix C**. The results have been summarized below:

Table 1: Water Supply Design Criteria and Water Demands

Site Area	1.11 ha
Residential	280 L/c/d
Other Commercial	28,000 L/ha/day
Average Day Demand (L/s)	1.73
Maximum Daily Demand (L/s)	3.78
Peak Hourly Demand (L/s)	9.42
OBC Fire Flow Requirement (L/s)	150.00
FUS Fire Flow Requirement (L/s)	316.67
Max Day + Fire Flow (FUS) (L/s)	320.40

The City provided the estimated water pressures at both for the average day scenario, peak hour scenario, and the max day plus fire flow scenario for the demands indicated by the correspondence in **Appendix C**. The resulting pressures for the boundary conditions results are shown in **Table 2**, below.

Table 2: Boundary Conditions Results

Scenario	Proposed Demands (L/S)	Connection 1 HGL (m H ₂ O)* /kPa
Average Day Demand	1.73	61.8 / 606.3
Maximum Daily + Fire Flow Demand (FUS)	3.78 + 316.7 = 320.4	52.4 / 514.0
Maximum Daily + Fire Flow Demand (OBC)	3.78 + 316.7 = 320.4	56.1 / 550.3
Peak Hourly Demand	9.42	56.8 / 557.2

**Adjusted for an estimated ground elevation of 99.5 m above the connection point for connection.*

The normal operating pressure range is anticipated to be 557.2 kPa to 606.3 kPa and will not be less than 275 kPa (40 psi) or exceed 689 kPa (100 psi). The proposed watermains will meet the minimum required 20 psi (140 kPa) from the **Ottawa Water Guidelines** at the ground level under maximum day demand and fire flow conditions. A pressure reducing valve (PRV) is anticipated to be required for the site since the pressure is anticipated to exceed 552 kPa (80 psi) in the average day scenario. A pressure test is required during construction to confirm PRV requirements.

To confirm the adequacy of fire flow to protect the proposed development, public and private fire hydrants within 150 m of the proposed building were analysed per City of Ottawa **ISTB 2018-02** Appendix I Table 1. The results are summarized below.

Table 3: Fire Protection Confirmation

Building	Fire Flow Demand (L/min.)	Fire Hydrant(s) within 75m	Fire Hydrant(s) within 150m	Combined Fire Flow (L/min.)
180 Kanata Ave	9,000 (OBC) 19,000 (FUS)	3 public	1 public	20,700

Based on City guidelines (**ISTB-2018-03**), the existing and proposed hydrants can provide adequate fire protection to the proposed development.

4.3 Proposed Sanitary Design

A new 300 mm diameter gravity sanitary service will be connected to the 750 mm diameter sanitary sewer within Kanata Avenue. The proposed 200 mm diameter gravity sanitary service will be installed with a minimum full flow target velocity (cleansing velocity) of 0.6 m/s and a full flow velocity of not more than 3.0 m/s.

The 250 mm diameter sanitary stub within the new roadway is proposed to be extended. The sanitary sewer design includes two maintenance manholes (MH1A and MH2A). Refer to drawing C102 for a detailed servicing layout.

Table 4, below, summarizes the wastewater design criteria identified by the *Ottawa Sewer Guidelines*.

Table 4: Sanitary Design Criteria

Design Parameter	Value
Site Area	1.11 ha
Residential	280 L/c/d
Other Commercial	28,000 L/ha/day
Residential Peaking Factor	3.37
Commercial Peaking Factor	1.5

Table 5 below, summarizes the estimated wastewater flow from the proposed development. Refer to *Appendix 'D'* for detailed calculations.

Table 5: Summary of Estimated Sanitary Flow

Design Parameter	Total Flow (L/s)
Total Estimated Average Dry Weather Flow	1.79
Total Estimated Peak Dry Weather Flow	5.82
Total Estimated Peak Wet Weather Flow	6.13

The full flowing capacity of a 300 mm diameter service at a 2.25% slope is estimated to be **151.3 L/s**. Per **Table 5**, a peak wet weather flow of **6.13 L/s** will be conveyed within the 300 mm diameter service, therefore the proposed system is sufficient sized for the development. The estimated velocity is **2.07 m/s**, within the range specified by the **Ottawa Sewer Guidelines**. Refer to **Appendix D** for sanitary calculations.

The 250 mm diameter sanitary sewer within the new roadway has been designed at a 1-2% slope. The resulting capacity is 62.04 L/s – 87.74 L/s. The estimated full flowing velocity is 1.22 m/s – 1.73 m/s, within the range specified by the **Ottawa Sewer Guidelines**. Refer to **Appendix D** for sanitary calculations.

4.4 Proposed Storm Design

Stormwater runoff from the site is currently tributary to the existing 525 mm diameter storm sewer within Kanata Avenue. The storm sewer directs stormwater to the Kanata Town Centre Stormwater Management facility (**KTC SWMF**) which subsequently drains to Watts Creek. The site is located within **Area 8** of the Kanata Town Centre SWMF design. Refer to **Appendix G** for the Stormwater Management Plan.

A new 375 mm diameter storm service is proposed to be extended from the existing 525 mm diameter storm sewer within Kanata Avenue. Stormwater runoff will be conveyed by way of roof drainage, overland sheet flow, and a proposed storm sewer network.

Runoff collected on the roof of the proposed building will be stored and controlled internally using twenty-three roof drains. Roof drains will be used to limit the flow from the roof to the specified allowable release rate. For calculation purposes a Watts Accutrol roof drain was used estimate a reasonable roof flow. Other products maybe specified at detailed building design so long as release rates and storage volumes are respected.

Drainage within parking lot and landscaped areas is proposed to be collected by a perforated subdrain system and area drains. Drainage is proposed to be collected and conveyed within the building mechanical system without flow attenuation. The direction and location of overland sheet flow has also been indicated on drawing C101, indicating that water will be directed towards Kanata Avenue in the event of a failure or blockage.

Foundation drainage is proposed to be pumped to the 375 mm diameter storm service without flow attenuation.

A 375 mm diameter storm sewer within the new roadway is proposed to provide servicing for the area. Refer to drawing C102 for a detailed servicing layout.

See CCO-21-3764 - *POST* include in **Appendix F** of this report for more details. The Stormwater Management design for the subject property will be outlined in **Section 7.0** of this report.

5.0 PROPOSED STORMWATER MANAGEMENT

5.1 Design Criteria and Methodology

Stormwater management for the proposed site will be maintained through rooftop attenuation. It is estimated that twenty-three Watts Accutrol Weirs will be used to control the release rate of the stormwater. Drainage within at-grade areas will be collected by a series of drains and will be conveyed unattenuated to the building outlet. The flow will be directed to the existing 525 mm storm sewer located within Kanata Avenue.

The quantitative and qualitative properties of the storm runoff for both the pre- and post-development flows are further detailed below. Stormwater Best Management Practices (SWM BMP's) will be implemented at the "Lot level", "Conveyance" and "End of Pipe" locations. These concepts will be explained further in Section 5.6. In summary, the following design criteria have been employed in developing the stormwater management design for the site as directed by the MVCA and the City:

Quality Control

- Based on coordination with the MVCA, no quality control is required. Quality control will be provided downstream of the site in the stormwater management facility (*KTC SWMF*) constructed as part of the Urbandale Kanata Town Centre Development.

Quantity Control

- Stormwater management design criteria for the proposed development were established by Kanata Town Centre, Central Business District, Stormwater Management Report (J.L. Richards, January 1999) and Servicing Brief (Revised) – Kanata Town Centre Central Business District Subdivision, Technical Memorandum (J.L. Richards, June 13, 2012). The SWM design criteria are as follows:
- Control post-development peak flows up-to and including the 100-year storm event to the allowable release rate. Provide on-site water quantity control for all flow in excess of the allowable release rate.
- The allowable release rate is to be determined by applying the following parameters to the site area:
 - A runoff coefficient of 0.57
 - A time of concentration of 20 minutes
 - A 5-year intensity using the City of Ottawa Intensity-Duration-Frequency (IDF) curves

5.2 Runoff Calculations

Runoff calculations presented in this report are derived using the Rational Method, given as:

$$Q = 2.78CIA \text{ (L/s)}$$

Where: C = Runoff coefficient
 I = Rainfall intensity in mm/hr (City of Ottawa IDF curves)
 A = Drainage area in hectares

It is recognized that the Rational Method tends to overestimate runoff rates. As a result, the conservative calculation of runoff ensures that any SWM facility sized using this method is expected to function as intended. The following coefficients were used to develop an average C for each area:

Roofs/Concrete/Asphalt	0.90
Undeveloped and Grass	0.20

As per the *City of Ottawa - Sewer Design Guidelines*, the 5-year balanced 'C' value must be increased by 25% for a 100-year storm event to a maximum of 1.0.

5.3 Pre-Development Drainage

There is an external drainage area located north, west, and east of the site. Drainage currently flows overland towards the existing catch basin located along Kanata Avenue and near the north west corner of the site.

It has been assumed that the existing development contained no stormwater management controls for flow attenuation. The drainage areas (Area A1 & A2) measure to be **2.08 ha**. The estimated pre-development peak flows for the 5 and 100-year events are summarized below in **Table 6**. See CCO-21-3764 - PRE in **Appendix E** and **Appendix G** for calculations.

Table 6: Pre-Development Runoff Summary

Area ID	Drainage Area (ha)	5-Year Runoff Coefficient	100-Year Runoff Coefficient	T _c (min)	Unrestricted 5-year Peak Flow (L/s)	Unrestricted 100-year Peak Flow (L/s)
A1	1.97	0.20	0.25	20	77.00	164.35
A2	0.11	0.20	0.25	20	4.43	9.46
Total	2.08				81.44	173.81

5.4 Post-Development Drainage

To meet stormwater objectives, the development will contain rooftop controls.

Based on the criteria listed in *Section 6.1*, the development will be required to restrict flow to the 5-year storm event. It is estimated that the target release rate during the 100-year event will be **219.46 L/s**. Grading works are proposed within pre-development Area A2, re-directing drainage from the subject site to Kanata Avenue. This area has been excluded for the proposed stormwater management design.

See **Appendix G** for calculations. See CCO-21-3764 – POST in **Appendix F** of this report for more details. A summary of the Post-Development Runoff Calculations can be found below.

Table 7: Post-Development Runoff Summary

Area ID	Drainage Area (ha)	5-Year Runoff Coefficient	100-Year Runoff Coefficient	T _c (min)	Unrestricted 5-year Peak Flow (L/s)	Unrestricted 100-year Peak Flow (L/s)
B1	0.319	0.37	0.43	20	23.10	46.06
B2	0.214	0.78	0.87	20	32.74	62.45
B3	0.505	0.90	1.00	20	88.79	168.44
B4	0.082	0.90	1.00	20	14.37	27.26
B5	0.851	0.20	0.25	20	33.24	70.95
Total	1.97				192.24	375.17

Runoff from the landscaped area of the site (Area B1) will be captured by a swale and subdrain system. The subdrains will connect into the building plumbing system and will be conveyed to the existing 525 mm storm sewer within Kanata Avenue. The swale system has been designed such that water is directed north and east towards the proposed surface parking lot (Area B2).

Runoff collected within the surface parking lot (Area B2) will be collected by one of four area drains. The area drain will connect into the building plumbing system and will be conveyed to the existing 525 mm diameter storm sewer within Kanata Avenue. The parking lot grading has been designed such that water is directed east towards the new roadway.

Runoff collected within the new roadway (Area B4) will flow downhill towards the existing Kanata Avenue catch basin system.

To match pre-development flows, on-site storage will be required. Storage will be provided on the roof (Area B3) via restricted roof drains. See **Appendix 'G'** for calculations.

5.5 Quantity Control

After reviewing the master drainage reports for the area, the total post-development runoff for this site has been restricted to match the 5-year pre-development flow rate with a C value of 0.57 and a time of concentration of 20 minutes. These values create the following allowable release rates and storage volumes for the development site. Refer to **Appendix B** for pre-consultation notes.

Table 8: Allowable Release Rate

Area ID	Drainage Area (ha)	Runoff Coefficient	T _c (min)	Required Restricted Flow 5-year (L/s)
A1	1.97	0.57	20	219.46
Total	1.97			219.46

See **Appendix 'G'** for calculations

Based on coordination with City staff, the CWSEL 100-year water level within the 525 mm storm sewer (at STM MH47348) is 97.90839 m. The storm service at the building has a proposed invert of 98.21, 30 cm higher than the CWSEL.

Reducing site flows will be achieved using flow restriction on the roof and will create the need for onsite storage. Runoff from Area B3 will be restricted as detailed in the table below.

Table 9: Post-Development Restricted Runoff

Area ID	Drainage Area (ha)	Restricted 5-year Peak Flow (L/s)	Restricted 100-year Peak Flow (L/s)	Restricted/ Unrestricted
B1	0.319	23.10	46.06	Unrestricted
B2	0.214	32.74	62.45	Unrestricted
B3	0.505	7.25	7.25	Restricted
B4	0.082	14.37	27.26	Unrestricted
B5	0.851	33.24	70.95	Unrestricted
Total	1.97	110.70	213.97	

See **Appendix 'G'** for calculations

Runoff from Area B3 will be restricted via twenty-three roof drains. The roof drains will restrict stormwater runoff to 7.25 L/s for the 100-year storm event with ponding depths of 35 mm (5-year storm) and 80 mm (100-year storm). The restricted flow from the roof will flow towards the existing 525 mm diameter storm sewer within Kanata Avenue via a 375 mm storm service. The roof restriction will compensate for areas without flow attenuation.

Table 10, below, summarizes the required and provided storage volumes for the site.

Table 10: Storage Summary

Drainage Area	Depth of Ponding (m)	Storage Required (m ³)	Storage Available (m ³)	Depth of Ponding (m)	Storage Required (m ³)	Storage Available (m ³)
		5-Year			100-Year	
B3	0.035	126.6	132.60	0.080	284.30	303.10

See Appendix 'G' for calculations

If a blockage within the storm network occurs, an emergency overland flow route has been provided to evacuate towards municipal ROWs and therefore away from the development. As per drawing C101, stormwater runoff will flow to both the new roadway and to Kanata Avenue. The water surface elevation (WSEL) will reach 100.50 providing 0.25 m freeboard separation from the finished floor elevation of 100.75. Based on coordination with City staff, 0.25m of freeboard for the development is acceptable.

Similarly, if there is a rainfall event above the 100-year storm event (including the climate change event), water will fill up the parking lot and swale system before spilling to the laneway (and Kanata Avenue) at a maximum elevation of 100.50. Therefore, the 25 cm freeboard between the spill elevation of 100.50 and finished floor of 100.75 will be maintain in storm larger then the 100-year. Emergency ponding limits have been noted on drawing C101 for reference.

5.6 Quality Control

The development of this lot will employ Best Management Practices (BMP's) wherever possible. The intent of implementing stormwater BMP's is to ensure that water quality and quantity concerns are addressed at all stages of development. Lot level BMP's typically include temporary retention of the parking lot runoff, minimizing ground slopes and maximizing landscaped areas. Some of these BMP's cannot be provided for this site due to site constraints and development requirements.

As per the discussions with the MVCA, the existing storm sewer within Kanata Avenue ties into the downstream **KTC SWMF**. The SWMF provides appropriate quality control for the site. This facility has been designed to accommodate runoff from Kanata Avenue within the tributary drainage area. The following design criteria, specified in the *Kanata Town Centre – Central Business District Stormwater Management report (KTC SWM)* prepared by JL Richards & Associates Ltd, were applied when sizing the downstream SWMF:

- Provide a water quality storage volume of 130 m³/ha,
- Provide an extended detention storage of 40 m³/ha,
- Provide a permanent pool volume of 90 m³/ha, and
- Provide a TSS removal of 70%.

Per Figure 3 of the *KTC SWM*, the property is located within 2.77 ha of designated Area 8 with a rational method coefficient of 0.57. Refer to **Appendix G** for Figure 3. As per drawing POST, 1.97 ha of land (within Areas B1-B5) are tributary to the proposed stormwater management design. The total 5-year and 100-year rational method coefficients tributary to the subject site is 0.49 and 0.56.

Based on coordination with the MVCA, the following design criteria have been implemented:

- Runoff from 45% of the site was collected on the rooftop, which can be treated as clean.
- Runoff from 25% area is through landscaped area, swale, and subdrain system.
- The remaining 30% is impervious area. The runoff from the parking lot (17% of the site) will be piped to the outlet where the rooftop drainage and landscape drainage will discharge.

As a result, the downstream SWMF has been sized to accommodate the development and no additional on-site quality treatment are required.

6.0 SEDIMENT EROSION CONTROL

6.1 Temporary Measures

Before construction begins, temporary silt fence, straw bale or rock flow check dams will be installed at all-natural runoff outlets from the property. It is crucial that these controls be maintained throughout construction and inspection of sediment and erosion control will be facilitated by the Contractor or Contract Administration staff throughout the construction period.

Silt fences will be installed where shown on the final engineering plans, specifically along the downstream property limits. The Contractor, at their discretion or at the instruction of the City, Conservation Authority or the Contract Administrator shall increase the quantity of sediment and erosion controls on-site to ensure that the site is operating as intended and no additional sediment finds its way off site. The rock flow, straw bale & silt fence check dams and barriers shall be inspected weekly and after rainfall events. Care shall be taken to properly remove sediment from the fences and check dams as required. Fibre roll barriers are to be installed at all existing curb inlet catch basins and filter fabric is to be placed under the grates of all existing catch basins and manholes along the frontage of the site and any new structures immediately upon installation. The measures for the existing/proposed structures is to be removed only after all areas have been paved. Care shall be taken at the removal stage to ensure that any silt that has accumulated is properly handled and disposed of. Removal of silt fences without prior removal of the sediments shall not be permitted.

Although not anticipated, work through winter months shall be closely monitored for erosion along sloped areas. Should erosion be noted, the Contractor shall be alerted and shall take all necessary steps to rectify the situation. Should the Contractor's efforts fail at remediating the eroded areas, the Contractor shall contact the City and/or Conservation Authority to review the site conditions and determine the appropriate course of action. As the ground begins to thaw, the Contractor shall place silt fencing at all required locations as soon as ground conditions warrant. Please see the *Site Grading, Drainage and Sediment & Erosion Control Plan* for additional details regarding the temporary measures to be installed and their appropriate OPSD references.

6.2 Permanent Measures

It is expected that the Contractor will promptly ensure that all disturbed areas receive topsoil and seed/sod and that grass be established as soon as possible. Any areas of excess fill shall be removed or levelled as soon as possible and must be located a sufficient distance from any watercourse to ensure that no sediment is washed out into the watercourse. As the vegetation growth within the site provides a key component to the control of sediment for the site, it must be properly maintained once established. Once the construction is complete, it will be up to the landowner to maintain the vegetation and ensure that the vegetation is not overgrown or impeded by foreign objects.

7.0 SUMMARY

- A new 5,043 m² six-storey mixed use residential and commercial building will be constructed at 180 Kanata Avenue;
- A new roadway will be constructed from Kanata Avenue to provide vehicle access and servicing to the site;
- A new 250 mm diameter sanitary sewer and manhole will be installed within the new roadway;
- A new 375 mm diameter storm sewer and manhole will be installed within the new roadway;
- A new 305 mm diameter watermain will be installed within the new roadway;
- The building will be serviced with a 300 mm diameter sanitary lateral, a 200 mm diameter water lateral, and 375 mm diameter storm (roof and foundation) lateral;
- As discussed with the City of Ottawa staff and the Kanata Town Centre stormwater design criteria, the stormwater management design will ensure post-development flow rates are restricted to 5-year storm event with a C value of 0.57 and a time of concentration of 20 minutes.
- Storm restriction and stormwater storage for the 5 through 100-year storm events will be provided on the roof; and
- The stormwater management facility located downstream has been previously constructed to provide appropriate quality control for the site based on coordination with the MVCA.

8.0 RECOMMENDATIONS

Based on the information presented in this report, we recommend that City of Ottawa approve this Servicing and Stormwater Management Report in support of the proposed mixed-use development at 180 Kanata Avenue.

The sediment and erosion control plan outlined in Section 6.0 and detailed in the Grading and Drainage Plan notes are to be implemented by the Contractor.

This report is respectfully being submitted for approval.



Alison Gosling, P.Eng.
Project Engineer, Land Development
McIntosh Perry Consulting Engineers
T: 613.714.4629
E: a.gosling@mcintoshperry.com

9.0 STATEMENT OF LIMITATIONS

This report was produced for the exclusive use of Kanata Woods Inc. The purpose of the report is to assess the existing stormwater management system and provide recommendations and designs for the post-construction scenario that are in compliance with the guidelines and standards from the Ministry of the Environment and Climate Change, City of Ottawa, and local approval agencies. McIntosh Perry reviewed the site information and background documents listed in Section 2.0 of this report. While the previous data was reviewed by McIntosh Perry and site visits were performed, no field verification/measures of any information were conducted.

Any use of this review by a third party, or any reliance on decisions made based on it, without a reliance report is the responsibility of such third parties. McIntosh Perry accepts no responsibility for damages, if any, suffered by any third party as a result of decisions or actions made based on this review.

The findings, conclusions, and/or recommendations of this report are only valid as of the date of this report. No assurance is made regarding any changes in conditions subsequent to this date. If additional information is discovered or becomes available at a future date, McIntosh Perry should be requested to re-evaluate the conclusions presented in this report, and provide amendments, if required.

**APPENDIX A
KEY PLAN**

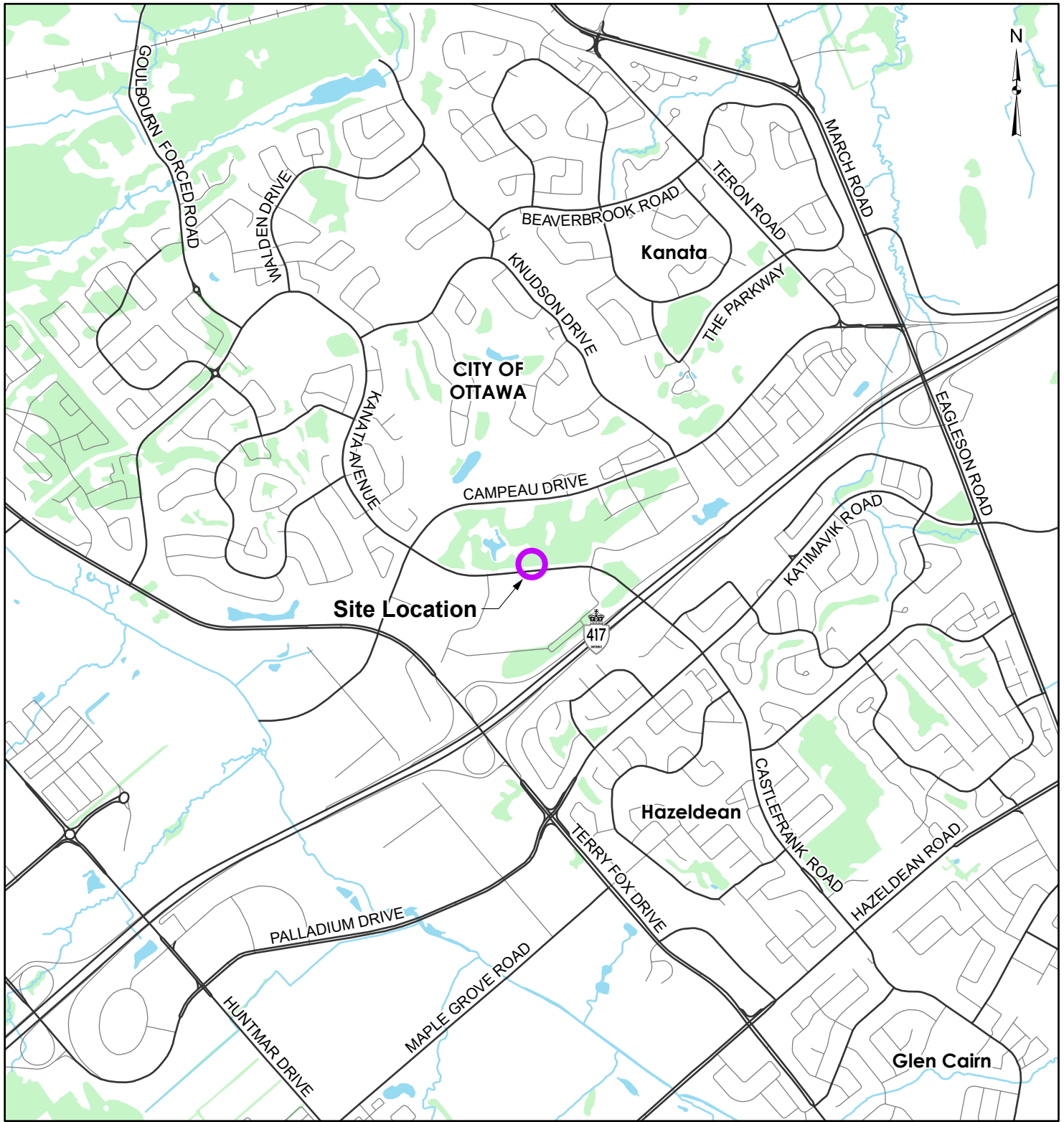

LEGEND

- Site Location
- Local Road
- Major Road
- Railroad
- Watercourse
- Waterbody
- Wooded Area



REFERENCE

GIS data provided by the Ontario Ministry of Natural Resources and Forestry, 2021.

CLIENT:	KANATA WOODS	
PROJECT:	180 KANATA AVENUE, OTTAWA, ON	
TITLE:	SITE LOCATION PLAN	
	PROJECT NO: CCO-21-3764	FIGURE:
	Date	Nov., 26, 2021
	GIS	EU
	Checked By	AG
McINTOSH PERRY <small>115 Walgreen Road, RR3, Carp, ON K0A1L0 Tel: 613-836-2184 Fax: 613-836-3742 www.mcintoshperry.com</small>		1

C:\Users\uncum\McIntosh Perry\GIS - Documents\Projects\2021\CCO\CCO-21-3764\TheBerge Dev - The Woods - 6905 Campeau\app\Key Maps\LandDevelopment\CCO-21-3764 - Ontario - SiteLocationPlan.aprx

APPENDIX B
BACKGROUND DOCUMENTS

Site Plan Pre- Application Consultation Notes

Date: Monday, February 8, 2021

Site Location: 6905 Campeau Drive

Type of Development: Residential (townhomes, stacked, singles, apartments), Office Space, Commercial, Retail, Institutional, Industrial, Other: N/A

Infrastructure

Existing Services on Kanata Avenue:

- 610 mm backbone watermain
- 305 mm watermain
- 750 mm trunk sanitary sewer main
- 250 mm sanitary main
- 675 mm storm sewer main

Recommendations: The existing 305mm watermain and 205mm sanitary sewer mains should be extended on the future street and serviced within the development. The storm service connections can be connected on Kanata Avenue.



Watermain Comments

Watermain Frontage Fees to be paid (\$190.00 per metre) Yes No

Boundary conditions:

Civil consultant must request boundary conditions from the City’s assigned Project Manager prior to first submission.

- Water boundary condition requests must include the location of the service(s) and the expected loads required by the proposed developments. Please provide all the following information:
 - Location of service(s)
 - Type of development and the amount of fire flow required (as per FUS, 1999).
 - Average daily demand: ___ l/s.
 - Maximum daily demand: ___ l/s.
 - Maximum hourly daily demand: ___ l/s.
- Fire protection (Fire demand, Hydrant Locations)

Sanitary Comments

- The Servicing Brief (Revised) Kanata Town Centre Central Business District Subdivision Memo prepared by J.L.Richards for Urbandale Corporation, dated June 13, 2012 (attached), and the sanitary sewer design sheet prepared by J.L.Richards for Urbandale dated October 12, 2016 (attached) are related to the design of the sanitary sewers along Cordillera/Canadian shield. These documents should be consulted when demonstrating capacity exists for sewage discharging to this location.
- It is anticipated that the proposed development is proposing a greater density of residential units than the approved report. The consultant must demonstrate that the proposed demands can satisfy the existing capacity.
- There are no known sanitary capacity issues downstream and additional capacity modelling will not be required.
- Is a monitoring manhole required on private property? Yes No
- Any premise in which there is commercial or institutional food preparation shall install a grease and oil inceptor on all fixtures.

- If an Environmental Site Assessment (ESA) is required for the proposed development, the ESA may provide recommendations where site contamination may be present. The recommendations from the ESA need to be coordinated with the servicing report to ensure compliance with the Sewer Use By-Law.

Stormwater Management

Quality Control:

- Mississippi Valley Conservation Authority to confirm quality control requirements.

Quantity Control:

- Please refer to the studies provided for allowable run-off coefficient.
- Time of concentration (Tc): Tc = pre-development; maximum Tc = 10 min
- Allowable flowrate: Control the 100-year storm events to the 5-year storm event

Ministry of Environment, Conservation and Parks (MECEP)

All development applications should be considered for an Environmental Compliance Approval, under MECP regulations.

- An ECA will be required for the extension of the services to the future parcel within 6905 Campeau Drive through the Transfer of Review program.
- Pre-consultation is not required if applying for standard or additional works (Schedule A of the Agreement) under Transfer Review.
- Pre-consultation with local District office of MECP is recommended for direct submission.
- Consultant completes an MECP request form for a pre-consultation. Sends request to moeccottawasewage@ontario.ca
- ECA applications are required to be submitted online through the MECP portal. A business account required to submit ECA application. For more information visit <https://www.ontario.ca/page/environmental-compliance-approval>

NOTE: Site Plan Approval, or Draft Approval, is required before any Ministry of the Environment and Climate Change (MOECC) application is sent

Other

Capital Works Projects within proximity to application? Yes No

References and Resources

- As per section 53 of the Professional Engineers Act, O. Reg 941/40, R.S.O. 1990, all documents prepared by engineers must be signed and dated on the seal.
- All required plans are to be submitted on standard A1 size sheets (594mm x 841mm) sheets, utilizing a reasonable and appropriate metric scale as per City of Ottawa Servicing and Grading Plan Requirements: title blocks are to be placed on the right of the sheets and not along the bottom. Engineering plans may be combined, but the Site Plans must be provided separately. Plans shall include the survey monument used to confirm datum. Information shall be provided to enable a non-surveyor to locate the survey monument presented by the consultant.
- All required plans & reports are to be provided in *.pdf format (at application submission and for any, and all, re-submissions)
- Please find relevant City of Ottawa Links to Preparing Studies and Plans below:
<https://ottawa.ca/en/city-hall/planning-and-development/information-developers/development-application-review-process/development-application-submission/guide-preparing-studies-and-plans#standards-policies-and-guidelines>
- To request City of Ottawa plan(s) or report information please contact the City of Ottawa Information Centre:
InformationCentre@ottawa.ca<mailto:InformationCentre@ottawa.ca>
(613) 580-2424 ext. 44455
- geoOttawa
<http://maps.ottawa.ca/geoOttawa/>

SITE PLAN APPLICATION – Municipal servicing

For information on preparing required studies and plans refer to:

<http://ottawa.ca/en/development-application-review-process-0/guide-preparing-studies-and-plans>

S/A	Number of copies	ENGINEERING		S/A	Number of copies
S		1. Site Servicing Plan	2. Site Servicing Brief	S	
S		3. Grade Control and Drainage Plan	4. Geotechnical Study	S	
		5. Composite Utility Plan	6. Groundwater Impact Study		
		7. Servicing Options Report	8. Wellhead Protection Study		
		9. Community Transportation Study and/or Transportation Impact Study / Brief	10. Erosion and Sediment Control Plan / Brief	S	
S		11. Storm water Management Brief	12. Hydro-geological and Terrain Analysis		
		13. Water main Analysis	14. Noise / Vibration Study	S	
		15. Roadway Modification Design Plan	16. Confederation Line Proximity Study		

It is important to note that the need for additional studies and plans may result during application review. If following the submission of your application, it is determined that material that is not identified in this checklist is required to achieve complete application status, in accordance with the Planning Act and Official Plan requirements, City Planning will notify you of outstanding material required within the required 30 day period. Mandatory pre-application consultation will not shorten the City’s standard processing timelines, or guarantee that an application will be approved. It is intended to help educate and inform the applicant about submission requirements as well as municipal processes, policies, and key issues in advance of submitting a formal development application. This list is valid for one year following the meeting date. If the application is not submitted within this timeframe the applicant must again pre-consult with the City.

Notes:

4. Geotechnical Study / Slope Stability Study – required as per Official Plan section 4.8.3. All site plan applications need to demonstrate the soils are suitable for development. A Slope Stability Study may be required with unique circumstances (Schedule K or topography may define slope stability concerns).

10. Erosion and Sediment Control Plan – required with all site plan applications as per Official Plan section 4.7.3.

11. Stormwater Management Report/Brief - required with all site plan applications as per Official Plan section 4.7.6.

AVERAGE NUMBER OF BEDROOMS PER DWELLING UNIT									
NO. OF UNITS:	GROUND FLOOR	2ND FLOOR	3RD FLOOR	4TH FLOOR	5TH FLOOR	6TH FLOOR	TOTAL NUMBER OF UNITS	NUMBER OF BEDROOMS	% OF BEDROOMS
STUDIO	4	9	9	9	9	9	49	49	11.4
ONE BEDROOM	15*	22	22	22	22	22	125	125	29.1
TWO BEDROOM	8*	24	24	24	24	24	128	256	59.5
TOTAL COMBINED	27*	55	55	55	55	55	302*	430	100%
AVERAGE NUMBER OF BEDROOMS								1.42	

*2 MODEL/GUEST UNITS NOT INCLUDED IN STATS (1 - ONE BEDROOM & 1 - TWO BEDROOM)

BARRIER FREE UNITS			
NO. OF UNITS = 302 x 15% = 46 UNITS REQ'D			
TYPE OF UNITS	# OF UNITS	REQ'D B.F. UNITS (15%)	PROVIDED B.F. UNITS
STUDIO	49	7.35	21
ONE BEDROOM	125*	18.75	6
TWO BEDROOM	128*	19.20	25
TOTAL COMBINED	302*	45.30	52

*2 MODEL/GUEST UNITS NOT INCLUDED IN STATS

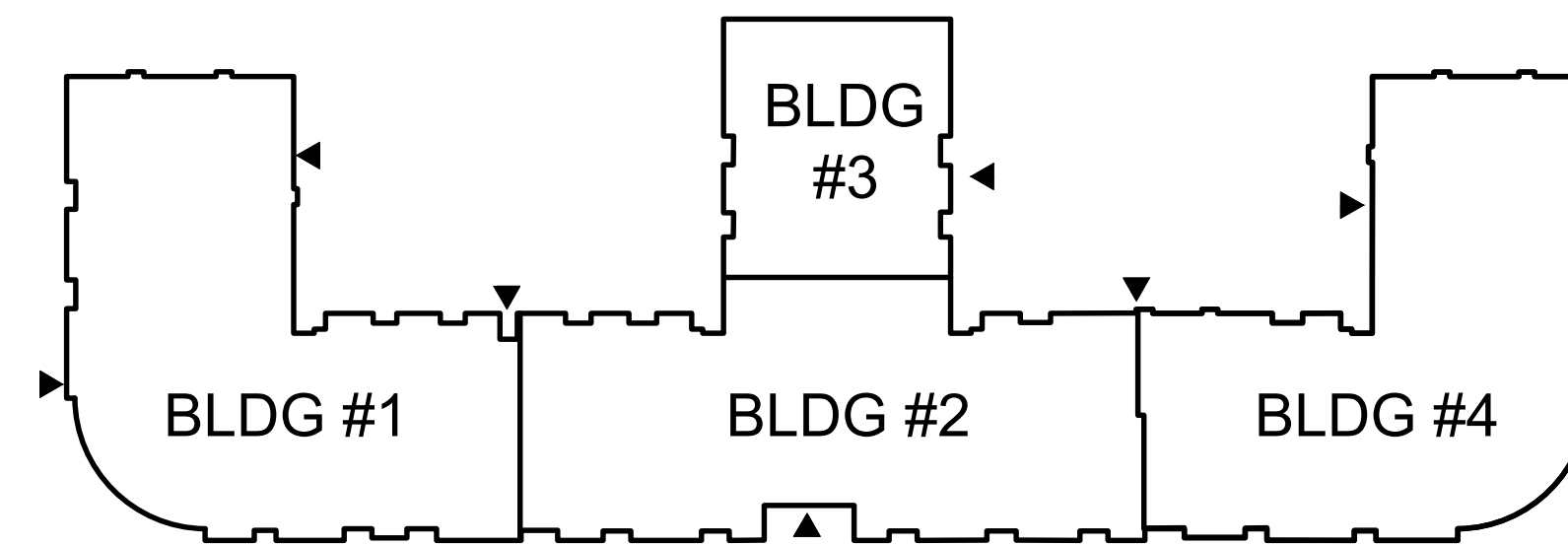

BUILDING #1 - 16,084ft² (1,494m²)
 BUILDING #2 - 15,533ft² (1,443m²)
 BUILDING #3 - 6,272ft² (583m²)
 BUILDING #4 - 16,145ft² (1,500m²)
 O.B.C. - 3.2.2.43A

CITY OF OTTAWA ZONING BY-LAW 2008-250		
MCS H(35) (MIXED-USE CENTRE ZONE)		
PROPOSED MID-RISE MIXED-USE DEVELOPMENT		
ZONING PROVISION	REQUIRED	PROVIDED
MIXED-USE CENTRE ZONE PROVISIONS		
LOT AREA (MIN.)	NO MINIMUM	11,135.1m ²
LOT WIDTH (MIN.)	NO MINIMUM	+/- 158.7m
FRONT YARD SETBACK (MIN. / MAX.)	NO MINIMUM / MAXIMUM 3.5m	2.6 m
INTERIOR SIDE YARD SETBACK (MIN.)	NO MINIMUM, EXCEPT WHERE THE BUILDING WALL CONTAINS ROOM WINDOWS, THE MINIMUM SETBACK ADJACENT TO WINDOWS IS 3.5m	5.1 m (EAST) & 5.5 m (WEST)
REAR YARD SETBACK (MIN.)	NO MINIMUM, EXCEPT WHERE THE BUILDING WALL CONTAINS ROOM WINDOWS, THE MINIMUM SETBACK ADJACENT TO WINDOWS IS 6m	12.7 m
FLOOR SPACE INDEX (MAX.)	2	2.1
FLOOR SPACE INDEX NON-RESIDENTIAL (MIN.)	0.75	0.11
BUILDING HEIGHT (MIN. / MAX.)	MINIMUM 6.7m / MAXIMUM 35.0m	21.2 m
WIDTH OF LANDSCAPED AREA (MIN.)	NO MINIMUM	VARIES
PARKING PROVISIONS (AREA C)		
PARKING SPACES (MIN.)	1.0 PER DWELLING UNIT = 304 3.4 PER 100m ² GFA RETAIL = 30.5 10 PER 100m ² GFA GYM = 15.4 10 PER 100m ² GFA CAFE = 21.2	TOTAL = 385
VISITOR PARKING SPACES (MIN.)	0.2 PER DWELLING UNIT = 60.8 TOTAL = 431.9	
ACCESSIBLE PARKING SPACES (MIN.)	5 TYPE A & 5 TYPE B	10 TOTAL
BICYCLE PARKING SPACES (MIN.)	0.5 PER DWELLING UNIT = 152 1 PER 250m ² GFA RETAIL = 4 1 PER 250m ² GFA CAFE = 1 1 PER 1500m ² GFA GYM = 0	TOTAL = 244 INCLUDES 0.75 PER DWELLING UNIT
AMENITY AREA PROVISIONS		
TOTAL AMENITY AREA (MIN.)	6m ² PER DWELLING UNIT = 1824	4,505 m ²
COMMUNAL AMENITY AREA (MIN.)	50% OF TOTAL = 912 m ²	3,238 m ²

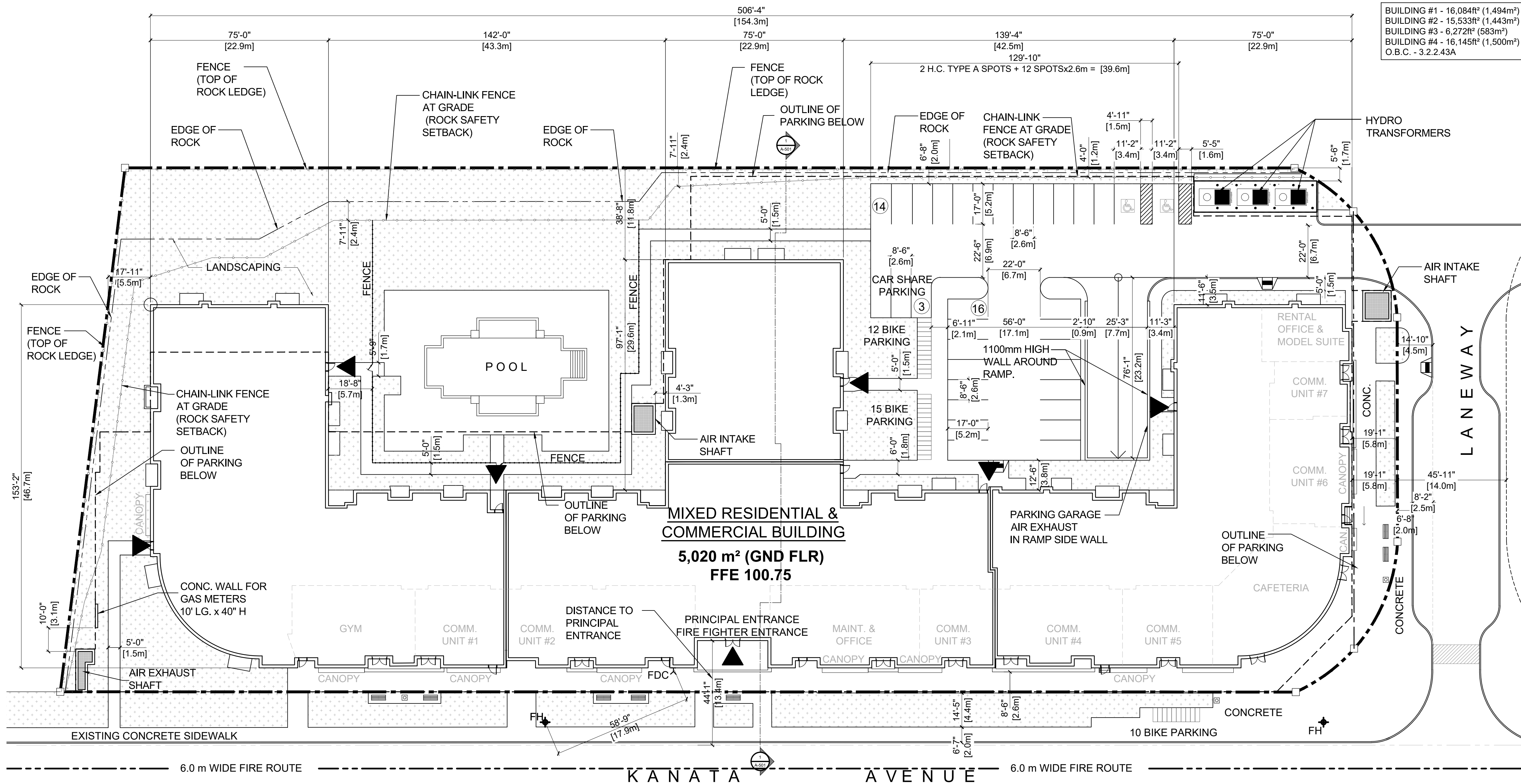

GROSS FLOOR AREAS (GFA) - PER CITY ZONING DEFINITION	
COMMERCIAL (1ST FLR)	= 1,261.8 m ² (13,582 ft ²)
RESIDENTIAL (1ST FLR)	= 2,049m ² (22,060ft ²)
RESIDENTIAL (2ND FLR)	= 4,266m ² (45,915ft ²)
RESIDENTIAL (3RD FLR)	= 4,266m ² (45,915ft ²)
RESIDENTIAL (4TH FLR)	= 4,266m ² (45,915ft ²)
RESIDENTIAL (5TH FLR)	= 4,266m ² (45,915ft ²)
RESIDENTIAL (6TH FLR)	= 4,266m ² (45,915ft ²)
TOTAL RES. & COMM.	= 24,639 m² (265,216ft²)

AMENITY AREAS	
COMMUNAL POOL/GRASS	= 2,465m ² (26,534ft ²)
ROOF TOP	= 397m ² (4,273ft ²)
GND FLR AMENITIES	= 376m ² (4,049ft ²)
PRIVATE BALCONIES	
GND FLOOR	= 109m ² (1,172ft ²)
2ND FLOOR	= 233m ² (2,508ft ²)
3RD FLOOR	= 233m ² (2,508ft ²)
4TH FLOOR	= 227m ² (2,447ft ²)
5TH FLOOR	= 232m ² (2,499ft ²)
6TH FLOOR	= 232m ² (2,499ft ²)
TOTAL	= 4,505m² (48,489ft²)

BUILDING AREA CALCULATIONS (PERIMETER) FOR BUILDING CODE	
U/G LEVEL 1 =	8,388m ² (90,283ft ²)
U/G LEVEL 2 =	3,052m ² (32,860ft ²)
GROUND FLR =	5,020m ² (54,035ft ²)
2ND FLR =	5,019m ² (54,021ft ²)
3RD FLR =	5,019m ² (54,021ft ²)
4TH FLR =	5,013m ² (53,963ft ²)
5TH FLR =	5,013m ² (53,963ft ²)
6TH FLR =	5,013m ² (53,963ft ²)
ROOF =	146m ² (1,576ft ²)

PARKING						
FLOOR	2.6m x 5.2m	2.4m x 5.2m	2.6m x 4.6m SMALL CAR	BF TYPE 'A' 3.4m x 5.2m	BF TYPE 'B' 2.6m x 5.2m	TOTAL
SITE	31	0	0	2	0	33
U/G LVL 1	196	64	1	2	2	265
U/G LVL 2	63	19	1	2	2	87
TOTAL	290	83	2	6	4	385



rev.	date	issued for	rev.	date	issued for
5	DEC. 09.21	SPA RESUBMISSION	10		
4	OCT. 27.21	RE-ZONING	9		
3	OCT. 20.21	UDRP	8		
2	JUNE 30.21	ZONING	7	MAR. 11.22	PLANNING RESUBMISSION
1	JUNE 11.21	REVIEW	6	FEB. 22.22	FOUNDATION PERMIT

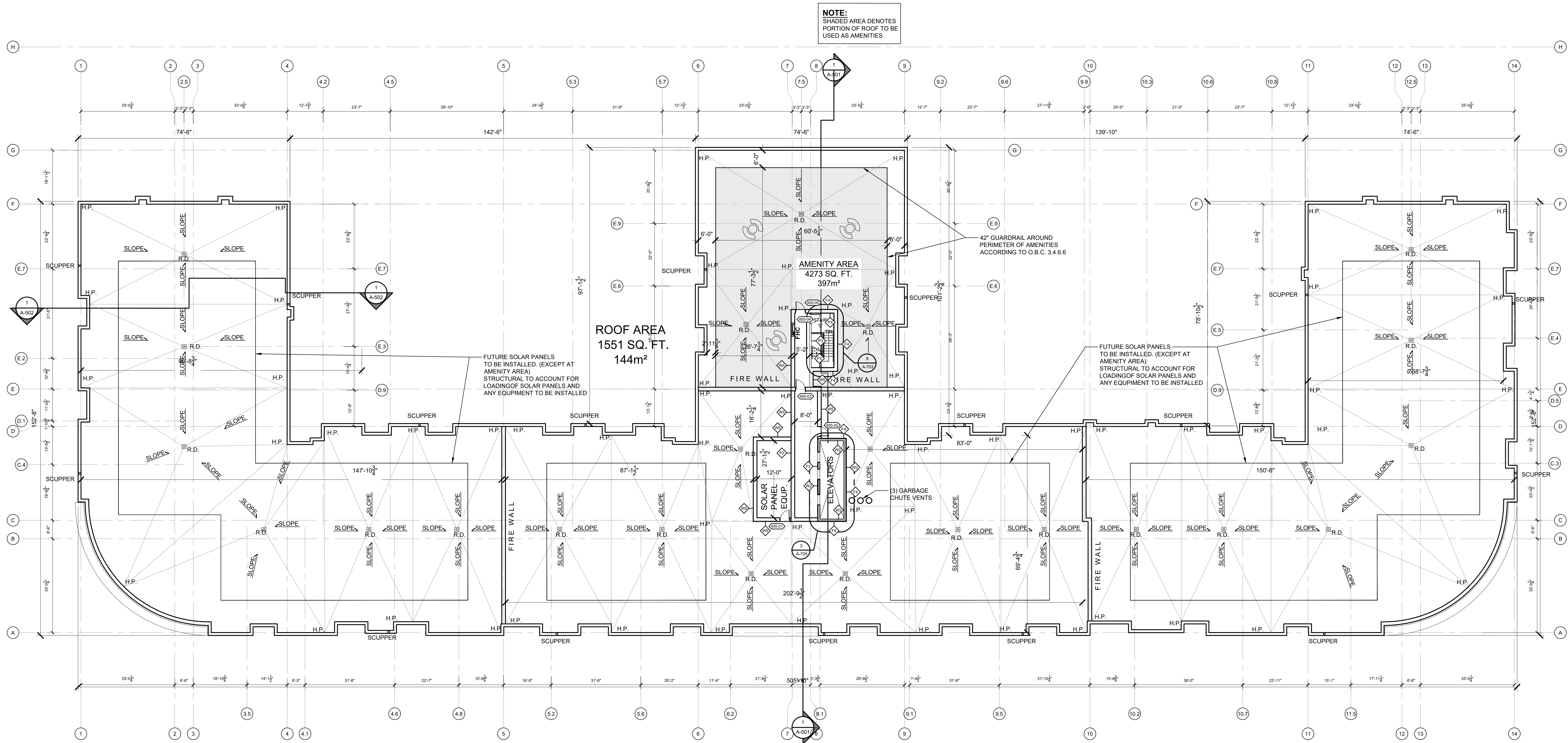

ROOF PLAN
SCALE: 1/16" = 1'-0"
NORTH

5		10		15	
4	FEB. 22.22	FOUNDATION PERMIT	9	14	
3	DEC. 09.21	SPA RESUBMISSION	8	13	
2	OCT. 20.21	UDRP	7	12	
1	JUNE 30.21	ZONING	6	11	
rev.	date	issued for	rev.	date	issued for


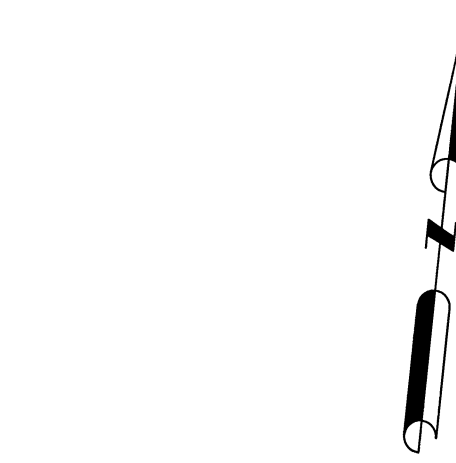

SKETCH SHOWING TOPOGRAPHIC INFORMATION OF
180 KANATA AVENUE
CITY OF OTTAWA
FARLEY, SMITH & DENIS SURVEYING LTD. 2021



Caution:
a) This is NOT a plan of survey and shall not be used except for the purpose indicated in the title block.
b) This Sketch is protected by Copyright ©

LEGAL DESCRIPTION OF PROPERTY:
PART OF LOT 3
CONCESSION 2
GEOGRAPHIC TOWNSHIP OF MARCH
CITY OF OTTAWA

Metric Note
Distances and coordinates on this plan are in metres and can be converted to feet by dividing by 0.3048.

Distance Note
Distances shown on this plan are ground distances and can be converted to grid distances by multiplying by the combined scale factor of 0.99992.

Bearing Note
Bearings hereon are grid bearings referred to the northerly limit of Kanata Avenue having a bearing of N84°02'30"E and are referred to the Central Meridian of MTM Zone 9 (76°30' West Longitude) Nad-83 (Original).

For bearing comparisons, a rotation of 0°00'45" counter-clockwise was applied to bearings on P1, P2, P3, P4.

- Elevation Notes
1. Elevations shown are geodetic and are referred to Geodetic Datum CGVD-1928-1978.
 2. Elevations derived from Vertical Benchmark 0011988U508 having a published elevation of 93.658m.
 3. It is the responsibility of the user of this information to verify that the job benchmark has not been altered or disturbed and that its relative elevation and description agrees with the information shown on this drawing.

- Utility Notes
1. This drawing cannot be accepted as acknowledging all of the utilities and it will be the responsibility of the user to contact the respective utility authorities for confirmation.
 2. Only visible surface utilities were located.
 3. Underground utility data derived from City of Ottawa utility sheet reference: 22452, 1-M-04, 1-M-05, 1-M-10, 1-M-11.
 4. Sanitary and storm sewer grades and inverts were compiled from: Field measurement and City of Ottawa.
 5. A field location of underground plant by the pertinent utility authority is mandatory before any work involving breaking ground, probing, excavating, etc.

- Notes & Legend
- +— Denotes Survey Monument Planted
 - +— Survey Monument Found
 - +— Standard Iron Bar
 - +— Short Standard Iron Bar
 - +— Not Tangential
 - +— Witness
 - +— Measured
 - +— (P1) Plan 48-9182
 - +— (P2) Plan 48-16146
 - +— (P3) Plan 48-24533
 - +— (P4) Plan 48-31544
 - +— Observed Reference Point
 - +— Rock Post
 - +— Maintenance Hole (Storm)
 - +— Maintenance Hole (Sanitary)
 - +— Valve Chamber (Watermain)
 - +— Undergound Hole (Sanitary)
 - +— Undergound Sanitary Sewer
 - +— Undergound Water
 - +— Undergound Storm Sewer
 - +— Undergound Gas
 - +— Undergound Bell
 - +— Undergound Cable TV
 - +— Undergound Power
 - +— Light Standard
 - +— Catch Basin
 - +— Fire Hydrant
 - +— Water Valve
 - +— Cable Terminal Box
 - +— Diameter
 - +— Borehole
 - +— Rock Retaining Wall
 - +— Inv.
 - +— Top of Grate
 - +— Centreline
 - +— ±65.00
 - +— ±65.00
 - +— Deciduous Tree - The Symbol shown denotes location and trunk diameter only. Size of its' root system/overhead canopy may be smaller/larger than the symbol size depicted on this plan.
 - +— Coniferous Tree - The Symbol shown denotes location and trunk diameter only. Size of its' root system/overhead canopy may be smaller/larger than the symbol size depicted on this plan.

WARNING: NO PERSON MAY COPY, REPRODUCE, DISTRIBUTE OR ALTER THIS PLAN IN WHOLE OR IN PART WITHOUT THE WRITTEN PERMISSION OF FARLEY, SMITH & DENIS SURVEYING LTD. © FARLEY, SMITH & DENIS SURVEYING LTD. 2021.

Field work was completed on the 13th day of April, 2021.

Daniel Robinson
Date: _____
Ontario Land Surveyor

FARLEY, SMITH & DENIS SURVEYING LTD.
ONTARIO LAND SURVEYORS
CANADIAN LAND SURVEYORS
190 COLONNADE ROAD, OTTAWA, ONTARIO K2E 7J5
TEL: (613) 727-8226 FAX: (613) 727-1826

Alison Gosling

Subject: RE: Kanata Avenue Development

From: Erica Ogden <eogden@mvc.on.ca>
Sent: April 9, 2021 10:51 AM
To: Curtis Melanson <c.melanson@mcintoshperry.com>
Subject: RE: Kanata Avenue Development

Hello Curtis,

Thank you for contacting MVCA. I believe the property you are referring to is currently a part of 6095 Campeau Drive and includes the portions fronting on to Kanata Avenue.

For the site an enhanced level of water quality protection (80% TSS removal is required). The property is not regulated by MVCA under Ontario Regulation 153/06.

It is my understanding there are existing storm service connections on Kanata Ave which would be used for the development, which outlets to the existing stormwater management facility on Maritime Way, constructed as a part of the Urbandale Kanata Town Centre Development. Please refer to the Stormwater Management Report, Kanata Town Centre, Central Business District (J.L. Richards & Associates Limited, Jan 1999). This stormwater facility was designed to provide an Enhanced Level of water quality control.

If you have any questions, please feel free to contact me.

Thank you,

Erica C. Ogden, MCIP, RPP | Environmental Planner | Mississippi Valley Conservation Authority
10970 Highway 7, Carleton Place, ON K7C 3P1
www.mvc.on.ca | c. 613 451 0463 | o. 613 253 0006 ext. 229 | eogden@mvc.on.ca

From: Curtis Melanson <c.melanson@mcintoshperry.com>
Sent: March 30, 2021 10:59 AM
To: Erica Ogden <eogden@mvc.on.ca>
Subject: Kanata Avenue Development

Hi Erica,

We're working on a project in the Kanata Centrum. It's located on the north side of Kanata Avenue and the project consists of a new 6 storey apartment building with commercial/retail on the ground floor. There will be approximately 200 units complete with 2 levels of underground parking. The footprint of the building is 4,720m² and will have limited at grade parking. The site will largely consist of landscaped areas. See attached site plan for reference.

We have pre-consulted with the City and received the stormwater management quantity control, but we're checking with MVCA for quality control. Can you let me know what, if any, quality control is required for the site?

If you have any questions/concerns please don't hesitate to call or email.

Thanks,

Curtis Melanson, C.E.T.

Practice Area Lead, Land Development

115 Walgreen Road, R.R. 3, Carp, ON K0A 1L0

T. 613.714.4621 | F. 613.836.3742 | C. 613.857.0784

c.melanson@mcintoshperry.com | www.mcintoshperry.com

McINTOSH PERRY

Confidentiality Notice – If this email wasn't intended for you, please return or delete it. Click [here](#) to read all of the legal language around this concept.



Platinum
member



APPENDIX C
WATERMAIN CALCULATIONS

City of Ottawa - Water Distribution System Facilities & Feeder mains

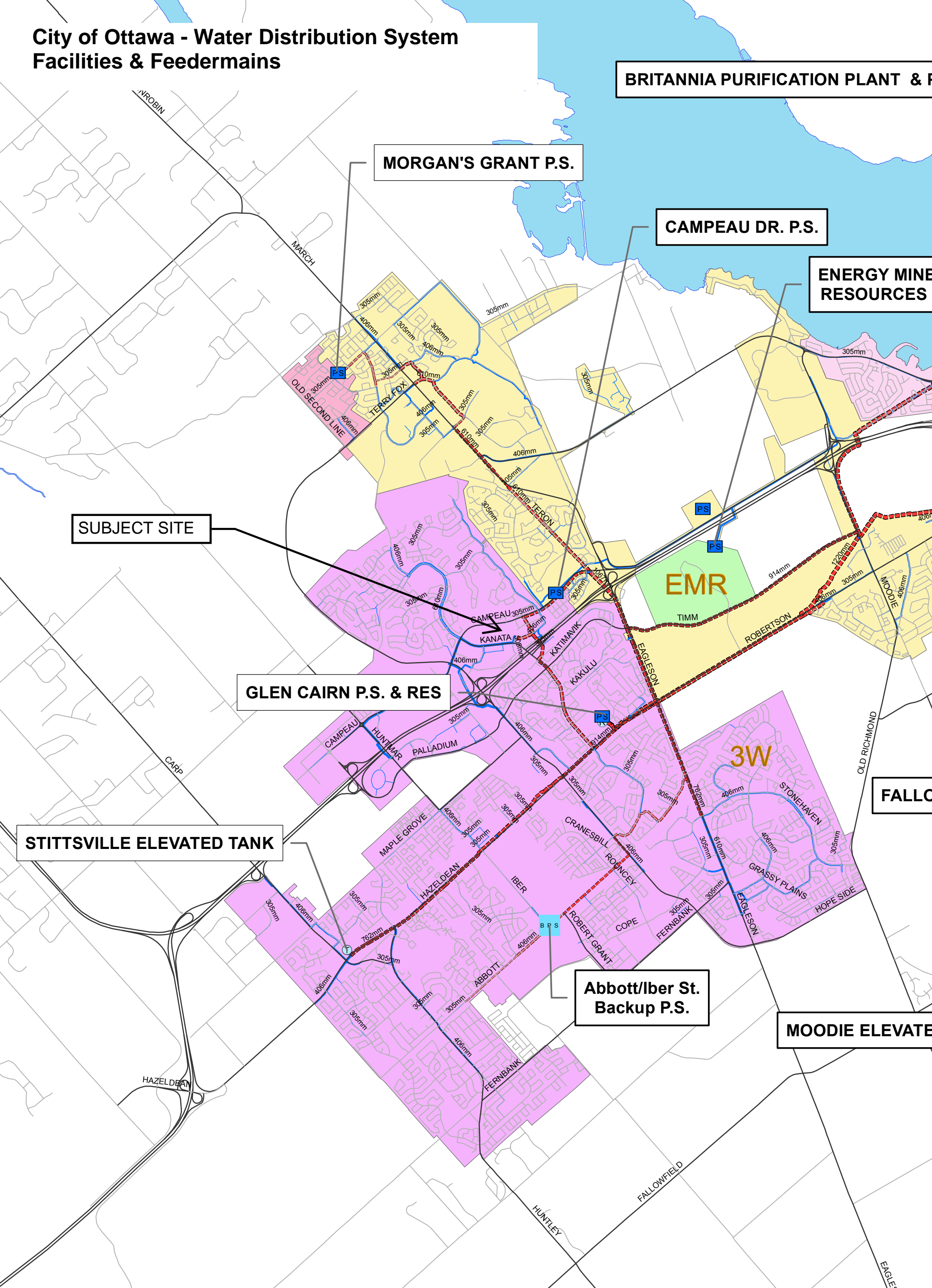

BRITANNIA PURIFICATION PLANT & RES.

MORGAN'S GRANT P.S.

CAMPEAU DR. P.S.

ENERGY MINE RESOURCES

SUBJECT SITE

GLEN CAIRN P.S. & RES.

STITTSVILLE ELEVATED TANK

Abbott/Iber St. Backup P.S.

MOODIE ELEVATED TANK

FALLO...

3W

McINTOSH PERRY

CCO-21-3764 - The Woods - 180 Kanata Ave - Water Demands

Project:	The Woods - 180 Kanata Ave
Project No.:	CCO-21-3764
Designed By:	RRR/AJG
Checked By:	CJM
Date:	March 10, 2022
Site Area:	1.11 gross ha

Residential	NUMBER OF UNITS	UNIT RATE	
Bachelor Apartment	17 units	1.4	persons/unit
1 Bedroom Apartment	148 units	1.4	persons/unit
2 Bedroom Apartment	139 units	2.1	persons/unit
Total Population	523 persons		

Commercial	1082 m2
Industrial - Light	m2
Industrial - Heavy	m2

AVERAGE DAILY DEMAND

DEMAND TYPE	AMOUNT	UNITS	
Residential	280	L/c/d	
Industrial - Light	35,000	L/gross ha/d	
Industrial - Heavy	55,000	L/gross ha/d	
Shopping Centres	2,500	L/(1000m ² /d)	
Hospital	900	L/(bed/day)	
Schools	70	L/(Student/d)	
Trailer Park with no Hook-Ups	340	L/(space/d)	
Trailer Park with Hook-Ups	800	L/(space/d)	
Campgrounds	225	L/(campsite/d)	
Mobile Home Parks	1,000	L/(Space/d)	
Motels	150	L/(bed-space/d)	
Hotels	225	L/(bed-space/d)	
Tourist Commercial	28,000	L/gross ha/d	
Other Commercial	28,000	L/gross ha/d	
AVERAGE DAILY DEMAND	Residential	1.69	L/s
	Commercial/Industrial/Institutional	0.04	L/s

McINTOSH PERRY

MAXIMUM DAILY DEMAND

DEMAND TYPE	AMOUNT		UNITS
Residential	2.2	x avg. day	L/c/d
Industrial	1.5	x avg. day	L/gross ha/d
Commercial	1.5	x avg. day	L/gross ha/d
Institutional	1.5	x avg. day	L/gross ha/d
MAXIMUM DAILY DEMAND	Residential	3.73	L/s
	Commerical/Industrial /Institutional	0.05	L/s

MAXIMUM HOUR DEMAND

DEMAND TYPE	AMOUNT		UNITS
Residential	5.5	x avg. day	L/c/d
Industrial	1.8	x max. day	L/gross ha/d
Commercial	1.8	x max. day	L/gross ha/d
Institutional	1.8	x max. day	L/gross ha/d
MAXIMUM HOUR DEMAND	Residential	9.32	L/s
	Commerical/Industrial /Institutional	0.09	L/s

WATER DEMAND DESIGN FLOWS PER UNIT COUNT

CITY OF OTTAWA - WATER DISTRIBUTION GUIDELINES, JULY 2010

AVERAGE DAILY DEMAND	1.73	L/s
MAXIMUM DAILY DEMAND	3.78	L/s
MAXIMUM HOUR DEMAND	9.42	L/s

McINTOSH PERRY

CCO-21-3764 - 180 Kanata Ave - OBC Calculations

Project:	The Woods - 180 Kanata Ave
Project No.:	CCO-21-3764
Designed By:	RRR/AJG
Checked By:	CJM
Date:	March 10, 2022

Ontario 2006 Building Code Compendium (Div. B - Part 3)

Water Supply for Fire-Fighting - Commercial/Residential Building

Building is classified as Group : **C** (from table 3.2.2.55)

Building is of combustible construction with fire separations and fire resistance ratings provided in accordance with Subsection 3.2.2., including loadbearing walls, columns and arches.

From Div. B A-3.2.5.7. of the Ontario Building Code - 3. Building On-Site Water Supply:

(a) $Q = K \times V \times Stot$

where:

Q = minimum supply of water in litres

K = water supply coefficient from Table 1

V = total building volume in cubic metres

Stot = total of spatial coefficient values from the property line exposures on all sides as obtained from the formula:

$Stot = 1.0 + [S_{side1} + S_{side2} + S_{side3} + \dots \text{etc.}]$

K	18	(from Table 1 pg A-31) (Worst case occupancy {E / F2} 'K' value used)
V	685,368	(Total building volume in m ³ .)
Stot	2.0	(From figure 1 pg A-32)
Q =	24,673,248.00 L	



			From Figure 1 (A-32)
Snorth	12.7	m	0.0
Seast	6.4	m	0.4
Ssouth	3.1	m	0.5
Swest	5.4	m	0.5

*approximate distances

From Table 2: Required Minimum Water Supply Flow Rate (L/s)

9000 L/min if $Q > 270,000 L$
2378 gpm

McINTOSH PERRY

CCO-21-3764 - The Woods - 180 Kanata Ave - Fire Underwriters Survey

Project: The Woods - 180 Kanata Ave
 Project No.: CCO-21-3764
 Designed By: RRR/AJG
 Checked By: CJM
 Date: March 10, 2022

From the Fire Underwriters Survey (1999)

From Part II – Guide for Determination of Required Fire Flow Copyright I.S.O.:
 Updated per City of Ottawa Technical Bulletin ISTB-2018-02

A. BASE REQUIREMENT (Rounded to the nearest 1000 L/min)

F = 220 x C x √A Where:

F = Required fire flow in liters per minute

C = Coefficient related to the type of construction.

A = The total floor area in square meters (including all storey's, but excluding basements at least 50 percent below grade) in the building being considered.

Construction Type **Ordinary Construction**

C 1

A 30,060.0 m²

Calculated Fire Flow

38,143.2 L/min

38,000.0 L/min

B. REDUCTION FOR OCCUPANCY TYPE (No Rounding)

From note 2, Page 18 of the Fire Underwriter Survey:

Limited Combustible -15%

Fire Flow

32,300.0 L/min

C. REDUCTION FOR SPRINKLER TYPE (No Rounding)

Fully Supervised Sprinklered -50%

Reduction

-16,150.0 L/min

D. INCREASE FOR EXPOSURE (No Rounding)

	Separation Distance (m)	Cons.of Exposed Wall	Length Exposed Adjacent Wall (m)	Height (Stories)	Length-Height Factor	
Exposure 1	>45				0.0	0%
Exposure 2	20.1 to 30	Non-Combustible	67.5	6	404.7	10% <i>*Estimated for future development</i>
Exposure 3	>45	Ordinary (Unprotected)	80	2	160.0	0%
Exposure 4	>45				0.0	0%
% Increase*						10%

Increase*

3,230.0 L/min

E. Total Fire Flow (Rounded to the Nearest 1000 L/min)

Fire Flow

19,380.0 L/min

Fire Flow Required**

19,000.0 L/min

*In accordance with Part II, Section 4, the Increase for separation distance is not to exceed 75%

McINTOSH PERRY

**In accordance with Section 4 the Fire flow is not to exceed 45,000 L/min or be less than 2,000 L/min

McINTOSH PERRY

CCO-21-3764 - The Woods - 180 Kanata Ave - Boundary Condition Unit Conversion

Project: The Woods - 180 Kanata Ave
Project No.: CCO-21-3764
Designed By: AJG
Checked By: CJM
Date: March 10, 2022

Boundary Conditions Unit Conversion

KANATA AVENUE

Scenario	Height (m)	Elevation (m)	m H ₂ O PSI		kPa
Avg. DD	161.3	99.5	61.8	87.9	606.3
Fire Flow (150 L/s or 9,000 L/min)	155.6	99.5	56.1	79.8	550.3
Fire Flow (316.7 L/s or 19,000 L/min)	151.9	99.5	52.4	74.6	514.0
Peak Hour	156.3	99.5	56.8	80.8	557.2

Boundary Conditions 180 Kanata Avenue

Provided Information

Scenario	Demand	
	L/min	L/s
Average Daily Demand	104	1.73
Maximum Daily Demand	227	3.78
Peak Hour	565	9.42
Fire Flow Demand #1	9,000	150.00
Fire Flow Demand #2	19,000	316.67

Location



Results

Connection 1 – Kanata Ave.

Demand Scenario	Head (m)	Pressure ¹ (psi)
Maximum HGL	161.3	87.9
Peak Hour	156.3	80.8
Max Day plus Fire 1	155.6	79.8
Max Day plus Fire 2	151.9	74.6

Ground Elevation = 99.5 m

Connection 2 – Kanata Ave.

Demand Scenario	Head (m)	Pressure ¹ (psi)
Maximum HGL	161.3	88.0
Peak Hour	156.3	80.9
Max Day plus Fire 1	155.6	79.9
Max Day plus Fire 2	151.9	74.7

Ground Elevation = 99.4 m

Notes

1. As per the Ontario Building Code in areas that may be occupied, the static pressure at any fixture shall not exceed 552 kPa (80 psi.) Pressure control measures to be considered are as follows, in order of preference:
 - a. If possible, systems to be designed to residual pressures of 345 to 552 kPa (50 to 80 psi) in all occupied areas outside of the public right-of-way without special pressure control equipment.
 - b. Pressure reducing valves to be installed immediately downstream of the isolation valve in the home/ building, located downstream of the meter so it is owner maintained.

Disclaimer

The boundary condition information is based on current operation of the city water distribution system. The computer model simulation is based on the best information available at the time. The operation of the water distribution system can change on a regular basis, resulting in a variation in boundary conditions. The physical properties of watermains deteriorate over time, as such must be assumed in the absence of actual field test data. The variation in physical watermain properties can therefore alter the results of the computer model simulation. Fire Flow analysis is a reflection of available flow in the watermain; there may be additional restrictions that occur between the watermain and the hydrant that the model cannot take into account.

APPENDIX D
SANITARY CALCULATIONS

McINTOSH PERRY

CCO-21-3764 - The Woods - 180 Kanata Ave - Sanitary Demands

Project:	The Woods - 180 Kanata Ave		
Project No.:	CCO-21-3764		
Designed By:	AJG		
Checked By:	AJG		
Date:	November 23, 2021		
Site Area	1.11	Gross ha	
Bachelor	17	1.40	Persons per unit
1 Bedroom	148	1.40	Persons per unit
2 Bedroom	139	2.10	Persons per unit
Total Population	523	Persons	
Commercial Area	1082.00	m ²	

DESIGN PARAMETERS

Institutional/Commercial Peaking Factor	1.5	
Residential Peaking Factor	3.37	* Using Harmon Formula = $1 + (14 / (4 + P^{0.5})) * 0.8$ where P = population in thousands, Harmon's Correction Factor = 0.8
Mannings coefficient (n)	0.013	
Demand (per capita)	280	L/day
Infiltration allowance	0.33	L/s/Ha

EXTRANEOUS FLOW ALLOWANCES

Infiltration / Inflow	Flow (L/s)
Dry	0.06
Wet	0.31
Total	0.37

AVERAGE DAILY DEMAND

DEMAND TYPE	AMOUNT	UNITS	POPULATION / AREA	Flow (L/s)
Residential	280	L/c/d	523	1.69
Industrial - Light**	35,000	L/gross ha/d		0
Industrial - Heavy**	55,000	L/gross ha/d		0
Commercial / Amenity	2,800	L/(1000m²/d)	1082.00	0.04
Hospital	900	L/(bed/day)		0
Schools	70	L/(Student/d)		0
Trailer Parks no Hook-Ups	340	L/(space/d)		0
Trailer Park with Hook-Ups	800	L/(space/d)		0
Campgrounds	225	L/(campsite/d)		0
Mobile Home Parks	1,000	L/(Space/d)		0
Motels	150	L/(bed-space/d)		0
Hotels	225	L/(bed-space/d)		0
Office	75	L/7.0m ² /d		0
Tourist Commercial	28,000	L/gross ha/d		0
Other Commercial	28,000	L/gross ha/d		0

McINTOSH PERRY

AVERAGE RESIDENTIAL FLOW	1.69	L/s
PEAK RESIDENTIAL FLOW	5.71	L/s
AVERAGE ICI FLOW	0.04	L/s
PEAK INSTITUTIONAL/COMMERCIAL FLOW	0.05	L/s
PEAK INDUSTRIAL FLOW	0.00	L/s
TOTAL PEAK ICI FLOW	0.05	L/s

TOTAL SANITARY DEMAND

TOTAL ESTIMATED AVERAGE DRY WEATHER FLOW	1.79	L/s
TOTAL ESTIMATED PEAK DRY WEATHER FLOW	5.82	L/s
TOTAL ESTIMATED PEAK WET WEATHER FLOW	6.13	L/s

SANITARY SEWER DESIGN SHEET

PROJECT: 180 Kanata Ave - The Woods
 LOCATION: Ottawa, Ontario
 CLIENT: Theberge



LOCATION				RESIDENTIAL								ICI AREAS								INFILTRATION ALLOWANCE			FLOW		SEWER DATA							
1	2	3	4	5	6	7	8	9	10	11	12	13	14	15	16	17	18	19	20	21	22	23	24	25	26	27	28	29	30	31		
STREET	AREA ID	FROM MH	TO MH	UNIT TYPES				AREA (ha)	POPULATION		PEAK FACTOR	PEAK FLOW (L/s)	AREA (ha)						PEAK FLOW (L/s)	AREA (ha)		DESIGN FLOW (L/s)	CAPACITY (L/s)	LENGTH (m)	DIA (mm)	SLOPE (%)	VELOCITY (full) (m/s)	AVAILABLE CAPACITY				
				SF	SD	TH	APT		IND	CUM			INSTITUTIONAL		COMMERCIAL		INDUSTRIAL			IND	CUM							IND	CUM	IND	CUM	L/s
				IND	CUM	IND	CUM	IND	CUM	IND			CUM	IND	CUM	IND	CUM	IND		CUM	IND							CUM	IND	CUM	L/s	(%)
		STUB	MH2A																			0.00	0.00	62.04	3.00	250	1.00	1.224	62.04	100.00		
		MH2A	MH1A																			0.00	0.00	87.74	61.93	250	2.00	1.731	87.74	100.00		
	BLDG	BLDG	750mm Sewer				304	1.11	0.0	0.0	3.37	5.71			0.11	0.11			0.05	1.11	1.11	0.37	6.13	151.32	27.15	300	2.25	2.074	145.19	95.95		
Design Parameters:				Notes:								Designed:								No.			Revision		Date							
Residential				ICI Areas								NBV								1.			City Submission #1		2021-06-30							
SF	3.4	p/p/u	Peak Factor	1. Mannings coefficient (n) = 0.013								CJM								2.			City Submission #2		2021-11-29							
TH/SD	2.7	p/p/u	1.5	2. Demand (per capita): 280 L/day																												
APT	2.3	p/p/u	1.5	3. Infiltration allowance: 0.33 L/s/Ha																												
Other	60	p/p/Ha	MOE Chart	4. Residential Peaking Factor: Harmon Formula = $1 + (14 / (4 + P^{0.5})) * 0.8$ where P = population in thousands																												
																									Sheet No: 1 of 1							

**APPENDIX E
PRE-DEVELOPMENT DRAINAGE PLAN**

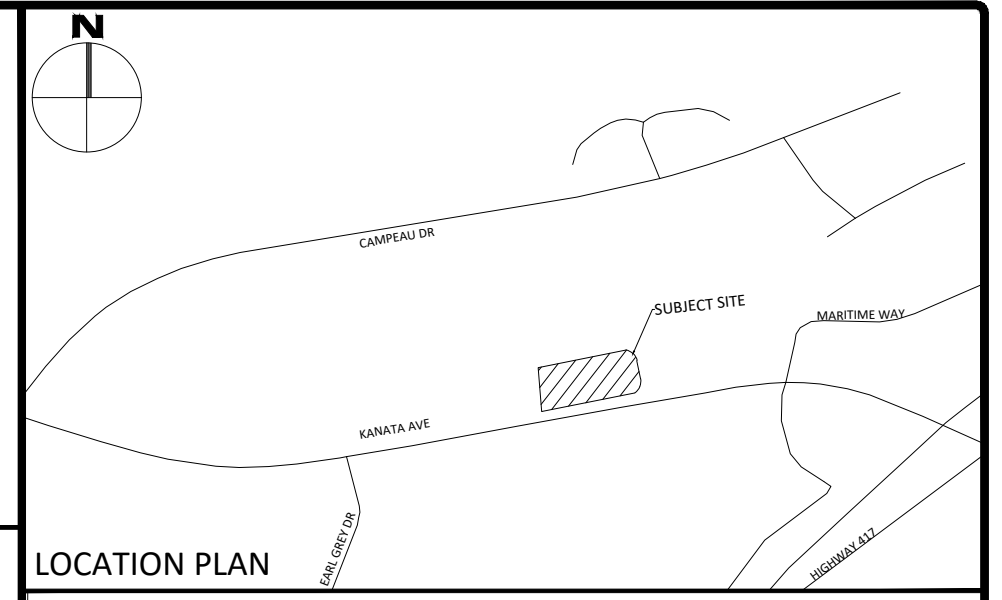
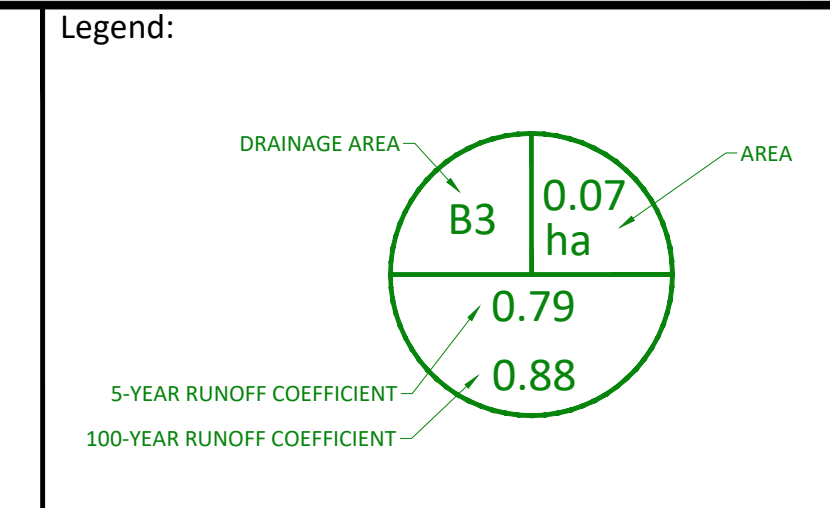

LEGEND

	CONCRETE BARRIER CURB		LIMIT OF CONSTRUCTION
	CONCRETE WALKWAY		DRAINAGE SWALE
	PROPOSED ASPHALT		DRAINAGE DITCH
	STORM SEWER MANHOLE		SLOPING AT 3:1 UNLESS SPECIFIED
	CATCHBASIN MANHOLE		SWALE ELEVATION
	AREA DRAIN CATCHBASIN MANHOLE		TOP OF WALL ELEVATION
	CATCHBASIN		BOTTOM OF WALL ELEVATION
	AREA DRAIN CATCHBASIN		OVERLAND FLOW ROUTE
	SANITARY SEWER MANHOLE		SILT FENCE BARRIER
	FIRE HYDRANT		STRAW BALE CHECK DAM
	WATER VALVE		PROPOSED WALL
	WATER METER		
	REMOTE WATER METER		
	ROOF DRAIN		
	LANDSCAPE CATCHBASIN		
	LANDSCAPE CATCHBASIN AREA DRAIN		
	SIAMESE CONNECTION		
	SUBDRAIN		

FOR REVIEW ONLY
NOT FOR CONSTRUCTION

No.	Revisions	Date
5	ISSUED FOR REVIEW	MAY 06, 2022
4	ISSUED FOR REVIEW	MAR 10, 2022
3	ISSUED FOR REVIEW	DEC 10, 2021
2	ISSUED FOR REVIEW	NOV 29, 2021
1	ISSUED FOR REVIEW	JUNE 30, 2021

Check and verify all dimensions before proceeding with the work. Do not scale drawings.

SCALE 1:400

McINTOSH PERRY
115 Walgreen Road, RR3, Carp, ON K0A 1L0
Tel: 613-836-2184 Fax: 613-836-3742
www.mcintoshperry.com

Client: **KANATA WOODS INC**
205 - 1600 LAPERRIERE AVE
OTTAWA, ON K1Z 8P5

Project: **THE WOODS**
180 KANATA AVE

Drawing Title: **PRE DEVELOPMENT DRAINAGE PLAN**

Scale: 1:400	Project Number: CCO-21-3764
Drawn By: R.R.R.	
Checked By: C.J.M.	Drawing Number: PRE
Designed By: C.J.M.	

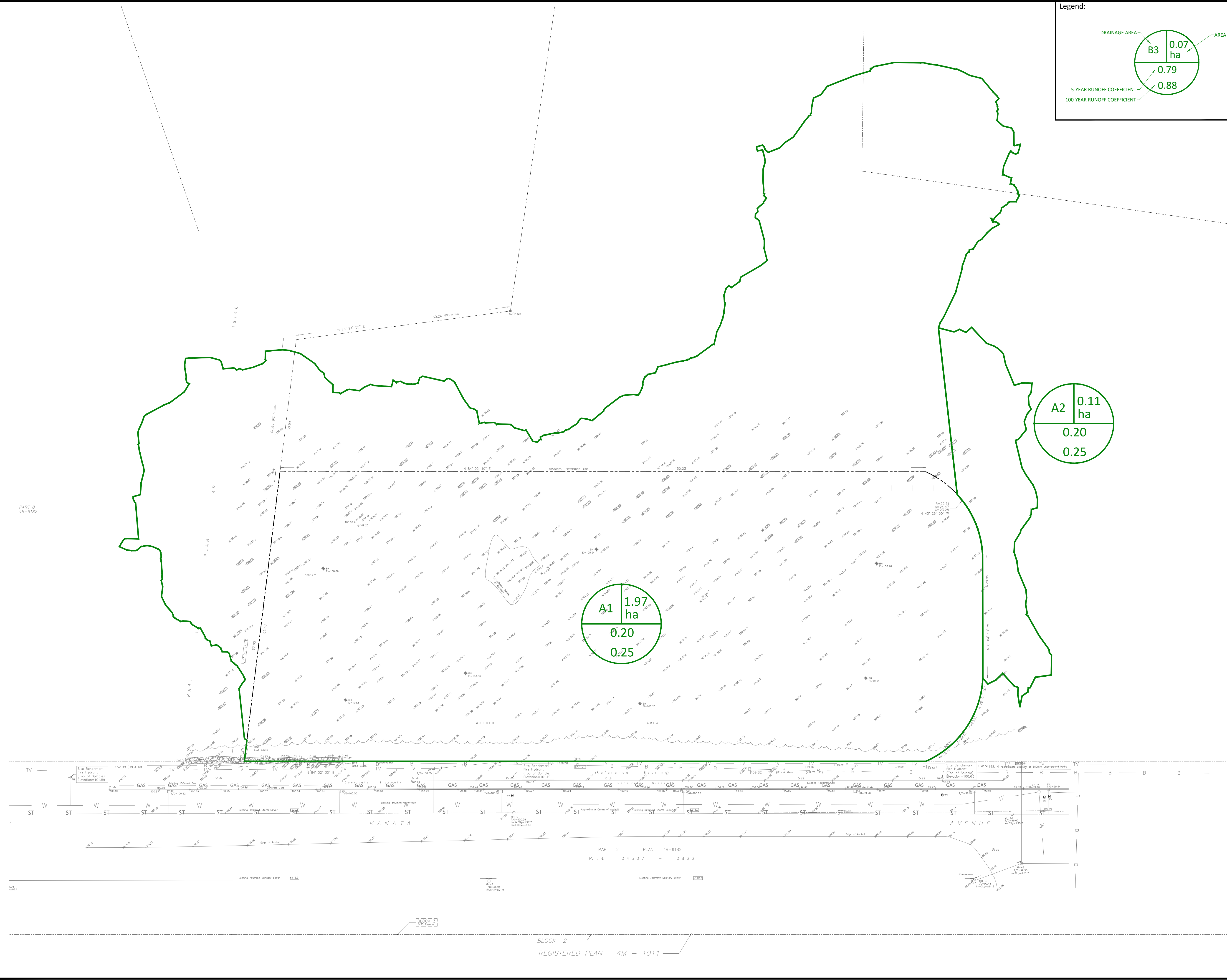

FILENAME: (U:\Other\01 Project - Proposed\2021\06\CCO-21-3764 - Drainage\CCO-21-3764_Presentation.dwg
 DATE PLOTTED: Thursday, May 05, 2022 1:51:52 PM
 LAST PLOTTED BY: rrobeneau
 LAST PLOTTED: Friday, May 06, 2022 10:11:02 AM

D07-12-21-0098

APPENDIX F
POST-DEVELOPMENT DRAINAGE PLAN

FILENAME: \\01ch\dwg\01 - Project - 2021\01\01\CCO-21-3764 - Drainage\CCO-21-3764_Presentation.dwg
 DATE PLOTTED: Friday, May 06, 2022 1:52:54 PM
 LAST PLOTTED: Friday, May 06, 2022 1:52:54 PM

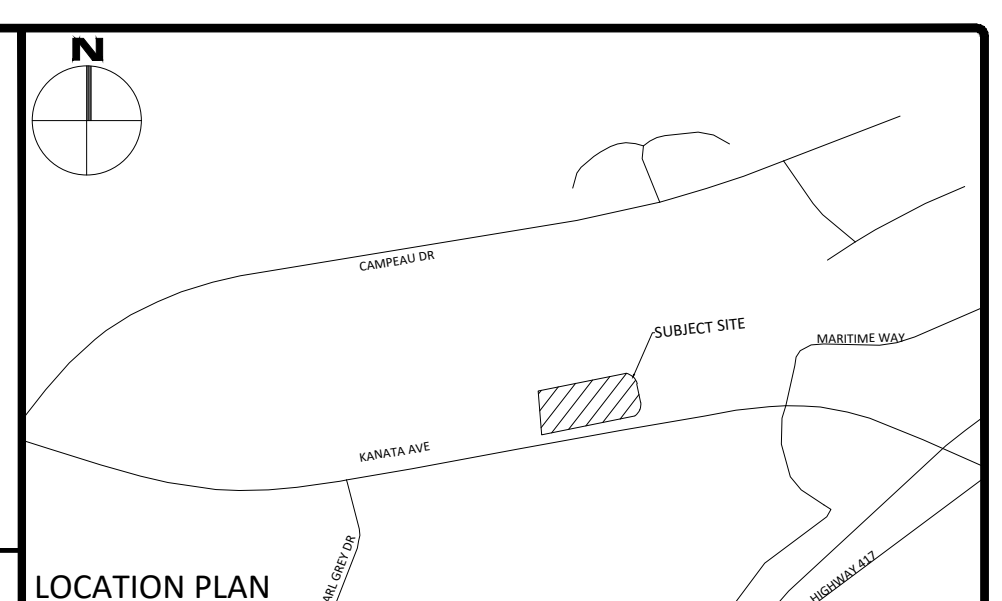
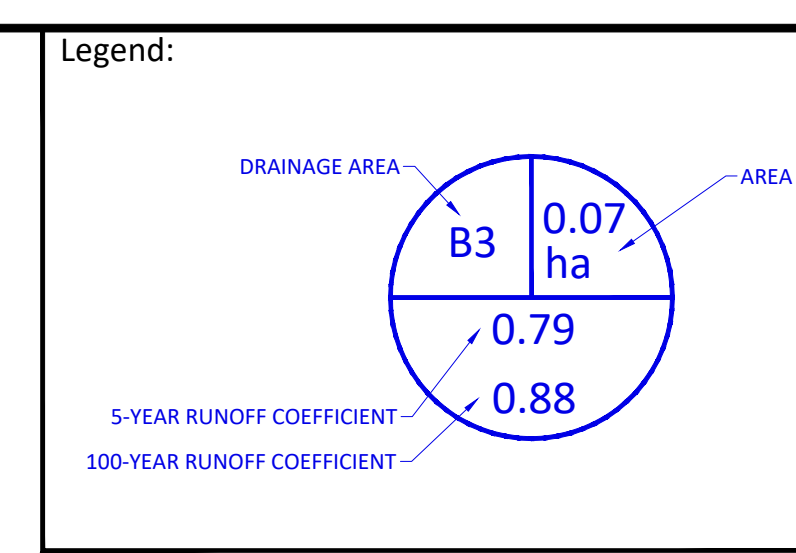
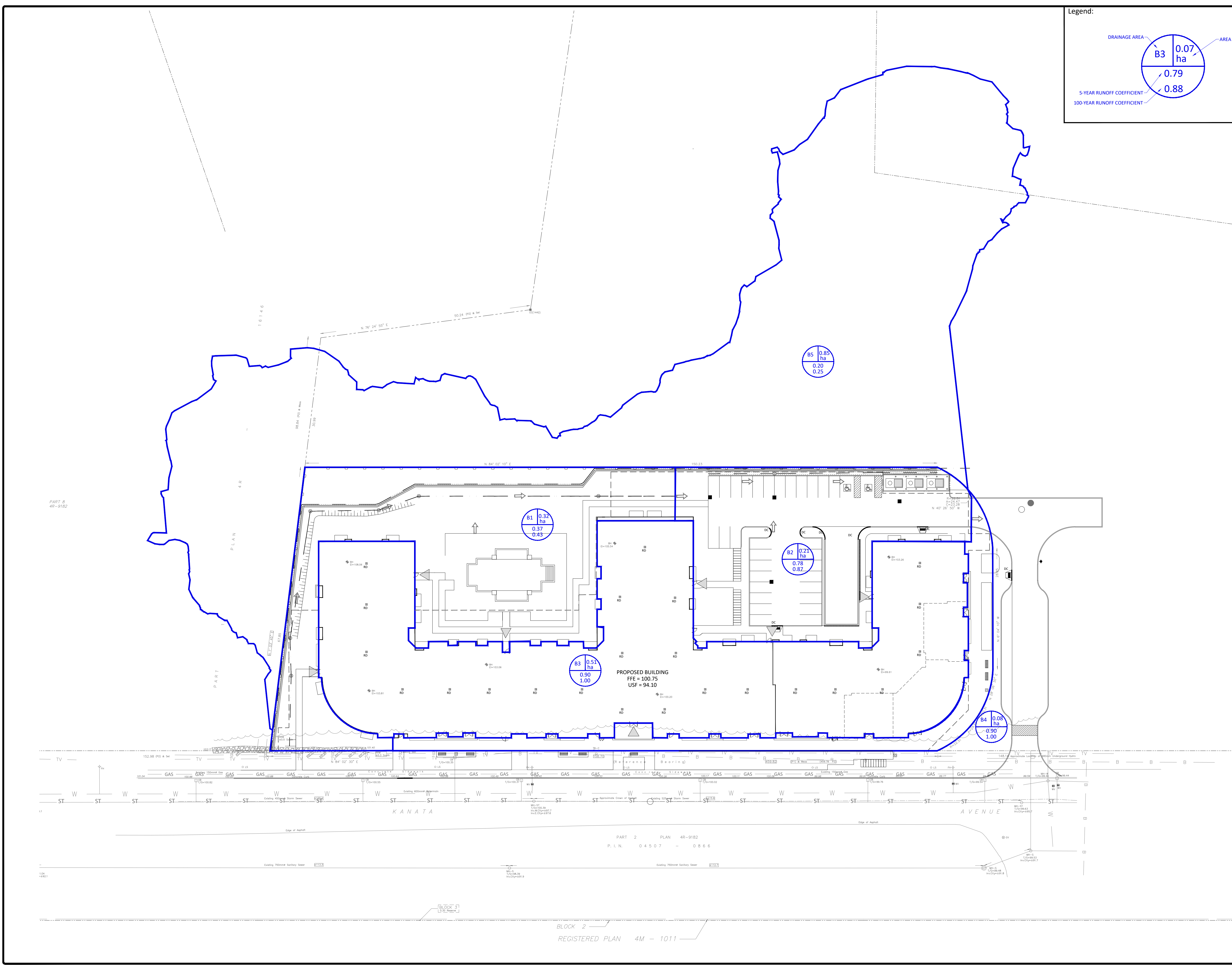

LEGEND

	CONCRETE BARRIER CURB		LIMIT OF CONSTRUCTION
	CONCRETE WALKWAY		DRAINAGE SWALE
	PROPOSED ASPHALT		DRAINAGE DITCH
	STORM SEWER MANHOLE		SLOPING AT 3:1 UNLESS SPECIFIED
	CATCHBASIN MANHOLE		SURFACE ELEVATION
	AREA DRAIN CATCHBASIN MANHOLE		SWALE ELEVATION
	CATCHBASIN		TOP OF WALL ELEVATION
	AREA DRAIN CATCHBASIN		BOTTOM OF WALL ELEVATION
	SANITARY SEWER MANHOLE		OVERLAND FLOW ROUTE
	FIRE HYDRANT		STRAW BALE CHECK DAM
	WATER VALVE		PROPOSED WALL
	WATER METER		
	REMOTE WATER METER		
	ROOF DRAIN		
	LANDSCAPE CATCHBASIN		
	LANDSCAPE CATCHBASIN AREA DRAIN		
	SIAMESE CONNECTION		
	SUBDRAIN		

FOR REVIEW ONLY
 NOT FOR CONSTRUCTION

No.	Revisions	Date
5	ISSUED FOR REVIEW	MAY 06, 2022
4	ISSUED FOR REVIEW	MAR 10, 2022
3	ISSUED FOR REVIEW	DEC 10, 2021
2	ISSUED FOR REVIEW	NOV 29, 2021
1	ISSUED FOR REVIEW	JUNE 30, 2021

Check and verify all dimensions before proceeding with the work. Do not scale drawings.

SCALE 1:400

McINTOSH PERRY
 115 Walgreen Road, RR3, Carp, ON K0A 1L0
 Tel: 613-836-2184 Fax: 613-836-3742
 www.mcintoshperry.com

	Stamp:
--	------------

Client: **KANATA WOODS INC**
205 - 1600 LAPERRIERE AVE
OTTAWA, ON K1Z 8P5

Project: **THE WOODS**
180 KANATA AVE

Drawing Title: POST DEVELOPMENT DRAINAGE PLAN	
Scale: 1:400	Project Number: CCO-21-3764
Drawn By: R.R.R.	Checked By: C.J.M.
Designed By: C.J.M.	Drawing Number: POST

PART 2 PLAN 4R-9182
 P.L.N. 04507 - 0866
 REGISTERED PLAN 4M - 1011

D07-12-21-0098

APPENDIX G
STORMWATER MANAGEMENT CALCULATIONS

McINTOSH PERRY

CCO-21-3764 - 180 Kanata Avenue - Runoff Calculations

1 of 3

Pre-Development Runoff Coefficient

Drainage Area	Area (ha)	Impervious Area (m ²)	C	Gravel Area (m ²)	C	Pervious Area (m ²)	C	C _{AVG} 2&5-Year	C _{AVG} 100-Year
A1	1.97	0.00	0.90	0.00	0.60	19,713.97	0.20	0.20	0.25
A2	0.11	0.00	0.90	0.00	0.60	1,134.95	0.20	0.20	0.25

Pre-Development Runoff Calculations

Drainage Area	Area (ha)	C 2&5-Year	C 100-Year	Tc (min)	I (mm/hr)			Q (L/s)		
					2-Year	5-Year	100-Year	2-Year	5-Year	100-Year
A1	1.97	0.20	0.25	20	52.0	70.3	120.0	57.03	77.00	164.35
A2	0.11	0.20	0.25	20	52.0	70.3	120.0	3.28	4.43	9.46
Total	2.08							60.31	81.44	173.81

Post-Development Runoff Coefficient

Drainage Area	Area (ha)	Impervious Area (m ²)	C	Gravel Area (m ²)	C	Pervious Area (m ²)	C	C _{AVG} 2&5-Year	C _{AVG} 100-Year	
B1	0.319	777.52	0.90	0.00	0.60	2,415.15	0.20	0.37	0.43	Unrestricted
B2	0.214	1,783.23	0.90	0.00	0.60	358.44	0.20	0.78	0.87	Unrestricted
B3	0.505	5,051.31	0.90	0.00	0.60	0.00	0.20	0.90	1.00	Restricted Roof
B4	0.082	817.62	0.90	0.00	0.60	0.00	0.20	0.90	1.00	Unrestricted
B5	0.851	0.00	0.90	0.00	0.60	8,510.70	0.20	0.20	0.25	Unrestricted

Post-Development Runoff Calculations

Drainage Area	Area (ha)	C 2&5-Year	C 100-Year	Tc (min)	I (mm/hr)			Q (L/s)		
					2-Year	5-Year	100-Year	2-Year	5-Year	100-Year
B1	0.319	0.37	0.43	20	52.0	70.3	120.0	17.11	23.10	46.06
B2	0.214	0.78	0.87	20	52.0	70.3	120.0	24.25	32.74	62.45
B3	0.505	0.90	1.00	20	52.0	70.3	120.0	65.76	88.79	168.44
B4	0.082	0.90	1.00	20	52.0	70.3	120.0	10.64	14.37	27.26
B5	0.851	0.20	0.25	20	52.0	70.3	120.0	24.62	33.24	70.95
Total	1.97							142.38	192.24	375.17

Required Restricted Flow

Drainage Area	Area (ha)	C (5-Year)	Tc (min)	I (mm/hr)	Q (L/s)
				5-Year	5-Year
A1	1.97	0.57	20	70.3	219.46
Total	1.97				219.46

Post-Development Restricted Runoff Calculations

Drainage Area	Unrestricted Flow (L/s)			Restricted Flow (L/s)			Storage Required (m ³)		Storage Provided (m ³)	
	2-Year	5-Year	100-Year	2-Year	5-Year	100-Year	5-Year	100-Year	5-Year	100-Year
B1	17.11	23.10	46.06	17.11	23.10	46.06	-	-	-	-
B2	24.25	32.74	62.45	24.25	32.74	62.45	-	-	-	-
B3	65.76	88.79	168.44	7.25	7.25	7.25	126.64	284.34	132.60	303.08
B4	10.64	14.37	27.26	10.64	14.37	27.26	-	-	-	-
B5	24.62	33.24	70.95	24.62	33.24	70.95	-	-	-	-
Total	142.38	192.24	375.17	83.87	110.70	213.97	126.64	284.34	132.60	303.08

McINTOSH PERRY

Storage Requirements for Area B3

2-Year Storm Event

Tc	I	B3 Runoff	Allowable	Runoff to	Storage
(min)	(min)	(L/s)	Outflow	be Stored	Required
			(L/s)	(L/s)	(m ³)
50	28.0	35.44	7.25	28.19	84.58
55	26.2	33.08	7.25	25.83	85.24
60	24.6	31.04	7.25	23.79	85.65
65	23.2	29.26	7.25	22.01	85.86
70	21.9	27.69	7.25	20.45	85.89
75	20.8	26.30	7.25	19.06	85.77
80	19.8	25.06	7.25	17.82	85.52

Maximum Storage Required 2-Year (m³) = 85.89

5-Year Storm Event

Tc	I	B3 Runoff	Allowable	Runoff to	Storage
(min)	(min)	(L/s)	Outflow	be Stored	Required
			(L/s)	(L/s)	(m ³)
70	29.4	37.12	7.25	29.88	125.48
75	27.9	35.25	7.25	28.00	126.01
80	26.6	33.57	7.25	26.33	126.36
85	25.4	32.06	7.25	24.82	126.57
90	24.3	30.70	7.25	23.45	126.64
95	23.3	29.45	7.25	22.21	126.59
100	22.4	28.32	7.25	21.07	126.44

Maximum Storage Required 5-Year (m³) = 126.64

100-Year Storm Event

Tc	I	B3 Runoff	Allowable	Runoff to	Storage
(min)	(min)	(L/s)	Outflow	be Stored	Required
			(L/s)	(L/s)	(m ³)
150	27.6	38.77	7.25	31.53	283.75
155	26.9	37.78	7.25	30.54	284.00
160	26.2	36.85	7.25	29.60	284.18
165	25.6	35.96	7.25	28.72	284.29
170	25.0	35.12	7.25	27.88	284.34
175	24.4	34.32	7.25	27.08	284.33
180	23.9	33.57	7.25	26.32	284.26

Maximum Storage Required 100-Year (m³) = 284.34

Storage Occupied In Area

2-Year Storm Event

Roof Storage			
Location	Area (m ²)	Depth (m)	Volume (m ³)
ROOFTOP	3788.5	0.025	94.7

Storage Available (m³) = 94.7
Storage Required (m³) = 85.9

5-Year Storm Event

Roof Storage			
Location	Area (m ²)	Depth (m)	Volume (m ³)
ROOFTOP	3788.5	0.035	132.6

Storage Available (m³) = 132.6
Storage Required (m³) = 126.6

100-YEAR STORM EVENT

Roof Storage			
Location	Area (m ²)	Depth (m)	Volume (m ³)
ROOFTOP	3788.5	0.080	303.1

Storage Available (m³) = 303.1
Storage Required (m³) = 284.3

* Area is calculated using 75% of the total roof area

McINTOSH PERRY

Roof Drain Flow (B3)

Roof Drains Summary			
Type of Control Device	Watts Drainage - Accutrol Weir		
Number of Roof Drains	23		
	2-Year	5-Year	100 Year
Rooftop Storage	94.71	132.60	303.08
Storage Depth (m)	0.025	0.035	0.080
Flow (Per Roof Drain) (L/s)	0.32	0.32	0.32
Total Flow (L/s)	7.25	7.25	7.25

Roof Drain Flow For Flat Roof B3

Flow Rate Vs. Build-Up (One Weir Closed)	
Depth (mm)	Flow (L/s)
15	0.32
20	0.32
25	0.32
30	0.32
35	0.32
40	0.32
45	0.32
50	0.32
55	0.32

* Roof Drain model to be Accutrol Weirs, See attached sheets

* Roof Drain Flow information taken from Watts Drainage website

CALCULATING ROOF FLOW EXAMPLES

1 roof drain during a 5 year storm

elevation of water = 25mm

Flow leaving 1 roof drain = (1 x 0.30 L/s) = 0.30 L/s

1 roof drain during a 100 year storm

elevation of water = 50mm

Flow leaving 1 roof drain = (1 x 0.60 L/s) = 0.60 L/s

4 roof drains during a 5 year storm

elevation of water = 25mm

Flow leaving 4 roof drains = (4 x 0.30 L/s) = 1.20 L/s

4 roof drains during a 100 year storm

elevation of water = 50mm

Flow leaving 4 roof drains = (4 x 0.60 L/s) = 2.40 L/s

Roof Drain Flow			
	Flow (L/s)	Storage Depth (mm)	Total Flow (L/s)
2-Yr	0.32	15	7.25
	0.32	20	7.25
	0.32	25	7.25
	0.32	30	7.25
	0.32	35	7.25
5-Yr	0.32	40	7.25
	0.32	45	7.25
	0.32	50	7.25
	0.32	55	7.25
	0.32	60	7.25
100-Yr	0.32	65	7.25
	0.32	70	7.25
	0.32	75	7.25
	0.32	80	7.25
	0.32	85	7.25
	0.32	90	7.25
	0.32	95	7.25
	0.32	100	7.25
	0.32	105	7.25
	0.32	110	7.25
0.32	115	7.25	
0.32	120	7.25	
0.32	125	7.25	
0.32	130	7.25	
0.32	135	7.25	
0.32	140	7.25	
0.32	145	7.25	
0.32	150	7.25	

Note: The flow leaving through a restricted roof drain is based on flow vs. head information

STORM SEWER DESIGN SHEET

PROJECT: Mixed Used Development
 LOCATION: 180 Kanata Avenue
 CLIENT:



LOCATION				CONTRIBUTING AREA (ha)				RATIONAL DESIGN FLOW										SEWER DATA																				
1	2	3	4	5	6	7	8	9	10	11	12	13	14	15	16	17	18	19	20	21	22	23	24	25	26	27	28											
STREET	AREA ID	FROM MH	TO MH	C-VALUE	AREA (ha)	INDIV AC	CUMUL AC	INLET (min)	TIME IN PIPE	TOTAL (min)	i (5) (mm/hr)	i (10) (mm/hr)	i (100) (mm/hr)	5yr PEAK FLOW (L/s)	10yr PEAK FLOW (L/s)	100yr PEAK FLOW (L/s)	FIXED FLOW (L/s)	DESIGN FLOW (L/s)	CAPACITY (L/s)	LENGTH (m)	PIPE SIZE (mm)			SLOPE (%)	VELOCITY (m/s)	AVAIL CAP (5yr)												
																					DIA	W	H			(L/s)	(%)											
	B1, B2, B3	Building	MH2	0.90	0.51	0.46	0.46	10.00	0.12	10.12	104.19	122.14	178.56	7.25				7.25	181.07	11.26	375			0.98	1.588	173.83	96.00%											
		Garage	MH2	0.78	0.21	0.16	0.16	10.00	0.12	10.12	104.19	122.14	178.56	47.45				47.45	181.07	11.26	375			0.98	1.588	133.63	73.80%											
		Garage	MH2		0.37	0.32	0.12	0.12	10.00	0.12	10.12	104.19	122.14	178.56	34.30				34.30	181.07	11.26	375			0.98	1.588	146.78	81.06%										
		Total						0.74	10.00	0.12	10.12	104.19	122.14	178.56	88.99				88.99	181.07	11.26	375			0.98	1.588	92.09	50.86%										
Definitions: Q = 2.78QA, where: Q = Peak Flow in Litres per Second (L/s) A = Area in Hectares (ha) i = Rainfall intensity in millimeters per hour (mm/hr) [i = 998.071 / (TC+6.053)^0.814] 5 YEAR [i = 1174.184 / (TC+6.014)^0.816] 10 YEAR [i = 1735.688 / (TC+6.014)^0.820] 100 YEAR				Notes: 1. Mannings coefficient (n) = 0.013				Designed: N.B.V.				Checked: C.J.M.				Project No.: COO-21-3764				<table border="1"> <thead> <tr> <th>No.</th> <th>Revision</th> <th>Date</th> </tr> </thead> <tbody> <tr> <td>1.</td> <td>ISSUED FOR REVIEW</td> <td>2021-06-30</td> </tr> <tr> <td>2</td> <td>ISSUED FOR REVIEW</td> <td>2021-11-29</td> </tr> <tr> <td>3</td> <td>ISSUED FOR REVIEW</td> <td>2021-12-09</td> </tr> <tr> <td>4</td> <td>ISSUED FOR REVIEW</td> <td>2022-05-05</td> </tr> </tbody> </table>				No.	Revision	Date	1.	ISSUED FOR REVIEW	2021-06-30	2	ISSUED FOR REVIEW	2021-11-29	3	ISSUED FOR REVIEW	2021-12-09	4	ISSUED FOR REVIEW	2022-05-05
No.	Revision	Date																																				
1.	ISSUED FOR REVIEW	2021-06-30																																				
2	ISSUED FOR REVIEW	2021-11-29																																				
3	ISSUED FOR REVIEW	2021-12-09																																				
4	ISSUED FOR REVIEW	2022-05-05																																				
																							Sheet No: 1 of 1															

STORMWATER MANAGEMENT REPORT

**KANATA TOWN CENTRE
CENTRAL BUSINESS DISTRICT**

VOLUME 1 OF 2

January, 1999

Prepared for:

URBANDALE CORPORATION
2193 Arch Street
Ottawa, ON K1G 2H5

Prepared by:

J.L. RICHARDS & ASSOCIATES LIMITED
Consulting Engineers, Architects & Planners
864 Lady Ellen Place
Ottawa, ON K1Z 5M2

JLR 15712

4.0 PROPOSED STORMWATER MANAGEMENT FACILITY

4.1 General

Urbanization of the lands referred as the Kanata Town Centre - Central Business District will change the hydrological regime of Watts Creek. The potential impacts associated with urban runoff arise primarily from the amount of urban area that is impervious to rain and snowmelt water. These impervious urban surfaces increase the amount of surface runoff that is generated and is conveyed more efficiently to the receiving stream via a storm sewer system. Furthermore, direct runoff from urban areas is known to carry a range of potentially undesirable compounds such as high loadings of suspended solids, heavy metals, nutrient compounds etc. To mitigate these potential impacts, the 1993 Master Drainage Study, has formulated alternatives to address these concerns. The 1993 study concluded that two detention facilities (incorporating both quality and quantity controls) is the preferred option to meet the current water quality and quantity guidelines and, at the same time, protect Watts Creek's existing environmental features. In 1996-1997, the first SWMF was constructed to service Phase 1 residential lands. With the beginning of development of the Kanata Town Centre - Central Business District in 1998 and with additional development scheduled in 1999 (Hotel Site), the need for a storm sewer outlet was required. In general, the second SWMF was designed following the same overall concept outlined in the 1993 Master Drainage Study and to meet current water quality guidelines.

4.2 Stormwater Management Sizing

The water quality treatment of the proposed SWMF has been designed based on Table 4.1 of the MOEE Stormwater Manual entitled "Stormwater Management Practices Planning and Design Manual, page 173, (MOEE, June 1994)". This table recommends that for a wet pond with a protection level 2 (this type of protection includes feeding areas particularly for adult fish, areas of unspecialized spawning habitat and pool-riffle-run complexes that occur along much of a watercourse), a water quality storage volume of 130 m³/ha is required for a TSS removal of 70% of a tributary area having an average imperviousness of 70%. Furthermore, this table recommends that 40 m³/ha be used as extended detention storage and the remaining i.e. 90 m³/ha, be used as permanent pool volume. To determine the required volume for both the permanent pool and the extended detention storage, a table showing all tributary areas to the proposed stormwater management facility was developed (refer to

Appendix 'H' for table). This table shows that 61.24 ha of contributing area will be serviced by the future SWMF. The average total imperviousness for these contributing areas was found to be 74%. Based on the information presented in this table (refer to Appendix 'H'), the MOEE design manual therefore recommends that a permanent pool volume of 5512 m³ and an extended storage volume of 2450 m³ be provided to achieve the required treatment for a protection level 2 (i.e. TSS removal of 70%).

4.2.1 SWMF Design Rationale

The length to width ratio for the proposed SWMF is approximately 5 to 1 which exceeds the 3 to 1 length to width ratio recommended in the "Stormwater Management Practices Planning and Design Manual, page 76, (MOEE, June 1994)". This manual also recommends that a minimum of 24 hour drawdown time be used to minimize the possibility of short-circuiting and hence maximizing the performance of the facility. To minimize the risk of short-circuiting and maximize the TSS removal, the outlet structure of the SWMF was designed using a 48 hour drawdown time (refer to Section 4.3 for additional information). Using this outlet configuration (i.e. 48 hour drawdown time), the maximum outflow rate at elevation 90.20 m (i.e. maximum elevation of the extended detention storage) is 0.028 m³/s. With this type of restricted outflow rate and with storm inflow to the SWMF of approximately 2.83 m³/s (total flow to facility generated by a 4 hour - 25 mm Chicago design storm event), it is expected that this configuration will eliminate any possibility of short-circuiting.

The length to width ratio for the sedimentation forebay is approximately 3 to 1 which exceeds the 2 to 1 ratio recommended in the "Stormwater Management Practices Planning and Design Manual, page 89, (MOEE, June 1994)".

JLR 15712

Kanata Town Centre - Central Business District

Tributary Subwatersheds to Proposed Stormwater Management Facility

QUALHYMO LUMPED AREA No.	OTTHYMO AREA No.	Description	Area (ha)	TIMP	On-Site Storage	Description of Storage	IMP areas (ha)
1	1	AMC Site	7.85	0.85	entirely *	up to 100 yr	6.67
	2	Park & Ride	1.46	0.95	none		1.39
	3	Phase IV	3.03	0.95	entirely	up to 100 yr	2.88
	4	Transitway	3.55	0.95	none		3.37
	5	Hotel Road	0.38	0.80	none		0.30
	6	Hotel Site	0.80	0.95	entirely	up to 100 yr	0.76
2	7	Castlefrank Road	2.84	0.80	none		2.27
	8	Adjacent Lands	2.77	0.57	none		1.58
	9	Exist Pond **	0.82	---	entirely	up to 100 yr	0.00
	10	Kanata North	4.66	0.85	none		3.96
	11	Adj Lands (east)	2.16	0.85	none		1.84
3	12	Adj Lands (south-east)	2.11	0.85	entirely	up to 100 yr	1.79
	13	Street "A"	1.32	0.85	Limited	up to 10 yr	1.12
	14	Urbandale North	10.41	0.85	Limited	up to 10 yr	8.85
	15	Urbandale South	4.48	0.85	entirely	up to 100 yr	3.81
	16	Urbandale East	1.82	0.57	Limited	up to 10 yr	1.04
	17	Urbandale East (park)	0.54	---	none		0.00
	18	Queensway	7.87	0.30	none		2.36
	19A	SWMF	0.95	0.99	none		0.94
	19B	SWMF	1.42	0.20	none		0.28
			TOTAL	61.24			
						Avg. TIMP =	0.74

*: Overflow of 13 l/s @ 1:100 year storm event

** : Peak flows from this area is to be restricted to 10 year based on Rc=0.2 (from CCL)

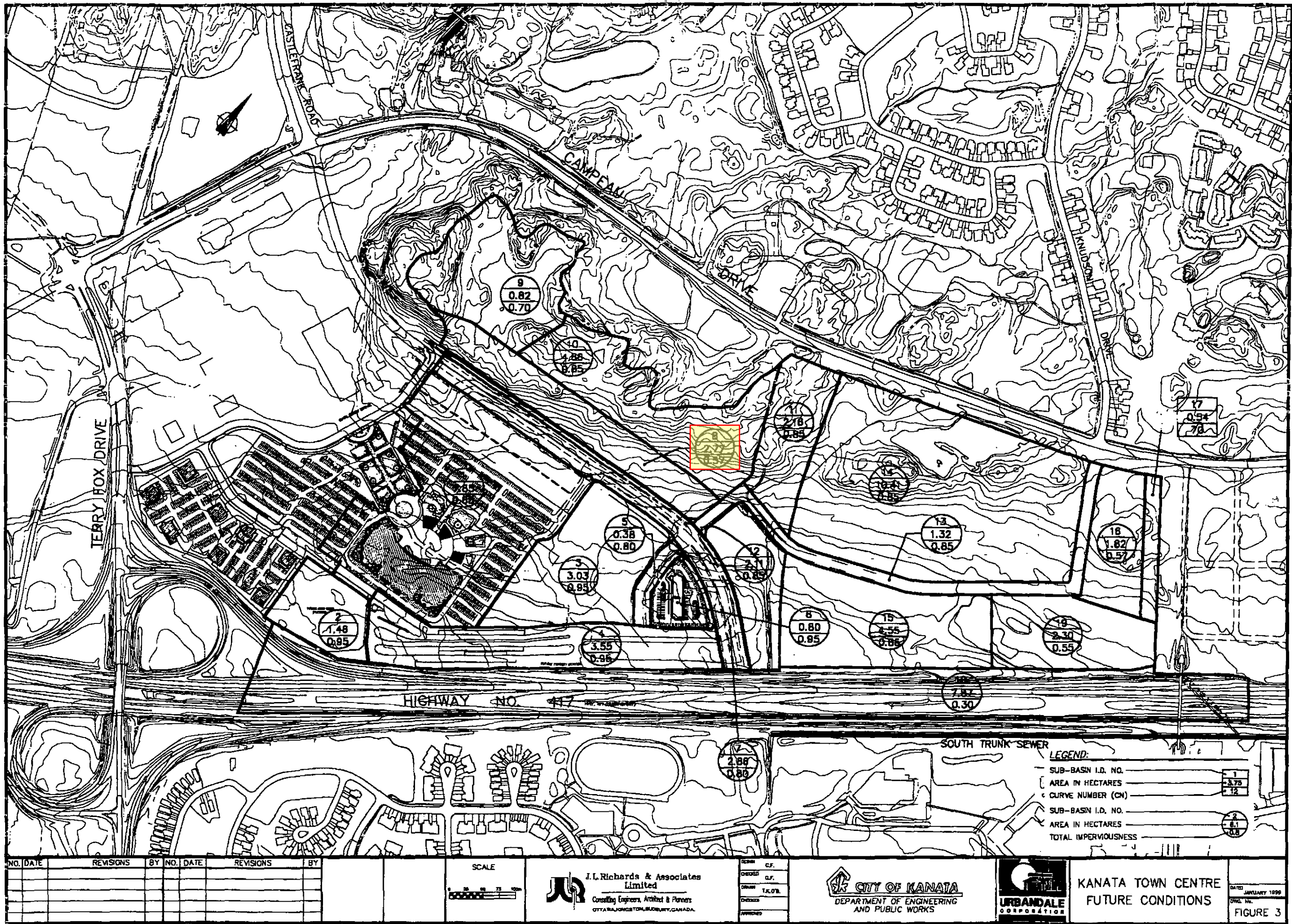

NO.	DATE	REVISIONS	BY	NO.	DATE	REVISIONS	BY

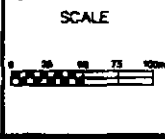

J.L. Richards & Associates Limited
 Consulting Engineers, Architect & Planners
 OTTAWA, KINGSTON, SUDBURY, CANADA

DESIGN C.F.
 CHECKED C.F.
 DRAWN T.L.O.B.
 CHECKED
 APPROVED

CITY OF KANATA
 DEPARTMENT OF ENGINEERING
 AND PUBLIC WORKS

URBANDALE CORPORATION

**KANATA TOWN CENTRE
 FUTURE CONDITIONS**

DATE: JANUARY 1999
 DRAWN BY: [Signature]
FIGURE 3

Alison Gosling

From: Cassidy, Tyler <tyler.cassidy@ottawa.ca>
Sent: October 15, 2021 2:19 PM
To: Alison Gosling
Cc: Curtis Melanson
Subject: RE: 21-3764 6905 Campeau Drive

Follow Up Flag: Follow up
Flag Status: Flagged

Hi Alison,

I've heard back from our Water Resources group regarding the HGL analysis of the storm sewer in Kanata Avenue that you are proposing to outlet to. From our Water Resources group:

“Our PCSWMM model shows no HGL issues on Kanata Avenue, even the 100 year is below the obvert (see below).”

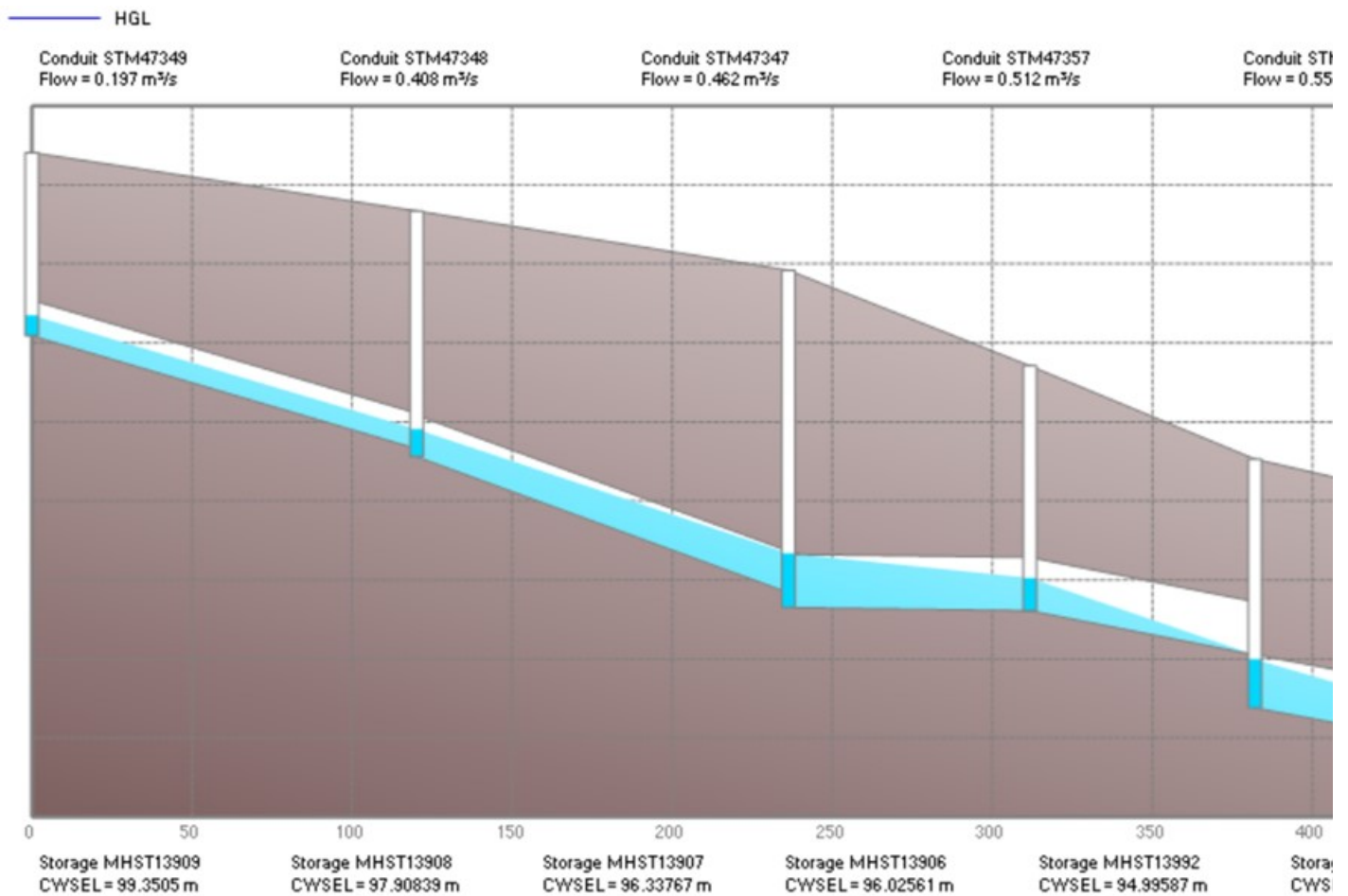

You can include this correspondence in an appendix in the revised SWM/Service Report once resubmitted. Please include a short write up in the report confirming there are no Storm HGL concerns.

Thank you,

Tyler Cassidy, EIT

Infrastructure Project Manager,
Planning, Infrastructure and Economic Development Department - Services de la planification, de l'infrastructure et du développement économique
Development Review - South Branch
City of Ottawa | Ville d'Ottawa
110 Laurier Avenue West Ottawa, ON | 110, avenue. Laurier Ouest. Ottawa (Ontario) K1P 1J1
613.580.2424 ext./poste 12977, Tyler.Cassidy@ottawa.ca

From: Alison Gosling <a.gosling@mcintoshperry.com>

Sent: October 13, 2021 1:44 PM

To: Cassidy, Tyler <tyler.cassidy@ottawa.ca>

Subject: RE: 21-3764 6905 Campeau Drive

CAUTION: This email originated from an External Sender. Please do not click links or open attachments unless you recognize the source.

ATTENTION : Ce courriel provient d'un expéditeur externe. Ne cliquez sur aucun lien et n'ouvrez pas de pièce jointe, excepté si vous connaissez l'expéditeur.

Great thank you for the prompt response. Feel free to give us a call if you have questions on the engineering design.

Alison Gosling, P.Eng.

Project Engineer, Land Development

115 Walgreen Road, Carp, ON, K0A 1L0

T. 613.714.4629

a.gosling@mcintoshperry.com | www.mcintoshperry.com

McINTOSH PERRY

From: Cassidy, Tyler <tyler.cassidy@ottawa.ca>

Sent: October 13, 2021 1:42 PM

To: Alison Gosling <a.gosling@mcintoshperry.com>; Armstrong, Justin <justin.armstrong@ottawa.ca>

Cc: Curtis Melanson <c.melanson@mcintoshperry.com>

Subject: RE: 21-3764 6905 Campeau Drive

Hi Alison,

I have sent the request off to our Water Resources team and I will follow up if I require any further information or to provide the results/recommendations from the analysis.

Thank you,

Tyler Cassidy, EIT

Infrastructure Project Manager,
Planning, Infrastructure and Economic Development Department - Services de la planification, de l'infrastructure et du développement économique
Development Review - South Branch
City of Ottawa | Ville d'Ottawa
110 Laurier Avenue West Ottawa, ON | 110, avenue. Laurier Ouest. Ottawa (Ontario) K1P 1J1
613.580.2424 ext./poste 12977, Tyler.Cassidy@ottawa.ca

From: Alison Gosling <a.gosling@mcintoshperry.com>
Sent: October 13, 2021 1:38 PM
To: Armstrong, Justin <justin.armstrong@ottawa.ca>
Cc: Curtis Melanson <c.melanson@mcintoshperry.com>; Cassidy, Tyler <tyler.cassidy@ottawa.ca>
Subject: RE: 21-3764 6905 Campeau Drive

CAUTION: This email originated from an External Sender. Please do not click links or open attachments unless you recognize the source.

ATTENTION : Ce courriel provient d'un expéditeur externe. Ne cliquez sur aucun lien et n'ouvrez pas de pièce jointe, excepté si vous connaissez l'expéditeur.

Hi Justin,

Thank you for letting us know. Tyler, please see below and let us know if you have any questions.

Thank you,

Alison Gosling, P.Eng.

Project Engineer, Land Development
115 Walgreen Road, Carp, ON, K0A 1L0
T. 613.714.4629
a.gosling@mcintoshperry.com | www.mcintoshperry.com

McINTOSH PERRY

From: Armstrong, Justin <justin.armstrong@ottawa.ca>
Sent: October 13, 2021 12:48 PM
To: Alison Gosling <a.gosling@mcintoshperry.com>
Cc: Curtis Melanson <c.melanson@mcintoshperry.com>; Cassidy, Tyler <tyler.cassidy@ottawa.ca>
Subject: RE: 21-3764 6905 Campeau Drive

Hi Alison,

Due to current application volumes, Tyler Casidy has been assigned as the new Infrastructure PM on this file and he is currently working on the review.

I have copied Tyler on this e-mail so that he can get in touch as it relates to your request below.

Regards,

Justin

From: Alison Gosling <a.gosling@mcintoshperry.com>
Sent: October 13, 2021 12:15 PM
To: Armstrong, Justin <justin.armstrong@ottawa.ca>
Cc: Curtis Melanson <c.melanson@mcintoshperry.com>
Subject: 21-3764 6905 Campeau Drive

CAUTION: This email originated from an External Sender. Please do not click links or open attachments unless you recognize the source.

ATTENTION : Ce courriel provient d'un expéditeur externe. Ne cliquez sur aucun lien et n'ouvrez pas de pièce jointe, excepté si vous connaissez l'expéditeur.

Good afternoon Justin,

We wanted to touch base with you regarding the development at 6905 Campeau Drive.

Partial comments were received on the engineering design dated June 30th, 2021. As part of the comments from the MVCA, they have requested a HGL analysis of the receiving storm system. Is this something the City can provide? Let us know what information you require to make the request. The target release rate for the development is 258.05 L/s.

Please let us know if you have any questions on the engineering design.

Thank you,
Alison

Alison Gosling, P.Eng.

Project Engineer, Land Development
115 Walgreen Road, Carp, ON, K0A 1L0
T. 613.714.4629

a.gosling@mcintoshperry.com | www.mcintoshperry.com

McINTOSH PERRY

Turning Possibilities Into Reality

Confidentiality Notice – If this email wasn't intended for you, please return or delete it. Click [here](#) to read all of the legal language around this concept.



This e-mail originates from the City of Ottawa e-mail system. Any distribution, use or copying of this e-mail or the information it contains by other than the intended recipient(s) is unauthorized. Thank you.

Le présent courriel a été expédié par le système de courriels de la Ville d'Ottawa. Toute distribution, utilisation ou reproduction du courriel ou des renseignements qui s'y trouvent par une personne autre que son destinataire prévu est interdite. Je vous remercie de votre collaboration.

This e-mail originates from the City of Ottawa e-mail system. Any distribution, use or copying of this e-mail or the information it contains by other than the intended recipient(s) is unauthorized. Thank you.

Le présent courriel a été expédié par le système de courriels de la Ville d'Ottawa. Toute distribution, utilisation ou reproduction du courriel ou des renseignements qui s'y trouvent par une personne autre que son destinataire prévu est interdite. Je vous remercie de votre collaboration.

'

This e-mail originates from the City of Ottawa e-mail system. Any distribution, use or copying of this e-mail or the information it contains by other than the intended recipient(s) is unauthorized. Thank you.

Le présent courriel a été expédié par le système de courriels de la Ville d'Ottawa. Toute distribution, utilisation ou reproduction du courriel ou des renseignements qui s'y trouvent par une personne autre que son destinataire prévu est interdite. Je vous remercie de votre collaboration.

'



Adjustable Accutrol Weir
 Tag: _____

**Adjustable Flow Control
 for Roof Drains**

ADJUSTABLE ACCUTROL (for Large Sump Roof Drains only)

For more flexibility in controlling flow with heads deeper than 2", Watts Drainage offers the Adjustable Accutrol. The Adjustable Accutrol Weir is designed with a single parabolic opening that can be covered to restrict flow above 2" of head to less than 5 gpm per inch, up to 6" of head. To adjust the flow rate for depths over 2" of head, set the slot in the adjustable upper cone according to the flow rate required. Refer to Table 1 below.
 Note: Flow rates are directly proportional to the amount of weir opening that is exposed.

EXAMPLE:

For example, if the adjustable upper cone is set to cover 1/2 of the weir opening, flow rates above 2" of head will be restricted to 2-1/2 gpm per inch of head.

Therefore, at 3" of head, the flow rate through the Accutrol Weir that has 1/2 the slot exposed will be:
 [5 gpm (per inch of head) x 2 inches of head] + 2-1/2 gpm (for the third inch of head) = 12-1/2 gpm.

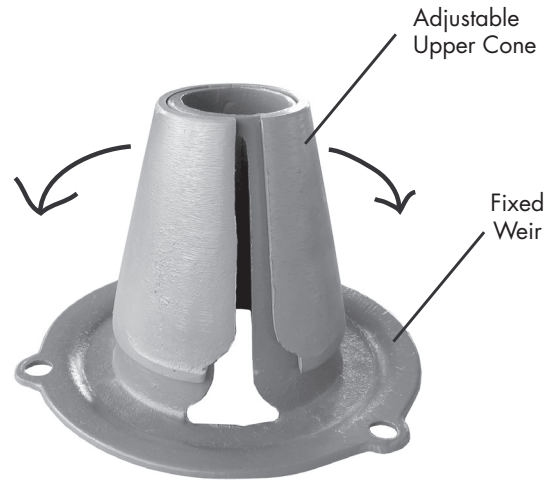
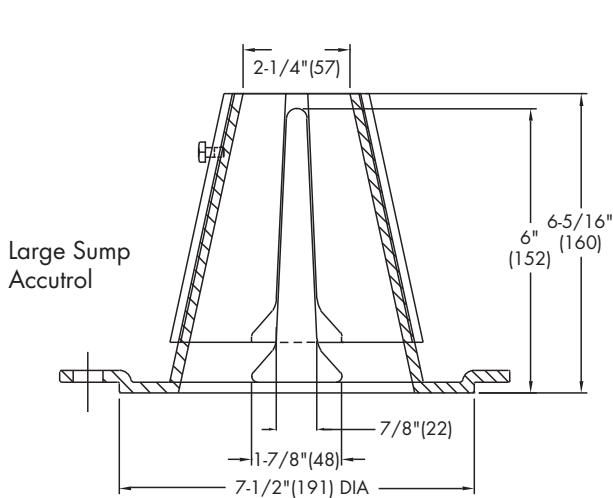

1/2 Weir Opening Exposed Shown Above

TABLE 1. Adjustable Accutrol Flow Rate Settings

Weir Opening Exposed	1"	2"	3"	4"	5"	6"
	Flow Rate (gallons per minute)					
Fully Exposed	5	10	15	20	25	30
3/4	5	10	13.75	17.5	21.25	25
1/2	5	10	12.5	15	17.5	20
1/4	5	10	11.25	12.5	13.75	15
Closed	5	5	5	5	5	5

Job Name _____
 Job Location _____
 Engineer _____

Contractor _____
 Contractor's P.O. No. _____
 Representative _____

Watts product specifications in U.S. customary units and metric are approximate and are provided for reference only. For precise measurements, please contact Watts Technical Service. Watts reserves the right to change or modify product design, construction, specifications, or materials without prior notice and without incurring any obligation to make such changes and modifications on Watts products previously or subsequently sold.

USA: Tel: (800) 338-2581 • Fax: (828) 248-3929 • Watts.com
Canada: Tel: (905) 332-4090 • Fax: (905) 332-7068 • Watts.ca
Latin America: Tel: (52) 81-1001-8600 • Fax: (52) 81-8000-7091 • Watts.com



**APPENDIX H
CITY OF OTTAWA DESIGN CHECKLIST**

City of Ottawa

4. Development Servicing Study Checklist

The following section describes the checklist of the required content of servicing studies. It is expected that the proponent will address each one of the following items for the study to be deemed complete and ready for review by City of Ottawa Infrastructure Approvals staff.

The level of required detail in the Servicing Study will increase depending on the type of application. For example, for Official Plan amendments and re-zoning applications, the main issues will be to determine the capacity requirements for the proposed change in land use and confirm this against the existing capacity constraint, and to define the solutions, phasing of works and the financing of works to address the capacity constraint. For subdivisions and site plans, the above will be required with additional detailed information supporting the servicing within the development boundary.

4.1 General Content

Criteria	Location (if applicable)
<input type="checkbox"/> Executive Summary (for larger reports only).	N/A
<input type="checkbox"/> Date and revision number of the report.	On Cover
<input type="checkbox"/> Location map and plan showing municipal address, boundary, and layout of proposed development.	Appendix A
<input type="checkbox"/> Plan showing the site and location of all existing services.	Site Servicing Plan (C102)
<input type="checkbox"/> Development statistics, land use, density, adherence to zoning and official plan, and reference to applicable subwatershed and watershed plans that provide context to which individual developments must adhere.	1.1 Purpose 1.2 Site Description 5.0 Stormwater Management
<input type="checkbox"/> Summary of pre-consultation meetings with City and other approval agencies.	Appendix B
<input type="checkbox"/> Reference and confirm conformance to higher level studies and reports (Master Servicing Studies, Environmental Assessments, Community Design Plans), or in the case where it is not in conformance, the proponent must provide justification and develop a defensible design criteria.	1.1 Purpose 1.2 Site Description 5.0 Stormwater Management
<input type="checkbox"/> Statement of objectives and servicing criteria.	3.0 Pre-Consultation Summary

<input type="checkbox"/> Identification of existing and proposed infrastructure available in the immediate area.	N/A
<input type="checkbox"/> Identification of Environmentally Significant Areas, watercourses and Municipal Drains potentially impacted by the proposed development (Reference can be made to the Natural Heritage Studies, if available).	Site Grading Plan (C101)
<input type="checkbox"/> Concept level master grading plan to confirm existing and proposed grades in the development. This is required to confirm the feasibility of proposed stormwater management and drainage, soil removal and fill constraints, and potential impacts to neighbouring properties. This is also required to confirm that the proposed grading will not impede existing major system flow paths.	Site Grading Plan (C101)
<input type="checkbox"/> Identification of potential impacts of proposed piped services on private services (such as wells and septic fields on adjacent lands) and mitigation required to address potential impacts.	N/A
<input type="checkbox"/> Proposed phasing of the development, if applicable.	N/A
<input type="checkbox"/> Reference to geotechnical studies and recommendations concerning servicing.	Section 2.0 Background Studies, Standards and References
<input type="checkbox"/> All preliminary and formal site plan submissions should have the following information: <ul style="list-style-type: none"> ○ Metric scale ○ North arrow (including construction North) ○ Key plan ○ Name and contact information of applicant and property owner ○ Property limits including bearings and dimensions ○ Existing and proposed structures and parking areas ○ Easements, road widening and rights-of-way ○ Adjacent street names 	Site Grading Plan (C101)

4.2 Development Servicing Report: Water

Criteria	Location (if applicable)
<input type="checkbox"/> Confirm consistency with Master Servicing Study, if available	N/A
<input type="checkbox"/> Availability of public infrastructure to service proposed development	N/A
<input type="checkbox"/> Identification of system constraints	N/A
<input type="checkbox"/> Identify boundary conditions	Appendix C
<input type="checkbox"/> Confirmation of adequate domestic supply and pressure	N/A
<input type="checkbox"/> Confirmation of adequate fire flow protection and confirmation that fire flow is calculated as per the Fire Underwriter’s Survey. Output should show available fire flow at locations throughout the development.	Appendix C
<input type="checkbox"/> Provide a check of high pressures. If pressure is found to be high, an assessment is required to confirm the application of pressure reducing valves.	N/A
<input type="checkbox"/> Definition of phasing constraints. Hydraulic modeling is required to confirm servicing for all defined phases of the project including the ultimate design	N/A
<input type="checkbox"/> Address reliability requirements such as appropriate location of shut-off valves	N/A
<input type="checkbox"/> Check on the necessity of a pressure zone boundary modification.	N/A
<input type="checkbox"/> Reference to water supply analysis to show that major infrastructure is capable of delivering sufficient water for the proposed land use. This includes data that shows that the expected demands under average day, peak hour and fire flow conditions provide water within the required pressure range	Appendix C, Section 4.2

<input type="checkbox"/> Description of the proposed water distribution network, including locations of proposed connections to the existing system, provisions for necessary looping, and appurtenances (valves, pressure reducing valves, valve chambers, and fire hydrants) including special metering provisions.	Site Servicing Plan (C101)
<input type="checkbox"/> Description of off-site required feeder mains, booster pumping stations, and other water infrastructure that will be ultimately required to service proposed development, including financing, interim facilities, and timing of implementation.	N/A
<input type="checkbox"/> Confirmation that water demands are calculated based on the City of Ottawa Design Guidelines.	Appendix C
<input type="checkbox"/> Provision of a model schematic showing the boundary conditions locations, streets, parcels, and building locations for reference.	N/A

4.3 Development Servicing Report: Wastewater

Criteria	Location (if applicable)
<input type="checkbox"/> Summary of proposed design criteria (Note: Wet-weather flow criteria should not deviate from the City of Ottawa Sewer Design Guidelines. Monitored flow data from relatively new infrastructure cannot be used to justify capacity requirements for proposed infrastructure).	N/A
<input type="checkbox"/> Confirm consistency with Master Servicing Study and/or justifications for deviations.	N/A
<input type="checkbox"/> Consideration of local conditions that may contribute to extraneous flows that are higher than the recommended flows in the guidelines. This includes groundwater and soil conditions, and age and condition of sewers.	N/A
<input type="checkbox"/> Description of existing sanitary sewer available for discharge of wastewater from proposed development.	Section 4.3 Proposed Sanitary Sewer

<input type="checkbox"/> Verify available capacity in downstream sanitary sewer and/or identification of upgrades necessary to service the proposed development. (Reference can be made to previously completed Master Servicing Study if applicable)	Section 4.3 Proposed Sanitary Design
<input type="checkbox"/> Calculations related to dry-weather and wet-weather flow rates from the development in standard MOE sanitary sewer design table (Appendix 'C') format.	N/A
<input type="checkbox"/> Description of proposed sewer network including sewers, pumping stations, and forcemains.	Section 4.3 Proposed Sanitary Sewer
<input type="checkbox"/> Discussion of previously identified environmental constraints and impact on servicing (environmental constraints are related to limitations imposed on the development in order to preserve the physical condition of watercourses, vegetation, soil cover, as well as protecting against water quantity and quality).	N/A
<input type="checkbox"/> Pumping stations: impacts of proposed development on existing pumping stations or requirements for new pumping station to service development.	N/A
<input type="checkbox"/> Forcemain capacity in terms of operational redundancy, surge pressure and maximum flow velocity.	N/A
<input type="checkbox"/> Identification and implementation of the emergency overflow from sanitary pumping stations in relation to the hydraulic grade line to protect against basement flooding.	N/A
<input type="checkbox"/> Special considerations such as contamination, corrosive environment etc.	N/A

4.4 Development Servicing Report: Stormwater Checklist

Criteria	Location (if applicable)
<input type="checkbox"/> Description of drainage outlets and downstream constraints including legality of outlets (i.e. municipal drain, right-of-way, watercourse, or private property)	Section 4.4 Stormwater Sewer Design & Section 5.0 Proposed Stormwater Management
<input type="checkbox"/> Analysis of available capacity in existing public infrastructure.	N/A
<input type="checkbox"/> A drawing showing the subject lands, its surroundings, the receiving watercourse, existing drainage patterns, and proposed drainage pattern.	Pre & Post-Development Plans
<input type="checkbox"/> Water quantity control objective (e.g. controlling post-development peak flows to pre-development level for storm events ranging from the 2 or 5-year event (dependent on the receiving sewer design) to 100-year return period); if other objectives are being applied, a rationale must be included with reference to hydrologic analyses of the potentially affected subwatersheds, taking into account long-term cumulative effects.	Section 4.4 Stormwater Sewer Design & Section 5.0 Proposed Stormwater Management
<input type="checkbox"/> Water Quality control objective (basic, normal or enhanced level of protection based on the sensitivities of the receiving watercourse) and storage requirements.	Section 4.4 Stormwater Sewer Design & Section 5.0 Proposed Stormwater Management
<input type="checkbox"/> Description of the stormwater management concept with facility locations and descriptions with references and supporting information.	Section 4.4 Stormwater Sewer Design & Section 5.0 Proposed Stormwater Management
<input type="checkbox"/> Set-back from private sewage disposal systems.	N/A
<input type="checkbox"/> Watercourse and hazard lands setbacks.	N/A
<input type="checkbox"/> Record of pre-consultation with the Ontario Ministry of Environment and the Conservation Authority that has jurisdiction on the affected watershed.	N/A
<input type="checkbox"/> Confirm consistency with sub-watershed and Master Servicing Study, if applicable study exists.	N/A
<input type="checkbox"/> Storage requirements (complete with calculations) and conveyance capacity for minor events (1:5-year return period) and major events (1:100-year return period).	Appendix G

<input type="checkbox"/> Identification of watercourses within the proposed development and how watercourses will be protected, or, if necessary, altered by the proposed development with applicable approvals.	Site Grading Plan (C101)
<input type="checkbox"/> Calculate pre-and post development peak flow rates including a description of existing site conditions and proposed impervious areas and drainage catchments in comparison to existing conditions.	Section 5.0 Proposed Stormwater Management Appendix G
<input type="checkbox"/> Any proposed diversion of drainage catchment areas from one outlet to another.	Section 4.4 Stormwater Sewer Design & Section 5.0 Proposed Stormwater Management
<input type="checkbox"/> Proposed minor and major systems including locations and sizes of stormwater trunk sewers, and stormwater management facilities.	Section 4.4 Stormwater Sewer Design & Section 5.0 Proposed Stormwater Management
<input type="checkbox"/> If quantity control is not proposed, demonstration that downstream system has adequate capacity for the post-development flows up to and including the 100-year return period storm event.	N/A
<input type="checkbox"/> Identification of potential impacts to receiving watercourses	N/A
<input type="checkbox"/> Identification of municipal drains and related approval requirements.	N/A
<input type="checkbox"/> Descriptions of how the conveyance and storage capacity will be achieved for the development.	Section 4.4 Stormwater Sewer Design & Section 5.0 Proposed Stormwater Management
<input type="checkbox"/> 100-year flood levels and major flow routing to protect proposed development from flooding for establishing minimum building elevations (MBE) and overall grading.	Site Grading Plan (C101)
<input type="checkbox"/> Inclusion of hydraulic analysis including hydraulic grade line elevations.	N/A

<input type="checkbox"/> Description of approach to erosion and sediment control during construction for the protection of receiving watercourse or drainage corridors.	Section 6.0 Sediment & Erosion Control
<input type="checkbox"/> Identification of floodplains – proponent to obtain relevant floodplain information from the appropriate Conservation Authority. The proponent may be required to delineate floodplain elevations to the satisfaction of the Conservation Authority if such information is not available or if information does not match current conditions.	N/A
<input type="checkbox"/> Identification of fill constraints related to floodplain and geotechnical investigation.	N/A

4.5 Approval and Permit Requirements: Checklist

The Servicing Study shall provide a list of applicable permits and regulatory approvals necessary for the proposed development as well as the relevant issues affecting each approval. The approval and permitting shall include but not be limited to the following:

Criteria	Location (if applicable)
<input type="checkbox"/> Conservation Authority as the designated approval agency for modification of floodplain, potential impact on fish habitat, proposed works in or adjacent to a watercourse, cut/fill permits and Approval under Lakes and Rivers Improvement Act. The Conservation Authority is not the approval authority for the Lakes and Rivers Improvement Act. Where there are Conservation Authority regulations in place, approval under the Lakes and Rivers Improvement Act is not required, except in cases of dams as defined in the Act.	N/A
<input type="checkbox"/> Application for Certificate of Approval (CofA) under the Ontario Water Resources Act.	N/A
<input type="checkbox"/> Changes to Municipal Drains.	N/A
<input type="checkbox"/> Other permits (National Capital Commission, Parks Canada, Public Works and Government Services Canada, Ministry of Transportation etc.)	N/A

4.6 Conclusion Checklist

Criteria	Location (if applicable)
<input type="checkbox"/> Clearly stated conclusions and recommendations	Section 7.0 Summary Section 8.0 Recommendations
<input type="checkbox"/> Comments received from review agencies including the City of Ottawa and information on how the comments were addressed. Final sign-off from the responsible reviewing agency.	All are stamped
<input type="checkbox"/> All draft and final reports shall be signed and stamped by a professional Engineer registered in Ontario	All are stamped