

165177 CANADA INC. c/o Jay Patel

# 275 King Edward Avenue Stormwater Management Report

July 23, 2021





# 275 King Edward Avenue Stormwater Management Report

165177 CANADA INC. c/o Jay Patel

Confidential  
Issue for City Review  
Project No.: 211-07007-00  
Date: July 23, 2021

WSP  
Suite 300  
2611 Queensview Drive  
Ottawa, ON, Canada K2B 8K2

T: +1 613 829-2800  
F: +1 613 829-8299  
wsp.com

# Revision History

## FIRST ISSUE

July 23, 2021	First Submission			
Prepared by	Reviewed by	Approved By		
Kathryn Kerker Water Resources E.I.T.	Michelle Hughes, P.Eng Team Lead, Water Resources	Michelle Hughes, P.Eng Team Lead, Water Resources		

---

# Signatures

Prepared by



July 23, 2021

---

Kathryn Kerker  
Water Resources E.I.T.

---

Date

APPROVED BY



---

Michelle Hughes, P.Eng., MSc.  
Team Lead, Water Resources

July 23, 2021

---

Date



WSP Canada Inc. prepared this report solely for the use of the intended recipient, Momentum Planning and Communications, in accordance with the professional services agreement. The intended recipient is solely responsible for the disclosure of any information contained in this report. The content and opinions contained in the present report are based on the observations and/or information available to WSP Canada Inc. at the time of preparation. If a third party makes use of, relies on, or makes decisions in accordance with this report, said third party is solely responsible for such use, reliance or decisions. WSP Canada Inc. does not accept responsibility for damages, if any, suffered by any third party as a result of decisions made or actions taken by said third party based on this report. This limitations statement is considered an integral part of this report.

The original of this digital file will be conserved by WSP Canada Inc. for a period of not less than 10 years. As the digital file transmitted to the intended recipient is no longer under the control of WSP Canada Inc., its integrity cannot be assured. As such, WSP Canada Inc. does not guarantee any modifications made to this digital file subsequent to its transmission to the intended recipient.



# TABLE OF CONTENTS

<b>1</b>	<b>INTRODUCTION.....</b>	<b>1</b>
1.1	Scope .....	1
1.2	Site Location.....	1
1.3	Stormwater Management Plan Objectives.....	1
1.4	Design Criteria.....	2
<b>2</b>	<b>PRE-DEVELOPMENT CONDITIONS .....</b>	<b>3</b>
2.1	General .....	3
2.2	Rainfall Information.....	3
2.3	Allowable Flow Rates .....	3
<b>3</b>	<b>POST-DEVELOPMENT CONDITIONS.....</b>	<b>5</b>
3.1	General .....	5
3.2	Water Quantity .....	5
3.3	Water Quality.....	6
<b>4</b>	<b>CONCLUSIONS.....</b>	<b>7</b>



---

*Tables*

Table 2-1: Pre-Development Peak Flow Rate  
Calculations (Runoff Coefficient,  
C = 0.50 and T<sub>c</sub>=10 min) ..... 4

Table 3-1: Summary of Modelling Results ..... 6

---

*Figures*

Figure 1: Site Location ..... 1

---

*Appendices*

- A** Pre-consultation meeting minutes (January 16, 2020)
- B** Pre-Development Stormwater Management Calculations
- C** HydroCAD Model Output
  - C-1 100-Year Analysis (Peak Discharge,  $T_C = 12$  Min)
  - C-2 100-Year Analysis (Peak Storage,  $T_C = 26$  Min)
- D** OGS Sizing

# 1 INTRODUCTION

---

## 1.1 Scope

WSP Canada Inc. was retained by Momentum Planning and Communications to conduct a stormwater management study in support of proposals to develop an 8-storey long term stay hotel on previously residential land.

---

## 1.2 Site Location

The site is located at 275 King Edward Avenue, Ottawa, Ontario, at the intersection of King Edward Avenue and Murray Street. The location of the proposed development is illustrated in **Figure 1**.

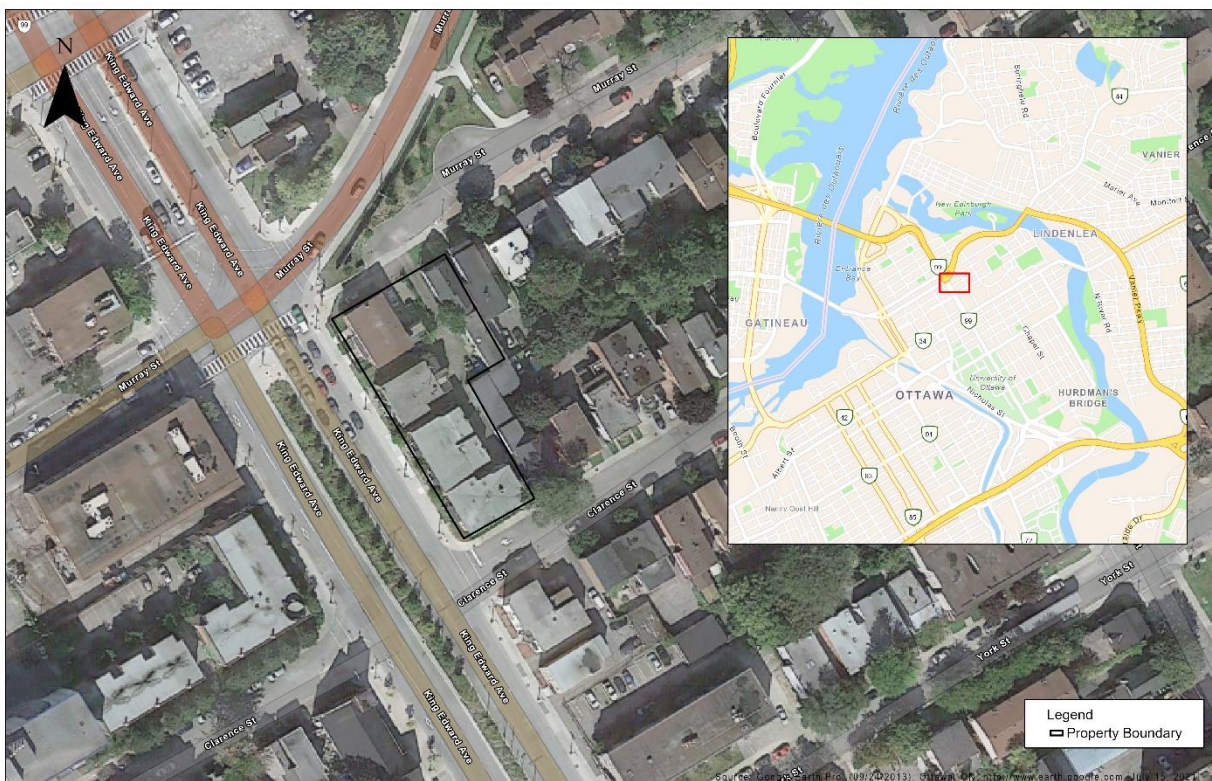

**Figure 1: Site Location**

---

## 1.3 Stormwater Management Plan Objectives

The objectives of the stormwater management (SWM) study are as follows:



- Collect and review background information.
  - Confirm applicable SWM design criteria with City of Ottawa staff.
  - Evaluate various SWM practices that meet the stormwater management requirements and recommend a preferred strategy—specifically related to the applicable quantity and quality control criteria.
- 

## 1.4 Design Criteria

Design criteria were confirmed through pre-consultation with the city of Ottawa held on January 16, 2020, with a confirmation of SWM criteria by email on June 11, 2021 (Meeting minutes and email included in **Appendix A**). Criteria for 275 King Edward Avenue are as follows:

### Water Quantity Control and Discharge to Municipal Infrastructure

- Stormwater must be controlled to the peak flow for the 5-year pre-development storm event. Runoff must be detained onsite to control all storm events up to and including the 100-year event.
- Allowable Runoff coefficient (C): C = the lesser of the existing pre-development conditions to a maximum of 0.5 (OSDG 8.3.7.3)
- Time of concentration (Tc): Tc = pre-development (Calculated); maximum Tc = 10 min

### Water Quality

- RVCA requires enhanced water quality protection (80% TSS removal) be provided on-site

# 2 PRE-DEVELOPMENT CONDITIONS

---

## 2.1 General

Currently the land proposed for the new development contains a two-storey residential building surrounded by land that previously held other residential buildings (shown in historical image in Figure 1). An overall existing runoff coefficient of 0.50 has been used for this analysis based on instruction from the city (see Appendix A). The total study area 0.16 ha.

---

## 2.2 Rainfall Information

The rainfall intensity is calculated in accordance with Section 5.4.2 of the Ottawa Sewer Design Guidelines (October 2012):

$$i = \left[ \frac{A}{(T_d + C)^B} \right]$$

Where;

- A, B, C = regression constants for each return period (defined in section 5.4.2)
  - i = rainfall intensity (mm/hour)
  - T<sub>d</sub> = storm duration (minutes)
  - The IDF parameters/regression constants are included in **Appendix B**.
- 

## 2.3 Allowable Flow Rates

As noted in **Section 1.4**, post-development stormwater runoff up to the 100-year design storms must not exceed the pre-development peak 5-year flow rate, calculated using a runoff coefficient being the lesser of 0.50 or existing conditions. In this instance existing conditions are represented by a runoff coefficient greater than 0.5, therefore this value has been used to calculate the allowable release rate.

The area will discharge west to a 1050mm storm pipe on Murray Street through a new storm connection. The calculated peak flow rates for the site in the pre-development condition are summarized below in Table 2-1.

**Table 2-1: Pre-Development Peak Flow Rate Calculations (Runoff Coefficient, C = 0.50 and T<sub>c</sub>=10 min)**

Return Period (Years)	Rainfall Intensity (MM/hour)	Peak Flow Rate (l/s)	Target Release Rate (l/s)
<b>2</b>	76.8	17	<b>23</b>
<b>5</b>	104.2	<b>23</b>	
<b>10</b>	122.1	27	
<b>25</b>	144.7	35	
<b>50</b>	161.5	43	
<b>100</b>	178.6	49	

# 3 POST-DEVELOPMENT CONDITIONS

---

## 3.1 General

The site will be developed with a new 8-storey long term stay hotel building. The developed site will have a runoff coefficient of 0.87 and study area of 0.16 ha. A cistern will be used to control the peak discharge of the newly developed site to 23 L/s.

Note that this report should be read in conjunction with the proposed site servicing drawing package—specifically drawings C02 (Grading Plan), C03 (Servicing Plan), and C04 (Storm Drainage Area Plan).

---

## 3.2 Water Quantity

As noted in **Section 2.3**, the target allowable discharge rate to Murray Street sewer is 23 L/s. This is equivalent to the peak runoff rate under pre-development conditions during a 5-year design storm event with a runoff coefficient of 0.50. Compliance with the 100-yr target offsite discharge rate will be achieved through use of a cistern with outlet control prior to discharge into the Murray Street storm sewer.

It is noted that a small portion of the study area will not drain to the proposed storage tank due to grading and pipe configuration constraints. Post-development runoff calculations have accounted for uncontrolled runoff from these areas, and the following analysis results report on the cumulative release rates from the study area (controlled plus uncontrolled). There are no external areas draining to the site.

A HydroCAD model of the project was created and includes:

- Cistern (minimum volume 35 m<sup>3</sup>), with outlet controlled using flow control ICD (HYDROVEX 100-VHV-1) to detain 0.14 ha of the new development with a runoff coefficient of 0.90 (+25% for 100-year event as per OSDG 5.4.5.2.1; C = 1.0).
- Uncontrolled runoff from 0.018 ha area with C = 0.71 (+25% for 100-year event as per OSDG 5.4.5.2.1; C = 0.82).

The Modified Rational Method (an inherent subroutine of the HydroCAD software) has been used for the modelling exercise, and the model has informed the maximum storage volume used in the cistern based on the proposed flow. The peak flow rate generated from the uncontrolled drainage area within the project site and controlled flow from the cistern is 22 L/s, which meets the total allowable 100-year release rate of 23 L/s. Modelling results are summarized below in **Table 3-1** and shown in **Appendix C**.

Note that results provided below describe performance of the proposed system at multiple storm durations, which have been solved iteratively within HydroCAD to represent critical conditions (i.e. maximum storage utilized within storage features, and peak release rate at the system discharge point). The results demonstrate that the target allowable 100-year release rate is satisfied at all durations.

**Table 3-1: Summary of Modelling Results**

Return Period (Years)	Time of Conc. (min)	Utilized Storage (m <sup>3</sup> )	Peak Water Elevation in storage (m)	Peak Flow Rate at control (L/s)	Total Flow Leaving Site* (L/s)	Allowable 100-yr Flow Rate (L/s)
100 (Peak Discharge)	12	29.5	56.361	17	22	23
100 (Peak Storage)	26	34.1	56.571	17	21	

\*Total Flow Leaving Site' includes uncontrolled area and cistern discharge.

---

### 3.3 Water Quality

As noted in section 1.4, quality control is required to provide enhanced water quality treatment of the site (80% TSS removal). An OGS unit (Stormceptor EFO4 or equivalent) will be installed just upstream of the city storm sewer connection to provide the required quality treatment. OGS sizing is provided in **Appendix D**.

## 4 CONCLUSIONS

A stormwater management plan has been prepared to support the site plan application for the 275 King Edward Avenue development in the City of Ottawa. The key points are summarized below.

### WATER QUANTITY

Runoff collected from the project site will be directed to a cistern with a minimum active storage volume of 35 m<sup>3</sup> to control the 100-year event. The peak 100-year discharge from the site is 22 L/s, which meets the allowable release rate of 23 L/s.

### WATER QUALITY

Water treatment is provided by an OGS unit placed just upstream of the city storm sewer connection.

This report demonstrates that the proposed SWM strategy will address stormwater management related impacts from this project and meet the requirements of the City of Ottawa.

# APPENDIX

**A**

Pre-consultation meeting minutes  
(January 16, 2020)

## **MINUTES**

Pre-Application Consultation Meeting: 260 Murray, 261, 269, 277 King Edward

Date: January 16, 2020

Time: 1:00 pm

Location: Laurier 110-4118E

### **Attendees**

#### *City of Ottawa*

John Lunney, File Lead  
Christopher Moise, Urban Designer  
John Wu, Engineer, Infrastructure  
Wally Dubyk, Transportation

#### *Applicant Team*

Dennis Jacobs  
Bob Woodman  
Tino Tolot  
Jay Patel

#### *Community Representation*

Peter Ferguson,  
Lowertown Community Association

### **Introductions**

Explanation of the pre-application consultation project and confirmation of the Non-Disclosure Agreement

### **Overview of Proposal**

#### Overview

- ~119 unit singular-use hotel
- Proposed vehicular entrance from King Edward Avenue with exit on the Murray Street frontage
- Principal nine storey mass occupying bulk of site, abutting interior lot lines against 257 Clarence
- Three storey mass in northeast corner, along rear lot line abutting 262 Murray Street



## Preliminary Comments from City

### Urban Design – Christopher Moise

- Attention should be made to support the prominent nature of King Edward in scale, activity (entrances, etc.), materiality, pedestrian supportive treatment;
- Materiality can be employed as a way to relate to the burgeoning context of King Edward and heritage nature of the neighbourhood. The use of brick or other 'noble' material is a good way to do this;
- Challenge will be in how to sensitively transition to the surrounding low-rise context to the east;
- Having the primary vehicular entrance off King Edward may compromise the pedestrian environment intended along that street;
- Further analysis of the massing of the project in relation to the neighbouring residential context and block pattern will help moving forward. We recommend an Informal visit to the UDRP where alternative approaches are presented and analyzed to gain the best feed back to develop a supportable approach moving forward.
- Create a public realm that:
  - Provides direct pedestrian connections between the building and the sidewalk;
  - Offers comfortable micro climate conditions for sitting, standing, and walking around the building at grade;
  - Is animated by active ground floor uses, streetscape amenities, and architectural features.
- Develop a design that:
  - Provides height and massing transition between the proposed development and existing low-rise residential area;
  - Responds to the characteristics of the three abutting streets
    - King Edward – a wide urban thoroughfare that carries heavy traffic. Potential considerations may include wider building setbacks to accommodate significant landscaping and improved pedestrian realm.
    - Murray – a quiet residential street. Considerations may include building setbacks that respect the setback pattern on the street and the retaining of existing trees and hedges (where applicable).
    - Clarence – a quiet residential street. Considerations may include building setbacks that respect the setback pattern on the street and the retaining of existing trees and hedges (where applicable).
  - Follows the principles of and incorporate features of sustainable design.

### John Lunney – Planning

- Proposal would require applications for Site Plan Control, Complex with minor Zoning By-law Amendment Application
- Unable to bridge prior planning applications submitted (and not completed) at the site
- Proposal could benefit from consolidation of lot at northwest corner of King Edward Avenue and St. Patrick Street
- Vehicular access features along King Edward Avenue potentially conflict with *Traditional Mainstreet Official Plan* policies promoting pedestrian-focused environment
- Robust rationale necessitated for Zoning Amendment permitting 9 storeys (~6 storeys) required, with specific reference to compatibility to low-rise context to the east (bound between Murray, Nelson, and Clarence Streets)

#### John Wu- Infrastructure

- Service connections available at King Edward Avenue and Clarence Street
- Noise Study for Stationary Noise (rooftop) required with submission
- Noise study for traffic noise not required but recommended
- Geotechnical report and ESA phase 1 required with submission

#### Wally Dubyk – Transportation

- King Edward Avenue is designated as an Arterial road within the City's Official Plan with a ROW protection of 40.0.0 metres. The ROW limits are to be shown on all the drawings and the offset distance (20.0 metres) to be dimensioned from the existing centerline of pavement.
- ROW interpretation – Land for a road widening will be taken equally from both sides of a road, measured from the centreline in existence at the time of the widening if required by the City. The centreline is a line running down the middle of a road surface, equidistant from both edges of the pavement. In determining the centreline, paved shoulders, bus lay-bys, auxiliary lanes, turning lanes and other special circumstances are not included in the road surface.
- The proposed tree planting maybe above the Street Lighting duct. Please contact Paolo Augello ([paolo.augello@ottawa.ca](mailto:paolo.augello@ottawa.ca)) at 613-580-2424 extension 32579.
- The concrete sidewalks should be 2.0 metres in width and be continuous and depressed through the proposed accesses (please refer to the City's sidewalk and curb standard drawing).
- All underground and above ground building footprints and permanent walls need to be shown on the plan to confirm that any permanent structure does not extend either above or below into the existing property lines, and/or future road widening protection limits.
- The City of Ottawa Zoning By-Law Corner Sight Triangles (Sec. 57) states that no obstruction to the vision of motor vehicle operators higher than 0.75 metres above grade. The consultant should review the sight distance to ensure that no obstructions hinder the view of the driver.
- Please note that the proposed access off King Edward Avenue will not be able to service tenants travelling in the southbound direction.
- Note Section 24(1) & (2) of the By-Law No. 2003-447, which prohibits the construction of a private approach that will create hazardous conditions due to queuing of vehicles on the roadway.
- The closure of an existing private approach shall reinstate the sidewalk, shoulder, curb and boulevard to City standards.
- Where an owner whose property abuts two or more highways, the City recommends that a private approach shall be permitted on the highway carrying the lesser volume of vehicular traffic and the private approach shall be located as far from the nearest intersections as possible.
- The TIA (Transportation Impact Assessment) Guidelines (2017) were approved by Transportation Committee and City Council on June 14, 2017. The new version of the TIA Guidelines (2017) that are posted on the web are now to be used for the TIA Submission for development applications.

The following list highlights the significant changes to the 2006 TIA Guidelines

1. A Screening Test (Step 1) quickly determines if a transportation study is required. Consultants should fill in the form in Appendix B.
2. Should the development generate 60 peak hour person trips, the TIA guidelines Step 2 – Scoping report would be required.
3. Study Scope (Step 2) is site specifically tailored; there are no longer three defined types of TIA reports. Scoping report is required and needs to be signed off by TPM before the consultant moves on to Forecasting volumes.

4. Sign off from City Transportation Project Manager is required at key points in the review process prior to TIA Submission (Step 5). See Figure 1 on page 9 for a good flow chart of the process.
5. Multi Modal Level of Service (MMLOS) and Complete Street analysis is required to assess the impact of all modes of travel rather than just vehicle traffic.
6. There is no longer a requirement for consultant pre-approval. Consultants must now sign and submit the Credentials Form included in the Appendix A with each TIA report.
7. The TIA Submission (report, drawings and/or monitoring plan) is required with the development application.

Click on the website: <https://ottawa.ca/en/transportation-impact-assessment-guidelines>

- A construction Traffic Management Plan is to be provided for approval by the Senior Engineer, Traffic Management, Transportation Services Dept.
- For the interlock pavers, landscaped areas and public art on City's road right-of-way the developer has to sign a "Maintenance Agreement" with the City to cover any claims.

### **Preliminary Comments from Community Association Representative**

Lowertown Community Association – Peter Ferguson

- Attention to rear transition of building to the east is important
- Consider materials complementary to the setting
- Vehicular access will be a challenge from King Edward Avenue

## Kerker, Kathryn

---

**From:** Yang, Winston  
**Sent:** July 8, 2021 10:50 AM  
**To:** Kerker, Kathryn  
**Subject:** FW: 260 Murray, 261, 269, 277 King Edward

FYI



### Ding Bang (Winston) Yang, P.Eng.

Project Engineer  
Municipal Engineering - Ottawa

T+ 1 613-690-0538  
M+ 1 647-628-8108

WSP Canada Inc.  
2611 Queensview Drive, Suite 300  
Ottawa, Ontario,  
K2B 8K2 Canada

[wsp.com](http://wsp.com)

---

**From:** Wu, John <John.Wu@ottawa.ca>  
**Sent:** June 11, 2021 8:37 AM  
**To:** Yang, Winston <Winston.Yang@wsp.com>  
**Subject:** RE: 260 Murray, 261, 269, 277 King Edward

C0.5 5 year's storm event is the release rate, quality control is needed, because it is close to river.  
Connections to local sewers.  
Connection for water , no 400mm water main, other watermains, no preference.  
DMA chamber means what?

john

---

**From:** Yang, Winston <[Winston.Yang@wsp.com](mailto:Winston.Yang@wsp.com)>  
**Sent:** June 10, 2021 4:37 PM  
**To:** Wu, John <[John.Wu@ottawa.ca](mailto:John.Wu@ottawa.ca)>  
**Subject:** Re: 260 Murray, 261, 269, 277 King Edward

**CAUTION: This email originated from an External Sender. Please do not click links or open attachments unless you recognize the source.**

**ATTENTION : Ce courriel provient d'un expéditeur externe. Ne cliquez sur aucun lien et n'ouvrez pas de pièce jointe, excepté si vous connaissez l'expéditeur.**

Hi John,

Just want to touch base with you regarding the proposed hotel at 275 King Edward.  
I could not find too much details from the pre-consultation meeting minute for civil infrastructure.

John Wu- Infrastructure

- Service connections available at King Edward Avenue and Clarence Street
- Noise Study for Stationary Noise (rooftop) required with submission
- Noise study for traffic noise not required but recommended
- Geotechnical report and ESA phase 1 required with submission

I am just wondering do you have any expectation for the SWM criteria?

I would like to make sure we are on the same page as we are putting up the design package for SPA.

I will be appreciated if you can provide your comments/responses to the following questionnaires.

- The site was used for commercial with mostly paved. What is the C value we can use to calculate the pre-development peak flows?
- Is there quality control required?
- There are trunk sewers of 1800mm dia. storm and 1050mm dia. sanitary in King Edward, and local sewers of 375mm dia. storm and 300mm dia. sanitary in Clarence St. What's your preference for the connection as you have mentioned service connections available at King Edward Ave and Clarence Street.
- There are 406mm dia watermain in King Edward and 203mm dia. and 152mm dia. watermain in Clarence St. which mains a water boundary condition request should be made?
- Is a DMA chamber needed for this private development?

Feel free to reach me out if you want to discuss this project further.

Thanks,

**Ding Bang (Winston) Yang, P.Eng.**

Project Engineer  
Infrastructure



T+ 1 613-690-0538

2611 Queensview Drive, Suite 300  
Ottawa, Ontario,  
K2B 8K2, Canada

[www.wsp.com](http://www.wsp.com)

---

NOTICE: This communication and any attachments ("this message") may contain information which is privileged, confidential, proprietary or otherwise subject to restricted disclosure under applicable law. This message is for the sole use of the intended recipient(s). Any unauthorized use, disclosure, viewing, copying, alteration, dissemination or distribution of, or reliance on, this message is strictly prohibited. If you have received this message in error, or you are not an authorized or intended recipient, please notify the sender immediately by replying to this message, delete this message and all copies from your e-mail system and destroy any printed copies. You are receiving this communication because you are listed as a current WSP contact. Should you have any questions regarding WSP's electronic communications policy, please consult our Anti-Spam Commitment at [www.wsp.com/cas](http://www.wsp.com/cas). For any concern or if you believe you should not be receiving this message, please forward this message to [cascompliance@wsp.com](mailto:cascompliance@wsp.com) so that we can promptly address your request. Note that not all messages sent by WSP qualify as commercial electronic messages.

AVIS : Ce message, incluant tout fichier l'accompagnant (« le message »), peut contenir des renseignements ou de l'information privilégiés, confidentiels, propriétaires ou à divulgation restreinte en vertu de la loi. Ce message est destiné à l'usage exclusif du/des destinataire(s) voulu(s). Toute utilisation non permise,

divulgateion, lecture, reproduction, modification, diffusion ou distribution est interdite. Si vous avez reçu ce message par erreur, ou que vous n'êtes pas un destinataire autorisé ou voulu, veuillez en aviser l'expéditeur immédiatement et détruire le message et toute copie électronique ou imprimée. Vous recevez cette communication car vous faites partie des contacts de WSP. Si vous avez des questions concernant la politique de communications électroniques de WSP, veuillez consulter notre Engagement anti-pourriel au [www.wsp.com/lcap](http://www.wsp.com/lcap). Pour toute question ou si vous croyez que vous ne devriez pas recevoir ce message, prière de le transférer au [conformitelcap@wsp.com](mailto:conformitelcap@wsp.com) afin que nous puissions rapidement traiter votre demande. Notez que ce ne sont pas tous les messages transmis par WSP qui constituent des messages électroniques commerciaux.

-LAEmHhHzdJzBITWfa4Hgs7pbKl

This e-mail originates from the City of Ottawa e-mail system. Any distribution, use or copying of this e-mail or the information it contains by other than the intended recipient(s) is unauthorized. Thank you.

Le présent courriel a été expédié par le système de courriels de la Ville d'Ottawa. Toute distribution, utilisation ou reproduction du courriel ou des renseignements qui s'y trouvent par une personne autre que son destinataire prévu est interdite. Je vous remercie de votre collaboration.

# APPENDIX

## B

### Pre-Development Stormwater Management Calculations



Project:	275 King Edward Ave.	No.:	211-07007-00	Page: <b>1</b>
By:	KK	Date:	2021-07-15	
Checked:	MH	Checked:	2021-07-15	

Subject: **SWM CALCULATIONS- Pre-Development Peak Flow**

Calculation of existing runoff rate is undertaken using the Rational Method:  $Q = 2.78CiA$

Where: Q = peak flow rate (litres/second)  
 C = runoff coefficient  
 i = rainfall intensity (mm/hour)  
 A = catchment area (hectares)

Site Area, A                                      1,590     m<sup>2</sup>  
 Site Area, A                                      0.16     hectares  
 Runoff Coefficient, C                          0.50

Rainfall intensity calculated in accordance with City of Ottawa Sewer Design Guidelines (section 5.4.2):

$$i = \left[ \frac{A}{(Td + C)^B} \right]$$

Where: A, B, C = regression constants for each return period (defined in section 5.4.2)  
 i = rainfall intensity (mm/hour)  
 Td = storm duration (minutes)                                      10 minutes

Return Period (Years)	2	5	10	25	50	100*
<b>A</b>	733.0	998.1	1,174.2	1,402.9	1,569.6	1,735.7
<b>B</b>	0.810	0.814	0.816	0.819	0.820	0.820
<b>C</b>	6.199	6.053	6.014	6.018	6.014	6.014
<b>T (mins)</b>	10	10	10	10	10	10
<b>I (mm/hr)</b>	76.8	104.2	122.1	144.7	161.5	178.6
<b>Runoff Coefficient C</b>	0.50	0.50	0.50	0.50	0.50	0.50
<b>C Multiplier (OSDG Table 5.7)</b>	1.00	1.00	1.00	1.10	1.20	1.25
<b>Revised Runoff Coefficient C</b>	0.50	0.50	0.50	0.55	0.60	0.63
<b>Q (litres/sec)</b>	17	23	27	35	43	49
<b>Q (m3/sec)</b>	0.02	0.02	0.03	0.04	0.04	0.05



# APPENDIX

## C

### HydroCAD Model Output

# APPENDIX

## C-1

### 100-Year Analysis (Peak Discharge, $T_c = 12$ Min)

*The storm system for the site is governed by the 100-year storm. Peak storage and peak discharge occur at separate times of concentration and are therefore reported separately.*

**20210707\_275\_King\_Edward**

Prepared by WSP Canada inc.

HydroCAD® 10.00-22 s/n 10697 © 2018 HydroCAD Software Solutions LLC

Printed 2021-07-15

Page 2

**Area Listing (selected nodes)**

Area (sq-meters)	C	Description (subcatchment-numbers)
1,200.0	1.00	B01 (31S)
220.0	1.00	B02 (31S)
86.0	0.64	B03 (32S)
90.0	1.00	B04 (32S)
<b>1,596.0</b>	<b>0.98</b>	<b>TOTAL AREA</b>



Time span=0.00-4.00 hrs, dt=0.01 hrs, 401 points  
 Runoff by Rational method, Rise/Fall=1.0/1.0 xTc  
 Reach routing by Stor-Ind+Trans method - Pond routing by Stor-Ind method

**Subcatchment 31S: Controlled** Runoff Area=0.1420 ha 100.00% Impervious Runoff Depth=32 mm  
 Tc=10.0 min C=1.00 Runoff=0.06395 m³/s 46.0 m³

**Subcatchment 32S: Uncontrolled** Runoff Area=0.0176 ha 51.14% Impervious Runoff Depth=27 mm  
 Tc=10.0 min C=0.82 Runoff=0.00650 m³/s 4.7 m³

**Pond 33P: Underground Storage** Peak Elev=56.361 m Storage=29.5 m³ Inflow=0.06395 m³/s 46.0 m³  
 Outflow=0.01670 m³/s 46.0 m³

**Link 34L: Outfall** Inflow=0.02163 m³/s 50.7 m³  
 Primary=0.02163 m³/s 50.7 m³

**Total Runoff Area = 1,596.0 m² Runoff Volume = 50.7 m³ Average Runoff Depth = 32 mm**  
**5.39% Pervious = 86.0 m² 94.61% Impervious = 1,510.0 m²**

**Summary for Subcatchment 31S: Controlled**

Runoff = 0.06395 m³/s @ 0.17 hrs, Volume= 46.0 m³, Depth= 32 mm

Runoff by Rational method, Rise/Fall=1.0/1.0 xTc, Time Span= 0.00-4.00 hrs, dt= 0.01 hrs  
 Ottawa\_+4hr25mm 100-Year Duration=12 min, Inten=162.1 mm/hr

Area (ha)	C	Description
0.1200	1.00	B01
0.0220	1.00	B02
0.1420	1.00	Weighted Average
0.1420		100.00% Impervious Area

Tc (min)	Length (meters)	Slope (m/m)	Velocity (m/sec)	Capacity (m³/s)	Description
10.0					Direct Entry,

**Subcatchment 31S: Controlled**

Hydrograph

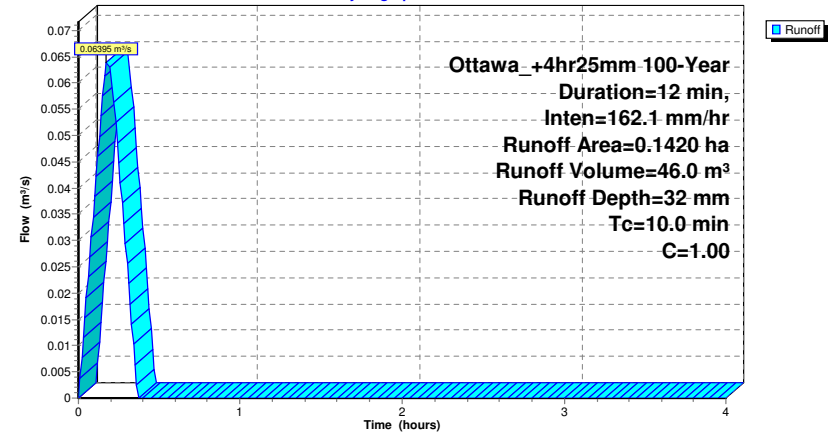

**Summary for Subcatchment 32S: Uncontrolled**

Runoff = 0.00650 m³/s @ 0.17 hrs, Volume= 4.7 m³, Depth= 27 mm

Runoff by Rational method, Rise/Fall=1.0/1.0 xTc, Time Span= 0.00-4.00 hrs, dt= 0.01 hrs  
 Ottawa\_+4hr25mm 100-Year Duration=12 min, Inten=162.1 mm/hr

Area (ha)	C	Description
0.0086	0.64	B03
0.0090	1.00	B04
0.0176	0.82	Weighted Average
0.0086		48.86% Pervious Area
0.0090		51.14% Impervious Area

Tc (min)	Length (meters)	Slope (m/m)	Velocity (m/sec)	Capacity (m³/s)	Description
10.0					Direct Entry,

**Subcatchment 32S: Uncontrolled**

Hydrograph

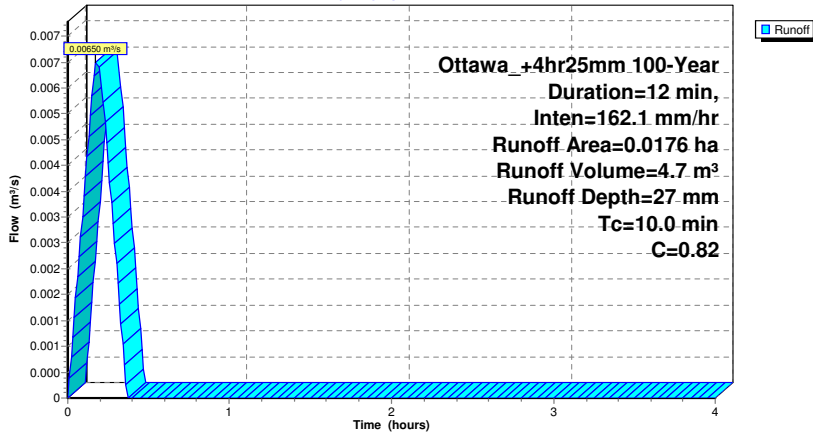

**Summary for Pond 33P: Underground Storage**

[44] Hint: Outlet device #1 is below defined storage

Inflow Area = 1,420.0 m², 100.00% Impervious, Inflow Depth = 32 mm for 100-Year event  
 Inflow = 0.06395 m³/s @ 0.17 hrs, Volume= 46.0 m³  
 Outflow = 0.01670 m³/s @ 0.32 hrs, Volume= 46.0 m³, Atten= 74%, Lag= 9.2 min  
 Primary = 0.01670 m³/s @ 0.32 hrs, Volume= 46.0 m³

Routing by Stor-Ind method, Time Span= 0.00-4.00 hrs, dt= 0.01 hrs  
 Peak Elev= 56.361 m @ 0.32 hrs Surf.Area= 22.0 m² Storage= 29.5 m³

Plug-Flow detention time= 16.9 min calculated for 45.9 m³ (100% of inflow)  
 Center-of-Mass det. time= 16.9 min ( 27.9 - 11.0 )

Volume	Invert	Avail.Storage	Storage Description
#1	55.020 m	44.0 m³	Custom Stage Data (Prismatic) Listed below
Elevation (meters)	Surf.Area (sq-meters)	Inc.Store (cubic-meters)	Cum.Store (cubic-meters)
55.020	22.0	0.0	0.0
57.020	22.0	44.0	44.0

Device	Routing	Invert	Outlet Devices
#1	Primary	53.174 m	<b>HYDROVEX 100-VHV-1 X 0.90</b> Head (meters) 0.000 0.200 0.500 1.000 1.500 2.000 3.000 4.000 6.000 Disch. (m³/s) 0.000000 0.000100 0.007000 0.010500 0.012500 0.014000 0.018000 0.021000 0.026000

Primary OutFlow Max=0.01670 m³/s @ 0.32 hrs HW=56.360 m (Free Discharge)  
 #1=HYDROVEX 100-VHV-1 (Custom Controls 0.01670 m³/s)

**Pond 33P: Underground Storage**

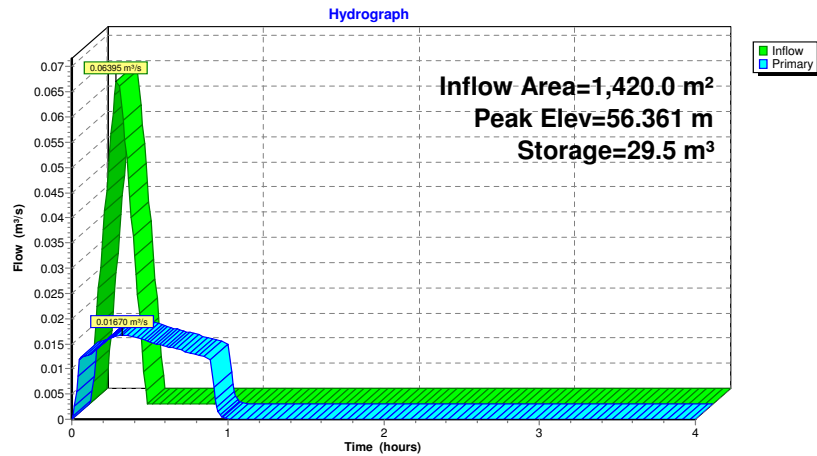

**Summary for Link 34L: Outfall**

Inflow Area = 1,596.0 m<sup>2</sup>, 94.61% Impervious, Inflow Depth = 32 mm for 100-Year event  
 Inflow = 0.02163 m<sup>3</sup>/s @ 0.20 hrs, Volume= 50.7 m<sup>3</sup>  
 Primary = 0.02163 m<sup>3</sup>/s @ 0.20 hrs, Volume= 50.7 m<sup>3</sup>, Atten= 0%, Lag= 0.0 min

Primary outflow = Inflow, Time Span= 0.00-4.00 hrs, dt= 0.01 hrs

**Link 34L: Outfall**

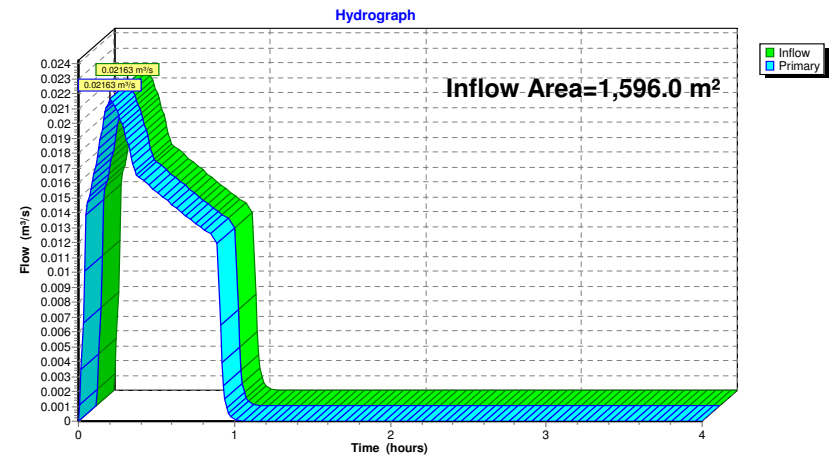

# APPENDIX

## C-2

### 100-Year Analysis (Peak Storage, $T_c = 26$ Min)

*The storm system for the site is governed by the 100-year storm. Peak storage and peak discharge occur at separate times of concentration and are therefore reported separately.*

**20210707\_275\_King\_Edward**

Prepared by WSP Canada inc.

HydroCAD® 10.00-22 s/n 10697 © 2018 HydroCAD Software Solutions LLC

Printed 2021-07-15

Page 2

**Area Listing (selected nodes)**

Area (sq-meters)	C	Description (subcatchment-numbers)
1,200.0	1.00	B01 (31S)
220.0	1.00	B02 (31S)
86.0	0.64	B03 (32S)
90.0	1.00	B04 (32S)
<b>1,596.0</b>	<b>0.98</b>	<b>TOTAL AREA</b>

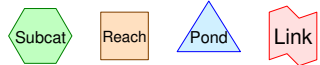
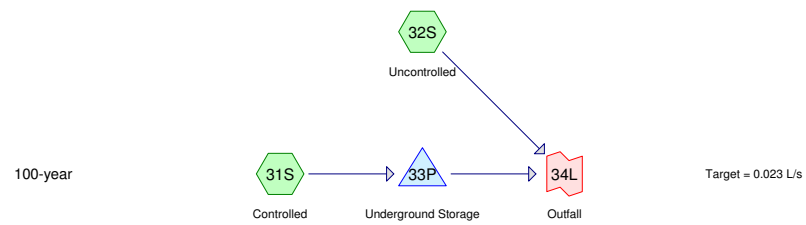

Routing Diagram for 20210707\_275\_King\_Edward  
Prepared by WSP Canada inc., Printed 2021-07-15  
HydroCAD® 10.00-22 s/n 10697 © 2018 HydroCAD Software Solutions LLC



Time span=0.00-4.00 hrs, dt=0.01 hrs, 401 points  
 Runoff by Rational method, Rise/Fall=1.0/1.0 xTc  
 Reach routing by Stor-Ind+Trans method - Pond routing by Stor-Ind method

**Subcatchment 31S: Controlled** Runoff Area=0.1420 ha 100.00% Impervious Runoff Depth=44 mm  
 Tc=10.0 min C=1.00 Runoff=0.03991 m³/s 62.2 m³

**Subcatchment 32S: Uncontrolled** Runoff Area=0.0176 ha 51.14% Impervious Runoff Depth=36 mm  
 Tc=10.0 min C=0.82 Runoff=0.00406 m³/s 6.3 m³

**Pond 33P: Underground Storage** Peak Elev=56.571 m Storage=34.1 m³ Inflow=0.03991 m³/s 62.2 m³  
 Outflow=0.01727 m³/s 62.2 m³

**Link 34L: Outfall** Inflow=0.02082 m³/s 68.6 m³  
 Primary=0.02082 m³/s 68.6 m³

**Total Runoff Area = 1,596.0 m² Runoff Volume = 68.6 m³ Average Runoff Depth = 43 mm**  
**5.39% Pervious = 86.0 m² 94.61% Impervious = 1,510.0 m²**

**Summary for Subcatchment 31S: Controlled**

Runoff = 0.03991 m³/s @ 0.17 hrs, Volume= 62.2 m³, Depth= 44 mm

Runoff by Rational method, Rise/Fall=1.0/1.0 xTc, Time Span= 0.00-4.00 hrs, dt= 0.01 hrs  
 Ottawa\_+4hr25mm 100-Year Duration=26 min, Inten=101.2 mm/hr

Area (ha)	C	Description
0.1200	1.00	B01
0.0220	1.00	B02
0.1420	1.00	Weighted Average
0.1420		100.00% Impervious Area

Tc (min)	Length (meters)	Slope (m/m)	Velocity (m/sec)	Capacity (m³/s)	Description
10.0					Direct Entry,

**Subcatchment 31S: Controlled**

Hydrograph

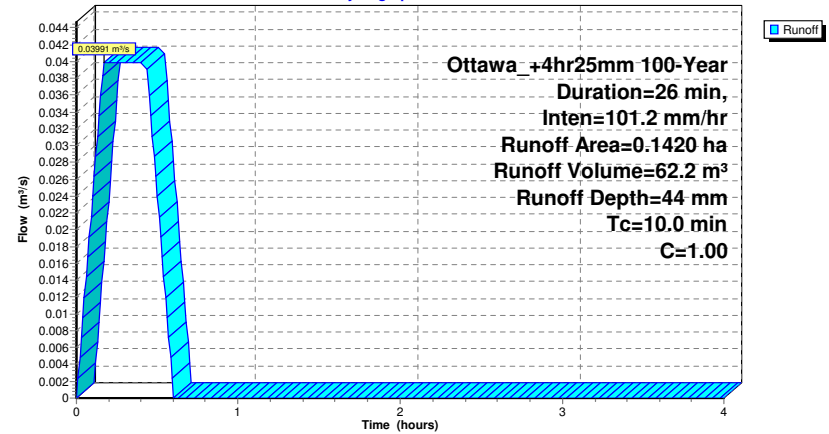

**Summary for Subcatchment 32S: Uncontrolled**

Runoff = 0.00406 m³/s @ 0.17 hrs, Volume= 6.3 m³, Depth= 36 mm

Runoff by Rational method, Rise/Fall=1.0/1.0 xTc, Time Span= 0.00-4.00 hrs, dt= 0.01 hrs  
 Ottawa\_+4hr25mm 100-Year Duration=26 min, Inten=101.2 mm/hr

Area (ha)	C	Description
0.0086	0.64	B03
0.0090	1.00	B04
0.0176	0.82	Weighted Average
0.0086		48.86% Pervious Area
0.0090		51.14% Impervious Area

Tc (min)	Length (meters)	Slope (m/m)	Velocity (m/sec)	Capacity (m³/s)	Description
10.0					Direct Entry,

**Subcatchment 32S: Uncontrolled**

Hydrograph

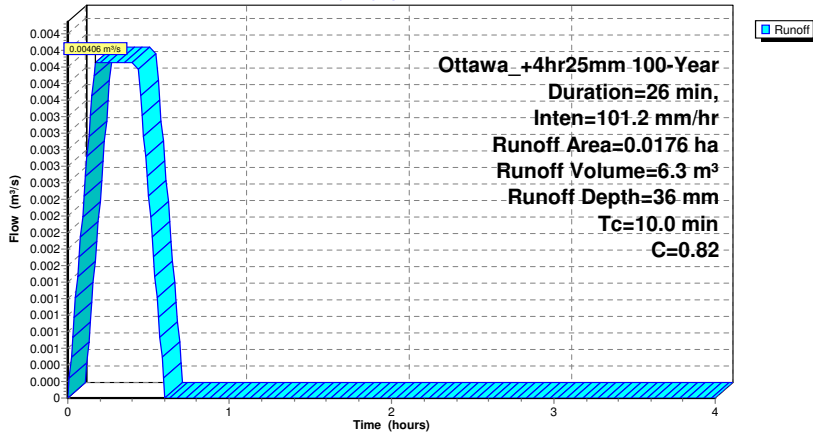

**Summary for Pond 33P: Underground Storage**

[44] Hint: Outlet device #1 is below defined storage

Inflow Area = 1,420.0 m², 100.00% Impervious, Inflow Depth = 44 mm for 100-Year event  
 Inflow = 0.03991 m³/s @ 0.17 hrs, Volume= 62.2 m³  
 Outflow = 0.01727 m³/s @ 0.53 hrs, Volume= 62.2 m³, Atten= 57%, Lag= 21.5 min  
 Primary = 0.01727 m³/s @ 0.53 hrs, Volume= 62.2 m³

Routing by Stor-Ind method, Time Span= 0.00-4.00 hrs, dt= 0.01 hrs  
 Peak Elev= 56.571 m @ 0.53 hrs Surf.Area= 22.0 m² Storage= 34.1 m³

Plug-Flow detention time= 19.2 min calculated for 62.1 m³ (100% of inflow)  
 Center-of-Mass det. time= 19.3 min ( 37.3 - 18.0 )

Volume	Invert	Avail.Storage	Storage Description
#1	55.020 m	44.0 m³	Custom Stage Data (Prismatic) Listed below
Elevation (meters)	Surf.Area (sq-meters)	Inc.Store (cubic-meters)	Cum.Store (cubic-meters)
55.020	22.0	0.0	0.0
57.020	22.0	44.0	44.0

Device	Routing	Invert	Outlet Devices
#1	Primary	53.174 m	<b>HYDROVEX 100-VHV-1 X 0.90</b> Head (meters) 0.000 0.200 0.500 1.000 1.500 2.000 3.000 4.000 6.000 Disch. (m³/s) 0.000000 0.000100 0.007000 0.010500 0.012500 0.014000 0.018000 0.021000 0.026000

Primary OutFlow Max=0.01727 m³/s @ 0.53 hrs HW=56.570 m (Free Discharge)  
 #1=HYDROVEX 100-VHV-1 (Custom Controls 0.01727 m³/s)

**Pond 33P: Underground Storage**

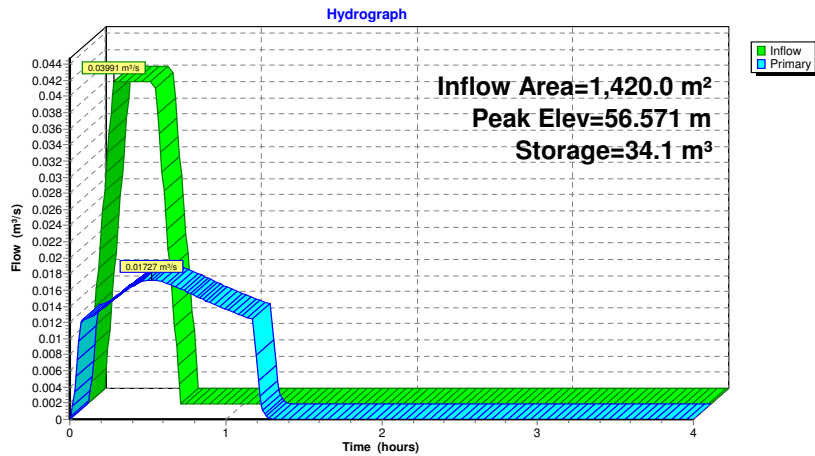

**Summary for Link 34L: Outfall**

Inflow Area = 1,596.0 m<sup>2</sup>, 94.61% Impervious, Inflow Depth = 43 mm for 100-Year event  
 Inflow = 0.02082 m<sup>3</sup>/s @ 0.43 hrs, Volume= 68.6 m<sup>3</sup>  
 Primary = 0.02082 m<sup>3</sup>/s @ 0.43 hrs, Volume= 68.6 m<sup>3</sup>, Atten=0%, Lag= 0.0 min

Primary outflow = Inflow, Time Span= 0.00-4.00 hrs, dt= 0.01 hrs

**Link 34L: Outfall**

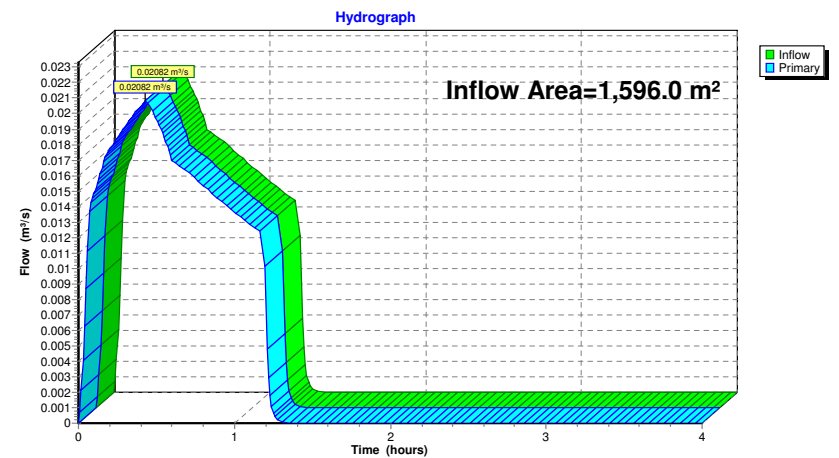

# APPENDIX

# D

OGS Sizing



## Stormceptor® EF Sizing Report

### STORMCEPTOR® ESTIMATED NET ANNUAL SEDIMENT (TSS) LOAD REDUCTION

07/22/2021

Province:	Ontario
City:	Ottawa
Nearest Rainfall Station:	OTTAWA MACDONALD-CARTIER INT'L AP
NCDC Rainfall Station Id:	6000
Years of Rainfall Data:	37

Project Name:	275 King Edward Ave
Project Number:	211-07007-00
Designer Name:	Kathryn Kerker
Designer Company:	WSP
Designer Email:	kathryn.kerker@wsp.com
Designer Phone:	613-690-1206
EOR Name:	
EOR Company:	
EOR Email:	
EOR Phone:	

Site Name:	
------------	--

Drainage Area (ha):	0.14
% Imperviousness:	100.00

Runoff Coefficient 'c': 0.90

Particle Size Distribution:	Fine
Target TSS Removal (%):	80.0

Required Water Quality Runoff Volume Capture (%):	90.00
Estimated Water Quality Flow Rate (L/s):	4.55
Oil / Fuel Spill Risk Site?	Yes
Upstream Flow Control?	Yes
Upstream Orifice Control Flow Rate to Stormceptor (L/s):	17.30
Peak Conveyance (maximum) Flow Rate (L/s):	
Site Sediment Transport Rate (kg/ha/yr):	

Net Annual Sediment (TSS) Load Reduction Sizing Summary	
Stormceptor Model	TSS Removal Provided (%)
EFO4	88
EFO6	91
EFO8	92
EFO10	93
EFO12	93

<b>Recommended Stormceptor EFO Model:</b>	<b>EFO4</b>
<b>Estimated Net Annual Sediment (TSS) Load Reduction (%):</b>	<b>88</b>
<b>Water Quality Runoff Volume Capture (%):</b>	<b>&gt; 90</b>

## Stormceptor® EF Sizing Report

### THIRD-PARTY TESTING AND VERIFICATION

► **Stormceptor® EF and Stormceptor® EFO** are the latest evolutions in the Stormceptor® oil-grit separator (OGS) technology series, and are designed to remove a wide variety of pollutants from stormwater and snowmelt runoff. These technologies have been third-party tested in accordance with the Canadian ETV **Procedure for Laboratory Testing of Oil-Grit Separators** and performance has been third-party verified in accordance with the **ISO 14034 Environmental Technology Verification (ETV)** protocol.

### PERFORMANCE

► **Stormceptor® EF and EFO** remove stormwater pollutants through gravity separation and floatation, and feature a patent-pending design that generates positive removal of total suspended solids (TSS) throughout each storm event, including high-intensity storms. Captured pollutants include sediment, free oils, and sediment-bound pollutants such as nutrients, heavy metals, and petroleum hydrocarbons. Stormceptor is sized to remove a high level of TSS from the frequent rainfall events that contribute the vast majority of annual runoff volume and pollutant load. The technology incorporates an internal bypass to convey excessive stormwater flows from high-intensity storms through the device without resuspension and washout (scour) of previously captured pollutants. Proper routine maintenance ensures high pollutant removal performance and protection of downstream waterways.

### PARTICLE SIZE DISTRIBUTION (PSD)

► The **Canadian ETV PSD** shown in the table below was used, or in part, for this sizing. This is the identical PSD that is referenced in the Canadian ETV **Procedure for Laboratory Testing of Oil-Grit Separators** for both sediment removal testing and scour testing. The Canadian ETV PSD contains a wide range of particle sizes in the sand and silt fractions, and is considered reasonably representative of the particle size fractions found in typical urban stormwater runoff.

Particle Size (µm)	Percent Less Than	Particle Size Fraction (µm)	Percent
1000	100	500-1000	5
500	95	250-500	5
250	90	150-250	15
150	75	100-150	15
100	60	75-100	10
75	50	50-75	5
50	45	20-50	10
20	35	8-20	15
8	20	5-8	10
5	10	2-5	5
2	5	<2	5

## Stormceptor<sup>®</sup> EF Sizing Report

### Upstream Flow Controlled Results

Rainfall Intensity (mm / hr)	Percent Rainfall Volume (%)	Cumulative Rainfall Volume (%)	Flow Rate (L/s)	Flow Rate (L/min)	Surface Loading Rate (L/min/m <sup>2</sup> )	Removal Efficiency (%)	Incremental Removal (%)	Cumulative Removal (%)
1	51.3	51.3	0.35	21.0	18.0	93	47.7	47.7
2	8.7	60.0	0.70	42.0	35.0	93	8.1	55.8
3	5.8	65.8	1.05	63.0	53.0	92	5.3	61.1
4	4.6	70.4	1.40	84.0	70.0	90	4.1	65.3
5	4.2	74.6	1.75	105.0	88.0	89	3.7	69.0
6	3.2	77.8	2.10	126.0	105.0	87	2.8	71.8
7	2.6	80.4	2.45	147.0	123.0	85	2.2	74.0
8	2.4	82.8	2.80	168.0	140.0	83	2.0	76.0
9	1.9	84.7	3.15	189.0	158.0	81	1.5	77.5
10	1.6	86.3	3.50	210.0	175.0	79	1.3	78.8
11	1.3	87.6	3.85	231.0	193.0	77	1.0	79.8
12	1.1	88.7	4.20	252.0	210.0	75	0.8	80.6
13	1.3	90.0	4.55	273.0	228.0	74	1.0	81.6
14	1.1	91.1	4.90	294.0	245.0	72	0.8	82.4
15	0.6	91.7	5.25	315.0	263.0	71	0.4	82.8
16	0.8	92.5	5.60	336.0	280.0	69	0.6	83.4
17	0.7	93.2	5.95	357.0	298.0	68	0.5	83.8
18	0.5	93.7	6.31	378.0	315.0	66	0.3	84.2
19	0.6	94.3	6.66	399.0	333.0	64	0.4	84.5
20	0.5	94.8	7.01	420.0	350.0	63	0.3	84.9
21	0.2	95.0	7.36	441.0	368.0	62	0.1	85.0
22	0.4	95.4	7.71	462.0	385.0	60	0.2	85.2
23	0.5	95.9	8.06	483.0	403.0	58	0.3	85.5
24	0.4	96.3	8.41	504.0	420.0	57	0.2	85.7
25	0.1	96.4	8.76	525.0	438.0	57	0.1	85.8

## Stormceptor<sup>®</sup> EF Sizing Report

Rainfall Intensity (mm / hr)	Percent Rainfall Volume (%)	Cumulative Rainfall Volume (%)	Flow Rate (L/s)	Flow Rate (L/min)	Surface Loading Rate (L/min/m <sup>2</sup> )	Removal Efficiency (%)	Incremental Removal (%)	Cumulative Removal (%)
26	0.3	96.7	9.11	546.0	455.0	57	0.2	86.0
27	0.4	97.1	9.46	567.0	473.0	56	0.2	86.2
28	0.2	97.3	9.81	588.0	490.0	55	0.1	86.3
29	0.2	97.5	10.16	609.0	508.0	55	0.1	86.4
30	0.2	97.7	10.51	631.0	525.0	54	0.1	86.5
31	0.1	97.8	10.86	652.0	543.0	54	0.1	86.6
32	0.2	98.0	11.21	673.0	560.0	53	0.1	86.7
33	0.1	98.1	11.56	694.0	578.0	53	0.1	86.7
34	0.1	98.2	11.91	715.0	595.0	52	0.1	86.8
35	0.1	98.3	12.26	736.0	613.0	52	0.1	86.8
36	0.2	98.5	12.61	757.0	631.0	52	0.1	86.9
37	1.5	100.0	12.96	778.0	648.0	52	0.8	87.7
38	0.1	100.1	13.31	799.0	666.0	52	0.1	87.8
39	0.1	100.2	13.66	820.0	683.0	52	0.1	87.8
40	0.1	100.3	14.01	841.0	701.0	52	0.1	87.9
41	0.1	100.4	14.36	862.0	718.0	51	0.1	87.9
42	0.1	100.5	14.71	883.0	736.0	51	0.1	88.0
43	0.2	100.7	15.06	904.0	753.0	51	0.1	88.1
44	0.1	100.8	15.41	925.0	771.0	51	0.1	88.1
45	0.1	100.9	15.76	946.0	788.0	51	0.1	88.2
46	-0.9	100.0	16.11	967.0	806.0	51	N/A	87.7
47	0.1	100.1	16.46	988.0	823.0	51	0.1	87.8
48	-0.1	100.0	16.81	1009.0	841.0	51	N/A	87.7
49	0.0	100.0	17.00	1020.0	850.0	51	0.0	87.7
50	0.0	100.0	17.00	1020.0	850.0	51	0.0	87.7
<b>Estimated Net Annual Sediment (TSS) Load Reduction =</b>								<b>88 %</b>



**Stormceptor® EF Sizing Report**

**RAINFALL DATA FROM OTTAWA MACDONALD-CARTIER INT'L AP RAINFALL STATION**

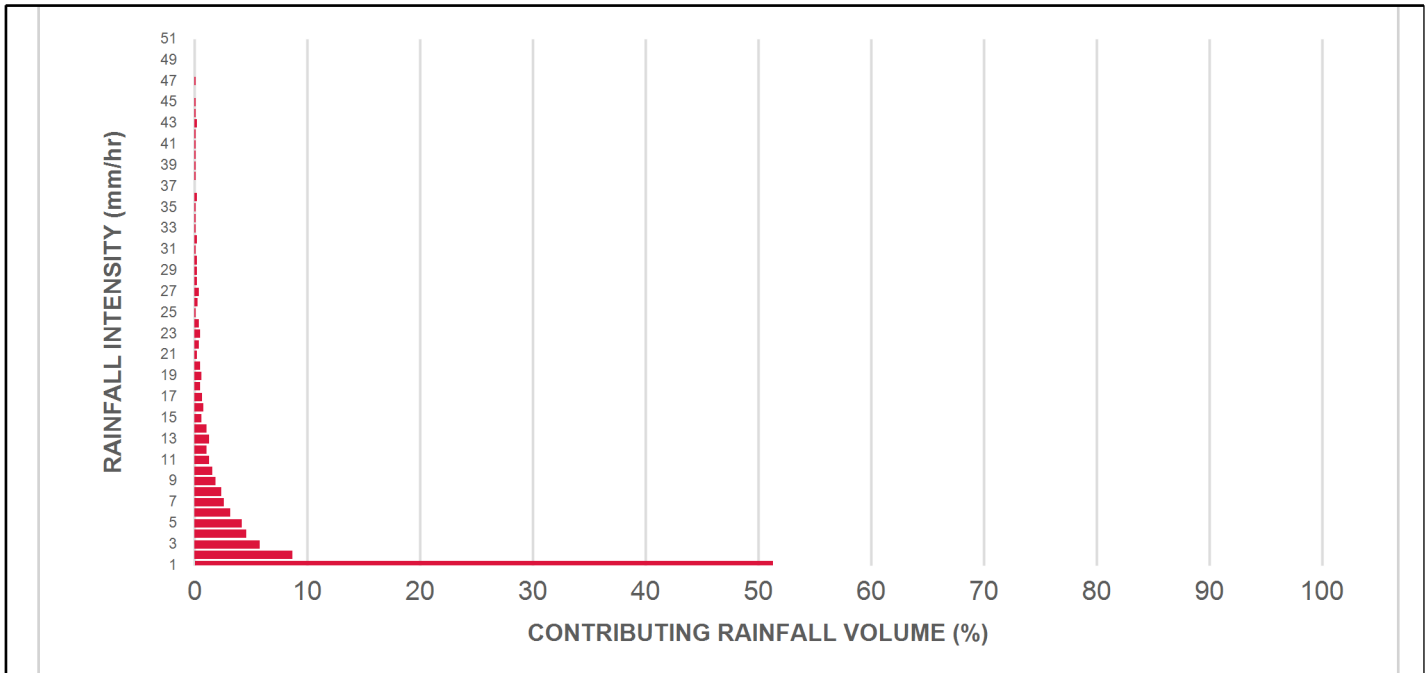

**INCREMENTAL AND CUMULATIVE TSS REMOVAL FOR THE RECOMMENDED STORMCEPTOR® MODEL**

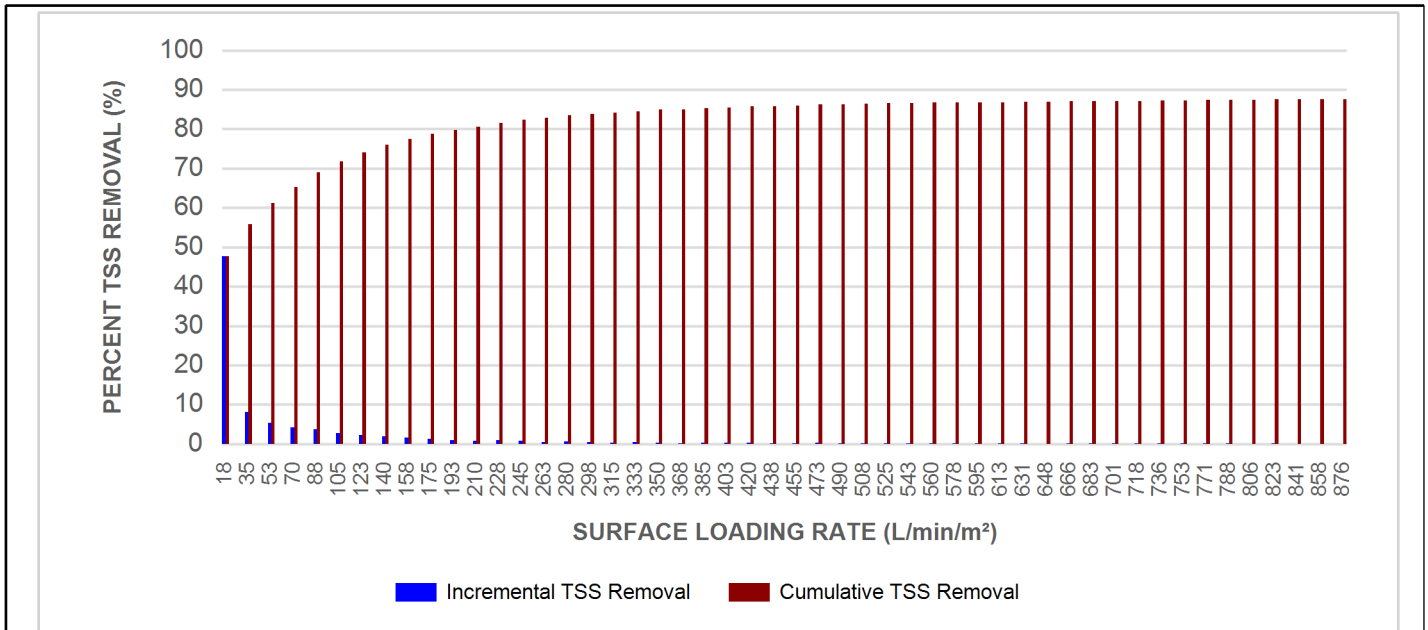

## Stormceptor® EF Sizing Report

### Maximum Pipe Diameter / Peak Conveyance

Stormceptor EF / EFO	Model Diameter		Min Angle Inlet / Outlet Pipes	Max Inlet Pipe Diameter		Max Outlet Pipe Diameter		Peak Conveyance Flow Rate	
	(m)	(ft)		(mm)	(in)	(mm)	(in)	(L/s)	(cfs)
EF4 / EFO4	1.2	4	90	609	24	609	24	425	15
EF6 / EFO6	1.8	6	90	914	36	914	36	990	35
EF8 / EFO8	2.4	8	90	1219	48	1219	48	1700	60
EF10 / EFO10	3.0	10	90	1828	72	1828	72	2830	100
EF12 / EFO12	3.6	12	90	1828	72	1828	72	2830	100

### SCOUR PREVENTION AND ONLINE CONFIGURATION

► **Stormceptor® EF and EFO** feature an internal bypass and superior scour prevention technology that have been demonstrated in third-party testing according to the scour testing provisions of the Canadian ETV **Procedure for Laboratory Testing of Oil-Grit Separators**, and the exceptional scour test performance has been third-party verified in accordance with the ISO 14034 ETV protocol. As a result, Stormceptor EF and EFO are approved for online installation, eliminating the need for costly additional bypass structures, piping, and installation expense.

### DESIGN FLEXIBILITY

► **Stormceptor® EF and EFO** offers design flexibility in one simplified platform, accepting stormwater flow from a single inlet pipe or multiple inlet pipes, and/or surface runoff through an inlet grate. The device can also serve as a junction structure, accommodate a 90-degree inlet-to-outlet bend angle, and can be modified to ensure performance in submerged conditions.

### OIL CAPTURE AND RETENTION

► While Stormceptor® EF will capture and retain oil from dry weather spills and low intensity runoff, **Stormceptor® EFO** has demonstrated superior oil capture and greater than 99% oil retention in third-party testing according to the light liquid re-entrainment testing provisions of the Canadian ETV **Procedure for Laboratory Testing of Oil-Grit Separators**. Stormceptor EFO is recommended for sites where oil capture and retention is a requirement.

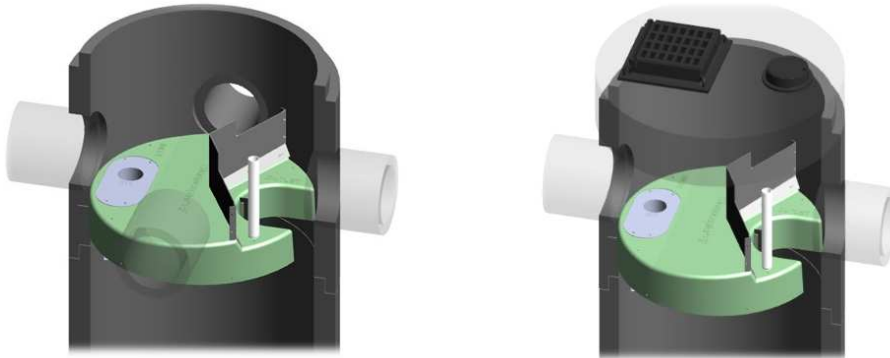

## Stormceptor<sup>®</sup> EF Sizing Report

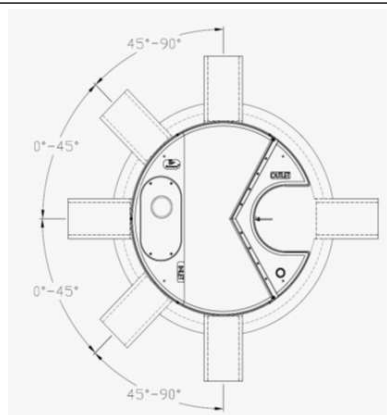

### INLET-TO-OUTLET DROP

Elevation differential between inlet and outlet pipe inverts is dictated by the angle at which the inlet pipe(s) enters the unit.

0° - 45° : The inlet pipe is 1-inch (25mm) higher than the outlet pipe.

45° - 90° : The inlet pipe is 2-inches (50mm) higher than the outlet pipe.

### HEAD LOSS

The head loss through Stormceptor EF is similar to that of a 60-degree bend structure. The applicable K value for calculating minor losses through the unit is 1.1.

For submerged conditions the applicable K value is 3.0.

### Pollutant Capacity

Stormceptor EF / EFO	Model Diameter		Depth (Outlet Pipe Invert to Sump Floor)		Oil Volume		Recommended Sediment Maintenance Depth *		Maximum Sediment Volume *		Maximum Sediment Mass **	
	(m)	(ft)	(m)	(ft)	(L)	(Gal)	(mm)	(in)	(L)	(ft <sup>3</sup> )	(kg)	(lb)
EF4 / EFO4	1.2	4	1.52	5.0	265	70	203	8	1190	42	1904	5250
EF6 / EFO6	1.8	6	1.93	6.3	610	160	305	12	3470	123	5552	15375
EF8 / EFO8	2.4	8	2.59	8.5	1070	280	610	24	8780	310	14048	38750
EF10 / EFO10	3.0	10	3.25	10.7	1670	440	610	24	17790	628	28464	78500
EF12 / EFO12	3.6	12	3.89	12.8	2475	655	610	24	31220	1103	49952	137875

\*Increased sump depth may be added to increase sediment storage capacity

\*\* Average density of wet packed sediment in sump = 1.6 kg/L (100 lb/ft<sup>3</sup>)

Feature	Benefit	Feature Appeals To
Patent-pending enhanced flow treatment and scour prevention technology	Superior, verified third-party performance	Regulator, Specifying & Design Engineer
Third-party verified light liquid capture and retention for EFO version	Proven performance for fuel/oil hotspot locations	Regulator, Specifying & Design Engineer, Site Owner
Functions as bend, junction or inlet structure	Design flexibility	Specifying & Design Engineer
Minimal drop between inlet and outlet	Site installation ease	Contractor
Large diameter outlet riser for inspection and maintenance	Easy maintenance access from grade	Maintenance Contractor & Site Owner

### STANDARD STORMCEPTOR EF/EFO DRAWINGS

For standard details, please visit <http://www.imbriumsystems.com/stormwater-treatment-solutions/stormceptor-ef>

### STANDARD STORMCEPTOR EF/EFO SPECIFICATION

For specifications, please visit <http://www.imbriumsystems.com/stormwater-treatment-solutions/stormceptor-ef>

## Stormceptor<sup>®</sup> EF Sizing Report

### STANDARD PERFORMANCE SPECIFICATION FOR “OIL GRIT SEPARATOR” (OGS) STORMWATER QUALITY TREATMENT DEVICE

#### PART 1 – GENERAL

##### 1.1 WORK INCLUDED

This section specifies requirements for selecting, sizing, and designing an underground Oil Grit Separator (OGS) device for stormwater quality treatment, with third-party testing results and a Statement of Verification in accordance with ISO 14034 Environmental Management – Environmental Technology Verification (ETV).

##### 1.2 REFERENCE STANDARDS & PROCEDURES

ISO 14034:2016 Environmental management – Environmental technology verification (ETV)

Canadian Environmental Technology Verification (ETV) Program’s **Procedure for Laboratory Testing of Oil-Grit Separators**

##### 1.3 SUBMITTALS

1.3.1 All submittals, including sizing reports & shop drawings, shall be submitted upon request with each order to the contractor then forwarded to the Engineer of Record for review and acceptance. Shop drawings shall detail all OGS components, elevations, and sequence of construction.

1.3.2 Alternative devices shall have features identical to or greater than the specified device, including: treatment chamber diameter, treatment chamber wet volume, sediment storage volume, and oil storage volume.

1.3.3 Unless directed otherwise by the Engineer of Record, OGS stormwater quality treatment product substitutions or alternatives submitted within ten days prior to project bid shall not be accepted. All alternatives or substitutions submitted shall be signed and sealed by a local registered Professional Engineer, based on the exact same criteria detailed in Section 3, in entirety, subject to review and approval by the Engineer of Record.

#### PART 2 – PRODUCTS

##### 2.1 OGS POLLUTANT STORAGE

The OGS device shall include a sump for sediment storage, and a protected volume for the capture and storage of petroleum hydrocarbons and buoyant gross pollutants. The minimum sediment & petroleum hydrocarbon storage capacity shall be as follows:

2.1.1	4 ft (1219 mm) Diameter OGS Units:	1.19 m <sup>3</sup> sediment / 265 L oil
	6 ft (1829 mm) Diameter OGS Units:	3.48 m <sup>3</sup> sediment / 609 L oil
	8 ft (2438 mm) Diameter OGS Units:	8.78 m <sup>3</sup> sediment / 1,071 L oil
	10 ft (3048 mm) Diameter OGS Units:	17.78 m <sup>3</sup> sediment / 1,673 L oil
	12 ft (3657 mm) Diameter OGS Units:	31.23 m <sup>3</sup> sediment / 2,476 L oil

#### PART 3 – PERFORMANCE & DESIGN

##### 3.1 GENERAL

The OGS stormwater quality treatment device shall be verified in accordance with ISO 14034:2016 Environmental management – Environmental technology verification (ETV). The OGS stormwater quality treatment device shall

## Stormceptor<sup>®</sup> EF Sizing Report

remove oil, sediment and gross pollutants from stormwater runoff during frequent wet weather events, and retain these pollutants during less frequent high flow wet weather events below the insert within the OGS for later removal during maintenance. The Manufacturer shall have at least ten (10) years of local experience, history and success in engineering design, manufacturing and production and supply of OGS stormwater quality treatment device systems, acceptable to the Engineer of Record.

### 3.2 SIZING METHODOLOGY

The OGS device shall be engineered, designed and sized to provide stormwater quality treatment based on treating a minimum of 90 percent of the average annual runoff volume and a minimum removal of an annual average 60% of the sediment (TSS) load based on the Particle Size Distribution (PSD) specified in the sizing report for the specified device. Sizing shall be determined using historical rainfall data and a sediment removal performance curve derived from the actual third-party verified laboratory testing data. The OGS device shall also have sufficient annual sediment storage capacity as specified and calculated in Section 2.1.

### 3.3 CANADIAN ETV or ISO 14034 ETV VERIFICATION OF SCOUR TESTING

The OGS device shall have Canadian ETV or ISO 14034 ETV Verification of third-party scour testing conducted in accordance with the Canadian ETV Program's **Procedure for Laboratory Testing of Oil-Grit Separators**.

3.3.1 To be acceptable for on-line installation, the OGS device must demonstrate an average scour test effluent concentration less than 10 mg/L at each surface loading rate tested, up to and including 2600 L/min/m<sup>2</sup>.

### 3.4 LIGHT LIQUID RE-ENTRAINMENT SIMULATION TESTING

The OGS device shall have Canadian ETV or ISO 14034 ETV Verification of completed third-party Light Liquid Re-entrainment Simulation Testing in accordance with the Canadian ETV **Program's Procedure for Laboratory Testing of Oil-Grit Separators**, with results reported within the Canadian ETV or ISO 14034 ETV verification. This re-entrainment testing is conducted with the device pre-loaded with low density polyethylene (LDPE) plastic beads as a surrogate for light liquids such as oil and fuel. Testing is conducted on the same OGS unit tested for sediment removal to assess whether light liquids captured after a spill are effectively retained at high flow rates.

3.4.1 For an OGS device to be an acceptable stormwater treatment device on a site where vehicular traffic occurs and the potential for an oil or fuel spill exists, the OGS device must have reported verified performance results of greater than 99% cumulative retention of LDPE plastic beads for the five specified surface loading rates (ranging 200 L/min/m<sup>2</sup> to 2600 L/min/m<sup>2</sup>) in accordance with the Light Liquid Re-entrainment Simulation Testing within the Canadian ETV Program's **Procedure for Laboratory Testing of Oil-Grit Separators**. However, an OGS device shall not be allowed if the Light Liquid Re-entrainment Simulation Testing was performed with screening components within the OGS device that are effective at retaining the LDPE plastic beads, but would not be expected to retain light liquids such as oil and fuel.