

Crowne Pointe Plaza Phase 3

TIA Strategy Report

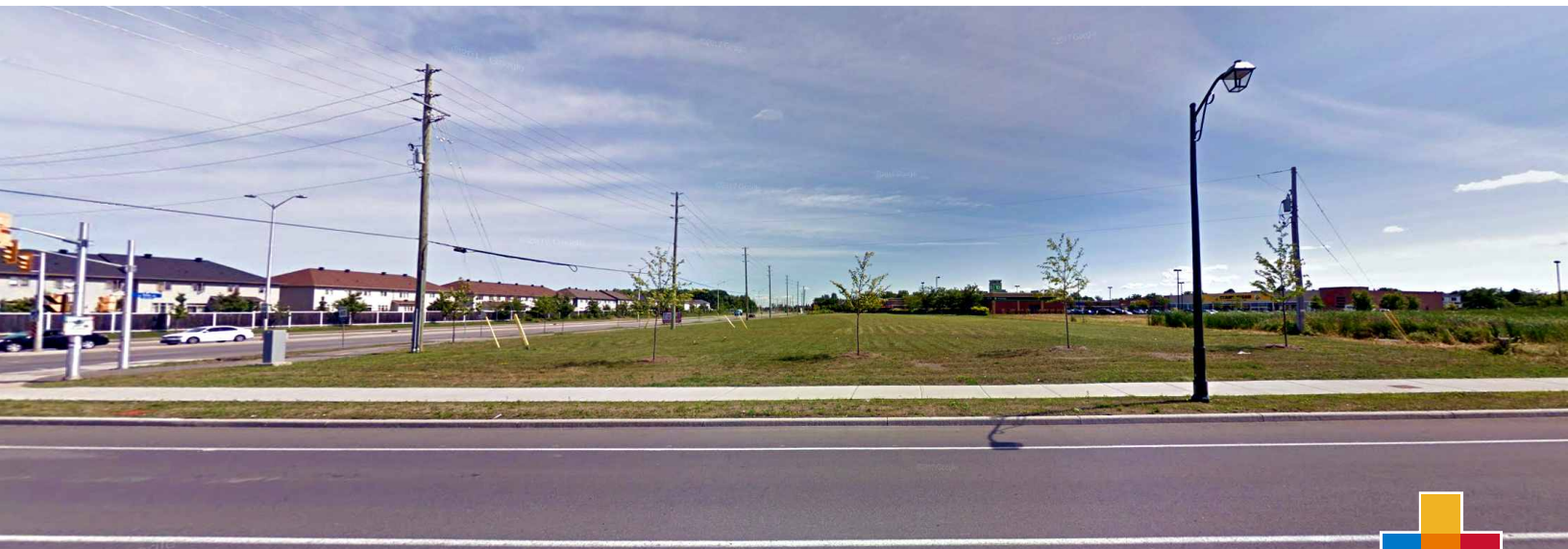

Crown Pointe Plaza Phase 3

Updated TIA Strategy Report

prepared for:
Taggart Realty Management
225 Metcalfe Street, Suite 708
Ottawa, Ontario
K2P 1P9

prepared by:
PARSONS
1223 Michael Street
Suite 100
Ottawa, ON K1J 7T2

October 29, 2021

478034-01000

TABLE OF CONTENTS

1.	SCREENING FORM	1
2.	SCOPING REPORT	1
2.1.	DESCRIPTION OF PROPOSED DEVELOPMENT	1
2.1.1.	PROPOSED DEVELOPMENT	1
2.1.2.	EXISTING CONDITIONS	3
2.1.3.	PLANNED CONDITIONS	9
2.2.	STUDY AREA AND TIME PERIODS	9
2.2.1.	STUDY AREA	9
2.2.2.	TIME PERIODS	10
2.2.3.	HORIZON YEARS	10
2.3.	EXEMPTIONS REVIEW	10
3.	FORECASTING	10
3.1.	DEVELOPMENT GENERATED TRAVEL DEMAND	10
3.1.1.	TRIP GENERATION AND MODE SHARES	10
3.1.2.	MODE SHARES	11
3.1.3.	TRIP DISTRIBUTION	12
3.1.4.	TRIP ASSIGNMENT	12
3.2.	BACKGROUND NETWORK TRAVEL DEMANDS	15
3.2.1.	TRANSPORTATION NETWORK PLANS	15
3.2.2.	BACKGROUND GROWTH	3
3.2.3.	OTHER AREA DEVELOPMENT	4
4.	ANALYSIS	5
4.1.	DEVELOPMENT DESIGN	5
4.1.1.	DESIGN FOR SUSTAINABLE MODES	5
4.1.2.	CIRCULATION AND ACCESS	5
4.2.	PARKING	5
4.2.1.	PARKING SUPPLY	5
4.3.	BOUNDARY STREET DESIGN	6
4.4.	ACCESS INTERSECTION DESIGN	7
4.4.1.	LOCATION AND DESIGN OF ACCESS	7
4.4.2.	INTERSECTION CONTROL AND DESIGN	7
4.5.	TRANSPORTATION DEMAND MANAGEMENT	7
4.6.	NEIGHBOURHOOD TRAFFIC MANAGEMENT	7
4.7.	TRANSIT	7
4.8.	REVIEW OF NETWORK CONCEPT	7
4.9.	INTERSECTION DESIGN	7
4.9.1.	INTERSECTION CONTROL	7
4.9.2.	INTERSECTION DESIGN	7
5.	FINDINGS, CONCLUSIONS AND RECOMMENDATIONS	13

LIST OF FIGURES

FIGURE 1: LOCAL CONTEXT 1

FIGURE 2: SITE PLAN 2

FIGURE 3: PEDESTRIAN NETWORK..... 3

FIGURE 4: CYCLING NETWORK..... 4

FIGURE 5: AREA TRANSIT NETWORK 5

FIGURE 6: EXISTING PEAK HOUR TRAFFIC VOLUMES 8

FIGURE 7: PERCENT ASSIGNMENT 13

FIGURE 8: SITE GENERATED TRIP VOLUMES 14

FIGURE 9: PASS-BY VOLUMES..... 15

FIGURE 10: 2031 AFFORDABLE NETWORK 2

FIGURE 11: 2031 NETWORK CONCEPT..... 2

FIGURE 12: 2022 FUTURE BACKGROUND TRAFFIC VOLUMES..... 3

FIGURE 13: 2027 FUTURE BACKGROUND TRAFFIC VOLUMES..... 4

FIGURE 14: TOTAL PROJECTED 2022 TRAFFIC VOLUMES 9

FIGURE 15: TOTAL PROJECTED 2027 TRAFFIC VOLUMES 11

LIST OF APPENDICES

APPENDIX A – SCREENING FORM AND CITY COMMENT RESPONSES

APPENDIX B – TRAFFIC DATA

APPENDIX C – SYNCHRO CAPACITY ANALYSIS: EXISTING CONDITIONS

APPENDIX D – COLLISION DATA

APPENDIX E – MMLOS

APPENDIX F – TRAFFIC WARRANTS

APPENDIX G – TDM CHECKLIST

APPENDIX H – SYNCHRO CAPACITY ANALYSIS: BACKGROUND 2022 CONDITIONS

APPENDIX I – SYNCHRO CAPACITY ANALYSIS: BACKGROUND 2027 CONDITIONS

APPENDIX J – SYNCHRO CAPACITY ANALYSIS: TOTAL PROJECTED 2022 CONDITIONS

APPENDIX K – SYNCHRO CAPACITY ANALYSIS: TOTAL PROJECTED 2027 CONDITIONS



TIA Plan Reports

On 14 June 2017, the Council of the City of Ottawa adopted new Transportation Impact Assessment (TIA) Guidelines. In adopting the guidelines, Council established a requirement for those preparing and delivering transportation impact assessments and reports to sign a letter of certification.

Individuals submitting TIA reports will be responsible for all aspects of development-related transportation assessment and reporting, and undertaking such work, in accordance and compliance with the City of Ottawa's Official Plan, the Transportation Master Plan and the Transportation Impact Assessment (2017) Guidelines.

By submitting the attached TIA report (and any associated documents) and signing this document, the individual acknowledges that s/he meets the four criteria listed below.

CERTIFICATION

1. I have reviewed and have a sound understanding of the objectives, needs and requirements of the City of Ottawa's Official Plan, Transportation Master Plan and the Transportation Impact Assessment (2017) Guidelines;
2. I have a sound knowledge of industry standard practice with respect to the preparation of transportation impact assessment reports, including multi modal level of service review;
3. I have substantial experience (more than 5 years) in undertaking and delivering transportation impact studies (analysis, reporting and geometric design) with strong background knowledge in transportation planning, engineering or traffic operations; and
4. I am either a licensed¹ or registered² professional in good standing, whose field of expertise [check appropriate field(s)] is either transportation engineering or transportation planning .

1,2 License of registration body that oversees the profession is required to have a code of conduct and ethics guidelines that will ensure appropriate conduct and representation for transportation planning and/or transportation engineering works.

City Of Ottawa
Infrastructure Services and Community
Sustainability
Planning and Growth Management
110 Laurier Avenue West, 4th fl.
Ottawa, ON K1P 1J1
Tel. : 613-580-2424
Fax: 613-560-6006

Ville d'Ottawa
Services d'infrastructure et Viabilité
des collectivités
Urbanisme et Gestion de la
croissance 110, avenue Laurier
Ouest
Ottawa (Ontario) K1P
1J1 Tél. : 613-580-2424
Télécopieur: 613-560-6006

Dated at Ottawa this 29th day of October, 2021. (City)

Name: Matthew Mantle
(Please Print)

Professional Title: Transportation Engineer

Signature of Individual certifier that s/he meets the above four criteria

Office Contact Information (Please Print)
Address: 1223 Michael Street
City / Postal Code: Ottawa K1J 7T2
Telephone / Extension: 613 - 691 - 1528
E-Mail Address: matthew.mantle@parsons.com

Stamp

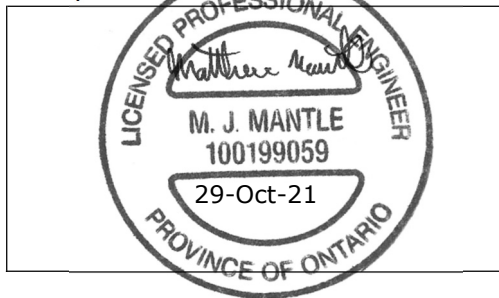

TIA Strategy Report

1. SCREENING FORM

The screening form was prepared for the subject development and included as part of the subsequent report. The screening form confirmed the need for a Transportation Impact Assessment (TIA) based on the Trip Generation and the safety trigger. The screening form is provided in Appendix A.

2. SCOPING REPORT

2.1. DESCRIPTION OF PROPOSED DEVELOPMENT

2.1.1. PROPOSED DEVELOPMENT

This study has been prepared as part of the Phase 3, Crown Pointe Plaza development located at the municipal address, 920 Watters Road. The subject site is proposed to include a drive-through restaurant and a grocery store and is expected to be fully constructed by 2022. The proposed development will have a total of four driveways with two existing connections to Trim Road, and one existing and one proposed access connecting to Watters Road.

Figure 1 shows the site location and the nearby road network, while Figure 2 shows the proposed site plan.

Figure 1: Local Context



Figure 2: Site Plan

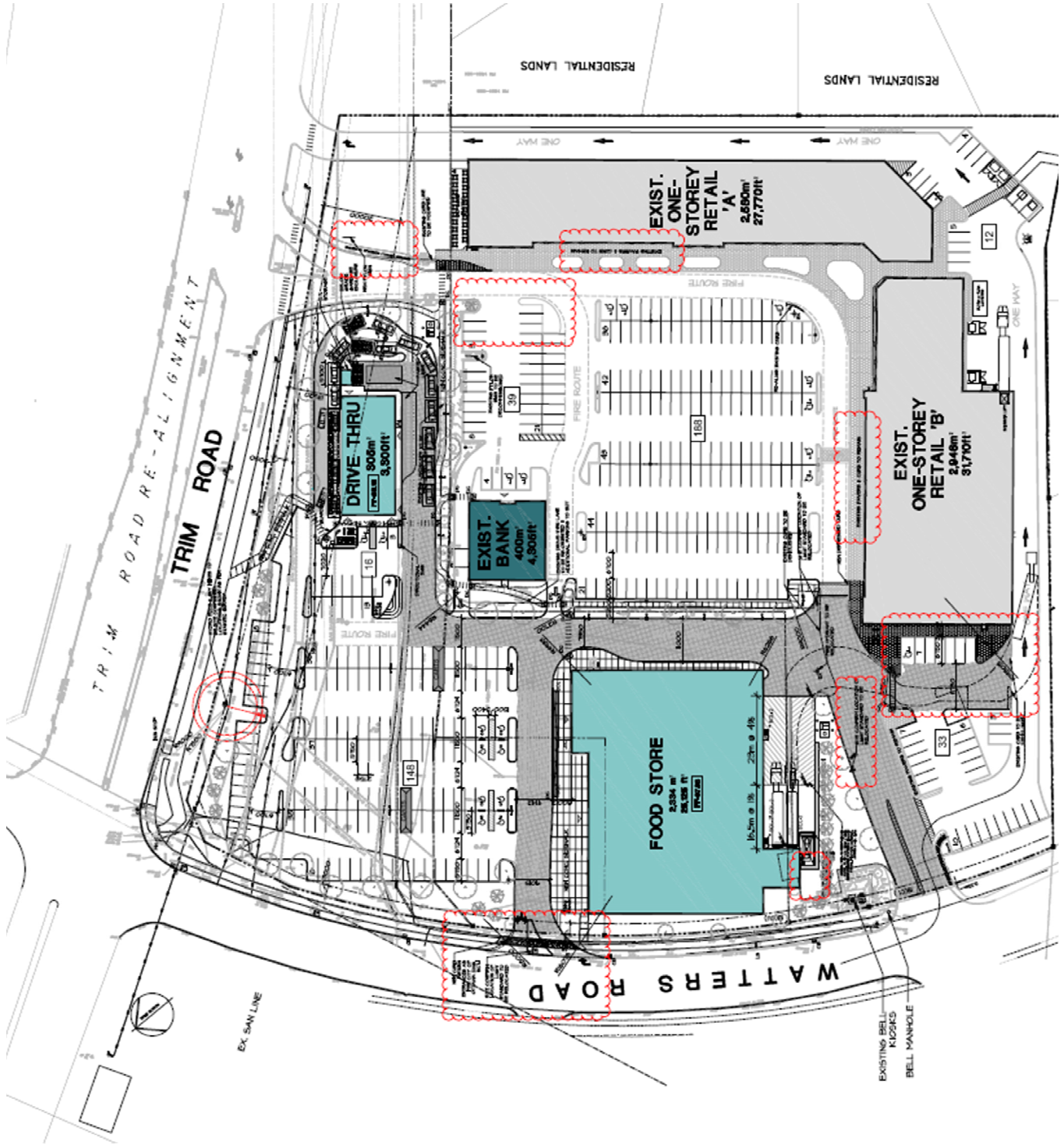

2.1.2. EXISTING CONDITIONS

AREA ROAD NETWORK

Trim Road is a north-south arterial road that runs from Petrie Island south through to a dead-end south of Perrault Road. Within the study area, Trim Road has two travel lanes and a cycle lane in each direction with a posted speed limit of 60km/h.

Watters Road is an east-west collector road that runs from Charlemagne Boulevard eastward past Trim Road where it dead ends and turns into a private driveway. The posted speed limit is 40km/h along the frontage of the proposed site. Watters Road is composed of one travel lane and bike lane in each direction.

LOCAL PESTRIAN FACILITES

The surrounding area to the proposed site, as shown in Figure 3, has access to several existing pedestrian facilities including concrete sidewalks, asphalt sidewalks and Multi-Use-Pathways (MUP). Within the study area, Trim Road currently provides pedestrians with a MUP on both the east and west sides of the road. Watters Road has concrete sidewalks provided on both sides of the roadway.

There are currently no additional planned pedestrian facilities identified on the Ottawa Pedestrian Plan (2013) within the vicinity of the site.

Figure 3: Pedestrian Network

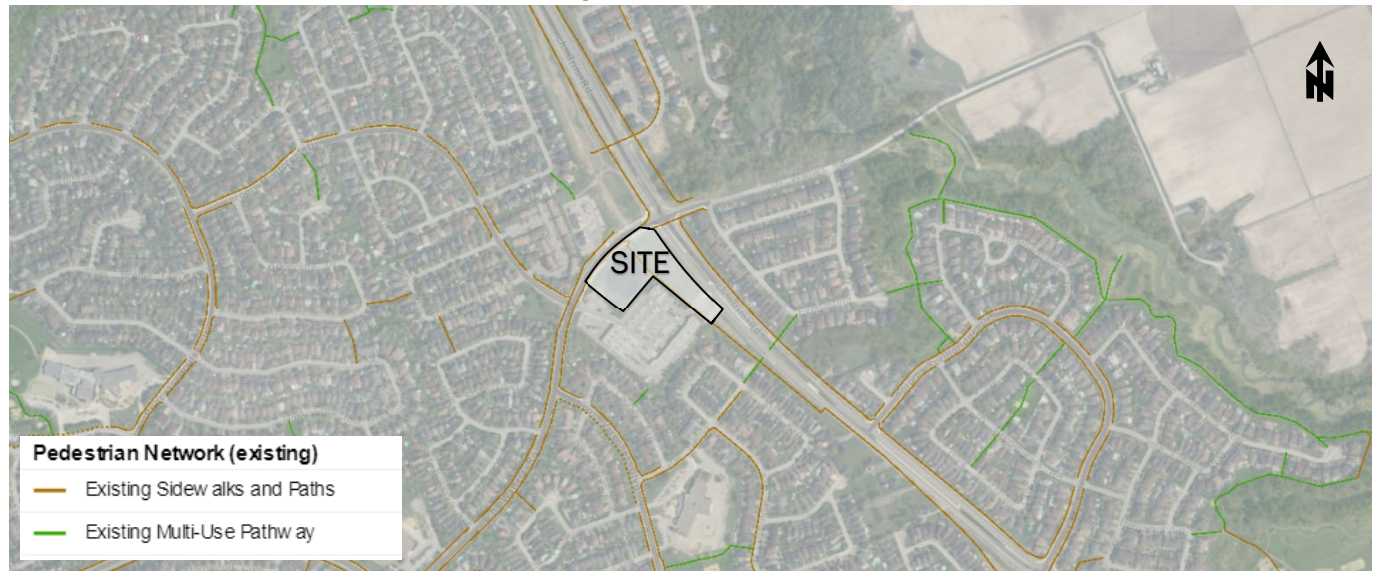

LOCAL CYCLING FACILITIES

The proposed site has several cycling facilities nearby, including Multi-Use Pathways (MUP) and cycle lanes, which are shown in Figure 4 below. The City of Ottawa's 2013 Cycling Plan identifies Trim Road as a 'Spine' Route and Watters Road as a 'Local' Route. Currently within the study area, Trim Road has a MUP on both the east and west sides of the road. Additionally, both Trim Road and Watters Road have cycling lanes in both directions.

Figure 4: Cycling Network

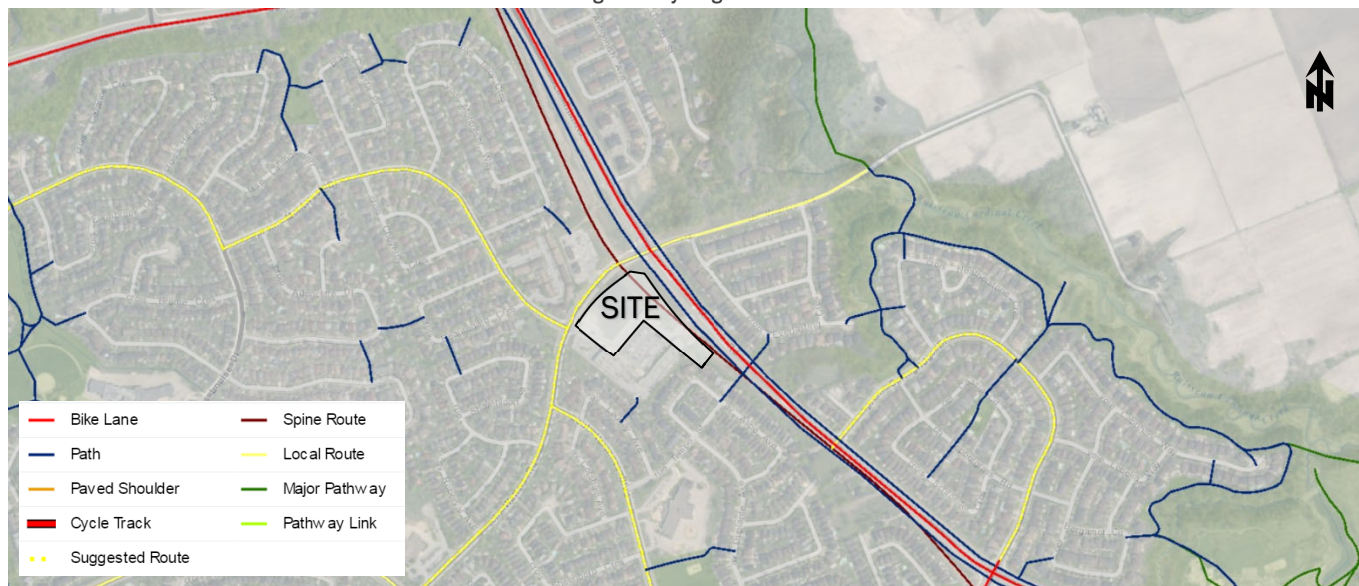

TRANSIT NETWORK

OC Transpo service currently has services running along the frontage of Crown Pointe Plaza on both Trim Road and Watters Road. The existing routes servicing the area are #33 and #39. Route #33 operates along Montcrest Drive and a small section of Watters Road and provide service at bus stops 6784 (southbound) and 2772 (northbound) on a 30-minute schedule during peak periods and up to an hour off-peak. Routes #39 operates along Trim Road and provides service at bus stops 3254 (southbound) and 3253 (northbound) on a 15-minute schedule during peak periods and 30-minute schedule off-peak.

It is also noted that approximately 1 km north of the site is the Trim Road BRT/park and ride station, which is included in the Stage 2 expansion of the LRT. Figure 5 illustrates the current system map.

Figure 5: Area Transit Network

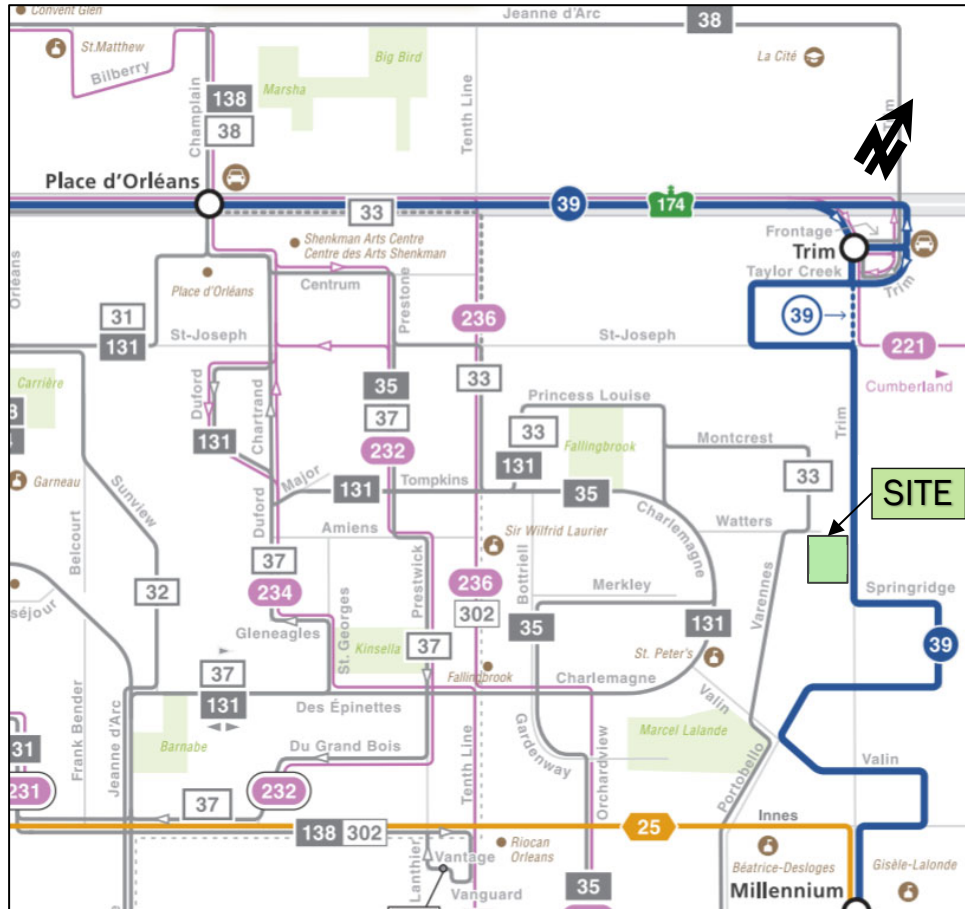

Retrieved on Oct. 28, 2021, <https://www.octranspo.com/images/files/maps/systemmap.pdf>

EXISTING STUDY AREA INTERSECTIONS

Trim/Watters

The Trim/Watters intersection is a signalized 4-legged intersection. Trim Road heading in the southbound and northbound directions consists of two through lanes, an auxiliary right-turn lane, an auxiliary left-turn lane and a cycle lane. Watters Road heading in either eastbound or westbound directions consists of a shared through/right-turn lane and auxiliary left-turn lane.

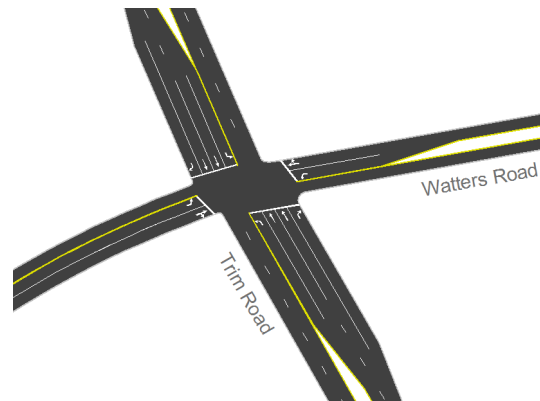

Trim/Crown Pointe Plaza Access 1

Trim/Access 1 intersection is an unsignalized T-intersection with stop control for vehicles leaving the Crown Pointe Plaza. Currently the intersection allows all movements in this access, but restricts movements heading eastbound (leaving) with a channelized right out. Trim Road heading southbound is composed of a through lane and a shared through/right-turn lane. Trim Road in the northbound direction is composed of two through lanes and an auxiliary left-turn lane.

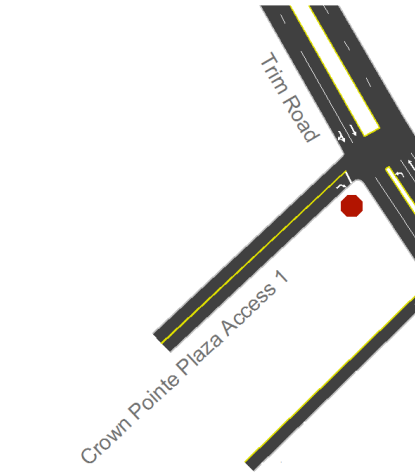

Trim/Crown Pointe Plaza Access 2

The intersection of Trim/Access 2 is an unsignalized intersection that functions as a right-out only. The driveway leaving the mall is stop controlled, and the two through lanes heading southbound are free-flow.

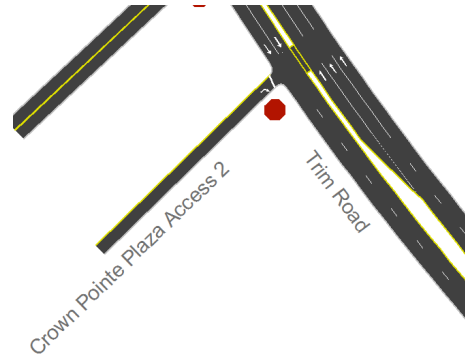

Trim/Portobello

The intersection of Trim/Portobello is a four-legged, signalized intersection. The north and south legs of Trim consist of two through lanes heading in either direction, an auxiliary left-turn lane and an auxiliary right-turn lane. The west leg (Portobello Boulevard) heading eastbound is composed of a single through lane, an auxiliary right-turn lane, an auxiliary right-turn lane and in the westbound direction there are two receiving lanes.

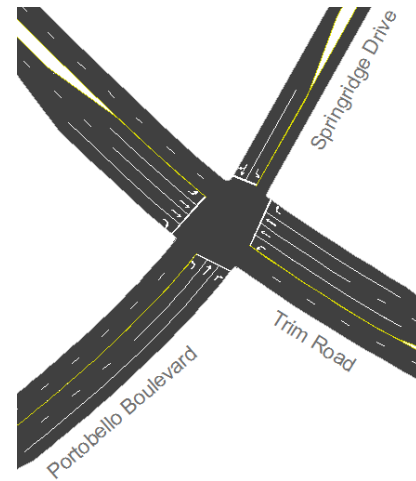

Watters/Montcrest

The intersection of Watters/Montcrest is a four-legged, unsignalized intersection. The east and west leg are composed of a single shared full-movement lane heading in both directions. The south leg is composed of a single full movement lane heading northbound. The north leg is composed of a single southbound full-movement lane.

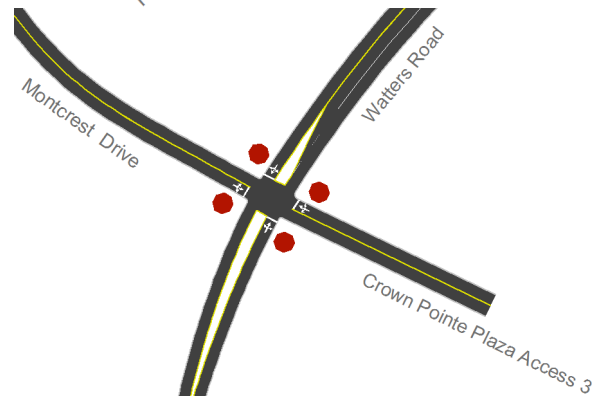

PARSONS

Watters/Charlemagne

Watters/Charlemagne intersection is a three-way stop controlled unsignalized T-intersection. The south leg of Charlemagne is comprised of a single through lane and a shared through right-turn lane heading northbound. The north leg of Charlemagne is composed of a single through lane and a shared through left-turn lane heading southbound. The east leg of Watters street is composed of a single shared left-turn/right-turn lane heading westbound.

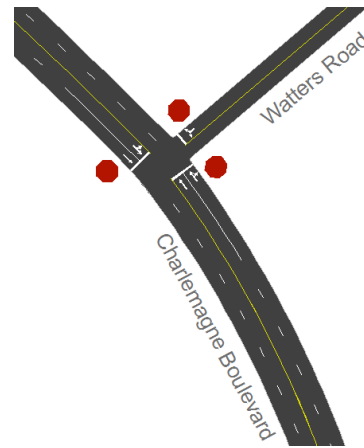

EXISTING INTERSECTION VOLUMES

To establish a baseline for the local traffic conditions, count data for the existing study area intersections were obtained from the City of Ottawa. The available data provided by the City is as follows:

- Trim Road at Watters Road (2019 – Weekday AM and PM peaks)
- Trim Road at Portobello Blvd/Springridge Dr S (2019 – Weekday AM and PM peaks)
- Watters Road at Charlemagne Boulevard (2015 – Weekday AM and PM peaks)

Due to the limited availability of recent count data for the study area, traffic counts were undertaken to supplement the count data at the following intersections:

- Trim Road at Watters Road (September 22, 2018 – SAT peak)
- Crown Pointe Centre Access 1 at Trim Road (September 27, 2018 – Weekday AM and PM peaks)
- Crown Pointe Centre Access 1 at Trim Road (October 13, 2018 – SAT peak)
- Crown Pointe Centre Access 2 at Trim Road (September 27, 2018 – Weekday AM and PM peaks)
- Crown Pointe Centre Access 2 at Trim Road (October 13, 2018 – SAT peak)
- Portobello/Springridge at Trim Road (September 22, 2018 – SAT peak)
- Watters Road at Charlemagne Boulevard (October 13, 2018 – SAT peak)

It should be noted that the count performed on Saturday September 22, 2018 took place on a day where an extreme weather event occurred in the west end of the City of Ottawa causing significant damage and power outages throughout the western region of the City. It was understood that the traffic signals at Trim Road and Watters Street and the surrounding area was functioning normally during the traffic count. The traffic counts at Trim Road and Watters Street were compared to counts performed on subsequent weekends at intersections south of Watters Street along Trim Road and recorded volumes are similar to the September 22, 2018 count.

Appendix B contains the detailed traffic data sheets. The existing traffic volumes for the study intersections are illustrated in Figure 6 and were conservatively grown to account for any increase in traffic along Trim Rd.

Figure 6: Existing Peak Hour Traffic Volumes

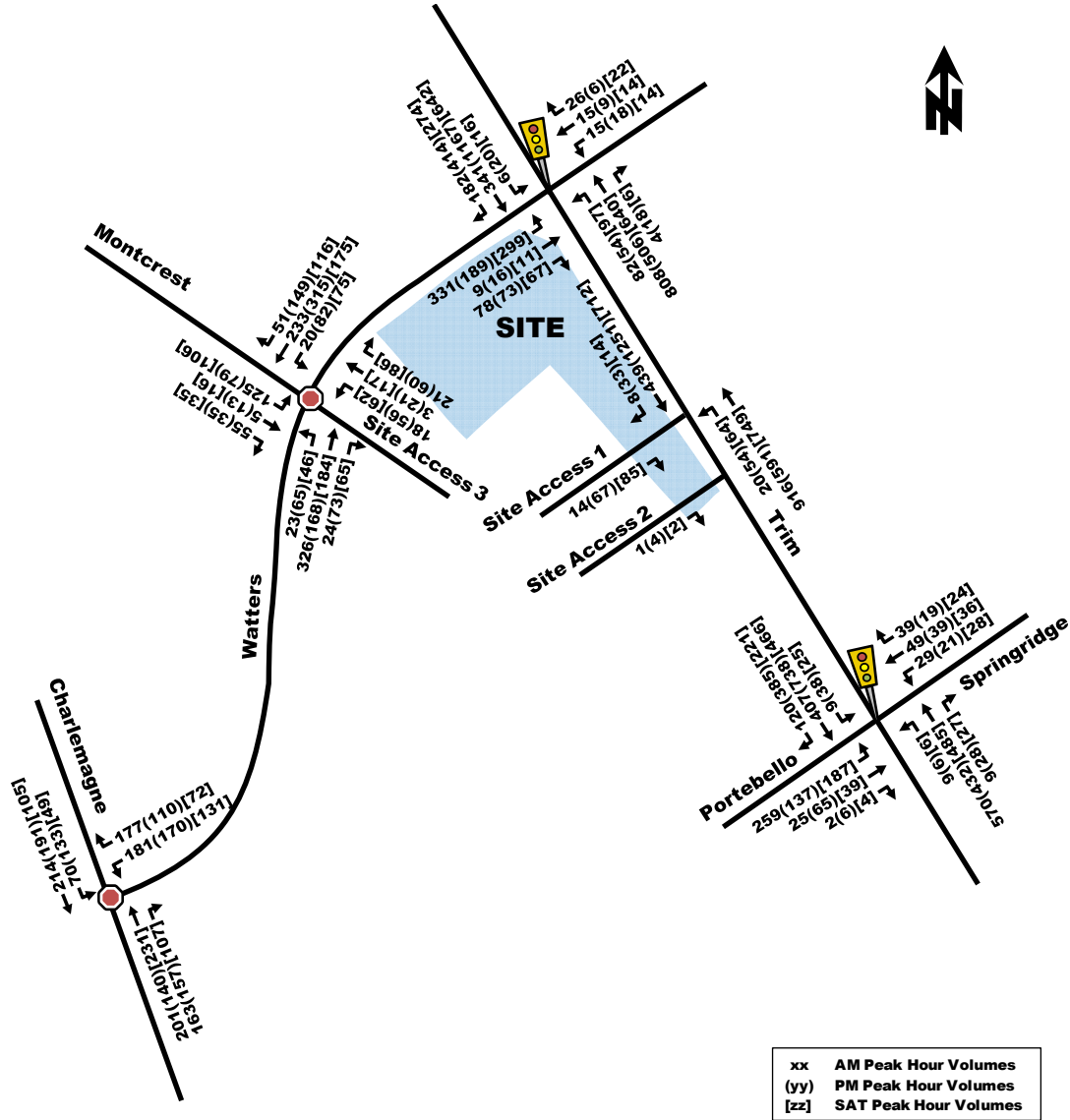

Table 1 summarizes the SYNCHRO (V10) existing intersection performance analysis. The SYNCHRO model output of existing conditions is included within Appendix C.

Table 1: Existing Intersection Performance

Intersection	Weekday AM Peak (PM Peak) [Saturday]					
	Critical Movement			Intersection 'As a Whole'		
	LoS	max. v/c or avg. delay (s)	Movement	Delay (s)	LoS	v/c
Trim/Watters (S)	B(F)[D]	0.70(1.07)[0.83]	EBL(SBT)[SBT]	22.3(46.4)[24.1]	B(E)[C]	0.65(0.95)[0.72]
Portebello/Trim (S)	C(C)[C]	0.78(0.71)[0.74]	NBT(NBT)[NBT]	27.4(23.9)[23.8]	B(A)[A]	0.63(0.53)[0.58]
Trim/Site Access 1 (U)	A(B)[A]	8.7(11.2)[9.6]	EB(EB)[EB]	0.2(0.7)[0.8]	-	-
Trim/Site Access 2 (U)	A(B)[A]	8.7(10.1)[9.1]	EB(EB)[EB]	0.0(0.0)[0.0]	-	-
Watters/Montcrest (U)	C(E)[C]	15.8(42.2)[17.6]	EB(WB)[WB]	13.6(28.0)[14.9]	-	-
Watters/Charlemagne (U)	C(B)[B]	16.6(13.3)[10.4]	WB(WB)[WB]	13.0(11.3)[9.2]	-	-

Note: Analysis of signalized intersections assumes a PHF of 0.90 and a saturation flow rate of 1800 veh/h/lane.
 (S) - Signalized intersection.
 (U) - Unsignalized intersection.

As shown in Table 1, the study area signalized intersections ‘as a whole’ operate at a LoS ‘E’ or better during the morning, afternoon and Saturday peak hour periods. The critical movements for the signalized intersections generally operate well with a LoS ‘D’ or better; However, during the afternoon peak at the Trim/Watters intersection, the southbound through movement operates at capacity with a LoS ‘F’.

The unsignalized intersections operate acceptably at LoS ‘E’ or better during the morning, afternoon, and Saturday peak periods. Regarding the all way stop at Watters/Montcrest intersection, it has been observed in the field that a queue forms during PM and Saturday peak period heading in the westbound direction (on Watters approaching Montcrest). Synchro analyses suggests that the City may want to consider providing an exclusive lane for right-turning vehicles as this measure would help alleviate the existing westbound queue, however, there are safety aspects to consider when introducing multiple approach lanes at a STOP controlled intersection.

EXISTING ROAD SAFETY CONDITIONS

Collision history for the study area intersections and roads (2015 to 2019, inclusive) was obtained from the City of Ottawa. The results indicate that a total of 58 collisions occurred in the study area and most collisions (67% or 39 collisions) involved only property damage, indicating low impact speeds, and 33% (19 collisions) involved non-fatal injuries. The primary causes of collisions cited by police include; rear end (31% or 18 collisions), turning movement (24% or 14 collisions), angle (22% or 13 collisions), single vehicle collisions (16% or 9 collisions), sideswipe (3% or 2 collision) and “other” (3% or 2 collisions) type collisions.

A standard unit of measure for assessing collisions at an intersection is based on the number collisions per million entering vehicles (MEV). At intersections within the study area, reported collisions have historically take place at a rate of:

- 0.41 collisions/MEV at the Trim Road and Watters Road intersection.
- 0.29 collisions/MEV at the Trim Road and Portobello Blvd/Springridge Dr S intersection.
- 0.37 collisions/MEV at the Charlemagne Blvd and Watters Road intersection.

Within the five-years of recorded collision data, two collisions involving a pedestrian were reported on Watters Road between Montcrest Drive and Trim Road. All collisions involving pedestrians resulted in non-fatal injuries. Additionally, four collisions involving a cyclist were reported, where the collisions occurred at the Charlamagne/Watters intersection, the Trim/Portobello/Springridge intersection, along Trim Rd between Watters Rd and Springridge Dr and along Watters Road between Montcrest Drive and Trim Road. All collisions involving cyclists resulted in non-fatal injuries only. The source collision data as provided by the City of Ottawa and related analysis is provided as Appendix D.

2.1.3. PLANNED CONDITIONS

PLANNED STUDY AREA TRANSPORTATION NETWORK CHANGES

According to the City of Ottawa Transportation Master Plan (TMP) 2013, Ultimate Network, Trim Road is identified for widening from two to four lanes between Innes Road and North Service Road (Jeanne D’Arc Boulevard N). This work has already been completed in combination with the realignment of Trim Road along the frontage of the proposed site and no other modifications to the roadways within the study area are anticipated at this time.

OTHER AREA DEVELOPMENTS

With respect to other area development, no other developments are currently posted on the City of Ottawa development application website within the vicinity of the proposed site.

2.2. STUDY AREA AND TIME PERIODS

2.2.1. STUDY AREA

TRANSIT

See section 4.7

INTERSECTION DESIGN

See section 4.9

2.2.2. TIME PERIODS

Given the land use, the weekday afternoon and weekend peak hours are considered the critical time periods for operational analysis for this commercial development.

2.2.3. HORIZON YEARS

For the purposes of the operational analysis it is assumed that the subject development will be completed by 2022. As such, the following horizons are recommended for analysis:

- Full Buildout – 2022
- Full Buildout + 5 Year Horizon – 2027

2.3. EXEMPTIONS REVIEW

Based on the foregoing analysis and review of the existing conditions, it is recommended that the TIA exclude the following modules and elements summarized in Table 2.

Table 2: Exemptions Review Summary

Module	Element	Exemption Consideration
4.1 Development Design	4.1.3 New Street Networks	Not required for applications involving site plans.
4.2 Parking	4.2.2 Spillover Parking	With 436 parking spaces proposed, the site is noted to meet the City's minimum By-Law requirements (143 stalls). As such, parking is not expected to spill out of the site.
4.6 Neighbourhood Traffic Management	All Elements	Significant access routes to the subject site will involve Trim Road, which is a designated Arterial, and Watters Road, which is a designated major collector. As such, it will not require screening of neighbourhood traffic management measures.
4.8 Review of Network Concept	All Elements	This development is not expected to generate 200-person trips more than the permitted zoning for the site.

3. FORECASTING

3.1. DEVELOPMENT GENERATED TRAVEL DEMAND

3.1.1. TRIP GENERATION AND MODE SHARES

The site is proposed to include approximately 305m² (3,300ft²) of new Fast-Food Restaurant with Drive-Through space, and 2,334m² (25,125ft²) of new Grocery/Supermarket space. The trip generation rates for the proposed development were obtained from the 10th Edition of the Institute of Transportation Engineers (ITE) Trip Generation Manual and are summarized in Table 3.

Table 3: ITE Vehicle Trip Generation Rates

Land Use	Data Source	Trip Rates		
		AM Peak	PM Peak	Sat Peak
Fast-Food-Restaurant with Drive-Through	ITE 934	T = 40.19	T = 32.67	T = 54.86
Supermarket	ITE 850	T = 3.82	T = 9.24; Ln(T) = 0.75Ln(x)+3.21	T = 10.34; Ln(T) = 0.69Ln(x)+3.61
Notes: T = Average Vehicle Trip Ends, x = square foot Gross Floor Area (1000ft ²)				

To convert ITE vehicle trip rates to person trips, an auto occupancy factor and a non-auto trip factor were applied to the ITE vehicle trip rates. Our review of available literature suggests that a combined factor of approximately 1.28 is considered reasonable to account for typical North American auto occupancy values of approximately 1.15 and combined transit and non-motorized modal shares of less than 10%. As such, the person trip generation for the proposed site is summarized in Table 4.

Table 4: Modified Person Trip Generation Rates

Land Use	G.F.A. (ft ²)	AM Peak (Person Trips/h)			PM Peak (Person Trips/h)			SAT Peak (Person Trips/h)		
		In	Out	Total	In	Out	Total	In	Out	Total
Fast-Food-Restaurant with Drive-Through	3,300	86	84	170	71	67	138	118	114	232
Supermarket	25,125	73	50	123	181	175	356	223	215	438
Total Person Trips		159	134	293	252	242	494	341	329	670

Note: 1.28 factor to account for typical North American auto occupancy values of approximately 1.15 and combined transit and non-motorized modal shares of less than 10%

3.1.2. MODE SHARES

The mode shares have been estimated using the 2011 OD Survey Data for the Orleans traffic zone. As this is an addition to an established suburban development, the mode share is not anticipated to change greatly during the study horizons. Thus, the existing mode shares have been carried forward as the Mode Share Targets for the purposes of this analysis. The mode share targets for the development have been summarized in Table 5 below.

Table 5: Mode Share Targets for the Development

Travel Mode	Mode Share Target	Rationale
Auto Driver	55%	See rationale below
Auto Passenger	15%	See rationale below
Transit	20%	See rationale below
Walking	5%	See rationale below
Cycling	5%	See rationale below

The person trips presented in Table 4 were divided into different travel modes using the mode share values in Table 5 and the results are summarized in Table 6 and Table 7.

The anticipated vehicle trips generated by the Fast-Food Restaurant with Drive-Through (as shown in Table 6) was reduced by 50% to account for pass-by trips and by an additional 10% to account for multi-purpose site trips (i.e. trips destined to more than one use on the site). As shown in Table 6, the resulting number of potential 'new' two-way vehicle trips generated by the Fast-Food Restaurant are approximately **42, 35** and **58 veh/h** during the weekday morning, afternoon and Saturday peak hours, respectively.

Table 6: Fast Food Restaurant with Drive-Through Trip Generation

Travel Mode	Mode Share	AM Peak (Person Trips/hr)			PM Peak (Person Trips/hr)			SAT Peak (Person Trips/hr)		
		In	Out	Total	In	Out	Total	In	Out	Total
Auto Driver	55%	48	47	95	40	37	77	65	63	128
Auto Passenger	15%	13	13	26	10	11	21	18	18	36
Transit	20%	17	16	33	14	13	27	24	22	46
Non-motorized	10%	8	8	16	7	6	13	11	11	22
Total Person Trips	100%	86	84	170	71	67	138	118	114	232
Pass-by Trips (50%)		-24	-24	-48	-19	-19	-38	-32	-32	-64
Multi-Purpose Trip Reduction (10%)		-3	-2	-5	-2	-2	-4	-3	-3	-6
Total 'New' Auto Trips		21	21	42	19	16	35	30	28	58

The anticipated vehicle trips generated for the Supermarket (as shown in Table 7) was reduced by 36% to account for pass-by trips and by an additional 10% to account for multi-purpose site trips (i.e. trips destined to more than one use on the site). As shown in Table 7, the resulting number of potential 'new' two-way vehicle trips generated by the Supermarket are approximately **41, 114** and **139 veh/h** during the weekday morning, afternoon and Saturday peak hours, respectively.

Table 7: Supermarket Trip Generation

Travel Mode	Mode Share	AM Peak (Person Trips/hr)			PM Peak (Person Trips/hr)			SAT Peak (Person Trips/hr)		
		In	Out	Total	In	Out	Total	In	Out	Total
Auto Driver	55%	41	28	69	100	97	197	123	119	242
Auto Passenger	15%	11	7	18	27	26	53	34	32	66
Transit	20%	14	10	24	36	35	71	44	43	87
Non-motorized	10%	7	5	12	18	17	35	22	21	43
Total Person Trips	100%	73	50	123	181	175	356	223	215	438
Pass-by Trips (36%)		-12	-12	-24	-35	-35	-70	-44	-44	-88
Multi-Purpose Trip Reduction (10%)		-2	-2	-4	-7	-6	-13	-8	-7	-15
Total 'New' Auto Trips		27	14	41	58	56	114	71	68	139

The total site-generated vehicle traffic are summarized in Table 8 below.

Table 8: Total Site Trip Generation

Travel Mode	AM Peak (veh/hr)			PM Peak (veh/hr)			SAT Peak (veh/hr)		
	In	Out	Total	In	Out	Total	In	Out	Total
Fast-Food-Restaurant with Drive-Through Trip Generation	48	47	95	40	37	77	65	63	128
Supermarket Trip Generation	41	28	69	100	97	197	123	119	242
Fast-Food-Restaurant with Drive-Through Pass-by (50%)	-24	-24	-48	-19	-19	-38	-32	-32	-64
Supermarket Pass-by (36%)	-12	-12	-24	-35	-35	-70	-44	-44	-88
Multi-purpose Trips (10%)	-5	-4	-9	-9	-8	-17	-11	-10	-21
Total 'New' Auto Trips	48	35	83	76	72	148	101	96	197

As shown in Table 8, the resulting number of potential 'new' two-way vehicle trips for the proposed development are approximately **83, 148** and **197 veh/h** during the weekday morning, afternoon and Saturday peak hours, respectively.

3.1.3. TRIP DISTRIBUTION

The vehicle traffic distribution was developed using a combination of traffic count data for the sites accesses and knowledge of the surrounding area. The resultant distribution is outlined in Table 9.

Table 9: Traffic Distribution

To/From	PM Peak Hour
North	40%
South	5%
East	5%
West	50%
Total	100%

3.1.4. TRIP ASSIGNMENT

New site generated trips were assigned to the study area intersections based on the above distribution, turning movement splits, proximity / connectivity to major transportation infrastructure (i.e. OR 174), and the proposed access configuration. Figure 7 below illustrates the percentage assignment, while Figure 8 illustrates the resulting volume assignment of the new site generated trip used in this analysis. The pass-by traffic volumes are depicted in Figure 9.

Figure 7: Percent Assignment

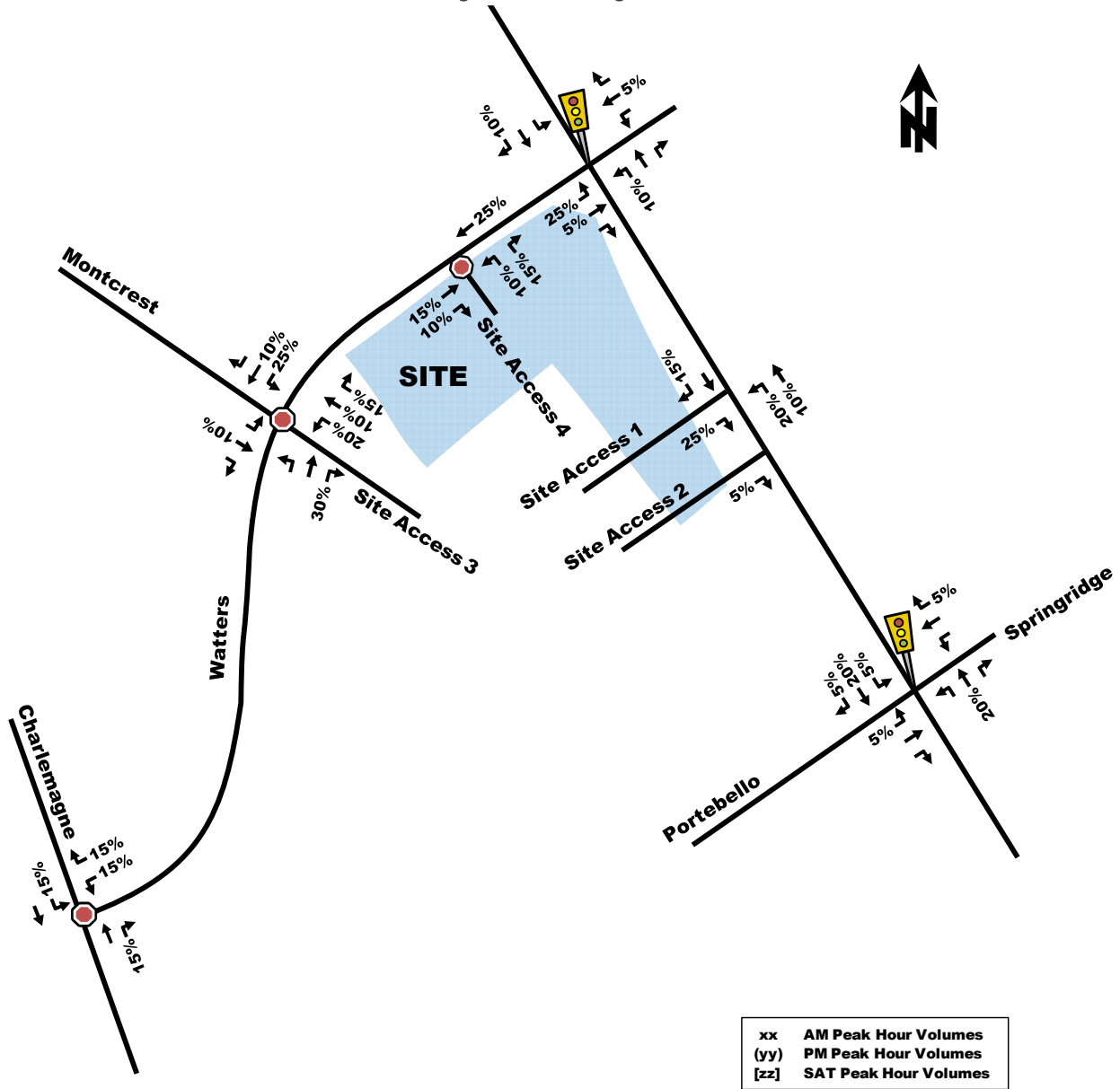

Figure 8: Site Generated Trip Volumes

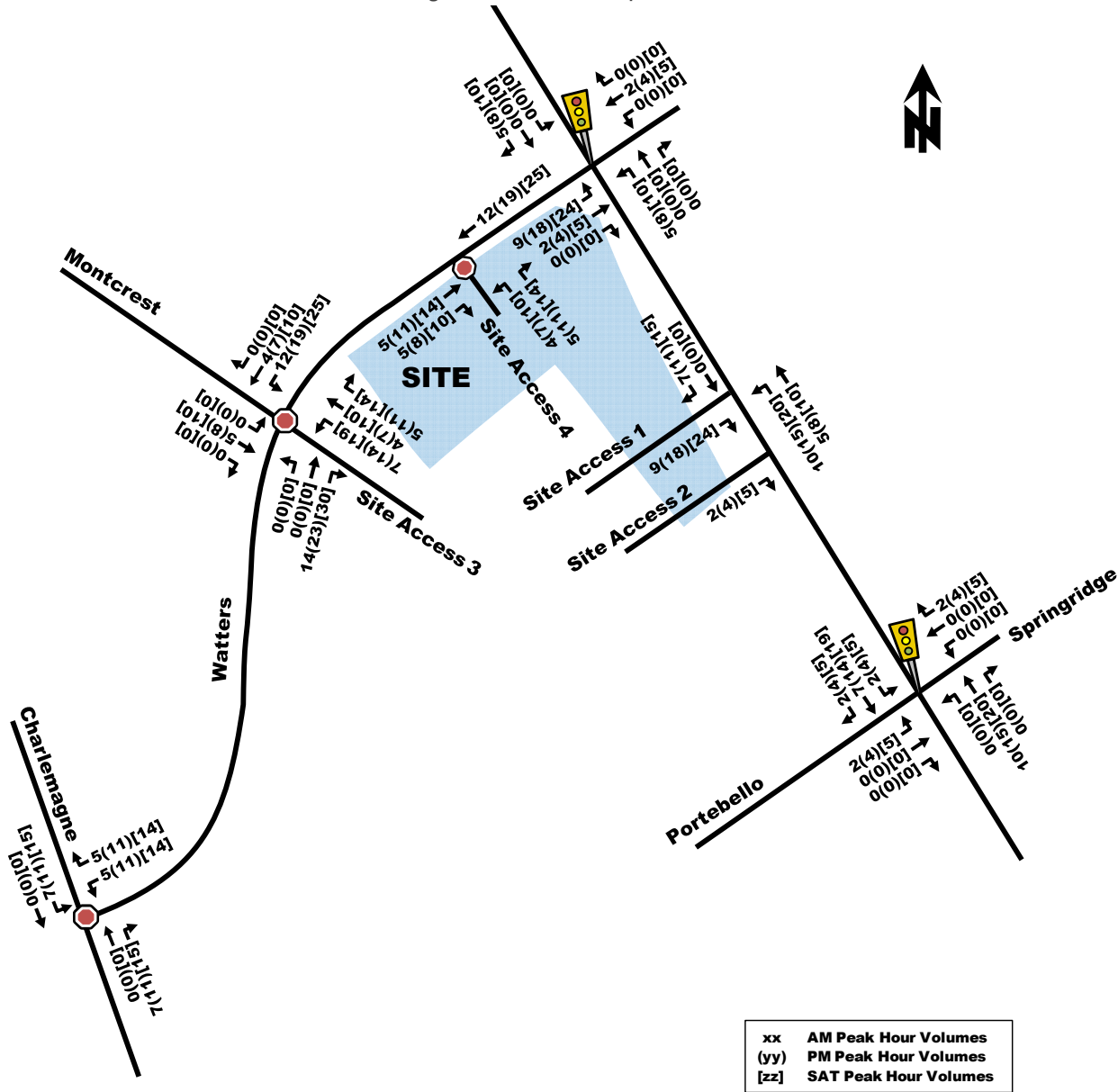
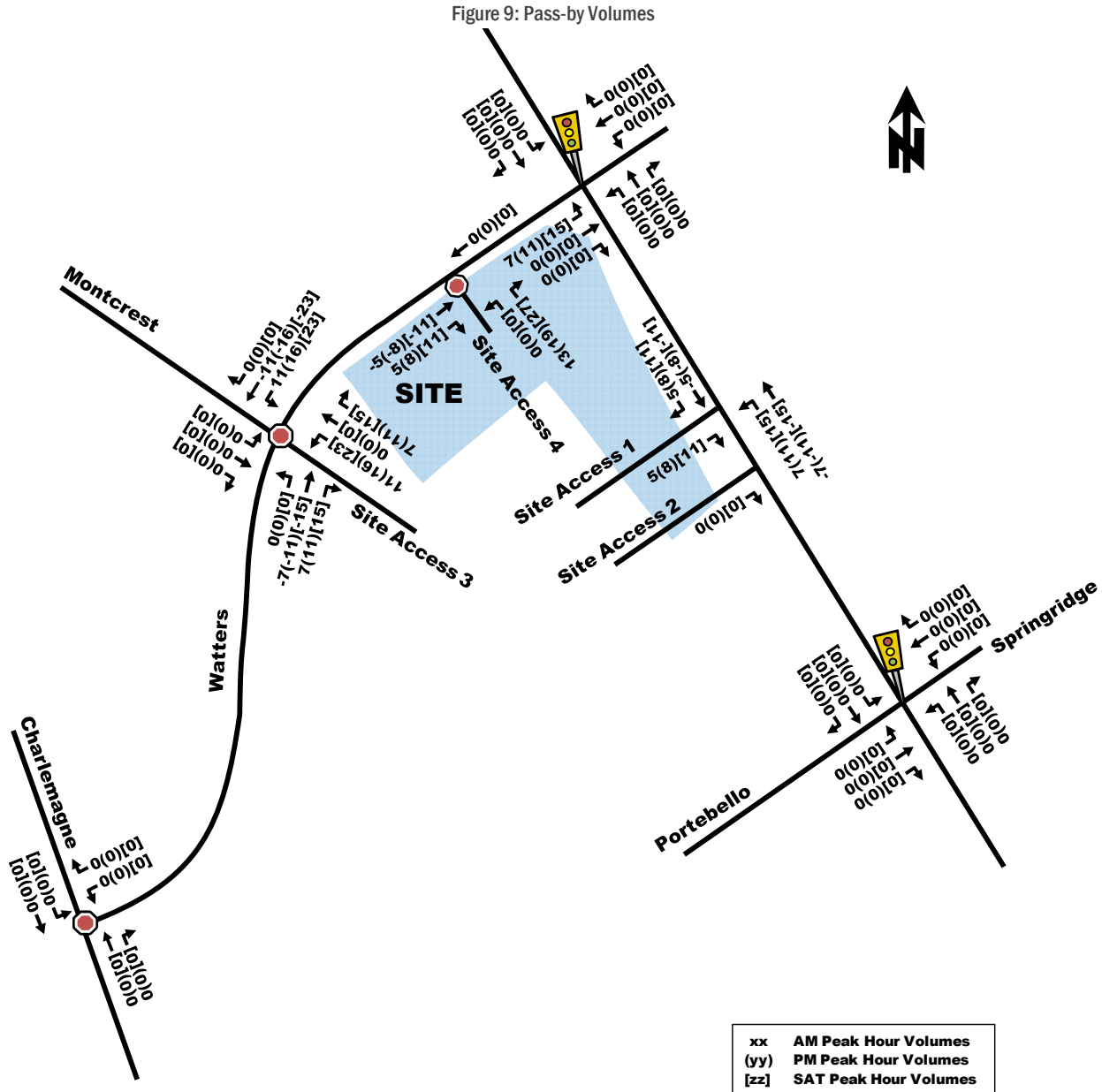

Figure 9: Pass-by Volumes



3.2. BACKGROUND NETWORK TRAVEL DEMANDS

3.2.1. TRANSPORTATION NETWORK PLANS

The 2013 Transportation Master Plan (TMP 2013) Affordable Network indicates that no major network changes are planned within the study area. Figure 10 below displays the planned network changes as per Exhibit 7.2: Affordable Road Network, of the TMP.

Figure 10: 2031 Affordable Network

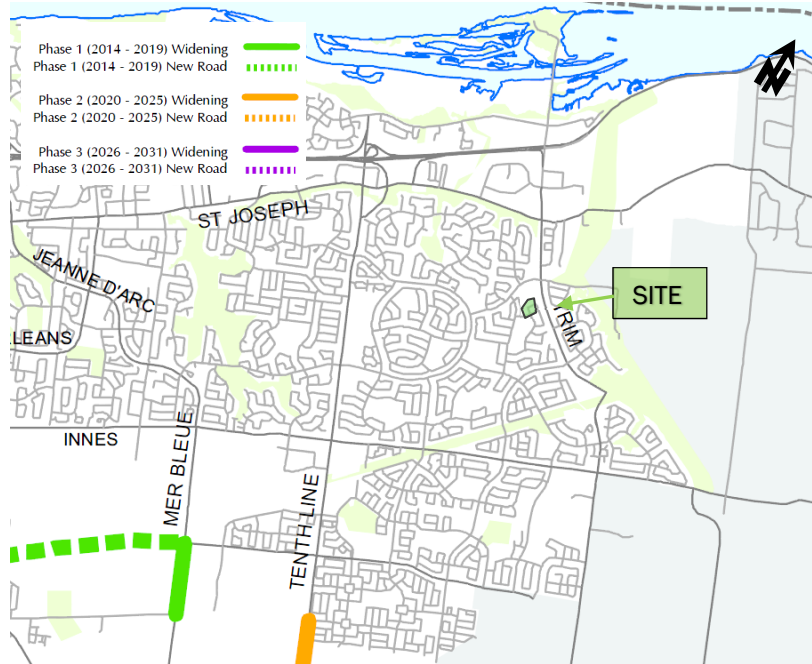

Retrieved from: 2013 Transportation Master Plan - Map 11, Road Network - 2031 Affordable Network.

The 2031 Network Concept displayed in Figure 11 includes a new arterial connection along the realigned Trim Road and a proposed widening along Old Montreal Road. Since these improvements have no anticipated date of construction they will not be used for analysis; however, they should be noted as they will add future connectivity throughout the surrounding community.

Figure 11: 2031 Network Concept



Retrieved from: 2013 Transportation Master Plan - Map 10, Road Network - 2031 Network Concept.

3.2.2. BACKGROUND GROWTH

To account for traffic growth beyond the Study Area a background growth rate of 2% has been applied to the northbound and southbound volumes along Trim Road. Through traffic volumes on Montcrest Drive were not adjusted to reflect background growth given the fact that it is a collector road serving a well-established neighbourhood. Figure 12 and Figure 13 show the future background traffic volumes for the 2022 and 2027 horizon years, respectively.

Figure 12: 2022 Future Background Traffic Volumes

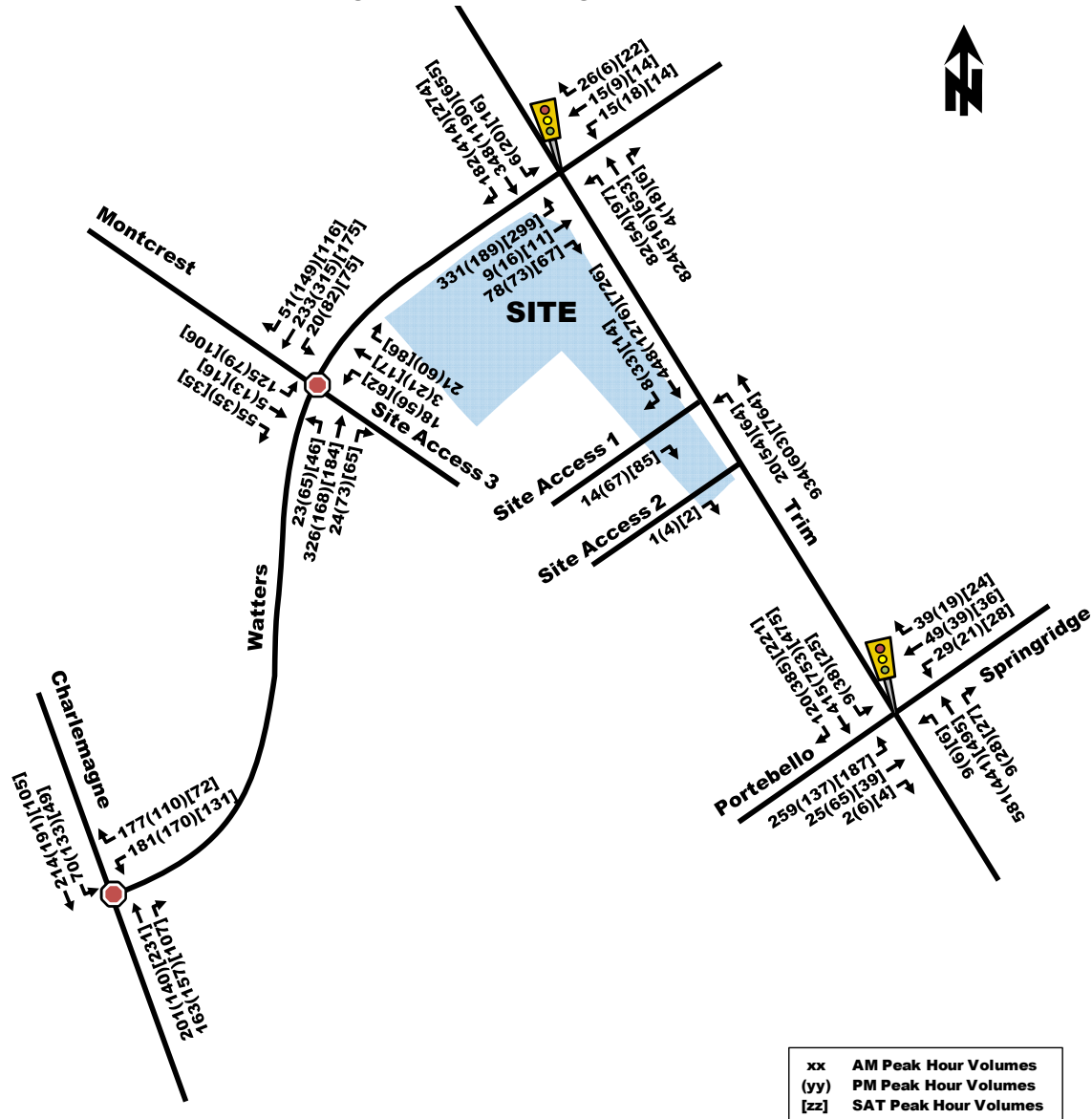
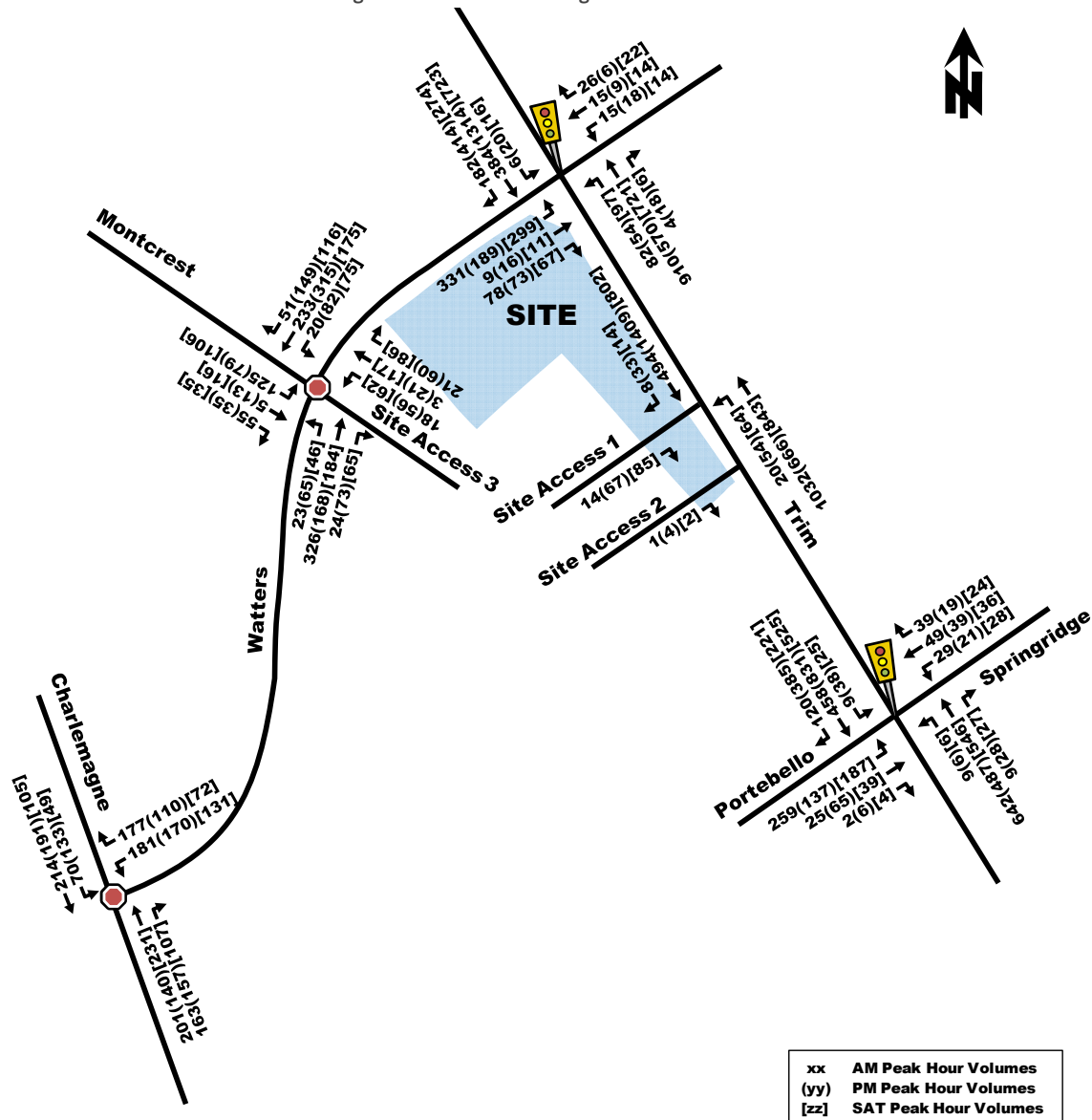

Figure 13: 2027 Future Background Traffic Volumes



3.2.3. OTHER AREA DEVELOPMENT

Refer to Section 2.2 - Study Area and Time Periods, Other Area Developments

4. ANALYSIS

4.1. DEVELOPMENT DESIGN

4.1.1. DESIGN FOR SUSTAINABLE MODES

A concrete sidewalk is currently provided bounding the site to the north along Watters Road, linking to the multi-use path located along the west side of Trim Road, which bounds the site to the east. The concrete sidewalk on Watters Road connects to the east to the Trim/Watters signalized intersection, which provides crossings on all approaches. To the west, it connects to crossings at Montcrest and at Charlemagne. The multi-use pathway on Trim Road connects to cycling facilities along Portobello to the south and along St Joseph Boulevard to the north, including the roundabout at the Trim/St Joseph intersection.

With regard to site design, pedestrian paths are noted to appropriately connect to the aforementioned bounding walking facilities. The proposed McDonalds Restaurant is proposed to be connected to the east to the Trim Road multi-use pathway via a walking crossing and a multi-use pathway connection, and to the existing TD Canada Trust via a formalized walking crossing. Both uses will be connected to the existing Crown Pointe Centre via a concrete sidewalk and a formalized walking crossing, and to the Giant Tiger, via a walkway that minimizes conflicts with parking vehicle activity. This walkway is noted to appropriately connect as well to the proposed Food Basics via a formalized walking crossing. It is estimated that 100% of the site's main entrance doors are within 400m walking distance.

Cyclists can use the on-site roadway network to access the cycling facilities (MUP's and cycle lanes) on Trim Road, or the curbside bike lanes along Watters Road. They can also use the existing multi-use pathway to connect to Launay Avenue south of the subject site and the adjacent residential areas.

Transit

Several existing bus stops are within walking distance of the site. The bus stops are located west side and east side of Trim Road near the Trim/Watters intersection and on the east and west sides of Montcrest Drive near the Montcrest/Watters intersection.

4.1.2. CIRCULATION AND ACCESS

The site has a total of four connections, which are composed of: An existing full movement driveway connection on Watters Street at Montcrest Drive, an existing full movement-in with a right-out only restriction on Trim Road, a right-out only on Trim Road and a new proposed right-in/right-out/left-out driveway connection to Watters Street, where a left-in will be prohibited.

4.2. PARKING

4.2.1. PARKING SUPPLY

Vehicle Parking

A total (including new and existing spaces) of 436 vehicle parking spaces are proposed to serve the subject development. This meets the minimum vehicle parking required by the City's By-Law. The parking space dimensions are noted to be 5.75 m in length and 2.75 m in width, which also meets the City's By-Law requirements.

Bicycle Parking

A total of 24 bicycle parking spaces are proposed to be provided for the site, which meets the City of Ottawa Parking Provisions requirement.

4.3. BOUNDARY STREET DESIGN

The boundary streets for the development are Trim Road and Watters Road.

Trim Road's existing geometry along the frontage of the Sites property consists of the following features:

- 2 vehicle travel lanes in each direction;
- 3m asphalt MUP on the east and west sides of the roadway;
- Posted speed limit of 60 km/h, assumed operating speed of 60 to 70 km/h;
- 5m wide median;
- 3.25 m wide outside lanes and 3.75m inside/median lanes;
- Dedicated 2m wide cycle lanes in both directions;
- Bus stops at the south west corner and north east corner of Trim Road at Watters Street intersection.
- No on-street parking.

Watters Road's existing geometry along the frontage of the Sites property consists of the following features:

- 1 vehicle travel lanes in each direction;
- 2m concrete sidewalks on the north and south sides of the roadway;
- Posted speed limit of 40 km/h, assumed operating speed of 40 to 50 km/h;
- Undivided/No median.
- 3.25m wide outside lanes and 3.75m inside lanes;
- Dedicated 1.8m wide cycle lanes in both directions;
- Bus stops at the south west corner and north east corner of Trim Road at Watters Street intersection.
- No on-street parking.

The multi-modal level of service analysis for the road segment along Trim Road and Watters Road adjacent to the site is summarized in Table 10, with detail analysis provided in Appendix E.

Table 10: MMLoS - Projected 2027 Boundary Road

Road Segment	Level of Service							
	Pedestrian (PLoS)		Bicycle (BLoS)		Transit (TLoS)		Truck (TKLoS)	
	PLoS	Target	BLoS	Target	TLoS	Target	TkLoS	Target
Trim Road	D	C	C	C	D	No target	C	D
Watters Road	C	C	A	B	D	No target	D	Not a truck route/no target

According to the City of Ottawa's Official Plan, Trim Road is classified as an arterial roadway and Watters Road is classified as a collector roadway, each of which may have different level of service targets under the City's "Minimum Desirable MMLoS Targets" exhibit for a General Urban Area. Red letters in the table above indicate a lower-than-desirable LoS.

With regards to pedestrians, Trim Road is projected to have a PLoS 'D' which is lower than the desirable minimum target PLoS 'C', this is due to the high traffic volumes and operating speeds exceeding 60 km/h. A PLoS 'C' is achievable if the speed is reduced to less than 60 km/h along Trim Road. Watters Road meets the minimum desirable target LoS 'C'.

With regards to cyclists, Trim Road and Watters Road are considered to be a Spine Route and a Local Route, respectively. Both roads meet their minimum desirable BLoS.

The two road segments of Trim Road and Watters Road are not a part of the Rapid Transit Corridor, or the Transit Priority Plans and as such, neither of them has a TLoS target.

With regards to Trucks, Trim Road forms a part of the City's truck route, while Watters Road does not, and as such, has no target TkLoS. Trim Road's TkLoS meets and exceeds the desirable minimum target LoS 'D'.

4.4. ACCESS INTERSECTION DESIGN

4.4.1. LOCATION AND DESIGN OF ACCESS

The site is proposed to use three existing driveway connections and 1 proposed right-in/right-out/left-out driveway. The new driveway is proposed to prohibit left turns in and connects to Watters Road approximately 100m west of Trim Road.

The existing driveway intersections are described in section 2.1.2 Existing Study Area Intersections.

4.4.2. INTERSECTION CONTROL AND DESIGN

Based on projected traffic volumes, the existing driveways located along Trim Road should remain with stop control on the minor (driveways). The proposed new access is to function as a right-in/right-out/left-out with a stop control on the minor (driveway) located off Watters Road. The remaining existing driveway located at Montcrest Drive and Watters Road is a four-way stop control intersection.

The SYNCHRO analysis shows minimal queues and delays at the site driveways along Trim Road and the proposed Waters Road right-in/right-out/left-out driveway for the 2022 and 2027 horizon years; However, at the existing four-way stop control intersection of Watters Road and Montcrest Drive, the projected delays and queues during the PM peak period are high (greater than 60 second delay) due to heavy westbound traffic volumes. The signal warrant, included as Appendix F, determined that traffic signal control is unwarranted (77% satisfied) based on total projected 2027 traffic volumes.

The SYNCHRO model output for the 2022 and 2027 horizon years are included in Appendix J and K, respectively.

All site accesses are unsignalized and as such, no MMLoS analysis can be provided for these intersections (MMLoS intersection analysis is for signalized intersections).

4.5. TRANSPORTATION DEMAND MANAGEMENT

The TDM checklist is attached as Appendix G.

4.6. NEIGHBOURHOOD TRAFFIC MANAGEMENT

Exempt – See Section 2.3.

4.7. TRANSIT

The anticipated additional transit trips generated by the site are approximately **57**, **98**, and **133** during the weekday morning peak, weekday afternoon peak and Saturday peak periods, respectively. It is worth noting that the largest anticipated demand impacts will be felt during the Saturday peak, as service is provided by one route (#39) once every 30 minutes.

4.8. REVIEW OF NETWORK CONCEPT

Exempt – See Section 2.3.

4.9. INTERSECTION DESIGN

4.9.1. INTERSECTION CONTROL

There are no anticipated changes to the intersection controls within the study area.

4.9.2. INTERSECTION DESIGN

BACKGROUND CONDITIONS

The following Table 11 and Table 12 provide a summary of the projected background traffic operations at the study area intersections based on the SYNCHRO (V10) and the 2022 and 2027 projected background traffic volumes (Figure 12 and Figure 13), respectively. The subject signalized intersections were assessed in terms of the volume-to-capacity (v/c) ratio and the corresponding Level of Service (LoS) for the critical movement(s). The subject signalized intersections ‘as a whole’ were assessed based on weighted v/c ratio. The unsignalized study area intersections were assessed based on delay of the critical movement and the overall intersection delay. Furthermore, the cycle length and phase splits were optimized at

the intersection of Trim/Watters in order to remain consistent and provide an equal comparison with the analysis done for future total conditions.

The 2022 and 2027 SYNCHRO reports of background conditions are provided in Appendix H and I, respectively.

Table 11: Background 2022 Intersection Performance

Intersection	Weekday AM Peak (PM Peak) [Saturday]					
	Critical Movement			Intersection 'As a Whole'		
	LoS	max. v/c or avg. delay (s)	Movement	Delay (s)	LoS	v/c
Trim/Watters (S)	B(D)[C]	0.68(0.85)[0.76]	NBT(SBT)[SBT]	21.8(23.4)[22.3]	B(C)[B]	0.63(0.77)[0.65]
Portobello/Trim (S)	C(B)[C]	0.76(0.69)[0.72]	NBT(NBT)[NBT]	26.9(23.6)[23.6]	A(A)[A]	0.60(0.51)[0.55]
Trim/Site Access 1 (U)	A(B)[A]	8.7(10.8)[9.4]	EB(EB)[EB]	0.2(0.6)[0.8]	-	-
Trim/Site Access 2 (U)	A(A)[A]	8.7(9.9)[9.0]	EB(EB)[EB]	0.0(0.0)[0.0]	-	-
Watters/Montcrest (U)	B(C)[B]	13.4(24.6)[14.2]	EB(WB)[WB]	12.0(18.3)[12.7]	-	-
Watters/Charlemagne (U)	B(B)[A]	14.1(11.9)[9.9]	WB(WB)[WB]	11.5(10.3)[8.8]	-	-

Note: Analysis of signalized intersections assumes a PHF of 1.0 and a saturation flow rate of 1800 veh/h/lane.
(S) - Signalized intersection.
(U) - Unsignalized intersection.

As shown in Table 11, the signalized intersections 'as a whole' are projected to operate at a LoS 'C' or better for the weekday morning, afternoon and Saturday peak hours.

The critical movements for the signalized intersections are generally projected to operate at a LoS 'C' or better; However, the SBT movement at the intersection of Trim/Watters is projected to operate at a LoS 'D' for the PM peak period.

The unsignalized intersections operate at LoS 'C' or better during the morning, afternoon, and Saturday peak periods.

It should be noted that all the intersections performance for the background conditions show improvement from the reported existing performance. This is attributed to the change of Peak Hour Factor (PHF) to 1.0 as recommended in the 2017 TIA Guidelines.

Table 12: Background 2027 Intersection Performance

Intersection	Weekday AM Peak (PM Peak) [Saturday]					
	Critical Movement			Intersection 'As a Whole'		
	LoS	max. v/c or avg. delay (s)	Movement	Delay (s)	LoS	v/c
Trim/Watters (S)	C(E)[D]	0.72(0.91)[0.82]	NBT(SBT)[SBT]	22.5(26.4)[23.6]	B(D)[B]	0.66(0.83)[0.70]
Portobello/Trim (S)	C(C)[C]	0.78(0.71)[0.74]	NBT(NBT)[NBT]	27.7(24.6)[24.4]	B(A)[A]	0.63(0.54)[0.58]
Trim/Site Access 1 (U)	A(B)[A]	8.7(11.4)[9.6]	EB(EB)[EB]	0.2(0.6)[0.8]	-	-
Trim/Site Access 2 (U)	A(B)[A]	8.7(10.3)[9.1]	EB(EB)[EB]	0.0(0.0)[0.0]	-	-
Watters/Montcrest (U)	B(C)[B]	13.4(24.6)[14.2]	EB(WB)[WB]	12.0(18.3)[12.7]	-	-
Watters/Charlemagne (U)	B(B)[A]	14.1(11.9)[9.9]	WB(WB)[WB]	11.5(10.3)[8.8]	-	-

Note: Analysis of signalized intersections assumes a PHF of 1.0 and a saturation flow rate of 1800 veh/h/lane.
(S) - Signalized intersection.
(U) - Unsignalized intersection.

The results shown in Table 12 are similar to the results obtained in the Background 2022 conditions analysis in Table 11, with slightly higher overall v/c ratios and delays experienced at the study area intersections. Signalized intersections operate at a LoS 'D' or better, with critical movements operating at LoS 'E' or better.

TOTAL PROJECTED 2022 CONDITIONS – FULL BUILD OUT

The total projected 2022 traffic volumes were derived by superimposing the site-generated traffic volumes (Figure 8) onto projected 2022 background traffic volumes (Figure 12).

Figure 14: Total Projected 2022 Traffic Volumes

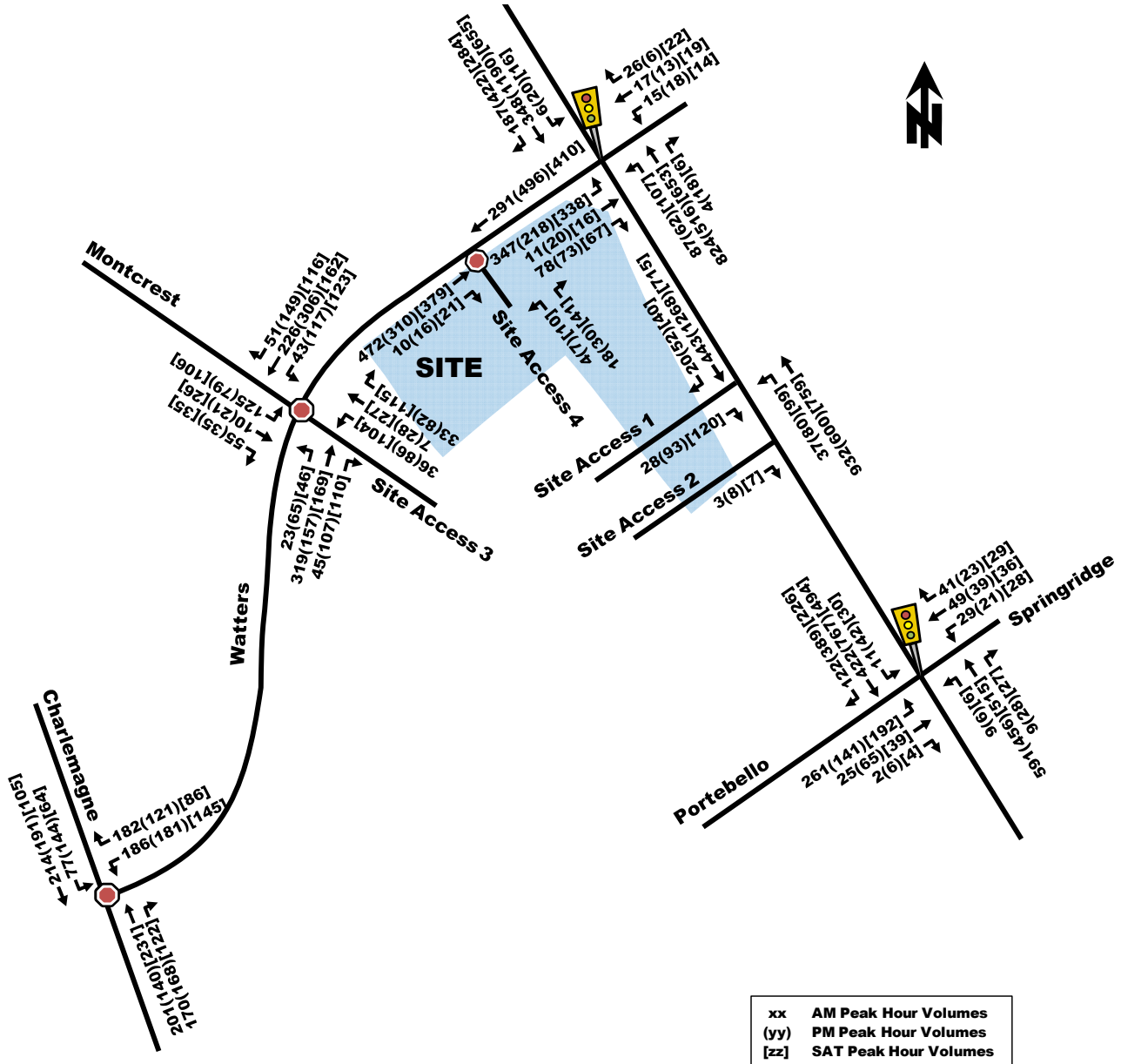

The following Table 13 provides a summary of the 2022 total projected operations at the study area intersection based on the SYNCHRO (V10) traffic analysis software. The SYNCHRO reports of 2022 total projected conditions are provided in Appendix J.

Table 13: Total Projected 2022 Performance at Study Area Intersections

Intersection	Weekday AM Peak (PM Peak) [Saturday]					
	Critical Movement			Intersection 'As a Whole'		
	LoS	max. v/c or avg. delay (s)	Movement	Delay (s)	LoS	v/c
Trim/Watters (S)	B(D)[C]	0.68(0.85)[0.72]	NBT(SBT)[SBT]	21.9(23.6)[21.8]	B(C)[B]	0.63(0.77)[0.65]
Portobello/Trim (S)	C(B)[C]	0.76(0.70)[0.73]	NBT(NBT)[NBT]	26.9(23.7)[23.8]	B(A)[A]	0.61(0.52)[0.56]
Trim/Site Access 1 (U)	A(B)[A]	8.7(11.0)[9.6]	EB(EB)[EB]	0.4(0.9)[1.2]	-	-
Trim/Site Access 2 (U)	A(A)[A]	8.8(9.9)[9.0]	EB(EB)[EB]	0.0(0.0)[0.0]	-	-
Watters/Montcrest (U)	B(E)[C]	14.6(38.4)[19.3]	EB(WB)[WB]	12.9(25.6)[16.1]	-	-
Watters/Charlemagne (U)	B(B)[B]	14.6(12.6)[10.4]	WB(WB)[WB]	11.8(10.8)[9.2]	-	-
Watters/Access 4 (U)	B(B)[B]	11.4(11.3)[11.7]	NB(NB)[NB]	0.3(0.5)[0.7]	-	-

Note: Analysis of signalized intersections assumes a PHF of 1.0 and a saturation flow rate of 1800 veh/h/lane.
(S) - Signalized intersection.
(U) - Unsignalized intersection.

As shown in Table 13, the intersections 'as a whole' are projected to operate at a LoS 'C' or better for the weekday morning, afternoon and Saturday peak hours. The signalized critical movements are projected to operate at a LoS 'D' or better during the morning, afternoon and Saturday peak periods.

Critical movements at unsignalized intersections are projected to operate at LoS 'C' or better during the morning, afternoon, and Saturday peak periods, except at the intersection of Watters/Montcrest, which operates at LoS 'E' during the afternoon peak hour.

TOTAL PROJECTED 2027 CONDITIONS – BUILD-OUT PLUS FIVE YEARS

The total projected 2027 traffic volumes were derived by superimposing the site-generated traffic volumes (Figure 8) onto projected 2027 background traffic volumes (Figure 13). The resulting total projected 2027 traffic volumes are illustrated in Figure 15.

Figure 15: Total Projected 2027 Traffic Volumes

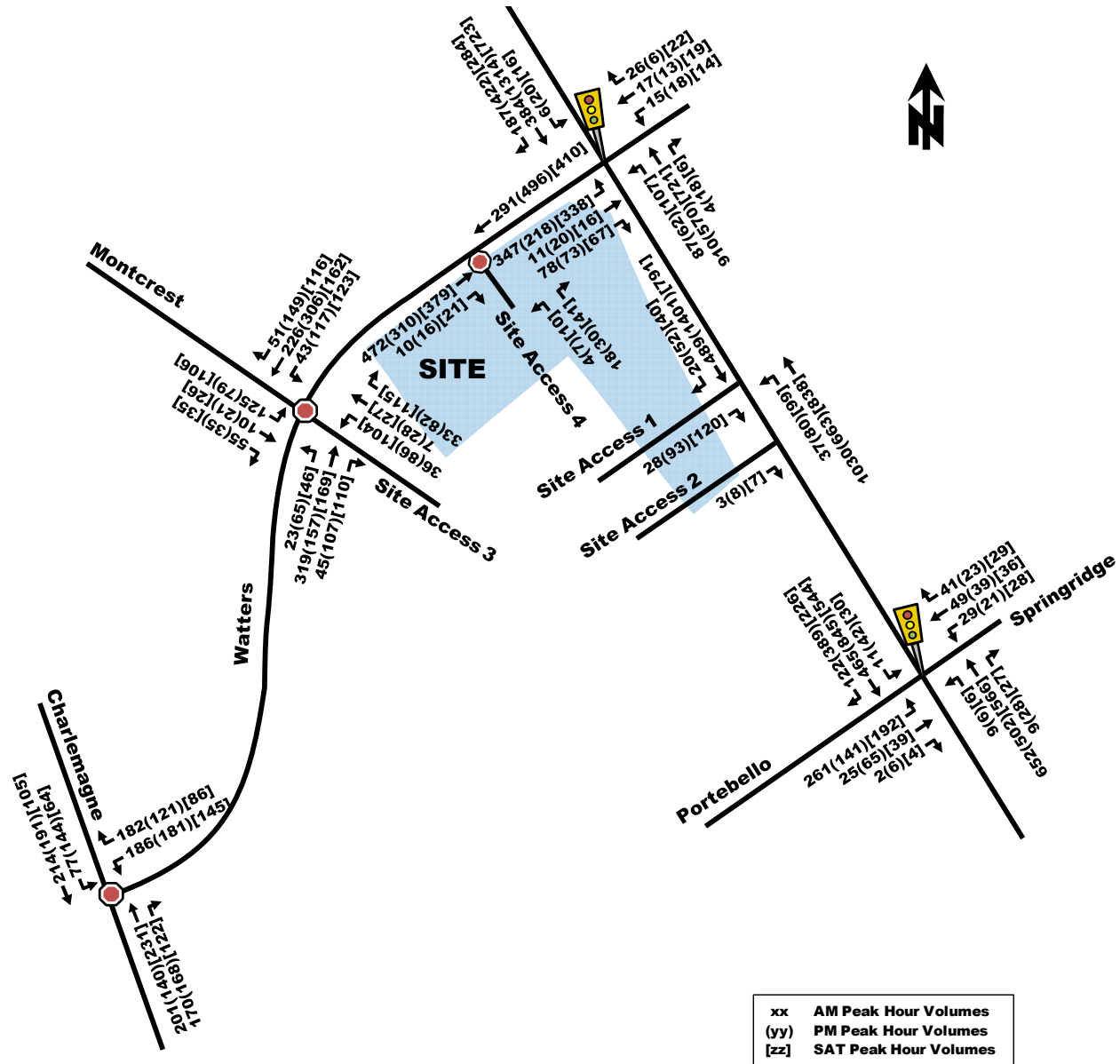

The following Table 14 provides a summary of the total projected operations at the study area intersection based on the SYNCHRO (V10) traffic analysis software. The SYNCHRO reports of total projected 2027 conditions are provided in Appendix K.

Table 14: Total Projected 2027 Performance at Study Area Intersections

Intersection	Weekday AM Peak (PM Peak) [Saturday]					
	Critical Movement			Intersection 'As a Whole'		
	LoS	max. v/c or avg. delay (s)	Movement	Delay (s)	LoS	v/c
Trim/Watters (S)	C(D)[C]	0.72(0.88)[0.76]	NBT(SBT)[SBT]	22.6(25.6)[22.7]	B(D)[B]	0.67(0.81)[0.68]
Portobello/Trim (S)	C(C)[C]	0.78(0.72)[0.74]	NBT(NBT)[NBT]	27.7(24.7)[24.4]	B(A)[A]	0.63(0.55)[0.58]
Trim/Site Access 1 (U)	A(B)[A]	8.8(11.5)[9.7]	EB(EB)[EB]	0.3(0.9)[1.1]	-	-
Trim/Site Access 2 (U)	A(B)[A]	8.7(10.2)[9.1]	EB(EB)[EB]	0.0(0.0)[0.0]	-	-
Watters/Montcrest (U)	B(E)[C]	14.6(38.4)[19.3]	EB(WB)[WB]	12.9(25.6)[16.1]	-	-
Watters/Charlemagne (U)	B(B)[B]	14.6(12.6)[10.4]	WB(WB)[WB]	11.8(10.8)[9.2]	-	-
Watters/Access 4 (U)	B(B)[B]	11.4(11.3)[11.7]	NB(NB)[NB]	0.3(0.5)[0.7]	-	-

Note: Analysis of signalized intersections assumes a PHF of 1.0 and a saturation flow rate of 1800 veh/h/lane.
(S) - Signalized intersection.
(U) - Unsignalized intersection.

As shown in Table 14, the intersections ‘as a whole’ are projected to operate at a LoS ‘D’ or better for the weekday morning, afternoon and Saturday peak hours. The signalized critical movements are projected to operate at a LoS ‘D’ or better during the morning, afternoon and Saturday peak periods.

The majority of the movements within the unsignalized intersections are projected to operate at a LoS ‘C’ or better; However, the westbound approach of Watters/Montcrest intersection is projected to operate at a LoS ‘E’ during the afternoon peak period. This is due to the high volume of traffic using intersection during the PM peak.

A signal warrant (Appendix F) has been prepared to analyze if a signal would be warranted and it is found that a signal is not warranted at this location; Additionally, a 4-way stop warrant (Appendix F) has been prepared and it was found that the existing 4-way stop is not warranted. Removing the stop signs for the westbound and eastbound movements on Watters Road would improve the level of service along Watters, however, it would also decrease the level of service on Montcrest and the sites driveway by increasing delays and queues.

MULTI-MODAL LEVEL OF SERVICE

The MMLoS analysis for the signalized intersection Trim Road/Watters Road is summarized in Table 15. The existing detailed MMLoS analysis is provided as Appendix E.

Table 15: MMLoS – Signalized Study Area Intersections

Intersection	Level of Service							
	Pedestrian (PLOS)		Bicycle (BLOS)		Transit (TLOS)		Truck (TkLOS)	
	PLOS	Target	BLOS	Target	TLOS	TLOS	TkLOS	Target
Trim Road and Watters Road	F	C	F	B	D	No target	E	D

The letters identified in red text in Table 15 do not meet the MMLoS Targets for their designated area. At the Trim/Watters intersection, the pedestrian, bicycle and truck target levels of service are not met. The following discussion regarding these modes is provided:

- Pedestrians have to cross 3 (east), 4 (west) or 6 (north and south) lanes of traffic at Trim/Watters, depending on which leg of the intersection they are crossing. Several things can be done to help improve the PLoS, such as providing a raised crosswalk and prohibiting the right turn on red for both the north and south crosswalks. However, this would only improve the PLoS to result in an ‘E’, which still does not meet the target PLoS of ‘C’. Furthermore, such improvements will likely decrease the transit and vehicle levels of service.
- Bike lanes are provided along the north, south and west legs of Trim/Watters intersection as well as a MUP on both sides of Trim Road. Trim/Watters features north and south bike lanes that are a part of the Spine Route of Ottawa, mixed traffic on the east leg and Local Route bike lanes on the west leg. The failure in BLoS at the intersection can be attributed to operating speed of vehicles, number of lanes bikes cross to turn left at the

intersection (for the bike lanes) and the right-turn lane configuration of the bike lanes. As such, there are no options that can help improve the BLoS significantly enough to meet the target BLoS.

- Trucks Level of Service (TkLoS) is based on the Effective Corner Radius and Number of Receiving Lanes from the approaching leg of the intersection. The south approach at both intersections causes the TkLoS to result in 'E' due to having only one receiving lane on the east leg and a 10-15 m effective corner radius.

5. FINDINGS, CONCLUSIONS AND RECOMMENDATIONS

Based on the results summarized herein the following transportation related conclusions are offered:

- The proposed development is anticipated to include a new drive-through restaurant and grocery store located at the northeast corner of the Crown Pointe Plaza (or on the southwest corner of the signalized Trim/Watters intersection);
- The transportation network surrounding the site includes sidewalks, MUP's and pedestrian pathways connecting to the surrounding areas;
- The existing MMLoS analysis indicates the following:
 - Along Trim Road, BLoS target is achieved, however the PLoS is not met as result high speeds and volumes;
 - Along Watters Road, the BLoS and PLoS targets are being achieved;
 - At the signalized Trim/Watters intersection indicates that the pedestrian and cycling level of service target is not being met according to meeting the City's guidelines, however minimal improvements can be made to improve performance for the active modes given the high traffic volumes and number of lanes on the adjacent street network;
- The existing study area intersections 'as a whole' are currently operating acceptably with a LoS 'E' or better. The critical SBT movement at the intersection of Trim/Watters currently operates at capacity during the PM peak;
- It was noted in the field that queues and delays are currently being experienced at the Watters/Montcrest intersection, with the westbound approach (Watters approaching Montcrest) being most critical;
- The increase in vehicle demand generated by the proposed development is approximately 83, 148 and 197 veh/h during the weekday morning, afternoon and Saturday peak hours, respectively;
- Based on local area developments and the historic traffic data, a 2% per annum growth rate was applied to the through movements along Trim Road;
- Based on the forecasted traffic volumes for the build-out year (2022); and 5-years beyond full build-out (2027), the study area intersections are projected to operate similar to existing conditions, with one notable exception:
 - Watters/Trim intersection – refinements to the signal timing plan are recommended in order to improve the vehicle performance to LoS D or better;
- An additional right-in/right-out/left-out only driveway connection to Watters Street is proposed, where a left-in would be prohibited. This intersection will be located approximately 100m west of Trim/Watters signalized intersection. The SYNCHRO model projects that this configuration will operate acceptably;
- Vehicle parking proposed to be provided is expected to meet the City's By-Law requirements.
- Bicycle parking proposed to be provided is expected to meet the City's By-Law requirements.

Based on the foregoing, the proposed development fits well into the context of the surrounding area, and its location and design serve to promote use of walking, cycling, and transit modes, thus supporting City of Ottawa policies, goals and objectives. As such, the proposed site of Crown Pointe Plaza is recommended to proceed from a transportation perspective.

Prepared By:



Basel Ansari, E.I.T.
Transportation Analyst

Reviewed By:



Matthew Mantle, P.Eng.
Transportation Engineer

APPENDIX A

SCREENING FORM AND CITY COMMENT RESPONSES

City of Ottawa 2017 TIA Guidelines
TIA Screening Form

Date 12-Oct-18
 Project Crown Point Plaza - Phase 2
 Project Number 476857-01000

Results of Screening	Yes/No
Development Satisfies the Trip Generation Trigger	Yes
Development Satisfies the Location Trigger	No
Development Satisfies the Safety Trigger	Yes

Module 1.1 - Description of Proposed Development	
Municipal Address	
Description of location	
Land Use	
Development Size	
Number of Accesses and Locations	
Development Phasing	
Buildout Year	
Sketch Plan / Site Plan	See attached

Module 1.2 - Trip Generation Trigger		
Land Use Type	Destination Retail	
Development Size	3141	sq. m
Trip Generation Trigger Met?	Yes	

Module 1.3 - Location Triggers	
Development Proposes a new driveway to a boundary street that is designated as part of the City's Transit Priority, Rapid Transit, or Spine Bicycle Networks (See Sheet 3)	No
Development is in a Design Priority Area (DPA) or Transit-oriented Development (TOD) zone. (See Sheet 3)	No
Location Trigger Met?	No

Module 1.4 - Safety Triggers		
Posted Speed Limit on any boundary road	<80	km/h
Horizontal / Vertical Curvature on a boundary street limits sight lines at a proposed driveway	No	
A proposed driveway is within the area of influence of an adjacent traffic signal or roundabout (i.e. within 300 m of intersection in rural conditions, or within 150 m of intersection in urban/ suburban conditions) or within auxiliary lanes of an intersection;	Yes	Proposed driveway on Watters Road within 150 m of the signalized Trim/Watters intersection.
A proposed driveway makes use of an existing median break that serves an existing site	No	
There is a documented history of traffic operations or safety concerns on the boundary streets within 500 m of the development	No	
The development includes a drive-thru facility	Yes	
Safety Trigger Met?	Yes	

28 October 2021

City of Ottawa
Development Review Services
110 Laurier Avenue West
Ottawa, ON K1P 1J1

Attention: Mike Giampa

Dear Mike Giampa:

**Re: 920 Watters Road (Crown Pointe Plaza)
Step 4 – Comment and Response Form**

This comment and response form have been prepared to address the comments received from the City of Ottawa on May 24th, 2019, with corresponding responses from Parsons.

TRANSPORTATION ENGINEERING SERVICES

Comment 1: *Module 4.7 - Transit is supposedly addressed in Section 2.2.3 according to the report. There is no Section 2.2.3 in the report. Please complete this module and assess transit capacity after including development-generated trips.*

Response 1: Updated to reference the correct section.

Comment 2: *In Module 4.9 - Intersection Design, it mentions that Elements 4.9.1 and 4.9.2 are exempt as per Section 2.3. Section 2.3 does not mention anything concerning exemption of these two elements. However, the content pertaining to these two elements has still been included afterwards in the report. Please remove the confusing wording concerning exemption of these elements.*

Response 2: Elements 4.9.1 and 4.9.2 were updated to resolve confusing wording.

Comment 3: *Element 4.4.1- Location and Design of Access of the TIA Guidelines must be included in the report for existing and proposed access. Review the sight distance for vehicles exiting the proposed access on Watters Road. According to TAC guidelines (Table 9.9.6), the stopping sight distance required from the proposed access on Watters Road is 65 m.*

Response 3: The new Watters Road access is proposed to be right-in/right-out/left-out and is located approximately 100m to the east of Watters/Montcrest. Since the intersection of Watters/Montcrest is an all-way STOP, vehicles heading EB on Watters Road will not likely reach design speed and should have sufficient time to see and stop for vehicles turning right out of the proposed new access. See Figure 1 below.

Figure 1: Relative Location of Access

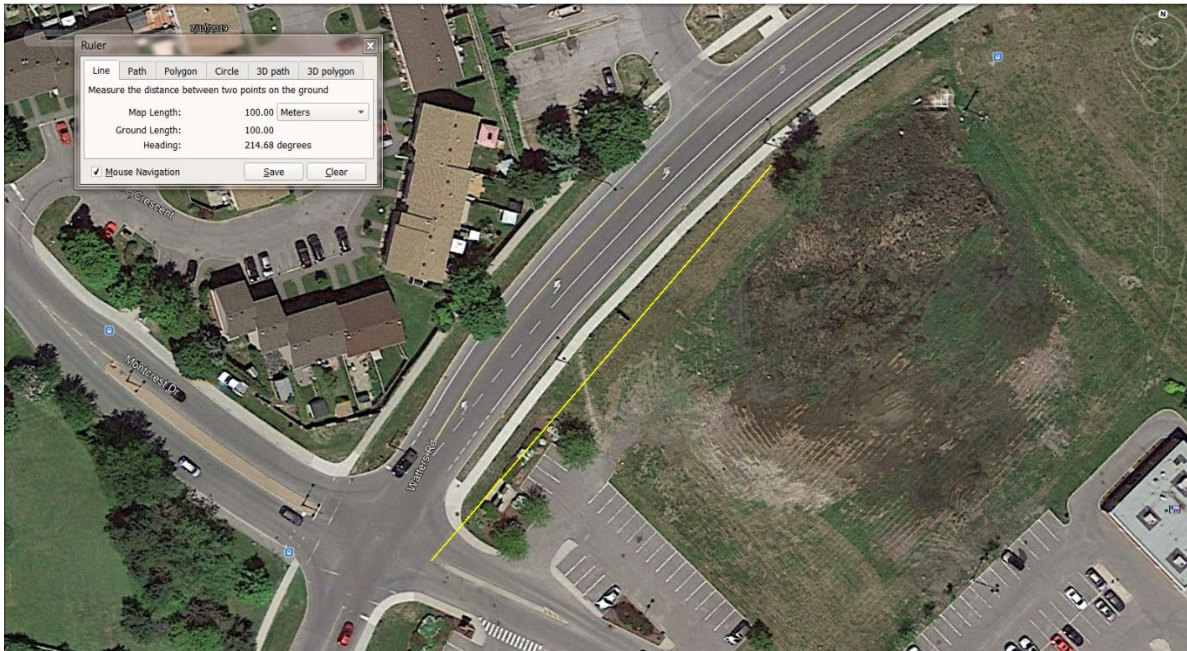

It is also noted that no vertical obstructions appear on the south side of the road edge that will block drivers view heading eastbound. Figure 2 below shows the street view looking westward from the approximate location of the new access.

Figure 2: Westward Street View



TRAFFIC SIGNAL OPERATIONS

Comment 4: Section 1: there is mention of 216 units - this is not a residential development.

Response 4: Report updated.

PARSONS

Comment 5: Incorrect speed limits are provided and should be corrected.

Response 5: Speed limits corrected.

Comment 6: Analyses for future background traffic use existing signal timings, but analyses for future total use optimized signal timings. This does not create an equal comparison of additional traffic added to the network. Timing should be optimized for future background signal timings to compare.

Response 6: Analysis updated.

Comment 7: Mutli-Modal LOS - The signalized intersection MMLOS rating is missing for Trim Road and Portobello Boulevard. This should be included and the paragraph above Table 15 says it does.

Response 7: The signalized intersection of Trim Road and Portobello Boulevard is not at the frontage of the site. As such, it is excluded from the MMLOS analysis. MMLOS text updated.

Comment 8: Synchro Notes:

- a. Incorrect PHF has been used, should use 2017 TIA Guidelines.
- b. Despite active modes proposed for the development, there are no pedestrian volumes nor pedestrian calls coded at the signalized intersections. This inconsistency should be addressed.
- c. Recall modes are not in accordance with provided timing plans. This drastically influences the v/c ratios used to determine LOS.
- d. Speed limits in model not consistent with those on the road and described in the report.

Response 8: Analysis updated.

TRAFFIC SIGNAL DESIGN

Comment 9: No comments to this TIA for this circulation. Traffic Signal Design and Specification reserves the right to make future comments based on subsequent submissions.

Future considerations:

If there are any future proposed changes in the existing roadway geometry for the purpose of construction of a new TCS(s) or modifications to existing TCS(s) the City of Ottawa Traffic Signal Design & Specification Unit is required to complete a review for traffic signal plant re-design and provide the actual re-design.

If the proposed traffic signals are warranted/approved for installation or modifications to existing TCS are approved, and RMA approved, please forward an approved geometry detail design drawings (dwg digital format in NAD 83 coordinates) including base mapping, existing and new underground utilities/sewers, new/existing catch basins locations, Turn-Radius Modeling and approved pavement markings drawings in separate files for detail traffic plant design lay out. Please send all digital (CADD) design files to Peter.Grajcar@ottawa.ca 613-580-2424 x 23035.

Response 9: Noted.

STREET LIGHTING

Comment 10: Site plan has possible conflict with street light on Watters Road.

PARSONS

No further comments with TIA for this circulation. Street Lighting reserves the right to make future comments based on subsequent submissions.

Future considerations may include as follows:

If there are any proposed changes to the existing roadway geometry, or changes to City of Ottawa traffic plant, the City of Ottawa Street Light Asset Management Group is required to provide a full review and possibly a street light design. Upon completion of proposed roadway geometry design changes, please submit digital Micro Station drawings with proposed roadway geometry changes to the Street Lighting Alterations and/or repairs are required where the existing street light plant is directly, indirectly or adversely affected by the scope of work under this circulation, due to the proposed road reconstruction process. All street light plant alterations and/or repairs must be performed by the City of Ottawa's Street Light maintenance provider.

Be advised that the applicant will be 100% responsible for all costs associated with any relocations/modifications to the existing street light plant.

Response 10: Noted.

TRANSIT SERVICES

Comment 11: No comments on this TIA distribution on behalf of OC Transpo. Recent stop infrastructure has been implemented on Trim Road and there are no plans to service Watters Road parallel to the site.

Response 11: Noted.

APPENDIX B

TRAFFIC DATA

Traffic Signal Timing

City of Ottawa, Transportation Services Department

Traffic Signal Operations Unit

Intersection:	Main: Trim	Side: Portobello/Springridge
Controller:	MS-3200	TSD: 6623
Author:	Yassine Bennani	Date: 10-Sep-2018

Existing Timing Plans†

	Plan					Ped Minimum Time		
	AM Peak 1	Off Peak 2	PM Peak 3	Night 4	Weekend 5	Walk	DW	A+R
Cycle	Free	Free	Free	Free	Free			
Offset	X	X	X	X	X			
NB Thru	min=51.4	min=46.4	min=51.4	min=36.4	min=46.4	7	21	3.7+2.7
SB Thru	min=51.4	min=46.4	min=51.4	min=36.4	min=46.4	7	21	3.7+2.7
EB Left	max=16.9	max=13.9	max=13.9	-	max=13.9	-	-	3.3+3.6
EB Thru	max=39.9	max=36.9	max=39.9	max=21.9	max=39.9	7	25	3.3+3.6
WB Thru	max=21.9	max=21.9	max=21.9	max=21.9	max=21.9	7	25	3.3+3.6
SB Left	max=11.4	max=11.4	max=13.4	-	max=11.4	-	-	3.7+2.7

Notes: 1) For the EB and WB Thru movements, if the pedestrian movements are actuated, the phases will receive enough time to service the Walk, Flashing-Don't-Walk and clearances. If the pedestrian movements are not actuated, the EB and WB Thru phases will only receive the maximum splits provided in the table.

Phasing Sequence‡

Plan: 1, 2, 3 & 5

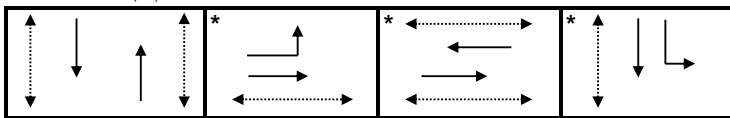

Plan: 4

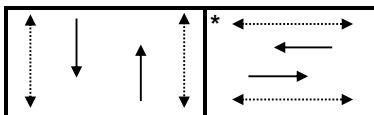

Schedule

Weekday		Saturday		Sunday	
Time	Plan	Time	Plan	Time	Plan
0:15	4	0:15	4	0:15	4
6:30	1	7:00	2	7:00	2
9:30	2	10:00	5	10:00	5
15:00	3	20:00	2	18:30	2
18:30	2	22:00	4	22:00	4
22:00	4				

Notes

†: Time for each direction includes amber and all red intervals
‡: Start of first phase should be used as reference point for offset
Asterisk (*) Indicates actuated phase
(fp): Fully Protected Left Turn
◄.....► Pedestrian signal

Cost is \$56.50 (\$50 + HST)

Traffic Signal Timing

City of Ottawa, Transportation Services Department

Traffic Signal Operations Unit

Intersection:	Main: Trim	Side: Watters
Controller:	MS-3200	TSD: 6383
Author:	Yassine Bennani	Date: 10-Sep-2018

Existing Timing Plans†

	Plan					Ped Minimum Time		
	AM Peak 1	Off Peak 2	PM Peak 3	Night 4	Weekend 5	Walk	DW	A+R
Cycle	Free	Free	Free	Free	Free			
Offset	X	X	X	X	X			
SB Thru	min=51.7	min=46.7	min=66.7	min=36.7	min=46.7	7	13	3.7+3.0
NB Thru	min=51.7	min=46.7	min=66.7	min=36.7	min=46.7	7	13	3.7+3.0
EB Thru	max=38.2	max=28.2	max=28.2	max=29.2	max=28.2	7	25	3.3+4.9
WB Thru	max=38.2	max=28.2	max=28.2	max=29.2	max=28.2	7	25	3.3+4.9
NB Left	max=16.7	max=13.7	max=21.7	-	max=16.7	-	-	3.7+3.0

Phasing Sequence‡

Plan: 1, 2, 3 & 5

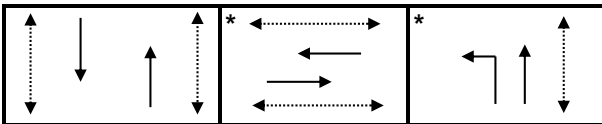

Plan: 4

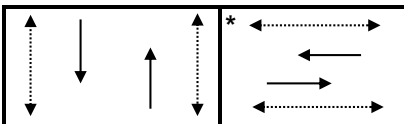

Schedule

Weekday

Time	Plan
0:15	4
6:30	1
9:00	2
15:00	3
18:00	2
22:30	4

Weekend

Time	Plan
0:15	4
8:30	5
18:00	2
22:30	4

Notes

†: Time for each direction includes amber and all red intervals

‡: Start of first phase should be used as reference point for offset

Asterisk (*) Indicates actuated phase

(fp): Fully Protected Left Turn

←.....→ Pedestrian signal

Cost is \$56.50 (\$50 + HST)

Turning Movement Count - Study Results

TRIM RD @ WATTERS RD

Survey Date: Tuesday, January 15, 2019

WO No: 38276

Start Time: 07:00

Device: Miovision

Full Study Diagram

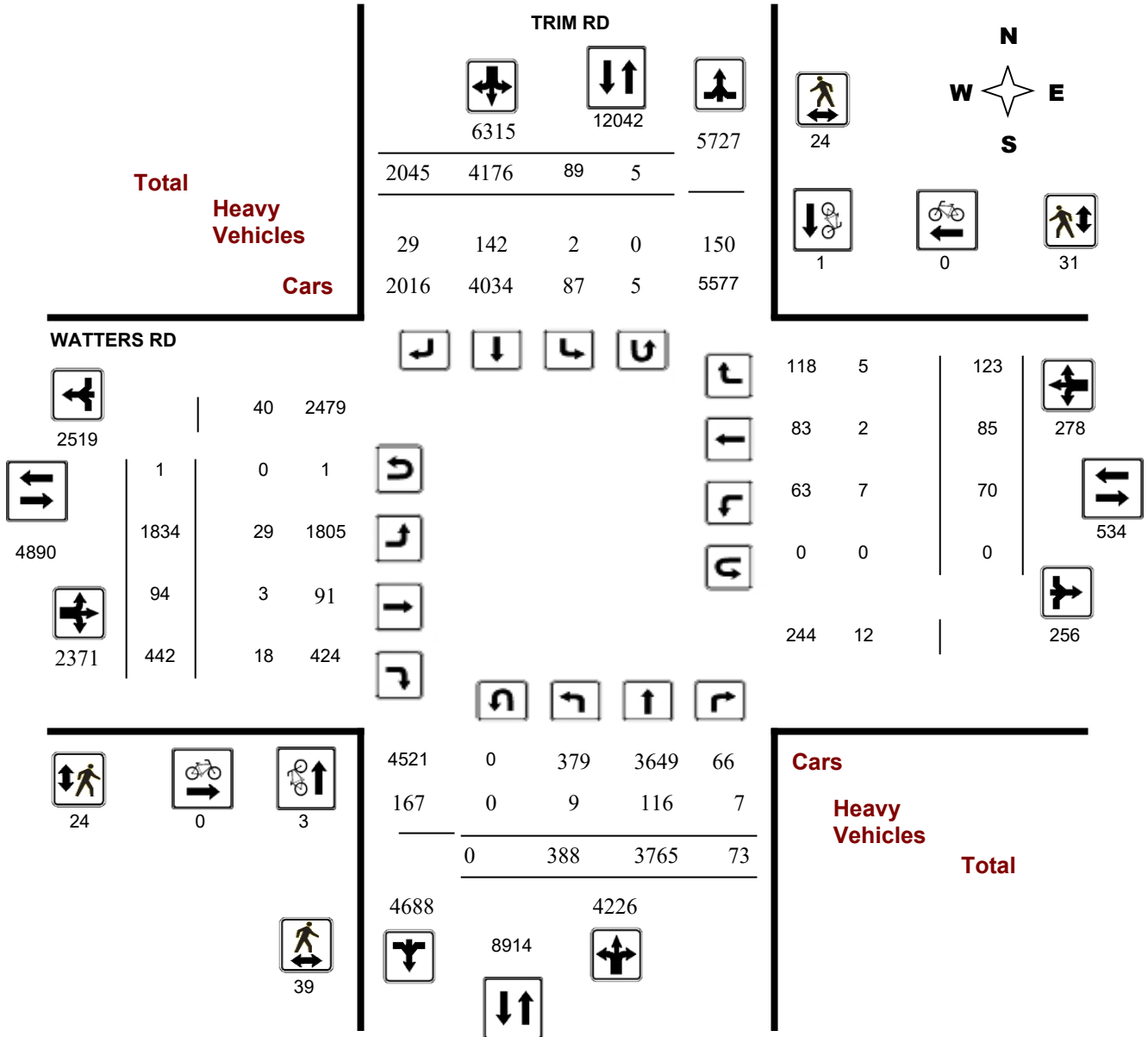

Survey Date: Tuesday, January 15, 2019

WO No: 38276

Start Time: 07:00

Device: Miovision

Full Study Peak Hour Diagram

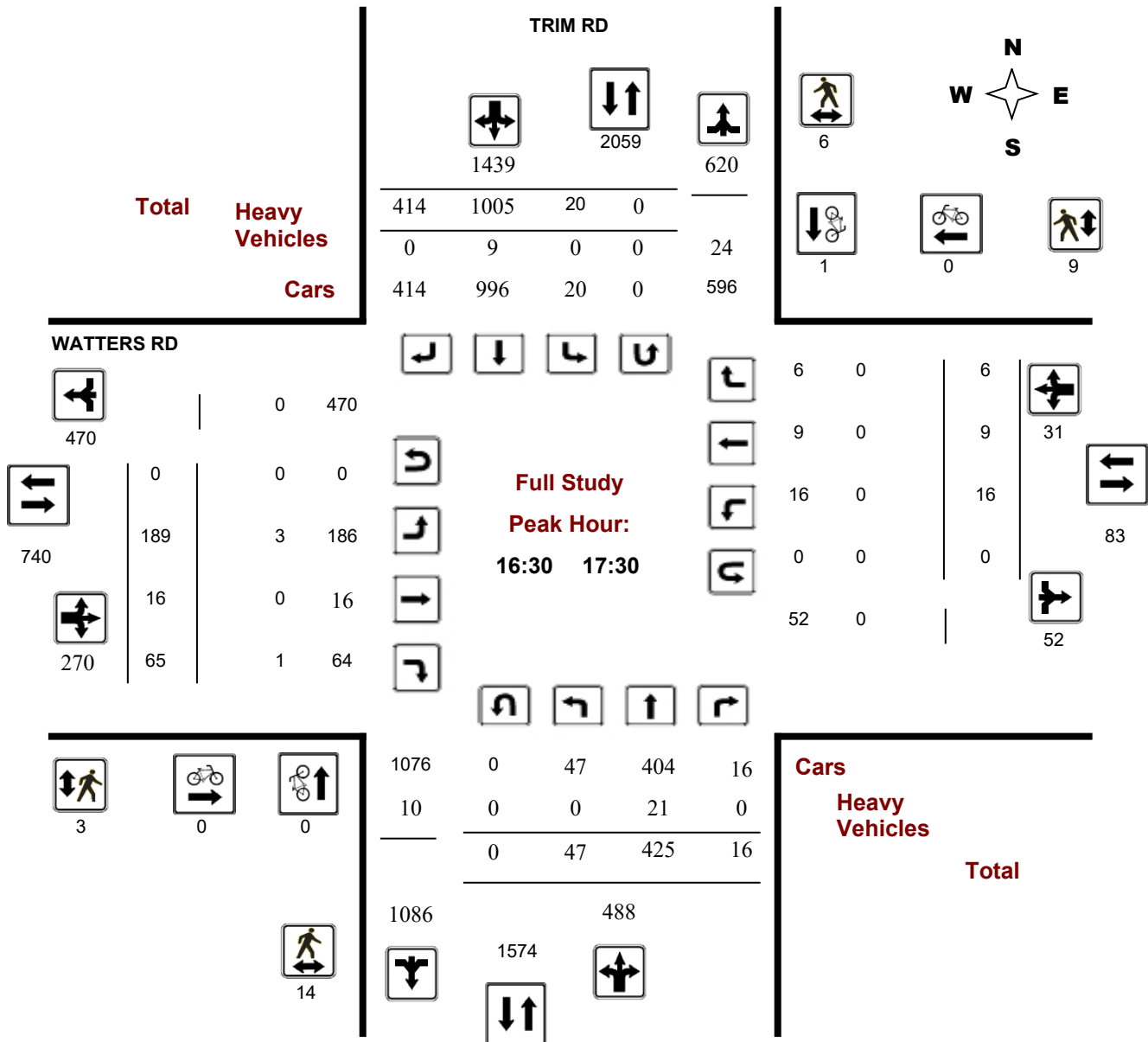

Turning Movement Count - Peak Hour Diagram

TRIM RD @ WATTERS RD

Survey Date: Tuesday, January 15, 2019

Start Time: 07:00

WO No: 38276

Device: Miovision

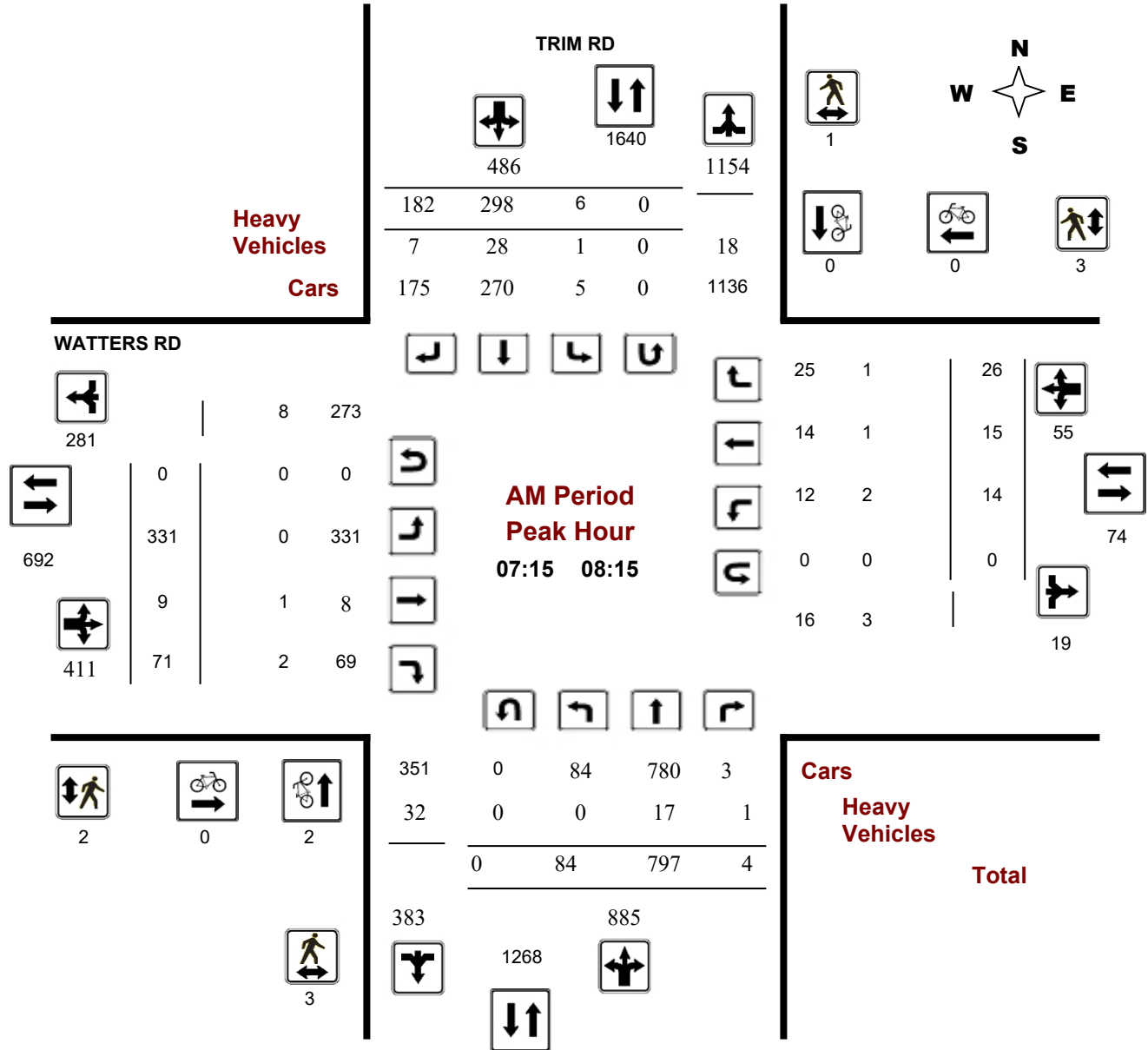

Comments

Turning Movement Count - Peak Hour Diagram

TRIM RD @ WATTERS RD

Survey Date: Tuesday, January 15, 2019

Start Time: 07:00

WO No: 38276

Device: Miovision

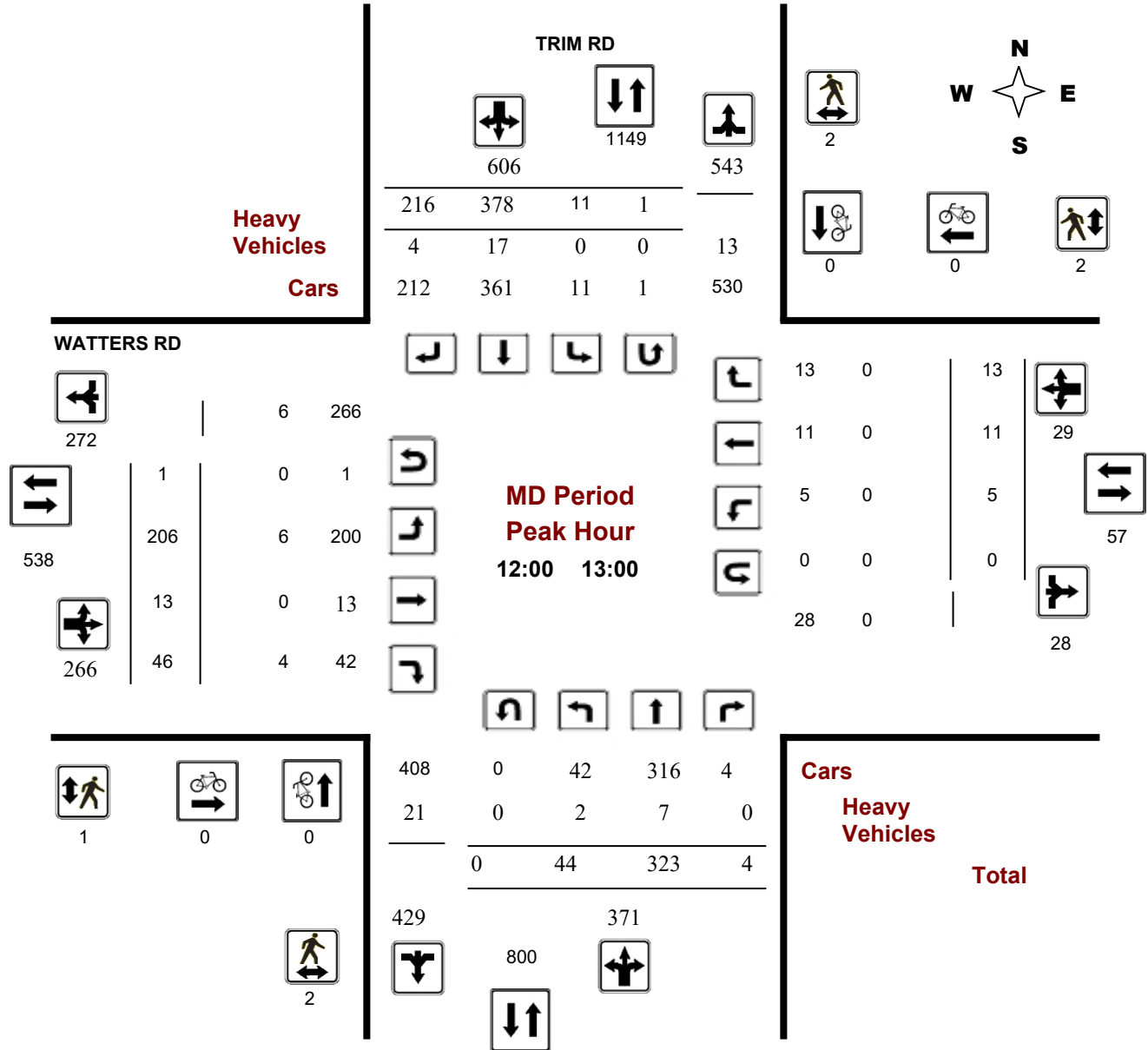

Comments

Turning Movement Count - Peak Hour Diagram

TRIM RD @ WATTERS RD

Survey Date: Tuesday, January 15, 2019

Start Time: 07:00

WO No: 38276

Device: Miovision

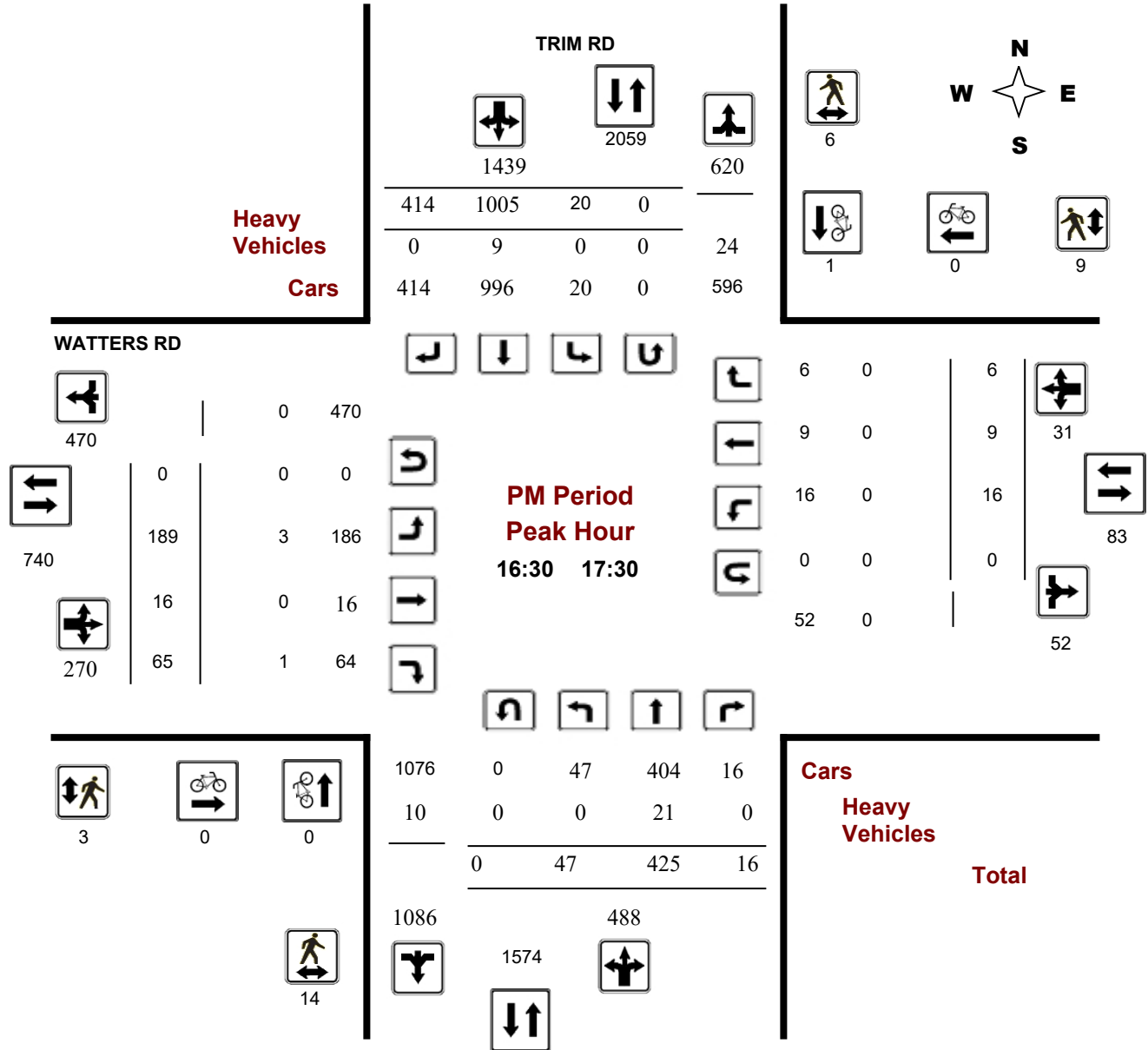



Transportation Services - Traffic Services

Turning Movement Count - Study Results

TRIM RD @ WATTERS RD

Survey Date: Tuesday, January 15, 2019

WO No: 38276

Start Time: 07:00

Device: Miovision

Full Study Summary (8 HR Standard)

Survey Date: Tuesday, January 15, 2019

Total Observed U-Turns

AADT Factor

Northbound: 0 Southbound: 5
 Eastbound: 1 Westbound: 0

1.10

Period	TRIM RD									WATTERS RD									Grand Total
	Northbound			NB TOT	Southbound			SB TOT	STR TOT	Eastbound			EB TOT	Westbound			WB TOT	STR TOT	
	LT	ST	RT		LT	ST	RT			LT	ST	RT		LT	ST	RT			
07:00 08:00	80	821	3	904	3	280	175	458	1362	332	10	61	403	9	16	26	51	454	1816
08:00 09:00	50	679	10	739	6	286	142	434	1173	287	7	59	353	15	11	22	48	401	1574
09:00 10:00	64	425	7	496	8	228	142	378	874	241	9	47	297	5	15	22	42	339	1213
11:30 12:30	30	295	7	332	8	358	203	569	901	180	13	32	225	4	11	16	31	256	1157
12:30 13:30	36	340	5	381	13	360	196	569	950	189	8	47	244	6	4	12	22	266	1216
15:00 16:00	49	392	7	448	10	753	358	1121	1569	204	16	70	290	7	6	9	22	312	1881
16:00 17:00	41	389	17	447	26	967	419	1412	1859	209	13	61	283	12	12	9	33	316	2175
17:00 18:00	38	424	17	479	15	944	410	1369	1848	192	18	65	275	12	10	7	29	304	2152
Sub Total	388	3765	73	4226	89	4176	2045	6310	10536	1834	94	442	2370	70	85	123	278	2648	13184
U Turns	0			0	5			5	5	1			1	0			0	1	6
Total	388	3765	73	4226	94	4176	2045	6315	10541	1835	94	442	2371	70	85	123	278	2649	13190
EQ 12Hr	539	5233	101	5873	131	5805	2843	8779	14652	2551	131	614	3296	97	118	171	386	3682	18334
Note: These values are calculated by multiplying the totals by the appropriate expansion factor.																1.39			
AVG 12Hr	593	5756	111	6460	144	6386	3127	9657	16117	2806	144	675	3625	107	130	188	425	4050	20167
Note: These volumes are calculated by multiplying the Equivalent 12 hr. totals by the AADT factor.																1.10			
AVG 24Hr	777	7540	145	8462	189	8366	4096	12651	21113	3676	189	884	4749	140	170	246	556	5305	26418

Note: These volumes are calculated by multiplying the Average Daily 12 hr. totals by 12 to 24 expansion factor. **1.31**

Note: U-Turns provided for approach totals. Refer to 'U-Turn' Report for specific breakdown.



Transportation Services - Traffic Services

Turning Movement Count - Study Results

TRIM RD @ WATTERS RD

Survey Date: Tuesday, January 15, 2019

WO No: 38276

Start Time: 07:00

Device: Miovision

Full Study 15 Minute Increments

TRIM RD

WATTERS RD

Northbound

Southbound

Eastbound

Westbound

Time Period	LT	ST	RT	N TOT	LT	ST	RT	S TOT	STR TOT	LT	ST	RT	E TOT	LT	ST	RT	W TOT	STR TOT	Grand Total
07:00 07:15	10	203	1	214	0	59	29	88	302	90	2	8	100	0	3	8	11	111	413
07:15 07:30	11	217	0	228	0	90	38	128	356	73	1	13	87	3	1	8	12	99	455
07:30 07:45	23	192	0	215	2	70	50	122	337	86	1	11	98	2	8	5	15	113	450
07:45 08:00	36	209	2	247	1	61	58	120	367	83	6	29	118	4	4	5	13	131	498
08:00 08:15	14	179	2	195	3	77	36	116	311	89	1	18	108	5	2	8	15	123	434
08:15 08:30	13	173	1	187	0	68	47	115	302	70	2	14	86	2	1	2	5	91	393
08:30 08:45	9	158	4	171	0	66	25	91	262	67	1	17	85	4	4	4	12	97	359
08:45 09:00	14	169	3	186	3	75	34	112	298	61	3	10	74	4	4	8	16	90	388
09:00 09:15	20	125	5	150	3	66	27	96	246	67	2	14	83	2	5	4	11	94	340
09:15 09:30	12	101	1	114	2	65	44	111	225	71	4	11	86	1	4	8	13	99	324
09:30 09:45	20	90	1	111	2	54	34	90	201	55	2	9	66	0	5	5	10	76	277
09:45 10:00	12	109	0	121	1	43	37	81	202	48	1	13	62	2	1	5	8	70	272
11:30 11:45	3	83	1	87	3	78	43	124	211	37	2	7	46	1	2	4	7	53	264
11:45 12:00	8	70	3	81	3	82	46	131	212	42	4	7	53	1	2	7	10	63	275
12:00 12:15	9	74	2	85	2	87	65	154	239	54	3	5	62	1	4	2	7	69	308
12:15 12:30	10	68	1	79	2	111	49	162	241	48	4	13	65	1	3	3	7	72	313
12:30 12:45	14	98	1	113	4	93	52	149	262	55	3	15	73	2	3	4	9	82	344
12:45 13:00	11	83	0	94	4	87	50	141	235	50	3	13	66	1	1	4	6	72	307
13:00 13:15	5	81	3	89	3	94	52	149	238	34	0	12	46	0	0	2	2	48	286
13:15 13:30	6	78	1	85	3	86	42	131	216	50	2	7	59	3	0	2	5	64	280
15:00 15:15	12	86	1	99	5	150	99	254	353	62	5	15	82	1	0	2	3	85	438
15:15 15:30	13	115	3	131	1	184	87	272	403	43	4	14	61	2	3	4	9	70	473
15:30 15:45	12	78	0	90	4	199	85	288	378	52	4	18	74	2	3	3	8	82	460
15:45 16:00	12	113	3	128	1	220	87	308	436	47	3	23	73	2	0	0	2	75	511
16:00 16:15	5	95	7	107	7	258	111	376	483	57	6	18	81	5	5	4	14	95	578
16:15 16:30	13	93	4	110	8	210	112	330	440	53	4	17	74	0	4	2	6	80	520
16:30 16:45	14	104	5	123	6	222	90	318	441	61	1	18	80	2	0	3	5	85	526
16:45 17:00	9	97	1	107	5	277	106	388	495	38	2	8	48	5	3	0	8	56	551
17:00 17:15	6	94	2	102	6	258	120	384	486	44	8	18	70	4	4	1	9	79	565
17:15 17:30	18	130	8	156	3	248	98	349	505	46	5	21	72	5	2	2	9	81	586
17:30 17:45	7	97	4	108	4	209	111	324	432	53	2	13	68	0	2	0	2	70	502
17:45 18:00	7	103	3	113	3	229	81	313	426	49	3	13	65	3	2	4	9	74	500
Total:	388	3765	73	4226	94	4176	2045	6315	10541	1835	94	442	2371	70	85	123	278	10541	13,190

Note: U-Turns are included in Totals.



Transportation Services - Traffic Services

Turning Movement Count - Study Results

TRIM RD @ WATTERS RD

Survey Date: Tuesday, January 15, 2019

WO No: 38276

Start Time: 07:00

Device: Miovision

Full Study Cyclist Volume

Time Period	TRIM RD			WATTERS RD			Grand Total
	Northbound	Southbound	Street Total	Eastbound	Westbound	Street Total	
07:00 07:15	0	0	0	0	0	0	0
07:15 07:30	0	0	0	0	0	0	0
07:30 07:45	2	0	2	0	0	0	2
07:45 08:00	0	0	0	0	0	0	0
08:00 08:15	0	0	0	0	0	0	0
08:15 08:30	0	0	0	0	0	0	0
08:30 08:45	1	0	1	0	0	0	1
08:45 09:00	0	0	0	0	0	0	0
09:00 09:15	0	0	0	0	0	0	0
09:15 09:30	0	0	0	0	0	0	0
09:30 09:45	0	0	0	0	0	0	0
09:45 10:00	0	0	0	0	0	0	0
11:30 11:45	0	0	0	0	0	0	0
11:45 12:00	0	0	0	0	0	0	0
12:00 12:15	0	0	0	0	0	0	0
12:15 12:30	0	0	0	0	0	0	0
12:30 12:45	0	0	0	0	0	0	0
12:45 13:00	0	0	0	0	0	0	0
13:00 13:15	0	0	0	0	0	0	0
13:15 13:30	0	0	0	0	0	0	0
15:00 15:15	0	0	0	0	0	0	0
15:15 15:30	0	0	0	0	0	0	0
15:30 15:45	0	0	0	0	0	0	0
15:45 16:00	0	0	0	0	0	0	0
16:00 16:15	0	0	0	0	0	0	0
16:15 16:30	0	0	0	0	0	0	0
16:30 16:45	0	0	0	0	0	0	0
16:45 17:00	0	1	1	0	0	0	1
17:00 17:15	0	0	0	0	0	0	0
17:15 17:30	0	0	0	0	0	0	0
17:30 17:45	0	0	0	0	0	0	0
17:45 18:00	0	0	0	0	0	0	0
Total	3	1	4	0	0	0	4



Transportation Services - Traffic Services

Turning Movement Count - Study Results

TRIM RD @ WATTERS RD

Survey Date: Tuesday, January 15, 2019

WO No: 38276

Start Time: 07:00

Device: Miovision

Full Study Pedestrian Volume

TRIM RD

WATTERS RD

Time Period	NB Approach (E or W Crossing)	SB Approach (E or W Crossing)	Total	EB Approach (N or S Crossing)	WB Approach (N or S Crossing)	Total	Grand Total
07:00 07:15	1	0	1	0	0	0	1
07:15 07:30	0	0	0	1	1	2	2
07:30 07:45	1	1	2	0	0	0	2
07:45 08:00	0	0	0	0	0	0	0
08:00 08:15	2	0	2	1	2	3	5
08:15 08:30	0	1	1	0	0	0	1
08:30 08:45	0	0	0	0	0	0	0
08:45 09:00	1	0	1	0	1	1	2
09:00 09:15	0	1	1	0	0	0	1
09:15 09:30	1	0	1	0	2	2	3
09:30 09:45	1	0	1	0	0	0	1
09:45 10:00	0	0	0	1	0	1	1
11:30 11:45	0	1	1	0	1	1	2
11:45 12:00	0	0	0	1	1	2	2
12:00 12:15	0	1	1	0	0	0	1
12:15 12:30	0	0	0	0	0	0	0
12:30 12:45	2	0	2	0	2	2	4
12:45 13:00	0	1	1	1	0	1	2
13:00 13:15	0	0	0	0	0	0	0
13:15 13:30	0	1	1	0	0	0	1
15:00 15:15	1	0	1	1	1	2	3
15:15 15:30	1	1	2	5	2	7	9
15:30 15:45	2	0	2	1	2	3	5
15:45 16:00	4	5	9	2	3	5	14
16:00 16:15	1	3	4	3	1	4	8
16:15 16:30	4	0	4	2	1	3	7
16:30 16:45	3	1	4	1	1	2	6
16:45 17:00	3	4	7	1	2	3	10
17:00 17:15	5	1	6	1	4	5	11
17:15 17:30	3	0	3	0	2	2	5
17:30 17:45	2	1	3	1	0	1	4
17:45 18:00	1	1	2	1	2	3	5
Total	39	24	63	24	31	55	118



Transportation Services - Traffic Services

Turning Movement Count - Study Results

TRIM RD @ WATTERS RD

Survey Date: Tuesday, January 15, 2019

WO No: 38276

Start Time: 07:00

Device: Miovision

Full Study Heavy Vehicles

Time Period	TRIM RD										WATTERS RD										Grand Total
	Northbound					Southbound					Eastbound					Westbound					
	LT	ST	RT	N TOT	LT	ST	RT	S TOT	STR TOT	LT	ST	RT	E TOT	LT	ST	RT	W TOT	STR TOT			
07:00 07:15	0	5	0	5	0	8	1	9	14	1	0	0	1	0	0	0	0	1	15		
07:15 07:30	0	5	0	5	0	11	1	12	17	0	1	0	1	0	0	0	0	1	18		
07:30 07:45	0	4	0	4	0	7	3	10	14	0	0	0	0	1	1	0	2	2	16		
07:45 08:00	0	3	0	3	0	3	2	5	8	0	0	2	2	0	0	0	0	2	10		
08:00 08:15	0	5	1	6	1	7	1	9	15	0	0	0	0	1	0	1	2	2	17		
08:15 08:30	1	4	0	5	0	2	1	3	8	1	0	0	1	0	0	0	0	1	9		
08:30 08:45	0	1	2	3	0	6	0	6	9	2	0	0	2	1	1	0	2	4	13		
08:45 09:00	0	3	0	3	1	2	2	5	8	0	0	0	0	1	0	0	1	1	9		
09:00 09:15	0	4	0	4	0	5	1	6	10	0	0	0	0	0	0	0	0	0	10		
09:15 09:30	1	2	0	3	0	16	3	19	22	3	0	0	3	0	0	0	0	3	25		
09:30 09:45	1	4	0	5	0	2	1	3	8	2	1	0	3	0	0	0	0	3	11		
09:45 10:00	1	4	0	5	0	4	0	4	9	1	0	2	3	1	0	0	1	4	13		
11:30 11:45	0	0	0	0	0	4	2	6	6	0	0	1	1	0	0	0	0	1	7		
11:45 12:00	1	1	0	2	0	2	1	3	5	1	0	0	1	0	0	0	0	1	6		
12:00 12:15	0	1	0	1	0	5	1	6	7	1	0	0	1	0	0	0	0	1	8		
12:15 12:30	0	0	0	0	0	1	1	2	2	1	0	0	1	0	0	0	0	1	3		
12:30 12:45	1	4	0	5	0	8	1	9	14	1	0	2	3	0	0	0	0	3	17		
12:45 13:00	1	2	0	3	0	3	1	4	7	3	0	2	5	0	0	0	0	5	12		
13:00 13:15	0	4	0	4	0	2	1	3	7	2	0	2	4	0	0	0	0	4	11		
13:15 13:30	0	4	0	4	0	3	3	6	10	0	0	0	0	0	0	0	0	0	10		
15:00 15:15	0	4	0	4	0	3	0	3	7	1	0	3	4	0	0	1	1	5	12		
15:15 15:30	1	6	1	8	0	2	1	3	11	1	0	0	1	0	0	1	1	2	13		
15:30 15:45	0	2	0	2	0	4	0	4	6	0	0	0	0	0	0	0	0	0	6		
15:45 16:00	0	6	0	6	0	1	0	1	7	0	0	0	0	0	0	0	0	0	7		
16:00 16:15	0	3	3	6	0	6	0	6	12	1	1	3	5	2	0	2	4	9	21		
16:15 16:30	0	2	0	2	0	10	1	11	13	2	0	0	2	0	0	0	0	2	15		
16:30 16:45	0	10	0	10	0	4	0	4	14	1	0	0	1	0	0	0	0	1	15		
16:45 17:00	0	4	0	4	0	2	0	2	6	2	0	0	2	0	0	0	0	2	8		
17:00 17:15	0	1	0	1	0	2	0	2	3	0	0	0	0	0	0	0	0	0	3		
17:15 17:30	0	6	0	6	0	1	0	1	7	0	0	1	1	0	0	0	0	1	8		
17:30 17:45	1	6	0	7	0	3	0	3	10	2	0	0	2	0	0	0	0	2	12		
17:45 18:00	0	6	0	6	0	3	0	3	9	0	0	0	0	0	0	0	0	0	9		
Total:	None	9	116	7	132	2	142	29	173	305	29	3	18	50	7	2	5	14	64	369	



Transportation Services - Traffic Services

Turning Movement Count - Study Results

TRIM RD @ WATTERS RD

Survey Date: Tuesday, January 15, 2019

WO No: 38276

Start Time: 07:00

Device: Miovision

Full Study 15 Minute U-Turn Total

TRIM RD

WATTERS RD

Time Period		Northbound U-Turn Total	Southbound U-Turn Total	Eastbound U-Turn Total	Westbound U-Turn Total	Total
07:00	07:15	0	0	0	0	0
07:15	07:30	0	0	0	0	0
07:30	07:45	0	0	0	0	0
07:45	08:00	0	0	0	0	0
08:00	08:15	0	0	0	0	0
08:15	08:30	0	0	0	0	0
08:30	08:45	0	0	0	0	0
08:45	09:00	0	0	0	0	0
09:00	09:15	0	0	0	0	0
09:15	09:30	0	0	0	0	0
09:30	09:45	0	0	0	0	0
09:45	10:00	0	0	0	0	0
11:30	11:45	0	2	0	0	2
11:45	12:00	0	0	0	0	0
12:00	12:15	0	0	0	0	0
12:15	12:30	0	0	1	0	1
12:30	12:45	0	1	0	0	1
12:45	13:00	0	0	0	0	0
13:00	13:15	0	0	0	0	0
13:15	13:30	0	0	0	0	0
15:00	15:15	0	1	0	0	1
15:15	15:30	0	0	0	0	0
15:30	15:45	0	0	0	0	0
15:45	16:00	0	0	0	0	0
16:00	16:15	0	0	0	0	0
16:15	16:30	0	0	0	0	0
16:30	16:45	0	0	0	0	0
16:45	17:00	0	0	0	0	0
17:00	17:15	0	0	0	0	0
17:15	17:30	0	0	0	0	0
17:30	17:45	0	0	0	0	0
17:45	18:00	0	1	0	0	1
Total		0	5	1	0	6

Turning Movement Count - Study Results

PORTOBELLO BLVD/SPRINGRIDGE DR S @ TRIM RD

Survey Date: Tuesday, January 15, 2019

WO No: 38279

Start Time: 07:00

Device: Miovision

Full Study Diagram

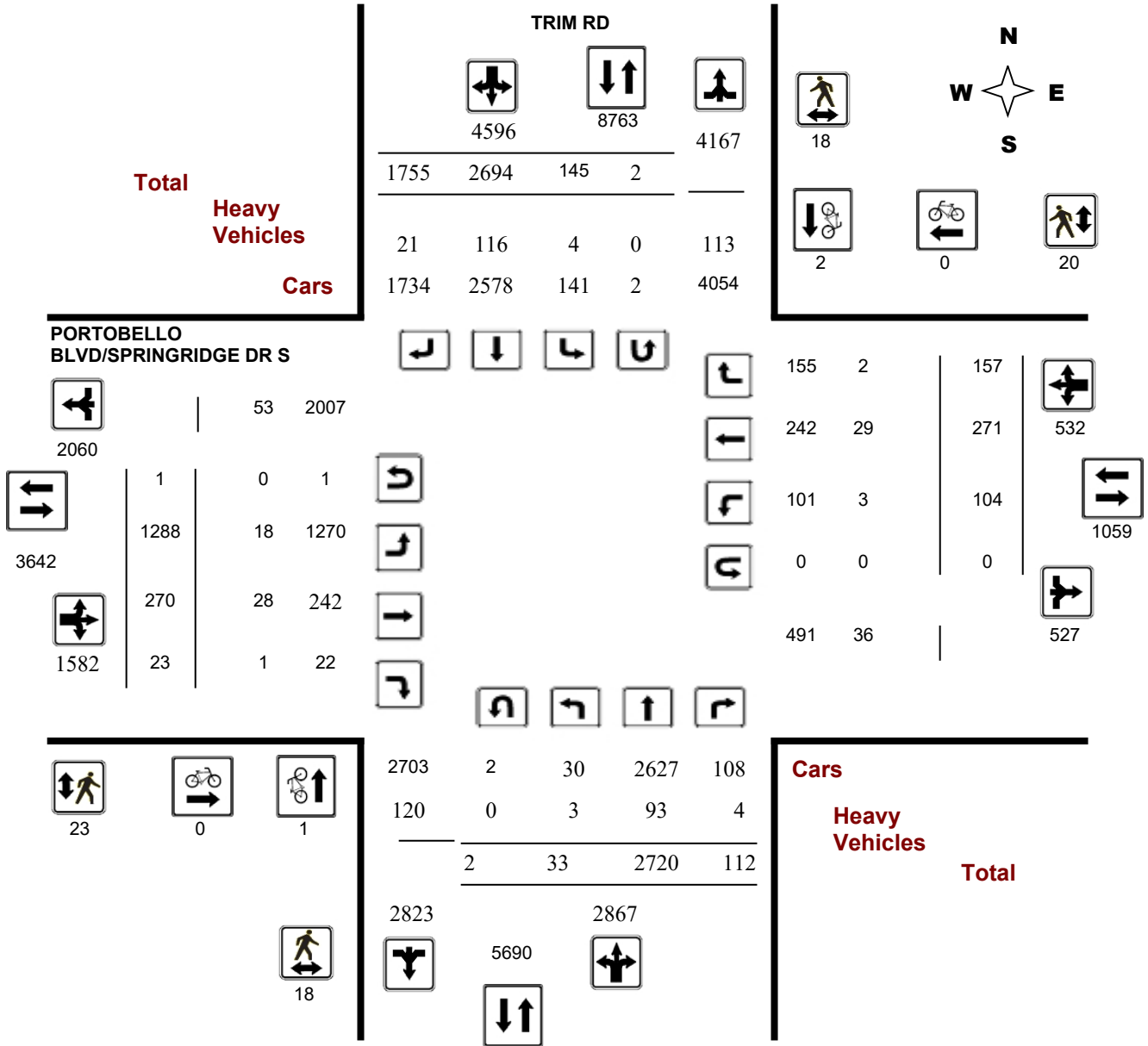

Turning Movement Count - Study Results

PORTOBELLO BLVD/SPRINGRIDGE DR S @ TRIM RD

Survey Date: Tuesday, January 15, 2019

WO No: 38279

Start Time: 07:00

Device: Miovision

Full Study Peak Hour Diagram

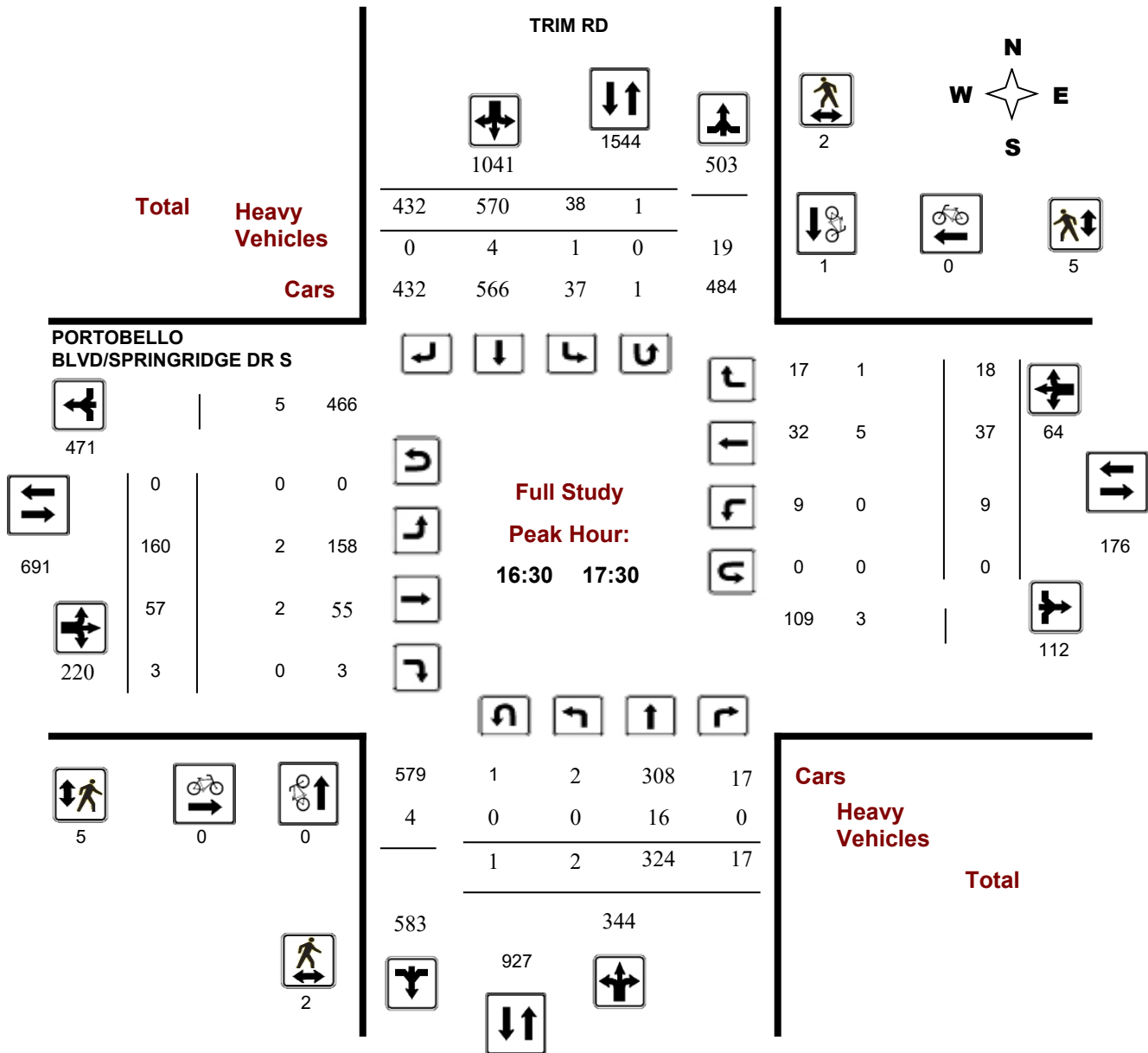

Turning Movement Count - Peak Hour Diagram

PORTOBELLO BLVD/SPRINGRIDGE DR S @ TRIM RD

Survey Date: Tuesday, January 15, 2019

Start Time: 07:00

WO No: 38279

Device: Miovision

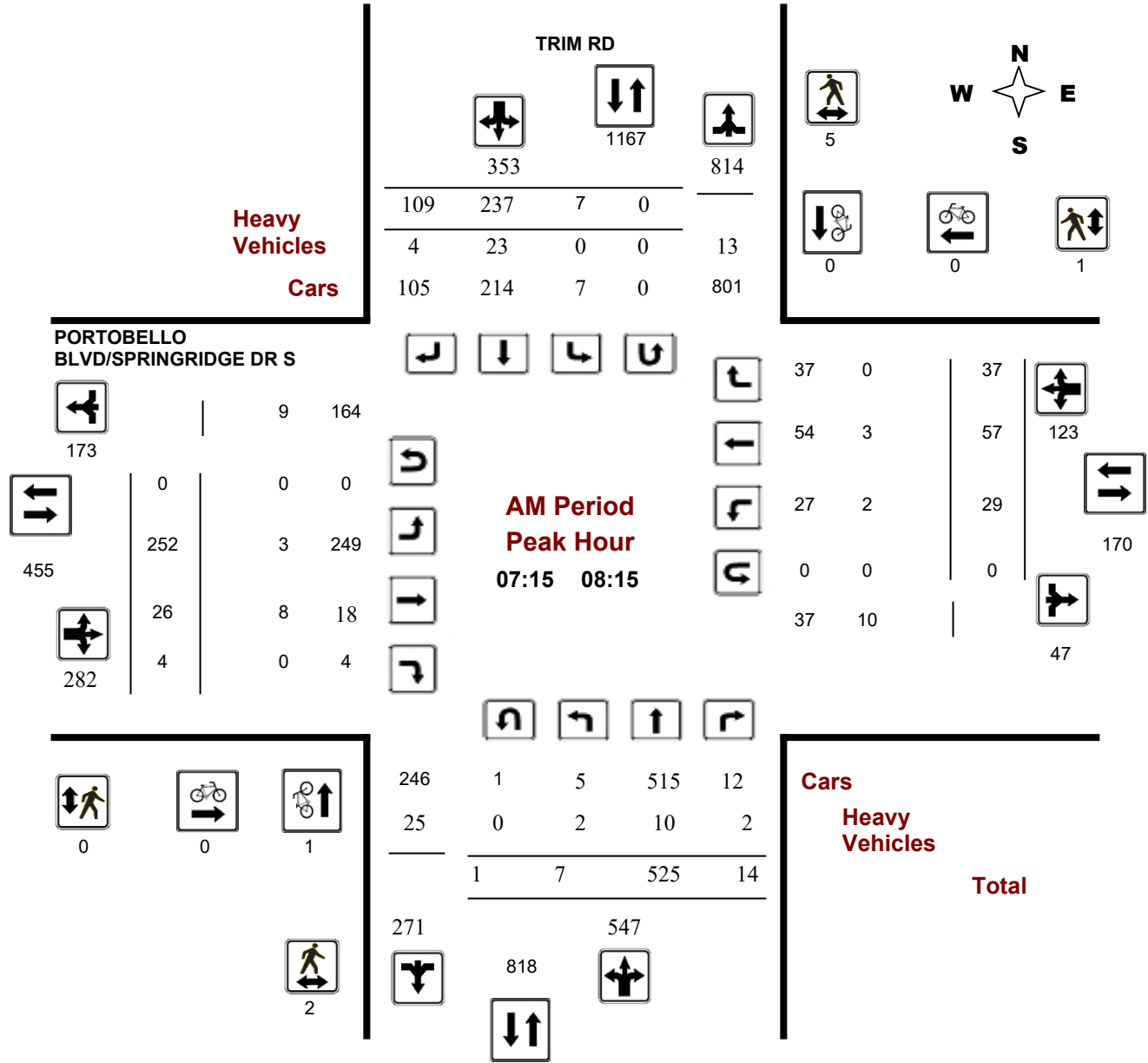

Comments

Turning Movement Count - Peak Hour Diagram

PORTOBELLO BLVD/SPRINGRIDGE DR S @ TRIM RD

Survey Date: Tuesday, January 15, 2019

Start Time: 07:00

WO No: 38279

Device: Miovision

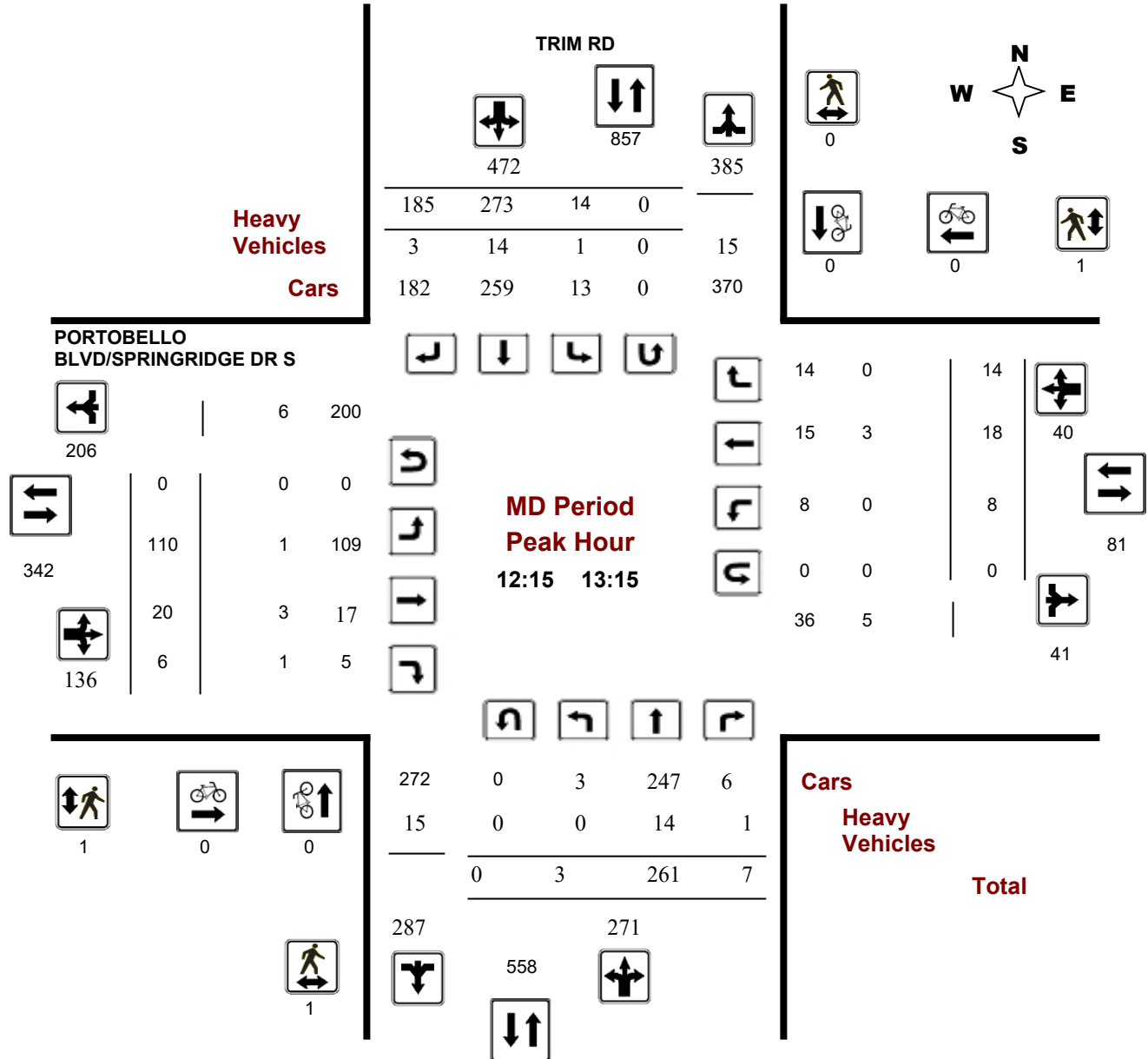

Turning Movement Count - Peak Hour Diagram

PORTOBELLO BLVD/SPRINGRIDGE DR S @ TRIM RD

Survey Date: Tuesday, January 15, 2019

Start Time: 07:00

WO No: 38279

Device: Miovision

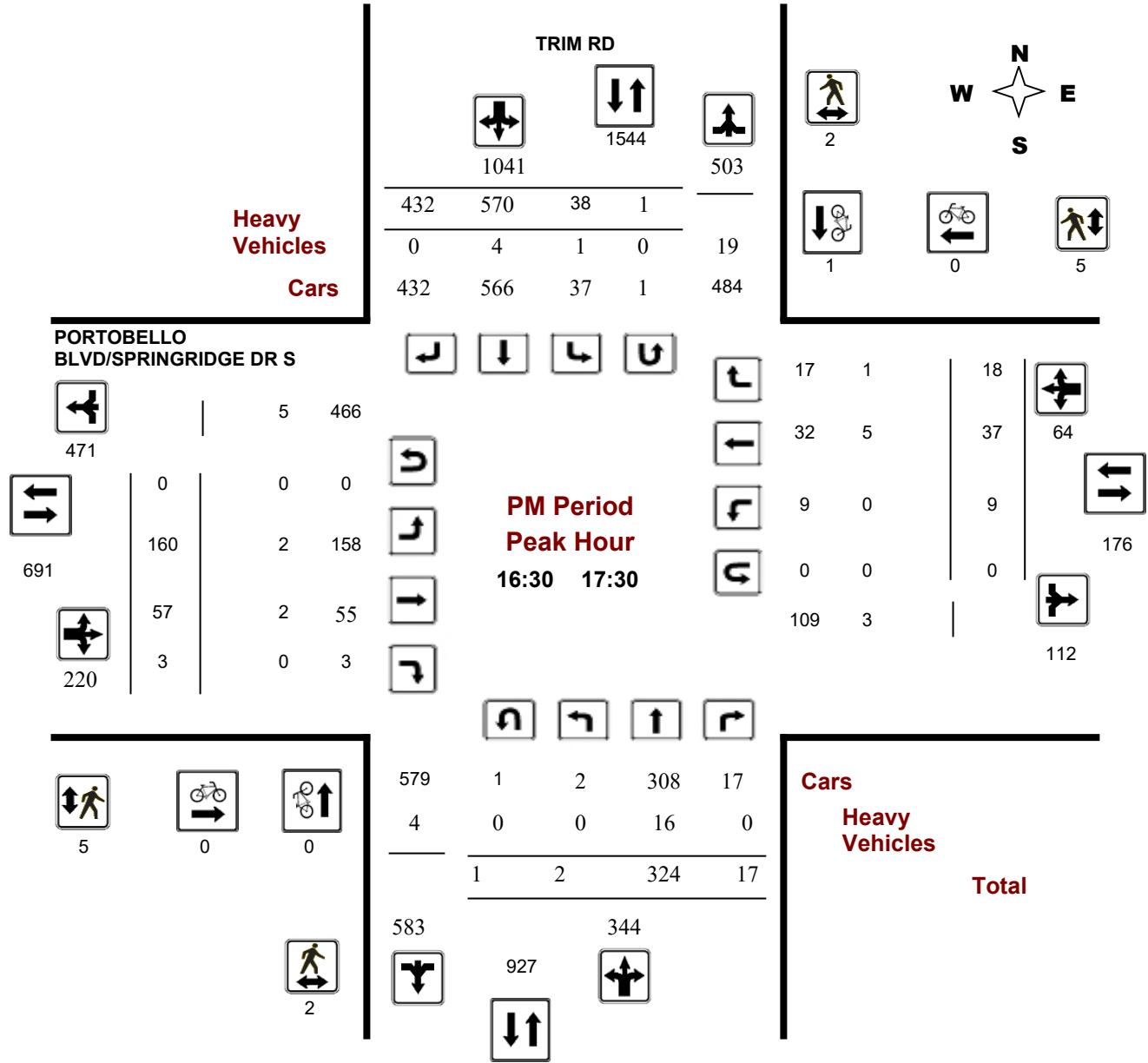



Transportation Services - Traffic Services

Turning Movement Count - Study Results

PORTOBELLO BLVD/SPRINGRIDGE DR S @ TRIM RD

Survey Date: Tuesday, January 15, 2019

WO No: 38279

Start Time: 07:00

Device: Miovision

Full Study Summary (8 HR Standard)

Survey Date: Tuesday, January 15, 2019

Total Observed U-Turns

AADT Factor

Northbound: 2 Southbound: 2
 Eastbound: 1 Westbound: 0

1.10

Period	TRIM RD									PORTOBELLO BLVD/SPRINGRIDGE DR S									Grand Total
	Northbound			NB TOT	Southbound			SB TOT	STR TOT	Eastbound			EB TOT	Westbound			WB TOT	STR TOT	
	LT	ST	RT		LT	ST	RT			LT	ST	RT		LT	ST	RT			
07:00 08:00	6	530	13	549	7	241	92	340	889	246	23	2	271	33	43	37	113	384	1273
08:00 09:00	4	427	5	436	14	208	114	336	772	234	22	2	258	13	53	32	98	356	1128
09:00 10:00	5	306	11	322	8	162	92	262	584	138	12	3	153	11	26	15	52	205	789
11:30 12:30	2	234	12	248	12	232	159	403	651	113	21	2	136	5	27	11	43	179	830
12:30 13:30	2	270	6	278	12	256	163	431	709	114	21	6	141	6	16	17	39	180	889
15:00 16:00	9	324	22	355	25	487	332	844	1199	134	52	4	190	12	29	13	54	244	1443
16:00 17:00	4	306	20	330	29	573	421	1023	1353	151	66	2	219	12	36	19	67	286	1639
17:00 18:00	1	323	23	347	38	535	382	955	1302	158	53	2	213	12	41	13	66	279	1581
Sub Total	33	2720	112	2865	145	2694	1755	4594	7459	1288	270	23	1581	104	271	157	532	2113	9572
U Turns	2			2	2			2	4	1			1	0			0	1	5
Total	35	2720	112	2867	147	2694	1755	4596	7463	1289	270	23	1582	104	271	157	532	2114	9577
EQ 12Hr	49	3781	156	3986	204	3745	2439	6388	10374	1792	375	32	2199	145	377	218	740	2939	13313
Note: These values are calculated by multiplying the totals by the appropriate expansion factor.																	1.39		
AVG 12Hr	54	4159	172	4385	224	4120	2683	7027	11412	1971	413	35	2419	160	415	240	815	3234	14646
Note: These volumes are calculated by multiplying the Equivalent 12 hr. totals by the AADT factor.																	1.10		
AVG 24Hr	71	5448	225	5744	293	5397	3515	9205	14949	2582	541	46	3169	210	544	314	1068	4237	19186
Note: These volumes are calculated by multiplying the Average Daily 12 hr. totals by 12 to 24 expansion factor.																	1.31		

Note: U-Turns provided for approach totals. Refer to 'U-Turn' Report for specific breakdown.



Transportation Services - Traffic Services

Turning Movement Count - Study Results

PORTOBELLO BLVD/SPRINGRIDGE DR S @ TRIM RD

Survey Date: Tuesday, January 15, 2019

WO No: 38279

Start Time: 07:00

Device: Miovision

Full Study 15 Minute Increments

TRIM RD

PORTOBELLO BLVD/SPRINGRIDGE
DR S

Northbound

Southbound

Eastbound

Westbound

Time Period	LT	ST	RT	N TOT	LT	ST	RT	S TOT	STR TOT	LT	ST	RT	E TOT	LT	ST	RT	W TOT	STR TOT	Grand Total
07:00 07:15	1	110	1	112	3	56	14	73	185	69	4	0	73	6	2	6	14	87	272
07:15 07:30	1	133	3	137	1	70	18	89	226	63	3	1	67	8	14	12	34	101	327
07:30 07:45	3	144	6	153	1	64	23	88	241	62	4	0	66	12	14	12	38	104	345
07:45 08:00	2	143	3	148	2	51	37	90	238	52	12	1	65	7	13	7	27	92	330
08:00 08:15	2	105	2	109	3	52	31	86	195	75	7	2	84	2	16	6	24	108	303
08:15 08:30	2	99	1	102	4	59	23	86	188	57	3	0	60	3	19	9	31	91	279
08:30 08:45	0	119	1	120	4	42	35	81	201	56	5	0	61	2	5	10	17	78	279
08:45 09:00	0	104	1	105	3	55	25	83	188	47	7	0	54	6	13	7	26	80	268
09:00 09:15	2	96	3	101	1	50	29	80	181	44	1	0	45	4	1	6	11	56	237
09:15 09:30	1	64	2	67	3	53	17	73	140	32	0	0	32	2	8	1	11	43	183
09:30 09:45	0	74	0	74	2	36	27	65	139	31	5	2	38	3	7	6	16	54	193
09:45 10:00	2	72	6	80	2	23	19	44	124	31	6	1	38	2	10	2	14	52	176
11:30 11:45	0	59	2	61	3	62	20	85	146	24	6	1	31	1	7	5	13	44	190
11:45 12:00	0	62	5	67	3	39	44	86	153	27	7	0	34	1	9	2	12	46	199
12:00 12:15	1	58	2	61	1	56	37	94	155	34	6	0	40	1	7	2	10	50	205
12:15 12:30	1	55	3	59	5	75	58	138	197	28	2	1	31	2	4	2	8	39	236
12:30 12:45	1	84	2	87	2	65	48	115	202	30	6	1	37	1	6	3	10	47	249
12:45 13:00	1	62	1	64	0	66	41	107	171	31	10	2	43	1	3	5	9	52	223
13:00 13:15	0	60	1	61	7	67	38	112	173	21	2	2	25	4	5	4	13	38	211
13:15 13:30	0	64	2	66	3	58	36	97	163	32	3	1	36	0	2	5	7	43	206
15:00 15:15	0	73	5	78	6	100	72	178	256	39	10	0	49	2	3	3	8	57	313
15:15 15:30	2	78	4	84	5	111	88	204	288	37	12	2	51	3	7	5	15	66	354
15:30 15:45	6	85	9	100	8	129	83	220	320	21	8	1	30	5	14	2	21	51	371
15:45 16:00	1	88	4	93	7	147	89	243	336	37	22	1	60	2	5	3	10	70	406
16:00 16:15	0	79	8	87	6	163	102	271	358	40	20	0	60	3	13	6	22	82	440
16:15 16:30	3	71	4	78	6	129	89	224	302	41	14	0	55	5	5	3	13	68	370
16:30 16:45	0	76	5	81	8	125	94	227	308	35	16	2	53	2	11	3	16	69	377
16:45 17:00	1	80	3	84	10	156	136	302	386	35	16	0	51	2	7	7	16	67	453
17:00 17:15	1	72	3	76	10	150	97	257	333	42	9	0	51	1	14	3	18	69	402
17:15 17:30	1	96	6	103	11	139	105	255	358	48	16	1	65	4	5	5	14	79	437
17:30 17:45	0	84	7	91	11	118	88	217	308	28	8	1	37	3	14	2	19	56	364
17:45 18:00	0	71	7	78	6	128	92	226	304	40	20	0	60	4	8	3	15	75	379
Total:	35	2720	112	2867	147	2694	1755	4596	7463	1289	270	23	1582	104	271	157	532	7463	9,577

Note: U-Turns are included in Totals.



Transportation Services - Traffic Services

Turning Movement Count - Study Results

PORTOBELLO BLVD/SPRINGRIDGE DR S @ TRIM RD

Survey Date: Tuesday, January 15, 2019

WO No: 38279

Start Time: 07:00

Device: Miovision

Full Study Cyclist Volume

Time Period	TRIM RD			PORTOBELLO BLVD/SPRINGRIDGE DR S			Grand Total
	Northbound	Southbound	Street Total	Eastbound	Westbound	Street Total	
07:00 07:15	0	0	0	0	0	0	0
07:15 07:30	0	0	0	0	0	0	0
07:30 07:45	1	0	1	0	0	0	1
07:45 08:00	0	0	0	0	0	0	0
08:00 08:15	0	0	0	0	0	0	0
08:15 08:30	0	0	0	0	0	0	0
08:30 08:45	0	0	0	0	0	0	0
08:45 09:00	0	0	0	0	0	0	0
09:00 09:15	0	0	0	0	0	0	0
09:15 09:30	0	0	0	0	0	0	0
09:30 09:45	0	0	0	0	0	0	0
09:45 10:00	0	0	0	0	0	0	0
11:30 11:45	0	0	0	0	0	0	0
11:45 12:00	0	0	0	0	0	0	0
12:00 12:15	0	0	0	0	0	0	0
12:15 12:30	0	0	0	0	0	0	0
12:30 12:45	0	0	0	0	0	0	0
12:45 13:00	0	0	0	0	0	0	0
13:00 13:15	0	0	0	0	0	0	0
13:15 13:30	0	0	0	0	0	0	0
15:00 15:15	0	0	0	0	0	0	0
15:15 15:30	0	0	0	0	0	0	0
15:30 15:45	0	1	1	0	0	0	1
15:45 16:00	0	0	0	0	0	0	0
16:00 16:15	0	0	0	0	0	0	0
16:15 16:30	0	0	0	0	0	0	0
16:30 16:45	0	0	0	0	0	0	0
16:45 17:00	0	1	1	0	0	0	1
17:00 17:15	0	0	0	0	0	0	0
17:15 17:30	0	0	0	0	0	0	0
17:30 17:45	0	0	0	0	0	0	0
17:45 18:00	0	0	0	0	0	0	0
Total	1	2	3	0	0	0	3



Transportation Services - Traffic Services

Turning Movement Count - Study Results

PORTOBELLO BLVD/SPRINGRIDGE DR S @ TRIM RD

Survey Date: Tuesday, January 15, 2019

WO No: 38279

Start Time: 07:00

Device: Miovision

Full Study Pedestrian Volume

TRIM RD

PORTOBELLO BLVD/SPRINGRIDGE
DR S

Time Period	NB Approach (E or W Crossing)	SB Approach (E or W Crossing)	Total	EB Approach (N or S Crossing)	WB Approach (N or S Crossing)	Total	Grand Total
07:00 07:15	2	2	4	0	0	0	4
07:15 07:30	1	0	1	0	0	0	1
07:30 07:45	0	3	3	0	0	0	3
07:45 08:00	0	2	2	0	1	1	3
08:00 08:15	1	0	1	0	0	0	1
08:15 08:30	1	0	1	1	1	2	3
08:30 08:45	0	0	0	1	0	1	1
08:45 09:00	2	1	3	2	1	3	6
09:00 09:15	0	0	0	0	0	0	0
09:15 09:30	1	0	1	1	1	2	3
09:30 09:45	0	0	0	1	0	1	1
09:45 10:00	0	1	1	0	0	0	1
11:30 11:45	0	0	0	0	0	0	0
11:45 12:00	0	0	0	0	0	0	0
12:00 12:15	0	0	0	0	0	0	0
12:15 12:30	0	0	0	0	1	1	1
12:30 12:45	0	0	0	0	0	0	0
12:45 13:00	0	0	0	1	0	1	1
13:00 13:15	1	0	1	0	0	0	1
13:15 13:30	3	0	3	3	2	5	8
15:00 15:15	1	1	2	1	2	3	5
15:15 15:30	1	2	3	3	3	6	9
15:30 15:45	0	3	3	0	1	1	4
15:45 16:00	0	0	0	2	0	2	2
16:00 16:15	2	0	2	0	1	1	3
16:15 16:30	0	0	0	0	1	1	1
16:30 16:45	0	1	1	1	1	2	3
16:45 17:00	0	1	1	3	1	4	5
17:00 17:15	0	0	0	0	3	3	3
17:15 17:30	2	0	2	1	0	1	3
17:30 17:45	0	0	0	2	0	2	2
17:45 18:00	0	1	1	0	0	0	1
Total	18	18	36	23	20	43	79



Transportation Services - Traffic Services

Turning Movement Count - Study Results

PORTOBELLO BLVD/SPRINGRIDGE DR S @ TRIM RD

Survey Date: Tuesday, January 15, 2019

WO No: 38279

Start Time: 07:00

Device: Miovision

Full Study Heavy Vehicles

TRIM RD

PORTOBELLO BLVD/SPRINGRIDGE
DR S

Northbound

Southbound

Eastbound

Westbound

Time Period	Northbound			N TOT	Southbound			S TOT	STR TOT	Eastbound			E TOT	Westbound			W TOT	STR TOT	Grand Total
	LT	ST	RT		LT	ST	RT			LT	ST	RT		LT	ST	RT			
07:00 07:15	0	6	0	6	0	7	1	8	14	0	1	0	1	0	0	0	0	1	15
07:15 07:30	0	3	0	3	0	8	1	9	12	0	3	0	3	0	0	0	0	3	15
07:30 07:45	1	4	1	6	0	7	1	8	14	0	1	0	1	2	1	0	3	4	18
07:45 08:00	0	2	0	2	0	4	0	4	6	0	2	0	2	0	0	0	0	2	8
08:00 08:15	1	1	1	3	0	4	2	6	9	3	2	0	5	0	2	0	2	7	16
08:15 08:30	1	3	0	4	0	3	1	4	8	0	2	0	2	0	0	0	0	2	10
08:30 08:45	0	1	0	1	0	2	0	2	3	1	0	0	1	0	2	0	2	3	6
08:45 09:00	0	2	1	3	0	3	0	3	6	0	1	0	1	0	2	0	2	3	9
09:00 09:15	0	3	0	3	0	6	2	8	11	0	0	0	0	0	0	0	0	0	11
09:15 09:30	0	2	0	2	1	11	1	13	15	3	0	0	3	0	1	0	1	4	19
09:30 09:45	0	3	0	3	0	4	0	4	7	1	0	0	1	1	0	0	1	2	9
09:45 10:00	0	1	0	1	0	3	0	3	4	0	1	0	1	0	0	0	0	1	5
11:30 11:45	0	0	0	0	0	5	0	5	5	0	0	0	0	0	0	0	0	0	5
11:45 12:00	0	1	0	1	0	1	2	3	4	0	1	0	1	0	1	0	1	2	6
12:00 12:15	0	1	0	1	0	3	1	4	5	1	0	0	1	0	0	0	0	1	6
12:15 12:30	0	3	0	3	0	4	0	4	7	0	1	0	1	0	0	0	0	1	8
12:30 12:45	0	3	1	4	0	4	1	5	9	1	1	0	2	0	1	0	1	3	12
12:45 13:00	0	4	0	4	0	5	2	7	11	0	1	0	1	0	1	0	1	2	13
13:00 13:15	0	4	0	4	1	1	0	2	6	0	0	1	1	0	1	0	1	2	8
13:15 13:30	0	1	0	1	0	1	2	3	4	0	1	0	1	0	1	0	1	2	6
15:00 15:15	0	5	0	5	1	4	0	5	10	0	0	0	0	0	1	0	1	1	11
15:15 15:30	0	5	0	5	0	0	1	1	6	0	1	0	1	0	0	0	0	1	7
15:30 15:45	0	3	0	3	0	3	1	4	7	0	0	0	0	0	1	0	1	1	8
15:45 16:00	0	3	0	3	0	2	0	2	5	2	5	0	7	0	1	0	1	8	13
16:00 16:15	0	1	0	1	0	6	1	7	8	1	0	0	1	0	4	1	5	6	14
16:15 16:30	0	2	0	2	0	8	1	9	11	1	1	0	2	0	1	0	1	3	14
16:30 16:45	0	7	0	7	0	4	0	4	11	0	0	0	0	0	1	0	1	1	12
16:45 17:00	0	2	0	2	0	0	0	0	2	0	1	0	1	0	1	0	1	2	4
17:00 17:15	0	2	0	2	0	0	0	0	2	0	0	0	0	0	2	0	2	2	4
17:15 17:30	0	5	0	5	1	0	0	1	6	2	1	0	3	0	1	1	2	5	11
17:30 17:45	0	5	0	5	0	1	0	1	6	1	0	0	1	0	2	0	2	3	9
17:45 18:00	0	5	0	5	0	2	0	2	7	1	1	0	2	0	1	0	1	3	10
Total: None	3	93	4	100	4	116	21	141	241	18	28	1	47	3	29	2	34	81	322



Transportation Services - Traffic Services

Turning Movement Count - Study Results

PORTOBELLO BLVD/SPRINGRIDGE DR S @ TRIM RD

Survey Date: Tuesday, January 15, 2019

WO No: 38279

Start Time: 07:00

Device: Miovision

Full Study 15 Minute U-Turn Total

Time Period	TRIM RD		PORTOBELLO BLVD/SPRINGRIDGE DR S		Total	
	Northbound U-Turn Total	Southbound U-Turn Total	Eastbound U-Turn Total	Westbound U-Turn Total		
07:00	07:15	0	0	0	0	
07:15	07:30	0	0	0	0	
07:30	07:45	0	0	0	0	
07:45	08:00	1	0	0	1	
08:00	08:15	0	0	0	0	
08:15	08:30	0	0	0	0	
08:30	08:45	0	0	1	1	
08:45	09:00	0	0	0	0	
09:00	09:15	0	0	0	0	
09:15	09:30	0	0	0	0	
09:30	09:45	0	0	0	0	
09:45	10:00	0	0	0	0	
11:30	11:45	0	0	0	0	
11:45	12:00	0	0	0	0	
12:00	12:15	0	0	0	0	
12:15	12:30	0	0	0	0	
12:30	12:45	0	0	0	0	
12:45	13:00	0	0	0	0	
13:00	13:15	0	0	0	0	
13:15	13:30	0	0	0	0	
15:00	15:15	0	1	0	1	
15:15	15:30	0	0	0	0	
15:30	15:45	0	0	0	0	
15:45	16:00	0	0	0	0	
16:00	16:15	0	0	0	0	
16:15	16:30	0	0	0	0	
16:30	16:45	0	1	0	1	
16:45	17:00	0	0	0	0	
17:00	17:15	1	0	0	1	
17:15	17:30	0	0	0	0	
17:30	17:45	0	0	0	0	
17:45	18:00	0	0	0	0	
Total		2	2	1	0	5

Turning Movement Count - 15 Minute Summary Report

CHARLEMAGNE BLVD @ WATTERS RD

Survey Date: Thursday, October 08, 2015

Total Observed U-Turns

Northbound: 0 Southbound: 1
Eastbound: 0 Westbound: 0

Time Period	Northbound			N TOT	Southbound			S TOT	STR TOT	Eastbound			E TOT	Westbound			W TOT	STR TOT	Grand Total
	LT	ST	RT		LT	ST	RT			LT	ST	RT		LT	ST	RT			
07:00 07:15	0	36	21	57	8	9	0	17	74	0	0	0	0	13	0	35	48	48	122
07:15 07:30	0	52	16	68	18	20	0	38	106	0	0	0	0	27	0	34	61	61	167
07:30 07:45	0	58	23	81	18	48	0	66	147	0	0	0	0	42	0	34	76	76	223
07:45 08:00	0	76	46	122	6	51	0	57	179	0	0	0	0	65	0	51	116	116	295
08:00 08:15	0	37	55	92	20	21	0	41	133	0	0	0	0	37	0	38	75	75	208
08:15 08:30	0	30	39	69	26	24	0	50	119	0	0	0	0	37	0	54	91	91	210
08:30 08:45	0	25	21	46	15	15	0	30	76	0	0	0	0	29	0	18	47	47	123
08:45 09:00	0	27	31	58	21	22	0	43	101	0	0	0	0	26	0	29	55	55	156
09:00 09:15	0	29	19	48	15	16	0	31	79	0	0	0	0	35	0	32	67	67	146
09:15 09:30	0	32	19	51	5	16	0	21	72	0	0	0	0	32	0	25	57	57	129
09:30 09:45	0	23	19	42	13	12	0	25	67	0	0	0	0	27	0	26	53	53	120
09:45 10:00	0	24	12	36	12	11	0	23	59	0	0	0	0	27	0	21	48	48	107
11:30 11:45	0	26	29	55	15	14	0	29	84	0	0	0	0	28	0	11	39	39	123
11:45 12:00	0	29	21	50	17	14	0	31	81	0	0	0	0	35	0	11	46	46	127
12:00 12:15	0	27	17	44	15	18	0	33	77	0	0	0	0	24	0	18	42	42	119
12:15 12:30	0	27	32	59	9	12	0	21	80	0	0	0	0	24	0	18	42	42	122
12:30 12:45	0	17	18	35	15	19	0	34	69	0	0	0	0	28	0	11	39	39	108
12:45 13:00	0	16	24	40	10	21	0	31	71	0	0	0	0	23	0	17	40	40	111
13:00 13:15	0	33	20	53	18	24	0	42	95	0	0	0	0	26	0	13	39	39	134
13:15 13:30	0	23	24	47	18	29	0	47	94	0	0	0	0	25	0	15	40	40	134
15:00 15:15	0	18	19	37	32	25	0	57	94	0	0	0	0	31	0	18	49	49	143
15:15 15:30	0	43	31	74	30	20	0	50	124	0	0	0	0	37	0	26	63	63	187
15:30 15:45	0	34	40	74	37	26	0	63	137	0	0	0	0	32	0	28	60	60	197
15:45 16:00	0	31	29	60	29	40	0	69	129	0	0	0	0	39	0	27	66	66	195
16:00 16:15	0	28	38	66	37	44	0	81	147	0	0	0	0	44	0	21	65	65	212
16:15 16:30	0	35	27	62	18	47	0	66	128	0	0	0	0	29	0	20	49	49	177
16:30 16:45	0	43	46	89	26	47	0	73	162	0	0	0	0	45	0	24	69	69	231
16:45 17:00	0	35	43	78	38	50	0	88	166	0	0	0	0	50	0	29	79	79	245
17:00 17:15	0	32	32	64	30	45	0	75	139	0	0	0	0	44	0	35	79	79	218
17:15 17:30	0	30	36	66	39	49	0	88	154	0	0	0	0	31	0	22	53	53	207
17:30 17:45	0	24	35	59	26	39	0	65	124	0	0	0	0	38	0	30	68	68	192
17:45 18:00	0	42	37	79	22	48	0	70	149	0	0	0	0	41	0	32	73	73	222
TOTAL:	0	1042	919	1961	658	896	0	1555	3516	0	0	0	0	1071	0	823	1894	1894	5410

Note: U-Turns are included in Totals.

Comment:



Transportation Services - Traffic Services

Turning Movement Count - Cyclist Volume Report

Work Order
35454

CHARLEMAGNE BLVD @ WATTERS RD

Count Date: Thursday, October 08, 2015

Start Time: 07:00

Time Period	Northbound	Southbound	Street Total	Eastbound	Westbound	Street Total	Grand Total
07:00 08:00	0	2	2	0	0	0	2
08:00 09:00	1	0	1	0	1	1	2
09:00 10:00	0	0	0	0	0	0	0
11:30 12:30	0	1	1	0	0	0	1
12:30 13:30	0	0	0	0	0	0	0
15:00 16:00	2	1	3	0	2	2	5
16:00 17:00	0	0	0	0	0	0	0
17:00 18:00	0	2	2	0	0	0	2
Total	3	6	9	0	3	3	12

Comment:

Note: These volumes consists of bicycles only (no mopeds or motorcycles) and ARE NOT included in the Turning Movement Count Summary.

Transportation Services - Traffic Services

Turning Movement Count - Full Study Diagram

CHARLEMAGNE BLVD @ WATTERS RD

Survey Date: Thursday, October 08, 2015

WO#: 35454

Device: Miovision

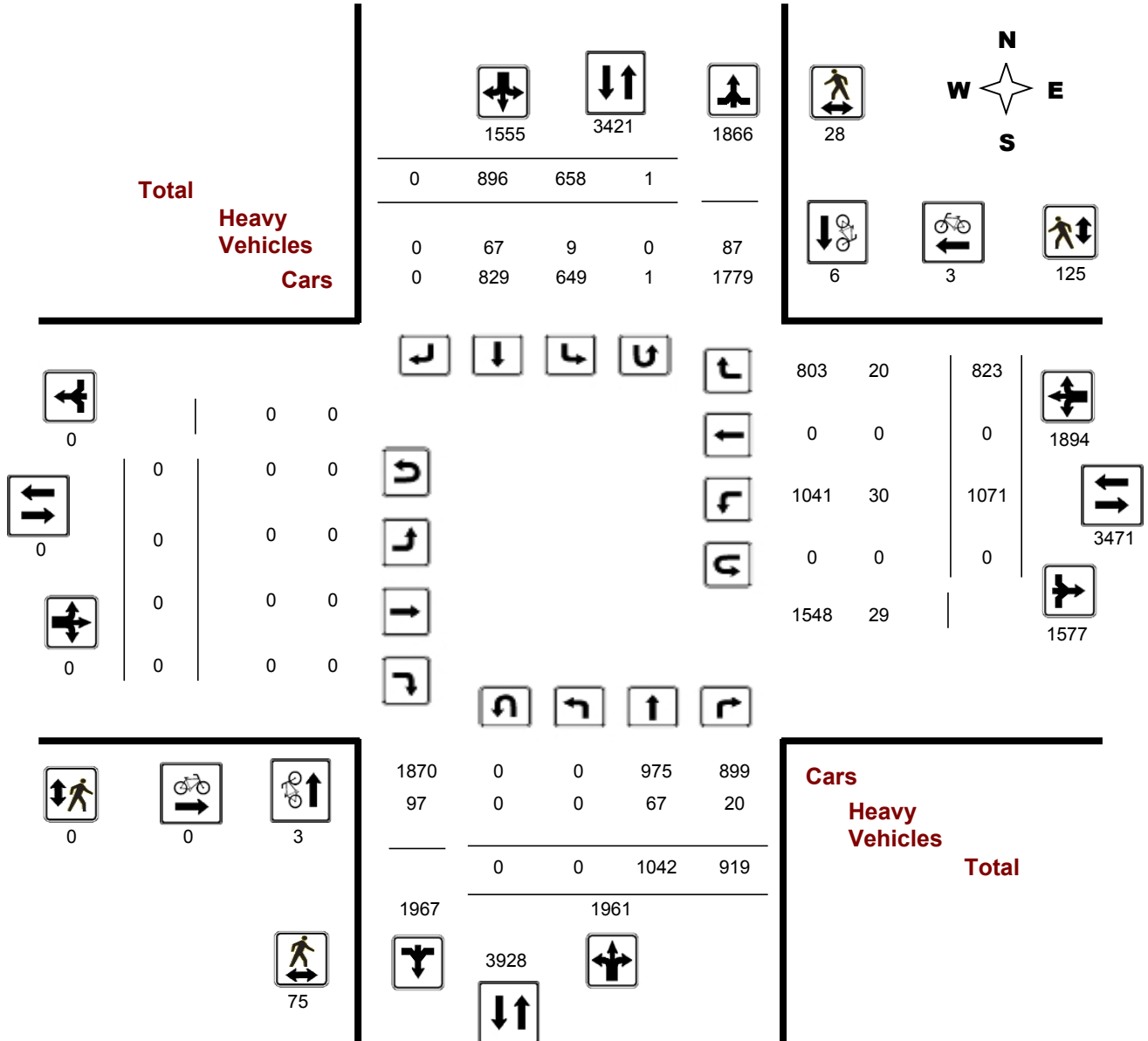



Transportation Services - Traffic Services

W.O.
35454

Turning Movement Count - Heavy Vehicle Report

CHARLEMAGNE BLVD @ WATTERS RD

Survey Date: Thursday, October 08, 2015

Time Period	Northbound			Southbound			Eastbound			Westbound			W TOT	STR TOT	Grand Total				
	LT	ST	RT	N TOT	LT	ST	RT	S TOT	STR TOT	LT	ST	RT				E TOT	LT	ST	RT
07:00 08:00	0	12	4	16	2	9	0	11	27	0	0	0	0	5	0	1	6	6	33
08:00 09:00	0	13	6	19	1	9	0	10	29	0	0	0	0	4	0	4	8	8	37
09:00 10:00	0	7	3	10	2	6	0	8	18	0	0	0	0	5	0	6	11	11	29
11:30 12:30	0	7	3	10	0	6	0	6	16	0	0	0	0	2	0	2	4	4	20
12:30 13:30	0	5	0	5	0	7	0	7	12	0	0	0	0	5	0	1	6	6	18
15:00 16:00	0	8	2	10	2	7	0	9	19	0	0	0	0	6	0	5	11	11	30
16:00 17:00	0	10	2	12	2	14	0	16	28	0	0	0	0	2	0	1	3	3	31
17:00 18:00	0	5	0	5	0	9	0	9	14	0	0	0	0	1	0	0	1	1	15
Sub Total	0	67	20	87	9	67	0	76	163	0	0	0	0	30	0	20	50	50	213
U-Turns (Heavy Vehicles)				0				0	0				0				0	0	0
Total	0	67	20	0	9	67	0	76	163	0	0	0	0	30	0	20	50	50	213

Heavy Vehicles include Buses, Single-Unit Trucks and Articulated Trucks. Further, they ARE included in the Turning Movement Count Summary.



Transportation Services - Traffic Services

Work Order

35454

Turning Movement Count - Pedestrian Volume Report

CHARLEMAGNE BLVD @ WATTERS RD

Count Date: Thursday, October 08, 2015

Start Time: 07:00

Time Period	NB Approach (E or W Crossing)	SB Approach (E or W Crossing)	Total	EB Approach (N or S Crossing)	WB Approach (N or S Crossing)	Total	Grand Total
07:00 07:15	2	0	2	0	2	2	4
07:15 07:30	4	2	6	0	3	3	9
07:30 07:45	9	0	9	0	15	15	24
07:45 08:00	4	0	4	0	26	26	30
07:00 08:00	19	2	21	0	46	46	67
08:00 08:15	1	0	1	0	5	5	6
08:15 08:30	2	1	3	0	2	2	5
08:30 08:45	2	0	2	0	3	3	5
08:45 09:00	0	3	3	0	3	3	6
08:00 09:00	5	4	9	0	13	13	22
09:00 09:15	1	1	2	0	4	4	6
09:15 09:30	4	0	4	0	1	1	5
09:30 09:45	1	0	1	0	1	1	2
09:45 10:00	1	1	2	0	1	1	3
09:00 10:00	7	2	9	0	7	7	16
11:30 11:45	0	0	0	0	2	2	2
11:45 12:00	0	1	1	0	2	2	3
12:00 12:15	4	1	5	0	2	2	7
12:15 12:30	2	0	2	0	2	2	4
11:30 12:30	6	2	8	0	8	8	16
12:30 12:45	0	0	0	0	3	3	3
12:45 13:00	0	0	0	0	1	1	1
13:00 13:15	1	2	3	0	4	4	7
13:15 13:30	0	0	0	0	1	1	1
12:30 13:30	1	2	3	0	9	9	12
15:00 15:15	6	1	7	0	4	4	11
15:15 15:30	1	0	1	0	3	3	4
15:30 15:45	6	3	9	0	6	6	15
15:45 16:00	1	2	3	0	7	7	10
15:00 16:00	14	6	20	0	20	20	40
16:00 16:15	2	1	3	0	4	4	7
16:15 16:30	8	1	9	0	3	3	12
16:30 16:45	0	0	0	0	2	2	2
16:45 17:00	3	1	4	0	4	4	8
16:00 17:00	13	3	16	0	13	13	29
17:00 17:15	4	1	5	0	2	2	7
17:15 17:30	3	0	3	0	1	1	4
17:30 17:45	1	1	2	0	4	4	6
17:45 18:00	2	5	7	0	2	2	9
17:00 18:00	10	7	17	0	9	9	26
Total	75	28	103	0	125	125	228

Comment:

Turning Movement Count - Full Study Summary Report

CHARLEMAGNE BLVD @ WATTERS RD

Survey Date: Thursday, October 08, 2015

Total Observed U-Turns

Northbound: 0 Southbound: 1
Eastbound: 0 Westbound: 0

AADT Factor

.90

Full Study

Period	Northbound				Southbound				STR TOT	Eastbound			Westbound			STR TOT	Grand Total			
	LT	ST	RT	NB TOT	LT	ST	RT	SB TOT		LT	ST	RT	EB TOT	LT	ST			RT	WB TOT	
07:00 08:00	0	222	106	328	50	128	0	178	506	0	0	0	0	147	0	154	301	301	807	
08:00 09:00	0	119	146	265	82	82	0	164	429	0	0	0	0	129	0	139	268	268	697	
09:00 10:00	0	108	69	177	45	55	0	100	277	0	0	0	0	121	0	104	225	225	502	
11:30 12:30	0	109	99	208	56	58	0	114	322	0	0	0	0	111	0	58	169	169	491	
12:30 13:30	0	89	86	175	61	93	0	154	329	0	0	0	0	102	0	56	158	158	487	
15:00 16:00	0	126	119	245	128	111	0	239	484	0	0	0	0	139	0	99	238	238	722	
16:00 17:00	0	141	154	295	119	188	0	307	602	0	0	0	0	168	0	94	262	262	864	
17:00 18:00	0	128	140	268	117	181	0	298	566	0	0	0	0	154	0	119	273	273	839	
Sub Total	0	1042	919	1961	658	896	0	1554	3515	0	0	0	0	1071	0	823	1894	1894	5409	
U Turns				0				1	1				0				0	0	1	
Total	0	1042	919	1961	658	896	0	1555	3516	0	0	0	0	1071	0	823	1894	1894	5410	
EQ 12Hr	0	1448	1277	2726	915	1245	0	2161	4887	0	0	0	0	1489	0	1144	2633	2633	7520	
Note: These values are calculated by multiplying the totals by the appropriate expansion factor.													1.39							
AVG 12Hr	0	1304	1150	2453	823	1121	0	1945	4398	0	0	0	0	1340	0	1030	2369	2369	6767	
Note: These volumes are calculated by multiplying the Equivalent 12 hr. totals by the AADT factor.													.90							
AVG 24Hr	0	1708	1506	3214	1078	1468	0	2548	5762	0	0	0	0	1755	0	1349	3104	3104	8866	
Note: These volumes are calculated by multiplying the Average Daily 12 hr. totals by 12 to 24 expansion factor.													1.31							

Comments:

Note: U-Turns provided for approach totals. Refer to 'U-Turn' Report for specific breakdown.

Turning Movement Count - Peak Hour Diagram

CHARLEMAGNE BLVD @ WATTERS RD

Survey Date: Thursday, October 08, 2015

Start Time: 07:00

WO No: 35454

Device: Miovision

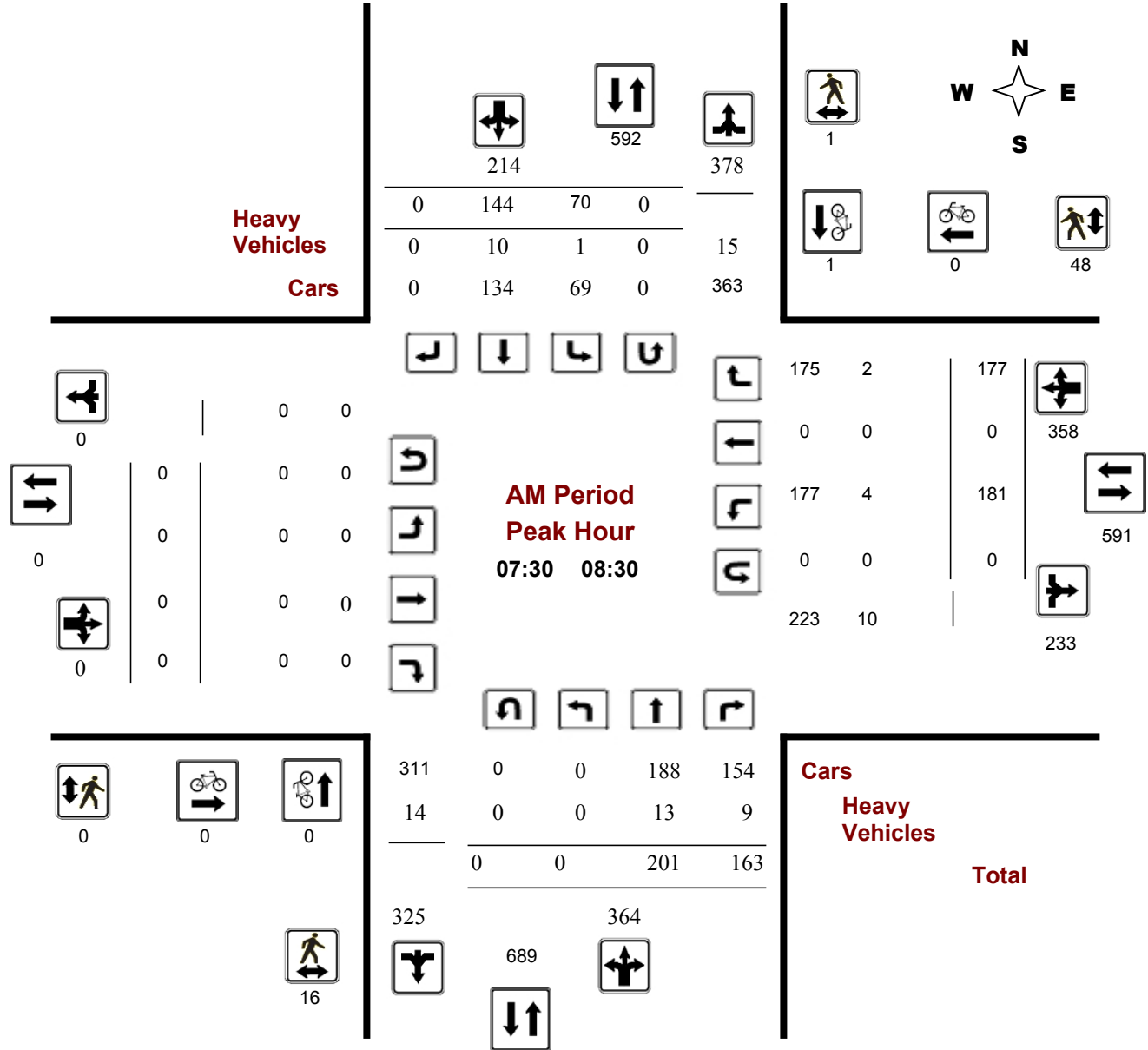

Comments

Turning Movement Count - Peak Hour Diagram

CHARLEMAGNE BLVD @ WATTERS RD

Survey Date: Thursday, October 08, 2015

Start Time: 07:00

WO No: 35454

Device: Miovision

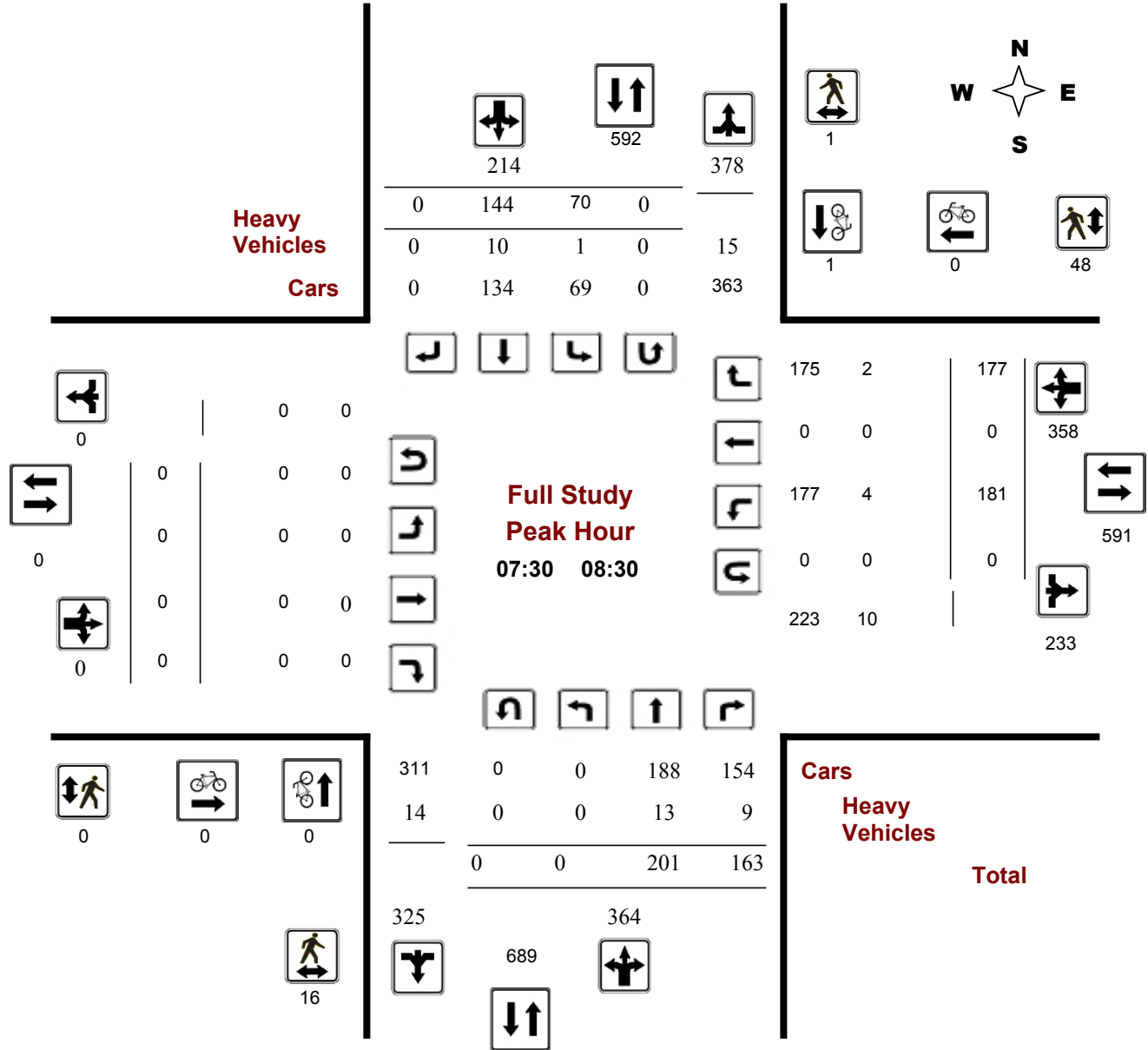

Comments

Turning Movement Count - Peak Hour Diagram

CHARLEMAGNE BLVD @ WATTERS RD

Survey Date: Thursday, October 08, 2015

Start Time: 07:00

WO No: 35454

Device: Miovision

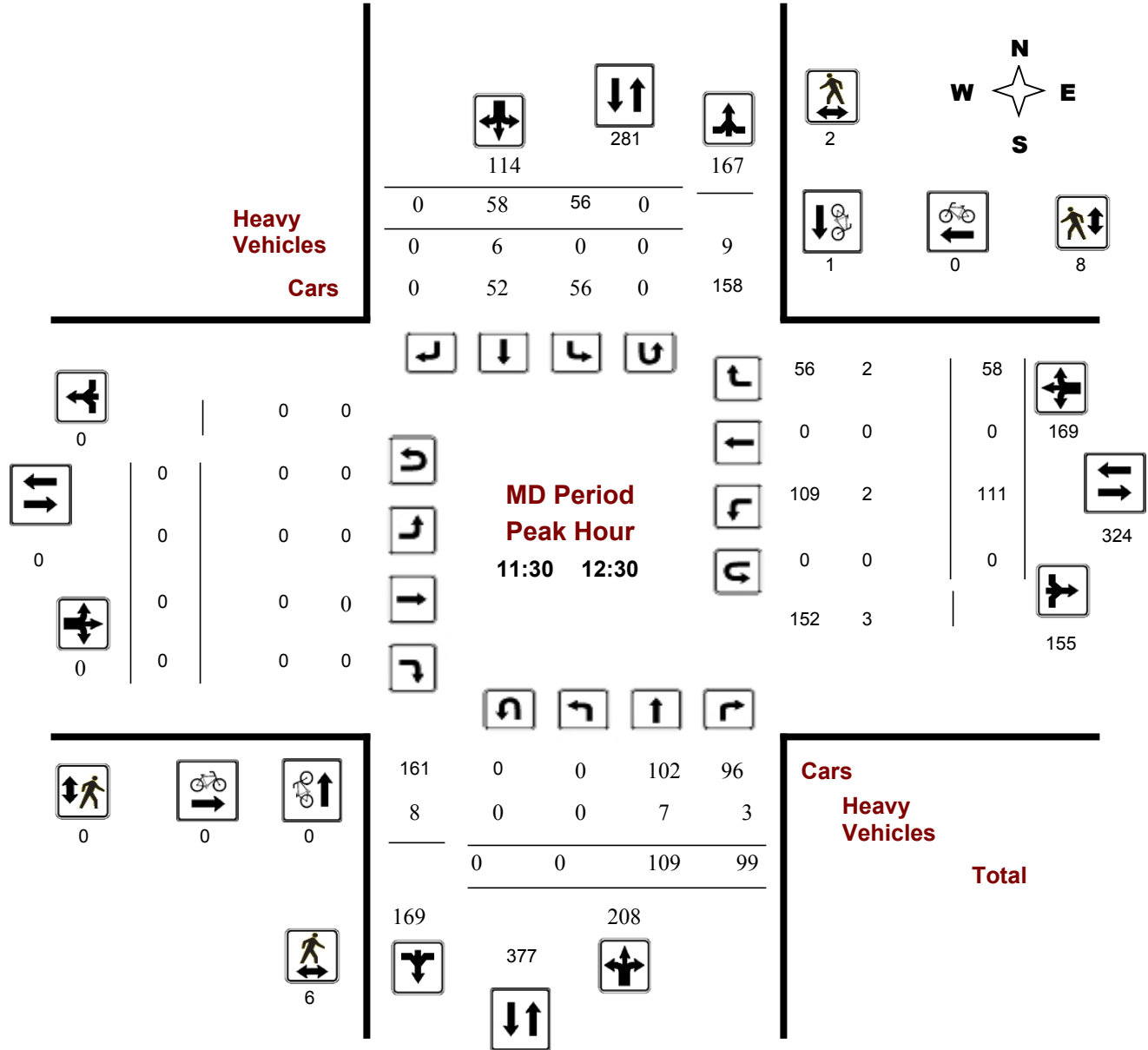

Comments

Turning Movement Count - Peak Hour Diagram

CHARLEMAGNE BLVD @ WATTERS RD

Survey Date: Thursday, October 08, 2015

Start Time: 07:00

WO No: 35454

Device: Miovision

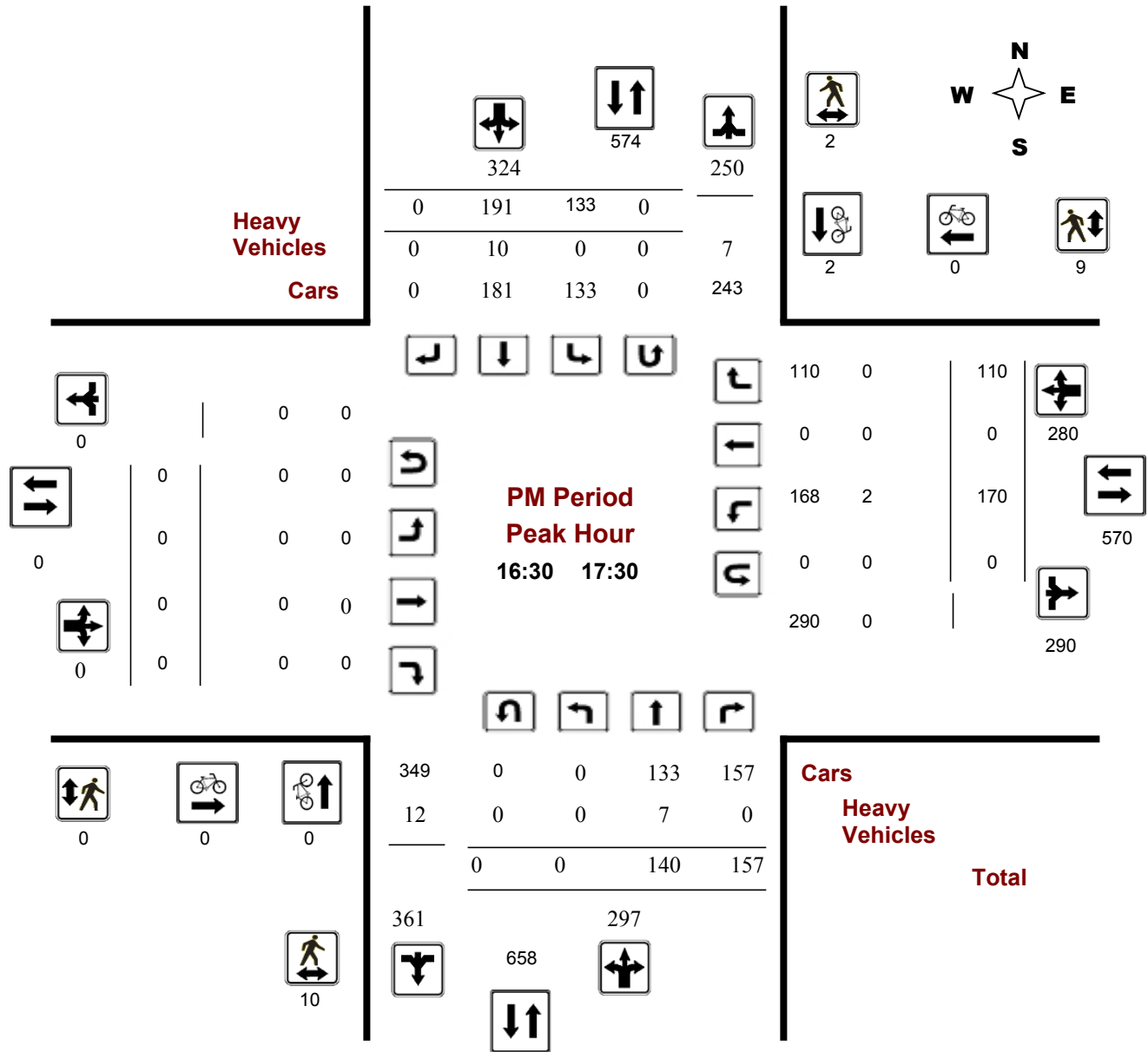

Comments

Turning Movement Count - 15 Min U-Turn Total Report

CHARLEMAGNE BLVD @ WATTERS RD

Survey Date: Thursday, October 08, 2015

Time Period		Northbound U-Turn Total	Southbound U-Turn Total	Eastbound U-Turn Total	Westbound U-Turn Total	Total
07:00	07:15	0	0	0	0	0
07:15	07:30	0	0	0	0	0
07:30	07:45	0	0	0	0	0
07:45	08:00	0	0	0	0	0
08:00	08:15	0	0	0	0	0
08:15	08:30	0	0	0	0	0
08:30	08:45	0	0	0	0	0
08:45	09:00	0	0	0	0	0
09:00	09:15	0	0	0	0	0
09:15	09:30	0	0	0	0	0
09:30	09:45	0	0	0	0	0
09:45	10:00	0	0	0	0	0
11:30	11:45	0	0	0	0	0
11:45	12:00	0	0	0	0	0
12:00	12:15	0	0	0	0	0
12:15	12:30	0	0	0	0	0
12:30	12:45	0	0	0	0	0
12:45	13:00	0	0	0	0	0
13:00	13:15	0	0	0	0	0
13:15	13:30	0	0	0	0	0
15:00	15:15	0	0	0	0	0
15:15	15:30	0	0	0	0	0
15:30	15:45	0	0	0	0	0
15:45	16:00	0	0	0	0	0
16:00	16:15	0	0	0	0	0
16:15	16:30	0	1	0	0	1
16:30	16:45	0	0	0	0	0
16:45	17:00	0	0	0	0	0
17:00	17:15	0	0	0	0	0
17:15	17:30	0	0	0	0	0
17:30	17:45	0	0	0	0	0
17:45	18:00	0	0	0	0	0
Total		0	1	0	0	1



Turning Movement Count Bicycle Summary Flow Diagram



Charlemagne Boulevard & Watters Road Orléans, ON

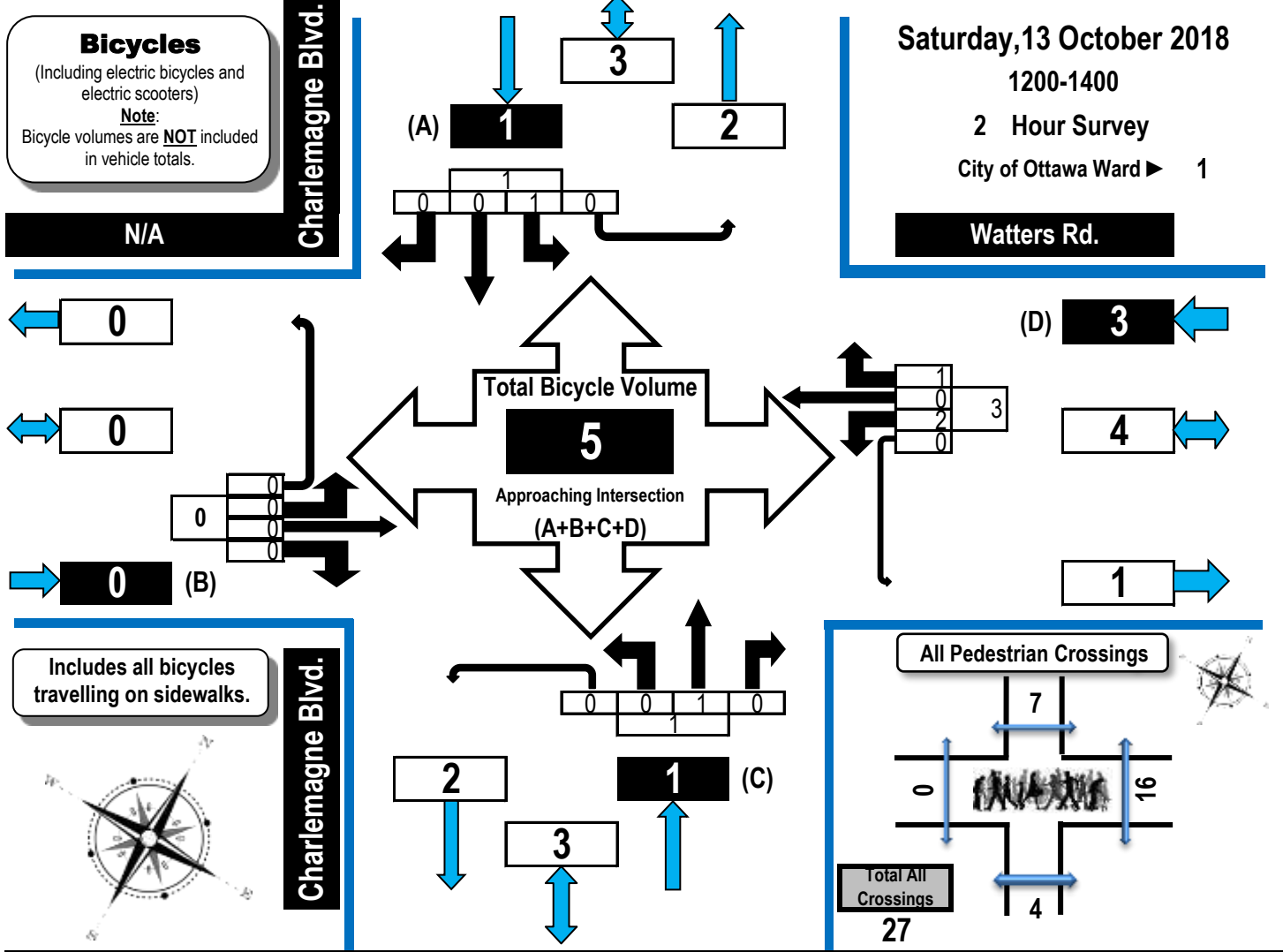

Time Period	N/A Eastbound					Watters Rd. Westbound					Charlemagne Blvd. Northbound					Charlemagne Blvd. Southbound					G.Tot.
	LT	ST	RT	UT	S. Tot.	LT	ST	RT	UT	S. Tot.	LT	ST	RT	UT	S. Tot.	LT	ST	RT	UT	S. Tot.	
1200-1300	0	0	0	0	0	1	0	0	0	1	0	1	0	0	1	1	0	0	0	1	3
1300-1400	0	0	0	0	0	1	0	1	0	2	0	0	0	0	0	0	0	0	0	0	2
Totals	0	0	0	0	0	2	0	1	0	3	0	1	0	0	1	1	0	0	0	1	5



Turning Movement Count Summary, OFF and EVENING Peak Hour Flow Diagrams

Automobiles, Taxis, Light Trucks, Vans, SUV's, Motorcycles, Heavy Trucks, Buses, and School Buses

Charlemagne Boulevard & Watters Road Orléans, ON

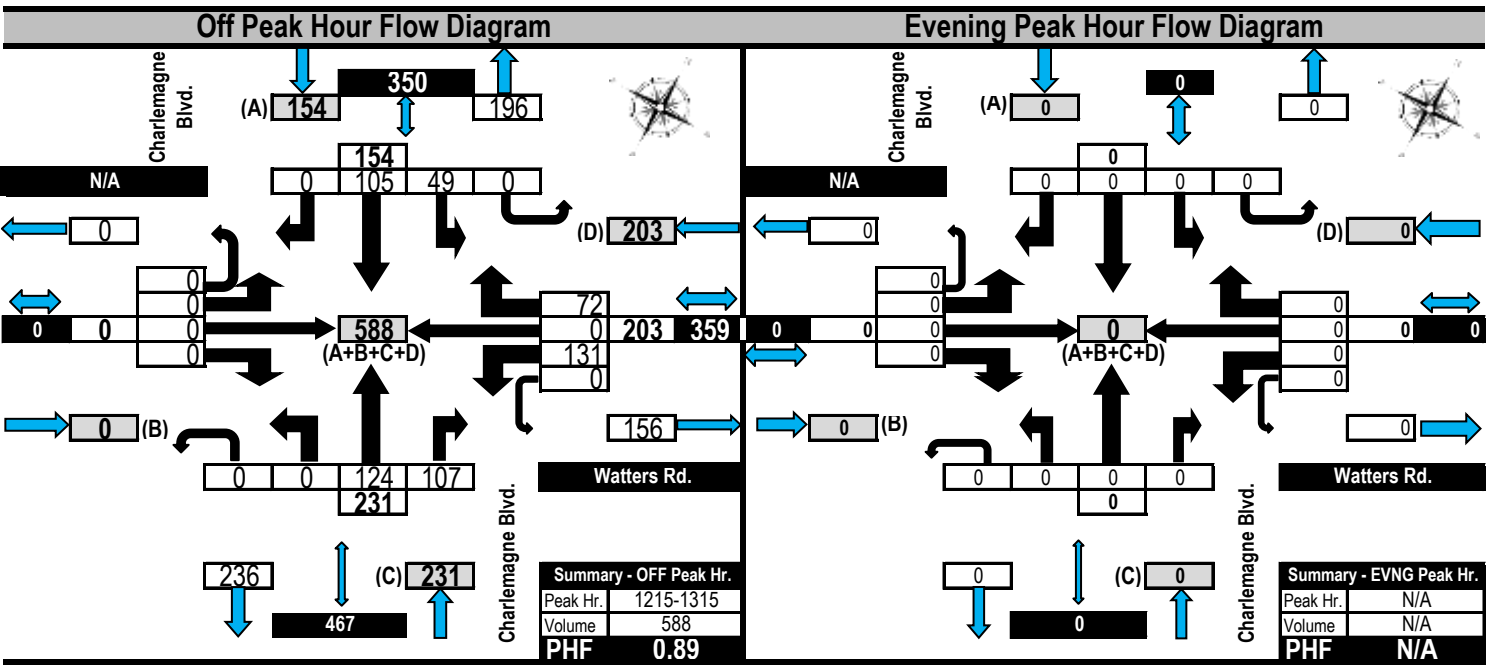
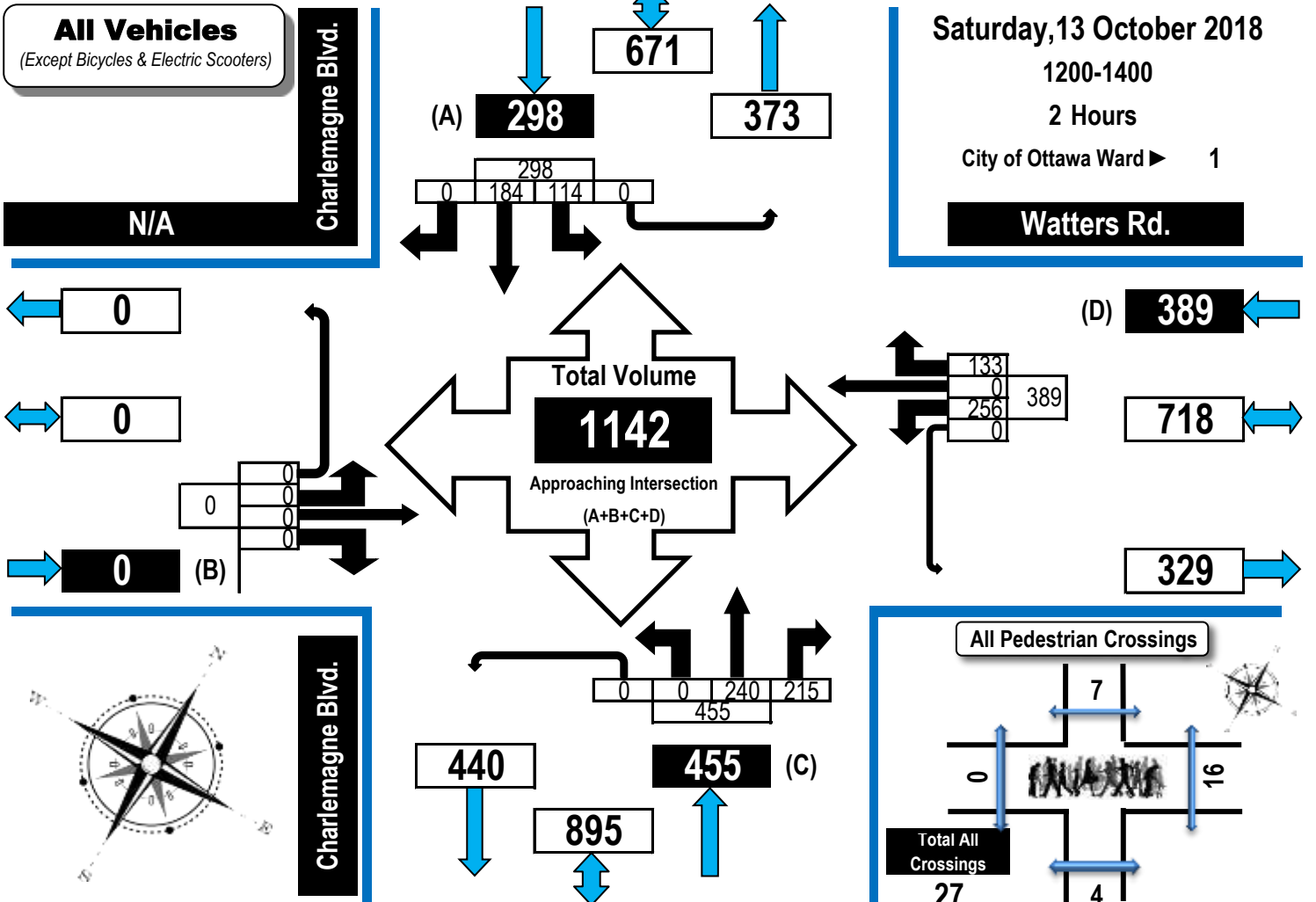



Turning Movement Count Heavy Vehicle Summary Flow Diagram

Heavy Trucks, Buses,
and School Buses

Charlemagne Boulevard & Watters Road Orléans, ON

Heavy Vehicles
(Construction Vehicles, Heavy Trucks, Buses & School Buses).
Heavy vehicle totals **ARE** included in the all vehicles summary and flow diagrams.

N/A Charlemagne Blvd.

Saturday, 13 October 2018
1200-1400
2 Hour Survey
City of Ottawa Ward 1

Watters Rd.

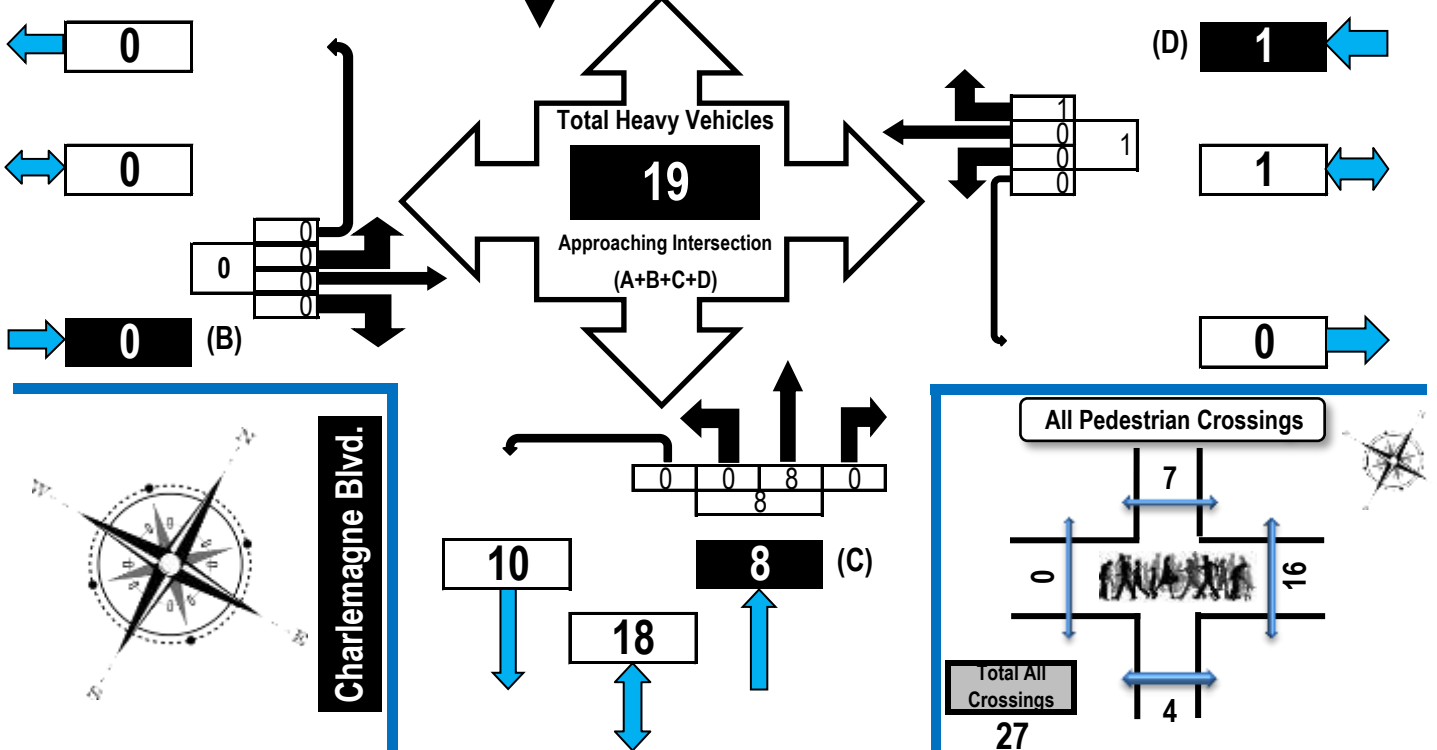

Time Period	N/A Eastbound					Watters Rd. Westbound					Charlemagne Blvd. Northbound					Charlemagne Blvd. Southbound					G.Tot.
	LT	ST	RT	UT	S. Tot.	LT	ST	RT	UT	S. Tot.	LT	ST	RT	UT	S. Tot.	LT	ST	RT	UT	S. Tot.	
1200-1300	0	0	0	0	0	0	0	0	0	0	0	4	0	0	4	0	5	0	0	5	9
1300-1400	0	0	0	0	0	0	0	1	0	1	0	4	0	0	4	0	5	0	0	5	10
Totals	0	0	0	0	0	0	0	1	0	1	0	8	0	0	8	0	10	0	0	10	19



Turning Movement Count

Pedestrian Crossings Summary and Flow Diagram



Charlemagne Boulevard & Watters Road

Orléans, ON

Pedestrian Crossings

Saturday, 13 October 2018

1200-1400

2 Hour Survey

City of Ottawa Ward 1

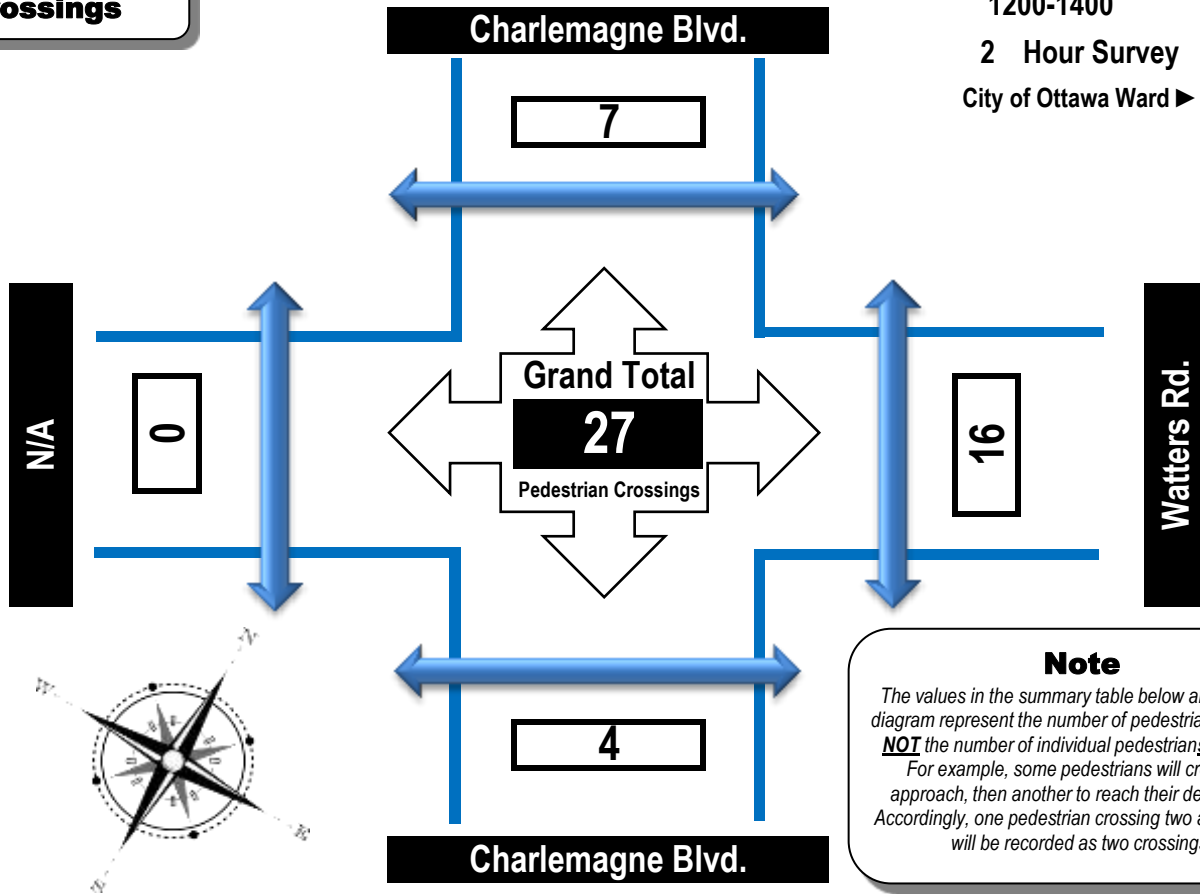

Note
The values in the summary table below and the flow diagram represent the number of pedestrian crossings **NOT** the number of individual pedestrians crossing. For example, some pedestrians will cross one approach, then another to reach their destination. Accordingly, one pedestrian crossing two approaches will be recorded as two crossings.

Time Period	West Side Crossing N/A	East Side Crossing Watters Rd.	Street Total	South Side Crossing Charlemagne Blvd.	North Side Crossing Charlemagne Blvd.	Street Total	Grand Total
1200-1300	0	12	12	2	2	4	16
1300-1400	0	4	4	2	5	7	11
Totals	0	16	16	4	7	11	27



Turning Movement Count

Summary Report Including AM, OFF Peak, PM, Evening Peak Hours, and PHF

Automobiles, Taxis,
Light Trucks, Vans,
SUV's, Motorcycles,
Heavy Trucks, Buses,
and School Buses

Charlemagne Boulevard & Watters Road

Orléans, ON

Survey Date: Saturday, 13 October 2018

Start Time: 1200

AADT Factor: 1.1

Weather: Partly Cloudy 4C

Survey Duration: 2 Hrs.

Survey Hours: 1200-1400

(AM/PM)

Time Period	N/A					Watters Rd.					Charlemagne Blvd.					Charlemagne Blvd.					Street Total	Grand Total	
	Eastbound					Westbound					Northbound					Southbound							
	LT	ST	RT	UT	E/B Tot	LT	ST	RT	UT	W/B Tot	LT	ST	RT	UT	N/B Tot	LT	ST	RT	UT	S/B Tot			
1200-1300						129	0	67	0	196	196	0	127	96	0	223	58	94	0	0	152	375	571
1300-1400						127	0	66	0	193	193	0	113	119	0	232	56	90	0	0	146	378	571
Totals	0	0	0	0	0	256	0	133	0	389	389	0	240	215	0	455	114	184	0	0	298	753	1142

Expansion factors are applied exclusively to standard weekday 8-hour turning movement counts conducted during the hours of 0700h - 1000h, 1130h - 1330h and 1500h - 1800h

AM Peak Hour Factor → ###											Highest Hourly Vehicle Volume Between 0500h & 1000h													
AM Peak Hr	LT	ST	RT	UT	TOT	LT	ST	RT	UT	TOT	S.TOT	LT	ST	RT	UT	TOT	LT	ST	RT	UT	TOT	S.TOT	G.TOT	
N/A	0	0	0	0	0	0	0	0	0	0	0	0	0	0	0	0	0	0	0	0	0	0	0	0
OFF Peak Hour Factor → 0.89											Highest Hourly Vehicle Volume Between 1000h & 1500h													
OFF Peak Hr	LT	ST	RT	UT	TOT	LT	ST	RT	UT	TOT	S.TOT	LT	ST	RT	UT	TOT	LT	ST	RT	UT	TOT	S.TOT	G.TOT	
1215-1315	0	0	0	0	0	131	0	72	0	203	203	0	124	107	0	231	49	105	0	0	154	385	588	
PM Peak Hour Factor → ###											Highest Hourly Vehicle Volume Between 1500h & 1900h													
PM Peak Hr	LT	ST	RT	UT	TOT	LT	ST	RT	UT	TOT	S.TOT	LT	ST	RT	UT	TOT	LT	ST	RT	UT	TOT	S.TOT	G.TOT	
N/A	0	0	0	0	0	0	0	0	0	0	0	0	0	0	0	0	0	0	0	0	0	0	0	0
EVNG Peak Hour Factor → ###											Highest Hourly Vehicle Volume Between 1900h & 2200h													
EVNG Peak Hr	LT	ST	RT	UT	TOT	LT	ST	RT	UT	TOT	S.TOT	LT	ST	RT	UT	TOT	LT	ST	RT	UT	TOT	S.TOT	G.TOT	
N/A	0	0	0	0	0	0	0	0	0	0	0	0	0	0	0	0	0	0	0	0	0	0	0	0

Comments:

The majority of the heavy vehicle traffic consists of OC Transpo buses.

Notes:

1. Includes all vehicle types except bicycles and electric scooters.
2. When expansion and AADT factors are applied, the results will differ slightly due to rounding.



Turning Movement Count Bicycle Summary Flow Diagram

Bicycles, Electric Bicycles,
and Electric Scooters

Crown Pointe Centre & Trim Road (North Access) Orléans, ON

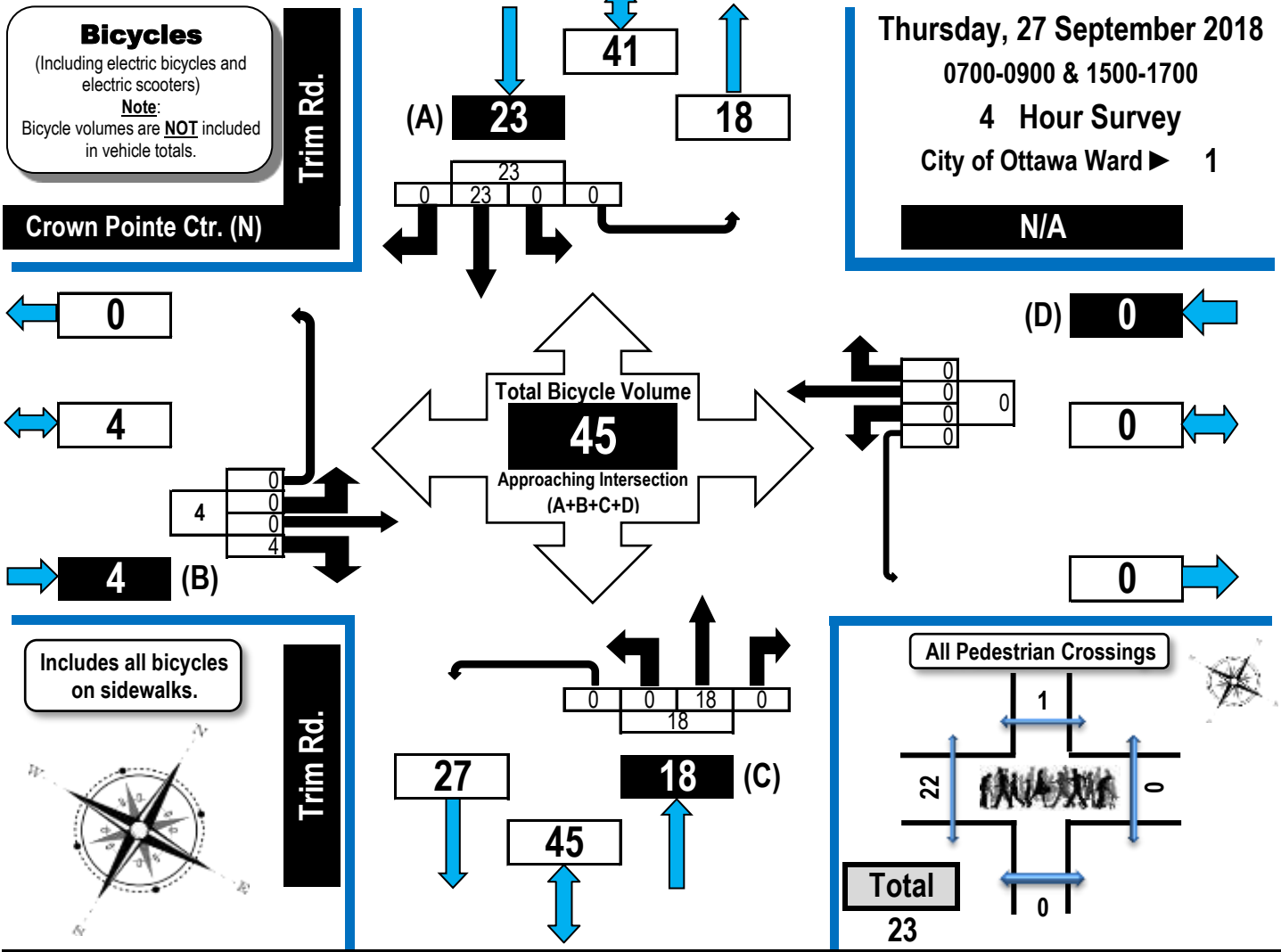

Crown Pointe Centre & Trim Road (North Access) Orléans, ON

Survey Date: Thursday, 27 September 2018 **Start Time:** 0700
Weather: Cloudy 18C **Survey Duration:** 4 Hrs. **Survey Hours:** 0700-0900 & 1500-1700
(AM/PM)

Time Period	Crown Pointe Ctr. (N)					N/A					Trim Rd.					Trim Rd.					G.Tot.
	Eastbound					Westbound					Northbound					Southbound					
	LT	ST	RT	UT	S. Tot.	LT	ST	RT	UT	S. Tot.	LT	ST	RT	UT	S. Tot.	LT	ST	RT	UT	S. Tot.	
0700-0800	0	0	0	0	0	0	0	0	0	0	0	4	0	0	4	0	1	0	0	1	5
0800-0900	0	0	0	0	0	0	0	0	0	0	0	4	0	0	4	0	1	0	0	1	5
1500-1600	0	0	2	0	2	0	0	0	0	0	0	6	0	0	6	0	9	0	0	9	17
1600-1700	0	0	2	0	2	0	0	0	0	0	0	4	0	0	4	0	12	0	0	12	18
Totals	0	0	4	0	4	0	0	0	0	0	0	18	0	0	18	0	23	0	0	23	45



Turning Movement Count Summary, AM and PM Peak Hour Flow Diagrams

Automobiles, Taxis, Light Trucks, Vans, SUV's, Motorcycles, Heavy Trucks, Buses, and School Buses

Crown Pointe Centre & Trim Road (North Access) Orléans, ON

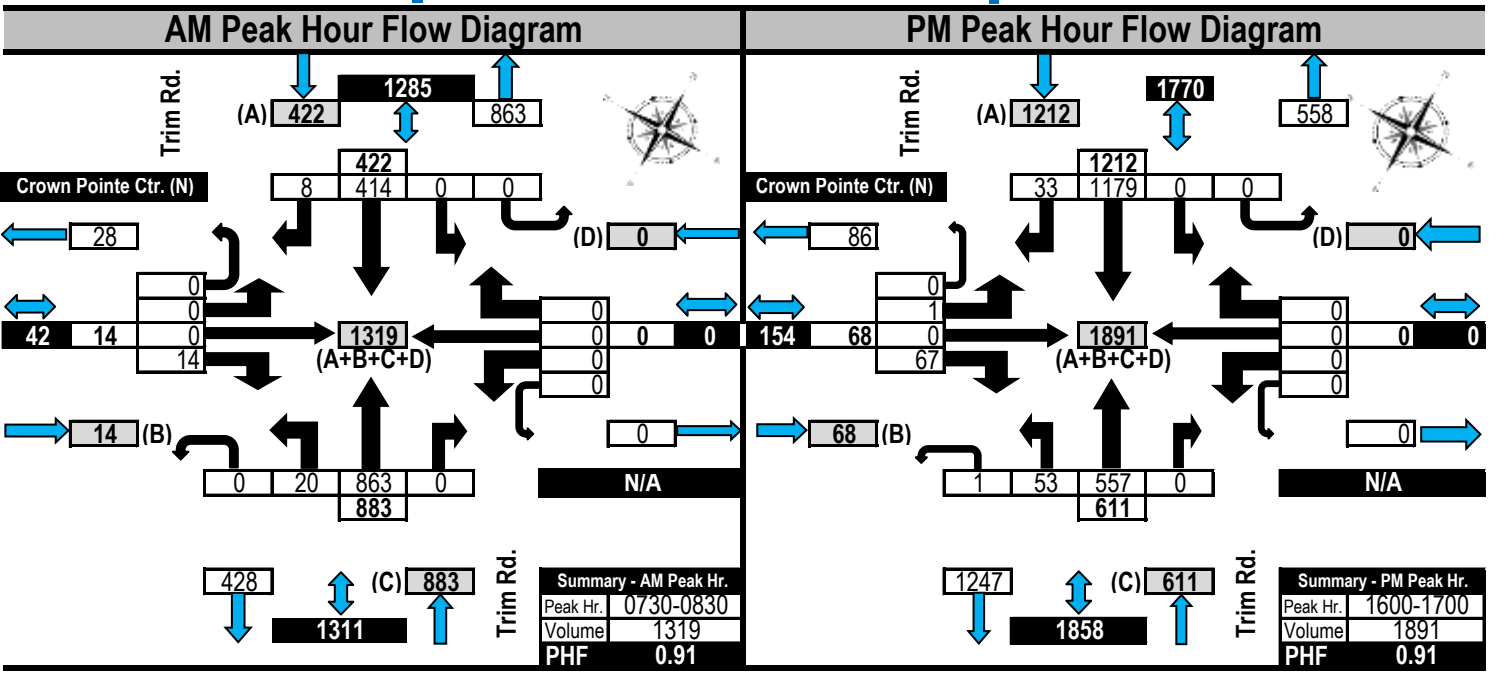
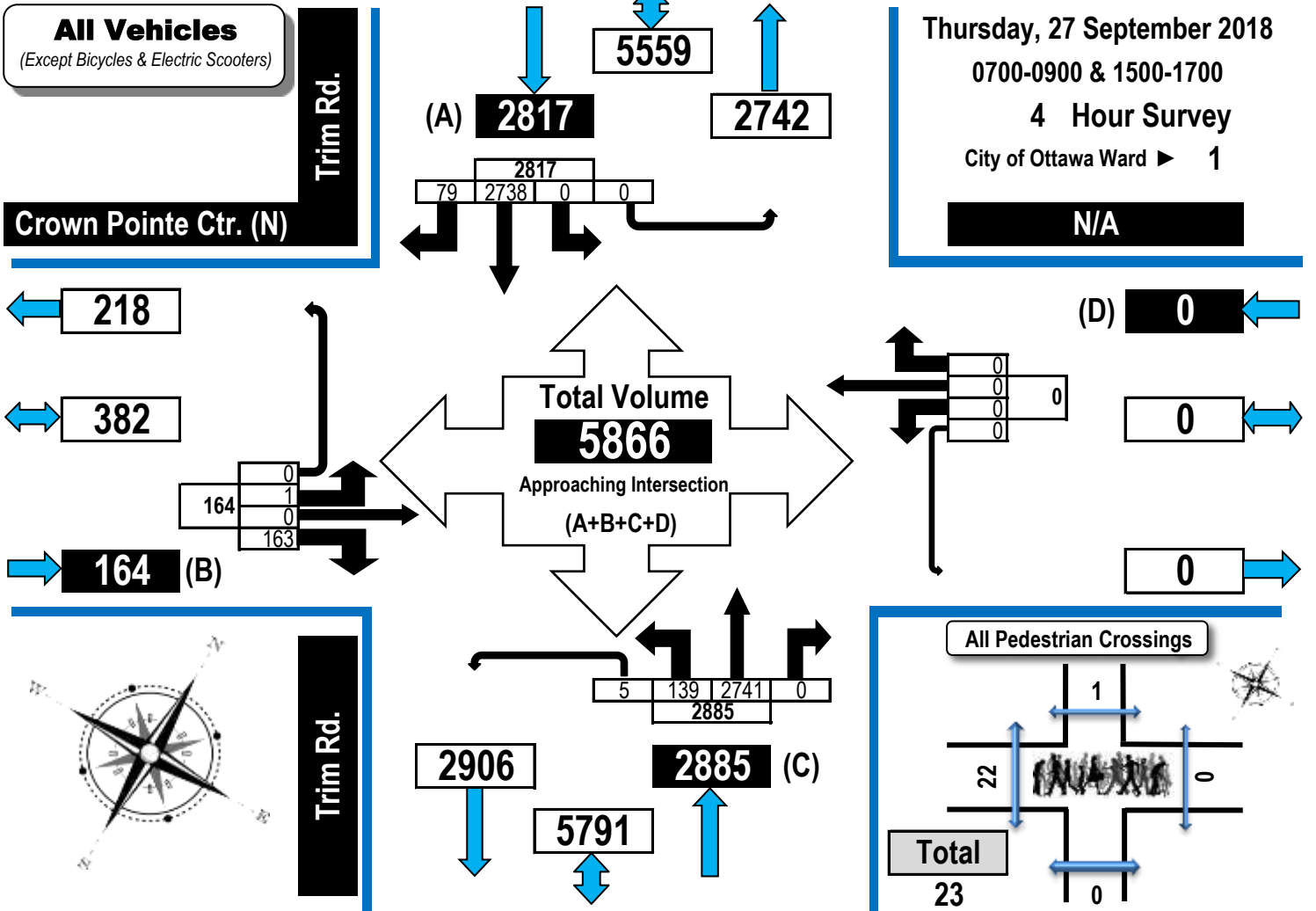



Turning Movement Count Heavy Vehicle Summary Flow Diagram

Heavy Trucks, Buses,
and School Buses

Crown Pointe Centre & Trim Road (North Access) Orléans, ON

Heavy Vehicles
(Construction Vehicles, Heavy Trucks, Buses & School Buses).
Heavy vehicle totals ARE included in the all vehicles summary and flow diagrams.

Thursday, 27 September 2018
0700-0900 & 1500-1700
4 Hour Survey
City of Ottawa Ward **1**

Crown Pointe Ctr. (N)

N/A

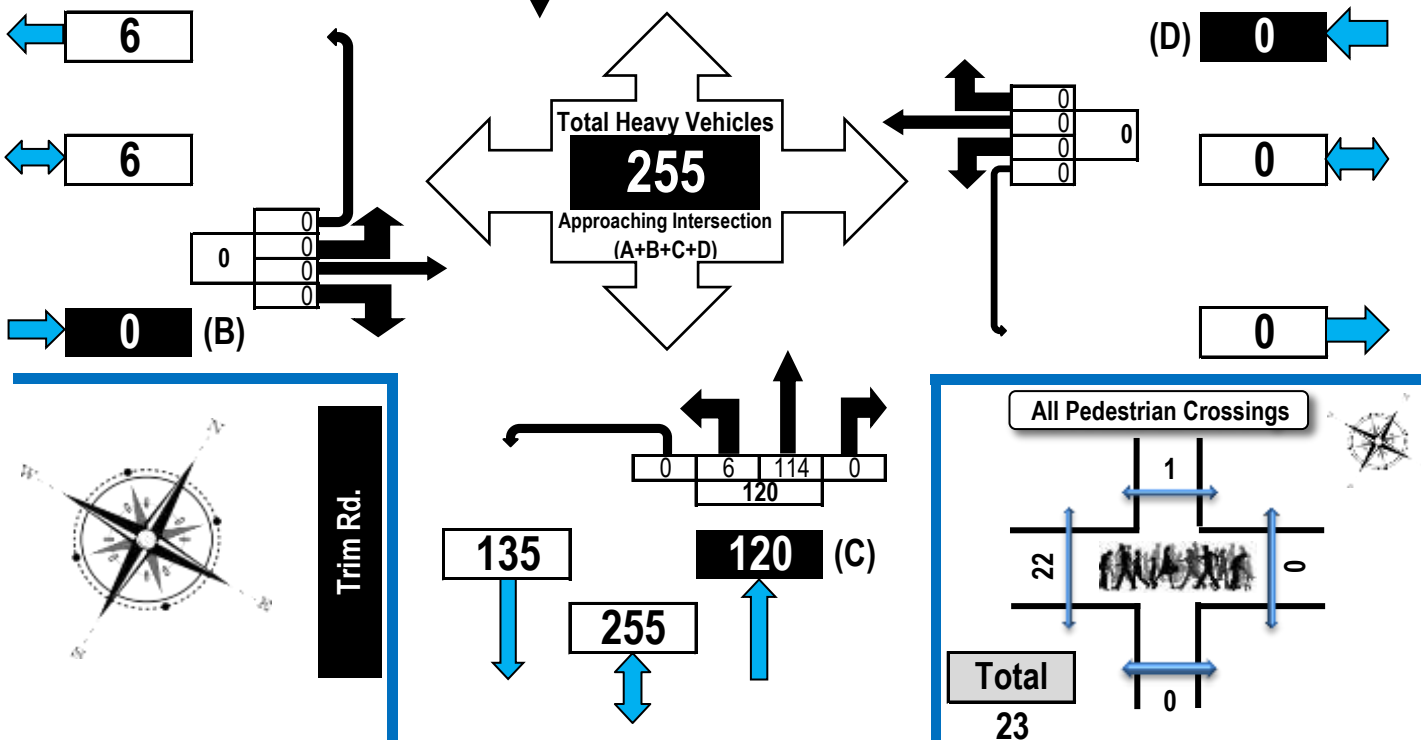

Crown Pointe Centre & Trim Road (North Access) Orléans, ON

Survey Date: Thursday, 27 September 2018 **Start Time:** 0700
Weather: Cloudy 18C **Survey Duration:** 4 Hrs. **Survey Hours:** 0700-0900 & 1500-1700
(AM/PM)

Time Period	Crown Pointe Ctr. (N)					N/A					Trim Rd.					Trim Rd.					G.Tot.
	Eastbound					Westbound					Northbound					Southbound					
	LT	ST	RT	UT	S. Tot.	LT	ST	RT	UT	S. Tot.	LT	ST	RT	UT	S. Tot.	LT	ST	RT	UT	S. Tot.	
0700-0800	0	0	0	0	0	0	0	0	0	0	4	27	0	0	31	0	38	0	0	38	69
0800-0900	0	0	0	0	0	0	0	0	0	0	1	31	0	0	32	0	26	0	0	26	58
1500-1600	0	0	0	0	0	0	0	0	0	0	1	29	0	0	30	0	30	0	0	30	60
1600-1700	0	0	0	0	0	0	0	0	0	0	0	27	0	0	27	0	41	0	0	41	68
Totals	0	0	0	0	0	0	0	0	0	0	6	114	0	0	120	0	135	0	0	135	255



Turning Movement Count

Pedestrian Crossings Summary and Flow Diagram



Crown Pointe Centre & Trim Road (North Access)

Orléans, ON

Pedestrian Crossings

Thursday, 27 September 2018

0700-0900 & 1500-1700

4 Hours

City of Ottawa Ward ► 1

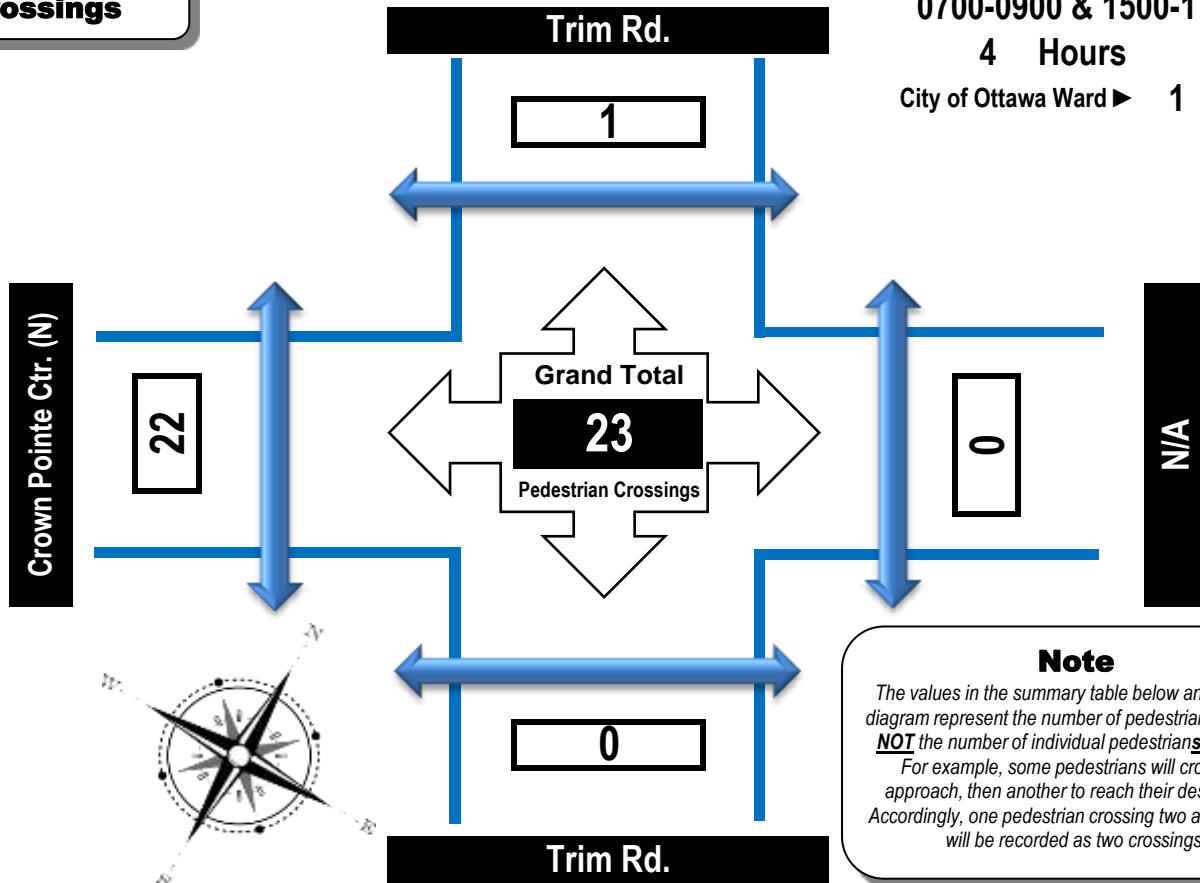

Note
 The values in the summary table below and the flow diagram represent the number of pedestrian crossings **NOT** the number of individual pedestrians crossing. For example, some pedestrians will cross one approach, then another to reach their destination. Accordingly, one pedestrian crossing two approaches will be recorded as two crossings.

Crown Pointe Centre & Trim Road (North Access)

Orléans, ON

Survey Date: Thursday, 27 September 2018

Start Time: 0700

Weather: Cloudy 18C
 (AM/PM)

Survey Duration: 4 Hrs.

Survey Hours:

0700-0900 & 1500-1700

Time Period	West Side Crossing Crown Pointe Ctr. (N)	East Side Crossing N/A	Street Total	South Side Crossing Trim Rd.	North Side Crossing Trim Rd.	Street Total	Grand Total
0700-0800	4	0	4	0	0	0	4
0800-0900	2	0	2	0	1	1	3
1500-1600	6	0	6	0	0	0	6
1600-1700	10	0	10	0	0	0	10
Totals	22	0	22	0	1	1	23



Turning Movement Count

Summary Report Including AM/PM Peak Hours, PHF, AADT and Expansion Factors

Automobiles, Taxis,
Light Trucks, Vans,
SUV's, Motorcycles,
Heavy Trucks, Buses,
and School Buses

Crown Pointe Centre & Trim Road (North Access) Orléans, ON

Survey Date: Thursday, 27 September 2018 **Start Time:** 0700 **AADT Factor:** 1.0
Weather-AM/PM: Cloudy 18C **Survey Duration:** 4 Hrs. **Survey Hours:** 0700-0900 & 1500-1700

Time Period	Crown Pointe Ctr. (N)					N/A					Trim Rd.					Trim Rd.					Grand Total		
	Eastbound					Westbound					Northbound					Southbound							
	LT	ST	RT	UT	E/B Tot	LT	ST	RT	UT	W/B Tot	Street Total	LT	ST	RT	UT	N/B Tot	LT	ST	RT	UT		S/B Tot	Street Total
0700-0800	0	0	10	0	10	0	0	0	0	0	10	25	877	0	1	903	0	374	7	0	381	1284	1294
0800-0900	0	0	18	0	18	0	0	0	0	0	18	28	817	0	0	845	0	353	14	0	367	1212	1230
1500-1600	0	0	68	0	68	0	0	0	0	0	68	33	490	0	3	526	0	832	25	0	857	1383	1451
1600-1700	1	0	67	0	68	0	0	0	0	0	68	53	557	0	1	611	0	1179	33	0	1212	1823	1891
Totals	1	0	163	0	164	0	0	0	0	0	164	139	2741	0	5	2885	0	2738	79	0	2817	5702	5866

Equivalent 12 & 24-hour Vehicle Volumes Including the Annual Average Daily Traffic (AADT) Factor
Applicable to the Day and Month of the Turning Movement Count

➔ **Expansion factors are applied exclusively to standard weekday 8-hour turning movement counts** ←

Equivalent 12-hour vehicle volumes. These volumes are calculated by multiplying the 8-hour totals by the 8 ➔12 expansion factor of 1.39

Equ. 12 Hr	n/a	n/a	n/a	n/a	n/a	n/a	n/a	n/a	n/a	n/a	n/a	n/a	n/a	n/a	n/a	n/a	n/a	n/a	n/a	n/a	n/a	n/a	n/a
------------	-----	-----	-----	-----	-----	-----	-----	-----	-----	-----	-----	-----	-----	-----	-----	-----	-----	-----	-----	-----	-----	-----	-----

Average daily 12-hour vehicle volumes. These volumes are calculated by multiplying the equivalent 12-hour totals by the AADT factor of: 1.0

AADT 12-hr	n/a	n/a	n/a	n/a	n/a	n/a	n/a	n/a	n/a	n/a	n/a	n/a	n/a	n/a	n/a	n/a	n/a	n/a	n/a	n/a	n/a	n/a	n/a
------------	-----	-----	-----	-----	-----	-----	-----	-----	-----	-----	-----	-----	-----	-----	-----	-----	-----	-----	-----	-----	-----	-----	-----

24-Hour AADT. These volumes are calculated by multiplying the average daily 12-hour vehicle volumes by the 12 ➔24 expansion factor of 1.31

AADT 24 Hr	n/a	n/a	n/a	n/a	n/a	n/a	n/a	n/a	n/a	n/a	n/a	n/a	n/a	n/a	n/a	n/a	n/a	n/a	n/a	n/a	n/a	n/a	n/a
------------	-----	-----	-----	-----	-----	-----	-----	-----	-----	-----	-----	-----	-----	-----	-----	-----	-----	-----	-----	-----	-----	-----	-----

AM Peak Hour Factor ➔ 0.91											Highest Hourly Vehicle Volume between 0700h & 1000h												
AM Peak Hr	LT	ST	RT	UT	TOT	LT	ST	RT	UT	TOT	S.TOT	LT	ST	RT	UT	TOT	LT	ST	RT	UT	TOT	S.TOT	G.TOT
0730-0830	0	0	14	0	14	0	0	0	0	0	14	20	863	0	0	883	0	414	8	0	422	1305	1319

OFF Peak Hour Factor ➔ ###											Highest Hourly Vehicle Volume between 1130h & 1330h												
Off Peak Hr	LT	ST	RT	UT	TOT	LT	ST	RT	UT	TOT	S.TOT	LT	ST	RT	UT	TOT	LT	ST	RT	UT	TOT	S.TOT	G.TOT
N/A	0	0	0	0	0	0	0	0	0	0	0	0	0	0	0	0	0	0	0	0	0	0	0

PM Peak Hour Factor ➔ 0.91											Highest Hourly Vehicle Volume between 1500h & 1800h												
PM Peak Hr	LT	ST	RT	UT	TOT	LT	ST	RT	UT	TOT	S.TOT	LT	ST	RT	UT	TOT	LT	ST	RT	UT	TOT	S.TOT	G.TOT
1600-1700	1	0	67	0	68	0	0	0	0	0	68	53	557	0	1	611	0	1179	33	0	1212	1823	1891

Comments

The majority of the cyclists use the sidewalks.

Notes:

1. Includes all vehicle types except bicycles and electric scooters.
2. Expansion factors are not applied to turning movement counts if they are less than 8-hours in duration.
3. When expansion and AADT factors are applied, the results will differ slightly due to rounding.

Disclaimer:

The information contained in this data summary is for information purposes only, and may not apply to your situation. Every effort is made to ensure the traffic count information is accurate for the survey date provided on the summary and flow diagram forms. The author, publisher, and distributor provide no warranty about the content or accuracy of either the data summary or flow diagrams. Information provided is subjective. The author, publisher, and distributor shall not be liable for any loss of profit or any other commercial damages resulting from use of this data.



Turning Movement Count Bicycle Summary Flow Diagram



Crown Pointe Centre & Trim Road (North Access)

Orléans, ON

Saturday, 13 October 2018

1200-1400

2 Hour Survey

City of Ottawa Ward 1

Bicycles
(Including electric bicycles and electric scooters)
Note:
Bicycle volumes are **NOT** included in vehicle totals.

Crown Pointe Ctr. (N)

N/A

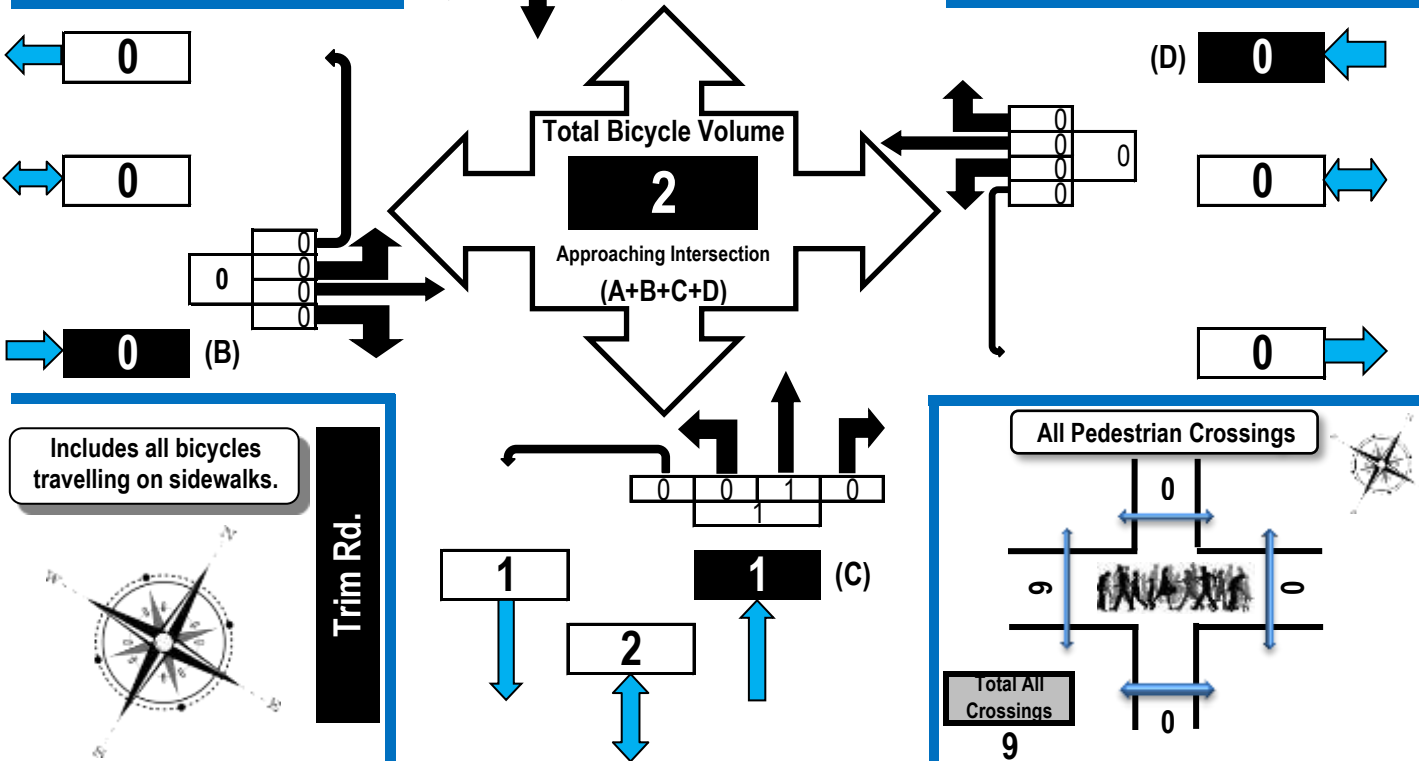

Time Period	Crown Pointe Ctr. (N) Eastbound					N/A Westbound					Trim Rd. Northbound					Trim Rd. Southbound					G.Tot.	
	LT	ST	RT	UT	S. Tot.	LT	ST	RT	UT	S. Tot.	LT	ST	RT	UT	S. Tot.	LT	ST	RT	UT	S. Tot.		
1200-1300	0	0	0	0	0	0	0	0	0	0	0	0	1	0	0	1	0	0	0	0	0	1
1300-1400	0	0	0	0	0	0	0	0	0	0	0	0	0	0	0	0	0	1	0	0	1	1
Totals	0	0	0	0	0	0	0	0	0	0	0	0	1	0	0	1	0	1	0	0	1	2



Turning Movement Count Summary, OFF and EVENING Peak Hour Flow Diagrams

Automobiles, Taxis, Light Trucks, Vans, SUV's, Motorcycles, Heavy Trucks, Buses, and School Buses

Crown Pointe Centre & Trim Road (North Access) Orléans, ON

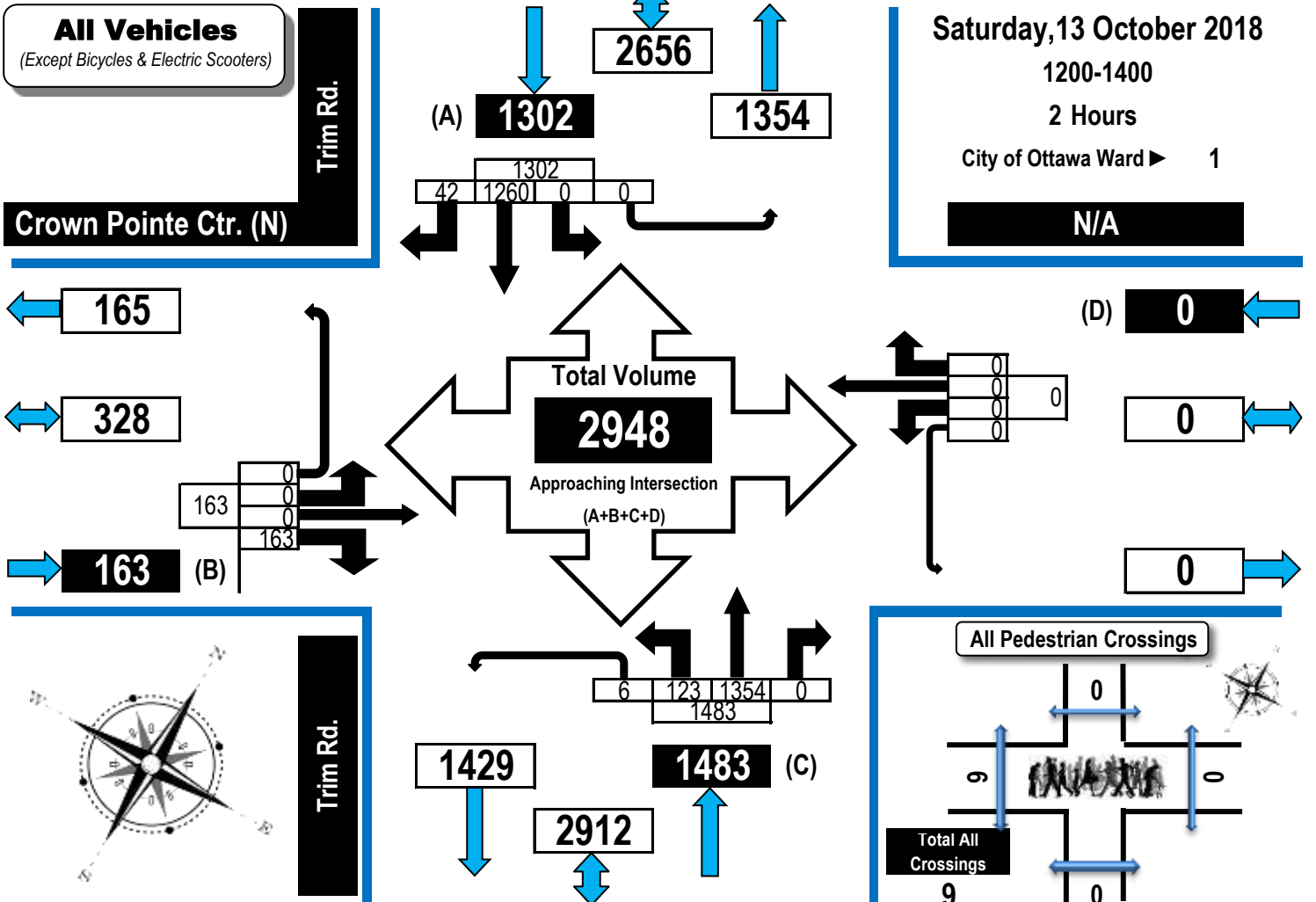

Off Peak Hour Flow Diagram Evening Peak Hour Flow Diagram

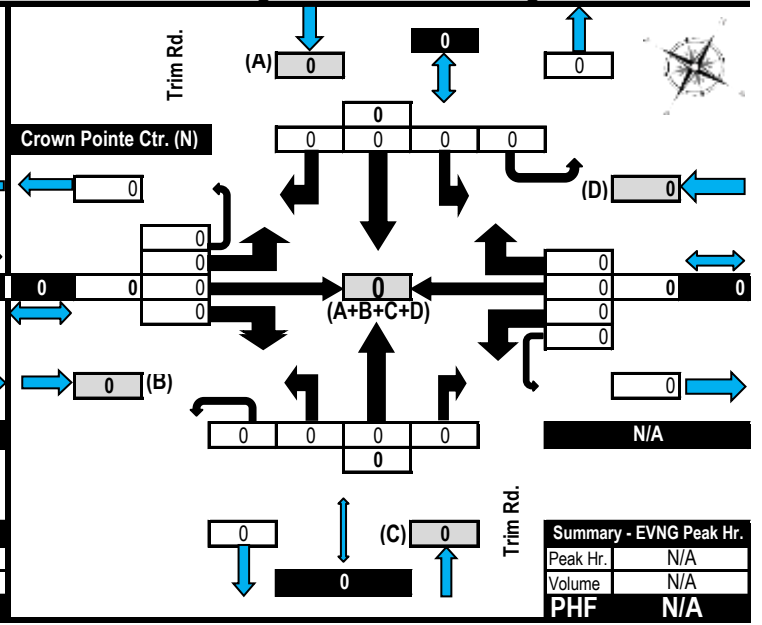
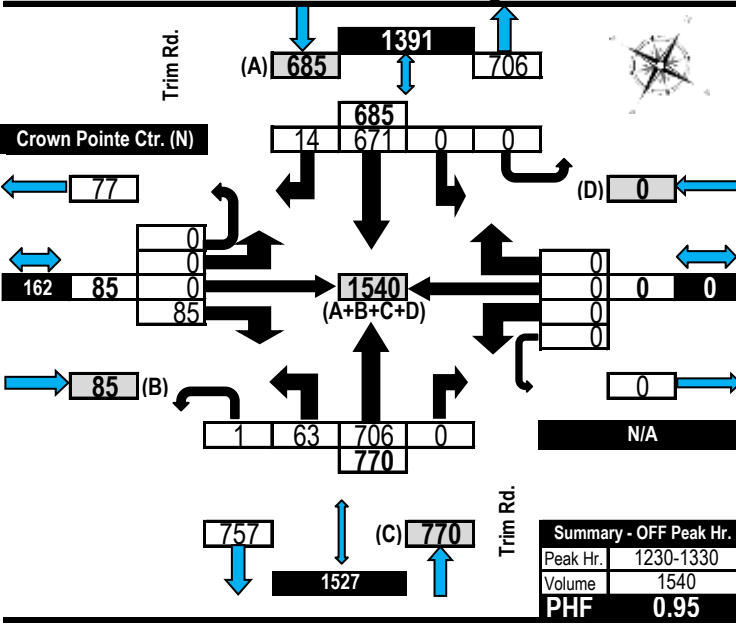



Turning Movement Count Heavy Vehicle Summary Flow Diagram

Heavy Trucks, Buses,
and School Buses

Crown Pointe Centre & Trim Road (North Access) Orléans, ON

Heavy Vehicles
(Construction Vehicles, Heavy Trucks, Buses & School Buses).
Heavy vehicle totals ARE included in the all vehicles summary and flow diagrams.

Saturday, 13 October 2018
1200-1400
2 Hour Survey
City of Ottawa Ward 1

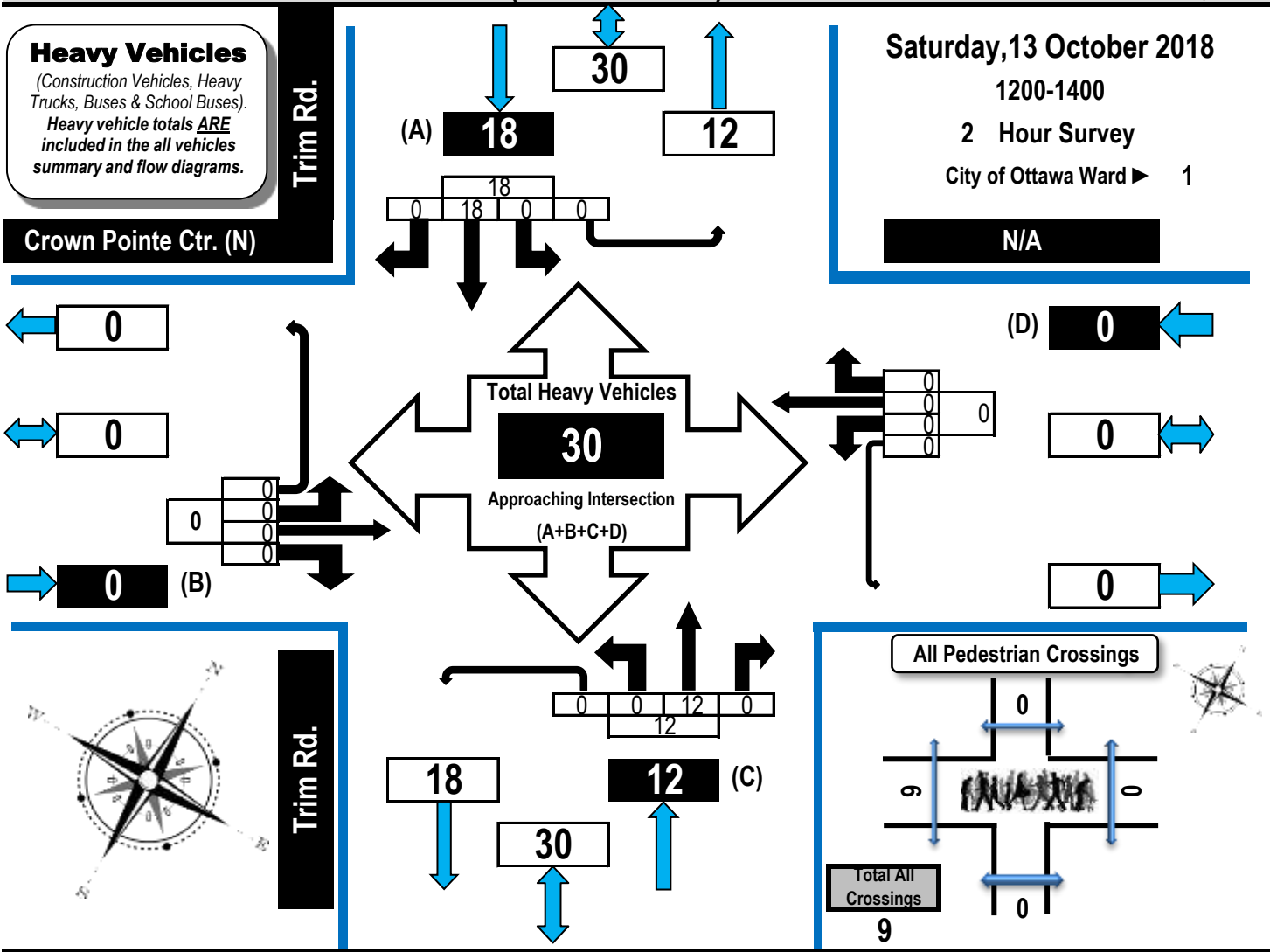

Time Period	Crown Pointe Ctr. (N) Eastbound					N/A Westbound					Trim Rd. Northbound					Trim Rd. Southbound					G.Tot.
	LT	ST	RT	UT	S. Tot.	LT	ST	RT	UT	S. Tot.	LT	ST	RT	UT	S. Tot.	LT	ST	RT	UT	S. Tot.	
1200-1300	0	0	0	0	0	0	0	0	0	0	0	6	0	0	6	0	9	0	0	9	15
1300-1400	0	0	0	0	0	0	0	0	0	0	0	6	0	0	6	0	9	0	0	9	15
Totals	0	0	0	0	0	0	0	0	0	0	0	12	0	0	12	0	18	0	0	18	30



Turning Movement Count

Pedestrian Crossings Summary and Flow Diagram



Crown Pointe Centre & Trim Road (North Access)

Orléans, ON

Pedestrian Crossings

Saturday, 13 October 2018

1200-1400

2 Hour Survey

City of Ottawa Ward 1

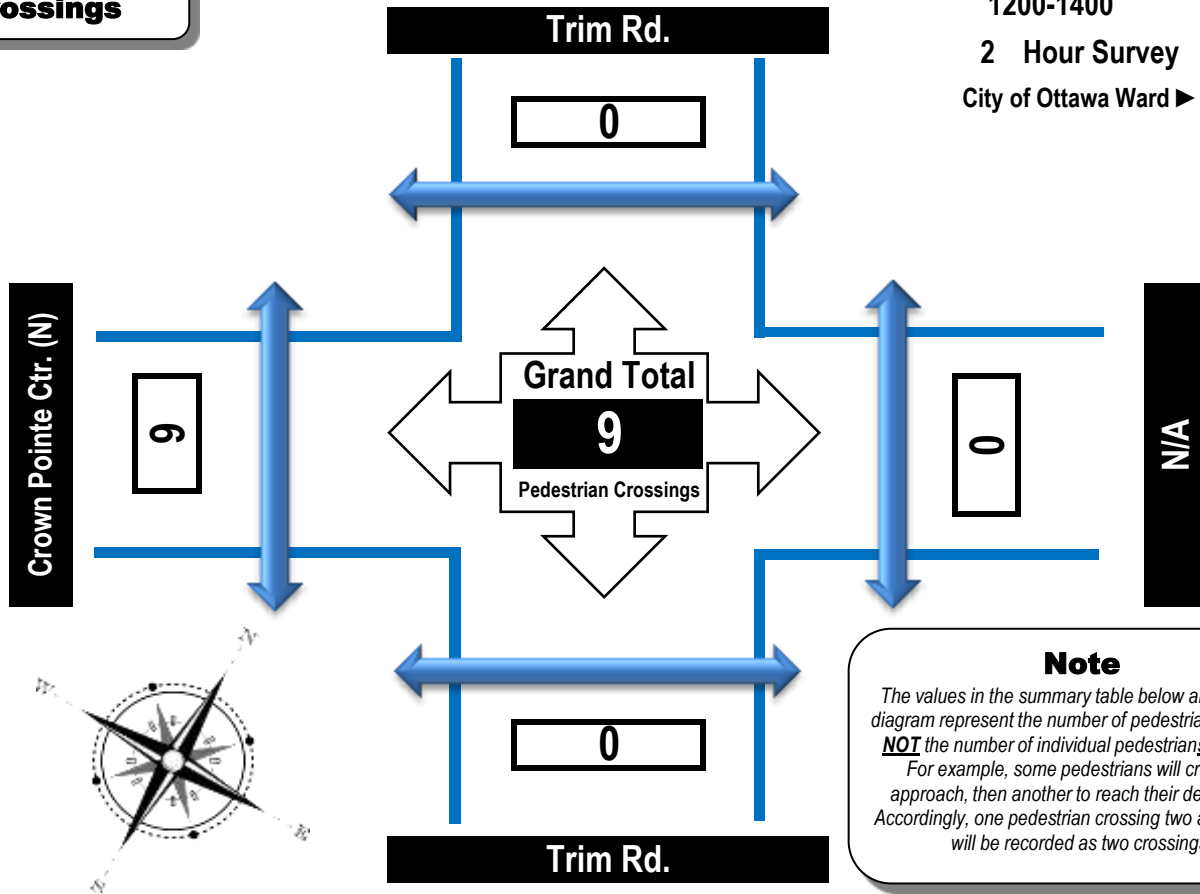

Time Period	West Side Crossing	East Side Crossing	Street Total	South Side Crossing	North Side Crossing	Street Total	Grand Total
	Crown Pointe Ctr. (N)	N/A		Trim Rd.	Trim Rd.		
1200-1300	6	0	6	0	0	0	6
1300-1400	3	0	3	0	0	0	3
Totals	9	0	9	0	0	0	9



Turning Movement Count

Summary Report Including AM, OFF Peak, PM, Evening Peak Hours, and PHF

Automobiles, Taxis,
Light Trucks, Vans,
SUV's, Motorcycles,
Heavy Trucks, Buses,
and School Buses

Crown Pointe Centre & Trim Road (North Access)

Orléans, ON

Survey Date: Saturday, 13 October 2018 **Start Time:** 1200 **AADT Factor:** 1.1
Weather: Partly Cloudy 4C **Survey Duration:** 2 Hrs. **Survey Hours:** 1200-1400
(AM/PM)

Time Period	Crown Pointe Ctr. (N)					N/A					Trim Rd.					Trim Rd.					Street Total	Grand Total	
	Eastbound					Westbound					Northbound					Southbound							
	LT	ST	RT	UT	E/B Tot	LT	ST	RT	UT	W/B Tot	LT	ST	RT	UT	N/B Tot	LT	ST	RT	UT	S/B Tot			
1200-1300	0	0	87	0	87						87	56	715	0	5	776	0	645	25	0	670	1446	1533
1300-1400	0	0	76	0	76						76	67	639	0	1	707	0	615	17	0	632	1339	1415
Totals	0	0	163	0	163	0	0	0	0	0	163	123	1354	0	6	1483	0	1260	42	0	1302	2785	2948

Expansion factors are applied exclusively to standard weekday 8-hour turning movement counts conducted during the hours of 0700h - 1000h, 1130h - 1330h and 1500h - 1800h

AM Peak Hour Factor → ###											Highest Hourly Vehicle Volume Between 0500h & 1000h													
AM Peak Hr	LT	ST	RT	UT	TOT	LT	ST	RT	UT	TOT	S.TOT	LT	ST	RT	UT	TOT	LT	ST	RT	UT	TOT	S.TOT	G.TOT	
N/A	0	0	0	0	0	0	0	0	0	0	0	0	0	0	0	0	0	0	0	0	0	0	0	0
OFF Peak Hour Factor → 0.95											Highest Hourly Vehicle Volume Between 1000h & 1500h													
OFF Peak Hr	LT	ST	RT	UT	TOT	LT	ST	RT	UT	TOT	S.TOT	LT	ST	RT	UT	TOT	LT	ST	RT	UT	TOT	S.TOT	G.TOT	
1230-1330	0	0	85	0	85	0	0	0	0	0	85	63	706	0	1	770	0	671	14	0	685	1455	1540	
PM Peak Hour Factor → ###											Highest Hourly Vehicle Volume Between 1500h & 1900h													
PM Peak Hr	LT	ST	RT	UT	TOT	LT	ST	RT	UT	TOT	S.TOT	LT	ST	RT	UT	TOT	LT	ST	RT	UT	TOT	S.TOT	G.TOT	
N/A	0	0	0	0	0	0	0	0	0	0	0	0	0	0	0	0	0	0	0	0	0	0	0	
EVNG Peak Hour Factor → ###											Highest Hourly Vehicle Volume Between 1900h & 2200h													
EVNG Peak Hr	LT	ST	RT	UT	TOT	LT	ST	RT	UT	TOT	S.TOT	LT	ST	RT	UT	TOT	LT	ST	RT	UT	TOT	S.TOT	G.TOT	
N/A	0	0	0	0	0	0	0	0	0	0	0	0	0	0	0	0	0	0	0	0	0	0	0	

Comments:

The majority of the northbound U-turns complete a right turn into the southerly access to the Crown Pointe Centre. The difference between the pedestrians crossing the north access on the west side and the south access is because most of the pedestrians originate from the shopping centre and do not cross the north access.

Notes:

1. Includes all vehicle types except bicycles and electric scooters.
2. When expansion and AADT factors are applied, the results will differ slightly due to rounding.



Turning Movement Count Bicycle Summary Flow Diagram

Bicycles, Electric Bicycles,
and Electric Scooters

Crown Pointe Centre & Trim Road (South Access) Orléans, ON

Bicycles
(Including electric bicycles and electric scooters)
Note:
Bicycle volumes are **NOT** included in vehicle totals.

Trim Rd.

Crown Pointe Ctr. (S)

Thursday, 27 September 2018
0700-0900 & 1500-1700
4 Hour Survey
City of Ottawa Ward **1**

N/A

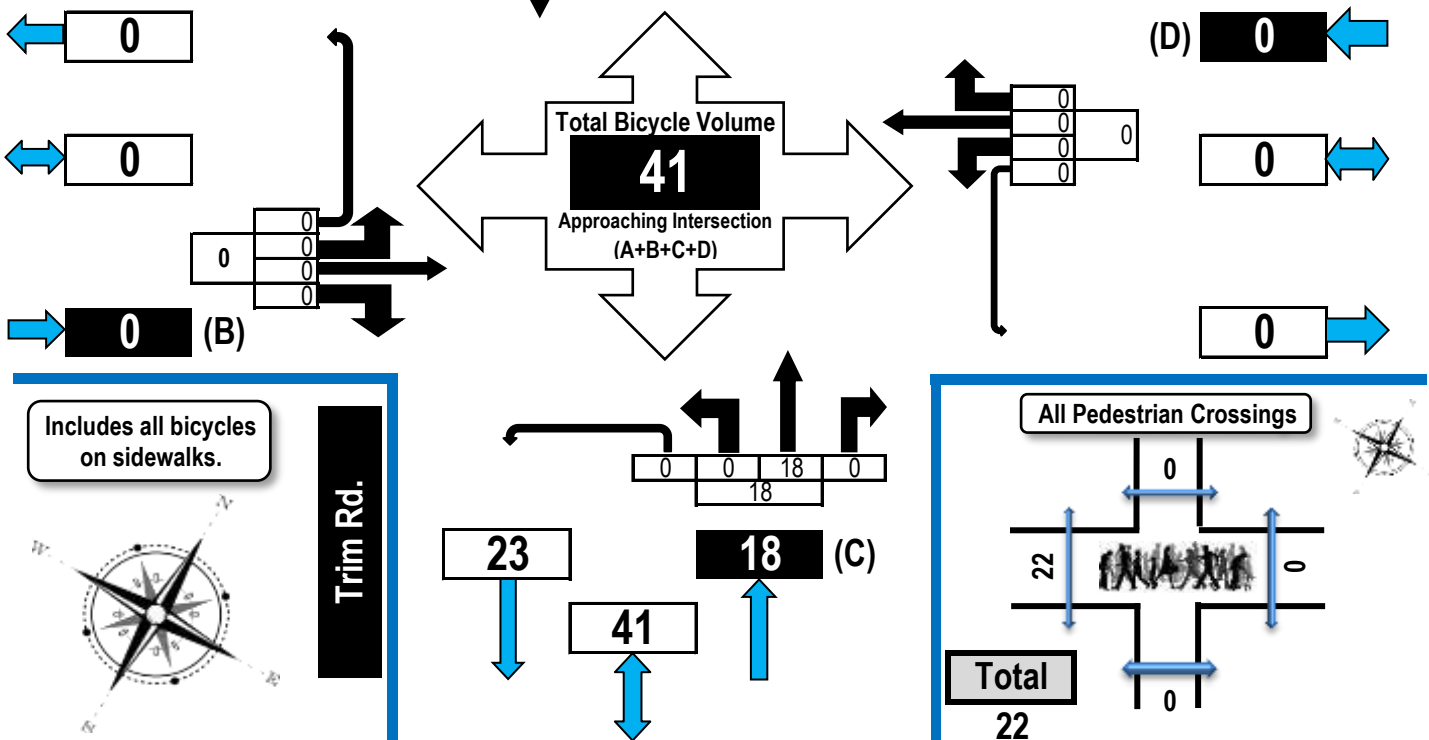

Crown Pointe Centre & Trim Road (South Access) Orléans, ON

Survey Date: Thursday, 27 September 2018 **Start Time:** 0700
Weather: Cloudy 18C **Survey Duration:** 4 Hrs. **Survey Hours:** 0700-0900 & 1500-1700
(AM/PM)

Time Period	Crown Pointe Ctr. (S)					N/A					Trim Rd.					Trim Rd.					G.Tot.
	Eastbound					Westbound					Northbound					Southbound					
	LT	ST	RT	UT	S. Tot.	LT	ST	RT	UT	S. Tot.	LT	ST	RT	UT	S. Tot.	LT	ST	RT	UT	S. Tot.	
0700-0800	0	0	0	0	0	0	0	0	0	0	0	4	0	0	4	0	1	0	0	1	5
0800-0900	0	0	0	0	0	0	0	0	0	0	0	4	0	0	4	0	1	0	0	1	5
1500-1600	0	0	0	0	0	0	0	0	0	0	0	6	0	0	6	0	9	0	0	9	15
1600-1700	0	0	0	0	0	0	0	0	0	0	0	4	0	0	4	0	12	0	0	12	16
Totals	0	0	0	0	0	0	0	0	0	0	0	18	0	0	18	0	23	0	0	23	41



Turning Movement Count Summary, AM and PM Peak Hour Flow Diagrams

Automobiles, Taxis, Light Trucks, Vans, SUV's, Motorcycles, Heavy Trucks, Buses, and School Buses

Crown Pointe Centre & Trim Road (South Access) Orléans, ON

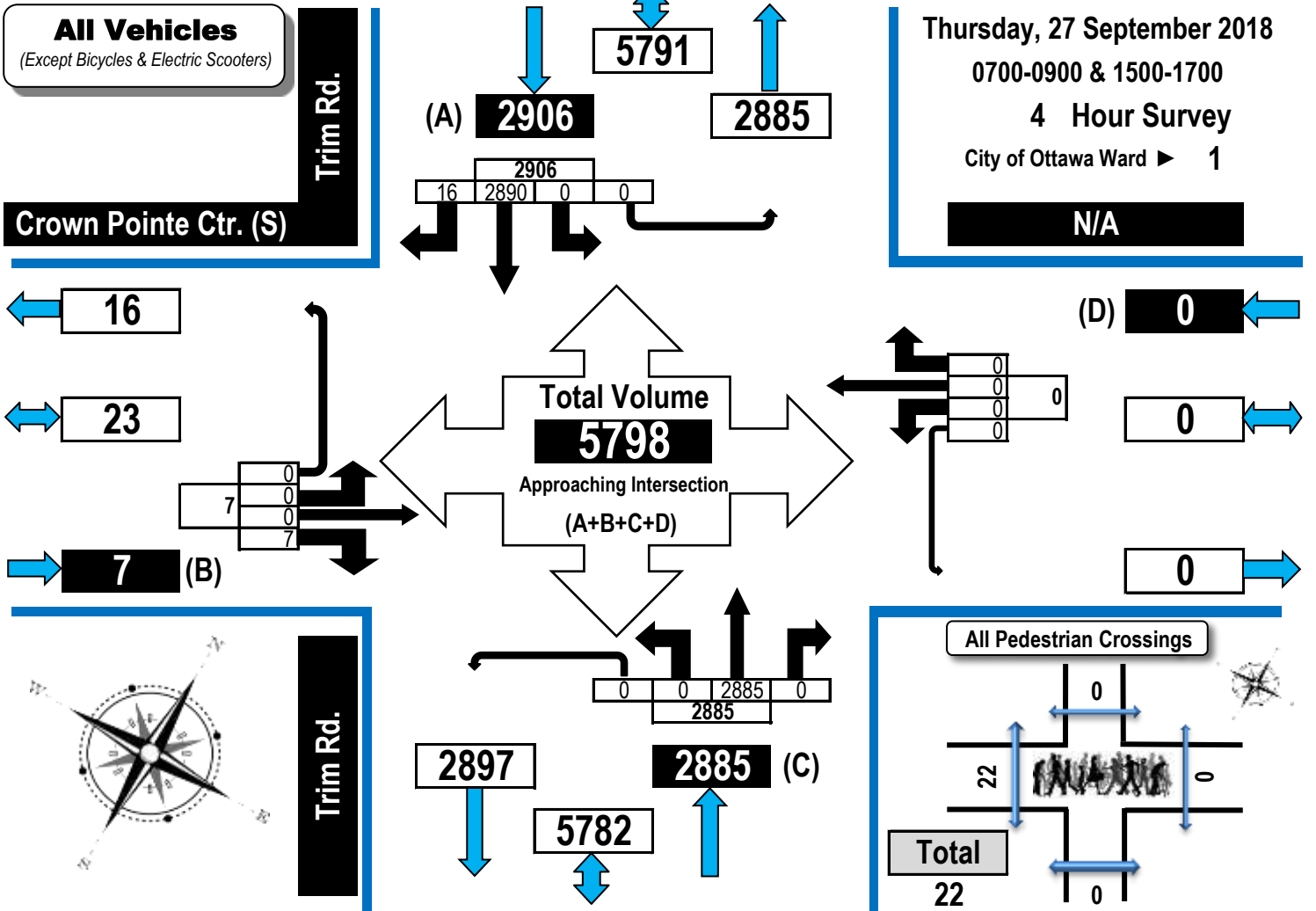

AM Peak Hour Flow Diagram PM Peak Hour Flow Diagram

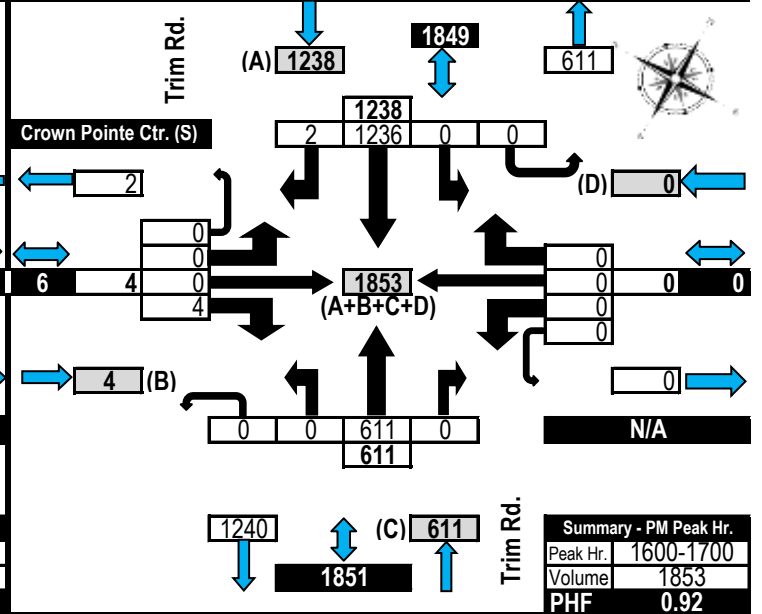
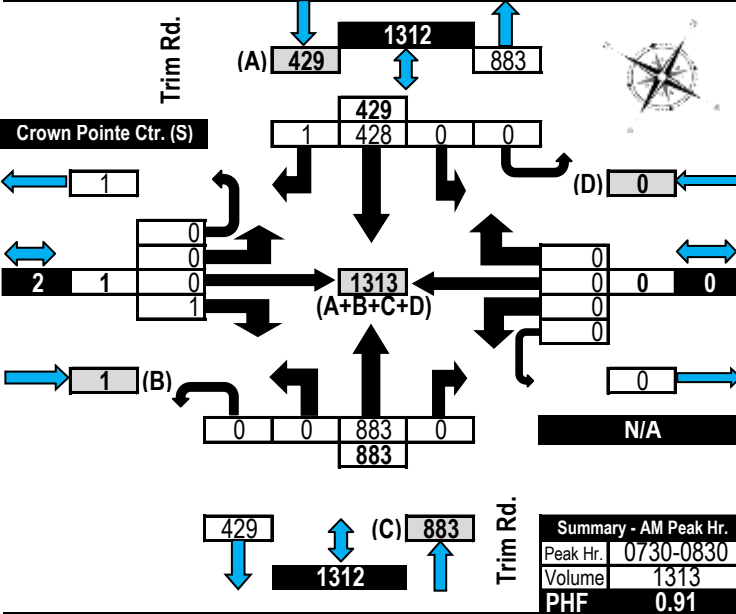



Turning Movement Count Heavy Vehicle Summary Flow Diagram

Heavy Trucks, Buses,
and School Buses

Crown Pointe Centre & Trim Road (South Access) Orléans, ON

Heavy Vehicles
(Construction Vehicles, Heavy Trucks, Buses & School Buses).
Heavy vehicle totals ARE included in the all vehicles summary and flow diagrams.

Thursday, 27 September 2018
0700-0900 & 1500-1700
4 Hour Survey
City of Ottawa Ward **1**
N/A

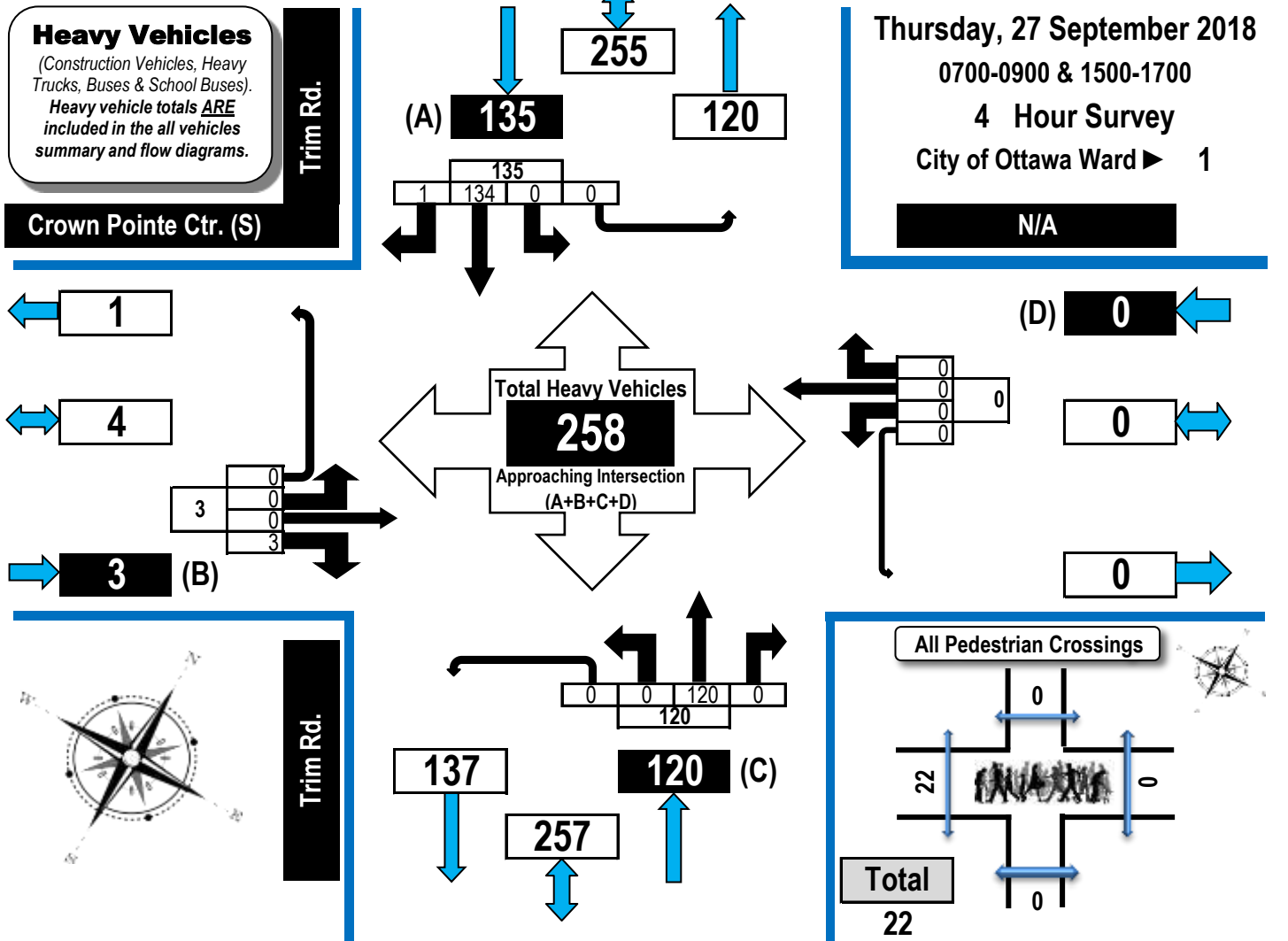

Crown Pointe Centre & Trim Road (South Access) Orléans, ON

Survey Date: Thursday, 27 September 2018
Weather: Cloudy 18C
Survey Duration: 4 Hrs.
Start Time: 0700
Survey Hours: 0700-0900 & 1500-1700

Time Period	Crown Pointe Ctr. (S)					N/A					Trim Rd.					Trim Rd.					G.Tot.
	Eastbound					Westbound					Northbound					Southbound					
	LT	ST	RT	UT	S. Tot.	LT	ST	RT	UT	S. Tot.	LT	ST	RT	UT	S. Tot.	LT	ST	RT	UT	S. Tot.	
0700-0800	0	0	0	0	0	0	0	0	0	0	0	31	0	0	31	0	38	0	0	38	69
0800-0900	0	0	3	0	3	0	0	0	0	0	0	32	0	0	32	0	25	1	0	26	61
1500-1600	0	0	0	0	0	0	0	0	0	0	0	30	0	0	30	0	30	0	0	30	60
1600-1700	0	0	0	0	0	0	0	0	0	0	0	27	0	0	27	0	41	0	0	41	68
Totals	0	0	3	0	3	0	0	0	0	0	0	120	0	0	120	0	134	1	0	135	258



Turning Movement Count

Pedestrian Crossings Summary and Flow Diagram



Crown Pointe Centre & Trim Road (South Access)

Orléans, ON

Pedestrian Crossings

Thursday, 27 September 2018

0700-0900 & 1500-1700

4 Hours

City of Ottawa Ward ► 1

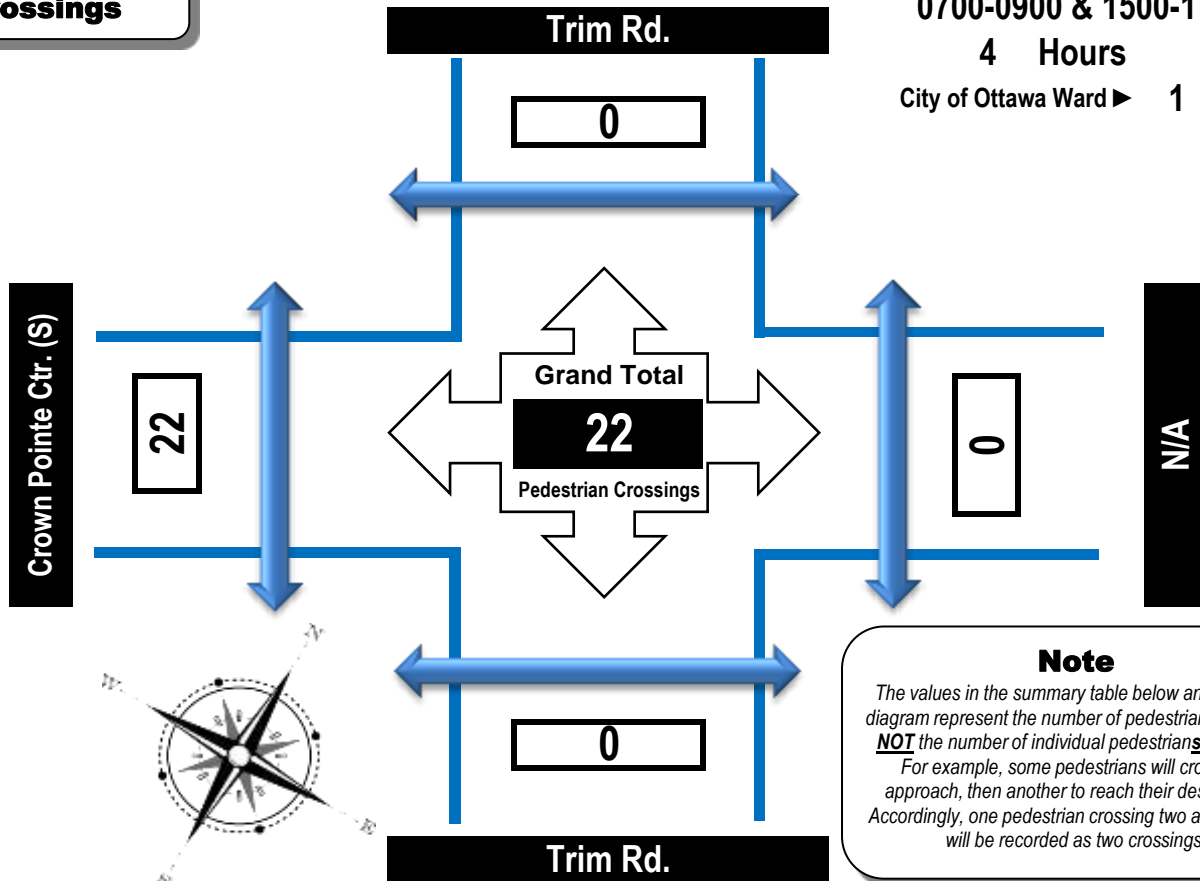

Note
 The values in the summary table below and the flow diagram represent the number of pedestrian crossings NOT the number of individual pedestrians crossing. For example, some pedestrians will cross one approach, then another to reach their destination. Accordingly, one pedestrian crossing two approaches will be recorded as two crossings.

Crown Pointe Centre & Trim Road (South Access)

Orléans, ON

Survey Date: Thursday, 27 September 2018

Start Time: 0700

Weather: Cloudy 18C
 (AM/PM)

Survey Duration: 4 Hrs.

Survey Hours:

0700-0900 & 1500-1700

Time Period	West Side Crossing Crown Pointe Ctr. (S)	East Side Crossing N/A	Street Total	South Side Crossing Trim Rd.	North Side Crossing Trim Rd.	Street Total	Grand Total
0700-0800	4	0	4	0	0	0	4
0800-0900	2	0	2	0	0	0	2
1500-1600	6	0	6	0	0	0	6
1600-1700	10	0	10	0	0	0	10
Totals	22	0	22	0	0	0	22



Turning Movement Count

Summary Report Including AM/PM Peak Hours, PHF, AADT and Expansion Factors

Automobiles, Taxis,
Light Trucks, Vans,
SUV's, Motorcycles,
Heavy Trucks, Buses,
and School Buses

Crown Pointe Centre & Trim Road (South Access) Orléans, ON

Survey Date: Thursday, 27 September 2018 **Start Time:** 0700 **AADT Factor:** 1.0
Weather-AM/PM: Cloudy 18C **Survey Duration:** 4 Hrs. **Survey Hours:** 0700-0900 & 1500-1700

Time Period	Crown Pointe Ctr. (S)					N/A					Trim Rd.					Trim Rd.					Street Total	Grand Total		
	Eastbound					Westbound					Northbound					Southbound								
	LT	ST	RT	UT	E/B Tot	LT	ST	RT	UT	W/B Tot	LT	ST	RT	UT	N/B Tot	LT	ST	RT	UT	S/B Tot				
0700-0800	0	0	1	0	1	0	0	0	0	0	0	1	0	903	0	0	903	0	383	2	0	385	1288	1289
0800-0900	0	0	1	0	1	0	0	0	0	0	0	1	0	845	0	0	845	0	371	5	0	376	1221	1222
1500-1600	0	0	1	0	1	0	0	0	0	0	0	1	0	526	0	0	526	0	900	7	0	907	1433	1434
1600-1700	0	0	4	0	4	0	0	0	0	0	0	4	0	611	0	0	611	0	1236	2	0	1238	1849	1853
Totals	0	0	7	0	7	0	0	0	0	0	0	7	0	2885	0	0	2885	0	2890	16	0	2906	5791	5798

Equivalent 12 & 24-hour Vehicle Volumes Including the Annual Average Daily Traffic (AADT) Factor
Applicable to the Day and Month of the Turning Movement Count

➔ **Expansion factors are applied exclusively to standard weekday 8-hour turning movement counts** ←

Equivalent 12-hour vehicle volumes. These volumes are calculated by multiplying the 8-hour totals by the 8 ➔12 expansion factor of 1.39

Equ. 12 Hr	n/a	n/a	n/a	n/a	n/a	n/a	n/a	n/a	n/a	n/a	n/a	n/a	n/a	n/a	n/a	n/a	n/a	n/a	n/a	n/a	n/a	n/a	n/a
------------	-----	-----	-----	-----	-----	-----	-----	-----	-----	-----	-----	-----	-----	-----	-----	-----	-----	-----	-----	-----	-----	-----	-----

Average daily 12-hour vehicle volumes. These volumes are calculated by multiplying the equivalent 12-hour totals by the AADT factor of: 1.0

AADT 12-hr	n/a	n/a	n/a	n/a	n/a	n/a	n/a	n/a	n/a	n/a	n/a	n/a	n/a	n/a	n/a	n/a	n/a	n/a	n/a	n/a	n/a	n/a	n/a
------------	-----	-----	-----	-----	-----	-----	-----	-----	-----	-----	-----	-----	-----	-----	-----	-----	-----	-----	-----	-----	-----	-----	-----

24-Hour AADT. These volumes are calculated by multiplying the average daily 12-hour vehicle volumes by the 12 ➔24 expansion factor of 1.31

AADT 24 Hr	n/a	n/a	n/a	n/a	n/a	n/a	n/a	n/a	n/a	n/a	n/a	n/a	n/a	n/a	n/a	n/a	n/a	n/a	n/a	n/a	n/a	n/a	n/a
------------	-----	-----	-----	-----	-----	-----	-----	-----	-----	-----	-----	-----	-----	-----	-----	-----	-----	-----	-----	-----	-----	-----	-----

AM Peak Hour Factor ➔ 0.91 **Highest Hourly Vehicle Volume between 0700h & 1000h**

AM Peak Hr	LT	ST	RT	UT	TOT	LT	ST	RT	UT	TOT	S.TOT	LT	ST	RT	UT	TOT	LT	ST	RT	UT	TOT	S.TOT	G.TOT
0730-0830	0	0	1	0	1	0	0	0	0	0	1	0	883	0	0	883	0	428	1	0	429	1312	1313

OFF Peak Hour Factor ➔ ### **Highest Hourly Vehicle Volume between 1130h & 1330h**

Off Peak Hr	LT	ST	RT	UT	TOT	LT	ST	RT	UT	TOT	S.TOT	LT	ST	RT	UT	TOT	LT	ST	RT	UT	TOT	S.TOT	G.TOT
N/A	0	0	0	0	0	0	0	0	0	0	0	0	0	0	0	0	0	0	0	0	0	0	0

PM Peak Hour Factor ➔ 0.92 **Highest Hourly Vehicle Volume between 1500h & 1800h**

PM Peak Hr	LT	ST	RT	UT	TOT	LT	ST	RT	UT	TOT	S.TOT	LT	ST	RT	UT	TOT	LT	ST	RT	UT	TOT	S.TOT	G.TOT
1600-1700	0	0	4	0	4	0	0	0	0	0	4	0	611	0	0	611	0	1236	2	0	1238	1849	1853

Comments

The majority of the cyclists use the sidewalks.

Notes:

1. Includes all vehicle types except bicycles and electric scooters.
2. Expansion factors are not applied to turning movement counts if they are less than 8-hours in duration.
3. When expansion and AADT factors are applied, the results will differ slightly due to rounding.

Disclaimer:

The information contained in this data summary is for information purposes only, and may not apply to your situation. Every effort is made to ensure the traffic count information is accurate for the survey date provided on the summary and flow diagram forms. The author, publisher, and distributor provide no warranty about the content or accuracy of either the data summary or flow diagrams. Information provided is subjective. The author, publisher, and distributor shall not be liable for any loss of profit or any other commercial damages resulting from use of this data.



Turning Movement Count Bicycle Summary Flow Diagram



Crown Pointe Centre & Trim Road (South Access)

Orléans, ON

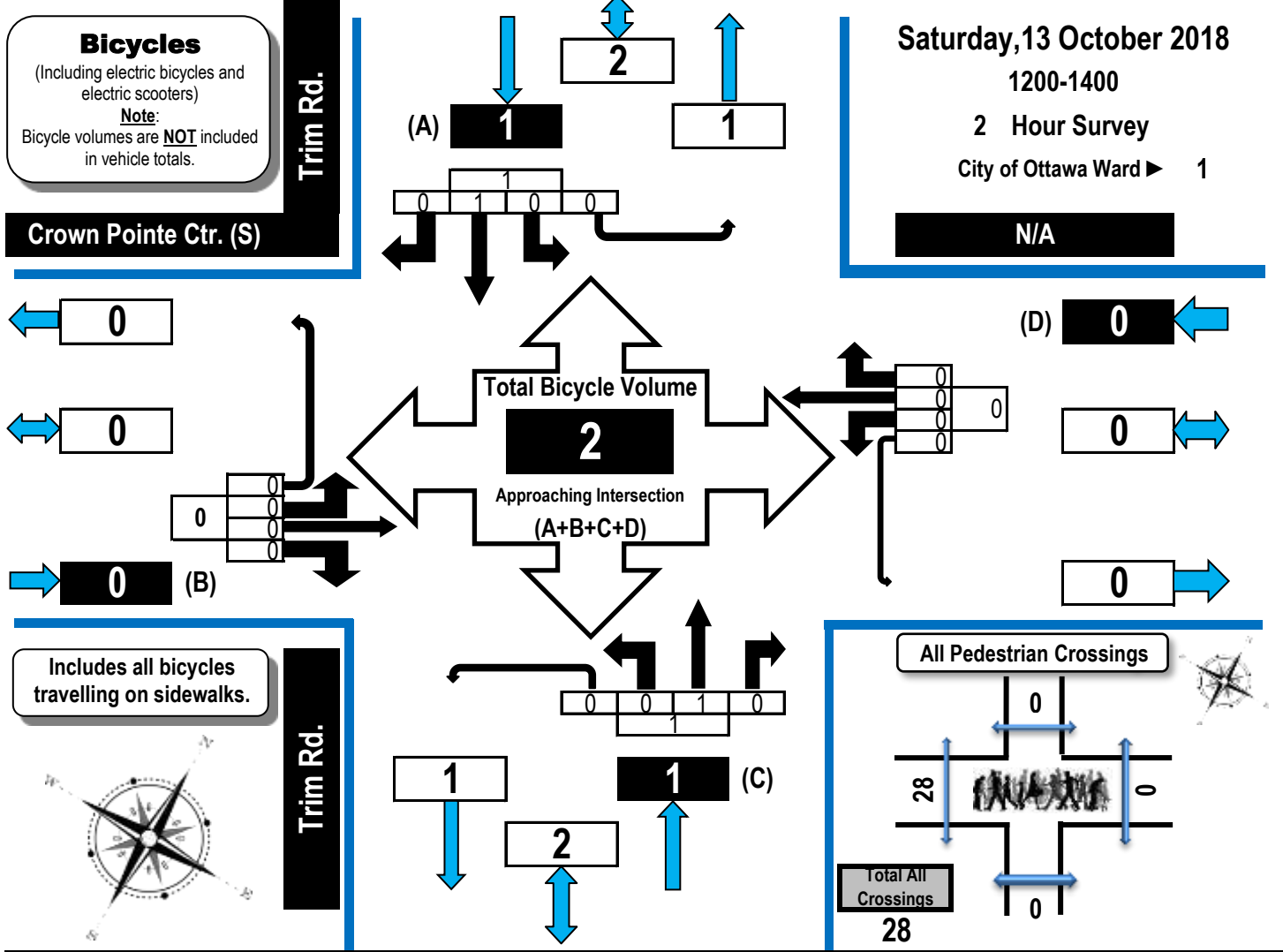

Time Period	Crown Pointe Ctr. (S) Eastbound					N/A Westbound					Trim Rd. Northbound					Trim Rd. Southbound					G.Tot.	
	LT	ST	RT	UT	S. Tot.	LT	ST	RT	UT	S. Tot.	LT	ST	RT	UT	S. Tot.	LT	ST	RT	UT	S. Tot.		
1200-1300	0	0	0	0	0	0	0	0	0	0	0	0	1	0	0	1	0	0	0	0	0	1
1300-1400	0	0	0	0	0	0	0	0	0	0	0	0	0	0	0	0	0	1	0	0	1	1
Totals	0	0	0	0	0	0	0	0	0	0	0	0	1	0	0	1	0	1	0	0	1	2



Turning Movement Count

Summary, OFF and EVENING Peak Hour

Flow Diagrams

Automobiles, Taxis, Light Trucks, Vans, SUV's, Motorcycles, Heavy Trucks, Buses, and School Buses

Crown Pointe Centre & Trim Road (South Access) Orléans, ON

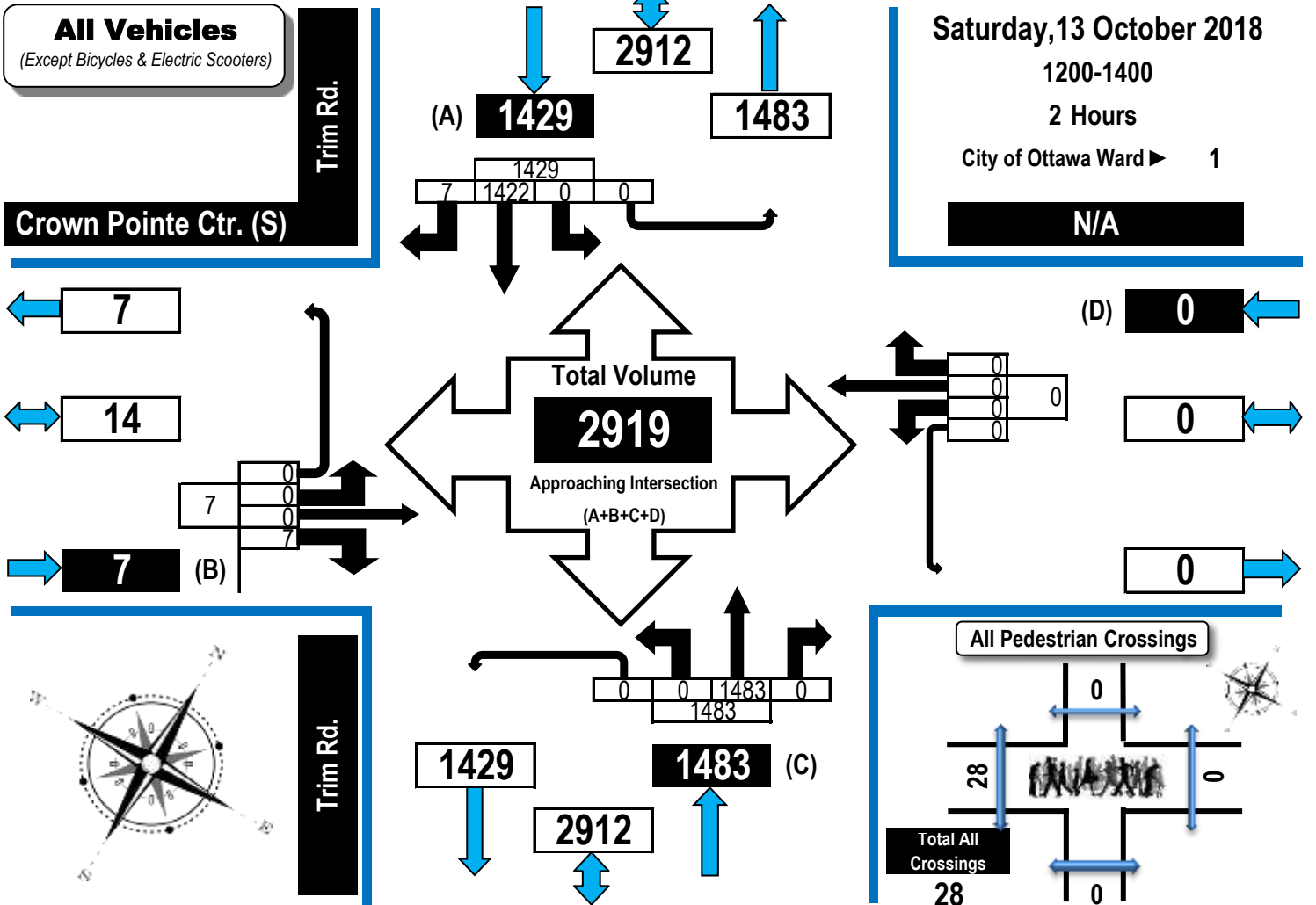

Off Peak Hour Flow Diagram Evening Peak Hour Flow Diagram

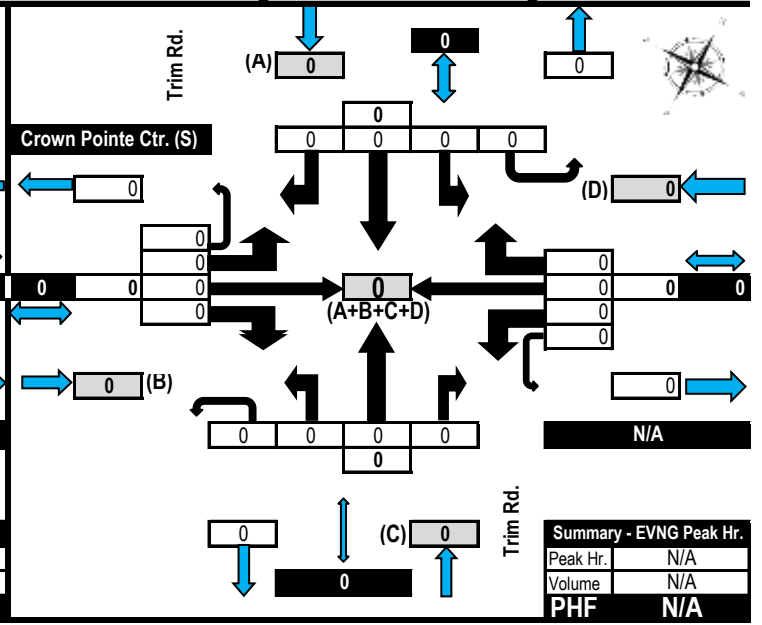
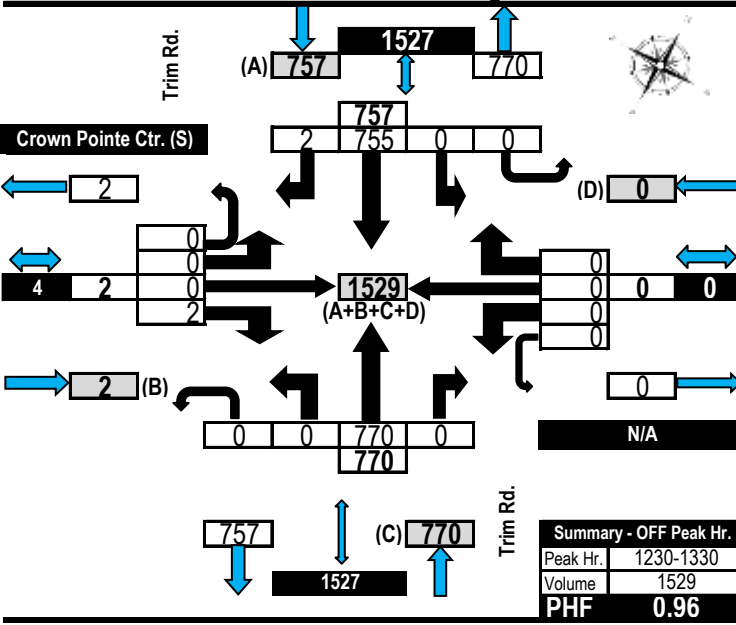



Turning Movement Count Heavy Vehicle Summary Flow Diagram

Heavy Trucks, Buses,
and School Buses

Crown Pointe Centre & Trim Road (South Access)

Orléans, ON

Heavy Vehicles
(Construction Vehicles, Heavy Trucks, Buses & School Buses).
Heavy vehicle totals ARE included in the all vehicles summary and flow diagrams.

Trim Rd.

Saturday, 13 October 2018
1200-1400
2 Hour Survey
City of Ottawa Ward ▶ 1

Crown Pointe Ctr. (S)

N/A

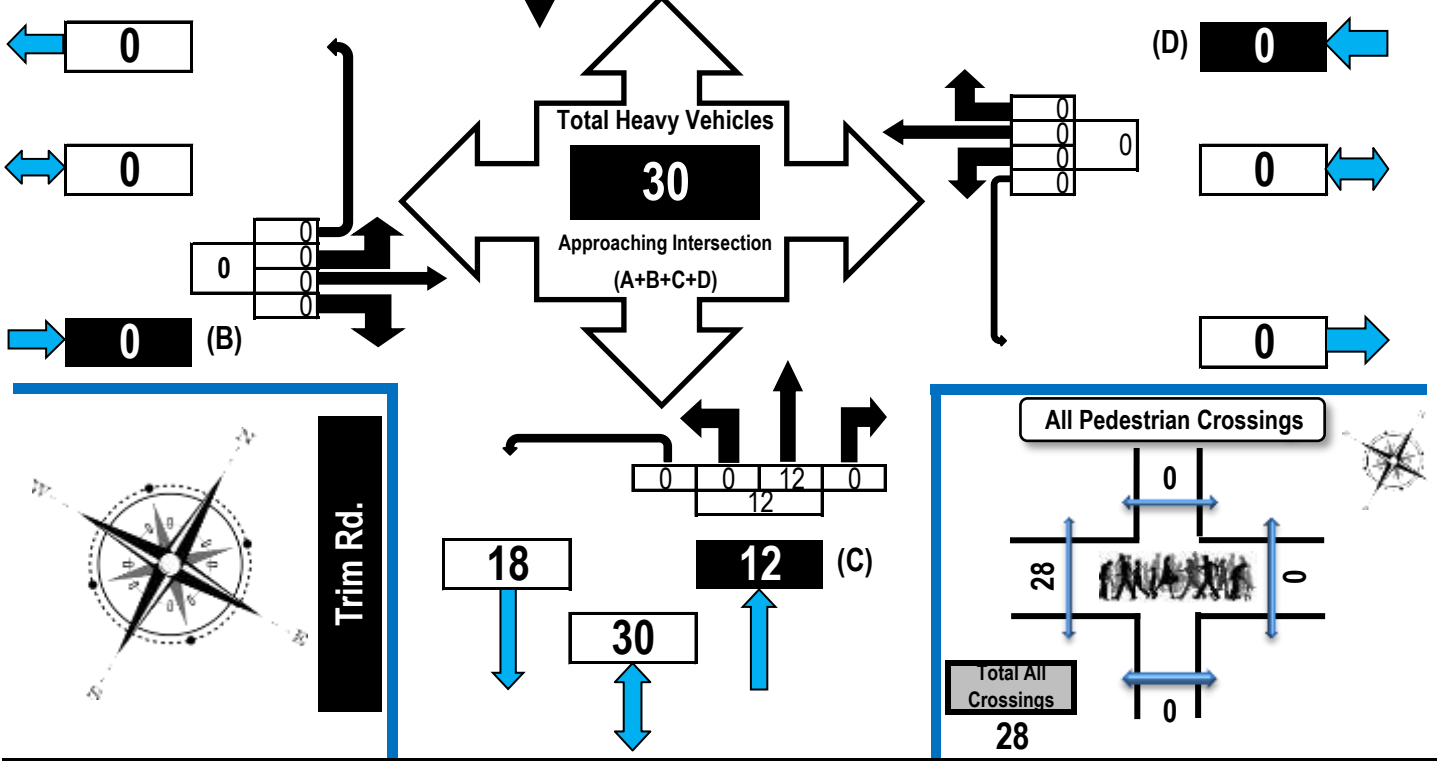

Time Period	Crown Pointe Ctr. (S) Eastbound					N/A Westbound					Trim Rd. Northbound					Trim Rd. Southbound					G.Tot.
	LT	ST	RT	UT	S. Tot.	LT	ST	RT	UT	S. Tot.	LT	ST	RT	UT	S. Tot.	LT	ST	RT	UT	S. Tot.	
1200-1300	0	0	0	0	0	0	0	0	0	0	0	6	0	0	6	0	9	0	0	9	15
1300-1400	0	0	0	0	0	0	0	0	0	0	0	6	0	0	6	0	9	0	0	9	15
Totals	0	0	0	0	0	0	0	0	0	0	0	12	0	0	12	0	18	0	0	18	30



Turning Movement Count

Pedestrian Crossings Summary and Flow Diagram



Crown Pointe Centre & Trim Road (South Access)

Orléans, ON

Pedestrian Crossings

Saturday, 13 October 2018

1200-1400

2 Hour Survey

City of Ottawa Ward 1

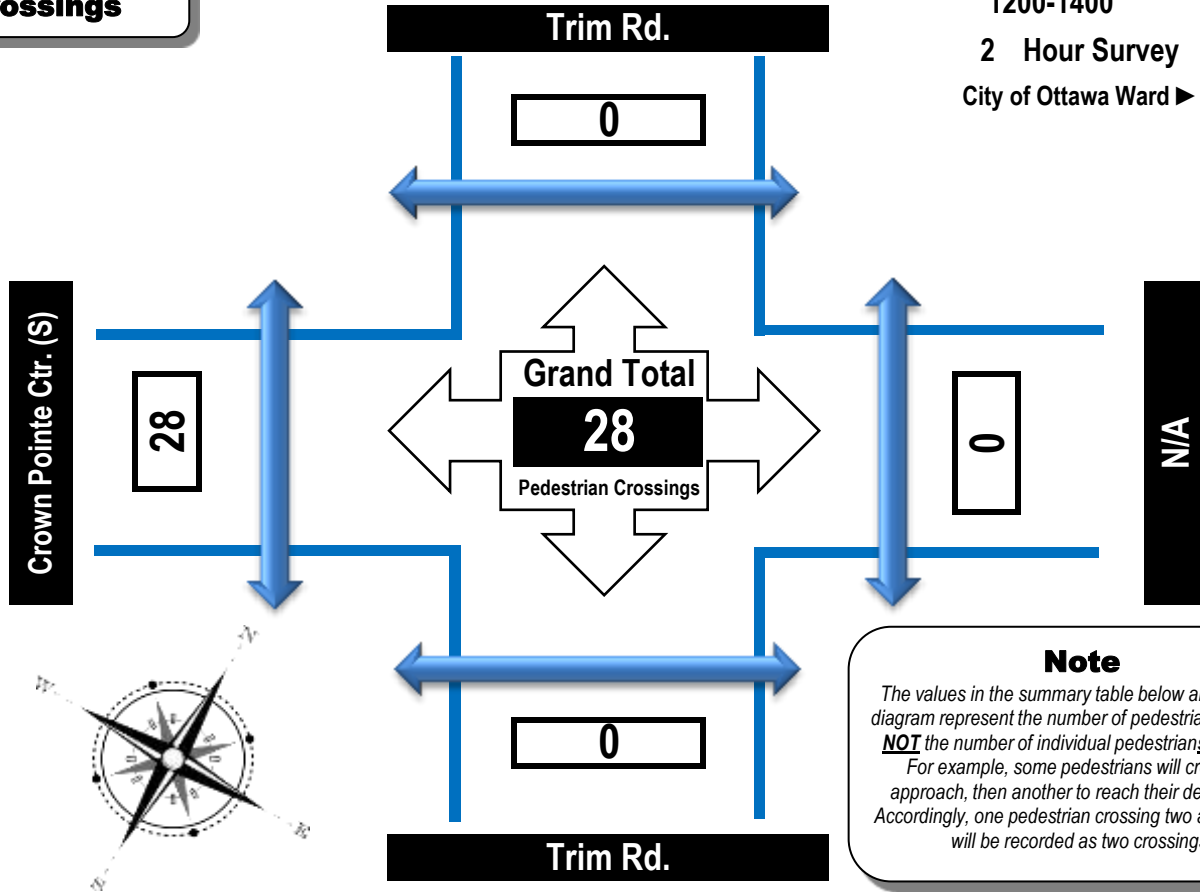

Note
 The values in the summary table below and the flow diagram represent the number of pedestrian crossings **NOT** the number of individual pedestrians crossing. For example, some pedestrians will cross one approach, then another to reach their destination. Accordingly, one pedestrian crossing two approaches will be recorded as two crossings.

Time Period	West Side Crossing Crown Pointe Ctr. (S)	East Side Crossing N/A	Street Total	South Side Crossing Trim Rd.	North Side Crossing Trim Rd.	Street Total	Grand Total
1200-1300	19	0	19	0	0	0	19
1300-1400	9	0	9	0	0	0	9
Totals	28	0	28	0	0	0	28



Turning Movement Count

Summary Report Including AM, OFF Peak, PM, Evening Peak Hours, and PHF

Automobiles, Taxis,
Light Trucks, Vans,
SUV's, Motorcycles,
Heavy Trucks, Buses,
and School Buses

Crown Pointe Centre & Trim Road (South Access)

Orléans, ON

Survey Date: Saturday, 13 October 2018

Start Time: 1200

AADT Factor: 1.1

Weather: Partly Cloudy 4C

Survey Duration: 2 Hrs.

Survey Hours: 1200-1400

(AM/PM)

Crown Pointe Ctr. (S)

N/A

Trim Rd.

Trim Rd.

Eastbound

Westbound

Northbound

Southbound

Time Period	Eastbound					Westbound					WB Tot	Street Total	Northbound					N/B Tot	Southbound					S/B Tot	Street Total	Grand Total
	LT	ST	RT	UT	E/B Tot	LT	ST	RT	UT	LT			ST	RT	UT	LT	ST		RT	UT	S/B Tot	LT	ST			
1200-1300	0	0	2	0	2						2	776	0	0	776	0	735	2	0	737	1513	1515				
1300-1400	0	0	5	0	5						5	707	0	0	707	0	687	5	0	692	1399	1404				
Totals	0	0	7	0	7	0	0	0	0	0	7	1483	0	0	1483	0	1422	7	0	1429	2912	2919				

Expansion factors are applied exclusively to standard weekday 8-hour turning movement counts conducted during the hours of 0700h - 1000h, 1130h - 1330h and 1500h - 1800h

AM Peak Hour Factor → ###											Highest Hourly Vehicle Volume Between 0500h & 1000h													
AM Peak Hr	LT	ST	RT	UT	TOT	LT	ST	RT	UT	TOT	S.TOT	LT	ST	RT	UT	TOT	LT	ST	RT	UT	TOT	S.TOT	G.TOT	
N/A	0	0	0	0	0	0	0	0	0	0	0	0	0	0	0	0	0	0	0	0	0	0	0	0
OFF Peak Hour Factor → 0.96											Highest Hourly Vehicle Volume Between 1000h & 1500h													
OFF Peak Hr	LT	ST	RT	UT	TOT	LT	ST	RT	UT	TOT	S.TOT	LT	ST	RT	UT	TOT	LT	ST	RT	UT	TOT	S.TOT	G.TOT	
1230-1330	0	0	2	0	2	0	0	0	0	0	2	770	0	0	770	0	755	2	0	757	1527	1529		
PM Peak Hour Factor → ###											Highest Hourly Vehicle Volume Between 1500h & 1900h													
PM Peak Hr	LT	ST	RT	UT	TOT	LT	ST	RT	UT	TOT	S.TOT	LT	ST	RT	UT	TOT	LT	ST	RT	UT	TOT	S.TOT	G.TOT	
N/A	0	0	0	0	0	0	0	0	0	0	0	0	0	0	0	0	0	0	0	0	0	0	0	0
EVNG Peak Hour Factor → ###											Highest Hourly Vehicle Volume Between 1900h & 2200h													
EVNG Peak Hr	LT	ST	RT	UT	TOT	LT	ST	RT	UT	TOT	S.TOT	LT	ST	RT	UT	TOT	LT	ST	RT	UT	TOT	S.TOT	G.TOT	
N/A	0	0	0	0	0	0	0	0	0	0	0	0	0	0	0	0	0	0	0	0	0	0	0	0

Comments:

The majority of the northbound U-turns at the north access complete a right turn into the southerly access to the Crown Pointe Centre. The difference between the pedestrians crossing the north access on the west side and the south access is because most of the pedestrians originate from the shopping centre and do not cross the north access.

Notes:

1. Includes all vehicle types except bicycles and electric scooters.
2. When expansion and AADT factors are applied, the results will differ slightly due to rounding.



Turning Movement Count Bicycle Summary Flow Diagram

Bicycles, Electric Bicycles,
and Electric Scooters

Crown Pointe Centre/Montcrest Drive & Watters Road Orléans, ON

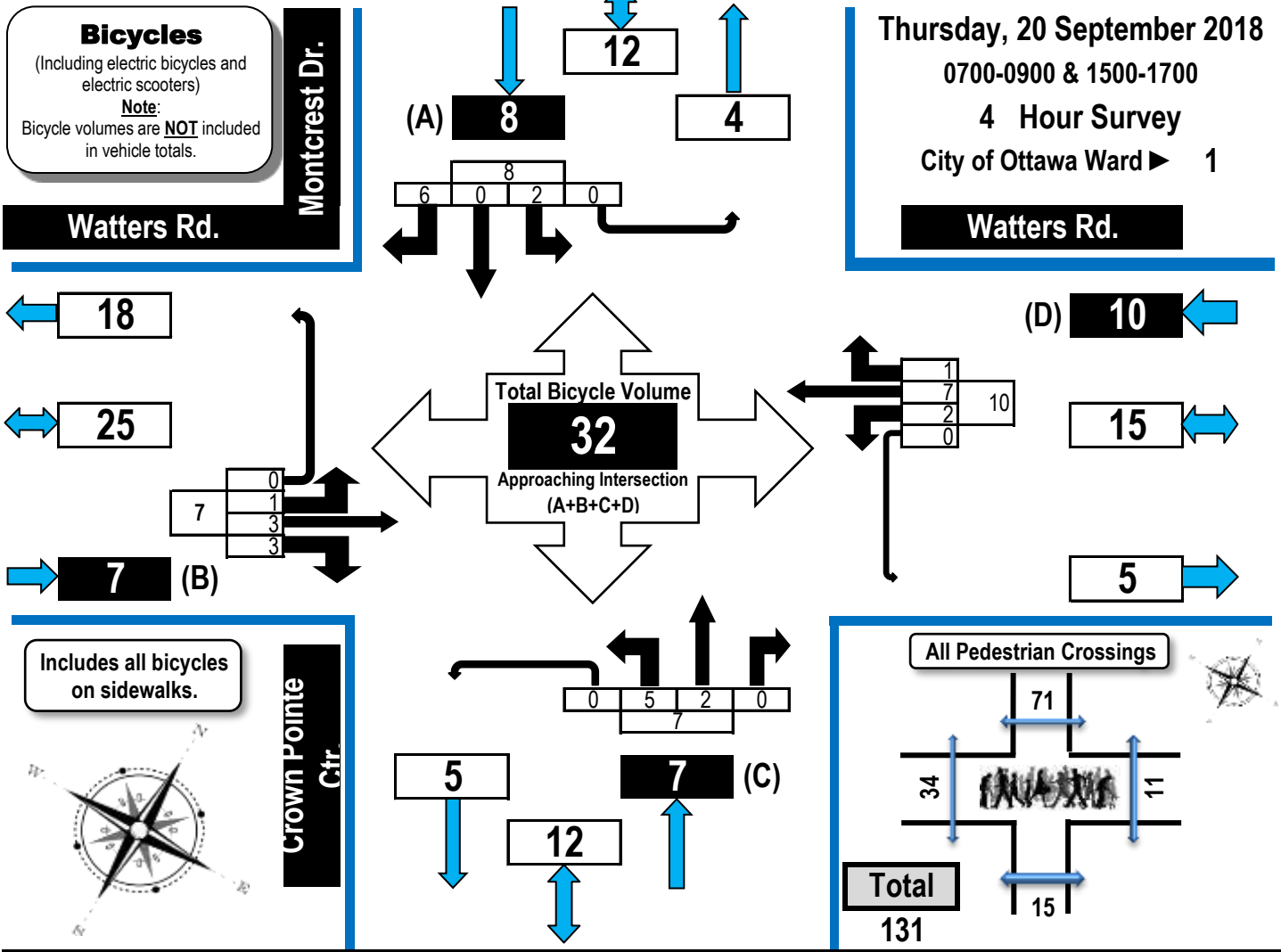

Crown Pointe Centre/Montcrest Drive & Watters Road Orléans, ON

Survey Date: Thursday, 20 September 2018 **Start Time:** 0700
Weather: Overcast +10C/Overcast +16C **Survey Duration:** 4 Hrs. **Survey Hours:** 0700-0900 & 1500-1700
(AM/PM)

Time Period	Watters Rd. Eastbound					Watters Rd. Westbound					Crown Pointe Ctr. Northbound					Montcrest Dr. Southbound					S. Tot	G.Tot.
	LT	ST	RT	UT	S. Tot	LT	ST	RT	UT	S. Tot	LT	ST	RT	UT	S. Tot	LT	ST	RT	UT	S. Tot		
	0700-0800	0	2	0	0	2	0	2	0	0	2	0	0	0	0	0	0	0	0	2		
0800-0900	0	0	1	0	1	0	1	0	0	1	1	0	0	0	1	0	0	0	0	0	0	3
1500-1600	0	1	1	0	2	0	2	1	0	3	3	1	0	0	4	0	0	4	0	4	4	13
1600-1700	1	0	1	0	2	2	2	0	0	4	1	1	0	0	2	2	0	0	0	0	2	10
Totals	1	3	3	0	7	2	7	1	0	10	5	2	0	0	7	2	0	6	0	8	32	



Turning Movement Count Summary, AM and PM Peak Hour Flow Diagrams

Automobiles, Taxis, Light Trucks, Vans, SUV's, Motorcycles, Heavy Trucks, Buses, and School Buses

Crown Pointe Centre/Montcrest Drive & Watters Road Orléans, ON

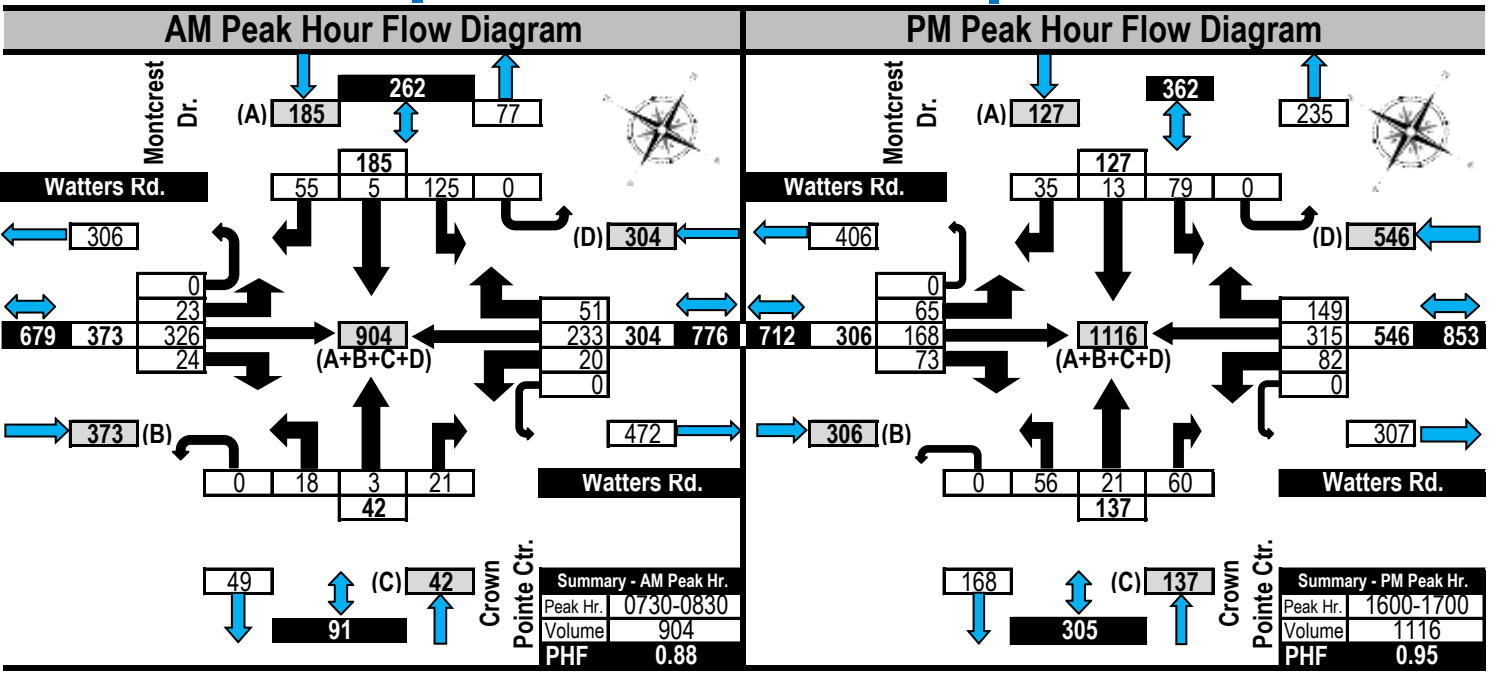
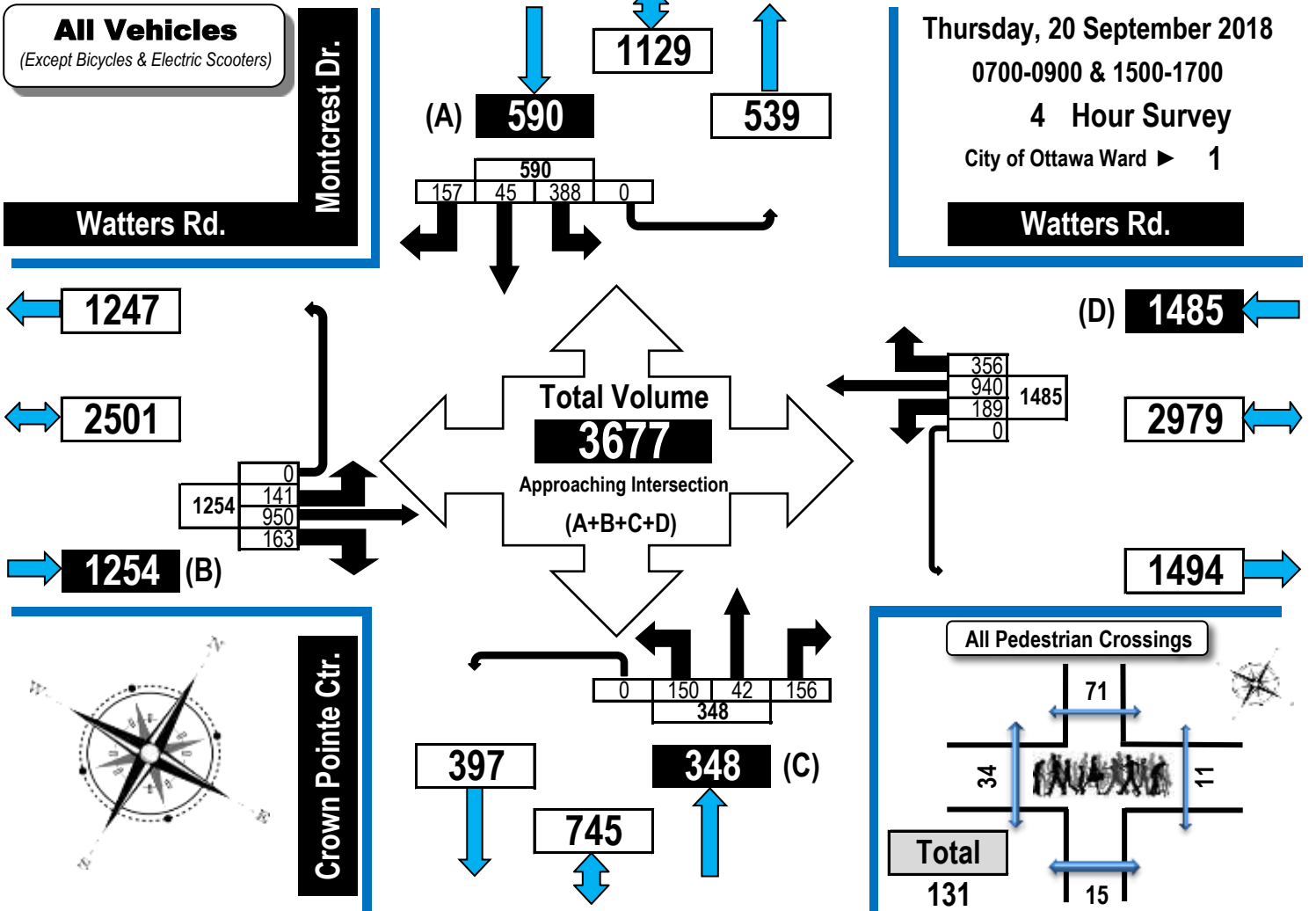



Turning Movement Count Heavy Vehicle Summary Flow Diagram

Heavy Trucks, Buses,
and School Buses

Crown Pointe Centre/Montcrest Drive & Watters Road Orléans, ON

Thursday, 20 September 2018

0700-0900 & 1500-1700

4 Hour Survey

City of Ottawa Ward 1

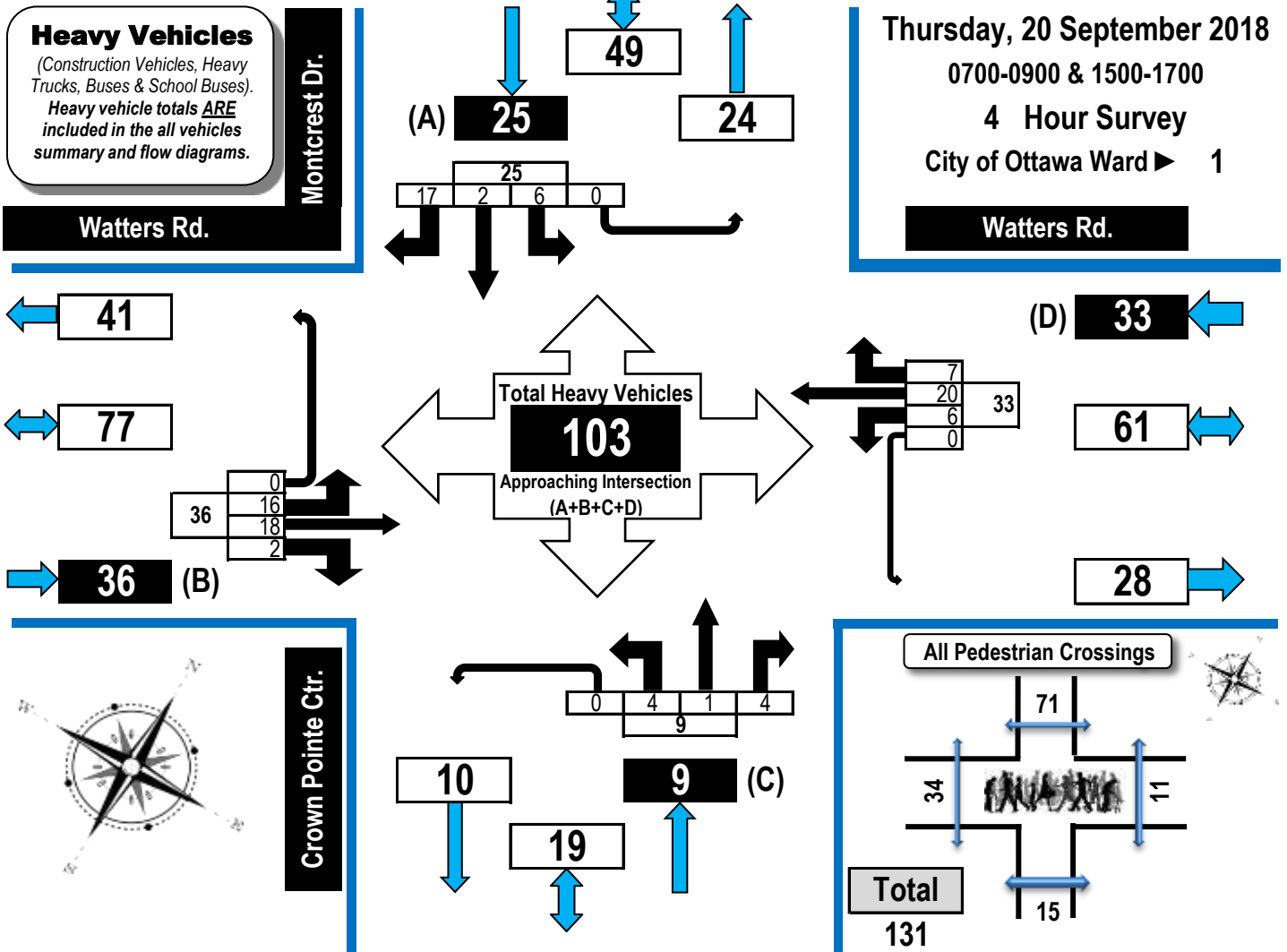

Crown Pointe Centre/Montcrest Drive & Watters Road Orléans, ON

Survey Date: Thursday, 20 September 2018

Start Time: 0700

Weather: Overcast +10C/Overcast +16C
(AM/PM)

Survey Duration: 4 Hrs.

Survey Hours: 0700-0900 & 1500-1700

Time Period	Watters Rd. Eastbound					Watters Rd. Westbound					Crown Pointe Ctr. Northbound					Montcrest Dr. Southbound					S. Tot	G.Tot.
	LT	ST	RT	UT	S. Tot	LT	ST	RT	UT	S. Tot	LT	ST	RT	UT	S. Tot	LT	ST	RT	UT	S. Tot		
	0700-0800	5	5	0	0	10	2	7	3	0	12	1	1	0	0	2	2	0	3	0		
0800-0900	4	4	1	0	9	3	6	1	0	10	2	0	1	0	3	1	1	5	0	7	29	
1500-1600	5	5	0	0	10	1	5	1	0	7	1	0	2	0	3	2	1	3	0	6	26	
1600-1700	2	4	1	0	7	0	2	2	0	4	0	0	1	0	1	1	0	6	0	7	19	
Totals	16	18	2	0	36	6	20	7	0	33	4	1	4	0	9	6	2	17	0	25	103	



Turning Movement Count Pedestrian Crossings Summary and Flow Diagram



Crown Pointe Centre/Montcrest Drive & Watters Road Orléans, ON

Pedestrian Crossings

Thursday, 20 September 2018
0700-0900 & 1500-1700
4 Hours
City of Ottawa Ward ► 1

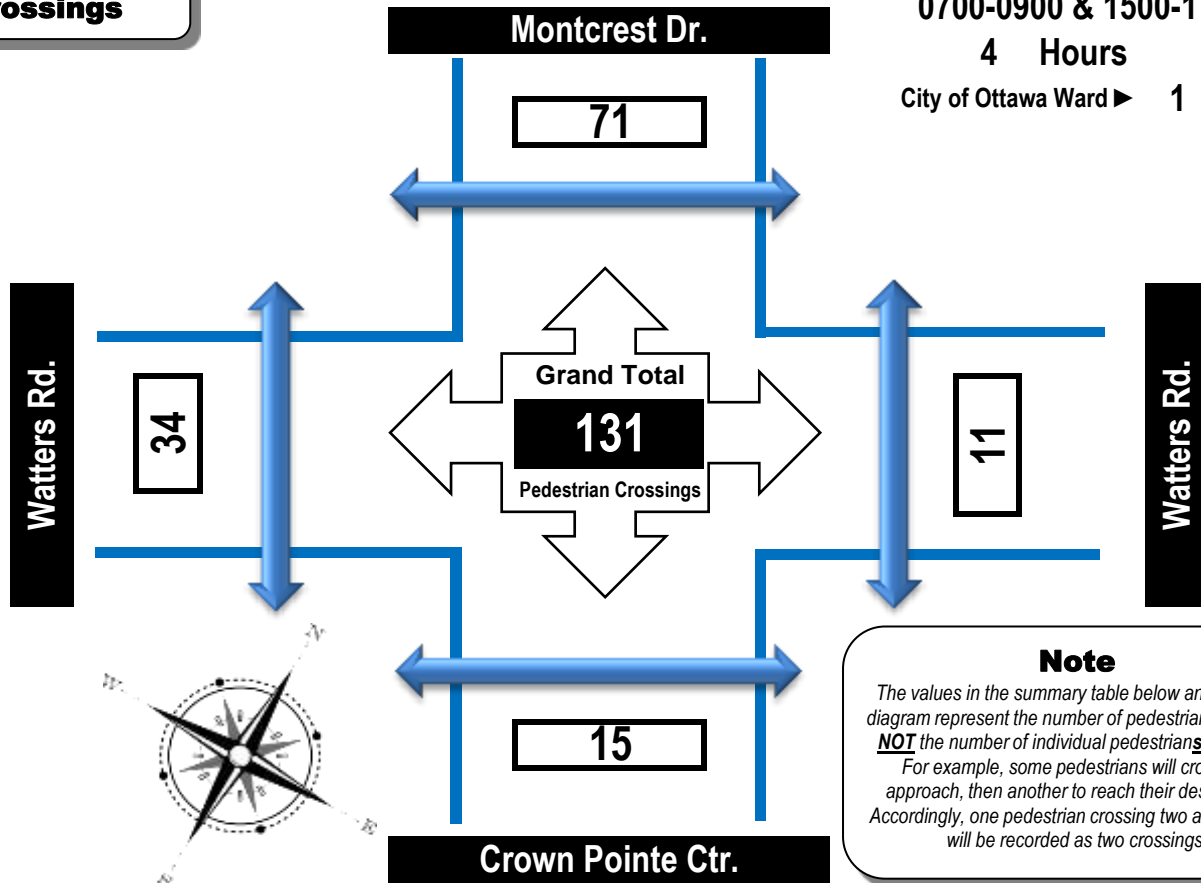

Note
The values in the summary table below and the flow diagram represent the number of pedestrian crossings NOT the number of individual pedestrians crossing. For example, some pedestrians will cross one approach, then another to reach their destination. Accordingly, one pedestrian crossing two approaches will be recorded as two crossings.

Crown Pointe Centre/Montcrest Drive & Watters Road Orléans, ON

Survey Date: Thursday, 20 September 2018 Start Time: 0700
Weather: Overcast +10C/Overcast +16C Survey Duration: 4 Hrs. Survey Hours: 0700-0900 & 1500-1700
(AM/PM)

Time Period	West Side Crossing Watters Rd.	East Side Crossing Watters Rd.	Street Total	South Side Crossing Crown Pointe Ctr.	North Side Crossing Montcrest Dr.	Street Total	Grand Total
0700-0800	0	5	5	4	6	10	15
0800-0900	1	0	1	4	9	13	14
1500-1600	12	0	12	3	31	34	46
1600-1700	21	6	27	4	25	29	56
Totals	34	11	45	15	71	86	131



Turning Movement Count

Summary Report Including AM/PM Peak Hours, PHF, AADT and Expansion Factors

Automobiles, Taxis,
Light Trucks, Vans,
SUV's, Motorcycles,
Heavy Trucks, Buses,
and School Buses

Crown Pointe Centre/Montcrest Drive & Watters Road Orléans, ON

Survey Date: Thursday, 20 September 2018 **Start Time:** 0700 **AADT Factor:** 1.0
Weather-AM/PM Overcast +10C/Overcast +16C **Survey Duration:** 4 Hrs. **Survey Hours:** 0700-0900 & 1500-1700

Time Period	Watters Rd. Eastbound					Watters Rd. Westbound					Crown Pointe Ctr. Northbound					Montcrest Dr. Southbound					Street Total	Grand Total	
	LT	ST	RT	UT	E/B Tot	LT	ST	RT	UT	W/B Tot	LT	ST	RT	UT	N/B Tot	LT	ST	RT	UT	S/B Tot			
	0700-0800	18	337	14	0	369	15	191	50	0	256	625	9	1	15	0	25	141	2	50			0
0800-0900	24	260	32	0	316	26	171	51	0	248	564	26	4	30	0	60	97	10	37	0	144	204	768
1500-1600	34	185	44	0	263	66	263	106	0	435	698	59	16	51	0	126	71	20	35	0	126	252	950
1600-1700	65	168	73	0	306	82	315	149	0	546	852	56	21	60	0	137	79	13	35	0	127	264	1116
Totals	141	950	163	0	1254	189	940	356	0	1485	2739	150	42	156	0	348	388	45	157	0	590	938	3677

Equivalent 12 & 24-hour Vehicle Volumes Including the Annual Average Daily Traffic (AADT) Factor
Applicable to the Day and Month of the Turning Movement Count

➔ **Expansion factors are applied exclusively to standard weekday 8-hour turning movement counts** ←

Equivalent 12-hour vehicle volumes. These volumes are calculated by multiplying the 8-hour totals by the 8 ➔ 12 expansion factor of 1.39

Equ. 12 Hr	n/a	n/a	n/a	n/a	n/a	n/a	n/a	n/a	n/a	n/a	n/a	n/a	n/a	n/a	n/a	n/a	n/a	n/a	n/a	n/a	n/a	n/a	n/a
------------	-----	-----	-----	-----	-----	-----	-----	-----	-----	-----	-----	-----	-----	-----	-----	-----	-----	-----	-----	-----	-----	-----	-----

Average daily 12-hour vehicle volumes. These volumes are calculated by multiplying the equivalent 12-hour totals by the AADT factor of: 1.0

AADT 12-hr	n/a	n/a	n/a	n/a	n/a	n/a	n/a	n/a	n/a	n/a	n/a	n/a	n/a	n/a	n/a	n/a	n/a	n/a	n/a	n/a	n/a	n/a	n/a
------------	-----	-----	-----	-----	-----	-----	-----	-----	-----	-----	-----	-----	-----	-----	-----	-----	-----	-----	-----	-----	-----	-----	-----

24-Hour AADT. These volumes are calculated by multiplying the average daily 12-hour vehicle volumes by the 12 ➔ 24 expansion factor of 1.31

AADT 24 Hr	n/a	n/a	n/a	n/a	n/a	n/a	n/a	n/a	n/a	n/a	n/a	n/a	n/a	n/a	n/a	n/a	n/a	n/a	n/a	n/a	n/a	n/a	n/a
------------	-----	-----	-----	-----	-----	-----	-----	-----	-----	-----	-----	-----	-----	-----	-----	-----	-----	-----	-----	-----	-----	-----	-----

AM Peak Hour Factor ➔ 0.88 **Highest Hourly Vehicle Volume between 0700h & 1000h**

AM Peak Hr	LT	ST	RT	UT	TOT	LT	ST	RT	UT	TOT	S.TOT	LT	ST	RT	UT	TOT	LT	ST	RT	UT	TOT	S.TOT	G.TOT
0730-0830	23	326	24	0	373	20	233	51	0	304	677	18	3	21	0	42	125	5	55	0	185	227	904

OFF Peak Hour Factor ➔ ### **Highest Hourly Vehicle Volume between 1130h & 1330h**

Off Peak Hr	LT	ST	RT	UT	TOT	LT	ST	RT	UT	TOT	S.TOT	LT	ST	RT	UT	TOT	LT	ST	RT	UT	TOT	S.TOT	G.TOT
N/A	0	0	0	0	0	0	0	0	0	0	0	0	0	0	0	0	0	0	0	0	0	0	0

PM Peak Hour Factor ➔ 0.95 **Highest Hourly Vehicle Volume between 1500h & 1800h**

PM Peak Hr	LT	ST	RT	UT	TOT	LT	ST	RT	UT	TOT	S.TOT	LT	ST	RT	UT	TOT	LT	ST	RT	UT	TOT	S.TOT	G.TOT
1600-1700	65	168	73	0	306	82	315	149	0	546	852	56	21	60	0	137	79	13	35	0	127	264	1116

Comments

The majority of the cyclists drove on the sidewalks.

Notes:

1. Includes all vehicle types except bicycles and electric scooters.
2. Expansion factors are not applied to turning movement counts if they are less than 8-hours in duration.
3. When expansion and AADT factors are applied, the results will differ slightly due to rounding.

Disclaimer:

The information contained in this data summary is for information purposes only, and may not apply to your situation. Every effort is made to ensure the traffic count information is accurate for the survey date provided on the summary and flow diagram forms. The author, publisher, and distributor provide no warranty about the content or accuracy of either the data summary or flow diagrams. Information provided is subjective. The author, publisher, and distributor shall not be liable for any loss of profit or any other commercial damages resulting from use of this data.

APPENDIX C

SYNCHRO CAPACITY ANALYSIS: EXISTING CONDITIONS

Existing AM
1: Trim Road & Watters Road

10/28/2021



Lane Group	EBL	EBT	WBL	WBT	NBL	NBT	NBR	SBL	SBT	SBR
Lane Configurations										
Traffic Volume (vph)	331	9	15	15	82	808	4	6	341	182
Future Volume (vph)	331	9	15	15	82	808	4	6	341	182
Lane Group Flow (vph)	368	97	17	46	91	898	4	7	379	202
Turn Type	Perm	NA	Perm	NA	pm+pt	NA	Perm	Perm	NA	Perm
Protected Phases		4		8	5	2			6	
Permitted Phases	4		8		2		2	6		6
Detector Phase	4	4	8	8	5	2	2	6	6	6
Switch Phase										
Minimum Initial (s)	10.0	10.0	10.0	10.0	5.0	10.0	10.0	10.0	10.0	10.0
Minimum Split (s)	40.2	40.2	40.2	40.2	13.6	51.7	51.7	35.0	35.0	35.0
Total Split (s)	38.2	38.2	38.2	38.2	16.7	51.7	51.7	35.0	35.0	35.0
Total Split (%)	42.5%	42.5%	42.5%	42.5%	18.6%	57.5%	57.5%	38.9%	38.9%	38.9%
Yellow Time (s)	3.3	3.3	3.3	3.3	3.7	3.7	3.7	3.7	3.7	3.7
All-Red Time (s)	4.9	4.9	4.9	4.9	3.0	3.0	3.0	3.0	3.0	3.0
Lost Time Adjust (s)	0.0	0.0	0.0	0.0	0.0	0.0	0.0	0.0	0.0	0.0
Total Lost Time (s)	8.2	8.2	8.2	8.2	6.7	6.7	6.7	6.7	6.7	6.7
Lead/Lag					Lead			Lag	Lag	Lag
Lead-Lag Optimize?					Yes			Yes	Yes	Yes
Recall Mode	Max	Max	Max	Max	Max	Min	Min	Min	Min	Min
Act Effct Green (s)	32.1	32.1	32.1	32.1	31.7	31.7	31.7	14.9	14.9	14.9
Actuated g/C Ratio	0.41	0.41	0.41	0.41	0.40	0.40	0.40	0.19	0.19	0.19
v/c Ratio	0.70	0.14	0.03	0.07	0.24	0.66	0.01	0.07	0.59	0.45
Control Delay	29.1	5.5	16.0	9.0	16.1	21.6	0.0	26.7	32.8	7.6
Queue Delay	0.0	0.0	0.0	0.0	0.0	0.0	0.0	0.0	0.0	0.0
Total Delay	29.1	5.5	16.0	9.0	16.1	21.6	0.0	26.7	32.8	7.6
LOS	C	A	B	A	B	C	A	C	C	A
Approach Delay		24.1		10.9		21.1			24.1	
Approach LOS		C		B		C			C	
Queue Length 50th (m)	43.9	0.9	1.5	1.5	8.3	55.6	0.0	0.9	27.3	0.0
Queue Length 95th (m)	#92.3	10.1	5.7	8.0	16.7	73.8	0.0	4.1	40.1	15.6
Internal Link Dist (m)		96.0		300.5		130.5			233.4	
Turn Bay Length (m)			25.0		35.0		50.0	30.0		45.0
Base Capacity (vph)	528	670	502	670	379	1943	875	203	1222	675
Starvation Cap Reductn	0	0	0	0	0	0	0	0	0	0
Spillback Cap Reductn	0	0	0	0	0	0	0	0	0	0
Storage Cap Reductn	0	0	0	0	0	0	0	0	0	0
Reduced v/c Ratio	0.70	0.14	0.03	0.07	0.24	0.46	0.00	0.03	0.31	0.30

Intersection Summary

Cycle Length: 89.9

Actuated Cycle Length: 78.7

Natural Cycle: 95

Control Type: Actuated-Uncoordinated

Maximum v/c Ratio: 0.70

Intersection Signal Delay: 22.3

Intersection LOS: C

Intersection Capacity Utilization 76.6%

ICU Level of Service D

Analysis Period (min) 15

95th percentile volume exceeds capacity, queue may be longer.

Existing AM
1: Trim Road & Watters Road

10/28/2021

Queue shown is maximum after two cycles.

Splits and Phases: 1: Trim Road & Watters Road

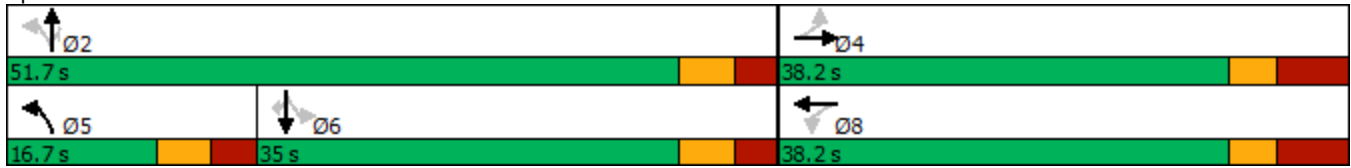

Existing AM
 2: Trim Road & Crown Pointe Plaza Access 1

10/28/2021



Lane Group	EBR	NBL	NBT	SBT
Lane Configurations				
Traffic Volume (vph)	14	20	916	439
Future Volume (vph)	14	20	916	439
Lane Group Flow (vph)	16	22	1018	497
Sign Control			Free	Free

Intersection Summary

Control Type: Unsignalized

Intersection Capacity Utilization 30.1% ICU Level of Service A

Analysis Period (min) 15

Existing AM
2: Trim Road & Crown Pointe Plaza Access 1

10/28/2021



Movement	EBL	EBR	NBL	NBT	SBT	SBR
Lane Configurations		↗	↖	↑↑	↑↓	
Traffic Volume (veh/h)	0	14	20	916	439	8
Future Volume (Veh/h)	0	14	20	916	439	8
Sign Control	Stop			Free	Free	
Grade	0%			0%	0%	
Peak Hour Factor	0.90	0.90	0.90	0.90	0.90	0.90
Hourly flow rate (vph)	0	16	22	1018	488	9
Pedestrians						
Lane Width (m)						
Walking Speed (m/s)						
Percent Blockage						
Right turn flare (veh)						
Median type				None	None	
Median storage veh						
Upstream signal (m)				155		
pX, platoon unblocked	0.91	0.91	0.91			
vC, conflicting volume	1046	248	497			
vC1, stage 1 conf vol						
vC2, stage 2 conf vol						
vCu, unblocked vol	854	0	252			
tC, single (s)	6.8	6.9	4.1			
tC, 2 stage (s)						
tF (s)	3.5	3.3	2.2			
p0 queue free %	100	98	98			
cM capacity (veh/h)	266	988	1194			
Direction, Lane #	EB 1	NB 1	NB 2	NB 3	SB 1	SB 2
Volume Total	16	22	509	509	325	172
Volume Left	0	22	0	0	0	0
Volume Right	16	0	0	0	0	9
cSH	988	1194	1700	1700	1700	1700
Volume to Capacity	0.02	0.02	0.30	0.30	0.19	0.10
Queue Length 95th (m)	0.4	0.4	0.0	0.0	0.0	0.0
Control Delay (s)	8.7	8.1	0.0	0.0	0.0	0.0
Lane LOS	A	A				
Approach Delay (s)	8.7	0.2	0.0			
Approach LOS	A					
Intersection Summary						
Average Delay			0.2			
Intersection Capacity Utilization			30.1%	ICU Level of Service	A	
Analysis Period (min)			15			

Existing AM
 3: Trim Road & Crown Pointe Plaza Access 2

10/28/2021



Lane Group	EBR	NBT	SBT
Lane Configurations	↗	↑↑↑	↑↑
Traffic Volume (vph)	1	937	455
Future Volume (vph)	1	937	455
Lane Group Flow (vph)	1	1041	506
Sign Control		Free	Free

Intersection Summary

Control Type: Unsignalized

Intersection Capacity Utilization 23.3% ICU Level of Service A

Analysis Period (min) 15

Existing AM
3: Trim Road & Crown Pointe Plaza Access 2

10/28/2021



Movement	EBL	EBR	NBL	NBT	SBT	SBR
Lane Configurations		↗		↑↑↑	↑↑	
Traffic Volume (veh/h)	0	1	0	937	455	0
Future Volume (Veh/h)	0	1	0	937	455	0
Sign Control	Stop			Free	Free	
Grade	0%			0%	0%	
Peak Hour Factor	0.90	0.90	0.90	0.90	0.90	0.90
Hourly flow rate (vph)	0	1	0	1041	506	0
Pedestrians						
Lane Width (m)						
Walking Speed (m/s)						
Percent Blockage						
Right turn flare (veh)						
Median type				None	None	
Median storage veh						
Upstream signal (m)				194		
pX, platoon unblocked	0.92	0.92	0.92			
vC, conflicting volume	853	253	506			
vC1, stage 1 conf vol						
vC2, stage 2 conf vol						
vCu, unblocked vol	661	7	283			
tC, single (s)	6.8	6.9	4.1			
tC, 2 stage (s)						
tF (s)	3.5	3.3	2.2			
p0 queue free %	100	100	100			
cM capacity (veh/h)	363	985	1172			
Direction, Lane #	EB 1	NB 1	NB 2	NB 3	SB 1	SB 2
Volume Total	1	347	347	347	253	253
Volume Left	0	0	0	0	0	0
Volume Right	1	0	0	0	0	0
cSH	985	1700	1700	1700	1700	1700
Volume to Capacity	0.00	0.20	0.20	0.20	0.15	0.15
Queue Length 95th (m)	0.0	0.0	0.0	0.0	0.0	0.0
Control Delay (s)	8.7	0.0	0.0	0.0	0.0	0.0
Lane LOS	A					
Approach Delay (s)	8.7	0.0	0.0			
Approach LOS	A					
Intersection Summary						
Average Delay	0.0					
Intersection Capacity Utilization	23.3%			ICU Level of Service	A	
Analysis Period (min)	15					

Existing AM
4: Trim Road & Portobello Boulevard/Springridge Drive

10/28/2021



Lane Group	EBL	EBT	EBR	WBL	WBT	NBL	NBT	NBR	SBL	SBT	SBR
Lane Configurations											
Traffic Volume (vph)	259	25	2	29	49	9	570	9	9	407	120
Future Volume (vph)	259	25	2	29	49	9	570	9	9	407	120
Lane Group Flow (vph)	288	28	2	32	97	10	633	10	10	452	133
Turn Type	pm+pt	NA	Perm	Perm	NA	Perm	NA	Perm	pm+pt	NA	Perm
Protected Phases	5	2			6		8		7	4	
Permitted Phases	2		2	6		8		8	4		4
Detector Phase	5	2	2	6	6	8	8	8	7	4	4
Switch Phase											
Minimum Initial (s)	5.0	10.0	10.0	10.0	10.0	10.0	10.0	10.0	5.0	10.0	10.0
Minimum Split (s)	16.9	38.9	38.9	38.9	38.9	40.0	40.0	40.0	12.3	51.4	51.4
Total Split (s)	16.9	39.9	39.9	23.0	23.0	40.0	40.0	40.0	11.4	51.4	51.4
Total Split (%)	18.5%	43.7%	43.7%	25.2%	25.2%	43.8%	43.8%	43.8%	12.5%	56.3%	56.3%
Yellow Time (s)	3.3	3.3	3.3	3.3	3.3	3.7	3.7	3.7	3.7	3.7	3.7
All-Red Time (s)	3.6	3.6	3.6	3.6	3.6	2.7	2.7	2.7	2.7	2.7	2.7
Lost Time Adjust (s)	0.0	0.0	0.0	0.0	0.0	0.0	0.0	0.0	0.0	0.0	0.0
Total Lost Time (s)	6.9	6.9	6.9	6.9	6.9	6.4	6.4	6.4	6.4	6.4	6.4
Lead/Lag	Lead			Lag	Lag	Lag	Lag	Lag	Lead		
Lead-Lag Optimize?	Yes			Yes	Yes	Yes	Yes	Yes	Yes		
Recall Mode	Max	Max	Max	Max	Max	Min	Min	Min	Max	Min	Min
Act Effct Green (s)	49.1	49.1	49.1	32.1	32.1	23.4	23.4	23.4	34.8	34.8	34.8
Actuated g/C Ratio	0.51	0.51	0.51	0.33	0.33	0.24	0.24	0.24	0.36	0.36	0.36
v/c Ratio	0.49	0.03	0.00	0.07	0.17	0.05	0.78	0.02	0.05	0.37	0.21
Control Delay	19.0	14.0	0.0	25.0	16.9	27.8	41.5	0.1	19.8	23.8	4.5
Queue Delay	0.0	0.0	0.0	0.0	0.0	0.0	0.0	0.0	0.0	0.0	0.0
Total Delay	19.0	14.0	0.0	25.0	16.9	27.8	41.5	0.1	19.8	23.8	4.5
LOS	B	B	A	C	B	C	D	A	B	C	A
Approach Delay		18.5			18.9		40.6			19.4	
Approach LOS		B			B		D			B	
Queue Length 50th (m)	30.5	2.5	0.0	4.1	7.6	1.4	58.4	0.0	1.2	32.5	0.0
Queue Length 95th (m)	56.5	7.8	0.0	11.6	20.8	5.4	77.1	0.0	4.4	44.6	11.0
Internal Link Dist (m)		89.0			153.8		234.9			500.4	
Turn Bay Length (m)			75.0	30.0		50.0		45.0	35.0		45.0
Base Capacity (vph)	582	900	810	433	569	303	1175	647	185	1574	763
Starvation Cap Reductn	0	0	0	0	0	0	0	0	0	0	0
Spillback Cap Reductn	0	0	0	0	0	0	0	0	0	0	0
Storage Cap Reductn	0	0	0	0	0	0	0	0	0	0	0
Reduced v/c Ratio	0.49	0.03	0.00	0.07	0.17	0.03	0.54	0.02	0.05	0.29	0.17

Intersection Summary

Cycle Length: 91.3

Actuated Cycle Length: 97.2

Natural Cycle: 110

Control Type: Semi Act-Uncoord

Maximum v/c Ratio: 0.78

Intersection Signal Delay: 27.4

Intersection LOS: C

Intersection Capacity Utilization 75.2%

ICU Level of Service D

Analysis Period (min) 15

Existing AM
4: Trim Road & Portobello Boulevard/Springridge Drive

10/28/2021

Splits and Phases: 4: Trim Road & Portobello Boulevard/Springridge Drive

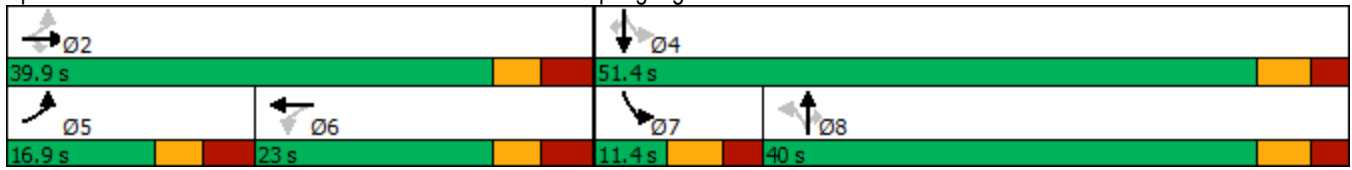

Existing AM
 5: Charlemagne Boulevard & Watters Road

10/28/2021



Lane Group	WBL	NBT	SBT
Lane Configurations			
Traffic Volume (vph)	181	201	214
Future Volume (vph)	181	201	214
Lane Group Flow (vph)	398	404	316
Sign Control	Stop	Stop	Stop

Intersection Summary

Control Type: Unsignalized

Intersection Capacity Utilization 51.8% ICU Level of Service A

Analysis Period (min) 15

Existing AM
5: Charlemagne Boulevard & Watters Road

10/28/2021



Movement	WBL	WBR	NBT	NBR	SBL	SBT
Lane Configurations						
Sign Control	Stop		Stop			Stop
Traffic Volume (vph)	181	177	201	163	70	214
Future Volume (vph)	181	177	201	163	70	214
Peak Hour Factor	0.90	0.90	0.90	0.90	0.90	0.90
Hourly flow rate (vph)	201	197	223	181	78	238
Direction, Lane #	WB 1	NB 1	NB 2	SB 1	SB 2	
Volume Total (vph)	398	149	255	157	159	
Volume Left (vph)	201	0	0	78	0	
Volume Right (vph)	197	0	181	0	0	
Hadj (s)	-0.16	0.03	-0.46	0.28	0.03	
Departure Headway (s)	5.5	6.3	5.8	6.6	6.4	
Degree Utilization, x	0.61	0.26	0.41	0.29	0.28	
Capacity (veh/h)	628	549	596	516	536	
Control Delay (s)	16.6	10.2	11.5	11.1	10.6	
Approach Delay (s)	16.6	11.0		10.8		
Approach LOS	C	B		B		
Intersection Summary						
Delay			13.0			
Level of Service			B			
Intersection Capacity Utilization			51.8%	ICU Level of Service		A
Analysis Period (min)			15			

Existing AM

6: Crown Pointe Plaza Access 3/Montcrest Drive & Watters Road

10/28/2021



Lane Group	EBT	WBT	NBT	SBT	SBR
Lane Configurations					
Traffic Volume (vph)	326	233	3	5	55
Future Volume (vph)	326	233	3	5	55
Lane Group Flow (vph)	415	338	46	145	61
Sign Control	Stop	Stop	Stop	Stop	

Intersection Summary

Control Type: Unsignalized

Intersection Capacity Utilization 47.6% ICU Level of Service A

Analysis Period (min) 15

Existing AM

6: Crown Pointe Plaza Access 3/Montcrest Drive & Watters Road

10/28/2021



Movement	EBL	EBT	EBR	WBL	WBT	WBR	NBL	NBT	NBR	SBL	SBT	SBR
Lane Configurations		↔			↔			↔			↔	↔
Sign Control		Stop			Stop			Stop			Stop	↔
Traffic Volume (vph)	23	326	24	20	233	51	18	3	21	125	5	55
Future Volume (vph)	23	326	24	20	233	51	18	3	21	125	5	55
Peak Hour Factor	0.90	0.90	0.90	0.90	0.90	0.90	0.90	0.90	0.90	0.90	0.90	0.90
Hourly flow rate (vph)	26	362	27	22	259	57	20	3	23	139	6	61

Direction, Lane #	EB 1	WB 1	NB 1	SB 1	SB 2
Volume Total (vph)	415	338	46	145	61
Volume Left (vph)	26	22	20	139	0
Volume Right (vph)	27	57	23	0	61
Hadj (s)	0.01	-0.05	-0.18	0.51	-0.67
Departure Headway (s)	5.2	5.3	6.3	7.1	5.9
Degree Utilization, x	0.60	0.50	0.08	0.28	0.10
Capacity (veh/h)	662	652	470	466	554
Control Delay (s)	15.8	13.3	9.9	11.6	8.3
Approach Delay (s)	15.8	13.3	9.9	10.7	
Approach LOS	C	B	A	B	

Intersection Summary				
Delay			13.6	
Level of Service			B	
Intersection Capacity Utilization		47.6%	ICU Level of Service	A
Analysis Period (min)			15	

Existing AM
7: Watters Road

10/28/2021



Lane Group	EBT	WBT
Lane Configurations	↔↑	↑↔
Traffic Volume (vph)	472	279
Future Volume (vph)	472	279
Lane Group Flow (vph)	524	310
Sign Control	Free	Free

Intersection Summary

Control Type: Unsignalized

Intersection Capacity Utilization 18.8% ICU Level of Service A

Analysis Period (min) 15

Existing AM
7: Watters Road

10/28/2021



Movement	EBL	EBT	WBT	WBR	SBL	SBR
Lane Configurations		↔↑	↔		↔	↔
Traffic Volume (veh/h)	0	472	279	0	0	0
Future Volume (Veh/h)	0	472	279	0	0	0
Sign Control		Free	Free		Stop	
Grade		0%	0%		0%	
Peak Hour Factor	0.90	0.90	0.90	0.90	0.90	0.90
Hourly flow rate (vph)	0	524	310	0	0	0
Pedestrians						
Lane Width (m)						
Walking Speed (m/s)						
Percent Blockage						
Right turn flare (veh)						
Median type		None	None			
Median storage (veh)						
Upstream signal (m)	120					
pX, platoon unblocked						
vC, conflicting volume	310				572	310
vC1, stage 1 conf vol						
vC2, stage 2 conf vol						
vCu, unblocked vol	310				572	310
tC, single (s)	4.1				6.8	6.9
tC, 2 stage (s)						
tF (s)	2.2				3.5	3.3
p0 queue free %	100				100	100
cM capacity (veh/h)	1247				450	686
Direction, Lane #	EB 1	EB 2	WB 1	SB 1	SB 2	
Volume Total	175	349	310	0	0	
Volume Left	0	0	0	0	0	
Volume Right	0	0	0	0	0	
cSH	1247	1700	1700	1700	1700	
Volume to Capacity	0.00	0.21	0.18	0.00	0.00	
Queue Length 95th (m)	0.0	0.0	0.0	0.0	0.0	
Control Delay (s)	0.0	0.0	0.0	0.0	0.0	
Lane LOS				A	A	
Approach Delay (s)	0.0	0.0		0.0		
Approach LOS				A		
Intersection Summary						
Average Delay			0.0			
Intersection Capacity Utilization			18.8%	ICU Level of Service	A	
Analysis Period (min)			15			

Existing PM
1: Trim Road & Watters Road

10/28/2021



Lane Group	EBL	EBT	WBL	WBT	NBL	NBT	NBR	SBL	SBT	SBR
Lane Configurations										
Traffic Volume (vph)	189	16	18	9	54	506	18	20	1167	414
Future Volume (vph)	189	16	18	9	54	506	18	20	1167	414
Lane Group Flow (vph)	210	99	20	17	60	562	20	22	1297	460
Turn Type	Perm	NA	Perm	NA	pm+pt	NA	Perm	Perm	NA	Perm
Protected Phases		4		8	5	2			6	
Permitted Phases	4		8		2		2	6		6
Detector Phase	4	4	8	8	5	2	2	6	6	6
Switch Phase										
Minimum Initial (s)	10.0	10.0	10.0	10.0	5.0	10.0	10.0	10.0	10.0	10.0
Minimum Split (s)	28.2	28.2	28.2	28.2	13.6	66.7	66.7	45.0	45.0	45.0
Total Split (s)	28.2	28.2	28.2	28.2	21.7	66.7	66.7	45.0	45.0	45.0
Total Split (%)	29.7%	29.7%	29.7%	29.7%	22.9%	70.3%	70.3%	47.4%	47.4%	47.4%
Yellow Time (s)	3.3	3.3	3.3	3.3	3.7	3.7	3.7	3.7	3.7	3.7
All-Red Time (s)	4.9	4.9	4.9	4.9	3.0	3.0	3.0	3.0	3.0	3.0
Lost Time Adjust (s)	0.0	0.0	0.0	0.0	0.0	0.0	0.0	0.0	0.0	0.0
Total Lost Time (s)	8.2	8.2	8.2	8.2	6.7	6.7	6.7	6.7	6.7	6.7
Lead/Lag					Lead			Lag	Lag	Lag
Lead-Lag Optimize?					Yes			Yes	Yes	Yes
Recall Mode	Max	Max	Max	Max	Max	Min	Min	Min	Min	Min
Act Effct Green (s)	32.0	32.0	32.0	32.0	60.0	60.0	60.0	38.3	38.3	38.3
Actuated g/C Ratio	0.30	0.30	0.30	0.30	0.56	0.56	0.56	0.36	0.36	0.36
v/c Ratio	0.53	0.19	0.05	0.03	0.20	0.30	0.02	0.08	1.07	0.63
Control Delay	36.9	9.6	27.3	20.1	12.3	12.9	0.1	23.8	80.1	13.8
Queue Delay	0.0	0.0	0.0	0.0	0.0	0.0	0.0	0.0	0.0	0.0
Total Delay	36.9	9.6	27.3	20.1	12.3	12.9	0.1	23.8	80.1	13.8
LOS	D	A	C	C	B	B	A	C	F	B
Approach Delay		28.2		24.0		12.4			62.3	
Approach LOS		C		C		B			E	
Queue Length 50th (m)	36.3	2.7	3.0	1.5	5.4	30.6	0.0	3.0	~157.7	25.7
Queue Length 95th (m)	59.6	14.6	8.7	6.4	11.3	40.7	0.0	8.6	#198.9	60.0
Internal Link Dist (m)		95.7		300.5		130.5			233.4	
Turn Bay Length (m)			25.0		35.0		50.0	30.0		45.0
Base Capacity (vph)	398	519	369	503	304	1902	877	281	1214	733
Starvation Cap Reductn	0	0	0	0	0	0	0	0	0	0
Spillback Cap Reductn	0	0	0	0	0	0	0	0	0	0
Storage Cap Reductn	0	0	0	0	0	0	0	0	0	0
Reduced v/c Ratio	0.53	0.19	0.05	0.03	0.20	0.30	0.02	0.08	1.07	0.63

Intersection Summary

Cycle Length: 94.9	
Actuated Cycle Length: 106.9	
Natural Cycle: 95	
Control Type: Actuated-Uncoordinated	
Maximum v/c Ratio: 1.07	
Intersection Signal Delay: 46.4	Intersection LOS: D
Intersection Capacity Utilization 82.9%	ICU Level of Service E
Analysis Period (min) 15	
~ Volume exceeds capacity, queue is theoretically infinite.	

Existing PM

1: Trim Road & Watters Road

10/28/2021

Queue shown is maximum after two cycles.

95th percentile volume exceeds capacity, queue may be longer.

Queue shown is maximum after two cycles.

Splits and Phases: 1: Trim Road & Watters Road



Existing PM
 2: Trim Road & Crown Pointe Plaza Access 1

10/28/2021



Lane Group	EBL	EBR	NBL	NBT	SBT
Lane Configurations					
Traffic Volume (vph)	1	67	54	591	1251
Future Volume (vph)	1	67	54	591	1251
Lane Group Flow (vph)	1	74	60	657	1427
Sign Control	Stop			Free	Free

Intersection Summary

Control Type: Unsignalized

Intersection Capacity Utilization Err% ICU Level of Service H

Analysis Period (min) 15

Existing PM
2: Trim Road & Crown Pointe Plaza Access 1

10/28/2021



Movement	EBL	EBR	NBL	NBT	SBT	SBR
Lane Configurations						
Traffic Volume (veh/h)	1	67	54	591	1251	33
Future Volume (Veh/h)	1	67	54	591	1251	33
Sign Control	Stop			Free	Free	
Grade	0%			0%	0%	
Peak Hour Factor	0.90	0.90	0.90	0.90	0.90	0.90
Hourly flow rate (vph)	1	74	60	657	1390	37
Pedestrians						
Lane Width (m)						
Walking Speed (m/s)						
Percent Blockage						
Right turn flare (veh)						
Median type				None	None	
Median storage veh						
Upstream signal (m)					155	
pX, platoon unblocked	0.65	0.65	0.65			
vC, conflicting volume	1857	714	1427			
vC1, stage 1 conf vol						
vC2, stage 2 conf vol						
vCu, unblocked vol	1246	0	586			
tC, single (s)	6.8	6.9	4.1			
tC, 2 stage (s)						
tF (s)	3.5	3.3	2.2			
p0 queue free %	99	90	91			
cM capacity (veh/h)	98	706	642			
Direction, Lane #	EB 1	NB 1	NB 2	NB 3	SB 1	SB 2
Volume Total	75	60	328	328	927	500
Volume Left	1	60	0	0	0	0
Volume Right	74	0	0	0	0	37
cSH	652	642	1700	1700	1700	1700
Volume to Capacity	0.11	0.09	0.19	0.19	0.55	0.29
Queue Length 95th (m)	2.9	2.3	0.0	0.0	0.0	0.0
Control Delay (s)	11.2	11.2	0.0	0.0	0.0	0.0
Lane LOS	B	B				
Approach Delay (s)	11.2	0.9	0.0			
Approach LOS	B					
Intersection Summary						
Average Delay			0.7			
Intersection Capacity Utilization			Err%	ICU Level of Service	H	
Analysis Period (min)			15			

Existing PM
 3: Trim Road & Crown Pointe Plaza Access 2

10/28/2021



Lane Group	EBR	NBT	SBT
Lane Configurations	↗	↑↑↑	↑↑
Traffic Volume (vph)	4	648	1314
Future Volume (vph)	4	648	1314
Lane Group Flow (vph)	4	720	1460
Sign Control		Free	Free

Intersection Summary

Control Type: Unsignalized

Intersection Capacity Utilization 48.3% ICU Level of Service A

Analysis Period (min) 15

Existing PM
3: Trim Road & Crown Pointe Plaza Access 2

10/28/2021



Movement	EBL	EBR	NBL	NBT	SBT	SBR
Lane Configurations		↗		↑↑↑	↑↑	
Traffic Volume (veh/h)	0	4	0	648	1314	0
Future Volume (Veh/h)	0	4	0	648	1314	0
Sign Control	Stop			Free	Free	
Grade	0%			0%	0%	
Peak Hour Factor	0.90	0.90	0.90	0.90	0.90	0.90
Hourly flow rate (vph)	0	4	0	720	1460	0
Pedestrians						
Lane Width (m)						
Walking Speed (m/s)						
Percent Blockage						
Right turn flare (veh)						
Median type				None	None	
Median storage veh						
Upstream signal (m)						194
pX, platoon unblocked	0.65	0.65	0.65			
vC, conflicting volume	1700	730	1460			
vC1, stage 1 conf vol						
vC2, stage 2 conf vol						
vCu, unblocked vol	1011	0	644			
tC, single (s)	6.8	6.9	4.1			
tC, 2 stage (s)						
tF (s)	3.5	3.3	2.2			
p0 queue free %	100	99	100			
cM capacity (veh/h)	154	709	612			
Direction, Lane #	EB 1	NB 1	NB 2	NB 3	SB 1	SB 2
Volume Total	4	240	240	240	730	730
Volume Left	0	0	0	0	0	0
Volume Right	4	0	0	0	0	0
cSH	709	1700	1700	1700	1700	1700
Volume to Capacity	0.01	0.14	0.14	0.14	0.43	0.43
Queue Length 95th (m)	0.1	0.0	0.0	0.0	0.0	0.0
Control Delay (s)	10.1	0.0	0.0	0.0	0.0	0.0
Lane LOS	B					
Approach Delay (s)	10.1	0.0	0.0			
Approach LOS	B					
Intersection Summary						
Average Delay	0.0					
Intersection Capacity Utilization	48.3%			ICU Level of Service	A	
Analysis Period (min)	15					

Existing PM
4: Trim Road & Portobello Boulevard/Springridge Drive

10/28/2021



Lane Group	EBL	EBT	EBR	WBL	WBT	NBL	NBT	NBR	SBL	SBT	SBR
Lane Configurations											
Traffic Volume (vph)	137	65	6	21	39	6	432	28	38	738	385
Future Volume (vph)	137	65	6	21	39	6	432	28	38	738	385
Lane Group Flow (vph)	152	72	7	23	64	7	480	31	42	820	428
Turn Type	pm+pt	NA	Perm	Perm	NA	Perm	NA	Perm	pm+pt	NA	Perm
Protected Phases	5	2			6		8		7	4	
Permitted Phases	2		2	6		8		8	4		4
Detector Phase	5	2	2	6	6	8	8	8	7	4	4
Switch Phase											
Minimum Initial (s)	5.0	10.0	10.0	10.0	10.0	10.0	10.0	10.0	5.0	10.0	10.0
Minimum Split (s)	13.9	38.9	38.9	26.0	26.0	38.0	38.0	38.0	12.3	51.4	51.4
Total Split (s)	13.9	39.9	39.9	26.0	26.0	38.0	38.0	38.0	13.4	51.4	51.4
Total Split (%)	15.2%	43.7%	43.7%	28.5%	28.5%	41.6%	41.6%	41.6%	14.7%	56.3%	56.3%
Yellow Time (s)	3.3	3.3	3.3	3.3	3.3	3.7	3.7	3.7	3.7	3.7	3.7
All-Red Time (s)	3.6	3.6	3.6	3.6	3.6	2.7	2.7	2.7	2.7	2.7	2.7
Lost Time Adjust (s)	0.0	0.0	0.0	0.0	0.0	0.0	0.0	0.0	0.0	0.0	0.0
Total Lost Time (s)	6.9	6.9	6.9	6.9	6.9	6.4	6.4	6.4	6.4	6.4	6.4
Lead/Lag	Lead			Lag	Lag	Lag	Lag	Lag	Lead		
Lead-Lag Optimize?	Yes			Yes	Yes	Yes	Yes	Yes	Yes		
Recall Mode	Max	Max	Max	Max	Max	Min	Min	Min	Max	Min	Min
Act Effct Green (s)	46.0	46.0	46.0	32.0	32.0	18.1	18.1	18.1	31.5	31.5	31.5
Actuated g/C Ratio	0.51	0.51	0.51	0.35	0.35	0.20	0.20	0.20	0.35	0.35	0.35
v/c Ratio	0.26	0.08	0.01	0.05	0.11	0.06	0.71	0.07	0.17	0.70	0.54
Control Delay	14.4	13.1	0.0	21.5	16.2	29.7	40.1	0.3	20.9	29.0	4.9
Queue Delay	0.0	0.0	0.0	0.0	0.0	0.0	0.0	0.0	0.0	0.0	0.0
Total Delay	14.4	13.1	0.0	21.5	16.2	29.7	40.1	0.3	20.9	29.0	4.9
LOS	B	B	A	C	B	C	D	A	C	C	A
Approach Delay		13.6			17.6		37.5			20.7	
Approach LOS		B			B		D			C	
Queue Length 50th (m)	13.6	6.1	0.0	2.6	4.9	1.0	41.3	0.0	4.9	63.9	0.0
Queue Length 95th (m)	27.9	14.7	0.0	8.5	14.6	4.5	57.1	0.0	11.5	83.2	17.9
Internal Link Dist (m)		89.0			153.8		234.9			500.4	
Turn Bay Length (m)			75.0	30.0		50.0		45.0	35.0		45.0
Base Capacity (vph)	579	903	813	445	608	212	1181	651	249	1682	952
Starvation Cap Reductn	0	0	0	0	0	0	0	0	0	0	0
Spillback Cap Reductn	0	0	0	0	0	0	0	0	0	0	0
Storage Cap Reductn	0	0	0	0	0	0	0	0	0	0	0
Reduced v/c Ratio	0.26	0.08	0.01	0.05	0.11	0.03	0.41	0.05	0.17	0.49	0.45

Intersection Summary

Cycle Length: 91.3

Actuated Cycle Length: 90.8

Natural Cycle: 95

Control Type: Semi Act-Uncoord

Maximum v/c Ratio: 0.71

Intersection Signal Delay: 23.9

Intersection LOS: C

Intersection Capacity Utilization 77.6%

ICU Level of Service D

Analysis Period (min) 15

Existing PM
4: Trim Road & Portobello Boulevard/Springridge Drive

10/28/2021

Splits and Phases: 4: Trim Road & Portobello Boulevard/Springridge Drive

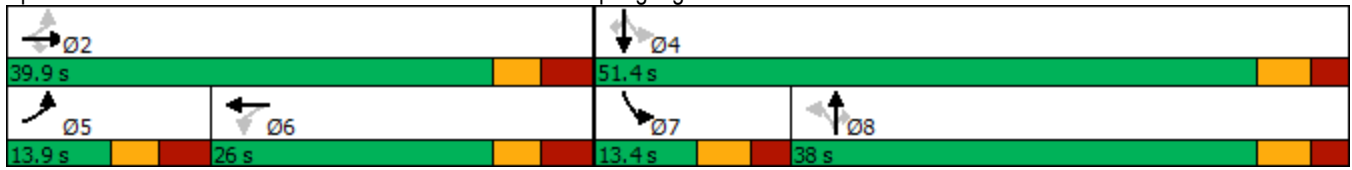

Existing PM
5: Charlemagne Boulevard & Watters Road

10/28/2021



Lane Group	WBL	NBT	SBT
Lane Configurations			
Traffic Volume (vph)	170	140	191
Future Volume (vph)	170	140	191
Lane Group Flow (vph)	311	330	360
Sign Control	Stop	Stop	Stop

Intersection Summary

Control Type: Unsignalized

Intersection Capacity Utilization 46.1% ICU Level of Service A

Analysis Period (min) 15

Existing PM
5: Charlemagne Boulevard & Watters Road

10/28/2021



Movement	WBL	WBR	NBT	NBR	SBL	SBT
Lane Configurations						
Sign Control	Stop		Stop			Stop
Traffic Volume (vph)	170	110	140	157	133	191
Future Volume (vph)	170	110	140	157	133	191
Peak Hour Factor	0.90	0.90	0.90	0.90	0.90	0.90
Hourly flow rate (vph)	189	122	156	174	148	212
Direction, Lane #	WB 1	NB 1	NB 2	SB 1	SB 2	
Volume Total (vph)	311	104	226	219	141	
Volume Left (vph)	189	0	0	148	0	
Volume Right (vph)	122	0	174	0	0	
Hadj (s)	-0.08	0.03	-0.50	0.37	0.03	
Departure Headway (s)	5.5	6.0	5.4	6.3	5.9	
Degree Utilization, x	0.47	0.17	0.34	0.38	0.23	
Capacity (veh/h)	622	572	630	552	582	
Control Delay (s)	13.3	9.0	10.1	11.8	9.5	
Approach Delay (s)	13.3	9.7		10.9		
Approach LOS	B	A		B		
Intersection Summary						
Delay			11.3			
Level of Service			B			
Intersection Capacity Utilization			46.1%	ICU Level of Service		A
Analysis Period (min)			15			



Lane Group	EBT	WBT	NBT	SBT	SBR
Lane Configurations					
Traffic Volume (vph)	168	315	21	13	35
Future Volume (vph)	168	315	21	13	35
Lane Group Flow (vph)	340	607	152	102	39
Sign Control	Stop	Stop	Stop	Stop	

Intersection Summary

Control Type: Unsignalized

Intersection Capacity Utilization 60.4% ICU Level of Service B

Analysis Period (min) 15

Existing PM

6: Crown Pointe Plaza Access 3/Montcrest Drive & Watters Road

10/28/2021



Movement	EBL	EBT	EBR	WBL	WBT	WBR	NBL	NBT	NBR	SBL	SBT	SBR
Lane Configurations		↔			↔			↔			↔	↔
Sign Control		Stop			Stop			Stop			Stop	↔
Traffic Volume (vph)	65	168	73	82	315	149	56	21	60	79	13	35
Future Volume (vph)	65	168	73	82	315	149	56	21	60	79	13	35
Peak Hour Factor	0.90	0.90	0.90	0.90	0.90	0.90	0.90	0.90	0.90	0.90	0.90	0.90
Hourly flow rate (vph)	72	187	81	91	350	166	62	23	67	88	14	39
Direction, Lane #	EB 1	WB 1	NB 1	SB 1	SB 2							
Volume Total (vph)	340	607	152	102	39							
Volume Left (vph)	72	91	62	88	0							
Volume Right (vph)	81	166	67	0	39							
Hadj (s)	-0.07	-0.10	-0.15	0.47	-0.67							
Departure Headway (s)	5.9	5.5	7.0	8.0	6.9							
Degree Utilization, x	0.56	0.92	0.29	0.23	0.07							
Capacity (veh/h)	582	641	490	423	490							
Control Delay (s)	16.3	42.2	12.8	12.2	9.2							
Approach Delay (s)	16.3	42.2	12.8	11.3								
Approach LOS	C	E	B	B								

Intersection Summary

Delay	28.0		
Level of Service	D		
Intersection Capacity Utilization	60.4%	ICU Level of Service	B
Analysis Period (min)	15		

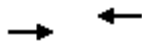

Lane Group	EBT	WBT
Lane Configurations		
Traffic Volume (vph)	307	477
Future Volume (vph)	307	477
Lane Group Flow (vph)	341	530
Sign Control	Free	Free

Intersection Summary

Control Type: Unsignalized

Intersection Capacity Utilization 29.8% ICU Level of Service A

Analysis Period (min) 15

Existing PM
7: Watters Road

10/28/2021



Movement	EBL	EBT	WBT	WBR	SBL	SBR
Lane Configurations		↔↑	↔		↔	↔
Traffic Volume (veh/h)	0	307	477	0	0	0
Future Volume (Veh/h)	0	307	477	0	0	0
Sign Control		Free	Free		Stop	
Grade		0%	0%		0%	
Peak Hour Factor	0.90	0.90	0.90	0.90	0.90	0.90
Hourly flow rate (vph)	0	341	530	0	0	0
Pedestrians						
Lane Width (m)						
Walking Speed (m/s)						
Percent Blockage						
Right turn flare (veh)						
Median type		None	None			
Median storage (veh)						
Upstream signal (m)	120					
pX, platoon unblocked						
vC, conflicting volume	530				700	530
vC1, stage 1 conf vol						
vC2, stage 2 conf vol						
vCu, unblocked vol	530				700	530
tC, single (s)	4.1				6.8	6.9
tC, 2 stage (s)						
tF (s)	2.2				3.5	3.3
p0 queue free %	100				100	100
cM capacity (veh/h)	1033				373	493
Direction, Lane #	EB 1	EB 2	WB 1	SB 1	SB 2	
Volume Total	114	227	530	0	0	
Volume Left	0	0	0	0	0	
Volume Right	0	0	0	0	0	
cSH	1033	1700	1700	1700	1700	
Volume to Capacity	0.00	0.13	0.31	0.00	0.00	
Queue Length 95th (m)	0.0	0.0	0.0	0.0	0.0	
Control Delay (s)	0.0	0.0	0.0	0.0	0.0	
Lane LOS				A	A	
Approach Delay (s)	0.0	0.0		0.0		
Approach LOS				A		
Intersection Summary						
Average Delay			0.0			
Intersection Capacity Utilization			29.8%	ICU Level of Service	A	
Analysis Period (min)			15			

Existing SAT
1: Trim Road & Watters Road

10/28/2021



Lane Group	EBL	EBT	WBL	WBT	NBL	NBT	NBR	SBL	SBT	SBR
Lane Configurations										
Traffic Volume (vph)	299	11	14	14	97	640	6	16	642	274
Future Volume (vph)	299	11	14	14	97	640	6	16	642	274
Lane Group Flow (vph)	332	86	16	40	108	711	7	18	713	304
Turn Type	Perm	NA	Perm	NA	pm+pt	NA	Perm	Perm	NA	Perm
Protected Phases		4		8	5	2			6	
Permitted Phases	4		8		2		2	6		6
Detector Phase	4	4	8	8	5	2	2	6	6	6
Switch Phase										
Minimum Initial (s)	10.0	10.0	10.0	10.0	5.0	10.0	10.0	10.0	10.0	10.0
Minimum Split (s)	28.2	28.2	28.2	28.2	13.6	46.7	46.7	30.0	30.0	30.0
Total Split (s)	28.2	28.2	28.2	28.2	16.7	46.7	46.7	30.0	30.0	30.0
Total Split (%)	37.7%	37.7%	37.7%	37.7%	22.3%	62.3%	62.3%	40.1%	40.1%	40.1%
Yellow Time (s)	3.3	3.3	3.3	3.3	3.7	3.7	3.7	3.7	3.7	3.7
All-Red Time (s)	4.9	4.9	4.9	4.9	3.0	3.0	3.0	3.0	3.0	3.0
Lost Time Adjust (s)	0.0	0.0	0.0	0.0	0.0	0.0	0.0	0.0	0.0	0.0
Total Lost Time (s)	8.2	8.2	8.2	8.2	6.7	6.7	6.7	6.7	6.7	6.7
Lead/Lag					Lead			Lag	Lag	Lag
Lead-Lag Optimize?					Yes			Yes	Yes	Yes
Recall Mode	Max	Max	Max	Max	Max	Min	Min	Min	Min	Min
Act Effct Green (s)	32.0	32.0	32.0	32.0	38.5	38.5	38.5	21.8	21.8	21.8
Actuated g/C Ratio	0.37	0.37	0.37	0.37	0.45	0.45	0.45	0.26	0.26	0.26
v/c Ratio	0.68	0.14	0.03	0.06	0.37	0.47	0.01	0.10	0.83	0.50
Control Delay	31.3	6.6	18.0	10.5	17.5	17.4	0.0	25.9	39.2	6.3
Queue Delay	0.0	0.0	0.0	0.0	0.0	0.0	0.0	0.0	0.0	0.0
Total Delay	31.3	6.6	18.0	10.5	17.5	17.4	0.0	25.9	39.2	6.3
LOS	C	A	B	B	B	B	A	C	D	A
Approach Delay		26.2		12.6		17.3			29.3	
Approach LOS		C		B		B			C	
Queue Length 50th (m)	46.0	1.2	1.7	1.7	10.0	40.8	0.0	2.2	57.7	0.0
Queue Length 95th (m)	76.6	10.1	5.6	7.8	19.1	55.2	0.0	7.6	78.0	18.2
Internal Link Dist (m)		95.3		300.5		130.5			233.4	
Turn Bay Length (m)	180.0		25.0		35.0		50.0	30.0		45.0
Base Capacity (vph)	488	628	468	623	291	1588	751	185	924	635
Starvation Cap Reductn	0	0	0	0	0	0	0	0	0	0
Spillback Cap Reductn	0	0	0	0	0	0	0	0	0	0
Storage Cap Reductn	0	0	0	0	0	0	0	0	0	0
Reduced v/c Ratio	0.68	0.14	0.03	0.06	0.37	0.45	0.01	0.10	0.77	0.48

Intersection Summary

Cycle Length: 74.9

Actuated Cycle Length: 85.4

Natural Cycle: 80

Control Type: Actuated-Uncoordinated

Maximum v/c Ratio: 0.83

Intersection Signal Delay: 24.1

Intersection LOS: C

Intersection Capacity Utilization 69.2%

ICU Level of Service C

Analysis Period (min) 15

Existing SAT
1: Trim Road & Watters Road

10/28/2021

Splits and Phases: 1: Trim Road & Watters Road

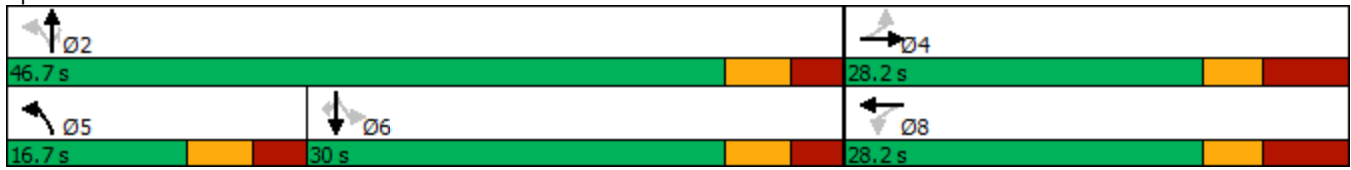

Existing SAT
 2: Trim Road & Crown Pointe Plaza Access 1

10/28/2021



Lane Group	EBR	NBL	NBT	SBT
Lane Configurations				
Traffic Volume (vph)	85	64	749	712
Future Volume (vph)	85	64	749	712
Lane Group Flow (vph)	94	71	832	807
Sign Control			Free	Free

Intersection Summary

Control Type: Unsignalized

Intersection Capacity Utilization 33.5% ICU Level of Service A

Analysis Period (min) 15

Existing SAT
2: Trim Road & Crown Pointe Plaza Access 1

10/28/2021



Movement	EBL	EBR	NBL	NBT	SBT	SBR
Lane Configurations						
Traffic Volume (veh/h)	0	85	64	749	712	14
Future Volume (Veh/h)	0	85	64	749	712	14
Sign Control	Stop			Free	Free	
Grade	0%			0%	0%	
Peak Hour Factor	0.90	0.90	0.90	0.90	0.90	0.90
Hourly flow rate (vph)	0	94	71	832	791	16
Pedestrians						
Lane Width (m)						
Walking Speed (m/s)						
Percent Blockage						
Right turn flare (veh)						
Median type				None	None	
Median storage veh						
Upstream signal (m)					155	
pX, platoon unblocked	0.81	0.81	0.81			
vC, conflicting volume	1357	404	807			
vC1, stage 1 conf vol						
vC2, stage 2 conf vol						
vCu, unblocked vol	964	0	283			
tC, single (s)	6.8	6.9	4.1			
tC, 2 stage (s)						
tF (s)	3.5	3.3	2.2			
p0 queue free %	100	89	93			
cM capacity (veh/h)	190	875	1030			
Direction, Lane #	EB 1	NB 1	NB 2	NB 3	SB 1	SB 2
Volume Total	94	71	416	416	527	280
Volume Left	0	71	0	0	0	0
Volume Right	94	0	0	0	0	16
cSH	875	1030	1700	1700	1700	1700
Volume to Capacity	0.11	0.07	0.24	0.24	0.31	0.16
Queue Length 95th (m)	2.7	1.7	0.0	0.0	0.0	0.0
Control Delay (s)	9.6	8.8	0.0	0.0	0.0	0.0
Lane LOS	A	A				
Approach Delay (s)	9.6	0.7	0.0			
Approach LOS	A					
Intersection Summary						
Average Delay	0.8					
Intersection Capacity Utilization	33.5%			ICU Level of Service	A	
Analysis Period (min)	15					

Existing SAT

3: Trim Road & Crown Pointe Plaza Access 2

10/28/2021



Lane Group	EBR	NBT	SBT
Lane Configurations	↖	↑↑↑	↑↑
Traffic Volume (vph)	2	817	801
Future Volume (vph)	2	817	801
Lane Group Flow (vph)	2	908	890
Sign Control		Free	Free

Intersection Summary

Control Type: Unsignalized

Intersection Capacity Utilization 33.4% ICU Level of Service A

Analysis Period (min) 15

Existing SAT
3: Trim Road & Crown Pointe Plaza Access 2

10/28/2021



Movement	EBL	EBR	NBL	NBT	SBT	SBR
Lane Configurations		↗		↑↑↑	↑↑	
Traffic Volume (veh/h)	0	2	0	817	801	0
Future Volume (Veh/h)	0	2	0	817	801	0
Sign Control	Stop			Free	Free	
Grade	0%			0%	0%	
Peak Hour Factor	0.90	0.90	0.90	0.90	0.90	0.90
Hourly flow rate (vph)	0	2	0	908	890	0
Pedestrians						
Lane Width (m)						
Walking Speed (m/s)						
Percent Blockage						
Right turn flare (veh)						
Median type				None	None	
Median storage veh						
Upstream signal (m)				194		
pX, platoon unblocked	0.81	0.81	0.81			
vC, conflicting volume	1193	445	890			
vC1, stage 1 conf vol						
vC2, stage 2 conf vol						
vCu, unblocked vol	772	0	399			
tC, single (s)	6.8	6.9	4.1			
tC, 2 stage (s)						
tF (s)	3.5	3.3	2.2			
p0 queue free %	100	100	100			
cM capacity (veh/h)	273	879	938			
Direction, Lane #	EB 1	NB 1	NB 2	NB 3	SB 1	SB 2
Volume Total	2	303	303	303	445	445
Volume Left	0	0	0	0	0	0
Volume Right	2	0	0	0	0	0
cSH	879	1700	1700	1700	1700	1700
Volume to Capacity	0.00	0.18	0.18	0.18	0.26	0.26
Queue Length 95th (m)	0.1	0.0	0.0	0.0	0.0	0.0
Control Delay (s)	9.1	0.0	0.0	0.0	0.0	0.0
Lane LOS	A					
Approach Delay (s)	9.1	0.0	0.0			
Approach LOS	A					
Intersection Summary						
Average Delay	0.0					
Intersection Capacity Utilization	33.4%			ICU Level of Service	A	
Analysis Period (min)	15					

Existing SAT

4: Trim Road & Portobello Boulevard/Springridge Drive

10/28/2021



Lane Group	EBL	EBT	EBR	WBL	WBT	NBL	NBT	NBR	SBL	SBT	SBR
Lane Configurations											
Traffic Volume (vph)	187	39	4	28	36	6	485	27	25	466	221
Future Volume (vph)	187	39	4	28	36	6	485	27	25	466	221
Lane Group Flow (vph)	208	43	4	31	67	7	539	30	28	518	246
Turn Type	pm+pt	NA	Perm	Perm	NA	Perm	NA	Perm	pm+pt	NA	Perm
Protected Phases	5	2			6		8		7	4	
Permitted Phases	2		2	6		8		8	4		4
Detector Phase	5	2	2	6	6	8	8	8	7	4	4
Switch Phase											
Minimum Initial (s)	5.0	10.0	10.0	10.0	10.0	10.0	10.0	10.0	5.0	10.0	10.0
Minimum Split (s)	13.9	38.9	38.9	26.0	26.0	35.0	35.0	35.0	11.4	46.4	46.4
Total Split (s)	13.9	39.9	39.9	26.0	26.0	35.0	35.0	35.0	11.4	46.4	46.4
Total Split (%)	16.1%	46.2%	46.2%	30.1%	30.1%	40.6%	40.6%	40.6%	13.2%	53.8%	53.8%
Yellow Time (s)	3.3	3.3	3.3	3.3	3.3	3.7	3.7	3.7	3.7	3.7	3.7
All-Red Time (s)	3.6	3.6	3.6	3.6	3.6	2.7	2.7	2.7	2.7	2.7	2.7
Lost Time Adjust (s)	0.0	0.0	0.0	0.0	0.0	0.0	0.0	0.0	0.0	0.0	0.0
Total Lost Time (s)	6.9	6.9	6.9	6.9	6.9	6.4	6.4	6.4	6.4	6.4	6.4
Lead/Lag	Lead			Lag	Lag	Lag	Lag	Lag	Lead		
Lead-Lag Optimize?	Yes			Yes	Yes	Yes	Yes	Yes	Yes		
Recall Mode	Max	Max	Max	Max	Max	Min	Min	Min	Max	Min	Min
Act Effct Green (s)	46.0	46.0	46.0	32.1	32.1	19.5	19.5	19.5	30.9	30.9	30.9
Actuated g/C Ratio	0.51	0.51	0.51	0.36	0.36	0.22	0.22	0.22	0.34	0.34	0.34
v/c Ratio	0.36	0.05	0.00	0.07	0.11	0.04	0.74	0.06	0.14	0.45	0.36
Control Delay	15.4	12.7	0.0	21.5	14.8	27.5	39.4	0.3	20.6	24.2	4.4
Queue Delay	0.0	0.0	0.0	0.0	0.0	0.0	0.0	0.0	0.0	0.0	0.0
Total Delay	15.4	12.7	0.0	21.5	14.8	27.5	39.4	0.3	20.6	24.2	4.4
LOS	B	B	A	C	B	C	D	A	C	C	A
Approach Delay		14.7			16.9		37.2			17.9	
Approach LOS		B			B		D			B	
Queue Length 50th (m)	19.0	3.5	0.0	3.5	4.5	1.0	46.0	0.0	3.2	36.1	0.0
Queue Length 95th (m)	37.3	9.9	0.0	10.4	14.3	4.4	62.8	0.0	8.6	49.4	14.3
Internal Link Dist (m)		89.0			153.8		234.9			500.4	
Turn Bay Length (m)			75.0	30.0		50.0		45.0	35.0		45.0
Base Capacity (vph)	584	909	822	461	610	261	1076	612	206	1506	801
Starvation Cap Reductn	0	0	0	0	0	0	0	0	0	0	0
Spillback Cap Reductn	0	0	0	0	0	0	0	0	0	0	0
Storage Cap Reductn	0	0	0	0	0	0	0	0	0	0	0
Reduced v/c Ratio	0.36	0.05	0.00	0.07	0.11	0.03	0.50	0.05	0.14	0.34	0.31

Intersection Summary

Cycle Length: 86.3

Actuated Cycle Length: 90.2

Natural Cycle: 90

Control Type: Semi Act-Uncoord

Maximum v/c Ratio: 0.74

Intersection Signal Delay: 23.8

Intersection LOS: C

Intersection Capacity Utilization 75.2%

ICU Level of Service D

Analysis Period (min) 15

Existing SAT
4: Trim Road & Portobello Boulevard/Springridge Drive

10/28/2021

Splits and Phases: 4: Trim Road & Portobello Boulevard/Springridge Drive

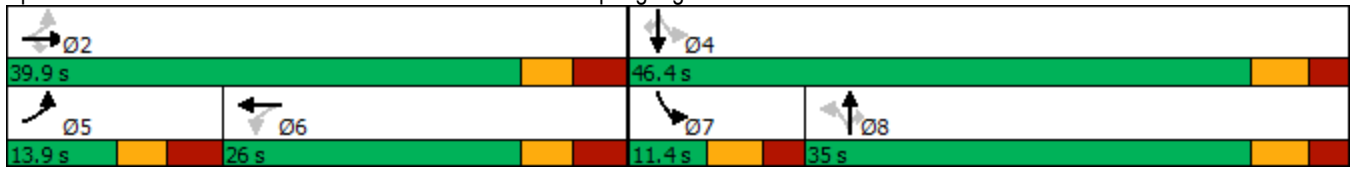

Existing SAT
 5: Charlemagne Boulevard & Watters Road

10/28/2021



Lane Group	WBL	NBT	SBT
Lane Configurations			
Traffic Volume (vph)	131	231	105
Future Volume (vph)	131	231	105
Lane Group Flow (vph)	226	376	171
Sign Control	Stop	Stop	Stop

Intersection Summary

Control Type: Unsignalized

Intersection Capacity Utilization 37.2% ICU Level of Service A

Analysis Period (min) 15

Existing SAT
5: Charlemagne Boulevard & Watters Road

10/28/2021



Movement	WBL	WBR	NBT	NBR	SBL	SBT
Lane Configurations						
Sign Control	Stop		Stop			Stop
Traffic Volume (vph)	131	72	231	107	49	105
Future Volume (vph)	131	72	231	107	49	105
Peak Hour Factor	0.90	0.90	0.90	0.90	0.90	0.90
Hourly flow rate (vph)	146	80	257	119	54	117
Direction, Lane #	WB 1	NB 1	NB 2	SB 1	SB 2	
Volume Total (vph)	226	171	205	93	78	
Volume Left (vph)	146	0	0	54	0	
Volume Right (vph)	80	0	119	0	0	
Hadj (s)	-0.05	0.03	-0.37	0.32	0.03	
Departure Headway (s)	5.1	5.4	5.0	5.9	5.6	
Degree Utilization, x	0.32	0.26	0.28	0.15	0.12	
Capacity (veh/h)	663	645	697	581	611	
Control Delay (s)	10.4	9.0	8.7	8.7	8.1	
Approach Delay (s)	10.4	8.8		8.4		
Approach LOS	B	A		A		

Intersection Summary					
Delay			9.2		
Level of Service			A		
Intersection Capacity Utilization		37.2%		ICU Level of Service	A
Analysis Period (min)			15		

Existing SAT

6: Crown Pointe Plaza Access 3/Montcrest Drive & Watters Road

10/28/2021



Lane Group	EBT	WBT	NBT	SBT	SBR
Lane Configurations					
Traffic Volume (vph)	184	175	17	16	35
Future Volume (vph)	184	175	17	16	35
Lane Group Flow (vph)	327	406	184	136	39
Sign Control	Stop	Stop	Stop	Stop	

Intersection Summary

Control Type: Unsignalized

Intersection Capacity Utilization 55.3% ICU Level of Service B

Analysis Period (min) 15

Existing SAT

6: Crown Pointe Plaza Access 3/Montcrest Drive & Watters Road

10/28/2021



Movement	EBL	EBT	EBR	WBL	WBT	WBR	NBL	NBT	NBR	SBL	SBT	SBR
Lane Configurations		↔			↔			↔			↔	↔
Sign Control		Stop			Stop			Stop			Stop	↔
Traffic Volume (vph)	46	184	65	75	175	116	62	17	86	106	16	35
Future Volume (vph)	46	184	65	75	175	116	62	17	86	106	16	35
Peak Hour Factor	0.90	0.90	0.90	0.90	0.90	0.90	0.90	0.90	0.90	0.90	0.90	0.90
Hourly flow rate (vph)	51	204	72	83	194	129	69	19	96	118	18	39
Direction, Lane #	EB 1	WB 1	NB 1	SB 1	SB 2							
Volume Total (vph)	327	406	184	136	39							
Volume Left (vph)	51	83	69	118	0							
Volume Right (vph)	72	129	96	0	39							
Hadj (s)	-0.07	-0.12	-0.20	0.47	-0.67							
Departure Headway (s)	5.8	5.6	6.4	7.5	6.3							
Degree Utilization, x	0.52	0.63	0.33	0.28	0.07							
Capacity (veh/h)	587	616	494	418	496							
Control Delay (s)	14.9	17.6	12.4	12.2	8.6							
Approach Delay (s)	14.9	17.6	12.4	11.4								
Approach LOS	B	C	B	B								
Intersection Summary												
Delay			14.9									
Level of Service			B									
Intersection Capacity Utilization			55.3%	ICU Level of Service	B							
Analysis Period (min)			15									

Existing SAT
7: Watters Road

10/28/2021

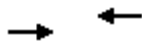

Lane Group	EBT	WBT
Lane Configurations	↔↑	↑↔
Traffic Volume (vph)	376	385
Future Volume (vph)	376	385
Lane Group Flow (vph)	418	428
Sign Control	Free	Free

Intersection Summary

Control Type: Unsignalized

Intersection Capacity Utilization 24.7% ICU Level of Service A

Analysis Period (min) 15

Existing SAT
7: Watters Road

10/28/2021



Movement	EBL	EBT	WBT	WBR	SBL	SBR
Lane Configurations		↔↑	↔		↔	↔
Traffic Volume (veh/h)	0	376	385	0	0	0
Future Volume (Veh/h)	0	376	385	0	0	0
Sign Control		Free	Free		Stop	
Grade		0%	0%		0%	
Peak Hour Factor	0.90	0.90	0.90	0.90	0.90	0.90
Hourly flow rate (vph)	0	418	428	0	0	0
Pedestrians						
Lane Width (m)						
Walking Speed (m/s)						
Percent Blockage						
Right turn flare (veh)						
Median type		None	None			
Median storage (veh)						
Upstream signal (m)	119					
pX, platoon unblocked	0.99			0.99	0.99	
vC, conflicting volume	428			637	428	
vC1, stage 1 conf vol						
vC2, stage 2 conf vol						
vCu, unblocked vol	422			632	422	
tC, single (s)	4.1			6.8	6.9	
tC, 2 stage (s)						
tF (s)	2.2			3.5	3.3	
p0 queue free %	100			100	100	
cM capacity (veh/h)	1127			410	577	
Direction, Lane #	EB 1	EB 2	WB 1	SB 1	SB 2	
Volume Total	139	279	428	0	0	
Volume Left	0	0	0	0	0	
Volume Right	0	0	0	0	0	
cSH	1127	1700	1700	1700	1700	
Volume to Capacity	0.00	0.16	0.25	0.00	0.00	
Queue Length 95th (m)	0.0	0.0	0.0	0.0	0.0	
Control Delay (s)	0.0	0.0	0.0	0.0	0.0	
Lane LOS				A	A	
Approach Delay (s)	0.0	0.0		0.0		
Approach LOS				A		
Intersection Summary						
Average Delay			0.0			
Intersection Capacity Utilization			24.7%	ICU Level of Service	A	
Analysis Period (min)			15			

APPENDIX D

COLLISION DATA



Transportation Services - Traffic Services

Collision Details Report - Public Version

From: January 1, 2015 To: December 31, 2019

Location: CHARLEMAGNE BLVD @ WATTERS RD

Traffic Control: Stop sign

Total Collisions: 6

Date/Day/Time	Environment	Impact Type	Classification	Surface Cond'n	Veh. Dir	Vehicle Manoeuver	Vehicle type	First Event	No. Ped
2015-May-22, Fri,12:02	Clear	Rear end	P.D. only	Wet	North	Stopped	Automobile, station wagon	Other motor vehicle	0
					North	Slowing or stopping	Automobile, station wagon	Other motor vehicle	
2015-Sep-29, Tue,11:48	Rain	Angle	Non-fatal injury	Wet	West	Turning right	Bicycle	Other motor vehicle	0
					South	Going ahead	Police vehicle	Cyclist	
2017-Oct-24, Tue,12:22	Clear	SMV other	P.D. only	Wet	South	Turning left	Automobile, station wagon	Curb	0
2018-Jan-02, Tue,23:00	Snow	Turning movement	P.D. only	Slush	North	Going ahead	Unknown	Other motor vehicle	0
					South	Turning left	Automobile, station wagon	Other motor vehicle	
2019-Jan-08, Tue,18:30	Snow	Turning movement	P.D. only	Ice	North	Going ahead	Unknown	Other motor vehicle	0
					South	Turning left	Automobile, station wagon	Other motor vehicle	
2019-Nov-04, Mon,00:00	Rain	SMV other	P.D. only	Wet	West	Turning left	Unknown	Pole (sign, parking meter)	0

Location: MONTCREST DR @ WATTERS RD

Traffic Control: Stop sign

Total Collisions: 3

Date/Day/Time	Environment	Impact Type	Classification	Surface Cond'n	Veh. Dir	Vehicle Manoeuver	Vehicle type	First Event	No. Ped
2015-Jun-12, Fri,12:15	Clear	Rear end	P.D. only	Dry	East	Slowing or stopping	Automobile, station wagon	Other motor vehicle	0
					East	Stopped	Automobile, station wagon	Other motor vehicle	
2017-Nov-02, Thu,15:09	Rain	Rear end	P.D. only	Wet	East	Turning left	Automobile, station wagon	Other motor vehicle	0
					East	Turning left	Automobile, station wagon	Other motor vehicle	
2019-Dec-06, Fri,07:15	Snow	Rear end	Non-fatal injury	Loose snow	East	Slowing or stopping	Municipal transit bus	Other motor vehicle	0
					East	Slowing or stopping	Automobile, station wagon	Other motor vehicle	

Location: PORTOBELLO BLVD/SPRINGRIDGE DR S @ TRIM RD

Traffic Control: Traffic signal

Total Collisions: 10

Date/Day/Time	Environment	Impact Type	Classification	Surface Cond'n	Veh. Dir	Vehicle Manoeuver	Vehicle type	First Event	No. Ped
---------------	-------------	-------------	----------------	----------------	----------	-------------------	--------------	-------------	---------



Transportation Services - Traffic Services

Collision Details Report - Public Version

From: January 1, 2015 To: December 31, 2019

Location: PORTOBELLO BLVD/SPRINGRIDGE DR S @ TRIM RD

Traffic Control: Traffic signal

Total Collisions: 10

Date/Day/Time	Environment	Impact Type	Classification	Surface Cond'n	Veh. Dir	Vehicle Manoeuvre	Vehicle type	First Event	No. Ped
2016-May-06, Fri,19:45	Clear	Turning movement	P.D. only	Dry	East	Turning left	Automobile, station wagon	Other motor vehicle	0
					West	Going ahead	Pick-up truck	Other motor vehicle	
2016-Sep-01, Thu,16:15	Clear	Rear end	P.D. only	Dry	North	Turning left	Automobile, station wagon	Other motor vehicle	0
					North	Turning left	Automobile, station wagon	Other motor vehicle	
					North	Turning left	Passenger van	Other motor vehicle	
2017-Jan-23, Mon,15:09	Clear	Angle	Non-fatal injury	Dry	East	Going ahead	Automobile, station wagon	Other motor vehicle	0
					South	Going ahead	Automobile, station wagon	Other motor vehicle	
2017-Jun-22, Thu,11:00	Clear	Rear end	P.D. only	Dry	East	Turning left	Automobile, station wagon	Other motor vehicle	0
					East	Turning left	Pick-up truck	Other motor vehicle	
2017-Nov-19, Sun,21:40	Clear	Rear end	P.D. only	Dry	North	Going ahead	Automobile, station wagon	Other motor vehicle	0
					North	Slowing or stopping	Automobile, station wagon	Other motor vehicle	
2017-Dec-21, Thu,08:11	Clear	SMV other	P.D. only	Dry	South	Going ahead	Automobile, station wagon	Snowbank/drift	0
2018-May-05, Sat,08:03	Clear	Angle	P.D. only	Dry	South	Going ahead	Automobile, station wagon	Other motor vehicle	0
					West	Going ahead	Pick-up truck	Other motor vehicle	
2018-Aug-31, Fri,03:48	Clear	SMV other	Non-fatal injury	Dry	South	Going ahead	Automobile, station wagon	Ran off road	0
2019-May-17, Fri,11:21	Clear	Angle	Non-fatal injury	Dry	East	Going ahead	Bicycle	Other motor vehicle	0
					South	Stopped	Automobile, station wagon	Cyclist	
2019-May-26, Sun,16:18	Clear	Angle	P.D. only	Dry	South	Going ahead	Pick-up truck	Other motor vehicle	0
					East	Turning left	Automobile, station wagon	Other motor vehicle	

Location: TRIM RD @ SPRINGRIDGE DR N

Traffic Control: Stop sign

Total Collisions: 2

Date/Day/Time	Environment	Impact Type	Classification	Surface Cond'n	Veh. Dir	Vehicle Manoeuvre	Vehicle type	First Event	No. Ped
---------------	-------------	-------------	----------------	----------------	----------	-------------------	--------------	-------------	---------



Transportation Services - Traffic Services

Collision Details Report - Public Version

From: January 1, 2015 To: December 31, 2019

Location: TRIM RD @ SPRINGRIDGE DR N

Traffic Control: Stop sign

Total Collisions: 2

Date/Day/Time	Environment	Impact Type	Classification	Surface Cond'n	Veh. Dir	Vehicle Manoeuvre	Vehicle type	First Event	No. Ped
2015-Nov-24, Tue,06:30	Rain	Angle	P.D. only	Packed snow	West	Slowing or stopping	Pick-up truck	Skidding/sliding	0
					North	Going ahead	Passenger van	Other motor vehicle	
2016-Sep-03, Sat,12:23	Clear	Rear end	Non-fatal injury	Dry	North	Going ahead	Motorcycle	Other motor vehicle	0
					North	Stopped	Motorcycle	Other motor vehicle	
					North	Stopped	Motorcycle	Other motor vehicle	
					North	Stopped	Motorcycle	Other motor vehicle	

Location: TRIM RD @ WATTERS RD

Traffic Control: Traffic signal

Total Collisions: 20

Date/Day/Time	Environment	Impact Type	Classification	Surface Cond'n	Veh. Dir	Vehicle Manoeuvre	Vehicle type	First Event	No. Ped
2015-Mar-31, Tue,15:36	Clear	Turning movement	Non-fatal injury	Dry	North	Turning left	Pick-up truck	Other motor vehicle	0
					South	Going ahead	Pick-up truck	Other motor vehicle	
2015-Aug-29, Sat,19:37	Rain	Turning movement	P.D. only	Wet	South	Going ahead	Pick-up truck	Other motor vehicle	0
					North	Turning left	Automobile, station wagon	Other motor vehicle	
2015-Dec-31, Thu,16:34	Clear	Turning movement	P.D. only	Wet	North	Turning left	Automobile, station wagon	Other motor vehicle	0
					South	Going ahead	Automobile, station wagon	Other motor vehicle	
2016-Jan-04, Mon,17:40	Clear	Turning movement	P.D. only	Dry	North	Turning left	Pick-up truck	Other motor vehicle	0
					South	Going ahead	Automobile, station wagon	Other motor vehicle	
2016-Mar-11, Fri,17:47	Clear	Angle	P.D. only	Dry	South	Turning left	Automobile, station wagon	Other motor vehicle	0
					West	Going ahead	Automobile, station wagon	Other motor vehicle	
2016-Apr-28, Thu,09:08	Clear	Angle	P.D. only	Dry	East	Turning right	Automobile, station wagon	Other motor vehicle	0
					South	Going ahead	School bus	Other motor vehicle	
2016-Oct-15, Sat,08:48	Clear	Angle	Non-fatal injury	Dry	South	Going ahead	Automobile, station wagon	Other motor vehicle	0
					East	Going ahead	Pick-up truck	Other motor vehicle	



Transportation Services - Traffic Services

Collision Details Report - Public Version

From: January 1, 2015 To: December 31, 2019

Location: TRIM RD @ WATTERS RD

Traffic Control: Traffic signal

Total Collisions: 20

Date/Day/Time	Environment	Impact Type	Classification	Surface Cond'n	Veh. Dir	Vehicle Manoeuvre	Vehicle type	First Event	No. Ped
2016-Nov-08, Tue,17:43	Clear	Angle	Non-fatal injury	Dry	South	Going ahead	Pick-up truck	Other motor vehicle	0
					East	Going ahead	Pick-up truck	Other motor vehicle	
2016-Dec-24, Sat,09:30	Snow	Rear end	P.D. only	Slush	North	Turning left	Automobile, station wagon	Other motor vehicle	0
					North	Turning left	Automobile, station wagon	Other motor vehicle	
2017-Sep-08, Fri,15:16	Clear	Turning movement	P.D. only	Dry	North	Turning left	Automobile, station wagon	Other motor vehicle	0
					South	Going ahead	Automobile, station wagon	Other motor vehicle	
2018-Mar-01, Thu,18:11	Clear	Turning movement	P.D. only	Dry	North	Going ahead	Automobile, station wagon	Other motor vehicle	0
					South	Turning left	Automobile, station wagon	Other motor vehicle	
2018-Mar-04, Sun,18:58	Clear	Rear end	Non-fatal injury	Dry	South	Going ahead	Automobile, station wagon	Other motor vehicle	0
					South	Stopped	Automobile, station wagon	Other motor vehicle	
2018-Aug-14, Tue,15:15	Clear	Turning movement	P.D. only	Dry	East	Turning left	Automobile, station wagon	Other motor vehicle	0
					West	Turning right	Automobile, station wagon	Other motor vehicle	
2018-Oct-05, Fri,17:00	Clear	Rear end	P.D. only	Dry	East	Going ahead	Automobile, station wagon	Other motor vehicle	0
					East	Stopped	Automobile, station wagon	Other motor vehicle	
2018-Dec-26, Wed,15:30	Snow	Turning movement	P.D. only	Slush	South	Going ahead	Automobile, station wagon	Other motor vehicle	0
					North	Turning left	Pick-up truck	Other motor vehicle	
2019-Feb-28, Thu,18:59	Clear	Turning movement	Non-fatal injury	Dry	South	Turning left	Automobile, station wagon	Other motor vehicle	0
					North	Going ahead	Automobile, station wagon	Other motor vehicle	
2019-Jun-11, Tue,19:11	Clear	Rear end	P.D. only	Dry	South	Going ahead	Automobile, station wagon	Other motor vehicle	0
					South	Slowing or stopping	Automobile, station wagon	Other motor vehicle	
2019-Jul-02, Tue,15:20	Clear	Rear end	P.D. only	Dry	East	Turning left	Automobile, station wagon	Other motor vehicle	0
					East	Turning left	Automobile, station wagon	Other motor vehicle	
2019-Oct-10, Thu,11:15	Clear	Angle	Non-fatal injury	Dry	West	Turning left	Automobile, station wagon	Other motor vehicle	0
					South	Going ahead	Automobile, station wagon	Other motor vehicle	



Transportation Services - Traffic Services

Collision Details Report - Public Version

From: January 1, 2015 To: December 31, 2019

Location: TRIM RD @ WATTERS RD

Traffic Control: Traffic signal

Total Collisions: 20

Date/Day/Time	Environment	Impact Type	Classification	Surface Cond'n	Veh. Dir	Vehicle Manoeuver	Vehicle type	First Event	No. Ped
2019-Dec-06, Fri,18:01	Snow	Rear end	Non-fatal injury	Wet	North	Slowing or stopping	Automobile, station wagon	Other motor vehicle	0
					North	Stopped	Automobile, station wagon	Other motor vehicle	

Location: TRIM RD btwn SPRINGRIDGE DR & PORTOBELLO BLVD

Traffic Control: No control

Total Collisions: 4

Date/Day/Time	Environment	Impact Type	Classification	Surface Cond'n	Veh. Dir	Vehicle Manoeuver	Vehicle type	First Event	No. Ped
2015-Feb-21, Sat,10:45	Snow	Rear end	P.D. only	Loose snow	North	Slowing or stopping	Automobile, station wagon	Other motor vehicle	0
					North	Turning right	Automobile, station wagon	Other motor vehicle	
2015-Jun-12, Fri,12:04	Clear	Other	P.D. only	Dry	North	Reversing	Truck - dump	Other motor vehicle	0
					South	Stopped	Automobile, station wagon	Other motor vehicle	
2016-Apr-06, Wed,21:00	Snow	SMV other	P.D. only	Slush	South	Going ahead	Automobile, station wagon	Skidding/sliding	0
2017-Apr-20, Thu,17:17	Clear	Sideswipe	P.D. only	Dry	South	Going ahead	Automobile, station wagon	Other motor vehicle	0
					South	Going ahead	Truck - closed	Other motor vehicle	

Location: TRIM RD btwn WATTERS RD & SPRINGRIDGE DR

Traffic Control: No control

Total Collisions: 4

Date/Day/Time	Environment	Impact Type	Classification	Surface Cond'n	Veh. Dir	Vehicle Manoeuver	Vehicle type	First Event	No. Ped
2015-Jan-14, Wed,08:15	Clear	SMV other	P.D. only	Ice	South	Going ahead	Automobile, station wagon	Skidding/sliding	0
2016-Feb-03, Wed,07:31	Freezing Rain	SMV other	P.D. only	Ice	North	Going ahead	Automobile, station wagon	Skidding/sliding	0
2017-Feb-24, Fri,07:36	Clear	Sideswipe	P.D. only	Wet	South	Going ahead	Passenger van	Other motor vehicle	0
					South	Stopped	Truck - dump	Other motor vehicle	
2019-Jun-12, Wed,15:01	Clear	Angle	Non-fatal injury	Dry	East	Turning right	Passenger van	Cyclist	0
					North	Going ahead	Bicycle	Other motor vehicle	



Transportation Services - Traffic Services

Collision Details Report - Public Version

From: January 1, 2015 **To:** December 31, 2019

Location: VARENNES BLVD @ WATTERS RD

Traffic Control: Stop sign

Total Collisions: 2

Date/Day/Time	Environment	Impact Type	Classification	Surface Cond'n	Veh. Dir	Vehicle Manoeuver	Vehicle type	First Event	No. Ped
2016-Feb-18, Thu,07:50	Clear	Rear end	Non-fatal injury	Ice	West	Slowing or stopping	Pick-up truck	Other motor vehicle	0
					West	Stopped	Automobile, station wagon	Other motor vehicle	
2017-Oct-08, Sun,11:54	Clear	Turning movement	Non-fatal injury	Dry	West	Turning left	Automobile, station wagon	Other motor vehicle	0
					East	Going ahead	Automobile, station wagon	Other motor vehicle	

Location: WATTERS RD btwn MONTCREST DR & TRIM RD

Traffic Control: No control

Total Collisions: 6

Date/Day/Time	Environment	Impact Type	Classification	Surface Cond'n	Veh. Dir	Vehicle Manoeuver	Vehicle type	First Event	No. Ped
2016-May-11, Wed,18:58	Clear	Other	Non-fatal injury	Dry	West	Turning right	Automobile, station wagon	Cyclist	0
					East	Going ahead	Bicycle	Other motor vehicle	
2016-Oct-20, Thu,19:00	Rain	Turning movement	P.D. only	Wet	East	Turning left	Automobile, station wagon	Other motor vehicle	0
					East	Going ahead	Pick-up truck	Other motor vehicle	
2016-Nov-30, Wed,19:41	Clear	SMV other	Non-fatal injury	Dry	North	Turning left	Unknown	Pedestrian	1
2018-May-10, Thu,15:29	Clear	Angle	P.D. only	Dry	South	Turning left	Automobile, station wagon	Other motor vehicle	0
					East	Going ahead	Automobile, station wagon	Other motor vehicle	
2018-Jun-01, Fri,15:10	Clear	Rear end	P.D. only	Dry	East	Slowing or stopping	Automobile, station wagon	Other motor vehicle	0
					East	Turning left	Automobile, station wagon	Other motor vehicle	
2019-Apr-23, Tue,21:03	Rain	SMV other	Non-fatal injury	Wet	East	Turning left	Automobile, station wagon	Pedestrian	1



Transportation Services - Traffic Services

Collision Details Report - Public Version

From: January 1, 2015 To: December 31, 2019

Location: 300 S OF WATTERS RD @ TRIM RD

Traffic Control: MPS

Total Collisions: 1

Date/Day/Time	Environment	Impact Type	Classification	Surface Cond'n	Veh. Dir	Vehicle Manoeuver	Vehicle type	First Event	No. Ped
2019-Jan-17, Thu,18:15	Clear	Rear end	P.D. only	Dry	South	Going ahead	Automobile, station wagon	Other motor vehicle	0
					South	Stopped	Automobile, station wagon	Other motor vehicle	

APPENDIX E

MMLOS

Multi-Modal Level of Service - Intersections Form

Consultant
Scenario
Comments

Parsons
Existing

Project
Date

476857
January 8th, 2019

Unlocked Rows for Replicating

INTERSECTIONS													
	Crossing Side	Intersection A - Trim Road and Watters Road				Intersection B				Intersection C			
		NORTH	SOUTH	EAST	WEST	NORTH	SOUTH	EAST	WEST	NORTH	SOUTH	EAST	WEST
Pedestrian	Lanes	6	6	3	3								
	Median	No Median - 2.4 m	No Median - 2.4 m	No Median - 2.4 m	No Median - 2.4 m								
	Conflicting Left Turns	Permissive	Permissive	Permissive	Protected/ Permissive								
	Conflicting Right Turns	Permissive or yield control	Permissive or yield control	Permissive or yield control	Permissive or yield control								
	Right Turns on Red (RTOR) ?	RTOR allowed	RTOR allowed	RTOR allowed	RTOR allowed								
	Ped Signal Leading Interval?	No	No	No	No								
	Right Turn Channel	No Channel	No Channel	No Channel	No Channel								
	Corner Radius	10-15m	10-15m	10-15m	10-15m								
	Crosswalk Type	Std transverse markings	Std transverse markings	Std transverse markings	Std transverse markings								
	PETSI Score	20	20	70	70								
Ped. Exposure to Traffic LoS	F	F	C	C	-	-	-	-	-	-	-	-	
Cycle Length	90	90	90	90									
Effective Walk Time	5	5	32	15									
Average Pedestrian Delay	40	40	19	31									
Pedestrian Delay LoS	E	E	B	D	-	-	-	-	-	-	-	-	
Level of Service	F	F	C	D	-	-	-	-	-	-	-	-	
		F											
	Approach From	NORTH	SOUTH	EAST	WEST	NORTH	SOUTH	EAST	WEST	NORTH	SOUTH	EAST	WEST
Bicycle	Bicycle Lane Arrangement on Approach	Curb Bike Lane, Cycletrack or MUP	Curb Bike Lane, Cycletrack or MUP	Mixed Traffic	Curb Bike Lane, Cycletrack or MUP								
	Right Turn Lane Configuration	Bike lane shifts to the left of right turn	Bike lane shifts to the left of right turn	≤ 50 m	Not Applicable								
	Right Turning Speed	≤ 25 km/h	≤ 25 km/h	≤ 25 km/h	Not Applicable								
	Cyclist relative to RT motorists	Not Applicable	Not Applicable	D	Not Applicable	-	-	-	-	-	-	-	-
	Separated or Mixed Traffic	Separated	Separated	Mixed Traffic	Separated	-	-	-	-	-	-	-	-
	Left Turn Approach	≥ 2 lanes crossed	≥ 2 lanes crossed	One lane crossed	1 lane crossed								
Operating Speed	≥ 60 km/h	≥ 60 km/h	> 40 to ≤ 50 km/h	> 40 to ≤ 50 km/h									
Left Turning Cyclist	F	F	D	C	-	-	-	-	-	-	-	-	
Level of Service	F	F	D	C	-	-	-	-	-	-	-	-	
		F											
Transit	Average Signal Delay	≤ 30 sec	≤ 20 sec	≤ 10 sec	≤ 30 sec								
	Level of Service	D	C	B	D	-	-	-	-	-	-	-	
		D											
Truck	Effective Corner Radius	10 - 15 m	10 - 15 m	> 15 m	> 15 m								
	Number of Receiving Lanes on Departure from Intersection	≥ 2	1	≥ 2	≥ 2								
Level of Service	B	E	A	A	-	-	-	-	-	-	-	-	
		E											
Auto	Volume to Capacity Ratio												
	Level of Service					-	-	-	-	-	-	-	

Multi-Modal Level of Service - Segments Form

Consultant	Parsons
Scenario	Existing
Comments	

Project	476857
Date	Jan. 8, 2019

SEGMENTS	Street A	Watters Road	Trim Road	Section	Section	Section	Section	Section	Section	
		1	2	3	4	5	6	7	8	9
Pedestrian	Sidewalk Width	≥ 2 m	≥ 2 m							
	Boulevard Width	0.5 - 2 m	> 2 m							
	Avg Daily Curb Lane Traffic Volume	> 3000	> 3000							
	Operating Speed	> 30 to 50 km/h	> 60 km/h							
	On-Street Parking	no	no							
	Exposure to Traffic PLoS	C	D	-	-	-	-	-	-	-
	Effective Sidewalk Width	2.0 m	2.0 m							
	Pedestrian Volume	250 ped/hr	250 ped/hr							
Crowding PLoS	B	B	-	-	-	-	-	-	-	
Level of Service	C	D	-	-	-	-	-	-	-	
Bicycle	Type of Cycling Facility	Curbside Bike Lane	Curbside Bike Lane							
	Number of Travel Lanes	≤ 1 each direction	2 ea. dir. (w median)							
	Operating Speed	≤ 50 km/h	>50 to 70 km/h							
	# of Lanes & Operating Speed LoS	A	C	-	-	-	-	-	-	-
	Bike Lane (+ Parking Lane) Width	≥ 1.8 m	≥ 1.8 m							
	Bike Lane Width LoS	A	A	-	-	-	-	-	-	-
	Bike Lane Blockages	Rare	Rare							
	Blockage LoS	A	A	-	-	-	-	-	-	-
	Median Refuge Width (no median = < 1.8 m)	< 1.8 m refuge	< 1.8 m refuge							
	No. of Lanes at Unsignalized Crossing	≤ 3 lanes	4-5 lanes							
	Sidestreet Operating Speed	≤ 40 km/h	≤ 40 km/h							
Unsignalized Crossing - Lowest LoS	A	B	-	-	-	-	-	-	-	
Level of Service	A	C	-	-	-	-	-	-	-	
Transit	Facility Type	Mixed Traffic	Mixed Traffic							
	Friction or Ratio Transit:Posted Speed	Vt/Vp ≥ 0.8	Vt/Vp ≥ 0.8							
	Level of Service	D	D	-	-	-	-	-	-	-
Truck	Truck Lane Width	≤ 3.3 m	≤ 3.3 m							
	Travel Lanes per Direction	1	> 1							
	Level of Service	D	C	-	-	-	-	-	-	-

APPENDIX F

TRAFFIC WARRANTS

Road/Road - Existing

AWSC Warrant		Description		Minimum Requirement for a four-leg intersection	Compliance		
					Sectional %	Entire %	Warrant
Intersection	1. Minimum Volume Criterion	A	Vehicle Volume, All Approaches for Each of the Heaviest 8 Hours of on Average Day, <u>or</u>	200	280%	70%	No
		B	Vehicle Volume, All Approaches for the Heaviest Peak Hour, <u>and</u>	350	319%		
		C	Vehicle and pedestrian Volume, Along Minor Streets for Each of the Same 8 Hours, <u>and</u>	80	191%		
		D	The volume split between the major and minor streets	65/35	70%		
	2. Minimum Collision Criterion	A	Vehicle Volume, Along Major Street for Each of the Heaviest 8 Hours of an Average Day, and	9		0%	

Watters/Montcrest - (peak hour signal warrant)

Signal Warrant		Description		Minimum Requirement for Two-Lane Roadways	Compliance		
				Restricted Flow - Operating Speed Less Than 70 km/h	Sectional %	Entire %	Warrant
Intersection	1. Minimum Vehicular Volume	(1) A	Vehicle Volume, All Approaches for Each of the Heaviest 8 Hours of on Average Day, and	720	77%	77%	77% No
		(4) B	Vehicle Volume, Along Minor Streets for Each of the Same 8 Hours	170	89%		
	2. Delay to Cross Traffic	(1) A	Vehicle Volume, Along Major Street for Each of the Heaviest 8 Hours of an Average Day, and	720	56%	56%	
		(2) B	Combined Vehicle and Pedestrian Volume <u>Crossing</u> the Major Street for Each of the Same 8 Hours	75	121%		

Notes

- 1 Vehicle Volume Warrants (1A), (2A) and (5B) for Roadways Having Two or More Moving Lanes in one Direction Should Be 25% Higher Than Values Given Above
- 2 For Definition of Crossing Volume Refer to Note 4 on the Signal Warrant Analysis Form B2.03.08
- 3 The Lowest Sectional Percentage Governs the Entire Warrant
- 4 For "T" Intersections the Warrant Values for Minor Street Should be Increased by 50% (Warrant 1B only)

No

No

APPENDIX G

TDM CHECKLIST

TDM-Supportive Development Design and Infrastructure Checklist:
Non-Residential Developments (office, institutional, retail or industrial)

Legend	
REQUIRED	The Official Plan or Zoning By-law provides related guidance that must be followed
BASIC	The measure is generally feasible and effective, and in most cases would benefit the development and its users
BETTER	The measure could maximize support for users of sustainable modes, and optimize development performance

TDM-supportive design & infrastructure measures: <i>Non-residential developments</i>		Check if completed & add descriptions, explanations or plan/drawing references
1. WALKING & CYCLING: ROUTES		
1.1 Building location & access points		
BASIC	1.1.1 Locate building close to the street, and do not locate parking areas between the street and building entrances	<input type="checkbox"/>
BASIC	1.1.2 Locate building entrances in order to minimize walking distances to sidewalks and transit stops/stations	<input checked="" type="checkbox"/>
BASIC	1.1.3 Locate building doors and windows to ensure visibility of pedestrians from the building, for their security and comfort	<input checked="" type="checkbox"/>
1.2 Facilities for walking & cycling		
REQUIRED	1.2.1 Provide convenient, direct access to stations or major stops along rapid transit routes within 600 metres; minimize walking distances from buildings to rapid transit; provide pedestrian-friendly, weather-protected (where possible) environment between rapid transit accesses and building entrances; ensure quality linkages from sidewalks through building entrances to integrated stops/stations (<i>see Official Plan policy 4.3.3</i>)	<input checked="" type="checkbox"/>
REQUIRED	1.2.2 Provide safe, direct and attractive pedestrian access from public sidewalks to building entrances through such measures as: reducing distances between public sidewalks and major building entrances; providing walkways from public streets to major building entrances; within a site, providing walkways along the front of adjoining buildings, between adjacent buildings, and connecting areas where people may congregate, such as courtyards and transit stops; and providing weather protection through canopies, colonnades, and other design elements wherever possible (<i>see Official Plan policy 4.3.12</i>)	<input checked="" type="checkbox"/>

TDM-supportive design & infrastructure measures: <i>Non-residential developments</i>		Check if completed & add descriptions, explanations or plan/drawing references
REQUIRED	1.2.3 Provide sidewalks of smooth, well-drained walking surfaces of contrasting materials or treatments to differentiate pedestrian areas from vehicle areas, and provide marked pedestrian crosswalks at intersection sidewalks (see <i>Official Plan policy 4.3.10</i>)	<input checked="" type="checkbox"/>
REQUIRED	1.2.4 Make sidewalks and open space areas easily accessible through features such as gradual grade transition, depressed curbs at street corners and convenient access to extra-wide parking spaces and ramps (see <i>Official Plan policy 4.3.10</i>)	<input checked="" type="checkbox"/>
REQUIRED	1.2.5 Include adequately spaced inter-block/street cycling and pedestrian connections to facilitate travel by active transportation. Provide links to the existing or planned network of public sidewalks, multi-use pathways and on-road cycle routes. Where public sidewalks and multi-use pathways intersect with roads, consider providing traffic control devices to give priority to cyclists and pedestrians (see <i>Official Plan policy 4.3.11</i>)	<input checked="" type="checkbox"/>
BASIC	1.2.6 Provide safe, direct and attractive walking routes from building entrances to nearby transit stops	<input type="checkbox"/>
BASIC	1.2.7 Ensure that walking routes to transit stops are secure, visible, lighted, shaded and wind-protected wherever possible	<input checked="" type="checkbox"/>
BASIC	1.2.8 Design roads used for access or circulation by cyclists using a target operating speed of no more than 30 km/h, or provide a separated cycling facility	<input checked="" type="checkbox"/>
1.3 Amenities for walking & cycling		
BASIC	1.3.1 Provide lighting, landscaping and benches along walking and cycling routes between building entrances and streets, sidewalks and trails	<input type="checkbox"/>
BASIC	1.3.2 Provide wayfinding signage for site access (where required, e.g. when multiple buildings or entrances exist) and egress (where warranted, such as when directions to reach transit stops/stations, trails or other common destinations are not obvious)	<input type="checkbox"/>

TDM-supportive design & infrastructure measures: <i>Non-residential developments</i>		Check if completed & add descriptions, explanations or plan/drawing references
2. WALKING & CYCLING: END-OF-TRIP FACILITIES		
2.1 Bicycle parking		
REQUIRED	2.1.1 Provide bicycle parking in highly visible and lighted areas, sheltered from the weather wherever possible (see <i>Official Plan policy 4.3.6</i>)	<input checked="" type="checkbox"/>
REQUIRED	2.1.2 Provide the number of bicycle parking spaces specified for various land uses in different parts of Ottawa; provide convenient access to main entrances or well-used areas (see <i>Zoning By-law Section 111</i>)	<input checked="" type="checkbox"/>
REQUIRED	2.1.3 Ensure that bicycle parking spaces and access aisles meet minimum dimensions; that no more than 50% of spaces are vertical spaces; and that parking racks are securely anchored (see <i>Zoning By-law Section 111</i>)	<input checked="" type="checkbox"/>
BASIC	2.1.4 Provide bicycle parking spaces equivalent to the expected number of commuter cyclists (assuming the cycling mode share target is met), plus the expected peak number of customer/visitor cyclists	<input type="checkbox"/>
BETTER	2.1.5 Provide bicycle parking spaces equivalent to the expected number of commuter and customer/visitor cyclists, plus an additional buffer (e.g. 25 percent extra) to encourage other cyclists and ensure adequate capacity in peak cycling season	<input type="checkbox"/>
2.2 Secure bicycle parking		
REQUIRED	2.2.1 Where more than 50 bicycle parking spaces are provided for a single office building, locate at least 25% of spaces within a building/structure, a secure area (e.g. supervised parking lot or enclosure) or bicycle lockers (see <i>Zoning By-law Section 111</i>)	<input checked="" type="checkbox"/>
BETTER	2.2.2 Provide secure bicycle parking spaces equivalent to the expected number of commuter cyclists (assuming the cycling mode share target is met)	<input type="checkbox"/>
2.3 Shower & change facilities		
BASIC	2.3.1 Provide shower and change facilities for the use of active commuters	<input type="checkbox"/>
BETTER	2.3.2 In addition to shower and change facilities, provide dedicated lockers, grooming stations, drying racks and laundry facilities for the use of active commuters	<input type="checkbox"/>
2.4 Bicycle repair station		
BETTER	2.4.1 Provide a permanent bike repair station, with commonly used tools and an air pump, adjacent to the main bicycle parking area (or secure bicycle parking area, if provided)	<input type="checkbox"/>

TDM-supportive design & infrastructure measures: <i>Non-residential developments</i>		Check if completed & add descriptions, explanations or plan/drawing references
3. TRANSIT		
3.1 Customer amenities		
BASIC	3.1.1 Provide shelters, lighting and benches at any on-site transit stops	<input type="checkbox"/>
BASIC	3.1.2 Where the site abuts an off-site transit stop and insufficient space exists for a transit shelter in the public right-of-way, protect land for a shelter and/or install a shelter	<input type="checkbox"/>
BETTER	3.1.3 Provide a secure and comfortable interior waiting area by integrating any on-site transit stops into the building	<input type="checkbox"/>
4. RIDESHARING		
4.1 Pick-up & drop-off facilities		
BASIC	4.1.1 Provide a designated area for carpool drivers (plus taxis and ride-hailing services) to drop off or pick up passengers without using fire lanes or other no-stopping zones	<input type="checkbox"/>
4.2 Carpool parking		
BASIC	4.2.1 Provide signed parking spaces for carpools in a priority location close to a major building entrance, sufficient in number to accommodate the mode share target for carpools	<input type="checkbox"/>
BETTER	4.2.2 At large developments, provide spaces for carpools in a separate, access-controlled parking area to simplify enforcement	<input type="checkbox"/>
5. CARSHARING & BIKESHARING		
5.1 Carshare parking spaces		
BETTER	5.1.1 Provide carshare parking spaces in permitted non-residential zones, occupying either required or provided parking spaces (<i>see Zoning By-law Section 94</i>)	<input type="checkbox"/>
5.2 Bikeshare station location		
BETTER	5.2.1 Provide a designated bikeshare station area near a major building entrance, preferably lighted and sheltered with a direct walkway connection	<input type="checkbox"/>

TDM-supportive design & infrastructure measures: <i>Non-residential developments</i>		Check if completed & add descriptions, explanations or plan/drawing references
6. PARKING		
6.1 Number of parking spaces		
REQUIRED	6.1.1 Do not provide more parking than permitted by zoning, nor less than required by zoning, unless a variance is being applied for	<input checked="" type="checkbox"/>
BASIC	6.1.2 Provide parking for long-term and short-term users that is consistent with mode share targets, considering the potential for visitors to use off-site public parking	<input type="checkbox"/>
BASIC	6.1.3 Where a site features more than one use, provide shared parking and reduce the cumulative number of parking spaces accordingly (<i>see Zoning By-law Section 104</i>)	<input type="checkbox"/>
BETTER	6.1.4 Reduce the minimum number of parking spaces required by zoning by one space for each 13 square metres of gross floor area provided as shower rooms, change rooms, locker rooms and other facilities for cyclists in conjunction with bicycle parking (<i>see Zoning By-law Section 111</i>)	<input type="checkbox"/>
6.2 Separate long-term & short-term parking areas		
BETTER	6.2.1 Separate short-term and long-term parking areas using signage or physical barriers, to permit access controls and simplify enforcement (i.e. to discourage employees from parking in visitor spaces, and vice versa)	<input type="checkbox"/>
7. OTHER		
7.1 On-site amenities to minimize off-site trips		
BETTER	7.1.1 Provide on-site amenities to minimize mid-day or mid-commute errands	<input type="checkbox"/>

APPENDIX H

SYNCHRO CAPACITY ANALYSIS: BACKGROUND 2022 CONDITIONS

Background 2022 AM
1: Trim Road & Watters Road

10/28/2021



Lane Group	EBL	EBT	WBL	WBT	NBL	NBT	NBR	SBL	SBT	SBR
Lane Configurations										
Traffic Volume (vph)	331	9	15	15	82	824	4	6	348	182
Future Volume (vph)	331	9	15	15	82	824	4	6	348	182
Lane Group Flow (vph)	331	87	15	41	82	824	4	6	348	182
Turn Type	Perm	NA	Perm	NA	pm+pt	NA	Perm	Perm	NA	Perm
Protected Phases		4		8	5	2			6	
Permitted Phases	4		8		2		2	6		6
Detector Phase	4	4	8	8	5	2	2	6	6	6
Switch Phase										
Minimum Initial (s)	10.0	10.0	10.0	10.0	5.0	10.0	10.0	10.0	10.0	10.0
Minimum Split (s)	40.2	40.2	40.2	40.2	13.6	51.7	51.7	35.0	35.0	35.0
Total Split (s)	42.0	42.0	42.0	42.0	13.6	53.0	53.0	39.4	39.4	39.4
Total Split (%)	44.2%	44.2%	44.2%	44.2%	14.3%	55.8%	55.8%	41.5%	41.5%	41.5%
Yellow Time (s)	3.3	3.3	3.3	3.3	3.7	3.7	3.7	3.7	3.7	3.7
All-Red Time (s)	4.9	4.9	4.9	4.9	3.0	3.0	3.0	3.0	3.0	3.0
Lost Time Adjust (s)	0.0	0.0	0.0	0.0	0.0	0.0	0.0	0.0	0.0	0.0
Total Lost Time (s)	8.2	8.2	8.2	8.2	6.7	6.7	6.7	6.7	6.7	6.7
Lead/Lag					Lead			Lag	Lag	Lag
Lead-Lag Optimize?					Yes			Yes	Yes	Yes
Recall Mode	Max	Max	Max	Max	Max	Min	Min	Min	Min	Min
Act Effct Green (s)	33.8	33.8	33.8	33.8	27.4	27.4	27.4	13.8	13.8	13.8
Actuated g/C Ratio	0.44	0.44	0.44	0.44	0.36	0.36	0.36	0.18	0.18	0.18
v/c Ratio	0.57	0.12	0.03	0.06	0.25	0.68	0.01	0.05	0.57	0.43
Control Delay	21.4	4.9	13.5	7.8	18.1	23.7	0.0	26.2	32.1	7.9
Queue Delay	0.0	0.0	0.0	0.0	0.0	0.0	0.0	0.0	0.0	0.0
Total Delay	21.4	4.9	13.5	7.8	18.1	23.7	0.0	26.2	32.1	7.9
LOS	C	A	B	A	B	C	A	C	C	A
Approach Delay		18.0		9.3		23.1			23.8	
Approach LOS		B		A		C			C	
Queue Length 50th (m)	34.1	0.7	1.2	1.2	7.8	51.6	0.0	0.7	24.2	0.0
Queue Length 95th (m)	65.8	8.6	4.7	6.8	16.3	69.5	0.0	3.8	36.4	14.8
Internal Link Dist (m)		95.1		300.5		130.5			233.4	
Turn Bay Length (m)			25.0		35.0		50.0	30.0		45.0
Base Capacity (vph)	578	718	552	726	324	2062	923	261	1456	755
Starvation Cap Reductn	0	0	0	0	0	0	0	0	0	0
Spillback Cap Reductn	0	0	0	0	0	0	0	0	0	0
Storage Cap Reductn	0	0	0	0	0	0	0	0	0	0
Reduced v/c Ratio	0.57	0.12	0.03	0.06	0.25	0.40	0.00	0.02	0.24	0.24

Intersection Summary

Cycle Length: 95	
Actuated Cycle Length: 76.2	
Natural Cycle: 95	
Control Type: Actuated-Uncoordinated	
Maximum v/c Ratio: 0.68	
Intersection Signal Delay: 21.8	Intersection LOS: C
Intersection Capacity Utilization 77.0%	ICU Level of Service D
Analysis Period (min) 15	

Splits and Phases: 1: Trim Road & Watters Road

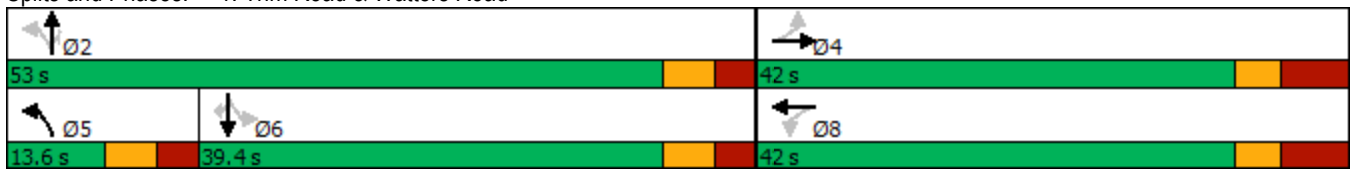

Background 2022 AM
 2: Trim Road & Crown Pointe Plaza Access 1

10/28/2021



Lane Group	EBR	NBL	NBT	SBT
Lane Configurations				
Traffic Volume (vph)	14	20	934	448
Future Volume (vph)	14	20	934	448
Lane Group Flow (vph)	14	20	934	456
Sign Control			Free	Free

Intersection Summary

Control Type: Unsignalized

Intersection Capacity Utilization 30.6% ICU Level of Service A

Analysis Period (min) 15

Background 2022 AM
2: Trim Road & Crown Pointe Plaza Access 1

10/28/2021



Movement	EBL	EBR	NBL	NBT	SBT	SBR
Lane Configurations						
Traffic Volume (veh/h)	0	14	20	934	448	8
Future Volume (Veh/h)	0	14	20	934	448	8
Sign Control	Stop			Free	Free	
Grade	0%			0%	0%	
Peak Hour Factor	1.00	1.00	1.00	1.00	1.00	1.00
Hourly flow rate (vph)	0	14	20	934	448	8
Pedestrians						
Lane Width (m)						
Walking Speed (m/s)						
Percent Blockage						
Right turn flare (veh)						
Median type				None	None	
Median storage veh						
Upstream signal (m)				155		
pX, platoon unblocked	0.92	0.92	0.92			
vC, conflicting volume	959	228	456			
vC1, stage 1 conf vol						
vC2, stage 2 conf vol						
vCu, unblocked vol	783	0	237			
tC, single (s)	6.8	6.9	4.1			
tC, 2 stage (s)						
tF (s)	3.5	3.3	2.2			
p0 queue free %	100	99	98			
cM capacity (veh/h)	299	998	1222			
Direction, Lane #	EB 1	NB 1	NB 2	NB 3	SB 1	SB 2
Volume Total	14	20	467	467	299	157
Volume Left	0	20	0	0	0	0
Volume Right	14	0	0	0	0	8
cSH	998	1222	1700	1700	1700	1700
Volume to Capacity	0.01	0.02	0.27	0.27	0.18	0.09
Queue Length 95th (m)	0.3	0.4	0.0	0.0	0.0	0.0
Control Delay (s)	8.7	8.0	0.0	0.0	0.0	0.0
Lane LOS	A	A				
Approach Delay (s)	8.7	0.2	0.0			
Approach LOS	A					
Intersection Summary						
Average Delay			0.2			
Intersection Capacity Utilization			30.6%	ICU Level of Service	A	
Analysis Period (min)			15			

Background 2022 AM
 3: Trim Road & Crown Pointe Plaza Access 2

10/28/2021



Lane Group	EBR	NBT	SBT
Lane Configurations	↗	↑↑↑	↑↑
Traffic Volume (vph)	1	956	464
Future Volume (vph)	1	956	464
Lane Group Flow (vph)	1	956	464
Sign Control		Free	Free

Intersection Summary

Control Type: Unsignalized

Intersection Capacity Utilization 23.5% ICU Level of Service A

Analysis Period (min) 15

Background 2022 AM
 3: Trim Road & Crown Pointe Plaza Access 2

10/28/2021



Movement	EBL	EBR	NBL	NBT	SBT	SBR
Lane Configurations		↗		↑↑↑	↑↑	
Traffic Volume (veh/h)	0	1	0	956	464	0
Future Volume (Veh/h)	0	1	0	956	464	0
Sign Control	Stop			Free	Free	
Grade	0%			0%	0%	
Peak Hour Factor	1.00	1.00	1.00	1.00	1.00	1.00
Hourly flow rate (vph)	0	1	0	956	464	0
Pedestrians						
Lane Width (m)						
Walking Speed (m/s)						
Percent Blockage						
Right turn flare (veh)						
Median type				None	None	
Median storage veh						
Upstream signal (m)				194		
pX, platoon unblocked	0.93	0.93	0.93			
vC, conflicting volume	783	232	464			
vC1, stage 1 conf vol						
vC2, stage 2 conf vol						
vCu, unblocked vol	612	20	269			
tC, single (s)	6.8	6.9	4.1			
tC, 2 stage (s)						
tF (s)	3.5	3.3	2.2			
p0 queue free %	100	100	100			
cM capacity (veh/h)	394	979	1199			
Direction, Lane #	EB 1	NB 1	NB 2	NB 3	SB 1	SB 2
Volume Total	1	319	319	319	232	232
Volume Left	0	0	0	0	0	0
Volume Right	1	0	0	0	0	0
cSH	979	1700	1700	1700	1700	1700
Volume to Capacity	0.00	0.19	0.19	0.19	0.14	0.14
Queue Length 95th (m)	0.0	0.0	0.0	0.0	0.0	0.0
Control Delay (s)	8.7	0.0	0.0	0.0	0.0	0.0
Lane LOS	A					
Approach Delay (s)	8.7	0.0	0.0			
Approach LOS	A					
Intersection Summary						
Average Delay	0.0					
Intersection Capacity Utilization	23.5%			ICU Level of Service	A	
Analysis Period (min)	15					



Lane Group	EBL	EBT	EBR	WBL	WBT	NBL	NBT	NBR	SBL	SBT	SBR
Lane Configurations											
Traffic Volume (vph)	259	25	2	29	49	9	581	9	9	415	120
Future Volume (vph)	259	25	2	29	49	9	581	9	9	415	120
Lane Group Flow (vph)	259	25	2	29	88	9	581	9	9	415	120
Turn Type	pm+pt	NA	Perm	Perm	NA	Perm	NA	Perm	pm+pt	NA	Perm
Protected Phases	5	2			6		8		7	4	
Permitted Phases	2		2	6		8		8	4		4
Detector Phase	5	2	2	6	6	8	8	8	7	4	4
Switch Phase											
Minimum Initial (s)	5.0	10.0	10.0	10.0	10.0	10.0	10.0	10.0	5.0	10.0	10.0
Minimum Split (s)	17.0	38.9	38.9	38.9	38.9	40.0	40.0	40.0	12.3	51.4	51.4
Total Split (s)	17.0	39.9	39.9	23.0	23.0	40.0	40.0	40.0	11.4	51.4	51.4
Total Split (%)	18.6%	43.7%	43.7%	25.2%	25.2%	43.8%	43.8%	43.8%	12.5%	56.2%	56.2%
Yellow Time (s)	3.3	3.3	3.3	3.3	3.3	3.7	3.7	3.7	3.7	3.7	3.7
All-Red Time (s)	3.6	3.6	3.6	3.6	3.6	2.7	2.7	2.7	2.7	2.7	2.7
Lost Time Adjust (s)	0.0	0.0	0.0	0.0	0.0	0.0	0.0	0.0	0.0	0.0	0.0
Total Lost Time (s)	6.9	6.9	6.9	6.9	6.9	6.4	6.4	6.4	6.4	6.4	6.4
Lead/Lag	Lead			Lag	Lag	Lag	Lag	Lag	Lead		
Lead-Lag Optimize?	Yes			Yes	Yes	Yes	Yes	Yes	Yes		
Recall Mode	Max	Max	Max	Max	Max	Min	Min	Min	Max	Min	Min
Act Effct Green (s)	49.1	49.1	49.1	32.1	32.1	21.6	21.6	21.6	33.1	33.1	33.1
Actuated g/C Ratio	0.51	0.51	0.51	0.34	0.34	0.23	0.23	0.23	0.35	0.35	0.35
v/c Ratio	0.43	0.03	0.00	0.07	0.15	0.04	0.76	0.02	0.05	0.35	0.20
Control Delay	17.0	13.2	0.0	24.0	15.6	28.2	41.2	0.1	20.1	23.9	4.1
Queue Delay	0.0	0.0	0.0	0.0	0.0	0.0	0.0	0.0	0.0	0.0	0.0
Total Delay	17.0	13.2	0.0	24.0	15.6	28.2	41.2	0.1	20.1	23.9	4.1
LOS	B	B	A	C	B	C	D	A	C	C	A
Approach Delay		16.5			17.7		40.4			19.5	
Approach LOS		B			B		D			B	
Queue Length 50th (m)	25.7	2.1	0.0	3.6	6.2	1.3	52.7	0.0	1.1	29.5	0.0
Queue Length 95th (m)	48.4	7.0	0.0	10.6	18.2	5.1	70.5	0.0	4.1	41.3	9.4
Internal Link Dist (m)		89.0			153.8		234.9			500.4	
Turn Bay Length (m)			75.0	30.0		50.0		45.0	35.0		45.0
Base Capacity (vph)	597	917	823	442	578	319	1195	654	193	1601	772
Starvation Cap Reductn	0	0	0	0	0	0	0	0	0	0	0
Spillback Cap Reductn	0	0	0	0	0	0	0	0	0	0	0
Storage Cap Reductn	0	0	0	0	0	0	0	0	0	0	0
Reduced v/c Ratio	0.43	0.03	0.00	0.07	0.15	0.03	0.49	0.01	0.05	0.26	0.16

Intersection Summary

Cycle Length: 91.4	
Actuated Cycle Length: 95.5	
Natural Cycle: 110	
Control Type: Semi Act-Uncoord	
Maximum v/c Ratio: 0.76	
Intersection Signal Delay: 26.9	Intersection LOS: C
Intersection Capacity Utilization 75.2%	ICU Level of Service D
Analysis Period (min) 15	

Splits and Phases: 4: Trim Road & Portobello Boulevard/Springridge Drive

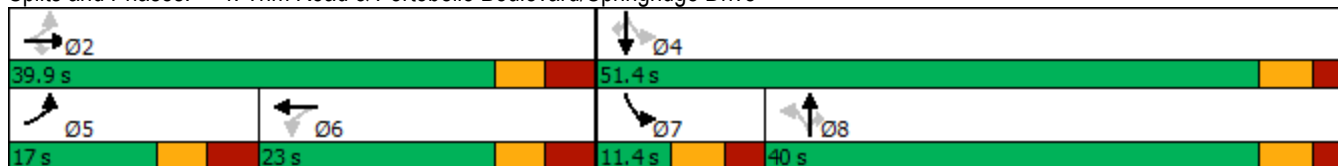

Background 2022 AM
 5: Charlemagne Boulevard & Watters Road

10/28/2021



Lane Group	WBL	NBT	SBT
Lane Configurations			
Traffic Volume (vph)	181	201	214
Future Volume (vph)	181	201	214
Lane Group Flow (vph)	358	364	284
Sign Control	Stop	Stop	Stop

Intersection Summary

Control Type: Unsignalized

Intersection Capacity Utilization 51.8% ICU Level of Service A

Analysis Period (min) 15

Background 2022 AM
 5: Charlemagne Boulevard & Watters Road

10/28/2021



Movement	WBL	WBR	NBT	NBR	SBL	SBT
Lane Configurations						
Sign Control	Stop		Stop			Stop
Traffic Volume (vph)	181	177	201	163	70	214
Future Volume (vph)	181	177	201	163	70	214
Peak Hour Factor	1.00	1.00	1.00	1.00	1.00	1.00
Hourly flow rate (vph)	181	177	201	163	70	214
Direction, Lane #	WB 1	NB 1	NB 2	SB 1	SB 2	
Volume Total (vph)	358	134	230	141	143	
Volume Left (vph)	181	0	0	70	0	
Volume Right (vph)	177	0	163	0	0	
Hadj (s)	-0.16	0.03	-0.46	0.28	0.03	
Departure Headway (s)	5.3	6.0	5.5	6.3	6.1	
Degree Utilization, x	0.53	0.22	0.35	0.25	0.24	
Capacity (veh/h)	647	570	622	538	560	
Control Delay (s)	14.1	9.5	10.3	10.2	9.8	
Approach Delay (s)	14.1	10.0		10.0		
Approach LOS	B	B		B		
Intersection Summary						
Delay			11.5			
Level of Service			B			
Intersection Capacity Utilization			51.8%	ICU Level of Service		A
Analysis Period (min)			15			



Lane Group	EBT	WBT	NBT	SBT	SBR
Lane Configurations					
Traffic Volume (vph)	326	233	3	5	55
Future Volume (vph)	326	233	3	5	55
Lane Group Flow (vph)	373	304	42	130	55
Sign Control	Stop	Stop	Stop	Stop	

Intersection Summary

Control Type: Unsignalized

Intersection Capacity Utilization 47.6% ICU Level of Service A

Analysis Period (min) 15



Movement	EBL	EBT	EBR	WBL	WBT	WBR	NBL	NBT	NBR	SBL	SBT	SBR
Lane Configurations		↔			↔			↔			↔	↔
Sign Control		Stop			Stop			Stop			Stop	↔
Traffic Volume (vph)	23	326	24	20	233	51	18	3	21	125	5	55
Future Volume (vph)	23	326	24	20	233	51	18	3	21	125	5	55
Peak Hour Factor	1.00	1.00	1.00	1.00	1.00	1.00	1.00	1.00	1.00	1.00	1.00	1.00
Hourly flow rate (vph)	23	326	24	20	233	51	18	3	21	125	5	55

Direction, Lane #	EB 1	WB 1	NB 1	SB 1	SB 2
Volume Total (vph)	373	304	42	130	55
Volume Left (vph)	23	20	18	125	0
Volume Right (vph)	24	51	21	0	55
Hadj (s)	0.01	-0.05	-0.18	0.51	-0.67
Departure Headway (s)	5.0	5.1	6.0	6.8	5.6
Degree Utilization, x	0.52	0.43	0.07	0.25	0.09
Capacity (veh/h)	685	676	508	485	581
Control Delay (s)	13.4	11.8	9.4	10.8	7.9
Approach Delay (s)	13.4	11.8	9.4	10.0	
Approach LOS	B	B	A	A	

Intersection Summary				
Delay			12.0	
Level of Service			B	
Intersection Capacity Utilization		47.6%	ICU Level of Service	A
Analysis Period (min)		15		

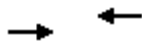

Lane Group	EBT	WBT
Lane Configurations	↔↑	↑↔
Traffic Volume (vph)	472	279
Future Volume (vph)	472	279
Lane Group Flow (vph)	472	279
Sign Control	Free	Free

Intersection Summary

Control Type: Unsignalized

Intersection Capacity Utilization 18.8% ICU Level of Service A

Analysis Period (min) 15

Background 2022 AM
7: Watters Road

10/28/2021



Movement	EBL	EBT	WBT	WBR	SBL	SBR
Lane Configurations		↔↑	↔		↔	↔
Traffic Volume (veh/h)	0	472	279	0	0	0
Future Volume (Veh/h)	0	472	279	0	0	0
Sign Control		Free	Free		Stop	
Grade		0%	0%		0%	
Peak Hour Factor	1.00	1.00	1.00	1.00	1.00	1.00
Hourly flow rate (vph)	0	472	279	0	0	0
Pedestrians						
Lane Width (m)						
Walking Speed (m/s)						
Percent Blockage						
Right turn flare (veh)						
Median type		None	None			
Median storage (veh)						
Upstream signal (m)			119			
pX, platoon unblocked						
vC, conflicting volume	279				515	279
vC1, stage 1 conf vol						
vC2, stage 2 conf vol						
vCu, unblocked vol	279				515	279
tC, single (s)	4.1				6.8	6.9
tC, 2 stage (s)						
tF (s)	2.2				3.5	3.3
p0 queue free %	100				100	100
cM capacity (veh/h)	1281				489	718
Direction, Lane #	EB 1	EB 2	WB 1	SB 1	SB 2	
Volume Total	157	315	279	0	0	
Volume Left	0	0	0	0	0	
Volume Right	0	0	0	0	0	
cSH	1281	1700	1700	1700	1700	
Volume to Capacity	0.00	0.19	0.16	0.00	0.00	
Queue Length 95th (m)	0.0	0.0	0.0	0.0	0.0	
Control Delay (s)	0.0	0.0	0.0	0.0	0.0	
Lane LOS				A	A	
Approach Delay (s)	0.0		0.0	0.0		
Approach LOS				A		
Intersection Summary						
Average Delay			0.0			
Intersection Capacity Utilization			18.8%		ICU Level of Service	A
Analysis Period (min)			15			

Background 2022 PM
1: Trim Road & Watters Road

10/28/2021



Lane Group	EBL	EBT	WBL	WBT	NBL	NBT	NBR	SBL	SBT	SBR
Lane Configurations										
Traffic Volume (vph)	189	16	18	9	54	516	18	20	1190	414
Future Volume (vph)	189	16	18	9	54	516	18	20	1190	414
Lane Group Flow (vph)	189	89	18	15	54	516	18	20	1190	414
Turn Type	Perm	NA	Perm	NA	pm+pt	NA	Perm	Perm	NA	Perm
Protected Phases		4		8	5	2			6	
Permitted Phases	4		8		2		2	6		6
Detector Phase	4	4	8	8	5	2	2	6	6	6
Switch Phase										
Minimum Initial (s)	10.0	10.0	10.0	10.0	5.0	10.0	10.0	10.0	10.0	10.0
Minimum Split (s)	28.2	28.2	28.2	28.2	13.6	66.7	66.7	45.0	45.0	45.0
Total Split (s)	28.2	28.2	28.2	28.2	13.6	66.8	66.8	53.2	53.2	53.2
Total Split (%)	29.7%	29.7%	29.7%	29.7%	14.3%	70.3%	70.3%	56.0%	56.0%	56.0%
Yellow Time (s)	3.3	3.3	3.3	3.3	3.7	3.7	3.7	3.7	3.7	3.7
All-Red Time (s)	4.9	4.9	4.9	4.9	3.0	3.0	3.0	3.0	3.0	3.0
Lost Time Adjust (s)	0.0	0.0	0.0	0.0	0.0	0.0	0.0	0.0	0.0	0.0
Total Lost Time (s)	8.2	8.2	8.2	8.2	6.7	6.7	6.7	6.7	6.7	6.7
Lead/Lag					Lead			Lag	Lag	Lag
Lead-Lag Optimize?					Yes			Yes	Yes	Yes
Recall Mode	Max	Max	Max	Max	Max	Min	Min	Min	Min	Min
Act Effct Green (s)	32.1	32.1	32.1	32.1	56.7	56.7	56.7	43.1	43.1	43.1
Actuated g/C Ratio	0.31	0.31	0.31	0.31	0.55	0.55	0.55	0.42	0.42	0.42
v/c Ratio	0.46	0.17	0.05	0.03	0.30	0.28	0.02	0.06	0.85	0.50
Control Delay	34.2	9.9	27.2	20.5	14.9	12.9	0.1	18.3	33.8	6.5
Queue Delay	0.0	0.0	0.0	0.0	0.0	0.0	0.0	0.0	0.0	0.0
Total Delay	34.2	9.9	27.2	20.5	14.9	12.9	0.1	18.3	33.8	6.5
LOS	C	A	C	C	B	B	A	B	C	A
Approach Delay		26.4		24.2		12.7			26.7	
Approach LOS		C		C		B			C	
Queue Length 50th (m)	32.1	2.4	2.7	1.3	4.8	27.6	0.0	2.4	111.1	9.0
Queue Length 95th (m)	53.5	13.6	7.9	6.1	10.4	37.3	0.0	7.1	138.7	30.5
Internal Link Dist (m)		95.7		300.5		130.5			233.4	
Turn Bay Length (m)	180.0		25.0		35.0		50.0	30.0		45.0
Base Capacity (vph)	413	528	385	520	183	1968	906	369	1523	868
Starvation Cap Reductn	0	0	0	0	0	0	0	0	0	0
Spillback Cap Reductn	0	0	0	0	0	0	0	0	0	0
Storage Cap Reductn	0	0	0	0	0	0	0	0	0	0
Reduced v/c Ratio	0.46	0.17	0.05	0.03	0.30	0.26	0.02	0.05	0.78	0.48

Intersection Summary

Cycle Length: 95	
Actuated Cycle Length: 103.7	
Natural Cycle: 95	
Control Type: Actuated-Uncoordinated	
Maximum v/c Ratio: 0.85	
Intersection Signal Delay: 23.4	Intersection LOS: C
Intersection Capacity Utilization 83.6%	ICU Level of Service E
Analysis Period (min) 15	

Splits and Phases: 1: Trim Road & Watters Road



Background 2022 PM
 2: Trim Road & Crown Pointe Plaza Access 1

10/28/2021



Lane Group	EBL	EBR	NBL	NBT	SBT
Lane Configurations					
Traffic Volume (vph)	1	67	54	603	1276
Future Volume (vph)	1	67	54	603	1276
Lane Group Flow (vph)	1	67	54	603	1309
Sign Control	Stop			Free	Free

Intersection Summary

Control Type: Unsignalized

Intersection Capacity Utilization Err% ICU Level of Service H

Analysis Period (min) 15

Background 2022 PM
2: Trim Road & Crown Pointe Plaza Access 1

10/28/2021



Movement	EBL	EBR	NBL	NBT	SBT	SBR
Lane Configurations						
Traffic Volume (veh/h)	1	67	54	603	1276	33
Future Volume (Veh/h)	1	67	54	603	1276	33
Sign Control	Stop			Free	Free	
Grade	0%			0%	0%	
Peak Hour Factor	1.00	1.00	1.00	1.00	1.00	1.00
Hourly flow rate (vph)	1	67	54	603	1276	33
Pedestrians						
Lane Width (m)						
Walking Speed (m/s)						
Percent Blockage						
Right turn flare (veh)						
Median type				None	None	
Median storage veh						
Upstream signal (m)				155		
pX, platoon unblocked	0.68	0.68	0.68			
vC, conflicting volume	1702	654	1309			
vC1, stage 1 conf vol						
vC2, stage 2 conf vol						
vCu, unblocked vol	1094	0	517			
tC, single (s)	6.8	6.9	4.1			
tC, 2 stage (s)						
tF (s)	3.5	3.3	2.2			
p0 queue free %	99	91	92			
cM capacity (veh/h)	131	738	712			
Direction, Lane #	EB 1	NB 1	NB 2	NB 3	SB 1	SB 2
Volume Total	68	54	302	302	851	458
Volume Left	1	54	0	0	0	0
Volume Right	67	0	0	0	0	33
cSH	691	712	1700	1700	1700	1700
Volume to Capacity	0.10	0.08	0.18	0.18	0.50	0.27
Queue Length 95th (m)	2.5	1.9	0.0	0.0	0.0	0.0
Control Delay (s)	10.8	10.5	0.0	0.0	0.0	0.0
Lane LOS	B	B				
Approach Delay (s)	10.8	0.9	0.0			
Approach LOS	B					
Intersection Summary						
Average Delay			0.6			
Intersection Capacity Utilization			Err%	ICU Level of Service	H	
Analysis Period (min)			15			

Background 2022 PM
 3: Trim Road & Crown Pointe Plaza Access 2

10/28/2021



Lane Group	EBR	NBT	SBT
Lane Configurations	↗	↑↑↑	↑↑
Traffic Volume (vph)	4	661	1340
Future Volume (vph)	4	661	1340
Lane Group Flow (vph)	4	661	1340
Sign Control		Free	Free

Intersection Summary

Control Type: Unsignalized

Intersection Capacity Utilization 49.1% ICU Level of Service A

Analysis Period (min) 15

Background 2022 PM
 3: Trim Road & Crown Pointe Plaza Access 2

10/28/2021



Movement	EBL	EBR	NBL	NBT	SBT	SBR
Lane Configurations		↗		↑↑↑	↑↑	
Traffic Volume (veh/h)	0	4	0	661	1340	0
Future Volume (Veh/h)	0	4	0	661	1340	0
Sign Control	Stop			Free	Free	
Grade	0%			0%	0%	
Peak Hour Factor	1.00	1.00	1.00	1.00	1.00	1.00
Hourly flow rate (vph)	0	4	0	661	1340	0
Pedestrians						
Lane Width (m)						
Walking Speed (m/s)						
Percent Blockage						
Right turn flare (veh)						
Median type				None	None	
Median storage veh						
Upstream signal (m)					194	
pX, platoon unblocked	0.68	0.68	0.68			
vC, conflicting volume	1560	670	1340			
vC1, stage 1 conf vol						
vC2, stage 2 conf vol						
vCu, unblocked vol	895	0	573			
tC, single (s)	6.8	6.9	4.1			
tC, 2 stage (s)						
tF (s)	3.5	3.3	2.2			
p0 queue free %	100	99	100			
cM capacity (veh/h)	192	742	681			
Direction, Lane #	EB 1	NB 1	NB 2	NB 3	SB 1	SB 2
Volume Total	4	220	220	220	670	670
Volume Left	0	0	0	0	0	0
Volume Right	4	0	0	0	0	0
cSH	742	1700	1700	1700	1700	1700
Volume to Capacity	0.01	0.13	0.13	0.13	0.39	0.39
Queue Length 95th (m)	0.1	0.0	0.0	0.0	0.0	0.0
Control Delay (s)	9.9	0.0	0.0	0.0	0.0	0.0
Lane LOS	A					
Approach Delay (s)	9.9	0.0	0.0			
Approach LOS	A					
Intersection Summary						
Average Delay	0.0					
Intersection Capacity Utilization	49.1%			ICU Level of Service	A	
Analysis Period (min)	15					



Lane Group	EBL	EBT	EBR	WBL	WBT	NBL	NBT	NBR	SBL	SBT	SBR
Lane Configurations											
Traffic Volume (vph)	137	65	6	21	39	6	441	28	38	753	385
Future Volume (vph)	137	65	6	21	39	6	441	28	38	753	385
Lane Group Flow (vph)	137	65	6	21	58	6	441	28	38	753	385
Turn Type	pm+pt	NA	Perm	Perm	NA	Perm	NA	Perm	pm+pt	NA	Perm
Protected Phases	5	2			6		8		7	4	
Permitted Phases	2		2	6		8		8	4		4
Detector Phase	5	2	2	6	6	8	8	8	7	4	4
Switch Phase											
Minimum Initial (s)	5.0	10.0	10.0	10.0	10.0	10.0	10.0	10.0	5.0	10.0	10.0
Minimum Split (s)	13.9	38.9	38.9	26.0	26.0	38.0	38.0	38.0	12.3	51.4	51.4
Total Split (s)	13.9	39.9	39.9	26.0	26.0	38.0	38.0	38.0	13.4	51.4	51.4
Total Split (%)	15.2%	43.7%	43.7%	28.5%	28.5%	41.6%	41.6%	41.6%	14.7%	56.3%	56.3%
Yellow Time (s)	3.3	3.3	3.3	3.3	3.3	3.7	3.7	3.7	3.7	3.7	3.7
All-Red Time (s)	3.6	3.6	3.6	3.6	3.6	2.7	2.7	2.7	2.7	2.7	2.7
Lost Time Adjust (s)	0.0	0.0	0.0	0.0	0.0	0.0	0.0	0.0	0.0	0.0	0.0
Total Lost Time (s)	6.9	6.9	6.9	6.9	6.9	6.4	6.4	6.4	6.4	6.4	6.4
Lead/Lag	Lead			Lag	Lag	Lag	Lag	Lag	Lead		
Lead-Lag Optimize?	Yes			Yes	Yes	Yes	Yes	Yes	Yes		
Recall Mode	Max	Max	Max	Max	Max	Min	Min	Min	Max	Min	Min
Act Effct Green (s)	46.0	46.0	46.0	32.1	32.1	16.9	16.9	16.9	30.3	30.3	30.3
Actuated g/C Ratio	0.51	0.51	0.51	0.36	0.36	0.19	0.19	0.19	0.34	0.34	0.34
v/c Ratio	0.23	0.07	0.01	0.05	0.09	0.05	0.69	0.06	0.15	0.66	0.51
Control Delay	13.5	12.4	0.0	20.8	15.6	29.8	39.9	0.3	20.9	28.2	4.9
Queue Delay	0.0	0.0	0.0	0.0	0.0	0.0	0.0	0.0	0.0	0.0	0.0
Total Delay	13.5	12.4	0.0	20.8	15.6	29.8	39.9	0.3	20.9	28.2	4.9
LOS	B	B	A	C	B	C	D	A	C	C	A
Approach Delay		12.8			17.0		37.4			20.3	
Approach LOS		B			B		D			C	
Queue Length 50th (m)	11.8	5.4	0.0	2.3	4.3	0.9	37.5	0.0	4.4	57.2	0.0
Queue Length 95th (m)	24.6	13.0	0.0	7.7	13.3	4.1	52.6	0.0	10.7	75.4	17.4
Internal Link Dist (m)		89.0			153.8		234.9			500.4	
Turn Bay Length (m)			75.0	30.0		50.0		45.0	35.0		45.0
Base Capacity (vph)	589	915	822	454	615	230	1197	657	256	1705	937
Starvation Cap Reductn	0	0	0	0	0	0	0	0	0	0	0
Spillback Cap Reductn	0	0	0	0	0	0	0	0	0	0	0
Storage Cap Reductn	0	0	0	0	0	0	0	0	0	0	0
Reduced v/c Ratio	0.23	0.07	0.01	0.05	0.09	0.03	0.37	0.04	0.15	0.44	0.41

Intersection Summary

Cycle Length: 91.3	
Actuated Cycle Length: 89.6	
Natural Cycle: 95	
Control Type: Semi Act-Uncoord	
Maximum v/c Ratio: 0.69	
Intersection Signal Delay: 23.6	Intersection LOS: C
Intersection Capacity Utilization 77.6%	ICU Level of Service D
Analysis Period (min) 15	

Splits and Phases: 4: Trim Road & Portobello Boulevard/Springridge Drive

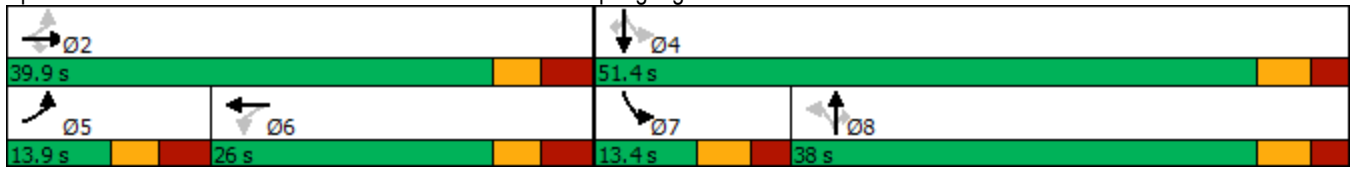

Background 2022 PM
 5: Charlemagne Boulevard & Watters Road

10/28/2021



Lane Group	WBL	NBT	SBT
Lane Configurations			
Traffic Volume (vph)	170	140	191
Future Volume (vph)	170	140	191
Lane Group Flow (vph)	280	297	324
Sign Control	Stop	Stop	Stop

Intersection Summary

Control Type: Unsignalized

Intersection Capacity Utilization 46.1% ICU Level of Service A

Analysis Period (min) 15

Background 2022 PM
5: Charlemagne Boulevard & Watters Road

10/28/2021



Movement	WBL	WBR	NBT	NBR	SBL	SBT
Lane Configurations						
Sign Control	Stop		Stop			Stop
Traffic Volume (vph)	170	110	140	157	133	191
Future Volume (vph)	170	110	140	157	133	191
Peak Hour Factor	1.00	1.00	1.00	1.00	1.00	1.00
Hourly flow rate (vph)	170	110	140	157	133	191
Direction, Lane #	WB 1	NB 1	NB 2	SB 1	SB 2	
Volume Total (vph)	280	93	204	197	127	
Volume Left (vph)	170	0	0	133	0	
Volume Right (vph)	110	0	157	0	0	
Hadj (s)	-0.08	0.03	-0.51	0.37	0.03	
Departure Headway (s)	5.3	5.8	5.2	6.1	5.7	
Degree Utilization, x	0.41	0.15	0.30	0.33	0.20	
Capacity (veh/h)	641	592	653	568	601	
Control Delay (s)	11.9	8.6	9.2	10.8	9.0	
Approach Delay (s)	11.9	9.0		10.1		
Approach LOS	B	A		B		

Intersection Summary					
Delay			10.3		
Level of Service			B		
Intersection Capacity Utilization			46.1%	ICU Level of Service	A
Analysis Period (min)			15		



Lane Group	EBT	WBT	NBT	SBT	SBR
Lane Configurations					
Traffic Volume (vph)	168	315	21	13	35
Future Volume (vph)	168	315	21	13	35
Lane Group Flow (vph)	306	546	137	92	35
Sign Control	Stop	Stop	Stop	Stop	

Intersection Summary

Control Type: Unsignalized

Intersection Capacity Utilization 60.4% ICU Level of Service B

Analysis Period (min) 15



Movement	EBL	EBT	EBR	WBL	WBT	WBR	NBL	NBT	NBR	SBL	SBT	SBR
Lane Configurations		↔			↔			↔			↔	↔
Sign Control		Stop			Stop			Stop			Stop	↔
Traffic Volume (vph)	65	168	73	82	315	149	56	21	60	79	13	35
Future Volume (vph)	65	168	73	82	315	149	56	21	60	79	13	35
Peak Hour Factor	1.00	1.00	1.00	1.00	1.00	1.00	1.00	1.00	1.00	1.00	1.00	1.00
Hourly flow rate (vph)	65	168	73	82	315	149	56	21	60	79	13	35
Direction, Lane #	EB 1	WB 1	NB 1	SB 1	SB 2							
Volume Total (vph)	306	546	137	92	35							
Volume Left (vph)	65	82	56	79	0							
Volume Right (vph)	73	149	60	0	35							
Hadj (s)	-0.07	-0.10	-0.15	0.46	-0.67							
Departure Headway (s)	5.6	5.2	6.5	7.5	6.4							
Degree Utilization, x	0.47	0.79	0.25	0.19	0.06							
Capacity (veh/h)	606	677	495	432	504							
Control Delay (s)	13.5	24.6	11.6	11.1	8.6							
Approach Delay (s)	13.5	24.6	11.6	10.4								
Approach LOS	B	C	B	B								

Intersection Summary

Delay	18.3
Level of Service	C
Intersection Capacity Utilization	60.4%
ICU Level of Service	B
Analysis Period (min)	15



Lane Group	EBT	WBT
Lane Configurations	↔↑	↑↔
Traffic Volume (vph)	307	477
Future Volume (vph)	307	477
Lane Group Flow (vph)	307	477
Sign Control	Free	Free

Intersection Summary

Control Type: Unsignalized

Intersection Capacity Utilization 29.8% ICU Level of Service A

Analysis Period (min) 15

Background 2022 PM
7: Watters Road

10/28/2021



Movement	EBL	EBT	WBT	WBR	SBL	SBR
Lane Configurations		↔↑	↔		↔	↔
Traffic Volume (veh/h)	0	307	477	0	0	0
Future Volume (Veh/h)	0	307	477	0	0	0
Sign Control		Free	Free		Stop	
Grade		0%	0%		0%	
Peak Hour Factor	1.00	1.00	1.00	1.00	1.00	1.00
Hourly flow rate (vph)	0	307	477	0	0	0
Pedestrians						
Lane Width (m)						
Walking Speed (m/s)						
Percent Blockage						
Right turn flare (veh)						
Median type		None	None			
Median storage (veh)						
Upstream signal (m)	120					
pX, platoon unblocked						
vC, conflicting volume	477				630	477
vC1, stage 1 conf vol						
vC2, stage 2 conf vol						
vCu, unblocked vol	477				630	477
tC, single (s)	4.1				6.8	6.9
tC, 2 stage (s)						
tF (s)	2.2				3.5	3.3
p0 queue free %	100				100	100
cM capacity (veh/h)	1082				414	534
Direction, Lane #	EB 1	EB 2	WB 1	SB 1	SB 2	
Volume Total	102	205	477	0	0	
Volume Left	0	0	0	0	0	
Volume Right	0	0	0	0	0	
cSH	1082	1700	1700	1700	1700	
Volume to Capacity	0.00	0.12	0.28	0.00	0.00	
Queue Length 95th (m)	0.0	0.0	0.0	0.0	0.0	
Control Delay (s)	0.0	0.0	0.0	0.0	0.0	
Lane LOS				A	A	
Approach Delay (s)	0.0	0.0		0.0		
Approach LOS				A		
Intersection Summary						
Average Delay			0.0			
Intersection Capacity Utilization			29.8%	ICU Level of Service	A	
Analysis Period (min)			15			

Background 2022 SAT
1: Trim Road & Watters Road

10/28/2021



Lane Group	EBL	EBT	WBL	WBT	NBL	NBT	NBR	SBL	SBT	SBR
Lane Configurations										
Traffic Volume (vph)	299	11	14	14	97	653	6	16	655	274
Future Volume (vph)	299	11	14	14	97	653	6	16	655	274
Lane Group Flow (vph)	299	78	14	36	97	653	6	16	655	274
Turn Type	Perm	NA	Perm	NA	pm+pt	NA	Perm	Perm	NA	Perm
Protected Phases		4		8	5	2			6	
Permitted Phases	4		8		2		2	6		6
Detector Phase	4	4	8	8	5	2	2	6	6	6
Switch Phase										
Minimum Initial (s)	10.0	10.0	10.0	10.0	5.0	10.0	10.0	10.0	10.0	10.0
Minimum Split (s)	28.2	28.2	28.2	28.2	16.0	46.7	46.7	30.0	30.0	30.0
Total Split (s)	28.2	28.2	28.2	28.2	16.0	46.8	46.8	30.8	30.8	30.8
Total Split (%)	37.6%	37.6%	37.6%	37.6%	21.3%	62.4%	62.4%	41.1%	41.1%	41.1%
Yellow Time (s)	3.3	3.3	3.3	3.3	3.7	3.7	3.7	3.7	3.7	3.7
All-Red Time (s)	4.9	4.9	4.9	4.9	3.0	3.0	3.0	3.0	3.0	3.0
Lost Time Adjust (s)	0.0	0.0	0.0	0.0	0.0	0.0	0.0	0.0	0.0	0.0
Total Lost Time (s)	8.2	8.2	8.2	8.2	6.7	6.7	6.7	6.7	6.7	6.7
Lead/Lag					Lead			Lag	Lag	Lag
Lead-Lag Optimize?					Yes			Yes	Yes	Yes
Recall Mode	Max	Max	Max	Max	Max	Min	Min	Min	Min	Min
Act Effct Green (s)	32.0	32.0	32.0	32.0	37.6	37.6	37.6	21.6	21.6	21.6
Actuated g/C Ratio	0.38	0.38	0.38	0.38	0.44	0.44	0.44	0.26	0.26	0.26
v/c Ratio	0.60	0.12	0.03	0.06	0.32	0.43	0.01	0.09	0.76	0.46
Control Delay	28.1	6.8	18.0	10.5	16.6	17.1	0.0	24.9	35.2	6.1
Queue Delay	0.0	0.0	0.0	0.0	0.0	0.0	0.0	0.0	0.0	0.0
Total Delay	28.1	6.8	18.0	10.5	16.6	17.1	0.0	24.9	35.2	6.1
LOS	C	A	B	B	B	B	A	C	D	A
Approach Delay		23.7		12.6		16.9			26.6	
Approach LOS		C		B		B			C	
Queue Length 50th (m)	40.1	1.2	1.5	1.5	8.9	36.7	0.0	2.0	51.3	0.0
Queue Length 95th (m)	67.2	9.6	5.3	7.2	17.5	50.1	0.0	6.7	69.8	17.1
Internal Link Dist (m)		95.2		300.5		130.5			233.4	
Turn Bay Length (m)	180.0		25.0		35.0		50.0	30.0		45.0
Base Capacity (vph)	495	629	477	626	300	1608	760	205	967	628
Starvation Cap Reductn	0	0	0	0	0	0	0	0	0	0
Spillback Cap Reductn	0	0	0	0	0	0	0	0	0	0
Storage Cap Reductn	0	0	0	0	0	0	0	0	0	0
Reduced v/c Ratio	0.60	0.12	0.03	0.06	0.32	0.41	0.01	0.08	0.68	0.44

Intersection Summary

Cycle Length: 75	
Actuated Cycle Length: 84.6	
Natural Cycle: 75	
Control Type: Actuated-Uncoordinated	
Maximum v/c Ratio: 0.76	
Intersection Signal Delay: 22.3	Intersection LOS: C
Intersection Capacity Utilization 69.5%	ICU Level of Service C
Analysis Period (min) 15	

Splits and Phases: 1: Trim Road & Watters Road

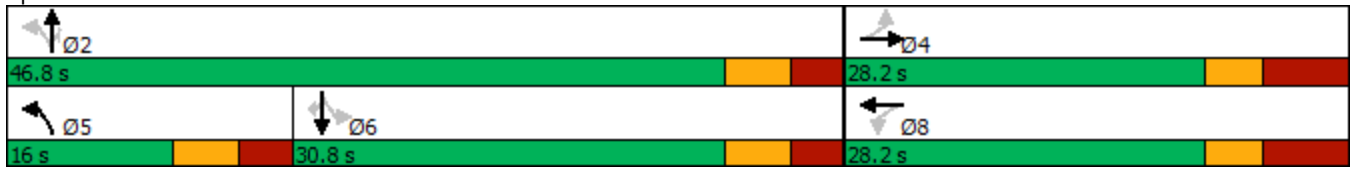

Background 2022 SAT
 2: Trim Road & Crown Pointe Plaza Access 1

10/28/2021



Lane Group	EBR	NBL	NBT	SBT
Lane Configurations				
Traffic Volume (vph)	85	64	764	726
Future Volume (vph)	85	64	764	726
Lane Group Flow (vph)	85	64	764	740
Sign Control			Free	Free

Intersection Summary

Control Type: Unsignalized

Intersection Capacity Utilization 33.9% ICU Level of Service A

Analysis Period (min) 15

Background 2022 SAT
2: Trim Road & Crown Pointe Plaza Access 1

10/28/2021



Movement	EBL	EBR	NBL	NBT	SBT	SBR
Lane Configurations						
Traffic Volume (veh/h)	0	85	64	764	726	14
Future Volume (Veh/h)	0	85	64	764	726	14
Sign Control	Stop			Free	Free	
Grade	0%			0%	0%	
Peak Hour Factor	1.00	1.00	1.00	1.00	1.00	1.00
Hourly flow rate (vph)	0	85	64	764	726	14
Pedestrians						
Lane Width (m)						
Walking Speed (m/s)						
Percent Blockage						
Right turn flare (veh)						
Median type			None		None	
Median storage veh						
Upstream signal (m)					155	
pX, platoon unblocked	0.83	0.83	0.83			
vC, conflicting volume	1243	370	740			
vC1, stage 1 conf vol						
vC2, stage 2 conf vol						
vCu, unblocked vol	878	0	271			
tC, single (s)	6.8	6.9	4.1			
tC, 2 stage (s)						
tF (s)	3.5	3.3	2.2			
p0 queue free %	100	91	94			
cM capacity (veh/h)	224	898	1068			
Direction, Lane #	EB 1	NB 1	NB 2	NB 3	SB 1	SB 2
Volume Total	85	64	382	382	484	256
Volume Left	0	64	0	0	0	0
Volume Right	85	0	0	0	0	14
cSH	898	1068	1700	1700	1700	1700
Volume to Capacity	0.09	0.06	0.22	0.22	0.28	0.15
Queue Length 95th (m)	2.4	1.5	0.0	0.0	0.0	0.0
Control Delay (s)	9.4	8.6	0.0	0.0	0.0	0.0
Lane LOS	A	A				
Approach Delay (s)	9.4	0.7	0.0			
Approach LOS	A					
Intersection Summary						
Average Delay			0.8			
Intersection Capacity Utilization			33.9%		ICU Level of Service	A
Analysis Period (min)			15			

Background 2022 SAT
 3: Trim Road & Crown Pointe Plaza Access 2

10/28/2021



Lane Group	EBR	NBT	SBT
Lane Configurations	↗	↑↑↑	↑↑
Traffic Volume (vph)	2	833	817
Future Volume (vph)	2	833	817
Lane Group Flow (vph)	2	833	817
Sign Control		Free	Free

Intersection Summary

Control Type: Unsignalized

Intersection Capacity Utilization 33.8% ICU Level of Service A

Analysis Period (min) 15

Background 2022 SAT
3: Trim Road & Crown Pointe Plaza Access 2

10/28/2021



Movement	EBL	EBR	NBL	NBT	SBT	SBR
Lane Configurations		↗		↑↑↑	↑↑	
Traffic Volume (veh/h)	0	2	0	833	817	0
Future Volume (Veh/h)	0	2	0	833	817	0
Sign Control	Stop			Free	Free	
Grade	0%			0%	0%	
Peak Hour Factor	1.00	1.00	1.00	1.00	1.00	1.00
Hourly flow rate (vph)	0	2	0	833	817	0
Pedestrians						
Lane Width (m)						
Walking Speed (m/s)						
Percent Blockage						
Right turn flare (veh)						
Median type				None	None	
Median storage veh						
Upstream signal (m)				194		
pX, platoon unblocked	0.83	0.83	0.83			
vC, conflicting volume	1095	408	817			
vC1, stage 1 conf vol						
vC2, stage 2 conf vol						
vCu, unblocked vol	711	0	377			
tC, single (s)	6.8	6.9	4.1			
tC, 2 stage (s)						
tF (s)	3.5	3.3	2.2			
p0 queue free %	100	100	100			
cM capacity (veh/h)	306	903	980			
Direction, Lane #	EB 1	NB 1	NB 2	NB 3	SB 1	SB 2
Volume Total	2	278	278	278	408	408
Volume Left	0	0	0	0	0	0
Volume Right	2	0	0	0	0	0
cSH	903	1700	1700	1700	1700	1700
Volume to Capacity	0.00	0.16	0.16	0.16	0.24	0.24
Queue Length 95th (m)	0.1	0.0	0.0	0.0	0.0	0.0
Control Delay (s)	9.0	0.0	0.0	0.0	0.0	0.0
Lane LOS	A					
Approach Delay (s)	9.0	0.0	0.0			
Approach LOS	A					
Intersection Summary						
Average Delay	0.0					
Intersection Capacity Utilization	33.8%			ICU Level of Service	A	
Analysis Period (min)	15					

Background 2022 SAT

4: Trim Road & Portobello Boulevard/Springridge Drive

10/28/2021



Lane Group	EBL	EBT	EBR	WBL	WBT	NBL	NBT	NBR	SBL	SBT	SBR
Lane Configurations											
Traffic Volume (vph)	187	39	4	28	36	6	495	27	25	475	221
Future Volume (vph)	187	39	4	28	36	6	495	27	25	475	221
Lane Group Flow (vph)	187	39	4	28	60	6	495	27	25	475	221
Turn Type	pm+pt	NA	Perm	Perm	NA	Perm	NA	Perm	pm+pt	NA	Perm
Protected Phases	5	2			6		8		7	4	
Permitted Phases	2		2	6		8		8	4		4
Detector Phase	5	2	2	6	6	8	8	8	7	4	4
Switch Phase											
Minimum Initial (s)	5.0	10.0	10.0	10.0	10.0	10.0	10.0	10.0	5.0	10.0	10.0
Minimum Split (s)	13.9	38.9	38.9	26.0	26.0	35.0	35.0	35.0	11.4	46.4	46.4
Total Split (s)	13.9	39.9	39.9	26.0	26.0	35.0	35.0	35.0	11.4	46.4	46.4
Total Split (%)	16.1%	46.2%	46.2%	30.1%	30.1%	40.6%	40.6%	40.6%	13.2%	53.8%	53.8%
Yellow Time (s)	3.3	3.3	3.3	3.3	3.3	3.7	3.7	3.7	3.7	3.7	3.7
All-Red Time (s)	3.6	3.6	3.6	3.6	3.6	2.7	2.7	2.7	2.7	2.7	2.7
Lost Time Adjust (s)	0.0	0.0	0.0	0.0	0.0	0.0	0.0	0.0	0.0	0.0	0.0
Total Lost Time (s)	6.9	6.9	6.9	6.9	6.9	6.4	6.4	6.4	6.4	6.4	6.4
Lead/Lag	Lead			Lag	Lag	Lag	Lag	Lag	Lead		
Lead-Lag Optimize?	Yes			Yes	Yes	Yes	Yes	Yes	Yes		
Recall Mode	Max	Max	Max	Max	Max	Min	Min	Min	Max	Min	Min
Act Effct Green (s)	46.0	46.0	46.0	32.1	32.1	18.2	18.2	18.2	29.6	29.6	29.6
Actuated g/C Ratio	0.52	0.52	0.52	0.36	0.36	0.20	0.20	0.20	0.33	0.33	0.33
v/c Ratio	0.31	0.04	0.00	0.06	0.10	0.03	0.72	0.06	0.12	0.42	0.34
Control Delay	14.2	12.1	0.0	20.7	14.4	27.8	39.1	0.2	20.6	24.1	4.5
Queue Delay	0.0	0.0	0.0	0.0	0.0	0.0	0.0	0.0	0.0	0.0	0.0
Total Delay	14.2	12.1	0.0	20.7	14.4	27.8	39.1	0.2	20.6	24.1	4.5
LOS	B	B	A	C	B	C	D	A	C	C	A
Approach Delay		13.6			16.4		36.9			17.9	
Approach LOS		B			B		D			B	
Queue Length 50th (m)	16.3	3.1	0.0	3.1	3.9	0.8	41.6	0.0	2.8	32.6	0.0
Queue Length 95th (m)	32.6	8.9	0.0	9.4	12.9	3.9	57.4	0.0	8.0	45.3	13.7
Internal Link Dist (m)		89.0			153.8		234.9			500.4	
Turn Bay Length (m)			75.0	30.0		50.0		45.0	35.0		45.0
Base Capacity (vph)	595	922	833	470	617	275	1092	617	214	1528	796
Starvation Cap Reductn	0	0	0	0	0	0	0	0	0	0	0
Spillback Cap Reductn	0	0	0	0	0	0	0	0	0	0	0
Storage Cap Reductn	0	0	0	0	0	0	0	0	0	0	0
Reduced v/c Ratio	0.31	0.04	0.00	0.06	0.10	0.02	0.45	0.04	0.12	0.31	0.28

Intersection Summary

Cycle Length: 86.3	
Actuated Cycle Length: 88.9	
Natural Cycle: 90	
Control Type: Semi Act-Uncoord	
Maximum v/c Ratio: 0.72	
Intersection Signal Delay: 23.6	Intersection LOS: C
Intersection Capacity Utilization 75.2%	ICU Level of Service D
Analysis Period (min) 15	

Splits and Phases: 4: Trim Road & Portobello Boulevard/Springridge Drive

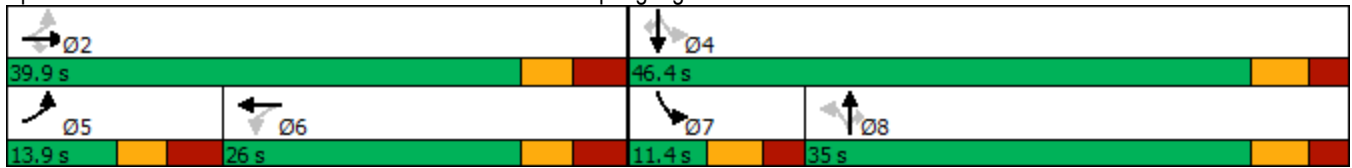

Background 2022 SAT
 5: Charlemagne Boulevard & Watters Road

10/28/2021



Lane Group	WBL	NBT	SBT
Lane Configurations			
Traffic Volume (vph)	131	231	105
Future Volume (vph)	131	231	105
Lane Group Flow (vph)	203	338	154
Sign Control	Stop	Stop	Stop

Intersection Summary

Control Type: Unsignalized

Intersection Capacity Utilization 37.2% ICU Level of Service A

Analysis Period (min) 15

Background 2022 SAT
5: Charlemagne Boulevard & Watters Road

10/28/2021



Movement	WBL	WBR	NBT	NBR	SBL	SBT
Lane Configurations						
Sign Control	Stop		Stop			Stop
Traffic Volume (vph)	131	72	231	107	49	105
Future Volume (vph)	131	72	231	107	49	105
Peak Hour Factor	1.00	1.00	1.00	1.00	1.00	1.00
Hourly flow rate (vph)	131	72	231	107	49	105
Direction, Lane #	WB 1	NB 1	NB 2	SB 1	SB 2	
Volume Total (vph)	203	154	184	84	70	
Volume Left (vph)	131	0	0	49	0	
Volume Right (vph)	72	0	107	0	0	
Hadj (s)	-0.05	0.03	-0.37	0.33	0.03	
Departure Headway (s)	5.0	5.3	4.9	5.7	5.4	
Degree Utilization, x	0.28	0.23	0.25	0.13	0.11	
Capacity (veh/h)	679	659	713	596	628	
Control Delay (s)	9.9	8.6	8.2	8.4	7.9	
Approach Delay (s)	9.9	8.4		8.2		
Approach LOS	A	A		A		
Intersection Summary						
Delay			8.8			
Level of Service			A			
Intersection Capacity Utilization			37.2%		ICU Level of Service	A
Analysis Period (min)			15			



Lane Group	EBT	WBT	NBT	SBT	SBR
Lane Configurations					
Traffic Volume (vph)	184	175	17	16	35
Future Volume (vph)	184	175	17	16	35
Lane Group Flow (vph)	295	366	165	122	35
Sign Control	Stop	Stop	Stop	Stop	

Intersection Summary

Control Type: Unsignalized

Intersection Capacity Utilization 55.3% ICU Level of Service B

Analysis Period (min) 15



Movement	EBL	EBT	EBR	WBL	WBT	WBR	NBL	NBT	NBR	SBL	SBT	SBR
Lane Configurations		↔			↔			↔			↔	↔
Sign Control		Stop			Stop			Stop			Stop	↔
Traffic Volume (vph)	46	184	65	75	175	116	62	17	86	106	16	35
Future Volume (vph)	46	184	65	75	175	116	62	17	86	106	16	35
Peak Hour Factor	1.00	1.00	1.00	1.00	1.00	1.00	1.00	1.00	1.00	1.00	1.00	1.00
Hourly flow rate (vph)	46	184	65	75	175	116	62	17	86	106	16	35
Direction, Lane #	EB 1	WB 1	NB 1	SB 1	SB 2							
Volume Total (vph)	295	366	165	122	35							
Volume Left (vph)	46	75	62	106	0							
Volume Right (vph)	65	116	86	0	35							
Hadj (s)	-0.07	-0.12	-0.20	0.47	-0.67							
Departure Headway (s)	5.4	5.3	6.0	7.1	5.9							
Degree Utilization, x	0.45	0.54	0.27	0.24	0.06							
Capacity (veh/h)	618	646	530	456	534							
Control Delay (s)	12.7	14.2	11.2	11.1	8.1							
Approach Delay (s)	12.7	14.2	11.2	10.4								
Approach LOS	B	B	B	B								

Intersection Summary

Delay	12.7		
Level of Service	B		
Intersection Capacity Utilization	55.3%	ICU Level of Service	B
Analysis Period (min)	15		

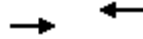

Lane Group	EBT	WBT
Lane Configurations	↔↑	↑↔
Traffic Volume (vph)	376	385
Future Volume (vph)	376	385
Lane Group Flow (vph)	376	385
Sign Control	Free	Free

Intersection Summary

Control Type: Unsignalized

Intersection Capacity Utilization 24.7% ICU Level of Service A

Analysis Period (min) 15

Background 2022 SAT
7: Watters Road

10/28/2021



Movement	EBL	EBT	WBT	WBR	SBL	SBR
Lane Configurations		↔↑	↔		↔	↔
Traffic Volume (veh/h)	0	376	385	0	0	0
Future Volume (Veh/h)	0	376	385	0	0	0
Sign Control		Free	Free		Stop	
Grade		0%	0%		0%	
Peak Hour Factor	1.00	1.00	1.00	1.00	1.00	1.00
Hourly flow rate (vph)	0	376	385	0	0	0
Pedestrians						
Lane Width (m)						
Walking Speed (m/s)						
Percent Blockage						
Right turn flare (veh)						
Median type		None	None			
Median storage (veh)						
Upstream signal (m)	119					
pX, platoon unblocked						
vC, conflicting volume	385				573	385
vC1, stage 1 conf vol						
vC2, stage 2 conf vol						
vCu, unblocked vol	385				573	385
tC, single (s)	4.1				6.8	6.9
tC, 2 stage (s)						
tF (s)	2.2				3.5	3.3
p0 queue free %	100				100	100
cM capacity (veh/h)	1170				450	613
Direction, Lane #	EB 1	EB 2	WB 1	SB 1	SB 2	
Volume Total	125	251	385	0	0	
Volume Left	0	0	0	0	0	
Volume Right	0	0	0	0	0	
cSH	1170	1700	1700	1700	1700	
Volume to Capacity	0.00	0.15	0.23	0.00	0.00	
Queue Length 95th (m)	0.0	0.0	0.0	0.0	0.0	
Control Delay (s)	0.0	0.0	0.0	0.0	0.0	
Lane LOS				A	A	
Approach Delay (s)	0.0	0.0		0.0		
Approach LOS				A		
Intersection Summary						
Average Delay			0.0			
Intersection Capacity Utilization			24.7%	ICU Level of Service	A	
Analysis Period (min)			15			

APPENDIX I

SYNCHRO CAPACITY ANALYSIS: BACKGROUND 2027 CONDITIONS

Background 2027 AM
1: Trim Road & Watters Road

10/28/2021



Lane Group	EBL	EBT	WBL	WBT	NBL	NBT	NBR	SBL	SBT	SBR
Lane Configurations										
Traffic Volume (vph)	331	9	15	15	82	910	4	6	384	182
Future Volume (vph)	331	9	15	15	82	910	4	6	384	182
Lane Group Flow (vph)	331	87	15	41	82	910	4	6	384	182
Turn Type	Perm	NA	Perm	NA	pm+pt	NA	Perm	Perm	NA	Perm
Protected Phases		4		8	5	2			6	
Permitted Phases	4		8		2		2	6		6
Detector Phase	4	4	8	8	5	2	2	6	6	6
Switch Phase										
Minimum Initial (s)	10.0	10.0	10.0	10.0	5.0	10.0	10.0	10.0	10.0	10.0
Minimum Split (s)	40.2	40.2	40.2	40.2	13.6	51.7	51.7	35.0	35.0	35.0
Total Split (s)	42.0	42.0	42.0	42.0	13.6	53.0	53.0	39.4	39.4	39.4
Total Split (%)	44.2%	44.2%	44.2%	44.2%	14.3%	55.8%	55.8%	41.5%	41.5%	41.5%
Yellow Time (s)	3.3	3.3	3.3	3.3	3.7	3.7	3.7	3.7	3.7	3.7
All-Red Time (s)	4.9	4.9	4.9	4.9	3.0	3.0	3.0	3.0	3.0	3.0
Lost Time Adjust (s)	0.0	0.0	0.0	0.0	0.0	0.0	0.0	0.0	0.0	0.0
Total Lost Time (s)	8.2	8.2	8.2	8.2	6.7	6.7	6.7	6.7	6.7	6.7
Lead/Lag					Lead			Lag	Lag	Lag
Lead-Lag Optimize?					Yes			Yes	Yes	Yes
Recall Mode	Max	Max	Max	Max	Max	Min	Min	Min	Min	Min
Act Effct Green (s)	33.9	33.9	33.9	33.9	29.0	29.0	29.0	15.3	15.3	15.3
Actuated g/C Ratio	0.44	0.44	0.44	0.44	0.37	0.37	0.37	0.20	0.20	0.20
v/c Ratio	0.58	0.12	0.03	0.06	0.26	0.72	0.01	0.06	0.58	0.41
Control Delay	22.9	5.3	14.7	8.5	17.7	24.5	0.0	25.3	31.6	7.2
Queue Delay	0.0	0.0	0.0	0.0	0.0	0.0	0.0	0.0	0.0	0.0
Total Delay	22.9	5.3	14.7	8.5	17.7	24.5	0.0	25.3	31.6	7.2
LOS	C	A	B	A	B	C	A	C	C	A
Approach Delay		19.3		10.2		23.9			23.8	
Approach LOS		B		B		C			C	
Queue Length 50th (m)	34.9	0.7	1.2	1.2	7.8	59.0	0.0	0.7	27.0	0.0
Queue Length 95th (m)	71.5	9.2	5.0	7.3	16.1	78.2	0.0	3.6	39.6	14.2
Internal Link Dist (m)		95.2		300.5		130.5			233.4	
Turn Bay Length (m)			25.0		35.0		50.0	30.0		45.0
Base Capacity (vph)	567	706	542	712	320	2023	907	235	1429	744
Starvation Cap Reductn	0	0	0	0	0	0	0	0	0	0
Spillback Cap Reductn	0	0	0	0	0	0	0	0	0	0
Storage Cap Reductn	0	0	0	0	0	0	0	0	0	0
Reduced v/c Ratio	0.58	0.12	0.03	0.06	0.26	0.45	0.00	0.03	0.27	0.24

Intersection Summary

Cycle Length: 95	
Actuated Cycle Length: 77.8	
Natural Cycle: 95	
Control Type: Actuated-Uncoordinated	
Maximum v/c Ratio: 0.72	
Intersection Signal Delay: 22.5	Intersection LOS: C
Intersection Capacity Utilization 79.6%	ICU Level of Service D
Analysis Period (min) 15	

Splits and Phases: 1: Trim Road & Watters Road



Background 2027 AM
 2: Trim Road & Crown Pointe Plaza Access 1

10/28/2021



Lane Group	EBR	NBL	NBT	SBT
Lane Configurations				
Traffic Volume (vph)	14	20	1032	494
Future Volume (vph)	14	20	1032	494
Lane Group Flow (vph)	14	20	1032	502
Sign Control			Free	Free

Intersection Summary

Control Type: Unsignalized

Intersection Capacity Utilization 33.4% ICU Level of Service A

Analysis Period (min) 15

Background 2027 AM
 2: Trim Road & Crown Pointe Plaza Access 1

10/28/2021



Movement	EBL	EBR	NBL	NBT	SBT	SBR
Lane Configurations						
Traffic Volume (veh/h)	0	14	20	1032	494	8
Future Volume (Veh/h)	0	14	20	1032	494	8
Sign Control	Stop			Free	Free	
Grade	0%			0%	0%	
Peak Hour Factor	1.00	1.00	1.00	1.00	1.00	1.00
Hourly flow rate (vph)	0	14	20	1032	494	8
Pedestrians						
Lane Width (m)						
Walking Speed (m/s)						
Percent Blockage						
Right turn flare (veh)						
Median type				None	None	
Median storage veh						
Upstream signal (m)				155		
pX, platoon unblocked	0.91	0.91	0.91			
vC, conflicting volume	1054	251	502			
vC1, stage 1 conf vol						
vC2, stage 2 conf vol						
vCu, unblocked vol	862	0	256			
tC, single (s)	6.8	6.9	4.1			
tC, 2 stage (s)						
tF (s)	3.5	3.3	2.2			
p0 queue free %	100	99	98			
cM capacity (veh/h)	263	987	1189			
Direction, Lane #	EB 1	NB 1	NB 2	NB 3	SB 1	SB 2
Volume Total	14	20	516	516	329	173
Volume Left	0	20	0	0	0	0
Volume Right	14	0	0	0	0	8
cSH	987	1189	1700	1700	1700	1700
Volume to Capacity	0.01	0.02	0.30	0.30	0.19	0.10
Queue Length 95th (m)	0.3	0.4	0.0	0.0	0.0	0.0
Control Delay (s)	8.7	8.1	0.0	0.0	0.0	0.0
Lane LOS	A	A				
Approach Delay (s)	8.7	0.2	0.0			
Approach LOS	A					
Intersection Summary						
Average Delay			0.2			
Intersection Capacity Utilization			33.4%	ICU Level of Service	A	
Analysis Period (min)			15			

Background 2027 AM
 3: Trim Road & Crown Pointe Plaza Access 2

10/28/2021



Lane Group	EBR	NBT	SBT
Lane Configurations	↗	↑↑↑	↑↑
Traffic Volume (vph)	1	1055	512
Future Volume (vph)	1	1055	512
Lane Group Flow (vph)	1	1055	512
Sign Control		Free	Free

Intersection Summary

Control Type: Unsignalized

Intersection Capacity Utilization 24.9% ICU Level of Service A

Analysis Period (min) 15

Background 2027 AM
 3: Trim Road & Crown Pointe Plaza Access 2

10/28/2021



Movement	EBL	EBR	NBL	NBT	SBT	SBR
Lane Configurations		↗		↑↑↑	↑↑	
Traffic Volume (veh/h)	0	1	0	1055	512	0
Future Volume (Veh/h)	0	1	0	1055	512	0
Sign Control	Stop			Free	Free	
Grade	0%			0%	0%	
Peak Hour Factor	1.00	1.00	1.00	1.00	1.00	1.00
Hourly flow rate (vph)	0	1	0	1055	512	0
Pedestrians						
Lane Width (m)						
Walking Speed (m/s)						
Percent Blockage						
Right turn flare (veh)						
Median type				None	None	
Median storage veh						
Upstream signal (m)				194		
pX, platoon unblocked	0.92	0.92	0.92			
vC, conflicting volume	864	256	512			
vC1, stage 1 conf vol						
vC2, stage 2 conf vol						
vCu, unblocked vol	671	9	288			
tC, single (s)	6.8	6.9	4.1			
tC, 2 stage (s)						
tF (s)	3.5	3.3	2.2			
p0 queue free %	100	100	100			
cM capacity (veh/h)	357	982	1166			
Direction, Lane #	EB 1	NB 1	NB 2	NB 3	SB 1	SB 2
Volume Total	1	352	352	352	256	256
Volume Left	0	0	0	0	0	0
Volume Right	1	0	0	0	0	0
cSH	982	1700	1700	1700	1700	1700
Volume to Capacity	0.00	0.21	0.21	0.21	0.15	0.15
Queue Length 95th (m)	0.0	0.0	0.0	0.0	0.0	0.0
Control Delay (s)	8.7	0.0	0.0	0.0	0.0	0.0
Lane LOS	A					
Approach Delay (s)	8.7	0.0	0.0			
Approach LOS	A					
Intersection Summary						
Average Delay	0.0					
Intersection Capacity Utilization	24.9%			ICU Level of Service	A	
Analysis Period (min)	15					



Lane Group	EBL	EBT	EBR	WBL	WBT	NBL	NBT	NBR	SBL	SBT	SBR
Lane Configurations											
Traffic Volume (vph)	259	25	2	29	49	9	642	9	9	458	120
Future Volume (vph)	259	25	2	29	49	9	642	9	9	458	120
Lane Group Flow (vph)	259	25	2	29	88	9	642	9	9	458	120
Turn Type	pm+pt	NA	Perm	Perm	NA	Perm	NA	Perm	pm+pt	NA	Perm
Protected Phases	5	2			6		8		7	4	
Permitted Phases	2		2	6		8		8	4		4
Detector Phase	5	2	2	6	6	8	8	8	7	4	4
Switch Phase											
Minimum Initial (s)	5.0	10.0	10.0	10.0	10.0	10.0	10.0	10.0	5.0	10.0	10.0
Minimum Split (s)	16.9	38.9	38.9	38.9	38.9	40.0	40.0	40.0	12.3	51.4	51.4
Total Split (s)	16.9	39.9	39.9	23.0	23.0	40.0	40.0	40.0	11.4	51.4	51.4
Total Split (%)	18.5%	43.7%	43.7%	25.2%	25.2%	43.8%	43.8%	43.8%	12.5%	56.3%	56.3%
Yellow Time (s)	3.3	3.3	3.3	3.3	3.3	3.7	3.7	3.7	3.7	3.7	3.7
All-Red Time (s)	3.6	3.6	3.6	3.6	3.6	2.7	2.7	2.7	2.7	2.7	2.7
Lost Time Adjust (s)	0.0	0.0	0.0	0.0	0.0	0.0	0.0	0.0	0.0	0.0	0.0
Total Lost Time (s)	6.9	6.9	6.9	6.9	6.9	6.4	6.4	6.4	6.4	6.4	6.4
Lead/Lag	Lead			Lag	Lag	Lag	Lag	Lag	Lead		
Lead-Lag Optimize?	Yes			Yes	Yes	Yes	Yes	Yes	Yes		
Recall Mode	Max	Max	Max	Max	Max	Min	Min	Min	Max	Min	Min
Act Effct Green (s)	49.1	49.1	49.1	32.1	32.1	23.7	23.7	23.7	35.1	35.1	35.1
Actuated g/C Ratio	0.50	0.50	0.50	0.33	0.33	0.24	0.24	0.24	0.36	0.36	0.36
v/c Ratio	0.44	0.03	0.00	0.07	0.16	0.04	0.78	0.02	0.05	0.38	0.19
Control Delay	18.2	14.2	0.0	25.1	16.3	27.6	41.6	0.1	19.7	23.8	3.9
Queue Delay	0.0	0.0	0.0	0.0	0.0	0.0	0.0	0.0	0.0	0.0	0.0
Total Delay	18.2	14.2	0.0	25.1	16.3	27.6	41.6	0.1	19.7	23.8	3.9
LOS	B	B	A	C	B	C	D	A	B	C	A
Approach Delay		17.7			18.5		40.8			19.6	
Approach LOS		B			B		D			B	
Queue Length 50th (m)	27.0	2.2	0.0	3.7	6.4	1.3	59.4	0.0	1.1	33.1	0.0
Queue Length 95th (m)	51.0	7.3	0.0	11.0	18.8	5.1	78.3	0.0	4.1	45.3	9.3
Internal Link Dist (m)		89.0			153.8		234.9			500.4	
Turn Bay Length (m)			75.0	30.0		50.0		45.0	35.0		45.0
Base Capacity (vph)	584	897	808	433	567	300	1172	646	184	1569	759
Starvation Cap Reductn	0	0	0	0	0	0	0	0	0	0	0
Spillback Cap Reductn	0	0	0	0	0	0	0	0	0	0	0
Storage Cap Reductn	0	0	0	0	0	0	0	0	0	0	0
Reduced v/c Ratio	0.44	0.03	0.00	0.07	0.16	0.03	0.55	0.01	0.05	0.29	0.16

Intersection Summary

Cycle Length: 91.3	
Actuated Cycle Length: 97.5	
Natural Cycle: 110	
Control Type: Semi Act-Uncoord	
Maximum v/c Ratio: 0.78	
Intersection Signal Delay: 27.7	Intersection LOS: C
Intersection Capacity Utilization 75.2%	ICU Level of Service D
Analysis Period (min) 15	

Splits and Phases: 4: Trim Road & Portobello Boulevard/Springridge Drive

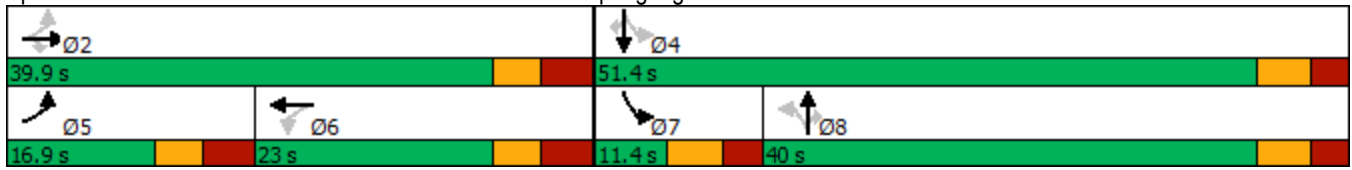

Background 2027 AM
 5: Charlemagne Boulevard & Watters Road

10/28/2021



Lane Group	WBL	NBT	SBT
Lane Configurations			
Traffic Volume (vph)	181	201	214
Future Volume (vph)	181	201	214
Lane Group Flow (vph)	358	364	284
Sign Control	Stop	Stop	Stop

Intersection Summary

Control Type: Unsignalized

Intersection Capacity Utilization 51.8% ICU Level of Service A

Analysis Period (min) 15

Background 2027 AM
 5: Charlemagne Boulevard & Watters Road

10/28/2021



Movement	WBL	WBR	NBT	NBR	SBL	SBT
Lane Configurations						
Sign Control	Stop		Stop			Stop
Traffic Volume (vph)	181	177	201	163	70	214
Future Volume (vph)	181	177	201	163	70	214
Peak Hour Factor	1.00	1.00	1.00	1.00	1.00	1.00
Hourly flow rate (vph)	181	177	201	163	70	214
Direction, Lane #	WB 1	NB 1	NB 2	SB 1	SB 2	
Volume Total (vph)	358	134	230	141	143	
Volume Left (vph)	181	0	0	70	0	
Volume Right (vph)	177	0	163	0	0	
Hadj (s)	-0.16	0.03	-0.46	0.28	0.03	
Departure Headway (s)	5.3	6.0	5.5	6.3	6.1	
Degree Utilization, x	0.53	0.22	0.35	0.25	0.24	
Capacity (veh/h)	647	570	622	538	560	
Control Delay (s)	14.1	9.5	10.3	10.2	9.8	
Approach Delay (s)	14.1	10.0		10.0		
Approach LOS	B	B		B		
Intersection Summary						
Delay			11.5			
Level of Service			B			
Intersection Capacity Utilization			51.8%	ICU Level of Service		A
Analysis Period (min)			15			



Lane Group	EBT	WBT	NBT	SBT	SBR
Lane Configurations					
Traffic Volume (vph)	326	233	3	5	55
Future Volume (vph)	326	233	3	5	55
Lane Group Flow (vph)	373	304	42	130	55
Sign Control	Stop	Stop	Stop	Stop	

Intersection Summary

Control Type: Unsignalized

Intersection Capacity Utilization 47.6% ICU Level of Service A

Analysis Period (min) 15



Movement	EBL	EBT	EBR	WBL	WBT	WBR	NBL	NBT	NBR	SBL	SBT	SBR
Lane Configurations		↔			↔			↔			↔	↔
Sign Control		Stop			Stop			Stop			Stop	↔
Traffic Volume (vph)	23	326	24	20	233	51	18	3	21	125	5	55
Future Volume (vph)	23	326	24	20	233	51	18	3	21	125	5	55
Peak Hour Factor	1.00	1.00	1.00	1.00	1.00	1.00	1.00	1.00	1.00	1.00	1.00	1.00
Hourly flow rate (vph)	23	326	24	20	233	51	18	3	21	125	5	55

Direction, Lane #	EB 1	WB 1	NB 1	SB 1	SB 2
Volume Total (vph)	373	304	42	130	55
Volume Left (vph)	23	20	18	125	0
Volume Right (vph)	24	51	21	0	55
Hadj (s)	0.01	-0.05	-0.18	0.51	-0.67
Departure Headway (s)	5.0	5.1	6.0	6.8	5.6
Degree Utilization, x	0.52	0.43	0.07	0.25	0.09
Capacity (veh/h)	685	676	508	485	581
Control Delay (s)	13.4	11.8	9.4	10.8	7.9
Approach Delay (s)	13.4	11.8	9.4	10.0	
Approach LOS	B	B	A	A	

Intersection Summary				
Delay			12.0	
Level of Service			B	
Intersection Capacity Utilization		47.6%	ICU Level of Service	A
Analysis Period (min)		15		

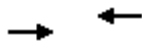

Lane Group	EBT	WBT
Lane Configurations	↔↑	↑↔
Traffic Volume (vph)	472	279
Future Volume (vph)	472	279
Lane Group Flow (vph)	472	279
Sign Control	Free	Free

Intersection Summary

Control Type: Unsignalized

Intersection Capacity Utilization 18.8% ICU Level of Service A

Analysis Period (min) 15

Background 2027 AM
7: Watters Road

10/28/2021



Movement	EBL	EBT	WBT	WBR	SBL	SBR
Lane Configurations		↔↑	↔		↔	↔
Traffic Volume (veh/h)	0	472	279	0	0	0
Future Volume (Veh/h)	0	472	279	0	0	0
Sign Control		Free	Free		Stop	
Grade		0%	0%		0%	
Peak Hour Factor	1.00	1.00	1.00	1.00	1.00	1.00
Hourly flow rate (vph)	0	472	279	0	0	0
Pedestrians						
Lane Width (m)						
Walking Speed (m/s)						
Percent Blockage						
Right turn flare (veh)						
Median type		None	None			
Median storage (veh)						
Upstream signal (m)	119					
pX, platoon unblocked						
vC, conflicting volume	279				515	279
vC1, stage 1 conf vol						
vC2, stage 2 conf vol						
vCu, unblocked vol	279				515	279
tC, single (s)	4.1				6.8	6.9
tC, 2 stage (s)						
tF (s)	2.2				3.5	3.3
p0 queue free %	100				100	100
cM capacity (veh/h)	1281				489	718
Direction, Lane #	EB 1	EB 2	WB 1	SB 1	SB 2	
Volume Total	157	315	279	0	0	
Volume Left	0	0	0	0	0	
Volume Right	0	0	0	0	0	
cSH	1281	1700	1700	1700	1700	
Volume to Capacity	0.00	0.19	0.16	0.00	0.00	
Queue Length 95th (m)	0.0	0.0	0.0	0.0	0.0	
Control Delay (s)	0.0	0.0	0.0	0.0	0.0	
Lane LOS				A	A	
Approach Delay (s)	0.0	0.0		0.0		
Approach LOS				A		
Intersection Summary						
Average Delay			0.0			
Intersection Capacity Utilization			18.8%	ICU Level of Service	A	
Analysis Period (min)			15			

Background 2027 PM
1: Trim Road & Watters Road

10/28/2021



Lane Group	EBL	EBT	WBL	WBT	NBL	NBT	NBR	SBL	SBT	SBR
Lane Configurations										
Traffic Volume (vph)	189	16	18	9	54	570	18	20	1314	414
Future Volume (vph)	189	16	18	9	54	570	18	20	1314	414
Lane Group Flow (vph)	189	89	18	15	54	570	18	20	1314	414
Turn Type	Perm	NA	Perm	NA	pm+pt	NA	Perm	Perm	NA	Perm
Protected Phases		4		8	5	2			6	
Permitted Phases	4		8		2		2	6		6
Detector Phase	4	4	8	8	5	2	2	6	6	6
Switch Phase										
Minimum Initial (s)	10.0	10.0	10.0	10.0	5.0	10.0	10.0	10.0	10.0	10.0
Minimum Split (s)	28.2	28.2	28.2	28.2	13.6	66.7	66.7	45.0	45.0	45.0
Total Split (s)	28.2	28.2	28.2	28.2	13.6	66.8	66.8	53.2	53.2	53.2
Total Split (%)	29.7%	29.7%	29.7%	29.7%	14.3%	70.3%	70.3%	56.0%	56.0%	56.0%
Yellow Time (s)	3.3	3.3	3.3	3.3	3.7	3.7	3.7	3.7	3.7	3.7
All-Red Time (s)	4.9	4.9	4.9	4.9	3.0	3.0	3.0	3.0	3.0	3.0
Lost Time Adjust (s)	0.0	0.0	0.0	0.0	0.0	0.0	0.0	0.0	0.0	0.0
Total Lost Time (s)	8.2	8.2	8.2	8.2	6.7	6.7	6.7	6.7	6.7	6.7
Lead/Lag					Lead			Lag	Lag	Lag
Lead-Lag Optimize?					Yes			Yes	Yes	Yes
Recall Mode	Max	Max	Max	Max	Max	Min	Min	Min	Min	Min
Act Effct Green (s)	32.0	32.0	32.0	32.0	58.6	58.6	58.6	44.9	44.9	44.9
Actuated g/C Ratio	0.30	0.30	0.30	0.30	0.56	0.56	0.56	0.43	0.43	0.43
v/c Ratio	0.47	0.17	0.05	0.03	0.30	0.30	0.02	0.06	0.91	0.50
Control Delay	34.9	9.9	27.3	20.5	15.1	13.0	0.1	18.4	38.9	7.9
Queue Delay	0.0	0.0	0.0	0.0	0.0	0.0	0.0	0.0	0.0	0.0
Total Delay	34.9	9.9	27.3	20.5	15.1	13.0	0.1	18.4	38.9	7.9
LOS	C	A	C	C	B	B	A	B	D	A
Approach Delay		26.9		24.2		12.8			31.4	
Approach LOS		C		C		B			C	
Queue Length 50th (m)	32.1	2.4	2.7	1.3	4.8	31.1	0.0	2.4	129.8	13.3
Queue Length 95th (m)	53.5	13.6	7.9	6.1	10.4	41.4	0.0	7.1	#166.0	37.1
Internal Link Dist (m)		95.2		300.5		130.5			233.4	
Turn Bay Length (m)	180.0		25.0		35.0		50.0	30.0		45.0
Base Capacity (vph)	405	520	378	511	179	1933	890	344	1495	840
Starvation Cap Reductn	0	0	0	0	0	0	0	0	0	0
Spillback Cap Reductn	0	0	0	0	0	0	0	0	0	0
Storage Cap Reductn	0	0	0	0	0	0	0	0	0	0
Reduced v/c Ratio	0.47	0.17	0.05	0.03	0.30	0.29	0.02	0.06	0.88	0.49

Intersection Summary

Cycle Length: 95
 Actuated Cycle Length: 105.5
 Natural Cycle: 95
 Control Type: Actuated-Uncoordinated
 Maximum v/c Ratio: 0.91
 Intersection Signal Delay: 26.4
 Intersection LOS: C
 Intersection Capacity Utilization 86.5%
 ICU Level of Service E
 Analysis Period (min) 15
 # 95th percentile volume exceeds capacity, queue may be longer.

Queue shown is maximum after two cycles.

Splits and Phases: 1: Trim Road & Watters Road



Background 2027 PM
 2: Trim Road & Crown Pointe Plaza Access 1

10/28/2021



Lane Group	EBL	EBR	NBL	NBT	SBT
Lane Configurations					
Traffic Volume (vph)	1	67	54	666	1409
Future Volume (vph)	1	67	54	666	1409
Lane Group Flow (vph)	1	67	54	666	1442
Sign Control	Stop			Free	Free

Intersection Summary

Control Type: Unsignalized

Intersection Capacity Utilization Err% ICU Level of Service H

Analysis Period (min) 15

Background 2027 PM
2: Trim Road & Crown Pointe Plaza Access 1

10/28/2021



Movement	EBL	EBR	NBL	NBT	SBT	SBR
Lane Configurations						
Traffic Volume (veh/h)	1	67	54	666	1409	33
Future Volume (Veh/h)	1	67	54	666	1409	33
Sign Control	Stop			Free	Free	
Grade	0%			0%	0%	
Peak Hour Factor	1.00	1.00	1.00	1.00	1.00	1.00
Hourly flow rate (vph)	1	67	54	666	1409	33
Pedestrians						
Lane Width (m)						
Walking Speed (m/s)						
Percent Blockage						
Right turn flare (veh)						
Median type				None	None	
Median storage veh						
Upstream signal (m)				155		
pX, platoon unblocked	0.63	0.63	0.63			
vC, conflicting volume	1866	721	1442			
vC1, stage 1 conf vol						
vC2, stage 2 conf vol						
vCu, unblocked vol	1203	0	530			
tC, single (s)	6.8	6.9	4.1			
tC, 2 stage (s)						
tF (s)	3.5	3.3	2.2			
p0 queue free %	99	90	92			
cM capacity (veh/h)	102	684	652			
Direction, Lane #	EB 1	NB 1	NB 2	NB 3	SB 1	SB 2
Volume Total	68	54	333	333	939	503
Volume Left	1	54	0	0	0	0
Volume Right	67	0	0	0	0	33
cSH	631	652	1700	1700	1700	1700
Volume to Capacity	0.11	0.08	0.20	0.20	0.55	0.30
Queue Length 95th (m)	2.7	2.1	0.0	0.0	0.0	0.0
Control Delay (s)	11.4	11.0	0.0	0.0	0.0	0.0
Lane LOS	B	B				
Approach Delay (s)	11.4	0.8	0.0			
Approach LOS	B					
Intersection Summary						
Average Delay	0.6					
Intersection Capacity Utilization	Err%			ICU Level of Service	H	
Analysis Period (min)	15					

Background 2027 PM
 3: Trim Road & Crown Pointe Plaza Access 2

10/28/2021



Lane Group	EBR	NBT	SBT
Lane Configurations	↗	↑↑↑	↑↑
Traffic Volume (vph)	4	730	1480
Future Volume (vph)	4	730	1480
Lane Group Flow (vph)	4	730	1480
Sign Control		Free	Free

Intersection Summary

Control Type: Unsignalized

Intersection Capacity Utilization 53.2% ICU Level of Service A

Analysis Period (min) 15

Background 2027 PM
 3: Trim Road & Crown Pointe Plaza Access 2

10/28/2021



Movement	EBL	EBR	NBL	NBT	SBT	SBR
Lane Configurations		↗		↑↑↑	↑↑	
Traffic Volume (veh/h)	0	4	0	730	1480	0
Future Volume (Veh/h)	0	4	0	730	1480	0
Sign Control	Stop			Free	Free	
Grade	0%			0%	0%	
Peak Hour Factor	1.00	1.00	1.00	1.00	1.00	1.00
Hourly flow rate (vph)	0	4	0	730	1480	0
Pedestrians						
Lane Width (m)						
Walking Speed (m/s)						
Percent Blockage						
Right turn flare (veh)						
Median type				None	None	
Median storage veh						
Upstream signal (m)					194	
pX, platoon unblocked	0.63	0.63	0.63			
vC, conflicting volume	1723	740	1480			
vC1, stage 1 conf vol						
vC2, stage 2 conf vol						
vCu, unblocked vol	983	0	598			
tC, single (s)	6.8	6.9	4.1			
tC, 2 stage (s)						
tF (s)	3.5	3.3	2.2			
p0 queue free %	100	99	100			
cM capacity (veh/h)	156	686	617			
Direction, Lane #	EB 1	NB 1	NB 2	NB 3	SB 1	SB 2
Volume Total	4	243	243	243	740	740
Volume Left	0	0	0	0	0	0
Volume Right	4	0	0	0	0	0
cSH	686	1700	1700	1700	1700	1700
Volume to Capacity	0.01	0.14	0.14	0.14	0.44	0.44
Queue Length 95th (m)	0.1	0.0	0.0	0.0	0.0	0.0
Control Delay (s)	10.3	0.0	0.0	0.0	0.0	0.0
Lane LOS	B					
Approach Delay (s)	10.3	0.0				0.0
Approach LOS	B					
Intersection Summary						
Average Delay	0.0					
Intersection Capacity Utilization	53.2%			ICU Level of Service	A	
Analysis Period (min)	15					



Lane Group	EBL	EBT	EBR	WBL	WBT	NBL	NBT	NBR	SBL	SBT	SBR
Lane Configurations											
Traffic Volume (vph)	137	65	6	21	39	6	487	28	38	831	385
Future Volume (vph)	137	65	6	21	39	6	487	28	38	831	385
Lane Group Flow (vph)	137	65	6	21	58	6	487	28	38	831	385
Turn Type	pm+pt	NA	Perm	Perm	NA	Perm	NA	Perm	pm+pt	NA	Perm
Protected Phases	5	2			6		8		7	4	
Permitted Phases	2		2	6		8		8	4		4
Detector Phase	5	2	2	6	6	8	8	8	7	4	4
Switch Phase											
Minimum Initial (s)	5.0	10.0	10.0	10.0	10.0	10.0	10.0	10.0	5.0	10.0	10.0
Minimum Split (s)	13.9	38.9	38.9	26.0	26.0	38.0	38.0	38.0	12.3	51.4	51.4
Total Split (s)	13.9	39.9	39.9	26.0	26.0	38.0	38.0	38.0	13.4	51.4	51.4
Total Split (%)	15.2%	43.7%	43.7%	28.5%	28.5%	41.6%	41.6%	41.6%	14.7%	56.3%	56.3%
Yellow Time (s)	3.3	3.3	3.3	3.3	3.3	3.7	3.7	3.7	3.7	3.7	3.7
All-Red Time (s)	3.6	3.6	3.6	3.6	3.6	2.7	2.7	2.7	2.7	2.7	2.7
Lost Time Adjust (s)	0.0	0.0	0.0	0.0	0.0	0.0	0.0	0.0	0.0	0.0	0.0
Total Lost Time (s)	6.9	6.9	6.9	6.9	6.9	6.4	6.4	6.4	6.4	6.4	6.4
Lead/Lag	Lead			Lag	Lag	Lag	Lag	Lag	Lead		
Lead-Lag Optimize?	Yes			Yes	Yes	Yes	Yes	Yes	Yes		
Recall Mode	Max	Max	Max	Max	Max	Min	Min	Min	Max	Min	Min
Act Effct Green (s)	46.0	46.0	46.0	32.1	32.1	18.3	18.3	18.3	31.8	31.8	31.8
Actuated g/C Ratio	0.50	0.50	0.50	0.35	0.35	0.20	0.20	0.20	0.35	0.35	0.35
v/c Ratio	0.24	0.07	0.01	0.05	0.10	0.05	0.71	0.06	0.15	0.70	0.50
Control Delay	14.3	13.1	0.0	21.6	16.3	29.3	40.1	0.2	20.6	29.1	4.7
Queue Delay	0.0	0.0	0.0	0.0	0.0	0.0	0.0	0.0	0.0	0.0	0.0
Total Delay	14.3	13.1	0.0	21.6	16.3	29.3	40.1	0.2	20.6	29.1	4.7
LOS	B	B	A	C	B	C	D	A	C	C	A
Approach Delay		13.5			17.7		37.8			21.4	
Approach LOS		B			B		D			C	
Queue Length 50th (m)	12.2	5.5	0.0	2.4	4.4	0.9	42.0	0.0	4.4	65.1	0.0
Queue Length 95th (m)	25.7	13.7	0.0	8.0	13.7	4.0	57.8	0.0	10.7	84.7	17.1
Internal Link Dist (m)		89.0			153.8		234.9			500.4	
Turn Bay Length (m)			75.0	30.0		50.0		45.0	35.0		45.0
Base Capacity (vph)	579	900	811	447	605	209	1178	650	248	1678	928
Starvation Cap Reductn	0	0	0	0	0	0	0	0	0	0	0
Spillback Cap Reductn	0	0	0	0	0	0	0	0	0	0	0
Storage Cap Reductn	0	0	0	0	0	0	0	0	0	0	0
Reduced v/c Ratio	0.24	0.07	0.01	0.05	0.10	0.03	0.41	0.04	0.15	0.50	0.41

Intersection Summary

Cycle Length: 91.3

Actuated Cycle Length: 91.1

Natural Cycle: 95

Control Type: Semi Act-Uncoord

Maximum v/c Ratio: 0.71

Intersection Signal Delay: 24.6

Intersection LOS: C

Intersection Capacity Utilization 77.6%

ICU Level of Service D

Analysis Period (min) 15

Splits and Phases: 4: Trim Road & Portobello Boulevard/Springridge Drive

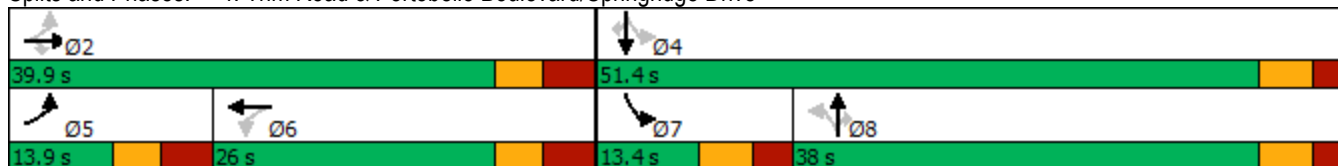

Background 2027 PM
 5: Charlemagne Boulevard & Watters Road

10/28/2021



Lane Group	WBL	NBT	SBT
Lane Configurations			
Traffic Volume (vph)	170	140	191
Future Volume (vph)	170	140	191
Lane Group Flow (vph)	280	297	324
Sign Control	Stop	Stop	Stop

Intersection Summary

Control Type: Unsignalized

Intersection Capacity Utilization 46.1% ICU Level of Service A

Analysis Period (min) 15

Background 2027 PM
 5: Charlemagne Boulevard & Watters Road

10/28/2021



Movement	WBL	WBR	NBT	NBR	SBL	SBT
Lane Configurations						
Sign Control	Stop		Stop			Stop
Traffic Volume (vph)	170	110	140	157	133	191
Future Volume (vph)	170	110	140	157	133	191
Peak Hour Factor	1.00	1.00	1.00	1.00	1.00	1.00
Hourly flow rate (vph)	170	110	140	157	133	191
Direction, Lane #	WB 1	NB 1	NB 2	SB 1	SB 2	
Volume Total (vph)	280	93	204	197	127	
Volume Left (vph)	170	0	0	133	0	
Volume Right (vph)	110	0	157	0	0	
Hadj (s)	-0.08	0.03	-0.51	0.37	0.03	
Departure Headway (s)	5.3	5.8	5.2	6.1	5.7	
Degree Utilization, x	0.41	0.15	0.30	0.33	0.20	
Capacity (veh/h)	641	592	653	568	601	
Control Delay (s)	11.9	8.6	9.2	10.8	9.0	
Approach Delay (s)	11.9	9.0		10.1		
Approach LOS	B	A		B		

Intersection Summary

Delay	10.3
Level of Service	B
Intersection Capacity Utilization	46.1%
ICU Level of Service	A
Analysis Period (min)	15



Lane Group	EBT	WBT	NBT	SBT	SBR
Lane Configurations					
Traffic Volume (vph)	168	315	21	13	35
Future Volume (vph)	168	315	21	13	35
Lane Group Flow (vph)	306	546	137	92	35
Sign Control	Stop	Stop	Stop	Stop	

Intersection Summary

Control Type: Unsignalized

Intersection Capacity Utilization 60.4% ICU Level of Service B

Analysis Period (min) 15



Movement	EBL	EBT	EBR	WBL	WBT	WBR	NBL	NBT	NBR	SBL	SBT	SBR
Lane Configurations		↔			↔			↔			↔	↔
Sign Control		Stop			Stop			Stop			Stop	↔
Traffic Volume (vph)	65	168	73	82	315	149	56	21	60	79	13	35
Future Volume (vph)	65	168	73	82	315	149	56	21	60	79	13	35
Peak Hour Factor	1.00	1.00	1.00	1.00	1.00	1.00	1.00	1.00	1.00	1.00	1.00	1.00
Hourly flow rate (vph)	65	168	73	82	315	149	56	21	60	79	13	35
Direction, Lane #	EB 1	WB 1	NB 1	SB 1	SB 2							
Volume Total (vph)	306	546	137	92	35							
Volume Left (vph)	65	82	56	79	0							
Volume Right (vph)	73	149	60	0	35							
Hadj (s)	-0.07	-0.10	-0.15	0.46	-0.67							
Departure Headway (s)	5.6	5.2	6.5	7.5	6.4							
Degree Utilization, x	0.47	0.79	0.25	0.19	0.06							
Capacity (veh/h)	606	677	495	432	504							
Control Delay (s)	13.5	24.6	11.6	11.1	8.6							
Approach Delay (s)	13.5	24.6	11.6	10.4								
Approach LOS	B	C	B	B								
Intersection Summary												
Delay			18.3									
Level of Service			C									
Intersection Capacity Utilization			60.4%		ICU Level of Service	B						
Analysis Period (min)			15									

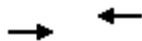

Lane Group	EBT	WBT
Lane Configurations	↔↑	↑↔
Traffic Volume (vph)	307	477
Future Volume (vph)	307	477
Lane Group Flow (vph)	307	477
Sign Control	Free	Free

Intersection Summary

Control Type: Unsignalized

Intersection Capacity Utilization 29.8% ICU Level of Service A

Analysis Period (min) 15

Background 2027 PM
7: Watters Road

10/28/2021



Movement	EBL	EBT	WBT	WBR	SBL	SBR
Lane Configurations		↔↑	↔		↔	↔
Traffic Volume (veh/h)	0	307	477	0	0	0
Future Volume (Veh/h)	0	307	477	0	0	0
Sign Control		Free	Free		Stop	
Grade		0%	0%		0%	
Peak Hour Factor	1.00	1.00	1.00	1.00	1.00	1.00
Hourly flow rate (vph)	0	307	477	0	0	0
Pedestrians						
Lane Width (m)						
Walking Speed (m/s)						
Percent Blockage						
Right turn flare (veh)						
Median type		None	None			
Median storage (veh)						
Upstream signal (m)	119					
pX, platoon unblocked						
vC, conflicting volume	477				630	477
vC1, stage 1 conf vol						
vC2, stage 2 conf vol						
vCu, unblocked vol	477				630	477
tC, single (s)	4.1				6.8	6.9
tC, 2 stage (s)						
tF (s)	2.2				3.5	3.3
p0 queue free %	100				100	100
cM capacity (veh/h)	1082				414	534
Direction, Lane #	EB 1	EB 2	WB 1	SB 1	SB 2	
Volume Total	102	205	477	0	0	
Volume Left	0	0	0	0	0	
Volume Right	0	0	0	0	0	
cSH	1082	1700	1700	1700	1700	
Volume to Capacity	0.00	0.12	0.28	0.00	0.00	
Queue Length 95th (m)	0.0	0.0	0.0	0.0	0.0	
Control Delay (s)	0.0	0.0	0.0	0.0	0.0	
Lane LOS				A	A	
Approach Delay (s)	0.0	0.0		0.0		
Approach LOS				A		
Intersection Summary						
Average Delay			0.0			
Intersection Capacity Utilization			29.8%	ICU Level of Service	A	
Analysis Period (min)			15			

Background 2027 SAT
1: Trim Road & Watters Road

10/28/2021



Lane Group	EBL	EBT	WBL	WBT	NBL	NBT	NBR	SBL	SBT	SBR
Lane Configurations										
Traffic Volume (vph)	299	11	14	14	97	721	6	16	723	274
Future Volume (vph)	299	11	14	14	97	721	6	16	723	274
Lane Group Flow (vph)	299	78	14	36	97	721	6	16	723	274
Turn Type	Perm	NA	Perm	NA	pm+pt	NA	Perm	Perm	NA	Perm
Protected Phases		4		8	5	2			6	
Permitted Phases	4		8		2		2	6		6
Detector Phase	4	4	8	8	5	2	2	6	6	6
Switch Phase										
Minimum Initial (s)	10.0	10.0	10.0	10.0	5.0	10.0	10.0	10.0	10.0	10.0
Minimum Split (s)	28.2	28.2	28.2	28.2	16.0	46.7	46.7	30.0	30.0	30.0
Total Split (s)	28.2	28.2	28.2	28.2	16.0	46.8	46.8	30.8	30.8	30.8
Total Split (%)	37.6%	37.6%	37.6%	37.6%	21.3%	62.4%	62.4%	41.1%	41.1%	41.1%
Yellow Time (s)	3.3	3.3	3.3	3.3	3.7	3.7	3.7	3.7	3.7	3.7
All-Red Time (s)	4.9	4.9	4.9	4.9	3.0	3.0	3.0	3.0	3.0	3.0
Lost Time Adjust (s)	0.0	0.0	0.0	0.0	0.0	0.0	0.0	0.0	0.0	0.0
Total Lost Time (s)	8.2	8.2	8.2	8.2	6.7	6.7	6.7	6.7	6.7	6.7
Lead/Lag					Lead			Lag	Lag	Lag
Lead-Lag Optimize?					Yes			Yes	Yes	Yes
Recall Mode	Max	Max	Max	Max	Max	Min	Min	Min	Min	Min
Act Effct Green (s)	32.0	32.0	32.0	32.0	38.3	38.3	38.3	22.3	22.3	22.3
Actuated g/C Ratio	0.38	0.38	0.38	0.38	0.45	0.45	0.45	0.26	0.26	0.26
v/c Ratio	0.61	0.12	0.03	0.06	0.35	0.47	0.01	0.09	0.82	0.46
Control Delay	28.5	6.8	18.0	10.5	17.1	17.6	0.0	25.1	37.9	6.1
Queue Delay	0.0	0.0	0.0	0.0	0.0	0.0	0.0	0.0	0.0	0.0
Total Delay	28.5	6.8	18.0	10.5	17.1	17.6	0.0	25.1	37.9	6.1
LOS	C	A	B	B	B	B	A	C	D	A
Approach Delay		24.0		12.6		17.4			29.1	
Approach LOS		C		B		B			C	
Queue Length 50th (m)	40.1	1.2	1.5	1.5	8.9	41.6	0.0	2.0	58.1	0.0
Queue Length 95th (m)	67.2	9.6	5.3	7.2	17.5	56.1	0.0	6.8	78.2	17.1
Internal Link Dist (m)		95.2		300.5		130.5			233.4	
Turn Bay Length (m)	180.0		25.0		35.0		50.0	30.0		45.0
Base Capacity (vph)	491	625	473	622	281	1596	754	190	959	625
Starvation Cap Reductn	0	0	0	0	0	0	0	0	0	0
Spillback Cap Reductn	0	0	0	0	0	0	0	0	0	0
Storage Cap Reductn	0	0	0	0	0	0	0	0	0	0
Reduced v/c Ratio	0.61	0.12	0.03	0.06	0.35	0.45	0.01	0.08	0.75	0.44

Intersection Summary

Cycle Length: 75	
Actuated Cycle Length: 85.3	
Natural Cycle: 75	
Control Type: Actuated-Uncoordinated	
Maximum v/c Ratio: 0.82	
Intersection Signal Delay: 23.6	Intersection LOS: C
Intersection Capacity Utilization 71.5%	ICU Level of Service C
Analysis Period (min) 15	

Splits and Phases: 1: Trim Road & Watters Road



Background 2027 SAT
 2: Trim Road & Crown Pointe Plaza Access 1

10/28/2021



Lane Group	EBR	NBL	NBT	SBT
Lane Configurations				
Traffic Volume (vph)	85	64	843	802
Future Volume (vph)	85	64	843	802
Lane Group Flow (vph)	85	64	843	816
Sign Control			Free	Free

Intersection Summary

Control Type: Unsignalized

Intersection Capacity Utilization 36.1% ICU Level of Service A

Analysis Period (min) 15

Background 2027 SAT
2: Trim Road & Crown Pointe Plaza Access 1

10/28/2021



Movement	EBL	EBR	NBL	NBT	SBT	SBR
Lane Configurations						
Traffic Volume (veh/h)	0	85	64	843	802	14
Future Volume (Veh/h)	0	85	64	843	802	14
Sign Control	Stop			Free	Free	
Grade	0%			0%	0%	
Peak Hour Factor	1.00	1.00	1.00	1.00	1.00	1.00
Hourly flow rate (vph)	0	85	64	843	802	14
Pedestrians						
Lane Width (m)						
Walking Speed (m/s)						
Percent Blockage						
Right turn flare (veh)						
Median type				None	None	
Median storage veh						
Upstream signal (m)					155	
pX, platoon unblocked	0.81	0.81	0.81			
vC, conflicting volume	1358	408	816			
vC1, stage 1 conf vol						
vC2, stage 2 conf vol						
vCu, unblocked vol	961	0	288			
tC, single (s)	6.8	6.9	4.1			
tC, 2 stage (s)						
tF (s)	3.5	3.3	2.2			
p0 queue free %	100	90	94			
cM capacity (veh/h)	192	873	1024			
Direction, Lane #	EB 1	NB 1	NB 2	NB 3	SB 1	SB 2
Volume Total	85	64	422	422	535	281
Volume Left	0	64	0	0	0	0
Volume Right	85	0	0	0	0	14
cSH	873	1024	1700	1700	1700	1700
Volume to Capacity	0.10	0.06	0.25	0.25	0.31	0.17
Queue Length 95th (m)	2.5	1.5	0.0	0.0	0.0	0.0
Control Delay (s)	9.6	8.8	0.0	0.0	0.0	0.0
Lane LOS	A	A				
Approach Delay (s)	9.6	0.6	0.0			
Approach LOS	A					
Intersection Summary						
Average Delay			0.8			
Intersection Capacity Utilization			36.1%	ICU Level of Service	A	
Analysis Period (min)			15			

Background 2027 SAT
 3: Trim Road & Crown Pointe Plaza Access 2

10/28/2021



Lane Group	EBR	NBT	SBT
Lane Configurations	↗	↑↑↑	↑↑
Traffic Volume (vph)	2	920	902
Future Volume (vph)	2	920	902
Lane Group Flow (vph)	2	920	902
Sign Control		Free	Free

Intersection Summary

Control Type: Unsignalized

Intersection Capacity Utilization 36.3% ICU Level of Service A

Analysis Period (min) 15

Background 2027 SAT
3: Trim Road & Crown Pointe Plaza Access 2

10/28/2021



Movement	EBL	EBR	NBL	NBT	SBT	SBR
Lane Configurations		↗		↑↑↑	↑↑	
Traffic Volume (veh/h)	0	2	0	920	902	0
Future Volume (Veh/h)	0	2	0	920	902	0
Sign Control	Stop			Free	Free	
Grade	0%			0%	0%	
Peak Hour Factor	1.00	1.00	1.00	1.00	1.00	1.00
Hourly flow rate (vph)	0	2	0	920	902	0
Pedestrians						
Lane Width (m)						
Walking Speed (m/s)						
Percent Blockage						
Right turn flare (veh)						
Median type				None	None	
Median storage veh						
Upstream signal (m)	194					
pX, platoon unblocked	0.81	0.81	0.81			
vC, conflicting volume	1209	451	902			
vC1, stage 1 conf vol						
vC2, stage 2 conf vol						
vCu, unblocked vol	785	0	406			
tC, single (s)	6.8	6.9	4.1			
tC, 2 stage (s)						
tF (s)	3.5	3.3	2.2			
p0 queue free %	100	100	100			
cM capacity (veh/h)	267	877	929			
Direction, Lane #	EB 1	NB 1	NB 2	NB 3	SB 1	SB 2
Volume Total	2	307	307	307	451	451
Volume Left	0	0	0	0	0	0
Volume Right	2	0	0	0	0	0
cSH	877	1700	1700	1700	1700	1700
Volume to Capacity	0.00	0.18	0.18	0.18	0.27	0.27
Queue Length 95th (m)	0.1	0.0	0.0	0.0	0.0	0.0
Control Delay (s)	9.1	0.0	0.0	0.0	0.0	0.0
Lane LOS	A					
Approach Delay (s)	9.1	0.0	0.0			
Approach LOS	A					
Intersection Summary						
Average Delay	0.0					
Intersection Capacity Utilization	36.3%			ICU Level of Service		A
Analysis Period (min)	15					

Background 2027 SAT

4: Trim Road & Portobello Boulevard/Springridge Drive

10/28/2021



Lane Group	EBL	EBT	EBR	WBL	WBT	NBL	NBT	NBR	SBL	SBT	SBR
Lane Configurations											
Traffic Volume (vph)	187	39	4	28	36	6	546	27	25	525	221
Future Volume (vph)	187	39	4	28	36	6	546	27	25	525	221
Lane Group Flow (vph)	187	39	4	28	60	6	546	27	25	525	221
Turn Type	pm+pt	NA	Perm	Perm	NA	Perm	NA	Perm	pm+pt	NA	Perm
Protected Phases	5	2			6		8		7	4	
Permitted Phases	2		2	6		8		8	4		4
Detector Phase	5	2	2	6	6	8	8	8	7	4	4
Switch Phase											
Minimum Initial (s)	5.0	10.0	10.0	10.0	10.0	10.0	10.0	10.0	5.0	10.0	10.0
Minimum Split (s)	13.9	38.9	38.9	26.0	26.0	35.0	35.0	35.0	12.3	46.4	46.4
Total Split (s)	13.9	39.9	39.9	26.0	26.0	35.0	35.0	35.0	11.4	46.4	46.4
Total Split (%)	16.1%	46.2%	46.2%	30.1%	30.1%	40.6%	40.6%	40.6%	13.2%	53.8%	53.8%
Yellow Time (s)	3.3	3.3	3.3	3.3	3.3	3.7	3.7	3.7	3.7	3.7	3.7
All-Red Time (s)	3.6	3.6	3.6	3.6	3.6	2.7	2.7	2.7	2.7	2.7	2.7
Lost Time Adjust (s)	0.0	0.0	0.0	0.0	0.0	0.0	0.0	0.0	0.0	0.0	0.0
Total Lost Time (s)	6.9	6.9	6.9	6.9	6.9	6.4	6.4	6.4	6.4	6.4	6.4
Lead/Lag	Lead			Lag	Lag	Lag	Lag	Lag	Lead		
Lead-Lag Optimize?	Yes			Yes	Yes	Yes	Yes	Yes	Yes		
Recall Mode	Max	Max	Max	Max	Max	Min	Min	Min	Max	Min	Min
Act Effct Green (s)	46.0	46.0	46.0	32.1	32.1	19.7	19.7	19.7	31.1	31.1	31.1
Actuated g/C Ratio	0.51	0.51	0.51	0.35	0.35	0.22	0.22	0.22	0.34	0.34	0.34
v/c Ratio	0.32	0.04	0.00	0.06	0.10	0.03	0.74	0.06	0.12	0.45	0.33
Control Delay	15.0	12.8	0.0	21.5	14.9	27.2	39.4	0.2	20.4	24.2	4.3
Queue Delay	0.0	0.0	0.0	0.0	0.0	0.0	0.0	0.0	0.0	0.0	0.0
Total Delay	15.0	12.8	0.0	21.5	14.9	27.2	39.4	0.2	20.4	24.2	4.3
LOS	B	B	A	C	B	C	D	A	C	C	A
Approach Delay		14.4			17.0		37.5			18.4	
Approach LOS		B			B		D			B	
Queue Length 50th (m)	17.0	3.2	0.0	3.2	4.1	0.8	46.7	0.0	2.8	36.7	0.0
Queue Length 95th (m)	34.0	9.2	0.0	9.7	13.2	3.8	63.6	0.0	8.0	50.2	13.6
Internal Link Dist (m)		89.0			153.8		234.9			500.4	
Turn Bay Length (m)			75.0	30.0		50.0		45.0	35.0		45.0
Base Capacity (vph)	585	907	821	462	607	258	1074	611	205	1502	786
Starvation Cap Reductn	0	0	0	0	0	0	0	0	0	0	0
Spillback Cap Reductn	0	0	0	0	0	0	0	0	0	0	0
Storage Cap Reductn	0	0	0	0	0	0	0	0	0	0	0
Reduced v/c Ratio	0.32	0.04	0.00	0.06	0.10	0.02	0.51	0.04	0.12	0.35	0.28

Intersection Summary

Cycle Length: 86.3	
Actuated Cycle Length: 90.5	
Natural Cycle: 90	
Control Type: Semi Act-Uncoord	
Maximum v/c Ratio: 0.74	
Intersection Signal Delay: 24.4	Intersection LOS: C
Intersection Capacity Utilization 75.2%	ICU Level of Service D
Analysis Period (min) 15	

Background 2027 SAT
4: Trim Road & Portobello Boulevard/Springridge Drive

10/28/2021

Splits and Phases: 4: Trim Road & Portobello Boulevard/Springridge Drive

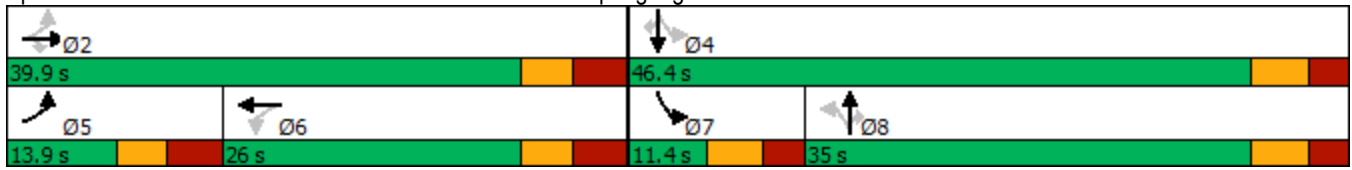

Background 2027 SAT
 5: Charlemagne Boulevard & Watters Road

10/28/2021



Lane Group	WBL	NBT	SBT
Lane Configurations			
Traffic Volume (vph)	131	231	105
Future Volume (vph)	131	231	105
Lane Group Flow (vph)	203	338	154
Sign Control	Stop	Stop	Stop

Intersection Summary

Control Type: Unsignalized

Intersection Capacity Utilization 37.2% ICU Level of Service A

Analysis Period (min) 15

Background 2027 SAT
 5: Charlemagne Boulevard & Watters Road

10/28/2021



Movement	WBL	WBR	NBT	NBR	SBL	SBT
Lane Configurations						
Sign Control	Stop		Stop			Stop
Traffic Volume (vph)	131	72	231	107	49	105
Future Volume (vph)	131	72	231	107	49	105
Peak Hour Factor	1.00	1.00	1.00	1.00	1.00	1.00
Hourly flow rate (vph)	131	72	231	107	49	105
Direction, Lane #	WB 1	NB 1	NB 2	SB 1	SB 2	
Volume Total (vph)	203	154	184	84	70	
Volume Left (vph)	131	0	0	49	0	
Volume Right (vph)	72	0	107	0	0	
Hadj (s)	-0.05	0.03	-0.37	0.33	0.03	
Departure Headway (s)	5.0	5.3	4.9	5.7	5.4	
Degree Utilization, x	0.28	0.23	0.25	0.13	0.11	
Capacity (veh/h)	679	659	713	596	628	
Control Delay (s)	9.9	8.6	8.2	8.4	7.9	
Approach Delay (s)	9.9	8.4		8.2		
Approach LOS	A	A		A		
Intersection Summary						
Delay			8.8			
Level of Service			A			
Intersection Capacity Utilization			37.2%		ICU Level of Service	A
Analysis Period (min)			15			



Lane Group	EBT	WBT	NBT	SBT	SBR
Lane Configurations					
Traffic Volume (vph)	184	175	17	16	35
Future Volume (vph)	184	175	17	16	35
Lane Group Flow (vph)	295	366	165	122	35
Sign Control	Stop	Stop	Stop	Stop	

Intersection Summary

Control Type: Unsignalized

Intersection Capacity Utilization 55.3% ICU Level of Service B

Analysis Period (min) 15



Movement	EBL	EBT	EBR	WBL	WBT	WBR	NBL	NBT	NBR	SBL	SBT	SBR
Lane Configurations		↔			↔			↔			↔	↔
Sign Control		Stop			Stop			Stop			Stop	↔
Traffic Volume (vph)	46	184	65	75	175	116	62	17	86	106	16	35
Future Volume (vph)	46	184	65	75	175	116	62	17	86	106	16	35
Peak Hour Factor	1.00	1.00	1.00	1.00	1.00	1.00	1.00	1.00	1.00	1.00	1.00	1.00
Hourly flow rate (vph)	46	184	65	75	175	116	62	17	86	106	16	35
Direction, Lane #	EB 1	WB 1	NB 1	SB 1	SB 2							
Volume Total (vph)	295	366	165	122	35							
Volume Left (vph)	46	75	62	106	0							
Volume Right (vph)	65	116	86	0	35							
Hadj (s)	-0.07	-0.12	-0.20	0.47	-0.67							
Departure Headway (s)	5.4	5.3	6.0	7.1	5.9							
Degree Utilization, x	0.45	0.54	0.27	0.24	0.06							
Capacity (veh/h)	618	646	530	456	534							
Control Delay (s)	12.7	14.2	11.2	11.1	8.1							
Approach Delay (s)	12.7	14.2	11.2	10.4								
Approach LOS	B	B	B	B								

Intersection Summary

Delay	12.7		
Level of Service	B		
Intersection Capacity Utilization	55.3%	ICU Level of Service	B
Analysis Period (min)	15		

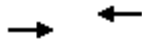

Lane Group	EBT	WBT
Lane Configurations	↔↑	↑↔
Traffic Volume (vph)	376	385
Future Volume (vph)	376	385
Lane Group Flow (vph)	376	385
Sign Control	Free	Free

Intersection Summary

Control Type: Unsignalized

Intersection Capacity Utilization 24.7% ICU Level of Service A

Analysis Period (min) 15

Background 2027 SAT
7: Watters Road

10/28/2021



Movement	EBL	EBT	WBT	WBR	SBL	SBR
Lane Configurations		↔↑	↔		↘	↘
Traffic Volume (veh/h)	0	376	385	0	0	0
Future Volume (Veh/h)	0	376	385	0	0	0
Sign Control		Free	Free		Stop	
Grade		0%	0%		0%	
Peak Hour Factor	1.00	1.00	1.00	1.00	1.00	1.00
Hourly flow rate (vph)	0	376	385	0	0	0
Pedestrians						
Lane Width (m)						
Walking Speed (m/s)						
Percent Blockage						
Right turn flare (veh)						
Median type		None	None			
Median storage (veh)						
Upstream signal (m)			119			
pX, platoon unblocked						
vC, conflicting volume	385				573	385
vC1, stage 1 conf vol						
vC2, stage 2 conf vol						
vCu, unblocked vol	385				573	385
tC, single (s)	4.1				6.8	6.9
tC, 2 stage (s)						
tF (s)	2.2				3.5	3.3
p0 queue free %	100				100	100
cM capacity (veh/h)	1170				450	613
Direction, Lane #	EB 1	EB 2	WB 1	SB 1	SB 2	
Volume Total	125	251	385	0	0	
Volume Left	0	0	0	0	0	
Volume Right	0	0	0	0	0	
cSH	1170	1700	1700	1700	1700	
Volume to Capacity	0.00	0.15	0.23	0.00	0.00	
Queue Length 95th (m)	0.0	0.0	0.0	0.0	0.0	
Control Delay (s)	0.0	0.0	0.0	0.0	0.0	
Lane LOS				A	A	
Approach Delay (s)	0.0		0.0	0.0		
Approach LOS				A		
Intersection Summary						
Average Delay			0.0			
Intersection Capacity Utilization			24.7%		ICU Level of Service	A
Analysis Period (min)			15			

APPENDIX J

SYNCHRO CAPACITY ANALYSIS: TOTAL PROJECTED 2022 CONDITIONS

Total 2022 AM
1: Trim Road & Watters Road



Lane Group	EBL	EBT	WBL	WBT	NBL	NBT	NBR	SBL	SBT	SBR
Lane Configurations										
Traffic Volume (vph)	347	11	15	17	87	824	4	6	348	187
Future Volume (vph)	347	11	15	17	87	824	4	6	348	187
Lane Group Flow (vph)	347	89	15	43	87	824	4	6	348	187
Turn Type	Perm	NA	Perm	NA	pm+pt	NA	Perm	Perm	NA	Perm
Protected Phases		4		8	5	2			6	
Permitted Phases	4		8		2		2	6		6
Detector Phase	4	4	8	8	5	2	2	6	6	6
Switch Phase										
Minimum Initial (s)	10.0	10.0	10.0	10.0	5.0	10.0	10.0	10.0	10.0	10.0
Minimum Split (s)	40.2	40.2	40.2	40.2	13.6	51.7	51.7	35.0	35.0	35.0
Total Split (s)	42.0	42.0	42.0	42.0	13.6	53.0	53.0	39.4	39.4	39.4
Total Split (%)	44.2%	44.2%	44.2%	44.2%	14.3%	55.8%	55.8%	41.5%	41.5%	41.5%
Yellow Time (s)	3.3	3.3	3.3	3.3	3.7	3.7	3.7	3.7	3.7	3.7
All-Red Time (s)	4.9	4.9	4.9	4.9	3.0	3.0	3.0	3.0	3.0	3.0
Lost Time Adjust (s)	0.0	0.0	0.0	0.0	0.0	0.0	0.0	0.0	0.0	0.0
Total Lost Time (s)	8.2	8.2	8.2	8.2	6.7	6.7	6.7	6.7	6.7	6.7
Lead/Lag					Lead			Lag	Lag	Lag
Lead-Lag Optimize?					Yes			Yes	Yes	Yes
Recall Mode	Max	Max	Max	Max	Max	Min	Min	Min	Min	Min
Act Effct Green (s)	33.8	33.8	33.8	33.8	27.4	27.4	27.4	13.8	13.8	13.8
Actuated g/C Ratio	0.44	0.44	0.44	0.44	0.36	0.36	0.36	0.18	0.18	0.18
v/c Ratio	0.60	0.12	0.03	0.06	0.27	0.68	0.01	0.05	0.57	0.44
Control Delay	22.3	5.0	13.5	7.9	18.4	23.7	0.0	26.2	32.1	7.9
Queue Delay	0.0	0.0	0.0	0.0	0.0	0.0	0.0	0.0	0.0	0.0
Total Delay	22.3	5.0	13.5	7.9	18.4	23.7	0.0	26.2	32.1	7.9
LOS	C	A	B	A	B	C	A	C	C	A
Approach Delay		18.7		9.4		23.1			23.7	
Approach LOS		B		A		C			C	
Queue Length 50th (m)	36.4	0.9	1.2	1.3	8.3	51.6	0.0	0.7	24.2	0.0
Queue Length 95th (m)	70.1	8.9	4.7	7.2	17.0	69.5	0.0	3.8	36.4	14.9
Internal Link Dist (m)		94.7		300.5		130.5			233.4	
Turn Bay Length (m)			25.0		35.0		50.0	30.0		45.0
Base Capacity (vph)	577	721	550	729	324	2062	923	261	1456	758
Starvation Cap Reductn	0	0	0	0	0	0	0	0	0	0
Spillback Cap Reductn	0	0	0	0	0	0	0	0	0	0
Storage Cap Reductn	0	0	0	0	0	0	0	0	0	0
Reduced v/c Ratio	0.60	0.12	0.03	0.06	0.27	0.40	0.00	0.02	0.24	0.25

Intersection Summary

Cycle Length: 95	
Actuated Cycle Length: 76.2	
Natural Cycle: 95	
Control Type: Actuated-Uncoordinated	
Maximum v/c Ratio: 0.68	
Intersection Signal Delay: 21.9	Intersection LOS: C
Intersection Capacity Utilization 77.3%	ICU Level of Service D
Analysis Period (min) 15	

Total 2022 AM
1: Trim Road & Watters Road

Splits and Phases: 1: Trim Road & Watters Road

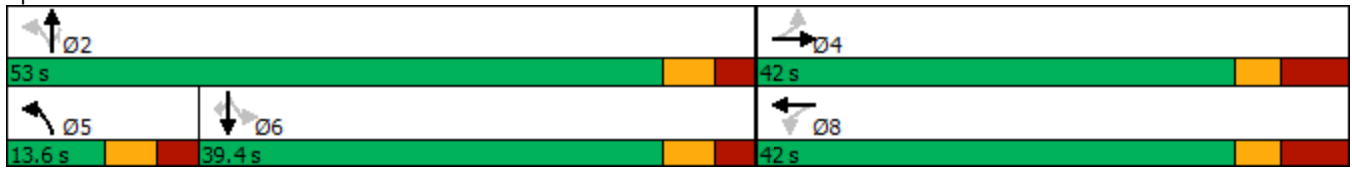

Total 2022 AM
 2: Trim Road & Crown Pointe Plaza Access 1



Lane Group	EBR	NBL	NBT	SBT
Lane Configurations				
Traffic Volume (vph)	28	37	932	443
Future Volume (vph)	28	37	932	443
Lane Group Flow (vph)	28	37	932	463
Sign Control			Free	Free

Intersection Summary

Control Type: Unsignalized

Intersection Capacity Utilization 30.5% ICU Level of Service A

Analysis Period (min) 15

Total 2022 AM
2: Trim Road & Crown Pointe Plaza Access 1



Movement	EBL	EBR	NBL	NBT	SBT	SBR
Lane Configurations						
Traffic Volume (veh/h)	0	28	37	932	443	20
Future Volume (Veh/h)	0	28	37	932	443	20
Sign Control	Stop			Free	Free	
Grade	0%			0%	0%	
Peak Hour Factor	1.00	1.00	1.00	1.00	1.00	1.00
Hourly flow rate (vph)	0	28	37	932	443	20
Pedestrians						
Lane Width (m)						
Walking Speed (m/s)						
Percent Blockage						
Right turn flare (veh)						
Median type				None	None	
Median storage veh						
Upstream signal (m)					155	
pX, platoon unblocked	0.92	0.92	0.92			
vC, conflicting volume	993	232	463			
vC1, stage 1 conf vol						
vC2, stage 2 conf vol						
vCu, unblocked vol	820	0	244			
tC, single (s)	6.8	6.9	4.1			
tC, 2 stage (s)						
tF (s)	3.5	3.3	2.2			
p0 queue free %	100	97	97			
cM capacity (veh/h)	279	998	1214			
Direction, Lane #	EB 1	NB 1	NB 2	NB 3	SB 1	SB 2
Volume Total	28	37	466	466	295	168
Volume Left	0	37	0	0	0	0
Volume Right	28	0	0	0	0	20
cSH	998	1214	1700	1700	1700	1700
Volume to Capacity	0.03	0.03	0.27	0.27	0.17	0.10
Queue Length 95th (m)	0.7	0.7	0.0	0.0	0.0	0.0
Control Delay (s)	8.7	8.1	0.0	0.0	0.0	0.0
Lane LOS	A	A				
Approach Delay (s)	8.7	0.3	0.0			
Approach LOS	A					
Intersection Summary						
Average Delay			0.4			
Intersection Capacity Utilization			30.5%	ICU Level of Service	A	
Analysis Period (min)			15			

Total 2022 AM
 3: Trim Road & Crown Pointe Plaza Access 2



Lane Group	EBR	NBT	SBT
Lane Configurations	↗	↑↑↑	↑↑
Traffic Volume (vph)	3	970	473
Future Volume (vph)	3	970	473
Lane Group Flow (vph)	3	970	473
Sign Control		Free	Free

Intersection Summary

Control Type: Unsignalized
 Intersection Capacity Utilization 23.8% ICU Level of Service A
 Analysis Period (min) 15

Total 2022 AM
3: Trim Road & Crown Pointe Plaza Access 2



Movement	EBL	EBR	NBL	NBT	SBT	SBR
Lane Configurations		↗		↑↑↑	↑↑	
Traffic Volume (veh/h)	0	3	0	970	473	0
Future Volume (Veh/h)	0	3	0	970	473	0
Sign Control	Stop			Free	Free	
Grade	0%			0%	0%	
Peak Hour Factor	1.00	1.00	1.00	1.00	1.00	1.00
Hourly flow rate (vph)	0	3	0	970	473	0
Pedestrians						
Lane Width (m)						
Walking Speed (m/s)						
Percent Blockage						
Right turn flare (veh)						
Median type				None	None	
Median storage veh						
Upstream signal (m)				194		
pX, platoon unblocked	0.93	0.93	0.93			
vC, conflicting volume	796	236	473			
vC1, stage 1 conf vol						
vC2, stage 2 conf vol						
vCu, unblocked vol	636	35	289			
tC, single (s)	6.8	6.9	4.1			
tC, 2 stage (s)						
tF (s)	3.5	3.3	2.2			
p0 queue free %	100	100	100			
cM capacity (veh/h)	383	960	1184			
Direction, Lane #	EB 1	NB 1	NB 2	NB 3	SB 1	SB 2
Volume Total	3	323	323	323	236	236
Volume Left	0	0	0	0	0	0
Volume Right	3	0	0	0	0	0
cSH	960	1700	1700	1700	1700	1700
Volume to Capacity	0.00	0.19	0.19	0.19	0.14	0.14
Queue Length 95th (m)	0.1	0.0	0.0	0.0	0.0	0.0
Control Delay (s)	8.8	0.0	0.0	0.0	0.0	0.0
Lane LOS	A					
Approach Delay (s)	8.8	0.0	0.0			
Approach LOS	A					
Intersection Summary						
Average Delay	0.0					
Intersection Capacity Utilization	23.8%			ICU Level of Service	A	
Analysis Period (min)	15					

Total 2022 AM
4: Trim Road & Portobello Boulevard/Springridge Drive



Lane Group	EBL	EBT	EBR	WBL	WBT	NBL	NBT	NBR	SBL	SBT	SBR
Lane Configurations											
Traffic Volume (vph)	261	25	2	29	49	9	591	9	11	422	122
Future Volume (vph)	261	25	2	29	49	9	591	9	11	422	122
Lane Group Flow (vph)	261	25	2	29	90	9	591	9	11	422	122
Turn Type	pm+pt	NA	Perm	Perm	NA	Perm	NA	Perm	pm+pt	NA	Perm
Protected Phases	5	2			6		8		7	4	
Permitted Phases	2		2	6		8		8	4		4
Detector Phase	5	2	2	6	6	8	8	8	7	4	4
Switch Phase											
Minimum Initial (s)	5.0	10.0	10.0	10.0	10.0	10.0	10.0	10.0	5.0	10.0	10.0
Minimum Split (s)	16.9	38.9	38.9	38.9	38.9	40.0	40.0	40.0	12.3	51.4	51.4
Total Split (s)	16.9	39.9	39.9	23.0	23.0	40.0	40.0	40.0	11.4	51.4	51.4
Total Split (%)	18.5%	43.7%	43.7%	25.2%	25.2%	43.8%	43.8%	43.8%	12.5%	56.3%	56.3%
Yellow Time (s)	3.3	3.3	3.3	3.3	3.3	3.7	3.7	3.7	3.7	3.7	3.7
All-Red Time (s)	3.6	3.6	3.6	3.6	3.6	2.7	2.7	2.7	2.7	2.7	2.7
Lost Time Adjust (s)	0.0	0.0	0.0	0.0	0.0	0.0	0.0	0.0	0.0	0.0	0.0
Total Lost Time (s)	6.9	6.9	6.9	6.9	6.9	6.4	6.4	6.4	6.4	6.4	6.4
Lead/Lag	Lead			Lag	Lag	Lag	Lag	Lag	Lead		
Lead-Lag Optimize?	Yes			Yes	Yes	Yes	Yes	Yes	Yes		
Recall Mode	Max	Max	Max	Max	Max	Min	Min	Min	Max	Min	Min
Act Effct Green (s)	49.0	49.0	49.0	32.1	32.1	21.9	21.9	21.9	33.4	33.4	33.4
Actuated g/C Ratio	0.51	0.51	0.51	0.34	0.34	0.23	0.23	0.23	0.35	0.35	0.35
v/c Ratio	0.44	0.03	0.00	0.07	0.16	0.04	0.76	0.02	0.06	0.36	0.20
Control Delay	17.3	13.4	0.0	24.2	15.4	28.1	41.2	0.1	20.2	23.8	4.2
Queue Delay	0.0	0.0	0.0	0.0	0.0	0.0	0.0	0.0	0.0	0.0	0.0
Total Delay	17.3	13.4	0.0	24.2	15.4	28.1	41.2	0.1	20.2	23.8	4.2
LOS	B	B	A	C	B	C	D	A	C	C	A
Approach Delay		16.8			17.6		40.4			19.5	
Approach LOS		B			B		D			B	
Queue Length 50th (m)	26.2	2.2	0.0	3.6	6.2	1.3	53.7	0.0	1.3	30.1	0.0
Queue Length 95th (m)	49.2	7.1	0.0	10.6	18.5	5.1	71.5	0.0	4.7	41.8	9.6
Internal Link Dist (m)		89.0			153.8		234.9			500.4	
Turn Bay Length (m)			75.0	30.0		50.0		45.0	35.0		45.0
Base Capacity (vph)	593	913	820	440	576	316	1192	653	192	1597	770
Starvation Cap Reductn	0	0	0	0	0	0	0	0	0	0	0
Spillback Cap Reductn	0	0	0	0	0	0	0	0	0	0	0
Storage Cap Reductn	0	0	0	0	0	0	0	0	0	0	0
Reduced v/c Ratio	0.44	0.03	0.00	0.07	0.16	0.03	0.50	0.01	0.06	0.26	0.16

Intersection Summary

Cycle Length: 91.3

Actuated Cycle Length: 95.7

Natural Cycle: 110

Control Type: Semi Act-Uncoord

Maximum v/c Ratio: 0.76

Intersection Signal Delay: 26.9

Intersection LOS: C

Intersection Capacity Utilization 75.2%

ICU Level of Service D

Analysis Period (min) 15

Total 2022 AM

4: Trim Road & Portobello Boulevard/Springridge Drive

Splits and Phases: 4: Trim Road & Portobello Boulevard/Springridge Drive

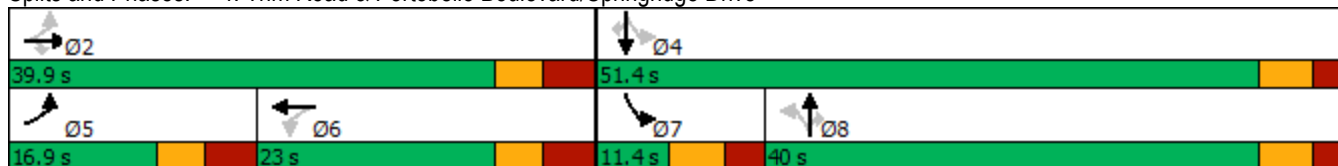

Total 2022 AM
 5: Charlemagne Boulevard & Watters Road



Lane Group	WBL	NBT	SBT
Lane Configurations			
Traffic Volume (vph)	186	201	214
Future Volume (vph)	186	201	214
Lane Group Flow (vph)	368	371	291
Sign Control	Stop	Stop	Stop

Intersection Summary

Control Type: Unsignalized

Intersection Capacity Utilization 52.9% ICU Level of Service A

Analysis Period (min) 15

Total 2022 AM
5: Charlemagne Boulevard & Watters Road



Movement	WBL	WBR	NBT	NBR	SBL	SBT
Lane Configurations						
Sign Control	Stop		Stop			Stop
Traffic Volume (vph)	186	182	201	170	77	214
Future Volume (vph)	186	182	201	170	77	214
Peak Hour Factor	1.00	1.00	1.00	1.00	1.00	1.00
Hourly flow rate (vph)	186	182	201	170	77	214
Direction, Lane #	WB 1	NB 1	NB 2	SB 1	SB 2	
Volume Total (vph)	368	134	237	148	143	
Volume Left (vph)	186	0	0	77	0	
Volume Right (vph)	182	0	170	0	0	
Hadj (s)	-0.16	0.03	-0.47	0.29	0.03	
Departure Headway (s)	5.3	6.1	5.6	6.4	6.1	
Degree Utilization, x	0.55	0.23	0.37	0.26	0.24	
Capacity (veh/h)	643	565	617	532	555	
Control Delay (s)	14.6	9.6	10.5	10.5	9.9	
Approach Delay (s)	14.6	10.2		10.2		
Approach LOS	B	B		B		
Intersection Summary						
Delay			11.8			
Level of Service			B			
Intersection Capacity Utilization			52.9%	ICU Level of Service		A
Analysis Period (min)			15			

Total 2022 AM

6: Crown Pointe Plaza Access 3/Montcrest Drive & Watters Road



Lane Group	EBT	WBT	NBT	SBT	SBR
Lane Configurations					
Traffic Volume (vph)	319	226	7	10	55
Future Volume (vph)	319	226	7	10	55
Lane Group Flow (vph)	387	320	76	135	55
Sign Control	Stop	Stop	Stop	Stop	

Intersection Summary

















Control Type: Unsignalized

Intersection Capacity Utilization 51.7% ICU Level of Service A

Analysis Period (min) 15

Total 2022 AM

6: Crown Pointe Plaza Access 3/Montcrest Drive & Watters Road

												
Movement	EBL	EBT	EBR	WBL	WBT	WBR	NBL	NBT	NBR	SBL	SBT	SBR
Lane Configurations												
Sign Control		Stop			Stop			Stop			Stop	
Traffic Volume (vph)	23	319	45	43	226	51	36	7	33	125	10	55
Future Volume (vph)	23	319	45	43	226	51	36	7	33	125	10	55
Peak Hour Factor	1.00	1.00	1.00	1.00	1.00	1.00	1.00	1.00	1.00	1.00	1.00	1.00
Hourly flow rate (vph)	23	319	45	43	226	51	36	7	33	125	10	55
Direction, Lane #	EB 1	WB 1	NB 1	SB 1	SB 2							
Volume Total (vph)	387	320	76	135	55							
Volume Left (vph)	23	43	36	125	0							
Volume Right (vph)	45	51	33	0	55							
Hadj (s)	-0.02	-0.03	-0.13	0.50	-0.67							
Departure Headway (s)	5.2	5.3	6.2	7.0	5.8							
Degree Utilization, x	0.56	0.47	0.13	0.26	0.09							
Capacity (veh/h)	660	645	492	467	554							
Control Delay (s)	14.6	12.9	10.1	11.3	8.2							
Approach Delay (s)	14.6	12.9	10.1	10.4								
Approach LOS	B	B	B	B								
Intersection Summary												
Delay			12.9									
Level of Service			B									
Intersection Capacity Utilization			51.7%		ICU Level of Service		A					
Analysis Period (min)			15									

Total 2022 AM
7: Watters Road

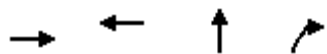

Lane Group	EBT	WBT	NBT	NBR
Lane Configurations				
Traffic Volume (vph)	472	291	0	18
Future Volume (vph)	472	291	0	18
Lane Group Flow (vph)	482	291	4	18
Sign Control	Free	Free	Stop	

















Intersection Summary

Control Type: Unsignalized

Intersection Capacity Utilization Err% ICU Level of Service H

Analysis Period (min) 15

Total 2022 AM
7: Watters Road

												
Movement	EBL	EBT	EBR	WBL	WBT	WBR	NBL	NBT	NBR	SBL	SBT	SBR
Lane Configurations												
Traffic Volume (veh/h)	0	472	10	0	291	0	4	0	18	0	0	0
Future Volume (Veh/h)	0	472	10	0	291	0	4	0	18	0	0	0
Sign Control		Free			Free			Stop			Stop	
Grade		0%			0%			0%			0%	
Peak Hour Factor	1.00	1.00	1.00	1.00	1.00	1.00	1.00	1.00	1.00	1.00	1.00	1.00
Hourly flow rate (vph)	0	472	10	0	291	0	4	0	18	0	0	0
Pedestrians												
Lane Width (m)												
Walking Speed (m/s)												
Percent Blockage												
Right turn flare (veh)												
Median type		None			None							
Median storage (veh)												
Upstream signal (m)					119							
pX, platoon unblocked												
vC, conflicting volume	291			482			768	768	241	545	773	291
vC1, stage 1 conf vol												
vC2, stage 2 conf vol												
vCu, unblocked vol	291			482			768	768	241	545	773	291
tC, single (s)	4.1			4.1			7.5	6.5	6.9	7.5	6.5	6.9
tC, 2 stage (s)												
tF (s)	2.2			2.2			3.5	4.0	3.3	3.5	4.0	3.3
p0 queue free %	100			100			99	100	98	100	100	100
cM capacity (veh/h)	1268			1077			291	330	760	411	328	706
Direction, Lane #	EB 1	EB 2	WB 1	NB 1	SB 1	SB 2						
Volume Total	236	246	291	22	0	0						
Volume Left	0	0	0	4	0	0						
Volume Right	0	10	0	18	0	0						
cSH	1268	1700	1700	588	1700	1700						
Volume to Capacity	0.00	0.14	0.17	0.04	0.00	0.00						
Queue Length 95th (m)	0.0	0.0	0.0	0.9	0.0	0.0						
Control Delay (s)	0.0	0.0	0.0	11.4	0.0	0.0						
Lane LOS				B	A	A						
Approach Delay (s)	0.0		0.0	11.4	0.0							
Approach LOS				B	A							
Intersection Summary												
Average Delay			0.3									
Intersection Capacity Utilization			Err%		ICU Level of Service				H			
Analysis Period (min)			15									

Total 2022 PM
1: Trim Road & Watters Road



Lane Group	EBL	EBT	WBL	WBT	NBL	NBT	NBR	SBL	SBT	SBR
Lane Configurations										
Traffic Volume (vph)	218	20	18	13	62	516	18	20	1190	422
Future Volume (vph)	218	20	18	13	62	516	18	20	1190	422
Lane Group Flow (vph)	218	93	18	19	62	516	18	20	1190	422
Turn Type	Perm	NA	Perm	NA	pm+pt	NA	Perm	Perm	NA	Perm
Protected Phases		4		8	5	2			6	
Permitted Phases	4		8		2		2	6		6
Detector Phase	4	4	8	8	5	2	2	6	6	6
Switch Phase										
Minimum Initial (s)	10.0	10.0	10.0	10.0	5.0	10.0	10.0	10.0	10.0	10.0
Minimum Split (s)	28.2	28.2	28.2	28.2	13.6	66.7	66.7	45.0	45.0	45.0
Total Split (s)	28.2	28.2	28.2	28.2	13.6	66.8	66.8	53.2	53.2	53.2
Total Split (%)	29.7%	29.7%	29.7%	29.7%	14.3%	70.3%	70.3%	56.0%	56.0%	56.0%
Yellow Time (s)	3.3	3.3	3.3	3.3	3.7	3.7	3.7	3.7	3.7	3.7
All-Red Time (s)	4.9	4.9	4.9	4.9	3.0	3.0	3.0	3.0	3.0	3.0
Lost Time Adjust (s)	0.0	0.0	0.0	0.0	0.0	0.0	0.0	0.0	0.0	0.0
Total Lost Time (s)	8.2	8.2	8.2	8.2	6.7	6.7	6.7	6.7	6.7	6.7
Lead/Lag					Lead			Lag	Lag	Lag
Lead-Lag Optimize?					Yes			Yes	Yes	Yes
Recall Mode	Max	Max	Max	Max	Max	Min	Min	Min	Min	Min
Act Effct Green (s)	32.1	32.1	32.1	32.1	56.7	56.7	56.7	43.1	43.1	43.1
Actuated g/C Ratio	0.31	0.31	0.31	0.31	0.55	0.55	0.55	0.42	0.42	0.42
v/c Ratio	0.53	0.18	0.05	0.04	0.34	0.28	0.02	0.06	0.85	0.51
Control Delay	36.3	10.4	27.2	21.2	15.8	12.9	0.1	18.3	33.8	6.6
Queue Delay	0.0	0.0	0.0	0.0	0.0	0.0	0.0	0.0	0.0	0.0
Total Delay	36.3	10.4	27.2	21.2	15.8	12.9	0.1	18.3	33.8	6.6
LOS	D	B	C	C	B	B	A	B	C	A
Approach Delay		28.5		24.1		12.8			26.6	
Approach LOS		C		C		B			C	
Queue Length 50th (m)	38.0	3.0	2.7	1.9	5.6	27.6	0.0	2.4	111.1	9.2
Queue Length 95th (m)	62.2	14.6	7.9	7.4	11.4	37.3	0.0	7.1	138.7	31.4
Internal Link Dist (m)		94.7		300.5		130.5			233.4	
Turn Bay Length (m)	180.0		25.0		35.0		50.0	30.0		45.0
Base Capacity (vph)	410	531	384	527	183	1968	906	369	1523	871
Starvation Cap Reductn	0	0	0	0	0	0	0	0	0	0
Spillback Cap Reductn	0	0	0	0	0	0	0	0	0	0
Storage Cap Reductn	0	0	0	0	0	0	0	0	0	0
Reduced v/c Ratio	0.53	0.18	0.05	0.04	0.34	0.26	0.02	0.05	0.78	0.48

Intersection Summary

Cycle Length: 95	
Actuated Cycle Length: 103.7	
Natural Cycle: 95	
Control Type: Actuated-Uncoordinated	
Maximum v/c Ratio: 0.85	
Intersection Signal Delay: 23.6	Intersection LOS: C
Intersection Capacity Utilization 83.6%	ICU Level of Service E
Analysis Period (min) 15	

Total 2022 PM
1: Trim Road & Watters Road

Splits and Phases: 1: Trim Road & Watters Road

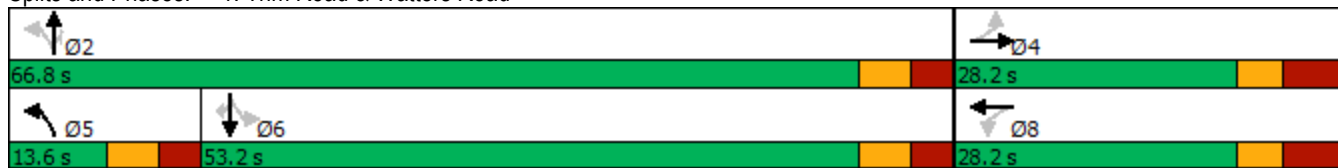

Total 2022 PM
 2: Trim Road & Crown Pointe Plaza Access 1



Lane Group	EBL	EBR	NBL	NBT	SBT
Lane Configurations					
Traffic Volume (vph)	1	93	80	600	1268
Future Volume (vph)	1	93	80	600	1268
Lane Group Flow (vph)	1	93	80	600	1320
Sign Control	Stop			Free	Free

Intersection Summary

Control Type: Unsignalized
 Intersection Capacity Utilization Err% ICU Level of Service H
 Analysis Period (min) 15

Total 2022 PM
2: Trim Road & Crown Pointe Plaza Access 1



Movement	EBL	EBR	NBL	NBT	SBT	SBR
Lane Configurations						
Traffic Volume (veh/h)	1	93	80	600	1268	52
Future Volume (Veh/h)	1	93	80	600	1268	52
Sign Control	Stop			Free	Free	
Grade	0%			0%	0%	
Peak Hour Factor	1.00	1.00	1.00	1.00	1.00	1.00
Hourly flow rate (vph)	1	93	80	600	1268	52
Pedestrians						
Lane Width (m)						
Walking Speed (m/s)						
Percent Blockage						
Right turn flare (veh)						
Median type				None	None	
Median storage veh						
Upstream signal (m)				155		
pX, platoon unblocked	0.68	0.68	0.68			
vC, conflicting volume	1754	660	1320			
vC1, stage 1 conf vol						
vC2, stage 2 conf vol						
vCu, unblocked vol	1170	0	533			
tC, single (s)	6.8	6.9	4.1			
tC, 2 stage (s)						
tF (s)	3.5	3.3	2.2			
p0 queue free %	99	87	89			
cM capacity (veh/h)	112	738	702			
Direction, Lane #	EB 1	NB 1	NB 2	NB 3	SB 1	SB 2
Volume Total	94	80	300	300	845	475
Volume Left	1	80	0	0	0	0
Volume Right	93	0	0	0	0	52
cSH	697	702	1700	1700	1700	1700
Volume to Capacity	0.13	0.11	0.18	0.18	0.50	0.28
Queue Length 95th (m)	3.5	2.9	0.0	0.0	0.0	0.0
Control Delay (s)	11.0	10.8	0.0	0.0	0.0	0.0
Lane LOS	B	B				
Approach Delay (s)	11.0	1.3	0.0			
Approach LOS	B					
Intersection Summary						
Average Delay	0.9					
Intersection Capacity Utilization	Err%			ICU Level of Service	H	
Analysis Period (min)	15					

Total 2022 PM
 3: Trim Road & Crown Pointe Plaza Access 2



Lane Group	EBR	NBT	SBT
Lane Configurations	↖	↑↑↑	↑↑
Traffic Volume (vph)	8	684	1358
Future Volume (vph)	8	684	1358
Lane Group Flow (vph)	8	684	1358
Sign Control		Free	Free

Intersection Summary

Control Type: Unsignalized
 Intersection Capacity Utilization 49.6% ICU Level of Service A
 Analysis Period (min) 15

Total 2022 PM
 3: Trim Road & Crown Pointe Plaza Access 2



Movement	EBL	EBR	NBL	NBT	SBT	SBR
Lane Configurations		↗		↑↑↑	↑↑	
Traffic Volume (veh/h)	0	8	0	684	1358	0
Future Volume (Veh/h)	0	8	0	684	1358	0
Sign Control	Stop			Free	Free	
Grade	0%			0%	0%	
Peak Hour Factor	1.00	1.00	1.00	1.00	1.00	1.00
Hourly flow rate (vph)	0	8	0	684	1358	0
Pedestrians						
Lane Width (m)						
Walking Speed (m/s)						
Percent Blockage						
Right turn flare (veh)						
Median type				None	None	
Median storage veh						
Upstream signal (m)					194	
pX, platoon unblocked	0.69	0.69	0.69			
vC, conflicting volume	1586	679	1358			
vC1, stage 1 conf vol						
vC2, stage 2 conf vol						
vCu, unblocked vol	938	0	606			
tC, single (s)	6.8	6.9	4.1			
tC, 2 stage (s)						
tF (s)	3.5	3.3	2.2			
p0 queue free %	100	99	100			
cM capacity (veh/h)	180	744	664			
Direction, Lane #	EB 1	NB 1	NB 2	NB 3	SB 1	SB 2
Volume Total	8	228	228	228	679	679
Volume Left	0	0	0	0	0	0
Volume Right	8	0	0	0	0	0
cSH	744	1700	1700	1700	1700	1700
Volume to Capacity	0.01	0.13	0.13	0.13	0.40	0.40
Queue Length 95th (m)	0.2	0.0	0.0	0.0	0.0	0.0
Control Delay (s)	9.9	0.0	0.0	0.0	0.0	0.0
Lane LOS	A					
Approach Delay (s)	9.9	0.0	0.0			
Approach LOS	A					
Intersection Summary						
Average Delay	0.0					
Intersection Capacity Utilization	49.6%			ICU Level of Service	A	
Analysis Period (min)	15					

Total 2022 PM
4: Trim Road & Portobello Boulevard/Springridge Drive



Lane Group	EBL	EBT	EBR	WBL	WBT	NBL	NBT	NBR	SBL	SBT	SBR
Lane Configurations											
Traffic Volume (vph)	141	65	6	21	39	6	456	28	42	767	389
Future Volume (vph)	141	65	6	21	39	6	456	28	42	767	389
Lane Group Flow (vph)	141	65	6	21	62	6	456	28	42	767	389
Turn Type	pm+pt	NA	Perm	Perm	NA	Perm	NA	Perm	pm+pt	NA	Perm
Protected Phases	5	2			6		8		7	4	
Permitted Phases	2		2	6		8		8	4		4
Detector Phase	5	2	2	6	6	8	8	8	7	4	4
Switch Phase											
Minimum Initial (s)	5.0	10.0	10.0	10.0	10.0	10.0	10.0	10.0	5.0	10.0	10.0
Minimum Split (s)	13.9	38.9	38.9	26.0	26.0	38.0	38.0	38.0	12.3	51.4	51.4
Total Split (s)	13.9	39.9	39.9	26.0	26.0	38.0	38.0	38.0	13.4	51.4	51.4
Total Split (%)	15.2%	43.7%	43.7%	28.5%	28.5%	41.6%	41.6%	41.6%	14.7%	56.3%	56.3%
Yellow Time (s)	3.3	3.3	3.3	3.3	3.3	3.7	3.7	3.7	3.7	3.7	3.7
All-Red Time (s)	3.6	3.6	3.6	3.6	3.6	2.7	2.7	2.7	2.7	2.7	2.7
Lost Time Adjust (s)	0.0	0.0	0.0	0.0	0.0	0.0	0.0	0.0	0.0	0.0	0.0
Total Lost Time (s)	6.9	6.9	6.9	6.9	6.9	6.4	6.4	6.4	6.4	6.4	6.4
Lead/Lag	Lead			Lag	Lag	Lag	Lag	Lag	Lead		
Lead-Lag Optimize?	Yes			Yes	Yes	Yes	Yes	Yes	Yes		
Recall Mode	Max	Max	Max	Max	Max	Min	Min	Min	Max	Min	Min
Act Effct Green (s)	46.0	46.0	46.0	32.0	32.0	17.3	17.3	17.3	30.7	30.7	30.7
Actuated g/C Ratio	0.51	0.51	0.51	0.36	0.36	0.19	0.19	0.19	0.34	0.34	0.34
v/c Ratio	0.24	0.07	0.01	0.05	0.10	0.05	0.70	0.06	0.17	0.66	0.51
Control Delay	13.8	12.6	0.0	21.0	15.1	29.7	40.0	0.2	21.1	28.3	4.8
Queue Delay	0.0	0.0	0.0	0.0	0.0	0.0	0.0	0.0	0.0	0.0	0.0
Total Delay	13.8	12.6	0.0	21.0	15.1	29.7	40.0	0.2	21.1	28.3	4.8
LOS	B	B	A	C	B	C	D	A	C	C	A
Approach Delay		13.1			16.6		37.6			20.4	
Approach LOS		B			B		D			C	
Queue Length 50th (m)	12.3	5.4	0.0	2.3	4.4	0.9	39.0	0.0	4.9	58.6	0.0
Queue Length 95th (m)	25.5	13.2	0.0	7.7	13.6	4.1	54.4	0.0	11.5	77.0	17.4
Internal Link Dist (m)		89.0			153.8		234.9			500.4	
Turn Bay Length (m)			75.0	30.0		50.0		45.0	35.0		45.0
Base Capacity (vph)	585	911	819	452	610	225	1191	655	253	1697	937
Starvation Cap Reductn	0	0	0	0	0	0	0	0	0	0	0
Spillback Cap Reductn	0	0	0	0	0	0	0	0	0	0	0
Storage Cap Reductn	0	0	0	0	0	0	0	0	0	0	0
Reduced v/c Ratio	0.24	0.07	0.01	0.05	0.10	0.03	0.38	0.04	0.17	0.45	0.42

Intersection Summary

Cycle Length: 91.3	
Actuated Cycle Length: 90	
Natural Cycle: 95	
Control Type: Semi Act-Uncoord	
Maximum v/c Ratio: 0.70	
Intersection Signal Delay: 23.7	Intersection LOS: C
Intersection Capacity Utilization 77.9%	ICU Level of Service D
Analysis Period (min) 15	

Total 2022 PM

4: Trim Road & Portobello Boulevard/Springridge Drive

Splits and Phases: 4: Trim Road & Portobello Boulevard/Springridge Drive

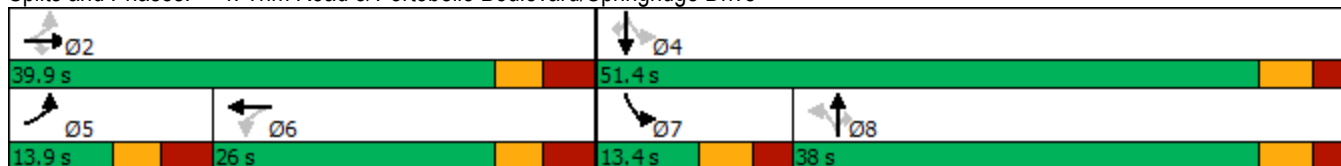

Total 2022 PM
 5: Charlemagne Boulevard & Watters Road



Lane Group	WBL	NBT	SBT
Lane Configurations			
Traffic Volume (vph)	181	140	191
Future Volume (vph)	181	140	191
Lane Group Flow (vph)	302	308	335
Sign Control	Stop	Stop	Stop

Intersection Summary

Control Type: Unsignalized	
Intersection Capacity Utilization 48.2%	ICU Level of Service A
Analysis Period (min) 15	

Total 2022 PM
5: Charlemagne Boulevard & Watters Road



Movement	WBL	WBR	NBT	NBR	SBL	SBT
Lane Configurations						
Sign Control	Stop		Stop			Stop
Traffic Volume (vph)	181	121	140	168	144	191
Future Volume (vph)	181	121	140	168	144	191
Peak Hour Factor	1.00	1.00	1.00	1.00	1.00	1.00
Hourly flow rate (vph)	181	121	140	168	144	191
Direction, Lane #	WB 1	NB 1	NB 2	SB 1	SB 2	
Volume Total (vph)	302	93	215	208	127	
Volume Left (vph)	181	0	0	144	0	
Volume Right (vph)	121	0	168	0	0	
Hadj (s)	-0.09	0.03	-0.51	0.38	0.03	
Departure Headway (s)	5.4	5.9	5.3	6.2	5.8	
Degree Utilization, x	0.45	0.15	0.32	0.36	0.21	
Capacity (veh/h)	636	580	641	558	590	
Control Delay (s)	12.6	8.8	9.6	11.4	9.1	
Approach Delay (s)	12.6	9.4		10.5		
Approach LOS	B	A		B		
Intersection Summary						
Delay			10.8			
Level of Service			B			
Intersection Capacity Utilization			48.2%	ICU Level of Service		A
Analysis Period (min)			15			

Total 2022 PM

6: Crown Pointe Plaza Access 3/Montcrest Drive & Watters Road



Lane Group	EBT	WBT	NBT	SBT	SBR
Lane Configurations					
Traffic Volume (vph)	157	306	28	21	35
Future Volume (vph)	157	306	28	21	35
Lane Group Flow (vph)	329	572	196	100	35
Sign Control	Stop	Stop	Stop	Stop	

Intersection Summary

















Control Type: Unsignalized

Intersection Capacity Utilization 70.5% ICU Level of Service C

Analysis Period (min) 15

Total 2022 PM

6: Crown Pointe Plaza Access 3/Montcrest Drive & Watters Road

												
Movement	EBL	EBT	EBR	WBL	WBT	WBR	NBL	NBT	NBR	SBL	SBT	SBR
Lane Configurations												
Sign Control		Stop			Stop			Stop			Stop	
Traffic Volume (vph)	65	157	107	117	306	149	86	28	82	79	21	35
Future Volume (vph)	65	157	107	117	306	149	86	28	82	79	21	35
Peak Hour Factor	1.00	1.00	1.00	1.00	1.00	1.00	1.00	1.00	1.00	1.00	1.00	1.00
Hourly flow rate (vph)	65	157	107	117	306	149	86	28	82	79	21	35
Direction, Lane #	EB 1	WB 1	NB 1	SB 1	SB 2							
Volume Total (vph)	329	572	196	100	35							
Volume Left (vph)	65	117	86	79	0							
Volume Right (vph)	107	149	82	0	35							
Hadj (s)	-0.12	-0.08	-0.13	0.43	-0.67							
Departure Headway (s)	6.0	5.6	6.9	8.0	6.9							
Degree Utilization, x	0.55	0.90	0.37	0.22	0.07							
Capacity (veh/h)	569	572	486	416	477							
Control Delay (s)	16.1	38.4	13.9	12.1	9.2							
Approach Delay (s)	16.1	38.4	13.9	11.4								
Approach LOS	C	E	B	B								
Intersection Summary												
Delay			25.6									
Level of Service			D									
Intersection Capacity Utilization			70.5%		ICU Level of Service	C						
Analysis Period (min)			15									

Total 2022 PM
7: Watters Road

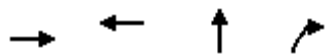

Lane Group	EBT	WBT	NBT	NBR
Lane Configurations				
Traffic Volume (vph)	310	496	0	30
Future Volume (vph)	310	496	0	30
Lane Group Flow (vph)	326	496	7	30
Sign Control	Free	Free	Stop	

















Intersection Summary

Control Type: Unsignalized

Intersection Capacity Utilization Err% ICU Level of Service H

Analysis Period (min) 15

Total 2022 PM
7: Watters Road

												
Movement	EBL	EBT	EBR	WBL	WBT	WBR	NBL	NBT	NBR	SBL	SBT	SBR
Lane Configurations												
Traffic Volume (veh/h)	0	310	16	0	496	0	7	0	30	0	0	0
Future Volume (Veh/h)	0	310	16	0	496	0	7	0	30	0	0	0
Sign Control		Free			Free			Stop			Stop	
Grade		0%			0%			0%			0%	
Peak Hour Factor	1.00	1.00	1.00	1.00	1.00	1.00	1.00	1.00	1.00	1.00	1.00	1.00
Hourly flow rate (vph)	0	310	16	0	496	0	7	0	30	0	0	0
Pedestrians												
Lane Width (m)												
Walking Speed (m/s)												
Percent Blockage												
Right turn flare (veh)												
Median type		None			None							
Median storage (veh)												
Upstream signal (m)					119							
pX, platoon unblocked												
vC, conflicting volume	496			326			814	814	163	681	822	496
vC1, stage 1 conf vol												
vC2, stage 2 conf vol												
vCu, unblocked vol	496			326			814	814	163	681	822	496
tC, single (s)	4.1			4.1			7.5	6.5	6.9	7.5	6.5	6.9
tC, 2 stage (s)												
tF (s)	2.2			2.2			3.5	4.0	3.3	3.5	4.0	3.3
p0 queue free %	100			100			97	100	96	100	100	100
cM capacity (veh/h)	1064			1230			270	311	853	325	307	519
Direction, Lane #	EB 1	EB 2	WB 1	NB 1	SB 1	SB 2						
Volume Total	155	171	496	37	0	0						
Volume Left	0	0	0	7	0	0						
Volume Right	0	16	0	30	0	0						
cSH	1064	1700	1700	605	1700	1700						
Volume to Capacity	0.00	0.10	0.29	0.06	0.00	0.00						
Queue Length 95th (m)	0.0	0.0	0.0	1.5	0.0	0.0						
Control Delay (s)	0.0	0.0	0.0	11.3	0.0	0.0						
Lane LOS				B	A	A						
Approach Delay (s)	0.0		0.0	11.3	0.0							
Approach LOS				B	A							
Intersection Summary												
Average Delay			0.5									
Intersection Capacity Utilization			Err%		ICU Level of Service				H			
Analysis Period (min)			15									

Total 2022 SAT

1: Trim Road & Watters Road



Lane Group	EBL	EBT	WBL	WBT	NBL	NBT	NBR	SBL	SBT	SBR
Lane Configurations										
Traffic Volume (vph)	338	16	14	19	107	653	6	16	655	284
Future Volume (vph)	338	16	14	19	107	653	6	16	655	284
Lane Group Flow (vph)	338	83	14	41	107	653	6	16	655	284
Turn Type	Perm	NA	Perm	NA	pm+pt	NA	Perm	Perm	NA	Perm
Protected Phases		4		8	5	2			6	
Permitted Phases	4		8		2		2	6		6
Detector Phase	4	4	8	8	5	2	2	6	6	6
Switch Phase										
Minimum Initial (s)	10.0	10.0	10.0	10.0	5.0	10.0	10.0	10.0	10.0	10.0
Minimum Split (s)	28.2	28.2	28.2	28.2	13.6	46.7	46.7	30.0	30.0	30.0
Total Split (s)	33.0	33.0	33.0	33.0	13.6	47.0	47.0	33.4	33.4	33.4
Total Split (%)	41.3%	41.3%	41.3%	41.3%	17.0%	58.8%	58.8%	41.8%	41.8%	41.8%
Yellow Time (s)	3.3	3.3	3.3	3.3	3.7	3.7	3.7	3.7	3.7	3.7
All-Red Time (s)	4.9	4.9	4.9	4.9	3.0	3.0	3.0	3.0	3.0	3.0
Lost Time Adjust (s)	0.0	0.0	0.0	0.0	0.0	0.0	0.0	0.0	0.0	0.0
Total Lost Time (s)	8.2	8.2	8.2	8.2	6.7	6.7	6.7	6.7	6.7	6.7
Lead/Lag					Lead			Lag	Lag	Lag
Lead-Lag Optimize?					Yes			Yes	Yes	Yes
Recall Mode	Max	Max	Max	Max	Max	Min	Min	Min	Min	Min
Act Effct Green (s)	32.1	32.1	32.1	32.1	36.0	36.0	36.0	22.4	22.4	22.4
Actuated g/C Ratio	0.39	0.39	0.39	0.39	0.43	0.43	0.43	0.27	0.27	0.27
v/c Ratio	0.67	0.13	0.03	0.06	0.40	0.44	0.01	0.08	0.72	0.46
Control Delay	30.2	7.3	17.8	11.0	18.4	17.4	0.0	23.1	32.2	5.7
Queue Delay	0.0	0.0	0.0	0.0	0.0	0.0	0.0	0.0	0.0	0.0
Total Delay	30.2	7.3	17.8	11.0	18.4	17.4	0.0	23.1	32.2	5.7
LOS	C	A	B	B	B	B	A	C	C	A
Approach Delay		25.7		12.8		17.4			24.2	
Approach LOS		C		B		B			C	
Queue Length 50th (m)	44.3	1.6	1.4	1.9	9.9	36.7	0.0	1.9	49.1	0.0
Queue Length 95th (m)	#79.0	10.4	5.3	8.3	18.9	50.1	0.0	6.5	66.9	16.7
Internal Link Dist (m)		99.5		300.5		130.5			233.4	
Turn Bay Length (m)	85.0		25.0		35.0		50.0	30.0		45.0
Base Capacity (vph)	503	646	484	648	268	1649	774	232	1092	681
Starvation Cap Reductn	0	0	0	0	0	0	0	0	0	0
Spillback Cap Reductn	0	0	0	0	0	0	0	0	0	0
Storage Cap Reductn	0	0	0	0	0	0	0	0	0	0
Reduced v/c Ratio	0.67	0.13	0.03	0.06	0.40	0.40	0.01	0.07	0.60	0.42

Intersection Summary

Cycle Length: 80
 Actuated Cycle Length: 83
 Natural Cycle: 80
 Control Type: Actuated-Uncoordinated
 Maximum v/c Ratio: 0.72
 Intersection Signal Delay: 21.8
 Intersection Capacity Utilization 71.8%
 Analysis Period (min) 15
 # 95th percentile volume exceeds capacity, queue may be longer.

Total 2022 SAT

1: Trim Road & Watters Road

Queue shown is maximum after two cycles.

Splits and Phases: 1: Trim Road & Watters Road

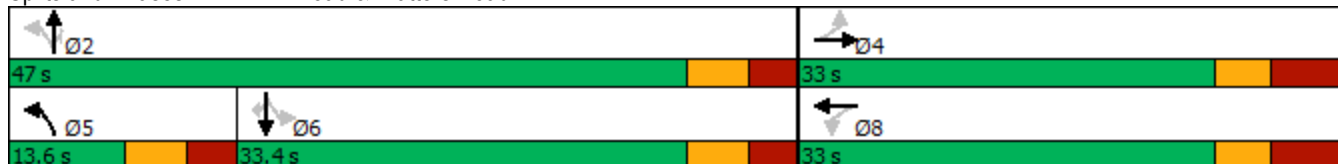

Total 2022 SAT
 2: Trim Road & Crown Pointe Plaza Access 1



Lane Group	EBR	NBL	NBT	SBT
Lane Configurations				
Traffic Volume (vph)	120	99	759	715
Future Volume (vph)	120	99	759	715
Lane Group Flow (vph)	120	99	759	755
Sign Control			Free	Free

Intersection Summary

Control Type: Unsignalized
 Intersection Capacity Utilization 36.7% ICU Level of Service A
 Analysis Period (min) 15

Total 2022 SAT
2: Trim Road & Crown Pointe Plaza Access 1



Movement	EBL	EBR	NBL	NBT	SBT	SBR
Lane Configurations						
Traffic Volume (veh/h)	0	120	99	759	715	40
Future Volume (Veh/h)	0	120	99	759	715	40
Sign Control	Stop			Free	Free	
Grade	0%			0%	0%	
Peak Hour Factor	1.00	1.00	1.00	1.00	1.00	1.00
Hourly flow rate (vph)	0	120	99	759	715	40
Pedestrians						
Lane Width (m)						
Walking Speed (m/s)						
Percent Blockage						
Right turn flare (veh)						
Median type				None	None	
Median storage veh						
Upstream signal (m)					155	
pX, platoon unblocked	0.83	0.83	0.83			
vC, conflicting volume	1312	378	755			
vC1, stage 1 conf vol						
vC2, stage 2 conf vol						
vCu, unblocked vol	971	0	301			
tC, single (s)	6.8	6.9	4.1			
tC, 2 stage (s)						
tF (s)	3.5	3.3	2.2			
p0 queue free %	100	87	91			
cM capacity (veh/h)	188	902	1046			
Direction, Lane #	EB 1	NB 1	NB 2	NB 3	SB 1	SB 2
Volume Total	120	99	380	380	477	278
Volume Left	0	99	0	0	0	0
Volume Right	120	0	0	0	0	40
cSH	902	1046	1700	1700	1700	1700
Volume to Capacity	0.13	0.09	0.22	0.22	0.28	0.16
Queue Length 95th (m)	3.5	2.4	0.0	0.0	0.0	0.0
Control Delay (s)	9.6	8.8	0.0	0.0	0.0	0.0
Lane LOS	A	A				
Approach Delay (s)	9.6	1.0			0.0	
Approach LOS	A					
Intersection Summary						
Average Delay			1.2			
Intersection Capacity Utilization			36.7%		ICU Level of Service	A
Analysis Period (min)			15			

Total 2022 SAT

3: Trim Road & Crown Pointe Plaza Access 2



Lane Group	EBR	NBT	SBT
Lane Configurations			
Traffic Volume (vph)	7	863	841
Future Volume (vph)	7	863	841
Lane Group Flow (vph)	7	863	841
Sign Control		Free	Free

Intersection Summary

Control Type: Unsignalized

Intersection Capacity Utilization 34.5% ICU Level of Service A

Analysis Period (min) 15

Total 2022 SAT
3: Trim Road & Crown Pointe Plaza Access 2



Movement	EBL	EBR	NBL	NBT	SBT	SBR
Lane Configurations		↗		↑↑↑	↑↑	
Traffic Volume (veh/h)	0	7	0	863	841	0
Future Volume (Veh/h)	0	7	0	863	841	0
Sign Control	Stop			Free	Free	
Grade	0%			0%	0%	
Peak Hour Factor	1.00	1.00	1.00	1.00	1.00	1.00
Hourly flow rate (vph)	0	7	0	863	841	0
Pedestrians						
Lane Width (m)						
Walking Speed (m/s)						
Percent Blockage						
Right turn flare (veh)						
Median type				None	None	
Median storage veh						
Upstream signal (m)					194	
pX, platoon unblocked	0.84	0.84	0.84			
vC, conflicting volume	1129	420	841			
vC1, stage 1 conf vol						
vC2, stage 2 conf vol						
vCu, unblocked vol	774	0	432			
tC, single (s)	6.8	6.9	4.1			
tC, 2 stage (s)						
tF (s)	3.5	3.3	2.2			
p0 queue free %	100	99	100			
cM capacity (veh/h)	282	911	945			
Direction, Lane #	EB 1	NB 1	NB 2	NB 3	SB 1	SB 2
Volume Total	7	288	288	288	420	420
Volume Left	0	0	0	0	0	0
Volume Right	7	0	0	0	0	0
cSH	911	1700	1700	1700	1700	1700
Volume to Capacity	0.01	0.17	0.17	0.17	0.25	0.25
Queue Length 95th (m)	0.2	0.0	0.0	0.0	0.0	0.0
Control Delay (s)	9.0	0.0	0.0	0.0	0.0	0.0
Lane LOS	A					
Approach Delay (s)	9.0	0.0	0.0			
Approach LOS	A					
Intersection Summary						
Average Delay	0.0					
Intersection Capacity Utilization	34.5%			ICU Level of Service	A	
Analysis Period (min)	15					

Total 2022 SAT

4: Trim Road & Portobello Boulevard/Springridge Drive



Lane Group	EBL	EBT	EBR	WBL	WBT	NBL	NBT	NBR	SBL	SBT	SBR
Lane Configurations											
Traffic Volume (vph)	192	39	4	28	36	6	515	27	30	494	226
Future Volume (vph)	192	39	4	28	36	6	515	27	30	494	226
Lane Group Flow (vph)	192	39	4	28	65	6	515	27	30	494	226
Turn Type	pm+pt	NA	Perm	Perm	NA	Perm	NA	Perm	pm+pt	NA	Perm
Protected Phases	5	2			6		8		7	4	
Permitted Phases	2		2	6		8		8	4		4
Detector Phase	5	2	2	6	6	8	8	8	7	4	4
Switch Phase											
Minimum Initial (s)	5.0	10.0	10.0	10.0	10.0	10.0	10.0	10.0	5.0	10.0	10.0
Minimum Split (s)	13.9	38.9	38.9	26.0	26.0	35.0	35.0	35.0	12.3	46.4	46.4
Total Split (s)	13.9	39.9	39.9	26.0	26.0	35.0	35.0	35.0	11.4	46.4	46.4
Total Split (%)	16.1%	46.2%	46.2%	30.1%	30.1%	40.6%	40.6%	40.6%	13.2%	53.8%	53.8%
Yellow Time (s)	3.3	3.3	3.3	3.3	3.3	3.7	3.7	3.7	3.7	3.7	3.7
All-Red Time (s)	3.6	3.6	3.6	3.6	3.6	2.7	2.7	2.7	2.7	2.7	2.7
Lost Time Adjust (s)	0.0	0.0	0.0	0.0	0.0	0.0	0.0	0.0	0.0	0.0	0.0
Total Lost Time (s)	6.9	6.9	6.9	6.9	6.9	6.4	6.4	6.4	6.4	6.4	6.4
Lead/Lag	Lead			Lag	Lag	Lag	Lag	Lag	Lead		
Lead-Lag Optimize?	Yes			Yes	Yes	Yes	Yes	Yes	Yes		
Recall Mode	Max	Max	Max	Max	Max	Min	Min	Min	Max	Min	Min
Act Effct Green (s)	46.0	46.0	46.0	32.1	32.1	18.8	18.8	18.8	30.2	30.2	30.2
Actuated g/C Ratio	0.51	0.51	0.51	0.36	0.36	0.21	0.21	0.21	0.34	0.34	0.34
v/c Ratio	0.33	0.04	0.00	0.06	0.11	0.03	0.73	0.06	0.14	0.43	0.35
Control Delay	14.6	12.4	0.0	21.0	13.8	27.5	39.2	0.2	20.9	24.1	4.4
Queue Delay	0.0	0.0	0.0	0.0	0.0	0.0	0.0	0.0	0.0	0.0	0.0
Total Delay	14.6	12.4	0.0	21.0	13.8	27.5	39.2	0.2	20.9	24.1	4.4
LOS	B	B	A	C	B	C	D	A	C	C	A
Approach Delay		14.0			16.0		37.1			18.0	
Approach LOS		B			B		D			B	
Queue Length 50th (m)	17.0	3.1	0.0	3.1	4.0	0.8	43.5	0.0	3.4	34.1	0.0
Queue Length 95th (m)	33.8	9.1	0.0	9.5	13.4	4.0	59.7	0.0	9.1	47.2	13.7
Internal Link Dist (m)		89.0			153.8		234.9			500.4	
Turn Bay Length (m)			75.0	30.0		50.0		45.0	35.0		45.0
Base Capacity (vph)	589	916	828	466	611	268	1085	615	210	1517	795
Starvation Cap Reductn	0	0	0	0	0	0	0	0	0	0	0
Spillback Cap Reductn	0	0	0	0	0	0	0	0	0	0	0
Storage Cap Reductn	0	0	0	0	0	0	0	0	0	0	0
Reduced v/c Ratio	0.33	0.04	0.00	0.06	0.11	0.02	0.47	0.04	0.14	0.33	0.28

Intersection Summary

Cycle Length: 86.3

Actuated Cycle Length: 89.5

Natural Cycle: 90

Control Type: Semi Act-Uncoord

Maximum v/c Ratio: 0.73

Intersection Signal Delay: 23.8

Intersection LOS: C

Intersection Capacity Utilization 75.2%

ICU Level of Service D

Analysis Period (min) 15

Total 2022 SAT

4: Trim Road & Portobello Boulevard/Springridge Drive

Splits and Phases: 4: Trim Road & Portobello Boulevard/Springridge Drive

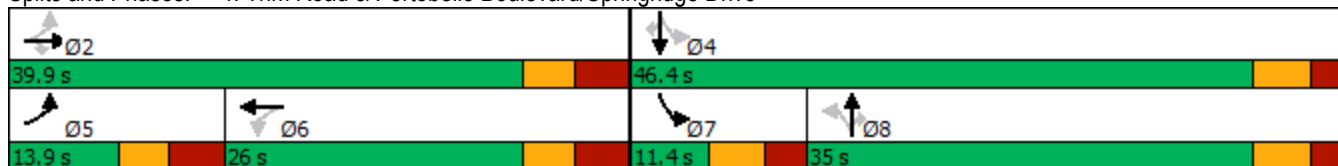

Total 2022 SAT
 5: Charlemagne Boulevard & Watters Road



Lane Group	WBL	NBT	SBT
Lane Configurations			
Traffic Volume (vph)	145	231	105
Future Volume (vph)	145	231	105
Lane Group Flow (vph)	231	353	169
Sign Control	Stop	Stop	Stop

Intersection Summary

Control Type: Unsignalized

Intersection Capacity Utilization 39.9% ICU Level of Service A

Analysis Period (min) 15

Total 2022 SAT
5: Charlemagne Boulevard & Watters Road



Movement	WBL	WBR	NBT	NBR	SBL	SBT
Lane Configurations						
Sign Control	Stop		Stop			Stop
Traffic Volume (vph)	145	86	231	122	64	105
Future Volume (vph)	145	86	231	122	64	105
Peak Hour Factor	1.00	1.00	1.00	1.00	1.00	1.00
Hourly flow rate (vph)	145	86	231	122	64	105
Direction, Lane #	WB 1	NB 1	NB 2	SB 1	SB 2	
Volume Total (vph)	231	154	199	99	70	
Volume Left (vph)	145	0	0	64	0	
Volume Right (vph)	86	0	122	0	0	
Hadj (s)	-0.06	0.03	-0.40	0.36	0.03	
Departure Headway (s)	5.0	5.4	4.9	5.9	5.6	
Degree Utilization, x	0.32	0.23	0.27	0.16	0.11	
Capacity (veh/h)	671	643	698	580	613	
Control Delay (s)	10.4	8.8	8.6	8.8	8.0	
Approach Delay (s)	10.4	8.7		8.5		
Approach LOS	B	A		A		
Intersection Summary						
Delay			9.2			
Level of Service			A			
Intersection Capacity Utilization			39.9%	ICU Level of Service		A
Analysis Period (min)			15			

Total 2022 SAT

6: Crown Pointe Plaza Access 3/Montcrest Drive & Watters Road



Lane Group	EBT	WBT	NBT	SBT	SBR
Lane Configurations					
Traffic Volume (vph)	169	162	27	26	35
Future Volume (vph)	169	162	27	26	35
Lane Group Flow (vph)	325	401	246	132	35
Sign Control	Stop	Stop	Stop	Stop	

Intersection Summary

















Control Type: Unsignalized

Intersection Capacity Utilization 72.9% ICU Level of Service C

Analysis Period (min) 15

Total 2022 SAT

6: Crown Pointe Plaza Access 3/Montcrest Drive & Watters Road

												
Movement	EBL	EBT	EBR	WBL	WBT	WBR	NBL	NBT	NBR	SBL	SBT	SBR
Lane Configurations												
Sign Control		Stop			Stop			Stop			Stop	
Traffic Volume (vph)	46	169	110	123	162	116	104	27	115	106	26	35
Future Volume (vph)	46	169	110	123	162	116	104	27	115	106	26	35
Peak Hour Factor	1.00	1.00	1.00	1.00	1.00	1.00	1.00	1.00	1.00	1.00	1.00	1.00
Hourly flow rate (vph)	46	169	110	123	162	116	104	27	115	106	26	35
Direction, Lane #	EB 1	WB 1	NB 1	SB 1	SB 2							
Volume Total (vph)	325	401	246	132	35							
Volume Left (vph)	46	123	104	106	0							
Volume Right (vph)	110	116	115	0	35							
Hadj (s)	-0.14	-0.08	-0.16	0.44	-0.67							
Departure Headway (s)	6.0	5.9	6.5	7.7	6.5							
Degree Utilization, x	0.54	0.65	0.44	0.28	0.06							
Capacity (veh/h)	562	574	498	405	469							
Control Delay (s)	15.7	19.3	14.5	12.5	8.8							
Approach Delay (s)	15.7	19.3	14.5	11.7								
Approach LOS	C	C	B	B								
Intersection Summary												
Delay			16.1									
Level of Service			C									
Intersection Capacity Utilization			72.9%		ICU Level of Service		C					
Analysis Period (min)			15									

Total 2022 SAT
7: Watters Road

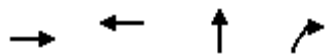

Lane Group	EBT	WBT	NBT	NBR
Lane Configurations				
Traffic Volume (vph)	379	410	0	41
Future Volume (vph)	379	410	0	41
Lane Group Flow (vph)	400	410	10	41
Sign Control	Free	Free	Stop	

















Intersection Summary

Control Type: Unsignalized

Intersection Capacity Utilization Err% ICU Level of Service H

Analysis Period (min) 15

Total 2022 SAT
7: Watters Road

													
Movement	EBL	EBT	EBR	WBL	WBT	WBR	NBL	NBT	NBR	SBL	SBT	SBR	
Lane Configurations													
Traffic Volume (veh/h)	0	379	21	0	410	0	10	0	41	0	0	0	
Future Volume (Veh/h)	0	379	21	0	410	0	10	0	41	0	0	0	
Sign Control		Free			Free			Stop			Stop		
Grade		0%			0%			0%			0%		
Peak Hour Factor	1.00	1.00	1.00	1.00	1.00	1.00	1.00	1.00	1.00	1.00	1.00	1.00	
Hourly flow rate (vph)	0	379	21	0	410	0	10	0	41	0	0	0	
Pedestrians													
Lane Width (m)													
Walking Speed (m/s)													
Percent Blockage													
Right turn flare (veh)													
Median type	None					None							
Median storage veh													
Upstream signal (m)						123							
pX, platoon unblocked	1.00						1.00	1.00			1.00	1.00	1.00
vC, conflicting volume	410						400	800	800	200	640	810	410
vC1, stage 1 conf vol													
vC2, stage 2 conf vol													
vCu, unblocked vol	406						400	797	797	200	637	807	406
tC, single (s)	4.1						4.1	7.5	6.5	6.9	7.5	6.5	6.9
tC, 2 stage (s)													
tF (s)	2.2						2.2	3.5	4.0	3.3	3.5	4.0	3.3
p0 queue free %	100						100	96	100	95	100	100	100
cM capacity (veh/h)	1145						1155	276	317	808	342	312	592
Direction, Lane #	EB 1	EB 2	WB 1	NB 1	SB 1	SB 2							
Volume Total	190	210	410	51	0	0							
Volume Left	0	0	0	10	0	0							
Volume Right	0	21	0	41	0	0							
cSH	1145	1700	1700	587	1700	1700							
Volume to Capacity	0.00	0.12	0.24	0.09	0.00	0.00							
Queue Length 95th (m)	0.0	0.0	0.0	2.2	0.0	0.0							
Control Delay (s)	0.0	0.0	0.0	11.7	0.0	0.0							
Lane LOS				B	A	A							
Approach Delay (s)	0.0			0.0	11.7	0.0							
Approach LOS				B	A								
Intersection Summary													
Average Delay			0.7										
Intersection Capacity Utilization			Err%	ICU Level of Service	H								
Analysis Period (min)			15										

APPENDIX K

SYNCHRO CAPACITY ANALYSIS: TOTAL PROJECTED 2027 CONDITIONS

Total 2027 AM
1: Trim Road & Watters Road



Lane Group	EBL	EBT	WBL	WBT	NBL	NBT	NBR	SBL	SBT	SBR
Lane Configurations										
Traffic Volume (vph)	347	11	15	17	87	910	4	6	384	187
Future Volume (vph)	347	11	15	17	87	910	4	6	384	187
Lane Group Flow (vph)	347	89	15	43	87	910	4	6	384	187
Turn Type	Perm	NA	Perm	NA	pm+pt	NA	Perm	Perm	NA	Perm
Protected Phases		4		8	5	2			6	
Permitted Phases	4		8		2		2	6		6
Detector Phase	4	4	8	8	5	2	2	6	6	6
Switch Phase										
Minimum Initial (s)	10.0	10.0	10.0	10.0	5.0	10.0	10.0	10.0	10.0	10.0
Minimum Split (s)	40.2	40.2	40.2	40.2	13.6	51.7	51.7	35.0	35.0	35.0
Total Split (s)	42.0	42.0	42.0	42.0	13.6	53.0	53.0	39.4	39.4	39.4
Total Split (%)	44.2%	44.2%	44.2%	44.2%	14.3%	55.8%	55.8%	41.5%	41.5%	41.5%
Yellow Time (s)	3.3	3.3	3.3	3.3	3.7	3.7	3.7	3.7	3.7	3.7
All-Red Time (s)	4.9	4.9	4.9	4.9	3.0	3.0	3.0	3.0	3.0	3.0
Lost Time Adjust (s)	0.0	0.0	0.0	0.0	0.0	0.0	0.0	0.0	0.0	0.0
Total Lost Time (s)	8.2	8.2	8.2	8.2	6.7	6.7	6.7	6.7	6.7	6.7
Lead/Lag					Lead			Lag	Lag	Lag
Lead-Lag Optimize?					Yes			Yes	Yes	Yes
Recall Mode	Max	Max	Max	Max	Max	Min	Min	Min	Min	Min
Act Effct Green (s)	33.9	33.9	33.9	33.9	29.0	29.0	29.0	15.3	15.3	15.3
Actuated g/C Ratio	0.44	0.44	0.44	0.44	0.37	0.37	0.37	0.20	0.20	0.20
v/c Ratio	0.61	0.13	0.03	0.06	0.27	0.72	0.01	0.06	0.58	0.42
Control Delay	23.8	5.5	14.8	8.7	17.9	24.5	0.0	25.3	31.6	7.2
Queue Delay	0.0	0.0	0.0	0.0	0.0	0.0	0.0	0.0	0.0	0.0
Total Delay	23.8	5.5	14.8	8.7	17.9	24.5	0.0	25.3	31.6	7.2
LOS	C	A	B	A	B	C	A	C	C	A
Approach Delay		20.1		10.3		23.9			23.6	
Approach LOS		C		B		C			C	
Queue Length 50th (m)	37.2	0.9	1.2	1.4	8.3	59.0	0.0	0.7	27.0	0.0
Queue Length 95th (m)	75.9	9.5	5.0	7.7	16.8	78.2	0.0	3.6	39.6	14.5
Internal Link Dist (m)		99.5		300.5		130.5			233.4	
Turn Bay Length (m)	85.0		25.0		35.0		50.0	30.0		45.0
Base Capacity (vph)	567	709	540	716	320	2023	907	235	1429	747
Starvation Cap Reductn	0	0	0	0	0	0	0	0	0	0
Spillback Cap Reductn	0	0	0	0	0	0	0	0	0	0
Storage Cap Reductn	0	0	0	0	0	0	0	0	0	0
Reduced v/c Ratio	0.61	0.13	0.03	0.06	0.27	0.45	0.00	0.03	0.27	0.25

Intersection Summary

Cycle Length: 95	
Actuated Cycle Length: 77.8	
Natural Cycle: 95	
Control Type: Actuated-Uncoordinated	
Maximum v/c Ratio: 0.72	
Intersection Signal Delay: 22.6	Intersection LOS: C
Intersection Capacity Utilization 79.8%	ICU Level of Service D
Analysis Period (min) 15	

Total 2027 AM
1: Trim Road & Watters Road

Splits and Phases: 1: Trim Road & Watters Road



Total 2027 AM
 2: Trim Road & Crown Pointe Plaza Access 1



Lane Group	EBR	NBL	NBT	SBT
Lane Configurations				
Traffic Volume (vph)	28	37	1030	489
Future Volume (vph)	28	37	1030	489
Lane Group Flow (vph)	28	37	1030	509
Sign Control			Free	Free

Intersection Summary

Control Type: Unsignalized

Intersection Capacity Utilization 33.4% ICU Level of Service A

Analysis Period (min) 15

Total 2027 AM
2: Trim Road & Crown Pointe Plaza Access 1



Movement	EBL	EBR	NBL	NBT	SBT	SBR
Lane Configurations						
Traffic Volume (veh/h)	0	28	37	1030	489	20
Future Volume (Veh/h)	0	28	37	1030	489	20
Sign Control	Stop			Free	Free	
Grade	0%			0%	0%	
Peak Hour Factor	1.00	1.00	1.00	1.00	1.00	1.00
Hourly flow rate (vph)	0	28	37	1030	489	20
Pedestrians						
Lane Width (m)						
Walking Speed (m/s)						
Percent Blockage						
Right turn flare (veh)						
Median type				None	None	
Median storage veh						
Upstream signal (m)				155		
pX, platoon unblocked	0.91	0.91	0.91			
vC, conflicting volume	1088	254	509			
vC1, stage 1 conf vol						
vC2, stage 2 conf vol						
vCu, unblocked vol	900	0	264			
tC, single (s)	6.8	6.9	4.1			
tC, 2 stage (s)						
tF (s)	3.5	3.3	2.2			
p0 queue free %	100	97	97			
cM capacity (veh/h)	245	987	1181			
Direction, Lane #	EB 1	NB 1	NB 2	NB 3	SB 1	SB 2
Volume Total	28	37	515	515	326	183
Volume Left	0	37	0	0	0	0
Volume Right	28	0	0	0	0	20
cSH	987	1181	1700	1700	1700	1700
Volume to Capacity	0.03	0.03	0.30	0.30	0.19	0.11
Queue Length 95th (m)	0.7	0.7	0.0	0.0	0.0	0.0
Control Delay (s)	8.8	8.1	0.0	0.0	0.0	0.0
Lane LOS	A	A				
Approach Delay (s)	8.8	0.3	0.0			
Approach LOS	A					
Intersection Summary						
Average Delay			0.3			
Intersection Capacity Utilization			33.4%	ICU Level of Service	A	
Analysis Period (min)			15			

Total 2027 AM

3: Trim Road & Crown Pointe Plaza Access 2



Lane Group	EBR	NBT	SBT
Lane Configurations	↗	↑↑↑	↑↑
Traffic Volume (vph)	3	1069	521
Future Volume (vph)	3	1069	521
Lane Group Flow (vph)	3	1069	521
Sign Control		Free	Free

Intersection Summary

Control Type: Unsignalized

Intersection Capacity Utilization 25.2% ICU Level of Service A

Analysis Period (min) 15

Total 2027 AM
3: Trim Road & Crown Pointe Plaza Access 2



Movement	EBL	EBR	NBL	NBT	SBT	SBR
Lane Configurations		↗		↑↑↑	↑↑	
Traffic Volume (veh/h)	0	3	0	1069	521	0
Future Volume (Veh/h)	0	3	0	1069	521	0
Sign Control	Stop			Free	Free	
Grade	0%			0%	0%	
Peak Hour Factor	1.00	1.00	1.00	1.00	1.00	1.00
Hourly flow rate (vph)	0	3	0	1069	521	0
Pedestrians						
Lane Width (m)						
Walking Speed (m/s)						
Percent Blockage						
Right turn flare (veh)						
Median type				None	None	
Median storage veh						
Upstream signal (m)					194	
pX, platoon unblocked	0.92	0.92	0.92			
vC, conflicting volume	877	260	521			
vC1, stage 1 conf vol						
vC2, stage 2 conf vol						
vCu, unblocked vol	694	23	306			
tC, single (s)	6.8	6.9	4.1			
tC, 2 stage (s)						
tF (s)	3.5	3.3	2.2			
p0 queue free %	100	100	100			
cM capacity (veh/h)	347	964	1152			
Direction, Lane #	EB 1	NB 1	NB 2	NB 3	SB 1	SB 2
Volume Total	3	356	356	356	260	260
Volume Left	0	0	0	0	0	0
Volume Right	3	0	0	0	0	0
cSH	964	1700	1700	1700	1700	1700
Volume to Capacity	0.00	0.21	0.21	0.21	0.15	0.15
Queue Length 95th (m)	0.1	0.0	0.0	0.0	0.0	0.0
Control Delay (s)	8.7	0.0	0.0	0.0	0.0	0.0
Lane LOS	A					
Approach Delay (s)	8.7	0.0	0.0			
Approach LOS	A					
Intersection Summary						
Average Delay	0.0					
Intersection Capacity Utilization	25.2%			ICU Level of Service	A	
Analysis Period (min)	15					

Total 2027 AM
4: Trim Road & Portobello Boulevard/Springridge Drive



Lane Group	EBL	EBT	EBR	WBL	WBT	NBL	NBT	NBR	SBL	SBT	SBR
Lane Configurations											
Traffic Volume (vph)	261	25	2	29	49	9	652	9	11	465	122
Future Volume (vph)	261	25	2	29	49	9	652	9	11	465	122
Lane Group Flow (vph)	261	25	2	29	90	9	652	9	11	465	122
Turn Type	pm+pt	NA	Perm	Perm	NA	Perm	NA	Perm	pm+pt	NA	Perm
Protected Phases	5	2			6		8		7	4	
Permitted Phases	2		2	6		8		8	4		4
Detector Phase	5	2	2	6	6	8	8	8	7	4	4
Switch Phase											
Minimum Initial (s)	5.0	10.0	10.0	10.0	10.0	10.0	10.0	10.0	5.0	10.0	10.0
Minimum Split (s)	16.9	38.9	38.9	38.9	38.9	40.0	40.0	40.0	12.3	51.4	51.4
Total Split (s)	16.9	39.9	39.9	23.0	23.0	40.0	40.0	40.0	11.4	51.4	51.4
Total Split (%)	18.5%	43.7%	43.7%	25.2%	25.2%	43.8%	43.8%	43.8%	12.5%	56.3%	56.3%
Yellow Time (s)	3.3	3.3	3.3	3.3	3.3	3.7	3.7	3.7	3.7	3.7	3.7
All-Red Time (s)	3.6	3.6	3.6	3.6	3.6	2.7	2.7	2.7	2.7	2.7	2.7
Lost Time Adjust (s)	0.0	0.0	0.0	0.0	0.0	0.0	0.0	0.0	0.0	0.0	0.0
Total Lost Time (s)	6.9	6.9	6.9	6.9	6.9	6.4	6.4	6.4	6.4	6.4	6.4
Lead/Lag	Lead			Lag	Lag	Lag	Lag	Lag	Lead		
Lead-Lag Optimize?	Yes			Yes	Yes	Yes	Yes	Yes	Yes		
Recall Mode	Max	Max	Max	Max	Max	Min	Min	Min	Max	Min	Min
Act Effct Green (s)	49.0	49.0	49.0	32.1	32.1	24.0	24.0	24.0	35.4	35.4	35.4
Actuated g/C Ratio	0.50	0.50	0.50	0.33	0.33	0.25	0.25	0.25	0.36	0.36	0.36
v/c Ratio	0.45	0.03	0.00	0.07	0.16	0.04	0.78	0.02	0.06	0.38	0.20
Control Delay	18.5	14.3	0.0	25.3	16.1	27.4	41.6	0.1	19.7	23.7	4.0
Queue Delay	0.0	0.0	0.0	0.0	0.0	0.0	0.0	0.0	0.0	0.0	0.0
Total Delay	18.5	14.3	0.0	25.3	16.1	27.4	41.6	0.1	19.7	23.7	4.0
LOS	B	B	A	C	B	C	D	A	B	C	A
Approach Delay		18.0			18.4		40.8			19.6	
Approach LOS		B			B		D			B	
Queue Length 50th (m)	27.5	2.3	0.0	3.7	6.5	1.3	60.6	0.0	1.3	33.6	0.0
Queue Length 95th (m)	51.6	7.4	0.0	11.1	19.1	5.1	79.4	0.0	4.7	46.0	9.5
Internal Link Dist (m)		89.0			153.8		234.9			500.4	
Turn Bay Length (m)			75.0	30.0		50.0		45.0	35.0		45.0
Base Capacity (vph)	581	894	805	431	565	297	1167	644	183	1563	757
Starvation Cap Reductn	0	0	0	0	0	0	0	0	0	0	0
Spillback Cap Reductn	0	0	0	0	0	0	0	0	0	0	0
Storage Cap Reductn	0	0	0	0	0	0	0	0	0	0	0
Reduced v/c Ratio	0.45	0.03	0.00	0.07	0.16	0.03	0.56	0.01	0.06	0.30	0.16

Intersection Summary

Cycle Length: 91.3	
Actuated Cycle Length: 97.8	
Natural Cycle: 110	
Control Type: Semi Act-Uncoord	
Maximum v/c Ratio: 0.78	
Intersection Signal Delay: 27.7	Intersection LOS: C
Intersection Capacity Utilization 75.2%	ICU Level of Service D
Analysis Period (min) 15	

Total 2027 AM

4: Trim Road & Portobello Boulevard/Springridge Drive

Splits and Phases: 4: Trim Road & Portobello Boulevard/Springridge Drive

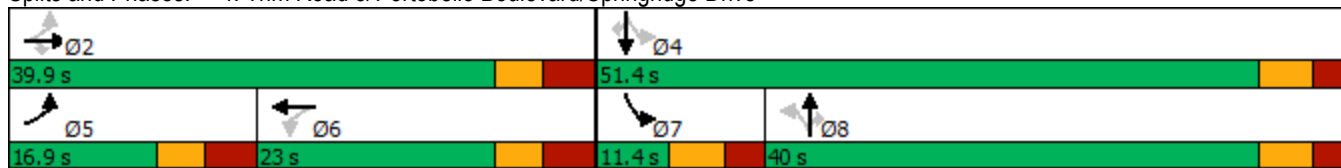

Total 2027 AM
 5: Charlemagne Boulevard & Watters Road



Lane Group	WBL	NBT	SBT
Lane Configurations			
Traffic Volume (vph)	186	201	214
Future Volume (vph)	186	201	214
Lane Group Flow (vph)	368	371	291
Sign Control	Stop	Stop	Stop

Intersection Summary

Control Type: Unsignalized

Intersection Capacity Utilization 52.9% ICU Level of Service A

Analysis Period (min) 15

Total 2027 AM
5: Charlemagne Boulevard & Watters Road



Movement	WBL	WBR	NBT	NBR	SBL	SBT
Lane Configurations						
Sign Control	Stop		Stop			Stop
Traffic Volume (vph)	186	182	201	170	77	214
Future Volume (vph)	186	182	201	170	77	214
Peak Hour Factor	1.00	1.00	1.00	1.00	1.00	1.00
Hourly flow rate (vph)	186	182	201	170	77	214
Direction, Lane #	WB 1	NB 1	NB 2	SB 1	SB 2	
Volume Total (vph)	368	134	237	148	143	
Volume Left (vph)	186	0	0	77	0	
Volume Right (vph)	182	0	170	0	0	
Hadj (s)	-0.16	0.03	-0.47	0.29	0.03	
Departure Headway (s)	5.3	6.1	5.6	6.4	6.1	
Degree Utilization, x	0.55	0.23	0.37	0.26	0.24	
Capacity (veh/h)	643	565	617	532	555	
Control Delay (s)	14.6	9.6	10.5	10.5	9.9	
Approach Delay (s)	14.6	10.2		10.2		
Approach LOS	B	B		B		
Intersection Summary						
Delay			11.8			
Level of Service			B			
Intersection Capacity Utilization			52.9%	ICU Level of Service		A
Analysis Period (min)			15			

Total 2027 AM

6: Crown Pointe Plaza Access 3/Montcrest Drive & Watters Road



Lane Group	EBT	WBT	NBT	SBT	SBR
Lane Configurations					
Traffic Volume (vph)	319	226	7	10	55
Future Volume (vph)	319	226	7	10	55
Lane Group Flow (vph)	387	320	76	135	55
Sign Control	Stop	Stop	Stop	Stop	

Intersection Summary

















Control Type: Unsignalized

Intersection Capacity Utilization 51.7% ICU Level of Service A

Analysis Period (min) 15

Total 2027 AM

6: Crown Pointe Plaza Access 3/Montcrest Drive & Watters Road

												
Movement	EBL	EBT	EBR	WBL	WBT	WBR	NBL	NBT	NBR	SBL	SBT	SBR
Lane Configurations												
Sign Control		Stop			Stop			Stop			Stop	
Traffic Volume (vph)	23	319	45	43	226	51	36	7	33	125	10	55
Future Volume (vph)	23	319	45	43	226	51	36	7	33	125	10	55
Peak Hour Factor	1.00	1.00	1.00	1.00	1.00	1.00	1.00	1.00	1.00	1.00	1.00	1.00
Hourly flow rate (vph)	23	319	45	43	226	51	36	7	33	125	10	55
Direction, Lane #	EB 1	WB 1	NB 1	SB 1	SB 2							
Volume Total (vph)	387	320	76	135	55							
Volume Left (vph)	23	43	36	125	0							
Volume Right (vph)	45	51	33	0	55							
Hadj (s)	-0.02	-0.03	-0.13	0.50	-0.67							
Departure Headway (s)	5.2	5.3	6.2	7.0	5.8							
Degree Utilization, x	0.56	0.47	0.13	0.26	0.09							
Capacity (veh/h)	660	645	492	467	554							
Control Delay (s)	14.6	12.9	10.1	11.3	8.2							
Approach Delay (s)	14.6	12.9	10.1	10.4								
Approach LOS	B	B	B	B								
Intersection Summary												
Delay			12.9									
Level of Service			B									
Intersection Capacity Utilization			51.7%		ICU Level of Service		A					
Analysis Period (min)			15									

Total 2027 AM
7: Watters Road

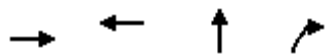

Lane Group	EBT	WBT	NBT	NBR
Lane Configurations				
Traffic Volume (vph)	472	291	0	18
Future Volume (vph)	472	291	0	18
Lane Group Flow (vph)	482	291	4	18
Sign Control	Free	Free	Stop	

















Intersection Summary

Control Type: Unsignalized

Intersection Capacity Utilization Err% ICU Level of Service H

Analysis Period (min) 15

Total 2027 AM
7: Watters Road

												
Movement	EBL	EBT	EBR	WBL	WBT	WBR	NBL	NBT	NBR	SBL	SBT	SBR
Lane Configurations												
Traffic Volume (veh/h)	0	472	10	0	291	0	4	0	18	0	0	0
Future Volume (Veh/h)	0	472	10	0	291	0	4	0	18	0	0	0
Sign Control		Free			Free			Stop			Stop	
Grade		0%			0%			0%			0%	
Peak Hour Factor	1.00	1.00	1.00	1.00	1.00	1.00	1.00	1.00	1.00	1.00	1.00	1.00
Hourly flow rate (vph)	0	472	10	0	291	0	4	0	18	0	0	0
Pedestrians												
Lane Width (m)												
Walking Speed (m/s)												
Percent Blockage												
Right turn flare (veh)												
Median type		None			None							
Median storage (veh)												
Upstream signal (m)					123							
pX, platoon unblocked												
vC, conflicting volume	291			482			768	768	241	545	773	291
vC1, stage 1 conf vol												
vC2, stage 2 conf vol												
vCu, unblocked vol	291			482			768	768	241	545	773	291
tC, single (s)	4.1			4.1			7.5	6.5	6.9	7.5	6.5	6.9
tC, 2 stage (s)												
tF (s)	2.2			2.2			3.5	4.0	3.3	3.5	4.0	3.3
p0 queue free %	100			100			99	100	98	100	100	100
cM capacity (veh/h)	1268			1077			291	330	760	411	328	706
Direction, Lane #	EB 1	EB 2	WB 1	NB 1	SB 1	SB 2						
Volume Total	236	246	291	22	0	0						
Volume Left	0	0	0	4	0	0						
Volume Right	0	10	0	18	0	0						
cSH	1268	1700	1700	588	1700	1700						
Volume to Capacity	0.00	0.14	0.17	0.04	0.00	0.00						
Queue Length 95th (m)	0.0	0.0	0.0	0.9	0.0	0.0						
Control Delay (s)	0.0	0.0	0.0	11.4	0.0	0.0						
Lane LOS				B	A	A						
Approach Delay (s)	0.0		0.0	11.4	0.0							
Approach LOS				B	A							
Intersection Summary												
Average Delay			0.3									
Intersection Capacity Utilization			Err%		ICU Level of Service				H			
Analysis Period (min)			15									

Total 2027 PM
1: Trim Road & Watters Road



Lane Group	EBL	EBT	WBL	WBT	NBL	NBT	NBR	SBL	SBT	SBR
Lane Configurations										
Traffic Volume (vph)	218	20	18	13	62	570	18	20	1314	422
Future Volume (vph)	218	20	18	13	62	570	18	20	1314	422
Lane Group Flow (vph)	218	93	18	19	62	570	18	20	1314	422
Turn Type	Perm	NA	Perm	NA	pm+pt	NA	Perm	Perm	NA	Perm
Protected Phases		4		8	5	2			6	
Permitted Phases	4		8		2		2	6		6
Detector Phase	4	4	8	8	5	2	2	6	6	6
Switch Phase										
Minimum Initial (s)	10.0	10.0	10.0	10.0	5.0	10.0	10.0	10.0	10.0	10.0
Minimum Split (s)	40.2	40.2	40.2	40.2	13.6	66.7	66.7	45.0	45.0	45.0
Total Split (s)	40.2	40.2	40.2	40.2	13.6	69.8	69.8	56.2	56.2	56.2
Total Split (%)	36.5%	36.5%	36.5%	36.5%	12.4%	63.5%	63.5%	51.1%	51.1%	51.1%
Yellow Time (s)	3.3	3.3	3.3	3.3	3.7	3.7	3.7	3.7	3.7	3.7
All-Red Time (s)	4.9	4.9	4.9	4.9	3.0	3.0	3.0	3.0	3.0	3.0
Lost Time Adjust (s)	0.0	0.0	0.0	0.0	0.0	0.0	0.0	0.0	0.0	0.0
Total Lost Time (s)	8.2	8.2	8.2	8.2	6.7	6.7	6.7	6.7	6.7	6.7
Lead/Lag					Lead			Lag	Lag	Lag
Lead-Lag Optimize?					Yes			Yes	Yes	Yes
Recall Mode	Max	Max	Max	Max	Max	Min	Min	Min	Min	Min
Act Effct Green (s)	32.0	32.0	32.0	32.0	61.4	61.4	61.4	47.8	47.8	47.8
Actuated g/C Ratio	0.30	0.30	0.30	0.30	0.57	0.57	0.57	0.44	0.44	0.44
v/c Ratio	0.56	0.18	0.05	0.04	0.36	0.30	0.02	0.06	0.88	0.52
Control Delay	39.2	10.8	28.7	22.1	16.3	12.7	0.1	17.8	35.7	10.7
Queue Delay	0.0	0.0	0.0	0.0	0.0	0.0	0.0	0.0	0.0	0.0
Total Delay	39.2	10.8	28.7	22.1	16.3	12.7	0.1	17.8	35.7	10.7
LOS	D	B	C	C	B	B	A	B	D	B
Approach Delay		30.7		25.3		12.6			29.5	
Approach LOS		C		C		B			C	
Queue Length 50th (m)	39.7	3.1	2.8	2.0	5.6	31.1	0.0	2.4	129.8	22.9
Queue Length 95th (m)	64.4	15.1	8.3	7.5	11.4	41.2	0.0	6.9	161.0	50.0
Internal Link Dist (m)		99.5		300.5		130.5			233.4	
Turn Bay Length (m)	85.0		25.0		35.0		50.0	30.0		45.0
Base Capacity (vph)	392	511	367	504	173	1975	906	357	1550	829
Starvation Cap Reductn	0	0	0	0	0	0	0	0	0	0
Spillback Cap Reductn	0	0	0	0	0	0	0	0	0	0
Storage Cap Reductn	0	0	0	0	0	0	0	0	0	0
Reduced v/c Ratio	0.56	0.18	0.05	0.04	0.36	0.29	0.02	0.06	0.85	0.51

Intersection Summary

Cycle Length: 110	
Actuated Cycle Length: 108.4	
Natural Cycle: 110	
Control Type: Actuated-Uncoordinated	
Maximum v/c Ratio: 0.88	
Intersection Signal Delay: 25.6	Intersection LOS: C
Intersection Capacity Utilization 87.2%	ICU Level of Service E
Analysis Period (min) 15	

Total 2027 PM
1: Trim Road & Watters Road

Splits and Phases: 1: Trim Road & Watters Road



Total 2027 PM
 2: Trim Road & Crown Pointe Plaza Access 1



Lane Group	EBL	EBR	NBL	NBT	SBT
Lane Configurations					
Traffic Volume (vph)	1	93	80	663	1401
Future Volume (vph)	1	93	80	663	1401
Lane Group Flow (vph)	1	93	80	663	1453
Sign Control	Stop			Free	Free

Intersection Summary

Control Type: Unsignalized

Intersection Capacity Utilization Err% ICU Level of Service H

Analysis Period (min) 15

Total 2027 PM
2: Trim Road & Crown Pointe Plaza Access 1



Movement	EBL	EBR	NBL	NBT	SBT	SBR
Lane Configurations						
Traffic Volume (veh/h)	1	93	80	663	1401	52
Future Volume (Veh/h)	1	93	80	663	1401	52
Sign Control	Stop			Free	Free	
Grade	0%			0%	0%	
Peak Hour Factor	1.00	1.00	1.00	1.00	1.00	1.00
Hourly flow rate (vph)	1	93	80	663	1401	52
Pedestrians						
Lane Width (m)						
Walking Speed (m/s)						
Percent Blockage						
Right turn flare (veh)						
Median type				None	None	
Median storage veh						
Upstream signal (m)				155		
pX, platoon unblocked	0.64	0.64	0.64			
vC, conflicting volume	1918	726	1453			
vC1, stage 1 conf vol						
vC2, stage 2 conf vol						
vCu, unblocked vol	1312	0	585			
tC, single (s)	6.8	6.9	4.1			
tC, 2 stage (s)						
tF (s)	3.5	3.3	2.2			
p0 queue free %	99	87	87			
cM capacity (veh/h)	84	695	631			
Direction, Lane #	EB 1	NB 1	NB 2	NB 3	SB 1	SB 2
Volume Total	94	80	332	332	934	519
Volume Left	1	80	0	0	0	0
Volume Right	93	0	0	0	0	52
cSH	645	631	1700	1700	1700	1700
Volume to Capacity	0.15	0.13	0.20	0.20	0.55	0.31
Queue Length 95th (m)	3.9	3.3	0.0	0.0	0.0	0.0
Control Delay (s)	11.5	11.5	0.0	0.0	0.0	0.0
Lane LOS	B	B				
Approach Delay (s)	11.5	1.2	0.0			
Approach LOS	B					
Intersection Summary						
Average Delay	0.9					
Intersection Capacity Utilization	Err%			ICU Level of Service	H	
Analysis Period (min)	15					

Total 2027 PM
 3: Trim Road & Crown Pointe Plaza Access 2



Lane Group	EBR	NBT	SBT
Lane Configurations	↗	↑↑↑	↑↑
Traffic Volume (vph)	8	753	1498
Future Volume (vph)	8	753	1498
Lane Group Flow (vph)	8	753	1498
Sign Control		Free	Free

Intersection Summary	
Control Type: Unsignalized	
Intersection Capacity Utilization 53.7%	ICU Level of Service A
Analysis Period (min) 15	

Total 2027 PM
 3: Trim Road & Crown Pointe Plaza Access 2



Movement	EBL	EBR	NBL	NBT	SBT	SBR
Lane Configurations		↗		↑↑↑	↑↑	
Traffic Volume (veh/h)	0	8	0	753	1498	0
Future Volume (Veh/h)	0	8	0	753	1498	0
Sign Control	Stop			Free	Free	
Grade	0%			0%	0%	
Peak Hour Factor	1.00	1.00	1.00	1.00	1.00	1.00
Hourly flow rate (vph)	0	8	0	753	1498	0
Pedestrians						
Lane Width (m)						
Walking Speed (m/s)						
Percent Blockage						
Right turn flare (veh)						
Median type				None	None	
Median storage veh						
Upstream signal (m)					194	
pX, platoon unblocked	0.64	0.64	0.64			
vC, conflicting volume	1749	749	1498			
vC1, stage 1 conf vol						
vC2, stage 2 conf vol						
vCu, unblocked vol	1059	0	670			
tC, single (s)	6.8	6.9	4.1			
tC, 2 stage (s)						
tF (s)	3.5	3.3	2.2			
p0 queue free %	100	99	100			
cM capacity (veh/h)	141	699	591			
Direction, Lane #	EB 1	NB 1	NB 2	NB 3	SB 1	SB 2
Volume Total	8	251	251	251	749	749
Volume Left	0	0	0	0	0	0
Volume Right	8	0	0	0	0	0
cSH	699	1700	1700	1700	1700	1700
Volume to Capacity	0.01	0.15	0.15	0.15	0.44	0.44
Queue Length 95th (m)	0.3	0.0	0.0	0.0	0.0	0.0
Control Delay (s)	10.2	0.0	0.0	0.0	0.0	0.0
Lane LOS	B					
Approach Delay (s)	10.2	0.0	0.0			
Approach LOS	B					
Intersection Summary						
Average Delay	0.0					
Intersection Capacity Utilization	53.7%			ICU Level of Service	A	
Analysis Period (min)	15					

Total 2027 PM

4: Trim Road & Portobello Boulevard/Springridge Drive



Lane Group	EBL	EBT	EBR	WBL	WBT	NBL	NBT	NBR	SBL	SBT	SBR
Lane Configurations											
Traffic Volume (vph)	141	65	6	21	39	6	502	28	42	845	389
Future Volume (vph)	141	65	6	21	39	6	502	28	42	845	389
Lane Group Flow (vph)	141	65	6	21	62	6	502	28	42	845	389
Turn Type	pm+pt	NA	Perm	Perm	NA	Perm	NA	Perm	pm+pt	NA	Perm
Protected Phases	5	2			6		8		7	4	
Permitted Phases	2		2	6		8		8	4		4
Detector Phase	5	2	2	6	6	8	8	8	7	4	4
Switch Phase											
Minimum Initial (s)	5.0	10.0	10.0	10.0	10.0	10.0	10.0	10.0	5.0	10.0	10.0
Minimum Split (s)	13.9	38.9	38.9	26.0	26.0	38.0	38.0	38.0	12.3	51.4	51.4
Total Split (s)	13.9	39.9	39.9	26.0	26.0	38.0	38.0	38.0	13.4	51.4	51.4
Total Split (%)	15.2%	43.7%	43.7%	28.5%	28.5%	41.6%	41.6%	41.6%	14.7%	56.3%	56.3%
Yellow Time (s)	3.3	3.3	3.3	3.3	3.3	3.7	3.7	3.7	3.7	3.7	3.7
All-Red Time (s)	3.6	3.6	3.6	3.6	3.6	2.7	2.7	2.7	2.7	2.7	2.7
Lost Time Adjust (s)	0.0	0.0	0.0	0.0	0.0	0.0	0.0	0.0	0.0	0.0	0.0
Total Lost Time (s)	6.9	6.9	6.9	6.9	6.9	6.4	6.4	6.4	6.4	6.4	6.4
Lead/Lag	Lead			Lag	Lag	Lag	Lag	Lag	Lead		
Lead-Lag Optimize?	Yes			Yes	Yes	Yes	Yes	Yes	Yes		
Recall Mode	Max	Max	Max	Max	Max	Min	Min	Min	Max	Min	Min
Act Effct Green (s)	46.0	46.0	46.0	32.1	32.1	18.8	18.8	18.8	32.2	32.2	32.2
Actuated g/C Ratio	0.50	0.50	0.50	0.35	0.35	0.21	0.21	0.21	0.35	0.35	0.35
v/c Ratio	0.25	0.07	0.01	0.05	0.10	0.05	0.72	0.06	0.17	0.71	0.50
Control Delay	14.6	13.4	0.0	21.9	15.7	29.2	40.2	0.2	20.8	29.2	4.6
Queue Delay	0.0	0.0	0.0	0.0	0.0	0.0	0.0	0.0	0.0	0.0	0.0
Total Delay	14.6	13.4	0.0	21.9	15.7	29.2	40.2	0.2	20.8	29.2	4.6
LOS	B	B	A	C	B	C	D	A	C	C	A
Approach Delay		13.8			17.3		37.9			21.4	
Approach LOS		B			B		D			C	
Queue Length 50th (m)	12.8	5.6	0.0	2.4	4.5	0.9	43.6	0.0	4.9	66.5	0.0
Queue Length 95th (m)	26.6	13.9	0.0	8.0	14.0	4.0	59.8	0.0	11.3	86.4	17.1
Internal Link Dist (m)		89.0			153.8		234.9			500.4	
Turn Bay Length (m)			75.0	30.0		50.0		45.0	35.0		45.0
Base Capacity (vph)	575	896	807	445	600	205	1172	648	245	1669	928
Starvation Cap Reductn	0	0	0	0	0	0	0	0	0	0	0
Spillback Cap Reductn	0	0	0	0	0	0	0	0	0	0	0
Storage Cap Reductn	0	0	0	0	0	0	0	0	0	0	0
Reduced v/c Ratio	0.25	0.07	0.01	0.05	0.10	0.03	0.43	0.04	0.17	0.51	0.42

Intersection Summary

Cycle Length: 91.3

Actuated Cycle Length: 91.6

Natural Cycle: 95

Control Type: Semi Act-Uncoord

Maximum v/c Ratio: 0.72

Intersection Signal Delay: 24.7

Intersection LOS: C

Intersection Capacity Utilization 77.9%

ICU Level of Service D

Analysis Period (min) 15

Total 2027 PM

4: Trim Road & Portobello Boulevard/Springridge Drive

Splits and Phases: 4: Trim Road & Portobello Boulevard/Springridge Drive

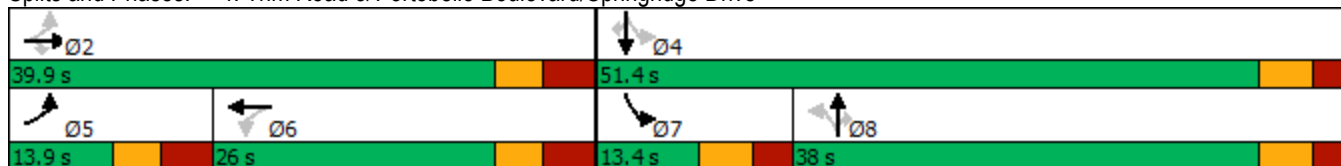

Total 2027 PM
 5: Charlemagne Boulevard & Watters Road



Lane Group	WBL	NBT	SBT
Lane Configurations			
Traffic Volume (vph)	181	140	191
Future Volume (vph)	181	140	191
Lane Group Flow (vph)	302	308	335
Sign Control	Stop	Stop	Stop

Intersection Summary

Control Type: Unsignalized

Intersection Capacity Utilization 48.2% ICU Level of Service A

Analysis Period (min) 15

Total 2027 PM
5: Charlemagne Boulevard & Watters Road



Movement	WBL	WBR	NBT	NBR	SBL	SBT
Lane Configurations						
Sign Control	Stop		Stop			Stop
Traffic Volume (vph)	181	121	140	168	144	191
Future Volume (vph)	181	121	140	168	144	191
Peak Hour Factor	1.00	1.00	1.00	1.00	1.00	1.00
Hourly flow rate (vph)	181	121	140	168	144	191
Direction, Lane #	WB 1	NB 1	NB 2	SB 1	SB 2	
Volume Total (vph)	302	93	215	208	127	
Volume Left (vph)	181	0	0	144	0	
Volume Right (vph)	121	0	168	0	0	
Hadj (s)	-0.09	0.03	-0.51	0.38	0.03	
Departure Headway (s)	5.4	5.9	5.3	6.2	5.8	
Degree Utilization, x	0.45	0.15	0.32	0.36	0.21	
Capacity (veh/h)	636	580	641	558	590	
Control Delay (s)	12.6	8.8	9.6	11.4	9.1	
Approach Delay (s)	12.6	9.4		10.5		
Approach LOS	B	A		B		
Intersection Summary						
Delay			10.8			
Level of Service			B			
Intersection Capacity Utilization			48.2%	ICU Level of Service		A
Analysis Period (min)			15			

Total 2027 PM

6: Crown Pointe Plaza Access 3/Montcrest Drive & Watters Road



Lane Group	EBT	WBT	NBT	SBT	SBR
Lane Configurations					
Traffic Volume (vph)	157	306	28	21	35
Future Volume (vph)	157	306	28	21	35
Lane Group Flow (vph)	329	572	196	100	35
Sign Control	Stop	Stop	Stop	Stop	

Intersection Summary

















Control Type: Unsignalized

Intersection Capacity Utilization 70.5% ICU Level of Service C

Analysis Period (min) 15

Total 2027 PM

6: Crown Pointe Plaza Access 3/Montcrest Drive & Watters Road

												
Movement	EBL	EBT	EBR	WBL	WBT	WBR	NBL	NBT	NBR	SBL	SBT	SBR
Lane Configurations												
Sign Control		Stop			Stop			Stop			Stop	
Traffic Volume (vph)	65	157	107	117	306	149	86	28	82	79	21	35
Future Volume (vph)	65	157	107	117	306	149	86	28	82	79	21	35
Peak Hour Factor	1.00	1.00	1.00	1.00	1.00	1.00	1.00	1.00	1.00	1.00	1.00	1.00
Hourly flow rate (vph)	65	157	107	117	306	149	86	28	82	79	21	35
Direction, Lane #	EB 1	WB 1	NB 1	SB 1	SB 2							
Volume Total (vph)	329	572	196	100	35							
Volume Left (vph)	65	117	86	79	0							
Volume Right (vph)	107	149	82	0	35							
Hadj (s)	-0.12	-0.08	-0.13	0.43	-0.67							
Departure Headway (s)	6.0	5.6	6.9	8.0	6.9							
Degree Utilization, x	0.55	0.90	0.37	0.22	0.07							
Capacity (veh/h)	569	572	486	416	477							
Control Delay (s)	16.1	38.4	13.9	12.1	9.2							
Approach Delay (s)	16.1	38.4	13.9	11.4								
Approach LOS	C	E	B	B								
Intersection Summary												
Delay			25.6									
Level of Service			D									
Intersection Capacity Utilization			70.5%		ICU Level of Service	C						
Analysis Period (min)			15									

Total 2027 PM
7: Watters Road

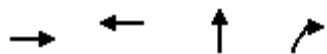

Lane Group	EBT	WBT	NBT	NBR
Lane Configurations				
Traffic Volume (vph)	310	496	0	30
Future Volume (vph)	310	496	0	30
Lane Group Flow (vph)	326	496	7	30
Sign Control	Free	Free	Stop	

















Intersection Summary

Control Type: Unsignalized

Intersection Capacity Utilization Err% ICU Level of Service H

Analysis Period (min) 15

Total 2027 PM
7: Watters Road

												
Movement	EBL	EBT	EBR	WBL	WBT	WBR	NBL	NBT	NBR	SBL	SBT	SBR
Lane Configurations												
Traffic Volume (veh/h)	0	310	16	0	496	0	7	0	30	0	0	0
Future Volume (Veh/h)	0	310	16	0	496	0	7	0	30	0	0	0
Sign Control		Free			Free			Stop			Stop	
Grade		0%			0%			0%			0%	
Peak Hour Factor	1.00	1.00	1.00	1.00	1.00	1.00	1.00	1.00	1.00	1.00	1.00	1.00
Hourly flow rate (vph)	0	310	16	0	496	0	7	0	30	0	0	0
Pedestrians												
Lane Width (m)												
Walking Speed (m/s)												
Percent Blockage												
Right turn flare (veh)												
Median type		None			None							
Median storage (veh)												
Upstream signal (m)					123							
pX, platoon unblocked												
vC, conflicting volume	496			326			814	814	163	681	822	496
vC1, stage 1 conf vol												
vC2, stage 2 conf vol												
vCu, unblocked vol	496			326			814	814	163	681	822	496
tC, single (s)	4.1			4.1			7.5	6.5	6.9	7.5	6.5	6.9
tC, 2 stage (s)												
tF (s)	2.2			2.2			3.5	4.0	3.3	3.5	4.0	3.3
p0 queue free %	100			100			97	100	96	100	100	100
cM capacity (veh/h)	1064			1230			270	311	853	325	307	519
Direction, Lane #	EB 1	EB 2	WB 1	NB 1	SB 1	SB 2						
Volume Total	155	171	496	37	0	0						
Volume Left	0	0	0	7	0	0						
Volume Right	0	16	0	30	0	0						
cSH	1064	1700	1700	605	1700	1700						
Volume to Capacity	0.00	0.10	0.29	0.06	0.00	0.00						
Queue Length 95th (m)	0.0	0.0	0.0	1.5	0.0	0.0						
Control Delay (s)	0.0	0.0	0.0	11.3	0.0	0.0						
Lane LOS				B	A	A						
Approach Delay (s)	0.0		0.0	11.3	0.0							
Approach LOS				B	A							
Intersection Summary												
Average Delay			0.5									
Intersection Capacity Utilization			Err%		ICU Level of Service				H			
Analysis Period (min)			15									

Total 2027 SAT

1: Trim Road & Watters Road



Lane Group	EBL	EBT	WBL	WBT	NBL	NBT	NBR	SBL	SBT	SBR
Lane Configurations										
Traffic Volume (vph)	338	16	14	19	107	721	6	16	723	284
Future Volume (vph)	338	16	14	19	107	721	6	16	723	284
Lane Group Flow (vph)	338	83	14	41	107	721	6	16	723	284
Turn Type	Perm	NA	Perm	NA	pm+pt	NA	Perm	Perm	NA	Perm
Protected Phases		4		8	5	2			6	
Permitted Phases	4		8		2		2	6		6
Detector Phase	4	4	8	8	5	2	2	6	6	6
Switch Phase										
Minimum Initial (s)	10.0	10.0	10.0	10.0	5.0	10.0	10.0	10.0	10.0	10.0
Minimum Split (s)	28.2	28.2	28.2	28.2	13.6	46.7	46.7	30.0	30.0	30.0
Total Split (s)	33.0	33.0	33.0	33.0	13.6	47.0	47.0	33.4	33.4	33.4
Total Split (%)	41.3%	41.3%	41.3%	41.3%	17.0%	58.8%	58.8%	41.8%	41.8%	41.8%
Yellow Time (s)	3.3	3.3	3.3	3.3	3.7	3.7	3.7	3.7	3.7	3.7
All-Red Time (s)	4.9	4.9	4.9	4.9	3.0	3.0	3.0	3.0	3.0	3.0
Lost Time Adjust (s)	0.0	0.0	0.0	0.0	0.0	0.0	0.0	0.0	0.0	0.0
Total Lost Time (s)	8.2	8.2	8.2	8.2	6.7	6.7	6.7	6.7	6.7	6.7
Lead/Lag					Lead			Lag	Lag	Lag
Lead-Lag Optimize?					Yes			Yes	Yes	Yes
Recall Mode	Max	Max	Max	Max	Max	Min	Min	Min	Min	Min
Act Effct Green (s)	32.1	32.1	32.1	32.1	37.3	37.3	37.3	23.6	23.6	23.6
Actuated g/C Ratio	0.38	0.38	0.38	0.38	0.44	0.44	0.44	0.28	0.28	0.28
v/c Ratio	0.68	0.13	0.03	0.06	0.43	0.48	0.01	0.08	0.76	0.45
Control Delay	31.2	7.3	18.0	11.2	19.1	17.8	0.0	23.1	33.5	5.5
Queue Delay	0.0	0.0	0.0	0.0	0.0	0.0	0.0	0.0	0.0	0.0
Total Delay	31.2	7.3	18.0	11.2	19.1	17.8	0.0	23.1	33.5	5.5
LOS	C	A	B	B	B	B	A	C	C	A
Approach Delay		26.5		12.9		17.8			25.6	
Approach LOS		C		B		B			C	
Queue Length 50th (m)	47.2	1.7	1.5	2.0	9.9	41.6	0.0	1.9	55.7	0.0
Queue Length 95th (m)	#79.0	10.4	5.3	8.3	18.9	56.1	0.0	6.5	74.9	16.7
Internal Link Dist (m)		96.4		300.5		130.5			233.4	
Turn Bay Length (m)	85.0		25.0		35.0		50.0	30.0		45.0
Base Capacity (vph)	496	638	477	638	251	1624	764	213	1076	675
Starvation Cap Reductn	0	0	0	0	0	0	0	0	0	0
Spillback Cap Reductn	0	0	0	0	0	0	0	0	0	0
Storage Cap Reductn	0	0	0	0	0	0	0	0	0	0
Reduced v/c Ratio	0.68	0.13	0.03	0.06	0.43	0.44	0.01	0.08	0.67	0.42

Intersection Summary

Cycle Length: 80	
Actuated Cycle Length: 84.3	
Natural Cycle: 80	
Control Type: Actuated-Uncoordinated	
Maximum v/c Ratio: 0.76	
Intersection Signal Delay: 22.7	Intersection LOS: C
Intersection Capacity Utilization 73.8%	ICU Level of Service D
Analysis Period (min) 15	
# 95th percentile volume exceeds capacity, queue may be longer.	

Total 2027 SAT
1: Trim Road & Watters Road

Queue shown is maximum after two cycles.

Splits and Phases: 1: Trim Road & Watters Road

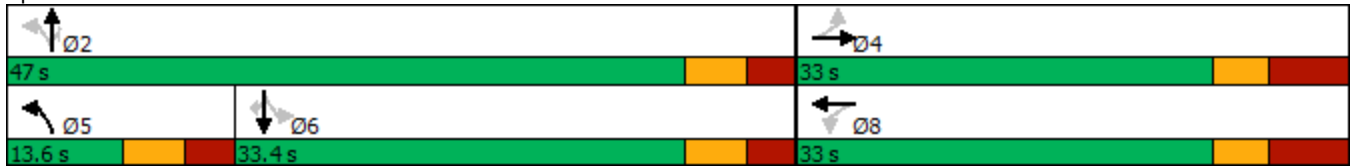

Total 2027 SAT
 2: Trim Road & Crown Pointe Plaza Access 1



Lane Group	EBR	NBL	NBT	SBT
Lane Configurations				
Traffic Volume (vph)	120	99	838	791
Future Volume (vph)	120	99	838	791
Lane Group Flow (vph)	120	99	838	831
Sign Control			Free	Free

Intersection Summary

Control Type: Unsignalized

Intersection Capacity Utilization 38.9% ICU Level of Service A

Analysis Period (min) 15

Total 2027 SAT
2: Trim Road & Crown Pointe Plaza Access 1



Movement	EBL	EBR	NBL	NBT	SBT	SBR
Lane Configurations						
Traffic Volume (veh/h)	0	120	99	838	791	40
Future Volume (Veh/h)	0	120	99	838	791	40
Sign Control	Stop			Free	Free	
Grade	0%			0%	0%	
Peak Hour Factor	1.00	1.00	1.00	1.00	1.00	1.00
Hourly flow rate (vph)	0	120	99	838	791	40
Pedestrians						
Lane Width (m)						
Walking Speed (m/s)						
Percent Blockage						
Right turn flare (veh)						
Median type				None	None	
Median storage veh						
Upstream signal (m)					155	
pX, platoon unblocked	0.81	0.81	0.81			
vC, conflicting volume	1428	416	831			
vC1, stage 1 conf vol						
vC2, stage 2 conf vol						
vCu, unblocked vol	1061	0	324			
tC, single (s)	6.8	6.9	4.1			
tC, 2 stage (s)						
tF (s)	3.5	3.3	2.2			
p0 queue free %	100	86	90			
cM capacity (veh/h)	160	879	999			
Direction, Lane #	EB 1	NB 1	NB 2	NB 3	SB 1	SB 2
Volume Total	120	99	419	419	527	304
Volume Left	0	99	0	0	0	0
Volume Right	120	0	0	0	0	40
cSH	879	999	1700	1700	1700	1700
Volume to Capacity	0.14	0.10	0.25	0.25	0.31	0.18
Queue Length 95th (m)	3.6	2.5	0.0	0.0	0.0	0.0
Control Delay (s)	9.7	9.0	0.0	0.0	0.0	0.0
Lane LOS	A	A				
Approach Delay (s)	9.7	1.0	0.0			
Approach LOS	A					
Intersection Summary						
Average Delay			1.1			
Intersection Capacity Utilization			38.9%	ICU Level of Service	A	
Analysis Period (min)			15			

Total 2027 SAT

3: Trim Road & Crown Pointe Plaza Access 2



Lane Group	EBR	NBT	SBT
Lane Configurations	↗	↑↑↑	↑↑
Traffic Volume (vph)	7	950	926
Future Volume (vph)	7	950	926
Lane Group Flow (vph)	7	950	926
Sign Control		Free	Free

Intersection Summary

Control Type: Unsignalized

Intersection Capacity Utilization 37.0% ICU Level of Service A

Analysis Period (min) 15

Total 2027 SAT

3: Trim Road & Crown Pointe Plaza Access 2



Movement	EBL	EBR	NBL	NBT	SBT	SBR
Lane Configurations		↗		↑↑↑	↑↑	
Traffic Volume (veh/h)	0	7	0	950	926	0
Future Volume (Veh/h)	0	7	0	950	926	0
Sign Control	Stop			Free	Free	
Grade	0%			0%	0%	
Peak Hour Factor	1.00	1.00	1.00	1.00	1.00	1.00
Hourly flow rate (vph)	0	7	0	950	926	0
Pedestrians						
Lane Width (m)						
Walking Speed (m/s)						
Percent Blockage						
Right turn flare (veh)						
Median type				None	None	
Median storage veh						
Upstream signal (m)					194	
pX, platoon unblocked	0.82	0.82	0.82			
vC, conflicting volume	1243	463	926			
vC1, stage 1 conf vol						
vC2, stage 2 conf vol						
vCu, unblocked vol	853	0	466			
tC, single (s)	6.8	6.9	4.1			
tC, 2 stage (s)						
tF (s)	3.5	3.3	2.2			
p0 queue free %	100	99	100			
cM capacity (veh/h)	244	887	894			
Direction, Lane #	EB 1	NB 1	NB 2	NB 3	SB 1	SB 2
Volume Total	7	317	317	317	463	463
Volume Left	0	0	0	0	0	0
Volume Right	7	0	0	0	0	0
cSH	887	1700	1700	1700	1700	1700
Volume to Capacity	0.01	0.19	0.19	0.19	0.27	0.27
Queue Length 95th (m)	0.2	0.0	0.0	0.0	0.0	0.0
Control Delay (s)	9.1	0.0	0.0	0.0	0.0	0.0
Lane LOS	A					
Approach Delay (s)	9.1	0.0	0.0			
Approach LOS	A					
Intersection Summary						
Average Delay	0.0					
Intersection Capacity Utilization	37.0%			ICU Level of Service	A	
Analysis Period (min)	15					

Total 2027 SAT

4: Trim Road & Portobello Boulevard/Springridge Drive



Lane Group	EBL	EBT	EBR	WBL	WBT	NBL	NBT	NBR	SBL	SBT	SBR
Lane Configurations											
Traffic Volume (vph)	192	39	4	28	36	6	566	27	30	544	226
Future Volume (vph)	192	39	4	28	36	6	566	27	30	544	226
Lane Group Flow (vph)	192	39	4	28	65	6	566	27	30	544	226
Turn Type	pm+pt	NA	Perm	Perm	NA	Perm	NA	Perm	pm+pt	NA	Perm
Protected Phases	5	2			6		8		7	4	
Permitted Phases	2		2	6		8		8	4		4
Detector Phase	5	2	2	6	6	8	8	8	7	4	4
Switch Phase											
Minimum Initial (s)	5.0	10.0	10.0	10.0	10.0	10.0	10.0	10.0	5.0	10.0	10.0
Minimum Split (s)	13.9	38.9	38.9	26.0	26.0	35.0	35.0	35.0	11.4	46.4	46.4
Total Split (s)	13.9	39.9	39.9	26.0	26.0	35.0	35.0	35.0	11.4	46.4	46.4
Total Split (%)	16.1%	46.2%	46.2%	30.1%	30.1%	40.6%	40.6%	40.6%	13.2%	53.8%	53.8%
Yellow Time (s)	3.3	3.3	3.3	3.3	3.3	3.7	3.7	3.7	3.7	3.7	3.7
All-Red Time (s)	3.6	3.6	3.6	3.6	3.6	2.7	2.7	2.7	2.7	2.7	2.7
Lost Time Adjust (s)	0.0	0.0	0.0	0.0	0.0	0.0	0.0	0.0	0.0	0.0	0.0
Total Lost Time (s)	6.9	6.9	6.9	6.9	6.9	6.4	6.4	6.4	6.4	6.4	6.4
Lead/Lag	Lead			Lag	Lag	Lag	Lag	Lag	Lead		
Lead-Lag Optimize?	Yes			Yes	Yes	Yes	Yes	Yes	Yes		
Recall Mode	Max	Max	Max	Max	Max	Min	Min	Min	Max	Min	Min
Act Effct Green (s)	46.0	46.0	46.0	32.1	32.1	20.5	20.5	20.5	32.0	32.0	32.0
Actuated g/C Ratio	0.50	0.50	0.50	0.35	0.35	0.22	0.22	0.22	0.35	0.35	0.35
v/c Ratio	0.33	0.04	0.00	0.06	0.11	0.03	0.74	0.05	0.15	0.46	0.34
Control Delay	15.6	13.2	0.0	22.0	14.5	27.0	39.2	0.2	20.6	24.1	4.3
Queue Delay	0.0	0.0	0.0	0.0	0.0	0.0	0.0	0.0	0.0	0.0	0.0
Total Delay	15.6	13.2	0.0	22.0	14.5	27.0	39.2	0.2	20.6	24.1	4.3
LOS	B	B	A	C	B	C	D	A	C	C	A
Approach Delay		14.9			16.7		37.3			18.4	
Approach LOS		B			B		D			B	
Queue Length 50th (m)	17.7	3.3	0.0	3.2	4.1	0.8	48.7	0.0	3.4	38.3	0.0
Queue Length 95th (m)	35.3	9.4	0.0	9.8	13.8	3.8	66.0	0.0	9.1	52.0	13.6
Internal Link Dist (m)		89.0			153.8		234.9			500.4	
Turn Bay Length (m)			75.0	30.0		50.0		45.0	35.0		45.0
Base Capacity (vph)	578	899	814	457	600	251	1064	607	203	1488	784
Starvation Cap Reductn	0	0	0	0	0	0	0	0	0	0	0
Spillback Cap Reductn	0	0	0	0	0	0	0	0	0	0	0
Storage Cap Reductn	0	0	0	0	0	0	0	0	0	0	0
Reduced v/c Ratio	0.33	0.04	0.00	0.06	0.11	0.02	0.53	0.04	0.15	0.37	0.29

Intersection Summary

Cycle Length: 86.3

Actuated Cycle Length: 91.3

Natural Cycle: 90

Control Type: Semi Act-Uncoord

Maximum v/c Ratio: 0.74

Intersection Signal Delay: 24.4

Intersection LOS: C

Intersection Capacity Utilization 75.2%

ICU Level of Service D

Analysis Period (min) 15

Total 2027 SAT

4: Trim Road & Portobello Boulevard/Springridge Drive

Splits and Phases: 4: Trim Road & Portobello Boulevard/Springridge Drive

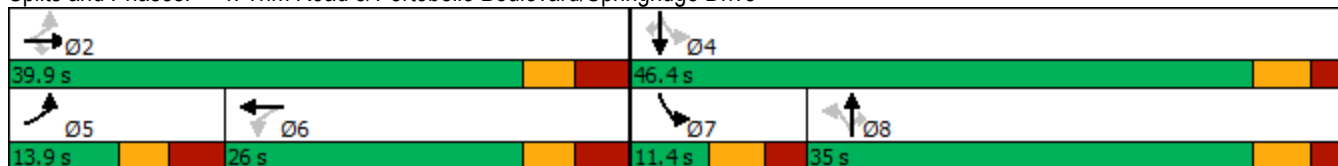

Total 2027 SAT
 5: Charlemagne Boulevard & Watters Road



Lane Group	WBL	NBT	SBT
Lane Configurations			
Traffic Volume (vph)	145	231	105
Future Volume (vph)	145	231	105
Lane Group Flow (vph)	231	353	169
Sign Control	Stop	Stop	Stop

Intersection Summary

Control Type: Unsignalized

Intersection Capacity Utilization 39.9% ICU Level of Service A

Analysis Period (min) 15

Total 2027 SAT
5: Charlemagne Boulevard & Watters Road



Movement	WBL	WBR	NBT	NBR	SBL	SBT
Lane Configurations						
Sign Control	Stop		Stop			Stop
Traffic Volume (vph)	145	86	231	122	64	105
Future Volume (vph)	145	86	231	122	64	105
Peak Hour Factor	1.00	1.00	1.00	1.00	1.00	1.00
Hourly flow rate (vph)	145	86	231	122	64	105
Direction, Lane #	WB 1	NB 1	NB 2	SB 1	SB 2	
Volume Total (vph)	231	154	199	99	70	
Volume Left (vph)	145	0	0	64	0	
Volume Right (vph)	86	0	122	0	0	
Hadj (s)	-0.06	0.03	-0.40	0.36	0.03	
Departure Headway (s)	5.0	5.4	4.9	5.9	5.6	
Degree Utilization, x	0.32	0.23	0.27	0.16	0.11	
Capacity (veh/h)	671	643	698	580	613	
Control Delay (s)	10.4	8.8	8.6	8.8	8.0	
Approach Delay (s)	10.4	8.7		8.5		
Approach LOS	B	A		A		
Intersection Summary						
Delay			9.2			
Level of Service			A			
Intersection Capacity Utilization			39.9%	ICU Level of Service		A
Analysis Period (min)			15			

Total 2027 SAT

6: Crown Pointe Plaza Access 3/Montcrest Drive & Watters Road



Lane Group	EBT	WBT	NBT	SBT	SBR
Lane Configurations					
Traffic Volume (vph)	169	162	27	26	35
Future Volume (vph)	169	162	27	26	35
Lane Group Flow (vph)	325	401	246	132	35
Sign Control	Stop	Stop	Stop	Stop	

Intersection Summary

















Control Type: Unsignalized

Intersection Capacity Utilization 72.9% ICU Level of Service C

Analysis Period (min) 15

Total 2027 SAT

6: Crown Pointe Plaza Access 3/Montcrest Drive & Watters Road

												
Movement	EBL	EBT	EBR	WBL	WBT	WBR	NBL	NBT	NBR	SBL	SBT	SBR
Lane Configurations												
Sign Control		Stop			Stop			Stop			Stop	
Traffic Volume (vph)	46	169	110	123	162	116	104	27	115	106	26	35
Future Volume (vph)	46	169	110	123	162	116	104	27	115	106	26	35
Peak Hour Factor	1.00	1.00	1.00	1.00	1.00	1.00	1.00	1.00	1.00	1.00	1.00	1.00
Hourly flow rate (vph)	46	169	110	123	162	116	104	27	115	106	26	35
Direction, Lane #	EB 1	WB 1	NB 1	SB 1	SB 2							
Volume Total (vph)	325	401	246	132	35							
Volume Left (vph)	46	123	104	106	0							
Volume Right (vph)	110	116	115	0	35							
Hadj (s)	-0.14	-0.08	-0.16	0.44	-0.67							
Departure Headway (s)	6.0	5.9	6.5	7.7	6.5							
Degree Utilization, x	0.54	0.65	0.44	0.28	0.06							
Capacity (veh/h)	562	574	498	405	469							
Control Delay (s)	15.7	19.3	14.5	12.5	8.8							
Approach Delay (s)	15.7	19.3	14.5	11.7								
Approach LOS	C	C	B	B								
Intersection Summary												
Delay			16.1									
Level of Service			C									
Intersection Capacity Utilization			72.9%		ICU Level of Service		C					
Analysis Period (min)			15									

Total 2027 SAT
7: Watters Road

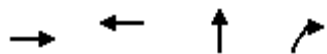

Lane Group	EBT	WBT	NBT	NBR
Lane Configurations				
Traffic Volume (vph)	379	410	0	41
Future Volume (vph)	379	410	0	41
Lane Group Flow (vph)	400	410	10	41
Sign Control	Free	Free	Stop	

















Intersection Summary

Control Type: Unsignalized

Intersection Capacity Utilization Err% ICU Level of Service H

Analysis Period (min) 15

Total 2027 SAT
7: Watters Road

												
Movement	EBL	EBT	EBR	WBL	WBT	WBR	NBL	NBT	NBR	SBL	SBT	SBR
Lane Configurations												
Traffic Volume (veh/h)	0	379	21	0	410	0	10	0	41	0	0	0
Future Volume (Veh/h)	0	379	21	0	410	0	10	0	41	0	0	0
Sign Control		Free			Free			Stop			Stop	
Grade		0%			0%			0%			0%	
Peak Hour Factor	1.00	1.00	1.00	1.00	1.00	1.00	1.00	1.00	1.00	1.00	1.00	1.00
Hourly flow rate (vph)	0	379	21	0	410	0	10	0	41	0	0	0
Pedestrians												
Lane Width (m)												
Walking Speed (m/s)												
Percent Blockage												
Right turn flare (veh)												
Median type		None			None							
Median storage (veh)												
Upstream signal (m)					120							
pX, platoon unblocked	0.99						0.99	0.99		0.99	0.99	0.99
vC, conflicting volume	410			400			800	800	200	640	810	410
vC1, stage 1 conf vol												
vC2, stage 2 conf vol												
vCu, unblocked vol	404			400			796	796	200	636	806	404
tC, single (s)	4.1			4.1			7.5	6.5	6.9	7.5	6.5	6.9
tC, 2 stage (s)												
tF (s)	2.2			2.2			3.5	4.0	3.3	3.5	4.0	3.3
p0 queue free %	100			100			96	100	95	100	100	100
cM capacity (veh/h)	1145			1155			276	317	808	342	312	593
Direction, Lane #	EB 1	EB 2	WB 1	NB 1	SB 1	SB 2						
Volume Total	190	210	410	51	0	0						
Volume Left	0	0	0	10	0	0						
Volume Right	0	21	0	41	0	0						
cSH	1145	1700	1700	587	1700	1700						
Volume to Capacity	0.00	0.12	0.24	0.09	0.00	0.00						
Queue Length 95th (m)	0.0	0.0	0.0	2.2	0.0	0.0						
Control Delay (s)	0.0	0.0	0.0	11.7	0.0	0.0						
Lane LOS				B	A	A						
Approach Delay (s)	0.0		0.0	11.7	0.0							
Approach LOS				B	A							
Intersection Summary												
Average Delay			0.7									
Intersection Capacity Utilization			Err%		ICU Level of Service				H			
Analysis Period (min)			15									