

ACCESS PROPERTY DEVELOPMENT INC

415 LEGGET DRIVE STORMWATER MANAGEMENT REPORT

OCTOBER 22, 2021





415 LEGGET DRIVE STORMWATER MANAGEMENT REPORT

ACCESS PROPERTY DEVELOPMENT INC.

1ST SUBMISSION

PROJECT NO.: 219-00058-04

CLIENT REF:

DATE: OCTOBER 22, 2021

WSP
SUITE 300
2611 QUEENSVIEW DRIVE
OTTAWA, ON, CANADA K2B 8K2

T: +1 613 829-2800

F: +1 613 829-8299

WSP.COM

REVISION HISTORY

FIRST ISSUE

| | | | | |
|---------------------------------|------------------|-------------|--|--|
| October 22 nd , 2021 | Draft SWM Report | | | |
| Prepared by | Reviewed by | Approved By | | |
| MO | AJ | AJ | | |

SIGNATURES

PREPARED BY

Meaghan O'Neill

October 22nd, 2021

Meaghan O'Neill
Designer, Water Resources

APPROVED¹ BY



October 22nd, 2021

Ayham Jadallah, M.Eng., P.Eng.
Project Engineer, Water Resources

WSP Canada Inc. (“WSP”) prepared this report solely for the use of the intended recipient, Access Property Development Inc., in accordance with the professional services agreement. The intended recipient is solely responsible for the disclosure of any information contained in this report. The content and opinions contained in the present report are based on the observations and/or information available to WSP at the time of preparation. If a third party makes use of, relies on, or makes decisions in accordance with this report, said third party is solely responsible for such use, reliance or decisions. WSP does not accept responsibility for damages, if any, suffered by any third party as a result of decisions made or actions taken by said third party based on this report. This limitations statement is considered an integral part of this report.

The original of this digital file will be conserved by WSP for a period of not less than 10 years. As the digital file transmitted to the intended recipient is no longer under the control of WSP, its integrity cannot be assured. As such, WSP does not guarantee any modifications made to this digital file subsequent to its transmission to the intended recipient.

¹ Approval of this document is an administrative function indicating readiness for release and does not impart legal liability on to the Approver for any technical content contained herein. Technical accuracy and fit-for-purpose of this content is obtained through the review process. The Approver shall ensure the applicable review process has occurred prior to signing the document.

CONTRIBUTORS

CLIENT

Access Property Development Inc.

WSP

Water Resources, Designer Meaghan O'Neill

Water Resources, Project Engineer Ayham Jadallah



TABLE OF CONTENTS

| | | |
|-----|---|---|
| 1 | INTRODUCTION | 1 |
| 1.1 | Scope | 1 |
| 1.2 | Site Location | 1 |
| 1.3 | Stormwater Management Plan Objectives | 1 |
| 1.4 | Design Criteria | 1 |
| 2 | PRE-DEVELOPMENT CONDITIONS | 2 |
| 2.1 | General | 2 |
| 2.2 | Rainfall Information | 3 |
| 2.3 | Allowable Flow Rates | 3 |
| 3 | POST-DEVELOPMENT CONDITIONS | 4 |
| 3.1 | General | 4 |
| 3.2 | Water Quantity | 5 |
| 3.3 | Water Quality | 7 |
| 3.4 | Floodplain Considerations | 7 |
| 3.5 | Temperature Considerations | 7 |
| 4 | CONCLUSIONS | 9 |

TABLES

| | |
|---|---|
| TABLE 1: PRE-DEVELOPMENT PEAK FLOW RATE (C = 0.5)..... | 3 |
| TABLE 2: PCSWMM MODELING RESULTS | 5 |

FIGURES

| | |
|---|---|
| FIGURE 1: EXISTING CONDITIONS CATCHMENT CHARACTERISTICS..... | 2 |
| FIGURE 2: PROPOSED CONDITIONS CATCHMENT CHARACTERISTICS..... | 4 |

APPENDICES

| | |
|----------|--|
| A | PRE-CONSULTATION MEETING MINUTES AND TECHNICAL COMMENTS |
| B | CALCULATIONS & PCSWMM OUTPUT |
| C | MVCA FLOODPLAIN MAP |
| D | SUPPORTING DOCUMENTS |

1 INTRODUCTION

1.1 SCOPE

WSP Canada Inc. was retained by Access Property Development Inc. to prepare a Stormwater Management (SWM) report for the proposed development at 415 Legget Drive in Ottawa, Ontario. This SWM report examines the potential water quality and quantity impacts of the proposed commercial development and summarizes how each will be addressed in accordance with applicable guidelines.

1.2 SITE LOCATION

The site of the proposed commercial development is located at 415 Legget Drive, Ottawa, Ontario. The subject site is bounded by Solandt Road to the north, Legget Drive to the west, other commercial properties to the south, and a golf course to the east. The site is accessed via Legget Drive and Solandt Road.

1.3 STORMWATER MANAGEMENT PLAN OBJECTIVES

The objectives of the stormwater management plan are as follows:

- Collect and review background information
 - Determine the site-specific stormwater management requirements to ensure that the proposals are in conformance with the applicable Provincial, Municipal and Conservation Authority stormwater management and development guidelines.
 - Evaluate various stormwater management practices that meet the applicable SWM and development requirements and recommend a preferred strategy.
 - Prepare a stormwater management report documenting the strategy along with the technical information necessary for the justification and sizing of the proposed stormwater management facilities.
-

1.4 DESIGN CRITERIA

Design criteria were obtained through pre-consultation with the City of Ottawa held on September 27th, 2021 (meeting minutes included in **Appendix A**). Criteria for 415 Legget Drive are as follows:

- **Stormwater Quantity**- control post-development flows to pre-development levels for the 2- to 100-year storm events. The existing drainage patterns for the site should be maintained. Allowable runoff coefficient (C) shall be the lesser of pre-development conditions to a maximum of 0.5.
- **Storm Quality**- enhanced level of protection per the Mississippi Valley Conservation Authority (MVCA) is required (80% TSS Removal).

2 PRE-DEVELOPMENT CONDITIONS

2.1 GENERAL

The subject site is a 7.29 ha parcel of land comprised of two paved parking areas and an approximately 9,600 m² commercial building. Vehicular access to the site is via two entrances on Legget Drive and Soldant Road. Under pre-development conditions the subject site consists of primarily impervious building and parking area with the exception of the north east corner of the property which is undeveloped pervious area. Within the northeast corner of the site there is an existing stormwater management wet pond. Existing drainage patterns for the site were determined based on topographic survey information and found that existing drainage, with the exception of the existing building, is towards the existing pond which discharges into the Kizell Drain. The existing building roof drainage discharges via roof drains into the Soldant Road sewer. It should be noted that the existing building will remain unchanged in the proposed development. Therefore, the existing building's drainage was not considered as part of the proposed stormwater management strategy as it will remain as existing. The existing runoff coefficient for the remaining 6.33 ha of the site is estimated as 0.58. Per the City of Ottawa Sewer Design Guidelines section 8.3.7.3, a pre-development runoff coefficient of 0.5 was used to analyze the pre-development conditions. The pre-development catchment characteristics are illustrated in Figure 1.

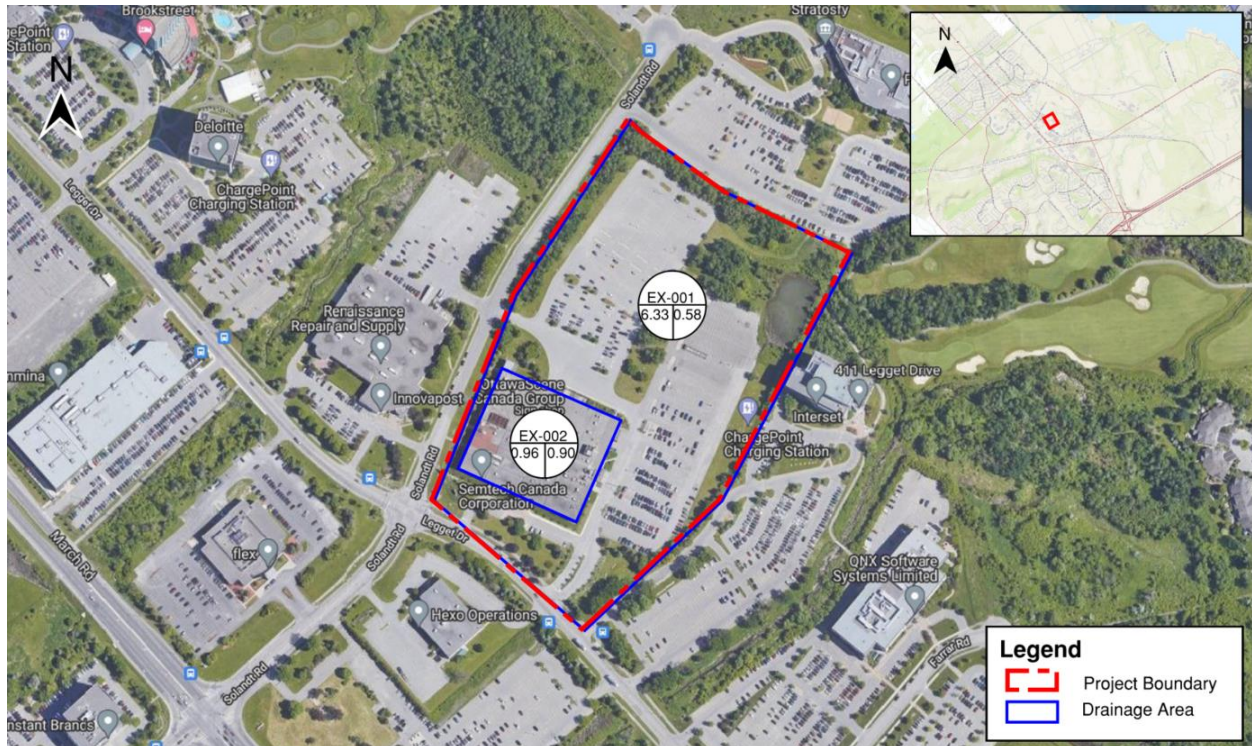

Figure 1: Existing Conditions Catchment Characteristics

2.2 RAINFALL INFORMATION

The rainfall intensity is calculated in accordance with Section 5.4.2 of the Ottawa Sewer Design Guidelines (October, 2012):

Where;

$$i = \left[\frac{A}{(Td + C)^B} \right]$$

- A, B, C = regression constants for each return period (defined in section 5.4.2)
- i = rainfall intensity (mm/hour)
- Td = storm duration (minutes)

The IDF parameters/regression constants are per the Ottawa Sewer Design Guidelines (October, 2012).

2.3 ALLOWABLE FLOW RATES

As noted in section 1.4, relevant policies from the OSDG for a re-development and the pre-consultation meeting require the post-development discharge rate from the site match pre-development levels for the 2- to 100-year storm events where pre-development conditions are analyzed using the lesser of the actual runoff coefficient and a runoff coefficient of 0.5.

As Previously discussed, runoff from the existing building was not considered as part of the stormwater management analysis as it will remain unchanged under proposed conditions. PCSWMM was used to analyze the existing conditions for the remaining 6.33 ha of the site and determine the allowable peak flow rates from the site into the existing wet pond, results are summarized in Error! Reference source not found.. Detailed results are provided in **Appendix B**.

Table 1: Pre-Development Peak Flow Rate (C = 0.5)

| RETURN PERIOD (Years) | SITE PEAK FLOW RATE (m ³ /sec) |
|--------------------------|--|
| 2 | 0.59 |
| 5 | 0.94 |
| 10 | 1.21 |
| 25 | 1.57 |
| 50 | 1.85 |
| 100 | 2.14 |

3 POST-DEVELOPMENT CONDITIONS

3.1 GENERAL

The proposed Legget Drive project is a commercial development in Ottawa. Post development condition catchment characteristics are shown in Figure 2. The proposed development includes the construction of two additional commercial buildings over a portion of the two existing parking areas. Vehicular access to the site will continue to be via the existing entrances off of Legget Drive and Soldant Road. Similar to existing conditions, all site runoff (with the exception of the existing building) will be towards the existing wet pond in the north east corner and ultimately into the Kizell Drain.

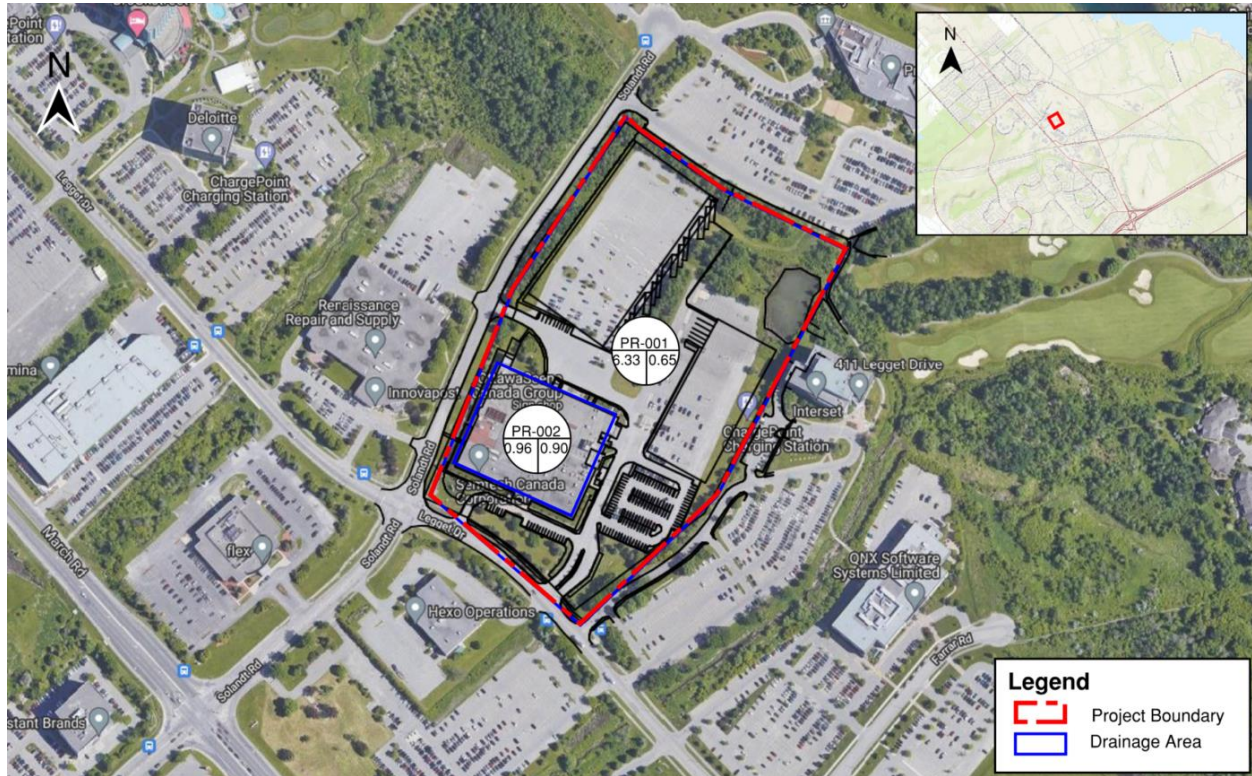

Figure 2: Proposed Conditions Catchment Characteristics

To meet stormwater management objectives, as defined by the design criteria outlined in Section 1.4, the following components have been proposed:

- Roof storage on the two proposed buildings, controlled by WATTS Adjustable Flow Control Roof Drains (or equivalent)
- Existing Wet Pond
- Existing grassed ditches

The application and sizing of these proposed stormwater management facilities is outlined in the following sections.

3.2 WATER QUANTITY

As noted previously, it is required that the post-development discharge rate from the site match pre-development levels for the 2- to 100-year storm events.

Proposed features to achieve these targets include;

- Roof storage with flow control roof drains

PCSWMM software has been used to model the behaviour of the proposed SWM system and determine its response under various storm events. The model was developed and tested in an iterative manner to determine the necessary storage volumes and flow control rates from the two proposed buildings. Roof storage areas were defined using storage nodes in the model, with appropriate stage-storage relationships based on the volumes available in each area. Outflow controls from each storage node were defined using outlets with appropriate head-discharge curves as defined using manufacture information provided in **Appendix D**.

A summary of the modeling results is provided in Table 2, detailed PCSWMM modeling results are provided in **Appendix B**.

The model was developed assuming 75% of the roof area is available for storage, and the use of 15 fully exposed WATTS Adjustable Flow Control Roof Drains (or equivalent) for both buildings. It should be noted that both buildings are still in the conceptual design stage and therefore a detailed roof plan, including the number and arrangement of roof drains, will be provided at the detailed design stage.

Table 2: PCSWMM Modeling Results

| RETURN PERIOD (Years) | TARGET RELEASE RATE (m ³ /sec) | PEAK DISCHARGE RATE (m ³ /sec) | MAX ROOF STORAGE UTILIZED (m ³) | MAX ROOF PONDING DEPTH (mm) |
|--------------------------|---|---|--|--------------------------------------|
| 2 | 0.59 | 0.52 | Building 1: 284 m ³ Building 2: 150 m ³ | Building 1: 35mm Building 2: 29mm |
| 5 | 0.95 | 0.83 | Building 1: 386 m ³ Building 2: 205 m ³ | Building 1: 47mm Building 2: 39mm |
| 10 | 1.22 | 1.04 | Building 1: 452m ³ Building 2: 242 m ³ | Building 1: 55mm Building 2: 46mm |
| 25 | 1.58 | 1.32 | Building 1: 535m ³ Building 2: 287m ³ | Building 1: 65mm Building 2: 55mm |
| 50 | 1.86 | 1.53 | Building 1: 598m ³ Building 2: 321m ³ | Building 1: 72mm Building 2: 61mm |
| 100 | 2.15 | 1.75 | Building 1: 664m ³ Building 2: 357m ³ | Building 1: 81mm Building 2: 68mm |

3.2.1 EXISTING WET POND

As previously discussed, there is an existing wet pond in the north-east corner of the site. A Phase 1 Environmental Site Assessment completed by SRL in April, 2021 determined that the existing wet pond is approximately 1m deep and noted some additional ponding in the area around the pond as shown on Figure 3. Detailed survey information found the pond to have an approximately 1,868 m² area with a top of water elevation of approximately 76.1 m at the time of the survey. The survey shows the pond to have a spill point elevation of 76.61 m into a ditch discharging into the Kizell Drain as shown on the MVCA Floodplain Map in **Appendix C**. The existing wet pond was modeled using PCSWMM with the appropriate stage-storage information based on the available information. A summary of the modeling results showing expected high-water elevations in the pond in both existing and proposed conditions is shown in Table 3, detailed modeling results can be found in **Appendix B**.

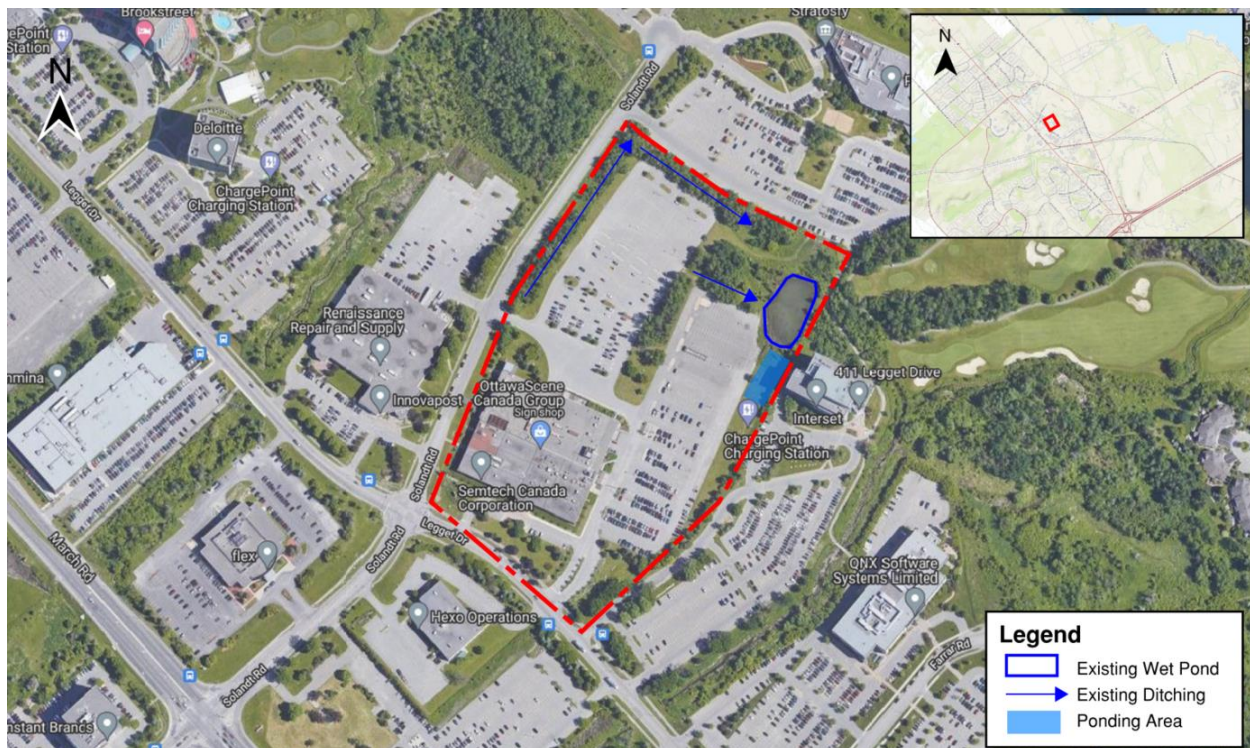

Figure 3: Existing Drainage

Table 3: PCSWMM Results - Wet Pond

| RETURN PERIOD (Years) | WET POND WATER ELEVATION – EXISTING CONDITIONS (m) | WET POND WATER ELEVATION – PROPOSED CONDITIONS (m) |
|--------------------------|--|--|
| 2 | 76.57 | 76.61 |
| 5 | 76.65 | 76.65 |
| 10 | 76.70 | 76.68 |
| 25 | 76.76 | 76.62 |
| 50 | 76.80 | 76.75 |
| 100 | 76.85 | 76.79 |

It is noted that there is a small increase in expected water surface elevation for the 2-year event under proposed conditions. This increase is considered negligible and not expected to impact the surrounding area.

3.3 WATER QUALITY

As noted previously, all site runoff (with the exception of the existing building) will continue to drain to the existing wet pond on site and ultimately discharge into the Kizell Drain.

It is assumed that runoff from the proposed rooftop areas and walkways areas will be free of typical sediment-generating activities and therefore runoff will leave them effectively unchanged and can be considered clean for the purposes of water quality assessment. It should be noted that the typical sediment-generating activities are in areas with vehicular access, such as loading areas and parking areas. In the case of this development, the overall parking area is reduced and replaced with the roof areas of the proposed buildings. Therefore, the overall water quality leaving the site is considered to be improved upon existing conditions.

Under existing conditions, a treatment train approach of grassed ditches and a wet pond exist on site which will be maintained under proposed conditions. Vegetation in the grassed ditches decrease the velocity of flow, allowing for sedimentation and filtration. Additionally, wet ponds allow for extended detention times allowing sediment to settle out prior to discharge. Finally, site runoff is generally directed over pervious grassed area, helping to filter out additional sediment and slow the runoff, prior to entering the pond. The combination of the existing quality control measures on site, as well as the overall reduction in parking area, is considered sufficient to meet the quality control requirements of this site.

Should re-grading of the existing ditches be re-quired, consideration can be given to improving the existing ditches to be enhanced grassed swales (design per TRCA,2010) to further improve quality control.

3.4 FLOODPLAIN CONSIDERATIONS

A flood plain map was provided by the MVCA and is included in **Appendix C**. As shown on the map, the proposed development is outside of both the Kizell Drain and Shirley’s Brook 1:100-year floodplain and therefore loss of floodplain storage is not a concern in the case of this development.

3.5 TEMPERATURE CONSIDERATIONS

Existing grassed ditches as well as the vegetation surrounding the existing pond help to cool runoff as it passes along/though naturally vegetated media and infiltrate flows from asphalt surfaces. These measures will all remain in place under existing conditions. Furthermore, additional tree planting around the existing wet pond is proposed to

further cool water within the pond. The possibility of adding a cooling trench at the outlet of the existing wet pond is also currently being explored as a final cooling measure prior to entering the Kizel Drain.

In conjunction, the above measures are considered sufficient to address MVCA requirements related to temperature of storm runoff from the site.

4 CONCLUSIONS

A stormwater management report has been prepared to support the feasibility study for the proposed development at 415 Legget Drive in the City of Ottawa. The key points are summarized below.

WATER QUALITY

Existing grassed ditches, and stormwater management wet pond is considered sufficient to meet the quality control requirements for the site.

WATER QUANTITY

Quantity control will be provided via roof storage on the two proposed buildings, controlled with flow control roof drains.

APPENDIX

A

PRE-CONSULTATION
MEETING MINUTES
AND TECHNICAL
COMMENTS

Pre-Application Consultation Meeting Notes

11:00am to 12:00pm, September 27, 2021, via Microsoft Teams
Property Address: 415 Legget Drive and 2700 Solandt Road
File No.: PC2021-0327

Attendees:

Molly Smith – Planner, City of Ottawa
Matthew Ippersiel – Planner (Urban Design), City of Ottawa
Matthew Hayley – Planner (Environmental), City of Ottawa
Jeffrey Ren – Co-op Student, City of Ottawa
Jill MacDonald – WSP
Justyna Garbos – WSP
Survir Pursnani – WSP
Jie Chen – Architecture49
Frank Abrantes – Access Storage
Hind Barnieh – Access Storage

Regrets:

Mark Richardson – Forester, City of Ottawa
Neeti Paudel – Project Manager (Transportation), City of Ottawa
Jessica Valic – Project Manager (Infrastructure), City of Ottawa
Jeff Goettling – Planner (Parks), City of Ottawa

Applicant's Proposal:

- The proposed development will be split into two phases – the first phase is interior retrofit of the existing building and the second phase is the construction of the two new warehouse buildings in the current parking lot
- The new buildings will be between 24 and 36 feet in height
- A total of 176 surface level parking spaces will be provided
- Access to the proposed development will be via the three existing accesses from Legget Drive and Solandt Road
- No minor variance being sought; the applicants expect that the proposed development conforms to the Zoning By-law.
- The applicant is targeting a submission on or before October 27

Preliminary comments and questions from staff and agencies, including follow-up actions:

Infrastructure

Water

Available Watermain

- 305mm (DI) – Legget Dr (existing 250mm service is located off this main)
- 305mm (PVC) – Solandt Rd

- Per WDG 4.3.1, where basic demand is greater than 50 m³/day, there shall be a minimum of two water services, separated by an isolation valve, to avoid creation of vulnerable service area.
- Per WDG 4.4.7.2, District Meter Area (DMA) Chamber is required for services greater than 150mm in diameter.
- Only one water service is permitted per parcel. Servicing for additional buildings must be accomplished through internal branching of existing water service. If larger water service is required to accommodate additional development, please utilize the location of the existing service to limit cuts in watermain. If a new service is required, and existing location cannot be used, the existing service must be blanked at the main
- Demonstrate that the water service is adequately sized for increased water use.
- Demonstrate that adequate fire flow from fire hydrants and required pressures per City of Ottawa Water Design Guidelines are available. Provide fire hydrant coverage plan.

Boundary Conditions

Request prior to first submission. Contact assigned City Infrastructure Project Manager with the following information

- Location of service(s)
- Type of development
- Fire flow (per FUS method – include FUS calculation sheet with boundary condition request – boundary conditions will not be requested without fire flow calculations)
- Average Daily Demand (l/s)
- Maximum Hourly Demand (l/s)
- Maximum Daily Demand (l/s)

Sanitary

Available Sanitary Sewer

- 750mm (CONR) – Legget Dr – Marchwood Collector
- No available sanitary main on Solandt Rd
- Connections to collector sewers are discouraged. It is assumed that the existing building sanitary service is connected to this collector sewer. Reuse existing connection location to limit cuts in sanitary sewer.
- Demonstrate that the existing sanitary service is adequately sized for increased flow.
- Demonstrate that there is sufficient/adequate residual capacity in the receiving system to accommodate increase in flow
- Provided the existing service is adequately sized, please CCTV existing lateral to determine the condition of the lateral and submit CCTV video and report with application. If service is in poor condition, repair/replacement will be required.

Storm

Available Storm Sewer

- 525mm (CONC) – Solandt Rd
- 375mm (PVC) – Legget Dr

Stormwater Management

- Quantity Control
 - Required for the site up to and including the 100-yr storm event.
 - Refer to Shirley's Brook and Watts Creek Subwatershed Study Report for relevant environmental protection targets.
 - Consult Stormwater Management Plan, Kanata Research Park, City of Kanata for relevant stormwater management criteria.
 - Existing ditch system and wet pond exist on site.
 - If underground/inline stormwater storage is proposed, an average release rate equal to 50% of the determined peak allowable rate must be used. Otherwise, disregard the underground/inline storage as available storage or provide modeling to support the proposed design. The reasoning for this restriction is that the discharge rate at full storage is not representative of the discharge rate for more frequent storm events. Halving the discharge rate compensates for the inaccuracies of the modified rational method when underground storage is used.
 - Provide both pre and post development stormwater management plans, showing individual drainage areas and their respective coefficient.
 - If roof storage is proposed, please provide a roof drainage plan showing the 5 and 100-year storm ponding levels. Include the roof drain type, opening settings, and flow rate.
 - Per Technical Bulletin PIEDTB-2016-01 section 8.3.11.1 there shall be no surface ponding on private parking areas during the 2-year storm rainfall event.
 - Please note that the minimum orifice dia. for a plug style ICD is 83mm and the minimum flow rate from a vortex ICD is 6 L/s in order to reduce the likelihood of plugging.
- Quality Control: Please consult Conservation Authority (CA) regarding water quality control restrictions for the subject site. Include correspondence in servicing report.
- Ministry of Environment, Conservation, and Parks (MECP): Designer to determine if approval for sewage works under Section 53 of OWRA is required and to determine the type of application required. Reviews will be done through Transfer of Review or Direct Submission.
- Stormwater drainage systems that are designed to accommodate drainage from two separate parcels require an ECA.

Geotechnical Investigation

- Geotechnical Report is required for this development proposal.
- The Geotechnical Report shall speak to any proposed underground stormwater storage and provide confirmation that the site subsurface characteristics (groundwater table elevation, soil type) are appropriate. Of note, the high groundwater table must be 1.0m above the bottom of any proposed storage system per MECP requirements.

Exterior Lighting

- If exterior light fixtures are proposed, provide a plan showing the location of all exterior fixtures and include a table providing fixture details (make, model, mounting heights). All external light fixtures must meet the criteria for full cut-off classification as recognized by the Illuminating Engineering Society of North America (IESNA or IES), resulting in minimal light spillage onto

adjacent properties (as a guideline, 0.5 fc is normally the maximum allowable spillage). Provide certification letter from a relevant Professional Engineer.

Required Studies

- Servicing/Stormwater Management Report (Submit completed Servicing Study Checklist with Servicing Report)
- Geotechnical Investigation

Required Plans

- Site Servicing Plan
- Grade Control and Drainage Plan (Show major overland flow route)
- Erosion and Sediment Control Plan (Can be combined with grading plan)
- Existing Conditions and Removals Plan
- SWM Plans

General Information

1. The Servicing Study Guidelines for Development Applications are available at the following address: <https://ottawa.ca/en/city-hall/planning-and-development/information-developers/development-application-review-process/development-application-submission/guide-preparing-studies-and-plans#servicing-study-guidelines-development-applications>
2. Servicing and site works shall be in accordance with the following documents:
 - Ottawa Sewer Design Guidelines (October 2012) (including subsequent Technical Bulletins)
 - Ottawa Design Guidelines – Water Distribution (2010) (including subsequent Technical Bulletins)
 - Geotechnical Investigation and Reporting Guidelines for Development Applications in the City of Ottawa (2007)
 - Ottawa Standard Tender Documents (latest version)
3. Record drawings and utility plans are also available for purchase from the City (Contact the City's Information Centre by email at InformationCentre@ottawa.ca or by phone at (613) 580-2424 x.44455).
4. Any proposed work in utility easements requires written consent of easement owner.
5. **All submitted report and plan pdf documents to be flattened and unsecured to allow for editing and ease of use.**
6. All documents prepared by Engineers shall be signed and dated on the seal.

Please contact Infrastructure Project Manager Jessica Valic (jessica.valic@ottawa.ca) for follow-up questions.

Planning

- The application will be considered Site Plan Control (Manager Approval, Public Consultation), please fine the application form and information on fees [here](#).
- Please review the following Official Plan policies and Zoning By-law provisions:

- The subject site is designated as [Urban Employment Area](#) in the Official Plan
- The subject site is zone [Business Park Industrial Zone, Subzone 6 – Kanata North Business Park \(IP6\)](#).
- The New Official Plan will be going to Planning Committee on October 14, 2021 and then to City Council for adoption on October 27, 2021 – please be aware of the following New Official Plan policies:
 - The subject site is designated as ‘Kanata North Economic District’ with an ‘Evolving Neighbourhood’ overlay; policies for the ‘Kanata North Economic District’ can be found under [Section 6.6.3.2 of the revised draft New Official Plan](#).
 - Please provide a review and summary of the designation and applicable policies as they apply to the site.
 - The ‘Kanata North Economic District’ is expected to be the site of a Community Planning Permit System pilot project – the pilot project would require the passage of a Community Planning Permit System by-law after the New Official Plan comes into effect.
 - A complete application is received by no later than the day before the new Official Plan is adopted (October 27, 2021), it will be processed on the basis of existing Official Plan policy provided it is consistent with the 2020 Provincial Policy Statement.
 - Applications received after the day before the new Official Plan is adopted will be reviewed and evaluated on the basis of the policies of the new Official Plan.
 - Based on the submitted concept plan and the draft New Official Plan available at the time of the pre-consultation meeting, the proposed development does not appear to be affected by any proposed policy changes.
- Please consider providing only the minimum number of required parking spaces.
- Please consider relocating the parking spaces between the right-of-way and the existing building.
- Please incorporate additional landscaping throughout the parking lot through the introduction of additional parking lot islands and along the perimeter of the property where sidewalks would be found.
- Please ensure that all landscaping provisions for parking lots are being followed; please refer to Section 110 of the Zoning By-law.
- Please provide shaded landscaped pedestrian connections from the public sidewalk to building entrances.
- For bicycle parking, consider providing covered shelters for bicycle parking or integrate within buildings.
- Please refrain from designing blank walls along the street frontages; buildings should be street-oriented with entrances facing the street with highly transparent ground-floor facades.
- Please consider integrating pedestrian-oriented features such as shade trees, bicycle/scooter parking, outdoor seating areas and street furniture.
- Please ensure that the proposed development complies with all applicable provisions of the Zoning By-law and provide a comprehensive zoning table on the submitted site plan and report.
- Please note that Councillor Jenna Sudds has resigned as Councillor for Kanata North (Ward 4) – please reach out to her successor when applicable.
 - City Council will be declaring the office vacant and staff will recommend that City Council approve interim delegations of authority with respect to Ward 4 matters on

October 13, 2021, Council will then appoint person to fill the vacancy or hold a by-election.

- The application will be subject to public consultation (conducted through the posting of on-site signage, the notification of community groups, and through the City of Ottawa's DevApps website); please note that the Councillor may also ask for a Community Information and Comment Session.
- Please determine if Section 37 applies.

Urban Design

- Specific Design Comments
 - Avoid blank walls facing the public realm. Integrate as much glazing, transparency, entrances and active frontages as possible facing Legget and Solandt, particularly at the ground floor.
 - Integrate a generous landscaping treatment along Solandt that is in keeping with the character of Kanata Business Park. This often includes coniferous species of trees.
 - Consider opportunities for pedestrian-oriented features such as shade trees, bicycle/scooter parking, outdoor seating areas and street furniture
 - To minimize the impact on the public realm, service areas such as parking, loading, vehicle access and service entrances should be at the rear of the buildings. Use landscaping to screen them from the public realm.
 - Where exposed to the public realm, use landscaping to screen parking lots as much as possible.
 - Integrate as much greening into the parking lot as possible and ensure strong and logical pedestrian connectivity to building entrances.
- New Official Plan (New OP) – Note that the draft new OP aims to designate the greater area that this property falls within as a “Special Economic District” and as a Design Priority Area. The new policy will aim to enhance mobility options, encourage mixed-use development and promote enhanced urban design. Please refer to [Section 6.6.3.2](#) of the draft plan. Though not currently in effect, the proponent is strongly encouraged to implement the new vision for the area as much as possible.
- Kanata North Tech Park Community Planning Permit Pilot Study (CPP) – Note that a study is currently underway for the greater area that this property falls within, which will have implications for urban design. It is being re-envisioned as a “highly-connected, vibrant mixed-use area where people live, work, connect and play”. Refer to the project [Website](#) for more details.
- Design Brief – As part of your submission, please include a Design Brief. Please refer to the attached Design Brief Terms of Reference to inform the content of the brief.
- Urban Design Review Panel – In the current policy context, this application is not subject to review by the Urban Design Review Panel (UDRP). While the draft new Official Plan aims to recognize the area as a Design Priority Area, early indications from staff working on the Kanata

North CPP are that the area will likely be exempt from review by the UDRP (though it is possible that this may be subject to change).

Please contact Urban Design Planner Matthew Ippersiel (Matthew.Ippersiel@ottawa.ca) for follow-up questions.

Environmental Planning

Bird-safe Design

- Given the height of the proposal (mid to high rise) the proposal will need to review and incorporate bird safe design elements. Some of the risk factors include glass and related design traps such as corner glass and fly-through conditions, ventilation grates and open pipes, landscaping, light pollution. More guidance and solutions are available in the guidelines which can be found here: <https://ottawa.ca/en/planning-development-and-construction/developing-property/development-application-review-process/development-application-submission/guide-preparing-studies-and-plans> .

Environmental Impact Statement (EIS) to address species at risk and provide recommendations on wildlife mitigations.

- Blanding's turtles sighted in the area, indicating regulated habitat may be present on the property, particularly in the parts around the pond. MECP consultation will likely be required to address the limits of Blanding's turtle habitat and to obtain the necessary approvals.

Please contact Environmental Planner Matthew Hayley (Matthew.Hayley@ottawa.ca) for follow-up questions.

Forestry

- A Tree Conservation Report (TCR) must be supplied for review along with the suite of other plans/reports required by the City
 - a. an approved TCR is a requirement of Site Plan approval.
 - b. The TCR may be combined with the Landscape Plan provided all information is supplied.
- As of January 1 2021, any removal of privately-owned trees 10cm or larger in diameter, or publicly (City) owned trees of any diameter requires a tree permit issued under the Tree Protection Bylaw (Bylaw 2020 – 340); the permit will be based on an approved TCR and made available at or near plan approval.
- The Planning Forester from Planning and Growth Management as well as foresters from Forestry Services will review the submitted TCR.
 - a. If tree removal is required, both municipal and privately-owned trees will be addressed in a single permit issued through the Planning Forester.
 - b. Compensation may be required for city owned trees – if so, it will need to be paid prior to the release of the tree permit.
- The TCR must list all trees on site, as well as off-site trees if the CRZ extends into the developed area, by species, diameter and health condition.
- Please identify trees by ownership – private onsite, private on adjoining site, city owned, co-owned (trees on a property line).
- The TCR must list all trees on adjacent sites if they have a critical root zone that extends onto the development site.

- If trees are to be removed, the TCR must clearly show where they are, and document the reason they cannot be retained.
- All retained trees must be shown and all retained trees within the area impacted by the development process must be protected as per City guidelines available at [Tree Protection Specification](#) or by searching Ottawa.ca.
 - a. The location of tree protection fencing must be shown on a plan
 - b. Show the critical root zone of the retained trees
 - c. If excavation will occur within the critical root zone, please show the limits of excavation
- The City encourages the retention of healthy trees; if possible, please seek opportunities for retention of trees that will contribute to the design/function of the site.
- For more information on the process or help with tree retention options, contact Mark Richardson mark.richardson@ottawa.ca or on [City of Ottawa](#).

Landscape Plan tree planting requirements:

For additional information on the following please contact tracy.smith@Ottawa.ca

Minimum Setbacks

- Maintain 1.5m from sidewalk or MUP/cycle track.
- Maintain 2.5m from curb
- Coniferous species require a minimum 4.5m setback from curb, sidewalk or MUP/cycle track/pathway.
- Maintain 7.5m between large growing trees, and 4m between small growing trees. Park or open space planting should consider 10m spacing.
- Adhere to Ottawa Hydro's planting guidelines (species and setbacks) when planting around overhead primary conductors.

Tree specifications

- Minimum stock size: 50mm tree caliper for deciduous, 200cm height for coniferous.
- Maximize the use of large deciduous species wherever possible to maximize future canopy coverage
- Tree planting on city property shall be in accordance with the City of Ottawa's Tree Planting Specification; and include watering and warranty as described in the specification (can be provided by Forestry Services).
- Plant native trees whenever possible
- No root barriers, dead-man anchor systems, or planters are permitted.
- No tree stakes unless necessary (and only 1 on the prevailing winds side of the tree)

Hard surface planting

- Curb style planter is highly recommended
- No grates are to be used and if guards are required, City of Ottawa standard (which can be provided) shall be used.
- Trees are to be planted at grade

Soil Volume

- Please ensure adequate soil volumes are met:

| Tree Type/Size | Single Tree Soil Volume (m3) | Multiple Tree Soil Volume (m3/tree) |
|----------------|------------------------------|-------------------------------------|
| Ornamental | 15 | 9 |
| Columnar | 15 | 9 |
| Small | 20 | 12 |
| Medium | 25 | 15 |
| Large | 30 | 18 |
| Conifer | 25 | 15 |

Please note that these soil volumes are not applicable in cases with Sensitive Marine Clay.

Sensitive Marine Clay

- Please follow the City's 2017 Tree Planting in Sensitive Marine Clay guidelines

Please contact Planning Forester Mark Richardson (Mark.Richardson@ottawa.ca) for follow-up questions.

Transportation

- Follow Traffic Impact Assessment Guidelines
 - Proceed with scoping.
 - Start this process asap.
 - Applicant advised that their application will not be deemed complete until the submission of the draft step 1-4, including the functional draft RMA package (if applicable) and/or monitoring report (if applicable). Collaboration and communication between development proponents and City staff are required at the end of every step in the TIA process
 - Request base mapping asap if RMA is required. Contact Engineering Services (<https://ottawa.ca/en/city-hall/planning-and-development/engineering-services>)
- Noise Impact Studies required for the following:
 - Stationary (if, within 100m of noise sensitive land use).
- Ensure clear throat length requirements as per TAC are met at the accesses.
- The easterly access on Legget Drive does not meet the private approach guidelines. This may have to be reconfigured and will be further reviewed in the TIA.
- On site plan:
 - Show all details of the roads abutting the site up to and including the opposite curb; include such items as pavement markings, accesses and/or sidewalks.
 - Turning templates will be required for all accesses showing the largest vehicle to access the site; required for internal movements and at all access (entering and exiting and going in both directions).
 - Show all curb radii measurements; ensure that all curb radii are reduced as much as possible
 - Grey out any area that will not be impacted by this application.

- As the proposed site is industrial and for general public use, AODA legislation applies. Consider using the City's Accessibility Design Standards.
- Number of accessible parking spaces should meet the requirements from Table 3 of the City's accessible Design Standards.
- Site triangles at the following locations on the final plan will be required:
 - Collector Road to Collector Road: 5 metre x 5 metres
- The scoping and forecasting can be submitted together and should be done as soon as possible.

Please contact Transportation Project Manager Neeti Paudel (Neeti.Paudel@ottawa.ca) for follow-up questions.

Parks

- How will the proposal meet the Parkland Dedication (By-law No. 2009-95)?
- For commercial and industrial purposes, the parkland requirement is calculated as 2% of the gross land area of the site being developed.
- The conveyance of land for purposes or the payment of money in-lieu of accepting the conveyance is not required for development, redevelopment, subdivisions or consents, where it is known, or can be demonstrated that the required parkland conveyance or money in-lieu thereof has been previously satisfied.

Please contact Parks Planner Jeff Goettling (Jeff.Goettling@ottawa.ca) for follow-up questions.

Other

Please refer to the links to the [guide to preparing studies and plans](#) and [development application fees](#) for general information. Additional information is available related to [building permits](#), [development charges](#), and [the Accessibility Design Standards](#). Be aware that other fees and permits may be required, outside of the development review process. You may obtain background drawings by contacting informationcentre@ottawa.ca.

These pre-consultation comments are valid for one year. If you submit a development application(s) after this time, you may be required to meet for another pre-consultation meeting and/or the submission requirements may change. You are as well encouraged to contact us for a follow-up meeting if the plan/concept will be further refined.

APPENDIX

B CALCULATIONS & PCSWMM OUTPUT



EPA STORM WATER MANAGEMENT MODEL - VERSION 5.1 (Build 5.1.013)

```

*****
Element Count
*****
Number of rain gages ..... 16
Number of subcatchments ... 4
Number of nodes ..... 3
Number of links ..... 1
Number of pollutants ..... 0
Number of land uses ..... 0
    
```

Raingage Summary

| Name | Data Source | Data Type | Recording Interval |
|----------------------------------|--------------------------------------|-----------|--------------------|
| 100yr_3hr_Chicago | 100yr_3hr_Chicago | INTENSITY | 10 min. |
| 100yr_3hr_Chicago_Climate_Change | 100yr_3hr_Chicago_Increase_20percent | INTENSITY | 10 min. |
| 100yr_6hr_Chicago | 100yr_6hr_Chicago | INTENSITY | 10 min. |
| 100yr_6hr_Chicago_Climate_Change | 100yr_6hr_Chicago_Increase_20percent | INTENSITY | 10 min. |
| 10yr_3hr_Chicago | 10yr_3hr_Chicago | INTENSITY | 10 min. |
| 10yr_6hr_Chicago | 10yr_6hr_Chicago | INTENSITY | 10 min. |
| 25mm_3hr_Chicago | 25mm_3hr_Chicago | INTENSITY | 10 min. |
| 25mm_4hr_Chicago | 25mm_4hr_Chicago | INTENSITY | 10 min. |
| 25yr_3hr_Chicago | 25yr_3hr_Chicago | INTENSITY | 10 min. |
| 25yr_6hr_Chicago | 25yr_6hr_Chicago | INTENSITY | 10 min. |
| 2yr_3hr_Chicago | 2yr_3hr_Chicago | INTENSITY | 10 min. |
| 2yr_6hr_Chicago | 2yr_6hr_Chicago | INTENSITY | 10 min. |
| 50yr_3hr_Chicago | 50yr_3hr_Chicago | INTENSITY | 10 min. |
| 50yr_6hr_Chicago | 50yr_6hr_Chicago | INTENSITY | 10 min. |
| 5yr_3hr_Chicago | 5yr_3hr_Chicago | INTENSITY | 10 min. |
| 5yr_6hr_Chicago | 5yr_6hr_Chicago | INTENSITY | 10 min. |

Subcatchment Summary

| Name | Area | Width | %Imperv | %Slope | Rain Gage | Outlet |
|------|------|--------|---------|--------|-----------------|-------------|
| S1 | 2.42 | 469.99 | 43.00 | 5.3370 | 2yr_3hr_Chicago | Legget_Pond |
| S1_1 | 0.28 | 491.26 | 43.00 | 5.2120 | 2yr_3hr_Chicago | Legget_Pond |
| S1_2 | 3.63 | 499.74 | 43.00 | 2.8320 | 2yr_3hr_Chicago | Legget_Pond |
| S1_4 | 0.97 | 458.49 | 98.37 | 1.0000 | 2yr_3hr_Chicago | OF2 |

Node Summary

| Name | Type | Invert Elev. | Max. Depth | Ponded Area | External Inflow |
|----------------|---------|--------------|------------|-------------|-----------------|
| OF_Legget_Pond | OUTFALL | 75.40 | 0.00 | 0.0 | |
| OF2 | OUTFALL | 77.70 | 0.00 | 0.0 | |
| Legget_Pond | STORAGE | 76.10 | 2.00 | 0.0 | |

Link Summary

| Name | From Node | To Node | Type | Length | %Slope | Roughness |
|------|-------------|----------------|---------|--------|--------|-----------|
| OR1 | Legget_Pond | OF_Legget_Pond | ORIFICE | | | |

Cross Section Summary

| Conduit | Shape | Full Depth | Full Area | Hyd. Rad. | Max. Width | No. of Barrels | Full Flow |
|---------|-------|------------|-----------|-----------|------------|----------------|-----------|
| | | | | | | | |

NOTE: The summary statistics displayed in this report are based on results found at every computational time step, not just on results from each reporting time step.

Analysis Options

Flow Units CMS
 Process Models:
 Rainfall/Runoff YES
 RDII NO
 Snowmelt NO
 Groundwater NO
 Flow Routing YES
 Ponding Allowed YES
 Water Quality NO
 Infiltration Method HORTON
 Flow Routing Method DYNWAVE
 Surcharge Method EXTRAN
 Starting Date 11/10/2013 00:00:00
 Ending Date 11/10/2013 06:00:00
 Antecedent Dry Days 0.0
 Report Time Step 00:05:00
 Wet Time Step 00:05:00
 Dry Time Step 00:05:00
 Routing Time Step 1.00 sec
 Variable Time Step YES
 Maximum Trials 20
 Number of Threads 1
 Head Tolerance 0.001500 m

| Volume | Depth |
|----------------------------|-----------|
| Runoff Quantity Continuity | hectare-m |
| Total Precipitation | 0.232 |
| Evaporation Loss | 0.000 |
| Infiltration Loss | 0.115 |
| Surface Runoff | 0.112 |
| Final Storage | 0.006 |
| Continuity Error (%) | -0.382 |

| Volume | Volume |
|-------------------------|-----------|
| Flow Routing Continuity | hectare-m |
| Dry Weather Inflow | 0.000 |
| Wet Weather Inflow | 0.112 |
| Groundwater Inflow | 0.000 |
| RDII Inflow | 0.000 |
| External Inflow | 0.000 |
| External Outflow | 0.029 |
| Flooding Loss | 0.000 |
| Evaporation Loss | 0.000 |
| Exfiltration Loss | 0.000 |
| Initial Stored Volume | 0.000 |
| Final Stored Volume | 0.083 |
| Continuity Error (%) | 0.008 |

Time-Step Critical Elements
 None

Highest Flow Instability Indexes
 All links are stable.

Routing Time Step Summary
 Minimum Time Step : 0.50 sec
 Average Time Step : 1.00 sec
 Maximum Time Step : 1.00 sec
 Percent in Steady State : 0.00
 Average Iterations per Step : 2.00
 Percent Not Converging : 0.00

Subcatchment Runoff Summary

| Subcatchment | Total Precip | Total Runon | Total Evap | Total Infil | Imperv Runoff | Perov Runoff | Total Runoff | Total Runoff | Peak Runoff | Runoff Coeff |
|--------------|--------------|-------------|------------|-------------|---------------|--------------|--------------|---------------------|-------------|--------------|
| | mm | mm | mm | mm | mm | mm | mm | 10 ⁶ ltr | CMS | |
| S1 | 31.86 | 0.00 | 0.00 | 18.14 | 13.09 | 0.04 | 13.12 | 0.32 | 0.22 | 0.412 |
| S1_1 | 31.86 | 0.00 | 0.00 | 18.05 | 13.09 | 0.28 | 13.37 | 0.04 | 0.03 | 0.420 |
| S1_2 | 31.86 | 0.00 | 0.00 | 18.15 | 13.12 | 0.02 | 13.14 | 0.48 | 0.33 | 0.412 |
| S1_4 | 31.86 | 0.00 | 0.00 | 0.52 | 30.02 | 0.02 | 30.04 | 0.29 | 0.20 | 0.943 |

Node Depth Summary

| Node | Type | Average Depth Meters | Maximum Depth Meters | Maximum HGL Meters | Time of Max Occurrence days hr:min | Reported Max Depth Meters |
|----------------|---------|----------------------|----------------------|--------------------|------------------------------------|---------------------------|
| OF_Legget_Pond | OUTFALL | 0.00 | 0.00 | 75.40 | 0 00:00 | 0.00 |
| OF2 | OUTFALL | 0.00 | 0.00 | 77.70 | 0 00:00 | 0.00 |
| Legget_Pond | STORAGE | 0.36 | 0.47 | 76.57 | 0 06:00 | 0.47 |

Node Inflow Summary

| Node | Type | Maximum Lateral Inflow CMS | Maximum Total Inflow CMS | Time of Max Occurrence days hr:min | Lateral Inflow Volume 10 ⁶ ltr | Total Inflow Volume 10 ⁶ ltr | Flow Balance Error Percent |
|----------------|---------|----------------------------|--------------------------|------------------------------------|---|---|----------------------------|
| OF_Legget_Pond | OUTFALL | 0.000 | 0.000 | 0 00:00 | 0 | 0 | 0.000 ltr |
| OF2 | OUTFALL | 0.203 | 0.203 | 0 01:10 | 0.29 | 0.29 | 0.000 |
| Legget_Pond | STORAGE | 0.587 | 0.587 | 0 01:10 | 0.831 | 0.831 | 0.011 |

Node Surcharge Summary

No nodes were surcharged.

Node Flooding Summary

No nodes were flooded.

Storage Volume Summary

| Storage Unit | Average Volume 1000 m3 | Avg Full Pcnt | Evap Pcnt | Exfil Pcnt | Maximum Volume 1000 m3 | Max Full Pcnt | Time of Max Occurrence days hr:min | Maximum Outflow CMS |
|--------------|------------------------|---------------|-----------|------------|------------------------|---------------|------------------------------------|---------------------|
| Legget_Pond | 0.637 | 12 | 0 | 0 | 0.831 | 16 | 0 06:00 | 0.000 |

Outfall Loading Summary

| Outfall Node | Flow Freq Pcnt | Avg Flow CMS | Max Flow CMS | Total Volume 10 ⁶ ltr |
|----------------|----------------|--------------|--------------|----------------------------------|
| OF_Legget_Pond | 0.00 | 0.000 | 0.000 | 0.000 |
| OF2 | 71.63 | 0.019 | 0.203 | 0.290 |
| System | 35.82 | 0.019 | 0.203 | 0.290 |

Link Flow Summary

| Link | Type | Maximum Flow CMS | Time of Max Occurrence days hr:min | Maximum Veloc m/sec | Max/ Full Flow | Max/ Full Depth |
|------|---------|--------------------|------------------------------------|-----------------------|----------------|-----------------|
| OR1 | ORIFICE | 0.000 | 0 00:00 | | | 0.00 |

Flow Classification Summary

| Adjusted /Actual | Fraction of Time in Flow Class | | | | | | |
|------------------|--------------------------------|------|-----|-----|----|------|------------|
| | Up | Down | Sub | Sup | Up | Down | Norm Inlet |

Conduit Length Dry Dry Dry Crit Crit Crit Crit Ltd Ctrl

Conduit Surcharge Summary

No conduits were surcharged.

Analysis begun on: Wed Oct 20 13:27:23 2021
Analysis ended on: Wed Oct 20 13:27:23 2021
Total elapsed time: < 1 sec

5-Year Pre-Development

EPA STORM WATER MANAGEMENT MODEL - VERSION 5.1 (Build 5.1.013)

Element Count

Number of rain gages 16
Number of subcatchments ... 4
Number of nodes 3
Number of links 1
Number of pollutants 0
Number of land uses 0

Rainage Summary

| Name | Data Source | Data Type | Recording Interval |
|----------------------------------|--------------------------------------|-----------|--------------------|
| 100yr_3hr_Chicago | 100yr_3hr_Chicago | INTENSITY | 10 min. |
| 100yr_3hr_Chicago_Climate_Change | 100yr_3hr_Chicago_Increase_20percent | INTENSITY | 10 min. |
| 100yr_6hr_Chicago | 100yr_6hr_Chicago | INTENSITY | 10 min. |
| 100yr_6hr_Chicago_Climate_Change | 100yr_6hr_Chicago_Increase_20percent | INTENSITY | 10 min. |
| 10yr_3hr_Chicago | 10yr_3hr_Chicago | INTENSITY | 10 min. |
| 10yr_6hr_Chicago | 10yr_6hr_Chicago | INTENSITY | 10 min. |
| 25mm_3hr_Chicago | 25mm_3hr_Chicago | INTENSITY | 10 min. |
| 25mm_4hr_Chicago | 25mm_4hr_Chicago | INTENSITY | 10 min. |
| 25yr_3hr_Chicago | 25yr_3hr_Chicago | INTENSITY | 10 min. |
| 25yr_6hr_Chicago | 25yr_6hr_Chicago | INTENSITY | 10 min. |
| 2yr_3hr_Chicago | 2yr_3hr_Chicago | INTENSITY | 10 min. |
| 2yr_6hr_Chicago | 2yr_6hr_Chicago | INTENSITY | 10 min. |
| 50yr_3hr_Chicago | 50yr_3hr_Chicago | INTENSITY | 10 min. |
| 50yr_6hr_Chicago | 50yr_6hr_Chicago | INTENSITY | 10 min. |
| 5yr_3hr_Chicago | 5yr_3hr_Chicago | INTENSITY | 10 min. |
| 5yr_6hr_Chicago | 5yr_6hr_Chicago | INTENSITY | 10 min. |

Subcatchment Summary

| Name | Area | Width | %Imperv | %Slope | Rain Gage | Outlet |
|------|------|--------|---------|--------|-----------------|-------------|
| S1 | 2.42 | 469.99 | 43.00 | 5.3370 | 5yr_3hr_Chicago | Legget_Pond |
| S1_1 | 0.28 | 491.26 | 43.00 | 5.2120 | 5yr_3hr_Chicago | Legget_Pond |
| S1_2 | 3.63 | 499.74 | 43.00 | 2.8320 | 5yr_3hr_Chicago | Legget_Pond |
| S1_4 | 0.97 | 458.49 | 98.37 | 1.0000 | 5yr_3hr_Chicago | OF2 |

Node Summary

| Name | Type | Invert Elev. | Max. Depth | Ponded Area | External Inflow |
|----------------|---------|--------------|------------|-------------|-----------------|
| OF_Legget_Pond | OUTFALL | 75.40 | 0.00 | 0.0 | |
| OF2 | OUTFALL | 77.70 | 0.00 | 0.0 | |
| Legget_Pond | STORAGE | 76.10 | 2.00 | 0.0 | |

Link Summary

| Name | From Node | To Node | Type | Length | %Slope | Roughness |
|------|-------------|----------------|---------|--------|--------|-----------|
| OR1 | Legget_Pond | OF_Legget_Pond | ORIFICE | | | |

Cross Section Summary

| Conduit | Shape | Full Depth | Full Area | Hyd. Rad. | Max. Width | No. of Barrels | Full Flow |
|---------|-------|------------|-----------|-----------|------------|----------------|-----------|
| ----- | | | | | | | |

NOTE: The summary statistics displayed in this report are based on results found at every computational time step, not just on results from each reporting time step.

Analysis Options

Flow Units CMS
 Process Models:
 Rainfall/Runoff YES
 RDII NO
 Snowmelt NO
 Groundwater NO
 Flow Routing YES
 Ponding Allowed YES
 Water Quality NO
 Infiltration Method HORTON
 Flow Routing Method DYNWAVE
 Surchage Method EXTRAN
 Starting Date 11/10/2013 00:00:00
 Ending Date 11/10/2013 06:00:00
 Antecedent Dry Days 0.0
 Report Time Step 00:05:00
 Wet Time Step 00:05:00
 Dry Time Step 00:05:00
 Routing Time Step 1.00 sec
 Variable Time Step YES
 Maximum Trials 20
 Number of Threads 1
 Head Tolerance 0.001500 m

***** Volume Depth
 Runoff Quantity Continuity hectare-m mm

 Total Precipitation 0.310 42.514
 Evaporation Loss 0.000 0.000
 Infiltration Loss 0.139 19.057
 Surface Runoff 0.167 22.871
 Final Storage 0.006 0.793
 Continuity Error (%) -0.486

***** Volume Volume
 Flow Routing Continuity hectare-m 10^6 ltr

 Dry Weather Inflow 0.000 0.000
 Wet Weather Inflow 0.167 1.667
 Groundwater Inflow 0.000 0.000
 RDII Inflow 0.000 0.000
 External Inflow 0.000 0.000
 External Outflow 0.073 0.726
 Flooding Loss 0.000 0.000
 Evaporation Loss 0.000 0.000
 Exfiltration Loss 0.000 0.000
 Initial Stored Volume 0.000 0.000
 Final Stored Volume 0.094 0.941
 Continuity Error (%) 0.006

 Time-Step Critical Elements

 None

 Highest Flow Instability Indexes

 All links are stable.

 Routing Time Step Summary

 Minimum Time Step : 0.50 sec
 Average Time Step : 1.00 sec
 Maximum Time Step : 1.00 sec
 Percent in Steady State : 0.00
 Average Iterations per Step : 2.00
 Percent Not Converging : 0.00

 Subcatchment Runoff Summary

| Subcatchment | Total Precip mm | Total Runon mm | Total Evap mm | Total Infil mm | Imperv Runoff mm | Perv Runoff mm | Total Runoff mm | Total Runoff 10^6 ltr | Peak Runoff CMS | Runoff Coeff |
|--------------|-----------------|----------------|---------------|----------------|------------------|----------------|-----------------|-----------------------|-----------------|--------------|
| S1 | 42.51 | 0.00 | 0.00 | 21.62 | 17.68 | 2.74 | 20.42 | 0.49 | 0.37 | 0.480 |
| S1_1 | 42.51 | 0.00 | 0.00 | 20.59 | 17.69 | 3.99 | 21.69 | 0.06 | 0.06 | 0.510 |
| S1_2 | 42.51 | 0.00 | 0.00 | 22.16 | 17.72 | 2.14 | 19.86 | 0.72 | 0.51 | 0.467 |
| S1_4 | 42.51 | 0.00 | 0.00 | 0.59 | 40.54 | 0.12 | 40.66 | 0.39 | 0.28 | 0.956 |

 Node Depth Summary

| Node | Type | Average Depth Meters | Maximum Depth Meters | Maximum HGL Meters | Time of Max Occurrence days hr:min | Reported Max Depth Meters |
|----------------|---------|----------------------|----------------------|--------------------|------------------------------------|---------------------------|
| OF_Legget_Pond | OUTFALL | 0.00 | 0.00 | 75.40 | 0 00:00 | 0.00 |
| OF2 | OUTFALL | 0.00 | 0.00 | 77.70 | 0 00:00 | 0.00 |
| Legget_Pond | STORAGE | 0.43 | 0.55 | 76.65 | 0 01:53 | 0.55 |

 Node Inflow Summary

| Node | Type | Maximum Lateral Inflow CMS | Maximum Total Inflow CMS | Time of Max Occurrence days hr:min | Lateral Inflow Volume 10^6 ltr | Total Inflow Volume 10^6 ltr | Flow Balance Error Percent |
|----------------|---------|----------------------------|--------------------------|------------------------------------|--------------------------------|------------------------------|----------------------------|
| OF_Legget_Pond | OUTFALL | 0.000 | 0.057 | 0 01:53 | 0 | 0.333 | 0.000 |
| OF2 | OUTFALL | 0.278 | 0.278 | 0 01:10 | 0.393 | 0.393 | 0.000 |
| Legget_Pond | STORAGE | 0.947 | 0.947 | 0 01:10 | 1.27 | 1.27 | 0.008 |

 Node Surchage Summary

No nodes were surcharged.

 Node Flooding Summary

No nodes were flooded.

 Storage Volume Summary

| Storage Unit | Average Volume 1000 m3 | Avg Full Pcnt | Evap Pcnt | Exfil Pcnt | Maximum Volume 1000 m3 | Max Full Pcnt | Time of Max Occurrence days hr:min | Maximum Outflow CMS |
|--------------|------------------------|---------------|-----------|------------|------------------------|---------------|------------------------------------|---------------------|
| Legget_Pond | 0.794 | 15 | 0 | 0 | 1.044 | 20 | 0 01:53 | 0.057 |

 Outfall Loading Summary

| Outfall Node | Flow Freq Pcnt | Avg Flow CMS | Max Flow CMS | Total Volume 10^6 ltr |
|----------------|----------------|--------------|--------------|-----------------------|
| OF_Legget_Pond | 76.13 | 0.020 | 0.057 | 0.333 |
| OF2 | 73.39 | 0.025 | 0.278 | 0.393 |
| System | 74.76 | 0.045 | 0.278 | 0.726 |

 Link Flow Summary

| Link | Type | Maximum Flow CMS | Time of Max Occurrence days hr:min | Maximum Veloc m/sec | Max/ Full Flow | Max/ Full Depth |
|------|---------|--------------------|------------------------------------|-----------------------|----------------|-----------------|
| OR1 | ORIFICE | 0.057 | 0 01:53 | | | 0.02 |

 Flow Classification Summary

| Adjusted /Actual | Fraction of Time in Flow Class | | | | | | |
|------------------|--------------------------------|------|-----|-----|----|------|------------|
| | Up | Down | Sub | Sup | Up | Down | Norm Inlet |

Conduit Length Dry Dry Dry Crit Crit Crit Crit Ltd Ctrl

Conduit Surcharge Summary

No conduits were surcharged.

Analysis begun on: Fri Oct 22 08:40:17 2021
Analysis ended on: Fri Oct 22 08:40:17 2021
Total elapsed time: < 1 sec

10-Year Pre-Development

EPA STORM WATER MANAGEMENT MODEL - VERSION 5.1 (Build 5.1.013)

Element Count

Number of rain gages 16
Number of subcatchments ... 4
Number of nodes 3
Number of links 1
Number of pollutants 0
Number of land uses 0

Rainage Summary

| Name | Data Source | Data Type | Recording Interval |
|----------------------------------|--------------------------------------|-----------|--------------------|
| 100yr_3hr_Chicago | 100yr_3hr_Chicago | INTENSITY | 10 min. |
| 100yr_3hr_Chicago_Climate_Change | 100yr_3hr_Chicago_Increase_20percent | INTENSITY | 10 min. |
| 100yr_6hr_Chicago | 100yr_6hr_Chicago | INTENSITY | 10 min. |
| 100yr_6hr_Chicago_Climate_Change | 100yr_6hr_Chicago_Increase_20percent | INTENSITY | 10 min. |
| 10yr_3hr_Chicago | 10yr_3hr_Chicago | INTENSITY | 10 min. |
| 10yr_6hr_Chicago | 10yr_6hr_Chicago | INTENSITY | 10 min. |
| 25mm_3hr_Chicago | 25mm_3hr_Chicago | INTENSITY | 10 min. |
| 25mm_4hr_Chicago | 25mm_4hr_Chicago | INTENSITY | 10 min. |
| 25yr_3hr_Chicago | 25yr_3hr_Chicago | INTENSITY | 10 min. |
| 25yr_6hr_Chicago | 25yr_6hr_Chicago | INTENSITY | 10 min. |
| 2yr_3hr_Chicago | 2yr_3hr_Chicago | INTENSITY | 10 min. |
| 2yr_6hr_Chicago | 2yr_6hr_Chicago | INTENSITY | 10 min. |
| 50yr_3hr_Chicago | 50yr_3hr_Chicago | INTENSITY | 10 min. |
| 50yr_6hr_Chicago | 50yr_6hr_Chicago | INTENSITY | 10 min. |
| 5yr_3hr_Chicago | 5yr_3hr_Chicago | INTENSITY | 10 min. |
| 5yr_6hr_Chicago | 5yr_6hr_Chicago | INTENSITY | 10 min. |

Subcatchment Summary

| Name | Area | Width | %Imperv | %Slope | Rain Gage | Outlet |
|------|------|--------|---------|--------|------------------|-------------|
| S1 | 2.42 | 469.99 | 43.00 | 5.3370 | 10yr_3hr_Chicago | Legget_Pond |
| S1_1 | 0.28 | 491.26 | 43.00 | 5.2120 | 10yr_3hr_Chicago | Legget_Pond |
| S1_2 | 3.63 | 499.74 | 43.00 | 2.8320 | 10yr_3hr_Chicago | Legget_Pond |
| S1_4 | 0.97 | 458.49 | 98.37 | 1.0000 | 10yr_3hr_Chicago | OF2 |

Node Summary

| Name | Type | Invert Elev. | Max. Depth | Ponded Area | External Inflow |
|----------------|---------|--------------|------------|-------------|-----------------|
| OF_Legget_Pond | OUTFALL | 75.40 | 0.00 | 0.0 | |
| OF2 | OUTFALL | 77.70 | 0.00 | 0.0 | |
| Legget_Pond | STORAGE | 76.10 | 2.00 | 0.0 | |

Link Summary

| Name | From Node | To Node | Type | Length | %Slope | Roughness |
|------|-------------|----------------|---------|--------|--------|-----------|
| OR1 | Legget_Pond | OF_Legget_Pond | ORIFICE | | | |

Cross Section Summary

| Conduit | Shape | Full Depth | Full Area | Hyd. Rad. | Max. Width | No. of Barrels | Full Flow |
|---------|-------|------------|-----------|-----------|------------|----------------|-----------|
| ----- | | | | | | | |

NOTE: The summary statistics displayed in this report are based on results found at every computational time step, not just on results from each reporting time step.

Analysis Options

Conduit Length Dry Dry Dry Crit Crit Crit Crit Ltd Ctrl

Conduit Surcharge Summary

No conduits were surcharged.

Analysis begun on: Fri Oct 22 08:41:41 2021
Analysis ended on: Fri Oct 22 08:41:41 2021
Total elapsed time: < 1 sec

25-Year Pre-Development

EPA STORM WATER MANAGEMENT MODEL - VERSION 5.1 (Build 5.1.013)

Element Count

Number of rain gages 16
Number of subcatchments ... 4
Number of nodes 3
Number of links 1
Number of pollutants 0
Number of land uses 0

Rainage Summary

| Name | Data Source | Data Type | Recording Interval |
|----------------------------------|--------------------------------------|-----------|--------------------|
| 100yr_3hr_Chicago | 100yr_3hr_Chicago | INTENSITY | 10 min. |
| 100yr_3hr_Chicago_Climate_Change | 100yr_3hr_Chicago_Increase_20percent | INTENSITY | 10 min. |
| 100yr_6hr_Chicago | 100yr_6hr_Chicago | INTENSITY | 10 min. |
| 100yr_6hr_Chicago_Climate_Change | 100yr_6hr_Chicago_Increase_20percent | INTENSITY | 10 min. |
| 10yr_3hr_Chicago | 10yr_3hr_Chicago | INTENSITY | 10 min. |
| 10yr_6hr_Chicago | 10yr_6hr_Chicago | INTENSITY | 10 min. |
| 25mm_3hr_Chicago | 25mm_3hr_Chicago | INTENSITY | 10 min. |
| 25mm_4hr_Chicago | 25mm_4hr_Chicago | INTENSITY | 10 min. |
| 25yr_3hr_Chicago | 25yr_3hr_Chicago | INTENSITY | 10 min. |
| 25yr_6hr_Chicago | 25yr_6hr_Chicago | INTENSITY | 10 min. |
| 2yr_3hr_Chicago | 2yr_3hr_Chicago | INTENSITY | 10 min. |
| 2yr_6hr_Chicago | 2yr_6hr_Chicago | INTENSITY | 10 min. |
| 50yr_3hr_Chicago | 50yr_3hr_Chicago | INTENSITY | 10 min. |
| 50yr_6hr_Chicago | 50yr_6hr_Chicago | INTENSITY | 10 min. |
| 5yr_3hr_Chicago | 5yr_3hr_Chicago | INTENSITY | 10 min. |
| 5yr_6hr_Chicago | 5yr_6hr_Chicago | INTENSITY | 10 min. |

Subcatchment Summary

| Name | Area | Width | %Imperv | %Slope | Rain Gage | Outlet |
|------|------|--------|---------|--------|------------------|-------------|
| S1 | 2.42 | 469.99 | 43.00 | 5.3370 | 25yr_3hr_Chicago | Legget_Pond |
| S1_1 | 0.28 | 491.26 | 43.00 | 5.2120 | 25yr_3hr_Chicago | Legget_Pond |
| S1_2 | 3.63 | 499.74 | 43.00 | 2.8320 | 25yr_3hr_Chicago | Legget_Pond |
| S1_4 | 0.97 | 458.49 | 98.37 | 1.0000 | 25yr_3hr_Chicago | OF2 |

Node Summary

| Name | Type | Invert Elev. | Max. Depth | Ponded Area | External Inflow |
|----------------|---------|--------------|------------|-------------|-----------------|
| OF_Legget_Pond | OUTFALL | 75.40 | 0.00 | 0.0 | |
| OF2 | OUTFALL | 77.70 | 0.00 | 0.0 | |
| Legget_Pond | STORAGE | 76.10 | 2.00 | 0.0 | |

Link Summary

| Name | From Node | To Node | Type | Length | %Slope | Roughness |
|------|-------------|----------------|---------|--------|--------|-----------|
| OR1 | Legget_Pond | OF_Legget_Pond | ORIFICE | | | |

Cross Section Summary

| Conduit | Shape | Full Depth | Full Area | Hyd. Rad. | Max. Width | No. of Barrels | Full Flow |
|---------|-------|------------|-----------|-----------|------------|----------------|-----------|
| ----- | | | | | | | |

NOTE: The summary statistics displayed in this report are based on results found at every computational time step, not just on results from each reporting time step.

Analysis Options

Flow Units CMS
 Process Models:
 Rainfall/Runoff YES
 RDII NO
 Snowmelt NO
 Groundwater NO
 Flow Routing YES
 Ponding Allowed YES
 Water Quality NO
 Infiltration Method HORTON
 Flow Routing Method DYNWAVE
 Surcharge Method EXTRAN
 Starting Date 11/10/2013 00:00:00
 Ending Date 11/10/2013 06:00:00
 Antecedent Dry Days 0.0
 Report Time Step 00:05:00
 Wet Time Step 00:05:00
 Dry Time Step 00:05:00
 Routing Time Step 1.00 sec
 Variable Time Step YES
 Maximum Trials 20
 Number of Threads 1
 Head Tolerance 0.001500 m

***** Volume Depth
 Runoff Quantity Continuity hectare-m mm

 Total Precipitation 0.424 58.226
 Evaporation Loss 0.000 0.000
 Infiltration Loss 0.156 21.406
 Surface Runoff 0.266 36.441
 Final Storage 0.006 0.793
 Continuity Error (%) -0.710

***** Volume Volume
 Flow Routing Continuity hectare-m 10^6 ltr

 Dry Weather Inflow 0.000 0.000
 Wet Weather Inflow 0.266 2.655
 Groundwater Inflow 0.000 0.000
 RDII Inflow 0.000 0.000
 External Inflow 0.000 0.000
 External Outflow 0.171 1.714
 Flooding Loss 0.000 0.000
 Evaporation Loss 0.000 0.000
 Exfiltration Loss 0.000 0.000
 Initial Stored Volume 0.000 0.000
 Final Stored Volume 0.094 0.941
 Continuity Error (%) 0.004

 Time-Step Critical Elements

 None

 Highest Flow Instability Indexes

 All links are stable.

 Routing Time Step Summary

 Minimum Time Step : 0.50 sec
 Average Time Step : 1.00 sec
 Maximum Time Step : 1.00 sec
 Percent in Steady State : 0.00
 Average Iterations per Step : 2.00
 Percent Not Converging : 0.00

 Subcatchment Runoff Summary

| Subcatchment | Total Precip mm | Total Runon mm | Total Evap mm | Total Infil mm | Imperv Runoff mm | Perv Runoff mm | Total Runoff mm | Total Runoff 10^6 ltr | Peak Runoff CMS | Runoff Coeff |
|--------------|-----------------|----------------|---------------|----------------|------------------|----------------|-----------------|-----------------------|-----------------|--------------|
| S1 | 58.23 | 0.00 | 0.00 | 24.17 | 24.44 | 9.36 | 33.80 | 0.82 | 0.64 | 0.580 |
| S1_1 | 58.23 | 0.00 | 0.00 | 23.20 | 24.47 | 11.54 | 36.01 | 0.10 | 0.10 | 0.618 |
| S1_2 | 58.23 | 0.00 | 0.00 | 24.95 | 24.48 | 8.43 | 32.92 | 1.19 | 0.84 | 0.565 |
| S1_4 | 58.23 | 0.00 | 0.00 | 0.66 | 56.03 | 0.36 | 56.40 | 0.55 | 0.39 | 0.969 |

 Node Depth Summary

| Node | Type | Average Depth Meters | Maximum Depth Meters | Maximum HGL Meters | Time of Max Occurrence days hr:min | Reported Max Depth Meters |
|----------------|---------|----------------------|----------------------|--------------------|------------------------------------|---------------------------|
| OF_Legget_Pond | OUTFALL | 0.00 | 0.00 | 75.40 | 0 00:00 | 0.00 |
| OF2 | OUTFALL | 0.00 | 0.00 | 77.70 | 0 00:00 | 0.00 |
| Legget_Pond | STORAGE | 0.45 | 0.66 | 76.76 | 0 01:25 | 0.66 |

 Node Inflow Summary

| Node | Type | Maximum Lateral Inflow CMS | Maximum Total Inflow CMS | Time of Max Occurrence days hr:min | Lateral Inflow Volume 10^6 ltr | Total Inflow Volume 10^6 ltr | Flow Balance Error Percent |
|----------------|---------|----------------------------|--------------------------|------------------------------------|--------------------------------|------------------------------|----------------------------|
| OF_Legget_Pond | OUTFALL | 0.000 | 0.361 | 0 01:25 | 0 | 1.17 | 0.000 |
| OF2 | OUTFALL | 0.387 | 0.387 | 0 01:10 | 0.545 | 0.545 | 0.000 |
| Legget_Pond | STORAGE | 1.580 | 1.580 | 0 01:10 | 2.11 | 2.11 | 0.005 |

 Node Surcharge Summary

No nodes were surcharged.

 Node Flooding Summary

No nodes were flooded.

 Storage Volume Summary

| Storage Unit | Average Volume 1000 m3 | Avg Full Pcnt | Evap Pcnt | Exfil Pcnt | Maximum Volume 1000 m3 | Max Full Pcnt | Time of Max Occurrence days hr:min | Maximum Outflow CMS |
|--------------|------------------------|---------------|-----------|------------|------------------------|---------------|------------------------------------|---------------------|
| Legget_Pond | 0.851 | 17 | 0 | 0 | 1.331 | 26 | 0 01:25 | 0.361 |

 Outfall Loading Summary

| Outfall Node | Flow Freq Pcnt | Avg Flow CMS | Max Flow CMS | Total Volume 10^6 ltr |
|----------------|----------------|--------------|--------------|-----------------------|
| OF_Legget_Pond | 80.26 | 0.067 | 0.361 | 1.169 |
| OF2 | 75.14 | 0.034 | 0.387 | 0.545 |
| System | 77.70 | 0.101 | 0.387 | 1.714 |

 Link Flow Summary

| Link | Type | Maximum Flow CMS | Time of Max Occurrence days hr:min | Maximum Veloc m/sec | Max/ Full Flow | Max/ Full Depth |
|------|---------|--------------------|------------------------------------|-----------------------|----------------|-----------------|
| OR1 | ORIFICE | 0.361 | 0 01:25 | | | 0.08 |

 Flow Classification Summary

| Adjusted /Actual | Fraction of Time in Flow Class | | | | | |
|------------------|--------------------------------|------|-----|-----|----|-----------------|
| | Up | Down | Sub | Sup | Up | Down Norm Inlet |

Conduit Length Dry Dry Dry Crit Crit Crit Crit Ltd Ctrl

 Conduit Surcharge Summary

No conduits were surcharged.

Analysis begun on: Fri Oct 22 08:43:09 2021
 Analysis ended on: Fri Oct 22 08:43:09 2021
 Total elapsed time: < 1 sec

50-Year Pre-Development

 EPA STORM WATER MANAGEMENT MODEL - VERSION 5.1 (Build 5.1.013)

 Element Count

 Number of rain gages 16
 Number of subcatchments ... 4
 Number of nodes 3
 Number of links 1
 Number of pollutants 0
 Number of land uses 0

 Rainage Summary

| Name | Data Source | Data Type | Recording Interval |
|----------------------------------|--------------------------------------|-----------|--------------------|
| 100yr_3hr_Chicago | 100yr_3hr_Chicago | INTENSITY | 10 min. |
| 100yr_3hr_Chicago_Climate_Change | 100yr_3hr_Chicago_Increase_20percent | INTENSITY | 10 min. |
| 100yr_6hr_Chicago | 100yr_6hr_Chicago | INTENSITY | 10 min. |
| 100yr_6hr_Chicago_Climate_Change | 100yr_6hr_Chicago_Increase_20percent | INTENSITY | 10 min. |
| 10yr_3hr_Chicago | 10yr_3hr_Chicago | INTENSITY | 10 min. |
| 10yr_6hr_Chicago | 10yr_6hr_Chicago | INTENSITY | 10 min. |
| 25mm_3hr_Chicago | 25mm_3hr_Chicago | INTENSITY | 10 min. |
| 25mm_4hr_Chicago | 25mm_4hr_Chicago | INTENSITY | 10 min. |
| 25yr_3hr_Chicago | 25yr_3hr_Chicago | INTENSITY | 10 min. |
| 25yr_6hr_Chicago | 25yr_6hr_Chicago | INTENSITY | 10 min. |
| 2yr_3hr_Chicago | 2yr_3hr_Chicago | INTENSITY | 10 min. |
| 2yr_6hr_Chicago | 2yr_6hr_Chicago | INTENSITY | 10 min. |
| 50yr_3hr_Chicago | 50yr_3hr_Chicago | INTENSITY | 10 min. |
| 50yr_6hr_Chicago | 50yr_6hr_Chicago | INTENSITY | 10 min. |
| 5yr_3hr_Chicago | 5yr_3hr_Chicago | INTENSITY | 10 min. |
| 5yr_6hr_Chicago | 5yr_6hr_Chicago | INTENSITY | 10 min. |

 Subcatchment Summary

| Name | Area | Width | %Imperv | %Slope | Rain Gage | Outlet |
|------|------|--------|---------|--------|------------------|-------------|
| S1 | 2.42 | 469.99 | 43.00 | 5.3370 | 50yr_3hr_Chicago | Legget_Pond |
| S1_1 | 0.28 | 491.26 | 43.00 | 5.2120 | 50yr_3hr_Chicago | Legget_Pond |
| S1_2 | 3.63 | 499.74 | 43.00 | 2.8320 | 50yr_3hr_Chicago | Legget_Pond |
| S1_4 | 0.97 | 458.49 | 98.37 | 1.0000 | 50yr_3hr_Chicago | OF2 |

 Node Summary

| Name | Type | Invert Elev. | Max. Depth | Ponded Area | External Inflow |
|----------------|---------|--------------|------------|-------------|-----------------|
| OF_Legget_Pond | OUTFALL | 75.40 | 0.00 | 0.0 | |
| OF2 | OUTFALL | 77.70 | 0.00 | 0.0 | |
| Legget_Pond | STORAGE | 76.10 | 2.00 | 0.0 | |

 Link Summary

| Name | From Node | To Node | Type | Length | %Slope | Roughness |
|------|-------------|----------------|---------|--------|--------|-----------|
| OR1 | Legget_Pond | OF_Legget_Pond | ORIFICE | | | |

 Cross Section Summary

| Conduit | Shape | Full Depth | Full Area | Hyd. Rad. | Max. Width | No. of Barrels | Full Flow |
|---------|-------|------------|-----------|-----------|------------|----------------|-----------|
| ----- | | | | | | | |

 NOTE: The summary statistics displayed in this report are based on results found at every computational time step, not just on results from each reporting time step.

 Analysis Options

Flow Units CMS
 Process Models:
 Rainfall/Runoff YES
 RDII NO
 Snowmelt NO
 Groundwater NO
 Flow Routing YES
 Ponding Allowed YES
 Water Quality NO
 Infiltration Method HORTON
 Flow Routing Method DYNWAVE
 Surge Method EXTRAN
 Starting Date 11/10/2013 00:00:00
 Ending Date 11/10/2013 06:00:00
 Antecedent Dry Days 0.0
 Report Time Step 00:05:00
 Wet Time Step 00:05:00
 Dry Time Step 00:05:00
 Routing Time Step 1.00 sec
 Variable Time Step YES
 Maximum Trials 20
 Number of Threads 1
 Head Tolerance 0.001500 m

| Volume | Depth |
|----------------------------|-----------|
| Runoff Quantity Continuity | hectare-m |
| Total Precipitation | 64.806 |
| Evaporation Loss | 0.000 |
| Infiltration Loss | 22.171 |
| Surface Runoff | 42.346 |
| Final Storage | 0.793 |
| Continuity Error (%) | -0.777 |

| Volume | Volume |
|-------------------------|----------|
| Flow Routing Continuity | 10^6 ltr |
| Dry Weather Inflow | 0.000 |
| Wet Weather Inflow | 3.086 |
| Groundwater Inflow | 0.000 |
| RDII Inflow | 0.000 |
| External Inflow | 0.000 |
| External Outflow | 2.144 |
| Flooding Loss | 0.000 |
| Evaporation Loss | 0.000 |
| Exfiltration Loss | 0.000 |
| Initial Stored Volume | 0.000 |
| Final Stored Volume | 0.094 |
| Continuity Error (%) | 0.003 |

Time-Step Critical Elements
 None

Highest Flow Instability Indexes
 All links are stable.

Routing Time Step Summary
 Minimum Time Step : 0.50 sec
 Average Time Step : 1.00 sec
 Maximum Time Step : 1.00 sec
 Percent in Steady State : 0.00
 Average Iterations per Step : 2.00
 Percent Not Converging : 0.00

Subcatchment Runoff Summary

| Subcatchment | Total Precip | Total Runon | Total Evap | Total Infil | Imperv Runoff | Perv Runoff | Total Runoff | Total Runoff | Peak Runoff | Runoff Coeff |
|--------------|--------------|-------------|------------|-------------|---------------|-------------|--------------|--------------|-------------|--------------|
| | mm | mm | mm | mm | mm | mm | mm | 10^6 ltr | CMS | |
| S1 | 64.81 | 0.00 | 0.00 | 25.04 | 27.26 | 12.36 | 39.62 | 0.96 | 0.76 | 0.611 |
| S1_1 | 64.81 | 0.00 | 0.00 | 24.12 | 27.24 | 14.77 | 42.01 | 0.12 | 0.11 | 0.648 |
| S1_2 | 64.81 | 0.00 | 0.00 | 25.84 | 27.32 | 11.37 | 38.69 | 1.40 | 0.99 | 0.597 |
| S1_4 | 64.81 | 0.00 | 0.00 | 0.69 | 62.52 | 0.45 | 62.97 | 0.61 | 0.43 | 0.972 |

Node Depth Summary

| Node | Type | Average Depth Meters | Maximum Depth Meters | Maximum HGL Meters | Time of Max Occurrence days hr:min | Reported Max Depth Meters |
|----------------|---------|----------------------|----------------------|--------------------|------------------------------------|---------------------------|
| OF_Legget_Pond | OUTFALL | 0.00 | 0.00 | 75.40 | 0 00:00 | 0.00 |
| OF2 | OUTFALL | 0.00 | 0.00 | 77.70 | 0 00:00 | 0.00 |
| Legget_Pond | STORAGE | 0.46 | 0.70 | 76.80 | 0 01:23 | 0.70 |

Node Inflow Summary

| Node | Type | Maximum Lateral Inflow CMS | Maximum Total Inflow CMS | Time of Max Occurrence days hr:min | Lateral Inflow Volume 10^6 ltr | Total Inflow Volume 10^6 ltr | Flow Balance Error Percent |
|----------------|---------|----------------------------|--------------------------|------------------------------------|--------------------------------|------------------------------|----------------------------|
| OF_Legget_Pond | OUTFALL | 0.000 | 0.522 | 0 01:23 | 0 | 1.54 | 0.000 |
| OF2 | OUTFALL | 0.432 | 0.432 | 0 01:10 | 0.609 | 0.609 | 0.000 |
| Legget_Pond | STORAGE | 1.858 | 1.858 | 0 01:10 | 2.48 | 2.48 | 0.004 |

Node Surge Summary

No nodes were surcharged.

Node Flooding Summary

No nodes were flooded.

Storage Volume Summary

| Storage Unit | Average Volume 1000 m3 | Avg Full Pcnt | Evap Pcnt | Exfil Pcnt | Maximum Volume 1000 m3 | Max Full Pcnt | Time of Max Occurrence days hr:min | Maximum Outflow CMS |
|--------------|------------------------|---------------|-----------|------------|------------------------|---------------|------------------------------------|---------------------|
| Legget_Pond | 0.869 | 17 | 0 | 0 | 1.450 | 28 | 0 01:23 | 0.522 |

Outfall Loading Summary

| Outfall Node | Flow Freq Pcnt | Avg Flow CMS | Max Flow CMS | Total Volume 10^6 ltr |
|----------------|----------------|--------------|--------------|-----------------------|
| OF_Legget_Pond | 80.65 | 0.088 | 0.522 | 1.536 |
| OF2 | 75.27 | 0.037 | 0.432 | 0.609 |
| System | 77.96 | 0.126 | 0.432 | 2.144 |

Link Flow Summary

| Link | Type | Maximum Flow CMS | Time of Max Occurrence days hr:min | Maximum Veloc m/sec | Max/ Full Flow | Max/ Full Depth |
|------|---------|--------------------|------------------------------------|-----------------------|----------------|-----------------|
| OR1 | ORIFICE | 0.522 | 0 01:23 | | | 0.10 |

Flow Classification Summary

| Adjusted /Actual | Fraction of Time in Flow Class | | | | | |
|------------------|--------------------------------|------|-----|-----|----|-----------------|
| | Up | Down | Sub | Sup | Up | Down Norm Inlet |

Conduit Length Dry Dry Dry Crit Crit Crit Crit Ltd Ctrl

Conduit Surcharge Summary

No conduits were surcharged.

Analysis begun on: Fri Oct 22 08:44:10 2021
Analysis ended on: Fri Oct 22 08:44:10 2021
Total elapsed time: < 1 sec

100-Year Pre-Development

EPA STORM WATER MANAGEMENT MODEL - VERSION 5.1 (Build 5.1.013)

Element Count

Number of rain gages 16
Number of subcatchments ... 4
Number of nodes 3
Number of links 1
Number of pollutants 0
Number of land uses 0

Rainage Summary

| Name | Data Source | Data Type | Recording Interval |
|----------------------------------|--------------------------------------|-----------|--------------------|
| 100yr_3hr_Chicago | 100yr_3hr_Chicago | INTENSITY | 10 min. |
| 100yr_3hr_Chicago_Climate_Change | 100yr_3hr_Chicago_Increase_20percent | INTENSITY | 10 min. |
| 100yr_6hr_Chicago | 100yr_6hr_Chicago | INTENSITY | 10 min. |
| 100yr_6hr_Chicago_Climate_Change | 100yr_6hr_Chicago_Increase_20percent | INTENSITY | 10 min. |
| 10yr_3hr_Chicago | 10yr_3hr_Chicago | INTENSITY | 10 min. |
| 10yr_6hr_Chicago | 10yr_6hr_Chicago | INTENSITY | 10 min. |
| 25mm_3hr_Chicago | 25mm_3hr_Chicago | INTENSITY | 10 min. |
| 25mm_4hr_Chicago | 25mm_4hr_Chicago | INTENSITY | 10 min. |
| 25yr_3hr_Chicago | 25yr_3hr_Chicago | INTENSITY | 10 min. |
| 25yr_6hr_Chicago | 25yr_6hr_Chicago | INTENSITY | 10 min. |
| 2yr_3hr_Chicago | 2yr_3hr_Chicago | INTENSITY | 10 min. |
| 2yr_6hr_Chicago | 2yr_6hr_Chicago | INTENSITY | 10 min. |
| 50yr_3hr_Chicago | 50yr_3hr_Chicago | INTENSITY | 10 min. |
| 50yr_6hr_Chicago | 50yr_6hr_Chicago | INTENSITY | 10 min. |
| 5yr_3hr_Chicago | 5yr_3hr_Chicago | INTENSITY | 10 min. |
| 5yr_6hr_Chicago | 5yr_6hr_Chicago | INTENSITY | 10 min. |

Subcatchment Summary

| Name | Area | Width | %Imperv | %Slope | Rain Gage | Outlet |
|------|------|--------|---------|--------|-------------------|-------------|
| S1 | 2.42 | 469.99 | 43.00 | 5.3370 | 100yr_3hr_Chicago | Legget_Pond |
| S1_1 | 0.28 | 491.26 | 43.00 | 5.2120 | 100yr_3hr_Chicago | Legget_Pond |
| S1_2 | 3.63 | 499.74 | 43.00 | 2.8320 | 100yr_3hr_Chicago | Legget_Pond |
| S1_4 | 0.97 | 458.49 | 98.37 | 1.0000 | 100yr_3hr_Chicago | OF2 |

Node Summary

| Name | Type | Invert Elev. | Max. Depth | Ponded Area | External Inflow |
|----------------|---------|--------------|------------|-------------|-----------------|
| OF_Legget_Pond | OUTFALL | 75.40 | 0.00 | 0.0 | |
| OF2 | OUTFALL | 77.70 | 0.00 | 0.0 | |
| Legget_Pond | STORAGE | 76.10 | 2.00 | 0.0 | |

Link Summary

| Name | From Node | To Node | Type | Length | %Slope | Roughness |
|------|-------------|----------------|---------|--------|--------|-----------|
| OR1 | Legget_Pond | OF_Legget_Pond | ORIFICE | | | |

Cross Section Summary

| Conduit | Shape | Full Depth | Full Area | Hyd. Rad. | Max. Width | No. of Barrels | Full Flow |
|---------|-------|------------|-----------|-----------|------------|----------------|-----------|
| ----- | | | | | | | |

NOTE: The summary statistics displayed in this report are based on results found at every computational time step, not just on results from each reporting time step.

Analysis Options

Flow Units CMS
 Process Models:
 Rainfall/Runoff YES
 RDII NO
 Snowmelt NO
 Groundwater NO
 Flow Routing YES
 Ponding Allowed YES
 Water Quality NO
 Infiltration Method HORTON
 Flow Routing Method DYNWAVE
 Surcharge Method EXTRAN
 Starting Date 11/10/2013 00:00:00
 Ending Date 11/10/2013 06:00:00
 Antecedent Dry Days 0.0
 Report Time Step 00:05:00
 Wet Time Step 00:05:00
 Dry Time Step 00:05:00
 Routing Time Step 1.00 sec
 Variable Time Step YES
 Maximum Trials 20
 Number of Threads 1
 Head Tolerance 0.001500 m

| Volume | Depth |
|----------------------------|-----------|
| Runoff Quantity Continuity | hectare-m |
| Total Precipitation | 0.522 |
| Evaporation Loss | 0.000 |
| Infiltration Loss | 0.167 |
| Surface Runoff | 0.354 |
| Final Storage | 0.006 |
| Continuity Error (%) | -0.813 |

| Volume | Volume |
|-------------------------|-----------|
| Flow Routing Continuity | hectare-m |
| Dry Weather Inflow | 0.000 |
| Wet Weather Inflow | 0.354 |
| Groundwater Inflow | 0.000 |
| RDII Inflow | 0.000 |
| External Inflow | 0.000 |
| External Outflow | 0.260 |
| Flooding Loss | 0.000 |
| Evaporation Loss | 0.000 |
| Exfiltration Loss | 0.000 |
| Initial Stored Volume | 0.000 |
| Final Stored Volume | 0.094 |
| Continuity Error (%) | 0.003 |

Time-Step Critical Elements
 None

Highest Flow Instability Indexes
 All links are stable.

Routing Time Step Summary
 Minimum Time Step : 0.50 sec
 Average Time Step : 1.00 sec
 Maximum Time Step : 1.00 sec
 Percent in Steady State : 0.00
 Average Iterations per Step : 2.00
 Percent Not Converging : 0.00

Subcatchment Runoff Summary

| Subcatchment | Total Precip | Total Runon | Total Evap | Total Infil | Imperv Runoff | Perov Runoff | Total Runoff | Total Runoff | Peak Runoff | Runoff Coeff |
|--------------|--------------|-------------|------------|-------------|---------------|--------------|--------------|---------------------|-------------|--------------|
| | mm | mm | mm | mm | mm | mm | mm | 10 ⁶ ltr | CMS | |
| S1 | 71.68 | 0.00 | 0.00 | 25.88 | 30.20 | 15.55 | 45.76 | 1.11 | 0.88 | 0.638 |
| S1_1 | 71.68 | 0.00 | 0.00 | 25.02 | 30.21 | 18.08 | 48.30 | 0.13 | 0.12 | 0.674 |
| S1_2 | 71.68 | 0.00 | 0.00 | 26.67 | 30.27 | 14.53 | 44.79 | 1.63 | 1.14 | 0.625 |
| S1_4 | 71.68 | 0.00 | 0.00 | 0.71 | 69.27 | 0.53 | 69.80 | 0.67 | 0.48 | 0.974 |

Node Depth Summary

| Node | Type | Average Depth Meters | Maximum Depth Meters | Maximum HGL Meters | Time of Max Occurrence days hr:min | Reported Max Depth Meters |
|----------------|---------|----------------------|----------------------|--------------------|------------------------------------|---------------------------|
| OF_Legget_Pond | OUTFALL | 0.00 | 0.00 | 75.40 | 0 00:00 | 0.00 |
| OF2 | OUTFALL | 0.00 | 0.00 | 77.70 | 0 00:00 | 0.00 |
| Legget_Pond | STORAGE | 0.47 | 0.75 | 76.85 | 0 01:22 | 0.74 |

Node Inflow Summary

| Node | Type | Maximum Lateral Inflow CMS | Maximum Total Inflow CMS | Time of Max Occurrence days hr:min | Lateral Inflow Volume 10 ⁶ ltr | Total Inflow Volume 10 ⁶ ltr | Flow Balance Error Percent |
|----------------|---------|----------------------------|--------------------------|------------------------------------|---|---|----------------------------|
| OF_Legget_Pond | OUTFALL | 0.000 | 0.695 | 0 01:22 | 0 | 1.92 | 0.000 |
| OF2 | OUTFALL | 0.478 | 0.478 | 0 01:10 | 0.675 | 0.675 | 0.000 |
| Legget_Pond | STORAGE | 2.152 | 2.152 | 0 01:10 | 2.86 | 2.86 | 0.004 |

Node Surcharge Summary

No nodes were surcharged.

Node Flooding Summary

No nodes were flooded.

Storage Volume Summary

| Storage Unit | Average Volume 1000 m3 | Avg Full Pcnt | Evap Pcnt | Exfil Pcnt | Maximum Volume 1000 m3 | Max Full Pcnt | Time of Max Occurrence days hr:min | Maximum Outflow CMS |
|--------------|------------------------|---------------|-----------|------------|------------------------|---------------|------------------------------------|---------------------|
| Legget_Pond | 0.887 | 17 | 0 | 0 | 1.567 | 31 | 0 01:22 | 0.695 |

Outfall Loading Summary

| Outfall Node | Flow Freq Pcnt | Avg Flow CMS | Max Flow CMS | Total Volume 10 ⁶ ltr |
|----------------|----------------|--------------|--------------|----------------------------------|
| OF_Legget_Pond | 80.95 | 0.110 | 0.695 | 1.923 |
| OF2 | 76.69 | 0.041 | 0.478 | 0.675 |
| System | 78.82 | 0.151 | 0.478 | 2.597 |

Link Flow Summary

| Link | Type | Maximum Flow CMS | Time of Max Occurrence days hr:min | Maximum Veloc m/sec | Max/ Full Flow | Max/ Full Depth |
|------|---------|--------------------|------------------------------------|-----------------------|----------------|-----------------|
| OR1 | ORIFICE | 0.695 | 0 01:22 | | | 0.12 |

Flow Classification Summary

| Adjusted /Actual | Fraction of Time in Flow Class | | | | | |
|------------------|--------------------------------|------|-----|-----|----|-----------------|
| | Up | Down | Sub | Sup | Up | Down Norm Inlet |

| Conduit | Length | Dry | Dry | Dry | Crit | Crit | Crit | Crit | Ltd | Ctrl |
|---------|--------|-----|-----|-----|------|------|------|------|-----|------|
|---------|--------|-----|-----|-----|------|------|------|------|-----|------|

Conduit Surcharge Summary

No conduits were surcharged.

Analysis begun on: Fri Oct 22 08:44:50 2021
Analysis ended on: Fri Oct 22 08:44:51 2021
Total elapsed time: 00:00:01

Post Development



| Node | Flow | Depth | Velocity | Time of Occurrence | Max Depth | Max Velocity | Max Time of Occurrence | Max Flow | Max Depth | Max Velocity | Max Time of Occurrence |
|------|-------|-------|----------|--------------------|-----------|--------------|------------------------|----------|-----------|--------------|------------------------|
| S1 | 31.86 | 0.00 | 0.00 | 0.08 | 30.44 | 0.01 | 30.45 | 0.20 | 0.14 | 0.956 | |
| S1_1 | 31.86 | 0.00 | 0.00 | 30.14 | 1.52 | 0.30 | 1.82 | 0.01 | 0.01 | 0.057 | |
| S1_3 | 31.86 | 0.00 | 0.00 | 0.27 | 30.25 | 0.02 | 30.27 | 0.29 | 0.20 | 0.950 | |
| S2 | 31.86 | 0.00 | 0.00 | 0.00 | 30.52 | 0.00 | 30.52 | 0.34 | 0.24 | 0.958 | |
| S3 | 31.86 | 0.00 | 0.00 | 2.20 | 28.44 | 0.02 | 28.45 | 0.64 | 0.45 | 0.893 | |
| S5 | 31.86 | 0.00 | 0.00 | 27.35 | 4.29 | 0.04 | 4.32 | 0.09 | 0.06 | 0.136 | |

Node Depth Summary

| Node | Type | Average Depth Meters | Maximum Depth Meters | Maximum HGL Meters | Time of Max Occurrence days hr:min | Reported Max Depth Meters |
|----------------|---------|----------------------|----------------------|--------------------|------------------------------------|---------------------------|
| OF_Legget_Pond | OUTFALL | 0.00 | 0.00 | 75.40 | 0 00:00 | 0.00 |
| OF2 | OUTFALL | 0.00 | 0.00 | 77.70 | 0 00:00 | 0.00 |
| Legget_Pond | STORAGE | 0.37 | 0.51 | 76.61 | 0 06:00 | 0.51 |
| SU1 | STORAGE | 0.03 | 0.03 | 95.53 | 0 03:10 | 0.03 |
| SU2 | STORAGE | 0.02 | 0.03 | 95.53 | 0 02:40 | 0.03 |

Node Inflow Summary

| Node | Type | Maximum Lateral Inflow CMS | Maximum Total Inflow CMS | Time of Max Occurrence days hr:min | Lateral Inflow Volume 10^6 ltr | Total Inflow Volume 10^6 ltr | Flow Balance Error Percent |
|----------------|---------|----------------------------|--------------------------|------------------------------------|--------------------------------|------------------------------|----------------------------|
| OF_Legget_Pond | OUTFALL | 0.000 | 0.001 | 0 06:00 | 0 | 0.000507 | 0.000 |
| OF2 | OUTFALL | 0.202 | 0.202 | 0 01:10 | 0.288 | 0.288 | 0.000 |
| Legget_Pond | STORAGE | 0.514 | 0.524 | 0 01:10 | 0.737 | 0.943 | 0.010 |
| SU1 | STORAGE | 0.237 | 0.237 | 0 01:10 | 0.34 | 0.34 | 0.011 |
| SU2 | STORAGE | 0.137 | 0.137 | 0 01:10 | 0.197 | 0.197 | 0.005 |

Node Surcharge Summary

No nodes were surcharged.

Node Flooding Summary

No nodes were flooded.

Storage Volume Summary

| Storage Unit | Average Volume 1000 m3 | Avg Full Pcnt | Evap Loss Pcnt | Exfil Loss Pcnt | Maximum Volume 1000 m3 | Max Full Pcnt | Time of Max Occurrence days hr:min | Maximum Outflow CMS |
|--------------|------------------------|---------------|----------------|-----------------|------------------------|---------------|------------------------------------|---------------------|
| Legget_Pond | 0.651 | 13 | 0 | 0 | 0.942 | 18 | 0 06:00 | 0.001 |
| SU1 | 0.211 | 1 | 0 | 0 | 0.284 | 2 | 0 03:10 | 0.006 |
| SU2 | 0.108 | 1 | 0 | 0 | 0.150 | 1 | 0 02:40 | 0.005 |

Outfall Loading Summary

| Outfall Node | Flow Freq Pcnt | Avg Flow CMS | Max Flow CMS | Total Volume 10^6 ltr |
|----------------|----------------|--------------|--------------|-----------------------|
| OF_Legget_Pond | 3.97 | 0.001 | 0.001 | 0.001 |
| OF2 | 71.68 | 0.019 | 0.202 | 0.288 |
| System | 37.82 | 0.019 | 0.202 | 0.289 |

Link Flow Summary

| Link | Type | Maximum Flow CMS | Time of Max Occurrence days hr:min | Maximum Veloc m/sec | Max/ Full Flow | Max/ Full Depth |
|------|---------|--------------------|------------------------------------|-----------------------|----------------|-----------------|
| OR1 | ORIFICE | 0.001 | 0 06:00 | | | 0.00 |
| OL2 | DUMMY | 0.006 | 0 03:10 | | | |
| OL3 | DUMMY | 0.005 | 0 02:40 | | | |

Flow Classification Summary

| Conduit | Adjusted /Actual Length | Fraction of Time in Flow Class | Up Dry | Down Dry | Sub Crit | Sup Crit | Flow Crit | Norm Ltd | Inlet Ctrl |
|---------|-------------------------|--------------------------------|--------|----------|----------|----------|-----------|----------|------------|
| | | | | | | | | | |

Conduit Surcharge Summary

No conduits were surcharged.

Analysis begun on: Wed Oct 20 14:16:05 2021
Analysis ended on: Wed Oct 20 14:16:05 2021
Total elapsed time: < 1 sec

| Node | Flow | Depth | Velocity | Time of Occurrence | Max Depth | Max Velocity | Max Time of Occurrence | Max Flow | Max Depth | Max Velocity | Max Time of Occurrence |
|------|-------|-------|----------|--------------------|-----------|--------------|------------------------|----------|-----------|--------------|------------------------|
| S1 | 42.51 | 0.00 | 0.00 | 0.09 | 41.12 | 0.02 | 41.14 | 0.27 | 0.19 | 0.968 | |
| S1_1 | 42.51 | 0.00 | 0.00 | 34.53 | 2.06 | 6.42 | 8.48 | 0.02 | 0.04 | 0.200 | |
| S1_3 | 42.51 | 0.00 | 0.00 | 0.31 | 40.86 | 0.07 | 40.92 | 0.39 | 0.27 | 0.963 | |
| S2 | 42.51 | 0.00 | 0.00 | 0.00 | 41.22 | 0.00 | 41.22 | 0.46 | 0.32 | 0.970 | |
| S3 | 42.51 | 0.00 | 0.00 | 2.54 | 38.43 | 0.45 | 38.88 | 0.88 | 0.63 | 0.915 | |
| S5 | 42.51 | 0.00 | 0.00 | 33.07 | 5.80 | 3.58 | 9.37 | 0.19 | 0.15 | 0.221 | |

Node Depth Summary

| Node | Type | Average Depth Meters | Maximum Depth Meters | Maximum HGL Meters | Time of Max Occurrence days hr:min | Reported Max Depth Meters |
|----------------|---------|----------------------|----------------------|--------------------|------------------------------------|---------------------------|
| OF_Legget_Pond | OUTFALL | 0.00 | 0.00 | 75.40 | 0 00:00 | 0.00 |
| OF2 | OUTFALL | 0.00 | 0.00 | 77.70 | 0 00:00 | 0.00 |
| Legget_Pond | STORAGE | 0.43 | 0.55 | 76.65 | 0 02:33 | 0.55 |
| SU1 | STORAGE | 0.03 | 0.05 | 95.55 | 0 03:10 | 0.05 |
| SU2 | STORAGE | 0.03 | 0.04 | 95.54 | 0 02:34 | 0.04 |

Node Inflow Summary

| Node | Type | Maximum Lateral Inflow CMS | Maximum Total Inflow CMS | Time of Max Occurrence days hr:min | Lateral Inflow Volume 10^6 ltr | Total Inflow Volume 10^6 ltr | Flow Balance Error Percent |
|----------------|---------|----------------------------|--------------------------|------------------------------------|--------------------------------|------------------------------|----------------------------|
| OF_Legget_Pond | OUTFALL | 0.000 | 0.044 | 0 02:33 | 0 | 0.391 | 0.000 |
| OF2 | OUTFALL | 0.275 | 0.275 | 0 01:10 | 0.39 | 0.39 | 0.000 |
| Legget_Pond | STORAGE | 0.817 | 0.826 | 0 01:10 | 1.09 | 1.37 | 0.006 |
| SU1 | STORAGE | 0.322 | 0.322 | 0 01:10 | 0.459 | 0.459 | 0.010 |
| SU2 | STORAGE | 0.187 | 0.187 | 0 01:10 | 0.266 | 0.266 | 0.010 |

Node Surcharge Summary

No nodes were surcharged.

Node Flooding Summary

No nodes were flooded.

Storage Volume Summary

| Storage Unit | Average Volume 1000 m3 | Avg Full Pcnt | Evap Loss Pcnt | Exfil Loss Pcnt | Maximum Volume 1000 m3 | Max Full Pcnt | Time of Max Occurrence days hr:min | Maximum Outflow CMS |
|--------------|------------------------|---------------|----------------|-----------------|------------------------|---------------|------------------------------------|---------------------|
| Legget_Pond | 0.793 | 15 | 0 | 0 | 1.026 | 20 | 0 02:33 | 0.044 |
| SU1 | 0.287 | 2 | 0 | 0 | 0.386 | 2 | 0 03:10 | 0.009 |
| SU2 | 0.148 | 1 | 0 | 0 | 0.205 | 2 | 0 02:34 | 0.007 |

Outfall Loading Summary

| Outfall Node | Flow Freq Pcnt | Avg Flow CMS | Max Flow CMS | Total Volume 10^6 ltr |
|----------------|----------------|--------------|--------------|-----------------------|
| OF_Legget_Pond | 71.94 | 0.025 | 0.044 | 0.391 |
| OF2 | 73.44 | 0.025 | 0.275 | 0.390 |
| System | 72.69 | 0.050 | 0.275 | 0.781 |

Link Flow Summary

| Link | Type | Maximum Flow CMS | Time of Max Occurrence days hr:min | Maximum Veloc m/sec | Max/ Full Flow | Max/ Full Depth |
|------|---------|--------------------|------------------------------------|-----------------------|----------------|-----------------|
| OR1 | ORIFICE | 0.044 | 0 02:33 | | | 0.02 |
| OL2 | DUMMY | 0.009 | 0 03:10 | | | |
| OL3 | DUMMY | 0.007 | 0 02:34 | | | |

Flow Classification Summary

| Conduit | Adjusted /Actual Length | Fraction of Time in Flow Class | Up Dry | Down Dry | Sub Dry | Sup Crit | Up Crit | Down Crit | Norm Ltd | Inlet Ctrl |
|---------|-------------------------|--------------------------------|--------|----------|---------|----------|---------|-----------|----------|------------|
| | | | | | | | | | | |

Conduit Surcharge Summary

No conduits were surcharged.

Analysis begun on: Fri Oct 22 08:48:12 2021
Analysis ended on: Fri Oct 22 08:48:12 2021
Total elapsed time: < 1 sec

| Node | Flow | Depth | Velocity | Time of Occurrence | Max Depth | Max Velocity | Max Time | Max Flow | Max Depth | Max Velocity | Max Time |
|------|-------|-------|----------|--------------------|-----------|--------------|----------|----------|-----------|--------------|----------|
| S1 | 49.50 | 0.00 | 0.00 | 0.09 | 48.09 | 0.04 | 48.13 | 0.31 | 0.22 | 0.972 | |
| S1_1 | 49.50 | 0.00 | 0.00 | 36.60 | 2.41 | 11.44 | 13.84 | 0.04 | 0.06 | 0.280 | |
| S1_3 | 49.50 | 0.00 | 0.00 | 0.33 | 47.79 | 0.14 | 47.93 | 0.46 | 0.32 | 0.968 | |
| S2 | 49.50 | 0.00 | 0.00 | 0.00 | 48.21 | 0.00 | 48.21 | 0.54 | 0.38 | 0.974 | |
| S3 | 49.50 | 0.00 | 0.00 | 2.68 | 44.98 | 0.81 | 45.79 | 1.04 | 0.74 | 0.925 | |
| S5 | 49.50 | 0.00 | 0.00 | 35.13 | 6.76 | 7.62 | 14.38 | 0.29 | 0.22 | 0.291 | |

Node Depth Summary

| Node | Type | Average Depth Meters | Maximum Depth Meters | Maximum HGL Meters | Time of Max Occurrence days hr:min | Reported Max Depth Meters |
|----------------|---------|----------------------|----------------------|--------------------|------------------------------------|---------------------------|
| OF_Legget_Pond | OUTFALL | 0.00 | 0.00 | 75.40 | 0 00:00 | 0.00 |
| OF2 | OUTFALL | 0.00 | 0.00 | 77.70 | 0 00:00 | 0.00 |
| Legget_Pond | STORAGE | 0.44 | 0.58 | 76.68 | 0 01:44 | 0.58 |
| SU1 | STORAGE | 0.04 | 0.06 | 95.56 | 0 03:10 | 0.06 |
| SU2 | STORAGE | 0.03 | 0.05 | 95.55 | 0 02:32 | 0.05 |

Node Inflow Summary

| Node | Type | Maximum Lateral Inflow CMS | Maximum Total Inflow CMS | Time of Max Occurrence days hr:min | Lateral Inflow Volume 10^6 ltr | Total Inflow Volume 10^6 ltr | Flow Balance Error Percent |
|----------------|---------|----------------------------|--------------------------|------------------------------------|--------------------------------|------------------------------|----------------------------|
| OF_Legget_Pond | OUTFALL | 0.000 | 0.104 | 0 01:44 | 0 | 0.705 | 0.000 |
| OF2 | OUTFALL | 0.322 | 0.322 | 0 01:10 | 0.457 | 0.457 | 0.000 |
| Legget_Pond | STORAGE | 1.030 | 1.040 | 0 01:10 | 1.37 | 1.68 | 0.006 |
| SU1 | STORAGE | 0.378 | 0.378 | 0 01:10 | 0.537 | 0.537 | 0.007 |
| SU2 | STORAGE | 0.219 | 0.219 | 0 01:10 | 0.311 | 0.311 | 0.009 |

Node Surcharge Summary

No nodes were surcharged.

Node Flooding Summary

No nodes were flooded.

Storage Volume Summary

| Storage Unit | Average Volume 1000 m3 | Avg Full Pcnt | Evap Loss Pcnt | Exfil Loss Pcnt | Maximum Volume 1000 m3 | Max Full Pcnt | Time of Max Occurrence days hr:min | Maximum Outflow CMS |
|--------------|------------------------|---------------|----------------|-----------------|------------------------|---------------|------------------------------------|---------------------|
| Legget_Pond | 0.826 | 16 | 0 | 0 | 1.100 | 21 | 0 01:44 | 0.104 |
| SU1 | 0.337 | 2 | 0 | 0 | 0.452 | 3 | 0 03:10 | 0.010 |
| SU2 | 0.175 | 2 | 0 | 0 | 0.242 | 2 | 0 02:32 | 0.009 |

Outfall Loading Summary

| Outfall Node | Flow Freq Pcnt | Avg Flow CMS | Max Flow CMS | Total Volume 10^6 ltr |
|----------------|----------------|--------------|--------------|-----------------------|
| OF_Legget_Pond | 77.56 | 0.042 | 0.104 | 0.705 |
| OF2 | 74.22 | 0.028 | 0.322 | 0.457 |
| System | 75.89 | 0.071 | 0.322 | 1.161 |

Link Flow Summary

| Link | Type | Maximum Flow CMS | Time of Max Occurrence days hr:min | Maximum Veloc m/sec | Max/ Full Flow | Max/ Full Depth |
|------|---------|--------------------|------------------------------------|-----------------------|----------------|-----------------|
| OR1 | ORIFICE | 0.104 | 0 01:44 | | | 0.03 |
| OL2 | DUMMY | 0.010 | 0 03:10 | | | |
| OL3 | DUMMY | 0.009 | 0 02:32 | | | |

Flow Classification Summary

| Conduit | Adjusted /Actual Length | Fraction of Time in Flow Class | Up Dry | Down Dry | Sub Dry | Sup Crit | Up Crit | Down Crit | Norm Ltd | Inlet Ctrl |
|---------|-------------------------|--------------------------------|--------|----------|---------|----------|---------|-----------|----------|------------|
| | | | | | | | | | | |

Conduit Surcharge Summary

No conduits were surcharged.

Analysis begun on: Fri Oct 22 08:48:54 2021
Analysis ended on: Fri Oct 22 08:48:54 2021
Total elapsed time: < 1 sec

| Node | Flow | Depth | Velocity | Time of Occurrence | Maximum Depth | Maximum Velocity | Maximum Time of Occurrence | Reported Depth |
|------|-------|-------|----------|--------------------|---------------|------------------|----------------------------|----------------|
| S1 | 58.23 | 0.00 | 0.00 | 0.10 | 56.83 | 0.06 | 56.88 | 0.37 |
| S1_1 | 58.23 | 0.00 | 0.00 | 38.81 | 2.85 | 18.37 | 21.21 | 0.06 |
| S1_3 | 58.23 | 0.00 | 0.00 | 0.35 | 56.47 | 0.20 | 56.67 | 0.54 |
| S2 | 58.23 | 0.00 | 0.00 | 0.00 | 56.97 | 0.00 | 56.97 | 0.63 |
| S3 | 58.23 | 0.00 | 0.00 | 2.84 | 53.16 | 1.30 | 54.46 | 1.23 |
| S5 | 58.23 | 0.00 | 0.00 | 37.10 | 8.01 | 13.29 | 21.31 | 0.43 |

Node Depth Summary

| Node | Type | Average Depth | Maximum Depth | Maximum HGL | Time of Max Occurrence | Reported Max Depth |
|----------------|---------|---------------|---------------|-------------|------------------------|--------------------|
| OF_Legget_Pond | OUTFALL | 0.00 | 0.00 | 75.40 | 0 00:00 | 0.00 |
| OF2 | OUTFALL | 0.00 | 0.00 | 77.70 | 0 00:00 | 0.00 |
| Legget_Pond | STORAGE | 0.46 | 0.62 | 76.72 | 0 01:32 | 0.62 |
| SU1 | STORAGE | 0.05 | 0.07 | 95.57 | 0 03:10 | 0.07 |
| SU2 | STORAGE | 0.04 | 0.05 | 95.55 | 0 02:31 | 0.05 |

Node Inflow Summary

| Node | Type | Maximum Lateral Inflow | Maximum Total Inflow | Time of Max Occurrence | Lateral Inflow Volume | Total Inflow Volume | Flow Balance Error |
|----------------|---------|------------------------|----------------------|------------------------|-----------------------|---------------------|--------------------|
| OF_Legget_Pond | OUTFALL | 0.000 | 0.227 | 0 01:32 | 0 | 1.11 | 0.000 |
| OF2 | OUTFALL | 0.382 | 0.382 | 0 01:10 | 0.54 | 0.54 | 0.000 |
| Legget_Pond | STORAGE | 1.306 | 1.318 | 0 01:10 | 1.72 | 2.1 | 0.005 |
| SU1 | STORAGE | 0.447 | 0.447 | 0 01:10 | 0.634 | 0.634 | 0.010 |
| SU2 | STORAGE | 0.259 | 0.259 | 0 01:10 | 0.367 | 0.367 | 0.003 |

Node Surcharge Summary

No nodes were surcharged.

Node Flooding Summary

No nodes were flooded.

Storage Volume Summary

| Storage Unit | Average Volume | Avg Full | Evap Loss | Exfil Loss | Maximum Volume | Max Full | Time of Max Occurrence | Maximum Outflow |
|--------------|----------------|----------|-----------|------------|----------------|----------|------------------------|-----------------|
| Legget_Pond | 0.856 | 17 | 0 | 0 | 1.221 | 24 | 0 01:32 | 0.227 |
| SU1 | 0.400 | 2 | 0 | 0 | 0.535 | 3 | 0 03:10 | 0.012 |
| SU2 | 0.207 | 2 | 0 | 0 | 0.287 | 3 | 0 02:31 | 0.010 |

Outfall Loading Summary

| Outfall Node | Flow Freq | Avg Flow | Max Flow | Total Volume |
|----------------|-----------|----------|----------|--------------|
| OF_Legget_Pond | 79.59 | 0.065 | 0.227 | 1.114 |
| OF2 | 75.20 | 0.033 | 0.382 | 0.540 |
| System | 77.39 | 0.098 | 0.382 | 1.654 |

Link Flow Summary

| Link | Type | Maximum Flow CMS | Time of Max Occurrence days hr:min | Maximum Veloc m/sec | Max/ Full Flow | Max/ Full Depth |
|------|---------|--------------------|------------------------------------|-----------------------|----------------|-----------------|
| OR1 | ORIFICE | 0.227 | 0 01:32 | | | 0.06 |
| OL2 | DUMMY | 0.012 | 0 03:10 | | | |
| OL3 | DUMMY | 0.010 | 0 02:31 | | | |

Flow Classification Summary

| Conduit | Adjusted /Actual Length | Fraction of Time in Flow Class | Flow Class |
|---------|-------------------------|---|---|
| | | Up Dry, Down Dry, Sub Dry, Sup Crit, Crit | Up Dry, Down Dry, Sub Dry, Sup Crit, Crit, Norm Ltd, Inlet Ctrl |

Conduit Surcharge Summary

No conduits were surcharged.

Analysis begun on: Fri Oct 22 08:49:45 2021
Analysis ended on: Fri Oct 22 08:49:45 2021
Total elapsed time: < 1 sec

| Node | Flow | Depth | Velocity | HGL | Volume | Time of Occurrence | Max Depth | Max Velocity | Max HGL | Max Volume |
|------|-------|-------|----------|-------|--------|--------------------|-----------|--------------|---------|------------|
| S1 | 64.81 | 0.00 | 0.00 | 0.10 | 63.40 | 0.07 | 63.47 | 0.41 | 0.29 | 0.979 |
| S1_1 | 64.81 | 0.00 | 0.00 | 40.34 | 3.17 | 23.68 | 26.85 | 0.07 | 0.10 | 0.414 |
| S1_3 | 64.81 | 0.00 | 0.00 | 0.37 | 63.01 | 0.24 | 63.25 | 0.60 | 0.43 | 0.976 |
| S2 | 64.81 | 0.00 | 0.00 | 0.00 | 63.56 | 0.00 | 63.56 | 0.71 | 0.50 | 0.981 |
| S3 | 64.81 | 0.00 | 0.00 | 2.96 | 59.32 | 1.68 | 61.00 | 1.38 | 1.00 | 0.941 |
| S5 | 64.81 | 0.00 | 0.00 | 38.41 | 8.93 | 17.76 | 26.70 | 0.54 | 0.42 | 0.412 |

Node Depth Summary

| Node | Type | Average Depth Meters | Maximum Depth Meters | Maximum HGL Meters | Time of Max Occurrence days hr:min | Reported Max Depth Meters |
|----------------|---------|----------------------|----------------------|--------------------|------------------------------------|---------------------------|
| OF_Legget_Pond | OUTFALL | 0.00 | 0.00 | 75.40 | 0 00:00 | 0.00 |
| OF2 | OUTFALL | 0.00 | 0.00 | 77.70 | 0 00:00 | 0.00 |
| Legget_Pond | STORAGE | 0.46 | 0.65 | 76.75 | 0 01:27 | 0.65 |
| SU1 | STORAGE | 0.05 | 0.07 | 95.57 | 0 03:10 | 0.07 |
| SU2 | STORAGE | 0.04 | 0.06 | 95.56 | 0 02:30 | 0.06 |

Node Inflow Summary

| Node | Type | Maximum Lateral Inflow CMS | Maximum Total Inflow CMS | Time of Max Occurrence days hr:min | Lateral Inflow Volume 10^6 ltr | Total Inflow Volume 10^6 ltr | Flow Balance Error Percent |
|----------------|---------|----------------------------|--------------------------|------------------------------------|--------------------------------|------------------------------|----------------------------|
| OF_Legget_Pond | OUTFALL | 0.000 | 0.332 | 0 01:27 | 0 | 1.43 | 0.000 |
| OF2 | OUTFALL | 0.427 | 0.427 | 0 01:10 | 0.602 | 0.602 | 0.000 |
| Legget_Pond | STORAGE | 1.516 | 1.530 | 0 01:10 | 2 | 2.41 | 0.004 |
| SU1 | STORAGE | 0.499 | 0.499 | 0 01:10 | 0.707 | 0.707 | 0.008 |
| SU2 | STORAGE | 0.290 | 0.290 | 0 01:10 | 0.41 | 0.41 | 0.011 |

Node Surcharge Summary

No nodes were surcharged.

Node Flooding Summary

No nodes were flooded.

Storage Volume Summary

| Storage Unit | Average Volume 1000 m3 | Avg Full Pcnt | Evap Loss Pcnt | Exfil Loss Pcnt | Maximum Volume 1000 m3 | Max Full Pcnt | Time of Max Occurrence days hr:min | Maximum Outflow CMS |
|--------------|------------------------|---------------|----------------|-----------------|------------------------|---------------|------------------------------------|---------------------|
| Legget_Pond | 0.874 | 17 | 0 | 0 | 1.309 | 25 | 0 01:27 | 0.332 |
| SU1 | 0.447 | 3 | 0 | 0 | 0.598 | 4 | 0 03:10 | 0.014 |
| SU2 | 0.232 | 2 | 0 | 0 | 0.321 | 3 | 0 02:30 | 0.011 |

Outfall Loading Summary

| Outfall Node | Flow Freq Pcnt | Avg Flow CMS | Max Flow CMS | Total Volume 10^6 ltr |
|----------------|----------------|--------------|--------------|-----------------------|
| OF_Legget_Pond | 80.19 | 0.082 | 0.332 | 1.426 |
| OF2 | 75.33 | 0.037 | 0.427 | 0.602 |
| System | 77.76 | 0.119 | 0.427 | 2.028 |

Link Flow Summary

| Link | Type | Maximum Flow CMS | Time of Max Occurrence days hr:min | Maximum Veloc m/sec | Max/ Full Flow | Max/ Full Depth |
|------|---------|--------------------|------------------------------------|-----------------------|----------------|-----------------|
| OR1 | ORIFICE | 0.332 | 0 01:27 | | | 0.07 |
| OL2 | DUMMY | 0.014 | 0 03:10 | | | |
| OL3 | DUMMY | 0.011 | 0 02:30 | | | |

Flow Classification Summary

| Conduit | Adjusted /Actual Length | Fraction of Time in Flow Class | Up Dry | Down Dry | Sub Crit | Sup Crit | Flow Class | Norm Ltd | Inlet Ctrl |
|---------|-------------------------|--------------------------------|--------|----------|----------|----------|------------|----------|------------|
| | | | | | | | | | |

Conduit Surcharge Summary

No conduits were surcharged.

Analysis begun on: Fri Oct 22 08:50:25 2021
Analysis ended on: Fri Oct 22 08:50:25 2021
Total elapsed time: < 1 sec

| Node | Flow | Depth | Velocity | Time of Occurrence | Max Depth | Max Velocity | Max Flow | Max Full Depth |
|------|-------|-------|----------|--------------------|-----------|--------------|----------|----------------|
| S1 | 71.68 | 0.00 | 0.00 | 0.11 | 70.25 | 0.08 | 70.33 | 0.45 |
| S1_1 | 71.68 | 0.00 | 0.00 | 41.83 | 3.53 | 29.24 | 32.77 | 0.09 |
| S1_3 | 71.68 | 0.00 | 0.00 | 0.38 | 69.81 | 0.28 | 70.09 | 0.67 |
| S2 | 71.68 | 0.00 | 0.00 | 0.00 | 70.42 | 0.00 | 70.42 | 0.78 |
| S3 | 71.68 | 0.00 | 0.00 | 3.06 | 65.75 | 2.08 | 67.83 | 1.53 |
| S5 | 71.68 | 0.00 | 0.00 | 39.67 | 9.89 | 22.54 | 32.44 | 0.66 |

Node Depth Summary

| Node | Type | Average Depth Meters | Maximum Depth Meters | Maximum HGL Meters | Time of Max Occurrence days hr:min | Reported Max Depth Meters |
|----------------|---------|----------------------|----------------------|--------------------|------------------------------------|---------------------------|
| OF_Legget_Pond | OUTFALL | 0.00 | 0.00 | 75.40 | 0 00:00 | 0.00 |
| OF2 | OUTFALL | 0.00 | 0.00 | 77.70 | 0 00:00 | 0.00 |
| Legget_Pond | STORAGE | 0.47 | 0.69 | 76.79 | 0 01:24 | 0.69 |
| SU1 | STORAGE | 0.06 | 0.08 | 95.58 | 0 03:10 | 0.08 |
| SU2 | STORAGE | 0.05 | 0.07 | 95.57 | 0 02:30 | 0.07 |

Node Inflow Summary

| Node | Type | Maximum Lateral Inflow CMS | Maximum Total Inflow CMS | Time of Max Occurrence days hr:min | Lateral Inflow Volume 10^6 ltr | Total Inflow Volume 10^6 ltr | Flow Balance Error Percent |
|----------------|---------|----------------------------|--------------------------|------------------------------------|--------------------------------|------------------------------|----------------------------|
| OF_Legget_Pond | OUTFALL | 0.000 | 0.458 | 0 01:24 | 0 | 1.75 | 0.000 |
| OF2 | OUTFALL | 0.472 | 0.472 | 0 01:10 | 0.668 | 0.668 | 0.000 |
| Legget_Pond | STORAGE | 1.734 | 1.749 | 0 01:10 | 2.29 | 2.74 | 0.004 |
| SU1 | STORAGE | 0.552 | 0.552 | 0 01:10 | 0.784 | 0.784 | 0.007 |
| SU2 | STORAGE | 0.320 | 0.320 | 0 01:10 | 0.454 | 0.454 | 0.008 |

Node Surcharge Summary

No nodes were surcharged.

Node Flooding Summary

No nodes were flooded.

Storage Volume Summary

| Storage Unit | Average Volume 1000 m3 | Avg Full Pcnt | Evap Loss Pcnt | Exfil Loss Pcnt | Maximum Volume 1000 m3 | Max Full Pcnt | Time of Max Occurrence days hr:min | Maximum Outflow CMS |
|--------------|------------------------|---------------|----------------|-----------------|------------------------|---------------|------------------------------------|---------------------|
| Legget_Pond | 0.891 | 17 | 0 | 0 | 1.404 | 27 | 0 01:24 | 0.458 |
| SU1 | 0.497 | 3 | 0 | 0 | 0.664 | 4 | 0 03:10 | 0.015 |
| SU2 | 0.258 | 2 | 0 | 0 | 0.356 | 3 | 0 02:30 | 0.013 |

Outfall Loading Summary

| Outfall Node | Flow Freq Pcnt | Avg Flow CMS | Max Flow CMS | Total Volume 10^6 ltr |
|----------------|----------------|--------------|--------------|-----------------------|
| OF_Legget_Pond | 80.57 | 0.101 | 0.458 | 1.754 |
| OF2 | 76.73 | 0.040 | 0.472 | 0.668 |
| System | 78.65 | 0.141 | 0.472 | 2.421 |

Link Flow Summary

| Link | Type | Maximum Flow CMS | Time of Max Occurrence days hr:min | Maximum Veloc m/sec | Max/ Full Flow | Max/ Full Depth |
|------|---------|--------------------|------------------------------------|-----------------------|----------------|-----------------|
| OR1 | ORIFICE | 0.458 | 0 01:24 | | | 0.09 |
| OL2 | DUMMY | 0.015 | 0 03:10 | | | |
| OL3 | DUMMY | 0.013 | 0 02:30 | | | |

Flow Classification Summary

| Conduit | Adjusted /Actual Length | Fraction of Time in Flow Class | Up Dry | Down Dry | Sub Crit | Sup Crit | Norm Crit | Inlet Ltd | Inlet Ctrl |
|---------|-------------------------|--------------------------------|--------|----------|----------|----------|-----------|-----------|------------|
| | | | | | | | | | |

Conduit Surcharge Summary

No conduits were surcharged.

Analysis begun on: Fri Oct 22 08:51:09 2021
Analysis ended on: Fri Oct 22 08:51:09 2021
Total elapsed time: < 1 sec

APPENDIX







C

MVCA

FLOODPLAIN

MAP

Legend

- Parcels - Assessment
-  Meander Belt
-  1:100 yr Flood Plain
-  Floodplain Spill Lines
-  Floodplain Study Limit
-  MVCA Regulation Limit
-  MVCA Streams
-  Ottawa_Subcatchments

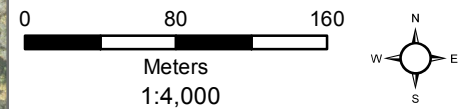

Projection: UTM Zone 18- NAD 83 Datum

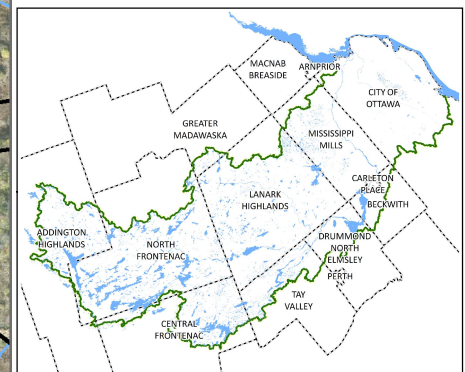

This map is produced in part with data provided by the Ontario Geographic Data Exchange under License with the Ontario Ministry of Natural Resources and the Queen's Printer for Ontario, 2019

Imagery @ Fugro Geospatial, May 2014



Map data © OpenStreetMap contributors, CC-BY-SA

APPENDIX

D SUPPORTING DOCUMENTS





Adjustable Accutrol Weir

Tag: _____

Adjustable Flow Control for Roof Drains

ADJUSTABLE ACCUTROL (for Large Sump Roof Drains only)

For more flexibility in controlling flow with heads deeper than 2", Watts Drainage offers the Adjustable Accutrol. The Adjustable Accutrol Weir is designed with a single parabolic opening that can be covered to restrict flow above 2" of head to less than 5 gpm per inch, up to 6" of head. To adjust the flow rate for depths over 2" of head, set the slot in the adjustable upper cone according to the flow rate required. Refer to Table 1 below.
 Note: Flow rates are directly proportional to the amount of weir opening that is exposed.

EXAMPLE:

For example, if the adjustable upper cone is set to cover 1/2 of the weir opening, flow rates above 2" of head will be restricted to 2-1/2 gpm per inch of head.

Therefore, at 3" of head, the flow rate through the Accutrol Weir that has 1/2 the slot exposed will be:
 [5 gpm (per inch of head) x 2 inches of head] + 2-1/2 gpm (for the third inch of head) = 12-1/2 gpm.

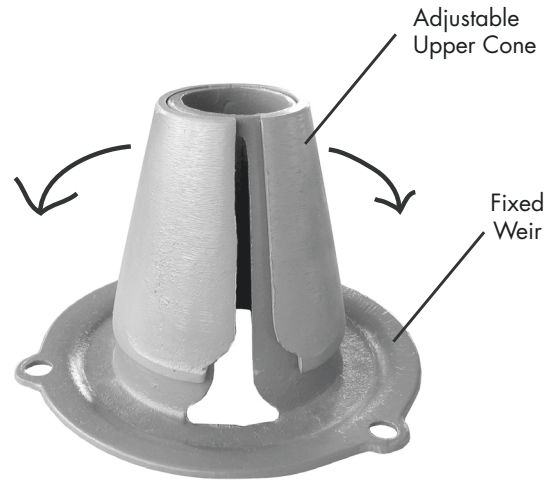
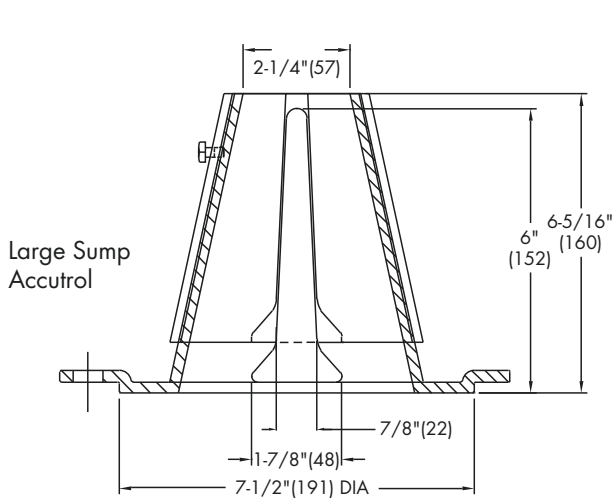

1/2 Weir Opening Exposed Shown Above

TABLE 1. Adjustable Accutrol Flow Rate Settings

| Weir Opening Exposed | 1" | 2" | 3" | 4" | 5" | 6" |
|----------------------|--------------------------------|----|-------|------|-------|----|
| | Flow Rate (gallons per minute) | | | | | |
| Fully Exposed | 5 | 10 | 15 | 20 | 25 | 30 |
| 3/4 | 5 | 10 | 13.75 | 17.5 | 21.25 | 25 |
| 1/2 | 5 | 10 | 12.5 | 15 | 17.5 | 20 |
| 1/4 | 5 | 10 | 11.25 | 12.5 | 13.75 | 15 |
| Closed | 5 | 5 | 5 | 5 | 5 | 5 |

Job Name _____
 Job Location _____
 Engineer _____

Contractor _____
 Contractor's P.O. No. _____
 Representative _____

Watts product specifications in U.S. customary units and metric are approximate and are provided for reference only. For precise measurements, please contact Watts Technical Service. Watts reserves the right to change or modify product design, construction, specifications, or materials without prior notice and without incurring any obligation to make such changes and modifications on Watts products previously or subsequently sold.

USA: Tel: (800) 338-2581 • Fax: (828) 248-3929 • Watts.com
 Canada: Tel: (905) 332-4090 • Fax: (905) 332-7068 • Watts.ca
 Latin America: Tel: (52) 81-1001-8600 • Fax: (52) 81-8000-7091 • Watts.com



A Watts Water Technologies Company