

FUNCTIONAL SERVICING AND STORMWATER MANAGEMENT REPORT

IN SUPPORT OF

ZONING BY-LAW AMENDMENT AND SITE PLAN CONTROL APPLICATION

Location: 1971 & 1975 St. Laurent Boulevard, Ottawa, Ontario

CPE Project #: 21106

City of Ottawa



8395 Jane Street, Suite 100
Vaughan, Ontario L4K 5Y2
Tel: (905) 326-1404

**Prepared For:
Starlight Developments**

No.	Revision	Date
1.	Issued for ZBA & SPA #1	March 11, 2022



TABLE OF CONTENTS

TABLE OF CONTENTS	2
LIST OF FIGURES, TABLES, APPENDICES & DRAWINGS	3
1.0 INTRODUCTION	5
1.1 <i>Background</i>	5
1.2 <i>Study Parameters</i>	7
2.0 STORMWATER MANAGEMENT	8
2.1 <i>Existing Conditions</i>	8
2.2 <i>Allowable Release Rate</i>	8
2.3 <i>Water Quantity</i>	10
2.4 <i>Water Quality</i>	11
2.5 <i>Erosion and Sediment Control</i>	11
3.0 SANITARY SERVICING	12
3.1 <i>Existing Sanitary Servicing</i>	12
3.2 <i>Proposed Sanitary Release Rate and Servicing</i>	13
4.0 WATERMAIN SERVICING	14
4.1 <i>Existing Water Servicing Strategy</i>	14
4.2 <i>Proposed Water Servicing Strategy</i>	14
4.3 <i>Watermain Modelling</i>	16
5.0 CONCLUSIONS	19



LIST OF FIGURES, TABLES, APPENDICES & DRAWINGS

Figures

Figure 1 – Site Location Plan

Tables

Table 1 – Allowable Release Rates

Table 2 – Composite Run-off Coefficient of Post-Development Condition

Table 3 – Peak Flow and Storage Summary - 100-Year Storm Event

Table 4 – Peak Sanitary Flow – Existing Buildings

Table 5 – Peak Sanitary Flow – Proposed Buildings

Table 6 – Water Servicing Statistics

Table 7 – Highest Residual Pressures during Non-Fire Flow Conditions

Table 8 – Lowest Residual Pressures during Non-Fire Flow Conditions

Table 9 – Residual Pressures during Fire Flow Conditions

Appendices

Appendix A

- Architectural site plan
- Topographic survey

Appendix B

- Pre-development storm event calculations
- Allowable release rate calculations
- Orifice plate calculations/controlled release
- Storage Required/Provided Calculations
- StormCon Greenstorm SWM tank design details
- Stormceptor Sizing Design Information

Appendix C

- Existing Sanitary Drainage Calculations
- Proposed Sanitary Drainage Calculations

Appendix D

- Water Demand Calculations
- FUS Calculations
- City of Ottawa watermain boundary conditions
- Watermain Modelling Results



Drawings (all dated March 9, 2022)

SW-S – Site Servicing Plan

SW-G – Site Grading Plan

SW-SWM1 – Pre-Development Storm Drainage Plan

SW-SWM2 – Post-Development Storm Drainage Plan

SW-ESC – Erosion and Sediment Control Plan

SW-ND – Notes and Details Plan



1.0 INTRODUCTION

1.1 BACKGROUND

This Site Servicing and Stormwater Management Report ('FSSR') has been prepared in support of a zoning by-law amendment ('ZBLA') and site plan control application ('SPA') for the proposed re-development located at 1971 & 1975 St. Laurent Boulevard within the City of Ottawa. The +/-3.46ha (+/-8.57 acre) subject site is bound by St. Laurent Boulevard along the north and west, Russell Road to the east and an existing City of Ottawa Community Housing residential complex to the south. The site is currently developed and contains two occupied 18-storey apartment buildings including associated surface parking lots and landscaped amenity areas. The site contains two existing vehicular accesses; one from St. Laurent Boulevard and one from Russell Road. The Russell Road access is shared with the adjacent property, 2080 Russell Road and there currently exists a shared access easement agreement. Refer to **Figure 1** for a key plan of the subject site.

The proposed development includes three new 17 storey apartment towers known here-on as "Building A" (165 units), "Building B" (168 units) and "Building C" (168 units) in addition to the two existing 18-storey apartment building which are to remain. In total, an additional 501 rental units are being added to the subject site to compliment the already existing 500 residential rental units. A new 4-storey vehicular parkade known as "Building D" is also proposed at the south end of the subject site. It is intended that the three new apartment towers, Building A, Building B and Building C, be severed off from the existing property for separate ownership at a future time. Site access is proposed through the two previously mentioned existing site accesses to St. Laurent Boulevard and Russell Road. The existing shared access easement agreement for the Russell Road vehicular access is to remain. There is a proposed road widening along Russell Road which consists of 0.46 ha (1.14 acres). The above grade parking structure, Building D, will also provide rooftop amenity space for residents in addition to parking spaces. The development concept includes for an increase in Gross Floor Area ('GFA') of 38,956 sq.m. Refer to **Appendix A** for a summary of site statistics and architectural site plan.

This FSSR has been prepared to address the site servicing strategy (stormwater, sanitary, and water servicing) in support of the above noted development applications.

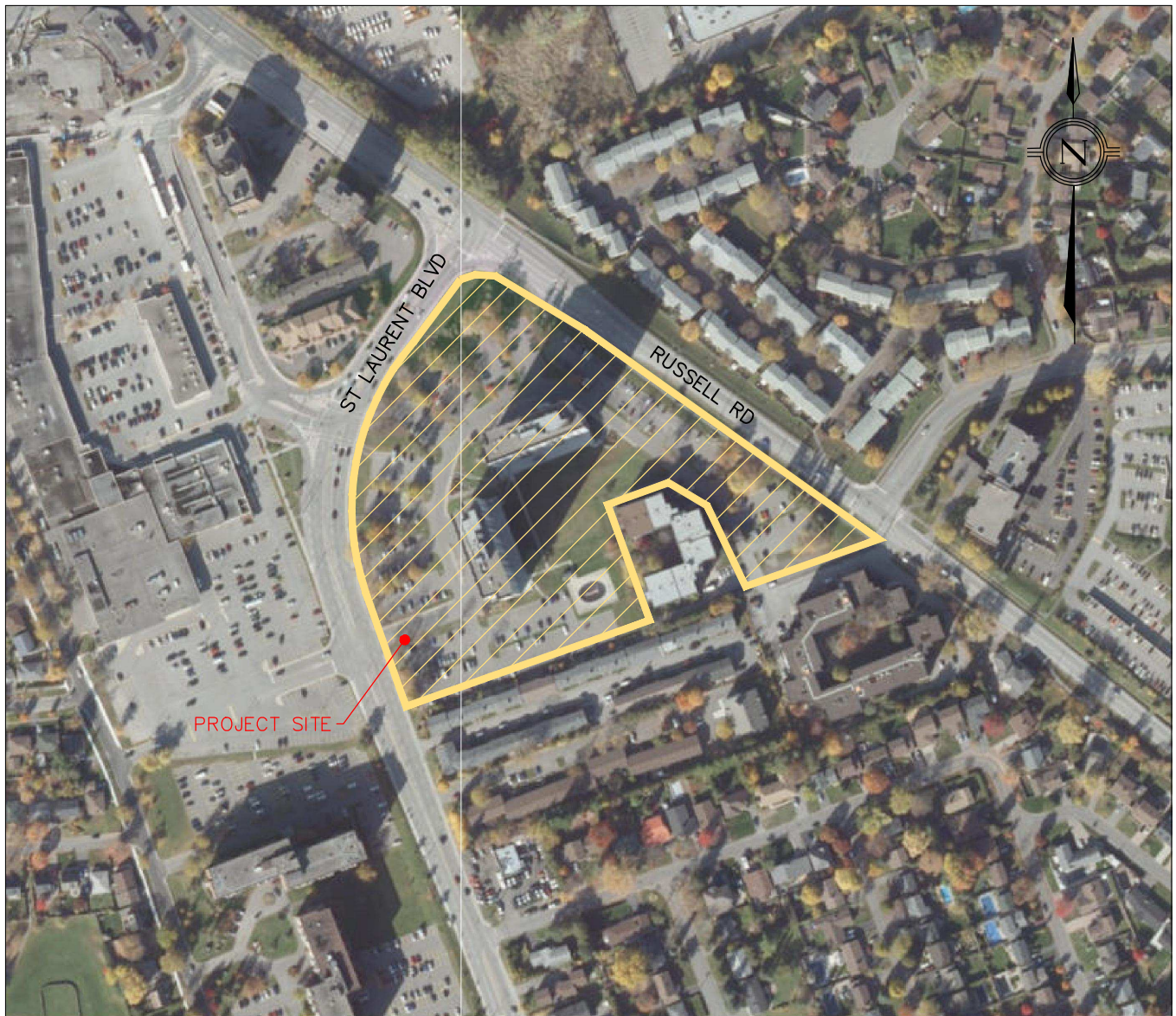

counterpoint 
ENGINEERING

COUNTERPOINT ENGINEERING INC.
8395 Jane St., Suite 100, Vaughan, ON L4K 5Y2 Phone 905.326.1404 Fax 905.326.1405

SITE LOCATION PLAN

PROPOSED MULTI-UNIT RESIDENTIAL
DEVELOPMENT
1971 & 1975 ST. LAURENT BLVD.
CITY OF OTTAWA, ONTARIO

DESIGNED BY: JD
CHECKED BY: GD
DRAWING BY: JD
CHECKED BY: GD
SCALE: N.T.S.

DATE: MARCH 2022
PROJECT No. 21106
FIGURE No. 1



1.2 STUDY PARAMETERS

The background documents listed below have been considered in the preparation of this FSSR:

- Architectural plans and inputs prepared by Petroff Partnership Architects;
- SUE investigation by T2 Utility Engineers, dated December 6, 2021;
- Topographic Survey by Annis, O’Sullivan, Vollebekk Ltd., dated September 27, 2021;
- Ottawa Sewer Design Guidelines, Second Edition, October 2012;
- Ottawa Design Guidelines – Water Distribution, First Edition, July 2010;
- Fire Underwriters Survey, 1999.
- City of Ottawa Technical Bulletin ISTB-2018-01 dated March 21, 2018
- City of Ottawa Technical Bulletin ISTB-2018-02 dated March 21, 2018
- City of Ottawa Technical Bulletin ISTB-2019-03 dated March 04, 2019
- City of Ottawa Technical Bulletin ISTB-2021-03 dated August 18, 2021

For the purpose of this report, we have referenced site and building statistics from the architectural site plan.



2.0 STORMWATER MANAGEMENT

2.1 EXISTING CONDITIONS

The subject site is currently occupied by two residential apartment buildings, associated surface parking lots and landscaped areas. The site currently utilizes a storm sewer network to capture minor flows (i.e. through catchbasins and storm sewers) and connects to a 450mm diameter municipal storm connection located at the south-east corner of the subject site. Based on a review of the topographic survey, major system overland flows exit the site at both the east and west frontages of the site, particularly at the existing vehicular access locations. Original design documents of the subject site were not located and due to the age of the existing infrastructure the assumption is that the existing site sewer does not have any stormwater controls. In addition, the storm sewer network servicing the neighboring Ottawa Community Housing buildings connects to the subject sites private storm sewer network at the southeast corner of the site, just upstream of the existing control manhole. Refer to the **Pre-Development storm Drainage Plan (dwg. SW-SWM1)** for an illustration of the existing drainage conditions.

2.2 ALLOWABLE RELEASE RATE

The site conditions as they exist today, drain stormwater runoff to three separate outlets. Currently a portion of the site sheet flows drainage off toward the west end of the site and into the St. Laurent Boulevard right-of-way (ROW) which is eventually collected by the municipal storm sewer that flows south along the road. This will be referred hereon as the St. Laurent Boulevard outlet. In addition, a portion of the site sheet flows drainage off toward the north of the site and into the municipal ROW where it is eventually collected by the municipal storm sewer that flows north along Russell Road. This will be referred hereon as the Russell Road outlet. The remainder of the site captures drainage by the existing site storm sewer via various catchbasins and catchbasin manholes located throughout the site. The existing onsite storm sewer has a municipal service connection located at the southeast corner of the site. The site storm service connects to the existing 450mm municipal storm sewer located on Southvale Crescent. This will be referred hereon as the Southvale Crescent outlet. The existing private storm sewer on site does not have any SWM controls. Therefore, the proposed stormwater management strategy will satisfy municipal criteria and promote the old design to new standards. To



*Site Servicing and Stormwater Management Report
1971 & 1975 St. Laurent Blvd., Ottawa*

determine the allowable discharge rate to each outlet, the pre-development drainage boundary and its subsequent runoff coefficient was calculated. Each municipal storm sewer in the City of Ottawa has its own specifically designed capacity based on storm year events. For the purposes of this design, the following storm events apply for each storm sewer outlet:

- St. Laurent Boulevard outlet = 2 Year Storm Event
- Russell Road Outlet = 5 Year Storm Event
- Southvale Crescent = 2 Year Storm Event

The control manhole has been proposed along the existing 450mm private storm sewer and upstream of the connections from the existing neighbouring Ottawa Community Housing building as to avoid any negative impacts to the neighbouring buildings storm sewer.

Table 1 below summarizes the predevelopment storm runoff calculation which is used to determine the post-development allowable release rate from the altered areas within the subject site:

Table 1: Allowable Release Rates

	$Q_A = C \times A \times i / 360$ (L/s)		
	Area 100 St. Laurent Outlet	Area 101 Russell Outlet	Area 102 Southvale Outlet
A - Site Area (ha)	0.20	0.19	3.16
T_c (min)	10	10	10
C - Runoff Coefficient	0.46	0.25	0.66
i – Intensity [5-year] (mm/hr)	76.81	104.19	76.81
Q - Release Rate [5-year] (l/s)	19.6	13.8	443.0

Post-development peak flows will be attenuated to the allowable release rates of each outlet as shown in **Table 1** or less for all storms up to and including the 100-year storm event, as summarized in **Appendix B**. Refer to **Appendix B** for the site-specific allowable release rate calculation. Refer to the **Pre-Development Storm Drainage Plan (dwg. SW-SWM1)** for an illustration of the existing drainage boundaries.



2.3 WATER QUANTITY

All stormwater runoff from the various components of the proposed development's site areas, including roofs, exterior hard paved surfaces, and soft landscaped areas, will be captured by roof drains and catchbasins and conveyed either via the building plumbing system or the site storm sewer system and directed to the existing/proposed storm sewers within the site. Refer to the **Post-Development Storm Drainage Plan** (dwg. **SW-SWM2**) for the post-development drainage condition, storm sewer network detail and connection to municipal infrastructure. A small portion of the site will drain uncontrolled in the post-development drainage condition. The post-development 100-year storm event discharging from the uncontrolled areas draining to the St. Laurent outlet and Russell outlet will not exceed their respective predevelopment allowable flows of 19.6 l/s and 13.8 l/s, respectively. Quantity control will be provided within the site to ensure that post-development peak flows up to the 100-year storm event are attenuated to the allowable release rate of 443.0 l/s to the Southvale outlet at the control MH.

For the purpose of calculating the required storage and orifice diameter required to achieve quantity control, composite run-off coefficients were calculated across the subject site.

Table 2: Composite Runoff Coefficients of Post-Development Condition

Area	Area [m ²]	RC
200 - Controlled to Southvale Outlet	3.418	0.75
201 - Uncontrolled to Southvale Outlet	0.007	0.25
202 - Uncontrolled to St. Laurent Outlet	0.052	0.31
203 - Uncontrolled to Russell Outlet	0.079	0.34

The resulting quantity control calculations are summarized in **Table 3** shown below. The on-site water quantity requirements can be achieved by in-sewer underground storage in combination with a 390mm orifice plate control, at the downstream side of the control Maintenance hole, to attenuate storm runoff to the required level. Refer to **Appendix B** for stormwater storage calculations. Underground storage tanks will provide the bulk of the required stormwater detention. The tanks specified for this site are GreenStorm-ST modules manufactured by Stormcon. Refer to **Appendix B** for detailed design



*Site Servicing and Stormwater Management Report
1971 & 1975 St. Laurent Blvd., Ottawa*

specifications of the Stormcon system. A combined storage total of **505.7m³** of storage is provided onsite.

Major storm events in excess of the 100-year event and not captured by the minor system will spill to the municipal right-of-way, primarily at the two existing vehicular accesses to St. Laurent Boulevard and Russell Road.

Table 3: Peak Flow and Storage Summary - 100-Year Storm Event

Area ID	Area (ha)	Runoff Coefficient	t _c (min)	Storage Available (m ³)	Storage Required (m ³)	Release Rate (L/s)	Description	Orifice Size (mm)	Orifice Release Rate (L/s)
Southvale Cres. Outlet									
200	3.418	0.75	10	505.7	505.5	441.4	CNTRL to Southvale	390	441.4
201	0.007	0.31	10		0	0.8	UNC to Southvale	N/A	N/A
Total	3.425				505.5	442.2			
St. Laurent Blvd. Outlet									
202	0.052	0.31	10		0	8.0	UNC to St. Laurent	N/A	N/A
Total	0.052				0	8.0			
Russell Road Outlet									
203	0.079	0.34	10		0	13.2	UNC to Russell	N/A	N/A
Total	0.079				0	13.2			

2.4 WATER QUALITY

Water quality treatment for the subject site is required to ensure Level I enhanced quality treatment is achieved, in accordance with City of Ottawa/MOE criteria, which requires an overall 80% Total Suspended Solids ('TSS') removal rate for the overall site.

As run-off from roof areas is generally considered to be clean, a quality control unit will be provided, at the downstream of the Control MH, to treat only runoff from paved surface areas upstream of the control manhole. In order to achieve a TSS removal rate of 80% and considering site characteristics, a Stormceptor EFO12 Oil/Grit Separator (OGS) unit was selected. Refer to **Appendix B** for more information. The specified EFO12 oil/grit separator will provide the required 80% TSS, at minimum.

2.5 EROSION AND SEDIMENT CONTROL

Erosion and sediment control will be provided on-site before major construction, including silt fence around the perimeter of the construction area, silt controls on existing catchbasins within and adjacent



to the site and if suitable, a mud mat at the construction entrance to prevent mud being tracked onto the adjacent roads by construction vehicles. Regular cleaning of the adjacent streets will also be carried out. The above measures are to be maintained throughout the course of construction and any areas disturbed by the installation of erosion and sediment control devices are to be restored to existing condition or better.

3.0 SANITARY SERVICING

3.1 EXISTING SANITARY SERVICING

The site currently is serviced by a sanitary sewer network that conveys sanitary flows from 1971 & 1975 St. Laurent Boulevard and connects to a 250mm diameter municipal sanitary sewer that crosses Russell Road and flows north easterly along Southvale Crescent. The existing sanitary service connection to the subject site also services the neighbouring Ottawa Community Housing buildings located at 2080 & 2100 Russell Road. Based on the proposed sanitary sewer design for the proposed development, it is considered independent of our scope and there is no intention to alter the sanitary sewer connection to either of the existing Ottawa Community Housing buildings. Refer to the **Site Servicing Plan** (dwg. **SW-S**) for the layout of the existing sewer network.

The peak sanitary discharge from the existing apartment towers was calculated using an average wastewater flow of 280 l/capita/day and using an infiltration rate of 0.33 l/s/ha. (City of Ottawa Technical Bulletin ISTB-2018-01, March 21, 2018). The unit count and mix for the two existing apartment towers on site was acquired from the Client to determine a population density for peak flow calculations. The unit count and mix for the two existing buildings located at 2080 & 2100 Russell Road was acquired from the Ottawa Community Housing website to determine a population density for peak flow calculations. Refer to **Appendix C** for supporting calculations. The following table summarized the existing sanitary peak flows generated from the site today:



Table 4: Peak Sanitary Flow – Existing Buildings

Building	Outlet Sewer	Units	Equiv. Pop	Peak Flow incl. Infil. (L/s)
1971 St. Laurent Blvd.	Southvale Cres.	162	412	14.46
1975 St. Laurent Blvd.	Southvale Cres.	162	412	
2080 & 2100 Russell Road	Southvale Cres.	335	303	

3.2 PROPOSED SANITARY RELEASE RATE AND SERVICING

The location of the private sanitary sewer network currently servicing the two existing 18-storey apartment buildings is ideal for providing a new, private connection for Building A and Building D. Building A currently has no public sanitary sewer availability across its frontage along St. Laurent Boulevard or Russell Road and therefore will require service from the existing private sanitary sewer network onsite. Building D is located between the two existing apartment towers and therefore is ideal to connect to the already available private sanitary sewer network onsite. Since the owner is currently intending a land severance, two new sewer connections are proposed from the existing 250mm municipal sanitary sewer along St. Laurent Boulevard to Building B and Building C. The new sanitary sewer connections will consist of 200mm PVC services at a slope of 2.0% connecting into existing sanitary manholes on St. Laurent boulevard and include proposed control manholes at the property lines. Further discussions with City staff are required in order to determine how to ensure the proposed servicing is building code and MECF compliant, considering Building A and Building D will be connecting into the existing private sanitary network onsite.

The peak sanitary discharge from the proposed apartment towers was calculated using an average wastewater flow of 280 l/capita/day and using an infiltration rate of 0.33 l/s/ha. (City of Ottawa Technical Bulletin ISTB-2018-01, March 21, 2018). The onsite sanitary peak discharge has been separated as per their respective sewer outlets.



Table 5: Peak Sanitary Flow – Proposed Buildings

Building	Outlet Sewer	Units	Equiv. Pop	Peak Flow incl. Infil. (L/s)
Building A	Southvale Cres.	165	296	3.64
Building D	Southvale Cres	0	0	
Building B	St. Laurent Blvd.	168	303	6.76
Building C	St. Laurent Blvd.	168	303	

Considering the subject site consist of existing apartment building to remain, the above peak sanitary flows represent the net increase of sanitary discharge from the existing site. Therefore, the total net increase in wet weather peak flow rate to the Southvale Crescent outlet is 3.64 L/s and the total net increase in wet weather peak flow rate to the St. Laurent Boulevard outlet is 6.76 L/s. This produces a total net increase in sanitary flow from the site of 10.4 L/s. Refer to **Appendix C** for supporting calculations.

According to the City of Ottawa, the proposed parkette does not require servicing. As such, a sanitary service has not been proposed as a part of this development application.

4.0 WATERMAIN SERVICING

4.1 EXISTING WATER SERVICING STRATEGY

The existing site is currently serviced by a private looped watermain on site consisting of 200mm and 150mm watermain pipes. The internal private watermain systems connects to the municipal watermain system in two locations along St. Laurent Boulevard. The internal private loop provides water service connections to the two existing apartment buildings. The private site watermain service continues southeast into the site where it eventually provides service connections to the Ottawa Community housing buildings. The private site contains three existing fire hydrants located throughout the subject site relatively in the vicinity of the existing buildings. Refer to drawing SW-S for the layout of the existing water service network and location of site service connections.

4.2 PROPOSED WATER SERVICING STRATEGY

We are proposing the following site watermain improvements as part of the development application. Refer to drawing SW-S for the proposed watermain improvements.



*Site Servicing and Stormwater Management Report
1971 & 1975 St. Laurent Blvd., Ottawa*

- Extend the existing private watermain loop to provide connections to the newly proposed buildings. Building A and Building D will be serviced by extensions of the existing internal watermain loop with 300mm diameter and 150mm diameter PVC watermain services providing domestic service and fire protection.
- Remove lengths of existing watermain that conflict with proposed buildings and infrastructure on site and replace with new watermain lengths to reconnect the internal private looped system.
- Provide two new separate water service connections each to Building B and Building C from the existing 300mm municipal watermain on St. Laurent Boulevard. Building B and Building C will each require two 150mm PVC water service connection separated by an isolation valve along the water main to provide a redundant looped system to each parcel. These water service connections will provide domestic and fire prevention service to each building.

Domestic water demands were calculated using a per capita rate of 280 litres/person/day and peaked in accordance with City standards (*Ottawa Water Distribution Design Guidelines – Table 4.2*). Fire flow demand was estimated using the Fire Underwriters Survey guidelines. A conservative assumption on construction type for each proposed building was made by applying ‘Non-Combustible’. An occupancy reduction (contents) factor of LC was used for all buildings as there are no non-residential uses being proposed.

Verification of the capacity of off-site watermain infrastructure is provided in **Section 4.3**. Refer to **Table 6** for a summary of water servicing requirements and **Appendix D** for detailed water service calculations.

Table 6: Water Servicing Statistics

Item	BLDG A, D & EX. Rate (l/s)	BLDG B Rate (l/s)	BLDG C Rate (l/s)
Average Day	5.2	1.0	1.0
Maximum Day	11.3	2.2	2.5
Maximum Hour	12.9	2.5	2.5
Fire Flow – FUS	300.0*	233.3	216.7
Max. Day + Fire Flow	311.3	235.5	218.8

* Please refer to **Appendix D** for detailed FUS calculations for each building. The largest fire demand was used as the governing fire flow for BLDG A, D and Existing Buildings.



It is our understanding from the project architect that a Fire Department Connection will be located on the face of each proposed and within 15m of the principal entrance. An existing fire hydrant or proposed fire hydrant will be within the required distance (45m) to the Fire Department Connection.

4.3 WATERMAIN MODELLING

Watermain modeling has been performed as requested by the City to evaluate the available pressures in the watermain system. The watermain analysis utilized EPANET to evaluate the capacity of the surrounding water infrastructure and available pressures. The model was run based on the average day, peak hour and maximum day + fire flow demands for the proposed development. The model analyzed max day + fire flow demand scenarios during fire flow conditions at proposed Building A and D, as well as the existing buildings located at 1971 St. Laurent Blvd, 1975 St. Laurent Blvd, 2080 Russell Road, and 2100 Russell Road. Proposed Buildings B and C will have direct connections into the existing watermain on St. Laurent Blvd and will therefore not be included in the EPANET modeling. The City has indicated that City staff will assess the existing watermain system's capacity to service these two buildings.

The model has been set up to focus on the limits of the development and shall connect into the existing watermain system with two connections to the existing watermain on St. Laurent Blvd, and connect as a dead-end to the existing watermain system at the southeast section of the site. The existing building and associated parking lot on the southeast section of the site are existing and the proposed development plans to leave this area remaining as existing. Therefore, the watermain model connects as a dead-end to this existing system that shall remain. Average day and peak hour demands were placed at the respective nodes where the servicing connections to buildings are located, and fire flows were inputted at the buildings or hydrants that will be servicing the buildings. Fire flows for the existing buildings at 2080 Russell Road and 2100 Russell Road were inputted at the dead-end node connecting to the existing watermain system (node J6), to demonstrate that adequate fire flow can be provided for these existing buildings.

The model was set up with "pump" locations as follows:

1. Two connections at the existing 300 mm \varnothing watermain along St. Laurent Blvd.



The characteristics of the supply/connection points were established based on the boundary conditions received from the City staff on February 14, 2022. These boundary conditions have been included in **Appendix D**. The results of the water distribution modeling are summarized in **Tables 7 to 9** below:

Table 7 – Highest Residual Pressures During Non-Fire Flow Conditions

Scenario	Pressure (m H ₂ O)	Pressure (psi)	Pressure (kPa)	Satisfies Pressure Requirements?
Avg. Day	54.34	77.27	532.8	Yes
Peak Hour	54.14	76.99	530.8	Yes

Table 8 – Lowest Residual Pressures During Non-Fire Flow Conditions

Scenario	Pressure (m H ₂ O)	Pressure (psi)	Pressure (kPa)	Satisfies Pressure Requirements?
Avg. Day	50.65	72.02	496.6	Yes
Peak Hour	50.43	71.71	494.4	Yes

Table 9 – Residual Pressures During Fire Flow Conditions

Fire Flow at Block	Max. Day + Fire Flow requirements (L/min)	Max. Velocity (m/s)	Lowest Pressure			Satisfies Fire Flow Requirements?
			Pressure (m H ₂ O)	Pressure (psi)	Pressure (kPa)	
Ex. 1971 St. Laurent Blvd	18,176	5.00	33.96	48.29	332.9	Yes
Ex. 1975 St. Laurent Blvd	18,176	9.69	19.95	28.37	195.6	Yes
Ex. 2080 Russell Road	13,202	7.05	28.16	40.04	276.1	Yes
Ex. 2100 Russell Road	15,000	8.11	22.36	31.80	219.2	Yes
Prop. Building A	12,126	3.77	37.56	53.41	368.2	Yes
Prop. Building D	3,000	2.83	41.92	59.61	411.0	Yes

Maximum Pressure = 532.8 kPa (77.27 psi)

Minimum Pressure – During Peak hour = 494.4 kPa (71.71 psi)

Minimum pressure – During Max Day + Fire Flow = 195.6 kPa (28.37 psi)



Refer to **Appendix D** for the details and full model outputs. As per City of Ottawa standards, required pressure ranges are outlined as follows:

- Preferred design pressure during normal operating conditions is within 345 kPa to 552 kPa
- Minimum pressure under non-fire conditions shall not be below 275 kPa
- Minimum pressure under max day + fire flow conditions is 140 kPa

As seen from **Tables 8 to 10** above, adequate pressure is available in the existing surrounding watermain system to service the proposed development and maintain pressures within the required range during all scenarios including average day demand, peak hour demand and max day + fire flow demand conditions.

The existing and proposed watermain system will therefore have adequate flow and pressure to service the proposed development under all required conditions. The proposed water distribution system for the development shall adequately provide max day + fire flow demand, while maintaining a residual pressure of over 140 kPa, as per the City of Ottawa criteria. Therefore, no external upgrades or retrofits are required on the existing surrounding watermain network to service the proposed development.



5.0 CONCLUSIONS

This report presents a site servicing strategy for the proposed development that addresses the requirements of the applicable design guidelines and provides the basis for detailed servicing design. The key points are summarized as follows:

Stormwater Management:

- Post-development stormwater flows are to be controlled to an allowable release rate of 19.6 l/s to the St. Laurent Boulevard outlet, 13.8 l/s to the Russell Road and 443.0 l/s to the Southvale Crescent outlet, which represents the 2-year, 5-year and 2-year design storms respectively.
- The on-site water quantity requirements will be achieved by in-sewer underground storage, primarily provided by Stormcon GreenStorm SWM detention units in combination with a 390mm orifice plate control, at the downstream side of the control manhole, in order to attenuate storm run-off to the required level.
- A Stormceptor model EFO12 Oil/Grit Separator (OGS) quality control unit will be provided downstream of the control manhole, in order to achieve the minimum 80% TSS removal quality control criteria.

Sanitary Servicing:

- The subject site required multiple sanitary service connections to accommodate the future parcel severances on site. A new sanitary service will be provided for Building B and Building C with sanitary sewer connection which will connect into the existing municipal 250mm sanitary sewer on St. Laurent Boulevard. Building A and Building D will connect to the existing private sanitary sewer system, which then eventually outlets to a 250mm diameter sanitary sewer on Southvale Crescent.
- The proposed development concept will generate a net increase of 3.64 l/s of peak wet weather sanitary flow to the Southvale Crescent sanitary sewer outlet. As well, the proposed development concept will generate a net increase of 6.76 l/s of peak wet weather sanitary flow



*Site Servicing and Stormwater Management Report
1971 & 1975 St. Laurent Blvd., Ottawa*

to the St. Laurent Boulevard sanitary sewer outlet, in addition to the existing sanitary flow from the existing apartment buildings to remain.

Water Servicing:

- The existing site is currently serviced by a private looped watermain on site consisting of 200mm and 150mm watermain pipes. Building A and Building D will be serviced by 300mm diameter and 150mm diameter PVC watermain extensions of the existing private looped watermain network.
- Building B and Building C will be serviced by the existing 300mm municipal watermain on St. Laurent Boulevard. Building B and Building C will each require two 150mm PVC water service connection separated by an isolation valve along the water main to provide a redundant looped system to each parcel.
- Building A and Building D as well as the existing buildings (1971 & 1975 St. Laurent Blvd. and 208 & 2100 Russell Road) have an average day domestic demand of 5.25 l/s, a maximum hour demand of 12.9 l/s and a maximum day demand of 11.3 l/s.
- Building B has an average day domestic demand of 1.0 l/s, a maximum hour demand of 2.5 l/s and a maximum day demand of 2.2 l/s.
- Building C has an average day domestic demand of 1.0 l/s, a maximum hour demand of 2.5 l/s and a maximum day demand of 2.2 l/s.
- Fire flow demand was estimated using the Fire Underwriters Survey guidelines. It was determined that the private looped watermain system (Buildings A, D & Existing) will require 18,000 l/min (300.0 l/s) to provide sufficient fire flow protection for the development. It was determined that Building B will require 14,000 l/min (233.3 l/s) to provide sufficient fire flow protection for the development. It was determined Building C will require 13,000 l/min (216.7 l/s) to provide sufficient fire flow protection for the development.
- The subject site was modeled using EPANET software and boundary conditions provided by City of Ottawa staff. The model confirmed that adequate pressure is available in the existing system to service the proposed development.



*Site Servicing and Stormwater Management Report
1971 & 1975 St. Laurent Blvd., Ottawa*

We trust this report sufficiently addresses the site servicing requirements in support of the proposed site plan application associated with the subject site. Please contact the undersigned with any questions or comments.

Counterpoint Engineering Inc.



Per: Gian-Michael Di Luca, P.Eng.
Project Designer
Direct: (416) 886-1075
Email: gdiluca@counterpointeng.com



Per: David Di Iorio, P.Eng.
Practice Area Lead – Commercial, Partner
Direct: (416) 574-1382
Email: ddiiorio@counterpointeng.com



APPENDIX A



1 SITE PLAN
A101 SCALE: 1:500

ST. LAURENT BLVD.

CARLETON CONDOMINIUM
PLAN No. 367

ST. LAURENT BLVD.
SR-7960

1975 ST. LAURENT BLVD.
±250 UNITS
18-STYs

1971 ST. LAURENT BLVD.
±250 UNITS
18-STYs

PARKADE
4-STYs
OUTDOOR ROOF
AMENITY ABOVE

2080 RUSSELL RD.

RUSSELL ROAD

- LEGEND
- PROPOSED SEVERANCE LINE (Building A, B and C)
 - PROPOSED PARKLAND DEDICATION
 - PROPOSED DEVELOPMENT AREA FOR STRUCTURED AND SURFACE PARKING
 - EXTENT OF MODIFIED ACCESS EASEMENT

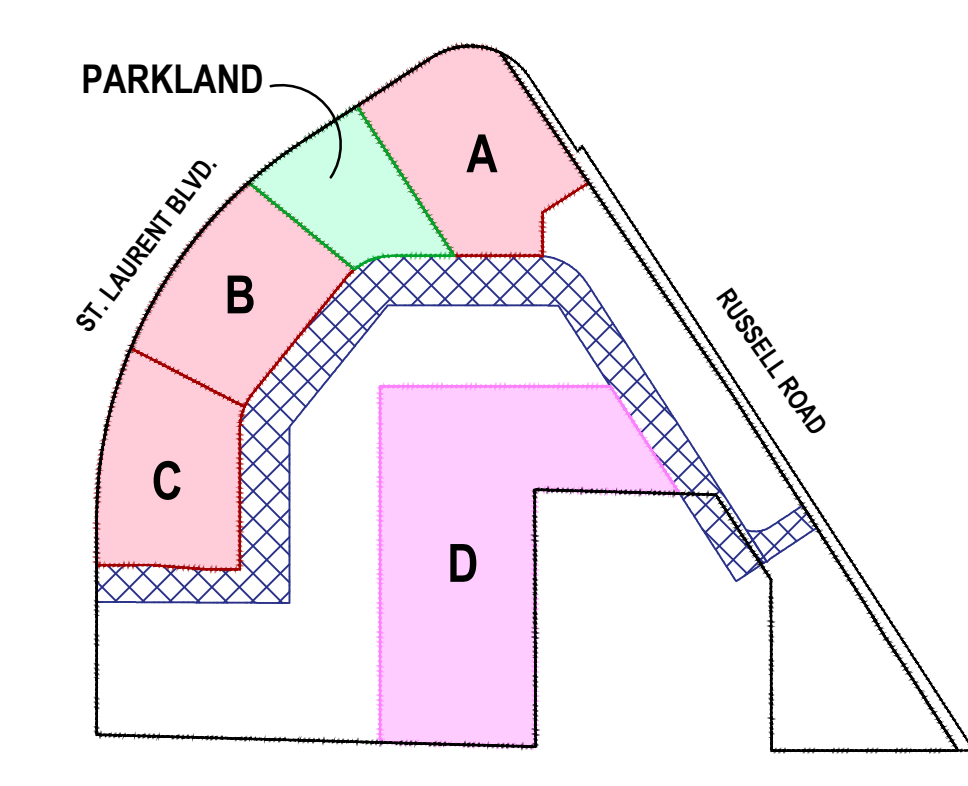

LEGAL DESCRIPTION:

PART OF LOT 27,
CONCESSION 3 (OTTAWA FRONT)
SOUTH OF DUNDAS STREET
(GEOGRAPHICAL TOWNSHIP OF GLOUCESTER)
CITY OF OTTAWA

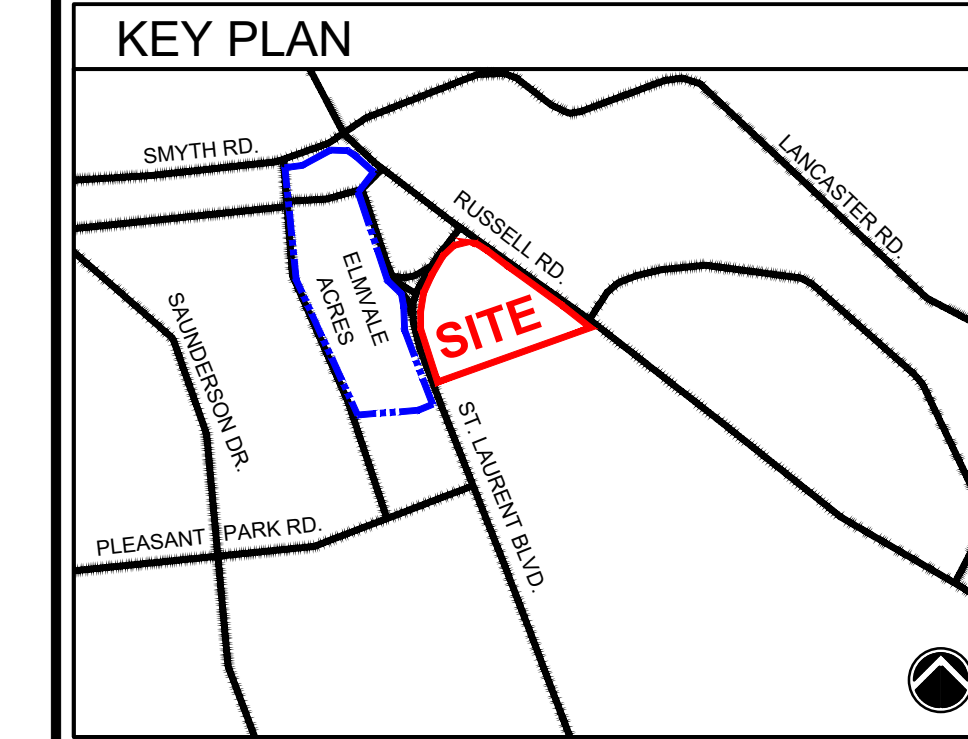

SITE PLAN LEGEND

	PROPOSED FIN. GRADE
	TOPOGRAPHICAL GRADE
	TOP OF CATCH BASIN
	DOOR LOCATIONS
	DRIVE AISLE/VEHICULAR TRAFFIC
	LOADING/GARAGE DOOR LOCATION
	C.B.
	SANITARY MANHOLE
	STORM SEWER MANHOLE
	FIRE HYDRANT
	ROOF DRAIN
	NEW LIGHT STANDARDS
	HEAVY DUTY ASPHALT PAVING
	BARRIER-FREE DEPRESSED CURB

SITE SERVICES & GRADING: BASED ON INFORMATION PREPARED BY COUNTERPOINT ENGINEERING INC. DATED 2022-JAN-31
LANDSCAPE: BASED ON INFORMATION PREPARED BY MIBC PLANNING, URBAN DESIGN & LANDSCAPE ARCHITECTURE, DATED 2022-FEB-XX
SURVEY & TOPOGRAPHICAL: INFORMATION BASED ON DRAWING PREPARED BY ANNIS, O'SULLIVAN, VOLLEBEK LTD., ONTARIO LAND SURVEYORS, DRAWING DATED SEPTEMBER 27TH, 2021.

NO.	REVISIONS	DATE	BY
2	ISSUED FOR SITE PLAN APPROVAL	FEB.09.2021	OH
1	ISSUED FOR CLIENT REVIEW	FEB.04.2021	OH

SITE PLAN

PROPOSED MULTI-FAMILY
RESIDENTIAL DEVELOPMENT
1971 & 1975 ST. LAURENT BLVD.
OTTAWA, ONTARIO
FOR: STARLIGHT DEVELOPMENTS

PETROFF
PETROFF PARTNERSHIP ARCHITECTS

260 TOWN CENTRE BLVD, SUITE 300
MARKHAM, ON L3R 8H8
PH: 905-470-7000 www.petroff.com



DRAWN BY	PETROFF	PROJECT NO.	21740
CHECKED BY	PETROFF	DWG. NO.	A101
DATE			
ISSUED			

PART OF LOT 27
CONCESSION 3 (OTTAWA FRONT)
Geographic Township of Gloucester
CITY OF OTTAWA

Surveyed by Annis, O'Sullivan, Vollebek Ltd.

Scale 1 : 400

Metric
DISTANCES SHOWN ON THIS PLAN ARE IN METRES AND
CAN BE CONVERTED TO FEET BY DIVIDING BY 0.3048

Surveyor's Certificate
I CERTIFY THAT:
1. This survey and plan are correct and in accordance with the Survey Act and the Surveyors Act and the regulations made under them.
2. The survey was completed on the 23rd day of September, 2021.
September 27, 2021
Date
Annis, O'Sullivan, Vollebek Ltd.
Ontario Land Surveyor

Notes & Legend

- Denotes Survey Monument Planted
- Survey Monument Found
- SSB Standard Iron Bar
- SSSB Short Standard Iron Bar
- IB Iron Bar
- CP Concrete Pin
- CC Cut Cross
- (WT) Witness
- Meas Measured
- (AOG) Annis, O'Sullivan, Vollebek Ltd.
- (AP) (AOG) Plan, March 31, 2020
- Deciduous Tree
- ★ Coniferous Tree
- Fire Hydrant
- Water Valve
- Maintenance Hole (Storm Sewer)
- Maintenance Hole (Sanitary)
- Maintenance Hole (Bell Telephone)
- Maintenance Hole (Traffic)
- Maintenance Hole (Hydro)
- Maintenance Hole (Gas)
- Maintenance Hole (Undersized)
- Valve Chamber (Watermain)
- Overhead Wires
- Catch Basin
- Corrugated Steel Pipe
- Gas Meter
- Hydro Meter
- Handhole
- Bell Terminal Box
- Cable Terminal Box
- Traffic Terminal Box
- Undersized Terminal Box
- Traffic Signal Post
- Sign
- Bolted
- S.S.
- Wood Pole
- Metal Pole
- Traffic Light
- Utility Pole
- AN
- Anchor
- LS
- Light Standard
- Diameter
- Location of Elevations
- Top of Concrete Curb Elevation
- Top of Wall Elevation
- Chain Link Fence
- Concrete Retaining Wall
- Edge of Pavement
- TOS
- Top of Slope
- SW
- Stone Retaining Wall

Bearings are astronomic, derived from the easterly limit of St. Laurent Boulevard, shown to be N 21°14'10" W on

ELEVATION NOTES
1. Elevations shown are geodetic and are referred to the CGVD28 geodetic datum.
2. It is the responsibility of the user of this information to verify that the job benchmark has not been altered or disturbed and that its relative elevation and description agrees with the information shown on this drawing.

UTILITY NOTES
1. This drawing cannot be accepted as acknowledging all of the utilities and it will be the responsibility of the user to contact the respective utility authorities for confirmation.
2. Only visible surface utilities were located.
3. A field location of underground plant by the pertinent utility authority is mandatory before any work involving breaking ground, probing, excavating, etc.

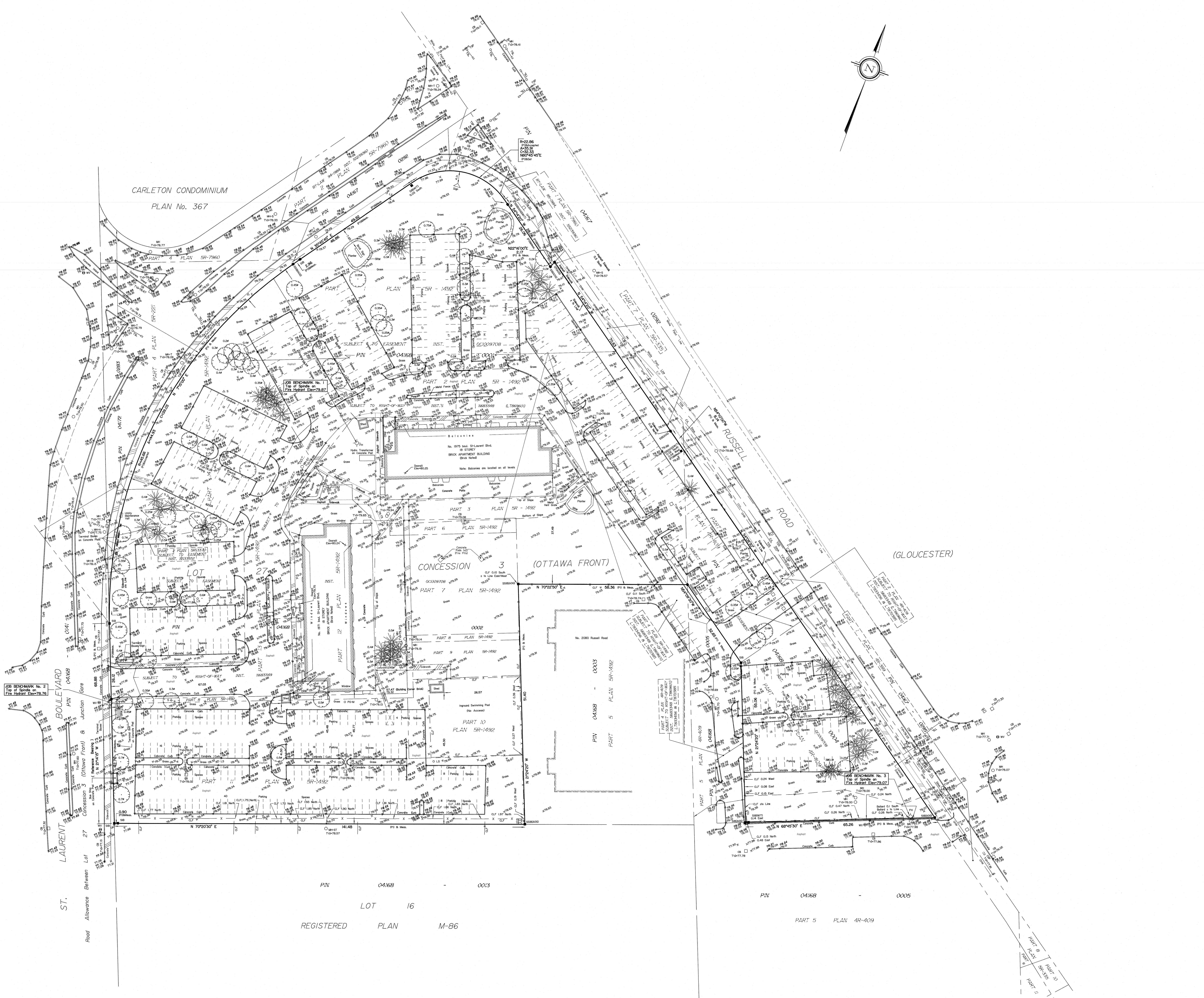



APPENDIX B

counterpoint engineering

Project Name: 1971 & 1975 St. Laurant Blvd. Residential Apartment Development
 Project Number: 21106

Rainfall Data			
Location:	Ottawa	a	1735.688
Event	100	b	6.014
		c	0.82

Area ID	Area (ha)	Runoff Coefficient	t_c (min)	Storage Available (m ³)	Storage Required (m ³)	Release Rate (L/s)	Description	Orifice Size (mm)	Orifice Release Rate (L/s)
Southvale Cres. Outlet									
200	3.418	0.75	10	505.7	505.5	441.4	CNTRL to Southvale	390	441.4
201	0.007	0.31	10		0	0.8	UNC to Southvale	N/A	N/A
Total	3.425				505.5	442.2			
St. Laurent Blvd. Outlet									
202	0.052	0.31	10		0	8.0	UNC to St. Laurent	N/A	N/A
Total	0.052				0	8.0			
Russell Road Outlet									
203	0.079	0.34	10		0	13.2	UNC to Russell	N/A	N/A
Total	0.079				0	13.2			

Allowable Release Rate 2yr (Southvale): 443.0 L/s
 Allowable Release Rate 2yr (St. Laurent): 19.6 L/s
 Allowable Release Rate 5yr (Russell): 13.8 L/s

counterpoint engineering

Allowable Release Rate to St. Laurent Blvd. STM Sewer

Project Name: 1971 & 1975 St. Laurant Blvd. Residential Apartment Development

Project Number: 21106

Rational Method - 2 Year Predevelopment

Event: years

ABC's:	A	<input type="text" value="732.951"/>
	B	<input type="text" value="6.199"/>
	C	<input type="text" value="0.81"/>

Time of Concentration: t min

Runoff Coefficient: C

Site Area A ha

Intensity i mm/hr
 $i=A/(T)^c$

Flow Q m³/s
Q=CiA/360 l/s

counterpoint engineering

Allowable Release Rate to St. Laurent Blvd. STM Sewer

Project Name: 1971 & 1975 St. Laurant Blvd. Residential Apartment Development

Project Number: 21106

Rational Method - 5 Year Predevelopment

Event: years

ABC's:	A	<input type="text" value="998.071"/>
	B	<input type="text" value="6.053"/>
	C	<input type="text" value="0.814"/>

Time of Concentration: t min

Runoff Coefficient: C

Site Area A ha

Intensity i mm/hr
 $i=A/(T)^c$

Flow Q m³/s
Q=CiA/360 l/s

counterpoint engineering

Allowable Release Rate to Southvale Cres. STM Sewer

Project Name: 1971 & 1975 St. Laurant Blvd. Residential Apartment Development
Project Number: 21106

Rational Method - 2 Year Predevelopment

Event:		<input type="text" value="2"/> years
ABC's:	A	<input type="text" value="732.951"/>
	B	<input type="text" value="6.199"/>
	C	<input type="text" value="0.81"/>
Time of Concentration:	t	<input type="text" value="10"/> min
Runoff Coefficient:	C	<input type="text" value="0.66"/>
Site Area	A	<input type="text" value="3.16"/> ha
Intensity $i=A/(T)^c$	i	<input type="text" value="76.81"/> mm/hr
Flow $Q=CiA/360$	Q	<input type="text" value="0.443"/> m ³ /s
		<input type="text" value="443.0"/> l/s

counterpoint engineering

Post-Development Un-Mitigated Release Rate to Southvale Crescent

Project Name: 1971 & 1975 St. Laurant Blvd. Residential Apartment Development
Project Number: 21106

AREA 200

Rational Method - 2 Year Post Development

Event:		2	years
ABC's:	A	732.951	
	B	6.199	
	C	0.81	
Time of Concentration:	t	10	min
Runoff Coefficient:	C	0.75	
Site Area	A	3.418	ha
Intensity $i=A/(T)^c$	i	76.81	mm/hr
Flow	Q	0.549	m ³ /s
	Q=CiA/360	548.8	l/s

Rational Method - 5 Year Post Development

Event:		5	years
ABC's:	A	998.071	
	B	6.053	
	C	0.814	
Time of Concentration:	t	10	min
Runoff Coefficient:	C	0.75	
Site Area	A	3.418	ha
Intensity $i=A/(T)^c$	i	104.19	mm/hr
Flow	Q	0.74	m ³ /s
	Q=CiA/360	744.6	l/s

Rational Method - 10 Year Post Development

Event:		10	years
ABC's:	A	1174.184	
	B	6.014	
	C	0.816	
Time of Concentration:	t	10	min
Runoff Coefficient:	C	0.75	
Site Area	A	3.418	ha
Intensity $i=A/(T)^c$	i	122.14	mm/hr
Flow	Q	0.87	m ³ /s
	Q=CiA/360	872.8	l/s

Rational Method - 25 Year Post Development

Event:		25	years
ABC's:	A	1402.884	
	B	6.018	
	C	0.819	
Time of Concentration:	t	10	min
Runoff Coefficient:	C	0.75	
Site Area	A	3.418	ha
Intensity $i=A/(T)^c$	i	144.69	mm/hr
Flow	Q	1.03	m ³ /s
	Q=CiA/360	1034.0	l/s

Rational Method - 50 Year Post Development

Event:		50	years
ABC's:	A	1569.58	
	B	6.014	
	C	0.82	
Time of Concentration:	t	10	min
Runoff Coefficient:	C	0.75	
Site Area	A	3.418	ha
Intensity $i=A/(T)^c$	i	161.47	mm/hr
Flow	Q	1.15	m ³ /s
	Q=CiA/360	1153.9	l/s

Rational Method - 100 Year Post Development

Event:		100	years
ABC's:	A	1735.688	
	B	6.014	
	C	0.82	
Time of Concentration:	t	10	min
Runoff Coefficient:	C	0.75	
Site Area	A	3.418	ha
Intensity $i=A/(T)^c$	i	178.56	mm/hr
Flow	Q	1.28	m ³ /s
	Q=CiA/360	1276.0	l/s

counterpoint engineering

Rational Method - Uncontrolled Areas to Southvale Cres. (Post Development)

Project Name: 1971 & 1975 St. Laurant Blvd. Residential Apartment Development
Project No: 21106

AREA 201

Event: 100 years

ABC's: A 1735.688
B 6.014
C 0.82

Time of Concentration: t 10 min

Runoff Coefficient: C 0.25

Site Area A 0.007 ha

Intensity i 178.56 mm/hr
 $i=A/(T)^c$

Flow Q 0.001 m³/s
Q=CiA/360 0.8 L/s

counterpoint engineering

Rational Method - Uncontrolled Areas to St. Laurent Blvd. (Post Development)

Project Name: 1971 & 1975 St. Laurant Blvd. Residential Apartment Development
Project No: 21106

AREA 202

Event: 100 years

ABC's: A 1735.688
B 6.014
C 0.82

Time of Concentration: t 10 min

Runoff Coefficient: C 0.31

Site Area A 0.052 ha

Intensity i 178.56 mm/hr
 $i=A/(T)^c$

Flow Q 0.008 m³/s
Q=CiA/360 8.0 L/s

counterpoint engineering

Rational Method - Uncontrolled Areas to Russell Road (Post Development)

Project Name: 1971 & 1975 St. Laurant Blvd. Residential Apartment Development
Project No: 21106

AREA 203

Event: 100 years

ABC's:	A	1735.688
	B	6.014
	C	0.82

Time of Concentration: t 10 min

Runoff Coefficient: C 0.34

Site Area A 0.079 ha

Intensity i 178.56 mm/hr
 $i=A/(T)^c$

Flow Q 0.013 m³/s
Q=CiA/360 13.2 L/s

counterpoint engineering

Job: 1971 & 1975 St. Laurant Blvd. Residential Apartment Development
Job No.: 21106

Orifice Control & Detention Storage

AREA 200

Orifice Equation: $Q = C_d A (2gh)^{1/2}$

Area: 200

Orifice Diameter: mm
Area: 0.119 m²
g = 9.81 m/s²
C_d =

Upsized Pipe	0 m ³
Manhole	0 m ³
Four Catchbasins	0 m ³
Total:	0 m³

	Stage	Head (m)	Storage (m3)	Discharge (L/s)
Orifice Inv:	74.74	0.00	0	0.00
100 year HWL:	76.55	1.81	0.0	441.4

counterpoint engineering

Modified Rational **Area:** 3.42 ha

Project Name: 1971 & 1975 St. Laurant Blvd. Residential Apartment Development
 Project Number: 21106

Rainfall Data			
Location:	Ottawa	a	1735.688
Event	100	b	6.014
		c	0.8200

Site Data	
Area	3.42 ha
Runoff Coefficient	0.75
AC	2.57
Tc	10
Time Increment	10
Release Rate	441.4 l/s
Storage Required	505 m ³

Time (min)	Rainfall Intensity (mm/hr)	Ground- water Discharge Rate (m ³ /s)	Storm Runoff Incl. GW Discharge (m ³ /s)	Runoff Volume (m ³)	Released Volume (m ³)	Storage Volume (m ³)	
10	179	0.0047	1.28	769	265	504	
20	120	0.0047	0.86	1035	530	505	*****
30	92	0.0047	0.66	1191	794	397	
40	75	0.0047	0.54	1301	1059	242	
50	64	0.0047	0.46	1386	1324	62	
60	56	0.0047	0.40	1456	1589	-133	
70	50	0.0047	0.36	1515	1854	-338	
80	45	0.0047	0.33	1567	2119	-551	
90	41	0.0047	0.30	1613	2383	-770	
100	38	0.0047	0.28	1655	2648	-993	
110	35	0.0047	0.26	1693	2913	-1220	
120	33	0.0047	0.24	1728	3178	-1450	
130	31	0.0047	0.23	1760	3443	-1682	
140	29	0.0047	0.21	1791	3707	-1916	
150	28	0.0047	0.20	1820	3972	-2153	
160	26	0.0047	0.19	1847	4237	-2390	
170	25	0.0047	0.18	1873	4502	-2629	
180	24	0.0047	0.18	1897	4767	-2869	
190	23	0.0047	0.17	1921	5032	-3111	
200	22	0.0047	0.16	1943	5296	-3353	
210	21	0.0047	0.16	1965	5561	-3596	
220	20	0.0047	0.15	1986	5826	-3840	
230	20	0.0047	0.15	2006	6091	-4085	
240	19	0.0047	0.14	2025	6356	-4330	
250	18	0.0047	0.14	2044	6621	-4576	
260	18	0.0047	0.13	2063	6885	-4823	
270	17	0.0047	0.13	2080	7150	-5070	
280	17	0.0047	0.12	2098	7415	-5317	
290	16	0.0047	0.12	2114	7680	-5565	
300	16	0.0047	0.12	2131	7945	-5814	
310	15	0.0047	0.12	2147	8209	-6063	
320	15	0.0047	0.11	2163	8474	-6312	
330	15	0.0047	0.11	2178	8739	-6561	
340	14	0.0047	0.11	2193	9004	-6811	
350	14	0.0047	0.11	2207	9269	-7061	
360	14	0.0047	0.10	2222	9534	-7312	
370	13	0.0047	0.10	2236	9798	-7562	
380	13	0.0047	0.10	2250	10063	-7813	
390	13	0.0047	0.10	2263	10328	-8065	
400	13	0.0047	0.09	2277	10593	-8316	
410	12	0.0047	0.09	2290	10858	-8568	
420	12	0.0047	0.09	2303	11122	-8820	
430	12	0.0047	0.09	2315	11387	-9072	
440	12	0.0047	0.09	2328	11652	-9324	
450	11	0.0047	0.09	2340	11917	-9577	

Rational Method - Uncontrolled Areas to Russell Road (Post Development)

Project Name: 1971 & 1975 St. Laurant Blvd. Residential Apartment Development
 Project No: 21106

Available Storage Underground in Sewer (100 Year Event)

UPSTREAM OF THE ORIFICE CONTROL AT MH 103: 100yr HWL = 76.55 m

From	To	Length of Pipe (m)	Length Below HWL (m)	Diameter (mm)	Volume (m ³)
CNTRL MH	CBMH4	5.4	5.4	450	0.86
CNTRL MH	EX.CBMH	82.0	82.0	400	10.30
EX.CBMH	CBMH1	41.4	41.4	300	2.93
CBMH1	CBMH2	57.3	0.0	450	0.00
EX.CBMH	MH1	54.7	57.4	450	9.13
MH1	EX.MH	40.7	40.7	450	6.47
EX.MH	MH2	32.2	32.2	350	3.10
MH2	MH3	35.8	35.8	300	2.53
MH3	MH4	39.7	39.7	250	1.95
MH4	MH5	10.9	10.9	250	0.54
MH2	MH6	23.6	23.6	300	1.67
MH6	MH7	19.7	19.7	300	1.39
MH7	MH8	36.4	34.6	300	2.45
MH8	MH9	35.0	35.0	300	2.47
MH8	MH10	16.3	16.3	300	1.15
MH10	MH11	41.4	24.8	300	1.76
Total Storage Underground in Sewers (m ³):					48.7

Available Storage Underground in Tank

Individual GreenStorm Tanks							
Tank Inv (m):	74.84	100yr HWL:	76.55	Units: (#)	10	44	2.5
Length (m)	Width (m)	Height (m)	Void Ratio	Length (m)	Width (m)	Height (m)	Volume (cu.m)
0.80	0.80	0.66	0.96	8	35.2	1.65	446.1
Total Storage in Underground Tanks:							446.1

Available Storage Underground in Sewer Catchbasins & Manholes

UPSTREAM OF THE ORIFICE CONTROL (BELOW HWL): 100Year HWL = 76.55 m

MH	Manhole ELEV or HWL (m)	Low Invert (m)	Diameter (m)	Volume (m ³)
CBMH4	76.55	74.80	1.20	1.98
EX.CBMH	76.55	74.89	1.20	1.88
CBMH1	76.55	75.80	1.20	0.85
MH1	76.55	75.05	1.20	1.70
MH2	76.55	75.33	1.50	2.16
MH3	76.55	75.55	1.20	0.36
MH4	76.55	75.81	1.20	0.27
MH5	76.55	76.08	1.20	0.17
MH6	76.55	75.45	1.20	0.40
MH7	76.55	75.57	1.20	0.35
MH8	76.55	75.71	1.20	0.30
MH9	76.55	75.90	1.20	0.23
MH10	76.55	75.79	1.80	0.27
MH11	76.55	76.30	1.20	0.09
Total Storage Underground in CB's & MH's (m ³):				11.0

DRAWING NOT TO BE USED FOR CONSTRUCTION

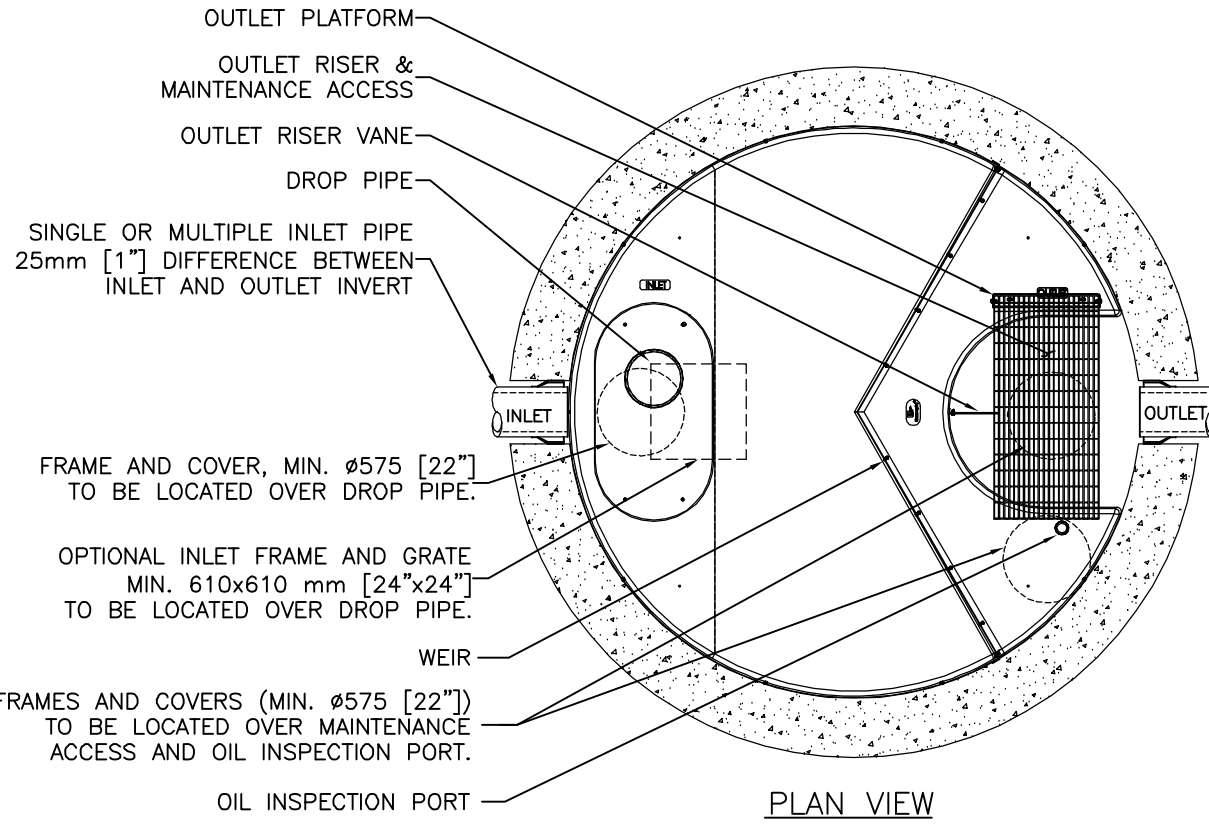
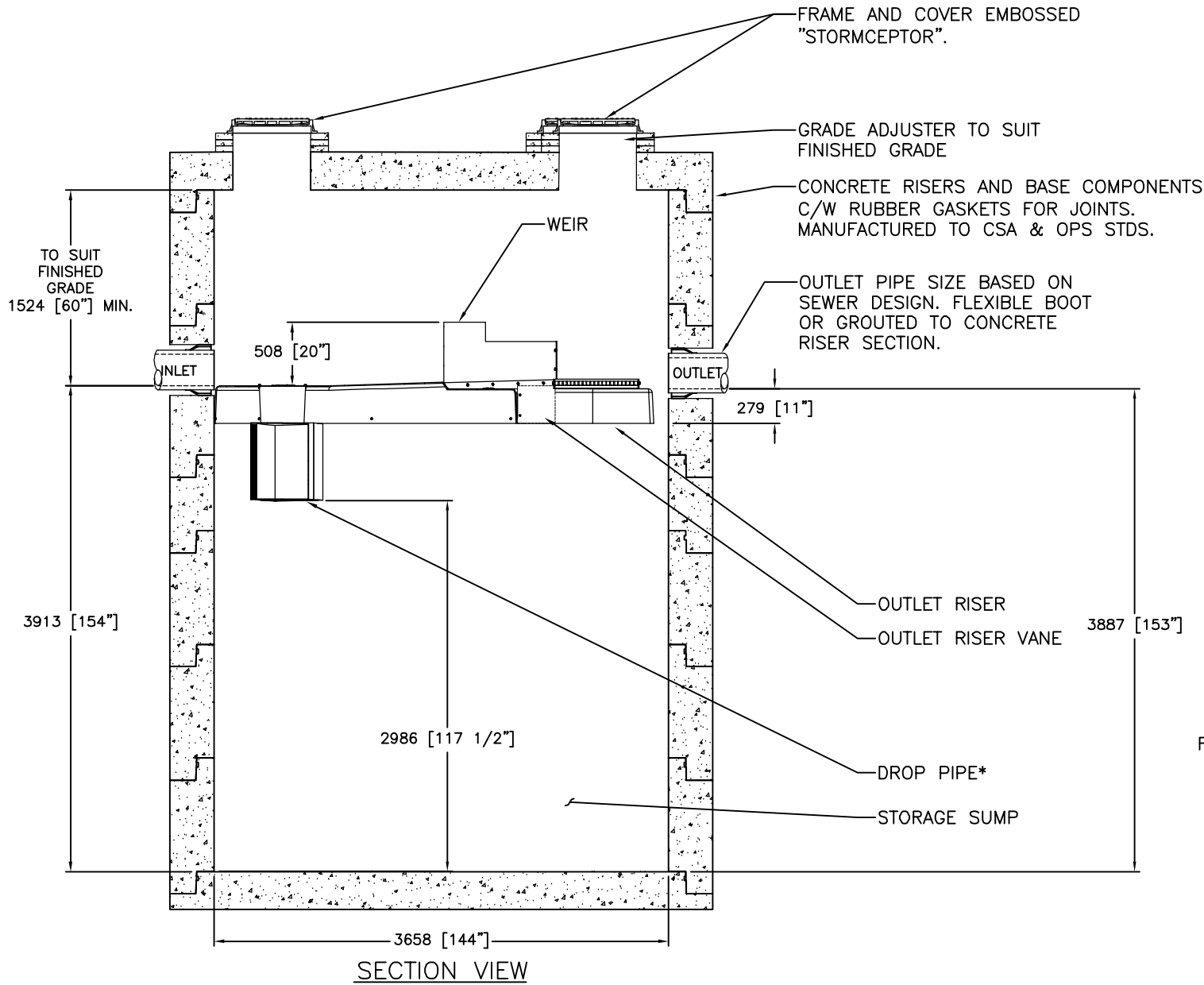

GENERAL NOTES:

- * MAXIMUM SURFACE LOADING RATE (SLR) INTO LOWER CHAMBER THROUGH DROP PIPE IS 1135 L/min/m² (27.9 gpm/ft²) FOR STORMCEPTOR EF12 AND 535 L/min/m² (13.1 gpm/ft²) FOR STORMCEPTOR EFO12 (OIL CAPTURE CONFIGURATION).
- 1. ALL DIMENSIONS INDICATED ARE IN MILLIMETERS (INCHES) UNLESS OTHERWISE SPECIFIED.
- 2. STORMCEPTOR STRUCTURE INLET AND OUTLET PIPE SIZE AND ORIENTATION SHOWN FOR INFORMATIONAL PURPOSES ONLY.
- 3. UNLESS OTHERWISE NOTED, BYPASS INFRASTRUCTURE, SUCH AS ALL UPSTREAM DIVERSION STRUCTURES, CONNECTING STRUCTURES, OR PIPE CONDUITS CONNECTING TO COMPLETE THE STORMCEPTOR SYSTEM SHALL BE PROVIDED AND ADDRESSED SEPARATELY.
- 4. DRAWING FOR INFORMATION PURPOSES ONLY. REFER TO ENGINEER'S SITE/UTILITY PLAN FOR STRUCTURE ORIENTATION.
- 5. NO PRODUCT SUBSTITUTIONS SHALL BE ACCEPTED UNLESS SUBMITTED 10 DAYS PRIOR TO PROJECT BID DATE, OR AS DIRECTED BY THE ENGINEER OF RECORD.

INSTALLATION NOTES

- A. ANY SUB-BASE, BACKFILL DEPTH, AND/OR ANTI-FLOTATION PROVISIONS ARE SITE-SPECIFIC DESIGN CONSIDERATIONS AND SHALL BE SPECIFIED BY ENGINEER OF RECORD.
- B. CONTRACTOR TO PROVIDE EQUIPMENT WITH SUFFICIENT LIFTING AND REACH CAPACITY TO LIFT AND SET THE STRUCTURE (LIFTING CLUTCHES PROVIDED)
- C. CONTRACTOR WILL INSTALL AND LEVEL THE STRUCTURE, SEALING THE JOINTS, LINE ENTRY AND EXIT POINTS (NON-SHRINK GROUT WITH APPROVED WATERSTOP OR FLEXIBLE BOOT)
- D. CONTRACTOR TO TAKE APPROPRIATE MEASURES TO PROTECT THE DEVICE FROM CONSTRUCTION-RELATED EROSION RUNOFF.
- E. DEVICE ACTIVATION, BY CONTRACTOR, SHALL OCCUR ONLY AFTER SITE HAS BEEN STABILIZED AND THE STORMCEPTOR UNIT IS CLEAN AND FREE OF DEBRIS.

FOR SITE SPECIFIC DRAWINGS PLEASE CONTACT YOUR LOCAL STORMCEPTOR REPRESENTATIVE. SITE SPECIFIC DRAWINGS ARE BASED ON THE BEST AVAILABLE INFORMATION AT THE TIME. SOME FIELD REVISIONS TO THE SYSTEM LOCATION OR CONNECTION PIPING MAY BE NECESSARY BASED ON AVAILABLE SPACE OR SITE CONFIGURATION REVISIONS. ELEVATIONS SHOULD BE MAINTAINED EXCEPT WHERE NOTED ON BYPASS STRUCTURE (IF REQUIRED).

STANDARD DETAIL NOT FOR CONSTRUCTION

SITE SPECIFIC DATA REQUIREMENTS					
STORMCEPTOR MODEL	EFO12				
STRUCTURE ID	*				
HYDROCARBON STORAGE REQ'D (L)	*				
WATER QUALITY FLOW RATE (L/s)	*				
PEAK FLOW RATE (L/s)	*				
RETURN PERIOD OF PEAK FLOW (yrs)	*				
DRAINAGE AREA (HA)	*				
DRAINAGE AREA IMPERVIOUSNESS (%)	*				
PIPE DATA:	I.E.	MAT'L	DIA	SLOPE %	HGL
INLET #1	*	*	*	*	*
INLET #2	*	*	*	*	*
OUTLET	*	*	*	*	*
* PER ENGINEER OF RECORD					

This design and information shown on this drawing is provided as a service to the project owner, engineer and contractor by Imbrium Systems ("Imbrium"). Neither the drawing, nor any part thereof, may be reproduced, stored in a retrieval system, or transmitted in any form or by any means, electronic, mechanical, photocopying, recording, or by any information storage and retrieval system, without the prior written consent of Imbrium. Failure to comply with the above conditions shall constitute a breach of the license granted by Imbrium to the user. Imbrium expressly disclaims any liability or responsibility for such use. If discrepancies between the supplied information upon which the drawing is based and actual field conditions are discovered, the user shall be responsible for re-evaluation of the design. Imbrium accepts no liability for designs based on missing, incomplete or inaccurate information supplied by others.

MARK	DATE	REVISION DESCRIPTION	BY
###	###/###/###	OUTLET PLATFORM	JSK
###	###/###/###	INITIAL RELEASE	JSK

Stormceptor® EF

imbrium
 7037 RIDGE ROAD, SUITE 350, HANOVER, MD 21076
 USA 888-278-8828 CA 800-588-4801 INTL. +1-410-960-9800
 THE ENGINEER OF RECORD IS RESPONSIBLE FOR THE ACCURACY OF THE INFORMATION PROVIDED ON THIS DRAWING. THE USER SHALL BE RESPONSIBLE FOR VERIFYING THE INFORMATION PROVIDED ON THIS DRAWING IS ACCURATE AND COMPLETE. THE USER SHALL BE RESPONSIBLE FOR OBTAINING ALL NECESSARY PERMITS AND APPROVALS FOR THE PROJECT. THE USER SHALL BE RESPONSIBLE FOR OBTAINING ALL NECESSARY INFORMATION FROM THE PROJECT OWNER AND CONTRACTOR. THE USER SHALL BE RESPONSIBLE FOR OBTAINING ALL NECESSARY INFORMATION FROM THE PROJECT OWNER AND CONTRACTOR. THE USER SHALL BE RESPONSIBLE FOR OBTAINING ALL NECESSARY INFORMATION FROM THE PROJECT OWNER AND CONTRACTOR.

DATE:	10/24/2017		
DESIGNED:	JSK	DRAWN:	JSK
CHECKED:	BSF	APPROVED:	SP
PROJECT No.:	EFO12	SEQUENCE No.:	*
SHEET:	1	OF	1

I:\IMBRIUM\PRODUCTS\STORMCEPTOR EF12\DRAWINGS & DETAIL\SISTANDARD DETAIL SEFO12-DETAIL.DWG 10/19/2018 8:57 AM

SCALE = NTS

Stormceptor® EF Sizing Report

STORMCEPTOR®		ESTIMATED NET ANNUAL SEDIMENT (TSS) LOAD REDUCTION		02/09/2022														
Province:	Ontario	Project Name:	1971 and 1975 St. Laurent Blvd.															
City:	Ottawa	Project Number:	21106															
Nearest Rainfall Station:	OTTAWA CDA RCS	Designer Name:	Brandon O'Leary															
Climate Station Id:	6105978	Designer Company:	Forterra															
Years of Rainfall Data:	20	Designer Email:	brandon.oleary@forterrabp.com															
Site Name:	1971 and 1975 St. Laurent Blvd.	Designer Phone:	905-630-0359															
Drainage Area (ha):	3.42	EOR Name:	Gian-Michael Di Luca															
Runoff Coefficient 'c':	0.75	EOR Company:	Counterpoint Engineering Inc.															
Particle Size Distribution:	Fine	EOR Email:	gdiluca@counterpointeng.com															
Target TSS Removal (%):	80.0	EOR Phone:	416-886-1075															
Required Water Quality Runoff Volume Capture (%):	90.0	<table border="1" style="width: 100%; border-collapse: collapse;"> <thead> <tr> <th colspan="2" style="text-align: center;">Net Annual Sediment (TSS) Load Reduction Sizing Summary</th> </tr> <tr> <th style="width: 50%;">Stormceptor Model</th> <th style="width: 50%;">TSS Removal Provided (%)</th> </tr> </thead> <tbody> <tr> <td>EFO4</td> <td>47</td> </tr> <tr> <td>EFO6</td> <td>62</td> </tr> <tr> <td>EFO8</td> <td>72</td> </tr> <tr> <td>EFO10</td> <td>79</td> </tr> <tr> <td>EFO12</td> <td>86</td> </tr> </tbody> </table>			Net Annual Sediment (TSS) Load Reduction Sizing Summary		Stormceptor Model	TSS Removal Provided (%)	EFO4	47	EFO6	62	EFO8	72	EFO10	79	EFO12	86
Net Annual Sediment (TSS) Load Reduction Sizing Summary																		
Stormceptor Model	TSS Removal Provided (%)																	
EFO4	47																	
EFO6	62																	
EFO8	72																	
EFO10	79																	
EFO12	86																	
Estimated Water Quality Flow Rate (L/s):	87.01																	
Oil / Fuel Spill Risk Site?	Yes																	
Upstream Flow Control?	Yes																	
Upstream Orifice Control Flow Rate to Stormceptor (L/s):	441.4																	
Peak Conveyance (maximum) Flow Rate (L/s):	441.4																	
<p>Recommended Stormceptor EFO Model: EFO12</p> <p>Estimated Net Annual Sediment (TSS) Load Reduction (%): 86</p> <p>Water Quality Runoff Volume Capture (%): > 90</p>																		



Stormceptor® **EF** Sizing Report

THIRD-PARTY TESTING AND VERIFICATION

► **Stormceptor® EF and Stormceptor® EFO** are the latest evolutions in the Stormceptor® oil-grit separator (OGS) technology series, and are designed to remove a wide variety of pollutants from stormwater and snowmelt runoff. These technologies have been third-party tested in accordance with the Canadian ETV **Procedure for Laboratory Testing of Oil-Grit Separators** and performance has been third-party verified in accordance with the **ISO 14034 Environmental Technology Verification (ETV)** protocol.

PERFORMANCE

► **Stormceptor® EF and EFO** remove stormwater pollutants through gravity separation and floatation, and feature a patent-pending design that generates positive removal of total suspended solids (TSS) throughout each storm event, including high-intensity storms. Captured pollutants include sediment, free oils, and sediment-bound pollutants such as nutrients, heavy metals, and petroleum hydrocarbons. Stormceptor is sized to remove a high level of TSS from the frequent rainfall events that contribute the vast majority of annual runoff volume and pollutant load. The technology incorporates an internal bypass to convey excessive stormwater flows from high-intensity storms through the device without resuspension and washout (scour) of previously captured pollutants. Proper routine maintenance ensures high pollutant removal performance and protection of downstream waterways.

PARTICLE SIZE DISTRIBUTION (PSD)

► The **Canadian ETV PSD** shown in the table below was used, or in part, for this sizing. This is the identical PSD that is referenced in the Canadian ETV **Procedure for Laboratory Testing of Oil-Grit Separators** for both sediment removal testing and scour testing. The Canadian ETV PSD contains a wide range of particle sizes in the sand and silt fractions, and is considered reasonably representative of the particle size fractions found in typical urban stormwater runoff.

Particle Size (µm)	Percent Less Than	Particle Size Fraction (µm)	Percent
1000	100	500-1000	5
500	95	250-500	5
250	90	150-250	15
150	75	100-150	15
100	60	75-100	10
75	50	50-75	5
50	45	20-50	10
20	35	8-20	15
8	20	5-8	10
5	10	2-5	5
2	5	<2	5



Stormceptor® EF Sizing Report

Upstream Flow Controlled Results

Rainfall Intensity (mm / hr)	Percent Rainfall Volume (%)	Cumulative Rainfall Volume (%)	Flow Rate (L/s)	Flow Rate (L/min)	Surface Loading Rate (L/min/m ²)	Removal Efficiency (%)	Incremental Removal (%)	Cumulative Removal (%)
1	22.3	22.3	7.13	428.0	34.0	100	22.3	22.3
2	17.8	40.0	14.26	856.0	68.0	96	17.0	39.3
3	13.1	53.1	21.39	1284.0	103.0	89	11.7	51.0
4	9.2	62.4	28.52	1711.0	137.0	85	7.9	58.9
5	6.5	68.9	35.65	2139.0	171.0	81	5.3	64.1
6	5.1	74.0	42.78	2567.0	205.0	77	3.9	68.1
7	3.4	77.3	49.91	2995.0	240.0	75	2.5	70.6
8	3.0	80.3	57.05	3423.0	274.0	74	2.2	72.8
9	3.6	84.0	64.18	3851.0	308.0	73	2.7	75.5
10	2.5	86.5	71.31	4278.0	342.0	71	1.8	77.2
11	1.7	88.2	78.44	4706.0	377.0	70	1.2	78.4
12	1.4	89.6	85.57	5134.0	411.0	68	1.0	79.4
13	1.9	91.5	92.70	5562.0	445.0	67	1.3	80.7
14	1.3	92.8	99.83	5990.0	479.0	65	0.9	81.6
15	1.3	94.1	106.96	6418.0	513.0	64	0.8	82.4
16	0.8	94.9	114.09	6845.0	548.0	63	0.5	82.8
17	0.8	95.7	121.22	7273.0	582.0	61	0.5	83.3
18	0.4	96.1	128.35	7701.0	616.0	60	0.3	83.6
19	0.5	96.6	135.48	8129.0	650.0	60	0.3	83.9
20	0.2	96.8	142.61	8557.0	685.0	59	0.1	84.0
21	0.5	97.3	149.74	8985.0	719.0	59	0.3	84.3
22	0.3	97.6	156.88	9413.0	753.0	59	0.2	84.5
23	1.1	98.7	164.01	9840.0	787.0	59	0.6	85.1
24	0.3	99.0	171.14	10268.0	821.0	58	0.2	85.3
25	1.0	100.0	178.27	10696.0	856.0	58	0.6	85.9
30	1.0	101.0	213.92	12835.0	1027.0	57	0.6	86.5
35	-1.0	100.0	249.57	14974.0	1198.0	53	0.0	85.9
40	0.0	100.0	285.23	17114.0	1369.0	49	0.0	85.9
45	0.0	100.0	320.88	19253.0	1540.0	44	0.0	85.9
50	0.0	100.0	356.54	21392.0	1711.0	40	0.0	85.9
Estimated Net Annual Sediment (TSS) Load Reduction =								86 %

Climate Station ID: 6105978 Years of Rainfall Data: 20



Stormceptor®**EF** Sizing Report

RAINFALL DATA FROM OTTAWA CDA RCS RAINFALL STATION

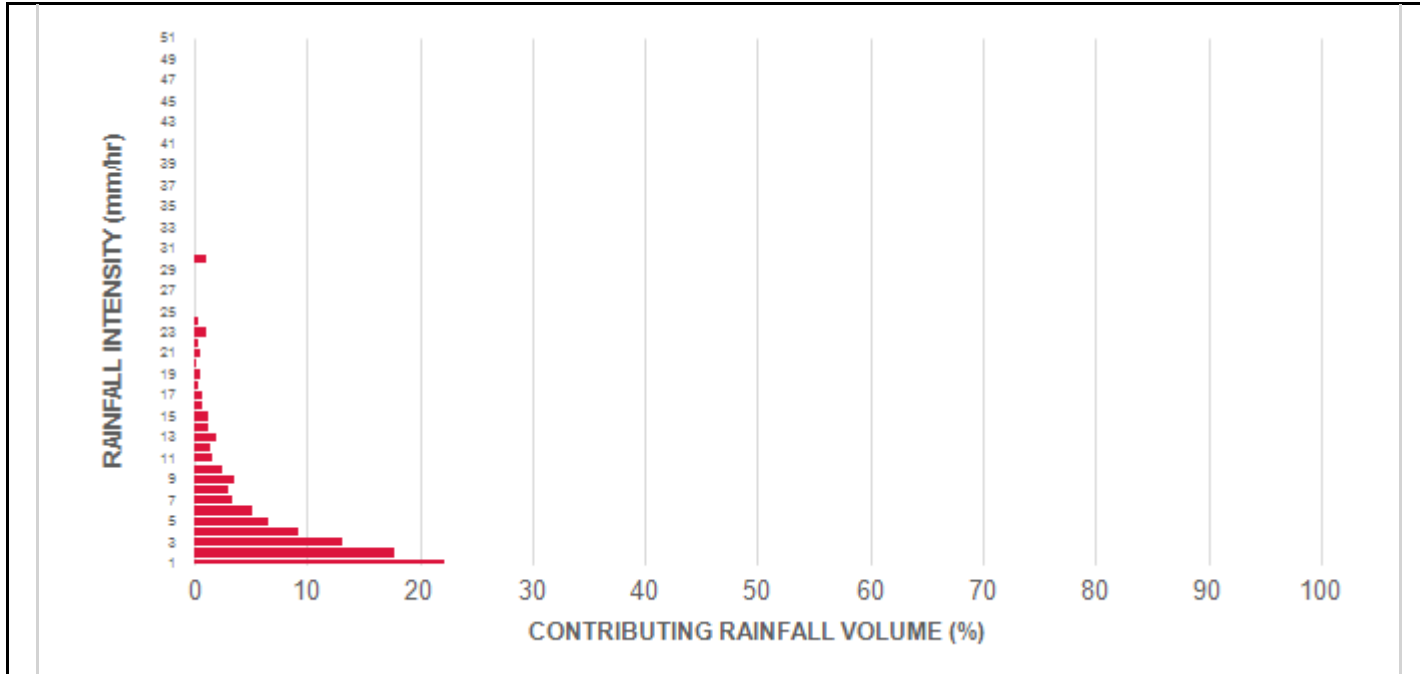

INCREMENTAL AND CUMULATIVE TSS REMOVAL FOR THE RECOMMENDED STORMCEPTOR® MODEL

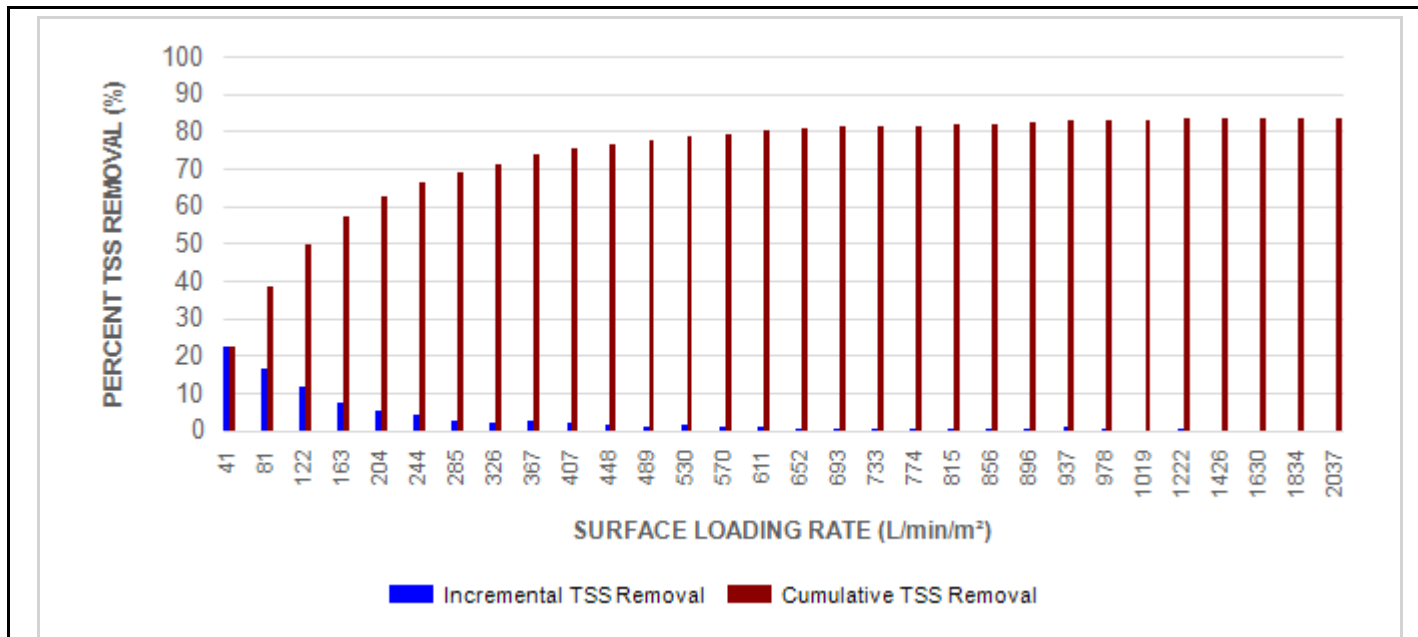

Stormceptor® EF Sizing Report

Maximum Pipe Diameter / Peak Conveyance

Stormceptor EF / EFO	Model Diameter		Min Angle Inlet / Outlet Pipes	Max Inlet Pipe Diameter		Max Outlet Pipe Diameter		Peak Conveyance Flow Rate	
	(m)	(ft)		(mm)	(in)	(mm)	(in)	(L/s)	(cfs)
EF4 / EFO4	1.2	4	90	609	24	609	24	425	15
EF6 / EFO6	1.8	6	90	914	36	914	36	990	35
EF8 / EFO8	2.4	8	90	1219	48	1219	48	1700	60
EF10 / EFO10	3.0	10	90	1828	72	1828	72	2830	100
EF12 / EFO12	3.6	12	90	1828	72	1828	72	2830	100

SCOUR PREVENTION AND ONLINE CONFIGURATION

► Stormceptor® EF and EFO feature an internal bypass and superior scour prevention technology that have been demonstrated in third-party testing according to the scour testing provisions of the Canadian ETV Procedure for Laboratory Testing of Oil-Grit Separators, and the exceptional scour test performance has been third-party verified in accordance with the ISO 14034 ETV protocol. As a result, Stormceptor EF and EFO are approved for online installation, eliminating the need for costly additional bypass structures, piping, and installation expense.

DESIGN FLEXIBILITY

► Stormceptor® EF and EFO offers design flexibility in one simplified platform, accepting stormwater flow from a single inlet pipe or multiple inlet pipes, and/or surface runoff through an inlet grate. The device can also serve as a junction structure, accommodate a 90-degree inlet-to-outlet bend angle, and can be modified to ensure performance in submerged conditions.

OIL CAPTURE AND RETENTION

► While Stormceptor® EF will capture and retain oil from dry weather spills and low intensity runoff, Stormceptor® EFO has demonstrated superior oil capture and greater than 99% oil retention in third-party testing according to the light liquid re-entrainment testing provisions of the Canadian ETV Procedure for Laboratory Testing of Oil-Grit Separators. Stormceptor EFO is recommended for sites where oil capture and retention is a requirement.



Stormceptor® EF Sizing Report

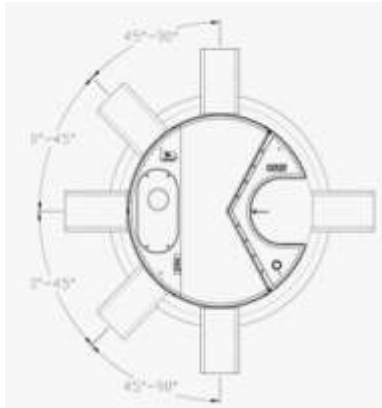

INLET-TO-OUTLET DROP

Elevation differential between inlet and outlet pipe inverts is dictated by the angle at which the inlet pipe(s) enters the unit.

0° - 45° : The inlet pipe is 1-inch (25mm) higher than the outlet pipe.

45° - 90° : The inlet pipe is 2-inches (50mm) higher than the outlet pipe.

HEAD LOSS

The head loss through Stormceptor EF is similar to that of a 60-degree bend structure. The applicable K value for calculating minor losses through the unit is 1.1.

For submerged conditions the applicable K value is 3.0.

Pollutant Capacity

Stormceptor EF / EFO	Model Diameter		Depth (Outlet Pipe Invert to Sump Floor)		Oil Volume		Recommended Sediment Maintenance Depth *		Maximum Sediment Volume *		Maximum Sediment Mass **	
	(m)	(ft)	(m)	(ft)	(L)	(Gal)	(mm)	(in)	(L)	(ft³)	(kg)	(lb)
EF4 / EFO4	1.2	4	1.52	5.0	265	70	203	8	1190	42	1904	5250
EF6 / EFO6	1.8	6	1.93	6.3	610	160	305	12	3470	123	5552	15375
EF8 / EFO8	2.4	8	2.59	8.5	1070	280	610	24	8780	310	14048	38750
EF10 / EFO10	3.0	10	3.25	10.7	1670	440	610	24	17790	628	28464	78500
EF12 / EFO12	3.6	12	3.89	12.8	2475	655	610	24	31220	1103	49952	137875

*Increased sump depth may be added to increase sediment storage capacity

** Average density of wet packed sediment in sump = 1.6 kg/L (100 lb/ft³)

Feature	Benefit	Feature Appeals To
Patent-pending enhanced flow treatment and scour prevention technology	Superior, verified third-party performance	Regulator, Specifying & Design Engineer
Third-party verified light liquid capture and retention for EFO version	Proven performance for fuel/oil hotspot locations	Regulator, Specifying & Design Engineer, Site Owner
Functions as bend, junction or inlet structure	Design flexibility	Specifying & Design Engineer
Minimal drop between inlet and outlet	Site installation ease	Contractor
Large diameter outlet riser for inspection and maintenance	Easy maintenance access from grade	Maintenance Contractor & Site Owner

STANDARD STORMCEPTOR EF/EFO DRAWINGS

For standard details, please visit <http://www.imbriumsystems.com/stormwater-treatment-solutions/stormceptor-ef>

STANDARD STORMCEPTOR EF/EFO SPECIFICATION

For specifications, please visit <http://www.imbriumsystems.com/stormwater-treatment-solutions/stormceptor-ef>



STANDARD PERFORMANCE SPECIFICATION FOR “OIL GRIT SEPARATOR” (OGS) STORMWATER QUALITY TREATMENT DEVICE

PART 1 – GENERAL

1.1 WORK INCLUDED

This section specifies requirements for selecting, sizing, and designing an underground Oil Grit Separator (OGS) device for stormwater quality treatment, with third-party testing results and a Statement of Verification in accordance with ISO 14034 Environmental Management – Environmental Technology Verification (ETV).

1.2 REFERENCE STANDARDS & PROCEDURES

ISO 14034:2016 Environmental management – Environmental technology verification (ETV)

Canadian Environmental Technology Verification (ETV) Program’s **Procedure for Laboratory Testing of Oil-Grit Separators**

1.3 SUBMITTALS

1.3.1 All submittals, including sizing reports & shop drawings, shall be submitted upon request with each order to the contractor then forwarded to the Engineer of Record for review and acceptance. Shop drawings shall detail all OGS components, elevations, and sequence of construction.

1.3.2 Alternative devices shall have features identical to or greater than the specified device, including: treatment chamber diameter, treatment chamber wet volume, sediment storage volume, and oil storage volume.

1.3.3 Unless directed otherwise by the Engineer of Record, OGS stormwater quality treatment product substitutions or alternatives submitted within ten days prior to project bid shall not be accepted. All alternatives or substitutions submitted shall be signed and sealed by a local registered Professional Engineer, based on the exact same criteria detailed in Section 3, in entirety, subject to review and approval by the Engineer of Record.

PART 2 – PRODUCTS

2.1 OGS POLLUTANT STORAGE

The OGS device shall include a sump for sediment storage, and a protected volume for the capture and storage of petroleum hydrocarbons and buoyant gross pollutants. The minimum sediment & petroleum hydrocarbon storage capacity shall be as follows:

2.1.1	4 ft (1219 mm) Diameter OGS Units:	1.19 m ³ sediment / 265 L oil
	6 ft (1829 mm) Diameter OGS Units:	3.48 m ³ sediment / 609 L oil
	8 ft (2438 mm) Diameter OGS Units:	8.78 m ³ sediment / 1,071 L oil
	10 ft (3048 mm) Diameter OGS Units:	17.78 m ³ sediment / 1,673 L oil
	12 ft (3657 mm) Diameter OGS Units:	31.23 m ³ sediment / 2,476 L oil

Stormceptor[®] EF Sizing Report

PART 3 – PERFORMANCE & DESIGN

3.1 GENERAL

The OGS stormwater quality treatment device shall be verified in accordance with ISO 14034:2016 Environmental management – Environmental technology verification (ETV). The OGS stormwater quality treatment device shall remove oil, sediment and gross pollutants from stormwater runoff during frequent wet weather events, and retain these pollutants during less frequent high flow wet weather events below the insert within the OGS for later removal during maintenance. The Manufacturer shall have at least ten (10) years of local experience, history and success in engineering design, manufacturing and production and supply of OGS stormwater quality treatment device systems, acceptable to the Engineer of Record.

3.2 SIZING METHODOLOGY

The OGS device shall be engineered, designed and sized to provide stormwater quality treatment based on treating a minimum of 90 percent of the average annual runoff volume and a minimum removal of an annual average 60% of the sediment (TSS) load based on the Particle Size Distribution (PSD) specified in the sizing report for the specified device. Sizing of the OGS shall be determined by use of a minimum ten (10) years of local historical rainfall data provided by Environment Canada, and only rainfall intensities greater than 0.5 mm/hr shall be included in sizing calculations. Sizing shall also be determined by use of the sediment removal performance data derived from the ISO 14034 ETV third-party verified laboratory testing data from testing conducted in accordance with the Canadian ETV protocol Procedure for Laboratory Testing of Oil-Grit Separators, as follows:

3.2.1 Sediment removal efficiency for a given surface loading rate and its associated flow rate shall be based on sediment removal efficiency demonstrated at the seven (7) tested surface loading rates specified in the protocol, ranging 40 L/min/m² to 1400 L/min/m², and as stated in the ISO 14034 ETV Verification Statement for the OGS device.

3.2.2 Sediment removal efficiency for surface loading rates between 40 L/min/m² and 1400 L/min/m² shall be based on linear interpolation of data between consecutive tested surface loading rates.

3.2.3 Sediment removal efficiency for surface loading rates less than the lowest tested surface loading rate of 40 L/min/m² shall be assumed to be identical to the sediment removal efficiency at 40 L/min/m². No extrapolation shall be allowed that results in a sediment removal efficiency that is greater than that demonstrated at 40 L/min/m².

3.2.4 Sediment removal efficiency for surface loading rates greater than the highest tested surface loading rate of 1400 L/min/m² shall assume zero sediment removal for the portion of flow that exceeds 1400 L/min/m², and shall be calculated using a simple proportioning formula, with 1400 L/min/m² in the numerator and the higher surface loading rate in the denominator, and multiplying the resulting fraction times the sediment removal efficiency at 1400 L/min/m².

The OGS device shall also have sufficient annual sediment storage capacity as specified and calculated in Section 2.1.

3.3 CANADIAN ETV or ISO 14034 ETV VERIFICATION OF SCOUR TESTING

Stormceptor[®] EF Sizing Report

The OGS device shall have Canadian ETV or ISO 14034 ETV Verification of third-party scour testing conducted in accordance with the Canadian ETV Program's **Procedure for Laboratory Testing of Oil-Grit Separators**.

3.3.1 To be acceptable for on-line installation, the OGS device must demonstrate an average scour test effluent concentration less than 10 mg/L at each surface loading rate tested, up to and including 2600 L/min/m².

3.4 LIGHT LIQUID RE-ENTRAINMENT SIMULATION TESTING

The OGS device shall have Canadian ETV or ISO 14034 ETV Verification of completed third-party Light Liquid Re-entrainment Simulation Testing in accordance with the Canadian ETV **Program's Procedure for Laboratory Testing of Oil-Grit Separators**, with results reported within the Canadian ETV or ISO 14034 ETV verification. This re-entrainment testing is conducted with the device pre-loaded with low density polyethylene (LDPE) plastic beads as a surrogate for light liquids such as oil and fuel. Testing is conducted on the same OGS unit tested for sediment removal to assess whether light liquids captured after a spill are effectively retained at high flow rates.

3.4.1 For an OGS device to be an acceptable stormwater treatment device on a site where vehicular traffic occurs and the potential for an oil or fuel spill exists, the OGS device must have reported verified performance results of greater than 99% cumulative retention of LDPE plastic beads for the five specified surface loading rates (ranging 200 L/min/m² to 2600 L/min/m²) in accordance with the Light Liquid Re-entrainment Simulation Testing within the Canadian ETV Program's **Procedure for Laboratory Testing of Oil-Grit Separators**. However, an OGS device shall not be allowed if the Light Liquid Re-entrainment Simulation Testing was performed with screening components within the OGS device that are effective at retaining the LDPE plastic beads, but would not be expected to retain light liquids such as oil and fuel.

3280 BLOOR STREET WEST

DRAWING INDEX

TITLE	SHEET NO
COVER SHEET	1 OF 5
SYSTEM LAYOUT SHEET	2 OF 5
SYSTEM CALCULATION SHEET	3 OF 5
SYSTEM OVERLAY SHEET	4 OF 5
DETAIL SHEET	5 OF 5

PROJECT INFORMATION				
SITE CONTACT	PHIL ALLEN	416-286-5990	PHILALLEN@STORMCON.CA	
ENGINEER / TECHNICAL SPECIALIST	ERIC CUMISKEY	289-380-3742	ECUMISKEY@STORMCON.CA	
SALES REP:	GREG DZIEWIECKI	437-231-6080	GREGD@STORMCON.CA	
PROJECT NO:	22-250.00			
COMMENTS:	REVISION	DATE	COMMENT	BY

GENERAL NOTES

- COORDINATE WITH MANUFACTURER'S REPRESENTATIVE/DISTRIBUTOR FOR PRE-CONSTRUCTION MEETING AND SITE INSPECTION DURING INSTALLATION.
- ENGINEERING DRAWINGS SUPERSEDE ALL PROVIDED DOCUMENTATION. REFER TO SITE ENGINEERS FOR ADDITIONAL INSTRUCTIONS.
- COORDINATE GREENSTORM INSTALLATION ACTIVITIES WITH OTHER SITE ACTIVITIES
- ALL DIMENSIONS ARE IN METERS UNLESS NOTED OTHERWISE
- THE SUB-GRADE AND SIDE BACKFILL TO BE COMPACTED TO 95% SPD OR AS DIRECTED BY THE QUALIFIED ENGINEER.
- CONFIRM GEOTECHNICAL SOIL EVALUATION BY A QUALIFIED ENGINEER TO DETERMINE SUITABILITY OF STRUCTURAL INSTALLATION
- CONFIRM FOR BURIED UNDERGROUND UTILITIES INCLUDING GAS, ELECTRICAL, PIPELINES OR CONDUITS
- WHEN INSTALLED IN CONFORMANCE TO THE INSTALLATION GUIDELINES, GREENSTORM-ST CAN HANDLE STANDARD CL-625 TRUCK LOADING. FOR NON-STANDARD LOADS CONTACT MANUFACTURER'S REPRESENTATIVE/DISTRIBUTOR
- PROTECT THE INSTALLATION AGAINST DAMAGE WITH CONSTRUCTION TAPE, FENCING OR OTHER MEANS TILL THE CONSTRUCTION IS COMPLETE.
- ENSURE THAT CONSTRUCTION FOLLOWS APPLICABLE FEDERAL, PROVINCIAL, LOCAL, MUNICIPAL AND LOCAL LAWS, ORDNANCES, REGULATIONS AND SAFETY REQUIREMENTS.
- VEHICULAR LOADING IS PROHIBITED UNTIL BACKFILLED AS PER MANUFACTURER'S INSTALLATION GUIDELINES. THE USE OF EQUIPMENT OVER GREENSTORM CHAMBERS IS LIMITED:
 - NO EQUIPMENT IS ALLOWED ON BARE CHAMBERS.
 - NO RUBBER Tired LOADER, DUMP TRUCK, OR EXCAVATORS ARE ALLOWED UNTIL PROPER FILL DEPTHS ARE REACHED IN ACCORDANCE WITH THE CONSTRUCTION GUIDE.
 - WEIGHT LIMITS FOR CONSTRUCTION EQUIPMENT CAN BE FOUND IN THE CONSTRUCTION GUIDE.
 - FULL 900 mm (36") OF STABILIZED COVER MATERIALS OVER THE CHAMBERS IS REQUIRED FOR DUMP TRUCK TRAVEL OR DUMPING.

CHECK - REQUIRED MATERIALS AND EQUIPMENT

- ALL GREENSTORM CHAMBERS AND ACCESSORIES AS SPECIFIED IN THE ENGINEER'S PLANS INCLUDING NON-WOVEN GEOTEXTILE, CONNECTORS, QUADS, SIDEWALLSADAPTER, RISER AND LINER WHERE APPLICABLE.
- RECIPROCATING SAW OR ROUTER
- TRANSIT OR LASER LEVEL MEASURING DEVICE
- COMPACTION EQUIPMENT WITH MAXIMUM GROSS VEHICLE WEIGHT OF 12,000 LBS (5,440 KGS).
- ACCEPTABLE FILL MATERIAL AS SHOWN IN INSTALLATION INSTRUCTIONS.
- QUANTITIES FOR GEOSYNTHETIC ARE APPROXIMATE AND MAY VARY BASED ON OVERLAP, WASTAGE.
- CHECK GREENSTORM CHAMBERS FOR DAMAGE PRIOR TO INSTALLATION. DO NOT USE DAMAGED CHAMBERS, CONTACT YOUR SUPPLIER IMMEDIATELY TO REPORT DAMAGE OR PACKING-LIST DISCREPANCIES.**

NOTES FOR BIDDING AND INSTALLATIONS

- CONTRACTORS ARE EXPECTED TO COMPREHEND AND USE THE MOST CURRENT INSTALLATION INSTRUCTIONS PRIOR TO BEGINNING A SYSTEM INSTALLATION. FOR THE MOST CURRENT INSTRUCTIONS, CONTACT STORMCON AT (647) 463-9803 OR VISIT WWW.STORMCON.CA.
- CONTACT STORMCON AT LEAST TWO WEEKS PRIOR TO SYSTEM INSTALLATION TO ARRANGE FOR A PRE-CONSTRUCTION MEETING.
- USE GREENSTORM INSTALLATION INSTRUCTIONS AS A GUIDELINE ONLY FOR MINIMUM/MAXIMUM REQUIREMENTS. ACTUAL DESIGN MAY VARY. REFER TO APPROVED CONSTRUCTION DRAWINGS FOR JOB-SPECIFIC DETAILS. ENGINEERING DRAWINGS SUPERSEDE ALL PROVIDED DOCUMENTATION.
- THE FOUNDATION STONE SHALL BE LEVEL AND COMPACTED PRIOR TO CHAMBER INSTALLATION.
- ANY DISCREPANCIES WITH THE SYSTEM SUB-GRADE SOIL'S BEARING CAPACITY MUST BE REPORTED TO THE GEOTECHNICAL ENGINEER.
- CONTRACTOR TO REFER TO GREENSTORM INSTALLATION INSTRUCTIONS CONCERNING VEHICULAR TRAFFIC. RESPONSIBILITY FOR PREVENTING VEHICLES THAT EXCEED REQUIREMENTS SPECIFIED FROM TRAVELING ACROSS OR PARKING OVER THE CHAMBER SYSTEM LIES SOLELY WITH THE CONTRACTOR THROUGHOUT THE ENTIRE SITE CONSTRUCTION PROCESS. THE PLACEMENT OF WARNING TAPE, TEMPORARY FENCING, AND/OR APPROPRIATELY LOCATED SIGNS IS HIGHLY RECOMMENDED.
- TRAFFIC OF INSTALLATION EQUIPMENT OR OTHER VEHICULAR TRAFFIC OVER TOP OF THE GREENSTORM STORMWATER SYSTEM IS STRICTLY RESTRICTED AND PROHIBITED UNTIL SATISFACTORY COVER AND COMPACTION IS ACHIEVED ACCORDING TO MANUFACTURER'S INSTALLATION INSTRUCTIONS.
- EROSION AND SEDIMENT-CONTROL MEASURES MUST MEET LOCAL CODES AND THE DESIGN ENGINEER'S SPECIFICATIONS THROUGHOUT THE ENTIRE SITE CONSTRUCTION PROCESS.
- GREENSTORM SYSTEMS MUST BE DESIGNED AND INSTALLED IN ACCORDANCE WITH STORMCON'S MINIMUM REQUIREMENTS. FAILURE TO DO SO WILL VOID THE LIMITED WARRANTY.



10 CEDAR AVE
THORNHILL ON
L3T 3W1

SALES@STORMCON.CA
WWW.STORMCON.CA

NOTE: THESE SHOP DRAWINGS MAY CONTAIN COMPONENTS INCLUDING BUT NOT LIMITED TO MANHOLES, CATCH BASINS, STORM PIPES AND FITTINGS, MANIFOLDS, CASTINGS AND OTHER NECESSARY APPURTENANCES THAT MAY NOT BE SUPPLIED BY STORMCON. IT IS THE RESPONSIBILITY OF THE CONTRACTOR AND/OR SUPPLIER TO CONFIRM THE MATERIALS PROVIDED.

THIS DRAWING WAS PREPARED TO SUPPORT THE PROJECT ENGINEER OF RECORD FOR THE PROPOSED SYSTEM. IT IS THE ULTIMATE RESPONSIBILITY OF THE PROJECT ENGINEER OF RECORD TO ENSURE THAT THE GREENSTORM SYSTEM'S DESIGN IS IN FULL COMPLIANCE WITH ALL APPLICABLE LAWS AND REGULATIONS. IT IS THE CONTRACTOR OF RECORD'S RESPONSIBILITY TO ENSURE THAT THE STORMCON PRODUCTS ARE DESIGNED IN ACCORDANCE WITH STORMCON'S MINIMUM REQUIREMENTS. STORMCON DOES NOT APPROVE PLANS, SIZING, OR SYSTEM DESIGNS.

PROPOSED SYSTEM ELEVATIONS

(TO BE APPROVED BY ENGINEER)
 *ENGINEER TO CONFIRM MINIMUM AND MAXIMUM BURIAL REQUIREMENTS ARE MET

80.47	MAXIMUM ALLOWABLE GRADE (TOP OF PAVEMENT/UNPAVED):
77.27	MINIMUM ALLOWABLE GRADE
76.47	GREENSTORM STORAGE TOP ELEVATION LEVEL 2.5
76.12	GREENSTORM STORAGE TOP ELEVATION LEVEL 2
75.46	GREENSTORM STORAGE TOP ELEVATION LEVEL 1
74.80	GREENSTORM STORAGE BOTTOM ELEVATION
74.70	BOTTOM OF EXCAVATION

GREENSTORM STORMWATER MANAGEMENT SYSTEM

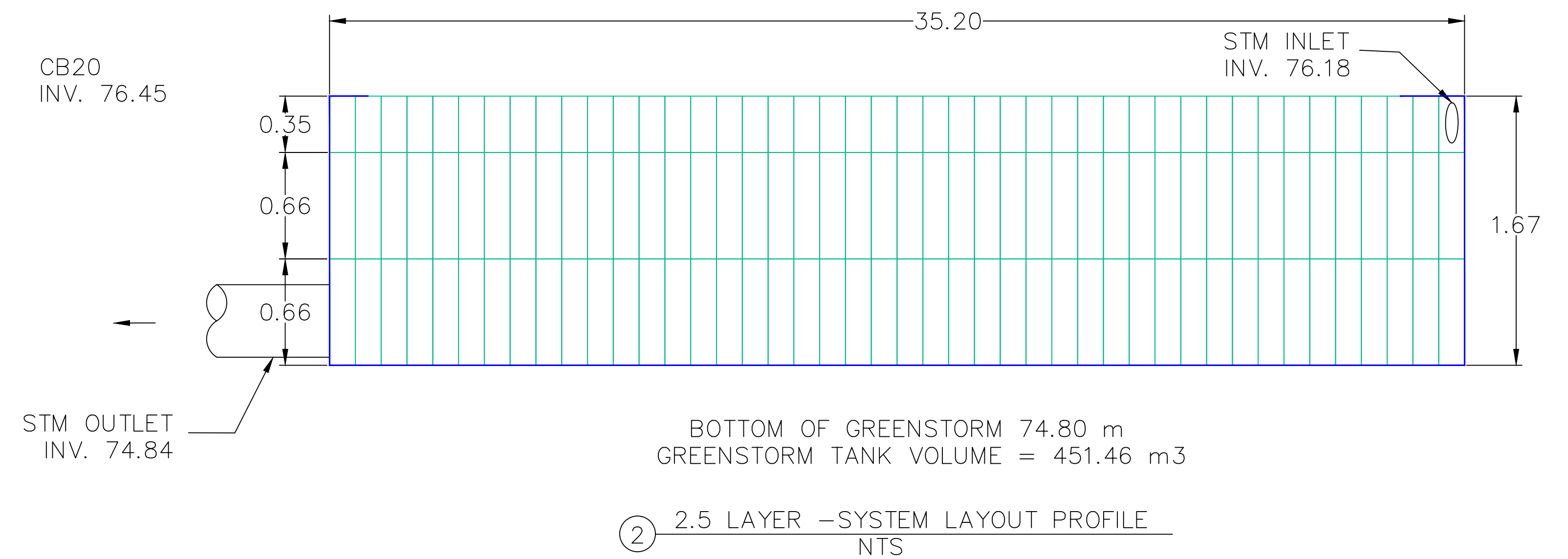
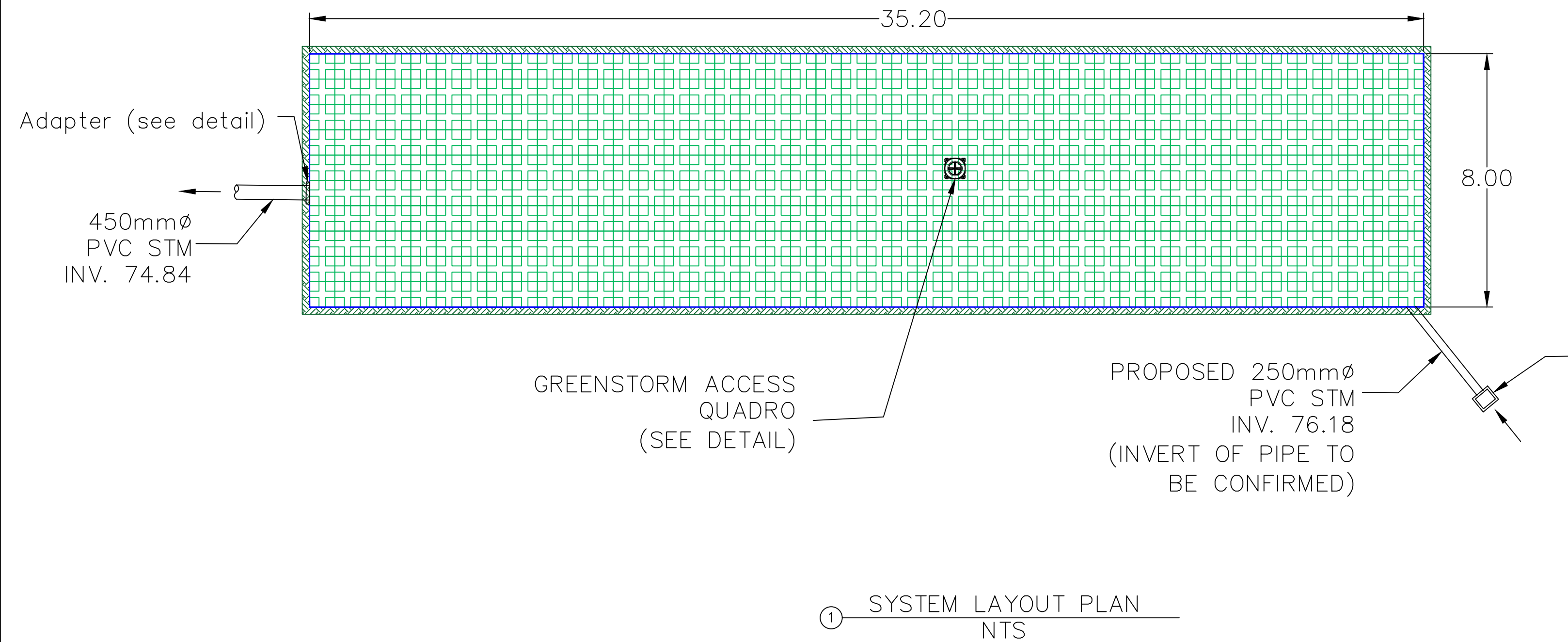

TOTAL STORAGE PROVIDED: 451.46 m³
 STORAGE VOID RATIO: 0.96
 SYSTEM AREA: 281.60 m²
 DEPTH OF EMBEDMENT STONE: 0 m
 DEPTH OF BEDDING STONE: 0 m
 STONE PERIMETER: 0 m



NOTE: *ALL EXTERNAL SYSTEM STRUCTURES, INLET/OUTLET PIPES, AND PROPOSED ELEVATIONS MUST BE DESIGNED AND APPROVED BY PROJECT ENGINEER OF RECORD. PROJECT ENGINEER OF RECORD MUST ENSURE CHAMBER BURIAL REQUIREMENTS ARE MET.

MATERIALS LIST SUPPLIED BY STORMCON		
(SYSTEM MATERIALS LIST - SEE COVER SHEET FOR COMBINED PROJECT MATERIALS LIST)		
GREENSTORM-ST 80x80x66 cm	880	BLOCKS
GREENSTORM-ST HALF BLOCKS 80x80x35 cm	440	BLOCKS
MULTI LAYER-CONNECTOR	1760	PIECES
SINGLE LAYER-CONNECTOR	0	PIECES
SIDEWALL GRID	216	PIECES
SIDEWALL GRID HALF BLOCKS	108	PIECES
GREENSTORM-ST HALF BLOCKS COVER PLATE	440	BLOCKS
ADAPTER	1	PIECES
LAYER QUADRO-CONTROL	4	PIECES
EXTENSION PIPE (6m LENGTH)	2	METER
CAST IRON COVER	1	PIECES
4 OZ NON-WOVEN GEOTEXTILE	0	SQ. METERS
8 OZ NON-WOVEN GEOTEXTILE	1480	SQ. METERS
30MIL PVC IMPERMEABLE LINER	470	SQ. METERS
GREENSTORM TREATMENT ROW	0	METER
100MM SUBDRAIN	0	METER

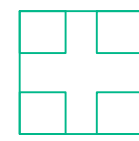
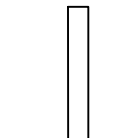
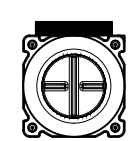
GREENSTORM LEGEND

-  GREENSTORM ST BLOCK
-  8 OZ NON-WOVEN GEOTEXTILE
-  Adapter (see detail)
-  GREENSTORM ACCESS QUADRO
-  30MIL PVC IMPERMEABLE LINER

Use of vehicles when applying the first cover layer:

The first cover layer can be applied for example using a wheel loader or a front-type mobile excavator. For a wheel loader or mobile excavator with a maximum total weight of 15 tons (chain, 4 wheels, twin-tyres), a compacted cover of at least 30 cm must be placed over the storage/infiltration system. Possible formation of ruts must be taken into account! Avoid steering manoeuvres at this construction stage.

Use of construction vehicles:

Driving over the cover with heavy construction vehicles with a wheel load of up to 50 kN (e.g. HGV 30) is possible if the thickness of the compacted cover is not less than 60 cm. Possible formation of ruts must be taken into account! When dumping the earthwork material, the wheel load of 50 kN must not be exceeded; if necessary, load distribution plates must be used.

Project Name	3280 BLOOR STREET WEST		
Location	OTTAWA		
Date	Thursday, February 10, 2022		
Chamber Model	GreenStorm-ST		
Number of Layers	2.5		Top Stone 0.00 m
Height of Chambers	1.67	m	Bottom Stone 0.00 m
Chamber Length	35.20		Perimeter Stone 0.00 m
Chamber Width	8.00		Stone Qty 0.00 m ³
Storage Void Ratio	0.96		Stone Void Ratio 40.00%
System Perimeter	86.40		
System Area	281.60	m ²	Liner Yes
System Base Elevation	74.80	m	

Height of System		GreenStorm Volume		Stone Volume		Cumulative Storage Volume		Elevation			Height of System		GreenStorm Volume		Stone Volume		Cumulative Storage Volume		Elevation		
mm	in	m ³	ft ³	m ³	ft ³	m ³	ft ³	m	ft		mm	in	m ³	ft ³	m ³	ft ³	m ³	ft ³	m	ft	
1670	65.75	12.17	429.61	0.00	0.00	451.46	15,943.20	76.47	250.89	Top of GreenStorm	425	16.73	6.76	238.67	0.00	0.00	114.89	4,057.40	75.23	246.80	
1625	63.98	6.76	238.67	0.00	0.00	439.30	15,513.59	76.43	250.74		400	15.75	6.76	238.67	0.00	0.00	108.13	3,818.73	75.20	246.72	
1600	62.99	6.76	238.67	0.00	0.00	432.54	15,274.92	76.40	250.66		375	14.76	6.76	238.67	0.00	0.00	101.38	3,580.06	75.18	246.64	
1575	62.01	6.76	238.67	0.00	0.00	425.78	15,036.25	76.38	250.57		350	13.78	6.76	238.67	0.00	0.00	94.62	3,341.39	75.15	246.56	
1550	61.02	6.76	238.67	0.00	0.00	419.02	14,797.58	76.35	250.49		325	12.80	6.76	238.67	0.00	0.00	87.86	3,102.72	75.13	246.47	
1525	60.04	6.76	238.67	0.00	0.00	412.26	14,558.91	76.33	250.41		300	11.81	6.76	238.67	0.00	0.00	81.10	2,864.05	75.10	246.39	
1500	59.06	6.76	238.67	0.00	0.00	405.50	14,320.24	76.30	250.33		275	10.83	6.76	238.67	0.00	0.00	74.34	2,625.38	75.08	246.31	
1475	58.07	6.76	238.67	0.00	0.00	398.75	14,081.57	76.28	250.25		250	9.84	6.76	238.67	0.00	0.00	67.58	2,386.71	75.05	246.23	
1450	57.09	6.76	238.67	0.00	0.00	391.99	13,842.90	76.25	250.16		225	8.86	6.76	238.67	0.00	0.00	60.83	2,148.04	75.03	246.15	
1425	56.10	6.76	238.67	0.00	0.00	385.23	13,604.23	76.23	250.08		200	7.87	6.76	238.67	0.00	0.00	54.07	1,909.37	75.00	246.06	
1400	55.12	6.76	238.67	0.00	0.00	378.47	13,365.56	76.20	250.00		175	6.89	6.76	238.67	0.00	0.00	47.31	1,670.69	74.98	245.98	
1375	54.13	6.76	238.67	0.00	0.00	371.71	13,126.89	76.18	249.92		150	5.91	6.76	238.67	0.00	0.00	40.55	1,432.02	74.95	245.90	
1350	53.15	6.76	238.67	0.00	0.00	364.95	12,888.21	76.15	249.84		125	4.92	6.76	238.67	0.00	0.00	33.79	1,193.35	74.93	245.82	
1325	52.17	6.76	238.67	0.00	0.00	358.20	12,649.54	76.13	249.75		100	3.94	6.76	238.67	0.00	0.00	27.03	954.68	74.90	245.73	
1300	51.18	6.76	238.67	0.00	0.00	351.44	12,410.87	76.10	249.67		75	2.95	6.76	238.67	0.00	0.00	20.28	716.01	74.88	245.65	
1275	50.20	6.76	238.67	0.00	0.00	344.68	12,172.20	76.08	249.59		50	1.97	6.76	238.67	0.00	0.00	13.52	477.34	74.85	245.57	
1250	49.21	6.76	238.67	0.00	0.00	337.92	11,933.53	76.05	249.51		25	0.98	6.76	238.67	0.00	0.00	6.76	238.67	74.83	245.49	
1225	48.23	6.76	238.67	0.00	0.00	331.16	11,694.86	76.03	249.43		0	0.00	0.00	0.00	2.82	99.45	0.00	0.00	74.80	245.41	System Bottom
1200	47.24	6.76	238.67	0.00	0.00	324.40	11,456.19	76.00	249.34												
1175	46.26	6.76	238.67	0.00	0.00	317.64	11,217.52	75.98	249.26												
1150	45.28	6.76	238.67	0.00	0.00	310.89	10,978.85	75.95	249.18												
1125	44.29	6.76	238.67	0.00	0.00	304.13	10,740.18	75.93	249.10												
1100	43.31	6.76	238.67	0.00	0.00	297.37	10,501.51	75.90	249.02												
1075	42.32	6.76	238.67	0.00	0.00	290.61	10,262.84	75.88	248.93												
1050	41.34	6.76	238.67	0.00	0.00	283.85	10,024.17	75.85	248.85												
1025	40.35	6.76	238.67	0.00	0.00	277.09	9,785.50	75.83	248.77												
1000	39.37	6.76	238.67	0.00	0.00	270.34	9,546.83	75.80	248.69												
975	38.39	6.76	238.67	0.00	0.00	263.58	9,308.16	75.78	248.61												
950	37.40	6.76	238.67	0.00	0.00	256.82	9,069.48	75.75	248.52												
925	36.42	6.76	238.67	0.00	0.00	250.06	8,830.81	75.73	248.44												
900	35.43	6.76	238.67	0.00	0.00	243.30	8,592.14	75.70	248.36												
875	34.45	6.76	238.67	0.00	0.00	236.54	8,353.47	75.68	248.28												
850	33.46	6.76	238.67	0.00	0.00	229.79	8,114.80	75.65	248.20												
825	32.48	6.76	238.67	0.00	0.00	223.03	7,876.13	75.63	248.11												
800	31.50	6.76	238.67	0.00	0.00	216.27	7,637.46	75.60	248.03												
775	30.51	6.76	238.67	0.00	0.00	209.51	7,398.79	75.58	247.95												
750	29.53	6.76	238.67	0.00	0.00	202.75	7,160.12	75.55	247.87												
725	28.54	6.76	238.67	0.00	0.00	195.99	6,921.45	75.53	247.79												
700	27.56	6.76	238.67	0.00	0.00	189.24	6,682.78	75.50	247.70												
675	26.57	6.76	238.67	0.00	0.00	182.48	6,444.11	75.48	247.62												
650	25.59	6.76	238.67	0.00	0.00	175.72	6,205.44	75.45	247.54												
625	24.61	6.76	238.67	0.00	0.00	168.96	5,966.77	75.43	247.46												
600	23.62	6.76	238.67	0.00	0.00	162.20	5,728.10	75.40	247.38												
575	22.64	6.76	238.67	0.00	0.00	155.44	5,489.42	75.38	247.29												
550	21.65	6.76	238.67	0.00	0.00	148.68	5,250.75	75.35	247.21												
525	20.67	6.76	238.67	0.00	0.00	141.93	5,012.08	75.33	247.13												
500	19.69	6.76	238.67	0.00	0.00	135.17	4,773.41	75.30	247.05												
475	18.70	6.76	238.67	0.00	0.00	128.41	4,534.74	75.28	246.97												
450	17.72	6.76	238.67	0.00	0.00	121.65	4,296.07	75.25	246.88												

2.5-LAYER GREENSTORM CALCULATION SHEET



10 CEDAR AVE
THORNHILL ON
L3T 3W1

SALES@STORMCON.CA
WWW.STORMCON.CA

THIS DRAWING WAS PREPARED TO SUPPORT THE PROJECT ENGINEER OF RECORD FOR THE PROPOSED SYSTEM. IT IS THE ULTIMATE RESPONSIBILITY OF THE PROJECT ENGINEER OF RECORD TO ENSURE THAT THE GREENSTORM SYSTEM'S DESIGN IS IN FULL COMPLIANCE WITH ALL APPLICABLE LAWS AND REGULATIONS. IT IS THE CONTRACTOR OF RECORD'S RESPONSIBILITY TO ENSURE THAT THE STORMCON PRODUCTS ARE DESIGNED IN ACCORDANCE WITH STORMCONS MINIMUM REQUIREMENTS. STORMCON DOES NOT APPROVE PLANS, SIZING, OR SYSTEM DESIGNS.

3280 BLOOR STREET WEST

SYSTEM CALCULATION SHEET

GREENSTORM STORMWATER CHAMBER

PROJECT NO: 22-250.00	DATE: 02/08/2022
DESIGNED BY: KP	CHECKED BY: VS
SCALE: N.T.S.	SHEET NO: 3 OF 5

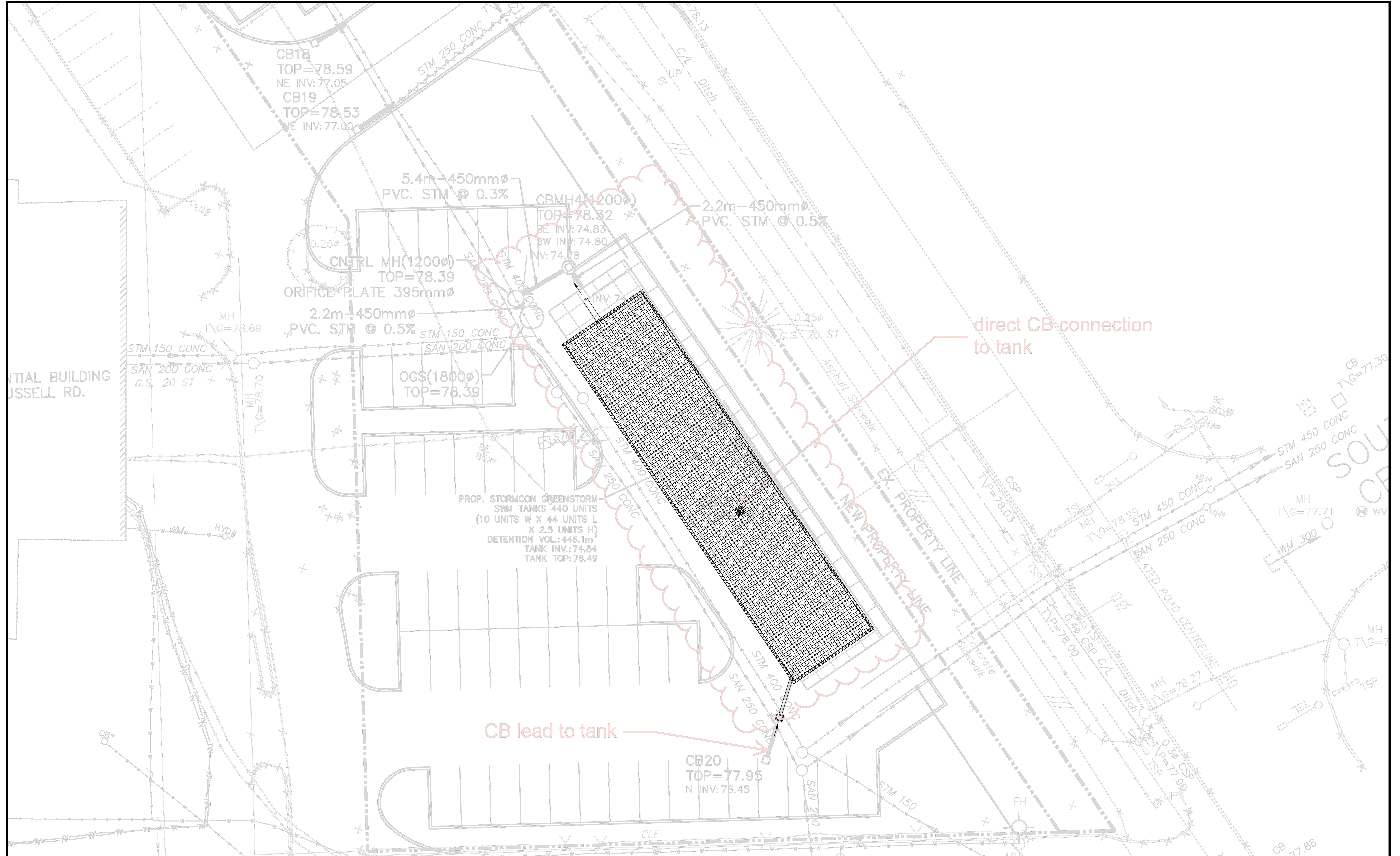



10 CEDAR AVE
THORNHILL ON
L3T 3W1
SALES@STORMCON.CA
WWW.STORMCON.CA

THIS DRAWING WAS PREPARED TO SUPPORT THE PROJECT ENGINEER OF RECORD FOR THE PROPOSED SYSTEM. IT IS THE ULTIMATE RESPONSIBILITY OF THE PROJECT ENGINEER OF RECORD TO ENSURE THAT THE GREENSTORM SYSTEM'S DESIGN IS IN FULL COMPLIANCE WITH ALL APPLICABLE LAWS AND REGULATIONS. IT IS THE CONTRACTOR OF RECORD'S RESPONSIBILITY TO ENSURE THAT THE STORMCON PRODUCTS ARE DESIGNED IN ACCORDANCE WITH STORMCONS MINIMUM REQUIREMENTS. STORMCON DOES NOT APPROVE PLANS, SIZING, OR SYSTEM DESIGNS.

3280 BLOOR STREET WEST

SYSTEM OVERLAY SHEET

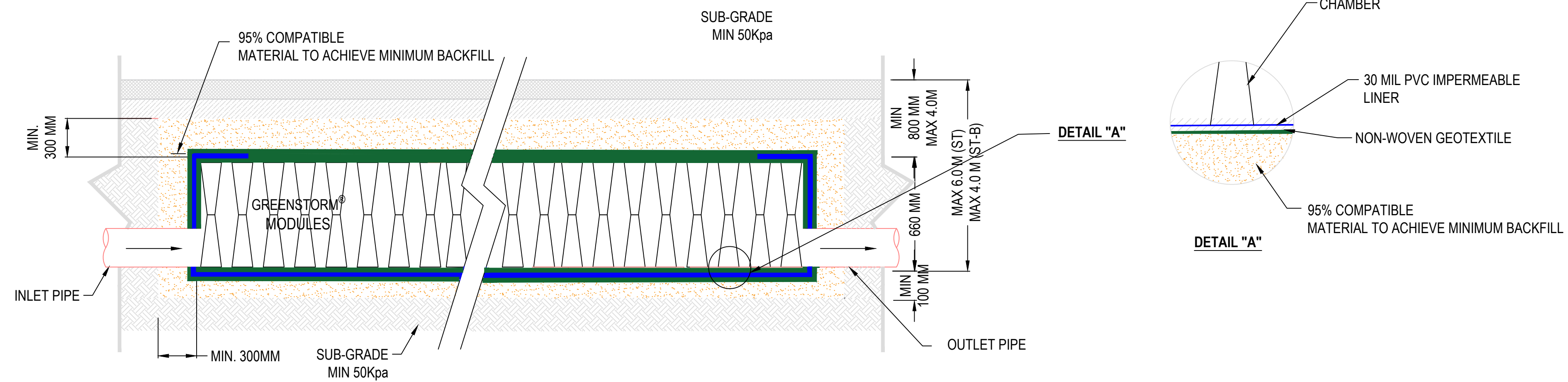
GREENSTORM STORMWATER CHAMBER	
PROJECT NO: 22-250.00	DATE: 02/08/2022
DESIGNED BY: KP	CHECKED BY: VS
SCALE: N.T.S.	SHEET NO: 4 OF 5



COMPACTABLE MATERIAL LIST	
•	GRANULAR A
•	GRANULAR B
•	STONE
•	3/4 INCH CLEAR WASHED STONE

LEGEND	
	30MIL PVC IMPERMEABLE LINER
	8 OZ NON-WOVEN GEOTEXTILE

TYPICAL ONE LAYER GREENSTORM CROSS SECTION

FULL CONNECTION OPTIONS
Dia 100mm, 150 mm, 200 mm, 250 mm, 300 mm AND 375 mm

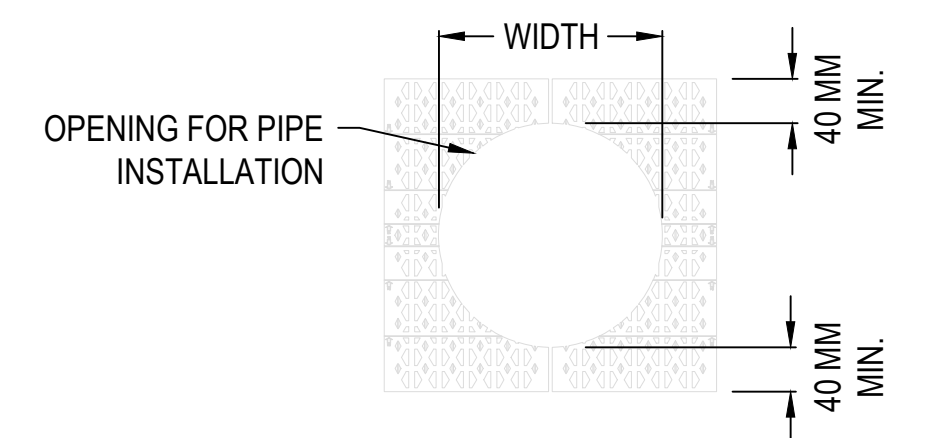
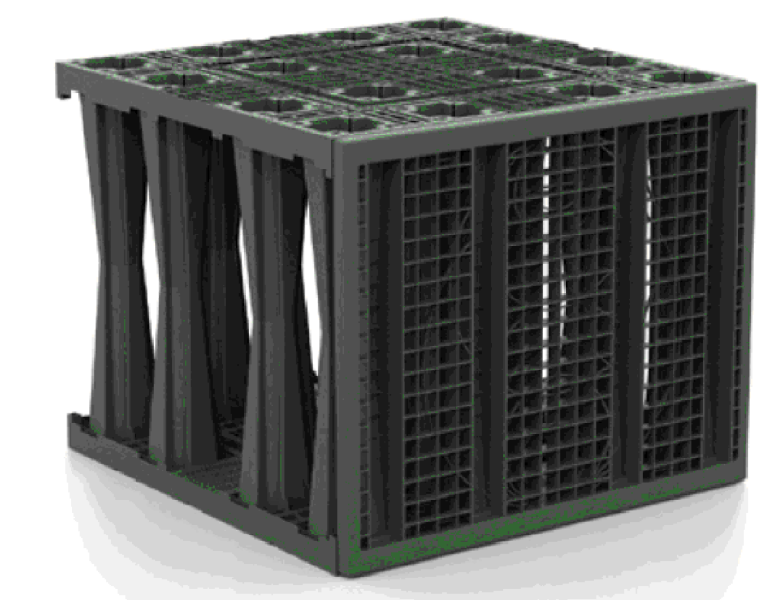

SIDE PANEL WITH DIRECT PIPE CUT

STANDARD SIDE PANEL WITH DIRECT PIPE CUT

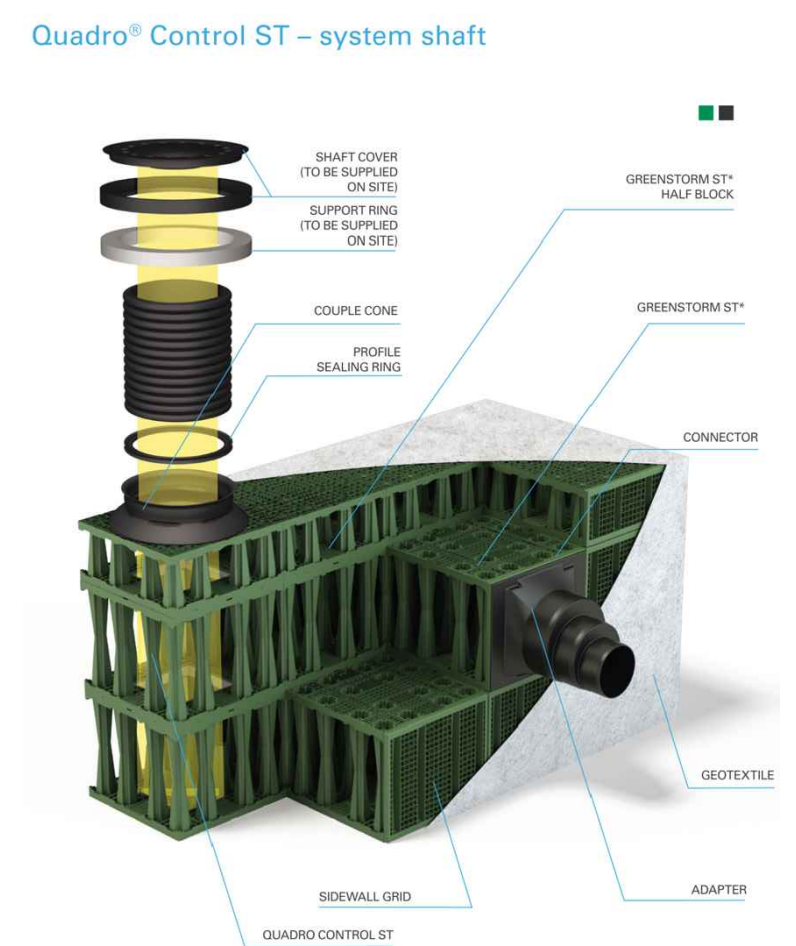
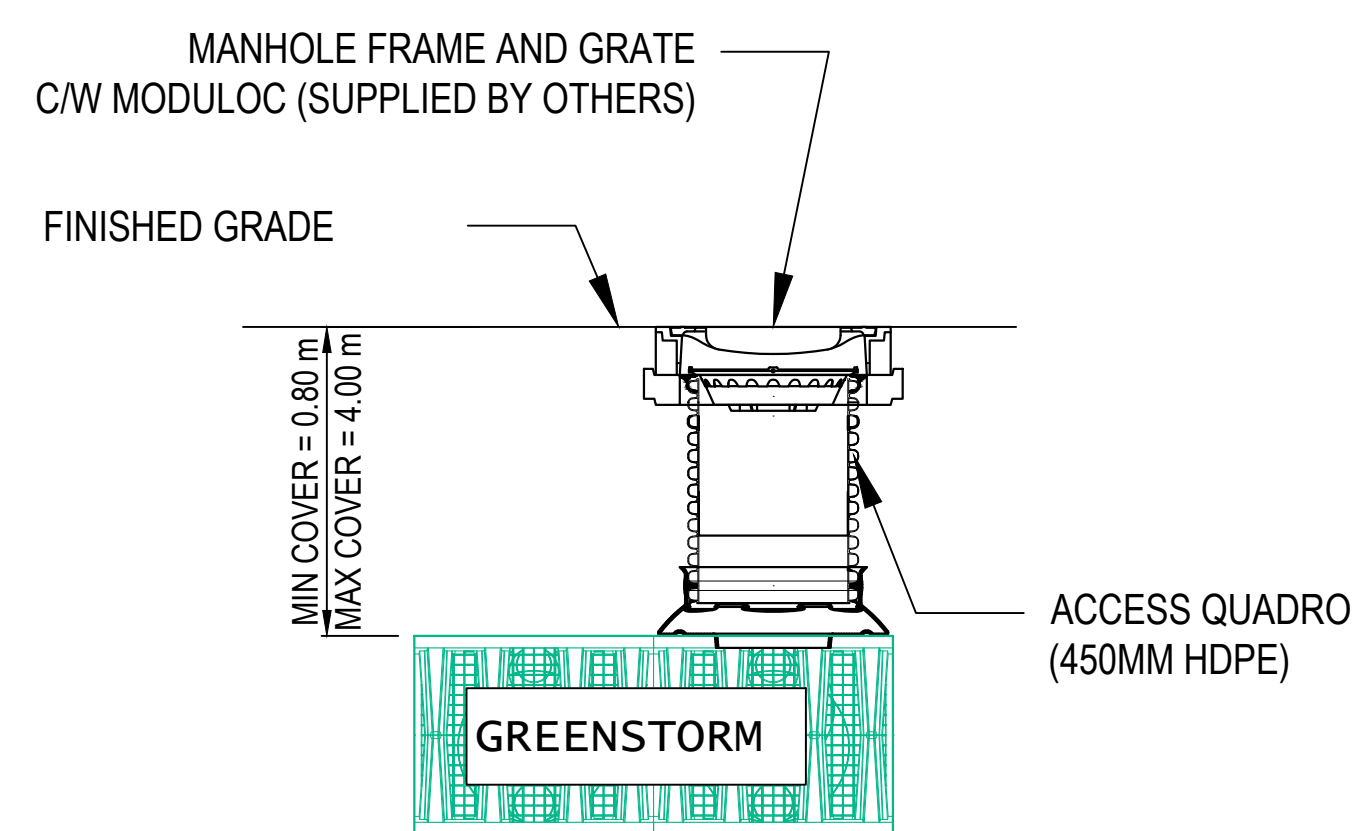

GREENSTORM ACCESS QUADRO DETAIL (WHERE APPLICABLE)

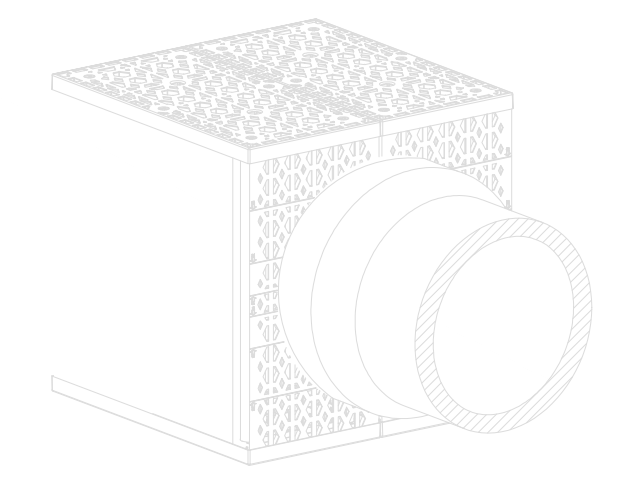
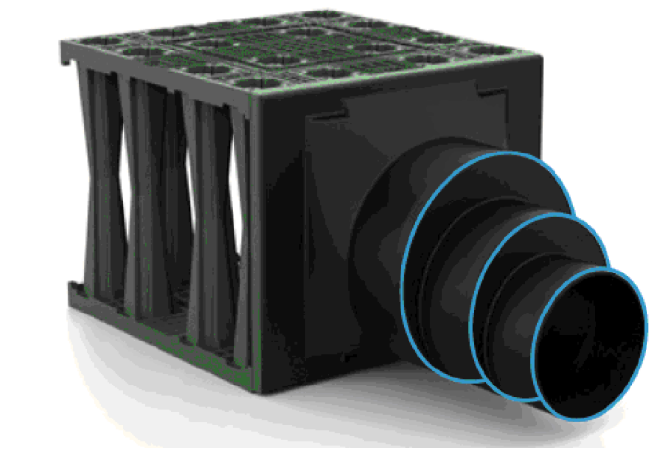

ADAPTER PANEL WITH DIA 450 AND 525

STANDARD ADAPTER PANEL WITH DIA 450 AND 525

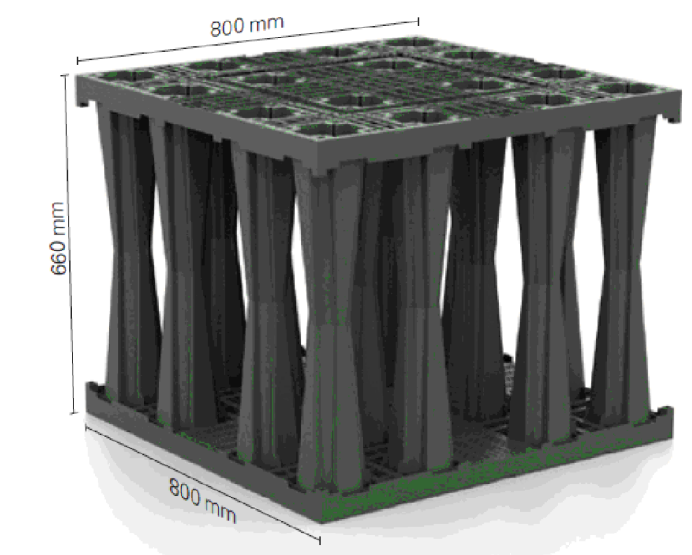
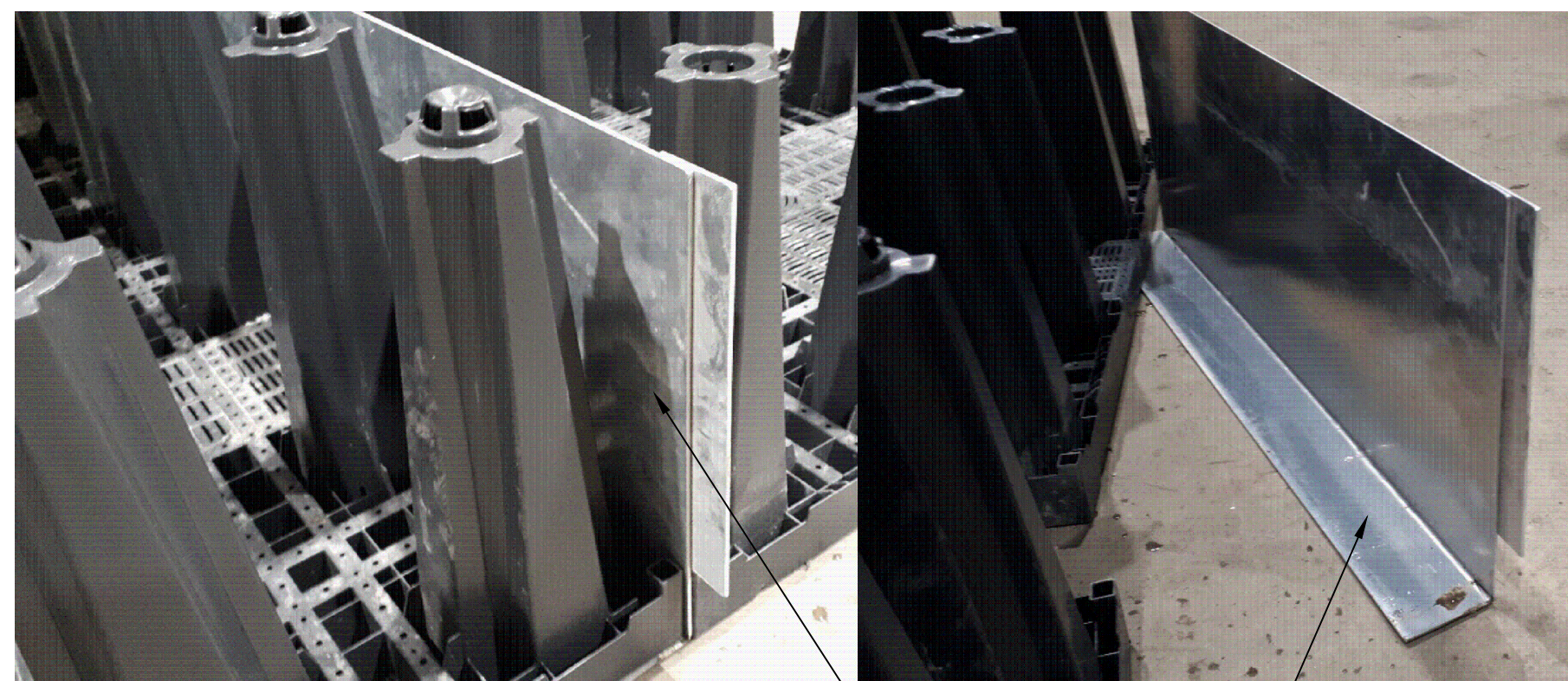

FULL BLOCK

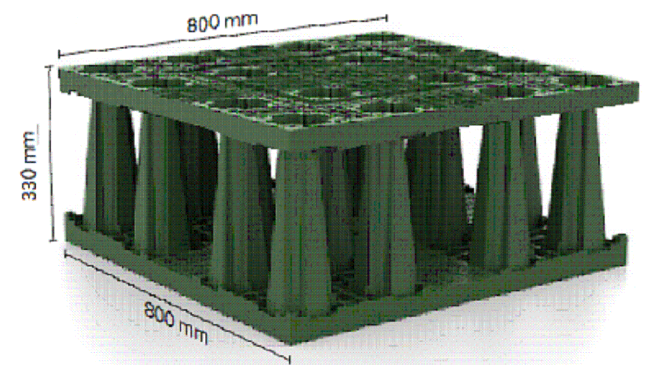

HALF BLOCK

PROJECT NO: 22-250.00	DATE: 02/08/2022
DESIGNED BY: KP	CHECKED BY: VS
SCALE: N.T.S.	SHEET NO: 5 OF 5



APPENDIX C

Counterpoint Engineering Inc.

PROPOSED BUILDING/SITE

Project: 1971 & 1975 St. Laurent Blvd.
Project No: 21106
Location: Ottawa
Site Area: 3.370 ha

Per Captia Flow for External Reviews

Residential	280	litres/person/day
Commercial	28,000	litres/gross ha/day
Infiltration (Dry)	0.33	litres/ha/second

Residential Population Criteria

Bachelor	1.4	ppu
1 Bedroom	1.4	ppu
2 Bedroom	2.1	ppu
3 Bedroom	3.1	ppu
Townhome	2.7	ppu

Proposed Buildings (Outlet to Southvale Cres. Sanitary Sewer)

Site Area: 0.980 ha

Building	No. of Units	Bachelor/ Bedroom	1	2 Bedroom	3 Bedroom	Townhome	Retail Area (Ha)	Total Res Population
Building A	165	94		52	9	10	0.000	296
Building D - Parkade	0	0		0	0	0	0.000	0
TOTAL	165	94		52	9	10	0.000	296

Harmon Peaking Factor Residential: (Min=2.0, Max=4.0), Commercial: 1.5

Building	Total Population	Harmon Peak Factor
Residential	296	3.5

Peak Residential flow with 0.33 l/s/ha Infiltration:

3.64	l/s
------	-----

Peak Commercial Flow:

0.00	l/s
------	-----

Proposed Buildings Total Peak Flow:

3.64	l/s
------	-----

Proposed Buildings (Outlet to St. Laurent Blvd. Sanitary Sewer)

Site Area: 0.550 ha

Building	No. of Units	Bachelor/ Bedroom	1	2 Bedroom	3 Bedroom	Townhome	Retail Area (Ha)	Total Res Population
Building B	168	94		52	8	14	0.000	303
Building C	168	94		52	8	14	0.000	303
TOTAL	336	188		104	16	28	0.000	607

Harmon Peaking Factor Residential: (Min=2.0, Max=4.0), Commerical: 1.5

Building	Total Population	Harmon Peak Factor
Residential	607	3.3

Peak Residential flow with 0.33 l/s/ha Infiltration:	6.76	l/s
Peak Commercial Flow:	0.00	l/s

Proposed Buildings Total Peak Flow:	6.76	l/s
--	-------------	------------

Combined Site Net Increase Total

Harmon Peaking Factor Residential: (Min=2.0, Max=4.0), Commerical: 1.5

Building	Total Population	Harmon Peak Factor
Residential	903	3.3

Peak Residential flow with 0.33 l/s/ha Infiltration:	10.65	l/s
Peak Commercial Flow:	0.00	l/s

Grand Total Peak Flow:	10.65	l/s
-------------------------------	--------------	------------

Counterpoint Engineering Inc.

EXISTING BUILDING/SITE

Project: 1971 & 1975 St. Laurent Blvd.
Project No: 21106
Location: Ottawa
Site Area: 3.370 ha

Per Capita Flow for External Reviews

Residential	280	litres/person/day
Commercial	28,000	litres/gross ha/day
Infiltration (Dry)	0.33	litres/ha/second

Residential Population Criteria

Bachelor	1.4	ppu
1 Bedroom	1.4	ppu
2 Bedroom	2.1	ppu
3 Bedroom	3.1	ppu
Townhome	2.7	ppu
Duplex	2.3	ppu
Semi-Detached	2.7	ppu
Detached	3.4	ppu

Building	No. of Units	1 Bedroom	2 Bedroom	3 Bedroom	Retail Area (Ha)	Total Res Population
Existing Apartment (1971 St. Laurent Blvd.)	250	162	88	0	0.000	412
Existing Apartment (1975 St. Laurent Blvd.)	250	162	88	0	0.000	412
2080 & 2081 Russell Road	335	331	4	0	0.000	472
TOTAL	835	655	180	0	0.000	1295

Harmon Peaking Factor Residential: (Min=2.0, Max=4.0), Commercial: 1.5

Building	Total Population	Harmon Peak Factor
Residential	1295	3.2
Commercial	0	1.5

Peak Residential flow with 0.33 l/s/ha Infiltration:	14.46	l/s
Peak Commercial Flow:	0.00	l/s
Total Peak Flow:	14.46	l/s

Property Details

 och-ico.ca/properties/russell-gardens/

Russell Gardens - Hawthorne Meadows

2080 Russell Road

2080 Russell Road

Russell Gardens is located on the west side of Russell Road, east of St. Laurent Boulevard. The community is close to public transportation and shopping malls. There is a community room in each building with an outdoor patio area.

Details

Property Type

Neighborhood	Hawthorne Meadows
--------------	-------------------

Location	2080 Russell Road, Ottawa Division, ON, Canada
----------	--

Accessible Units	no
------------------	----

Seniors Only	no
--------------	----

Number of Units	335
-----------------	-----

Number of Stories	6
-------------------	---

Market units	no
--------------	----

Subsidized units	yes
------------------	-----

Hydro paid by tenant	no
----------------------	----

Heat paid by tenant	no
---------------------	----

Parking on site	yes
-----------------	-----

Parking charge	yes
----------------	-----

District Contact

District Contact

Bank Office
 1365 Bank St.,
 Ottawa, ON
613-731-1182

Russell Gardens - Hawthorne Meadows

2080 Russell Road

Details

Hydro paid by tenant	no
----------------------	----

Heat paid by tenant	no
---------------------	----

Parking on site	yes
-----------------	-----

Parking charge	yes
----------------	-----

Washer Available	no
------------------	----

Dryer Available	no
-----------------	----

Elevator	yes
----------	-----

Unit Breakdown

Type	Room	Bach	1BR	2BR	3BR	4BR	5BR
apartments			331	4			



APPENDIX D

counterpoint engineering

Water Demand Calculations

BUILDING A, PARKADE & EXISTING BUILDINGS

Project Name: 1971 & 1975 St. Laurent Blvd.
 Project Number: 21106
 Location: Ottawa
 Date: January 2022

City of Ottawa Watermain Design Guidelines

Water Demand = Maximum Day Flow + Fire Flow or Peak Hour Flow

Domestic Demand

Residential Flow	280	L/capita/day
Peak Hour (2.5 x Avg Day Demand)	700	L/capita/day
Maximum Day (2.2 x Avg Day Demand)	616	L/capita/day

Commercial & Institutional Demand

Retail/Shopping Centres	2,500	L/1000m ² /day
-------------------------	-------	---------------------------

Fire Demand

Fire Flow	18,000	L / min
Fire Flow Duration	2	hours

- See FUS calculations.

Residential Population	1,590.7 Ppl	- See Sanitary Flow Calculations
Domestic Demand:	445396 L / day	
, or	309 L/min	5.2 L/s
Peak Hour Water Demand - Domestic:	1,113,490 L / day	
Total Peak Hour Demand:	1,113,490 L / day	
, or	773 L / min	12.9 L/s
Maximum Day Water Demand - Domestic:	979,871 L / day	
Total Maximum Day Water Demand:	979,871 L / day	
, or	680 L / min	11.3 L/s
Retail Area	0.0 m ²	- See Sanitary Flow Calculations
Commercial & Institutional Demand:	0 L / day	
, or	0 L/min	
Maximum Day + Fire Flow:	18,680 L / min	311.3 L/s
	or	
	4,935 USGPM	

counterpoint engineering

Water Demand Calculations

BUILDING B

Project Name: 1971 & 1975 St. Laurent Blvd.
 Project Number: 21106
 Location: Ottawa
 Date: January 2022

City of Ottawa Watermain Design Guidelines

Water Demand = Maximum Day Flow + Fire Flow or Peak Hour Flow

Domestic Demand

Residential Flow	280	L/capita/day
Peak Hour (2.5 x Avg Day Demand)	700	L/capita/day
Maximum Day (2.2 x Avg Day Demand)	616	L/capita/day

Commercial & Institutional Demand

Retail/Shopping Centres	2,500	L/1000m ² /day
-------------------------	-------	---------------------------

Fire Demand

Fire Flow	14,000	L / min
Fire Flow Duration	2	hours

- See FUS calculations.

Residential Population	303.4 Ppl	- See Sanitary Flow Calculations
Domestic Demand:	84952 L / day	
, or	59 L/min	1.0 L/s
Peak Hour Water Demand - Domestic:	212,380 L / day	
Total Peak Hour Demand:	212,380 L / day	
, or	147 L / min	2.5 L/s
Maximum Day Water Demand - Domestic:	186,894 L / day	
Total Maximum Day Water Demand:	186,894 L / day	
, or	130 L / min	2.2 L/s
Retail Area	0.0 m ²	- See Sanitary Flow Calculations
Commercial & Institutional Demand:	0 L / day	
, or	0 L/min	
Maximum Day + Fire Flow:	14,130 L / min	235.5 L/s
	or	
	3,733 USGPM	

counterpoint engineering

Water Demand Calculations

BUILDING C

Project Name: 1971 & 1975 St. Laurent Blvd.
 Project Number: 21106
 Location: Ottawa
 Date: January 2022

City of Ottawa Watermain Design Guidelines

Water Demand = Maximum Day Flow + Fire Flow or Peak Hour Flow

Domestic Demand

Residential Flow	280	L/capita/day
Peak Hour (2.5 x Avg Day Demand)	700	L/capita/day
Maximum Day (2.2 x Avg Day Demand)	616	L/capita/day

Commercial & Institutional Demand

Retail/Shopping Centres	2,500	L/1000m ² /day
-------------------------	-------	---------------------------

Fire Demand

Fire Flow	13,000	L / min
Fire Flow Duration	2	hours

- See FUS calculations.

Residential Population	303.4 Ppl	- See Sanitary Flow Calculations
Domestic Demand:	84952 L / day	
, or	59 L/min	1.0 L/s
Peak Hour Water Demand - Domestic:	212,380 L / day	
Total Peak Hour Demand:	212,380 L / day	
, or	147 L / min	2.5 L/s
Maximum Day Water Demand - Domestic:	186,894 L / day	
Total Maximum Day Water Demand:	186,894 L / day	
, or	130 L / min	2.2 L/s
Retail Area	0.0 m ²	- See Sanitary Flow Calculations
Commercial & Institutional Demand:	0 L / day	
, or	0 L/min	
Maximum Day + Fire Flow:	13,130 L / min	218.8 L/s
	or	
	3,468 USGPM	

counterpoint engineering

Fire Underwriter Survey Fire Flow Calculation - 1971 St. Laurent Blvd Existing Building

Project Name: 1971 & 1975 St. Laurent Blvd.
 Project Number: 21106
 Date: January 2022

$$F = 220C\sqrt{A}$$

where

F = the required fire flow in litres per minute.
 C = coefficient related to the type of construction.
 = 1.5 for wood frame construction (structure essentially all combustible).
 = 1.0 for ordinary construction (brick or other masonry walls, combustible floor and interior).
 = 0.8 for non-combustible construction (unprotected metal structural components, masonry or metal walls).
 = 0.6 for fire-resistive construction (fully protected frame, floors, roof).

A = The total floor area in square metres (including all storeys, but excluding basements at least 50 percent below grade) in the building being considered.

Legend

Construction Class		Contents Factor	
WF	wood frame construction	NC	non-combustible
OC	ordinary construction	LC	limited combustible
NC	non-combustible construction	C	combustible
FC	fire-resistive construction	FB	free burning
		RB	rapid burning

Contents Factor: Non-Combustible -25% Free Burning +15%
 Limited Combustible -15% Rapid Burning +25%
 Combustible No Charge

Separation	Charge	Separation	Charge
0 to 3m	25%	20.1 to 30 m	10%
3.1 to 10m	20%	30.1 to 45m	5%
10.1 to 20m	15%		

1) Fire Flow

Type of Construction: NC
 C = 0.8
 A = 16416 m² - Total GFA above grade
 F = 23,000 L/min

2) Occupancy Reduction

Contents Factor: LC
 Occupancy Charge = -15%
 -15% of 23,000 L/min = -3,450 L/min
 F = 13000 L/min + 3250 L/min = 19,550 L/min

3) System Type Reduction (to be reduced from result of Step 2)

NFPA 13 Sprinkler: 30% YES
 Standard Water Supply: 10% YES
 Fully Supervised: 10% YES
 Total System Type Reduction = 50%

50% of 19,550 L/min = 9,775 L/min
 (to be reduced from result of Step 2)

4) Separation Charge (to be added to result of Step 2)

<u>Building Face</u>	<u>Distance</u>	<u>Charge</u>
North	20.1m-30.0m	10%
East	10.1m-20.0m	15%
South	>45m	0%
West	10.1m-20.0m	15%
Total		40% (max exposure charge can be 75%)

40% of **19,550 L/min** = **7,820 L/min**
(to be added to result of Step 2)

F = 18,000 L/min (round to the nearest 1,000 L/min) (2,000 L/min < F < 45,000 L/min)
F = 4,755 GPM

counterpoint engineering

Fire Underwriter Survey Fire Flow Calculation - 1975 St. Laurent Blvd Existing Building

Project Name: 1971 & 1975 St. Laurent Blvd.
 Project Number: 21106
 Date: January 2022

$$F = 220C\sqrt{A}$$

where

- F = the required fire flow in litres per minute.
- C = coefficient related to the type of construction.
 - = 1.5 for wood frame construction (structure essentially all combustible).
 - = 1.0 for ordinary construction (brick or other masonry walls, combustible floor and interior).
 - = 0.8 for non-combustible construction (unprotected metal structural components, masonry or metal walls).
 - = 0.6 for fire-resistive construction (fully protected frame, floors, roof).
- A = The total floor area in square metres (including all storeys, but excluding basements at least 50 percent below grade) in the building being considered.

Legend

Construction Class	Contents Factor
WF wood frame construction	NC non-combustible
OC ordinary construction	LC limited combustible
NC non-combustible construction	C combustible
FC fire-resistive construction	FB free burning
	RB rapid burning

Contents Factor:

Non-Combustible	-25%	Free Burning	+15%
Limited Combustible	-15%	Rapid Burning	+25%
Combustible	No Charge		

Separation	Charge	Separation	Charge
0 to 3m	25%	20.1 to 30 m	10%
3.1 to 10m	20%	30.1 to 45m	5%
10.1 to 20m	15%		

1) Fire Flow

Type of Construction: NC
 C = 0.8
 A = 16830 m² - Total GFA above grade
 F = 23,000 L/min

2) Occupancy Reduction

Contents Factor: LC
 Occupancy Charge = -15%

-15% of 23,000 L/min = -3,450 L/min
 F = 13000 L/min + 3250 L/min = 19,550 L/min

3) System Type Reduction (to be reduced from result of Step 2)

NFPA 13 Sprinkler: 30% YES
 Standard Water Supply: 10% YES
 Fully Supervised: 10% YES
Total System Type Reduction = 50%

50% of 19,550 L/min = 9,775 L/min
 (to be reduced from result of Step 2)

4) Separation Charge (to be added to result of Step 2)

<u>Building Face</u>	<u>Distance</u>	<u>Charge</u>
North	10.1m-20.0m	15%
East	>45m	0%
South	10.1m-20.0m	15%
West	20.1m-30.0m	10%
Total		40% (max exposure charge can be 75%)

40% of **19,550 L/min** = **7,820 L/min**
(to be added to result of Step 2)

F = 18,000 L/min (round to the nearest 1,000 L/min) (2,000 L/min < F < 45,000 L/min)
F = 4,755 GPM

counterpoint engineering

Fire Underwriter Survey Fire Flow Calculation - 2080 Russell Road Existing Building

Project Name: 1971 & 1975 St. Laurent Blvd.
 Project Number: 21106
 Date: January 2022

$$F = 220C\sqrt{A}$$

where

F = the required fire flow in litres per minute.
 C = coefficient related to the type of construction.
 = 1.5 for wood frame construction (structure essentially all combustible).
 = 1.0 for ordinary construction (brick or other masonry walls, combustible floor and interior).
 = 0.8 for non-combustible construction (unprotected metal structural components, masonry or metal walls).
 = 0.6 for fire-resistive construction (fully protected frame, floors, roof).

A = The total floor area in square metres (including all storeys, but excluding basements at least 50 percent below grade) in the building being considered.

Legend

Construction Class	Contents Factor
WF wood frame construction	NC non-combustible
OC ordinary construction	LC limited combustible
NC non-combustible construction	C combustible
FC fire-resistive construction	FB free burning
	RB rapid burning

Contents Factor: Non-Combustible -25% Free Burning +15%
 Limited Combustible -15% Rapid Burning +25%
 Combustible No Charge

Separation	Charge	Separation	Charge
0 to 3m	25%	20.1 to 30 m	10%
3.1 to 10m	20%	30.1 to 45m	5%
10.1 to 20m	15%		

1) Fire Flow

Type of Construction: NC
 C = 0.8
 A = 10037 m² - Total GFA above grade
 F = 18,000 L/min

2) Occupancy Reduction

Contents Factor: LC
 Occupancy Charge = -15%
 -15% of 18,000 L/min = -2,700 L/min
 F = 13000 L/min + 3250 L/min = 15,300 L/min

3) System Type Reduction (to be reduced from result of Step 2)

NFPA 13 Sprinkler: 30% YES
 Standard Water Supply: 10% YES
 Fully Supervised: 10% YES
 Total System Type Reduction = 50%

50% of 15,300 L/min = 7,650 L/min
 (to be reduced from result of Step 2)

4) Separation Charge (to be added to result of Step 2)

<u>Building Face</u>	<u>Distance</u>	<u>Charge</u>
North	>45m	0%
East	>45m	0%
South	10.1m-20.0m	15%
West	10.1m-20.0m	15%
Total		30% (max exposure charge can be 75%)

30% of **15,300 L/min** = **4,590 L/min**
(to be added to result of Step 2)

F = 13,000 L/min (round to the nearest 1,000 L/min) (2,000 L/min < F < 45,000 L/min)
F = 3,434 GPM

counterpoint engineering

Fire Underwriter Survey Fire Flow Calculation - 2100 Russell Road Existing Building

Project Name: 1971 & 1975 St. Laurent Blvd.
 Project Number: 21106
 Date: January 2022

$$F = 220C\sqrt{A}$$

where

- F = the required fire flow in litres per minute.
- C = coefficient related to the type of construction.
 - = 1.5 for wood frame construction (structure essentially all combustible).
 - = 1.0 for ordinary construction (brick or other masonry walls, combustible floor and interior).
 - = 0.8 for non-combustible construction (unprotected metal structural components, masonry or metal walls).
 - = 0.6 for fire-resistive construction (fully protected frame, floors, roof).
- A = The total floor area in square metres (including all storeys, but excluding basements at least 50 percent below grade) in the building being considered.

Legend

Construction Class	Contents Factor
WF wood frame construction	NC non-combustible
OC ordinary construction	LC limited combustible
NC non-combustible construction	C combustible
FC fire-resistive construction	FB free burning
	RB rapid burning

Contents Factor:	Non-Combustible	-25%	Free Burning	+15%
	Limited Combustible	-15%	Rapid Burning	+25%
	Combustible	No Charge		

Separation	Charge	Separation	Charge
0 to 3m	25%	20.1 to 30 m	10%
3.1 to 10m	20%	30.1 to 45m	5%
10.1 to 20m	15%		

1) Fire Flow

Type of Construction: NC
 C = 0.8
 A = 14650 m² - Total GFA above grade
 F = 22,000 L/min

2) Occupancy Reduction

Contents Factor: LC
 Occupancy Charge = -15%
 -15% of 22,000 L/min = -3,300 L/min
 F = 13000 L/min + 3250 L/min = 18,700 L/min

3) System Type Reduction (to be reduced from result of Step 2)

NFPA 13 Sprinkler: 30% YES
 Standard Water Supply: 10% YES
 Fully Supervised: 10% YES
 Total System Type Reduction = 50%

50% of 18,700 L/min = 9,350 L/min
 (to be reduced from result of Step 2)

4) Separation Charge (to be added to result of Step 2)

<u>Building Face</u>	<u>Distance</u>	<u>Charge</u>
North	>45m	0%
East	>45m	0%
South	20.1m-30.0m	10%
West	10.1m-20.0m	15%
Total		25% (max exposure charge can be 75%)

25% of **18,700 L/min** = **4,675 L/min**
(to be added to result of Step 2)

F = 15,000 L/min (round to the nearest 1,000 L/min) (2,000 L/min < F < 45,000 L/min)
F = 3,963 GPM

counterpoint engineering

Fire Underwriter Survey Fire Flow Calculation - Proposed Building A

Project Name: 1971 & 1975 St. Laurent Blvd.
 Project Number: 21106
 Date: January 2022

$$F = 220C\sqrt{A}$$

where

F = the required fire flow in litres per minute.
 C = coefficient related to the type of construction.
 = 1.5 for wood frame construction (structure essentially all combustible).
 = 1.0 for ordinary construction (brick or other masonry walls, combustible floor and interior).
 = 0.8 for non-combustible construction (unprotected metal structural components, masonry or metal walls).
 = 0.6 for fire-resistive construction (fully protected frame, floors, roof).

A = The total floor area in square metres (including all storeys, but excluding basements at least 50 percent below grade) in the building being considered.

Legend

Construction Class		Contents Factor	
WF	wood frame construction	NC	non-combustible
OC	ordinary construction	LC	limited combustible
NC	non-combustible construction	C	combustible
FC	fire-resistive construction	FB	free burning
		RB	rapid burning

Contents Factor: Non-Combustible -25% Free Burning +15%
 Limited Combustible -15% Rapid Burning +25%
 Combustible No Charge

Separation	Charge	Separation	Charge
0 to 3m	25%	20.1 to 30 m	10%
3.1 to 10m	20%	30.1 to 45m	5%
10.1 to 20m	15%		

1) Fire Flow

Type of Construction: NC
 C = 0.8
 A = 15330 m² - Total GFA above grade
 F = 22,000 L/min

2) Occupancy Reduction

Contents Factor: LC
 Occupancy Charge = -15%
 -15% of 22,000 L/min = -3,300 L/min
 F = 13000 L/min + 3250 L/min = 18,700 L/min

3) System Type Reduction (to be reduced from result of Step 2)

NFPA 13 Sprinkler: 30% YES
 Standard Water Supply: 10% YES
 Fully Supervised: 10% YES
 Total System Type Reduction = 50%

50% of 18,700 L/min = 9,350 L/min
 (to be reduced from result of Step 2)

4) Separation Charge (to be added to result of Step 2)

<u>Building Face</u>	<u>Distance</u>	<u>Charge</u>
North	>45m	0%
East	>45m	0%
South	30.1m-45.0m	5%
West	30.1m-45.0m	5%
Total		10% (max exposure charge can be 75%)

10% of **18,700 L/min** = **1,870 L/min**
(to be added to result of Step 2)

F = 12,000 L/min (round to the nearest 1,000 L/min) (2,000 L/min < F < 45,000 L/min)
F = 3,170 GPM

counterpoint engineering

Fire Underwriter Survey Fire Flow Calculation - Proposed Building B

Project Name: 1971 & 1975 St. Laurent Blvd.
 Project Number: 21106
 Date: January 2022

$$F = 220C\sqrt{A}$$

where

- F = the required fire flow in litres per minute.
- C = coefficient related to the type of construction.
 - = 1.5 for wood frame construction (structure essentially all combustible).
 - = 1.0 for ordinary construction (brick or other masonry walls, combustible floor and interior).
 - = 0.8 for non-combustible construction (unprotected metal structural components, masonry or metal walls).
 - = 0.6 for fire-resistive construction (fully protected frame, floors, roof).
- A = The total floor area in square metres (including all storeys, but excluding basements at least 50 percent below grade) in the building being considered.

Legend

Construction Class	Contents Factor
WF wood frame construction	NC non-combustible
OC ordinary construction	LC limited combustible
NC non-combustible construction	C combustible
FC fire-resistive construction	FB free burning
	RB rapid burning

Contents Factor:	Non-Combustible	-25%	Free Burning	+15%
	Limited Combustible	-15%	Rapid Burning	+25%
	Combustible	No Charge		

Separation	Charge	Separation	Charge
0 to 3m	25%	20.1 to 30 m	10%
3.1 to 10m	20%	30.1 to 45m	5%
10.1 to 20m	15%		

1) Fire Flow

Type of Construction: NC
 C = 0.8
 A = 15525 m² - Total GFA above grade
 F = 22,000 L/min

2) Occupancy Reduction

Contents Factor: LC
 Occupancy Charge = -15%

-15% of 22,000 L/min = -3,300 L/min
 F = 13000 L/min + 3250 L/min = 18,700 L/min

3) System Type Reduction (to be reduced from result of Step 2)

NFPA 13 Sprinkler: 30% YES
 Standard Water Supply: 10% YES
 Fully Supervised: 10% YES
Total System Type Reduction = 50%

50% of 18,700 L/min = 9,350 L/min
 (to be reduced from result of Step 2)

4) Separation Charge (to be added to result of Step 2)

<u>Building Face</u>	<u>Distance</u>	<u>Charge</u>
North	>45m	0%
East	20.1m-30.0m	10%
South	20.1m-30.0m	10%
West	>45m	0%
Total		20% (max exposure charge can be 75%)

20% of **18,700 L/min** = **3,740 L/min**
(to be added to result of Step 2)

F = 14,000 L/min (round to the nearest 1,000 L/min) (2,000 L/min < F < 45,000 L/min)
F = 3,698 GPM

counterpoint engineering

Fire Underwriter Survey Fire Flow Calculation - Proposed Building C

Project Name: 1971 & 1975 St. Laurent Blvd.
 Project Number: 21106
 Date: January 2022

$$F = 220C\sqrt{A}$$

where

- F = the required fire flow in litres per minute.
- C = coefficient related to the type of construction.
 - = 1.5 for wood frame construction (structure essentially all combustible).
 - = 1.0 for ordinary construction (brick or other masonry walls, combustible floor and interior).
 - = 0.8 for non-combustible construction (unprotected metal structural components, masonry or metal walls).
 - = 0.6 for fire-resistive construction (fully protected frame, floors, roof).
- A = The total floor area in square metres (including all storeys, but excluding basements at least 50 percent below grade) in the building being considered.

Legend

Construction Class	Contents Factor
WF wood frame construction	NC non-combustible
OC ordinary construction	LC limited combustible
NC non-combustible construction	C combustible
FC fire-resistive construction	FB free burning
	RB rapid burning

Contents Factor:	Non-Combustible	-25%	Free Burning	+15%
	Limited Combustible	-15%	Rapid Burning	+25%
	Combustible	No Charge		

Separation	Charge	Separation	Charge
0 to 3m	25%	20.1 to 30 m	10%
3.1 to 10m	20%	30.1 to 45m	5%
10.1 to 20m	15%		

1) Fire Flow

Type of Construction: NC
 C = 0.8
 A = 15525 m² - Total GFA above grade
 F = 22,000 L/min

2) Occupancy Reduction

Contents Factor: LC
 Occupancy Charge = -15%
 -15% of 22,000 L/min = -3,300 L/min
 F = 13000 L/min + 3250 L/min = 18,700 L/min

3) System Type Reduction (to be reduced from result of Step 2)

NFPA 13 Sprinkler: 30% YES
 Standard Water Supply: 10% YES
 Fully Supervised: 10% YES
 Total System Type Reduction = 50%

50% of 18,700 L/min = 9,350 L/min
 (to be reduced from result of Step 2)

4) Separation Charge (to be added to result of Step 2)

<u>Building Face</u>	<u>Distance</u>	<u>Charge</u>
North	30.1m-45.0m	5%
East	20.1m-30.0m	10%
South	>45.0m	0%
West	>45.0m	0%
Total		15% (max exposure charge can be 75%)

15% of **18,700 L/min** = **2,805 L/min**
(to be added to result of Step 2)

F = 13,000 L/min (round to the nearest 1,000 L/min) (2,000 L/min < F < 45,000 L/min)
F = 3,434 GPM

counterpoint engineering

Fire Underwriter Survey Fire Flow Calculation - Proposed Building D (Parkade)

Project Name: 1971 & 1975 St. Laurent Blvd.
 Project Number: 21106
 Date: January 2022

$$F = 220C\sqrt{A}$$

where

- F = the required fire flow in litres per minute.
- C = coefficient related to the type of construction.
 - = 1.5 for wood frame construction (structure essentially all combustible).
 - = 1.0 for ordinary construction (brick or other masonry walls, combustible floor and interior).
 - = 0.8 for non-combustible construction (unprotected metal structural components, masonry or metal walls).
 - = 0.6 for fire-resistive construction (fully protected frame, floors, roof).
- A = The total floor area in square metres (including all storeys, but excluding basements at least 50 percent below grade) in the building being considered.

Legend

Construction Class		Contents Factor	
WF	wood frame construction	NC	non-combustible
OC	ordinary construction	LC	limited combustible
NC	non-combustible construction	C	combustible
FC	fire-resistive construction	FB	free burning
		RB	rapid burning

Contents Factor:	Non-Combustible	-25%	Free Burning	+15%
	Limited Combustible	-15%	Rapid Burning	+25%
	Combustible	No Charge		

Separation	Charge	Separation	Charge
0 to 3m	25%	20.1 to 30 m	10%
3.1 to 10m	20%	30.1 to 45m	5%
10.1 to 20m	15%		

1) Fire Flow

Type of Construction: NC
 C = 0.8
 A = 517 m² - Total GFA of elevator lobby, stairwells & mechanical rooms
 F = 4,000 L/min

2) Occupancy Reduction

Contents Factor: LC
 Occupancy Charge = -15%
 -15% of 4,000 L/min = -600 L/min
 F = 13000 L/min + 3250 L/min = 3,400 L/min

3) System Type Reduction (to be reduced from result of Step 2)

NFPA 13 Sprinkler: 30% YES
 Standard Water Supply: 10% YES
 Fully Supervised: 10% YES
 Total System Type Reduction = 50%

50% of 3,400 L/min = 1,700 L/min
 (to be reduced from result of Step 2)

4) Separation Charge (to be added to result of Step 2)

<u>Building Face</u>	<u>Distance</u>	<u>Charge</u>
North	30.1m-45.0m	5%
East	20.1m-30.0m	10%
South	>45.0m	0%
West	>45.0m	0%
Total		15% (max exposure charge can be 75%)

15% of **3,400 L/min** = **510 L/min**
(to be added to result of Step 2)

F = 3,000 L/min (round to the nearest 1,000 L/min) (2,000 L/min < F < 45,000 L/min)
F = 793 GPM

Boundary Conditions for 1971, 1975 St-Laurent Boulevard



Connection 3

Connection 2

Connection 4

Connection 1

Legend

- PRIVATE
- PUBLIC

Gian-Michael Di Luca

From: Bramah, Bruce <bruce.bramah@ottawa.ca>
Sent: February 14, 2022 10:36 AM
To: Gian-Michael Di Luca
Cc: David Di Iorio; 21106_ Starlight Dev't_ 1971 & 1975 St. Laurent Blvd
Subject: RE: 1971, 1975 St Laurent, TEAMS link, sorry!
Attachments: 1971, 1975 St. Laurent Blvd January 2022.pdf

Good morning Gian-Michael,

The following are boundary conditions, HGL, for hydraulic analysis at 1971, 1975 St-Laurent Boulevard (zone 2W2C) assumed to be connected to the 305 mm watermain on St-Laurent Boulevard (see attached PDF for location).

	Connection 1 Building A	Connection 2 Building A	Connection 3 Building B	Connection 4 Building C
Minimum HGL (m)	123.3	123.3	123.3	123.3
Maximum HGL (m)	130.0	130.0	130.0	130.0

Max Day + Fire Flow (300 L/s): 114.1 m and 113.1 m (Connections 1 and 2, Building A)

Max Day + Fire Flow (233 L/s): 117.5 m (Connection 3, Building B)

Max Day + Fire Flow (217 L/s): 119.0 m (Connection 4, Building C)

These are for current conditions and are based on computer model simulation.

Disclaimer: The boundary condition information is based on current operation of the city water distribution system. The computer model simulation is based on the best information available at the time. The operation of the water distribution system can change on a regular basis, resulting in a variation in boundary conditions. The physical properties of watermains deteriorate over time, as such must be assumed in the absence of actual field test data. The variation in physical watermain properties can therefore alter the results of the computer model simulation.

Regards,

Bruce Bramah, EIT
Project Manager



Planning, Real Estate and
Economic Development

Development Review South

110 Laurier Avenue
Ottawa, ON K1P 1J1
Bruce.Bramah@ottawa.ca
Tel: (613) 580-2424 ext. 29686



EPANET Model Network Layout

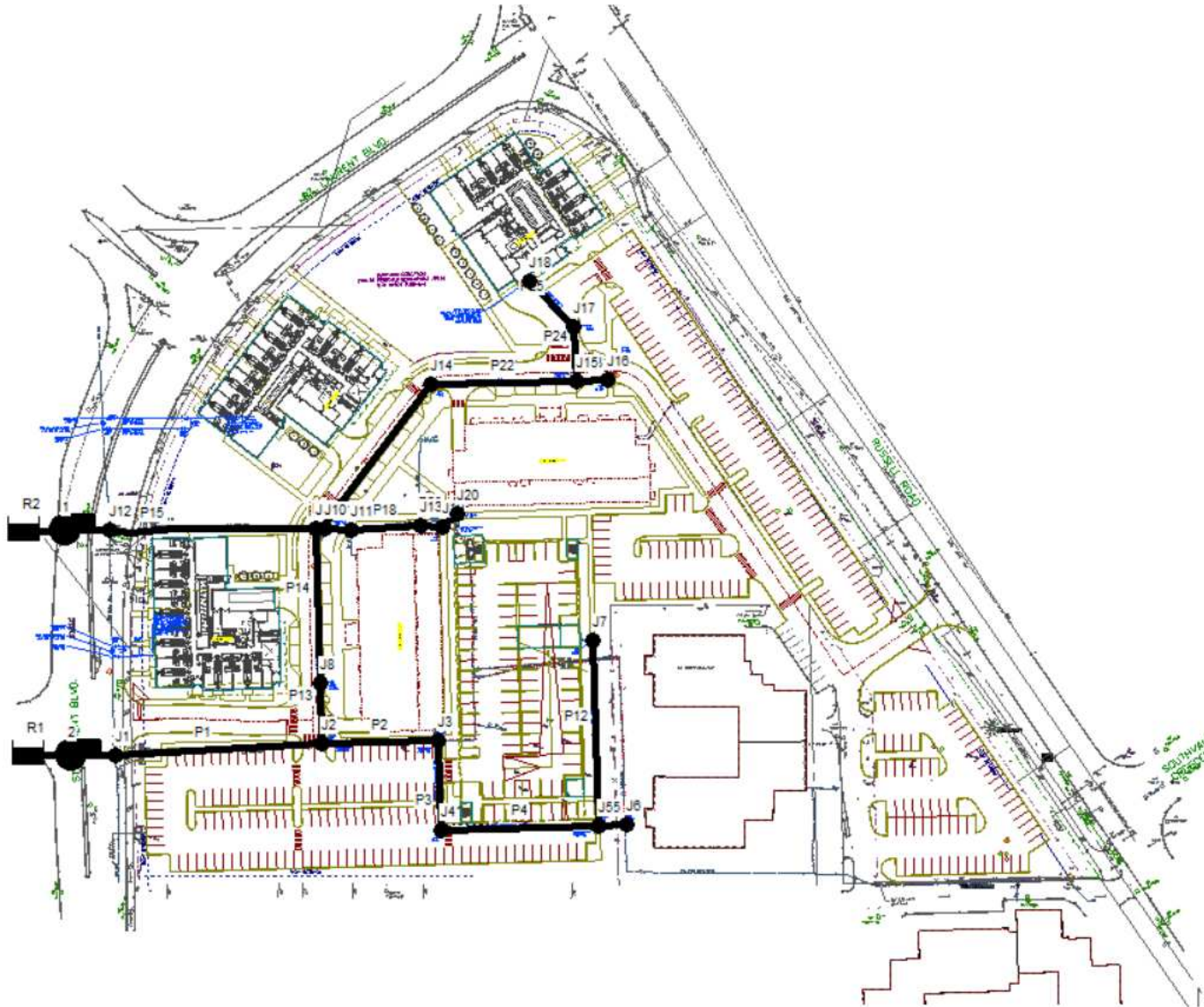



Residual Pressure during Non-Fire Scenarios

Scenario	Lowest Pressure			Satisfies Pressure Requirements?
	Pressure	Pressure	Pressure	
	(m H2O)	(psi)	(kPa)	
Avg. Day	50.65	72.02	496.6	Yes
Peak Hour	50.43	71.71	494.4	Yes

Scenario	Highest Pressure			Satisfies Pressure Requirements?
	Pressure	Pressure	Pressure	
	(m H2O)	(psi)	(kPa)	
Avg. Day	54.34	77.27	532.8	Yes
Peak Hour	54.14	76.99	530.8	Yes

Notes:

1. Preferred design pressure during normal operating conditions is approximately 345 kPa to 552 kPa
2. The maximum static pressure shall not exceed 552 kPa
3. The minimum pressure under any non-fire demand scenario should not be less than 275 kPa
4. In cases where all services are protected by an individual pressure reducing device, the maximum pressure in the watermain system will not exceed 689 kilopascals.

Residual Pressure based on Maximum Day Demand + Fire Flow

Fire Flow at Critical Building / Node	Max. Velocity (m/s)	Lowest Pressure			Satisfies Pressure & Velocity Requirements?
		Pressure	Pressure	Pressure	
		(m H2O)	(psi)	(kPa)	
<i>Ex. 1971 St. Laurent Blvd / J8</i>	5.00	33.96	48.29	332.9	Yes
<i>Ex. 1975 St. Laurent Blvd / J13</i>	9.69	19.95	28.37	195.6	Yes
<i>Ex. 2080 Russell Road / J6</i>	7.05	28.16	40.04	276.1	Yes
<i>Ex. 2100 Russell Road / J6</i>	8.11	22.36	31.80	219.2	Yes
Prop. Building A / J18	3.77	37.56	53.41	368.2	Yes
Prop. Building D / J7	2.83	41.92	59.61	411.0	Yes

Notes:

1. Fire flow requirements satisfied if lowest pressure in is system > 140 kPa (20 psi)



Average Day Demand Conditions

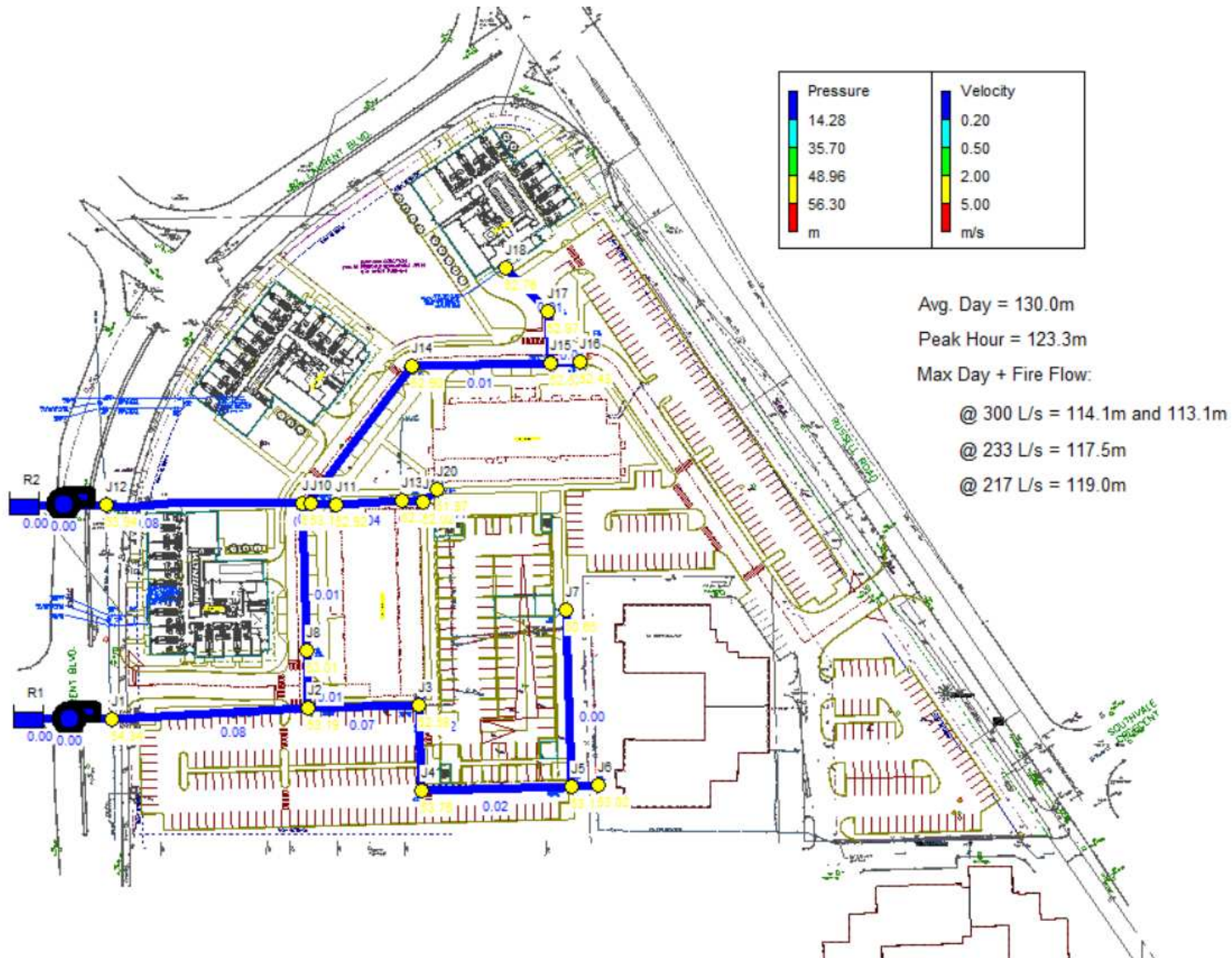



```

*****
*                               E P A N E T                               *
*                               Hydraulic and Water Quality                 *
*                               Analysis for Pipe Networks                   *
*                               Version 2.2                                 *
*****

```

Input

Link

```

-----
Link
ID
-----

```

- P1
- P2
- P3
- P4
- P5
- P12
- P13
- P14
- P15
- P16
- P17
- P18
- P19
- P20
- P21
- P22
- P23
- P24
- P25
- 1
- 2

Energy

Pump

- ```

1
2

```



Page 2

Node Results at 0:00 Hrs:

| Node ID | Demand LPS | Head m | Pressure m | Quality |           |
|---------|------------|--------|------------|---------|-----------|
| J1      | 0.00       | 129.87 | 54.34      | 0.00    |           |
| J2      | 0.00       | 129.86 | 53.19      | 0.00    |           |
| J3      | 0.67       | 129.86 | 52.58      | 0.00    |           |
| J4      | 0.00       | 129.86 | 53.76      | 0.00    |           |
| J5      | 0.00       | 129.86 | 53.17      | 0.00    |           |
| J6      | 1.53       | 129.86 | 53.02      | 0.00    |           |
| J7      | 0.00       | 129.86 | 50.65      | 0.00    |           |
| J8      | 0.00       | 129.86 | 53.01      | 0.00    |           |
| J9      | 0.00       | 129.86 | 53.09      | 0.00    |           |
| J10     | 0.00       | 129.86 | 53.17      | 0.00    |           |
| J11     | 0.67       | 129.86 | 52.92      | 0.00    |           |
| J12     | 0.00       | 129.87 | 53.94      | 0.00    |           |
| J13     | 0.00       | 129.86 | 52.23      | 0.00    |           |
| J14     | 0.00       | 129.86 | 52.90      | 0.00    |           |
| J15     | 0.00       | 129.86 | 52.52      | 0.00    |           |
| J16     | 0.00       | 129.86 | 52.43      | 0.00    |           |
| J17     | 0.00       | 129.86 | 52.97      | 0.00    |           |
| J18     | 0.96       | 129.86 | 52.76      | 0.00    |           |
| J19     | 0.00       | 129.86 | 52.02      | 0.00    |           |
| J20     | 1.33       | 129.86 | 51.97      | 0.00    |           |
| R1      | -2.58      | 0.00   | 0.00       | 0.00    | Reservoir |
| R2      | -2.58      | 0.00   | 0.00       | 0.00    | Reservoir |

Link Results at 0:00 Hrs:

| Link ID | Flow LPS | Velocity m/s | Unit Headloss m/km | Status |
|---------|----------|--------------|--------------------|--------|
| P1      | 2.58     | 0.08         | 0.07               | Open   |
| P2      | 2.20     | 0.07         | 0.05               | Open   |
| P3      | 1.53     | 0.02         | 0.00               | Open   |
| P4      | 1.53     | 0.02         | 0.00               | Open   |
| P5      | 1.53     | 0.02         | 0.00               | Open   |
| P12     | 0.00     | 0.00         | 0.00               | Open   |
| P13     | 0.38     | 0.01         | 0.00               | Open   |
| P14     | 0.38     | 0.01         | 0.00               | Open   |
| P15     | -2.58    | 0.08         | 0.07               | Open   |
| P16     | 2.96     | 0.09         | 0.09               | Open   |
| P17     | 2.00     | 0.06         | 0.05               | Open   |
| P18     | 1.33     | 0.04         | 0.02               | Open   |
| P19     | 1.33     | 0.04         | 0.02               | Open   |
| P20     | 1.33     | 0.04         | 0.02               | Open   |



|     |      |      |      |      |
|-----|------|------|------|------|
| P21 | 0.96 | 0.01 | 0.00 | Open |
| P22 | 0.96 | 0.01 | 0.00 | Open |
| P23 | 0.00 | 0.00 | 0.00 | Open |
| P24 | 0.96 | 0.01 | 0.00 | Open |
| P25 | 0.96 | 0.01 | 0.00 | Open |



Page 3

Link Results at 0:00 Hrs: (continued)

| Link ID | Flow LPS | Velocity m/s | Unit Headloss m/km | Status    |
|---------|----------|--------------|--------------------|-----------|
| 1       | 2.58     | 0.00         | -129.87            | Open Pump |
| 2       | 2.58     | 0.00         | -129.87            | Open Pump |

Node Results at 1:00 Hrs:

| Node ID | Demand LPS | Head m | Pressure m | Quality        |
|---------|------------|--------|------------|----------------|
| J1      | 0.00       | 129.87 | 54.34      | 0.00           |
| J2      | 0.00       | 129.86 | 53.19      | 0.00           |
| J3      | 0.67       | 129.86 | 52.58      | 0.00           |
| J4      | 0.00       | 129.86 | 53.76      | 0.00           |
| J5      | 0.00       | 129.86 | 53.17      | 0.00           |
| J6      | 1.53       | 129.86 | 53.02      | 0.00           |
| J7      | 0.00       | 129.86 | 50.65      | 0.00           |
| J8      | 0.00       | 129.86 | 53.01      | 0.00           |
| J9      | 0.00       | 129.86 | 53.09      | 0.00           |
| J10     | 0.00       | 129.86 | 53.17      | 0.00           |
| J11     | 0.67       | 129.86 | 52.92      | 0.00           |
| J12     | 0.00       | 129.87 | 53.94      | 0.00           |
| J13     | 0.00       | 129.86 | 52.23      | 0.00           |
| J14     | 0.00       | 129.86 | 52.90      | 0.00           |
| J15     | 0.00       | 129.86 | 52.52      | 0.00           |
| J16     | 0.00       | 129.86 | 52.43      | 0.00           |
| J17     | 0.00       | 129.86 | 52.97      | 0.00           |
| J18     | 0.96       | 129.86 | 52.76      | 0.00           |
| J19     | 0.00       | 129.86 | 52.02      | 0.00           |
| J20     | 1.33       | 129.86 | 51.97      | 0.00           |
| R1      | -2.58      | 0.00   | 0.00       | 0.00 Reservoir |
| R2      | -2.58      | 0.00   | 0.00       | 0.00 Reservoir |

Link Results at 1:00 Hrs:

| Link ID | Flow LPS | Velocity m/s | Unit Headloss m/km | Status |
|---------|----------|--------------|--------------------|--------|
| P1      | 2.58     | 0.08         | 0.07               | Open   |



|     |       |      |      |      |
|-----|-------|------|------|------|
| P2  | 2.20  | 0.07 | 0.05 | Open |
| P3  | 1.53  | 0.02 | 0.00 | Open |
| P4  | 1.53  | 0.02 | 0.00 | Open |
| P5  | 1.53  | 0.02 | 0.00 | Open |
| P12 | 0.00  | 0.00 | 0.00 | Open |
| P13 | 0.38  | 0.01 | 0.00 | Open |
| P14 | 0.38  | 0.01 | 0.00 | Open |
| P15 | -2.58 | 0.08 | 0.07 | Open |
| P16 | 2.96  | 0.09 | 0.09 | Open |
| P17 | 2.00  | 0.06 | 0.05 | Open |



Page 4

Link Results at 1:00 Hrs: (continued)

| Link ID | Flow LPS | Velocity m/s | Unit Headloss m/km | Status    |
|---------|----------|--------------|--------------------|-----------|
| P18     | 1.33     | 0.04         | 0.02               | Open      |
| P19     | 1.33     | 0.04         | 0.02               | Open      |
| P20     | 1.33     | 0.04         | 0.02               | Open      |
| P21     | 0.96     | 0.01         | 0.00               | Open      |
| P22     | 0.96     | 0.01         | 0.00               | Open      |
| P23     | 0.00     | 0.00         | 0.00               | Open      |
| P24     | 0.96     | 0.01         | 0.00               | Open      |
| P25     | 0.96     | 0.01         | 0.00               | Open      |
| 1       | 2.58     | 0.00         | -129.87            | Open Pump |
| 2       | 2.58     | 0.00         | -129.87            | Open Pump |

Node Results at 2:00 Hrs:

| Node ID | Demand LPS | Head m | Pressure m | Quality |
|---------|------------|--------|------------|---------|
| J1      | 0.00       | 129.87 | 54.34      | 0.00    |
| J2      | 0.00       | 129.86 | 53.19      | 0.00    |
| J3      | 0.67       | 129.86 | 52.58      | 0.00    |
| J4      | 0.00       | 129.86 | 53.76      | 0.00    |
| J5      | 0.00       | 129.86 | 53.17      | 0.00    |
| J6      | 1.53       | 129.86 | 53.02      | 0.00    |
| J7      | 0.00       | 129.86 | 50.65      | 0.00    |
| J8      | 0.00       | 129.86 | 53.01      | 0.00    |
| J9      | 0.00       | 129.86 | 53.09      | 0.00    |
| J10     | 0.00       | 129.86 | 53.17      | 0.00    |
| J11     | 0.67       | 129.86 | 52.92      | 0.00    |
| J12     | 0.00       | 129.87 | 53.94      | 0.00    |
| J13     | 0.00       | 129.86 | 52.23      | 0.00    |
| J14     | 0.00       | 129.86 | 52.90      | 0.00    |
| J15     | 0.00       | 129.86 | 52.52      | 0.00    |
| J16     | 0.00       | 129.86 | 52.43      | 0.00    |





|     |       |        |       |      |           |
|-----|-------|--------|-------|------|-----------|
| J17 | 0.00  | 129.86 | 52.97 | 0.00 |           |
| J18 | 0.96  | 129.86 | 52.76 | 0.00 |           |
| J19 | 0.00  | 129.86 | 52.02 | 0.00 |           |
| J20 | 1.33  | 129.86 | 51.97 | 0.00 |           |
| R1  | -2.58 | 0.00   | 0.00  | 0.00 | Reservoir |
| R2  | -2.58 | 0.00   | 0.00  | 0.00 | Reservoir |



Page 5

Link Results at 2:00 Hrs:

| Link ID | Flow LPS | Velocity m/s | Unit Headloss m/km | Status    |
|---------|----------|--------------|--------------------|-----------|
| P1      | 2.58     | 0.08         | 0.07               | Open      |
| P2      | 2.20     | 0.07         | 0.05               | Open      |
| P3      | 1.53     | 0.02         | 0.00               | Open      |
| P4      | 1.53     | 0.02         | 0.00               | Open      |
| P5      | 1.53     | 0.02         | 0.00               | Open      |
| P12     | 0.00     | 0.00         | 0.00               | Open      |
| P13     | 0.38     | 0.01         | 0.00               | Open      |
| P14     | 0.38     | 0.01         | 0.00               | Open      |
| P15     | -2.58    | 0.08         | 0.07               | Open      |
| P16     | 2.96     | 0.09         | 0.09               | Open      |
| P17     | 2.00     | 0.06         | 0.05               | Open      |
| P18     | 1.33     | 0.04         | 0.02               | Open      |
| P19     | 1.33     | 0.04         | 0.02               | Open      |
| P20     | 1.33     | 0.04         | 0.02               | Open      |
| P21     | 0.96     | 0.01         | 0.00               | Open      |
| P22     | 0.96     | 0.01         | 0.00               | Open      |
| P23     | 0.00     | 0.00         | 0.00               | Open      |
| P24     | 0.96     | 0.01         | 0.00               | Open      |
| P25     | 0.96     | 0.01         | 0.00               | Open      |
| 1       | 2.58     | 0.00         | -129.87            | Open Pump |
| 2       | 2.58     | 0.00         | -129.87            | Open Pump |

Node Results at 3:00 Hrs:

| Node ID | Demand LPS | Head m | Pressure m | Quality |
|---------|------------|--------|------------|---------|
| J1      | 0.00       | 129.87 | 54.34      | 0.00    |
| J2      | 0.00       | 129.86 | 53.19      | 0.00    |
| J3      | 0.67       | 129.86 | 52.58      | 0.00    |
| J4      | 0.00       | 129.86 | 53.76      | 0.00    |
| J5      | 0.00       | 129.86 | 53.17      | 0.00    |
| J6      | 1.53       | 129.86 | 53.02      | 0.00    |
| J7      | 0.00       | 129.86 | 50.65      | 0.00    |
| J8      | 0.00       | 129.86 | 53.01      | 0.00    |



|     |      |        |       |      |
|-----|------|--------|-------|------|
| J9  | 0.00 | 129.86 | 53.09 | 0.00 |
| J10 | 0.00 | 129.86 | 53.17 | 0.00 |
| J11 | 0.67 | 129.86 | 52.92 | 0.00 |
| J12 | 0.00 | 129.87 | 53.94 | 0.00 |
| J13 | 0.00 | 129.86 | 52.23 | 0.00 |
| J14 | 0.00 | 129.86 | 52.90 | 0.00 |
| J15 | 0.00 | 129.86 | 52.52 | 0.00 |
| J16 | 0.00 | 129.86 | 52.43 | 0.00 |
| J17 | 0.00 | 129.86 | 52.97 | 0.00 |
| J18 | 0.96 | 129.86 | 52.76 | 0.00 |
| J19 | 0.00 | 129.86 | 52.02 | 0.00 |
| J20 | 1.33 | 129.86 | 51.97 | 0.00 |



Page 6

Node Results at 3:00 Hrs: (continued)

| Node ID | Demand LPS | Head m | Pressure m | Quality        |
|---------|------------|--------|------------|----------------|
| R1      | -2.58      | 0.00   | 0.00       | 0.00 Reservoir |
| R2      | -2.58      | 0.00   | 0.00       | 0.00 Reservoir |

Link Results at 3:00 Hrs:

| Link ID | Flow LPS | Velocity m/s | Unit Headloss m/km | Status    |
|---------|----------|--------------|--------------------|-----------|
| P1      | 2.58     | 0.08         | 0.07               | Open      |
| P2      | 2.20     | 0.07         | 0.05               | Open      |
| P3      | 1.53     | 0.02         | 0.00               | Open      |
| P4      | 1.53     | 0.02         | 0.00               | Open      |
| P5      | 1.53     | 0.02         | 0.00               | Open      |
| P12     | 0.00     | 0.00         | 0.00               | Open      |
| P13     | 0.38     | 0.01         | 0.00               | Open      |
| P14     | 0.38     | 0.01         | 0.00               | Open      |
| P15     | -2.58    | 0.08         | 0.07               | Open      |
| P16     | 2.96     | 0.09         | 0.09               | Open      |
| P17     | 2.00     | 0.06         | 0.05               | Open      |
| P18     | 1.33     | 0.04         | 0.02               | Open      |
| P19     | 1.33     | 0.04         | 0.02               | Open      |
| P20     | 1.33     | 0.04         | 0.02               | Open      |
| P21     | 0.96     | 0.01         | 0.00               | Open      |
| P22     | 0.96     | 0.01         | 0.00               | Open      |
| P23     | 0.00     | 0.00         | 0.00               | Open      |
| P24     | 0.96     | 0.01         | 0.00               | Open      |
| P25     | 0.96     | 0.01         | 0.00               | Open      |
| 1       | 2.58     | 0.00         | -129.87            | Open Pump |
| 2       | 2.58     | 0.00         | -129.87            | Open Pump |



## Node Results at 4:00 Hrs:

| Node ID | Demand LPS | Head m | Pressure m | Quality |
|---------|------------|--------|------------|---------|
| J1      | 0.00       | 129.87 | 54.34      | 0.00    |
| J2      | 0.00       | 129.86 | 53.19      | 0.00    |
| J3      | 0.67       | 129.86 | 52.58      | 0.00    |
| J4      | 0.00       | 129.86 | 53.76      | 0.00    |
| J5      | 0.00       | 129.86 | 53.17      | 0.00    |
| J6      | 1.53       | 129.86 | 53.02      | 0.00    |
| J7      | 0.00       | 129.86 | 50.65      | 0.00    |
| J8      | 0.00       | 129.86 | 53.01      | 0.00    |
| J9      | 0.00       | 129.86 | 53.09      | 0.00    |
| J10     | 0.00       | 129.86 | 53.17      | 0.00    |
| J11     | 0.67       | 129.86 | 52.92      | 0.00    |
| J12     | 0.00       | 129.87 | 53.94      | 0.00    |



Page 7

## Node Results at 4:00 Hrs: (continued)

| Node ID | Demand LPS | Head m | Pressure m | Quality        |
|---------|------------|--------|------------|----------------|
| J13     | 0.00       | 129.86 | 52.23      | 0.00           |
| J14     | 0.00       | 129.86 | 52.90      | 0.00           |
| J15     | 0.00       | 129.86 | 52.52      | 0.00           |
| J16     | 0.00       | 129.86 | 52.43      | 0.00           |
| J17     | 0.00       | 129.86 | 52.97      | 0.00           |
| J18     | 0.96       | 129.86 | 52.76      | 0.00           |
| J19     | 0.00       | 129.86 | 52.02      | 0.00           |
| J20     | 1.33       | 129.86 | 51.97      | 0.00           |
| R1      | -2.58      | 0.00   | 0.00       | 0.00 Reservoir |
| R2      | -2.58      | 0.00   | 0.00       | 0.00 Reservoir |

## Link Results at 4:00 Hrs:

| Link ID | Flow LPS | Velocity m/s | Unit Headloss m/km | Status |
|---------|----------|--------------|--------------------|--------|
| P1      | 2.58     | 0.08         | 0.07               | Open   |
| P2      | 2.20     | 0.07         | 0.05               | Open   |
| P3      | 1.53     | 0.02         | 0.00               | Open   |
| P4      | 1.53     | 0.02         | 0.00               | Open   |
| P5      | 1.53     | 0.02         | 0.00               | Open   |
| P12     | 0.00     | 0.00         | 0.00               | Open   |
| P13     | 0.38     | 0.01         | 0.00               | Open   |
| P14     | 0.38     | 0.01         | 0.00               | Open   |
| P15     | -2.58    | 0.08         | 0.07               | Open   |



|     |      |      |         |           |
|-----|------|------|---------|-----------|
| P16 | 2.96 | 0.09 | 0.09    | Open      |
| P17 | 2.00 | 0.06 | 0.05    | Open      |
| P18 | 1.33 | 0.04 | 0.02    | Open      |
| P19 | 1.33 | 0.04 | 0.02    | Open      |
| P20 | 1.33 | 0.04 | 0.02    | Open      |
| P21 | 0.96 | 0.01 | 0.00    | Open      |
| P22 | 0.96 | 0.01 | 0.00    | Open      |
| P23 | 0.00 | 0.00 | 0.00    | Open      |
| P24 | 0.96 | 0.01 | 0.00    | Open      |
| P25 | 0.96 | 0.01 | 0.00    | Open      |
| 1   | 2.58 | 0.00 | -129.87 | Open Pump |
| 2   | 2.58 | 0.00 | -129.87 | Open Pump |



# Peak Hour Demand Conditions

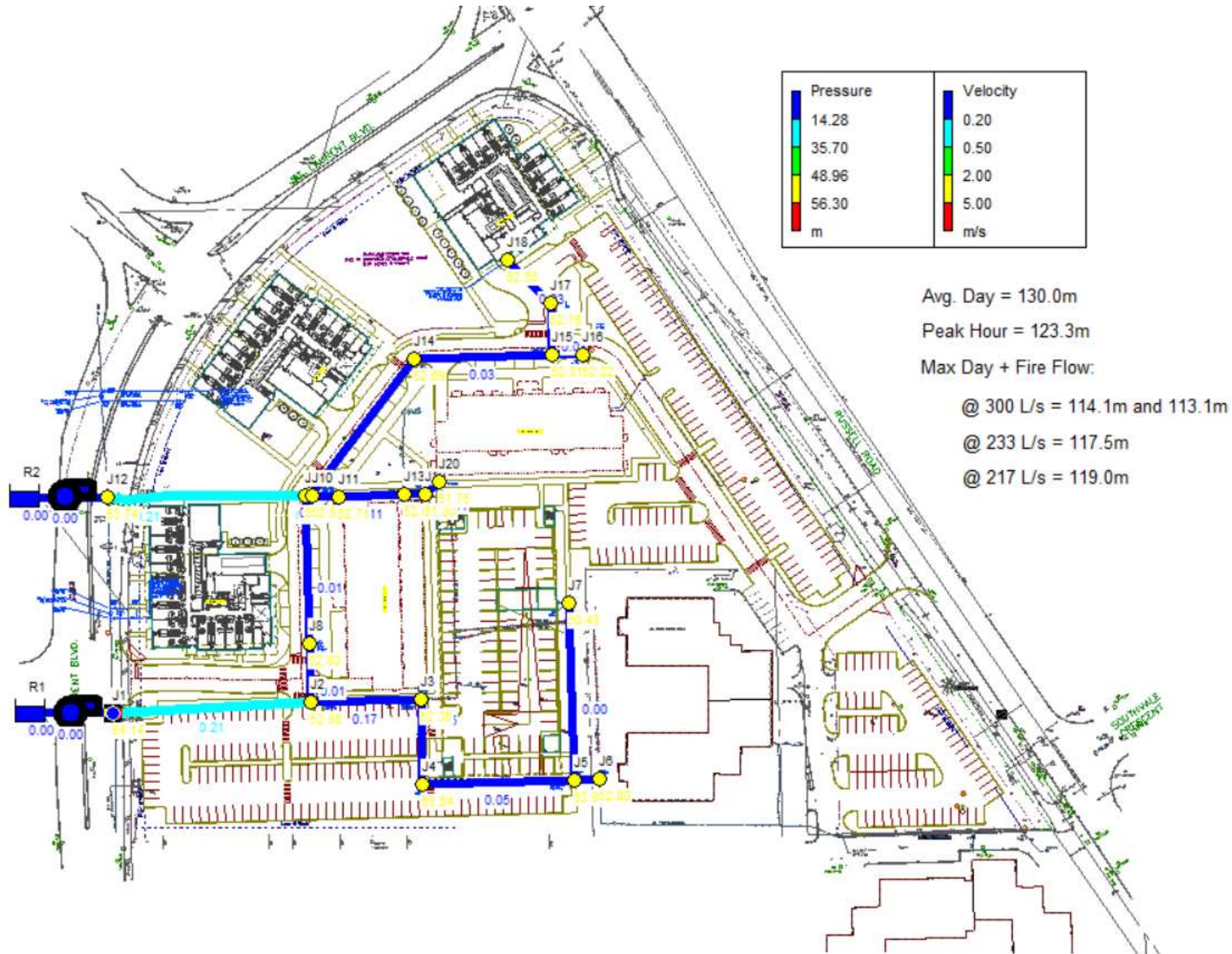



```

* E P A N E T *
* Hydraulic and Water Quality *
* Analysis for Pipe Networks *
* Version 2.2 *

```

Input File: 21106\_Peak Hour.net

Link - Node Table:

| Link ID | Start Node | End Node | Length m | Diameter mm |
|---------|------------|----------|----------|-------------|
| P1      | J1         | J2       | 60.84    | 200         |
| P2      | J2         | J3       | 33.98    | 200         |
| P3      | J3         | J4       | 26.25    | 300         |
| P4      | J4         | J5       | 46.55    | 300         |
| P5      | J5         | J6       | 8.07     | 300         |
| P12     | J5         | J7       | 54.58    | 150         |
| P13     | J2         | J8       | 17.74    | 300         |
| P14     | J8         | J9       | 45.71    | 300         |
| P15     | J9         | J12      | 60.90    | 200         |
| P16     | J9         | J10      | 2.19     | 200         |
| P17     | J10        | J11      | 8.06     | 200         |
| P18     | J11        | J13      | 20.28    | 200         |
| P19     | J13        | J19      | 6.65     | 200         |
| P20     | J19        | J20      | 5.64     | 200         |
| P21     | J10        | J14      | 52.85    | 300         |
| P22     | J14        | J15      | 42.61    | 300         |
| P23     | J15        | J16      | 9.46     | 300         |
| P24     | J15        | J17      | 15.91    | 300         |
| P25     | J17        | J18      | 18.66    | 300         |
| 1       | R2         | J12      | #N/A     | #N/A Pump   |
| 2       | R1         | J1       | #N/A     | #N/A Pump   |

Energy Usage:

| Pump | Usage Factor | Avg. Effic. | Kw-hr /m3 | Avg. Kw | Peak Kw        | Cost /day |
|------|--------------|-------------|-----------|---------|----------------|-----------|
| 1    | 100.00       | 75.00       | 0.47      | 10.92   | 10.92          | 0.00      |
| 2    | 100.00       | 75.00       | 0.47      | 10.92   | 10.92          | 0.00      |
|      |              |             |           |         | Demand Charge: | 0.00      |
|      |              |             |           |         | Total Cost:    | 0.00      |



Page 2

Node Results at 0:00 Hrs:

| Node ID | Demand LPS | Head m | Pressure m | Quality |           |
|---------|------------|--------|------------|---------|-----------|
| J1      | 0.00       | 129.67 | 54.14      | 0.00    |           |
| J2      | 0.00       | 129.65 | 52.98      | 0.00    |           |
| J3      | 1.67       | 129.64 | 52.36      | 0.00    |           |
| J4      | 0.00       | 129.64 | 53.54      | 0.00    |           |
| J5      | 0.00       | 129.64 | 52.95      | 0.00    |           |
| J6      | 3.82       | 129.64 | 52.80      | 0.00    |           |
| J7      | 0.00       | 129.64 | 50.43      | 0.00    |           |
| J8      | 0.00       | 129.65 | 52.80      | 0.00    |           |
| J9      | 0.00       | 129.65 | 52.88      | 0.00    |           |
| J10     | 0.00       | 129.65 | 52.96      | 0.00    |           |
| J11     | 1.67       | 129.65 | 52.71      | 0.00    |           |
| J12     | 0.00       | 129.67 | 53.74      | 0.00    |           |
| J13     | 0.00       | 129.64 | 52.01      | 0.00    |           |
| J14     | 0.00       | 129.65 | 52.69      | 0.00    |           |
| J15     | 0.00       | 129.65 | 52.31      | 0.00    |           |
| J16     | 0.00       | 129.65 | 52.22      | 0.00    |           |
| J17     | 0.00       | 129.65 | 52.76      | 0.00    |           |
| J18     | 2.40       | 129.65 | 52.55      | 0.00    |           |
| J19     | 0.00       | 129.64 | 51.80      | 0.00    |           |
| J20     | 3.33       | 129.64 | 51.75      | 0.00    |           |
| R1      | -6.44      | 0.00   | 0.00       | 0.00    | Reservoir |
| R2      | -6.45      | 0.00   | 0.00       | 0.00    | Reservoir |

Link Results at 0:00 Hrs:

| Link ID | Flow LPS | Velocity m/s | Unit Headloss m/km | Status |
|---------|----------|--------------|--------------------|--------|
| P1      | 6.44     | 0.21         | 0.39               | Open   |
| P2      | 5.49     | 0.17         | 0.29               | Open   |
| P3      | 3.82     | 0.05         | 0.02               | Open   |
| P4      | 3.82     | 0.05         | 0.02               | Open   |
| P5      | 3.82     | 0.05         | 0.02               | Open   |
| P12     | 0.00     | 0.00         | 0.00               | Open   |
| P13     | 0.95     | 0.01         | 0.00               | Open   |
| P14     | 0.95     | 0.01         | 0.00               | Open   |
| P15     | -6.45    | 0.21         | 0.39               | Open   |
| P16     | 7.40     | 0.24         | 0.51               | Open   |
| P17     | 5.00     | 0.16         | 0.25               | Open   |
| P18     | 3.33     | 0.11         | 0.12               | Open   |
| P19     | 3.33     | 0.11         | 0.12               | Open   |
| P20     | 3.33     | 0.11         | 0.12               | Open   |



|     |      |      |      |      |
|-----|------|------|------|------|
| P21 | 2.40 | 0.03 | 0.01 | Open |
| P22 | 2.40 | 0.03 | 0.01 | Open |
| P23 | 0.00 | 0.00 | 0.00 | Open |
| P24 | 2.40 | 0.03 | 0.01 | Open |
| P25 | 2.40 | 0.03 | 0.01 | Open |



Page 3

Link Results at 0:00 Hrs: (continued)

| Link ID | Flow LPS | Velocity m/s | Unit Headloss m/km | Status    |
|---------|----------|--------------|--------------------|-----------|
| 1       | 6.45     | 0.00         | -129.67            | Open Pump |
| 2       | 6.44     | 0.00         | -129.67            | Open Pump |

Node Results at 1:00 Hrs:

| Node ID | Demand LPS | Head m | Pressure m | Quality        |
|---------|------------|--------|------------|----------------|
| J1      | 0.00       | 129.67 | 54.14      | 0.00           |
| J2      | 0.00       | 129.65 | 52.98      | 0.00           |
| J3      | 1.67       | 129.64 | 52.36      | 0.00           |
| J4      | 0.00       | 129.64 | 53.54      | 0.00           |
| J5      | 0.00       | 129.64 | 52.95      | 0.00           |
| J6      | 3.82       | 129.64 | 52.80      | 0.00           |
| J7      | 0.00       | 129.64 | 50.43      | 0.00           |
| J8      | 0.00       | 129.65 | 52.80      | 0.00           |
| J9      | 0.00       | 129.65 | 52.88      | 0.00           |
| J10     | 0.00       | 129.65 | 52.96      | 0.00           |
| J11     | 1.67       | 129.65 | 52.71      | 0.00           |
| J12     | 0.00       | 129.67 | 53.74      | 0.00           |
| J13     | 0.00       | 129.64 | 52.01      | 0.00           |
| J14     | 0.00       | 129.65 | 52.69      | 0.00           |
| J15     | 0.00       | 129.65 | 52.31      | 0.00           |
| J16     | 0.00       | 129.65 | 52.22      | 0.00           |
| J17     | 0.00       | 129.65 | 52.76      | 0.00           |
| J18     | 2.40       | 129.65 | 52.55      | 0.00           |
| J19     | 0.00       | 129.64 | 51.80      | 0.00           |
| J20     | 3.33       | 129.64 | 51.75      | 0.00           |
| R1      | -6.44      | 0.00   | 0.00       | 0.00 Reservoir |
| R2      | -6.45      | 0.00   | 0.00       | 0.00 Reservoir |

Link Results at 1:00 Hrs:

| Link ID | Flow LPS | Velocity m/s | Unit Headloss m/km | Status |
|---------|----------|--------------|--------------------|--------|
| P1      | 6.44     | 0.21         | 0.39               | Open   |





|     |       |      |      |      |
|-----|-------|------|------|------|
| P2  | 5.49  | 0.17 | 0.29 | Open |
| P3  | 3.82  | 0.05 | 0.02 | Open |
| P4  | 3.82  | 0.05 | 0.02 | Open |
| P5  | 3.82  | 0.05 | 0.02 | Open |
| P12 | 0.00  | 0.00 | 0.00 | Open |
| P13 | 0.95  | 0.01 | 0.00 | Open |
| P14 | 0.95  | 0.01 | 0.00 | Open |
| P15 | -6.45 | 0.21 | 0.39 | Open |
| P16 | 7.40  | 0.24 | 0.51 | Open |
| P17 | 5.00  | 0.16 | 0.25 | Open |



Page 4

Link Results at 1:00 Hrs: (continued)

| Link ID | Flow LPS | Velocity m/s | Unit Headloss m/km | Status    |
|---------|----------|--------------|--------------------|-----------|
| P18     | 3.33     | 0.11         | 0.12               | Open      |
| P19     | 3.33     | 0.11         | 0.12               | Open      |
| P20     | 3.33     | 0.11         | 0.12               | Open      |
| P21     | 2.40     | 0.03         | 0.01               | Open      |
| P22     | 2.40     | 0.03         | 0.01               | Open      |
| P23     | 0.00     | 0.00         | 0.00               | Open      |
| P24     | 2.40     | 0.03         | 0.01               | Open      |
| P25     | 2.40     | 0.03         | 0.01               | Open      |
| 1       | 6.45     | 0.00         | -129.67            | Open Pump |
| 2       | 6.44     | 0.00         | -129.67            | Open Pump |

Node Results at 2:00 Hrs:

| Node ID | Demand LPS | Head m | Pressure m | Quality |
|---------|------------|--------|------------|---------|
| J1      | 0.00       | 129.67 | 54.14      | 0.00    |
| J2      | 0.00       | 129.65 | 52.98      | 0.00    |
| J3      | 1.67       | 129.64 | 52.36      | 0.00    |
| J4      | 0.00       | 129.64 | 53.54      | 0.00    |
| J5      | 0.00       | 129.64 | 52.95      | 0.00    |
| J6      | 3.82       | 129.64 | 52.80      | 0.00    |
| J7      | 0.00       | 129.64 | 50.43      | 0.00    |
| J8      | 0.00       | 129.65 | 52.80      | 0.00    |
| J9      | 0.00       | 129.65 | 52.88      | 0.00    |
| J10     | 0.00       | 129.65 | 52.96      | 0.00    |
| J11     | 1.67       | 129.65 | 52.71      | 0.00    |
| J12     | 0.00       | 129.67 | 53.74      | 0.00    |
| J13     | 0.00       | 129.64 | 52.01      | 0.00    |
| J14     | 0.00       | 129.65 | 52.69      | 0.00    |
| J15     | 0.00       | 129.65 | 52.31      | 0.00    |
| J16     | 0.00       | 129.65 | 52.22      | 0.00    |



|     |       |        |       |      |           |
|-----|-------|--------|-------|------|-----------|
| J17 | 0.00  | 129.65 | 52.76 | 0.00 |           |
| J18 | 2.40  | 129.65 | 52.55 | 0.00 |           |
| J19 | 0.00  | 129.64 | 51.80 | 0.00 |           |
| J20 | 3.33  | 129.64 | 51.75 | 0.00 |           |
| R1  | -6.44 | 0.00   | 0.00  | 0.00 | Reservoir |
| R2  | -6.45 | 0.00   | 0.00  | 0.00 | Reservoir |



Page 5

Link Results at 2:00 Hrs:

| Link ID | Flow LPS | Velocity m/s | Unit Headloss m/km | Status    |
|---------|----------|--------------|--------------------|-----------|
| P1      | 6.44     | 0.21         | 0.39               | Open      |
| P2      | 5.49     | 0.17         | 0.29               | Open      |
| P3      | 3.82     | 0.05         | 0.02               | Open      |
| P4      | 3.82     | 0.05         | 0.02               | Open      |
| P5      | 3.82     | 0.05         | 0.02               | Open      |
| P12     | 0.00     | 0.00         | 0.00               | Open      |
| P13     | 0.95     | 0.01         | 0.00               | Open      |
| P14     | 0.95     | 0.01         | 0.00               | Open      |
| P15     | -6.45    | 0.21         | 0.39               | Open      |
| P16     | 7.40     | 0.24         | 0.51               | Open      |
| P17     | 5.00     | 0.16         | 0.25               | Open      |
| P18     | 3.33     | 0.11         | 0.12               | Open      |
| P19     | 3.33     | 0.11         | 0.12               | Open      |
| P20     | 3.33     | 0.11         | 0.12               | Open      |
| P21     | 2.40     | 0.03         | 0.01               | Open      |
| P22     | 2.40     | 0.03         | 0.01               | Open      |
| P23     | 0.00     | 0.00         | 0.00               | Open      |
| P24     | 2.40     | 0.03         | 0.01               | Open      |
| P25     | 2.40     | 0.03         | 0.01               | Open      |
| 1       | 6.45     | 0.00         | -129.67            | Open Pump |
| 2       | 6.44     | 0.00         | -129.67            | Open Pump |

Node Results at 3:00 Hrs:

| Node ID | Demand LPS | Head m | Pressure m | Quality |
|---------|------------|--------|------------|---------|
| J1      | 0.00       | 129.67 | 54.14      | 0.00    |
| J2      | 0.00       | 129.65 | 52.98      | 0.00    |
| J3      | 1.67       | 129.64 | 52.36      | 0.00    |
| J4      | 0.00       | 129.64 | 53.54      | 0.00    |
| J5      | 0.00       | 129.64 | 52.95      | 0.00    |
| J6      | 3.82       | 129.64 | 52.80      | 0.00    |
| J7      | 0.00       | 129.64 | 50.43      | 0.00    |
| J8      | 0.00       | 129.65 | 52.80      | 0.00    |



|     |      |        |       |      |
|-----|------|--------|-------|------|
| J9  | 0.00 | 129.65 | 52.88 | 0.00 |
| J10 | 0.00 | 129.65 | 52.96 | 0.00 |
| J11 | 1.67 | 129.65 | 52.71 | 0.00 |
| J12 | 0.00 | 129.67 | 53.74 | 0.00 |
| J13 | 0.00 | 129.64 | 52.01 | 0.00 |
| J14 | 0.00 | 129.65 | 52.69 | 0.00 |
| J15 | 0.00 | 129.65 | 52.31 | 0.00 |
| J16 | 0.00 | 129.65 | 52.22 | 0.00 |
| J17 | 0.00 | 129.65 | 52.76 | 0.00 |
| J18 | 2.40 | 129.65 | 52.55 | 0.00 |
| J19 | 0.00 | 129.64 | 51.80 | 0.00 |
| J20 | 3.33 | 129.64 | 51.75 | 0.00 |



Page 6

Node Results at 3:00 Hrs: (continued)

| Node ID | Demand LPS | Head m | Pressure m | Quality        |
|---------|------------|--------|------------|----------------|
| R1      | -6.44      | 0.00   | 0.00       | 0.00 Reservoir |
| R2      | -6.45      | 0.00   | 0.00       | 0.00 Reservoir |

Link Results at 3:00 Hrs:

| Link ID | Flow LPS | Velocity m/s | Unit Headloss m/km | Status    |
|---------|----------|--------------|--------------------|-----------|
| P1      | 6.44     | 0.21         | 0.39               | Open      |
| P2      | 5.49     | 0.17         | 0.29               | Open      |
| P3      | 3.82     | 0.05         | 0.02               | Open      |
| P4      | 3.82     | 0.05         | 0.02               | Open      |
| P5      | 3.82     | 0.05         | 0.02               | Open      |
| P12     | 0.00     | 0.00         | 0.00               | Open      |
| P13     | 0.95     | 0.01         | 0.00               | Open      |
| P14     | 0.95     | 0.01         | 0.00               | Open      |
| P15     | -6.45    | 0.21         | 0.39               | Open      |
| P16     | 7.40     | 0.24         | 0.51               | Open      |
| P17     | 5.00     | 0.16         | 0.25               | Open      |
| P18     | 3.33     | 0.11         | 0.12               | Open      |
| P19     | 3.33     | 0.11         | 0.12               | Open      |
| P20     | 3.33     | 0.11         | 0.12               | Open      |
| P21     | 2.40     | 0.03         | 0.01               | Open      |
| P22     | 2.40     | 0.03         | 0.01               | Open      |
| P23     | 0.00     | 0.00         | 0.00               | Open      |
| P24     | 2.40     | 0.03         | 0.01               | Open      |
| P25     | 2.40     | 0.03         | 0.01               | Open      |
| 1       | 6.45     | 0.00         | -129.67            | Open Pump |
| 2       | 6.44     | 0.00         | -129.67            | Open Pump |



## Node Results at 4:00 Hrs:

| Node ID | Demand LPS | Head m | Pressure m | Quality |
|---------|------------|--------|------------|---------|
| J1      | 0.00       | 129.67 | 54.14      | 0.00    |
| J2      | 0.00       | 129.65 | 52.98      | 0.00    |
| J3      | 1.67       | 129.64 | 52.36      | 0.00    |
| J4      | 0.00       | 129.64 | 53.54      | 0.00    |
| J5      | 0.00       | 129.64 | 52.95      | 0.00    |
| J6      | 3.82       | 129.64 | 52.80      | 0.00    |
| J7      | 0.00       | 129.64 | 50.43      | 0.00    |
| J8      | 0.00       | 129.65 | 52.80      | 0.00    |
| J9      | 0.00       | 129.65 | 52.88      | 0.00    |
| J10     | 0.00       | 129.65 | 52.96      | 0.00    |
| J11     | 1.67       | 129.65 | 52.71      | 0.00    |
| J12     | 0.00       | 129.67 | 53.74      | 0.00    |



Page 7

## Node Results at 4:00 Hrs: (continued)

| Node ID | Demand LPS | Head m | Pressure m | Quality        |
|---------|------------|--------|------------|----------------|
| J13     | 0.00       | 129.64 | 52.01      | 0.00           |
| J14     | 0.00       | 129.65 | 52.69      | 0.00           |
| J15     | 0.00       | 129.65 | 52.31      | 0.00           |
| J16     | 0.00       | 129.65 | 52.22      | 0.00           |
| J17     | 0.00       | 129.65 | 52.76      | 0.00           |
| J18     | 2.40       | 129.65 | 52.55      | 0.00           |
| J19     | 0.00       | 129.64 | 51.80      | 0.00           |
| J20     | 3.33       | 129.64 | 51.75      | 0.00           |
| R1      | -6.44      | 0.00   | 0.00       | 0.00 Reservoir |
| R2      | -6.45      | 0.00   | 0.00       | 0.00 Reservoir |

## Link Results at 4:00 Hrs:

| Link ID | Flow LPS | Velocity m/s | Unit Headloss m/km | Status |
|---------|----------|--------------|--------------------|--------|
| P1      | 6.44     | 0.21         | 0.39               | Open   |
| P2      | 5.49     | 0.17         | 0.29               | Open   |
| P3      | 3.82     | 0.05         | 0.02               | Open   |
| P4      | 3.82     | 0.05         | 0.02               | Open   |
| P5      | 3.82     | 0.05         | 0.02               | Open   |
| P12     | 0.00     | 0.00         | 0.00               | Open   |
| P13     | 0.95     | 0.01         | 0.00               | Open   |
| P14     | 0.95     | 0.01         | 0.00               | Open   |
| P15     | -6.45    | 0.21         | 0.39               | Open   |



|     |      |      |         |           |
|-----|------|------|---------|-----------|
| P16 | 7.40 | 0.24 | 0.51    | Open      |
| P17 | 5.00 | 0.16 | 0.25    | Open      |
| P18 | 3.33 | 0.11 | 0.12    | Open      |
| P19 | 3.33 | 0.11 | 0.12    | Open      |
| P20 | 3.33 | 0.11 | 0.12    | Open      |
| P21 | 2.40 | 0.03 | 0.01    | Open      |
| P22 | 2.40 | 0.03 | 0.01    | Open      |
| P23 | 0.00 | 0.00 | 0.00    | Open      |
| P24 | 2.40 | 0.03 | 0.01    | Open      |
| P25 | 2.40 | 0.03 | 0.01    | Open      |
| 1   | 6.45 | 0.00 | -129.67 | Open Pump |
| 2   | 6.44 | 0.00 | -129.67 | Open Pump |



### Max Day + Fire Flow Conditions at Existing Building 1971 St. Laurent Blvd (Node J8)

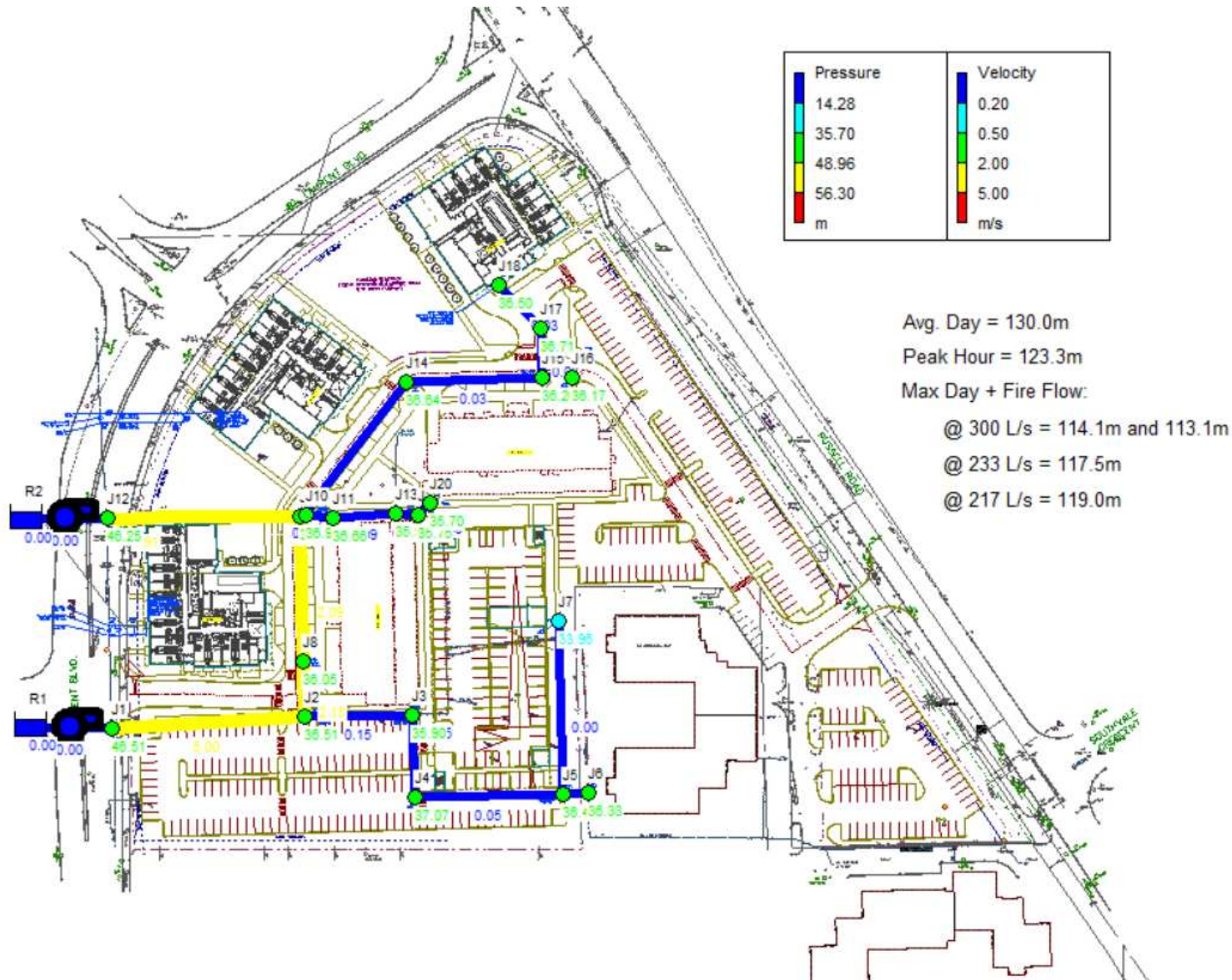



\*\*\*\*\*

```

* E P A N E T *
* Hydraulic and Water Quality *
* Analysis for Pipe Networks *
* Version 2.2.0 *

```

\*\*\*\*\*

Input

Link

Link

ID

- P1
- P2
- P3
- P4
- P5
- P12
- P13
- P14
- P15
- P16
- P17
- P18
- P19
- P20
- P21
- P22
- P23
- P24
- P25

- 1
- 2

Energ

Pump

- 1
- 2





Page 2

Node Results at 0:00 Hrs:

| Node ID | Demand LPS | Head m | Pressure m | Quality |           |
|---------|------------|--------|------------|---------|-----------|
| J1      | 0.00       | 122.04 | 46.51      | 0.00    |           |
| J2      | 0.00       | 113.18 | 36.51      | 0.00    |           |
| J3      | 1.47       | 113.18 | 35.90      | 0.00    |           |
| J4      | 0.00       | 113.17 | 37.07      | 0.00    |           |
| J5      | 0.00       | 113.17 | 36.48      | 0.00    |           |
| J6      | 3.36       | 113.17 | 36.33      | 0.00    |           |
| J7      | 0.00       | 113.17 | 33.96      | 0.00    |           |
| J8      | 300.00     | 112.90 | 36.05      | 0.00    |           |
| J9      | 0.00       | 113.60 | 36.83      | 0.00    |           |
| J10     | 0.00       | 113.60 | 36.91      | 0.00    |           |
| J11     | 1.47       | 113.60 | 36.66      | 0.00    |           |
| J12     | 0.00       | 122.18 | 46.25      | 0.00    |           |
| J13     | 0.00       | 113.59 | 35.96      | 0.00    |           |
| J14     | 0.00       | 113.60 | 36.64      | 0.00    |           |
| J15     | 0.00       | 113.60 | 36.26      | 0.00    |           |
| J16     | 0.00       | 113.60 | 36.17      | 0.00    |           |
| J17     | 0.00       | 113.60 | 36.71      | 0.00    |           |
| J18     | 2.11       | 113.60 | 36.50      | 0.00    |           |
| J19     | 0.00       | 113.59 | 35.75      | 0.00    |           |
| J20     | 2.93       | 113.59 | 35.70      | 0.00    |           |
| R1      | -157.04    | 0.00   | 0.00       | 0.00    | Reservoir |
| R2      | -154.30    | 0.00   | 0.00       | 0.00    | Reservoir |

Link Results at 0:00 Hrs:

| Link ID | Flow LPS | Velocity m/s | Unit Headloss m/km | Status |
|---------|----------|--------------|--------------------|--------|
| P1      | 157.04   | 5.00         | 145.57             | Open   |
| P2      | 4.83     | 0.15         | 0.23               | Open   |
| P3      | 3.36     | 0.05         | 0.01               | Open   |
| P4      | 3.36     | 0.05         | 0.01               | Open   |
| P5      | 3.36     | 0.05         | 0.01               | Open   |
| P12     | 0.00     | 0.00         | 0.00               | Open   |
| P13     | 152.21   | 2.15         | 16.23              | Open   |
| P14     | -147.79  | 2.09         | 15.36              | Open   |
| P15     | -154.30  | 4.91         | 140.90             | Open   |
| P16     | 6.51     | 0.21         | 0.40               | Open   |
| P17     | 4.40     | 0.14         | 0.19               | Open   |
| P18     | 2.93     | 0.09         | 0.09               | Open   |
| P19     | 2.93     | 0.09         | 0.09               | Open   |
| P20     | 2.93     | 0.09         | 0.09               | Open   |





|     |      |      |      |      |
|-----|------|------|------|------|
| P21 | 2.11 | 0.03 | 0.01 | Open |
| P22 | 2.11 | 0.03 | 0.01 | Open |
| P23 | 0.00 | 0.00 | 0.00 | Open |
| P24 | 2.11 | 0.03 | 0.01 | Open |
| P25 | 2.11 | 0.03 | 0.01 | Open |



Page 3

Link Results at 0:00 Hrs: (continued)

| Link ID | Flow LPS | Velocity m/s | Unit Headloss m/km | Status    |
|---------|----------|--------------|--------------------|-----------|
| 1       | 154.30   | 0.00         | -122.18            | Open Pump |
| 2       | 157.04   | 0.00         | -122.04            | Open Pump |

Node Results at 1:00 Hrs:

| Node ID | Demand LPS | Head m | Pressure m | Quality        |
|---------|------------|--------|------------|----------------|
| J1      | 0.00       | 122.04 | 46.51      | 0.00           |
| J2      | 0.00       | 113.18 | 36.51      | 0.00           |
| J3      | 1.47       | 113.18 | 35.90      | 0.00           |
| J4      | 0.00       | 113.17 | 37.07      | 0.00           |
| J5      | 0.00       | 113.17 | 36.48      | 0.00           |
| J6      | 3.36       | 113.17 | 36.33      | 0.00           |
| J7      | 0.00       | 113.17 | 33.96      | 0.00           |
| J8      | 300.00     | 112.90 | 36.05      | 0.00           |
| J9      | 0.00       | 113.60 | 36.83      | 0.00           |
| J10     | 0.00       | 113.60 | 36.91      | 0.00           |
| J11     | 1.47       | 113.60 | 36.66      | 0.00           |
| J12     | 0.00       | 122.18 | 46.25      | 0.00           |
| J13     | 0.00       | 113.59 | 35.96      | 0.00           |
| J14     | 0.00       | 113.60 | 36.64      | 0.00           |
| J15     | 0.00       | 113.60 | 36.26      | 0.00           |
| J16     | 0.00       | 113.60 | 36.17      | 0.00           |
| J17     | 0.00       | 113.60 | 36.71      | 0.00           |
| J18     | 2.11       | 113.60 | 36.50      | 0.00           |
| J19     | 0.00       | 113.59 | 35.75      | 0.00           |
| J20     | 2.93       | 113.59 | 35.70      | 0.00           |
| R1      | -157.04    | 0.00   | 0.00       | 0.00 Reservoir |
| R2      | -154.30    | 0.00   | 0.00       | 0.00 Reservoir |

Link Results at 1:00 Hrs:

| Link ID | Flow LPS | Velocity m/s | Unit Headloss m/km | Status |
|---------|----------|--------------|--------------------|--------|
| P1      | 157.04   | 5.00         | 145.57             | Open   |



|     |         |      |        |      |
|-----|---------|------|--------|------|
| P2  | 4.83    | 0.15 | 0.23   | Open |
| P3  | 3.36    | 0.05 | 0.01   | Open |
| P4  | 3.36    | 0.05 | 0.01   | Open |
| P5  | 3.36    | 0.05 | 0.01   | Open |
| P12 | 0.00    | 0.00 | 0.00   | Open |
| P13 | 152.21  | 2.15 | 16.23  | Open |
| P14 | -147.79 | 2.09 | 15.36  | Open |
| P15 | -154.30 | 4.91 | 140.90 | Open |
| P16 | 6.51    | 0.21 | 0.40   | Open |
| P17 | 4.40    | 0.14 | 0.19   | Open |



Page 4

Link Results at 1:00 Hrs: (continued)

| Link ID | Flow LPS | Velocity m/s | Unit Headloss m/km | Status    |
|---------|----------|--------------|--------------------|-----------|
| P18     | 2.93     | 0.09         | 0.09               | Open      |
| P19     | 2.93     | 0.09         | 0.09               | Open      |
| P20     | 2.93     | 0.09         | 0.09               | Open      |
| P21     | 2.11     | 0.03         | 0.01               | Open      |
| P22     | 2.11     | 0.03         | 0.01               | Open      |
| P23     | 0.00     | 0.00         | 0.00               | Open      |
| P24     | 2.11     | 0.03         | 0.01               | Open      |
| P25     | 2.11     | 0.03         | 0.01               | Open      |
| 1       | 154.30   | 0.00         | -122.18            | Open Pump |
| 2       | 157.04   | 0.00         | -122.04            | Open Pump |

Node Results at 2:00 Hrs:

| Node ID | Demand LPS | Head m | Pressure m | Quality |
|---------|------------|--------|------------|---------|
| J1      | 0.00       | 122.04 | 46.51      | 0.00    |
| J2      | 0.00       | 113.18 | 36.51      | 0.00    |
| J3      | 1.47       | 113.18 | 35.90      | 0.00    |
| J4      | 0.00       | 113.17 | 37.07      | 0.00    |
| J5      | 0.00       | 113.17 | 36.48      | 0.00    |
| J6      | 3.36       | 113.17 | 36.33      | 0.00    |
| J7      | 0.00       | 113.17 | 33.96      | 0.00    |
| J8      | 300.00     | 112.90 | 36.05      | 0.00    |
| J9      | 0.00       | 113.60 | 36.83      | 0.00    |
| J10     | 0.00       | 113.60 | 36.91      | 0.00    |
| J11     | 1.47       | 113.60 | 36.66      | 0.00    |
| J12     | 0.00       | 122.18 | 46.25      | 0.00    |
| J13     | 0.00       | 113.59 | 35.96      | 0.00    |
| J14     | 0.00       | 113.60 | 36.64      | 0.00    |
| J15     | 0.00       | 113.60 | 36.26      | 0.00    |
| J16     | 0.00       | 113.60 | 36.17      | 0.00    |



|     |         |        |       |      |           |
|-----|---------|--------|-------|------|-----------|
| J17 | 0.00    | 113.60 | 36.71 | 0.00 |           |
| J18 | 2.11    | 113.60 | 36.50 | 0.00 |           |
| J19 | 0.00    | 113.59 | 35.75 | 0.00 |           |
| J20 | 2.93    | 113.59 | 35.70 | 0.00 |           |
| R1  | -157.04 | 0.00   | 0.00  | 0.00 | Reservoir |
| R2  | -154.30 | 0.00   | 0.00  | 0.00 | Reservoir |



Page 5

Link Results at 2:00 Hrs:

| Link ID | Flow LPS | Velocity m/s | Unit Headloss m/km | Status    |
|---------|----------|--------------|--------------------|-----------|
| P1      | 157.04   | 5.00         | 145.57             | Open      |
| P2      | 4.83     | 0.15         | 0.23               | Open      |
| P3      | 3.36     | 0.05         | 0.01               | Open      |
| P4      | 3.36     | 0.05         | 0.01               | Open      |
| P5      | 3.36     | 0.05         | 0.01               | Open      |
| P12     | 0.00     | 0.00         | 0.00               | Open      |
| P13     | 152.21   | 2.15         | 16.23              | Open      |
| P14     | -147.79  | 2.09         | 15.36              | Open      |
| P15     | -154.30  | 4.91         | 140.90             | Open      |
| P16     | 6.51     | 0.21         | 0.40               | Open      |
| P17     | 4.40     | 0.14         | 0.19               | Open      |
| P18     | 2.93     | 0.09         | 0.09               | Open      |
| P19     | 2.93     | 0.09         | 0.09               | Open      |
| P20     | 2.93     | 0.09         | 0.09               | Open      |
| P21     | 2.11     | 0.03         | 0.01               | Open      |
| P22     | 2.11     | 0.03         | 0.01               | Open      |
| P23     | 0.00     | 0.00         | 0.00               | Open      |
| P24     | 2.11     | 0.03         | 0.01               | Open      |
| P25     | 2.11     | 0.03         | 0.01               | Open      |
| 1       | 154.30   | 0.00         | -122.18            | Open Pump |
| 2       | 157.04   | 0.00         | -122.04            | Open Pump |

Node Results at 3:00 Hrs:

| Node ID | Demand LPS | Head m | Pressure m | Quality |
|---------|------------|--------|------------|---------|
| J1      | 0.00       | 122.04 | 46.51      | 0.00    |
| J2      | 0.00       | 113.18 | 36.51      | 0.00    |
| J3      | 1.47       | 113.18 | 35.90      | 0.00    |
| J4      | 0.00       | 113.17 | 37.07      | 0.00    |
| J5      | 0.00       | 113.17 | 36.48      | 0.00    |
| J6      | 3.36       | 113.17 | 36.33      | 0.00    |
| J7      | 0.00       | 113.17 | 33.96      | 0.00    |
| J8      | 300.00     | 112.90 | 36.05      | 0.00    |



|     |      |        |       |      |
|-----|------|--------|-------|------|
| J9  | 0.00 | 113.60 | 36.83 | 0.00 |
| J10 | 0.00 | 113.60 | 36.91 | 0.00 |
| J11 | 1.47 | 113.60 | 36.66 | 0.00 |
| J12 | 0.00 | 122.18 | 46.25 | 0.00 |
| J13 | 0.00 | 113.59 | 35.96 | 0.00 |
| J14 | 0.00 | 113.60 | 36.64 | 0.00 |
| J15 | 0.00 | 113.60 | 36.26 | 0.00 |
| J16 | 0.00 | 113.60 | 36.17 | 0.00 |
| J17 | 0.00 | 113.60 | 36.71 | 0.00 |
| J18 | 2.11 | 113.60 | 36.50 | 0.00 |
| J19 | 0.00 | 113.59 | 35.75 | 0.00 |
| J20 | 2.93 | 113.59 | 35.70 | 0.00 |



Page 6

Node Results at 3:00 Hrs: (continued)

| Node ID | Demand LPS | Head m | Pressure m | Quality        |
|---------|------------|--------|------------|----------------|
| R1      | -157.04    | 0.00   | 0.00       | 0.00 Reservoir |
| R2      | -154.30    | 0.00   | 0.00       | 0.00 Reservoir |

Link Results at 3:00 Hrs:

| Link ID | Flow LPS | Velocity m/s | Unit Headloss m/km | Status    |
|---------|----------|--------------|--------------------|-----------|
| P1      | 157.04   | 5.00         | 145.57             | Open      |
| P2      | 4.83     | 0.15         | 0.23               | Open      |
| P3      | 3.36     | 0.05         | 0.01               | Open      |
| P4      | 3.36     | 0.05         | 0.01               | Open      |
| P5      | 3.36     | 0.05         | 0.01               | Open      |
| P12     | 0.00     | 0.00         | 0.00               | Open      |
| P13     | 152.21   | 2.15         | 16.23              | Open      |
| P14     | -147.79  | 2.09         | 15.36              | Open      |
| P15     | -154.30  | 4.91         | 140.90             | Open      |
| P16     | 6.51     | 0.21         | 0.40               | Open      |
| P17     | 4.40     | 0.14         | 0.19               | Open      |
| P18     | 2.93     | 0.09         | 0.09               | Open      |
| P19     | 2.93     | 0.09         | 0.09               | Open      |
| P20     | 2.93     | 0.09         | 0.09               | Open      |
| P21     | 2.11     | 0.03         | 0.01               | Open      |
| P22     | 2.11     | 0.03         | 0.01               | Open      |
| P23     | 0.00     | 0.00         | 0.00               | Open      |
| P24     | 2.11     | 0.03         | 0.01               | Open      |
| P25     | 2.11     | 0.03         | 0.01               | Open      |
| 1       | 154.30   | 0.00         | -122.18            | Open Pump |
| 2       | 157.04   | 0.00         | -122.04            | Open Pump |



## Node Results at 4:00 Hrs:

| Node ID | Demand LPS | Head m | Pressure m | Quality |
|---------|------------|--------|------------|---------|
| J1      | 0.00       | 122.04 | 46.51      | 0.00    |
| J2      | 0.00       | 113.18 | 36.51      | 0.00    |
| J3      | 1.47       | 113.18 | 35.90      | 0.00    |
| J4      | 0.00       | 113.17 | 37.07      | 0.00    |
| J5      | 0.00       | 113.17 | 36.48      | 0.00    |
| J6      | 3.36       | 113.17 | 36.33      | 0.00    |
| J7      | 0.00       | 113.17 | 33.96      | 0.00    |
| J8      | 300.00     | 112.90 | 36.05      | 0.00    |
| J9      | 0.00       | 113.60 | 36.83      | 0.00    |
| J10     | 0.00       | 113.60 | 36.91      | 0.00    |
| J11     | 1.47       | 113.60 | 36.66      | 0.00    |
| J12     | 0.00       | 122.18 | 46.25      | 0.00    |



Page 7

## Node Results at 4:00 Hrs: (continued)

| Node ID | Demand LPS | Head m | Pressure m | Quality        |
|---------|------------|--------|------------|----------------|
| J13     | 0.00       | 113.59 | 35.96      | 0.00           |
| J14     | 0.00       | 113.60 | 36.64      | 0.00           |
| J15     | 0.00       | 113.60 | 36.26      | 0.00           |
| J16     | 0.00       | 113.60 | 36.17      | 0.00           |
| J17     | 0.00       | 113.60 | 36.71      | 0.00           |
| J18     | 2.11       | 113.60 | 36.50      | 0.00           |
| J19     | 0.00       | 113.59 | 35.75      | 0.00           |
| J20     | 2.93       | 113.59 | 35.70      | 0.00           |
| R1      | -157.04    | 0.00   | 0.00       | 0.00 Reservoir |
| R2      | -154.30    | 0.00   | 0.00       | 0.00 Reservoir |

## Link Results at 4:00 Hrs:

| Link ID | Flow LPS | Velocity m/s | Unit Headloss m/km | Status |
|---------|----------|--------------|--------------------|--------|
| P1      | 157.04   | 5.00         | 145.57             | Open   |
| P2      | 4.83     | 0.15         | 0.23               | Open   |
| P3      | 3.36     | 0.05         | 0.01               | Open   |
| P4      | 3.36     | 0.05         | 0.01               | Open   |
| P5      | 3.36     | 0.05         | 0.01               | Open   |
| P12     | 0.00     | 0.00         | 0.00               | Open   |
| P13     | 152.21   | 2.15         | 16.23              | Open   |
| P14     | -147.79  | 2.09         | 15.36              | Open   |
| P15     | -154.30  | 4.91         | 140.90             | Open   |



|     |        |      |         |           |
|-----|--------|------|---------|-----------|
| P16 | 6.51   | 0.21 | 0.40    | Open      |
| P17 | 4.40   | 0.14 | 0.19    | Open      |
| P18 | 2.93   | 0.09 | 0.09    | Open      |
| P19 | 2.93   | 0.09 | 0.09    | Open      |
| P20 | 2.93   | 0.09 | 0.09    | Open      |
| P21 | 2.11   | 0.03 | 0.01    | Open      |
| P22 | 2.11   | 0.03 | 0.01    | Open      |
| P23 | 0.00   | 0.00 | 0.00    | Open      |
| P24 | 2.11   | 0.03 | 0.01    | Open      |
| P25 | 2.11   | 0.03 | 0.01    | Open      |
| 1   | 154.30 | 0.00 | -122.18 | Open Pump |
| 2   | 157.04 | 0.00 | -122.04 | Open Pump |



### Max Day + Fire Flow Conditions at Existing Building 1975 St. Laurent Blvd (Node J13)

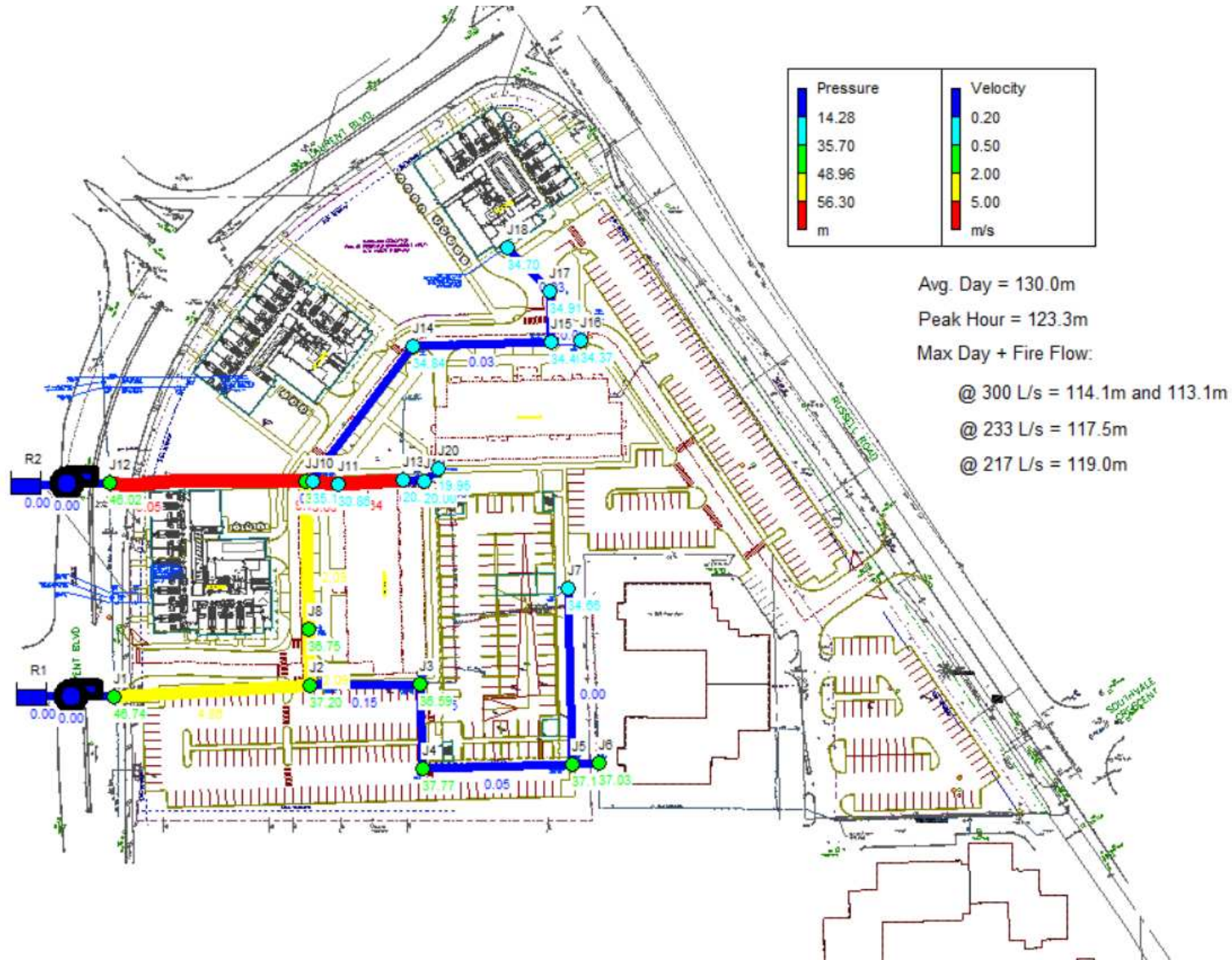



\*\*\*\*\*

\* E P A N E T \*

\* Hydraulic and Water Quality \*

\* Analysis for Pipe Networks \*

\*

\*\*\*\*

Input

Link

----

Link

ID

----

P1

P2

P3

P4

P5

P12

P13

P14

P15

P16

P17

P18

P19

P20

P21

P22

P23

P24

P25

1

2

Ener

----

Pump

----

1

2

----





Page 2

Node Results at 0:00 Hrs:

| Node ID | Demand LPS | Head m | Pressure m | Quality |           |
|---------|------------|--------|------------|---------|-----------|
| J1      | 0.00       | 122.27 | 46.74      | 0.00    |           |
| J2      | 0.00       | 113.87 | 37.20      | 0.00    |           |
| J3      | 1.47       | 113.87 | 36.59      | 0.00    |           |
| J4      | 0.00       | 113.87 | 37.77      | 0.00    |           |
| J5      | 0.00       | 113.87 | 37.18      | 0.00    |           |
| J6      | 3.36       | 113.87 | 37.03      | 0.00    |           |
| J7      | 0.00       | 113.87 | 34.66      | 0.00    |           |
| J8      | 0.00       | 113.60 | 36.75      | 0.00    |           |
| J9      | 0.00       | 112.90 | 36.13      | 0.00    |           |
| J10     | 0.00       | 111.80 | 35.11      | 0.00    |           |
| J11     | 1.47       | 107.80 | 30.86      | 0.00    |           |
| J12     | 0.00       | 121.95 | 46.02      | 0.00    |           |
| J13     | 300.00     | 97.84  | 20.21      | 0.00    |           |
| J14     | 0.00       | 111.80 | 34.84      | 0.00    |           |
| J15     | 0.00       | 111.80 | 34.46      | 0.00    |           |
| J16     | 0.00       | 111.80 | 34.37      | 0.00    |           |
| J17     | 0.00       | 111.80 | 34.91      | 0.00    |           |
| J18     | 2.11       | 111.80 | 34.70      | 0.00    |           |
| J19     | 0.00       | 97.84  | 20.00      | 0.00    |           |
| J20     | 2.93       | 97.84  | 19.95      | 0.00    |           |
| R1      | -152.54    | 0.00   | 0.00       | 0.00    | Reservoir |
| R2      | -158.80    | 0.00   | 0.00       | 0.00    | Reservoir |

Link Results at 0:00 Hrs:

| Link ID | Flow LPS | Velocity m/s | Unit Headloss m/km | Status |
|---------|----------|--------------|--------------------|--------|
| P1      | 152.54   | 4.86         | 137.94             | Open   |
| P2      | 4.83     | 0.15         | 0.23               | Open   |
| P3      | 3.36     | 0.05         | 0.01               | Open   |
| P4      | 3.36     | 0.05         | 0.01               | Open   |
| P5      | 3.36     | 0.05         | 0.01               | Open   |
| P12     | 0.00     | 0.00         | 0.00               | Open   |
| P13     | 147.71   | 2.09         | 15.35              | Open   |
| P14     | 147.71   | 2.09         | 15.35              | Open   |
| P15     | -158.80  | 5.05         | 148.60             | Open   |
| P16     | 306.51   | 9.76         | 502.29             | Open   |
| P17     | 304.40   | 9.69         | 495.90             | Open   |
| P18     | 302.93   | 9.64         | 491.47             | Open   |
| P19     | 2.93     | 0.09         | 0.09               | Open   |
| P20     | 2.93     | 0.09         | 0.09               | Open   |



|     |      |      |      |      |
|-----|------|------|------|------|
| P21 | 2.11 | 0.03 | 0.01 | Open |
| P22 | 2.11 | 0.03 | 0.01 | Open |
| P23 | 0.00 | 0.00 | 0.00 | Open |
| P24 | 2.11 | 0.03 | 0.01 | Open |
| P25 | 2.11 | 0.03 | 0.01 | Open |



Page 3

Link Results at 0:00 Hrs: (continued)

| Link ID | Flow LPS | Velocity m/s | Unit Headloss m/km | Status    |
|---------|----------|--------------|--------------------|-----------|
| 1       | 158.80   | 0.00         | -121.95            | Open Pump |
| 2       | 152.54   | 0.00         | -122.27            | Open Pump |

Node Results at 1:00 Hrs:

| Node ID | Demand LPS | Head m | Pressure m | Quality        |
|---------|------------|--------|------------|----------------|
| J1      | 0.00       | 122.27 | 46.74      | 0.00           |
| J2      | 0.00       | 113.87 | 37.20      | 0.00           |
| J3      | 1.47       | 113.87 | 36.59      | 0.00           |
| J4      | 0.00       | 113.87 | 37.77      | 0.00           |
| J5      | 0.00       | 113.87 | 37.18      | 0.00           |
| J6      | 3.36       | 113.87 | 37.03      | 0.00           |
| J7      | 0.00       | 113.87 | 34.66      | 0.00           |
| J8      | 0.00       | 113.60 | 36.75      | 0.00           |
| J9      | 0.00       | 112.90 | 36.13      | 0.00           |
| J10     | 0.00       | 111.80 | 35.11      | 0.00           |
| J11     | 1.47       | 107.80 | 30.86      | 0.00           |
| J12     | 0.00       | 121.95 | 46.02      | 0.00           |
| J13     | 300.00     | 97.84  | 20.21      | 0.00           |
| J14     | 0.00       | 111.80 | 34.84      | 0.00           |
| J15     | 0.00       | 111.80 | 34.46      | 0.00           |
| J16     | 0.00       | 111.80 | 34.37      | 0.00           |
| J17     | 0.00       | 111.80 | 34.91      | 0.00           |
| J18     | 2.11       | 111.80 | 34.70      | 0.00           |
| J19     | 0.00       | 97.84  | 20.00      | 0.00           |
| J20     | 2.93       | 97.84  | 19.95      | 0.00           |
| R1      | -152.54    | 0.00   | 0.00       | 0.00 Reservoir |
| R2      | -158.80    | 0.00   | 0.00       | 0.00 Reservoir |

Link Results at 1:00 Hrs:

| Link ID | Flow LPS | Velocity m/s | Unit Headloss m/km | Status |
|---------|----------|--------------|--------------------|--------|
| P1      | 152.54   | 4.86         | 137.94             | Open   |



|     |         |      |        |      |
|-----|---------|------|--------|------|
| P2  | 4.83    | 0.15 | 0.23   | Open |
| P3  | 3.36    | 0.05 | 0.01   | Open |
| P4  | 3.36    | 0.05 | 0.01   | Open |
| P5  | 3.36    | 0.05 | 0.01   | Open |
| P12 | 0.00    | 0.00 | 0.00   | Open |
| P13 | 147.71  | 2.09 | 15.35  | Open |
| P14 | 147.71  | 2.09 | 15.35  | Open |
| P15 | -158.80 | 5.05 | 148.60 | Open |
| P16 | 306.51  | 9.76 | 502.28 | Open |
| P17 | 304.40  | 9.69 | 495.90 | Open |



Page 4

Link Results at 1:00 Hrs: (continued)

| Link ID | Flow LPS | Velocity m/s | Unit Headloss m/km | Status    |
|---------|----------|--------------|--------------------|-----------|
| P18     | 302.93   | 9.64         | 491.47             | Open      |
| P19     | 2.93     | 0.09         | 0.09               | Open      |
| P20     | 2.93     | 0.09         | 0.09               | Open      |
| P21     | 2.11     | 0.03         | 0.01               | Open      |
| P22     | 2.11     | 0.03         | 0.01               | Open      |
| P23     | 0.00     | 0.00         | 0.00               | Open      |
| P24     | 2.11     | 0.03         | 0.01               | Open      |
| P25     | 2.11     | 0.03         | 0.01               | Open      |
| 1       | 158.80   | 0.00         | -121.95            | Open Pump |
| 2       | 152.54   | 0.00         | -122.27            | Open Pump |

Node Results at 2:00 Hrs:

| Node ID | Demand LPS | Head m | Pressure m | Quality |
|---------|------------|--------|------------|---------|
| J1      | 0.00       | 122.27 | 46.74      | 0.00    |
| J2      | 0.00       | 113.87 | 37.20      | 0.00    |
| J3      | 1.47       | 113.87 | 36.59      | 0.00    |
| J4      | 0.00       | 113.87 | 37.77      | 0.00    |
| J5      | 0.00       | 113.87 | 37.18      | 0.00    |
| J6      | 3.36       | 113.87 | 37.03      | 0.00    |
| J7      | 0.00       | 113.87 | 34.66      | 0.00    |
| J8      | 0.00       | 113.60 | 36.75      | 0.00    |
| J9      | 0.00       | 112.90 | 36.13      | 0.00    |
| J10     | 0.00       | 111.80 | 35.11      | 0.00    |
| J11     | 1.47       | 107.80 | 30.86      | 0.00    |
| J12     | 0.00       | 121.95 | 46.02      | 0.00    |
| J13     | 300.00     | 97.84  | 20.21      | 0.00    |
| J14     | 0.00       | 111.80 | 34.84      | 0.00    |
| J15     | 0.00       | 111.80 | 34.46      | 0.00    |
| J16     | 0.00       | 111.80 | 34.37      | 0.00    |



|     |         |        |       |      |           |
|-----|---------|--------|-------|------|-----------|
| J17 | 0.00    | 111.80 | 34.91 | 0.00 |           |
| J18 | 2.11    | 111.80 | 34.70 | 0.00 |           |
| J19 | 0.00    | 97.84  | 20.00 | 0.00 |           |
| J20 | 2.93    | 97.84  | 19.95 | 0.00 |           |
| R1  | -152.54 | 0.00   | 0.00  | 0.00 | Reservoir |
| R2  | -158.80 | 0.00   | 0.00  | 0.00 | Reservoir |



Page 5

Link Results at 2:00 Hrs:

| Link ID | Flow LPS | Velocity m/s | Unit Headloss m/km | Status    |
|---------|----------|--------------|--------------------|-----------|
| P1      | 152.54   | 4.86         | 137.94             | Open      |
| P2      | 4.83     | 0.15         | 0.23               | Open      |
| P3      | 3.36     | 0.05         | 0.01               | Open      |
| P4      | 3.36     | 0.05         | 0.01               | Open      |
| P5      | 3.36     | 0.05         | 0.01               | Open      |
| P12     | 0.00     | 0.00         | 0.00               | Open      |
| P13     | 147.71   | 2.09         | 15.35              | Open      |
| P14     | 147.71   | 2.09         | 15.35              | Open      |
| P15     | -158.80  | 5.05         | 148.60             | Open      |
| P16     | 306.51   | 9.76         | 502.28             | Open      |
| P17     | 304.40   | 9.69         | 495.90             | Open      |
| P18     | 302.93   | 9.64         | 491.47             | Open      |
| P19     | 2.93     | 0.09         | 0.09               | Open      |
| P20     | 2.93     | 0.09         | 0.09               | Open      |
| P21     | 2.11     | 0.03         | 0.01               | Open      |
| P22     | 2.11     | 0.03         | 0.01               | Open      |
| P23     | 0.00     | 0.00         | 0.00               | Open      |
| P24     | 2.11     | 0.03         | 0.01               | Open      |
| P25     | 2.11     | 0.03         | 0.01               | Open      |
| 1       | 158.80   | 0.00         | -121.95            | Open Pump |
| 2       | 152.54   | 0.00         | -122.27            | Open Pump |

Node Results at 3:00 Hrs:

| Node ID | Demand LPS | Head m | Pressure m | Quality |
|---------|------------|--------|------------|---------|
| J1      | 0.00       | 122.27 | 46.74      | 0.00    |
| J2      | 0.00       | 113.87 | 37.20      | 0.00    |
| J3      | 1.47       | 113.87 | 36.59      | 0.00    |
| J4      | 0.00       | 113.87 | 37.77      | 0.00    |
| J5      | 0.00       | 113.87 | 37.18      | 0.00    |
| J6      | 3.36       | 113.87 | 37.03      | 0.00    |
| J7      | 0.00       | 113.87 | 34.66      | 0.00    |
| J8      | 0.00       | 113.60 | 36.75      | 0.00    |



|     |        |        |       |      |
|-----|--------|--------|-------|------|
| J9  | 0.00   | 112.90 | 36.13 | 0.00 |
| J10 | 0.00   | 111.80 | 35.11 | 0.00 |
| J11 | 1.47   | 107.80 | 30.86 | 0.00 |
| J12 | 0.00   | 121.95 | 46.02 | 0.00 |
| J13 | 300.00 | 97.84  | 20.21 | 0.00 |
| J14 | 0.00   | 111.80 | 34.84 | 0.00 |
| J15 | 0.00   | 111.80 | 34.46 | 0.00 |
| J16 | 0.00   | 111.80 | 34.37 | 0.00 |
| J17 | 0.00   | 111.80 | 34.91 | 0.00 |
| J18 | 2.11   | 111.80 | 34.70 | 0.00 |
| J19 | 0.00   | 97.84  | 20.00 | 0.00 |
| J20 | 2.93   | 97.84  | 19.95 | 0.00 |



Page 6

Node Results at 3:00 Hrs: (continued)

| Node ID | Demand LPS | Head m | Pressure m | Quality        |
|---------|------------|--------|------------|----------------|
| R1      | -152.54    | 0.00   | 0.00       | 0.00 Reservoir |
| R2      | -158.80    | 0.00   | 0.00       | 0.00 Reservoir |

Link Results at 3:00 Hrs:

| Link ID | Flow LPS | Velocity m/s | Unit Headloss m/km | Status    |
|---------|----------|--------------|--------------------|-----------|
| P1      | 152.54   | 4.86         | 137.94             | Open      |
| P2      | 4.83     | 0.15         | 0.23               | Open      |
| P3      | 3.36     | 0.05         | 0.01               | Open      |
| P4      | 3.36     | 0.05         | 0.01               | Open      |
| P5      | 3.36     | 0.05         | 0.01               | Open      |
| P12     | 0.00     | 0.00         | 0.00               | Open      |
| P13     | 147.71   | 2.09         | 15.35              | Open      |
| P14     | 147.71   | 2.09         | 15.35              | Open      |
| P15     | -158.80  | 5.05         | 148.60             | Open      |
| P16     | 306.51   | 9.76         | 502.28             | Open      |
| P17     | 304.40   | 9.69         | 495.90             | Open      |
| P18     | 302.93   | 9.64         | 491.47             | Open      |
| P19     | 2.93     | 0.09         | 0.09               | Open      |
| P20     | 2.93     | 0.09         | 0.09               | Open      |
| P21     | 2.11     | 0.03         | 0.01               | Open      |
| P22     | 2.11     | 0.03         | 0.01               | Open      |
| P23     | 0.00     | 0.00         | 0.00               | Open      |
| P24     | 2.11     | 0.03         | 0.01               | Open      |
| P25     | 2.11     | 0.03         | 0.01               | Open      |
| 1       | 158.80   | 0.00         | -121.95            | Open Pump |
| 2       | 152.54   | 0.00         | -122.27            | Open Pump |



## Node Results at 4:00 Hrs:

| Node ID | Demand LPS | Head m | Pressure m | Quality |
|---------|------------|--------|------------|---------|
| J1      | 0.00       | 122.27 | 46.74      | 0.00    |
| J2      | 0.00       | 113.87 | 37.20      | 0.00    |
| J3      | 1.47       | 113.87 | 36.59      | 0.00    |
| J4      | 0.00       | 113.87 | 37.77      | 0.00    |
| J5      | 0.00       | 113.87 | 37.18      | 0.00    |
| J6      | 3.36       | 113.87 | 37.03      | 0.00    |
| J7      | 0.00       | 113.87 | 34.66      | 0.00    |
| J8      | 0.00       | 113.60 | 36.75      | 0.00    |
| J9      | 0.00       | 112.90 | 36.13      | 0.00    |
| J10     | 0.00       | 111.80 | 35.11      | 0.00    |
| J11     | 1.47       | 107.80 | 30.86      | 0.00    |
| J12     | 0.00       | 121.95 | 46.02      | 0.00    |



Page 7

## Node Results at 4:00 Hrs: (continued)

| Node ID | Demand LPS | Head m | Pressure m | Quality        |
|---------|------------|--------|------------|----------------|
| J13     | 300.00     | 97.84  | 20.21      | 0.00           |
| J14     | 0.00       | 111.80 | 34.84      | 0.00           |
| J15     | 0.00       | 111.80 | 34.46      | 0.00           |
| J16     | 0.00       | 111.80 | 34.37      | 0.00           |
| J17     | 0.00       | 111.80 | 34.91      | 0.00           |
| J18     | 2.11       | 111.80 | 34.70      | 0.00           |
| J19     | 0.00       | 97.84  | 20.00      | 0.00           |
| J20     | 2.93       | 97.84  | 19.95      | 0.00           |
| R1      | -152.54    | 0.00   | 0.00       | 0.00 Reservoir |
| R2      | -158.80    | 0.00   | 0.00       | 0.00 Reservoir |

## Link Results at 4:00 Hrs:

| Link ID | Flow LPS | Velocity m/s | Unit Headloss m/km | Status |
|---------|----------|--------------|--------------------|--------|
| P1      | 152.54   | 4.86         | 137.94             | Open   |
| P2      | 4.83     | 0.15         | 0.23               | Open   |
| P3      | 3.36     | 0.05         | 0.01               | Open   |
| P4      | 3.36     | 0.05         | 0.01               | Open   |
| P5      | 3.36     | 0.05         | 0.01               | Open   |
| P12     | 0.00     | 0.00         | 0.00               | Open   |
| P13     | 147.71   | 2.09         | 15.35              | Open   |
| P14     | 147.71   | 2.09         | 15.35              | Open   |
| P15     | -158.80  | 5.05         | 148.60             | Open   |



|     |        |      |         |           |
|-----|--------|------|---------|-----------|
| P16 | 306.51 | 9.76 | 502.28  | Open      |
| P17 | 304.40 | 9.69 | 495.90  | Open      |
| P18 | 302.93 | 9.64 | 491.47  | Open      |
| P19 | 2.93   | 0.09 | 0.09    | Open      |
| P20 | 2.93   | 0.09 | 0.09    | Open      |
| P21 | 2.11   | 0.03 | 0.01    | Open      |
| P22 | 2.11   | 0.03 | 0.01    | Open      |
| P23 | 0.00   | 0.00 | 0.00    | Open      |
| P24 | 2.11   | 0.03 | 0.01    | Open      |
| P25 | 2.11   | 0.03 | 0.01    | Open      |
| 1   | 158.80 | 0.00 | -121.95 | Open Pump |
| 2   | 152.54 | 0.00 | -122.27 | Open Pump |



### Max Day + Fire Flow Conditions at Existing Building 2080 Russell Road (Node J6)

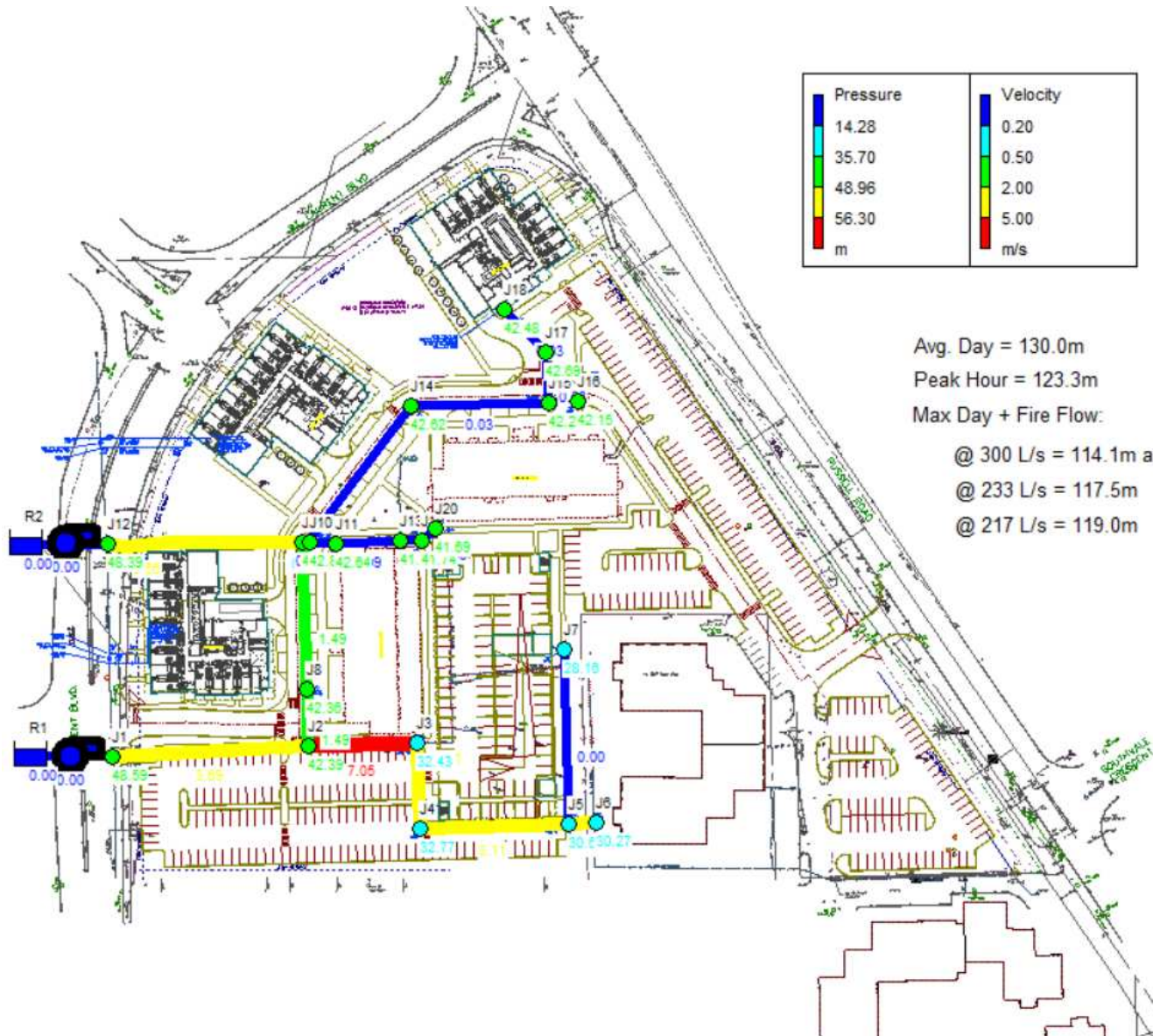

Avg. Day = 130.0m  
 Peak Hour = 123.3m  
 Max Day + Fire Flow:  
 @ 300 L/s = 114.1m and 113.1m  
 @ 233 L/s = 117.5m  
 @ 217 L/s = 119.0m





```

* E P A N E T *
* Hydraulic and Water Quality *
* Analysis for Pipe Networks *
* Version 2.2 *

```

Input

Link

Link

ID

- P1
- P2
- P3
- P4
- P5
- P12
- P13
- P14
- P15
- P16
- P17
- P18
- P19
- P20
- P21
- P22
- P23
- P24
- P25

- 1
- 2

Ener

Pump

- 1
- 2

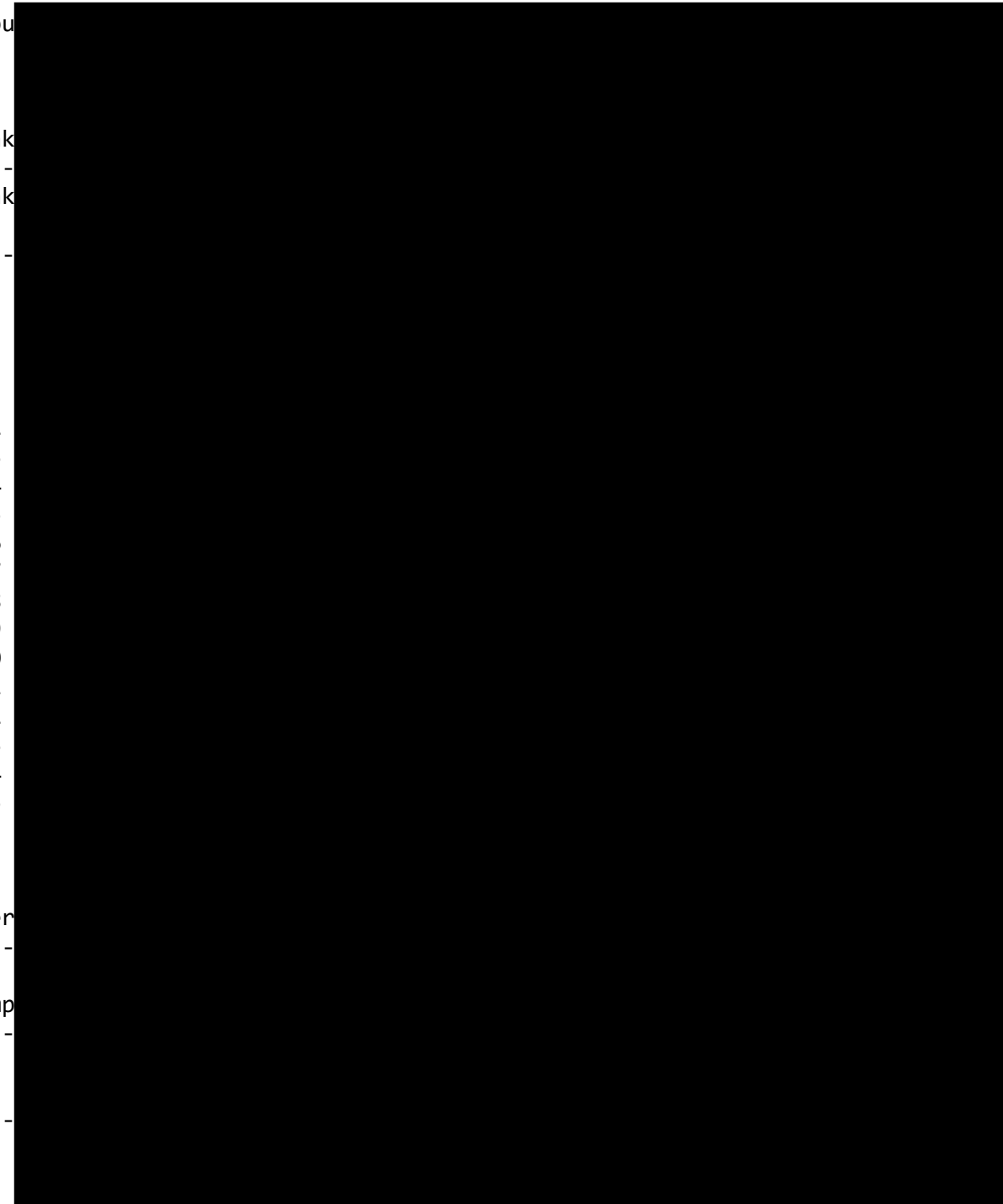



Page 2

Node Results at 0:00 Hrs:

| Node ID | Demand LPS | Head m | Pressure m | Quality |           |
|---------|------------|--------|------------|---------|-----------|
| J1      | 0.00       | 124.12 | 48.59      | 0.00    |           |
| J2      | 0.00       | 119.06 | 42.39      | 0.00    |           |
| J3      | 1.47       | 109.71 | 32.43      | 0.00    |           |
| J4      | 0.00       | 108.87 | 32.77      | 0.00    |           |
| J5      | 0.00       | 107.37 | 30.68      | 0.00    |           |
| J6      | 220.03     | 107.11 | 30.27      | 0.00    |           |
| J7      | 0.00       | 107.37 | 28.16      | 0.00    |           |
| J8      | 0.00       | 119.21 | 42.36      | 0.00    |           |
| J9      | 0.00       | 119.58 | 42.81      | 0.00    |           |
| J10     | 0.00       | 119.58 | 42.89      | 0.00    |           |
| J11     | 1.47       | 119.58 | 42.64      | 0.00    |           |
| J12     | 0.00       | 124.32 | 48.39      | 0.00    |           |
| J13     | 0.00       | 119.58 | 41.95      | 0.00    |           |
| J14     | 0.00       | 119.58 | 42.62      | 0.00    |           |
| J15     | 0.00       | 119.58 | 42.24      | 0.00    |           |
| J16     | 0.00       | 119.58 | 42.15      | 0.00    |           |
| J17     | 0.00       | 119.58 | 42.69      | 0.00    |           |
| J18     | 2.11       | 119.58 | 42.48      | 0.00    |           |
| J19     | 0.00       | 119.58 | 41.74      | 0.00    |           |
| J20     | 2.93       | 119.58 | 41.69      | 0.00    |           |
| R1      | -116.03    | 0.00   | 0.00       | 0.00    | Reservoir |
| R2      | -111.98    | 0.00   | 0.00       | 0.00    | Reservoir |

Link Results at 0:00 Hrs:

| Link ID | Flow LPS | Velocity m/s | Unit Headloss m/km | Status |
|---------|----------|--------------|--------------------|--------|
| P1      | 116.03   | 3.69         | 83.10              | Open   |
| P2      | 221.50   | 7.05         | 275.22             | Open   |
| P3      | 220.03   | 3.11         | 32.11              | Open   |
| P4      | 220.03   | 3.11         | 32.11              | Open   |
| P5      | 220.03   | 3.11         | 32.11              | Open   |
| P12     | 0.00     | 0.00         | 0.00               | Open   |
| P13     | -105.47  | 1.49         | 8.23               | Open   |
| P14     | -105.47  | 1.49         | 8.23               | Open   |
| P15     | -111.98  | 3.56         | 77.82              | Open   |
| P16     | 6.51     | 0.21         | 0.40               | Open   |
| P17     | 4.40     | 0.14         | 0.19               | Open   |
| P18     | 2.93     | 0.09         | 0.09               | Open   |
| P19     | 2.93     | 0.09         | 0.09               | Open   |
| P20     | 2.93     | 0.09         | 0.09               | Open   |



|     |      |      |      |      |
|-----|------|------|------|------|
| P21 | 2.11 | 0.03 | 0.01 | Open |
| P22 | 2.11 | 0.03 | 0.01 | Open |
| P23 | 0.00 | 0.00 | 0.00 | Open |
| P24 | 2.11 | 0.03 | 0.01 | Open |
| P25 | 2.11 | 0.03 | 0.01 | Open |



Page 3

Link Results at 0:00 Hrs: (continued)

| Link ID | Flow LPS | Velocity m/s | Unit Headloss m/km | Status    |
|---------|----------|--------------|--------------------|-----------|
| 1       | 111.98   | 0.00         | -124.32            | Open Pump |
| 2       | 116.03   | 0.00         | -124.12            | Open Pump |

Node Results at 1:00 Hrs:

| Node ID | Demand LPS | Head m | Pressure m | Quality        |
|---------|------------|--------|------------|----------------|
| J1      | 0.00       | 124.12 | 48.59      | 0.00           |
| J2      | 0.00       | 119.06 | 42.39      | 0.00           |
| J3      | 1.47       | 109.71 | 32.43      | 0.00           |
| J4      | 0.00       | 108.87 | 32.77      | 0.00           |
| J5      | 0.00       | 107.37 | 30.68      | 0.00           |
| J6      | 220.03     | 107.11 | 30.27      | 0.00           |
| J7      | 0.00       | 107.37 | 28.16      | 0.00           |
| J8      | 0.00       | 119.21 | 42.36      | 0.00           |
| J9      | 0.00       | 119.58 | 42.81      | 0.00           |
| J10     | 0.00       | 119.58 | 42.89      | 0.00           |
| J11     | 1.47       | 119.58 | 42.64      | 0.00           |
| J12     | 0.00       | 124.32 | 48.39      | 0.00           |
| J13     | 0.00       | 119.58 | 41.95      | 0.00           |
| J14     | 0.00       | 119.58 | 42.62      | 0.00           |
| J15     | 0.00       | 119.58 | 42.24      | 0.00           |
| J16     | 0.00       | 119.58 | 42.15      | 0.00           |
| J17     | 0.00       | 119.58 | 42.69      | 0.00           |
| J18     | 2.11       | 119.58 | 42.48      | 0.00           |
| J19     | 0.00       | 119.58 | 41.74      | 0.00           |
| J20     | 2.93       | 119.58 | 41.69      | 0.00           |
| R1      | -116.03    | 0.00   | 0.00       | 0.00 Reservoir |
| R2      | -111.98    | 0.00   | 0.00       | 0.00 Reservoir |

Link Results at 1:00 Hrs:

| Link ID | Flow LPS | Velocity m/s | Unit Headloss m/km | Status |
|---------|----------|--------------|--------------------|--------|
| P1      | 116.03   | 3.69         | 83.10              | Open   |



|     |         |      |        |      |
|-----|---------|------|--------|------|
| P2  | 221.50  | 7.05 | 275.22 | Open |
| P3  | 220.03  | 3.11 | 32.11  | Open |
| P4  | 220.03  | 3.11 | 32.11  | Open |
| P5  | 220.03  | 3.11 | 32.11  | Open |
| P12 | 0.00    | 0.00 | 0.00   | Open |
| P13 | -105.47 | 1.49 | 8.23   | Open |
| P14 | -105.47 | 1.49 | 8.23   | Open |
| P15 | -111.98 | 3.56 | 77.82  | Open |
| P16 | 6.51    | 0.21 | 0.40   | Open |
| P17 | 4.40    | 0.14 | 0.19   | Open |



Page 4

Link Results at 1:00 Hrs: (continued)

| Link ID | Flow LPS | Velocity m/s | Unit Headloss m/km | Status    |
|---------|----------|--------------|--------------------|-----------|
| P18     | 2.93     | 0.09         | 0.09               | Open      |
| P19     | 2.93     | 0.09         | 0.09               | Open      |
| P20     | 2.93     | 0.09         | 0.09               | Open      |
| P21     | 2.11     | 0.03         | 0.01               | Open      |
| P22     | 2.11     | 0.03         | 0.01               | Open      |
| P23     | 0.00     | 0.00         | 0.00               | Open      |
| P24     | 2.11     | 0.03         | 0.01               | Open      |
| P25     | 2.11     | 0.03         | 0.01               | Open      |
| 1       | 111.98   | 0.00         | -124.32            | Open Pump |
| 2       | 116.03   | 0.00         | -124.12            | Open Pump |

Node Results at 2:00 Hrs:

| Node ID | Demand LPS | Head m | Pressure m | Quality |
|---------|------------|--------|------------|---------|
| J1      | 0.00       | 124.12 | 48.59      | 0.00    |
| J2      | 0.00       | 119.06 | 42.39      | 0.00    |
| J3      | 1.47       | 109.71 | 32.43      | 0.00    |
| J4      | 0.00       | 108.87 | 32.77      | 0.00    |
| J5      | 0.00       | 107.37 | 30.68      | 0.00    |
| J6      | 220.03     | 107.11 | 30.27      | 0.00    |
| J7      | 0.00       | 107.37 | 28.16      | 0.00    |
| J8      | 0.00       | 119.21 | 42.36      | 0.00    |
| J9      | 0.00       | 119.58 | 42.81      | 0.00    |
| J10     | 0.00       | 119.58 | 42.89      | 0.00    |
| J11     | 1.47       | 119.58 | 42.64      | 0.00    |
| J12     | 0.00       | 124.32 | 48.39      | 0.00    |
| J13     | 0.00       | 119.58 | 41.95      | 0.00    |
| J14     | 0.00       | 119.58 | 42.62      | 0.00    |
| J15     | 0.00       | 119.58 | 42.24      | 0.00    |
| J16     | 0.00       | 119.58 | 42.15      | 0.00    |



|     |         |        |       |      |           |
|-----|---------|--------|-------|------|-----------|
| J17 | 0.00    | 119.58 | 42.69 | 0.00 |           |
| J18 | 2.11    | 119.58 | 42.48 | 0.00 |           |
| J19 | 0.00    | 119.58 | 41.74 | 0.00 |           |
| J20 | 2.93    | 119.58 | 41.69 | 0.00 |           |
| R1  | -116.03 | 0.00   | 0.00  | 0.00 | Reservoir |
| R2  | -111.98 | 0.00   | 0.00  | 0.00 | Reservoir |



Page 5

Link Results at 2:00 Hrs:

| Link ID | Flow LPS | Velocity m/s | Unit Headloss m/km | Status    |
|---------|----------|--------------|--------------------|-----------|
| P1      | 116.03   | 3.69         | 83.10              | Open      |
| P2      | 221.50   | 7.05         | 275.22             | Open      |
| P3      | 220.03   | 3.11         | 32.11              | Open      |
| P4      | 220.03   | 3.11         | 32.11              | Open      |
| P5      | 220.03   | 3.11         | 32.11              | Open      |
| P12     | 0.00     | 0.00         | 0.00               | Open      |
| P13     | -105.47  | 1.49         | 8.23               | Open      |
| P14     | -105.47  | 1.49         | 8.23               | Open      |
| P15     | -111.98  | 3.56         | 77.82              | Open      |
| P16     | 6.51     | 0.21         | 0.40               | Open      |
| P17     | 4.40     | 0.14         | 0.19               | Open      |
| P18     | 2.93     | 0.09         | 0.09               | Open      |
| P19     | 2.93     | 0.09         | 0.09               | Open      |
| P20     | 2.93     | 0.09         | 0.09               | Open      |
| P21     | 2.11     | 0.03         | 0.01               | Open      |
| P22     | 2.11     | 0.03         | 0.01               | Open      |
| P23     | 0.00     | 0.00         | 0.00               | Open      |
| P24     | 2.11     | 0.03         | 0.01               | Open      |
| P25     | 2.11     | 0.03         | 0.01               | Open      |
| 1       | 111.98   | 0.00         | -124.32            | Open Pump |
| 2       | 116.03   | 0.00         | -124.12            | Open Pump |

Node Results at 3:00 Hrs:

| Node ID | Demand LPS | Head m | Pressure m | Quality |
|---------|------------|--------|------------|---------|
| J1      | 0.00       | 124.12 | 48.59      | 0.00    |
| J2      | 0.00       | 119.06 | 42.39      | 0.00    |
| J3      | 1.47       | 109.71 | 32.43      | 0.00    |
| J4      | 0.00       | 108.87 | 32.77      | 0.00    |
| J5      | 0.00       | 107.37 | 30.68      | 0.00    |
| J6      | 220.03     | 107.11 | 30.27      | 0.00    |
| J7      | 0.00       | 107.37 | 28.16      | 0.00    |
| J8      | 0.00       | 119.21 | 42.36      | 0.00    |



|     |      |        |       |      |
|-----|------|--------|-------|------|
| J9  | 0.00 | 119.58 | 42.81 | 0.00 |
| J10 | 0.00 | 119.58 | 42.89 | 0.00 |
| J11 | 1.47 | 119.58 | 42.64 | 0.00 |
| J12 | 0.00 | 124.32 | 48.39 | 0.00 |
| J13 | 0.00 | 119.58 | 41.95 | 0.00 |
| J14 | 0.00 | 119.58 | 42.62 | 0.00 |
| J15 | 0.00 | 119.58 | 42.24 | 0.00 |
| J16 | 0.00 | 119.58 | 42.15 | 0.00 |
| J17 | 0.00 | 119.58 | 42.69 | 0.00 |
| J18 | 2.11 | 119.58 | 42.48 | 0.00 |
| J19 | 0.00 | 119.58 | 41.74 | 0.00 |
| J20 | 2.93 | 119.58 | 41.69 | 0.00 |



Page 6

Node Results at 3:00 Hrs: (continued)

| Node ID | Demand LPS | Head m | Pressure m | Quality        |
|---------|------------|--------|------------|----------------|
| R1      | -116.03    | 0.00   | 0.00       | 0.00 Reservoir |
| R2      | -111.98    | 0.00   | 0.00       | 0.00 Reservoir |

Link Results at 3:00 Hrs:

| Link ID | Flow LPS | Velocity m/s | Unit Headloss m/km | Status    |
|---------|----------|--------------|--------------------|-----------|
| P1      | 116.03   | 3.69         | 83.10              | Open      |
| P2      | 221.50   | 7.05         | 275.22             | Open      |
| P3      | 220.03   | 3.11         | 32.11              | Open      |
| P4      | 220.03   | 3.11         | 32.11              | Open      |
| P5      | 220.03   | 3.11         | 32.11              | Open      |
| P12     | 0.00     | 0.00         | 0.00               | Open      |
| P13     | -105.47  | 1.49         | 8.23               | Open      |
| P14     | -105.47  | 1.49         | 8.23               | Open      |
| P15     | -111.98  | 3.56         | 77.82              | Open      |
| P16     | 6.51     | 0.21         | 0.40               | Open      |
| P17     | 4.40     | 0.14         | 0.19               | Open      |
| P18     | 2.93     | 0.09         | 0.09               | Open      |
| P19     | 2.93     | 0.09         | 0.09               | Open      |
| P20     | 2.93     | 0.09         | 0.09               | Open      |
| P21     | 2.11     | 0.03         | 0.01               | Open      |
| P22     | 2.11     | 0.03         | 0.01               | Open      |
| P23     | 0.00     | 0.00         | 0.00               | Open      |
| P24     | 2.11     | 0.03         | 0.01               | Open      |
| P25     | 2.11     | 0.03         | 0.01               | Open      |
| 1       | 111.98   | 0.00         | -124.32            | Open Pump |
| 2       | 116.03   | 0.00         | -124.12            | Open Pump |



## Node Results at 4:00 Hrs:

| Node ID | Demand LPS | Head m | Pressure m | Quality |
|---------|------------|--------|------------|---------|
| J1      | 0.00       | 124.12 | 48.59      | 0.00    |
| J2      | 0.00       | 119.06 | 42.39      | 0.00    |
| J3      | 1.47       | 109.71 | 32.43      | 0.00    |
| J4      | 0.00       | 108.87 | 32.77      | 0.00    |
| J5      | 0.00       | 107.37 | 30.68      | 0.00    |
| J6      | 220.03     | 107.11 | 30.27      | 0.00    |
| J7      | 0.00       | 107.37 | 28.16      | 0.00    |
| J8      | 0.00       | 119.21 | 42.36      | 0.00    |
| J9      | 0.00       | 119.58 | 42.81      | 0.00    |
| J10     | 0.00       | 119.58 | 42.89      | 0.00    |
| J11     | 1.47       | 119.58 | 42.64      | 0.00    |
| J12     | 0.00       | 124.32 | 48.39      | 0.00    |



Page 7

## Node Results at 4:00 Hrs: (continued)

| Node ID | Demand LPS | Head m | Pressure m | Quality        |
|---------|------------|--------|------------|----------------|
| J13     | 0.00       | 119.58 | 41.95      | 0.00           |
| J14     | 0.00       | 119.58 | 42.62      | 0.00           |
| J15     | 0.00       | 119.58 | 42.24      | 0.00           |
| J16     | 0.00       | 119.58 | 42.15      | 0.00           |
| J17     | 0.00       | 119.58 | 42.69      | 0.00           |
| J18     | 2.11       | 119.58 | 42.48      | 0.00           |
| J19     | 0.00       | 119.58 | 41.74      | 0.00           |
| J20     | 2.93       | 119.58 | 41.69      | 0.00           |
| R1      | -116.03    | 0.00   | 0.00       | 0.00 Reservoir |
| R2      | -111.98    | 0.00   | 0.00       | 0.00 Reservoir |

## Link Results at 4:00 Hrs:

| Link ID | Flow LPS | Velocity m/s | Unit Headloss m/km | Status |
|---------|----------|--------------|--------------------|--------|
| P1      | 116.03   | 3.69         | 83.10              | Open   |
| P2      | 221.50   | 7.05         | 275.22             | Open   |
| P3      | 220.03   | 3.11         | 32.11              | Open   |
| P4      | 220.03   | 3.11         | 32.11              | Open   |
| P5      | 220.03   | 3.11         | 32.11              | Open   |
| P12     | 0.00     | 0.00         | 0.00               | Open   |
| P13     | -105.47  | 1.49         | 8.23               | Open   |
| P14     | -105.47  | 1.49         | 8.23               | Open   |
| P15     | -111.98  | 3.56         | 77.82              | Open   |



|     |        |      |         |           |
|-----|--------|------|---------|-----------|
| P16 | 6.51   | 0.21 | 0.40    | Open      |
| P17 | 4.40   | 0.14 | 0.19    | Open      |
| P18 | 2.93   | 0.09 | 0.09    | Open      |
| P19 | 2.93   | 0.09 | 0.09    | Open      |
| P20 | 2.93   | 0.09 | 0.09    | Open      |
| P21 | 2.11   | 0.03 | 0.01    | Open      |
| P22 | 2.11   | 0.03 | 0.01    | Open      |
| P23 | 0.00   | 0.00 | 0.00    | Open      |
| P24 | 2.11   | 0.03 | 0.01    | Open      |
| P25 | 2.11   | 0.03 | 0.01    | Open      |
| 1   | 111.98 | 0.00 | -124.32 | Open Pump |
| 2   | 116.03 | 0.00 | -124.12 | Open Pump |





### Max Day + Fire Flow Conditions at Existing Building 2100 Russell Road (Node J6)

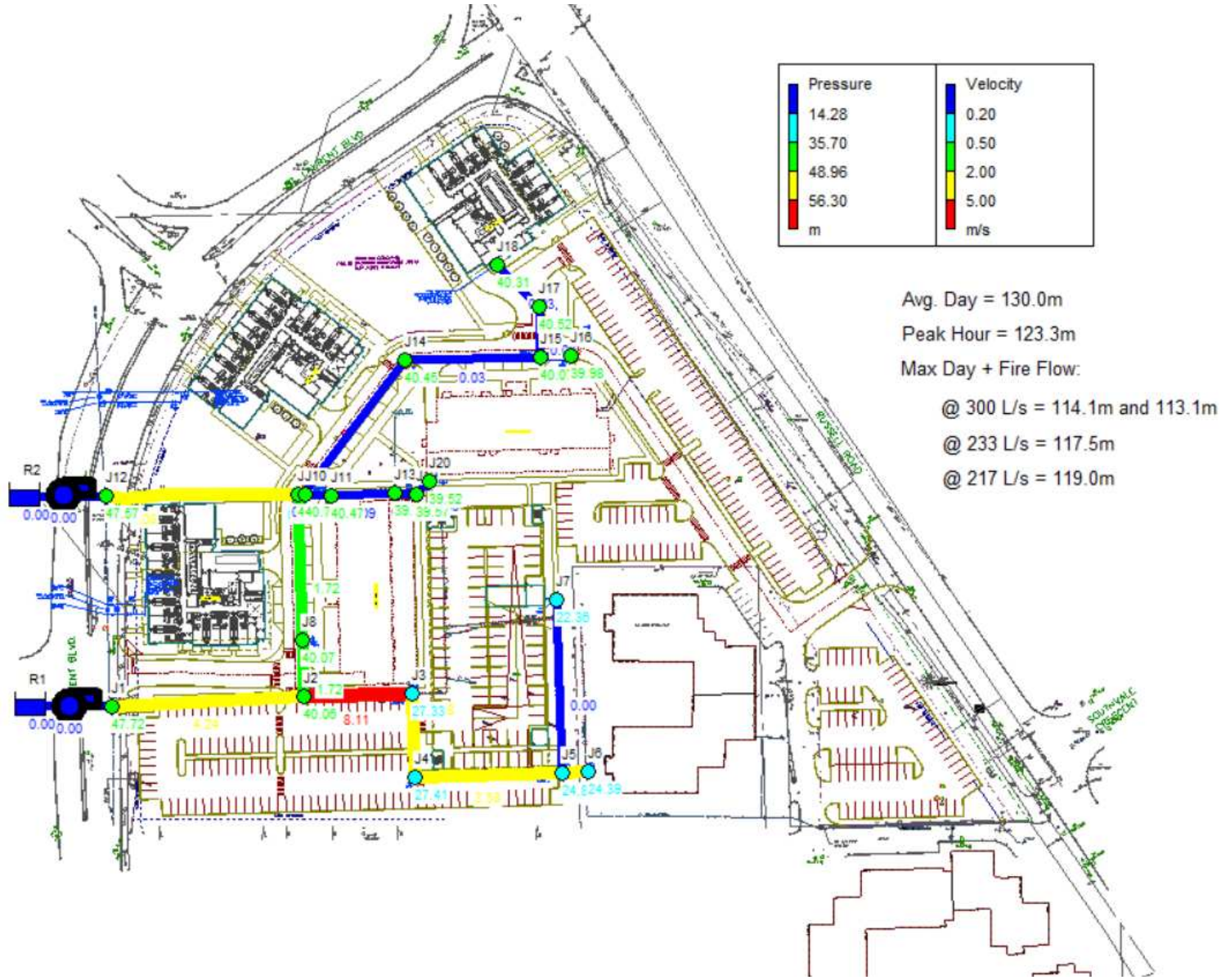



\*\*\*\*\*

```

* E P A N E T *
* Hydraulic and Water Quality *
* Analysis for Pipe Networks *
* Version 2.2 *

```

\*\*\*\*

Input

Link

---

Link

ID

---

P1

P2

P3

P4

P5

P12

P13

P14

P15

P16

P17

P18

P19

P20

P21

P22

P23

P24

P25

1

2

Ene

---

Pump

---

1

2

---



Page 2

Node Results at 0:00 Hrs:

| Node ID | Demand LPS | Head m | Pressure m | Quality |           |
|---------|------------|--------|------------|---------|-----------|
| J1      | 0.00       | 123.25 | 47.72      | 0.00    |           |
| J2      | 0.00       | 116.73 | 40.06      | 0.00    |           |
| J3      | 1.47       | 104.61 | 27.33      | 0.00    |           |
| J4      | 0.00       | 103.51 | 27.41      | 0.00    |           |
| J5      | 0.00       | 101.57 | 24.88      | 0.00    |           |
| J6      | 253.36     | 101.23 | 24.39      | 0.00    |           |
| J7      | 0.00       | 101.57 | 22.36      | 0.00    |           |
| J8      | 0.00       | 116.92 | 40.07      | 0.00    |           |
| J9      | 0.00       | 117.41 | 40.64      | 0.00    |           |
| J10     | 0.00       | 117.41 | 40.72      | 0.00    |           |
| J11     | 1.47       | 117.41 | 40.47      | 0.00    |           |
| J12     | 0.00       | 123.50 | 47.57      | 0.00    |           |
| J13     | 0.00       | 117.41 | 39.78      | 0.00    |           |
| J14     | 0.00       | 117.41 | 40.45      | 0.00    |           |
| J15     | 0.00       | 117.41 | 40.07      | 0.00    |           |
| J16     | 0.00       | 117.41 | 39.98      | 0.00    |           |
| J17     | 0.00       | 117.41 | 40.52      | 0.00    |           |
| J18     | 2.11       | 117.41 | 40.31      | 0.00    |           |
| J19     | 0.00       | 117.41 | 39.57      | 0.00    |           |
| J20     | 2.93       | 117.41 | 39.52      | 0.00    |           |
| R1      | -133.12    | 0.00   | 0.00       | 0.00    | Reservoir |
| R2      | -128.22    | 0.00   | 0.00       | 0.00    | Reservoir |

Link Results at 0:00 Hrs:

| Link ID | Flow LPS | Velocity m/s | Unit Headloss m/km | Status |
|---------|----------|--------------|--------------------|--------|
| P1      | 133.12   | 4.24         | 107.19             | Open   |
| P2      | 254.83   | 8.11         | 356.80             | Open   |
| P3      | 253.36   | 3.58         | 41.69              | Open   |
| P4      | 253.36   | 3.58         | 41.69              | Open   |
| P5      | 253.36   | 3.58         | 41.69              | Open   |
| P12     | 0.00     | 0.00         | 0.00               | Open   |
| P13     | -121.71  | 1.72         | 10.72              | Open   |
| P14     | -121.71  | 1.72         | 10.72              | Open   |
| P15     | -128.22  | 4.08         | 100.00             | Open   |
| P16     | 6.51     | 0.21         | 0.40               | Open   |
| P17     | 4.40     | 0.14         | 0.19               | Open   |
| P18     | 2.93     | 0.09         | 0.09               | Open   |
| P19     | 2.93     | 0.09         | 0.09               | Open   |
| P20     | 2.93     | 0.09         | 0.09               | Open   |



|     |      |      |      |      |
|-----|------|------|------|------|
| P21 | 2.11 | 0.03 | 0.01 | Open |
| P22 | 2.11 | 0.03 | 0.01 | Open |
| P23 | 0.00 | 0.00 | 0.00 | Open |
| P24 | 2.11 | 0.03 | 0.01 | Open |
| P25 | 2.11 | 0.03 | 0.01 | Open |



Page 3

Link Results at 0:00 Hrs: (continued)

| Link ID | Flow LPS | Velocity m/s | Unit Headloss m/km | Status    |
|---------|----------|--------------|--------------------|-----------|
| 1       | 128.22   | 0.00         | -123.50            | Open Pump |
| 2       | 133.12   | 0.00         | -123.25            | Open Pump |

Node Results at 1:00 Hrs:

| Node ID | Demand LPS | Head m | Pressure m | Quality        |
|---------|------------|--------|------------|----------------|
| J1      | 0.00       | 123.25 | 47.72      | 0.00           |
| J2      | 0.00       | 116.73 | 40.06      | 0.00           |
| J3      | 1.47       | 104.61 | 27.33      | 0.00           |
| J4      | 0.00       | 103.51 | 27.41      | 0.00           |
| J5      | 0.00       | 101.57 | 24.88      | 0.00           |
| J6      | 253.36     | 101.23 | 24.39      | 0.00           |
| J7      | 0.00       | 101.57 | 22.36      | 0.00           |
| J8      | 0.00       | 116.92 | 40.07      | 0.00           |
| J9      | 0.00       | 117.41 | 40.64      | 0.00           |
| J10     | 0.00       | 117.41 | 40.72      | 0.00           |
| J11     | 1.47       | 117.41 | 40.47      | 0.00           |
| J12     | 0.00       | 123.50 | 47.57      | 0.00           |
| J13     | 0.00       | 117.41 | 39.78      | 0.00           |
| J14     | 0.00       | 117.41 | 40.45      | 0.00           |
| J15     | 0.00       | 117.41 | 40.07      | 0.00           |
| J16     | 0.00       | 117.41 | 39.98      | 0.00           |
| J17     | 0.00       | 117.41 | 40.52      | 0.00           |
| J18     | 2.11       | 117.41 | 40.31      | 0.00           |
| J19     | 0.00       | 117.41 | 39.57      | 0.00           |
| J20     | 2.93       | 117.41 | 39.52      | 0.00           |
| R1      | -133.12    | 0.00   | 0.00       | 0.00 Reservoir |
| R2      | -128.22    | 0.00   | 0.00       | 0.00 Reservoir |

Link Results at 1:00 Hrs:

| Link ID | Flow LPS | Velocity m/s | Unit Headloss m/km | Status |
|---------|----------|--------------|--------------------|--------|
| P1      | 133.12   | 4.24         | 107.19             | Open   |



|     |         |      |        |      |
|-----|---------|------|--------|------|
| P2  | 254.83  | 8.11 | 356.80 | Open |
| P3  | 253.36  | 3.58 | 41.69  | Open |
| P4  | 253.36  | 3.58 | 41.69  | Open |
| P5  | 253.36  | 3.58 | 41.69  | Open |
| P12 | 0.00    | 0.00 | 0.00   | Open |
| P13 | -121.71 | 1.72 | 10.72  | Open |
| P14 | -121.71 | 1.72 | 10.72  | Open |
| P15 | -128.22 | 4.08 | 100.00 | Open |
| P16 | 6.51    | 0.21 | 0.40   | Open |
| P17 | 4.40    | 0.14 | 0.19   | Open |



Page 4

Link Results at 1:00 Hrs: (continued)

| Link ID | Flow LPS | Velocity m/s | Unit Headloss m/km | Status    |
|---------|----------|--------------|--------------------|-----------|
| P18     | 2.93     | 0.09         | 0.09               | Open      |
| P19     | 2.93     | 0.09         | 0.09               | Open      |
| P20     | 2.93     | 0.09         | 0.09               | Open      |
| P21     | 2.11     | 0.03         | 0.01               | Open      |
| P22     | 2.11     | 0.03         | 0.01               | Open      |
| P23     | 0.00     | 0.00         | 0.00               | Open      |
| P24     | 2.11     | 0.03         | 0.01               | Open      |
| P25     | 2.11     | 0.03         | 0.01               | Open      |
| 1       | 128.22   | 0.00         | -123.50            | Open Pump |
| 2       | 133.12   | 0.00         | -123.25            | Open Pump |

Node Results at 2:00 Hrs:

| Node ID | Demand LPS | Head m | Pressure m | Quality |
|---------|------------|--------|------------|---------|
| J1      | 0.00       | 123.25 | 47.72      | 0.00    |
| J2      | 0.00       | 116.73 | 40.06      | 0.00    |
| J3      | 1.47       | 104.61 | 27.33      | 0.00    |
| J4      | 0.00       | 103.51 | 27.41      | 0.00    |
| J5      | 0.00       | 101.57 | 24.88      | 0.00    |
| J6      | 253.36     | 101.23 | 24.39      | 0.00    |
| J7      | 0.00       | 101.57 | 22.36      | 0.00    |
| J8      | 0.00       | 116.92 | 40.07      | 0.00    |
| J9      | 0.00       | 117.41 | 40.64      | 0.00    |
| J10     | 0.00       | 117.41 | 40.72      | 0.00    |
| J11     | 1.47       | 117.41 | 40.47      | 0.00    |
| J12     | 0.00       | 123.50 | 47.57      | 0.00    |
| J13     | 0.00       | 117.41 | 39.78      | 0.00    |
| J14     | 0.00       | 117.41 | 40.45      | 0.00    |
| J15     | 0.00       | 117.41 | 40.07      | 0.00    |
| J16     | 0.00       | 117.41 | 39.98      | 0.00    |



|     |         |        |       |      |           |
|-----|---------|--------|-------|------|-----------|
| J17 | 0.00    | 117.41 | 40.52 | 0.00 |           |
| J18 | 2.11    | 117.41 | 40.31 | 0.00 |           |
| J19 | 0.00    | 117.41 | 39.57 | 0.00 |           |
| J20 | 2.93    | 117.41 | 39.52 | 0.00 |           |
| R1  | -133.12 | 0.00   | 0.00  | 0.00 | Reservoir |
| R2  | -128.22 | 0.00   | 0.00  | 0.00 | Reservoir |



Page 5

Link Results at 2:00 Hrs:

| Link ID | Flow LPS | Velocity m/s | Unit Headloss m/km | Status    |
|---------|----------|--------------|--------------------|-----------|
| P1      | 133.12   | 4.24         | 107.19             | Open      |
| P2      | 254.83   | 8.11         | 356.80             | Open      |
| P3      | 253.36   | 3.58         | 41.69              | Open      |
| P4      | 253.36   | 3.58         | 41.69              | Open      |
| P5      | 253.36   | 3.58         | 41.69              | Open      |
| P12     | 0.00     | 0.00         | 0.00               | Open      |
| P13     | -121.71  | 1.72         | 10.72              | Open      |
| P14     | -121.71  | 1.72         | 10.72              | Open      |
| P15     | -128.22  | 4.08         | 100.00             | Open      |
| P16     | 6.51     | 0.21         | 0.40               | Open      |
| P17     | 4.40     | 0.14         | 0.19               | Open      |
| P18     | 2.93     | 0.09         | 0.09               | Open      |
| P19     | 2.93     | 0.09         | 0.09               | Open      |
| P20     | 2.93     | 0.09         | 0.09               | Open      |
| P21     | 2.11     | 0.03         | 0.01               | Open      |
| P22     | 2.11     | 0.03         | 0.01               | Open      |
| P23     | 0.00     | 0.00         | 0.00               | Open      |
| P24     | 2.11     | 0.03         | 0.01               | Open      |
| P25     | 2.11     | 0.03         | 0.01               | Open      |
| 1       | 128.22   | 0.00         | -123.50            | Open Pump |
| 2       | 133.12   | 0.00         | -123.25            | Open Pump |

Node Results at 3:00 Hrs:

| Node ID | Demand LPS | Head m | Pressure m | Quality |
|---------|------------|--------|------------|---------|
| J1      | 0.00       | 123.25 | 47.72      | 0.00    |
| J2      | 0.00       | 116.73 | 40.06      | 0.00    |
| J3      | 1.47       | 104.61 | 27.33      | 0.00    |
| J4      | 0.00       | 103.51 | 27.41      | 0.00    |
| J5      | 0.00       | 101.57 | 24.88      | 0.00    |
| J6      | 253.36     | 101.23 | 24.39      | 0.00    |
| J7      | 0.00       | 101.57 | 22.36      | 0.00    |
| J8      | 0.00       | 116.92 | 40.07      | 0.00    |



|     |      |        |       |      |
|-----|------|--------|-------|------|
| J9  | 0.00 | 117.41 | 40.64 | 0.00 |
| J10 | 0.00 | 117.41 | 40.72 | 0.00 |
| J11 | 1.47 | 117.41 | 40.47 | 0.00 |
| J12 | 0.00 | 123.50 | 47.57 | 0.00 |
| J13 | 0.00 | 117.41 | 39.78 | 0.00 |
| J14 | 0.00 | 117.41 | 40.45 | 0.00 |
| J15 | 0.00 | 117.41 | 40.07 | 0.00 |
| J16 | 0.00 | 117.41 | 39.98 | 0.00 |
| J17 | 0.00 | 117.41 | 40.52 | 0.00 |
| J18 | 2.11 | 117.41 | 40.31 | 0.00 |
| J19 | 0.00 | 117.41 | 39.57 | 0.00 |
| J20 | 2.93 | 117.41 | 39.52 | 0.00 |



Page 6

Node Results at 3:00 Hrs: (continued)

| Node ID | Demand LPS | Head m | Pressure m | Quality        |
|---------|------------|--------|------------|----------------|
| R1      | -133.12    | 0.00   | 0.00       | 0.00 Reservoir |
| R2      | -128.22    | 0.00   | 0.00       | 0.00 Reservoir |

Link Results at 3:00 Hrs:

| Link ID | Flow LPS | Velocity m/s | Unit Headloss m/km | Status    |
|---------|----------|--------------|--------------------|-----------|
| P1      | 133.12   | 4.24         | 107.19             | Open      |
| P2      | 254.83   | 8.11         | 356.80             | Open      |
| P3      | 253.36   | 3.58         | 41.69              | Open      |
| P4      | 253.36   | 3.58         | 41.69              | Open      |
| P5      | 253.36   | 3.58         | 41.69              | Open      |
| P12     | 0.00     | 0.00         | 0.00               | Open      |
| P13     | -121.71  | 1.72         | 10.72              | Open      |
| P14     | -121.71  | 1.72         | 10.72              | Open      |
| P15     | -128.22  | 4.08         | 100.00             | Open      |
| P16     | 6.51     | 0.21         | 0.40               | Open      |
| P17     | 4.40     | 0.14         | 0.19               | Open      |
| P18     | 2.93     | 0.09         | 0.09               | Open      |
| P19     | 2.93     | 0.09         | 0.09               | Open      |
| P20     | 2.93     | 0.09         | 0.09               | Open      |
| P21     | 2.11     | 0.03         | 0.01               | Open      |
| P22     | 2.11     | 0.03         | 0.01               | Open      |
| P23     | 0.00     | 0.00         | 0.00               | Open      |
| P24     | 2.11     | 0.03         | 0.01               | Open      |
| P25     | 2.11     | 0.03         | 0.01               | Open      |
| 1       | 128.22   | 0.00         | -123.50            | Open Pump |
| 2       | 133.12   | 0.00         | -123.25            | Open Pump |



## Node Results at 4:00 Hrs:

| Node ID | Demand LPS | Head m | Pressure m | Quality |
|---------|------------|--------|------------|---------|
| J1      | 0.00       | 123.25 | 47.72      | 0.00    |
| J2      | 0.00       | 116.73 | 40.06      | 0.00    |
| J3      | 1.47       | 104.61 | 27.33      | 0.00    |
| J4      | 0.00       | 103.51 | 27.41      | 0.00    |
| J5      | 0.00       | 101.57 | 24.88      | 0.00    |
| J6      | 253.36     | 101.23 | 24.39      | 0.00    |
| J7      | 0.00       | 101.57 | 22.36      | 0.00    |
| J8      | 0.00       | 116.92 | 40.07      | 0.00    |
| J9      | 0.00       | 117.41 | 40.64      | 0.00    |
| J10     | 0.00       | 117.41 | 40.72      | 0.00    |
| J11     | 1.47       | 117.41 | 40.47      | 0.00    |
| J12     | 0.00       | 123.50 | 47.57      | 0.00    |



Page 7

## Node Results at 4:00 Hrs: (continued)

| Node ID | Demand LPS | Head m | Pressure m | Quality        |
|---------|------------|--------|------------|----------------|
| J13     | 0.00       | 117.41 | 39.78      | 0.00           |
| J14     | 0.00       | 117.41 | 40.45      | 0.00           |
| J15     | 0.00       | 117.41 | 40.07      | 0.00           |
| J16     | 0.00       | 117.41 | 39.98      | 0.00           |
| J17     | 0.00       | 117.41 | 40.52      | 0.00           |
| J18     | 2.11       | 117.41 | 40.31      | 0.00           |
| J19     | 0.00       | 117.41 | 39.57      | 0.00           |
| J20     | 2.93       | 117.41 | 39.52      | 0.00           |
| R1      | -133.12    | 0.00   | 0.00       | 0.00 Reservoir |
| R2      | -128.22    | 0.00   | 0.00       | 0.00 Reservoir |

## Link Results at 4:00 Hrs:

| Link ID | Flow LPS | Velocity m/s | Unit Headloss m/km | Status |
|---------|----------|--------------|--------------------|--------|
| P1      | 133.12   | 4.24         | 107.19             | Open   |
| P2      | 254.83   | 8.11         | 356.80             | Open   |
| P3      | 253.36   | 3.58         | 41.69              | Open   |
| P4      | 253.36   | 3.58         | 41.69              | Open   |
| P5      | 253.36   | 3.58         | 41.69              | Open   |
| P12     | 0.00     | 0.00         | 0.00               | Open   |
| P13     | -121.71  | 1.72         | 10.72              | Open   |
| P14     | -121.71  | 1.72         | 10.72              | Open   |
| P15     | -128.22  | 4.08         | 100.00             | Open   |





|     |        |      |         |           |
|-----|--------|------|---------|-----------|
| P16 | 6.51   | 0.21 | 0.40    | Open      |
| P17 | 4.40   | 0.14 | 0.19    | Open      |
| P18 | 2.93   | 0.09 | 0.09    | Open      |
| P19 | 2.93   | 0.09 | 0.09    | Open      |
| P20 | 2.93   | 0.09 | 0.09    | Open      |
| P21 | 2.11   | 0.03 | 0.01    | Open      |
| P22 | 2.11   | 0.03 | 0.01    | Open      |
| P23 | 0.00   | 0.00 | 0.00    | Open      |
| P24 | 2.11   | 0.03 | 0.01    | Open      |
| P25 | 2.11   | 0.03 | 0.01    | Open      |
| 1   | 128.22 | 0.00 | -123.50 | Open Pump |
| 2   | 133.12 | 0.00 | -123.25 | Open Pump |



### Max Day + Fire Flow Conditions at Proposed Building A (Node J18)

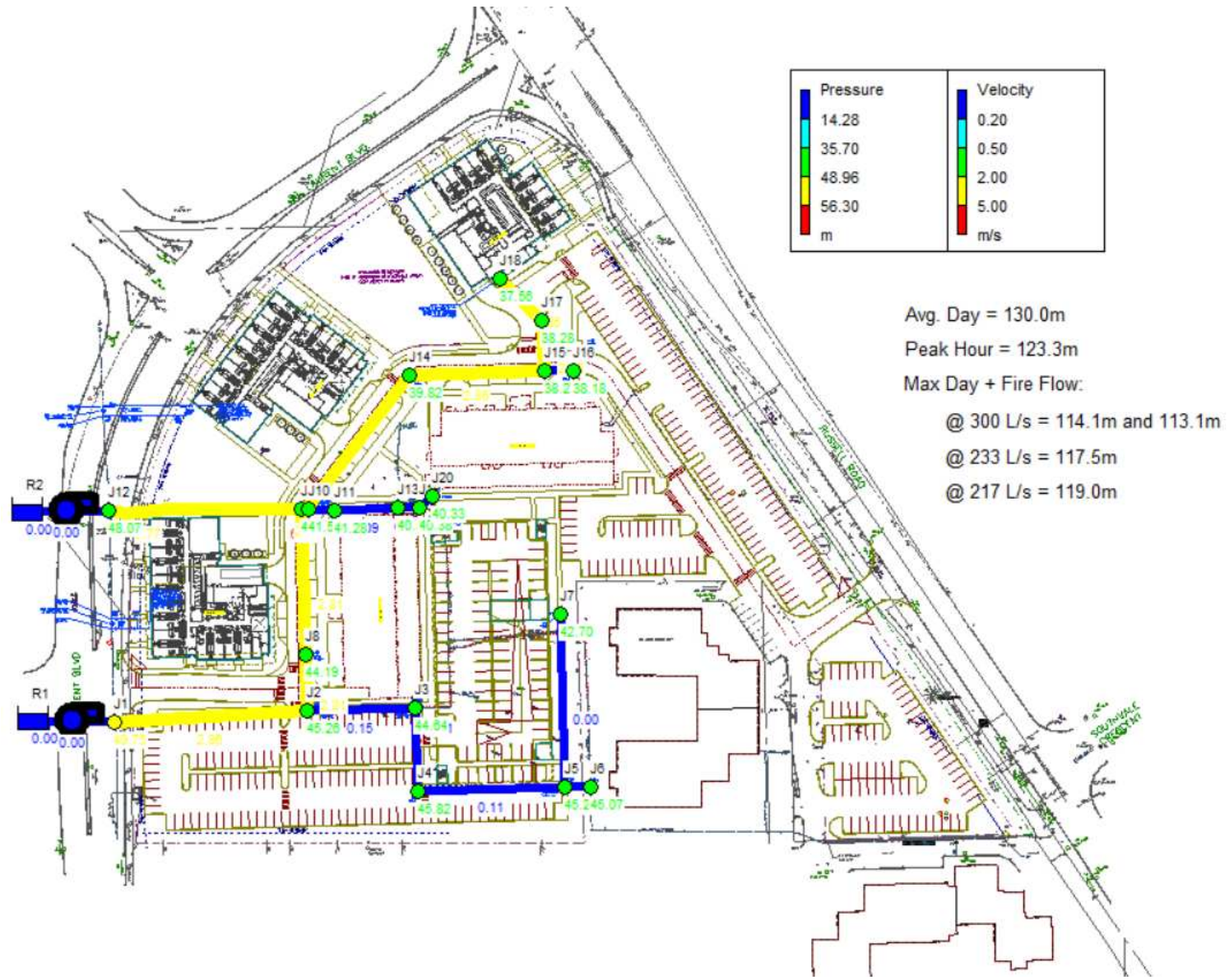



\*\*\*\*\*

```

* E P A N E T *
* Hydraulic and Water Quality *
* Analysis for Pipe Networks *
* Version 2.2 *

```

\*\*\*\*

Input

Link

----

Link

ID

----

P1

P2

P3

P4

P5

P12

P13

P14

P15

P16

P17

P18

P19

P20

P21

P22

P23

P24

P25

1

2

Ener

----

Pump

----

1

2

----





Page 2

Node Results at 0:00 Hrs:

| Node ID | Demand LPS | Head m | Pressure m | Quality |           |
|---------|------------|--------|------------|---------|-----------|
| J1      | 0.00       | 125.28 | 49.75      | 0.00    |           |
| J2      | 0.00       | 121.93 | 45.26      | 0.00    |           |
| J3      | 1.47       | 121.92 | 44.64      | 0.00    |           |
| J4      | 0.00       | 121.92 | 45.82      | 0.00    |           |
| J5      | 0.00       | 121.91 | 45.22      | 0.00    |           |
| J6      | 3.36       | 121.91 | 45.07      | 0.00    |           |
| J7      | 0.00       | 121.91 | 42.70      | 0.00    |           |
| J8      | 0.00       | 121.04 | 44.19      | 0.00    |           |
| J9      | 0.00       | 118.75 | 41.98      | 0.00    |           |
| J10     | 0.00       | 118.23 | 41.54      | 0.00    |           |
| J11     | 1.47       | 118.22 | 41.28      | 0.00    |           |
| J12     | 0.00       | 124.00 | 48.07      | 0.00    |           |
| J13     | 0.00       | 118.22 | 40.59      | 0.00    |           |
| J14     | 0.00       | 116.78 | 39.82      | 0.00    |           |
| J15     | 0.00       | 115.61 | 38.27      | 0.00    |           |
| J16     | 0.00       | 115.61 | 38.18      | 0.00    |           |
| J17     | 0.00       | 115.17 | 38.28      | 0.00    |           |
| J18     | 202.11     | 114.66 | 37.56      | 0.00    |           |
| J19     | 0.00       | 118.22 | 40.38      | 0.00    |           |
| J20     | 2.93       | 118.22 | 40.33      | 0.00    |           |
| R1      | -93.02     | 0.00   | 0.00       | 0.00    | Reservoir |
| R2      | -118.32    | 0.00   | 0.00       | 0.00    | Reservoir |

Link Results at 0:00 Hrs:

| Link ID | Flow LPS | Velocity m/s | Unit Headloss m/km | Status |
|---------|----------|--------------|--------------------|--------|
| P1      | 93.02    | 2.96         | 55.19              | Open   |
| P2      | 4.83     | 0.15         | 0.23               | Open   |
| P3      | 3.36     | 0.11         | 0.12               | Open   |
| P4      | 3.36     | 0.11         | 0.12               | Open   |
| P5      | 3.36     | 0.11         | 0.12               | Open   |
| P12     | 0.00     | 0.00         | 0.00               | Open   |
| P13     | 88.19    | 2.81         | 50.00              | Open   |
| P14     | 88.19    | 2.81         | 50.00              | Open   |
| P15     | -118.32  | 3.77         | 86.17              | Open   |
| P16     | 206.51   | 6.57         | 241.73             | Open   |
| P17     | 4.40     | 0.14         | 0.19               | Open   |
| P18     | 2.93     | 0.09         | 0.09               | Open   |
| P19     | 2.93     | 0.09         | 0.09               | Open   |
| P20     | 2.93     | 0.09         | 0.09               | Open   |



|     |        |      |       |      |
|-----|--------|------|-------|------|
| P21 | 202.11 | 2.86 | 27.43 | Open |
| P22 | 202.11 | 2.86 | 27.43 | Open |
| P23 | 0.00   | 0.00 | 0.00  | Open |
| P24 | 202.11 | 2.86 | 27.43 | Open |
| P25 | 202.11 | 2.86 | 27.43 | Open |



Page 3

Link Results at 0:00 Hrs: (continued)

| Link ID | Flow LPS | Velocity m/s | Unit Headloss m/km | Status    |
|---------|----------|--------------|--------------------|-----------|
| 1       | 118.32   | 0.00         | -124.00            | Open Pump |
| 2       | 93.02    | 0.00         | -125.28            | Open Pump |

Node Results at 1:00 Hrs:

| Node ID | Demand LPS | Head m | Pressure m | Quality        |
|---------|------------|--------|------------|----------------|
| J1      | 0.00       | 125.28 | 49.75      | 0.00           |
| J2      | 0.00       | 121.93 | 45.26      | 0.00           |
| J3      | 1.47       | 121.92 | 44.64      | 0.00           |
| J4      | 0.00       | 121.92 | 45.82      | 0.00           |
| J5      | 0.00       | 121.91 | 45.22      | 0.00           |
| J6      | 3.36       | 121.91 | 45.07      | 0.00           |
| J7      | 0.00       | 121.91 | 42.70      | 0.00           |
| J8      | 0.00       | 121.04 | 44.19      | 0.00           |
| J9      | 0.00       | 118.75 | 41.98      | 0.00           |
| J10     | 0.00       | 118.23 | 41.54      | 0.00           |
| J11     | 1.47       | 118.22 | 41.28      | 0.00           |
| J12     | 0.00       | 124.00 | 48.07      | 0.00           |
| J13     | 0.00       | 118.22 | 40.59      | 0.00           |
| J14     | 0.00       | 116.78 | 39.82      | 0.00           |
| J15     | 0.00       | 115.61 | 38.27      | 0.00           |
| J16     | 0.00       | 115.61 | 38.18      | 0.00           |
| J17     | 0.00       | 115.17 | 38.28      | 0.00           |
| J18     | 202.11     | 114.66 | 37.56      | 0.00           |
| J19     | 0.00       | 118.22 | 40.38      | 0.00           |
| J20     | 2.93       | 118.22 | 40.33      | 0.00           |
| R1      | -93.02     | 0.00   | 0.00       | 0.00 Reservoir |
| R2      | -118.32    | 0.00   | 0.00       | 0.00 Reservoir |

Link Results at 1:00 Hrs:

| Link ID | Flow LPS | Velocity m/s | Unit Headloss m/km | Status |
|---------|----------|--------------|--------------------|--------|
| P1      | 93.02    | 2.96         | 55.19              | Open   |



|     |         |      |        |      |
|-----|---------|------|--------|------|
| P2  | 4.83    | 0.15 | 0.23   | Open |
| P3  | 3.36    | 0.11 | 0.12   | Open |
| P4  | 3.36    | 0.11 | 0.12   | Open |
| P5  | 3.36    | 0.11 | 0.12   | Open |
| P12 | 0.00    | 0.00 | 0.00   | Open |
| P13 | 88.19   | 2.81 | 50.00  | Open |
| P14 | 88.19   | 2.81 | 50.00  | Open |
| P15 | -118.32 | 3.77 | 86.17  | Open |
| P16 | 206.51  | 6.57 | 241.73 | Open |
| P17 | 4.40    | 0.14 | 0.19   | Open |



Page 4

Link Results at 1:00 Hrs: (continued)

| Link ID | Flow LPS | Velocity m/s | Unit Headloss m/km | Status    |
|---------|----------|--------------|--------------------|-----------|
| P18     | 2.93     | 0.09         | 0.09               | Open      |
| P19     | 2.93     | 0.09         | 0.09               | Open      |
| P20     | 2.93     | 0.09         | 0.09               | Open      |
| P21     | 202.11   | 2.86         | 27.43              | Open      |
| P22     | 202.11   | 2.86         | 27.43              | Open      |
| P23     | 0.00     | 0.00         | 0.00               | Open      |
| P24     | 202.11   | 2.86         | 27.43              | Open      |
| P25     | 202.11   | 2.86         | 27.43              | Open      |
| 1       | 118.32   | 0.00         | -124.00            | Open Pump |
| 2       | 93.02    | 0.00         | -125.28            | Open Pump |

Node Results at 2:00 Hrs:

| Node ID | Demand LPS | Head m | Pressure m | Quality |
|---------|------------|--------|------------|---------|
| J1      | 0.00       | 125.28 | 49.75      | 0.00    |
| J2      | 0.00       | 121.93 | 45.26      | 0.00    |
| J3      | 1.47       | 121.92 | 44.64      | 0.00    |
| J4      | 0.00       | 121.92 | 45.82      | 0.00    |
| J5      | 0.00       | 121.91 | 45.22      | 0.00    |
| J6      | 3.36       | 121.91 | 45.07      | 0.00    |
| J7      | 0.00       | 121.91 | 42.70      | 0.00    |
| J8      | 0.00       | 121.04 | 44.19      | 0.00    |
| J9      | 0.00       | 118.75 | 41.98      | 0.00    |
| J10     | 0.00       | 118.23 | 41.54      | 0.00    |
| J11     | 1.47       | 118.22 | 41.28      | 0.00    |
| J12     | 0.00       | 124.00 | 48.07      | 0.00    |
| J13     | 0.00       | 118.22 | 40.59      | 0.00    |
| J14     | 0.00       | 116.78 | 39.82      | 0.00    |
| J15     | 0.00       | 115.61 | 38.27      | 0.00    |
| J16     | 0.00       | 115.61 | 38.18      | 0.00    |



|     |         |        |       |      |           |
|-----|---------|--------|-------|------|-----------|
| J17 | 0.00    | 115.17 | 38.28 | 0.00 |           |
| J18 | 202.11  | 114.66 | 37.56 | 0.00 |           |
| J19 | 0.00    | 118.22 | 40.38 | 0.00 |           |
| J20 | 2.93    | 118.22 | 40.33 | 0.00 |           |
| R1  | -93.02  | 0.00   | 0.00  | 0.00 | Reservoir |
| R2  | -118.32 | 0.00   | 0.00  | 0.00 | Reservoir |



Page 5

Link Results at 2:00 Hrs:

| Link ID | Flow LPS | Velocity m/s | Unit Headloss m/km | Status    |
|---------|----------|--------------|--------------------|-----------|
| P1      | 93.02    | 2.96         | 55.19              | Open      |
| P2      | 4.83     | 0.15         | 0.23               | Open      |
| P3      | 3.36     | 0.11         | 0.12               | Open      |
| P4      | 3.36     | 0.11         | 0.12               | Open      |
| P5      | 3.36     | 0.11         | 0.12               | Open      |
| P12     | 0.00     | 0.00         | 0.00               | Open      |
| P13     | 88.19    | 2.81         | 50.00              | Open      |
| P14     | 88.19    | 2.81         | 50.00              | Open      |
| P15     | -118.32  | 3.77         | 86.17              | Open      |
| P16     | 206.51   | 6.57         | 241.73             | Open      |
| P17     | 4.40     | 0.14         | 0.19               | Open      |
| P18     | 2.93     | 0.09         | 0.09               | Open      |
| P19     | 2.93     | 0.09         | 0.09               | Open      |
| P20     | 2.93     | 0.09         | 0.09               | Open      |
| P21     | 202.11   | 2.86         | 27.43              | Open      |
| P22     | 202.11   | 2.86         | 27.43              | Open      |
| P23     | 0.00     | 0.00         | 0.00               | Open      |
| P24     | 202.11   | 2.86         | 27.43              | Open      |
| P25     | 202.11   | 2.86         | 27.43              | Open      |
| 1       | 118.32   | 0.00         | -124.00            | Open Pump |
| 2       | 93.02    | 0.00         | -125.28            | Open Pump |

Node Results at 3:00 Hrs:

| Node ID | Demand LPS | Head m | Pressure m | Quality |
|---------|------------|--------|------------|---------|
| J1      | 0.00       | 125.28 | 49.75      | 0.00    |
| J2      | 0.00       | 121.93 | 45.26      | 0.00    |
| J3      | 1.47       | 121.92 | 44.64      | 0.00    |
| J4      | 0.00       | 121.92 | 45.82      | 0.00    |
| J5      | 0.00       | 121.91 | 45.22      | 0.00    |
| J6      | 3.36       | 121.91 | 45.07      | 0.00    |
| J7      | 0.00       | 121.91 | 42.70      | 0.00    |
| J8      | 0.00       | 121.04 | 44.19      | 0.00    |



|     |        |        |       |      |
|-----|--------|--------|-------|------|
| J9  | 0.00   | 118.75 | 41.98 | 0.00 |
| J10 | 0.00   | 118.23 | 41.54 | 0.00 |
| J11 | 1.47   | 118.22 | 41.28 | 0.00 |
| J12 | 0.00   | 124.00 | 48.07 | 0.00 |
| J13 | 0.00   | 118.22 | 40.59 | 0.00 |
| J14 | 0.00   | 116.78 | 39.82 | 0.00 |
| J15 | 0.00   | 115.61 | 38.27 | 0.00 |
| J16 | 0.00   | 115.61 | 38.18 | 0.00 |
| J17 | 0.00   | 115.17 | 38.28 | 0.00 |
| J18 | 202.11 | 114.66 | 37.56 | 0.00 |
| J19 | 0.00   | 118.22 | 40.38 | 0.00 |
| J20 | 2.93   | 118.22 | 40.33 | 0.00 |



Page 6

Node Results at 3:00 Hrs: (continued)

| Node ID | Demand LPS | Head m | Pressure m | Quality        |
|---------|------------|--------|------------|----------------|
| R1      | -93.02     | 0.00   | 0.00       | 0.00 Reservoir |
| R2      | -118.32    | 0.00   | 0.00       | 0.00 Reservoir |

Link Results at 3:00 Hrs:

| Link ID | Flow LPS | Velocity m/s | Unit Headloss m/km | Status    |
|---------|----------|--------------|--------------------|-----------|
| P1      | 93.02    | 2.96         | 55.19              | Open      |
| P2      | 4.83     | 0.15         | 0.23               | Open      |
| P3      | 3.36     | 0.11         | 0.12               | Open      |
| P4      | 3.36     | 0.11         | 0.12               | Open      |
| P5      | 3.36     | 0.11         | 0.12               | Open      |
| P12     | 0.00     | 0.00         | 0.00               | Open      |
| P13     | 88.19    | 2.81         | 50.00              | Open      |
| P14     | 88.19    | 2.81         | 50.00              | Open      |
| P15     | -118.32  | 3.77         | 86.17              | Open      |
| P16     | 206.51   | 6.57         | 241.73             | Open      |
| P17     | 4.40     | 0.14         | 0.19               | Open      |
| P18     | 2.93     | 0.09         | 0.09               | Open      |
| P19     | 2.93     | 0.09         | 0.09               | Open      |
| P20     | 2.93     | 0.09         | 0.09               | Open      |
| P21     | 202.11   | 2.86         | 27.43              | Open      |
| P22     | 202.11   | 2.86         | 27.43              | Open      |
| P23     | 0.00     | 0.00         | 0.00               | Open      |
| P24     | 202.11   | 2.86         | 27.43              | Open      |
| P25     | 202.11   | 2.86         | 27.43              | Open      |
| 1       | 118.32   | 0.00         | -124.00            | Open Pump |
| 2       | 93.02    | 0.00         | -125.28            | Open Pump |





## Node Results at 4:00 Hrs:

| Node ID | Demand LPS | Head m | Pressure m | Quality |
|---------|------------|--------|------------|---------|
| J1      | 0.00       | 125.28 | 49.75      | 0.00    |
| J2      | 0.00       | 121.93 | 45.26      | 0.00    |
| J3      | 1.47       | 121.92 | 44.64      | 0.00    |
| J4      | 0.00       | 121.92 | 45.82      | 0.00    |
| J5      | 0.00       | 121.91 | 45.22      | 0.00    |
| J6      | 3.36       | 121.91 | 45.07      | 0.00    |
| J7      | 0.00       | 121.91 | 42.70      | 0.00    |
| J8      | 0.00       | 121.04 | 44.19      | 0.00    |
| J9      | 0.00       | 118.75 | 41.98      | 0.00    |
| J10     | 0.00       | 118.23 | 41.54      | 0.00    |
| J11     | 1.47       | 118.22 | 41.28      | 0.00    |
| J12     | 0.00       | 124.00 | 48.07      | 0.00    |



Page 7

## Node Results at 4:00 Hrs: (continued)

| Node ID | Demand LPS | Head m | Pressure m | Quality        |
|---------|------------|--------|------------|----------------|
| J13     | 0.00       | 118.22 | 40.59      | 0.00           |
| J14     | 0.00       | 116.78 | 39.82      | 0.00           |
| J15     | 0.00       | 115.61 | 38.27      | 0.00           |
| J16     | 0.00       | 115.61 | 38.18      | 0.00           |
| J17     | 0.00       | 115.17 | 38.28      | 0.00           |
| J18     | 202.11     | 114.66 | 37.56      | 0.00           |
| J19     | 0.00       | 118.22 | 40.38      | 0.00           |
| J20     | 2.93       | 118.22 | 40.33      | 0.00           |
| R1      | -93.02     | 0.00   | 0.00       | 0.00 Reservoir |
| R2      | -118.32    | 0.00   | 0.00       | 0.00 Reservoir |

## Link Results at 4:00 Hrs:

| Link ID | Flow LPS | Velocity m/s | Unit Headloss m/km | Status |
|---------|----------|--------------|--------------------|--------|
| P1      | 93.02    | 2.96         | 55.19              | Open   |
| P2      | 4.83     | 0.15         | 0.23               | Open   |
| P3      | 3.36     | 0.11         | 0.12               | Open   |
| P4      | 3.36     | 0.11         | 0.12               | Open   |
| P5      | 3.36     | 0.11         | 0.12               | Open   |
| P12     | 0.00     | 0.00         | 0.00               | Open   |
| P13     | 88.19    | 2.81         | 50.00              | Open   |
| P14     | 88.19    | 2.81         | 50.00              | Open   |
| P15     | -118.32  | 3.77         | 86.17              | Open   |



|     |        |      |         |           |
|-----|--------|------|---------|-----------|
| P16 | 206.51 | 6.57 | 241.73  | Open      |
| P17 | 4.40   | 0.14 | 0.19    | Open      |
| P18 | 2.93   | 0.09 | 0.09    | Open      |
| P19 | 2.93   | 0.09 | 0.09    | Open      |
| P20 | 2.93   | 0.09 | 0.09    | Open      |
| P21 | 202.11 | 2.86 | 27.43   | Open      |
| P22 | 202.11 | 2.86 | 27.43   | Open      |
| P23 | 0.00   | 0.00 | 0.00    | Open      |
| P24 | 202.11 | 2.86 | 27.43   | Open      |
| P25 | 202.11 | 2.86 | 27.43   | Open      |
| 1   | 118.32 | 0.00 | -124.00 | Open Pump |
| 2   | 93.02  | 0.00 | -125.28 | Open Pump |



### Max Day + Fire Flow Conditions at Proposed Building D (Node J7)

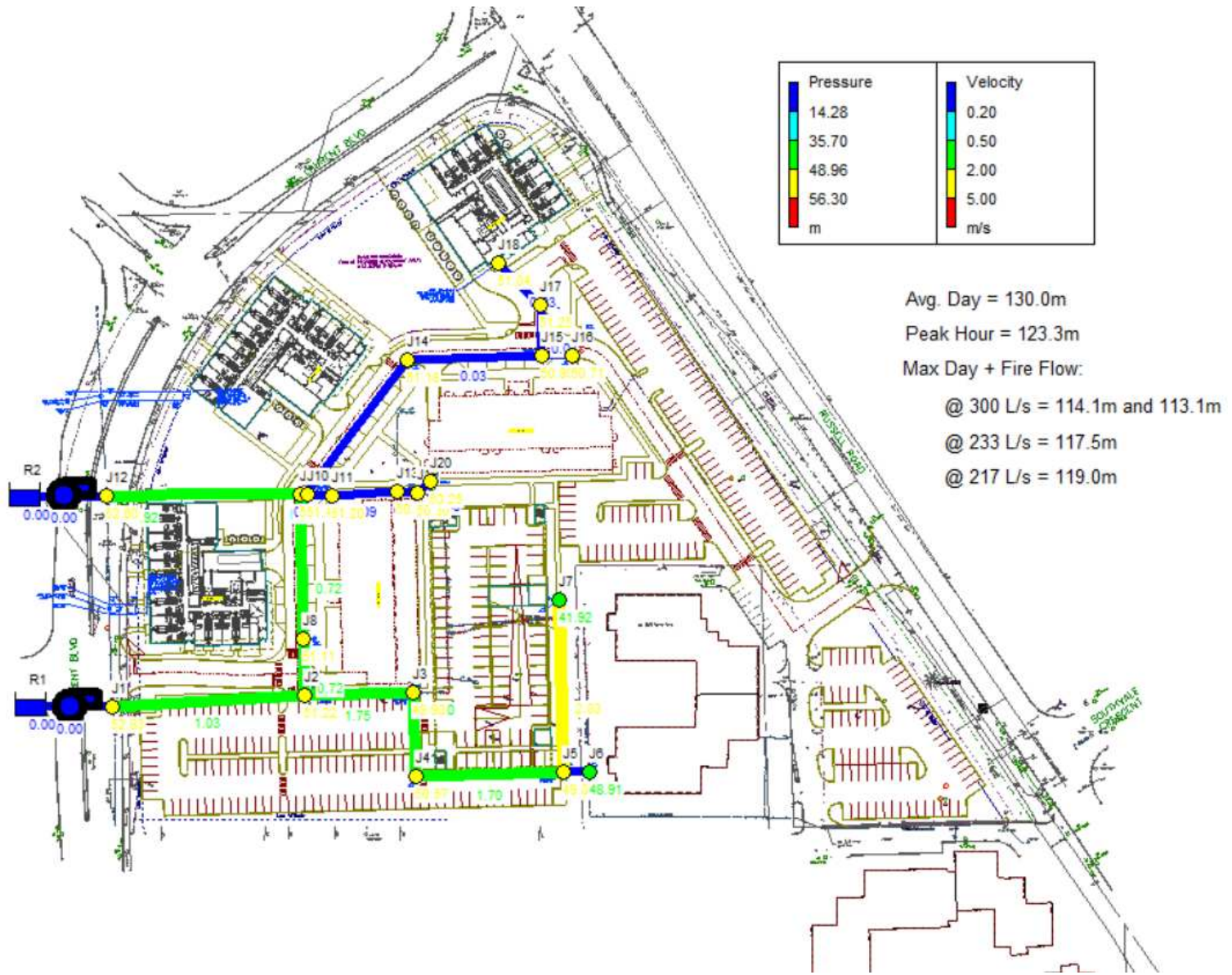



\*\*\*\*\*

```

* E P A N E T *
* Hydraulic and Water Quality *
* Analysis for Pipe Networks *
*

```

\*\*\*\*

Input

Link

Link

ID

- P1
- P2
- P3
- P4
- P5
- P12
- P13
- P14
- P15
- P16
- P17
- P18
- P19
- P20
- P21
- P22
- P23
- P24
- P25

- 1
- 2

Ener

Pump

- 1
- 2

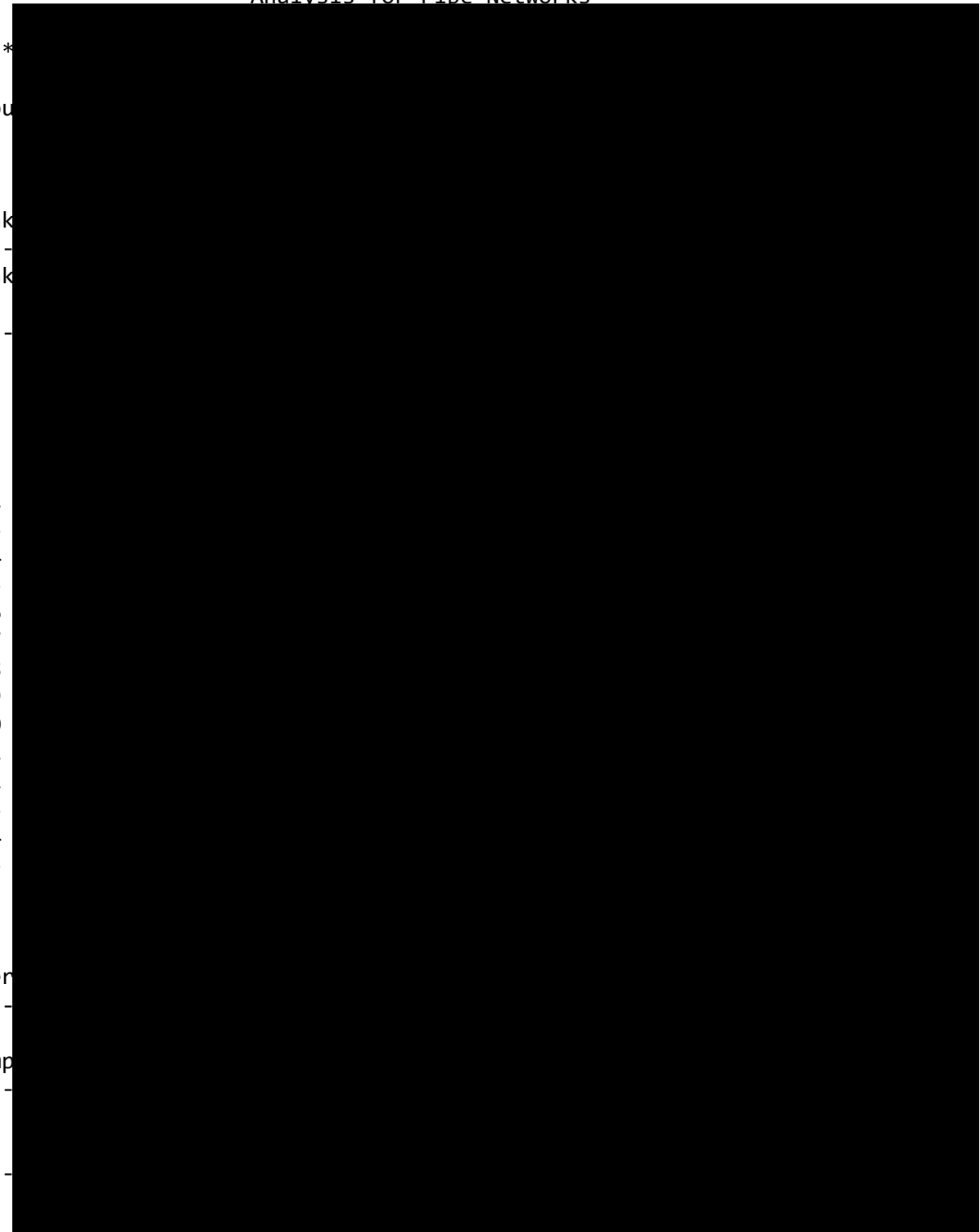



Page 2

Node Results at 0:00 Hrs:

| Node ID | Demand LPS | Head m | Pressure m | Quality |           |
|---------|------------|--------|------------|---------|-----------|
| J1      | 0.00       | 128.36 | 52.83      | 0.00    |           |
| J2      | 0.00       | 127.89 | 51.22      | 0.00    |           |
| J3      | 1.47       | 127.18 | 49.90      | 0.00    |           |
| J4      | 0.00       | 126.67 | 50.57      | 0.00    |           |
| J5      | 0.00       | 125.75 | 49.06      | 0.00    |           |
| J6      | 3.36       | 125.75 | 48.91      | 0.00    |           |
| J7      | 50.00      | 121.13 | 41.92      | 0.00    |           |
| J8      | 0.00       | 127.96 | 51.11      | 0.00    |           |
| J9      | 0.00       | 128.14 | 51.37      | 0.00    |           |
| J10     | 0.00       | 128.14 | 51.45      | 0.00    |           |
| J11     | 1.47       | 128.14 | 51.20      | 0.00    |           |
| J12     | 0.00       | 128.53 | 52.60      | 0.00    |           |
| J13     | 0.00       | 128.14 | 50.51      | 0.00    |           |
| J14     | 0.00       | 128.14 | 51.18      | 0.00    |           |
| J15     | 0.00       | 128.14 | 50.80      | 0.00    |           |
| J16     | 0.00       | 128.14 | 50.71      | 0.00    |           |
| J17     | 0.00       | 128.14 | 51.25      | 0.00    |           |
| J18     | 2.11       | 128.14 | 51.04      | 0.00    |           |
| J19     | 0.00       | 128.14 | 50.30      | 0.00    |           |
| J20     | 2.93       | 128.14 | 50.25      | 0.00    |           |
| R1      | -32.32     | 0.00   | 0.00       | 0.00    | Reservoir |
| R2      | -29.02     | 0.00   | 0.00       | 0.00    | Reservoir |

Link Results at 0:00 Hrs:

| Link ID | Flow LPS | Velocity m/s | Unit Headloss m/km | Status |
|---------|----------|--------------|--------------------|--------|
| P1      | 32.32    | 1.03         | 7.79               | Open   |
| P2      | 54.83    | 1.75         | 20.74              | Open   |
| P3      | 53.36    | 1.70         | 19.72              | Open   |
| P4      | 53.36    | 1.70         | 19.72              | Open   |
| P5      | 3.36     | 0.11         | 0.12               | Open   |
| P12     | 50.00    | 2.83         | 84.68              | Open   |
| P13     | -22.51   | 0.72         | 3.99               | Open   |
| P14     | -22.51   | 0.72         | 3.99               | Open   |
| P15     | -29.02   | 0.92         | 6.38               | Open   |
| P16     | 6.51     | 0.21         | 0.40               | Open   |
| P17     | 4.40     | 0.14         | 0.19               | Open   |
| P18     | 2.93     | 0.09         | 0.09               | Open   |
| P19     | 2.93     | 0.09         | 0.09               | Open   |
| P20     | 2.93     | 0.09         | 0.09               | Open   |



|     |      |      |      |      |
|-----|------|------|------|------|
| P21 | 2.11 | 0.03 | 0.01 | Open |
| P22 | 2.11 | 0.03 | 0.01 | Open |
| P23 | 0.00 | 0.00 | 0.00 | Open |
| P24 | 2.11 | 0.03 | 0.01 | Open |
| P25 | 2.11 | 0.03 | 0.01 | Open |



Page 3

Link Results at 0:00 Hrs: (continued)

| Link ID | Flow LPS | Velocity m/s | Unit Headloss m/km | Status    |
|---------|----------|--------------|--------------------|-----------|
| 1       | 29.02    | 0.00         | -128.53            | Open Pump |
| 2       | 32.32    | 0.00         | -128.36            | Open Pump |

Node Results at 1:00 Hrs:

| Node ID | Demand LPS | Head m | Pressure m | Quality        |
|---------|------------|--------|------------|----------------|
| J1      | 0.00       | 128.36 | 52.83      | 0.00           |
| J2      | 0.00       | 127.89 | 51.22      | 0.00           |
| J3      | 1.47       | 127.18 | 49.90      | 0.00           |
| J4      | 0.00       | 126.67 | 50.57      | 0.00           |
| J5      | 0.00       | 125.75 | 49.06      | 0.00           |
| J6      | 3.36       | 125.75 | 48.91      | 0.00           |
| J7      | 50.00      | 121.13 | 41.92      | 0.00           |
| J8      | 0.00       | 127.96 | 51.11      | 0.00           |
| J9      | 0.00       | 128.14 | 51.37      | 0.00           |
| J10     | 0.00       | 128.14 | 51.45      | 0.00           |
| J11     | 1.47       | 128.14 | 51.20      | 0.00           |
| J12     | 0.00       | 128.53 | 52.60      | 0.00           |
| J13     | 0.00       | 128.14 | 50.51      | 0.00           |
| J14     | 0.00       | 128.14 | 51.18      | 0.00           |
| J15     | 0.00       | 128.14 | 50.80      | 0.00           |
| J16     | 0.00       | 128.14 | 50.71      | 0.00           |
| J17     | 0.00       | 128.14 | 51.25      | 0.00           |
| J18     | 2.11       | 128.14 | 51.04      | 0.00           |
| J19     | 0.00       | 128.14 | 50.30      | 0.00           |
| J20     | 2.93       | 128.14 | 50.25      | 0.00           |
| R1      | -32.32     | 0.00   | 0.00       | 0.00 Reservoir |
| R2      | -29.02     | 0.00   | 0.00       | 0.00 Reservoir |

Link Results at 1:00 Hrs:

| Link ID | Flow LPS | Velocity m/s | Unit Headloss m/km | Status |
|---------|----------|--------------|--------------------|--------|
| P1      | 32.32    | 1.03         | 7.79               | Open   |



|     |        |      |       |      |
|-----|--------|------|-------|------|
| P2  | 54.83  | 1.75 | 20.74 | Open |
| P3  | 53.36  | 1.70 | 19.72 | Open |
| P4  | 53.36  | 1.70 | 19.72 | Open |
| P5  | 3.36   | 0.11 | 0.12  | Open |
| P12 | 50.00  | 2.83 | 84.68 | Open |
| P13 | -22.51 | 0.72 | 3.99  | Open |
| P14 | -22.51 | 0.72 | 3.99  | Open |
| P15 | -29.02 | 0.92 | 6.38  | Open |
| P16 | 6.51   | 0.21 | 0.40  | Open |
| P17 | 4.40   | 0.14 | 0.19  | Open |



Page 4

Link Results at 1:00 Hrs: (continued)

| Link ID | Flow LPS | Velocity m/s | Unit Headloss m/km | Status    |
|---------|----------|--------------|--------------------|-----------|
| P18     | 2.93     | 0.09         | 0.09               | Open      |
| P19     | 2.93     | 0.09         | 0.09               | Open      |
| P20     | 2.93     | 0.09         | 0.09               | Open      |
| P21     | 2.11     | 0.03         | 0.01               | Open      |
| P22     | 2.11     | 0.03         | 0.01               | Open      |
| P23     | 0.00     | 0.00         | 0.00               | Open      |
| P24     | 2.11     | 0.03         | 0.01               | Open      |
| P25     | 2.11     | 0.03         | 0.01               | Open      |
| 1       | 29.02    | 0.00         | -128.53            | Open Pump |
| 2       | 32.32    | 0.00         | -128.36            | Open Pump |

Node Results at 2:00 Hrs:

| Node ID | Demand LPS | Head m | Pressure m | Quality |
|---------|------------|--------|------------|---------|
| J1      | 0.00       | 128.36 | 52.83      | 0.00    |
| J2      | 0.00       | 127.89 | 51.22      | 0.00    |
| J3      | 1.47       | 127.18 | 49.90      | 0.00    |
| J4      | 0.00       | 126.67 | 50.57      | 0.00    |
| J5      | 0.00       | 125.75 | 49.06      | 0.00    |
| J6      | 3.36       | 125.75 | 48.91      | 0.00    |
| J7      | 50.00      | 121.13 | 41.92      | 0.00    |
| J8      | 0.00       | 127.96 | 51.11      | 0.00    |
| J9      | 0.00       | 128.14 | 51.37      | 0.00    |
| J10     | 0.00       | 128.14 | 51.45      | 0.00    |
| J11     | 1.47       | 128.14 | 51.20      | 0.00    |
| J12     | 0.00       | 128.53 | 52.60      | 0.00    |
| J13     | 0.00       | 128.14 | 50.51      | 0.00    |
| J14     | 0.00       | 128.14 | 51.18      | 0.00    |
| J15     | 0.00       | 128.14 | 50.80      | 0.00    |
| J16     | 0.00       | 128.14 | 50.71      | 0.00    |



|     |        |        |       |      |           |
|-----|--------|--------|-------|------|-----------|
| J17 | 0.00   | 128.14 | 51.25 | 0.00 |           |
| J18 | 2.11   | 128.14 | 51.04 | 0.00 |           |
| J19 | 0.00   | 128.14 | 50.30 | 0.00 |           |
| J20 | 2.93   | 128.14 | 50.25 | 0.00 |           |
| R1  | -32.32 | 0.00   | 0.00  | 0.00 | Reservoir |
| R2  | -29.02 | 0.00   | 0.00  | 0.00 | Reservoir |



Page 5

Link Results at 2:00 Hrs:

| Link ID | Flow LPS | Velocity m/s | Unit Headloss m/km | Status    |
|---------|----------|--------------|--------------------|-----------|
| P1      | 32.32    | 1.03         | 7.79               | Open      |
| P2      | 54.83    | 1.75         | 20.74              | Open      |
| P3      | 53.36    | 1.70         | 19.72              | Open      |
| P4      | 53.36    | 1.70         | 19.72              | Open      |
| P5      | 3.36     | 0.11         | 0.12               | Open      |
| P12     | 50.00    | 2.83         | 84.68              | Open      |
| P13     | -22.51   | 0.72         | 3.99               | Open      |
| P14     | -22.51   | 0.72         | 3.99               | Open      |
| P15     | -29.02   | 0.92         | 6.38               | Open      |
| P16     | 6.51     | 0.21         | 0.40               | Open      |
| P17     | 4.40     | 0.14         | 0.19               | Open      |
| P18     | 2.93     | 0.09         | 0.09               | Open      |
| P19     | 2.93     | 0.09         | 0.09               | Open      |
| P20     | 2.93     | 0.09         | 0.09               | Open      |
| P21     | 2.11     | 0.03         | 0.01               | Open      |
| P22     | 2.11     | 0.03         | 0.01               | Open      |
| P23     | 0.00     | 0.00         | 0.00               | Open      |
| P24     | 2.11     | 0.03         | 0.01               | Open      |
| P25     | 2.11     | 0.03         | 0.01               | Open      |
| 1       | 29.02    | 0.00         | -128.53            | Open Pump |
| 2       | 32.32    | 0.00         | -128.36            | Open Pump |

Node Results at 3:00 Hrs:

| Node ID | Demand LPS | Head m | Pressure m | Quality |
|---------|------------|--------|------------|---------|
| J1      | 0.00       | 128.36 | 52.83      | 0.00    |
| J2      | 0.00       | 127.89 | 51.22      | 0.00    |
| J3      | 1.47       | 127.18 | 49.90      | 0.00    |
| J4      | 0.00       | 126.67 | 50.57      | 0.00    |
| J5      | 0.00       | 125.75 | 49.06      | 0.00    |
| J6      | 3.36       | 125.75 | 48.91      | 0.00    |
| J7      | 50.00      | 121.13 | 41.92      | 0.00    |
| J8      | 0.00       | 127.96 | 51.11      | 0.00    |





|     |      |        |       |      |
|-----|------|--------|-------|------|
| J9  | 0.00 | 128.14 | 51.37 | 0.00 |
| J10 | 0.00 | 128.14 | 51.45 | 0.00 |
| J11 | 1.47 | 128.14 | 51.20 | 0.00 |
| J12 | 0.00 | 128.53 | 52.60 | 0.00 |
| J13 | 0.00 | 128.14 | 50.51 | 0.00 |
| J14 | 0.00 | 128.14 | 51.18 | 0.00 |
| J15 | 0.00 | 128.14 | 50.80 | 0.00 |
| J16 | 0.00 | 128.14 | 50.71 | 0.00 |
| J17 | 0.00 | 128.14 | 51.25 | 0.00 |
| J18 | 2.11 | 128.14 | 51.04 | 0.00 |
| J19 | 0.00 | 128.14 | 50.30 | 0.00 |
| J20 | 2.93 | 128.14 | 50.25 | 0.00 |



Page 6

Node Results at 3:00 Hrs: (continued)

| Node ID | Demand LPS | Head m | Pressure m | Quality        |
|---------|------------|--------|------------|----------------|
| R1      | -32.32     | 0.00   | 0.00       | 0.00 Reservoir |
| R2      | -29.02     | 0.00   | 0.00       | 0.00 Reservoir |

Link Results at 3:00 Hrs:

| Link ID | Flow LPS | Velocity m/s | Unit Headloss m/km | Status    |
|---------|----------|--------------|--------------------|-----------|
| P1      | 32.32    | 1.03         | 7.79               | Open      |
| P2      | 54.83    | 1.75         | 20.74              | Open      |
| P3      | 53.36    | 1.70         | 19.72              | Open      |
| P4      | 53.36    | 1.70         | 19.72              | Open      |
| P5      | 3.36     | 0.11         | 0.12               | Open      |
| P12     | 50.00    | 2.83         | 84.68              | Open      |
| P13     | -22.51   | 0.72         | 3.99               | Open      |
| P14     | -22.51   | 0.72         | 3.99               | Open      |
| P15     | -29.02   | 0.92         | 6.38               | Open      |
| P16     | 6.51     | 0.21         | 0.40               | Open      |
| P17     | 4.40     | 0.14         | 0.19               | Open      |
| P18     | 2.93     | 0.09         | 0.09               | Open      |
| P19     | 2.93     | 0.09         | 0.09               | Open      |
| P20     | 2.93     | 0.09         | 0.09               | Open      |
| P21     | 2.11     | 0.03         | 0.01               | Open      |
| P22     | 2.11     | 0.03         | 0.01               | Open      |
| P23     | 0.00     | 0.00         | 0.00               | Open      |
| P24     | 2.11     | 0.03         | 0.01               | Open      |
| P25     | 2.11     | 0.03         | 0.01               | Open      |
| 1       | 29.02    | 0.00         | -128.53            | Open Pump |
| 2       | 32.32    | 0.00         | -128.36            | Open Pump |



## Node Results at 4:00 Hrs:

| Node ID | Demand LPS | Head m | Pressure m | Quality |
|---------|------------|--------|------------|---------|
| J1      | 0.00       | 128.36 | 52.83      | 0.00    |
| J2      | 0.00       | 127.89 | 51.22      | 0.00    |
| J3      | 1.47       | 127.18 | 49.90      | 0.00    |
| J4      | 0.00       | 126.67 | 50.57      | 0.00    |
| J5      | 0.00       | 125.75 | 49.06      | 0.00    |
| J6      | 3.36       | 125.75 | 48.91      | 0.00    |
| J7      | 50.00      | 121.13 | 41.92      | 0.00    |
| J8      | 0.00       | 127.96 | 51.11      | 0.00    |
| J9      | 0.00       | 128.14 | 51.37      | 0.00    |
| J10     | 0.00       | 128.14 | 51.45      | 0.00    |
| J11     | 1.47       | 128.14 | 51.20      | 0.00    |
| J12     | 0.00       | 128.53 | 52.60      | 0.00    |



Page 7

## Node Results at 4:00 Hrs: (continued)

| Node ID | Demand LPS | Head m | Pressure m | Quality        |
|---------|------------|--------|------------|----------------|
| J13     | 0.00       | 128.14 | 50.51      | 0.00           |
| J14     | 0.00       | 128.14 | 51.18      | 0.00           |
| J15     | 0.00       | 128.14 | 50.80      | 0.00           |
| J16     | 0.00       | 128.14 | 50.71      | 0.00           |
| J17     | 0.00       | 128.14 | 51.25      | 0.00           |
| J18     | 2.11       | 128.14 | 51.04      | 0.00           |
| J19     | 0.00       | 128.14 | 50.30      | 0.00           |
| J20     | 2.93       | 128.14 | 50.25      | 0.00           |
| R1      | -32.32     | 0.00   | 0.00       | 0.00 Reservoir |
| R2      | -29.02     | 0.00   | 0.00       | 0.00 Reservoir |

## Link Results at 4:00 Hrs:

| Link ID | Flow LPS | Velocity m/s | Unit Headloss m/km | Status |
|---------|----------|--------------|--------------------|--------|
| P1      | 32.32    | 1.03         | 7.79               | Open   |
| P2      | 54.83    | 1.75         | 20.74              | Open   |
| P3      | 53.36    | 1.70         | 19.72              | Open   |
| P4      | 53.36    | 1.70         | 19.72              | Open   |
| P5      | 3.36     | 0.11         | 0.12               | Open   |
| P12     | 50.00    | 2.83         | 84.68              | Open   |
| P13     | -22.51   | 0.72         | 3.99               | Open   |
| P14     | -22.51   | 0.72         | 3.99               | Open   |
| P15     | -29.02   | 0.92         | 6.38               | Open   |



|     |       |      |         |           |
|-----|-------|------|---------|-----------|
| P16 | 6.51  | 0.21 | 0.40    | Open      |
| P17 | 4.40  | 0.14 | 0.19    | Open      |
| P18 | 2.93  | 0.09 | 0.09    | Open      |
| P19 | 2.93  | 0.09 | 0.09    | Open      |
| P20 | 2.93  | 0.09 | 0.09    | Open      |
| P21 | 2.11  | 0.03 | 0.01    | Open      |
| P22 | 2.11  | 0.03 | 0.01    | Open      |
| P23 | 0.00  | 0.00 | 0.00    | Open      |
| P24 | 2.11  | 0.03 | 0.01    | Open      |
| P25 | 2.11  | 0.03 | 0.01    | Open      |
| 1   | 29.02 | 0.00 | -128.53 | Open Pump |
| 2   | 32.32 | 0.00 | -128.36 | Open Pump |