

FUNCTIONAL SERVICING AND STORMWATER MANAGEMENT REPORT

IN SUPPORT OF

ZONING BY-LAW AMENDMENT AND SITE PLAN CONTROL APPLICATION

Location: 1971 & 1975 St. Laurent Boulevard, Ottawa, Ontario

CPE Project #: 21106

City of Ottawa

City File No.:D07-12-22-0044



8395 Jane Street, Suite 100
Vaughan, Ontario L4K 5Y2
Tel: (905) 326-1404

**Prepared For:
Starlight Developments**

No.	Revision	Date
2.	Issued for ZBA & SPA #2	March 17, 2023
1.	Issued for ZBA & SPA #1	March 11, 2022



TABLE OF CONTENTS

TABLE OF CONTENTS	2
LIST OF FIGURES, TABLES, APPENDICES & DRAWINGS	3
1.0 INTRODUCTION	5
1.1 <i>Background.....</i>	5
1.2 <i>Study Parameters.....</i>	8
2.0 STORMWATER MANAGEMENT	9
2.1 <i>Existing Conditions</i>	9
2.2 <i>Allowable Release Rate</i>	9
2.3 <i>Water Quantity</i>	11
2.4 <i>Water Quality.....</i>	13
2.5 <i>Erosion and Sediment Control.....</i>	13
3.0 SANITARY SERVICING	14
3.1 <i>Existing Sanitary Servicing</i>	14
3.2 <i>Proposed Sanitary Release Rate and Servicing</i>	15
4.0 WATERMAIN SERVICING	16
4.1 <i>Existing Water Servicing Strategy.....</i>	16
4.2 <i>Proposed Water Servicing Strategy.....</i>	16
4.3 <i>Watermain Modelling.....</i>	18
5.0 CONCLUSIONS	23



LIST OF FIGURES, TABLES, APPENDICES & DRAWINGS

Figures

Figure 1 – Site Location Plan

Figure 2 – Site Watermain Network Figure

Tables

Table 1 – Allowable Release Rates

Table 2 – Composite Run-off Coefficient of Post-Development Condition

Table 3 – Peak Flow and Storage Summary

Table 4 – Peak Sanitary Flow – Existing Buildings

Table 5 – Peak Sanitary Flow – Proposed Buildings

Table 6 – Water Servicing Statistics

Table 7 – Highest Residual Pressures during Non-Fire Flow Conditions

Table 8 – Lowest Residual Pressures during Non-Fire Flow Conditions

Table 9 – Residual Pressures during Fire Flow Conditions

Appendices

Appendix A

- Architectural site plan
- Topographic survey
- City Pre-consultation Meeting Notes

Appendix B

- Pre-development storm event calculations
- Allowable release rate calculations
- Orifice plate calculations/controlled release
- Storage Required/Provided Calculations
- StormCon Greenstorm SWM tank design details
- OGS Sizing Design Information

Appendix C

- Existing Sanitary Drainage Calculations
- Proposed Sanitary Drainage Calculations
- Site Sanitary Sewer Design Sheet

Appendix D

- Water Demand Calculations
- FUS Calculations
- City of Ottawa watermain boundary conditions
- Watermain Modelling Results



Drawings (all dated March 17, 2023)

SW-S – Site Servicing Plan

SW-G – Site Grading Plan

SW-SWM1 – Pre-Development Storm Drainage Plan

SW-SWM2 – Post-Development Storm Drainage Plan

SW-ESC – Erosion and Sediment Control Plan

SW-ND – Notes and Details Plan

SW-REM – Site Removals Plan

SW-SAN1 – Site Sanitary Drainage Plan



1.0 INTRODUCTION

1.1 BACKGROUND

This Site Servicing and Stormwater Management Report ('FSSR') has been prepared in support of a zoning by-law amendment ('ZBLA') and site plan control application ('SPA') for the proposed re-development located at 1971 & 1975 St. Laurent Boulevard within the City of Ottawa. The +/-3.46ha (+/-8.57 acre) subject site is bound by St. Laurent Boulevard along the north and west, Russell Road to the east and an existing City of Ottawa Community Housing residential complex to the south. The site is currently developed and contains two occupied 18-storey apartment buildings including associated surface parking lots and landscaped amenity areas. The site contains two existing vehicular accesses; one from St. Laurent Boulevard and one from Russell Road. The Russell Road access is shared with the adjacent property, 2080 Russell Road and there currently exists a shared access easement agreement. Refer to **Figure 1** for a key plan of the subject site.

The proposed development includes three new 17 storey apartment towers known here-on as "Building A" (167 units), "Building B" (164 units) and "Building C" (167 units) in addition to the two existing 18-storey apartment building which are to remain. In total, an additional 498 rental units are being added to the subject site to compliment the already existing 500 residential rental units. A new 4-storey vehicular parkade known as "Building D" is also proposed at the south end of the subject site. It is intended that the three new apartment towers, Building A, Building B and Building C, be severed off from the existing property for separate ownership at a future time. Site access is proposed through the two site accesses, one newly proposed access from St. Laurent Boulevard and one existing access from Russell Road. The existing shared access easement agreement for the Russell Road vehicular access is to remain. There is a proposed road widening along Russell Road which consists of 0.46 ha (1.14 acres). The above grade parking structure, Building D, will also provide rooftop amenity space for residents in addition to parking spaces. The development concept includes for an increase in Gross Floor Area ('GFA') of 36,100 sq.m. Refer to **Appendix A** for a summary of site statistics and architectural site plan.



*Site Servicing and Stormwater Management Report
1971 & 1975 St. Laurent Blvd., Ottawa*

This FSSR has been prepared to address the site servicing strategy (stormwater, sanitary, and water servicing) in support of the above noted development applications.

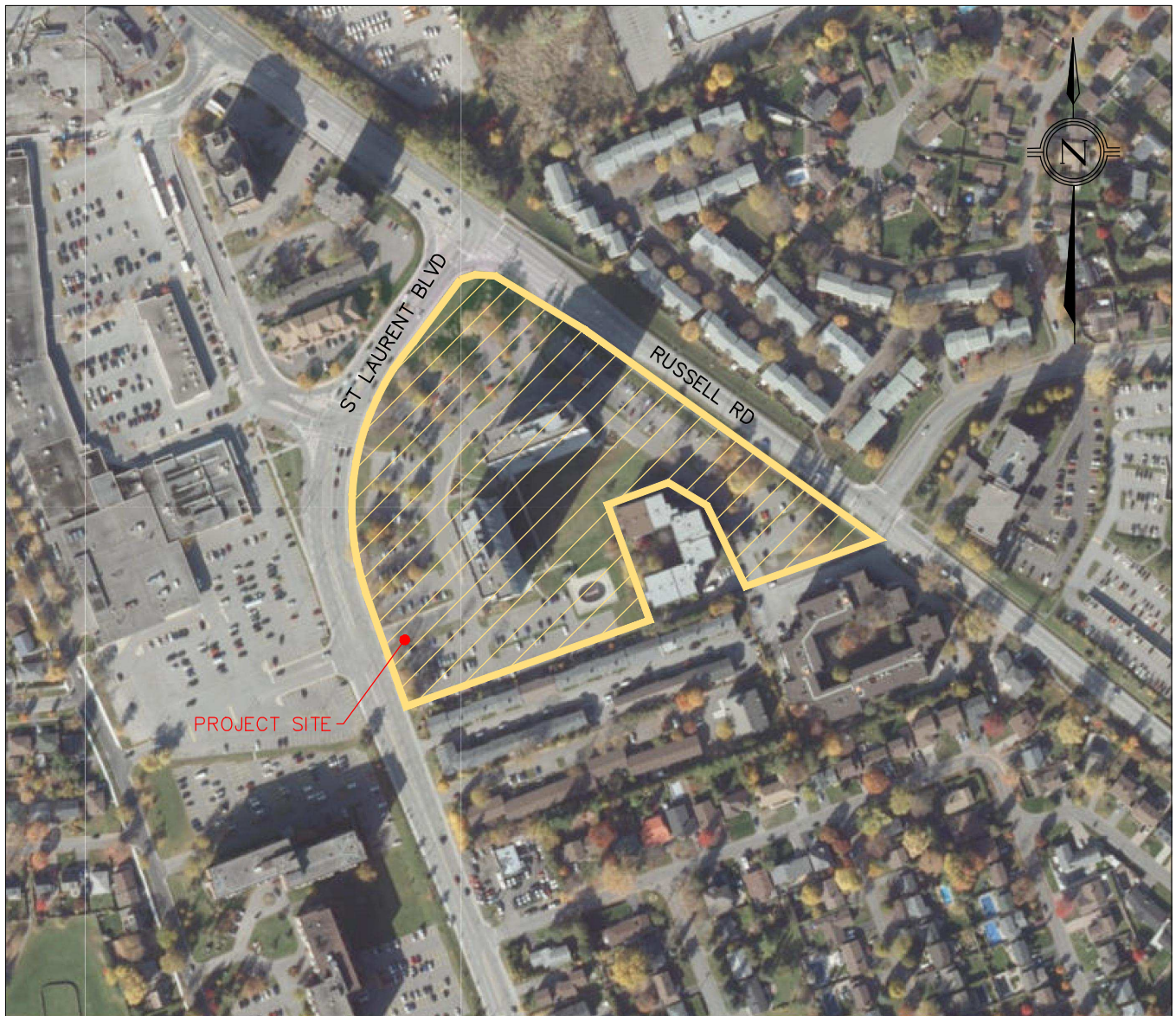

counterpoint 
ENGINEERING

COUNTERPOINT ENGINEERING INC.
8395 Jane St., Suite 100, Vaughan, ON L4K 5Y2 Phone 905.326.1404 Fax 905.326.1405

SITE LOCATION PLAN

PROPOSED MULTI-UNIT RESIDENTIAL
DEVELOPMENT
1971 & 1975 ST. LAURENT BLVD.
CITY OF OTTAWA, ONTARIO

DESIGNED BY: JD
CHECKED BY: GD
DRAWING BY: JD
CHECKED BY: GD
SCALE: N.T.S.

DATE: MARCH 2023
PROJECT No. 21106
FIGURE No. 1



1.2 STUDY PARAMETERS

The background documents listed below have been considered in the preparation of this FSSR:

- Architectural plans and inputs prepared by Petroff Partnership Architects;
- SUE investigation by T2 Utility Engineers, dated December 6, 2021;
- Topographic Survey by Annis, O’Sullivan, Vollebekk Ltd., dated September 27, 2021;
- Ottawa Sewer Design Guidelines, Second Edition, October 2012;
- Ottawa Design Guidelines – Water Distribution, First Edition, July 2010;
- Fire Underwriters Survey, 1999.
- City of Ottawa Technical Bulletin ISTB-2018-01 dated March 21, 2018
- City of Ottawa Technical Bulletin ISTB-2018-02 dated March 21, 2018
- City of Ottawa Technical Bulletin ISTB-2019-03 dated March 04, 2019
- City of Ottawa Technical Bulletin ISTB-2021-03 dated August 18, 2021

For the purpose of this report, we have referenced site and building statistics from the architectural site plan.



2.0 STORMWATER MANAGEMENT

2.1 EXISTING CONDITIONS

The subject site is currently occupied by two residential apartment buildings, associated surface parking lots and landscaped areas. The site currently utilizes a storm sewer network to capture minor flows (i.e. through catchbasins and storm sewers) and connects to a 450mm diameter municipal storm connection located at the south-east corner of the subject site. Based on a review of the topographic survey, major system overland flows exit the site at both the east and west frontages of the site, particularly at the existing vehicular access locations. Original design documents of the subject site were not located and due to the age of the existing infrastructure the assumption is that the existing site sewer does not have any stormwater controls. In addition, the storm sewer network servicing the neighboring Ottawa Community Housing buildings connects to the subject sites private storm sewer network at the southeast corner of the site, just upstream of the existing municipal control manhole. Refer to the **Pre-Development storm Drainage Plan (dwg. SW-SWM1)** for an illustration of the existing drainage conditions.

2.2 ALLOWABLE RELEASE RATE

The site conditions as they exist today, drain stormwater runoff to three separate outlets. Currently a portion of the site sheet flows drainage off toward the west end of the site and into the St. Laurent Boulevard right-of-way (ROW) which is eventually collected by the municipal storm sewer that flows south along the road. This will be referred hereon as the St. Laurent Boulevard outlet. In addition, a portion of the site sheet flows drainage off toward the north of the site and into the municipal ROW where it is eventually collected by the municipal storm sewer that flows north along Russell Road. This will be referred hereon as the Russell Road outlet. The remainder of the site captures drainage by the existing site storm sewer via various catchbasins and catchbasin manholes located throughout the site. The existing onsite storm sewer has a municipal service connection located at the southeast corner of the site. The site storm service connects to the existing 450mm municipal storm sewer located on Southvale Crescent. This will be referred hereon as the Southvale Crescent outlet. The existing private storm sewer on site does not have any SWM controls. Therefore, the proposed stormwater management strategy will satisfy municipal criteria and improve the old design to new standards. To



*Site Servicing and Stormwater Management Report
1971 & 1975 St. Laurent Blvd., Ottawa*

determine the allowable discharge rate to each outlet, the pre-development drainage boundary and its subsequent runoff coefficient was calculated. Each municipal storm sewer in the City of Ottawa has its own specifically designed capacity based on storm year events. For the purposes of this design, the following storm events apply for each storm sewer outlet:

- St. Laurent Boulevard outlet = 2 Year Storm Event
- Russell Road Outlet = 5 Year Storm Event
- Southvale Crescent = 2 Year Storm Event

The control manhole has been proposed along the existing 450mm private storm sewer and upstream of the connections from the existing neighbouring Ottawa Community Housing building as to avoid any negative impacts to the neighbouring buildings storm sewer.

Table 1 below summarizes the predevelopment storm runoff calculation which is used to determine the post-development allowable release rate from the altered areas within the subject site:

Table 1: Allowable Release Rates

	$Q_A = C \times A \times i / 360$ (L/s)		
	Area 100 St. Laurent Outlet	Area 101 Russell Outlet	Area 102 Southvale Outlet
A - Site Area (ha)	0.20	0.19	3.16
T_c (min)	10	10	10
C - Runoff Coefficient	0.46	0.25	0.50*
i – Intensity [5-year] (mm/hr)	76.81	104.19	76.81
Q - Release Rate [5-year] (l/s)	19.6	13.8	336.6

* Runoff coefficient used to calculate allowable release rate limited to maximum of 0.5 per City of Ottawa design manual

The overall total combined release rate from the site is **369.9 L/s**. Post-development peak flows will be attenuated to the allowable release rates of each outlet as shown in **Table 1** or less if possible for all storms up to and including the 100-year storm event, as summarized in **Appendix B**. If the release rate for a particular outlet marginally exceeds the allowable release for that particular outlet, another outlet will be additional attenuated to ensure the overall total allowable release rate is not exceeded. Refer



to **Appendix B** for the site-specific allowable release rate calculation. Refer to the **Pre-Development Storm Drainage Plan (dwg. SW-SWM1)** for an illustration of the existing drainage boundaries.

2.3 WATER QUANTITY

All stormwater runoff from the various components of the proposed development's site areas, including roofs, exterior hard paved surfaces, and soft landscaped areas, will be captured by roof drains and catchbasins and conveyed either via the building plumbing system or the site storm sewer system and directed to the existing/proposed storm sewers within the site. Refer to the **Post-Development Storm Drainage Plan (dwg. SW-SWM2)** for the post-development drainage condition, storm sewer network detail and connection to municipal infrastructure. A small portion of the site will drain uncontrolled in the post-development drainage condition. The proposed parkland dedication to the City (0.178 ha) will drain uncontrolled and contributes a large portion of uncontrolled drainage to the St. Laurent Blvd outlet. The post-development 100-year storm event discharging from the uncontrolled areas draining to the St. Laurent outlet and Russell outlet will marginally exceed their respective predevelopment allowable flows of **19.6 l/s** and **13.8 l/s**, respectively. The majority of the site stormwater will be captured and controlled via the onsite storm sewer system and discharge to the Southvale outlet. Quantity control will be provided within the site to ensure that post-development peak flows up to the 100-year storm event are attenuated to the allowable release rate of **336.6 l/s** to the Southvale outlet at the control MH. To compensate for the additional uncontrolled discharge to the St. Laurent outlet and Russell outlet, the controlled discharge to the Southvale outlet will be over attenuated to ensure the overall site discharge does not exceed the total allowable for the site of **369.9 l/s**.

For the purpose of calculating the required storage and orifice diameter required to achieve quantity control, composite run-off coefficients were calculated across the subject site.



Table 2: Composite Runoff Coefficients of Post-Development Condition

Area	Area [m ²]	RC
200 - Controlled to Southvale Outlet	3.318	0.77
201 - Uncontrolled to Southvale Outlet	0.007	0.25
202 - Uncontrolled to St. Laurent Outlet	0.022	0.33
Parkland Dedication	0.178	0.25
203 - Uncontrolled to Russell Outlet	0.108	0.42

The resulting quantity control calculations are summarized in **Table 3** shown below. The on-site water quantity requirements can be achieved by in-sewer underground storage in combination with a 350mm orifice plate control, at the downstream side of the control maintenance hole, to attenuate storm runoff to the required level. Refer to **Appendix B** for stormwater storage calculations. Underground storage tanks will provide the bulk of the required stormwater detention. The tanks specified for this site are GreenStorm-ST modules manufactured by Stormcon. Refer to **Appendix B** for detailed design specifications of the Stormcon system. A combined storage total of **639.5 m³** of storage is provided onsite for the 100-year storm event. As per the Ottawa Sewer Design Guideline requirements (SDG 8.3.12) an additional climate stress test is to be applied to the provided 100-year stormwater storage onsite. The stress test requires the SWM storage facility onsite to be able to accommodate an additional 20% storage volume on top of the required 100-year storage requirement. The 100-year +20% storage volume require onsite is calculated to be **851.3 m³**.

Major storm events in excess of the 100-year event and not captured by the minor system will spill to the municipal right-of-way, primarily at the two vehicular accesses to St. Laurent Boulevard and Russell Road.



Site Servicing and Stormwater Management Report
1971 & 1975 St. Laurent Blvd., Ottawa

Table 3: Peak Flow and Storage Summary

Area ID	Area (ha)	Runoff Coefficient	t _c (min)	5yr Flows				100yr Flows				Description	Orifice Size (mm)	Orifice Release Rate (L/s)
				Allowable Release Rate (L/s)	Provided Release Rate (L/s)	Storage Required (m ³)	Storage Provided (m ³)	Allowable Release Rate (L/s)	Provided Release Rate (L/s)	Storage Required (m ³)	Storage Provided (m ³)			
Southvale Cres. Outlet														
200	3.318	0.77	10	336.6	207.9	350.1	350.9	336.6	320.2	639.5	851.3	CNTRL to Southvale	350	320.2
201	0.007	0.25	10	336.6	0.5	-	-	336.6	0.8	-	-	UNC to Southvale	N/A	N/A
Total	3.324			336.6	28.1	350.1	350.9	336.6	321.1	639.5	851.3			
St. Laurent Blvd. Outlet														
202	0.022	0.33	10	19.6	2.1	-	-	19.6	3.6	-	-	UNC to St. Laurent	N/A	N/A
PARK	0.178	0.25	10	19.6	12.9	-	-	19.6	22.1	-	-	UNC to St. Laurent	N/A	N/A
Total	0.022			19.6	15.0	0.0	0.0	19.6	25.7	0.0	0.0			
Russell Road Outlet														
203	0.108	0.42	10	13.8	13.1	-	-	13.8	22.5	-	-	UNC to Russell	N/A	N/A
Total	0.108			13.8	13.1	0.0	0.0	13.8	22.5	0.0	0.0			
SITE TOTALS	3.455			369.9	56.2	350.1	350.9	369.9	369.2	639.5	851.3			

2.4 WATER QUALITY

Water quality treatment for the subject site is required to ensure Level I enhanced quality treatment is achieved, in accordance with City of Ottawa/MOE criteria, which requires an overall 80% Total Suspended Solids ('TSS') removal rate for the overall site.

As run-off from roof areas is generally considered to be clean, a quality control unit will be provided, at the downstream of the Control MH, to treat only runoff from paved surface areas upstream of the control manhole. In order to achieve a TSS removal rate of 80% and considering site characteristics, a CSD PMSU3020-6-C Oil/Grit Separator (OGS) unit manufactured by Contech Engineered Solutions was selected. Refer to **Appendix B** for more information. The specified oil/grit separator will provide the required 80% TSS removal, at minimum.

2.5 EROSION AND SEDIMENT CONTROL

Erosion and sediment control will be provided on-site before major construction, including silt fence around the perimeter of the construction area, silt controls on existing catchbasins within and adjacent to the site and if suitable, a mud mat at the construction entrance to prevent mud being tracked onto the adjacent roads by construction vehicles. Regular cleaning of the adjacent streets will also be carried out. The above measures are to be maintained throughout the course of construction and any areas disturbed by the installation of erosion and sediment control devices are to be restored to existing condition or better.



3.0 SANITARY SERVICING

3.1 EXISTING SANITARY SERVICING

The site currently is serviced by a sanitary sewer network that conveys sanitary flows from 1971 & 1975 St. Laurent Boulevard and connects to a 250mm diameter municipal sanitary sewer that crosses Russell Road and flows north easterly along Southvale Crescent. The existing sanitary service connection to the subject site also services the neighbouring Ottawa Community Housing buildings located at 2080 & 2100 Russell Road. Based on the proposed sanitary sewer design for the proposed development, it is considered independent of our scope and there is no intention to alter the sanitary sewer connection to either of the existing Ottawa Community Housing buildings. Refer to the **Site Servicing Plan** (dwg. **SW-S**) for the layout of the existing sewer network.

The peak sanitary discharge from the existing apartment towers was calculated using an average wastewater flow of 280 l/capita/day and using an infiltration rate of 0.33 l/s/ha. (City of Ottawa Technical Bulletin ISTB-2018-01, March 21, 2018). The unit count and mix for the two existing apartment towers on site was acquired from the Client to determine a population density for peak flow calculations. The unit count and mix for the two existing buildings located at 2080 & 2100 Russell Road was acquired from the Ottawa Community Housing website to determine a population density for peak flow calculations. Refer to **Appendix C** for supporting calculations. The following table summarized the existing sanitary peak flows generated from the site today:

Table 4: Peak Sanitary Flow – Existing Buildings

Building	Outlet Sewer	Units	Equiv. Pop	Peak Flow incl. Infil. (L/s)
1971 St. Laurent Blvd.	Southvale Cres.	250	412	14.62
1975 St. Laurent Blvd.	Southvale Cres.	250	412	
2080 & 2100 Russell Road	Southvale Cres.	335	472	



3.2 PROPOSED SANITARY RELEASE RATE AND SERVICING

The location of the private sanitary sewer network currently servicing the two existing 18-storey apartment buildings is ideal for providing a new, private connection for Building A and Building D. Building A currently has no public sanitary sewer availability across its frontage along St. Laurent Boulevard or Russell Road and therefore will require service from the existing private sanitary sewer network onsite. Building D is located between the two existing apartment towers and therefore is ideal to connect to the already available private sanitary sewer network onsite. Since the owner is currently intending a land severance, two new sewer connections are proposed from the existing 250mm municipal sanitary sewer along St. Laurent Boulevard to Building B and Building C. The new sanitary sewer connections will consist of 200mm PVC services at a slope of 2.0% connecting into existing sanitary manholes on St. Laurent boulevard and include proposed control manholes at the property lines. Per City request, an additional individual sanitary service connection is provided to the park dedication lands which includes a 150mm PVC service at a slope of 2.0% which includes a control maintenance hole 2.0m inside the property line. Further discussions with City staff are required in order to determine how to ensure the proposed servicing is building code and MECP compliant, considering Building A and Building D will be connecting into the existing private sanitary network onsite.

The peak sanitary discharge from the proposed apartment towers was calculated using an average wastewater flow of 280 l/capita/day and using an infiltration rate of 0.33 l/s/ha. (City of Ottawa Technical Bulletin ISTB-2018-01, March 21, 2018). The onsite sanitary peak discharge has been separated as per their respective sewer outlets.

Table 5: Peak Sanitary Flow – Proposed Buildings

Building	Outlet Sewer	Units	Equiv. Pop	Peak Flow incl. Infil. (L/s)
Building A	Southvale Cres.	167	302	3.72
Building D	Southvale Cres	0	0	
Building B	St. Laurent Blvd.	164	295	6.70
Building C	St. Laurent Blvd.	167	300	



Considering the subject site consists of existing apartment building to remain, the above peak sanitary flows represent the net increase of sanitary discharge from the existing site. Therefore, the total net increase in wet weather peak flow rate to the Southvale Crescent outlet is **3.72 L/s** and the total net increase in wet weather peak flow rate to the St. Laurent Boulevard outlet is **6.70 L/s**. This produces a total net increase in sanitary flow from the site of **10.77 L/s**. Refer to **Appendix C** for supporting calculations.

4.0 WATERMAIN SERVICING

4.1 EXISTING WATER SERVICING STRATEGY

The existing site is currently serviced by a private looped watermain on site consisting of 200mm and 150mm watermain pipes. The internal private watermain systems connects to the municipal watermain system in two locations along St. Laurent Boulevard. The internal private loop provides water service connections to the two existing apartment buildings. The private site watermain service continues southeast into the site where it eventually provides service connections to the Ottawa Community housing buildings. The private site contains three existing fire hydrants located throughout the subject site relatively in the vicinity of the existing buildings. Refer to drawing **SW-S** for the layout of the existing water service network and location of site service connections.

4.2 PROPOSED WATER SERVICING STRATEGY

The following watermain improvements are proposed as part of the development application. Refer to drawing **SW-S** for the proposed watermain improvements.

- Extend the existing private watermain loop to provide connections to the newly proposed buildings. Building A and Building D will be serviced by extensions of the existing internal watermain loop with 300mm diameter and 150mm diameter PVC watermain services providing domestic service and fire protection.
- Remove lengths of existing watermain that conflict with proposed buildings and infrastructure on site and replace with new watermain lengths to reconnect the internal private looped system.



*Site Servicing and Stormwater Management Report
1971 & 1975 St. Laurent Blvd., Ottawa*

- Extend the existing onsite watermain next to complete the loop on either end of the site to eliminate any dead-end lengths of watermain extending to Ottawa Community housing buildings.
- Provide two new separate water service connections each to Building B and Building C from the existing 300mm municipal watermain on St. Laurent Boulevard. Building B and Building C will each require two 150mm PVC water service connection separated by an isolation valve along the water main to provide a redundant looped system to each parcel. These water service connections will provide domestic and fire prevention service to each building.
- Provide a new separate water service connections to the proposed Park Dedication lands from the existing 300mm municipal watermain on St. Laurent Boulevard. The Park Dedication land will require one 50mm copper water service connection complete with a water meter chamber within the property line and terminating into a standpipe. This water service connection will provide any future water provisions required for the park.
- Both portions of the existing watermain system as well as new additions to the watermain network are proposed onsite due to the nature of this project being a retrofit of an existing development. For this reason, construction of the new watermain system and decommissioning of existing watermains to be abandoned will require a detailed water testing and connection commissioning plan to outline the procedure. The contractor is required prior to commencing watermain construction to provide a water chlorination and commissioning plan to the satisfaction of City staff.

Domestic water demands were calculated using a per capita rate of 280 litres/person/day and peaked in accordance with City standards (*Ottawa Water Distribution Design Guidelines – Table 4.2*). Fire flow demand was estimated using the Fire Underwriters Survey (2020) guidelines. A conservative assumption on construction type for each proposed building was made by applying ‘Non-Combustible’. An occupancy reduction (contents) factor of LC was used for all residential buildings with the exception of the parkade structure (Building D) which has a combustible contents factor.



Verification of the capacity of off-site watermain infrastructure is provided in **Section 4.3**. Refer to **Table 6** for a summary of water servicing requirements and **Appendix D** for detailed water service calculations.

Table 6: Water Servicing Statistics

Item	BLDG A, D & EX. Rate (l/s)	BLDG B Rate (l/s)	BLDG C Rate (l/s)
Average Day	5.2	1.0	1.0
Maximum Day	12.9	2.4	2.4
Maximum Hour	28.5	5.3	5.4
Fire Flow – FUS	250.0*	66.7	66.7
Max. Day + Fire Flow	262.9	69.1	69.1

** Please refer to **Appendix D** for detailed FUS calculations for each building. The largest fire demand was used as the governing fire flow for BLDG A, D and Existing Buildings.*

Per the architectural site plan, a Fire Department Connection will be located on the face of each proposed and within 15m of the principal entrance. An existing fire hydrant or proposed fire hydrant will be within the required distance (45m) to the Fire Department Connection.

4.3 WATERMAIN MODELLING

Watermain modeling has been performed as requested by the City to evaluate the available pressures in the watermain system. The watermain analysis utilized EPANET to evaluate the capacity of the surrounding water infrastructure and available pressures. The model was run based on the average day, peak hour and maximum day + fire flow demands for the proposed development. The model analyzed max day + fire flow demand scenarios during fire flow conditions at proposed Building A and D, as well as the existing buildings located at 1971 St. Laurent Blvd, 1975 St. Laurent Blvd, 2080 Russell Road, and 2100 Russell Road. Proposed Buildings B and C will have direct connections into the existing watermain on St. Laurent Blvd and therefore do not rely on the model of the private system to ensure sufficient pressure. The City has indicated that City staff will assess the existing watermain system's capacity to service these two buildings.

The model has been set up to focus on the limits of the development and shall connect into the existing watermain system with two connections to the existing watermain on St. Laurent Blvd, and connect at the existing watermain system in the southeast corner of the site (adjacent to the entrance for 2100 Russell Road) to complete a full loop of the private watermain system. Average day and peak hour



*Site Servicing and Stormwater Management Report
1971 & 1975 St. Laurent Blvd., Ottawa*

demands were placed at the respective nodes where the servicing connections to buildings are located, and fire flows were inputted at the buildings or hydrants that will be servicing the buildings. Fire flows for the existing buildings at 2080 Russell Road and 2100 Russell Road were inputted at their connections to the existing watermain, to demonstrate that adequate fire flow can be provided for these existing buildings.

The model was set up with “pump” locations as follows:

1. Two connections at the existing 300 mm \varnothing watermain along St. Laurent Blvd.

The characteristics of the supply/connection points were established based on the boundary conditions received from the City staff on February 21, 2023. These boundary conditions have been included in **Appendix D**. The results of the water distribution modeling are summarized in **Tables 7 to 9** below:

Table 7 – Highest Residual Pressures During Non-Fire Flow Conditions

Scenario	Pressure (m H ₂ O)	Pressure (psi)	Pressure (kPa)	Satisfies Pressure Requirements?
Avg. Day	52.4	74.51	513.7	Yes
Peak Hour	50.74	72.15	497.5	Yes

Table 8 – Lowest Residual Pressures During Non-Fire Flow Conditions

Scenario	Pressure (m H ₂ O)	Pressure (psi)	Pressure (kPa)	Satisfies Pressure Requirements?
Avg. Day	49.81	70.83	488.3	Yes
Peak Hour	48.07	68.35	471.3	Yes



Table 9 – Residual Pressures During Fire Flow Conditions

Fire Flow at Block	Max. Day + Fire Flow requirements (L/min)	Max. Velocity (m/s)	Lowest Pressure			Satisfies Fire Flow Requirements?
			Pressure (m H ₂ O)	Pressure (psi)	Pressure (kPa)	
Ex. 1971 St. Laurent Blvd	9,200	3.05	41.70	59.30	408.8	Yes
Ex. 1975 St. Laurent Blvd	7,200	3.82	40.23	57.21	394.4	Yes
Ex. 2080 Russell Road	10,092	5.35	22.52	32.02	220.8	Yes
Ex. 2100 Russell Road	11,138	4.24	18.96	26.96	185.9	Yes
Prop. Building A	4,147	2.2	44.26	62.94	433.9	Yes
Prop. Building D	15,000	8.06	17.60	25.03	172.6	Yes

Maximum Pressure = 532.8 kPa (77.27 psi)

Minimum Pressure – During Peak hour = 494.4 kPa (71.71 psi)

Minimum pressure – During Max Day + Fire Flow = 195.6 kPa (28.37 psi)

Refer to **Appendix D** for the details and full model outputs. As per City of Ottawa standards, required pressure ranges are outlined as follows:

- Preferred design pressure during normal operating conditions is within 345 kPa to 552 kPa
- Minimum pressure under non-fire conditions shall not be below 275 kPa
- Minimum pressure under max day + fire flow conditions is 140 kPa

As seen from **Tables 7 to 9** above, adequate pressure is available in the existing surrounding watermain system to service the proposed development and maintain pressures within the required range during all scenarios including average day demand, peak hour demand and max day + fire flow demand conditions.

The existing and proposed watermain system will therefore have adequate flow and pressure to service the proposed development under all required conditions. The proposed water distribution system for



*Site Servicing and Stormwater Management Report
1971 & 1975 St. Laurent Blvd., Ottawa*

the development shall adequately provide max day + fire flow demand, while maintaining a residual pressure of over 140 kPa, as per the City of Ottawa criteria. Therefore, no external upgrades or retrofits are required on the existing surrounding watermain network to service the proposed development.

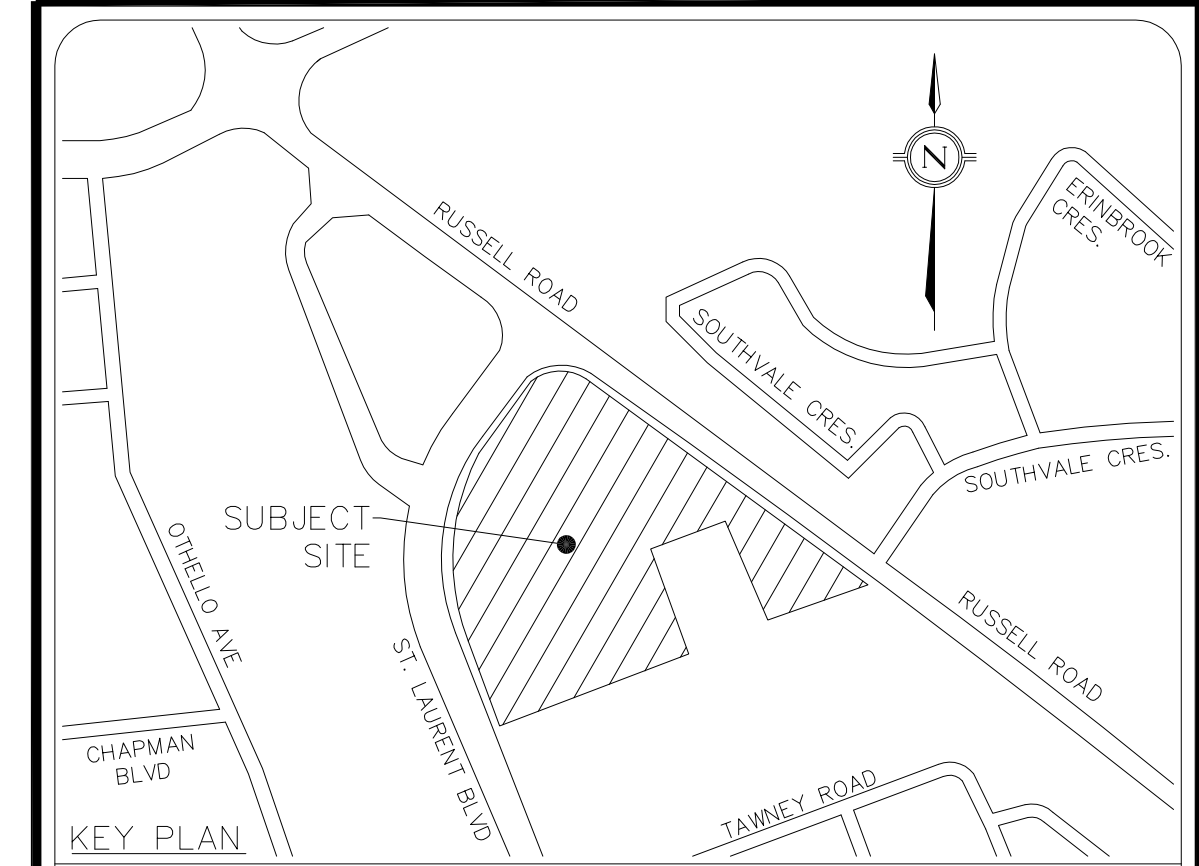
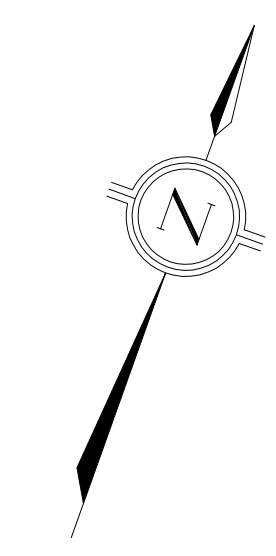
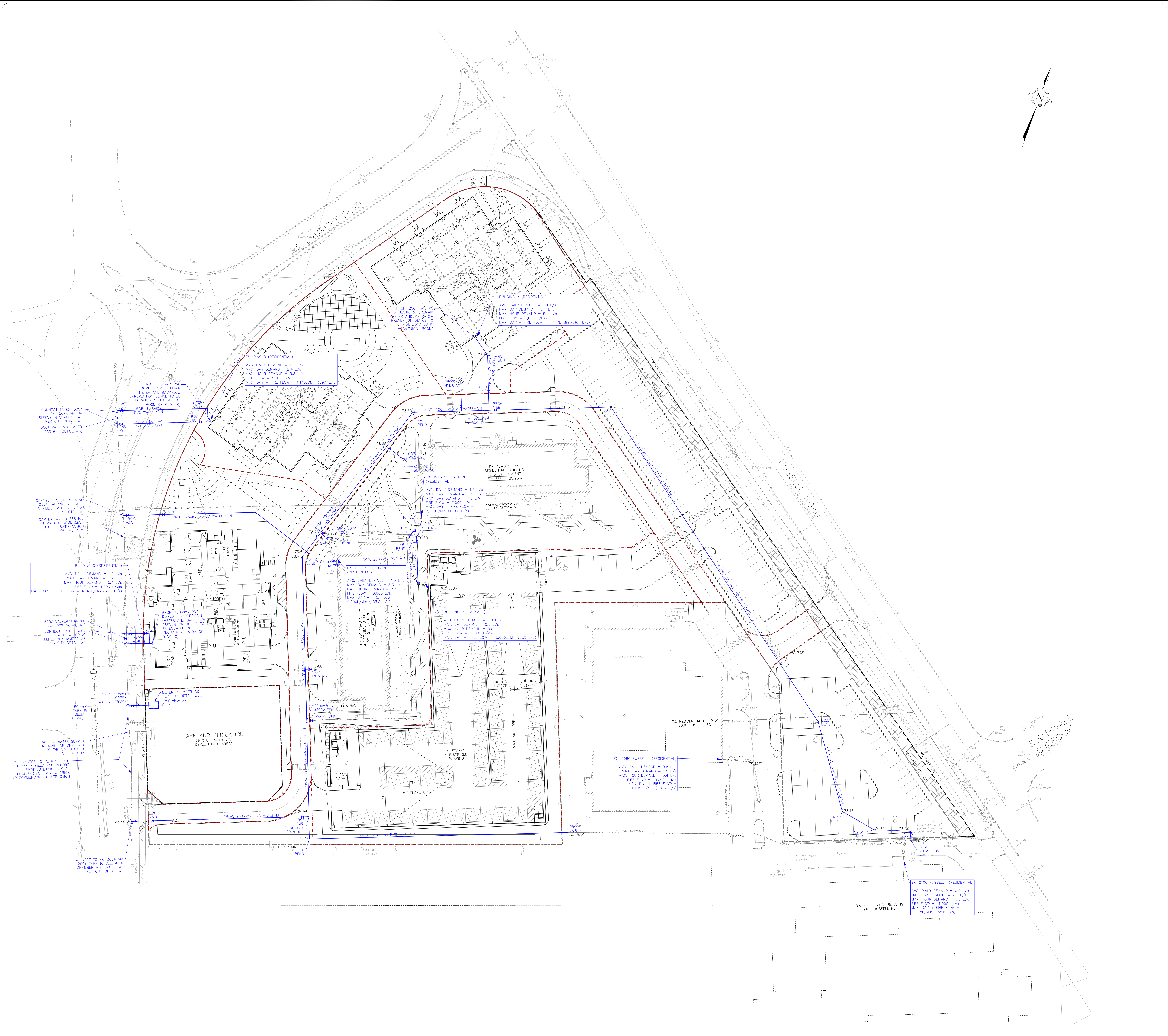

- LEGEND**
- ◊ EXISTING HYDRANT
 - EXISTING STORM SEWER
 - EXISTING SANITARY SEWER
 - EXISTING WATERMAIN
 - PROPOSED STORM SEWER AND MH
 - PROPOSED AREA BRAN
 - PROPOSED SANITARY SEWER AND MH
 - PROPOSED HYDRANT AND VALVE
 - PROPOSED VALVE AND BOX
 - PROPOSED DETECTOR ASSEMBLY
 - PROPOSED BACKFLOW PREVENTOR
 - PROPOSED WATER METER
 - PROPOSED WATERMAIN
 - PROPERTY LINE

BUILDING B (RESIDENTIAL)
 AVG. DAILY DEMAND = 1.0 L/S
 MAX. DAY DEMAND = 2.4 L/S
 MAX. HOUR DEMAND = 5.3 L/S
 FIRE FLOW = 4,000 L/MIN
 MAX. DAY + FIRE FLOW = 4,143 L/MIN (69.1 L/S)

BUILDING A (RESIDENTIAL)
 AVG. DAILY DEMAND = 1.0 L/S
 MAX. DAY DEMAND = 2.4 L/S
 MAX. HOUR DEMAND = 5.4 L/S
 FIRE FLOW = 4,000 L/MIN
 MAX. DAY + FIRE FLOW = 4,147 L/MIN (69.1 L/S)

CONNECT TO EX. 300#
 150# TAPPING
 SLEEVE IN CHAMBER AS
 PER CITY DETAIL #4
 300# VALVE/CHAMBER
 (AS PER DETAIL #3)

CONNECT TO EX. 300# VIA
 250# TAPPING SLEEVE IN
 CHAMBER WITH VALVE AS
 PER CITY DETAIL #4
 CAP EX. WATER SERVICE
 AT MAIN RECOMMISSION
 TO THE SATISFACTION
 OF THE CITY

BUILDING C (RESIDENTIAL)
 AVG. DAILY DEMAND = 1.0 L/S
 MAX. DAY DEMAND = 2.4 L/S
 MAX. HOUR DEMAND = 5.4 L/S
 FIRE FLOW = 4,000 L/MIN
 MAX. DAY + FIRE FLOW = 4,146 L/MIN (69.1 L/S)

**EX. 1975 ST. LAURENT
 RESIDENTIAL BUILDING
 (RESIDENTIAL)**
 AVG. DAILY DEMAND = 1.3 L/S
 MAX. DAY DEMAND = 3.3 L/S
 MAX. HOUR DEMAND = 7.3 L/S
 FIRE FLOW = 7,000 L/MIN
 MAX. DAY + FIRE FLOW =
 12,200 L/MIN (120.0 L/S)

**EX. 1971 ST. LAURENT
 RESIDENTIAL
 (RESIDENTIAL)**
 AVG. DAILY DEMAND = 1.3 L/S
 MAX. DAY DEMAND = 3.3 L/S
 MAX. HOUR DEMAND = 7.3 L/S
 FIRE FLOW = 8,000 L/MIN
 MAX. DAY + FIRE FLOW =
 13,200 L/MIN (133.3 L/S)

BUILDING D (PARKING)
 AVG. DAILY DEMAND = 0.0 L/S
 MAX. DAY DEMAND = 0.0 L/S
 MAX. HOUR DEMAND = 0.0 L/S
 FIRE FLOW = 15,000 L/MIN
 MAX. DAY + FIRE FLOW =
 15,000 L/MIN (250 L/S)

EX. 2080 RUSSELL (RESIDENTIAL)
 AVG. DAILY DEMAND = 0.6 L/S
 MAX. DAY DEMAND = 1.5 L/S
 MAX. HOUR DEMAND = 3.4 L/S
 FIRE FLOW = 10,000 L/MIN
 MAX. DAY + FIRE FLOW =
 10,092 L/MIN (168.2 L/S)

EX. 2100 RUSSELL (RESIDENTIAL)
 AVG. DAILY DEMAND = 0.9 L/S
 MAX. DAY DEMAND = 2.3 L/S
 MAX. HOUR DEMAND = 5.0 L/S
 FIRE FLOW = 11,000 L/MIN
 MAX. DAY + FIRE FLOW =
 11,136 L/MIN (185.6 L/S)

LEGAL & TOPOGRAPHY
 PROVIDED BY: ANNE, O'SULLIVAN, VOLLEBERG LTD.
 14 CONDORSE GATE, SUITE 500
 MARKHAM, ONTARIO, L3R 7S6
 PHONE: (905) 727-0850

BENCHMARK
 NOTE: BENCHMARKS ARE ASTROMERIC, DERIVED FROM THE EASTERLY LIMIT OF ST. LAURENT
 BOULEVARD, SHOWN TO BE N21°15'15"W

ELEVATION NOTE
 NOTES: ELEVATIONS SHOWN ARE GEODETIC AND ARE REFERRED TO THE COV028
 GEODETIC DATUM.

NO.	DESCRIPTION	DATE	BY	CITY
03	ISSUED FOR SITE PLAN APPLICATION APPROVAL #2	MAR 13, 2022	J.Y.	
02	ISSUED FOR COORDINATION	DEC 22, 2022	J.Y.	
01	ISSUED FOR SITE PLAN APPLICATION APPROVAL #1	MAR 13, 2022	J.Y.	

counterpoint ENGINEERING
 COUNTERPOINT ENGINEERING INC.
 8390 Jane St., Suite 100, Vaughan, ON L4V 1Y2 Phone: 905.326.1404 Fax: 905.326.1405

J.S. KODAMATHAN
 100100545
 MAR 17 2023
 PROFESSIONAL ENGINEER
 ENGINEER'S STAMP

APPLICANT:
STARLIGHT DEVELOPMENTS INC.
 3280 BLOOR STREET WEST, CENTRE TOWER - UNIT# 1400
 TORONTO, ONTARIO M8X 2X3
 PHONE: (416) 234-8444
 FAX: (416) 855-4192
 CONTACT: MATTHEW CELLUCCI

SITE LOCATION:
PROPOSED RESIDENTIAL DEVELOPMENT
 MULTIHUNT RESIDENTIAL TOWER DEVELOPMENT
 1971 & 1975 ST. LAURENT BLVD., OTTAWA

SITE WATERMAIN NETWORK FIGURE

DESIGNED BY: G.D.	CHECKED BY: J.Y.	DATE: MAR 11, 2022
DRAWING BY: G.D.	CHECKED BY: J.Y.	PROJECT NO: 21106
SCALE: 1:400m	DRAWING NO: FIGURE 2	



5.0 CONCLUSIONS

This report presents a site servicing strategy for the proposed development that addresses the requirements of the applicable design guidelines and provides the basis for detailed servicing design. The key points are summarized as follows:

Stormwater Management:

- Post-development stormwater flows are to be controlled to an allowable release rate of 19.6 l/s to the St. Laurent Boulevard outlet, 13.8 l/s to the Russell Road and 336.6 l/s to the Southvale Crescent outlet, which represents the 2-year, 5-year and 2-year design storms respectively. The overall site allowable release must not exceed 269.9 L/s.
- The on-site water quantity requirements will be achieved by in-sewer underground storage, primarily provided by Stormcon GreenStorm SWM detention units in combination with a 350mm orifice plate control, at the downstream side of the control manhole, in order to attenuate storm run-off to the required level.
- A Contech model CDS PSMU3020-6-C Oil/Grit Separator (OGS) quality control unit will be provided downstream of the control manhole, in order to achieve the minimum 80% TSS removal quality control criteria.

Sanitary Servicing:

- The subject site required multiple sanitary service connections to accommodate the future parcel severances on site. A new sanitary service will be provided for Building B, Building C and the park dedication lands with sanitary sewer connection which will connect into the existing municipal 250mm sanitary sewer on St. Laurent Boulevard. Building A and Building D will connect to the existing private sanitary sewer system, which then eventually outlets to a 250mm diameter sanitary sewer on Southvale Crescent.
- The proposed development concept will generate a net increase of 3.72 l/s of peak wet weather sanitary flow to the Southvale Crescent sanitary sewer outlet. As well, the proposed development concept will generate a net increase of 6.70 l/s of peak wet weather sanitary flow



*Site Servicing and Stormwater Management Report
1971 & 1975 St. Laurent Blvd., Ottawa*

to the St. Laurent Boulevard sanitary sewer outlet, in addition to the existing sanitary flow from the existing apartment buildings to remain.

Water Servicing:

- The existing site is currently serviced by a private looped watermain on site consisting of 200mm and 150mm watermain pipes. Building A and Building D will be serviced by 200mm diameter and 150mm diameter PVC watermain extensions of the existing private looped watermain network.
- Building B and Building C will be serviced by the existing 300mm municipal watermain on St. Laurent Boulevard. Building B and Building C will each require two 150mm PVC water service connection separated by an isolation valve along the water main to provide a redundant looped system to each parcel.
- Building A and Building D as well as the existing buildings (1971 & 1975 St. Laurent Blvd. and 208 & 2100 Russell Road) have an average day domestic demand of 5.2 l/s, a maximum day demand of 12.9 l/s and a maximum hour demand of 28.5 l/s.
- Building B has an average day domestic demand of 1.0 l/s, a maximum day demand of 2.4 l/s and a maximum hour demand of 5.3 l/s.
- Building C has an average day domestic demand of 1.0 l/s, a maximum day demand of 2.4 l/s and a maximum hour demand of 5.4 l/s.
- Fire flow demand was estimated using the Fire Underwriters Survey (2020) guidelines. It was determined that the private looped watermain system (Buildings A, D & Existing) will require 15,000 l/min (250.0 l/s) to provide sufficient fire flow protection for the development. It was determined that Building B will require 4,000 l/min (66.7 l/s) to provide sufficient fire flow protection for the development. It was determined Building C will require 4,000 l/min (66.7 l/s) to provide sufficient fire flow protection for the development.
- The subject site was modeled using EPANET software and boundary conditions provided by City of Ottawa staff. The model confirmed that adequate pressure is available in the existing system to service the proposed development.



We trust this report sufficiently addresses the site servicing requirements in support of the proposed site plan application associated with the subject site. Please contact the undersigned with any questions or comments.

Counterpoint Engineering Inc.



Per: Gian-Michael Di Luca, P.Eng.
Project Designer
Direct: (416) 886-1075
Email: gdiluca@counterpointeng.com



Per: David Di Iorio, P.Eng.
Practice Area Lead – Commercial, Partner
Direct: (416) 574-1382
Email: ddiorio@counterpointeng.com



APPENDIX A



PROPOSED MULTI-UNIT RESIDENTIAL DEVELOPMENT STARLIGHT DEVELOPMENTS

CONSULTANTS LIST

PLANNING CONSULTANTS
 FOTENN PLANNING & DESIGN
 396 COOPER STREET, SUITE 300
 OTTAWA, ONTARIO K2P-2H7
 TEL: 613-730-5709

SITE SERVICES & GRADING ENGINEERS
 COUNTERPOINT ENGINEERING
 8395 JANE STREET, SUITE 100
 VAUGHAN, ONTARIO L4K-5Y2
 TEL: 416-886-1075

LANDSCAPE ARCHITECTS
 MHBC PLANNING, URBAN DESIGN &
 LANDSCAPE ARCHITECTURE
 7050 WESTON ROAD, SUITE 230
 WOODBRIDGE, ONTARIO L4L-8G7
 TEL: 905-761-5588

TRANSPORTATION ENGINEER
 CGH TRANSPORTATION INC.
 13 MARKHAM AVE
 OTTAWA, ONTARIO K2G-3Z1
 TEL: 613-697-3797

WIND ENGINEER
 GRADIENT WIND ENGINEERING
 127 WALGREEN ROAD
 OTTAWA, ONTARIO K0A-1L0
 TEL: 613-836-0934

GEOTECHNICAL ENGINEER
 6221 HWY #7, UNIT 16
 VAUGHAN, ONTARIO, L4H-0K8
 TEL: 905-264-9393

ELECTRICAL ENGINEER
 MULVEY & BANANI INTERNATIONAL INC. (MBII)
 90 SHEPPARD AVE. EAST, SUITE 500
 TORONTO, ONTARIO M2N-3A1
 TEL: 416-751-2122

ARCHITECTURAL DRAWING LIST

A000 COVER SHEET
 A001 SITE & DEVELOPMENT STATISTICS

A101 CONTEXT SITE PLAN
 A102 SITE PLAN

A201 PARKADE GROUND FLOOR PLAN
 A202 PARKADE 2ND FLOOR PLAN
 A203 PARKADE 3RD FLOOR PLAN
 A204 PARKADE 4TH FLOOR PLAN
 A205 PARKADE AMENITY LEVEL/ ROOF PLAN

A211 BUILDING 'A' - GROUND FLOOR PLAN
 A212 BUILDING 'A' - BASEMENT FLOOR PLAN
 A213 BUILDING 'A' - SECOND FLOOR FLOOR PLAN
 A214 BUILDING 'A' - THIRD FLOOR
 A215 BUILDING 'A' - 4TH TO 6TH FLOOR PLAN
 A216 BUILDING 'A' - 7TH TO 17TH FLOOR PLAN
 A217 BUILDING 'A' - ROOF PLAN

A221 BUILDING 'B' - GROUND FLOOR PLAN
 A222 BUILDING 'B' - BASEMENT FLOOR PLAN
 A223 BUILDING 'B' - SECOND FLOOR FLOOR PLAN
 A224 BUILDING 'B' - 3RD TO 6TH FLOOR PLAN
 A225 BUILDING 'B' - 7TH TO 17TH FLOOR PLAN
 A226 BUILDING 'B' - ROOF PLAN

A231 BUILDING 'C' - GROUND FLOOR PLAN
 A232 BUILDING 'C' - BASEMENT FLOOR PLAN
 A233 BUILDING 'C' - SECOND FLOOR FLOOR PLAN
 A234 BUILDING 'C' - 3RD TO 6TH FLOOR PLAN
 A235 BUILDING 'C' - 7TH TO 17TH FLOOR PLAN
 A236 BUILDING 'C' - ROOF PLAN

A310 ELEVATIONS - BUILDING 'A'
 A311 ELEVATIONS - BUILDING 'A'
 A312 ELEVATIONS - ENLARGED
 A320 ELEVATIONS - BUILDING 'B'
 A321 ELEVATIONS - BUILDING 'B'
 A330 ELEVATIONS - BUILDING 'C'
 A331 ELEVATIONS - BUILDING 'C'
 A340 ELEVATIONS - PARKADE
 A341 ELEVATIONS - PARKADE

A401 BUILDING SECTIONS
 A402 BUILDING SECTIONS
 A403 PARKADE SECTIONS
 A404 PARKADE SECTIONS

NO.	REVISIONS	DATE	BY
3	ISSUED FOR SITE PLAN APPROVAL #2	MAR.21.2023	OH
2	ISSUED FOR SITE PLAN APPROVAL #1	FEB.09.2023	OH
1	ISSUED FOR CLIENT REVIEW	FEB.04.2021	OH

Contractor must check and verify all dimensions on the job and report any discrepancies to the Architect before proceeding with the work.
 Do not scale the drawing.
 This drawing contains copyright material belonging to the Architect.
 This drawing was developed for a specific purpose; use for any other purpose is not permitted.
 This drawing shall not be reproduced in whole or in part without the written approval of the Architect.
 This drawing must be read in the context of all the other drawings which constitute the document.

COVER SHEET

SCALE AS NOTED

**PROPOSED MULTI-FAMILY
 RESIDENTIAL DEVELOPMENT**
 1971 & 1975 ST. LAURENT BLVD.
 OTTAWA, ONTARIO
 FOR: STARLIGHT DEVELOPMENTS

PETROFF
 PETROFF PARTNERSHIP ARCHITECTS
 260 TOWN CENTRE BLVD, SUITE 300
 MARKHAM, ON L3R 8H8
 PH: 905-470-7000 www.petroff.com



DRAWN BY	PETROFF	PROJECT NO.	21740
CHECKED BY	PETROFF	DWG. NO.	A000
DATE			
ISSUED			



1 SITE CONTEXT & CONSTRAINTS PLAN
 A001 SCALE: 1:5000

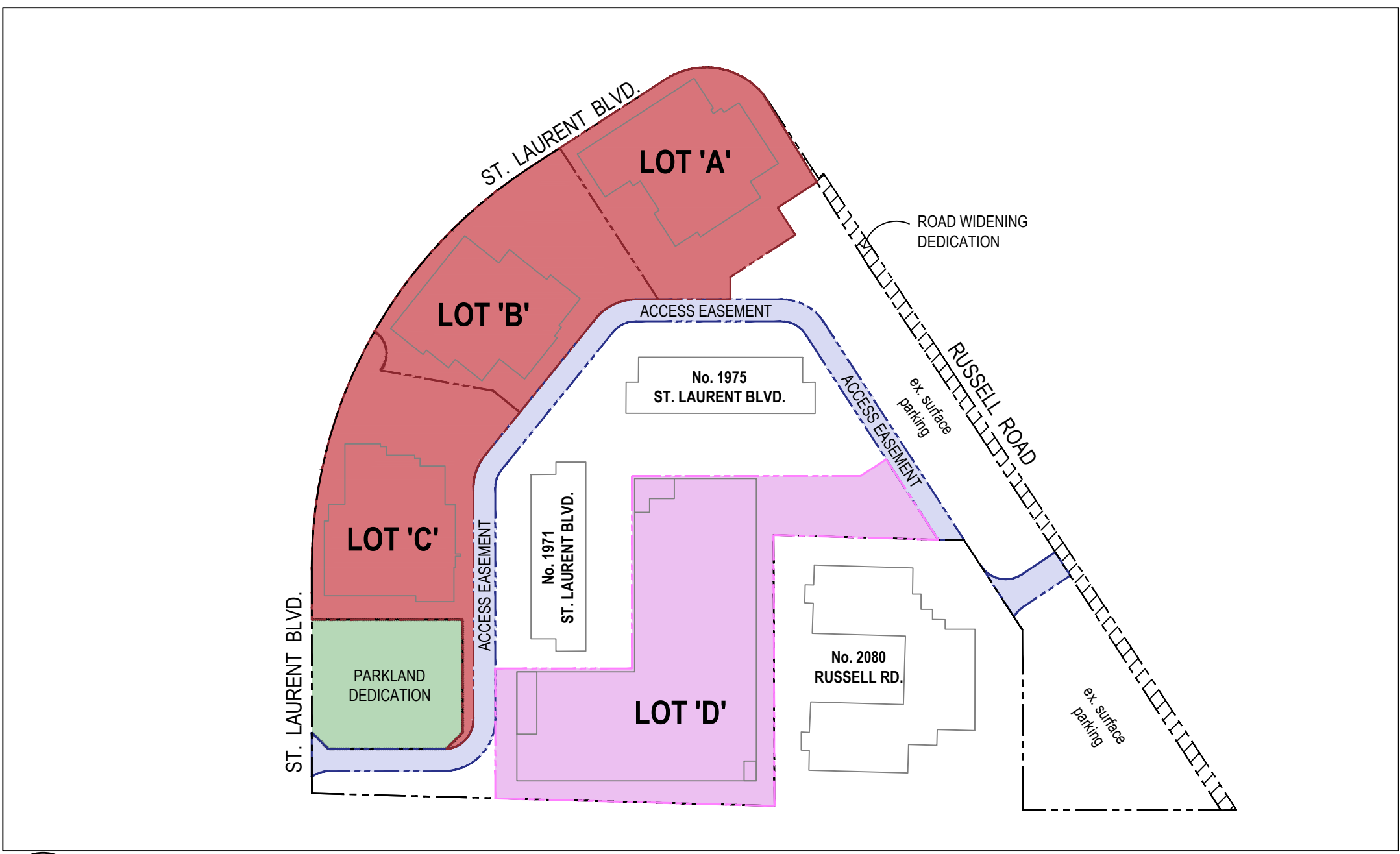

2 DEVELOPABLE LOTS AREA DIAGRAM
 A001 SCALE: 1:1500

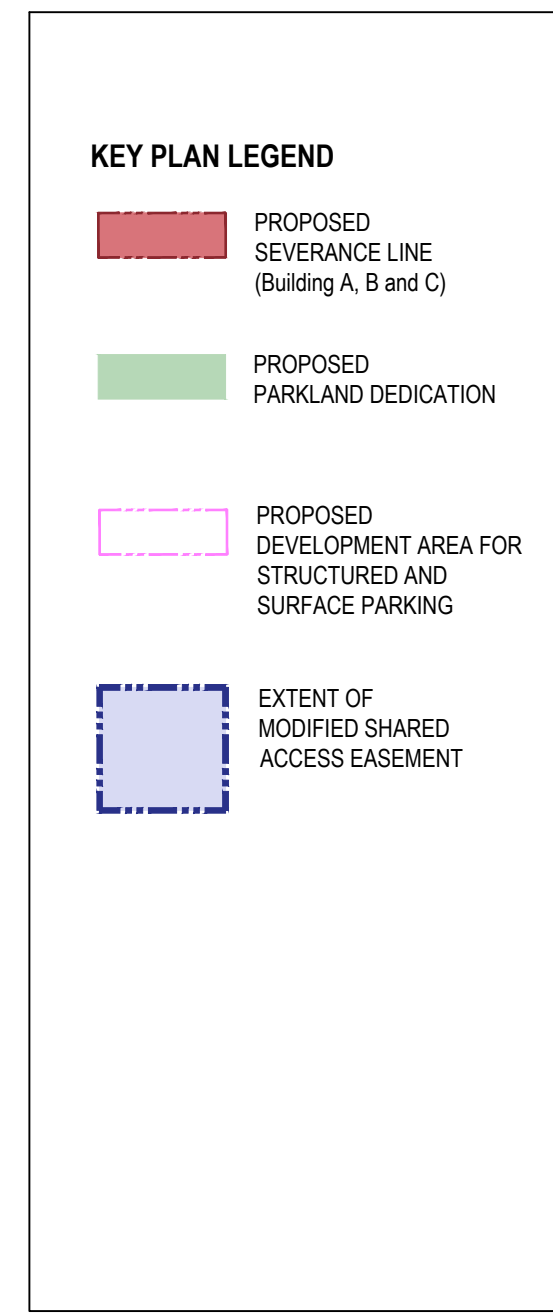

BUILDING & DEVELOPMENT STATISTICS

SITE

TOTAL SITE AREA	38,878.3m ² (3.88 Ha/ 9.60 acres)
SUBJECT SITE AREA excluding road widening and shared access easements	35,525.2m ² (3.55 Ha/ 8.78 acres)
ROAD WIDENING LAND DEDICATION along Russell Rd.	875.8m ² (0.08 Ha/ 2.16 acres)
SHARED ACCESS EASEMENT internal private driveway	2,477.3m ² (0.24 Ha/ 1.14 acres)
PROPOSED DEVELOPABLE LOTS	
LOT 'A' (Bldg. 'A')	3,490.8m ² (0.34 Ha/ 0.86 acres)
LOT 'B' (Bldg. 'B')	3,618.2m ² (0.36 Ha/ 0.89 acres)
LOT 'C' (Bldg. 'C')	3,831.7m ² (0.38 Ha/ 0.95 acres)
LOT 'D' (Parkade)	6,883.4m ² (0.68 Ha/ 1.70 acres)
TOTALS	17,824.1m² (1.78 Ha/ 4.40 acres)
PARKLAND DEDICATION (min. 10%)	1,796.1m ² (0.17 Ha/ 0.38 acres)
Parkland Dedication calculation is based on 10% of the sum total of Lot A+B+C+D	
RESIDENTIAL UNIT COUNT	
BUILDING 'A'	167
BUILDING 'B'	164
BUILDING 'C'	167
EXISTING	500
TOTAL	998
PROPOSED RESIDENTIAL GFA	
BUILDING 'A'	12,075m ² (129,975 SF)
BUILDING 'B'	11,905m ² (128,145 SF)
BUILDING 'C'	12,120m ² (130,460 SF)
EXISTING	36,100m ² (388,580 SF)
TOTAL	36,100m² (388,580 SF)
PROPOSED DENSITY (units/ hectare)	
LOT 'A' (Bldg. 'A')	167/ 0.34 Ha = 491
LOT 'B' (Bldg. 'B')	164/ 0.36 Ha = 456
LOT 'C' (Bldg. 'C')	167/ 0.38 Ha = 439
PROPOSED F.S.I.	
LOT 'A' (Bldg. 'A')	3.4
LOT 'B' (Bldg. 'B')	3.3
LOT 'C' (Bldg. 'C')	3.2
PROPOSED BUILDING HEIGHTS	
(Bldg. 'A')	17-STOUREYS (54.0m)
(Bldg. 'B')	17-STOUREYS (54.0m)
(Bldg. 'C')	17-STOUREYS (54.0m)
(Parkade)	4.5-STOUREYS (16.0m)
*From established grade to top of main roof. Excluding mechanical penthouse, exit stair and elevator enclosures	
MIN. DISTANCE BETWEEN BUILDINGS	min. 23.0m
COMMON AMENITY AREAS	
(Bldg. 'A')	Indoor: 335m ² / Outdoor: 235m ² / TOTAL: 570m ²
(Bldg. 'B')	Indoor: 215m ² / Outdoor: 910m ² / TOTAL: 1,125m ²
(Bldg. 'C')	Indoor: 215m ² / Outdoor: 895m ² / TOTAL: 1,110m ²
(Parkade Roof)	Indoor: 0m ² / Outdoor: 3,540m ² / TOTAL: 3,540m ²
(Ext. / Modified)	Indoor: 0m ² / Outdoor: 665m ² / TOTAL: 665m ²
TOTALS	Indoor: 765m² / Outdoor: 6,245m² / TOTAL: 7,010m²
*±7.0sm/ Unit = (7,010m ² / 998 units)	

LANDSCAPE OPEN SPACE AREA

Total Area At-Grade	13,665m ²
Total Roof Amenity Areas	600m ²
TOTALS	14,265m² (40%)

*Landscape Open Space Area % is based on Existing Site Area excluding Parkland Dedication Area

OFF-STREET PARKING - Required

(Bldg. 'A')	117 spaces
(Bldg. 'B')	115 spaces
(Bldg. 'C')	117 spaces
Existing Apartments	350 spaces
TOTALS	699 spaces

*Residents (0.5 spaces/ unit) + Visitors (0.2 spaces/ unit)

OFF-STREET PARKING - Provided

Provided Surface Parking at-grade = 176 spaces	
Provided Structured Parking = 523 spaces	
TOTALS	699 spaces

BICYCLE PARKING

(Bldg. 'A')	167 spaces
(Bldg. 'B')	164 spaces
(Bldg. 'C')	167 spaces
Existing Apartments	24 existing spaces
TOTALS	522 spaces

*Residents (1.0 bicycle storage spaces/ unit) for proposed Buildings 'A, B and C'

BUILDING STATS

BUILDING 'A'

TOTAL NUMBER OF RESIDENTIAL UNITS	167 units
PARKING PROPOSED FOR RESIDENTIAL	117 spaces
Res. Parking Ratio: 0.7 spaces/ unit	
GROUND FLOOR AREA	1,750m ²
no exclusions (overhangs & canopies included)	
PROPOSED GBA	16,620m ² (178,896 SF)
area to outside walls for all floors, above and below grade, including m.p.h.	
RESIDENTIAL GFA	12,075m ² (129,975 SF)
per City of Ottawa Zoning By-Law 2008-250	
UNIT TYPE MIX BREAKDOWN	
2-STY TOWNS (1-BR+D & 2-BR)	13 (7%)
STUDIO	3 (2%)
1-BEDROOM	71 (43%)
1-BEDROOM + DEN	20 (12%)
2-BEDROOM	51 (31%)
3-BEDROOM	9 (5%)
TOTALS	167

BUILDING 'B'

TOTAL NUMBER OF RESIDENTIAL UNITS	164 units
PARKING PROPOSED FOR RESIDENTIAL	115 spaces
Res. Parking Ratio: 0.7 spaces/ unit	
GROUND FLOOR AREA	1,553m ²
no exclusions (overhangs & canopies included)	
PROPOSED GBA	16,090m ² (173,190 SF)
area to outside walls for all floors, above and below grade, including m.p.h.	
RESIDENTIAL GFA	11,905m ² (128,145 SF)
per City of Ottawa Zoning By-Law 2008-250	
UNIT TYPE MIX BREAKDOWN	
2-STY TOWNS (1-BR+D & 2-BR)	10 (6%)
STUDIO	4 (2%)
1-BEDROOM	69 (42%)
1-BEDROOM + DEN	19 (12%)
2-BEDROOM	53 (32%)
3-BEDROOM	9 (6%)
TOTALS	164

BUILDING 'C'

TOTAL NUMBER OF RESIDENTIAL UNITS	167 units
PARKING PROPOSED FOR RESIDENTIAL	117 spaces
Res. Parking Ratio: 0.7 spaces/ unit	
GROUND FLOOR AREA	1,705m ²
no exclusions (overhangs & canopies included)	
PROPOSED GBA	16,490m ² (177,495 SF)
area to outside walls for all floors, above and below grade, including m.p.h.	
RESIDENTIAL GFA	12,120m ² (130,460 SF)
per City of Ottawa Zoning By-Law 2008-250	
UNIT TYPE MIX BREAKDOWN	
2-STY TOWNS (1-BR+D & 2-BR)	12 (7%)
STUDIO	4 (2%)
1-BEDROOM	71 (42%)
1-BEDROOM + DEN	20 (12%)
2-BEDROOM	51 (30%)
3-BEDROOM	9 (6%)
TOTALS	167

STRUCTURED PARKADE

PROPOSED GBA	15,230m ² (163,935 SF)
no exclusions, except for outdoor roof amenity areas	
PROPOSED GFA	160m ² (1,722 SF)
Area to outside walls for all floors, above and below grade, including elevator lobby. Excluding: Stairs, Elevators, Mechanical and Electrical Rooms, Parking Decks and Outdoor Roof Amenity Areas.	

*Residential Gross Floor Area is calculated based on the City of Ottawa Consolidated Zoning By-Law 2008-250;

Gross floor area means the total area of each floor whether located above, at or below grade, measured from the interiors of outside walls and including floor area occupied by interior walls and floor area created by bay windows, but excluding:

- floor area occupied by shared mechanical, service and electrical equipment that serve the building (By-law 2008-326)
- common hallways, corridors, stairwells, elevator shafts and other voids, steps and landings; (By-law 2008-326) (By-law 2017-302)
- bicycle parking, motor vehicle parking or loading facilities;
- common laundry, storage and washroom facilities that serve the building or tenants;
- common storage areas that are accessory to the principal use of the building; (By-law 2008-326)
- common amenity area and play areas accessory to a principal use on the lot; and (By-law 2008-326)
- living quarters for a caretaker of the building, (surface de plancher hors oeuvre brute)

RESIDENTIAL UNIT DISTRIBUTION SUMMARY

	TOWN 2-BEDROOM + DEN	TOWN 1-BEDROOM + DEN	STUDIO	1-BEDROOM	1-BEDROOM + DEN	2-BEDROOM	2-BEDROOM + DEN	3-BEDROOM	TOTALS
GR FL	2	11	-	-	-	-	-	-	13
2 FL	-	-	-	-	-	-	-	-	1
3 FL	-	-	-	4	3	1	-	-	10
4 FL	-	-	1	4	2	2	-	-	11
5 FL	-	-	1	4	2	2	-	-	11
6 FL	-	-	1	4	2	2	-	-	11
7 FL	-	-	5	1	4	-	-	-	10
8 FL	-	-	5	1	4	-	-	-	10
9 FL	-	-	5	1	4	-	-	-	10
10 FL	-	-	5	1	4	-	-	-	10
11 FL	-	-	5	1	4	-	-	-	10
12 FL	-	-	5	1	4	-	-	-	10
13 FL	-	-	5	1	4	-	-	-	10
14 FL	-	-	5	1	4	-	-	-	10
15 FL	-	-	5	1	4	-	-	-	10
16 FL	-	-	5	1	4	-	-	-	10
17 FL	-	-	5	1	4	-	-	-	10
TOTALS	2	11	3	71	20	51	9	-	167
	12%	6.6%	1.8%	42.5%	12%	30.5%	-	-	100%

RESIDENTIAL UNIT DISTRIBUTION SUMMARY

	TOWN 2-BEDROOM + DEN	TOWN 1-BEDROOM + DEN	STUDIO	1-BEDROOM	1-BEDROOM + DEN	2-BEDROOM	2-BEDROOM + DEN	3-BEDROOM	TOTALS
GR FL	2	8	-	-	-	-	-	-	10
2 FL	-	-	-	-	-	-	-	-	1
3 FL	-	-	1	2	2	3	-	-	10
4 FL	-	-	1	4	2	2	-	-	11
5 FL	-	-	1	4	2	2	-	-	11
6 FL	-	-	1	4	2	2	-	-	11
7 FL	-	-	5	1	4	-	-	-	10
8 FL	-	-	5	1	4	-	-	-	10
9 FL	-	-	5	1	4	-	-	-	10
10 FL	-	-	5	1	4	-	-	-	10
11 FL	-	-	5	1	4	-	-	-	10
12 FL	-	-	5	1	4	-	-	-	10
13 FL	-	-	5	1	4	-	-	-	10
14 FL	-	-	5	1	4	-	-	-	10
15 FL	-	-	5	1	4	-	-	-	10
16 FL	-	-	5	1	4	-	-	-	10
17 FL	-	-	5	1	4	-	-	-	10
TOTALS	2	8	4	69	19	53	9	-	164
	1.2%	4.9%	2.4%	42.1%	11.6%	32.3%	-	-	100%

RESIDENTIAL UNIT DISTRIBUTION SUMMARY

	TOWN 2-BEDROOM + DEN	TOWN 1-BEDROOM + DEN	STUDIO	1-BEDROOM	1-BEDROOM + DEN	2-BEDROOM	2-BEDROOM + DEN	3-BEDROOM	TOTALS
GR FL	2	10	-	-	-	-	-	-	12
2 FL	-	-	-	-	-	-	-	-	1
3 FL	-	-	1	4	3	1	-	-	11
4 FL	-	-	1	4	2	2	-	-	11
5 FL	-	-	1	4	2	2	-	-	11
6 FL	-	-	1	4	2	2	-	-	11
7 FL	-	-	5	1	4	-	-	-	10
8 FL	-	-	5	1	4	-	-	-	10
9 FL	-	-	5	1	4	-	-	-	10
10 FL	-	-	5	1	4	-	-	-	10
11 FL	-	-	5	1	4	-	-	-	10
12 FL	-	-	5	1	4	-	-	-	10
13 FL	-	-	5	1	4	-	-	-	10
14 FL	-	-	5	1	4	-	-	-	10
15 FL	-	-	5	1	4	-	-	-	10
16 FL	-	-	5	1	4	-	-	-	10
17 FL	-	-	5	1	4	-	-	-	10
TOTALS	2	10	4	71	20	51	9	-	167
	1.2%	6.0%	2.4%	42.5%	12%	30.5%	-	-	100%

NO.	REVISIONS	DATE	BY
3	ISSUED FOR SITE PLAN APPROVAL #2	MAR. 21, 2023	OH
2	ISSUED FOR SITE PLAN APPROVAL #1	FEB. 09, 2023	OH
1	ISSUED FOR CLIENT REVIEW	FEB. 04, 2021	OH

Contractor must check and verify all dimensions on the job and report any discrepancies to the Architect before proceeding with the work.

This drawing contains copyright material belonging to the Architect.

This drawing was developed for a specific purpose; use for any other purpose is not permitted.

This drawing shall not be reproduced in whole or in part without the written approval of the Architect.

This drawing must be read in the context of all the other drawings which constitute the document.

SITE & DEVELOPMENT STATISTICS

PROPOSED MULTI-FAMILY RESIDENTIAL DEVELOPMENT

1971 & 1975 ST. LAURENT BLVD.
 OTTAWA, ONTARIO
 FOR: STARLIGHT DEVELOPMENTS

PETROFF
 PARTNERSHIP ARCHITECTS

260 TOWN CENTRE BLVD, SUITE 300
 MARKHAM, ON L3R 8H8
 PH: 905-470-7000 www.petroff.com

ONTARIO ASSOCIATION OF ARCHITECTS
 ALLY HANMAY LICENCE 6768

DRAWN BY	PETROFF	PROJECT NO.	21740
CHECKED BY	PETROFF	DWG. NO.	A001
DATE			
ISSUED			

FILE NUMBER: D07-12-22-0044

PLAN NUMBER #18715

LEGAL DESCRIPTION:

PART OF LOT 27,
CONCESSION 3 (OTTAWA FRONT)
SOUTH OF DUNDAS STREET
(GEOGRAPHICAL TOWNSHIP OF GLOUCESTER)
CITY OF OTTAWA

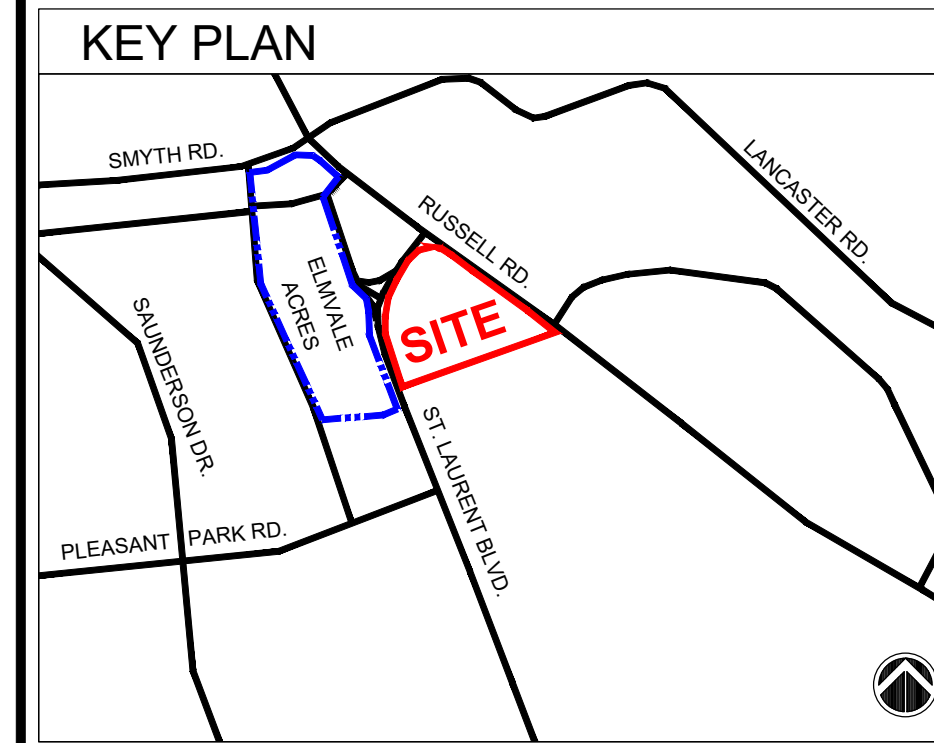

SITE PLAN LEGEND

[Symbol]	PROPOSED FIN. GRADE
[Symbol]	TOPOGRAPHICAL GRADE
[Symbol]	TOP OF CATCH BASIN
[Symbol]	DOOR LOCATIONS
[Symbol]	DRIVE AISLE/VEHICULAR TRAFFIC
[Symbol]	LOADING/GARAGE DOOR LOCATION
[Symbol]	CATCH BASIN
[Symbol]	SANITARY MANHOLE
[Symbol]	STORM SEWER MANHOLE
[Symbol]	FIRE HYDRANT
[Symbol]	ROOF DRAIN
[Symbol]	NEW LIGHT STANDARDS
[Symbol]	HEAVY DUTY ASPHALT PAVING
[Symbol]	BARRIER-FREE DEPRESSED CURB

SITE SERVICES & GRADING: BASED ON INFORMATION PREPARED BY COUNTERPOINT ENGINEERING INC. DATED 2022-JAN-31
LANDSCAPE: BASED ON INFORMATION PREPARED BY MHBC PLANNING, URBAN DESIGN & LANDSCAPE ARCHITECTURE, DATED 2022-FEB-XX
SURVEY & TOPOGRAPHICAL: INFORMATION BASED ON DRAWING PREPARED BY: ANNIS, O'SULLIVAN, VOLLEBEKK LTD., ONTARIO LAND SURVEYORS, DRAWING DATED SEPTEMBER 27TH, 2021.

3	ISSUED FOR SITE PLAN APPROVAL #2	MAR. 21, 2023	OH
2	ISSUED FOR SITE PLAN APPROVAL #1	FEB. 09, 2021	OH
1	ISSUED FOR CLIENT REVIEW	FEB. 04, 2021	OH

NO.	REVISIONS	DATE	BY

SITE PLAN

SCALE: AS SHOWN
PROPOSED MULTI-FAMILY RESIDENTIAL DEVELOPMENT
1971 & 1975 ST. LAURENT BLVD.
OTTAWA, ONTARIO
FOR: STARLIGHT DEVELOPMENTS

PETROFF
PETROFF PARTNERSHIP ARCHITECTS
260 TOWN CENTRE BLVD., SUITE 300
MARKHAM, ON L3R 8H8
PH: 905-470-7000 www.petroff.com



DRAWN BY:	PETROFF	PROJECT NO.:	21740
CHECKED BY:	PETROFF	DWG. NO.:	A102
DATE:			
ISSUED:			

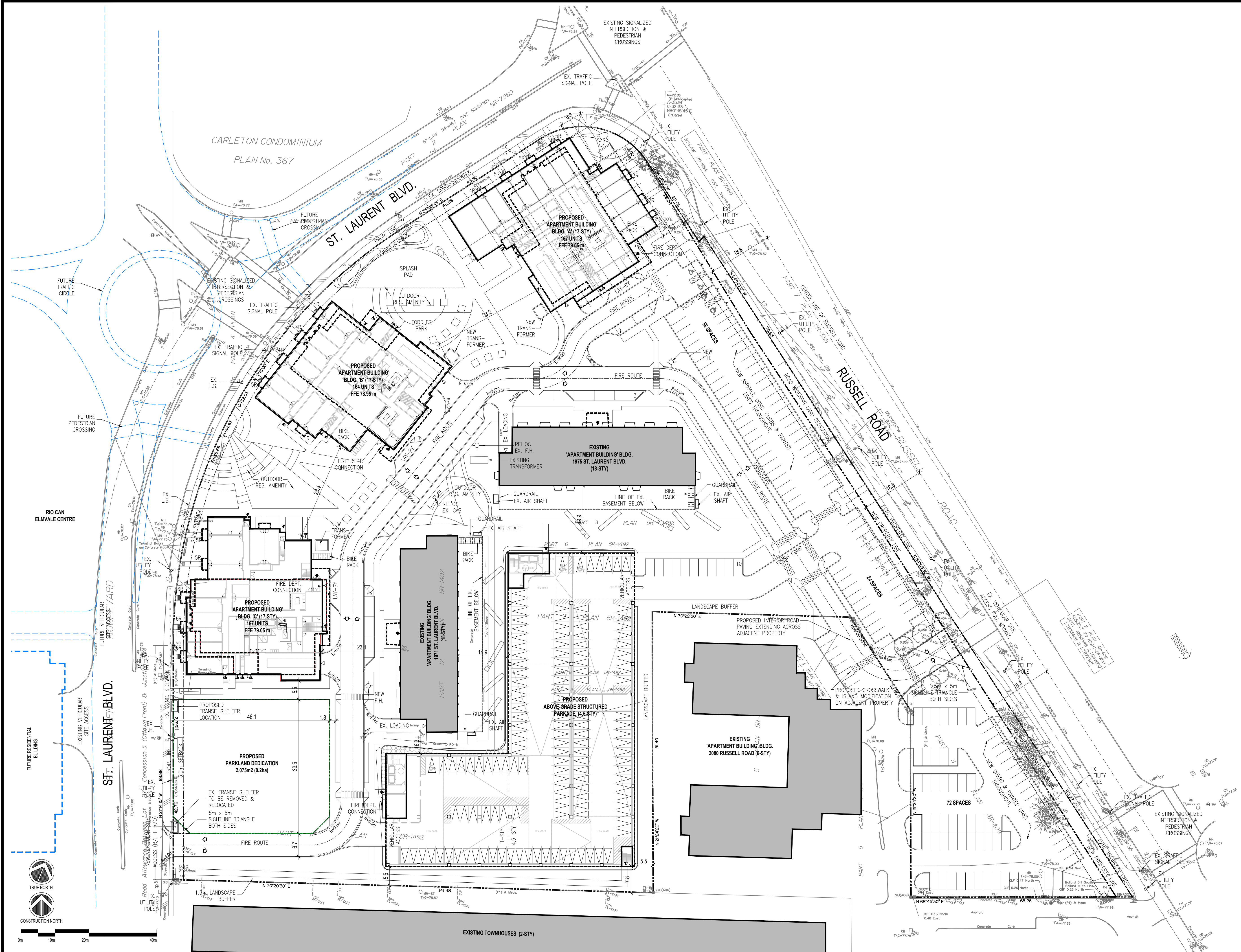

1 SITE PLAN
SCALE: 1:500



PART OF LOT 27
CONCESSION 3 (OTTAWA FRONT)
Geographic Township of Gloucester
CITY OF OTTAWA

Surveyed by Annis, O'Sullivan, Vollebek Ltd.

Scale 1 : 400

Metric
DISTANCES SHOWN ON THIS PLAN ARE IN METRES AND
CAN BE CONVERTED TO FEET BY DIVIDING BY 0.3048

Surveyor's Certificate
I CERTIFY THAT:
1. This survey and plan are correct and in accordance with the Survey Act and the Surveyors Act and the regulations made under them.
2. The survey was completed on the 23rd day of September, 2021.
September 27, 2021
Date
Annis, O'Sullivan, Vollebek Ltd.
Ontario Land Surveyor

Notes & Legend

- Denotes Survey Monument Planted
- Survey Monument Found
- SSB Standard Iron Bar
- SSSB Short Standard Iron Bar
- IB Iron Bar
- CP Concrete Pin
- CC Cut Cross
- (WT) Witness
- Mess Measured
- (AOG) Annis, O'Sullivan, Vollebek Ltd.
- (AP) (AOG) Plan, March 31, 2020
- Deciduous Tree
- ★ Coniferous Tree
- Fire Hydrant
- Water Valve
- Maintenance Hole (Storm Sewer)
- Maintenance Hole (Sanitary)
- Maintenance Hole (Bell Telephone)
- Maintenance Hole (Traffic)
- Maintenance Hole (Hydro)
- Maintenance Hole (Gas)
- Maintenance Hole (Underserved)
- Valve Chamber (Watermain)
- Overhead Wires
- Catch Basin
- Corrugated Steel Pipe
- Gas Meter
- Hydro Meter
- Handhole
- Bell Terminal Box
- Cable Terminal Box
- Traffic Terminal Box
- Underserved Terminal Box
- Traffic Signal Post
- Sign
- Bolt
- S
- Wood Pole
- Metal Pole
- Traffic Light
- Utility Pole
- AN
- Anchor
- LS
- Light Standard
- Diameter
- Location of Elevations
- Top of Concrete Curb Elevation
- Top of Wall Elevation
- Centreline
- Chain Link Fence
- Concrete Retaining Wall
- Edge of Pavement
- TOS
- Top of Slope
- SW
- Stone Retaining Wall

Bearings are astronomic, derived from the easterly limit of St. Laurent Boulevard, shown to be N 21°14'10" W on

ELEVATION NOTES
1. Elevations shown are geodetic and are referred to the CGVD28 geodetic datum.
2. It is the responsibility of the user of this information to verify that the job benchmark has not been altered or disturbed and that its relative elevation and description agrees with the information shown on this drawing.

UTILITY NOTES
1. This drawing cannot be accepted as acknowledging all of the utilities and it will be the responsibility of the user to contact the respective utility authorities for confirmation.
2. Only visible surface utilities were located.
3. A field location of underground plant by the pertinent utility authority is mandatory before any work involving breaking ground, probing, excavating, etc.



ANNIS, O'SULLIVAN, VOLLEBEK LTD.
14 Concession 3, Suite 200
Mississauga, Ont. M2E 7S8
Phone: (905) 271-0200 / Fax: (905) 271-1079
© Annis, O'Sullivan, Vollebek Ltd. 2021. THIS PLAN IS PROTECTED BY COPYRIGHT.

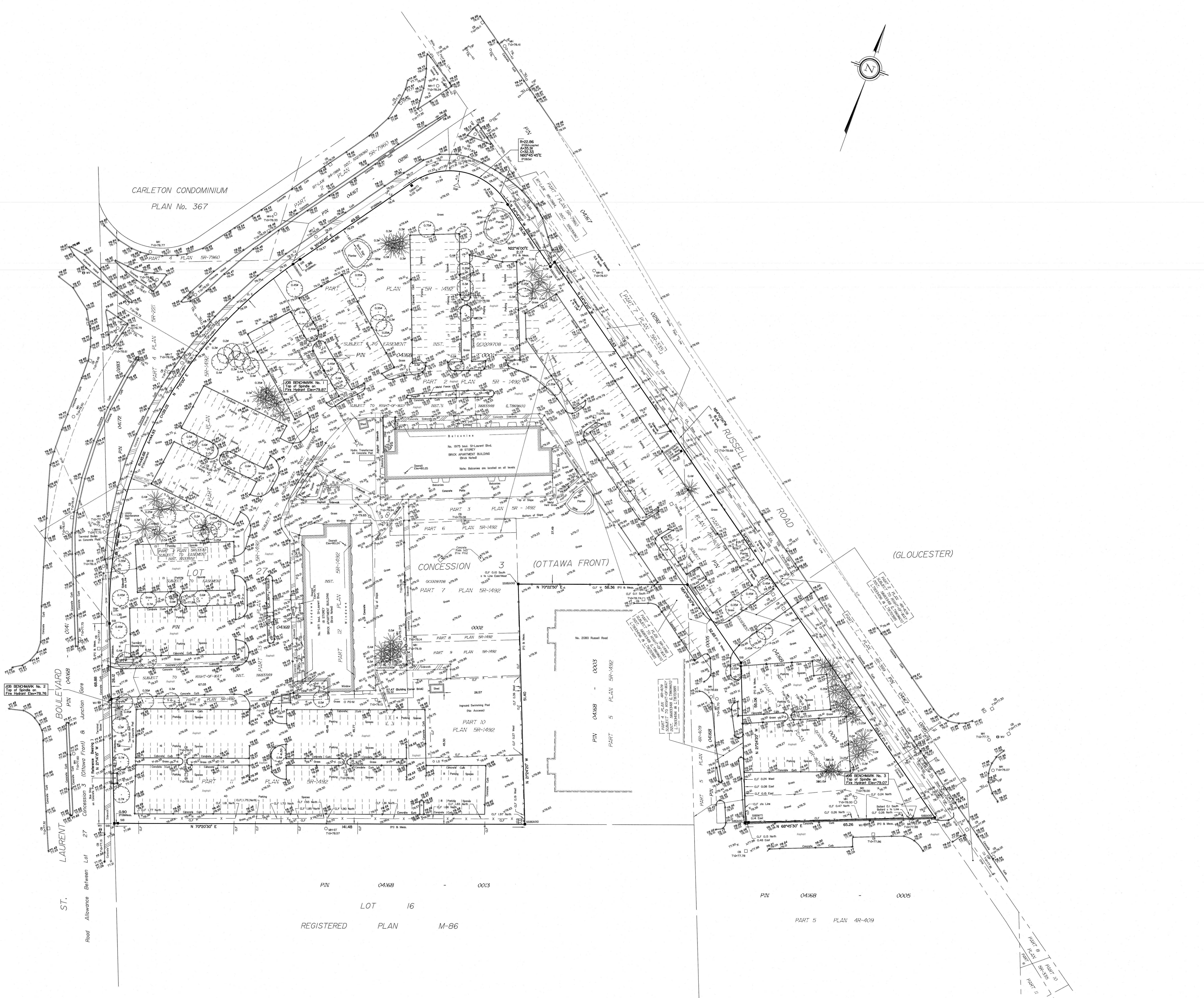

1. Infrastructure/Servicing (Bruce Bramah):

Infrastructure

Please provide a servicing sketch/drawing once available to Bruce.Bramah@ottawa.ca to confirm criteria for proposed storm & sanitary outlet

Water

Existing public services:

- St-Laurent Blvd. – 305mm CI



Existing on-site water service must be shown on the plans. The existing on-site water services will be blanked at the watermain if it will not be reused.

- Service areas with a basic demand greater than 50 m³/day or with a sum of 50 residential units or more shall be connected with a minimum of two water services, separate from an isolation valve, to avoid creation of vulnerable service area.

Boundary conditions:

Civil consultant must request boundary conditions from the City's assigned Project Manager prior to first submission.

· Water boundary condition requests must include the location of the service(s) and the expected loads required by the proposed developments. Please provide all the following information:

- o Location of service(s)
- o Type of development and the amount of fire flow required (as per FUS, 1999).
- o Average daily demand: ___ l/s.
- o Maximum daily demand: ___ l/s.
- o Maximum hourly daily demand: ___ l/s.

· Fire protection (Fire demand, Hydrant Locations)

· A water meter sizing questionnaire (water data card) will have to be completed prior to receiving a water permit (water card will be provided post approval)

Sanitary Sewer

Existing public services:

- St-Laurent Blvd. – 250mm conc.
- Southvale Crescent – 250mm conc.

Please note the existing private sanitary sewer onsite outlets to the Southvale Crescent sanitary sewer.



Existing connection:

· Existing on-site sanitary service must be shown on the plans. If existing sanitary sewer is to be reused, provide CCTV inspection report along with consultant's assessment of

the existing sewer conditions. Existing on-site sanitary sewer to be capped and abandoned to City of Ottawa standards at the property line if it will not be reused.

Is a monitoring manhole required on private property? Yes No

· The designer should be aware there may be limited capacity in the downstream sanitary sewer system. The sanitary demand needs to be coordinated with the City Planning Dept. to determine if the existing sanitary sewer system has sufficient capacity to support a rezoning. Provide sanitary demands to the City project manager for coordination.

· Any premise in which there is commercial or institutional food preparation shall install a grease and oil inceptor on all fixtures.

Storm Sewer

Existing public services:

- St-Laurent Blvd. (West) – 675mm conc.
- Russel Road/St-Laurent Blvd. (North) – 300mm conc.
- Southvale Crescent – 600mm conc.

Please note the existing private storm sewer onsite outlets to the Southvale Crescent storm sewer.



Existing on-site storm service must be shown on the plans. If existing storm sewer is to be reused, provide CCTV inspection report along with consultant's assessment of the

existing sewer conditions. Existing on-site storm sewer to be capped and abandoned to City of Ottawa standards at the property line if it will not be reused.

- For concrete sewer pipe, maintenance holes shall be installed when the service is greater than 50% of the diameter of the mainline concrete pipe
- The Environmental Site Assessment (ESA) may provide recommendations where site contamination may be present. Any recommendations from an ESA need to be coordinated with the servicing report to ensure compliance with the Sewer Use By-Law.

Stormwater Management

Quality Control:

- Rideau Valley Conservation Authority to provide quality control requirements for property.

Quantity Control:

- Master Servicing Study: N/A
- Allowable Runoff coefficient (C): C = the lesser of the existing pre-development conditions to a maximum of 0.5.
- Time of concentration (Tc): Tc = pre-development; maximum Tc = 10 min
- Allowable flowrate for connection on existing internal services/Southvale Crescent: Control the 100-year storm events to the 2-year storm event.
- Allowable flowrate for connection on St-Laurent Blvd. (West): Control the 100-year storm events to the 2-year storm event.
- Allowable flowrate for connection on Russel Road/St-Laurent Blvd. (North): Control the 100-year storm events to the 5-year storm event.

Ministry of Environment, Conservation and Parks (MECEP)

All development applications should be considered for an Environmental Compliance Approval, under MECP regulations.

- a. The consultants determine if an approval for sewage works under Section 53 of OWRA is required and determines what type of application. The City's project manager may help confirm and coordinate with the MECP as required.
- b. The project will be either transfer of review (standard), transfer of review (additional), direct submission, or exempt as per O. Reg. 525/98.
- c. Pre-consultation is not required if applying for standard or additional works (Schedule A of the Agreement) under Transfer Review.
- d. Pre-consultation with local District office of MECP is recommended for direct submission.
- e. Consultant completes an MECP request form for a pre-consultation. Sends request to moecottawasewage@ontario.ca
- f. ECA applications are required to be submitted online through the MECP portal. A business account required to submit ECA application. For more information visit <https://www.ontario.ca/page/environmental-compliance-approval>
- g. It is unclear if the proposed development will remain as one property. An ECA will be required where the stormwater management services more than one property parcel.

NOTE: Site Plan Approval, or Draft Approval, is required before any Ministry of the Environment and Climate Change (MOECC) application is sent

General Service Design Comments

- The City of Ottawa requests that all new services be located within the existing service trench to minimize necessary road cuts.
- Monitoring manholes should be located within the property near the property line in an accessible location to City forces and free from obstruction (i.e. not a parking).
- Where service length is greater than 30 m between the building and the first maintenance hole / connection, a cleanout is required.
- The City of Ottawa Standard Detail Drawings should be referenced where possible for all work within the Public Right-of-Way.
- The upstream and downstream manhole top of grate and invert elevations are required for all new sewer connections.
- Services crossing the existing watermain or sewers need to clearly provide the obvert/invert elevations to demonstrate minimum separation distances. A watermain crossing table may be provided.

Other

Are there are Capital Works Projects scheduled that will impact the application? Yes

No

References and Resources

- As per section 53 of the Professional Engineers Act, O. Reg 941/40, R.S.O. 1990, all documents prepared by engineers must be signed and dated on the seal.
- All required plans & reports are to be provided in *.pdf format (at application submission and for any, and all, re-submissions)
- Please find relevant City of Ottawa Links to Preparing Studies and Plans below:
<https://ottawa.ca/en/city-hall/planning-and-development/information-developers/development-application-review-process/development-application-submission/guide-preparing-studies-and-plans#standards-policies-and-guidelines>
- To request City of Ottawa plan(s) or report information please contact the City of Ottawa Information Centre:
InformationCentre@ottawa.ca<mailto:InformationCentre@ottawa.ca>
(613) 580-2424 ext. 44455
- geoOttawa <http://maps.ottawa.ca/geoOttawa/>



APPENDIX B

Project Name: 1971 & 1975 St. Laurant Blvd. Residential Apartment Development
 Project Number: 21106

Stormwater Quantity Summary Table

Area ID	Area (ha)	Runoff Coefficient	t _c (min)	5yr Flows				100yr Flows				Description	Orifice Size (mm)	Orifice Release Rate (L/s)
				Allowable Release Rate (L/s)	Provided Release Rate (L/s)	Storage Required (m ³)	Storage Provided (m ³)	Allowable Release Rate (L/s)	Provided Release Rate (L/s)	Storage Required (m ³)	Storage Provided (m ³)			
Southvale Cres. Outlet														
200	3.318	0.77	10	336.6	207.9	350.1	350.9	336.6	320.2	639.5	851.3	CNTRL to Southvale	350	320.2
201	0.007	0.25	10	336.6	0.5	-	-	336.6	0.8	-	-	UNC to Southvale	N/A	N/A
Total	3.324			336.6	28.1	350.1	350.9	336.6	321.1	639.5	851.3			
St. Laurent Blvd. Outlet														
202	0.022	0.33	10	19.6	2.1	-	-	19.6	3.6	-	-	UNC to St. Laurent	N/A	N/A
PARK	0.178	0.25	10	19.6	12.9	-	-	19.6	22.1	-	-	UNC to St. Laurent	N/A	N/A
Total	0.022			19.6	15.0	0.0	0.0	19.6	25.7	0.0	0.0			
Russell Road Outlet														
203	0.108	0.42	10	13.8	13.1	-	-	13.8	22.5	-	-	UNC to Russell	N/A	N/A
Total	0.108			13.8	13.1	0.0	0.0	13.8	22.5	0.0	0.0			
SITE TOTALS	3.455			369.9	56.2	350.1	350.9	369.9	369.2	639.5	851.3			

Allowable Release Rate 2yr (Southvale): 336.6 L/s
 Allowable Release Rate 2yr (St. Laurent): 19.6 L/s
 Allowable Release Rate 5yr (Russell): 13.8 L/s
 Total Allowable Release Rate From Site: 369.9 L/s

Allowable Release Rate to Southvale Cres. STM Sewer

Project Name: 1971 & 1975 St. Laurant Blvd. Residential Apartment Development
 Project Number: 21106

Rational Method - 2 Year Predevelopment

Event: 2 years

ABC's:	A	732.951
	B	6.199
	C	0.81

Time of Concentration: t 10 min

Runoff Coefficient: C 0.50 *Max. RC for Determining Allowable Release Rate.

Site Area A 3.16 ha

Intensity i 76.81 mm/hr
 $i=A/(T)^c$

Flow Q 0.337 m³/s
 $Q=CiA/360$
336.6 l/s

Pre-development Area

Composite RC Value	Area [ha]	RC	RC * Area
Landscaping	1.165	0.25	0.2913
Building/Impervious Area	1.912	0.90	1.7211
	3.077	Total	2.0124
	Divided by Total Area		0.65

Pre-development Area EXTERNAL

Composite RC Value	Area [ha]	RC	RC * Area
Landscaping	0.009	0.25	0.0022
Building/Impervious Area	0.069	0.90	0.0621
	0.078	Total	0.0643
	Divided by Total Area		0.83

Pre-development Area - TOTAL (Area + Ext)

Composite RC Value	Area [ha]	RC	RC * Area
Landscaping	1.174	0.25	0.2935
Building/Impervious Area	1.981	0.90	1.7832
	3.155	Total	2.0766
	Divided by Total Area		0.66

Allowable Release Rate to St. Laurent Blvd. STM Sewer

Project Name: 1971 & 1975 St. Laurant Blvd. Residential Apartment Development
 Project Number: 21106

Rational Method - 2 Year Predevelopment

Event: 2 years

ABC's:	A	732.951
	B	6.199
	C	0.81

Time of Concentration: t 10 min

Runoff Coefficient: C 0.46

Site Area A 0.20 ha

Intensity i 76.81 mm/hr
 $i=A/(T)^c$

Flow Q 0.020 m³/s
 $Q=CiA/360$
19.6 l/s

Pre-development Area

Composite RC Value	Area [ha]	RC	RC * Area
Landscaping	0.135	0.25	0.0336
Building/Impervious Area	0.065	0.90	0.0582
	0.199	Total	0.0919
	Divided by Total Area		0.46

Pre-development Area - TOTAL (Area + Ext)

Composite RC Value	Area [ha]	RC	RC * Area
Landscaping	0.135	0.25	0.0336
Building/Impervious Area	0.065	0.90	0.0582
	0.199	Total	0.0919
	Divided by Total Area		0.46

Allowable Release Rate to Russell Road STM Sewer

Project Name: 1971 & 1975 St. Laurant Blvd. Residential Apartment Development
 Project Number: 21106

Rational Method - 5 Year Predevelopment

Event: 5 years

ABC's: A 998.071
 B 6.053
 C 0.814

Time of Concentration: t 10 min

Runoff Coefficient: C 0.25

Site Area A 0.19 ha

Intensity i 104.19 mm/hr
 $i=A/(T)^c$

Flow Q 0.014 m³/s
 $Q=CiA/360$ 13.8 l/s

Pre-development Area

Composite RC Value	Area [ha]	RC	RC * Area
Landscaping	0.190	0.25	0.0476
Building/Impervious Area	0.000	0.90	0.0000
	0.190	Total	0.0476
	Divided by Total Area		0.25

Pre-development Area - TOTAL (Area + Ext)

Composite RC Value	Area [ha]	RC	RC * Area
Landscaping	0.190	0.25	0.0476
Building/Impervious Area	0.000	0.90	0.0000
	0.190	Total	0.0476
	Divided by Total Area		0.25

counterpoint engineering

Post-Development Un-Mitigated Release Rate to Southvale Crescent

Table B4

Project Name: 1971 & 1975 St. Laurant Blvd. Residential Apartment Development
 Project Number: 21106

AREA 200

Rational Method - 2 Year Post Development

Event: years

ABC's: A
 B
 C

Time of Concentration: t min

Runoff Coefficient: C

Site Area A ha

Intensity i mm/hr
 $i=A(T)^c$

Flow Q m³/s
 $Q=CiA/360$ l/s

Rational Method - 5 Year Post Development

Event: years

ABC's: A
 B
 C

Time of Concentration: t min

Runoff Coefficient: C

Site Area A ha

Intensity i mm/hr
 $i=A(T)^c$

Flow Q m³/s
 $Q=CiA/360$ l/s

Rational Method - 10 Year Post Development

Event: years

ABC's: A
 B
 C

Time of Concentration: t min

Runoff Coefficient: C

Site Area A ha

Intensity i mm/hr
 $i=A(T)^c$

Flow Q m³/s
 $Q=CiA/360$ l/s

Rational Method - 25 Year Post Development

Event: years

ABC's: A
 B
 C

Time of Concentration: t min

Runoff Coefficient: C

Site Area A ha

Intensity i mm/hr
 $i=A(T)^c$

Flow Q m³/s
 $Q=CiA/360$ l/s

Rational Method - 50 Year Post Development

Event: years

ABC's: A
 B
 C

Time of Concentration: t min

Runoff Coefficient: C

Site Area A ha

Intensity i mm/hr
 $i=A(T)^c$

Flow Q m³/s
 $Q=CiA/360$ l/s

Rational Method - 100 Year Post Development

Event: years

ABC's: A
 B
 C

Time of Concentration: t min

Runoff Coefficient: C

Site Area A ha

Intensity i mm/hr
 $i=A(T)^c$

Flow Q m³/s
 $Q=CiA/360$ l/s

Rational Method - 100yr + 20% IDF Increase Post Development

Event: years

ABC's: A
 B
 C

Time of Concentration: t min

Runoff Coefficient: C

Site Area A ha

Intensity i mm/hr
 $i=A(T)^c$

Flow Q m³/s
 $Q=CiA/360$ l/s

Post-development Area

Composite RC Value	Area [ha]	RC	RC * Area
Landscaping	0.650	0.25	0.1624
Building/Impervious Area	2.591	0.90	2.3317
	3.240	Total	2.4941
		Divided by Total Area	0.77

Post-development Area EXTERNAL

Composite RC Value	Area [ha]	RC	RC * Area
Landscaping	0.009	0.25	0.0021
Building/Impervious Area	0.069	0.90	0.0622
	0.078	Total	0.0643
		Divided by Total Area	0.83

Post-development Area - TOTAL (Area + Ext)

Composite RC Value	Area [ha]	RC	RC * Area
Landscaping	0.658	0.25	0.1645
Building/Impervious Area	2.660	0.90	2.3939
	3.318	Total	2.5584
		Divided by Total Area	0.77

counterpoint engineering

Table B5

Post-Development Un-Controlled Release Rate to Southvale Crescent

Project Name: 1971 & 1975 St. Laurant Blvd. Residential Apartment Development
 Project Number: 21106

AREA 201

Rational Method - 2 Year Post Development

Event: years

ABC's:	A	732.951
	B	6.199
	C	0.81

Time of Concentration: t min

Runoff Coefficient: C

Site Area: A ha

Intensity: i mm/hr
i=A/(T)^c

Flow: Q m³/s
Q=CiA/360 l/s

Rational Method - 5 Year Post Development

Event: years

ABC's:	A	998.071
	B	6.053
	C	0.814

Time of Concentration: t min

Runoff Coefficient: C

Site Area: A ha

Intensity: i mm/hr
i=A/(T)^c

Flow: Q m³/s
Q=CiA/360 l/s

Rational Method - 10 Year Post Development

Event: years

ABC's:	A	1174.184
	B	6.014
	C	0.816

Time of Concentration: t min

Runoff Coefficient: C

Site Area: A ha

Intensity: i mm/hr
i=A/(T)^c

Flow: Q m³/s
Q=CiA/360 l/s

Rational Method - 25 Year Post Development

Event: years

ABC's:	A	1402.884
	B	6.018
	C	0.819

Time of Concentration: t min

Runoff Coefficient: C

Site Area: A ha

Intensity: i mm/hr
i=A/(T)^c

Flow: Q m³/s
Q=CiA/360 l/s

Rational Method - 50 Year Post Development

Event: years

ABC's:	A	1569.58
	B	6.014
	C	0.82

Time of Concentration: t min

Runoff Coefficient: C

Site Area: A ha

Intensity: i mm/hr
i=A/(T)^c

Flow: Q m³/s
Q=CiA/360 l/s

Rational Method - 100 Year Post Development

Event: years

ABC's:	A	1735.688
	B	6.014
	C	0.82

Time of Concentration: t min

Runoff Coefficient: C

Site Area: A ha

Intensity: i mm/hr
i=A/(T)^c

Flow: Q m³/s
Q=CiA/360 l/s

Post-development Area

Composite RC Value	Area [ha]	RC	RC * Area
Landscaping	0.007	0.25	0.0016
Building/Impervious Area	0.000	0.90	0.0000
	0.007	Total	0.0016
	Divided by Total Area		0.25

Post-development Area EXTERNAL

Composite RC Value	Area [ha]	RC	RC * Area
Landscaping	0.000	0.25	0.0000
Building/Impervious Area	0.000	0.90	0.0000
	0.000	Total	0.0000
	Divided by Total Area		#DIV/0!

Post-development Area - TOTAL (Area + Ext)

Composite RC Value	Area [ha]	RC	RC * Area
Landscaping	0.007	0.25	0.0016
Building/Impervious Area	0.000	0.90	0.0000
	0.007	Total	0.0016
	Divided by Total Area		0.25

counterpoint engineering

Table B6

Post-Development Un-Controlled Release Rate to St. Laurent Blvd.

Project Name: 1971 & 1975 St. Laurant Blvd. Residential Apartment Development
 Project Number: 21106

AREA 202

Rational Method - 2 Year Post Development

Event: 2 years

ABC's:	A	732.951
	B	6.199
	C	0.81

Time of Concentration: t 10 min

Runoff Coefficient: C 0.33

Site Area: A 0.022 ha

Intensity: i 76.81 mm/hr
i=A(T)^c

Flow: Q 0.002 m³/s
Q=CiA/360 1.5 l/s

Rational Method - 5 Year Post Development

Event: 5 years

ABC's:	A	998.071
	B	6.053
	C	0.814

Time of Concentration: t 10 min

Runoff Coefficient: C 0.33

Site Area: A 0.022 ha

Intensity: i 104.19 mm/hr
i=A(T)^c

Flow: Q 0.00 m³/s
Q=CiA/360 2.1 l/s

Rational Method - 10 Year Post Development

Event: 10 years

ABC's:	A	1174.184
	B	6.014
	C	0.816

Time of Concentration: t 10 min

Runoff Coefficient: C 0.33

Site Area: A 0.022 ha

Intensity: i 122.14 mm/hr
i=A(T)^c

Flow: Q 0.00 m³/s
Q=CiA/360 2.5 l/s

Rational Method - 25 Year Post Development

Event: 25 years

ABC's:	A	1402.884
	B	6.018
	C	0.819

Time of Concentration: t 10 min

Runoff Coefficient: C 0.33

Site Area: A 0.022 ha

Intensity: i 144.69 mm/hr
i=A(T)^c

Flow: Q 0.00 m³/s
Q=CiA/360 2.9 l/s

Rational Method - 50 Year Post Development

Event: 50 years

ABC's:	A	1569.58
	B	6.014
	C	0.82

Time of Concentration: t 10 min

Runoff Coefficient: C 0.33

Site Area: A 0.022 ha

Intensity: i 161.47 mm/hr
i=A(T)^c

Flow: Q 0.00 m³/s
Q=CiA/360 3.2 l/s

Rational Method - 100 Year Post Development

Event: 100 years

ABC's:	A	1735.688
	B	6.014
	C	0.82

Time of Concentration: t 10 min

Runoff Coefficient: C 0.33

Site Area: A 0.022 ha

Intensity: i 178.56 mm/hr
i=A(T)^c

Flow: Q 0.00 m³/s
Q=CiA/360 3.6 l/s

Post-development Area

Composite RC Value	Area [ha]	RC	RC * Area
Landscaping	0.020	0.25	0.0049
Building/Impervious Area	0.003	0.90	0.0023
	0.022	Total	0.0072
	Divided by Total Area		0.33

Post-development Area EXTERNAL

Composite RC Value	Area [ha]	RC	RC * Area
Landscaping	0.000	0.25	0.0000
Building/Impervious Area	0.000	0.90	0.0000
	0.000	Total	0.0000
	Divided by Total Area		#DIV/0!

Post-development Area - TOTAL (Area + Ext)

Composite RC Value	Area [ha]	RC	RC * Area
Landscaping	0.020	0.25	0.0049
Building/Impervious Area	0.003	0.90	0.0023
	0.022	Total	0.0072
	Divided by Total Area		0.33

counterpoint engineering

Table B7

Post-Development Parkland Dedication Un-Controlled Release Rate to St. Laurent Blvd.

Project Name: 1971 & 1975 St. Laurant Blvd. Residential Apartment Development
 Project Number: 21106

AREA: PARK

Rational Method - 2 Year Post Development

Event: years

ABC's:	A	732.951
	B	6.199
	C	0.81

Time of Concentration: t min

Runoff Coefficient: C

Site Area: A ha

Intensity: i mm/hr
i=A/(T)^c

Flow: Q m³/s
Q=CiA/360 l/s

Rational Method - 5 Year Post Development

Event: years

ABC's:	A	998.071
	B	6.053
	C	0.814

Time of Concentration: t min

Runoff Coefficient: C

Site Area: A ha

Intensity: i mm/hr
i=A/(T)^c

Flow: Q m³/s
Q=CiA/360 l/s

Rational Method - 10 Year Post Development

Event: years

ABC's:	A	1174.184
	B	6.014
	C	0.816

Time of Concentration: t min

Runoff Coefficient: C

Site Area: A ha

Intensity: i mm/hr
i=A/(T)^c

Flow: Q m³/s
Q=CiA/360 l/s

Rational Method - 25 Year Post Development

Event: years

ABC's:	A	1402.884
	B	6.018
	C	0.819

Time of Concentration: t min

Runoff Coefficient: C

Site Area: A ha

Intensity: i mm/hr
i=A/(T)^c

Flow: Q m³/s
Q=CiA/360 l/s

Rational Method - 50 Year Post Development

Event: years

ABC's:	A	1569.58
	B	6.014
	C	0.82

Time of Concentration: t min

Runoff Coefficient: C

Site Area: A ha

Intensity: i mm/hr
i=A/(T)^c

Flow: Q m³/s
Q=CiA/360 l/s

Rational Method - 100 Year Post Development

Event: years

ABC's:	A	1735.688
	B	6.014
	C	0.82

Time of Concentration: t min

Runoff Coefficient: C

Site Area: A ha

Intensity: i mm/hr
i=A/(T)^c

Flow: Q m³/s
Q=CiA/360 l/s

Post-development Area

Composite RC Value	Area [ha]	RC	RC * Area
Landscaping	0.178	0.25	0.0445
Building/Impervious Area	0.000	0.90	0.0000
	0.178	Total	0.0445
	Divided by Total Area		0.25

Post-development Area EXTERNAL

Composite RC Value	Area [ha]	RC	RC * Area
Landscaping	0.000	0.25	0.0000
Building/Impervious Area	0.000	0.90	0.0000
	0.000	Total	0.0000
	Divided by Total Area		#DIV/0!

Post-development Area - TOTAL (Area + Ext)

Composite RC Value	Area [ha]	RC	RC * Area
Landscaping	0.178	0.25	0.0445
Building/Impervious Area	0.000	0.90	0.0000
	0.178	Total	0.0445
	Divided by Total Area		0.25

counterpoint engineering

Table B8

Post-Development Un-Controlled Release Rate to Russell Road

Project Name: 1971 & 1975 St. Laurant Blvd. Residential Apartment Development
 Project Number: 21106

AREA 203

Rational Method - 2 Year Post Development

Event: years

ABC's:	A	732.951
	B	6.199
	C	0.81

Time of Concentration: t min

Runoff Coefficient: C

Site Area: A ha

Intensity: i mm/hr
i=A/(T)^c

Flow: Q m³/s
Q=CiA/360 l/s

Rational Method - 5 Year Post Development

Event: years

ABC's:	A	998.071
	B	6.053
	C	0.814

Time of Concentration: t min

Runoff Coefficient: C

Site Area: A ha

Intensity: i mm/hr
i=A/(T)^c

Flow: Q m³/s
Q=CiA/360 l/s

Rational Method - 10 Year Post Development

Event: years

ABC's:	A	1174.184
	B	6.014
	C	0.816

Time of Concentration: t min

Runoff Coefficient: C

Site Area: A ha

Intensity: i mm/hr
i=A/(T)^c

Flow: Q m³/s
Q=CiA/360 l/s

Rational Method - 25 Year Post Development

Event: years

ABC's:	A	1402.884
	B	6.018
	C	0.819

Time of Concentration: t min

Runoff Coefficient: C

Site Area: A ha

Intensity: i mm/hr
i=A/(T)^c

Flow: Q m³/s
Q=CiA/360 l/s

Rational Method - 50 Year Post Development

Event: years

ABC's:	A	1569.58
	B	6.014
	C	0.82

Time of Concentration: t min

Runoff Coefficient: C

Site Area: A ha

Intensity: i mm/hr
i=A/(T)^c

Flow: Q m³/s
Q=CiA/360 l/s

Rational Method - 100 Year Post Development

Event: years

ABC's:	A	1735.688
	B	6.014
	C	0.82

Time of Concentration: t min

Runoff Coefficient: C

Site Area: A ha

Intensity: i mm/hr
i=A/(T)^c

Flow: Q m³/s
Q=CiA/360 l/s

Post-development Area

Composite RC Value	Area [ha]	RC	RC * Area
Landscaping	0.080	0.25	0.0201
Building/Impervious Area	-0.058	0.90	-0.0524
	0.022	Total	-0.0323
		Divided by Total Area	-1.46

Post-development Area EXTERNAL

Composite RC Value	Area [ha]	RC	RC * Area
Landscaping	0.000	0.25	0.0000
Building/Impervious Area	0.000	0.90	0.0000
	0.000	Total	0.0000
		Divided by Total Area	#DIV/0!

Post-development Area - TOTAL (Area + Ext)

Composite RC Value	Area [ha]	RC	RC * Area
Landscaping	0.080	0.25	0.0201
Building/Impervious Area	0.028	0.90	0.0253
	0.108	Total	0.0454
		Divided by Total Area	0.42

Job 1971 & 1975 St. Laurant Blvd. Residential Apartment Development
Job No. 21106

Orifice Control & Detention Storage

5 YEAR

AREA 200

Orifice Equation: $Q = C_d A (2gh)^{1/2}$

Orifice Diameter: mm

Area: 0.096 m²

g = 9.81 m/s²

C_d =

	Stage	Head (m)	Storage (m3)	Discharge (L/s)
Orifice Inv:	74.74	0.00	0	0.00
5 year HWL:	75.53	0.62	350.1	207.9

Job: 1971 & 1975 St. Laurant Blvd. Residential Apartment Development
Job No.: 21106

Orifice Control & Detention Storage

100 YEAR

AREA 200

Orifice Equation: $Q = C_d A (2gh)^{1/2}$

Orifice Diameter: mm
Area: 0.096 m²
g = 9.81 m/s²
C_d =

	Stage	Head (m)	Required Storage (m3)	Discharge (L/s)
Orifice Inv:	74.74	0.00	0	0.00
100 year HWL:	76.38	1.47	639.5	320.2

Modified Rational **Area:** 3.32 ha

Project Name: 1971 & 1975 St. Laurant Blvd. Residential Apartment Development
 Project Number: 21106

5 YEAR

Rainfall Data			
Location:	Ottawa	a	998.071
Event	5	b	6.053
		c	0.814

Site Data	
Area	3.32 ha
Runoff Coefficient	0.77
AC	2.56
Tc	10
Time Increment	10
Release Rate	207.9 l/s
Storage Required	350 m ³

Time	Rainfall Intensity	Storm Runoff	Runoff Volume	Released Volume	Storage Volume	
(min)	(mm/hr)	(m ³ /s)	(m ³)	(m ³)	(m ³)	
10	104	0.74	445	125	320	
20	70	0.50	600	249	350	*****
30	54	0.38	690	374	316	
40	44	0.31	754	499	255	
50	38	0.27	803	624	180	
60	33	0.23	844	748	95	
70	29	0.21	877	873	4	
80	27	0.19	907	998	-91	
90	24	0.17	933	1123	-190	
100	22	0.16	956	1247	-291	
110	21	0.15	977	1372	-395	
120	19	0.14	997	1497	-500	
130	18	0.13	1015	1621	-607	
140	17	0.12	1032	1746	-715	
150	16	0.12	1047	1871	-824	
160	16	0.11	1062	1996	-934	
170	15	0.11	1076	2120	-1044	
180	14	0.10	1089	2245	-1156	
190	14	0.10	1102	2370	-1268	
200	13	0.09	1114	2495	-1381	
210	13	0.09	1125	2619	-1494	
220	12	0.09	1136	2744	-1608	
230	12	0.08	1147	2869	-1722	
240	11	0.08	1157	2993	-1837	
250	11	0.08	1167	3118	-1952	
260	11	0.08	1176	3243	-2067	
270	10	0.07	1185	3368	-2183	
280	10	0.07	1194	3492	-2299	
290	10	0.07	1202	3617	-2415	
300	9	0.07	1211	3742	-2531	
310	9	0.07	1219	3867	-2648	
320	9	0.06	1226	3991	-2765	
330	9	0.06	1234	4116	-2882	
340	9	0.06	1241	4241	-2999	
350	8	0.06	1249	4365	-3117	
360	8	0.06	1256	4490	-3234	
370	8	0.06	1263	4615	-3352	
380	8	0.06	1269	4740	-3470	
390	8	0.05	1276	4864	-3588	
400	8	0.05	1282	4989	-3707	
410	7	0.05	1289	5114	-3825	
420	7	0.05	1295	5239	-3944	
430	7	0.05	1301	5363	-4062	
440	7	0.05	1307	5488	-4181	
450	7	0.05	1313	5613	-4300	

Modified Rational **Area:** 3.32 ha

Project Name: 1971 & 1975 St. Laurant Blvd. Residential Apartment Development
 Project Number: 21106

100 YEAR

Rainfall Data			
Location:	Ottawa	a	1735.688
Event	100	b	6.014
		c	0.8200

Site Data	
Area	3.32 ha
Runoff Coefficient	0.77
AC	2.56
Tc	10
Time Increment	10
Release Rate	320.2 l/s
Storage Required	639 m ³

Time	Rainfall Intensity	Storm Runoff	Runoff Volume	Released Volume	Storage Volume	
(min)	(mm/hr)	(m ³ /s)	(m ³)	(m ³)	(m ³)	
10	179	1.27	762	192	570	
20	120	0.85	1024	384	639	*****
30	92	0.65	1176	576	600	
40	75	0.53	1283	769	514	
50	64	0.45	1365	961	404	
60	56	0.40	1431	1153	278	
70	50	0.35	1487	1345	142	
80	45	0.32	1536	1537	-1	
90	41	0.29	1579	1729	-150	
100	38	0.27	1617	1921	-304	
110	35	0.25	1652	2114	-461	
120	33	0.23	1685	2306	-621	
130	31	0.22	1714	2498	-784	
140	29	0.21	1742	2690	-948	
150	28	0.20	1767	2882	-1115	
160	26	0.19	1792	3074	-1283	
170	25	0.18	1814	3266	-1452	
180	24	0.17	1836	3459	-1623	
190	23	0.16	1857	3651	-1794	
200	22	0.16	1876	3843	-1967	
210	21	0.15	1895	4035	-2140	
220	20	0.14	1913	4227	-2314	
230	20	0.14	1930	4419	-2489	
240	19	0.14	1947	4611	-2665	
250	18	0.13	1962	4804	-2841	
260	18	0.13	1978	4996	-3018	
270	17	0.12	1993	5188	-3195	
280	17	0.12	2007	5380	-3373	
290	16	0.12	2021	5572	-3551	
300	16	0.11	2034	5764	-3730	
310	15	0.11	2048	5956	-3909	
320	15	0.11	2060	6149	-4088	
330	15	0.10	2073	6341	-4268	
340	14	0.10	2085	6533	-4448	
350	14	0.10	2097	6725	-4629	
360	14	0.10	2108	6917	-4809	
370	13	0.10	2119	7109	-4990	
380	13	0.09	2130	7302	-5171	
390	13	0.09	2141	7494	-5353	
400	13	0.09	2151	7686	-5535	
410	12	0.09	2161	7878	-5716	
420	12	0.09	2171	8070	-5899	
430	12	0.08	2181	8262	-6081	
440	12	0.08	2191	8454	-6263	
450	11	0.08	2200	8647	-6446	

Modified Rational **Area:** 3.32 ha

Project Name: 1971 & 1975 St. Laurant Blvd. Residential Apartment Development
 Project Number: 21106

100 YEAR+20%

Rainfall Data			
Location:	Ottawa	a	1735.688
Event	100	b	6.014
		c	0.8200

Site Data	
Area	3.32 ha
Runoff Coefficient	0.77
AC	2.56
Tc	10
Time Increment	10
Release Rate	320.2 l/s
Storage Required	844 m ³

Time (min)	Rainfall Intensity (100yr + 20% Increase) (mm/hr)	Storm Runoff (m ³ /s)	Runoff Volume (m ³)	Released Volume (m ³)	Storage Volume (m ³)
10	214	1.52	914	192	722
20	144	1.02	1229	384	844*****
30	110	0.78	1411	576	835
40	90	0.64	1539	769	771
50	77	0.55	1638	961	677
60	67	0.48	1717	1153	565
70	60	0.42	1785	1345	440
80	54	0.38	1843	1537	306
90	49	0.35	1895	1729	165
100	45	0.32	1941	1921	20
110	42	0.30	1983	2114	-131
120	39	0.28	2021	2306	-284
130	37	0.26	2057	2498	-441
140	35	0.25	2090	2690	-600
150	33	0.24	2121	2882	-761
160	31	0.22	2150	3074	-924
170	30	0.21	2177	3266	-1089
180	29	0.20	2203	3459	-1255
190	27	0.20	2228	3651	-1423
200	26	0.19	2251	3843	-1591
210	25	0.18	2274	4035	-1761
220	24	0.17	2295	4227	-1932
230	24	0.17	2316	4419	-2103
240	23	0.16	2336	4611	-2276
250	22	0.16	2355	4804	-2449
260	21	0.15	2373	4996	-2622
270	21	0.15	2391	5188	-2797
280	20	0.14	2408	5380	-2972
290	20	0.14	2425	5572	-3147
300	19	0.14	2441	5764	-3323
310	19	0.13	2457	5956	-3499
320	18	0.13	2472	6149	-3676
330	18	0.13	2487	6341	-3854
340	17	0.12	2502	6533	-4031
350	17	0.12	2516	6725	-4209
360	16	0.12	2530	6917	-4388
370	16	0.11	2543	7109	-4566
380	16	0.11	2556	7302	-4745
390	15	0.11	2569	7494	-4925
400	15	0.11	2582	7686	-5104
410	15	0.11	2594	7878	-5284
420	15	0.10	2606	8070	-5464
430	14	0.10	2618	8262	-5645
440	14	0.10	2629	8454	-5825
450	14	0.10	2640	8647	-6006

Rational Method - Uncontrolled Areas to Russell Road (Post Development)

Project Name: 1971 & 1975 St. Laurant Blvd. Residential Apartment Development
 Project No: 21106

Available Storage Underground in Sewer (5 Year Event)

UPSTREAM OF THE ORIFICE CONTROL AT MH 103: 5yr HWL = 75.53 m

From	To	Length of Pipe (m)	Length Below HWL (m)	Diameter (mm)	Volume (m ³)
CNTRL MH	CBMH4	5.0	0.0	450	0.00
CNTRL MH	EX.CBMH	82.0	0.0	400	0.00
EX.CBMH	CBMH1	41.1	0.0	375	0.00
CBMH1	CBMH2	49.9	0.0	450	0.00
EX.CBMH	MH1	54.7	0.0	450	0.00
MH1	EX.MH	40.7	0.0	450	0.00
MH1	CBMH3	80.2	0.0	300	0.00
EX.MH	MH2	32.2	0.0	350	0.00
MH2	MH3	37.9	0.0	375	0.00
MH3	MH4	22.5	0.0	300	0.00
MH4	MH5	12.5	0.0	300	0.00
MH4	MH11	28.4	0.0	300	0.00
MH2	MH6	27.7	0.0	375	0.00
MH6	MH7	14.5	0.0	375	0.00
MH7	MH8	28.5	0.0	375	0.00
MH8	MH9	43.6	0.0	300	0.00
MH8	CBMH5	45.8	0.0	250	0.00
MH9	MH10	40.4	0.0	300	0.00
Total Storage Underground in Sewers (m ³):					0.0

Available Storage Underground in Tank

Individual GreenStorm Tanks									
TANK#	Tank Inv (m)	74.84	5yr HWL:	75.53	Units: (#)	52	11	2.5	572
	Length (m)	Width (m)	Height (m)	Void Ratio		Length (m)	Width (m)	Height (m)	Volume (cu.m)
	0.80	0.80	0.66	0.96		41.6	8.8	0.694	243.9
TANK#2	Tank Inv (m)	74.84	5yr HWL:	75.53	Units: (#)	22	11	2.5	242
	Length (m)	Width (m)	Height (m)	Void Ratio		Length (m)	Width (m)	Height (m)	Volume (cu.m)
	0.80	0.80	0.66	0.96		17.6	8.8	0.69	103.2
Total Storage in Underground Tanks:									347.1

Available Storage Underground in Sewer Catchbasins & Manholes

UPSTREAM OF THE ORIFICE CONTROL (BELOW HWL): 5Year HWL = 75.53 m

MH	Manhole ELEV or HWL (m)	Low Invert (m)	Diameter (m)	Volume (m ³)
CBMH4	75.53	74.80	1.20	0.83
EX.CBMH	75.53	74.89	1.20	0.73
CBMH1	75.53	75.80	1.20	0.00
MH1	75.53	75.00	1.20	0.60
CBMH3	75.53	75.95	1.20	0.00
EX.MH	75.53	75.04	1.20	0.56
MH2	75.53	75.31	2.40	1.01
MH3	75.53	75.55	1.20	0.00
MH4	75.53	75.75	1.20	0.00
MH5	75.53	76.07	1.20	0.00
MH6	75.53	75.50	1.80	0.09
MH7	75.53	75.60	1.20	0.00
MH8	75.53	75.72	1.20	0.00
CBMH5	75.53	76.03	1.20	0.00
MH9	75.53	75.88	1.80	0.00
MH10	75.53	76.09	1.20	0.00
MH11	75.53	76.33	1.50	0.00
Total Storage Underground in CB's & MH's (m ³):				3.8

Total Available Underground Storage (m³): 3.8
 (In Sewer, Manholes and Catchbasins)

Available Surface Storage (m³): 0.0
 (Ponding at CBMH and CB)

Available Gallery Storage (m³): 347.1
 (Underground in Storage Units)

Total Available 5yr Stormwater Storage (m³): 350.9

Required 5yr Stormwater Storage (m³): 350.1

Rational Method - Uncontrolled Areas to Russell Road (Post Development)

Project Name: 1971 & 1975 St. Laurant Blvd. Residential Apartment Development
 Project No: 21106

Available Storage Underground in Sewer (100 Year Event)

UPSTREAM OF THE ORIFICE CONTROL AT MH 103: 100yr HWL = 76.38 m

From	To	Length of Pipe (m)	Length Below HWL (m)	Diameter (mm)	Volume (m ³)
CNTRL MH	CBMH4	5.0	5.0	450	0.80
CNTRL MH	EX.CBMH	82.0	82.0	400	10.30
EX.CBMH	CBMH1	41.1	41.1	375	4.54
CBMH1	CBMH2	49.9	12.5	450	1.99
EX.CBMH	MH1	54.7	57.4	450	9.13
MH1	EX.MH	40.7	40.7	450	6.47
MH1	CBMH3	80.2	80.2	300	5.67
EX.MH	MH2	32.2	32.2	350	3.10
MH2	MH3	37.9	37.9	375	4.19
MH3	MH4	22.5	22.5	300	1.59
MH4	MH5	12.5	12.5	300	0.88
MH4	MH11	28.4	16.0	300	1.13
MH2	MH6	27.7	27.7	375	3.06
MH6	MH7	14.5	14.5	375	1.60
MH7	MH8	28.5	28.5	375	3.15
MH8	MH9	43.6	43.6	300	3.08
MH8	CBMH5	45.8	45.8	250	2.25
MH9	MH10	40.4	24.2	300	1.71
Total Storage Underground in Sewers (m ³):					64.6

Available Storage Underground in Tank

Individual GreenStorm Tanks									
TANK#1	Tank Inv (m):	74.84	100yr HWL:	76.38	Units: (#)	52	11	2.5	572
	Length (m)	Width (m)	Height (m)	Void Ratio		Length (m)	Width (m)	Height (m)	Volume (cu.m)
	0.80	0.80	0.66	0.96		41.6	8.8	1.54	542.6
TANK#2	Tank Inv (m):	74.84	100yr HWL:	76.38	Units: (#)	22	11	2.5	242
	Length (m)	Width (m)	Height (m)	Void Ratio		Length (m)	Width (m)	Height (m)	Volume (cu.m)
	0.80	0.80	0.66	0.96		17.6	8.8	1.54	229.6
Total Storage in Underground Tanks:									772.2

Available Storage Underground in Sewer Catchbasins & Manholes

UPSTREAM OF THE ORIFICE CONTROL (BELOW HWL): 100Year HWL = 76.38 m

MH	Manhole ELEV or HWL (m)	Low Invert (m)	Diameter (m)	Volume (m ³)
CBMH4	76.38	74.80	1.20	1.79
EX.CBMH	76.38	74.89	1.20	1.69
CBMH1	76.38	75.80	1.20	0.66
MH1	76.38	75.00	1.20	1.57
CBMH3	76.38	75.95	1.20	0.49
EX.MH	76.38	75.04	1.20	1.52
MH2	76.38	75.31	2.40	4.86
MH3	76.38	75.55	1.20	0.30
MH4	76.38	75.75	1.20	0.23
MH5	76.38	76.07	1.20	0.11
MH6	76.38	75.50	1.80	0.32
MH7	76.38	75.60	1.20	0.28
MH8	76.38	75.72	1.20	0.24
CBMH5	76.38	76.03	1.20	0.13
MH9	76.38	75.88	1.80	0.18
MH10	76.38	76.09	1.20	0.11
MH11	76.38	76.33	1.50	0.02
Total Storage Underground in CB's & MH's (m ³):				14.5

Total Available Underground Storage (m³): 79.1
 (In Sewer, Manholes and Catchbasins)

Available Surface Storage (m³): 0.0
 (Ponding at CBMH and CB)

Available Gallery Storage (m³): 772.2
 (Underground in Storage Units)

Total Available Stormwater Storage (m³): 851.3

Required Stormwater Storage (m³): 844.2

ST. LAURENT RESIDENTIAL DEVELOPMENT

1971 & 1975 ST. LAURENT BLVD. OTTAWA, ON

DRAWING INDEX

TITLE	SHEET NO
COVER SHEET	1 OF 7
SYSTEM LAYOUT SHEET&SYSTEM CALCULATION SHEET	2-5 OF 7
SYSTEM OVERLAY SHEET	6 OF 7
DETAIL SHEET	7 OF 7

PROJECT INFORMATION				
SITE CONTACT	PHIL ALLEN	416-286-5990	PHILALLEN@STORMCON.CA	
ENGINEER / TECHNICAL SPECIALIST	ERIC CUMISKEY	289-380-3742	ECUMISKEY@STORMCON.CA	
SALES REP:	GREG DZIEWIECKI	437-231-6080	GREGD@STORMCON.CA	
PROJECT NO:	2023-034			
COMMENTS:	REVISION	DATE	COMMENT	BY

GENERAL NOTES

- COORDINATE WITH MANUFACTURER'S REPRESENTATIVE/DISTRIBUTOR FOR PRE-CONSTRUCTION MEETING AND SITE INSPECTION DURING INSTALLATION.
- ENGINEERING DRAWINGS SUPERSEDE ALL PROVIDED DOCUMENTATION. REFER TO SITE ENGINEERS FOR ADDITIONAL INSTRUCTIONS.
- COORDINATE GREENSTORM INSTALLATION ACTIVITIES WITH OTHER SITE ACTIVITIES
- ALL DIMENSIONS ARE IN METERS UNLESS NOTED OTHERWISE
- THE SUB-GRADE AND SIDE BACKFILL TO BE COMPACTED TO 95% SPD OR AS DIRECTED BY THE QUALIFIED ENGINEER.
- PRESENCE OF GROUND WATER ABOVE THE BASE OF THE SYSTEM MUST BE IDENTIFIED TO STORMCON. ALL PUBLISHED MAXIMUM AND MINIMUM INSTALLATION DEPTHS ASSUME THE GROUND WATER IS AT OR BELOW THE BASE OF THE SYSTEM UNLESS OTHERWISE NOTED.
- CONFIRM GEOTECHNICAL SOIL EVALUATION BY A QUALIFIED ENGINEER TO DETERMINE SUITABILITY OF STRUCTURAL INSTALLATION
- CONFIRM FOR BURIED UNDERGROUND UTILITIES INCLUDING GAS, ELECTRICAL, PIPELINES OR CONDUITS
- ROOTS FROM SURROUNDING TREES MAY DAMAGE THE SYSTEM. DESIGN ENGINEER TO ENSURE ADEQUATE SEPARATION FROM ALL TREES
- WHEN INSTALLED IN CONFORMANCE TO THE INSTALLATION GUIDELINES, GREENSTORM-ST CAN HANDLE STANDARD CL-625 TRUCK LOADING AFTER 0.80m COVER. FOR NON-STANDARD LOADS AND INSTALLATION WITHIN GROUNDWATER, CONTACT MANUFACTURER'S REPRESENTATIVE/DISTRIBUTOR
- PROTECT THE INSTALLATION AGAINST DAMAGE WITH CONSTRUCTION TAPE, FENCING OR OTHER MEANS TILL THE CONSTRUCTION IS COMPLETE.
- ENSURE THAT CONSTRUCTION FOLLOWS APPLICABLE FEDERAL, PROVINCIAL, LOCAL, MUNICIPAL AND LOCAL LAWS, ORDINANCES, REGULATIONS AND SAFETY REQUIREMENTS.
- VEHICULAR LOADING IS PROHIBITED UNTIL BACKFILLED AS PER MANUFACTURER'S INSTALLATION GUIDELINES. THE USE OF EQUIPMENT OVER GREENSTORM CHAMBERS IS LIMITED:
 - NO EQUIPMENT IS ALLOWED ON BARE CHAMBERS.
 - NO RUBBER TIERED LOADER, DUMP TRUCK, OR EXCAVATORS ARE ALLOWED UNTIL PROPER FILL DEPTHS ARE REACHED IN ACCORDANCE WITH THE CONSTRUCTION GUIDE.
 - WEIGHT LIMITS FOR CONSTRUCTION EQUIPMENT CAN BE FOUND IN THE CONSTRUCTION GUIDE.

CHECK - REQUIRED MATERIALS AND EQUIPMENT

- ALL GREENSTORM CHAMBERS AND ACCESSORIES AS SPECIFIED IN THE ENGINEER'S PLANS INCLUDING NON-WOVEN GEOTEXTILE, CONNECTORS, QUADS, SIDEWALLS ADAPTER, RISER AND LINER WHERE APPLICABLE.
- RECIPROCATING SAW OR ROUTER
- TRANSIT OR LASER LEVEL MEASURING DEVICE
- COMPACTION EQUIPMENT WITH MAXIMUM GROSS VEHICLE WEIGHT OF 12,000 LBS (5,440 KGS).
- ACCEPTABLE FILL MATERIAL AS SHOWN IN INSTALLATION INSTRUCTIONS.
- QUANTITIES FOR GEOSYNTHETIC ARE APPROXIMATE AND MAY VARY BASED ON OVERLAP, WASTAGE.
- CHECK GREENSTORM CHAMBERS FOR DAMAGE PRIOR TO INSTALLATION. DO NOT USE DAMAGED CHAMBERS, CONTACT YOUR SUPPLIER IMMEDIATELY TO REPORT DAMAGE OR PACKING-LIST DISCREPANCIES.**

NOTES FOR BIDDING AND INSTALLATIONS

- CONTRACTORS ARE EXPECTED TO COMPREHEND AND USE THE MOST CURRENT INSTALLATION INSTRUCTIONS PRIOR TO BEGINNING A SYSTEM INSTALLATION. FOR THE MOST CURRENT INSTRUCTIONS, CONTACT STORMCON AT (289) 380-3742 OR VISIT WWW.STORMCON.CA.
- CONTACT STORMCON AT LEAST TWO WEEKS PRIOR TO SYSTEM INSTALLATION TO ARRANGE FOR A PRE-CONSTRUCTION MEETING.
- USE GREENSTORM INSTALLATION INSTRUCTIONS AS A GUIDELINE ONLY FOR MINIMUM/MAXIMUM REQUIREMENTS. ACTUAL DESIGN MAY VARY. REFER TO APPROVED CONSTRUCTION DRAWINGS FOR JOB-SPECIFIC DETAILS. ENGINEERING DRAWINGS SUPERSEDE ALL PROVIDED DOCUMENTATION.
- THE FOUNDATION STONE SHALL BE LEVEL AND COMPACTED PRIOR TO CHAMBER INSTALLATION.
- ANY DISCREPANCIES WITH THE SYSTEM SUB-GRADE SOIL'S BEARING CAPACITY MUST BE REPORTED TO THE GEOTECHNICAL ENGINEER.
- CONTRACTOR TO REFER TO GREENSTORM INSTALLATION INSTRUCTIONS CONCERNING VEHICULAR TRAFFIC. RESPONSIBILITY FOR PREVENTING VEHICLES THAT EXCEED REQUIREMENTS SPECIFIED FROM TRAVELING ACROSS OR PARKING OVER THE CHAMBER SYSTEM LIES SOLELY WITH THE CONTRACTOR THROUGHOUT THE ENTIRE SITE CONSTRUCTION PROCESS. THE PLACEMENT OF WARNING TAPE, TEMPORARY FENCING, AND/OR APPROPRIATELY LOCATED SIGNS IS HIGHLY RECOMMENDED.
- TRAFFIC OF INSTALLATION EQUIPMENT OR OTHER VEHICULAR TRAFFIC OVER TOP OF THE GREENSTORM STORMWATER SYSTEM IS STRICTLY RESTRICTED AND PROHIBITED UNTIL SATISFACTORY COVER AND COMPACTION IS ACHIEVED ACCORDING TO MANUFACTURER'S INSTALLATION INSTRUCTIONS.
- EROSION AND SEDIMENT-CONTROL MEASURES MUST MEET LOCAL CODES AND THE DESIGN ENGINEER'S SPECIFICATIONS THROUGHOUT THE ENTIRE SITE CONSTRUCTION PROCESS.
- GREENSTORM SYSTEMS MUST BE DESIGNED AND INSTALLED IN ACCORDANCE WITH STORMCON'S MINIMUM REQUIREMENTS. FAILURE TO DO SO WILL VOID THE LIMITED WARRANTY.



10 CEDAR AVE
THORNHILL ON
L3T 3W1

SALES@STORMCON.CA
WWW.STORMCON.CA

NOTE: THESE SHOP DRAWINGS MAY CONTAIN COMPONENTS INCLUDING BUT NOT LIMITED TO MANHOLES, CATCH BASINS, STORM PIPES AND FITTINGS, MANIFOLDS, CASTINGS AND OTHER NECESSARY APPURTENANCES THAT MAY NOT BE SUPPLIED BY STORMCON. IT IS THE RESPONSIBILITY OF THE CONTRACTOR AND/OR SUPPLIER TO CONFIRM THE MATERIALS PROVIDED.

THIS DRAWING WAS PREPARED TO SUPPORT THE PROJECT ENGINEER OF RECORD FOR THE PROPOSED SYSTEM. IT IS THE ULTIMATE RESPONSIBILITY OF THE PROJECT ENGINEER OF RECORD TO ENSURE THAT THE GREENSTORM SYSTEM'S DESIGN IS IN FULL COMPLIANCE WITH ALL APPLICABLE LAWS AND REGULATIONS. IT IS THE CONTRACTOR OF RECORD'S RESPONSIBILITY TO ENSURE THAT THE STORMCON PRODUCTS ARE DESIGNED IN ACCORDANCE WITH STORMCON'S MINIMUM REQUIREMENTS. STORMCON DOES NOT APPROVE PLANS, SIZING, OR SYSTEM DESIGNS.

PROPOSED SYSTEM 1 ELEVATIONS

(TO BE APPROVED BY ENGINEER)
 *ENGINEER TO CONFIRM MINIMUM AND MAXIMUM BURIAL REQUIREMENTS ARE MET

80.47	MAXIMUM ALLOWABLE GRADE (TOP OF PAVEMENT/UNPAVED)
77.27	MINIMUM ALLOWABLE GRADE
76.47	GREENSTORM STORAGE TOP ELEVATION LEVEL 2.5
76.12	GREENSTORM STORAGE TOP ELEVATION LEVEL 2
75.46	GREENSTORM STORAGE TOP ELEVATION LEVEL 1
74.80	GREENSTORM BASE ELEVATION
74.70	BOTTOM OF EXCAVATION
<74.80	SEASONAL HIGH GROUNDWATER ELEVATION

GREENSTORM STORMWATER MANAGEMENT SYSTEM

TOTAL STORAGE PROVIDED: 248.30 m³
 STORAGE VOID RATIO: 0.96
 SYSTEM AREA: 154.88 m²
 DEPTH OF EMBEDMENT STONE: 0.00 m
 DEPTH OF BEDDING STONE: 0.00 m
 STONE PERIMETER: 0.00 m

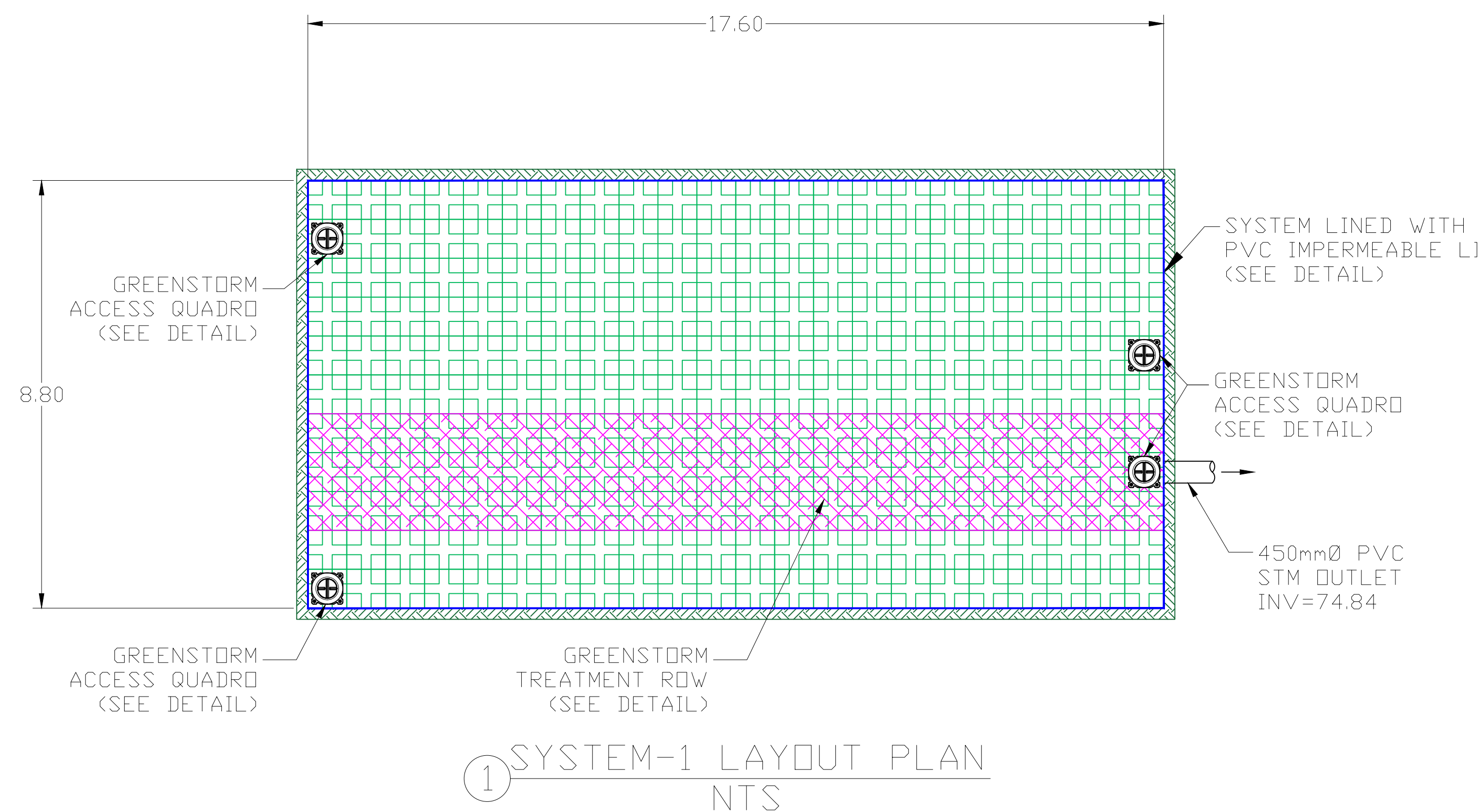

① SYSTEM-1 LAYOUT PLAN NTS

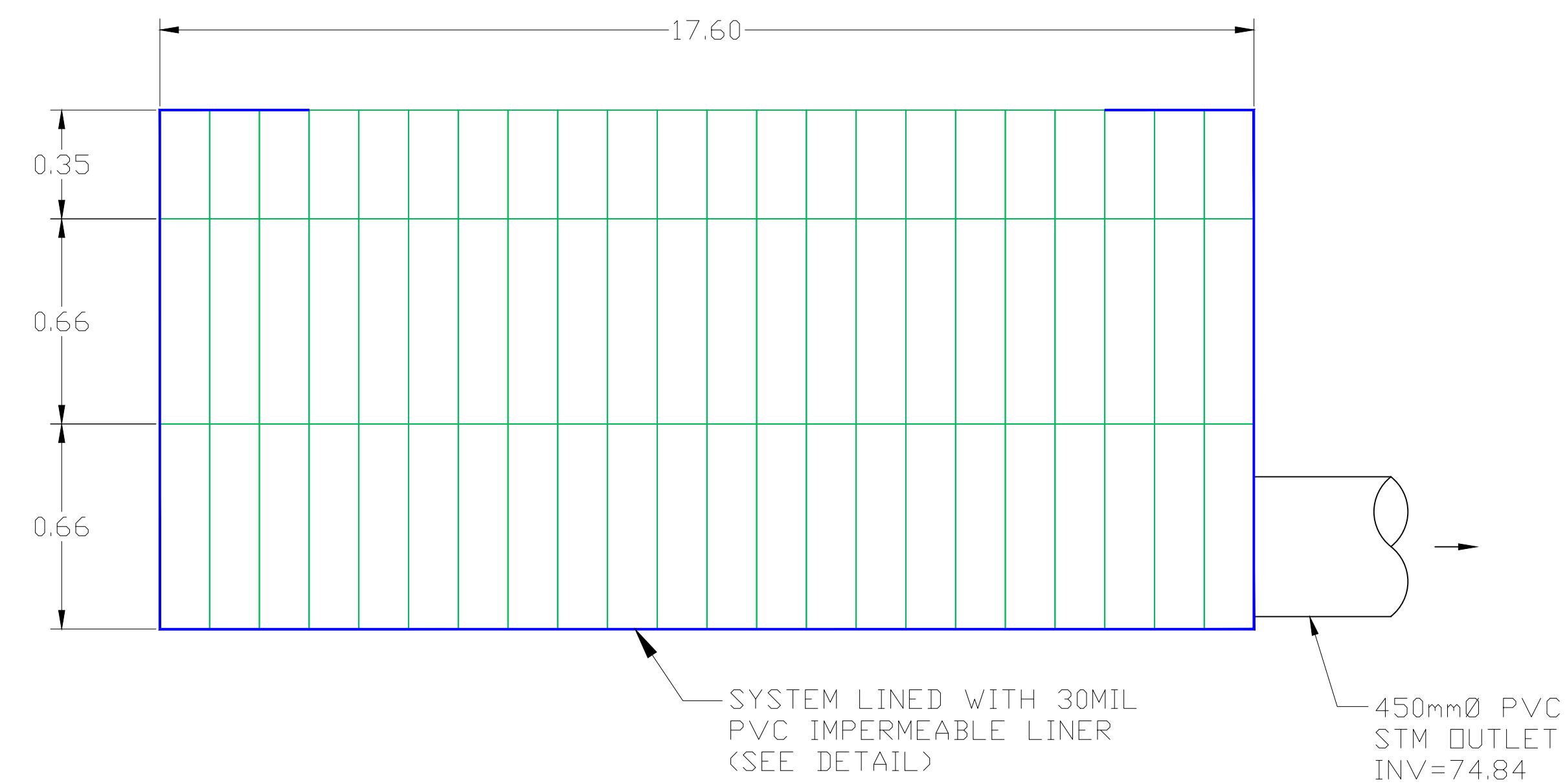

② 2.5 LAYER SYSTEM-1 LAYOUT PROFILE NTS

NOTE:*ALL EXTERNAL SYSTEM STRUCTURES, INLET/OUTLET PIPES, AND PROPOSED ELEVATIONS MUST BE DESIGNED AND APPROVED BY PROJECT ENGINEER OF RECORD. PROJECT ENGINEER OF RECORD MUST ENSURE CHAMBER BURIAL REQUIREMENTS ARE MET.

MATERIALS LIST SUPPLIED BY STORMCON		
(SYSTEM MATERIALS LIST - SEE COVER SHEET FOR COMBINED PROJECT MATERIALS LIST)		
GREENSTORM-ST 80x80x66 cm	484	BLOCKS
GREENSTORM-ST 80x80x35 cm (HALF BLOCK)	242	BLOCKS
SINGLE LAYER-CONNECTOR	500	PIECES
MULTI LAYER-CONNECTOR	1000	PIECES
SIDEWALL GRID	132	PIECES
SIDEWALL GRID HALF BLOCK	66	PIECES
HALF BLOCK COVER PLATE	242	PIECES
QUADRO-CONTROL	16	PIECES
NO. OF PIPE ADAPTER	0	PIECES
EXTENSION PIPE	12	METER
CAST IRON COVER	4	PIECES
MIDDLE GRIDS	0	PIECES
8 OZ NON-WOVEN GEOTEXTILE	900	SQ. METERS
30MIL PVC IMPERMEABLE LINER	350	SQ. METERS
GREENSTORM TREATMENT ROW	44	PIECES
100MM SUBDRAIN	0	METER

GREENSTORM LEGEND

-  GREENSTORM ST BLOCK
-  8 OZ NON-WOVEN GEOTEXTILE
-  GREENSTORM TREATMENT ROW
-  GREENSTORM ACCESS QUADRO
-  30MIL PVC IMPERMEABLE LINER

NOTE:*

1) USE OF VEHICLES WHEN APPLYING THE FIRST COVER LAYER :

THE FIRST COVER LAYER CAN BE APPLIED FOR EXAMPLE USING A WHEEL LOADER OR A FRONT-TYPE MOBILE EXCAVATOR. FOR A WHEEL LOADER OR MOBILE EXCAVATOR WITH A MAXIMUM TOTAL WEIGHT OF 15TONS(CHAIN,WHEELS,TWIN-TYRES), A COMPACTED COVER OF AT LEAST 30CM MUST BE PLACED OVER THE STORAGE/INFILTRATION SYSTEM. POSSIBLE FORMATION OF RUTS MUST BE TAKEN INTO ACCOUNT! AVOID STEERING MANOEUVRES AT THIS CONSTRUCTION STAGE

2) USE OF CONSTRUCTION VEHICLES:

DRIVING OVER THE COVER WITH HEAVY CONSTRUCTION VEHICLES WITH A WHEEL LOAD OF UP TO 50KN (E.G. HGV 30) IS POSSIBLE IF THE THICKNESS OF THE COMPACTED COVER IS NOT LESS THAN 60CM. POSSIBLE FORMATION OF RUTS MUST BE TAKEN INTO ACCOUNT! WHEN DUMPING THE EARTHQUAKE MATERIAL, THE WHEEL LOAD OF 140KN MUST NOT BE EXCEEDED;IF NECESSARY,LOAD DISTRIBUTION PLATES MUST BE USED.



10 CEDAR AVE
 THORNHILL ON
 L3T 3W1

SALES@STORMCON.CA
 WWW.STORMCON.CA

THIS DRAWING WAS PREPARED TO SUPPORT THE PROJECT ENGINEER OF RECORD FOR THE PROPOSED SYSTEM. IT IS THE ULTIMATE RESPONSIBILITY OF THE PROJECT ENGINEER OF RECORD TO ENSURE THAT THE GREENSTORM SYSTEM'S DESIGN IS IN FULL COMPLIANCE WITH ALL APPLICABLE LAWS AND REGULATIONS. IT IS THE CONTRACTOR OF RECORD'S RESPONSIBILITY TO ENSURE THAT THE STORMCON PRODUCTS ARE DESIGNED IN ACCORDANCE WITH STORMCONS MINIMUM REQUIREMENTS. STORMCON DOES NOT APPROVE PLANS, SIZING, OR SYSTEM DESIGNS.

ST. LAURENT RESIDENTIAL DEVELOPMENT
 1971 & 1975 ST. LAURENT BLVD.
 OTTAWA, ON
 SYSTEM-1 LAYOUT SHEET STORAGE TANK

GREENSTORM STORMWATER CHAMBER			
PROJECT NO:	2023-034	DATE:	03/08/2023
DESIGNED BY:	JD	CHECKED BY:	EC
SCALE:	N.T.S.	SHEET NO:	2 OF 7

2023-03-08 - GreenStorm Stage Storage-St. Laurent Residential Development
Stage Storage LW S1

Project Name	St. Laurent Residential Development		
Location	1971 & 1975 St. Laurent Blvd., Ottawa, ON		
Date	March 8, 2023		
Chamber Model	GreenStorm-ST		
Number of Layers	2.5		
Height of Chambers	1.67	m	Top Stone 0.00 m
Chamber Length	17.60		Bottom Stone 0.00 m
Chamber Width	8.80		Perimeter Stone 0.00 m
Storage Void Ratio	0.96		Stone Qty 0.00 m ³
System Perimeter	52.80		Stone Void Ratio 40.00%
System Area	154.88	m ²	Liner Yes
System Base Elevation	74.80	m	

2023-03-08 - GreenStorm Stage Storage-St. Laurent Residential Development
Stage Storage LW S1

Height of System	GreenStorm Volume	Stone Volume	Cumulative Storage Volume	Elevation		Height of System	GreenStorm Volume	Stone Volume	Cumulative Storage Volume	Elevation	
mm	m ³	m ³	m ³	m		mm	m ³	m ³	m ³	m	
1670	6.69	0.00	248.30	76.47	Top of GreenStorm	800	3.72	0.00	118.95	75.60	
1625	3.72	0.00	241.61	76.43		775	3.72	0.00	115.23	75.58	
1600	3.72	0.00	237.90	76.40		750	3.72	0.00	111.51	75.55	
1575	3.72	0.00	234.18	76.38		725	3.72	0.00	107.80	75.53	
1550	3.72	0.00	230.46	76.35		700	3.72	0.00	104.08	75.50	
1525	3.72	0.00	226.74	76.33		675	3.72	0.00	100.36	75.48	
1500	3.72	0.00	223.03	76.30		650	3.72	0.00	96.65	75.45	
1475	3.72	0.00	219.31	76.28		625	3.72	0.00	92.93	75.43	
1450	3.72	0.00	215.59	76.25		600	3.72	0.00	89.21	75.40	
1425	3.72	0.00	211.88	76.23		575	3.72	0.00	85.49	75.38	
1400	3.72	0.00	208.16	76.20		550	3.72	0.00	81.78	75.35	
1375	3.72	0.00	204.44	76.18		525	3.72	0.00	78.06	75.33	
1350	3.72	0.00	200.72	76.15		500	3.72	0.00	74.34	75.30	
1325	3.72	0.00	197.01	76.13		475	3.72	0.00	70.63	75.28	
1300	3.72	0.00	193.29	76.10		450	3.72	0.00	66.91	75.25	
1275	3.72	0.00	189.57	76.08		425	3.72	0.00	63.19	75.23	
1250	3.72	0.00	185.86	76.05		400	3.72	0.00	59.47	75.20	
1225	3.72	0.00	182.14	76.03		375	3.72	0.00	55.76	75.18	
1200	3.72	0.00	178.42	76.00		350	3.72	0.00	52.04	75.15	
1175	3.72	0.00	174.70	75.98		325	3.72	0.00	48.32	75.13	
1150	3.72	0.00	170.99	75.95		300	3.72	0.00	44.61	75.10	
1125	3.72	0.00	167.27	75.93		275	3.72	0.00	40.89	75.08	
1100	3.72	0.00	163.55	75.90		250	3.72	0.00	37.17	75.05	
1075	3.72	0.00	159.84	75.88		225	3.72	0.00	33.45	75.03	
1050	3.72	0.00	156.12	75.85		200	3.72	0.00	29.74	75.00	
1025	3.72	0.00	152.40	75.83		175	3.72	0.00	26.02	74.98	
1000	3.72	0.00	148.68	75.80		150	3.72	0.00	22.30	74.95	
975	3.72	0.00	144.97	75.78		125	3.72	0.00	18.59	74.93	
950	3.72	0.00	141.25	75.75		100	3.72	0.00	14.87	74.90	
925	3.72	0.00	137.53	75.73		75	3.72	0.00	11.15	74.88	
900	3.72	0.00	133.82	75.70		50	3.72	0.00	7.43	74.85	
875	3.72	0.00	130.10	75.68		25	3.72	0.00	3.72	74.83	
850	3.72	0.00	126.38	75.65		0	0.00	1.55	0.00	74.80	System Bottom
825	3.72	0.00	122.66	75.63							

2.5-LAYER GREENSTORM CALCULATION SHEET (SYSTEM STAGE-STORAGE TABLE)



10 CEDAR AVE
THORNHILL ON
L3T 3W1

SALES@STORMCON.CA
WWW.STORMCON.CA

THIS DRAWING WAS PREPARED TO SUPPORT THE PROJECT ENGINEER OF RECORD FOR THE PROPOSED SYSTEM. IT IS THE ULTIMATE RESPONSIBILITY OF THE PROJECT ENGINEER OF RECORD TO ENSURE THAT THE GREENSTORM SYSTEM'S DESIGN IS IN FULL COMPLIANCE WITH ALL APPLICABLE LAWS AND REGULATIONS. IT IS THE CONTRACTOR OF RECORD'S RESPONSIBILITY TO ENSURE THAT THE STORMCON PRODUCTS ARE DESIGNED IN ACCORDANCE WITH STORMCONS MINIMUM REQUIREMENTS. STORMCON DOES NOT APPROVE PLANS, SIZING, OR SYSTEM DESIGNS.

ST. LAURENT RESIDENTIAL DEVELOPMENT
1971 & 1975 ST. LAURENT BLVD.
OTTAWA, ON
SYSTEM-1 CALCULATION SHEET

GREENSTORM STORMWATER CHAMBER

PROJECT NO: 2023-034	DATE: 03/08/2023
DESIGNED BY: JD	CHECKED BY: EC
SCALE: N.T.S.	SHEET NO: 3 OF 7

PROPOSED SYSTEM 2 ELEVATIONS

(TO BE APPROVED BY ENGINEER)
 *ENGINEER TO CONFIRM MINIMUM AND MAXIMUM BURIAL REQUIREMENTS ARE MET

80.47	MAXIMUM ALLOWABLE GRADE (TOP OF PAVEMENT/UNPAVED)
77.27	MINIMUM ALLOWABLE GRADE
76.47	GREENSTORM STORAGE TOP ELEVATION LEVEL 2.5
76.12	GREENSTORM STORAGE TOP ELEVATION LEVEL 2
75.46	GREENSTORM STORAGE TOP ELEVATION LEVEL 1
74.80	GREENSTORM BASE ELEVATION
74.70	BOTTOM OF EXCAVATION
<74.80	SEASONAL HIGH GROUNDWATER ELEVATION

GREENSTORM STORMWATER MANAGEMENT SYSTEM

TOTAL STORAGE PROVIDED: 577.67 m³
 STORAGE VOID RATIO: 0.96
 SYSTEM AREA: 360.32 m²
 DEPTH OF EMBEDMENT STONE: 0.00 m
 DEPTH OF BEDDING STONE: 0.00 m
 STONE PERIMETER: 0.00 m

GREENSTORM LEGEND

-  GREENSTORM ST BLOCK
-  8 OZ NON-WOVEN GEOTEXTILE
-  GREENSTORM TREATMENT ROW
-  GREENSTORM ACCESS QUADRO
-  30MIL PVC IMPERMEABLE LINER

NOTE:*ALL EXTERNAL SYSTEM STRUCTURES, INLET/OUTLET PIPES, AND PROPOSED ELEVATIONS MUST BE DESIGNED AND APPROVED BY PROJECT ENGINEER OF RECORD. PROJECT ENGINEER OF RECORD MUST ENSURE CHAMBER BURIAL REQUIREMENTS ARE MET.

MATERIALS LIST SUPPLIED BY STORMCON		
(SYSTEM MATERIALS LIST - SEE COVER SHEET FOR COMBINED PROJECT MATERIALS LIST)		
GREENSTORM-ST 80x80x66 cm	1126	BLOCKS
GREENSTORM-ST 80x80x35 cm (HALF BLOCK)	563	BLOCKS
SINGLE LAYER-CONNECTOR	1100	PIECES
MULTI LAYER-CONNECTOR	2200	PIECES
SIDEWALL GRID	276	PIECES
SIDEWALL GRID HALF BLOCK	138	PIECES
HALF BLOCK COVER PLATE	563	PIECES
QUADRO-CONTROL	24	PIECES
NO. OF PIPE ADAPTER	0	PIECES
EXTENSION PIPE	18	METER
CAST IRON COVER	6	PIECES
MIDDLE GRIDS	0	PIECES
8 OZ NON-WOVEN GEOTEXTILE	2030	SQ. METERS
30MIL PVC IMPERMEABLE LINER	770	SQ. METERS
GREENSTORM TREATMENT ROW	56	PIECES
100MM SUBDRAIN	0	METER

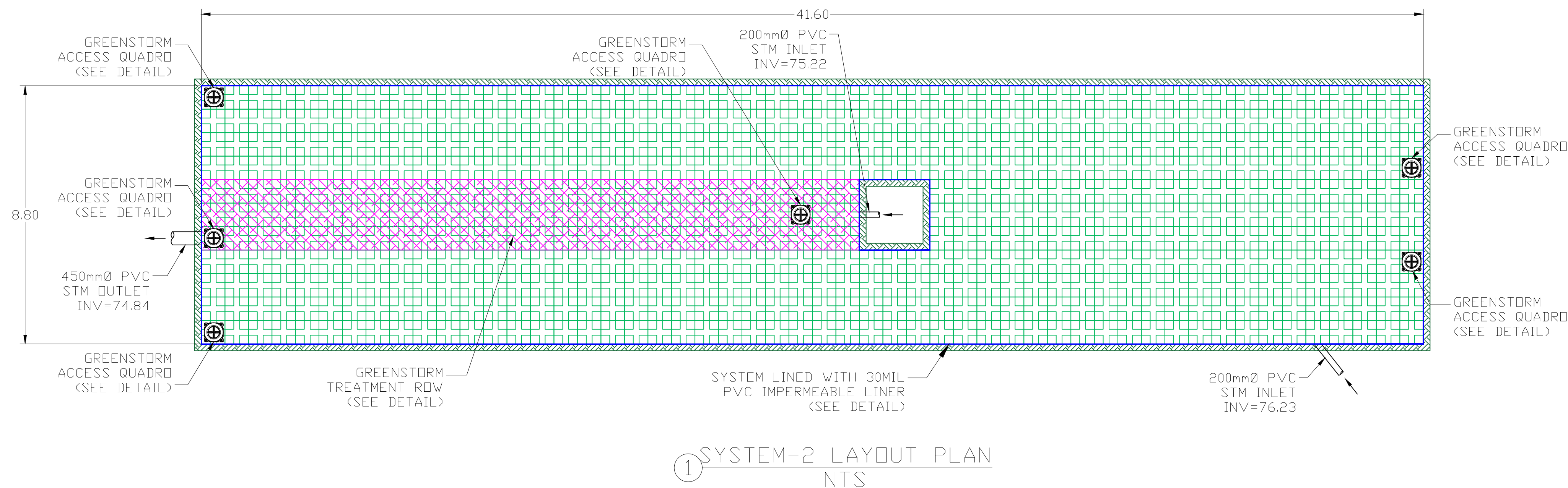
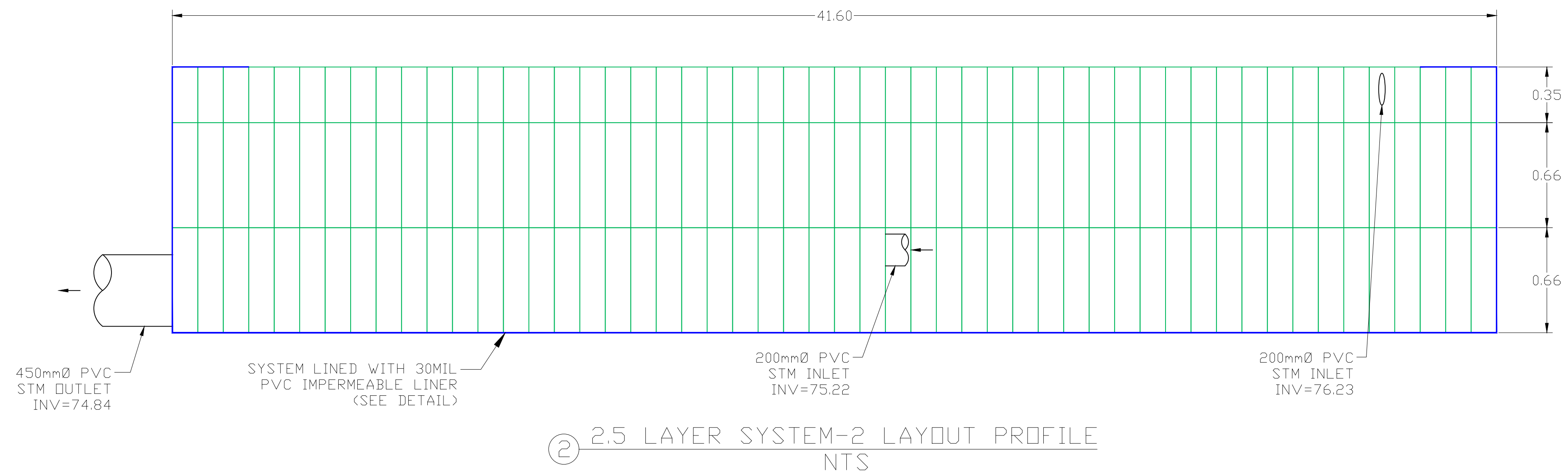

NOTE:*

1) USE OF VEHICLES WHEN APPLYING THE FIRST COVER LAYER :
 THE FIRST COVER LAYER CAN BE APPLIED FOR EXAMPLE USING A WHEEL LOADER OR A FRONT-TYPE MOBILE EXCAVATOR. FOR A WHEEL LOADER OR MOBILE EXCAVATOR WITH A MAXIMUM TOTAL WEIGHT OF 15TONS(CHAIN,WHEELS,TWIN-TYRES), A COMPACTED COVER OF AT LEAST 30CM MUST BE PLACED OVER THE STORAGE/INFILTRATION SYSTEM. POSSIBLE FORMATION OF RUTS MUST BE TAKEN INTO ACCOUNT! AVOID STEERING MANOEUVRES AT THIS CONSTRUCTION STAGE

2) USE OF CONSTRUCTION VEHICLES:
 DRIVING OVER THE COVER WITH HEAVY CONSTRUCTION VEHICLES WITH A WHEEL LOAD OF UP TO 50KN (E.G. HGV 30) IS POSSIBLE IF THE THICKNESS OF THE COMPACTED COVER IS NOT LESS THAN 60CM. POSSIBLE FORMATION OF RUTS MUST BE TAKEN INTO ACCOUNT! WHEN DUMPING THE EARTHQUAKE MATERIAL, THE WHEEL LOAD OF 140KN MUST NOT BE EXCEEDED;IF NECESSARY,LOAD DISTRIBUTION PLATES MUST BE USED.

2023-03-08 - GreenStorm Stage Storage-St. Laurent Residential Development
Stage Storage Area S2

Project Name	St. Laurent Residential Development			
Location	1971 & 1975 St. Laurent Blvd., Ottawa, ON			
Date	March 8, 2023			
Chamber Model	GreenStorm-ST			
Number of Layers	2.5		Top Stone	0.00 m
Height of Chambers	1.67	m	Bottom Stone	0.00 m
Storage Void Ratio	0.96		Perimeter Stone	0.00 m
System Perimeter with Stone	110.40		Stone Qty	0.00 m ³
System Area with Stone	360.32	m ²	Stone Void Ratio	40.00%
System Perimeter GreenStorm	110.40			
System Area GreenStorm	360.32		Liner	Yes
System Base Elevation	74.80	m		

2023-03-08 - GreenStorm Stage Storage-St. Laurent Residential Development
Stage Storage Area S2

Height of System	GreenStorm Volume	Stone Volume	Cumulative Storage Volume	Elevation		Height of System	GreenStorm Volume	Stone Volume	Cumulative Storage Volume	Elevation	
mm	m ³	m ³	m ³	m		mm	m ³	m ³	m ³	m	
1670	15.57	0.00	577.67	76.47	Top of GreenStorm	800	8.65	0.00	276.73	75.60	
1625	8.65	0.00	562.10	76.43		775	8.65	0.00	268.08	75.58	
1600	8.65	0.00	553.45	76.40		750	8.65	0.00	259.43	75.55	
1575	8.65	0.00	544.80	76.38		725	8.65	0.00	250.78	75.53	
1550	8.65	0.00	536.16	76.35		700	8.65	0.00	242.14	75.50	
1525	8.65	0.00	527.51	76.33		675	8.65	0.00	233.49	75.48	
1500	8.65	0.00	518.86	76.30		650	8.65	0.00	224.84	75.45	
1475	8.65	0.00	510.21	76.28		625	8.65	0.00	216.19	75.43	
1450	8.65	0.00	501.57	76.25		600	8.65	0.00	207.54	75.40	
1425	8.65	0.00	492.92	76.23		575	8.65	0.00	198.90	75.38	
1400	8.65	0.00	484.27	76.20		550	8.65	0.00	190.25	75.35	
1375	8.65	0.00	475.62	76.18		525	8.65	0.00	181.60	75.33	
1350	8.65	0.00	466.97	76.15		500	8.65	0.00	172.95	75.30	
1325	8.65	0.00	458.33	76.13		475	8.65	0.00	164.31	75.28	
1300	8.65	0.00	449.68	76.10		450	8.65	0.00	155.66	75.25	
1275	8.65	0.00	441.03	76.08		425	8.65	0.00	147.01	75.23	
1250	8.65	0.00	432.38	76.05		400	8.65	0.00	138.36	75.20	
1225	8.65	0.00	423.74	76.03		375	8.65	0.00	129.72	75.18	
1200	8.65	0.00	415.09	76.00		350	8.65	0.00	121.07	75.15	
1175	8.65	0.00	406.44	75.98		325	8.65	0.00	112.42	75.13	
1150	8.65	0.00	397.79	75.95		300	8.65	0.00	103.77	75.10	
1125	8.65	0.00	389.15	75.93		275	8.65	0.00	95.12	75.08	
1100	8.65	0.00	380.50	75.90		250	8.65	0.00	86.48	75.05	
1075	8.65	0.00	371.85	75.88		225	8.65	0.00	77.83	75.03	
1050	8.65	0.00	363.20	75.85		200	8.65	0.00	69.18	75.00	
1025	8.65	0.00	354.55	75.83		175	8.65	0.00	60.53	74.98	
1000	8.65	0.00	345.91	75.80		150	8.65	0.00	51.89	74.95	
975	8.65	0.00	337.26	75.78		125	8.65	0.00	43.24	74.93	
950	8.65	0.00	328.61	75.75		100	8.65	0.00	34.59	74.90	
925	8.65	0.00	319.96	75.73		75	8.65	0.00	25.94	74.88	
900	8.65	0.00	311.32	75.70		50	8.65	0.00	17.30	74.85	
875	8.65	0.00	302.67	75.68		25	8.65	0.00	8.65	74.83	
850	8.65	0.00	294.02	75.65		0	0.00	3.60	0.00	74.80	System Bottom
825	8.65	0.00	285.37	75.63							

2.5-LAYER GREENSTORM CALCULATION SHEET (SYSTEM STAGE-STORAGE TABLE)



10 CEDAR AVE
THORNHILL ON
L3T 3W1

SALES@STORMCON.CA
WWW.STORMCON.CA

THIS DRAWING WAS PREPARED TO SUPPORT THE PROJECT ENGINEER OF RECORD FOR THE PROPOSED SYSTEM. IT IS THE ULTIMATE RESPONSIBILITY OF THE PROJECT ENGINEER OF RECORD TO ENSURE THAT THE GREENSTORM SYSTEM'S DESIGN IS IN FULL COMPLIANCE WITH ALL APPLICABLE LAWS AND REGULATIONS. IT IS THE CONTRACTOR OF RECORD'S RESPONSIBILITY TO ENSURE THAT THE STORMCON PRODUCTS ARE DESIGNED IN ACCORDANCE WITH STORMCONS MINIMUM REQUIREMENTS. STORMCON DOES NOT APPROVE PLANS, SIZING, OR SYSTEM DESIGNS.

ST. LAURENT RESIDENTIAL DEVELOPMENT
1971 & 1975 ST. LAURENT BLVD.
OTTAWA, ON
SYSTEM-2 CALCULATION SHEET

GREENSTORM STORMWATER CHAMBER

PROJECT NO: 2023-034	DATE: 03/08/2023
DESIGNED BY: JD	CHECKED BY: EC
SCALE: N.T.S.	SHEET NO: 5 OF 7

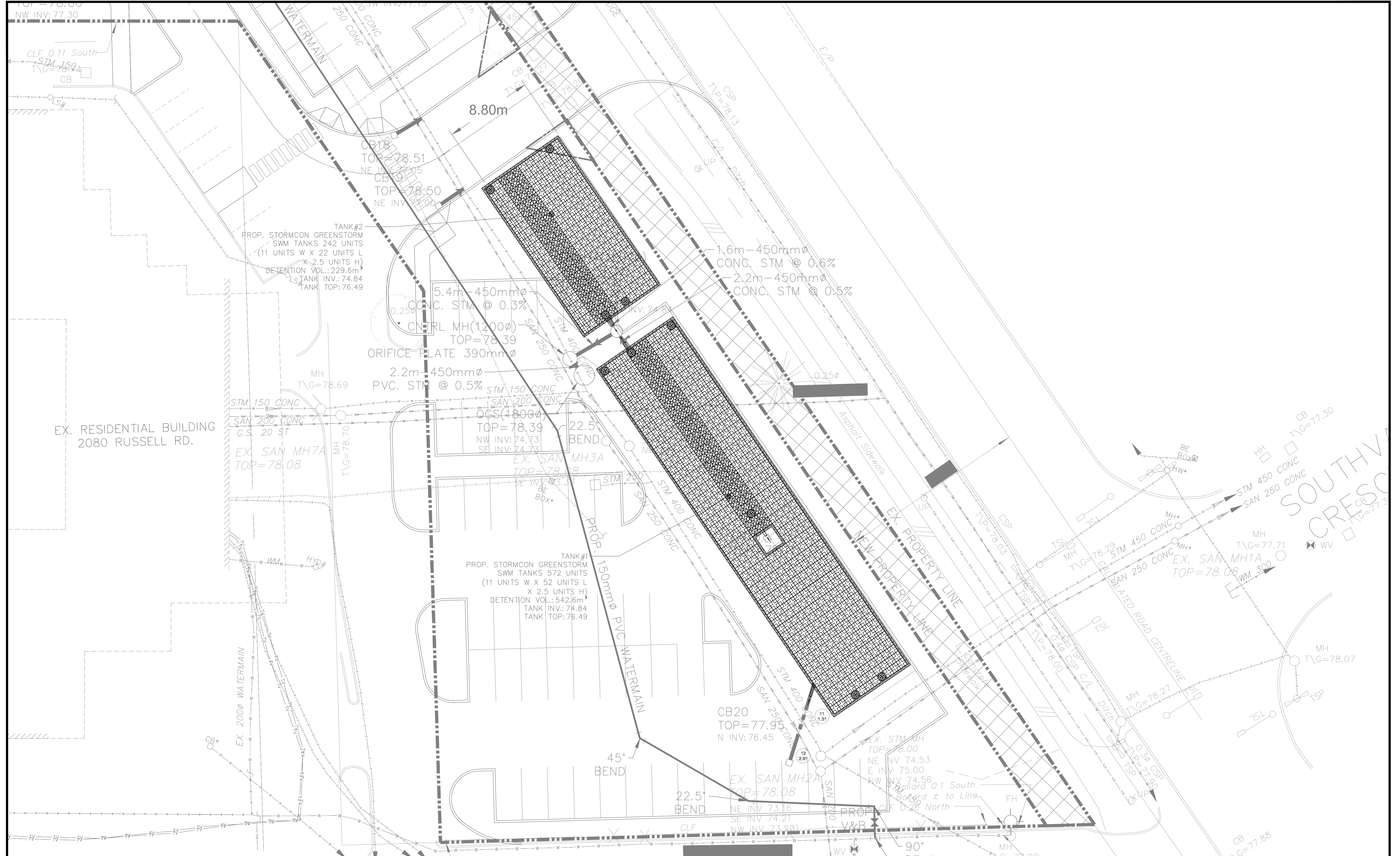

10 CEDAR AVE
THORNHILL ON
L3T 3W1

SALES@STORMCON.CA
WWW.STORMCON.CA

THIS DRAWING WAS PREPARED TO SUPPORT THE PROJECT ENGINEER OF RECORD FOR THE PROPOSED SYSTEM. IT IS THE ULTIMATE RESPONSIBILITY OF THE PROJECT ENGINEER OF RECORD TO ENSURE THAT THE GREENSTORM SYSTEM'S DESIGN IS IN FULL COMPLIANCE WITH ALL APPLICABLE LAWS AND REGULATIONS. IT IS THE CONTRACTOR OF RECORD'S RESPONSIBILITY TO ENSURE THAT THE STORMCON PRODUCTS ARE DESIGNED IN ACCORDANCE WITH STORMCONS MINIMUM REQUIREMENTS. STORMCON DOES NOT APPROVE PLANS, SIZING, OR SYSTEM DESIGNS.

ST. LAURENT RESIDENTIAL DEVELOPMENT
1971 & 1975 ST. LAURENT BLVD.
OTTAWA, ON
SYSTEM OVERLAY SHEET

GREENSTORM STORMWATER CHAMBER	
PROJECT NO: 2023-034	DATE: 03/08/2023
DESIGNED BY: JD	CHECKED BY: EC
SCALE: N.T.S.	SHEET NO: 6 OF 7

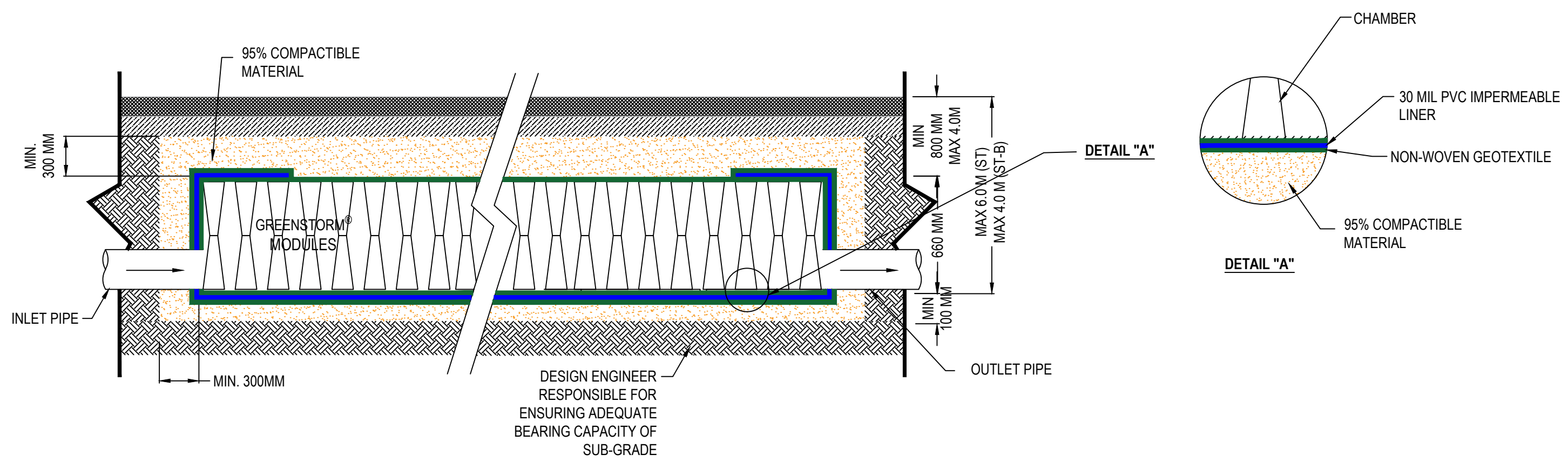

*COMPACTIBLE MATERIAL LIST	LEGEND
• GRANULAR A	30MIL PVC IMPERMEABLE LINER
• GRANULAR B	8 OZ NON-WOVEN GEOTEXTILE
• 19mm CLEAR ANGULAR STONE	

TYPICAL ONE LAYER GREENSTORM CROSS SECTION

FULL CONNECTION OPTIONS
Dia 100mm, 150 mm, 200 mm, 250 mm, 300 mm AND 375 mm

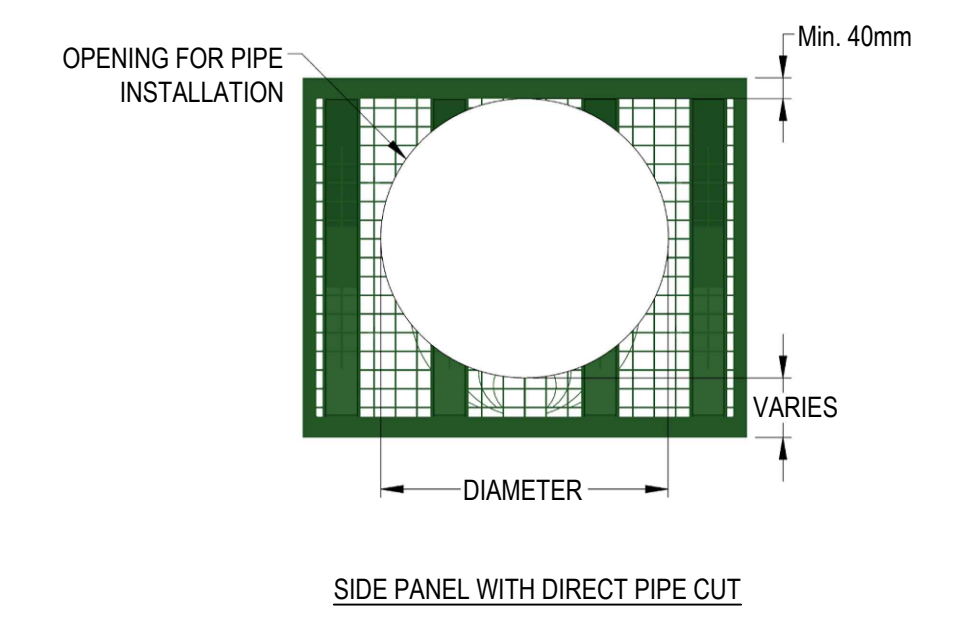

STANDARD SIDE PANEL WITH DIRECT PIPE CUT

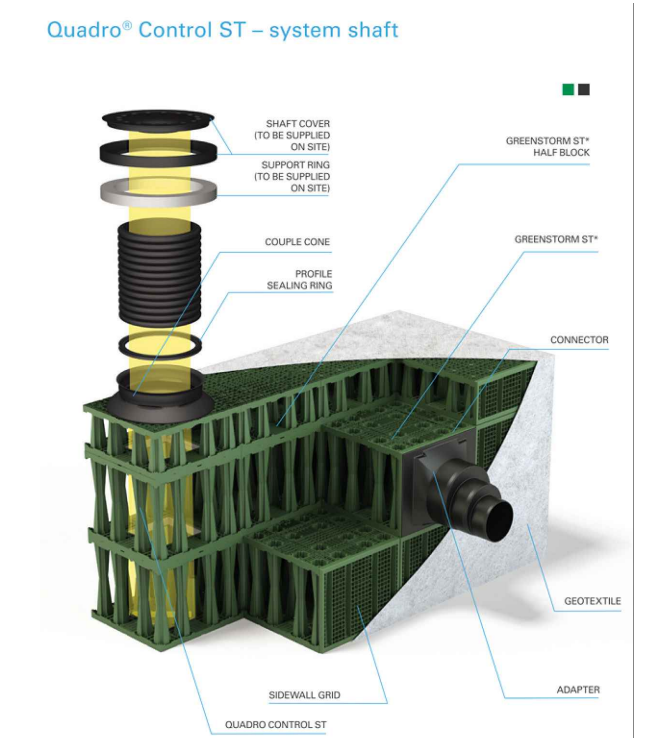
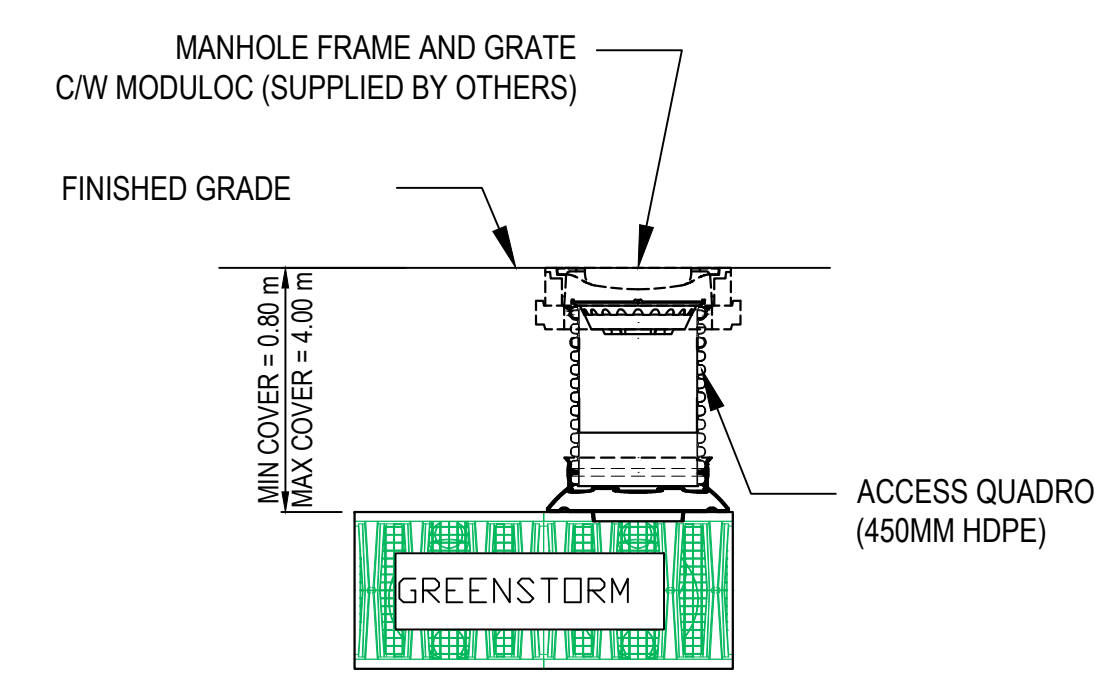

GREENSTORM ACCESS QUADRO DETAIL (WHERE APPLICABLE)

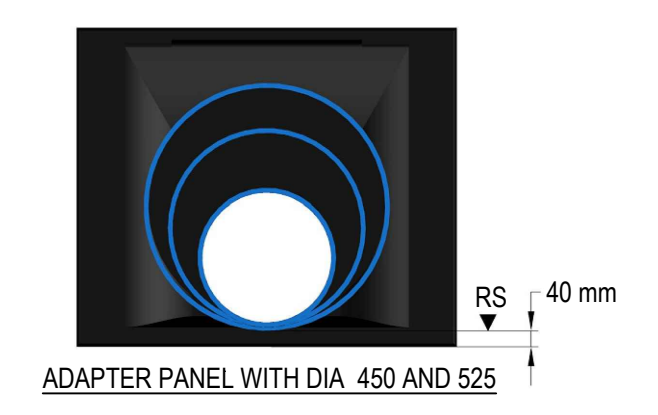
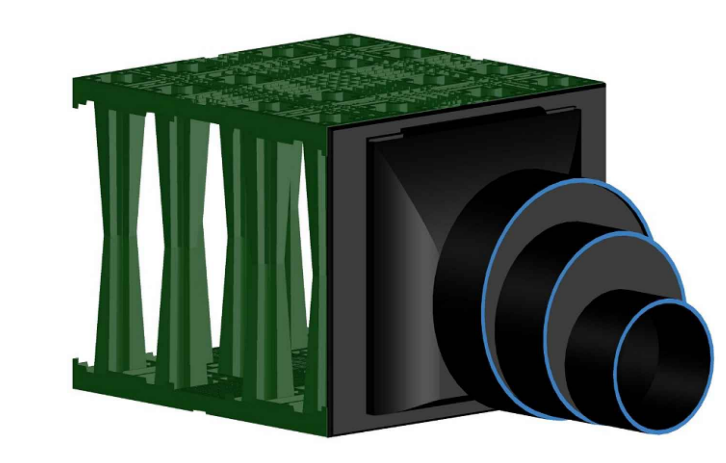

STANDARD ADAPTER PANEL WITH DIA 450 AND 525

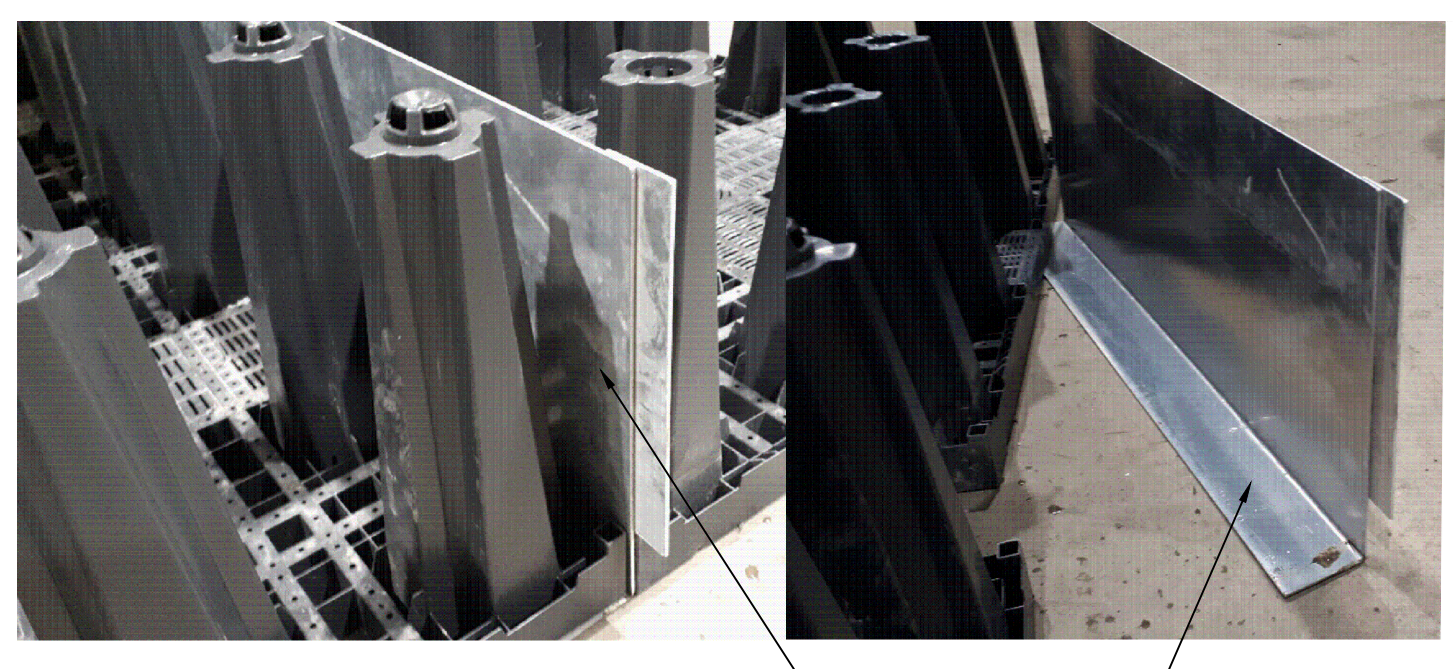

STANDARD TREATMENT ROW DETAIL (WHERE APPLICABLE)

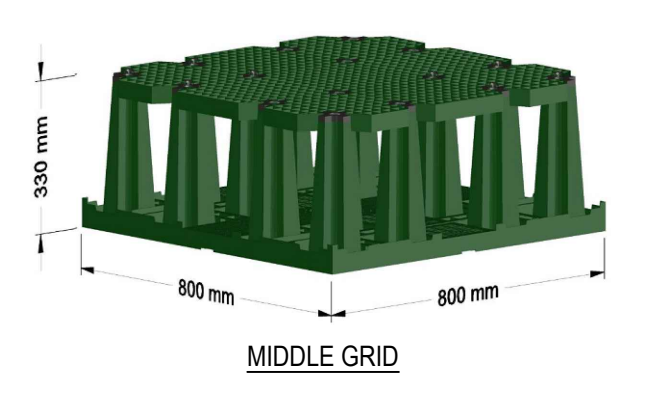
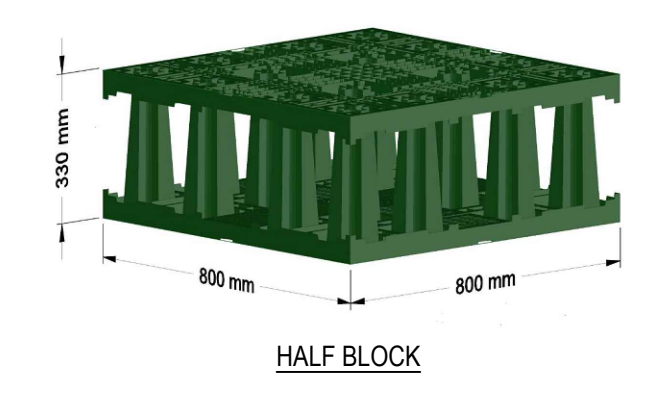
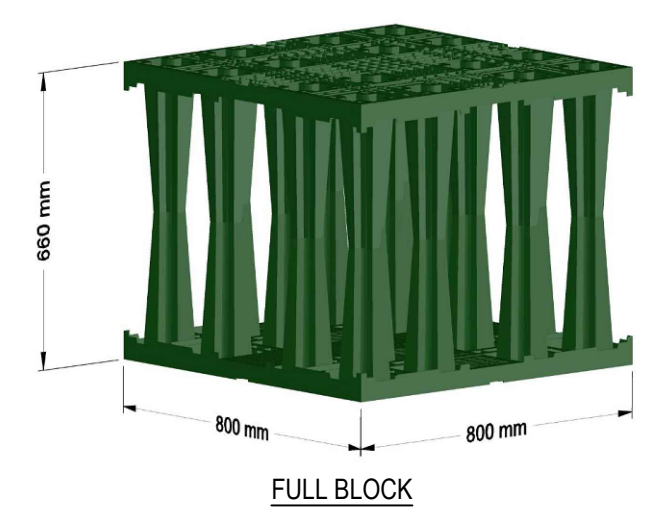

STANDARD GREENSTORM BLOCK DETAIL



CDS AVERAGE ANNUAL EFFICIENCY FOR TSS REMOVAL & TOTAL ANNUAL VOLUME TREATED



Project: 1971 & 1975 St. Laurent Blvd
Location: Ottawa, ON
OGS ID: OGS

Engineer: Counterpoint Engineering
Contact: G. Di Luca, P.Eng.
Date: 15/Mar/23

Area: 3.32 ha
Rc: 0.77
Upstream Storage: 640 m³
CDS Model: PMSU3020-6

Treatment Capacity: 57 l/s
Particle Size Distribution: FINE
IDF Rainfall Data: Ottawa

Return	Period	Peak Flow	TSS Percentage Captured	Treated Flow Volume	Total Flow Volume	Annual Exceedance Probability	System Flow	CDS Flow	By-Pass Flow	Volume Percentage Treated
month / yr	Yr	l/s	%	litres	litres	%	l/s	l/s	l/s	%
1-M	0.083	0.48	98.71	886	886	100.00	0.48	0.48	0.00	100.00
2-M	0.1667	12.61	94.51	29641	29641	99.75	12.61	12.61	0.00	100.00
3-M	0.25	22.33	91.19	53553	53553	98.17	22.33	22.33	0.00	100.00
4-M	0.333	30.95	88.23	75328	75328	95.04	30.95	30.95	0.00	100.00
5-M	0.417	37.52	85.98	92202	92202	90.91	37.52	37.52	0.00	100.00
6-M	0.5	44.09	83.72	109077	109077	86.47	44.09	44.09	0.00	100.00
7-M	0.583	48.95	82.00	121758	121921	82.01	48.95	48.95	0.00	99.89
8-M	0.667	53.81	80.27	134439	134765	77.67	53.81	53.81	0.00	99.78
9-M	0.75	58.67	78.54	147121	147610	73.64	58.67	56.99	1.68	99.67
10-M	0.833	62.46	76.54	153904	157737	69.90	62.46	56.99	5.47	97.81
11-M	0.917	66.25	74.54	160686	167864	66.40	66.25	56.99	9.26	95.95
1-Yr	1	70.04	72.53	167469	177991	63.21	70.04	56.99	13.05	94.09
2-Yr	2	100.93	58.28	203735	264336	39.35	100.93	56.99	43.94	77.07
5-Yr	5	161.81	41.96	253832	450340	18.13	161.81	56.99	104.81	56.36
10-Yr	10	203.73	35.14	282095	593830	9.52	203.73	56.99	146.74	47.50
25-Yr	25	251.00	29.56	312549	777632	3.92	251.00	56.99	194.01	40.19
50-Yr	50	288.26	26.08	336774	945953	1.98	288.26	56.99	231.27	35.60
100-Yr	100	322.67	23.37	361186	1127797	1.00	322.67	56.99	265.67	32.03

Average Annual TSS Removal Efficiency [%]: 80.0 Ave. Ann. T. Volume [%]: 96.0

Notes:

- 1) CDS Efficiency based on testing conducted at the University of Central Florida
- 2) CDS design flowrate and scaling based on standard manufacturer model & product specifications

CDS PMSU3020-6-C DESIGN NOTES

THE STANDARD CDS PMSU3020-6-C CONFIGURATION IS SHOWN. ALTERNATE CONFIGURATIONS ARE AVAILABLE AND ARE LISTED BELOW. SOME CONFIGURATIONS MAY BE COMBINED TO SUIT SITE REQUIREMENTS.

CONFIGURATION DESCRIPTION

- GRATED INLET ONLY (NO INLET PIPE)
- GRATED INLET WITH INLET PIPE OR PIPES
- CURB INLET ONLY (NO INLET PIPE)
- CURB INLET WITH INLET PIPE OR PIPES
- CUSTOMIZABLE SUMP DEPTH AVAILABLE
- ANTI-FLOTATION DESIGN AVAILABLE UPON REQUEST

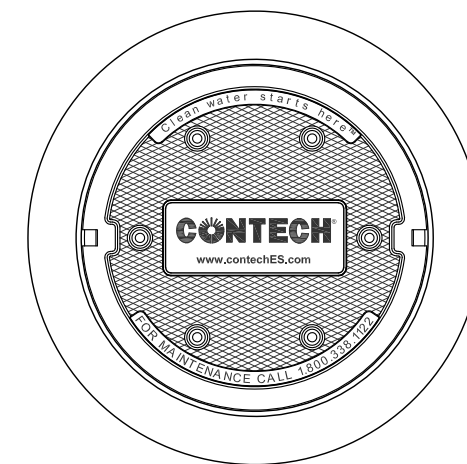
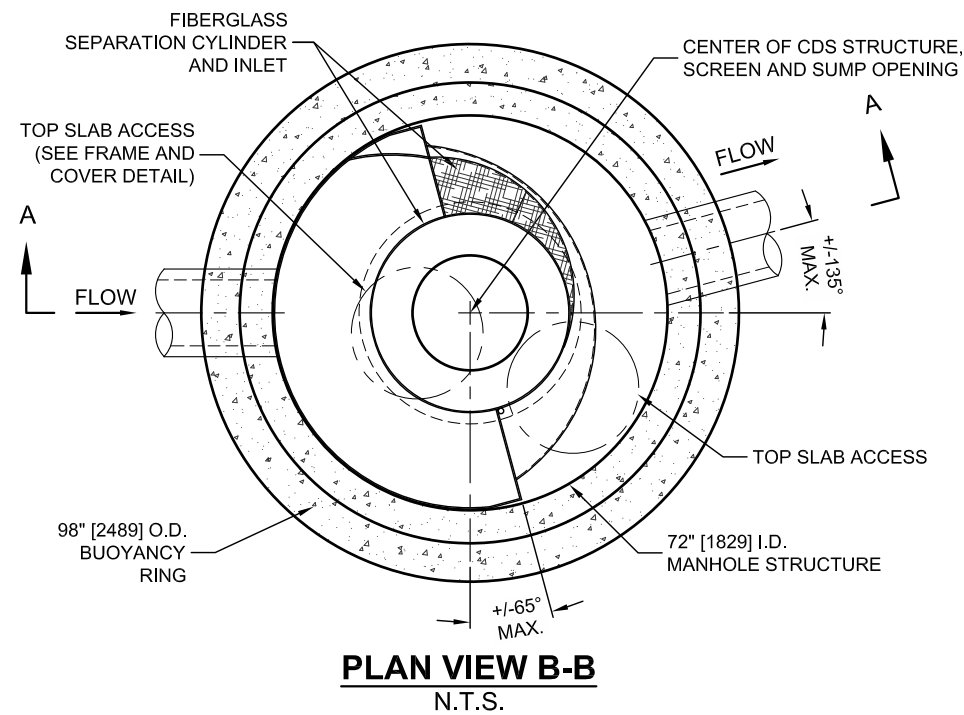

FRAME AND COVER
(DIAMETER VARIES)
N.T.S.

SITE SPECIFIC DATA REQUIREMENTS

STRUCTURE ID				
WATER QUALITY FLOW RATE (CFS OR L/s)				*
PEAK FLOW RATE (CFS OR L/s)				*
RETURN PERIOD OF PEAK FLOW (YRS)				*
SCREEN APERTURE (2400 OR 4700)				*
PIPE DATA:	I.E.	MATERIAL	DIAMETER	
INLET PIPE 1	*	*	*	
INLET PIPE 2	*	*	*	
OUTLET PIPE	*	*	*	
RIM ELEVATION				*
ANTI-FLOTATION BALLAST	*	WIDTH	*	HEIGHT
NOTES/SPECIAL REQUIREMENTS:				
* PER ENGINEER OF RECORD				

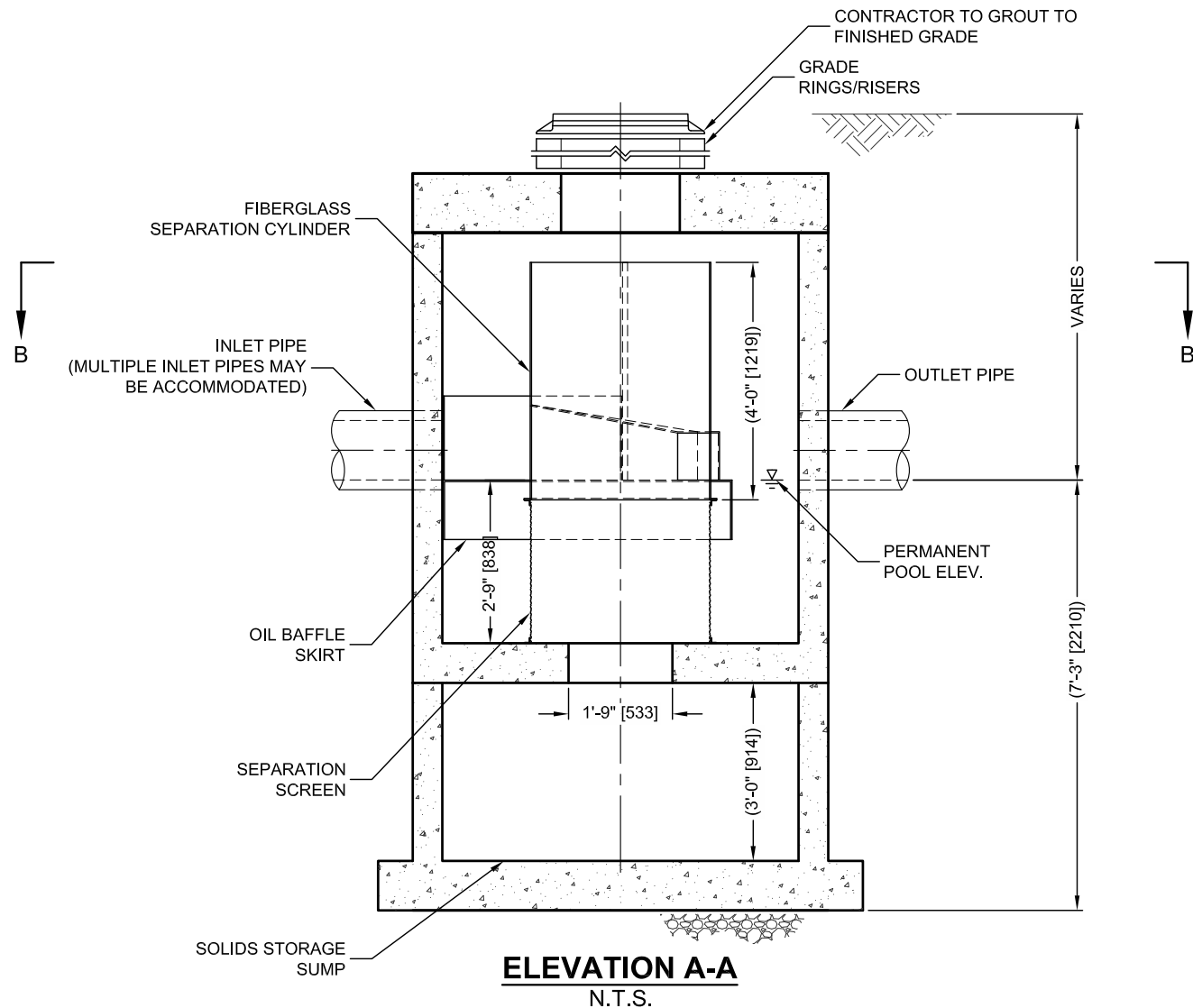

GENERAL NOTES

1. CONTECH TO PROVIDE ALL MATERIALS UNLESS NOTED OTHERWISE.
2. DIMENSIONS MARKED WITH () ARE REFERENCE DIMENSIONS. ACTUAL DIMENSIONS MAY VARY.
3. FOR FABRICATION DRAWINGS WITH DETAILED STRUCTURE DIMENSIONS AND WEIGHTS, PLEASE CONTACT YOUR CONTECH ENGINEERED SOLUTIONS LLC REPRESENTATIVE. www.contechES.com
4. CDS WATER QUALITY STRUCTURE SHALL BE IN ACCORDANCE WITH ALL DESIGN DATA AND INFORMATION CONTAINED IN THIS DRAWING.
5. STRUCTURE SHALL MEET AASHTO HS20 AND CASTINGS SHALL MEET HS20 (AASHTO M 306) LOAD RATING, ASSUMING GROUNDWATER ELEVATION AT, OR BELOW, THE OUTLET PIPE INVERT ELEVATION. ENGINEER OF RECORD TO CONFIRM ACTUAL GROUNDWATER ELEVATION.
6. PVC HYDRAULIC SHEAR PLATE IS PLACED ON SHELF AT BOTTOM OF SCREEN CYLINDER. REMOVE AND REPLACE AS NECESSARY DURING MAINTENANCE CLEANING.

INSTALLATION NOTES

- A. ANY SUB-BASE, BACKFILL DEPTH, AND/OR ANTI-FLOTATION PROVISIONS ARE SITE-SPECIFIC DESIGN CONSIDERATIONS AND SHALL BE SPECIFIED BY ENGINEER OF RECORD.
- B. CONTRACTOR TO PROVIDE EQUIPMENT WITH SUFFICIENT LIFTING AND REACH CAPACITY TO LIFT AND SET THE CDS MANHOLE STRUCTURE (LIFTING CLUTCHES PROVIDED).
- C. CONTRACTOR TO ADD JOINT SEALANT BETWEEN ALL STRUCTURE SECTIONS, AND ASSEMBLE STRUCTURE.
- D. CONTRACTOR TO PROVIDE, INSTALL, AND GROUT PIPES. MATCH PIPE INVERTS WITH ELEVATIONS SHOWN.
- E. CONTRACTOR TO TAKE APPROPRIATE MEASURES TO ASSURE UNIT IS WATER TIGHT, HOLDING WATER TO FLOWLINE INVERT MINIMUM. IT IS SUGGESTED THAT ALL JOINTS BELOW PIPE INVERTS ARE GROUTED.



www.contechES.com
9025 Centre Pointe Dr., Suite 400, West Chester, OH 45069
800-338-1122 513-645-7000 513-645-7993 FAX

CDS PMSU3020-6-C
INLINE CDS
STANDARD DETAIL



APPENDIX C

Counterpoint Engineering Inc.

SUMMARY OF PEAK FLOWS

Table C

Project: 1971 & 1975 St. Laurent Blvd.
Project No: 21106
Location: Ottawa

Block	Site Area (ha)	Retail Area (Ha)	Residential Population (Persons)	Peak Flow with Infiltration (l/s)
Existing Development	3.88	-	1,295	14.62
Proposed Developemnt (Net Increase - Total Site)		-	897	10.77

Counterpoint Engineering Inc.

EXISTING BUILDING/SITE

Table C1

Project: 1971 & 1975 St. Laurent Blvd.
Project No: 21106
Location: Ottawa
Site Area: 3.878 ha

Per Captia Flow for External Reviews

Residential	280	litres/person/day
Commercial	28,000	litres/gross ha/day
Infiltration (Dry)	0.33	litres/ha/second

Residential Population Criteria

Bachelor	1.4	ppu
1 Bedroom	1.4	ppu
2 Bedroom	2.1	ppu
3 Bedroom	3.1	ppu
Townhome	2.7	ppu
Duplex	2.3	ppu
Semi-Detached	2.7	ppu
Detached	3.4	ppu

Building	No. of Units	1 Bedroom	2 Bedroom	3 Bedroom	Retail Area (Ha)	Total Res Population
Existing Apartment (1971 St. Laurent Blvd.)	250	162	88	0	0.000	412
Existing Apartment (1975 St. Laurent Blvd.)	250	162	88	0	0.000	412
2080 & 2081 Russell Road	335	331	4	0	0.000	472
TOTAL	835	655	180	0	0.000	1295

Harmon Peaking Factor Residential: (Min=2.0, Max=4.0), Commercial: 1.5

Building	Total Population	Harmon Peak Factor
Residential	1295	3.2
Commercial	0	1.5

Peak Residential flow with 0.33 l/s/ha Infiltration:	14.62	l/s
Peak Commercial Flow:	0.00	l/s
Total Peak Flow:	14.62	l/s

Counterpoint Engineering Inc.

PROPOSED BUILDING/SITE

Table C2

Project: 1971 & 1975 St. Laurent Blvd.
 Project No: 21106
 Location: Ottawa
 Site Area: 3.878 ha

Per Capita Flow for External Reviews

Residential	280 litres/person/day
Commercial	28,000 litres/gross ha/day
Infiltration (Dry)	0.33 litres/ha/second

Residential Population Criteria

Bachelor	1.4 ppu
1 Bedroom	1.4 ppu
2 Bedroom	2.1 ppu
3 Bedroom	3.1 ppu
Townhome	2.7 ppu

Proposed Buildings (Outlet to Southvale Cres. Sanitary Sewer)

Site Area: 1.020 ha

Building	No. of Units	Bachelor/ Bedroom	1	2 Bedroom	3 Bedroom	Townhome	Retail Area (Ha)	Total Res Population
Building A	167	94		51	9	13	0.000	302
Building D - Parkade	0	0		0	0	0	0.000	0
TOTAL	167	94		51	9	13	0.000	302

Harmon Peaking Factor Residential: (Min=2.0, Max=4.0), Commercial: 1.5

Building	Total Population	Harmon Peak Factor
Residential	302	3.5

Peak Residential flow with 0.33 l/s/ha Infiltration: 3.72 l/s
 Peak Commercial Flow: 0.00 l/s

Proposed Buildings Total Peak Flow: 3.72 l/s

Proposed Buildings (Outlet to St. Laurent Blvd. Sanitary Sewer)

Site Area: 0.740 ha

Building	No. of Units	Bachelor/ Bedroom	1	2 Bedroom	3 Bedroom	Townhome	Retail Area (Ha)	Total Res Population
Building B	164	92		53	9	10	0.000	295
Building C	167	95		51	9	12	0.000	300
TOTAL	331	187		104	18	22	0.000	595

Harmon Peaking Factor Residential: (Min=2.0, Max=4.0), Commercial: 1.5

Building	Total Population	Harmon Peak Factor
Residential	595	3.3

Peak Residential flow with 0.33 l/s/ha Infiltration: 6.70 l/s
 Peak Commercial Flow: 0.00 l/s

Proposed Buildings Total Peak Flow: 6.70 l/s

Proposed Parkland (Outlet to St. Laurent Blvd. Sanitary Sewer)

Site Area: 0.180 ha

Building	No. of Units	Bachelor/ Bedroom	1	2 Bedroom	3 Bedroom	Townhome	Retail Area (Ha)	Total Res Population
Parkland Dedication	0	0		0	0	0	0.000	0
TOTAL	0	0		0	0	0	0.000	0

Harmon Peaking Factor Residential: (Min=2.0, Max=4.0), Commercial: 1.5

Building	Total Population	Harmon Peak Factor
Residential	0	3.8

Peak Residential flow with 0.33 l/s/ha Infiltration: 0.06 l/s
 Peak Commercial Flow: 0.00 l/s

Proposed Parkland Total Peak Flow: 0.06 l/s

Combined Site Net Increase Total

Harmon Peaking Factor Residential: (Min=2.0, Max=4.0), Commercial: 1.5

Building	Total Population	Harmon Peak Factor
Residential	897	3.3

Peak Residential flow with 0.33 l/s/ha Infiltration:	10.77	l/s
Peak Commercial Flow:	0.00	l/s

Grand Total Peak Flow:	10.77	l/s
-------------------------------	--------------	------------

Proposed Conditions - Sanitary Flow

1971 & 1975 St. Laurent Blvd. - Russell Rd. Sewer

Composite population density per unit:
 Single/Semi-Detached = 3.4
 Townhouse = 2.7
 1 Bdrm. Apartments = 1.4
 2 Bdrm. Apartments = 2.1
 3 Bdrm. Apartments = 3.1

Design Flow-Commercial= 28,000 L/Gross Ha/day
 Population density-Office= 28,000 L/Gross Ha/day
 A = area ha

Infiltration (Dry Conditions)= 0.33 l/s/ha
 Flow (Residential), Q= 280 l/person/day

p - Equivalent residential population density (based on ppl/ha)
 AREA - Area of the commercial/institutional/industrial site
 EQUIV RES P - Equivalent residential population (based on ppl/ha)
 RES UNITS - Residential number of units
 RES POP P - Residential population
 A SITE - Residential Area
 A GROSS - Cumulative Residential + Non-Residential Area

P = population = sum p A site
 Pflow = M q P / 86400 = population flow l/s
 M = $1 + (14/(4+(P/10^3)^{0.5}))$ Min=2.0, Max=4.0
 I = 0.33 x A gross l/s
 Q TOTAL = P flow + I l/s
 q = 280 l/person/day (For the analysis of existing sewers - residential)
 q = 28,000 l/gross hectares/day inc. infiltration and peaking effect (For the analysis of existing sewers - comm/ind/office)

Date: #####
 Designed by GD
 Checked by JY

STREET	MANHOLE		Area and Total Population			Commercial/Industrial/Inst. Cumulative				Residential Cumulative				A	I	Prop.	Q	LENGTH	SLOPE	D	TYPE	ROUGH.	Q	Velocity	Capacity	
	FROM	TO	GROSS AREA ha	EQUIV. POP P	ACCUM. EQUIV. POP P	FLOOR AREA ha	ACCUM. FLOOR AREA ha	M	PEAK FLOW l/s	RES. AREA ha	POP. P	M	PEAK FLOW l/s	Infiltrated Area ha	l/s	Foundation Drain l/s	TOTAL l/s	(m)	S %	(mm)	OF PIPE	COEFF.	FULL (L/s)	Full (m/s)	(%)	
Russell Road																										
Building A	BLDG A	MH3A	0.34	302	302	0.00	0.000	1.00	0.0	0.34	302	4.00	3.9	0.34	0.11	0.00	4.0	16.0	2.00	200	PVC	0.013	48.3	1.49	8%	
Subject Site-Building A	MH3A	EX.MH4A	0.20	0	302	0.00	0.000	1.00	0.0	0.54	302	4.00	3.9	0.54	0.18	0.00	4.1	85.0	1.00	200	PVC	0.013	34.1	1.05	12%	
EX. Building	EX.1971	EX.MH6A	0.48	412	412	0.00	0.000	1.00	0.0	0.48	412	4.00	5.3	0.48	0.16	0.00	5.5	12.0	1.00	150	CONC	0.013	15.2	0.86	36%	
EX. Building	EX.1975	EX.MH6A	0.34	412	824	0.00	0.000	1.00	0.0	0.82	824	3.85	10.3	0.82	0.27	0.00	10.6	12.0	1.00	150	CONC	0.013	15.2	0.86	69%	
EX. Building	EX.MH6A	EX.MH5A	0.000	0	824	0.00	0.000	1.00	0.0	0.82	824	3.85	10.3	0.00	0.00	0.00	10.3	15.0	1.00	150	CONC	0.013	15.2	0.86	68%	
Proposed Parking	PARKADE	MH7A	0.69	0	0	0.00	0.000	1.00	0.0	0.69	0	4.00	0.0	0.69	0.23	0.00	0.2	1.3	2.00	150	PVC	0.013	21.5	1.22	1%	
Proposed Parking	MH7A	EX.MH5A	0.00	0	0	0.00	0.000	1.00	0.0	0.69	0	4.00	0.0	0.69	0.23	0.00	0.2	13.7	2.00	150	PVC	0.013	21.5	1.22	1%	
Subject Site-Ex. Building	EX.MH5A	EX.MH4A	0.10	0	824	0.00	0.000	1.00	0.0	1.61	824	3.85	10.3	1.61	0.53	0.00	10.8	96.7	0.44	200	CONC	0.013	22.6	0.70	48%	
Subject Site	EX.MH4A	EX.MH3A	0.20	0	1126	0.00	0.000	1.00	0.0	2.36	1126	3.77	13.7	2.36	0.78	0.00	14.5	80.5	0.43	250	CONC	0.013	40.7	0.80	36%	
EX. Building - 2080 Russell Rd.	EX.2080	EX.MH3A	0.60	236	236	0.00	0.000	1.00	0.0	0.60	236	4.00	3.1	0.60	0.20	0.00	3.3	35.2	2.00	200	CONC	0.013	48.3	1.49	7%	
Subject Site	EX.MH3A	EX.MH2A	0.20	0	1362	0.00	0.000	1.00	0.0	3.15	1362	3.71	16.4	3.15	1.04	0.00	17.4	38.4	0.34	250	CONC	0.013	36.2	0.71	48%	
EX. Building - 2100 Russell Rd.	EX.2100	EX.MH2.	0.60	236	236	0.00	0.000	1.00	0.0	0.60	236	4.00	3.1	0.60	0.20	0.00	3.3	10.5	0.50	200	PVC	0.013	24.1	0.75	14%	
Municipal Connection	EX.MH2A	EX.MH1A	0.00	0	1598	0.00	0.000	1.00	0.0	3.76	1598	3.66	19.0	3.76	1.24	0.00	20.2	44.5	1.30	250	CONC	0.013	70.7	1.40	29%	

Proposed Conditions - Sanitary Flow

1971 & 1975 St. Laurent Blvd. - St. Laurent Blvd. Sewer

Composite population density per unit: Design Flow-Commercial= 28,000 L/Gross Ha/day
 Single/Semi-Detached = 3.4 Population density-Office= 28,000 L/Gross Ha/day
 Townhouse = 2.7 A = area ha
 1 Bdrm. Apartments = 1.4
 2 Bdrm. Apartments = 2.1
 3 Bdrm. Apartments = 3.1

Infiltration (Dry Conditions)= 0.33 I/s/ha
 Flow (Residential), Q= 280 I/person/day

P = population = sum p A site
 Pflow = M q P / 86400 = population flow l/s
 M = 1 + (14/(4+(P/10³)^{0.5})) Min=2.0, Max=4.0
 Q TOTAL = P flow + I I/s
 I = 0.33 x A gross l/s
 q = 280 l/person/day (For the analysis of existing sewers - residential)
 q = 28,000 l/gross hectares/day inc. infiltration and peaking effect (For the analysis of existing sewers - comm/ind/office)

Date: 17-Mar-23
 Designed by GD
 Checked by: JY

p - Equivalent residential population density (based on ppl/ha)
 AREA - Area of the commercial/institutional/industrial site
 EQUIV RES P - Equivalent residential population (based on ppl/ha)
 RES UNITS - Residential number of units
 RES POP P - Residential population
 A SITE - Residential Area
 A GROSS - Cumulative Residential + Non-Residential Area

STREET	MANHOLE		Area and Total Population			Commercial/Industrial/Inst. Cumulative				Residential Cumulative				A	I	Prop.	Q	LENGTH	SLOPE	D	TYPE	ROUGH.	Q	Velocity	Capacity	
	FROM	TO	GROSS AREA	EQUIV. POP P	ACCUM. EQUIV. POP P	FLOOR AREA	ACCUM. FLOOR AREA	M	PEAK FLOW I/s	RES. AREA ha	POP. P	M	PEAK FLOW I/s													Infiltrated Area ha
St. Laurent Blvd.																										
Subject Site-Building B	Bldg B	MH102A	0.36	295	295	0.000	0.000	1.00	0.0	0.36	295	4.00	3.8	0.36	0.12	0.00	3.9	2.0	2.00	200	PVC	0.013	48.3	1.49	8%	
Subject Site-Building B	MH102A	EX. MH8A	0.00	0	295	0.000	0.000	1.00	0.0	0.36	295	4.00	3.8	0.36	0.12	0.00	3.9	30.6	2.00	200	PVC	0.013	48.3	1.49	8%	
												4.00														
Subject Site-Building C	Bldg C	MH101A	0.38	300	300	0.000	0.000	1.00	0.0	0.38	300	4.00	3.9	0.38	0.13	0.00	4.0	2.0	2.00	200	PVC	0.013	48.3	1.49	8%	
Subject Site-Building C	MH101A	EX. MH9A	0.00	0	300	0.000	0.000	1.00	0.0	0.38	300	4.00	3.9	0.38	0.13	0.00	4.0	10.8	2.00	200	PVC	0.013	48.3	1.49	8%	
												4.00														
Park	Parkland	MH104A	0.180	0	0	0.000	0.000	1.00	0.0	0.180	0	4.00	0.0	0.18	0.06	0.00	0.1	2.0	2.00	200	PVC	0.013	48.3	1.49	0%	
Park	MH104A	MH103A	0.000	0	0	0.000	0.000	1.00	0.0	0.180	0	4.00	0.0	0.18	0.06	0.00	0.1	12.4	2.00	200	PVC	0.013	48.3	1.49	0%	

Property Details

 och-ico.ca/properties/russell-gardens/

Russell Gardens - Hawthorne Meadows

2080 Russell Road

2080 Russell Road

Russell Gardens is located on the west side of Russell Road, east of St. Laurent Boulevard. The community is close to public transportation and shopping malls. There is a community room in each building with an outdoor patio area.

Details

Property Type

Neighborhood	Hawthorne Meadows
--------------	-------------------

Location	2080 Russell Road, Ottawa Division, ON, Canada
----------	--

Accessible Units	no
------------------	----

Seniors Only	no
--------------	----

Number of Units	335
-----------------	-----

Number of Stories	6
-------------------	---

Market units	no
--------------	----

Subsidized units	yes
------------------	-----

Hydro paid by tenant	no
----------------------	----

Heat paid by tenant	no
---------------------	----

Parking on site	yes
-----------------	-----

Parking charge	yes
----------------	-----

District Contact

District Contact

Bank Office
1365 Bank St.,
Ottawa, ON
613-731-1182

Russell Gardens - Hawthorne Meadows

2080 Russell Road

Details

Hydro paid by tenant no

Heat paid by tenant no

Parking on site yes

Parking charge yes

Washer Available no

Dryer Available no

Elevator yes

Unit Breakdown

Type	Room	Bach	1BR	2BR	3BR	4BR	5BR
apartments			331	4			



APPENDIX D

Water Demand Calculations

BUILDING A, PARKADE & EXISTING BUILDINGS

Project Name: 1971 & 1975 St. Laurent Blvd.
 Project Number: 21106
 Location: Ottawa
 Date: March 2023

City of Ottawa Watermain Design Guidelines

Water Demand = Maximum Day Flow + Fire Flow or Peak Hour Flow

Domestic Demand

Residential Flow (Avg Day Demand)	280	L/capita/day
Max Day Demand (2.5 x Avg Day Demand)	700	L/capita/day
Max Hour Demand (2.2 x Max Day Demand)	1540	L/capita/day

Commercial & Institutional Demand

Retail/Shopping Centres	2,500	L/1000m ² /day
-------------------------	-------	---------------------------

Fire Demand

Fire Flow	15,000	L / min
Fire Flow Duration	2	hours

- See FUS calculations.

Residential Population	1,597 Ppl	- See Sanitary Flow Calculations
Domestic Demand:	447076 L / day	
, or	310 L/min	5.2 L/s
Maximum Day Water Demand - Domestic:	1,117,690 L / day	
Total Maximum Day Water Demand:	1,117,690 L / day	
, or	776 L / min	12.9 L/s
Maximum Hour Water Demand - Domestic:	2,458,918 L / day	
Total Maximum Hour Water Demand:	2,458,918 L / day	
, or	1,708 L / min	28.5 L/s
Retail Area	0.0 m ²	- See Sanitary Flow Calculations
Commercial & Institutional Demand:	0 L / day	
, or	0 L/min	
Maximum Day + Fire Flow:	15,776 L / min	262.9 L/s
	or	
	4,168 USGPM	

Water Demand Calculations

BUILDING B

Project Name: 1971 & 1975 St. Laurent Blvd.
 Project Number: 21106
 Location: Ottawa
 Date: January 2022

City of Ottawa Watermain Design Guidelines

Water Demand = Maximum Day Flow + Fire Flow or Peak Hour Flow

Domestic Demand

Residential Flow (Avg Day Demand)	280	L/capita/day
Max Day Demand (2.5 x Avg Day Demand)	700	L/capita/day
Max Hour Demand (2.2 x Max Day Demand)	1540	L/capita/day

**Peaking factors as per Table 3-3 of the MOE Design Guidelines for Drinking Water Systems
 (used for opulations 500ppl or less in City of Ottawa)*

Commercial & Institutional Demand

Retail/Shopping Centres	2,500	L/1000m ² /day
-------------------------	-------	---------------------------

Fire Demand

Fire Flow	4,000	L / min
Fire Flow Duration	2	hours

- See FUS calculations.

Residential Population	295 Ppl	- See Sanitary Flow Calculations
Domestic Demand:	82600 L / day	
, or	57 L/min	1.0 L/s
Maximum Day Water Demand - Domestic:	206,500 L / day	
Total Max Day Demand:	206,500 L / day	
, or	143 L / min	2.4 L/s
Maximum Hour Water Demand - Domestic:	454,300 L / day	
Total Maximum Hour Water Demand:	454,300 L / day	
, or	315 L / min	5.3 L/s
Retail Area	0.0 m ²	- See Sanitary Flow Calculations
Commercial & Institutional Demand:	0 L / day	
, or	0 L/min	
Maximum Day + Fire Flow:	4,143 L / min	69.1 L/s
	or	
	1,095 USGPM	

Water Demand Calculations

BUILDING C

Project Name: 1971 & 1975 St. Laurent Blvd.
 Project Number: 21106
 Location: Ottawa
 Date: January 2022

City of Ottawa Watermain Design Guidelines

Water Demand = Maximum Day Flow + Fire Flow or Peak Hour Flow

Domestic Demand

Residential Flow (Avg Day Demand)	280	L/capita/day
Max Day Demand (2.5 x Avg Day Demand)	700	L/capita/day
Max Hour Demand (2.2 x Max Day Demand)	1540	L/capita/day

**Peaking factors as per Table 3-3 of the MOE Design Guidelines for Drinking Water Systems
 (used for opulations 500ppl or less in City of Ottawa)*

Commercial & Institutional Demand

Retail/Shopping Centres	2,500	L/1000m ² /day
-------------------------	-------	---------------------------

Fire Demand

Fire Flow	4,000	L / min
Fire Flow Duration	2	hours

- See FUS calculations.

Residential Population	300 Ppl	- See Sanitary Flow Calculations
Domestic Demand:	84112 L / day	
, or	58 L/min	1.0 L/s
Maximum Day Water Demand - Domestic:	210,280 L / day	
Total Maximum Day Water Demand:	210,280 L / day	
, or	146 L / min	2.4 L/s
Maximum Hour Water Demand - Domestic:	462,616 L / day	
Total Maximum Hour Water Demand:	462,616 L / day	
, or	321 L / min	5.4 L/s
Retail Area	0.0 m ²	- See Sanitary Flow Calculations
Commercial & Institutional Demand:	0 L / day	
, or	0 L/min	
Maximum Day + Fire Flow:	4,146 L / min	69.1 L/s
	or	
	1,095 USGPM	

Fire Underwriter Survey (2020) Fire Flow Calculation - 1971 St. Laurent Blvd Existing Building

Project Name: 1971 & 1975 St. Laurent Blvd.
 Project Number: 21106
 Date: January 2022

$$F = 220C\sqrt{A}$$

Where

NPF = The Required Fire Flow in litres per minute (LPM)
 C = the Construction Coefficient is related to the type of construction of the building
 A = the Total Effective Floor Area (effective building area) in square metres of the building

- C = 1.5 for Type V Wood Frame Construction
- 1.0 for Type IVa Mass Timber Construction
- 0.9 for Type IVb Mass Timber Construction
- 1.0 for Type IVc Mass Timber Construction
- 1.5 for Type IVd Mass Timber Construction
- 2.0 for Type III Ordinary Construction
- 0.8 for Type II Noncombustible Construction
- 0.5 for Type I Fire Resistive Construction

A = The total floor area in square metres (including all storeys, but excluding basements at least 50 percent below grade) in the building being considered.

Legend

Construction Class	Contents Factor
WF wood frame construction	NC non-combustible
OC ordinary construction	LC limited combustible
NC non-combustible construction	C combustible
FC fire-resistive construction	FB free burning
	RB rapid burning

Contents Factor:	Non-Combustible	-25%	Free Burning	+15%
	Limited Combustible	-15%	Rapid Burning	+25%
	Combustible	No Charge		

Separation	Charge	Separation	Charge
0 to 3m	25%	20.1 to 30 m	10%
3.1 to 10m	20%	30.1 to 45m	5%
10.1 to 20m	15%		

1) Fire Flow

Type of Construction: NC
 C = 0.8
 A = 5472 m² - Area of two largest adjoining floors plus 50% of all floors above upto 8 floors.
 F = 14,000 L/min

2) Occupancy Reduction

Contents Factor: LC
 Occupancy Charge = -15%
 -15% of 14,000 L/min = -2,100 L/min
 F = 13000 L/min + 3250 L/min = 11,900 L/min

3) System Type Reduction (to be reduced from result of Step 2)

NFPA 13 Sprinkler: 30% YES
 Standard Water Supply: 10% YES
 Fully Supervised: 10% YES
 Total System Type Reduction = 50%

50% of 11,900 L/min = 5,950 L/min
 (to be reduced from result of Step 2)

4) Separation Charge (to be added to result of Step 2)

Building Face	Distance (m)	Length- Height Factor	Bldg Type	Auto Sprinkler	Charge
				Protection: Exposed BLDG (50% charge). Exposed & Subject Bldg (0% charge)	
North	>30	-	-	-	= 0%
East	15	236	Type III-IV ²	0%	= 0%
South	6.5	140	Type III-IV ²	NO	= 15%
West	23	510	Type III-IV ²	NO	= 5%
Total					20% (max exposure charge can be 75%)

20% of 11,900 L/min = 2,380
 (to be added to result of Step 2)

F = 9,000 L/min (round to the nearest 1,000 L/min) (2,000 L/min < F < 45,000 L/min)
 F = 2,378 GPM

Fire Underwriter Survey (2020) Fire Flow Calculation - 1975 St. Laurent Blvd Existing Building

Project Name: 1971 & 1975 St. Laurent Blvd.
 Project Number: 21106
 Date: January 2022

$$F = 220C\sqrt{A}$$

whereas

FFF = the Required Fire Flow in litres per minute (LPM)
C = the Contents Factor, dependent on the type of construction of the building
A = the Total Effective Floor Area (including areas to require water of the building)

- C** =
- 1.5 for Type I Wood Frame Construction
 - 0.8 for Type II-A Mass Timber Construction
 - 0.8 for Type II-B Mass Timber Construction
 - 1.0 for Type III-C Mass Timber Construction
 - 1.5 for Type III-D Mass Timber Construction
 - 1.0 for Type III Ordinary Construction
 - 0.5 for Type I Non-combustible Construction
 - 0.5 for Type I Fire Resistive Construction

A = The total floor area in square metres (including all storeys, but excluding basements at least 50 percent below grade) in the building being considered.

Legend

Construction Class		Contents Factor	
WF	wood frame construction	NC	non-combustible
OC	ordinary construction	LC	limited combustible
NC	non-combustible construction	C	combustible
FC	fire-resistive construction	FB	free burning
		RB	rapid burning

Contents Factor:

Non-Combustible	-25%	Free Burning	+15%
Limited Combustible	-15%	Rapid Burning	+25%
Combustible	No Charge		

Separation	Charge	Separation	Charge
0 to 3m	25%	20.1 to 30 m	10%
3.1 to 10m	20%	30.1 to 45m	5%
10.1 to 20m	15%		

1) Fire Flow

Type of Construction: NC
 C = 0.8
 A = 5610 m² - Area of two largest adjoining floors plus 50% of all floors above upto 8 floors.
 F = 14,000 L/min

2) Occupancy Reduction

Contents Factor: LC
 Occupancy Charge = -15%
 -15% of 14,000 L/min = -2,100 L/min
 F = 13000 L/min + 3250 L/min = 11,900 L/min

3) System Type Reduction (to be reduced from result of Step 2)

NFPA 13 Sprinkler: 30% YES
 Standard Water Supply: 10% YES
 Fully Supervised: 10% YES
 Total System Type Reduction = 50%
 50% of 11,900 L/min = 5,950 L/min
 (to be reduced from result of Step 2)

4) Separation Charge (to be added to result of Step 2)

Building Face	Distance (m)	Length-Height Factor	Bldg Type	Auto Sprinkler	Charge
				Protection: Exposed BLDG (50% charge), Exposed & Subject Bldg (0% charge)	
North	>30	-	-	-	= 0%
East	>30	-	-	-	= 0%
South	19.7	148	Type III-IV ²	0%	= 0%
West	28.7	510	Type III-IV ²	NO	= 5%
Total					5% (max exposure charge can be 75%)

5% of 11,900 L/min = 595 L/min
 (to be added to result of Step 2)
 F = 7,000 L/min (round to the nearest 1,000 L/min) (2,000 L/min < F < 45,000 L/min)
 F = 1,849 GPM

Fire Underwriter Survey (2020) Fire Flow Calculation - 2080 Russell Road Existing Building

Project Name: 1971 & 1975 St. Laurent Blvd.
 Project Number: 21106
 Date: January 2022

$$F = 220C\sqrt{A}$$

where
 F = the required fire flow in litres per minute.
 C = coefficient related to the type of construction.
 = 1.5 for wood frame construction (structure essentially all combustible).
 = 1.0 for ordinary construction (brick or other masonry walls, combustible floor and interior).
 = 0.8 for non-combustible construction (unprotected metal structural components, masonry or metal walls).
 = 0.6 for fire-resistive construction (fully protected frame, floors, roof).
 A = The total floor area in square metres (including all storeys, but excluding basements at least 50 percent below grade) in the building being considered.

Legend

Construction Class	Contents Factor
WF wood frame construction	NC non-combustible
OC ordinary construction	LC limited combustible
NC non-combustible construction	C combustible
FC fire-resistive construction	FB free burning
	RB rapid burning

Contents Factor: Non-Combustible -25% Free Burning +15%
 Limited Combustible -15% Rapid Burning +25%
 Combustible No Charge

Separation	Charge	Separation	Charge
0 to 3m	25%	20.1 to 30 m	10%
3.1 to 10m	20%	30.1 to 45m	5%
10.1 to 20m	15%		

1) Fire Flow

Type of Construction: NC
 C = 0.8
 A = 6845 m² - Area of two largest adjoining floors plus 50% of all floors above upto 8 floors.
 F = 15,000 L/min

2) Occupancy Reduction

Contents Factor: LC
 Occupancy Charge = -15%
 -15% of 15,000 L/min = -2,250 L/min
 F = 13000 L/min + 3250 L/min = 12,750 L/min

3) System Type Reduction (to be reduced from result of Step 2)

NFPA 13 Sprinkler: 30% YES
 Standard Water Supply: 10% YES
 Fully Supervised: 10% YES
 Total System Type Reduction = 50%
 50% of 12,750 L/min = 6,375 L/min
 (to be reduced from result of Step 2)

4) Separation Charge (to be added to result of Step 2)

Building Face	Distance (m)	Length-Height Factor	Bldg Type	Auto Sprinkler Protection: Exposed BLDG (50% charge), Exposed & Subject Bldg (0% charge)	Charge
North	>30	-	-	-	= 0%
East	>30	-	-	-	= 0%
South	18	129	Type V	NO	= 15%
West	13.6	372	Type III-IV ²	NO	= 10%
Total					25% (max exposure charge can be 75%)

25% of 12,750 L/min = 3,188 L/min
 (to be added to result of Step 2)

F = 10,000 L/min (round to the nearest 1,000 L/min) (2,000 L/min < F < 45,000 L/min)
 F = 2,642 GPM

Fire Underwriter Survey (2020) Fire Flow Calculation - 2100 Russell Road Existing Building

Project Name: 1971 & 1975 St. Laurent Blvd.
 Project Number: 21106
 Date: January 2022

$$F = 220C\sqrt{A}$$

where
 F = the required fire flow in litres per minute.
 C = coefficient related to the type of construction.
 = 1.5 for wood frame construction (structure essentially all combustible).
 = 1.0 for ordinary construction (brick or other masonry walls, combustible floor and interior).
 = 0.8 for non-combustible construction (unprotected metal structural components, masonry or metal walls).
 = 0.6 for fire-resistive construction (fully protected frame, floors, roof).
 A = The total floor area in square metres (including all storeys, but excluding basements at least 50 percent below grade) in the building being considered.

Legend

Construction Class	Contents Factor
WF wood frame construction	NC non-combustible
OC ordinary construction	LC limited combustible
NC non-combustible construction	C combustible
FC fire-resistive construction	FB free burning
	RB rapid burning

Contents Factor: Non-Combustible -25% Free Burning +15%
 Limited Combustible -15% Rapid Burning +25%
 Combustible No Charge

Separation	Charge	Separation	Charge
0 to 3m	25%	20.1 to 30 m	10%
3.1 to 10m	20%	30.1 to 45m	5%
10.1 to 20m	15%		

1) Fire Flow

Type of Construction: NC
 C = 0.8
 A = 10675 m² -Area of two largest adjoining floors plus 50% of all floors above upto 8 floors.
 F = 19,000 L/min

2) Occupancy Reduction

Contents Factor: LC
 Occupancy Charge = -15%
 -15% of 19,000 L/min = -2,850 L/min
 F = 13000 L/min + 3250 L/min = 16,150 L/min

3) System Type Reduction (to be reduced from result of Step 2)

NFPA 13 Sprinkler: 30% YES
 Standard Water Supply: 10% YES
 Fully Supervised: 10% YES
 Total System Type Reduction = 50%
 50% of 16,150 L/min = 8,075 L/min
 (to be reduced from result of Step 2)

4) Separation Charge (to be added to result of Step 2)

Building Face	Distance (m)	Length-Height Factor	Bldg Type	Auto Sprinkler Protection Reduction:		Charge
				Exposed BLDG (50% charge), Exposed & Subject Bldg (0% charge)		
North	>30	-	-	-	=	0%
East	>30	-	-	-	=	0%
South	23	28	Type V	NO	=	2%
West	14	69	Type V	NO	=	13%
Total						15% (max exposure charge can be 75%)

15% of 16,150 L/min = 2,423 L/min
 (to be added to result of Step 2)

F = 11,000 L/min (round to the nearest 1,000 L/min) (2,000 L/min < F < 45,000 L/min)
 F = 2,906 GPM

Fire Underwriter Survey (2020) Fire Flow Calculation - Proposed Building A

Project Name: 1971 & 1975 St. Laurent Blvd.
 Project Number: 21106
 Date: January 2022

$$F = 220C\sqrt{A}$$

Where:

RFC = The Required Fire Flow in litres per minute (LPM)
C = The Construction Coefficient related to the type of construction of the building
A = The Total Effective Floor Area (of the building area) in square metres of the building

- C**
- 1.5 for Type I Wood Frame Construction
 - 0.8 for Type IV or Mass Timber Construction
 - 0.5 for Type III or Mass Timber Construction
 - 1.0 for Type IV-C Mass Timber Construction
 - 1.5 for Type IV-B Mass Timber Construction
 - 1.0 for Type III Ordinary Construction
 - 0.5 for Type II Non-combustible Construction
 - 0.5 for Type I Fire Resistive Construction

A = The total floor area in square metres (including all storeys, but excluding basements at least 50 percent below grade) in the building being considered.

Legend

Construction Class	Contents Factor
WF wood frame construction	NC non-combustible
OC ordinary construction	LC limited combustible
NC non-combustible construction	C combustible
FC fire-resistive construction	FB free burning
	RB rapid burning

Contents Factor:

Non-Combustible	-25%	Free Burning	+15%
Limited Combustible	-15%	Rapid Burning	+25%
Combustible	No Charge		

Separation	Charge	Separation	Charge
0 to 3m	25%	20.1 to 30 m	10%
3.1 to 10m	20%	30.1 to 45m	5%
10.1 to 20m	15%		

1) Fire Flow

Type of Construction: NC
 C = 0.8
 A = 2327 m² - Area of Largest Floor plus 25% of the two adjacent floors
 F = 9,000 L/min

2) Occupancy Reduction

Contents Factor: LC
 Occupancy Charge = -15%
 -15% of 9,000 L/min = -1,350 L/min
 F = 13000 L/min + 3250 L/min = 7,650 L/min

3) System Type Reduction (to be reduced from result of Step 2)

NFPA 13 Sprinkler: 30% YES
 Standard Water Supply: 10% YES
 Fully Supervised: 10% YES
 Total System Type Reduction = 50%
 50% of 7,650 L/min = 3,825 L/min
 (to be reduced from result of Step 2)

4) Separation Charge (to be added to result of Step 2)

Building Face	Distance (m)	Length-Height Factor	Bldg Type	Auto Sprinkler Protection	Charge
				Reduction: Exposed BLDG (50% charge), Exposed & Subject Bldg (0% charge)	
North	>30	-	-	-	= 0%
East	>30	-	-	-	= 0%
South	28	442	Type III-IV ²	0%	= 0%
West	>30	-	-	-	= 0%
Total					0% (max exposure charge can be 75%)

0% of 7,650 L/min = 0 L/min
 (to be added to result of Step 2)

F = 4,000 L/min (round to the nearest 1,000 L/min) (2,000 L/min < F < 45,000 L/min)
 F = 1,057 GPM

Fire Underwriter Survey (2020) Fire Flow Calculation - Proposed Building B

Project Name: 1971 & 1975 St. Laurent Blvd.
 Project Number: 21106
 Date: January 2022

$$F = 220C\sqrt{A}$$

Where:

CFF = Fire Required Flow in Litres per minute (LPM)
C = the Contents Factor, reduced to the type of construction of the building
A = the Total Effective Floor Area, effective building area in square metres of the building.

- C**
- = 1.5 For Type V Wood Frame Construction
 - = 0.8 For Type III-B Mass Timber Construction
 - = 0.8 For Type III-C Mass Timber Construction
 - = 1.0 For Type III-D Mass Timber Construction
 - = 1.5 For Type III-E Mass Timber Construction
 - = 1.0 For Type III Ordinary Construction
 - = 0.8 For Type III Noncombustible Construction
 - = 0.5 For Type I Fire Resistive Construction

A = The total floor area in square metres (including all storeys, but excluding basements at least 50 percent below grade) in the building being considered.

Legend

Construction Class	Contents Factor
WF wood frame construction	NC non-combustible
OC ordinary construction	LC limited combustible
NC non-combustible construction	C combustible
FC fire-resistive construction	FB free burning
	RB rapid burning

Contents Factor:

Non-Combustible	-25%	Free Burning	+15%
Limited Combustible	-15%	Rapid Burning	+25%
Combustible	No Charge		

Separation	Charge	Separation	Charge
0 to 3m	25%	20.1 to 30 m	10%
3.1 to 10m	20%	30.1 to 45m	5%
10.1 to 20m	15%		

1) Fire Flow

Type of Construction: NC
 C = 0.8
 A = 2066 m² - Area of Largest Floor plus 25% of the two adjacent floors
 F = 8,000 L/min

2) Occupancy Reduction

Contents Factor: LC
 Occupancy Charge = -15%
 -15% of 8,000 L/min = -1,200 L/min
 F = 13000 L/min + 3250 L/min = 6,800 L/min

3) System Type Reduction (to be reduced from result of Step 2)

NFPA 13 Sprinkler: 30% YES
 Standard Water Supply: 10% YES
 Fully Supervised: 10% YES
 Total System Type Reduction = 50%
 50% of 6,800 L/min = 3,400 L/min
 (to be reduced from result of Step 2)

4) Separation Charge (to be added to result of Step 2)

Building Face	Distance (m)	Length-Height Factor	Bldg Type	Auto Sprinkler Protection Reduction:		Charge
				Exposed BLDG (50% charge), Exposed & Subject Bldg (0% charge)		
North	28	442	Type III-IV ²	0%	=	0%
East	25	306	Type III-IV ²	0%	=	0%
South	28	518.5	Type III-IV ²	0%	=	0%
West	>30	-	-	-	=	0%
Total						0% (max exposure charge can be 75%)

0% of 6,800 L/min = 0 L/min
 (to be added to result of Step 2)

F = 4,000 L/min (round to the nearest 1,000 L/min) (2,000 L/min < F < 45,000 L/min)
 F = 1,057 GPM

Fire Underwriter Survey (2020) Fire Flow Calculation - Proposed Building C

Project Name: 1971 & 1975 St. Laurent Blvd.
 Project Number: 21106
 Date: January 2022

$$F = 220C\sqrt{A}$$

Where:
RFF = the Required Fire Flow in litres per minute (LPM)
C = the Contents Factor is related to the type of construction of the building
A = the Total Effective Floor Area (Effective Building Area) in square metres of the building

C =
 1.5 For Type I Wood Frame Construction
 0.8 For Type II-A Mass Timber Construction
 0.9 For Type II-B Mass Timber Construction
 1.0 For Type II-C Mass Timber Construction
 1.5 For Type III Mass Timber Construction
 1.0 For Type III Ordinary Construction
 0.8 For Type II Noncombustible Construction
 0.4 For Type I Fire Resistive Construction

A = The total floor area in square metres (including all storeys, but excluding basements at least 50 percent below grade) in the building being considered.

Legend

Construction Class	Contents Factor
WF wood frame construction	NC non-combustible
OC ordinary construction	LC limited combustible
NC non-combustible construction	C combustible
FC fire-resistive construction	FB free burning
	RB rapid burning

Contents Factor:
 Non-Combustible -25% Free Burning +15%
 Limited Combustible -15% Rapid Burning +25%
 Combustible No Charge

Separation	Charge	Separation	Charge
0 to 3m	25%	20.1 to 30 m	10%
3.1 to 10m	20%	30.1 to 45m	5%
10.1 to 20m	15%		

1) Fire Flow

Type of Construction: NC
 C = 0.8
 A = 2289 m² - Area of Largest Floor plus 25% of the two adjacent floors
 F = 9,000 L/min

2) Occupancy Reduction

Contents Factor: LC
 Occupancy Charge = -15%
 -15% of 9,000 L/min = -1,350 L/min
 F = 13000 L/min + 3250 L/min = 7,650 L/min

3) System Type Reduction (to be reduced from result of Step 2)

NFPA 13 Sprinkler: 30% YES
 Standard Water Supply: 10% YES
 Fully Supervised: 10% YES
 Total System Type Reduction = 50%
 50% of 7,650 L/min = 3,825 L/min
 (to be reduced from result of Step 2)

4) Separation Charge (to be added to result of Step 2)

Building Face	Distance (m)	Length-Height Factor	Bldg Type	Auto Sprinkler Protection		Charge
				Reduction: Exposed BLDG (50% charge)	Exposed & Subject Bldg (0% charge)	
North	28	519	Type III-IV ²	0%	=	0%
East	23	918	Type III-IV ²	0%	=	0%
South	>30	-	-	-	=	0%
West	>30	-	-	-	=	0%
Total						0% (max exposure charge can be 75%)

0% of 7,650 L/min = 0 L/min
 (to be added to result of Step 2)

F = 4,000 L/min (round to the nearest 1,000 L/min) (2,000 L/min < F < 45,000 L/min)
 F = 1,057 GPM

Fire Underwriter Survey (2020) Fire Flow Calculation - Proposed Building D (Parkade)

Project Name: 1971 & 1975 St. Laurent Blvd.
 Project Number: 21106
 Date: January 2022

$$F = 220C\sqrt{A}$$

Where:

RPF = the Required Fire Flow in litres per minute (LPM)
 C = the Construction Coefficient related to the type of construction of the building
 A = the Total Effective Floor Area (effective building area) in square metres of the building

- C =
- 1.5 for Type I Wood Frame Construction
 - 0.9 for Type IV-A Mass Timber Construction
 - 0.8 for Type IV-B Mass Timber Construction
 - 2.0 for Type IV-C Mass Timber Construction
 - 1.5 for Type IV-D Mass Timber Construction
 - 1.0 for Type III Ordinary Construction
 - 0.8 for Type II Noncombustible Construction
 - 0.5 for Type I Fire Resistive Construction

A = The total floor area in square metres (including all storeys, but excluding basements at least 50 percent below grade) in the building being considered.

Legend

Construction Class	Contents Factor
WF wood frame construction	NC non-combustible
OC ordinary construction	LC limited combustible
NC non-combustible construction	C combustible
FC fire-resistive construction	FB free burning
	RB rapid burning

Contents Factor:

Non-Combustible	-25%	Free Burning	+15%
Limited Combustible	-15%	Rapid Burning	+25%
Combustible	No Charge		

Separation	Charge	Separation	Charge
0 to 3m	25%	20.1 to 30 m	10%
3.1 to 10m	20%	30.1 to 45m	5%
10.1 to 20m	15%		

1) Fire Flow

Type of Construction: NC
 C = 0.8
 A = 4636 m² - For open parking garages, use the area of the largest floor
 F = 12,000 L/min as Total Effective Area

2) Occupancy Reduction

Contents Factor: C
 Occupancy Charge = 0%
 0% of 12,000 L/min = 0 L/min
 F = 13000 L/min + 3250 L/min = 12,000 L/min

3) System Type Reduction (to be reduced from result of Step 2)

NFPA 13 Sprinkler: 0% No
 Standard Water Supply: 0% No
 Fully Supervised: 0% No
 Total System Type Reduction = 0%
 0% of 12,000 L/min = 0 L/min
 (to be reduced from result of Step 2)

4) Separation Charge (to be added to result of Step 2)

Building Face	Distance (m)	Length-Height Factor	Bldg Type	Auto Sprinkler Protection		Charge
				Reduction: Exposed BLDG (50% charge).	Exposed & Subject Bldg (0% charge)	
North	19	1026	Type III-IV ²	50%	=	5%
East	14	240	Type V	50%	=	5%
South	14	170	Type V	NO	=	10%
West	15	1026	Type III-IV ²	50%	=	5%
Total						25% (max exposure charge can be 75%)

25% of 12,000 L/min = 3,000 L/min
 (to be added to result of Step 2)

F = 15,000 L/min (round to the nearest 1,000 L/min) (2,000 L/min < F < 45,000 L/min)
 F = 3,963 GPM



EPANET Model Network Layout

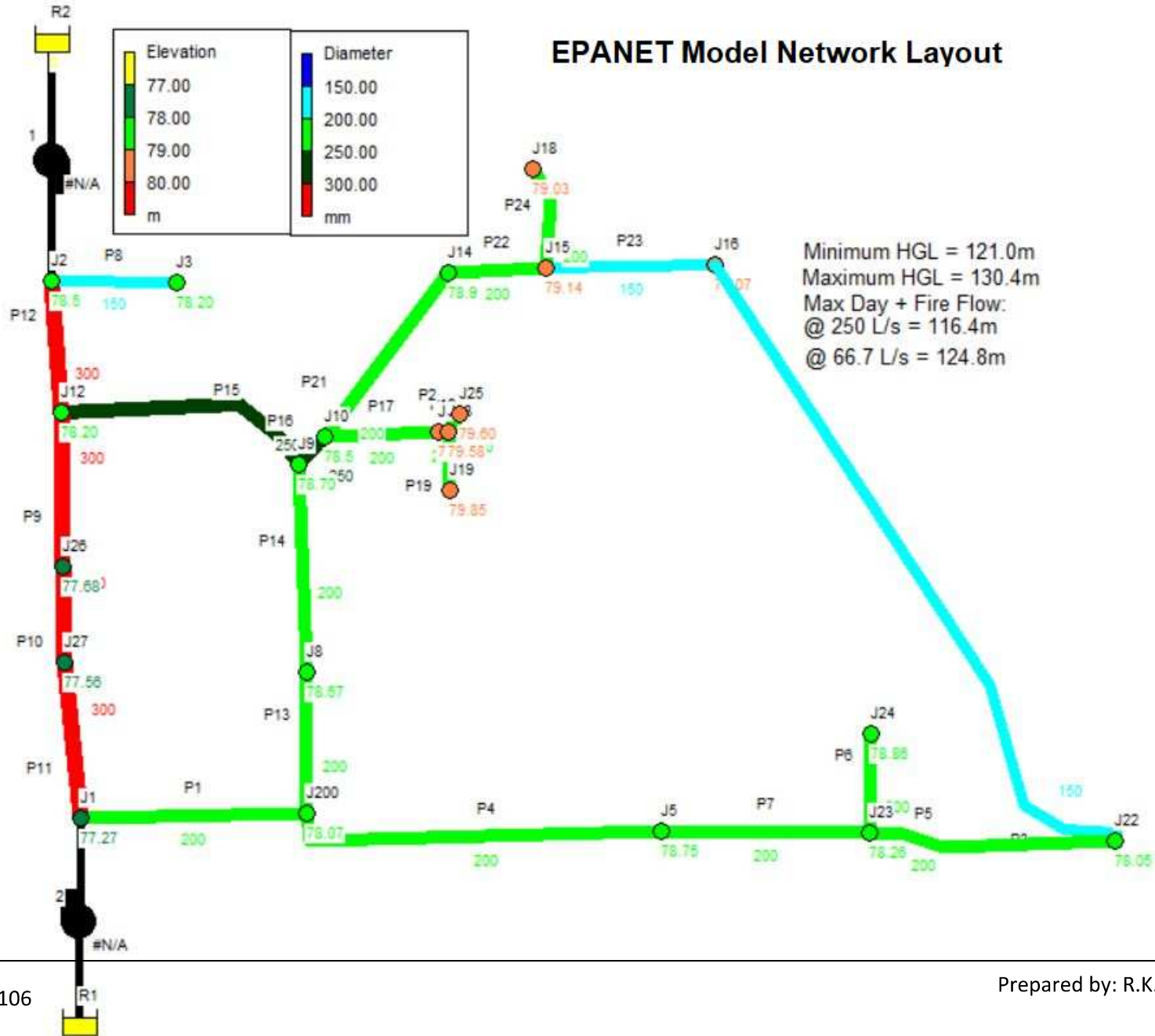



Residual Pressure during Non-Fire Scenarios

Scenario	Lowest Pressure			Satisfies Pressure Requirements?
	Pressure	Pressure	Pressure	
	(m H ₂ O)	(psi)	(kPa)	
Avg. Day	49.81	70.83	488.3	Yes
Max. Day	49.15	69.89	481.9	Yes
Max. Day Using Minimum Pressure	41.13	58.49	403.2	Yes
Peak Hour	48.07	68.35	471.3	Yes

Scenario	Highest Pressure			Satisfies Pressure Requirements?
	Pressure	Pressure	Pressure	
	(m H ₂ O)	(psi)	(kPa)	
Avg. Day	52.4	74.51	513.7	Yes
Max. Day	51.76	73.60	507.5	Yes
Max. Day Using Minimum Pressure	43.73	62.18	428.7	Yes
Peak Hour	50.74	72.15	497.5	Yes

Scenario	Pressure @ Connection Node J1			Satisfies Pressure Requirements?
	Pressure	Pressure	Pressure	
	(m H ₂ O)	(psi)	(kPa)	
Avg. Day	52.4	74.51	513.7	Yes
Max. Day	51.76	73.60	507.5	Yes
Max. Day Using Minimum Pressure	43.73	62.18	428.7	Yes
Peak Hour	50.74	72.15	497.5	Yes

Scenario	Pressure @ Connection Node J2			Satisfies Pressure Requirements?
	Pressure	Pressure	Pressure	
	(m H ₂ O)	(psi)	(kPa)	
Avg. Day	51.17	72.76	501.7	Yes
Max. Day	50.53	71.85	495.4	Yes
Max. Day Using Minimum Pressure	42.5	60.43	416.7	Yes
Peak Hour	49.51	70.40	485.4	Yes

Scenario	Pressure @ Connection Node J12			Satisfies Pressure Requirements?
	Pressure	Pressure	Pressure	
	(m H ₂ O)	(psi)	(kPa)	
Avg. Day	51.47	73.19	504.6	Yes
Max. Day	50.82	72.26	498.2	Yes
Max. Day Using Minimum Pressure	42.8	60.86	419.6	Yes
Peak Hour	49.8	70.81	488.2	Yes

Notes:

1. Preferred design pressure during normal operating conditions is approximately 345 kPa to 552 kPa
2. The maximum static pressure shall not exceed 552 kPa
3. The minimum pressure under any non-fire demand scenario should not be less than 276 kPa
4. In cases where all services are protected by an individual pressure reducing device, the maximum pressure in the watermain system will not exceed 689 kilopascals.

Residual Pressure based on Maximum Day Demand + Fire Flow

Fire Flow at Critical Building / Node	Max. Velocity (m/s)	Lowest Pressure			Satisfies Pressure & Velocity Requirements?
		Pressure (m H ₂ O)	Pressure (psi)	Pressure (kPa)	
<i>Ex. 1971 St. Laurent Blvd / J10</i>	3.05	41.70	59.30	408.8	Yes
<i>Ex. 1975 St. Laurent Blvd / J25</i>	3.82	40.23	57.21	394.4	Yes
<i>Ex. 2080 Russell Road / J24</i>	5.35	22.52	32.02	220.8	Yes
<i>Ex. 2100 Russell Road / J22</i>	4.24	18.96	26.96	185.9	Yes
Prop. Building A / J18	2.20	44.26	62.94	433.9	Yes
Prop. Building B / J3	3.91	43.15	61.36	423.0	Yes
Prop. Building D / J19	8.06	17.60	25.03	172.6	Yes

Notes:

1. Fire flow requirements satisfied if lowest pressure in is system > 140 kPa (20 psi)



Average Day Demand Condition

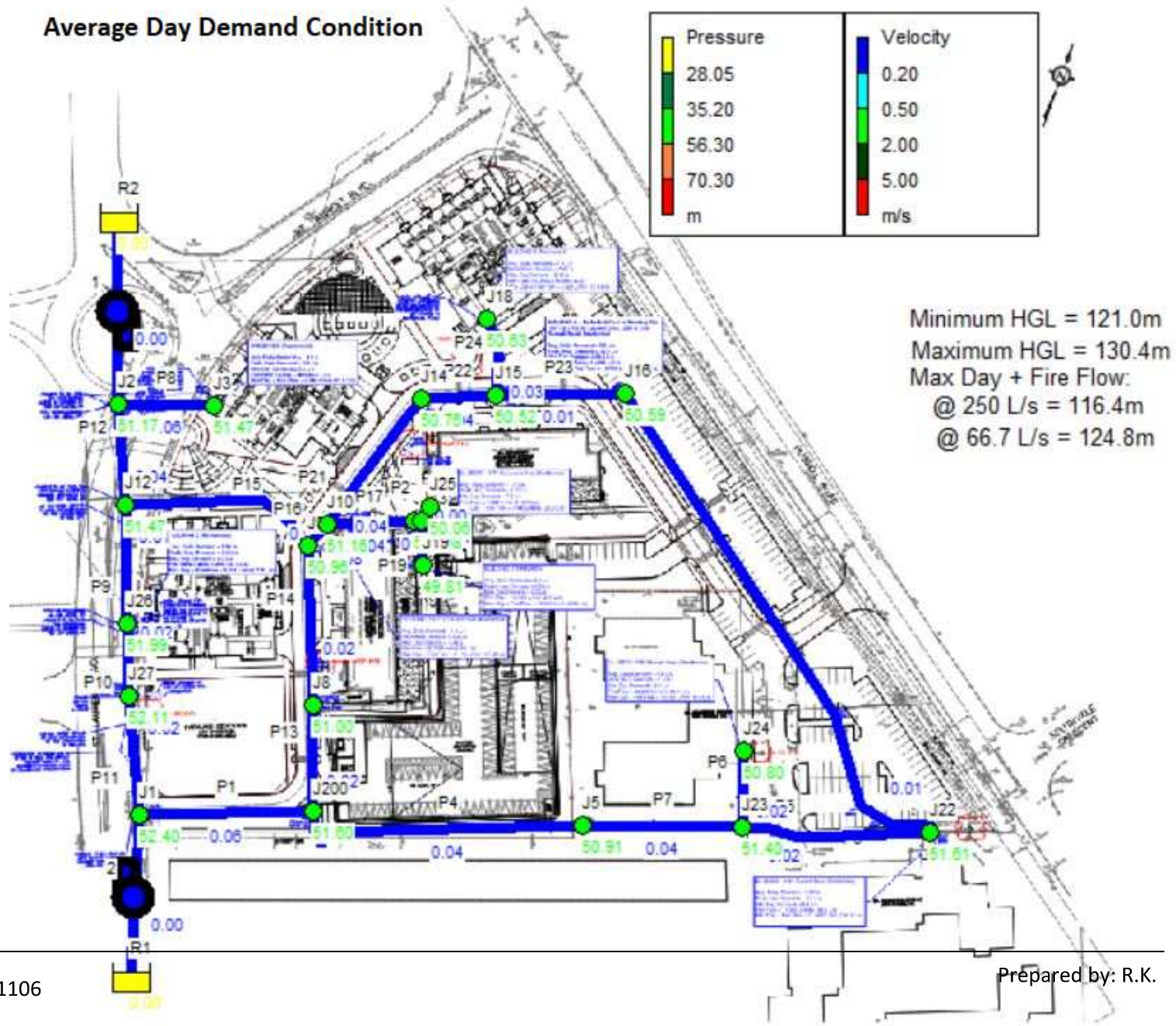



21106_Average Day Demand.rpt

Page 1

2023-03-14 3:33:16 PM

```
*****
*                               *
*             E P A N E T       *
*           Hydraulic and Water *
*           Analysis for Pipe   *
*           Networks           *
*           Version 2.2        *
*****
```

Input File: 21106_Average Day Demand-2023.net

Link - Node Table:

Link ID	Start Node	End Node	Length m	Diameter mm	
P1	J1	J200	60.78	200	
P4	J5	J200	96.37	200	
P13	J200	J8	32.72	200	
P14	J8	J9	58.6	200	
P15	J9	J12	67.26	250	
P16	J9	J10	7.91	250	
P17	J10	J11	31.176	200	
P18	J11	J13	2.28	200	
P19	J13	J19	18.81	200	
P21	J10	J14	51.579	200	
P22	J14	J15	23.86	200	
P23	J15	J16	41.8	150	
P24	J15	J18	26	200	
P2	J25	J13	5.633	200	
P3	J16	J22	189.127	150	
P5	J22	J23	62.85	200	
P6	J24	J23	25.34	200	
P7	J23	J5	55.03	200	
P9	J12	J26	44	300	
P10	J26	J27	21.3	300	
P11	J27	J1	39.51	300	
P12	J12	J2	36.02	300	
P8	J3	J2	31.93	150	
1	R2	J2	#N/A	#N/A	Pump
2	R1	J1	#N/A	#N/A	Pump

Energy Usage:

Pump	Usage Factor	Avg. Effic.	Kw-hr /m3	Avg. Kw	Peak Kw	Cost /day



21106_Average Day Demand.rpt

1	100.00	75.00	0.47	6.02	6.02	0.00
2	100.00	75.00	0.47	6.02	6.02	0.00

Demand Charge:	0.00
Total Cost:	0.00



Page 2

Node Results at 0:00 Hrs:

Node ID	Demand LPS	Head m	Pressure m	Quality	
J1	0.00	129.67	52.40	0.00	
J200	0.00	129.67	51.60	0.00	
J5	0.00	129.66	50.91	0.00	
J8	0.00	129.67	51.00	0.00	
J9	0.00	129.66	50.96	0.00	
J10	1.30	129.66	51.16	0.00	
J11	0.00	129.66	50.13	0.00	
J12	0.00	129.67	51.47	0.00	
J13	0.00	129.66	50.08	0.00	
J14	0.00	129.66	50.76	0.00	
J15	0.00	129.66	50.52	0.00	
J16	0.00	129.66	50.59	0.00	
J18	1.00	129.66	50.63	0.00	
J19	0.00	129.66	49.81	0.00	
J2	0.00	129.67	51.17	0.00	
J22	0.90	129.66	51.61	0.00	
J23	0.00	129.66	51.40	0.00	
J24	0.60	129.66	50.80	0.00	
J25	1.30	129.66	50.06	0.00	
J26	1.00	129.67	51.99	0.00	
J27	0.00	129.67	52.11	0.00	
J3	1.00	129.67	51.47	0.00	
R1	-3.55	0.00	0.00	0.00	Reservoir
R2	-3.55	0.00	0.00	0.00	Reservoir

Link Results at 0:00 Hrs:

Link ID	Flow LPS	Velocity m/s	Unit Headloss m/km	Status
P1	1.85	0.06	0.04	Open
P4	-1.26	0.04	0.02	Open
P13	0.60	0.02	0.00	Open
P14	0.60	0.02	0.00	Open

Page 2



21106_Average Day Demand.rpt

P15	-3.25	0.07	0.04	Open
P16	-3.84	0.08	0.05	Open
P17	1.30	0.04	0.02	Open
P18	1.30	0.04	0.02	Open
P19	0.00	0.00	0.00	Open
P21	1.24	0.04	0.02	Open
P22	1.24	0.04	0.02	Open
P23	0.24	0.01	0.00	Open
P24	1.00	0.03	0.01	Open
P2	-1.30	0.04	0.02	Open
P3	0.24	0.01	0.00	Open
P5	-0.66	0.02	0.01	Open
P6	-0.60	0.02	0.00	Open



Page 3

Link Results at 0:00 Hrs: (continued)

Link ID	Flow LPS	Velocity m/s	Unit Headloss m/km	Status
P7	-1.26	0.04	0.02	Open
P9	-0.70	0.01	0.00	Open
P10	-1.70	0.02	0.00	Open
P11	-1.70	0.02	0.00	Open
P12	-2.55	0.04	0.01	Open
P8	-1.00	0.06	0.06	Open
1	3.55	0.00	-129.67	Open Pump
2	3.55	0.00	-129.67	Open Pump

Node Results at 1:00 Hrs:

Node ID	Demand LPS	Head m	Pressure m	Quality
J1	0.00	129.67	52.40	0.00
J200	0.00	129.67	51.60	0.00
J5	0.00	129.66	50.91	0.00
J8	0.00	129.67	51.00	0.00
J9	0.00	129.66	50.96	0.00
J10	1.30	129.66	51.16	0.00
J11	0.00	129.66	50.13	0.00
J12	0.00	129.67	51.47	0.00
J13	0.00	129.66	50.08	0.00
J14	0.00	129.66	50.76	0.00
J15	0.00	129.66	50.52	0.00
J16	0.00	129.66	50.59	0.00
J18	1.00	129.66	50.63	0.00

Page 3



21106_Average Day Demand.rpt

J19	0.00	129.66	49.81	0.00	
J2	0.00	129.67	51.17	0.00	
J22	0.90	129.66	51.61	0.00	
J23	0.00	129.66	51.40	0.00	
J24	0.60	129.66	50.80	0.00	
J25	1.30	129.66	50.06	0.00	
J26	1.00	129.67	51.99	0.00	
J27	0.00	129.67	52.11	0.00	
J3	1.00	129.67	51.47	0.00	
R1	-3.55	0.00	0.00	0.00	Reservoir
R2	-3.55	0.00	0.00	0.00	Reservoir



Page 4

Link Results at 1:00 Hrs:

Link ID	Flow LPS	Velocity m/s	Unit Headloss m/km	Status
P1	1.85	0.06	0.04	Open
P4	-1.26	0.04	0.02	Open
P13	0.60	0.02	0.00	Open
P14	0.60	0.02	0.00	Open
P15	-3.25	0.07	0.04	Open
P16	3.84	0.08	0.05	Open
P17	1.30	0.04	0.02	Open
P18	1.30	0.04	0.02	Open
P19	0.00	0.00	0.00	Open
P21	1.24	0.04	0.02	Open
P22	1.24	0.04	0.02	Open
P23	0.24	0.01	0.00	Open
P24	1.00	0.03	0.01	Open
P2	-1.30	0.04	0.02	Open
P3	0.24	0.01	0.00	Open
P5	-0.66	0.02	0.01	Open
P6	-0.60	0.02	0.00	Open
P7	-1.26	0.04	0.02	Open
P9	-0.70	0.01	0.00	Open
P10	-1.70	0.02	0.00	Open
P11	-1.70	0.02	0.00	Open
P12	-2.55	0.04	0.01	Open
P8	-1.00	0.06	0.06	Open
1	3.55	0.00	-129.67	Open Pump
2	3.55	0.00	-129.67	Open Pump

Node Results at 2:00 Hrs:

Page 4



21106_Average Day Demand.rpt

Node ID	Demand LPS	Head m	Pressure m	Quality
J1	0.00	129.67	52.40	0.00
J200	0.00	129.67	51.60	0.00
J5	0.00	129.66	50.91	0.00
J8	0.00	129.67	51.00	0.00
J9	0.00	129.66	50.96	0.00
J10	1.30	129.66	51.16	0.00
J11	0.00	129.66	50.13	0.00
J12	0.00	129.67	51.47	0.00
J13	0.00	129.66	50.08	0.00
J14	0.00	129.66	50.76	0.00
J15	0.00	129.66	50.52	0.00
J16	0.00	129.66	50.59	0.00
J18	1.00	129.66	50.63	0.00
J19	0.00	129.66	49.81	0.00
J2	0.00	129.67	51.17	0.00
J22	0.90	129.66	51.61	0.00



Page 5

Node Results at 2:00 Hrs: (continued)

Node ID	Demand LPS	Head m	Pressure m	Quality
J23	0.00	129.66	51.40	0.00
J24	0.60	129.66	50.80	0.00
J25	1.30	129.66	50.06	0.00
J26	1.00	129.67	51.99	0.00
J27	0.00	129.67	52.11	0.00
J3	1.00	129.67	51.47	0.00
R1	-3.55	0.00	0.00	0.00 Reservoir
R2	-3.55	0.00	0.00	0.00 Reservoir

Link Results at 2:00 Hrs:

Link ID	Flow LPS	Velocity m/s	Unit Headloss m/km	Status
P1	1.85	0.06	0.04	Open
P4	-1.26	0.04	0.02	Open
P13	0.60	0.02	0.00	Open
P14	0.60	0.02	0.00	Open
P15	-3.25	0.07	0.04	Open
P16	3.84	0.08	0.05	Open
P17	1.30	0.04	0.02	Open

Page 5



21106_Average Day Demand.rpt

P18	1.30	0.04	0.02	Open
P19	0.00	0.00	0.00	Open
P21	1.24	0.04	0.02	Open
P22	1.24	0.04	0.02	Open
P23	0.24	0.01	0.00	Open
P24	1.00	0.03	0.01	Open
P2	-1.30	0.04	0.02	Open
P3	0.24	0.01	0.00	Open
P5	-0.66	0.02	0.01	Open
P6	-0.60	0.02	0.00	Open
P7	-1.26	0.04	0.02	Open
P9	-0.70	0.01	0.00	Open
P10	-1.70	0.02	0.00	Open
P11	-1.70	0.02	0.00	Open
P12	-2.55	0.04	0.01	Open
P8	-1.00	0.06	0.06	Open
1	3.55	0.00	-129.67	Open Pump
2	3.55	0.00	-129.67	Open Pump



Page 6

Node Results at 3:00 Hrs:

Node ID	Demand LPS	Head m	Pressure m	Quality
J1	0.00	129.67	52.40	0.00
J200	0.00	129.67	51.60	0.00
J5	0.00	129.66	50.91	0.00
J8	0.00	129.67	51.00	0.00
J9	0.00	129.66	50.96	0.00
J10	1.30	129.66	51.16	0.00
J11	0.00	129.66	50.13	0.00
J12	0.00	129.67	51.47	0.00
J13	0.00	129.66	50.08	0.00
J14	0.00	129.66	50.76	0.00
J15	0.00	129.66	50.52	0.00
J16	0.00	129.66	50.59	0.00
J18	1.00	129.66	50.63	0.00
J19	0.00	129.66	49.81	0.00
J2	0.00	129.67	51.17	0.00
J22	0.90	129.66	51.61	0.00
J23	0.00	129.66	51.40	0.00
J24	0.60	129.66	50.80	0.00
J25	1.30	129.66	50.06	0.00
J26	1.00	129.67	51.99	0.00
J27	0.00	129.67	52.11	0.00

Page 6



21106_Average Day Demand.rpt

J3	1.00	129.67	51.47	0.00	
R1	-3.55	0.00	0.00	0.00	Reservoir
R2	-3.55	0.00	0.00	0.00	Reservoir

Link Results at 3:00 Hrs:

Link ID	Flow LPS	Velocity m/s	Unit Headloss m/km	Status
P1	1.85	0.06	0.04	Open
P4	-1.26	0.04	0.02	Open
P13	0.60	0.02	0.00	Open
P14	0.60	0.02	0.00	Open
P15	-3.25	0.07	0.04	Open
P16	3.84	0.08	0.05	Open
P17	1.30	0.04	0.02	Open
P18	1.30	0.04	0.02	Open
P19	0.00	0.00	0.00	Open
P21	1.24	0.04	0.02	Open
P22	1.24	0.04	0.02	Open
P23	0.24	0.01	0.00	Open
P24	1.00	0.03	0.01	Open
P2	-1.30	0.04	0.02	Open
P3	0.24	0.01	0.00	Open
P5	-0.66	0.02	0.01	Open
P6	-0.60	0.02	0.00	Open



Page 7

Link Results at 3:00 Hrs: (continued)

Link ID	Flow LPS	Velocity m/s	Unit Headloss m/km	Status
P7	-1.26	0.04	0.02	Open
P9	-0.70	0.01	0.00	Open
P10	-1.70	0.02	0.00	Open
P11	-1.70	0.02	0.00	Open
P12	-2.55	0.04	0.01	Open
P8	-1.00	0.06	0.06	Open
1	3.55	0.00	-129.67	Open Pump
2	3.55	0.00	-129.67	Open Pump

Node Results at 4:00 Hrs:

Node ID	Demand LPS	Head m	Pressure m	Quality
---------	------------	--------	------------	---------



21106_Average Day Demand.rpt

J1	0.00	129.67	52.40	0.00	
J200	0.00	129.67	51.60	0.00	
J5	0.00	129.66	50.91	0.00	
J8	0.00	129.67	51.00	0.00	
J9	0.00	129.66	50.96	0.00	
J10	1.30	129.66	51.16	0.00	
J11	0.00	129.66	50.13	0.00	
J12	0.00	129.67	51.47	0.00	
J13	0.00	129.66	50.08	0.00	
J14	0.00	129.66	50.76	0.00	
J15	0.00	129.66	50.52	0.00	
J16	0.00	129.66	50.59	0.00	
J18	1.00	129.66	50.63	0.00	
J19	0.00	129.66	49.81	0.00	
J2	0.00	129.67	51.17	0.00	
J22	0.90	129.66	51.61	0.00	
J23	0.00	129.66	51.40	0.00	
J24	0.60	129.66	50.80	0.00	
J25	1.30	129.66	50.06	0.00	
J26	1.00	129.67	51.99	0.00	
J27	0.00	129.67	52.11	0.00	
J3	1.00	129.67	51.47	0.00	
R1	-3.55	0.00	0.00	0.00	Reservoir
R2	-3.55	0.00	0.00	0.00	Reservoir



Page 8

Link Results at 4:00 Hrs:

Link ID	Flow LPS	Velocity m/s	Unit Headloss m/km	Status
P1	1.85	0.06	0.04	Open
P4	-1.26	0.04	0.02	Open
P13	0.60	0.02	0.00	Open
P14	0.60	0.02	0.00	Open
P15	-3.25	0.07	0.04	Open
P16	3.84	0.08	0.05	Open
P17	1.30	0.04	0.02	Open
P18	1.30	0.04	0.02	Open
P19	0.00	0.00	0.00	Open
P21	1.24	0.04	0.02	Open
P22	1.24	0.04	0.02	Open
P23	0.24	0.01	0.00	Open
P24	1.00	0.03	0.01	Open
P2	-1.30	0.04	0.02	Open
P3	0.24	0.01	0.00	Open

Page 8



21106_Average Day Demand.rpt

P5	-0.66	0.02	0.01	Open
P6	-0.60	0.02	0.00	Open
P7	-1.26	0.04	0.02	Open
P9	-0.70	0.01	0.00	Open
P10	-1.70	0.02	0.00	Open
P11	-1.70	0.02	0.00	Open
P12	-2.55	0.04	0.01	Open
P8	-1.00	0.06	0.06	Open
1	3.55	0.00	-129.67	Open Pump
2	3.55	0.00	-129.67	Open Pump



Maximum Day Demand Condition

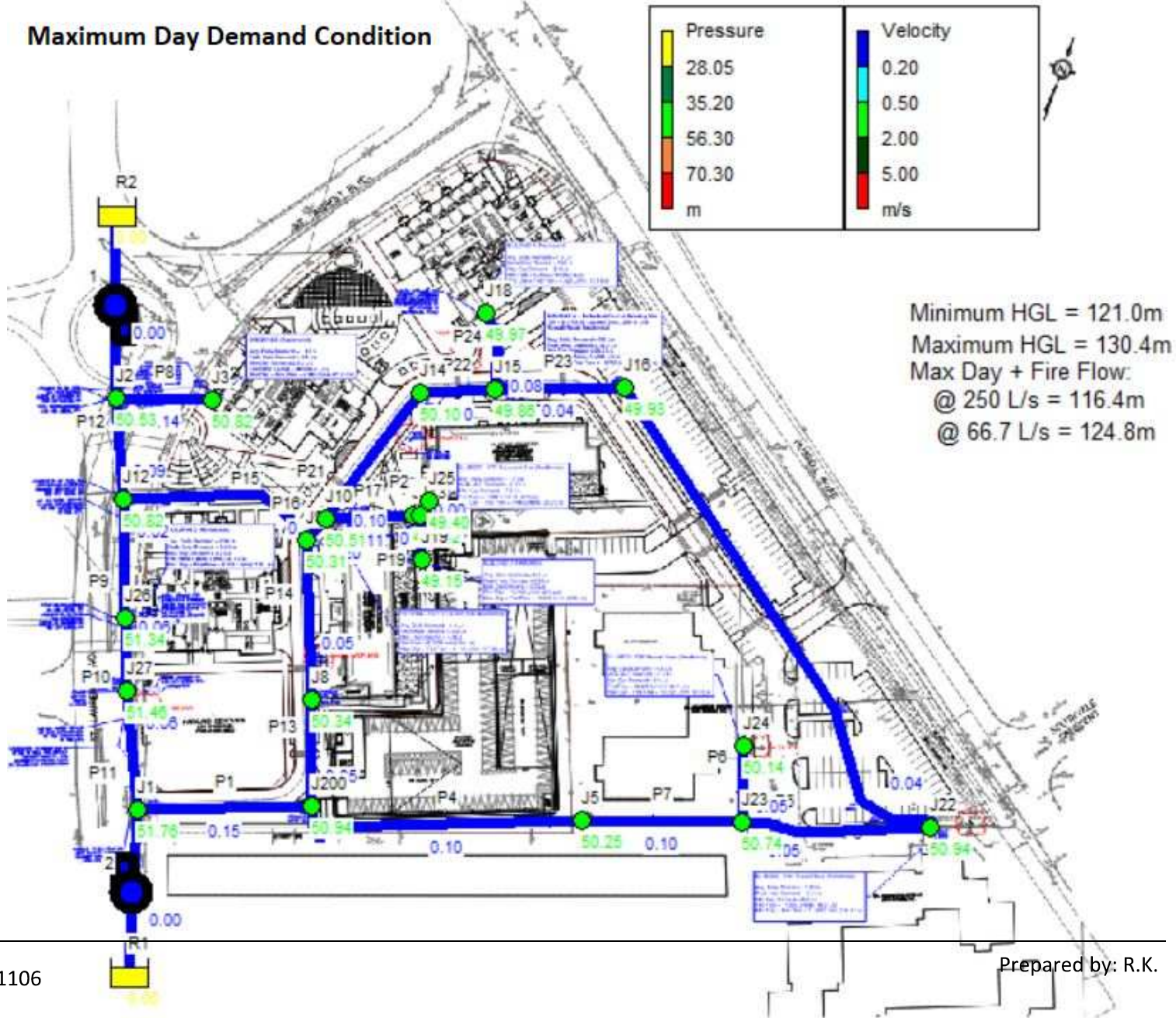



21106_Max Day Demand.rpt

Page 1

2023-03-14 3:35:38 PM

```
*****
*                               E P A N E T                               *
*                               Hydraulic and Water Quality                 *
*                               Analysis for Pipe Networks                   *
*                               Version 2.2                                 *
*****
```

Input File: 21106_Maximum Day Demand-2023.net

Link - Node Table:

Link ID	Start Node	End Node	Length m	Diameter mm	
P1	J1	J200	60.78	200	
P4	J5	J200	96.37	200	
P13	J200	J8	32.72	200	
P14	J8	J9	58.6	200	
P15	J9	J12	67.26	250	
P16	J9	J10	7.91	250	
P17	J10	J11	31.176	200	
P18	J11	J13	2.28	200	
P19	J13	J19	18.81	200	
P21	J10	J14	51.579	200	
P22	J14	J15	23.86	200	
P23	J15	J16	41.8	150	
P24	J15	J18	26	200	
P2	J25	J13	5.633	200	
P3	J16	J22	189.127	150	
P5	J22	J23	62.85	200	
P6	J24	J23	25.34	200	
P7	J23	J5	55.03	200	
P9	J12	J26	44	300	
P10	J26	J27	21.3	300	
P11	J27	J1	39.51	300	
P12	J12	J2	36.02	300	
P8	J3	J2	31.93	150	
1	R2	J2	#N/A	#N/A	Pump
2	R1	J1	#N/A	#N/A	Pump

Energy Usage:

Pump	Usage Factor	Avg. Effic.	Kw-hr /m3	Avg. Kw	Peak Kw	Cost /day



21106_Max Day Demand.rpt

1	100.00	75.00	0.47	14.84	14.84	0.00
2	100.00	75.00	0.47	14.84	14.84	0.00

Demand Charge:	0.00
Total Cost:	0.00



Page 2

Node Results at 0:00 Hrs:

Node ID	Demand LPS	Head m	Pressure m	Quality	
J1	0.00	129.03	51.76	0.00	
J200	0.00	129.01	50.94	0.00	
J5	0.00	129.00	50.25	0.00	
J8	0.00	129.01	50.34	0.00	
J9	0.00	129.01	50.31	0.00	
J10	3.30	129.01	50.51	0.00	
J11	0.00	129.00	49.47	0.00	
J12	0.00	129.02	50.82	0.00	
J13	0.00	129.00	49.42	0.00	
J14	0.00	129.00	50.10	0.00	
J15	0.00	129.00	49.86	0.00	
J16	0.00	129.00	49.93	0.00	
J18	2.40	129.00	49.97	0.00	
J19	0.00	129.00	49.15	0.00	
J2	0.00	129.03	50.53	0.00	
J22	2.30	128.99	50.94	0.00	
J23	0.00	129.00	50.74	0.00	
J24	1.50	129.00	50.14	0.00	
J25	3.30	129.00	49.40	0.00	
J26	2.40	129.02	51.34	0.00	
J27	0.00	129.02	51.46	0.00	
J3	2.40	129.02	50.82	0.00	
R1	-8.80	0.00	0.00	0.00	Reservoir
R2	-8.80	0.00	0.00	0.00	Reservoir

Link Results at 0:00 Hrs:

Link ID	Flow LPS	Velocity m/s	Unit Headloss m/km	Status
P1	4.65	0.15	0.21	Open
P4	-3.16	0.10	0.11	Open
P13	1.49	0.05	0.03	Open
P14	1.49	0.05	0.02	Open

Page 2



21106_Max Day Demand.rpt

P15	-8.15	0.17	0.20	Open
P16	-9.64	0.20	0.28	Open
P17	3.30	0.11	0.11	Open
P18	3.30	0.11	0.11	Open
P19	0.00	0.00	0.00	Open
P21	3.04	0.10	0.10	Open
P22	3.04	0.10	0.10	Open
P23	0.64	0.04	0.03	Open
P24	2.40	0.08	0.06	Open
P2	-3.30	0.11	0.11	Open
P3	0.64	0.04	0.03	Open
P5	-1.66	0.05	0.03	Open
P6	-1.50	0.05	0.03	Open



Page 3

Link Results at 0:00 Hrs: (continued)

Link ID	Flow LPS	Velocity m/s	Unit Headloss m/km	Status
P7	-3.16	0.10	0.10	Open
P9	-1.75	0.02	0.00	Open
P10	-4.15	0.06	0.02	Open
P11	-4.15	0.06	0.02	Open
P12	-6.40	0.09	0.05	Open
P8	-2.40	0.14	0.31	Open
1	8.80	0.00	-129.03	Open Pump
2	8.80	0.00	-129.03	Open Pump

Node Results at 1:00 Hrs:

Node ID	Demand LPS	Head m	Pressure m	Quality
J1	0.00	129.03	51.76	0.00
J200	0.00	129.01	50.94	0.00
J5	0.00	129.00	50.25	0.00
J8	0.00	129.01	50.34	0.00
J9	0.00	129.01	50.31	0.00
J10	3.30	129.01	50.51	0.00
J11	0.00	129.00	49.47	0.00
J12	0.00	129.02	50.82	0.00
J13	0.00	129.00	49.42	0.00
J14	0.00	129.00	50.10	0.00
J15	0.00	129.00	49.86	0.00
J16	0.00	129.00	49.93	0.00
J18	2.40	129.00	49.97	0.00

Page 3



21106_Max Day Demand.rpt

J19	0.00	129.00	49.15	0.00	
J2	0.00	129.03	50.53	0.00	
J22	2.30	128.99	50.94	0.00	
J23	0.00	129.00	50.74	0.00	
J24	1.50	129.00	50.14	0.00	
J25	3.30	129.00	49.40	0.00	
J26	2.40	129.02	51.34	0.00	
J27	0.00	129.02	51.46	0.00	
J3	2.40	129.02	50.82	0.00	
R1	-8.80	0.00	0.00	0.00	Reservoir
R2	-8.80	0.00	0.00	0.00	Reservoir



Page 4

Link Results at 1:00 Hrs:

Link ID	Flow LPS	Velocity m/s	Unit Headloss m/km	Status
P1	4.65	0.15	0.21	Open
P4	-3.16	0.10	0.11	Open
P13	1.49	0.05	0.03	Open
P14	1.49	0.05	0.02	Open
P15	-8.15	0.17	0.20	Open
P16	9.64	0.20	0.28	Open
P17	3.30	0.11	0.11	Open
P18	3.30	0.11	0.11	Open
P19	0.00	0.00	0.00	Open
P21	3.04	0.10	0.10	Open
P22	3.04	0.10	0.10	Open
P23	0.64	0.04	0.03	Open
P24	2.40	0.08	0.06	Open
P2	-3.30	0.11	0.11	Open
P3	0.64	0.04	0.03	Open
P5	-1.66	0.05	0.03	Open
P6	-1.50	0.05	0.03	Open
P7	-3.16	0.10	0.10	Open
P9	-1.75	0.02	0.00	Open
P10	-4.15	0.06	0.02	Open
P11	-4.15	0.06	0.02	Open
P12	-6.40	0.09	0.05	Open
P8	-2.40	0.14	0.31	Open
1	8.80	0.00	-129.03	Open Pump
2	8.80	0.00	-129.03	Open Pump

Node Results at 2:00 Hrs:



21106_Max Day Demand.rpt				
Node ID	Demand LPS	Head m	Pressure m	Quality
J1	0.00	129.03	51.76	0.00
J200	0.00	129.01	50.94	0.00
J5	0.00	129.00	50.25	0.00
J8	0.00	129.01	50.34	0.00
J9	0.00	129.01	50.31	0.00
J10	3.30	129.01	50.51	0.00
J11	0.00	129.00	49.47	0.00
J12	0.00	129.02	50.82	0.00
J13	0.00	129.00	49.42	0.00
J14	0.00	129.00	50.10	0.00
J15	0.00	129.00	49.86	0.00
J16	0.00	129.00	49.93	0.00
J18	2.40	129.00	49.97	0.00
J19	0.00	129.00	49.15	0.00
J2	0.00	129.03	50.53	0.00
J22	2.30	128.99	50.94	0.00



Page 5

Node Results at 2:00 Hrs: (continued)

Node ID	Demand LPS	Head m	Pressure m	Quality
J23	0.00	129.00	50.74	0.00
J24	1.50	129.00	50.14	0.00
J25	3.30	129.00	49.40	0.00
J26	2.40	129.02	51.34	0.00
J27	0.00	129.02	51.46	0.00
J3	2.40	129.02	50.82	0.00
R1	-8.80	0.00	0.00	0.00 Reservoir
R2	-8.80	0.00	0.00	0.00 Reservoir

Link Results at 2:00 Hrs:

Link ID	Flow LPS	Velocity m/s	Unit Headloss m/km	Status
P1	4.65	0.15	0.21	Open
P4	-3.16	0.10	0.11	Open
P13	1.49	0.05	0.03	Open
P14	1.49	0.05	0.02	Open
P15	-8.15	0.17	0.20	Open
P16	9.64	0.20	0.28	Open
P17	3.30	0.11	0.11	Open

Page 5



		21106_Max	Day	Demand.rpt	
P18	3.30	0.11	0.11	Open	
P19	0.00	0.00	0.00	Open	
P21	3.04	0.10	0.10	Open	
P22	3.04	0.10	0.10	Open	
P23	0.64	0.04	0.03	Open	
P24	2.40	0.08	0.06	Open	
P2	-3.30	0.11	0.11	Open	
P3	0.64	0.04	0.03	Open	
P5	-1.66	0.05	0.03	Open	
P6	-1.50	0.05	0.03	Open	
P7	-3.16	0.10	0.10	Open	
P9	-1.75	0.02	0.00	Open	
P10	-4.15	0.06	0.02	Open	
P11	-4.15	0.06	0.02	Open	
P12	-6.40	0.09	0.05	Open	
P8	-2.40	0.14	0.31	Open	
1	8.80	0.00	-129.03	Open Pump	
2	8.80	0.00	-129.03	Open Pump	



Page 6

Node Results at 3:00 Hrs:

Node ID	Demand LPS	Head m	Pressure m	Quality
J1	0.00	129.03	51.76	0.00
J200	0.00	129.01	50.94	0.00
J5	0.00	129.00	50.25	0.00
J8	0.00	129.01	50.34	0.00
J9	0.00	129.01	50.31	0.00
J10	3.30	129.01	50.51	0.00
J11	0.00	129.00	49.47	0.00
J12	0.00	129.02	50.82	0.00
J13	0.00	129.00	49.42	0.00
J14	0.00	129.00	50.10	0.00
J15	0.00	129.00	49.86	0.00
J16	0.00	129.00	49.93	0.00
J18	2.40	129.00	49.97	0.00
J19	0.00	129.00	49.15	0.00
J2	0.00	129.03	50.53	0.00
J22	2.30	128.99	50.94	0.00
J23	0.00	129.00	50.74	0.00
J24	1.50	129.00	50.14	0.00
J25	3.30	129.00	49.40	0.00
J26	2.40	129.02	51.34	0.00
J27	0.00	129.02	51.46	0.00

Page 6



21106_Max Day Demand.rpt

J3	2.40	129.02	50.82	0.00	
R1	-8.80	0.00	0.00	0.00	Reservoir
R2	-8.80	0.00	0.00	0.00	Reservoir

Link Results at 3:00 Hrs:

Link ID	Flow LPS	Velocity m/s	Unit Headloss m/km	Status
P1	4.65	0.15	0.21	Open
P4	-3.16	0.10	0.11	Open
P13	1.49	0.05	0.03	Open
P14	1.49	0.05	0.02	Open
P15	-8.15	0.17	0.20	Open
P16	9.64	0.20	0.28	Open
P17	3.30	0.11	0.11	Open
P18	3.30	0.11	0.11	Open
P19	0.00	0.00	0.00	Open
P21	3.04	0.10	0.10	Open
P22	3.04	0.10	0.10	Open
P23	0.64	0.04	0.03	Open
P24	2.40	0.08	0.06	Open
P2	-3.30	0.11	0.11	Open
P3	0.64	0.04	0.03	Open
P5	-1.66	0.05	0.03	Open
P6	-1.50	0.05	0.03	Open



Page 7

Link Results at 3:00 Hrs: (continued)

Link ID	Flow LPS	Velocity m/s	Unit Headloss m/km	Status
P7	-3.16	0.10	0.10	Open
P9	-1.75	0.02	0.00	Open
P10	-4.15	0.06	0.02	Open
P11	-4.15	0.06	0.02	Open
P12	-6.40	0.09	0.05	Open
P8	-2.40	0.14	0.31	Open
1	8.80	0.00	-129.03	Open Pump
2	8.80	0.00	-129.03	Open Pump

Node Results at 4:00 Hrs:

Node ID	Demand LPS	Head m	Pressure m	Quality
---------	------------	--------	------------	---------



21106_Max Day Demand.rpt

J1	0.00	129.03	51.76	0.00
J200	0.00	129.01	50.94	0.00
J5	0.00	129.00	50.25	0.00
J8	0.00	129.01	50.34	0.00
J9	0.00	129.01	50.31	0.00
J10	3.30	129.01	50.51	0.00
J11	0.00	129.00	49.47	0.00
J12	0.00	129.02	50.82	0.00
J13	0.00	129.00	49.42	0.00
J14	0.00	129.00	50.10	0.00
J15	0.00	129.00	49.86	0.00
J16	0.00	129.00	49.93	0.00
J18	2.40	129.00	49.97	0.00
J19	0.00	129.00	49.15	0.00
J2	0.00	129.03	50.53	0.00
J22	2.30	128.99	50.94	0.00
J23	0.00	129.00	50.74	0.00
J24	1.50	129.00	50.14	0.00
J25	3.30	129.00	49.40	0.00
J26	2.40	129.02	51.34	0.00
J27	0.00	129.02	51.46	0.00
J3	2.40	129.02	50.82	0.00
R1	-8.80	0.00	0.00	0.00 Reservoir
R2	-8.80	0.00	0.00	0.00 Reservoir



Page 8

Link Results at 4:00 Hrs:

Link ID	Flow LPS	Velocity m/s	Unit Headloss m/km	Status
P1	4.65	0.15	0.21	Open
P4	-3.16	0.10	0.11	Open
P13	1.49	0.05	0.03	Open
P14	1.49	0.05	0.02	Open
P15	-8.15	0.17	0.20	Open
P16	9.64	0.20	0.28	Open
P17	3.30	0.11	0.11	Open
P18	3.30	0.11	0.11	Open
P19	0.00	0.00	0.00	Open
P21	3.04	0.10	0.10	Open
P22	3.04	0.10	0.10	Open
P23	0.64	0.04	0.03	Open
P24	2.40	0.08	0.06	Open
P2	-3.30	0.11	0.11	Open
P3	0.64	0.04	0.03	Open

Page 8



		21106_Max	Day	Demand.rpt	
P5	-1.66	0.05	0.03	Open	
P6	-1.50	0.05	0.03	Open	
P7	-3.16	0.10	0.10	Open	
P9	-1.75	0.02	0.00	Open	
P10	-4.15	0.06	0.02	Open	
P11	-4.15	0.06	0.02	Open	
P12	-6.40	0.09	0.05	Open	
P8	-2.40	0.14	0.31	Open	
1	8.80	0.00	-129.03	Open	Pump
2	8.80	0.00	-129.03	Open	Pump



**Maximum Day Demand Condition
with Minimum Available Pressure at
Connection Nodes**

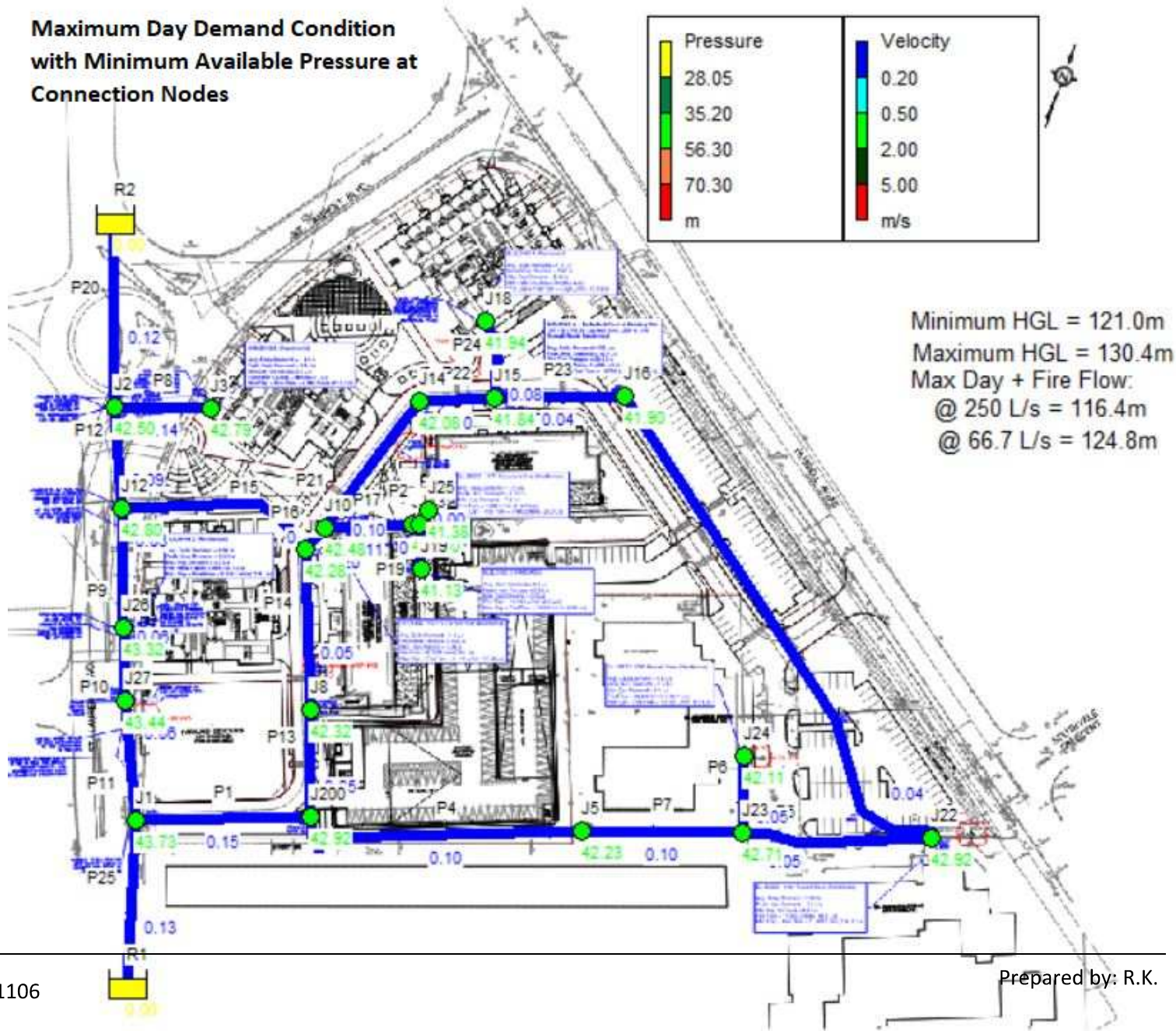
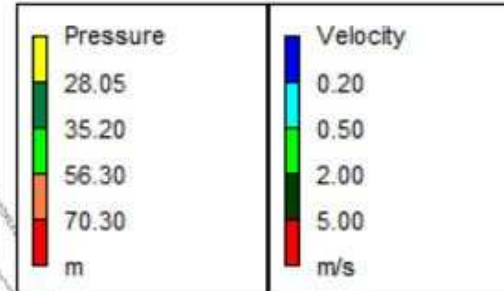



21106_Max Day Demand with Minimum Pressure.rpt

Page 1

2023-03-15 9:12:25 AM

```
*****
*                               E P A N E T                               *
*                               Hydraulic and Water Quality                 *
*                               Analysis for Pipe Networks                 *
*                               Version 2.2                               *
*****
```

Input File: 21106_Maximum Day Demand-2023 - With Minimum Pressure.net

Link - Node Table:

Link ID	Start Node	End Node	Length m	Diameter mm
P1	J1	J200	60.78	200
P4	J5	J200	96.37	200
P13	J200	J8	32.72	200
P14	J8	J9	58.6	200
P15	J9	J12	67.26	250
P16	J9	J10	7.91	250
P17	J10	J11	31.176	200
P18	J11	J13	2.28	200
P19	J13	J19	18.81	200
P21	J10	J14	51.579	200
P22	J14	J15	23.86	200
P23	J15	J16	41.8	150
P24	J15	J18	26	200
P2	J25	J13	5.633	200
P3	J16	J22	189.127	150
P5	J22	J23	62.85	200
P6	J24	J23	25.34	200
P7	J23	J5	55.03	200
P9	J12	J26	44	300
P10	J26	J27	21.3	300
P11	J27	J1	39.51	300
P12	J12	J2	36.02	300
P8	J3	J2	31.93	150
P20	R2	J2	0.1	300
P25	R1	J1	0.1	300

Node Results at 0:00 Hrs:

Node ID	Demand LPS	Head m	Pressure m	Quality
---------	------------	--------	------------	---------



21106_Max Day Demand with Minimum Pressure.rpt

J1	0.00	121.00	43.73	0.00
J200	0.00	120.99	42.92	0.00
J5	0.00	120.98	42.23	0.00
J8	0.00	120.99	42.32	0.00
J9	0.00	120.98	42.28	0.00
J10	3.30	120.98	42.48	0.00



Page 2

Node Results at 0:00 Hrs: (continued)

Node ID	Demand LPS	Head m	Pressure m	Quality
J11	0.00	120.98	41.45	0.00
J12	0.00	121.00	42.80	0.00
J13	0.00	120.98	41.40	0.00
J14	0.00	120.98	42.08	0.00
J15	0.00	120.98	41.84	0.00
J16	0.00	120.97	41.90	0.00
J18	2.40	120.97	41.94	0.00
J19	0.00	120.98	41.13	0.00
J2	0.00	121.00	42.50	0.00
J22	2.30	120.97	42.92	0.00
J23	0.00	120.97	42.71	0.00
J24	1.50	120.97	42.11	0.00
J25	3.30	120.98	41.38	0.00
J26	2.40	121.00	43.32	0.00
J27	0.00	121.00	43.44	0.00
J3	2.40	120.99	42.79	0.00
R1	-8.98	121.00	0.00	0.00 Reservoir
R2	-8.62	121.00	0.00	0.00 Reservoir

Link Results at 0:00 Hrs:

Link ID	Flow LPS	Velocity m/s	Unit Headloss m/km	Status
P1	4.66	0.15	0.22	Open
P4	-3.16	0.10	0.11	Open
P13	1.50	0.05	0.03	Open
P14	1.50	0.05	0.02	Open
P15	-8.14	0.17	0.20	Open
P16	9.64	0.20	0.28	Open
P17	3.30	0.11	0.11	Open
P18	3.30	0.11	0.11	Open
P19	0.00	0.00	0.00	Open
P21	3.04	0.10	0.10	Open

Page 2



21106_Max Day Demand with Minimum Pressure.rpt

P22	3.04	0.10	0.10	Open
P23	0.64	0.04	0.03	Open
P24	2.40	0.08	0.06	Open
P2	-3.30	0.11	0.11	Open
P3	0.64	0.04	0.03	Open
P5	-1.66	0.05	0.03	Open
P6	-1.50	0.05	0.03	Open
P7	-3.16	0.10	0.11	Open
P9	-1.92	0.03	0.00	Open
P10	-4.32	0.06	0.02	Open
P11	-4.32	0.06	0.02	Open
P12	-6.22	0.09	0.04	Open
P8	-2.40	0.14	0.31	Open



Page 3

Link Results at 0:00 Hrs: (continued)

Link ID	Flow LPS	Velocity m/s	Unit Headloss m/km	Status
P20	8.62	0.12	0.09	Open
P25	8.98	0.13	0.09	Open

Node Results at 1:00 Hrs:

Node ID	Demand LPS	Head m	Pressure m	Quality
J1	0.00	121.00	43.73	0.00
J200	0.00	120.99	42.92	0.00
J5	0.00	120.98	42.23	0.00
J8	0.00	120.99	42.32	0.00
J9	0.00	120.98	42.28	0.00
J10	3.30	120.98	42.48	0.00
J11	0.00	120.98	41.45	0.00
J12	0.00	121.00	42.80	0.00
J13	0.00	120.98	41.40	0.00
J14	0.00	120.98	42.08	0.00
J15	0.00	120.98	41.84	0.00
J16	0.00	120.97	41.90	0.00
J18	2.40	120.97	41.94	0.00
J19	0.00	120.98	41.13	0.00
J2	0.00	121.00	42.50	0.00
J22	2.30	120.97	42.92	0.00
J23	0.00	120.97	42.71	0.00
J24	1.50	120.97	42.11	0.00
J25	3.30	120.98	41.38	0.00

Page 3



21106_Max Day Demand with Minimum Pressure.rpt

J26	2.40	121.00	43.32	0.00	
J27	0.00	121.00	43.44	0.00	
J3	2.40	120.99	42.79	0.00	
R1	-8.98	121.00	0.00	0.00	Reservoir
R2	-8.62	121.00	0.00	0.00	Reservoir

Link Results at 1:00 Hrs:

Link ID	Flow LPS	Velocity m/s	Headloss m/km	Status
P1	4.66	0.15	0.22	Open
P4	-3.16	0.10	0.11	Open
P13	1.50	0.05	0.03	Open
P14	1.50	0.05	0.02	Open
P15	-8.14	0.17	0.20	Open
P16	9.64	0.20	0.28	Open
P17	3.30	0.11	0.11	Open
P18	3.30	0.11	0.11	Open
P19	0.00	0.00	0.00	Open



Page 4

Link Results at 1:00 Hrs: (continued)

Link ID	Flow LPS	Velocity m/s	Headloss m/km	Status
P21	3.04	0.10	0.10	Open
P22	3.04	0.10	0.10	Open
P23	0.64	0.04	0.03	Open
P24	2.40	0.08	0.06	Open
P2	-3.30	0.11	0.11	Open
P3	0.64	0.04	0.03	Open
P5	-1.66	0.05	0.03	Open
P6	-1.50	0.05	0.03	Open
P7	-3.16	0.10	0.11	Open
P9	-1.92	0.03	0.00	Open
P10	-4.32	0.06	0.02	Open
P11	-4.32	0.06	0.02	Open
P12	-6.22	0.09	0.04	Open
P8	-2.40	0.14	0.31	Open
P20	8.62	0.12	0.09	Open
P25	8.98	0.13	0.09	Open

Node Results at 2:00 Hrs:

Node	Demand	Head	Pressure	Quality
------	--------	------	----------	---------



21106_Max Day Demand with Minimum Pressure.rpt

ID	LPS	m	m	
J1	0.00	121.00	43.73	0.00
J200	0.00	120.99	42.92	0.00
J5	0.00	120.98	42.23	0.00
J8	0.00	120.99	42.32	0.00
J9	0.00	120.98	42.28	0.00
J10	3.30	120.98	42.48	0.00
J11	0.00	120.98	41.45	0.00
J12	0.00	121.00	42.80	0.00
J13	0.00	120.98	41.40	0.00
J14	0.00	120.98	42.08	0.00
J15	0.00	120.98	41.84	0.00
J16	0.00	120.97	41.90	0.00
J18	2.40	120.97	41.94	0.00
J19	0.00	120.98	41.13	0.00
J2	0.00	121.00	42.50	0.00
J22	2.30	120.97	42.92	0.00
J23	0.00	120.97	42.71	0.00
J24	1.50	120.97	42.11	0.00
J25	3.30	120.98	41.38	0.00
J26	2.40	121.00	43.32	0.00
J27	0.00	121.00	43.44	0.00
J3	2.40	120.99	42.79	0.00
R1	-8.98	121.00	0.00	0.00 Reservoir
R2	-8.62	121.00	0.00	0.00 Reservoir



Page 5

Link Results at 2:00 Hrs:

Link ID	Flow LPS	Velocity m/s	Unit Headloss m/km	Status
P1	4.66	0.15	0.22	Open
P4	-3.16	0.10	0.11	Open
P13	1.50	0.05	0.03	Open
P14	1.50	0.05	0.02	Open
P15	-8.14	0.17	0.20	Open
P16	9.64	0.20	0.28	Open
P17	3.30	0.11	0.11	Open
P18	3.30	0.11	0.11	Open
P19	0.00	0.00	0.00	Open
P21	3.04	0.10	0.10	Open
P22	3.04	0.10	0.10	Open
P23	0.64	0.04	0.03	Open
P24	2.40	0.08	0.06	Open

Page 5



21106_Max Day Demand with Minimum Pressure.rpt

P2	-3.30	0.11	0.11	Open
P3	-0.64	0.04	0.03	Open
P5	-1.66	0.05	0.03	Open
P6	-1.50	0.05	0.03	Open
P7	-3.16	0.10	0.11	Open
P9	-1.92	0.03	0.00	Open
P10	-4.32	0.06	0.02	Open
P11	-4.32	0.06	0.02	Open
P12	-6.22	0.09	0.04	Open
P8	-2.40	0.14	0.31	Open
P20	8.62	0.12	0.09	Open
P25	8.98	0.13	0.09	Open

Node Results at 3:00 Hrs:

Node ID	Demand LPS	Head m	Pressure m	Quality
J1	0.00	121.00	43.73	0.00
J200	0.00	120.99	42.92	0.00
J5	0.00	120.98	42.23	0.00
J8	0.00	120.99	42.32	0.00
J9	0.00	120.98	42.28	0.00
J10	3.30	120.98	42.48	0.00
J11	0.00	120.98	41.45	0.00
J12	0.00	121.00	42.80	0.00
J13	0.00	120.98	41.40	0.00
J14	0.00	120.98	42.08	0.00
J15	0.00	120.98	41.84	0.00
J16	0.00	120.97	41.90	0.00
J18	2.40	120.97	41.94	0.00
J19	0.00	120.98	41.13	0.00
J2	0.00	121.00	42.50	0.00
J22	2.30	120.97	42.92	0.00

↑
Page 6

Node Results at 3:00 Hrs: (continued)

Node ID	Demand LPS	Head m	Pressure m	Quality
J23	0.00	120.97	42.71	0.00
J24	1.50	120.97	42.11	0.00
J25	3.30	120.98	41.38	0.00
J26	2.40	121.00	43.32	0.00
J27	0.00	121.00	43.44	0.00
J3	2.40	120.99	42.79	0.00

Page 6



21106_Max Day Demand with Minimum Pressure.rpt

R1	-8.98	121.00	0.00	0.00	Reservoir
R2	-8.62	121.00	0.00	0.00	Reservoir

Link Results at 3:00 Hrs:

Link ID	Flow LPS	Velocity m/s	Unit Headloss m/km	Status
P1	4.66	0.15	0.22	Open
P4	-3.16	0.10	0.11	Open
P13	1.50	0.05	0.03	Open
P14	1.50	0.05	0.02	Open
P15	-8.14	0.17	0.20	Open
P16	9.64	0.20	0.28	Open
P17	3.30	0.11	0.11	Open
P18	3.30	0.11	0.11	Open
P19	0.00	0.00	0.00	Open
P21	3.04	0.10	0.10	Open
P22	3.04	0.10	0.10	Open
P23	0.64	0.04	0.03	Open
P24	2.40	0.08	0.06	Open
P2	-3.30	0.11	0.11	Open
P3	0.64	0.04	0.03	Open
P5	-1.66	0.05	0.03	Open
P6	-1.50	0.05	0.03	Open
P7	-3.16	0.10	0.11	Open
P9	-1.92	0.03	0.00	Open
P10	-4.32	0.06	0.02	Open
P11	-4.32	0.06	0.02	Open
P12	-6.22	0.09	0.04	Open
P8	-2.40	0.14	0.31	Open
P20	8.62	0.12	0.09	Open
P25	8.98	0.13	0.09	Open



Page 7

Node Results at 4:00 Hrs:

Node ID	Demand LPS	Head m	Pressure m	Quality
J1	0.00	121.00	43.73	0.00
J200	0.00	120.99	42.92	0.00
J5	0.00	120.98	42.23	0.00
J8	0.00	120.99	42.32	0.00
J9	0.00	120.98	42.28	0.00
J10	3.30	120.98	42.48	0.00



21106_Max Day Demand with Minimum Pressure.rpt

J11	0.00	120.98	41.45	0.00
J12	0.00	121.00	42.80	0.00
J13	0.00	120.98	41.40	0.00
J14	0.00	120.98	42.08	0.00
J15	0.00	120.98	41.84	0.00
J16	0.00	120.97	41.90	0.00
J18	2.40	120.97	41.94	0.00
J19	0.00	120.98	41.13	0.00
J2	0.00	121.00	42.50	0.00
J22	2.30	120.97	42.92	0.00
J23	0.00	120.97	42.71	0.00
J24	1.50	120.97	42.11	0.00
J25	3.30	120.98	41.38	0.00
J26	2.40	121.00	43.32	0.00
J27	0.00	121.00	43.44	0.00
J3	2.40	120.99	42.79	0.00
R1	-8.98	121.00	0.00	0.00 Reservoir
R2	-8.62	121.00	0.00	0.00 Reservoir

Link Results at 4:00 Hrs:

Link ID	Flow LPS	Velocity m/s	Unit Headloss m/km	Status
P1	4.66	0.15	0.22	Open
P4	-3.16	0.10	0.11	Open
P13	1.50	0.05	0.03	Open
P14	1.50	0.05	0.02	Open
P15	-8.14	0.17	0.20	Open
P16	9.64	0.20	0.28	Open
P17	3.30	0.11	0.11	Open
P18	3.30	0.11	0.11	Open
P19	0.00	0.00	0.00	Open
P21	3.04	0.10	0.10	Open
P22	3.04	0.10	0.10	Open
P23	0.64	0.04	0.03	Open
P24	2.40	0.08	0.06	Open
P2	-3.30	0.11	0.11	Open
P3	0.64	0.04	0.03	Open
P5	-1.66	0.05	0.03	Open
P6	-1.50	0.05	0.03	Open



Page 8

Link Results at 4:00 Hrs: (continued)

Link ID	Flow LPS	Velocity m/s	Unit Headloss m/km	Status
---------	----------	--------------	--------------------	--------



21106_Max Day Demand with Minimum Pressure.rpt

P7	-3.16	0.10	0.11	Open
P9	-1.92	0.03	0.00	Open
P10	-4.32	0.06	0.02	Open
P11	-4.32	0.06	0.02	Open
P12	-6.22	0.09	0.04	Open
P8	-2.40	0.14	0.31	Open
P20	8.62	0.12	0.09	Open
P25	8.98	0.13	0.09	Open



Peak Hour Demand Condition

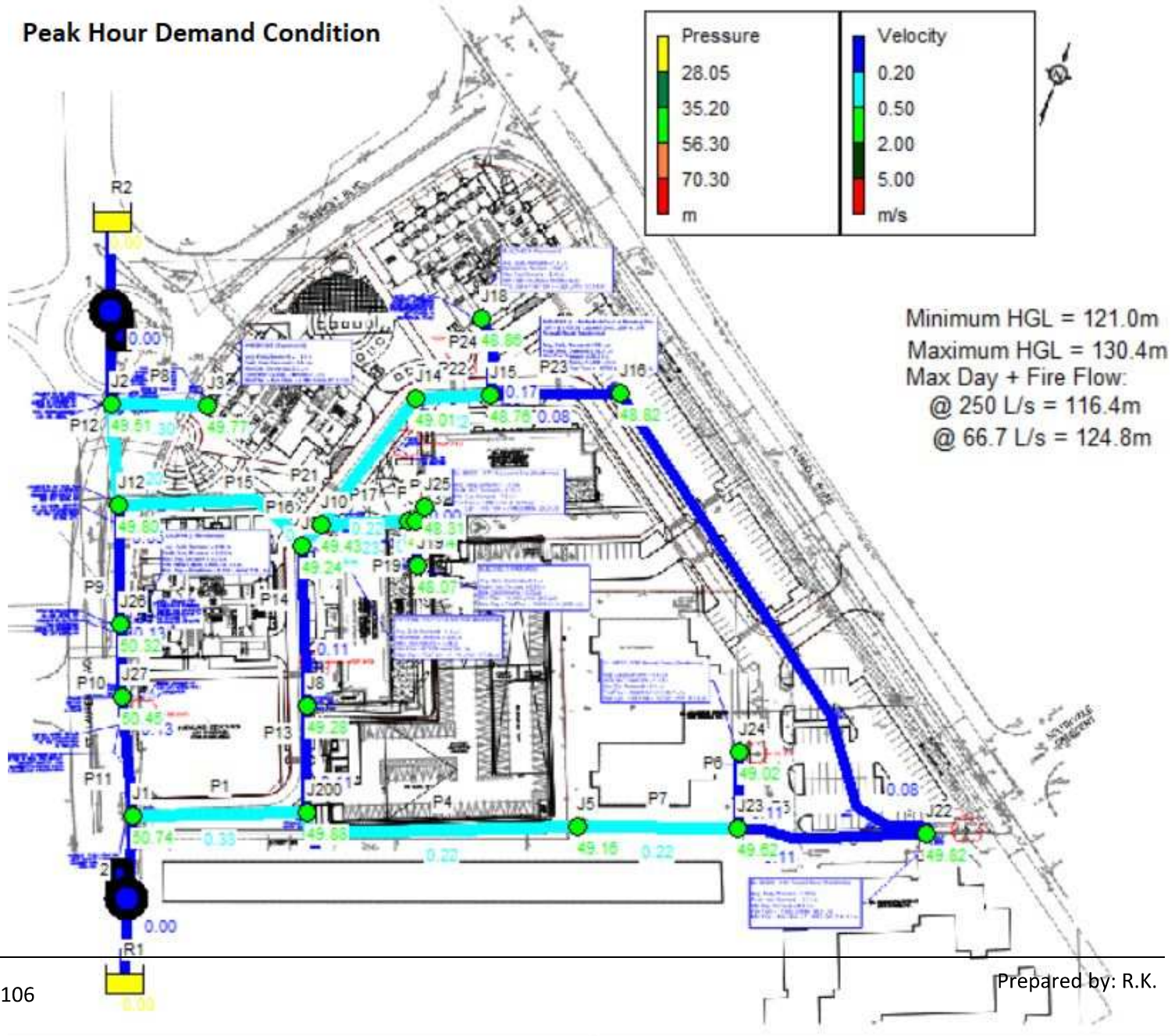



21106_Peak Hour.rpt

Page 1

2023-03-14 3:37:15 PM

```
*****
*                               *
*           E P A N E T         *
*           Hydraulic and Water *
*           Analysis for Pipe   *
*           Networks            *
*           Version 2.2         *
*****
```

Input File: 21106_Peak Hour Demand-2023.net

Link - Node Table:

Link ID	Start Node	End Node	Length m	Diameter mm	
P1	J1	J200	60.78	200	
P4	J5	J200	96.37	200	
P13	J200	J8	32.72	200	
P14	J8	J9	58.6	200	
P15	J9	J12	67.26	250	
P16	J9	J10	7.91	250	
P17	J10	J11	31.176	200	
P18	J11	J13	2.28	200	
P19	J13	J19	18.81	200	
P21	J10	J14	51.579	200	
P22	J14	J15	23.86	200	
P23	J15	J16	41.8	150	
P24	J15	J18	26	200	
P2	J25	J13	5.633	200	
P3	J16	J22	189.127	150	
P5	J22	J23	62.85	200	
P6	J24	J23	25.34	200	
P7	J23	J5	55.03	200	
P9	J12	J26	44	300	
P10	J26	J27	21.3	300	
P11	J27	J1	39.51	300	
P12	J12	J2	36.02	300	
P8	J3	J2	31.93	150	
1	R2	J2	#N/A	#N/A	Pump
2	R1	J1	#N/A	#N/A	Pump

Energy Usage:

Pump	Usage Factor	Avg. Effic.	Kw-hr /m3	Avg. Kw	Peak Kw	Cost /day



21106_Peak Hour.rpt

1	100.00	75.00	0.46	32.70	32.70	0.00
2	100.00	75.00	0.46	32.72	32.72	0.00

Demand Charge:	0.00
Total Cost:	0.00



Page 2

Node Results at 0:00 Hrs:

Node ID	Demand LPS	Head m	Pressure m	Quality	
J1	0.00	128.01	50.74	0.00	
J200	0.00	127.95	49.88	0.00	
J5	0.00	127.91	49.16	0.00	
J8	0.00	127.95	49.28	0.00	
J9	0.00	127.94	49.24	0.00	
J10	7.30	127.93	49.43	0.00	
J11	0.00	127.92	48.39	0.00	
J12	0.00	128.00	49.80	0.00	
J13	0.00	127.92	48.34	0.00	
J14	0.00	127.91	49.01	0.00	
J15	0.00	127.90	48.76	0.00	
J16	0.00	127.89	48.82	0.00	
J18	5.40	127.89	48.86	0.00	
J19	0.00	127.92	48.07	0.00	
J2	0.00	128.01	49.51	0.00	
J22	5.00	127.87	49.82	0.00	
J23	0.00	127.88	49.62	0.00	
J24	3.40	127.88	49.02	0.00	
J25	7.30	127.91	48.31	0.00	
J26	5.40	128.00	50.32	0.00	
J27	0.00	128.01	50.45	0.00	
J3	5.30	127.97	49.77	0.00	
R1	-19.56	0.00	0.00	0.00	Reservoir
R2	-19.54	0.00	0.00	0.00	Reservoir

Link Results at 0:00 Hrs:

Link ID	Flow LPS	Velocity m/s	Unit Headloss m/km	Status
P1	10.32	0.33	0.94	Open
P4	-7.00	0.22	0.46	Open
P13	3.31	0.11	0.11	Open
P14	3.31	0.11	0.10	Open

Page 2



21106_Peak Hour.rpt

P15	-18.08	0.37	0.90	Open
P16	-21.40	0.44	1.22	Open
P17	7.30	0.23	0.50	Open
P18	7.30	0.23	0.49	Open
P19	0.00	0.00	0.00	Open
P21	6.80	0.22	0.43	Open
P22	6.80	0.22	0.43	Open
P23	1.40	0.08	0.11	Open
P24	5.40	0.17	0.28	Open
P2	-7.30	0.23	0.50	Open
P3	1.40	0.08	0.11	Open
P5	-3.60	0.11	0.13	Open
P6	-3.40	0.11	0.12	Open



Page 3

Link Results at 0:00 Hrs: (continued)

Link ID	Flow LPS	Velocity m/s	Unit Headloss m/km	Status
P7	-7.00	0.22	0.46	Open
P9	-3.84	0.05	0.02	Open
P10	-9.24	0.13	0.09	Open
P11	-9.24	0.13	0.09	Open
P12	-14.24	0.20	0.20	Open
P8	-5.30	0.30	1.33	Open
1	19.54	0.00	-128.01	Open Pump
2	19.56	0.00	-128.01	Open Pump

Node Results at 1:00 Hrs:

Node ID	Demand LPS	Head m	Pressure m	Quality
J1	0.00	128.01	50.74	0.00
J200	0.00	127.95	49.88	0.00
J5	0.00	127.91	49.16	0.00
J8	0.00	127.95	49.28	0.00
J9	0.00	127.94	49.24	0.00
J10	7.30	127.93	49.43	0.00
J11	0.00	127.92	48.39	0.00
J12	0.00	128.00	49.80	0.00
J13	0.00	127.92	48.34	0.00
J14	0.00	127.91	49.01	0.00
J15	0.00	127.90	48.76	0.00
J16	0.00	127.89	48.82	0.00
J18	5.40	127.89	48.86	0.00

Page 3



21106_Peak Hour.rpt

J19	0.00	127.92	48.07	0.00
J2	0.00	128.01	49.51	0.00
J22	5.00	127.87	49.82	0.00
J23	0.00	127.88	49.62	0.00
J24	3.40	127.88	49.02	0.00
J25	7.30	127.91	48.31	0.00
J26	5.40	128.00	50.32	0.00
J27	0.00	128.01	50.45	0.00
J3	5.30	127.97	49.77	0.00
R1	-19.56	0.00	0.00	0.00 Reservoir
R2	-19.54	0.00	0.00	0.00 Reservoir



Page 4

Link Results at 1:00 Hrs:

Link ID	Flow LPS	Velocity m/s	Unit Headloss m/km	Status
P1	10.32	0.33	0.94	Open
P4	-7.00	0.22	0.46	Open
P13	3.31	0.11	0.11	Open
P14	3.31	0.11	0.10	Open
P15	-18.08	0.37	0.90	Open
P16	21.40	0.44	1.22	Open
P17	7.30	0.23	0.50	Open
P18	7.30	0.23	0.49	Open
P19	0.00	0.00	0.00	Open
P21	6.80	0.22	0.43	Open
P22	6.80	0.22	0.43	Open
P23	1.40	0.08	0.11	Open
P24	5.40	0.17	0.28	Open
P2	-7.30	0.23	0.50	Open
P3	1.40	0.08	0.11	Open
P5	-3.60	0.11	0.13	Open
P6	-3.40	0.11	0.12	Open
P7	-7.00	0.22	0.46	Open
P9	-3.84	0.05	0.02	Open
P10	-9.24	0.13	0.09	Open
P11	-9.24	0.13	0.09	Open
P12	-14.24	0.20	0.20	Open
P8	-5.30	0.30	1.33	Open
1	19.54	0.00	-128.01	Open Pump
2	19.56	0.00	-128.01	Open Pump

Node Results at 2:00 Hrs:



21106_Peak Hour.rpt

Node ID	Demand LPS	Head m	Pressure m	Quality
J1	0.00	128.01	50.74	0.00
J200	0.00	127.95	49.88	0.00
J5	0.00	127.91	49.16	0.00
J8	0.00	127.95	49.28	0.00
J9	0.00	127.94	49.24	0.00
J10	7.30	127.93	49.43	0.00
J11	0.00	127.92	48.39	0.00
J12	0.00	128.00	49.80	0.00
J13	0.00	127.92	48.34	0.00
J14	0.00	127.91	49.01	0.00
J15	0.00	127.90	48.76	0.00
J16	0.00	127.89	48.82	0.00
J18	5.40	127.89	48.86	0.00
J19	0.00	127.92	48.07	0.00
J2	0.00	128.01	49.51	0.00
J22	5.00	127.87	49.82	0.00



Page 5

Node Results at 2:00 Hrs: (continued)

Node ID	Demand LPS	Head m	Pressure m	Quality
J23	0.00	127.88	49.62	0.00
J24	3.40	127.88	49.02	0.00
J25	7.30	127.91	48.31	0.00
J26	5.40	128.00	50.32	0.00
J27	0.00	128.01	50.45	0.00
J3	5.30	127.97	49.77	0.00
R1	-19.56	0.00	0.00	0.00 Reservoir
R2	-19.54	0.00	0.00	0.00 Reservoir

Link Results at 2:00 Hrs:

Link ID	Flow LPS	Velocity m/s	Unit Headloss m/km	Status
P1	10.32	0.33	0.94	Open
P4	-7.00	0.22	0.46	Open
P13	3.31	0.11	0.11	Open
P14	3.31	0.11	0.10	Open
P15	-18.08	0.37	0.90	Open
P16	21.40	0.44	1.22	Open
P17	7.30	0.23	0.50	Open

Page 5



21106_Peak Hour.rpt

P18	7.30	0.23	0.49	Open
P19	0.00	0.00	0.00	Open
P21	6.80	0.22	0.43	Open
P22	6.80	0.22	0.43	Open
P23	1.40	0.08	0.11	Open
P24	5.40	0.17	0.28	Open
P2	-7.30	0.23	0.50	Open
P3	1.40	0.08	0.11	Open
P5	-3.60	0.11	0.13	Open
P6	-3.40	0.11	0.12	Open
P7	-7.00	0.22	0.46	Open
P9	-3.84	0.05	0.02	Open
P10	-9.24	0.13	0.09	Open
P11	-9.24	0.13	0.09	Open
P12	-14.24	0.20	0.20	Open
P8	-5.30	0.30	1.33	Open
1	19.54	0.00	-128.01	Open Pump
2	19.56	0.00	-128.01	Open Pump



Page 6

Node Results at 3:00 Hrs:

Node ID	Demand LPS	Head m	Pressure m	Quality
J1	0.00	128.01	50.74	0.00
J200	0.00	127.95	49.88	0.00
J5	0.00	127.91	49.16	0.00
J8	0.00	127.95	49.28	0.00
J9	0.00	127.94	49.24	0.00
J10	7.30	127.93	49.43	0.00
J11	0.00	127.92	48.39	0.00
J12	0.00	128.00	49.80	0.00
J13	0.00	127.92	48.34	0.00
J14	0.00	127.91	49.01	0.00
J15	0.00	127.90	48.76	0.00
J16	0.00	127.89	48.82	0.00
J18	5.40	127.89	48.86	0.00
J19	0.00	127.92	48.07	0.00
J2	0.00	128.01	49.51	0.00
J22	5.00	127.87	49.82	0.00
J23	0.00	127.88	49.62	0.00
J24	3.40	127.88	49.02	0.00
J25	7.30	127.91	48.31	0.00
J26	5.40	128.00	50.32	0.00
J27	0.00	128.01	50.45	0.00

Page 6



21106_Peak Hour.rpt				
J3	5.30	127.97	49.77	0.00
R1	-19.56	0.00	0.00	0.00 Reservoir
R2	-19.54	0.00	0.00	0.00 Reservoir

Link Results at 3:00 Hrs:

Link ID	Flow LPS	Velocity m/s	Unit Headloss m/km	Status
P1	10.32	0.33	0.94	Open
P4	-7.00	0.22	0.46	Open
P13	3.31	0.11	0.11	Open
P14	3.31	0.11	0.10	Open
P15	-18.08	0.37	0.90	Open
P16	21.40	0.44	1.22	Open
P17	7.30	0.23	0.50	Open
P18	7.30	0.23	0.49	Open
P19	0.00	0.00	0.00	Open
P21	6.80	0.22	0.43	Open
P22	6.80	0.22	0.43	Open
P23	1.40	0.08	0.11	Open
P24	5.40	0.17	0.28	Open
P2	-7.30	0.23	0.50	Open
P3	1.40	0.08	0.11	Open
P5	-3.60	0.11	0.13	Open
P6	-3.40	0.11	0.12	Open



Page 7

Link Results at 3:00 Hrs: (continued)

Link ID	Flow LPS	Velocity m/s	Unit Headloss m/km	Status
P7	-7.00	0.22	0.46	Open
P9	-3.84	0.05	0.02	Open
P10	-9.24	0.13	0.09	Open
P11	-9.24	0.13	0.09	Open
P12	-14.24	0.20	0.20	Open
P8	-5.30	0.30	1.33	Open
1	19.54	0.00	-128.01	Open Pump
2	19.56	0.00	-128.01	Open Pump

Node Results at 4:00 Hrs:

Node ID	Demand LPS	Head m	Pressure m	Quality
---------	------------	--------	------------	---------



21106_Peak Hour.rpt					
J1	0.00	128.01	50.74	0.00	
J200	0.00	127.95	49.88	0.00	
J5	0.00	127.91	49.16	0.00	
J8	0.00	127.95	49.28	0.00	
J9	0.00	127.94	49.24	0.00	
J10	7.30	127.93	49.43	0.00	
J11	0.00	127.92	48.39	0.00	
J12	0.00	128.00	49.80	0.00	
J13	0.00	127.92	48.34	0.00	
J14	0.00	127.91	49.01	0.00	
J15	0.00	127.90	48.76	0.00	
J16	0.00	127.89	48.82	0.00	
J18	5.40	127.89	48.86	0.00	
J19	0.00	127.92	48.07	0.00	
J2	0.00	128.01	49.51	0.00	
J22	5.00	127.87	49.82	0.00	
J23	0.00	127.88	49.62	0.00	
J24	3.40	127.88	49.02	0.00	
J25	7.30	127.91	48.31	0.00	
J26	5.40	128.00	50.32	0.00	
J27	0.00	128.01	50.45	0.00	
J3	5.30	127.97	49.77	0.00	
R1	-19.56	0.00	0.00	0.00	Reservoir
R2	-19.54	0.00	0.00	0.00	Reservoir



Page 8

Link Results at 4:00 Hrs:

Link ID	Flow LPS	Velocity m/s	Unit Headloss m/km	Status
P1	10.32	0.33	0.94	Open
P4	-7.00	0.22	0.46	Open
P13	3.31	0.11	0.11	Open
P14	3.31	0.11	0.10	Open
P15	-18.08	0.37	0.90	Open
P16	21.40	0.44	1.22	Open
P17	7.30	0.23	0.50	Open
P18	7.30	0.23	0.49	Open
P19	0.00	0.00	0.00	Open
P21	6.80	0.22	0.43	Open
P22	6.80	0.22	0.43	Open
P23	1.40	0.08	0.11	Open
P24	5.40	0.17	0.28	Open
P2	-7.30	0.23	0.50	Open
P3	1.40	0.08	0.11	Open

Page 8



21106_Peak Hour.rpt					
P5	-3.60	0.11	0.13	Open	
P6	-3.40	0.11	0.12	Open	
P7	-7.00	0.22	0.46	Open	
P9	-3.84	0.05	0.02	Open	
P10	-9.24	0.13	0.09	Open	
P11	-9.24	0.13	0.09	Open	
P12	-14.24	0.20	0.20	Open	
P8	-5.30	0.30	1.33	Open	
1	19.54	0.00	-128.01	Open	Pump
2	19.56	0.00	-128.01	Open	Pump



Maximum Day + Fire Flow Conditions at Existing Building 1971 St. Laurent Blvd. (Node J10)

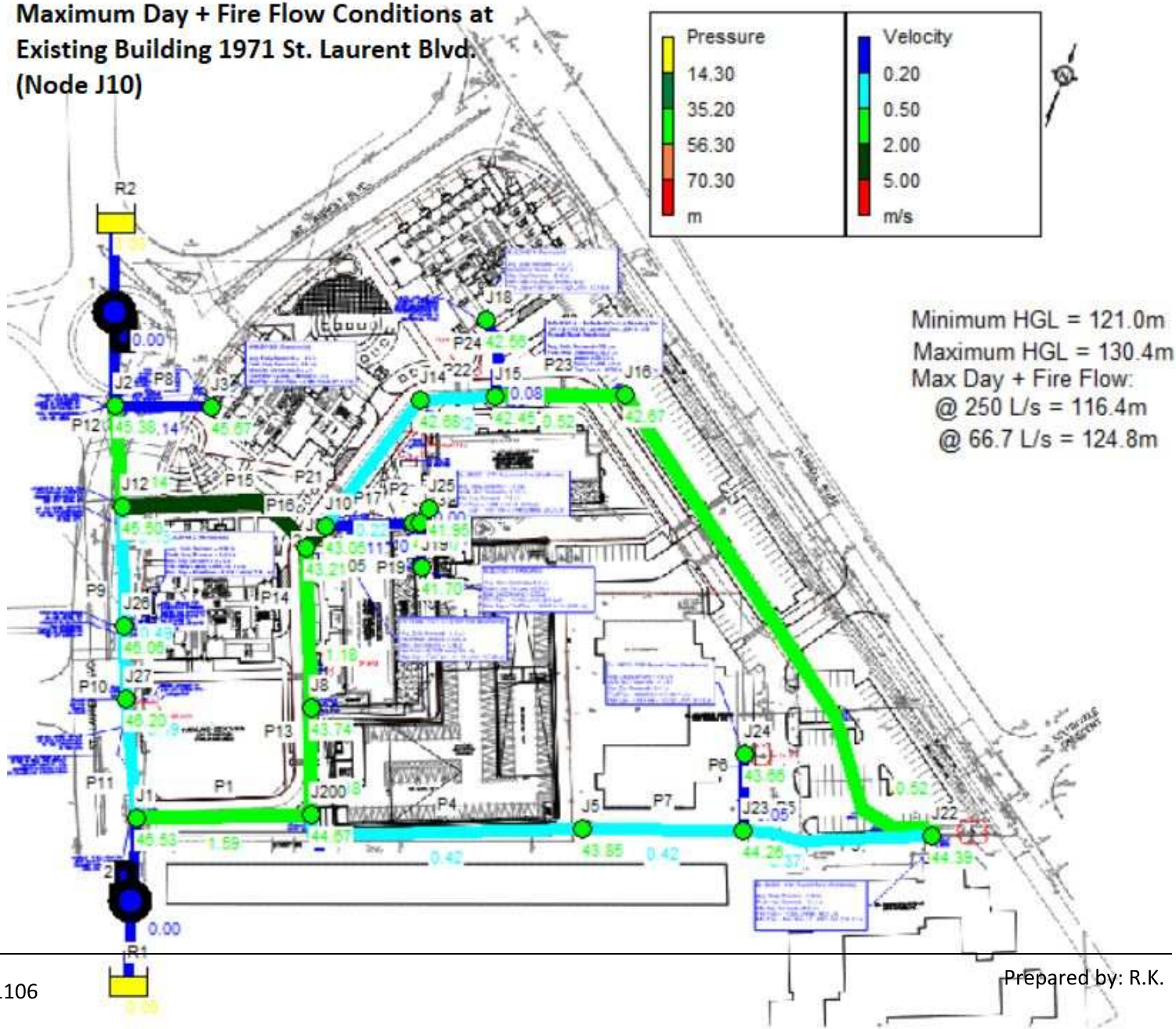



21106_Max Day + Fire @ 1971 St. Laurent.rpt

Page 1

2023-03-14 4:04:52 PM

```
*****
*                               E P A N E T                               *
*                               Hydraulic and Water Quality                 *
*                               Analysis for Pipe Networks                   *
*                               Version 2.2                                 *
*****
```

Input File: 21106_Max Day + Fire @ Building 1971 St. Lurent-2023.net

Link - Node Table:

Link ID	Start Node	End Node	Length m	Diameter mm	
P1	J1	J200	60.78	200	
P4	J5	J200	96.37	200	
P13	J200	J8	32.72	200	
P14	J8	J9	58.6	200	
P15	J9	J12	67.26	250	
P16	J9	J10	7.91	250	
P17	J10	J11	31.176	200	
P18	J11	J13	2.28	200	
P19	J13	J19	18.81	200	
P21	J10	J14	51.579	200	
P22	J14	J15	23.86	200	
P23	J15	J16	41.8	150	
P24	J15	J18	26	200	
P2	J25	J13	5.633	200	
P3	J16	J22	189.127	150	
P5	J22	J23	62.85	200	
P6	J24	J23	25.34	200	
P7	J23	J5	55.03	200	
P9	J12	J26	44	300	
P10	J26	J27	21.3	300	
P11	J27	J1	39.51	300	
P12	J12	J2	36.02	300	
P8	J3	J2	31.93	150	
1	R2	J2	#N/A	#N/A	Pump
2	R1	J1	#N/A	#N/A	Pump

Energy Usage:

Pump	Usage Factor	Avg. Effic.	Kw-hr /m3	Avg. Kw	Peak Kw	Cost /day



21106_Max Day + Fire @ 1971 St. Laurent.rpt

1	100.00	75.00	0.45	134.52	134.52	0.00
2	100.00	75.00	0.45	136.75	136.75	0.00

Demand Charge:	0.00
Total Cost:	0.00



Page 2

Node Results at 0:00 Hrs:

Node ID	Demand LPS	Head m	Pressure m	Quality	
J1	0.00	123.80	46.53	0.00	
J200	0.00	122.74	44.67	0.00	
J5	0.00	122.60	43.85	0.00	
J8	0.00	122.41	43.74	0.00	
J9	0.00	121.91	43.21	0.00	
J10	153.30	121.55	43.05	0.00	
J11	0.00	121.55	42.02	0.00	
J12	0.00	123.70	45.50	0.00	
J13	0.00	121.55	41.97	0.00	
J14	0.00	121.58	42.68	0.00	
J15	0.00	121.59	42.45	0.00	
J16	0.00	121.74	42.67	0.00	
J18	2.40	121.59	42.56	0.00	
J19	0.00	121.55	41.70	0.00	
J2	0.00	123.88	45.38	0.00	
J22	2.30	122.44	44.39	0.00	
J23	0.00	122.52	44.26	0.00	
J24	1.50	122.52	43.66	0.00	
J25	3.30	121.55	41.95	0.00	
J26	2.40	123.74	46.06	0.00	
J27	0.00	123.76	46.20	0.00	
J3	2.40	123.87	45.67	0.00	
R1	-84.51	0.00	0.00	0.00	Reservoir
R2	-83.09	0.00	0.00	0.00	Reservoir

Link Results at 0:00 Hrs:

Link ID	Flow LPS	Velocity m/s	Unit Headloss m/km	Status
P1	50.04	1.59	17.51	Open
P4	-13.04	0.42	1.45	Open
P13	37.00	1.18	10.01	Open
P14	37.00	1.18	8.52	Open

Page 2



21106_Max Day + Fire @ 1971 St. Laurent.rpt

P15	-112.76	2.30	26.58	Open
P16	-149.76	3.05	44.96	Open
P17	3.30	0.11	0.11	Open
P18	3.30	0.11	0.11	Open
P19	0.00	0.00	0.00	Open
P21	-6.84	0.22	0.44	Open
P22	-6.84	0.22	0.44	Open
P23	-9.24	0.52	3.71	Open
P24	2.40	0.08	0.06	Open
P2	-3.30	0.11	0.11	Open
P3	-9.24	0.52	3.71	Open
P5	-11.54	0.37	1.16	Open
P6	-1.50	0.05	0.03	Open



Page 3

Link Results at 0:00 Hrs: (continued)

Link ID	Flow LPS	Velocity m/s	Unit Headloss m/km	Status
P7	-13.04	0.42	1.45	Open
P9	-32.07	0.45	0.91	Open
P10	-34.47	0.49	1.04	Open
P11	-34.47	0.49	1.04	Open
P12	-80.69	1.14	5.01	Open
P8	-2.40	0.14	0.31	Open
1	83.09	0.00	-123.88	Open Pump
2	84.51	0.00	-123.80	Open Pump

Node Results at 1:00 Hrs:

Node ID	Demand LPS	Head m	Pressure m	Quality
J1	0.00	123.80	46.53	0.00
J200	0.00	122.74	44.67	0.00
J5	0.00	122.60	43.85	0.00
J8	0.00	122.41	43.74	0.00
J9	0.00	121.91	43.21	0.00
J10	153.30	121.55	43.05	0.00
J11	0.00	121.55	42.02	0.00
J12	0.00	123.70	45.50	0.00
J13	0.00	121.55	41.97	0.00
J14	0.00	121.58	42.68	0.00
J15	0.00	121.59	42.45	0.00
J16	0.00	121.74	42.67	0.00
J18	2.40	121.59	42.56	0.00

Page 3



21106_Max Day + Fire @ 1971 St. Laurent.rpt

J19	0.00	121.55	41.70	0.00
J2	0.00	123.88	45.38	0.00
J22	2.30	122.44	44.39	0.00
J23	0.00	122.52	44.26	0.00
J24	1.50	122.52	43.66	0.00
J25	3.30	121.55	41.95	0.00
J26	2.40	123.74	46.06	0.00
J27	0.00	123.76	46.20	0.00
J3	2.40	123.87	45.67	0.00
R1	-84.51	0.00	0.00	0.00 Reservoir
R2	-83.09	0.00	0.00	0.00 Reservoir



Page 4

Link Results at 1:00 Hrs:

Link ID	Flow LPS	Velocity m/s	Unit Headloss m/km	Status
P1	50.04	1.59	17.51	Open
P4	-13.04	0.42	1.45	Open
P13	37.00	1.18	10.01	Open
P14	37.00	1.18	8.52	Open
P15	-112.76	2.30	26.58	Open
P16	149.76	3.05	44.96	Open
P17	3.30	0.11	0.11	Open
P18	3.30	0.11	0.11	Open
P19	0.00	0.00	0.00	Open
P21	-6.84	0.22	0.44	Open
P22	-6.84	0.22	0.44	Open
P23	-9.24	0.52	3.71	Open
P24	2.40	0.08	0.06	Open
P2	-3.30	0.11	0.11	Open
P3	-9.24	0.52	3.71	Open
P5	-11.54	0.37	1.16	Open
P6	-1.50	0.05	0.03	Open
P7	-13.04	0.42	1.45	Open
P9	-32.07	0.45	0.91	Open
P10	-34.47	0.49	1.04	Open
P11	-34.47	0.49	1.04	Open
P12	-80.69	1.14	5.01	Open
P8	-2.40	0.14	0.31	Open
1	83.09	0.00	-123.88	Open Pump
2	84.51	0.00	-123.80	Open Pump

Node Results at 2:00 Hrs:



21106_Max Day + Fire @ 1971 St. Laurent.rpt

Node ID	Demand LPS	Head m	Pressure m	Quality
J1	0.00	123.80	46.53	0.00
J200	0.00	122.74	44.67	0.00
J5	0.00	122.60	43.85	0.00
J8	0.00	122.41	43.74	0.00
J9	0.00	121.91	43.21	0.00
J10	153.30	121.55	43.05	0.00
J11	0.00	121.55	42.02	0.00
J12	0.00	123.70	45.50	0.00
J13	0.00	121.55	41.97	0.00
J14	0.00	121.58	42.68	0.00
J15	0.00	121.59	42.45	0.00
J16	0.00	121.74	42.67	0.00
J18	2.40	121.59	42.56	0.00
J19	0.00	121.55	41.70	0.00
J2	0.00	123.88	45.38	0.00
J22	2.30	122.44	44.39	0.00



Page 5

Node Results at 2:00 Hrs: (continued)

Node ID	Demand LPS	Head m	Pressure m	Quality
J23	0.00	122.52	44.26	0.00
J24	1.50	122.52	43.66	0.00
J25	3.30	121.55	41.95	0.00
J26	2.40	123.74	46.06	0.00
J27	0.00	123.76	46.20	0.00
J3	2.40	123.87	45.67	0.00
R1	-84.51	0.00	0.00	0.00 Reservoir
R2	-83.09	0.00	0.00	0.00 Reservoir

Link Results at 2:00 Hrs:

Link ID	Flow LPS	Velocity m/s	Unit Headloss m/km	Status
P1	50.04	1.59	17.51	Open
P4	-13.04	0.42	1.45	Open
P13	37.00	1.18	10.01	Open
P14	37.00	1.18	8.52	Open
P15	-112.76	2.30	26.58	Open
P16	149.76	3.05	44.96	Open
P17	3.30	0.11	0.11	Open

Page 5



21106_Max Day + Fire @ 1971 St. Laurent.rpt

P18	3.30	0.11	0.11	Open
P19	0.00	0.00	0.00	Open
P21	-6.84	0.22	0.44	Open
P22	-6.84	0.22	0.44	Open
P23	-9.24	0.52	3.71	Open
P24	2.40	0.08	0.06	Open
P2	-3.30	0.11	0.11	Open
P3	-9.24	0.52	3.71	Open
P5	-11.54	0.37	1.16	Open
P6	-1.50	0.05	0.03	Open
P7	-13.04	0.42	1.45	Open
P9	-32.07	0.45	0.91	Open
P10	-34.47	0.49	1.04	Open
P11	-34.47	0.49	1.04	Open
P12	-80.69	1.14	5.01	Open
P8	-2.40	0.14	0.31	Open
1	83.09	0.00	-123.88	Open Pump
2	84.51	0.00	-123.80	Open Pump



Page 6

Node Results at 3:00 Hrs:

Node ID	Demand LPS	Head m	Pressure m	Quality
J1	0.00	123.80	46.53	0.00
J200	0.00	122.74	44.67	0.00
J5	0.00	122.60	43.85	0.00
J8	0.00	122.41	43.74	0.00
J9	0.00	121.91	43.21	0.00
J10	153.30	121.55	43.05	0.00
J11	0.00	121.55	42.02	0.00
J12	0.00	123.70	45.50	0.00
J13	0.00	121.55	41.97	0.00
J14	0.00	121.58	42.68	0.00
J15	0.00	121.59	42.45	0.00
J16	0.00	121.74	42.67	0.00
J18	2.40	121.59	42.56	0.00
J19	0.00	121.55	41.70	0.00
J2	0.00	123.88	45.38	0.00
J22	2.30	122.44	44.39	0.00
J23	0.00	122.52	44.26	0.00
J24	1.50	122.52	43.66	0.00
J25	3.30	121.55	41.95	0.00
J26	2.40	123.74	46.06	0.00
J27	0.00	123.76	46.20	0.00

Page 6



21106_Max Day + Fire @ 1971 St. Laurent.rpt

J3	2.40	123.87	45.67	0.00	
R1	-84.51	0.00	0.00	0.00	Reservoir
R2	-83.09	0.00	0.00	0.00	Reservoir

Link Results at 3:00 Hrs:

Link ID	Flow LPS	Velocity m/s	Unit Headloss m/km	Status
P1	50.04	1.59	17.51	Open
P4	-13.04	0.42	1.45	Open
P13	37.00	1.18	10.01	Open
P14	37.00	1.18	8.52	Open
P15	-112.76	2.30	26.58	Open
P16	149.76	3.05	44.96	Open
P17	3.30	0.11	0.11	Open
P18	3.30	0.11	0.11	Open
P19	0.00	0.00	0.00	Open
P21	-6.84	0.22	0.44	Open
P22	-6.84	0.22	0.44	Open
P23	-9.24	0.52	3.71	Open
P24	2.40	0.08	0.06	Open
P2	-3.30	0.11	0.11	Open
P3	-9.24	0.52	3.71	Open
P5	-11.54	0.37	1.16	Open
P6	-1.50	0.05	0.03	Open



Page 7

Link Results at 3:00 Hrs: (continued)

Link ID	Flow LPS	Velocity m/s	Unit Headloss m/km	Status
P7	-13.04	0.42	1.45	Open
P9	-32.07	0.45	0.91	Open
P10	-34.47	0.49	1.04	Open
P11	-34.47	0.49	1.04	Open
P12	-80.69	1.14	5.01	Open
P8	-2.40	0.14	0.31	Open
1	83.09	0.00	-123.88	Open Pump
2	84.51	0.00	-123.80	Open Pump

Node Results at 4:00 Hrs:

Node ID	Demand LPS	Head m	Pressure m	Quality
---------	------------	--------	------------	---------



21106_Max Day + Fire @ 1971 St. Laurent.rpt

J1	0.00	123.80	46.53	0.00
J200	0.00	122.74	44.67	0.00
J5	0.00	122.60	43.85	0.00
J8	0.00	122.41	43.74	0.00
J9	0.00	121.91	43.21	0.00
J10	153.30	121.55	43.05	0.00
J11	0.00	121.55	42.02	0.00
J12	0.00	123.70	45.50	0.00
J13	0.00	121.55	41.97	0.00
J14	0.00	121.58	42.68	0.00
J15	0.00	121.59	42.45	0.00
J16	0.00	121.74	42.67	0.00
J18	2.40	121.59	42.56	0.00
J19	0.00	121.55	41.70	0.00
J2	0.00	123.88	45.38	0.00
J22	2.30	122.44	44.39	0.00
J23	0.00	122.52	44.26	0.00
J24	1.50	122.52	43.66	0.00
J25	3.30	121.55	41.95	0.00
J26	2.40	123.74	46.06	0.00
J27	0.00	123.76	46.20	0.00
J3	2.40	123.87	45.67	0.00
R1	-84.51	0.00	0.00	0.00 Reservoir
R2	-83.09	0.00	0.00	0.00 Reservoir



Page 8

Link Results at 4:00 Hrs:

Link ID	Flow LPS	Velocity m/s	Unit Headloss m/km	Status
P1	50.04	1.59	17.51	Open
P4	-13.04	0.42	1.45	Open
P13	37.00	1.18	10.01	Open
P14	37.00	1.18	8.52	Open
P15	-112.76	2.30	26.58	Open
P16	149.76	3.05	44.96	Open
P17	3.30	0.11	0.11	Open
P18	3.30	0.11	0.11	Open
P19	0.00	0.00	0.00	Open
P21	-6.84	0.22	0.44	Open
P22	-6.84	0.22	0.44	Open
P23	-9.24	0.52	3.71	Open
P24	2.40	0.08	0.06	Open
P2	-3.30	0.11	0.11	Open
P3	-9.24	0.52	3.71	Open

Page 8



21106_Max Day + Fire @ 1971 St. Laurent.rpt

P5	-11.54	0.37	1.16	Open
P6	-1.50	0.05	0.03	Open
P7	-13.04	0.42	1.45	Open
P9	-32.07	0.45	0.91	Open
P10	-34.47	0.49	1.04	Open
P11	-34.47	0.49	1.04	Open
P12	-80.69	1.14	5.01	Open
P8	-2.40	0.14	0.31	Open
1	83.09	0.00	-123.88	Open Pump
2	84.51	0.00	-123.80	Open Pump

Maximum Day + Fire Flow Conditions at Existing Building 1975 St. Laurent Blvd. (Node J25)

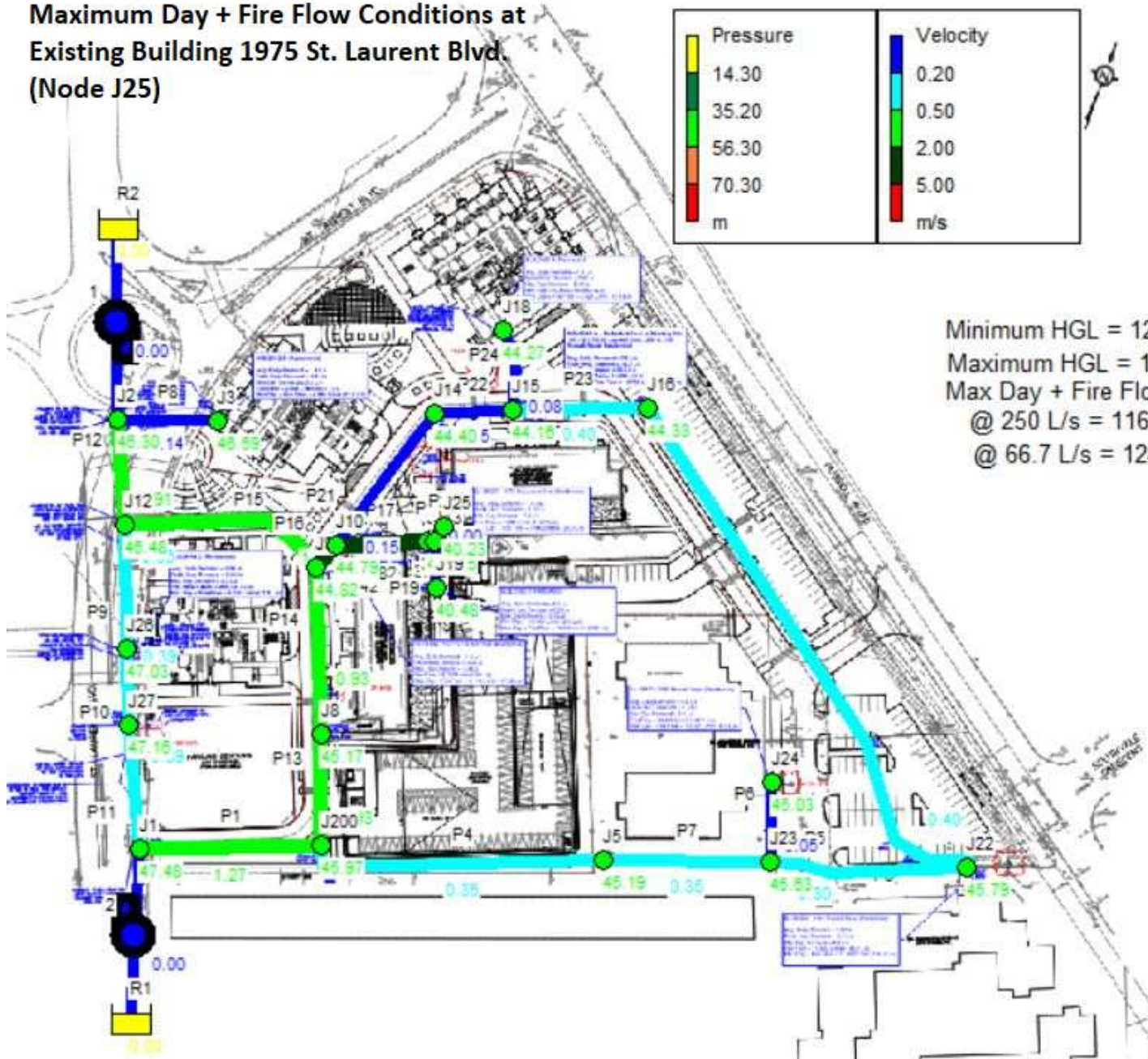
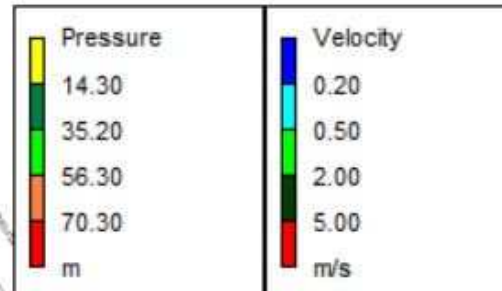

Minimum HGL = 121.0m
 Maximum HGL = 130.4m
 Max Day + Fire Flow:
 @ 250 L/s = 116.4m
 @ 66.7 L/s = 124.8m



21106_Max Day + Fire @ 1975 St. Laurent.rpt

Page 1

2023-03-14 4:06:29 PM

```
*****
*                               E P A N E T                               *
*                               Hydraulic and Water Quality                 *
*                               Analysis for Pipe Networks                   *
*                               Version 2.2                                 *
*****
```

Input File: 21106_Max Day + Fire @ Building 1975 St. Lurent-2023.net

Link - Node Table:

Link ID	Start Node	End Node	Length m	Diameter mm	
P1	J1	J200	60.78	200	
P4	J5	J200	96.37	200	
P13	J200	J8	32.72	200	
P14	J8	J9	58.6	200	
P15	J9	J12	67.26	250	
P16	J9	J10	7.91	250	
P17	J10	J11	31.176	200	
P18	J11	J13	2.28	200	
P19	J13	J19	18.81	200	
P21	J10	J14	51.579	200	
P22	J14	J15	23.86	200	
P23	J15	J16	41.8	150	
P24	J15	J18	26	200	
P2	J25	J13	5.633	200	
P3	J16	J22	189.127	150	
P5	J22	J23	62.85	200	
P6	J24	J23	25.34	200	
P7	J23	J5	55.03	200	
P9	J12	J26	44	300	
P10	J26	J27	21.3	300	
P11	J27	J1	39.51	300	
P12	J12	J2	36.02	300	
P8	J3	J2	31.93	150	
1	R2	J2	#N/A	#N/A	Pump
2	R1	J1	#N/A	#N/A	Pump

Energy Usage:

Pump	Usage Factor	Avg. Effic.	Kw-hr /m3	Avg. Kw	Peak Kw	Cost /day



21106_Max Day + Fire @ 1975 St. Laurent.rpt

1	100.00	75.00	0.45	108.81	108.81	0.00
2	100.00	75.00	0.45	110.20	110.20	0.00

Demand Charge:	0.00
Total Cost:	0.00



Page 2

Node Results at 0:00 Hrs:

Node ID	Demand LPS	Head m	Pressure m	Quality
J1	0.00	124.75	47.48	0.00
J200	0.00	124.04	45.97	0.00
J5	0.00	123.94	45.19	0.00
J8	0.00	123.84	45.17	0.00
J9	0.00	123.52	44.82	0.00
J10	3.30	123.29	44.79	0.00
J11	0.00	120.53	41.00	0.00
J12	0.00	124.68	46.48	0.00
J13	0.00	120.33	40.75	0.00
J14	0.00	123.30	44.40	0.00
J15	0.00	123.30	44.16	0.00
J16	0.00	123.40	44.33	0.00
J18	2.40	123.30	44.27	0.00
J19	0.00	120.33	40.48	0.00
J2	0.00	124.80	46.30	0.00
J22	2.30	123.84	45.79	0.00
J23	0.00	123.89	45.63	0.00
J24	1.50	123.89	45.03	0.00
J25	120.00	119.83	40.23	0.00
J26	2.40	124.71	47.03	0.00
J27	0.00	124.72	47.16	0.00
J3	2.40	124.79	46.59	0.00
R1	-67.59	0.00	0.00	0.00 Reservoir
R2	-66.71	0.00	0.00	0.00 Reservoir

Link Results at 0:00 Hrs:

Link ID	Flow LPS	Velocity m/s	Unit Headloss m/km	Status
P1	40.02	1.27	11.57	Open
P4	-10.95	0.35	1.05	Open
P13	29.07	0.93	6.40	Open
P14	29.07	0.93	5.45	Open

Page 2



21106_Max Day + Fire @ 1975 St. Laurent.rpt

P15	-89.48	1.82	17.32	Open
P16	118.55	2.42	29.16	Open
P17	120.00	3.82	88.45	Open
P18	120.00	3.82	88.45	Open
P19	0.00	0.00	0.00	Open
P21	-4.75	0.15	0.22	Open
P22	-4.75	0.15	0.22	Open
P23	-7.15	0.40	2.31	Open
P24	2.40	0.08	0.06	Open
P2	-120.00	3.82	88.45	Open
P3	-7.15	0.40	2.31	Open
P5	-9.45	0.30	0.80	Open
P6	-1.50	0.05	0.03	Open



Page 3

Link Results at 0:00 Hrs: (continued)

Link ID	Flow LPS	Velocity m/s	Unit Headloss m/km	Status
P7	-10.95	0.35	1.05	Open
P9	-25.17	0.36	0.58	Open
P10	-27.57	0.39	0.69	Open
P11	-27.57	0.39	0.69	Open
P12	-64.31	0.91	3.29	Open
P8	-2.40	0.14	0.31	Open
1	66.71	0.00	-124.80	Open Pump
2	67.59	0.00	-124.75	Open Pump

Node Results at 1:00 Hrs:

Node ID	Demand LPS	Head m	Pressure m	Quality
J1	0.00	124.75	47.48	0.00
J200	0.00	124.04	45.97	0.00
J5	0.00	123.94	45.19	0.00
J8	0.00	123.84	45.17	0.00
J9	0.00	123.52	44.82	0.00
J10	3.30	123.29	44.79	0.00
J11	0.00	120.53	41.00	0.00
J12	0.00	124.68	46.48	0.00
J13	0.00	120.33	40.75	0.00
J14	0.00	123.30	44.40	0.00
J15	0.00	123.30	44.16	0.00
J16	0.00	123.40	44.33	0.00
J18	2.40	123.30	44.27	0.00

Page 3



21106_Max Day + Fire @ 1975 St. Laurent.rpt

J19	0.00	120.33	40.48	0.00
J2	0.00	124.80	46.30	0.00
J22	2.30	123.84	45.79	0.00
J23	0.00	123.89	45.63	0.00
J24	1.50	123.89	45.03	0.00
J25	120.00	119.83	40.23	0.00
J26	2.40	124.71	47.03	0.00
J27	0.00	124.72	47.16	0.00
J3	2.40	124.79	46.59	0.00
R1	-67.59	0.00	0.00	0.00 Reservoir
R2	-66.71	0.00	0.00	0.00 Reservoir



Page 4

Link Results at 1:00 Hrs:

Link ID	Flow LPS	Velocity m/s	Unit Headloss m/km	Status
P1	40.02	1.27	11.57	Open
P4	-10.95	0.35	1.05	Open
P13	29.07	0.93	6.40	Open
P14	29.07	0.93	5.45	Open
P15	-89.48	1.82	17.32	Open
P16	118.55	2.42	29.16	Open
P17	120.00	3.82	88.45	Open
P18	120.00	3.82	88.45	Open
P19	0.00	0.00	0.00	Open
P21	-4.75	0.15	0.22	Open
P22	-4.75	0.15	0.22	Open
P23	-7.15	0.40	2.31	Open
P24	2.40	0.08	0.06	Open
P2	-120.00	3.82	88.45	Open
P3	-7.15	0.40	2.31	Open
P5	-9.45	0.30	0.80	Open
P6	-1.50	0.05	0.03	Open
P7	-10.95	0.35	1.05	Open
P9	-25.17	0.36	0.58	Open
P10	-27.57	0.39	0.69	Open
P11	-27.57	0.39	0.69	Open
P12	-64.31	0.91	3.29	Open
P8	-2.40	0.14	0.31	Open
1	66.71	0.00	-124.80	Open Pump
2	67.59	0.00	-124.75	Open Pump

Node Results at 2:00 Hrs:

Page 4



21106_Max Day + Fire @ 1975 St. Laurent.rpt

Node ID	Demand LPS	Head m	Pressure m	Quality
J1	0.00	124.75	47.48	0.00
J200	0.00	124.04	45.97	0.00
J5	0.00	123.94	45.19	0.00
J8	0.00	123.84	45.17	0.00
J9	0.00	123.52	44.82	0.00
J10	3.30	123.29	44.79	0.00
J11	0.00	120.53	41.00	0.00
J12	0.00	124.68	46.48	0.00
J13	0.00	120.33	40.75	0.00
J14	0.00	123.30	44.40	0.00
J15	0.00	123.30	44.16	0.00
J16	0.00	123.40	44.33	0.00
J18	2.40	123.30	44.27	0.00
J19	0.00	120.33	40.48	0.00
J2	0.00	124.80	46.30	0.00
J22	2.30	123.84	45.79	0.00



Page 5

Node Results at 2:00 Hrs: (continued)

Node ID	Demand LPS	Head m	Pressure m	Quality
J23	0.00	123.89	45.63	0.00
J24	1.50	123.89	45.03	0.00
J25	120.00	119.83	40.23	0.00
J26	2.40	124.71	47.03	0.00
J27	0.00	124.72	47.16	0.00
J3	2.40	124.79	46.59	0.00
R1	-67.59	0.00	0.00	0.00 Reservoir
R2	-66.71	0.00	0.00	0.00 Reservoir

Link Results at 2:00 Hrs:

Link ID	Flow LPS	Velocity m/s	Unit Headloss m/km	Status
P1	40.02	1.27	11.57	Open
P4	-10.95	0.35	1.05	Open
P13	29.07	0.93	6.40	Open
P14	29.07	0.93	5.45	Open
P15	-89.48	1.82	17.32	Open
P16	118.55	2.42	29.16	Open
P17	120.00	3.82	88.45	Open

Page 5



21106_Max Day + Fire @ 1975 St. Laurent.rpt

P18	120.00	3.82	88.45	Open
P19	0.00	0.00	0.00	Open
P21	-4.75	0.15	0.22	Open
P22	-4.75	0.15	0.22	Open
P23	-7.15	0.40	2.31	Open
P24	2.40	0.08	0.06	Open
P2	-120.00	3.82	88.45	Open
P3	-7.15	0.40	2.31	Open
P5	-9.45	0.30	0.80	Open
P6	-1.50	0.05	0.03	Open
P7	-10.95	0.35	1.05	Open
P9	-25.17	0.36	0.58	Open
P10	-27.57	0.39	0.69	Open
P11	-27.57	0.39	0.69	Open
P12	-64.31	0.91	3.29	Open
P8	-2.40	0.14	0.31	Open
1	66.71	0.00	-124.80	Open Pump
2	67.59	0.00	-124.75	Open Pump



Page 6

Node Results at 3:00 Hrs:

Node ID	Demand LPS	Head m	Pressure m	Quality
J1	0.00	124.75	47.48	0.00
J200	0.00	124.04	45.97	0.00
J5	0.00	123.94	45.19	0.00
J8	0.00	123.84	45.17	0.00
J9	0.00	123.52	44.82	0.00
J10	3.30	123.29	44.79	0.00
J11	0.00	120.53	41.00	0.00
J12	0.00	124.68	46.48	0.00
J13	0.00	120.33	40.75	0.00
J14	0.00	123.30	44.40	0.00
J15	0.00	123.30	44.16	0.00
J16	0.00	123.40	44.33	0.00
J18	2.40	123.30	44.27	0.00
J19	0.00	120.33	40.48	0.00
J2	0.00	124.80	46.30	0.00
J22	2.30	123.84	45.79	0.00
J23	0.00	123.89	45.63	0.00
J24	1.50	123.89	45.03	0.00
J25	120.00	119.83	40.23	0.00
J26	2.40	124.71	47.03	0.00
J27	0.00	124.72	47.16	0.00

Page 6



21106_Max Day + Fire @ 1975 St. Laurent.rpt

J3	2.40	124.79	46.59	0.00	
R1	-67.59	0.00	0.00	0.00	Reservoir
R2	-66.71	0.00	0.00	0.00	Reservoir

Link Results at 3:00 Hrs:

Link ID	Flow LPS	Velocity m/s	Unit Headloss m/km	Status
P1	40.02	1.27	11.57	Open
P4	-10.95	0.35	1.05	Open
P13	29.07	0.93	6.40	Open
P14	29.07	0.93	5.45	Open
P15	-89.48	1.82	17.32	Open
P16	118.55	2.42	29.16	Open
P17	120.00	3.82	88.45	Open
P18	120.00	3.82	88.45	Open
P19	0.00	0.00	0.00	Open
P21	-4.75	0.15	0.22	Open
P22	-4.75	0.15	0.22	Open
P23	-7.15	0.40	2.31	Open
P24	2.40	0.08	0.06	Open
P2	-120.00	3.82	88.45	Open
P3	-7.15	0.40	2.31	Open
P5	-9.45	0.30	0.80	Open
P6	-1.50	0.05	0.03	Open



Page 7

Link Results at 3:00 Hrs: (continued)

Link ID	Flow LPS	Velocity m/s	Unit Headloss m/km	Status
P7	-10.95	0.35	1.05	Open
P9	-25.17	0.36	0.58	Open
P10	-27.57	0.39	0.69	Open
P11	-27.57	0.39	0.69	Open
P12	-64.31	0.91	3.29	Open
P8	-2.40	0.14	0.31	Open
1	66.71	0.00	-124.80	Open Pump
2	67.59	0.00	-124.75	Open Pump

Node Results at 4:00 Hrs:

Node ID	Demand LPS	Head m	Pressure m	Quality
---------	------------	--------	------------	---------



21106_Max Day + Fire @ 1975 St. Laurent.rpt

J1	0.00	124.75	47.48	0.00
J200	0.00	124.04	45.97	0.00
J5	0.00	123.94	45.19	0.00
J8	0.00	123.84	45.17	0.00
J9	0.00	123.52	44.82	0.00
J10	3.30	123.29	44.79	0.00
J11	0.00	120.53	41.00	0.00
J12	0.00	124.68	46.48	0.00
J13	0.00	120.33	40.75	0.00
J14	0.00	123.30	44.40	0.00
J15	0.00	123.30	44.16	0.00
J16	0.00	123.40	44.33	0.00
J18	2.40	123.30	44.27	0.00
J19	0.00	120.33	40.48	0.00
J2	0.00	124.80	46.30	0.00
J22	2.30	123.84	45.79	0.00
J23	0.00	123.89	45.63	0.00
J24	1.50	123.89	45.03	0.00
J25	120.00	119.83	40.23	0.00
J26	2.40	124.71	47.03	0.00
J27	0.00	124.72	47.16	0.00
J3	2.40	124.79	46.59	0.00
R1	-67.59	0.00	0.00	0.00 Reservoir
R2	-66.71	0.00	0.00	0.00 Reservoir



Page 8

Link Results at 4:00 Hrs:

Link ID	Flow LPS	Velocity m/s	Unit Headloss m/km	Status
P1	40.02	1.27	11.57	Open
P4	-10.95	0.35	1.05	Open
P13	29.07	0.93	6.40	Open
P14	29.07	0.93	5.45	Open
P15	-89.48	1.82	17.32	Open
P16	118.55	2.42	29.16	Open
P17	120.00	3.82	88.45	Open
P18	120.00	3.82	88.45	Open
P19	0.00	0.00	0.00	Open
P21	-4.75	0.15	0.22	Open
P22	-4.75	0.15	0.22	Open
P23	-7.15	0.40	2.31	Open
P24	2.40	0.08	0.06	Open
P2	-120.00	3.82	88.45	Open
P3	-7.15	0.40	2.31	Open

Page 8



21106_Max Day + Fire @ 1975 St. Laurent.rpt

P5	-9.45	0.30	0.80	Open
P6	-1.50	0.05	0.03	Open
P7	-10.95	0.35	1.05	Open
P9	-25.17	0.36	0.58	Open
P10	-27.57	0.39	0.69	Open
P11	-27.57	0.39	0.69	Open
P12	-64.31	0.91	3.29	Open
P8	-2.40	0.14	0.31	Open
1	66.71	0.00	-124.80	Open Pump
2	67.59	0.00	-124.75	Open Pump



**Maximum Day + Fire Flow Conditions
at Existing Building 2080 Russell Road
(Node J24)**

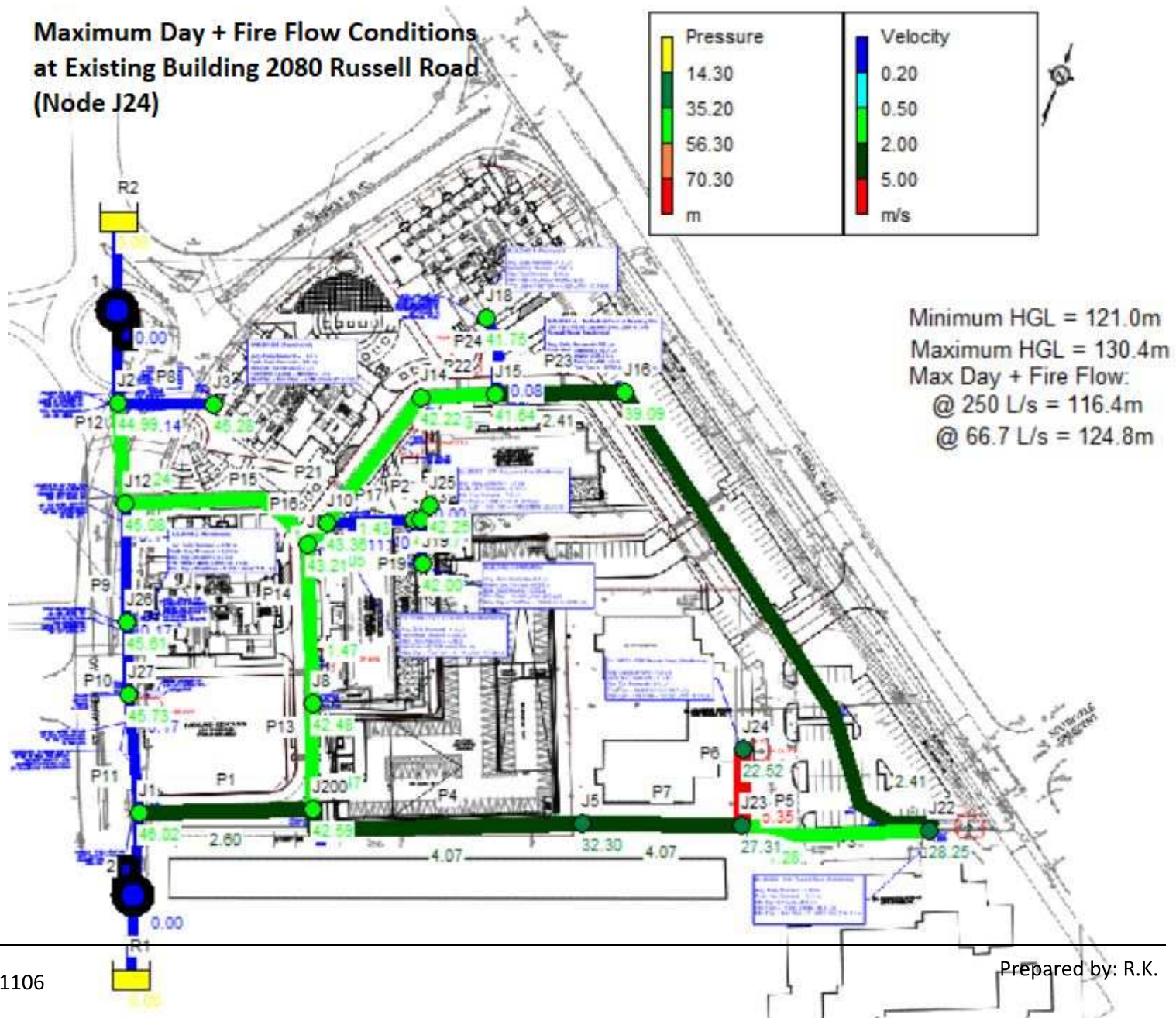
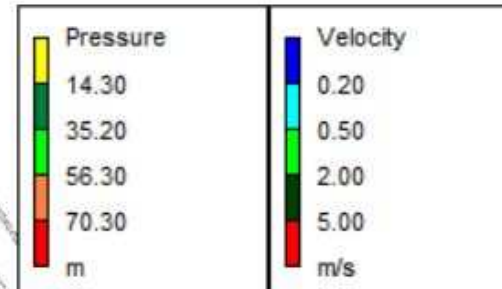



21106_Max Day + Fire @ 2080 Russell.rpt

Page 1

2023-03-14 4:07:36 PM

```
*****
*                               *
*             E P A N E T       *
*           Hydraulic and Water *
*           Analysis for Pipe   *
*           Networks            *
*           Version 2.2         *
*****
```

Input File: 21106_Max Day + Fire @ 2080 Russell-2023.net

Link - Node Table:

Link ID	Start Node	End Node	Length m	Diameter mm	
P1	J1	J200	60.78	200	
P4	J5	J200	96.37	200	
P13	J200	J8	32.72	200	
P14	J8	J9	58.6	200	
P15	J9	J12	67.26	250	
P16	J9	J10	7.91	250	
P17	J10	J11	31.176	200	
P18	J11	J13	2.28	200	
P19	J13	J19	18.81	200	
P21	J10	J14	51.579	200	
P22	J14	J15	23.86	200	
P23	J15	J16	41.8	150	
P24	J15	J18	26	200	
P2	J25	J13	5.633	200	
P3	J16	J22	189.127	150	
P5	J22	J23	62.85	200	
P6	J24	J23	25.34	200	
P7	J23	J5	55.03	200	
P9	J12	J26	44	300	
P10	J26	J27	21.3	300	
P11	J27	J1	39.51	300	
P12	J12	J2	36.02	300	
P8	J3	J2	31.93	150	
1	R2	J2	#N/A	#N/A	Pump
2	R1	J1	#N/A	#N/A	Pump

Energy Usage:

Pump	Usage Factor	Avg. Effic.	Kw-hr /m3	Avg. Kw	Peak Kw	Cost /day



21106_Max Day + Fire @ 2080 Russell.rpt

1	100.00	75.00	0.45	145.71	145.71	0.00
2	100.00	75.00	0.45	151.51	151.51	0.00

Demand Charge: 0.00
Total Cost: 0.00



Page 2

Node Results at 0:00 Hrs:

Node ID	Demand LPS	Head m	Pressure m	Quality	
J1	0.00	123.29	46.02	0.00	
J200	0.00	120.66	42.59	0.00	
J5	0.00	111.05	32.30	0.00	
J8	0.00	121.15	42.48	0.00	
J9	0.00	121.91	43.21	0.00	
J10	3.30	121.86	43.36	0.00	
J11	0.00	121.85	42.32	0.00	
J12	0.00	123.28	45.08	0.00	
J13	0.00	121.85	42.27	0.00	
J14	0.00	121.12	42.22	0.00	
J15	0.00	120.78	41.64	0.00	
J16	0.00	118.16	39.09	0.00	
J18	2.40	120.78	41.75	0.00	
J19	0.00	121.85	42.00	0.00	
J2	0.00	123.49	44.99	0.00	
J22	2.30	106.30	28.25	0.00	
J23	0.00	105.57	27.31	0.00	
J24	168.20	101.38	22.52	0.00	
J25	3.30	121.85	42.25	0.00	
J26	2.40	123.29	45.61	0.00	
J27	0.00	123.29	45.73	0.00	
J3	2.40	123.48	45.28	0.00	
R1	-94.02	0.00	0.00	0.00	Reservoir
R2	-90.28	0.00	0.00	0.00	Reservoir

Link Results at 0:00 Hrs:

Link ID	Flow LPS	Velocity m/s	Unit Headloss m/km	Status
P1	81.71	2.60	43.41	Open
P4	-127.99	4.07	99.67	Open
P13	-46.28	1.47	15.15	Open
P14	-46.28	1.47	12.89	Open

Page 2



	21106_Max Day + Fire @ 2080 Russell.rpt			
P15	-97.79	1.99	20.42	Open
P16	-51.51	1.05	6.23	Open
P17	3.30	0.11	0.11	Open
P18	3.30	0.11	0.11	Open
P19	0.00	0.00	0.00	Open
P21	44.91	1.43	14.33	Open
P22	44.91	1.43	14.33	Open
P23	42.51	2.41	62.69	Open
P24	2.40	0.08	0.06	Open
P2	-3.30	0.11	0.11	Open
P3	42.51	2.41	62.69	Open
P5	40.21	1.28	11.67	Open
P6	-168.20	5.35	165.30	Open



Page 3

Link Results at 0:00 Hrs: (continued)

Link ID	Flow LPS	Velocity m/s	Unit Headloss m/km	Status
P7	-127.99	4.07	99.67	Open
P9	-9.91	0.14	0.10	Open
P10	-12.31	0.17	0.15	Open
P11	-12.31	0.17	0.15	Open
P12	-87.88	1.24	5.87	Open
P8	-2.40	0.14	0.31	Open
1	90.28	0.00	-123.49	Open Pump
2	94.02	0.00	-123.29	Open Pump

Node Results at 1:00 Hrs:

Node ID	Demand LPS	Head m	Pressure m	Quality
J1	0.00	123.29	46.02	0.00
J200	0.00	120.66	42.59	0.00
J5	0.00	111.05	32.30	0.00
J8	0.00	121.15	42.48	0.00
J9	0.00	121.91	43.21	0.00
J10	3.30	121.86	43.36	0.00
J11	0.00	121.85	42.32	0.00
J12	0.00	123.28	45.08	0.00
J13	0.00	121.85	42.27	0.00
J14	0.00	121.12	42.22	0.00
J15	0.00	120.78	41.64	0.00
J16	0.00	118.16	39.09	0.00
J18	2.40	120.78	41.75	0.00

Page 3



	21106_Max	Day + Fire @ 2080	Russell.rpt	
J19	0.00	121.85	42.00	0.00
J2	0.00	123.49	44.99	0.00
J22	2.30	106.30	28.25	0.00
J23	0.00	105.57	27.31	0.00
J24	168.20	101.38	22.52	0.00
J25	3.30	121.85	42.25	0.00
J26	2.40	123.29	45.61	0.00
J27	0.00	123.29	45.73	0.00
J3	2.40	123.48	45.28	0.00
R1	-94.02	0.00	0.00	0.00 Reservoir
R2	-90.28	0.00	0.00	0.00 Reservoir



Page 4

Link Results at 1:00 Hrs:

Link ID	Flow LPS	Velocity m/s	Unit Headloss m/km	Status
P1	81.71	2.60	43.41	Open
P4	-127.99	4.07	99.67	Open
P13	-46.28	1.47	15.15	Open
P14	-46.28	1.47	12.89	Open
P15	-97.79	1.99	20.42	Open
P16	51.51	1.05	6.23	Open
P17	3.30	0.11	0.11	Open
P18	3.30	0.11	0.11	Open
P19	0.00	0.00	0.00	Open
P21	44.91	1.43	14.33	Open
P22	44.91	1.43	14.33	Open
P23	42.51	2.41	62.69	Open
P24	2.40	0.08	0.06	Open
P2	-3.30	0.11	0.11	Open
P3	42.51	2.41	62.69	Open
P5	40.21	1.28	11.67	Open
P6	-168.20	5.35	165.30	Open
P7	-127.99	4.07	99.67	Open
P9	-9.91	0.14	0.10	Open
P10	-12.31	0.17	0.15	Open
P11	-12.31	0.17	0.15	Open
P12	-87.88	1.24	5.87	Open
P8	-2.40	0.14	0.31	Open
1	90.28	0.00	-123.49	Open Pump
2	94.02	0.00	-123.29	Open Pump

Node Results at 2:00 Hrs:



21106_Max Day + Fire @ 2080 Russell.rpt				
Node	Demand	Head	Pressure	Quality
ID	LPS	m	m	
J1	0.00	123.29	46.02	0.00
J200	0.00	120.66	42.59	0.00
J5	0.00	111.05	32.30	0.00
J8	0.00	121.15	42.48	0.00
J9	0.00	121.91	43.21	0.00
J10	3.30	121.86	43.36	0.00
J11	0.00	121.85	42.32	0.00
J12	0.00	123.28	45.08	0.00
J13	0.00	121.85	42.27	0.00
J14	0.00	121.12	42.22	0.00
J15	0.00	120.78	41.64	0.00
J16	0.00	118.16	39.09	0.00
J18	2.40	120.78	41.75	0.00
J19	0.00	121.85	42.00	0.00
J2	0.00	123.49	44.99	0.00
J22	2.30	106.30	28.25	0.00



Page 5

Node Results at 2:00 Hrs: (continued)

Node	Demand	Head	Pressure	Quality	
ID	LPS	m	m		
J23	0.00	105.57	27.31	0.00	
J24	168.20	101.38	22.52	0.00	
J25	3.30	121.85	42.25	0.00	
J26	2.40	123.29	45.61	0.00	
J27	0.00	123.29	45.73	0.00	
J3	2.40	123.48	45.28	0.00	
R1	-94.02	0.00	0.00	0.00	Reservoir
R2	-90.28	0.00	0.00	0.00	Reservoir

Link Results at 2:00 Hrs:

Link	Flow	Velocity	Unit	Headloss	Status
ID	LPS	m/s		m/km	
P1	81.71	2.60		43.41	Open
P4	-127.99	4.07		99.67	Open
P13	-46.28	1.47		15.15	Open
P14	-46.28	1.47		12.89	Open
P15	-97.79	1.99		20.42	Open
P16	51.51	1.05		6.23	Open
P17	3.30	0.11		0.11	Open

Page 5



	21106_Max	Day + Fire	@ 2080	Russell.rpt	
P18	3.30	0.11	0.11	Open	
P19	0.00	0.00	0.00	Open	
P21	44.91	1.43	14.33	Open	
P22	44.91	1.43	14.33	Open	
P23	42.51	2.41	62.69	Open	
P24	2.40	0.08	0.06	Open	
P2	-3.30	0.11	0.11	Open	
P3	42.51	2.41	62.69	Open	
P5	40.21	1.28	11.67	Open	
P6	-168.20	5.35	165.30	Open	
P7	-127.99	4.07	99.67	Open	
P9	-9.91	0.14	0.10	Open	
P10	-12.31	0.17	0.15	Open	
P11	-12.31	0.17	0.15	Open	
P12	-87.88	1.24	5.87	Open	
P8	-2.40	0.14	0.31	Open	
1	90.28	0.00	-123.49	Open Pump	
2	94.02	0.00	-123.29	Open Pump	



Page 6

Node Results at 3:00 Hrs:

Node ID	Demand LPS	Head m	Pressure m	Quality
J1	0.00	123.29	46.02	0.00
J200	0.00	120.66	42.59	0.00
J5	0.00	111.05	32.30	0.00
J8	0.00	121.15	42.48	0.00
J9	0.00	121.91	43.21	0.00
J10	3.30	121.86	43.36	0.00
J11	0.00	121.85	42.32	0.00
J12	0.00	123.28	45.08	0.00
J13	0.00	121.85	42.27	0.00
J14	0.00	121.12	42.22	0.00
J15	0.00	120.78	41.64	0.00
J16	0.00	118.16	39.09	0.00
J18	2.40	120.78	41.75	0.00
J19	0.00	121.85	42.00	0.00
J2	0.00	123.49	44.99	0.00
J22	2.30	106.30	28.25	0.00
J23	0.00	105.57	27.31	0.00
J24	168.20	101.38	22.52	0.00
J25	3.30	121.85	42.25	0.00
J26	2.40	123.29	45.61	0.00
J27	0.00	123.29	45.73	0.00

Page 6



21106_Max Day + Fire @ 2080 Russell.rpt

J3	2.40	123.48	45.28	0.00	
R1	-94.02	0.00	0.00	0.00	Reservoir
R2	-90.28	0.00	0.00	0.00	Reservoir

Link Results at 3:00 Hrs:

Link ID	Flow LPS	Velocity m/s	Unit Headloss m/km	Status
P1	81.71	2.60	43.41	Open
P4	-127.99	4.07	99.67	Open
P13	-46.28	1.47	15.15	Open
P14	-46.28	1.47	12.89	Open
P15	-97.79	1.99	20.42	Open
P16	51.51	1.05	6.23	Open
P17	3.30	0.11	0.11	Open
P18	3.30	0.11	0.11	Open
P19	0.00	0.00	0.00	Open
P21	44.91	1.43	14.33	Open
P22	44.91	1.43	14.33	Open
P23	42.51	2.41	62.69	Open
P24	2.40	0.08	0.06	Open
P2	-3.30	0.11	0.11	Open
P3	42.51	2.41	62.69	Open
P5	40.21	1.28	11.67	Open
P6	-168.20	5.35	165.30	Open



Page 7

Link Results at 3:00 Hrs: (continued)

Link ID	Flow LPS	Velocity m/s	Unit Headloss m/km	Status
P7	-127.99	4.07	99.67	Open
P9	-9.91	0.14	0.10	Open
P10	-12.31	0.17	0.15	Open
P11	-12.31	0.17	0.15	Open
P12	-87.88	1.24	5.87	Open
P8	-2.40	0.14	0.31	Open
1	90.28	0.00	-123.49	Open Pump
2	94.02	0.00	-123.29	Open Pump

Node Results at 4:00 Hrs:

Node ID	Demand LPS	Head m	Pressure m	Quality
---------	------------	--------	------------	---------



	21106_Max	Day + Fire @ 2080	Russell.rpt	
J1	0.00	123.29	46.02	0.00
J200	0.00	120.66	42.59	0.00
J5	0.00	111.05	32.30	0.00
J8	0.00	121.15	42.48	0.00
J9	0.00	121.91	43.21	0.00
J10	3.30	121.86	43.36	0.00
J11	0.00	121.85	42.32	0.00
J12	0.00	123.28	45.08	0.00
J13	0.00	121.85	42.27	0.00
J14	0.00	121.12	42.22	0.00
J15	0.00	120.78	41.64	0.00
J16	0.00	118.16	39.09	0.00
J18	2.40	120.78	41.75	0.00
J19	0.00	121.85	42.00	0.00
J2	0.00	123.49	44.99	0.00
J22	2.30	106.30	28.25	0.00
J23	0.00	105.57	27.31	0.00
J24	168.20	101.38	22.52	0.00
J25	3.30	121.85	42.25	0.00
J26	2.40	123.29	45.61	0.00
J27	0.00	123.29	45.73	0.00
J3	2.40	123.48	45.28	0.00
R1	-94.02	0.00	0.00	0.00 Reservoir
R2	-90.28	0.00	0.00	0.00 Reservoir



Page 8

Link Results at 4:00 Hrs:

Link ID	Flow LPS	Velocity m/s	Unit Headloss m/km	Status
P1	81.71	2.60	43.41	Open
P4	-127.99	4.07	99.67	Open
P13	-46.28	1.47	15.15	Open
P14	-46.28	1.47	12.89	Open
P15	-97.79	1.99	20.42	Open
P16	51.51	1.05	6.23	Open
P17	3.30	0.11	0.11	Open
P18	3.30	0.11	0.11	Open
P19	0.00	0.00	0.00	Open
P21	44.91	1.43	14.33	Open
P22	44.91	1.43	14.33	Open
P23	42.51	2.41	62.69	Open
P24	2.40	0.08	0.06	Open
P2	-3.30	0.11	0.11	Open
P3	42.51	2.41	62.69	Open

Page 8



21106_Max Day + Fire @ 2080 Russell.rpt				
P5	40.21	1.28	11.67	Open
P6	-168.20	5.35	165.30	Open
P7	-127.99	4.07	99.67	Open
P9	-9.91	0.14	0.10	Open
P10	-12.31	0.17	0.15	Open
P11	-12.31	0.17	0.15	Open
P12	-87.88	1.24	5.87	Open
P8	-2.40	0.14	0.31	Open
1	90.28	0.00	-123.49	Open Pump
2	94.02	0.00	-123.29	Open Pump



**Maximum Day + Fire Flow Conditions
at Existing Building 2100 Russell Road
(Node J22)**

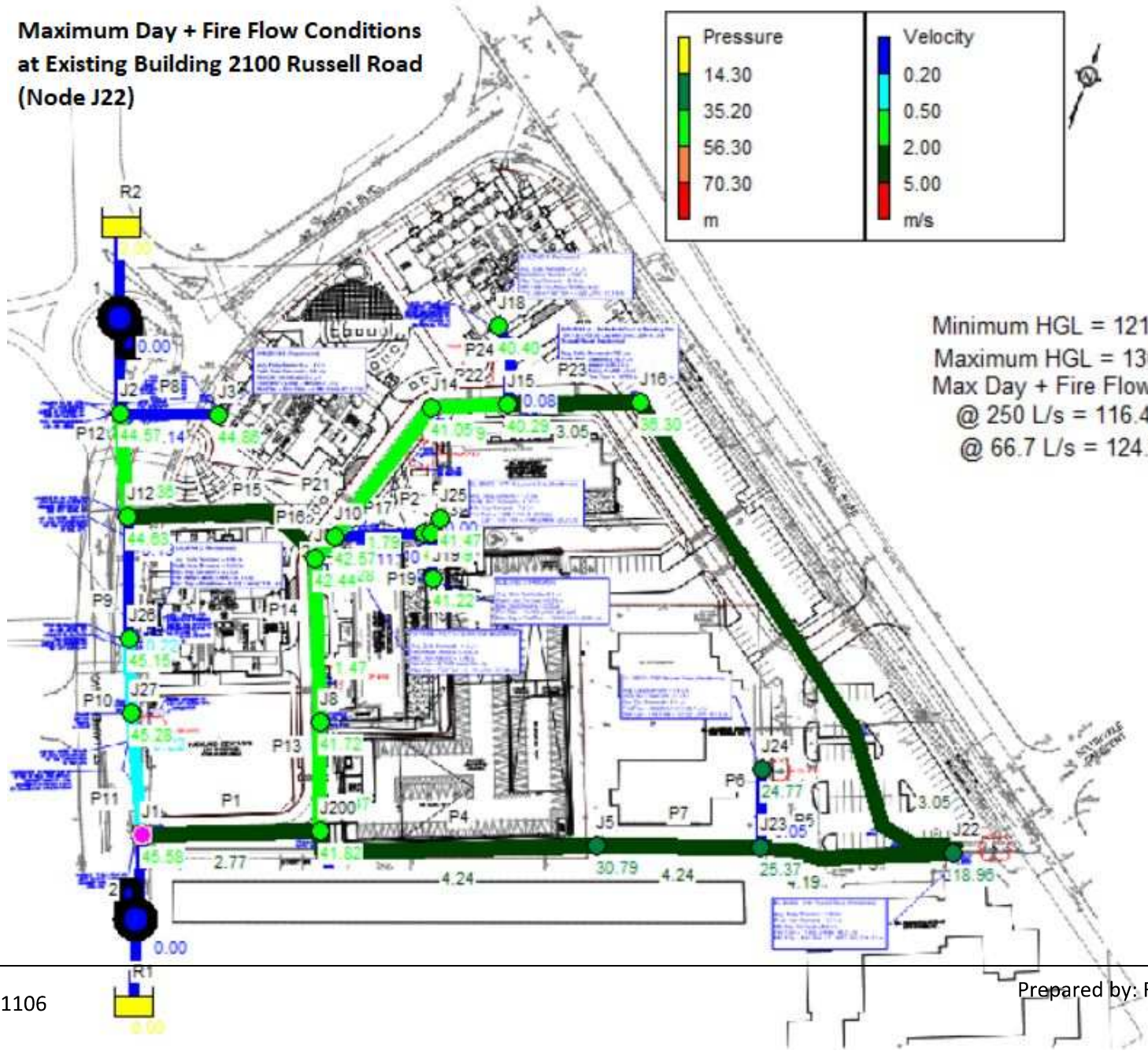
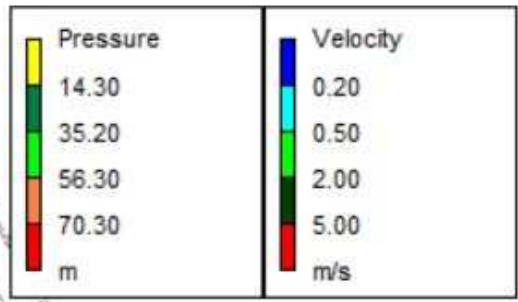

Minimum HGL = 121.0m
 Maximum HGL = 130.4m
 Max Day + Fire Flow:
 @ 250 L/s = 116.4m
 @ 66.7 L/s = 124.8m



21106_Max Day + Fire @ 2100 Russell.rpt

Page 1

2023-03-14 4:08:06 PM

```
*****
*                               *
*           E P A N E T         *
*           Hydraulic and Water Quality *
*           Analysis for Pipe Networks *
*           Version 2.2         *
*                               *
*****
```

Input File: 21106_Max Day + Fire @ 2100 Russell-2023.net

Link - Node Table:

Link ID	Start Node	End Node	Length m	Diameter mm	
P1	J1	J200	60.78	200	
P4	J5	J200	96.37	200	
P13	J200	J8	32.72	200	
P14	J8	J9	58.6	200	
P15	J9	J12	67.26	250	
P16	J9	J10	7.91	250	
P17	J10	J11	31.176	200	
P18	J11	J13	2.28	200	
P19	J13	J19	18.81	200	
P21	J10	J14	51.579	200	
P22	J14	J15	23.86	200	
P23	J15	J16	41.8	150	
P24	J15	J18	26	200	
P2	J25	J13	5.633	200	
P3	J16	J22	189.127	150	
P5	J22	J23	62.85	200	
P6	J24	J23	25.34	200	
P7	J23	J5	55.03	200	
P9	J12	J26	44	300	
P10	J26	J27	21.3	300	
P11	J27	J1	39.51	300	
P12	J12	J2	36.02	300	
P8	J3	J2	31.93	150	
1	R2	J2	#N/A	#N/A	Pump
2	R1	J1	#N/A	#N/A	Pump

Energy Usage:

Pump	Usage Factor	Avg. Effic.	Kw-hr /m3	Avg. Kw	Peak Kw	Cost /day



21106_Max Day + Fire @ 2100 Russell.rpt

1	100.00	75.00	0.45	158.04	158.04	0.00
2	100.00	75.00	0.45	164.81	164.81	0.00

Demand Charge: 0.00
Total Cost: 0.00



Page 2

Node Results at 0:00 Hrs:

Node ID	Demand LPS	Head m	Pressure m	Quality	
J1	0.00	122.85	45.58	0.00	
J200	0.00	119.89	41.82	0.00	
J5	0.00	109.54	30.79	0.00	
J8	0.00	120.39	41.72	0.00	
J9	0.00	121.14	42.44	0.00	
J10	3.30	121.07	42.57	0.00	
J11	0.00	121.07	41.54	0.00	
J12	0.00	122.83	44.63	0.00	
J13	0.00	121.07	41.49	0.00	
J14	0.00	119.95	41.05	0.00	
J15	0.00	119.43	40.29	0.00	
J16	0.00	115.37	36.30	0.00	
J18	2.40	119.43	40.40	0.00	
J19	0.00	121.07	41.22	0.00	
J2	0.00	123.07	44.57	0.00	
J22	185.60	97.01	18.96	0.00	
J23	0.00	103.63	25.37	0.00	
J24	1.50	103.63	24.77	0.00	
J25	3.30	121.07	41.47	0.00	
J26	2.40	122.83	45.15	0.00	
J27	0.00	122.84	45.28	0.00	
J3	2.40	123.06	44.86	0.00	
R1	-102.65	0.00	0.00	0.00	Reservoir
R2	-98.25	0.00	0.00	0.00	Reservoir

Link Results at 0:00 Hrs:

Link ID	Flow LPS	Velocity m/s	Unit Headloss m/km	Status
P1	86.94	2.77	48.70	Open
P4	-133.27	4.24	107.42	Open
P13	-46.33	1.47	15.18	Open
P14	-46.33	1.47	12.92	Open

Page 2



21106_Max Day + Fire @ 2100 Russell.rpt				
P15	-109.16	2.22	25.03	Open
P16	-62.83	1.28	9.00	Open
P17	3.30	0.11	0.11	Open
P18	3.30	0.11	0.11	Open
P19	0.00	0.00	0.00	Open
P21	56.23	1.79	21.73	Open
P22	56.23	1.79	21.73	Open
P23	53.83	3.05	97.08	Open
P24	2.40	0.08	0.06	Open
P2	-3.30	0.11	0.11	Open
P3	53.83	3.05	97.08	Open
P5	-131.77	4.19	105.19	Open
P6	-1.50	0.05	0.03	Open



Page 3

Link Results at 0:00 Hrs: (continued)

Link ID	Flow LPS	Velocity m/s	Unit Headloss m/km	Status
P7	-133.27	4.24	107.42	Open
P9	-13.30	0.19	0.18	Open
P10	-15.70	0.22	0.24	Open
P11	-15.70	0.22	0.24	Open
P12	-95.85	1.36	6.89	Open
P8	-2.40	0.14	0.31	Open
1	98.25	0.00	-123.07	Open Pump
2	102.65	0.00	-122.85	Open Pump

Node Results at 1:00 Hrs:

Node ID	Demand LPS	Head m	Pressure m	Quality
J1	0.00	122.85	45.58	0.00
J200	0.00	119.89	41.82	0.00
J5	0.00	109.54	30.79	0.00
J8	0.00	120.39	41.72	0.00
J9	0.00	121.14	42.44	0.00
J10	3.30	121.07	42.57	0.00
J11	0.00	121.07	41.54	0.00
J12	0.00	122.83	44.63	0.00
J13	0.00	121.07	41.49	0.00
J14	0.00	119.95	41.05	0.00
J15	0.00	119.43	40.29	0.00
J16	0.00	115.37	36.30	0.00
J18	2.40	119.43	40.40	0.00

Page 3



	21106_Max	Day + Fire @ 2100	Russell.rpt	
J19	0.00	121.07	41.22	0.00
J2	0.00	123.07	44.57	0.00
J22	185.60	97.01	18.96	0.00
J23	0.00	103.63	25.37	0.00
J24	1.50	103.63	24.77	0.00
J25	3.30	121.07	41.47	0.00
J26	2.40	122.83	45.15	0.00
J27	0.00	122.84	45.28	0.00
J3	2.40	123.06	44.86	0.00
R1	-102.65	0.00	0.00	0.00 Reservoir
R2	-98.25	0.00	0.00	0.00 Reservoir



Page 4

Link Results at 1:00 Hrs:

Link ID	Flow LPS	Velocity m/s	Unit Headloss m/km	Status
P1	86.94	2.77	48.70	Open
P4	-133.27	4.24	107.42	Open
P13	-46.33	1.47	15.18	Open
P14	-46.33	1.47	12.92	Open
P15	-109.16	2.22	25.03	Open
P16	62.83	1.28	9.00	Open
P17	3.30	0.11	0.11	Open
P18	3.30	0.11	0.11	Open
P19	0.00	0.00	0.00	Open
P21	56.23	1.79	21.73	Open
P22	56.23	1.79	21.73	Open
P23	53.83	3.05	97.08	Open
P24	2.40	0.08	0.06	Open
P2	-3.30	0.11	0.11	Open
P3	53.83	3.05	97.08	Open
P5	-131.77	4.19	105.19	Open
P6	-1.50	0.05	0.03	Open
P7	-133.27	4.24	107.42	Open
P9	-13.30	0.19	0.18	Open
P10	-15.70	0.22	0.24	Open
P11	-15.70	0.22	0.24	Open
P12	-95.85	1.36	6.89	Open
P8	-2.40	0.14	0.31	Open
1	98.25	0.00	-123.07	Open Pump
2	102.65	0.00	-122.85	Open Pump

Node Results at 2:00 Hrs:



21106_Max Day + Fire @ 2100 Russell.rpt				
Node	Demand	Head	Pressure	Quality
ID	LPS	m	m	
J1	0.00	122.85	45.58	0.00
J200	0.00	119.89	41.82	0.00
J5	0.00	109.54	30.79	0.00
J8	0.00	120.39	41.72	0.00
J9	0.00	121.14	42.44	0.00
J10	3.30	121.07	42.57	0.00
J11	0.00	121.07	41.54	0.00
J12	0.00	122.83	44.63	0.00
J13	0.00	121.07	41.49	0.00
J14	0.00	119.95	41.05	0.00
J15	0.00	119.43	40.29	0.00
J16	0.00	115.37	36.30	0.00
J18	2.40	119.43	40.40	0.00
J19	0.00	121.07	41.22	0.00
J2	0.00	123.07	44.57	0.00
J22	185.60	97.01	18.96	0.00



Page 5

Node Results at 2:00 Hrs: (continued)

Node	Demand	Head	Pressure	Quality	
ID	LPS	m	m		
J23	0.00	103.63	25.37	0.00	
J24	1.50	103.63	24.77	0.00	
J25	3.30	121.07	41.47	0.00	
J26	2.40	122.83	45.15	0.00	
J27	0.00	122.84	45.28	0.00	
J3	2.40	123.06	44.86	0.00	
R1	-102.65	0.00	0.00	0.00	Reservoir
R2	-98.25	0.00	0.00	0.00	Reservoir

Link Results at 2:00 Hrs:

Link	Flow	Velocity	Unit	Headloss	Status
ID	LPS	m/s		m/km	
P1	86.94	2.77		48.70	Open
P4	-133.27	4.24		107.42	Open
P13	-46.33	1.47		15.18	Open
P14	-46.33	1.47		12.92	Open
P15	-109.16	2.22		25.03	Open
P16	62.83	1.28		9.00	Open
P17	3.30	0.11		0.11	Open

Page 5



	21106_Max	Day + Fire	@ 2100	Russell.rpt	
P18	3.30	0.11	0.11	Open	
P19	0.00	0.00	0.00	Open	
P21	56.23	1.79	21.73	Open	
P22	56.23	1.79	21.73	Open	
P23	53.83	3.05	97.08	Open	
P24	2.40	0.08	0.06	Open	
P2	-3.30	0.11	0.11	Open	
P3	53.83	3.05	97.08	Open	
P5	-131.77	4.19	105.19	Open	
P6	-1.50	0.05	0.03	Open	
P7	-133.27	4.24	107.42	Open	
P9	-13.30	0.19	0.18	Open	
P10	-15.70	0.22	0.24	Open	
P11	-15.70	0.22	0.24	Open	
P12	-95.85	1.36	6.89	Open	
P8	-2.40	0.14	0.31	Open	
1	98.25	0.00	-123.07	Open Pump	
2	102.65	0.00	-122.85	Open Pump	



Page 6

Node Results at 3:00 Hrs:

Node ID	Demand LPS	Head m	Pressure m	Quality
J1	0.00	122.85	45.58	0.00
J200	0.00	119.89	41.82	0.00
J5	0.00	109.54	30.79	0.00
J8	0.00	120.39	41.72	0.00
J9	0.00	121.14	42.44	0.00
J10	3.30	121.07	42.57	0.00
J11	0.00	121.07	41.54	0.00
J12	0.00	122.83	44.63	0.00
J13	0.00	121.07	41.49	0.00
J14	0.00	119.95	41.05	0.00
J15	0.00	119.43	40.29	0.00
J16	0.00	115.37	36.30	0.00
J18	2.40	119.43	40.40	0.00
J19	0.00	121.07	41.22	0.00
J2	0.00	123.07	44.57	0.00
J22	185.60	97.01	18.96	0.00
J23	0.00	103.63	25.37	0.00
J24	1.50	103.63	24.77	0.00
J25	3.30	121.07	41.47	0.00
J26	2.40	122.83	45.15	0.00
J27	0.00	122.84	45.28	0.00

Page 6



21106_Max Day + Fire @ 2100 Russell.rpt

J3	2.40	123.06	44.86	0.00	
R1	-102.65	0.00	0.00	0.00	Reservoir
R2	-98.25	0.00	0.00	0.00	Reservoir

Link Results at 3:00 Hrs:

Link ID	Flow LPS	Velocity m/s	Unit Headloss m/km	Status
P1	86.94	2.77	48.70	Open
P4	-133.27	4.24	107.42	Open
P13	-46.33	1.47	15.18	Open
P14	-46.33	1.47	12.92	Open
P15	-109.16	2.22	25.03	Open
P16	62.83	1.28	9.00	Open
P17	3.30	0.11	0.11	Open
P18	3.30	0.11	0.11	Open
P19	0.00	0.00	0.00	Open
P21	56.23	1.79	21.73	Open
P22	56.23	1.79	21.73	Open
P23	53.83	3.05	97.08	Open
P24	2.40	0.08	0.06	Open
P2	-3.30	0.11	0.11	Open
P3	53.83	3.05	97.08	Open
P5	-131.77	4.19	105.19	Open
P6	-1.50	0.05	0.03	Open



Page 7

Link Results at 3:00 Hrs: (continued)

Link ID	Flow LPS	Velocity m/s	Unit Headloss m/km	Status
P7	-133.27	4.24	107.42	Open
P9	-13.30	0.19	0.18	Open
P10	-15.70	0.22	0.24	Open
P11	-15.70	0.22	0.24	Open
P12	-95.85	1.36	6.89	Open
P8	-2.40	0.14	0.31	Open
1	98.25	0.00	-123.07	Open Pump
2	102.65	0.00	-122.85	Open Pump

Node Results at 4:00 Hrs:

Node ID	Demand LPS	Head m	Pressure m	Quality
---------	------------	--------	------------	---------



	21106_Max	Day + Fire	@ 2100	Russell.rpt	
J1	0.00	122.85	45.58	0.00	
J200	0.00	119.89	41.82	0.00	
J5	0.00	109.54	30.79	0.00	
J8	0.00	120.39	41.72	0.00	
J9	0.00	121.14	42.44	0.00	
J10	3.30	121.07	42.57	0.00	
J11	0.00	121.07	41.54	0.00	
J12	0.00	122.83	44.63	0.00	
J13	0.00	121.07	41.49	0.00	
J14	0.00	119.95	41.05	0.00	
J15	0.00	119.43	40.29	0.00	
J16	0.00	115.37	36.30	0.00	
J18	2.40	119.43	40.40	0.00	
J19	0.00	121.07	41.22	0.00	
J2	0.00	123.07	44.57	0.00	
J22	185.60	97.01	18.96	0.00	
J23	0.00	103.63	25.37	0.00	
J24	1.50	103.63	24.77	0.00	
J25	3.30	121.07	41.47	0.00	
J26	2.40	122.83	45.15	0.00	
J27	0.00	122.84	45.28	0.00	
J3	2.40	123.06	44.86	0.00	
R1	-102.65	0.00	0.00	0.00	Reservoir
R2	-98.25	0.00	0.00	0.00	Reservoir



Page 8

Link Results at 4:00 Hrs:

Link ID	Flow LPS	Velocity m/s	Unit Headloss m/km	Status
P1	86.94	2.77	48.70	Open
P4	-133.27	4.24	107.42	Open
P13	-46.33	1.47	15.18	Open
P14	-46.33	1.47	12.92	Open
P15	-109.16	2.22	25.03	Open
P16	62.83	1.28	9.00	Open
P17	3.30	0.11	0.11	Open
P18	3.30	0.11	0.11	Open
P19	0.00	0.00	0.00	Open
P21	56.23	1.79	21.73	Open
P22	56.23	1.79	21.73	Open
P23	53.83	3.05	97.08	Open
P24	2.40	0.08	0.06	Open
P2	-3.30	0.11	0.11	Open
P3	53.83	3.05	97.08	Open

Page 8



21106_Max Day + Fire @ 2100 Russell.rpt					
P5	-131.77	4.19	105.19	Open	
P6	-1.50	0.05	0.03	Open	
P7	-133.27	4.24	107.42	Open	
P9	-13.30	0.19	0.18	Open	
P10	-15.70	0.22	0.24	Open	
P11	-15.70	0.22	0.24	Open	
P12	-95.85	1.36	6.89	Open	
P8	-2.40	0.14	0.31	Open	
1	98.25	0.00	-123.07	Open	Pump
2	102.65	0.00	-122.85	Open	Pump



**Maximum Day + Fire Flow
Conditions at Building A
(Node J18)**

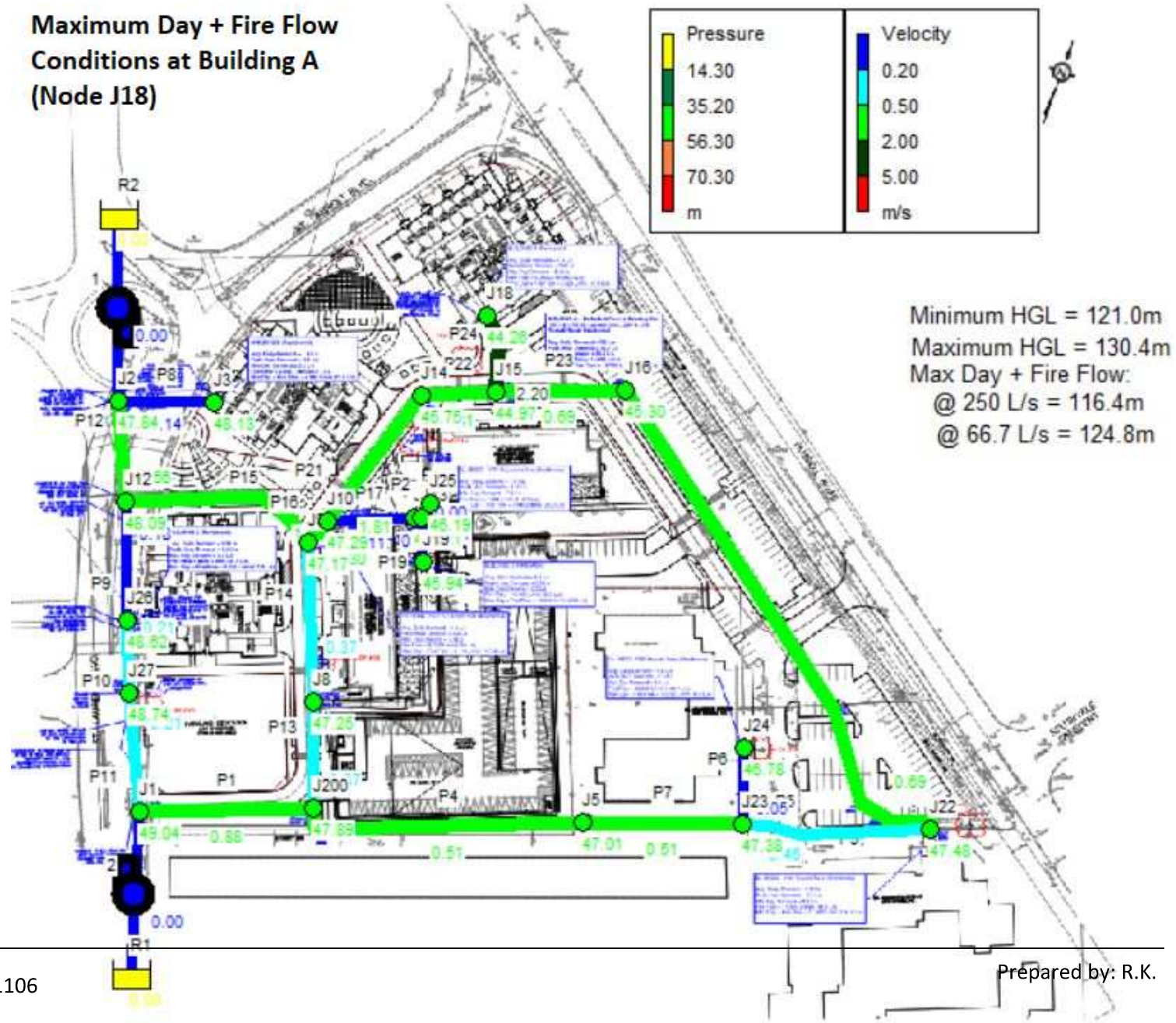
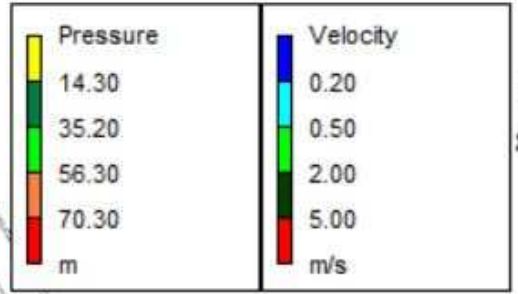

Minimum HGL = 121.0m
 Maximum HGL = 130.4m
 Max Day + Fire Flow:
 @ 250 L/s = 116.4m
 @ 66.7 L/s = 124.8m



21106_Max Day + Fire @ Building A.rpt

Page 1

2023-03-14 3:43:15 PM

```
*****
*                               *
*               E P A N E T      *
*           Hydraulic and Water Quality *
*           Analysis for Pipe Networks *
*               Version 2.2       *
*****
```

Input File: 21106_Max Day + Fire @ Building A-2023.net

Link - Node Table:

Link ID	Start Node	End Node	Length m	Diameter mm	
P1	J1	J200	60.78	200	
P4	J5	J200	96.37	200	
P13	J200	J8	32.72	200	
P14	J8	J9	58.6	200	
P15	J9	J12	67.26	250	
P16	J9	J10	7.91	250	
P17	J10	J11	31.176	200	
P18	J11	J13	2.28	200	
P19	J13	J19	18.81	200	
P21	J10	J14	51.579	200	
P22	J14	J15	23.86	200	
P23	J15	J16	41.8	150	
P24	J15	J18	26	200	
P2	J25	J13	5.633	200	
P3	J16	J22	189.127	150	
P5	J22	J23	62.85	200	
P6	J24	J23	25.34	200	
P7	J23	J5	55.03	200	
P9	J12	J26	44	300	
P10	J26	J27	21.3	300	
P11	J27	J1	39.51	300	
P12	J12	J2	36.02	300	
P8	J3	J2	31.93	150	
1	R2	J2	#N/A	#N/A	Pump
2	R1	J1	#N/A	#N/A	Pump

Energy Usage:

Pump	Usage Factor	Avg. Effic.	Kw-hr /m3	Avg. Kw	Peak Kw	Cost /day



21106_Max Day + Fire @ Building A.rpt

1	100.00	75.00	0.46	69.26	69.26	0.00
2	100.00	75.00	0.46	69.93	69.93	0.00

 Demand Charge: 0.00
 Total Cost: 0.00



Page 2

Node Results at 0:00 Hrs:

Node ID	Demand LPS	Head m	Pressure m	Quality	
J1	0.00	126.31	49.04	0.00	
J200	0.00	125.96	47.89	0.00	
J5	0.00	125.76	47.01	0.00	
J8	0.00	125.92	47.25	0.00	
J9	0.00	125.87	47.17	0.00	
J10	3.30	125.79	47.29	0.00	
J11	0.00	125.79	46.26	0.00	
J12	0.00	126.29	48.09	0.00	
J13	0.00	125.79	46.21	0.00	
J14	0.00	124.65	45.75	0.00	
J15	0.00	124.11	44.97	0.00	
J16	0.00	124.37	45.30	0.00	
J18	69.10	123.29	44.26	0.00	
J19	0.00	125.79	45.94	0.00	
J2	0.00	126.34	47.84	0.00	
J22	2.30	125.53	47.48	0.00	
J23	0.00	125.64	47.38	0.00	
J24	1.50	125.64	46.78	0.00	
J25	3.30	125.79	46.19	0.00	
J26	2.40	126.30	48.62	0.00	
J27	0.00	126.30	48.74	0.00	
J3	2.40	126.33	48.13	0.00	
R1	-42.36	0.00	0.00	0.00	Reservoir
R2	-41.94	0.00	0.00	0.00	Reservoir

Link Results at 0:00 Hrs:

Link ID	Flow LPS	Velocity m/s	Unit Headloss m/km	Status
P1	27.49	0.88	5.77	Open
P4	-15.93	0.51	2.10	Open
P13	11.56	0.37	1.16	Open
P14	11.56	0.37	0.99	Open

Page 2



21106_Max Day + Fire @ Building A.rpt				
P15	-52.01	1.06	6.34	Open
P16	-63.57	1.30	9.20	Open
P17	3.30	0.11	0.11	Open
P18	3.30	0.11	0.11	Open
P19	0.00	0.00	0.00	Open
P21	56.97	1.81	22.26	Open
P22	56.97	1.81	22.26	Open
P23	-12.13	0.69	6.15	Open
P24	69.10	2.20	31.83	Open
P2	-3.30	0.11	0.11	Open
P3	-12.13	0.69	6.15	Open
P5	-14.43	0.46	1.75	Open
P6	-1.50	0.05	0.03	Open



Page 3

Link Results at 0:00 Hrs: (continued)

Link ID	Flow LPS	Velocity m/s	Unit Headloss m/km	Status
P7	-15.93	0.51	2.10	Open
P9	-12.47	0.18	0.16	Open
P10	-14.87	0.21	0.22	Open
P11	-14.87	0.21	0.22	Open
P12	-39.54	0.56	1.34	Open
P8	-2.40	0.14	0.31	Open
1	41.94	0.00	-126.34	Open Pump
2	42.36	0.00	-126.31	Open Pump

Node Results at 1:00 Hrs:

Node ID	Demand LPS	Head m	Pressure m	Quality
J1	0.00	126.31	49.04	0.00
J200	0.00	125.96	47.89	0.00
J5	0.00	125.76	47.01	0.00
J8	0.00	125.92	47.25	0.00
J9	0.00	125.87	47.17	0.00
J10	3.30	125.79	47.29	0.00
J11	0.00	125.79	46.26	0.00
J12	0.00	126.29	48.09	0.00
J13	0.00	125.79	46.21	0.00
J14	0.00	124.65	45.75	0.00
J15	0.00	124.11	44.97	0.00
J16	0.00	124.37	45.30	0.00
J18	69.10	123.29	44.26	0.00

Page 3



21106_Max Day + Fire @ Building A.rpt				
J19	0.00	125.79	45.94	0.00
J2	0.00	126.34	47.84	0.00
J22	2.30	125.53	47.48	0.00
J23	0.00	125.64	47.38	0.00
J24	1.50	125.64	46.78	0.00
J25	3.30	125.79	46.19	0.00
J26	2.40	126.30	48.62	0.00
J27	0.00	126.30	48.74	0.00
J3	2.40	126.33	48.13	0.00
R1	-42.36	0.00	0.00	0.00 Reservoir
R2	-41.94	0.00	0.00	0.00 Reservoir



Page 4

Link Results at 1:00 Hrs:

Link ID	Flow LPS	Velocity m/s	Unit Headloss m/km	Status
P1	27.49	0.88	5.77	Open
P4	-15.93	0.51	2.10	Open
P13	11.56	0.37	1.16	Open
P14	11.56	0.37	0.99	Open
P15	-52.01	1.06	6.34	Open
P16	63.57	1.30	9.20	Open
P17	3.30	0.11	0.11	Open
P18	3.30	0.11	0.11	Open
P19	0.00	0.00	0.00	Open
P21	56.97	1.81	22.26	Open
P22	56.97	1.81	22.26	Open
P23	-12.13	0.69	6.15	Open
P24	69.10	2.20	31.83	Open
P2	-3.30	0.11	0.11	Open
P3	-12.13	0.69	6.15	Open
P5	-14.43	0.46	1.75	Open
P6	-1.50	0.05	0.03	Open
P7	-15.93	0.51	2.10	Open
P9	-12.47	0.18	0.16	Open
P10	-14.87	0.21	0.22	Open
P11	-14.87	0.21	0.22	Open
P12	-39.54	0.56	1.34	Open
P8	-2.40	0.14	0.31	Open
1	41.94	0.00	-126.34	Open Pump
2	42.36	0.00	-126.31	Open Pump

Node Results at 2:00 Hrs:



21106_Max Day + Fire @ Building A.rpt				
Node	Demand	Head	Pressure	Quality
ID	LPS	m	m	
J1	0.00	126.31	49.04	0.00
J200	0.00	125.96	47.89	0.00
J5	0.00	125.76	47.01	0.00
J8	0.00	125.92	47.25	0.00
J9	0.00	125.87	47.17	0.00
J10	3.30	125.79	47.29	0.00
J11	0.00	125.79	46.26	0.00
J12	0.00	126.29	48.09	0.00
J13	0.00	125.79	46.21	0.00
J14	0.00	124.65	45.75	0.00
J15	0.00	124.11	44.97	0.00
J16	0.00	124.37	45.30	0.00
J18	69.10	123.29	44.26	0.00
J19	0.00	125.79	45.94	0.00
J2	0.00	126.34	47.84	0.00
J22	2.30	125.53	47.48	0.00



Page 5

Node Results at 2:00 Hrs: (continued)

Node	Demand	Head	Pressure	Quality	
ID	LPS	m	m		
J23	0.00	125.64	47.38	0.00	
J24	1.50	125.64	46.78	0.00	
J25	3.30	125.79	46.19	0.00	
J26	2.40	126.30	48.62	0.00	
J27	0.00	126.30	48.74	0.00	
J3	2.40	126.33	48.13	0.00	
R1	-42.36	0.00	0.00	0.00	Reservoir
R2	-41.94	0.00	0.00	0.00	Reservoir

Link Results at 2:00 Hrs:

Link	Flow	Velocity	Unit	Headloss	Status
ID	LPS	m/s		m/km	
P1	27.49	0.88		5.77	Open
P4	-15.93	0.51		2.10	Open
P13	11.56	0.37		1.16	Open
P14	11.56	0.37		0.99	Open
P15	-52.01	1.06		6.34	Open
P16	63.57	1.30		9.20	Open
P17	3.30	0.11		0.11	Open

Page 5



	21106_Max Day + Fire @ Building A.rpt				
P18	3.30	0.11	0.11	Open	
P19	0.00	0.00	0.00	Open	
P21	56.97	1.81	22.26	Open	
P22	56.97	1.81	22.26	Open	
P23	-12.13	0.69	6.15	Open	
P24	69.10	2.20	31.83	Open	
P2	-3.30	0.11	0.11	Open	
P3	-12.13	0.69	6.15	Open	
P5	-14.43	0.46	1.75	Open	
P6	-1.50	0.05	0.03	Open	
P7	-15.93	0.51	2.10	Open	
P9	-12.47	0.18	0.16	Open	
P10	-14.87	0.21	0.22	Open	
P11	-14.87	0.21	0.22	Open	
P12	-39.54	0.56	1.34	Open	
P8	-2.40	0.14	0.31	Open	
1	41.94	0.00	-126.34	Open Pump	
2	42.36	0.00	-126.31	Open Pump	



Page 6

Node Results at 3:00 Hrs:

Node ID	Demand LPS	Head m	Pressure m	Quality
J1	0.00	126.31	49.04	0.00
J200	0.00	125.96	47.89	0.00
J5	0.00	125.76	47.01	0.00
J8	0.00	125.92	47.25	0.00
J9	0.00	125.87	47.17	0.00
J10	3.30	125.79	47.29	0.00
J11	0.00	125.79	46.26	0.00
J12	0.00	126.29	48.09	0.00
J13	0.00	125.79	46.21	0.00
J14	0.00	124.65	45.75	0.00
J15	0.00	124.11	44.97	0.00
J16	0.00	124.37	45.30	0.00
J18	69.10	123.29	44.26	0.00
J19	0.00	125.79	45.94	0.00
J2	0.00	126.34	47.84	0.00
J22	2.30	125.53	47.48	0.00
J23	0.00	125.64	47.38	0.00
J24	1.50	125.64	46.78	0.00
J25	3.30	125.79	46.19	0.00
J26	2.40	126.30	48.62	0.00
J27	0.00	126.30	48.74	0.00

Page 6



	21106_Max Day + Fire @ Building A.rpt				
J3	2.40	126.33	48.13	0.00	
R1	-42.36	0.00	0.00	0.00	Reservoir
R2	-41.94	0.00	0.00	0.00	Reservoir

Link Results at 3:00 Hrs:

Link ID	Flow LPS	Velocity m/s	Unit Headloss m/km	Status
P1	27.49	0.88	5.77	Open
P4	-15.93	0.51	2.10	Open
P13	11.56	0.37	1.16	Open
P14	11.56	0.37	0.99	Open
P15	-52.01	1.06	6.34	Open
P16	63.57	1.30	9.20	Open
P17	3.30	0.11	0.11	Open
P18	3.30	0.11	0.11	Open
P19	0.00	0.00	0.00	Open
P21	56.97	1.81	22.26	Open
P22	56.97	1.81	22.26	Open
P23	-12.13	0.69	6.15	Open
P24	69.10	2.20	31.83	Open
P2	-3.30	0.11	0.11	Open
P3	-12.13	0.69	6.15	Open
P5	-14.43	0.46	1.75	Open
P6	-1.50	0.05	0.03	Open



Page 7

Link Results at 3:00 Hrs: (continued)

Link ID	Flow LPS	Velocity m/s	Unit Headloss m/km	Status
P7	-15.93	0.51	2.10	Open
P9	-12.47	0.18	0.16	Open
P10	-14.87	0.21	0.22	Open
P11	-14.87	0.21	0.22	Open
P12	-39.54	0.56	1.34	Open
P8	-2.40	0.14	0.31	Open
1	41.94	0.00	-126.34	Open Pump
2	42.36	0.00	-126.31	Open Pump

Node Results at 4:00 Hrs:

Node ID	Demand LPS	Head m	Pressure m	Quality
---------	------------	--------	------------	---------



21106_Max Day + Fire @ Building A.rpt				
J1	0.00	126.31	49.04	0.00
J200	0.00	125.96	47.89	0.00
J5	0.00	125.76	47.01	0.00
J8	0.00	125.92	47.25	0.00
J9	0.00	125.87	47.17	0.00
J10	3.30	125.79	47.29	0.00
J11	0.00	125.79	46.26	0.00
J12	0.00	126.29	48.09	0.00
J13	0.00	125.79	46.21	0.00
J14	0.00	124.65	45.75	0.00
J15	0.00	124.11	44.97	0.00
J16	0.00	124.37	45.30	0.00
J18	69.10	123.29	44.26	0.00
J19	0.00	125.79	45.94	0.00
J2	0.00	126.34	47.84	0.00
J22	2.30	125.53	47.48	0.00
J23	0.00	125.64	47.38	0.00
J24	1.50	125.64	46.78	0.00
J25	3.30	125.79	46.19	0.00
J26	2.40	126.30	48.62	0.00
J27	0.00	126.30	48.74	0.00
J3	2.40	126.33	48.13	0.00
R1	-42.36	0.00	0.00	0.00 Reservoir
R2	-41.94	0.00	0.00	0.00 Reservoir



Page 8

Link Results at 4:00 Hrs:

Link ID	Flow LPS	Velocity m/s	Unit Headloss m/km	Status
P1	27.49	0.88	5.77	Open
P4	-15.93	0.51	2.10	Open
P13	11.56	0.37	1.16	Open
P14	11.56	0.37	0.99	Open
P15	-52.01	1.06	6.34	Open
P16	63.57	1.30	9.20	Open
P17	3.30	0.11	0.11	Open
P18	3.30	0.11	0.11	Open
P19	0.00	0.00	0.00	Open
P21	56.97	1.81	22.26	Open
P22	56.97	1.81	22.26	Open
P23	-12.13	0.69	6.15	Open
P24	69.10	2.20	31.82	Open
P2	-3.30	0.11	0.11	Open
P3	-12.13	0.69	6.15	Open

Page 8



21106_Max Day + Fire @ Building A.rpt					
P5	-14.43	0.46	1.75	Open	
P6	-1.50	0.05	0.03	Open	
P7	-15.93	0.51	2.10	Open	
P9	-12.47	0.18	0.16	Open	
P10	-14.87	0.21	0.22	Open	
P11	-14.87	0.21	0.22	Open	
P12	-39.54	0.56	1.34	Open	
P8	-2.40	0.14	0.31	Open	
1	41.94	0.00	-126.34	Open Pump	
2	42.36	0.00	-126.31	Open Pump	



**Maximum Day + Fire Flow
Conditions at Building B
(Node J3)**

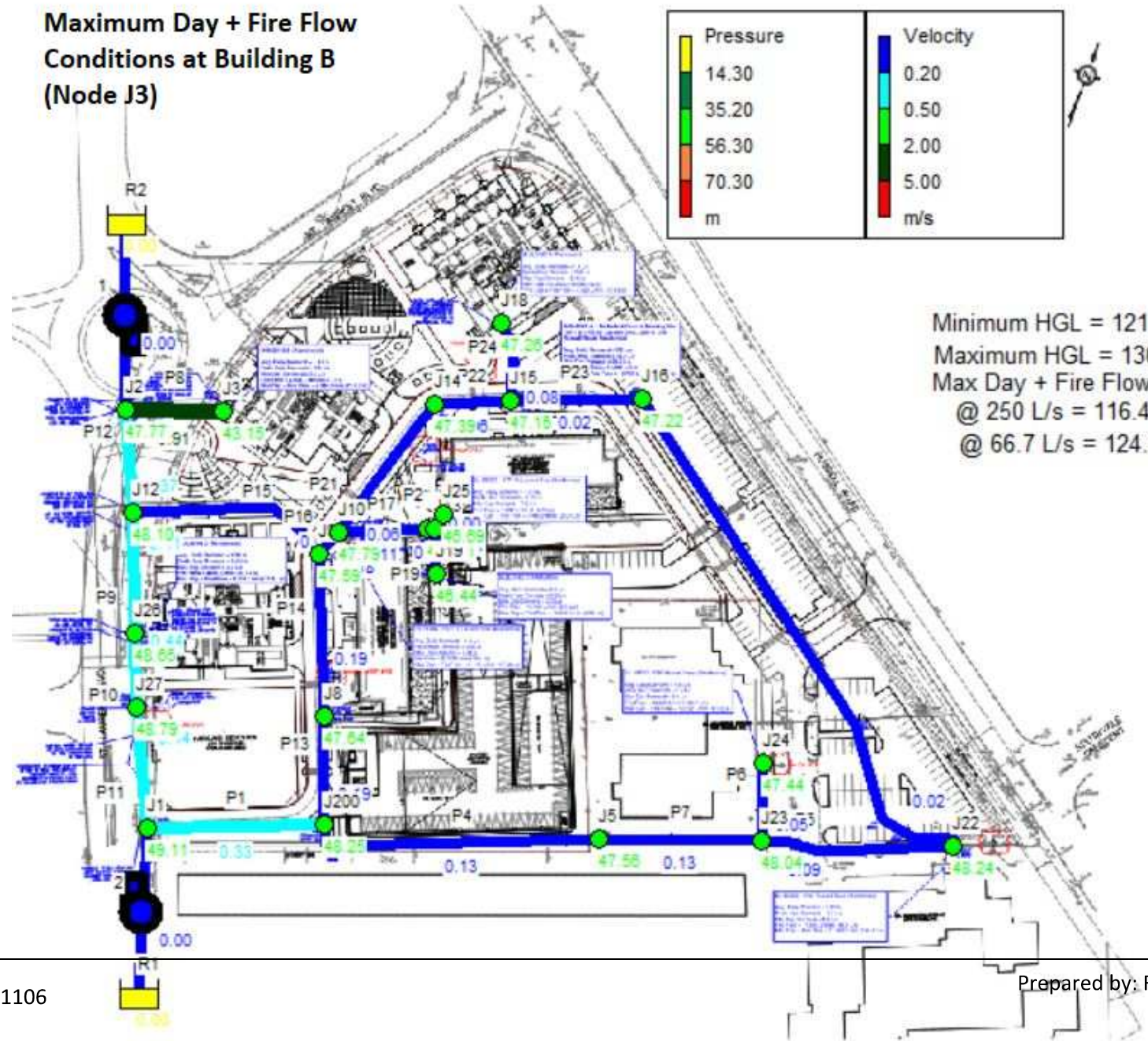
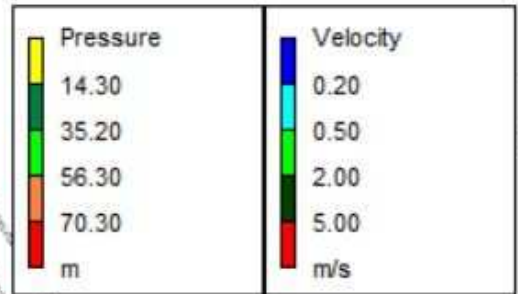

Minimum HGL = 121.0m
 Maximum HGL = 130.4m
 Max Day + Fire Flow:
 @ 250 L/s = 116.4m
 @ 66.7 L/s = 124.8m



21106_Max Day + Fire @ Building B.rpt

Page 1

2023-03-14 3:42:06 PM

```
*****
*                               E P A N E T                               *
*                               Hydraulic and Water Quality                 *
*                               Analysis for Pipe Networks                   *
*                               Version 2.2                                 *
*****
```

Input File: 21106_Max Day + Fire @ Building B-2023.net

Link - Node Table:

Link ID	Start Node	End Node	Length m	Diameter mm	
P1	J1	J200	60.78	200	
P4	J5	J200	96.37	200	
P13	J200	J8	32.72	200	
P14	J8	J9	58.6	200	
P15	J9	J12	67.26	250	
P16	J9	J10	7.91	250	
P17	J10	J11	31.176	200	
P18	J11	J13	2.28	200	
P19	J13	J19	18.81	200	
P21	J10	J14	51.579	200	
P22	J14	J15	23.86	200	
P23	J15	J16	41.8	150	
P24	J15	J18	26	200	
P2	J25	J13	5.633	200	
P3	J16	J22	189.127	150	
P5	J22	J23	62.85	200	
P6	J24	J23	25.34	200	
P7	J23	J5	55.03	200	
P9	J12	J26	44	300	
P10	J26	J27	21.3	300	
P11	J27	J1	39.51	300	
P12	J12	J2	36.02	300	
P8	J3	J2	31.93	150	
1	R2	J2	#N/A	#N/A	Pump
2	R1	J1	#N/A	#N/A	Pump

Energy Usage:

Pump	Usage Factor	Avg. Effic.	Kw-hr /m3	Avg. Kw	Peak Kw	Cost /day



21106_Max Day + Fire @ Building B.rpt

1	100.00	75.00	0.46	70.88	70.88	0.00
2	100.00	75.00	0.46	68.31	68.31	0.00

 Demand Charge: 0.00
 Total Cost: 0.00



Page 2

Node Results at 0:00 Hrs:

Node ID	Demand LPS	Head m	Pressure m	Quality	
J1	0.00	126.38	49.11	0.00	
J200	0.00	126.32	48.25	0.00	
J5	0.00	126.31	47.56	0.00	
J8	0.00	126.31	47.64	0.00	
J9	0.00	126.29	47.59	0.00	
J10	3.30	126.29	47.79	0.00	
J11	0.00	126.29	46.76	0.00	
J12	0.00	126.30	48.10	0.00	
J13	0.00	126.29	46.71	0.00	
J14	0.00	126.29	47.39	0.00	
J15	0.00	126.29	47.15	0.00	
J16	0.00	126.29	47.22	0.00	
J18	2.40	126.29	47.26	0.00	
J19	0.00	126.29	46.44	0.00	
J2	0.00	126.27	47.77	0.00	
J22	2.30	126.29	48.24	0.00	
J23	0.00	126.30	48.04	0.00	
J24	1.50	126.30	47.44	0.00	
J25	3.30	126.29	46.69	0.00	
J26	2.40	126.33	48.65	0.00	
J27	0.00	126.35	48.79	0.00	
J3	69.10	121.35	43.15	0.00	
R1	-41.35	0.00	0.00	0.00	Reservoir
R2	-42.95	0.00	0.00	0.00	Reservoir

Link Results at 0:00 Hrs:

Link ID	Flow LPS	Velocity m/s	Unit Headloss m/km	Status
P1	10.28	0.33	0.93	Open
P4	-4.20	0.13	0.18	Open
P13	6.09	0.19	0.35	Open
P14	6.09	0.19	0.30	Open

Page 2



	21106_Max Day + Fire @ Building B.rpt			
P15	-2.52	0.05	0.02	Open
P16	-8.60	0.18	0.23	Open
P17	3.30	0.11	0.11	Open
P18	3.30	0.11	0.11	Open
P19	0.00	0.00	0.00	Open
P21	2.00	0.06	0.05	Open
P22	2.00	0.06	0.04	Open
P23	-0.40	0.02	0.01	Open
P24	2.40	0.08	0.06	Open
P2	-3.30	0.11	0.11	Open
P3	-0.40	0.02	0.01	Open
P5	-2.70	0.09	0.08	Open
P6	-1.50	0.05	0.03	Open



Page 3

Link Results at 0:00 Hrs: (continued)

Link ID	Flow LPS	Velocity m/s	Unit Headloss m/km	Status
P7	-4.20	0.13	0.18	Open
P9	-28.67	0.41	0.74	Open
P10	-31.07	0.44	0.86	Open
P11	-31.07	0.44	0.86	Open
P12	26.15	0.37	0.62	Open
P8	-69.10	3.91	154.17	Open
1	42.95	0.00	-126.27	Open Pump
2	41.35	0.00	-126.38	Open Pump

Node Results at 1:00 Hrs:

Node ID	Demand LPS	Head m	Pressure m	Quality
J1	0.00	126.38	49.11	0.00
J200	0.00	126.32	48.25	0.00
J5	0.00	126.31	47.56	0.00
J8	0.00	126.31	47.64	0.00
J9	0.00	126.29	47.59	0.00
J10	3.30	126.29	47.79	0.00
J11	0.00	126.29	46.76	0.00
J12	0.00	126.30	48.10	0.00
J13	0.00	126.29	46.71	0.00
J14	0.00	126.29	47.39	0.00
J15	0.00	126.29	47.15	0.00
J16	0.00	126.29	47.22	0.00
J18	2.40	126.29	47.26	0.00

Page 3



21106_Max Day + Fire @ Building B.rpt				
J19	0.00	126.29	46.44	0.00
J2	0.00	126.27	47.77	0.00
J22	2.30	126.29	48.24	0.00
J23	0.00	126.30	48.04	0.00
J24	1.50	126.30	47.44	0.00
J25	3.30	126.29	46.69	0.00
J26	2.40	126.33	48.65	0.00
J27	0.00	126.35	48.79	0.00
J3	69.10	121.35	43.15	0.00
R1	-41.35	0.00	0.00	0.00 Reservoir
R2	-42.95	0.00	0.00	0.00 Reservoir



Page 4

Link Results at 1:00 Hrs:

Link ID	Flow LPS	Velocity m/s	Unit Headloss m/km	Status
P1	10.28	0.33	0.93	Open
P4	-4.20	0.13	0.18	Open
P13	6.09	0.19	0.35	Open
P14	6.09	0.19	0.30	Open
P15	-2.52	0.05	0.02	Open
P16	8.60	0.18	0.23	Open
P17	3.30	0.11	0.11	Open
P18	3.30	0.11	0.11	Open
P19	0.00	0.00	0.00	Open
P21	2.00	0.06	0.05	Open
P22	2.00	0.06	0.04	Open
P23	-0.40	0.02	0.01	Open
P24	2.40	0.08	0.06	Open
P2	-3.30	0.11	0.11	Open
P3	-0.40	0.02	0.01	Open
P5	-2.70	0.09	0.08	Open
P6	-1.50	0.05	0.03	Open
P7	-4.20	0.13	0.18	Open
P9	-28.67	0.41	0.74	Open
P10	-31.07	0.44	0.86	Open
P11	-31.07	0.44	0.86	Open
P12	26.15	0.37	0.62	Open
P8	-69.10	3.91	154.17	Open
1	42.95	0.00	-126.27	Open Pump
2	41.35	0.00	-126.38	Open Pump

Node Results at 2:00 Hrs:

Page 4



21106_Max Day + Fire @ Building B.rpt				
Node	Demand	Head	Pressure	Quality
ID	LPS	m	m	
J1	0.00	126.38	49.11	0.00
J200	0.00	126.32	48.25	0.00
J5	0.00	126.31	47.56	0.00
J8	0.00	126.31	47.64	0.00
J9	0.00	126.29	47.59	0.00
J10	3.30	126.29	47.79	0.00
J11	0.00	126.29	46.76	0.00
J12	0.00	126.30	48.10	0.00
J13	0.00	126.29	46.71	0.00
J14	0.00	126.29	47.39	0.00
J15	0.00	126.29	47.15	0.00
J16	0.00	126.29	47.22	0.00
J18	2.40	126.29	47.26	0.00
J19	0.00	126.29	46.44	0.00
J2	0.00	126.27	47.77	0.00
J22	2.30	126.29	48.24	0.00



Page 5

Node Results at 2:00 Hrs: (continued)

Node	Demand	Head	Pressure	Quality	
ID	LPS	m	m		
J23	0.00	126.30	48.04	0.00	
J24	1.50	126.30	47.44	0.00	
J25	3.30	126.29	46.69	0.00	
J26	2.40	126.33	48.65	0.00	
J27	0.00	126.35	48.79	0.00	
J3	69.10	121.35	43.15	0.00	
R1	-41.35	0.00	0.00	0.00	Reservoir
R2	-42.95	0.00	0.00	0.00	Reservoir

Link Results at 2:00 Hrs:

Link	Flow	Velocity	Unit	Headloss	Status
ID	LPS	m/s		m/km	
P1	10.28	0.33		0.93	Open
P4	-4.20	0.13		0.18	Open
P13	6.09	0.19		0.35	Open
P14	6.09	0.19		0.30	Open
P15	-2.52	0.05		0.02	Open
P16	8.60	0.18		0.23	Open
P17	3.30	0.11		0.11	Open

Page 5



	21106_Max Day + Fire @ Building B.rpt				
P18	3.30	0.11	0.11	Open	
P19	0.00	0.00	0.00	Open	
P21	2.00	0.06	0.05	Open	
P22	2.00	0.06	0.04	Open	
P23	-0.40	0.02	0.01	Open	
P24	2.40	0.08	0.06	Open	
P2	-3.30	0.11	0.11	Open	
P3	-0.40	0.02	0.01	Open	
P5	-2.70	0.09	0.08	Open	
P6	-1.50	0.05	0.03	Open	
P7	-4.20	0.13	0.18	Open	
P9	-28.67	0.41	0.74	Open	
P10	-31.07	0.44	0.86	Open	
P11	-31.07	0.44	0.86	Open	
P12	26.15	0.37	0.62	Open	
P8	-69.10	3.91	154.17	Open	
1	42.95	0.00	-126.27	Open Pump	
2	41.35	0.00	-126.38	Open Pump	



Page 6

Node Results at 3:00 Hrs:

Node ID	Demand LPS	Head m	Pressure m	Quality
J1	0.00	126.38	49.11	0.00
J200	0.00	126.32	48.25	0.00
J5	0.00	126.31	47.56	0.00
J8	0.00	126.31	47.64	0.00
J9	0.00	126.29	47.59	0.00
J10	3.30	126.29	47.79	0.00
J11	0.00	126.29	46.76	0.00
J12	0.00	126.30	48.10	0.00
J13	0.00	126.29	46.71	0.00
J14	0.00	126.29	47.39	0.00
J15	0.00	126.29	47.15	0.00
J16	0.00	126.29	47.22	0.00
J18	2.40	126.29	47.26	0.00
J19	0.00	126.29	46.44	0.00
J2	0.00	126.27	47.77	0.00
J22	2.30	126.29	48.24	0.00
J23	0.00	126.30	48.04	0.00
J24	1.50	126.30	47.44	0.00
J25	3.30	126.29	46.69	0.00
J26	2.40	126.33	48.65	0.00
J27	0.00	126.35	48.79	0.00

Page 6



	21106_Max Day + Fire @ Building B.rpt				
J3	69.10	121.35	43.15	0.00	
R1	-41.35	0.00	0.00	0.00	Reservoir
R2	-42.95	0.00	0.00	0.00	Reservoir

Link Results at 3:00 Hrs:

Link ID	Flow LPS	Velocity m/s	Unit Headloss m/km	Status
P1	10.28	0.33	0.93	Open
P4	-4.20	0.13	0.18	Open
P13	6.09	0.19	0.35	Open
P14	6.09	0.19	0.30	Open
P15	-2.52	0.05	0.02	Open
P16	8.60	0.18	0.23	Open
P17	3.30	0.11	0.11	Open
P18	3.30	0.11	0.11	Open
P19	0.00	0.00	0.00	Open
P21	2.00	0.06	0.05	Open
P22	2.00	0.06	0.04	Open
P23	-0.40	0.02	0.01	Open
P24	2.40	0.08	0.06	Open
P2	-3.30	0.11	0.11	Open
P3	-0.40	0.02	0.01	Open
P5	-2.70	0.09	0.08	Open
P6	-1.50	0.05	0.03	Open



Page 7

Link Results at 3:00 Hrs: (continued)

Link ID	Flow LPS	Velocity m/s	Unit Headloss m/km	Status
P7	-4.20	0.13	0.18	Open
P9	-28.67	0.41	0.74	Open
P10	-31.07	0.44	0.86	Open
P11	-31.07	0.44	0.86	Open
P12	26.15	0.37	0.62	Open
P8	-69.10	3.91	154.17	Open
1	42.95	0.00	-126.27	Open Pump
2	41.35	0.00	-126.38	Open Pump

Node Results at 4:00 Hrs:

Node ID	Demand LPS	Head m	Pressure m	Quality
---------	------------	--------	------------	---------



21106_Max Day + Fire @ Building B.rpt				
J1	0.00	126.38	49.11	0.00
J200	0.00	126.32	48.25	0.00
J5	0.00	126.31	47.56	0.00
J8	0.00	126.31	47.64	0.00
J9	0.00	126.29	47.59	0.00
J10	3.30	126.29	47.79	0.00
J11	0.00	126.29	46.76	0.00
J12	0.00	126.30	48.10	0.00
J13	0.00	126.29	46.71	0.00
J14	0.00	126.29	47.39	0.00
J15	0.00	126.29	47.15	0.00
J16	0.00	126.29	47.22	0.00
J18	2.40	126.29	47.26	0.00
J19	0.00	126.29	46.44	0.00
J2	0.00	126.27	47.77	0.00
J22	2.30	126.29	48.24	0.00
J23	0.00	126.30	48.04	0.00
J24	1.50	126.30	47.44	0.00
J25	3.30	126.29	46.69	0.00
J26	2.40	126.33	48.65	0.00
J27	0.00	126.35	48.79	0.00
J3	69.10	121.35	43.15	0.00
R1	-41.35	0.00	0.00	0.00 Reservoir
R2	-42.95	0.00	0.00	0.00 Reservoir



Page 8

Link Results at 4:00 Hrs:

Link ID	Flow LPS	Velocity m/s	Unit Headloss m/km	Status
P1	10.28	0.33	0.93	Open
P4	-4.20	0.13	0.18	Open
P13	6.09	0.19	0.35	Open
P14	6.09	0.19	0.30	Open
P15	-2.52	0.05	0.02	Open
P16	8.60	0.18	0.23	Open
P17	3.30	0.11	0.11	Open
P18	3.30	0.11	0.11	Open
P19	0.00	0.00	0.00	Open
P21	2.00	0.06	0.05	Open
P22	2.00	0.06	0.04	Open
P23	-0.40	0.02	0.01	Open
P24	2.40	0.08	0.06	Open
P2	-3.30	0.11	0.11	Open
P3	-0.40	0.02	0.01	Open

Page 8



21106_Max Day + Fire @ Building B.rpt					
P5	-2.70	0.09	0.08		Open
P6	-1.50	0.05	0.03		Open
P7	-4.20	0.13	0.18		Open
P9	-28.67	0.41	0.74		Open
P10	-31.07	0.44	0.86		Open
P11	-31.07	0.44	0.86		Open
P12	26.15	0.37	0.62		Open
P8	-69.10	3.91	154.17		Open
1	42.95	0.00	-126.27		Open Pump
2	41.35	0.00	-126.38		Open Pump



Maximum Day + Fire Flow Conditions at Building D (Node J19)

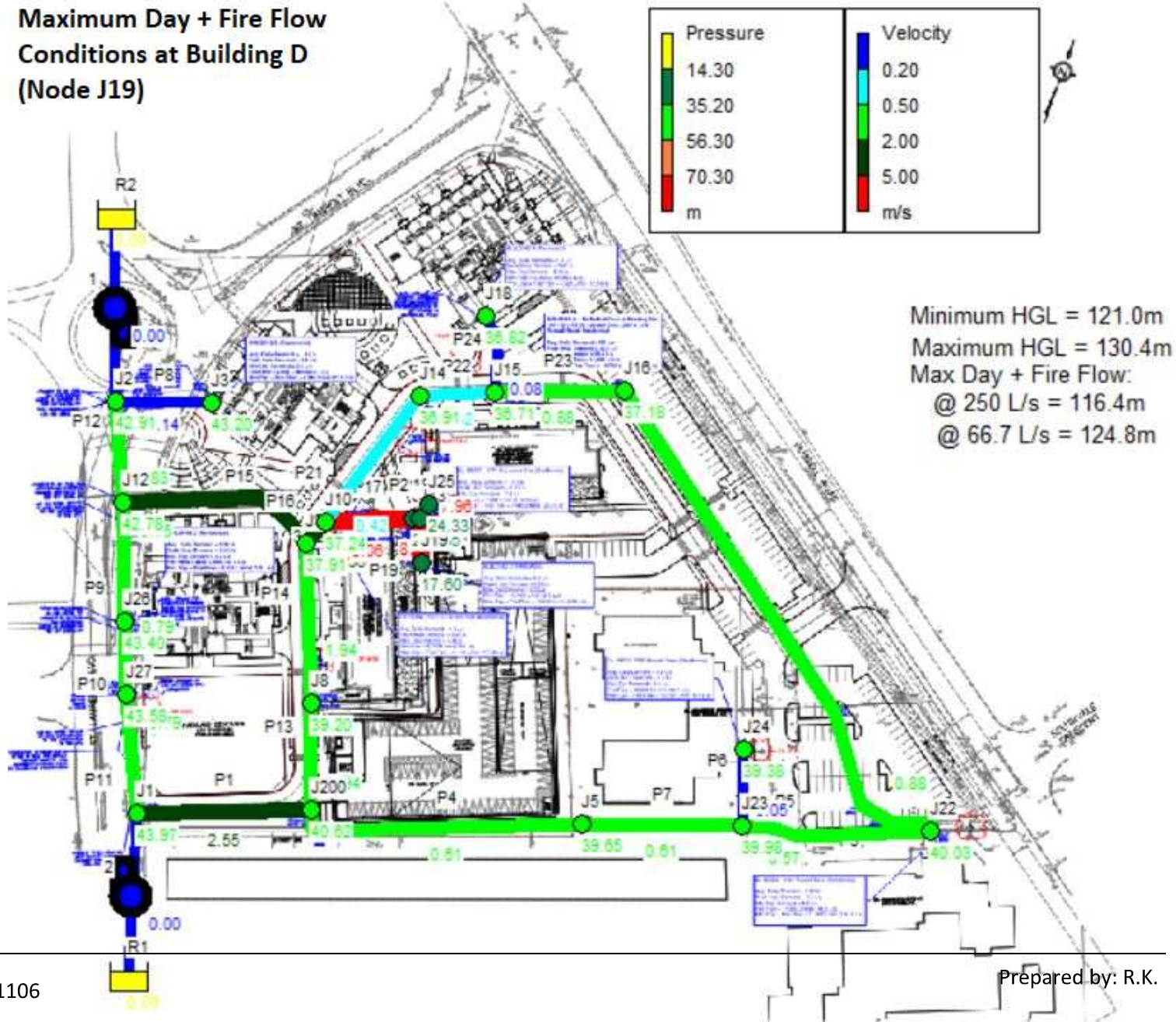



21106_Max Day + Fire @ Building D.rpt

Page 1

2023-03-14 3:39:18 PM

```
*****
*                               *
*           E P A N E T         *
*           Hydraulic and Water Quality *
*           Analysis for Pipe Networks *
*           Version 2.2         *
*****
```

Input File: 21106_Max Day + Fire @ Building D-2023.net

Link - Node Table:

Link ID	Start Node	End Node	Length m	Diameter mm	
P1	J1	J200	60.78	200	
P4	J5	J200	96.37	200	
P13	J200	J8	32.72	200	
P14	J8	J9	58.6	200	
P15	J9	J12	67.26	250	
P16	J9	J10	7.91	250	
P17	J10	J11	31.176	200	
P18	J11	J13	2.28	200	
P19	J13	J19	18.81	200	
P21	J10	J14	51.579	200	
P22	J14	J15	23.86	200	
P23	J15	J16	41.8	150	
P24	J15	J18	26	200	
P2	J25	J13	5.633	200	
P3	J16	J22	189.127	150	
P5	J22	J23	62.85	200	
P6	J24	J23	25.34	200	
P7	J23	J5	55.03	200	
P9	J12	J26	44	300	
P10	J26	J27	21.3	300	
P11	J27	J1	39.51	300	
P12	J12	J2	36.02	300	
P8	J3	J2	31.93	150	
1	R2	J2	#N/A	#N/A	Pump
2	R1	J1	#N/A	#N/A	Pump

Energy Usage:

Pump	Usage Factor	Avg. Effic.	Kw-hr /m3	Avg. Kw	Peak Kw	Cost /day



21106_Max Day + Fire @ Building D.rpt						
1	100.00	75.00	0.44	209.30	209.30	0.00
2	100.00	75.00	0.44	215.02	215.02	0.00

Demand Charge: 0.00
Total Cost: 0.00



Page 2

Node Results at 0:00 Hrs:

Node ID	Demand LPS	Head m	Pressure m	Quality	
J1	0.00	121.24	43.97	0.00	
J200	0.00	118.69	40.62	0.00	
J5	0.00	118.40	39.65	0.00	
J8	0.00	117.87	39.20	0.00	
J9	0.00	116.61	37.91	0.00	
J10	3.30	115.74	37.24	0.00	
J11	0.00	104.74	25.21	0.00	
J12	0.00	120.98	42.78	0.00	
J13	0.00	103.93	24.35	0.00	
J14	0.00	115.81	36.91	0.00	
J15	0.00	115.85	36.71	0.00	
J16	0.00	116.25	37.18	0.00	
J18	2.40	115.85	36.82	0.00	
J19	250.00	97.45	17.60	0.00	
J2	0.00	121.41	42.91	0.00	
J22	2.30	118.08	40.03	0.00	
J23	0.00	118.24	39.98	0.00	
J24	1.50	118.24	39.38	0.00	
J25	3.30	103.93	24.33	0.00	
J26	2.40	121.08	43.40	0.00	
J27	0.00	121.14	43.58	0.00	
J3	2.40	121.40	43.20	0.00	
R1	-135.70	0.00	0.00	0.00	Reservoir
R2	-131.90	0.00	0.00	0.00	Reservoir

Link Results at 0:00 Hrs:

Link ID	Flow LPS	Velocity m/s	Unit Headloss m/km	Status
P1	80.14	2.55	41.87	Open
P4	-19.28	0.61	2.99	Open
P13	60.86	1.94	25.16	Open
P14	60.86	1.94	21.41	Open

Page 2



21106_Max Day + Fire @ Building D.rpt

P15	-182.66	3.72	64.95	Open
P16	243.52	4.96	110.63	Open
P17	253.30	8.06	352.85	Open
P18	253.30	8.06	352.85	Open
P19	250.00	7.96	344.38	Open
P21	-13.08	0.42	1.46	Open
P22	-13.08	0.42	1.46	Open
P23	-15.48	0.88	9.65	Open
P24	2.40	0.08	0.06	Open
P2	-3.30	0.11	0.11	Open
P3	-15.48	0.88	9.65	Open
P5	-17.78	0.57	2.57	Open
P6	-1.50	0.05	0.03	Open



Page 3

Link Results at 0:00 Hrs: (continued)

Link ID	Flow LPS	Velocity m/s	Unit Headloss m/km	Status
P7	-19.28	0.61	2.99	Open
P9	-53.17	0.75	2.31	Open
P10	-55.57	0.79	2.51	Open
P11	-55.57	0.79	2.51	Open
P12	-129.50	1.83	12.03	Open
P8	-2.40	0.14	0.31	Open
1	131.90	0.00	-121.41	Open Pump
2	135.70	0.00	-121.24	Open Pump

Node Results at 1:00 Hrs:

Node ID	Demand LPS	Head m	Pressure m	Quality
J1	0.00	121.24	43.97	0.00
J200	0.00	118.69	40.62	0.00
J5	0.00	118.40	39.65	0.00
J8	0.00	117.87	39.20	0.00
J9	0.00	116.61	37.91	0.00
J10	3.30	115.74	37.24	0.00
J11	0.00	104.74	25.21	0.00
J12	0.00	120.98	42.78	0.00
J13	0.00	103.93	24.35	0.00
J14	0.00	115.81	36.91	0.00
J15	0.00	115.85	36.71	0.00
J16	0.00	116.25	37.18	0.00
J18	2.40	115.85	36.82	0.00

Page 3



21106_Max Day + Fire @ Building D.rpt				
J19	250.00	97.45	17.60	0.00
J2	0.00	121.41	42.91	0.00
J22	2.30	118.08	40.03	0.00
J23	0.00	118.24	39.98	0.00
J24	1.50	118.24	39.38	0.00
J25	3.30	103.93	24.33	0.00
J26	2.40	121.08	43.40	0.00
J27	0.00	121.14	43.58	0.00
J3	2.40	121.40	43.20	0.00
R1	-135.70	0.00	0.00	0.00 Reservoir
R2	-131.90	0.00	0.00	0.00 Reservoir



Page 4

Link Results at 1:00 Hrs:

Link ID	Flow LPS	Velocity m/s	Unit Headloss m/km	Status
P1	80.14	2.55	41.87	Open
P4	-19.28	0.61	2.99	Open
P13	60.86	1.94	25.16	Open
P14	60.86	1.94	21.41	Open
P15	-182.66	3.72	64.95	Open
P16	243.52	4.96	110.63	Open
P17	253.30	8.06	352.85	Open
P18	253.30	8.06	352.85	Open
P19	250.00	7.96	344.38	Open
P21	-13.08	0.42	1.46	Open
P22	-13.08	0.42	1.46	Open
P23	-15.48	0.88	9.65	Open
P24	2.40	0.08	0.06	Open
P2	-3.30	0.11	0.11	Open
P3	-15.48	0.88	9.65	Open
P5	-17.78	0.57	2.57	Open
P6	-1.50	0.05	0.03	Open
P7	-19.28	0.61	2.99	Open
P9	-53.17	0.75	2.31	Open
P10	-55.57	0.79	2.51	Open
P11	-55.57	0.79	2.51	Open
P12	-129.50	1.83	12.03	Open
P8	-2.40	0.14	0.31	Open
1	131.90	0.00	-121.41	Open Pump
2	135.70	0.00	-121.24	Open Pump

Node Results at 2:00 Hrs:



21106_Max Day + Fire @ Building D.rpt				
Node	Demand	Head	Pressure	Quality
ID	LPS	m	m	
J1	0.00	121.24	43.97	0.00
J200	0.00	118.69	40.62	0.00
J5	0.00	118.40	39.65	0.00
J8	0.00	117.87	39.20	0.00
J9	0.00	116.61	37.91	0.00
J10	3.30	115.74	37.24	0.00
J11	0.00	104.74	25.21	0.00
J12	0.00	120.98	42.78	0.00
J13	0.00	103.93	24.35	0.00
J14	0.00	115.81	36.91	0.00
J15	0.00	115.85	36.71	0.00
J16	0.00	116.25	37.18	0.00
J18	2.40	115.85	36.82	0.00
J19	250.00	97.45	17.60	0.00
J2	0.00	121.41	42.91	0.00
J22	2.30	118.08	40.03	0.00



Page 5

Node Results at 2:00 Hrs: (continued)

Node	Demand	Head	Pressure	Quality	
ID	LPS	m	m		
J23	0.00	118.24	39.98	0.00	
J24	1.50	118.24	39.38	0.00	
J25	3.30	103.93	24.33	0.00	
J26	2.40	121.08	43.40	0.00	
J27	0.00	121.14	43.58	0.00	
J3	2.40	121.40	43.20	0.00	
R1	-135.70	0.00	0.00	0.00	Reservoir
R2	-131.90	0.00	0.00	0.00	Reservoir

Link Results at 2:00 Hrs:

Link	Flow	Velocity	Unit	Headloss	Status
ID	LPS	m/s		m/km	
P1	80.14	2.55		41.87	Open
P4	-19.28	0.61		2.99	Open
P13	60.86	1.94		25.16	Open
P14	60.86	1.94		21.41	Open
P15	-182.66	3.72		64.95	Open
P16	243.52	4.96		110.63	Open
P17	253.30	8.06		352.85	Open

Page 5



	21106_Max Day + Fire @ Building D.rpt				
P18	253.30	8.06	352.85	Open	
P19	250.00	7.96	344.38	Open	
P21	-13.08	0.42	1.46	Open	
P22	-13.08	0.42	1.46	Open	
P23	-15.48	0.88	9.65	Open	
P24	2.40	0.08	0.06	Open	
P2	-3.30	0.11	0.11	Open	
P3	-15.48	0.88	9.65	Open	
P5	-17.78	0.57	2.57	Open	
P6	-1.50	0.05	0.03	Open	
P7	-19.28	0.61	2.99	Open	
P9	-53.17	0.75	2.31	Open	
P10	-55.57	0.79	2.51	Open	
P11	-55.57	0.79	2.51	Open	
P12	-129.50	1.83	12.03	Open	
P8	-2.40	0.14	0.31	Open	
1	131.90	0.00	-121.41	Open Pump	
2	135.70	0.00	-121.24	Open Pump	



Page 6

Node Results at 3:00 Hrs:

Node ID	Demand LPS	Head m	Pressure m	Quality
J1	0.00	121.24	43.97	0.00
J200	0.00	118.69	40.62	0.00
J5	0.00	118.40	39.65	0.00
J8	0.00	117.87	39.20	0.00
J9	0.00	116.61	37.91	0.00
J10	3.30	115.74	37.24	0.00
J11	0.00	104.74	25.21	0.00
J12	0.00	120.98	42.78	0.00
J13	0.00	103.93	24.35	0.00
J14	0.00	115.81	36.91	0.00
J15	0.00	115.85	36.71	0.00
J16	0.00	116.25	37.18	0.00
J18	2.40	115.85	36.82	0.00
J19	250.00	97.45	17.60	0.00
J2	0.00	121.41	42.91	0.00
J22	2.30	118.08	40.03	0.00
J23	0.00	118.24	39.98	0.00
J24	1.50	118.24	39.38	0.00
J25	3.30	103.93	24.33	0.00
J26	2.40	121.08	43.40	0.00
J27	0.00	121.14	43.58	0.00

Page 6



21106_Max Day + Fire @ Building D.rpt				
J3	2.40	121.40	43.20	0.00
R1	-135.70	0.00	0.00	0.00 Reservoir
R2	-131.90	0.00	0.00	0.00 Reservoir

Link Results at 3:00 Hrs:

Link ID	Flow LPS	Velocity m/s	Unit Headloss m/km	Status
P1	80.14	2.55	41.87	Open
P4	-19.28	0.61	2.99	Open
P13	60.86	1.94	25.16	Open
P14	60.86	1.94	21.41	Open
P15	-182.66	3.72	64.95	Open
P16	243.52	4.96	110.63	Open
P17	253.30	8.06	352.85	Open
P18	253.30	8.06	352.85	Open
P19	250.00	7.96	344.38	Open
P21	-13.08	0.42	1.46	Open
P22	-13.08	0.42	1.46	Open
P23	-15.48	0.88	9.65	Open
P24	2.40	0.08	0.06	Open
P2	-3.30	0.11	0.11	Open
P3	-15.48	0.88	9.65	Open
P5	-17.78	0.57	2.57	Open
P6	-1.50	0.05	0.03	Open

Page 7

Link Results at 3:00 Hrs: (continued)

Link ID	Flow LPS	Velocity m/s	Unit Headloss m/km	Status
P7	-19.28	0.61	2.99	Open
P9	-53.17	0.75	2.31	Open
P10	-55.57	0.79	2.51	Open
P11	-55.57	0.79	2.51	Open
P12	-129.50	1.83	12.03	Open
P8	-2.40	0.14	0.31	Open
1	131.90	0.00	-121.41	Open Pump
2	135.70	0.00	-121.24	Open Pump

Node Results at 4:00 Hrs:

Node ID	Demand LPS	Head m	Pressure m	Quality
---------	------------	--------	------------	---------



21106_Max Day + Fire @ Building D.rpt				
J1	0.00	121.24	43.97	0.00
J200	0.00	118.69	40.62	0.00
J5	0.00	118.40	39.65	0.00
J8	0.00	117.87	39.20	0.00
J9	0.00	116.61	37.91	0.00
J10	3.30	115.74	37.24	0.00
J11	0.00	104.74	25.21	0.00
J12	0.00	120.98	42.78	0.00
J13	0.00	103.93	24.35	0.00
J14	0.00	115.81	36.91	0.00
J15	0.00	115.85	36.71	0.00
J16	0.00	116.25	37.18	0.00
J18	2.40	115.85	36.82	0.00
J19	250.00	97.45	17.60	0.00
J2	0.00	121.41	42.91	0.00
J22	2.30	118.08	40.03	0.00
J23	0.00	118.24	39.98	0.00
J24	1.50	118.24	39.38	0.00
J25	3.30	103.93	24.33	0.00
J26	2.40	121.08	43.40	0.00
J27	0.00	121.14	43.58	0.00
J3	2.40	121.40	43.20	0.00
R1	-135.70	0.00	0.00	0.00 Reservoir
R2	-131.90	0.00	0.00	0.00 Reservoir



Page 8

Link Results at 4:00 Hrs:

Link ID	Flow LPS	Velocity m/s	Unit Headloss m/km	Status
P1	80.14	2.55	41.87	Open
P4	-19.28	0.61	2.99	Open
P13	60.86	1.94	25.16	Open
P14	60.86	1.94	21.41	Open
P15	-182.66	3.72	64.95	Open
P16	243.52	4.96	110.63	Open
P17	253.30	8.06	352.85	Open
P18	253.30	8.06	352.85	Open
P19	250.00	7.96	344.38	Open
P21	-13.08	0.42	1.46	Open
P22	-13.08	0.42	1.46	Open
P23	-15.48	0.88	9.65	Open
P24	2.40	0.08	0.06	Open
P2	-3.30	0.11	0.11	Open
P3	-15.48	0.88	9.65	Open

Page 8



21106_Max Day + Fire @ Building D.rpt				
P5	-17.78	0.57	2.57	Open
P6	-1.50	0.05	0.03	Open
P7	-19.28	0.61	2.99	Open
P9	-53.17	0.75	2.31	Open
P10	-55.57	0.79	2.51	Open
P11	-55.57	0.79	2.51	Open
P12	-129.50	1.83	12.03	Open
P8	-2.40	0.14	0.31	Open
1	131.90	0.00	-121.41	Open Pump
2	135.70	0.00	-121.24	Open Pump

Boundary Conditions for 1971, 1975 St. Laurent Boulevard

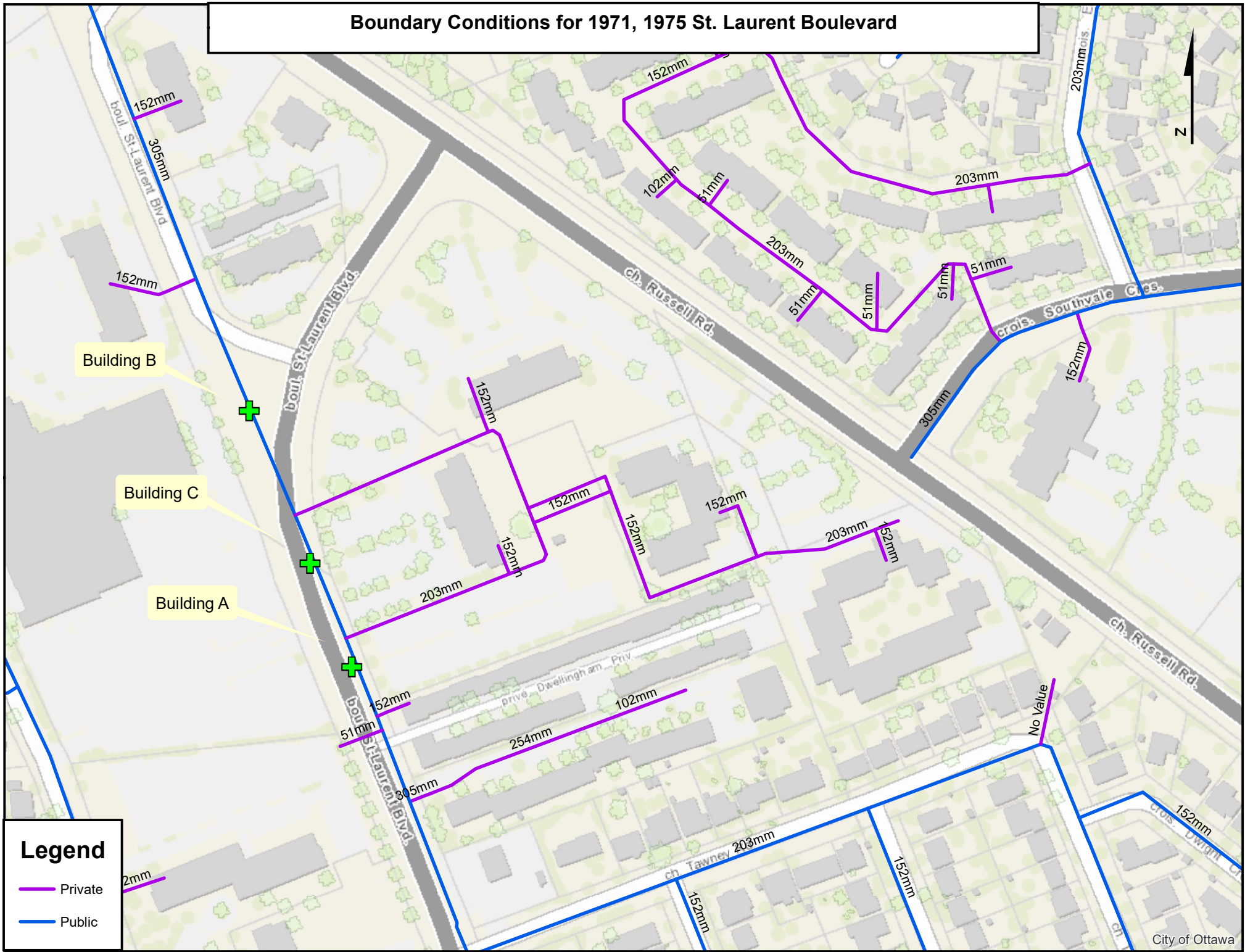

Legend

- Private
- Public

Sent: February 21, 2023 11:55 AM

To: Gian-Michael Di Luca <GDILuca@counterpointeng.com>

Cc: David Di Iorio <ddiiorio@counterpointeng.com>; 21106_ Starlight Dev't_ 1971 & 1975 St. Laurent Blvd <21106@counterpointeng.com>

Subject: RE: 1971, 1975 St Laurent, TEAMS link, sorry!

Good morning,

The following are boundary conditions, HGL, for hydraulic analysis at 1971, 1975 St-Laurent Boulevard (zone 2W2C) assumed to be connected to the 305 mm watermain on St-Laurent Boulevard (see attached PDF for location).

	Connection 1 Building A	Connection 2 Building C	Connection 3 Building B
Minimum HGL (m)	121.0	121.0	121.0
Maximum HGL (m)	130.4	130.4	130.4

Max Day + Fire Flow (250 L/s): 116.4 m (Building A)

Max Day + Fire Flow (66.7 L/s): 124.8 m (Building B)

Max Day + Fire Flow (66.7 L/s): 124.8 m (Building C)

These are for current conditions and are based on computer model simulation.

Disclaimer: The boundary condition information is based on current operation of the city water distribution system. The computer model simulation is based on the best information available at the time. The operation of the water distribution system can change on a regular basis, resulting in a variation in boundary conditions. The physical properties of watermains deteriorate over time, as such must be assumed in the absence of actual field test data. The variation in physical watermain properties can therefore alter the results of the computer model simulation.

Thank you,

--

Bruce Bramah, EIT

Project Manager

Planning, Real Estate and Economic Development Department / Direction générale de la planification, des biens immobiliers et du développement économique

Development Review - South Branch

City of Ottawa | Ville d'Ottawa

110 Laurier Avenue West Ottawa, ON | 110, avenue Laurier Ouest Ottawa (Ontario) K1P 1J1

613.580.2424 ext./poste 29686, Bruce.Bramah@ottawa.ca

Water Demand Calculations

BUILDING A, PARKADE & EXISTING BUILDINGS

Project Name: 1971 & 1975 St. Laurent Blvd.
 Project Number: 21106
 Location: Ottawa
 Date: March 2023

City of Ottawa Watermain Design Guidelines

Water Demand = Maximum Day Flow + Fire Flow or Peak Hour Flow

Domestic Demand

Residential Flow (Avg Day Demand)	280	L/capita/day
Max Day Demand (2.5 x Avg Day Demand)	700	L/capita/day
Max Hour Demand (2.2 x Max Day Demand)	1540	L/capita/day

Commercial & Institutional Demand

Retail/Shopping Centres	2,500	L/1000m ² /day
-------------------------	-------	---------------------------

Fire Demand

Fire Flow	15,000	L / min
Fire Flow Duration	2	hours

- See FUS calculations.

Residential Population	1,597 Ppl	- See Sanitary Flow Calculations
Domestic Demand:	447076 L / day	
, or	310 L/min	5.2 L/s
Maximum Day Water Demand - Domestic:	1,117,690 L / day	
Total Maximum Day Water Demand:	1,117,690 L / day	
, or	776 L / min	12.9 L/s
Maximum Hour Water Demand - Domestic:	2,458,918 L / day	
Total Maximum Hour Water Demand:	2,458,918 L / day	
, or	1,708 L / min	28.5 L/s
Retail Area	0.0 m ²	- See Sanitary Flow Calculations
Commercial & Institutional Demand:	0 L / day	
, or	0 L/min	
Maximum Day + Fire Flow:	15,776 L / min	262.9 L/s
	or	
	4,168 USGPM	

Water Demand Calculations

BUILDING B

Project Name: 1971 & 1975 St. Laurent Blvd.
 Project Number: 21106
 Location: Ottawa
 Date: January 2022

City of Ottawa Watermain Design Guidelines

Water Demand = Maximum Day Flow + Fire Flow or Peak Hour Flow

Domestic Demand

Residential Flow (Avg Day Demand)	280	L/capita/day
Max Day Demand (2.5 x Avg Day Demand)	700	L/capita/day
Max Hour Demand (2.2 x Max Day Demand)	1540	L/capita/day

**Peaking factors as per Table 3-3 of the MOE Design Guidelines for Drinking Water Systems
 (used for opulations 500ppl or less in City of Ottawa)*

Commercial & Institutional Demand

Retail/Shopping Centres	2,500	L/1000m ² /day
-------------------------	-------	---------------------------

Fire Demand

Fire Flow	4,000	L / min
Fire Flow Duration	2	hours

- See FUS calculations.

Residential Population	295 Ppl	- See Sanitary Flow Calculations
Domestic Demand:	82600 L / day	
, or	57 L/min	1.0 L/s
Maximum Day Water Demand - Domestic:	206,500 L / day	
Total Max Day Demand:	206,500 L / day	
, or	143 L / min	2.4 L/s
Maximum Hour Water Demand - Domestic:	454,300 L / day	
Total Maximum Hour Water Demand:	454,300 L / day	
, or	315 L / min	5.3 L/s
Retail Area	0.0 m ²	- See Sanitary Flow Calculations
Commercial & Institutional Demand:	0 L / day	
, or	0 L/min	
Maximum Day + Fire Flow:	4,143 L / min	69.1 L/s
	or	
	1,095 USGPM	

Water Demand Calculations

BUILDING C

Project Name: 1971 & 1975 St. Laurent Blvd.
 Project Number: 21106
 Location: Ottawa
 Date: January 2022

City of Ottawa Watermain Design Guidelines

Water Demand = Maximum Day Flow + Fire Flow or Peak Hour Flow

Domestic Demand

Residential Flow (Avg Day Demand)	280	L/capita/day
Max Day Demand (2.5 x Avg Day Demand)	700	L/capita/day
Max Hour Demand (2.2 x Max Day Demand)	1540	L/capita/day

**Peaking factors as per Table 3-3 of the MOE Design Guidelines for Drinking Water Systems
 (used for opulations 500ppl or less in City of Ottawa)*

Commercial & Institutional Demand

Retail/Shopping Centres	2,500	L/1000m ² /day
-------------------------	-------	---------------------------

Fire Demand

Fire Flow	4,000	L / min
Fire Flow Duration	2	hours

- See FUS calculations.

Residential Population	300 Ppl	- See Sanitary Flow Calculations
Domestic Demand:	84112 L / day	
, or	58 L/min	1.0 L/s
Maximum Day Water Demand - Domestic:	210,280 L / day	
Total Maximum Day Water Demand:	210,280 L / day	
, or	146 L / min	2.4 L/s
Maximum Hour Water Demand - Domestic:	462,616 L / day	
Total Maximum Hour Water Demand:	462,616 L / day	
, or	321 L / min	5.4 L/s
Retail Area	0.0 m ²	- See Sanitary Flow Calculations
Commercial & Institutional Demand:	0 L / day	
, or	0 L/min	
Maximum Day + Fire Flow:	4,146 L / min	69.1 L/s
	or	
	1,095 USGPM	

Fire Underwriter Survey (2020) Fire Flow Calculation - 1971 St. Laurent Blvd Existing Building

Project Name: 1971 & 1975 St. Laurent Blvd.
 Project Number: 21106
 Date: January 2022

$$F = 220C\sqrt{A}$$

Where

NPF = The Required Fire Flow in litres per minute (LPM)
 C = the Construction Coefficient is related to the type of construction of the building
 A = the Total Effective Floor Area (effective building area) in square metres of the building

- C = 1.5 for Type V Wood Frame Construction
- OC = 0.8 for Type IV Ordinary Construction
- OC = 0.9 for Type IV-B Mass Timber Construction
- OC = 1.0 for Type IV-C Mass Timber Construction
- OC = 1.5 for Type IV-D Mass Timber Construction
- OC = 2.0 for Type III Ordinary Construction
- OC = 0.8 for Type II Noncombustible Construction
- OC = 0.5 for Type I Fire Resistive Construction

A = The total floor area in square metres (including all storeys, but excluding basements at least 50 percent below grade) in the building being considered.

Legend

Construction Class	Contents Factor		
WF wood frame construction	NC non-combustible		
OC ordinary construction	LC limited combustible		
NC non-combustible construction	C combustible		
FC fire-resistive construction	FB free burning		
	RB rapid burning		

Contents Factor:	Non-Combustible	-25%	Free Burning	+15%
	Limited Combustible	-15%	Rapid Burning	+25%
	Combustible	No Charge		

Separation	Charge	Separation	Charge
0 to 3m	25%	20.1 to 30 m	10%
3.1 to 10m	20%	30.1 to 45m	5%
10.1 to 20m	15%		

1) Fire Flow

Type of Construction: NC
 C = 0.8
 A = 5472 m² - Area of two largest adjoining floors plus 50% of all floors above upto 8 floors.
 F = 14,000 L/min

2) Occupancy Reduction

Contents Factor: LC
 Occupancy Charge = -15%
 -15% of 14,000 L/min = -2,100 L/min
 F = 13000 L/min + 3250 L/min = 11,900 L/min

3) System Type Reduction (to be reduced from result of Step 2)

NFPA 13 Sprinkler: 30% YES
 Standard Water Supply: 10% YES
 Fully Supervised: 10% YES
 Total System Type Reduction = 50%

50% of 11,900 L/min = 5,950 L/min
 (to be reduced from result of Step 2)

4) Separation Charge (to be added to result of Step 2)

Building Face	Distance (m)	Length- Height Factor	Bldg Type	Auto Sprinkler	Charge
				Protection: Exposed BLDG (50% charge). Exposed & Subject Bldg (0% charge)	
North	>30	-	-	-	= 0%
East	15	236	Type III-IV ²	0%	= 0%
South	6.5	140	Type III-IV ²	NO	= 15%
West	23	510	Type III-IV ²	NO	= 5%
Total					20% (max exposure charge can be 75%)

20% of 11,900 L/min = 2,380
 (to be added to result of Step 2)

F = 9,000 L/min (round to the nearest 1,000 L/min) (2,000 L/min < F < 45,000 L/min)
 F = 2,378 GPM

Fire Underwriter Survey (2020) Fire Flow Calculation - 1975 St. Laurent Blvd Existing Building

Project Name: 1971 & 1975 St. Laurent Blvd.
 Project Number: 21106
 Date: January 2022

$$F = 220C\sqrt{A}$$

whereas

FFF = the Required Fire Flow in litres per minute (LPM)
C = the Contents Factor, dependent on the type of construction of the building
A = the Total Effective Floor Area (including areas to square metres of the building)

- C** =
- 1.5 for Type I Wood Frame Construction
 - 0.8 for Type II-A Mass Timber Construction
 - 0.8 for Type II-B Mass Timber Construction
 - 1.0 for Type III-C Mass Timber Construction
 - 1.5 for Type III-D Mass Timber Construction
 - 1.0 for Type III Ordinary Construction
 - 0.5 for Type I Non-combustible Construction
 - 0.5 for Type I Fire Resistive Construction

A = The total floor area in square metres (including all storeys, but excluding basements at least 50 percent below grade) in the building being considered.

Legend

Construction Class		Contents Factor	
WF	wood frame construction	NC	non-combustible
OC	ordinary construction	LC	limited combustible
NC	non-combustible construction	C	combustible
FC	fire-resistive construction	FB	free burning
		RB	rapid burning

Contents Factor:

Non-Combustible	-25%	Free Burning	+15%
Limited Combustible	-15%	Rapid Burning	+25%
Combustible	No Charge		

Separation	Charge	Separation	Charge
0 to 3m	25%	20.1 to 30 m	10%
3.1 to 10m	20%	30.1 to 45m	5%
10.1 to 20m	15%		

1) Fire Flow

Type of Construction: NC
 C = 0.8
 A = 5610 m² - Area of two largest adjoining floors plus 50% of all floors above upto 8 floors.
 F = 14,000 L/min

2) Occupancy Reduction

Contents Factor: LC
 Occupancy Charge = -15%
 -15% of 14,000 L/min = -2,100 L/min
 F = 13000 L/min + 3250 L/min = 11,900 L/min

3) System Type Reduction (to be reduced from result of Step 2)

NFPA 13 Sprinkler: 30% YES
 Standard Water Supply: 10% YES
 Fully Supervised: 10% YES
 Total System Type Reduction = 50%
 50% of 11,900 L/min = 5,950 L/min
 (to be reduced from result of Step 2)

4) Separation Charge (to be added to result of Step 2)

Building Face	Distance (m)	Length-Height Factor	Bldg Type	Auto Sprinkler	Charge
				Protection: Exposed BLDG (50% charge), Exposed & Subject Bldg (0% charge)	
North	>30	-	-	-	= 0%
East	>30	-	-	-	= 0%
South	19.7	148	Type III-IV ²	0%	= 0%
West	28.7	510	Type III-IV ²	NO	= 5%
Total					5% (max exposure charge can be 75%)

5% of 11,900 L/min = 595 L/min
 (to be added to result of Step 2)
 F = 7,000 L/min (round to the nearest 1,000 L/min) (2,000 L/min < F < 45,000 L/min)
 F = 1,849 GPM

Fire Underwriter Survey (2020) Fire Flow Calculation - 2080 Russell Road Existing Building

Project Name: 1971 & 1975 St. Laurent Blvd.
 Project Number: 21106
 Date: January 2022

$$F = 220C\sqrt{A}$$

where
 F = the required fire flow in litres per minute.
 C = coefficient related to the type of construction.
 = 1.5 for wood frame construction (structure essentially all combustible).
 = 1.0 for ordinary construction (brick or other masonry walls, combustible floor and interior).
 = 0.8 for non-combustible construction (unprotected metal structural components, masonry or metal walls).
 = 0.6 for fire-resistive construction (fully protected frame, floors, roof).
 A = The total floor area in square metres (including all storeys, but excluding basements at least 50 percent below grade) in the building being considered.

Legend

Construction Class	Contents Factor
WF wood frame construction	NC non-combustible
OC ordinary construction	LC limited combustible
NC non-combustible construction	C combustible
FC fire-resistive construction	FB free burning
	RB rapid burning

Contents Factor: Non-Combustible -25% Free Burning +15%
 Limited Combustible -15% Rapid Burning +25%
 Combustible No Charge

Separation	Charge	Separation	Charge
0 to 3m	25%	20.1 to 30 m	10%
3.1 to 10m	20%	30.1 to 45m	5%
10.1 to 20m	15%		

1) Fire Flow

Type of Construction: NC
 C = 0.8
 A = 6845 m² - Area of two largest adjoining floors plus 50% of all floors above upto 8 floors.
 F = 15,000 L/min

2) Occupancy Reduction

Contents Factor: LC
 Occupancy Charge = -15%
 -15% of 15,000 L/min = -2,250 L/min
 F = 13000 L/min + 3250 L/min = 12,750 L/min

3) System Type Reduction (to be reduced from result of Step 2)

NFPA 13 Sprinkler: 30% YES
 Standard Water Supply: 10% YES
 Fully Supervised: 10% YES
 Total System Type Reduction = 50%
 50% of 12,750 L/min = 6,375 L/min
 (to be reduced from result of Step 2)

4) Separation Charge (to be added to result of Step 2)

Building Face	Distance (m)	Length-Height Factor	Bldg Type	Auto Sprinkler Protection: Exposed BLDG (50% charge), Exposed & Subject Bldg (0% charge)		Charge
North	>30	-	-	-	-	= 0%
East	>30	-	-	-	-	= 0%
South	18	129	Type V	NO	-	= 15%
West	13.6	372	Type III-IV ²	NO	-	= 10%
Total						25% (max exposure charge can be 75%)

25% of 12,750 L/min = 3,188 L/min
 (to be added to result of Step 2)

F = 10,000 L/min (round to the nearest 1,000 L/min) (2,000 L/min < F < 45,000 L/min)
 F = 2,642 GPM

Fire Underwriter Survey (2020) Fire Flow Calculation - 2100 Russell Road Existing Building

Project Name: 1971 & 1975 St. Laurent Blvd.
 Project Number: 21106
 Date: January 2022

$$F = 220C\sqrt{A}$$

where
 F = the required fire flow in litres per minute.
 C = coefficient related to the type of construction.
 = 1.5 for wood frame construction (structure essentially all combustible).
 = 1.0 for ordinary construction (brick or other masonry walls, combustible floor and interior).
 = 0.8 for non-combustible construction (unprotected metal structural components, masonry or metal walls).
 = 0.6 for fire-resistive construction (fully protected frame, floors, roof).
 A = The total floor area in square metres (including all storeys, but excluding basements at least 50 percent below grade) in the building being considered.

Legend

Construction Class	Contents Factor
WF wood frame construction	NC non-combustible
OC ordinary construction	LC limited combustible
NC non-combustible construction	C combustible
FC fire-resistive construction	FB free burning
	RB rapid burning

Contents Factor: Non-Combustible -25% Free Burning +15%
 Limited Combustible -15% Rapid Burning +25%
 Combustible No Charge

Separation	Charge	Separation	Charge
0 to 3m	25%	20.1 to 30 m	10%
3.1 to 10m	20%	30.1 to 45m	5%
10.1 to 20m	15%		

1) Fire Flow

Type of Construction: NC
 C = 0.8
 A = 10675 m² -Area of two largest adjoining floors plus 50% of all floors above upto 8 floors.
 F = 19,000 L/min

2) Occupancy Reduction

Contents Factor: LC
 Occupancy Charge = -15%
 -15% of 19,000 L/min = -2,850 L/min
 F = 13000 L/min + 3250 L/min = 16,150 L/min

3) System Type Reduction (to be reduced from result of Step 2)

NFPA 13 Sprinkler: 30% YES
 Standard Water Supply: 10% YES
 Fully Supervised: 10% YES
 Total System Type Reduction = 50%
 50% of 16,150 L/min = 8,075 L/min
 (to be reduced from result of Step 2)

4) Separation Charge (to be added to result of Step 2)

Building Face	Distance (m)	Length-Height Factor	Bldg Type	Auto Sprinkler Protection Reduction:		Charge
				Exposed BLDG (50% charge), Exposed & Subject Bldg (0% charge)		
North	>30	-	-	-	=	0%
East	>30	-	-	-	=	0%
South	23	28	Type V	NO	=	2%
West	14	69	Type V	NO	=	13%
Total						15% (max exposure charge can be 75%)

15% of 16,150 L/min = 2,423 L/min
 (to be added to result of Step 2)

F = 11,000 L/min (round to the nearest 1,000 L/min) (2,000 L/min < F < 45,000 L/min)
 F = 2,906 GPM

Fire Underwriter Survey (2020) Fire Flow Calculation - Proposed Building A

Project Name: 1971 & 1975 St. Laurent Blvd.
 Project Number: 21106
 Date: January 2022

$$F = 220C\sqrt{A}$$

Where:

RFC = The Required Fire Flow in litres per minute (LPM)
C = The Construction Coefficient related to the type of construction of the building
A = The Total Effective Floor Area (for the building area) in square metres of the building

- C**
- 1.5 for Type I Wood Frame Construction
 - 0.8 for Type IV or Mass Timber Construction
 - 0.5 for Type III or Mass Timber Construction
 - 1.0 for Type IV-C Mass Timber Construction
 - 1.5 for Type IV-B Mass Timber Construction
 - 1.0 for Type III Ordinary Construction
 - 0.5 for Type II Non-combustible Construction
 - 0.5 for Type I Fire Resistive Construction

A = The total floor area in square metres (including all storeys, but excluding basements at least 50 percent below grade) in the building being considered.

Legend

Construction Class	Contents Factor
WF wood frame construction	NC non-combustible
OC ordinary construction	LC limited combustible
NC non-combustible construction	C combustible
FC fire-resistive construction	FB free burning
	RB rapid burning

Contents Factor:

Non-Combustible	-25%	Free Burning	+15%
Limited Combustible	-15%	Rapid Burning	+25%
Combustible	No Charge		

Separation	Charge	Separation	Charge
0 to 3m	25%	20.1 to 30 m	10%
3.1 to 10m	20%	30.1 to 45m	5%
10.1 to 20m	15%		

1) Fire Flow

Type of Construction: NC
 C = 0.8
 A = 2327 m² - Area of Largest Floor plus 25% of the two adjacent floors
 F = 9,000 L/min

2) Occupancy Reduction

Contents Factor: LC
 Occupancy Charge = -15%
 -15% of 9,000 L/min = -1,350 L/min
 F = 13000 L/min + 3250 L/min = 7,650 L/min

3) System Type Reduction (to be reduced from result of Step 2)

NFPA 13 Sprinkler: 30% YES
 Standard Water Supply: 10% YES
 Fully Supervised: 10% YES
 Total System Type Reduction = 50%
 50% of 7,650 L/min = 3,825 L/min
 (to be reduced from result of Step 2)

4) Separation Charge (to be added to result of Step 2)

Building Face	Distance (m)	Length-Height Factor	Bldg Type	Auto Sprinkler Protection	Charge
				Reduction: Exposed BLDG (50% charge), Exposed & Subject Bldg (0% charge)	
North	>30	-	-	-	= 0%
East	>30	-	-	-	= 0%
South	28	442	Type III-IV ²	0%	= 0%
West	>30	-	-	-	= 0%
Total					0% (max exposure charge can be 75%)

0% of 7,650 L/min = 0 L/min
 (to be added to result of Step 2)

F = 4,000 L/min (round to the nearest 1,000 L/min) (2,000 L/min < F < 45,000 L/min)
 F = 1,057 GPM

Fire Underwriter Survey (2020) Fire Flow Calculation - Proposed Building B

Project Name: 1971 & 1975 St. Laurent Blvd.
 Project Number: 21106
 Date: January 2022

$$F = 220C\sqrt{A}$$

Where:

CFF = Fire Required Flow in Litres per minute (LPM)
C = the Contents Factor, reduced to the type of construction of the building
A = the Total Effective Floor Area, effective building area in square metres of the building.

- C**
- = 1.5 For Type V Wood Frame Construction
 - = 0.8 For Type III-A Mass Timber Construction
 - = 0.8 For Type III-B Mass Timber Construction
 - = 1.0 For Type III-C Mass Timber Construction
 - = 1.5 For Type III-D Mass Timber Construction
 - = 1.0 For Type III Ordinary Construction
 - = 0.8 For Type II Noncombustible Construction
 - = 0.5 For Type I Fire Resistive Construction

A = The total floor area in square metres (including all storeys, but excluding basements at least 50 percent below grade) in the building being considered.

Legend

Construction Class	Contents Factor
WF wood frame construction	NC non-combustible
OC ordinary construction	LC limited combustible
NC non-combustible construction	C combustible
FC fire-resistive construction	FB free burning
	RB rapid burning

Contents Factor: Non-Combustible -25% Free Burning +15%
 Limited Combustible -15% Rapid Burning +25%
 Combustible No Charge

Separation	Charge	Separation	Charge
0 to 3m	25%	20.1 to 30 m	10%
3.1 to 10m	20%	30.1 to 45m	5%
10.1 to 20m	15%		

1) Fire Flow

Type of Construction: NC
 C = 0.8
 A = 2066 m² - Area of Largest Floor plus 25% of the two adjacent floors
 F = 8,000 L/min

2) Occupancy Reduction

Contents Factor: LC
 Occupancy Charge = -15%
 -15% of 8,000 L/min = -1,200 L/min
 F = 13000 L/min + 3250 L/min = 6,800 L/min

3) System Type Reduction (to be reduced from result of Step 2)

NFPA 13 Sprinkler: 30% YES
 Standard Water Supply: 10% YES
 Fully Supervised: 10% YES
 Total System Type Reduction = 50%
 50% of 6,800 L/min = 3,400 L/min
 (to be reduced from result of Step 2)

4) Separation Charge (to be added to result of Step 2)

Building Face	Distance (m)	Length-Height Factor	Bldg Type	Auto Sprinkler Protection Reduction:		Charge
				Exposed BLDG (50% charge), Exposed & Subject Bldg (0% charge)		
North	28	442	Type III-IV ²	0%	=	0%
East	25	306	Type III-IV ²	0%	=	0%
South	28	518.5	Type III-IV ²	0%	=	0%
West	>30	-	-	-	=	0%
Total						0% (max exposure charge can be 75%)

0% of 6,800 L/min = 0 L/min
 (to be added to result of Step 2)

F = 4,000 L/min (round to the nearest 1,000 L/min) (2,000 L/min < F < 45,000 L/min)
 F = 1,057 GPM

Fire Underwriter Survey (2020) Fire Flow Calculation - Proposed Building C

Project Name: 1971 & 1975 St. Laurent Blvd.
 Project Number: 21106
 Date: January 2022

$$F = 220C\sqrt{A}$$

Where:
RFF = the Required Fire Flow in litres per minute (LPM)
C = the Contents Factor is related to the type of construction of the building
A = the Total Effective Floor Area (Effective Building Area) in square metres of the building

C =
 1.5 For Type I Wood Frame Construction
 0.8 For Type II-A Mass Timber Construction
 0.9 For Type II-B Mass Timber Construction
 1.0 For Type II-C Mass Timber Construction
 1.5 For Type III Mass Timber Construction
 1.0 For Type III Ordinary Construction
 0.8 For Type II Noncombustible Construction
 0.4 For Type I Fire Resistive Construction

A = The total floor area in square metres (including all storeys, but excluding basements at least 50 percent below grade) in the building being considered.

Legend

Construction Class	Contents Factor
WF wood frame construction	NC non-combustible
OC ordinary construction	LC limited combustible
NC non-combustible construction	C combustible
FC fire-resistive construction	FB free burning
	RB rapid burning

Contents Factor:
 Non-Combustible -25% Free Burning +15%
 Limited Combustible -15% Rapid Burning +25%
 Combustible No Charge

Separation	Charge	Separation	Charge
0 to 3m	25%	20.1 to 30 m	10%
3.1 to 10m	20%	30.1 to 45m	5%
10.1 to 20m	15%		

1) Fire Flow

Type of Construction: NC
 C = 0.8
 A = 2289 m² - Area of Largest Floor plus 25% of the two adjacent floors
 F = 9,000 L/min

2) Occupancy Reduction

Contents Factor: LC
 Occupancy Charge = -15%
 -15% of 9,000 L/min = -1,350 L/min
 F = 13000 L/min + 3250 L/min = 7,650 L/min

3) System Type Reduction (to be reduced from result of Step 2)

NFPA 13 Sprinkler: 30% YES
 Standard Water Supply: 10% YES
 Fully Supervised: 10% YES
 Total System Type Reduction = 50%
 50% of 7,650 L/min = 3,825 L/min
 (to be reduced from result of Step 2)

4) Separation Charge (to be added to result of Step 2)

Building Face	Distance (m)	Length-Height Factor	Bldg Type	Auto Sprinkler Protection		Charge
				Reduction: Exposed BLDG (50% charge), Exposed & Subject Bldg (0% charge)		
North	28	519	Type III-IV ²	0%	=	0%
East	23	918	Type III-IV ²	0%	=	0%
South	>30	-	-	-	=	0%
West	>30	-	-	-	=	0%
Total						0% (max exposure charge can be 75%)

0% of 7,650 L/min = 0 L/min
 (to be added to result of Step 2)

F = 4,000 L/min (round to the nearest 1,000 L/min) (2,000 L/min < F < 45,000 L/min)
 F = 1,057 GPM

Fire Underwriter Survey (2020) Fire Flow Calculation - Proposed Building D (Parkade)

Project Name: 1971 & 1975 St. Laurent Blvd.
 Project Number: 21106
 Date: January 2022

$$F = 220C\sqrt{A}$$

Where:

RPF = the Required Fire Flow in litres per minute (LPM)
 C = the Construction Coefficient related to the type of construction of the building
 A = the Total Effective Floor Area (effective building area) in square metres of the building

- C = 2.5 for Type I Wood Frame Construction
- 1.0 for Type IV-A Mass Timber Construction
- 0.8 for Type IV-B Mass Timber Construction
- 1.0 for Type IV-C Mass Timber Construction
- 1.5 for Type IV-D Mass Timber Construction
- 2.0 for Type III Ordinary Construction
- 0.8 for Type II Noncombustible Construction
- 0.5 for Type I Fire Resistive Construction

A = The total floor area in square metres (including all storeys, but excluding basements at least 50 percent below grade) in the building being considered.

Legend

Construction Class	Contents Factor
WF wood frame construction	NC non-combustible
OC ordinary construction	LC limited combustible
NC non-combustible construction	C combustible
FC fire-resistive construction	FB free burning
	RB rapid burning

Contents Factor: Non-Combustible -25% Free Burning +15%
 Limited Combustible -15% Rapid Burning +25%
 Combustible No Charge

Separation	Charge	Separation	Charge
0 to 3m	25%	20.1 to 30 m	10%
3.1 to 10m	20%	30.1 to 45m	5%
10.1 to 20m	15%		

1) Fire Flow

Type of Construction: NC
 C = 0.8
 A = 4636 m² - For open parking garages, use the area of the largest floor
 F = 12,000 L/min as Total Effective Area

2) Occupancy Reduction

Contents Factor: C
 Occupancy Charge = 0%
 0% of 12,000 L/min = 0 L/min
 F = 13000 L/min + 3250 L/min = 12,000 L/min

3) System Type Reduction (to be reduced from result of Step 2)

NFPA 13 Sprinkler: 0% No
 Standard Water Supply: 0% No
 Fully Supervised: 0% No
 Total System Type Reduction = 0%
 0% of 12,000 L/min = 0 L/min
 (to be reduced from result of Step 2)

4) Separation Charge (to be added to result of Step 2)

Building Face	Distance (m)	Length-Height Factor	Bldg Type	Auto Sprinkler Protection		Charge
				Reduction: Exposed BLDG (50% charge)	Exposed & Subject Bldg (0% charge)	
North	19	1026	Type III-IV ²	50%	=	5%
East	14	240	Type V	50%	=	5%
South	14	170	Type V	NO	=	10%
West	15	1026	Type III-IV ²	50%	=	5%
Total						25% (max exposure charge can be 75%)

25% of 12,000 L/min = 3,000 L/min
 (to be added to result of Step 2)

F = 15,000 L/min (round to the nearest 1,000 L/min) (2,000 L/min < F < 45,000 L/min)
 F = 3,963 GPM



EPANET Model Network Layout

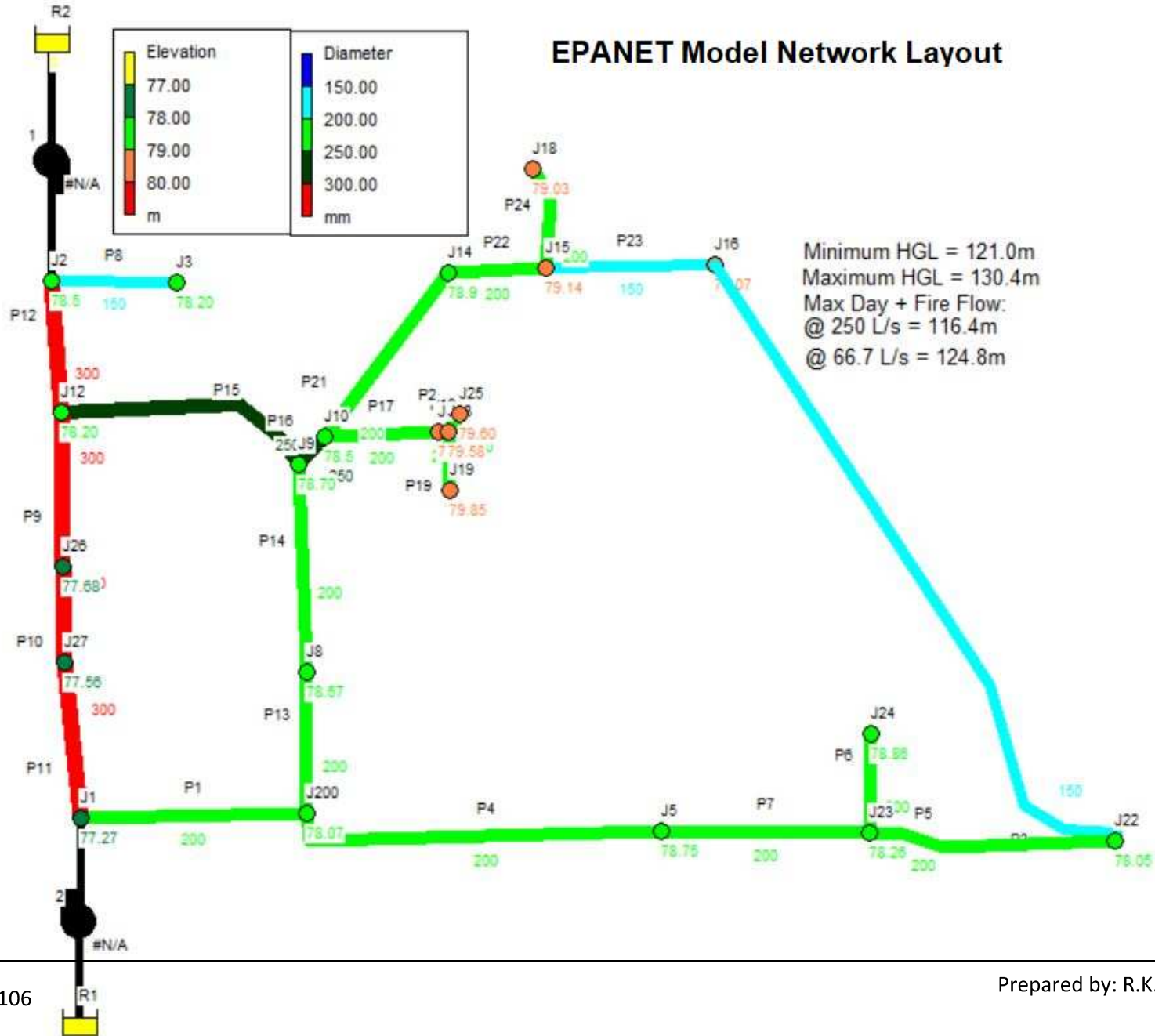



Residual Pressure during Non-Fire Scenarios

Scenario	Lowest Pressure			Satisfies Pressure Requirements?
	Pressure	Pressure	Pressure	
	(m H ₂ O)	(psi)	(kPa)	
Avg. Day	49.81	70.83	488.3	Yes
Max. Day	49.15	69.89	481.9	Yes
Max. Day Using Minimum Pressure	41.13	58.49	403.2	Yes
Peak Hour	48.07	68.35	471.3	Yes

Scenario	Highest Pressure			Satisfies Pressure Requirements?
	Pressure	Pressure	Pressure	
	(m H ₂ O)	(psi)	(kPa)	
Avg. Day	52.4	74.51	513.7	Yes
Max. Day	51.76	73.60	507.5	Yes
Max. Day Using Minimum Pressure	43.73	62.18	428.7	Yes
Peak Hour	50.74	72.15	497.5	Yes

Scenario	Pressure @ Connection Node J1			Satisfies Pressure Requirements?
	Pressure	Pressure	Pressure	
	(m H ₂ O)	(psi)	(kPa)	
Avg. Day	52.4	74.51	513.7	Yes
Max. Day	51.76	73.60	507.5	Yes
Max. Day Using Minimum Pressure	43.73	62.18	428.7	Yes
Peak Hour	50.74	72.15	497.5	Yes

Scenario	Pressure @ Connection Node J2			Satisfies Pressure Requirements?
	Pressure	Pressure	Pressure	
	(m H ₂ O)	(psi)	(kPa)	
Avg. Day	51.17	72.76	501.7	Yes
Max. Day	50.53	71.85	495.4	Yes
Max. Day Using Minimum Pressure	42.5	60.43	416.7	Yes
Peak Hour	49.51	70.40	485.4	Yes

Scenario	Pressure @ Connection Node J12			Satisfies Pressure Requirements?
	Pressure	Pressure	Pressure	
	(m H ₂ O)	(psi)	(kPa)	
Avg. Day	51.47	73.19	504.6	Yes
Max. Day	50.82	72.26	498.2	Yes
Max. Day Using Minimum Pressure	42.8	60.86	419.6	Yes
Peak Hour	49.8	70.81	488.2	Yes

Notes:

1. Preferred design pressure during normal operating conditions is approximately 345 kPa to 552 kPa
2. The maximum static pressure shall not exceed 552 kPa
3. The minimum pressure under any non-fire demand scenario should not be less than 276 kPa
4. In cases where all services are protected by an individual pressure reducing device, the maximum pressure in the watermain system will not exceed 689 kilopascals.

Residual Pressure based on Maximum Day Demand + Fire Flow

Fire Flow at Critical Building / Node	Max. Velocity (m/s)	Lowest Pressure			Satisfies Pressure & Velocity Requirements?
		Pressure (m H ₂ O)	Pressure (psi)	Pressure (kPa)	
<i>Ex. 1971 St. Laurent Blvd / J10</i>	3.05	41.70	59.30	408.8	Yes
<i>Ex. 1975 St. Laurent Blvd / J25</i>	3.82	40.23	57.21	394.4	Yes
<i>Ex. 2080 Russell Road / J24</i>	5.35	22.52	32.02	220.8	Yes
<i>Ex. 2100 Russell Road / J22</i>	4.24	18.96	26.96	185.9	Yes
Prop. Building A / J18	2.20	44.26	62.94	433.9	Yes
Prop. Building B / J3	3.91	43.15	61.36	423.0	Yes
Prop. Building D / J19	8.06	17.60	25.03	172.6	Yes

Notes:

1. Fire flow requirements satisfied if lowest pressure in is system > 140 kPa (20 psi)



Average Day Demand Condition

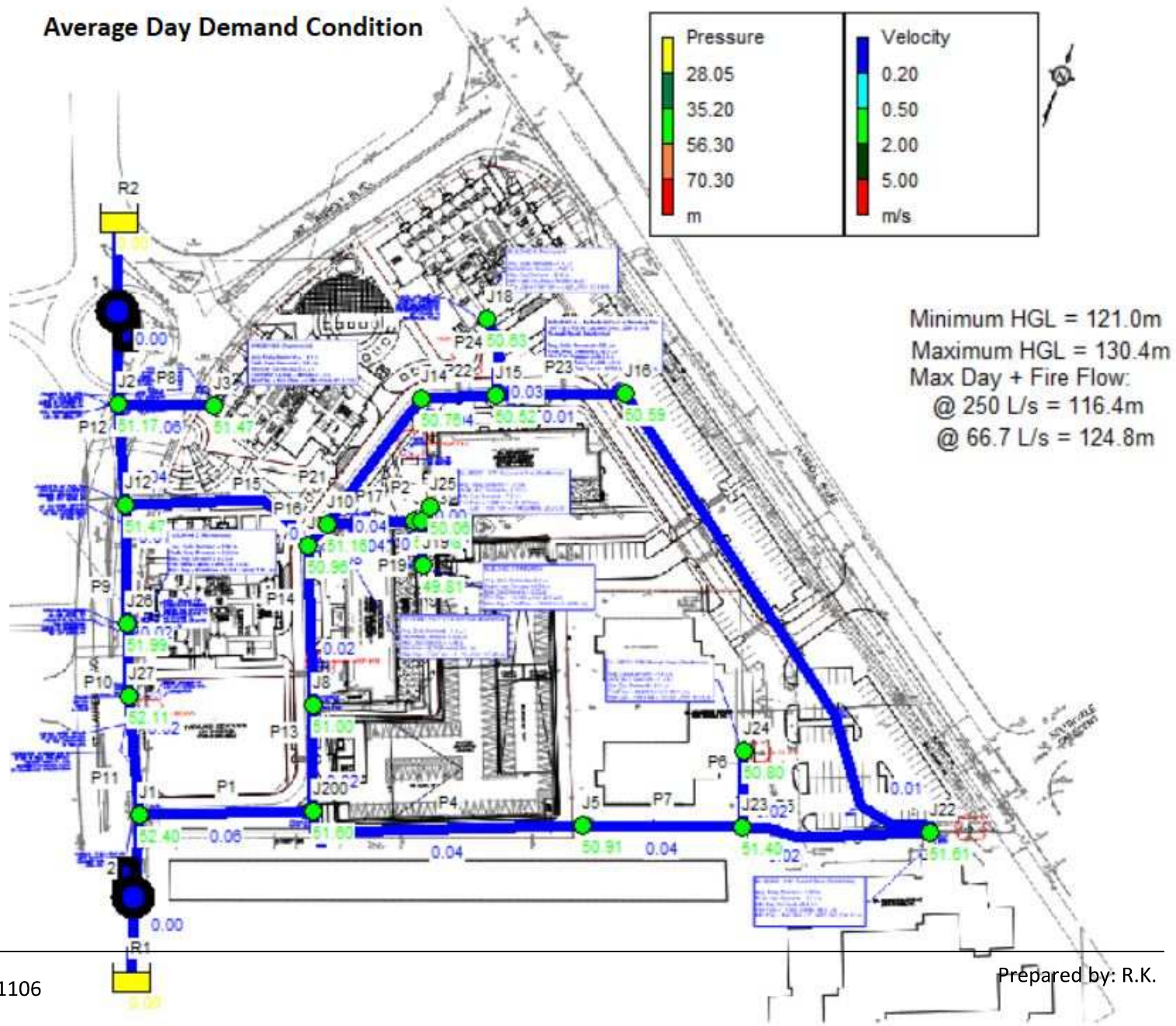



21106_Average Day Demand.rpt

Page 1

2023-03-14 3:33:16 PM

```
*****
*                               *
*           E P A N E T         *
*           Hydraulic and Water *
*           Analysis for Pipe   *
*           Networks            *
*           Version 2.2         *
*****
```

Input File: 21106_Average Day Demand-2023.net

Link - Node Table:

Link ID	Start Node	End Node	Length m	Diameter mm	
P1	J1	J200	60.78	200	
P4	J5	J200	96.37	200	
P13	J200	J8	32.72	200	
P14	J8	J9	58.6	200	
P15	J9	J12	67.26	250	
P16	J9	J10	7.91	250	
P17	J10	J11	31.176	200	
P18	J11	J13	2.28	200	
P19	J13	J19	18.81	200	
P21	J10	J14	51.579	200	
P22	J14	J15	23.86	200	
P23	J15	J16	41.8	150	
P24	J15	J18	26	200	
P2	J25	J13	5.633	200	
P3	J16	J22	189.127	150	
P5	J22	J23	62.85	200	
P6	J24	J23	25.34	200	
P7	J23	J5	55.03	200	
P9	J12	J26	44	300	
P10	J26	J27	21.3	300	
P11	J27	J1	39.51	300	
P12	J12	J2	36.02	300	
P8	J3	J2	31.93	150	
1	R2	J2	#N/A	#N/A	Pump
2	R1	J1	#N/A	#N/A	Pump

Energy Usage:

Pump	Usage Factor	Avg. Effic.	Kw-hr /m3	Avg. Kw	Peak Kw	Cost /day



21106_Average Day Demand.rpt

1	100.00	75.00	0.47	6.02	6.02	0.00
2	100.00	75.00	0.47	6.02	6.02	0.00

Demand Charge:	0.00
Total Cost:	0.00



Page 2

Node Results at 0:00 Hrs:

Node ID	Demand LPS	Head m	Pressure m	Quality	
J1	0.00	129.67	52.40	0.00	
J200	0.00	129.67	51.60	0.00	
J5	0.00	129.66	50.91	0.00	
J8	0.00	129.67	51.00	0.00	
J9	0.00	129.66	50.96	0.00	
J10	1.30	129.66	51.16	0.00	
J11	0.00	129.66	50.13	0.00	
J12	0.00	129.67	51.47	0.00	
J13	0.00	129.66	50.08	0.00	
J14	0.00	129.66	50.76	0.00	
J15	0.00	129.66	50.52	0.00	
J16	0.00	129.66	50.59	0.00	
J18	1.00	129.66	50.63	0.00	
J19	0.00	129.66	49.81	0.00	
J2	0.00	129.67	51.17	0.00	
J22	0.90	129.66	51.61	0.00	
J23	0.00	129.66	51.40	0.00	
J24	0.60	129.66	50.80	0.00	
J25	1.30	129.66	50.06	0.00	
J26	1.00	129.67	51.99	0.00	
J27	0.00	129.67	52.11	0.00	
J3	1.00	129.67	51.47	0.00	
R1	-3.55	0.00	0.00	0.00	Reservoir
R2	-3.55	0.00	0.00	0.00	Reservoir

Link Results at 0:00 Hrs:

Link ID	Flow LPS	Velocity m/s	Unit Headloss m/km	Status
P1	1.85	0.06	0.04	Open
P4	-1.26	0.04	0.02	Open
P13	0.60	0.02	0.00	Open
P14	0.60	0.02	0.00	Open

Page 2



21106_Average Day Demand.rpt

P15	-3.25	0.07	0.04	Open
P16	-3.84	0.08	0.05	Open
P17	1.30	0.04	0.02	Open
P18	1.30	0.04	0.02	Open
P19	0.00	0.00	0.00	Open
P21	1.24	0.04	0.02	Open
P22	1.24	0.04	0.02	Open
P23	0.24	0.01	0.00	Open
P24	1.00	0.03	0.01	Open
P2	-1.30	0.04	0.02	Open
P3	0.24	0.01	0.00	Open
P5	-0.66	0.02	0.01	Open
P6	-0.60	0.02	0.00	Open



Page 3

Link Results at 0:00 Hrs: (continued)

Link ID	Flow LPS	Velocity m/s	Unit Headloss m/km	Status
P7	-1.26	0.04	0.02	Open
P9	-0.70	0.01	0.00	Open
P10	-1.70	0.02	0.00	Open
P11	-1.70	0.02	0.00	Open
P12	-2.55	0.04	0.01	Open
P8	-1.00	0.06	0.06	Open
1	3.55	0.00	-129.67	Open Pump
2	3.55	0.00	-129.67	Open Pump

Node Results at 1:00 Hrs:

Node ID	Demand LPS	Head m	Pressure m	Quality
J1	0.00	129.67	52.40	0.00
J200	0.00	129.67	51.60	0.00
J5	0.00	129.66	50.91	0.00
J8	0.00	129.67	51.00	0.00
J9	0.00	129.66	50.96	0.00
J10	1.30	129.66	51.16	0.00
J11	0.00	129.66	50.13	0.00
J12	0.00	129.67	51.47	0.00
J13	0.00	129.66	50.08	0.00
J14	0.00	129.66	50.76	0.00
J15	0.00	129.66	50.52	0.00
J16	0.00	129.66	50.59	0.00
J18	1.00	129.66	50.63	0.00

Page 3



21106_Average Day Demand.rpt

J19	0.00	129.66	49.81	0.00	
J2	0.00	129.67	51.17	0.00	
J22	0.90	129.66	51.61	0.00	
J23	0.00	129.66	51.40	0.00	
J24	0.60	129.66	50.80	0.00	
J25	1.30	129.66	50.06	0.00	
J26	1.00	129.67	51.99	0.00	
J27	0.00	129.67	52.11	0.00	
J3	1.00	129.67	51.47	0.00	
R1	-3.55	0.00	0.00	0.00	Reservoir
R2	-3.55	0.00	0.00	0.00	Reservoir



Page 4

Link Results at 1:00 Hrs:

Link ID	Flow LPS	Velocity m/s	Unit Headloss m/km	Status
P1	1.85	0.06	0.04	Open
P4	-1.26	0.04	0.02	Open
P13	0.60	0.02	0.00	Open
P14	0.60	0.02	0.00	Open
P15	-3.25	0.07	0.04	Open
P16	3.84	0.08	0.05	Open
P17	1.30	0.04	0.02	Open
P18	1.30	0.04	0.02	Open
P19	0.00	0.00	0.00	Open
P21	1.24	0.04	0.02	Open
P22	1.24	0.04	0.02	Open
P23	0.24	0.01	0.00	Open
P24	1.00	0.03	0.01	Open
P2	-1.30	0.04	0.02	Open
P3	0.24	0.01	0.00	Open
P5	-0.66	0.02	0.01	Open
P6	-0.60	0.02	0.00	Open
P7	-1.26	0.04	0.02	Open
P9	-0.70	0.01	0.00	Open
P10	-1.70	0.02	0.00	Open
P11	-1.70	0.02	0.00	Open
P12	-2.55	0.04	0.01	Open
P8	-1.00	0.06	0.06	Open
1	3.55	0.00	-129.67	Open Pump
2	3.55	0.00	-129.67	Open Pump

Node Results at 2:00 Hrs:

Page 4



21106_Average Day Demand.rpt

Node ID	Demand LPS	Head m	Pressure m	Quality
J1	0.00	129.67	52.40	0.00
J200	0.00	129.67	51.60	0.00
J5	0.00	129.66	50.91	0.00
J8	0.00	129.67	51.00	0.00
J9	0.00	129.66	50.96	0.00
J10	1.30	129.66	51.16	0.00
J11	0.00	129.66	50.13	0.00
J12	0.00	129.67	51.47	0.00
J13	0.00	129.66	50.08	0.00
J14	0.00	129.66	50.76	0.00
J15	0.00	129.66	50.52	0.00
J16	0.00	129.66	50.59	0.00
J18	1.00	129.66	50.63	0.00
J19	0.00	129.66	49.81	0.00
J2	0.00	129.67	51.17	0.00
J22	0.90	129.66	51.61	0.00



Page 5

Node Results at 2:00 Hrs: (continued)

Node ID	Demand LPS	Head m	Pressure m	Quality
J23	0.00	129.66	51.40	0.00
J24	0.60	129.66	50.80	0.00
J25	1.30	129.66	50.06	0.00
J26	1.00	129.67	51.99	0.00
J27	0.00	129.67	52.11	0.00
J3	1.00	129.67	51.47	0.00
R1	-3.55	0.00	0.00	0.00 Reservoir
R2	-3.55	0.00	0.00	0.00 Reservoir

Link Results at 2:00 Hrs:

Link ID	Flow LPS	Velocity m/s	Unit Headloss m/km	Status
P1	1.85	0.06	0.04	Open
P4	-1.26	0.04	0.02	Open
P13	0.60	0.02	0.00	Open
P14	0.60	0.02	0.00	Open
P15	-3.25	0.07	0.04	Open
P16	3.84	0.08	0.05	Open
P17	1.30	0.04	0.02	Open

Page 5



21106_Average Day Demand.rpt

P18	1.30	0.04	0.02	Open
P19	0.00	0.00	0.00	Open
P21	1.24	0.04	0.02	Open
P22	1.24	0.04	0.02	Open
P23	0.24	0.01	0.00	Open
P24	1.00	0.03	0.01	Open
P2	-1.30	0.04	0.02	Open
P3	0.24	0.01	0.00	Open
P5	-0.66	0.02	0.01	Open
P6	-0.60	0.02	0.00	Open
P7	-1.26	0.04	0.02	Open
P9	-0.70	0.01	0.00	Open
P10	-1.70	0.02	0.00	Open
P11	-1.70	0.02	0.00	Open
P12	-2.55	0.04	0.01	Open
P8	-1.00	0.06	0.06	Open
1	3.55	0.00	-129.67	Open Pump
2	3.55	0.00	-129.67	Open Pump



Page 6

Node Results at 3:00 Hrs:

Node ID	Demand LPS	Head m	Pressure m	Quality
J1	0.00	129.67	52.40	0.00
J200	0.00	129.67	51.60	0.00
J5	0.00	129.66	50.91	0.00
J8	0.00	129.67	51.00	0.00
J9	0.00	129.66	50.96	0.00
J10	1.30	129.66	51.16	0.00
J11	0.00	129.66	50.13	0.00
J12	0.00	129.67	51.47	0.00
J13	0.00	129.66	50.08	0.00
J14	0.00	129.66	50.76	0.00
J15	0.00	129.66	50.52	0.00
J16	0.00	129.66	50.59	0.00
J18	1.00	129.66	50.63	0.00
J19	0.00	129.66	49.81	0.00
J2	0.00	129.67	51.17	0.00
J22	0.90	129.66	51.61	0.00
J23	0.00	129.66	51.40	0.00
J24	0.60	129.66	50.80	0.00
J25	1.30	129.66	50.06	0.00
J26	1.00	129.67	51.99	0.00
J27	0.00	129.67	52.11	0.00

Page 6



21106_Average Day Demand.rpt

J3	1.00	129.67	51.47	0.00	
R1	-3.55	0.00	0.00	0.00	Reservoir
R2	-3.55	0.00	0.00	0.00	Reservoir

Link Results at 3:00 Hrs:

Link ID	Flow LPS	Velocity m/s	Unit Headloss m/km	Status
P1	1.85	0.06	0.04	Open
P4	-1.26	0.04	0.02	Open
P13	0.60	0.02	0.00	Open
P14	0.60	0.02	0.00	Open
P15	-3.25	0.07	0.04	Open
P16	3.84	0.08	0.05	Open
P17	1.30	0.04	0.02	Open
P18	1.30	0.04	0.02	Open
P19	0.00	0.00	0.00	Open
P21	1.24	0.04	0.02	Open
P22	1.24	0.04	0.02	Open
P23	0.24	0.01	0.00	Open
P24	1.00	0.03	0.01	Open
P2	-1.30	0.04	0.02	Open
P3	0.24	0.01	0.00	Open
P5	-0.66	0.02	0.01	Open
P6	-0.60	0.02	0.00	Open



Page 7

Link Results at 3:00 Hrs: (continued)

Link ID	Flow LPS	Velocity m/s	Unit Headloss m/km	Status
P7	-1.26	0.04	0.02	Open
P9	-0.70	0.01	0.00	Open
P10	-1.70	0.02	0.00	Open
P11	-1.70	0.02	0.00	Open
P12	-2.55	0.04	0.01	Open
P8	-1.00	0.06	0.06	Open
1	3.55	0.00	-129.67	Open Pump
2	3.55	0.00	-129.67	Open Pump

Node Results at 4:00 Hrs:

Node ID	Demand LPS	Head m	Pressure m	Quality
---------	------------	--------	------------	---------



21106_Average Day Demand.rpt

J1	0.00	129.67	52.40	0.00
J200	0.00	129.67	51.60	0.00
J5	0.00	129.66	50.91	0.00
J8	0.00	129.67	51.00	0.00
J9	0.00	129.66	50.96	0.00
J10	1.30	129.66	51.16	0.00
J11	0.00	129.66	50.13	0.00
J12	0.00	129.67	51.47	0.00
J13	0.00	129.66	50.08	0.00
J14	0.00	129.66	50.76	0.00
J15	0.00	129.66	50.52	0.00
J16	0.00	129.66	50.59	0.00
J18	1.00	129.66	50.63	0.00
J19	0.00	129.66	49.81	0.00
J2	0.00	129.67	51.17	0.00
J22	0.90	129.66	51.61	0.00
J23	0.00	129.66	51.40	0.00
J24	0.60	129.66	50.80	0.00
J25	1.30	129.66	50.06	0.00
J26	1.00	129.67	51.99	0.00
J27	0.00	129.67	52.11	0.00
J3	1.00	129.67	51.47	0.00
R1	-3.55	0.00	0.00	0.00 Reservoir
R2	-3.55	0.00	0.00	0.00 Reservoir



Page 8

Link Results at 4:00 Hrs:

Link ID	Flow LPS	Velocity m/s	Unit Headloss m/km	Status
P1	1.85	0.06	0.04	Open
P4	-1.26	0.04	0.02	Open
P13	0.60	0.02	0.00	Open
P14	0.60	0.02	0.00	Open
P15	-3.25	0.07	0.04	Open
P16	3.84	0.08	0.05	Open
P17	1.30	0.04	0.02	Open
P18	1.30	0.04	0.02	Open
P19	0.00	0.00	0.00	Open
P21	1.24	0.04	0.02	Open
P22	1.24	0.04	0.02	Open
P23	0.24	0.01	0.00	Open
P24	1.00	0.03	0.01	Open
P2	-1.30	0.04	0.02	Open
P3	0.24	0.01	0.00	Open

Page 8



21106_Average Day Demand.rpt

P5	-0.66	0.02	0.01	Open
P6	-0.60	0.02	0.00	Open
P7	-1.26	0.04	0.02	Open
P9	-0.70	0.01	0.00	Open
P10	-1.70	0.02	0.00	Open
P11	-1.70	0.02	0.00	Open
P12	-2.55	0.04	0.01	Open
P8	-1.00	0.06	0.06	Open
1	3.55	0.00	-129.67	Open Pump
2	3.55	0.00	-129.67	Open Pump



Maximum Day Demand Condition

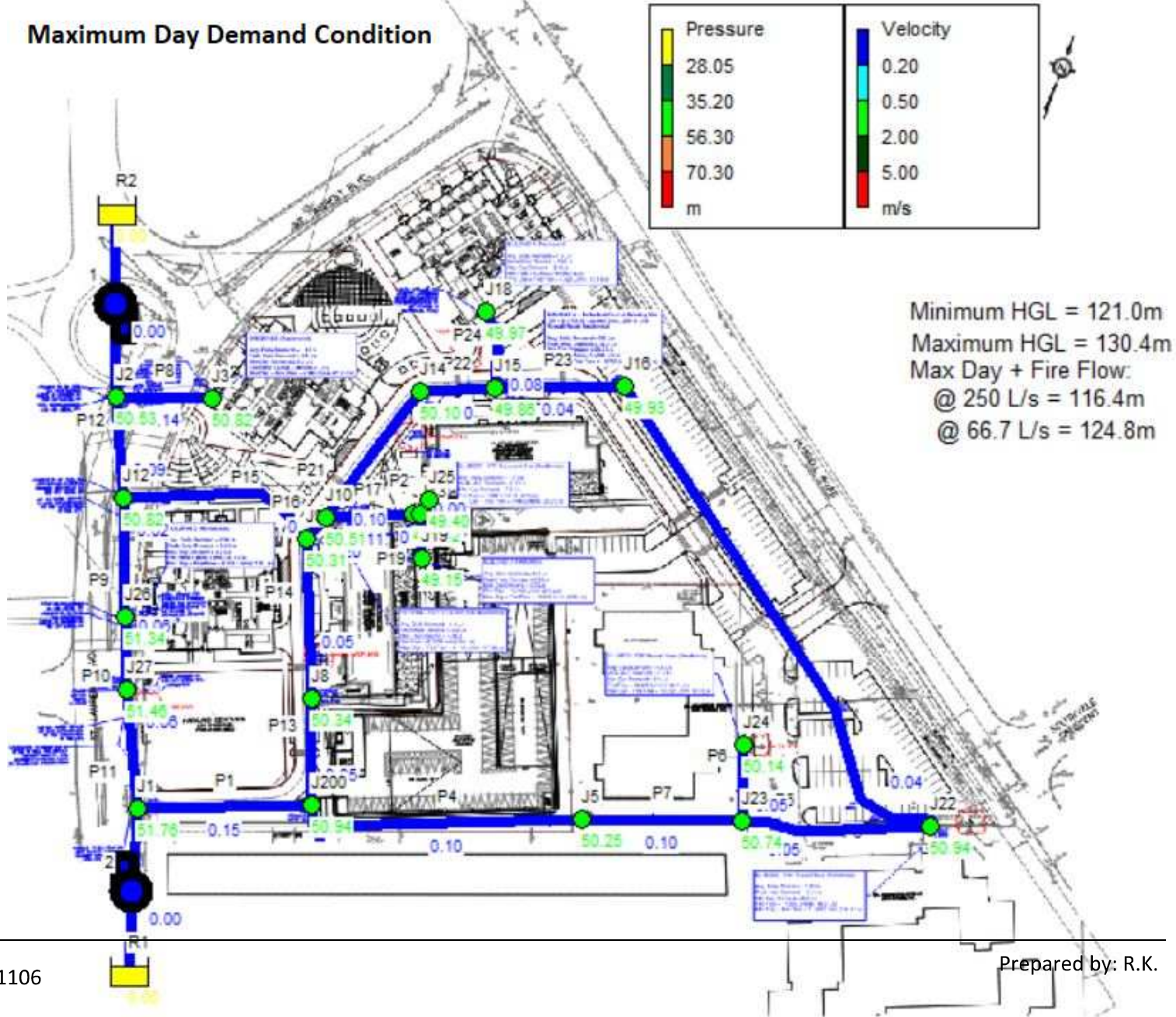



21106_Max Day Demand.rpt

Page 1

2023-03-14 3:35:38 PM

```
*****
*                               *
*           E P A N E T         *
*       Hydraulic and Water Quality *
*       Analysis for Pipe Networks *
*           Version 2.2         *
*****
```

Input File: 21106_Maximum Day Demand-2023.net

Link - Node Table:

Link ID	Start Node	End Node	Length m	Diameter mm	
P1	J1	J200	60.78	200	
P4	J5	J200	96.37	200	
P13	J200	J8	32.72	200	
P14	J8	J9	58.6	200	
P15	J9	J12	67.26	250	
P16	J9	J10	7.91	250	
P17	J10	J11	31.176	200	
P18	J11	J13	2.28	200	
P19	J13	J19	18.81	200	
P21	J10	J14	51.579	200	
P22	J14	J15	23.86	200	
P23	J15	J16	41.8	150	
P24	J15	J18	26	200	
P2	J25	J13	5.633	200	
P3	J16	J22	189.127	150	
P5	J22	J23	62.85	200	
P6	J24	J23	25.34	200	
P7	J23	J5	55.03	200	
P9	J12	J26	44	300	
P10	J26	J27	21.3	300	
P11	J27	J1	39.51	300	
P12	J12	J2	36.02	300	
P8	J3	J2	31.93	150	
1	R2	J2	#N/A	#N/A	Pump
2	R1	J1	#N/A	#N/A	Pump

Energy Usage:

Pump	Usage Factor	Avg. Effic.	Kw-hr /m3	Avg. Kw	Peak Kw	Cost /day



21106_Max Day Demand.rpt

1	100.00	75.00	0.47	14.84	14.84	0.00
2	100.00	75.00	0.47	14.84	14.84	0.00

Demand Charge:	0.00
Total Cost:	0.00



Page 2

Node Results at 0:00 Hrs:

Node ID	Demand LPS	Head m	Pressure m	Quality	
J1	0.00	129.03	51.76	0.00	
J200	0.00	129.01	50.94	0.00	
J5	0.00	129.00	50.25	0.00	
J8	0.00	129.01	50.34	0.00	
J9	0.00	129.01	50.31	0.00	
J10	3.30	129.01	50.51	0.00	
J11	0.00	129.00	49.47	0.00	
J12	0.00	129.02	50.82	0.00	
J13	0.00	129.00	49.42	0.00	
J14	0.00	129.00	50.10	0.00	
J15	0.00	129.00	49.86	0.00	
J16	0.00	129.00	49.93	0.00	
J18	2.40	129.00	49.97	0.00	
J19	0.00	129.00	49.15	0.00	
J2	0.00	129.03	50.53	0.00	
J22	2.30	128.99	50.94	0.00	
J23	0.00	129.00	50.74	0.00	
J24	1.50	129.00	50.14	0.00	
J25	3.30	129.00	49.40	0.00	
J26	2.40	129.02	51.34	0.00	
J27	0.00	129.02	51.46	0.00	
J3	2.40	129.02	50.82	0.00	
R1	-8.80	0.00	0.00	0.00	Reservoir
R2	-8.80	0.00	0.00	0.00	Reservoir

Link Results at 0:00 Hrs:

Link ID	Flow LPS	Velocity m/s	Unit Headloss m/km	Status
P1	4.65	0.15	0.21	Open
P4	-3.16	0.10	0.11	Open
P13	1.49	0.05	0.03	Open
P14	1.49	0.05	0.02	Open

Page 2



21106_Max Day Demand.rpt

P15	-8.15	0.17	0.20	Open
P16	-9.64	0.20	0.28	Open
P17	3.30	0.11	0.11	Open
P18	3.30	0.11	0.11	Open
P19	0.00	0.00	0.00	Open
P21	3.04	0.10	0.10	Open
P22	3.04	0.10	0.10	Open
P23	0.64	0.04	0.03	Open
P24	2.40	0.08	0.06	Open
P2	-3.30	0.11	0.11	Open
P3	0.64	0.04	0.03	Open
P5	-1.66	0.05	0.03	Open
P6	-1.50	0.05	0.03	Open



Page 3

Link Results at 0:00 Hrs: (continued)

Link ID	Flow LPS	Velocity m/s	Unit Headloss m/km	Status
P7	-3.16	0.10	0.10	Open
P9	-1.75	0.02	0.00	Open
P10	-4.15	0.06	0.02	Open
P11	-4.15	0.06	0.02	Open
P12	-6.40	0.09	0.05	Open
P8	-2.40	0.14	0.31	Open
1	8.80	0.00	-129.03	Open Pump
2	8.80	0.00	-129.03	Open Pump

Node Results at 1:00 Hrs:

Node ID	Demand LPS	Head m	Pressure m	Quality
J1	0.00	129.03	51.76	0.00
J200	0.00	129.01	50.94	0.00
J5	0.00	129.00	50.25	0.00
J8	0.00	129.01	50.34	0.00
J9	0.00	129.01	50.31	0.00
J10	3.30	129.01	50.51	0.00
J11	0.00	129.00	49.47	0.00
J12	0.00	129.02	50.82	0.00
J13	0.00	129.00	49.42	0.00
J14	0.00	129.00	50.10	0.00
J15	0.00	129.00	49.86	0.00
J16	0.00	129.00	49.93	0.00
J18	2.40	129.00	49.97	0.00

Page 3



21106_Max Day Demand.rpt

J19	0.00	129.00	49.15	0.00
J2	0.00	129.03	50.53	0.00
J22	2.30	128.99	50.94	0.00
J23	0.00	129.00	50.74	0.00
J24	1.50	129.00	50.14	0.00
J25	3.30	129.00	49.40	0.00
J26	2.40	129.02	51.34	0.00
J27	0.00	129.02	51.46	0.00
J3	2.40	129.02	50.82	0.00
R1	-8.80	0.00	0.00	0.00 Reservoir
R2	-8.80	0.00	0.00	0.00 Reservoir



Page 4

Link Results at 1:00 Hrs:

Link ID	Flow LPS	Velocity m/s	Unit Headloss m/km	Status
P1	4.65	0.15	0.21	Open
P4	-3.16	0.10	0.11	Open
P13	1.49	0.05	0.03	Open
P14	1.49	0.05	0.02	Open
P15	-8.15	0.17	0.20	Open
P16	9.64	0.20	0.28	Open
P17	3.30	0.11	0.11	Open
P18	3.30	0.11	0.11	Open
P19	0.00	0.00	0.00	Open
P21	3.04	0.10	0.10	Open
P22	3.04	0.10	0.10	Open
P23	0.64	0.04	0.03	Open
P24	2.40	0.08	0.06	Open
P2	-3.30	0.11	0.11	Open
P3	0.64	0.04	0.03	Open
P5	-1.66	0.05	0.03	Open
P6	-1.50	0.05	0.03	Open
P7	-3.16	0.10	0.10	Open
P9	-1.75	0.02	0.00	Open
P10	-4.15	0.06	0.02	Open
P11	-4.15	0.06	0.02	Open
P12	-6.40	0.09	0.05	Open
P8	-2.40	0.14	0.31	Open
1	8.80	0.00	-129.03	Open Pump
2	8.80	0.00	-129.03	Open Pump

Node Results at 2:00 Hrs:



21106_Max Day Demand.rpt				
Node ID	Demand LPS	Head m	Pressure m	Quality
J1	0.00	129.03	51.76	0.00
J200	0.00	129.01	50.94	0.00
J5	0.00	129.00	50.25	0.00
J8	0.00	129.01	50.34	0.00
J9	0.00	129.01	50.31	0.00
J10	3.30	129.01	50.51	0.00
J11	0.00	129.00	49.47	0.00
J12	0.00	129.02	50.82	0.00
J13	0.00	129.00	49.42	0.00
J14	0.00	129.00	50.10	0.00
J15	0.00	129.00	49.86	0.00
J16	0.00	129.00	49.93	0.00
J18	2.40	129.00	49.97	0.00
J19	0.00	129.00	49.15	0.00
J2	0.00	129.03	50.53	0.00
J22	2.30	128.99	50.94	0.00



Page 5

Node Results at 2:00 Hrs: (continued)

Node ID	Demand LPS	Head m	Pressure m	Quality
J23	0.00	129.00	50.74	0.00
J24	1.50	129.00	50.14	0.00
J25	3.30	129.00	49.40	0.00
J26	2.40	129.02	51.34	0.00
J27	0.00	129.02	51.46	0.00
J3	2.40	129.02	50.82	0.00
R1	-8.80	0.00	0.00	0.00 Reservoir
R2	-8.80	0.00	0.00	0.00 Reservoir

Link Results at 2:00 Hrs:

Link ID	Flow LPS	Velocity m/s	Unit Headloss m/km	Status
P1	4.65	0.15	0.21	Open
P4	-3.16	0.10	0.11	Open
P13	1.49	0.05	0.03	Open
P14	1.49	0.05	0.02	Open
P15	-8.15	0.17	0.20	Open
P16	9.64	0.20	0.28	Open
P17	3.30	0.11	0.11	Open

Page 5



		21106_Max	Day	Demand.rpt	
P18	3.30	0.11	0.11	Open	
P19	0.00	0.00	0.00	Open	
P21	3.04	0.10	0.10	Open	
P22	3.04	0.10	0.10	Open	
P23	0.64	0.04	0.03	Open	
P24	2.40	0.08	0.06	Open	
P2	-3.30	0.11	0.11	Open	
P3	0.64	0.04	0.03	Open	
P5	-1.66	0.05	0.03	Open	
P6	-1.50	0.05	0.03	Open	
P7	-3.16	0.10	0.10	Open	
P9	-1.75	0.02	0.00	Open	
P10	-4.15	0.06	0.02	Open	
P11	-4.15	0.06	0.02	Open	
P12	-6.40	0.09	0.05	Open	
P8	-2.40	0.14	0.31	Open	
1	8.80	0.00	-129.03	Open Pump	
2	8.80	0.00	-129.03	Open Pump	



Page 6

Node Results at 3:00 Hrs:

Node ID	Demand LPS	Head m	Pressure m	Quality
J1	0.00	129.03	51.76	0.00
J200	0.00	129.01	50.94	0.00
J5	0.00	129.00	50.25	0.00
J8	0.00	129.01	50.34	0.00
J9	0.00	129.01	50.31	0.00
J10	3.30	129.01	50.51	0.00
J11	0.00	129.00	49.47	0.00
J12	0.00	129.02	50.82	0.00
J13	0.00	129.00	49.42	0.00
J14	0.00	129.00	50.10	0.00
J15	0.00	129.00	49.86	0.00
J16	0.00	129.00	49.93	0.00
J18	2.40	129.00	49.97	0.00
J19	0.00	129.00	49.15	0.00
J2	0.00	129.03	50.53	0.00
J22	2.30	128.99	50.94	0.00
J23	0.00	129.00	50.74	0.00
J24	1.50	129.00	50.14	0.00
J25	3.30	129.00	49.40	0.00
J26	2.40	129.02	51.34	0.00
J27	0.00	129.02	51.46	0.00

Page 6



21106_Max Day Demand.rpt

J3	2.40	129.02	50.82	0.00	
R1	-8.80	0.00	0.00	0.00	Reservoir
R2	-8.80	0.00	0.00	0.00	Reservoir

Link Results at 3:00 Hrs:

Link ID	Flow LPS	Velocity m/s	Unit Headloss m/km	Status
P1	4.65	0.15	0.21	Open
P4	-3.16	0.10	0.11	Open
P13	1.49	0.05	0.03	Open
P14	1.49	0.05	0.02	Open
P15	-8.15	0.17	0.20	Open
P16	9.64	0.20	0.28	Open
P17	3.30	0.11	0.11	Open
P18	3.30	0.11	0.11	Open
P19	0.00	0.00	0.00	Open
P21	3.04	0.10	0.10	Open
P22	3.04	0.10	0.10	Open
P23	0.64	0.04	0.03	Open
P24	2.40	0.08	0.06	Open
P2	-3.30	0.11	0.11	Open
P3	0.64	0.04	0.03	Open
P5	-1.66	0.05	0.03	Open
P6	-1.50	0.05	0.03	Open



Page 7

Link Results at 3:00 Hrs: (continued)

Link ID	Flow LPS	Velocity m/s	Unit Headloss m/km	Status
P7	-3.16	0.10	0.10	Open
P9	-1.75	0.02	0.00	Open
P10	-4.15	0.06	0.02	Open
P11	-4.15	0.06	0.02	Open
P12	-6.40	0.09	0.05	Open
P8	-2.40	0.14	0.31	Open
1	8.80	0.00	-129.03	Open Pump
2	8.80	0.00	-129.03	Open Pump

Node Results at 4:00 Hrs:

Node ID	Demand LPS	Head m	Pressure m	Quality
---------	------------	--------	------------	---------



21106_Max Day Demand.rpt

J1	0.00	129.03	51.76	0.00
J200	0.00	129.01	50.94	0.00
J5	0.00	129.00	50.25	0.00
J8	0.00	129.01	50.34	0.00
J9	0.00	129.01	50.31	0.00
J10	3.30	129.01	50.51	0.00
J11	0.00	129.00	49.47	0.00
J12	0.00	129.02	50.82	0.00
J13	0.00	129.00	49.42	0.00
J14	0.00	129.00	50.10	0.00
J15	0.00	129.00	49.86	0.00
J16	0.00	129.00	49.93	0.00
J18	2.40	129.00	49.97	0.00
J19	0.00	129.00	49.15	0.00
J2	0.00	129.03	50.53	0.00
J22	2.30	128.99	50.94	0.00
J23	0.00	129.00	50.74	0.00
J24	1.50	129.00	50.14	0.00
J25	3.30	129.00	49.40	0.00
J26	2.40	129.02	51.34	0.00
J27	0.00	129.02	51.46	0.00
J3	2.40	129.02	50.82	0.00
R1	-8.80	0.00	0.00	0.00 Reservoir
R2	-8.80	0.00	0.00	0.00 Reservoir



Page 8

Link Results at 4:00 Hrs:

Link ID	Flow LPS	Velocity m/s	Unit Headloss m/km	Status
P1	4.65	0.15	0.21	Open
P4	-3.16	0.10	0.11	Open
P13	1.49	0.05	0.03	Open
P14	1.49	0.05	0.02	Open
P15	-8.15	0.17	0.20	Open
P16	9.64	0.20	0.28	Open
P17	3.30	0.11	0.11	Open
P18	3.30	0.11	0.11	Open
P19	0.00	0.00	0.00	Open
P21	3.04	0.10	0.10	Open
P22	3.04	0.10	0.10	Open
P23	0.64	0.04	0.03	Open
P24	2.40	0.08	0.06	Open
P2	-3.30	0.11	0.11	Open
P3	0.64	0.04	0.03	Open

Page 8



		21106_Max	Day	Demand.rpt	
P5	-1.66	0.05	0.03	Open	
P6	-1.50	0.05	0.03	Open	
P7	-3.16	0.10	0.10	Open	
P9	-1.75	0.02	0.00	Open	
P10	-4.15	0.06	0.02	Open	
P11	-4.15	0.06	0.02	Open	
P12	-6.40	0.09	0.05	Open	
P8	-2.40	0.14	0.31	Open	
1	8.80	0.00	-129.03	Open	Pump
2	8.80	0.00	-129.03	Open	Pump



**Maximum Day Demand Condition
with Minimum Available Pressure at
Connection Nodes**

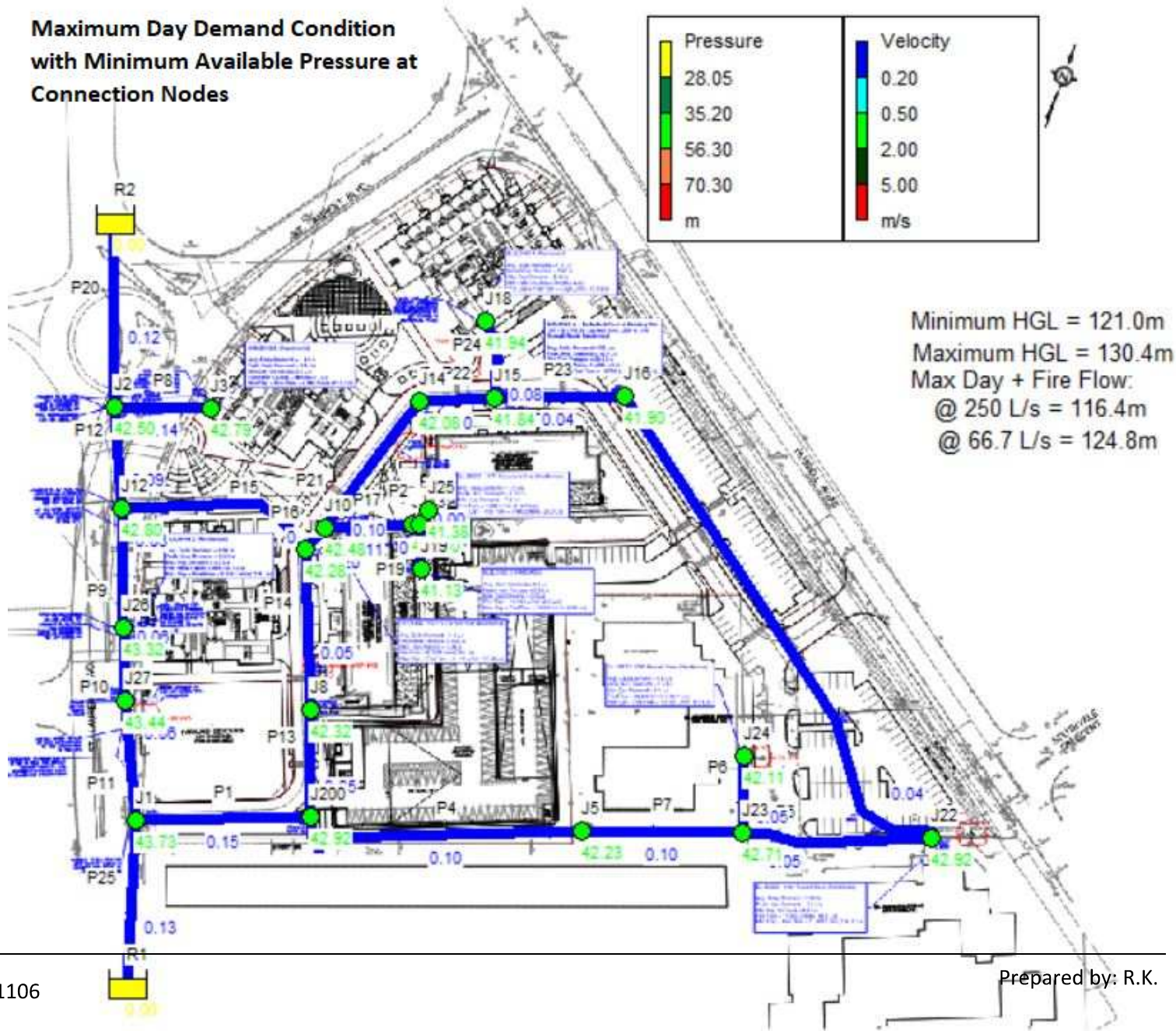
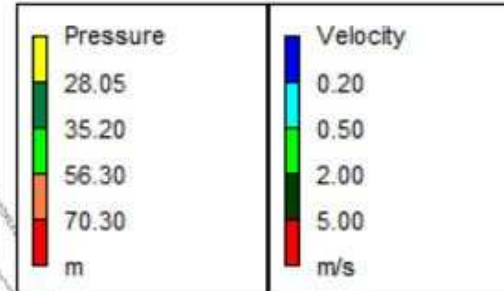



21106_Max Day Demand with Minimum Pressure.rpt

J1	0.00	121.00	43.73	0.00
J200	0.00	120.99	42.92	0.00
J5	0.00	120.98	42.23	0.00
J8	0.00	120.99	42.32	0.00
J9	0.00	120.98	42.28	0.00
J10	3.30	120.98	42.48	0.00



Page 2

Node Results at 0:00 Hrs: (continued)

Node ID	Demand LPS	Head m	Pressure m	Quality
J11	0.00	120.98	41.45	0.00
J12	0.00	121.00	42.80	0.00
J13	0.00	120.98	41.40	0.00
J14	0.00	120.98	42.08	0.00
J15	0.00	120.98	41.84	0.00
J16	0.00	120.97	41.90	0.00
J18	2.40	120.97	41.94	0.00
J19	0.00	120.98	41.13	0.00
J2	0.00	121.00	42.50	0.00
J22	2.30	120.97	42.92	0.00
J23	0.00	120.97	42.71	0.00
J24	1.50	120.97	42.11	0.00
J25	3.30	120.98	41.38	0.00
J26	2.40	121.00	43.32	0.00
J27	0.00	121.00	43.44	0.00
J3	2.40	120.99	42.79	0.00
R1	-8.98	121.00	0.00	0.00 Reservoir
R2	-8.62	121.00	0.00	0.00 Reservoir

Link Results at 0:00 Hrs:

Link ID	Flow LPS	Velocity m/s	Unit Headloss m/km	Status
P1	4.66	0.15	0.22	Open
P4	-3.16	0.10	0.11	Open
P13	1.50	0.05	0.03	Open
P14	1.50	0.05	0.02	Open
P15	-8.14	0.17	0.20	Open
P16	9.64	0.20	0.28	Open
P17	3.30	0.11	0.11	Open
P18	3.30	0.11	0.11	Open
P19	0.00	0.00	0.00	Open
P21	3.04	0.10	0.10	Open

Page 2



21106_Max Day Demand with Minimum Pressure.rpt

P22	3.04	0.10	0.10	Open
P23	0.64	0.04	0.03	Open
P24	2.40	0.08	0.06	Open
P2	-3.30	0.11	0.11	Open
P3	0.64	0.04	0.03	Open
P5	-1.66	0.05	0.03	Open
P6	-1.50	0.05	0.03	Open
P7	-3.16	0.10	0.11	Open
P9	-1.92	0.03	0.00	Open
P10	-4.32	0.06	0.02	Open
P11	-4.32	0.06	0.02	Open
P12	-6.22	0.09	0.04	Open
P8	-2.40	0.14	0.31	Open



Page 3

Link Results at 0:00 Hrs: (continued)

Link ID	Flow LPS	Velocity m/s	Unit Headloss m/km	Status
P20	8.62	0.12	0.09	Open
P25	8.98	0.13	0.09	Open

Node Results at 1:00 Hrs:

Node ID	Demand LPS	Head m	Pressure m	Quality
J1	0.00	121.00	43.73	0.00
J200	0.00	120.99	42.92	0.00
J5	0.00	120.98	42.23	0.00
J8	0.00	120.99	42.32	0.00
J9	0.00	120.98	42.28	0.00
J10	3.30	120.98	42.48	0.00
J11	0.00	120.98	41.45	0.00
J12	0.00	121.00	42.80	0.00
J13	0.00	120.98	41.40	0.00
J14	0.00	120.98	42.08	0.00
J15	0.00	120.98	41.84	0.00
J16	0.00	120.97	41.90	0.00
J18	2.40	120.97	41.94	0.00
J19	0.00	120.98	41.13	0.00
J2	0.00	121.00	42.50	0.00
J22	2.30	120.97	42.92	0.00
J23	0.00	120.97	42.71	0.00
J24	1.50	120.97	42.11	0.00
J25	3.30	120.98	41.38	0.00

Page 3



21106_Max Day Demand with Minimum Pressure.rpt

J26	2.40	121.00	43.32	0.00	
J27	0.00	121.00	43.44	0.00	
J3	2.40	120.99	42.79	0.00	
R1	-8.98	121.00	0.00	0.00	Reservoir
R2	-8.62	121.00	0.00	0.00	Reservoir

Link Results at 1:00 Hrs:

Link ID	Flow LPS	VelocityUnit m/s	Headloss m/km	Status
P1	4.66	0.15	0.22	Open
P4	-3.16	0.10	0.11	Open
P13	1.50	0.05	0.03	Open
P14	1.50	0.05	0.02	Open
P15	-8.14	0.17	0.20	Open
P16	9.64	0.20	0.28	Open
P17	3.30	0.11	0.11	Open
P18	3.30	0.11	0.11	Open
P19	0.00	0.00	0.00	Open



Page 4

Link Results at 1:00 Hrs: (continued)

Link ID	Flow LPS	VelocityUnit m/s	Headloss m/km	Status
P21	3.04	0.10	0.10	Open
P22	3.04	0.10	0.10	Open
P23	0.64	0.04	0.03	Open
P24	2.40	0.08	0.06	Open
P2	-3.30	0.11	0.11	Open
P3	0.64	0.04	0.03	Open
P5	-1.66	0.05	0.03	Open
P6	-1.50	0.05	0.03	Open
P7	-3.16	0.10	0.11	Open
P9	-1.92	0.03	0.00	Open
P10	-4.32	0.06	0.02	Open
P11	-4.32	0.06	0.02	Open
P12	-6.22	0.09	0.04	Open
P8	-2.40	0.14	0.31	Open
P20	8.62	0.12	0.09	Open
P25	8.98	0.13	0.09	Open

Node Results at 2:00 Hrs:

Node	Demand	Head Pressure	Quality
------	--------	---------------	---------



21106_Max Day Demand with Minimum Pressure.rpt

ID	LPS	m	m	
J1	0.00	121.00	43.73	0.00
J200	0.00	120.99	42.92	0.00
J5	0.00	120.98	42.23	0.00
J8	0.00	120.99	42.32	0.00
J9	0.00	120.98	42.28	0.00
J10	3.30	120.98	42.48	0.00
J11	0.00	120.98	41.45	0.00
J12	0.00	121.00	42.80	0.00
J13	0.00	120.98	41.40	0.00
J14	0.00	120.98	42.08	0.00
J15	0.00	120.98	41.84	0.00
J16	0.00	120.97	41.90	0.00
J18	2.40	120.97	41.94	0.00
J19	0.00	120.98	41.13	0.00
J2	0.00	121.00	42.50	0.00
J22	2.30	120.97	42.92	0.00
J23	0.00	120.97	42.71	0.00
J24	1.50	120.97	42.11	0.00
J25	3.30	120.98	41.38	0.00
J26	2.40	121.00	43.32	0.00
J27	0.00	121.00	43.44	0.00
J3	2.40	120.99	42.79	0.00
R1	-8.98	121.00	0.00	0.00 Reservoir
R2	-8.62	121.00	0.00	0.00 Reservoir



Page 5

Link Results at 2:00 Hrs:

Link ID	Flow LPS	Velocity m/s	Unit Headloss m/km	Status
P1	4.66	0.15	0.22	Open
P4	-3.16	0.10	0.11	Open
P13	1.50	0.05	0.03	Open
P14	1.50	0.05	0.02	Open
P15	-8.14	0.17	0.20	Open
P16	9.64	0.20	0.28	Open
P17	3.30	0.11	0.11	Open
P18	3.30	0.11	0.11	Open
P19	0.00	0.00	0.00	Open
P21	3.04	0.10	0.10	Open
P22	3.04	0.10	0.10	Open
P23	0.64	0.04	0.03	Open
P24	2.40	0.08	0.06	Open

Page 5



21106_Max Day Demand with Minimum Pressure.rpt

P2	-3.30	0.11	0.11	Open
P3	-0.64	0.04	0.03	Open
P5	-1.66	0.05	0.03	Open
P6	-1.50	0.05	0.03	Open
P7	-3.16	0.10	0.11	Open
P9	-1.92	0.03	0.00	Open
P10	-4.32	0.06	0.02	Open
P11	-4.32	0.06	0.02	Open
P12	-6.22	0.09	0.04	Open
P8	-2.40	0.14	0.31	Open
P20	8.62	0.12	0.09	Open
P25	8.98	0.13	0.09	Open

Node Results at 3:00 Hrs:

Node ID	Demand LPS	Head m	Pressure m	Quality
J1	0.00	121.00	43.73	0.00
J200	0.00	120.99	42.92	0.00
J5	0.00	120.98	42.23	0.00
J8	0.00	120.99	42.32	0.00
J9	0.00	120.98	42.28	0.00
J10	3.30	120.98	42.48	0.00
J11	0.00	120.98	41.45	0.00
J12	0.00	121.00	42.80	0.00
J13	0.00	120.98	41.40	0.00
J14	0.00	120.98	42.08	0.00
J15	0.00	120.98	41.84	0.00
J16	0.00	120.97	41.90	0.00
J18	2.40	120.97	41.94	0.00
J19	0.00	120.98	41.13	0.00
J2	0.00	121.00	42.50	0.00
J22	2.30	120.97	42.92	0.00



Page 6

Node Results at 3:00 Hrs: (continued)

Node ID	Demand LPS	Head m	Pressure m	Quality
J23	0.00	120.97	42.71	0.00
J24	1.50	120.97	42.11	0.00
J25	3.30	120.98	41.38	0.00
J26	2.40	121.00	43.32	0.00
J27	0.00	121.00	43.44	0.00
J3	2.40	120.99	42.79	0.00



21106_Max Day Demand with Minimum Pressure.rpt

R1	-8.98	121.00	0.00	0.00	Reservoir
R2	-8.62	121.00	0.00	0.00	Reservoir

Link Results at 3:00 Hrs:

Link ID	Flow LPS	Velocity m/s	Unit Headloss m/km	Status
P1	4.66	0.15	0.22	Open
P4	-3.16	0.10	0.11	Open
P13	1.50	0.05	0.03	Open
P14	1.50	0.05	0.02	Open
P15	-8.14	0.17	0.20	Open
P16	9.64	0.20	0.28	Open
P17	3.30	0.11	0.11	Open
P18	3.30	0.11	0.11	Open
P19	0.00	0.00	0.00	Open
P21	3.04	0.10	0.10	Open
P22	3.04	0.10	0.10	Open
P23	0.64	0.04	0.03	Open
P24	2.40	0.08	0.06	Open
P2	-3.30	0.11	0.11	Open
P3	0.64	0.04	0.03	Open
P5	-1.66	0.05	0.03	Open
P6	-1.50	0.05	0.03	Open
P7	-3.16	0.10	0.11	Open
P9	-1.92	0.03	0.00	Open
P10	-4.32	0.06	0.02	Open
P11	-4.32	0.06	0.02	Open
P12	-6.22	0.09	0.04	Open
P8	-2.40	0.14	0.31	Open
P20	8.62	0.12	0.09	Open
P25	8.98	0.13	0.09	Open



Page 7

Node Results at 4:00 Hrs:

Node ID	Demand LPS	Head m	Pressure m	Quality
J1	0.00	121.00	43.73	0.00
J200	0.00	120.99	42.92	0.00
J5	0.00	120.98	42.23	0.00
J8	0.00	120.99	42.32	0.00
J9	0.00	120.98	42.28	0.00
J10	3.30	120.98	42.48	0.00



21106_Max Day Demand with Minimum Pressure.rpt

J11	0.00	120.98	41.45	0.00
J12	0.00	121.00	42.80	0.00
J13	0.00	120.98	41.40	0.00
J14	0.00	120.98	42.08	0.00
J15	0.00	120.98	41.84	0.00
J16	0.00	120.97	41.90	0.00
J18	2.40	120.97	41.94	0.00
J19	0.00	120.98	41.13	0.00
J2	0.00	121.00	42.50	0.00
J22	2.30	120.97	42.92	0.00
J23	0.00	120.97	42.71	0.00
J24	1.50	120.97	42.11	0.00
J25	3.30	120.98	41.38	0.00
J26	2.40	121.00	43.32	0.00
J27	0.00	121.00	43.44	0.00
J3	2.40	120.99	42.79	0.00
R1	-8.98	121.00	0.00	0.00 Reservoir
R2	-8.62	121.00	0.00	0.00 Reservoir

Link Results at 4:00 Hrs:

Link ID	Flow LPS	Velocity m/s	Unit Headloss m/km	Status
P1	4.66	0.15	0.22	Open
P4	-3.16	0.10	0.11	Open
P13	1.50	0.05	0.03	Open
P14	1.50	0.05	0.02	Open
P15	-8.14	0.17	0.20	Open
P16	9.64	0.20	0.28	Open
P17	3.30	0.11	0.11	Open
P18	3.30	0.11	0.11	Open
P19	0.00	0.00	0.00	Open
P21	3.04	0.10	0.10	Open
P22	3.04	0.10	0.10	Open
P23	0.64	0.04	0.03	Open
P24	2.40	0.08	0.06	Open
P2	-3.30	0.11	0.11	Open
P3	0.64	0.04	0.03	Open
P5	-1.66	0.05	0.03	Open
P6	-1.50	0.05	0.03	Open



Page 8

Link Results at 4:00 Hrs: (continued)

Link ID	Flow LPS	Velocity m/s	Unit Headloss m/km	Status
---------	----------	--------------	--------------------	--------



21106_Max Day Demand with Minimum Pressure.rpt

P7	-3.16	0.10	0.11	Open
P9	-1.92	0.03	0.00	Open
P10	-4.32	0.06	0.02	Open
P11	-4.32	0.06	0.02	Open
P12	-6.22	0.09	0.04	Open
P8	-2.40	0.14	0.31	Open
P20	8.62	0.12	0.09	Open
P25	8.98	0.13	0.09	Open



Peak Hour Demand Condition

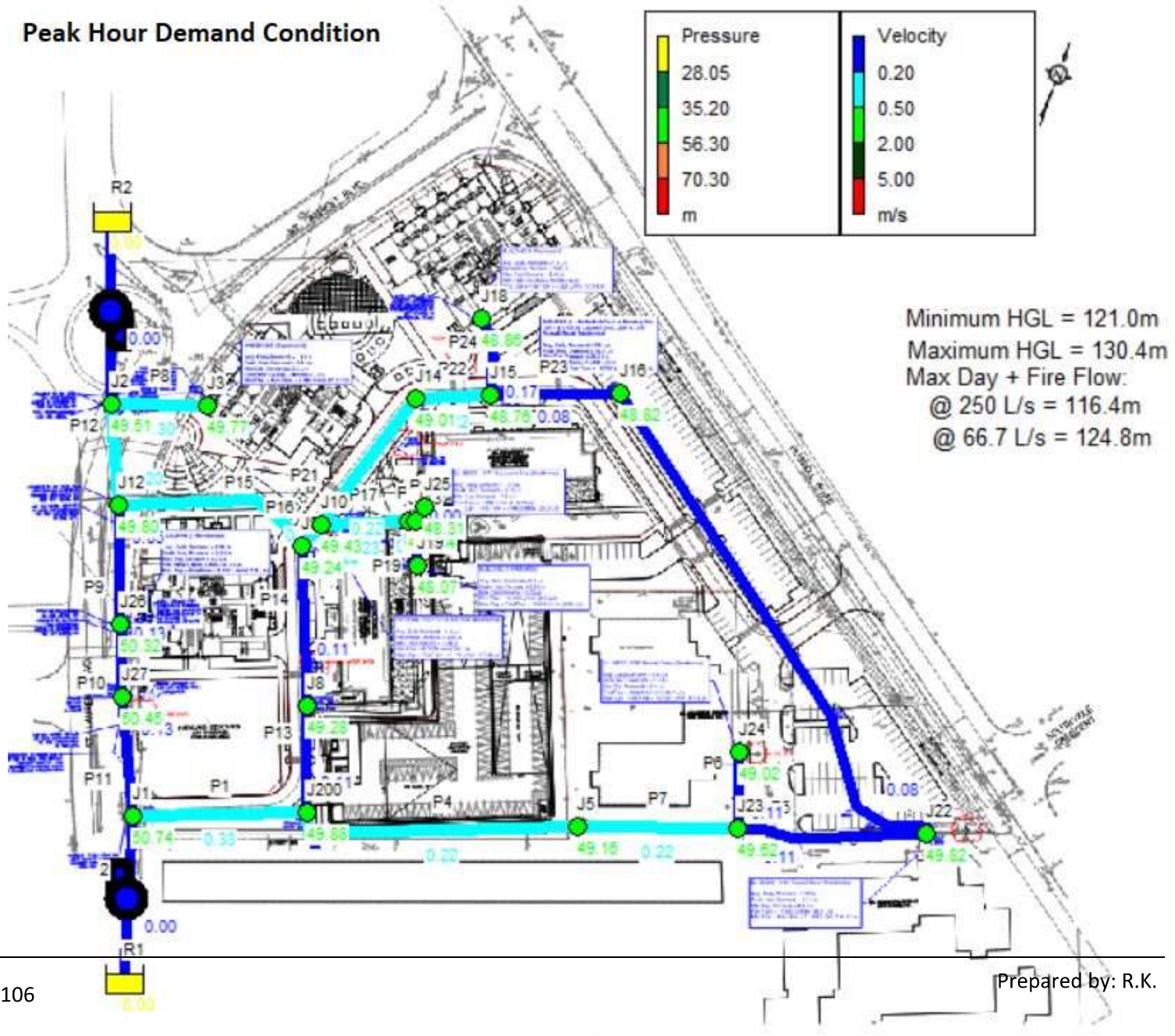



21106_Peak Hour.rpt

Page 1

2023-03-14 3:37:15 PM

```
*****
*                               *
*             E P A N E T       *
*             Hydraulic and Water Quality *
*             Analysis for Pipe Networks *
*             Version 2.2       *
*                               *
*****
```

Input File: 21106_Peak Hour Demand-2023.net

Link - Node Table:

Link ID	Start Node	End Node	Length m	Diameter mm	
P1	J1	J200	60.78	200	
P4	J5	J200	96.37	200	
P13	J200	J8	32.72	200	
P14	J8	J9	58.6	200	
P15	J9	J12	67.26	250	
P16	J9	J10	7.91	250	
P17	J10	J11	31.176	200	
P18	J11	J13	2.28	200	
P19	J13	J19	18.81	200	
P21	J10	J14	51.579	200	
P22	J14	J15	23.86	200	
P23	J15	J16	41.8	150	
P24	J15	J18	26	200	
P2	J25	J13	5.633	200	
P3	J16	J22	189.127	150	
P5	J22	J23	62.85	200	
P6	J24	J23	25.34	200	
P7	J23	J5	55.03	200	
P9	J12	J26	44	300	
P10	J26	J27	21.3	300	
P11	J27	J1	39.51	300	
P12	J12	J2	36.02	300	
P8	J3	J2	31.93	150	
1	R2	J2	#N/A	#N/A	Pump
2	R1	J1	#N/A	#N/A	Pump

Energy Usage:

Pump	Usage Factor	Avg. Effic.	Kw-hr /m3	Avg. Kw	Peak Kw	Cost /day



21106_Peak Hour.rpt

1	100.00	75.00	0.46	32.70	32.70	0.00
2	100.00	75.00	0.46	32.72	32.72	0.00

Demand Charge:	0.00
Total Cost:	0.00



Page 2

Node Results at 0:00 Hrs:

Node ID	Demand LPS	Head m	Pressure m	Quality	
J1	0.00	128.01	50.74	0.00	
J200	0.00	127.95	49.88	0.00	
J5	0.00	127.91	49.16	0.00	
J8	0.00	127.95	49.28	0.00	
J9	0.00	127.94	49.24	0.00	
J10	7.30	127.93	49.43	0.00	
J11	0.00	127.92	48.39	0.00	
J12	0.00	128.00	49.80	0.00	
J13	0.00	127.92	48.34	0.00	
J14	0.00	127.91	49.01	0.00	
J15	0.00	127.90	48.76	0.00	
J16	0.00	127.89	48.82	0.00	
J18	5.40	127.89	48.86	0.00	
J19	0.00	127.92	48.07	0.00	
J2	0.00	128.01	49.51	0.00	
J22	5.00	127.87	49.82	0.00	
J23	0.00	127.88	49.62	0.00	
J24	3.40	127.88	49.02	0.00	
J25	7.30	127.91	48.31	0.00	
J26	5.40	128.00	50.32	0.00	
J27	0.00	128.01	50.45	0.00	
J3	5.30	127.97	49.77	0.00	
R1	-19.56	0.00	0.00	0.00	Reservoir
R2	-19.54	0.00	0.00	0.00	Reservoir

Link Results at 0:00 Hrs:

Link ID	Flow LPS	Velocity m/s	Unit Headloss m/km	Status
P1	10.32	0.33	0.94	Open
P4	-7.00	0.22	0.46	Open
P13	3.31	0.11	0.11	Open
P14	3.31	0.11	0.10	Open

Page 2



21106_Peak Hour.rpt

P15	-18.08	0.37	0.90	Open
P16	-21.40	0.44	1.22	Open
P17	7.30	0.23	0.50	Open
P18	7.30	0.23	0.49	Open
P19	0.00	0.00	0.00	Open
P21	6.80	0.22	0.43	Open
P22	6.80	0.22	0.43	Open
P23	1.40	0.08	0.11	Open
P24	5.40	0.17	0.28	Open
P2	-7.30	0.23	0.50	Open
P3	1.40	0.08	0.11	Open
P5	-3.60	0.11	0.13	Open
P6	-3.40	0.11	0.12	Open



Page 3

Link Results at 0:00 Hrs: (continued)

Link ID	Flow LPS	Velocity m/s	Unit Headloss m/km	Status
P7	-7.00	0.22	0.46	Open
P9	-3.84	0.05	0.02	Open
P10	-9.24	0.13	0.09	Open
P11	-9.24	0.13	0.09	Open
P12	-14.24	0.20	0.20	Open
P8	-5.30	0.30	1.33	Open
1	19.54	0.00	-128.01	Open Pump
2	19.56	0.00	-128.01	Open Pump

Node Results at 1:00 Hrs:

Node ID	Demand LPS	Head m	Pressure m	Quality
J1	0.00	128.01	50.74	0.00
J200	0.00	127.95	49.88	0.00
J5	0.00	127.91	49.16	0.00
J8	0.00	127.95	49.28	0.00
J9	0.00	127.94	49.24	0.00
J10	7.30	127.93	49.43	0.00
J11	0.00	127.92	48.39	0.00
J12	0.00	128.00	49.80	0.00
J13	0.00	127.92	48.34	0.00
J14	0.00	127.91	49.01	0.00
J15	0.00	127.90	48.76	0.00
J16	0.00	127.89	48.82	0.00
J18	5.40	127.89	48.86	0.00

Page 3



21106_Peak Hour.rpt

J19	0.00	127.92	48.07	0.00
J2	0.00	128.01	49.51	0.00
J22	5.00	127.87	49.82	0.00
J23	0.00	127.88	49.62	0.00
J24	3.40	127.88	49.02	0.00
J25	7.30	127.91	48.31	0.00
J26	5.40	128.00	50.32	0.00
J27	0.00	128.01	50.45	0.00
J3	5.30	127.97	49.77	0.00
R1	-19.56	0.00	0.00	0.00 Reservoir
R2	-19.54	0.00	0.00	0.00 Reservoir



Page 4

Link Results at 1:00 Hrs:

Link ID	Flow LPS	Velocity m/s	Unit Headloss m/km	Status
P1	10.32	0.33	0.94	Open
P4	-7.00	0.22	0.46	Open
P13	3.31	0.11	0.11	Open
P14	3.31	0.11	0.10	Open
P15	-18.08	0.37	0.90	Open
P16	21.40	0.44	1.22	Open
P17	7.30	0.23	0.50	Open
P18	7.30	0.23	0.49	Open
P19	0.00	0.00	0.00	Open
P21	6.80	0.22	0.43	Open
P22	6.80	0.22	0.43	Open
P23	1.40	0.08	0.11	Open
P24	5.40	0.17	0.28	Open
P2	-7.30	0.23	0.50	Open
P3	1.40	0.08	0.11	Open
P5	-3.60	0.11	0.13	Open
P6	-3.40	0.11	0.12	Open
P7	-7.00	0.22	0.46	Open
P9	-3.84	0.05	0.02	Open
P10	-9.24	0.13	0.09	Open
P11	-9.24	0.13	0.09	Open
P12	-14.24	0.20	0.20	Open
P8	-5.30	0.30	1.33	Open
1	19.54	0.00	-128.01	Open Pump
2	19.56	0.00	-128.01	Open Pump

Node Results at 2:00 Hrs:



21106_Peak Hour.rpt

Node ID	Demand LPS	Head m	Pressure m	Quality
J1	0.00	128.01	50.74	0.00
J200	0.00	127.95	49.88	0.00
J5	0.00	127.91	49.16	0.00
J8	0.00	127.95	49.28	0.00
J9	0.00	127.94	49.24	0.00
J10	7.30	127.93	49.43	0.00
J11	0.00	127.92	48.39	0.00
J12	0.00	128.00	49.80	0.00
J13	0.00	127.92	48.34	0.00
J14	0.00	127.91	49.01	0.00
J15	0.00	127.90	48.76	0.00
J16	0.00	127.89	48.82	0.00
J18	5.40	127.89	48.86	0.00
J19	0.00	127.92	48.07	0.00
J2	0.00	128.01	49.51	0.00
J22	5.00	127.87	49.82	0.00



Page 5

Node Results at 2:00 Hrs: (continued)

Node ID	Demand LPS	Head m	Pressure m	Quality
J23	0.00	127.88	49.62	0.00
J24	3.40	127.88	49.02	0.00
J25	7.30	127.91	48.31	0.00
J26	5.40	128.00	50.32	0.00
J27	0.00	128.01	50.45	0.00
J3	5.30	127.97	49.77	0.00
R1	-19.56	0.00	0.00	0.00 Reservoir
R2	-19.54	0.00	0.00	0.00 Reservoir

Link Results at 2:00 Hrs:

Link ID	Flow LPS	Velocity m/s	Unit Headloss m/km	Status
P1	10.32	0.33	0.94	Open
P4	-7.00	0.22	0.46	Open
P13	3.31	0.11	0.11	Open
P14	3.31	0.11	0.10	Open
P15	-18.08	0.37	0.90	Open
P16	21.40	0.44	1.22	Open
P17	7.30	0.23	0.50	Open

Page 5



21106_Peak Hour.rpt

P18	7.30	0.23	0.49	Open
P19	0.00	0.00	0.00	Open
P21	6.80	0.22	0.43	Open
P22	6.80	0.22	0.43	Open
P23	1.40	0.08	0.11	Open
P24	5.40	0.17	0.28	Open
P2	-7.30	0.23	0.50	Open
P3	1.40	0.08	0.11	Open
P5	-3.60	0.11	0.13	Open
P6	-3.40	0.11	0.12	Open
P7	-7.00	0.22	0.46	Open
P9	-3.84	0.05	0.02	Open
P10	-9.24	0.13	0.09	Open
P11	-9.24	0.13	0.09	Open
P12	-14.24	0.20	0.20	Open
P8	-5.30	0.30	1.33	Open
1	19.54	0.00	-128.01	Open Pump
2	19.56	0.00	-128.01	Open Pump



Page 6

Node Results at 3:00 Hrs:

Node ID	Demand LPS	Head m	Pressure m	Quality
J1	0.00	128.01	50.74	0.00
J200	0.00	127.95	49.88	0.00
J5	0.00	127.91	49.16	0.00
J8	0.00	127.95	49.28	0.00
J9	0.00	127.94	49.24	0.00
J10	7.30	127.93	49.43	0.00
J11	0.00	127.92	48.39	0.00
J12	0.00	128.00	49.80	0.00
J13	0.00	127.92	48.34	0.00
J14	0.00	127.91	49.01	0.00
J15	0.00	127.90	48.76	0.00
J16	0.00	127.89	48.82	0.00
J18	5.40	127.89	48.86	0.00
J19	0.00	127.92	48.07	0.00
J2	0.00	128.01	49.51	0.00
J22	5.00	127.87	49.82	0.00
J23	0.00	127.88	49.62	0.00
J24	3.40	127.88	49.02	0.00
J25	7.30	127.91	48.31	0.00
J26	5.40	128.00	50.32	0.00
J27	0.00	128.01	50.45	0.00

Page 6



21106_Peak Hour.rpt				
J3	5.30	127.97	49.77	0.00
R1	-19.56	0.00	0.00	0.00 Reservoir
R2	-19.54	0.00	0.00	0.00 Reservoir

Link Results at 3:00 Hrs:

Link ID	Flow LPS	Velocity m/s	Unit Headloss m/km	Status
P1	10.32	0.33	0.94	Open
P4	-7.00	0.22	0.46	Open
P13	3.31	0.11	0.11	Open
P14	3.31	0.11	0.10	Open
P15	-18.08	0.37	0.90	Open
P16	21.40	0.44	1.22	Open
P17	7.30	0.23	0.50	Open
P18	7.30	0.23	0.49	Open
P19	0.00	0.00	0.00	Open
P21	6.80	0.22	0.43	Open
P22	6.80	0.22	0.43	Open
P23	1.40	0.08	0.11	Open
P24	5.40	0.17	0.28	Open
P2	-7.30	0.23	0.50	Open
P3	1.40	0.08	0.11	Open
P5	-3.60	0.11	0.13	Open
P6	-3.40	0.11	0.12	Open



Page 7

Link Results at 3:00 Hrs: (continued)

Link ID	Flow LPS	Velocity m/s	Unit Headloss m/km	Status
P7	-7.00	0.22	0.46	Open
P9	-3.84	0.05	0.02	Open
P10	-9.24	0.13	0.09	Open
P11	-9.24	0.13	0.09	Open
P12	-14.24	0.20	0.20	Open
P8	-5.30	0.30	1.33	Open
1	19.54	0.00	-128.01	Open Pump
2	19.56	0.00	-128.01	Open Pump

Node Results at 4:00 Hrs:

Node ID	Demand LPS	Head m	Pressure m	Quality
---------	------------	--------	------------	---------



21106_Peak Hour.rpt

J1	0.00	128.01	50.74	0.00
J200	0.00	127.95	49.88	0.00
J5	0.00	127.91	49.16	0.00
J8	0.00	127.95	49.28	0.00
J9	0.00	127.94	49.24	0.00
J10	7.30	127.93	49.43	0.00
J11	0.00	127.92	48.39	0.00
J12	0.00	128.00	49.80	0.00
J13	0.00	127.92	48.34	0.00
J14	0.00	127.91	49.01	0.00
J15	0.00	127.90	48.76	0.00
J16	0.00	127.89	48.82	0.00
J18	5.40	127.89	48.86	0.00
J19	0.00	127.92	48.07	0.00
J2	0.00	128.01	49.51	0.00
J22	5.00	127.87	49.82	0.00
J23	0.00	127.88	49.62	0.00
J24	3.40	127.88	49.02	0.00
J25	7.30	127.91	48.31	0.00
J26	5.40	128.00	50.32	0.00
J27	0.00	128.01	50.45	0.00
J3	5.30	127.97	49.77	0.00
R1	-19.56	0.00	0.00	0.00 Reservoir
R2	-19.54	0.00	0.00	0.00 Reservoir



Page 8

Link Results at 4:00 Hrs:

Link ID	Flow LPS	Velocity m/s	Unit Headloss m/km	Status
P1	10.32	0.33	0.94	Open
P4	-7.00	0.22	0.46	Open
P13	3.31	0.11	0.11	Open
P14	3.31	0.11	0.10	Open
P15	-18.08	0.37	0.90	Open
P16	21.40	0.44	1.22	Open
P17	7.30	0.23	0.50	Open
P18	7.30	0.23	0.49	Open
P19	0.00	0.00	0.00	Open
P21	6.80	0.22	0.43	Open
P22	6.80	0.22	0.43	Open
P23	1.40	0.08	0.11	Open
P24	5.40	0.17	0.28	Open
P2	-7.30	0.23	0.50	Open
P3	1.40	0.08	0.11	Open

Page 8



21106_Peak Hour.rpt					
P5	-3.60	0.11	0.13	Open	
P6	-3.40	0.11	0.12	Open	
P7	-7.00	0.22	0.46	Open	
P9	-3.84	0.05	0.02	Open	
P10	-9.24	0.13	0.09	Open	
P11	-9.24	0.13	0.09	Open	
P12	-14.24	0.20	0.20	Open	
P8	-5.30	0.30	1.33	Open	
1	19.54	0.00	-128.01	Open	Pump
2	19.56	0.00	-128.01	Open	Pump



Maximum Day + Fire Flow Conditions at Existing Building 1971 St. Laurent Blvd. (Node J10)

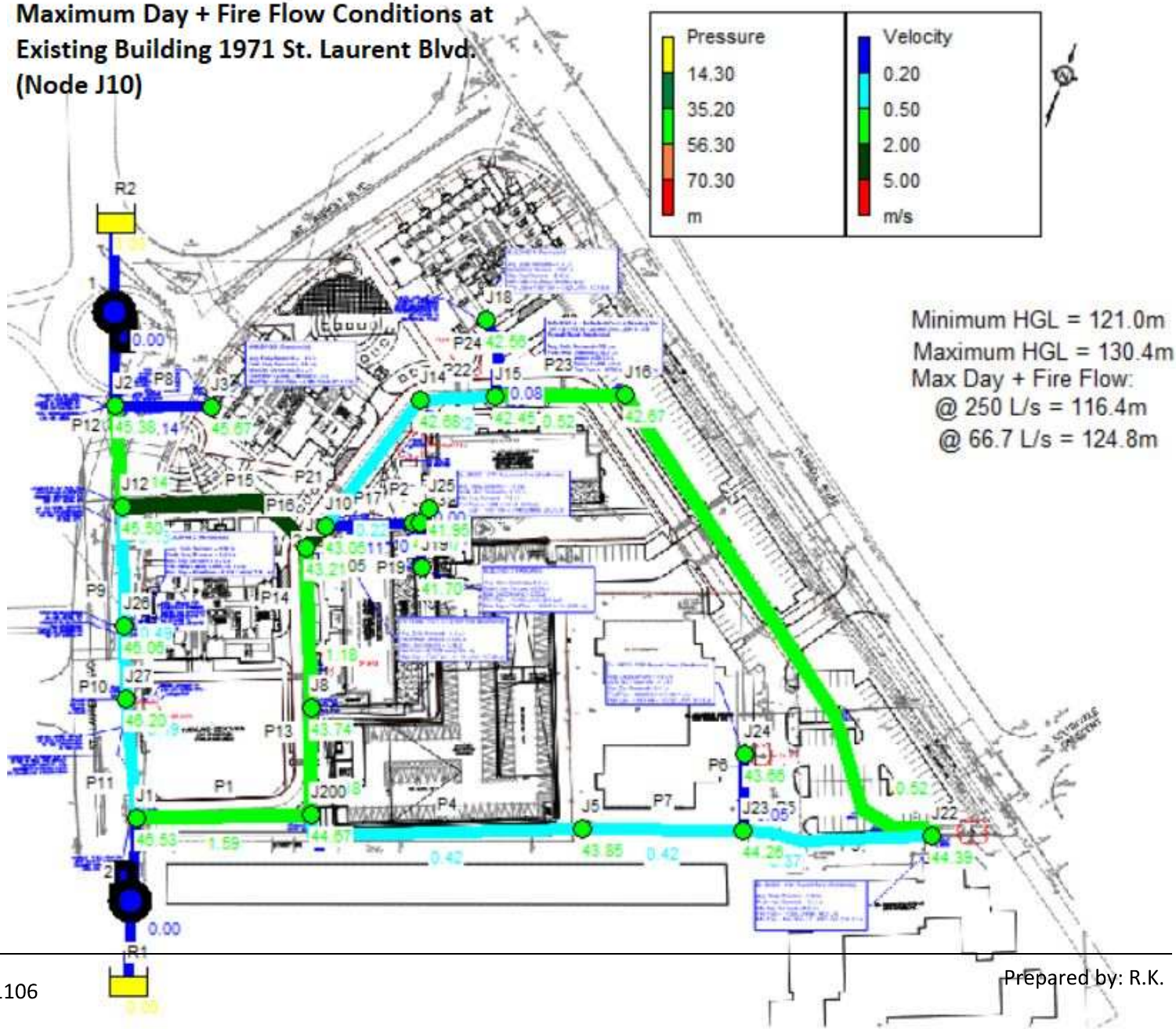



21106_Max Day + Fire @ 1971 St. Laurent.rpt

Page 1

2023-03-14 4:04:52 PM

```
*****
*                               *
*               E P A N E T      *
*           Hydraulic and Water Quality *
*           Analysis for Pipe Networks *
*               Version 2.2       *
*                               *
*****
```

Input File: 21106_Max Day + Fire @ Building 1971 St. Lurent-2023.net

Link - Node Table:

Link ID	Start Node	End Node	Length m	Diameter mm	
P1	J1	J200	60.78	200	
P4	J5	J200	96.37	200	
P13	J200	J8	32.72	200	
P14	J8	J9	58.6	200	
P15	J9	J12	67.26	250	
P16	J9	J10	7.91	250	
P17	J10	J11	31.176	200	
P18	J11	J13	2.28	200	
P19	J13	J19	18.81	200	
P21	J10	J14	51.579	200	
P22	J14	J15	23.86	200	
P23	J15	J16	41.8	150	
P24	J15	J18	26	200	
P2	J25	J13	5.633	200	
P3	J16	J22	189.127	150	
P5	J22	J23	62.85	200	
P6	J24	J23	25.34	200	
P7	J23	J5	55.03	200	
P9	J12	J26	44	300	
P10	J26	J27	21.3	300	
P11	J27	J1	39.51	300	
P12	J12	J2	36.02	300	
P8	J3	J2	31.93	150	
1	R2	J2	#N/A	#N/A	Pump
2	R1	J1	#N/A	#N/A	Pump

Energy Usage:

Pump	Usage Factor	Avg. Effic.	Kw-hr /m3	Avg. Kw	Peak Kw	Cost /day



21106_Max Day + Fire @ 1971 St. Laurent.rpt

1	100.00	75.00	0.45	134.52	134.52	0.00
2	100.00	75.00	0.45	136.75	136.75	0.00

Demand Charge:	0.00
Total Cost:	0.00



Page 2

Node Results at 0:00 Hrs:

Node ID	Demand LPS	Head m	Pressure m	Quality	
J1	0.00	123.80	46.53	0.00	
J200	0.00	122.74	44.67	0.00	
J5	0.00	122.60	43.85	0.00	
J8	0.00	122.41	43.74	0.00	
J9	0.00	121.91	43.21	0.00	
J10	153.30	121.55	43.05	0.00	
J11	0.00	121.55	42.02	0.00	
J12	0.00	123.70	45.50	0.00	
J13	0.00	121.55	41.97	0.00	
J14	0.00	121.58	42.68	0.00	
J15	0.00	121.59	42.45	0.00	
J16	0.00	121.74	42.67	0.00	
J18	2.40	121.59	42.56	0.00	
J19	0.00	121.55	41.70	0.00	
J2	0.00	123.88	45.38	0.00	
J22	2.30	122.44	44.39	0.00	
J23	0.00	122.52	44.26	0.00	
J24	1.50	122.52	43.66	0.00	
J25	3.30	121.55	41.95	0.00	
J26	2.40	123.74	46.06	0.00	
J27	0.00	123.76	46.20	0.00	
J3	2.40	123.87	45.67	0.00	
R1	-84.51	0.00	0.00	0.00	Reservoir
R2	-83.09	0.00	0.00	0.00	Reservoir

Link Results at 0:00 Hrs:

Link ID	Flow LPS	Velocity m/s	Unit Headloss m/km	Status
P1	50.04	1.59	17.51	Open
P4	-13.04	0.42	1.45	Open
P13	37.00	1.18	10.01	Open
P14	37.00	1.18	8.52	Open

Page 2



21106_Max Day + Fire @ 1971 St. Laurent.rpt

P15	-112.76	2.30	26.58	Open
P16	-149.76	3.05	44.96	Open
P17	3.30	0.11	0.11	Open
P18	3.30	0.11	0.11	Open
P19	0.00	0.00	0.00	Open
P21	-6.84	0.22	0.44	Open
P22	-6.84	0.22	0.44	Open
P23	-9.24	0.52	3.71	Open
P24	2.40	0.08	0.06	Open
P2	-3.30	0.11	0.11	Open
P3	-9.24	0.52	3.71	Open
P5	-11.54	0.37	1.16	Open
P6	-1.50	0.05	0.03	Open



Page 3

Link Results at 0:00 Hrs: (continued)

Link ID	Flow LPS	Velocity m/s	Unit Headloss m/km	Status
P7	-13.04	0.42	1.45	Open
P9	-32.07	0.45	0.91	Open
P10	-34.47	0.49	1.04	Open
P11	-34.47	0.49	1.04	Open
P12	-80.69	1.14	5.01	Open
P8	-2.40	0.14	0.31	Open
1	83.09	0.00	-123.88	Open Pump
2	84.51	0.00	-123.80	Open Pump

Node Results at 1:00 Hrs:

Node ID	Demand LPS	Head m	Pressure m	Quality
J1	0.00	123.80	46.53	0.00
J200	0.00	122.74	44.67	0.00
J5	0.00	122.60	43.85	0.00
J8	0.00	122.41	43.74	0.00
J9	0.00	121.91	43.21	0.00
J10	153.30	121.55	43.05	0.00
J11	0.00	121.55	42.02	0.00
J12	0.00	123.70	45.50	0.00
J13	0.00	121.55	41.97	0.00
J14	0.00	121.58	42.68	0.00
J15	0.00	121.59	42.45	0.00
J16	0.00	121.74	42.67	0.00
J18	2.40	121.59	42.56	0.00

Page 3



21106_Max Day + Fire @ 1971 St. Laurent.rpt

J19	0.00	121.55	41.70	0.00
J2	0.00	123.88	45.38	0.00
J22	2.30	122.44	44.39	0.00
J23	0.00	122.52	44.26	0.00
J24	1.50	122.52	43.66	0.00
J25	3.30	121.55	41.95	0.00
J26	2.40	123.74	46.06	0.00
J27	0.00	123.76	46.20	0.00
J3	2.40	123.87	45.67	0.00
R1	-84.51	0.00	0.00	0.00 Reservoir
R2	-83.09	0.00	0.00	0.00 Reservoir



Page 4

Link Results at 1:00 Hrs:

Link ID	Flow LPS	Velocity m/s	Unit Headloss m/km	Status
P1	50.04	1.59	17.51	Open
P4	-13.04	0.42	1.45	Open
P13	37.00	1.18	10.01	Open
P14	37.00	1.18	8.52	Open
P15	-112.76	2.30	26.58	Open
P16	149.76	3.05	44.96	Open
P17	3.30	0.11	0.11	Open
P18	3.30	0.11	0.11	Open
P19	0.00	0.00	0.00	Open
P21	-6.84	0.22	0.44	Open
P22	-6.84	0.22	0.44	Open
P23	-9.24	0.52	3.71	Open
P24	2.40	0.08	0.06	Open
P2	-3.30	0.11	0.11	Open
P3	-9.24	0.52	3.71	Open
P5	-11.54	0.37	1.16	Open
P6	-1.50	0.05	0.03	Open
P7	-13.04	0.42	1.45	Open
P9	-32.07	0.45	0.91	Open
P10	-34.47	0.49	1.04	Open
P11	-34.47	0.49	1.04	Open
P12	-80.69	1.14	5.01	Open
P8	-2.40	0.14	0.31	Open
1	83.09	0.00	-123.88	Open Pump
2	84.51	0.00	-123.80	Open Pump

Node Results at 2:00 Hrs:

Page 4



21106_Max Day + Fire @ 1971 St. Laurent.rpt

Node ID	Demand LPS	Head m	Pressure m	Quality
J1	0.00	123.80	46.53	0.00
J200	0.00	122.74	44.67	0.00
J5	0.00	122.60	43.85	0.00
J8	0.00	122.41	43.74	0.00
J9	0.00	121.91	43.21	0.00
J10	153.30	121.55	43.05	0.00
J11	0.00	121.55	42.02	0.00
J12	0.00	123.70	45.50	0.00
J13	0.00	121.55	41.97	0.00
J14	0.00	121.58	42.68	0.00
J15	0.00	121.59	42.45	0.00
J16	0.00	121.74	42.67	0.00
J18	2.40	121.59	42.56	0.00
J19	0.00	121.55	41.70	0.00
J2	0.00	123.88	45.38	0.00
J22	2.30	122.44	44.39	0.00



Page 5

Node Results at 2:00 Hrs: (continued)

Node ID	Demand LPS	Head m	Pressure m	Quality
J23	0.00	122.52	44.26	0.00
J24	1.50	122.52	43.66	0.00
J25	3.30	121.55	41.95	0.00
J26	2.40	123.74	46.06	0.00
J27	0.00	123.76	46.20	0.00
J3	2.40	123.87	45.67	0.00
R1	-84.51	0.00	0.00	0.00 Reservoir
R2	-83.09	0.00	0.00	0.00 Reservoir

Link Results at 2:00 Hrs:

Link ID	Flow LPS	Velocity m/s	Unit Headloss m/km	Status
P1	50.04	1.59	17.51	Open
P4	-13.04	0.42	1.45	Open
P13	37.00	1.18	10.01	Open
P14	37.00	1.18	8.52	Open
P15	-112.76	2.30	26.58	Open
P16	149.76	3.05	44.96	Open
P17	3.30	0.11	0.11	Open

Page 5



21106_Max Day + Fire @ 1971 St. Laurent.rpt

P18	3.30	0.11	0.11	Open
P19	0.00	0.00	0.00	Open
P21	-6.84	0.22	0.44	Open
P22	-6.84	0.22	0.44	Open
P23	-9.24	0.52	3.71	Open
P24	2.40	0.08	0.06	Open
P2	-3.30	0.11	0.11	Open
P3	-9.24	0.52	3.71	Open
P5	-11.54	0.37	1.16	Open
P6	-1.50	0.05	0.03	Open
P7	-13.04	0.42	1.45	Open
P9	-32.07	0.45	0.91	Open
P10	-34.47	0.49	1.04	Open
P11	-34.47	0.49	1.04	Open
P12	-80.69	1.14	5.01	Open
P8	-2.40	0.14	0.31	Open
1	83.09	0.00	-123.88	Open Pump
2	84.51	0.00	-123.80	Open Pump



Page 6

Node Results at 3:00 Hrs:

Node ID	Demand LPS	Head m	Pressure m	Quality
J1	0.00	123.80	46.53	0.00
J200	0.00	122.74	44.67	0.00
J5	0.00	122.60	43.85	0.00
J8	0.00	122.41	43.74	0.00
J9	0.00	121.91	43.21	0.00
J10	153.30	121.55	43.05	0.00
J11	0.00	121.55	42.02	0.00
J12	0.00	123.70	45.50	0.00
J13	0.00	121.55	41.97	0.00
J14	0.00	121.58	42.68	0.00
J15	0.00	121.59	42.45	0.00
J16	0.00	121.74	42.67	0.00
J18	2.40	121.59	42.56	0.00
J19	0.00	121.55	41.70	0.00
J2	0.00	123.88	45.38	0.00
J22	2.30	122.44	44.39	0.00
J23	0.00	122.52	44.26	0.00
J24	1.50	122.52	43.66	0.00
J25	3.30	121.55	41.95	0.00
J26	2.40	123.74	46.06	0.00
J27	0.00	123.76	46.20	0.00

Page 6



21106_Max Day + Fire @ 1971 St. Laurent.rpt

J3	2.40	123.87	45.67	0.00	
R1	-84.51	0.00	0.00	0.00	Reservoir
R2	-83.09	0.00	0.00	0.00	Reservoir

Link Results at 3:00 Hrs:

Link ID	Flow LPS	Velocity m/s	Unit Headloss m/km	Status
P1	50.04	1.59	17.51	Open
P4	-13.04	0.42	1.45	Open
P13	37.00	1.18	10.01	Open
P14	37.00	1.18	8.52	Open
P15	-112.76	2.30	26.58	Open
P16	149.76	3.05	44.96	Open
P17	3.30	0.11	0.11	Open
P18	3.30	0.11	0.11	Open
P19	0.00	0.00	0.00	Open
P21	-6.84	0.22	0.44	Open
P22	-6.84	0.22	0.44	Open
P23	-9.24	0.52	3.71	Open
P24	2.40	0.08	0.06	Open
P2	-3.30	0.11	0.11	Open
P3	-9.24	0.52	3.71	Open
P5	-11.54	0.37	1.16	Open
P6	-1.50	0.05	0.03	Open



Page 7

Link Results at 3:00 Hrs: (continued)

Link ID	Flow LPS	Velocity m/s	Unit Headloss m/km	Status
P7	-13.04	0.42	1.45	Open
P9	-32.07	0.45	0.91	Open
P10	-34.47	0.49	1.04	Open
P11	-34.47	0.49	1.04	Open
P12	-80.69	1.14	5.01	Open
P8	-2.40	0.14	0.31	Open
1	83.09	0.00	-123.88	Open Pump
2	84.51	0.00	-123.80	Open Pump

Node Results at 4:00 Hrs:

Node ID	Demand LPS	Head m	Pressure m	Quality
---------	------------	--------	------------	---------



21106_Max Day + Fire @ 1971 St. Laurent.rpt

J1	0.00	123.80	46.53	0.00
J200	0.00	122.74	44.67	0.00
J5	0.00	122.60	43.85	0.00
J8	0.00	122.41	43.74	0.00
J9	0.00	121.91	43.21	0.00
J10	153.30	121.55	43.05	0.00
J11	0.00	121.55	42.02	0.00
J12	0.00	123.70	45.50	0.00
J13	0.00	121.55	41.97	0.00
J14	0.00	121.58	42.68	0.00
J15	0.00	121.59	42.45	0.00
J16	0.00	121.74	42.67	0.00
J18	2.40	121.59	42.56	0.00
J19	0.00	121.55	41.70	0.00
J2	0.00	123.88	45.38	0.00
J22	2.30	122.44	44.39	0.00
J23	0.00	122.52	44.26	0.00
J24	1.50	122.52	43.66	0.00
J25	3.30	121.55	41.95	0.00
J26	2.40	123.74	46.06	0.00
J27	0.00	123.76	46.20	0.00
J3	2.40	123.87	45.67	0.00
R1	-84.51	0.00	0.00	0.00 Reservoir
R2	-83.09	0.00	0.00	0.00 Reservoir



Page 8

Link Results at 4:00 Hrs:

Link ID	Flow LPS	Velocity m/s	Unit Headloss m/km	Status
P1	50.04	1.59	17.51	Open
P4	-13.04	0.42	1.45	Open
P13	37.00	1.18	10.01	Open
P14	37.00	1.18	8.52	Open
P15	-112.76	2.30	26.58	Open
P16	149.76	3.05	44.96	Open
P17	3.30	0.11	0.11	Open
P18	3.30	0.11	0.11	Open
P19	0.00	0.00	0.00	Open
P21	-6.84	0.22	0.44	Open
P22	-6.84	0.22	0.44	Open
P23	-9.24	0.52	3.71	Open
P24	2.40	0.08	0.06	Open
P2	-3.30	0.11	0.11	Open
P3	-9.24	0.52	3.71	Open

Page 8



21106_Max Day + Fire @ 1971 St. Laurent.rpt

P5	-11.54	0.37	1.16	Open
P6	-1.50	0.05	0.03	Open
P7	-13.04	0.42	1.45	Open
P9	-32.07	0.45	0.91	Open
P10	-34.47	0.49	1.04	Open
P11	-34.47	0.49	1.04	Open
P12	-80.69	1.14	5.01	Open
P8	-2.40	0.14	0.31	Open
1	83.09	0.00	-123.88	Open Pump
2	84.51	0.00	-123.80	Open Pump

Maximum Day + Fire Flow Conditions at Existing Building 1975 St. Laurent Blvd. (Node J25)

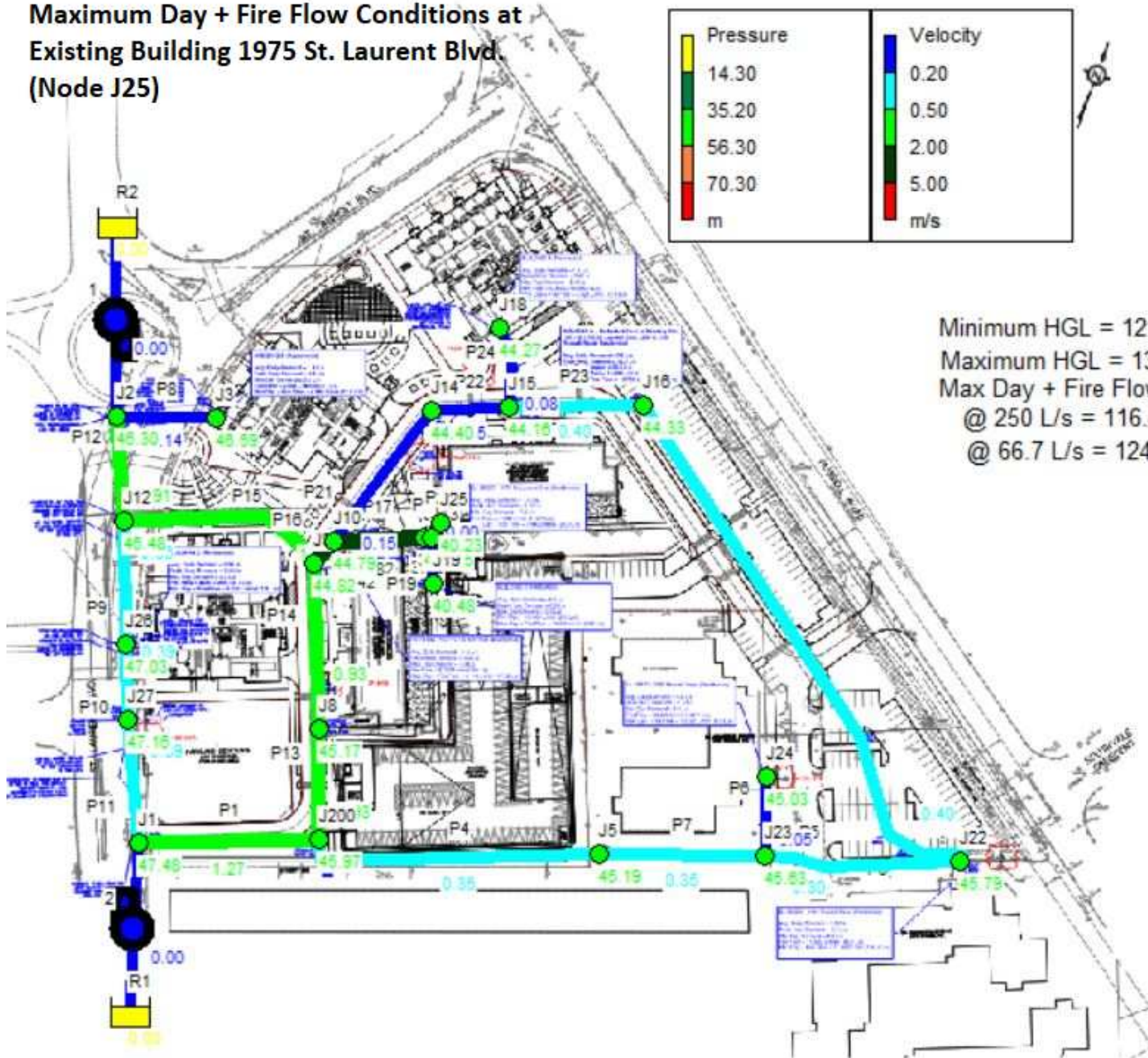
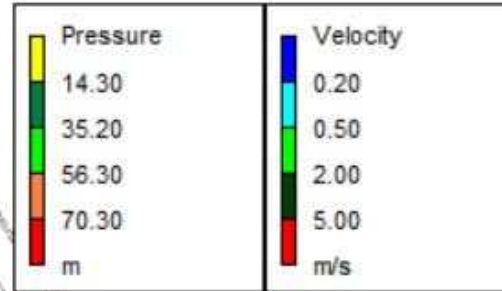

Minimum HGL = 121.0m
 Maximum HGL = 130.4m
 Max Day + Fire Flow:
 @ 250 L/s = 116.4m
 @ 66.7 L/s = 124.8m



21106_Max Day + Fire @ 1975 St. Laurent.rpt

Page 1

2023-03-14 4:06:29 PM

```
*****
*                               E P A N E T                               *
*                               Hydraulic and Water Quality                 *
*                               Analysis for Pipe Networks                   *
*                               Version 2.2                                 *
*****
```

Input File: 21106_Max Day + Fire @ Building 1975 St. Lurent-2023.net

Link - Node Table:

Link ID	Start Node	End Node	Length m	Diameter mm	
P1	J1	J200	60.78	200	
P4	J5	J200	96.37	200	
P13	J200	J8	32.72	200	
P14	J8	J9	58.6	200	
P15	J9	J12	67.26	250	
P16	J9	J10	7.91	250	
P17	J10	J11	31.176	200	
P18	J11	J13	2.28	200	
P19	J13	J19	18.81	200	
P21	J10	J14	51.579	200	
P22	J14	J15	23.86	200	
P23	J15	J16	41.8	150	
P24	J15	J18	26	200	
P2	J25	J13	5.633	200	
P3	J16	J22	189.127	150	
P5	J22	J23	62.85	200	
P6	J24	J23	25.34	200	
P7	J23	J5	55.03	200	
P9	J12	J26	44	300	
P10	J26	J27	21.3	300	
P11	J27	J1	39.51	300	
P12	J12	J2	36.02	300	
P8	J3	J2	31.93	150	
1	R2	J2	#N/A	#N/A	Pump
2	R1	J1	#N/A	#N/A	Pump

Energy Usage:

Pump	Usage Factor	Avg. Effic.	Kw-hr /m3	Avg. Kw	Peak Kw	Cost /day



21106_Max Day + Fire @ 1975 St. Laurent.rpt

1	100.00	75.00	0.45	108.81	108.81	0.00
2	100.00	75.00	0.45	110.20	110.20	0.00

Demand Charge:	0.00
Total Cost:	0.00



Page 2

Node Results at 0:00 Hrs:

Node ID	Demand LPS	Head m	Pressure m	Quality
J1	0.00	124.75	47.48	0.00
J200	0.00	124.04	45.97	0.00
J5	0.00	123.94	45.19	0.00
J8	0.00	123.84	45.17	0.00
J9	0.00	123.52	44.82	0.00
J10	3.30	123.29	44.79	0.00
J11	0.00	120.53	41.00	0.00
J12	0.00	124.68	46.48	0.00
J13	0.00	120.33	40.75	0.00
J14	0.00	123.30	44.40	0.00
J15	0.00	123.30	44.16	0.00
J16	0.00	123.40	44.33	0.00
J18	2.40	123.30	44.27	0.00
J19	0.00	120.33	40.48	0.00
J2	0.00	124.80	46.30	0.00
J22	2.30	123.84	45.79	0.00
J23	0.00	123.89	45.63	0.00
J24	1.50	123.89	45.03	0.00
J25	120.00	119.83	40.23	0.00
J26	2.40	124.71	47.03	0.00
J27	0.00	124.72	47.16	0.00
J3	2.40	124.79	46.59	0.00
R1	-67.59	0.00	0.00	0.00 Reservoir
R2	-66.71	0.00	0.00	0.00 Reservoir

Link Results at 0:00 Hrs:

Link ID	Flow LPS	Velocity m/s	Unit Headloss m/km	Status
P1	40.02	1.27	11.57	Open
P4	-10.95	0.35	1.05	Open
P13	29.07	0.93	6.40	Open
P14	29.07	0.93	5.45	Open

Page 2



21106_Max Day + Fire @ 1975 St. Laurent.rpt

P15	-89.48	1.82	17.32	Open
P16	118.55	2.42	29.16	Open
P17	120.00	3.82	88.45	Open
P18	120.00	3.82	88.45	Open
P19	0.00	0.00	0.00	Open
P21	-4.75	0.15	0.22	Open
P22	-4.75	0.15	0.22	Open
P23	-7.15	0.40	2.31	Open
P24	2.40	0.08	0.06	Open
P2	-120.00	3.82	88.45	Open
P3	-7.15	0.40	2.31	Open
P5	-9.45	0.30	0.80	Open
P6	-1.50	0.05	0.03	Open



Page 3

Link Results at 0:00 Hrs: (continued)

Link ID	Flow LPS	Velocity m/s	Unit Headloss m/km	Status
P7	-10.95	0.35	1.05	Open
P9	-25.17	0.36	0.58	Open
P10	-27.57	0.39	0.69	Open
P11	-27.57	0.39	0.69	Open
P12	-64.31	0.91	3.29	Open
P8	-2.40	0.14	0.31	Open
1	66.71	0.00	-124.80	Open Pump
2	67.59	0.00	-124.75	Open Pump

Node Results at 1:00 Hrs:

Node ID	Demand LPS	Head m	Pressure m	Quality
J1	0.00	124.75	47.48	0.00
J200	0.00	124.04	45.97	0.00
J5	0.00	123.94	45.19	0.00
J8	0.00	123.84	45.17	0.00
J9	0.00	123.52	44.82	0.00
J10	3.30	123.29	44.79	0.00
J11	0.00	120.53	41.00	0.00
J12	0.00	124.68	46.48	0.00
J13	0.00	120.33	40.75	0.00
J14	0.00	123.30	44.40	0.00
J15	0.00	123.30	44.16	0.00
J16	0.00	123.40	44.33	0.00
J18	2.40	123.30	44.27	0.00

Page 3



21106_Max Day + Fire @ 1975 St. Laurent.rpt

J19	0.00	120.33	40.48	0.00
J2	0.00	124.80	46.30	0.00
J22	2.30	123.84	45.79	0.00
J23	0.00	123.89	45.63	0.00
J24	1.50	123.89	45.03	0.00
J25	120.00	119.83	40.23	0.00
J26	2.40	124.71	47.03	0.00
J27	0.00	124.72	47.16	0.00
J3	2.40	124.79	46.59	0.00
R1	-67.59	0.00	0.00	0.00 Reservoir
R2	-66.71	0.00	0.00	0.00 Reservoir



Page 4

Link Results at 1:00 Hrs:

Link ID	Flow LPS	Velocity m/s	Unit Headloss m/km	Status
P1	40.02	1.27	11.57	Open
P4	-10.95	0.35	1.05	Open
P13	29.07	0.93	6.40	Open
P14	29.07	0.93	5.45	Open
P15	-89.48	1.82	17.32	Open
P16	118.55	2.42	29.16	Open
P17	120.00	3.82	88.45	Open
P18	120.00	3.82	88.45	Open
P19	0.00	0.00	0.00	Open
P21	-4.75	0.15	0.22	Open
P22	-4.75	0.15	0.22	Open
P23	-7.15	0.40	2.31	Open
P24	2.40	0.08	0.06	Open
P2	-120.00	3.82	88.45	Open
P3	-7.15	0.40	2.31	Open
P5	-9.45	0.30	0.80	Open
P6	-1.50	0.05	0.03	Open
P7	-10.95	0.35	1.05	Open
P9	-25.17	0.36	0.58	Open
P10	-27.57	0.39	0.69	Open
P11	-27.57	0.39	0.69	Open
P12	-64.31	0.91	3.29	Open
P8	-2.40	0.14	0.31	Open
1	66.71	0.00	-124.80	Open Pump
2	67.59	0.00	-124.75	Open Pump

Node Results at 2:00 Hrs:

Page 4



21106_Max Day + Fire @ 1975 St. Laurent.rpt

Node ID	Demand LPS	Head m	Pressure m	Quality
J1	0.00	124.75	47.48	0.00
J200	0.00	124.04	45.97	0.00
J5	0.00	123.94	45.19	0.00
J8	0.00	123.84	45.17	0.00
J9	0.00	123.52	44.82	0.00
J10	3.30	123.29	44.79	0.00
J11	0.00	120.53	41.00	0.00
J12	0.00	124.68	46.48	0.00
J13	0.00	120.33	40.75	0.00
J14	0.00	123.30	44.40	0.00
J15	0.00	123.30	44.16	0.00
J16	0.00	123.40	44.33	0.00
J18	2.40	123.30	44.27	0.00
J19	0.00	120.33	40.48	0.00
J2	0.00	124.80	46.30	0.00
J22	2.30	123.84	45.79	0.00



Page 5

Node Results at 2:00 Hrs: (continued)

Node ID	Demand LPS	Head m	Pressure m	Quality
J23	0.00	123.89	45.63	0.00
J24	1.50	123.89	45.03	0.00
J25	120.00	119.83	40.23	0.00
J26	2.40	124.71	47.03	0.00
J27	0.00	124.72	47.16	0.00
J3	2.40	124.79	46.59	0.00
R1	-67.59	0.00	0.00	0.00 Reservoir
R2	-66.71	0.00	0.00	0.00 Reservoir

Link Results at 2:00 Hrs:

Link ID	Flow LPS	Velocity m/s	Unit Headloss m/km	Status
P1	40.02	1.27	11.57	Open
P4	-10.95	0.35	1.05	Open
P13	29.07	0.93	6.40	Open
P14	29.07	0.93	5.45	Open
P15	-89.48	1.82	17.32	Open
P16	118.55	2.42	29.16	Open
P17	120.00	3.82	88.45	Open

Page 5



21106_Max Day + Fire @ 1975 St. Laurent.rpt

P18	120.00	3.82	88.45	Open
P19	0.00	0.00	0.00	Open
P21	-4.75	0.15	0.22	Open
P22	-4.75	0.15	0.22	Open
P23	-7.15	0.40	2.31	Open
P24	2.40	0.08	0.06	Open
P2	-120.00	3.82	88.45	Open
P3	-7.15	0.40	2.31	Open
P5	-9.45	0.30	0.80	Open
P6	-1.50	0.05	0.03	Open
P7	-10.95	0.35	1.05	Open
P9	-25.17	0.36	0.58	Open
P10	-27.57	0.39	0.69	Open
P11	-27.57	0.39	0.69	Open
P12	-64.31	0.91	3.29	Open
P8	-2.40	0.14	0.31	Open
1	66.71	0.00	-124.80	Open Pump
2	67.59	0.00	-124.75	Open Pump



Page 6

Node Results at 3:00 Hrs:

Node ID	Demand LPS	Head m	Pressure m	Quality
J1	0.00	124.75	47.48	0.00
J200	0.00	124.04	45.97	0.00
J5	0.00	123.94	45.19	0.00
J8	0.00	123.84	45.17	0.00
J9	0.00	123.52	44.82	0.00
J10	3.30	123.29	44.79	0.00
J11	0.00	120.53	41.00	0.00
J12	0.00	124.68	46.48	0.00
J13	0.00	120.33	40.75	0.00
J14	0.00	123.30	44.40	0.00
J15	0.00	123.30	44.16	0.00
J16	0.00	123.40	44.33	0.00
J18	2.40	123.30	44.27	0.00
J19	0.00	120.33	40.48	0.00
J2	0.00	124.80	46.30	0.00
J22	2.30	123.84	45.79	0.00
J23	0.00	123.89	45.63	0.00
J24	1.50	123.89	45.03	0.00
J25	120.00	119.83	40.23	0.00
J26	2.40	124.71	47.03	0.00
J27	0.00	124.72	47.16	0.00

Page 6



21106_Max Day + Fire @ 1975 St. Laurent.rpt

J3	2.40	124.79	46.59	0.00	
R1	-67.59	0.00	0.00	0.00	Reservoir
R2	-66.71	0.00	0.00	0.00	Reservoir

Link Results at 3:00 Hrs:

Link ID	Flow LPS	Velocity m/s	Unit Headloss m/km	Status
P1	40.02	1.27	11.57	Open
P4	-10.95	0.35	1.05	Open
P13	29.07	0.93	6.40	Open
P14	29.07	0.93	5.45	Open
P15	-89.48	1.82	17.32	Open
P16	118.55	2.42	29.16	Open
P17	120.00	3.82	88.45	Open
P18	120.00	3.82	88.45	Open
P19	0.00	0.00	0.00	Open
P21	-4.75	0.15	0.22	Open
P22	-4.75	0.15	0.22	Open
P23	-7.15	0.40	2.31	Open
P24	2.40	0.08	0.06	Open
P2	-120.00	3.82	88.45	Open
P3	-7.15	0.40	2.31	Open
P5	-9.45	0.30	0.80	Open
P6	-1.50	0.05	0.03	Open



Page 7

Link Results at 3:00 Hrs: (continued)

Link ID	Flow LPS	Velocity m/s	Unit Headloss m/km	Status
P7	-10.95	0.35	1.05	Open
P9	-25.17	0.36	0.58	Open
P10	-27.57	0.39	0.69	Open
P11	-27.57	0.39	0.69	Open
P12	-64.31	0.91	3.29	Open
P8	-2.40	0.14	0.31	Open
1	66.71	0.00	-124.80	Open Pump
2	67.59	0.00	-124.75	Open Pump

Node Results at 4:00 Hrs:

Node ID	Demand LPS	Head m	Pressure m	Quality
---------	------------	--------	------------	---------



21106_Max Day + Fire @ 1975 St. Laurent.rpt

J1	0.00	124.75	47.48	0.00
J200	0.00	124.04	45.97	0.00
J5	0.00	123.94	45.19	0.00
J8	0.00	123.84	45.17	0.00
J9	0.00	123.52	44.82	0.00
J10	3.30	123.29	44.79	0.00
J11	0.00	120.53	41.00	0.00
J12	0.00	124.68	46.48	0.00
J13	0.00	120.33	40.75	0.00
J14	0.00	123.30	44.40	0.00
J15	0.00	123.30	44.16	0.00
J16	0.00	123.40	44.33	0.00
J18	2.40	123.30	44.27	0.00
J19	0.00	120.33	40.48	0.00
J2	0.00	124.80	46.30	0.00
J22	2.30	123.84	45.79	0.00
J23	0.00	123.89	45.63	0.00
J24	1.50	123.89	45.03	0.00
J25	120.00	119.83	40.23	0.00
J26	2.40	124.71	47.03	0.00
J27	0.00	124.72	47.16	0.00
J3	2.40	124.79	46.59	0.00
R1	-67.59	0.00	0.00	0.00 Reservoir
R2	-66.71	0.00	0.00	0.00 Reservoir



Page 8

Link Results at 4:00 Hrs:

Link ID	Flow LPS	Velocity m/s	Unit Headloss m/km	Status
P1	40.02	1.27	11.57	Open
P4	-10.95	0.35	1.05	Open
P13	29.07	0.93	6.40	Open
P14	29.07	0.93	5.45	Open
P15	-89.48	1.82	17.32	Open
P16	118.55	2.42	29.16	Open
P17	120.00	3.82	88.45	Open
P18	120.00	3.82	88.45	Open
P19	0.00	0.00	0.00	Open
P21	-4.75	0.15	0.22	Open
P22	-4.75	0.15	0.22	Open
P23	-7.15	0.40	2.31	Open
P24	2.40	0.08	0.06	Open
P2	-120.00	3.82	88.45	Open
P3	-7.15	0.40	2.31	Open

Page 8



21106_Max Day + Fire @ 1975 St. Laurent.rpt

P5	-9.45	0.30	0.80	Open
P6	-1.50	0.05	0.03	Open
P7	-10.95	0.35	1.05	Open
P9	-25.17	0.36	0.58	Open
P10	-27.57	0.39	0.69	Open
P11	-27.57	0.39	0.69	Open
P12	-64.31	0.91	3.29	Open
P8	-2.40	0.14	0.31	Open
1	66.71	0.00	-124.80	Open Pump
2	67.59	0.00	-124.75	Open Pump



**Maximum Day + Fire Flow Conditions
at Existing Building 2080 Russell Road
(Node J24)**

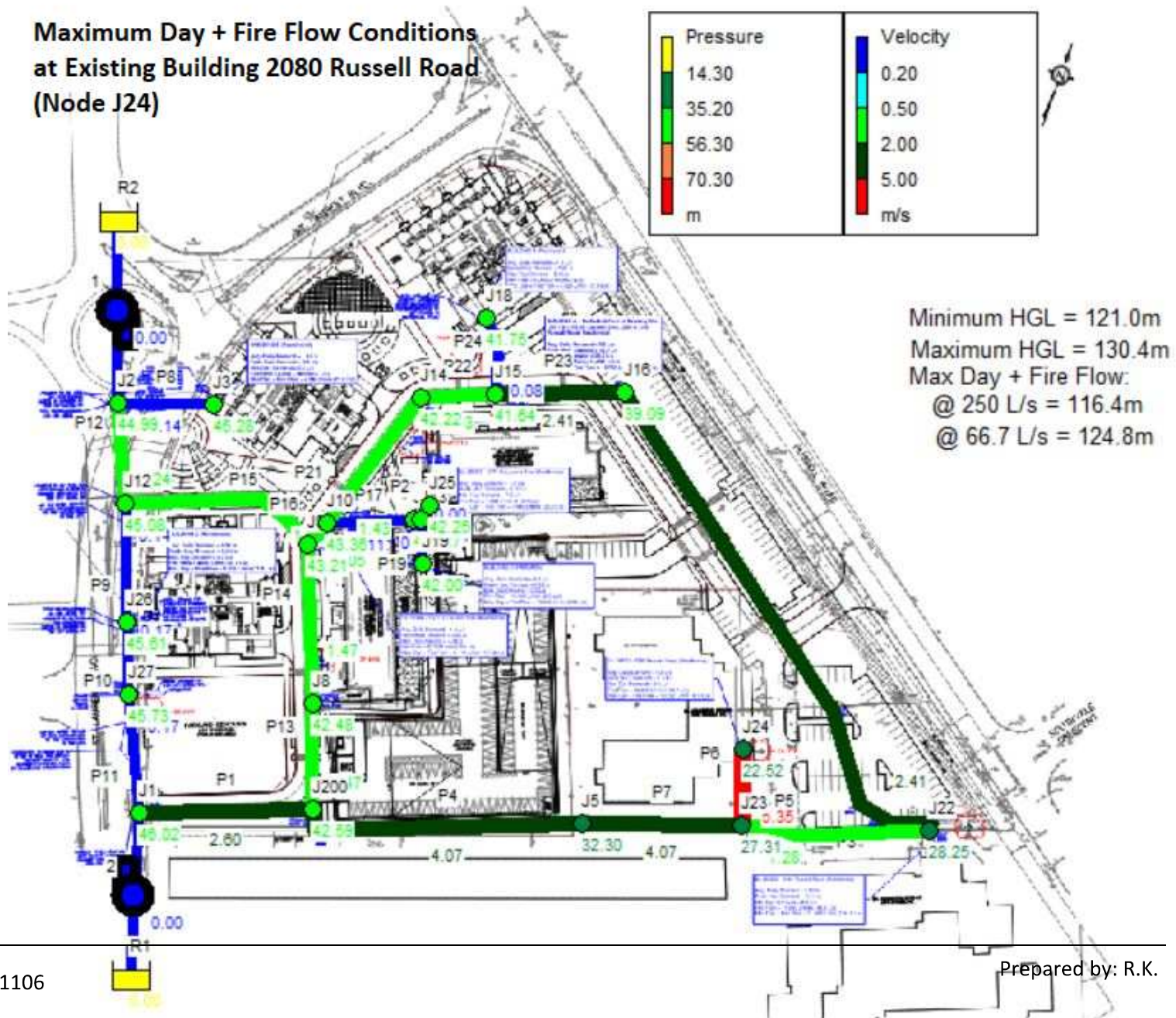
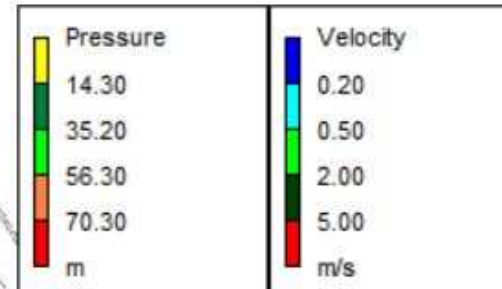



```
*****
*                               E P A N E T                               *
*                               Hydraulic and Water Quality                 *
*                               Analysis for Pipe Networks                   *
*                               Version 2.2                                 *
*****
```

Input File: 21106_Max Day + Fire @ 2080 Russell-2023.net

Link - Node Table:

Link ID	Start Node	End Node	Length m	Diameter mm	
P1	J1	J200	60.78	200	
P4	J5	J200	96.37	200	
P13	J200	J8	32.72	200	
P14	J8	J9	58.6	200	
P15	J9	J12	67.26	250	
P16	J9	J10	7.91	250	
P17	J10	J11	31.176	200	
P18	J11	J13	2.28	200	
P19	J13	J19	18.81	200	
P21	J10	J14	51.579	200	
P22	J14	J15	23.86	200	
P23	J15	J16	41.8	150	
P24	J15	J18	26	200	
P2	J25	J13	5.633	200	
P3	J16	J22	189.127	150	
P5	J22	J23	62.85	200	
P6	J24	J23	25.34	200	
P7	J23	J5	55.03	200	
P9	J12	J26	44	300	
P10	J26	J27	21.3	300	
P11	J27	J1	39.51	300	
P12	J12	J2	36.02	300	
P8	J3	J2	31.93	150	
1	R2	J2	#N/A	#N/A	Pump
2	R1	J1	#N/A	#N/A	Pump

Energy Usage:

Pump	Usage Factor	Avg. Effic.	Kw-hr /m3	Avg. Kw	Peak Kw	Cost /day



21106_Max Day + Fire @ 2080 Russell.rpt

1	100.00	75.00	0.45	145.71	145.71	0.00
2	100.00	75.00	0.45	151.51	151.51	0.00

Demand Charge: 0.00
Total Cost: 0.00



Page 2

Node Results at 0:00 Hrs:

Node ID	Demand LPS	Head m	Pressure m	Quality	
J1	0.00	123.29	46.02	0.00	
J200	0.00	120.66	42.59	0.00	
J5	0.00	111.05	32.30	0.00	
J8	0.00	121.15	42.48	0.00	
J9	0.00	121.91	43.21	0.00	
J10	3.30	121.86	43.36	0.00	
J11	0.00	121.85	42.32	0.00	
J12	0.00	123.28	45.08	0.00	
J13	0.00	121.85	42.27	0.00	
J14	0.00	121.12	42.22	0.00	
J15	0.00	120.78	41.64	0.00	
J16	0.00	118.16	39.09	0.00	
J18	2.40	120.78	41.75	0.00	
J19	0.00	121.85	42.00	0.00	
J2	0.00	123.49	44.99	0.00	
J22	2.30	106.30	28.25	0.00	
J23	0.00	105.57	27.31	0.00	
J24	168.20	101.38	22.52	0.00	
J25	3.30	121.85	42.25	0.00	
J26	2.40	123.29	45.61	0.00	
J27	0.00	123.29	45.73	0.00	
J3	2.40	123.48	45.28	0.00	
R1	-94.02	0.00	0.00	0.00	Reservoir
R2	-90.28	0.00	0.00	0.00	Reservoir

Link Results at 0:00 Hrs:

Link ID	Flow LPS	Velocity m/s	Unit Headloss m/km	Status
P1	81.71	2.60	43.41	Open
P4	-127.99	4.07	99.67	Open
P13	-46.28	1.47	15.15	Open
P14	-46.28	1.47	12.89	Open

Page 2



	21106_Max Day + Fire @ 2080 Russell.rpt			
P15	-97.79	1.99	20.42	Open
P16	-51.51	1.05	6.23	Open
P17	3.30	0.11	0.11	Open
P18	3.30	0.11	0.11	Open
P19	0.00	0.00	0.00	Open
P21	44.91	1.43	14.33	Open
P22	44.91	1.43	14.33	Open
P23	42.51	2.41	62.69	Open
P24	2.40	0.08	0.06	Open
P2	-3.30	0.11	0.11	Open
P3	42.51	2.41	62.69	Open
P5	40.21	1.28	11.67	Open
P6	-168.20	5.35	165.30	Open



Page 3

Link Results at 0:00 Hrs: (continued)

Link ID	Flow LPS	Velocity m/s	Unit Headloss m/km	Status
P7	-127.99	4.07	99.67	Open
P9	-9.91	0.14	0.10	Open
P10	-12.31	0.17	0.15	Open
P11	-12.31	0.17	0.15	Open
P12	-87.88	1.24	5.87	Open
P8	-2.40	0.14	0.31	Open
1	90.28	0.00	-123.49	Open Pump
2	94.02	0.00	-123.29	Open Pump

Node Results at 1:00 Hrs:

Node ID	Demand LPS	Head m	Pressure m	Quality
J1	0.00	123.29	46.02	0.00
J200	0.00	120.66	42.59	0.00
J5	0.00	111.05	32.30	0.00
J8	0.00	121.15	42.48	0.00
J9	0.00	121.91	43.21	0.00
J10	3.30	121.86	43.36	0.00
J11	0.00	121.85	42.32	0.00
J12	0.00	123.28	45.08	0.00
J13	0.00	121.85	42.27	0.00
J14	0.00	121.12	42.22	0.00
J15	0.00	120.78	41.64	0.00
J16	0.00	118.16	39.09	0.00
J18	2.40	120.78	41.75	0.00

Page 3



	21106_Max	Day + Fire @ 2080	Russell.rpt	
J19	0.00	121.85	42.00	0.00
J2	0.00	123.49	44.99	0.00
J22	2.30	106.30	28.25	0.00
J23	0.00	105.57	27.31	0.00
J24	168.20	101.38	22.52	0.00
J25	3.30	121.85	42.25	0.00
J26	2.40	123.29	45.61	0.00
J27	0.00	123.29	45.73	0.00
J3	2.40	123.48	45.28	0.00
R1	-94.02	0.00	0.00	0.00 Reservoir
R2	-90.28	0.00	0.00	0.00 Reservoir



Page 4

Link Results at 1:00 Hrs:

Link ID	Flow LPS	Velocity m/s	Unit Headloss m/km	Status
P1	81.71	2.60	43.41	Open
P4	-127.99	4.07	99.67	Open
P13	-46.28	1.47	15.15	Open
P14	-46.28	1.47	12.89	Open
P15	-97.79	1.99	20.42	Open
P16	51.51	1.05	6.23	Open
P17	3.30	0.11	0.11	Open
P18	3.30	0.11	0.11	Open
P19	0.00	0.00	0.00	Open
P21	44.91	1.43	14.33	Open
P22	44.91	1.43	14.33	Open
P23	42.51	2.41	62.69	Open
P24	2.40	0.08	0.06	Open
P2	-3.30	0.11	0.11	Open
P3	42.51	2.41	62.69	Open
P5	40.21	1.28	11.67	Open
P6	-168.20	5.35	165.30	Open
P7	-127.99	4.07	99.67	Open
P9	-9.91	0.14	0.10	Open
P10	-12.31	0.17	0.15	Open
P11	-12.31	0.17	0.15	Open
P12	-87.88	1.24	5.87	Open
P8	-2.40	0.14	0.31	Open
1	90.28	0.00	-123.49	Open Pump
2	94.02	0.00	-123.29	Open Pump

Node Results at 2:00 Hrs:



21106_Max Day + Fire @ 2080 Russell.rpt				
Node	Demand	Head	Pressure	Quality
ID	LPS	m	m	
J1	0.00	123.29	46.02	0.00
J200	0.00	120.66	42.59	0.00
J5	0.00	111.05	32.30	0.00
J8	0.00	121.15	42.48	0.00
J9	0.00	121.91	43.21	0.00
J10	3.30	121.86	43.36	0.00
J11	0.00	121.85	42.32	0.00
J12	0.00	123.28	45.08	0.00
J13	0.00	121.85	42.27	0.00
J14	0.00	121.12	42.22	0.00
J15	0.00	120.78	41.64	0.00
J16	0.00	118.16	39.09	0.00
J18	2.40	120.78	41.75	0.00
J19	0.00	121.85	42.00	0.00
J2	0.00	123.49	44.99	0.00
J22	2.30	106.30	28.25	0.00



Page 5

Node Results at 2:00 Hrs: (continued)

Node	Demand	Head	Pressure	Quality	
ID	LPS	m	m		
J23	0.00	105.57	27.31	0.00	
J24	168.20	101.38	22.52	0.00	
J25	3.30	121.85	42.25	0.00	
J26	2.40	123.29	45.61	0.00	
J27	0.00	123.29	45.73	0.00	
J3	2.40	123.48	45.28	0.00	
R1	-94.02	0.00	0.00	0.00	Reservoir
R2	-90.28	0.00	0.00	0.00	Reservoir

Link Results at 2:00 Hrs:

Link	Flow	Velocity	Unit Headloss	Status
ID	LPS	m/s	m/km	
P1	81.71	2.60	43.41	Open
P4	-127.99	4.07	99.67	Open
P13	-46.28	1.47	15.15	Open
P14	-46.28	1.47	12.89	Open
P15	-97.79	1.99	20.42	Open
P16	51.51	1.05	6.23	Open
P17	3.30	0.11	0.11	Open

Page 5



	21106_Max	Day + Fire	@ 2080	Russell.rpt	
P18	3.30	0.11	0.11	Open	
P19	0.00	0.00	0.00	Open	
P21	44.91	1.43	14.33	Open	
P22	44.91	1.43	14.33	Open	
P23	42.51	2.41	62.69	Open	
P24	2.40	0.08	0.06	Open	
P2	-3.30	0.11	0.11	Open	
P3	42.51	2.41	62.69	Open	
P5	40.21	1.28	11.67	Open	
P6	-168.20	5.35	165.30	Open	
P7	-127.99	4.07	99.67	Open	
P9	-9.91	0.14	0.10	Open	
P10	-12.31	0.17	0.15	Open	
P11	-12.31	0.17	0.15	Open	
P12	-87.88	1.24	5.87	Open	
P8	-2.40	0.14	0.31	Open	
1	90.28	0.00	-123.49	Open Pump	
2	94.02	0.00	-123.29	Open Pump	



Page 6

Node Results at 3:00 Hrs:

Node ID	Demand LPS	Head m	Pressure m	Quality
J1	0.00	123.29	46.02	0.00
J200	0.00	120.66	42.59	0.00
J5	0.00	111.05	32.30	0.00
J8	0.00	121.15	42.48	0.00
J9	0.00	121.91	43.21	0.00
J10	3.30	121.86	43.36	0.00
J11	0.00	121.85	42.32	0.00
J12	0.00	123.28	45.08	0.00
J13	0.00	121.85	42.27	0.00
J14	0.00	121.12	42.22	0.00
J15	0.00	120.78	41.64	0.00
J16	0.00	118.16	39.09	0.00
J18	2.40	120.78	41.75	0.00
J19	0.00	121.85	42.00	0.00
J2	0.00	123.49	44.99	0.00
J22	2.30	106.30	28.25	0.00
J23	0.00	105.57	27.31	0.00
J24	168.20	101.38	22.52	0.00
J25	3.30	121.85	42.25	0.00
J26	2.40	123.29	45.61	0.00
J27	0.00	123.29	45.73	0.00

Page 6



21106_Max Day + Fire @ 2080 Russell.rpt

J3	2.40	123.48	45.28	0.00	
R1	-94.02	0.00	0.00	0.00	Reservoir
R2	-90.28	0.00	0.00	0.00	Reservoir

Link Results at 3:00 Hrs:

Link ID	Flow LPS	Velocity m/s	Unit Headloss m/km	Status
P1	81.71	2.60	43.41	Open
P4	-127.99	4.07	99.67	Open
P13	-46.28	1.47	15.15	Open
P14	-46.28	1.47	12.89	Open
P15	-97.79	1.99	20.42	Open
P16	51.51	1.05	6.23	Open
P17	3.30	0.11	0.11	Open
P18	3.30	0.11	0.11	Open
P19	0.00	0.00	0.00	Open
P21	44.91	1.43	14.33	Open
P22	44.91	1.43	14.33	Open
P23	42.51	2.41	62.69	Open
P24	2.40	0.08	0.06	Open
P2	-3.30	0.11	0.11	Open
P3	42.51	2.41	62.69	Open
P5	40.21	1.28	11.67	Open
P6	-168.20	5.35	165.30	Open



Page 7

Link Results at 3:00 Hrs: (continued)

Link ID	Flow LPS	Velocity m/s	Unit Headloss m/km	Status
P7	-127.99	4.07	99.67	Open
P9	-9.91	0.14	0.10	Open
P10	-12.31	0.17	0.15	Open
P11	-12.31	0.17	0.15	Open
P12	-87.88	1.24	5.87	Open
P8	-2.40	0.14	0.31	Open
1	90.28	0.00	-123.49	Open Pump
2	94.02	0.00	-123.29	Open Pump

Node Results at 4:00 Hrs:

Node ID	Demand LPS	Head m	Pressure m	Quality
---------	------------	--------	------------	---------



	21106_Max	Day + Fire @ 2080	Russell.rpt	
J1	0.00	123.29	46.02	0.00
J200	0.00	120.66	42.59	0.00
J5	0.00	111.05	32.30	0.00
J8	0.00	121.15	42.48	0.00
J9	0.00	121.91	43.21	0.00
J10	3.30	121.86	43.36	0.00
J11	0.00	121.85	42.32	0.00
J12	0.00	123.28	45.08	0.00
J13	0.00	121.85	42.27	0.00
J14	0.00	121.12	42.22	0.00
J15	0.00	120.78	41.64	0.00
J16	0.00	118.16	39.09	0.00
J18	2.40	120.78	41.75	0.00
J19	0.00	121.85	42.00	0.00
J2	0.00	123.49	44.99	0.00
J22	2.30	106.30	28.25	0.00
J23	0.00	105.57	27.31	0.00
J24	168.20	101.38	22.52	0.00
J25	3.30	121.85	42.25	0.00
J26	2.40	123.29	45.61	0.00
J27	0.00	123.29	45.73	0.00
J3	2.40	123.48	45.28	0.00
R1	-94.02	0.00	0.00	0.00 Reservoir
R2	-90.28	0.00	0.00	0.00 Reservoir



Page 8

Link Results at 4:00 Hrs:

Link ID	Flow LPS	Velocity m/s	Unit Headloss m/km	Status
P1	81.71	2.60	43.41	Open
P4	-127.99	4.07	99.67	Open
P13	-46.28	1.47	15.15	Open
P14	-46.28	1.47	12.89	Open
P15	-97.79	1.99	20.42	Open
P16	51.51	1.05	6.23	Open
P17	3.30	0.11	0.11	Open
P18	3.30	0.11	0.11	Open
P19	0.00	0.00	0.00	Open
P21	44.91	1.43	14.33	Open
P22	44.91	1.43	14.33	Open
P23	42.51	2.41	62.69	Open
P24	2.40	0.08	0.06	Open
P2	-3.30	0.11	0.11	Open
P3	42.51	2.41	62.69	Open

Page 8



21106_Max Day + Fire @ 2080 Russell.rpt				
P5	40.21	1.28	11.67	Open
P6	-168.20	5.35	165.30	Open
P7	-127.99	4.07	99.67	Open
P9	-9.91	0.14	0.10	Open
P10	-12.31	0.17	0.15	Open
P11	-12.31	0.17	0.15	Open
P12	-87.88	1.24	5.87	Open
P8	-2.40	0.14	0.31	Open
1	90.28	0.00	-123.49	Open Pump
2	94.02	0.00	-123.29	Open Pump



**Maximum Day + Fire Flow Conditions
at Existing Building 2100 Russell Road
(Node J22)**

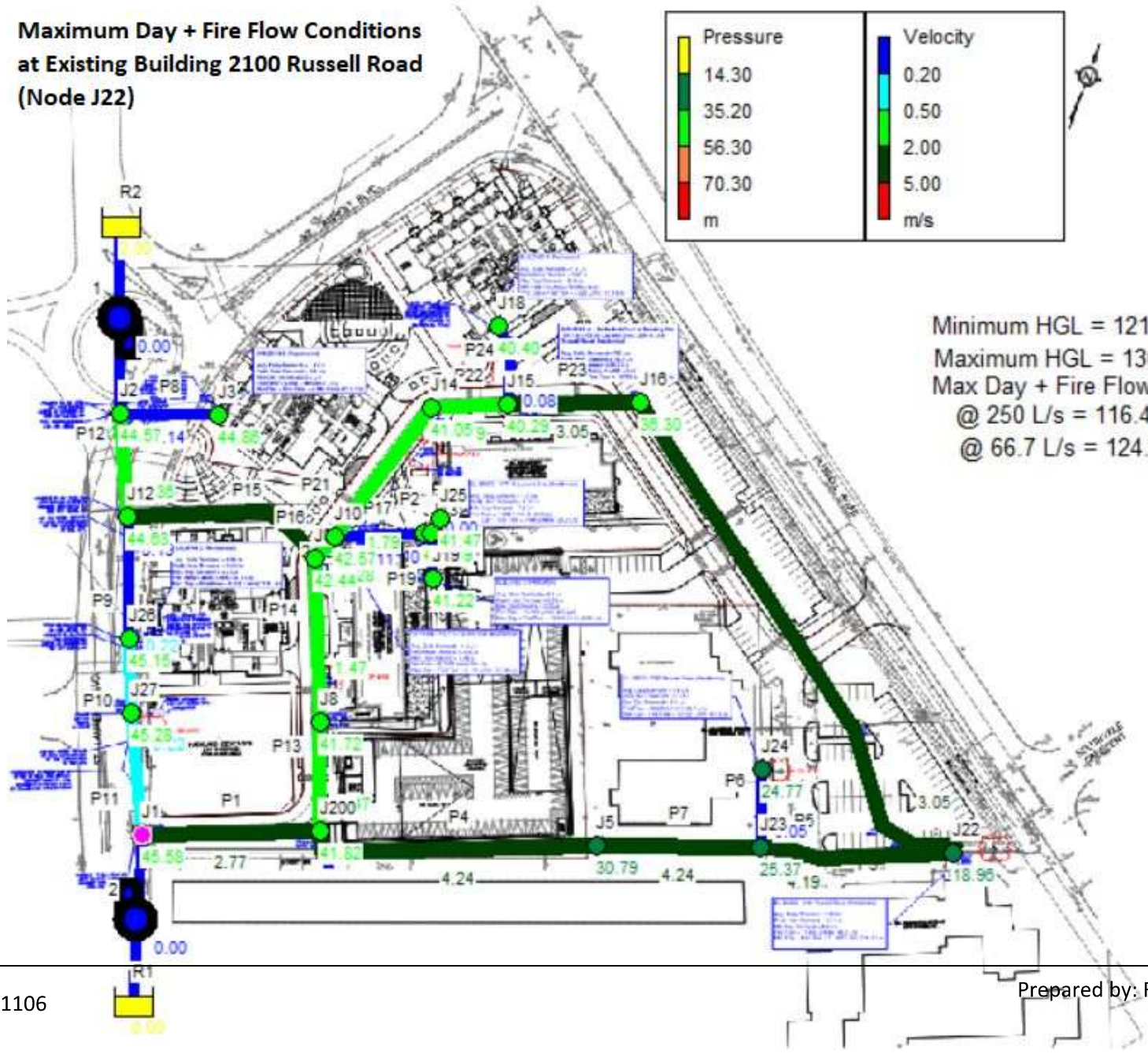
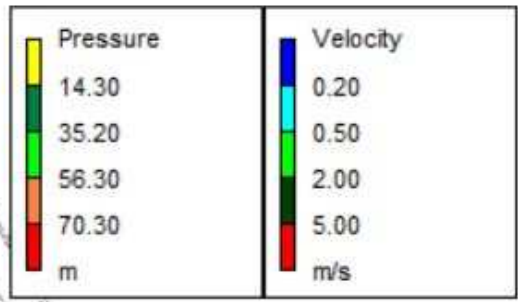

Minimum HGL = 121.0m
 Maximum HGL = 130.4m
 Max Day + Fire Flow:
 @ 250 L/s = 116.4m
 @ 66.7 L/s = 124.8m



21106_Max Day + Fire @ 2100 Russell.rpt

Page 1

2023-03-14 4:08:06 PM

```
*****
*                               *
*               E P A N E T     *
*           Hydraulic and Water Quality *
*           Analysis for Pipe Networks *
*               Version 2.2       *
*                               *
*****
```

Input File: 21106_Max Day + Fire @ 2100 Russell-2023.net

Link - Node Table:

Link ID	Start Node	End Node	Length m	Diameter mm	
P1	J1	J200	60.78	200	
P4	J5	J200	96.37	200	
P13	J200	J8	32.72	200	
P14	J8	J9	58.6	200	
P15	J9	J12	67.26	250	
P16	J9	J10	7.91	250	
P17	J10	J11	31.176	200	
P18	J11	J13	2.28	200	
P19	J13	J19	18.81	200	
P21	J10	J14	51.579	200	
P22	J14	J15	23.86	200	
P23	J15	J16	41.8	150	
P24	J15	J18	26	200	
P2	J25	J13	5.633	200	
P3	J16	J22	189.127	150	
P5	J22	J23	62.85	200	
P6	J24	J23	25.34	200	
P7	J23	J5	55.03	200	
P9	J12	J26	44	300	
P10	J26	J27	21.3	300	
P11	J27	J1	39.51	300	
P12	J12	J2	36.02	300	
P8	J3	J2	31.93	150	
1	R2	J2	#N/A	#N/A	Pump
2	R1	J1	#N/A	#N/A	Pump

Energy Usage:

Pump	Usage Factor	Avg. Effic.	Kw-hr /m3	Avg. Kw	Peak Kw	Cost /day



21106_Max Day + Fire @ 2100 Russell.rpt

1	100.00	75.00	0.45	158.04	158.04	0.00
2	100.00	75.00	0.45	164.81	164.81	0.00

Demand Charge: 0.00
Total Cost: 0.00



Page 2

Node Results at 0:00 Hrs:

Node ID	Demand LPS	Head m	Pressure m	Quality	
J1	0.00	122.85	45.58	0.00	
J200	0.00	119.89	41.82	0.00	
J5	0.00	109.54	30.79	0.00	
J8	0.00	120.39	41.72	0.00	
J9	0.00	121.14	42.44	0.00	
J10	3.30	121.07	42.57	0.00	
J11	0.00	121.07	41.54	0.00	
J12	0.00	122.83	44.63	0.00	
J13	0.00	121.07	41.49	0.00	
J14	0.00	119.95	41.05	0.00	
J15	0.00	119.43	40.29	0.00	
J16	0.00	115.37	36.30	0.00	
J18	2.40	119.43	40.40	0.00	
J19	0.00	121.07	41.22	0.00	
J2	0.00	123.07	44.57	0.00	
J22	185.60	97.01	18.96	0.00	
J23	0.00	103.63	25.37	0.00	
J24	1.50	103.63	24.77	0.00	
J25	3.30	121.07	41.47	0.00	
J26	2.40	122.83	45.15	0.00	
J27	0.00	122.84	45.28	0.00	
J3	2.40	123.06	44.86	0.00	
R1	-102.65	0.00	0.00	0.00	Reservoir
R2	-98.25	0.00	0.00	0.00	Reservoir

Link Results at 0:00 Hrs:

Link ID	Flow LPS	Velocity m/s	Unit Headloss m/km	Status
P1	86.94	2.77	48.70	Open
P4	-133.27	4.24	107.42	Open
P13	-46.33	1.47	15.18	Open
P14	-46.33	1.47	12.92	Open

Page 2



21106_Max Day + Fire @ 2100 Russell.rpt				
P15	-109.16	2.22	25.03	Open
P16	-62.83	1.28	9.00	Open
P17	3.30	0.11	0.11	Open
P18	3.30	0.11	0.11	Open
P19	0.00	0.00	0.00	Open
P21	56.23	1.79	21.73	Open
P22	56.23	1.79	21.73	Open
P23	53.83	3.05	97.08	Open
P24	2.40	0.08	0.06	Open
P2	-3.30	0.11	0.11	Open
P3	53.83	3.05	97.08	Open
P5	-131.77	4.19	105.19	Open
P6	-1.50	0.05	0.03	Open



Page 3

Link Results at 0:00 Hrs: (continued)

Link ID	Flow LPS	Velocity m/s	Unit Headloss m/km	Status
P7	-133.27	4.24	107.42	Open
P9	-13.30	0.19	0.18	Open
P10	-15.70	0.22	0.24	Open
P11	-15.70	0.22	0.24	Open
P12	-95.85	1.36	6.89	Open
P8	-2.40	0.14	0.31	Open
1	98.25	0.00	-123.07	Open Pump
2	102.65	0.00	-122.85	Open Pump

Node Results at 1:00 Hrs:

Node ID	Demand LPS	Head m	Pressure m	Quality
J1	0.00	122.85	45.58	0.00
J200	0.00	119.89	41.82	0.00
J5	0.00	109.54	30.79	0.00
J8	0.00	120.39	41.72	0.00
J9	0.00	121.14	42.44	0.00
J10	3.30	121.07	42.57	0.00
J11	0.00	121.07	41.54	0.00
J12	0.00	122.83	44.63	0.00
J13	0.00	121.07	41.49	0.00
J14	0.00	119.95	41.05	0.00
J15	0.00	119.43	40.29	0.00
J16	0.00	115.37	36.30	0.00
J18	2.40	119.43	40.40	0.00

Page 3



	21106_Max	Day + Fire	@ 2100	Russell.rpt	
J19	0.00	121.07	41.22	0.00	
J2	0.00	123.07	44.57	0.00	
J22	185.60	97.01	18.96	0.00	
J23	0.00	103.63	25.37	0.00	
J24	1.50	103.63	24.77	0.00	
J25	3.30	121.07	41.47	0.00	
J26	2.40	122.83	45.15	0.00	
J27	0.00	122.84	45.28	0.00	
J3	2.40	123.06	44.86	0.00	
R1	-102.65	0.00	0.00	0.00	Reservoir
R2	-98.25	0.00	0.00	0.00	Reservoir



Page 4

Link Results at 1:00 Hrs:

Link ID	Flow LPS	Velocity m/s	Unit Headloss m/km	Status
P1	86.94	2.77	48.70	Open
P4	-133.27	4.24	107.42	Open
P13	-46.33	1.47	15.18	Open
P14	-46.33	1.47	12.92	Open
P15	-109.16	2.22	25.03	Open
P16	62.83	1.28	9.00	Open
P17	3.30	0.11	0.11	Open
P18	3.30	0.11	0.11	Open
P19	0.00	0.00	0.00	Open
P21	56.23	1.79	21.73	Open
P22	56.23	1.79	21.73	Open
P23	53.83	3.05	97.08	Open
P24	2.40	0.08	0.06	Open
P2	-3.30	0.11	0.11	Open
P3	53.83	3.05	97.08	Open
P5	-131.77	4.19	105.19	Open
P6	-1.50	0.05	0.03	Open
P7	-133.27	4.24	107.42	Open
P9	-13.30	0.19	0.18	Open
P10	-15.70	0.22	0.24	Open
P11	-15.70	0.22	0.24	Open
P12	-95.85	1.36	6.89	Open
P8	-2.40	0.14	0.31	Open
1	98.25	0.00	-123.07	Open Pump
2	102.65	0.00	-122.85	Open Pump

Node Results at 2:00 Hrs:



21106_Max Day + Fire @ 2100 Russell.rpt				
Node	Demand	Head	Pressure	Quality
ID	LPS	m	m	
J1	0.00	122.85	45.58	0.00
J200	0.00	119.89	41.82	0.00
J5	0.00	109.54	30.79	0.00
J8	0.00	120.39	41.72	0.00
J9	0.00	121.14	42.44	0.00
J10	3.30	121.07	42.57	0.00
J11	0.00	121.07	41.54	0.00
J12	0.00	122.83	44.63	0.00
J13	0.00	121.07	41.49	0.00
J14	0.00	119.95	41.05	0.00
J15	0.00	119.43	40.29	0.00
J16	0.00	115.37	36.30	0.00
J18	2.40	119.43	40.40	0.00
J19	0.00	121.07	41.22	0.00
J2	0.00	123.07	44.57	0.00
J22	185.60	97.01	18.96	0.00



Page 5

Node Results at 2:00 Hrs: (continued)

Node	Demand	Head	Pressure	Quality	
ID	LPS	m	m		
J23	0.00	103.63	25.37	0.00	
J24	1.50	103.63	24.77	0.00	
J25	3.30	121.07	41.47	0.00	
J26	2.40	122.83	45.15	0.00	
J27	0.00	122.84	45.28	0.00	
J3	2.40	123.06	44.86	0.00	
R1	-102.65	0.00	0.00	0.00	Reservoir
R2	-98.25	0.00	0.00	0.00	Reservoir

Link Results at 2:00 Hrs:

Link	Flow	Velocity	Unit	Headloss	Status
ID	LPS	m/s		m/km	
P1	86.94	2.77		48.70	Open
P4	-133.27	4.24		107.42	Open
P13	-46.33	1.47		15.18	Open
P14	-46.33	1.47		12.92	Open
P15	-109.16	2.22		25.03	Open
P16	62.83	1.28		9.00	Open
P17	3.30	0.11		0.11	Open

Page 5



	21106_Max	Day + Fire	@ 2100	Russell.rpt	
P18	3.30	0.11	0.11	Open	
P19	0.00	0.00	0.00	Open	
P21	56.23	1.79	21.73	Open	
P22	56.23	1.79	21.73	Open	
P23	53.83	3.05	97.08	Open	
P24	2.40	0.08	0.06	Open	
P2	-3.30	0.11	0.11	Open	
P3	53.83	3.05	97.08	Open	
P5	-131.77	4.19	105.19	Open	
P6	-1.50	0.05	0.03	Open	
P7	-133.27	4.24	107.42	Open	
P9	-13.30	0.19	0.18	Open	
P10	-15.70	0.22	0.24	Open	
P11	-15.70	0.22	0.24	Open	
P12	-95.85	1.36	6.89	Open	
P8	-2.40	0.14	0.31	Open	
1	98.25	0.00	-123.07	Open Pump	
2	102.65	0.00	-122.85	Open Pump	



Page 6

Node Results at 3:00 Hrs:

Node ID	Demand LPS	Head m	Pressure m	Quality
J1	0.00	122.85	45.58	0.00
J200	0.00	119.89	41.82	0.00
J5	0.00	109.54	30.79	0.00
J8	0.00	120.39	41.72	0.00
J9	0.00	121.14	42.44	0.00
J10	3.30	121.07	42.57	0.00
J11	0.00	121.07	41.54	0.00
J12	0.00	122.83	44.63	0.00
J13	0.00	121.07	41.49	0.00
J14	0.00	119.95	41.05	0.00
J15	0.00	119.43	40.29	0.00
J16	0.00	115.37	36.30	0.00
J18	2.40	119.43	40.40	0.00
J19	0.00	121.07	41.22	0.00
J2	0.00	123.07	44.57	0.00
J22	185.60	97.01	18.96	0.00
J23	0.00	103.63	25.37	0.00
J24	1.50	103.63	24.77	0.00
J25	3.30	121.07	41.47	0.00
J26	2.40	122.83	45.15	0.00
J27	0.00	122.84	45.28	0.00

Page 6



21106_Max Day + Fire @ 2100 Russell.rpt

J3	2.40	123.06	44.86	0.00	
R1	-102.65	0.00	0.00	0.00	Reservoir
R2	-98.25	0.00	0.00	0.00	Reservoir

Link Results at 3:00 Hrs:

Link ID	Flow LPS	Velocity m/s	Unit Headloss m/km	Status
P1	86.94	2.77	48.70	Open
P4	-133.27	4.24	107.42	Open
P13	-46.33	1.47	15.18	Open
P14	-46.33	1.47	12.92	Open
P15	-109.16	2.22	25.03	Open
P16	62.83	1.28	9.00	Open
P17	3.30	0.11	0.11	Open
P18	3.30	0.11	0.11	Open
P19	0.00	0.00	0.00	Open
P21	56.23	1.79	21.73	Open
P22	56.23	1.79	21.73	Open
P23	53.83	3.05	97.08	Open
P24	2.40	0.08	0.06	Open
P2	-3.30	0.11	0.11	Open
P3	53.83	3.05	97.08	Open
P5	-131.77	4.19	105.19	Open
P6	-1.50	0.05	0.03	Open



Page 7

Link Results at 3:00 Hrs: (continued)

Link ID	Flow LPS	Velocity m/s	Unit Headloss m/km	Status
P7	-133.27	4.24	107.42	Open
P9	-13.30	0.19	0.18	Open
P10	-15.70	0.22	0.24	Open
P11	-15.70	0.22	0.24	Open
P12	-95.85	1.36	6.89	Open
P8	-2.40	0.14	0.31	Open
1	98.25	0.00	-123.07	Open Pump
2	102.65	0.00	-122.85	Open Pump

Node Results at 4:00 Hrs:

Node ID	Demand LPS	Head m	Pressure m	Quality
---------	------------	--------	------------	---------



	21106_Max	Day + Fire	@ 2100	Russell.rpt	
J1	0.00	122.85	45.58	0.00	
J200	0.00	119.89	41.82	0.00	
J5	0.00	109.54	30.79	0.00	
J8	0.00	120.39	41.72	0.00	
J9	0.00	121.14	42.44	0.00	
J10	3.30	121.07	42.57	0.00	
J11	0.00	121.07	41.54	0.00	
J12	0.00	122.83	44.63	0.00	
J13	0.00	121.07	41.49	0.00	
J14	0.00	119.95	41.05	0.00	
J15	0.00	119.43	40.29	0.00	
J16	0.00	115.37	36.30	0.00	
J18	2.40	119.43	40.40	0.00	
J19	0.00	121.07	41.22	0.00	
J2	0.00	123.07	44.57	0.00	
J22	185.60	97.01	18.96	0.00	
J23	0.00	103.63	25.37	0.00	
J24	1.50	103.63	24.77	0.00	
J25	3.30	121.07	41.47	0.00	
J26	2.40	122.83	45.15	0.00	
J27	0.00	122.84	45.28	0.00	
J3	2.40	123.06	44.86	0.00	
R1	-102.65	0.00	0.00	0.00	Reservoir
R2	-98.25	0.00	0.00	0.00	Reservoir



Page 8

Link Results at 4:00 Hrs:

Link ID	Flow LPS	Velocity m/s	Unit Headloss m/km	Status
P1	86.94	2.77	48.70	Open
P4	-133.27	4.24	107.42	Open
P13	-46.33	1.47	15.18	Open
P14	-46.33	1.47	12.92	Open
P15	-109.16	2.22	25.03	Open
P16	62.83	1.28	9.00	Open
P17	3.30	0.11	0.11	Open
P18	3.30	0.11	0.11	Open
P19	0.00	0.00	0.00	Open
P21	56.23	1.79	21.73	Open
P22	56.23	1.79	21.73	Open
P23	53.83	3.05	97.08	Open
P24	2.40	0.08	0.06	Open
P2	-3.30	0.11	0.11	Open
P3	53.83	3.05	97.08	Open

Page 8



21106_Max Day + Fire @ 2100 Russell.rpt				
P5	-131.77	4.19	105.19	Open
P6	-1.50	0.05	0.03	Open
P7	-133.27	4.24	107.42	Open
P9	-13.30	0.19	0.18	Open
P10	-15.70	0.22	0.24	Open
P11	-15.70	0.22	0.24	Open
P12	-95.85	1.36	6.89	Open
P8	-2.40	0.14	0.31	Open
1	98.25	0.00	-123.07	Open Pump
2	102.65	0.00	-122.85	Open Pump



**Maximum Day + Fire Flow
Conditions at Building A
(Node J18)**

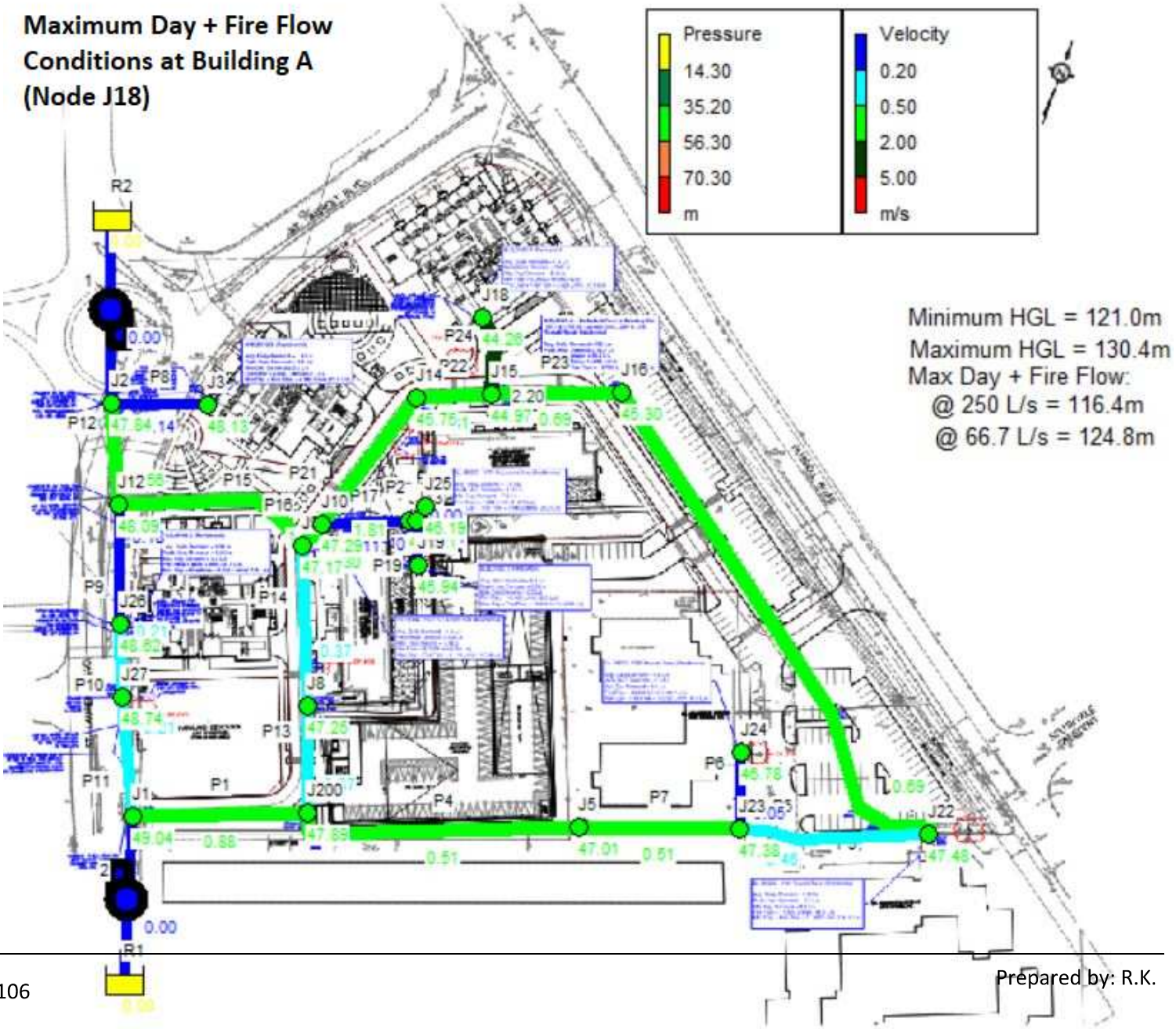
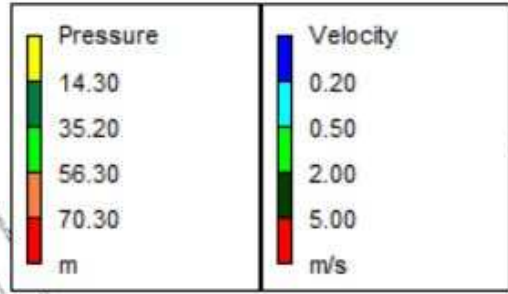



21106_Max Day + Fire @ Building A.rpt

Page 1

2023-03-14 3:43:15 PM

```
*****
*                               *
*           E P A N E T         *
*           Hydraulic and Water Quality *
*           Analysis for Pipe Networks *
*           Version 2.2         *
*****
```

Input File: 21106_Max Day + Fire @ Building A-2023.net

Link - Node Table:

Link ID	Start Node	End Node	Length m	Diameter mm	
P1	J1	J200	60.78	200	
P4	J5	J200	96.37	200	
P13	J200	J8	32.72	200	
P14	J8	J9	58.6	200	
P15	J9	J12	67.26	250	
P16	J9	J10	7.91	250	
P17	J10	J11	31.176	200	
P18	J11	J13	2.28	200	
P19	J13	J19	18.81	200	
P21	J10	J14	51.579	200	
P22	J14	J15	23.86	200	
P23	J15	J16	41.8	150	
P24	J15	J18	26	200	
P2	J25	J13	5.633	200	
P3	J16	J22	189.127	150	
P5	J22	J23	62.85	200	
P6	J24	J23	25.34	200	
P7	J23	J5	55.03	200	
P9	J12	J26	44	300	
P10	J26	J27	21.3	300	
P11	J27	J1	39.51	300	
P12	J12	J2	36.02	300	
P8	J3	J2	31.93	150	
1	R2	J2	#N/A	#N/A	Pump
2	R1	J1	#N/A	#N/A	Pump

Energy Usage:

Pump	Usage Factor	Avg. Effic.	Kw-hr /m3	Avg. Kw	Peak Kw	Cost /day



21106_Max Day + Fire @ Building A.rpt

1	100.00	75.00	0.46	69.26	69.26	0.00
2	100.00	75.00	0.46	69.93	69.93	0.00

 Demand Charge: 0.00
 Total Cost: 0.00



Page 2

Node Results at 0:00 Hrs:

Node ID	Demand LPS	Head m	Pressure m	Quality	
J1	0.00	126.31	49.04	0.00	
J200	0.00	125.96	47.89	0.00	
J5	0.00	125.76	47.01	0.00	
J8	0.00	125.92	47.25	0.00	
J9	0.00	125.87	47.17	0.00	
J10	3.30	125.79	47.29	0.00	
J11	0.00	125.79	46.26	0.00	
J12	0.00	126.29	48.09	0.00	
J13	0.00	125.79	46.21	0.00	
J14	0.00	124.65	45.75	0.00	
J15	0.00	124.11	44.97	0.00	
J16	0.00	124.37	45.30	0.00	
J18	69.10	123.29	44.26	0.00	
J19	0.00	125.79	45.94	0.00	
J2	0.00	126.34	47.84	0.00	
J22	2.30	125.53	47.48	0.00	
J23	0.00	125.64	47.38	0.00	
J24	1.50	125.64	46.78	0.00	
J25	3.30	125.79	46.19	0.00	
J26	2.40	126.30	48.62	0.00	
J27	0.00	126.30	48.74	0.00	
J3	2.40	126.33	48.13	0.00	
R1	-42.36	0.00	0.00	0.00	Reservoir
R2	-41.94	0.00	0.00	0.00	Reservoir

Link Results at 0:00 Hrs:

Link ID	Flow LPS	Velocity m/s	Unit Headloss m/km	Status
P1	27.49	0.88	5.77	Open
P4	-15.93	0.51	2.10	Open
P13	11.56	0.37	1.16	Open
P14	11.56	0.37	0.99	Open

Page 2



	21106_Max Day + Fire @ Building A.rpt			
P15	-52.01	1.06	6.34	Open
P16	-63.57	1.30	9.20	Open
P17	3.30	0.11	0.11	Open
P18	3.30	0.11	0.11	Open
P19	0.00	0.00	0.00	Open
P21	56.97	1.81	22.26	Open
P22	56.97	1.81	22.26	Open
P23	-12.13	0.69	6.15	Open
P24	69.10	2.20	31.83	Open
P2	-3.30	0.11	0.11	Open
P3	-12.13	0.69	6.15	Open
P5	-14.43	0.46	1.75	Open
P6	-1.50	0.05	0.03	Open



Page 3

Link Results at 0:00 Hrs: (continued)

Link ID	Flow LPS	Velocity m/s	Unit Headloss m/km	Status
P7	-15.93	0.51	2.10	Open
P9	-12.47	0.18	0.16	Open
P10	-14.87	0.21	0.22	Open
P11	-14.87	0.21	0.22	Open
P12	-39.54	0.56	1.34	Open
P8	-2.40	0.14	0.31	Open
1	41.94	0.00	-126.34	Open Pump
2	42.36	0.00	-126.31	Open Pump

Node Results at 1:00 Hrs:

Node ID	Demand LPS	Head m	Pressure m	Quality
J1	0.00	126.31	49.04	0.00
J200	0.00	125.96	47.89	0.00
J5	0.00	125.76	47.01	0.00
J8	0.00	125.92	47.25	0.00
J9	0.00	125.87	47.17	0.00
J10	3.30	125.79	47.29	0.00
J11	0.00	125.79	46.26	0.00
J12	0.00	126.29	48.09	0.00
J13	0.00	125.79	46.21	0.00
J14	0.00	124.65	45.75	0.00
J15	0.00	124.11	44.97	0.00
J16	0.00	124.37	45.30	0.00
J18	69.10	123.29	44.26	0.00

Page 3



21106_Max Day + Fire @ Building A.rpt				
J19	0.00	125.79	45.94	0.00
J2	0.00	126.34	47.84	0.00
J22	2.30	125.53	47.48	0.00
J23	0.00	125.64	47.38	0.00
J24	1.50	125.64	46.78	0.00
J25	3.30	125.79	46.19	0.00
J26	2.40	126.30	48.62	0.00
J27	0.00	126.30	48.74	0.00
J3	2.40	126.33	48.13	0.00
R1	-42.36	0.00	0.00	0.00 Reservoir
R2	-41.94	0.00	0.00	0.00 Reservoir



Page 4

Link Results at 1:00 Hrs:

Link ID	Flow LPS	Velocity m/s	Unit Headloss m/km	Status
P1	27.49	0.88	5.77	Open
P4	-15.93	0.51	2.10	Open
P13	11.56	0.37	1.16	Open
P14	11.56	0.37	0.99	Open
P15	-52.01	1.06	6.34	Open
P16	63.57	1.30	9.20	Open
P17	3.30	0.11	0.11	Open
P18	3.30	0.11	0.11	Open
P19	0.00	0.00	0.00	Open
P21	56.97	1.81	22.26	Open
P22	56.97	1.81	22.26	Open
P23	-12.13	0.69	6.15	Open
P24	69.10	2.20	31.83	Open
P2	-3.30	0.11	0.11	Open
P3	-12.13	0.69	6.15	Open
P5	-14.43	0.46	1.75	Open
P6	-1.50	0.05	0.03	Open
P7	-15.93	0.51	2.10	Open
P9	-12.47	0.18	0.16	Open
P10	-14.87	0.21	0.22	Open
P11	-14.87	0.21	0.22	Open
P12	-39.54	0.56	1.34	Open
P8	-2.40	0.14	0.31	Open
1	41.94	0.00	-126.34	Open Pump
2	42.36	0.00	-126.31	Open Pump

Node Results at 2:00 Hrs:



21106_Max Day + Fire @ Building A.rpt				
Node	Demand	Head	Pressure	Quality
ID	LPS	m	m	
J1	0.00	126.31	49.04	0.00
J200	0.00	125.96	47.89	0.00
J5	0.00	125.76	47.01	0.00
J8	0.00	125.92	47.25	0.00
J9	0.00	125.87	47.17	0.00
J10	3.30	125.79	47.29	0.00
J11	0.00	125.79	46.26	0.00
J12	0.00	126.29	48.09	0.00
J13	0.00	125.79	46.21	0.00
J14	0.00	124.65	45.75	0.00
J15	0.00	124.11	44.97	0.00
J16	0.00	124.37	45.30	0.00
J18	69.10	123.29	44.26	0.00
J19	0.00	125.79	45.94	0.00
J2	0.00	126.34	47.84	0.00
J22	2.30	125.53	47.48	0.00



Page 5

Node Results at 2:00 Hrs: (continued)

Node	Demand	Head	Pressure	Quality	
ID	LPS	m	m		
J23	0.00	125.64	47.38	0.00	
J24	1.50	125.64	46.78	0.00	
J25	3.30	125.79	46.19	0.00	
J26	2.40	126.30	48.62	0.00	
J27	0.00	126.30	48.74	0.00	
J3	2.40	126.33	48.13	0.00	
R1	-42.36	0.00	0.00	0.00	Reservoir
R2	-41.94	0.00	0.00	0.00	Reservoir

Link Results at 2:00 Hrs:

Link	Flow	Velocity	Unit	Headloss	Status
ID	LPS	m/s		m/km	
P1	27.49	0.88		5.77	Open
P4	-15.93	0.51		2.10	Open
P13	11.56	0.37		1.16	Open
P14	11.56	0.37		0.99	Open
P15	-52.01	1.06		6.34	Open
P16	63.57	1.30		9.20	Open
P17	3.30	0.11		0.11	Open

Page 5



	21106_Max Day + Fire @ Building A.rpt				
P18	3.30	0.11	0.11	Open	
P19	0.00	0.00	0.00	Open	
P21	56.97	1.81	22.26	Open	
P22	56.97	1.81	22.26	Open	
P23	-12.13	0.69	6.15	Open	
P24	69.10	2.20	31.83	Open	
P2	-3.30	0.11	0.11	Open	
P3	-12.13	0.69	6.15	Open	
P5	-14.43	0.46	1.75	Open	
P6	-1.50	0.05	0.03	Open	
P7	-15.93	0.51	2.10	Open	
P9	-12.47	0.18	0.16	Open	
P10	-14.87	0.21	0.22	Open	
P11	-14.87	0.21	0.22	Open	
P12	-39.54	0.56	1.34	Open	
P8	-2.40	0.14	0.31	Open	
1	41.94	0.00	-126.34	Open Pump	
2	42.36	0.00	-126.31	Open Pump	



Page 6

Node Results at 3:00 Hrs:

Node ID	Demand LPS	Head m	Pressure m	Quality
J1	0.00	126.31	49.04	0.00
J200	0.00	125.96	47.89	0.00
J5	0.00	125.76	47.01	0.00
J8	0.00	125.92	47.25	0.00
J9	0.00	125.87	47.17	0.00
J10	3.30	125.79	47.29	0.00
J11	0.00	125.79	46.26	0.00
J12	0.00	126.29	48.09	0.00
J13	0.00	125.79	46.21	0.00
J14	0.00	124.65	45.75	0.00
J15	0.00	124.11	44.97	0.00
J16	0.00	124.37	45.30	0.00
J18	69.10	123.29	44.26	0.00
J19	0.00	125.79	45.94	0.00
J2	0.00	126.34	47.84	0.00
J22	2.30	125.53	47.48	0.00
J23	0.00	125.64	47.38	0.00
J24	1.50	125.64	46.78	0.00
J25	3.30	125.79	46.19	0.00
J26	2.40	126.30	48.62	0.00
J27	0.00	126.30	48.74	0.00

Page 6



21106_Max Day + Fire @ Building A.rpt				
J3	2.40	126.33	48.13	0.00
R1	-42.36	0.00	0.00	0.00 Reservoir
R2	-41.94	0.00	0.00	0.00 Reservoir

Link Results at 3:00 Hrs:

Link ID	Flow LPS	Velocity m/s	Unit Headloss m/km	Status
P1	27.49	0.88	5.77	Open
P4	-15.93	0.51	2.10	Open
P13	11.56	0.37	1.16	Open
P14	11.56	0.37	0.99	Open
P15	-52.01	1.06	6.34	Open
P16	63.57	1.30	9.20	Open
P17	3.30	0.11	0.11	Open
P18	3.30	0.11	0.11	Open
P19	0.00	0.00	0.00	Open
P21	56.97	1.81	22.26	Open
P22	56.97	1.81	22.26	Open
P23	-12.13	0.69	6.15	Open
P24	69.10	2.20	31.83	Open
P2	-3.30	0.11	0.11	Open
P3	-12.13	0.69	6.15	Open
P5	-14.43	0.46	1.75	Open
P6	-1.50	0.05	0.03	Open



Page 7

Link Results at 3:00 Hrs: (continued)

Link ID	Flow LPS	Velocity m/s	Unit Headloss m/km	Status
P7	-15.93	0.51	2.10	Open
P9	-12.47	0.18	0.16	Open
P10	-14.87	0.21	0.22	Open
P11	-14.87	0.21	0.22	Open
P12	-39.54	0.56	1.34	Open
P8	-2.40	0.14	0.31	Open
1	41.94	0.00	-126.34	Open Pump
2	42.36	0.00	-126.31	Open Pump

Node Results at 4:00 Hrs:

Node ID	Demand LPS	Head m	Pressure m	Quality
---------	------------	--------	------------	---------



21106_Max Day + Fire @ Building A.rpt				
J1	0.00	126.31	49.04	0.00
J200	0.00	125.96	47.89	0.00
J5	0.00	125.76	47.01	0.00
J8	0.00	125.92	47.25	0.00
J9	0.00	125.87	47.17	0.00
J10	3.30	125.79	47.29	0.00
J11	0.00	125.79	46.26	0.00
J12	0.00	126.29	48.09	0.00
J13	0.00	125.79	46.21	0.00
J14	0.00	124.65	45.75	0.00
J15	0.00	124.11	44.97	0.00
J16	0.00	124.37	45.30	0.00
J18	69.10	123.29	44.26	0.00
J19	0.00	125.79	45.94	0.00
J2	0.00	126.34	47.84	0.00
J22	2.30	125.53	47.48	0.00
J23	0.00	125.64	47.38	0.00
J24	1.50	125.64	46.78	0.00
J25	3.30	125.79	46.19	0.00
J26	2.40	126.30	48.62	0.00
J27	0.00	126.30	48.74	0.00
J3	2.40	126.33	48.13	0.00
R1	-42.36	0.00	0.00	0.00 Reservoir
R2	-41.94	0.00	0.00	0.00 Reservoir



Page 8

Link Results at 4:00 Hrs:

Link ID	Flow LPS	Velocity m/s	Unit Headloss m/km	Status
P1	27.49	0.88	5.77	Open
P4	-15.93	0.51	2.10	Open
P13	11.56	0.37	1.16	Open
P14	11.56	0.37	0.99	Open
P15	-52.01	1.06	6.34	Open
P16	63.57	1.30	9.20	Open
P17	3.30	0.11	0.11	Open
P18	3.30	0.11	0.11	Open
P19	0.00	0.00	0.00	Open
P21	56.97	1.81	22.26	Open
P22	56.97	1.81	22.26	Open
P23	-12.13	0.69	6.15	Open
P24	69.10	2.20	31.82	Open
P2	-3.30	0.11	0.11	Open
P3	-12.13	0.69	6.15	Open

Page 8



21106_Max Day + Fire @ Building A.rpt					
P5	-14.43	0.46	1.75	Open	
P6	-1.50	0.05	0.03	Open	
P7	-15.93	0.51	2.10	Open	
P9	-12.47	0.18	0.16	Open	
P10	-14.87	0.21	0.22	Open	
P11	-14.87	0.21	0.22	Open	
P12	-39.54	0.56	1.34	Open	
P8	-2.40	0.14	0.31	Open	
1	41.94	0.00	-126.34	Open Pump	
2	42.36	0.00	-126.31	Open Pump	



**Maximum Day + Fire Flow
Conditions at Building B
(Node J3)**

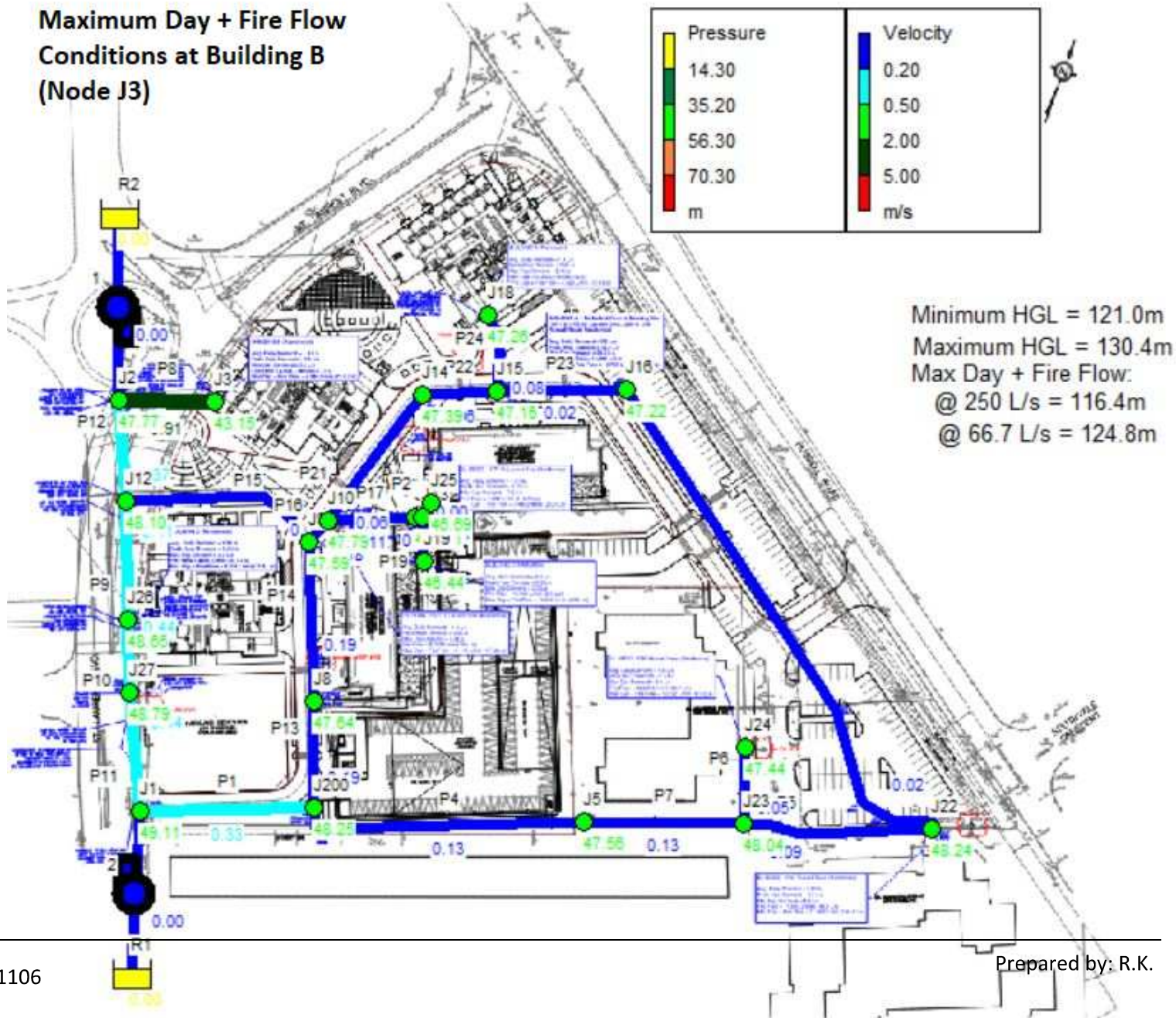



21106_Max Day + Fire @ Building B.rpt

Page 1

2023-03-14 3:42:06 PM

```
*****
*                               *
*               E P A N E T     *
*           Hydraulic and Water Quality *
*           Analysis for Pipe Networks *
*               Version 2.2       *
*                               *
*****
```

Input File: 21106_Max Day + Fire @ Building B-2023.net

Link - Node Table:

Link ID	Start Node	End Node	Length m	Diameter mm	
P1	J1	J200	60.78	200	
P4	J5	J200	96.37	200	
P13	J200	J8	32.72	200	
P14	J8	J9	58.6	200	
P15	J9	J12	67.26	250	
P16	J9	J10	7.91	250	
P17	J10	J11	31.176	200	
P18	J11	J13	2.28	200	
P19	J13	J19	18.81	200	
P21	J10	J14	51.579	200	
P22	J14	J15	23.86	200	
P23	J15	J16	41.8	150	
P24	J15	J18	26	200	
P2	J25	J13	5.633	200	
P3	J16	J22	189.127	150	
P5	J22	J23	62.85	200	
P6	J24	J23	25.34	200	
P7	J23	J5	55.03	200	
P9	J12	J26	44	300	
P10	J26	J27	21.3	300	
P11	J27	J1	39.51	300	
P12	J12	J2	36.02	300	
P8	J3	J2	31.93	150	
1	R2	J2	#N/A	#N/A	Pump
2	R1	J1	#N/A	#N/A	Pump

Energy Usage:

Pump	Usage Factor	Avg. Effic.	Kw-hr /m3	Avg. Kw	Peak Kw	Cost /day



21106_Max Day + Fire @ Building B.rpt

1	100.00	75.00	0.46	70.88	70.88	0.00
2	100.00	75.00	0.46	68.31	68.31	0.00

Demand Charge: 0.00
Total Cost: 0.00



Page 2

Node Results at 0:00 Hrs:

Node ID	Demand LPS	Head m	Pressure m	Quality	
J1	0.00	126.38	49.11	0.00	
J200	0.00	126.32	48.25	0.00	
J5	0.00	126.31	47.56	0.00	
J8	0.00	126.31	47.64	0.00	
J9	0.00	126.29	47.59	0.00	
J10	3.30	126.29	47.79	0.00	
J11	0.00	126.29	46.76	0.00	
J12	0.00	126.30	48.10	0.00	
J13	0.00	126.29	46.71	0.00	
J14	0.00	126.29	47.39	0.00	
J15	0.00	126.29	47.15	0.00	
J16	0.00	126.29	47.22	0.00	
J18	2.40	126.29	47.26	0.00	
J19	0.00	126.29	46.44	0.00	
J2	0.00	126.27	47.77	0.00	
J22	2.30	126.29	48.24	0.00	
J23	0.00	126.30	48.04	0.00	
J24	1.50	126.30	47.44	0.00	
J25	3.30	126.29	46.69	0.00	
J26	2.40	126.33	48.65	0.00	
J27	0.00	126.35	48.79	0.00	
J3	69.10	121.35	43.15	0.00	
R1	-41.35	0.00	0.00	0.00	Reservoir
R2	-42.95	0.00	0.00	0.00	Reservoir

Link Results at 0:00 Hrs:

Link ID	Flow LPS	Velocity m/s	Unit Headloss m/km	Status
P1	10.28	0.33	0.93	Open
P4	-4.20	0.13	0.18	Open
P13	6.09	0.19	0.35	Open
P14	6.09	0.19	0.30	Open

Page 2



	21106_Max Day + Fire @ Building B.rpt			
P15	-2.52	0.05	0.02	Open
P16	-8.60	0.18	0.23	Open
P17	3.30	0.11	0.11	Open
P18	3.30	0.11	0.11	Open
P19	0.00	0.00	0.00	Open
P21	2.00	0.06	0.05	Open
P22	2.00	0.06	0.04	Open
P23	-0.40	0.02	0.01	Open
P24	2.40	0.08	0.06	Open
P2	-3.30	0.11	0.11	Open
P3	-0.40	0.02	0.01	Open
P5	-2.70	0.09	0.08	Open
P6	-1.50	0.05	0.03	Open



Page 3

Link Results at 0:00 Hrs: (continued)

Link ID	Flow LPS	Velocity m/s	Unit Headloss m/km	Status
P7	-4.20	0.13	0.18	Open
P9	-28.67	0.41	0.74	Open
P10	-31.07	0.44	0.86	Open
P11	-31.07	0.44	0.86	Open
P12	26.15	0.37	0.62	Open
P8	-69.10	3.91	154.17	Open
1	42.95	0.00	-126.27	Open Pump
2	41.35	0.00	-126.38	Open Pump

Node Results at 1:00 Hrs:

Node ID	Demand LPS	Head m	Pressure m	Quality
J1	0.00	126.38	49.11	0.00
J200	0.00	126.32	48.25	0.00
J5	0.00	126.31	47.56	0.00
J8	0.00	126.31	47.64	0.00
J9	0.00	126.29	47.59	0.00
J10	3.30	126.29	47.79	0.00
J11	0.00	126.29	46.76	0.00
J12	0.00	126.30	48.10	0.00
J13	0.00	126.29	46.71	0.00
J14	0.00	126.29	47.39	0.00
J15	0.00	126.29	47.15	0.00
J16	0.00	126.29	47.22	0.00
J18	2.40	126.29	47.26	0.00

Page 3



21106_Max Day + Fire @ Building B.rpt				
J19	0.00	126.29	46.44	0.00
J2	0.00	126.27	47.77	0.00
J22	2.30	126.29	48.24	0.00
J23	0.00	126.30	48.04	0.00
J24	1.50	126.30	47.44	0.00
J25	3.30	126.29	46.69	0.00
J26	2.40	126.33	48.65	0.00
J27	0.00	126.35	48.79	0.00
J3	69.10	121.35	43.15	0.00
R1	-41.35	0.00	0.00	0.00 Reservoir
R2	-42.95	0.00	0.00	0.00 Reservoir



Page 4

Link Results at 1:00 Hrs:

Link ID	Flow LPS	Velocity m/s	Unit Headloss m/km	Status
P1	10.28	0.33	0.93	Open
P4	-4.20	0.13	0.18	Open
P13	6.09	0.19	0.35	Open
P14	6.09	0.19	0.30	Open
P15	-2.52	0.05	0.02	Open
P16	8.60	0.18	0.23	Open
P17	3.30	0.11	0.11	Open
P18	3.30	0.11	0.11	Open
P19	0.00	0.00	0.00	Open
P21	2.00	0.06	0.05	Open
P22	2.00	0.06	0.04	Open
P23	-0.40	0.02	0.01	Open
P24	2.40	0.08	0.06	Open
P2	-3.30	0.11	0.11	Open
P3	-0.40	0.02	0.01	Open
P5	-2.70	0.09	0.08	Open
P6	-1.50	0.05	0.03	Open
P7	-4.20	0.13	0.18	Open
P9	-28.67	0.41	0.74	Open
P10	-31.07	0.44	0.86	Open
P11	-31.07	0.44	0.86	Open
P12	26.15	0.37	0.62	Open
P8	-69.10	3.91	154.17	Open
1	42.95	0.00	-126.27	Open Pump
2	41.35	0.00	-126.38	Open Pump

Node Results at 2:00 Hrs:

Page 4



21106_Max Day + Fire @ Building B.rpt				
Node	Demand	Head	Pressure	Quality
ID	LPS	m	m	
J1	0.00	126.38	49.11	0.00
J200	0.00	126.32	48.25	0.00
J5	0.00	126.31	47.56	0.00
J8	0.00	126.31	47.64	0.00
J9	0.00	126.29	47.59	0.00
J10	3.30	126.29	47.79	0.00
J11	0.00	126.29	46.76	0.00
J12	0.00	126.30	48.10	0.00
J13	0.00	126.29	46.71	0.00
J14	0.00	126.29	47.39	0.00
J15	0.00	126.29	47.15	0.00
J16	0.00	126.29	47.22	0.00
J18	2.40	126.29	47.26	0.00
J19	0.00	126.29	46.44	0.00
J2	0.00	126.27	47.77	0.00
J22	2.30	126.29	48.24	0.00



Page 5

Node Results at 2:00 Hrs: (continued)

Node	Demand	Head	Pressure	Quality	
ID	LPS	m	m		
J23	0.00	126.30	48.04	0.00	
J24	1.50	126.30	47.44	0.00	
J25	3.30	126.29	46.69	0.00	
J26	2.40	126.33	48.65	0.00	
J27	0.00	126.35	48.79	0.00	
J3	69.10	121.35	43.15	0.00	
R1	-41.35	0.00	0.00	0.00	Reservoir
R2	-42.95	0.00	0.00	0.00	Reservoir

Link Results at 2:00 Hrs:

Link	Flow	Velocity	Unit	Headloss	Status
ID	LPS	m/s		m/km	
P1	10.28	0.33		0.93	Open
P4	-4.20	0.13		0.18	Open
P13	6.09	0.19		0.35	Open
P14	6.09	0.19		0.30	Open
P15	-2.52	0.05		0.02	Open
P16	8.60	0.18		0.23	Open
P17	3.30	0.11		0.11	Open

Page 5



	21106_Max Day + Fire @ Building B.rpt				
P18	3.30	0.11	0.11	Open	
P19	0.00	0.00	0.00	Open	
P21	2.00	0.06	0.05	Open	
P22	2.00	0.06	0.04	Open	
P23	-0.40	0.02	0.01	Open	
P24	2.40	0.08	0.06	Open	
P2	-3.30	0.11	0.11	Open	
P3	-0.40	0.02	0.01	Open	
P5	-2.70	0.09	0.08	Open	
P6	-1.50	0.05	0.03	Open	
P7	-4.20	0.13	0.18	Open	
P9	-28.67	0.41	0.74	Open	
P10	-31.07	0.44	0.86	Open	
P11	-31.07	0.44	0.86	Open	
P12	26.15	0.37	0.62	Open	
P8	-69.10	3.91	154.17	Open	
1	42.95	0.00	-126.27	Open Pump	
2	41.35	0.00	-126.38	Open Pump	



Page 6

Node Results at 3:00 Hrs:

Node ID	Demand LPS	Head m	Pressure m	Quality
J1	0.00	126.38	49.11	0.00
J200	0.00	126.32	48.25	0.00
J5	0.00	126.31	47.56	0.00
J8	0.00	126.31	47.64	0.00
J9	0.00	126.29	47.59	0.00
J10	3.30	126.29	47.79	0.00
J11	0.00	126.29	46.76	0.00
J12	0.00	126.30	48.10	0.00
J13	0.00	126.29	46.71	0.00
J14	0.00	126.29	47.39	0.00
J15	0.00	126.29	47.15	0.00
J16	0.00	126.29	47.22	0.00
J18	2.40	126.29	47.26	0.00
J19	0.00	126.29	46.44	0.00
J2	0.00	126.27	47.77	0.00
J22	2.30	126.29	48.24	0.00
J23	0.00	126.30	48.04	0.00
J24	1.50	126.30	47.44	0.00
J25	3.30	126.29	46.69	0.00
J26	2.40	126.33	48.65	0.00
J27	0.00	126.35	48.79	0.00

Page 6



	21106_Max Day + Fire @ Building B.rpt				
J3	69.10	121.35	43.15	0.00	
R1	-41.35	0.00	0.00	0.00	Reservoir
R2	-42.95	0.00	0.00	0.00	Reservoir

Link Results at 3:00 Hrs:

Link ID	Flow LPS	Velocity m/s	Unit Headloss m/km	Status
P1	10.28	0.33	0.93	Open
P4	-4.20	0.13	0.18	Open
P13	6.09	0.19	0.35	Open
P14	6.09	0.19	0.30	Open
P15	-2.52	0.05	0.02	Open
P16	8.60	0.18	0.23	Open
P17	3.30	0.11	0.11	Open
P18	3.30	0.11	0.11	Open
P19	0.00	0.00	0.00	Open
P21	2.00	0.06	0.05	Open
P22	2.00	0.06	0.04	Open
P23	-0.40	0.02	0.01	Open
P24	2.40	0.08	0.06	Open
P2	-3.30	0.11	0.11	Open
P3	-0.40	0.02	0.01	Open
P5	-2.70	0.09	0.08	Open
P6	-1.50	0.05	0.03	Open



Page 7

Link Results at 3:00 Hrs: (continued)

Link ID	Flow LPS	Velocity m/s	Unit Headloss m/km	Status
P7	-4.20	0.13	0.18	Open
P9	-28.67	0.41	0.74	Open
P10	-31.07	0.44	0.86	Open
P11	-31.07	0.44	0.86	Open
P12	26.15	0.37	0.62	Open
P8	-69.10	3.91	154.17	Open
1	42.95	0.00	-126.27	Open Pump
2	41.35	0.00	-126.38	Open Pump

Node Results at 4:00 Hrs:

Node ID	Demand LPS	Head m	Pressure m	Quality
---------	------------	--------	------------	---------



21106_Max Day + Fire @ Building B.rpt				
J1	0.00	126.38	49.11	0.00
J200	0.00	126.32	48.25	0.00
J5	0.00	126.31	47.56	0.00
J8	0.00	126.31	47.64	0.00
J9	0.00	126.29	47.59	0.00
J10	3.30	126.29	47.79	0.00
J11	0.00	126.29	46.76	0.00
J12	0.00	126.30	48.10	0.00
J13	0.00	126.29	46.71	0.00
J14	0.00	126.29	47.39	0.00
J15	0.00	126.29	47.15	0.00
J16	0.00	126.29	47.22	0.00
J18	2.40	126.29	47.26	0.00
J19	0.00	126.29	46.44	0.00
J2	0.00	126.27	47.77	0.00
J22	2.30	126.29	48.24	0.00
J23	0.00	126.30	48.04	0.00
J24	1.50	126.30	47.44	0.00
J25	3.30	126.29	46.69	0.00
J26	2.40	126.33	48.65	0.00
J27	0.00	126.35	48.79	0.00
J3	69.10	121.35	43.15	0.00
R1	-41.35	0.00	0.00	0.00 Reservoir
R2	-42.95	0.00	0.00	0.00 Reservoir



Page 8

Link Results at 4:00 Hrs:

Link ID	Flow LPS	Velocity m/s	Unit Headloss m/km	Status
P1	10.28	0.33	0.93	Open
P4	-4.20	0.13	0.18	Open
P13	6.09	0.19	0.35	Open
P14	6.09	0.19	0.30	Open
P15	-2.52	0.05	0.02	Open
P16	8.60	0.18	0.23	Open
P17	3.30	0.11	0.11	Open
P18	3.30	0.11	0.11	Open
P19	0.00	0.00	0.00	Open
P21	2.00	0.06	0.05	Open
P22	2.00	0.06	0.04	Open
P23	-0.40	0.02	0.01	Open
P24	2.40	0.08	0.06	Open
P2	-3.30	0.11	0.11	Open
P3	-0.40	0.02	0.01	Open

Page 8



21106_Max Day + Fire @ Building B.rpt					
P5	-2.70	0.09	0.08		Open
P6	-1.50	0.05	0.03		Open
P7	-4.20	0.13	0.18		Open
P9	-28.67	0.41	0.74		Open
P10	-31.07	0.44	0.86		Open
P11	-31.07	0.44	0.86		Open
P12	26.15	0.37	0.62		Open
P8	-69.10	3.91	154.17		Open
1	42.95	0.00	-126.27		Open Pump
2	41.35	0.00	-126.38		Open Pump



**Maximum Day + Fire Flow
Conditions at Building D
(Node J19)**

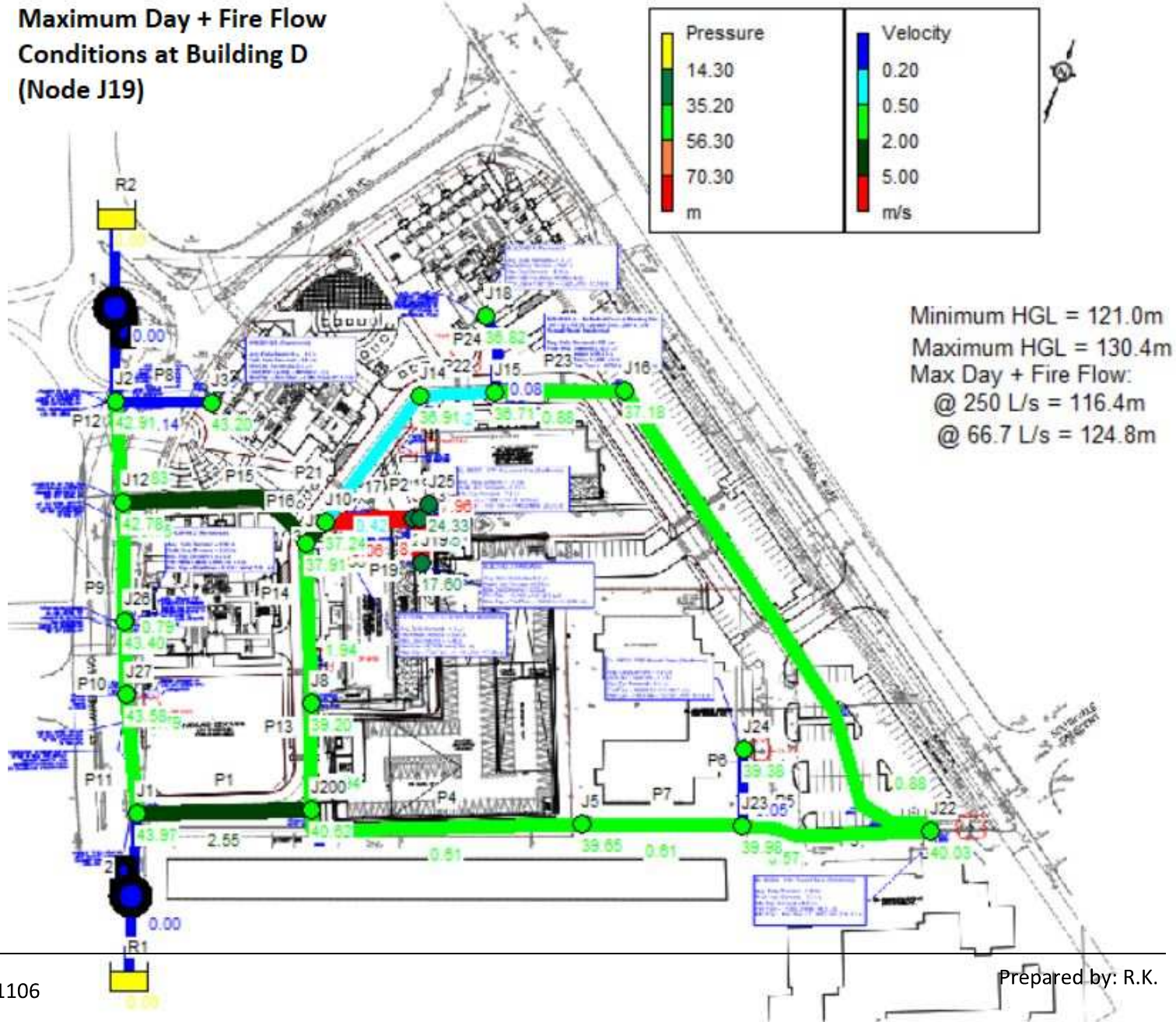



21106_Max Day + Fire @ Building D.rpt

Page 1

2023-03-14 3:39:18 PM

```
*****
*                               E P A N E T                               *
*                               Hydraulic and Water Quality                 *
*                               Analysis for Pipe Networks                   *
*                               Version 2.2                                 *
*****
```

Input File: 21106_Max Day + Fire @ Building D-2023.net

Link - Node Table:

Link ID	Start Node	End Node	Length m	Diameter mm	
P1	J1	J200	60.78	200	
P4	J5	J200	96.37	200	
P13	J200	J8	32.72	200	
P14	J8	J9	58.6	200	
P15	J9	J12	67.26	250	
P16	J9	J10	7.91	250	
P17	J10	J11	31.176	200	
P18	J11	J13	2.28	200	
P19	J13	J19	18.81	200	
P21	J10	J14	51.579	200	
P22	J14	J15	23.86	200	
P23	J15	J16	41.8	150	
P24	J15	J18	26	200	
P2	J25	J13	5.633	200	
P3	J16	J22	189.127	150	
P5	J22	J23	62.85	200	
P6	J24	J23	25.34	200	
P7	J23	J5	55.03	200	
P9	J12	J26	44	300	
P10	J26	J27	21.3	300	
P11	J27	J1	39.51	300	
P12	J12	J2	36.02	300	
P8	J3	J2	31.93	150	
1	R2	J2	#N/A	#N/A	Pump
2	R1	J1	#N/A	#N/A	Pump

Energy Usage:

Pump	Usage Factor	Avg. Effic.	Kw-hr /m3	Avg. Kw	Peak Kw	Cost /day



21106_Max Day + Fire @ Building D.rpt						
1	100.00	75.00	0.44	209.30	209.30	0.00
2	100.00	75.00	0.44	215.02	215.02	0.00

Demand Charge: 0.00
Total Cost: 0.00



Page 2

Node Results at 0:00 Hrs:

Node ID	Demand LPS	Head m	Pressure m	Quality	
J1	0.00	121.24	43.97	0.00	
J200	0.00	118.69	40.62	0.00	
J5	0.00	118.40	39.65	0.00	
J8	0.00	117.87	39.20	0.00	
J9	0.00	116.61	37.91	0.00	
J10	3.30	115.74	37.24	0.00	
J11	0.00	104.74	25.21	0.00	
J12	0.00	120.98	42.78	0.00	
J13	0.00	103.93	24.35	0.00	
J14	0.00	115.81	36.91	0.00	
J15	0.00	115.85	36.71	0.00	
J16	0.00	116.25	37.18	0.00	
J18	2.40	115.85	36.82	0.00	
J19	250.00	97.45	17.60	0.00	
J2	0.00	121.41	42.91	0.00	
J22	2.30	118.08	40.03	0.00	
J23	0.00	118.24	39.98	0.00	
J24	1.50	118.24	39.38	0.00	
J25	3.30	103.93	24.33	0.00	
J26	2.40	121.08	43.40	0.00	
J27	0.00	121.14	43.58	0.00	
J3	2.40	121.40	43.20	0.00	
R1	-135.70	0.00	0.00	0.00	Reservoir
R2	-131.90	0.00	0.00	0.00	Reservoir

Link Results at 0:00 Hrs:

Link ID	Flow LPS	Velocity m/s	Unit Headloss m/km	Status
P1	80.14	2.55	41.87	Open
P4	-19.28	0.61	2.99	Open
P13	60.86	1.94	25.16	Open
P14	60.86	1.94	21.41	Open

Page 2



21106_Max Day + Fire @ Building D.rpt

P15	-182.66	3.72	64.95	Open
P16	243.52	4.96	110.63	Open
P17	253.30	8.06	352.85	Open
P18	253.30	8.06	352.85	Open
P19	250.00	7.96	344.38	Open
P21	-13.08	0.42	1.46	Open
P22	-13.08	0.42	1.46	Open
P23	-15.48	0.88	9.65	Open
P24	2.40	0.08	0.06	Open
P2	-3.30	0.11	0.11	Open
P3	-15.48	0.88	9.65	Open
P5	-17.78	0.57	2.57	Open
P6	-1.50	0.05	0.03	Open



Page 3

Link Results at 0:00 Hrs: (continued)

Link ID	Flow LPS	Velocity m/s	Unit Headloss m/km	Status
P7	-19.28	0.61	2.99	Open
P9	-53.17	0.75	2.31	Open
P10	-55.57	0.79	2.51	Open
P11	-55.57	0.79	2.51	Open
P12	-129.50	1.83	12.03	Open
P8	-2.40	0.14	0.31	Open
1	131.90	0.00	-121.41	Open Pump
2	135.70	0.00	-121.24	Open Pump

Node Results at 1:00 Hrs:

Node ID	Demand LPS	Head m	Pressure m	Quality
J1	0.00	121.24	43.97	0.00
J200	0.00	118.69	40.62	0.00
J5	0.00	118.40	39.65	0.00
J8	0.00	117.87	39.20	0.00
J9	0.00	116.61	37.91	0.00
J10	3.30	115.74	37.24	0.00
J11	0.00	104.74	25.21	0.00
J12	0.00	120.98	42.78	0.00
J13	0.00	103.93	24.35	0.00
J14	0.00	115.81	36.91	0.00
J15	0.00	115.85	36.71	0.00
J16	0.00	116.25	37.18	0.00
J18	2.40	115.85	36.82	0.00

Page 3



	21106_Max Day + Fire @ Building D.rpt				
J19	250.00	97.45	17.60	0.00	
J2	0.00	121.41	42.91	0.00	
J22	2.30	118.08	40.03	0.00	
J23	0.00	118.24	39.98	0.00	
J24	1.50	118.24	39.38	0.00	
J25	3.30	103.93	24.33	0.00	
J26	2.40	121.08	43.40	0.00	
J27	0.00	121.14	43.58	0.00	
J3	2.40	121.40	43.20	0.00	
R1	-135.70	0.00	0.00	0.00	Reservoir
R2	-131.90	0.00	0.00	0.00	Reservoir



Page 4

Link Results at 1:00 Hrs:

Link ID	Flow LPS	Velocity m/s	Unit Headloss m/km	Status
P1	80.14	2.55	41.87	Open
P4	-19.28	0.61	2.99	Open
P13	60.86	1.94	25.16	Open
P14	60.86	1.94	21.41	Open
P15	-182.66	3.72	64.95	Open
P16	243.52	4.96	110.63	Open
P17	253.30	8.06	352.85	Open
P18	253.30	8.06	352.85	Open
P19	250.00	7.96	344.38	Open
P21	-13.08	0.42	1.46	Open
P22	-13.08	0.42	1.46	Open
P23	-15.48	0.88	9.65	Open
P24	2.40	0.08	0.06	Open
P2	-3.30	0.11	0.11	Open
P3	-15.48	0.88	9.65	Open
P5	-17.78	0.57	2.57	Open
P6	-1.50	0.05	0.03	Open
P7	-19.28	0.61	2.99	Open
P9	-53.17	0.75	2.31	Open
P10	-55.57	0.79	2.51	Open
P11	-55.57	0.79	2.51	Open
P12	-129.50	1.83	12.03	Open
P8	-2.40	0.14	0.31	Open
1	131.90	0.00	-121.41	Open Pump
2	135.70	0.00	-121.24	Open Pump

Node Results at 2:00 Hrs:



21106_Max Day + Fire @ Building D.rpt				
Node	Demand	Head	Pressure	Quality
ID	LPS	m	m	
J1	0.00	121.24	43.97	0.00
J200	0.00	118.69	40.62	0.00
J5	0.00	118.40	39.65	0.00
J8	0.00	117.87	39.20	0.00
J9	0.00	116.61	37.91	0.00
J10	3.30	115.74	37.24	0.00
J11	0.00	104.74	25.21	0.00
J12	0.00	120.98	42.78	0.00
J13	0.00	103.93	24.35	0.00
J14	0.00	115.81	36.91	0.00
J15	0.00	115.85	36.71	0.00
J16	0.00	116.25	37.18	0.00
J18	2.40	115.85	36.82	0.00
J19	250.00	97.45	17.60	0.00
J2	0.00	121.41	42.91	0.00
J22	2.30	118.08	40.03	0.00



Page 5

Node Results at 2:00 Hrs: (continued)

Node	Demand	Head	Pressure	Quality	
ID	LPS	m	m		
J23	0.00	118.24	39.98	0.00	
J24	1.50	118.24	39.38	0.00	
J25	3.30	103.93	24.33	0.00	
J26	2.40	121.08	43.40	0.00	
J27	0.00	121.14	43.58	0.00	
J3	2.40	121.40	43.20	0.00	
R1	-135.70	0.00	0.00	0.00	Reservoir
R2	-131.90	0.00	0.00	0.00	Reservoir

Link Results at 2:00 Hrs:

Link	Flow	Velocity	Unit	Headloss	Status
ID	LPS	m/s		m/km	
P1	80.14	2.55		41.87	Open
P4	-19.28	0.61		2.99	Open
P13	60.86	1.94		25.16	Open
P14	60.86	1.94		21.41	Open
P15	-182.66	3.72		64.95	Open
P16	243.52	4.96		110.63	Open
P17	253.30	8.06		352.85	Open

Page 5



	21106_Max Day + Fire @ Building D.rpt				
P18	253.30	8.06	352.85	Open	
P19	250.00	7.96	344.38	Open	
P21	-13.08	0.42	1.46	Open	
P22	-13.08	0.42	1.46	Open	
P23	-15.48	0.88	9.65	Open	
P24	2.40	0.08	0.06	Open	
P2	-3.30	0.11	0.11	Open	
P3	-15.48	0.88	9.65	Open	
P5	-17.78	0.57	2.57	Open	
P6	-1.50	0.05	0.03	Open	
P7	-19.28	0.61	2.99	Open	
P9	-53.17	0.75	2.31	Open	
P10	-55.57	0.79	2.51	Open	
P11	-55.57	0.79	2.51	Open	
P12	-129.50	1.83	12.03	Open	
P8	-2.40	0.14	0.31	Open	
1	131.90	0.00	-121.41	Open Pump	
2	135.70	0.00	-121.24	Open Pump	



Page 6

Node Results at 3:00 Hrs:

Node ID	Demand LPS	Head m	Pressure m	Quality
J1	0.00	121.24	43.97	0.00
J200	0.00	118.69	40.62	0.00
J5	0.00	118.40	39.65	0.00
J8	0.00	117.87	39.20	0.00
J9	0.00	116.61	37.91	0.00
J10	3.30	115.74	37.24	0.00
J11	0.00	104.74	25.21	0.00
J12	0.00	120.98	42.78	0.00
J13	0.00	103.93	24.35	0.00
J14	0.00	115.81	36.91	0.00
J15	0.00	115.85	36.71	0.00
J16	0.00	116.25	37.18	0.00
J18	2.40	115.85	36.82	0.00
J19	250.00	97.45	17.60	0.00
J2	0.00	121.41	42.91	0.00
J22	2.30	118.08	40.03	0.00
J23	0.00	118.24	39.98	0.00
J24	1.50	118.24	39.38	0.00
J25	3.30	103.93	24.33	0.00
J26	2.40	121.08	43.40	0.00
J27	0.00	121.14	43.58	0.00

Page 6



21106_Max Day + Fire @ Building D.rpt				
J3	2.40	121.40	43.20	0.00
R1	-135.70	0.00	0.00	0.00 Reservoir
R2	-131.90	0.00	0.00	0.00 Reservoir

Link Results at 3:00 Hrs:

Link ID	Flow LPS	Velocity m/s	Unit Headloss m/km	Status
P1	80.14	2.55	41.87	Open
P4	-19.28	0.61	2.99	Open
P13	60.86	1.94	25.16	Open
P14	60.86	1.94	21.41	Open
P15	-182.66	3.72	64.95	Open
P16	243.52	4.96	110.63	Open
P17	253.30	8.06	352.85	Open
P18	253.30	8.06	352.85	Open
P19	250.00	7.96	344.38	Open
P21	-13.08	0.42	1.46	Open
P22	-13.08	0.42	1.46	Open
P23	-15.48	0.88	9.65	Open
P24	2.40	0.08	0.06	Open
P2	-3.30	0.11	0.11	Open
P3	-15.48	0.88	9.65	Open
P5	-17.78	0.57	2.57	Open
P6	-1.50	0.05	0.03	Open

Page 7

Link Results at 3:00 Hrs: (continued)

Link ID	Flow LPS	Velocity m/s	Unit Headloss m/km	Status
P7	-19.28	0.61	2.99	Open
P9	-53.17	0.75	2.31	Open
P10	-55.57	0.79	2.51	Open
P11	-55.57	0.79	2.51	Open
P12	-129.50	1.83	12.03	Open
P8	-2.40	0.14	0.31	Open
1	131.90	0.00	-121.41	Open Pump
2	135.70	0.00	-121.24	Open Pump

Node Results at 4:00 Hrs:

Node ID	Demand LPS	Head m	Pressure m	Quality
---------	------------	--------	------------	---------



21106_Max Day + Fire @ Building D.rpt				
J1	0.00	121.24	43.97	0.00
J200	0.00	118.69	40.62	0.00
J5	0.00	118.40	39.65	0.00
J8	0.00	117.87	39.20	0.00
J9	0.00	116.61	37.91	0.00
J10	3.30	115.74	37.24	0.00
J11	0.00	104.74	25.21	0.00
J12	0.00	120.98	42.78	0.00
J13	0.00	103.93	24.35	0.00
J14	0.00	115.81	36.91	0.00
J15	0.00	115.85	36.71	0.00
J16	0.00	116.25	37.18	0.00
J18	2.40	115.85	36.82	0.00
J19	250.00	97.45	17.60	0.00
J2	0.00	121.41	42.91	0.00
J22	2.30	118.08	40.03	0.00
J23	0.00	118.24	39.98	0.00
J24	1.50	118.24	39.38	0.00
J25	3.30	103.93	24.33	0.00
J26	2.40	121.08	43.40	0.00
J27	0.00	121.14	43.58	0.00
J3	2.40	121.40	43.20	0.00
R1	-135.70	0.00	0.00	0.00 Reservoir
R2	-131.90	0.00	0.00	0.00 Reservoir



Page 8

Link Results at 4:00 Hrs:

Link ID	Flow LPS	Velocity m/s	Unit Headloss m/km	Status
P1	80.14	2.55	41.87	Open
P4	-19.28	0.61	2.99	Open
P13	60.86	1.94	25.16	Open
P14	60.86	1.94	21.41	Open
P15	-182.66	3.72	64.95	Open
P16	243.52	4.96	110.63	Open
P17	253.30	8.06	352.85	Open
P18	253.30	8.06	352.85	Open
P19	250.00	7.96	344.38	Open
P21	-13.08	0.42	1.46	Open
P22	-13.08	0.42	1.46	Open
P23	-15.48	0.88	9.65	Open
P24	2.40	0.08	0.06	Open
P2	-3.30	0.11	0.11	Open
P3	-15.48	0.88	9.65	Open

Page 8



21106_Max Day + Fire @ Building D.rpt				
P5	-17.78	0.57	2.57	Open
P6	-1.50	0.05	0.03	Open
P7	-19.28	0.61	2.99	Open
P9	-53.17	0.75	2.31	Open
P10	-55.57	0.79	2.51	Open
P11	-55.57	0.79	2.51	Open
P12	-129.50	1.83	12.03	Open
P8	-2.40	0.14	0.31	Open
1	131.90	0.00	-121.41	Open Pump
2	135.70	0.00	-121.24	Open Pump

Boundary Conditions for 1971, 1975 St. Laurent Boulevard

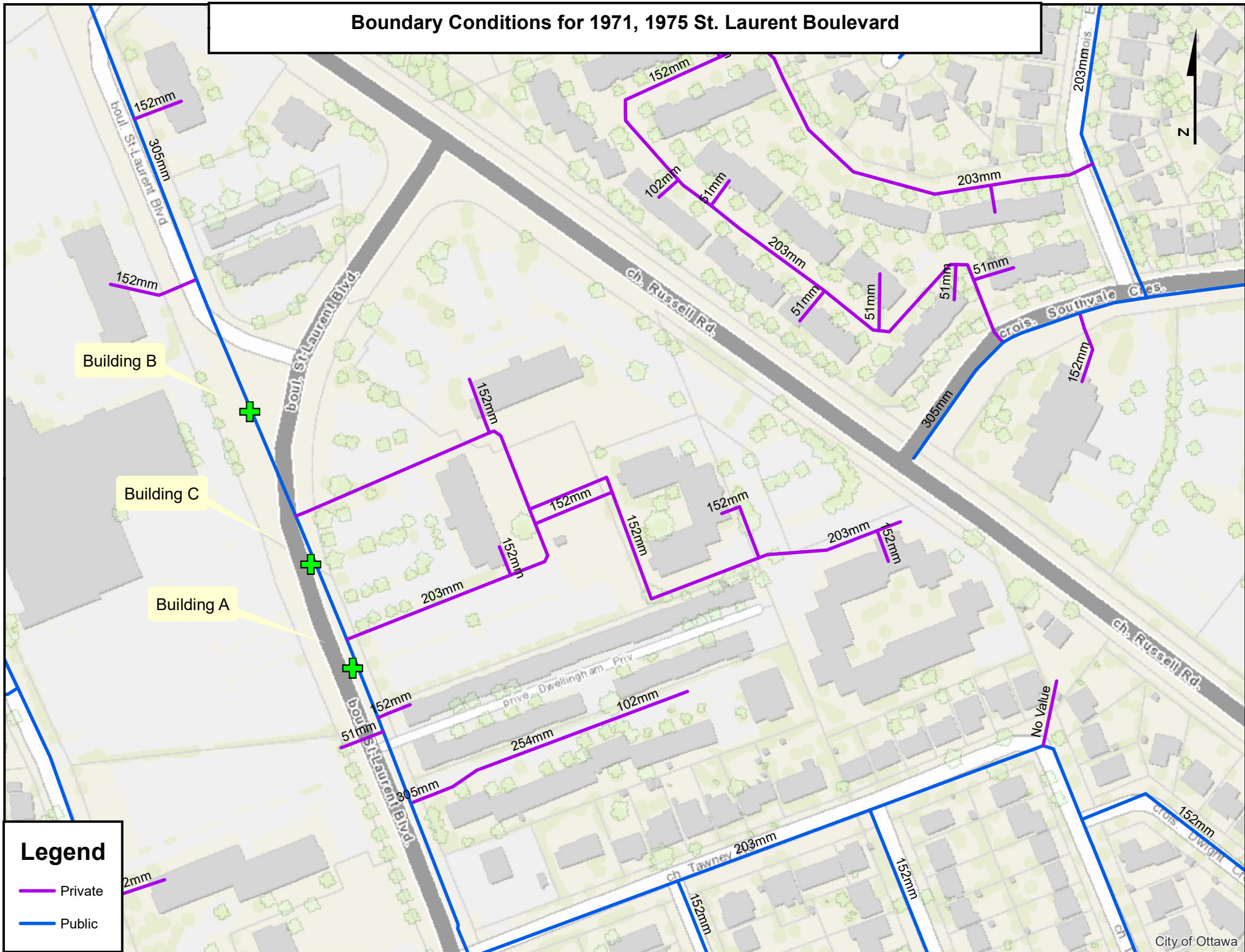

Legend

- Private
- Public

Sent: February 21, 2023 11:55 AM

To: Gian-Michael Di Luca <GDILuca@counterpointeng.com>

Cc: David Di Iorio <ddiiorio@counterpointeng.com>; 21106_ Starlight Dev't_ 1971 & 1975 St. Laurent Blvd <21106@counterpointeng.com>

Subject: RE: 1971, 1975 St Laurent, TEAMS link, sorry!

Good morning,

The following are boundary conditions, HGL, for hydraulic analysis at 1971, 1975 St-Laurent Boulevard (zone 2W2C) assumed to be connected to the 305 mm watermain on St-Laurent Boulevard (see attached PDF for location).

	Connection 1 Building A	Connection 2 Building C	Connection 3 Building B
Minimum HGL (m)	121.0	121.0	121.0
Maximum HGL (m)	130.4	130.4	130.4

Max Day + Fire Flow (250 L/s): 116.4 m (Building A)

Max Day + Fire Flow (66.7 L/s): 124.8 m (Building B)

Max Day + Fire Flow (66.7 L/s): 124.8 m (Building C)

These are for current conditions and are based on computer model simulation.

Disclaimer: The boundary condition information is based on current operation of the city water distribution system. The computer model simulation is based on the best information available at the time. The operation of the water distribution system can change on a regular basis, resulting in a variation in boundary conditions. The physical properties of watermains deteriorate over time, as such must be assumed in the absence of actual field test data. The variation in physical watermain properties can therefore alter the results of the computer model simulation.

Thank you,

--

Bruce Bramah, EIT

Project Manager

Planning, Real Estate and Economic Development Department / Direction générale de la planification, des biens immobiliers et du développement économique

Development Review - South Branch

City of Ottawa | Ville d'Ottawa

110 Laurier Avenue West Ottawa, ON | 110, avenue Laurier Ouest Ottawa (Ontario) K1P 1J1

613.580.2424 ext./poste 29686, Bruce.Bramah@ottawa.ca