

SERVICING & STORMWATER MANAGEMENT REPORT

68 SWEETLAND AVENUE, OTTAWA



Building Perspective Prepared by Woodman Architect & Associates Ltd.

Project No.: CCO-22-5087

City File No.: D07-12-22-0106

Prepared for:

Smart Living Properties
226 Argyle Avenue
Ottawa, Ontario
K2P 1B9

Prepared by:

McIntosh Perry Consulting Engineers Ltd.
115 Walgreen Road
Carp, ON K0A 1L0

June 10, 2022

Revised January 20th, 2023

McINTOSH PERRY

TABLE OF CONTENTS

1.0	PROJECT DESCRIPTION	3
1.1	Purpose	3
1.2	Site Description.....	3
1.3	Proposed Development and Statistics	4
1.4	Existing Conditions and Infrastructures.....	4
1.5	Approvals.....	4
2.0	BACKGROUND STUDIES, STANDARDS, AND REFERENCES	5
2.1	Background Reports / Reference Information.....	5
2.2	Applicable Guidelines and Standards.....	5
3.0	PRE-CONSULTATION SUMMARY	6
4.0	WATERMAIN	7
4.1	Existing Watermain	7
4.2	Proposed Watermain.....	7
5.0	SANITARY DESIGN	9
5.1	Existing Sanitary Sewer.....	9
5.2	Proposed Sanitary Sewer	9
6.0	STORM SEWER DESIGN	11
6.1	Existing Storm Sewers.....	11
6.2	Proposed Storm Sewers	11
7.0	PROPOSED STORM WATER MANAGEMENT	12
7.1	Design Criteria and Methodology.....	12
7.2	Runoff Calculations.....	12
7.3	Pre-Development Drainage.....	12
7.4	Post-Development Drainage	13
7.4.1	Development Area Drainage (B1-B3).....	13
7.4.2	Existing Drainage (B4-B7)	14
7.4.3	Sweetland Avenue ROW – Flow Breakdown.....	14
8.0	EROSION AND SEDIMENT CONTROL	16

8.1	Temporary Measures.....	16
8.2	Permanent Measures.....	16
9.0	SUMMARY.....	17
10.0	RECOMMENDATION.....	18
11.0	STATEMENT OF LIMITATIONS.....	19

LIST OF TABLES

Table 1: Water Supply Design Criteria.....	7
Table 2: Summary of Estimated Water Demand.....	7
Table 3: Boundary Conditions Results.....	8
Table 4: Fire Protection Confirmation.....	8
Table 5: Sanitary Design Criteria.....	9
Table 6: Summary of Estimated Sanitary Flow.....	9
Table 7: Pre-Development Runoff Summary.....	13
Table 8: Post-Development Runoff Summary.....	13
Table 9: Post-Development Sweetland Avenue Flows.....	14

APPENDICES

Appendix A: Site Location Plan

Appendix B: Background Documents

Appendix C: Watermain Calculations

Appendix D: Sanitary Calculations

Appendix E: Pre-Development Drainage Plan

Appendix F: Post-Development Drainage Plan

Appendix G: Stormwater Management Calculations

Appendix H: City of Ottawa Design Checklist

1.0 PROJECT DESCRIPTION

1.1 Purpose

McIntosh Perry (MP) has been retained by Smart Living Properties to prepare this Servicing and Stormwater Management Report in support of the Site Plan Control for the proposed development located at 68 Sweetland Avenue within the City of Ottawa.

The main purpose of this report is to present a servicing and stormwater management design for the development in accordance with the recommendations and guidelines provided by the City of Ottawa (City), the Rideau Valley Conservation Authority (RVCA), and the Ministry of the Environment, Conservation and Parks (MECP). This report will address the water, sanitary and storm sewer servicing for the development, ensuring that existing and available services will adequately service the proposed development.

This report should be read in conjunction with the following drawings:

- COO-22-5087, C101 – Grading, Drainage, Erosion & Sediment Control Plan
- COO-22-5087, C102 – Site Servicing Plan
- COO-22-5087, PRE – Pre-Development Drainage Area Plan (Appendix E)
- COO-22-5087, POST – Post-Development Drainage Area Plan (Appendix F)

1.2 Site Description



Figure 1: Site Map

The subject property, herein referred to as the Site, is located at 68 Sweetland Avenue within the Rideau-Vanier Ward. The site covers approximately 0.22 ha and is located along Sweetland Avenue

between Osgoode Street and Somerset Street East. The site is zoned for Residential Fourth Density (R4UD [480]). See Site Location Plan in Appendix A for reference.

1.3 Proposed Development and Statistics

The proposed development consists of a 3 ½-storey residential building addition to the existing 2 ½-storey residential building. The building addition will add an additional 33 units to the existing 9 units. The gravel drive aisle is proposed to be replaced with pavers as part of the development. Development is proposed within 0.041 ha of the site. Refer to Site Plan prepared by Woodman Architect & Associates Ltd. in Appendix B for further details.

1.4 Existing Conditions and Infrastructures

The site currently contains a 2 ½-storey detached residential building containing 9 units and a gravel drive aisle along the northern property line. The site currently slopes from the west property line towards Sweetland Avenue.

Sewer and watermain mapping collected from the City of Ottawa indicate that the following services exist across the property frontages within the adjacent municipal rights-of-way(s):

- ❖ Sweetland Avenue
 - 203 mm diameter ductile iron watermain,
 - 250 mm diameter concrete sanitary sewer tributary to the Somerset Street Combined Trunk Sewer, and
 - A 450 mm diameter concrete storm sewer tributary to the Somerset Street Combined Trunk Sewer approximately 0.16 km downstream.

1.5 Approvals

The proposed development is subject to the City of Ottawa site plan control process. Site plan control requires the City to review, provided concurrence and approve the engineering design package. Permits to construct can be requested once the City has issued a site plan agreement.

An Environmental Compliance Approval (ECA) through the Ministry of Environment, Conservation and Parks (MECP) is not required for the development since the development is located on one parcel of land, does not propose industrial usage, and is not located within a combined sewershed. As a result, the stormwater management system meets the exemption requirements under O.Reg 525/90.

2.0 BACKGROUND STUDIES, STANDARDS, AND REFERENCES

2.1 Background Reports/ Reference Information

As-built drawings of existing services, provided by the City of Ottawa Information centre, within the vicinity of the proposed site were reviewed in order to identify infrastructure available to service the proposed development.

A topographic survey (2104105) of the site was completed by Annis, O'Sullivan, Vollebakk Ltd.

The Site Plan (SP01) was prepared by Woodman Architect & Associates Ltd. and revised October 12th, 2022 (Site Plan).

2.2 Applicable Guidelines and Standards

Qty of Ottawa:

- ◆ Ottawa Sewer Design Guidelines, City of Ottawa, SDG002, October 2012. (Ottawa Sewer Guidelines)
 - Technical Bulletin ISTB-2014-01 City of Ottawa, February 2014. (ISTB-2014-01)
 - Technical Bulletin PIEDTB-2016-01 City of Ottawa, September 2016. (PIEDTB-2016-01)
 - Technical Bulletin ISTB-2018-01 City of Ottawa, January 2018. (ISTB-2018-01)
 - Technical Bulletin ISTB-2018-03 City of Ottawa, March 2018. (ISTB-2018-03)
 - Technical Bulletin ISTB-2019-01 City of Ottawa, January 2019. (ISTB-2019-01)
 - Technical Bulletin ISTB-2019-02 City of Ottawa, February 2019. (ISTB-2019-02)
- ◆ Ottawa Design Guidelines – Water Distribution City of Ottawa, July 2010. (Ottawa Water Guidelines)
 - Technical Bulletin ISD-2010-2 City of Ottawa, December 15, 2010. (ISD-2010-2)
 - Technical Bulletin ISDTB-2014-02 City of Ottawa, May 2014. (ISDTB-2014-02)
 - Technical Bulletin ISTB-2018-02 City of Ottawa, March 2018. (ISTB-2018-02)

Ministry of Environment, Conservation and Parks:

- ◆ Stormwater Planning and Design Manual, Ministry of the Environment, March 2003. (MECP Stormwater Design Manual)
- ◆ Design Guidelines for Sewage Works, Ministry of the Environment, 2008. (MECP Sewer Design Guidelines)

Other:

- ◆ Water Supply for Public Fire Protection, Fire Underwriters Survey, 2020. (FUSGuidelines)

3.0 PRE-CONSULTATION SUMMARY

An informal pre-consultation meeting was held with City staff in October 2021 regarding the proposed site servicing. Specific design parameters to be incorporated within this design include the following:

- Pre-development and post-development flows shall be calculated using a time of concentration (T_c) no less than 10 minutes.
- Control 5 through 100-year post-development flows to the 2-year pre-development flow.

4.0 WATERMAIN

4.1 Existing Watermain

There is an existing 203 mm diameter DI located watermain within Sweetland Avenue. The site is located within the 1W pressure zone, as per the Water Distribution System mapping included in Appendix C. There are three municipal fire hydrants along Sweetland Avenue that are available to service the development.

4.2 Proposed Watermain

It is proposed to service the proposed building addition through the existing building. A mechanical consultant will need to review and confirm whether upgrades to the existing building are required to accommodate the addition.

Table 1, below, summarizes the water supply design criteria obtained from the Ottawa Water Guidelines and utilized for the water analysis.

Table 1: Water Supply Design Criteria

Ste Area	0.06 ha
Residential	280 L/day/person
Residential Apartment – 1 Bedroom	1.4 person/unit
Max Day Peaking Factor - Residential	9.5 x avg. day
Peak Hour Peaking Factor - Residential	14.3 x avg. day

The water analysis results have been summarized in Table 2, below. The fire flow demand accounted for both the existing above-ground floor area and the proposed area.

Table 2: Summary of Estimated Water Demand

Design Parameter	Total Flow (L/s) Proposed
Average Daily Demand	0.19
Max Day Demand	1.82
Max Day Demand + FUS (133.33 L/s)	135.15
Max Day Demand + OBC (45L/s)	46.82
Peak Hour Demand	2.73

The Fire Underwriters Survey 2020 (FUS) method was utilized to estimate the required fire flow for the site. The following parameters were coordinated with the architect:

- ❖ Type of construction – Wood Frame Construction
- ❖ Occupancy Type – Limited Combustible
- ❖ Sprinkler Protection – Standard Water Supply Sprinklered

The results of the calculations yielded a required fire flow of 8,000 L/min (133.33 L/s) using the FUS method and 2,700 L/min (45 L/s) using the OBC method. The detailed calculations for the FUS and OBC can be found in Appendix C.

The City provided the estimated water pressures for the average day scenario, peak hour scenario and the max day plus fire flow scenario for the demands indicated by the correspondence in Appendix C. The resulting pressures for the boundary conditions results are shown in Table 3, below.

Table 3: Boundary Conditions Results

Scenario	Proposed Demands (L/s)	Connection 1 HGL (m H ₂ O)* / kPa
Average Day Demand	0.19	50.4 / 494.7
Maximum Daily + Fire Flow Demand	46.82	43.8 / 430.0
Peak Hourly Demand	2.73	41.0 / 402.5

* Adjusted for an estimated ground elevation of 67.3m above the connection point.

The normal operating pressure range is anticipated to be 402.5 kPa to 494.7 kPa and will not be less than 275 kPa (40 psi) or exceed 689 kPa (100 psi). The proposed watermains will meet the minimum required 20 psi (140 kPa) from the Ottawa Water Guidelines at the ground level under maximum day demand and fire flow conditions.

To confirm the adequacy of fire flow to protect the proposed development, public fire hydrants within 150 m of the proposed building were analysed per City of Ottawa ISTB 2018-02 Appendix I Table 1. Based on City guidelines (ISTB-2018-02), the existing hydrants can provide adequate fire protection to the proposed development. The results are summarized below.

Table 4: Fire Protection Confirmation

Building	Fire Flow Demand (L/min.)	Fire Hydrant(s) within 75m	Fire Hydrant(s) within 150m	Combined Fire Flow (L/min.)
68 Sweetland Ave	8,000 (FUS) 2,700 (OBC)	2 public	1 public	15,200

5.0 SANITARY DESIGN

5.1 Existing Sanitary Sewer

The existing building is serviced by a 150 mm diameter sanitary lateral connected to the existing 250 mm diameter sanitary sewer within Sweetland Avenue, fronting the subject site. The subject site currently contributes wastewater to the Sweetland Avenue sewer system, tributary to the Somerset Street Combined Trunk Sewer.

5.2 Proposed Sanitary Sewer

It is proposed to service the proposed building addition through the existing building. A mechanical consultant will need to review and confirm whether upgrades to the existing building are required to accommodate the addition.

Table 5, below, summarizes the wastewater design criteria identified by the Ottawa Sewer Guidelines.

Table 5: Sanitary Design Criteria

Design Parameter	Value
Site Area	0.06 ha
Residential	280 L/person/day
1 Bedroom Apartment	1.4 persons/unit
Residential Peaking Factor	3.64
Extraneous Flow Allowance	0.33 L/s/ha

Table 6, below, summarizes the estimated wastewater flow from the proposed development. Refer to Appendix D for detailed calculations.

Table 6: Summary of Estimated Sanitary Flow

Design Parameter	Total Flow (L/s)
Total Estimated Average Dry Weather Flow	0.19
Total Estimated Peak Dry Weather Flow	0.70
Total Estimated Peak Wet Weather Flow	0.72

The full flowing capacity of a 150 mm diameter service at 1.0% slope is estimated to be 15.89 L/s. Per Table 5, a peak wet weather flow of 0.72 L/s will be conveyed within the 150 mm diameter service, therefore the existing system is sufficiently sized for the development. Due to the complexity of the downstream network the City will need to advise of any downstream constraints.

6.0 STORM SEWER DESIGN

6.1 Existing Storm Sewers

Stormwater runoff from the site is currently tributary to the Somerset Street Combined Trunk Sewer. There is an existing 450 mm diameter storm sewer within Sweetland Avenue available to service the site. The existing sewer is tributary to the Somerset Street Combined Trunk Sewer approximately 0.16km downstream.

6.2 Proposed Storm Sewers

Foundation drainage for the proposed building is proposed to be conveyed via a 150 mm diameter connection to the proposed 300 mm diameter storm service.

Runoff from the rear yard will be directed towards landscaping catchbasins and one standard catchbasin. Runoff will then be conveyed through the proposed 250-300 mm subdrain and 300 mm diameter PVC storm service to the existing 450 mm diameter storm sewer within Sweetland Avenue. It is proposed to connect to the existing 450 mm diameter storm sewer with a 1200 mm diameter maintenance hole.

Runoff collected on the roof of the proposed building addition will be stored and controlled internally using two roof drains. The roof drains will be used to limit the flow from the roof to the specified allowable release rate. For calculation purposes a Watts Accutrol roof drain in the closed position was used estimate a reasonable roof flow. Other products maybe specified at detailed building design so long as release rates and storage volumes are respected. Runoff from the roof will be directed to the proposed 300 mm diameter storm service.

See OOO-22-5087 - POST include in Appendix F of this report for more details. The Stormwater Management design for the subject property will be outlined in Section 7.0 of this report.

7.0 PROPOSED STORMWATER MANAGEMENT

7.1 Design Criteria and Methodology

The following design criteria have been employed in developing the stormwater management design for the site as directed by the City and the RVCA:

Quality Control

- Quality controls are not required for this site because the site is tributary to a combined sewershed.

Quantity Control

- Any storm events greater than 2-year, up to 100-year, and including 100-year storm event must be detained on site.
- Post-development to be restricted to the 2-year storm event, based on a calculated time of concentration greater than 10 minutes. Refer to Section 7.2 for further details.

7.2 Runoff Calculations

Runoff calculations presented in this report are derived using the Rational Method, given as:

$$Q = 2.78CIA \text{ (L/s)}$$

Where:	C	= Runoff coefficient
	I	= Rainfall intensity in mm/hr (City of Ottawa IDF curves)
	A	= Drainage area in hectares

It is recognized that the Rational Method tends to overestimate runoff rates. As a result, the conservative calculation of runoff ensures that any SWM facility sized using this method is expected to function as intended. The following coefficients were used to develop an average C for each area:

Roofs/ Concrete/ Asphalt	0.90
Undeveloped and Grass	0.20

As per the City of Ottawa - Sewer Design Guidelines, the 5-year balanced 'C' value must be increased by 25% for a 100-year storm event to a maximum of 1.0.

7.3 Pre-Development Drainage

It has been assumed that the site contains no stormwater management controls for flow attenuation. The estimated pre-development peak flows for the 2, 5, and 100-year events are summarized below in Table 7. See COO-22-5087 - PRE in Appendix E and Appendix G for calculations.

Table 7: Pre-Development Runoff Summary

Drainage Area	Area (ha)	Q (L/s)			
		2-Year	5-Year	100-Year	
A1	0.041	5.27	7.15	15.30	Development Area
Total (Dev Area)	0.041	5.27	7.15	15.30	
A2	0.127	21.55	29.23	57.27	Ex. Sweetland Drainage
A3	0.027	4.57	6.20	12.16	Ex. Osgoode Drainage
A4	0.020	2.84	3.86	7.58	Ex. Nelson Drainage
Total (Ex. Drainage)	0.175	28.97	39.30	77.00	

Area A1 encompasses the proposed development area. Areas A2, A3, and A4 include existing drainage towards the Sweetland Avenue, Osgoode Street, and Nelson Street ROW's, respectively.

7.4 Post-Development Drainage

To meet the stormwater objectives the development will contain rooftop control.

Based on the criteria listed in Section 7.2, the development will be required to restrict flow to the 2-year storm event. It is estimated that the target release rate during the 100-year event will be 5.27 L/s.

The proposed site drainage limits are demonstrated on the Post-Development Drainage Area Plan. See OOO-22-5087 - POST in Appendix F of this report for more details. A summary of the post-development runoff calculations can be found below.

Table 8: Post-Development Runoff Summary

Drainage Area	Area (ha)	5-year Peak Flow (L/s)	100-year Peak Flow (L/s)	100-year Storage Required (m ³)	100-year Storage Available (m ³)
B1	0.023	2.52	5.03		
B2	0.003	0.27	0.56		
B3	0.015	0.63	0.63	5.90	6.09
Total (Dev Area)	0.041	3.42	6.22	5.90	6.09
B4	0.072	15.91	30.48		
B5	0.056	13.58	25.93		
B6	0.027	4.59	8.90		
B7	0.020	4.80	9.17		
Total (Ex. Drainage)	0.175	38.88	74.48		

7.4.1 Development Area Drainage (B1-B3)

Areas B1 to B3 include collected runoff, uncollected runoff, and roof runoff within the development area, respectively.

Runoff for area B1 will be collected by a proposed rear yard catch basin system and directed to the proposed 300 mm diameter storm service. Runoff for area B2 will surface drain towards the Sweetland Avenue ROW. Runoff for area B3 will be stored on the roof of the proposed building addition and restricted using two Watts Acutrol roof drain (or equivalent product) to a maximum release rate of 0.63 L/s and will provide up to 6.09 m³ of storage. Roof flow will be directed to the proposed 300 mm diameter storm service.

The proposed 300 mm diameter storm service will discharge flow from areas B1 and B3 to the existing 450 mm diameter storm sewer within Sweetland Avenue.

Foundation drainage is proposed to be connected to the proposed 300 mm diameter storm service without flow attenuation. The internal servicing layout is to be reviewed by the mechanical engineer.

As seen in Table 8, above, post-development runoff will exceed the allowable release rate by 0.95 L/s during the 100-year event. Surface storage options were explored in order to meet SWM requirements by reducing the flow from area B1. Given the small flow rates from this area, it was determined that any ICD sized for these flows would not meet the minimum ICD dimensions provided in the Ottawa Sewer Design Guidelines.

7.4.2 Existing Drainage (B4-B7)

Runoff from areas B4 to B7 consists of existing drainage to the Sweetland Avenue ROW (B4-B5), drainage to the Osgoode Street ROW (B6), and drainage to the Nelson Street ROW (B7).

Runoff from Area B4 primarily consists of existing runoff from the sloped roofs. Area B4 will be collected by the proposed catchbasin system and directed to the proposed 300 mm diameter storm service. Runoff from Area B5 primarily consists of existing runoff from the sloped roofs, downstream of the catchbasin system. Area B5 will surface drain towards the Sweetland Avenue ROW. Runoff from areas B6 and B7 will surface drain towards the Osgoode Street and Nelson Street ROW's, respectively.

7.4.3 Sweetland Avenue ROW – Flow Breakdown

Table 9, below, summarizes post-development 100-year flows to the Sweetland Avenue ROW.

Table 9: Post-Development Sweetland Avenue Flows

Area ID	Area (ha)	C(100-Year)	100-year Peak Flow (L/s)
B1	0.023	0.44	5.03
B3	0.015	1.00	0.63
B4	0.072	0.86	30.48
Total (Collected)	0.109	-	36.14
B2	0.003	0.34	0.56

B5	0.056	0.94	25.93
Total (Surface Flow)	0.059	-	26.48

As seen in Table 9, above, flow within the proposed 300mm storm service will be 36.14 L/s during the 100-year event, while surface drainage to the Sweetland Avenue ROW will be 26.48 L/s. Refer to Appendix G for detailed calculations.

8.0 EROSION AND SEDIMENT CONTROL

8.1 Temporary Measures

Before construction begins, temporary silt fence, straw bale or rock flow check dams will be installed at all-natural runoff outlets from the property. It is crucial that these controls be maintained throughout construction and inspection of sediment and erosion control will be facilitated by the Contractor or Contract Administration staff throughout the construction period.

Silt fences will be installed where shown on the final engineering plans, specifically along the downstream property limits. The Contractor, at their discretion or at the instruction of the City, Conservation Authority or the Contract Administrator shall increase the quantity of sediment and erosion controls on-site to ensure that the site is operating as intended and no additional sediment finds its way off site. The rock flow, straw bale & silt fence check dams and barriers shall be inspected weekly and after rainfall events. Care shall be taken to properly remove sediment from the fences and check dams as required. Fibre roll barriers are to be installed at all existing curb inlet catch basins and filter fabric is to be placed under the grates of all existing catch basins and manholes along the frontage of the site and any new structures immediately upon installation. The measures for the existing/proposed structures are to be removed only after all areas have been paved. Care shall be taken at the removal stage to ensure that any silt that has accumulated is properly handled and disposed of. Removal of silt fences without prior removal of the sediments shall not be permitted.

Although not anticipated, work through winter months shall be closely monitored for erosion along sloped areas. Should erosion be noted, the Contractor shall be alerted and shall take all necessary steps to rectify the situation. Should the Contractor's efforts fail at remediating the eroded areas, the Contractor shall contact the City and/or Conservation Authority to review the site conditions and determine the appropriate course of action. As the ground begins to thaw, the Contractor shall place silt fencing at all required locations as soon as ground conditions warrant. Please see the Site Grading, Drainage and Sediment & Erosion Control Plan for additional details regarding the temporary measures to be installed and their appropriate OPSD references.

8.2 Permanent Measures

It is expected that the Contractor will promptly ensure that all disturbed areas receive topsoil and seed/ sod and that grass be established as soon as possible. Any areas of excess fill shall be removed or levelled as soon as possible and must be located a sufficient distance from any watercourse to ensure that no sediment is washed out into the watercourse. As the vegetation growth within the site provides a key component to the control of sediment for the site, it must be properly maintained once established. Once the construction is complete, it will be up to the landowner to maintain the vegetation and ensure that the vegetation is not overgrown or impeded by foreign objects.

9.0 SUMMARY

- A 3 ½-storey residential rear addition is proposed to be constructed at 68 Sweetland Avenue. The Site Plan proposes an additional 33 units to the existing 9 units, with street access from Nelson Street.
- The FUS method estimated fire flow indicated that 8,000 L/min is required for the proposed development.
- The OBC method estimated fire flow indicated that 2,700 L/min is required for the proposed development.
- The development is estimated to have a combined peak wet weather flow of 0.72 L/s.
- Based on City of Ottawa guidelines, the development will be required to attenuate post-development flows to the 2-year release rate of 5.27 L/s.
- To meet the stormwater objectives the development will contain 6 m³ of rooftop storage for flow attenuation; and
- Quality controls are not required as the site is tributary to a combined sewershed.

10.0 RECOMMENDATION

Based on the information presented in this report, we recommend that City of Ottawa approve this Servicing and Stormwater Management report in support of the proposed development at 68 Sweetland Avenue.

This report is respectfully being submitted for approval.

Regards,

McIntosh Perry Consulting Engineers Ltd.



Charissa Hampel, P.Eng.
Project Engineer, Land Development
T: 613.714.4625
E: c.hampel@mcintoshperry.com

A handwritten signature in black ink that reads "Francis Valenti".

Francis J. Valenti, EIT.
Engineering Intern, Land Development
T: 613.808.2123
E: f.valenti@mcintoshperry.com

11.0 STATEMENT OF LIMITATIONS

This report was produced for the exclusive use of Smart Living Properties. The purpose of the report is to assess the existing stormwater management system and provide recommendations and designs for the post-construction scenario that are in compliance with the guidelines and standards from the Ministry of the Environment, Parks and Climate Change, City of Ottawa and local approval agencies. McIntosh Perry reviewed the site information and background documents listed in Section 2.0 of this report. While the previous data was reviewed by McIntosh Perry and site visits were performed, no field verification/ measures of any information were conducted.

Any use of this review by a third party, or any reliance on decisions made based on it, without a reliance report is the responsibility of such third parties. McIntosh Perry accepts no responsibility for damages, if any, suffered by any third party as a result of decisions or actions made based on this review.

The findings, conclusions and/or recommendations of this report are only valid as of the date of this report. No assurance is made regarding any changes in conditions subsequent to this date. If additional information is discovered or becomes available at a future date, McIntosh Perry should be requested to re-evaluate the conclusions presented in this report, and provide amendments, if required.

APPENDIX A
KEY PLAN

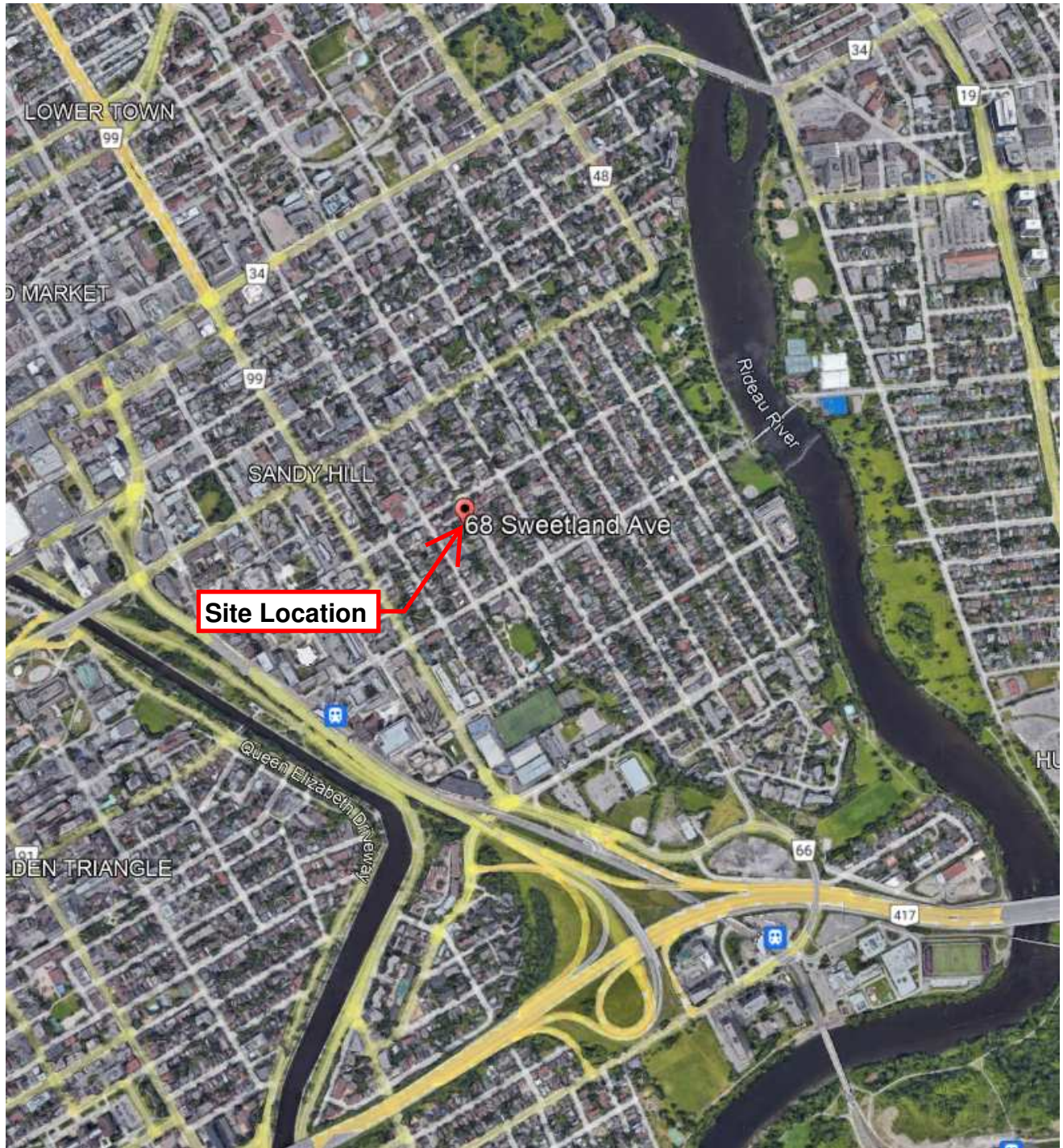

CLIENT:	Smart Living Properties	
PROJECT:	68 Sweetland Avenue	
TITLE:	SITE LOCATION	
McINTOSH PERRY 115 Walgreen Road, RR3, Carp, ON K0A 1L0 Tel: 613-836-2184 Fax: 613-836-3742 www.mcintoshperry.com	PROJECT: CCO-22-5087	FIGURE: 1
	DATE: MAY. 26, 2022	SCALE: N.T.S

APPENDIX B
BACKGROUND DOCUMENTS

From: [Nadeau, Jeff](#)
To: [Haris Khan](#)
Cc: [Lisa Dalla Rosa](#)
Subject: Informal Pre-con Follow-up - 68 Sweetland and 146 Osgoode
Date: March 31, 2022 7:17:04 PM
Attachments: [146 Osgoode & 68 Sweetland Study and Plan Identification List.pdf](#)

CAUTION: This email is from an external sender. Do not click links or open attachments unless you recognize the sender and know the content is safe.

Hello Haris,

Please refer to the below notes regarding review and informal discussion of the development proposal for 68 Sweetland Avenue and 146 Osgoode Avenue, as initially presented in October 2021 and as submitted in revised form in January and February 2022, to allow for the expansion of the rooming house at 68 Sweetland and for the adjustment of the lot line shared by 68 Sweetland and 146 Osgoode.

I have also attached the required Plans & Study List for application submission.

Below are staff's preliminary comments based on the information available:

Planning

- Current Official Plan has this site in the General Urban Area (3.6.1). New Official Plan has this site in a Neighbourhood (6.3) within the Downtown Core transect area (5.1).
 - Higher-density, urban development forms with minimal on-site parking are encouraged.
- The site is zoned R4UD[480].
 - It is understood that the two non-rooming units in the building were permitted through a minor variance in 1991.
 - The lot line adjustment will result in 68 Sweetland having a depth of 51.7m and a lot area of approx. 416.5m². Per s.144(3) a rear yard setback of 30% of lot depth (15.5m) and a rear yard area of 25% of lot area (104m²) is required; these are being met.
 - The landscaping requirements introduced via the R4 revisions, namely s.161(15), do not apply to rooming houses. The amenity requirements under s.137 do apply to rooming houses. The division of units and amenity spaces between 146 Osgoode and 68 Sweetland is not clear, but it is evident that the lands as a whole will fall well short of the s.137(1) requirement of 489m² amenity space for 151 units.
 - Further to the above – there is a 100m² green strip indicated over the eastern half of the laneway. Is this to be counted as amenity area? It will be incumbent on the applicant to demonstrate how a space this narrow can realistically serve as an amenity space.
 - 36 bike-parking stalls are noted. This is slightly short of the 38-stall

requirement under s.111 (rooming house: 0.25 per unit). Staff encourage maximizing the quantity and quality of bike storage on-site.

- Meeting waste management provisions in s.134 will be a high priority.
- Councillor Fleury's preference for structurally-integrated waste areas is well-established. Earth Bins were considered as an option for retaining open space that would otherwise be consumed by a waste shed. The assumption had been that these would have a minimal elevation above grade, however product details have made clear that Earth Bins have a notable above-grade presence. Having a large cluster of these in the rear yard cancels out any "open-space-preserving" advantage of this approach. Given that distributing them across the site(s) was noted to be logistically difficult and intrusive on the ROW, these may not work as a solution in this case.
- The project stats noted on the February 17 plans indicate 118 existing rooming units, increasing to 151 through this proposal. It's assumed this count is inclusive of both 68 Sweetland and 146 Osgoode. Please break down unit counts per building in future submissions.
- It is understood that the proposed applications will address the lands at 146 Osgoode and 68 Sweetland as a whole. "One Lot for Zoning Purposes" (s.93) does not formally apply to residential lots like this; as such treating these lands as one lot may be a component of your ZBLA request. This may bring us back into PUD territory. Staff expect further discussion of this approach will be required to iron out the details as your plans evolve.
- Recommend submitting for ZBLA and SPC in advance of lot line adjustment to work out initial high-level site design issues prior to making any consent application to the Committee of Adjustment.
- Recognizing that this concept is still in its early stages, these plans would benefit from more detailed information as the project matures. Please ensure that plans for any formal submissions are prepared in accordance with standards and guidelines available here: <https://ottawa.ca/en/planning-development-and-construction/developing-property/development-application-review-process/development-application-submission/guide-preparing-studies-and-plans>.

Engineering

PLANS:

- Existing Conditions and Removals Plan
- Site Servicing Plan
- Grade Control and Drainage Plan
- Road Reinstatement Plan
- Erosion and Sediment Control Plan
- Roof Drainage Plan
- Topographical survey

REPORTS:

- Site Servicing and Stormwater Management Report
- Geotechnical Study/Investigation

Noise Control Study

- Phase I ESA
- Phase II ESA (Depending on recommendations of Phase I ESA)
- Please submit boundary condition request early in the process so we can confirm if the required fire flow is available
- Please control post-development runoff from the subject site, up to and including the 100-year storm event, to a 2-year pre-development level.

Feel free to contact the Infrastructure Project Manager, Nishant Jhamb, at nishant.jhamb@ottawa.ca, for follow-up questions.

City Surveyor

- The determination of property boundaries, minimum setbacks and other regulatory constraints are a critical component of development. An Ontario Land Surveyor (O.L.S.) needs to be consulted at the outset of a project to ensure properties are properly defined and can be used as the geospatial framework for the development.
- Topographic details may also be required for a project and should be either carried out by the O.L.S. that has provided the Legal Survey or done in consultation with the O.L.S. to ensure that the project is integrated to the appropriate control network.

Questions regarding the above requirements can be directed to the City's Surveyor, Bill Harper, at bill.harper@ottawa.ca.

Other

- Plans are to be standard A1 size (594 mm x 841 mm) sheets, utilizing an appropriate Metric scale (1:200, 1:250, 1:300, 1:400 or 1:500).
- All PDF submitted documents are to be unlocked and flattened.

Please refer to the links to [Guide to preparing studies and plans](#) and [fees](#) for further information. Additional information is available related to [building permits](#), [development charges](#), and the [Accessibility Design Standards](#). Be aware that other fees and permits may be required, outside of the development review process. You may obtain background drawings by contacting informationcentre@ottawa.ca.

These pre-con comments are valid for one year. If you submit a development application(s) after this time, you may be required to meet for another pre-consultation meeting and/or the submission requirements may change. You are as well encouraged to contact us for a follow-up meeting if the plan/concept will be further refined.

Please do not hesitate to contact me if you have any questions.

Regards,

Jeff Nadeau

Planner II | *Urbaniste II*

Development Review, Central | *Examen des projets d'aménagement, Central*

Planning, Real Estate and Economic Development Department | *Services de la planification, des biens immobiliers et du développement économique*
City of Ottawa | *Ville d'Ottawa*
110 Laurier Avenue West. Ottawa, ON | 110, avenue. Laurier Ouest. Ottawa (Ontario) K1P 1J1
☎ 613.580.2424 ext./poste 16802
ottawa.ca/planning/ / ottawa.ca/urbanisme

*****Please note that, while my work hours may be affected by the current situation, I have regular access to email and check telephone messages periodically. Email is currently the best way to contact me*****

,

This e-mail originates from the City of Ottawa e-mail system. Any distribution, use or copying of this e-mail or the information it contains by other than the intended recipient(s) is unauthorized. Thank you.

Le présent courriel a été expédié par le système de courriels de la Ville d'Ottawa. Toute distribution, utilisation ou reproduction du courriel ou des renseignements qui s'y trouvent par une personne autre que son destinataire prévu est interdite. Je vous remercie de votre collaboration.

,

REGISTERED PLAN 15632

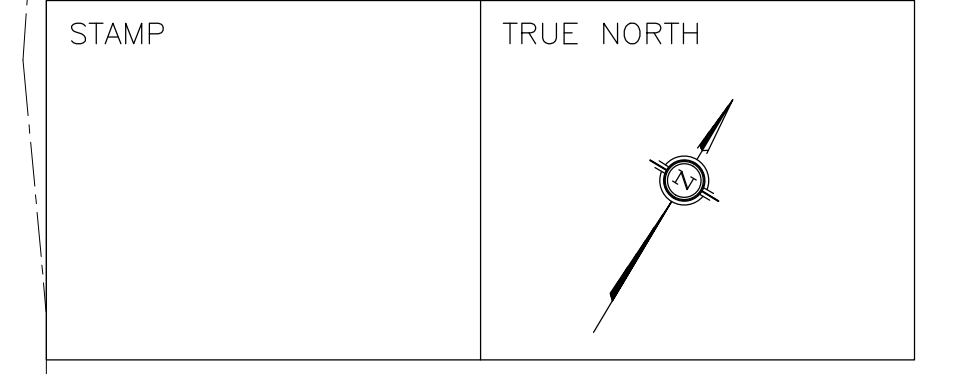
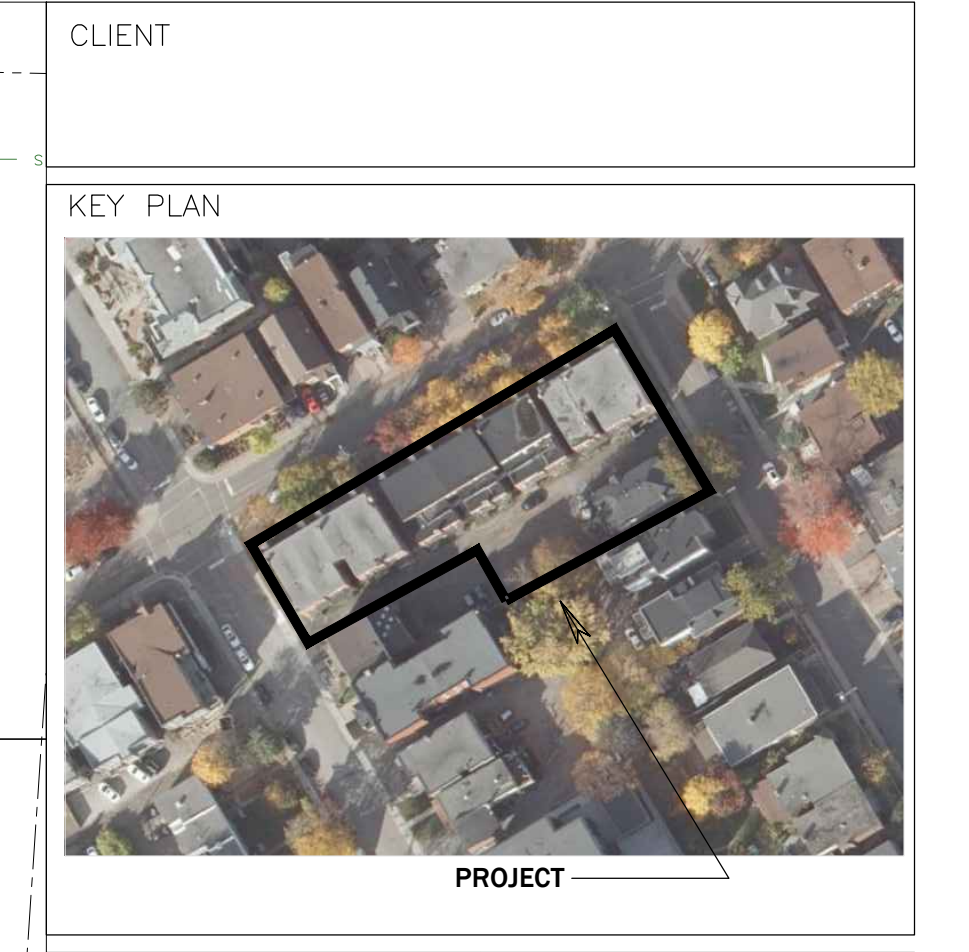
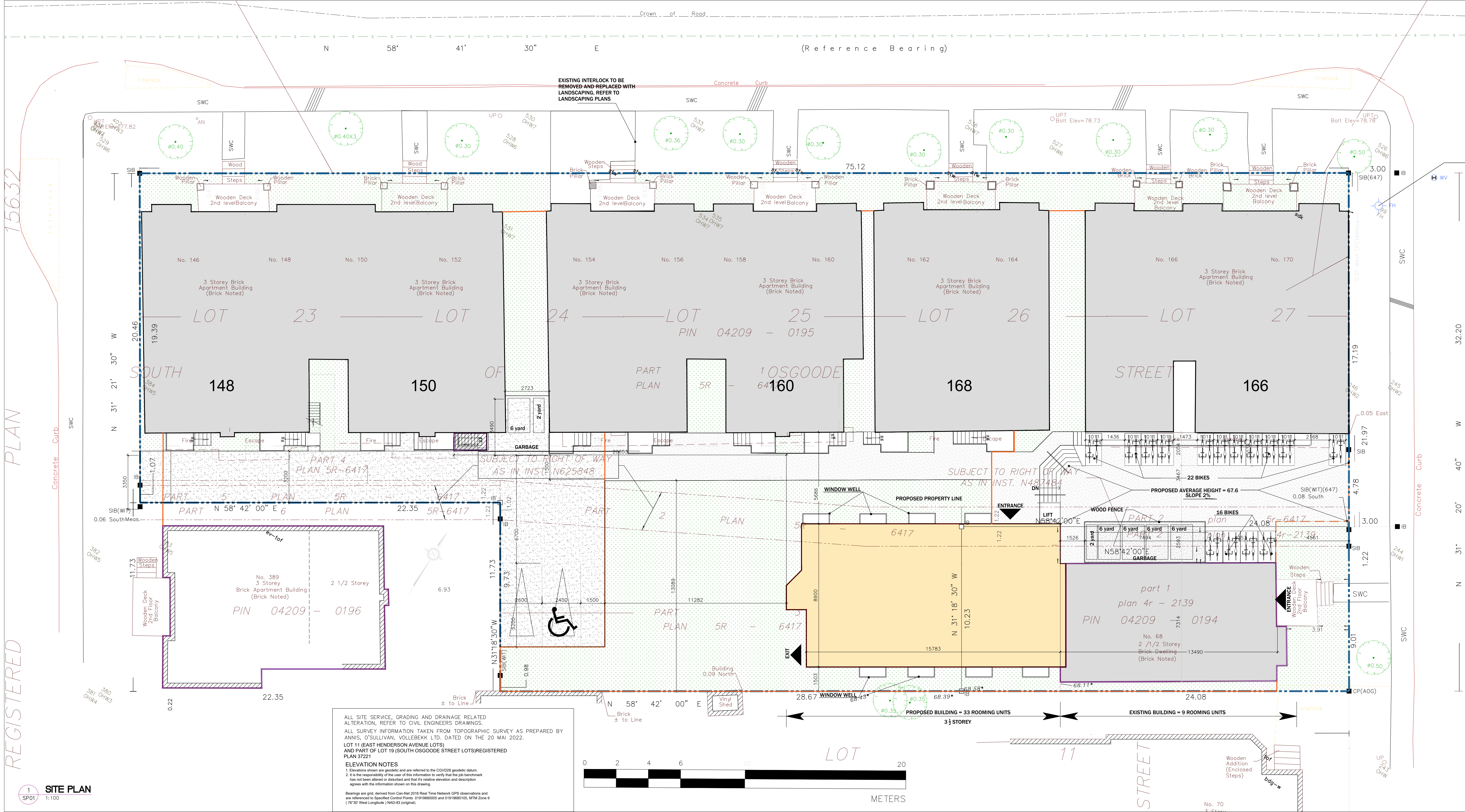

ALL CONTRACTORS TO VERIFY ALL DIMENSIONS ON SITE AND TO REPORT ALL ERRORS AND/OR OMISSIONS TO THE ARCHITECT. ALL CONTRACTORS MUST COMPLY WITH ALL CODES AND BYLAWS AND OTHER AUTHORITIES HAVING JURISDICTION OVER THE WORK. DO NOT SCALE DRAWINGS. THIS DRAWING MAY NOT BE USED FOR CONSTRUCTION UNTIL SIGNED BY THE ARCHITECT. COPYRIGHT RESERVED.

Revision table with columns for NO., REVISION, and DATE. Includes entries for 'ISSUED FOR APPROVAL' and 'ISSUED FOR REVIEW'.



CONSULTANTS: ENGINEERING - MCINTOSH PERRY SURVEY - ANNIS, O'SULLIVAN, VOLLEBEKK LTDA LANDSCAPE - JAMES. B. LENNOX & ASSOCIATES INC.

PROJECT: 68 SWEETLAND - 146/170 OSGOOD STREET OTTAWA

DRAWING: SITE PLAN DATE: 11/05/2022 SCALE: 1:100 DRAWN BY: J.G. REVIEWED BY: R.W. JOB No. 2201 REVISION DATE: DRAWING: SP01

ALL SITE SERVICE, GRADING AND DRAINAGE RELATED ALTERATION, REFER TO CIVIL ENGINEERS DRAWINGS. ALL SURVEY INFORMATION TAKEN FROM TOPOGRAPHIC SURVEY AS PREPARED BY ANNIS, O'SULLIVAN, VOLLEBEKK LTD. DATED ON THE 20 MAY 2022.

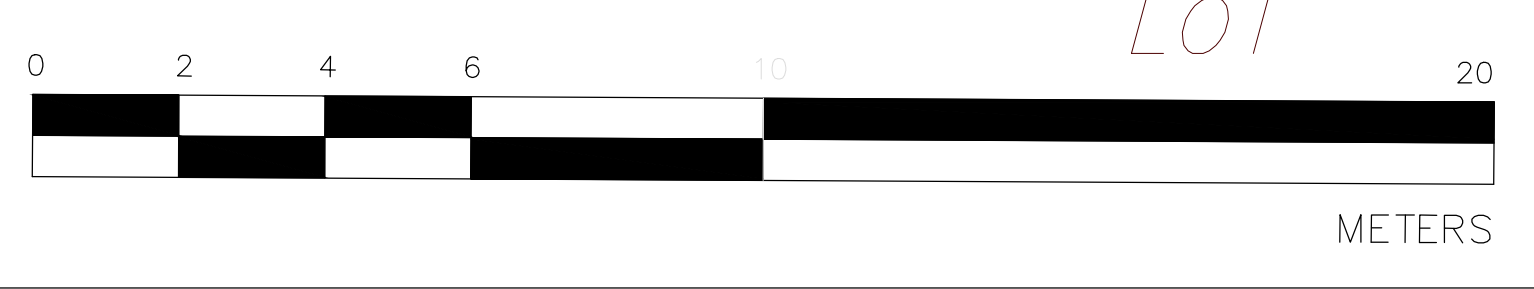

1 SITE PLAN SP01 1:100

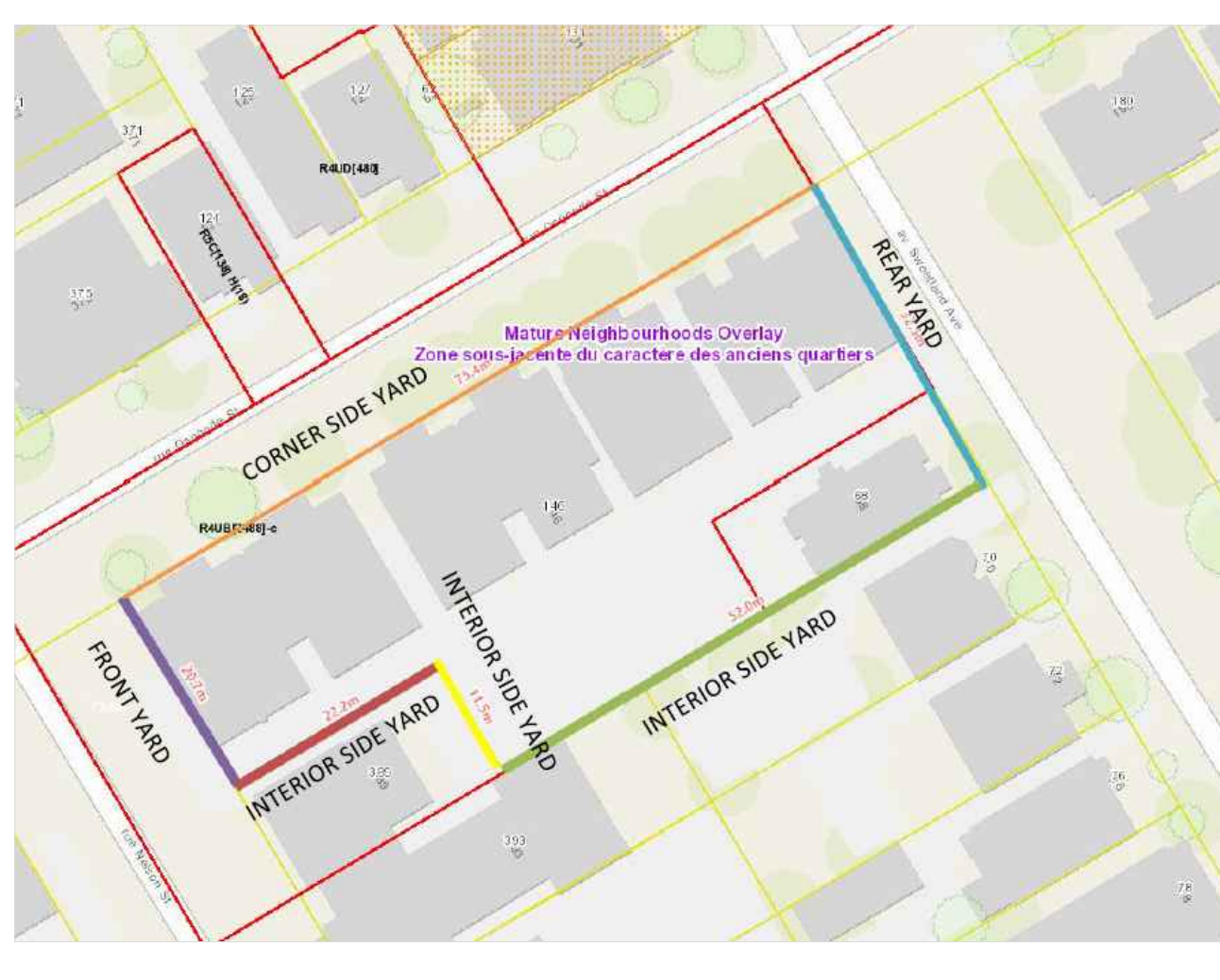

2 KEY PLAN N.T.S. SP01

Table with columns for G.B.A., G.L.A., and NUMBER OF UNITS. Includes sub-tables for '68 SWEETLAND' and 'OSGOOD (rooming units)'.

Table for R4UD [480] XXXX- PUD zoning requirements. Columns: Requirement, Provided, Compliance. Rows include Minimum Lot Area, Minimum Lot Width, etc.

Table for RAUD [480] XXXX- PUD zoning requirements. Columns: Requirement, Provided, Compliance. Rows include Amenity Area, Principal Entrance, etc.

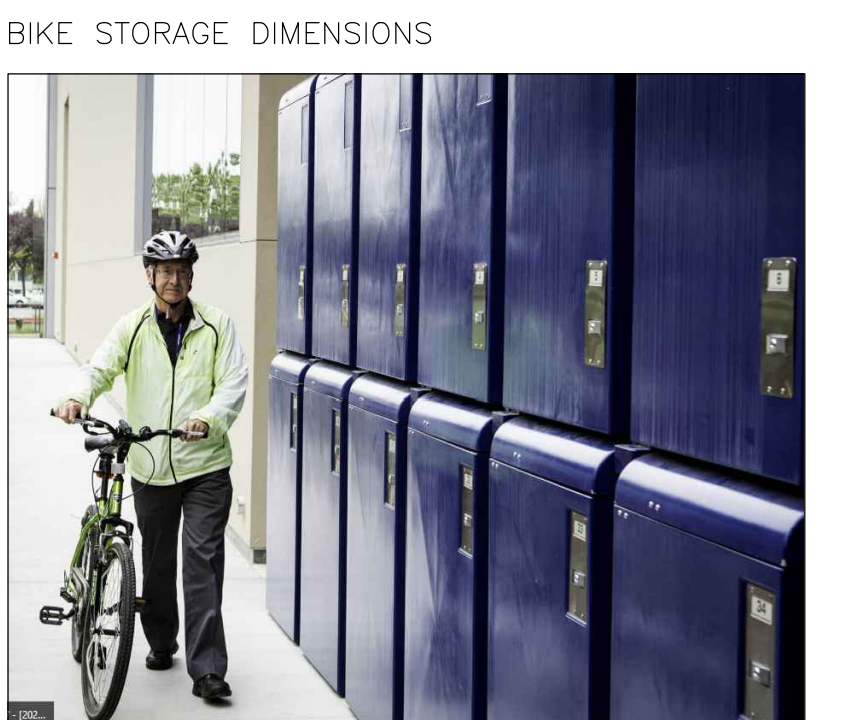
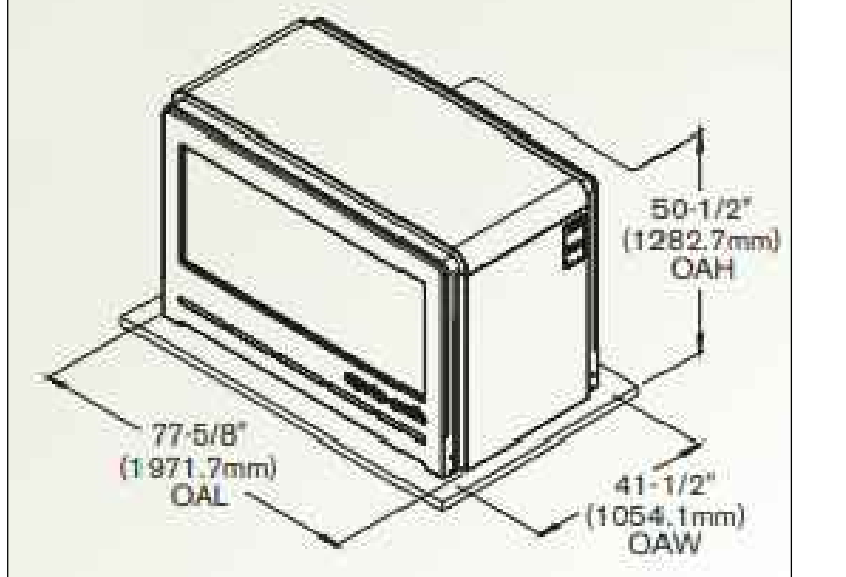

- LEGEND: EXISTING BUILDING, PROPOSED ADDITION, MANHOLE, REFER TO CIVIL, NEW INTERLOCK/PAVERS, NEW SOD, CONCRETE FLOOR, ASPHALT, FIRE DEPARTMENT CONNECTION, FIRE HYDRANT, REFER TO CIVIL, CATCH BASIN, REFER TO CIVIL, BUILDING ENTRANCE, DIRECTIONAL ARROW, PROPERTY LINE, PROPOSED 2.1 HT. ORNAMENTAL METAL FENCE, REFER TO LANDSCAPE PLAN FOR DETAILS, EXISTING CITY LIGHT STANDARD, NEW LIGHT STANDARD, FIRE ROUTE SIGN, STOP SIGN, CENTERLINE, PROPOSED TREE, BIKE STORAGE.

D07-12-22-0106

#18783

APPENDIX C
WATERMAIN CALCULATIONS

BRITTANY DRIVE P.S.

FLEET STREET P.S.

Subject Site

BILLINGS BRIDGE P.S.

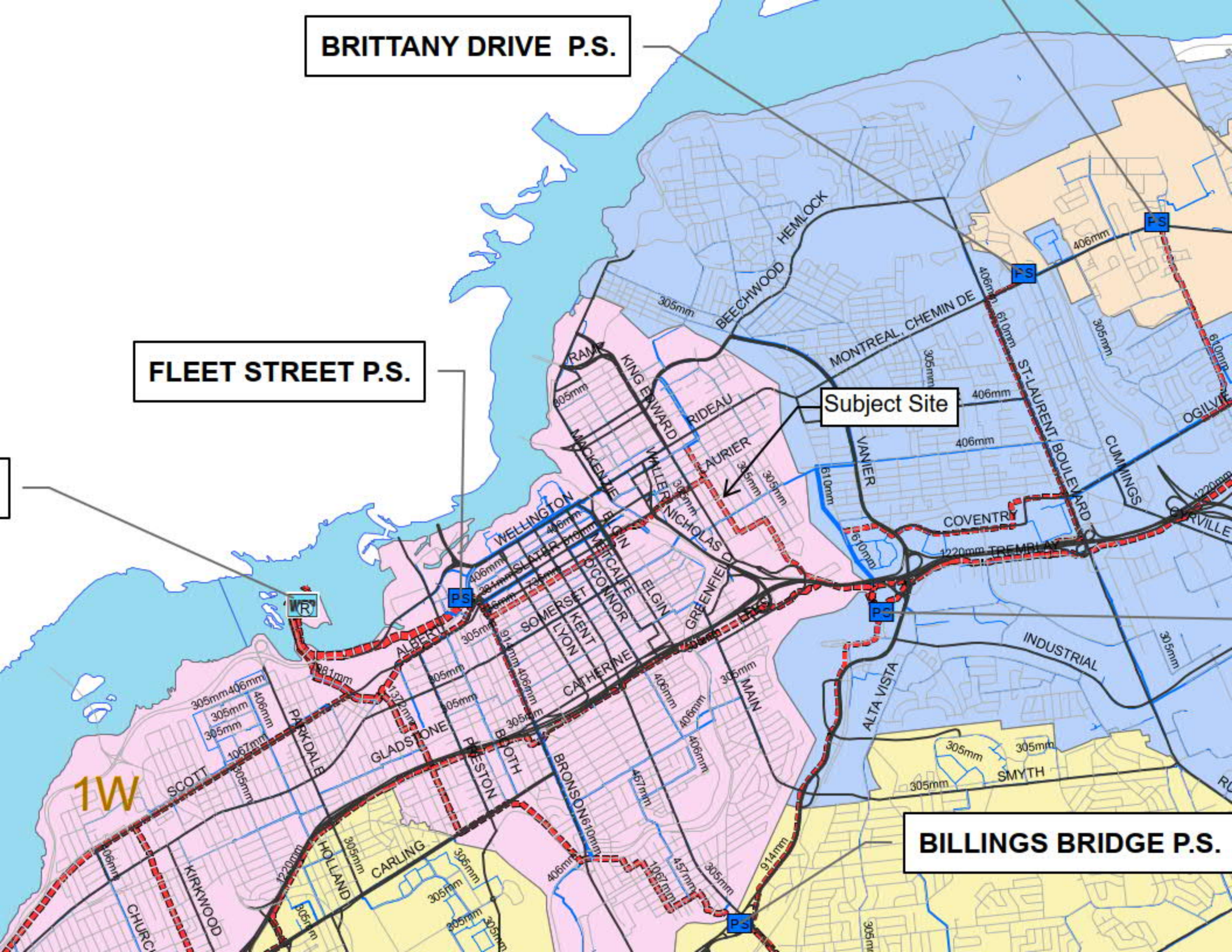

McINTOSH PERRY

000-22-5087 - 68 Sweetland Avenue - Existing Water Demands

Project:	68 Sweetland Avenue
Project No.:	000-22-5087
Designed By:	FV
Checked By:	AG
Date:	June 10, 2022
Site Area:	0.02 gross ha

Residential	NUMBER OF UNITS	UNIT RATE	
1 Bedroom Apartment	9 units	1.4	persons/unit
Total Population	13 persons		

AVERAGE DAILY DEMAND

DEMAND TYPE	AMOUNT	UNITS
Residential	280	L/c/d
Industrial - Light	35,000	L/gross ha/d
Industrial - Heavy	55,000	L/gross ha/d
Shopping Centres	2,500	L/(1000m ² /d)
Hospital	900	L/(bed/day)
Schools	70	L/(Student/d)
Trailer Park with no Hook-Ups	340	L/(space/d)
Trailer Park with Hook-Ups	800	L/(space/d)
Campgrounds	225	L/(campsite/d)
Mobile Home Parks	1,000	L/(Space/d)
Motels	150	L/(bed-space/d)
Hotels	225	L/(bed-space/d)
Tourist Commercial	28,000	L/gross ha/d
Other Commercial	28,000	L/gross ha/d
AVERAGE DAILY DEMAND Residential		0.04 L/s
AVERAGE DAILY DEMAND Commerical/ Industrial/ Institutional		0.00 L/s

MAXIMUM DAILY DEMAND

DEMAND TYPE	AMOUNT	UNITS
Residential	9.5	x avg. day
Industrial	1.5	x avg. day
Commercial	1.5	x avg. day
Institutional	1.5	x avg. day
MAXIMUM DAILY DEMAND Residential		0.40 L/s
MAXIMUM DAILY DEMAND Commerical/ Industrial/ Institutional		0.00 L/s

MAXIMUM HOUR DEMAND

DEMAND TYPE	AMOUNT	UNITS
Residential	14.3	x avg. day
Industrial	1.8	x max. day
Commercial	1.8	x max. day
Institutional	1.8	x max. day
MAXIMUM HOUR DEMAND Residential		0.60 L/s
MAXIMUM HOUR DEMAND Commerical/ Industrial/ Institutional		0.00 L/s

WATER DEMAND DESIGN FLOWS PER UNIT COUNT
CITY OF OTTAWA - WATER DISTRIBUTION GUIDELINES, JULY 2010

AVERAGE DAILY DEMAND	0.04	L/s
MAXIMUM DAILY DEMAND	0.40	L/s
MAXIMUM HOUR DEMAND	0.60	L/s

McINTOSH PERRY

000-22-5087 - 68 Sweetland Avenue - Proposed Water Demands

Project:	68 Sweetland Avenue
Project No.:	000-22-5087
Designed By:	FV
Checked By:	AG
Date:	June 10, 2022
Ste Area:	0.06 gross ha

Residential	NUMBER OF UNITS	UNIT RATE	
1 Bedroom Apartment (Existing)	9 units	1.4	persons/unit
1 Bedroom Apartment (Proposed)	33 units	1.4	persons/unit
Total Population	59 persons		

AVERAGE DAILY DEMAND

DEMAND TYPE	AMOUNT	UNITS
Residential	280	L/c/d
Industrial - Light	35,000	L/gross ha/d
Industrial - Heavy	55,000	L/gross ha/d
Shopping Centres	2,500	L/(1000m ² /d)
Hospital	900	L/(bed/day)
Schools	70	L/(Student/d)
Trailer Park with no Hook-Ups	340	L/(space/d)
Trailer Park with Hook-Ups	800	L/(space/d)
Campgrounds	225	L/(campsite/d)
Mobile Home Parks	1,000	L/(Space/d)
Motels	150	L/(bed-space/d)
Hotels	225	L/(bed-space/d)
Tourist Commercial	28,000	L/gross ha/d
Other Commercial	28,000	L/gross ha/d
AVERAGE DAILY DEMAND Residential		0.19 L/s
AVERAGE DAILY DEMAND Commercial/Industrial/Institutional		0.00 L/s

MAXIMUM DAILY DEMAND

DEMAND TYPE	AMOUNT	UNITS
Residential	9.5	x avg. day L/c/d
Industrial	1.5	x avg. day L/gross ha/d
Commercial	1.5	x avg. day L/gross ha/d
Institutional	1.5	x avg. day L/gross ha/d
MAXIMUM DAILY DEMAND Residential		1.82 L/s
MAXIMUM DAILY DEMAND Commercial/Industrial/Institutional		0.00 L/s

MAXIMUM HOUR DEMAND

DEMAND TYPE	AMOUNT	UNITS
Residential	14.3	x avg. day L/c/d
Industrial	1.8	x max. day L/gross ha/d
Commercial	1.8	x max. day L/gross ha/d
Institutional	1.8	x max. day L/gross ha/d
MAXIMUM HOUR DEMAND Residential		2.73 L/s
MAXIMUM HOUR DEMAND Commercial/Industrial/Institutional		0.00 L/s

WATER DEMAND DESIGN FLOWS PER UNIT COUNT
CITY OF OTTAWA - WATER DISTRIBUTION GUIDELINES, JULY 2010

AVERAGE DAILY DEMAND	0.19	L/s
MAXIMUM DAILY DEMAND	1.82	L/s
MAXIMUM HOUR DEMAND	2.73	L/s

McINTOSH PERRY

000-22-5087 - 68 Sweetland Avenue - OBC Fire Calculations

Project :	68 Sweetland Avenue
Project No.:	000-22-5087
Designed By:	FV
Checked By:	AG
Date:	June 10, 2022

Ontario 2006 Building Code Compendium (Div. B - Part 3)

Water Supply for Fire-Fighting - Residential Building

Building is classified as Group : **C- Residential Occupancies** (from table 3.2.2.55)

Building is of combustible construction. Floor assemblies are fire separations but with no fire-resistance ratings. Roof assemblies, mezzanies, loadbearing walls, columns and arches do not have a fire-resistance rating.

From Div. B A-3.2.5.7. of the Ontario Building Code - 3. Building On-Site Water Supply:

(a) $Q = K \times V \times S_{tot}$

where:

Q = minimum supply of water in litres

K = water supply coefficient from Table 1

V = total building volume in cubic metres

S_{tot} = total of spatial coefficient values from the property line exposures on all sides as obtained from the formula:

$S_{tot} = 1.0 + [S_{side1} + S_{side2} + S_{side3} + \dots \text{etc.}]$

K	23	(from Table 1 pg A-31) (Worst case occupancy {E/ F2} 'K' value used)			
V	2,101	(Total building volume in m ³ .)			
S _{tot}	2.0	(From figure 1 pg A-32)			
Q =	96,668.59 L				

				From Figure 1 (A-32)
Shorth	1.3	m	0.5	
Seast	3.88	m	0.5	
South	0.6	m	0.5	
Swest	16.62	m	0.0	

* approximate distances

From Table 2: Required Minimum Water Supply Flow Rate (L/s)

2700 L/min if Q < 108,000 L
713 gpm

McINTOSH PERRY

000-22-5087 - 68 Sweetland Avenue - Existing Conditions - Fire Underwriters Survey

Project: 68 Sweetland Avenue - Existing Conditions
 Project No.: 000-22-5087
 Designed By: FV
 Checked By: AG
 Date: June 10, 2022

From the Fire Underwriters Survey (2020)

From Part II – Guide for Determination of Required Fire Flow Copyright I.S.O.:
 City of Ottawa Technical Bulletin ISTB-2018-02 Applied Where Applicable

A. BASE REQUIREMENT (Rounded to the nearest 1000 L/min)

F = 220 x C x vA Where: F = Required fire flow in liters per minute
 C = Coefficient related to the type of construction.
 A = The total floor area in square meters (including all storey's, but excluding basements at least 50 percent below grade) in the building being considered.

Construction Type **Wood Frame**

C	1.5	A	387.0 m ²
Total Floor Area (per the 2020 FUS Page 20 - Total Effective Area)			387.0 m ² * Unprotected Vertical Openings

Calculated Fire Flow	6,491.9 L/min
	6,000.0 L/min

B. REDUCTION FOR OCCUPANCY TYPE (No Rounding)

From Page 24 of the Fire Underwriters Survey:
 Limited Combustible -15%

Fire Flow	5,100.0 L/min
-----------	---------------

C. REDUCTION FOR SPRINKLER TYPE (No Rounding)

Standard Water Supply Sprinklered -40%

Reduction	-2,040.0 L/min
-----------	----------------

D. INCREASE FOR EXPOSURE (No Rounding)

	Separation Distance (m)	Cons. of Exposed Wall	Length Exposed Adjacent Wall (m)	Height (Stories)	Length-Height Factor	
Exposure 1	3.1 to 10	Wood frame	16.4	3	49.2	17%
Exposure 2	20.1 to 30	Wood frame	9.2	3	27.6	2%
Exposure 3	3.1 to 10	Wood frame	15.2	3	45.6	17%
Exposure 4	Over 30 m	Wood frame	N/A	N/A	N/A	0%
% Increase*						36%

Increase*	1,836.0 L/min
-----------	---------------

E. Total Fire Flow (Rounded to the Nearest 1000 L/min)

Fire Flow	4,896.0 L/min
Fire Flow Required**	5,000.0 L/min

* In accordance with Part II, Section 4, the Increase for separation distance is not to exceed 75%

** In accordance with Section 4 the Fire flow is not to exceed 45,000 L/min or be less than 2,000 L/min

McINTOSH PERRY

000-22-5087 - 68 Sweetland Avenue - Proposed Development - Fire Underwriters Survey

Project: 68 Sweetland Avenue - Proposed Development
 Project No.: 000-22-5087
 Designed By: FV
 Checked By: AG
 Date: June 10, 2022

From the Fire Underwriters Survey (2020)

From Part II – Guide for Determination of Required Fire Flow Copyright I.S.O.:
 City of Ottawa Technical Bulletin ISTB-2018-02 Applied Where Applicable

A. BASE REQUIREMENT (Rounded to the nearest 1000 L/min)

F = $220 \times C \times \sqrt{A}$ Where:
 F = Required fire flow in liters per minute
 C = Coefficient related to the type of construction.
 A = The total floor area in square meters (including all storey's, but excluding basements at least 50 percent below grade) in the building being considered.

Construction Type **Wood Frame**

C	1.5	A	961.0 m ²
Total Floor Area (per the 2020 FUS Page 20 - Total Effective Area)			961.0 m ² * Unprotected Vertical Openings

Calculated Fire Flow	10,230.0 L/min
	10,000.0 L/min

B. REDUCTION FOR OCCUPANCY TYPE (No Rounding)

From Page 24 of the Fire Underwriters Survey:
 Limited Combustible -15%

Fire Flow	8,500.0 L/min
-----------	---------------

C. REDUCTION FOR SPRINKLER TYPE (No Rounding)

Standard Water Supply Sprinklered -40%

Reduction	-3,400.0 L/min
-----------	----------------

D. INCREASE FOR EXPOSURE (No Rounding)

	Separation Distance (m)	Cons. of Exposed Wall	Length Exposed Adjacent Wall (m)	Height (Stories)	Length-Height Factor	
Exposure 1	3.1 to 10	Wood frame	16.4	3	49.2	17%
Exposure 2	20.1 to 30	Wood frame	9.2	3	27.6	2%
Exposure 3	3.1 to 10	Wood frame	15.2	3	45.6	17%
Exposure 4	20.1 to 30	Wood frame	8.9	3	26.7	2%
						% Increase* 38%

Increase*	3,230.0 L/min
-----------	---------------

E Total Fire Flow (Rounded to the Nearest 1000 L/min)

Fire Flow	8,330.0 L/min
Fire Flow Required**	8,000.0 L/min

* In accordance with Part II, Section 4, the Increase for separation distance is not to exceed 75%
 ** In accordance with Section 4 the Fire flow is not to exceed 45,000 L/min or be less than 2,000 L/min

McINTOSH PERRY

000-22-5087 - 68 Sweetland Avenue - Boundary Condition Unit Conversion

Project: 68 Sweetland Avenue

Project No.: 000-22-5087

Designed By: FV

Checked By: AG

Date: June 10, 2022

Boundary Conditions Unit Conversion

Sweetland Avenue

Scenario	Height (m)	Elevation (m)	m H ₂ O	PSI	kPa
Avg. DD	115.4	65.0	50.4	71.8	494.7
Max Day + Fire Flow (45 L/s)	108.8	65.0	43.8	62.4	430.0
Peak Hour	106.0	65.0	41.0	58.4	402.5

Francis Valenti

From: Jhamb, Nishant <nishant.jhamb@ottawa.ca>
Sent: June 9, 2022 1:07 PM
To: Francis Valenti
Subject: RE: 22-5087 - Boundary Condition Request - 68 Sweetland Avenue
Attachments: 68 Sweetland Avenue June 2022.pdf

Hello Francis

The following are boundary conditions, HGL, for hydraulic analysis at 68 Sweetland Avenue (zone 1W) assumed to be connected to the 203 mm watermain on Sweetland Avenue (see attached PDF for location).

Minimum HGL: 106.0 m

Maximum HGL: 115.4 m

Max Day + Fire Flow (45 L/s): 108.8 m

These are for current conditions and are based on computer model simulation.

Disclaimer: The boundary condition information is based on current operation of the city water distribution system. The computer model simulation is based on the best information available at the time. The operation of the water distribution system can change on a regular basis, resulting in a variation in boundary conditions. The physical properties of watermains deteriorate over time, as such must be assumed in the absence of actual field test data. The variation in physical watermain properties can therefore alter the results of the computer model simulation.

Thanks

Nishant Jhamb, P.Eng
Project Manager | Gestionnaire de projet
Planning, Real Estate and Economic Development Department
Development Review - Central Branch
City of Ottawa | Ville d'Ottawa
110 Laurier Avenue West Ottawa, ON | 110, avenue. Laurier Ouest. Ottawa (Ontario) K1P 1J1
613.580.2424 ext./poste 23112, nishant.jhamb@ottawa.ca

From: Francis Valenti <F.Valenti@McIntoshPerry.com>
Sent: May 27, 2022 9:45 AM
To: Jhamb, Nishant <nishant.jhamb@ottawa.ca>
Subject: RE: 22-5087 - Boundary Condition Request - 68 Sweetland Avenue

CAUTION: This email originated from an External Sender. Please do not click links or open attachments unless you recognize the source.

ATTENTION : Ce courriel provient d'un expéditeur externe. Ne cliquez sur aucun lien et n'ouvrez pas de pièce jointe, excepté si vous connaissez l'expéditeur.

Hello Nishant,

Revise water calcs are attached including OBC fire flow. The demands are summarized below:

- The estimated fire flow is 8,000 L/min based on the FUS
- The estimated fire flow is 2,700 L/min based on the OBC
- Average Daily Demand: 0.19 L/s
- Maximum Daily Demand: 1.82 L/s
- Maximum hourly daily demand: 2.73 L/s

I've also attached the pre-consultation notes that were provided to us.

Regards,

Francis Valenti, EIT

Engineering Intern, Land Development

T. 613.714.6895 | C. 613.808.2123

F.Valenti@McIntoshPerry.com | www.mcintoshperry.com

McINTOSH PERRY

Turning Possibilities Into Reality

From: Jhamb, Nishant <nishant.jhamb@ottawa.ca>

Sent: May 26, 2022 2:42 PM

To: Francis Valenti <F.Valenti@McIntoshPerry.com>

Subject: RE: 22-5087 - Boundary Condition Request - 68 Sweetland Avenue

Hello Francis,

What is the Fire Demand with OBC method? Are you getting more than 9000L/min?

Was a pre application consultation done on this application?

Thanks

Nishant Jhamb, P.Eng

Project Manager | Gestionnaire de projet

Planning, Real Estate and Economic Development Department

Development Review - Central Branch

City of Ottawa | Ville d'Ottawa

110 Laurier Avenue West Ottawa, ON | 110, avenue. Laurier Ouest. Ottawa (Ontario) K1P 1J1

613.580.2424 ext./poste 23112, nishant.jhamb@ottawa.ca

From: Francis Valenti <F.Valenti@McIntoshPerry.com>

Sent: May 26, 2022 1:16 PM

To: Jhamb, Nishant <nishant.jhamb@ottawa.ca>

Subject: 22-5087 - Boundary Condition Request - 68 Sweetland Avenue

CAUTION: This email originated from an External Sender. Please do not click links or open attachments unless you recognize the source.

ATTENTION : Ce courriel provient d'un expéditeur externe. Ne cliquez sur aucun lien et n'ouvrez pas de pièce jointe, excepté si vous connaissez l'expéditeur.

Good Afternoon,

We would like to request boundary conditions for the proposed development at 68 Sweetland Avenue. The proposed development consists of a 3-storey residential rear addition. The existing building includes 9 units and the proposed addition includes 33 units. The proposed connection (single) will be to the existing 203 mm dia. watermain located within Sweetland Avenue.

- The estimated fire flow is 8,000 L/min based on the FUS
- Average Daily Demand: 0.19 L/s
- Maximum Daily Demand: 1.82 L/s
- Maximum hourly daily demand: 2.73 L/s

Please find attached a map showing the proposed connection location and calculations prepared for the demands listed above.

Regards,

Francis Valenti, EIT

Engineering Intern, Land Development

T. 613.714.6895 | C. 613.808.2123

F.Valenti@McIntoshPerry.com | www.mcintoshperry.com

McINTOSH PERRY

Turning Possibilities Into Reality

Confidentiality Notice – If this email wasn't intended for you, please return or delete it. Click [here](#) to read all of the legal language around this concept.



Platinum
member

This e-mail originates from the City of Ottawa e-mail system. Any distribution, use or copying of this e-mail or the information it contains by other than the intended recipient(s) is unauthorized. Thank you.

Le présent courriel a été expédié par le système de courriels de la Ville d'Ottawa. Toute distribution, utilisation ou reproduction du courriel ou des renseignements qui s'y trouvent par une personne autre que son destinataire prévu est interdite. Je vous remercie de votre collaboration.

This e-mail originates from the City of Ottawa e-mail system. Any distribution, use or copying of this e-mail or the information it contains by other than the intended recipient(s) is unauthorized. Thank you.

Le présent courriel a été expédié par le système de courriels de la Ville d'Ottawa. Toute distribution, utilisation ou reproduction du courriel ou des renseignements qui s'y trouvent par une personne autre que son destinataire prévu est interdite. Je vous remercie de votre collaboration.

Boundary Conditions for 68 Sweetland Avenue

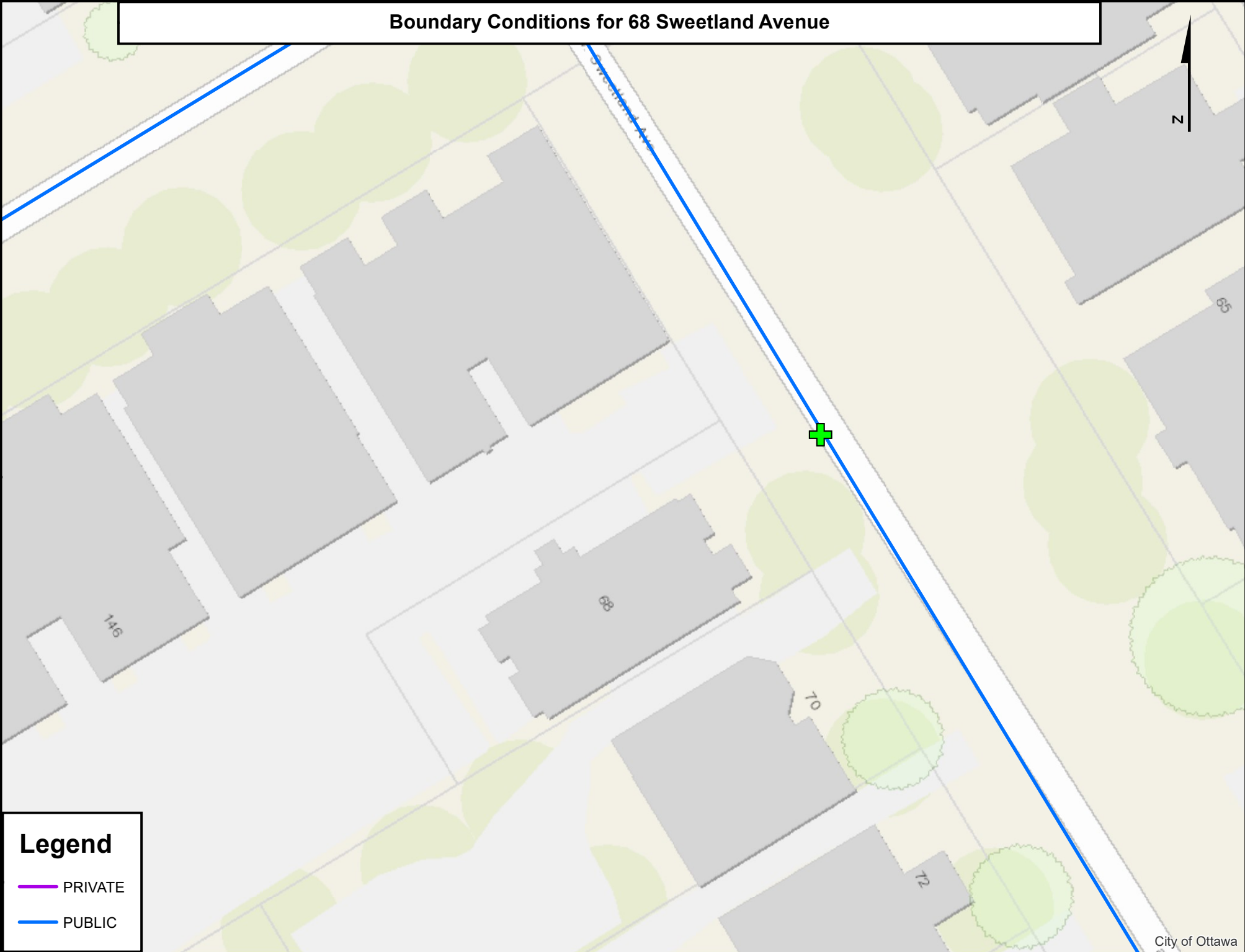

Legend

- PRIVATE
- PUBLIC

Francis Valenti

From: Juan Gomez <gomez@woodmanarchitect.com>
Sent: September 23, 2022 12:36 PM
To: Francis Valenti
Cc: Alison Gosling
Subject: Re: 22-5087 - FUS Parameters - 68 Sweetland Ave
Attachments: image759506.png

Type C

Le ven. 23 sept. 2022 11 h 12, Francis Valenti <F.Valenti@mcintoshperry.com> a écrit :

Hi Juan,

Can you please confirm the occupancy type as well? Definitions can be found on pages 24-25 of the attached PDF.

Thanks,

Francis Valenti, EIT

Engineering Intern, Land Development

T. 613.714.6895 | C. 613.808.2123

F.Valenti@McIntoshPerry.com | www.mcintoshperry.com



Turning Possibilities Into Reality

Confidentiality Notice – If this email wasn't intended for you, please return or delete it. Click [here](#) to read all of the legal language around this concept.

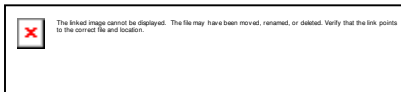

From: Juan Gomez <gomez@woodmanarchitect.com>
Sent: September 23, 2022 12:05 PM
To: Francis Valenti <F.Valenti@McIntoshPerry.com>
Cc: Alison Gosling <a.gosling@mcintoshperry.com>
Subject: Re: 22-5087 - FUS Parameters - 68 Sweetland Ave

Hi Francis,

Yes to your questions, construction type, wood frame. Sprinkler Type is standard.

Thank you

Juan Gomez



Associate

4 Beechwood Ave. Suite 201, Ottawa, ON K1L 8L9

Tel: 613.228.9850 ext. 225

Fax: 613.228.9848

Email: gomez@woodmanarchitect.com

On Thu, Sep 22, 2022 at 10:01 AM Francis Valenti <F.Valenti@mcintoshperry.com> wrote:

Good morning Juan,

In order to respond to City comments we require additional confirmation of the building parameters used in fire flow calculations for 68 Sweetland. Can you please confirm once more that the below parameters are correct?

- Construction Type: Wood Frame
- Sprinkler Type: Standard

We also require confirmation of the occupancy type. Based on the 2020 FUS guidelines (see attached), residential occupancies are classified as "Limited Combustible". Can you please confirm the occupancy type is "Limited Combustible" for the proposed building?

Thanks,

Francis Valenti, EIT

Engineering Intern, Land Development

T. 613.714.6895 | C. 613.808.2123

F.Valenti@McIntoshPerry.com | www.mcintoshperry.com

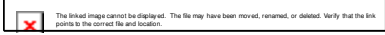

Turning Possibilities Into Reality

Confidentiality Notice – If this email wasn't intended for you, please return or delete it. Click [here](#) to read all of the legal language around this concept.

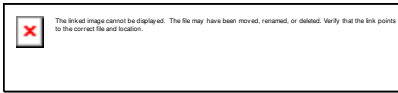

68 Sweetland Avenue Hydrant Coverage Figure

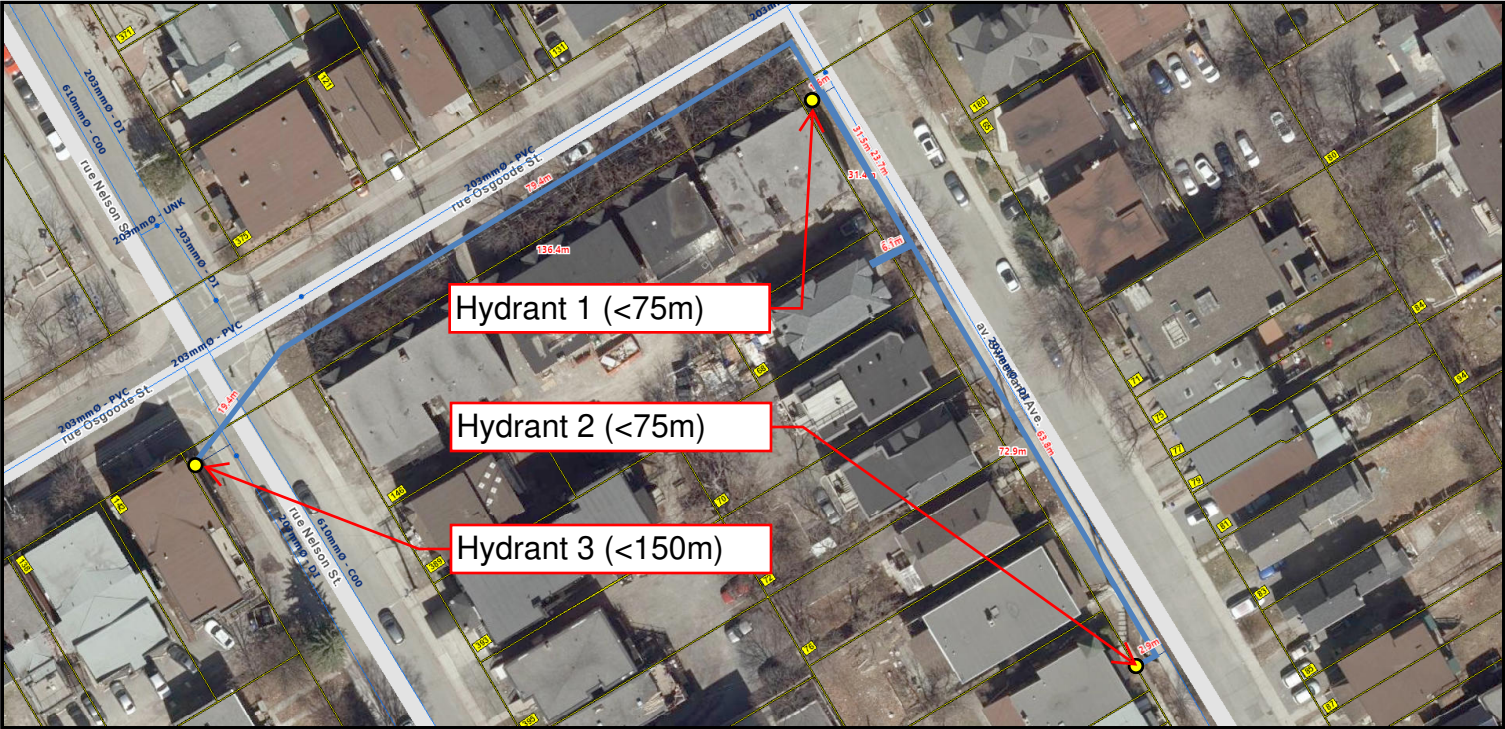

APPENDIX D
SANITARY CALCULATIONS

McINTOSH PERRY

000-22-5087 - 68 Sweetland Avenue - Sanitary Demands

Project:	68 Sweetland Avenue
Project No.:	000-22-5087
Designed By:	FV
Checked By:	AG
Date:	May-22

Ste Area	0.06	Gross ha
1 Bedroom (Existing)	9	1.40 Persons per unit
1 Bedroom (Proposed)	33	1.40 Persons per unit
Total Population	59	Persons

DESIGN PARAMETERS

Institutional/ Commercial Peaking Factor	1.5	
Residential Peaking Factor	3.64	* Using Harmon Formula = $1 + (14 / (4 + P^{0.5})) * 0.8$ where P = population in thousands, Harmon's Correction Factor = 0.8
Mannings coefficient (n)	0.013	
Demand (per capita)	280	L/day
Infiltration allowance	0.33	L/s/Ha

EXTRANEOUS FLOW ALLOWANCES

Infiltration / Inflow	Flow (L/s)
Dry	0.00
Wet	0.02
Total	0.02

AVERAGE DAILY DEMAND

DEMAND TYPE	AMOUNT	UNITS	POPULATION / AREA	Flow (L/s)
Residential	280	L/c/d	59	0.19
Industrial - Light**	35,000	L/gross ha/d		0
Industrial - Heavy**	55,000	L/gross ha/d		0
Commercial / Amenity	2,800	L/(1000m ² /d)		0
Hospital	900	L/(bed/day)		0
Schools	70	L/(Student/d)		0
Trailer Parks no Hook-Ups	340	L/(space/d)		0
Trailer Park with Hook-Ups	800	L/(space/d)		0
Campgrounds	225	L/(campsite/d)		0
Mobile Home Parks	1,000	L/(Space/d)		0
Motels	150	L/(bed-space/d)		0
Hotels	225	L/(bed-space/d)		0
Office	75	L/7.0m ² /d		0
Tourist Commercial	28,000	L/gross ha/d		0
Other Commercial	28,000	L/gross ha/d		0

AVERAGE RESIDENTIAL FLOW	0.19	L/s
PEAK RESIDENTIAL FLOW	0.70	L/s
AVERAGE ICI FLOW	0.00	L/s
PEAK INSTITUTIONAL/ COMMERCIAL FLOW	0.00	L/s
PEAK INDUSTRIAL FLOW	0.00	L/s
TOTAL PEAK ICI FLOW	0.00	L/s

TOTAL SANITARY DEMAND

TOTAL ESTIMATED AVERAGE DRY WEATHER FLOW	0.19	L/s
TOTAL ESTIMATED PEAK DRY WEATHER FLOW	0.70	L/s
TOTAL ESTIMATED PEAK WET WEATHER FLOW	0.72	L/s

SANITARY SEWER DESIGN SHEET

PROJECT: OOO-22-5087
 LOCATION: 68 Sweetland Avenue
 CLIENT: Smart Living Properties



LOCATION				RESIDENTIAL									INFILTRATION ALLOWANCE			FLOW	SEWER DATA											
1	2	3	4	5	6	7	8	9	10	11	12	13	21	22	23	24	25	26	27	28	29	30	31					
STREET	AREA ID	FROM MH	TO MH	UNIT TYPES				AREA (ha)	POPULATION		PEAK FACTOR	PEAK FLOW (L/s)	AREA (ha)		FLOW (L/s)	DESIGN FLOW (L/s)	CAPACITY (L/s)	LENGTH (m)	DIA (mm)	SLOPE (%)	VELOCITY (full) (m/s)	AVAILABLE CAPACITY						
				SF	SD	TH	APT		IND	CUM			IND	CUM								L/s	L/s	L/s	(%)			
Sweetland Ave		EX. BLDG	MAIN				42	0.06	59.0	59.0	3.64	0.70	0.06	0.06	0.02	0.72	15.89	13.60	150	1.00	0.871	15.17	95.49					
Design Parameters:				Notes:									Designed:			Revision							Date					
Residential				1. Mannings coefficient (n) = 0.013									FV			Revision 1							2022.11.21					
ICI Areas				2. Demand (per capita): 280 L/day									Checked:															
SF	3.4	p/p/u		3. Infiltration allowance: 0.33 L/s/Ha									CJM															
TH/SD	2.7	p/p/u	INST	28,000	L/Ha/day		1.5	4. Residential Peaking Factor:									Project No.:										Sheet No:	
1-BR	1.4	p/p/u	COM	28,000	L/Ha/day		1.5	Harmon Formula = $1 + (14 / (4 + P^{0.5})) * 0.8$									OOO-22-5087										1 of 1	
Other	60	p/p/Ha	IND	35,000	L/Ha/day		MOEChart	where P = population in thousands																				

APPENDIX E
PRE-DEVELOPMENT DRAINAGE PLAN

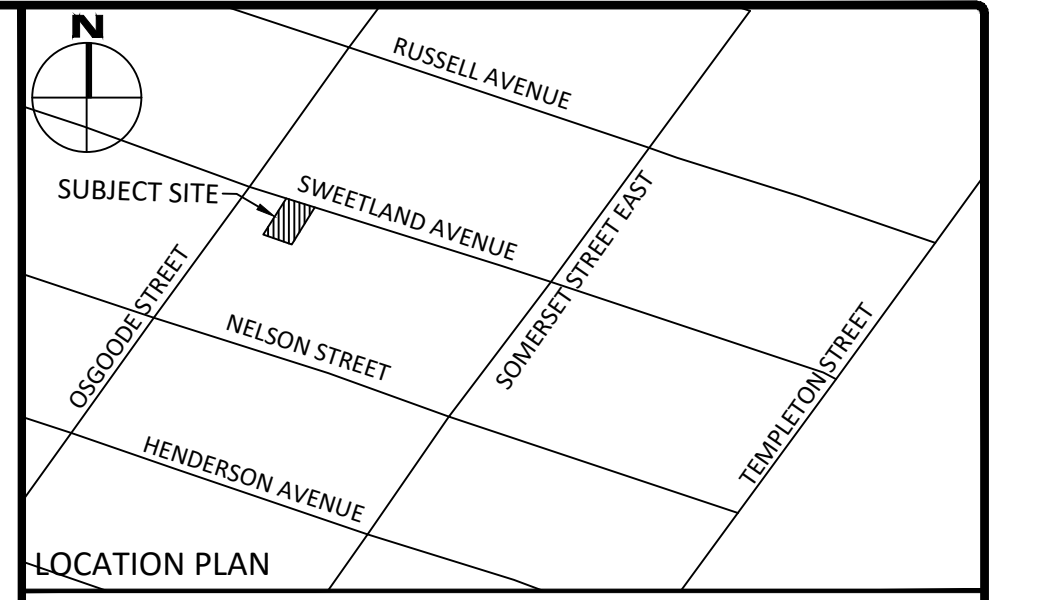
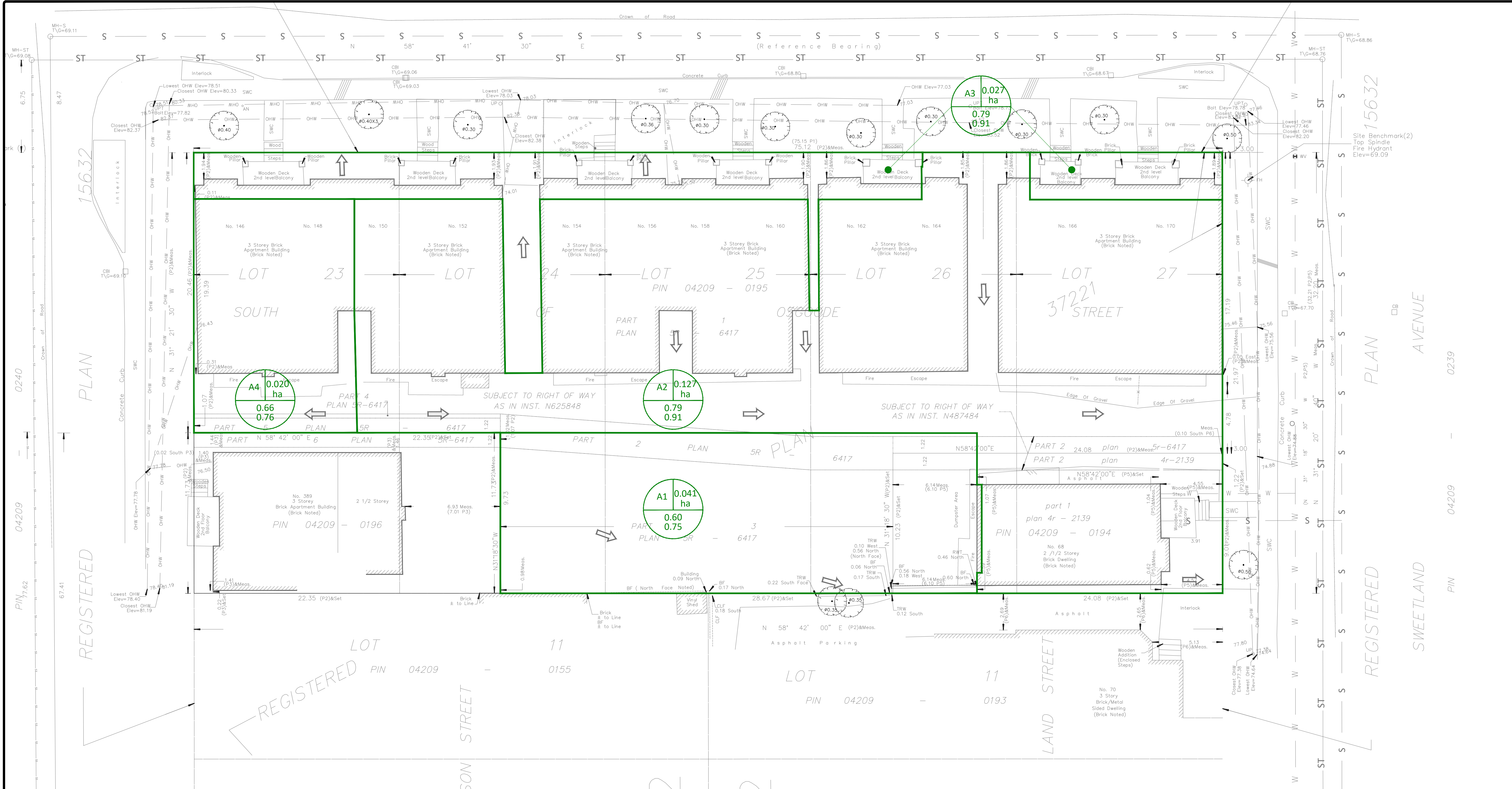

FOR REVIEW ONLY
NOT FOR CONSTRUCTION

No.	Revisions	Date
2	REVISED PER CITY COMMENTS	JAN. 18, 2023
1	ISSUED FOR REVIEW	JUNE 07, 2022

Check and verify all dimensions before proceeding with the work. Do not scale drawings.

SCALE 1:150

McINTOSH PERRY
115 Walgreen Road, RR3, Carp, ON K0A 1L0
Tel: 613-836-2184 Fax: 613-836-3742
www.mcintoshperry.com

Client: **SMART LIVING PROPERTIES**
226 ARGYLE AVENUE
OTTAWA, ON K2P 1B9

Project: **APARTMENT BUILDING ADDITION**
68 SWEETLAND AVENUE

Drawing Title: **PRE-DEVELOPMENT DRAINAGE PLAN**

Scale: 1:150 Project Number: CCO-22-5087

Drawn By: FV

Checked By: AG

Designed By: FV

- GENERAL NOTES**
- THE ORIGINAL TOPOGRAPHY, GROUND ELEVATION AND SURVEY DATA SHOWN ARE SUPPLIED FOR INFORMATION PURPOSES ONLY, AND IMPLY NO GUARANTEE OF ACCURACY. IT SHALL BE THE RESPONSIBILITY OF THE CONTRACTOR TO VERIFY ALL INFORMATION SHOWN.
 - THIS PLAN IS NOT A CADASTRAL SURVEY SHOWING LEGAL PROPERTY BOUNDARIES AND EASEMENTS. THE PROPERTY BOUNDARIES SHOWN HEREON HAVE BEEN DERIVED FROM INFORMATION SUPPLIED BY (OR SHOWN ON) ANNIS O'SULLIVAN VOLLEBECK LTD. DWS 2015-19 COMPLETED NOVEMBER 28, 2019, AND CANNOT BE RELIED UPON TO BE ACCURATE OR COMPLETE. THE PRECISE LOCATION OF THE CURRENT PROPERTY BOUNDARIES AND EASEMENTS CAN ONLY BE DETERMINED BY AN UP-TO-DATE LAND TITLES SEARCH AND A SUBSEQUENT CADASTRAL SURVEY PERFORMED AND CERTIFIED BY AN ONTARIO LAND SURVEYOR.
 - THE CONTRACTOR IS TO OBTAIN AND PAY FOR ALL NECESSARY PERMITS AND APPROVALS FROM THE CITY BEFORE COMMENCING CONSTRUCTION.
 - THE CONTRACTOR IS RESPONSIBLE FOR ALL LAYOUT.
 - THE CONTRACTOR IS TO DETERMINE THE EXACT LOCATION, SIZE, MATERIAL AND ELEVATION OF ALL EXISTING UTILITIES PRIOR TO COMMENCING CONSTRUCTION. PROTECT AND ASSUME ALL RESPONSIBILITY FOR EXISTING UTILITIES WHETHER OR NOT SHOWN ON THESE DRAWINGS. IF THERE IS ANY DISCREPANCY THE CONTRACTOR IS TO NOTIFY THE ENGINEER PROMPTLY.
 - RESTORE ALL TRENCHES AND SURFACES OF PUBLIC ROAD ALLOWANCES TO CONDITION EQUAL OR BETTER THAN ORIGINAL CONDITION AND TO THE SATISFACTION OF THE CITY AUTHORITIES.
 - EXCAVATE AND DISPOSE OF ALL EXCESS EXCAVATED MATERIAL, SUCH AS ASPHALT, CURBING AND DEBRIS, OFF SITE AS DIRECTED BY THE ENGINEER AND THE CITY.
 - TOPSOIL TO BE STRIPPED AND STOCKPILED FOR REHABILITATION. CLEAN FILL TO BE PLACED IN FILL AREAS AND COMPACTED TO 95% STANDARD PROCTOR DENSITY.
 - ALL DISTURBED AREAS TO BE RESTORED TO ORIGINAL

- CONDITION OR BETTER UNLESS OTHERWISE SPECIFIED. THE CONTRACTOR SHALL BE RESPONSIBLE FOR ALL TRAFFIC CONTROL AND SAFETY MEASURES DURING THE CONSTRUCTION PERIOD, INCLUDING THE SUPPLY, INSTALLATION, AND REMOVAL OF ALL NECESSARY SIGNAGE, DELINEATORS, MARKERS AND BARRIERS.
- DO NOT ALTER GRADING OF THE SITE WITHOUT PRIOR APPROVAL OF THE ENGINEER/CITY.
- ALL ROADWAY, PARKING LOT, AND GRADING WORKS TO BE UNDERTAKEN IN ACCORDANCE WITH CITY STANDARDS AND SPECIFICATIONS. THE CONTRACTOR IS TO PROVIDE POSITIVE DRAINAGE AWAY FROM THE BUILDING.
- CONTACT THE CITY FOR INSPECTION OF ROUGH GRADING OF PARKING LOTS, ROADWAYS AND LANDSCAPED AREAS PRIOR TO PLACEMENT OF ASPHALT AND TOPSOIL. ALL DEFICIENCIES NOTED SHALL BE RECTIFIED TO THE CITY'S SATISFACTION PRIOR TO PLACEMENT OF ANY ASPHALT, TOPSOIL, SEED & MULCH AND/OR SOD.
- ALL DIMENSIONS AND INVERTS MUST BE VERIFIED PRIOR TO CONSTRUCTION, IF THERE IS ANY DISCREPANCY THE CONTRACTOR IS TO NOTIFY THE ENGINEER PROMPTLY.
- ELECTRICAL, GAS, TELEPHONE AND TELEVISION SERVICE LOCATIONS ARE SUBJECT TO THE INDIVIDUAL AGENCY.
 - ELECTRICAL SERVICE - HYDRO ONE,
 - GAS SERVICE - ENBRIDGE,
 - TELEPHONE SERVICE - BELL CANADA,
 - TELEVISION SERVICE - ROGERS.
- INSTALLATION TO BE IN ACCORDANCE WITH CURRENT CODES AND STANDARDS OF APPROVAL AGENCIES HYDRO ONE, BELL AND THE CITY.
- CONTRACTOR TO ENSURE ALL APPLICABLE OPS SPECIFICATIONS ARE FOLLOWED DURING CONSTRUCTION
- ALL PROPOSED CURB TO BE CONCRETE BARRIER CURB UNLESS OTHERWISE SPECIFIED.
- THIS PLAN MUST BE READ IN CONJUNCTION WITH THE GEOTECHNICAL INVESTIGATION COMPLETED BY EXP. DATED JUNE 20, 2022.

LEGEND:

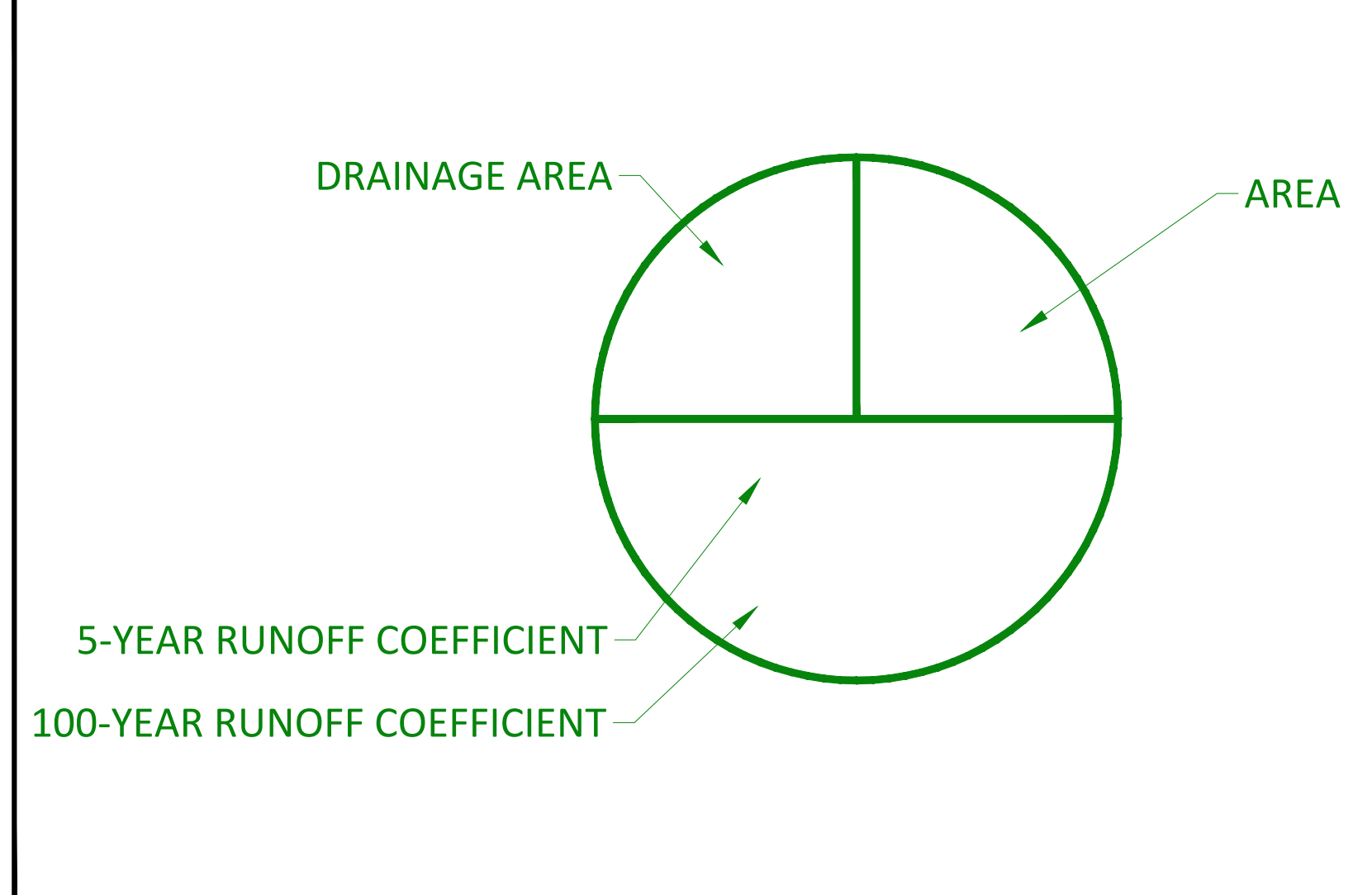

FILENAME: U:\City\0101 Project - Proposals\2022\06\CCO\CCO-22-5087 Smart Living Apartments_68 Sweetland Ave\12 - Drawing\CCO-22-5087_Presentation.dwg
 USER: FV (F. VANDERKAM) DATE: 2022-06-17 10:52:11 AM
 LAST PLOTTED: Tuesday, January 17, 2023 10:52:11 AM

D07-12-XX-XXXX

#XXXX

APPENDIX F
POST-DEVELOPMENT DRAINAGE PLAN

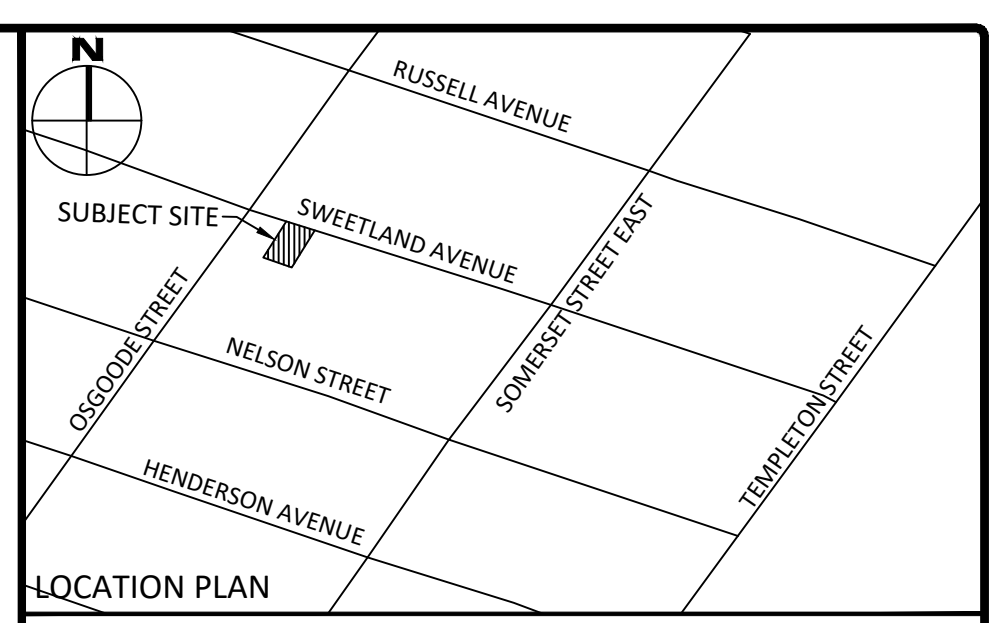
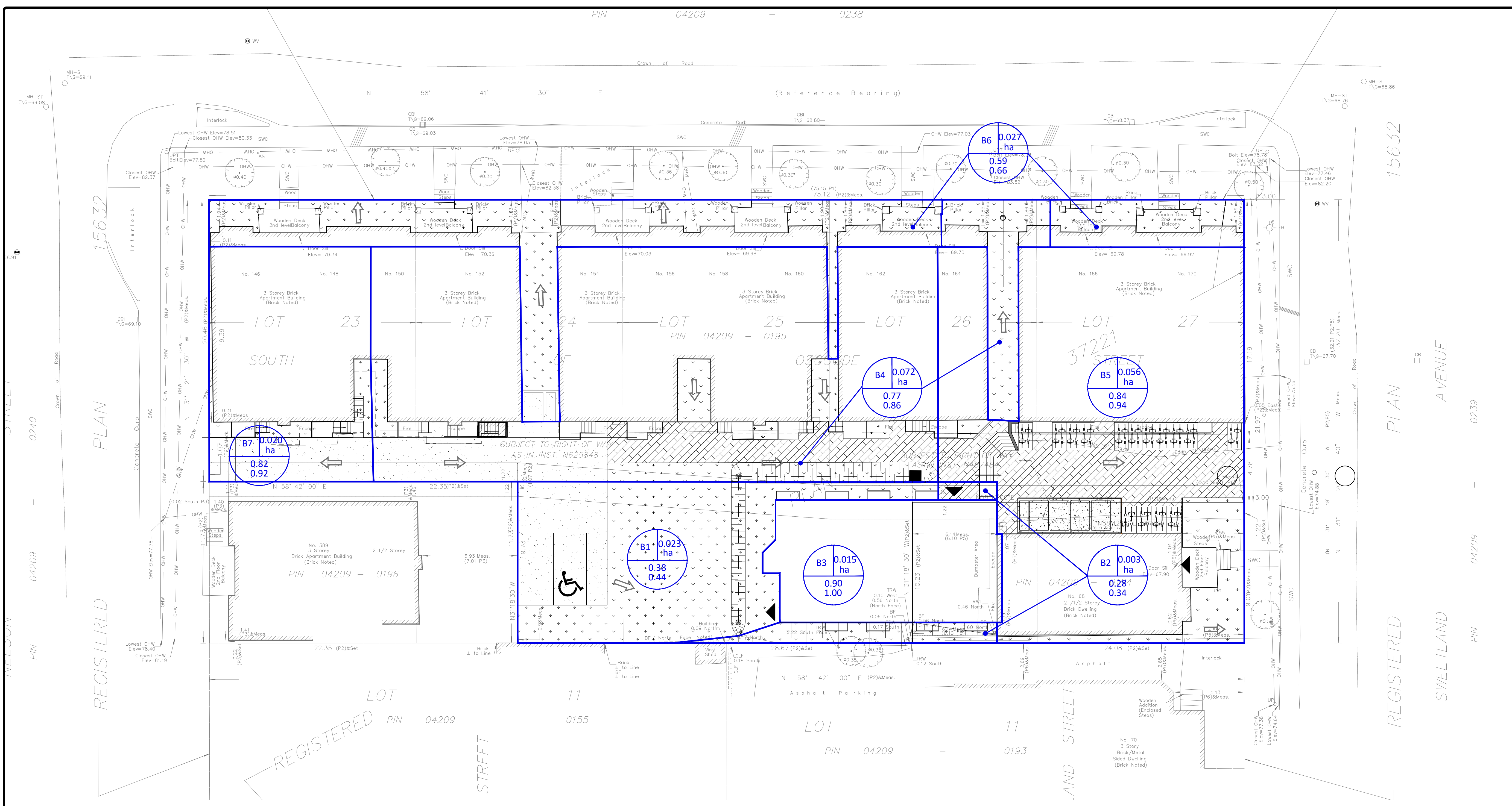

No.	Revisions	Date
2	REVISED PER CITY COMMENTS	JAN. 18, 2023
1	ISSUED FOR REVIEW	JUNE 07, 2022

FOR REVIEW ONLY
NOT FOR CONSTRUCTION

Check and verify all dimensions before proceeding with the work. Do not scale drawings.		
SCALE	1 : 150	

McINTOSH PERRY
115 Walgreen Road, RR3, Carp, ON K0A 1L0
Tel: 613-836-2184 Fax: 613-836-3742
www.mcintoshperry.com

Client: **SMART LIVING PROPERTIES**
226 ARGYLE AVENUE
OTTAWA, ON K2P 1B9

Project: **APARTMENT BUILDING ADDITION**
68 SWEETLAND AVENUE

Drawing Title: **POST-DEVELOPMENT DRAINAGE PLAN**

Scale: 1:150	Project Number: CCO-22-5087
Drawn By: FV	Checked By: AG
Designed By: FV	Stamp: POST

- GENERAL NOTES**
- THE ORIGINAL TOPOGRAPHY, GROUND ELEVATION AND SURVEY DATA SHOWN ARE SUPPLIED FOR INFORMATION PURPOSES ONLY, AND IMPLY NO GUARANTEE OF ACCURACY. IT SHALL BE THE RESPONSIBILITY OF THE CONTRACTOR TO VERIFY ALL INFORMATION SHOWN.
 - THIS PLAN IS NOT A CADASTRAL SURVEY SHOWING LEGAL PROPERTY BOUNDARIES AND EASEMENTS. THE PROPERTY BOUNDARIES SHOWN HEREON HAVE BEEN DERIVED FROM INFORMATION SUPPLIED BY (OR SHOWN ON) ANNIS O'SULLIVAN VOLLEBEK LTD. DWG 2015-19 COMPLETED NOVEMBER 28, 2019, AND CANNOT BE RELIED UPON TO BE ACCURATE OR COMPLETE. THE PRECISE LOCATION OF THE CURRENT PROPERTY BOUNDARIES AND EASEMENTS CAN ONLY BE DETERMINED BY AN UP-TO-DATE LAND TITLES SEARCH AND A SUBSEQUENT CADASTRAL SURVEY PERFORMED AND CERTIFIED BY AN ONTARIO LAND SURVEYOR.
 - THE CONTRACTOR IS TO OBTAIN AND PAY FOR ALL NECESSARY PERMITS AND APPROVALS FROM THE CITY BEFORE COMMENCING CONSTRUCTION.
 - THE CONTRACTOR IS RESPONSIBLE FOR ALL LAYOUT.
 - THE CONTRACTOR IS TO DETERMINE THE EXACT LOCATION, SIZE, MATERIAL AND ELEVATION OF ALL EXISTING UTILITIES PRIOR TO COMMENCING CONSTRUCTION. PROTECT AND ASSUME ALL RESPONSIBILITY FOR EXISTING UTILITIES WHETHER OR NOT SHOWN ON THESE DRAWINGS. IF THERE IS ANY DISCREPANCY THE CONTRACTOR IS TO NOTIFY THE ENGINEER PROMPTLY.
 - RESTORE ALL TRENCHES AND SURFACES OF PUBLIC ROAD ALLOWANCES TO CONDITION EQUAL OR BETTER THAN ORIGINAL CONDITION AND TO THE SATISFACTION OF THE CITY AUTHORITIES.
 - EXCAVATE AND DISPOSE OF ALL EXCESS EXCAVATED MATERIAL, SUCH AS ASPHALT, CURBING AND DEBRIS, OFF SITE AS DIRECTED BY THE ENGINEER AND THE CITY.
 - TOPSOIL TO BE STRIPPED AND STOCKPILED FOR REHABILITATION. CLEAN FILL TO BE PLACED IN FILL AREAS AND COMPACTED TO 95% STANDARD PROCTOR DENSITY.
 - ALL DISTURBED AREAS TO BE RESTORED TO ORIGINAL

- CONDITION OR BETTER UNLESS OTHERWISE SPECIFIED. THE CONTRACTOR SHALL BE RESPONSIBLE FOR ALL TRAFFIC CONTROL AND SAFETY MEASURES DURING THE CONSTRUCTION PERIOD, INCLUDING THE SUPPLY, INSTALLATION, AND REMOVAL OF ALL NECESSARY SIGNAGE, DELINEATORS, MARKERS AND BARRIERS.
- DO NOT ALTER GRADING OF THE SITE WITHOUT PRIOR APPROVAL OF THE ENGINEER/CITY.
- ALL ROADWAY, PARKING LOT, AND GRADING WORKS TO BE UNDERTAKEN IN ACCORDANCE WITH CITY STANDARDS AND SPECIFICATIONS. THE CONTRACTOR IS TO PROVIDE POSITIVE DRAINAGE AWAY FROM THE BUILDING.
- CONTACT THE CITY FOR INSPECTION OF ROUGH GRADING OF PARKING LOTS, ROADWAYS AND LANDSCAPED AREAS PRIOR TO PLACEMENT OF ASPHALT AND TOPSOIL. ALL DEFICIENCIES NOTED SHALL BE RECTIFIED TO THE CITY'S SATISFACTION PRIOR TO PLACEMENT OF ANY ASPHALT, TOPSOIL, SEED & MULCH AND/OR SOD.
- ALL DIMENSIONS AND INVERTS MUST BE VERIFIED PRIOR TO CONSTRUCTION, IF THERE IS ANY DISCREPANCY THE CONTRACTOR IS TO NOTIFY THE ENGINEER PROMPTLY.
- ELECTRICAL, GAS, TELEPHONE AND TELEVISION SERVICE LOCATIONS ARE SUBJECT TO THE INDIVIDUAL AGENCY.
 - ELECTRICAL SERVICE - HYDRO ONE,
 - GAS SERVICE - ENBRIDGE,
 - TELEPHONE SERVICE - BELL CANADA,
 - TELEVISION SERVICE - ROGERS.
- INSTALLATION TO BE IN ACCORDANCE WITH CURRENT CODES AND STANDARDS OF APPROVAL AGENCIES HYDRO ONE, BELL AND THE CITY.
- CONTRACTOR TO ENSURE ALL APPLICABLE OPS SPECIFICATIONS ARE FOLLOWED DURING CONSTRUCTION
- ALL PROPOSED CURB TO BE CONCRETE BARRIER CURB UNLESS OTHERWISE SPECIFIED.
- THIS PLAN MUST BE READ IN CONJUNCTION WITH THE GEOTECHNICAL INVESTIGATION COMPLETED BY EXP. DATED JUNE 20, 2022.

LEGEND:

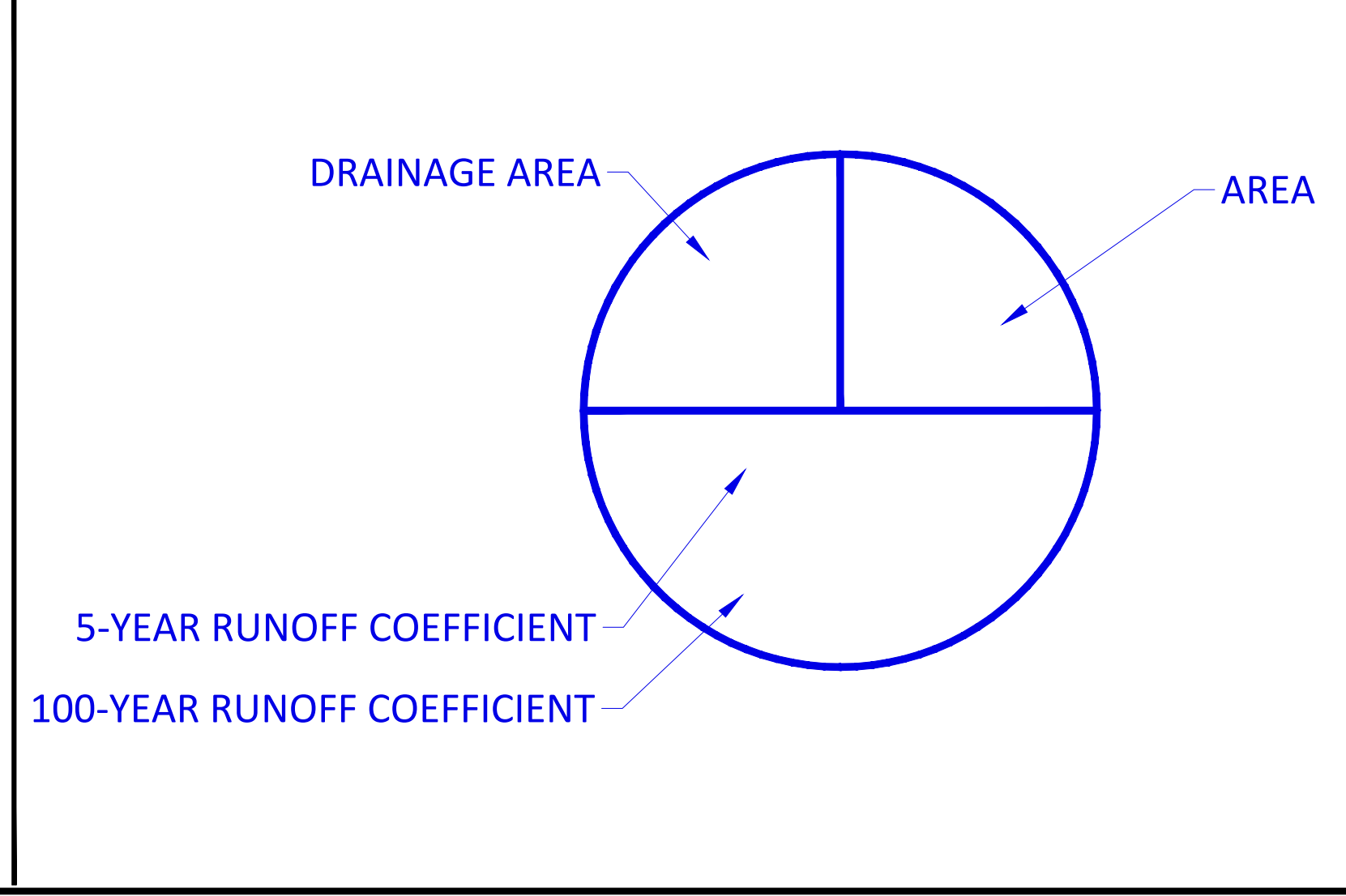

D07-12-XX-XXXX

APPENDIX G
STORMWATER MANAGEMENT CALCULATIONS

McINTOSH PERRY

CCO-22-5087 - 68 Sweetland Avenue

1 of 4

Tc (min)	Intensity (mm/hr)		
	2-Year	5-Year	100-Year
10	76.8	104.2	178.6

C-Values	
Impervious	0.90
Gravel	0.60
Pervious	0.20

Pre-Development Runoff Coefficient

Drainage Area	Impervious Area (m ²)	Gravel (m ²)	Pervious Area (m ²)	Average C (2/ 5-year)	Average C (100-year)	
A1	3	407	0	0.60	0.75	Development Area Drainage
A2	863	376	36	0.79	0.91	Existing Sweetland Drainage
A3	149	52	70	0.66	0.76	Existing Osgoode Drainage
A4	141	57	3	0.81	0.92	Existing Nelson Drainage

Pre-Development Runoff Calculations

Drainage Area	Area (ha)	C 2/ 5-Year	C 100-Year	Tc (min)	Q (L/s)		
					2-Year	5-Year	100-Year
A1	0.041	0.60	0.75	10	5.27	7.15	15.30
Total (Dev Area)	0.041				5.27	7.15	15.30
A2	0.127	0.79	0.91	10	21.55	29.23	57.27
A3	0.027	0.79	0.91	10	4.57	6.20	12.16
A4	0.020	0.66	0.76	10	2.84	3.86	7.58
Total (Ex. Drainage)	0.175				28.97	39.30	77.00

Post-Development Runoff Coefficient

Drainage Area	Impervious Area (m ²)	Gravel (m ²)	Pervious Area (m ²)	Average C (2/ 5-year)	Average C (100-year)	
B1	58	0	172	0.38	0.44	Collected
B2	4	0	30	0.28	0.34	Uncollected
B3	146	0	0	0.90	1.00	Roof
B4	580	0	137	0.77	0.86	Ex. Sweetland Collected
B5	510	0	48	0.84	0.94	Ex. Sweetland Uncollected
B6	149	0	122	0.59	0.66	Ex. Osgoode Drainage
B7	179	0	22	0.82	0.92	Ex. Nelson Drainage

Post-Development Runoff Calculations

Drainage Area	Area (ha)	C 2/ 5-Year	C 100-Year	Tc (min)	Q (L/s)			
					2-Year	5-Year	100-Year	
B1	0.023	0.38	0.44	10	1.85	2.52	5.03	Collected
B2	0.003	0.28	0.34	10	0.20	0.27	0.56	Uncollected
B3	0.015	0.90	1.00	10	2.81	3.81	7.25	Roof
Total (Dev Area)	0.041				4.86	6.60	12.84	
B4	0.072	0.77	0.86	10	11.73	15.91	30.48	Ex. Sweetland Collected
B5	0.056	0.84	0.94	10	10.01	13.58	25.93	Ex. Sweetland Uncollected
B6	0.027	0.59	0.66	10	3.38	4.59	8.90	Ex. Osgoode Drainage
B7	0.020	0.82	0.92	10	3.54	4.80	9.17	Ex. Nelson Drainage
Total (Ex. Drainage)	0.175				28.66	38.88	74.48	

Required Restricted Flow (Development Area)

Drainage Area	Area (ha)	C 2/ 5-Year	Tc (min)	Q (L/s)
				2-Year
A1	0.041	0.60	10	5.27

Post-Development Restricted Runoff Calculations

Drainage Area	Unrestricted Flow (L/S)			Restricted Flow (L/S)			
	2-year	5-year	100-Year	2-Year	5-Year	100-Year	
B1	1.85	2.52	5.03	1.85	2.52	5.03	Collected
B2	0.20	0.27	0.56	0.20	0.27	0.56	Uncollected
B3	2.81	3.81	7.25	0.63	0.63	0.63	Roof
Total (Dev Area)	4.86	6.60	12.84	2.69	3.42	6.22	
B4	11.73	15.91	30.48	11.73	15.91	30.48	Ex. Sweetland Collected
B5	10.01	13.58	25.93	10.01	13.58	25.93	Ex. Sweetland Uncollected
B6	3.38	4.59	8.90	3.38	4.59	8.90	Ex. Osgoode
B7	3.54	4.80	9.17	3.54	4.80	9.17	Ex. Nelson
Total (Ex. Drainage)	28.66	38.88	74.48	28.66	38.88	74.48	

Post-Development Storage Summary

Drainage Area	Storage Required (m ³)			Storage Provided (m ³)		
	2-Year	5-Year	100-Year	2-Year	5-Year	100-Year
B3	1.53	2.41	5.90	1.64	2.56	6.09
Total	1.53	2.41	5.90	1.64	2.56	6.09

McINTOSH PERRY

CCO-22-5087 - 68 Sweetland Avenue - Roof Storage

2 of 4

2-Year Storm Event

Tc (min)	I (mm/hr)	B3 Runoff (L/s)	Allowable Outflow (L/s)	Runoff to be Stored (L/s)	Storage Required (m ³)
10	76.8	2.81	0.63	2.18	1.31
20	52.0	1.90	0.63	1.27	1.53
30	40.0	1.46	0.63	0.83	1.50
40	32.9	1.20	0.63	0.57	1.37
50	28.0	1.02	0.63	0.39	1.18
60	24.6	0.90	0.63	0.27	0.96
70	21.9	0.80	0.63	0.17	0.71
80	19.8	0.72	0.63	0.09	0.45

Maximum Storage Required 5-Year (m³) = 1.53

5-Year Storm Event

Tc (min)	I (mm/hr)	B3 Runoff (L/s)	Allowable Outflow (L/s)	Runoff to be Stored (L/s)	Storage Required (m ³)
10	104.2	3.81	0.63	3.18	1.91
20	70.3	2.57	0.63	1.94	2.33
30	53.9	1.97	0.63	1.34	2.41
40	44.2	1.62	0.63	0.98	2.36
50	37.7	1.38	0.63	0.75	2.24
60	32.9	1.20	0.63	0.57	2.06
70	29.4	1.07	0.63	0.44	1.86
80	26.6	0.97	0.63	0.34	1.64

Maximum Storage Required 5-Year (m³) = 2.41

100-Year Storm Event

Tc (min)	I (mm/hr)	B3 Runoff (L/s)	Allowable Outflow (L/s)	Runoff to be Stored (L/s)	Storage Required (m ³)
10	178.6	7.25	0.63	6.62	3.97
20	120.0	4.87	0.63	4.24	5.09
30	91.9	3.73	0.63	3.10	5.58
40	75.1	3.05	0.63	2.42	5.81
50	64.0	2.60	0.63	1.97	5.90
60	55.9	2.27	0.63	1.64	5.90
70	49.8	2.02	0.63	1.39	5.84
80	45.0	1.83	0.63	1.20	5.74

Maximum Storage Required 100-Year (m³) = 5.90

Storage Parameters

Roof Area (m ²)	146.09
Usable Roof Area (%)	75%
Usable Roof Area (m ²)	109.57

5-Year Storage Summary

Max. Storage Available (m ³)	2.56
5-Year Storage Required (m ³)	2.41
Max. Ponding Depth (m)	0.07

2-Year Storage Summary

Max. Storage Available (m ³)	1.64
2-Year Storage Required (m ³)	1.53
Max. Ponding Depth (m)	0.045

100-Year Storage Summary

Max. Storage Available (m ³)	6.09
100-Year Storage Required (m ³)	5.90
Max. Ponding Depth (m)	0.125

McINTOSH PERRY

CCO-22-5087 - 68 Sweetland Avenue - Roof Storage

Roof Drain Flow (B3)

3 of 4

Roof Drains Summary	
Type of Control Device	Watts Drainage - Accutrol Weir
Number of Roof Drains	2
Roof Drain Position	Closed

	2-Year	5-Year	100-Year
Rooftop Storage Available (m ³)	1.64	2.56	6.09
Rooftop Storage Required (m ³)	1.53	2.41	5.90
Storage Depth (m)	0.045	0.070	0.125
Flow (Per Roof Drain) (L/s)	0.32	0.32	0.32
Total Flow (L/s)	0.63	0.63	0.63

Flow Rate Vs. Build-Up (Individual Drain)	
Depth (mm)	Flow (L/s)
0	0.00
5	0.06
10	0.13
15	0.19
20	0.25
25	0.32
30	0.32
35	0.32
40	0.32
45	0.32
50	0.32
55	0.32
60	0.32
65	0.32
70	0.32
75	0.32
80	0.32
85	0.32
90	0.32
95	0.32
100	0.32
105	0.32
110	0.32
115	0.32
120	0.32
125	0.32
130	0.32
135	0.32
140	0.32
145	0.32
150	0.32

Roof Drain Flow			
	Individual Flow (l/s)	Storage Depth (mm)	Cumulative Flow (l/s)
	0.00	0	0.00
	0.06	5	0.13
	0.13	10	0.25
	0.19	15	0.38
	0.25	20	0.50
	0.32	25	0.63
	0.32	30	0.63
	0.32	35	0.63
	0.32	40	0.63
2-Year	0.32	45	0.63
	0.32	50	0.63
	0.32	55	0.63
	0.32	60	0.63
5-Year	0.32	65	0.63
	0.32	70	0.63
	0.32	75	0.63
	0.32	80	0.63
	0.32	85	0.63
	0.32	90	0.63
	0.32	95	0.63
	0.32	100	0.63
	0.32	105	0.63
	0.32	110	0.63
	0.32	115	0.63
100-Year	0.32	120	0.63
	0.32	125	0.63
	0.32	130	0.63
	0.32	135	0.63
	0.32	140	0.63
	0.32	145	0.63
	0.32	150	0.63

* Roof Drain model to be Accutrol Weirs, See attached sheets

* Roof Drain Flow information taken from Watts Drainage website

Note: The flow leaving through a restricted roof drain is based on flow vs. head information

McINTOSH PERRY

CCO-22-5087 - 68 Sweetland Avenue

4 of 4

Time of Concentration Pre-Development

Drainage Area ID	Sheet Flow Distance (m)	Slope of Land (%)	Tc (min) (5-Year)	Tc (min) (100-Year)
A1	53	3.60	8	5

Therefore, a Tc of 10 can be used

$$T_c = (3.26(1.1-c)L^{0.5}/S^{0.33})$$

c = Balanced Runoff Coefficient

L = Length of drainage area

S = Average slope of watershed

STORM SEWER DESIGN SHEET

PROJECT: CCO-22-5087
 LOCATION: 68 Sweetland Avenue
 CLIENT: Smart Living Properties



LOCATION				CONTRIBUTING AREA (ha)				RATIONAL DESIGN FLOW								SEWER DATA						
1	2	3	4	5	6	7	8	9	10	11	12	13	14	15	19	20	21	22	25	26	27	28
STREET	AREA ID	FROM MH	TO MH	C-VALUE	AREA	INDIV AC	CUMUL AC	INLET (min)	TIME IN PIPE	TOTAL (min)	i (5) (mm/hr)	i (10) (mm/hr)	i (100) (mm/hr)	5yr PEAK FLOW (L/s)	DESIGN FLOW (L/s)	CAPACITY (L/s)	LENGTH (m)	PIPE SIZE (mm DIA)	SLOPE (%)	VELOCITY (m/s)	AVAIL CAP (5yr) (L/s)	AVAIL CAP (5yr) (%)
Sweetland Ave	B1	LSCB5	LSCB4	0.38	0.02	0.01	0.01	10.00	0.20	10.20	104.19	122.14	178.56	2.54	2.54	43.87	10.60	250	0.50	0.866	41.33	94.22%
	B1 + B4	LSCB4	CB3	0.77	0.07	0.06	0.06	10.20	0.11	10.32	103.13	120.89	176.71	18.32	18.32	142.67	13.25	300	2.00	1.955	124.34	87.16%
	B1 + B3 + B4	CB3	MH2	0.90	0.01	0.01	0.08	10.32	0.15	10.47	102.55	120.20	175.71	21.97	21.97	179.90	22.64	300	3.18	2.466	157.93	87.79%
	B1 + B3 + B4	MH2	MH1				0.08	10.47	0.10	10.57	101.77	119.29	174.37	21.80	21.80	100.88	8.54	300	1.00	1.383	79.08	78.39%
Definitions:				Notes:				Designed:								Revision						
Q = 2.78QA, where:				1. Mannings coefficient (n) = 0.013				FV								1.						
Q = Peak Flow in Litres per Second (L/s)																ISSUED FOR REVIEW						
A = Area in Hectares (ha)																						
i = Rainfall intensity in millimeters per hour (mm/hr)																						
[i = 998.071 / (TC+6.053)^0.814] 5 YEAR																						
[i = 1174.184 / (TC+6.014)^0.816] 10 YEAR																						
[i = 1735.688 / (TC+6.014)^0.820] 100 YEAR																						
								Checked:														
								CH														
								Project No.:														
								CCO-22-5087								Date:						
																2023.01.20						
																Sheet No:						
																1 of 1						

APPENDIX H
CITY OF OTTAWA DESIGN CHECKLIST

City of Ottawa

4. Development Servicing Study Checklist

The following section describes the checklist of the required content of servicing studies. It is expected that the proponent will address each one of the following items for the study to be deemed complete and ready for review by City of Ottawa Infrastructure Approvals staff.

The level of required detail in the Servicing Study will increase depending on the type of application. For example, for Official Plan amendments and re-zoning applications, the main issues will be to determine the capacity requirements for the proposed change in land use and confirm this against the existing capacity constraint, and to define the solutions, phasing of works and the financing of works to address the capacity constraint. For subdivisions and site plans, the above will be required with additional detailed information supporting the servicing within the development boundary.

4.1 General Content

Criteria	Location (if applicable)
<input type="checkbox"/> Executive Summary (for larger reports only).	N/A
<input type="checkbox"/> Date and revision number of the report.	On Cover
<input type="checkbox"/> Location map and plan showing municipal address, boundary, and layout of proposed development.	Appendix A
<input type="checkbox"/> Plan showing the site and location of all existing services.	Site Servicing Plan (C102)
<input type="checkbox"/> Development statistics, land use, density, adherence to zoning and official plan, and reference to applicable subwatershed and watershed plans that provide context to which individual developments must adhere.	1.1 Purpose 1.2 Site Description 6.0 Stormwater Management
<input type="checkbox"/> Summary of pre-consultation meetings with City and other approval agencies.	Appendix B
<input type="checkbox"/> Reference and confirm conformance to higher level studies and reports (Master Servicing Studies, Environmental Assessments, Community Design Plans), or in the case where it is not in conformance, the proponent must provide justification and develop a defensible design criteria.	1.1 Purpose 1.2 Site Description 6.0 Stormwater Management
<input type="checkbox"/> Statement of objectives and servicing criteria.	3.0 Pre-Consultation Summary

<input type="checkbox"/> Identification of existing and proposed infrastructure available in the immediate area.	N/A
<input type="checkbox"/> Identification of Environmentally Significant Areas, watercourses and Municipal Drains potentially impacted by the proposed development (Reference can be made to the Natural Heritage Studies, if available).	Ste Grading Plan (C101)
<input type="checkbox"/> Concept level master grading plan to confirm existing and proposed grades in the development. This is required to confirm the feasibility of proposed stormwater management and drainage, soil removal and fill constraints, and potential impacts to neighbouring properties. This is also required to confirm that the proposed grading will not impede existing major system flow paths.	Ste Grading Plan (C101)
<input type="checkbox"/> Identification of potential impacts of proposed piped services on private services (such as wells and septic fields on adjacent lands) and mitigation required to address potential impacts.	N/A
<input type="checkbox"/> Proposed phasing of the development, if applicable.	N/A
<input type="checkbox"/> Reference to geotechnical studies and recommendations concerning servicing.	Section 2.0 Background Studies, Standards and References
<input type="checkbox"/> All preliminary and formal site plan submissions should have the following information: <ul style="list-style-type: none"> ○ Metric scale ○ North arrow (including construction North) ○ Key plan ○ Name and contact information of applicant and property owner ○ Property limits including bearings and dimensions ○ Existing and proposed structures and parking areas ○ Easements, road widening and rights-of-way ○ Adjacent street names 	Ste Grading Plan (C101)

4.2 Development Servicing Report: Water

Criteria	Location (if applicable)
<input type="checkbox"/> Confirm consistency with Master Servicing Study, if available	N/A
<input type="checkbox"/> Availability of public infrastructure to service proposed development	N/A
<input type="checkbox"/> Identification of system constraints	N/A
<input type="checkbox"/> Identify boundary conditions	Appendix C
<input type="checkbox"/> Confirmation of adequate domestic supply and pressure	N/A
<input type="checkbox"/> Confirmation of adequate fire flow protection and confirmation that fire flow is calculated as per the Fire Underwriter's Survey. Output should show available fire flow at locations throughout the development.	Appendix C
<input type="checkbox"/> Provide a check of high pressures. If pressure is found to be high, an assessment is required to confirm the application of pressure reducing valves.	N/A
<input type="checkbox"/> Definition of phasing constraints. Hydraulic modeling is required to confirm servicing for all defined phases of the project including the ultimate design	N/A
<input type="checkbox"/> Address reliability requirements such as appropriate location of shut-off valves	N/A
<input type="checkbox"/> Check on the necessity of a pressure zone boundary modification.	N/A
<input type="checkbox"/> Reference to water supply analysis to show that major infrastructure is capable of delivering sufficient water for the proposed land use. This includes data that shows that the expected demands under average day, peak hour and fire flow conditions provide water within the required pressure range	Appendix C, Section 4.2

<input type="checkbox"/> Description of the proposed water distribution network, including locations of proposed connections to the existing system, provisions for necessary looping, and appurtenances (valves, pressure reducing valves, valve chambers, and fire hydrants) including special metering provisions.	Site Servicing Plan (C101)
<input type="checkbox"/> Description of off-site required feeder mains, booster pumping stations, and other water infrastructure that will be ultimately required to service proposed development, including financing, interim facilities, and timing of implementation.	N/A
<input type="checkbox"/> Confirmation that water demands are calculated based on the City of Ottawa Design Guidelines.	Appendix C
<input type="checkbox"/> Provision of a model schematic showing the boundary conditions locations, streets, parcels, and building locations for reference.	N/A

4.3 Development Servicing Report: Wastewater

Criteria	Location (if applicable)
<input type="checkbox"/> Summary of proposed design criteria (Note: Wet-weather flow criteria should not deviate from the City of Ottawa Sewer Design Guidelines. Monitored flow data from relatively new infrastructure cannot be used to justify capacity requirements for proposed infrastructure).	N/A
<input type="checkbox"/> Confirm consistency with Master Servicing Study and/or justifications for deviations.	N/A
<input type="checkbox"/> Consideration of local conditions that may contribute to extraneous flows that are higher than the recommended flows in the guidelines. This includes groundwater and soil conditions, and age and condition of sewers.	N/A
<input type="checkbox"/> Description of existing sanitary sewer available for discharge of wastewater from proposed development.	Section 5.2 Proposed Sanitary Sewer

<input type="checkbox"/> Verify available capacity in downstream sanitary sewer and/or identification of upgrades necessary to service the proposed development. (Reference can be made to previously completed Master Servicing Study if applicable)	Section 5.3 Proposed Sanitary Design
<input type="checkbox"/> Calculations related to dry-weather and wet-weather flow rates from the development in standard MOE sanitary sewer design table (Appendix 'C') format.	N/A
<input type="checkbox"/> Description of proposed sewer network including sewers, pumping stations, and forcemains.	Section 5.2 Proposed Sanitary Sewer
<input type="checkbox"/> Discussion of previously identified environmental constraints and impact on servicing (environmental constraints are related to limitations imposed on the development in order to preserve the physical condition of watercourses, vegetation, soil cover, as well as protecting against water quantity and quality).	N/A
<input type="checkbox"/> Pumping stations: impacts of proposed development on existing pumping stations or requirements for new pumping station to service development.	N/A
<input type="checkbox"/> Forcemain capacity in terms of operational redundancy, surge pressure and maximum flow velocity.	N/A
<input type="checkbox"/> Identification and implementation of the emergency overflow from sanitary pumping stations in relation to the hydraulic grade line to protect against basement flooding.	N/A
<input type="checkbox"/> Special considerations such as contamination, corrosive environment etc.	N/A

4.4 Development Servicing Report: Stormwater Checklist

Criteria	Location (if applicable)
<input type="checkbox"/> Description of drainage outlets and downstream constraints including legality of outlets (i.e. municipal drain, right-of-way, watercourse, or private property)	Section 6.0 Stormwater Sewer Design & Section 7.0 Proposed Stormwater Management
<input type="checkbox"/> Analysis of available capacity in existing public infrastructure.	N/A
<input type="checkbox"/> A drawing showing the subject lands, its surroundings, the receiving watercourse, existing drainage patterns, and proposed drainage pattern.	Pre & Post-Development Plans
<input type="checkbox"/> Water quantity control objective (e.g. controlling post-development peak flows to pre-development level for storm events ranging from the 2 or 5-year event (dependent on the receiving sewer design) to 100-year return period); if other objectives are being applied, a rationale must be included with reference to hydrologic analyses of the potentially affected subwatersheds, taking into account long-term cumulative effects.	Section 6.0 Stormwater Sewer Design & Section 7.0 Proposed Stormwater Management
<input type="checkbox"/> Water Quality control objective (basic, normal or enhanced level of protection based on the sensitivities of the receiving watercourse) and storage requirements.	Section 6.0 Stormwater Sewer Design & Section 7.0 Proposed Stormwater Management
<input type="checkbox"/> Description of the stormwater management concept with facility locations and descriptions with references and supporting information.	Section 6.0 Stormwater Sewer Design & Section 7.0 Proposed Stormwater Management
<input type="checkbox"/> Set-back from private sewage disposal systems.	N/A
<input type="checkbox"/> Watercourse and hazard lands setbacks.	N/A
<input type="checkbox"/> Record of pre-consultation with the Ontario Ministry of Environment and the Conservation Authority that has jurisdiction on the affected watershed.	N/A
<input type="checkbox"/> Confirm consistency with sub-watershed and Master Servicing Study, if applicable study exists.	N/A
<input type="checkbox"/> Storage requirements (complete with calculations) and conveyance capacity for minor events (1:5-year return period) and major events (1:100-year return period).	Appendix G

<input type="checkbox"/> Identification of watercourses within the proposed development and how watercourses will be protected, or, if necessary, altered by the proposed development with applicable approvals.	Site Grading Plan
<input type="checkbox"/> Calculate pre-and post development peak flow rates including a description of existing site conditions and proposed impervious areas and drainage catchments in comparison to existing conditions.	Section 7.0 Proposed Stormwater Management Appendix G
<input type="checkbox"/> Any proposed diversion of drainage catchment areas from one outlet to another.	Section 6.0 Stormwater Sewer Design & Section 7.0 Proposed Stormwater Management
<input type="checkbox"/> Proposed minor and major systems including locations and sizes of stormwater trunk sewers, and stormwater management facilities.	Section 6.0 Stormwater Sewer Design & Section 7.0 Proposed Stormwater Management
<input type="checkbox"/> If quantity control is not proposed, demonstration that downstream system has adequate capacity for the post-development flows up to and including the 100-year return period storm event.	N/A
<input type="checkbox"/> Identification of potential impacts to receiving watercourses	N/A
<input type="checkbox"/> Identification of municipal drains and related approval requirements.	N/A
<input type="checkbox"/> Descriptions of how the conveyance and storage capacity will be achieved for the development.	Section 6.0 Stormwater Sewer Design & Section 7.0 Proposed Stormwater Management
<input type="checkbox"/> 100-year flood levels and major flow routing to protect proposed development from flooding for establishing minimum building elevations (MBE) and overall grading.	Site Grading Plan (C101)
<input type="checkbox"/> Inclusion of hydraulic analysis including hydraulic grade line elevations.	N/A

<input type="checkbox"/> Description of approach to erosion and sediment control during construction for the protection of receiving watercourse or drainage corridors.	Section 8.0 Sediment & Erosion Control
<input type="checkbox"/> Identification of floodplains – proponent to obtain relevant floodplain information from the appropriate Conservation Authority. The proponent may be required to delineate floodplain elevations to the satisfaction of the Conservation Authority if such information is not available or if information does not match current conditions.	N/A
<input type="checkbox"/> Identification of fill constraints related to floodplain and geotechnical investigation.	N/A

4.5 Approval and Permit Requirements: Checklist

The Servicing Study shall provide a list of applicable permits and regulatory approvals necessary for the proposed development as well as the relevant issues affecting each approval. The approval and permitting shall include but not be limited to the following:

Criteria	Location (if applicable)
<input type="checkbox"/> Conservation Authority as the designated approval agency for modification of floodplain, potential impact on fish habitat, proposed works in or adjacent to a watercourse, cut/fill permits and Approval under Lakes and Rivers Improvement Act. The Conservation Authority is not the approval authority for the Lakes and Rivers Improvement Act. Where there are Conservation Authority regulations in place, approval under the Lakes and Rivers Improvement Act is not required, except in cases of dams as defined in the Act.	N/A
<input type="checkbox"/> Application for Certificate of Approval (CofA) under the Ontario Water Resources Act.	N/A
<input type="checkbox"/> Changes to Municipal Drains.	N/A
<input type="checkbox"/> Other permits (National Capital Commission, Parks Canada, Public Works and Government Services Canada, Ministry of Transportation etc.)	N/A

4.6 Conclusion Checklist

Criteria	Location (if applicable)
<input type="checkbox"/> Clearly stated conclusions and recommendations	Section 9.0 Summary Section 10.0 Recommendations
<input type="checkbox"/> Comments received from review agencies including the City of Ottawa and information on how the comments were addressed. Final sign-off from the responsible reviewing agency.	All are stamped
<input type="checkbox"/> All draft and final reports shall be signed and stamped by a professional Engineer registered in Ontario	All are stamped