

STORMWATER MANAGEMENT AND SERVICING REPORT

29 RUSSELL AVENUE
CITY OF OTTAWA



PEARSON
ENGINEERING

PEARSONENG.COM

(Revised July 2023)

June 2022

22030



TABLE OF CONTENTS

1. INTRODUCTION	1
2. SUPPORTING DOCUMENTS	1
3. DESIGN POPULATION.....	1
4. WATER SUPPLY AND DISTRIBUTION.....	1
4.1. WATER SERVICING DESIGN CRITERIA	1
4.2. INTERNAL WATER DISTRIBUTION SYSTEM	2
4.3. FIRE FIGHTING REQUIREMENTS.....	2
5. SANITARY SERVICING.....	2
5.1. SANITARY DESIGN CRITERIA	2
5.2. INTERNAL SANITARY SEWER SYSTEM	3
6. STORMWATER MANAGEMENT	3
6.1. ANALYSIS METHODOLOGY.....	3
6.2. EXISTING DRAINAGE CONDITIONS.....	3
6.3. PROPOSED STORM DRAINAGE SYSTEM	4
6.4. STORMWATER QUANTITY CONTROL.....	4
6.5. STORMWATER QUALITY CONTROL.....	4
6.5.1. PERMANENT QUALITY CONTROL	5
6.5.2. QUALITY CONTROL DURING CONSTRUCTION ACTIVITIES	5
7. CONCLUSIONS	6

APPENDICES

Appendix A – Water Servicing Calculations

Appendix B – Sanitary Servicing Calculations

Appendix C – Stormwater Management Calculations

Appendix D – Ottawa Servicing Report Checklist

Appendix E – Pre-Consultation Summary

Appendix F – RVCA Correspondence

Appendix G – Vortex Valve Information

Appendix H – StormTech Chambers Information

Appendix I – Taggart Construction Ltd. Pre-Construction CCTV Inspection Report

Appendix J – Pearson Engineering Drawings



LIST OF FIGURES & DRAWINGS

- Figure 1** – Site Location Plan
- Dwg SGS-1** – Site Grading and Servicing Plan
- Dwg STM-1** – Pre-Development Storm Catchment Plan
- Dwg STM-2** – Post-Development Storm Catchment Plan
- Dwg EPR-1** – Erosion Protection and Removals Plan



ASSESSMENT OF ADEQUACY OF PUBLIC SERVICES

29 RUSSELL AVE, OTTAWA

1. INTRODUCTION

PEARSON Engineering Ltd. has been retained by Smart Living Properties (Client) to prepare an Assessment of Adequacy of Public Services report in support of a proposed 3-Storey residential apartment development located at 29 Russell Ave in the City of Ottawa (City).

The subject property is approximately 0.05 ha in size and fronts onto Russell Avenue to the west and existing residential homes to the south and east and a parking lot to the north. The Project site currently consists of a residential lot occupied by a semi-detached dwelling and proposes the development of a 3-storey rear addition residential apartment building. The location of the site can be seen on Figure 1.

The objective of this report is to assess the existing municipal infrastructure in the vicinity of the Project, the onsite Stormwater Management (SWM) facilities and internal services required to service the proposed Project. The report also includes design calculations and a brief outline of the proposed internal services, as well as comments regarding the ability of the various secondary utilities to service the site.

2. SUPPORTING DOCUMENTS

The following documents have been referenced in the preparation of this report:

- Ministry of the Environment, Design Guidelines for Sewage Works, 2008
- Ministry of the Environment, Design Guidelines for Drinking-Water Systems, 2008
- Ministry of the Environment, Stormwater Management Planning and Design Manual, March 2003
- City of Ottawa, Sewer Design Guidelines, October 2012
- City of Ottawa, Water Distribution Design Guidelines, July 2010

3. DESIGN POPULATION

The proposed development is to consist of a 3-storey residential building with a total of 7 apartment units consisting of four bachelor units, one 3-bedroom unit, and two 4-bedroom units. The existing residential building totals 14 units consisting of twelve bachelor units, one 3-bedroom unit, and one 2-bedroom unit. Based on City of Ottawa residential flows data, a design population of 1.40 persons per bachelor unit, 3.10 persons per 3-bedroom unit and 4 persons per 4-bedroom unit were selected. This results in a maximum projected design population of 38 persons. Refer to Appendix A for calculations.

4. WATER SUPPLY AND DISTRIBUTION

4.1. WATER SERVICING DESIGN CRITERIA

The site is to have a total design population of 38 persons for both, existing and proposed units. Utilizing the City of Ottawa Guidelines and the latest technical bulletin ISTB-2021-03 for Domestic Water Use of 280 L/capita/day, an Average Day Demand (ADD) of 0.12 L/s is required. A Peak Rate factor of 14.3 was used in calculating a Peak Hour Demand (PHD) of 1.76 L/s for the development. Calculations for the domestic water requirements for the site can be found in Appendix A.

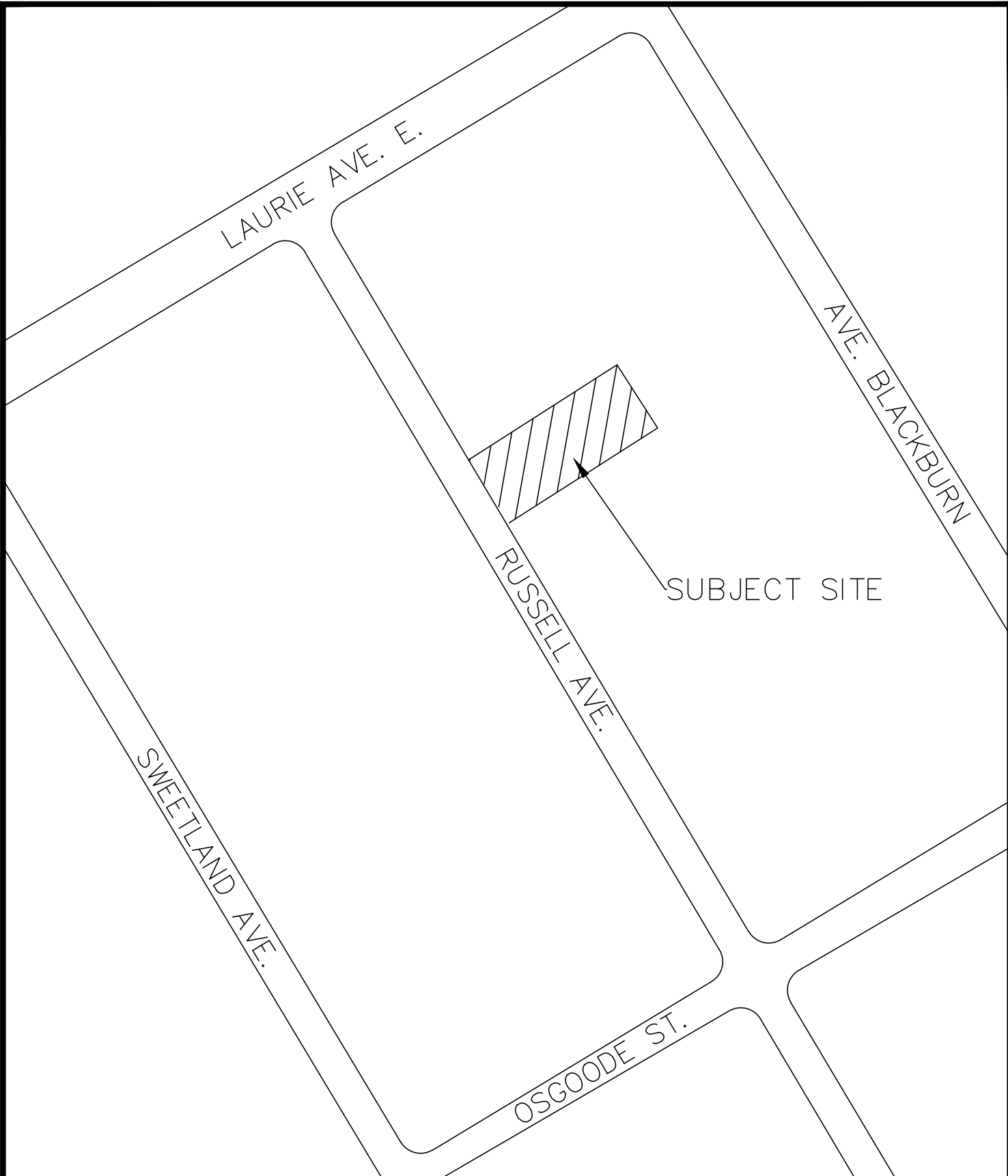

FOTENN, 29 RUSSEL AVE,
CITY OF OTTAWA

SITE LOCATION PLAN



PEARSON
ENGINEERING
PEARSONENG.COM PH. 705.719.4785

DESIGNED BY	NW	HORIZ SCALE	N/A	PROJECT #	22030
DRAWN BY	JM	VERT SCALE	N/A	DRAWING #	FIG-1
CHECKED BY	MWD	DATE	MAY 2022	REVISION #	0



4.2. INTERNAL WATER DISTRIBUTION SYSTEM

The Project will be serviced by municipal water for domestic and fire protection and designed as per City standards. As per the City of Ottawa’s as-built drawing, a 200 mm diameter municipal watermain is located on the east side of Russell Avenue. The site will be serviced by a proposed 50mm diameter water service connecting to the existing watermain on Russell Ave. for domestic service. Proposed layout of the water services can be seen on SGS-1 drawing in Appendix J.

4.3. FIRE FIGHTING REQUIREMENTS

Fire Flow calculations have been conducted as per OBC and OFM guidelines and resulted in a required fire flow of 90 L/s (5400 L/min). There are two existing AA class hydrants within 75 m and six existing AA class hydrant within 150 m of the site. As per Table 1 in Appendix I of Tech Bulletin ISTB 2018-02 issued by the City of Ottawa, the combined fire flow of these hydrants totals 34,200 L/min. As the required fire flow is less than the 34,200 L/min, the existing hydrant spacing is adequate for the site.

The Boundary Conditions for the site were provided by the City of Ottawa using the project’s domestic and fire flow demands. Water pressures shown in Table 1 were calculated based on the Hydraulic Grade Lines (HGL) provided by the City from these boundary conditions. When comparing to the minimum and maximum allowable water pressures from City of Ottawa Water Design Guidelines, it can be seen that the site water pressures fall within City limits. Fire flow analysis, water pressure conversion and boundary conditions supplied by the City can be found in Appendix A.

Table 1: Water Demand

Design Parameter	Demand (L/s)	HGL (m)	Pressure (PSI)	Pressure (kPa)	City of Ottawa minimum (kPa)	City of Ottawa maximum (kPa)
Average Daily Demand	0.12	106.0	64.4	444.3	-	552
Peak Hour	1.76	115.4	51.1	352.2	276	552
Max Day + Fire Flow	1.17	93.6	33.4	230.6	140	552

5. SANITARY SERVICING

5.1. SANITARY DESIGN CRITERIA

The site is to have a total design population of 38 persons for both, existing and proposed units. Utilizing the City of Ottawa Guidelines for domestic sewer use of 280 L/capita/day, an Average Daily Flow (ADF) of 0.12 L/s was calculated. Using a Peaking Factor of 3.67 for this project, a Peak Flow of 0.47 L/s was calculated for the project site.



5.2. INTERNAL SANITARY SEWER SYSTEM

The existing 150 mm diameter sanitary service is to be reused for this Project and will convey sanitary flow to the existing 250 mm diameter sanitary sewer on Russell Avenue. CCTV inspection was conducted by Taggart Construction Ltd. on the sanitary service and confirms the service is free of any obstructions and has no defects. The Taggart Construction Ltd. Pre-Construction CCTV Inspection Report and a sealed memo confirming the review of CCTV footage can be found in Appendix I. The existing 250 mm diameter sanitary sewer on Russell Ave runs south to north and has a capacity of 36 L/s at a slope of 0.36%. The proposed peak flow is 1.30 % of the existing capacity and therefore the existing sanitary sewer is expected to have sufficient capacity to convey the sanitary design flows. Refer to Drawing SGS-1 for the proposed sanitary servicing layout.

6. STORMWATER MANAGEMENT

A key component of the development is the need to address environmental and related SWM issues. These are examined in a framework aimed at meeting the City of Ottawa and MECP requirements. This report focuses on the necessary measures to satisfy the MECP's SWM requirements.

It is understood the objectives of the SWM plan are to:

- Protect life and property from flooding and erosion;
- Maintain water quality for ecological integrity, recreational opportunities, etc.;
- Protect and maintain groundwater flow regime(s);
- Protect aquatic and fishery communities and habitats; and
- Maintain and protect significant natural features.

6.1. ANALYSIS METHODOLOGY

The design of the SWM Facilities for this site has been conducted in accordance with:

- The Ministry of the Environment Stormwater Management Planning and Design Manual, March 2003
- City of Ottawa Sewer Design Guidelines, October 2012

In order to design the facilities to meet these requirements, it is essential to select the appropriate modeling methodology for the storm system design. Given the size of the site, the Rational Method is appropriate for the design for the SWM system.

6.2. EXISTING DRAINAGE CONDITIONS

The Project site consists of a residential lot occupied by a semi-detached dwelling. Review of the site's current drainage conditions identifies that the site splits and drains to both the east and west. The west half of the existing building is conveyed west via roof leaders and ultimately to an existing storm sewer on Russell Avenue. The east half drains towards an alley east of the building and ultimately to Osgoode Street. Details of existing storm drainage conditions are shown on Drawing STM-1 in Appendix J.

EXP Services Inc., completed a geotechnical investigation for the site in February 2022. The investigation revealed that the site consists of a thin layer of granular fill over silty sand, Groundwater was found at a depth of about 7.10 m below the existing ground surface.



A pre-development coefficient of 0.55 was calculated for the site but was reduced to 0.50 as per the City of Ottawa Stormwater Management Guidelines. Allowable peak flows for the site were calculated using City of Ottawa IDF information and can be seen in Table 2 below. Detailed calculations for the existing drainage conditions can be found in Appendix C.

Table 2: Allowable Peak Flows

	2 Year Storm	5 Year Storm	10 Year Storm	25 Year Storm	50 Year Storm	100 Year Storm
Allowable Peak Flows (L/s)	1.46	1.98	2.32	3.03	3.69	4.25

PROPOSED STORM DRAINAGE SYSTEM

The proposed drainage conditions from the site will generally follow pre-development patterns. Stormwater from the walkway will be directed overland to a proposed swale and ultimately to the rear alley similar to pre-development. Drainage from the proposed building addition will flow via roof leader to underground storage chambers which have been sized to reduce the 100-year storm event to the 5-year allowable peak flow. In the event of a storm greater than the 100-year storm, the storm sewer will overflow, and runoff will drain overland to Russell Avenue. Post-development storm drainage patterns can be found on Drawing STM-2 in Appendix J.

6.3. STORMWATER QUANTITY CONTROL

The proposed development will increase the imperviousness of the site and as such the post development peak flows will increase. The calculated post-development runoff coefficient of 0.90 is greater than the allowable runoff coefficient of 0.50. It is important to quantify the increase in stormwater runoff rates and attenuate these increases.

Quantity control on site will be provided through underground storage chambers located west of the existing building. A 66mm diameter Vortex Valve orifice (model CEV 275) will be implemented downstream of the CBMH to reduce the post-development peak flows leaving the site, causing stormwater to back up into the StormTech underground storage chambers. Calculations in Appendix C demonstrate that 3.93 m³ of volume is required to control 100-year storm event to 5-year pre-development values. Detailed calculations can be found in Appendix C. Table 3 summarizes post-development peak flows for the development.

Table 3: Post-Development Peak Flows

	2 Year Storm	5 Year Storm	10 Year Storm	25 Year Storm	50 Year Storm	100 Year Storm
Controlled Peak Flows (L/s)	1.46	1.98	1.98	1.98	1.98	1.98

6.4. STORMWATER QUALITY CONTROL

The MECP in March 2003 issued a “Stormwater Management Planning and Design Manual”. This manual has been adopted by a variety of agencies including the City of Ottawa. The objective of the Stormwater Quality Control will be to ensure Enhanced Protection quality control as stated in the MECP manual. To achieve enhanced protection, permanent and temporary control of erosion and sediment transport are proposed and are discussed in the following sections.



6.4.1. PERMANENT QUALITY CONTROL

The development's impervious areas pose a potential risk to stormwater quality through the collection of grit, sand, and oils. The east end of the site is being converted from a gravel parking lot to an addition to the existing building with no driveway or parking. Additionally, re-development of the site will increase the landscape area and the majority of the site's runoff occurs on the rooftop of the proposed building, which is considered generally clean. Due to the nature of the site and the nominal change in total imperviousness, no treatment is proposed to treat flows from the Project site.

As per the pre-consultation notes with the City of Ottawa, the RVCA was consulted to establish any water quality control restrictions, criteria and measures for the site. Based on the site's design and location, the RVCA determined that no further water quality measures were required. Pre-consultation notes with City of Ottawa can be found in Appendix E and correspondence with the conservation authority can be found in Appendix F.

6.4.2. QUALITY CONTROL DURING CONSTRUCTION ACTIVITIES

During construction, earth grading and excavation will create the potential for soil erosion and sedimentation. It is imperative that effective environmental and sedimentation controls are in place and maintained throughout the duration of construction activities to ensure stormwater runoff's quality.

Therefore, the following recommendations shall be implemented and maintained during construction to achieve acceptable stormwater runoff quality:

- Installation of silt fence along the entire perimeter of the site to reduce sediment migration onto surrounding properties;
- Restoration of exposed surfaces with vegetative and non-vegetative material as soon as construction schedules permit. The duration in which surfaces are disturbed/exposed shall not exceed 30 days;
- Reduce stormwater drainage velocities where possible; and,
- Minimize the amount of existing vegetation removed.



7. CONCLUSIONS

The proposed development will require the connection of sanitary and watermain services to the existing services within the subject site.

As the site proposes the construction of a building addition and rooftop drainage is considered generally clean, additional on-site quality control measures are not proposed.

Quantity control for the site is provided in underground storage chambers which will reduce the 100-year post development flows to the 5-year allowable peak flows values.

All of which is respectfully submitted,

PEARSON ENGINEERING LTD.

Taylor Arkell, P.Eng.
Senior Project Manager

Mike Dejean, P.Eng.
Partner, Manager of Engineering Services





APPENDIX A

WATER SERVICING CALCULATIONS

29 Russell Ave., Ottawa Water Flow Calculations

Design Criteria:

Demand per capita (Q):	280	L/cap/day	(As per the City of Ottawa latest technical bulletin ISTB-2021-03)
Peak Rate Factor (Max. Hour)	14.3		(Table 3-3: Peaking Factors, MOE Design Guidelines for Drinking-Water Systems)
Max. Day Factor	9.5		(Table 3-3: Peaking Factors, MOE Design Guidelines for Drinking-Water Systems)

Site Data:

Description	Density	Units	Flow Rate
Apartments - Bachelor Un	1.40	person/unit	17 units 280 L/cap/d
Apartments - 3 Bedroom	3.10	person/unit	2 units 280 L/cap/d
Apartments - 4 Bedroom	4.00	person/unit	2 units 280 L/cap/d

Max Day Factor* 9.50
Peak Rate Factor 14.30
*From MOE Manual based
Population of 38

Calculate Population

$$\begin{aligned} \text{Pop. Apartments} &= 1.40 \times 4 + 3.10 \times 1 + 4.00 \times 2 \\ \text{Pop.} &= 38 \text{ people} \end{aligned}$$

*Density for 4-bedroom is
assumed

Calculate Average Day Demand

$$\begin{aligned} \text{ADD} &= 280 \times 38 \\ \text{ADD} &= 10640 \text{ L/day} \\ \text{ADD} &= 0.12 \text{ L/s} \end{aligned}$$

Calculate Max Day Flow

$$\begin{aligned} \text{MDF} &= 0.12 \times 9.50 \\ \text{MDF} &= 1.17 \text{ L/s} \end{aligned}$$

Calculate Peak Hour Demand

$$\begin{aligned} \text{PHD} &= 0.12 \times 14.30 \\ &= 1.76 \text{ L/s} \end{aligned}$$

**FOTENN, 29, Russell Ave, Ottawa
Fire Flow Calculations - Apartment Building**

Required fire flow calculations as per OFM/OBC guidelines

Location:	Smart Living Properties, City of Ottawa	
OBC Occupancy:	Residential Occupancies - Class C	
Building Foot Print:	293 m ²	
Height of the Building	12.1	Apartment Buildings

Date: 2023-07-25
Project: FOTENN, 29 Russell Ave
Project Number: 22030

Exposure 1 (north) Ex. Residential	Distance to Property Line from Exterior face of the proposed building	4.1	0.55
Exposure 2 (east) Ex. Residential	Distance to Property Line from Exterior face of the proposed building	3.2	0.68
Exposure 3 (south) Ex. Residential	Distance to Property Line from Exterior face of the proposed building	5.9	0.41
Exposure 4 (west) Ex. Residential	Distance to Property Line from Exterior face of the proposed building	0.0	0

Exposure Distance (m)	Spatial Coefficient
5	0.5
6	0.4
7	0.3
8	0.2
9	0.1
10	0.0

Total: 2.64
S_{Total} **2** *no more than 2

Calculations: $K =$

$Q = KVS_{Total}$ $V =$ m³

$S_{total} =$

Round to Nearest 1,000 L/min $Q =$ L

Where: $Q =$ minimum supply of water in litres (L)
 $K =$ water supply coefficient from Table 1 of OFM guidelines
 $V =$ total building volume in cubic metres
 $S_{Total} =$ total of spatial coefficient values from property line exposures on all sides, as obtained from the formula
 $S_{Total} = 1.0 + [(S_{North}) + (S_{East}) + (S_{South}) + (S_{West})]$

Fire Flow Requirements from Table 2 of OFM guidelines

since minimum supply of water >162,000L and <= 190,000L

Required Fire Flow **RFF =** **L/min**

RFF = **GPM**

RFF = **L/s**



29 Russell Ave., Ottawa
Boundary Conditions Unit Conversion

Project:

FOTENN, 29 Russell Ave

Project Number:

22030

Street:

Russell Avenue

Ground Elev (m):

70.08

	Height (m)	m H₂O	PSI	kPa
Avg. Day	115.4	45.3	64.4	444.3
Peak Hour	106.0	35.9	51.1	352.2
Max Day + Fire Flow	93.6	23.5	33.4	230.6

From: [Bakhit, Reza](#)
To: [Nicole Wells](#)
Cc: [Nikhil Parmar](#)
Subject: RE: 29 Russell Ave - Boundary Conditions
Date: December 4, 2022 6:11:02 PM
Attachments: [image001.jpg](#)
[image002.png](#)
[29 Russell Avenue November 2022.pdf](#)

Hi Nicole,

Hope you had a good weekend.

The following are boundary conditions, HGL, for hydraulic analysis at 29 Russell Avenue (zone 1W) assumed to be a dual connection to the 203 mm watermain on Russell Avenue (see attached PDF for location).

Both Connections:

Minimum HGL: 106.0 m

Maximum HGL: 115.4 m

Max Day + Fire Flow (90 L/s): 108.8 m

Max Day + Fire Flow (266.67 L/s): 93.6 m

-

These are for current conditions and are based on computer model simulation.

Disclaimer: The boundary condition information is based on current operation of the city water distribution system. The computer model simulation is based on the best information available at the time. The operation of the water distribution system can change on a regular basis, resulting in a variation in boundary conditions. The physical properties of watermains deteriorate over time, as such must be assumed in the absence of actual field test data. The variation in physical watermain properties can therefore alter the results of the computer model simulation.

Kind regards,

Reza Bakhit, P.Eng, C.E.T

Project Manager

Planning, Real Estate and Economic Development Department / Direction générale de la planification, des biens immobiliers et du développement économique

Development Review - Central Branch

City of Ottawa | Ville d'Ottawa

110 Laurier Avenue West Ottawa, ON | 110, avenue. Laurier Ouest. Ottawa (Ontario) K1P 1J1

613.580.2424 ext./poste 19346, reza.bakhit@ottawa.ca

Please note: Given the current pandemic, I will be working from home until further notice; reaching me by email is the easiest. I will be checking my voicemail, just not as frequently as I normally would be.

From: Nicole Wells <nwells@pearsoneng.com>
Sent: Saturday, December 03, 2022 1:31 PM
To: Bakhit, Reza <reza.bakhit@ottawa.ca>
Cc: Nikhil Parmar <nparmar@pearsoneng.com>
Subject: RE: 29 Russell Ave - Boundary Conditions

CAUTION: This email originated from an External Sender. Please do not click links or open attachments unless you recognize the source.

ATTENTION : Ce courriel provient d'un expéditeur externe. Ne cliquez sur aucun lien et n'ouvrez pas de pièce jointe, excepté si vous connaissez l'expéditeur.

Hi Reza,

Just following up on my email from a couple weeks ago. Is there an update to the boundary conditions?

Thank you,

Nicole Wells, C.E.T.
Project Coordinator/Design Technologist



OTTAWA OFFICE

900 Morrison Drive, Unit 100
Ottawa, ON K2H 8K7
P: 613-416-1232 ext. 249
nwells@pearsoneng.com
pearsoneng.com

BARRIE

705-719-4785

GTA

905-597-5572

OWEN SOUND

519-614-2523

From: Nicole Wells
Sent: November 14, 2022 11:44 AM
To: Bakhit, Reza <reza.bakhit@ottawa.ca>
Cc: Nikhil Parmar <nparmar@pearsoneng.com>
Subject: RE: 29 Russell Ave - Boundary Conditions

Thank you Reza

From: Bakhit, Reza <reza.bakhit@ottawa.ca>
Sent: November 14, 2022 11:23 AM
To: Nicole Wells <nwells@pearsoneng.com>
Cc: Nikhil Parmar <nparmar@pearsoneng.com>
Subject: RE: 29 Russell Ave - Boundary Conditions

Hi Nicole,

Thanks for the reminder.
For some reason I have not received the results. I will follow up and let you know.

Regards,

Reza Bakhit, P.Eng, C.E.T

Project Manager

Planning, Real Estate and Economic Development Department / Direction générale de la planification, des biens immobiliers et du développement économique

Development Review - Central Branch

City of Ottawa | Ville d'Ottawa

110 Laurier Avenue West Ottawa, ON | 110, avenue. Laurier Ouest. Ottawa (Ontario) K1P 1J1

613.580.2424 ext./poste 19346, reza.bakhit@ottawa.ca

Please note: Given the current pandemic, I will be working from home until further notice; reaching me by email is the easiest. I will be checking my voicemail, just not as frequently as I normally would be.

From: Nicole Wells <nwells@pearsoneng.com>

Sent: Monday, November 14, 2022 10:32 AM

To: Bakhit, Reza <reza.bakhit@ottawa.ca>

Cc: Nikhil Parmar <nparmar@pearsoneng.com>

Subject: RE: 29 Russell Ave - Boundary Conditions

CAUTION: This email originated from an External Sender. Please do not click links or open attachments unless you recognize the source.

ATTENTION : Ce courriel provient d'un expéditeur externe. Ne cliquez sur aucun lien et n'ouvrez pas de pièce jointe, excepté si vous connaissez l'expéditeur.

Hi Reza,

Just wanted to follow up on our boundary condition update. Please advise if you require any further information to complete the request.

Thank you,

Nicole Wells, C.E.T.

Project Coordinator/Design Technologist



OTTAWA OFFICE

900 Morrison Drive, Unit 100

Ottawa, ON K2H 8K7

P: 613-416-1232 ext. 249

nwells@pearsoneng.com

pearsoneng.com

BARRIE

705-719-4785

GTA

905-597-5572

OWEN SOUND

519-614-2523

From: Nicole Wells
Sent: November 4, 2022 11:32 AM
To: Bakhit, Reza <reza.bakhit@ottawa.ca>
Cc: Nikhil Parmar <nparmar@pearsoneng.com>
Subject: RE: 29 Russell Ave - Boundary Conditions

Hi Reza,

Please see the attached calcs and our summary information below.

- The estimate fire flows based on FUS = 16,000 L/min
- The estimate fire flows based on OBC = 5400 L/min
- Average Daily Demand = 0.12 L/s
- Maximum Daily Demand = 1.17 L/s
- Maximum Peak Hour Demand = 1.76 L/s

Please note, I had the wrong OBC value in my previous email.

Thank you,

Nicole Wells, C.E.T.
Project Coordinator/Design Technologist



OTTAWA OFFICE

900 Morrison Drive, Unit 100
Ottawa, ON K2H 8K7
P: 613-416-1232 ext. 249
nwells@pearsoneng.com
pearsoneng.com

BARRIE	GTA	OWEN SOUND
705-719-4785	905-597-5572	519-614-2523

From: Bakhit, Reza <reza.bakhit@ottawa.ca>
Sent: November 4, 2022 10:35 AM
To: Nicole Wells <nwells@pearsoneng.com>
Cc: Nikhil Parmar <nparmar@pearsoneng.com>
Subject: RE: 29 Russell Ave - Boundary Conditions

Hi Nicole,

Please provide me with the calculations for all the parameters you noted in your request.

Thanks,

Reza Bakhit, P.Eng, C.E.T

Project Manager

Planning, Real Estate and Economic Development Department / Direction générale de la planification, des biens immobiliers et du développement économique

Development Review - Central Branch

City of Ottawa | Ville d'Ottawa

110 Laurier Avenue West Ottawa, ON | 110, avenue. Laurier Ouest. Ottawa (Ontario) K1P 1J1

613.580.2424 ext./poste 19346, reza.bakhit@ottawa.ca

Please note: Given the current pandemic, I will be working from home until further notice; reaching me by email is the easiest. I will be checking my voicemail, just not as frequently as I normally would be.

From: Nicole Wells <nwells@pearsoneng.com>

Sent: Friday, November 04, 2022 10:20 AM

To: Bakhit, Reza <reza.bakhit@ottawa.ca>

Cc: Nikhil Parmar <nparmar@pearsoneng.com>

Subject: RE: 29 Russell Ave - Boundary Conditions

CAUTION: This email originated from an External Sender. Please do not click links or open attachments unless you recognize the source.

ATTENTION : Ce courriel provient d'un expéditeur externe. Ne cliquez sur aucun lien et n'ouvrez pas de pièce jointe, excepté si vous connaissez l'expéditeur.

Hi Reza,

As per City comments, we have revised our water demand calculations to include both the proposed and existing portions of the building and as a result, may need revised boundary conditions. Please see our updated information below:

- The estimate fire flow based on FUS = 16,000 L/min
- The estimated fire flow based on OBC = 2700 L/min
- Average Daily Demand = 0.12 L/s
- Maximum Daily Demand = 1.17 L/s
- Maximum Peak hour demand = 1.76 L/s

Please advise if you need any further information to complete the boundary condition request.

Thank you,

Nicole Wells, C.E.T.

Project Coordinator/Design Technologist

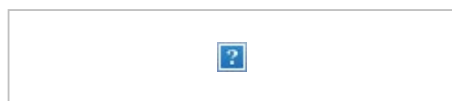

OTTAWA OFFICE

900 Morrison Drive, Unit 100

Ottawa, ON K2H 8K7

P: 613-416-1232 ext. 249
nwells@pearsoneng.com
pearsoneng.com

BARRIE
705-719-4785

GTA
905-597-5572

OWEN SOUND
519-614-2523

From: Bakhit, Reza <reza.bakhit@ottawa.ca>
Sent: June 15, 2022 2:37 PM
To: Nicole Wells <nwells@pearsoneng.com>
Cc: Nikhil Parmar <nparmar@pearsoneng.com>
Subject: RE: 29 Russell Ave - Boundary Conditions

Hi Nicole,

It has no impact.

Thanks,

Reza Bakhit, P.Eng, C.E.T

Project Manager

Planning, Real Estate and Economic Development Department / Direction générale de la planification, des biens immobiliers et du développement économique

Development Review - Central Branch

City of Ottawa | Ville d'Ottawa

110 Laurier Avenue West Ottawa, ON | 110, avenue. Laurier Ouest. Ottawa (Ontario) K1P 1J1

613.580.2424 ext./poste 19346, reza.bakhit@ottawa.ca

Please note: Given the current pandemic, I will be working from home until further notice; reaching me by email is the easiest. I will be checking my voicemail, just not as frequently as I normally would be.

From: Nicole Wells <nwells@pearsoneng.com>
Sent: Wednesday, June 15, 2022 2:00 PM
To: Bakhit, Reza <reza.bakhit@ottawa.ca>
Cc: Nikhil Parmar <nparmar@pearsoneng.com>
Subject: RE: 29 Russell Ave - Boundary Conditions

CAUTION: This email originated from an External Sender. Please do not click links or open attachments unless you recognize the source.

ATTENTION : Ce courriel provient d'un expéditeur externe. Ne cliquez sur aucun lien et n'ouvrez pas de pièce jointe, excepté si vous connaissez l'expéditeur.

Hi Reza,

Thank you for sending that information. Looks like the dual connection shown on the PDF is for the building next to ours. I have 29 Russell Ave written on our building. I believe it ranges from 23-29 Russell Ave and is also a dual connection. Will that impact the HGL and max day + fire flow values you provided?

From: Bakhit, Reza <reza.bakhit@ottawa.ca>
Sent: June 15, 2022 1:48 PM
To: Nicole Wells <nwells@pearsoneng.com>
Subject: RE: 29 Russell Ave - Boundary Conditions

Hi Nicole,

The following are boundary conditions, HGL, for hydraulic analysis at 29 Russell Avenue (zone 1W) assumed to be a dual connection to the 203 mm watermain on Russell Avenue (see attached PDF for location).

Both Connections:

Minimum HGL: 106.0 m

Maximum HGL: 115.4 m

Max Day + Fire Flow (45 L/s): 108.8 m

Max Day + Fire Flow (183.3 L/s): 101.3 m

These are for current conditions and are based on computer model simulation.

Disclaimer: The boundary condition information is based on current operation of the city water distribution system. The computer model simulation is based on the best information available at the time. The operation of the water distribution system can change on a regular basis, resulting in a variation in boundary conditions. The physical properties of watermains deteriorate over time, as such must be assumed in the absence of actual field test data. The variation in physical watermain properties can therefore alter the results of the computer model simulation.

Regards,

Reza Bakhit, P.Eng, C.E.T

Project Manager

Planning, Real Estate and Economic Development Department / Direction générale de la planification, des biens immobiliers et du développement économique

Development Review - Central Branch

City of Ottawa | Ville d'Ottawa

110 Laurier Avenue West Ottawa, ON | 110, avenue. Laurier Ouest. Ottawa (Ontario) K1P 1J1

613.580.2424 ext./poste 19346, reza.bakhit@ottawa.ca

Please note: Given the current pandemic, I will be working from home until further notice; reaching me by email is the easiest. I will be checking my voicemail, just not as frequently as I normally would be.

From: Nicole Wells <nwells@pearsoneng.com>
Sent: Friday, June 03, 2022 12:24 PM
To: Bakhit, Reza <reza.bakhit@ottawa.ca>
Subject: RE: 29 Russell Ave - Boundary Conditions

CAUTION: This email originated from an External Sender. Please do not click links or open attachments unless you recognize the source.

ATTENTION : Ce courriel provient d'un expéditeur externe. Ne cliquez sur aucun lien et n'ouvrez pas de pièce jointe, excepté si vous connaissez l'expéditeur.

Hi Reza,

Thank you for the clarifications. Please find enclosed a sketch showing the existing connection locations based on City as-builts. As mentioned in my previous email, we intend on reusing these connections for the development. I have also included our calcs attached and a summary below. Hopefully that is everything you need for the boundary conditions, if not, let me know.

- The estimate fire flow based on the FUS – 11,000 L/min
- The estimate fire flow based on the OBC – 2700 L/min
- Average Daily Demand: 0.05 L/s
- Maximum Daily Demand: 0.51 L/s
- Maximum hourly daily demand: 0.77 L/s

Thank you,

Nicole Wells
Project Coordinator/AutoCAD Designer



OTTAWA OFFICE

900 Morrison Drive, Unit 100
Ottawa, ON K2H 8K7
P: 613-416-1232 ext. 249
nwells@pearsoneng.com
pearsoneng.com

BARRIE

705-719-4785

GTA

905-597-5572

OWEN SOUND

519-614-2523

From: Bakhit, Reza <reza.bakhit@ottawa.ca>
Sent: June 3, 2022 8:31 AM
To: Nicole Wells <nwells@pearsoneng.com>
Subject: RE: 29 Russell Ave - Boundary Conditions

Hi Nicole,

Thanks for the updated calculation.

Please note that as per the latest tech bulletin that I sent you the ADD is now 280 L/c/d and not 350. Please review and update the calculations. Also please include a summary (Similar to what I noted here) in the body of your email . That would help to get the results much faster . Another thing is that to add a map (sketch) showing the approximate proposed connection location.

Please send all documents in one shot and I will forward them to the modeling group.

Kind regards,

- The estimate fire flow is L/min based on the FUS
- The estimate fire flow is L/min based on the OBC
- Average Daily Demand:
- Maximum Daily Demand:
- Maximum hourly daily demand:

Reza Bakhit, P.Eng, C.E.T

Project Manager

Planning, Real Estate and Economic Development Department / Direction générale de la planification, des biens immobiliers et du développement économique

Development Review - Central Branch

City of Ottawa | Ville d'Ottawa

110 Laurier Avenue West Ottawa, ON | 110, avenue. Laurier Ouest. Ottawa (Ontario) K1P 1J1

613.580.2424 ext./poste 19346, reza.bakhit@ottawa.ca

Please note: Given the current pandemic, I will be working from home until further notice; reaching me by email is the easiest. I will be checking my voicemail, just not as frequently as I normally would be.

From: Nicole Wells <nwells@pearsoneng.com>

Sent: Wednesday, June 01, 2022 2:11 PM

To: Bakhit, Reza <reza.bakhit@ottawa.ca>

Subject: 29 Russell Ave - Boundary Conditions

CAUTION: This email originated from an External Sender. Please do not click links or open attachments unless you recognize the source.

ATTENTION : Ce courriel provient d'un expéditeur externe. Ne cliquez sur aucun lien et n'ouvrez pas de pièce jointe, excepté si vous connaissez l'expéditeur.

Hi Reza,

We are in need of the boundary conditions for our site at 29 Russell Ave. Please see the attached calculations for the domestic and fire flows required for our building. The development is an addition to an existing building that will become a 3-storey residential building and will use the existing water services. Let me know if you need any further information to complete the request.

Thank you,

Nicole Wells

Project Coordinator/AutoCAD Designer



OTTAWA OFFICE

900 Morrison Drive, Unit 100

Ottawa, ON K2H 8K7

P: 613-416-1232 ext. 249

nwells@pearsoneng.com

BARRIE

705-719-4785

GTA

905-597-5572

OWEN SOUND

519-614-2523

Please note that Pearson Engineering Limited will be blocking all emails containing attachments with a .zip or similar compression extension. When sending a compression file please rename the extension and include details in the body of the email on how to make the file useable again.

This e-mail originates from the City of Ottawa e-mail system. Any distribution, use or copying of this e-mail or the information it contains by other than the intended recipient(s) is unauthorized. Thank you.

Le présent courriel a été expédié par le système de courriels de la Ville d'Ottawa. Toute distribution, utilisation ou reproduction du courriel ou des renseignements qui s'y trouvent par une personne autre que son destinataire prévu est interdite. Je vous remercie de votre collaboration.

This e-mail originates from the City of Ottawa e-mail system. Any distribution, use or copying of this e-mail or the information it contains by other than the intended recipient(s) is unauthorized. Thank you.

Le présent courriel a été expédié par le système de courriels de la Ville d'Ottawa. Toute distribution, utilisation ou reproduction du courriel ou des renseignements qui s'y trouvent par une personne autre que son destinataire prévu est interdite. Je vous remercie de votre collaboration.

This e-mail originates from the City of Ottawa e-mail system. Any distribution, use or copying of this e-mail or the information it contains by other than the intended recipient(s) is unauthorized. Thank you.

Le présent courriel a été expédié par le système de courriels de la Ville d'Ottawa. Toute distribution, utilisation ou reproduction du courriel ou des renseignements qui s'y trouvent par une personne autre que son destinataire prévu est interdite. Je vous remercie de votre collaboration.

This e-mail originates from the City of Ottawa e-mail system. Any distribution, use or copying of this e-mail or the information it contains by other than the intended recipient(s) is unauthorized. Thank you.

Le présent courriel a été expédié par le système de courriels de la Ville d'Ottawa. Toute distribution, utilisation ou reproduction du courriel ou des renseignements qui s'y trouvent par une personne autre que son destinataire prévu est interdite. Je vous remercie de votre collaboration.

This e-mail originates from the City of Ottawa e-mail system. Any distribution, use or copying of this e-

mail or the information it contains by other than the intended recipient(s) is unauthorized. Thank you.

Le présent courriel a été expédié par le système de courriels de la Ville d'Ottawa. Toute distribution, utilisation ou reproduction du courriel ou des renseignements qui s'y trouvent par une personne autre que son destinataire prévu est interdite. Je vous remercie de votre collaboration.

,

This e-mail originates from the City of Ottawa e-mail system. Any distribution, use or copying of this e-mail or the information it contains by other than the intended recipient(s) is unauthorized. Thank you.

Le présent courriel a été expédié par le système de courriels de la Ville d'Ottawa. Toute distribution, utilisation ou reproduction du courriel ou des renseignements qui s'y trouvent par une personne autre que son destinataire prévu est interdite. Je vous remercie de votre collaboration.

,

Boundary Conditions for 29 Russell Avenue

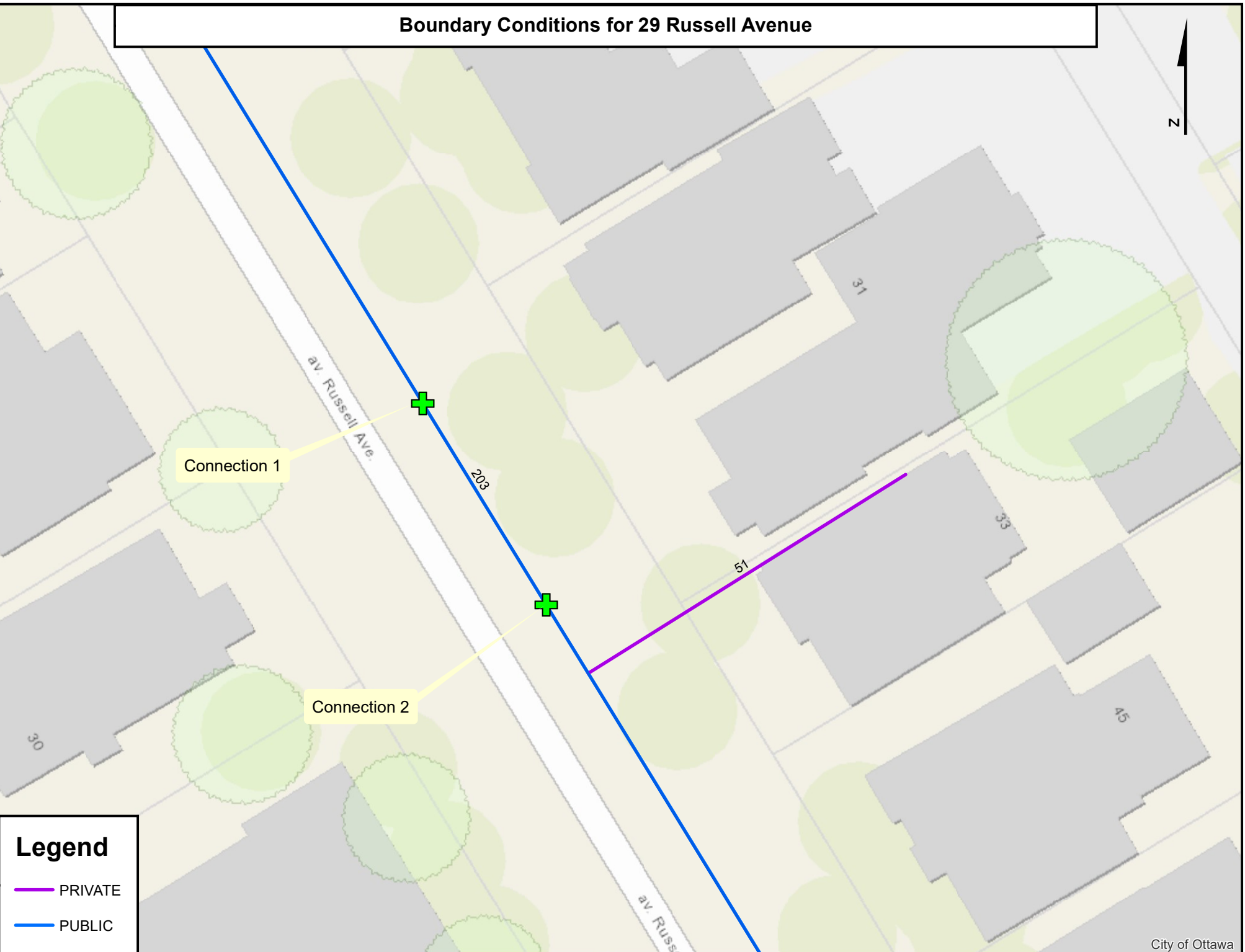

Connection 1

Connection 2

Legend

- PRIVATE
- PUBLIC



APPENDIX B

SANITARY SERVICING CALCULATIONS

29 Russell Ave., Ottawa Sanitary Flow Calculations

Design Criteria

Flow per capita (Q): 280 L/cap/day
 Peak Flow $Q_p = P * Q * M / 86400$
 Peaking Factor (Harmon Formula) $M = 1 + ((14 / (4 + (P / 1000)^{0.5})) * 0.8)^2 \leq M \leq 4$

Site Data

Description	Density	Units	Flow Rate
Apartments - Bachelor	1.40 person/unit	17 units	280 L/cap/d
Apartments - 3 Bedroom	3.10 person/unit	2 units	280 L/cap/d
Apartments - 4 Bedroom	4.00 person/unit	2 units	280 L/cap/d

*Density for 4-bedroom is assumed

Calculate Population

Pop. Apartments = 1.40 x 4 + 3.10 x 1 + 4.00 x 2
 Pop. = 38 people

Calculate Average Daily Demand

ADD = $\frac{280 \times 38}{86400}$
 ADD = 0.12 L/s

Calculate Peaking Factor

M = $1 + \frac{14}{4 + \frac{38^{0.5}}{1,000}} \times 0.8$
 M = 3.67

Infiltration Allowance = 0.33 x 0.06
 = 0.02 L/s

Calculate Peak Flow

Qp = 0.12 x 3.67 + 0.02
 = 0.47 L/s



APPENDIX C

STORMWATER MANAGEMENT CALCULATIONS



**29 Russell Ave, Ottawa
Calculation of Runoff Coefficients**

Runoff Coefficient	=	0.20	0.9	0.9	0.80	0.9	Weighted Runoff Coefficient
Surface Cover	=	Grass	Asphalt	Building	Gravel	Conc.	
Pre-Development	Total Area	Area	Area	Area	Area	Area	
	(m ²)	(m ²)	(m ²)	(m ²)	(m ²)	(m ²)	
1	137	44	0	0	93	0	
Pre Total	137	44	0	0	93	0	
Post-Development	Total Area	Area	Area	Area	Area	Area	
	(m ²)	(m ²)	(m ²)	(m ²)	(m ²)	(m ²)	
1	137	0	0	137	0	0	
Post Total	137	0	0	137	0	0	
							0.61
							0.61
							0.90
							0.90

29 Russell Ave, Ottawa Pre-Development Peak Flows

Storm Event (yrs)	City of Ottawa		
	Coeff A	Coeff B	Coeff C
2	732.95	6.20	0.81
5	998.07	6.05	0.81
10	1174.18	6.01	0.82
25	1402.88	6.02	0.82
50	1569.58	6.01	0.82
100	1735.69	6.01	0.82

Modified Rational Method
 $Q = CiCIA / 360$

Where:

- Q - Flow Rate (m^3/s)
- C - Rational Method Runoff Coefficient
- I - Storm Intensity (mm/hr)
- A - Area (ha.)
- Ci - Peaking Coefficient

Area Number	1
Area	0.014 ha
Runoff Coefficient	0.50 *
Time of Concentration	10 min
Return Rate	2 year
Peaking Coefficient (Ci)	1.00
Rainfall Intensity	76.81 mm/hr
Pre-Development Peak Flow	1.46 L/s

Return Rate	5 year
Peaking Coefficient (Ci)	1.00
Rainfall Intensity	104.19 mm/hr
Pre-Development Peak Flow	1.98 L/s

Return Rate	10 year
Peaking Coefficient (Ci)	1.00
Rainfall Intensity	122.1 mm/hr
Pre-Development Peak Flow	2.32 L/s

Return Rate	25 year
Peaking Coefficient (Ci)	1.10
Rainfall Intensity	144.7 mm/hr
Pre-Development Peak Flow	3.03 L/s

Return Rate	50 year
Peaking Coefficient (Ci)	1.20
Rainfall Intensity	161.5 mm/hr
Pre-Development Peak Flow	3.69 L/s

Return Rate	100 year
Peaking Coefficient (Ci)	1.25
Rainfall Intensity	178.6 mm/hr
Pre-Development Peak Flow	4.25 L/s

*Note: Maximum runoff coefficient of 0.50 was used for pre-development as per the City of Ottawa guidelines



29 Russell Ave, Ottawa Post-Development Peak Flows

City of Ottawa
Storm Event (yrs) Coeff A Coeff B Coeff C

2	732.95	6.20	0.81
5	998.07	6.05	0.81
10	1174.18	6.01	0.82
25	1402.88	6.02	0.82
50	1569.58	6.01	0.82
100	1735.69	6.01	0.82

Modified Rational Method
 $Q = C_i C_i A / 360$

Where:

- Q - Flow Rate (m³/s)
- C - Rational Method Runoff Coefficient
- I - Storm Intensity (mm/hr)
- A - Area (ha.)
- C_i - Peaking Coefficient

Controlled Area	
Area Number	1
Area	0.014 ha
Runoff Coefficient	0.90
Time of Concentration	10 min
Return Rate	2 year
Peaking Coefficient (C _i)	1.00
Rainfall Intensity	76.81 mm/hr
Post-Development Peak Flow	2.63 L/s

Return Rate	5 year
Peaking Coefficient (C _i)	1.00
Rainfall Intensity	104.19 mm/hr
Post-Development Peak Flow	3.57 L/s

Return Rate	10 year
Peaking Coefficient (C _i)	1.00
Rainfall Intensity	122.14 mm/hr
Post-Development Peak Flow	4.18 L/s

Return Rate	25 year
Peaking Coefficient (C _i)	1.10
Rainfall Intensity	144.69 mm/hr
Post-Development Peak Flow	5.45 L/s

Return Rate	50 year
Peaking Coefficient (C _i)	1.20
Rainfall Intensity	161.47 mm/hr
Post-Development Peak Flow	6.64 L/s

Return Rate	100 year
Peaking Coefficient (C _i)	1.25
Rainfall Intensity	178.56 mm/hr
Post-Development Peak Flow	7.65 L/s



29 Russell Ave, Ottawa Stage-Storage-Discharge Table

Elevation (m)	Volume (m ³)	Cum. Vol. (m ³)	Orifice Head (m)	Orifice Flow (m ³ /s)	Total Flow (m ³ /s)
67.88	0	0.00	0.000	0.00	0.00
67.90	0.20	0.20	0.000	0.00	0.00
67.95	0.20	0.39	0.036	0.26	0.26
68.00	0.20	0.59	0.086	0.91	0.91
68.05	0.20	0.79	0.136	1.37	1.37
68.10	0.20	0.98	0.186	1.73	1.73
68.15	0.20	1.18	0.236	1.96	1.96
68.20	0.20	1.38	0.286	1.75	1.75
68.25	0.20	1.57	0.336	1.20	1.20
68.30	0.20	1.77	0.386	1.28	1.28
68.35	0.20	1.97	0.436	1.35	1.35
68.40	0.20	2.16	0.486	1.44	1.44
68.45	0.20	2.36	0.536	1.52	1.52
68.50	0.20	2.55	0.586	1.54	1.54
68.55	0.20	2.75	0.636	1.63	1.63
68.60	0.20	2.95	0.686	1.71	1.71
68.65	0.20	3.14	0.736	1.77	1.77
68.70	0.20	3.34	0.786	1.81	1.81
68.75	0.20	3.54	0.836	1.87	1.87
68.80	0.20	3.73	0.886	1.93	1.93
68.85	0.20	3.93	0.936	1.98	1.98
68.90	0	3.93	0.985	2.00	2.00

Note: Orifice Flows are given by the Head Discharge curve for the Vortex Valve Model CEV 275

Orifice	
Diameter	64 mm
Invert Elevation	67.88



APPENDIX D

OTTAWA SERVICING REPORT CHECKLIST

4. Development Servicing Study Checklist

The following section describes the checklist of the required content of servicing studies. It is expected that the proponent will address each one of the following items for the study to be deemed complete and ready for review by City of Ottawa Infrastructure Approvals staff.

The level of required detail in the Servicing Study will increase depending on the type of application. For example, for Official Plan amendments and re-zoning applications, the main issues will be to determine the capacity requirements for the proposed change in land use and confirm this against the existing capacity constraint, and to define the solutions, phasing of works and the financing of works to address the capacity constraint. For subdivisions and site plans, the above will be required with additional detailed information supporting the servicing within the development boundary.

4.1 General Content

- Executive Summary (for larger reports only).
- Date and revision number of the report.
- Location map and plan showing municipal address, boundary, and layout of proposed development.
- Plan showing the site and location of all existing services.
- Development statistics, land use, density, adherence to zoning and official plan, and reference to applicable subwatershed and watershed plans that provide context to which individual developments must adhere.
- Summary of Pre-consultation Meetings with City and other approval agencies.
- Reference and confirm conformance to higher level studies and reports (Master Servicing Studies, Environmental Assessments, Community Design Plans), or in the case where it is not in conformance, the proponent must provide justification and develop a defensible design criteria.
- Statement of objectives and servicing criteria.
- Identification of existing and proposed infrastructure available in the immediate area.
- Identification of Environmentally Significant Areas, watercourses and Municipal Drains potentially impacted by the proposed development (Reference can be made to the Natural Heritage Studies, if available).

- Concept level master grading plan to confirm existing and proposed grades in the development. This is required to confirm the feasibility of proposed stormwater management and drainage, soil removal and fill constraints, and potential impacts to neighbouring properties. This is also required to confirm that the proposed grading will not impede existing major system flow paths.
- Identification of potential impacts of proposed piped services on private services (such as wells and septic fields on adjacent lands) and mitigation required to address potential impacts.
- Proposed phasing of the development, if applicable.
- Reference to geotechnical studies and recommendations concerning servicing.
- All preliminary and formal site plan submissions should have the following information:
 - Metric scale
 - North arrow (including construction North)
 - Key plan
 - Name and contact information of applicant and property owner
 - Property limits including bearings and dimensions
 - Existing and proposed structures and parking areas
 - Easements, road widening and rights-of-way
 - Adjacent street names

4.2 Development Servicing Report: Water

- Confirm consistency with Master Servicing Study, if available
- Availability of public infrastructure to service proposed development
- Identification of system constraints
- Identify boundary conditions
- Confirmation of adequate domestic supply and pressure
- Confirmation of adequate fire flow protection and confirmation that fire flow is calculated as per the Fire Underwriter's Survey. Output should show available fire flow at locations throughout the development.
- Provide a check of high pressures. If pressure is found to be high, an assessment is required to confirm the application of pressure reducing valves.
- Definition of phasing constraints. Hydraulic modeling is required to confirm servicing for all defined phases of the project including the ultimate design
- Address reliability requirements such as appropriate location of shut-off valves
- Check on the necessity of a pressure zone boundary modification.

- Reference to water supply analysis to show that major infrastructure is capable of delivering sufficient water for the proposed land use. This includes data that shows that the expected demands under average day, peak hour and fire flow conditions provide water within the required pressure range
- Description of the proposed water distribution network, including locations of proposed connections to the existing system, provisions for necessary looping, and appurtenances (valves, pressure reducing valves, valve chambers, and fire hydrants) including special metering provisions.
- Description of off-site required feeder mains, booster pumping stations, and other water infrastructure that will be ultimately required to service proposed development, including financing, interim facilities, and timing of implementation.
- Confirmation that water demands are calculated based on the City of Ottawa Design Guidelines.
- Provision of a model schematic showing the boundary conditions locations, streets, parcels, and building locations for reference.

4.3 Development Servicing Report: Wastewater

- Summary of proposed design criteria (Note: Wet-weather flow criteria should not deviate from the City of Ottawa Sewer Design Guidelines. Monitored flow data from relatively new infrastructure cannot be used to justify capacity requirements for proposed infrastructure).
- Confirm consistency with Master Servicing Study and/or justifications for deviations.
- Consideration of local conditions that may contribute to extraneous flows that are higher than the recommended flows in the guidelines. This includes groundwater and soil conditions, and age and condition of sewers.
- Description of existing sanitary sewer available for discharge of wastewater from proposed development.
- Verify available capacity in downstream sanitary sewer and/or identification of upgrades necessary to service the proposed development. (Reference can be made to previously completed Master Servicing Study if applicable)
- Calculations related to dry-weather and wet-weather flow rates from the development in standard MOE sanitary sewer design table (Appendix 'C') format.
- Description of proposed sewer network including sewers, pumping stations, and forcemains.

- Discussion of previously identified environmental constraints and impact on servicing (environmental constraints are related to limitations imposed on the development in order to preserve the physical condition of watercourses, vegetation, soil cover, as well as protecting against water quantity and quality).
- Pumping stations: impacts of proposed development on existing pumping stations or requirements for new pumping station to service development.
- Forcemain capacity in terms of operational redundancy, surge pressure and maximum flow velocity.
- Identification and implementation of the emergency overflow from sanitary pumping stations in relation to the hydraulic grade line to protect against basement flooding.
- Special considerations such as contamination, corrosive environment etc.

4.4 Development Servicing Report: Stormwater Checklist

- Description of drainage outlets and downstream constraints including legality of outlets (i.e. municipal drain, right-of-way, watercourse, or private property)
- Analysis of available capacity in existing public infrastructure.
- A drawing showing the subject lands, its surroundings, the receiving watercourse, existing drainage patterns, and proposed drainage pattern.
- Water quantity control objective (e.g. controlling post-development peak flows to pre-development level for storm events ranging from the 2 or 5 year event (dependent on the receiving sewer design) to 100 year return period); if other objectives are being applied, a rationale must be included with reference to hydrologic analyses of the potentially affected subwatersheds, taking into account long-term cumulative effects.
- Water Quality control objective (basic, normal or enhanced level of protection based on the sensitivities of the receiving watercourse) and storage requirements.
- Description of the stormwater management concept with facility locations and descriptions with references and supporting information.
- Set-back from private sewage disposal systems.
- Watercourse and hazard lands setbacks.
- Record of pre-consultation with the Ontario Ministry of Environment and the Conservation Authority that has jurisdiction on the affected watershed.
- Confirm consistency with sub-watershed and Master Servicing Study, if applicable study exists.

- Storage requirements (complete with calculations) and conveyance capacity for minor events (1:5 year return period) and major events (1:100 year return period).
- Identification of watercourses within the proposed development and how watercourses will be protected, or, if necessary, altered by the proposed development with applicable approvals.
- Calculate pre and post development peak flow rates including a description of existing site conditions and proposed impervious areas and drainage catchments in comparison to existing conditions.
- Any proposed diversion of drainage catchment areas from one outlet to another.
- Proposed minor and major systems including locations and sizes of stormwater trunk sewers, and stormwater management facilities.
- If quantity control is not proposed, demonstration that downstream system has adequate capacity for the post-development flows up to and including the 100-year return period storm event.
- Identification of potential impacts to receiving watercourses
- Identification of municipal drains and related approval requirements.
- Descriptions of how the conveyance and storage capacity will be achieved for the development.
- 100 year flood levels and major flow routing to protect proposed development from flooding for establishing minimum building elevations (MBE) and overall grading.
- Inclusion of hydraulic analysis including hydraulic grade line elevations.
- Description of approach to erosion and sediment control during construction for the protection of receiving watercourse or drainage corridors.
- Identification of floodplains – proponent to obtain relevant floodplain information from the appropriate Conservation Authority. The proponent may be required to delineate floodplain elevations to the satisfaction of the Conservation Authority if such information is not available or if information does not match current conditions.
- Identification of fill constraints related to floodplain and geotechnical investigation.

4.5 Approval and Permit Requirements: Checklist

The Servicing Study shall provide a list of applicable permits and regulatory approvals necessary for the proposed development as well as the relevant issues affecting each approval. The approval and permitting shall include but not be limited to the following:

- Conservation Authority as the designated approval agency for modification of floodplain, potential impact on fish habitat, proposed works in or adjacent to a watercourse, cut/fill permits and Approval under Lakes and Rivers Improvement Act. The Conservation Authority is not the approval authority for the Lakes and Rivers Improvement Act. Where there are Conservation Authority regulations in place, approval under the Lakes and Rivers Improvement Act is not required, except in cases of dams as defined in the Act.
- Application for Certificate of Approval (CofA) under the Ontario Water Resources Act.
- Changes to Municipal Drains.
- Other permits (National Capital Commission, Parks Canada, Public Works and Government Services Canada, Ministry of Transportation etc.)

4.6 Conclusion Checklist

- Clearly stated conclusions and recommendations
- Comments received from review agencies including the City of Ottawa and information on how the comments were addressed. Final sign-off from the responsible reviewing agency.
- All draft and final reports shall be signed and stamped by a professional Engineer registered in Ontario



APPENDIX E

PRE-CONSULTATION SUMMARY

From: [Nadeau, Jeff](#)
To: [Haris Khan](#)
Cc: [Kotarba, Ashley](#); [van Wyk, Adrian](#); [Bakhit, Reza](#); [Dubyk, Wally](#); [David Elden ASH](#)
Subject: Pre-con Follow-up - 29 Russell Avenue
Date: January 27, 2022 1:49:25 PM
Attachments: [image001.gif](#)
[Design Brief TOR.pdf](#)
[29 Russell - Study and Plan Identification List.pdf](#)

CAUTION: This email is from an external sender. Do not click links or open attachments unless you recognize the sender and know the content is safe.

CC: Ashley Kotarba, Adrian van Wyk, Reza Bakhit, Wally Dubyk, David Elden

Hello Haris,

Please refer to the below notes regarding the Pre-Application Consultation (“pre-con”) Meeting held on December 14 for the property at 29 Russell Avenue for Site Plan Control and Zoning By-law Amendment in order to allow the construction of a 16-unit addition at the rear of the existing building. I have also attached the required Plans & Study List for application submission.

Below are staff’s preliminary comments based on the information available at the time of pre-con meeting:

PLANNING

- The current/existing Official Plan designates the site as General Urban Area. The new Official Plan identifies the site as Downtown Core (Section 5.1) / Neighbourhood (Section 6.3). Applications submitted before Ministry approval of the new Official Plan will be evaluated on the basis of the existing Official Plan with regard for the new Official Plan; the more restrictive policies will apply.
- The Sandy Hill Secondary Plan applies here. This site is designated Low-Rise Residential on Schedule J of the Secondary Plan.
- In the pre-application consult, there was some confusion about whether we are looking at rooming units. While staff now understand that self-contained studio units are being proposed, we request that floorplans provide more clarity as to the unit composition and distinction(s) between private units and common amenity or circulation spaces. Moreover, it was not evident how the building’s internal circulation works, i.e. how someone entering via the front of the building is supposed to access the new units at the rear of the building. Circulation to, around, and within the building should be discernible from review of the plans.
- The proposed central courtyard has potential, but this will depend on careful study and a strong execution. Can sunlight penetrate this space? How can it be accessed, and by whom? What are the overlook/privacy implications? How will maintenance & snow clearance work? As per Urban Design recommendations, study further & consider alternatives.
 - From a zoning standpoint, communal amenity area for a rooming house must be provided at-grade in the rear yard (Table 137(1)) – thus the internal courtyard will not count toward compliance with that provision.

- The laneway at the rear of the site is confirmed as public-owned.
- Provision of any parking spaces in the rear yard should be subordinate to meeting amenity area & landscaping requirements.
- Bicycle parking (as per s.111) and waste management (as per s.143) need to be provided/resolved.

URBAN DESIGN

- An Urban Design Brief will be required as part of a complete application. Please see the attached Terms of Reference for requirements.
- Concern is expressed with the proposed internal courtyard. It is strongly advised that this element be studied further and that alternative building massing options be considered.

HERITAGE

- This property is designated under Part V of the *Ontario Heritage Act* as part of the Russell-Range Heritage Conservation District. Any exterior alteration to this property will require a heritage permit. More information about the application process and applicable fees can be found here: [Changes to Heritage Properties | City of Ottawa](#)
- This project may be subject to the Heritage Planning Branch's Heritage Pre-Application program. At this meeting, we would review the proposal against the Russell-Range Heritage Conservation District Plan to ensure compliance with its policies and guidelines. Once this application is further developed, heritage staff will reach out to set this up.
- The applicant may wish to consider restoration of the heritage building. This may include items such as re-instating the wrap-around on the front façade, or cedar roofing. If restoration takes place on this building, the project may qualify for our new Heritage CIP program. This program provides a tax incentive to development projects with a restoration component. The property owner may receive up to 75% back in the increase in property taxes up to \$500,000. More information can be found on our website: [Heritage Community Improvement Plan | City of Ottawa](#)

ENGINEERING

General:

- It is the sole responsibility of the consultant to investigate the location of existing underground utilities in the proposed servicing area and submit a request for locates to avoid conflict(s). The location of existing utilities and services shall be documented on an Existing Conditions Plan.
- Any easements on the subject site shall be identified and respected by any development proposal and shall adhere to the conditions identified in the easement agreement. A legal survey plan shall be provided and all easements shall be shown on the engineering plans.
- Concern about Sanitary sewer capacity, please provide the new Sanitary sewer discharge and we confirm if sanitary sewer main has the capacity. Also provide the existing/proposed size of sanitary service.
- Existing buildings require a CCTV inspection and report to ensure existing services to be re-used are in good working order and meet current minimum size requirements. Located services to be placed on site servicing plans.

Reference documents for information purposes :

- Ottawa Sewer Design Guidelines (October 2012)
- Technical Bulletin PIEDTB-2016-01
- Technical Bulletins ISTB-2018-01, ISTB-2018-02 and ISTB-2018-03.
- Ottawa Design Guidelines - Water Distribution (2010)
- Technical Bulletin ISTB-2021-03
- Geotechnical Investigation and Reporting Guidelines for Development Applications in the City of Ottawa (2007)
- City of Ottawa Slope Stability Guidelines for Development Applications (revised 2012)
- City of Ottawa Environmental Noise Control Guidelines (January 2016)
- City of Ottawa Accessibility Design Standards (2012) (City recommends development be in accordance with these standards on private property)
- Ottawa Standard Tender Documents (latest version)
- Ontario Provincial Standards for Roads & Public Works (2013)
- Record drawings and utility plans are also available for purchase from the City (Contact the City's Information Centre by email at InformationCentre@ottawa.ca or by phone at (613) 580-424 x.44455).

Please note that this is the applicant responsibility to refer to the latest applicable guidelines while preparing reports and studies.

Disclaimer:

The City of Ottawa does not guarantee the accuracy or completeness of the data and information contained on the above image(s) and does not assume any responsibility or liability with respect to any damage or loss arising from the use or interpretation of the image(s) provided. This image is for schematic purposes only.

Site Servicing Report (Adequacy of Servicing) :

- This study is required to support the approval of the proposed servicing of the development application. The study defines the water, sanitary, and stormwater services to be accepted for operation by the City.
- Describe the overland flow path of drainage over the entire site.
- Identify if there is an existing storm lateral that drains the foundation weeping tile, if currently installed. If weeping tile is connected to the sanitary lateral, it must be disconnected and drained via separate lateral to the storm sewer system
- Identify and describe any roof drainage outlets (roof drains, eavestrough, downspouts, etc.) and describe how they outlet to the storm sewer. If roof drainage is connected to the sanitary system, it must be disconnected and drained via direct lateral to the storm sewer system or via overland flow.
- Please note that foundation drainage is to be independently connected to sewer main unless being pumped with appropriate back up power, sufficient sized pump and back flow prevention. It is recommended that the foundation drainage system be drained by a sump pump connection to the storm sewer to minimize risk of basement flooding as it will provide the best protection from the uncontrolled sewer system compared to relying on the backwater valve.
- Water Quality Control: Please consult with the local conservation authority (RVCA)

regarding water quality criteria prior to submission of a Site Plan Control Proposal application to establish any water quality control restrictions, criteria and measures for the site. Correspondence and clearance shall be provided in the Appendix of the report.

- Please note that as per Technical Bulletin PIEDTB-2016-01 section 8.3.11.1 (p.12 of 14) there shall be no surface ponding on private parking areas during the 5-year storm rainfall event.
- Post-development site grading shall match existing property line grades in order to minimize disruption to the adjacent residential properties. A topographical plan of survey shall be provided as part of the submission and a note provided on the plans.
- If Window wells are proposed, they are to be indirectly connected to the footing drains. A detail of window well with indirect connection is required, as is a note at window well location speaking to indirect connection.
- There must be at least 15cm of vertical clearance between the spill elevation and the ground elevation at the building envelope that is in proximity of the flow route or ponding area. The exception in this case would be at reverse sloped loading dock locations. At these locations, a minimum of 15cm of vertical clearance must be provided below loading dock openings. Ensure to provide discussion in report and ensure grading plan matches if applicable.
- If it's proposed to reuse the existing service laterals A CCTV scan and report (By an Engineer) will be required to verify the absence of any service or structural defects (Both Sanitary and Storm) . This strategy should be discussed in the serving report and the engineer to confirm the integrity of the existing services to be reused. (Replacement of lateral is required if minimum size or current material requirements are not met.)

Storm Sewer:

- A 375mm dia. CONR storm sewer (1986) is available within Russell Avenue.

Sanitary Sewer:

- A 250 mm dia. CONR Sanitary sewer (1986) is available within Russell Avenue.
- Please provide the new Sanitary sewer discharge and confirm if sanitary sewer main has the capacity. An analysis and demonstration that there is sufficient/adequate residual capacity to accommodate any increase in wastewater flows in the receiving and downstream wastewater system is required to be provided. Needs to be demonstrated that there is adequate capacity to support any increase in wastewater flow.
- Please apply the wastewater design flow parameters in Technical Bulletin PIEDTB-2018-01.
- A backwater valve is required on the sanitary service for protection.

Water :

- A 203 mm dia. DI watermain (1986) is available within Russell Avenue.
- Water Supply Redundancy: Residential buildings with a basic day demand greater than 50m³/day (0.57 L/s) are required to be connected to a minimum of two water services separated by an isolation valve to avoid a vulnerable service area as per the Ottawa Design Guidelines - Water Distribution, WDG001, July 2010 Clause 4.3.1 Configuration.

- Please review Technical Bulletin ISTB-2018-0, maximum fire flow hydrant capacity is provided in Section 3 Table 1 of Appendix I. A hydrant coverage figure shall be provided and demonstrate there is adequate fire protection for the proposal. Two or more public hydrants are anticipated to be required to handle fire flow.
- Boundary conditions are required to confirm that the require fire flows can be achieved as well as availability of the domestic water pressure on the City street in front of the development. Use Table 3-3 of the MOE Design Guidelines for Drinking-Water System to determine Maximum Day and Maximum Hour peaking factors for 0 to 500 persons and use Table 4.2 of the Ottawa Design Guidelines, Water Distribution for 501 to 3,000 persons. Please provide the following information to the City of Ottawa via email to request water distribution network boundary conditions for the subject site. Please note that once this information has been provided to the City of Ottawa it takes approximately 5-10 business days to receive boundary conditions.
 - Type of Development and Units
 - Site Address
 - A plan showing the proposed water service connection location.
 - Average Daily Demand (L/s)
 - Maximum Daily Demand (L/s)
 - Peak Hour Demand (L/s)
 - Fire Flow (L/min)

[Fire flow demand requirements shall be based on Fire Underwriters Survey (FUS) Water Supply for Public Fire Protection 1999]

[Fire flow demand requirements shall be based on ISTB-2021-03]

Note: The OBC method can be used if the fire demand for the private property is less than 9,000 L/min. If the OBC fire demand reaches 9000 L/min, then the FUS method is to be used.

- Exposure separation distances shall be defined on a figure to support the FUS calculation and required fore flow (RFF).
- Hydrant capacity shall be assessed to demonstrate the RFF can be achieved. Please identify which hydrants are being considered to meet the RFF on a fire hydrant coverage plan as part of the boundary conditions request.

Gas pressure regulating station

A gas pressure regulating station may be required depending on HVAC needs (typically for 12+ units). Be sure to include this on the Grading, Site Servicing, SWM and Landscape plans. This is to ensure that there are no barriers for overland flow routes (SWM) or conflicts with any proposed grading or landscape features with installed structures and has nothing to do with supply and demand of any product.

Regarding Quantity Estimates:

Please note that external Garbage and/or bicycle storage structures are to be added to QE under Landscaping as it is subject to securities. In addition, sump pumps for Sanitary and Storm laterals and/or cisterns are to be added to QE under Hard items as it is subject to securities, even though it is internal and is spoken to under SWM and Site Servicing Report and Plan.

CCTV sewer inspection

CCTV sewer inspection required for pre and post construction conditions to ensure no damage to City Assets surrounding site.

Required Engineering Plans and Studies:

PLANS:

- Existing Conditions and Removals Plan
- Site Servicing Plan
- Grade Control and Drainage Plan
- Erosion and Sediment Control Plan
- Topographical survey

REPORTS:

- Site Servicing Report (Assessment of the adequacy of services and servicing options)
- Geotechnical Study/Investigation
- Phase I ESA
- Phase II ESA (Depending on recommendations of Phase I ESA)

Please refer to the City of Ottawa Guide to Preparing Studies and Plans [Engineering]:

- Specific information has been incorporated into both the Guide to Preparing Studies and Plans for a site plan. The guide outlines the requirement for a statement to be provided on the plan about where the property boundaries have been derived from.
- Added to the general information for servicing and grading plans is a note that an O.L.S. should be engaged when reporting on or relating information to property boundaries or existing conditions. The importance of engaging an O.L.S. for development projects is emphasized.

Phase One Environmental Site Assessment:

- A Phase I ESA is required to be completed in accordance with Ontario Regulation 153/04 in support of this development proposal to determine the potential for site contamination. Depending on the Phase I recommendations a Phase II ESA may be required.
- The Phase I ESA shall provide all the required Environmental Source Information as required by O. Reg. 153/04. ERIS records are available to public at a reasonable cost and need to be included in the ESA report to comply with O.Reg. 153/04 and the Official Plan. The City will not be in a position to approve the Phase I ESA without the inclusion of the ERIS reports.
- Official Plan Section 4.8.4: <https://ottawa.ca/en/city-hall/planning-and-development/official-plan-and-master-plans/official-plan/volume-1-official-plan/section-4-review-development-applications#4-8-protection-health-and-safety>

Geotechnical Investigation:

- A Geotechnical Study/Investigation shall be prepared in support of this development proposal.
- Reducing the groundwater level in this area can lead to potential damages to surrounding structures due to excessive differential settlements of the ground. The

impact of groundwater lowering on adjacent properties needs to be discussed and investigated to ensure there will be no short term and long term damages associated with lowering the groundwater in this area.

- Geotechnical Study shall be consistent with the Geotechnical Investigation and Reporting Guidelines for Development Applications.

https://documents.ottawa.ca/sites/documents/files/geotech_report_en.pdf

Exterior Site Lighting:

Any proposed light fixtures (both pole-mounted and wall mounted) must be part of the approved Site Plan. All external light fixtures must meet the criteria for Full Cut-off Classification as recognized by the Illuminating Engineering Society of North America (IESNA or IES), and must result in minimal light spillage onto adjacent properties (as a guideline, 0.5 fc is normally the maximum allowable spillage). In order to satisfy these criteria, the please provide the City with a Certification (Statement) Letter from an acceptable professional engineer stating that the design is compliant.

Construction approach:

- Please contact the Right-of-Ways Permit Office TMconstruction@ottawa.ca early in the Site Plan process to determine the ability to construct site and copy File Lead jeff.nadeau@ottawa.ca on this request.

Please note that these comments are considered preliminary based on the information available to date and therefore maybe amended as additional details become available and presented to the City. It is the responsibility of the applicant to verify the above information. The applicant may contact me for follow-up questions related to engineering/infrastructure prior to submission of an application if necessary.

Feel free to contact the Infrastructure Project Manager, Reza Bakhit, at reza.bakhit@ottawa.ca, for follow-up questions.

TRANSPORTATION

- Russell Avenue is classified as an Arterial road. There are no additional protected ROW limits identified in the OP.
- The drawing is to identify the street name and roadway features.
- The development site proposes an extension to the rear of the building. This development would not generate sufficient traffic to warrant a TIA report. Submission of TDM checklists is encouraged even if a TIA study report is not considered to be required.
- The purchaser, tenant or sub-lessee acknowledges the unit being rented/sold is not provided with any on-site parking and should a tenant/purchaser have a vehicle for which they wish to have parking that alternative and lawful arrangements will need to be made to accommodate their parking need at an alternative location. The Purchaser/Tenant also acknowledges that the availability and regulations governing on-street parking vary; that access to on-street parking, including through residential on-street parking permits issued by the City cannot be guaranteed now or in the future; and that a purchaser, tenant or sub-lessee intending to rely on on-street parking for their vehicle or vehicles does so at their own risk.
- Please keep in mind that on street parking is not a viable option for tenants. Ensure that potential tenants are aware that there is no provision for parking.
- Permanent structures such as curbing, stairs, retaining walls, and underground parking

foundation also bicycle parking racks are not to extend into the City's right-of-way limits.

- The Owner shall be required to enter into maintenance and liability agreement for all pavers, plant and landscaping material placed in the City right-of-way and the Owner shall assume all maintenance and replacement responsibilities in perpetuity.
- Bicycle parking spaces are required as per Section 111 of the Ottawa Comprehensive Zoning By-law. Bicycle parking spaces should be located in safe, secure places near main entrances and preferably protected from the weather.

Feel free to contact the Transportation Project Manager, Wally Dubyk, at wally.dubyk@ottawa.ca, for follow-up questions.

CITY SURVEYOR

- The determination of property boundaries, minimum setbacks and other regulatory constraints are a critical component of development. An Ontario Land Surveyor (O.L.S.) needs to be consulted at the outset of a project to ensure properties are properly defined and can be used as the geospatial framework for the development.
- Topographic details may also be required for a project and should be either carried out by the O.L.S. that has provided the Legal Survey or done in consultation with the O.L.S. to ensure that the project is integrated to the appropriate control network.

Questions regarding the above requirements can be directed to the City's Surveyor, Bill Harper, at bill.harper@ottawa.ca.

-

OTHER

- Plans are to be standard A1 size (594 mm x 841 mm) sheets, utilizing an appropriate Metric scale (1:200, 1:250, 1:300, 1:400 or 1:500).
- All PDF submitted documents are to be unlocked and flattened.
- You are encouraged to contact the Ward Councillor, Councillor Fleury, at mathieu.fleury@ottawa.ca about the proposal. You may also consider contacting Action Sandy Hill at info@ash-acs.ca.

Please refer to the links to [Guide to preparing studies and plans](#) and [fees](#) for further information. Additional information is available related to [building permits](#), [development charges](#), and the [Accessibility Design Standards](#). Be aware that other fees and permits may be required, outside of the development review process. You may obtain background drawings by contacting informationcentre@ottawa.ca.

These pre-con comments are valid for one year. If you submit a development application(s) after this time, you may be required to meet for another pre-consultation meeting and/or the submission requirements may change. You are as well encouraged to contact us for a follow-up meeting if the plan/concept will be further refined.

Please do not hesitate to contact me if you have any questions.

Regards,

Jeff Nadeau

Planner II | *Urbaniste II*

Development Review, Central | *Examen des projets d'aménagement, Central*

Planning, Real Estate and Economic Development Department | *Services de la planification, des biens immobiliers et du développement économique*

City of Ottawa | *Ville d'Ottawa*

110 Laurier Avenue West. Ottawa, ON | *110, avenue. Laurier Ouest. Ottawa (Ontario) K1P 1J1*

☐ 613.580.2424 ext./poste 16802

ottawa.ca/planning/ ottawa.ca/urbanisme

*****Please note that, while my work hours may be affected by the current situation, I have regular access to email and check telephone messages periodically. Email is currently the best way to contact me*****

,

This e-mail originates from the City of Ottawa e-mail system. Any distribution, use or copying of this e-mail or the information it contains by other than the intended recipient(s) is unauthorized. Thank you.

Le présent courriel a été expédié par le système de courriels de la Ville d'Ottawa. Toute distribution, utilisation ou reproduction du courriel ou des renseignements qui s'y trouvent par une personne autre que son destinataire prévu est interdite. Je vous remercie de votre collaboration.

,



APPENDIX F

RVCA CORRESPONDENCE

From: [Eric Lalande](#)
To: [Nicole Wells](#)
Subject: RE: 29 Russell Ave - Quality Control Requirements
Date: June 24, 2022 1:48:39 PM

Hi Nicole,

Based on the proposed plan, the RVCA does not have any on-site water quality requirements. Best management practices are encouraged where possible.

Thank you,

Eric Lalande, MCIP, RPP
Planner, RVCA
613-692-3571 x1137

From: Nicole Wells <nwells@pearsoneng.com>
Sent: Friday, June 24, 2022 1:46 PM
To: Eric Lalande <eric.lalande@rvca.ca>
Subject: 29 Russell Ave - Quality Control Requirements

Hi Eric,

We have a proposed development at 29 Russell Ave. Can you confirm if the RVCA would have any specific comments for stormwater quality control on the proposed site plan application? There is no parking or driveway proposed on site. We are intending on controlling the rooftop flows in an underground tank in the front yard. Please see the attached site plan for your reference. Let me know if you need any further information.

Thank you,

Nicole Wells
Project Coordinator/AutoCAD Designer



OTTAWA OFFICE

900 Morrison Drive, Unit
100
Ottawa, ON K2H 8K7
P: 613-416-1232 ext. 249
nwells@pearsoneng.com
pearsoneng.com

BARRIE
705-719-4785

GTA
905-597-5572

OWEN SOUND
519-614-2523



APPENDIX G

VORTEX VALVE INFORMATION

CEV 275 ø66

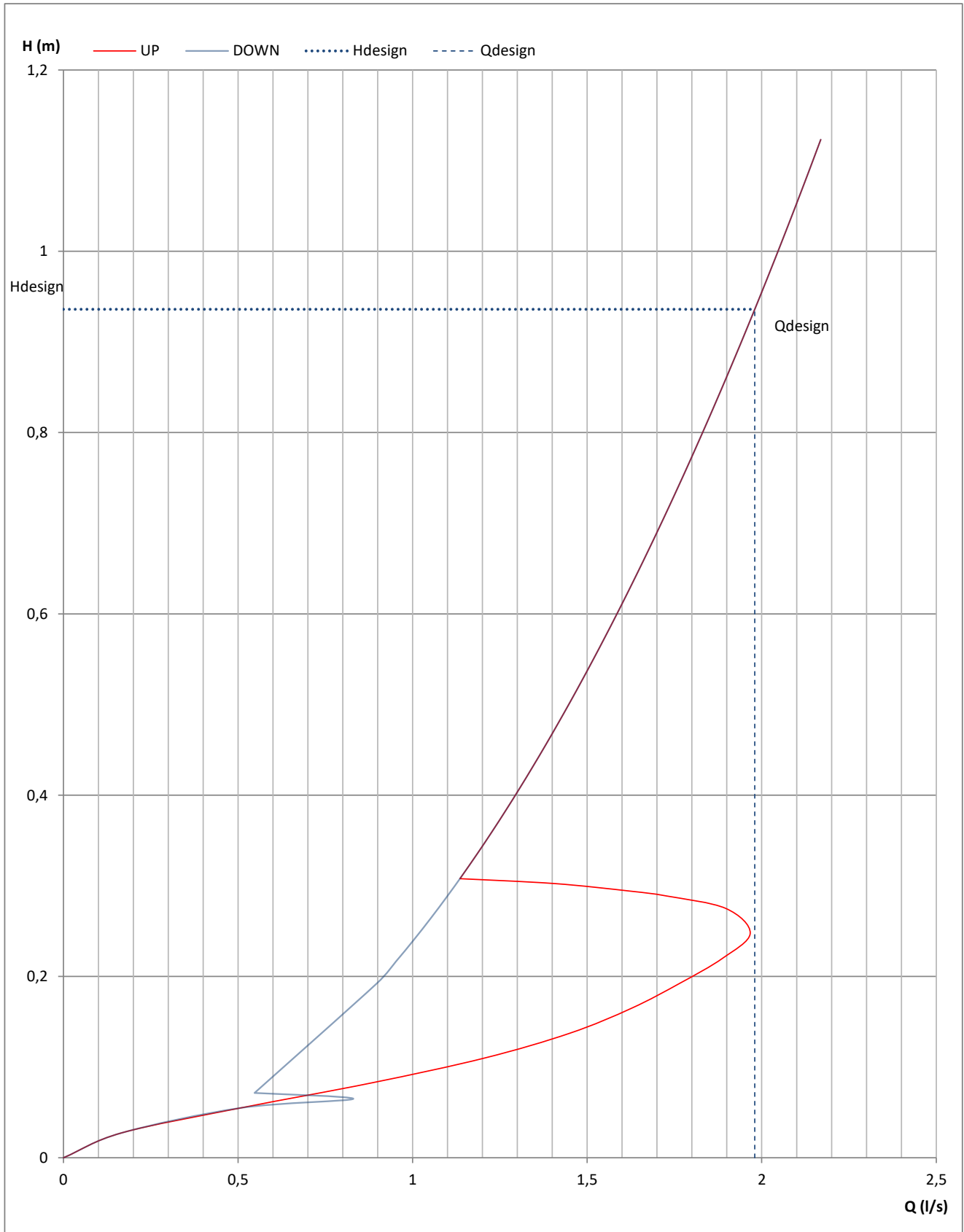



This drawing with specifications remains our property and should not be utilised or handed over to any third party without our consent.

When ordering please state the information as follows:

- 1) Ref. No. : 25430.3.1
- 2) d : min. \varnothing 110 mm
- 3) L : min. 2xD mm
- 4) W : min. 1.5xD mm
- 5) D : 275 mm

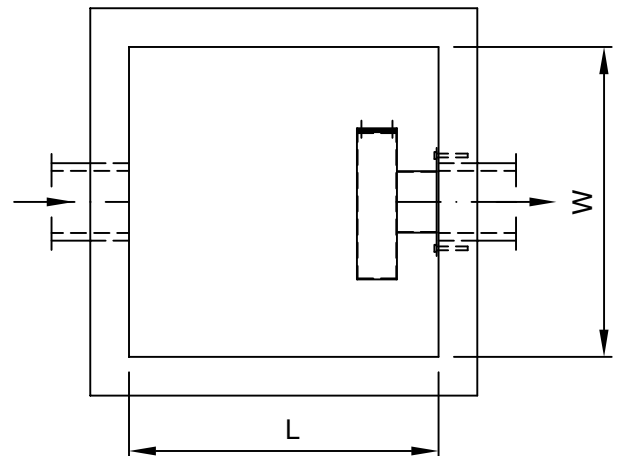
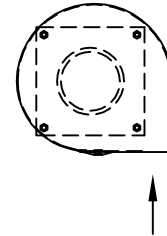
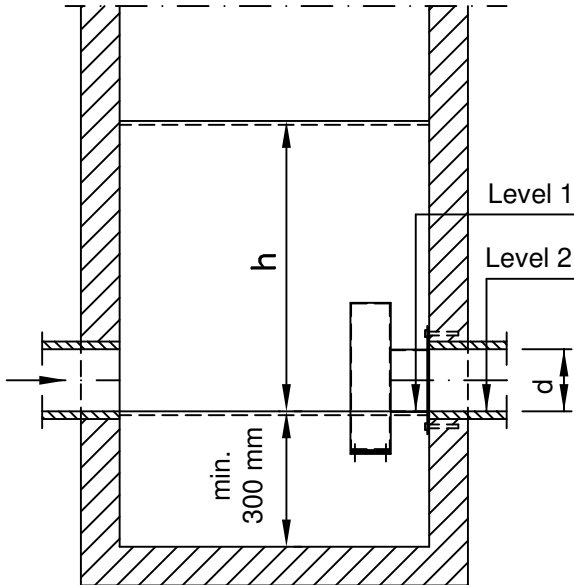

Installation

The flow regulator is provided with a mounting plate. The mounting plate must be fastened to the wall of the chamber covering the outlet opening by means of drilled or embedded bolts/threaded rods of acid-resistant steel.

Please note that level 1 and level 2 must be equal.

Tightening between plate and wall of chamber is made with waterresistant silicone, rubber sealing or the like.



APPENDIX H

STORMTECH CHAMBERS INFORMATION

STORMTECH SC-740 CHAMBER

Designed to meet the most stringent industry performance standards for superior structural integrity while providing designers with a cost-effective method to save valuable land and protect water resources. The StormTech system is designed primarily to be used under parking lots, thus maximizing land usage for private (commercial) and public applications. StormTech chambers can also be used in conjunction with Green Infrastructure, thus enhancing the performance and extending the service life of these practices.

STORMTECH SC-740 CHAMBER (not to scale)

Nominal Chamber Specifications

Size (L x W x H)
85.4" x 51" x 30"
2,170 mm x 1,295 mm x 762 mm

Chamber Storage
45.9 ft³ (1.30 m³)

Min. Installed Storage*
74.9 ft³ (2.12 m³)

Weight
74.0 lbs (33.6 kg)

Shipping
30 chambers/pallet
60 end caps/pallet
12 pallets/truck

*Assumes 6" (150 mm) stone above, below and between chambers and 40% stone porosity.

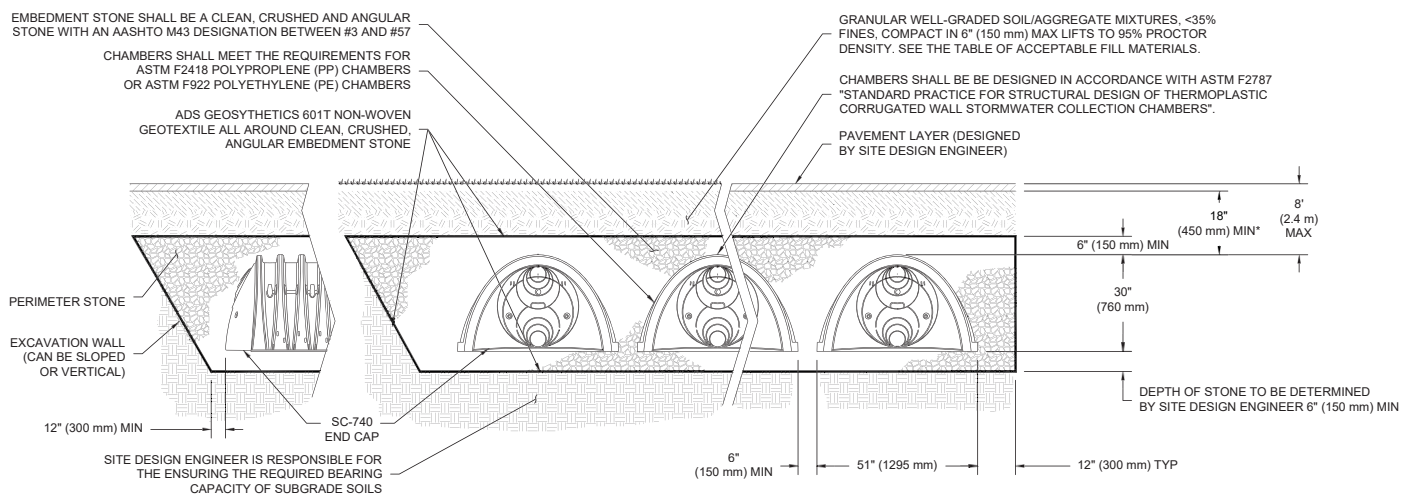
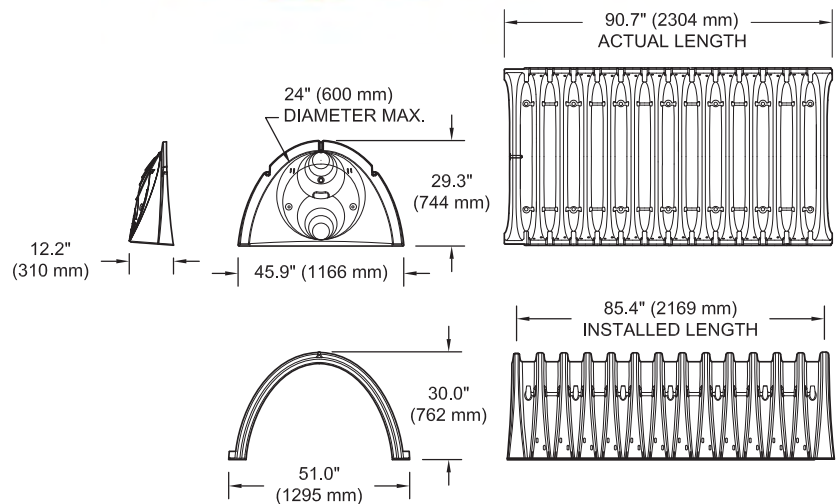
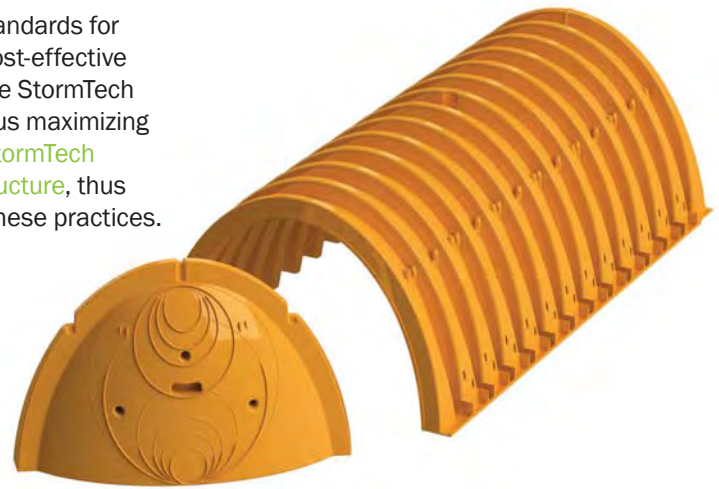

*MINIMUM COVER TO BOTTOM OF FLEXIBLE PAVEMENT. FOR UNPAVED INSTALLATIONS WHERE RUTTING FROM VEHICLES MAY OCCUR, INCREASE COVER TO 24" (600 mm).

SC-740 CUMULATIVE STORAGE VOLUMES PER CHAMBER

Assumes 40% Stone Porosity. Calculations are Based Upon a 6" (150 mm) Stone Base Under Chambers.

Depth of Water in System Inches (mm)	Cumulative Chamber Storage ft ³ (m ³)	Total System Cumulative Storage ft ³ (m ³)
42 (1067)	45.90 (1.300)	74.90 (2.121)
41 (1041)	45.90 (1.300)	73.77 (2.089)
40 (1016)	45.90 (1.300)	72.64 (2.057)
39 (991)	45.90 (1.300)	71.52 (2.025)
38 (965)	45.90 (1.300)	70.39 (1.993)
37 (940)	45.90 (1.300)	69.26 (1.961)
36 (914)	45.90 (1.300)	68.14 (1.929)
35 (889)	45.85 (1.298)	66.98 (1.897)
34 (864)	45.69 (1.294)	65.75 (1.862)
33 (838)	45.41 (1.286)	64.46 (1.825)
32 (813)	44.81 (1.269)	62.97 (1.783)
31 (787)	44.01 (1.246)	61.36 (1.737)
30 (762)	43.06 (1.219)	59.66 (1.689)
29 (737)	41.98 (1.189)	57.89 (1.639)
28 (711)	40.80 (1.155)	56.05 (1.587)
27 (686)	39.54 (1.120)	54.17 (1.534)
26 (660)	38.18 (1.081)	52.23 (1.479)
25 (635)	36.74 (1.040)	50.23 (1.422)
24 (610)	35.22 (0.977)	48.19 (1.365)
23 (584)	33.64 (0.953)	46.11 (1.306)
22 (559)	31.99 (0.906)	44.00 (1.246)
21 (533)	30.29 (0.858)	4.185 (1.185)
20 (508)	28.54 (0.808)	39.67 (1.123)
19 (483)	26.74 (0.757)	37.47 (1.061)
18 (457)	24.89 (0.705)	35.23 (0.997)
17 (432)	23.00 (0.651)	32.96 (0.939)
16 (406)	21.06 (0.596)	30.68 (0.869)
15 (381)	19.09 (0.541)	28.36 (0.803)
14 (356)	17.08 (0.484)	26.03 (0.737)
13 (330)	15.04 (0.426)	23.68 (0.670)
12 (305)	12.97 (0.367)	21.31 (0.608)
11 (279)	10.87 (0.309)	18.92 (0.535)
10 (254)	8.74 (0.247)	16.51 (0.468)
9 (229)	6.58 (0.186)	14.09 (0.399)
8 (203)	4.41 (0.125)	11.66 (0.330)
7 (178)	2.21 (0.063)	9.21 (0.264)
6 (152)	0 (0)	6.76 (0.191)
5 (127)	0 (0)	5.63 (0.160)
4 (102)	0 (0)	4.51 (0.128)
3 (76)	0 (0)	3.38 (0.096)
2 (51)	0 (0)	2.25 (0.064)
1 (25)	0 (0)	1.13 (0.032)

Note: Add 1.13 ft³ (0.032 m³) of storage for each additional inch (25 mm) of stone foundation.

For more information on the StormTech SC-740 Chamber and other ADS products, please contact our Customer Service Representatives at 1-800-821-6710

STORAGE VOLUME PER CHAMBER FT³ (M³)

	Bare Chamber Storage ft ³ (m ³)	Chamber and Stone Foundation Depth in. (mm)		
		6 (150)	12 (300)	18 (450)
SC-740 Chamber	45.9 (1.3)	74.9 (2.1)	81.7 (2.3)	88.4 (2.5)

Note: Assumes 6" (150 mm) stone above chambers, 6" (150 mm) row spacing and 40% stone porosity.

AMOUNT OF STONE PER CHAMBER

ENGLISH TONS (yds ³)	Stone Foundation Depth		
	6"	12"	16"
SC-740	3.8 (2.8)	4.6 (3.3)	5.5 (3.9)
METRIC KILOGRAMS (m ³)	150 mm	300 mm	450 mm
SC-740	3,450 (2.1)	4,170 (2.5)	4,490 (3.0)

Note: Assumes 6" (150 mm) of stone above and between chambers.

VOLUME EXCAVATION PER CHAMBER YD³ (M³)

	Stone Foundation Depth		
	6 (150)	12 (300)	18 (450)
SC-740	5.5 (4.2)	6.2 (4.7)	6.8 (5.2)

Note: Assumes 6" (150 mm) of row separation and 18" (450 mm) of cover. The volume of excavation will vary as depth of cover increases.



Working on a project?
Visit us at www.stormtech.com
and utilize the StormTech Design Tool

ACCEPTABLE FILL MATERIALS: STORMTECH SC-740 CHAMBER SYSTEMS

MATERIAL LOCATION		DESCRIPTION	AASHTO MATERIAL CLASSIFICATIONS	COMPACTION / DENSITY REQUIREMENT
D	FINAL FILL: FILL MATERIAL FOR LAYER 'D' STARTS FROM THE TOP OF THE 'C' LAYER TO THE BOTTOM OF FLEXIBLE PAVEMENT OR UNPAVED FINISHED GRADE ABOVE. NOTE THAT PAVEMENT SUBBASE MAY BE PART OF THE 'D' LAYER.	ANY SOIL/ROCK MATERIALS, NATIVE SOILS, OR PER ENGINEER'S PLANS. CHECK PLANS FOR PAVEMENT SUBGRADE REQUIREMENTS.	N/A	PREPARE PER SITE DESIGN ENGINEER'S PLANS. PAVED INSTALLATIONS MAY HAVE STRINGENT MATERIAL AND PREPARATION REQUIREMENTS.
C	INITIAL FILL: FILL MATERIAL FOR LAYER 'C' STARTS FROM THE TOP OF THE EMBEDMENT STONE ('B' LAYER) TO 18" (450 mm) ABOVE THE TOP OF THE CHAMBER. NOTE THAT PAVEMENT SUBBASE MAY BE A PART OF THE 'C' LAYER.	GRANULAR WELL-GRADED SOIL/AGGREGATE MIXTURES, <35% FINES OR PROCESSED AGGREGATE. MOST PAVEMENT SUBBASE MATERIALS CAN BE USED IN LIEU OF THIS LAYER.	AASHTO M145 ¹ A-1, A-2-4, A-3 OR AASHTO M43 ¹ 3, 357, 4, 467, 5, 56, 57, 6, 67, 68, 7, 78, 8, 89, 9, 10	BEGIN COMPACTIONS AFTER 12" (300 mm) OF MATERIAL OVER THE CHAMBERS IS REACHED. COMPACT ADDITIONAL LAYERS IN 6" (150 mm) MAX LIFTS TO A MIN. 95% PROCTOR DENSITY FOR WELL GRADED MATERIAL AND 95% RELATIVE DENSITY FOR PROCESSED AGGREGATE MATERIALS. ROLLER GROSS VEHICLE WEIGHT NOT TO EXCEED 12,000 lbs (53 kN). DYNAMIC FORCE NOT TO EXCEED 20,000 lbs (89 kN).
B	EMBEDMENT STONE: FILL SURROUNDING THE CHAMBERS FROM THE FOUNDATION STONE ('A' LAYER) TO THE 'C' LAYER ABOVE.	CLEAN, CRUSHED, ANGULAR STONE	AASHTO M43 ¹ 3, 357, 4, 467, 5, 56, 57	NO COMPACTION REQUIRED.
A	FOUNDATION STONE: FILL BELOW CHAMBERS FROM THE SUBGRADE UP TO THE FOOT (BOTTOM) OF THE CHAMBER.	CLEAN, CRUSHED, ANGULAR STONE	AASHTO M43 ¹ 3, 357, 4, 467, 5, 56, 57	PLATE COMPACT OR ROLL TO ACHIEVE A FLAT SURFACE. ^{2,3}

PLEASE NOTE:

- THE LISTED AASHTO DESIGNATIONS ARE FOR GRADATIONS ONLY. THE STONE MUST ALSO BE CLEAN, CRUSHED, ANGULAR. FOR EXAMPLE, A SPECIFICATION FOR #4 STONE WOULD STATE: "CLEAN, CRUSHED, ANGULAR NO. 4 (AASHTO M43) STONE".
- STORMTECH COMPACTION REQUIREMENTS ARE MET FOR 'A' LOCATION MATERIALS WHEN PLACED AND COMPACTED IN 6" (150 mm) (MAX) LIFTS USING TWO FULL COVERAGES WITH A VIBRATORY COMPACTOR.
- WHERE INFILTRATION SURFACES MAY BE COMPROMISED BY COMPACTION, FOR STANDARD DESIGN LOAD CONDITIONS, A FLAT SURFACE MAY BE ACHIEVED BY RAKING OR DRAGGING WITHOUT COMPACTION EQUIPMENT. FOR SPECIAL LOAD DESIGNS, CONTACT STORMTECH FOR COMPACTION REQUIREMENTS.
- ONCE LAYER 'C' IS PLACED, ANY SOIL/MATERIAL CAN BE PLACED IN LAYER 'D' UP TO THE FINISHED GRADE. MOST PAVEMENT SUBBASE SOILS CAN BE USED TO REPLACE THE MATERIAL REQUIREMENTS OF LAYER 'C' OR 'D' AT THE SITE DESIGN ENGINEER'S DISCRETION.

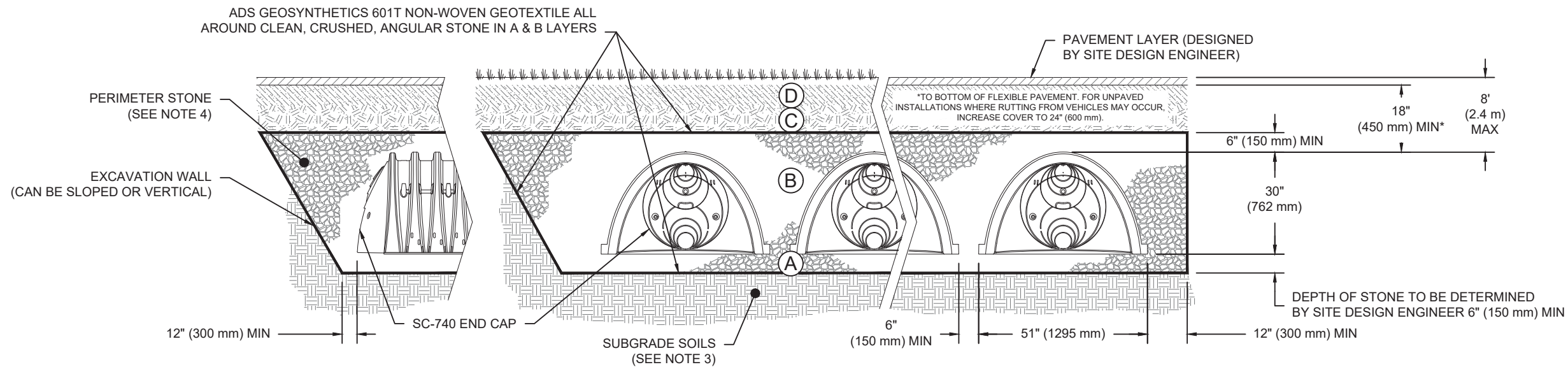

NOTES:

- CHAMBERS SHALL MEET THE REQUIREMENTS OF ASTM F2418-16a, "STANDARD SPECIFICATION FOR POLYPROPYLENE (PP) CORRUGATED WALL STORMWATER COLLECTION CHAMBERS".
- SC-740 CHAMBERS SHALL BE DESIGNED IN ACCORDANCE WITH ASTM F2787 "STANDARD PRACTICE FOR STRUCTURAL DESIGN OF THERMOPLASTIC CORRUGATED WALL STORMWATER COLLECTION CHAMBERS".
- THE SITE DESIGN ENGINEER IS RESPONSIBLE FOR ASSESSING THE BEARING RESISTANCE (ALLOWABLE BEARING CAPACITY) OF THE SUBGRADE SOILS AND THE DEPTH OF FOUNDATION STONE WITH CONSIDERATION FOR THE RANGE OF EXPECTED SOIL MOISTURE CONDITIONS.
- PERIMETER STONE MUST BE EXTENDED HORIZONTALLY TO THE EXCAVATION WALL FOR BOTH VERTICAL AND SLOPED EXCAVATION WALLS.
- REQUIREMENTS FOR HANDLING AND INSTALLATION:
 - TO MAINTAIN THE WIDTH OF CHAMBERS DURING SHIPPING AND HANDLING, CHAMBERS SHALL HAVE INTEGRAL, INTERLOCKING STACKING LUGS.
 - TO ENSURE A SECURE JOINT DURING INSTALLATION AND BACKFILL, THE HEIGHT OF THE CHAMBER JOINT SHALL NOT BE LESS THAN 2".
 - TO ENSURE THE INTEGRITY OF THE ARCH SHAPE DURING INSTALLATION, a) THE ARCH STIFFNESS CONSTANT AS DEFINED IN SECTION 6.2.8 OF ASTM F2418 SHALL BE GREATER THAN OR EQUAL TO 550 LBS/IN/IN. AND b) TO RESIST CHAMBER DEFORMATION DURING INSTALLATION AT ELEVATED TEMPERATURES (ABOVE 73° F / 23° C), CHAMBERS SHALL BE PRODUCED FROM REFLECTIVE GOLD OR YELLOW COLORS.

STANDARD CROSS SECTION

DATE: 05-10-19

PROJECT #:

SC-740

DRAWN: KR

CHECKED: KR

DESCRIPTION

DATE

DRWN

CHKD

70 INWOOD ROAD, SUITE 3 | ROCKY HILL | CT | 06867

860-525-8188 | 888-892-2694 | WWW.STORMTECH.COM

StormTech
Dedication. Retention. Water Quality.

4640 TRUEMAN BLVD
HILLIARD, OH 43026

ADS
ADVANCED DRAINAGE SYSTEMS, INC.

THIS DRAWING HAS BEEN PREPARED BASED ON INFORMATION PROVIDED TO ADS UNDER THE DIRECTION OF THE SITE DESIGN ENGINEER OR OTHER PROJECT REPRESENTATIVE. THE SITE DESIGN ENGINEER SHALL REVIEW THIS DRAWING PRIOR TO CONSTRUCTION. IT IS THE ULTIMATE RESPONSIBILITY OF THE SITE DESIGN ENGINEER TO ENSURE THAT THE PRODUCT(S) DEPICTED AND ALL ASSOCIATED DETAILS MEET ALL APPLICABLE LAWS, REGULATIONS, AND PROJECT REQUIREMENTS.

SC-740 TECHNICAL SPECIFICATION

NTS

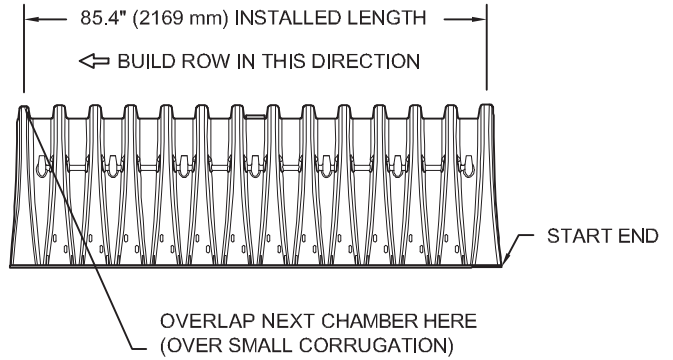
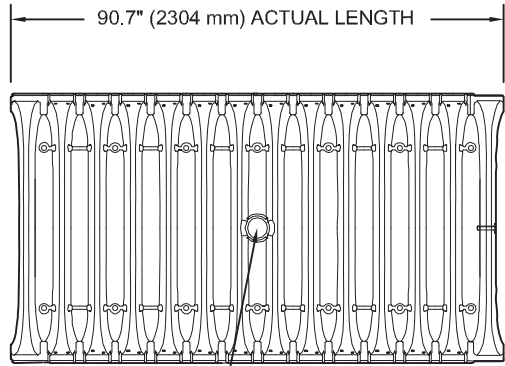

ACCEPTS 4" (100 mm) SCH 40 PVC PIPE FOR INSPECTION PORT. FOR PIPE SIZES LARGER THAN 4" (100 mm) UP TO 10" (250 mm) USE INSERTA TEE CONNECTION CENTERED ON A CHAMBER CREST CORRUGATION

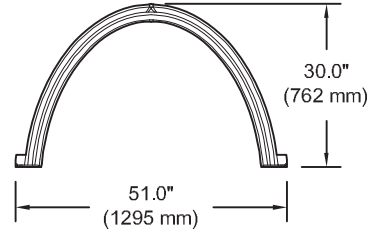
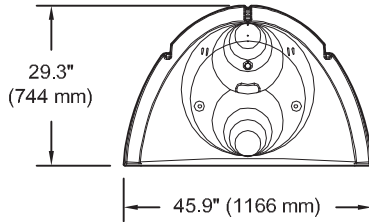
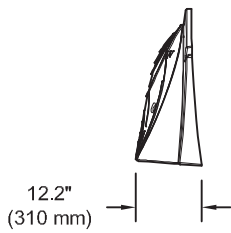

NOMINAL CHAMBER SPECIFICATIONS

SIZE (W X H X INSTALLED LENGTH)	51.0" X 30.0" X 85.4"	(1295 mm X 762 mm X 2169 mm)
CHAMBER STORAGE	45.9 CUBIC FEET	(1.30 m ³)
MINIMUM INSTALLED STORAGE*	74.9 CUBIC FEET	(2.12 m ³)
WEIGHT	75.0 lbs.	(33.6 kg)

*ASSUMES 6" (152 mm) STONE ABOVE, BELOW, AND BETWEEN CHAMBERS

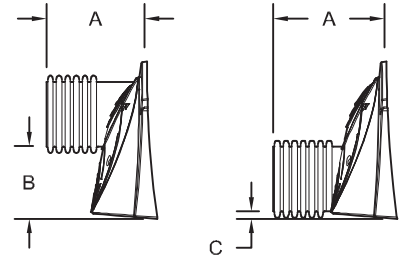

STUBS AT BOTTOM OF END CAP FOR PART NUMBERS ENDING WITH "B"
STUBS AT TOP OF END CAP FOR PART NUMBERS ENDING WITH "T"

PART #	STUB	A	B	C
SC740EPE06T / SC740EPE06TPC	6" (150 mm)	10.9" (277 mm)	18.5" (470 mm)	—
SC740EPE06B / SC740EPE06BPC			—	0.5" (13 mm)
SC740EPE08T / SC740EPE08TPC	8" (200 mm)	12.2" (310 mm)	16.5" (419 mm)	—
SC740EPE08B / SC740EPE08BPC			—	0.6" (15 mm)
SC740EPE10T / SC740EPE10TPC	10" (250 mm)	13.4" (340 mm)	14.5" (368 mm)	—
SC740EPE10B / SC740EPE10BPC			—	0.7" (18 mm)
SC740EPE12T / SC740EPE12TPC	12" (300 mm)	14.7" (373 mm)	12.5" (318 mm)	—
SC740EPE12B / SC740EPE12BPC			—	1.2" (30 mm)
SC740EPE15T / SC740EPE15TPC	15" (375 mm)	18.4" (467 mm)	9.0" (229 mm)	—
SC740EPE15B / SC740EPE15BPC			—	1.3" (33 mm)
SC740EPE18T / SC740EPE18TPC	18" (450 mm)	19.7" (500 mm)	5.0" (127 mm)	—
SC740EPE18B / SC740EPE18BPC			—	1.6" (41 mm)
SC740EPE24B*	24" (600 mm)	18.5" (470 mm)	—	0.1" (3 mm)

ALL STUBS, EXCEPT FOR THE SC740EPE24B ARE PLACED AT BOTTOM OF END CAP SUCH THAT THE OUTSIDE DIAMETER OF THE STUB IS FLUSH WITH THE BOTTOM OF THE END CAP. FOR ADDITIONAL INFORMATION CONTACT STORMTECH AT 1-888-892-2694.

* FOR THE SC740EPE24B THE 24" (600 mm) STUB LIES BELOW THE BOTTOM OF THE END CAP APPROXIMATELY 1.75" (44 mm). BACKFILL MATERIAL SHOULD BE REMOVED FROM BELOW THE N-12 STUB SO THAT THE FITTING SITS LEVEL.

NOTE: ALL DIMENSIONS ARE NOMINAL

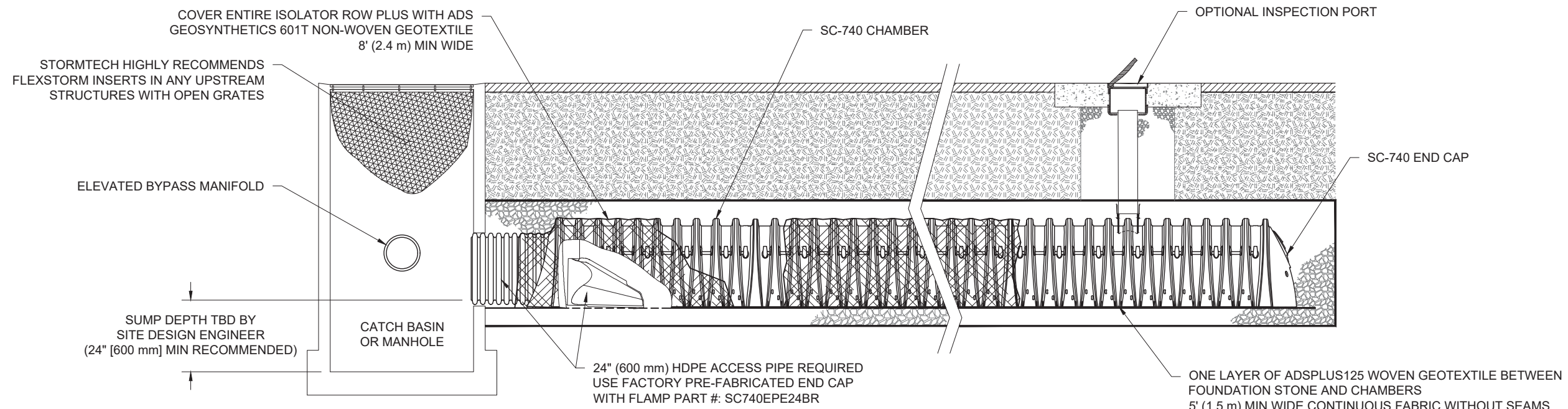

SC-740 ISOLATOR ROW PLUS DETAIL
NTS

INSPECTION & MAINTENANCE

- STEP 1) INSPECT ISOLATOR ROW PLUS FOR SEDIMENT
- A. INSPECTION PORTS (IF PRESENT)
 - A.1. REMOVE/OPEN LID ON NYLOPLAST INLINE DRAIN
 - A.2. REMOVE AND CLEAN FLEXSTORM FILTER IF INSTALLED
 - A.3. USING A FLASHLIGHT AND STADIA ROD, MEASURE DEPTH OF SEDIMENT AND RECORD ON MAINTENANCE LOG
 - A.4. LOWER A CAMERA INTO ISOLATOR ROW PLUS FOR VISUAL INSPECTION OF SEDIMENT LEVELS (OPTIONAL)
 - A.5. IF SEDIMENT IS AT, OR ABOVE, 3" (80 mm) PROCEED TO STEP 2. IF NOT, PROCEED TO STEP 3.
 - B. ALL ISOLATOR PLUS ROWS
 - B.1. REMOVE COVER FROM STRUCTURE AT UPSTREAM END OF ISOLATOR ROW PLUS
 - B.2. USING A FLASHLIGHT, INSPECT DOWN THE ISOLATOR ROW PLUS THROUGH OUTLET PIPE
 - i) MIRRORS ON POLES OR CAMERAS MAY BE USED TO AVOID A CONFINED SPACE ENTRY
 - ii) FOLLOW OSHA REGULATIONS FOR CONFINED SPACE ENTRY IF ENTERING MANHOLE
 - B.3. IF SEDIMENT IS AT, OR ABOVE, 3" (80 mm) PROCEED TO STEP 2. IF NOT, PROCEED TO STEP 3.
- STEP 2) CLEAN OUT ISOLATOR ROW PLUS USING THE JETVAC PROCESS
- A. A FIXED CULVERT CLEANING NOZZLE WITH REAR FACING SPREAD OF 45" (1.1 m) OR MORE IS PREFERRED
 - B. APPLY MULTIPLE PASSES OF JETVAC UNTIL BACKFLUSH WATER IS CLEAN
 - C. VACUUM STRUCTURE SUMP AS REQUIRED
- STEP 3) REPLACE ALL COVERS, GRATES, FILTERS, AND LIDS; RECORD OBSERVATIONS AND ACTIONS.
- STEP 4) INSPECT AND CLEAN BASINS AND MANHOLES UPSTREAM OF THE STORMTECH SYSTEM.

NOTES

1. INSPECT EVERY 6 MONTHS DURING THE FIRST YEAR OF OPERATION. ADJUST THE INSPECTION INTERVAL BASED ON PREVIOUS OBSERVATIONS OF SEDIMENT ACCUMULATION AND HIGH WATER ELEVATIONS.
2. CONDUCT JETTING AND VACTORING ANNUALLY OR WHEN INSPECTION SHOWS THAT MAINTENANCE IS NECESSARY.

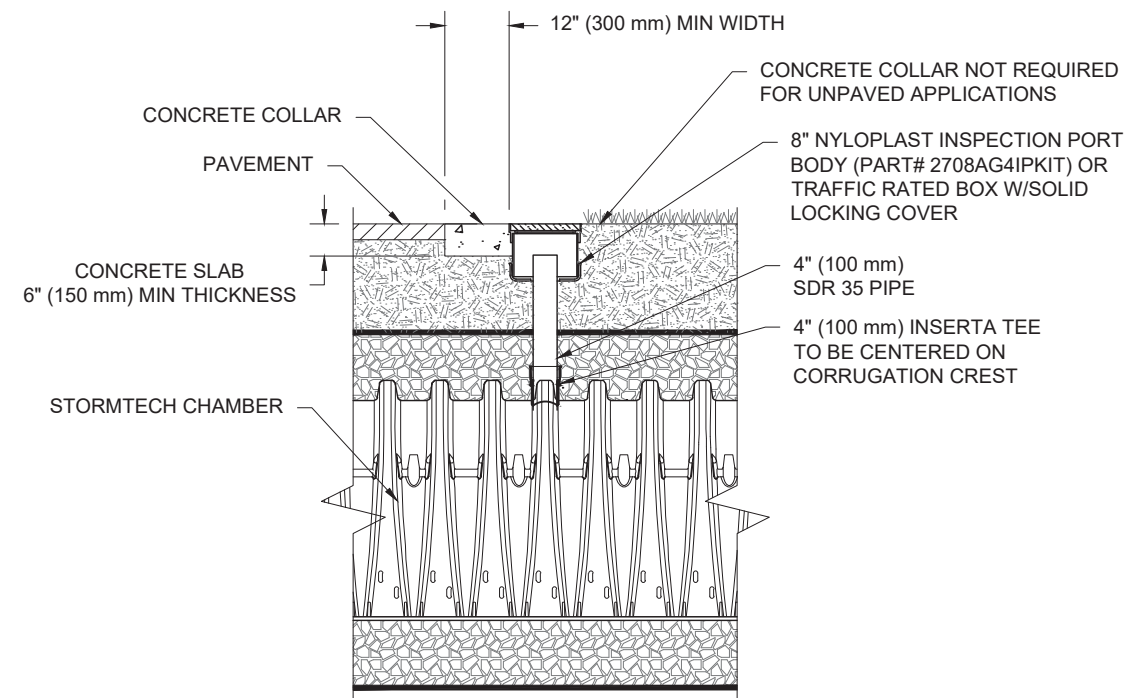

NOTE:
INSPECTION PORTS MAY BE CONNECTED THROUGH ANY CHAMBER CORRUGATION CREST.

4" PVC INSPECTION PORT DETAIL
(SC SERIES CHAMBER)
NTS

SC-740	ISOLATOR ROW PLUS DETAILS	DATE: 08/26/20	DRAWN: ALI	PROJECT #: ----	CHECKED: ALI
<p style="font-size: small; margin: 0;">520 CROMWELL AVENUE ROCKY HILL, CT 06067 860-528-8188 866-892-2684 WWW.STORMTECH.COM</p>					
<p style="font-size: small; margin: 0;">4640 TRUEMAN BLVD HILLIARD, OH 43026</p> <p style="font-size: x-small; margin: 0;">ADVANCED DRAINAGE SYSTEMS, INC.</p>					
THIS DRAWING HAS BEEN PREPARED BASED ON INFORMATION PROVIDED TO ADS UNDER THE DIRECTION OF THE SITE DESIGN ENGINEER OR OTHER PROJECT REPRESENTATIVE. THE SITE DESIGN ENGINEER SHALL REVIEW THIS DRAWING PRIOR TO CONSTRUCTION. IT IS THE ULTIMATE RESPONSIBILITY OF THE SITE DESIGN ENGINEER TO ENSURE THAT THE PRODUCT(S) DEPICTED AND ALL ASSOCIATED DETAILS MEET ALL APPLICABLE LAWS, REGULATIONS, AND PROJECT REQUIREMENTS.					
1		SHEET		1	
1		OF		1	

Isolator[®] Row PLUS O&M Manual

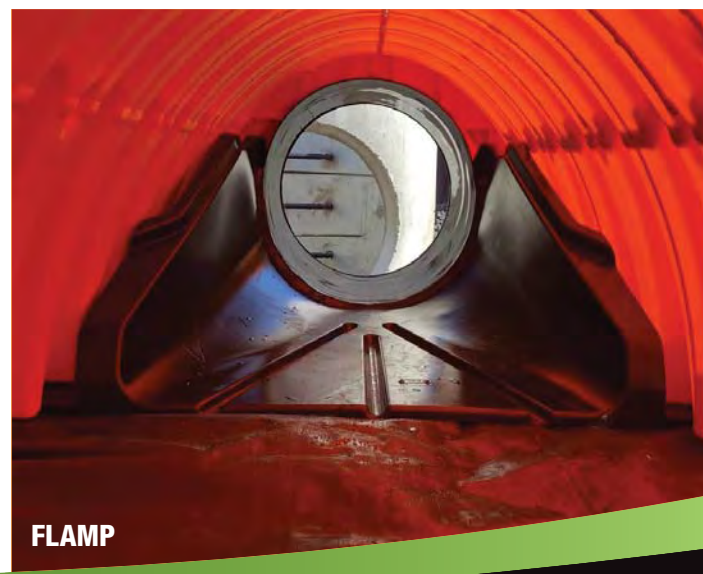

THE ISOLATOR® ROW PLUS

INTRODUCTION

An important component of any Stormwater Pollution Prevention Plan is inspection and maintenance. The StormTech Isolator Row PLUS is a technique to inexpensively enhance Total Suspended Solids (TSS) and Total Phosphorus (TP) removal with easy access for inspection and maintenance.

THE ISOLATOR ROW PLUS

The Isolator Row PLUS is a row of StormTech chambers, either SC-160, SC-310, SC-310-3, SC-740, DC-780, MC-3500 or MC-4500 models, that is surrounded with filter fabric and connected to a closely located manhole for easy access. The fabric-wrapped chambers provide for settling and filtration of sediment as storm water rises in the Isolator Row PLUS and ultimately passes through the filter fabric. The open bottom chambers and perforated sidewalls (SC-310, SC-310-3 and SC-740 models) allow storm water to flow both vertically and horizontally out of the chambers. Sediments are captured in the Isolator Row PLUS protecting the storage areas of the adjacent stone and chambers from sediment accumulation.

ADS geotextile fabric is placed between the stone and the Isolator Row PLUS chambers. The woven geotextile provides a media for stormwater filtration, a durable surface for maintenance, prevents scour of the underlying stone and remains intact during high pressure jetting. A non-woven fabric is placed over the chambers to provide a filter media for flows passing through the perforations in the sidewall of the chamber. The non-woven fabric is not required over the SC-160, DC-780, MC-3500 or MC-4500 models as these chambers do not have perforated side walls.

The Isolator Row PLUS is designed to capture the “first flush” runoff and offers the versatility to be sized on a volume basis or a flow-rate basis. An upstream manhole not only provides access to the Isolator Row PLUS but includes a high/low concept such that stormwater flow rates or volumes that exceed the capacity of the Isolator Row PLUS bypass through a manifold to the other chambers. This is achieved with either an elevated bypass manifold or a high-flow weir. This creates a differential between the Isolator Row PLUS row of chambers and the manifold to the rest of the system, thus allowing for settlement time in the Isolator Row PLUS. After Stormwater flows through the Isolator Row PLUS and into the rest of the StormTech chamber system it is either exfiltrated into the soils below or passed at a controlled rate through an outlet manifold and outlet control structure.

The Isolator Row FLAMP™ (patent pending) is a flared end ramp apparatus that is attached to the inlet pipe on the inside of the chamber end cap. The FLAMP provides a smooth transition from pipe invert to fabric bottom. It is configured to improve chamber function performance over time by enhancing outflow of solid debris that would otherwise collect at an end of the chamber. It also serves to improve the fluid and solid flow into the access pipe during maintenance and cleaning and to guide cleaning and inspection equipment back into the inlet pipe when complete.

The Isolator Row PLUS may be part of a treatment train system. The design of the treatment train and selection of pretreatment devices by the design engineer is often driven by regulatory requirements. Whether pretreatment is used or not, the Isolator Row PLUS is recommended by StormTech as an effective means to minimize maintenance requirements and maintenance costs.

Note: See the StormTech Design Manual for detailed information on designing inlets for a StormTech system, including the Isolator Row PLUS.



Looking down the Isolator Row PLUS from the manhole opening, ADS PLUS Fabric is shown between the chamber and stone base.



StormTech Isolator Row PLUS with Overflow Spillway (not to scale)

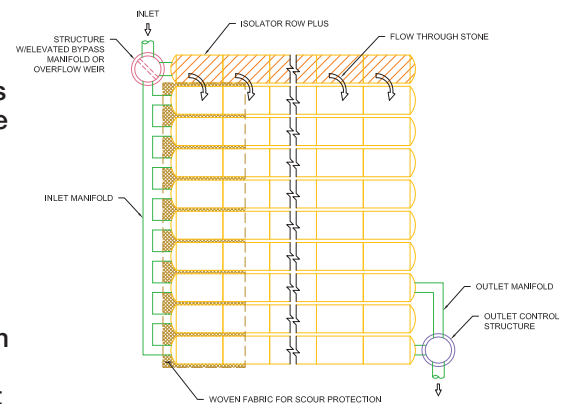



ISOLATOR ROW PLUS INSPECTION/MAINTENANCE

INSPECTION

The frequency of inspection and maintenance varies by location. A routine inspection schedule needs to be established for each individual location based upon site specific variables. The type of land use (i.e. industrial, commercial, residential), anticipated pollutant load, percent imperviousness, climate, etc. all play a critical role in determining the actual frequency of inspection and maintenance practices.

At a minimum, StormTech recommends annual inspections. Initially, the Isolator Row PLUS should be inspected every 6 months for the first year of operation. For subsequent years, the inspection should be adjusted based upon previous observation of sediment deposition.

The Isolator Row PLUS incorporates a combination of standard manhole(s) and strategically located inspection ports (as needed). The inspection ports allow for easy access to the system from the surface, eliminating the need to perform a confined space entry for inspection purposes.

If upon visual inspection it is found that sediment has accumulated, a stadia rod should be inserted to determine the depth of sediment. When the average depth of sediment exceeds 3 inches throughout the length of the Isolator Row PLUS, clean-out should be performed.

MAINTENANCE

The Isolator Row PLUS was designed to reduce the cost of periodic maintenance. By “isolating” sediments to just one row, costs are dramatically reduced by eliminating the need to clean out each row of the entire storage bed. If inspection indicates the potential need for maintenance, access is provided via a manhole(s) located on the end(s) of the row for cleanout. If entry into the manhole is required, please follow local and OSHA rules for a confined space entries.

Maintenance is accomplished with the JetVac process. The JetVac process utilizes a high pressure water nozzle to propel itself down the Isolator Row PLUS while scouring and suspending sediments. As the nozzle is retrieved, the captured pollutants are flushed back into the manhole for vacuuming. Most sewer and pipe maintenance companies have vacuum/JetVac combination vehicles. Selection of an appropriate JetVac nozzle will improve maintenance efficiency. Fixed nozzles designed for culverts or large diameter pipe cleaning are preferable. Rear facing jets with an effective spread of at least 45° are best. StormTech recommends a maximum nozzle pressure of 2000 psi be utilized during cleaning. Most JetVac reels have 400 feet of hose allowing maintenance of an Isolator Row PLUS up to 50 chambers long. **The JetVac process shall only be performed on StormTech Isolator Row PLUS that have ADS PLUS Fabric (as specified by StormTech) over their angular base stone.**

StormTech Isolator Row PLUS (not to scale)

Note: Non-woven fabric is only required over the inlet pipe connection into the end cap for SC-160LP, DC-780, MC-3500 and MC-4500 chamber models and is not required over the entire Isolator Row PLUS.

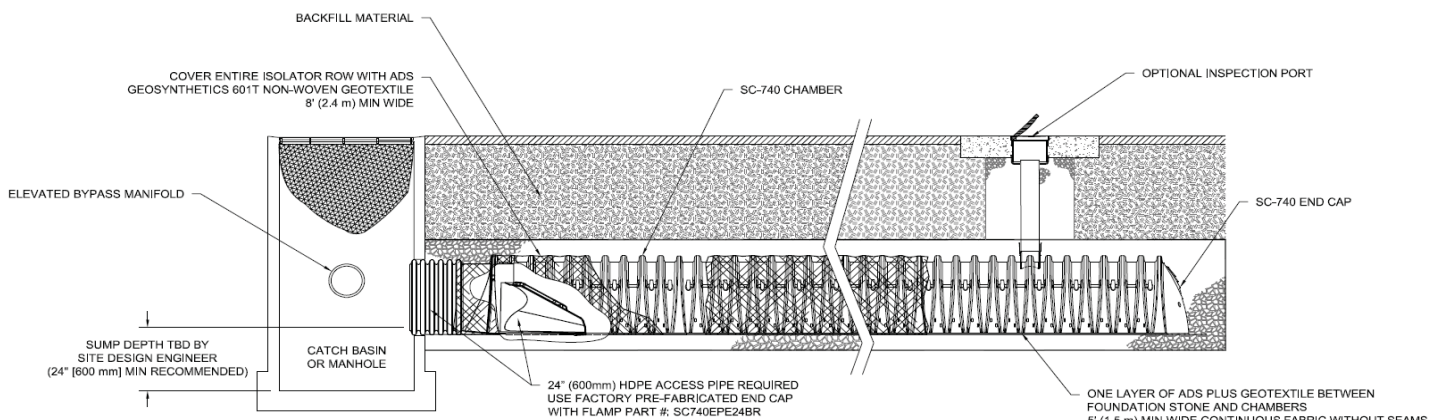

ISOLATOR ROW PLUS STEP BY STEP MAINTENANCE PROCEDURES

STEP 1

Inspect Isolator Row PLUS for sediment.

- A) Inspection ports (if present)
 - i. Remove lid from floor box frame
 - ii. Remove cap from inspection riser
 - iii. Using a flashlight and stadia rod, measure depth of sediment and record results on maintenance log.
 - iv. If sediment is at or above 3 inch depth, proceed to Step 2. If not, proceed to Step 3.
- B) All Isolator Row PLUS
 - i. Remove cover from manhole at upstream end of Isolator Row PLUS
 - ii. Using a flashlight, inspect down Isolator Row PLUS through outlet pipe
 1. Mirrors on poles or cameras may be used to avoid a confined space entry
 2. Follow OSHA regulations for confined space entry if entering manhole
 - iii. If sediment is at or above the lower row of sidewall holes (approximately 3 inches), proceed to Step 2. If not, proceed to Step 3.

STEP 2

Clean out Isolator Row PLUS using the JetVac process.

- A) A fixed floor cleaning nozzle with rear facing nozzle spread of 45 inches or more is preferable
- B) Apply multiple passes of JetVac until backflush water is clean
- C) Vacuum manhole sump as required

STEP 3

Replace all caps, lids and covers, record observations and actions.

STEP 4

Inspect & clean catch basins and manholes upstream of the StormTech system.

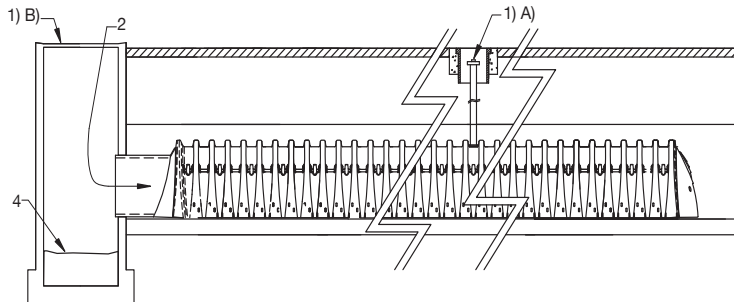

SAMPLE MAINTENANCE LOG

Date	Stadia Rod Readings		Sediment Depth (1)-(2)	Observations/Actions	Inspector
	Fixed point to chamber bottom (1)	Fixed point to top of sediment (2)			
3/15/11	6.3 ft	none		New installation. Fixed point is CI frame at grade	DJM
9/24/11		6.2	0.1 ft	Some grit felt	SM
6/20/13		5.8	0.5 ft	Mucky feel, debris visible in manhole and in Isolator Row PLUS, maintenance due	NV
7/7/13	6.3 ft		0	System jetted and vacuumed	DJM



StormTech Construction Guide

REQUIRED MATERIALS AND EQUIPMENT LIST

- Acceptable fill materials per Table 1
- ADS Plus and non-woven geotextile fabrics
- StormTech solid end caps and pre-cored end caps
- StormTech chambers
- StormTech manifolds and fittings

IMPORTANT NOTES:

A. This installation guide provides the minimum requirements for proper installation of chambers. Non-adherence to this guide may result in damage to chambers during installation. Replacement of damaged chambers during or after backfilling is costly and very time consuming. It is recommended that all installers are familiar with this guide, and that the contractor inspects the chambers for distortion, damage and joint integrity as work progresses.

B. Use of a dozer to push embedment stone between the rows of chambers may cause damage to chambers and is not an acceptable backfill method. Any chambers damaged by using the “dump and push” method are not covered under the StormTech standard warranty.

C. Care should be taken in the handling of chambers and end caps. Avoid dropping, prying or excessive force on chambers during removal from pallet and initial placement.

Requirements for System Installation



Excavate bed and prepare subgrade per engineer’s plans.



Place non-woven geotextile over prepared soils and up excavation walls. Install underdrains if required.



Place clean, crushed, angular stone foundation 6” (150 mm) min. Compact to achieve a flat surface.

Manifold, Scour Fabric and Chamber Assembly



Install manifolds and lay out ADS PLUS fabric at inlet rows [min. 12.5 ft (3.8 m)] at each inlet end cap. Place a continuous piece along entire length of Isolator® PLUS Row(s).

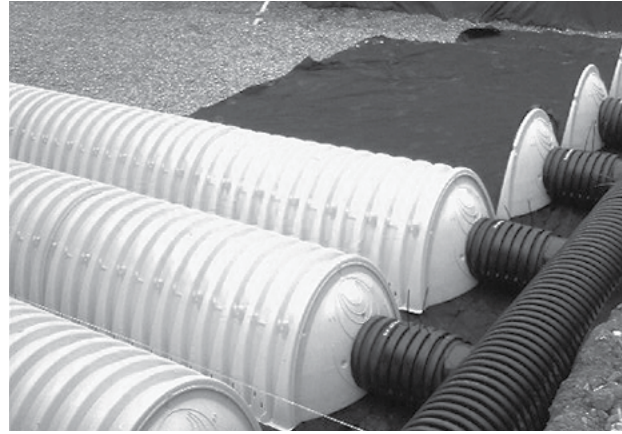

Align the first chamber and end cap of each row with inlet pipes. Contractor may choose to postpone stone placement around end chambers and leave ends of rows open for easy inspection of chambers during the backfill process.



Continue installing chambers by overlapping chamber end corrugations. Chamber joints are labeled “Lower Joint – Overlap Here” and “Build this direction – Upper Joint” Be sure that the chamber placement does not exceed the reach of the construction equipment used to place the stone. Maintain minimum 6” (150 mm) spacing between rows.

Attaching the End Caps



Lift the end of the chamber a few inches off the ground. With the curved face of the end cap facing outward, place the end cap into the chamber's end corrugation.

Prefabricated End Caps

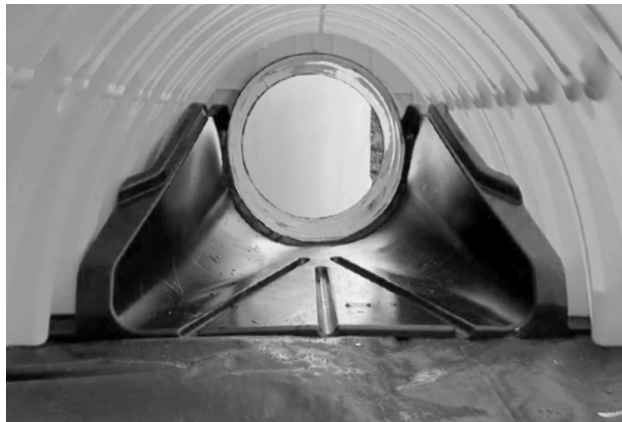

24” (600 mm) inlets are the maximum size that can fit into a SC-740/DC-780 end cap and must be prefabricated with a 24” (600 mm) pipe stub. SC-310 chambers with a 12” (300 mm) inlet pipe must use a prefabricated end cap with a 12” (300 mm) pipe stub. When used on an Isolator Row PLUS, these end caps will contain a welded FLAMP (flared end ramp) that will lay on top of the ADS PLUS fabric (shown above)

Isolator Row PLUS



Place a continuous layer of ADS PLUS fabric between the foundation stone and the Isolator Row PLUS chambers, making sure the fabric lays flat and extends the entire width of the chamber feet. Drape a strip of ADS non-woven geotextile over the row of chambers (not required over DC-780). This is the same type of non-woven geotextile used as a separation layer around the angular stone of the StormTech system.

Initial Anchoring of Chambers – Embedment Stone



Initial embedment shall be spotted along the centerline of the chamber evenly anchoring the lower portion of the chamber. This is best accomplished with a stone conveyor or excavator reaching along the row.



No equipment shall be operated on the bed at this stage of the installation. Excavators must be located off the bed. Dump trucks shall not dump stone directly on to the bed. Dozers or loaders are not allowed on the bed at this time.

Backfill of Chambers – Embedment Stone

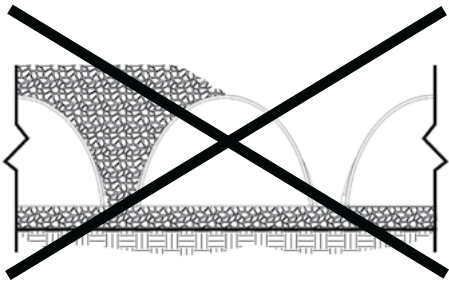

UNEVEN BACKFILL

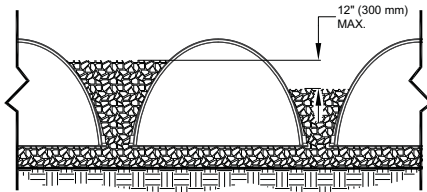

EVEN BACKFILL

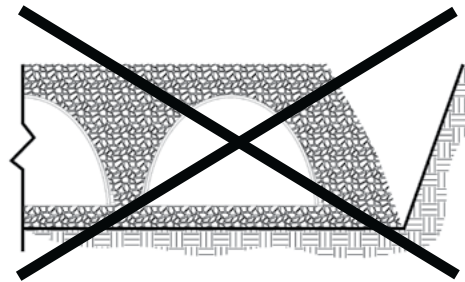

PERIMETER NOT BACKFILLED

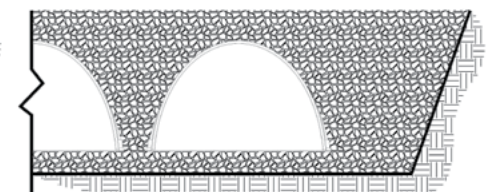

PERIMETER FULLY BACKFILLED

Backfill chambers evenly. Stone column height should never differ by more than 12" (300 mm) between adjacent chamber rows or between chamber rows and perimeter.

Perimeter stone must be brought up evenly with chamber rows. Perimeter must be fully backfilled, with stone extended horizontally to the excavation wall.

Backfill - Embedment Stone & Cover Stone



Continue evenly backfilling between rows and around perimeter until embedment stone reaches tops of chambers. Perimeter stone must extend horizontally to the excavation wall for both straight or sloped sidewalls. **Only after chambers have been backfilled to top of chamber and with a minimum 6" (150 mm) of cover stone on top of chambers can small dozers be used over the chambers for backfilling remaining cover stone.**

Small dozers and skid loaders may be used to finish grading stone backfill in accordance with ground pressure limits in Table 2. They must push material parallel to rows only. Never push perpendicular to rows. StormTech recommends that the contractor inspect chambers before placing final backfill. Any chambers damaged by construction shall be removed and replaced.

Inserta Tee Detail

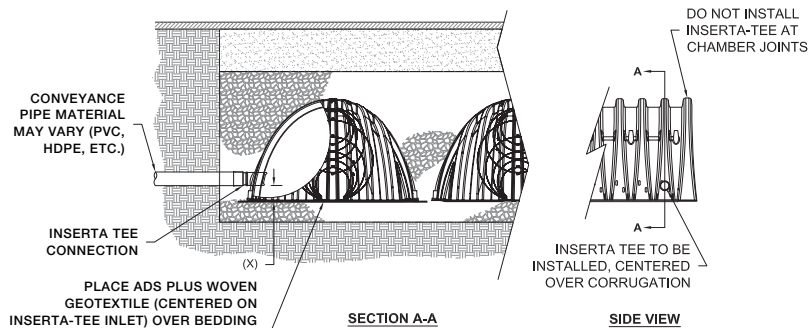

NOTE:
PART NUMBERS WILL VARY BASED ON INLET PIPE MATERIALS. CONTACT STORMTECH FOR MORE INFORMATION.

CHAMBER	MAX DIAMETER OF INSERTA TEE	HEIGHT FROM BASE OF CHAMBER (X)
SC-310	6" (150 mm)	4" (100 mm)
SC-740	10" (250 mm)	4" (100 mm)
DC-780	10" (250 mm)	4" (100 mm)

INSERTA TEE FITTINGS AVAILABLE FOR SDR 26, SDR 36, SCH 40 IPS GASKETED & SOLVENT WELD, N-12, HP STORM, C-900 OR DUCTILE IRON.

Final Backfill of Chambers – Fill Material



Install non-woven geotextile over stone. Geotextile must overlap 24" (600 mm) min. where edges meet. Compact each lift of backfill as specified in the site design engineer's drawings. Roller travel parallel with rows.

StormTech Isolator Row PLUS Detail

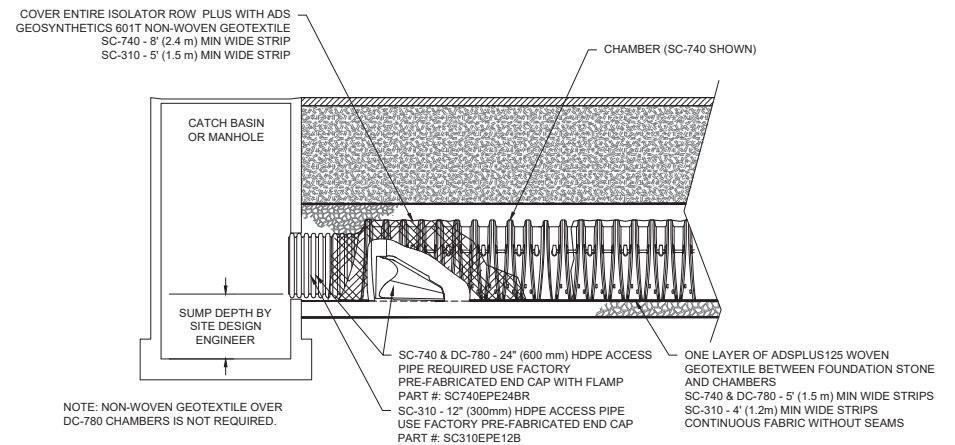

Table 1- Acceptable Fill Materials

Material Location	Description	AASHTO M43 Designation ¹	Compaction/Density Requirement
D Final Fill: Fill Material for layer 'D' starts from the top of the 'C' layer to the bottom of flexible pavement or unpaved finished grade above. Note that the pavement subbase may be part of the 'D' layer.	Any soil/rock materials, native soils or per engineer's plans. Check plans for pavement subgrade requirements.	N/A	Prepare per site design engineer's plans. Paved installations may have stringent material and preparation requirements.
C Initial Fill: Fill Material for layer 'C' starts from the top of the embedment stone ('B' layer) to 18" (450 mm) above the top of the chamber. Note that pavement subbase may be part of the 'C' layer.	Granular well-graded soil/ aggregate mixtures, <35% fines or processed aggregate. Most pavement subbase materials can be used in lieu of this layer.	AASHTO M45 A-1, A-2-4, A-3 or AASHTO M431 3, 357, 4, 467, 5, 56, 57, 6, 67, 68, 7, 78, 8, 89, 9, 10	Begin compaction after min. 12" (300 mm) of material over the chambers is reached. Compact additional layers in 6" (150 mm) max. lifts to a min. 95% Proctor density for well-graded material and 95% relative density for processed aggregate materials. Roller gross vehicle weight not to exceed 12,000 lbs (53 kN). Dynamic force not to exceed 20,000 lbs (89 kN)
B Embedment Stone: Embedment Stone surrounding chambers from the foundation stone to the 'C' layer above.	Clean, crushed, angular stone	AASHTO M43 ¹ 3, 357, 4, 467, 5, 56, 57	No compaction required.
A Foundation Stone: Foundation Stone below the chambers from the subgrade up to the foot (bottom) of the chamber.	Clean, crushed, angular stone,	AASHTO M43 ¹ 3, 357, 4, 467, 5, 56, 57	Place and compact in 6" (150 mm) lifts using two full coverages with a vibratory compactor. ^{2,3}

PLEASE NOTE:

- The listed AASHTO designations are for gradations only. The stone must also be clean, crushed, angular. For example, a specification for #4 stone would state: "clean, crushed, angular no. 4 (AASHTO M43) stone".*
- StormTech compaction requirements are met for 'A' location materials when placed and compacted in 6" (150 mm) (max) lifts using two full coverages with a vibratory compactor.*
- Where infiltration surfaces may be comprised by compaction, for standard installations and standard design load conditions, a flat surface may be achieved by raking or dragging without compaction equipment. For special load designs, contact StormTech for compaction requirements.*

Figure 1- Inspection Port Detail

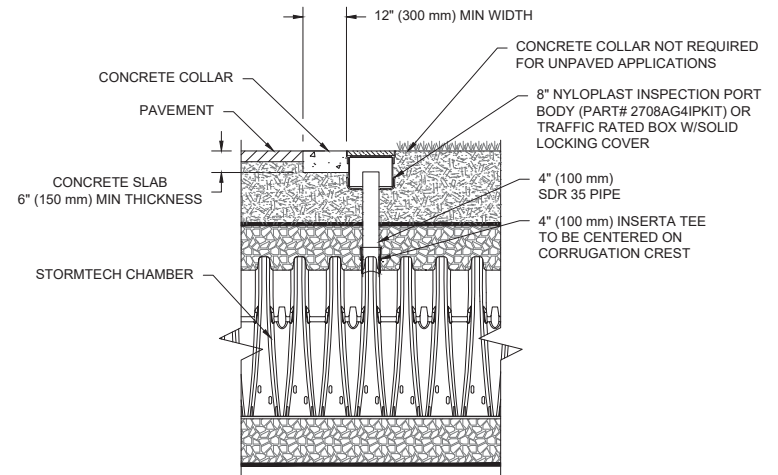

NOTE:
INSPECTION PORTS MAY BE CONNECTED THROUGH ANY CHAMBER CORRUGATION CREST.

Figure 2 - Fill Material Locations

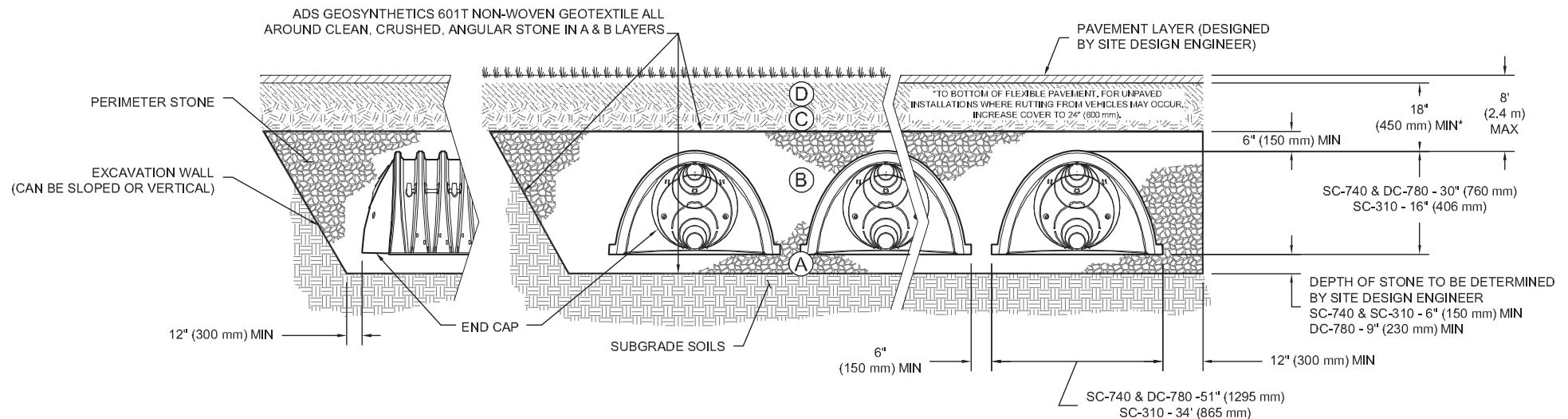

NOTES:

1. 36" (900 mm) of stabilized cover materials over the chambers is required for full dump truck travel and dumping.
2. During paving operations, dump truck axle loads on 18" (450 mm) of cover may be necessary. Precautions should be taken to avoid rutting of the road base layer, to ensure that compaction requirements have been met, and that a minimum of 18" (450 mm) of cover exists over the chambers. Contact StormTech for additional guidance on allowable axle loads during paving.
3. Ground pressure for track dozers is the vehicle operating weight divided by total ground contact area for both tracks. Excavators will exert higher ground pressures based on loaded bucket weight and boom extension.
4. Mini-excavators (< 8,000lbs/3,628 kg) can be used with at least 12" (300 mm) of stone over the chambers and are limited by the maximum ground pressures in Table 2 based on a full bucket at maximum boom extension.
5. Storage of materials such as construction materials, equipment, spoils, etc. should not be located over the StormTech system. The use of equipment over the StormTech system not covered in Table 2 (ex. soil mixing equipment, cranes, etc) is limited. Please contact StormTech for more information.
6. Allowable track loads based on vehicle travel only. Excavators shall not operate on chamber beds until the total backfill reaches 3 feet (900 mm) over the entire bed.

Table 2 - Maximum Allowable Construction Vehicle Loads⁵

Material Location	Fill Depth over Chambers in. [mm]	Maximum Allowable Wheel Loads		Maximum Allowable Track Loads ⁶		Maximum Allowable Roller Loads
		Max Axle Load for Trucks lbs [kN]	Max Wheel Load for Loaders lbs [kN]	Track Width in. [mm]	Max Ground Pressure psf [kPa]	Max Drum Weight or Dynamic Force lbs [kN]
D Final Fill Material	36" [900] Compacted	32,000 [142]	16,000 [71]	12" [305]	3420 [164]	38,000 [169]
				18" [457]	2350 [113]	
				24" [610]	1850 [89]	
				30" [762]	1510 [72]	
				36" [914]	1310 [63]	
C Initial Fill Material	24" [600] Compacted	32,000 [142]	16,000 [71]	12" [305]	2480 [119]	20,000 [89]
				18" [457]	1770 [85]	
				24" [610]	1430 [68]	
				30" [762]	1210 [58]	
				36" [914]	1070 [51]	
				24" [600] Loose/Dumped	32,000 [142]	
	18" [457]	16,000 [71]	18" [457]	1625 [78]		
	24" [610]	16,000 [71]	24" [610]	1325 [63]		
	30" [762]	16,000 [71]	30" [762]	1135 [54]		
	36" [914]	16,000 [71]	36" [914]	1010 [48]		
	18" [450]	32,000 [142]	16,000 [71]	12" [305]	2010 [96]	20,000 [89] Roller gross vehicle weight not to exceed 12,000 lbs. [53 kN]
	18" [457]	16,000 [71]	18" [457]	1480 [71]		
24" [610]	16,000 [71]	24" [610]	1220 [58]			
30" [762]	16,000 [71]	30" [762]	1060 [51]			
36" [914]	16,000 [71]	36" [914]	950 [45]			
B Embedment Stone	12" [300]	16,000 [71]	NOT ALLOWED	12" [305]	1540 [74]	
				18" [457]	1190 [57]	
				24" [610]	1010 [48]	
				30" [762]	910 [43]	
				36" [914]	840 [40]	
	6" [150]	8,000 [35]	NOT ALLOWED	12" [305]	1070 [51]	NOT ALLOWED
				18" [457]	900 [43]	
				24" [610]	800 [38]	
				30" [762]	760 [36]	
				36" [914]	720 [34]	

Table 3 - Placement Methods and Descriptions

Material Location	Placement Methods/ Restrictions	Wheel Load Restrictions	Track Load Restrictions	Roller Load Restrictions
		See Table 2 for Maximum Construction Loads		
D Final Fill Material	A variety of placement methods may be used. All construction loads must not exceed the maximum limits in Table 2.	36" (900 mm) minimum cover required for dump trucks to dump over chambers.	Dozers to push parallel to rows until 36" (900mm) compacted cover is reached. ⁴	Roller travel parallel to rows only until 36" (900 mm) compacted cover is reached.
C Initial Fill Material	Excavator positioned off bed recommended. Small excavator allowed over chambers. Small dozer allowed.	Asphalt can be dumped into paver when compacted pavement subbase reaches 18" (450 mm) above top of chambers.	Small LGP track dozers & skid loaders allowed to grade cover stone with at least 6" (150 mm) stone under tracks at all times. Equipment must push parallel to rows at all times.	Use dynamic force of roller only after compacted fill depth reaches 12" (300 mm) over chambers. Roller travel parallel to chamber rows only.
B Embedment Stone	No equipment allowed on bare chambers. Use excavator or stone conveyor positioned off bed or on foundation stone to evenly fill around all chambers to at least the top of chambers.	No wheel loads allowed. Material must be placed outside the limits of the chamber bed.	No tracked equipment is allowed on chambers until a min. 6" (150 mm) cover stone is in place.	No rollers allowed.
A Foundation Stone	No StormTech restrictions. Contractor responsible for any conditions or requirements by others relative to subgrade bearing capacity, dewatering or protection of subgrade.			

ADS "Terms and Conditions of Sale" are available on the ADS website, www.ads-pipe.com. Advanced Drainage Systems, the ADS logo, and the green stripe are registered trademarks of Advanced Drainage Systems, Inc. StormTech® and the Isolator® Row PLUS are registered trademarks of Storm-Tech, Inc
#11010 09/20 CS

©2020 Advanced Drainage Systems, Inc.

17.0 Standard Limited Warranty



STANDARD LIMITED WARRANTY OF STORMTECH LLC ("STORMTECH"): PRODUCTS

- (A) This Limited Warranty applies solely to the StormTech chambers and end plates manufactured by StormTech and sold to the original purchaser (the "Purchaser"). The chambers and end plates are collectively referred to as the "Products."
- (B) The structural integrity of the Products, when installed strictly in accordance with StormTech's written installation instructions at the time of installation, are warranted to the Purchaser against defective materials and workmanship for one (1) year from the date of purchase. Should a defect appear in the Limited Warranty period, the Purchaser shall provide StormTech with written notice of the alleged defect at StormTech's corporate headquarters within ten (10) days of the discovery of the defect. The notice shall describe the alleged defect in reasonable detail. StormTech agrees to supply replacements for those Products determined by StormTech to be defective and covered by this Limited Warranty. The supply of replacement products is the sole remedy of the Purchaser for breaches of this Limited Warranty. StormTech's liability specifically excludes the cost of removal and/or installation of the Products.
- (C) **THIS LIMITED WARRANTY IS EXCLUSIVE. THERE ARE NO OTHER WARRANTIES WITH RESPECT TO THE PRODUCTS, INCLUDING NO IMPLIED WARRANTIES OF MERCHANTABILITY OR OF FITNESS FOR A PARTICULAR PURPOSE.**
- (D) This Limited Warranty only applies to the Products when the Products are installed in a single layer. **UNDER NO CIRCUMSTANCES, SHALL THE PRODUCTS BE INSTALLED IN A MULTI-LAYER CONFIGURATION.**
- (E) No representative of StormTech has the authority to change this Limited Warranty in any manner or to extend this Limited Warranty. This Limited Warranty does not apply to any person other than to the Purchaser.
- (F) Under no circumstances shall StormTech be liable to the Purchaser or to any third party for product liability claims; claims arising from the design, shipment, or installation of the Products, or the cost of other goods or services related to the purchase and installation of the Products. For this Limited Warranty to apply, the Products must be installed in accordance with all site conditions required by state and local codes; all other applicable laws; and StormTech's written installation instructions.
- (G) **THE LIMITED WARRANTY DOES NOT EXTEND TO INCIDENTAL, CONSEQUENTIAL, SPECIAL OR INDIRECT DAMAGES. STORMTECH SHALL NOT BE LIABLE FOR PENALTIES OR LIQUIDATED DAMAGES, INCLUDING LOSS OF PRODUCTION AND PROFITS; LABOR AND MATERIALS; OVERHEAD COSTS; OR OTHER LOSS OR EXPENSE INCURRED BY THE PURCHASER OR ANY THIRD PARTY. SPECIFICALLY EXCLUDED FROM LIMITED WARRANTY COVERAGE ARE DAMAGE TO THE PRODUCTS ARISING FROM ORDINARY WEAR AND TEAR; ALTERATION, ACCIDENT, MISUSE, ABUSE OR NEGLIGENCE; THE PRODUCTS BEING SUBJECTED TO VEHICLE TRAFFIC OR OTHER CONDITIONS WHICH ARE NOT PERMITTED BY STORMTECH'S WRITTEN SPECIFICATIONS OR INSTALLATION INSTRUCTIONS; FAILURE TO MAINTAIN THE MINIMUM GROUND COVERS SET FORTH IN THE INSTALLATION INSTRUCTIONS; THE PLACEMENT OF IMPROPER MATERIALS INTO THE PRODUCTS; FAILURE OF THE PRODUCTS DUE TO IMPROPER SITING OR IMPROPER SIZING; OR ANY OTHER EVENT NOT CAUSED BY STORMTECH. A PRODUCT ALSO IS EXCLUDED FROM LIMITED WARRANTY COVERAGE IF SUCH PRODUCT IS USED IN A PROJECT OR SYSTEM IN WHICH ANY GEOTEXTILE PRODUCTS OTHER THAN THOSE PROVIDED BY ADVANCED DRAINAGE SYSTEMS ARE USED. THIS LIMITED WARRANTY REPRESENTS STORMTECH'S SOLE LIABILITY TO THE PURCHASER FOR CLAIMS RELATED TO THE PRODUCTS, WHETHER THE CLAIM IS BASED UPON CONTRACT, TORT, OR OTHER LEGAL THEORY.**



An  company

20 Beaver Road, Suite 104 | Wethersfield | Connecticut | 06109
888.892.2694 fax 866.328.8401

www.stormtech.com



ADS GEOSYNTHETICS 0601T NONWOVEN GEOTEXTILE

Scope

This specification describes ADS Geosynthetics 6.0 oz (0601T) nonwoven geotextile.

Filter Fabric Requirements

ADS Geosynthetics 6.0 oz (0601T) is a needle-punched nonwoven geotextile made of 100% polypropylene staple fibers, which are formed into a random network for dimensional stability. ADS Geosynthetics 6.0 oz (0601T) resists ultraviolet deterioration, rotting, biological degradation, naturally encountered basics and acids. Polypropylene is stable within a pH range of 2 to 13. ADS Geosynthetics 6.0 oz (0601T) conforms to the physical property values listed below:

Filter Fabric Properties

PROPERTY	TEST METHOD	UNIT	M.A.R.V. (Minimum Average Roll Value)
Weight (Typical)	ASTM D 5261	oz/yd ² (g/m ²)	6.0 (203)
Grab Tensile	ASTM D 4632	lbs (kN)	160 (0.711)
Grab Elongation	ASTM D 4632	%	50
Trapezoid Tear Strength	ASTM D 4533	lbs (kN)	60 (0.267)
CBR Puncture Resistance	ASTM D 6241	lbs (kN)	410 (1.82)
Permittivity*	ASTM D 4491	sec ⁻¹	1.5
Water Flow*	ASTM D 4491	gpm/ft ² (l/min/m ²)	110 (4480)
AOS*	ASTM D 4751	US Sieve (mm)	70 (0.212)
UV Resistance	ASTM D 4355	%/hrs	70/500

PACKAGING	
Roll Dimensions (W x L) – ft	12.5 x 360 / 15 x 300
Square Yards Per Roll	500
Estimated Roll Weight – lbs	195

* At the time of manufacturing. Handling may change these properties.



ADS GEOSYNTHETICS 315W WOVEN GEOTEXTILE

Scope

This specification describes ADS Geosynthetics 315W woven geotextile.

Filter Fabric Requirements

ADS Geosynthetics 315W is manufactured using high tenacity polypropylene yarns that are woven to form a dimensionally stable network, which allows the yarns to maintain their relative position. ADS Geosynthetics 315W resists ultraviolet deterioration, rotting and biological degradation and is inert to commonly encountered soil chemicals. ADS Geosynthetics 315W conforms to the physical property values listed below:

Filter Fabric Properties

PROPERTY	TEST METHOD	ENGLISH M.A.R.V. (Minimum Average Roll Value)	METRIC M.A.R.V. (Minimum Average Roll Value)
Tensile Strength (Grab)	ASTM D-4632	315 lbs	1400 N
Elongation	ASTM D-4632	15%	15%
CBR Puncture	ASTM D-6241	900 lbs	4005 N
Puncture	ASTM D-4833	150 lbs	667 N
Mullen Burst	ASTM D-3786	600 psi	4134 kPa
Trapezoidal Tear	ASTM D-4533	120 lbs	533 N
UV Resistance (at 500 hrs)	ASTM D-4355	70%	70%
Apparent Opening Size (AOS)*	ASTM D-4751	40 US Std. Sieve	0.425 mm
Permittivity	ASTM D-4491	.05 sec ⁻¹	.05 sec ⁻¹
Water Flow Rate	ASTM D-4491	4 gpm/ft ²	163 l/min/m ²
Roll Sizes		12.5' x 360' 15.0' x 300' 17.5' x 258'	3.81 m x 109.8 m 4.57 m x 91.5 m 5.33 m x 78.6 m

*Maximum average roll value.



APPENDIX I

TAGGART CONSTRUCTION LTD. PRE-CONSTRUCTION CCTV INSPECTION REPORT



PEARSON ENGINEERING

July 31, 2023

File: 22030

Attention: Mohammed Fawzi

City of Ottawa
110 Laurier Avenue West
Ottawa, ON
K1P 1J1

Email only: mohammed.fawzi@ottawa.ca

Re: 29 Russell Ave - CCTV Footage Certification

Dear Mohammed,

In regard to the reuse of the sanitary service, our office has reviewed the CCTV Inspection Report and footage provided by Taggart Construction Ltd and we confirm that the existing sanitary service is adequate for reuse as it is free of obstructions and deficiencies. Please see attached the CCTV Inspection Report and footage provided by Taggart Construction Ltd. in support of the reuse of the sanitary service.

If you have any questions regarding the enclosed or require any further information, please feel free to call me at 705-719-4785, ext. 224.

Regards,

PEARSON ENGINEERING LTD.

Mike Dejean, P.Eng.
Partner, Manager of Engineering Services



cc. Corey Kou, Smart Living Properties Ltd.

Barrie
705-719-4785
pearsoneng.com

GTA
905-597-5572

Ottawa
613-416-1232

Owen Sound
226-256-7957



PRE-CONSTRUCTION CCTV INSPECTION REPORT

Report ID:

PC-5226 29 RUSSELL AVENUE

Sewer Type:

Sanitary

Completion Date:

July 18th, 2022

Total Distance:

124.10 M

99.3 m

Integrity. Quality. Community. Since 1948

☎ 613-521-3000 📄 613-526-5909 🌐 taggartconstruction.com

🏠 3187 Albion Road South, Ottawa, Ontario, Canada, K1V 8Y3

Table of contents



	Page
1. Index of Pipes (Custom)	2
2. Structural rating	3
3. O&M rating	4
4. Pipe summary and condition details	5
5. Vision Report© Legend	9

1. Index of Pipes (Custom)



2 items

Start/End	Direction	Road	Inspection Date	Inspected Length	Total Length
MHSA 38938 --> MHSA 38937	D - Downstream	RUSSELL AVENUE	18/07/2022 8:06 AM	99.3	99.3
BUILDING --> MAIN	D - Downstream	RUSSELL AVENUE	05/07/2023 3:27 PM	24.8	24.8
				Total: 124.1	Total: 124.1

2. Structural rating

Structural rating of the pipes

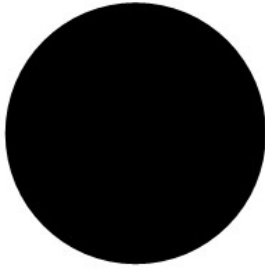

0 - No Defects

Most important structural observations (Grades 3, 4 and 5)

2 items

0 - No Defects (2 of 2 items)

Score	Quick	Index	Pipe	Start/End	Direction	Road	Page
0	0000	0	BUILDING MAIN	BUILDING --> MAIN	Direction of flow	RUSSELL AVENUE	5
0	0000	0	MHSA 38938 MHSA 38937	MHSA 38938 --> MHSA 38937	Direction of flow	RUSSELL AVENUE	7

3. O&M rating

Operation and maintenance rating of the pipes

Most important operation & maintenance observations (Grades 3, 4 and 5)

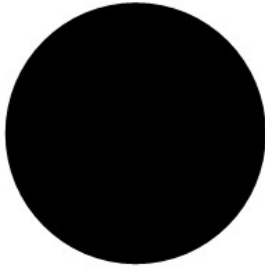

0 - No Defects

2 items

0 - No Defects (2 of 2 items)

Score	Quick	Index	Structural	Pipe	Start/End	Direction	Road	Page
0	0000	0	0	BUILDING MAIN	BUILDING --> MAIN	Direction of flow	RUSSELL AVENUE	5
0	0000	0	0	MHSA 38938 MHSA 38937	MHSA 38938 --> MHSA 38937	Direction of flow	RUSSELL AVENUE	7

4. Pipe summary and condition details

Pipe identification

Pipe: BUILDING MAIN
 Direction of flow: BUILDING --> MAIN

Pipe location

Road:	RUSSELL AVENUE	<u>UPSTREAM</u>	<u>DOWNSTREAM</u>
Crossroad:		Easting (X):	Easting (X):
Drainage Area:		Northing (Y):	Northing (Y):
City:	OTTAWA ON	Elevation (Z):	Elevation (Z):
Location:		GPS Accuracy:	
Owner:	CITY OF OTTAWA	Coordinate System:	
Road segment:		Vertical Datum:	

Pipe characteristics

Sewer Use:	Sanitary	Inspected length:	24.8
Height:	150	Total length:	24.8
Width:		Rim/Inv.:	
Shape:	Circular	Grade/Inv.:	
Material:	Reinforced Concrete Pipe	Rim/Grade:	
Lining:		Rim/Inv.:	
Joint length:		Grade/Inv.:	
Year laid:		Rim/Grade:	
Year renewed:		Sewer category:	

Additional details

Date:	05/07/2023 3:27 PM	Location details:	
Project Number:		Surveyed by:	RYAN LANCE
Customer:	PC-5226-PEARSON ENGINEERING	Certificate #:	P0035571-012022
PO number:		Pre-Cleaning:	Jetting
Work order:		Date cleaned:	
Purpose:		Unit of measurement:	Metric
Weather:	Dry	Media label:	
Flow control:	Lift Station	Sheet #:	

Structural rating

Peak: 0
 Quick rating: 0000
 Score: 0
 Index: 0

O&M rating

Peak: 0
 Quick rating: 0000
 Score: 0
 Index: 0

Overall rating

Peak: 0
 Quick rating: 0000
 Score: 0
 Index: 0

Additional information

Other information

Information 1:	Information 6:
Information 2:	Information 7:
Information 3:	Information 8:
Information 4:	Information 9:
Information 5:	Information 10:

4. Pipe summary and condition details

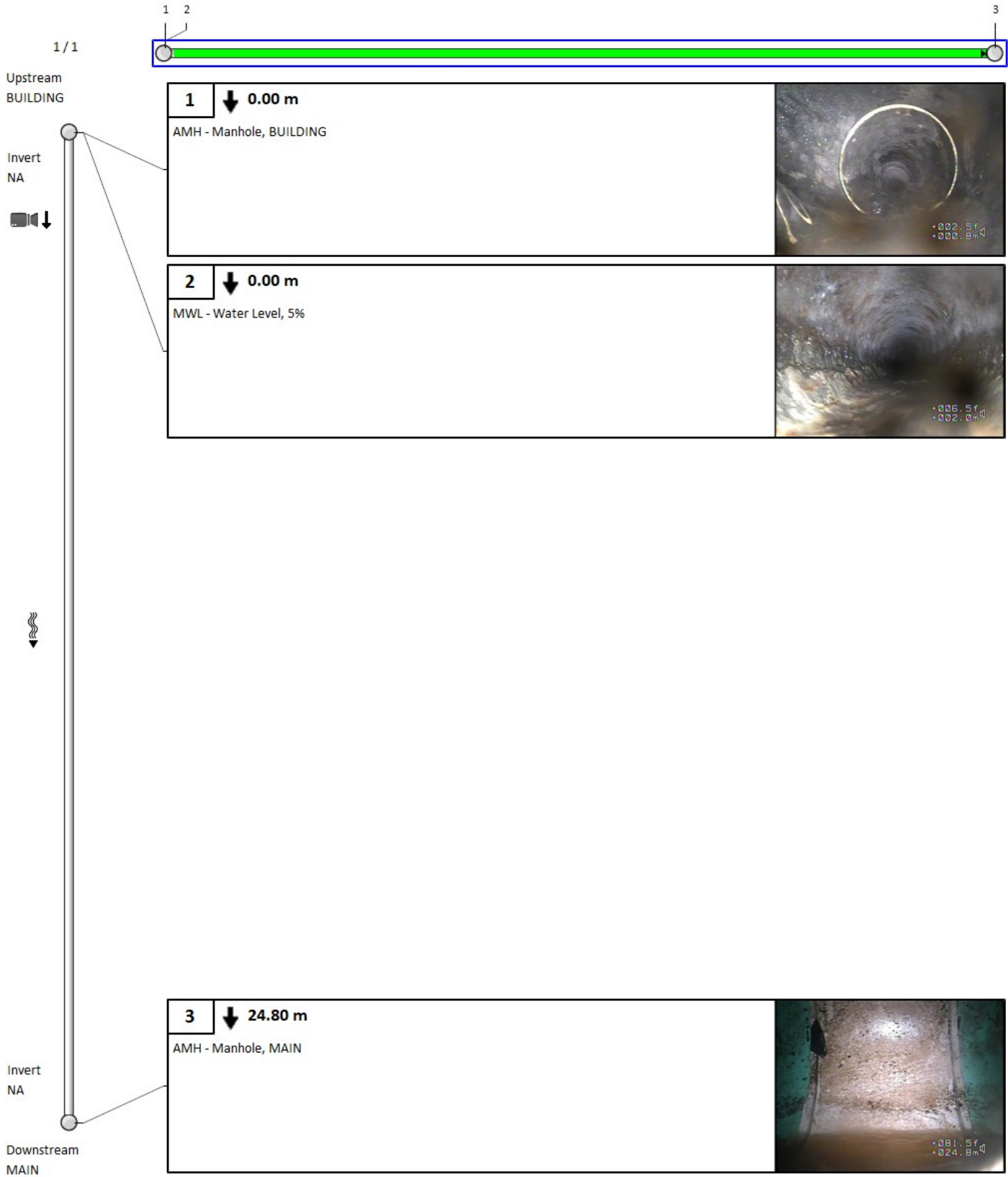

4. Pipe summary and condition details

Pipe identification

Pipe: MHTA 38938 MHTA 38937
 Direction of flow: MHTA 38938 --> MHTA 38937

Pipe location

Road:	RUSSELL AVENUE	<u>UPSTREAM</u>	<u>DOWNSTREAM</u>
Crossroad:		Easting (X):	Easting (X):
Drainage Area:		Northing (Y):	Northing (Y):
City:	OTTAWA ON	Elevation (Z):	Elevation (Z):
Location:		GPS Accuracy:	
Owner:	CITY OF OTTAWA	Coordinate System:	
Road segment:		Vertical Datum:	

Pipe characteristics

Sewer Use:	Sanitary	Inspected length:	99.3
Height:	200	Total length:	99.3
Width:		Rim/Inv.:	
Shape:	Circular	Grade/Inv.:	
Material:	Polyvinyl Chloride	Rim/Grade:	
Lining:		Rim/Inv.:	
Joint length:		Grade/Inv.:	
Year laid:		Rim/Grade:	
Year renewed:		Sewer category:	

Additional details

Date:	18/07/2022 8:06 AM	Location details:	
Project Number:		Surveyed by:	RYAN LANCE
Customer:	PC-5226-PEARSON ENGINEERING	Certificate #:	P0035571-012022
PO number:		Pre-Cleaning:	Jetting
Work order:		Date cleaned:	
Purpose:		Unit of measurement:	Metric
Weather:	Dry	Media label:	
Flow control:	Lift Station	Sheet #:	

Structural rating

Peak: 0
 Quick rating: 0000
 Score: 0
 Index: 0

O&M rating

Peak: 0
 Quick rating: 0000
 Score: 0
 Index: 0

Overall rating

Peak: 0
 Quick rating: 0000
 Score: 0
 Index: 0

Additional information







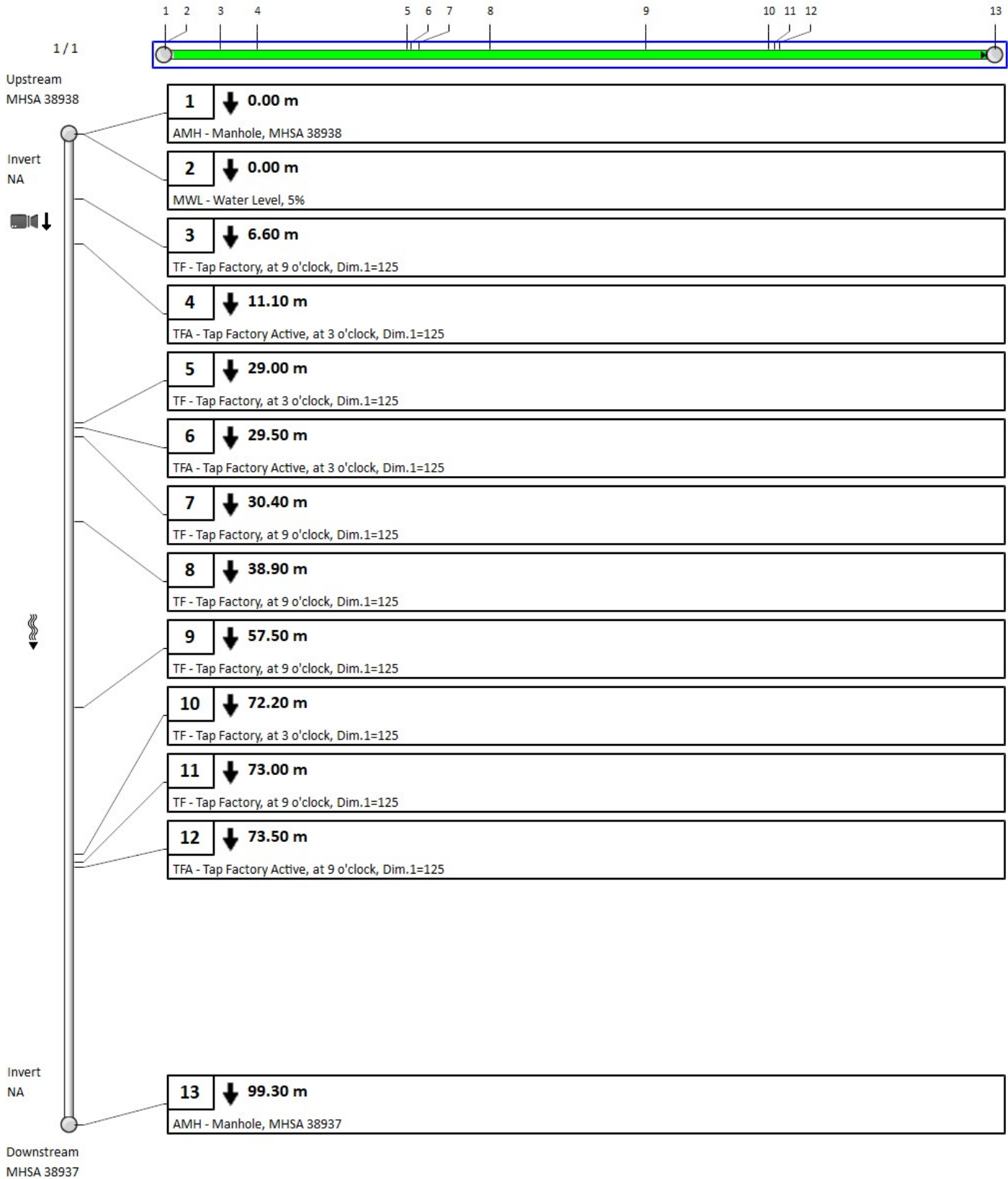







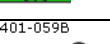

Other information

Information 1:	Information 6:
Information 2:	Information 7:
Information 3:	Information 8:
Information 4:	Information 9:
Information 5:	Information 10:

4. Pipe summary and condition details



Vision Report © Legend

	The numbers sequentially identify each observation. They allow you to find complete descriptions and related photos throughout the pages. Note that when the pipe contains too many observations, the Vision© report hides the least important observations to optimize the display*.
60	A number with neither a square nor circle indicates a general observation.
	A circled number indicates a structural anomaly. The color of the circle indicates the severity of the anomaly on a scale of 1 to 5, 5 being the most severe: green=1, blue=2, magenta=3, orange=4 and red=5.
	A number in a square indicates an operation and maintenance anomaly. The color of the square indicates the severity of the anomaly on a scale of 1 to 5, 5 being the most severe: green=1, blue=2, magenta=3, orange=4 and red=5.
◀ 3 / 31 ▶	Indicates the current page number of the inspection report.
	The blue square indicates a section of the pipe; this section is covered in detail on the current page of the report.
	The green line indicates the inspected part of the pipe. The remaining white line indicates the uninspected part of the pipe.
	Indicates the hold points on the camera during an inspection.
	Indicates the hold points on the camera during the reverse inspection.
	Indicates that a reverse inspection was carried out, however the camera did not reach the initial inspection hold point. (the hold point of the initial inspection)
	Indicates that a reverse inspection was carried out and that it has joined (has arrived at) the initial inspection hold point.
401-059B 	Identifies the start manhole number. Note that this manhole is not necessarily the upstream manhole of the pipe.
401-631 	Identifies the end manhole number. Note that this manhole is not necessarily the downstream manhole of the pipe.
	A downward arrow indicates that the inspection was carried out in the direction of the current, whereas an upward arrow indicates an inspection against the current. Note that the manhole located on the upper left of the page is always the start manhole, but not necessarily the upstream manhole of the pipe.
	This camera followed by a downward arrow is located on the upper left of the vertical pipe; it indicates that an inspection was done from this manhole.
	When the second camera appears on the bottom left page it means that a reverse inspection was carried out. Information about the reverse inspection is included in the report, thereby combining both inspections.
Invert 3.40	The measurement shown under the word <Invert> indicates the measurements between the frame and the pipe captured during the inspection. This measurement is available at the top left for the start manhole and the bottom left for the end manhole. If the invert was not measured during the inspection, an <NA> mark will be displayed.
	The downward bold arrow to the right of the observation number indicates that this observation was captured during the initial inspection.
	The blank arrow pointing upwards and located to the right of the observation number indicates that this observation was taken during the reverse inspection period, thereby confirming that this report combined both inspections.
18.40 m	Located to the right of the observation number is a number identifying the observation distance in relation to the start of the pipe.
SRV - Armature visible	A full description of the observation code according to the protocol used.

*Any hidden observations are readily accessible from the database as well as in other CTSpec report templates.

** CTSpec inc. reserves the right to modify, eliminate or add to the product features described in this pamphlet without notice.

© 2012 CTSpec inc. All rights reserved.



PRE-CONSTRUCTION CCTV INSPECTION REPORT

Report ID:

PC-5226 29 RUSSELL AVENUE

Completion Date:

July 18th, 2022



Sewer Type:

Storm

Total Distance:

91.9 m

Integrity. Quality. Community. Since 1948

 613-521-3000  613-526-5909  taggartconstruction.com

 3187 Albion Road South, Ottawa, Ontario, Canada, K1V 8Y3

Table of contents



	Page
1. Index of Pipes (Custom)	2
2. Structural rating	3
3. O&M rating	4
4. Pipe summary and condition details	5
5. Vision Report© Legend	7

1. Index of Pipes (Custom)



1 item

Start/End	Direction	Road	Inspection Date	Inspected Length	Total Length
MHST 38975 --> MHST 38976	D - Downstream	RUSSELL AVENUE	18/07/2022 8:31 AM	91.9	91.9
				Total: 91.9	Total: 91.9

2. Structural rating

Structural rating of the pipes

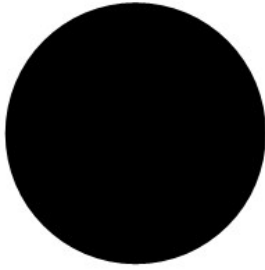

0 - No Defects

Most important structural observations (Grades 3, 4 and 5)

1 item

0 - No Defects (1 of 1 items)

Score	Quick	Index	Pipe	Start/End	Direction	Road	Page
0	0000	0	MHST 38975 MHST 38976	MHST 38975 --> MHST 38976	Direction of flow	RUSSELL AVENUE	5

3. O&M rating

Operation and maintenance rating of the pipes

Most important operation & maintenance observations (Grades 3, 4 and 5)

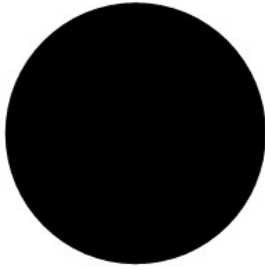

0 - No Defects

1 item

0 - No Defects (1 of 1 items)

Score	Quick	Index	Structural	Pipe	Start/End	Direction	Road	Page
0	0000	0	0	MHST 38975 MHST 38976	MHST 38975 --> MHST 38976	Direction of flow	RUSSELL AVENUE	5

4. Pipe summary and condition details

Pipe identification

Pipe: MHST 38975 MHST 38976
 Direction of flow: MHST 38975 --> MHST 38976

Pipe location

Road:	RUSSELL AVENUE	<u>UPSTREAM</u>	<u>DOWNSTREAM</u>
Crossroad:		Easting (X):	Easting (X):
Drainage Area:		Northing (Y):	Northing (Y):
City:	OTTAWA ON	Elevation (Z):	Elevation (Z):
Location:		GPS Accuracy:	
Owner:	CITY OF OTTAWA	Corrdinate System:	
Road segment:		Vertical Datum:	

Pipe characteristics

Sewer Use:	Stormwater	Inspected length:	91.9
Height:	375	Total length:	91.9
Width:		Rim/Inv.:	
Shape:	Circular	Grade/Inv.:	
Material:	Concrete Pipe (non-reinforced)	Rim/Grade:	
Lining:		Rim/Inv.:	
Joint length:		Grade/Inv.:	
Year laid:		Rim/Grade:	
Year renewed:		Sewer category:	

Additional details

Date:	18/07/2022 8:31 AM	Location details:	
Project Number:		Surveyed by:	RYAN LANCE
Customer:	PC-5226-PEARSON ENGINEERING	Certificate #:	P0035571-012022
PO number:		Pre-Cleaning:	Jetting
Work order:		Date cleaned:	
Purpose:		Unit of measurement:	Metric
Weather:	Dry	Media label:	
Flow control:	Not Controlled	Sheet #:	

Structural rating

O&M rating

Overall rating

Peak:	0	Peak:	0	Peak:	0
Quick rating:	0000	Quick rating:	0000	Quick rating:	0000
Score:	0	Score:	0	Score:	0
Index:	0	Index:	0	Index:	0

Additional information

Other information

Information 1:	Information 6:
Information 2:	Information 7:
Information 3:	Information 8:
Information 4:	Information 9:
Information 5:	Information 10:

4. Pipe summary and condition details

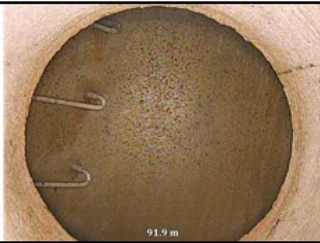
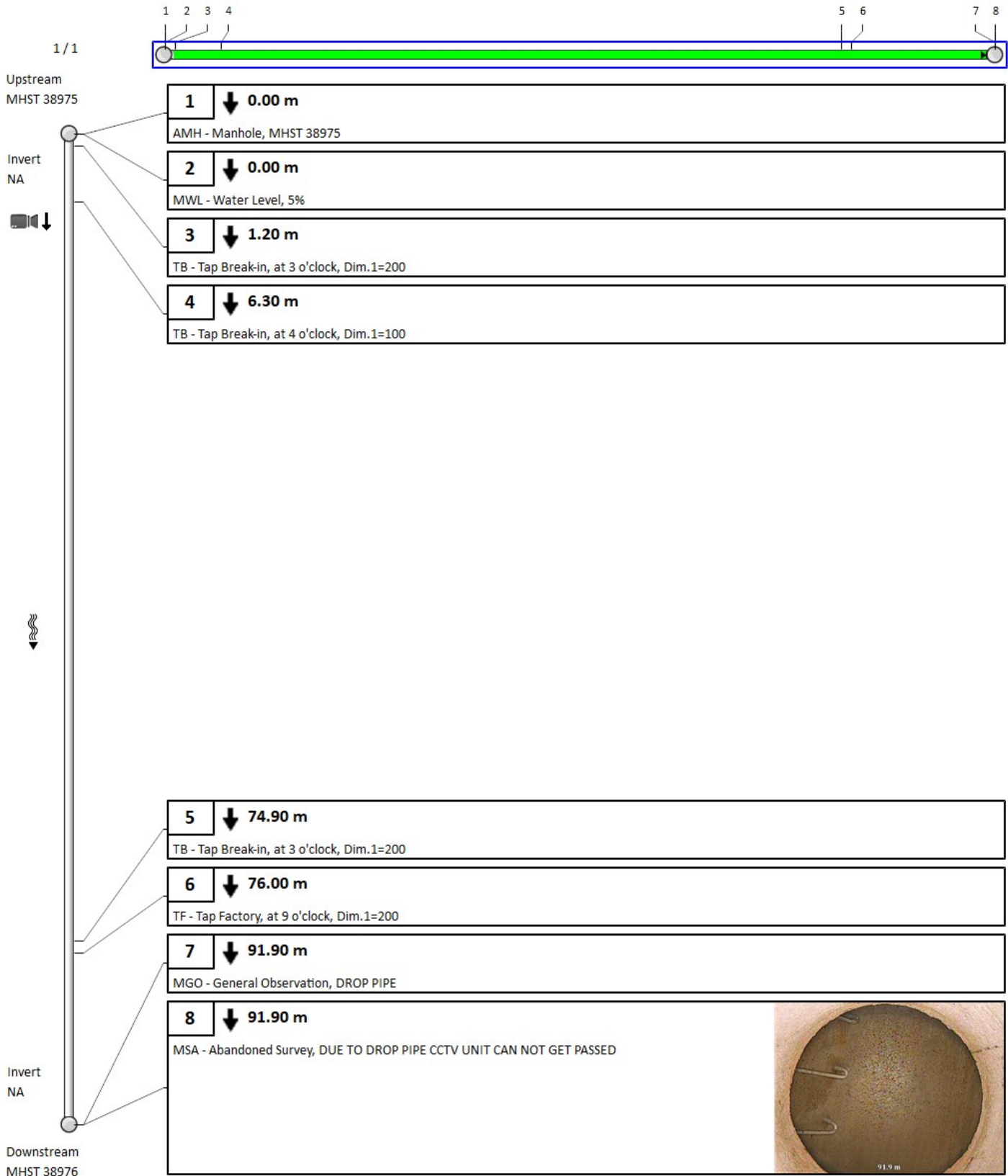

Vision Report © Legend

	The numbers sequentially indicate each observation that was picked up throughout the inspection period. This will allow you to sift through the pages and view the accompanying description and photos in each section. Note that when a pipe section contains too many observations, Vision© Report must hide secondary observations in order to optimize the display.*
60	A number with neither a square nor circle indicates a general observation.
	A circled number indicates a structural anomaly. The color of the circle indicates the severity of the anomaly on a scale of 1 to 5, 5 being the most severe: green=1, blue=2, magenta=3, orange=4 and red=5.
	A number in a square indicates an operation and maintenance anomaly. The color of the square indicates the severity of the anomaly on a scale of 1 to 5, 5 being the most severe: green=1, blue=2, magenta=3, orange=4 and red=5.
◀ 3 / 31 ▶	Indicates the current page number of the inspection report.
	The blue square indicates a section of the pipe; this section is covered in detail on the current page of the report.
	The green line indicates the inspected part of the pipe. The remaining white line indicates the uninspected part of the pipe.
	Indicates the hold points on the camera during an inspection.
	Indicates the hold points on the camera during the reverse inspection.
	Indicates that a reverse inspection was carried out, however the camera did not reach the initial inspection hold point. (the hold point of the initial inspection)
	Indicates that a reverse inspection was carried out and that it has joined (has arrived at) the initial inspection hold point.
401-059B 	Identifies the start manhole number. Note that this manhole is not necessarily the upstream manhole of the pipe.
401-631 	Identifies the end manhole number. Note that this manhole is not necessarily the downstream manhole of the pipe.
	A downward arrow indicates that the inspection was carried out in the direction of the current, whereas an upward arrow indicates an inspection against the current. Note that the manhole located on the upper left of the page is always the start manhole, but not necessarily the upstream manhole of the pipe.
	This camera followed by a downward arrow is located on the upper left of the vertical pipe; it indicates that an inspection was done from this manhole.
	When the second camera appears on the bottom left page it means that a reverse inspection was carried out. Information about the reverse inspection is included in the report, thereby combining both inspections.
Invert 3.40	The measurement shown under the word <Invert> indicates the measurements between the frame and the pipe captured during the inspection. This measurement is available at the top left for the start manhole and the bottom left for the end manhole. If the invert was not measured during the inspection, an <NA> mark will be displayed.
	The downward bold arrow to the right of the observation number indicates that this observation was captured during the initial inspection.
	The blank arrow pointing upwards and located to the right of the observation number indicates that this observation was taken during the reverse inspection period, thereby confirming that this report combined both inspections.
18.40 m	Located to the right of the observation number is a number identifying the observation distance in relation to the start of the pipe.
SRV - Armature visib	A full description of the observation code according to the protocol used.

*Any hidden observations are readily accessible from the database as well as in other CTSpec report templates.

** CTSpec inc. reserves the right to modify, eliminate or add to the product features described in this pamphlet without notice.

© 2012 CTSpec inc. All rights reserved.



APPENDIX J

PEARSON ENGINEERING DRAWINGS

C:\Users\ppearson\AppData\Local\Temp\Temp\Layout\SGS-1 - Base.dwg Layout\SGS-1 Plotted Aug. 02, 2023 @ 5:00pm by ppearson © PEARSON ENGINEERING LTD.

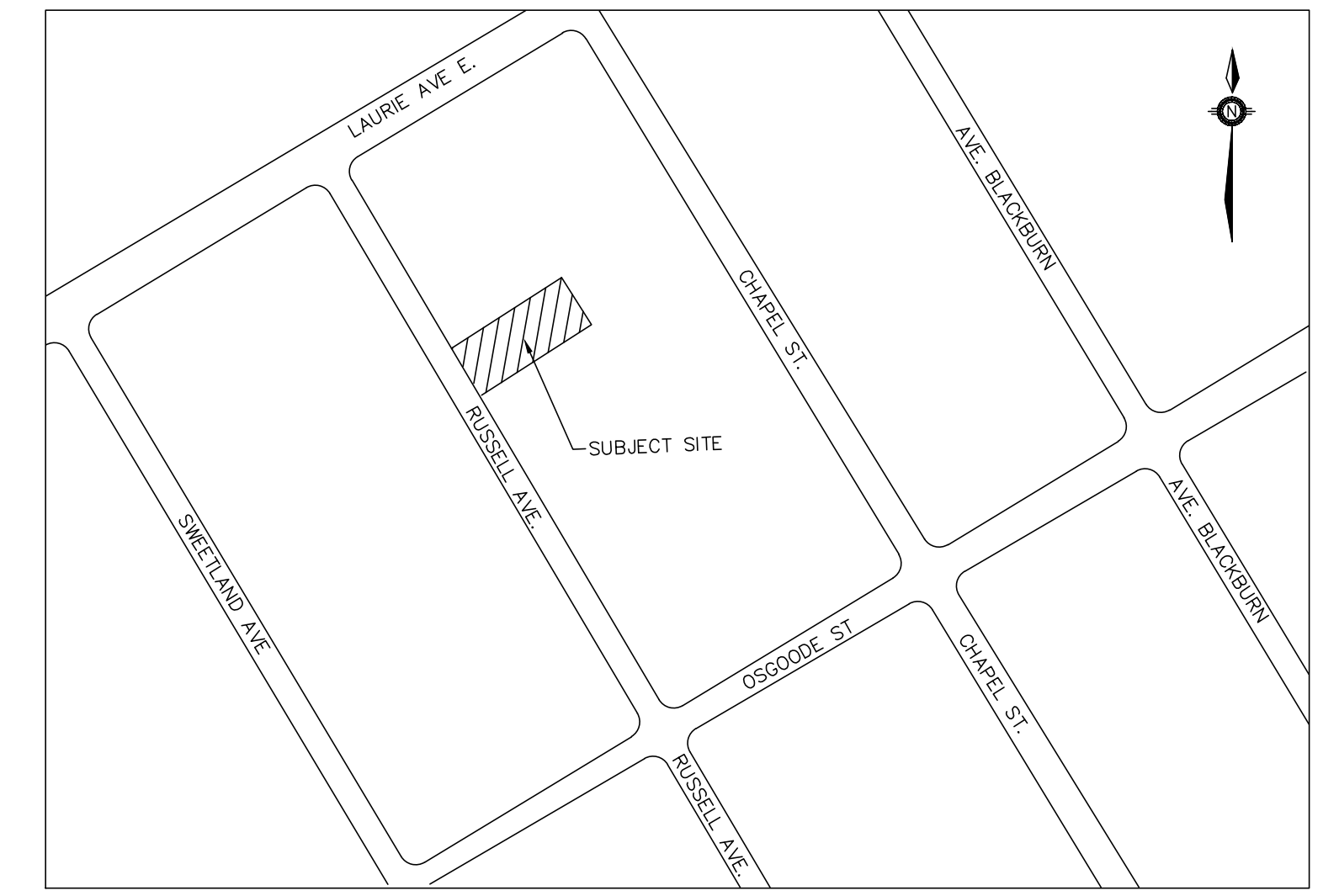
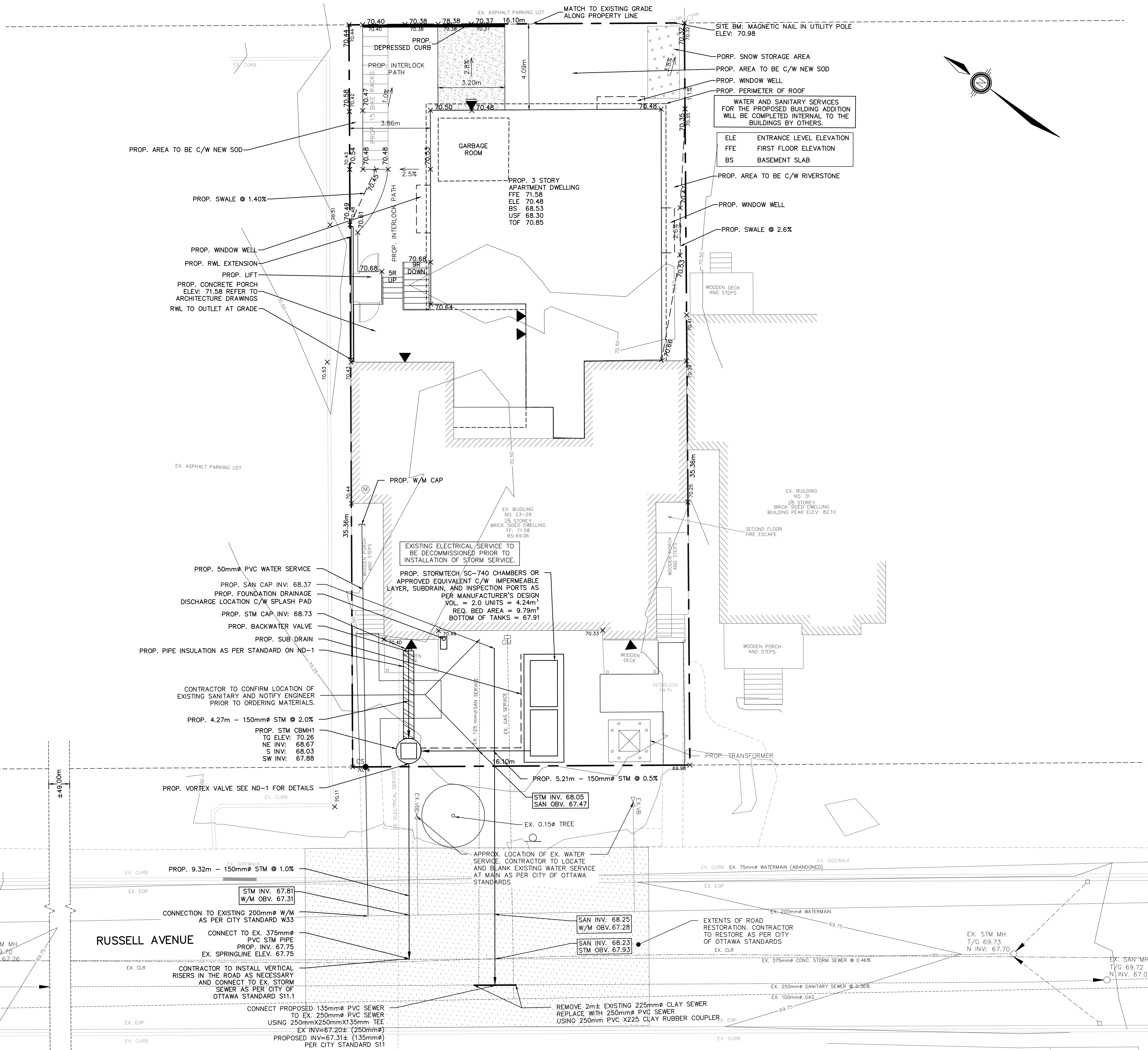

KEY MAP
N.T.S.

LEGEND

- CB CATCH BASIN
- DCB DOUBLE CATCH BASIN
- CBMH CATCH BASIN
- MH STORM MANHOLE
- MH SANITARY MANHOLE
- SERVICE CAP
- HYD. FIRE HYDRANT
- VB WATER VALVE
- CS CURB STOP W/ SERVICE
- 254.63 PROPOSED ELEVATION
- 254.09 EXISTING ELEVATION
- 1.5% PROPOSED DIRECTION AND GRADE
- BACK OF CURB
- EDGE OF PAVEMENT
- CURB CUT LOCATION
-) (HIGH POINT
- PROP. ROOF LEADER
- ▼ PEDESTRIAN DOOR
- ▼ OVERHEAD DOOR

SITE GRADING NOTES:

1. NO EXCESS DRAINAGE, DURING OR AFTER CONSTRUCTION TO BE DIRECTED TOWARDS NEIGHBORING PROPERTIES.
2. EXISTING DRAINAGE PATTERNS TO BE MAINTAINED.
3. ENSURE POSITIVE DRAINAGE AWAY FROM FOUNDATION
4. LANDSCAPE AREAS TO HAVE MINIMUM 2% MAXIMUM 7% SLOPE UNLESS TERRACED AT 3:1 MAXIMUM.
5. NO ALTERATION TO EXISTING GRADES ON PROPERTY LINES.
6. USF TO BE MINIMUM 1.5m BELOW FINISHED GRADE OR INSULATION IS REQUIRED.
7. TOP TO BE MINIMUM 0.15m ABOVE FINISHED GRADE.
8. SUNKEN ENTRANCE DRAIN ANNOT CONNECT DIRECTLY TO WEeping TILE. ANY WATER IN SUNKEN ENTRANCE TO DRAIN DOWN INTO PERMEABLE FILL WHERE IT WILL BE PICKED UP BY WEeping TILE SYSTEM.

SITE SERVICING NOTES:

1. OBTAIN ALL NECESSARY PERMITS AND APPROVALS FROM CITY OF OTTAWA BEFORE COMMENCING WORK.
2. REFER TO CITY OF OTTAWA STANDARD R10 FOR ASPHALT THE INS.
3. BACKWATER VALVES TO BE INSTALLED AS PER CITY OF OTTAWA STANDARD S14, AND S14.1 OR S14.2
4. EXISTING SERVICES TO BE BLANKED AT MAIN.
5. THERMAL INSULATION TO BE PROVIDED FOR WATER SERVICES LESS THAN 2.4m FROM OPEN STRUCTURES AS PER CITY OF OTTAWA STANDARD W23.
6. WATER SERVICE TO HAVE MORE THAN 2.4m OF COVER OR BE INSULATED AS PER CITY OF OTTAWA STANDARD DRAWING W22.
7. SUNKEN ENTRANCE DRAIN CANNOT CONNECT DIRECTLY TO WEeping TILE. ANY WATER IN SUNKEN ENTRANCE TO DRAIN DOWN INTO PERMEABLE FILL WHERE IT WILL BE PICKED UP BY WEeping TILE SYSTEM.

NO.	REVISION NOTE	DATE	BY
04.	AS PER UPDATED SITE PLAN	07/31/23	NP
03.	AS PER MECHANICAL COORDINATION	05/30/23	NW
02.	AS PER 2ND SUBMISSION COMMENTS	04/12/23	NW
01.	AS PER CITY COMMENTS	01/11/23	JM

BENCHMARK
MAGNETIC NAIL IN UTILITY POLE LOCATED AT THE NORTH EAST CORNER OF THE PROPOSED SITE.
ELEVATION: 70.98



SMART LIVING PROPERTIES
29 RUSSELL AVE,
CITY OF OTTAWA

**SITE GRADING AND SERVICING
PLAN**



DESIGNED BY	NW	HORIZ SCALE	1:100	PROJECT #	22030
DRAWN BY	JM	VERT SCALE	N/A	DRAWING #	SGS-1
CHECKED BY	MWD	DATE	MAY 2022	REVISION #	4

C:\Users\pearson\AppData\Local\Temp\AspPublish_27144\22030 - Base.dwg Layout: STM-1 Plotter: Aug 02, 2023 @ 5:00pm by rpearson @ PEARSON ENGINEERING LTD.

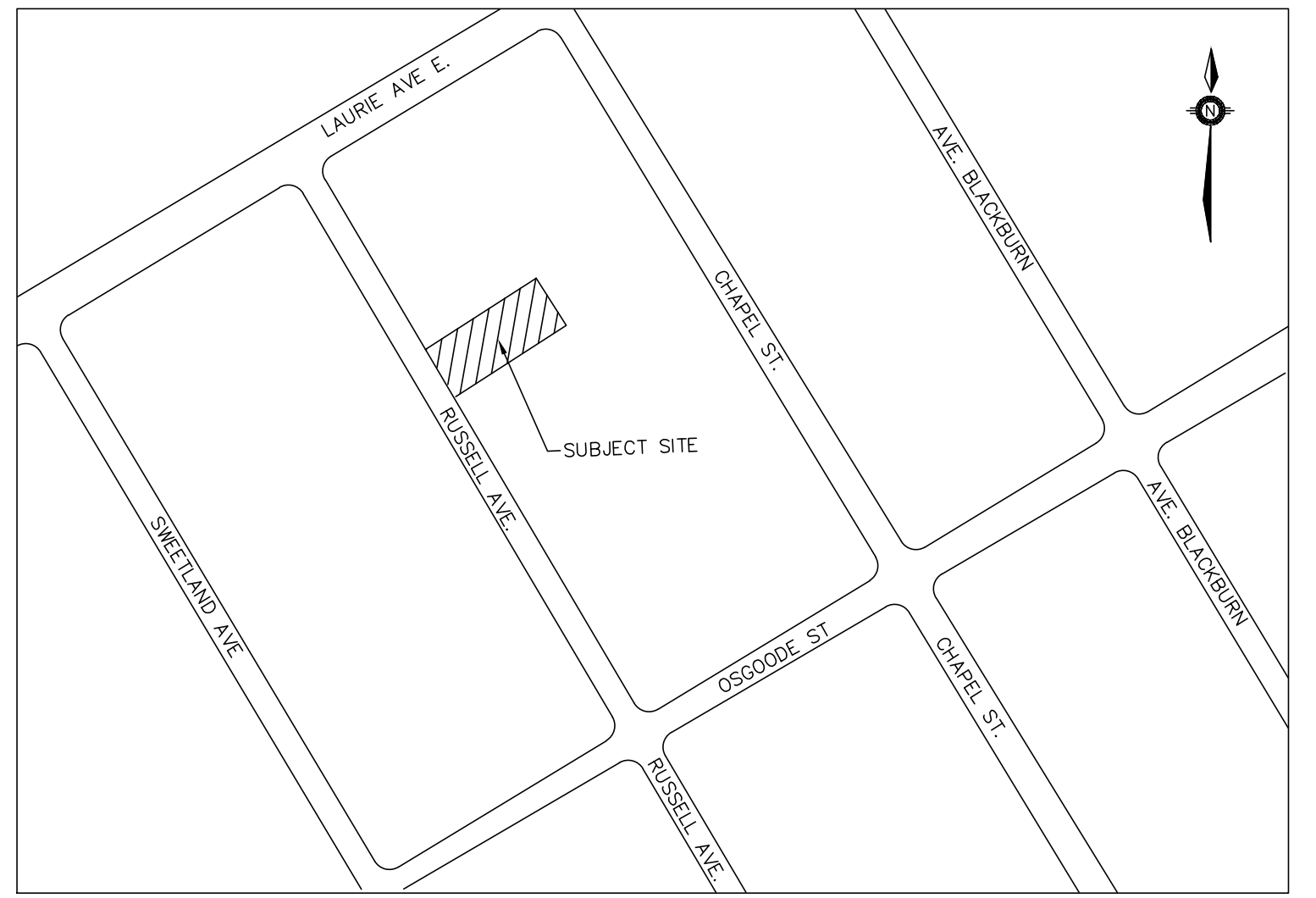
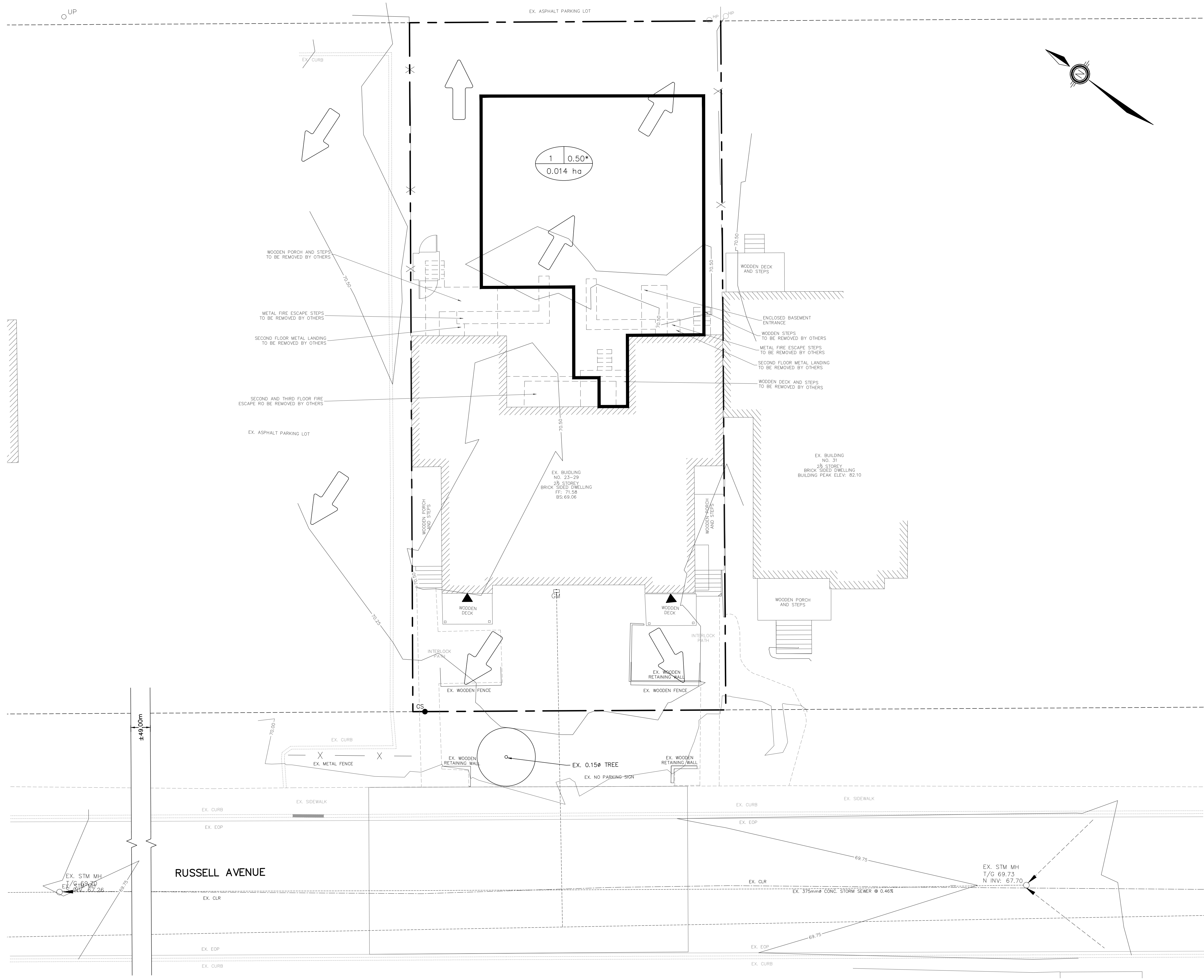

KEY MAP
N.T.S.

LEGEND

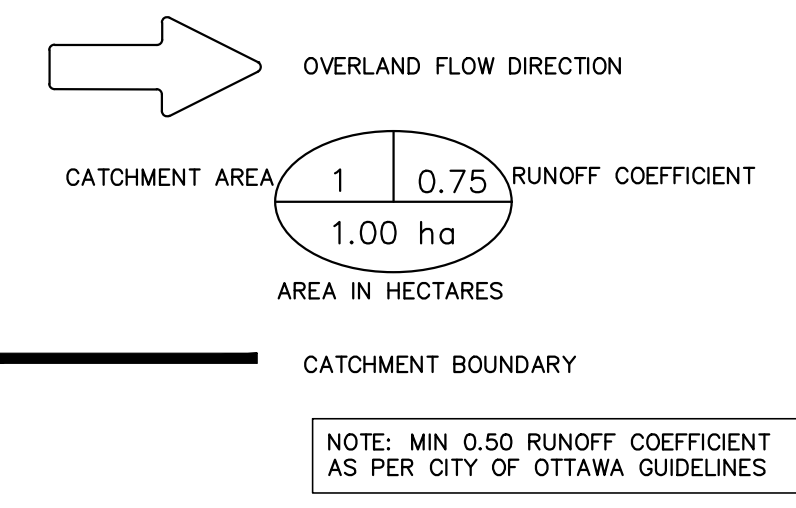

RUSSELL AVENUE

NO.	REVISION NOTE	DATE	BY
04.	AS PER UPDATED SITE PLAN	07/31/23	NP
03.	AS PER MECHANICAL COORDINATION	05/30/23	NW
02.	AS PER 2ND SUBMISSION COMMENTS	04/12/23	NW
01.	AS PER CITY COMMENTS	01/11/23	JM

BENCHMARK
MAGNETIC NAIL IN UTILITY POLE LOCATED AT THE NORTH EAST CORNER OF THE PROPOSED SITE.
ELEVATION: 70.98



SMART LIVING PROPERTIES
29 RUSSELL AVE,
CITY OF OTTAWA

PRE-DEVELOPMENT STORM
CATCHMENT PLAN



DESIGNED BY	NW	HORIZ SCALE	1:100	PROJECT #	22030
DRAWN BY	JM	VERT SCALE	N/A	DRAWING #	STM-1
CHECKED BY	MWD	DATE	MAY 2022	REVISION #	4

C:\Users\jpearson\AppData\Local\Temp\AspData\Local\Temp\AspPublab_27144_22030 - Base.dwg Layout:STM-2 Plotted Aug 02, 2023 @ 5:00pm by rpearson @ PEARSON ENGINEERING LTD.

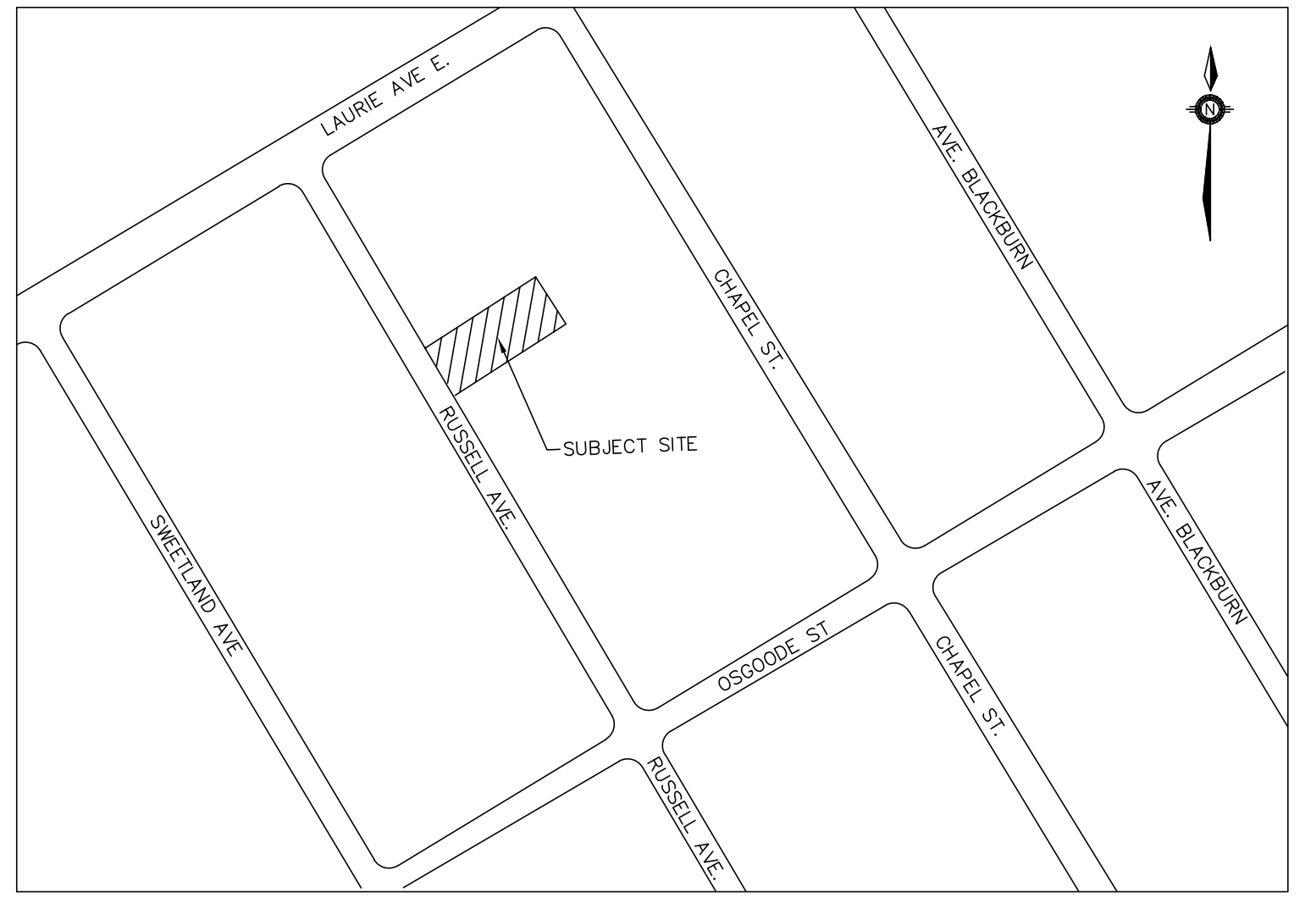
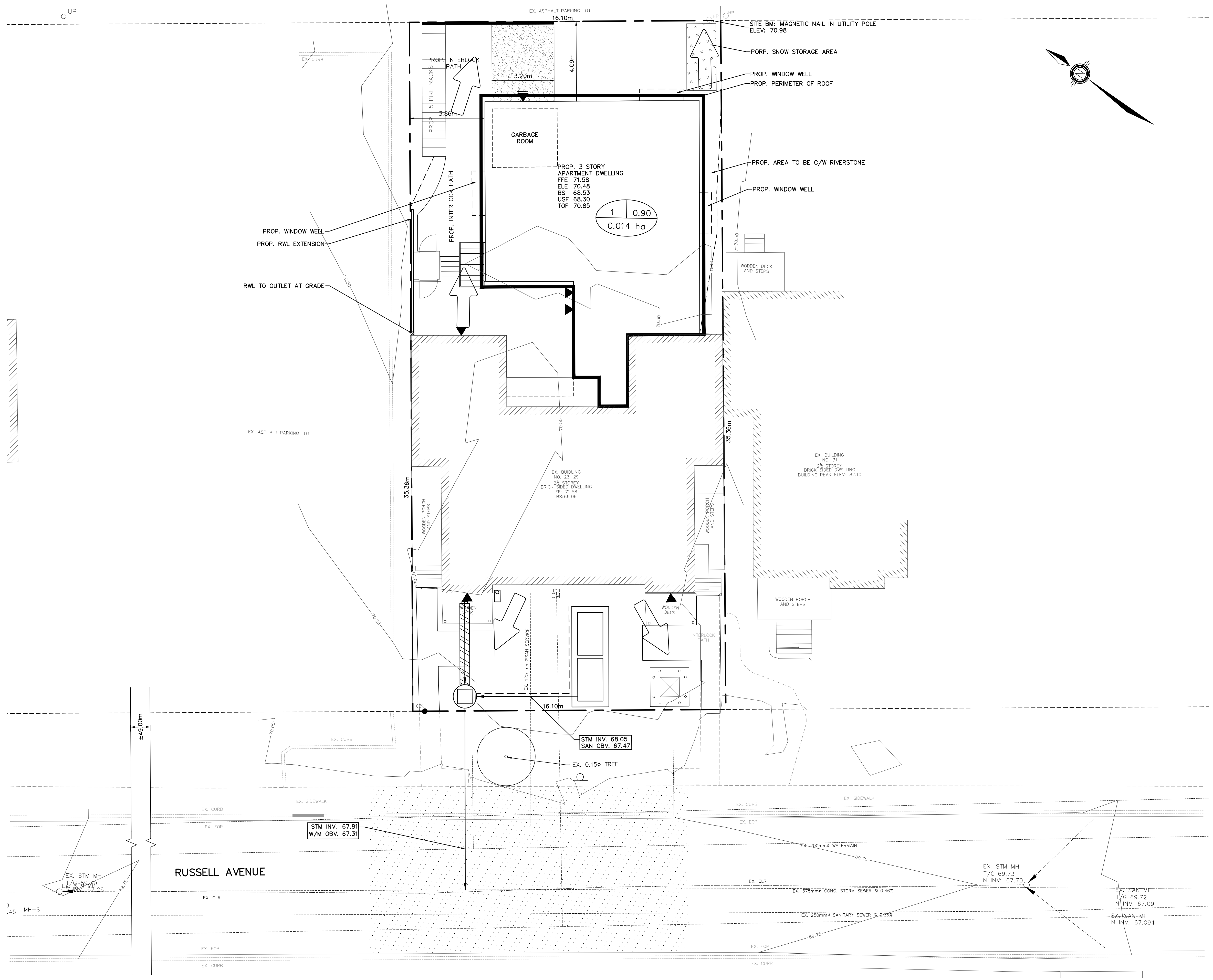

KEY MAP
N.T.S.

LEGEND

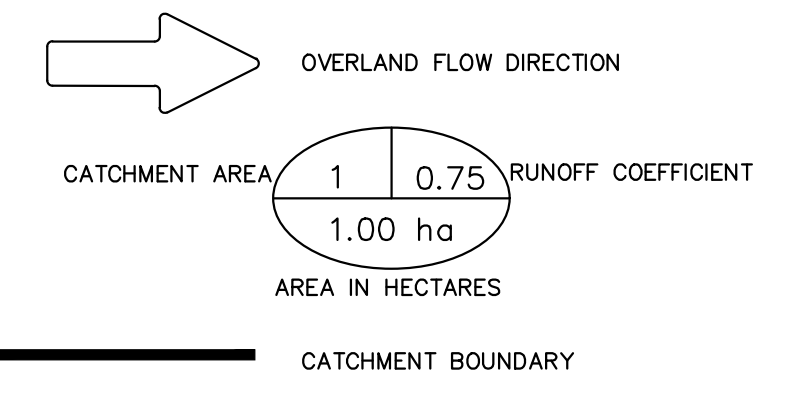

NO.	REVISION NOTE	DATE	BY
04.	AS PER UPDATED SITE PLAN	07/31/23	NP
03.	AS PER MECHANICAL COORDINATION	05/30/23	NW
02.	AS PER 2ND SUBMISSION COMMENTS	04/12/23	NW
01.	AS PER CITY COMMENTS	01/11/23	JM

BENCHMARK
MAGNETIC NAIL IN UTILITY POLE LOCATED AT THE NORTH EAST CORNER OF THE PROPOSED SITE.
ELEVATION: 70.98



SMART LIVING PROPERTIES
29 RUSSELL AVE,
CITY OF OTTAWA

POST-DEVELOPMENT STORM
CATCHMENT PLAN



DESIGNED BY	NW	HORIZ SCALE	1:100	PROJECT #	22030
DRAWN BY	JM	VERT SCALE	N/A	DRAWING #	STM-2
CHECKED BY	MWD	DATE	MAY 2022	REVISION #	4

