

Engineering

- Land / Site Development
- Municipal Infrastructure
- Environmental / Water Resources
- Traffic / Transportation
- Structural
- Recreational

Planning

- Land / Site Development
- Planning Application Management
- Municipal Planning Documents & Studies
- Expert Witness (OMB)
- Wireless Industry

Landscape Architecture

- Urban Design & Streetscapes
- Open Space, Parks & Recreation Planning
- Community & Residential Developments
- Commercial & Institutional Sites
- Environmental Restoration



National Capital Business Park

Traffic Impact Assessment

National Capital Business Park
4055 and 4120 Russell Road
Transportation Impact Assessment

Prepared By:

NOVATECH
Suite 200, 240 Michael Cowpland Drive
Ottawa, Ontario
K2M 1P6

May 2020

Novatech File: 119124
Ref: R-2020-015

May 19, 2020

Ministry of Transportation - Eastern Region
Corridor Management Planner
1355 John Counter Blvd.
Kingston, Ontario K7L 5A3

Attention: Mr. Stephen Kapusta

City of Ottawa
Planning and Growth Management Department
110 Laurier Ave. W., 4th Floor,
Ottawa, Ontario K1P 1J1

Attention: Mr. Wally Dubyk

Dear Sirs:

**Reference: National Capital Business Park
Transportation Impact Assessment
Novatech File No. 119124**

We are pleased to submit the following Transportation Impact Assessment in support of a Master Site Plan Application for the development of the National Capital Business Park (4055 and 4120 Russell Road). The structure and format of this report is in accordance with the City of Ottawa Transportation Impact Assessment Guidelines (June 2017) and the MTO General Guidelines for the Preparation of Traffic Impact Studies (December 2009).

If you have any questions or comments regarding this report, please feel free to contact me.

Yours truly,

NOVATECH



Patrick Hatton, P.Eng.
Project Manager | Transportation/Traffic



TIA Plan Reports

On 14 June 2017, the Council of the City of Ottawa adopted new Transportation Impact Assessment (TIA) Guidelines. In adopting the guidelines, Council established a requirement for those preparing and delivering transportation impact assessments and reports to sign a letter of certification.

Individuals submitting TIA reports will be responsible for all aspects of development-related transportation assessment and reporting, and undertaking such work, in accordance and compliance with the City of Ottawa's Official Plan, the Transportation Master Plan and the Transportation Impact Assessment (2017) Guidelines.

By submitting the attached TIA report (and any associated documents) and signing this document, the individual acknowledges that s/he meets the four criteria listed below.

CERTIFICATION

1. I have reviewed and have a sound understanding of the objectives, needs and requirements of the City of Ottawa's Official Plan, Transportation Master Plan and the Transportation Impact Assessment (2017) Guidelines;
2. I have a sound knowledge of industry standard practice with respect to the preparation of transportation impact assessment reports, including multi modal level of service review;
3. I have substantial experience (more than 5 years) in undertaking and delivering transportation impact studies (analysis, reporting and geometric design) with strong background knowledge in transportation planning, engineering or traffic operations; and
4. I am either a licensed¹ or registered² professional in good standing, whose field of expertise [check appropriate field(s)] is either transportation engineering or transportation planning .

1,2 License of registration body that oversees the profession is required to have a code of conduct and ethics guidelines that will ensure appropriate conduct and representation for transportation planning and/or transportation engineering works.

City Of Ottawa
Infrastructure Services and Community
Sustainability
Planning and Growth Management
110 Laurier Avenue West, 4th fl.
Ottawa, ON K1P 1J1
Tel. : 613-580-2424
Fax: 613-560-6006

Ville d'Ottawa
Services d'infrastructure et Viabilité des
collectivités
Urbanisme et Gestion de la croissance
110, avenue Laurier Ouest
Ottawa (Ontario) K1P 1J1
Tél. : 613-580-2424
Télécopieur: 613-560-6006

Dated at Ottawa this 19th day of May, 2020.
(City)

Name: Patrick Hatton, P.Eng.
(Please Print)

Professional Title: Project Manager, Transportation / Traffic



Signature of Individual certifier that s/he meets the above four criteria

Office Contact Information (Please Print)	
Address:	240 Michael Cowpland Drive, Suite 200
City / Postal Code:	Ottawa, ON, K2M 1P6
Telephone / Extension:	613-254-9643 x 322
E-Mail Address:	p.hatton@novatech-eng.com

TABLE OF CONTENTS

1.0 SITE LOCATION..... 1

2.0 PROPOSED DEVELOPMENT 1

3.0 SCREENING..... 2

4.0 SCOPING..... 2

4.1 EXISTING CONDITIONS 2

4.1.1 Roadways..... 2

4.1.2 Pedestrian and Cycling Facilities 3

4.1.3 Transit 3

4.1.4 Study Area Intersections..... 4

4.1.5 Existing Study Area Traffic Volumes 7

4.1.6 Collision Data 9

4.1.7 Driveways 11

4.1.8 Area Traffic Management 11

4.2 PLANNED CONDITIONS 11

4.3 STUDY AREA AND TIME PERIODS 13

4.4 EXEMPTIONS REVIEW..... 13

5.0 FORECASTING 14

5.1 DEVELOPMENT-GENERATED TRAFFIC 14

5.1.1 Trip Generation..... 14

5.1.2 Trip Distribution / Assignment 16

5.2 BACKGROUND TRAFFIC 18

5.2.1 General Background Traffic Growth Rate 18

5.2.2 Other Area Development 18

5.2.3 Demand Rationalization..... 18

5.2.4 Future Background and Total Traffic Volume Projections 18

6.0 ANALYSIS..... 26

6.1 DEVELOPMENT DESIGN 26

6.2 PARKING 26

6.3 BOUNDARY STREETS 26

6.4 ACCESS INTERSECTIONS 27

6.5 TRANSPORTATION DEMAND MANAGEMENT 28

6.6 TRANSIT 28

6.7 INTERSECTION ANALYSIS..... 29

6.7.1 Existing MMLOS 30

6.7.2 2023 Intersection Operations – Future Background Traffic 32

6.7.3 2023 Intersection Operations – Total Traffic with Site Generated Trips..... 34

6.7.4 2028 Intersection Operations – Future Background Traffic 36

6.7.5 2028 Intersection Operations – Total Traffic with Site Generated Trips..... 38

6.7.6 2033 Intersection Operations – Future Background Traffic 40

6.7.7 2033 Intersection Operations – Total Traffic with Site Generated Trips..... 41

6.7.8 Right Turn Channelized Highway Ramps – Traffic Analysis and Results 41

7.0 CONCLUSIONS AND RECOMMENDATIONS 43

Figures

Figure 1: Site Location and Study Area 1
 Figure 2: OC Transpo Bus Stop Locations 3
 Figure 3: Existing Traffic Volumes..... 8
 Figure 4: Innes-Walkley-Hunt Club Connection..... 12
 Figure 5: Site Generated Traffic Volumes 17
 Figure 6: Other Development Traffic Volumes..... 19
 Figure 7: 2023 Future Background Traffic Volumes 20
 Figure 8: 2028 Future Background Traffic Volumes 21
 Figure 9: 2033 Future Background Traffic Volumes 22
 Figure 10: 2023 Total Traffic Volumes with Site Generated Trips..... 23
 Figure 11: 2028 Total Traffic Volumes with Site Generated Trips..... 24
 Figure 12: 2033 Total Traffic Volumes with Site Generated Trips..... 25

Tables

Table 1: Reported Collisions 9
 Table 2: TIA Exemptions..... 13
 Table 3: Person Trip Generation 14
 Table 4: Person Trips by Modal Share 15
 Table 5: Trip Assignment Assumptions 16
 Table 6: Segment MMLOS Summary..... 27
 Table 7: Intersection MMLOS Summary..... 30
 Table 8: 2023 Background Traffic - Intersection Operations..... 33
 Table 9: 2023 Background Traffic - Queuing..... 33
 Table 10: 2023 Total Traffic - Intersection Operations..... 35
 Table 11: 2023 Total Traffic – Queuing 35
 Table 12: 2028 Background Traffic - Intersection Operations..... 37
 Table 13: 2028 Background Traffic - Queuing 37
 Table 14: 2028 Total Traffic - Intersection Operations..... 38
 Table 15: 2028 Total Traffic - Queuing..... 39
 Table 16: 2033 Background Traffic - Intersection Operations..... 40
 Table 17: 2033 Background Traffic - Queuing..... 40
 Table 18: 2033 Total Traffic - Intersection Operations..... 41
 Table 19: 2033 Total Traffic - Queuing..... 41
 Table 20: 2033 Background Traffic – SimTraffic Delay Results..... 42
 Table 21: 2033 Total Traffic – SimTraffic Delay Results..... 42
 Table 22: 2033 Background Traffic – SimTraffic Merging Queue Results..... 42
 Table 23: 2033 Total Traffic – SimTraffic Merging Queue Results..... 42

Appendices

Appendix A: Concept Plan
 Appendix B: TIA Screening Form
 Appendix C: OC Transpo System Information
 Appendix D: Traffic Count Data and Long-Range Snapshots
 Appendix E: Collision Records
 Appendix F: Excerpts from Relevant Traffic Studies
 Appendix G: MMLOS Results
 Appendix H: Existing Signal Timings
 Appendix I: Left Turn and Signal Warrants, Roundabout Evaluation
 Appendix J: Traffic Analysis Reports

EXECUTIVE SUMMARY

This Transportation Impact Assessment (TIA) report has been prepared in support of a Master Site Plan application for the National Capital Business Park at 4055 and 4120 Russell Road.

The general area is characterized by a combination of various commercial and industrial land uses, including an existing hydro substation immediately north of 4055 Russell Road and a newly constructed Hydro Ottawa office just to the west of 4120 Russell Road.

The subject sites are designated as 'Urban Employment Area' on Schedule 'B' of the City of Ottawa's Official Plan and zoned IH (Heavy Industrial). The proposed development is planned to be completed by 2023 and includes:

- Site 1- one warehouse with 8,325m² (89,610ft²);
- Site 2- two warehouses with 17,400m² (187,300ft²); and,
- Site 3- three warehouses with 75,685m² (814,700ft²).

The development is planned to include a total of about 976 parking spaces as well as loading bays and trailer drop spaces within each site. The concept includes six accesses to Russell Road and a connection to Hunt Club Road.

The study area intersections are:

- Russell Road / Walkley Road
- Russell Road/ Hawthorne Road
- Hawthorne Road / Stevenage Road
- Hawthorne Road / Hunt Club Road
- Russell Road / Belgreen Drive
- Russell Road/Anderson Road
- Hunt Club Road/Highway 417 EB Off-Ramp
- Ramsayville Road/Russell Road (South)
- Ramsayville Road/Russell Road (North)
- Walkley Road / Highway 417 SB Off-Ramp
- Walkley Road / Highway 417 NB Off-Ramp
- The five site driveway intersections (seven accesses)

The weekday AM and PM peak hours are considered to represent the "worst case" combination of site-generated traffic and peak traffic conditions of the adjacent roadways. Intersection capacity analysis has been completed for the weekday AM and PM peak hours. Analysis of potential transportation impacts has been completed for the 2023 opening year, the 2028 five-year horizon, and the 2033 ten-year horizon year. Weekday AM and PM traffic counts were completed at the existing study area intersections by the City of Ottawa, the MTO, or coordinated by Novatech.

A 1% background growth rate was applied to traffic along Walkley Road, Russell Road, Hunt Club Road, Hawthorne Road, the Hwy 417 ramps, and Ramsayville Road between Russell Road North and Russell Road South with a 0% growth rate on other study streets. Other study area developments have been accounted for separately. Background traffic volumes for the 2023 opening year and the 2028 and 2033 horizon years were determined by applying the annual traffic growth rate to the peak hour traffic volumes and by adding the traffic from the new developments in the area. Site generated traffic was estimated using *Trip Generation Manual, 10th Edition* (Institute of Transportation Engineers, Washington 2017). Site traffic was distributed and added to the projected background traffic to determine future total traffic volumes.

The main conclusions and recommendations of this TIA are:

Development Design and Parking

- Pedestrian facilities will be provided between the main buildings and the parking lots. New pedestrian walkways will be constructed, providing connectivity to Russell Road.
- The Transportation Demand Management (TDM) infrastructure and measures checklists will be prepared for each site plan submission.
- The conceptual vehicular parking spaces meet the requirements of the Zoning By-Law (ZBL) for each of the three sites. Vehicular, accessible, and bicycle parking requirements for each building will be confirmed with the site plan submissions.
- Stops #3336 and 3339 are located immediately in front of Buildings A and B. Stops #3335 and 3340 are less than 400m to Buildings C, D, and F. Building E is about 650m from the nearest bus stop. Walking distance between exterior access doors and the transit stops will be reviewed at site plan submission.
- Each building exceeds the minimum requirements of the ZBL for vehicle loading space, and this will be confirmed at site plan submission.

Boundary Street Multi-Modal Level of Service (MMLOS)

The results of the segment MMLOS analysis for Russell Road and Hunt Club Road can be summarized as follows:

- Both Russell Road and Hunt Club Road operate with a Pedestrian Level of Service (PLOS) F, missing the target PLOS C;
- Russell Road (F) and Hunt Club Road (E) miss the target Bicycle Level of Service (BLOS) of E and C, respectively;
- Russell Road (C) misses and Hunt Club Road (A) exceeds the target Truck Level of Service (TkLOS) of B; and,
- If the City urbanizes Russell Road in the future, sidewalk and onstreet bicycle lanes should be considered. The existing gravel shoulders are approximately 2.5m. The City may wish to consider paving an additional 0.5m on either side of the road.

Transit

- The proposed development is anticipated to generate an additional 110 transit trips (60 in, 50 out) during the weekday AM peak hour and 111 transit trips (68 in, 43 out) during the weekday PM peak hour.
- The City should consider providing additional transit service during the peak period. The transit trips will be reviewed with each site plan submission.

Access Design

- The proposed development will be served by a total of seven accesses. The accesses will be 7-9m wide, measured at the property line. The accesses meet the requirements of the City's Private Approach By-law and provide adequate turning sight distance for heavy vehicles. Access design will be further reviewed with each site plan submission.
- Southbound left turn lanes are warranted along Russell Road at both accesses to Building A.
- An eastbound left turn lane is warranted along Hunt Club Road at the Street 1 connection.
- Left turn lanes are not warranted on Russell Road at the access intersections for Sites 1 and 2 or Building F.
- The Street 1 connection to Hunt Club Road should be signalized while the remaining connections operate well with STOP control.

- The signalized Street 1 connection to Hunt Club is proposed approximately 250m east of the Hydro Ottawa (signalized) Access. The location and ultimate functional design of this intersection have been agreed by the City of Ottawa in a tri-party agreement with NCC and Hydro Ottawa in 2016.
- The Street 1 connection is 60m east of Hydro Ottawa's right-in, right-out (RIRO) driveway. Per the 2711 Hunt Club TIS, it is understood that Hydro's RIRO access may be closed with construction of the Street 1 access and a new connection provided between the Hydro Ottawa site and Street 1.

Intersection MMLOS Analysis

- The Walkley at Russell and Hunt Club at Hawthorne intersections do not meet the target Auto LOS.
- Auto Level of Service:
 - The northbound, eastbound, and westbound approaches at the **Walkley Road / Russell Road** intersection do not meet the target Auto LOS D in the PM peak hour. The eastbound left turn movement in the PM peak can be improved to LOS D or better with signal timing adjustments at the expense of the westbound through movement. To achieve the target, a reduction in PM peak hour traffic volumes for the following movements are required:
 - Northbound right turn: reduction of approximately 130 vehicles;
 - Eastbound through: reduction of approximately 165 vehicles;
 - Westbound left turn: reduction of approximately 110 vehicles.
 - At the **Hunt Club Road / Hawthorne Road** intersection, the northbound through and eastbound left movements do not meet the target Auto LOS D in the AM peak hour and the westbound left movement does not meet the target Auto LOS D in the PM peak hour. The installation of dual eastbound and westbound left turn lanes and signal timing adjustments would improve the existing Auto LOS to D.
- In existing and future traffic conditions, capacity issues have been identified for the following movements:
 - Walkley Road/Russell Road
 - Northbound left turn (AM peak)
 - Northbound right turn (PM peak)
 - Eastbound left turn (PM peak)
 - Eastbound through (PM peak)
 - Westbound left turn (PM peak)
 - Russell Road/Hawthorne Road
 - Southbound left turn (AM and PM peak)
 - Westbound right turn (AM peak)
 - Hawthorne Road/Hunt Club Road
 - Northbound through (AM peak)
 - Eastbound left turn (AM and PM peak)
 - Eastbound through (PM peak)
 - Westbound left (PM peak)
 - Walkley Road/Highway 417 NB Off-ramp
 - Northbound approach (AM peak)
 - Walkley Road/Highway 417 SB Off-ramp
 - Southbound approach (PM peak)
 - Russell Road/Anderson Road

- Northbound approach (AM peak)
- Westbound approach (AM peak)

Recommended Modifications

Several modifications have been identified for consideration. The need and timing will be confirmed at site plan submission. Functional designs of required road modifications to accommodate the development will be included in the site plan submissions. The modifications that have been identified for consideration are:

Existing/Background Traffic:

These modifications are identified for the City's/MTO's consideration without added site development.

- Install dual eastbound and westbound left turn lanes on Hunt Club Road at Hawthorne Road to improve the level of service and accommodate the existing and projected queues without and with site generated trips.
- Consider installation of a roundabout at the Russell Road/Anderson Road intersection to accommodate existing and projected traffic without and with site generated trips.
- Install traffic signals at the Walkley Road/Highway 417 northbound and southbound off-ramps to accommodate existing and projected traffic without and with site generated trips.
- Modify the right turn ramp for Highway 417 eastbound off-ramp onto Hunt Club Road with an increased radius or a second lane to accommodate projected traffic without and with site generated trips.

Site Traffic:

These modifications are identified to accommodate site generated trips.

- Install a left turn protected/permissive phase southbound on Russell Road at the Hawthorne intersection. This is expected to be required to accommodate site generated trips.
- Install southbound left turn lanes on Russell Road at both connections to the parcel hub (Civic #4055) to accommodate site generated trips.
- Install a northbound left turn lane on Russell Road at Belgreen Drive, warranted with site development. As development progresses in the Russell Road corridor and with the addition of new site accesses, it is expected that the operating speed may decrease and the posted speed of 60 km/h further north on Russell Road should be extended.
- Install an eastbound left turn lane and traffic signals at the Street 1 connection to Hunt Club Road to accommodate site generated trips.

Required Road Modification Approvals (RMA) for these potential modifications will be prepared at site plan when the details of the individual sites are known.

1.0 SITE LOCATION

This Transportation Impact Assessment (TIA) Forecasting report has been prepared in support of a Master Site Plan application for the National Capital Business Park at 4055 and 4120 Russell Road located west of the Hunt Club / Hwy 417 interchange (See **Figure 1**). Civic #4120 is vacant while civic #4055 includes a vacant farm as well as one single family dwelling.

The general area is characterized by a combination of various commercial and industrial land uses, including an existing hydro substation immediately north of 4055 Russell Road and a newly constructed Hydro Ottawa office just to the west of 4120 Russell Road.

Figure 1: Site Location and Study Area

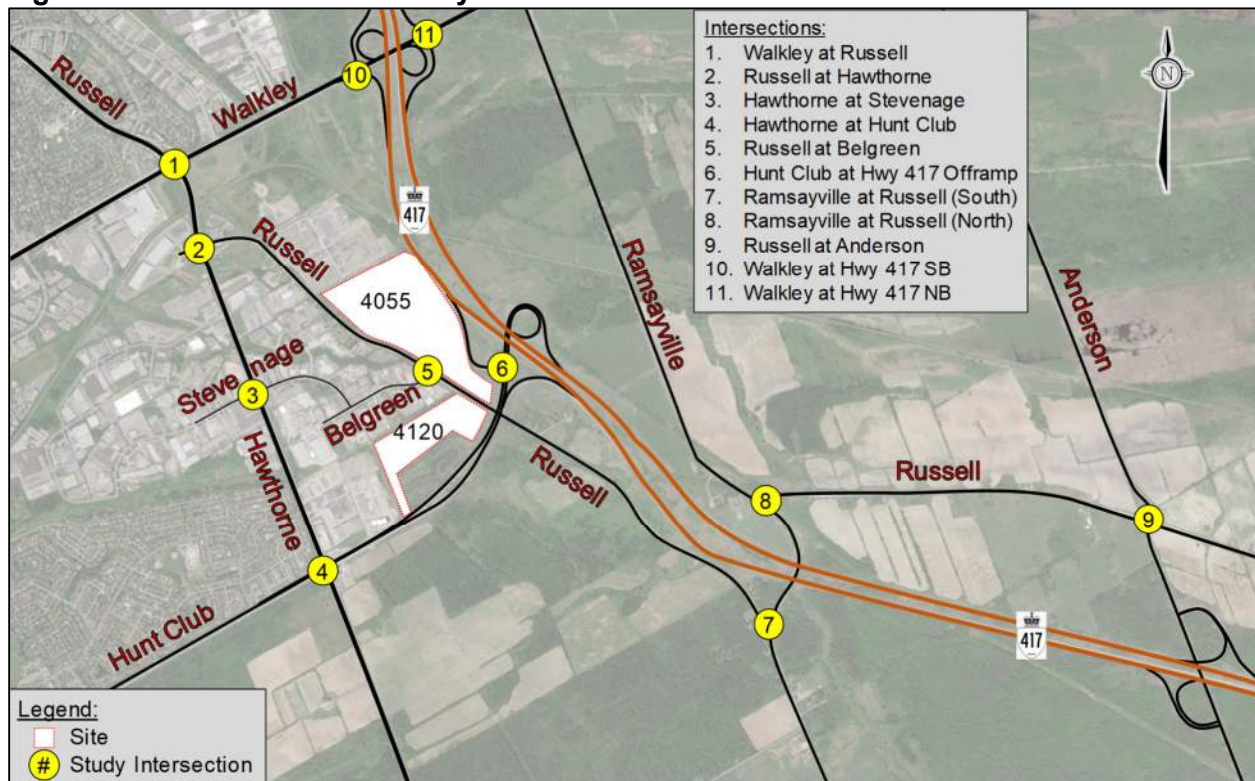

2.0 PROPOSED DEVELOPMENT

The subject sites are designated as 'Urban Employment Area' on Schedule 'B' of the City of Ottawa's Official Plan and zoned IH (Heavy Industrial). The proposed development (See **Appendix A**) is planned to be completed by 2023 and includes:

- Site 1- one warehouse with 8,325m² (89,610ft²);
- Site 2- two warehouses with 17,400m² (187,300ft²); and,
- Site 3- three warehouses with 75,685m² (814,700ft²).

The development is planned to include a total of about 976 parking spaces as well as loading bays and trailer drop spaces within each site. The concept includes six accesses to Russell Road and a connection to Hunt Club Road (Street 1).

3.0 SCREENING

The City of Ottawa's 2017 TIA Guidelines identifies three triggers for completing a TIA report, including trip generation, location, and safety. The criteria for each trigger are outlined in the City's TIA Screening Form.

The proposed development satisfies all three triggers for completing a TIA since:

1. The development is expected to generate more than 60 person trips;
2. A connection to Hunt Club is proposed; and,
3. The posted speed limit on Russell Road is 80 km/h.

The TIA screening form is included in **Appendix B**.

4.0 SCOPING

4.1 Existing Conditions

4.1.1 Roadways

Russell Road is a two-lane undivided rural arterial and is classified as a truck route, allowing full loads. It runs northwest-southeast through the area and has a posted speed limit of 80km/h. The City of Ottawa Official Plan identifies 30m ROW protection and widening may be required as part of development applications.

Hunt Club Road is a four-lane divided arterial roadway and is classified as a truck route, allowing full loads. It runs east-west and has a posted speed limit of 80km/h. The City of Ottawa Official Plan identifies 42.5m - 50m ROW protection from Hawthorne Road to Highway 417.

Walkley Road is a four-lane divided arterial roadway and is classified as a truck route, allowing full loads. It runs east-west and has a posted speed limit of 80km/h east of Russell and 50km/h west of Russell.

Hawthorne Road is a five-lane undivided arterial roadway and is classified as a truck route, allowing full loads between the north-south Russell Road intersections, north and south of the 417. It runs north-south and has a posted speed limit of 70km/h in this area.

Ramsayville Road is a two-lane undivided rural arterial roadway and is classified as a truck route between Russell North and Russell South. It runs north-south and has a posted speed limit of 80km/h in this area.

Anderson Road is a two-lane undivided rural arterial roadway and is classified as a truck route, allowing full loads south of Russell and restricted loads north of Russell. It runs north-south and has a posted speed limit of 80km/h in this area.

Stevenage Drive and **Belgreen Drive** are two-lane local roadways with posted speed limits of 40km/h.

4.1.2 Pedestrian and Cycling Facilities

Walkley Road, Hunt Club Road, Hawthorne Road, Ramsayville Road, and Russell Road east of Ramsayville Road are identified as spine cycling routes in the City’s Cycling Network. There are currently on-street bicycle lanes along Hawthorne Road between Russell Road and Hunt Club Road.

Concrete sidewalks are provided along both sides of Walkley Road, along the west side of Hawthorne Road and along the north side of Hunt Club Road east of Hawthorne. There are greenbelt pathway connections at Russell / Ramsayville South.

4.1.3 Transit

Transit service (via route #47) is provided along Russell Road in front of the civic #4055 site and along Belgreen Drive with bus stops #3335 and #3336 (northbound service) and #3339 and #3340 (southbound service).

Additional transit service is provided (via route #98) with bus stops at the Hunt Club / Hawthorne intersection. These bus stop locations are shown in **Figure 2**.

OC Transpo Route #47 travels from the Hydro station just north of civic #4055, past the civic #4055 site along Russell Road and to the St Laurent Station. It provides weekday peak period service (from St Laurent toward the site in the morning and from the site toward St Laurent in the afternoon).

OC Transpo Route #98 travels from the Hunt Club / Hawthorne intersection to Hurdman station. It provides all day service 7 days per week.

Figure 2: OC Transpo Bus Stop Locations

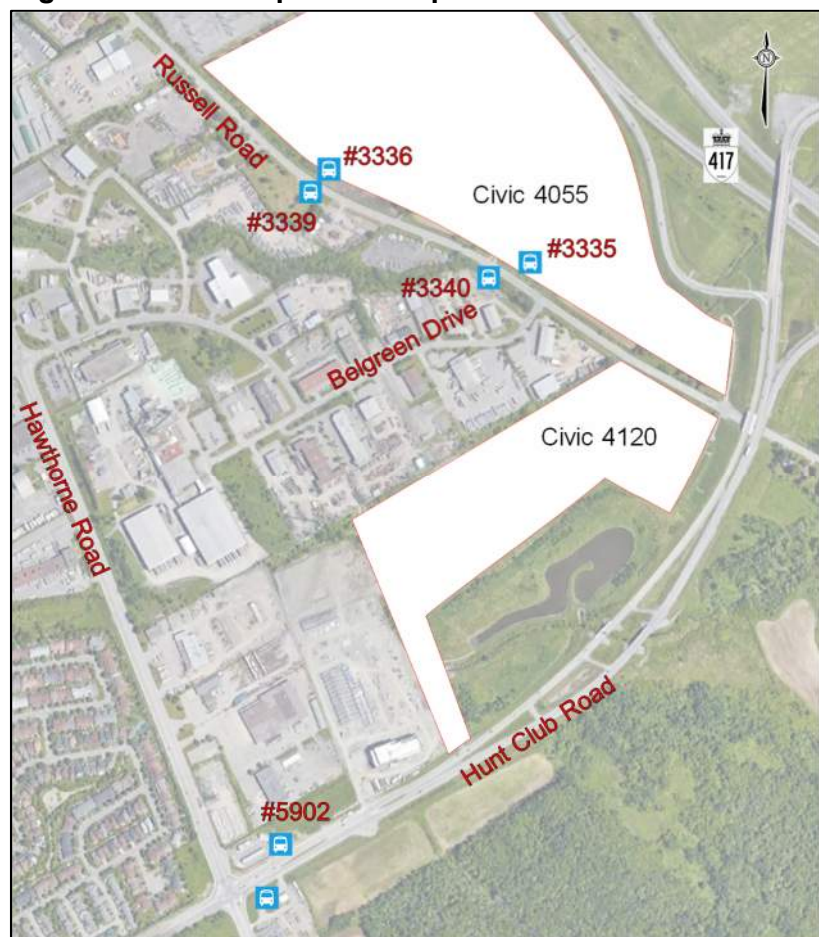

OC Transpo Route information is included in **Appendix C**.

4.1.4 Study Area Intersections

The following are considered the study area intersections with layout and lane configurations of each described below.

1. Russell Road at Walkley Road

- Signalized intersection
- Northbound (Russell Road): two left turn lanes, two through lanes, one pocket bicycle lane, and one channelized right turn lane.
- Southbound (Russell Road): two left turn lanes, two through lanes, and one channelized right turn lane.
- Eastbound (Walkley Road): one left turn lane, two through lanes, and one channelized right turn lane.
- Westbound (Walkley Road): two left turn lanes, two through lanes, and one right turn lane.
- Standard crosswalks are provided on all legs.

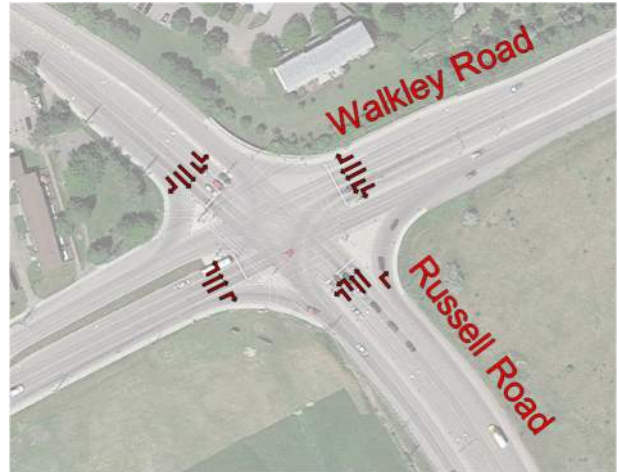

2. Russell Road at Hawthorne Road

- Signalized intersection
- Northbound (Hawthorne Road): one left turn lane, one through lane, one shared through/right turn (channelized) lane, and one bicycle lane.
- Southbound (Russell Road): one left turn lane, one through lane, one shared through/right turn (channelized) lane, and one pocket bicycle lane.
- Eastbound (3020 Hawthorne Road): one left turn lane, and one shared through/right turn (channelized) lane.
- Westbound (Russell Road): one left turn lane, one through lane, and one channelized right turn lane.
- Standard crosswalks are provided on all legs.

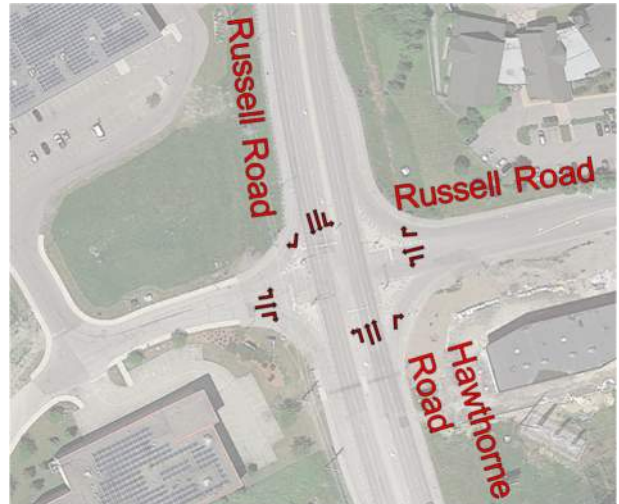

3. Hawthorne Road at Stevenage Drive

- Signalized intersection
- Northbound (Hawthorne Road): one left turn lane, one through lane, one shared through/right turn (channelized) lane, and one bicycle lane.
- Southbound (Hawthorne Road): one left turn lane, two through lanes, one bicycle lane, and one channelized right turn lane.
- Eastbound/Westbound (Stevenage Drive): one left turn lane, and one shared through/right turn (channelized) lane.
- Standard crosswalks are provided on all legs.



4. Hawthorne Road at Hunt Club Road

- Signalized intersection
- Northbound (Hawthorne Road): one left turn lane, one through lane, one shared through/right turn (channelized) lane, and one bicycle lane.
- Southbound (Hawthorne Road): one left turn lane, two through lanes, one bicycle lane, and one channelized right turn lane.
- Eastbound (Hunt Club Road): one left turn lane, one through lane, one shared through/right turn (channelized) lane.
- Westbound (Hunt Club Road): one left turn lane, two through lanes, one pocket bicycle lane, and one channelized right turn lane.
- Standard crosswalks are provided on all legs.

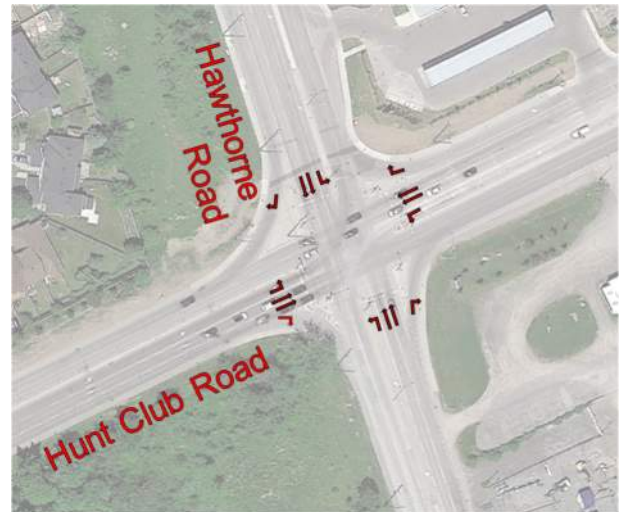

5. Russell Road at Belgreen Drive

- Minor STOP controlled intersection (STOP on Belgreen)
- Single lane approaches.



6. Hunt Club Road at Highway 417 EB Off-ramp

- STOP controlled intersection (STOP on ramp)
- Northbound/Southbound (Hunt Club Road): one through lane.
- Eastbound (Highway 417): one left turn lane and one channelized right turn lane.



7. Ramsayville Road at Russell Road (South)

- Minor STOP controlled intersection (STOP on Russell)
- Single Lane Approaches



8. Ramsayville Road at Russell Road (North)

- STOP controlled intersection (All-way STOP)
- Single Lane Approaches



9. Russell Road at Anderson Road

- STOP controlled intersection (All-way STOP)
- Single Lane Approaches



10, 11. Walkley Road at Highway 417 Ramps

- Partial cloverleaf interchange with channelized right turn lanes for all on-ramps
- Both intersections are unsignalized
- East/West: two through lanes
- Southbound off-ramp: One left turn lane and one channelized right turn lane
- Northbound off-ramp: One shared left turn / right turn lane



4.1.5 Existing Study Area Traffic Volumes

Weekday traffic counts were collected at the study area intersections to determine the existing pedestrian, cyclist and vehicular traffic volumes. The counts were completed by the City of Ottawa or MTO, or coordinated by Novatech on the following dates:

• Russell Road/Walkley Road	February 22, 2018	(City)
• Russell Road/Hawthorne Road	January 30, 2019	(City)
• Hawthorne Road/Stevenage Road	December 7, 2016	(City)
• Hawthorne Road/Hunt Club Road	July 24, 2018	(City)
• Russell Road/Belgreen Drive	November 14, 2019	(Novatech)
• Hunt Club Road/Highway 417 EB Off-Ramp	December 12, 2019	(Novatech)
• Ramsayville Road/Russell Road (South)	November 14, 2019	(Novatech)
• Ramsayville Road/Russell Road (North)	November 14, 2019	(Novatech)
• Russell Road/Anderson Road	November 14, 2019	(Novatech)
• Walkley Road / Highway 417 SB Off-Ramp	August 6, 2019	(MTO)
• Walkley Road / Highway 417 NB Off-Ramp	June 1, 2015	(MTO)

Observed weekday AM and PM peak hour traffic volumes at the study area intersections are shown in **Figure 3**. Peak hour summary sheets of the above traffic counts are included in **Appendix D**.

Figure 3: Existing Traffic Volumes

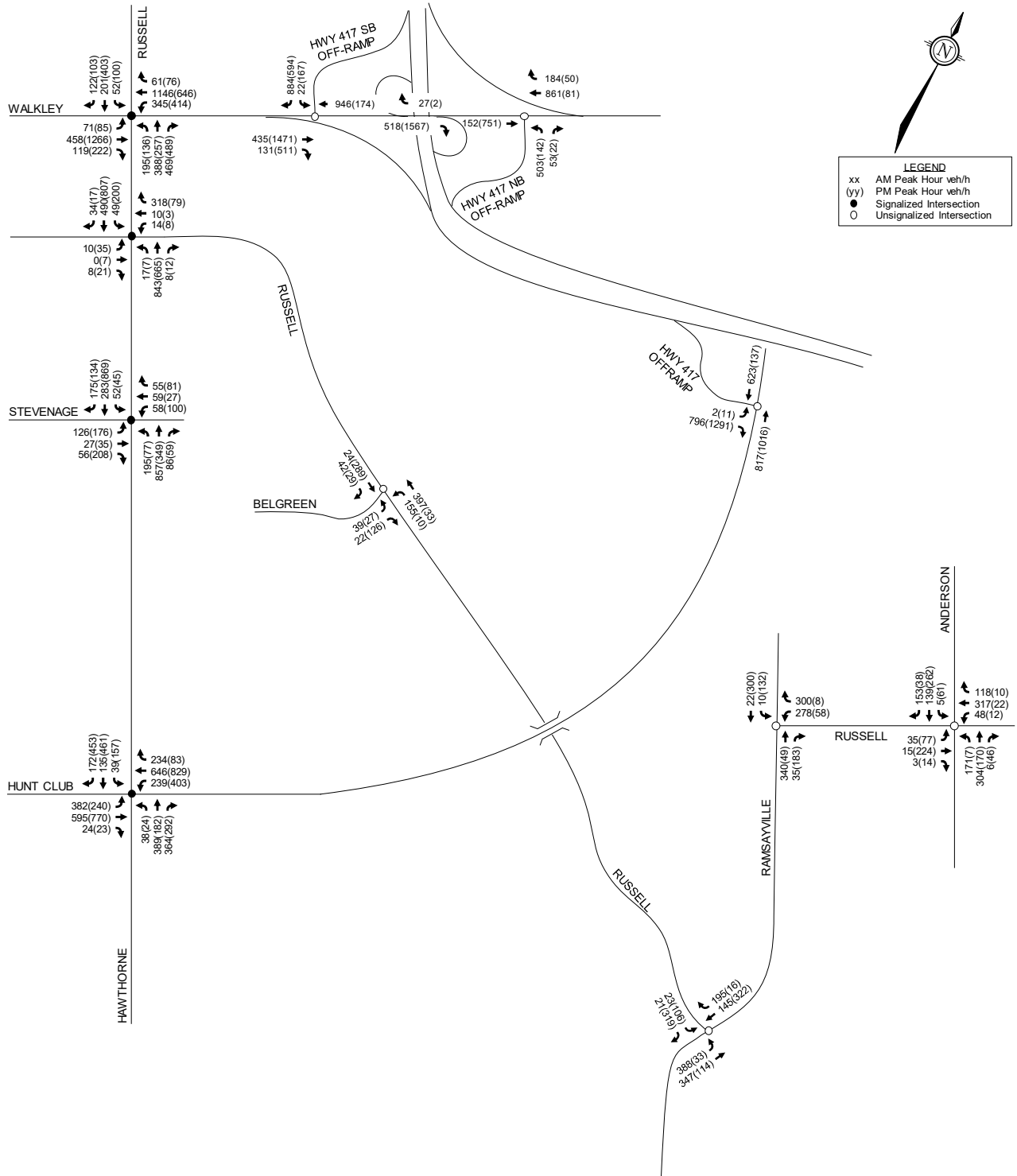

4.1.6 Collision Data

Historical collision data from the last five years were obtained from the City's Public Works and Service Department for the eleven study area intersections. Copies of the collision summary reports are included in **Appendix E**.

The collision data have been evaluated to determine if there are identifiable collision patterns. **Table 1** summarizes the number of collisions at each study intersection from January 1, 2014 to December 31, 2018. During the period, there were zero fatal collisions reported at the study intersections.

Table 1: Reported Collisions

Intersection	Number of Collisions						
	SMV ¹ / Other	Approach- ing	Rear-End	Angle	Turning Mvmt	Side- swipe	Total
Russell at Walkley	8	1	66	7	6	18	106
Russell at Hawthorne	0	0	1	0	2	1	4
Hawthorne at Stevenage	0	0	5	3	14	2	24
Hawthorne at Hunt Club	9	1	87	10	22	15	144
Russell at Belgreen	1	0	0	0	0	0	1
Hunt Club at Hwy 417 Off-ramp	1	0	6	1	0	0	8
Ramsayville at Russell (S)	1	0	0	1	1	0	3
Ramsayville at Russell (N)	7	0	0	0	1	0	8
Russell at Anderson	0	0	3	2	0	0	5
Walkley at Hwy 417 SB Off-ramp	0	0	2	5	0	0	7
Walkley at Hwy 417 NB Off-ramp	1	0	0	1	1	2	5

1. SMV: Single Motor Vehicle

Russell at Walkley

A total of 106 collisions were reported at this intersection over the last five years, of which there were 66 rear-end impacts, six turning movement impacts, 18 sideswipe impacts, seven angle impacts, and eight single-vehicle/other impacts. Twenty of the collisions caused injuries, but none caused fatalities.

Of the 66 rear-end impacts, 23 occurred at the northbound approach (five through vehicle incidents, 14 right turn incidents, and four unknown), 15 occurred at the southbound approach (one left turn incident, six through vehicle incidents, and eight right turn incidents), 18 occurred at the eastbound approach (10 through vehicle incidents, four right turn incidents, and four unknown), and 10 occurred at the westbound approach (one left turn incident, eight through vehicle incidents, one right turn incident). Twenty-four of the 66 impacts occurred in poor driving conditions. Each approach features at least six rear-end impacts for at least one movement, meeting the threshold to be considered a collision pattern. High traffic volumes, including a high percentage of heavy vehicle traffic, create the potential for more collisions of this type. Additionally, the speed limit of the northbound approach is 70 km/h, the speed limit of the westbound approach changes from 80km/h to 50 km/h within approximately 75m of the intersection. All of these attributes may play a factor in the high number of rear-end collisions at this intersection. A red-light camera has been implemented at this intersection.

Of the 18 sideswipe impacts, five occurred at the northbound approach, two occurred at the southbound approach, two occurred at the eastbound approach, and nine occurred at the westbound approach. Six of the 18 impacts occurred in poor driving conditions. As discussed previously, high traffic volumes and a high percentage of heavy vehicles create the potential for collisions of this type. For westbound traffic, the upstream signal at Walkley Road/Lancaster Road is approximately 220m east, measured stop bar to stop bar. The westbound left turn lane extends back through the intersection with Lancaster Road as a third “through” lane, which may contribute to westbound sideswipes.

Of the seven angle impacts, two involved a northbound vehicle and an eastbound vehicle, one involved a northbound vehicle and a westbound vehicle, one involved a southbound vehicle and an eastbound vehicle, and three involved a southbound vehicle and a westbound vehicle. Two of the seven impacts occurred in poor driving conditions.

Of the eight single-vehicle/other impacts, two occurred at the northbound approach, two occurred at the southbound approach, three occurred at the eastbound approach, and one occurred at the westbound approach. Four of the eight impacts occurred in poor driving conditions.

Hawthorne at Stevenage

Six of the collisions caused an injury. Twelve collisions occurred in clear conditions, five in rain conditions, six in snow conditions, and one in freezing rain conditions.

Of the 14 turning movement impacts, seven were between northbound left turning vehicles and southbound through vehicles, three were between southbound left turning vehicles and northbound through vehicles, one was between a westbound left turning vehicle and a eastbound right turning vehicle, two were between eastbound left turning vehicles and westbound through vehicles, and one was between northbound right turning heavy vehicle and a northbound through vehicle.

With an 70km/h posted speed limit and high through volumes along Hawthorne, the City could consider providing protected only signal phasing for left turns from Hawthorne Road.

Hawthorne at Hunt Club

A total of 144 collisions were reported at this intersection over the last five years, of which there were 87 rear-end impacts, 22 turning movement impacts, 15 sideswipe impacts, 10 angle impacts, and nine single-vehicle/other impacts. 29 of the collisions caused injuries, but none caused fatalities.

Of the 87 rear-end impacts, 18 occurred at the northbound approach (five through vehicle incidents, 12 right turn incidents, and one unknown), 36 occurred at the southbound approach (one through vehicle incidents, 33 right turn incidents, and two unknowns), 17 occurred at the eastbound approach (five left turn incidents, four through vehicle incidents, two right turn incidents, and six unknown), and 16 occurred at the westbound approach (one left turn incident, three through vehicle incident, eight right turn incidents, and four unknown). Sixteen of the 87 impacts occurred in poor driving conditions. Each approach features at least six rear-end impacts for at least one movement, meeting the threshold to be considered a collision pattern. A recent TIS (2017) was completed for development at 3500 Hawthorne and recommended modifying the southbound right turn channel to create a ‘Smart’ channel. The City has accepted this study and registered an agreement for the development.

Of the 15 sideswipe impacts, two occurred at the northbound approach, two occurred at the southbound approach, five occurred at the eastbound approach, and six occurred at the westbound

approach. Two of the 15 impacts occurred in poor driving conditions. As discussed previously, high traffic volumes and a high percentage of heavy vehicles create the potential for collisions of this type.

Of the 10 angle impacts, three involved a northbound vehicle and an eastbound vehicle, one involved a northbound vehicle and a westbound vehicle, one involved a southbound vehicle and an eastbound vehicle, and five involved a southbound vehicle and a westbound vehicle. One of the 10 impacts occurred in poor driving conditions.

Of the nine single-vehicle/other impacts, one occurred at the northbound approach, four occurred at the southbound approach, one occurred at the eastbound approach, and three occurred at the westbound approach. Three of the nine impacts occurred in poor driving conditions.

4.1.7 Driveways

In accordance with the City's 2017 TIA guidelines, a review of adjacent driveways along the boundary roads are provided as follows:

Russell Road, West Side:

- One looped residential driveway and one commercial driveway for 3830 Russell
- One looped driveway for 3894 Russell
- One commercial driveway and one residential driveway for 3900 Russell
- One commercial driveway and one driveway for a cemetery for 3970 Russell
- One commercial driveway for 4000 Russell

Russell Road, East Side:

- One driveway for a farm and one residential driveway at 4055 Russell

Hunt Club Road, North Side:

- One signalized driveway for Hydro Ottawa 250m west of Street 1
- One right-in, right-out driveway about 60m west of Street 1.

4.1.8 Area Traffic Management

There are no Area Traffic Management (ATM) studies within the study area that have been completed or are currently in progress.

4.2 Planned Conditions

The 2031 Rapid Transit and Transit Priority (RTTP) Network identifies a bus rapid transit (BRT) project within the study area. The Baseline/Heron/Walkley/St. Laurent BRT project will provide high-quality transit access to employment, commercial, and institutional land uses along the corridor. In the 2031 Affordable Network, at-grade BRT will connect from Baseline Station to Heron Station. In the 2031 Network Concept, at-grade BRT will connect from Bayshore Station to St. Laurent Station. The 2031 Network Concept will not be implemented until after 2031.

The Innes-Walkley-Hunt Club Connection (See **Figure 4**) is identified in the City of Ottawa's 2031 network concept. This is a new four lane road (initial phase two-lanes) between Hunt Club and Innes

Road west of Blackburn Hamlet. The road would bypass congestion on a section of Innes Road and provides direct connection between Orléans and Hunt Club.

Information on other area developments is included in **Section 5.2.2**.

Figure 4: Innes-Walkley-Hunt Club Connection

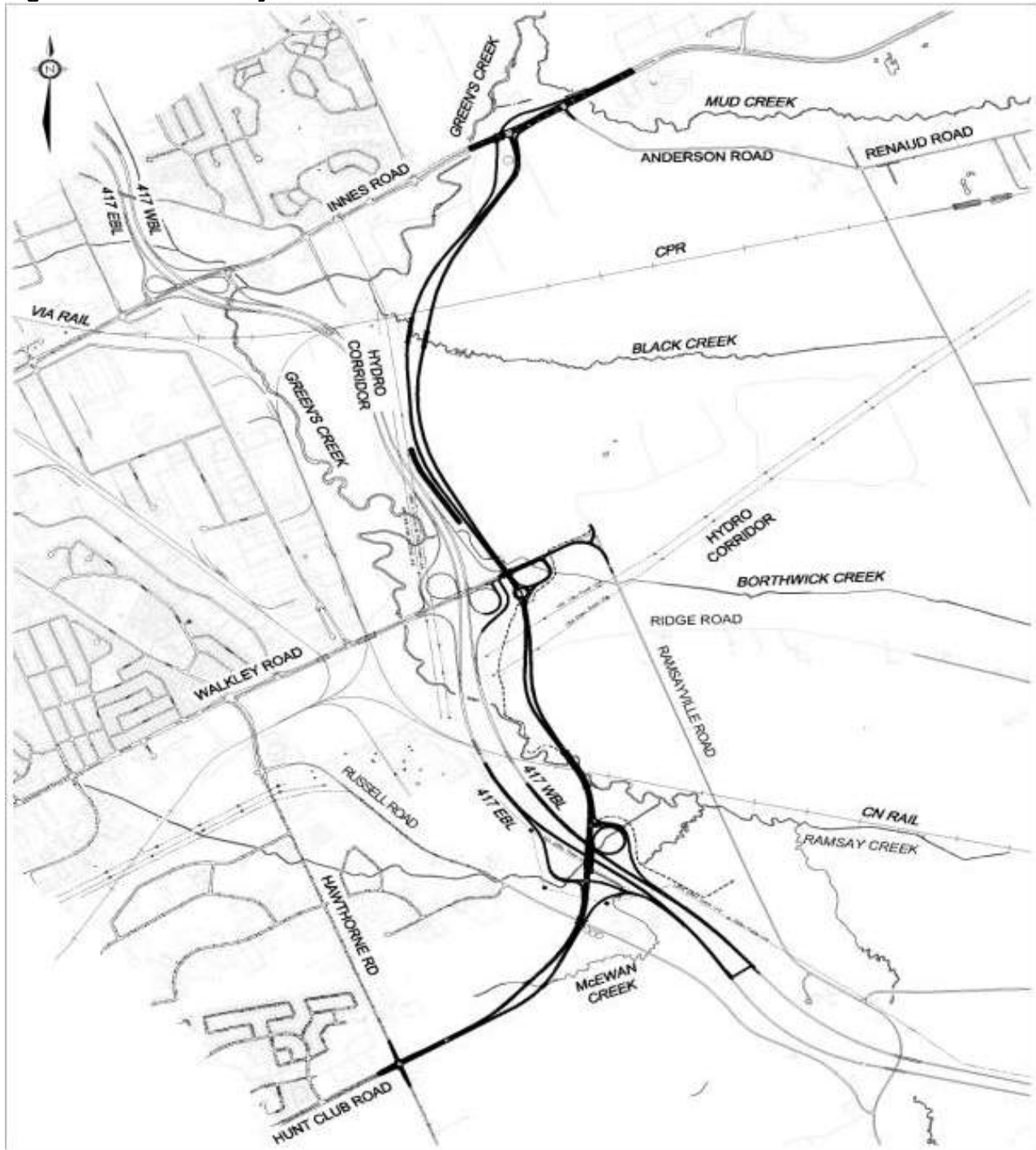

Source: Innes-Walkley-Hunt Club Connection Environmental Assessment – Study Recommendations, City of Ottawa Transportation Committee

4.3 Study Area and Time Periods

A boundary street review will be conducted for Russell Road and Hunt Club Road. The study area intersections are the 11 existing intersections (See **Section 4.1.4**) as well as the site accesses.

The selected time periods for the analysis are the weekday AM and PM peak hours, as they represent the ‘highest volume’ of site generated traffic and adjacent street traffic. This TIA will perform analysis for the weekday AM and PM peak periods with full buildout in 2023, as well as the 2028 and 2033 horizon years.

4.4 Exemptions Review

This module reviews possible exemptions from the final Transportation Impact Assessment, as outlined in the City’s TIA guidelines. The applicable exemptions for this site are shown in **Table 2**.

Table 2: TIA Exemptions

Module	Element	Exemption Criteria	Exemption Status
Design Review Component			
4.1 Development Design	4.1.2 Circulation and Access	<ul style="list-style-type: none"> Only required for site plans 	Exempt
	4.1.3 New Street Networks	<ul style="list-style-type: none"> Only required for plans of subdivision 	Exempt
4.2 Parking	4.2.1 Parking Supply	<ul style="list-style-type: none"> Only required for site plans 	Exempt
	4.2.2 Spillover Parking	<ul style="list-style-type: none"> Only required for site plans where parking supply is 15% below unconstrained demand 	Exempt
Network Impact Component			
4.5 Transportation Demand Management	<i>All elements</i>	<ul style="list-style-type: none"> Not required for non-residential site plans expected to have fewer than 60 employees and/or students on location at any given time 	Exempt
4.6 Neighbourhood Traffic Management	4.6.1 Adjacent Neighbourhoods	<ul style="list-style-type: none"> Only required when the development relies on local or collector streets for access and total volumes exceed ATM capacity thresholds 	Exempt
4.8 Network Concept	<i>All elements</i>	<ul style="list-style-type: none"> Only required when proposed development generates more than 200 person-trips during the peak hour in excess of the equivalent volume permitted by the established zoning 	Exempt

Note: Review of Modules 4.1.2, 4.2.1, 4.2.2 and 4.5 will be required as individual site plan submissions are made.

5.0 Forecasting

5.1 Development-Generated Traffic

5.1.1 Trip Generation

The proposed development is planned to be completed with three subareas consisting of:

- Site 1- one warehouse with 8,325m² (89,610ft²);
- Site 2- two warehouses with 17,400m² (187,300ft²); and,
- Site 3- three warehouses with 75,685m² (814,700ft²).

Trips generated by the proposed site development were estimated using *Trip Generation, 10th Edition* (Institute of Transportation Engineers, Washington, 2017). Person trips were estimated (See **Table 3**) using an ITE Trip to Person Trip conversion factor of 1.28, consistent with the City of Ottawa TIA Guidelines.

Table 3: Person Trip Generation

Land Use ¹	Units ²	Person Trips Generated ³					
		AM Peak Hour			PM Peak Hour		
		In	Out	Total	In	Out	Total
Site 1							
Warehouse (ITE 150)	89.6	35	11	46	13	36	49
Site 2							
Warehouse (ITE 150)	187.3	47	14	61	17	47	64
Site 3							
Warehouse (ITE 150)	120.2	39	12	51	15	39	54
High-Cube Parcel Hub Warehouse (ITE 156)	694.5	470	469	939	631	297	928
Total Development Trip Generation Sites 1-3		591	506	1097	676	419	1095
Notes: 1. Trip Generation for the associated Land Use from <i>Trip Generation 10th Edition</i> (Institute of Transportation Engineers, Washington, 2017). Trips have been increased by 28% to account for 10% non-auto mode share and average vehicle occupancy of 1.15. 2. Units are 1,000 ft ² of GFA. 3. Person trips per hour for peak hours.							

The modal shares for the proposed development are anticipated to be generally consistent with the existing modal shares (See **Table 4**) outlined in the *2011 TRANS O-D Survey Report*, specific to the Hunt Club region which indicate the modal share values for the trips to/from and within the Hunt Club district. An increase to the auto driver share has been applied based on the location of the subject site, as the site is somewhat removed from significant residential development with minimal active transportation connections and transit service. The projected person trips by modal share for this full development are shown in **Table 4**.

Table 4: Person Trips by Modal Share

Travel Mode	Existing Modal Share	Target Modal Share	AM Peak			PM Peak		
			IN	OUT	TOT	IN	OUT	TOT
Site 1								
Person Trips			35	11	46	13	36	49
Auto Driver	60%	70%	24	7	31	9	25	34
Auto Passenger	15%	15%	5	2	7	2	5	7
Transit	15%	10%	4	1	5	1	4	5
Active Trips	10%	5%	2	1	3	1	2	3
Site 2								
Person Trips			47	14	61	17	47	64
Auto Driver	60%	70%	33	10	43	11	33	44
Auto Passenger	15%	15%	7	2	9	3	7	10
Transit	15%	10%	5	1	6	2	5	7
Active Trips	10%	5%	2	1	3	1	2	3
Site 3								
Person Trips			509	481	990	646	336	982
Auto Driver	60%	70%	357	337	694	452	235	687
Auto Passenger	15%	15%	76	72	148	97	50	147
Transit	15%	10%	51	48	99	65	34	99
Active Trips	10%	5%	25	24	49	32	17	49
Total Development								
Person Trips			591	506	1097	676	419	1095
Auto Driver	60%	70%	414	354	768	472	293	765
Auto Passenger	15%	15%	88	76	164	102	62	164
Transit	15%	10%	60	50	110	68	43	111
Active Trips	10%	5%	29	26	55	34	21	55

Full Buildout of the proposed development is estimated to generate 768 two-way vehicle trips during the AM peak hour and 765 two-way vehicle trips during the PM peak hour.

5.1.2 Trip Distribution / Assignment

The overall distribution of trips generated by the development has been estimated (see below) based on the observed volumes along the study area roadways as well as a review of the existing settlement patterns.

- 10% to/from the north via Russell Road (Alta Vista)
- 10% to/from the south / east (Russell Road south, Hwy 417 E)
- 5% to/from the south (East Barrhaven and Airport via Ramsayville Road)
- 40% to/from the north/west (Hwy 417 W)
- 15% to/from the west via Walkley Road (Alta Vista, Baseline Road)
- 20% to/from the west via Hunt Club (Nepean)

Trips have been assigned based on the assumptions presented in **Table 5**.

Table 5: Trip Assignment Assumptions

	Buildings A & B	Buildings D & E	Buildings C & F
Trip Breakdown	The parcel hub (Building A) accounts for ~95% of all the Site 3 trips	These buildings account for all the Site 2 trips	Building F is ~1% of all Site 3 trips Building C is all the Site 1 trips
Hwy 417^{1,2}	50% of trips will use the Hunt Club interchange and the Street 1 connection to Hunt Club	100% of trips will use the Hunt Club interchange and the Street 1 connection to Hunt Club	80% of trips will use the Hunt Club interchange and the Street 1 connection to Hunt Club
Hunt Club W	50% of trips will use the Street 1 connection to Hunt Club, remainder will use Hawthorne to Russell	100% of trips will use the Street 1 connection to Hunt Club	100% of trips will use the Street 1 connection to Hunt Club
To / from north on Russell	70% of trips will use the north driveway	100% of trips will use the north driveway	60% of trips will use the north driveway
To / from south on Russell	30% of trips will use the north driveway	100% of trips will use the north driveway	20% of trips will use the north driveway

Notes: 1. All Highway 417 trips from and to the west not assigned to the Hunt Club Street 1 connection were assigned to the Walkley Road interchange.

Notes: 2. All Highway 417 trips from and to the east not assigned to the Hunt Club Street 1 connection were assigned to the Anderson Road interchange.

Site generated traffic volumes for the three sub area sites have been assigned to the study area intersections and are shown in **Figure 5**.

Figure 5: Site Generated Traffic Volumes

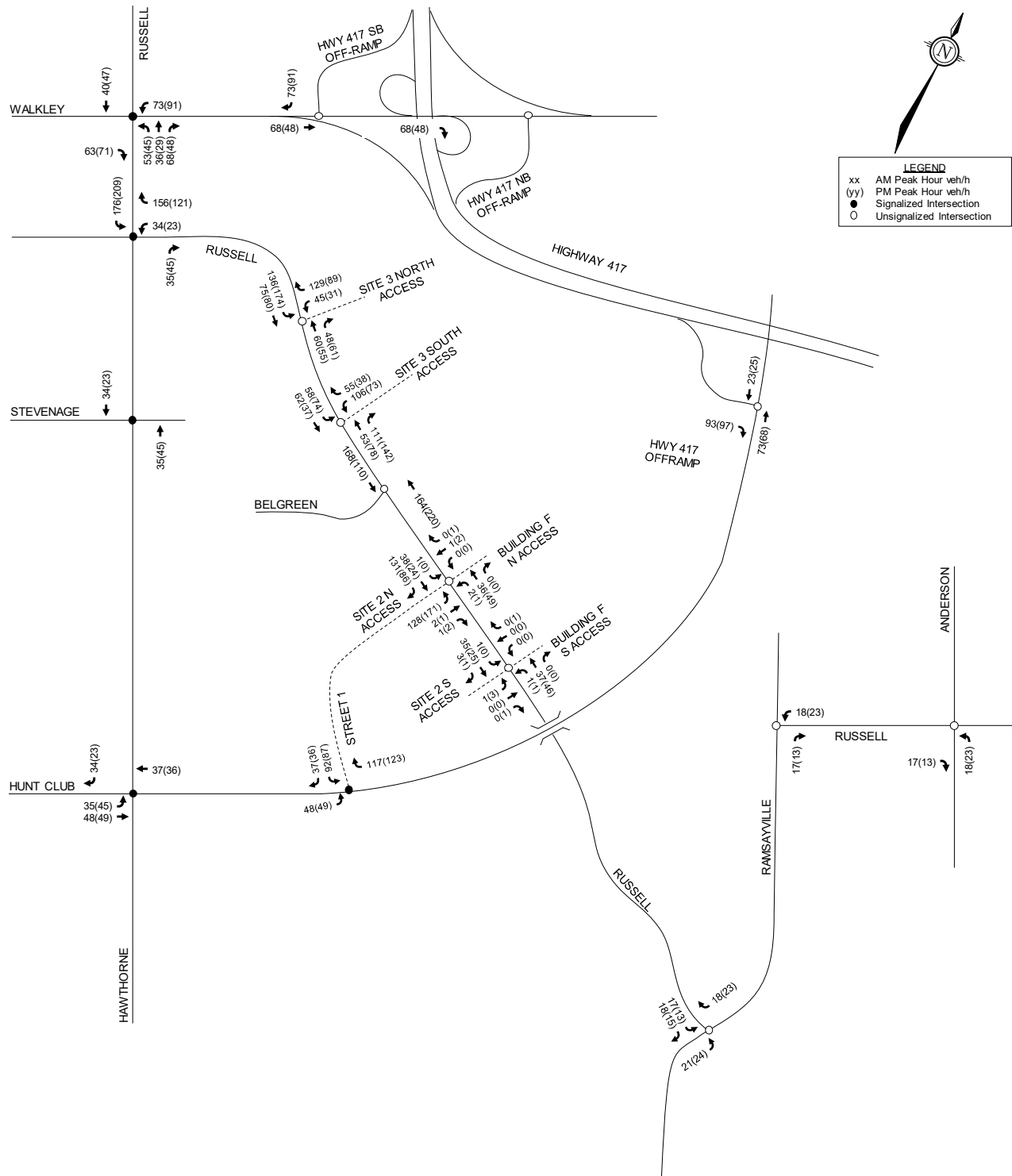

5.2 Background Traffic

5.2.1 General Background Traffic Growth Rate

A rate of background growth has been established through a review of the City of Ottawa's 2013 TMP and Strategic Long Range Model (comparing snapshots of 2011 and 2031 AM peak volumes). The snapshots (See **Appendix D**) suggest a growth rate of -0.5% to 1.5% per year on arterial roadways within the study area. For the 'Inner Suburbs' area of Ottawa, Exhibit 2.10 of the 2013 TMP projects population and employment growth rates of approximately 0.3% and 1.2% per year, respectively. To reflect the study area's development as an employment area, a 1% annual background growth rate has been applied to traffic along Walkley Road, Russell Road, Hunt Club Road, Hawthorne Road, the Hwy 417 ramps, and Ramsayville Road between Russell Road North and Russell Road South. A 0% growth rate has been applied to all other roadways within the study area. This growth rate is consistent with the recent Giant Tiger TIA approximately 1km to the north.

5.2.2 Other Area Development

There are other developments planned within the area including:

- 3500 Hawthorne Road – A gas station with convenience store and a fast food restaurant with drive-through. A TIS was prepared (Stantec 2017) and estimated the site would generate 21 and 24 net new two-way auto trips during the AM and PM peak hours, respectively. The TIS recommended modifying the southbound right turn channel to create a 'Smart' channel. The City has accepted this study and registered an agreement for the development.
- 2510 Walkley Road – A retail showroom (929m²) and warehouse (2,323m²). A TIA was prepared (Parsons 2018) and estimates the site will generate 15 and 30 two-way vehicle trips during the AM and PM peak hours, respectively.
- 2390 Stevenage Drive – An additional approximately 13,000m² of industrial use added to the approximately 10,000m². A TIA was prepared (Parsons 2018) and estimated the site would generate 55 and 58 new two-way auto trips during the AM and PM peak hours, respectively.
- 2480 Walkley Road – Reconfiguration of the existing Giant Tiger site to become the headquarters. A TIA was prepared (Novatech 2019) and estimated the site would generate 69 and 56 new two-way auto trips during the AM and PM peak hours, respectively.

The traffic volumes projected by the buildout of each of these developments from their associated traffic studies are shown in **Figure 6** with relevant excerpts of the traffic studies included in **Appendix F**. Each background development is anticipated to be complete by 2023.

5.2.3 Demand Rationalization

In existing conditions, some movements at the study area intersections operate outside of City Guidelines in the weekday AM and PM peak hours. Existing intersection performance is part of the Intersection MMLOS review included in **Appendix G**. Future intersection performance of the study area is included in **Section 6.6**.

5.2.4 Future Background and Total Traffic Volume Projections

Future Background Traffic Volumes have been projected for the 2023, 2028, and 2033 (See **Figures 7, 8, and 9**, respectively) and include the annual background growth and background development trips. Total Traffic Volumes have been projected for the Study Area intersections for the weekday

Figure 7: 2023 Future Background Traffic Volumes

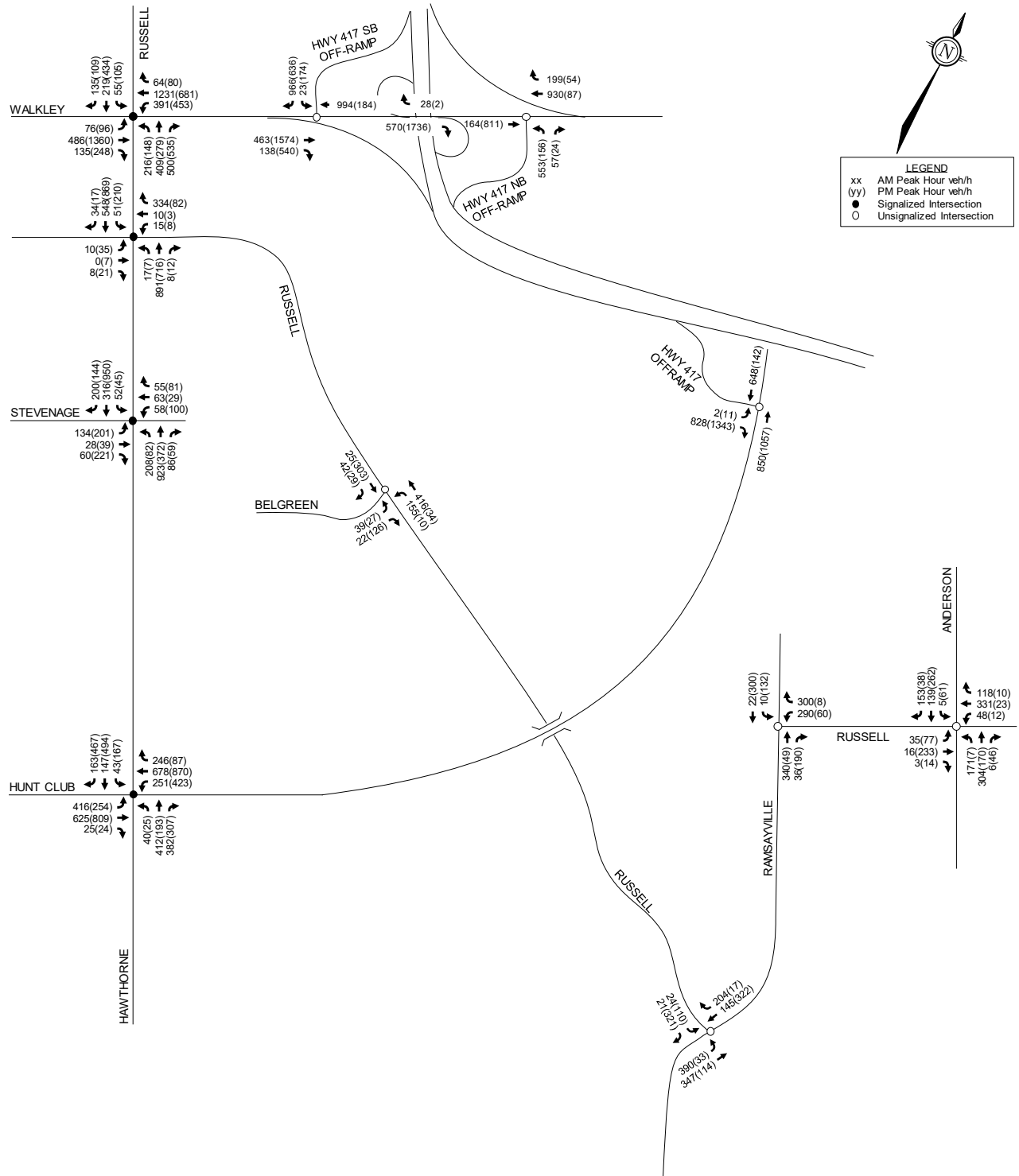

Figure 8: 2028 Future Background Traffic Volumes

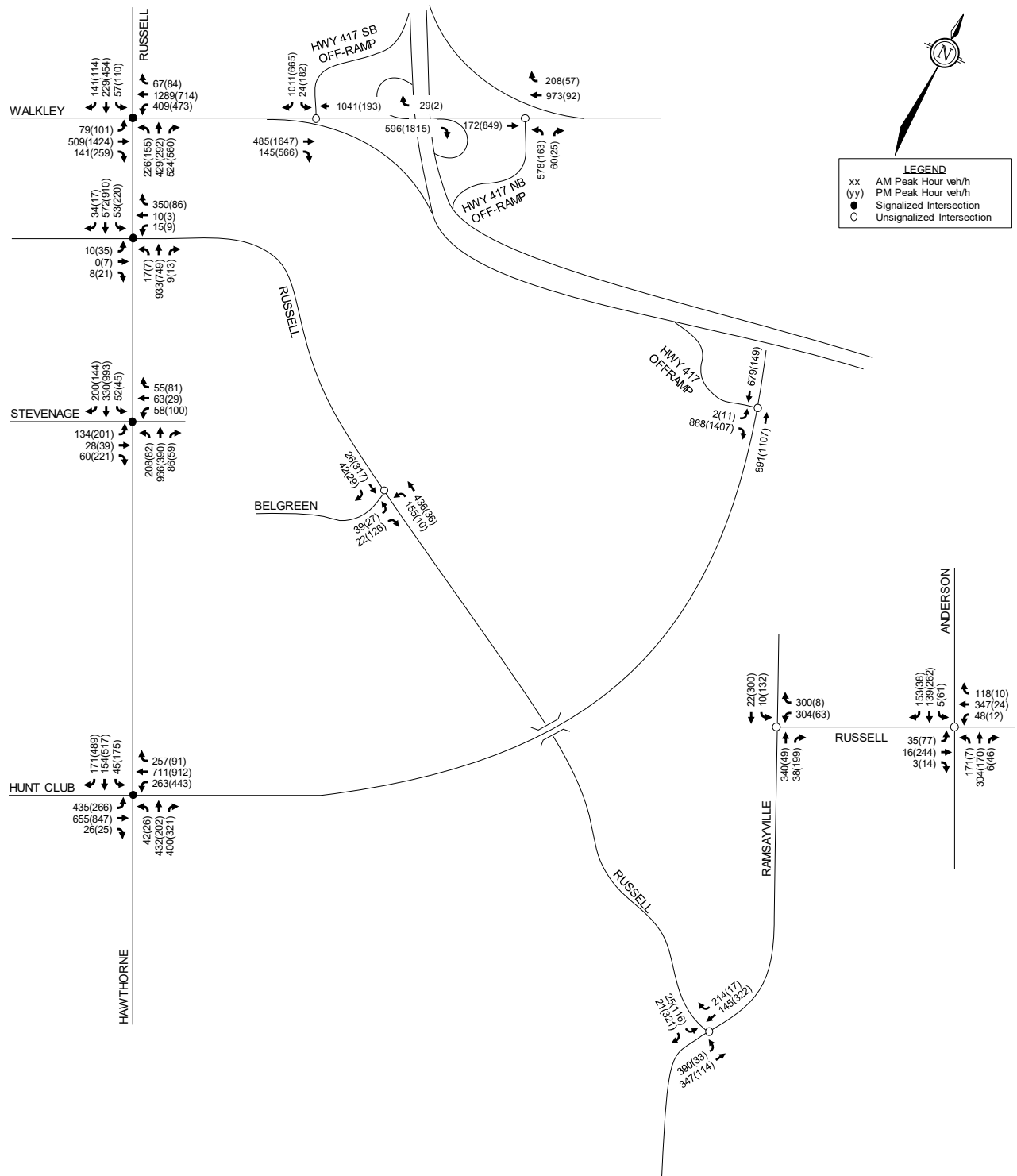

Figure 9: 2033 Future Background Traffic Volumes

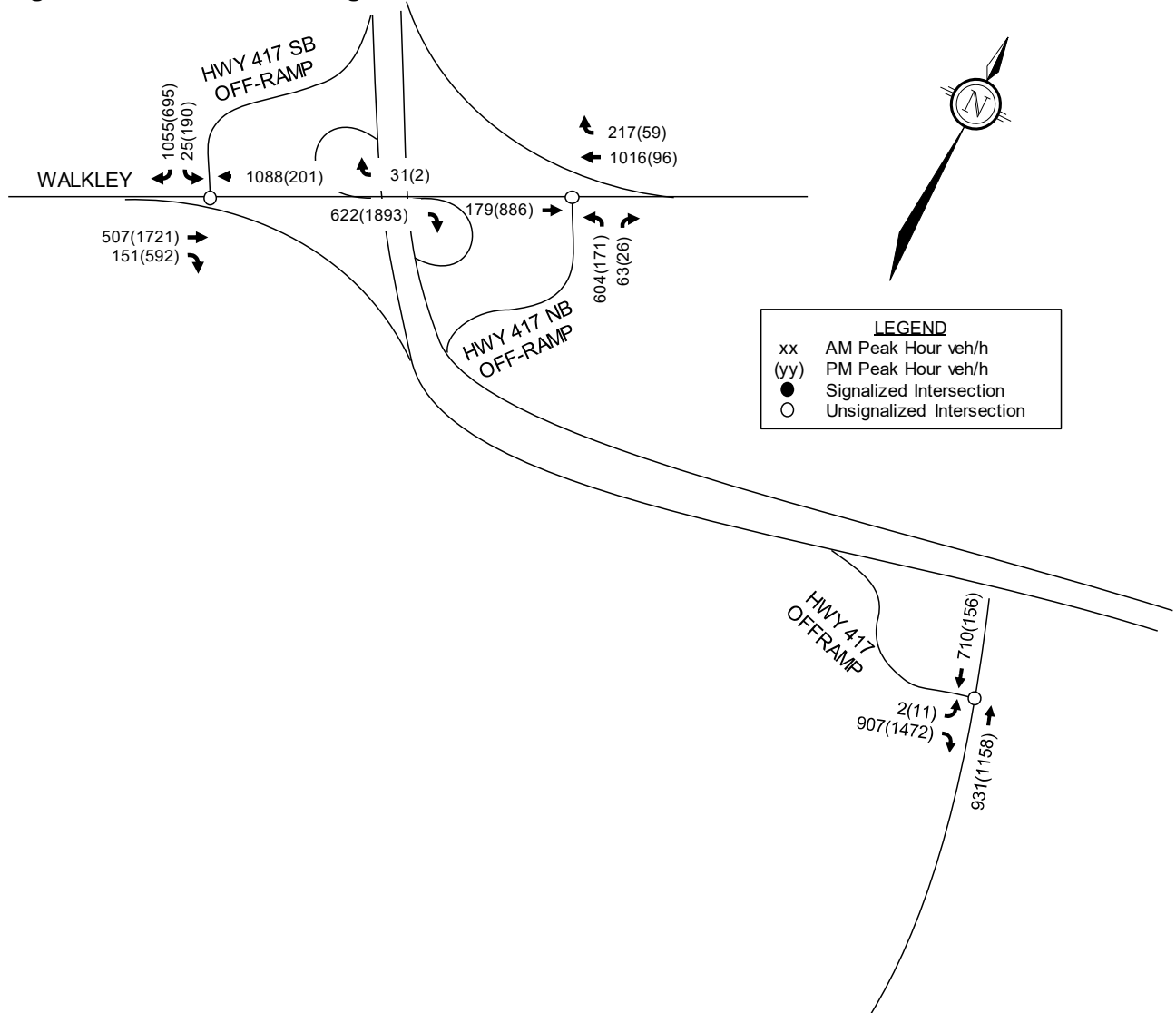

Figure 10: 2023 Total Traffic Volumes with Site Generated Trips

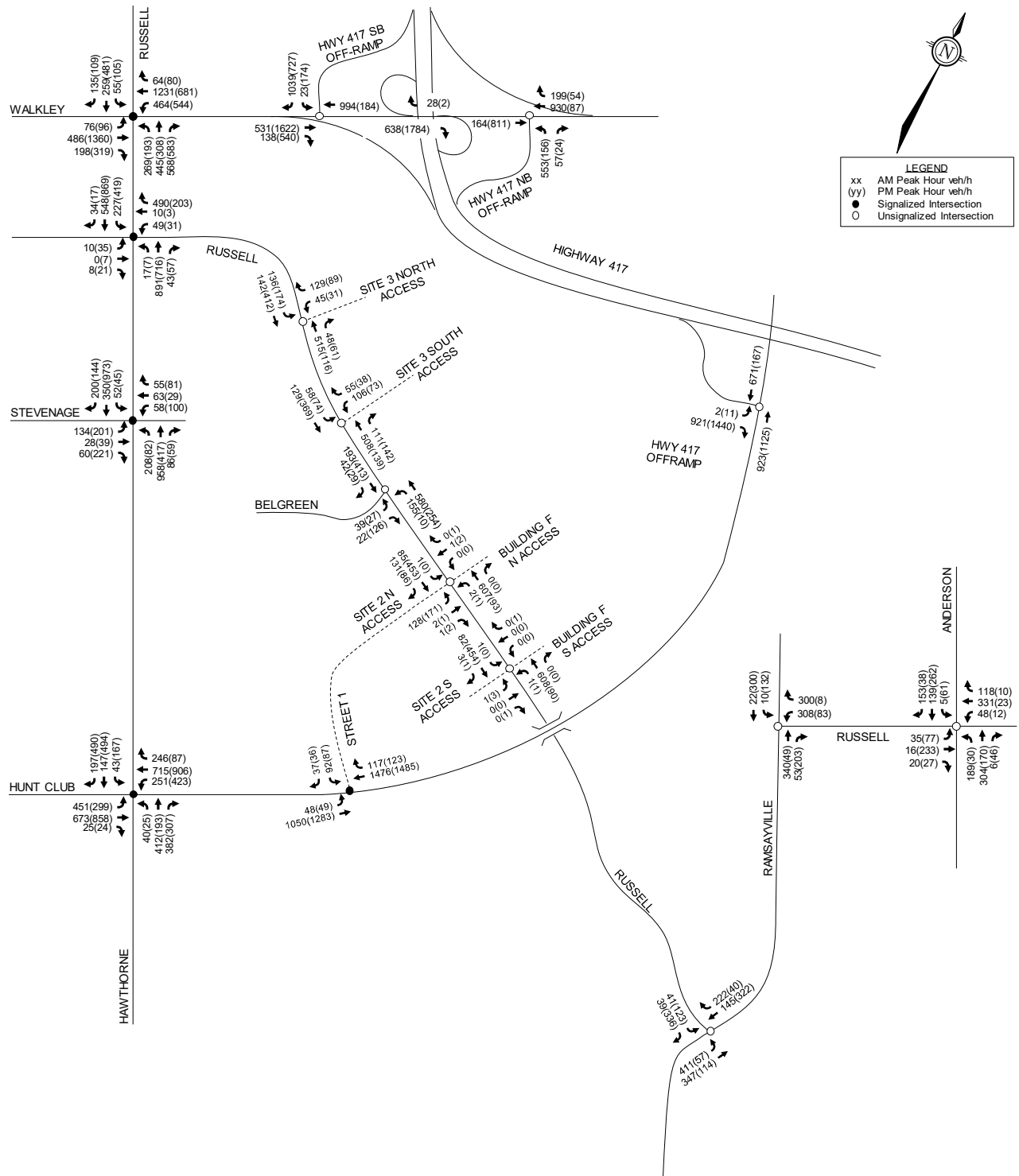

Figure 11: 2028 Total Traffic Volumes with Site Generated Trips

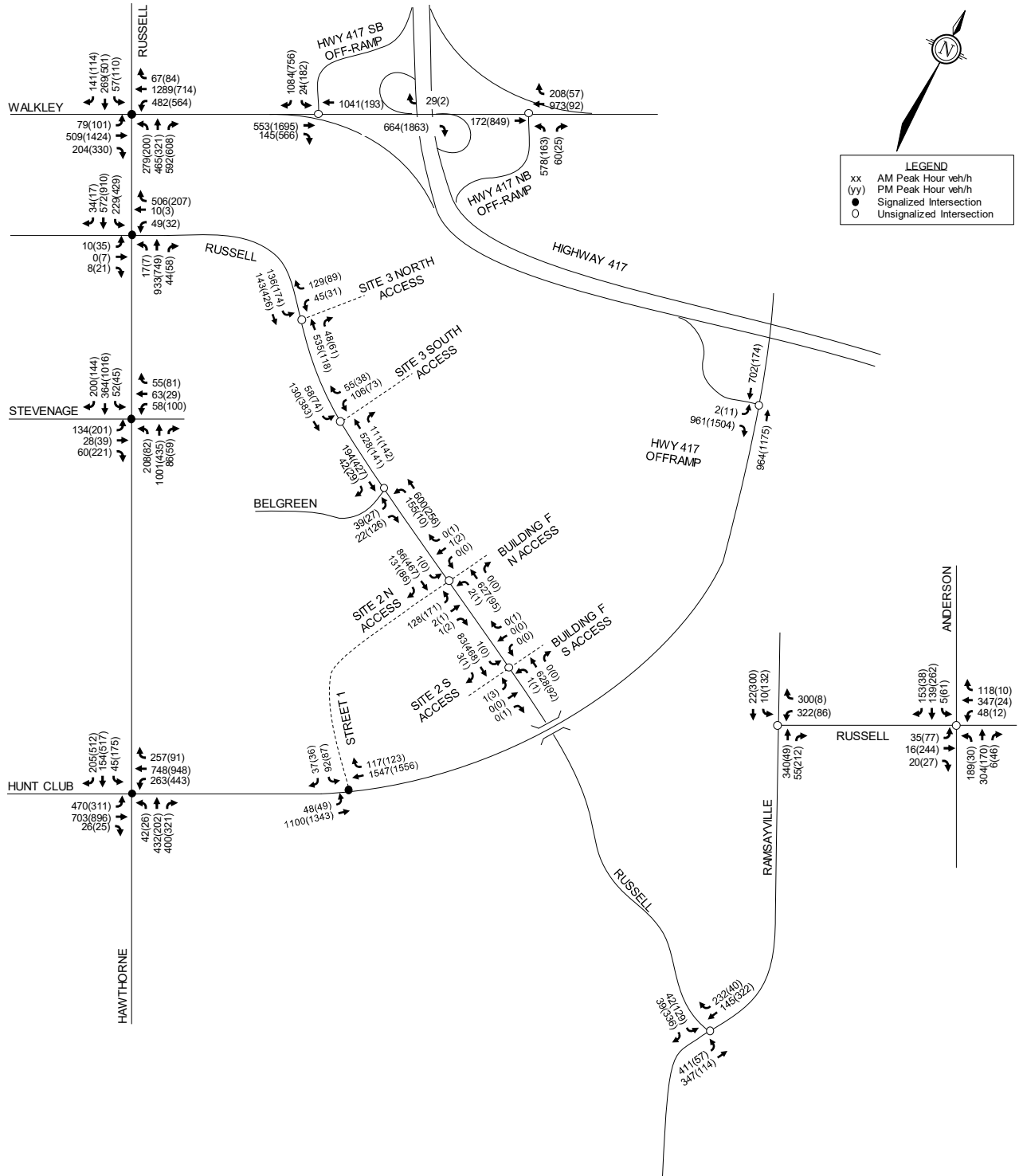
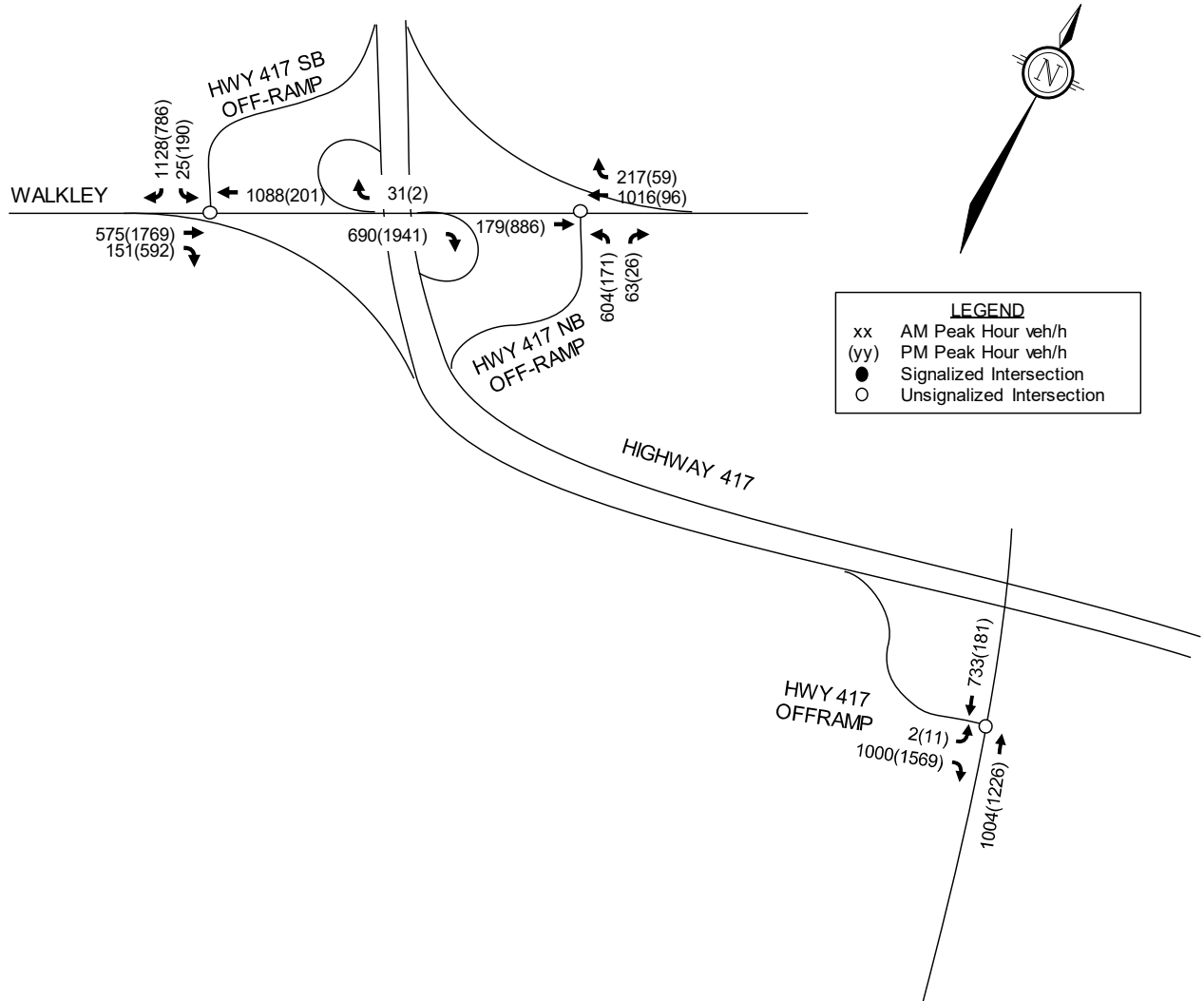

Figure 12: 2033 Total Traffic Volumes with Site Generated Trips



6.0 Analysis

6.1 Development Design

Conceptually, it is expected that pedestrian facilities will be provided between each building and the parking lots, to be reviewed at site plan for each site. New pedestrian walkways will be constructed, providing connectivity to Russell Road.

OC Transpo's service design guideline for peak period service is to provide service within a five minute (400m) walk of the home, school and work location of 95% of urban residents. The existing bus stops near the subject sites are described in **Section 4.1.3**.

Stops #3336 and 3339 are located in front of Buildings A and B. Stops #3335 and 3340 are less than 400m to Buildings C, D, and F. The distance between the stops and Building E is about 650m. Actual walking distance between exterior access doors and the transit stops will be measured and reviewed at site plan submission.

Each development block includes two connections to Russell Road to separate trucks and employees and have been aligned with opposing driveways where possible. Connections will be further reviewed at site plan.

Onsite turning paths of heavy vehicles and review of garbage collection and fire routes will also be reviewed at site plan.

6.2 Parking

The subject site is located in Area C on Schedule 1 and 1A of the City of Ottawa's ZBL. Minimum vehicular parking rates (0.8 / 100 m²) and bicycle parking rates (1 / 100 m²) for light industrial development are identified in the ZBL. The concept plan indicates sufficient vehicular parking within each of sites 1, 2, and 3, and the vehicular, accessible, and bicycle parking requirements for each building will be confirmed with the site plan submissions.

Minimum vehicle loading for light industrial are identified in the ZBL and indicate that for warehouse / light industrial uses, 1 space is required for buildings up to 9,999 m², 2 spaces are required for sites up to 24,999 m², and 3 spaces are required for sites over 25,000m². Each building exceeds these minimum requirements, and this will be confirmed at site plan submission.

6.3 Boundary Streets

Schedule 'B' of the City of Ottawa's Official Plan indicates the site is in an Urban Employment Area. Targets for pedestrian level of service (PLOS), bicycle level of service (BLOS), and truck level of service (TkLOS) for Russell Road and Hunt Club Road reflect those outlined for an arterial road located within an employment area in Exhibit 22 of the MMLOS guidelines. Since neither boundary street is identified as a transit priority corridor, the transit level of service (TLOS) has not been evaluated. The Segment PLOS, BLOS, and TkLOS and associated targets for Russell Road and Hunt Club Road are summarized in

Table 6. Details on the Segment MMLOS are included in **Appendix G**.

Table 6: Segment MMLOS Summary

Intersection	PLOS	BLOS	TkLOS
Russell Road	F	F	C
Target	C	E	B
Hunt Club Road	F	E	A
Target	C	C	B

The PLOS along both Russell Road and Hunt Club Road fronting the site is currently failing. Both streets have 80km/h posted speed limits fronting the site and more than 3,000 vehicles per day AADT. Even if sidewalk were installed, the highest attainable PLOS score for each roadway is D due to the roadway speed and volume. Hunt Club Road fronting the site currently only leads to the Highway 417 ramps and has no pedestrian destinations. If Russell Road in this area is urbanized in the future and a reduced operating speed of 60km/h (posted 50km/h) is achieved, the City could include 2m sidewalk with 2m boulevard to achieve the PLOS target.

The BLOS along both Russell Road and Hunt Club Road fronting the site is currently failing. Without physically separated bikeways, the highest attainable BLOS score on both roadways is E due to the high operating speed. Hunt Club Road fronting the site currently only leads to the Highway 417 ramps and has no cycling destinations. The addition of on-street bicycle lanes along Russell Road would achieve the City’s BLOS target for that street. This is identified for the City’s consideration pending funding.

The TkLOS along Russell Road fronting the site misses the target B. To achieve the target TkLOS of B, 3.7m wide lanes are required. The existing gravel shoulders are approximately 2.5m. The City may wish to consider paving an additional 0.5m on either side of the road.

6.4 Access Intersections

The proposed development will be served by seven connections, six to Russell Road and one to Hunt Club Road. Each Russell Road driveway is intended to be STOP controlled with free flow traffic on Russell Road.

Signals are required at the connection to Hunt Club based on high approach intersection delay (See **Table 10**). The Street 1 connection to Hunt Club Road is proposed approximately 250m east of the Hydro Ottawa (signalized) access road. The location and ultimate functional design of this intersection have been agreed by the City of Ottawa in a tri-party agreement with NCC and Hydro Ottawa in 2016.

The driveway configurations with respect to design guidelines and requirements of the City’s Private Approach By-law will be reviewed at site plan submission for each site, however the following are noted:

- The Transportation Association of Canada (TAC) outlines minimum clear throat lengths for driveways based on the land use, development size, and type of roadway. For the proposed building sizes, the clear throat requirements are:
 - 60m for driveways to Building A (60m is provided);
 - 30m for driveways to Sites 1 and 2 (30m is provided);

- 15m for driveways to Building F (15m is provided for the south driveway, 10m is provided at the north driveway, this will be reviewed at site plan submission);
- Section 25 (a) of the City's Private Approach By-Law identifies a maximum number of private approaches that can be provided, based on the amount of frontage. With about 1350m of frontage for Site 1 (east side of Russell Road) and about 205m of frontage for Sites 2 and 3 (west side of Russell Road) the number of proposed accesses meets the by-law.
- Section 25 (m) of the *Private Approach By-Law* identifies a minimum driveway spacing along arterial and major collector roads. Each driveway has a spacing in excess of 60m, meeting this by-law requirement.
- The Stopping Sight Distance (SSD) along a 90 km/h design speed is 155.5m. Available SSD is expected to be greater than 200m at each driveway and will be confirmed at site plan.
- The Turning Sight Distance (TSD) requirements for a left turning and right turning heavy vehicle from STOP on a two-lane roadway are 287.5m and 262.5m, respectively. The TSD has been reviewed at each proposed driveway location and sufficient (>300m) TSD is available at each driveway and will be confirmed at site plan.

The Street 1 connection is 60m east of Hydro Ottawa's right-in, right-out (RIRO) driveway. Per the 2711 Hunt Club TIS, it is understood that Hydro's RIRO access may be closed with construction of the Street 1 access and a new connection provided between the Hydro Ottawa site and Street 1.

Each of the seven accesses (six to Russell Road and one to Hunt Club Road) meet the requirements of the City's Zoning By-law and Private Approach By-law and these will be reviewed with each site plan submission.

Traffic analysis of the driveway intersections is included in **Section 6.7**.

6.5 Transportation Demand Management

The TDM infrastructure and measures checklists will be prepared for each site plan submission once more information is known about the placement of bicycle parking and other site features. TDM measures could include:

- Display local area maps with walking/cycling access routes and key destinations at major entrances;
- Display relevant transit schedules and route maps at entrances;
- Provide online links to OC Transpo and STO information;
- Provide a dedicated ridematching portal at OttawaRideMatch.com; and,
- Provide a multimodal travel option information package for employees.

6.6 Transit

Based on the modal share presented in **Table 4**, the proposed development is anticipated to generate an additional 110 transit trips (60 in, 50 out) during the weekday AM peak hour and 111 transit trips (68 in, 43 out) during the weekday PM peak hour.

The City should consider providing additional transit service during the peak periods along Russell Road. The transit trips will be reviewed with each site plan submission.

6.7 Intersection Analysis

Signal warrants have been completed (See **Appendix I**) for the Anderson Road at Russell Road and Walkley Road at Northbound Off-ramp intersections with observed traffic volumes and indicate:

- **Anderson Road at Russell Road:** The intersection nearly warrants traffic signals based on Justification 3 (79/80) and warrants based on Justification 4. This analysis is based on observed traffic volumes without background growth or site traffic and the City of Ottawa should consider installing a roundabout at this intersection. The City of Ottawa's Roundabout Screening Tool was prepared (See **Appendix I**) for this intersection and recommends the City proceed with an Intersection Control Study. This analysis is based on existing conditions and is offered for the City's consideration.
- **Walkley Road at Northbound Off-ramp:** The intersection nearly warrants traffic signals based on Justification 3 (71/80) and warrants based on Justification 4. The available count was completed in 2015 and is quite a bit (about 40%) higher than the recent counts at the southbound off-ramp. Since it is not possible to conduct a representative count at this time due to COVID-19, when possible MTO should conduct a new traffic count to confirm the signal warrant. This analysis is based on observed traffic volumes without background growth or site traffic and MTO should consider signaling this intersection. This analysis is based on existing conditions and is offered for MTO's consideration.

Traffic analysis of both above intersections has been completed with the existing traffic control.

Left turn lane warrants (See **Appendix I**) has also been prepared for the site access as well as the Russell Road at Belgreen Drive intersection and indicate:

- Southbound left turn lanes are warranted on Russell Road at both accesses serving Building A with site generated trips;
- An eastbound left turn lane is warranted on Hunt Club Road at the Street 1 connection with site generated trips;
- Due to the low turning volumes, left turn lanes are not warranted on Russell Road at the access intersections for Sites 1 and 2 or Building F; and,
- A left turn lane is warranted on Russell Road at Belgreen Drive with the addition of site generated trips in the 5-year horizon. With low opposing volumes during the AM peak and low advancing volumes during the PM peak the left turn lane is not warranted without site development. As development progresses in the Russell Road corridor and with the addition of new site accesses, it is expected that the operating speed may decrease and the posted speed of 60 km/h further north on Russell Road should be extended. The warrant for this lane will be reviewed with each site plan submission.

Required RMAs for these potential modifications will be prepared at site plan when the details of the individual sites are known.

MMLOS analysis has been completed for the existing conditions using the methodology presented in the City of Ottawa's MMLOS Guidelines. Auto LOS (*Synchro 10*) analysis for the existing as well as the 2023, 2028, and 2033 peak periods without and with the addition of site generated trips are summarized in the following sections. Intersection parameters in the analysis are consistent with the TIA guidelines (saturation flow rate: 1800 vphpl, existing conditions Peak Hour Factor (PHF): 0.9, future conditions PHF: 1.0).

Since there are receiving lanes to accommodate the right turning traffic from the Highway 417 off-ramps along Walkley Road (Southbound ramp) and Hunt Club Road, the right turn channels for these ramps generally operate in free flow with delay and capacity constraints due to downstream merging with mainline through traffic. For the Hunt Club ramp, this receiving lane is continuous and does not require a merge except at downstream intersections over 1km away. For the below analysis, the volume-to-capacity ratios of the left turn movements is reported at these intersections. Analysis of these offramps and their right turn channels has been prepared using SimTraffic and is included in **Section 6.7.8** with results included in **Appendix J**.

6.7.1 Existing MMLOS

Identified and target PLOS, BLOS, TkLOS and Auto LOS for the study area signalized intersections are summarized in **Table 7**. Existing traffic signal timings are included in **Appendix H** and detailed MMLOS calculations are included in **Appendix F**.

Table 7: Intersection MMLOS Summary

Intersection	PLOS	BLOS	TkLOS	Auto LOS
Walkley at Russell	F	F	A	F
Target	C	C	B	D
Russell at Hawthorne	F	F	C	D
Target	C	C	B	D
Hawthorne at Stevenage	F	F	C	C
Target	C	C	D	D
Hunt Club at Hawthorne	F	F	A	F
Target	C	C	B	D
Russell at Belgreen ¹	-	-	-	C
Target	-	-	-	D
Hunt Club at Hwy 417 Off-ramp ¹	-	-	-	E
Target	-	-	-	D
Ramsayville at Russell (S) ¹	-	-	-	F
Target	-	-	-	D
Ramsayville at Russell (N) ¹	-	-	-	E
Target	-	-	-	D
Russell at Anderson ¹	-	-	-	F
Target	-	-	-	D
Walkley at Hwy 417 SB Off-ramp ¹	-	-	-	F
Target	-	-	-	D
Walkley at Hwy 417 NB Off-ramp ¹	-	-	-	F
Target	-	-	-	D

1. Unsignalized intersection, evaluated for Auto LOS only

6.7.1.1 Walkley Road / Russell Road

Walkley Road/Russell Road does not meet the target PLOS C, BLOS C, or Auto LOS D.

All approaches have a divided cross-section with a width equivalent to ten lanes crossed or more. There is limited opportunity in improving the PLOS at each approach without reducing the number of travel lanes or restricting turning movements. The level of comfort for pedestrians can be increased by implementing zebra-striped crosswalks. The east and west approaches meet the City's vehicle/pedestrian conflict threshold for zebra-striped crosswalks (greater than 400,000 vehicle/pedestrian conflicts over an eight-hour period). There is also limited opportunity in improving the delay score for pedestrians without incurring major delays for vehicles.

None of the approaches meet the target BLOS C based on both left and right turn characteristics. Given the high traffic volumes on both roadways, the existing right turn lanes and dual left turn lanes are required. Cyclists would be best served to perform turns at a different intersection. Therefore, no recommendations have been made in improving the BLOS at this intersection.

The northbound, eastbound, and westbound approaches do not meet the target Auto LOS D in the PM peak hour. The eastbound left turn movement in the PM peak can be improved to LOS D or better with signal timing adjustments at the expense of the westbound through movement. To achieve the target, a reduction in PM peak hour traffic volumes for the following movements are required (See **Appendix J**):

- Northbound right turn: reduction of approximately 130 vehicles;
- Eastbound through: reduction of approximately 165 vehicles;
- Westbound left turn: reduction of approximately 110 vehicles.

6.7.1.2 Russell Road / Hawthorne Road

Russell Road/Hawthorne Road does not meet the target PLOS C, BLOS C, or TkLOS B.

The north and south approaches both have a divided cross-section with widths equivalent to ten lanes crossed or more. The east and west approaches have auxiliary turn lanes and right turn channels with widths equivalent to 9 or more lanes crossed. There is limited opportunity in improving the PLOS at each approach without reducing the number of lanes. With lower left turning volumes at the eastbound and westbound approaches, consideration could be given to removing the left turn lanes on these approaches, however this would not improve the overall PLOS. Improving the delay scores for pedestrians crossing the north and south approaches would require reducing green time for the heavy northbound and southbound movements and is not desirable.

All approaches do not meet the target BLOS C based on right turn or both left and right turn characteristics. Given the high travel speeds along Hawthorne Road and Russell Road and the high traffic volumes along the north and south approaches, there is limited opportunity for improving the BLOS along the north and south approaches. With lower left turning volumes at the eastbound and westbound approaches, consideration could be given to removing the left turn lanes on these approaches.

The north and south approach misses the target TkLOS B, achieving a C. To achieve TkLOS B, a second receiving lane is required on the east and west approach, however, the TkLOS is close to meeting the City's target and large curb radii are provided to accommodate truck movements.

6.7.1.3 Hawthorne Road / Stevenage Drive

Hawthorne Road/Stevenage Drive does not meet the target PLOS C or BLOS C.

The north and south approaches both have a divided cross-section with widths equivalent to ten lanes crossed or more. The east and west approaches have auxiliary turn lanes and right turn channels with widths equivalent to 10 lanes crossed. There is limited opportunity in improving the PLOS at each approach without reducing the number of lanes. Improving the delay scores for pedestrians crossing the north and south approaches would require reducing green time for the heavy northbound and southbound movements and is not recommended.

All approaches do not meet the target BLOS C based on right turn and / or left turn characteristics. Given the high travel speeds along Hawthorne Road and the high traffic volumes along the north and south approaches, there is limited opportunity for improving the BLOS along the north and south approaches.

6.7.1.4 Hunt Club / Hawthorne Road

Hunt Club Road/Hawthorne Road does not meet the target PLOS C, BLOS C, or Auto LOS D.

All approaches have a divided cross-section with a width equivalent to ten lanes crossed or more. There is limited opportunity in improving the PLOS at each approach without reducing the number of travel lanes or restricting turning movements. There is also limited opportunity in improving the delay score for pedestrians without incurring major delays for vehicles.

All approaches do not meet the target BLOS C based on right turn and / or left turn characteristics. Given the high traffic volumes on both roadways, the existing right turn lanes and left turn lanes are required. Cyclists would be best served to perform turns at a different intersection. Therefore, no recommendations have been made in improving the BLOS at this intersection.

The northbound through and eastbound left movements do not meet the target Auto LOS D in the AM peak hour and the westbound left movement does not meet the target Auto LOS D in the PM peak hour. The installation of dual eastbound and westbound left turn lanes and signal timing adjustments to improve the northbound movement would improve the existing Auto LOS to D.

6.7.1.5 Unsignalized Intersections

The Hunt Club at Hwy 417 Off-ramp, Ramsayville at Russell (S), Ramsayville at Russell (N), Russell at Anderson, and both Walkley at Hwy 417 Off-ramp intersections operate with LOS E or F during either the AM or PM peak hour. Signalization warrants and improvement recommendations are identified in the subsequent sections

6.7.2 2023 Intersection Operations – Future Background Traffic

Intersection capacity analysis has been completed for the projected 2023 AM and PM peak hours with background traffic volumes (See **Figure 7**) are summarized in **Table 8**. Approaches where long queuing is expected are shown with the associated 50th and 95th percentile queue lengths in **Table 9**.

Existing signal timing plans obtained from the City of Ottawa are included in **Appendix H**. Detailed *Synchro 10* reports are included in **Appendix J**.

Table 8: 2023 Background Traffic - Intersection Operations

Intersection	AM Peak			PM Peak		
	Max. v/c or delay	LOS	Mvmt	Max. v/c or delay	LOS	Mvmt
Russell at Walkley	0.85	D	NBL	1.44	F	WBL
Russell at Hawthorne	0.80	C	WBR	0.42	A	SBL
Hawthorne at Stevenage	0.64	B	EBL	0.71	C	WBL
Hawthorne at Hunt Club	0.98	E	NBT	0.93	E	WBL
Russell at Belgreen ¹	16 sec	C	NB	12 sec	B	NB
Hunt Club at Hwy 417 Off-ramp ¹	32 sec	D	EBL	24 sec	C	EBL
Ramsayville at Russell (S) ¹	40 sec	E	EB	22 sec	C	EB
Ramsayville at Russell (N) ¹	26 sec	D	WB	12 sec	B	SB
Russell at Anderson ¹	41 sec	E	NB	15 sec	B	SB
Walkley at Highway 417 SB Off-ramp ¹	30 sec	D	SBL	49 sec	E	SBL
Walkey at Highway 417 NB Off-ramp ¹	226 sec	F	NB	31 sec	D	NB

1. Unsignalized intersection

Table 9: 2023 Background Traffic - Queuing

Intersection	Mvmt	AM Peak			PM Peak		
		v/c or Delay	50 th % Queue (m)	95 th % Queue (m)	v/c or Delay	50 th % Queue (m)	95 th % Queue (m)
Russell at Walkley	NBL	0.85	31	#51	0.66	18	28
	NBR	0.74	0	34	1.15	~109	#172
	EBL	0.63	20	36	1.39	~30	#63
	EBT	0.38	52	74	1.01	~169	#215
	WBL	0.79	54	67	1.44	~75	#105
	WBT	0.77	151	#208	0.44	57	71
Russell at Hawthorne	SBL	0.16	3	8	0.42	10	23
	WBR	0.80	24	50	0.32	0	11
Hawthorne at Hunt Club	NBT	0.98	~89	#133	0.81	35	54
	SBL	0.37	7	15	0.78	34	#59
	EBL	0.93	101	#167	0.85	63	#101
	EBT	0.59	69	100	0.85	105	134
	WBL	0.80	59	83	0.93	108	#176
	WBT	0.79	81	105	0.67	100	130
Walkley at 417 NB Ramp	NB	226 sec	-	210	31 sec	-	24

#: volume for the 95th percentile cycle exceeds capacity

~: approach is above capacity

The heavy left turning volume on the Hwy 417 NB ramp at Walkley Road yields a v/c ratio over MTO thresholds, indicating that geometric improvements should be considered. This ramp operates with very heavy NB and WB volumes during the AM peak hour and signalization should be considered.

This modification is also noted for existing conditions and is provided for MTO's consideration. The intersection improves to LOS C or better with the addition of signals (See signalized intersection analysis, **Appendix J**).

With the right turn channelized on the Hwy 417 SB ramp at Walkley Road, there is insufficient left turn volume to warrant signalization (67%, See **Appendix I**), however, signalization could be considered to improve the operations of the southbound left turning volume. This modification is provided for MTO's consideration. The SBL movement and overall intersection improves to LOS B, See **Appendix J**.

At Walkley Road/Russell Road, capacity issues are identified for the northbound right turn, eastbound left turn, eastbound through, and westbound left turn movements during the PM peak hour. The Synchro analysis also identifies that the 95th-percentile northbound right turn queue length is greater than the approximately 120m auxiliary lane during the PM peak hour. To achieve the target in the PM peak hour, a reduction in PM peak hour traffic volumes for the following movements are required (See **Appendix J**):

- Northbound right turn: reduction of approximately 165 vehicles;
- Eastbound through: reduction of approximately 120 vehicles;
- Westbound left turn: reduction of approximately 140 vehicles.

At Hawthorne Road / Hunt Club Road, capacity issues were identified for the northbound through and eastbound left turn movements during the AM peak hour and for the westbound left turn movement during the PM peak hour. The Synchro analysis also identifies that the 95th-percentile eastbound left turn queue length during the AM peak hour is greater than the approximately 105m auxiliary lane and the 95th-percentile northbound westbound left turn queue length during the PM peak hour is greater than the approximately 65m auxiliary lane during the PM peak hour. The installation of dual eastbound and westbound left turn lanes would reduce this queue spillback and bring the intersection within City Guidelines. These added lanes are based on existing / background conditions and is provided for the City's consideration.

The Russell Road at Anderson Road intersection (LOS E during the AM peak hour) was found to warrant traffic signals (Justification 4) based on existing volumes and the City should consider installing a roundabout at this intersection, improving the LOS to B. This modification is based on existing conditions and is offered for the City's consideration.

The Ramsayville at Russell Road (S) intersection operates with LOS E but has residual capacity (v/c is about 0.35 or less). There are no recommended modifications for this intersection at this time.

6.7.3 2023 Intersection Operations – Total Traffic with Site Generated Trips

Intersection capacity analysis has been completed for the projected 2023 AM and PM peak hours with the addition of site generated trips (See **Figure 10**). The results of the analysis are summarized in **Table 10** for the weekday AM and PM peak hours. Approaches where long queuing is expected are shown with the associated 50th and 95th percentile queue lengths in **Table 11**.

Existing signal timing plans obtained from the City of Ottawa are included in **Appendix H**. Detailed *Synchro 10* reports are included in **Appendix J**.

Table 10: 2023 Total Traffic - Intersection Operations

Intersection	AM Peak			PM Peak		
	Max. v/c or delay	LOS	Mvmt	Max. v/c or delay	LOS	Mvmt
Russell at Walkley	1.05	F	NBL	1.73	F	WBL
Russell at Hawthorne	1.03	F	WBR	0.98	E	SBL
Hawthorne at Stevenage	0.64	B	EBL	0.71	C	WBL
Hawthorne at Hunt Club	1.02	F	EBL	0.93	E	WBL
Russell at Belgreen ¹	25 sec	C	NBLR	14 sec	B	NB
Hunt Club at Hwy 417 Off-ramp ¹	36 sec	E	EBL	26 sec	D	EBL
Ramsayville at Russell (S) ¹	64 sec	F	EB	27 sec	D	EB
Ramsayville at Russell (N) ¹	29 sec	D	WB	13 sec	B	SB
Russell at Anderson ¹	53 sec	F	NB	15 sec	B	EB
Walkley at Highway 417 SB Off-ramp ¹	32 sec	D	SBL	53 sec	F	SBL
Walkey at Highway 417 NB Off-ramp ¹	226 sec	F	NB	31 sec	D	NB
Hunt Club at Street 1	0.65	B	WBT	0.64	B	WBT
Hunt Club at Street 1 (Unsignalized) ¹	1011 sec	F	SB	Error	F	SB
Russell at Site 3 North Access ¹	23 sec	C	SBL	20 sec	C	SBL
Russell at Site 3 South Access ¹	22 sec	C	SB	16 sec	C	SB
Russell at Site 1 North Access ¹	24 sec	C	NB	20 sec	C	NB
Russell at Site 1 South Access ¹	15 sec	C	NB	13 sec	B	NB

1. Unsignalized intersection

Table 11: 2023 Total Traffic – Queuing

Intersection	Mvmt	AM Peak			PM Peak		
		v/c or Delay	50 th % Queue (m)	95 th % Queue (m)	v/c or Delay	50 th % Queue (m)	95 th % Queue (m)
Russell at Walkley	NBL	1.05	~41	#68	0.84	24	#42
	NBR	0.80	7	53	1.25	~133	#197
	EBL	0.63	20	36	1.39	~30	#63
	EBT	0.42	56	77	1.01	~169	#215
	WBL	0.81	64	77	1.73	~98	#128
	WBT	0.79	160	#208	0.44	57	71
Russell at Hawthorne	SBL	0.82	25	#70	0.98	42	#118
	WBR	1.03	~60	#114	0.51	0	14
Hawthorne at Hunt Club	NBT	0.99	~89	#133	0.81	35	54
	SBL	0.37	7	15	0.79	34	#60
	EBL	1.02	~120	#187	0.91	76	#129
	EBT	0.63	76	109	0.88	114	#152
	WBL	0.80	59	83	0.93	108	#176
	WBT	0.82	86	112	0.73	107	137
Walkley at 417 NB Ramp	NB	226 sec	-	210	31 sec	-	24

#: volume for the 95th percentile cycle exceeds capacity

~: approach is above capacity

Based on the previous tables and compared to the 2023 background traffic conditions, increases in v/c ratios and queue lengths at the Russell / Walkley and Hawthorne / Hunt Club intersections are anticipated, as a result of increased traffic generated by the proposed development.

Signal timing adjustments could be made to improve the NBL movement during the AM peak hour at the Russell Road at Walkley Road intersection and bring the intersection within City Guidelines during the AM peak hour (See **Appendix J**). To achieve the target in the PM peak hour, a reduction in PM peak hour traffic volumes for the following movements are required (See **Appendix J**):

- Northbound right turn: reduction of approximately 190 vehicles;
- Eastbound through: reduction of approximately 120 vehicles;
- Westbound left turn: reduction of approximately 235 vehicles.

With the signalized Street 1 connection to Hunt Club it is expected that minimal to no site traffic will be added to the Walkley Road at 417 NB Off-ramp intersection. The operation of that intersection (overall LOS C) with traffic signals is included in **Appendix J**.

It is expected that minimal to no site traffic will be added to the southbound left movement at the 417 SB Off-ramp at Walkley Road. The operation of that intersection with traffic signals (overall LOS B) is included in **Appendix J**.

The Russell Road at Anderson Road intersection (LOS F during the AM peak hour) with All-Way STOP control improves to LOS C with construction of a roundabout (See **Appendix J**).

With installation of dual eastbound and westbound left turn lanes, the Hunt Club Road at Hawthorne Road intersection is expected to operate within City Guidelines with added site generated trips.

The Ramsayville at Russell Road (S) intersection operates with LOS F but has residual capacity (v/c is about 0.60 or less). There are no recommended modifications for this intersection at this time.

A southbound left turn protected / permissive phase should be added to the Russell at Hawthorne intersection to accommodate site generated trips and bring the intersection to within City Guidelines (See **Appendix J**).

The signalized Street 1 connection to Hunt Club Road is expected to operate within City Guidelines with site generated trips. The STOP controlled site accesses (along Russell Road) are expected to operate with LOS 'C' or better under 2023 total traffic conditions.

6.7.4 2028 Intersection Operations – Future Background Traffic

Intersection capacity analysis has been completed for the projected 2028 AM and PM peak hours with background traffic volumes for the weekday AM and PM peak hours (See **Figure 8**) and are summarized in **Table 12**. Approaches where long queuing is expected are shown with the associated 50th and 95th percentile queue lengths in **Table 13**.

Existing signal timing plans obtained from the City of Ottawa are included in **Appendix H**. Detailed *Synchro 10* reports are included in **Appendix J**.

Table 12: 2028 Background Traffic - Intersection Operations

Intersection	AM Peak			PM Peak		
	Max. v/c or delay	LOS	Mvmt	Max. v/c or delay	LOS	Mvmt
Russell at Walkley	0.89	D	NBL	1.50	F	WBL
Russell at Hawthorne	0.84	D	WBR	0.45	A	SBL
Hawthorne at Stevenage	0.64	B	EBL	0.71	C	WBL
Hawthorne at Hunt Club	1.03	F	NBT	0.98	E	WBL
Russell at Belgreen ¹	17 sec	C	NB	12 sec	B	NB
Hunt Club at Hwy 417 Off-ramp ¹	35 sec	D	EBL	25 sec	D	EBL
Ramsayville at Russell (S) ¹	42 sec	E	EB	22 sec	C	EB
Ramsayville at Russell (N) ¹	28 sec	D	WB	13 sec	B	SB
Russell at Anderson ¹	46 sec	E	NB	15 sec	B	SB
Walkley at Highway 417 SB Off-ramp ¹	33 sec	D	SBL	63 sec	F	SBL
Walkey at Highway 417 NB Off-ramp ¹	281 sec	F	NB	36 sec	E	NB

1. Unsignalized intersection

Table 13: 2028 Background Traffic - Queuing

Intersection	Mvmt	AM Peak			PM Peak		
		v/c or Delay	50 th % Queue (m)	95 th % Queue (m)	v/c or Delay	50 th % Queue (m)	95 th % Queue (m)
Russell at Walkley	NBL	0.89	32	#54	0.69	19	#31
	NBR	0.75	0	35	1.20	~121	#185
	EBL	0.64	21	37	1.46	~33	#66
	EBT	0.41	56	78	1.05	~193	#232
	WBL	0.79	56	70	1.50	~80	#111
	WBT	0.82	167	#225	0.46	60	75
Russell at Hawthorne	SBL	0.18	3	8	0.45	11	25
	WBR	0.84	28	#65	0.33	0	11
Hawthorne at Hunt Club	NBT	1.03	~102	#144	0.83	39	59
	SBL	0.38	8	16	0.83	36	#68
	EBL	0.98	~112	#178	0.87	67	#108
	EBT	0.63	75	106	0.88	115	#149
	WBL	0.82	62	87	0.98	~123	#188
	WBT	0.82	86	111	0.71	112	138
Walkley at 417 NB Ramp	NB	281 sec	-	245	36 sec	-	28

#: volume for the 95th percentile cycle exceeds capacity

~: approach is above capacity

Based on the previous tables and compared to the 2023 background traffic conditions, marginal increases in v/c ratios and queue lengths are anticipated as a result of background growth within the study area.

With signalization of the Walkley Road at 417 NB Off-ramp, that intersection is expected to operate with LOS C (See **Appendix J**).

With signalization of the Walkley Road at 417 SB Off-ramp, that intersection is expected to operate with LOS B (See **Appendix J**).

The Russell Road at Anderson Road intersection (LOS E during the AM peak hour) with All-Way STOP control improves to LOS C with construction of a roundabout (See **Appendix J**).

With installation of dual eastbound and westbound left turn lanes, the Hunt Club Road at Hawthorne Road is expected to operate within City Guidelines.

The Ramsayville at Russell Road (S) intersection operates with LOS F but has residual capacity (v/c is about 0.35 or less). There are no recommended modifications for this intersection at this time.

6.7.5 2028 Intersection Operations – Total Traffic with Site Generated Trips

Intersection capacity analysis has been completed for the 2028 AM and PM peak hours with the addition of site generated trips (See **Figure 11**). The results of the analysis are summarized in **Table 14** for the weekday AM and PM peak hours. Approaches where long queuing is expected are shown with the associated 50th and 95th percentile queue lengths in **Table 15**.

Existing signal timing plans obtained from the City of Ottawa are included in **Appendix H**. Detailed *Synchro 10* reports are included in **Appendix J**.

Table 14: 2028 Total Traffic - Intersection Operations

Intersection	AM Peak			PM Peak		
	Max. v/c or delay	LOS	Mvmt	Max. v/c or delay	LOS	Mvmt
Russell at Walkley	1.09	F	NBL	1.79	F	WBL
Russell at Hawthorne	1.08	F	WBR	1.05	F	SBL
Hawthorne at Stevenage	0.64	B	EBL	0.71	C	WBL
Hawthorne at Hunt Club	1.07	F	EBL	0.99	E	WBL
Russell at Belgreen ¹	26 sec	D	NBLR	14 sec	B	NB
Hunt Club at Hwy 417 Off-ramp ¹	39 sec	E	EBL	28 sec	D	EBL
Ramsayville at Russell (S) ¹	67 sec	F	EB	28 sec	D	EB
Ramsayville at Russell (N) ¹	32 sec	D	WB	13 sec	B	SB
Russell at Anderson ¹	56 sec	F	NB	15 sec	B	SB
Walkley at Highway 417 SB Off-ramp ¹	35 sec	D	SBL	69 sec	F	SBL
Walkey at Highway 417 NB Off-ramp ¹	281 sec	F	NB	36 sec	E	NB
Hunt Club at Street 1	0.68	B	WBT	0.67	B	WBT
Russell at Site 3 North Access ¹	24 sec	C	SBL	21 sec	C	SBL
Russell at Site 3 South Access ¹	23 sec	C	SB	16 sec	C	SB
Russell at Site 1 North Access ¹	25 sec	D	NB	21 sec	C	NB
Russell at Site 1 South Access ¹	16 sec	C	NB	13 sec	B	NB

1. Unsignalized intersection

Table 15: 2028 Total Traffic - Queuing

Intersection	Mvmt	AM Peak			PM Peak		
		v/c or Delay	50 th % Queue (m)	95 th % Queue (m)	v/c or Delay	50 th % Queue (m)	95 th % Queue (m)
Russell at Walkley	NBL	1.09	~44	#72	0.87	24	#44
	NBR	0.83	14	70	1.30	~145	#210
	EBL	0.64	21	37	1.46	~33	#66
	EBT	0.45	60	82	1.05	~193	#232
	WBL	0.82	66	79	1.79	~103	#135
	WBT	0.83	172	#225	0.46	60	75
Russell at Hawthorne	SBL	0.88	27	#73	1.05	~52	#75
	WBR	1.08	~70	#125	0.52	0	14
Hawthorne at Hunt Club	NBT	1.04	~102	#144	0.83	39	59
	SBL	0.38	8	16	0.83	36	#68
	EBL	1.07	~130	#198	0.94	81	#137
	EBT	0.67	81	#117	0.92	124	#163
	WBL	0.82	62	87	0.99	~123	#188
	WBT	0.85	92	#123	0.77	118	145
Walkley at 417 NB Ramp	NB	281 sec	-	245	36 sec	-	28

#: volume for the 95th percentile cycle exceeds capacity
 ~: approach is above capacity

Based on the previous tables and compared to the 2028 background traffic conditions, increases in v/c ratios and queue lengths within the study area are anticipated, as a result of increased traffic generated by the proposed development.

With the signalized Street 1 connection to Hunt Club it is expected that minimal to no site traffic will be added to the Walkley Road at 417 NB Off-ramp intersection. The operation of that intersection (overall LOS C) with traffic signals is included in **Appendix J**.

It is expected that minimal to no site traffic will be added to the southbound left movement at the 417 SB Off-ramp at Walkley Road. The operation of that intersection with traffic signals (overall LOS C) is included in **Appendix J**.

The Russell Road at Anderson Road intersection (LOS F during the AM peak hour) with All-Way STOP control improves to LOS D with construction of a roundabout (See **Appendix J**).

The Ramsayville at Russell Road (S) intersection operates with LOS F but has residual capacity (v/c is about 0.61). There are no recommended modifications for this intersection at this time.

With the signal timing adjustments during the AM peak identified for the 2023 Total Traffic at the Russell Road at Walkley intersection, that intersection would operate within City Guidelines during the AM peak hour with 2028 Total Traffic volumes (See **Appendix J**).

With the southbound left turn protected / permissive phase identified for the 2023 Total Traffic at the Russell at Hawthorne intersection, that intersection would operate within City Guidelines during the AM and PM peak hour with 2028 Total Traffic volumes (See **Appendix J**).

With installation of dual eastbound and westbound left turn lanes, the Hunt Club Road at Hawthorne Road is expected to operate within City Guidelines with 2028 Total Traffic volumes.

The signalized Street 1 connection to Hunt Club Road is expected to operate within City Guidelines. The STOP controlled site accesses (along Russell Road) are expected to operate with LOS 'C' or better under 2028 total traffic conditions.

6.7.6 2033 Intersection Operations – Future Background Traffic

Intersection capacity analysis has been completed for the projected 2033 AM and PM peak hours with background traffic volumes (See **Figure 9**) for the MTO intersections per the MTO General Guidelines for the Preparation of Traffic Impact Studies (December 2009) and is summarized in **Table 16** for the weekday AM and PM peak hours. Approaches where long queuing is expected are shown with the associated 50th and 95th percentile queue lengths in **Table 17**.

Existing signal timing plans obtained from the City of Ottawa are included in **Appendix H**. Detailed *Synchro 10* reports are included in **Appendix J**.

Table 16: 2033 Background Traffic - Intersection Operations

Intersection	AM Peak			PM Peak		
	Max. v/c or delay	LOS	Mvmt	Max. v/c or delay	LOS	Mvmt
Hunt Club at Hwy 417 Off-ramp ¹	38 sec	E	EBL	27 sec	D	EBL
Walkley at Highway 417 SB Off-ramp ¹	36 sec	E	SBL	83 sec	F	SBL
Walkey at Highway 417 NB Off-ramp ¹	342 sec	F	NB	44 sec	E	NB

1. Unsignalized intersection

Table 17: 2033 Background Traffic - Queuing

Intersection	Mvmt	AM Peak			PM Peak		
		v/c or Delay	50 th % Queue (m)	95 th % Queue (m)	v/c or Delay	50 th % Queue (m)	95 th % Queue (m)
Walkley at 417 NB Ramp	NB	342 sec	-	280	44 sec	-	34

#: volume for the 95th percentile cycle exceeds capacity

~: approach is above capacity

Based on the previous tables and compared to the 2028 background traffic conditions, marginal increases in v/c ratios and queue lengths are anticipated as a result of background growth within the study area.

With signalization of the Walkley Road at 417 NB Off-ramp, that intersection is expected to operate with LOS C (See **Appendix J**).

With signalization of the Walkley Road at 417 SB Off-ramp, that intersection is expected to operate with LOS C (See **Appendix J**).

6.7.7 2033 Intersection Operations – Total Traffic with Site Generated Trips

Intersection capacity analysis has been completed for the 2033 AM and PM peak hours with the addition of site generated trips at the MTO intersections per the MTO guidelines (See **Figure 12**). The results of the analysis are summarized in **Table 18** for the weekday AM and PM peak hours. Approaches where long queuing is expected are shown with the associated 50th and 95th percentile queue lengths in **Table 19**.

Existing signal timing plans obtained from the City of Ottawa are included in **Appendix H**. Detailed *Synchro 10* reports are included in **Appendix J**.

Table 18: 2033 Total Traffic - Intersection Operations

Intersection	AM Peak			PM Peak		
	Max. v/c or delay	LOS	Mvmt	Max. v/c or delay	LOS	Mvmt
Hunt Club at Hwy 417 Off-ramp ¹	43 sec	E	EBL	30 sec	D	EBL
Walkley at Highway 417 SB Off-ramp ¹	38 sec	E	SBL	92 sec	F	SBL
Walkey at Highway 417 NB Off-ramp ¹	342 sec	F	NB	44 sec	E	NB

1. Unsignalized intersection

Table 19: 2033 Total Traffic - Queuing

Intersection	Mvmt	AM Peak			PM Peak		
		v/c or Delay	50 th % Queue (m)	95 th % Queue (m)	v/c or Delay	50 th % Queue (m)	95 th % Queue (m)
Walkley at 417 NB Ramp	NB	342 sec	-	280	44 sec	-	34

#: volume for the 95th percentile cycle exceeds capacity
 ~: approach is above capacity

Based on the previous tables and compared to the 2033 background traffic conditions, increases in v/c ratios and queue lengths within the study area are anticipated, as a result of increased traffic generated by the proposed development.

With signalization of the Walkley Road at 417 NB Off-ramp, that intersection is expected to operate with LOS C (See **Appendix J**).

With signalization of the Walkley Road at 417 SB Off-ramp, that intersection is expected to operate with LOS C (See **Appendix J**).

6.7.8 Right Turn Channelized Highway Ramps – Traffic Analysis and Results

SimTraffic is a microscopic model used to simulate a wide variety of traffic controls. Each vehicle in the traffic system is individually tracked through the model and comprehensive operational measures of effectiveness are collected on every vehicle during each 0.1-second of the simulation. Unlike Synchro, SimTraffic measures the full impact of queuing and blocking.

Eleven 1-hour SimTraffic simulation runs have been prepared for each of the AM and PM peak hours with 2033 Total Traffic to analyze the operations of the Highway 417 off-ramps to Hunt Club Road and Walkley Road (SB ramp). This analysis considers the free flow channel and impacts of

downstream merging. The delay results of this SimTraffic analysis for the 2033 future background and total traffic scenarios are included in **Table 20** and **Table 21**, respectively. The merging queues along Hunt Club Road and Walkley Road downstream of these channels for the 2033 future background and total traffic scenarios are summarized in **Table 22** and **Table 23**, respectively. Detailed SimTraffic reports are included in **Appendix J**.

Table 20: 2033 Background Traffic – SimTraffic Delay Results

Intersection	AM Peak			PM Peak		
	Max. v/c or delay	LOS	Mvmt	Max. v/c or delay	LOS	Mvmt
Hunt Club at Highway 417 Off-ramp	4 secs	A	EBR	21 sec	C	EBR
Walkley at Highway 417 SB Off-ramp	3 secs	A	SBR	2 sec	A	SBR

Table 21: 2033 Total Traffic – SimTraffic Delay Results

Intersection	AM Peak			PM Peak		
	Max. v/c or delay	LOS	Mvmt	Max. v/c or delay	LOS	Mvmt
Hunt Club at Highway 417 Off-ramp	5 secs	A	EBR	71 sec	F	EBR
Walkley at Highway 417 SB Off-ramp	3 secs	A	SBR	2 sec	A	SBR

Table 22: 2033 Background Traffic – SimTraffic Merging Queue Results

Intersection	AM Peak			PM Peak		
	Average Queue (m)	95th % Queue (m)	Maximum Queue (m)	Average Queue (m)	95th % Queue (m)	Maximum Queue (m)
Hunt Club at Highway 417 Off-ramp	-	-	-	-	-	-
Walkley at Highway 417 SB Off-ramp	0.0	2	2	-	-	-

Table 23: 2033 Total Traffic – SimTraffic Merging Queue Results

Intersection	AM Peak			PM Peak		
	Average Queue (m)	95th % Queue (m)	Maximum Queue (m)	Average Queue (m)	95th % Queue (m)	Maximum Queue (m)
Hunt Club at Highway 417 Off-ramp	-	-	-	-	-	-
Walkley at Highway 417 SB Off-ramp	0	13	23	-	-	-

The SimTraffic analysis indicates that:

Hunt Club at Highway 417 Offramp:

- During the 2033 AM peak hour without and with added site generated trips, the right turn from the Highway 417 SB off-ramp onto Hunt Club Road will operate well. With a continuous lane along Hunt Club, merging is only required for lane selection at downstream intersections, about 1km away.
- During the 2033 PM peak hour, with projected right turning volume approaching or exceeding 1500 vehicles coming from the highway turning right to Hunt Club, the turn is approaching (or may exceed) its lane capacity without and with site generated trips.

- Consideration should be given to creating a wider radius channel to accommodate higher speeds around this turn or a second right turning lane may be required for this movement. This is identified for MTO's consideration.

Walkley at Highway 417 Offramp:

- During the 2033 AM and PM peak hours without and with added site generated trips, the right turn from the Highway 417 SB off-ramp onto Walkley Road will operate well.

7.0 Conclusions and Recommendations

Development Design and Parking

- Pedestrian facilities will be provided between the main buildings and the parking lots. New pedestrian walkways will be constructed, providing connectivity to Russell Road.
- The Transportation Demand Management (TDM) infrastructure and measures checklists will be prepared for each site plan submission.
- The conceptual vehicular parking spaces meet the requirements of the Zoning By-Law (ZBL) for each of the three sites. Vehicular, accessible, and bicycle parking requirements for each building will be confirmed with the site plan submissions.
- Stops #3336 and 3339 are located immediately in front of Buildings A and B. Stops #3335 and 3340 are less than 400m to Buildings C, D, and F. Building E is about 650m from the nearest bus stop. Walking distance between exterior access doors and the transit stops will be reviewed at site plan submission.
- Each building exceeds the minimum requirements of the ZBL for vehicle loading space, and this will be confirmed at site plan submission.

Boundary Street Multi-Modal Level of Service (MMLOS)

The results of the segment MMLOS analysis for Russell Road and Hunt Club Road can be summarized as follows:

- Both Russell Road and Hunt Club Road operate with a Pedestrian Level of Service (PLOS) F, missing the target PLOS C;
- Russell Road (F) and Hunt Club Road (E) miss the target Bicycle Level of Service (BLOS) of E and C, respectively;
- Russell Road (C) misses and Hunt Club Road (A) exceeds the target Truck Level of Service (TkLOS) of B; and,
- If the City urbanizes Russell Road in the future, sidewalk and onstreet bicycle lanes should be considered. The existing gravel shoulders are approximately 2.5m. The City may wish to consider paving an additional 0.5m on either side of the road.

Transit

- The proposed development is anticipated to generate an additional 110 transit trips (60 in, 50 out) during the weekday AM peak hour and 111 transit trips (68 in, 43 out) during the weekday PM peak hour.
- The City should consider providing additional transit service during the peak period. The transit trips will be reviewed with each site plan submission.

Access Design

- The proposed development will be served by a total of seven accesses. The accesses will be 7-9m wide, measured at the property line. The accesses meet the requirements of the

City's Private Approach By-law and provide adequate turning sight distance for heavy vehicles. Access design will be further reviewed with each site plan submission.

- Southbound left turn lanes are warranted along Russell Road at both accesses to Building A.
- An eastbound left turn lane is warranted along Hunt Club Road at the Street 1 connection.
- Left turn lanes are not warranted on Russell Road at the access intersections for Sites 1 and 2 or Building F.
- The Street 1 connection to Hunt Club Road should be signalized while the remaining connections operate well with STOP control.
- The signalized Street 1 connection to Hunt Club is proposed approximately 250m east of the Hydro Ottawa (signalized) Access. The location and ultimate functional design of this intersection have been agreed by the City of Ottawa in a tri-party agreement with NCC and Hydro Ottawa in 2016.
- The Street 1 connection is 60m east of Hydro Ottawa's right-in, right-out (RIRO) driveway. Per the 2711 Hunt Club TIS, it is understood that Hydro's RIRO access may be closed with construction of the Street 1 access and a new connection provided between the Hydro Ottawa site and Street 1.

Intersection MMLoS Analysis

- The Walkley at Russell and Hunt Club at Hawthorne intersections do not meet the target Auto LOS.
- Auto Level of Service:
 - The northbound, eastbound, and westbound approaches at the **Walkley Road / Russell Road** intersection do not meet the target Auto LOS D in the PM peak hour. The eastbound left turn movement in the PM peak can be improved to LOS D or better with signal timing adjustments at the expense of the westbound through movement. To achieve the target, a reduction in PM peak hour traffic volumes for the following movements are required:
 - Northbound right turn: reduction of approximately 130 vehicles;
 - Eastbound through: reduction of approximately 165 vehicles;
 - Westbound left turn: reduction of approximately 110 vehicles.
 - At the **Hunt Club Road / Hawthorne Road** intersection, the northbound through and eastbound left movements do not meet the target Auto LOS D in the AM peak hour and the westbound left movement does not meet the target Auto LOS D in the PM peak hour. The installation of dual eastbound and westbound left turn lanes and signal timing adjustments would improve the existing Auto LOS to D.
- In existing and future traffic conditions, capacity issues have been identified for the following movements:
 - Walkley Road/Russell Road
 - Northbound left turn (AM peak)
 - Northbound right turn (PM peak)
 - Eastbound left turn (PM peak)
 - Eastbound through (PM peak)
 - Westbound left turn (PM peak)
 - Russell Road/Hawthorne Road
 - Southbound left turn (AM and PM peak)
 - Westbound right turn (AM peak)
 - Hawthorne Road/Hunt Club Road

- Northbound through (AM peak)
- Eastbound left turn (AM and PM peak)
- Eastbound through (PM peak)
- Westbound left (PM peak)
- Walkley Road/Highway 417 NB Off-ramp
 - Northbound approach (AM peak)
- Walkley Road/Highway 417 SB Off-ramp
 - Southbound approach (PM peak)
- Russell Road/Anderson Road
 - Northbound approach (AM peak)
 - Westbound approach (AM peak)

Recommended Modifications

Several modifications have been identified for consideration. The need and timing will be confirmed at site plan submission. Functional designs of required road modifications to accommodate the development will be included in the site plan submissions. The modifications that have been identified for consideration are:

Existing/Background Traffic:

These modifications are identified for the City's/MTO's consideration without added site development.

- Install dual eastbound and westbound left turn lanes on Hunt Club Road at Hawthorne Road to improve the level of service and accommodate the existing and projected queues without and with site generated trips.
- Consider installation of a roundabout at the Russell Road/Anderson Road intersection to accommodate existing and projected traffic without and with site generated trips.
- Install traffic signals at the Walkley Road/Highway 417 northbound and southbound off-ramps to accommodate existing and projected traffic without and with site generated trips.
- Modify the right turn ramp for Highway 417 eastbound off-ramp onto Hunt Club Road with an increased radius or a second lane to accommodate projected traffic without and with site generated trips.

Site Traffic:

These modifications are identified to accommodate site generated trips.

- Install a left turn protected/permissive phase southbound on Russell Road at the Hawthorne intersection. This is expected to be required to accommodate site generated trips.
- Install southbound left turn lanes on Russell Road at both connections to the parcel hub (Civic #4055) to accommodate site generated trips.
- Install a northbound left turn lane on Russell Road at Belgreen Drive, warranted with site development. As development progresses in the Russell Road corridor and with the addition of new site accesses, it is expected that the operating speed may decrease and the posted speed of 60 km/h further north on Russell Road should be extended.
- Install an eastbound left turn lane and traffic signals at the Street 1 connection to Hunt Club Road to accommodate site generated trips.

Required Road Modification Approvals (RMA) for these potential modifications will be prepared at site plan when the details of the individual sites are known.

NOVATECH

Prepared by:



Patrick Hatton, P.Eng.
Project Manager | Transportation/Traffic

APPENDIX A

Concept Plan

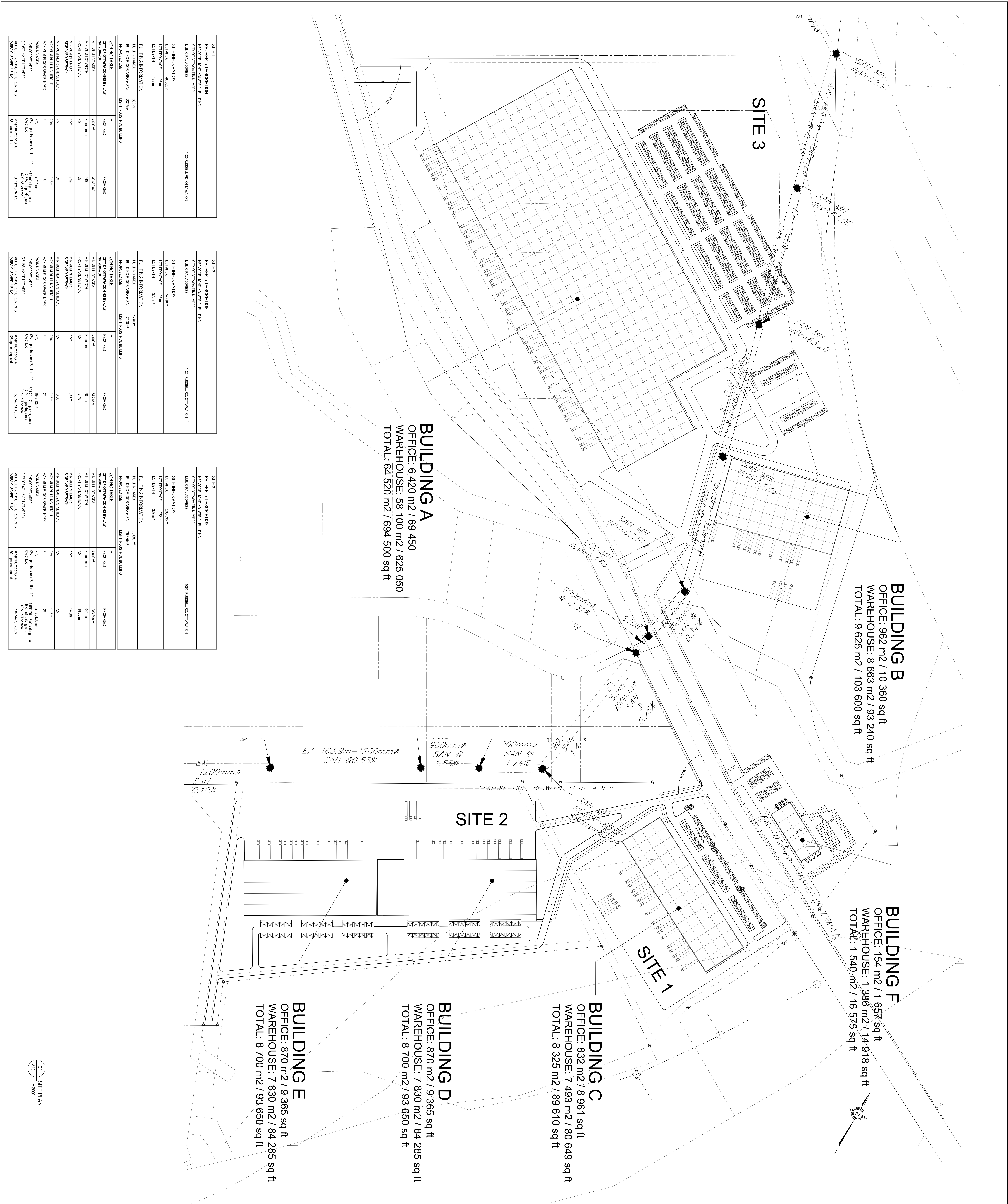

BUILDING B
 OFFICE: 962 m² / 10 360 sq ft
 WAREHOUSE: 8 663 m² / 93 240 sq ft
 TOTAL: 9 625 m² / 103 600 sq ft

BUILDING F
 OFFICE: 154 m² / 1 657 sq ft
 WAREHOUSE: 1 386 m² / 14 918 sq ft
 TOTAL: 1 540 m² / 16 575 sq ft

BUILDING C
 OFFICE: 832 m² / 8 961 sq ft
 WAREHOUSE: 7 493 m² / 80 649 sq ft
 TOTAL: 8 325 m² / 89 610 sq ft

BUILDING D
 OFFICE: 870 m² / 9 365 sq ft
 WAREHOUSE: 7 830 m² / 84 285 sq ft
 TOTAL: 8 700 m² / 93 650 sq ft

BUILDING E
 OFFICE: 870 m² / 9 365 sq ft
 WAREHOUSE: 7 830 m² / 84 285 sq ft
 TOTAL: 8 700 m² / 93 650 sq ft

BUILDING A
 OFFICE: 6 420 m² / 69 450
 WAREHOUSE: 58 100 m² / 625 050
 TOTAL: 64 520 m² / 694 500 sq ft

SITE 1	
PROPERTY DESCRIPTION	PROPOSED
PROPOSED BUILDING	PROPOSED
CITY OF OTTAWA NUMBER	4120 RUSSELL RD OTTAWA, ON
MUNICIPAL ADDRESS	4120 RUSSELL RD OTTAWA, ON
SITE INFORMATION	
LOT NUMBER	4828#
LOT FRONTAGE	48.28 m
LOT DEPTH	143 m
BUILDING INFORMATION	
BUILDING AREA	8238#
BUILDING FLOOR AREA (GFA)	8238#
PROPOSED USE	LIHT INDUSTRIAL BUILDING
ZONING TABLE	
No. of stories	2
MINIMUM LOT AREA	4000#
MINIMUM LOT WIDTH	No minimum
FRONT YARD SETBACK	7.5#
MINIMUM INTERIOR CLEARANCE	2.0#
MINIMUM SIDE YARD SETBACK	1.5#
MINIMUM REAR YARD SETBACK	1.5#
MAXIMUM BUILDING HEIGHT	25#
MAXIMUM FLOOR SPACE INDEX	2
PARKING AREA	18
LANDSCAPED AREA	42% of parking area
VEHICLE PARKING REQUIREMENTS	42% of lot area
VEHICLE PARKING REQUIREMENTS	42% of lot area
VEHICLE PARKING REQUIREMENTS	80 new spaces

SITE 2	
PROPERTY DESCRIPTION	PROPOSED
PROPOSED BUILDING	PROPOSED
CITY OF OTTAWA NUMBER	4120 RUSSELL RD OTTAWA, ON
MUNICIPAL ADDRESS	4120 RUSSELL RD OTTAWA, ON
SITE INFORMATION	
LOT NUMBER	1419#
LOT FRONTAGE	141.9#
LOT DEPTH	30#
BUILDING INFORMATION	
BUILDING AREA	1769#
BUILDING FLOOR AREA (GFA)	1769#
PROPOSED USE	LIHT INDUSTRIAL BUILDING
ZONING TABLE	
No. of stories	2
MINIMUM LOT AREA	4000#
MINIMUM LOT WIDTH	No minimum
FRONT YARD SETBACK	7.5#
MINIMUM INTERIOR CLEARANCE	2.0#
MINIMUM SIDE YARD SETBACK	1.5#
MINIMUM REAR YARD SETBACK	1.5#
MAXIMUM BUILDING HEIGHT	25#
MAXIMUM FLOOR SPACE INDEX	2
PARKING AREA	23
LANDSCAPED AREA	44.2% of parking area
VEHICLE PARKING REQUIREMENTS	44.2% of lot area
VEHICLE PARKING REQUIREMENTS	56% of lot area
VEHICLE PARKING REQUIREMENTS	196 new spaces

SITE 3	
PROPERTY DESCRIPTION	PROPOSED
PROPOSED BUILDING	PROPOSED
CITY OF OTTAWA NUMBER	4655 RUSSELL RD OTTAWA, ON
MUNICIPAL ADDRESS	4655 RUSSELL RD OTTAWA, ON
SITE INFORMATION	
LOT NUMBER	88#
LOT FRONTAGE	1.07#
LOT DEPTH	137#
BUILDING INFORMATION	
BUILDING AREA	75 668#
BUILDING FLOOR AREA (GFA)	75 668#
PROPOSED USE	LIHT INDUSTRIAL BUILDING
ZONING TABLE	
No. of stories	2
MINIMUM LOT AREA	4000#
MINIMUM LOT WIDTH	No minimum
FRONT YARD SETBACK	7.5#
MINIMUM INTERIOR CLEARANCE	2.0#
MINIMUM SIDE YARD SETBACK	1.5#
MINIMUM REAR YARD SETBACK	1.5#
MAXIMUM BUILDING HEIGHT	25#
MAXIMUM FLOOR SPACE INDEX	2
PARKING AREA	26
LANDSCAPED AREA	100% of parking area
VEHICLE PARKING REQUIREMENTS	100% of lot area
VEHICLE PARKING REQUIREMENTS	48% of lot area
VEHICLE PARKING REQUIREMENTS	74 new spaces

APPENDIX B

TIA Screening Form

City of Ottawa 2017 TIA Guidelines Screening Form

1. Description of Proposed Development

Municipal Address	4055 and 4120 Russell Road
Description of Location	Along Russell Road north of Hunt Club Overpass
Land Use Classification	Industrial
Development Size (units)	
Development Size (m ²)	~101,410m² of industrial (warehouse)
Number of Accesses and Locations	6 accesses to Russell Road (2 north of Belgreen Drive, 4 south of Belgreen Drive), 1 access to Hunt Club Road (east of Hydro Ottawa, future signalized Access)
Phase of Development	
Buildout Year	2023

If available, please attach a sketch of the development or site plan to this form.

2. Trip Generation Trigger

Considering the Development’s Land Use type and Size (as filled out in the previous section), please refer to the Trip Generation Trigger checks below.

Land Use Type	Minimum Development Size
Single-family homes	40 units
Townhomes or apartments	90 units
Office	3,500 m ²
Industrial	5,000 m ²
Fast-food restaurant or coffee shop	100 m ²
Destination retail	1,000 m ²
Gas station or convenience market	75 m ²

** If the development has a land use type other than what is presented in the table above, estimates of person-trip generation may be made based on average trip generation characteristics represented in the current edition of the Institute of Transportation Engineers (ITE) Trip Generation Manual.*

If the proposed development size is greater than the sizes identified above, the Trip Generation Trigger is satisfied.

3. Location Triggers

	Yes	No
Does the development propose a new driveway to a boundary street that is designated as part of the City’s Transit Priority, Rapid Transit or Spine Bicycle Networks?	✓	
Is the development in a Design Priority Area (DPA) or Transit-oriented Development (TOD) zone?*		✓

**DPA and TOD are identified in the City of Ottawa Official Plan (DPA in Section 2.5.1 and Schedules A and B; TOD in Annex 6). See Chapter 4 for a list of City of Ottawa Planning and Engineering documents that support the completion of TIA).*

If any of the above questions were answered with ‘Yes,’ the Location Trigger is satisfied.

4. Safety Triggers

	Yes	No
Are posted speed limits on a boundary street are 80 km/hr or greater?	✓	
Are there any horizontal/vertical curvatures on a boundary street limits sight lines at a proposed driveway?	✓	
Is the proposed driveway within the area of influence of an adjacent traffic signal or roundabout (i.e. within 300 m of intersection in rural conditions, or within 150 m of intersection in urban/ suburban conditions)?		✓
Is the proposed driveway within auxiliary lanes of an intersection?		✓
Does the proposed driveway make use of an existing median break that serves an existing site?	✓	
Is there is a documented history of traffic operations or safety concerns on the boundary streets within 500 m of the development?		✓
Does the development include a drive-thru facility?		✓

If any of the above questions were answered with ‘Yes,’ the Safety Trigger is satisfied.

5. Summary

	Yes	No
Does the development satisfy the Trip Generation Trigger?	✓	
Does the development satisfy the Location Trigger?	✓	
Does the development satisfy the Safety Trigger?	✓	

If none of the triggers are satisfied, the TIA Study is complete. If one or more of the triggers is satisfied, the TIA Study must continue into the next stage (Screening and Scoping).

APPENDIX C

OC Transpo System Information

47

HAWTHORNE ST-LAURENT

Local

Monday to Friday / Lundi au vendredi

Peak periods only

Périodes de pointe seulement

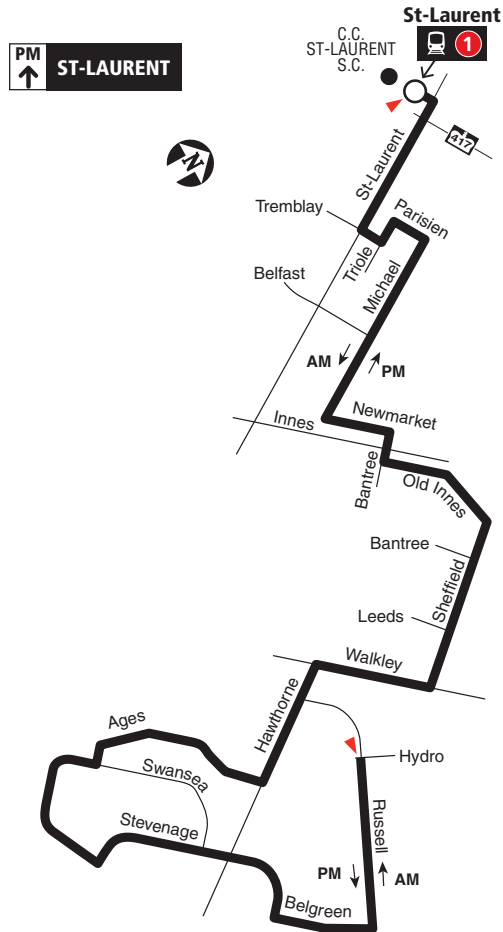

PM
↑
ST-LAURENT

AM
↓
HAWTHORNE

- Station
- ▲ Timepoint / Heures de passage

2019.06

Schedule / Horaire613-560-1000

Text / Texto560560

plus your four digit bus stop number / plus votre numéro d'arrêt à quatre chiffres

Customer Service

Service à la clientèle 613-741-4390

Lost and Found / Objets perdus..... 613-563-4011

Security / Sécurité 613-741-2478

Effective June 25, 2017

En vigueur 25 juin 2017



INFO 613-741-4390
octranspo.com



98

HAWTHORNE HURDMAN

Rapid^e

7 days a week / 7 jours par semaine

All day service
Service toute la journée

HURDMAN

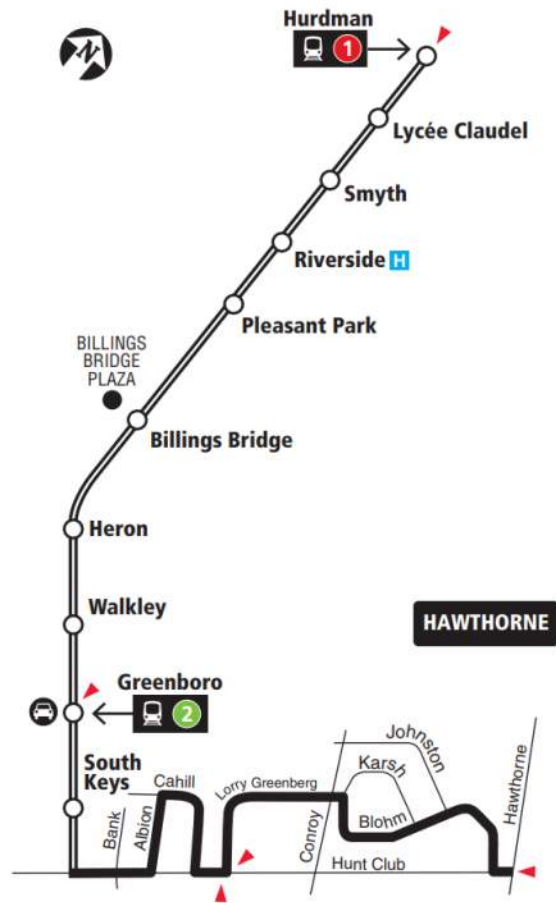

HAWTHORNE

- Transitway & Station
- Park & Ride | Parc-o-bus
- Timepoint | Heures de passage

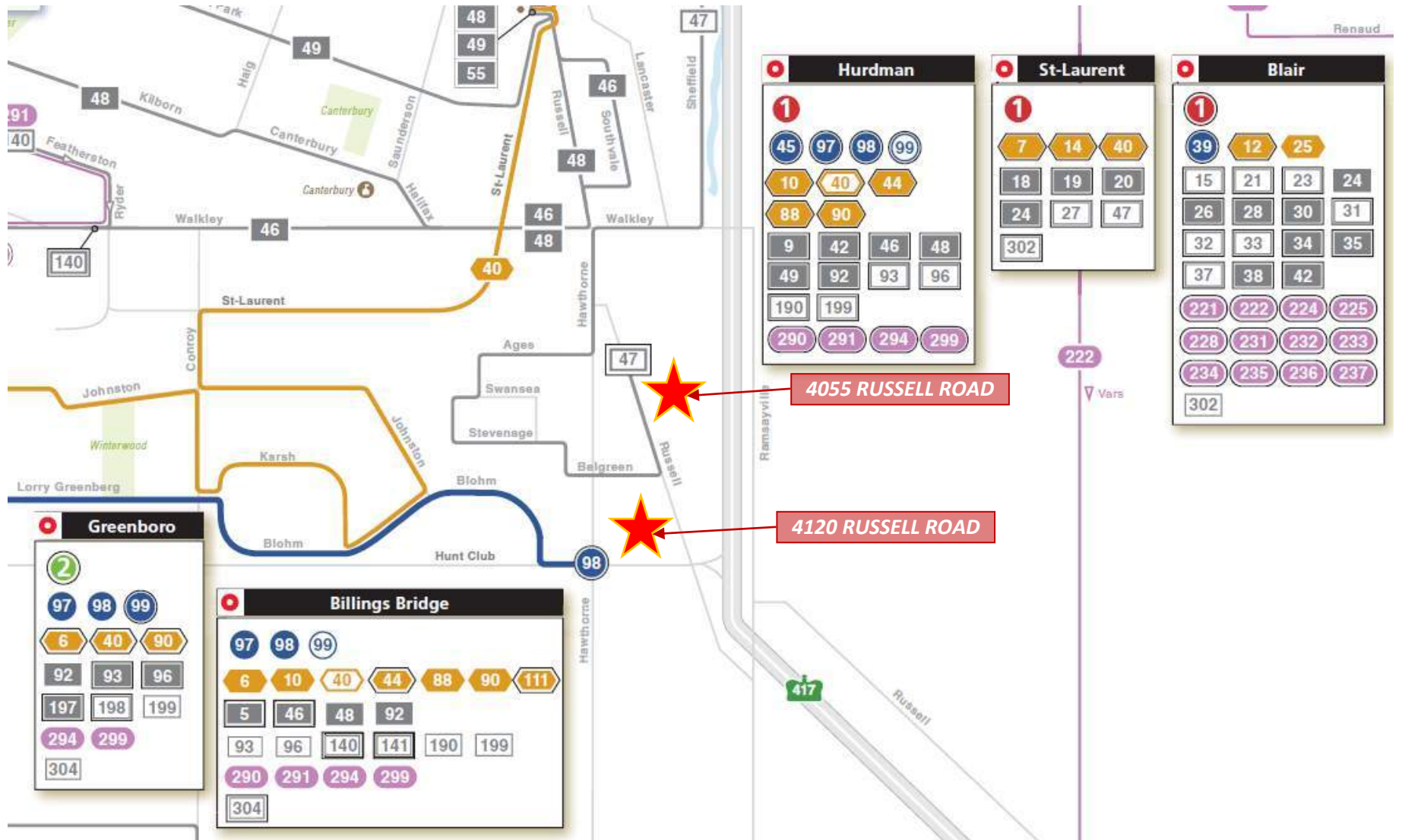

APPENDIX D

Traffic Count Data and Long-Range Snapshots

Transportation Services - Traffic Services

Turning Movement Count - Peak Hour Diagram HAWTHORNE RD/RUSSELL RD @ WALKLEY RD

Survey Date: Thursday, February 22, 2018

Start Time: 07:00

WO No: 37561

Device: Miovision

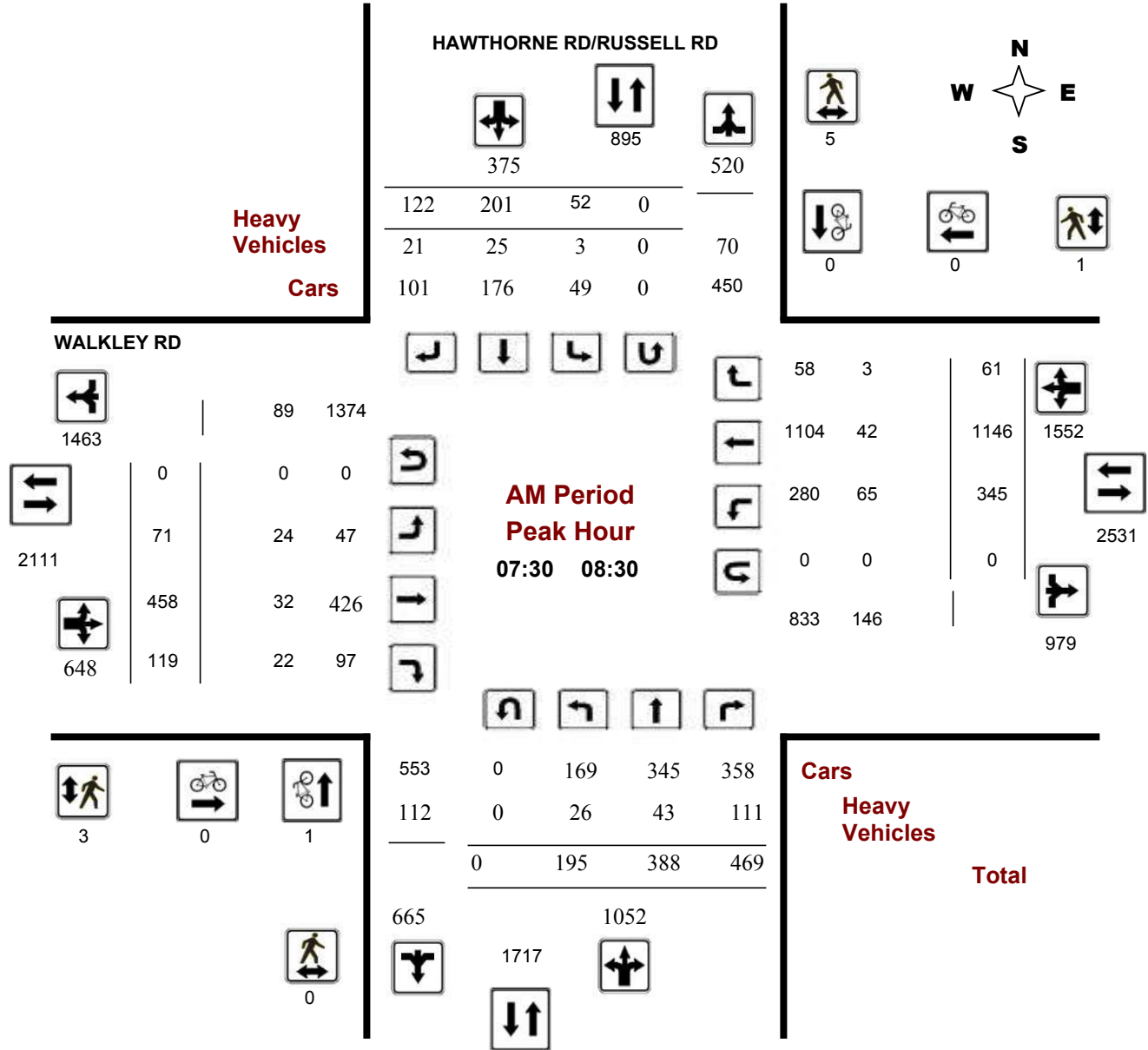

Comments

Turning Movement Count - Peak Hour Diagram

HAWTHORNE RD/RUSSELL RD @ WALKLEY RD

Survey Date: Thursday, February 22, 2018

Start Time: 07:00

WO No: 37561

Device: Miovision

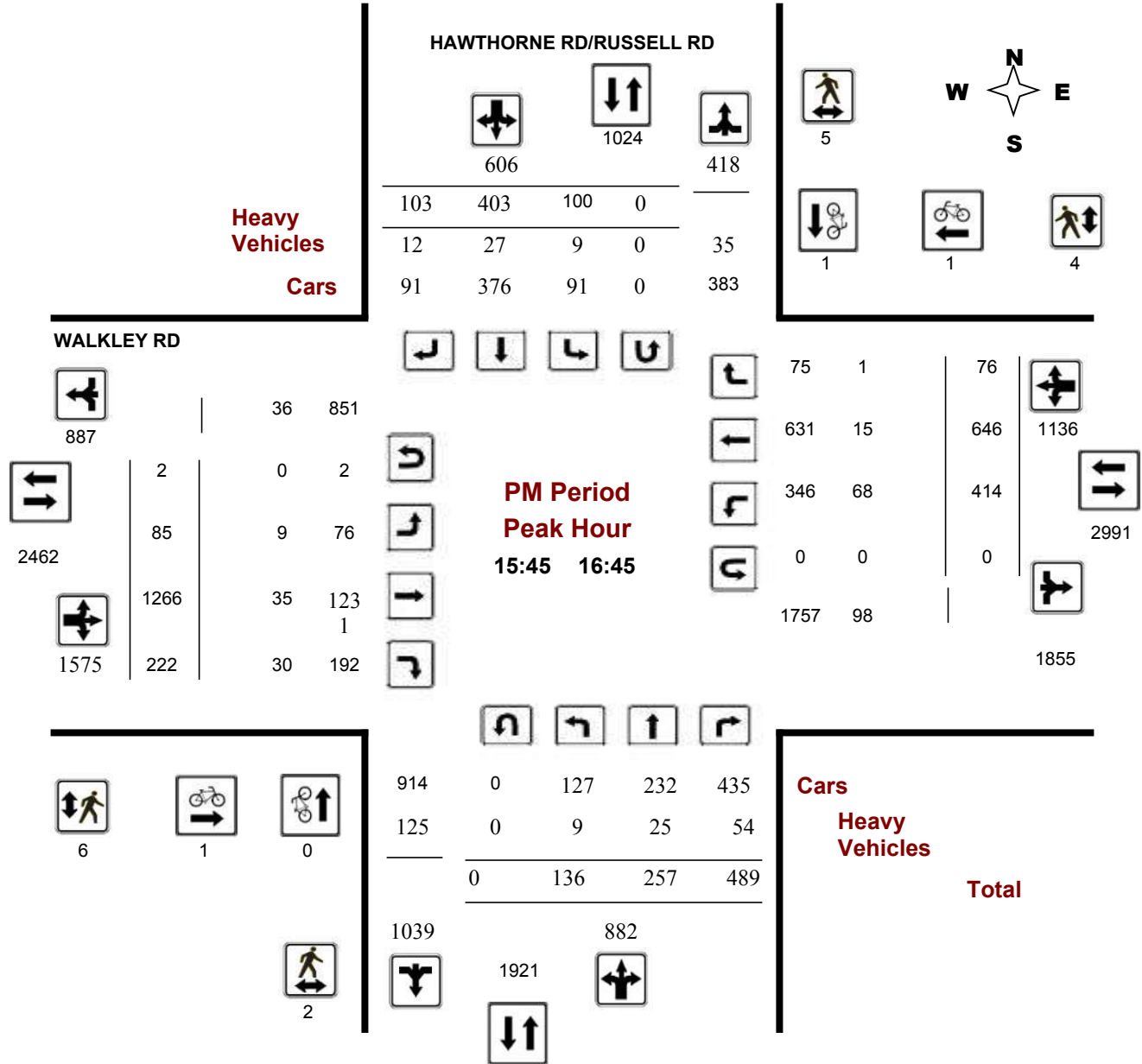

Comments



Transportation Services - Traffic Services

Turning Movement Count - Full Study Peak Hour Diagram

HAWTHORNE RD @ RUSSELL RD

Survey Date: Wednesday, January 30, 2019

Start Time: 07:00

WO No: 38330

Device: Miovision

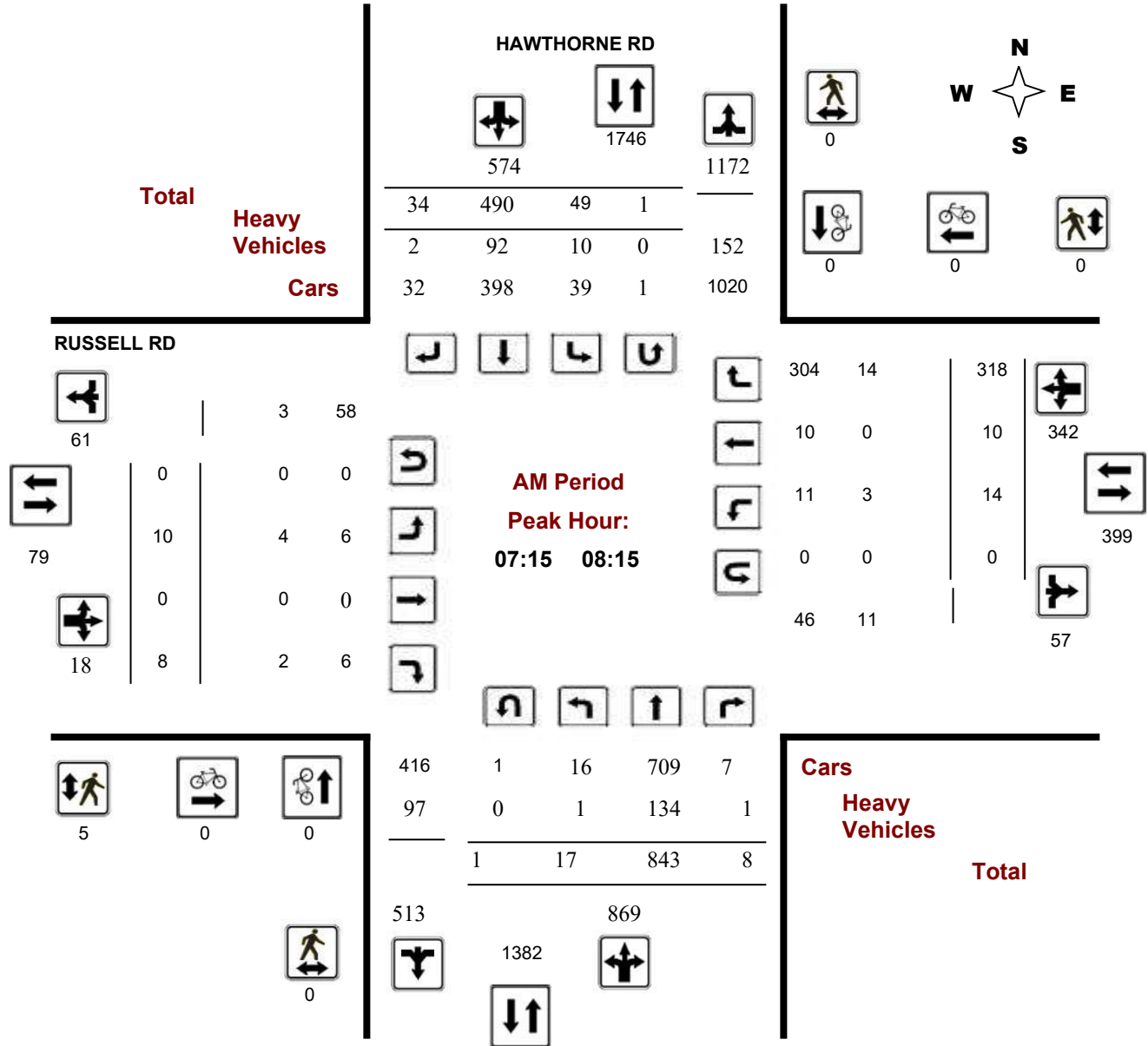

Comments



Transportation Services - Traffic Services

Turning Movement Count - Full Study Peak Hour Diagram

HAWTHORNE RD @ RUSSELL RD

Survey Date: Wednesday, January 30, 2019

Start Time: 07:00

WO No: 38330

Device: Miovision

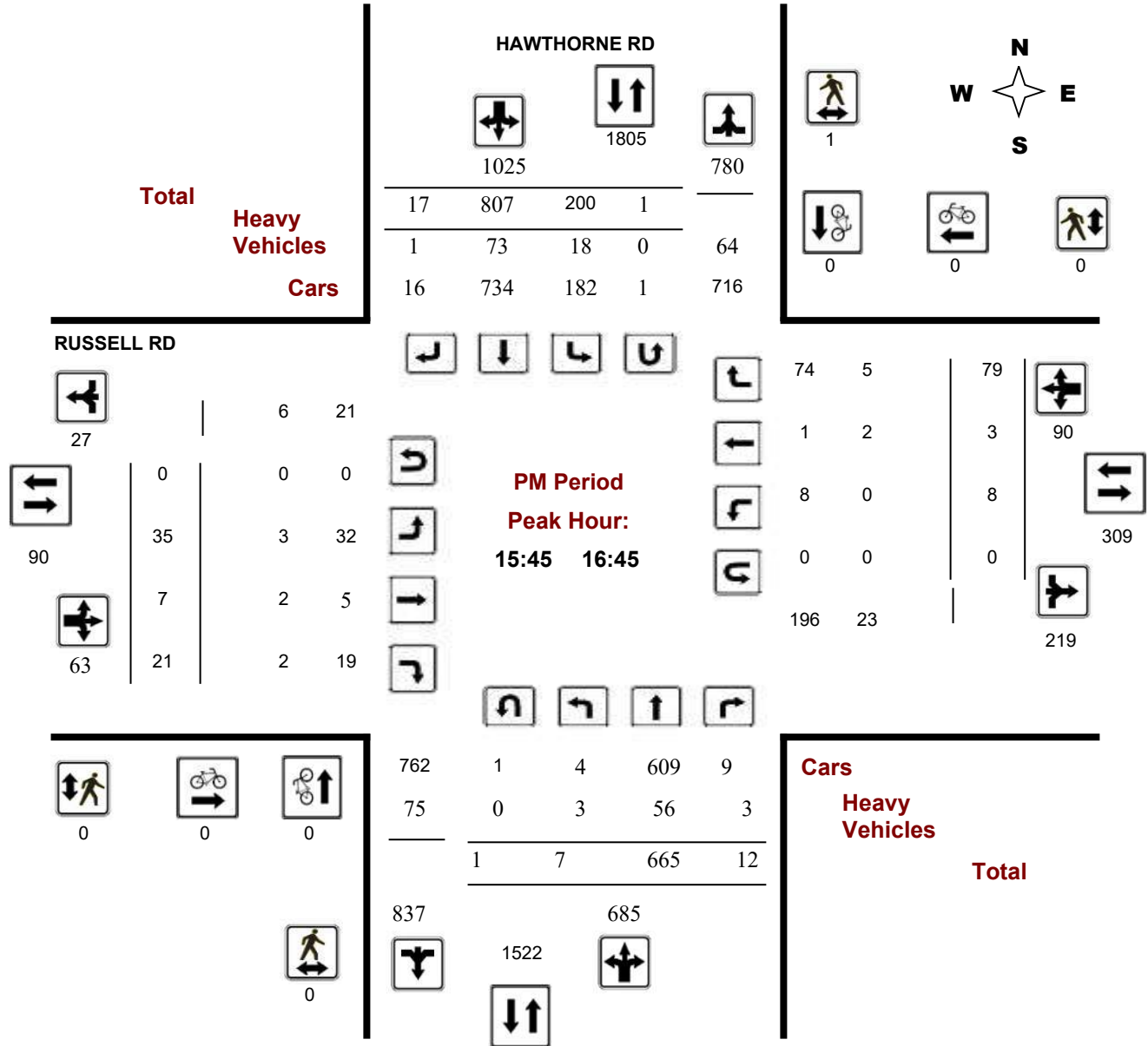



Transportation Services - Traffic Services

Turning Movement Count - Full Study Peak Hour Diagram

HAWTHORNE RD @ STEVENAGE DR

Survey Date: Wednesday, December 07, 2016

Start Time: 07:00

WO No: 36598

Device: Miovision

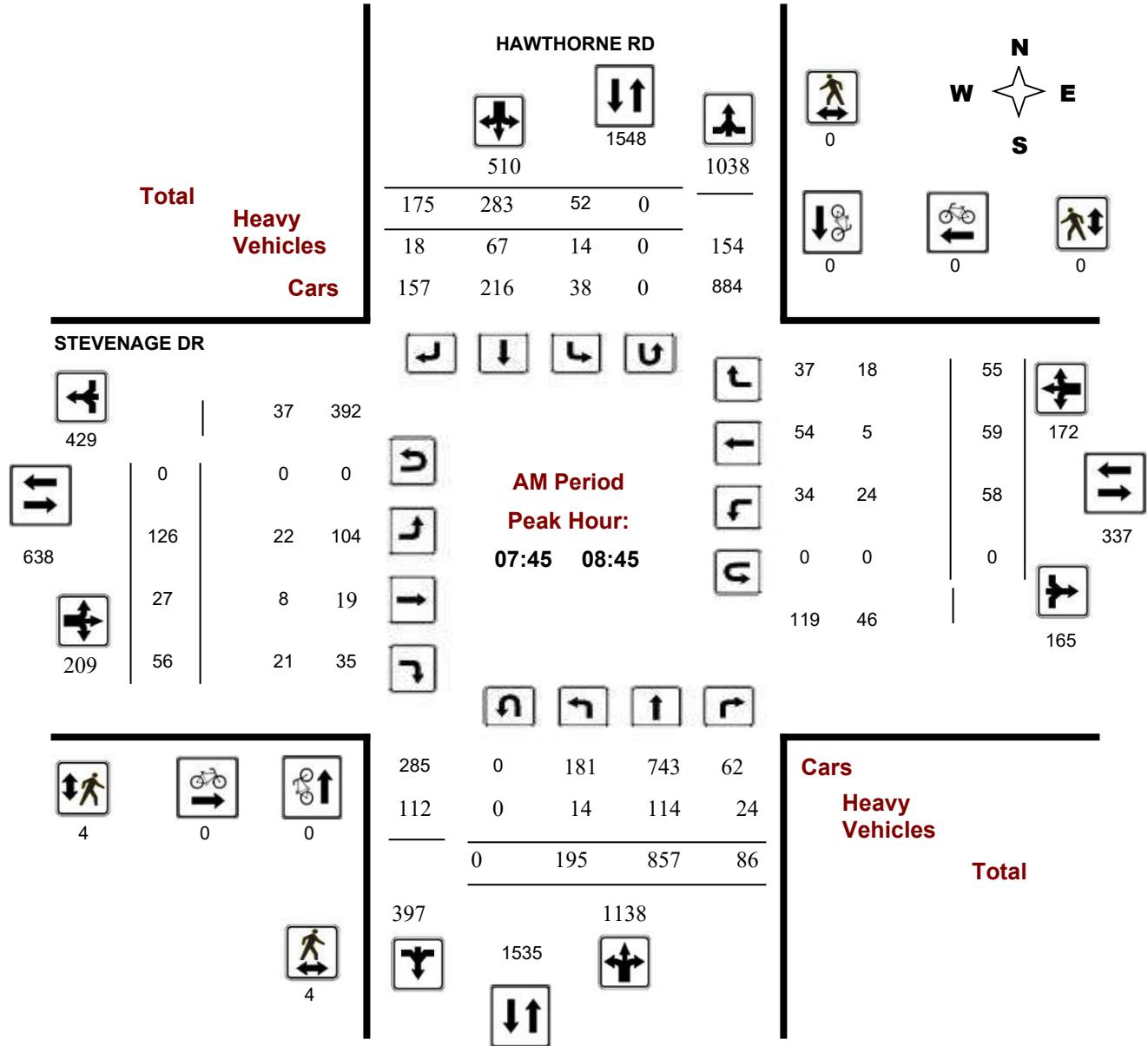



Transportation Services - Traffic Services

Turning Movement Count - Full Study Peak Hour Diagram

HAWTHORNE RD @ STEVENAGE DR

Survey Date: Wednesday, December 07, 2016

Start Time: 07:00

WO No: 36598

Device: Miovision

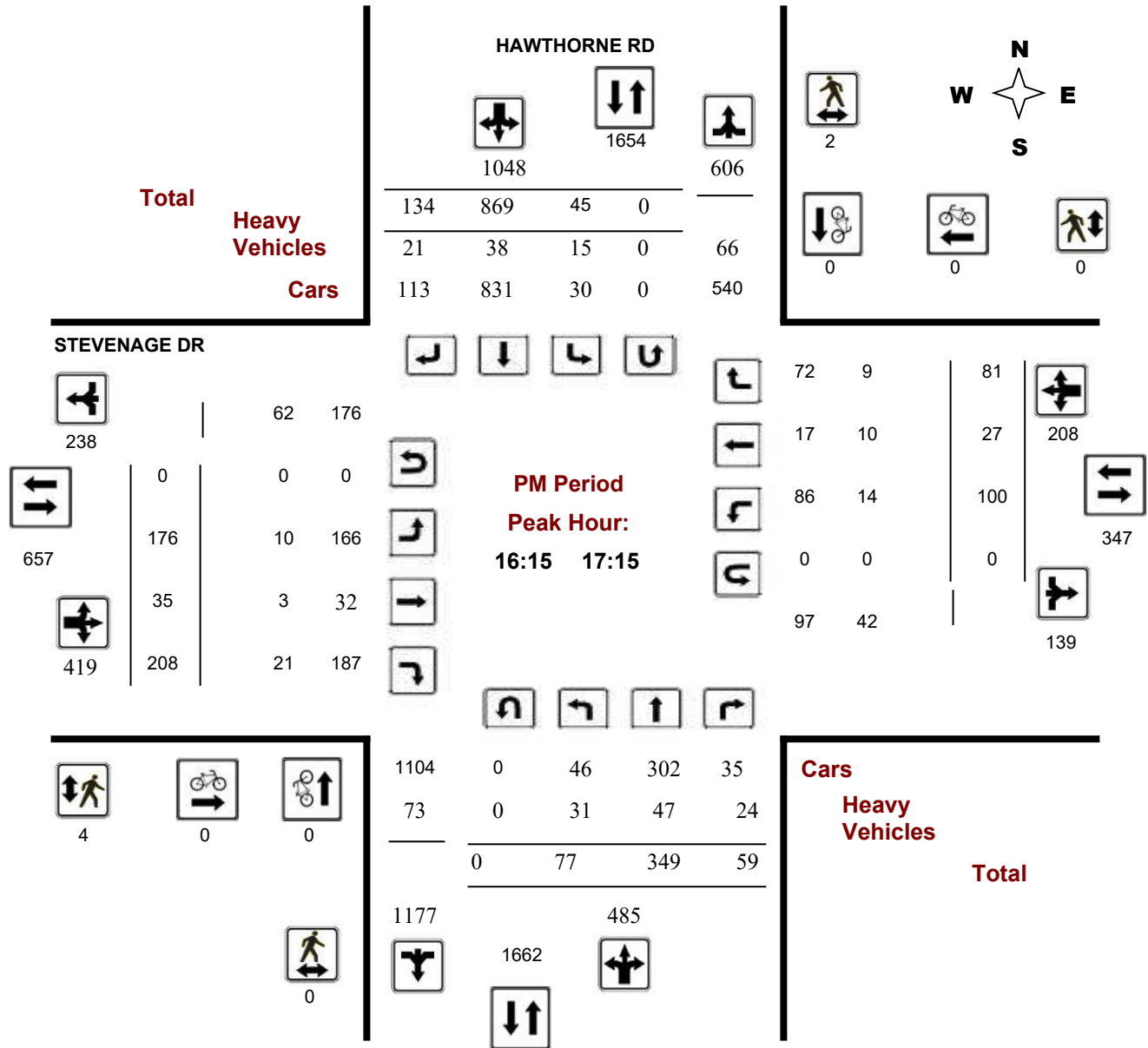



Transportation Services - Traffic Services

Turning Movement Count - Full Study Peak Hour Diagram

HAWTHORNE RD @ HUNT CLUB RD

Survey Date: Tuesday, July 24, 2018

Start Time: 07:00

WO No: 37991

Device: Miovision

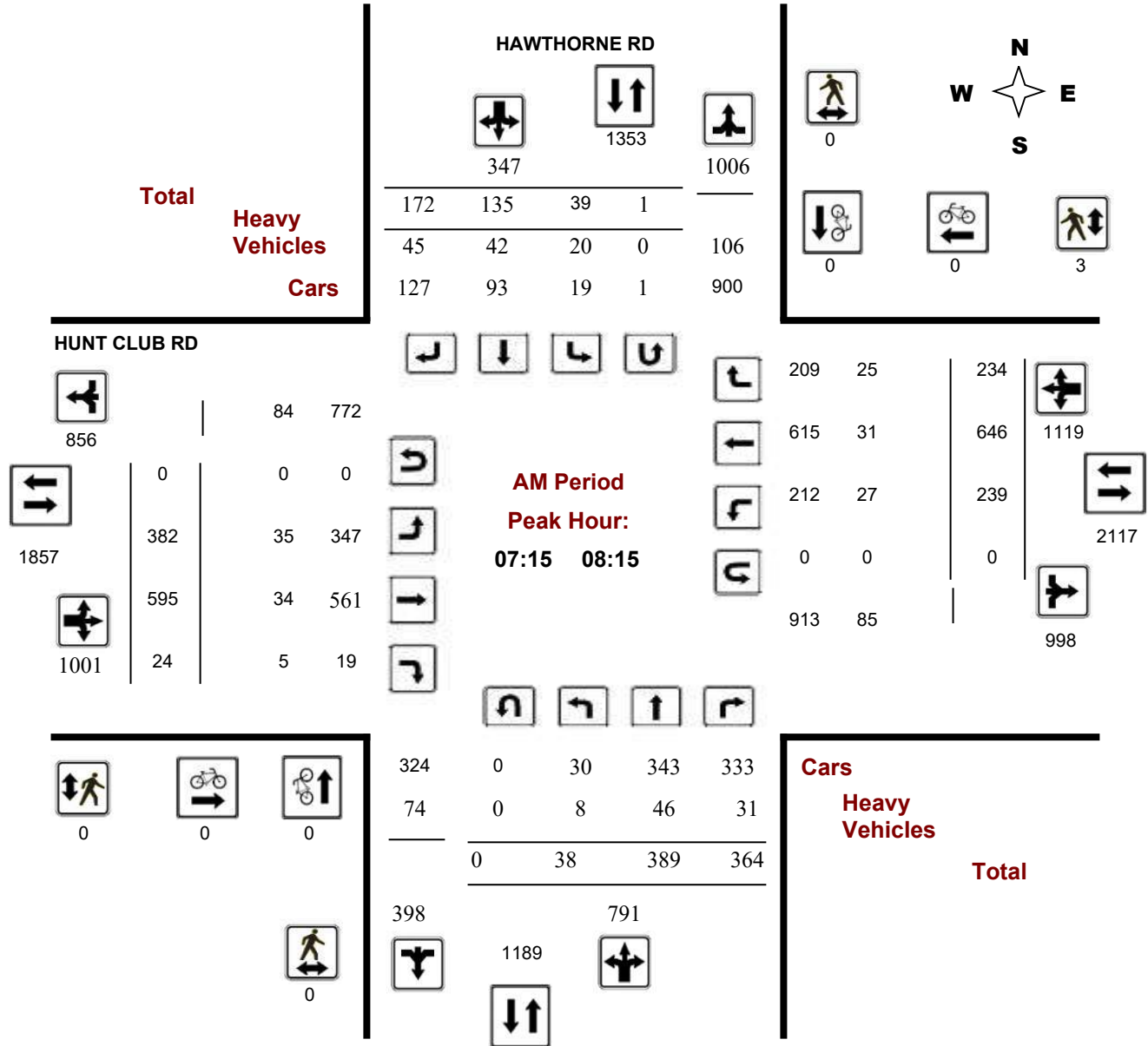

Comments



Transportation Services - Traffic Services

Turning Movement Count - Full Study Peak Hour Diagram

HAWTHORNE RD @ HUNT CLUB RD

Survey Date: Tuesday, July 24, 2018

Start Time: 07:00

WO No: 37991

Device: Miovision

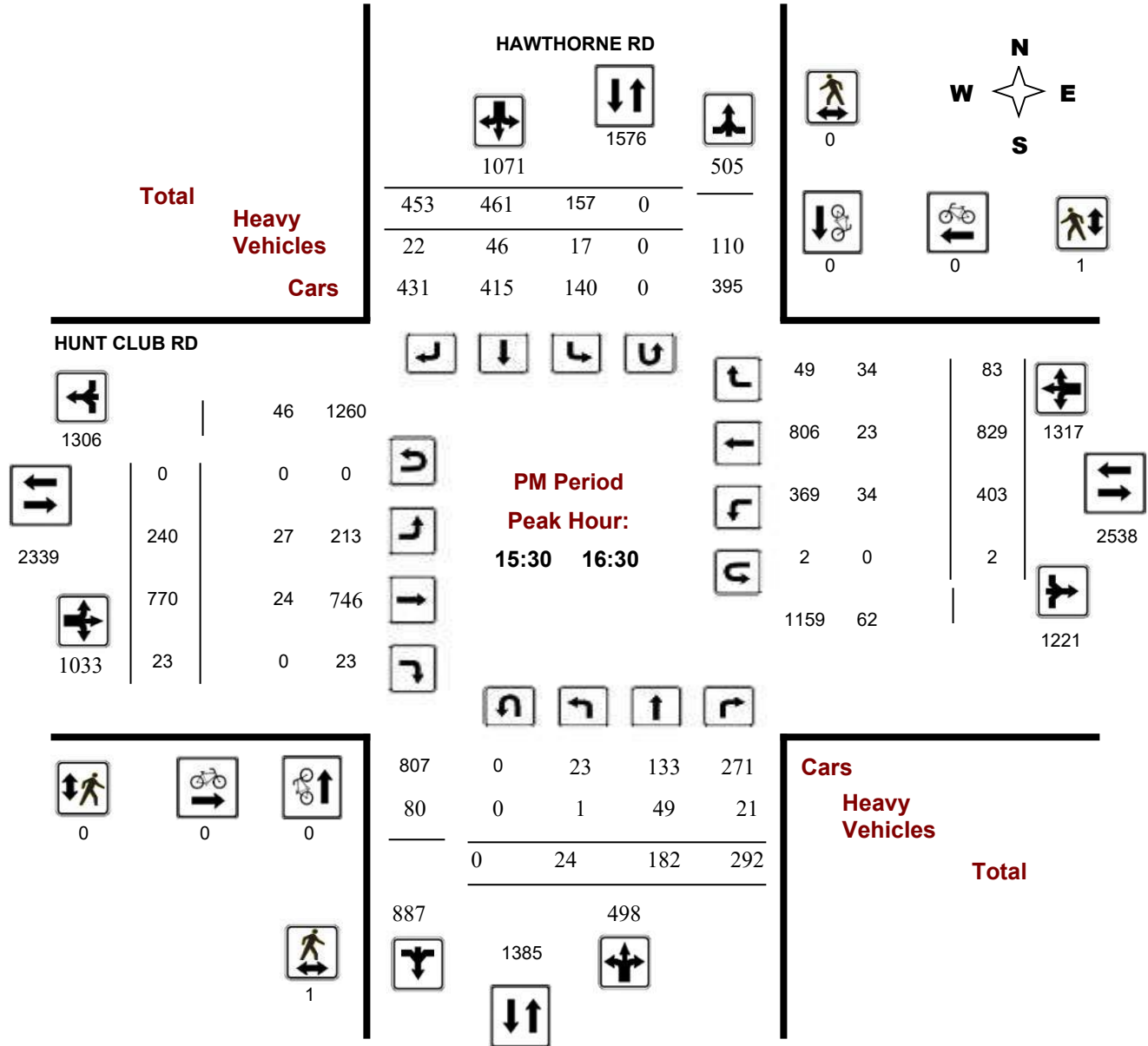

Comments



Turning Movement Count Summary, AM and PM Peak Hour Flow Diagrams

Automobiles, Taxis, Light Trucks, Vans, SUV's, Motorcycles, Heavy Trucks, Buses, and School Buses

Belgreen Drive & Russell Road Ramsayville, ON

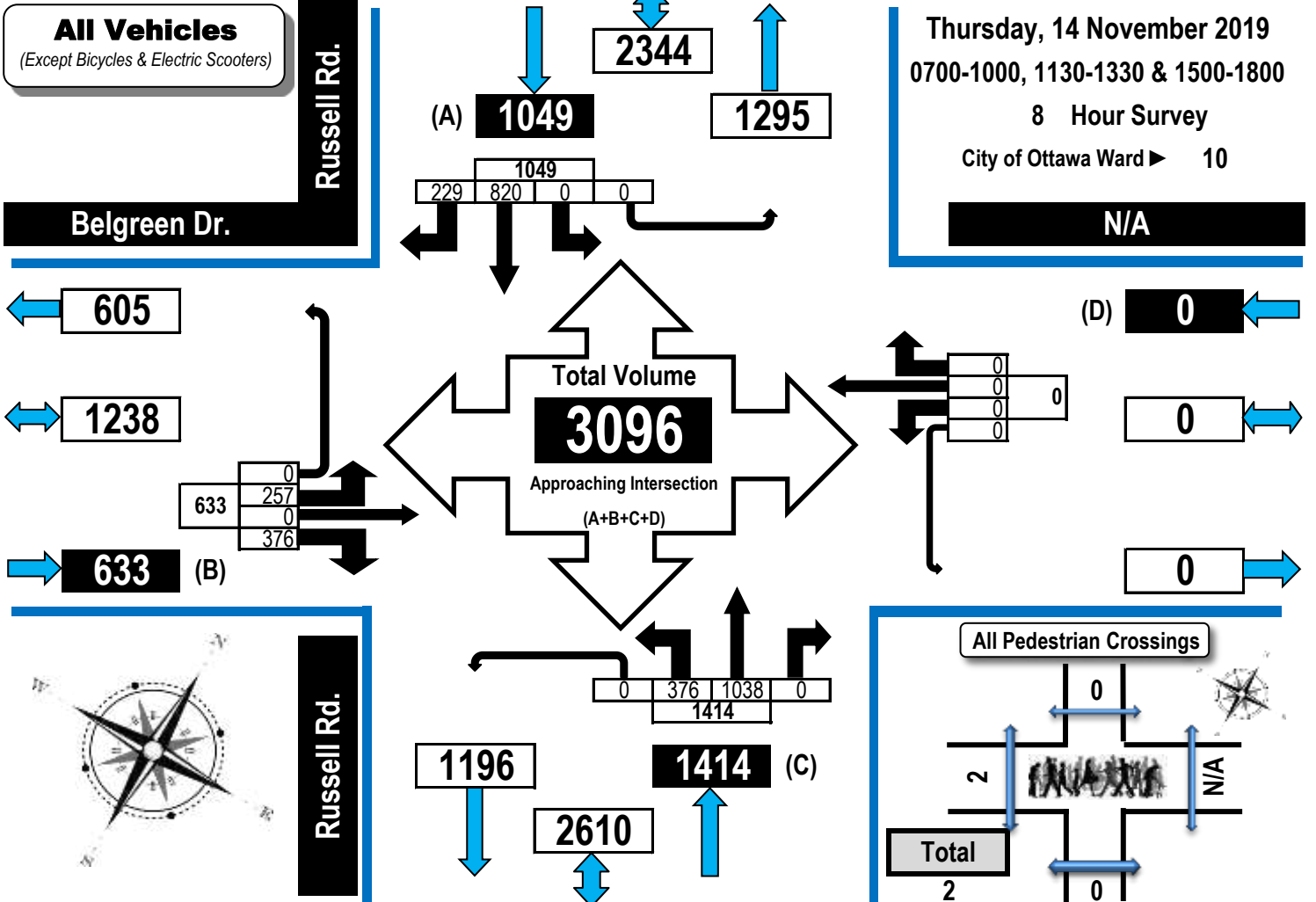

AM Peak Hour Flow Diagram PM Peak Hour Flow Diagram

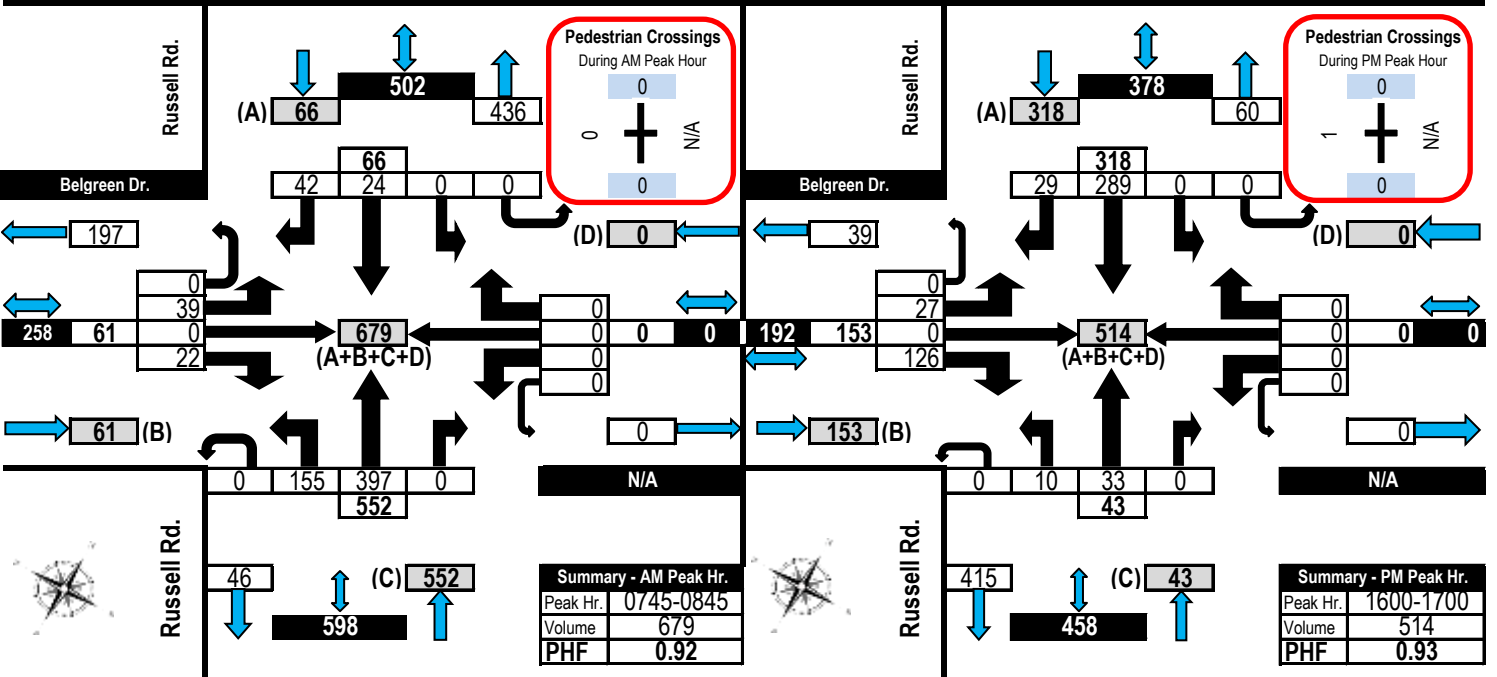



Turning Movement Count Summary Report AADT and Expansion Factors

Automobiles, Taxis,
Light Trucks, Vans,
SUV's, Motorcycles,
Heavy Trucks, Buses,
and School Buses

Belgreen Drive & Russell Road Ramsayville, ON

Survey Date: Thursday, 14 November 2019 **Start Time:** 0700 **AADT Factor:** 0.9
Weather AM: Light snow -9°C **Survey Duration:** 8 Hrs. **Survey Hours:** 0700-1000, 1130-1330 & 1500-1800
Weather PM: Overcast 0°C **Surveyor(s):** Carmody

Belgreen Dr.	N/A	Russell Rd.	Russell Rd.
Eastbound	Westbound	Northbound	Southbound

Time Period	Eastbound					Westbound					W/B Tot	Street Total	Northbound					Southbound					S/B Tot	Street Total	Grand Total
	LT	ST	RT	UT	E/B Tot	LT	ST	RT	UT	LT			ST	RT	UT	N/B Tot	LT	ST	RT	UT					
0700-0800	23	0	7	0	30	0	0	0	0	0	30	109	415	0	0	524	0	19	30	0	49	573	603		
0800-0900	45	0	24	0	69	0	0	0	0	0	69	153	340	0	0	493	0	26	38	0	64	557	626		
0900-1000	67	0	41	0	108	0	0	0	0	0	108	48	130	0	0	178	0	37	26	0	63	241	349		
1130-1230	21	0	21	0	42	0	0	0	0	0	42	23	30	0	0	53	0	33	27	0	60	113	155		
1230-1330	28	0	15	0	43	0	0	0	0	0	43	12	32	0	0	44	0	36	25	0	61	105	148		
1500-1600	19	0	78	0	97	0	0	0	0	0	97	11	29	0	0	40	0	192	30	0	222	262	359		
1600-1700	27	0	126	0	153	0	0	0	0	0	153	10	33	0	0	43	0	289	29	0	318	361	514		
1700-1800	27	0	64	0	91	0	0	0	0	0	91	10	29	0	0	39	0	188	24	0	212	251	342		
Totals	257	0	376	0	633	0	0	0	0	0	633	376	1038	0	0	1414	0	820	229	0	1049	2463	3096		

Equivalent 12 & 24-hour Vehicle Volumes Including the Annual Average Daily Traffic (AADT) Factor Applicable to the Day and Month of the Turning Movement Count

Expansion factors are applied exclusively to standard weekday 8-hour turning movement counts conducted during the hours of 0700h - 1000h, 1130h - 1330h and 1500h - 1800h

Equivalent 12-hour vehicle volumes. These volumes are calculated by multiplying the 8-hour totals by the 8 → 12 expansion factor of 1.39																							
Equ. 12 Hr	357	0	523	0	880	0	0	0	0	0	880	523	1443	0	0	1965	0	1140	318	0	1458	3424	4303

Average daily 12-hour vehicle volumes. These volumes are calculated by multiplying the equivalent 12-hour totals by the AADT factor of: 0.9																							
AADT 12-hr	322	0	470	0	792	0	0	0	0	0	792	470	1299	0	0	1769	0	1026	286	0	1312	3081	3873

24-Hour AADT. These volumes are calculated by multiplying the average daily 12-hour vehicle volumes by the 12 → 24 expansion factor of 1.31																							
AADT 24 Hr	421	0	616	0	1037	0	0	0	0	0	1037	616	1701	0	0	2317	0	1344	375	0	1719	4036	5074

AADT and expansion factors provided by the City of Ottawa

AM Peak Hour Factor → 0.92											Highest Hourly Vehicle Volume Between 0700h & 1000h												
AM Peak Hr	LT	ST	RT	UT	TOT	LT	ST	RT	UT	TOT	S.TOT	LT	ST	RT	UT	TOT	LT	ST	RT	UT	TOT	S.TOT	G.TOT
0745-0845	39	0	22	0	61	0	0	0	0	0	61	155	397	0	0	552	0	24	42	0	66	618	679
OFF Peak Hour Factor → 0.84											Highest Hourly Vehicle Volume Between 1130h & 1330h												
OFF Peak Hr	LT	ST	RT	UT	TOT	LT	ST	RT	UT	TOT	S.TOT	LT	ST	RT	UT	TOT	LT	ST	RT	UT	TOT	S.TOT	G.TOT
1145-1245	26	0	25	0	51	0	0	0	0	0	51	21	30	0	0	51	0	33	29	0	62	113	164
PM Peak Hour Factor → 0.93											Highest Hourly Vehicle Volume Between 1500h & 1800h												
PM Peak Hr	LT	ST	RT	UT	TOT	LT	ST	RT	UT	TOT	S.TOT	LT	ST	RT	UT	TOT	LT	ST	RT	UT	TOT	S.TOT	G.TOT
1600-1700	27	0	126	0	153	0	0	0	0	0	153	10	33	0	0	43	0	289	29	0	318	361	514

Comments:

Some northbound drivers pass northbound left-turning vehicles waiting to turn onto Belgreen Drive by using the east shoulder. A few southbound drivers pass southbound right-turning vehicles - in some cases heavy vehicles - and cannot see if there are any eastbound right-turning vehicles from Belgreen Drive occurring at the same time. There were no bicycles. The heavy vehicle total includes 36 buses - primarily school buses with some OC Transpo buses.

Notes:

1. Includes all vehicle types except bicycles, electric bicycles, and electric scooters.
2. When expansion and AADT factors are applied, the results will differ slightly due to rounding.



Turning Movement Count Summary, AM and PM Peak Hour Flow Diagrams

Automobiles, Taxis, Light Trucks, Vans, SUV's, Motorcycles, Heavy Trucks, Buses, and School Buses

Highway 417 & Hunt Club Road S/B Off Ramp Ramsayville, ON

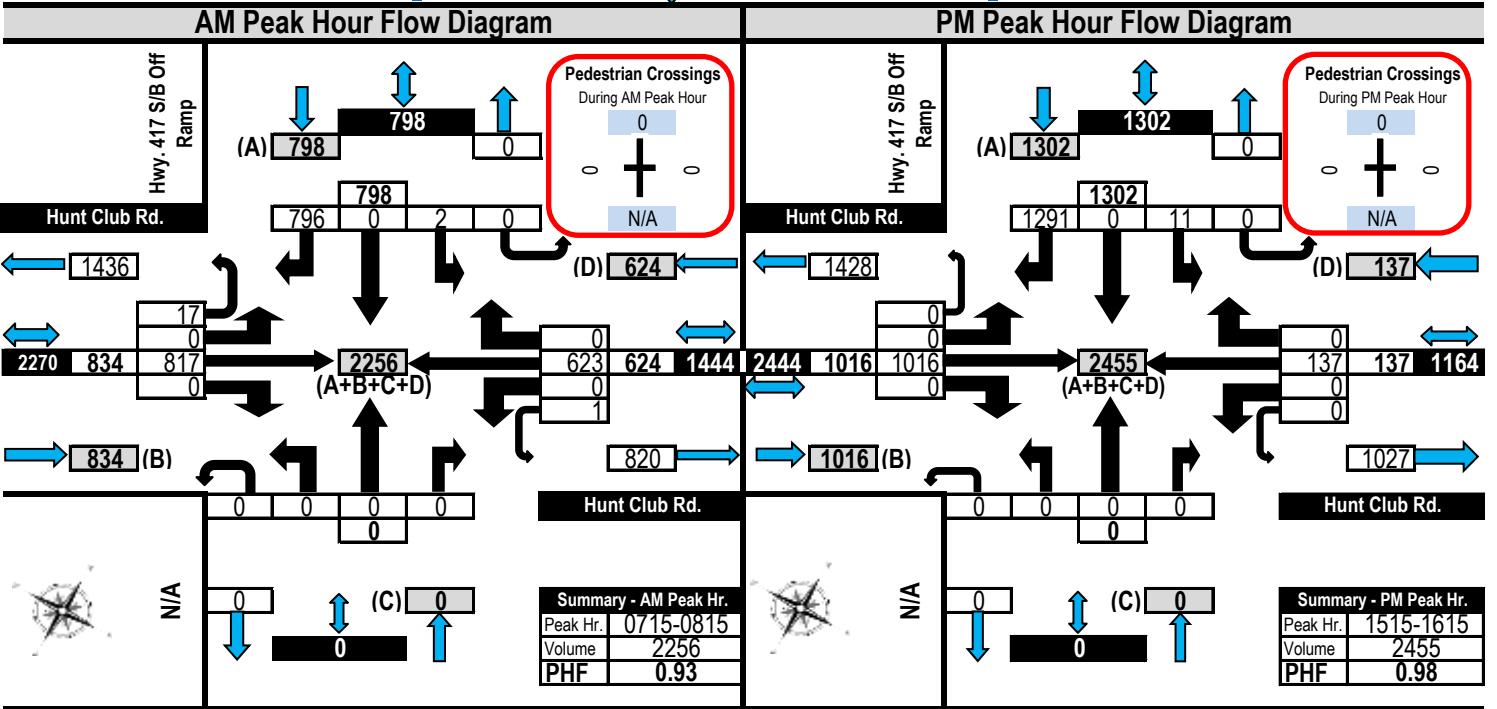
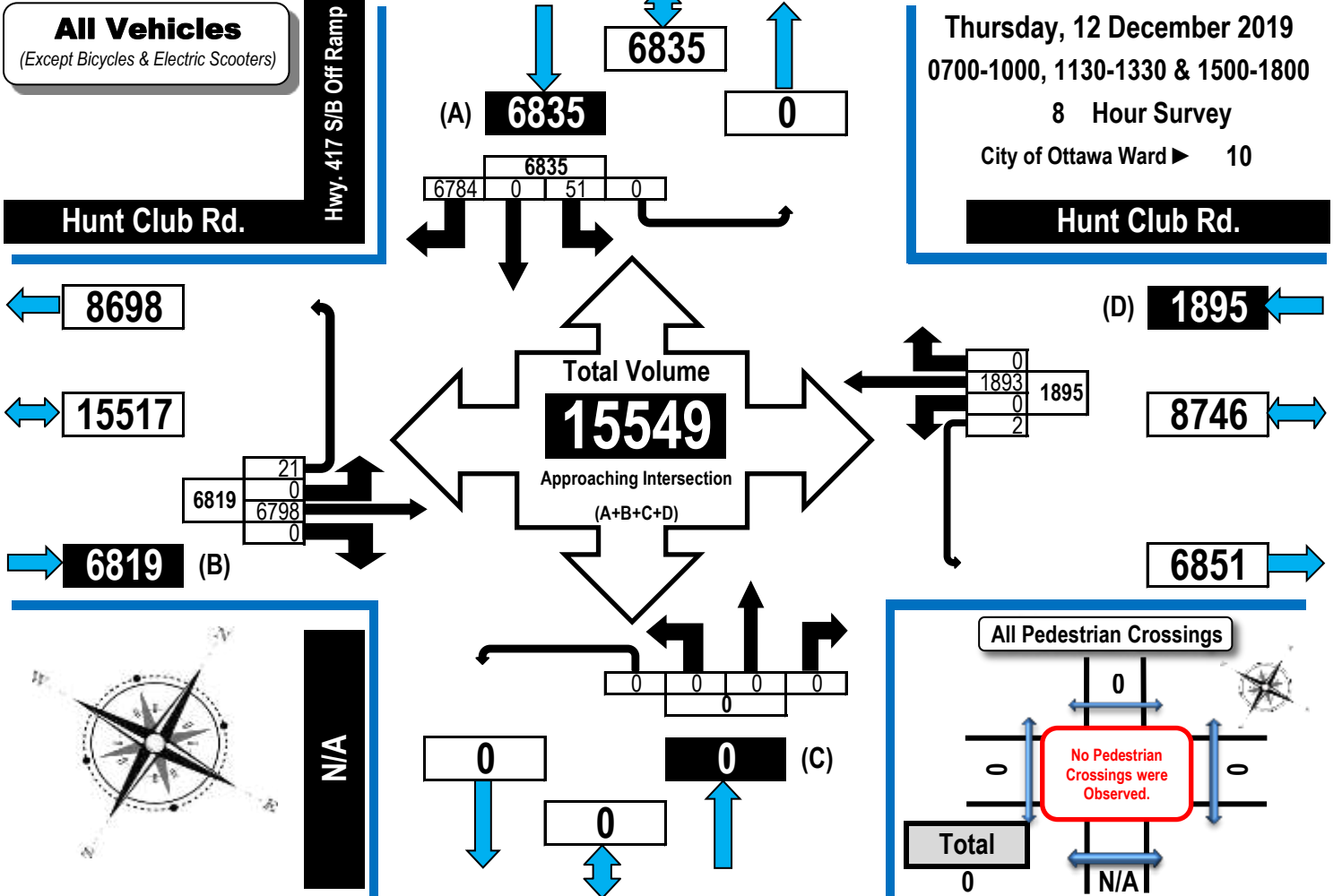

Start Time	Ramsayville Road From North				Ramsayville Road From South				Russell Road From West				Int. Total
	Right	Thru	Peds	App. Total	Thru	Left	Peds	App. Total	Right	Left	Peds	App. Total	
Peak Hour Analysis From 07:00 AM to 09:45 AM - Peak 1 of 1													
Peak Hour for Entire Intersection Begins at 07:30 AM													
07:30 AM	39	28	0	67	91	132	0	223	6	2	0	8	298
07:45 AM	43	39	0	82	89	90	0	179	1	10	0	11	272
08:00 AM	47	35	0	82	95	91	2	188	5	8	2	15	285
08:15 AM	66	43	1	110	72	75	0	147	9	3	0	12	269
Total Volume	195	145	1	341	347	388	2	737	21	23	2	46	1124
% App. Total	57.2	42.5	0.3		47.1	52.6	0.3		45.7	50	4.3		
PHF	.739	.843	.250	.775	.913	.735	.250	.826	.583	.575	.250	.767	.943
Passenger Vehicles	181	140	1	322	336	374	2	712	17	11	2	30	1064
% Passenger Vehicles	92.8	96.6	100	94.4	96.8	96.4	100	96.6	81.0	47.8	100	65.2	94.7
Light Trucks	5	5	0	10	9	14	0	23	2	5	0	7	40
% Light Trucks	2.6	3.4	0	2.9	2.6	3.6	0	3.1	9.5	21.7	0	15.2	3.6
Heavy Trucks	9	0	0	9	2	0	0	2	2	7	0	9	20
% Heavy Trucks	4.6	0	0	2.6	0.6	0	0	0.3	9.5	30.4	0	19.6	1.8

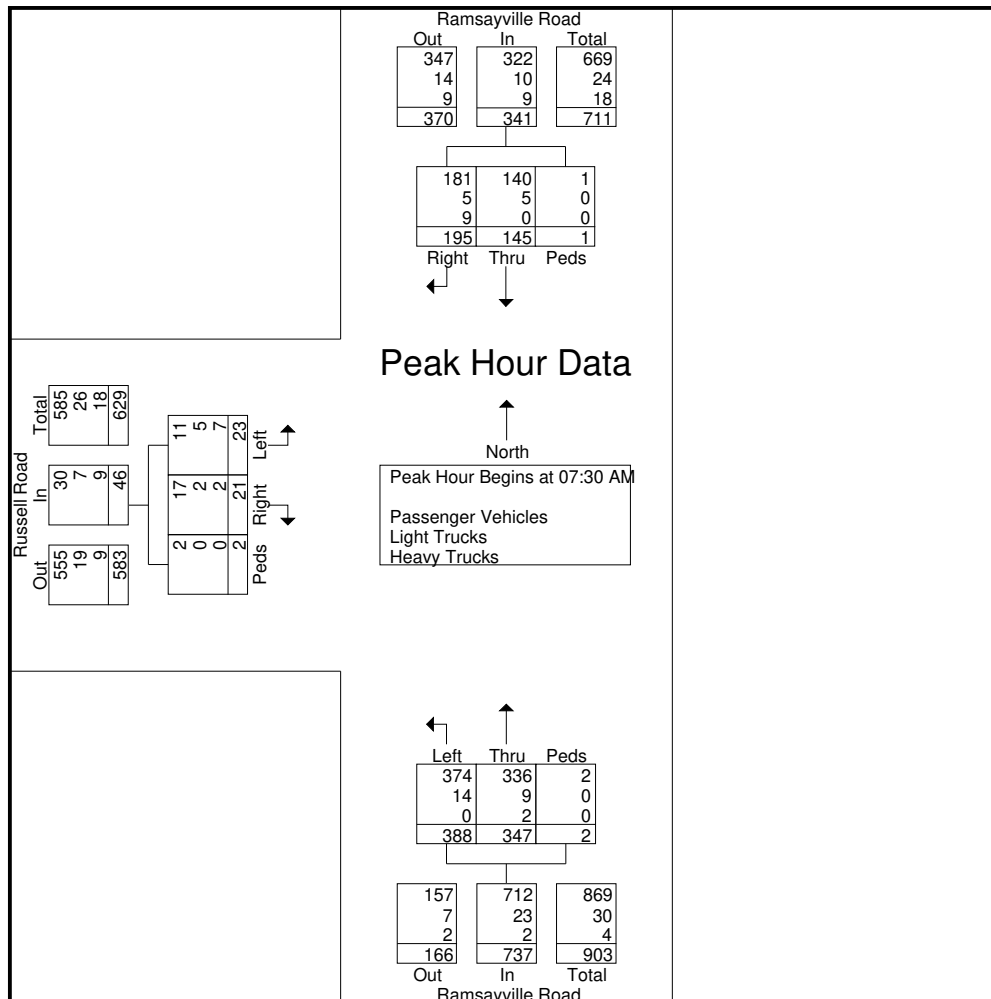

File Name : Ramsayville_Russell
Site Code : 00119124
Start Date : 11/14/2019
Page No : 6

Start Time	Ramsayville Road From North				Ramsayville Road From South				Russell Road From West				Int. Total
	Right	Thru	Peds	App. Total	Thru	Left	Peds	App. Total	Right	Left	Peds	App. Total	
Peak Hour Analysis From 02:00 PM to 05:45 PM - Peak 1 of 1													
Peak Hour for Entire Intersection Begins at 04:15 PM													
04:15 PM	5	80	0	85	30	7	0	37	64	35	0	99	221
04:30 PM	4	87	0	91	32	9	0	41	99	22	0	121	253
04:45 PM	2	73	0	75	20	8	0	28	83	29	0	112	215
05:00 PM	5	82	0	87	32	9	0	41	73	20	0	93	221
Total Volume	16	322	0	338	114	33	0	147	319	106	0	425	910
% App. Total	4.7	95.3	0		77.6	22.4	0		75.1	24.9	0		
PHF	.800	.925	.000	.929	.891	.917	.000	.896	.806	.757	.000	.878	.899
Passenger Vehicles	12	305	0	317	108	28	0	136	296	100	0	396	849
% Passenger Vehicles	75.0	94.7	0	93.8	94.7	84.8	0	92.5	92.8	94.3	0	93.2	93.3
Light Trucks	0	10	0	10	4	2	0	6	16	5	0	21	37
% Light Trucks	0	3.1	0	3.0	3.5	6.1	0	4.1	5.0	4.7	0	4.9	4.1
Heavy Trucks	4	7	0	11	2	3	0	5	7	1	0	8	24
% Heavy Trucks	25.0	2.2	0	3.3	1.8	9.1	0	3.4	2.2	0.9	0	1.9	2.6

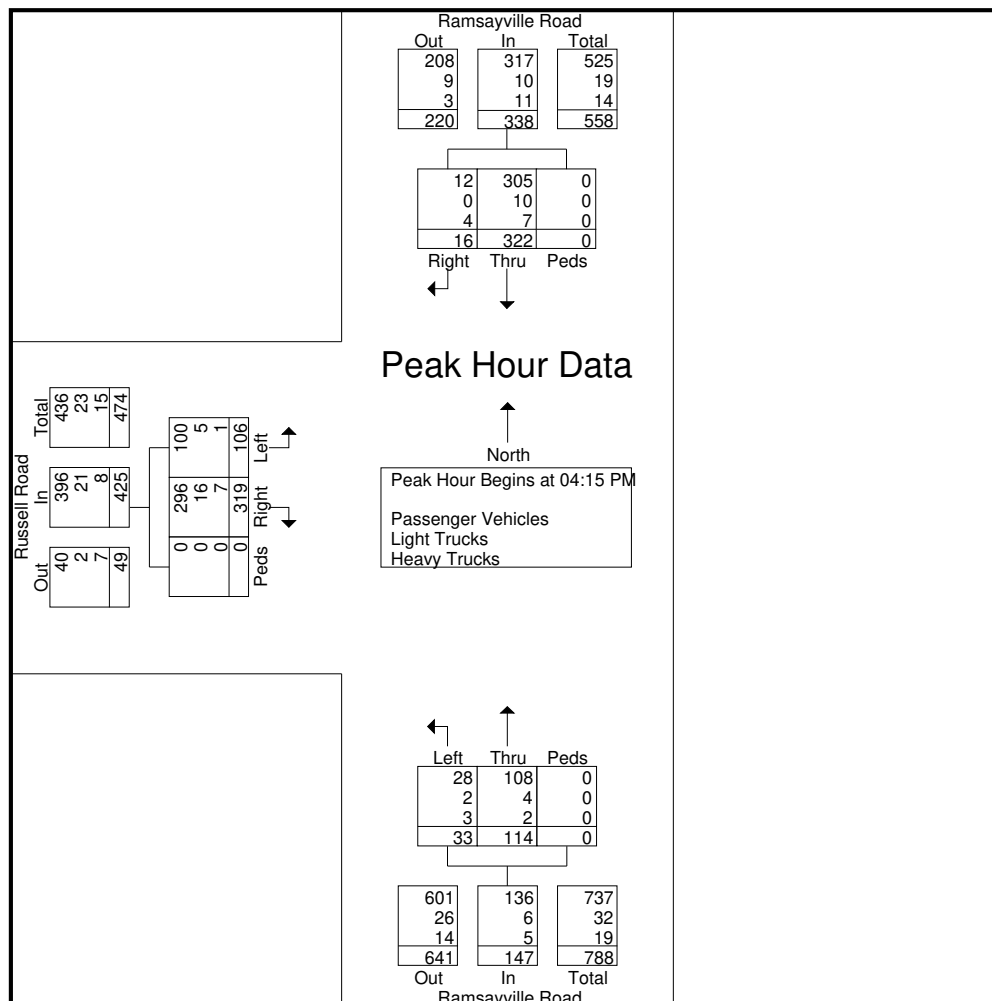



Turning Movement Count Summary, AM and PM Peak Hour Flow Diagrams

Automobiles, Taxis, Light Trucks, Vans, SUV's, Motorcycles, Heavy Trucks, Buses, and School Buses

Ramsayville Road & Russell Road (North) Ramsayville, ON

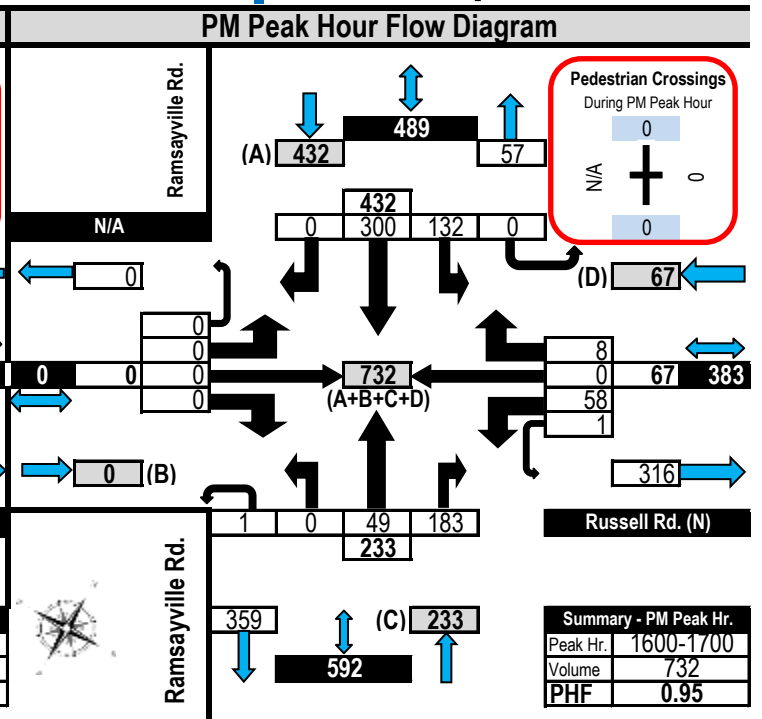
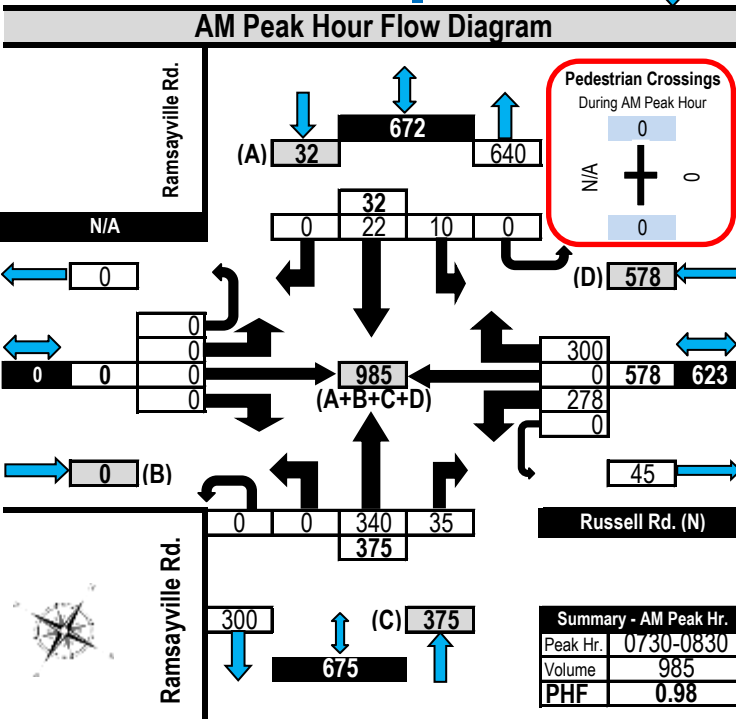
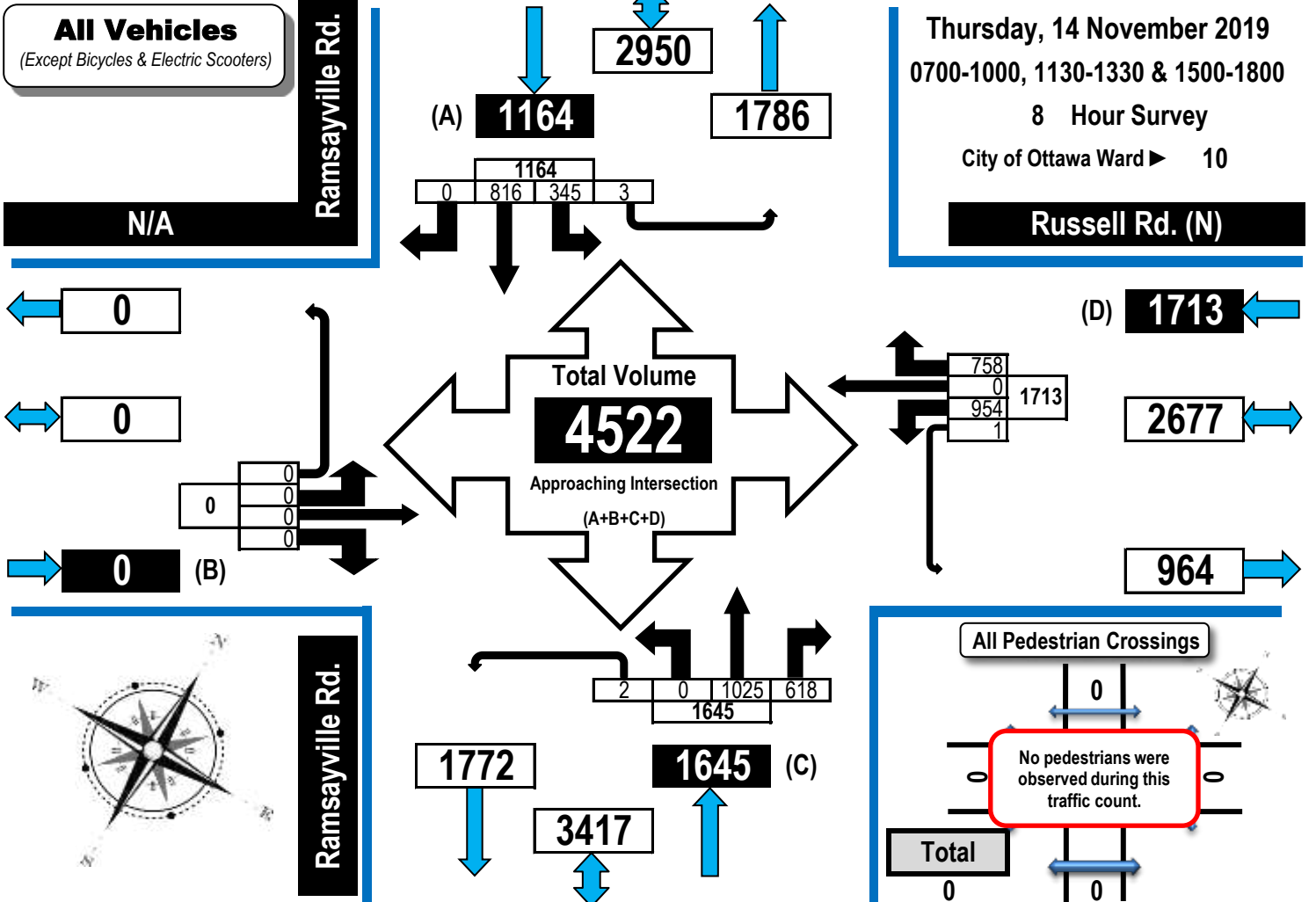

Start Time	Anderson Road From North					Russell Road From East					Anderson Road From South					Russell Road From West					Int. Total
	Right	Thru	Left	Peds	App. Total	Right	Thru	Left	Peds	App. Total	Right	Thru	Left	Peds	App. Total	Right	Thru	Left	Peds	App. Total	
Peak Hour Analysis From 07:00 AM to 09:45 AM - Peak 1 of 1																					
Peak Hour for Entire Intersection Begins at 07:30 AM																					
07:30 AM	23	34	0	0	57	31	96	9	0	136	3	79	37	0	119	0	4	6	0	10	322
07:45 AM	35	24	3	0	62	32	85	10	0	127	1	72	51	0	124	0	4	6	0	10	323
08:00 AM	60	36	1	0	97	21	84	11	0	116	0	58	55	0	113	1	3	10	0	14	340
08:15 AM	35	45	1	0	81	34	52	18	0	104	2	95	28	0	125	2	4	13	0	19	329
Total Volume	153	139	5	0	297	118	317	48	0	483	6	304	171	0	481	3	15	35	0	53	1314
% App. Total	51.5	46.8	1.7	0		24.4	65.6	9.9	0		1.2	63.2	35.6	0		5.7	28.3	66	0		
PHF	.638	.772	.417	.000	.765	.868	.826	.667	.000	.888	.500	.800	.777	.000	.962	.375	.938	.673	.000	.697	.966
Passenger Vehicles	151	134	5	0	290	115	310	48	0	473	5	295	169	0	469	3	14	31	0	48	1280
% Passenger Vehicles	98.7	96.4	100	0	97.6	97.5	97.8	100	0	97.9	83.3	97.0	98.8	0	97.5	100	93.3	88.6	0	90.6	97.4
Light Trucks	2	5	0	0	7	3	7	0	0	10	1	9	2	0	12	0	1	4	0	5	34
% Light Trucks	1.3	3.6	0	0	2.4	2.5	2.2	0	0	2.1	16.7	3.0	1.2	0	2.5	0	6.7	11.4	0	9.4	2.6
Heavy Trucks	0	0	0	0	0	0	0	0	0	0	0	0	0	0	0	0	0	0	0	0	0
% Heavy Trucks	0	0	0	0	0	0	0	0	0	0	0	0	0	0	0	0	0	0	0	0	0

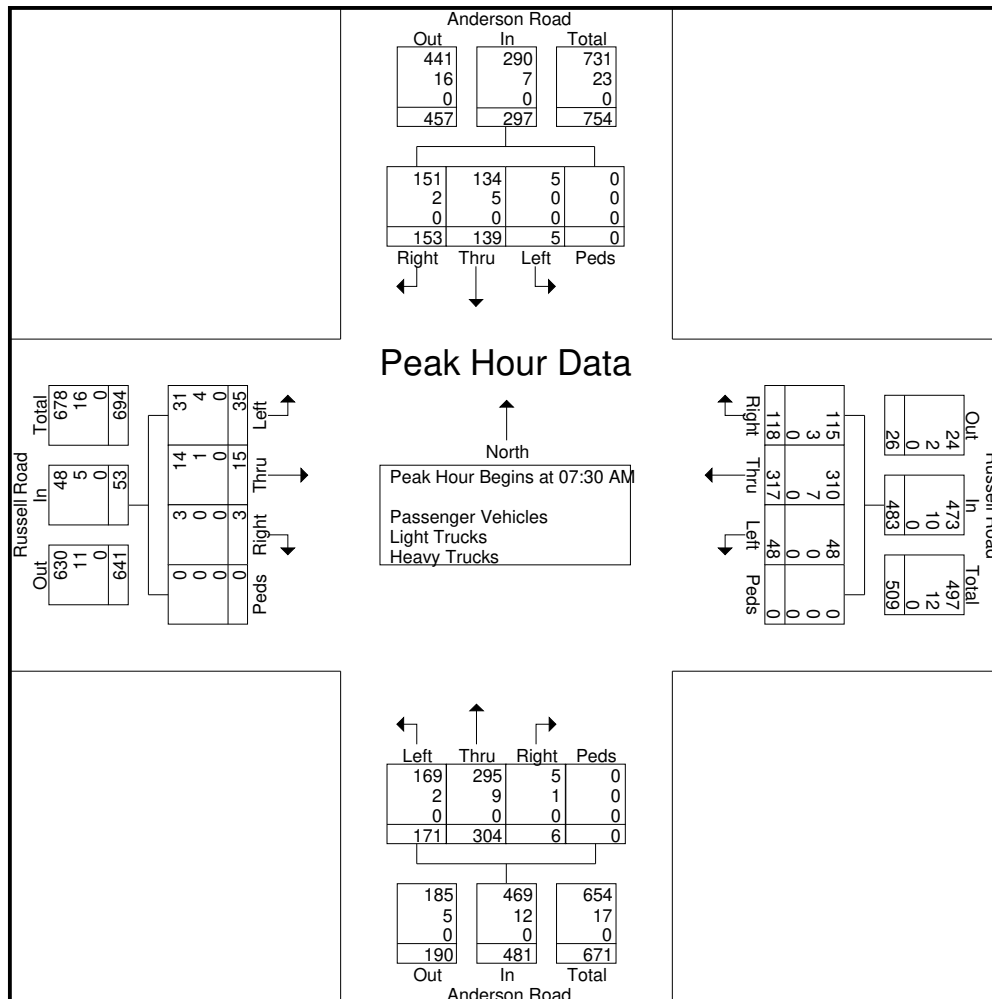

Start Time	Anderson Road From North					Russell Road From East					Anderson Road From South					Russell Road From West					Int. Total
	Right	Thru	Left	Peds	App. Total	Right	Thru	Left	Peds	App. Total	Right	Thru	Left	Peds	App. Total	Right	Thru	Left	Peds	App. Total	
Peak Hour Analysis From 02:00 PM to 05:45 PM - Peak 1 of 1																					
Peak Hour for Entire Intersection Begins at 04:00 PM																					
04:00 PM	8	61	25	0	94	5	9	0	0	14	13	41	3	0	57	6	54	19	0	79	244
04:15 PM	7	80	16	0	103	1	4	3	0	8	19	48	2	0	69	4	57	21	0	82	262
04:30 PM	10	64	13	0	87	2	3	5	0	10	4	33	1	0	38	1	54	17	0	72	207
04:45 PM	13	57	7	0	77	2	6	4	0	12	10	48	1	0	59	3	59	20	0	82	230
Total Volume	38	262	61	0	361	10	22	12	0	44	46	170	7	0	223	14	224	77	0	315	943
% App. Total	10.5	72.6	16.9	0		22.7	50	27.3	0		20.6	76.2	3.1	0		4.4	71.1	24.4	0		
PHF	.731	.819	.610	.000	.876	.500	.611	.600	.000	.786	.605	.885	.583	.000	.808	.583	.949	.917	.000	.960	.900
Passenger Vehicles	37	254	60	0	351	10	19	12	0	41	43	170	7	0	220	14	224	76	0	314	926
% Passenger Vehicles	97.4	96.9	98.4	0	97.2	100	86.4	100	0	93.2	93.5	100	100	0	98.7	100	100	98.7	0	99.7	98.2
Light Trucks	1	8	1	0	10	0	3	0	0	3	3	0	0	0	3	0	0	1	0	1	17
% Light Trucks	2.6	3.1	1.6	0	2.8	0	13.6	0	0	6.8	6.5	0	0	0	1.3	0	0	1.3	0	0.3	1.8
Heavy Trucks	0	0	0	0	0	0	0	0	0	0	0	0	0	0	0	0	0	0	0	0	0
% Heavy Trucks	0	0	0	0	0	0	0	0	0	0	0	0	0	0	0	0	0	0	0	0	0

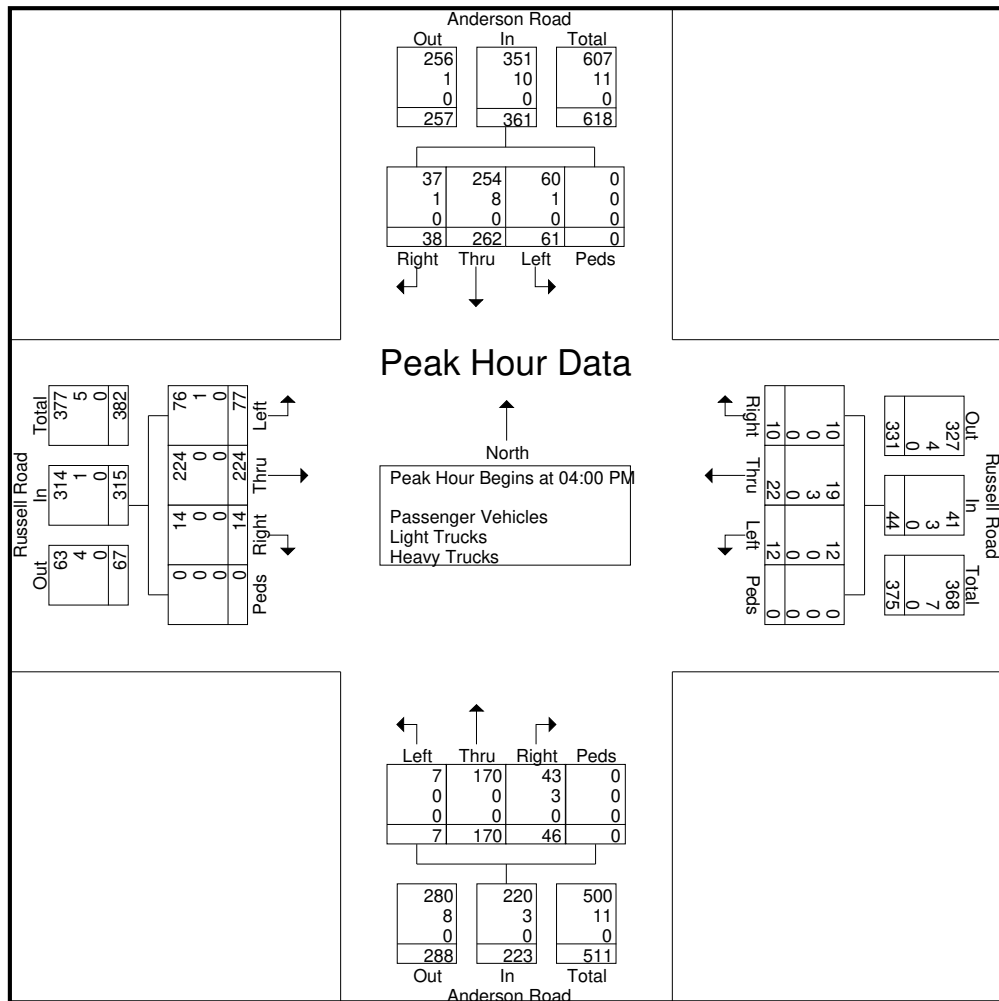



Hwy 417 @ WALKLEY RD IC-110

Eastern

Intersection ID:493540000(--S--)

Count Day: Tuesday

Count Date: 06-Aug-2019

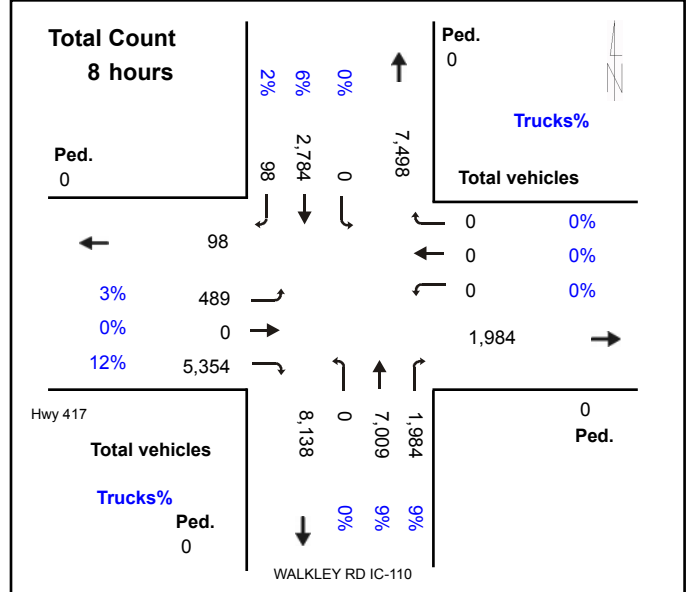
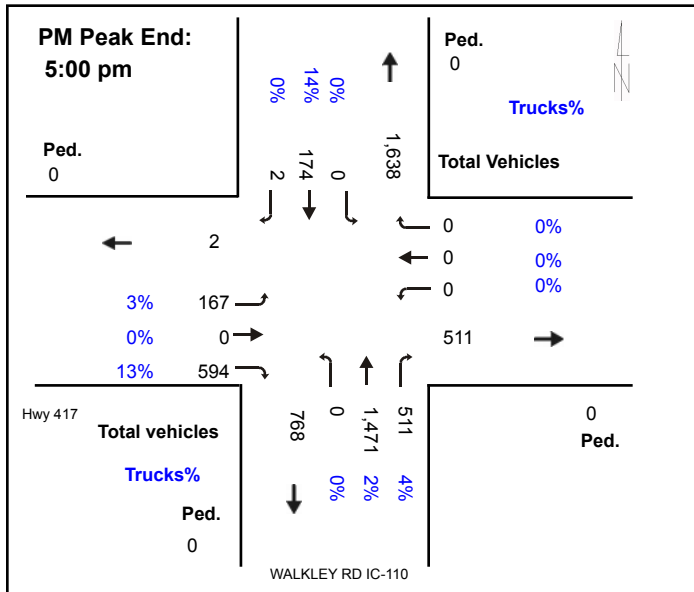
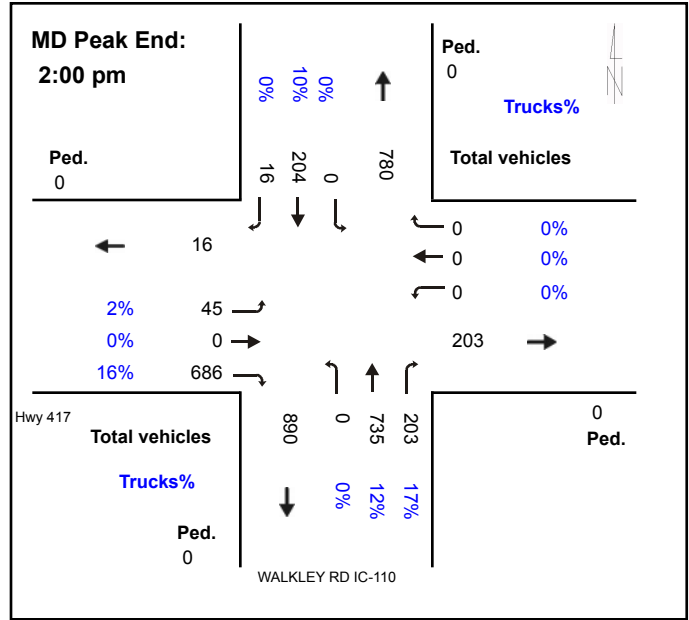
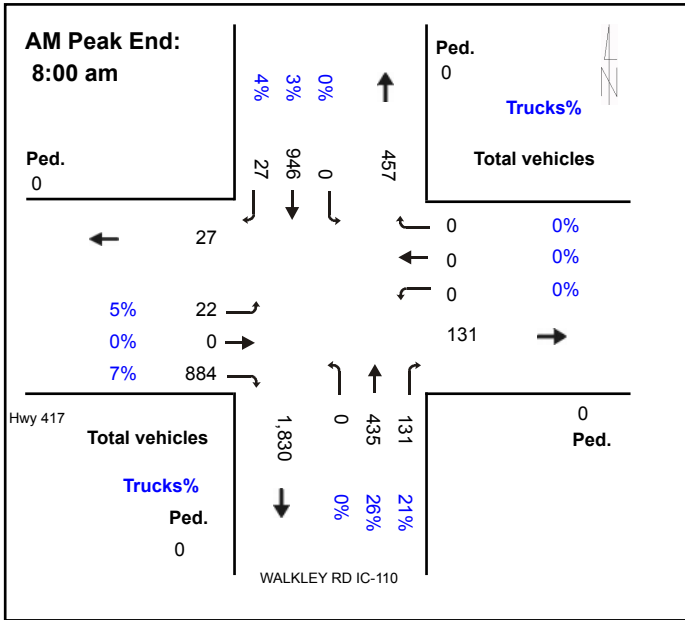



Hwy 417 @ WALKLEY RD IC-110

Eastern

Intersection ID:493540000(--N--)

Count Day: Monday

Count Date: 01-Jun-2015

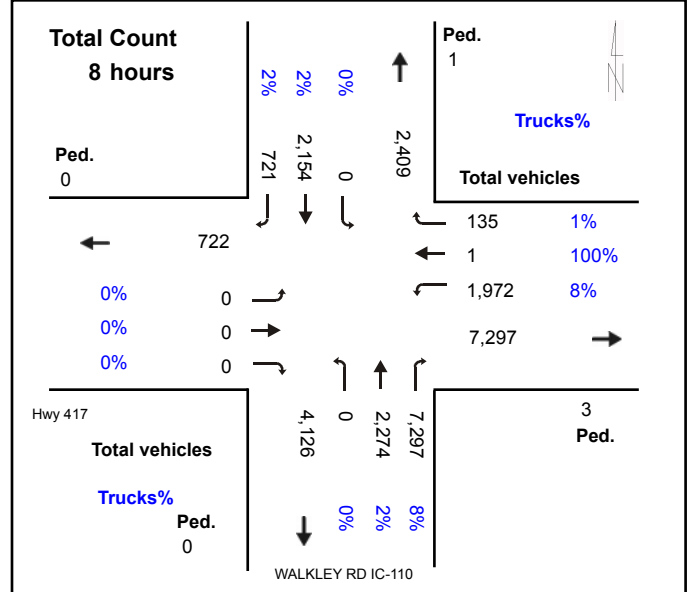
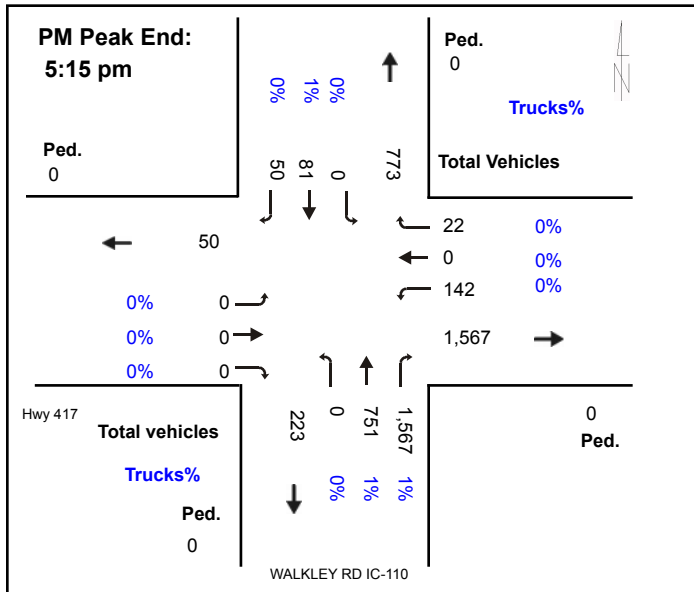
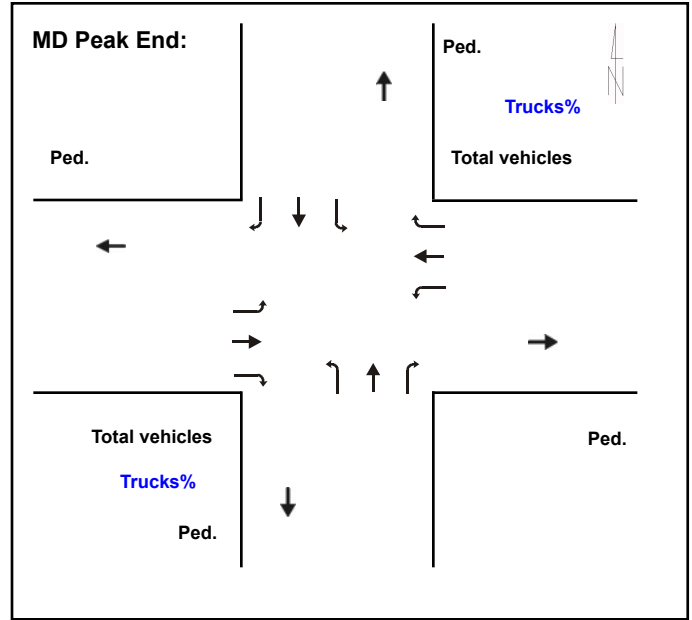
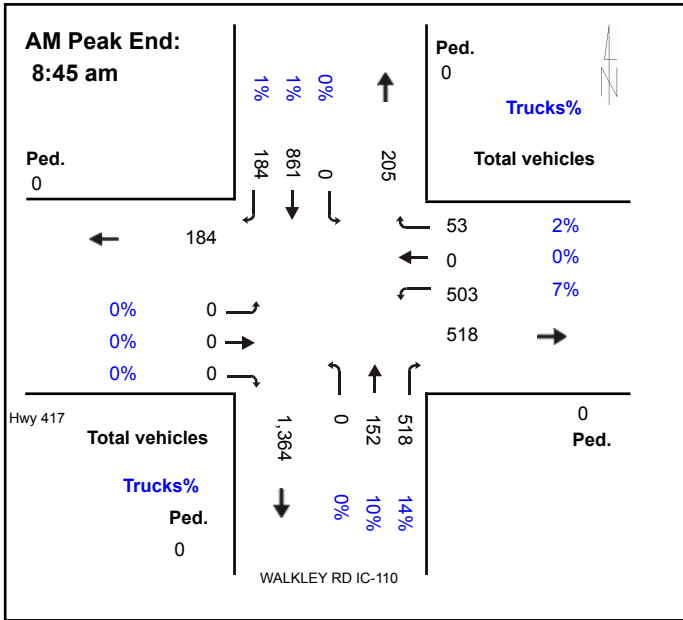

TRANS Regional Model

2011 Version V 1.12 - last updated January 18, 2018

AM Peak Hour Total Traffic Volume

Walkley Rd.

Scenario 11112

Modifications from base version:
none

User Initials: JF
Preparation Date: August 8, 2018



Legend

AM Peak Hour Total Traffic Volume

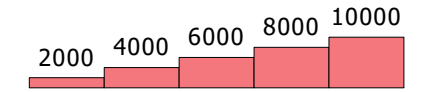

N

The TRANS model is continuously refined & maintained, and all information is provided in good faith. However, model outputs are provided "as is", and no warranty or guarantee is provided as to the accuracy, reliability or reasonableness of the results. In using this data, you agree to accept any and all risks arising from any incorrect, incomplete, or misleading information.

Recipients are required to use caution and professional judgement in using and interpreting model outputs. In particular, caution should be used when focusing on a geographically limited area (such as a single road or intersection), as the model is primarily designed to simulate regional-scale phenomena and has been calibrated at a regional level.

As general good practice, it is recommended that the user confirm the network coding within the area of interest, and compare base year forecasts against traffic count data to assess the extent to which the model may be over- or under-estimating the travel demand.

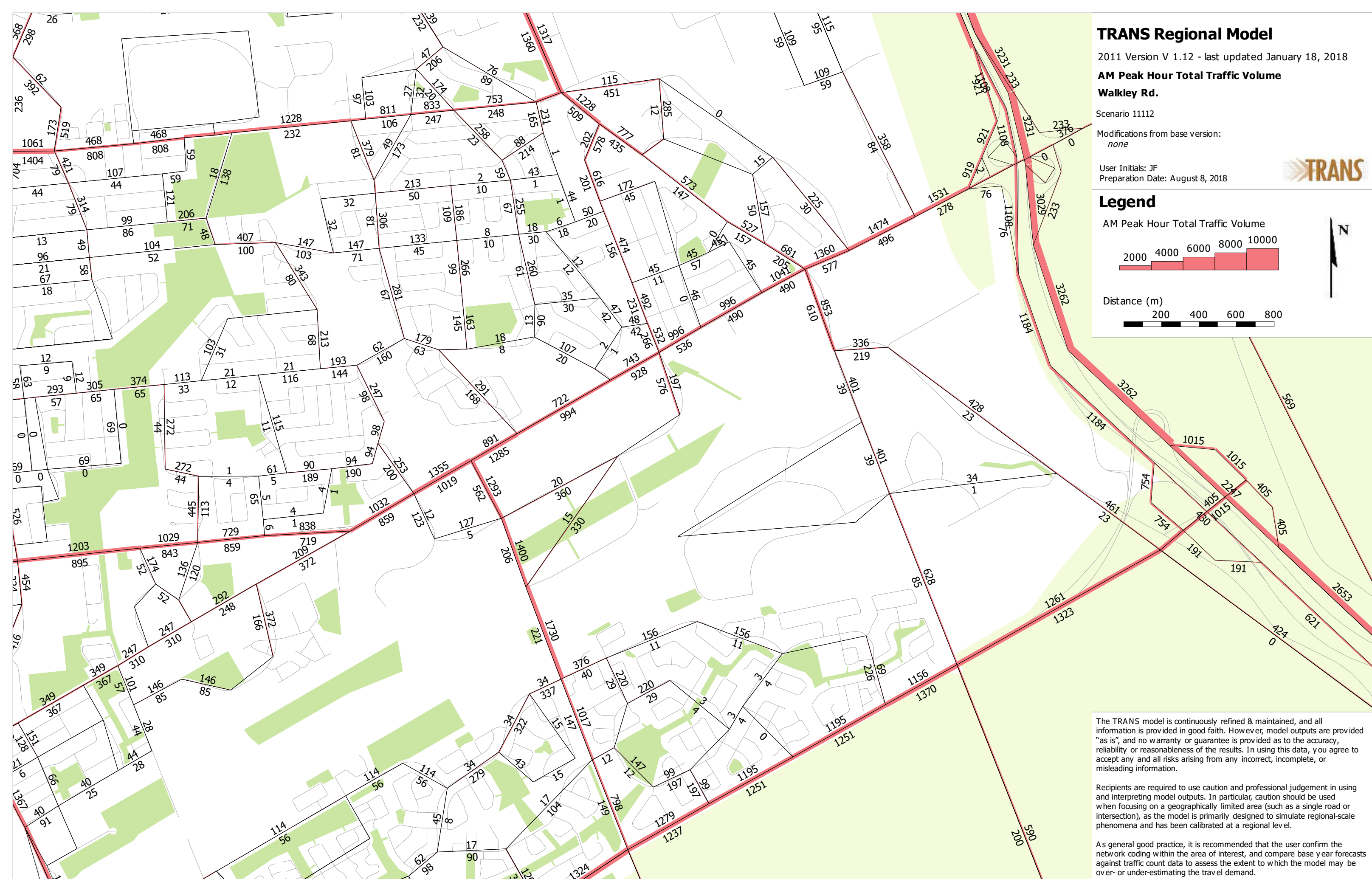

TRANS Regional Model

2031 Version V 1.12 - last updated January 18, 2018

AM Peak Hour Total Traffic Volume

Walkley Rd.

Scenario 12334

Modifications from base version:
none

User Initials: JF
Preparation Date: August 8, 2018



Legend

AM Peak Hour Total Traffic Volume

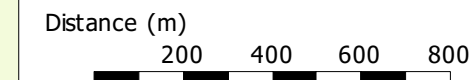
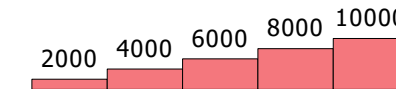

The TRANS model is continuously refined & maintained, and all information is provided in good faith. However, model outputs are provided "as is", and no warranty or guarantee is provided as to the accuracy, reliability or reasonableness of the results. In using this data, you agree to accept any and all risks arising from any incorrect, incomplete, or misleading information.

Recipients are required to use caution and professional judgement in using and interpreting model outputs. In particular, caution should be used when focusing on a geographically limited area (such as a single road or intersection), as the model is primarily designed to simulate regional-scale phenomena and has been calibrated at a regional level.

As general good practice, it is recommended that the user confirm the network coding within the area of interest, and compare base year forecasts against traffic count data to assess the extent to which the model may be over- or under-estimating the travel demand.

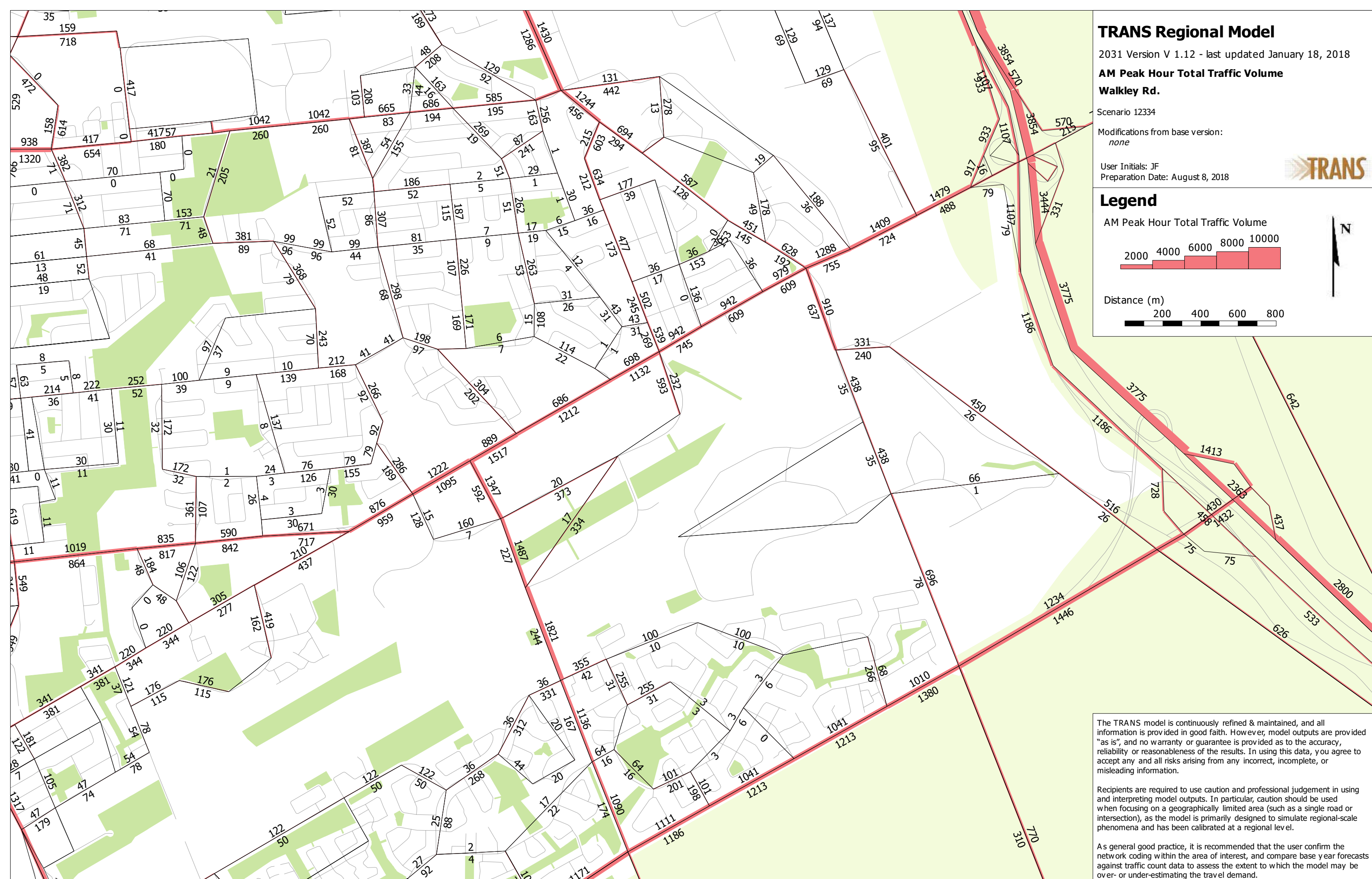

APPENDIX E

Collision Records



City Operations - Transportation Services

Collision Details Report - Public Version

From: January 1, 2014 **To:** December 31, 2018

Location: ANDERSON RD @ RUSSELL RD

Traffic Control: Stop sign

Total Collisions: 5

Date/Day/Time	Environment	Impact Type	Classification	Surface Cond'n	Veh. Dir	Vehicle Manoeuvre	Vehicle type	First Event	No. Ped
2014-Sep-30, Tue,06:30	Clear	Rear end	Non-fatal injury	Dry	West	Slowing or stopping	Pick-up truck	Other motor vehicle	
					West	Stopped	Automobile, station wagon	Other motor vehicle	
					West	Stopped	Automobile, station wagon	Other motor vehicle	
2014-Jul-15, Tue,16:55	Clear	Rear end	P.D. only	Dry	East	Going ahead	Pick-up truck	Other motor vehicle	
					East	Stopped	Automobile, station wagon	Other motor vehicle	
2016-Aug-04, Thu,16:06	Clear	Angle	Non-fatal injury	Dry	East	Going ahead	Automobile, station wagon	Other motor vehicle	
					North	Going ahead	Pick-up truck	Other motor vehicle	
2016-May-26, Thu,11:39	Clear	Rear end	P.D. only	Dry	South	Going ahead	Automobile, station wagon	Other motor vehicle	
					South	Slowing or stopping	Automobile, station wagon	Other motor vehicle	
2016-Sep-12, Mon,12:15	Clear	Angle	Non-fatal injury	Dry	East	Turning left	Passenger van	Other motor vehicle	
					South	Going ahead	Pick-up truck	Other motor vehicle	

Location: BELGREEN DR @ RUSSELL RD

Traffic Control: Stop sign

Total Collisions: 1

Date/Day/Time	Environment	Impact Type	Classification	Surface Cond'n	Veh. Dir	Vehicle Manoeuvre	Vehicle type	First Event	No. Ped
2017-Sep-24, Sun,07:06	Clear	SMV other	P.D. only	Dry	South	Going ahead	Automobile, station wagon	Ran off road	

Location: HAWTHORNE RD @ HUNT CLUB RD

Traffic Control: Traffic signal

Total Collisions: 144

Date/Day/Time	Environment	Impact Type	Classification	Surface Cond'n	Veh. Dir	Vehicle Manoeuvre	Vehicle type	First Event	No. Ped
2014-Jan-09, Thu,10:35	Clear	Approaching	P.D. only	Dry	North	Going ahead	Automobile, station wagon	Other motor vehicle	
					South	Going ahead	Municipal transit bus	Other motor vehicle	
2014-Feb-18, Tue,06:33	Snow	Rear end	P.D. only	Loose snow	East	Turning left	Automobile, station wagon	Other motor vehicle	
					East	Turning left	Pick-up truck	Other motor vehicle	
2014-Aug-27, Wed,21:58	Clear	Sideswipe	P.D. only	Dry	South	Changing lanes	Automobile, station wagon	Other motor vehicle	
					South	Slowing or stopping	Automobile, station wagon	Other motor vehicle	
2014-Sep-03, Wed,07:41	Clear	Turning movement	Non-fatal injury	Dry	West	Turning left	Pick-up truck	Other motor vehicle	
					East	Going ahead	Automobile, station wagon	Other motor vehicle	
2014-Sep-07, Sun,16:34	Clear	Turning movement	P.D. only	Dry	West	Turning left	Automobile, station wagon	Other motor vehicle	
					East	Going ahead	Automobile, station wagon	Other motor vehicle	

2014-Sep-10, Wed,15:51	Clear	Turning movement	P.D. only	Dry	East	Turning left	Automobile, station wagon	Other motor vehicle
					West	Going ahead	Automobile, station wagon	Other motor vehicle
2014-Apr-26, Sat,11:47	Clear	Turning movement	P.D. only	Wet	South	Turning left	Automobile, station wagon	Other motor vehicle
					North	Going ahead	Pick-up truck	Other motor vehicle
2014-Sep-11, Thu,16:14	Clear	Rear end	P.D. only	Dry	South	Turning right	Automobile, station wagon	Other motor vehicle
					South	Turning right	Automobile, station wagon	Other motor vehicle
2014-Sep-21, Sun,18:30	Clear	Turning movement	P.D. only	Dry	East	Going ahead	Automobile, station wagon	Other motor vehicle
					East	Turning left	Automobile, station wagon	Other motor vehicle
2014-May-06, Tue,07:27	Freezing Rain	Sideswipe	P.D. only	Wet	East	Changing lanes	Pick-up truck	Other motor vehicle
					East	Turning left	Automobile, station wagon	Other motor vehicle
2014-May-26, Mon,09:00	Clear	Turning movement	P.D. only	Wet	East	Turning left	Truck and trailer	Other motor vehicle
					East	Turning left	Automobile, station wagon	Other motor vehicle
2014-Oct-07, Tue,18:11	Clear	Turning movement	Non-fatal injury	Dry	East	Turning left	Automobile, station wagon	Other motor vehicle
					West	Going ahead	Automobile, station wagon	Other motor vehicle

2014-Oct-21, Tue,06:30	Rain	Turning movement	P.D. only	Wet	East	Turning left	Automobile, station wagon	Other motor vehicle
					West	Going ahead	Automobile, station wagon	Other motor vehicle
2014-Nov-19, Wed,15:26	Clear	Rear end	P.D. only	Dry	East	Turning right	Automobile, station wagon	Other motor vehicle
					East	Turning right	Automobile, station wagon	Other motor vehicle
2014-Dec-30, Tue,08:51	Clear	Angle	P.D. only	Dry	North	Turning right	Truck and trailer	Other motor vehicle
					East	Going ahead	Automobile, station wagon	Other motor vehicle
2014-Sep-26, Fri,18:35	Clear	Turning movement	Non-fatal injury	Dry	East	Turning left	Passenger van	Other motor vehicle
					West	Going ahead	Pick-up truck	Other motor vehicle
2014-Jun-27, Fri,14:40	Clear	Turning movement	Non-fatal injury	Dry	North	Turning left	Pick-up truck	Other motor vehicle
					South	Slowing or stopping	Truck - dump	Other motor vehicle
2014-Sep-06, Sat,15:40	Clear	Angle	Non-fatal injury	Dry	East	Going ahead	Automobile, station wagon	Other motor vehicle
					South	Going ahead	Automobile, station wagon	Other motor vehicle
					North	Stopped	Pick-up truck	Other motor vehicle
2014-Dec-04, Thu,17:11	Clear	Rear end	Non-fatal injury	Dry	North	Turning right	Automobile, station wagon	Other motor vehicle
					North	Turning right	Automobile, station wagon	Other motor vehicle

2015-Jan-08, Thu,07:45	Snow	Rear end	P.D. only	Packed snow	East	Turning left	Passenger van	Other motor vehicle
					East	Turning left	Pick-up truck	Other motor vehicle
2015-Jan-22, Thu,15:23	Clear	Rear end	P.D. only	Dry	East	Going ahead	Unknown	Other motor vehicle
					East	Stopped	Pick-up truck	Other motor vehicle
2015-Jan-28, Wed,08:00	Clear	Rear end	P.D. only	Dry	South	Turning right	Passenger van	Other motor vehicle
					South	Turning right	Pick-up truck	Other motor vehicle
2015-Jan-31, Sat,16:00	Clear	Rear end	P.D. only	Dry	North	Turning right	Automobile, station wagon	Other motor vehicle
					North	Turning right	Automobile, station wagon	Other motor vehicle
2015-Feb-25, Wed,14:18	Clear	Rear end	Non-fatal injury	Wet	East	Slowing or stopping	Truck - closed	Other motor vehicle
					East	Stopped	Passenger van	Other motor vehicle
2015-Mar-06, Fri,16:34	Clear	Other	P.D. only	Dry	North	Reversing	Automobile, station wagon	Other motor vehicle
					South	Turning right	Pick-up truck	Other motor vehicle
2015-Mar-07, Sat,09:40	Clear	Angle	P.D. only	Dry	North	Turning right	Automobile, station wagon	Other motor vehicle
					East	Going ahead	Automobile, station wagon	Other motor vehicle

2015-Mar-21, Sat, 14:45	Rain	Rear end	P.D. only	Wet	West	Slowing or stopping	Automobile, station wagon	Other motor vehicle
					West	Stopped	Delivery van	Other motor vehicle
2015-Mar-31, Tue, 14:00	Clear	Rear end	P.D. only	Dry	South	Turning right	Pick-up truck	Other motor vehicle
					South	Turning right	Automobile, station wagon	Other motor vehicle
2015-Apr-22, Wed, 18:10	Clear	Turning movement	P.D. only	Dry	North	Turning left	Pick-up truck	Other motor vehicle
					South	Turning right	Pick-up truck	Other motor vehicle
2015-May-04, Mon, 03:22	Clear	Angle	Non-fatal injury	Dry	West	Going ahead	Automobile, station wagon	Other motor vehicle
					South	Going ahead	Automobile, station wagon	Other motor vehicle
2015-Jun-04, Thu, 21:20	Clear	Sideswipe	P.D. only	Dry	West	Changing lanes	Automobile, station wagon	Other motor vehicle
					West	Going ahead	Automobile, station wagon	Other motor vehicle
2015-Jan-08, Thu, 12:04	Snow	Rear end	P.D. only	Ice	North	Turning right	Automobile, station wagon	Other motor vehicle
					North	Turning right	Automobile, station wagon	Other motor vehicle
2014-Sep-24, Wed, 20:08	Clear	Turning movement	Non-fatal injury	Dry	East	Turning left	Pick-up truck	Other motor vehicle
					West	Going ahead	Automobile, station wagon	Other motor vehicle

2014-Oct-16, Thu,05:54	Clear	Turning movement	P.D. only	Wet	East	Turning left	Automobile, station wagon	Other motor vehicle
					West	Going ahead	Automobile, station wagon	Other motor vehicle
2014-Dec-24, Wed,19:56	Rain	Rear end	P.D. only	Wet	South	Turning right	Automobile, station wagon	Other motor vehicle
					South	Turning right	Automobile, station wagon	Other motor vehicle
2014-Aug-27, Wed,18:33	Clear	Rear end	P.D. only	Dry	South	Turning right	Pick-up truck	Other motor vehicle
					South	Turning right	Unknown	Other motor vehicle
2015-Sep-17, Thu,13:06	Clear	Rear end	P.D. only	Dry	South	Turning right	Pick-up truck	Other motor vehicle
					South	Turning right	Passenger van	Other motor vehicle
2015-May-05, Tue,12:46	Clear	Rear end	Non-fatal injury	Dry	West	Turning right	Automobile, station wagon	Other motor vehicle
					West	Turning right	Automobile, station wagon	Other motor vehicle
2015-Apr-30, Thu,17:12	Clear	Sideswipe	P.D. only	Dry	West	Unknown	Unknown	Other motor vehicle
					West	Going ahead	Automobile, station wagon	Other motor vehicle
2015-Jul-06, Mon,12:11	Clear	Rear end	Non-fatal injury	Dry	East	Turning right	Automobile, station wagon	Other motor vehicle
					East	Turning right	Delivery van	Other motor vehicle

2015-Jul-20, Mon, 15:35	Clear	Turning movement	P.D. only	Dry	North	Turning left	Automobile, station wagon	Other motor vehicle
					South	Going ahead	Pick-up truck	Other motor vehicle
					East	Turning left	Automobile, station wagon	Other motor vehicle

2015-May-21, Thu, 11:15	Clear	Sideswipe	P.D. only	Dry	West	Changing lanes	Automobile, station wagon	Other motor vehicle
					West	Going ahead	Motorcycle	Other motor vehicle

2015-Aug-27, Thu, 15:00	Clear	Rear end	P.D. only	Dry	East	Going ahead	Delivery van	Other motor vehicle
					East	Stopped	Pick-up truck	Other motor vehicle

2015-Jul-28, Tue, 15:00	Clear	Rear end	P.D. only	Dry	South	Turning right	Automobile, station wagon	Other motor vehicle
					South	Turning right	Pick-up truck	Other motor vehicle

2015-Oct-07, Wed, 08:40	Clear	Rear end	P.D. only	Dry	North	Turning right	Automobile, station wagon	Other motor vehicle
					North	Turning right	Automobile, station wagon	Other motor vehicle

2015-Oct-09, Fri, 11:30	Rain	Rear end	Non-fatal injury	Wet	South	Turning right	Automobile, station wagon	Other motor vehicle
					South	Turning right	Automobile, station wagon	Other motor vehicle

2015-Aug-13, Thu, 10:05	Clear	Rear end	P.D. only	Dry	South	Turning right	Pick-up truck	Other motor vehicle
					South	Turning right	Automobile, station wagon	Other motor vehicle

2015-Nov-08, Sun,17:32	Clear	Turning movement	Non-fatal injury	Dry	East	Turning left	Automobile, station wagon	Other motor vehicle
					West	Going ahead	Pick-up truck	Other motor vehicle
2015-Nov-25, Wed,08:15	Clear	Sideswipe	P.D. only	Dry	North	Changing lanes	Automobile, station wagon	Other motor vehicle
					North	Going ahead	Automobile, station wagon	Other motor vehicle
2015-Aug-25, Tue,22:05	Clear	Rear end	P.D. only	Dry	South	Turning right	Pick-up truck	Other motor vehicle
					South	Turning right	Automobile, station wagon	Other motor vehicle
2015-Dec-02, Wed,17:17	Clear	Rear end	P.D. only	Wet	West	Going ahead	Automobile, station wagon	Other motor vehicle
					West	Slowing or stopping	Automobile, station wagon	Other motor vehicle
2016-Jan-05, Tue,09:40	Clear	Rear end	P.D. only	Dry	West	Slowing or stopping	Pick-up truck	Other motor vehicle
					West	Stopped	Automobile, station wagon	Other motor vehicle
2016-Feb-15, Mon,17:22	Clear	Rear end	P.D. only	Dry	South	Turning right	Pick-up truck	Other motor vehicle
					South	Turning right	Automobile, station wagon	Other motor vehicle
2015-Sep-01, Tue,15:06	Clear	Angle	P.D. only	Dry	South	Turning right	Automobile, station wagon	Other motor vehicle
					West	Going ahead	Automobile, station wagon	Other motor vehicle

2016-Mar-25, Fri,03:15	Freezing Rain	SMV other	P.D. only	Ice	West	Going ahead	Automobile, station wagon	Pole (utility, power)
2016-Jan-20, Wed,07:25	Clear	Rear end	P.D. only	Dry	East	Turning left	Pick-up truck	Other motor vehicle
					East	Turning left	Pick-up truck	Other motor vehicle
2016-Mar-15, Tue,18:53	Rain	Rear end	P.D. only	Wet	South	Turning right	Pick-up truck	Other motor vehicle
					South	Turning right	Automobile, station wagon	Other motor vehicle
2016-Mar-16, Wed,16:41	Clear	Rear end	P.D. only	Dry	South	Turning right	Pick-up truck	Other motor vehicle
					South	Turning right	Automobile, station wagon	Other motor vehicle
2016-Feb-25, Thu,20:09	Clear	Rear end	P.D. only	Ice	South	Turning right	Automobile, station wagon	Other motor vehicle
					South	Turning right	Automobile, station wagon	Other motor vehicle
2016-Mar-09, Wed,14:31	Rain	Rear end	P.D. only	Wet	West	Turning right	Delivery van	Other motor vehicle
					West	Turning right	Passenger van	Other motor vehicle
2016-May-09, Mon,13:43	Clear	Rear end	P.D. only	Dry	South	Turning right	Automobile, station wagon	Other motor vehicle
					South	Turning right	Pick-up truck	Other motor vehicle
2016-May-15, Sun,01:09	Clear	SMV other	P.D. only	Dry	South	Turning right	Automobile, station wagon	Curb

2016-May-04, Wed,11:43	Clear	Sideswipe	P.D. only	Dry	East	Changing lanes	Automobile, station wagon	Other motor vehicle
					East	Going ahead	Pick-up truck	Other motor vehicle

2016-May-18, Wed,09:57	Clear	Rear end	P.D. only	Dry	North	Turning right	Automobile, station wagon	Other motor vehicle
					North	Turning right	Pick-up truck	Other motor vehicle

2016-May-18, Wed,06:00	Clear	Angle	P.D. only	Dry	North	Going ahead	Passenger van	Other motor vehicle
					West	Turning right	Truck and trailer	Other motor vehicle

2016-Jun-27, Mon,11:45	Clear	Rear end	P.D. only	Dry	South	Going ahead	Pick-up truck	Other motor vehicle
					South	Stopped	Automobile, station wagon	Other motor vehicle

2016-Jun-07, Tue,06:46	Clear	Rear end	P.D. only	Dry	East	Unknown	Unknown	Other motor vehicle
					East	Stopped	Pick-up truck	Other motor vehicle
					East	Stopped	Pick-up truck	Other motor vehicle

2016-Jul-19, Tue,15:20	Clear	Sideswipe	P.D. only	Dry	West	Changing lanes	Automobile, station wagon	Other motor vehicle
					West	Turning left	Automobile, station wagon	Other motor vehicle

2016-Jul-22, Fri,15:47	Clear	Angle	P.D. only	Dry	East	Going ahead	Pick-up truck	Other motor vehicle
					North	Turning left	Automobile, station wagon	Other motor vehicle

2016-Nov-06, Sun,16:25	Clear	Rear end	P.D. only	Dry	West	Merging	Automobile, station wagon	Other motor vehicle
					West	Merging	Automobile, station wagon	Other motor vehicle
2016-Dec-21, Wed,15:57	Clear	Rear end	P.D. only	Dry	East	Turning left	Unknown	Other motor vehicle
					East	Turning left	Automobile, station wagon	Other motor vehicle
2016-Dec-20, Tue,15:23	Clear	Turning movement	P.D. only	Wet	East	Turning left	Pick-up truck	Other motor vehicle
					West	Going ahead	Pick-up truck	Other motor vehicle
2016-Jul-21, Thu,21:58	Clear	Rear end	P.D. only	Dry	South	Turning right	Automobile, station wagon	Other motor vehicle
					South	Turning right	Automobile, station wagon	Other motor vehicle
2016-Jul-02, Sat,17:20	Clear	Rear end	P.D. only	Dry	West	Turning right	Pick-up truck	Other motor vehicle
					West	Turning right	Automobile, station wagon	Other motor vehicle
2016-Dec-05, Mon,17:22	Clear	Rear end	Non-fatal injury	Loose snow	South	Turning right	Automobile, station wagon	Other motor vehicle
					South	Turning right	Automobile, station wagon	Other motor vehicle
2016-Nov-16, Wed,09:41	Clear	Rear end	P.D. only	Dry	East	Slowing or stopping	Pick-up truck	Other motor vehicle
					East	Stopped	Pick-up truck	Other motor vehicle

2016-May-14, Sat,02:40	Clear	SMV other	P.D. only	Dry	South	Turning right	Automobile, station wagon	Curb
2016-Jan-19, Tue,08:16	Clear	Rear end	P.D. only	Dry	North	Turning right	Automobile, station wagon	Other motor vehicle
					North	Turning right	Pick-up truck	Other motor vehicle
2016-Jul-12, Tue,16:56	Clear	Rear end	P.D. only	Dry	East	Slowing or stopping	Pick-up truck	Other motor vehicle
					East	Slowing or stopping	Truck - closed	Other motor vehicle
					East	Stopped	Automobile, station wagon	Other motor vehicle
2016-Sep-02, Fri,17:54	Clear	Rear end	Non-fatal injury	Dry	South	Turning right	Delivery van	Other motor vehicle
					South	Turning right	Automobile, station wagon	Other motor vehicle
					South	Turning right	Pick-up truck	Other motor vehicle
2016-Oct-09, Sun,14:57	Clear	Rear end	P.D. only	Dry	West	Turning right	Pick-up truck	Other motor vehicle
					West	Turning right	Pick-up truck	Other motor vehicle
2016-Nov-07, Mon,06:45	Clear	Rear end	P.D. only	Dry	West	Turning right	Pick-up truck	Other motor vehicle
					West	Turning right	Pick-up truck	Other motor vehicle
2016-Nov-16, Wed,16:10	Clear	Rear end	P.D. only	Dry	North	Slowing or stopping	Automobile, station wagon	Other motor vehicle
					North	Stopped	Pick-up truck	Other motor vehicle

2017-Jan-05, Thu,09:26	Clear	Rear end	P.D. only	Ice	North	Turning right	Automobile, station wagon	Other motor vehicle
					North	Turning right	Pick-up truck	Other motor vehicle
2017-Jan-14, Sat,11:30	Clear	Turning movement	P.D. only	Dry	East	Turning left	Automobile, station wagon	Other motor vehicle
					West	Going ahead	Passenger van	Other motor vehicle
2016-Jan-29, Fri,20:11	Clear	Rear end	P.D. only	Dry	South	Turning right	Automobile, station wagon	Other motor vehicle
					South	Turning right	Passenger van	Other motor vehicle
2017-Mar-04, Sat,22:48	Clear	Rear end	Non-fatal injury	Dry	West	Going ahead	Automobile, station wagon	Other motor vehicle
					West	Stopped	Automobile, station wagon	Other motor vehicle
2016-Feb-17, Wed,14:00	Clear	Rear end	P.D. only	Dry	South	Turning right	Automobile, station wagon	Other motor vehicle
					South	Turning right	Pick-up truck	Other motor vehicle
2017-Mar-22, Wed,18:12	Clear	Rear end	P.D. only	Dry	South	Turning right	Pick-up truck	Other motor vehicle
					South	Turning right	Automobile, station wagon	Other motor vehicle
2017-Aug-10, Thu,19:45	Clear	Rear end	P.D. only	Dry	North	Going ahead	Automobile, station wagon	Other motor vehicle
					North	Stopped	Automobile, station wagon	Other motor vehicle

2017-Apr-24, Mon,11:56	Clear	Rear end	P.D. only	Dry	South	Turning right	Pick-up truck	Other motor vehicle	
					South	Turning right	Truck - closed	Other motor vehicle	
2017-Apr-26, Wed,17:28	Clear	Rear end	P.D. only	Dry	South	Turning right	Pick-up truck	Other motor vehicle	
					South	Turning right	Automobile, station wagon	Other motor vehicle	
2017-May-02, Tue,15:50	Clear	Rear end	P.D. only	Wet	South	Turning right	Automobile, station wagon	Other motor vehicle	
					South	Turning right	Pick-up truck	Other motor vehicle	
2017-May-05, Fri,11:30	Clear	Sideswipe	P.D. only	Wet	West	Changing lanes	Pick-up truck	Other motor vehicle	
					West	Going ahead	Truck - closed	Other motor vehicle	
2017-May-20, Sat,12:52	Clear	SMV other	Non-fatal injury	Dry	South	Going ahead	Automobile, station wagon	Pedestrian	1
2017-May-23, Tue,14:35	Clear	Rear end	Non-fatal injury	Dry	West	Going ahead	Tow truck	Other motor vehicle	
					West	Slowing or stopping	Automobile, station wagon	Other motor vehicle	
2017-Sep-24, Sun,11:11	Clear	Rear end	Non-fatal injury	Dry	West	Turning right	Automobile, station wagon	Other motor vehicle	
					West	Turning right	Automobile, station wagon	Other motor vehicle	
2017-May-27, Sat,19:01	Clear	Rear end	Non-fatal injury	Dry	South	Turning right	Automobile, station wagon	Other motor vehicle	

					South	Turning right	Automobile, station wagon	Other motor vehicle
2017-Oct-07, Sat,08:53	Clear	Rear end	Non-fatal injury	Dry	North	Turning right	Truck-other	Other motor vehicle
					North	Turning right	Automobile, station wagon	Other motor vehicle
2017-Feb-03, Fri,17:15	Clear	Rear end	P.D. only	Dry	North	Going ahead	Automobile, station wagon	Other motor vehicle
					North	Stopped	Automobile, station wagon	Other motor vehicle
2017-Jun-14, Wed,11:28	Clear	Angle	P.D. only	Dry	South	Turning right	Automobile, station wagon	Other motor vehicle
					West	Going ahead	Pick-up truck	Other motor vehicle
2017-Jun-08, Thu,15:17	Clear	Turning movement	Non-fatal injury	Dry	South	Going ahead	Passenger van	Other motor vehicle
					North	Turning left	Automobile, station wagon	Other motor vehicle
2017-Jan-20, Fri,13:41	Clear	Other	P.D. only	Wet	West	Reversing	Truck - tractor	Other motor vehicle
					West	Stopped	Automobile, station wagon	Other motor vehicle
2017-Oct-18, Wed,17:45	Clear	Rear end	P.D. only	Dry	South	Turning right	Automobile, station wagon	Other motor vehicle
					South	Turning right	Automobile, station wagon	Other motor vehicle
2017-Jul-07, Fri,15:38	Clear	Rear end	P.D. only	Dry	South	Slowing or stopping	Automobile, station wagon	Other motor vehicle

					South	Stopped	Pick-up truck	Other motor vehicle
2017-Jan-05, Thu, 16:20	Clear	Rear end	Non-fatal injury	Ice	South	Turning right	Automobile, station wagon	Other motor vehicle
					South	Turning right	Automobile, station wagon	Other motor vehicle
2017-Dec-01, Fri, 14:31	Clear	Rear end	P.D. only	Dry	North	Going ahead	Automobile, station wagon	Other motor vehicle
					North	Stopped	Truck - dump	Other motor vehicle
2017-Dec-27, Wed, 10:24	Clear	Turning movement	P.D. only	Wet	South	Turning left	Truck - tractor	Other motor vehicle
					North	Going ahead	Passenger van	Other motor vehicle
2017-Dec-12, Tue, 14:21	Snow	Rear end	P.D. only	Slush	West	Slowing or stopping	Truck - open	Other motor vehicle
					West	Stopped	Automobile, station wagon	Other motor vehicle
2017-Dec-21, Thu, 12:30	Clear	Other	P.D. only	Dry	South	Unknown	Unknown	Construction marker
					South	Going ahead	Construction equipment	Construction marker
2018-Jan-05, Fri, 11:38	Clear	Rear end	P.D. only	Dry	South	Turning right	Delivery van	Other motor vehicle
					South	Turning right	Automobile, station wagon	Other motor vehicle
2017-Feb-13, Mon, 13:04	Clear	Rear end	P.D. only	Slush	South	Turning right	Automobile, station wagon	Other motor vehicle

					South	Turning right	Automobile, station wagon	Other motor vehicle
2017-Feb-14, Tue,22:50	Snow	Rear end	Non-reportable	Packed snow	North	Turning right	Automobile, station wagon	Skidding/sliding
					North	Turning right	Automobile, station wagon	Other motor vehicle
2017-Feb-27, Mon,16:40	Clear	Rear end	P.D. only	Dry	South	Turning right	Automobile, station wagon	Other motor vehicle
					South	Turning right	Pick-up truck	Other motor vehicle
2017-Mar-16, Thu,15:53	Clear	Rear end	Non-fatal injury	Dry	West	Turning right	Delivery van	Other motor vehicle
					West	Turning right	Pick-up truck	Other motor vehicle
2017-Apr-09, Sun,13:15	Clear	Rear end	P.D. only	Dry	East	Turning left	Automobile, station wagon	Other motor vehicle
					East	Turning left	Pick-up truck	Other motor vehicle
2017-Jul-22, Sat,12:25	Clear	Rear end	Non-fatal injury	Dry	South	Turning right	Pick-up truck	Other motor vehicle
					South	Turning right	Automobile, station wagon	Other motor vehicle
2017-Oct-21, Sat,14:42	Clear	Rear end	P.D. only	Dry	West	Turning right	Automobile, station wagon	Other motor vehicle
					West	Turning right	Automobile, station wagon	Other motor vehicle
2017-Nov-03, Fri,12:58	Rain	Sideswipe	P.D. only	Wet	North	Going ahead	Bus (other)	Curb

					North	Stopped	Automobile, station wagon	Other motor vehicle
2017-Nov-04, Sat,15:27	Clear	Rear end	P.D. only	Dry	West	Turning left	Automobile, station wagon	Other motor vehicle
					West	Turning left	Automobile, station wagon	Other motor vehicle
2017-Nov-24, Fri,15:27	Clear	Sideswipe	P.D. only	Dry	East	Changing lanes	Unknown	Other motor vehicle
					East	Stopped	Automobile, station wagon	Other motor vehicle
2018-Mar-01, Thu,20:40	Clear	Rear end	P.D. only	Dry	East	Going ahead	Automobile, station wagon	Other motor vehicle
					East	Stopped	Automobile, station wagon	Other motor vehicle
2018-Jan-02, Tue,08:03	Clear	Sideswipe	P.D. only	Ice	East	Going ahead	Automobile, station wagon	Other motor vehicle
					East	Going ahead	Passenger van	Other motor vehicle
2018-Jan-03, Wed,15:23	Rain	Angle	P.D. only	Wet	South	Turning right	Automobile, station wagon	Other motor vehicle
					West	Going ahead	Truck and trailer	Other motor vehicle
2018-May-08, Tue,17:01	Clear	Sideswipe	P.D. only	Dry	West	Changing lanes	Truck - dump	Other motor vehicle
					West	Going ahead	Automobile, station wagon	Other motor vehicle
2018-Feb-12, Mon,15:35	Clear	Turning movement	P.D. only	Dry	South	Going ahead	Automobile, station wagon	Other motor vehicle

					North	Turning left	Pick-up truck	Other motor vehicle
2018-Jun-09, Sat, 19:06	Clear	Turning movement	Non-fatal injury	Dry	North	Turning left	Automobile, station wagon	Other motor vehicle
					South	Going ahead	Automobile, station wagon	Other motor vehicle
					East	Stopped	Automobile, station wagon	Other motor vehicle
2018-Aug-20, Mon, 17:45	Clear	Rear end	P.D. only	Dry	South	Unknown	Unknown	Other motor vehicle
					South	Stopped	Automobile, station wagon	Other motor vehicle
2018-Sep-11, Tue, 00:23	Rain	SMV other	P.D. only	Wet	East	Going ahead	Automobile, station wagon	Ran off road
2018-Sep-16, Sun, 12:33	Clear	Rear end	P.D. only	Dry	North	Turning right	Automobile, station wagon	Other motor vehicle
					North	Turning right	Tow truck	Other motor vehicle
2018-Sep-18, Tue, 17:44	Clear	Rear end	Non-fatal injury	Dry	East	Going ahead	Automobile, station wagon	Other motor vehicle
					East	Stopped	Delivery van	Other motor vehicle
					East	Stopped	Pick-up truck	Other motor vehicle
2018-Nov-29, Thu, 16:39	Clear	Turning movement	P.D. only	Wet	South	Turning left	Automobile, station wagon	Other motor vehicle
					North	Going ahead	Pick-up truck	Other motor vehicle
					South	Stopped	Automobile, station wagon	Other motor vehicle

2018-Nov-27, Tue,16:43	Snow	Rear end	Non-fatal injury	Wet	South	Turning right	Automobile, station wagon	Other motor vehicle
					South	Turning right	Automobile, station wagon	Other motor vehicle
2018-Nov-22, Thu,11:49	Clear	Rear end	P.D. only	Dry	East	Slowing or stopping	Automobile, station wagon	Other motor vehicle
					East	Stopped	Pick-up truck	Other motor vehicle
2018-Oct-31, Wed,13:11	Rain	Rear end	P.D. only	Wet	North	Turning right	Truck - closed	Other motor vehicle
					North	Turning right	Automobile, station wagon	Other motor vehicle
2018-Nov-13, Tue,06:45	Snow	Rear end	P.D. only	Wet	North	Going ahead	Truck - tank	Other motor vehicle
					North	Stopped	Automobile, station wagon	Other motor vehicle
2018-Nov-13, Tue,17:15	Rain	Rear end	P.D. only	Wet	North	Going ahead	Automobile, station wagon	Other motor vehicle
					North	Stopped	Automobile, station wagon	Other motor vehicle
2018-Nov-08, Thu,20:51	Snow	Rear end	P.D. only	Slush	North	Turning right	Pick-up truck	Other motor vehicle
					North	Turning right	Automobile, station wagon	Other motor vehicle
2018-Dec-21, Fri,15:07	Clear	Angle	Non-fatal injury	Dry	South	Turning right	Automobile, station wagon	Other motor vehicle
					West	Going ahead	Pick-up truck	Other motor vehicle

2018-Dec-03, Mon,08:36	Rain	Other	P.D. only	Wet	West	Reversing	Unknown	Other motor vehicle
					East	Stopped	Automobile, station wagon	Other motor vehicle
2015-Aug-26, Wed,13:00	Clear	Sideswipe	P.D. only	Dry	East	Changing lanes	Automobile, station wagon	Other motor vehicle
					East	Turning left	Pick-up truck	Other motor vehicle
2018-Nov-07, Wed,20:45	Rain	Rear end	P.D. only	Wet	South	Turning right	Automobile, station wagon	Other motor vehicle
					South	Turning right	Unknown	Other motor vehicle
2018-Apr-19, Thu,13:50	Clear	Rear end	P.D. only	Dry	East	Changing lanes	Automobile, station wagon	Other motor vehicle
					East	Stopped	Automobile, station wagon	Other motor vehicle
2018-Sep-14, Fri,08:07	Clear	Sideswipe	P.D. only	Dry	South	Changing lanes	Automobile, station wagon	Other motor vehicle
					South	Turning left	Truck - dump	Other motor vehicle

Location: HAWTHORNE RD @ RUSSELL RD

Traffic Control: Traffic signal

Total Collisions: 4

Date/Day/Time	Environment	Impact Type	Classification	Surface Cond'n	Veh. Dir	Vehicle Manoeuvre	Vehicle type	First Event	No. Ped
2014-May-07, Wed,11:00	Clear	Turning movement	P.D. only	Dry	South	Turning left	Truck and trailer	Other motor vehicle	
					North	Going ahead	Automobile, station wagon	Other motor vehicle	
2015-Sep-26, Sat,10:39	Clear	Turning movement	Non-fatal injury	Dry	South	Turning left	Pick-up truck	Other motor vehicle	

					North	Going ahead	Pick-up truck	Other motor vehicle
2016-Jun-28, Tue,09:18	Clear	Rear end	P.D. only	Dry	West	Going ahead	Automobile, station wagon	Other motor vehicle
					West	Stopped	Pick-up truck	Other motor vehicle
2018-Aug-21, Tue,16:13	Rain	Sideswipe	P.D. only	Wet	South	Merging	Automobile, station wagon	Other motor vehicle
					South	Going ahead	Automobile, station wagon	Other motor vehicle

Location: HAWTHORNE RD @ STEVENAGE DR

Traffic Control: Traffic signal

Total Collisions: 24

Date/Day/Time	Environment	Impact Type	Classification	Surface Cond'n	Veh. Dir	Vehicle Manoeuver	Vehicle type	First Event	No. Ped
2014-Feb-19, Wed,16:39	Clear	Turning movement	P.D. only	Wet	North	Turning left	Pick-up truck	Other motor vehicle	
					South	Going ahead	Automobile, station wagon	Other motor vehicle	
2014-Mar-12, Wed,15:30	Snow	Turning movement	P.D. only	Loose snow	North	Turning left	Pick-up truck	Other motor vehicle	
					South	Going ahead	Automobile, station wagon	Other motor vehicle	
2014-Jun-11, Wed,15:21	Rain	Turning movement	P.D. only	Wet	South	Turning left	Truck - open	Other motor vehicle	
					North	Going ahead	Automobile, station wagon	Other motor vehicle	
2014-Aug-18, Mon,22:43	Clear	Rear end	P.D. only	Dry	South	Slowing or stopping	Automobile, station wagon	Other motor vehicle	
					South	Slowing or stopping	Passenger van	Other motor vehicle	

2014-Nov-20, Thu,17:50	Clear	Turning movement	P.D. only	Dry	South	Turning left	Automobile, station wagon	Other motor vehicle
					North	Going ahead	Pick-up truck	Other motor vehicle

2014-Jul-30, Wed,12:37	Clear	Turning movement	Non-fatal injury	Dry	South	Going ahead	Motorcycle	Other motor vehicle
					North	Turning left	Pick-up truck	Other motor vehicle

2015-May-08, Fri,18:50	Clear	Rear end	Non-fatal injury	Dry	East	Turning left	Automobile, station wagon	Other motor vehicle
					East	Turning left	Pick-up truck	Other motor vehicle

2015-May-26, Tue,09:58	Clear	Turning movement	P.D. only	Dry	North	Turning left	Delivery van	Other motor vehicle
					South	Going ahead	Automobile, station wagon	Other motor vehicle

2015-Aug-11, Tue,18:17	Rain	Rear end	P.D. only	Wet	East	Turning right	Pick-up truck	Other motor vehicle
					East	Turning right	Pick-up truck	Other motor vehicle

2015-Dec-01, Tue,11:35	Clear	Angle	Non-fatal injury	Dry	North	Going ahead	Pick-up truck	Other motor vehicle
					East	Turning left	Truck and trailer	Other motor vehicle
					West	Turning left	Pick-up truck	Other motor vehicle

2016-Jan-14, Thu,12:48	Clear	Angle	Non-fatal injury	Wet	West	Going ahead	Automobile, station wagon	Other motor vehicle
					South	Going ahead	Delivery van	Other motor vehicle

2016-Feb-09, Tue,06:50	Snow	Turning movement	P.D. only	Slush	North	Turning right	Truck - tractor	Other motor vehicle
					North	Going ahead	Automobile, station wagon	Other motor vehicle
2016-Apr-06, Wed,13:36	Snow	Turning movement	P.D. only	Wet	North	Turning left	Pick-up truck	Other motor vehicle
					South	Going ahead	Truck and trailer	Other motor vehicle
2016-Apr-22, Fri,06:19	Rain	Turning movement	P.D. only	Wet	South	Turning left	Automobile, station wagon	Other motor vehicle
					North	Going ahead	Pick-up truck	Other motor vehicle
2016-May-13, Fri,08:30	Rain	Turning movement	P.D. only	Wet	West	Turning left	Pick-up truck	Other motor vehicle
					East	Turning right	Truck - tractor	Other motor vehicle
2017-Apr-21, Fri,04:28	Rain	Turning movement	Non-fatal injury	Wet	North	Turning left	Automobile, station wagon	Other motor vehicle
					South	Going ahead	Automobile, station wagon	Other motor vehicle
2017-Aug-16, Wed,18:07	Clear	Sideswipe	P.D. only	Dry	South	Changing lanes	Automobile, station wagon	Other motor vehicle
					South	Changing lanes	Automobile, station wagon	Other motor vehicle
2017-Jun-14, Wed,12:45	Clear	Turning movement	P.D. only	Dry	East	Turning left	Pick-up truck	Other motor vehicle
					West	Going ahead	Automobile, station wagon	Other motor vehicle

2017-Mar-29, Wed,08:17	Clear	Rear end	P.D. only	Dry	North	Going ahead	Truck - dump	Other motor vehicle
					North	Going ahead	Automobile, station wagon	Other motor vehicle
2018-Jan-08, Mon,06:30	Snow	Turning movement	P.D. only	Loose snow	East	Turning left	Automobile, station wagon	Other motor vehicle
					West	Going ahead	Pick-up truck	Other motor vehicle
2018-Jun-19, Tue,15:25	Clear	Angle	Non-fatal injury	Dry	South	Going ahead	Automobile, station wagon	Other motor vehicle
					West	Going ahead	Truck - closed	Other motor vehicle
2018-Nov-16, Fri,17:31	Snow	Sideswipe	P.D. only	Loose snow	South	Going ahead	Delivery van	Other motor vehicle
					South	Going ahead	Automobile, station wagon	Other motor vehicle
2018-Dec-21, Fri,13:10	Freezing Rain	Rear end	P.D. only	Wet	North	Slowing or stopping	Automobile, station wagon	Other motor vehicle
					North	Unknown	Unknown	Other motor vehicle
2018-Jan-17, Wed,06:02	Snow	Turning movement	P.D. only	Slush	North	Turning left	Automobile, station wagon	Other motor vehicle
					South	Going ahead	Automobile, station wagon	Other motor vehicle

Location: HAWTHORNE RD/RUSSELL RD @ WALKLEY RD

Traffic Control: Traffic signal

Total Collisions: 106

Date/Day/Time	Environment	Impact Type	Classification	Surface Cond'n	Veh. Dir	Vehicle Manoeuver	Vehicle type	First Event	No. Ped
2014-Feb-17, Mon,19:29	Clear	Turning movement	Non-fatal injury	Dry	North	Turning left	Automobile, station wagon	Other motor vehicle	

					South	Going ahead	Automobile, station wagon	Other motor vehicle
2014-Feb-16, Sun,15:50	Clear	Rear end	P.D. only	Dry	North	Going ahead	Pick-up truck	Other motor vehicle
					North	Stopped	Automobile, station wagon	Other motor vehicle
2014-Mar-05, Wed,18:40	Clear	Rear end	P.D. only	Ice	West	Changing lanes	Pick-up truck	Other motor vehicle
					West	Turning left	Automobile, station wagon	Other motor vehicle
2014-Mar-30, Sun,15:01	Snow	SMV other	P.D. only	Packed snow	South	Turning right	Automobile, station wagon	Skidding/sliding
2014-May-02, Fri,02:34	Clear	Angle	Non-fatal injury	Dry	South	Going ahead	Automobile, station wagon	Other motor vehicle
					West	Going ahead	Automobile, station wagon	Other motor vehicle
2014-Apr-14, Mon,15:52	Rain	Rear end	P.D. only	Wet	West	Going ahead	Pick-up truck	Other motor vehicle
					West	Slowing or stopping	Pick-up truck	Other motor vehicle
2014-May-29, Thu,18:00	Clear	Rear end	Non-fatal injury	Dry	South	Turning right	Automobile, station wagon	Other motor vehicle
					South	Turning right	Automobile, station wagon	Other motor vehicle
2014-Jun-15, Sun,15:00	Clear	Rear end	P.D. only	Dry	North	Turning right	Automobile, station wagon	Other motor vehicle
					North	Turning right	Pick-up truck	Other motor vehicle

2014-Jul-12, Sat,15:12	Clear	Rear end	P.D. only	Dry	South	Going ahead	Automobile, station wagon	Other motor vehicle
					South	Slowing or stopping	Automobile, station wagon	Other motor vehicle
2014-Aug-08, Fri,13:00	Clear	Rear end	P.D. only	Dry	North	Slowing or stopping	Automobile, station wagon	Other motor vehicle
					North	Stopped	Automobile, station wagon	Other motor vehicle
2014-Aug-26, Tue,07:24	Clear	Rear end	Non-fatal injury	Dry	North	Going ahead	Truck - closed	Other motor vehicle
					North	Stopped	Automobile, station wagon	Other motor vehicle
2014-Aug-12, Tue,17:05	Rain	Sideswipe	P.D. only	Wet	West	Changing lanes	Automobile, station wagon	Other motor vehicle
					West	Turning left	Pick-up truck	Other motor vehicle
2014-Sep-26, Fri,15:30	Clear	Rear end	P.D. only	Dry	East	Going ahead	Automobile, station wagon	Other motor vehicle
					East	Stopped	Automobile, station wagon	Other motor vehicle
2014-Oct-16, Thu,09:45	Clear	Rear end	P.D. only	Dry	South	Turning right	Automobile, station wagon	Other motor vehicle
					South	Turning right	Delivery van	Other motor vehicle
2014-Oct-01, Wed,18:05	Clear	Rear end	P.D. only	Dry	East	Unknown	Automobile, station wagon	Other motor vehicle
					East	Unknown	Truck - closed	Other motor vehicle

2014-Dec-26, Fri,14:01	Clear	Rear end	P.D. only	Dry	North	Turning right	Automobile, station wagon	Other motor vehicle
					North	Turning right	Pick-up truck	Other motor vehicle
2014-Dec-31, Wed,08:00	Clear	Rear end	P.D. only	Dry	North	Turning right	Truck - closed	Other motor vehicle
					North	Turning right	Pick-up truck	Other motor vehicle
2014-Dec-17, Wed,13:15	Rain	Rear end	P.D. only	Wet	South	Turning right	Automobile, station wagon	Other motor vehicle
					South	Turning right	Automobile, station wagon	Other motor vehicle
2014-Apr-12, Sat,09:29	Clear	Sideswipe	P.D. only	Dry	North	Changing lanes	Truck - dump	Other motor vehicle
					North	Going ahead	Automobile, station wagon	Other motor vehicle
2014-Jun-05, Thu,18:20	Clear	Sideswipe	P.D. only	Dry	South	Going ahead	Automobile, station wagon	Other motor vehicle
					South	Going ahead	Automobile, station wagon	Other motor vehicle
2014-Dec-16, Tue,13:17	Rain	Rear end	P.D. only	Wet	South	Going ahead	Construction equipment	Other motor vehicle
					South	Going ahead	Automobile, station wagon	Other motor vehicle
2014-Apr-26, Sat,09:35	Clear	Rear end	P.D. only	Dry	North	Turning right	Unknown	Other motor vehicle
					North	Turning right	Automobile, station wagon	Other motor vehicle

2014-Apr-30, Wed,17:33	Clear	Rear end	P.D. only	Dry	East	Turning right	Automobile, station wagon	Other motor vehicle
					East	Turning right	Automobile, station wagon	Other motor vehicle

2014-Feb-04, Tue,15:32	Clear	Sideswipe	P.D. only	Dry	West	Turning left	Truck and trailer	Other motor vehicle
					West	Turning left	Automobile, station wagon	Other motor vehicle

2014-Feb-11, Tue,08:30	Clear	Rear end	P.D. only	Dry	West	Going ahead	Automobile, station wagon	Other motor vehicle
					West	Stopped	Passenger van	Other motor vehicle
					West	Going ahead	Pick-up truck	Other motor vehicle
					West	Stopped	Pick-up truck	Other motor vehicle

2014-Mar-27, Thu,11:19	Clear	Rear end	P.D. only	Dry	South	Turning left	Automobile, station wagon	Other motor vehicle
					South	Turning left	Pick-up truck	Other motor vehicle

2014-May-26, Mon,09:11	Clear	Other	P.D. only	Dry	East	Reversing	Truck - open	Other motor vehicle
					West	Turning left	Passenger van	Other motor vehicle

2014-Jun-02, Mon,16:48	Clear	Turning movement	Non-fatal injury	Dry	North	Turning right	Truck and trailer	Cyclist
					North	Going ahead	Bicycle	Other motor vehicle

2014-Jun-23, Mon,17:39	Clear	Sideswipe	P.D. only	Dry	North	Changing lanes	Automobile, station wagon	Other motor vehicle
------------------------	-------	-----------	-----------	-----	-------	----------------	---------------------------	---------------------

					North	Turning left	Truck - dump	Other motor vehicle
2014-Oct-17, Fri,15:58	Rain	Sideswipe	Non-fatal injury	Wet	East	Changing lanes	Automobile, station wagon	Other motor vehicle
					East	Slowing or stopping	Automobile, station wagon	Other motor vehicle
2014-Dec-16, Tue,17:15	Freezing Rain	Sideswipe	P.D. only	Wet	South	Changing lanes	Automobile, station wagon	Other motor vehicle
					South	Turning left	Pick-up truck	Other motor vehicle
2015-Jan-12, Mon,16:16	Clear	Rear end	P.D. only	Packed snow	North	Going ahead	Unknown	Other motor vehicle
					North	Slowing or stopping	Automobile, station wagon	Other motor vehicle
2015-Jan-12, Mon,15:37	Snow	Rear end	P.D. only	Loose snow	South	Turning right	Truck - closed	Other motor vehicle
					South	Turning right	Automobile, station wagon	Other motor vehicle
2015-Feb-07, Sat,11:40	Clear	Angle	P.D. only	Slush	East	Going ahead	Automobile, station wagon	Other motor vehicle
					North	Turning left	Truck - closed	Other motor vehicle
2015-Feb-14, Sat,12:45	Snow	Sideswipe	P.D. only	Loose snow	West	Unknown	Pick-up truck	Other motor vehicle
					West	Unknown	Automobile, station wagon	Other motor vehicle
2015-Mar-25, Wed,10:20	Clear	Rear end	P.D. only	Dry	South	Turning right	Automobile, station wagon	Other motor vehicle

					South	Turning right	Automobile, station wagon	Other motor vehicle
2015-Apr-04, Sat,22:27	Clear	Rear end	Non-fatal injury	Dry	East	Going ahead	Automobile, station wagon	Other motor vehicle
					East	Slowing or stopping	Pick-up truck	Other motor vehicle
2015-May-07, Thu,13:13	Clear	Sideswipe	P.D. only	Dry	East	Changing lanes	Automobile, station wagon	Other motor vehicle
					East	Stopped	Truck and trailer	Other motor vehicle
2015-Jun-04, Thu,09:56	Clear	Angle	P.D. only	Dry	North	Turning left	Pick-up truck	Other motor vehicle
					East	Going ahead	Pick-up truck	Other motor vehicle
2015-Jul-22, Wed,09:29	Clear	Rear end	Non-fatal injury	Dry	East	Unknown	Unknown	Other motor vehicle
					East	Stopped	Automobile, station wagon	Other motor vehicle
2015-Jun-18, Thu,10:54	Clear	Rear end	P.D. only	Dry	North	Slowing or stopping	Passenger van	Other motor vehicle
					North	Stopped	Automobile, station wagon	Other motor vehicle
2015-May-23, Sat,13:27	Clear	Angle	P.D. only	Dry	East	Going ahead	Automobile, station wagon	Other motor vehicle
					South	Going ahead	Police vehicle	Other motor vehicle
2015-Sep-08, Tue,07:27	Clear	Rear end	P.D. only	Dry	East	Going ahead	Truck and trailer	Other motor vehicle

					East	Stopped	Automobile, station wagon	Other motor vehicle
					East	Stopped	Passenger van	Other motor vehicle
2015-Jul-21, Tue,10:29	Rain	Rear end	P.D. only	Wet	East	Slowing or stopping	Truck and trailer	Other motor vehicle
					East	Stopped	Automobile, station wagon	Other motor vehicle
2015-Nov-03, Tue,15:57	Clear	Rear end	Non-fatal injury	Dry	East	Going ahead	Automobile, station wagon	Other motor vehicle
					East	Slowing or stopping	Automobile, station wagon	Other motor vehicle
2015-Nov-27, Fri,16:20	Clear	Rear end	P.D. only	Dry	North	Turning right	Automobile, station wagon	Other motor vehicle
					North	Turning right	Automobile, station wagon	Other motor vehicle
					North	Turning right	Pick-up truck	Other motor vehicle
2015-Nov-09, Mon,14:10	Clear	Rear end	P.D. only	Dry	East	Turning right	Automobile, station wagon	Other motor vehicle
					East	Turning right	Pick-up truck	Other motor vehicle
2015-Nov-13, Fri,14:04	Rain	Rear end	P.D. only	Wet	South	Turning right	Pick-up truck	Other motor vehicle
					South	Turning right	Pick-up truck	Other motor vehicle
2015-Nov-24, Tue,12:25	Snow	Rear end	P.D. only	Slush	West	Going ahead	Automobile, station wagon	Other motor vehicle
					West	Stopped	Automobile, station wagon	Other motor vehicle

2015-Dec-22, Tue,16:13	Rain	Rear end	Non-fatal injury	Wet	East	Slowing or stopping	Automobile, station wagon	Other motor vehicle
					East	Stopped	Automobile, station wagon	Other motor vehicle
2014-Aug-12, Tue,17:23	Rain	Rear end	P.D. only	Wet	West	Going ahead	Automobile, station wagon	Other motor vehicle
					West	Stopped	Automobile, station wagon	Other motor vehicle
2016-Feb-16, Tue,06:50	Snow	Rear end	P.D. only	Slush	East	Going ahead	Pick-up truck	Other motor vehicle
					East	Slowing or stopping	Automobile, station wagon	Other motor vehicle
2016-Mar-01, Tue,18:56	Snow	Turning movement	P.D. only	Slush	East	Going ahead	Automobile, station wagon	Other motor vehicle
					West	Turning left	Truck - tractor	Other motor vehicle
2016-Mar-11, Fri,15:40	Clear	Rear end	Non-fatal injury	Dry	North	Turning right	Delivery van	Other motor vehicle
					North	Turning right	Pick-up truck	Other motor vehicle
2016-Apr-12, Tue,06:21	Clear	Angle	Non-fatal injury	Dry	West	Going ahead	Automobile, station wagon	Other motor vehicle
					North	Going ahead	Pick-up truck	Other motor vehicle
2016-May-03, Tue,08:02	Clear	Rear end	Non-fatal injury	Dry	North	Turning right	Pick-up truck	Other motor vehicle
					North	Turning right	Pick-up truck	Other motor vehicle

2016-May-06, Fri,10:22	Clear	Rear end	P.D. only	Dry	East	Turning right	Automobile, station wagon	Other motor vehicle
					East	Turning right	Pick-up truck	Other motor vehicle
2016-May-13, Fri,08:01	Rain	Rear end	P.D. only	Wet	North	Turning right	Delivery van	Other motor vehicle
					North	Turning right	Automobile, station wagon	Other motor vehicle
2016-Jun-20, Mon,07:44	Clear	Other	P.D. only	Dry	East	Reversing	Truck - tractor	Other motor vehicle
					West	Stopped	Truck - tractor	Other motor vehicle
2016-Sep-11, Sun,20:10	Clear	Rear end	P.D. only	Dry	South	Turning right	Automobile, station wagon	Other motor vehicle
					South	Turning right	Pick-up truck	Other motor vehicle
2016-Sep-27, Tue,15:45	Clear	Rear end	Non-fatal injury	Dry	East	Going ahead	Motorcycle	Other motor vehicle
					East	Stopped	Automobile, station wagon	Other motor vehicle
2016-Sep-28, Wed,10:57	Clear	Sideswipe	P.D. only	Dry	West	Changing lanes	Truck and trailer	Other motor vehicle
					West	Going ahead	Truck - open	Other motor vehicle
2016-Sep-30, Fri,15:53	Clear	Turning movement	Non-fatal injury	Dry	East	Turning left	Pick-up truck	Other motor vehicle
					West	Going ahead	Automobile, station wagon	Other motor vehicle
					West	Going ahead	Automobile, station wagon	Other motor vehicle

2016-Oct-05, Wed,18:45	Clear	Angle	P.D. only	Dry	South	Turning right	Automobile, station wagon	Other motor vehicle
					West	Going ahead	Automobile, station wagon	Other motor vehicle
2016-Oct-19, Wed,17:46	Clear	Approaching	P.D. only	Dry	West	Going ahead	Automobile, station wagon	Other motor vehicle
					East	Stopped	Automobile, station wagon	Other motor vehicle
2016-Dec-16, Fri,06:52	Clear	Rear end	P.D. only	Wet	South	Turning right	Truck - closed	Other motor vehicle
					South	Turning right	Truck - closed	Other motor vehicle
					South	Turning right	Truck - closed	Other motor vehicle
2016-Dec-17, Sat,13:33	Snow	SMV other	P.D. only	Packed snow	North	Going ahead	Automobile, station wagon	Animal - wild
2016-Dec-05, Mon,05:55	Snow	Other	P.D. only	Packed snow	North	Turning right	Pick-up truck	Skidding/sliding
					East	Going ahead	Automobile, station wagon	Other motor vehicle
2016-Jul-22, Fri,14:43	Clear	Other	P.D. only	Dry	West	Reversing	Truck - tractor	Other motor vehicle
					West	Stopped	Automobile, station wagon	Other motor vehicle
2016-Sep-14, Wed,17:30	Clear	Rear end	P.D. only	Dry	North	Turning right	Automobile, station wagon	Other motor vehicle
					North	Turning right	Automobile, station wagon	Other motor vehicle

2017-Mar-29, Wed, 16:57	Clear	Rear end	P.D. only	Dry	South	Going ahead	Automobile, station wagon	Other motor vehicle
					South	Stopped	Passenger van	Other motor vehicle

2017-Feb-05, Sun, 15:29	Drifting Snow	Rear end	P.D. only	Packed snow	West	Slowing or stopping	Police vehicle	Other motor vehicle
					West	Stopped	Automobile, station wagon	Other motor vehicle

2016-Nov-07, Mon, 16:24	Clear	Rear end	P.D. only	Dry	West	Going ahead	Automobile, station wagon	Other motor vehicle
					West	Stopped	Automobile, station wagon	Other motor vehicle

2017-Jan-05, Thu, 14:17	Clear	Rear end	P.D. only	Loose snow	North	Going ahead	Pick-up truck	Other motor vehicle
					North	Stopped	Automobile, station wagon	Other motor vehicle

2017-Mar-24, Fri, 09:39	Snow	Rear end	P.D. only	Loose snow	West	Slowing or stopping	Pick-up truck	Other motor vehicle
					West	Stopped	Pick-up truck	Other motor vehicle

2017-Mar-14, Tue, 15:45	Clear	Sideswipe	P.D. only	Dry	West	Unknown	Automobile, station wagon	Other motor vehicle
					West	Unknown	Pick-up truck	Other motor vehicle

2017-Mar-28, Tue, 11:25	Clear	Turning movement	Non-fatal injury	Wet	East	Going ahead	Pick-up truck	Other motor vehicle
					West	Turning left	Ambulance	Other motor vehicle

2017-Aug-14, Mon,09:16	Clear	Rear end	P.D. only	Dry	South	Going ahead	Other	Other motor vehicle
					South	Stopped	Truck - tractor	Other motor vehicle
2017-Feb-02, Thu,08:49	Clear	Rear end	P.D. only	Dry	North	Going ahead	Delivery van	Other motor vehicle
					North	Stopped	Passenger van	Other motor vehicle
2017-Jul-11, Tue,09:32	Clear	Rear end	P.D. only	Dry	East	Turning right	Automobile, station wagon	Other motor vehicle
					East	Turning right	Automobile, station wagon	Other motor vehicle
2017-Jun-27, Tue,17:00	Clear	Sideswipe	P.D. only	Dry	West	Changing lanes	Passenger van	Other motor vehicle
					West	Going ahead	Pick-up truck	Other motor vehicle
2017-Nov-10, Fri,16:45	Clear	Sideswipe	P.D. only	Dry	North	Turning left	Unknown	Other motor vehicle
					North	Turning left	Truck - tractor	Other motor vehicle
2017-Nov-23, Thu,06:23	Clear	Sideswipe	P.D. only	Dry	West	Slowing or stopping	Automobile, station wagon	Other motor vehicle
					West	Stopped	Delivery van	Other motor vehicle
2017-Nov-30, Thu,20:37	Rain	Angle	P.D. only	Wet	South	Going ahead	Automobile, station wagon	Other motor vehicle
					West	Going ahead	Automobile, station wagon	Other motor vehicle

2017-Jan-17, Tue, 14:00	Clear	Sideswipe	P.D. only	Dry	West	Turning left	Truck - tractor	Other motor vehicle
					West	Turning left	Pick-up truck	Other motor vehicle
2017-Dec-28, Thu, 12:05	Clear	Rear end	P.D. only	Dry	East	Going ahead	Truck - dump	Other motor vehicle
					East	Going ahead	Automobile, station wagon	Other motor vehicle
2017-Oct-20, Fri, 14:42	Clear	Sideswipe	P.D. only	Dry	North	Turning right	Passenger van	Other motor vehicle
					North	Turning right	Automobile, station wagon	Other motor vehicle
2018-Feb-01, Thu, 11:51	Snow	Rear end	P.D. only	Ice	North	Slowing or stopping	Passenger van	Skidding/sliding
					North	Stopped	Pick-up truck	Other motor vehicle
2018-Jan-07, Sun, 18:08	Snow	Turning movement	P.D. only	Loose snow	West	Turning left	Automobile, station wagon	Other motor vehicle
					East	Going ahead	Ambulance	Other motor vehicle
2018-Jan-09, Tue, 05:59	Snow	Sideswipe	Non-fatal injury	Loose snow	West	Turning left	Truck - dump	Other motor vehicle
					West	Turning left	Automobile, station wagon	Other motor vehicle
2018-Jan-25, Thu, 12:50	Clear	Rear end	P.D. only	Dry	North	Turning right	Automobile, station wagon	Other motor vehicle
					North	Stopped	Automobile, station wagon	Other motor vehicle

2018-May-29, Tue,12:33	Clear	Rear end	P.D. only	Dry	East	Stopped	Pick-up truck	Other motor vehicle
					East	Going ahead	Automobile, station wagon	Other motor vehicle
2018-Jun-04, Mon,12:00	Rain	Rear end	P.D. only	Wet	South	Going ahead	Automobile, station wagon	Other motor vehicle
					South	Unknown	Unknown	Other motor vehicle
2018-Jun-11, Mon,12:19	Clear	Rear end	P.D. only	Dry	West	Slowing or stopping	Automobile, station wagon	Other motor vehicle
					West	Slowing or stopping	Automobile, station wagon	Other motor vehicle
2018-Jul-09, Mon,08:35	Clear	Rear end	Non-fatal injury	Dry	West	Turning right	Automobile, station wagon	Other motor vehicle
					West	Turning right	Pick-up truck	Other motor vehicle
2018-Nov-28, Wed,12:28	Rain	Other	P.D. only	Wet	South	Reversing	Pick-up truck	Other motor vehicle
					North	Stopped	Automobile, station wagon	Other motor vehicle
2018-Nov-20, Tue,08:45	Freezing Rain	Rear end	P.D. only	Loose snow	North	Unknown	Unknown	Other motor vehicle
					North	Stopped	Automobile, station wagon	Other motor vehicle
					North	Unknown	Unknown	Other motor vehicle
2018-Nov-09, Fri,17:30	Snow	Rear end	P.D. only	Ice	South	Going ahead	Truck - closed	Other motor vehicle
					South	Stopped	Automobile, station wagon	Other motor vehicle

2018-Dec-19, Wed,09:23	Clear	Rear end	P.D. only	Dry	North	Turning right	Automobile, station wagon	Other motor vehicle
					North	Turning right	Automobile, station wagon	Other motor vehicle
2018-Dec-17, Mon,12:22	Snow	Sideswipe	P.D. only	Loose snow	North	Changing lanes	Delivery van	Other motor vehicle
					North	Going ahead	Automobile, station wagon	Other motor vehicle
2018-Sep-12, Wed,15:06	Clear	Rear end	P.D. only	Dry	East	Going ahead	Pick-up truck	Other motor vehicle
					East	Stopped	Automobile, station wagon	Other motor vehicle
2018-Dec-13, Thu,21:33	Clear	Rear end	Non-fatal injury	Dry	North	Turning right	Automobile, station wagon	Other motor vehicle
					North	Turning right	Delivery van	Other motor vehicle
2018-May-23, Wed,10:06	Clear	Other	P.D. only	Dry	East	Reversing	Automobile, station wagon	Other motor vehicle
					West	Stopped	Automobile, station wagon	Other motor vehicle
2018-Dec-14, Fri,13:30	Freezing Rain	Rear end	P.D. only	Ice	North	Turning right	Passenger van	Other motor vehicle
					North	Turning right	Automobile, station wagon	Other motor vehicle
2016-Dec-05, Mon,06:10	Snow	Rear end	P.D. only	Packed snow	North	Turning right	Pick-up truck	Skidding/sliding
					North	Turning right	Truck - closed	Other motor vehicle

2017-Apr-15, Sat,16:18	Rain	Rear end	Non-fatal injury	Wet	East	Going ahead	Municipal transit bus	Other motor vehicle
					East	Stopped	Automobile, station wagon	Other motor vehicle

Location: HUNT CLUB RD @ HWY417 HUNT CLUB IC109 RAMP52

Traffic Control: Stop sign

Total Collisions: 8

Date/Day/Time	Environment	Impact Type	Classification	Surface Cond'n	Veh. Dir	Vehicle Manoeuver	Vehicle type	First Event	No. Ped
2016-Jun-24, Fri,18:08	Clear	Angle	P.D. only	Dry	South	Turning right	Automobile, station wagon	Other motor vehicle	
					West	Going ahead	Automobile, station wagon	Other motor vehicle	
2016-Dec-14, Wed,17:30	Clear	Rear end	Non-fatal injury	Dry	West	Slowing or stopping	Pick-up truck	Other motor vehicle	
					West	Turning right	Automobile, station wagon	Other motor vehicle	
2015-Dec-11, Fri,02:00	Clear	SMV other	P.D. only	Dry	East	Turning right	Passenger van	Curb	
2015-Jan-26, Mon,16:00	Clear	Rear end	P.D. only	Dry	East	Slowing or stopping	Automobile, station wagon	Other motor vehicle	
					East	Stopped	Pick-up truck	Other motor vehicle	
2015-Apr-28, Tue,15:45	Clear	Rear end	Non-fatal injury	Dry	East	Going ahead	Pick-up truck	Other motor vehicle	
					East	Stopped	Automobile, station wagon	Other motor vehicle	
					East	Stopped	Automobile, station wagon	Other motor vehicle	
2015-Jan-26, Mon,16:30	Clear	Rear end	P.D. only	Dry	East	Going ahead	Automobile, station wagon	Other motor vehicle	

					East	Stopped	Automobile, station wagon	Other motor vehicle
2015-Jan-31, Sat, 16:00	Clear	Rear end	P.D. only	Slush	East	Going ahead	Automobile, station wagon	Other motor vehicle
					East	Stopped	Automobile, station wagon	Other motor vehicle
2018-Sep-08, Sat, 12:31	Clear	Rear end	P.D. only	Dry	North	Going ahead	Automobile, station wagon	Other motor vehicle
					North	Stopped	Automobile, station wagon	Other motor vehicle

Location: RAMSAYVILLE RD @ RUSSELL RD N

Traffic Control: Stop sign

Total Collisions: 8

Date/Day/Time	Environment	Impact Type	Classification	Surface Cond'n	Veh. Dir	Vehicle Manoeuver	Vehicle type	First Event	No. Ped
2014-Aug-12, Tue, 19:23	Rain	SMV other	Non-fatal injury	Wet	West	Going ahead	Automobile, station wagon	Ran off road	
2014-Sep-21, Sun, 14:43	Rain	SMV other	P.D. only	Wet	West	Going ahead	Automobile, station wagon	Ran off road	
2015-Aug-09, Sun, 13:59	Clear	SMV other	Non-fatal injury	Loose sand or gravel	West	Slowing or stopping	Motorcycle	Skidding/sliding	
2016-Nov-20, Sun, 08:58	Rain	Turning movement	P.D. only	Wet	North	Going ahead	Automobile, station wagon	Other motor vehicle	
					South	Turning left	Passenger van	Other motor vehicle	
2017-Mar-10, Fri, 01:23	Clear	SMV other	Non-fatal injury	Dry	West	Slowing or stopping	Pick-up truck	Ran off road	
2018-Jan-16, Tue, 13:40	Clear	SMV other	P.D. only	Wet	West	Going ahead	Pick-up truck	Skidding/sliding	

2018-Aug-22, Wed,06:51	Rain	SMV other	P.D. only	Wet	North	Going ahead	Automobile, station wagon	Debris on road
------------------------	------	-----------	-----------	-----	-------	-------------	---------------------------	----------------

2018-Aug-23, Thu,18:39	Clear	SMV other	Non-fatal injury	Dry	North	Going ahead	Motorcycle	Ran off road
------------------------	-------	-----------	------------------	-----	-------	-------------	------------	--------------

Location: RAMSAYVILLE RD @ RUSSELL RD S

Traffic Control: Stop sign

Total Collisions: 3

Date/Day/Time	Environment	Impact Type	Classification	Surface Cond'n	Veh. Dir	Vehicle Manoeuver	Vehicle type	First Event	No. Ped
2015-Jul-27, Mon,19:37	Clear	Angle	P.D. only	Dry	East	Turning right	Automobile, station wagon	Other motor vehicle	
					South	Going ahead	Automobile, station wagon	Other motor vehicle	
2017-Jun-19, Mon,10:07	Clear	SMV other	P.D. only	Dry	East	Slowing or stopping	Municipal transit bus	Ran off road	
2018-Dec-04, Tue,07:30	Clear	Turning movement	Non-fatal injury	Dry	North	Turning left	Automobile, station wagon	Other motor vehicle	
					South	Going ahead	Automobile, station wagon	Other motor vehicle	



City Operations - Transportation Services

Collision Details Report - Public Version

From: January 1, 2014 **To:** December 31, 2018

Location: HWY 417 WALKLEY IC110R57 @ WALKLEY EXTENSION R

Traffic Control: Stop sign

Total Collisions: 7

Date/Day/Time	Environment	Impact Type	Classification	Surface Cond'n	Veh. Dir	Vehicle Manoeuvre	Vehicle type	First Event	No. Ped
2018-Dec-04, Tue,15:45	Clear	Angle	P.D. only	Dry	South	Turning left	Automobile, station wagon	Other motor vehicle	
					East	Going ahead	Automobile, station wagon	Other motor vehicle	
2017-Sep-25, Mon,16:13	Clear	Rear end	P.D. only	Dry	East	Going ahead	Passenger van	Other motor vehicle	
					East	Slowing or stopping	Automobile, station wagon	Other motor vehicle	
2016-Dec-07, Wed,16:12	Clear	Angle	P.D. only	Wet	South	Turning left	Automobile, station wagon	Other motor vehicle	
					West	Going ahead	Delivery van	Other motor vehicle	
2016-Aug-02, Tue,11:38	Clear	Rear end	Non-fatal injury	Dry	East	Making "U" turn	Police vehicle	Other motor vehicle	
					East	Going ahead	Automobile, station wagon	Other motor vehicle	
2016-Jul-03, Sun,21:24	Clear	Angle	P.D. only	Dry	South	Turning left	Automobile, station wagon	Other motor vehicle	
					West	Going ahead	Motorcycle	Other motor vehicle	
2016-Apr-06, Wed,14:57	Snow	Angle	P.D. only	Slush	South	Turning left	Pick-up truck	Other motor vehicle	

					East	Going ahead	Pick-up truck	Other motor vehicle
2015-Dec-14, Mon,13:00	Clear	Angle	P.D. only	Dry	South	Turning left	Automobile, station wagon	Other motor vehicle
					East	Going ahead	Pick-up truck	Other motor vehicle

Location: HWY 417 WALKLEY IC110R64 @ WALKLEY EXTENSION R

Traffic Control: Stop sign

Total Collisions: 5

Date/Day/Time	Environment	Impact Type	Classification	Surface Cond'n	Veh. Dir	Vehicle Manoeuver	Vehicle type	First Event	No. Ped
2018-Jun-20, Wed,18:10	Clear	Turning movement	P.D. only	Dry	East	Making "U" turn	Unknown	Other motor vehicle	
					East	Going ahead	Automobile, station wagon	Other motor vehicle	
2018-May-22, Tue,10:37	Clear	Angle	P.D. only	Dry	North	Turning left	Pick-up truck	Other motor vehicle	
					East	Going ahead	Delivery van	Other motor vehicle	
2017-Dec-16, Sat,07:56	Snow	Sideswipe	P.D. only	Slush	North	Changing lanes	Snow plow	Other motor vehicle	
					North	Going ahead	Automobile, station wagon	Other motor vehicle	
2017-Sep-09, Sat,12:23	Clear	Sideswipe	P.D. only	Dry	North	Unknown	Automobile, station wagon	Other motor vehicle	
					North	Unknown	Unknown	Other motor vehicle	
2016-Jul-04, Mon,13:34	Clear	SMV other	P.D. only	Dry	West	Turning left	Automobile, station wagon	Ran off road	

APPENDIX F

Excerpts from Relevant Traffic Studies

3.3 SITE TRAFFIC GENERATION

3.3.1 Land Use and Trip Generation Rates

The *Institute of Transportation Engineers (ITE) Trip Generation Manual (9th Edition)* was used to estimate traffic generated by the subject site. The ITE land use codes 945 – Gas Station with Convenience Market and 934 – Fast-Food Restaurant with Drive-Through Window were thought to be most representative of the proposed land uses.

Table 1 summarizes the anticipated site trips.

Table 1 Trips Generated by the Proposed Commercial Development

ITE LAND USE		MORNING PEAK HOUR			AFTERNOON PEAK HOUR			
		In	Out	Total	In	Out	Total	
ITE Trip Generation Rates								
945 – Gas Station with Convenience Market	Gross Floor Area (1000's ft ²)	1.3	41.89	41.07	82.13	48.74	48.74	97.47
934 – Fast-Food Restaurant with Drive-Through Window	Gross Floor Area (1000's ft ²)	1.4	23.16	22.26	45.42	16.98	15.67	32.65
Trips Generated								
945 – Gas Station with Convenience Market	Trip Gen		54	53	107	63	63	126
934 – Fast-Food Restaurant with Drive-Through Window	Trip Gen		32	31	63	24	22	46
Pass-By and Internal Capture								
945 – Gas Station with Convenience Market	Auto Trips		54	53	107	63	63	126
	Pass-By	80%	43	43	86	51	51	102
	Internal Capture	0%	0	0	0	0	0	0
	Net New Auto Trips		11	10	21	12	12	24
934 – Fast-Food Restaurant with Drive-Through Window	Auto Trips		32	31	63	24	22	46
	Pass-By	50%	16	16	32	12	11	23
	Internal Capture	50%	16	16	32	12	11	23
	Net New Auto Trips		0	0	0	0	0	0
Net New Auto Trips								
Total Development	Auto Trips		86	84	170	87	85	172
	Pass-By Trips		59	59	118	63	62	125
	Internal Capture Trips		16	15	31	12	11	23
	Net New Auto Trips		11	10	21	12	12	24

3.3.2 Pass-By and Internal Capture

Pass-by trips are considered intermediate stops between an origin and a destination. They are site trips that are drawn from existing traffic volumes on the road network that are “passing-by” the site. While the overall total number of trips generated by a given development remains the same, the pass-by site trips are deducted from existing / background volumes and added to the site access locations to reflect this.

Based on a combination of technical sources and professional judgement, it was assumed that the gas station and convenience store will have a pass-by rate of 80% while the fast food restaurant will have a pass-by rate of 50%.

Figure 8 illustrates the pass-by trips the proposed development is anticipated to generate.

When predicting site trips that are associated with different land use types on the same site, the interaction between those land use types must be accounted for to reflect the synergy between uses. Internal capture trips – also referred to as “shared-use” trips - are trips which are shared between two or more uses on the same site. A portion of the generated trips for each individual land use, therefore, are drawn from the adjacent land uses on the same site and primarily by the “anchor” land use. Internal capture adjustments were made to account for vehicles that visit more than one use within the subject commercial development. Since these trips are contained within the subject site, accounting for each trip separately on the roadway network would result in “double-counting”. For this reason, land uses that may have associated shared-use trips between one another ultimately have their net new trips adjusted.

Within the proposed commercial development, the trips that are subject to internal capture adjustments are the trips generated from the fast food restaurant. No adjustments were made to the gas station as this land use is considered to be the site anchor. An assumed internal capture rate of 50% was assumed for the fast food restaurant.

Following the application of the pass-by and internal capture adjustments, the commercial development is expected to generate approximately 21 and 24 net new auto trips (two-way) during the AM and PM peak hours, respectively.

Figure 9 illustrates the net new site trips the proposed commercial development is anticipated to generate.

3.3.3 Traffic Distribution and Assignment

The distribution of traffic to / from the study area was determined through examination of the current traffic patterns at the Hunt Club Road at Hawthorne Road intersection.

Figure 10 illustrates the total site traffic volumes the proposed commercial development is anticipated to generate.

AM Peak Hour

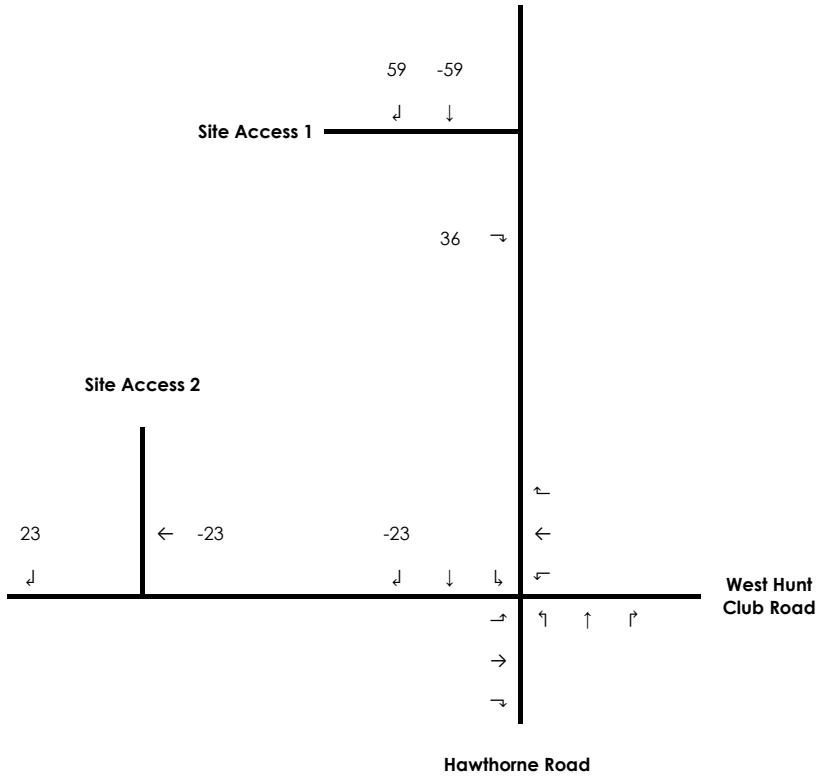

PM Peak Hour

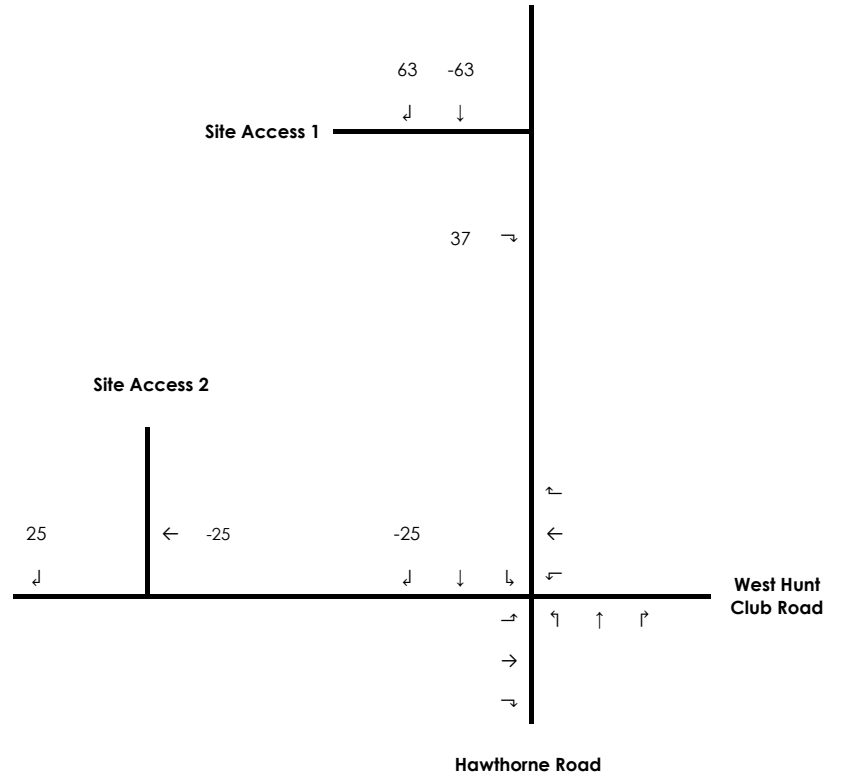

3500 Hawthorne Road

Figure 8

Pass-By Volumes

AM Peak Hour

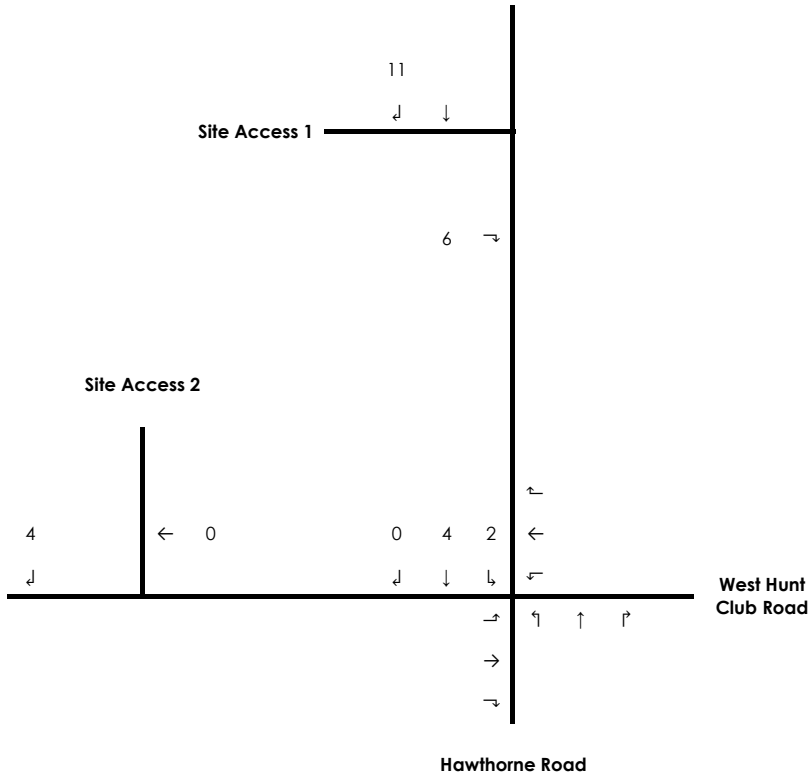

PM Peak Hour

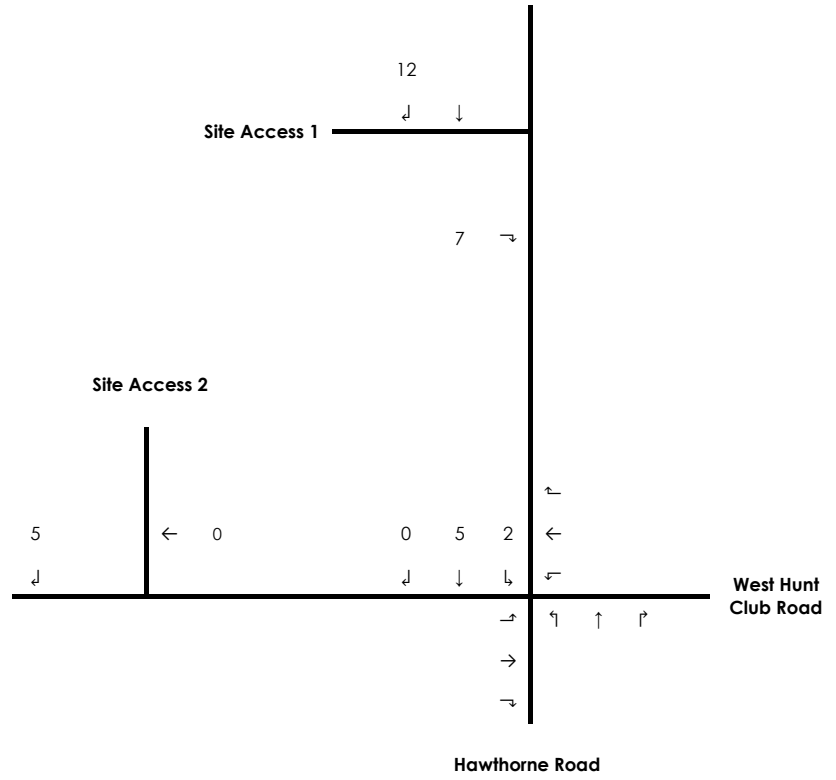

3500 Hawthorne Road
 Figure 9
 Net New Site Traffic Volumes

AM Peak Hour

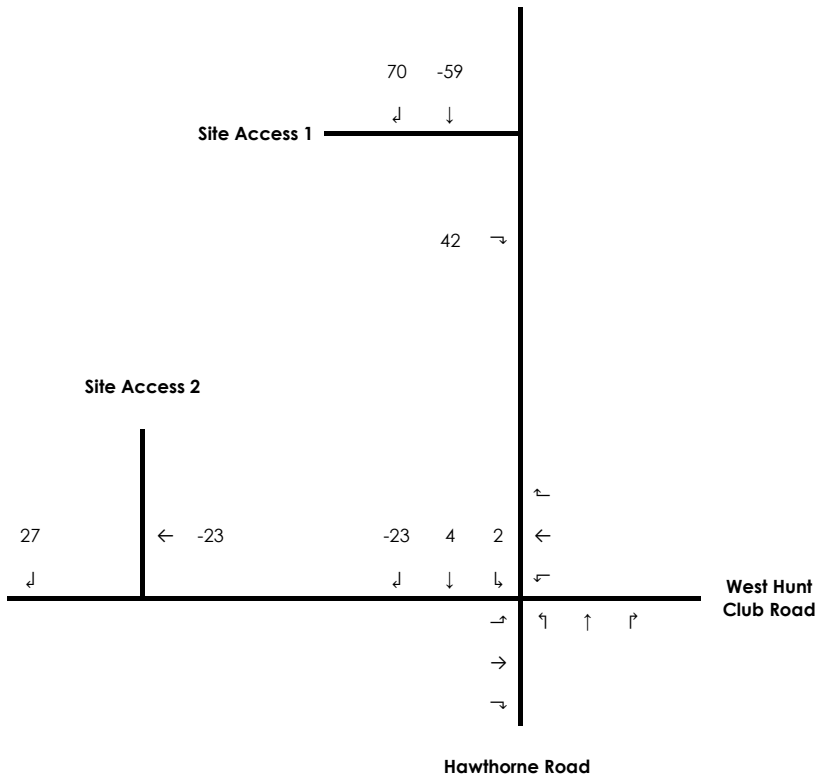

PM Peak Hour

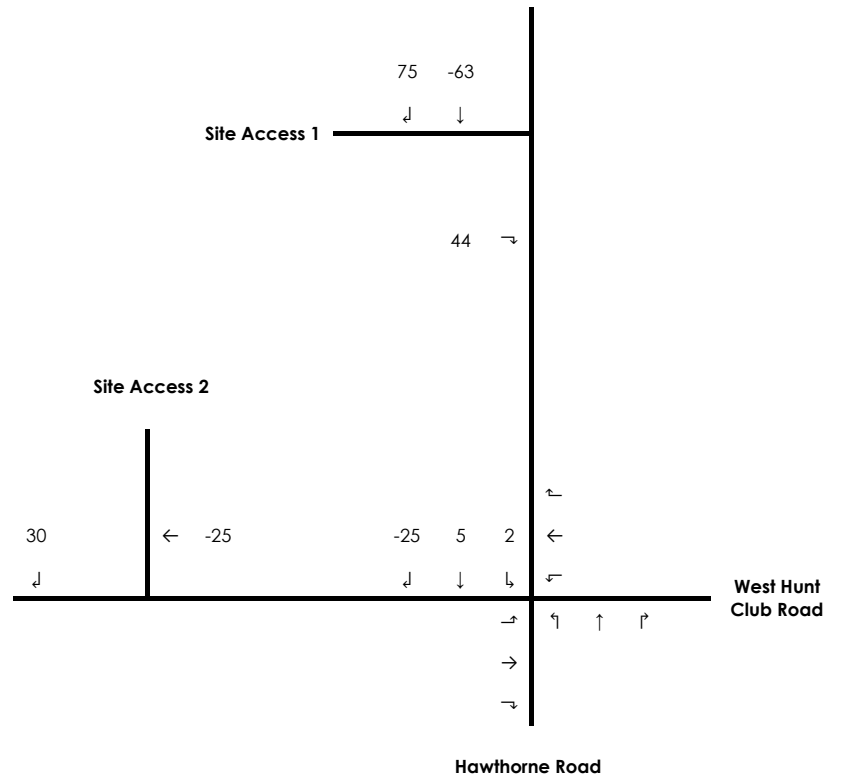

3500 Hawthorne Road
 Figure 10
 Total Site Traffic Volumes

reduction in traffic volumes through the Walkley/Russell intersection and on Russell Road adjacent to the site. We are also not aware of any other meaningful new development projects in close proximity to the site.

3.0 STUDY AREA AND TIME PERIODS

As the proposed development is an extremely low traffic generator (10 veh/h and 30 veh/h during morning and afternoon peak hours respectively) and as its only traffic impact is on the immediate adjacent section of southbound Russell Road, the study area is the Walkley/Russell intersection and Russell Road adjacent to the site.

Again, as site-generated traffic is very low and spread out throughout the day, only the weekday morning and afternoon peak hours are analyzed as this is when background traffic on Russell Road is highest. As the project is expected to be built in 2018 and operational in 2018/19, and as site traffic is so low (it does not meet the TIA Guidelines trip generation trigger), no horizon year analysis was considered necessary. If there are any real or perceived traffic operations issues associated with the proposed development, they can be fully assessed based on current volumes.

4.0 EXEMPTIONS REVIEW

Based on the type and size of the proposed development for which a Site Plan Application is being submitted, the following identifies which analyses are required and which are exempt in further analysis/modules, according to the City's new TIA Guidelines.

Design Review Component:

Development Design

- Circulation and Access.....REQUIRED
- New Street Networks.....EXEMPT

Parking

- Parking Supply.....REQUIRED
- Spillover Parking.....EXEMPT

Network Impact Component:

Development Design

- Transportation Demand Management....EXEMPT
- Neighbourhood Traffic ManagementEXEMPT
- Network ConceptEXEMPT

In summary, as this submission accompanies a Site Plan Application for a very low traffic generator, the only items that need any level of assessment are on-site operation and the design of the site driveway connection to Russell Road.

5.0 DEVELOPMENT GENERATED TRAFFIC

5.1 Vehicle Trip Generation

Using appropriate trip generation rates (Table 1) from a number of relevant land uses identified in the 9th Edition ITE Trip Generation Manual, the resultant two-way peak hour site-trip generation for the proposed 2,323 m² warehouse and 929 m² retail showroom is estimated to be in the range of 10 to 35 veh/h two-way total.

Table 1: Peak Hour Trip Generation Rates

Land Use	Average Rate AM (PM)	Trip Generation Two-Way AM (PM)
General Light Industrial	0.92 (0.97)	33 (35) veh/h
Manufacturing	0.73 (0.73)	26 (26) veh/h
Warehousing	0.30 (0.32)	11 (12) veh/h

Our familiarity with other Ottawa area tile warehouses is that the estimated peak hour vehicle trip generation using the ITE trip rates is in the correct range. For analysis purposes, we are assuming 10 veh/h in and 5 veh/h out during the morning peak hour and 15 veh/h in and 15 veh/h out during the afternoon peak hour.

Weekend peak hour trip generation is determined to be the same as the afternoon peak hour, however, as Saturday traffic is less than weekday traffic on Russell Road adjacent to the site, this time period was not assessed.

5.2 Modal Shares

Given the site’s location, somewhat remote from any significant residential development, combined with the type and weight of products being sold, we do not foresee any patron walking/cycling component. For similar reasons, even though there are adjacent bus routes, we foresee very low, if any, transit ridership. We would expect transit ridership would be primarily employees and would be in the 0 to 3 person range during peak hours, as summarized in Table 2.

Table 2: Future Mode Share Targets for the Development

Travel Mode	Mode Share Target	Rationale
Transit	15%	Some employees may use transit but no customers due to products sold.
Walking	0%	Due to somewhat remote location, type of business and products sold.
Cycling	0%	Due to somewhat remote location, type of business and products sold.
Auto Passenger	20%	Often 2 persons/car looking at product.
Auto Driver	65%	Highly car-oriented due to location, and type of product sold.

5.3 Trip Distribution and Assignment

As the proposed site driveway is on Russell Road and would be restricted to right-in/right-out only, trip distribution and assignment is quite straight-forward. It has been assumed that site-generated traffic at the Russell /Walkley and Russell/Hawthorne intersections would distribute similar to the distribution of existing volumes at this intersection as depicted in Figure 5.

5.4 Pass-By Traffic

Due to the site’s location and type of products it sells, it is considered a “destination” site and we do not foresee any pass-by traffic.

Figure 5: Site-Generated Traffic Assignment

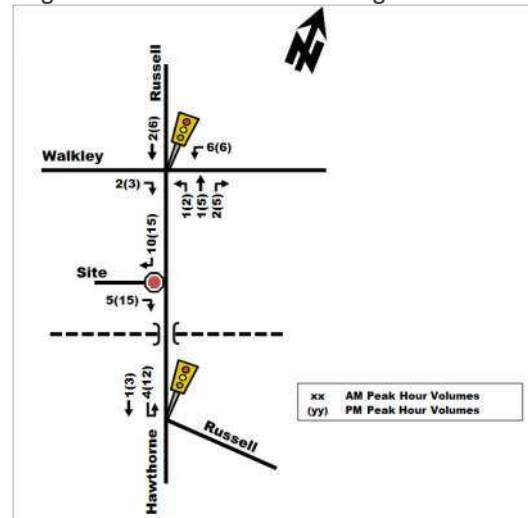

8. DEVELOPMENT GENERATED TRAVEL DEMAND

8.1. TRIP GENERATION AND MODE SHARES

8.1.1. TRIP GENERATION

Appropriate trip generation rates for the proposed development were obtained from the ITE Trip Generation Manual, 10th Edition and are summarized in Table 3.

Table 3: ITE Trip Generation Manual, 10th Ed. Vehicle Trip Generation Rates for Warehousing Land Use

Land Use	Data Source	Fitted Curve Equation	
		AM Peak	PM Peak
Warehousing	ITE 150	$T = 0.12(x) + 25.32$	$T = 0.12(x) + 27.82$

As ITE trip generation surveys only record vehicle trips and typically reflect highly suburban locations (with little to no access by travel modes other than private automobiles), adjustment factors appropriate to the Ottawa study area context were applied to attain estimates of person trips for the subject development.

Using the ITE Trip Generation rate, the total amount of vehicle trips generated by the proposed development were projected and the results are summarized in Table 4. To convert ITE vehicle trip rates to person trips, an auto occupancy factor and a non-auto trip factor were applied to the ITE vehicle trip rates. Our review of available literature suggests that a combined factor of approximately 1.3 is considered reasonable to account for typical North American auto occupancy values of approximately 1.15 and combined transit and non-motorized modal shares of less than 10%. As such, the person trip generation for the subject development is summarized in Table 4.

Table 4: Site Person Trip Generation

Land Use	Data Source	Area	AM Peak (Person Trips/hr)			PM Peak (Person Trips/hr)		
			In	Out	Total	In	Out	Total
Warehousing	ITE 150	256,106 ft ²	55	17	72	20	55	75

8.1.2. MODE SHARES

Using the Person-Trips projected in Table 4 and the modal share percentages from the 2011 NCR Household Origin – Destination Survey for Hunt Club, the modal share for the proposed development is summarized in Table 5.

Table 5: Site Trip Generation by Mode of Transportation

Travel Mode	Mode Share	AM Peak (Person Trips/hr)			PM Peak (Person Trips/hr)		
		In	Out	Total	In	Out	Total
Auto Driver	76%	42	13	55	16	42	58
Auto Passenger	10%	6	2	8	2	6	8
Transit	14%	7	2	9	2	7	9
Non-motorized	0%	0	0	0	0	0	0
Total Person Trips	100%	55	17	72	20	55	75
Less Pass-by (0%)		0	0	0	0	0	0
Total 'New' Auto Trips		42	13	55	16	42	58

As shown in Table 5, based on the Modified ITE's Person-Trip Generation method and the 2011 NCR Household Origin – Destination Survey for Hunt Club, the proposed site is projected to generate approximately 70-75 two-way person-trips per hour during the weekday peak hours. Approximately 55 two-way vehicles per hour will be accessing/leaving the site during

the weekday peak hours and 10 two-way trips will be made by transit. Considering the heavy industrial character of the area and adjacent transportation network, no active mode trips are expected during the peak hours for this site.

8.2. TRIP DISTRIBUTION

Considering the existing traffic distribution at Hawthorne/Stevenage intersection, the site trip distribution is outlined next:

- 60% To/From the North;
 - 30% To/From the South; and
 - 10% To/From the East
- 100%

8.3. TRIP ASSIGNMENT

Based on this distribution, site-generated traffic at full build-out (2020) was assigned to the existing adjacent network and is illustrated in Figure 8.

Figure 8: Full Build-Out Site-Generated Traffic (year 2020)

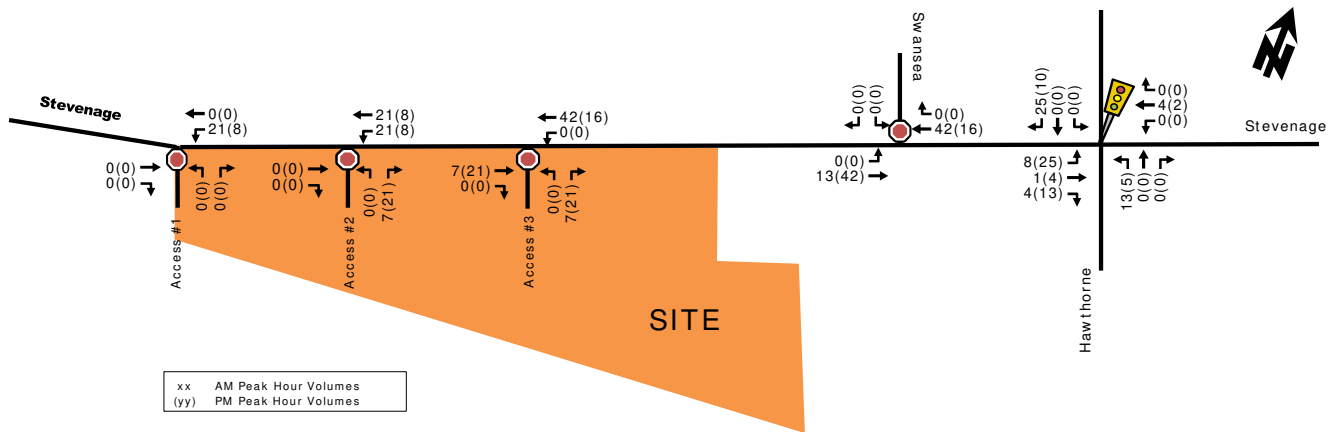

9. BACKGROUND NETWORK TRAVEL DEMAND

9.1. TRANSPORTATION NETWORK PLANS

The transportation network changes have been discussed within Section 4.1 and none are anticipated to impact the transportation analysis for this development.

9.2. BACKGROUND GROWTH

Regarding background traffic growth, historical traffic count data for years 2007, 2012, and 2015 was provided by the City of Ottawa at the Hawthorne/Hunt Club intersection. Detailed analysis of trends at Hunt Club/Hawthorne intersection indicated low reliability of data, most likely due to the recent (2014) construction of the Hunt Club/Highway 417 interchange. For this reason, and given our knowledge of the area, a 2% annual growth rate has been assumed. This growth rate is consistent with the City of Ottawa intersection traffic growth rates.

With respect to Stevenage Drive, given a low level of new development has been observed within the past 5 years, a 0% growth will be assumed for the analysis horizon.

5.0 FORECASTING

5.1 Development-Generated Travel Demand

5.1.1 Trip Generation

Currently, the subject site is occupied by approximately 40,389 ft² of retail space, 76,652 ft² of office space, and 302,002 ft² of warehouse space. The proposed reconfiguration of the site will contain approximately 30,962 ft² retail space, 187,087 ft² of office space, and 182,685 ft² of warehouse space. Trips generated by these land uses have been estimated using the *ITE Trip Generation Manual, 10th Edition*. Retail trips have been estimated based on the Free-Standing Discount Store land use (land use 815), office trips have been estimated based on the General Office Building land use (land use 710), and warehouse trips have been estimated based on the Warehousing land use (land use 150). It is noted that only a portion of the existing parking is required for the remaining warehouse use. As future development for this part of the subject site is unknown at this time, it is proposed that the existing parking be retained and remain vacant. The vacant parking in excess of the warehouse parking will not serve the existing or proposed land uses and is not expected to generate trips.

The estimated number of trips generated by the existing development and proposed redevelopment are shown in **Table 3**.

Table 3: Person Trip Generation

Land Use	ITE Code	GFA	AM Peak (PPH ⁽¹⁾)			PM Peak (PPH)		
			IN	OUT	TOT	IN	OUT	TOT
Existing Development								
Free-Standing Discount Store	815	40,389 ft ²	41	19	60	125	125	250
General Office Building	710	76,652 ft ²	109	18	127	18	95	113
Warehousing	150	302,002 ft ²	61	18	79	22	60	82
Total			211	55	266	165	280	445
Proposed Redevelopment								
Free-Standing Discount Store	815	30,962 ft ²	32	14	46	95	95	190
General Office Building	710	187,087 ft ²	223	36	259	42	222	264
Warehousing	150	182,685 ft ²	46	14	60	17	47	64
Total			301	64	365	154	364	518
Difference			90	9	99	-11	84	73

1. PPH: Persons Per Hour – ITE Trip to Person Trip Factor of 1.28 has been applied, consistent with the 2017 TIA Guidelines

From the previous table, the proposed redevelopment is projected to generate an additional 99 person trips during the AM peak hour and 73 person trips during the PM peak hour.

The modal shares for the existing development and proposed redevelopment are anticipated to be consistent with the modal shares outlined in the *2011 TRANS O-D Survey Report*, specific to the Alta Vista region. The modal share values applied to the existing and proposed office space are based on all trips to/within the Alta Vista district in the AM peak hour and all trips from/within the Alta Vista district in the PM peak hour, with an increase to the auto driver share based on location of the subject site. The modal share values applied to the retail and warehousing spaces are based on all

observed trips to/within the Alta Vista district. A full breakdown of the projected net increase in person trips by modal share are shown in **Table 4**.

Table 4: Person Trips by Modal Share

Travel Mode	Modal Share	AM Peak			PM Peak		
		IN	OUT	TOT	IN	OUT	TOT
Existing Development							
<i>Retail Person Trips</i>		41	19	60	125	125	250
Auto Driver	60%	25	11	36	75	75	150
Auto Passenger	15%	6	3	9	19	19	38
Transit	20%	8	4	12	25	25	50
Non-Auto	5%	2	1	3	6	6	12
<i>Office Person Trips</i>		109	18	127	18	95	113
Auto Driver	65%	71	11	82	11	62	73
Auto Passenger	15%	16	3	19	3	14	17
Transit	15%	16	3	19	3	14	17
Non-Auto	5%	6	1	7	1	5	6
<i>Warehouse Person Trips</i>		61	18	79	22	60	82
Auto Driver	60%	36	11	47	14	36	50
Auto Passenger	15%	9	3	12	3	9	12
Transit	20%	13	3	16	4	12	16
Non-Auto	5%	3	1	4	1	3	4
Auto Driver (Total)		132	33	165	100	173	273
Auto Passenger (Total)		31	9	40	25	42	67
Transit (Total)		37	10	47	32	51	83
Non-Auto (Total)		11	3	14	8	14	22
Proposed Redevelopment							
<i>Retail Person Trips</i>		32	14	46	95	95	190
Auto Driver	60%	19	8	27	56	56	112
Auto Passenger	15%	5	2	7	15	15	30
Transit	20%	6	3	9	20	20	40
Non-Auto	5%	2	1	3	4	4	8
<i>Office Person Trips</i>		223	36	259	42	222	264
Auto Driver	65%	145	24	169	28	145	173
Auto Passenger	15%	33	5	38	6	33	39
Transit	15%	33	5	38	6	33	39
Non-Auto	5%	12	2	14	2	11	13
<i>Warehouse Person Trips</i>		46	14	60	17	47	64
Auto Driver	60%	28	8	36	10	28	38
Auto Passenger	15%	7	2	9	3	7	10
Transit	20%	9	3	12	3	10	13
Non-Auto	5%	2	1	3	1	2	3
Auto Driver (Total)		192	40	232	94	229	323
Auto Passenger (Total)		45	9	54	24	55	79
Transit (Total)		48	11	59	29	63	92
Non-Auto (Total)		16	4	20	7	17	24
Auto Driver (Difference)		60	7	67	-6	56	50
Auto Pass. (Difference)		14	0	14	-1	13	12
Transit (Difference)		11	1	12	-3	12	9
Non-Auto (Difference)		5	1	6	-1	3	2

From the previous table, the proposed redevelopment is anticipated to generate an additional 67 vehicle trips during the AM peak hour and 50 vehicle trips during the PM peak hour.

A percentage of the trips generated by the proposed redevelopment are anticipated to be internally captured (for example, office workers making a trip to the retail store). It is likely that the number of trips of this nature will only make up a small proportion of the overall site-generated trip volume, and as such, no deduction has been made to account for internally-captured trips. All trips generated by the subject site are assumed to have an origin or destination beyond the subject site. This simplifying assumption also allows for a more conservative analysis.

The retail land use is expected to generate two types of external peak hour trips: primary and pass-by trips. Primary trips are made for the specific purpose of visiting the site, while pass-by trips are made as intermediate stops on the way to another destination. Peak hour pass-by trips have been estimated based on a pass-by rate of 17%, which is the average rate identified in the *ITE Trip Generation Handbook, 3rd Edition* for the Free-Standing Discount Store land use. The pass-by trips generated by the retail store are part of the observed background traffic, and do not constitute new trips on the adjacent road network.

The primary and pass-by trip generation for the existing and proposed retail stores is summarized in **Table 5**.

Table 5: Primary and Pass-By Trips

Trip Type	AM Peak			PM Peak		
	IN	OUT	TOT	IN	OUT	TOT
<i>Existing Retail Vehicle Trips</i>	25	11	36	75	75	150
Pass-by (17%)	3	3	6	13	13	26
Primary (83%)	22	8	30	62	62	124
<i>Proposed Retail Vehicle Trips</i>	19	8	27	56	56	112
Pass-by (17%)	2	2	4	10	10	20
Primary (83%)	17	6	23	46	46	92

5.1.2 Trip Distribution

The assumed distribution of trips generated by the subject site has been derived from existing traffic patterns within the study area. Each land use is anticipated to draw its respective trips from different areas. Considerations for each trip distribution is described below.

The distribution of trips generated by the retail land use anticipates a higher draw of customers in the areas proximally north and west of the subject site, and is based on the off-peak traffic counts within the study area.

The distribution of trips generated by the office and warehouse land uses is anticipated to follow the traffic patterns associated with the typical commute (arriving at work during the AM peak hour and departing from work during the PM peak hour).

The trip distribution for each land use is described as follows:

Retail Distribution

- 20% to/from the north via St. Laurent Boulevard
- 10% to/from the north via Russell Road
- 10% to/from the south via St. Laurent Boulevard
- 15% to/from the south via Russell Road
- 15% to/from the east via Walkley Road
- 30% to/from the west via Walkley Road

Office/Warehouse Distribution

- 10% to/from the north via St. Laurent Boulevard
- 10% to/from the north via Russell Road
- 15% to/from the south via Russell Road
- 45% to/from the east via Walkley Road
- 20% to/from the west via Walkley Road

5.1.3 Trip Assignment

The trip assignment in existing conditions and future conditions is assumed to be different, as a new signalized access is proposed at Melfort Street, and the existing access on Walkley Road will become a RIRO access by modifying the existing median.

In existing conditions, the easternmost access on Walkley Road restricts inbound left turns during the PM peak hour, requiring all inbound traffic from the east to enter via the access on Banton Street.

Trips generated by the existing development will be assigned to the accesses as follows:

Full-Movement Access at Banton Street

- 75% of trips arriving and departing to the north and south via St. Laurent Boulevard and the west via Walkley Road;
- 25% of AM peak trips arriving and departing to the north and south via Russell Road and the east via Walkley Road;
- 100% of PM peak trips arriving and 25% of PM peak trips departing to the north and south via Russell Road and the east via Walkley Road.

Full-Movement Access at Walkley Road (PM inbound left turns restricted)

- 25% of trips arriving and departing to the north and south via St. Laurent Boulevard and the west via Walkley Road;
- 75% of AM peak trips arriving and departing to the north and south via Russell Road and the east via Walkley Road;
- 75% of PM peak trips departing to the north and south via Russell Road and the east via Walkley Road.

In future conditions, the easternmost access on Walkley Road will become right-in/right-out only, and will exclusively access parking designated for retail customers. Employees will be directed to not park in this area, meaning no office or warehouse trips have been assigned to this access. The proposed signalized access at Walkley Road/Melfort Street will act as the main entrance and exit to the site, and the existing access on Banton Street will remain in place. Both of these driveways provide access to office and warehouse parking, as well as warehouse loading at the rear of the site. Therefore, office and warehouse trips have been assigned to both accesses.

Trips generated by the proposed redevelopment will be assigned to the accesses as follows:

Full-Movement Access at Banton Street

- 30% of office trips arriving and departing to the north and south via St. Laurent Boulevard and the west via Walkley Road;
- 100% of warehouse trips arriving and departing to the north and south via St. Laurent Boulevard and the west via Walkley Road.

Full-Movement Access at Walkley Road/Melfort Street

- 50% of retail trips arriving and 100% of retail trips departing to the north and south via St. Laurent Boulevard and the west via Walkley Road;
- 100% of retail trips arriving and 50% of retail trips departing to the north and south via Russell Road and the east via Walkley Road;
- 70% of office trips arriving and departing to the north and south via St. Laurent Boulevard and the west via Walkley Road;
- 100% of office trips arriving and departing to the north and south via Russell Road and the east via Walkley Road;
- 100% of warehouse trips arriving and departing to the north and south via Russell Road and the east via Walkley Road.

RIRO Access at Walkley Road

- 50% of retail trips arriving from the north and south via St. Laurent Boulevard and the west via Walkley Road;
- 50% of retail trips departing to the north and south via Russell Road and the east via Walkley Road.

Pass-by trips generated by the existing development have been distributed evenly to the accesses at Banton Street and Walkley Road. Pass-by trips generated by the proposed redevelopment have been assigned to the proposed signalized access at Walkley Road/Melfort Street.

It is anticipated that most vehicular traffic generated by the neighbourhoods north of Walkley Road currently avoid accessing Walkley Road from Melfort Street, given the high traffic volumes on Walkley Road. The analysis conservatively assumes more left-turning vehicular traffic will enter and exit Melfort Street in future background and total traffic conditions, upon implementation of the proposed four-way traffic signal.

5.2 Background Traffic

5.2.1 General Background Growth Rate

A rate of background growth has been established through a review of the City of Ottawa's 2013 TMP and Strategic Long Range Model (comparing snapshots of 2011 and 2031 AM peak volumes). The snapshots suggest a growth rate of -0.5% to 1.5% per annum on arterial roadways within the study area. For the 'Inner Suburbs' area of Ottawa, Exhibit 2.10 of the 2013 TMP projects a population growth rate of approximately 0.3% per annum and an employment growth rate of approximately 1.1% per annum. To reflect the study area's development as an employment area, a 1% background growth rate has been applied to Walkley Road, St. Laurent Boulevard, and Russell Road. A 0% growth rate has been applied to all other roadways within the study area.

Figure 9: Net Site-Generated Traffic

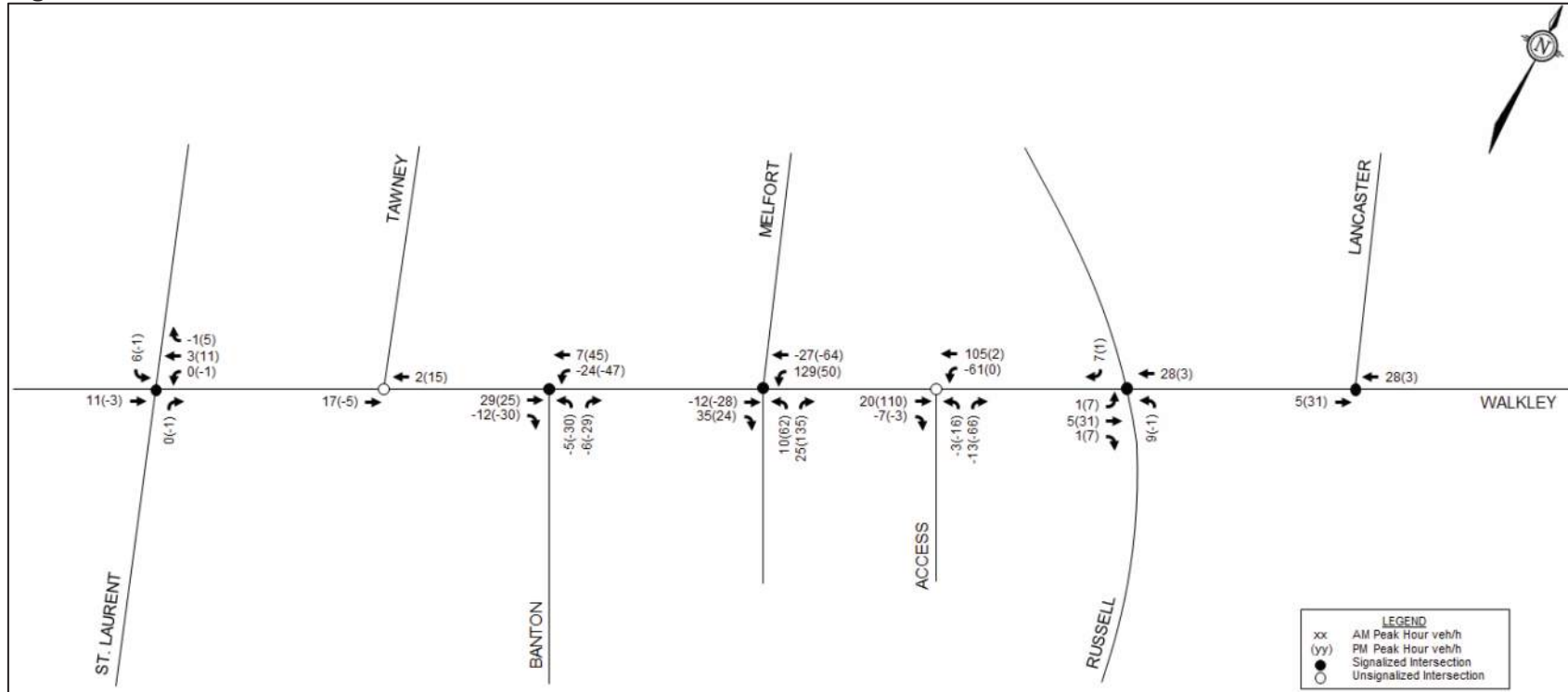

APPENDIX G

Multi-Modal Level Of Service (MMLoS)

Segment Level of Service

Pedestrian Level of Service (PLOS)

Direction	Sidewalk Width	Boulevard Width	Motor Vehicle Traffic Volume (AADT)	Presence of On-Street Parking	Operating Speed	Segment PLOS
Russell Road						
North	None	N/A	> 3,000 vpd	No	>60 km/h	F
South	None	N/A	> 3,000 vpd	No	>60 km/h	F
Hunt Club Road						
North	None	N/A	> 3,000 vpd	No	>60 km/h	F
South	None	N/A	> 3,000 vpd	No	>60 km/h	F

Bicycle Level of Service (BLOS)

Bike Route	Type of Bikeway	Travel Lanes	Centreline Markings	Operating Speed	Segment BLOS
Russell Road					
None	Mixed Traffic	2	Yes	>60 km/h	F
Hunt Club Road WB¹					
Spine	Mixed Traffic	4	Median	>70 km/h	F
Note: 1. Eastbound Bicyclists are restricted on Hunt Club in front of the site.					

Truck Level of Service (TkLOS)

Curb Lane Width	Travel Lanes	Segment TkLOS
Russell Road		
3.25m	2 travel lanes	C
Hunt Club Road		
3.25m	More than 2 travel lanes	A

National Capital Business Park –MMLOS Analysis – Existing

Intersection MMLOS Pedestrian Level of Service

Criteria	North Approach		South Approach		East Approach		West Approach	
Walkley at Russell								
PETSI SCORE								
<i>CROSSING DISTANCE CONDITIONS</i>								
Median > 2.4m in Width	No	-10	No	-10	No	-10	No	-10
Lanes Crossed (3.5m Lane Width)	10 +		10 +		10 +		10 +	
<i>SIGNAL PHASING AND TIMING</i>								
Left Turn Conflict	Protected	0	Protected	0	Protected	0	Protected	0
Right Turn Conflict	Permissive or Yield	-5	Permissive or Yield	-5	Permissive or Yield	-5	Permissive or Yield	-5
Right Turn on Red	N/A	0	N/A	0	RTOR Allowed	-3	N/A	0
Leading Pedestrian Interval	No	-2	No	-2	No	-2	No	-2
<i>CORNER RADIUS</i>								
Parallel Radius	> 25m	-9	> 25m	-9	> 15m to 25m	-8	> 15m to 25m	-8
Parallel Right Turn Channel	No Right Turn Channel	-4	Conventional without Receiving	0	Conventional without Receiving	0	Conventional without Receiving	0
Perpendicular Radius	> 15m to 25m	-8	> 15m to 25m	-8	N/A	0	> 25m	-9
Perpendicular Right Turn Channel	Conventional without Receiving	0	Conventional without Receiving	0	N/A	0	Conventional without Receiving	0
<i>CROSSING TREATMENT</i>								
Treatment	Standard	-7	Standard	-7	Standard	-7	Standard	-7
PETSI SCORE		-45	PETSI SCORE		-41	PETSI SCORE		-41
LOS		F	LOS		F	LOS		F
DELAY SCORE								
Cycle Length		150		150		150		150
Pedestrian Walk Time		40.3		19.7		12.6		12.6
DELAY SCORE		40.1	DELAY SCORE		56.6	DELAY SCORE		62.9
LOS		E	LOS		E	LOS		F
OVERALL		F	OVERALL		F	OVERALL		F

Criteria	North Approach		South Approach		East Approach		West Approach	
Russell at Hawthorne								
PETSI SCORE								
<i>CROSSING DISTANCE CONDITIONS</i>								
Median > 2.4m in Width	No	-10	No	-10	No	-10	No	6
Lanes Crossed (3.5m Lane Width)	10 +		10 +		10 +		9	
<i>SIGNAL PHASING AND TIMING</i>								
Left Turn Conflict	Permissive	-8	Permissive	-8	Permissive	-8	Permissive	-8
Right Turn Conflict	Permissive or Yield	-5	Permissive or Yield	-5	Permissive or Yield	-5	Permissive or Yield	-5
Right Turn on Red	N/A	0	N/A	0	N/A	0	N/A	0
Leading Pedestrian Interval	No	-2	No	-2	No	-2	No	-2
<i>CORNER RADIUS</i>								
Parallel Radius	> 15m to 25m	-8	> 15m to 25m	-8	> 25m	-9	> 25m	-9
Parallel Right Turn Channel	Conventional without Receiving	0	Conventional with Receiving	-3	Conventional without Receiving	0	Conventional without Receiving	0
Perpendicular Radius	> 25m	-9	> 25m	-9	> 15m to 25m	-8	> 15m to 25m	-8
Perpendicular Right Turn Channel	Conventional without Receiving	0	Conventional without Receiving	0	Conventional without Receiving	0	Conventional with Receiving	-3
<i>CROSSING TREATMENT</i>								
Treatment	Standard	-7	Standard	-7	Standard	-7	Standard	-7
PETSI SCORE		-49	PETSI SCORE		-52	PETSI SCORE		-36
LOS		F	LOS		F	LOS		F
DELAY SCORE								
Cycle Length		90		90		80		80
Pedestrian Walk Time		7.3		7.3		42.5		42.5
DELAY SCORE		38	DELAY SCORE		38	DELAY SCORE		8.8
LOS		D	LOS		D	LOS		A
OVERALL		F	OVERALL		F	OVERALL		F

National Capital Business Park –MMLOS Analysis – Existing

Criteria	North Approach		South Approach		East Approach		West Approach	
Hawthorne at Stevenage								
PETSI SCORE								
<i>CROSSING DISTANCE CONDITIONS</i>								
Median > 2.4m in Width	No	-10	No	-10	No	-10	No	-10
Lanes Crossed (3.5m Lane Width)	10 +		10 +		10 +		10 +	
<i>SIGNAL PHASING AND TIMING</i>								
Left Turn Conflict	Permissive	-8	Permissive	-8	Perm + Prot	-8	Perm + Prot	-8
Right Turn Conflict	Permissive or Yield	-5	Permissive or Yield	-5	Permissive or Yield	-5	Permissive or Yield	-5
Right Turn on Red	N/A	0	N/A	0	N/A	0	N/A	0
Leading Pedestrian Interval	No	-2	No	-2	No	-2	No	-2
<i>CORNER RADIUS</i>								
Parallel Radius	> 25m	-9	> 15m to 25m	-8	> 25m	-9	> 15m to 25m	-8
Parallel Right Turn Channel	Conventional without Receiving	0	Conventional without Receiving	0	Conventional without Receiving	0	Conventional without Receiving	0
Perpendicular Radius	> 15m to 25m	-8	> 25m	-9	> 25m	-9	> 15m to 25m	-8
Perpendicular Right Turn Channel	Conventional without Receiving	0	Conventional without Receiving	0	Conventional without Receiving	0	Conventional without Receiving	0
<i>CROSSING TREATMENT</i>								
Treatment	Standard	-7	Standard	-7	Standard	-7	Standard	-7
PETSI SCORE		-49	PETSI SCORE		-49	PETSI SCORE		-50
LOS		F	LOS		F	LOS		F
DELAY SCORE								
Cycle Length		95		95		90		90
Pedestrian Walk Time		17.3		17.3		27.5		27.5
DELAY SCORE		31.8	DELAY SCORE		31.8	DELAY SCORE		21.7
LOS		D	LOS		D	LOS		C
OVERALL		F	OVERALL		F	OVERALL		F

Criteria	North Approach		South Approach		East Approach		West Approach	
Hunt Club at Hawthorne								
PETSI SCORE								
<i>CROSSING DISTANCE CONDITIONS</i>								
Median > 2.4m in Width	No	-10	No	-10	No	-10	No	-10
Lanes Crossed (3.5m Lane Width)	10 +		10 +		10 +		10 +	
<i>SIGNAL PHASING AND TIMING</i>								
Left Turn Conflict	Protected	0	Protected	0	Perm + Prot	-8	Perm + Prot	-8
Right Turn Conflict	Permissive or Yield	-5	Permissive or Yield	-5	Permissive or Yield	-5	Permissive or Yield	-5
Right Turn on Red	N/A	0	N/A	0	N/A	0	N/A	0
Leading Pedestrian Interval	No	-2	No	-2	No	-2	No	-2
<i>CORNER RADIUS</i>								
Parallel Radius	> 15m to 25m	-8	> 15m to 25m	-8	> 15m to 25m	-8	> 25m	-9
Parallel Right Turn Channel	Smart Channel	2	Conventional without Receiving	0	Smart Channel	2	Conventional without Receiving	0
Perpendicular Radius	> 25m	-9	> 15m to 25m	-8	> 15m to 25m	-8	> 15m to 25m	-8
Perpendicular Right Turn Channel	Conventional without Receiving	0	Smart Channel	2	Smart Channel	2	Conventional without Receiving	0
<i>CROSSING TREATMENT</i>								
Treatment	Standard	-7	Standard	-7	Standard	-7	Standard	-7
PETSI SCORE		-39	PETSI SCORE		-38	PETSI SCORE		-44
LOS		F	LOS		F	LOS		F
DELAY SCORE								
Cycle Length		140.4		140.4		145.4		145.4
Pedestrian Walk Time		16		16		6		6
DELAY SCORE		55.1	DELAY SCORE		55.1	DELAY SCORE		66.8
LOS		E	LOS		E	LOS		F
OVERALL		F	OVERALL		F	OVERALL		F

Bicycle Level of Service

Approach	Bikeway Facility Type	Criteria	Travel Lanes and/or Speed ¹	BLOS
<i>Walkley at Russell – F Overall</i>				
North Approach	Mixed Traffic Approach	Right turn lane characteristics	Right turn lane 25m to 50m; turning speed ≤25km/h	D
		Left turn accommodation	Dual left turn lanes	F
South Approach	Pocket Bike Lane	Right turn lane characteristics	Right turn lane 25m to 50m; turning speed ≤25km/h	D
		Left turn accommodation	Dual left turn lanes	F
East Approach	Mixed Traffic Approach	Right turn lane characteristics	Right turn lane 25m to 50m; turning speed ≤25km/h	D
		Left turn accommodation	Dual left turn lanes	F
West Approach	Mixed Traffic Approach	Right turn lane characteristics	Right turn lane longer than 50m	F
		Left turn accommodation	2 or more lanes crossed; ≥ 50km/hr	F
<i>Russell at Hawthorne – F Overall</i>				
North Approach	Pocket Bike Lane	Right turn lane characteristics	Right turn lane to the right of bike lane and <50m, turning speed ≤ 25km/h	B
		Left turn accommodation	2 or more lanes crossed; ≥ 50km/hr	F
South Approach	Pocket Bike Lane	Right turn lane characteristics	Right turn lane to the right of bike lane and <50m, turning speed ≤ 25km/h	B
		Left turn accommodation	2 or more lanes crossed; ≥ 50km/hr	F
East Approach	Mixed Traffic Approach	Right turn lane characteristics	Right turn lane longer than 50m	F
		Left turn accommodation	1 lane crossed; ≥ 50km/hr	D
West Approach	Mixed Traffic Approach	Right turn lane characteristics	Right turn lane < 50m, turning speed ≤ 25km/h	D
		Left turn accommodation	1 lane crossed; 50km/hr	D
<i>Hawthorne at Stevenage – F Overall</i>				
North Approach	Pocket Bike Lane	Right turn lane characteristics	Right turn lane to the right of bike lane >50m, turning speed ≤ 30km/h	D
		Left turn accommodation	2 or more lanes crossed; ≥ 50km/hr	F

National Capital Business Park –MMLOS Analysis – Existing

Approach	Bikeway Facility Type	Criteria	Travel Lanes and/or Speed ¹	BLOS
South Approach	Pocket Bike Lane	Right turn lane characteristics	Right turn lane to the right of bike lane <50m, turning speed ≤ 25km/h	B
		Left turn accommodation	2 or more lanes crossed; ≥ 50km/hr	F
East Approach	Mixed Traffic Approach	Right turn lane characteristics	Right turn lane < 50m, turning speed ≤ 25km/h	D
		Left turn accommodation	1 lane crossed; 50km/hr	D
West Approach	Mixed Traffic Approach	Right turn lane characteristics	Right turn lane <50m, turning speed ≤ 25km/h	D
		Left turn accommodation	1 lane crossed; 50km/hr	D
Hunt Club at Hawthorne – F Overall				
North Approach	Pocket Bike Lane	Right turn lane characteristics	Right turn lane to the right of bike lane >50m, turning speed ≤ 30km/h	D
		Left turn accommodation	2 or more lanes crossed; ≥ 50km/hr	F
South Approach	Pocket Bike Lane	Right turn lane characteristics	Right turn lane to the right of bike lane, turning speed ≤ 25km/h	B
		Left turn accommodation	2 or more lanes crossed; ≥ 50km/hr	F
East Approach	Pocket Bike Lane	Right turn lane characteristics	Right turn lane to the right of bike lane >50m, turning speed ≤ 30km/h	D
		Left turn accommodation	2 or more lanes crossed; ≥ 50km/hr	F
West Approach	Mixed Traffic Approach	Right turn lane characteristics	Right turn lane <50m, turning speed ≤ 25km/h	D
		Left turn accommodation	2 lanes crossed; ≥ 50km/hr	F

Truck Level of Service

Approach	Effective Corner Radius (m)	Number of Receiving Lanes on Departure from Intersection	LOS
Walkley at Russell – A Overall			
North Approach	> 15m	2+	A
South Approach	> 15m	2+	A
East Approach	> 15m	2+	A
West Approach	> 15m	2+	A
Russell at Hawthorne – C Overall			
North Approach	> 15m	1	C
South Approach	> 15m	1	C
East Approach	> 15m	2+	A
West Approach	> 15m	2+	A
Hawthorne at Stevenage – C Overall			
North Approach	> 15m	1	C
South Approach	> 15m	1	C
East Approach	> 15m	2+	A
West Approach	> 15m	2+	A
Hunt Club at Hawthorne – A Overall			
North Approach	> 15m	2+	A
South Approach	> 15m	2+	A
East Approach	> 15m	2+	A
West Approach	> 15m	2+	A

Auto LOS

Intersection	AM Peak			PM Peak		
	Max. v/c or delay	LOS	Mvmt	Max. v/c or delay	LOS	Mvmt
Russell at Walkley	0.85	D	NBL	1.46	F	WBL
Russell at Hawthorne	0.84	D	WBR	0.45	A	SBL
Hawthorne at Stevenage	0.66	B	EBL	0.71	C	WBL
Hawthorne at Hunt Club	1.04	F	NBT	0.99	E	WBL
Russell at Belgreen ¹	18 sec	C	NB	12 sec	B	NB
Hunt Club at Hwy 417 Off-ramp ¹	36 sec	E	EBL	26 sec	D	EBL
Ramsayville at Russell (S) ¹	60 sec	F	EB	30 sec	D	EB
Ramsayville at Russell (N) ¹	38 sec	E	WB	14 sec	B	SB
Russell at Anderson ¹	78 sec	F	NB	17 sec	C	SB
Walkley at Highway 417 SB Off-ramp ¹	33 sec	D	SBL	64 sec	F	SBL
Walkey at Highway 417 NB Off-ramp ¹	239 sec	F	NB	34 sec	D	NB

APPENDIX H

Existing Signal Timings

Traffic Signal Timing

City of Ottawa, Transportation Services Department

Traffic Signal Operations Unit

Intersection:	<i>Main:</i> Walkley	<i>Side:</i> Russell/Hawthorne
Controller:	MS-3200	TSD: 5326
Author:	Sarah Saade	Date: 07-Aug-18

Existing Timing Plans†

	Plan						Ped Minimum Time		
	AM Peak 1	AM Peak 2 10	Off Peak 2	PM Peak 3	Night 4	Weekend 5	Walk	DW	A+R
Cycle	130	150	120	130	120	100			
Offset	19	102	21	35	X	52			
EB Thru	39	45	38	58	33	35	7	18	3.3+4.0
WB Thru	54.6	65.6	45.6	66	33	35	7	18	3.3+4.0
NBLT (fp)	16	20	15	17	14	13	-	-	3.3+4.3
SBLT (fp)	16	20	15	17	14	13	-	-	3.3+4.3
NB Thru	35	40	35	35	35	35	7	20	3.3+4.1
SB Thru	35	40	35	35	35	35	7	20	3.3+4.1
EBLT (fp)	24.4	24.4	24.4	12	24.4	17	-	-	3.3+3.1
WBLT (fp)	40	45	32	20	38	17	-	-	3.3+3.1

Phasing Sequence‡

Plan: 4

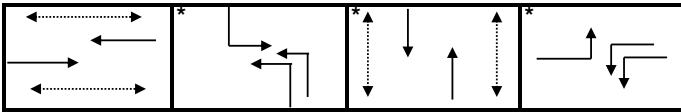

Plan: 1, 2, 3, 5, 10

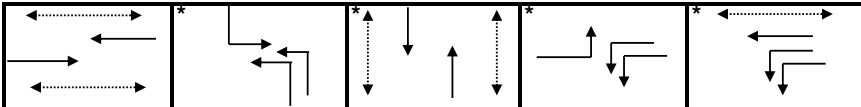

NOTE:

- 1) In plans 1, 4 & 5, if the pedestrian phase is not actuated, the NS movement will be forced off after 15 seconds of green time and the extra time will go to the next phase whereas for plans 2 & 3, it will be 18 seconds.
- 2) For all plans, the EBL phase only receives 18 seconds of green time, regardless of the split time allocated

Schedule

Weekday

Time	Plan
0:15	4
6:30	1
7:00	10
9:30	2
15:00	3
18:30	2
21:30	4

Saturday

Time	Plan
0:15	4
6:30	2
11:00	5
19:30	2
22:00	4

Sunday

Time	Plan
0:15	4
6:30	2
21:00	4

Notes

†: Time for each direction includes amber and all red intervals

‡: Start of first phase should be used as reference point for offset

Asterisk (*) Indicates actuated phase

(fp): Fully Protected Left Turn

◄.....► Pedestrian signal

Cost is \$56.50 (\$50 + HST)

Traffic Signal Timing

City of Ottawa, Transportation Services Department

Traffic Signal Operations Unit

Intersection:	<i>Main:</i> Hawthorne	<i>Side:</i>	Russell
Controller:	ATC 3	TSD:	5722
Author:	Ahmed Abdullah	Date:	28-Oct-2019

Existing Timing Plans†

	Plan					Ped Minimum Time		
	AM Peak 1	Off Peak 2	PM Peak 3	Night 4	Weekend 5	Walk	DW	A+R
Cycle	90	85	80	70	70			
Offset	23	34	16	X	34			
NB Thru	64	59	54	44	44	15	5	4.2+2.3
SB Thru	64	59	54	44	44	15	5	4.2+2.3
EB Thru	26	26	26	26	26	7	13	3.7+2.0
WB Thru	26	26	26	26	26	7	13	3.7+2.0

Phasing Sequence‡

Plan: All

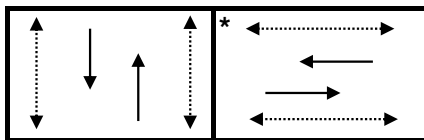

Schedule

Weekday		Saturday		Sunday	
Time	Plan	Time	Plan	Time	Plan
0:15	4	0:15	4	0:15	4
6:30	1	6:30	2	6:30	2
9:30	2	11:00	5	21:00	4
15:00	3	19:30	2		
18:30	2	22:00	4		
21:30	4				

Notes

†: Time for each direction includes amber and all red intervals
‡: Start of first phase should be used as reference point for offset

Asterisk (*) Indicates actuated phase

(fp): Fully Protected Left Turn

◀-----▶ Pedestrian signal

Cost is \$57.63 (\$51 + HST)

Traffic Signal Timing

City of Ottawa, Transportation Services Department

Traffic Signal Operations Unit

Intersection:	<i>Main:</i> Hawthorne	<i>Side:</i> Stevenage
Controller:	MS 3200	TSD: 6325
Author:	Ahmed Abdullah	Date: 28-Oct-2019

Existing Timing Plans†

	Plan					Ped Minimum Time		
	AM Peak 1	Off Peak 2	PM Peak 3	Night 4	Weekend 5	Walk	DW	A+R
Cycle	90	85	95	65	80			
Offset	0	0	0	0	0			
NB Thru	40	35	45	40	55	20	7	4.2+1.3
SB Thru	40	35	45	40	55	20	7	4.2+1.3
EB Thru	35	35	35	25	25	7	12	3.3+2.4
WB Thru	35	35	35	25	25	7	12	3.3+2.4
NB Left	15	15	15	-	-	-	-	4.2+1.5
SB Left	15	15	15	-	-	-	-	4.2+1.5

Phasing Sequence‡

Plan: 1, 2, 3

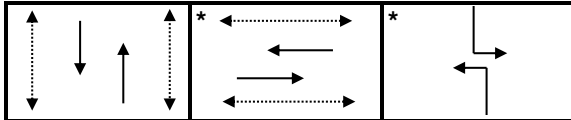

4, 5

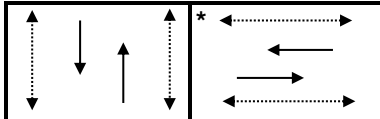

Schedule

Weekday		Saturday		Sunday	
Time	Plan	Time	Plan	Time	Plan
0:15	4	0:15	4	0:15	4
6:30	1	6:30	2	6:30	2
9:30	2	11:00	5	21:00	4
15:00	3	19:30	2		
18:30	2	22:00	4		
21:30	4				

Notes

†: Time for each direction includes amber and all red intervals
 ‡: Start of first phase should be used as reference point for offset

Asterisk (*) Indicates actuated phase

(fp): Fully Protected Left Turn

◄.....► Pedestrian signal

Cost is \$57.63 (\$51 + HST)

Traffic Signal Timing

City of Ottawa, Transportation Services Department

Traffic Signal Operations Unit

Intersection:	<i>Main:</i> Hunt Club	<i>Side:</i> Hawthorne
Controller:	ATC 3	TSD: 6024
Author:	Ahmed Abdullah	Date: 28-Oct-2019

Existing Timing Plans[†]

	Plan					Ped Minimum Time		
	AM Peak 1	Off Peak 2	PM Peak 3	Night 4	Weekend 5	Walk	DW	A+R
Cycle	Free	Free	Free	Free	Free			
Offset	X	X	X	X	X			
EB Thru	41.4	36.4	48.4	31.4	36.4	7	19	4.6+1.8
WB Thru	41.4	36.4	56.4	31.4	36.4	7	19	4.6+1.8
<i>NB Left</i>	21.3	21.3	21.3	16.3	16.3	-	-	4.2+2.1
<i>SB Left</i>	21.3	21.3	21.3	16.3	16.3	-	-	4.2+2.1
NB Thru	36.3	26.3	31.3	26.3	26.3	7	19	4.2+2.1
SB Thru	36.3	26.3	31.3	26.3	26.3	7	19	4.2+2.1
<i>EB Left (fp)</i>	41.4	41.4	36.4	31.4	31.4	-	-	4.6+1.8
<i>WB Left (fp)</i>	41.4	41.4	44.4	31.4	31.4	-	-	4.6+1.8

Phasing Sequence[‡]

Plan: All

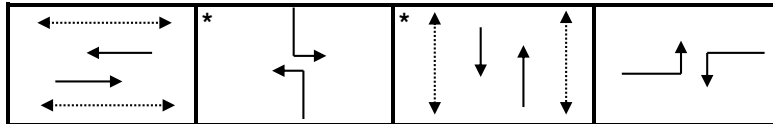

Notes: 1) All plans have a minimum recall of 26 seconds green for the EW Thru movement

Schedule

Weekday		Saturday		Sunday	
Time	Plan	Time	Plan	Time	Plan
0:10	4	0:10	4	0:10	4
6:00	1	8:30	5	8:30	5
9:30	2	19:00	2	19:00	2
15:00	3	20:00	4	20:00	4
19:00	2				
22:00	4				

Notes

†: Time for each direction includes amber and all red intervals
‡: Start of first phase should be used as reference point for offset
Asterisk (*) Indicates actuated phase
(fp): Fully Protected Left Turn
◄-----► Pedestrian signal

Cost is \$57.63 (\$51 + HST)

APPENDIX I

Left Turn and Signal Warrants, Roundabout Evaluation



TRAFFIC SIGNAL JUSTIFICATION

LOCATION: Walkley Road at 417 NB Off-ramp

DATE: April 30, 2020

JUSTIFICATION 1 – Minimum Vehicular Volume

APPROACH LANES	MINIMUM REQUIREMENTS (80% SHOWN IN BRACKETS)				PERCENTAGE WARRANT								TOTAL ACROSS
	1		2 or MORE		HOUR ENDING								
FLOW CONDITION	FREE FLOW	RESTR FLOW	FREE FLOW	RESTR FLOW	8:00	9:00	10:00	12:30	13:30	16:00	17:00	18:00	
A.	480	720	600	900	1567	1312	473	309	416	706	1028	718	
	(385)	(575)	(480)	(720)									
ALL APPROACHES	100% FULFILLED				✓	✓				✓	✓	✓	500
	80% FULFILLED												0
	ACTUAL % IF BELOW 80% VALUE						79%	52%	69%				200
TOTAL DOWN:												700	
AVERAGE (TOTAL/8):												87%	

T Intersection Add 50%													
1		2 or MORE											
FLOW CONDITION	FREE FLOW	RESTR FLOW	FREE FLOW	RESTR FLOW	8:00	9:00	10:00	12:30	13:30	16:00	17:00	18:00	TOTAL ACROSS
B.	180	255	180	255	614	460	241	168	135	169	168	148	
	(143)	(203)	(143)	(203)									
MINOR STREET BOTH APPROACHES	120	170	120	170	✓	✓	✓						300
	(95)	(135)	(95)	(135)				✓		✓	✓	✓	320
	ACTUAL % IF BELOW 80% VALUE								75%				75
TOTAL DOWN:												695	
AVERAGE (TOTAL/8):												87%	

JUSTIFICATION 2 – Delay to Cross Traffic

APPROACH LANES	MINIMUM REQUIREMENTS (80% SHOWN IN BRACKETS)				PERCENTAGE WARRANT								TOTAL ACROSS
	1		2 or MORE		HOUR ENDING								
FLOW CONDITION	FREE FLOW	RESTR FLOW	FREE FLOW	RESTR FLOW	8:00	9:00	10:00	12:30	13:30	16:00	17:00	18:00	
A.	480	720	600	900	953	852	232	141	281	537	860	570	
	(385)	(575)	(480)	(720)									
MAJOR STREET BOTH APPROACHES	100% FULFILLED				✓	✓					✓		300
	80% FULFILLED									✓		✓	160
	ACTUAL % IF BELOW 80% VALUE						39%	24%	47%				109
TOTAL DOWN:												569	
AVERAGE (TOTAL/8):												71%	

APPROACH LANES	MINIMUM REQUIREMENTS (80% SHOWN IN BRACKETS)				PERCENTAGE WARRANT								TOTAL ACROSS
	1		2 or MORE		HOUR ENDING								
FLOW CONDITION	FREE FLOW	RESTR FLOW	FREE FLOW	RESTR FLOW	8:00	9:00	10:00	12:30	13:30	16:00	17:00	18:00	
B.	50	75	50	75	584	428	236	165	130	146	149	130	
	(40)	(60)	(40)	(60)									
TRAFFIC CROSSING MAJOR STREET	100% FULFILLED				✓	✓	✓	✓	✓	✓	✓	✓	800
	80% FULFILLED												0
	ACTUAL % IF BELOW 80% VALUE												0
TOTAL DOWN:												800	
AVERAGE (TOTAL/8):												100%	

JUSTIFICATION 4 – Minimum Four-Hour Vehicle Volume

A. Restricted Flow

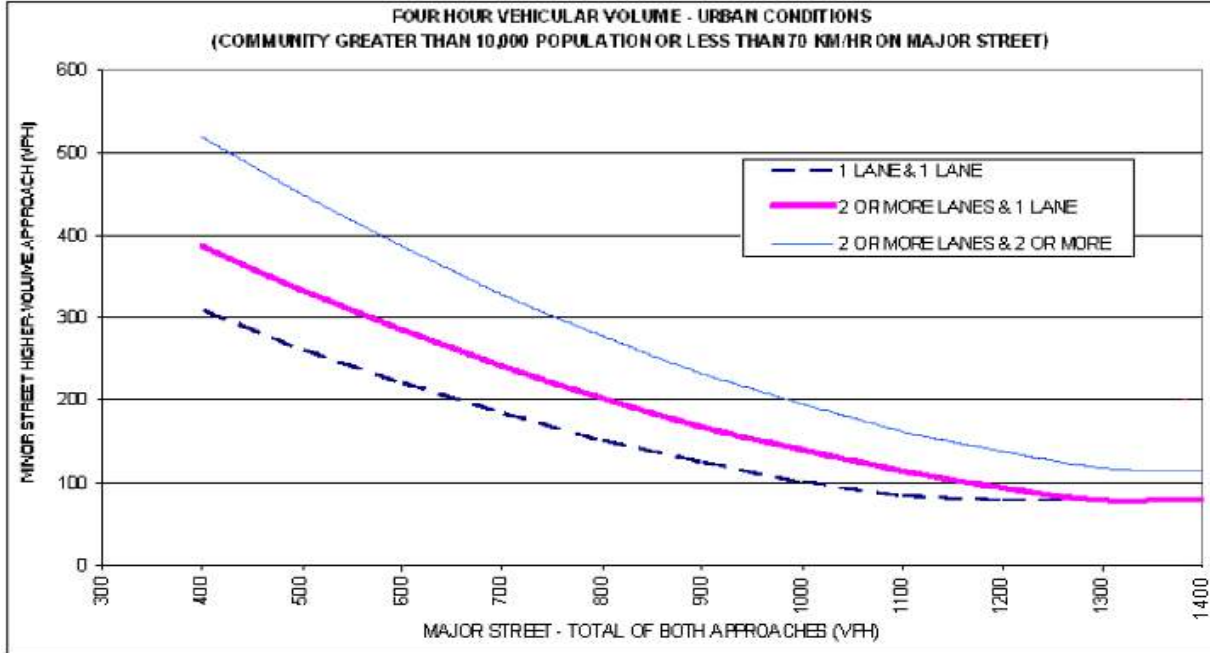

B. Free Flow

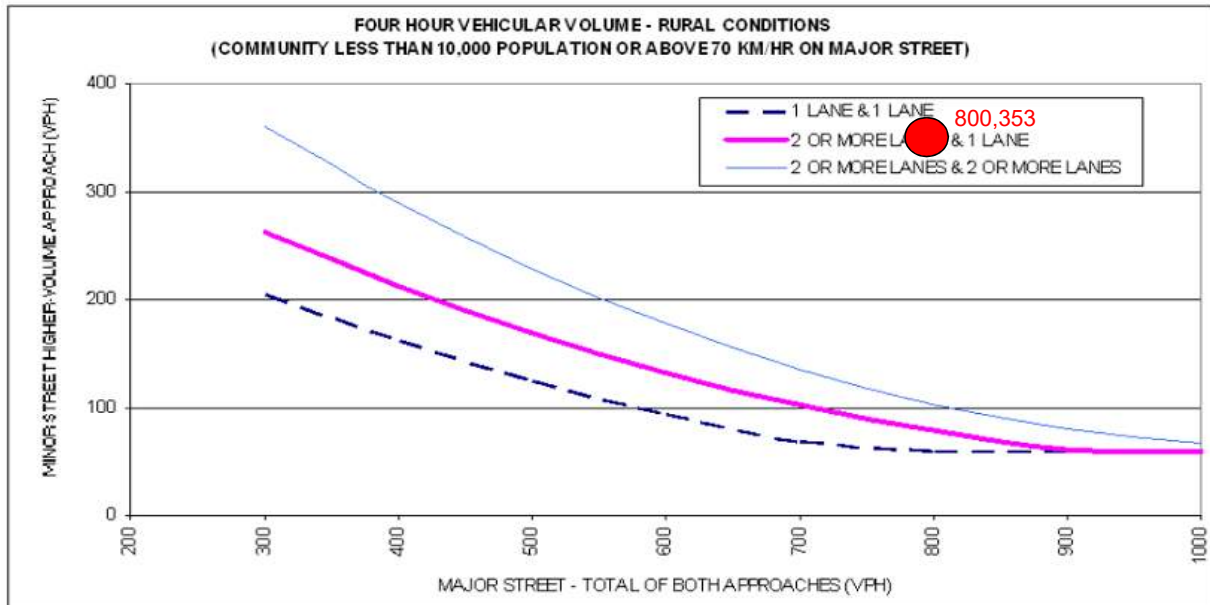

TRAFFIC SIGNAL JUSTIFICATION

LOCATION: Walkley Road at 417 NB Off-ramp

DATE: April 30, 2020

JUSTIFICATION	DESCRIPTION	Minimum Requirement		Compliance	
		Free Flow	Restricted Flow	Sectional %	Entire % ⁽²⁾
		Operating Speed ≥ 70km/h	Operating Speed < 70 km/h		
1. MINIMUM VEHICULAR WARRANT	A. Vehicle volume, all approaches for each of the heaviest 8 hours of an average day, and	480 600 (2 or more lane approach)	720 900 (2 or more lane approach)	87%	87%
	B. Vehicle volume, along minor street, for each of the same 8 hours.	120 180 (tee intersection)	170 255 (tee intersection)	87%	
2. DELAY TO CROSS TRAFFIC	A. Vehicle volume, along major street for each of the heaviest 8 hours of an average day, and	480 600 (2 or more lane approach)	720 900 (2 or more lane approach)	71%	71%
	B ⁽¹⁾ . Combined vehicle and pedestrian volume <u>crossing</u> the major street for each of the same 8 hours	50	75	100%	
3. VOLUME/DELAY COMBINATION	The above Justifications (1 and 2) both satisfied to the extent of 80% or more	No			
4. MINIMUM FOUR HOUR VEHICLE VOLUME	Plotted point representing hourly volume for minor approach vs. major approach for four highest hours of an average day fall above the applicable curve	Yes			
5. COLLISION EXPERIENCE	A. Total reported accidents of types susceptible to correction by a traffic signal, per 12 month period averaged over a 36 month period, and	5			
	B. Adequate trial of less restrictive remedies, where satisfactory observance and enforcement have failed to reduce the number of accidents	No			
6. PEDESTRIAN VOLUME AND DELAY	A. Plotted point representing 8 hour pedestrian volume vs. 8 hour vehicular volume fall in justified zone, and	No			
	B. Plotted point representing 8 hour volume of pedestrian experiencing delays of 10 s or more vs. 8 hour pedestrian volume fall in justified zone	No			



TRAFFIC SIGNAL JUSTIFICATION

LOCATION: Anderson Road at Russell Road

DATE: April 28, 2020

JUSTIFICATION 1 – Minimum Vehicular Volume

APPROACH LANES	MINIMUM REQUIREMENTS (80% SHOWN IN BRACKETS)				PERCENTAGE WARRANT								TOTAL ACROSS
	1		2 or MORE		HOUR ENDING								
FLOW CONDITION	FREE FLOW	RESTR FLOW	FREE FLOW	RESTR FLOW	8:00	9:00	10:00	12:30	13:30	16:00	17:00	18:00	
A.	480	720	600	900	1235	1206	689	279	290	694	943	690	
	(385)	(575)	(480)	(720)									
ALL APPROACHES	100% FULFILLED				✓	✓	✓			✓	✓	✓	600
	80% FULFILLED												0
	ACTUAL % IF BELOW 80% VALUE							58%	60%				119
TOTAL DOWN:												719	
AVERAGE (TOTAL/8):												90%	

T Intersection Add 50%													
					HOUR ENDING								
FLOW CONDITION	FREE FLOW	RESTR FLOW	FREE FLOW	RESTR FLOW	8:00	9:00	10:00	12:30	13:30	16:00	17:00	18:00	TOTAL ACROSS
B.	180	255	180	255	594	396	191	105	101	267	359	243	
	(143)	(203)	(143)	(203)									
MINOR STREET BOTH APPROACHES	120	170	120	170	✓	✓	✓			✓	✓	✓	600
	(95)	(135)	(95)	(135)				✓	✓				160
	ACTUAL % IF BELOW 80% VALUE												0
TOTAL DOWN:												760	
AVERAGE (TOTAL/8):												95%	

JUSTIFICATION 2 – Delay to Cross Traffic

APPROACH LANES	MINIMUM REQUIREMENTS (80% SHOWN IN BRACKETS)				PERCENTAGE WARRANT								TOTAL ACROSS
	1		2 or MORE		HOUR ENDING								
FLOW CONDITION	FREE FLOW	RESTR FLOW	FREE FLOW	RESTR FLOW	8:00	9:00	10:00	12:30	13:30	16:00	17:00	18:00	
A.	480	720	600	900	641	810	498	174	189	427	584	447	
	(385)	(575)	(480)	(720)									
MAJOR STREET BOTH APPROACHES	100% FULFILLED				✓	✓	✓				✓		400
	80% FULFILLED									✓		✓	160
	ACTUAL % IF BELOW 80% VALUE							36%	39%				76
TOTAL DOWN:												636	
AVERAGE (TOTAL/8):												79%	

APPROACH LANES	MINIMUM REQUIREMENTS (80% SHOWN IN BRACKETS)				PERCENTAGE WARRANT								TOTAL ACROSS
	1		2 or MORE		HOUR ENDING								
FLOW CONDITION	FREE FLOW	RESTR FLOW	FREE FLOW	RESTR FLOW	8:00	9:00	10:00	12:30	13:30	16:00	17:00	18:00	
B.	50	75	50	75	453	282	143	66	61	201	313	201	
	(40)	(60)	(40)	(60)									
TRAFFIC CROSSING MAJOR STREET	100% FULFILLED				✓	✓	✓	✓	✓	✓	✓	✓	800
	80% FULFILLED												0
	ACTUAL % IF BELOW 80% VALUE												0
TOTAL DOWN:												800	
AVERAGE (TOTAL/8):												100%	

JUSTIFICATION 4 – Minimum Four-Hour Vehicle Volume

A. Restricted Flow

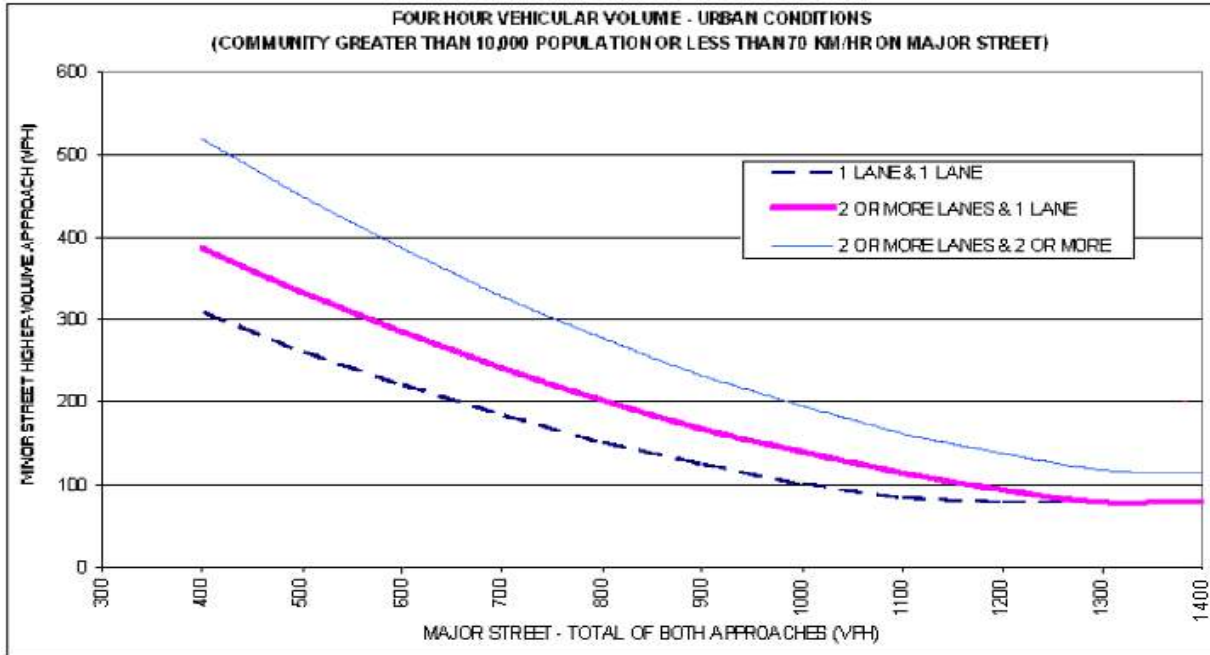

B. Free Flow

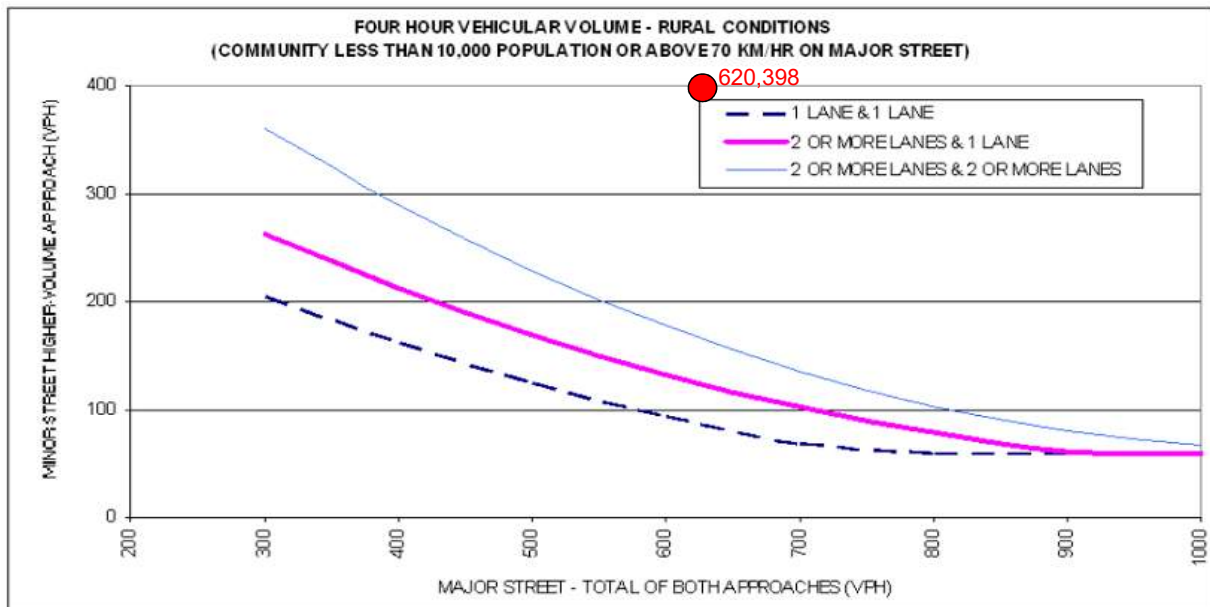

TRAFFIC SIGNAL JUSTIFICATION

LOCATION: Anderson Road at Russell Road

DATE: April 28, 2020

JUSTIFICATION	DESCRIPTION	Minimum Requirement		Compliance	
		Free Flow	Restricted Flow	Sectional %	Entire % ⁽²⁾
		Operating Speed ≥ 70km/h	Operating Speed < 70 km/h		
1. MINIMUM VEHICULAR WARRANT	A. Vehicle volume, all approaches for each of the heaviest 8 hours of an average day, and	480 600 (2 or more lane approach)	720 900 (2 or more lane approach)	90%	90%
	B. Vehicle volume, along minor street, for each of the same 8 hours.	120 180 (tee intersection)	170 255 (tee intersection)	95%	
2. DELAY TO CROSS TRAFFIC	A. Vehicle volume, along major street for each of the heaviest 8 hours of an average day, and	480 600 (2 or more lane approach)	720 900 (2 or more lane approach)	79%	79%
	B ⁽¹⁾ . Combined vehicle and pedestrian volume <u>crossing</u> the major street for each of the same 8 hours	50	75	100%	
3. VOLUME/DELAY COMBINATION	The above Justifications (1 and 2) both satisfied to the extent of 80% or more	No			
4. MINIMUM FOUR HOUR VEHICLE VOLUME	Plotted point representing hourly volume for minor approach vs. major approach for four highest hours of an average day fall above the applicable curve	Yes			
5. COLLISION EXPERIENCE	A. Total reported accidents of types susceptible to correction by a traffic signal, per 12 month period averaged over a 36 month period, and	5			
	B. Adequate trial of less restrictive remedies, where satisfactory observance and enforcement have failed to reduce the number of accidents	No			
6. PEDESTRIAN VOLUME AND DELAY	A. Plotted point representing 8 hour pedestrian volume vs. 8 hour vehicular volume fall in justified zone, and	No			
	B. Plotted point representing 8 hour volume of pedestrian experiencing delays of 10 s or more vs. 8 hour pedestrian volume fall in justified zone	No			



TRAFFIC SIGNAL JUSTIFICATION

LOCATION: Walkley Road at 417 SB Off-ramp

DATE: April 30, 2020

JUSTIFICATION 1 – Minimum Vehicular Volume

APPROACH LANES	MINIMUM REQUIREMENTS (80% SHOWN IN BRACKETS)				PERCENTAGE WARRANT								TOTAL ACROSS
	1		2 or MORE		HOUR ENDING								
FLOW CONDITION	FREE FLOW	RESTR FLOW	FREE FLOW	RESTR FLOW	8:00	9:00	10:00	12:30	13:30	16:00	17:00	18:00	
A.	480	720	600	900	1403	1050	832	856	984	1697	1812	1648	
	(385)	(575)	(480)	(720)									
ALL APPROACHES	100% FULFILLED				✓	✓	✓	✓	✓	✓	✓	✓	800
	80% FULFILLED												0
	ACTUAL % IF BELOW 80% VALUE												0
TOTAL DOWN:												800	
AVERAGE (TOTAL/8):												100%	

T Intersection Add 50%													
1		2 or MORE											
FLOW CONDITION	FREE FLOW	RESTR FLOW	FREE FLOW	RESTR FLOW	8:00	9:00	10:00	12:30	13:30	16:00	17:00	18:00	TOTAL ACROSS
B.	180	255	180	255	22	15	12	30	45	120	167	78	
	(143)	(203)	(143)	(203)									
MINOR STREET BOTH APPROACHES	120	170	120	170									0
	(95)	(135)	(95)	(135)							✓		80
	ACTUAL % IF BELOW 80% VALUE				12%	8%	7%	17%	25%	67%		43%	179
TOTAL DOWN:												259	
AVERAGE (TOTAL/8):												32%	

JUSTIFICATION 2 – Delay to Cross Traffic

APPROACH LANES	MINIMUM REQUIREMENTS (80% SHOWN IN BRACKETS)				PERCENTAGE WARRANT								TOTAL ACROSS
	1		2 or MORE		HOUR ENDING								
FLOW CONDITION	FREE FLOW	RESTR FLOW	FREE FLOW	RESTR FLOW	8:00	9:00	10:00	12:30	13:30	16:00	17:00	18:00	
A.	480	720	600	900	1381	1035	820	826	939	1577	1645	1570	
	(385)	(575)	(480)	(720)									
MAJOR STREET BOTH APPROACHES	100% FULFILLED				✓	✓	✓	✓	✓	✓	✓	✓	800
	80% FULFILLED												0
	ACTUAL % IF BELOW 80% VALUE												0
TOTAL DOWN:												800	
AVERAGE (TOTAL/8):												100%	

		1		2 or MORE										
		FREE FLOW	RESTR FLOW	FREE FLOW	RESTR FLOW									
FLOW CONDITION		FREE FLOW	RESTR FLOW	FREE FLOW	RESTR FLOW	8:00	9:00	10:00	12:30	13:30	16:00	17:00	18:00	TOTAL ACROSS
B.	TRAFFIC CROSSING MAJOR STREET	50	75	50	75	22	15	12	30	45	120	167	78	
		(40)	(60)	(40)	(60)									
		100% FULFILLED									✓	✓	✓	300
		80% FULFILLED									✓			80
		ACTUAL % IF BELOW 80% VALUE				44%	30%	24%	60%					158
TOTAL DOWN:												538		
AVERAGE (TOTAL/8):												67%		

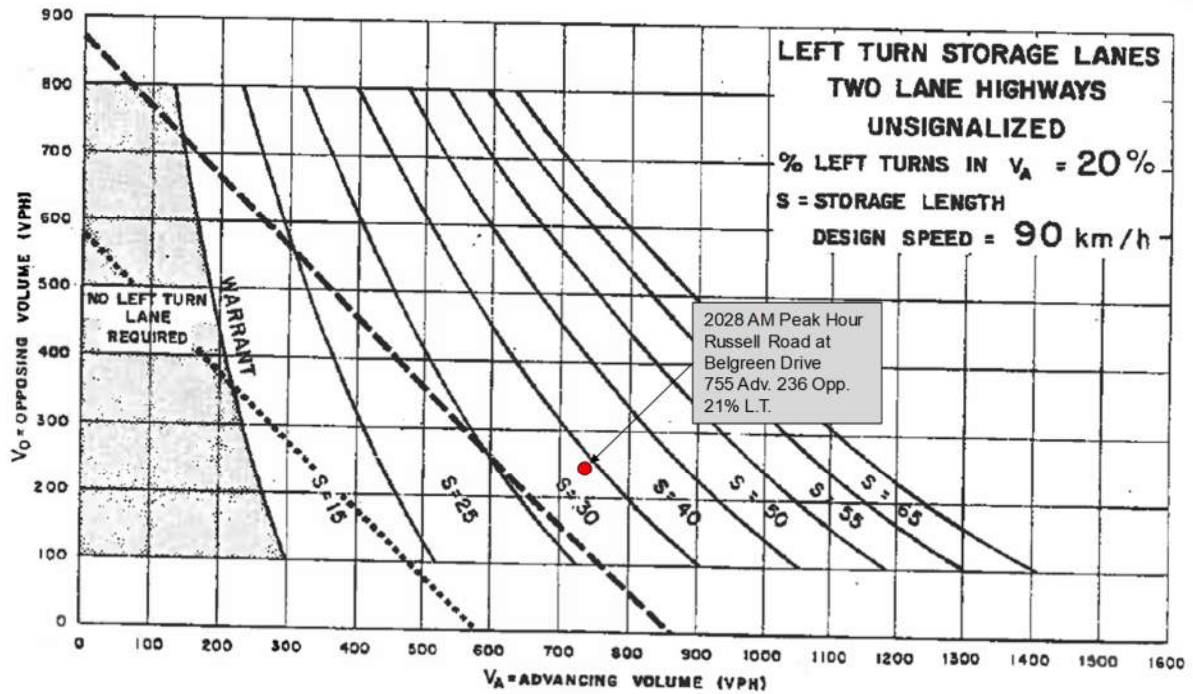
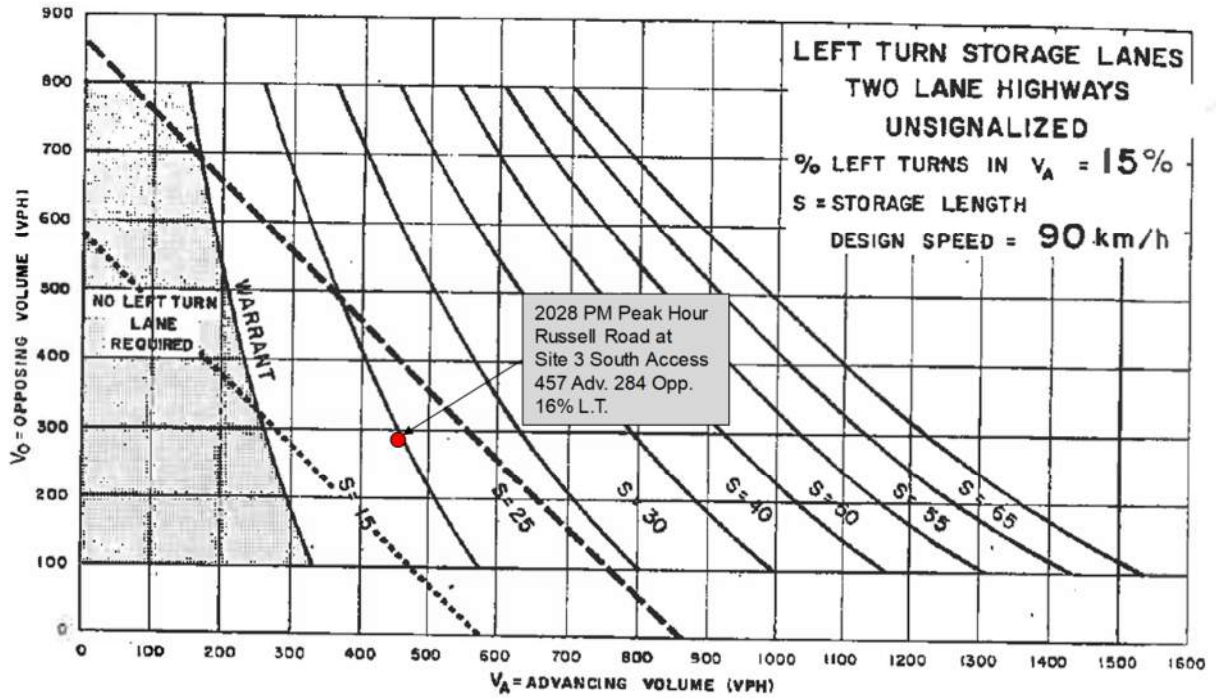

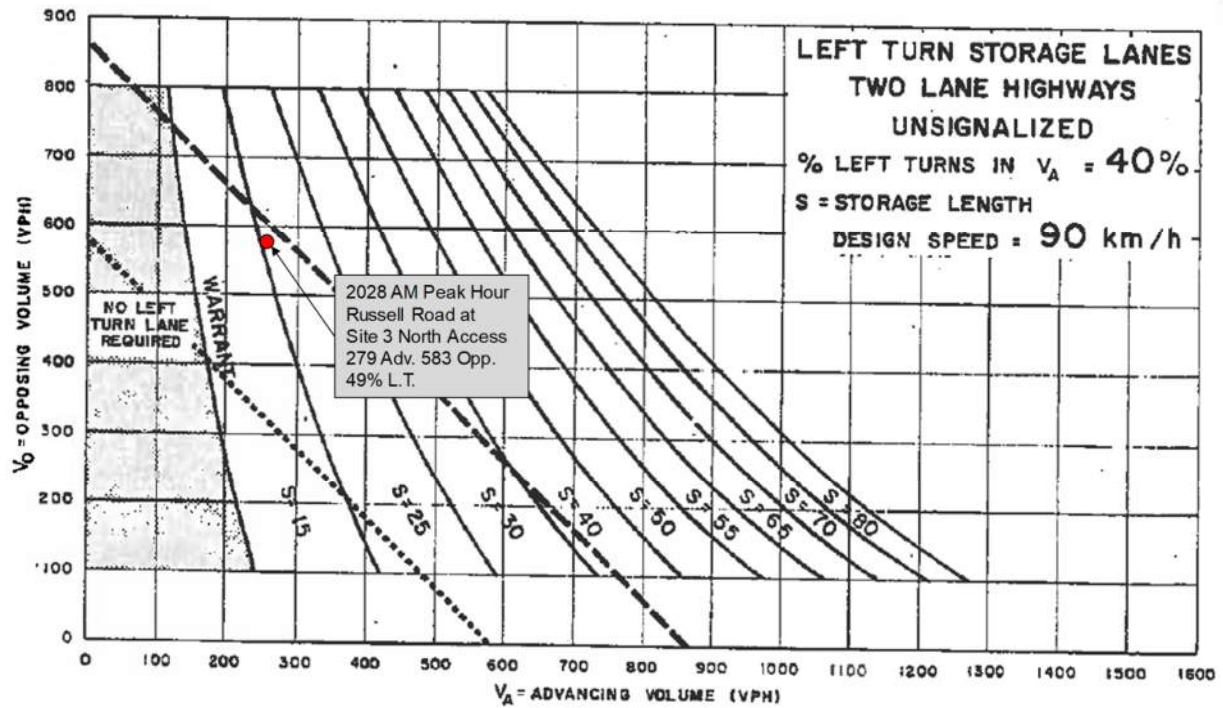
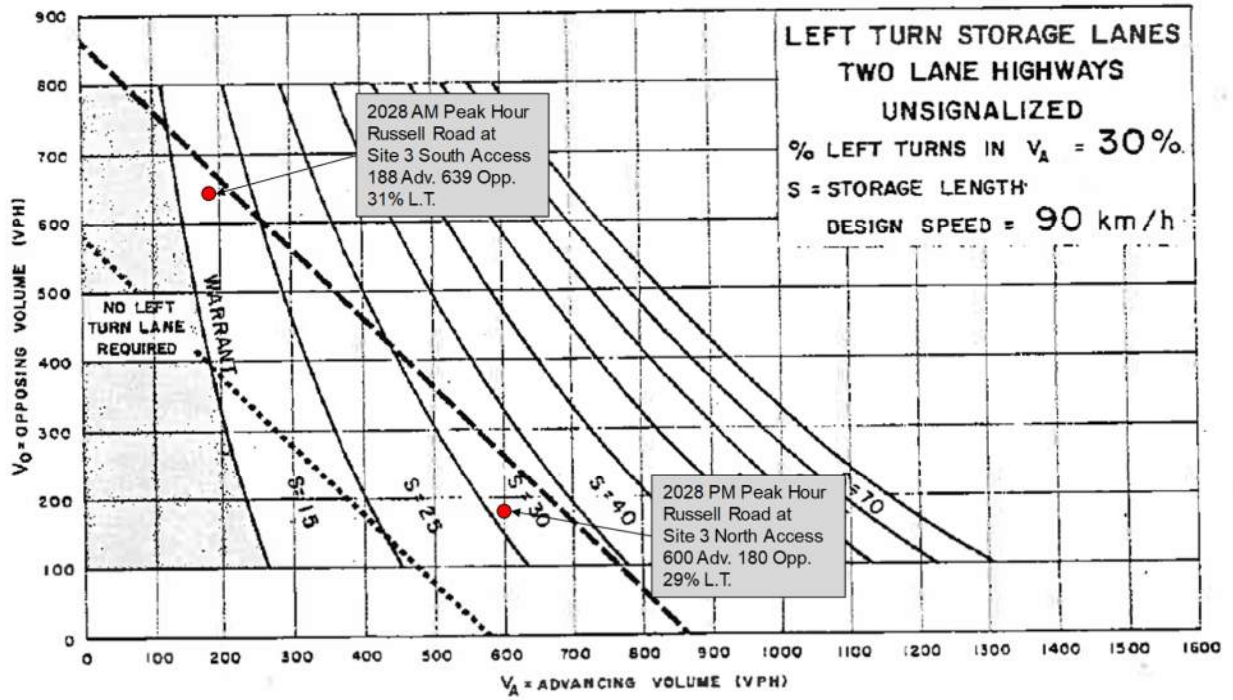

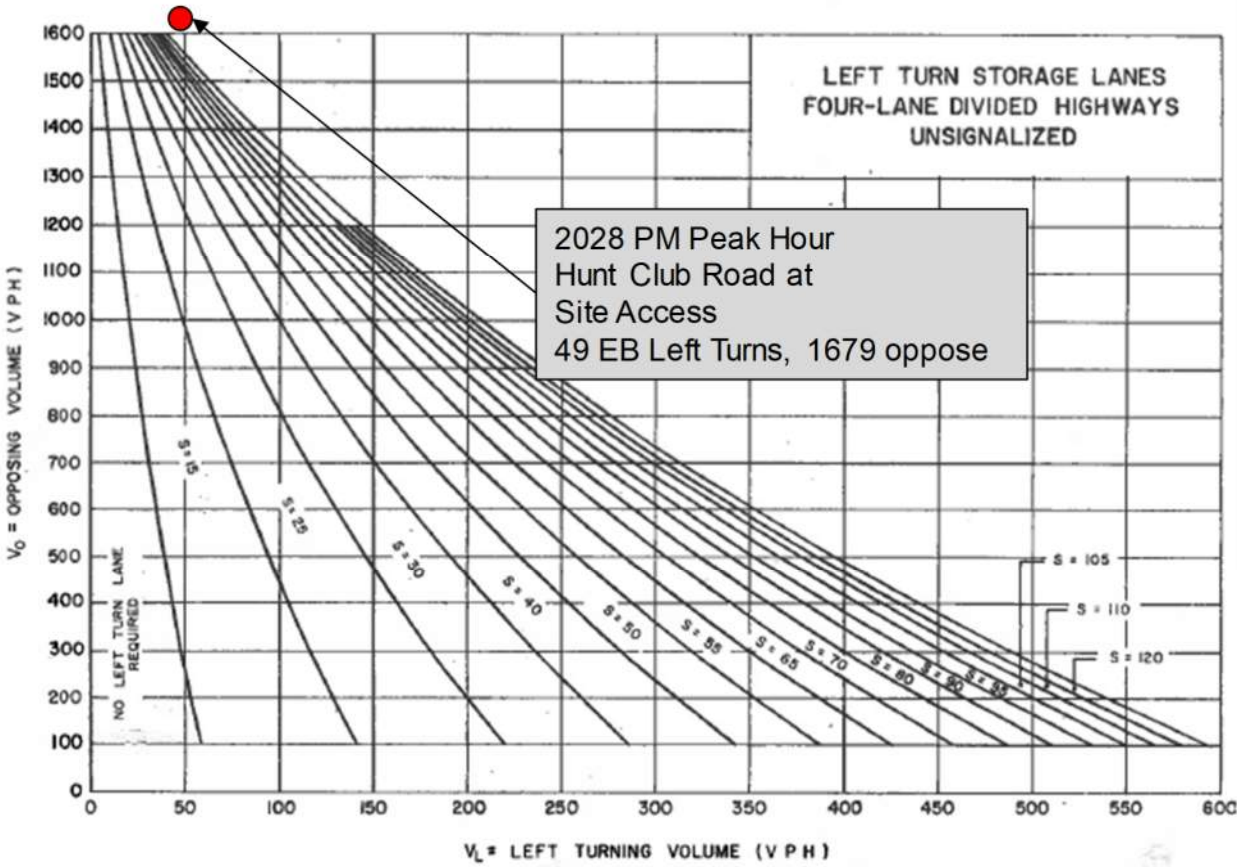

City of Ottawa Roundabout Initial Feasibility Screening Tool

The intent of this screening tool is to provide a relatively quick assessment of the feasibility of a roundabout at a particular intersection in comparison to other appropriate forms of traffic control or road modifications including all-way stop control, traffic signals, auxiliary lanes, etc. The intended outcome of this tool is to provide enough information to assist staff in deciding whether or not to proceed with an Intersection Control Study to investigate the feasibility of a roundabout in more detail.

1	Project Name:	National Capital Business Park
2	Intersection:	Russell Road and Anderson Road
3	Location and Description of Intersection: Lane configuration, total or approach AADT, distance to nearby intersection(s), etc. Attach or sketch a diagram and include existing and/or horizon-year turning movements. If an existing intersection then indicate type of control.	Existing All-Way STOP with single lane approaches in a rural area Existing and projected volumes are included in the TIA.
4	What traditional modifications are proposed? All-way stop control, traffic signals, auxiliary lanes, etc. Attach or sketch a diagram if necessary.	Signalization is warranted.
5	What size of roundabout is being considered? Describe, and attach a Roundabout Traffic Flow Worksheet.	Four legged, Single Lane Roundabout
6	Why is a roundabout being considered?	Signalization is warranted, consider a roundabout per City Policy.

- 7 Are there contra-indications for a roundabout? If “Yes” is indicated for one or more of the contra-indications then a roundabout may be problematic at the subject intersection. That is not to say that a roundabout is not possible, just that there may be difficulties or high costs.

No.	Contra-Indication	Outcome
1	Is there insufficient property at the intersection (i.e. less than 44 metres diameter if considering a single-lane roundabout, and less than 60 metres if considering a two-lane roundabout) or property constraints that would require demolition of adjacent structures?	Yes <input type="checkbox"/> No <input checked="" type="checkbox"/>
2	Are there any instances where stopping sight distance (SSD) of a roundabout yield line may not be attainable (i.e. the intersection is on a crest vertical curve)?	Yes <input type="checkbox"/> No <input checked="" type="checkbox"/>
3	Is there an existing uncontrolled approach with a grade in excess of 4 percent?	Yes <input type="checkbox"/> No <input checked="" type="checkbox"/>
4	Is the intersection located within a coordinated signal system?	Yes <input type="checkbox"/> No <input checked="" type="checkbox"/>
5	Is there a closely-spaced traffic signal or railway crossing that could not be controlled with a nearby roundabout?	Yes <input type="checkbox"/> No <input checked="" type="checkbox"/>
6	Are significant differences in directional flows or any situations of sudden high demand expected?	Yes <input type="checkbox"/> No <input checked="" type="checkbox"/>
7	Are there known visually-impaired pedestrians that cross this intersection?	Yes <input type="checkbox"/> No <input checked="" type="checkbox"/>

- 8 Are there suitability factors for a roundabout? If “Yes” is indicated for two or more of the suitability factors then a roundabout should be technically feasible at the subject intersection.

No.	Suitability Factor	Outcome
1	Does the intersection currently experience an average collision frequency of more than 1.5 injury crashes per year, or a collision rate in excess of 1 injury crash per 1 million vehicles entering (MVE)?	Yes <input type="checkbox"/> No <input checked="" type="checkbox"/>
2	Has there been a fatal crash at the intersection in the last 10 years?	Yes <input type="checkbox"/> No <input checked="" type="checkbox"/>
3	Are capacity problems currently being experienced, or expected in the future?	Yes <input checked="" type="checkbox"/> No <input type="checkbox"/>
4	Are traffic signals warranted, or expected to be warranted in the future?	Yes <input checked="" type="checkbox"/> No <input type="checkbox"/>
5	Does the intersection have more than 4 legs, or unusual geometry?	Yes <input type="checkbox"/> No <input checked="" type="checkbox"/>
6	Will planned modifications to the intersection require that nearby structures be widened (i.e. to accommodate left-turn lanes)?	Yes <input checked="" type="checkbox"/> No <input type="checkbox"/>
7	Is the intersection located at a transition between rural and urban environments (i.e. an urban boundary) such that a roundabout could act as a means of speed transition?	Yes <input checked="" type="checkbox"/> No <input type="checkbox"/>

- 9 Conclusions/recommendation whether to proceed with an Intersection Control Study:

The Feasibility results indicate that the City should proceed with an Intersection Control Study.

DRAFT

APPENDIX J

Traffic Analysis Reports

4055 & 4120 Russell Road
1: Russell & Walkley

Existing Traffic AM Peak Hour

Lane Group	EBL	EBT	EBR	WBL	WBT	WBR	NBL	NBT	NBR	SBL	SBT	SBR
Lane Configurations												
Traffic Volume (vph)	71	458	119	345	1146	61	195	388	469	52	201	122
Future Volume (vph)	71	458	119	345	1146	61	195	388	469	52	201	122
Satd. Flow (prot)	1374	3307	1332	3013	3435	1522	3094	3218	1332	3269	3189	1390
Flt Permitted	0.950			0.950			0.950			0.950		
Satd. Flow (perm)	1372	3307	1332	3013	3435	1490	3082	3218	1314	3264	3189	1365
Satd. Flow (RTOR)			180			134			521			180
Lane Group Flow (vph)	79	509	132	383	1273	68	217	431	521	58	223	136
Turn Type	Prot	NA	Perm	Prot	NA	Perm	Prot	NA	Perm	Prot	NA	Perm
Protected Phases	5	2		1	6		3	8		7	4	
Permitted Phases			2			6			8			4
Total Split (s)	24.4	45.0	45.0	45.0	65.6	65.6	20.0	40.0	40.0	20.0	40.0	40.0
Total Lost Time (s)	6.4	7.3	7.3	6.4	7.3	7.3	7.6	7.4	7.4	7.6	7.4	7.4
Act Effct Green (s)	13.5	58.2	58.2	24.4	69.1	69.1	12.4	33.3	33.3	8.1	26.3	26.3
Actuated g/C Ratio	0.09	0.39	0.39	0.16	0.46	0.46	0.08	0.22	0.22	0.05	0.18	0.18
v/c Ratio	0.64	0.40	0.21	0.78	0.80	0.09	0.85	0.60	0.75	0.33	0.40	0.35
Control Delay	87.8	36.7	2.1	71.4	41.4	0.2	96.3	56.2	11.2	72.9	55.5	4.5
Queue Delay	0.0	0.0	0.0	0.0	0.0	0.0	0.0	0.0	0.0	0.0	0.0	0.0
Total Delay	87.8	36.7	2.1	71.4	41.4	0.2	96.3	56.2	11.2	72.9	55.5	4.5
LOS	F	D	A	E	D	A	F	E	B	E	E	A
Approach Delay		36.0			46.5			43.6			41.3	
Approach LOS		D			D			D			D	
Queue Length 50th (m)	21.2	55.3	0.0	52.5	164.2	0.0	30.7	55.7	0.0	8.0	27.8	0.0
Queue Length 95th (m)	37.0	77.0	4.5	66.1	#220.4	0.0	#50.9	72.2	35.2	14.8	39.0	6.0
Internal Link Dist (m)		485.7			361.7			432.2			296.2	
Turn Bay Length (m)	85.0		225.0	100.0		45.0	140.0		110.0	80.0		55.0
Base Capacity (vph)	164	1283	626	775	1582	758	255	732	701	270	693	437
Starvation Cap Reductn	0	0	0	0	0	0	0	0	0	0	0	0
Spillback Cap Reductn	0	0	0	0	0	0	0	0	0	0	0	0
Storage Cap Reductn	0	0	0	0	0	0	0	0	0	0	0	0
Reduced v/c Ratio	0.48	0.40	0.21	0.49	0.80	0.09	0.85	0.59	0.74	0.21	0.32	0.31

Intersection Summary

Cycle Length: 150

Actuated Cycle Length: 150

Offset: 102 (68%), Referenced to phase 2:EBT and 6:WBT, Start of Green

Control Type: Actuated-Coordinated

Maximum v/c Ratio: 0.85

Intersection Signal Delay: 43.2

Intersection LOS: D

Intersection Capacity Utilization 77.4%

ICU Level of Service D

Analysis Period (min) 15

95th percentile volume exceeds capacity, queue may be longer.

Queue shown is maximum after two cycles.

Splits and Phases: 1: Russell & Walkley

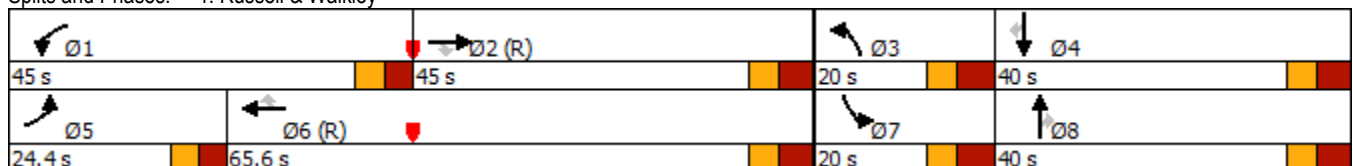

4055 & 4120 Russell Road
2: Hawthorne & Russell

Existing Traffic AM Peak Hour

Lane Group	EBL	EBT	EBR	WBL	WBT	WBR	NBL	NBT	NBR	SBL	SBT	SBR
Lane Configurations												
Traffic Volume (vph)	10	0	8	14	10	318	17	843	8	49	490	34
Future Volume (vph)	10	0	8	14	10	318	17	843	8	49	490	34
Satd. Flow (prot)	1276	1278	0	1488	1790	1522	1701	3104	0	1488	2984	0
Flt Permitted	0.750			0.752			0.433			0.278		
Satd. Flow (perm)	1007	1278	0	1178	1790	1522	771	3104	0	436	2984	0
Satd. Flow (RTOR)		355				159		2			16	
Lane Group Flow (vph)	11	9	0	16	11	353	19	946	0	54	582	0
Turn Type	Perm	NA		Perm	NA	Perm	Perm	NA		Perm	NA	
Protected Phases		4			8			2			6	
Permitted Phases	4			8		8	2			6		
Total Split (s)	26.0	26.0		26.0	26.0	26.0	64.0	64.0		64.0	64.0	
Total Lost Time (s)	5.7	5.7		5.7	5.7	5.7	6.5	6.5		6.5	6.5	
Act Effct Green (s)	17.3	17.3		17.3	17.3	17.3	60.5	60.5		60.5	60.5	
Actuated g/C Ratio	0.19	0.19		0.19	0.19	0.19	0.67	0.67		0.67	0.67	
v/c Ratio	0.06	0.02		0.07	0.03	0.84	0.04	0.45		0.18	0.29	
Control Delay	28.4	0.0		28.6	27.6	37.2	4.0	4.8		8.5	6.7	
Queue Delay	0.0	0.0		0.0	0.0	0.0	0.0	0.0		0.0	0.0	
Total Delay	28.4	0.0		28.6	27.6	37.2	4.0	4.8		8.5	6.7	
LOS	C	A		C	C	D	A	A		A	A	
Approach Delay		15.6			36.5			4.8			6.9	
Approach LOS		B			D			A			A	
Queue Length 50th (m)	1.4	0.0		2.0	1.4	28.9	0.5	14.1		3.2	18.9	
Queue Length 95th (m)	5.3	0.0		6.7	5.2	#65.6	m1.0	17.6		8.3	26.4	
Internal Link Dist (m)		63.3			159.0			795.0			432.2	
Turn Bay Length (m)	20.0			40.0		100.0	40.0			60.0		
Base Capacity (vph)	227	563		265	403	466	518	2088		293	2012	
Starvation Cap Reductn	0	0		0	0	0	0	0		0	0	
Spillback Cap Reductn	0	0		0	0	0	0	0		0	0	
Storage Cap Reductn	0	0		0	0	0	0	0		0	0	
Reduced v/c Ratio	0.05	0.02		0.06	0.03	0.76	0.04	0.45		0.18	0.29	

Intersection Summary

Cycle Length: 90

Actuated Cycle Length: 90

Offset: 23 (26%), Referenced to phase 2:NBTL and 6:SBTL, Start of Green

Control Type: Actuated-Coordinated

Maximum v/c Ratio: 0.84

Intersection Signal Delay: 11.6

Intersection LOS: B

Intersection Capacity Utilization 68.9%

ICU Level of Service C

Analysis Period (min) 15

95th percentile volume exceeds capacity, queue may be longer.

Queue shown is maximum after two cycles.

m Volume for 95th percentile queue is metered by upstream signal.

Splits and Phases: 2: Hawthorne & Russell

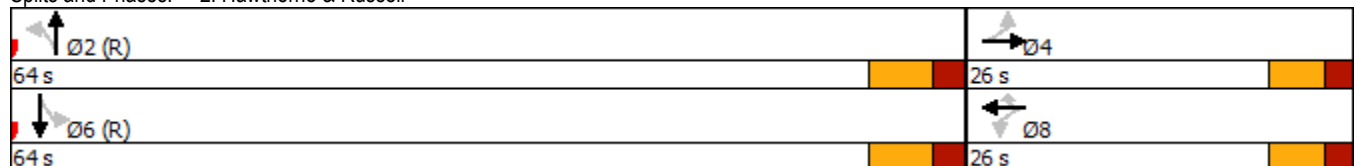

4055 & 4120 Russell Road
3: Hawthorne & Stevenage

Existing Traffic AM Peak Hour

Lane Group	EBL	EBT	EBR	WBL	WBT	WBR	NBL	NBT	NBR	SBL	SBT	SBR
Lane Configurations												
Traffic Volume (vph)	126	27	56	58	59	55	195	857	86	52	283	175
Future Volume (vph)	126	27	56	58	59	55	195	857	86	52	283	175
Satd. Flow (prot)	1553	1221	0	1276	1459	0	1669	3087	0	1429	2858	1453
Flt Permitted	0.676			0.697			0.516			0.224		
Satd. Flow (perm)	1105	1221	0	931	1459	0	903	3087	0	337	2858	1414
Satd. Flow (RTOR)		62			55			14				194
Lane Group Flow (vph)	140	92	0	64	127	0	217	1048	0	58	314	194
Turn Type	Perm	NA		Perm	NA		pm+pt	NA		pm+pt	NA	Perm
Protected Phases		4			8		5	2		1	6	
Permitted Phases	4			8			2			6		6
Total Split (s)	35.0	35.0		35.0	35.0		15.0	40.0		15.0	40.0	40.0
Total Lost Time (s)	5.7	5.7		5.7	5.7		5.7	5.5		5.7	5.5	5.5
Act Effct Green (s)	17.4	17.4		17.4	17.4		59.3	51.1		52.6	45.9	45.9
Actuated g/C Ratio	0.19	0.19		0.19	0.19		0.66	0.57		0.58	0.51	0.51
v/c Ratio	0.66	0.32		0.36	0.39		0.32	0.60		0.21	0.22	0.24
Control Delay	47.0	14.7		34.8	20.4		7.8	16.8		4.2	10.2	6.7
Queue Delay	0.0	0.0		0.0	0.0		0.0	0.0		0.0	0.0	0.0
Total Delay	47.0	14.7		34.8	20.4		7.8	16.8		4.2	10.2	6.7
LOS	D	B		C	C		A	B		A	B	A
Approach Delay		34.2			25.2			15.2			8.4	
Approach LOS		C			C			B			A	
Queue Length 50th (m)	21.0	4.0		9.0	9.9		10.8	54.9		2.0	14.6	5.4
Queue Length 95th (m)	34.1	13.8		17.4	21.2		25.3	96.6		2.0	28.3	24.9
Internal Link Dist (m)		201.3			257.1			958.8			795.0	
Turn Bay Length (m)	45.0			25.0			75.0			85.0		85.0
Base Capacity (vph)	359	439		303	512		686	1757		319	1458	816
Starvation Cap Reductn	0	0		0	0		0	0		0	0	0
Spillback Cap Reductn	0	0		0	0		0	0		0	0	0
Storage Cap Reductn	0	0		0	0		0	0		0	0	0
Reduced v/c Ratio	0.39	0.21		0.21	0.25		0.32	0.60		0.18	0.22	0.24

Intersection Summary

Cycle Length: 90

Actuated Cycle Length: 90

Offset: 0 (0%), Referenced to phase 2:NBTL and 6:SBTL, Start of Green

Control Type: Actuated-Coordinated

Maximum v/c Ratio: 0.66

Intersection Signal Delay: 16.3

Intersection LOS: B

Intersection Capacity Utilization 62.2%

ICU Level of Service B

Analysis Period (min) 15

Splits and Phases: 3: Hawthorne & Stevenage

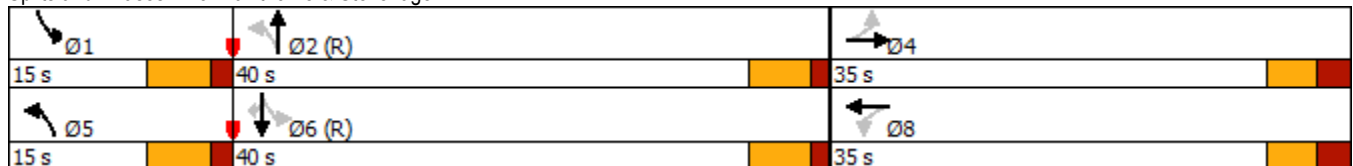

4055 & 4120 Russell Road
4: Hawthorne & Hunt Club

Existing Traffic AM Peak Hour

Lane Group	EBL	EBT	EBR	WBL	WBT	WBR	NBL	NBT	NBR	SBL	SBT	SBR
Lane Configurations												
Traffic Volume (vph)	382	595	24	239	646	234	38	389	364	39	135	172
Future Volume (vph)	382	595	24	239	646	234	38	389	364	39	135	172
Satd. Flow (prot)	1639	3332	0	1595	3402	1440	1488	2974	0	1191	2748	1278
Flt Permitted	0.950			0.950			0.657			0.129		
Satd. Flow (perm)	1639	3332	0	1595	3402	1440	1029	2974	0	162	2748	1278
Satd. Flow (RTOR)		3				260		153				191
Lane Group Flow (vph)	424	688	0	266	718	260	42	836	0	43	150	191
Turn Type	Prot	NA		Prot	NA	Perm	pm+pt	NA		pm+pt	NA	Perm
Protected Phases	7	4		3	8		5	2		1	6	
Permitted Phases						8	2			6		6
Total Split (s)	41.4	41.4		41.4	41.4	41.4	21.3	36.3		21.3	36.3	36.3
Total Lost Time (s)	6.4	6.4		6.4	6.4	6.4	6.3	6.3		6.3	6.3	6.3
Act Effct Green (s)	35.2	42.0		26.5	33.2	33.2	36.9	30.2		38.4	30.9	30.9
Actuated g/C Ratio	0.27	0.32		0.20	0.25	0.25	0.28	0.23		0.29	0.24	0.24
v/c Ratio	0.96	0.64		0.82	0.83	0.46	0.13	1.04		0.37	0.23	0.43
Control Delay	81.4	43.1		70.3	55.5	7.5	31.5	81.5		39.8	42.8	8.9
Queue Delay	0.0	0.0		0.0	0.0	0.0	0.0	0.0		0.0	0.0	0.0
Total Delay	81.4	43.1		70.3	55.5	7.5	31.5	81.5		39.8	42.8	8.9
LOS	F	D		E	E	A	C	F		D	D	A
Approach Delay		57.7			48.6			79.1			25.6	
Approach LOS		E			D			E			C	
Queue Length 50th (m)	103.7	75.6		62.6	86.8	0.0	7.0	~102.3		7.2	15.8	0.0
Queue Length 95th (m)	#171.2	107.0		88.4	112.0	20.1	14.8	#144.8		15.4	25.5	18.3
Internal Link Dist (m)		420.4			1343.9			595.0			958.8	
Turn Bay Length (m)	90.0			50.0		80.0	50.0			80.0		80.0
Base Capacity (vph)	443	1076		431	920	579	381	807		171	653	449
Starvation Cap Reductn	0	0		0	0	0	0	0		0	0	0
Spillback Cap Reductn	0	0		0	0	0	0	0		0	0	0
Storage Cap Reductn	0	0		0	0	0	0	0		0	0	0
Reduced v/c Ratio	0.96	0.64		0.62	0.78	0.45	0.11	1.04		0.25	0.23	0.43

Intersection Summary

Cycle Length: 140.4
 Actuated Cycle Length: 130.2
 Control Type: Semi Act-Uncoord
 Maximum v/c Ratio: 1.04
 Intersection Signal Delay: 56.4
 Intersection LOS: E
 Intersection Capacity Utilization 90.4%
 ICU Level of Service E
 Analysis Period (min) 15
 ~ Volume exceeds capacity, queue is theoretically infinite.
 Queue shown is maximum after two cycles.
 # 95th percentile volume exceeds capacity, queue may be longer.
 Queue shown is maximum after two cycles.

Splits and Phases: 4: Hawthorne & Hunt Club

Ø3	Ø4	Ø1	Ø2
41.4 s	41.4 s	21.3 s	36.3 s
Ø7	Ø8	Ø5	Ø6
41.4 s	41.4 s	21.3 s	36.3 s

4055 & 4120 Russell Road
5: Belgreen & Russell

Existing Traffic AM Peak Hour



Movement	EBT	EBR	WBL	WBT	NBL	NBR
Lane Configurations						
Traffic Volume (veh/h)	24	42	155	397	39	22
Future Volume (Veh/h)	24	42	155	397	39	22
Sign Control	Free		Free		Stop	
Grade	0%		0%		0%	
Peak Hour Factor	0.90	0.90	0.90	0.90	0.90	0.90
Hourly flow rate (vph)	27	47	172	441	43	24
Pedestrians						
Lane Width (m)						
Walking Speed (m/s)						
Percent Blockage						
Right turn flare (veh)						
Median type	None		None			
Median storage (veh)						
Upstream signal (m)						
pX, platoon unblocked						
vC, conflicting volume			74		836	50
vC1, stage 1 conf vol						
vC2, stage 2 conf vol						
vCu, unblocked vol			74		836	50
tC, single (s)			4.1		6.8	6.5
tC, 2 stage (s)						
tF (s)			2.2		3.9	3.5
p0 queue free %			89		83	97
cM capacity (veh/h)			1519		258	956

Direction, Lane #	EB 1	WB 1	NB 1
Volume Total	74	613	67
Volume Left	0	172	43
Volume Right	47	0	24
cSH	1700	1519	350
Volume to Capacity	0.04	0.11	0.19
Queue Length 95th (m)	0.0	2.7	4.9
Control Delay (s)	0.0	3.0	17.7
Lane LOS		A	C
Approach Delay (s)	0.0	3.0	17.7
Approach LOS			C

Intersection Summary			
Average Delay			4.0
Intersection Capacity Utilization	48.1%	ICU Level of Service	A
Analysis Period (min)			15

4055 & 4120 Russell Road
6: Hunt Club & Hwy 417 Offramp

Existing Traffic AM Peak Hour



Movement	EBL	EBR	NBL	NBT	SBT	SBR
Lane Configurations						
Traffic Volume (veh/h)	2	796	0	817	623	0
Future Volume (Veh/h)	2	796	0	817	623	0
Sign Control	Stop			Free	Free	
Grade	0%			0%	0%	
Peak Hour Factor	0.90	0.90	0.90	0.90	0.90	0.90
Hourly flow rate (vph)	2	884	0	908	692	0
Pedestrians						
Lane Width (m)						
Walking Speed (m/s)						
Percent Blockage						
Right turn flare (veh)						
Median type				None	None	
Median storage (veh)						
Upstream signal (m)						
pX, platoon unblocked						
vC, conflicting volume	1600	692	692			
vC1, stage 1 conf vol						
vC2, stage 2 conf vol						
vCu, unblocked vol	1600	692	692			
tC, single (s)	6.4	6.3	4.1			
tC, 2 stage (s)						
tF (s)	3.5	3.4	2.2			
p0 queue free %	98	0	100			
cM capacity (veh/h)	117	432	912			
Direction, Lane #	EB 1	EB 2	NB 1	SB 1		
Volume Total	2	884	908	692		
Volume Left	2	0	0	0		
Volume Right	0	884	0	0		
cSH	117	432	1700	1700		
Volume to Capacity	0.02	2.05	0.53	0.41		
Queue Length 95th (m)	0.4	432.9	0.0	0.0		
Control Delay (s)	36.2	499.5	0.0	0.0		
Lane LOS	E	F				
Approach Delay (s)	498.5		0.0	0.0		
Approach LOS	F					
Intersection Summary						
Average Delay			177.7			
Intersection Capacity Utilization			93.3%	ICU Level of Service	F	
Analysis Period (min)			15			

4055 & 4120 Russell Road
7: Ramsayville & Russell

Existing Traffic AM Peak Hour



Movement	EBL	EBR	NBL	NBT	SBT	SBR
Lane Configurations						
Traffic Volume (veh/h)	23	21	388	347	145	195
Future Volume (Veh/h)	23	21	388	347	145	195
Sign Control	Stop			Free	Free	
Grade	0%			0%	0%	
Peak Hour Factor	0.90	0.90	0.90	0.90	0.90	0.90
Hourly flow rate (vph)	26	23	431	386	161	217
Pedestrians	2					
Lane Width (m)	4.0					
Walking Speed (m/s)	1.0					
Percent Blockage	0					
Right turn flare (veh)						
Median type				None	None	
Median storage (veh)						
Upstream signal (m)						
pX, platoon unblocked						
vC, conflicting volume	1518	272	378			
vC1, stage 1 conf vol						
vC2, stage 2 conf vol						
vCu, unblocked vol	1518	272	378			
tC, single (s)	6.9	6.4	4.1			
tC, 2 stage (s)						
tF (s)	4.0	3.5	2.2			
p0 queue free %	60	97	63			
cM capacity (veh/h)	64	724	1170			
Direction, Lane #	EB 1	NB 1	SB 1			
Volume Total	49	817	378			
Volume Left	26	431	0			
Volume Right	23	0	217			
cSH	113	1170	1700			
Volume to Capacity	0.43	0.37	0.22			
Queue Length 95th (m)	13.1	12.0	0.0			
Control Delay (s)	59.6	7.4	0.0			
Lane LOS	F	A				
Approach Delay (s)	59.6	7.4	0.0			
Approach LOS	F					
Intersection Summary						
Average Delay			7.2			
Intersection Capacity Utilization			76.6%	ICU Level of Service	D	
Analysis Period (min)	15					

4055 & 4120 Russell Road
10: Walkley & SB off-ramp

Existing Traffic AM Peak Hour



Movement	EBL	EBT	WBT	WBR	SBL	SBR
Lane Configurations		↑↑	↑↑		↓	↗
Traffic Volume (veh/h)	0	435	946	0	22	884
Future Volume (Veh/h)	0	435	946	0	22	884
Sign Control		Free	Free		Stop	
Grade		0%	0%		0%	
Peak Hour Factor	0.90	0.90	0.90	0.90	0.90	0.90
Hourly flow rate (vph)	0	483	1051	0	24	982
Pedestrians						
Lane Width (m)						
Walking Speed (m/s)						
Percent Blockage						
Right turn flare (veh)						
Median type		None	None			
Median storage (veh)						
Upstream signal (m)						
pX, platoon unblocked						
vC, conflicting volume	1051				1292	526
vC1, stage 1 conf vol						
vC2, stage 2 conf vol						
vCu, unblocked vol	1051				1292	526
tC, single (s)	4.1				6.8	6.9
tC, 2 stage (s)						
tF (s)	2.2				3.5	3.3
p0 queue free %	100				84	0
cM capacity (veh/h)	658				155	497
Direction, Lane #	EB 1	EB 2	WB 1	WB 2	SB 1	SB 2
Volume Total	242	242	526	526	24	982
Volume Left	0	0	0	0	24	0
Volume Right	0	0	0	0	0	982
cSH	1700	1700	1700	1700	155	497
Volume to Capacity	0.14	0.14	0.31	0.31	0.16	1.98
Queue Length 95th (m)	0.0	0.0	0.0	0.0	3.7	463.5
Control Delay (s)	0.0	0.0	0.0	0.0	32.5	465.9
Lane LOS					D	F
Approach Delay (s)	0.0		0.0		455.6	
Approach LOS					F	
Intersection Summary						
Average Delay			180.4			
Intersection Capacity Utilization			92.0%		ICU Level of Service	F
Analysis Period (min)			15			

4055 & 4120 Russell Road
11: NB Off-ramp & Walkley

Existing Traffic AM Peak Hour

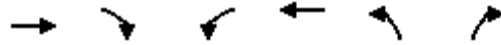

Movement	EBT	EBR	WBL	WBT	NBL	NBR
Lane Configurations	↑↑			↑↑	↘	
Traffic Volume (veh/h)	152	0	0	861	503	53
Future Volume (Veh/h)	152	0	0	861	503	53
Sign Control	Free			Free	Stop	
Grade	0%			0%	0%	
Peak Hour Factor	0.90	0.90	0.90	0.90	0.90	0.90
Hourly flow rate (vph)	169	0	0	957	559	59
Pedestrians						
Lane Width (m)						
Walking Speed (m/s)						
Percent Blockage						
Right turn flare (veh)						
Median type	None		None			
Median storage (veh)						
Upstream signal (m)						
pX, platoon unblocked						
vC, conflicting volume			169		648	84
vC1, stage 1 conf vol						
vC2, stage 2 conf vol						
vCu, unblocked vol			169		648	84
tC, single (s)			4.1		6.8	6.9
tC, 2 stage (s)						
tF (s)			2.2		3.5	3.3
p0 queue free %			100		0	94
cM capacity (veh/h)			1406		403	958
Direction, Lane #						
	EB 1	EB 2	WB 1	WB 2	NB 1	
Volume Total	84	84	478	478	618	
Volume Left	0	0	0	0	559	
Volume Right	0	0	0	0	59	
cSH	1700	1700	1700	1700	427	
Volume to Capacity	0.05	0.05	0.28	0.28	1.45	
Queue Length 95th (m)	0.0	0.0	0.0	0.0	219.0	
Control Delay (s)	0.0	0.0	0.0	0.0	239.1	
Lane LOS					F	
Approach Delay (s)	0.0		0.0		239.1	
Approach LOS					F	
Intersection Summary						
Average Delay			84.7			
Intersection Capacity Utilization			92.0%		ICU Level of Service	F
Analysis Period (min)			15			

4055 & 4120 Russell Road
8: Ramsayville & Russell N

Existing Traffic AM Peak Hour

Intersection	
Intersection Delay, s/veh	29.8
Intersection LOS	D

Movement	WBL	WBR	NBT	NBR	SBL	SBT
Lane Configurations	W		T			T
Traffic Vol, veh/h	278	300	340	35	10	22
Future Vol, veh/h	278	300	340	35	10	22
Peak Hour Factor	0.90	0.90	0.90	0.90	0.90	0.90
Heavy Vehicles, %	4	1	1	15	1	20
Mvmt Flow	309	333	378	39	11	24
Number of Lanes	1	0	1	0	0	1

Approach	WB	NB	SB
Opposing Approach		SB	NB
Opposing Lanes	0	1	1
Conflicting Approach Left	NB		WB
Conflicting Lanes Left	1	0	1
Conflicting Approach Right	SB	WB	
Conflicting Lanes Right	1	1	0
HCM Control Delay	37.8	19.1	10
HCM LOS	E	C	A

Lane	NBLn1	WBLn1	SBLn1
Vol Left, %	0%	48%	31%
Vol Thru, %	91%	0%	69%
Vol Right, %	9%	52%	0%
Sign Control	Stop	Stop	Stop
Traffic Vol by Lane	375	578	32
LT Vol	0	278	10
Through Vol	340	0	22
RT Vol	35	300	0
Lane Flow Rate	417	642	36
Geometry Grp	1	1	1
Degree of Util (X)	0.658	0.909	0.064
Departure Headway (Hd)	5.685	5.093	6.505
Convergence, Y/N	Yes	Yes	Yes
Cap	633	713	548
Service Time	3.731	3.132	4.578
HCM Lane V/C Ratio	0.659	0.9	0.066
HCM Control Delay	19.1	37.8	10
HCM Lane LOS	C	E	A
HCM 95th-tile Q	4.9	12	0.2

4055 & 4120 Russell Road
9: Anderson & Russell

Existing Traffic AM Peak Hour

Intersection	
Intersection Delay, s/veh	58.9
Intersection LOS	F

Movement	EBL	EBT	EBR	WBL	WBT	WBR	NBL	NBT	NBR	SBL	SBT	SBR
Lane Configurations		↕			↕			↕			↕	
Traffic Vol, veh/h	35	15	3	48	317	118	171	304	6	5	139	153
Future Vol, veh/h	35	15	3	48	317	118	171	304	6	5	139	153
Peak Hour Factor	0.90	0.90	0.90	0.90	0.90	0.90	0.90	0.90	0.90	0.90	0.90	0.90
Heavy Vehicles, %	11	7	1	1	2	3	1	3	17	1	4	2
Mvmt Flow	39	17	3	53	352	131	190	338	7	6	154	170
Number of Lanes	0	1	0	0	1	0	0	1	0	0	1	0
Approach	EB			WB			NB			SB		
Opposing Approach	WB			EB			SB			NB		
Opposing Lanes	1			1			1			1		
Conflicting Approach Left	SB			NB			EB			WB		
Conflicting Lanes Left	1			1			1			1		
Conflicting Approach Right	NB			SB			WB			EB		
Conflicting Lanes Right	1			1			1			1		
HCM Control Delay	13.8			66.9			78.3			22.7		
HCM LOS	B			F			F			C		

Lane	NBLn1	EBLn1	WBLn1	SBLn1
Vol Left, %	36%	66%	10%	2%
Vol Thru, %	63%	28%	66%	47%
Vol Right, %	1%	6%	24%	52%
Sign Control	Stop	Stop	Stop	Stop
Traffic Vol by Lane	481	53	483	297
LT Vol	171	35	48	5
Through Vol	304	15	317	139
RT Vol	6	3	118	153
Lane Flow Rate	534	59	537	330
Geometry Grp	1	1	1	1
Degree of Util (X)	1.043	0.146	1.004	0.647
Departure Headway (Hd)	7.023	9.269	6.957	7.293
Convergence, Y/N	Yes	Yes	Yes	Yes
Cap	513	389	526	498
Service Time	5.091	7.269	4.957	5.293
HCM Lane V/C Ratio	1.041	0.152	1.021	0.663
HCM Control Delay	78.3	13.8	66.9	22.7
HCM Lane LOS	F	B	F	C
HCM 95th-tile Q	15.5	0.5	14.1	4.5

Lane Group	EBL	EBT	EBR	WBL	WBT	WBR	NBL	NBT	NBR	SBL	SBT	SBR
Lane Configurations												
Traffic Volume (vph)	85	1266	222	414	646	76	136	257	489	100	403	103
Future Volume (vph)	85	1266	222	414	646	76	136	257	489	100	403	103
Satd. Flow (prot)	1609	3468	1390	3013	3468	1567	3179	3338	1427	3238	3247	1427
Flt Permitted	0.950			0.950			0.950			0.950		
Satd. Flow (perm)	1604	3468	1368	3011	3468	1535	3154	3338	1402	3217	3247	1396
Satd. Flow (RTOR)			247			154			207			207
Lane Group Flow (vph)	94	1407	247	460	718	84	151	286	543	111	448	114
Turn Type	Prot	NA	Perm	Prot	NA	Perm	Prot	NA	Perm	Prot	NA	Perm
Protected Phases	5	2		1	6		3	8		7	4	
Permitted Phases			2			6			8			4
Total Split (s)	12.0	58.0	58.0	20.0	66.0	66.0	17.0	35.0	35.0	17.0	35.0	35.0
Total Lost Time (s)	6.4	7.3	7.3	6.4	7.3	7.3	7.6	7.4	7.4	7.6	7.4	7.4
Act Effct Green (s)	5.6	50.7	50.7	13.6	58.7	58.7	9.2	28.2	28.2	8.8	27.8	27.8
Actuated g/C Ratio	0.04	0.39	0.39	0.10	0.45	0.45	0.07	0.22	0.22	0.07	0.21	0.21
v/c Ratio	1.36	1.04	0.36	1.46	0.46	0.11	0.68	0.40	1.17	0.51	0.64	0.25
Control Delay	277.0	74.6	4.6	264.1	25.9	0.3	74.5	45.7	123.9	66.8	51.6	1.3
Queue Delay	0.0	0.0	0.0	0.0	0.0	0.0	0.0	0.0	0.0	0.0	0.0	0.0
Total Delay	277.0	74.6	4.6	264.1	25.9	0.3	74.5	45.7	123.9	66.8	51.6	1.3
LOS	F	E	A	F	C	A	E	D	F	E	D	A
Approach Delay		75.6			111.0			93.5			45.6	
Approach LOS		E			F			F			D	
Queue Length 50th (m)	~29.1	~188.5	0.0	~76.4	60.5	0.0	18.1	30.8	~112.7	13.1	51.2	0.0
Queue Length 95th (m)	#61.4	#227.7	15.0	#107.0	75.8	0.0	#28.7	43.4	#176.4	22.1	67.9	0.0
Internal Link Dist (m)		485.7			397.0			432.2			296.2	
Turn Bay Length (m)	85.0		225.0	100.0		45.0	140.0		110.0	80.0		55.0
Base Capacity (vph)	69	1352	684	315	1565	777	229	724	466	234	695	461
Starvation Cap Reductn	0	0	0	0	0	0	0	0	0	0	0	0
Spillback Cap Reductn	0	0	0	0	0	0	0	0	0	0	0	0
Storage Cap Reductn	0	0	0	0	0	0	0	0	0	0	0	0
Reduced v/c Ratio	1.36	1.04	0.36	1.46	0.46	0.11	0.66	0.40	1.17	0.47	0.64	0.25

Intersection Summary

Cycle Length: 130
 Actuated Cycle Length: 130
 Offset: 35 (27%), Referenced to phase 2:EBT and 6:WBT, Start of Green
 Control Type: Actuated-Coordinated
 Maximum v/c Ratio: 1.46
 Intersection Signal Delay: 84.6
 Intersection LOS: F
 Intersection Capacity Utilization 92.1%
 ICU Level of Service F
 Analysis Period (min) 15
 ~ Volume exceeds capacity, queue is theoretically infinite.
 Queue shown is maximum after two cycles.
 # 95th percentile volume exceeds capacity, queue may be longer.
 Queue shown is maximum after two cycles.

Splits and Phases: 1: Russell & Walkley

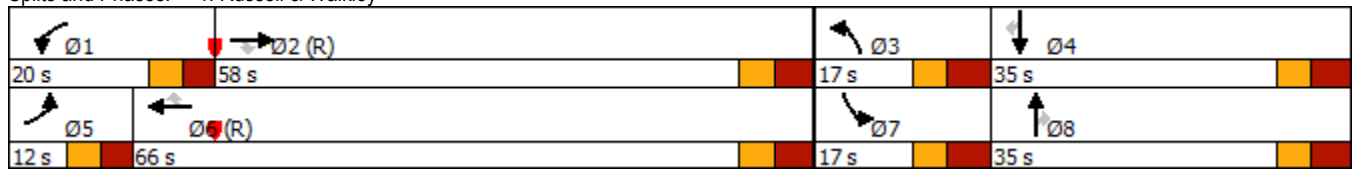

4055 & 4120 Russell Road
 2: Hawthorne & Russell

Existing Traffic PM Peak Hour

Lane Group	EBL	EBT	EBR	WBL	WBT	WBR	NBL	NBT	NBR	SBL	SBT	SBR
Lane Configurations												
Traffic Volume (vph)	35	7	21	8	3	79	7	665	12	200	807	17
Future Volume (vph)	35	7	21	8	3	79	7	665	12	200	807	17
Satd. Flow (prot)	1624	1468	0	1768	1139	1508	1232	3289	0	1639	3270	0
Flt Permitted	0.756			0.737			0.303			0.366		
Satd. Flow (perm)	1291	1468	0	1372	1139	1488	393	3289	0	631	3270	0
Satd. Flow (RTOR)		23				88		4			5	
Lane Group Flow (vph)	39	31	0	9	3	88	8	752	0	222	916	0
Turn Type	Perm	NA		Perm	NA	Perm	Perm	NA		Perm	NA	
Protected Phases		4			8			2			6	
Permitted Phases	4			8		8	2			6		
Total Split (s)	26.0	26.0		26.0	26.0	26.0	54.0	54.0		54.0	54.0	
Total Lost Time (s)	5.7	5.7		5.7	5.7	5.7	6.5	6.5		6.5	6.5	
Act Effct Green (s)	12.0	12.0		12.0	12.0	12.0	60.2	60.2		60.2	60.2	
Actuated g/C Ratio	0.15	0.15		0.15	0.15	0.15	0.75	0.75		0.75	0.75	
v/c Ratio	0.20	0.13		0.04	0.02	0.30	0.03	0.30		0.47	0.37	
Control Delay	30.8	15.2		27.0	26.3	9.3	5.4	5.1		10.8	5.6	
Queue Delay	0.0	0.0		0.0	0.0	0.0	0.0	0.0		0.0	0.0	
Total Delay	30.8	15.2		27.0	26.3	9.3	5.4	5.1		10.8	5.6	
LOS	C	B		C	C	A	A	A		B	A	
Approach Delay		23.9			11.4			5.1			6.6	
Approach LOS		C			B			A			A	
Queue Length 50th (m)	5.0	1.0		1.1	0.4	0.0	0.3	16.0		10.8	20.9	
Queue Length 95th (m)	11.0	6.6		4.1	2.1	9.5	2.0	35.6		39.4	45.8	
Internal Link Dist (m)		63.3			159.0			795.0			432.2	
Turn Bay Length (m)	20.0			40.0		100.0	40.0			60.0		
Base Capacity (vph)	327	389		348	289	443	295	2477		475	2463	
Starvation Cap Reductn	0	0		0	0	0	0	0		0	0	
Spillback Cap Reductn	0	0		0	0	0	0	0		0	0	
Storage Cap Reductn	0	0		0	0	0	0	0		0	0	
Reduced v/c Ratio	0.12	0.08		0.03	0.01	0.20	0.03	0.30		0.47	0.37	

Intersection Summary

Cycle Length: 80
 Actuated Cycle Length: 80
 Offset: 16 (20%), Referenced to phase 2:NBTL and 6:SBTL, Start of Green
 Control Type: Actuated-Coordinated
 Maximum v/c Ratio: 0.47
 Intersection Signal Delay: 6.9
 Intersection LOS: A
 Intersection Capacity Utilization 56.7%
 ICU Level of Service B
 Analysis Period (min) 15

Splits and Phases: 2: Hawthorne & Russell

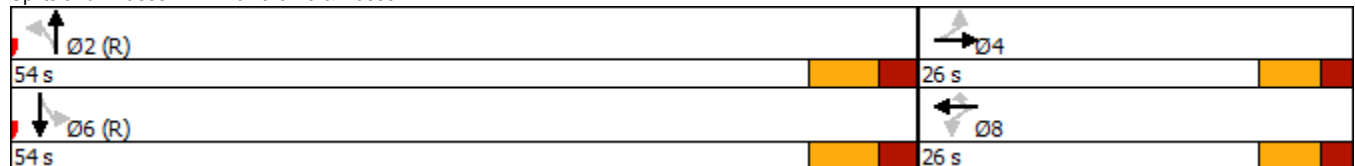

4055 & 4120 Russell Road
3: Hawthorne & Stevenage

Existing Traffic PM Peak Hour

Lane Group	EBL	EBT	EBR	WBL	WBT	WBR	NBL	NBT	NBR	SBL	SBT	SBR
Lane Configurations												
Traffic Volume (vph)	176	35	208	100	27	81	77	349	59	45	869	134
Future Volume (vph)	176	35	208	100	27	81	77	349	59	45	869	134
Satd. Flow (prot)	1669	1490	0	1567	1425	0	1323	3064	0	1323	3402	1390
Flt Permitted	0.680			0.405			0.212			0.490		
Satd. Flow (perm)	1192	1490	0	668	1425	0	295	3064	0	682	3402	1352
Satd. Flow (RTOR)		231			90			25				149
Lane Group Flow (vph)	196	270	0	111	120	0	86	454	0	50	966	149
Turn Type	Perm	NA		Perm	NA		pm+pt	NA		pm+pt	NA	Perm
Protected Phases		4			8		5	2		1	6	
Permitted Phases	4			8			2			6		6
Total Split (s)	35.0	35.0		35.0	35.0		15.0	45.0		15.0	45.0	45.0
Total Lost Time (s)	5.7	5.7		5.7	5.7		5.7	5.5		5.7	5.5	5.5
Act Effct Green (s)	22.4	22.4		22.4	22.4		58.3	53.3		55.9	50.2	50.2
Actuated g/C Ratio	0.24	0.24		0.24	0.24		0.61	0.56		0.59	0.53	0.53
v/c Ratio	0.70	0.51		0.71	0.30		0.32	0.26		0.11	0.54	0.19
Control Delay	45.5	9.3		55.6	10.7		11.6	13.2		9.0	18.7	3.6
Queue Delay	0.0	0.0		0.0	0.0		0.0	0.0		0.0	0.0	0.0
Total Delay	45.5	9.3		55.6	10.7		11.6	13.2		9.0	18.7	3.6
LOS	D	A		E	B		B	B		A	B	A
Approach Delay		24.6			32.3			13.0			16.3	
Approach LOS		C			C			B			B	
Queue Length 50th (m)	30.0	5.1		17.0	3.9		5.2	21.0		2.9	58.2	0.0
Queue Length 95th (m)	47.4	21.8		32.2	14.9		12.5	36.0		8.1	88.3	10.1
Internal Link Dist (m)		201.3			257.1			958.8			795.0	
Turn Bay Length (m)	45.0			25.0			75.0			85.0		85.0
Base Capacity (vph)	367	619		206	501		282	1728		474	1797	784
Starvation Cap Reductn	0	0		0	0		0	0		0	0	0
Spillback Cap Reductn	0	0		0	0		0	0		0	0	0
Storage Cap Reductn	0	0		0	0		0	0		0	0	0
Reduced v/c Ratio	0.53	0.44		0.54	0.24		0.30	0.26		0.11	0.54	0.19

Intersection Summary

Cycle Length: 95

Actuated Cycle Length: 95

Offset: 0 (0%), Referenced to phase 2:NBTL and 6:SBTL, Start of Green

Control Type: Actuated-Coordinated

Maximum v/c Ratio: 0.71

Intersection Signal Delay: 18.7

Intersection LOS: B

Intersection Capacity Utilization 72.5%

ICU Level of Service C

Analysis Period (min) 15

Splits and Phases: 3: Hawthorne & Stevenage

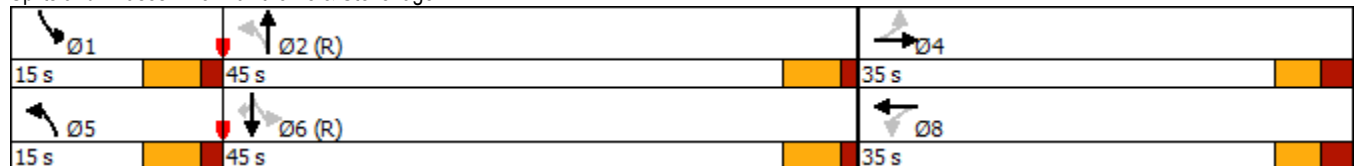

4055 & 4120 Russell Road
 4: Hawthorne & Hunt Club

Existing Traffic PM Peak Hour

Lane Group	EBL	EBT	EBR	WBL	WBT	WBR	NBL	NBT	NBR	SBL	SBT	SBR
Lane Configurations												
Traffic Volume (vph)	240	770	23	403	829	83	24	182	292	157	461	453
Future Volume (vph)	240	770	23	403	829	83	24	182	292	157	461	453
Satd. Flow (prot)	1595	3422	0	1654	3468	1141	1717	2808	0	1609	3247	1522
Flt Permitted	0.950			0.950			0.404			0.134		
Satd. Flow (perm)	1595	3422	0	1653	3468	1141	730	2808	0	227	3247	1522
Satd. Flow (RTOR)		2				119		242				503
Lane Group Flow (vph)	267	882	0	448	921	92	27	526	0	174	512	503
Turn Type	Prot	NA		Prot	NA	Perm	pm+pt	NA		pm+pt	NA	Perm
Protected Phases	7	4		3	8		5	2		1	6	
Permitted Phases						8	2			6		6
Total Split (s)	36.4	48.4		44.4	56.4	56.4	21.3	32.3		21.3	32.3	32.3
Total Lost Time (s)	6.4	6.4		6.4	6.4	6.4	6.3	6.3		6.3	6.3	6.3
Act Effct Green (s)	26.7	40.3		38.2	51.7	51.7	28.4	21.3		42.0	33.8	33.8
Actuated g/C Ratio	0.19	0.29		0.27	0.37	0.37	0.20	0.15		0.30	0.24	0.24
v/c Ratio	0.88	0.89		0.99	0.72	0.19	0.14	0.83		0.83	0.65	0.67
Control Delay	83.2	60.2		91.3	43.1	3.3	36.7	42.7		69.6	53.5	8.8
Queue Delay	0.0	0.0		0.0	0.0	0.0	0.0	0.0		0.0	0.0	0.0
Total Delay	83.2	60.2		91.3	43.1	3.3	36.7	42.7		69.6	53.5	8.8
LOS	F	E		F	D	A	D	D		E	D	A
Approach Delay		65.5			55.3			42.4			37.0	
Approach LOS		E			E			D			D	
Queue Length 50th (m)	67.4	116.5		~125.3	113.1	0.0	5.0	39.0		35.4	66.2	0.0
Queue Length 95th (m)	#108.9	#151.6		#190.8	139.6	6.2	11.7	58.7		#67.5	86.2	30.6
Internal Link Dist (m)		420.4			1343.9			595.0			958.8	
Turn Bay Length (m)	90.0			50.0		80.0	50.0			80.0		80.0
Base Capacity (vph)	344	1035		452	1284	497	296	721		217	785	749
Starvation Cap Reductn	0	0		0	0	0	0	0		0	0	0
Spillback Cap Reductn	0	0		0	0	0	0	0		0	0	0
Storage Cap Reductn	0	0		0	0	0	0	0		0	0	0
Reduced v/c Ratio	0.78	0.85		0.99	0.72	0.19	0.09	0.73		0.80	0.65	0.67

Intersection Summary

Cycle Length: 146.4
 Actuated Cycle Length: 139.7
 Control Type: Semi Act-Uncoord
 Maximum v/c Ratio: 0.99
 Intersection Signal Delay: 51.4
 Intersection Capacity Utilization 92.7%
 Analysis Period (min) 15
 ~ Volume exceeds capacity, queue is theoretically infinite.
 Queue shown is maximum after two cycles.
 # 95th percentile volume exceeds capacity, queue may be longer.
 Queue shown is maximum after two cycles.

Splits and Phases: 4: Hawthorne & Hunt Club

Ø3	Ø4	Ø1	Ø2
44.4 s	48.4 s	21.3 s	32.3 s
Ø7	Ø8	Ø5	Ø6
36.4 s	56.4 s	21.3 s	32.3 s

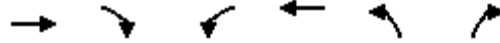

Movement	EBT	EBR	WBL	WBT	NBL	NBR
Lane Configurations						
Traffic Volume (veh/h)	289	29	10	33	27	126
Future Volume (Veh/h)	289	29	10	33	27	126
Sign Control	Free			Free	Stop	
Grade	0%			0%	0%	
Peak Hour Factor	0.90	0.90	0.90	0.90	0.90	0.90
Hourly flow rate (vph)	321	32	11	37	30	140
Pedestrians						
Lane Width (m)						
Walking Speed (m/s)						
Percent Blockage						
Right turn flare (veh)						
Median type	None			None		
Median storage (veh)						
Upstream signal (m)						
pX, platoon unblocked						
vC1, conflicting volume			353		396	337
vC2, stage 2 conf vol						
vCu, unblocked vol			353		396	337
tC, single (s)			4.2		6.6	6.2
tC, 2 stage (s)						
tF (s)			2.3		3.7	3.3
p0 queue free %			99		95	80
cM capacity (veh/h)			1163		570	703
Direction, Lane #	EB 1	WB 1	NB 1			
Volume Total	353	48	170			
Volume Left	0	11	30			
Volume Right	32	0	140			
cSH	1700	1163	675			
Volume to Capacity	0.21	0.01	0.25			
Queue Length 95th (m)	0.0	0.2	7.0			
Control Delay (s)	0.0	1.9	12.1			
Lane LOS		A	B			
Approach Delay (s)	0.0	1.9	12.1			
Approach LOS			B			
Intersection Summary						
Average Delay			3.8			
Intersection Capacity Utilization			34.4%	ICU Level of Service	A	
Analysis Period (min)			15			









Movement	EBL	EBR	NBL	NBT	SBT	SBR
Lane Configurations						
Traffic Volume (veh/h)	11	1291	0	1016	137	0
Future Volume (Veh/h)	11	1291	0	1016	137	0
Sign Control	Stop			Free	Free	
Grade	0%			0%	0%	
Peak Hour Factor	0.90	0.90	0.90	0.90	0.90	0.90
Hourly flow rate (vph)	12	1434	0	1129	152	0
Pedestrians						
Lane Width (m)						
Walking Speed (m/s)						
Percent Blockage						
Right turn flare (veh)						
Median type				None	None	
Median storage (veh)						
Upstream signal (m)						
pX, platoon unblocked						
vC, conflicting volume	1281	152	152			
vC1, stage 1 conf vol						
vC2, stage 2 conf vol						
vCu, unblocked vol	1281	152	152			
tC, single (s)	6.4	6.3	4.1			
tC, 2 stage (s)						
tF (s)	3.5	3.4	2.2			
p0 queue free %	93	0	100			
cM capacity (veh/h)	184	881	1441			
Direction, Lane #	EB 1	EB 2	NB 1	SB 1		
Volume Total	12	1434	1129	152		
Volume Left	12	0	0	0		
Volume Right	0	1434	0	0		
cSH	184	881	1700	1700		
Volume to Capacity	0.07	1.63	0.66	0.09		
Queue Length 95th (m)	1.5	533.1	0.0	0.0		
Control Delay (s)	26.0	301.6	0.0	0.0		
Lane LOS	D	F				
Approach Delay (s)	299.3		0.0	0.0		
Approach LOS	F					
Intersection Summary						
Average Delay			158.7			
Intersection Capacity Utilization			98.7%	ICU Level of Service	F	
Analysis Period (min)			15			



Movement	EBL	EBR	NBL	NBT	SBT	SBR
Lane Configurations						
Traffic Volume (veh/h)	106	319	33	114	322	16
Future Volume (Veh/h)	106	319	33	114	322	16
Sign Control	Stop			Free	Free	
Grade	0%			0%	0%	
Peak Hour Factor	0.90	0.90	0.90	0.90	0.90	0.90
Hourly flow rate (vph)	118	354	37	127	358	18
Pedestrians						
Lane Width (m)						
Walking Speed (m/s)						
Percent Blockage						
Right turn flare (veh)						
Median type				None	None	
Median storage (veh)						
Upstream signal (m)						
pX, platoon unblocked						
vC, conflicting volume	568	367	376			
vC1, stage 1 conf vol						
vC2, stage 2 conf vol						
vCu, unblocked vol	568	367	376			
tC, single (s)	6.5	6.3	4.2			
tC, 2 stage (s)						
tF (s)	3.6	3.4	2.3			
p0 queue free %	74	47	97			
cM capacity (veh/h)	462	667	1115			
Direction, Lane #	EB 1	NB 1	SB 1			
Volume Total	472	164	376			
Volume Left	118	37	0			
Volume Right	354	0	18			
cSH	600	1115	1700			
Volume to Capacity	0.79	0.03	0.22			
Queue Length 95th (m)	52.6	0.7	0.0			
Control Delay (s)	29.5	2.1	0.0			
Lane LOS	D	A				
Approach Delay (s)	29.5	2.1	0.0			
Approach LOS	D					
Intersection Summary						
Average Delay			14.1			
Intersection Capacity Utilization			64.1%	ICU Level of Service	C	
Analysis Period (min)			15			



Movement	EBL	EBT	WBT	WBR	SBL	SBR
Lane Configurations		↑↑	↑↑		↓	↓
Traffic Volume (veh/h)	0	1471	174	0	167	594
Future Volume (Veh/h)	0	1471	174	0	167	594
Sign Control		Free	Free		Stop	
Grade		0%	0%		0%	
Peak Hour Factor	0.90	0.90	0.90	0.90	0.90	0.90
Hourly flow rate (vph)	0	1634	193	0	186	660
Pedestrians						
Lane Width (m)						
Walking Speed (m/s)						
Percent Blockage						
Right turn flare (veh)						
Median type		None	None			
Median storage (veh)						
Upstream signal (m)						
pX, platoon unblocked						
vC, conflicting volume	193				1010	96
vC1, stage 1 conf vol						
vC2, stage 2 conf vol						
vCu, unblocked vol	193				1010	96
tC, single (s)	4.2				6.9	7.0
tC, 2 stage (s)						
tF (s)	2.2				3.5	3.3
p0 queue free %	100				20	29
cM capacity (veh/h)	1356				231	931
Direction, Lane #	EB 1	EB 2	WB 1	WB 2	SB 1	SB 2
Volume Total	817	817	96	96	186	660
Volume Left	0	0	0	0	186	0
Volume Right	0	0	0	0	0	660
cSH	1700	1700	1700	1700	231	931
Volume to Capacity	0.48	0.48	0.06	0.06	0.80	0.71
Queue Length 95th (m)	0.0	0.0	0.0	0.0	42.0	43.2
Control Delay (s)	0.0	0.0	0.0	0.0	63.7	17.7
Lane LOS					F	C
Approach Delay (s)	0.0		0.0		27.8	
Approach LOS					D	
Intersection Summary						
Average Delay			8.8			
Intersection Capacity Utilization			59.4%		ICU Level of Service	B
Analysis Period (min)			15			

						
Movement	EBT	EBR	WBL	WBT	NBL	NBR
Lane Configurations	↑↑			↑↑	↑↑	
Traffic Volume (veh/h)	751	0	0	81	142	22
Future Volume (Veh/h)	751	0	0	81	142	22
Sign Control	Free			Free	Stop	
Grade	0%			0%	0%	
Peak Hour Factor	0.90	0.90	0.90	0.90	0.90	0.90
Hourly flow rate (vph)	834	0	0	90	158	24
Pedestrians						
Lane Width (m)						
Walking Speed (m/s)						
Percent Blockage						
Right turn flare (veh)						
Median type	None		None			
Median storage (veh)						
Upstream signal (m)						
pX, platoon unblocked						
vC, conflicting volume			834		879	417
vC1, stage 1 conf vol						
vC2, stage 2 conf vol						
vCu, unblocked vol			834		879	417
tC, single (s)			4.2		6.9	7.0
tC, 2 stage (s)						
tF (s)			2.2		3.5	3.3
p0 queue free %			100		44	96
cM capacity (veh/h)			776		281	576
Direction, Lane #	EB 1	EB 2	WB 1	WB 2	NB 1	
Volume Total	417	417	45	45	182	
Volume Left	0	0	0	0	158	
Volume Right	0	0	0	0	24	
cSH	1700	1700	1700	1700	302	
Volume to Capacity	0.25	0.25	0.03	0.03	0.60	
Queue Length 95th (m)	0.0	0.0	0.0	0.0	25.7	
Control Delay (s)	0.0	0.0	0.0	0.0	33.5	
Lane LOS						D
Approach Delay (s)	0.0		0.0		33.5	
Approach LOS						D
Intersection Summary						
Average Delay			5.5			
Intersection Capacity Utilization			59.4%	ICU Level of Service	B	
Analysis Period (min)	15					

Intersection	
Intersection Delay, s/veh	12
Intersection LOS	B

Movement	WBL	WBR	NBT	NBR	SBL	SBT
Lane Configurations	W		T			T
Traffic Vol, veh/h	58	8	49	183	132	300
Future Vol, veh/h	58	8	49	183	132	300
Peak Hour Factor	0.90	0.90	0.90	0.90	0.90	0.90
Heavy Vehicles, %	10	1	7	4	2	2
Mvmt Flow	64	9	54	203	147	333
Number of Lanes	1	0	1	0	0	1

Approach	WB	NB	SB
Opposing Approach		SB	NB
Opposing Lanes	0	1	1
Conflicting Approach Left	NB		WB
Conflicting Lanes Left	1	0	1
Conflicting Approach Right	SB	WB	
Conflicting Lanes Right	1	1	0
HCM Control Delay	9.6	9.2	13.9
HCM LOS	A	A	B

Lane	NBLn1	WBLn1	SBLn1
Vol Left, %	0%	88%	31%
Vol Thru, %	21%	0%	69%
Vol Right, %	79%	12%	0%
Sign Control	Stop	Stop	Stop
Traffic Vol by Lane	232	66	432
LT Vol	0	58	132
Through Vol	49	0	300
RT Vol	183	8	0
Lane Flow Rate	258	73	480
Geometry Grp	1	1	1
Degree of Util (X)	0.306	0.117	0.596
Departure Headway (Hd)	4.267	5.752	4.467
Convergence, Y/N	Yes	Yes	Yes
Cap	840	620	806
Service Time	2.3	3.814	2.496
HCM Lane V/C Ratio	0.307	0.118	0.596
HCM Control Delay	9.2	9.6	13.9
HCM Lane LOS	A	A	B
HCM 95th-tile Q	1.3	0.4	4

Intersection	
Intersection Delay, s/veh	15.5
Intersection LOS	C

Movement	EBL	EBT	EBR	WBL	WBT	WBR	NBL	NBT	NBR	SBL	SBT	SBR
Lane Configurations		↕			↕			↕			↕	
Traffic Vol, veh/h	77	224	14	12	22	10	7	170	46	61	262	38
Future Vol, veh/h	77	224	14	12	22	10	7	170	46	61	262	38
Peak Hour Factor	0.90	0.90	0.90	0.90	0.90	0.90	0.90	0.90	0.90	0.90	0.90	0.90
Heavy Vehicles, %	2	1	1	1	14	1	1	1	7	2	3	4
Mvmt Flow	86	249	16	13	24	11	8	189	51	68	291	42
Number of Lanes	0	1	0	0	1	0	0	1	0	0	1	0

Approach	EB	WB	NB	SB
Opposing Approach	WB	EB	SB	NB
Opposing Lanes	1	1	1	1
Conflicting Approach Left	SB	NB	EB	WB
Conflicting Lanes Left	1	1	1	1
Conflicting Approach Right	NB	SB	WB	EB
Conflicting Lanes Right	1	1	1	1
HCM Control Delay	16.3	10.1	12.4	17.3
HCM LOS	C	B	B	C

Lane	NBLn1	EBLn1	WBLn1	SBLn1
Vol Left, %		3%	24%	27%
Vol Thru, %		76%	71%	50%
Vol Right, %		21%	4%	23%
Sign Control		Stop	Stop	Stop
Traffic Vol by Lane		223	315	44
LT Vol		7	77	12
Through Vol		170	224	22
RT Vol		46	14	10
Lane Flow Rate		248	350	49
Geometry Grp		1	1	1
Degree of Util (X)		0.392	0.567	0.088
Departure Headway (Hd)		5.691	5.833	6.5
Convergence, Y/N		Yes	Yes	Yes
Cap		627	616	554
Service Time		3.768	3.902	4.5
HCM Lane V/C Ratio		0.396	0.568	0.088
HCM Control Delay		12.4	16.3	10.1
HCM Lane LOS		B	C	B
HCM 95th-tile Q		1.9	3.5	0.3

Lane Group	EBL	EBT	EBR	WBL	WBT	WBR	NBL	NBT	NBR	SBL	SBT	SBR
Lane Configurations												
Traffic Volume (vph)	85	1101	222	304	646	76	136	257	359	100	403	103
Future Volume (vph)	85	1101	222	304	646	76	136	257	359	100	403	103
Satd. Flow (prot)	1609	3468	1390	3013	3468	1567	3179	3338	1427	3238	3247	1427
Flt Permitted	0.950			0.950			0.950			0.950		
Satd. Flow (perm)	1604	3468	1368	3010	3468	1535	3154	3338	1402	3217	3247	1396
Satd. Flow (RTOR)			247			154			207			207
Lane Group Flow (vph)	94	1223	247	338	718	84	151	286	399	111	448	114
Turn Type	Prot	NA	Perm	Prot	NA	Perm	Prot	NA	Perm	Prot	NA	Perm
Protected Phases	5	2		1	6		3	8		7	4	
Permitted Phases			2			6			8			4
Total Split (s)	13.0	58.0	58.0	20.0	65.0	65.0	17.0	35.0	35.0	17.0	35.0	35.0
Total Lost Time (s)	6.4	7.3	7.3	6.4	7.3	7.3	7.6	7.4	7.4	7.6	7.4	7.4
Act Effct Green (s)	9.3	50.8	50.8	16.2	57.7	57.7	9.2	25.5	25.5	8.8	25.1	25.1
Actuated g/C Ratio	0.07	0.39	0.39	0.12	0.44	0.44	0.07	0.20	0.20	0.07	0.19	0.19
v/c Ratio	0.82	0.90	0.36	0.90	0.47	0.11	0.68	0.44	0.90	0.51	0.71	0.26
Control Delay	105.7	47.8	4.6	83.1	26.6	0.3	74.5	47.7	48.9	66.8	55.6	1.4
Queue Delay	0.0	0.0	0.0	0.0	0.0	0.0	0.0	0.0	0.0	0.0	0.0	0.0
Total Delay	105.7	47.8	4.6	83.1	26.6	0.3	74.5	47.7	48.9	66.8	55.6	1.4
LOS	F	D	A	F	C	A	E	D	D	E	E	A
Approach Delay		44.5			41.4			53.1			48.3	
Approach LOS		D			D			D			D	
Queue Length 50th (m)	~26.1	141.7	0.0	~45.5	61.3	0.0	18.1	30.8	47.0	13.1	51.2	0.0
Queue Length 95th (m)	#58.4	#174.8	15.0	#73.1	77.0	0.0	#28.7	43.4	#98.7	22.1	67.9	0.0
Internal Link Dist (m)		485.7			397.0			432.2			296.2	
Turn Bay Length (m)	85.0		225.0	100.0		45.0	140.0		110.0	80.0		55.0
Base Capacity (vph)	115	1354	684	376	1539	766	229	708	460	234	689	459
Starvation Cap Reductn	0	0	0	0	0	0	0	0	0	0	0	0
Spillback Cap Reductn	0	0	0	0	0	0	0	0	0	0	0	0
Storage Cap Reductn	0	0	0	0	0	0	0	0	0	0	0	0
Reduced v/c Ratio	0.82	0.90	0.36	0.90	0.47	0.11	0.66	0.40	0.87	0.47	0.65	0.25

Intersection Summary

Cycle Length: 130

Actuated Cycle Length: 130

Offset: 35 (27%), Referenced to phase 2:EBT and 6:WBT, Start of Green

Control Type: Actuated-Coordinated

Maximum v/c Ratio: 0.90

Intersection Signal Delay: 46.0

Intersection LOS: D

Intersection Capacity Utilization 83.1%

ICU Level of Service E

Analysis Period (min) 15

~ Volume exceeds capacity, queue is theoretically infinite.

Queue shown is maximum after two cycles.

95th percentile volume exceeds capacity, queue may be longer.

Queue shown is maximum after two cycles.

Splits and Phases: 1: Russell & Walkley

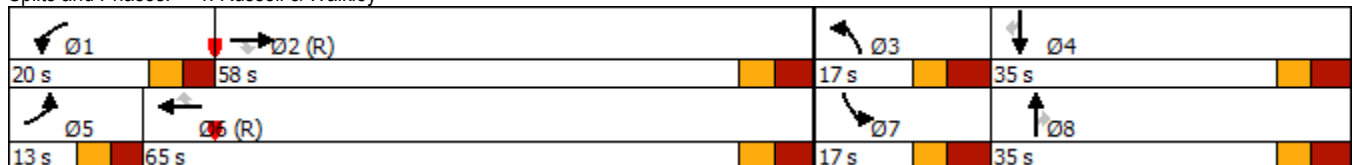

4055 & 4120 Russell Road
1: Russell & Walkley

2023 Future Background AM Peak Hour



Lane Group	EBL	EBT	EBR	WBL	WBT	WBR	NBL	NBT	NBR	SBL	SBT	SBR
Lane Configurations												
Traffic Volume (vph)	76	486	135	391	1231	64	216	409	500	55	219	135
Future Volume (vph)	76	486	135	391	1231	64	216	409	500	55	219	135
Satd. Flow (prot)	1374	3307	1332	3013	3435	1522	3094	3218	1332	3269	3189	1390
Flt Permitted	0.950			0.950			0.950			0.950		
Satd. Flow (perm)	1372	3307	1332	3013	3435	1490	3082	3218	1314	3264	3189	1365
Satd. Flow (RTOR)			180			134			500			180
Lane Group Flow (vph)	76	486	135	391	1231	64	216	409	500	55	219	135
Turn Type	Prot	NA	Perm	Prot	NA	Perm	Prot	NA	Perm	Prot	NA	Perm
Protected Phases	5	2		1	6		3	8		7	4	
Permitted Phases			2			6			8			4
Total Split (s)	24.4	45.0	45.0	45.0	65.6	65.6	20.0	40.0	40.0	20.0	40.0	40.0
Total Lost Time (s)	6.4	7.3	7.3	6.4	7.3	7.3	7.6	7.4	7.4	7.6	7.4	7.4
Act Effct Green (s)	13.3	58.6	58.6	24.8	70.1	70.1	12.4	32.7	32.7	7.9	25.5	25.5
Actuated g/c Ratio	0.09	0.39	0.39	0.17	0.47	0.47	0.08	0.22	0.22	0.05	0.17	0.17
v/c Ratio	0.63	0.38	0.21	0.79	0.77	0.08	0.85	0.58	0.74	0.32	0.40	0.35
Control Delay	87.4	36.1	2.3	71.3	39.1	0.2	95.8	56.1	11.2	72.9	56.2	4.5
Queue Delay	0.0	0.0	0.0	0.0	0.0	0.0	0.0	0.0	0.0	0.0	0.0	0.0
Total Delay	87.4	36.1	2.3	71.3	39.1	0.2	95.8	56.1	11.2	72.9	56.2	4.5
LOS	F	D	A	E	D	A	F	E	B	E	E	A
Approach Delay		35.2			45.1			43.7				41.4
Approach LOS		D			D			D				D
Queue Length 50th (m)	20.4	51.5	0.0	53.6	151.4	0.0	30.6	53.2	0.0	7.6	27.8	0.0
Queue Length 95th (m)	35.5	73.6	5.1	67.1	#207.8	0.0	#50.6	68.4	33.6	14.4	38.3	5.7
Internal Link Dist (m)		485.7			361.7			432.2			296.2	
Turn Bay Length (m)	85.0		225.0	100.0		45.0	140.0		110.0	80.0		55.0
Base Capacity (vph)	164	1290	629	775	1606	768	255	726	683	270	693	437
Starvation Cap Reductn	0	0	0	0	0	0	0	0	0	0	0	0
Spillback Cap Reductn	0	0	0	0	0	0	0	0	0	0	0	0
Storage Cap Reductn	0	0	0	0	0	0	0	0	0	0	0	0
Reduced v/c Ratio	0.46	0.38	0.21	0.50	0.77	0.08	0.85	0.56	0.73	0.20	0.32	0.31

Intersection Summary

Cycle Length: 150

Actuated Cycle Length: 150

Offset: 102 (68%), Referenced to phase 2:EBT and 6:WBT, Start of Green

Control Type: Actuated-Coordinated

Maximum v/c Ratio: 0.85

Intersection Signal Delay: 42.6

Intersection LOS: D

Intersection Capacity Utilization 80.7%

ICU Level of Service D

Analysis Period (min) 15

95th percentile volume exceeds capacity, queue may be longer.

Queue shown is maximum after two cycles.

Splits and Phases: 1: Russell & Walkley

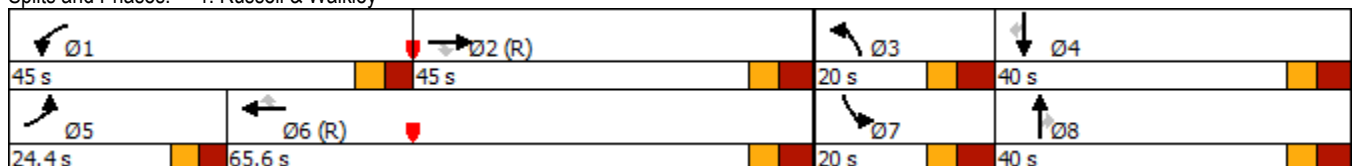

4055 & 4120 Russell Road
2: Hawthorne & Russell

2023 Future Background AM Peak Hour

Lane Group	EBL	EBT	EBR	WBL	WBT	WBR	NBL	NBT	NBR	SBL	SBT	SBR
Lane Configurations												
Traffic Volume (vph)	10	0	8	15	10	334	17	891	8	51	548	34
Future Volume (vph)	10	0	8	15	10	334	17	891	8	51	548	34
Satd. Flow (prot)	1276	1278	0	1488	1790	1522	1701	3104	0	1488	2985	0
Flt Permitted	0.751			0.752			0.433			0.298		
Satd. Flow (perm)	1008	1278	0	1178	1790	1522	771	3104	0	467	2985	0
Satd. Flow (RTOR)		352				175		2			14	
Lane Group Flow (vph)	10	8	0	15	10	334	17	899	0	51	582	0
Turn Type	Perm	NA		Perm	NA	Perm	Perm	NA		Perm	NA	
Protected Phases		4			8			2			6	
Permitted Phases	4			8		8	2			6		
Total Split (s)	26.0	26.0		26.0	26.0	26.0	64.0	64.0		64.0	64.0	
Total Lost Time (s)	5.7	5.7		5.7	5.7	5.7	6.5	6.5		6.5	6.5	
Act Effct Green (s)	16.2	16.2		16.2	16.2	16.2	61.6	61.6		61.6	61.6	
Actuated g/C Ratio	0.18	0.18		0.18	0.18	0.18	0.68	0.68		0.68	0.68	
v/c Ratio	0.06	0.02		0.07	0.03	0.80	0.03	0.42		0.16	0.28	
Control Delay	28.6	0.0		28.9	27.9	31.1	3.9	4.9		7.7	6.4	
Queue Delay	0.0	0.0		0.0	0.0	0.0	0.0	0.0		0.0	0.0	
Total Delay	28.6	0.0		28.9	27.9	31.1	3.9	4.9		7.7	6.4	
LOS	C	A		C	C	C	A	A		A	A	
Approach Delay		15.9			30.9			4.9			6.5	
Approach LOS		B			C			A			A	
Queue Length 50th (m)	1.3	0.0		2.0	1.3	23.7	0.5	13.1		2.7	17.1	
Queue Length 95th (m)	5.0	0.0		6.5	5.0	50.4	m1.0	16.5		7.7	26.5	
Internal Link Dist (m)		63.3			159.0			795.0			432.2	
Turn Bay Length (m)	20.0			40.0		100.0	40.0			60.0		
Base Capacity (vph)	227	560		265	403	478	527	2124		319	2047	
Starvation Cap Reductn	0	0		0	0	0	0	0		0	0	
Spillback Cap Reductn	0	0		0	0	0	0	0		0	0	
Storage Cap Reductn	0	0		0	0	0	0	0		0	0	
Reduced v/c Ratio	0.04	0.01		0.06	0.02	0.70	0.03	0.42		0.16	0.28	

Intersection Summary

Cycle Length: 90

Actuated Cycle Length: 90

Offset: 23 (26%), Referenced to phase 2:NBT and 6:SBTL, Start of Green

Control Type: Actuated-Coordinated

Maximum v/c Ratio: 0.80

Intersection Signal Delay: 10.4

Intersection LOS: B

Intersection Capacity Utilization 71.3%

ICU Level of Service C

Analysis Period (min) 15

m Volume for 95th percentile queue is metered by upstream signal.

Splits and Phases: 2: Hawthorne & Russell

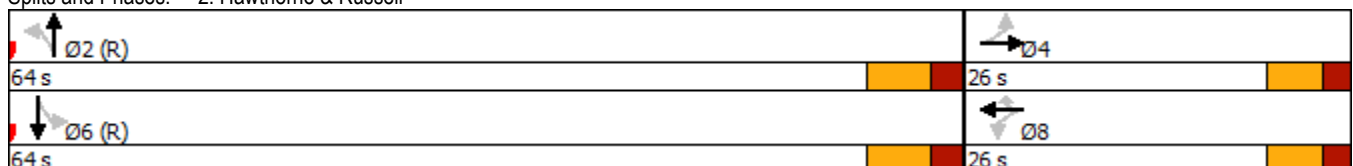

4055 & 4120 Russell Road
3: Hawthorne & Stevenage

2023 Future Background AM Peak Hour



Lane Group	EBL	EBT	EBR	WBL	WBT	WBR	NBL	NBT	NBR	SBL	SBT	SBR
Lane Configurations												
Traffic Volume (vph)	134	28	60	58	63	55	208	923	86	52	316	200
Future Volume (vph)	134	28	60	58	63	55	208	923	86	52	316	200
Satd. Flow (prot)	1553	1219	0	1276	1465	0	1669	3092	0	1429	2858	1453
Flt Permitted	0.681			0.700			0.503			0.252		
Satd. Flow (perm)	1113	1219	0	935	1465	0	880	3092	0	379	2858	1414
Satd. Flow (RTOR)		60			52			13				200
Lane Group Flow (vph)	134	88	0	58	118	0	208	1009	0	52	316	200
Turn Type	Perm	NA		Perm	NA		pm+pt	NA		pm+pt	NA	Perm
Protected Phases		4			8		5	2		1	6	
Permitted Phases	4			8			2			6		6
Total Split (s)	35.0	35.0		35.0	35.0		15.0	40.0		15.0	40.0	40.0
Total Lost Time (s)	5.7	5.7		5.7	5.7		5.7	5.5		5.7	5.5	5.5
Act Effct Green (s)	16.9	16.9		16.9	16.9		60.6	54.0		53.0	46.4	46.4
Actuated g/C Ratio	0.19	0.19		0.19	0.19		0.67	0.60		0.59	0.52	0.52
v/c Ratio	0.64	0.32		0.33	0.37		0.31	0.54		0.17	0.21	0.24
Control Delay	46.6	14.8		34.5	20.5		7.4	14.6		3.4	10.1	6.8
Queue Delay	0.0	0.0		0.0	0.0		0.0	0.0		0.0	0.0	0.0
Total Delay	46.6	14.8		34.5	20.5		7.4	14.6		3.4	10.1	6.8
LOS	D	B		C	C		A	B		A	B	A
Approach Delay		34.0			25.1			13.4			8.3	
Approach LOS		C			C			B			A	
Queue Length 50th (m)	20.1	3.8		8.2	9.1		10.0	50.7		0.7	14.3	3.6
Queue Length 95th (m)	33.0	13.4		16.2	20.1		23.8	89.0		1.1	28.5	25.4
Internal Link Dist (m)		201.3			257.1			958.8			795.0	
Turn Bay Length (m)	45.0			25.0			75.0			85.0		85.0
Base Capacity (vph)	362	437		304	512		684	1860		342	1474	826
Starvation Cap Reductn	0	0		0	0		0	0		0	0	0
Spillback Cap Reductn	0	0		0	0		0	0		0	0	0
Storage Cap Reductn	0	0		0	0		0	0		0	0	0
Reduced v/c Ratio	0.37	0.20		0.19	0.23		0.30	0.54		0.15	0.21	0.24

Intersection Summary

Cycle Length: 90

Actuated Cycle Length: 90

Offset: 0 (0%), Referenced to phase 2:NBTL and 6:SBTL, Start of Green

Control Type: Actuated-Coordinated

Maximum v/c Ratio: 0.64

Intersection Signal Delay: 15.1

Intersection LOS: B

Intersection Capacity Utilization 63.4%

ICU Level of Service B

Analysis Period (min) 15

Splits and Phases: 3: Hawthorne & Stevenage

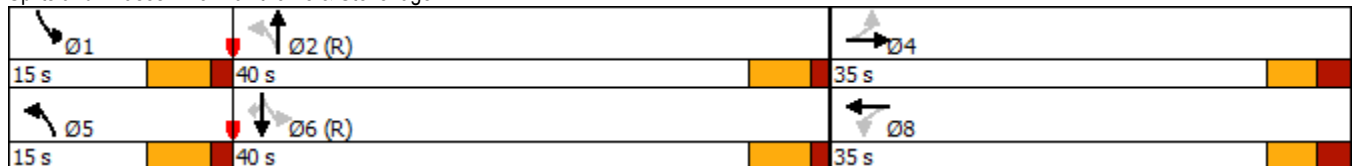

4055 & 4120 Russell Road
4: Hawthorne & Hunt Club

2023 Future Background AM Peak Hour



Lane Group	EBL	EBT	EBR	WBL	WBT	WBR	NBL	NBT	NBR	SBL	SBT	SBR
Lane Configurations												
Traffic Volume (vph)	416	625	25	251	678	246	40	412	382	43	147	163
Future Volume (vph)	416	625	25	251	678	246	40	412	382	43	147	163
Satd. Flow (prot)	1639	3333	0	1595	3402	1440	1488	2974	0	1191	2748	1278
Flt Permitted	0.950			0.950			0.659			0.129		
Satd. Flow (perm)	1639	3333	0	1595	3402	1440	1032	2974	0	162	2748	1278
Satd. Flow (RTOR)		3				246		152				163
Lane Group Flow (vph)	416	650	0	251	678	246	40	794	0	43	147	163
Turn Type	Prot	NA		Prot	NA	Perm	pm+pt	NA		pm+pt	NA	Perm
Protected Phases	7	4		3	8		5	2		1	6	
Permitted Phases						8	2			6		6
Total Split (s)	41.4	41.4		41.4	41.4	41.4	21.3	36.3		21.3	36.3	36.3
Total Lost Time (s)	6.4	6.4		6.4	6.4	6.4	6.3	6.3		6.3	6.3	6.3
Act Effct Green (s)	35.2	42.5		25.5	32.8	32.8	36.8	30.2		38.5	31.1	31.1
Actuated g/C Ratio	0.27	0.33		0.20	0.25	0.25	0.28	0.23		0.30	0.24	0.24
v/c Ratio	0.93	0.59		0.80	0.79	0.45	0.12	0.98		0.37	0.22	0.38
Control Delay	76.9	41.3		69.1	53.4	7.5	31.4	68.3		39.6	42.5	8.9
Queue Delay	0.0	0.0		0.0	0.0	0.0	0.0	0.0		0.0	0.0	0.0
Total Delay	76.9	41.3		69.1	53.4	7.5	31.4	68.3		39.6	42.5	8.9
LOS	E	D		E	D	A	C	E		D	D	A
Approach Delay		55.2			47.1			66.5			26.7	
Approach LOS		E			D			E			C	
Queue Length 50th (m)	101.1	69.4		59.1	80.7	0.0	6.6	~88.8		7.2	15.4	0.0
Queue Length 95th (m)	#166.5	100.1		83.2	104.8	19.4	14.4	#133.1		15.4	25.0	16.9
Internal Link Dist (m)		420.4			1343.9			595.0			958.8	
Turn Bay Length (m)	90.0			50.0		80.0	50.0			80.0		80.0
Base Capacity (vph)	445	1094		433	924	570	383	808		172	657	429
Starvation Cap Reductn	0	0		0	0	0	0	0		0	0	0
Spillback Cap Reductn	0	0		0	0	0	0	0		0	0	0
Storage Cap Reductn	0	0		0	0	0	0	0		0	0	0
Reduced v/c Ratio	0.93	0.59		0.58	0.73	0.43	0.10	0.98		0.25	0.22	0.38

Intersection Summary

Cycle Length: 140.4
 Actuated Cycle Length: 129.8
 Control Type: Semi Act-Uncoord
 Maximum v/c Ratio: 0.98
 Intersection Signal Delay: 52.3
 Intersection LOS: D
 Intersection Capacity Utilization 94.6%
 ICU Level of Service F
 Analysis Period (min) 15
 ~ Volume exceeds capacity, queue is theoretically infinite.
 Queue shown is maximum after two cycles.
 # 95th percentile volume exceeds capacity, queue may be longer.
 Queue shown is maximum after two cycles.

Splits and Phases: 4: Hawthorne & Hunt Club

Ø3	Ø4	Ø1	Ø2
41.4 s	41.4 s	21.3 s	36.3 s
Ø7	Ø8	Ø5	Ø6
41.4 s	41.4 s	21.3 s	36.3 s

4055 & 4120 Russell Road
5: Belgreen & Russell

2023 Future Background AM Peak Hour



Movement	EBT	EBR	WBL	WBT	NBL	NBR
Lane Configurations						
Traffic Volume (veh/h)	25	42	155	416	39	22
Future Volume (Veh/h)	25	42	155	416	39	22
Sign Control	Free		Free		Stop	
Grade	0%		0%		0%	
Peak Hour Factor	1.00	1.00	1.00	1.00	1.00	1.00
Hourly flow rate (vph)	25	42	155	416	39	22
Pedestrians						
Lane Width (m)						
Walking Speed (m/s)						
Percent Blockage						
Right turn flare (veh)						
Median type	None		None			
Median storage (veh)						
Upstream signal (m)						
pX, platoon unblocked						
vC, conflicting volume			67		772	46
vC1, stage 1 conf vol						
vC2, stage 2 conf vol						
vCu, unblocked vol			67		772	46
tC, single (s)			4.1		6.8	6.5
tC, 2 stage (s)						
tF (s)			2.2		3.9	3.5
p0 queue free %			90		86	98
cM capacity (veh/h)			1528		287	962

Direction, Lane #	EB 1	WB 1	NB 1
Volume Total	67	571	61
Volume Left	0	155	39
Volume Right	42	0	22
cSH	1700	1528	384
Volume to Capacity	0.04	0.10	0.16
Queue Length 95th (m)	0.0	2.4	3.9
Control Delay (s)	0.0	2.8	16.1
Lane LOS		A	C
Approach Delay (s)	0.0	2.8	16.1
Approach LOS			C

Intersection Summary			
Average Delay			3.7
Intersection Capacity Utilization	49.2%		ICU Level of Service
Analysis Period (min)	15		A

4055 & 4120 Russell Road
6: Hunt Club & Hwy 417 Offramp

2023 Future Background AM Peak Hour



Movement	EBL	EBR	NBL	NBT	SBT	SBR
Lane Configurations						
Traffic Volume (veh/h)	2	828	0	850	648	0
Future Volume (Veh/h)	2	828	0	850	648	0
Sign Control	Stop			Free	Free	
Grade	0%			0%	0%	
Peak Hour Factor	1.00	1.00	1.00	1.00	1.00	1.00
Hourly flow rate (vph)	2	828	0	850	648	0
Pedestrians						
Lane Width (m)						
Walking Speed (m/s)						
Percent Blockage						
Right turn flare (veh)						
Median type				None	None	
Median storage (veh)						
Upstream signal (m)						
pX, platoon unblocked						
vC, conflicting volume	1498	648	648			
vC1, stage 1 conf vol						
vC2, stage 2 conf vol						
vCu, unblocked vol	1498	648	648			
tC, single (s)	6.4	6.3	4.1			
tC, 2 stage (s)						
tF (s)	3.5	3.4	2.2			
p0 queue free %	99	0	100			
cM capacity (veh/h)	135	458	947			
Direction, Lane #						
	EB 1	EB 2	NB 1	SB 1		
Volume Total	2	828	850	648		
Volume Left	2	0	0	0		
Volume Right	0	828	0	0		
cSH	135	458	1700	1700		
Volume to Capacity	0.01	1.81	0.50	0.38		
Queue Length 95th (m)	0.3	365.3	0.0	0.0		
Control Delay (s)	32.0	392.9	0.0	0.0		
Lane LOS	D	F				
Approach Delay (s)	392.1		0.0	0.0		
Approach LOS	F					
Intersection Summary						
Average Delay			139.8			
Intersection Capacity Utilization			96.8%	ICU Level of Service	F	
Analysis Period (min)			15			

4055 & 4120 Russell Road
7: Ramsayville & Russell

2023 Future Background AM Peak Hour



Movement	EBL	EBR	NBL	NBT	SBT	SBR
Lane Configurations						
Traffic Volume (veh/h)	24	21	390	347	145	204
Future Volume (Veh/h)	24	21	390	347	145	204
Sign Control	Stop			Free	Free	
Grade	0%			0%	0%	
Peak Hour Factor	1.00	1.00	1.00	1.00	1.00	1.00
Hourly flow rate (vph)	24	21	390	347	145	204
Pedestrians	2					
Lane Width (m)	4.0					
Walking Speed (m/s)	1.0					
Percent Blockage	0					
Right turn flare (veh)						
Median type				None	None	
Median storage (veh)						
Upstream signal (m)						
pX, platoon unblocked						
vC, conflicting volume	1374	249	349			
vC1, stage 1 conf vol						
vC2, stage 2 conf vol						
vCu, unblocked vol	1374	249	349			
tC, single (s)	6.9	6.4	4.1			
tC, 2 stage (s)						
tF (s)	4.0	3.5	2.2			
p0 queue free %	72	97	67			
cM capacity (veh/h)	86	746	1199			
Direction, Lane #	EB 1	NB 1	SB 1			
Volume Total	45	737	349			
Volume Left	24	390	0			
Volume Right	21	0	204			
cSH	146	1199	1700			
Volume to Capacity	0.31	0.33	0.21			
Queue Length 95th (m)	8.6	10.0	0.0			
Control Delay (s)	40.4	6.8	0.0			
Lane LOS	E	A				
Approach Delay (s)	40.4	6.8	0.0			
Approach LOS	E					
Intersection Summary						
Average Delay	6.0					
Intersection Capacity Utilization	77.3%			ICU Level of Service	D	
Analysis Period (min)	15					

4055 & 4120 Russell Road
10: Walkley & SB off-ramp

2023 Future Background AM Peak Hour



Movement	EBL	EBT	WBT	WBR	SBL	SBR
Lane Configurations		↑↑	↑↑		↓	↗
Traffic Volume (veh/h)	0	463	994	0	23	966
Future Volume (Veh/h)	0	463	994	0	23	966
Sign Control		Free	Free		Stop	
Grade		0%	0%		0%	
Peak Hour Factor	1.00	1.00	1.00	1.00	1.00	1.00
Hourly flow rate (vph)	0	463	994	0	23	966
Pedestrians						
Lane Width (m)						
Walking Speed (m/s)						
Percent Blockage						
Right turn flare (veh)						
Median type		None	None			
Median storage (veh)						
Upstream signal (m)						
pX, platoon unblocked						
vC, conflicting volume	994				1226	497
vC1, stage 1 conf vol						
vC2, stage 2 conf vol						
vCu, unblocked vol	994				1226	497
tC, single (s)	4.2				6.9	7.0
tC, 2 stage (s)						
tF (s)	2.2				3.5	3.3
p0 queue free %	100				86	0
cM capacity (veh/h)	674				167	511
Direction, Lane #	EB 1	EB 2	WB 1	WB 2	SB 1	SB 2
Volume Total	232	232	497	497	23	966
Volume Left	0	0	0	0	23	0
Volume Right	0	0	0	0	0	966
cSH	1700	1700	1700	1700	167	511
Volume to Capacity	0.14	0.14	0.29	0.29	0.14	1.89
Queue Length 95th (m)	0.0	0.0	0.0	0.0	3.3	438.9
Control Delay (s)	0.0	0.0	0.0	0.0	30.0	427.8
Lane LOS					D	F
Approach Delay (s)	0.0		0.0		418.5	
Approach LOS					F	
Intersection Summary						
Average Delay			169.2			
Intersection Capacity Utilization			98.8%		ICU Level of Service	F
Analysis Period (min)			15			

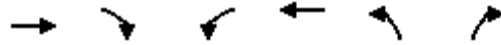

4055 & 4120 Russell Road
11: NB Off-ramp & Walkley

2023 Future Background AM Peak Hour



Movement	EBT	EBR	WBL	WBT	NBL	NBR
Lane Configurations	↑↑			↑↑	↑↓	
Traffic Volume (veh/h)	164	0	0	930	553	57
Future Volume (Veh/h)	164	0	0	930	553	57
Sign Control	Free			Free	Stop	
Grade	0%			0%	0%	
Peak Hour Factor	1.00	1.00	1.00	1.00	1.00	1.00
Hourly flow rate (vph)	164	0	0	930	553	57
Pedestrians						
Lane Width (m)						
Walking Speed (m/s)						
Percent Blockage						
Right turn flare (veh)						
Median type	None		None			
Median storage (veh)						
Upstream signal (m)						
pX, platoon unblocked						
vC, conflicting volume			164		629	82
vC1, stage 1 conf vol						
vC2, stage 2 conf vol						
vCu, unblocked vol			164		629	82
tC, single (s)			4.2		6.9	7.0
tC, 2 stage (s)						
tF (s)			2.2		3.5	3.3
p0 queue free %			100		0	94
cM capacity (veh/h)			1390		408	952
Direction, Lane #	EB 1	EB 2	WB 1	WB 2	NB 1	
Volume Total	82	82	465	465	610	
Volume Left	0	0	0	0	553	
Volume Right	0	0	0	0	57	
cSH	1700	1700	1700	1700	431	
Volume to Capacity	0.05	0.05	0.27	0.27	1.42	
Queue Length 95th (m)	0.0	0.0	0.0	0.0	210.3	
Control Delay (s)	0.0	0.0	0.0	0.0	225.9	
Lane LOS					F	
Approach Delay (s)	0.0		0.0		225.9	
Approach LOS					F	
Intersection Summary						
Average Delay			80.9			
Intersection Capacity Utilization			98.8%		ICU Level of Service	F
Analysis Period (min)			15			

Intersection	
Intersection Delay, s/veh	21.5
Intersection LOS	C

Movement	WBL	WBR	NBT	NBR	SBL	SBT
Lane Configurations						
Traffic Vol, veh/h	290	300	340	36	10	22
Future Vol, veh/h	290	300	340	36	10	22
Peak Hour Factor	1.00	1.00	1.00	1.00	1.00	1.00
Heavy Vehicles, %	4	1	1	15	1	20
Mvmt Flow	290	300	340	36	10	22
Number of Lanes	1	0	1	0	0	1

Approach	WB	NB	SB
Opposing Approach		SB	NB
Opposing Lanes	0	1	1
Conflicting Approach Left	NB		WB
Conflicting Lanes Left	1	0	1
Conflicting Approach Right	SB	WB	
Conflicting Lanes Right	1	1	0
HCM Control Delay	25.9	15.7	9.6
HCM LOS	D	C	A

Lane	NBLn1	WBLn1	SBLn1
Vol Left, %	0%	49%	31%
Vol Thru, %	90%	0%	69%
Vol Right, %	10%	51%	0%
Sign Control	Stop	Stop	Stop
Traffic Vol by Lane	376	590	32
LT Vol	0	290	10
Through Vol	340	0	22
RT Vol	36	300	0
Lane Flow Rate	376	590	32
Geometry Grp	1	1	1
Degree of Util (X)	0.573	0.814	0.055
Departure Headway (Hd)	5.485	4.965	6.2
Convergence, Y/N	Yes	Yes	Yes
Cap	658	732	575
Service Time	3.529	2.965	4.263
HCM Lane V/C Ratio	0.571	0.806	0.056
HCM Control Delay	15.7	25.9	9.6
HCM Lane LOS	C	D	A
HCM 95th-tile Q	3.6	8.7	0.2

4055 & 4120 Russell Road
9: Anderson & Russell

2023 Future Background AM Peak Hour

Intersection	
Intersection Delay, s/veh	34.1
Intersection LOS	D

Movement	EBL	EBT	EBR	WBL	WBT	WBR	NBL	NBT	NBR	SBL	SBT	SBR
Lane Configurations		↕			↕			↕			↕	
Traffic Vol, veh/h	35	16	3	48	331	118	171	304	6	5	139	153
Future Vol, veh/h	35	16	3	48	331	118	171	304	6	5	139	153
Peak Hour Factor	1.00	1.00	1.00	1.00	1.00	1.00	1.00	1.00	1.00	1.00	1.00	1.00
Heavy Vehicles, %	11	7	1	1	2	3	1	3	17	1	4	2
Mvmt Flow	35	16	3	48	331	118	171	304	6	5	139	153
Number of Lanes	0	1	0	0	1	0	0	1	0	0	1	0
Approach	EB			WB			NB			SB		
Opposing Approach	WB			EB			SB			NB		
Opposing Lanes	1			1			1			1		
Conflicting Approach Left	SB			NB			EB			WB		
Conflicting Lanes Left	1			1			1			1		
Conflicting Approach Right	NB			SB			WB			EB		
Conflicting Lanes Right	1			1			1			1		
HCM Control Delay	12.5			40.6			40			17.5		
HCM LOS	B			E			E			C		

Lane	NBLn1	EBLn1	WBLn1	SBLn1
Vol Left, %	36%	65%	10%	2%
Vol Thru, %	63%	30%	67%	47%
Vol Right, %	1%	6%	24%	52%
Sign Control	Stop	Stop	Stop	Stop
Traffic Vol by Lane	481	54	497	297
LT Vol	171	35	48	5
Through Vol	304	16	331	139
RT Vol	6	3	118	153
Lane Flow Rate	481	54	497	297
Geometry Grp	1	1	1	1
Degree of Util (X)	0.876	0.125	0.885	0.546
Departure Headway (Hd)	6.558	8.342	6.411	6.619
Convergence, Y/N	Yes	Yes	Yes	Yes
Cap	548	433	562	541
Service Time	4.639	6.342	4.487	4.715
HCM Lane V/C Ratio	0.878	0.125	0.884	0.549
HCM Control Delay	40	12.5	40.6	17.5
HCM Lane LOS	E	B	E	C
HCM 95th-tile Q	9.8	0.4	10.2	3.3

4055 & 4120 Russell Road
1: Russell & Walkley

2023 Future Background AM Peak Hour Mod

Lane Group	EBL	EBT	EBR	WBL	WBT	WBR	NBL	NBT	NBR	SBL	SBT	SBR
Lane Configurations												
Traffic Volume (vph)	76	486	135	391	1231	64	216	409	500	55	219	135
Future Volume (vph)	76	486	135	391	1231	64	216	409	500	55	219	135
Satd. Flow (prot)	1374	3307	1332	3013	3435	1522	3094	3218	1332	3269	3189	1390
Flt Permitted	0.950			0.950			0.950			0.950		
Satd. Flow (perm)	1372	3307	1332	3013	3435	1490	3082	3218	1314	3264	3189	1365
Satd. Flow (RTOR)			180			134			500			180
Lane Group Flow (vph)	76	486	135	391	1231	64	216	409	500	55	219	135
Turn Type	Prot	NA	Perm	Prot	NA	Perm	Prot	NA	Perm	Prot	NA	Perm
Protected Phases	5	2		1	6		3	8		7	4	
Permitted Phases			2			6			8			4
Total Split (s)	24.4	45.0	45.0	45.0	65.6	65.6	20.0	40.0	40.0	20.0	40.0	40.0
Total Lost Time (s)	6.4	7.3	7.3	6.4	7.3	7.3	7.6	7.4	7.4	7.6	7.4	7.4
Act Effct Green (s)	13.3	58.6	58.6	24.8	70.1	70.1	12.4	32.7	32.7	7.9	25.5	25.5
Actuated g/C Ratio	0.09	0.39	0.39	0.17	0.47	0.47	0.08	0.22	0.22	0.05	0.17	0.17
v/c Ratio	0.63	0.38	0.21	0.79	0.77	0.08	0.85	0.58	0.74	0.32	0.40	0.35
Control Delay	87.4	36.1	2.3	71.3	39.1	0.2	95.8	56.1	11.2	72.9	56.2	4.5
Queue Delay	0.0	0.0	0.0	0.0	0.0	0.0	0.0	0.0	0.0	0.0	0.0	0.0
Total Delay	87.4	36.1	2.3	71.3	39.1	0.2	95.8	56.1	11.2	72.9	56.2	4.5
LOS	F	D	A	E	D	A	F	E	B	E	E	A
Approach Delay		35.2			45.1			43.7				41.4
Approach LOS		D			D			D				D
Queue Length 50th (m)	20.4	51.5	0.0	53.6	151.4	0.0	30.6	53.2	0.0	7.6	27.8	0.0
Queue Length 95th (m)	35.5	73.6	5.1	67.1	#207.8	0.0	#50.6	68.4	33.6	14.4	38.3	5.7
Internal Link Dist (m)		485.7			361.7			432.2			296.2	
Turn Bay Length (m)	85.0		225.0	100.0		45.0	140.0		110.0	80.0		55.0
Base Capacity (vph)	164	1290	629	775	1606	768	255	726	683	270	693	437
Starvation Cap Reductn	0	0	0	0	0	0	0	0	0	0	0	0
Spillback Cap Reductn	0	0	0	0	0	0	0	0	0	0	0	0
Storage Cap Reductn	0	0	0	0	0	0	0	0	0	0	0	0
Reduced v/c Ratio	0.46	0.38	0.21	0.50	0.77	0.08	0.85	0.56	0.73	0.20	0.32	0.31

Intersection Summary

Cycle Length: 150

Actuated Cycle Length: 150

Offset: 102 (68%), Referenced to phase 2:EBT and 6:WBT, Start of Green

Control Type: Actuated-Coordinated

Maximum v/c Ratio: 0.85

Intersection Signal Delay: 42.6

Intersection LOS: D

Intersection Capacity Utilization 80.7%

ICU Level of Service D

Analysis Period (min) 15

95th percentile volume exceeds capacity, queue may be longer.

Queue shown is maximum after two cycles.

Splits and Phases: 1: Russell & Walkley

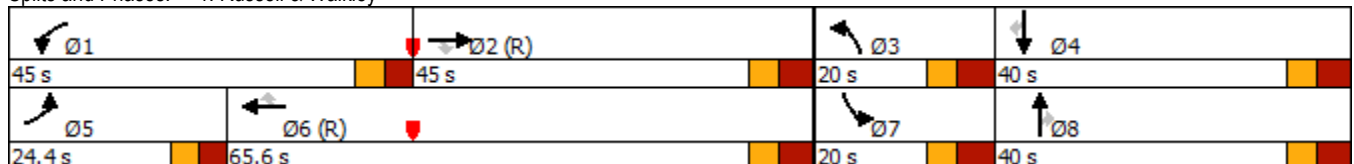

4055 & 4120 Russell Road
2: Hawthorne & Russell

2023 Future Background AM Peak Hour Mod

Lane Group	EBL	EBT	EBR	WBL	WBT	WBR	NBL	NBT	NBR	SBL	SBT	SBR
Lane Configurations												
Traffic Volume (vph)	10	0	8	15	10	334	17	891	8	51	548	34
Future Volume (vph)	10	0	8	15	10	334	17	891	8	51	548	34
Satd. Flow (prot)	1276	1278	0	1488	1790	1522	1701	3104	0	1488	2985	0
Flt Permitted	0.751			0.752			0.433			0.298		
Satd. Flow (perm)	1008	1278	0	1178	1790	1522	771	3104	0	467	2985	0
Satd. Flow (RTOR)		352				175		2			14	
Lane Group Flow (vph)	10	8	0	15	10	334	17	899	0	51	582	0
Turn Type	Perm	NA		Perm	NA	Perm	Perm	NA		Perm	NA	
Protected Phases		4			8			2			6	
Permitted Phases	4			8		8	2			6		
Total Split (s)	26.0	26.0		26.0	26.0	26.0	64.0	64.0		64.0	64.0	
Total Lost Time (s)	5.7	5.7		5.7	5.7	5.7	6.5	6.5		6.5	6.5	
Act Effct Green (s)	16.2	16.2		16.2	16.2	16.2	61.6	61.6		61.6	61.6	
Actuated g/C Ratio	0.18	0.18		0.18	0.18	0.18	0.68	0.68		0.68	0.68	
v/c Ratio	0.06	0.02		0.07	0.03	0.80	0.03	0.42		0.16	0.28	
Control Delay	28.6	0.0		28.9	27.9	31.1	3.9	4.9		7.7	6.4	
Queue Delay	0.0	0.0		0.0	0.0	0.0	0.0	0.0		0.0	0.0	
Total Delay	28.6	0.0		28.9	27.9	31.1	3.9	4.9		7.7	6.4	
LOS	C	A		C	C	C	A	A		A	A	
Approach Delay		15.9			30.9			4.9			6.5	
Approach LOS		B			C			A			A	
Queue Length 50th (m)	1.3	0.0		2.0	1.3	23.7	0.5	13.1		2.7	17.1	
Queue Length 95th (m)	5.0	0.0		6.5	5.0	50.4	m1.0	16.5		7.7	26.5	
Internal Link Dist (m)		63.3			159.0			795.0			432.2	
Turn Bay Length (m)	20.0			40.0		100.0	40.0			60.0		
Base Capacity (vph)	227	560		265	403	478	527	2124		319	2047	
Starvation Cap Reductn	0	0		0	0	0	0	0		0	0	
Spillback Cap Reductn	0	0		0	0	0	0	0		0	0	
Storage Cap Reductn	0	0		0	0	0	0	0		0	0	
Reduced v/c Ratio	0.04	0.01		0.06	0.02	0.70	0.03	0.42		0.16	0.28	

Intersection Summary

Cycle Length: 90
 Actuated Cycle Length: 90
 Offset: 23 (26%), Referenced to phase 2:NBT and 6:SBTL, Start of Green
 Control Type: Actuated-Coordinated
 Maximum v/c Ratio: 0.80
 Intersection Signal Delay: 10.4
 Intersection LOS: B
 Intersection Capacity Utilization 71.3%
 ICU Level of Service C
 Analysis Period (min) 15
 m Volume for 95th percentile queue is metered by upstream signal.

Splits and Phases: 2: Hawthorne & Russell

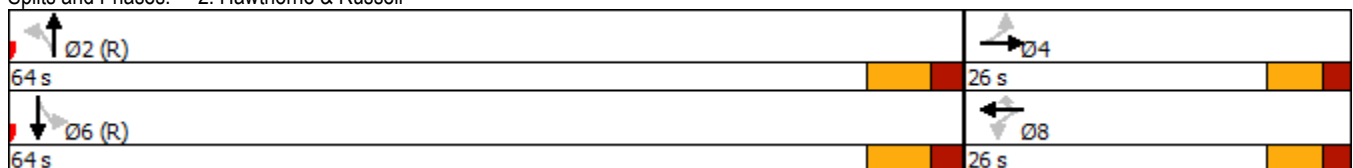

4055 & 4120 Russell Road
3: Hawthorne & Stevenage

2023 Future Background AM Peak Hour Mod



Lane Group	EBL	EBT	EBR	WBL	WBT	WBR	NBL	NBT	NBR	SBL	SBT	SBR
Lane Configurations												
Traffic Volume (vph)	134	28	60	58	63	55	206	923	86	52	316	200
Future Volume (vph)	134	28	60	58	63	55	206	923	86	52	316	200
Satd. Flow (prot)	1553	1219	0	1276	1465	0	1669	3092	0	1429	2858	1453
Flt Permitted	0.681			0.700			0.503			0.252		
Satd. Flow (perm)	1113	1219	0	935	1465	0	880	3092	0	379	2858	1414
Satd. Flow (RTOR)		60			52			13				200
Lane Group Flow (vph)	134	88	0	58	118	0	206	1009	0	52	316	200
Turn Type	Perm	NA		Perm	NA		pm+pt	NA		pm+pt	NA	Perm
Protected Phases		4			8		5	2		1	6	
Permitted Phases	4			8			2			6		6
Total Split (s)	35.0	35.0		35.0	35.0		15.0	40.0		15.0	40.0	40.0
Total Lost Time (s)	5.7	5.7		5.7	5.7		5.7	5.5		5.7	5.5	5.5
Act Effct Green (s)	16.9	16.9		16.9	16.9		60.6	54.0		53.0	46.5	46.5
Actuated g/C Ratio	0.19	0.19		0.19	0.19		0.67	0.60		0.59	0.52	0.52
v/c Ratio	0.64	0.32		0.33	0.37		0.30	0.54		0.17	0.21	0.24
Control Delay	46.6	14.8		34.5	20.5		7.4	14.6		3.4	10.1	6.7
Queue Delay	0.0	0.0		0.0	0.0		0.0	0.0		0.0	0.0	0.0
Total Delay	46.6	14.8		34.5	20.5		7.4	14.6		3.4	10.1	6.7
LOS	D	B		C	C		A	B		A	B	A
Approach Delay		34.0			25.1			13.4			8.3	
Approach LOS		C			C			B			A	
Queue Length 50th (m)	20.1	3.8		8.2	9.1		9.9	50.7		0.7	14.3	3.6
Queue Length 95th (m)	33.0	13.4		16.2	20.1		23.6	89.0		1.1	28.5	25.4
Internal Link Dist (m)		201.3			257.1			958.8			795.0	
Turn Bay Length (m)	45.0			25.0			75.0			85.0		85.0
Base Capacity (vph)	362	437		304	512		684	1860		342	1476	827
Starvation Cap Reductn	0	0		0	0		0	0		0	0	0
Spillback Cap Reductn	0	0		0	0		0	0		0	0	0
Storage Cap Reductn	0	0		0	0		0	0		0	0	0
Reduced v/c Ratio	0.37	0.20		0.19	0.23		0.30	0.54		0.15	0.21	0.24

Intersection Summary

Cycle Length: 90
 Actuated Cycle Length: 90
 Offset: 0 (0%), Referenced to phase 2:NBTL and 6:SBTL, Start of Green
 Control Type: Actuated-Coordinated
 Maximum v/c Ratio: 0.64
 Intersection Signal Delay: 15.1
 Intersection LOS: B
 Intersection Capacity Utilization 63.3%
 ICU Level of Service B
 Analysis Period (min) 15

Splits and Phases: 3: Hawthorne & Stevenage

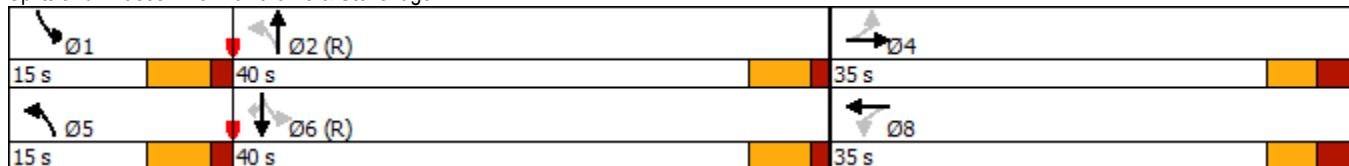

4055 & 4120 Russell Road
4: Hawthorne & Hunt Club

2023 Future Background AM Peak Hour Mod

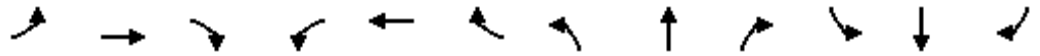

Lane Group	EBL	EBT	EBR	WBL	WBT	WBR	NBL	NBT	NBR	SBL	SBT	SBR
Lane Configurations	↖↗	↕		↖↗	↕	↗	↖	↕		↖	↕	↗
Traffic Volume (vph)	416	625	25	251	678	246	40	412	382	43	147	163
Future Volume (vph)	416	625	25	251	678	246	40	412	382	43	147	163
Satd. Flow (prot)	3179	3333	0	3094	3402	1440	1488	2974	0	1191	2748	1278
Flt Permitted	0.950			0.950			0.659			0.128		
Satd. Flow (perm)	3179	3333	0	3094	3402	1440	1032	2974	0	160	2748	1278
Satd. Flow (RTOR)		3				246		152				163
Lane Group Flow (vph)	416	650	0	251	678	246	40	794	0	43	147	163
Turn Type	Prot	NA		Prot	NA	Perm	pm+pt	NA		pm+pt	NA	Perm
Protected Phases	7	4		3	8		5	2		1	6	
Permitted Phases						8	2			6		6
Total Split (s)	41.4	41.4		41.4	41.4	41.4	21.3	36.3		21.3	36.3	36.3
Total Lost Time (s)	6.4	6.4		6.4	6.4	6.4	6.3	6.3		6.3	6.3	6.3
Act Effct Green (s)	20.3	37.8		14.8	32.2	32.2	36.7	30.5		38.1	31.2	31.2
Actuated g/C Ratio	0.18	0.33		0.13	0.28	0.28	0.32	0.27		0.33	0.27	0.27
v/c Ratio	0.74	0.59		0.63	0.71	0.42	0.11	0.88		0.34	0.20	0.35
Control Delay	53.8	35.1		56.0	42.7	6.8	26.1	45.9		32.8	36.0	8.0
Queue Delay	0.0	0.0		0.0	0.0	0.0	0.0	0.0		0.0	0.0	0.0
Total Delay	53.8	35.1		56.0	42.7	6.8	26.1	45.9		32.8	36.0	8.0
LOS	D	D		E	D	A	C	D		C	D	A
Approach Delay		42.4			38.0			45.0			22.7	
Approach LOS		D			D			D			C	
Queue Length 50th (m)	44.4	59.7		26.9	67.9	0.0	5.5	73.4		6.0	13.1	0.0
Queue Length 95th (m)	61.9	85.0		40.7	96.9	18.5	13.4	#121.5		14.3	23.3	16.3
Internal Link Dist (m)		420.4			1343.9			595.0			958.8	
Turn Bay Length (m)	90.0			50.0		80.0	50.0			80.0		80.0
Base Capacity (vph)	992	1144		965	1061	618	435	906		196	751	468
Starvation Cap Reductn	0	0		0	0	0	0	0		0	0	0
Spillback Cap Reductn	0	0		0	0	0	0	0		0	0	0
Storage Cap Reductn	0	0		0	0	0	0	0		0	0	0
Reduced v/c Ratio	0.42	0.57		0.26	0.64	0.40	0.09	0.88		0.22	0.20	0.35

Intersection Summary

Cycle Length: 140.4
 Actuated Cycle Length: 114.2
 Control Type: Semi Act-Uncoord
 Maximum v/c Ratio: 0.88
 Intersection Signal Delay: 39.5
 Intersection LOS: D
 Intersection Capacity Utilization 82.8%
 ICU Level of Service E
 Analysis Period (min) 15
 # 95th percentile volume exceeds capacity, queue may be longer.
 Queue shown is maximum after two cycles.

Splits and Phases: 4: Hawthorne & Hunt Club

↖ Ø3 41.4 s	→ Ø4 41.4 s	↖ Ø1 21.3 s	↕ Ø2 36.3 s
↗ Ø7 41.4 s	← Ø8 41.4 s	↗ Ø5 21.3 s	↘ Ø6 36.3 s

4055 & 4120 Russell Road
10: Walkley & SB off-ramp

2023 Future Background AM Peak Hour Mod



Lane Group	EBL	EBT	WBT	WBR	SBL	SBR
Lane Configurations		↑↑	↑↑		↓	↓
Traffic Volume (vph)	0	463	994	0	23	936
Future Volume (vph)	0	463	994	0	23	936
Satd. Flow (prot)	0	3402	3402	0	1701	1522
Flt Permitted					0.950	
Satd. Flow (perm)	0	3402	3402	0	1701	1522
Satd. Flow (RTOR)						388
Lane Group Flow (vph)	0	463	994	0	23	936
Turn Type		NA	NA		Prot	Free
Protected Phases		4	8		6	
Permitted Phases						Free
Total Split (s)		87.0	87.0		33.0	
Total Lost Time (s)		6.3	6.3		6.3	
Act Effct Green (s)		107.6	107.6		7.2	120.0
Actuated g/C Ratio		0.90	0.90		0.06	1.00
v/c Ratio		0.15	0.33		0.23	0.61
Control Delay		1.6	4.6		58.3	1.9
Queue Delay		0.0	0.0		0.0	0.0
Total Delay		1.6	4.6		58.3	1.9
LOS		A	A		E	A
Approach Delay		1.6	4.6		3.2	
Approach LOS		A	A		A	
Queue Length 50th (m)		7.4	42.6		4.9	0.0
Queue Length 95th (m)		11.7	61.1		12.4	0.0
Internal Link Dist (m)		708.0	344.3		267.0	
Turn Bay Length (m)					100.0	
Base Capacity (vph)		3049	3049		378	1522
Starvation Cap Reductn		0	0		0	0
Spillback Cap Reductn		0	0		0	0
Storage Cap Reductn		0	0		0	0
Reduced v/c Ratio		0.15	0.33		0.06	0.61

Intersection Summary

Cycle Length: 120

Actuated Cycle Length: 120

Offset: 78 (65%), Referenced to phase 4:EBT and 8:WBT, Start of Green

Control Type: Actuated-Coordinated

Maximum v/c Ratio: 0.61

Intersection Signal Delay: 3.5

Intersection LOS: A

Intersection Capacity Utilization 73.6%

ICU Level of Service D

Analysis Period (min) 15

Splits and Phases: 10: Walkley & SB off-ramp

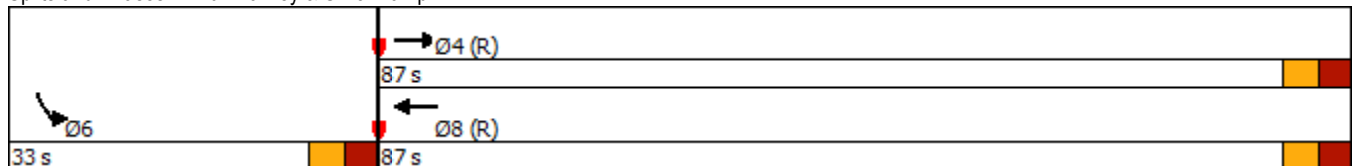

4055 & 4120 Russell Road
11: NB Off-ramp & Walkley

2023 Future Background AM Peak Hour Mod

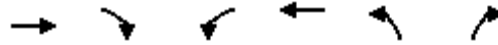

Lane Group	EBT	EBR	WBL	WBT	NBL	NBR
Lane Configurations	↑↑			↑↑	↔	
Traffic Volume (vph)	164	0	0	930	553	57
Future Volume (vph)	164	0	0	930	553	57
Satd. Flow (prot)	3402	0	0	3402	1691	0
Flt Permitted					0.957	
Satd. Flow (perm)	3402	0	0	3402	1691	0
Satd. Flow (RTOR)					6	
Lane Group Flow (vph)	164	0	0	930	610	0
Turn Type	NA			NA	Prot	
Protected Phases	4			8	2	
Permitted Phases						
Total Split (s)	53.0			53.0	67.0	
Total Lost Time (s)	6.3			6.3	6.3	
Act Effct Green (s)	44.6			44.6	62.8	
Actuated g/C Ratio	0.37			0.37	0.52	
v/c Ratio	0.13			0.74	0.69	
Control Delay	24.2			36.4	26.7	
Queue Delay	0.0			0.0	0.0	
Total Delay	24.2			36.4	26.7	
LOS	C			D	C	
Approach Delay	24.2			36.4	26.7	
Approach LOS	C			D	C	
Queue Length 50th (m)	12.2			88.2	97.9	
Queue Length 95th (m)	19.3			109.7	138.5	
Internal Link Dist (m)	344.3			347.3	355.2	
Turn Bay Length (m)						
Base Capacity (vph)	1323			1323	887	
Starvation Cap Reductn	0			0	0	
Spillback Cap Reductn	0			0	0	
Storage Cap Reductn	0			0	0	
Reduced v/c Ratio	0.12			0.70	0.69	

Intersection Summary

Cycle Length: 120

Actuated Cycle Length: 120

Offset: 0 (0%), Referenced to phase 4:EBT and 8:WBT, Start of Green

Control Type: Actuated-Coordinated

Maximum v/c Ratio: 0.74

Intersection Signal Delay: 31.8

Intersection LOS: C

Intersection Capacity Utilization 73.6%

ICU Level of Service D

Analysis Period (min) 15

Splits and Phases: 11: NB Off-ramp & Walkley



Scheme Summary

Control Data

Control Data and Model Parameters

119124	2023 PHF Flow Profile (veh)
2023 Background Traffic Volumes	7.5 min Time Slice
Rodel-Win1	Queuing Delays (sec)
Right Hand Drive	Daylight conditions
AM Peak Hour	Peak 60/15 min Results
AVERAGE DELAY to Geometry	Output flows: Vehicles
Metric Units (m)	85% Confidence Level

Available Data

Entry Capacity Calibrated	No
Entry Capacity Modified	No
Crosswalks	No
Flows Factored	No
Approach/Exit Road Capacity Calibrated	No
Accidents	No
Accident Costs	No
Bypass Model	No
Bypass Calibration	No
Global Results	Yes

Operational Data

Main Geometry (m)

Geometry and Design Target

Leg	Leg Names	Approach Geometry (m)				Target	Circulating and Exit Geom		
		Bearing (deg)	Grade Sep G	Half Width V	Lanes n	Average Delay (sec/veh)	Inscribed Diameter D	Half Width Vx	Lanes n
1	SB - Anderson	0	0	4.00	1	30	45.00	4.00	1
2	EB - Russell	90	0	4.00	1	30	45.00	4.00	1
3	NB- Anderson	180	0	4.00	1	30	45.00	4.00	1
4	WB - Russell	270	0	4.00	1	30	45.00	4.00	1

Capacity Modifiers and Capacity Calibration (veh/hr)

Leg	Leg Names	Entry Capacity		Entry Calibration		Approach Road			Exit Road		
		Capacity + or -	XWalk Factor	Intercept + or -	Slope Factor	V (m)	Default Capacity	Calib Capacity	V (m)	Default Capacity	Calib Capacity
1	SB - Anderson	0	1.000	0	1.000	6.00	1960	0	4.00	1960	0
2	EB - Russell	0	1.000	0	1.000	6.00	1960	0	4.00	1960	0
3	NB- Anderson	0	1.000	0	1.000	6.00	1960	0	4.00	1960	0
4	WB - Russell	0	1.000	0	1.000	6.00	1960	0	4.00	1960	0

Traffic Flow Data (veh/hr)

2023 AM Peak Peak Hour Flows

Leg	Leg Names	Turning Flows					Flow Modifiers		
		U-Turn	Exit-3	Exit-2	Exit-1	Bypass	Trucks %	Flow Factor	Peak Hour Factor
1	SB - Anderson	0	171	304	6	0	3.0	1.00	0.900
2	EB - Russell	0	35	16	3	0	3.0	1.00	0.900
3	NB- Anderson	0	5	139	153	0	3.0	1.00	0.900
4	WB - Russell	0	48	331	118	0	3.0	1.00	0.900

Operational Results

Geometry for Target Input

Geometry Options for 2023 AM Peak

				Leg 1 - SB - Anderson	
nv	ne	nc	nx	E (m)	L' (m)
1	1	1	1	4.00	0.00

Geometry Options for 2023 AM Peak

				Leg 2 - EB - Russell	
nv	ne	nc	nx	E (m)	L' (m)
1	1	1	1	4.00	0.00

Geometry Options for 2023 AM Peak

				Leg 3 - NB- Anderson	
nv	ne	nc	nx	E (m)	L' (m)
1	1	1	1	4.00	0.00

Geometry Options for 2023 AM Peak

				Leg 4 - WB - Russell	
nv	ne	nc	nx	E (m)	L' (m)
1	1	1	1	4.00	0.00

2023 AM Peak - 60 minutes

Flows and Capacity

Leg	Leg Names	Bypass Type	Flows (veh/hr)				Capacity (veh/hr)			
			Arrival Flow		Opposing Flow		Capacity		Average VCR	
			Entry	Bypass	Entry	Bypass	Entry	Bypass	Entry	Bypass
1	SB - Anderson	None	481		384		292	749		0.6422
2	EB - Russell	None	54		522		342	677		0.0797
3	NB- Anderson	None	297		222		355	833		0.3567
4	WB - Russell	None	497		179		340	855		0.5814

Delays, Queues and Level of Service

Leg	Leg Names	Bypass Type	Average Delay (sec)			95% Queue (veh)		Level of Service		
			Entry	Bypass	Leg	Entry	Bypass	Entry	Bypass	Leg
1	SB - Anderson	None	12.30		12.30	5.81		B		B
2	EB - Russell	None	5.53		5.53	0.26		A		A
3	NB- Anderson	None	6.34		6.34	1.64		A		A
4	WB - Russell	None	9.27		9.27	4.24		A		A

2023 AM Peak - 15 minutes

Flows and Capacity

Leg	Leg Names	Bypass Type	Flows (veh/hr)				Capacity (veh/hr)			
			Arrival Flow		Opposing Flow		Capacity		Average VCR	
			Entry	Bypass	Entry	Bypass	Exit Flow	Entry	Bypass	Entry
1	SB - Anderson	None	534		425		324	728		0.7346
2	EB - Russell	None	60		578		379	649		0.0925
3	NB- Anderson	None	330		245		392	820		0.4022
4	WB - Russell	None	552		199		376	845		0.6538

Delays, Queues and Level of Service

Leg	Leg Names	Bypass Type	Average Delay (sec)			95% Queue (veh)		Level of Service		
			Entry	Bypass	Leg	Entry	Bypass	Entry	Bypass	Leg
1	SB - Anderson	None	13.93		13.93	5.81		B		B
2	EB - Russell	None	5.57		5.57	0.26		A		A
3	NB- Anderson	None	6.48		6.48	1.64		A		A
4	WB - Russell	None	9.99		9.99	4.24		A		A

Lane Group	EBL	EBT	EBR	WBL	WBT	WBR	NBL	NBT	NBR	SBL	SBT	SBR
Lane Configurations												
Traffic Volume (vph)	96	1360	248	453	681	80	148	279	535	105	434	109
Future Volume (vph)	96	1360	248	453	681	80	148	279	535	105	434	109
Satd. Flow (prot)	1609	3468	1390	3013	3468	1567	3179	3338	1427	3238	3247	1427
Flt Permitted	0.950			0.950			0.950			0.950		
Satd. Flow (perm)	1604	3468	1368	3011	3468	1535	3154	3338	1402	3217	3247	1396
Satd. Flow (RTOR)			248			154			207			207
Lane Group Flow (vph)	96	1360	248	453	681	80	148	279	535	105	434	109
Turn Type	Prot	NA	Perm	Prot	NA	Perm	Prot	NA	Perm	Prot	NA	Perm
Protected Phases	5	2		1	6		3	8		7	4	
Permitted Phases			2			6			8			4
Total Split (s)	12.0	58.0	58.0	20.0	66.0	66.0	17.0	35.0	35.0	17.0	35.0	35.0
Total Lost Time (s)	6.4	7.3	7.3	6.4	7.3	7.3	7.6	7.4	7.4	7.6	7.4	7.4
Act Effct Green (s)	5.6	50.7	50.7	13.6	58.7	58.7	9.1	28.3	28.3	8.7	27.9	27.9
Actuated g/C Ratio	0.04	0.39	0.39	0.10	0.45	0.45	0.07	0.22	0.22	0.07	0.21	0.21
v/c Ratio	1.39	1.01	0.36	1.44	0.44	0.10	0.66	0.38	1.15	0.48	0.62	0.24
Control Delay	287.3	65.5	4.7	255.2	25.4	0.3	73.8	45.5	117.1	66.0	51.0	1.2
Queue Delay	0.0	0.0	0.0	0.0	0.0	0.0	0.0	0.0	0.0	0.0	0.0	0.0
Total Delay	287.3	65.5	4.7	255.2	25.4	0.3	73.8	45.5	117.1	66.0	51.0	1.2
LOS	F	E	A	F	C	A	E	D	F	E	D	A
Approach Delay		69.1			109.5			89.7			45.0	
Approach LOS		E			F			F			D	
Queue Length 50th (m)	~30.1	~169.4	0.0	~74.6	56.6	0.0	17.8	30.0	~108.7	12.4	49.4	0.0
Queue Length 95th (m)	#62.9	#215.3	15.1	#104.9	71.3	0.0	28.1	42.5	#171.9	21.2	65.7	0.0
Internal Link Dist (m)		485.7			397.0			432.2			296.2	
Turn Bay Length (m)	85.0		225.0	100.0		45.0	140.0		110.0	80.0		55.0
Base Capacity (vph)	69	1352	684	315	1565	777	229	725	466	234	695	461
Starvation Cap Reductn	0	0	0	0	0	0	0	0	0	0	0	0
Spillback Cap Reductn	0	0	0	0	0	0	0	0	0	0	0	0
Storage Cap Reductn	0	0	0	0	0	0	0	0	0	0	0	0
Reduced v/c Ratio	1.39	1.01	0.36	1.44	0.44	0.10	0.65	0.38	1.15	0.45	0.62	0.24

Intersection Summary

Cycle Length: 130

Actuated Cycle Length: 130

Offset: 35 (27%), Referenced to phase 2:EBT and 6:WBT, Start of Green

Control Type: Actuated-Coordinated

Maximum v/c Ratio: 1.44

Intersection Signal Delay: 80.9

Intersection LOS: F

Intersection Capacity Utilization 97.8%

ICU Level of Service F

Analysis Period (min) 15

~ Volume exceeds capacity, queue is theoretically infinite.

Queue shown is maximum after two cycles.

95th percentile volume exceeds capacity, queue may be longer.

Queue shown is maximum after two cycles.

Splits and Phases: 1: Russell & Walkley

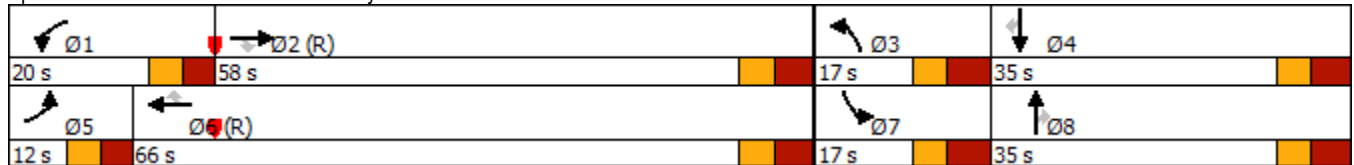

4055 & 4120 Russell Road
 2: Hawthorne & Russell

2023 Future Background PM Peak Hour

Lane Group	EBL	EBT	EBR	WBL	WBT	WBR	NBL	NBT	NBR	SBL	SBT	SBR
Lane Configurations												
Traffic Volume (vph)	35	7	21	8	3	82	7	716	12	210	869	17
Future Volume (vph)	35	7	21	8	3	82	7	716	12	210	869	17
Satd. Flow (prot)	1624	1466	0	1768	1139	1508	1232	3292	0	1639	3270	0
Flt Permitted	0.756			0.739			0.318			0.375		
Satd. Flow (perm)	1291	1466	0	1376	1139	1488	412	3292	0	647	3270	0
Satd. Flow (RTOR)		21				82		4			4	
Lane Group Flow (vph)	35	28	0	8	3	82	7	728	0	210	886	0
Turn Type	Perm	NA		Perm	NA	Perm	Perm	NA		Perm	NA	
Protected Phases		4			8			2			6	
Permitted Phases	4			8		8	2			6		
Total Split (s)	26.0	26.0		26.0	26.0	26.0	54.0	54.0		54.0	54.0	
Total Lost Time (s)	5.7	5.7		5.7	5.7	5.7	6.5	6.5		6.5	6.5	
Act Effct Green (s)	10.1	10.1		10.1	10.1	10.1	62.1	62.1		62.1	62.1	
Actuated g/C Ratio	0.13	0.13		0.13	0.13	0.13	0.78	0.78		0.78	0.78	
v/c Ratio	0.21	0.14		0.05	0.02	0.32	0.02	0.28		0.42	0.35	
Control Delay	34.9	18.4		31.4	31.0	11.7	3.4	3.8		7.5	4.2	
Queue Delay	0.0	0.0		0.0	0.0	0.0	0.0	0.0		0.0	0.0	
Total Delay	34.9	18.4		31.4	31.0	11.7	3.4	3.8		7.5	4.2	
LOS	C	B		C	C	B	A	A		A	A	
Approach Delay		27.6			14.0			3.8			4.8	
Approach LOS		C			B			A			A	
Queue Length 50th (m)	4.5	0.9		1.0	0.4	0.0	0.2	15.3		9.8	20.1	
Queue Length 95th (m)	11.9	7.2		4.4	2.5	10.7	1.1	21.9		22.5	28.1	
Internal Link Dist (m)		63.3			159.0			795.0			432.2	
Turn Bay Length (m)	20.0			40.0		100.0	40.0			60.0		
Base Capacity (vph)	327	387		349	289	438	319	2557		502	2540	
Starvation Cap Reductn	0	0		0	0	0	0	0		0	0	
Spillback Cap Reductn	0	0		0	0	0	0	0		0	0	
Storage Cap Reductn	0	0		0	0	0	0	0		0	0	
Reduced v/c Ratio	0.11	0.07		0.02	0.01	0.19	0.02	0.28		0.42	0.35	

Intersection Summary

Cycle Length: 80
 Actuated Cycle Length: 80
 Offset: 16 (20%), Referenced to phase 2:NBT and 6:SBTL, Start of Green
 Control Type: Actuated-Coordinated
 Maximum v/c Ratio: 0.42
 Intersection Signal Delay: 5.6
 Intersection LOS: A
 Intersection Capacity Utilization 58.6%
 ICU Level of Service B
 Analysis Period (min) 15

Splits and Phases: 2: Hawthorne & Russell

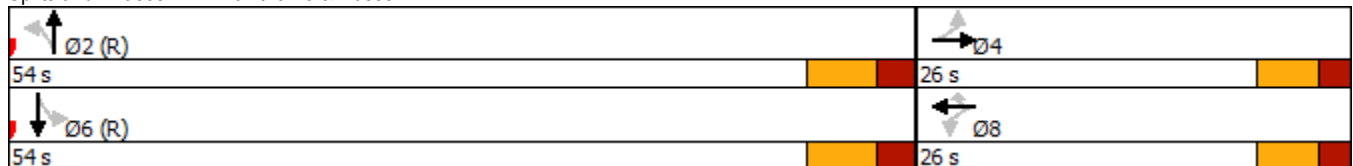

4055 & 4120 Russell Road
3: Hawthorne & Stevenage

2023 Future Background PM Peak Hour

Lane Group	EBL	EBT	EBR	WBL	WBT	WBR	NBL	NBT	NBR	SBL	SBT	SBR
Lane Configurations												
Traffic Volume (vph)	201	39	221	100	29	81	82	372	59	45	950	144
Future Volume (vph)	201	39	221	100	29	81	82	372	59	45	950	144
Satd. Flow (prot)	1669	1490	0	1567	1426	0	1323	3069	0	1323	3402	1390
Flt Permitted	0.686			0.426			0.217			0.501		
Satd. Flow (perm)	1202	1490	0	703	1426	0	302	3069	0	698	3402	1352
Satd. Flow (RTOR)		221			81			23				144
Lane Group Flow (vph)	201	260	0	100	110	0	82	431	0	45	950	144
Turn Type	Perm	NA		Perm	NA		pm+pt	NA		pm+pt	NA	Perm
Protected Phases		4			8		5	2		1	6	
Permitted Phases	4			8			2			6		6
Total Split (s)	35.0	35.0		35.0	35.0		15.0	45.0		15.0	45.0	45.0
Total Lost Time (s)	5.7	5.7		5.7	5.7		5.7	5.5		5.7	5.5	5.5
Act Effct Green (s)	22.6	22.6		22.6	22.6		58.2	53.2		55.7	50.1	50.1
Actuated g/C Ratio	0.24	0.24		0.24	0.24		0.61	0.56		0.59	0.53	0.53
v/c Ratio	0.71	0.50		0.60	0.27		0.31	0.25		0.10	0.53	0.18
Control Delay	45.6	9.3		45.8	11.0		11.4	13.2		9.0	18.6	3.7
Queue Delay	0.0	0.0		0.0	0.0		0.0	0.0		0.0	0.0	0.0
Total Delay	45.6	9.3		45.8	11.0		11.4	13.2		9.0	18.6	3.7
LOS	D	A		D	B		B	B		A	B	A
Approach Delay		25.1			27.6			12.9			16.4	
Approach LOS		C			C			B			B	
Queue Length 50th (m)	30.7	5.1		14.8	3.8		4.9	19.8		2.6	57.1	0.0
Queue Length 95th (m)	48.7	21.5		28.3	14.2		12.0	34.0		7.5	86.4	9.8
Internal Link Dist (m)		201.3			257.1			958.8			795.0	
Turn Bay Length (m)	45.0			25.0			75.0			85.0		85.0
Base Capacity (vph)	370	612		216	495		286	1728		482	1792	780
Starvation Cap Reductn	0	0		0	0		0	0		0	0	0
Spillback Cap Reductn	0	0		0	0		0	0		0	0	0
Storage Cap Reductn	0	0		0	0		0	0		0	0	0
Reduced v/c Ratio	0.54	0.42		0.46	0.22		0.29	0.25		0.09	0.53	0.18

Intersection Summary

Cycle Length: 95

Actuated Cycle Length: 95

Offset: 0 (0%), Referenced to phase 2:NBTL and 6:SBTL, Start of Green

Control Type: Actuated-Coordinated

Maximum v/c Ratio: 0.71

Intersection Signal Delay: 18.3

Intersection LOS: B

Intersection Capacity Utilization 76.2%

ICU Level of Service D

Analysis Period (min) 15

Splits and Phases: 3: Hawthorne & Stevenage

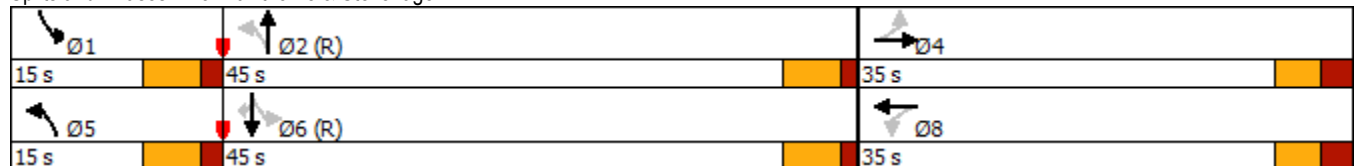

Lane Group	EBL	EBT	EBR	WBL	WBT	WBR	NBL	NBT	NBR	SBL	SBT	SBR
Lane Configurations												
Traffic Volume (vph)	254	809	24	423	870	87	25	193	307	167	494	467
Future Volume (vph)	254	809	24	423	870	87	25	193	307	167	494	467
Satd. Flow (prot)	1595	3422	0	1654	3468	1141	1717	2807	0	1609	3247	1522
Flt Permitted	0.950			0.950			0.428			0.150		
Satd. Flow (perm)	1595	3422	0	1653	3468	1141	774	2807	0	254	3247	1522
Satd. Flow (RTOR)		2				119		242				467
Lane Group Flow (vph)	254	833	0	423	870	87	25	500	0	167	494	467
Turn Type	Prot	NA		Prot	NA	Perm	pm+pt	NA		pm+pt	NA	Perm
Protected Phases	7	4		3	8		5	2		1	6	
Permitted Phases						8	2			6		6
Total Split (s)	36.4	48.4		44.4	56.4	56.4	21.3	32.3		21.3	32.3	32.3
Total Lost Time (s)	6.4	6.4		6.4	6.4	6.4	6.3	6.3		6.3	6.3	6.3
Act Effct Green (s)	25.7	39.1		37.7	51.1	51.1	27.2	20.2		40.5	32.6	32.6
Actuated g/C Ratio	0.19	0.29		0.28	0.37	0.37	0.20	0.15		0.30	0.24	0.24
v/c Ratio	0.85	0.85		0.93	0.67	0.17	0.12	0.81		0.78	0.64	0.65
Control Delay	79.3	55.9		76.8	40.5	2.8	36.6	39.5		63.0	52.7	8.7
Queue Delay	0.0	0.0		0.0	0.0	0.0	0.0	0.0		0.0	0.0	0.0
Total Delay	79.3	55.9		76.8	40.5	2.8	36.6	39.5		63.0	52.7	8.7
LOS	E	E		E	D	A	D	D		E	D	A
Approach Delay		61.4			49.2			39.4			36.0	
Approach LOS		E			D			D			D	
Queue Length 50th (m)	63.1	105.2		107.8	99.5	0.0	4.6	34.9		33.7	63.3	0.0
Queue Length 95th (m)	#101.1	134.2		#175.8	130.0	5.1	11.1	53.8		#58.7	82.8	29.4
Internal Link Dist (m)		420.4			1343.9			595.0			958.8	
Turn Bay Length (m)	90.0			50.0		80.0	50.0			80.0		80.0
Base Capacity (vph)	353	1062		464	1304	503	304	734		225	773	718
Starvation Cap Reductn	0	0		0	0	0	0	0		0	0	0
Spillback Cap Reductn	0	0		0	0	0	0	0		0	0	0
Storage Cap Reductn	0	0		0	0	0	0	0		0	0	0
Reduced v/c Ratio	0.72	0.78		0.91	0.67	0.17	0.08	0.68		0.74	0.64	0.65

Intersection Summary

Cycle Length: 146.4
 Actuated Cycle Length: 136.6
 Control Type: Semi Act-Uncoord
 Maximum v/c Ratio: 0.93
 Intersection Signal Delay: 47.6
 Intersection LOS: D
 Intersection Capacity Utilization 96.4%
 ICU Level of Service F
 Analysis Period (min) 15
 # 95th percentile volume exceeds capacity, queue may be longer.
 Queue shown is maximum after two cycles.

Splits and Phases: 4: Hawthorne & Hunt Club

Ø3 44.4 s	Ø4 48.4 s	Ø1 21.3 s	Ø2 32.3 s
Ø7 36.4 s	Ø8 56.4 s	Ø5 21.3 s	Ø6 32.3 s



Movement	EBT	EBR	WBL	WBT	NBL	NBR
Lane Configurations						
Traffic Volume (veh/h)	303	29	10	34	27	126
Future Volume (Veh/h)	303	29	10	34	27	126
Sign Control	Free			Free	Stop	
Grade	0%			0%	0%	
Peak Hour Factor	1.00	1.00	1.00	1.00	1.00	1.00
Hourly flow rate (vph)	303	29	10	34	27	126
Pedestrians						
Lane Width (m)						
Walking Speed (m/s)						
Percent Blockage						
Right turn flare (veh)						
Median type	None			None		
Median storage (veh)						
Upstream signal (m)						
pX, platoon unblocked						
vC, conflicting volume				332	372	318
vC1, stage 1 conf vol						
vC2, stage 2 conf vol						
vCu, unblocked vol				332	372	318
tC, single (s)				4.2	6.6	6.2
tC, 2 stage (s)						
tF (s)				2.3	3.7	3.3
p0 queue free %				99	95	83
cM capacity (veh/h)				1184	590	721
Direction, Lane #	EB 1	WB 1	NB 1			
Volume Total	332	44	153			
Volume Left	0	10	27			
Volume Right	29	0	126			
cSH	1700	1184	694			
Volume to Capacity	0.20	0.01	0.22			
Queue Length 95th (m)	0.0	0.2	5.9			
Control Delay (s)	0.0	1.9	11.7			
Lane LOS		A	B			
Approach Delay (s)	0.0	1.9	11.7			
Approach LOS			B			
Intersection Summary						
Average Delay				3.5		
Intersection Capacity Utilization				35.1%	ICU Level of Service	A
Analysis Period (min)				15		



Movement	EBL	EBR	NBL	NBT	SBT	SBR
Lane Configurations						
Traffic Volume (veh/h)	11	1343	0	1057	142	0
Future Volume (Veh/h)	11	1343	0	1057	142	0
Sign Control	Stop			Free	Free	
Grade	0%			0%	0%	
Peak Hour Factor	1.00	1.00	1.00	1.00	1.00	1.00
Hourly flow rate (vph)	11	1343	0	1057	142	0
Pedestrians						
Lane Width (m)						
Walking Speed (m/s)						
Percent Blockage						
Right turn flare (veh)						
Median type			None		None	
Median storage (veh)						
Upstream signal (m)						
pX, platoon unblocked						
vC, conflicting volume	1199	142	142			
vC1, stage 1 conf vol						
vC2, stage 2 conf vol						
vCu, unblocked vol	1199	142	142			
tC, single (s)	6.4	6.3	4.1			
tC, 2 stage (s)						
tF (s)	3.5	3.4	2.2			
p0 queue free %	95	0	100			
cM capacity (veh/h)	206	893	1453			
Direction, Lane #	EB 1	EB 2	NB 1	SB 1		
Volume Total	11	1343	1057	142		
Volume Left	11	0	0	0		
Volume Right	0	1343	0	0		
cSH	206	893	1700	1700		
Volume to Capacity	0.05	1.50	0.62	0.08		
Queue Length 95th (m)	1.2	449.1	0.0	0.0		
Control Delay (s)	23.5	247.6	0.0	0.0		
Lane LOS	C	F				
Approach Delay (s)	245.7		0.0	0.0		
Approach LOS	F					
Intersection Summary						
Average Delay			130.3			
Intersection Capacity Utilization			102.3%	ICU Level of Service	G	
Analysis Period (min)			15			



Movement	EBL	EBR	NBL	NBT	SBT	SBR
Lane Configurations						
Traffic Volume (veh/h)	110	321	33	114	322	17
Future Volume (Veh/h)	110	321	33	114	322	17
Sign Control	Stop			Free	Free	
Grade	0%			0%	0%	
Peak Hour Factor	1.00	1.00	1.00	1.00	1.00	1.00
Hourly flow rate (vph)	110	321	33	114	322	17
Pedestrians						
Lane Width (m)						
Walking Speed (m/s)						
Percent Blockage						
Right turn flare (veh)						
Median type				None	None	
Median storage (veh)						
Upstream signal (m)						
pX, platoon unblocked						
vC, conflicting volume	510	330	339			
vC1, stage 1 conf vol						
vC2, stage 2 conf vol						
vCu, unblocked vol	510	330	339			
tC, single (s)	6.5	6.3	4.2			
tC, 2 stage (s)						
tF (s)	3.6	3.4	2.3			
p0 queue free %	78	54	97			
cM capacity (veh/h)	501	700	1151			
Direction, Lane #	EB 1	NB 1	SB 1			
Volume Total	431	147	339			
Volume Left	110	33	0			
Volume Right	321	0	17			
cSH	635	1151	1700			
Volume to Capacity	0.68	0.03	0.20			
Queue Length 95th (m)	36.7	0.6	0.0			
Control Delay (s)	21.8	2.0	0.0			
Lane LOS	C	A				
Approach Delay (s)	21.8	2.0	0.0			
Approach LOS	C					
Intersection Summary						
Average Delay			10.6			
Intersection Capacity Utilization			64.5%	ICU Level of Service	C	
Analysis Period (min)			15			



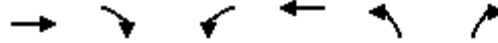

Movement	EBL	EBT	WBT	WBR	SBL	SBR
Lane Configurations		↑↑	↑↑		↓	↓
Traffic Volume (veh/h)	0	1574	184	0	174	636
Future Volume (Veh/h)	0	1574	184	0	174	636
Sign Control		Free	Free		Stop	
Grade		0%	0%		0%	
Peak Hour Factor	1.00	1.00	1.00	1.00	1.00	1.00
Hourly flow rate (vph)	0	1574	184	0	174	636
Pedestrians						
Lane Width (m)						
Walking Speed (m/s)						
Percent Blockage						
Right turn flare (veh)						
Median type		None	None			
Median storage (veh)						
Upstream signal (m)						
pX, platoon unblocked						
vC, conflicting volume	184				971	92
vC1, stage 1 conf vol						
vC2, stage 2 conf vol						
vCu, unblocked vol	184				971	92
tC, single (s)	4.2				6.9	7.0
tC, 2 stage (s)						
tF (s)	2.2				3.5	3.3
p0 queue free %	100				29	32
cM capacity (veh/h)	1367				245	938
Direction, Lane #	EB 1	EB 2	WB 1	WB 2	SB 1	SB 2
Volume Total	787	787	92	92	174	636
Volume Left	0	0	0	0	174	0
Volume Right	0	0	0	0	0	636
cSH	1700	1700	1700	1700	245	938
Volume to Capacity	0.46	0.46	0.05	0.05	0.71	0.68
Queue Length 95th (m)	0.0	0.0	0.0	0.0	33.4	38.6
Control Delay (s)	0.0	0.0	0.0	0.0	49.1	16.5
Lane LOS					E	C
Approach Delay (s)	0.0		0.0		23.5	
Approach LOS					C	
Intersection Summary						
Average Delay			7.4			
Intersection Capacity Utilization			62.8%		ICU Level of Service	B
Analysis Period (min)			15			



Movement	EBT	EBR	WBL	WBT	NBL	NBR
Lane Configurations	↑↑			↑↑	↘↘	
Traffic Volume (veh/h)	811	0	0	87	156	24
Future Volume (Veh/h)	811	0	0	87	156	24
Sign Control	Free			Free	Stop	
Grade	0%			0%	0%	
Peak Hour Factor	1.00	1.00	1.00	1.00	1.00	1.00
Hourly flow rate (vph)	811	0	0	87	156	24
Pedestrians						
Lane Width (m)						
Walking Speed (m/s)						
Percent Blockage						
Right turn flare (veh)						
Median type	None		None			
Median storage (veh)						
Upstream signal (m)						
pX, platoon unblocked						
vC, conflicting volume			811		854	406
vC1, stage 1 conf vol						
vC2, stage 2 conf vol						
vCu, unblocked vol			811		854	406
tC, single (s)			4.2		6.9	7.0
tC, 2 stage (s)						
tF (s)			2.2		3.5	3.3
p0 queue free %			100		47	96
cM capacity (veh/h)			792		292	586
Direction, Lane #	EB 1	EB 2	WB 1	WB 2	NB 1	
Volume Total	406	406	44	44	180	
Volume Left	0	0	0	0	156	
Volume Right	0	0	0	0	24	
cSH	1700	1700	1700	1700	313	
Volume to Capacity	0.24	0.24	0.03	0.03	0.58	
Queue Length 95th (m)	0.0	0.0	0.0	0.0	23.7	
Control Delay (s)	0.0	0.0	0.0	0.0	31.0	
Lane LOS					D	
Approach Delay (s)	0.0		0.0		31.0	
Approach LOS					D	
Intersection Summary						
Average Delay			5.2			
Intersection Capacity Utilization			62.8%		ICU Level of Service	B
Analysis Period (min)			15			

Intersection	
Intersection Delay, s/veh	11
Intersection LOS	B

Movement	WBL	WBR	NBT	NBR	SBL	SBT
Lane Configurations						
Traffic Vol, veh/h	60	8	49	190	132	300
Future Vol, veh/h	60	8	49	190	132	300
Peak Hour Factor	1.00	1.00	1.00	1.00	1.00	1.00
Heavy Vehicles, %	10	1	7	4	2	2
Mvmt Flow	60	8	49	190	132	300
Number of Lanes	1	0	1	0	0	1

Approach	WB	NB	SB
Opposing Approach		SB	NB
Opposing Lanes	0	1	1
Conflicting Approach Left	NB		WB
Conflicting Lanes Left	1	0	1
Conflicting Approach Right	SB	WB	
Conflicting Lanes Right	1	1	0
HCM Control Delay	9.3	8.8	12.4
HCM LOS	A	A	B

Lane	NBLn1	WBLn1	SBLn1
Vol Left, %	0%	88%	31%
Vol Thru, %	21%	0%	69%
Vol Right, %	79%	12%	0%
Sign Control	Stop	Stop	Stop
Traffic Vol by Lane	239	68	432
LT Vol	0	60	132
Through Vol	49	0	300
RT Vol	190	8	0
Lane Flow Rate	239	68	432
Geometry Grp	1	1	1
Degree of Util (X)	0.278	0.106	0.531
Departure Headway (Hd)	4.188	5.611	4.425
Convergence, Y/N	Yes	Yes	Yes
Cap	858	637	816
Service Time	2.215	3.659	2.449
HCM Lane V/C Ratio	0.279	0.107	0.529
HCM Control Delay	8.8	9.3	12.4
HCM Lane LOS	A	A	B
HCM 95th-tile Q	1.1	0.4	3.2

Intersection	
Intersection Delay, s/veh	13.5
Intersection LOS	B

Movement	EBL	EBT	EBR	WBL	WBT	WBR	NBL	NBT	NBR	SBL	SBT	SBR
Lane Configurations		↕			↕			↕			↕	
Traffic Vol, veh/h	77	233	14	12	23	10	7	170	46	61	262	38
Future Vol, veh/h	77	233	14	12	23	10	7	170	46	61	262	38
Peak Hour Factor	1.00	1.00	1.00	1.00	1.00	1.00	1.00	1.00	1.00	1.00	1.00	1.00
Heavy Vehicles, %	2	1	1	1	14	1	1	1	7	2	3	4
Mvmt Flow	77	233	14	12	23	10	7	170	46	61	262	38
Number of Lanes	0	1	0	0	1	0	0	1	0	0	1	0

Approach	EB	WB	NB	SB
Opposing Approach	WB	EB	SB	NB
Opposing Lanes	1	1	1	1
Conflicting Approach Left	SB	NB	EB	WB
Conflicting Lanes Left	1	1	1	1
Conflicting Approach Right	NB	SB	WB	EB
Conflicting Lanes Right	1	1	1	1
HCM Control Delay	14.3	9.6	11.3	14.5
HCM LOS	B	A	B	B

Lane	NBLn1	EBLn1	WBLn1	SBLn1
Vol Left, %		3%	24%	27%
Vol Thru, %		76%	72%	51%
Vol Right, %		21%	4%	22%
Sign Control		Stop	Stop	Stop
Traffic Vol by Lane		223	324	45
LT Vol		7	77	12
Through Vol		170	233	23
RT Vol		46	14	10
Lane Flow Rate		223	324	45
Geometry Grp		1	1	1
Degree of Util (X)		0.338	0.504	0.076
Departure Headway (Hd)		5.46	5.604	6.055
Convergence, Y/N		Yes	Yes	Yes
Cap		656	642	589
Service Time		3.511	3.652	4.125
HCM Lane V/C Ratio		0.34	0.505	0.076
HCM Control Delay		11.3	14.3	9.6
HCM Lane LOS		B	B	A
HCM 95th-tile Q		1.5	2.8	0.2

Lane Group	EBL	EBT	EBR	WBL	WBT	WBR	NBL	NBT	NBR	SBL	SBT	SBR
Lane Configurations												
Traffic Volume (vph)	96	1240	248	325	681	80	148	279	370	105	434	109
Future Volume (vph)	96	1240	248	325	681	80	148	279	370	105	434	109
Satd. Flow (prot)	1609	3468	1390	3013	3468	1567	3179	3338	1427	3238	3247	1427
Flt Permitted	0.950			0.950			0.950			0.950		
Satd. Flow (perm)	1604	3468	1368	3010	3468	1535	3154	3338	1402	3217	3247	1396
Satd. Flow (RTOR)			248			154			169			154
Lane Group Flow (vph)	96	1240	248	325	681	80	148	279	370	105	434	109
Turn Type	Prot	NA	Perm	Prot	NA	Perm	Prot	NA	Perm	Prot	NA	Perm
Protected Phases	5	2		1	6		3	8		7	4	
Permitted Phases			2			6			8			4
Total Split (s)	15.0	58.0	58.0	20.0	63.0	63.0	17.0	35.0	35.0	17.0	35.0	35.0
Total Lost Time (s)	6.4	7.3	7.3	6.4	7.3	7.3	7.6	7.4	7.4	7.6	7.4	7.4
Act Effct Green (s)	9.5	51.4	51.4	15.7	57.5	57.5	9.1	25.5	25.5	8.7	25.1	25.1
Actuated g/C Ratio	0.07	0.40	0.40	0.12	0.44	0.44	0.07	0.20	0.20	0.07	0.19	0.19
v/c Ratio	0.81	0.90	0.36	0.90	0.44	0.10	0.66	0.43	0.90	0.48	0.69	0.28
Control Delay	103.9	47.6	4.6	83.7	26.7	0.3	73.8	47.5	53.0	66.0	54.8	3.6
Queue Delay	0.0	0.0	0.0	0.0	0.0	0.0	0.0	0.0	0.0	0.0	0.0	0.0
Total Delay	103.9	47.6	4.6	83.7	26.7	0.3	73.8	47.5	53.0	66.0	54.8	3.6
LOS	F	D	A	F	C	A	E	D	D	E	D	A
Approach Delay		44.3			41.8			54.9			48.0	
Approach LOS		D			D			D			D	
Queue Length 50th (m)	22.9	144.8	0.0	~42.3	59.2	0.0	17.8	30.0	48.6	12.4	49.4	0.0
Queue Length 95th (m)	#53.8	#184.4	15.1	#69.5	74.6	0.0	28.1	42.5	#97.9	21.2	65.7	4.8
Internal Link Dist (m)		485.7			397.0			432.2			296.2	
Turn Bay Length (m)	85.0		225.0	100.0		45.0	140.0		110.0	80.0		55.0
Base Capacity (vph)	118	1371	690	363	1534	765	229	708	430	234	689	417
Starvation Cap Reductn	0	0	0	0	0	0	0	0	0	0	0	0
Spillback Cap Reductn	0	0	0	0	0	0	0	0	0	0	0	0
Storage Cap Reductn	0	0	0	0	0	0	0	0	0	0	0	0
Reduced v/c Ratio	0.81	0.90	0.36	0.90	0.44	0.10	0.65	0.39	0.86	0.45	0.63	0.26

Intersection Summary

Cycle Length: 130

Actuated Cycle Length: 130

Offset: 35 (27%), Referenced to phase 2:EBT and 6:WBT, Start of Green

Control Type: Actuated-Coordinated

Maximum v/c Ratio: 0.90

Intersection Signal Delay: 46.3

Intersection LOS: D

Intersection Capacity Utilization 88.8%

ICU Level of Service E

Analysis Period (min) 15

~ Volume exceeds capacity, queue is theoretically infinite.

Queue shown is maximum after two cycles.

95th percentile volume exceeds capacity, queue may be longer.

Queue shown is maximum after two cycles.

Splits and Phases: 1: Russell & Walkley

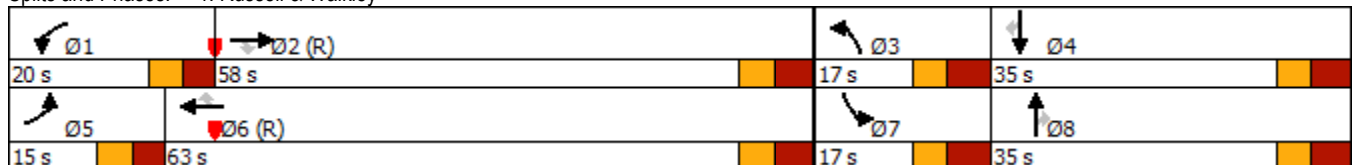

4055 & 4120 Russell Road
 2: Hawthorne & Russell

2023 Future Background PM Peak Hour Mod

Lane Group	EBL	EBT	EBR	WBL	WBT	WBR	NBL	NBT	NBR	SBL	SBT	SBR
Lane Configurations												
Traffic Volume (vph)	35	7	21	8	3	82	7	716	12	210	869	17
Future Volume (vph)	35	7	21	8	3	82	7	716	12	210	869	17
Satd. Flow (prot)	1624	1466	0	1768	1139	1508	1232	3292	0	1639	3270	0
Flt Permitted	0.756			0.739			0.318			0.375		
Satd. Flow (perm)	1291	1466	0	1376	1139	1488	412	3292	0	647	3270	0
Satd. Flow (RTOR)		21				82		4			4	
Lane Group Flow (vph)	35	28	0	8	3	82	7	728	0	210	886	0
Turn Type	Perm	NA		Perm	NA	Perm	Perm	NA		Perm	NA	
Protected Phases		4			8			2			6	
Permitted Phases	4			8		8	2			6		
Total Split (s)	26.0	26.0		26.0	26.0	26.0	54.0	54.0		54.0	54.0	
Total Lost Time (s)	5.7	5.7		5.7	5.7	5.7	6.5	6.5		6.5	6.5	
Act Effct Green (s)	10.1	10.1		10.1	10.1	10.1	62.1	62.1		62.1	62.1	
Actuated g/C Ratio	0.13	0.13		0.13	0.13	0.13	0.78	0.78		0.78	0.78	
v/c Ratio	0.21	0.14		0.05	0.02	0.32	0.02	0.28		0.42	0.35	
Control Delay	34.9	18.4		31.4	31.0	11.7	3.4	3.8		7.5	4.2	
Queue Delay	0.0	0.0		0.0	0.0	0.0	0.0	0.0		0.0	0.0	
Total Delay	34.9	18.4		31.4	31.0	11.7	3.4	3.8		7.5	4.2	
LOS	C	B		C	C	B	A	A		A	A	
Approach Delay		27.6			14.0			3.8			4.8	
Approach LOS		C			B			A			A	
Queue Length 50th (m)	4.5	0.9		1.0	0.4	0.0	0.2	15.3		9.8	20.1	
Queue Length 95th (m)	11.9	7.2		4.4	2.5	10.7	1.1	21.9		22.5	28.1	
Internal Link Dist (m)		63.3			159.0			795.0			432.2	
Turn Bay Length (m)	20.0			40.0		100.0	40.0			60.0		
Base Capacity (vph)	327	387		349	289	438	319	2557		502	2540	
Starvation Cap Reductn	0	0		0	0	0	0	0		0	0	
Spillback Cap Reductn	0	0		0	0	0	0	0		0	0	
Storage Cap Reductn	0	0		0	0	0	0	0		0	0	
Reduced v/c Ratio	0.11	0.07		0.02	0.01	0.19	0.02	0.28		0.42	0.35	

Intersection Summary

Cycle Length: 80
 Actuated Cycle Length: 80
 Offset: 16 (20%), Referenced to phase 2:NBTL and 6:SBTL, Start of Green
 Control Type: Actuated-Coordinated
 Maximum v/c Ratio: 0.42
 Intersection Signal Delay: 5.6
 Intersection LOS: A
 Intersection Capacity Utilization 58.6%
 ICU Level of Service B
 Analysis Period (min) 15

Splits and Phases: 2: Hawthorne & Russell

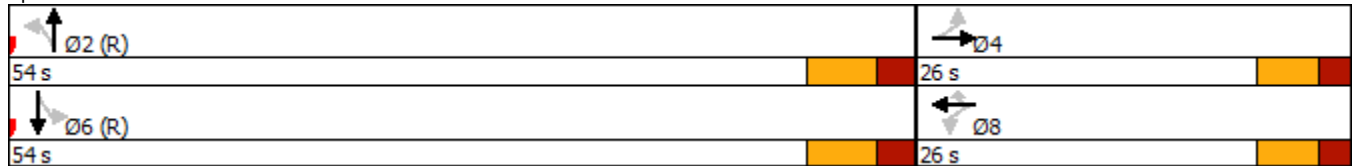

4055 & 4120 Russell Road
3: Hawthorne & Stevenage

2023 Future Background PM Peak Hour Mod

Lane Group	EBL	EBT	EBR	WBL	WBT	WBR	NBL	NBT	NBR	SBL	SBT	SBR
Lane Configurations												
Traffic Volume (vph)	201	39	221	100	29	81	82	372	59	45	950	144
Future Volume (vph)	201	39	221	100	29	81	82	372	59	45	950	144
Satd. Flow (prot)	1669	1490	0	1567	1426	0	1323	3069	0	1323	3402	1390
Flt Permitted	0.686			0.426			0.217			0.501		
Satd. Flow (perm)	1202	1490	0	703	1426	0	302	3069	0	698	3402	1352
Satd. Flow (RTOR)		221			81			23				144
Lane Group Flow (vph)	201	260	0	100	110	0	82	431	0	45	950	144
Turn Type	Perm	NA		Perm	NA		pm+pt	NA		pm+pt	NA	Perm
Protected Phases		4			8		5	2		1	6	
Permitted Phases	4			8			2			6		6
Total Split (s)	35.0	35.0		35.0	35.0		15.0	45.0		15.0	45.0	45.0
Total Lost Time (s)	5.7	5.7		5.7	5.7		5.7	5.5		5.7	5.5	5.5
Act Effct Green (s)	22.6	22.6		22.6	22.6		58.2	53.2		55.7	50.1	50.1
Actuated g/C Ratio	0.24	0.24		0.24	0.24		0.61	0.56		0.59	0.53	0.53
v/c Ratio	0.71	0.50		0.60	0.27		0.31	0.25		0.10	0.53	0.18
Control Delay	45.6	9.3		45.8	11.0		11.4	13.2		9.0	18.6	3.7
Queue Delay	0.0	0.0		0.0	0.0		0.0	0.0		0.0	0.0	0.0
Total Delay	45.6	9.3		45.8	11.0		11.4	13.2		9.0	18.6	3.7
LOS	D	A		D	B		B	B		A	B	A
Approach Delay		25.1			27.6			12.9			16.4	
Approach LOS		C			C			B			B	
Queue Length 50th (m)	30.7	5.1		14.8	3.8		4.9	19.8		2.6	57.1	0.0
Queue Length 95th (m)	48.7	21.5		28.3	14.2		12.0	34.0		7.5	86.4	9.8
Internal Link Dist (m)		201.3			257.1			958.8			795.0	
Turn Bay Length (m)	45.0			25.0			75.0			85.0		85.0
Base Capacity (vph)	370	612		216	495		286	1728		482	1792	780
Starvation Cap Reductn	0	0		0	0		0	0		0	0	0
Spillback Cap Reductn	0	0		0	0		0	0		0	0	0
Storage Cap Reductn	0	0		0	0		0	0		0	0	0
Reduced v/c Ratio	0.54	0.42		0.46	0.22		0.29	0.25		0.09	0.53	0.18

Intersection Summary

Cycle Length: 95

Actuated Cycle Length: 95

Offset: 0 (0%), Referenced to phase 2:NBTL and 6:SBTL, Start of Green

Control Type: Actuated-Coordinated

Maximum v/c Ratio: 0.71

Intersection Signal Delay: 18.3

Intersection LOS: B

Intersection Capacity Utilization 76.2%

ICU Level of Service D

Analysis Period (min) 15

Splits and Phases: 3: Hawthorne & Stevenage

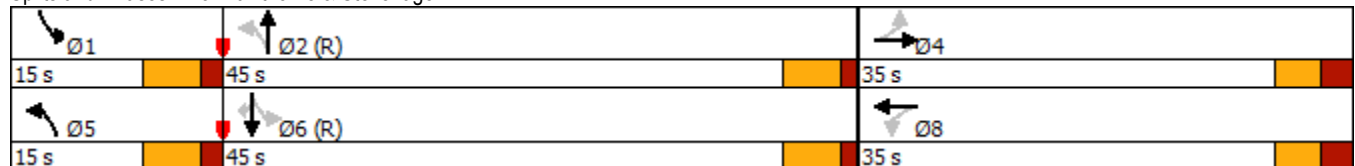

Lane Group	EBL	EBT	EBR	WBL	WBT	WBR	NBL	NBT	NBR	SBL	SBT	SBR
Lane Configurations												
Traffic Volume (vph)	254	809	24	423	870	87	25	193	307	167	494	467
Future Volume (vph)	254	809	24	423	870	87	25	193	307	167	494	467
Satd. Flow (prot)	3094	3422	0	3208	3468	1141	1717	2807	0	1609	3247	1522
Flt Permitted	0.950			0.950			0.471			0.195		
Satd. Flow (perm)	3094	3422	0	3205	3468	1141	851	2807	0	330	3247	1522
Satd. Flow (RTOR)		2				119		242				467
Lane Group Flow (vph)	254	833	0	423	870	87	25	500	0	167	494	467
Turn Type	Prot	NA		Prot	NA	Perm	pm+pt	NA		pm+pt	NA	Perm
Protected Phases	7	4		3	8		5	2		1	6	
Permitted Phases						8	2			6		6
Total Split (s)	36.4	48.4		44.4	56.4	56.4	21.3	32.3		21.3	32.3	32.3
Total Lost Time (s)	6.4	6.4		6.4	6.4	6.4	6.3	6.3		6.3	6.3	6.3
Act Effct Green (s)	15.4	36.6		21.3	42.5	42.5	25.7	18.8		38.6	31.2	31.2
Actuated g/C Ratio	0.13	0.31		0.18	0.37	0.37	0.22	0.16		0.33	0.27	0.27
v/c Ratio	0.62	0.77		0.72	0.69	0.18	0.10	0.76		0.65	0.57	0.62
Control Delay	57.1	42.9		53.7	35.4	2.8	30.5	32.6		43.3	42.6	7.8
Queue Delay	0.0	0.0		0.0	0.0	0.0	0.0	0.0		0.0	0.0	0.0
Total Delay	57.1	42.9		53.7	35.4	2.8	30.5	32.6		43.3	42.6	7.8
LOS	E	D		D	D	A	C	C		D	D	A
Approach Delay		46.2			38.9			32.5			28.3	
Approach LOS		D			D			C			C	
Queue Length 50th (m)	27.6	84.7		45.6	82.4	0.0	3.7	28.8		26.9	52.0	0.0
Queue Length 95th (m)	43.5	122.8		66.1	117.9	4.9	10.2	50.2		47.9	76.3	27.7
Internal Link Dist (m)		420.4			1343.9			595.0			958.8	
Turn Bay Length (m)	90.0			50.0		80.0	50.0			80.0		80.0
Base Capacity (vph)	823	1276		1080	1537	572	366	833		279	871	750
Starvation Cap Reductn	0	0		0	0	0	0	0		0	0	0
Spillback Cap Reductn	0	0		0	0	0	0	0		0	0	0
Storage Cap Reductn	0	0		0	0	0	0	0		0	0	0
Reduced v/c Ratio	0.31	0.65		0.39	0.57	0.15	0.07	0.60		0.60	0.57	0.62

Intersection Summary

Cycle Length: 146.4
 Actuated Cycle Length: 116.2
 Control Type: Semi Act-Uncoord
 Maximum v/c Ratio: 0.77
 Intersection Signal Delay: 37.1
 Intersection Capacity Utilization 84.4%
 Analysis Period (min) 15

Intersection LOS: D
 ICU Level of Service E

Splits and Phases: 4: Hawthorne & Hunt Club

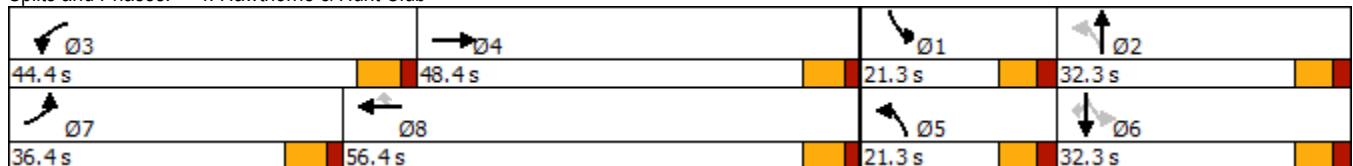



Lane Group	EBL	EBT	WBT	WBR	SBL	SBR
Lane Configurations		↑↑	↑↑		↓	↓
Traffic Volume (vph)	0	1574	184	0	174	636
Future Volume (vph)	0	1574	184	0	174	636
Satd. Flow (prot)	0	3402	3402	0	1701	1522
Flt Permitted					0.950	
Satd. Flow (perm)	0	3402	3402	0	1701	1522
Satd. Flow (RTOR)						636
Lane Group Flow (vph)	0	1574	184	0	174	636
Turn Type		NA	NA		Prot	Free
Protected Phases		4	8		6	
Permitted Phases						Free
Total Split (s)		57.0	57.0		33.0	
Total Lost Time (s)		6.3	6.3		6.3	
Act Effct Green (s)		62.9	62.9		14.5	90.0
Actuated g/C Ratio		0.70	0.70		0.16	1.00
v/c Ratio		0.66	0.08		0.64	0.42
Control Delay		10.0	5.0		45.3	0.8
Queue Delay		0.0	0.0		0.0	0.0
Total Delay		10.0	5.0		45.3	0.8
LOS		B	A		D	A
Approach Delay		10.0	5.0		10.4	
Approach LOS		B	A		B	
Queue Length 50th (m)		63.3	5.1		26.2	0.0
Queue Length 95th (m)		103.1	7.6		41.6	0.0
Internal Link Dist (m)		667.9	357.7		275.3	
Turn Bay Length (m)					100.0	
Base Capacity (vph)		2377	2377		504	1522
Starvation Cap Reductn		0	0		0	0
Spillback Cap Reductn		0	0		0	0
Storage Cap Reductn		0	0		0	0
Reduced v/c Ratio		0.66	0.08		0.35	0.42

Intersection Summary

Cycle Length: 90
 Actuated Cycle Length: 90
 Offset: 0 (0%), Referenced to phase 4:EBT and 8:WBT, Start of Green
 Control Type: Actuated-Coordinated
 Maximum v/c Ratio: 0.66
 Intersection Signal Delay: 9.8
 Intersection LOS: A
 Intersection Capacity Utilization 66.6%
 ICU Level of Service C
 Analysis Period (min) 15

Splits and Phases: 10: Walkley & SB off-ramp

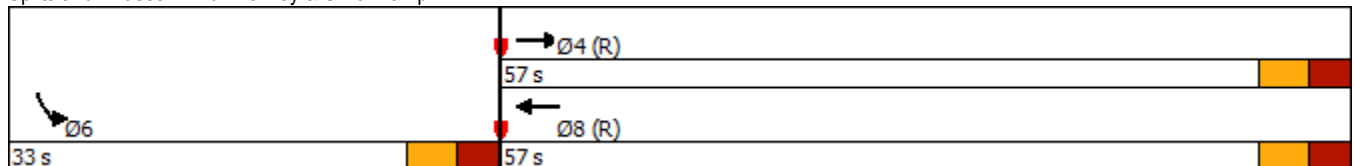

Scheme Summary

Control Data

Control Data and Model Parameters

119124	2023 PHF Flow Profile (veh)
2023 Background Traffic Volumes	7.5 min Time Slice
Rodel-Win1	Queuing Delays (sec)
Right Hand Drive	Daylight conditions
PM Peak Hour	Peak 60/15 min Results
AVERAGE DELAY to Geometry	Output flows: Vehicles
Metric Units (m)	85% Confidence Level

Available Data

Entry Capacity Calibrated	No
Entry Capacity Modified	No
Crosswalks	No
Flows Factored	No
Approach/Exit Road Capacity Calibrated	No
Accidents	No
Accident Costs	No
Bypass Model	No
Bypass Calibration	No
Global Results	Yes

Operational Data

Main Geometry (m)

Geometry and Design Target

Leg	Leg Names	Approach Geometry (m)				Target	Circulating and Exit Geom		
		Bearing (deg)	Grade Sep G	Half Width V	Lanes n	Average Delay (sec/veh)	Inscribed Diameter D	Half Width Vx	Lanes n
1	SB - Anderson	0	0	4.00	1	30	45.00	4.00	1
2	EB - Russell	90	0	4.00	1	30	45.00	4.00	1
3	NB- Anderson	180	0	4.00	1	30	45.00	4.00	1
4	WB - Russell	270	0	4.00	1	30	45.00	4.00	1

Capacity Modifiers and Capacity Calibration (veh/hr)

Leg	Leg Names	Entry Capacity		Entry Calibration		Approach Road			Exit Road		
		Capacity + or -	XWalk Factor	Intercept + or -	Slope Factor	V (m)	Default Capacity	Calib Capacity	V (m)	Default Capacity	Calib Capacity
1	SB - Anderson	0	1.000	0	1.000	6.00	1960	0	4.00	1960	0
2	EB - Russell	0	1.000	0	1.000	6.00	1960	0	4.00	1960	0
3	NB- Anderson	0	1.000	0	1.000	6.00	1960	0	4.00	1960	0
4	WB - Russell	0	1.000	0	1.000	6.00	1960	0	4.00	1960	0

Traffic Flow Data (veh/hr)

2023 PM Peak Peak Hour Flows

Leg	Leg Names	Turning Flows					Flow Modifiers		
		U-Turn	Exit-3	Exit-2	Exit-1	Bypass	Trucks %	Flow Factor	Peak Hour Factor
1	SB - Anderson	0	61	262	38	0	3.0	1.00	1.000
2	EB - Russell	0	77	233	14	0	3.0	1.00	1.000
3	NB- Anderson	0	7	170	46	0	3.0	1.00	1.000
4	WB - Russell	0	12	23	10	0	3.0	1.00	1.000

Operational Results

Geometry for Target Input

Geometry Options for 2023 PM Peak

				Leg 1 - SB - Anderson	
nv	ne	nc	nx	E (m)	L' (m)
1	1	1	1	4.00	0.00

Geometry Options for 2023 PM Peak

				Leg 2 - EB - Russell	
nv	ne	nc	nx	E (m)	L' (m)
1	1	1	1	4.00	0.00

Geometry Options for 2023 PM Peak

				Leg 3 - NB- Anderson	
nv	ne	nc	nx	E (m)	L' (m)
1	1	1	1	4.00	0.00

Geometry Options for 2023 PM Peak

				Leg 4 - WB - Russell	
nv	ne	nc	nx	E (m)	L' (m)
1	1	1	1	4.00	0.00

2023 PM Peak - 60 minutes

Flows and Capacity

Leg	Leg Names	Bypass Type	Flows (veh/hr)				Capacity (veh/hr)			
			Arrival Flow		Opposing Flow		Capacity		Average VCR	
			Entry	Bypass	Entry	Bypass	Entry	Bypass	Entry	Bypass
1	SB - Anderson	None	361		42		257	926		0.3900
2	EB - Russell	None	324		335		68	774		0.4185
3	NB- Anderson	None	223		371		288	755		0.2952
4	WB - Russell	None	45		254		340	816		0.0551

Delays, Queues and Level of Service

Leg	Leg Names	Bypass Type	Average Delay (sec)			95% Queue (veh)		Level of Service		
			Entry	Bypass	Leg	Entry	Bypass	Entry	Bypass	Leg
1	SB - Anderson	None	6.05		6.05	1.58		A		A
2	EB - Russell	None	7.56		7.56	1.77		A		A
3	NB- Anderson	None	6.46		6.46	1.05		A		A
4	WB - Russell	None	4.52		4.52	0.15		A		A

2023 PM Peak - 15 minutes

Flows and Capacity

Leg	Leg Names	Bypass Type	Flows (veh/hr)				Capacity (veh/hr)			
			Arrival Flow		Opposing Flow		Capacity		Average VCR	
			Entry	Bypass	Entry	Bypass	Entry	Bypass	Entry	Bypass
1	SB - Anderson	None	361		42		257	926		0.3900
2	EB - Russell	None	324		335		68	774		0.4185
3	NB- Anderson	None	223		371		288	755		0.2952
4	WB - Russell	None	45		254		340	816		0.0551

Delays, Queues and Level of Service

Leg	Leg Names	Bypass Type	Average Delay (sec)			95% Queue (veh)		Level of Service		
			Entry	Bypass	Leg	Entry	Bypass	Entry	Bypass	Leg
1	SB - Anderson	None	6.06		6.06	1.58		A		A
2	EB - Russell	None	7.58		7.58	1.77		A		A
3	NB- Anderson	None	6.47		6.47	1.05		A		A
4	WB - Russell	None	4.52		4.52	0.15		A		A

Lane Group	EBL	EBT	EBR	WBL	WBT	WBR	NBL	NBT	NBR	SBL	SBT	SBR
Lane Configurations												
Traffic Volume (vph)	76	486	198	464	1231	64	269	445	568	55	259	135
Future Volume (vph)	76	486	198	464	1231	64	269	445	568	55	259	135
Satd. Flow (prot)	1374	3307	1332	3013	3435	1522	3094	3218	1332	3269	3189	1390
Flt Permitted	0.950			0.950			0.950			0.950		
Satd. Flow (perm)	1372	3307	1332	3013	3435	1490	3083	3218	1314	3264	3189	1365
Satd. Flow (RTOR)			198			134			535			180
Lane Group Flow (vph)	76	486	198	464	1231	64	269	445	568	55	259	135
Turn Type	Prot	NA	Perm	Prot	NA	Perm	Prot	NA	Perm	Prot	NA	Perm
Protected Phases	5	2		1	6		3	8		7	4	
Permitted Phases			2			6			8			4
Total Split (s)	24.4	45.0	45.0	45.0	65.6	65.6	20.0	40.0	40.0	20.0	40.0	40.0
Total Lost Time (s)	6.4	7.3	7.3	6.4	7.3	7.3	7.6	7.4	7.4	7.6	7.4	7.4
Act Effct Green (s)	13.3	53.1	53.1	28.5	68.3	68.3	12.4	34.5	34.5	7.9	27.3	27.3
Actuated g/C Ratio	0.09	0.35	0.35	0.19	0.46	0.46	0.08	0.23	0.23	0.05	0.18	0.18
v/c Ratio	0.63	0.42	0.33	0.81	0.79	0.09	1.05	0.60	0.80	0.32	0.45	0.34
Control Delay	87.4	40.5	6.7	69.4	41.0	0.2	135.2	55.4	14.8	72.9	55.9	4.3
Queue Delay	0.0	0.0	0.0	0.0	0.0	0.0	0.0	0.0	0.0	0.0	0.0	0.0
Total Delay	87.4	40.5	6.7	69.4	41.0	0.2	135.2	55.4	14.8	72.9	55.9	4.3
LOS	F	D	A	E	D	A	F	E	B	E	E	A
Approach Delay		36.4			47.0			54.2			42.5	
Approach LOS		D			D			D			D	
Queue Length 50th (m)	20.4	56.0	0.0	63.5	159.5	0.0	-41.3	56.5	7.0	7.6	32.1	0.0
Queue Length 95th (m)	35.5	77.2	18.0	76.9	#207.8	0.0	#68.2	74.6	52.9	14.4	44.8	5.7
Internal Link Dist (m)		485.7			404.4			432.2			296.2	
Turn Bay Length (m)	85.0		225.0	100.0		45.0	140.0		110.0	80.0		55.0
Base Capacity (vph)	164	1170	598	775	1564	751	255	744	715	270	693	437
Starvation Cap Reductn	0	0	0	0	0	0	0	0	0	0	0	0
Spillback Cap Reductn	0	0	0	0	0	0	0	0	0	0	0	0
Storage Cap Reductn	0	0	0	0	0	0	0	0	0	0	0	0
Reduced v/c Ratio	0.46	0.42	0.33	0.60	0.79	0.09	1.05	0.60	0.79	0.20	0.37	0.31

Intersection Summary

Cycle Length: 150

Actuated Cycle Length: 150

Offset: 102 (68%), Referenced to phase 2:EBT and 6:WBT, Start of Green

Control Type: Actuated-Coordinated

Maximum v/c Ratio: 1.05

Intersection Signal Delay: 46.8

Intersection LOS: D

Intersection Capacity Utilization 82.1%

ICU Level of Service E

Analysis Period (min) 15

~ Volume exceeds capacity, queue is theoretically infinite.

Queue shown is maximum after two cycles.

95th percentile volume exceeds capacity, queue may be longer.

Queue shown is maximum after two cycles.

Splits and Phases: 1: Russell & Walkley

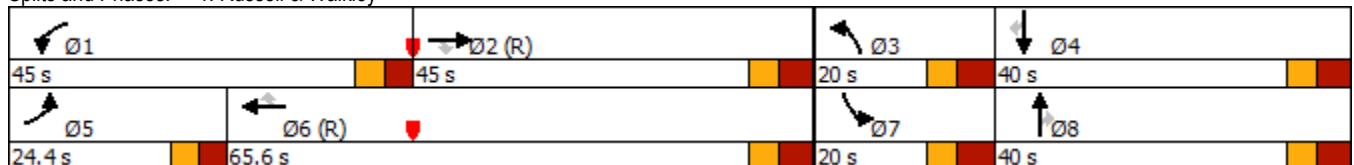

Lane Group	EBL	EBT	EBR	WBL	WBT	WBR	NBL	NBT	NBR	SBL	SBT	SBR
Lane Configurations												
Traffic Volume (vph)	10	0	8	40	10	490	17	891	43	227	548	34
Future Volume (vph)	10	0	8	40	10	490	17	891	43	227	548	34
Satd. Flow (prot)	1276	1278	0	1488	1790	1522	1701	3091	0	1488	2985	0
Flt Permitted	0.751			0.752			0.431			0.276		
Satd. Flow (perm)	1008	1278	0	1178	1790	1522	768	3091	0	432	2985	0
Satd. Flow (RTOR)		352				175		11			14	
Lane Group Flow (vph)	10	8	0	40	10	490	17	934	0	227	582	0
Turn Type	Perm	NA		Perm	NA	Perm	Perm	NA		Perm	NA	
Protected Phases		4			8			2			6	
Permitted Phases	4			8		8	2			6		
Total Split (s)	26.0	26.0		26.0	26.0	26.0	64.0	64.0		64.0	64.0	
Total Lost Time (s)	5.7	5.7		5.7	5.7	5.7	6.5	6.5		6.5	6.5	
Act Effct Green (s)	20.3	20.3		20.3	20.3	20.3	57.5	57.5		57.5	57.5	
Actuated g/C Ratio	0.23	0.23		0.23	0.23	0.23	0.64	0.64		0.64	0.64	
v/c Ratio	0.04	0.01		0.15	0.02	1.03	0.03	0.47		0.82	0.30	
Control Delay	28.1	0.0		29.8	27.5	72.0	3.9	6.6		39.9	7.6	
Queue Delay	0.0	0.0		0.0	0.0	0.0	0.0	0.0		0.0	0.0	
Total Delay	28.1	0.0		29.8	27.5	72.0	3.9	6.6		39.9	7.6	
LOS	C	A		C	C	E	A	A		D	A	
Approach Delay		15.6			68.0			6.5			16.7	
Approach LOS		B			E			A			B	
Queue Length 50th (m)	1.3	0.0		5.1	1.3	~60.2	0.5	13.0		24.7	19.0	
Queue Length 95th (m)	5.0	0.0		12.8	5.0	#114.3	m0.9	16.2		#69.6	26.5	
Internal Link Dist (m)		63.3			159.0			795.0			432.2	
Turn Bay Length (m)	20.0			40.0		100.0	40.0			60.0		
Base Capacity (vph)	227	560		265	403	478	490	1978		276	1912	
Starvation Cap Reductn	0	0		0	0	0	0	0		0	0	
Spillback Cap Reductn	0	0		0	0	0	0	0		0	0	
Storage Cap Reductn	0	0		0	0	0	0	0		0	0	
Reduced v/c Ratio	0.04	0.01		0.15	0.02	1.03	0.03	0.47		0.82	0.30	

Intersection Summary

Cycle Length: 90

Actuated Cycle Length: 90

Offset: 23 (26%), Referenced to phase 2:NBTL and 6:SBTL, Start of Green

Control Type: Actuated-Coordinated

Maximum v/c Ratio: 1.03

Intersection Signal Delay: 24.5

Intersection LOS: C

Intersection Capacity Utilization 82.7%

ICU Level of Service E

Analysis Period (min) 15

~ Volume exceeds capacity, queue is theoretically infinite.

Queue shown is maximum after two cycles.

95th percentile volume exceeds capacity, queue may be longer.

Queue shown is maximum after two cycles.

m Volume for 95th percentile queue is metered by upstream signal.

Splits and Phases: 2: Hawthorne & Russell

Ø2 (R)			Ø4		
64 s			26 s		
Ø6 (R)			Ø8		
64 s			26 s		

4055 & 4120 Russell Road
3: Hawthorne & Stevenage

2023 Total Traffic AM Peak Hour

Lane Group	EBL	EBT	EBR	WBL	WBT	WBR	NBL	NBT	NBR	SBL	SBT	SBR
Lane Configurations												
Traffic Volume (vph)	134	28	60	58	63	55	208	958	86	52	350	200
Future Volume (vph)	134	28	60	58	63	55	208	958	86	52	350	200
Satd. Flow (prot)	1553	1219	0	1276	1465	0	1669	3096	0	1429	2858	1453
Flt Permitted	0.681			0.700			0.487			0.239		
Satd. Flow (perm)	1113	1219	0	935	1465	0	852	3096	0	359	2858	1414
Satd. Flow (RTOR)		60			52			12				200
Lane Group Flow (vph)	134	88	0	58	118	0	208	1044	0	52	350	200
Turn Type	Perm	NA		Perm	NA		pm+pt	NA		pm+pt	NA	Perm
Protected Phases		4			8		5	2		1	6	
Permitted Phases	4			8			2			6		6
Total Split (s)	35.0	35.0		35.0	35.0		15.0	40.0		15.0	40.0	40.0
Total Lost Time (s)	5.7	5.7		5.7	5.7		5.7	5.5		5.7	5.5	5.5
Act Effct Green (s)	16.9	16.9		16.9	16.9		60.6	54.0		53.0	46.4	46.4
Actuated g/C Ratio	0.19	0.19		0.19	0.19		0.67	0.60		0.59	0.52	0.52
v/c Ratio	0.64	0.32		0.33	0.37		0.31	0.56		0.18	0.24	0.24
Control Delay	46.6	14.8		34.5	20.5		7.5	15.0		4.9	10.6	6.0
Queue Delay	0.0	0.0		0.0	0.0		0.0	0.0		0.0	0.0	0.0
Total Delay	46.6	14.8		34.5	20.5		7.5	15.0		4.9	10.6	6.0
LOS	D	B		C	C		A	B		A	B	A
Approach Delay		34.0			25.1			13.7			8.6	
Approach LOS		C			C			B			A	
Queue Length 50th (m)	20.1	3.8		8.2	9.1		10.0	53.5		1.5	16.8	5.1
Queue Length 95th (m)	33.0	13.4		16.2	20.1		23.8	93.6		2.2	32.4	23.5
Internal Link Dist (m)		201.3			257.1			958.8			795.0	
Turn Bay Length (m)	45.0			25.0			75.0			85.0		85.0
Base Capacity (vph)	362	437		304	512		669	1863		332	1474	826
Starvation Cap Reductn	0	0		0	0		0	0		0	0	0
Spillback Cap Reductn	0	0		0	0		0	0		0	0	0
Storage Cap Reductn	0	0		0	0		0	0		0	0	0
Reduced v/c Ratio	0.37	0.20		0.19	0.23		0.31	0.56		0.16	0.24	0.24

Intersection Summary

Cycle Length: 90

Actuated Cycle Length: 90

Offset: 0 (0%), Referenced to phase 2:NBTL and 6:SBTL, Start of Green

Control Type: Actuated-Coordinated

Maximum v/c Ratio: 0.64

Intersection Signal Delay: 15.2

Intersection LOS: B

Intersection Capacity Utilization 63.8%

ICU Level of Service B

Analysis Period (min) 15

Splits and Phases: 3: Hawthorne & Stevenage

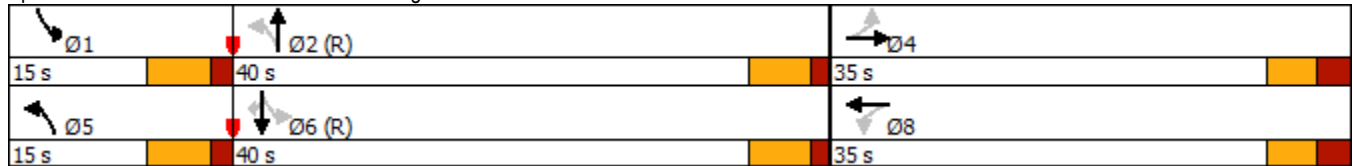

Lane Group	EBL	EBT	EBR	WBL	WBT	WBR	NBL	NBT	NBR	SBL	SBT	SBR
Lane Configurations												
Traffic Volume (vph)	451	673	25	251	715	246	40	412	382	43	147	197
Future Volume (vph)	451	673	25	251	715	246	40	412	382	43	147	197
Satd. Flow (prot)	1639	3337	0	1595	3402	1440	1488	2974	0	1191	2748	1278
Flt Permitted	0.950			0.950			0.659			0.129		
Satd. Flow (perm)	1639	3337	0	1595	3402	1440	1032	2974	0	162	2748	1278
Satd. Flow (RTOR)		2				246		152				197
Lane Group Flow (vph)	451	698	0	251	715	246	40	794	0	43	147	197
Turn Type	Prot	NA		Prot	NA	Perm	pm+pt	NA		pm+pt	NA	Perm
Protected Phases	7	4		3	8		5	2		1	6	
Permitted Phases						8	2			6		6
Total Split (s)	41.4	41.4		41.4	41.4	41.4	21.3	36.3		21.3	36.3	36.3
Total Lost Time (s)	6.4	6.4		6.4	6.4	6.4	6.3	6.3		6.3	6.3	6.3
Act Effct Green (s)	35.2	42.9		25.6	33.2	33.2	36.8	30.2		38.5	31.1	31.1
Actuated g/C Ratio	0.27	0.33		0.20	0.25	0.25	0.28	0.23		0.30	0.24	0.24
v/c Ratio	1.02	0.63		0.80	0.82	0.45	0.13	0.99		0.37	0.22	0.43
Control Delay	95.0	42.4		69.3	55.3	7.5	31.4	69.0		39.7	42.7	8.8
Queue Delay	0.0	0.0		0.0	0.0	0.0	0.0	0.0		0.0	0.0	0.0
Total Delay	95.0	42.4		69.3	55.3	7.5	31.4	69.0		39.7	42.7	8.8
LOS	F	D		E	E	A	C	E		D	D	A
Approach Delay		63.0			48.5			67.2			25.1	
Approach LOS		E			D			E			C	
Queue Length 50th (m)	~120.2	76.0		59.1	86.3	0.0	6.6	~88.8		7.2	15.4	0.0
Queue Length 95th (m)	#186.8	108.8		83.2	111.5	19.4	14.4	#133.1		15.4	25.0	18.8
Internal Link Dist (m)		420.4			459.3			595.0			958.8	
Turn Bay Length (m)	90.0			50.0		80.0	50.0			80.0		80.0
Base Capacity (vph)	443	1100		431	921	569	382	806		171	655	454
Starvation Cap Reductn	0	0		0	0	0	0	0		0	0	0
Spillback Cap Reductn	0	0		0	0	0	0	0		0	0	0
Storage Cap Reductn	0	0		0	0	0	0	0		0	0	0
Reduced v/c Ratio	1.02	0.63		0.58	0.78	0.43	0.10	0.99		0.25	0.22	0.43

Intersection Summary

Cycle Length: 140.4
 Actuated Cycle Length: 130.2
 Control Type: Semi Act-Uncoord
 Maximum v/c Ratio: 1.02
 Intersection Signal Delay: 55.0
 Intersection Capacity Utilization 97.7%
 Analysis Period (min) 15
 ~ Volume exceeds capacity, queue is theoretically infinite.
 Queue shown is maximum after two cycles.
 # 95th percentile volume exceeds capacity, queue may be longer.
 Queue shown is maximum after two cycles.

Splits and Phases: 4: Hawthorne & Hunt Club

Ø3	Ø4	Ø1	Ø2
41.4 s	41.4 s	21.3 s	36.3 s
Ø7	Ø8	Ø5	Ø6
41.4 s	41.4 s	21.3 s	36.3 s



Lane Group	EBL	EBT	WBT	WBR	SBL	SBR
Lane Configurations						
Traffic Volume (vph)	48	1050	1476	117	92	37
Future Volume (vph)	48	1050	1476	117	92	37
Satd. Flow (prot)	1701	3402	3364	0	1662	0
Flt Permitted	0.117				0.966	
Satd. Flow (perm)	209	3402	3364	0	1662	0
Satd. Flow (RTOR)			14		6	
Lane Group Flow (vph)	48	1050	1593	0	129	0
Turn Type	Perm	NA	NA		Prot	
Protected Phases		2	6		4	
Permitted Phases	2					
Total Split (s)	34.0	34.0	34.0		36.2	
Total Lost Time (s)	6.4	6.4	6.4		5.8	
Act Effct Green (s)	51.1	51.1	51.1		10.6	
Actuated g/C Ratio	0.73	0.73	0.73		0.15	
v/c Ratio	0.32	0.42	0.65		0.50	
Control Delay	13.5	6.1	8.7		32.1	
Queue Delay	0.0	0.0	0.0		0.0	
Total Delay	13.5	6.1	8.7		32.1	
LOS	B	A	A		C	
Approach Delay		6.4	8.7		32.1	
Approach LOS		A	A		C	
Queue Length 50th (m)	2.0	26.1	51.5		13.8	
Queue Length 95th (m)	11.0	45.3	89.5		25.7	
Internal Link Dist (m)		459.3	853.4		137.8	
Turn Bay Length (m)	30.0				30.0	
Base Capacity (vph)	152	2474	2450		723	
Starvation Cap Reductn	0	0	0		0	
Spillback Cap Reductn	0	0	0		0	
Storage Cap Reductn	0	0	0		0	
Reduced v/c Ratio	0.32	0.42	0.65		0.18	

Intersection Summary

Cycle Length: 70.2
 Actuated Cycle Length: 70.2
 Offset: 0 (0%), Referenced to phase 2:EBTL and 6:WBT, Start of Green
 Control Type: Actuated-Coordinated
 Maximum v/c Ratio: 0.65
 Intersection Signal Delay: 8.9
 Intersection Capacity Utilization 64.9%
 Analysis Period (min) 15
 Intersection LOS: A
 ICU Level of Service C

Splits and Phases: 12: Hunt Club & Access

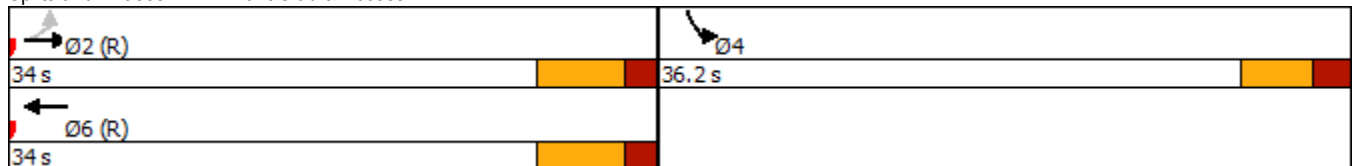



Movement	EBT	EBR	WBL	WBT	NBL	NBR
Lane Configurations						
Traffic Volume (veh/h)	193	42	155	580	39	22
Future Volume (Veh/h)	193	42	155	580	39	22
Sign Control	Free		Free		Stop	
Grade	0%		0%		0%	
Peak Hour Factor	1.00	1.00	1.00	1.00	1.00	1.00
Hourly flow rate (vph)	193	42	155	580	39	22
Pedestrians						
Lane Width (m)						
Walking Speed (m/s)						
Percent Blockage						
Right turn flare (veh)						
Median type	None		None			
Median storage (veh)						
Upstream signal (m)						
pX, platoon unblocked						
vC, conflicting volume			235		1104	214
vC1, stage 1 conf vol						
vC2, stage 2 conf vol						
vCu, unblocked vol			235		1104	214
tC, single (s)			4.1		6.8	6.5
tC, 2 stage (s)						
tF (s)			2.2		3.9	3.5
p0 queue free %			88		78	97
cM capacity (veh/h)			1326		175	771

Direction, Lane #	EB 1	WB 1	NB 1
Volume Total	235	735	61
Volume Left	0	155	39
Volume Right	42	0	22
cSH	1700	1326	242
Volume to Capacity	0.14	0.12	0.25
Queue Length 95th (m)	0.0	2.8	6.8
Control Delay (s)	0.0	2.8	24.8
Lane LOS		A	C
Approach Delay (s)	0.0	2.8	24.8
Approach LOS			C

Intersection Summary			
Average Delay		3.5	
Intersection Capacity Utilization		68.4%	ICU Level of Service C
Analysis Period (min)		15	



Movement	EBL	EBR	NBL	NBT	SBT	SBR
Lane Configurations						
Traffic Volume (veh/h)	2	921	0	923	671	0
Future Volume (Veh/h)	2	921	0	923	671	0
Sign Control	Stop			Free	Free	
Grade	0%			0%	0%	
Peak Hour Factor	1.00	1.00	1.00	1.00	1.00	1.00
Hourly flow rate (vph)	2	921	0	923	671	0
Pedestrians						
Lane Width (m)						
Walking Speed (m/s)						
Percent Blockage						
Right turn flare (veh)						
Median type				None	None	
Median storage (veh)						
Upstream signal (m)						
pX, platoon unblocked						
vC, conflicting volume	1594	671	671			
vC1, stage 1 conf vol						
vC2, stage 2 conf vol						
vCu, unblocked vol	1594	671	671			
tC, single (s)	6.4	6.3	4.1			
tC, 2 stage (s)						
tF (s)	3.5	3.4	2.2			
p0 queue free %	98	0	100			
cM capacity (veh/h)	118	444	929			
Direction, Lane #						
	EB 1	EB 2	NB 1	SB 1		
Volume Total	2	921	923	671		
Volume Left	2	0	0	0		
Volume Right	0	921	0	0		
cSH	118	444	1700	1700		
Volume to Capacity	0.02	2.07	0.54	0.39		
Queue Length 95th (m)	0.4	454.3	0.0	0.0		
Control Delay (s)	35.9	510.9	0.0	0.0		
Lane LOS	E	F				
Approach Delay (s)	509.9		0.0	0.0		
Approach LOS	F					
Intersection Summary						
Average Delay			187.0			
Intersection Capacity Utilization			104.1%	ICU Level of Service		G
Analysis Period (min)			15			



Movement	EBL	EBR	NBL	NBT	SBT	SBR
Lane Configurations						
Traffic Volume (veh/h)	41	39	411	347	145	222
Future Volume (Veh/h)	41	39	411	347	145	222
Sign Control	Stop			Free	Free	
Grade	0%			0%	0%	
Peak Hour Factor	1.00	1.00	1.00	1.00	1.00	1.00
Hourly flow rate (vph)	41	39	411	347	145	222
Pedestrians	2					
Lane Width (m)	4.0					
Walking Speed (m/s)	1.0					
Percent Blockage	0					
Right turn flare (veh)						
Median type				None	None	
Median storage (veh)						
Upstream signal (m)						
pX, platoon unblocked						
vC, conflicting volume	1425	258	367			
vC1, stage 1 conf vol						
vC2, stage 2 conf vol						
vCu, unblocked vol	1425	258	367			
tC, single (s)	6.9	6.4	4.1			
tC, 2 stage (s)						
tF (s)	4.0	3.5	2.2			
p0 queue free %	46	95	65			
cM capacity (veh/h)	77	737	1181			
Direction, Lane #	EB 1	NB 1	SB 1			
Volume Total	80	758	367			
Volume Left	41	411	0			
Volume Right	39	0	222			
cSH	136	1181	1700			
Volume to Capacity	0.59	0.35	0.22			
Queue Length 95th (m)	21.0	11.0	0.0			
Control Delay (s)	63.8	7.2	0.0			
Lane LOS	F	A				
Approach Delay (s)	63.8	7.2	0.0			
Approach LOS	F					
Intersection Summary						
Average Delay	8.7					
Intersection Capacity Utilization	81.3%			ICU Level of Service	D	
Analysis Period (min)	15					



Movement	EBL	EBT	WBT	WBR	SBL	SBR
Lane Configurations		↑↑	↑↑		↓	↓
Traffic Volume (veh/h)	0	531	994	0	23	1039
Future Volume (Veh/h)	0	531	994	0	23	1039
Sign Control		Free	Free		Stop	
Grade		0%	0%		0%	
Peak Hour Factor	1.00	1.00	1.00	1.00	1.00	1.00
Hourly flow rate (vph)	0	531	994	0	23	1039
Pedestrians						
Lane Width (m)						
Walking Speed (m/s)						
Percent Blockage						
Right turn flare (veh)						
Median type		None	None			
Median storage (veh)						
Upstream signal (m)						
pX, platoon unblocked						
vC, conflicting volume	994				1260	497
vC1, stage 1 conf vol						
vC2, stage 2 conf vol						
vCu, unblocked vol	994				1260	497
tC, single (s)	4.2				6.9	7.0
tC, 2 stage (s)						
tF (s)	2.2				3.5	3.3
p0 queue free %	100				85	0
cM capacity (veh/h)	674				158	511
Direction, Lane #	EB 1	EB 2	WB 1	WB 2	SB 1	SB 2
Volume Total	266	266	497	497	23	1039
Volume Left	0	0	0	0	23	0
Volume Right	0	0	0	0	0	1039
cSH	1700	1700	1700	1700	158	511
Volume to Capacity	0.16	0.16	0.29	0.29	0.15	2.03
Queue Length 95th (m)	0.0	0.0	0.0	0.0	3.5	500.5
Control Delay (s)	0.0	0.0	0.0	0.0	31.5	491.1
Lane LOS					D	F
Approach Delay (s)	0.0		0.0		481.2	
Approach LOS					F	
Intersection Summary						
Average Delay			197.5			
Intersection Capacity Utilization			103.6%		ICU Level of Service	G
Analysis Period (min)			15			

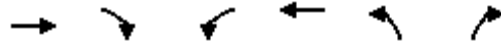

Movement	EBT	EBR	WBL	WBT	NBL	NBR
Lane Configurations	↑↑			↑↑	↘	
Traffic Volume (veh/h)	164	0	0	930	553	57
Future Volume (Veh/h)	164	0	0	930	553	57
Sign Control	Free			Free	Stop	
Grade	0%			0%	0%	
Peak Hour Factor	1.00	1.00	1.00	1.00	1.00	1.00
Hourly flow rate (vph)	164	0	0	930	553	57
Pedestrians						
Lane Width (m)						
Walking Speed (m/s)						
Percent Blockage						
Right turn flare (veh)						
Median type	None		None			
Median storage (veh)						
Upstream signal (m)						
pX, platoon unblocked						
vC, conflicting volume			164		629	82
vC1, stage 1 conf vol						
vC2, stage 2 conf vol						
vCu, unblocked vol			164		629	82
tC, single (s)			4.2		6.9	7.0
tC, 2 stage (s)						
tF (s)			2.2		3.5	3.3
p0 queue free %			100		0	94
cM capacity (veh/h)			1390		408	952
Direction, Lane #	EB 1	EB 2	WB 1	WB 2	NB 1	
Volume Total	82	82	465	465	610	
Volume Left	0	0	0	0	553	
Volume Right	0	0	0	0	57	
cSH	1700	1700	1700	1700	431	
Volume to Capacity	0.05	0.05	0.27	0.27	1.42	
Queue Length 95th (m)	0.0	0.0	0.0	0.0	210.3	
Control Delay (s)	0.0	0.0	0.0	0.0	225.9	
Lane LOS					F	
Approach Delay (s)	0.0		0.0		225.9	
Approach LOS					F	
Intersection Summary						
Average Delay			80.9			
Intersection Capacity Utilization			103.6%		ICU Level of Service	G
Analysis Period (min)			15			



















Movement	EBL	EBT	WBT	WBR	SBL	SBR
Lane Configurations						
Traffic Volume (veh/h)	136	142	515	48	45	129
Future Volume (Veh/h)	136	142	515	48	45	129
Sign Control		Free	Free		Stop	
Grade		0%	0%		0%	
Peak Hour Factor	1.00	1.00	1.00	1.00	1.00	1.00
Hourly flow rate (vph)	136	142	515	48	45	129
Pedestrians						
Lane Width (m)						
Walking Speed (m/s)						
Percent Blockage						
Right turn flare (veh)						
Median type		None	None			
Median storage (veh)						
Upstream signal (m)						
pX, platoon unblocked						
vC, conflicting volume	563				953	539
vC1, stage 1 conf vol						
vC2, stage 2 conf vol						
vCu, unblocked vol	563				953	539
tC, single (s)	4.1				6.4	6.2
tC, 2 stage (s)						
tF (s)	2.2				3.5	3.3
p0 queue free %	86				82	76
cM capacity (veh/h)	994				245	537
Direction, Lane #	EB 1	EB 2	WB 1	SB 1	SB 2	
Volume Total	136	142	563	45	129	
Volume Left	136	0	0	45	0	
Volume Right	0	0	48	0	129	
cSH	994	1700	1700	245	537	
Volume to Capacity	0.14	0.08	0.33	0.18	0.24	
Queue Length 95th (m)	3.3	0.0	0.0	4.6	6.5	
Control Delay (s)	9.2	0.0	0.0	23.0	13.8	
Lane LOS	A			C	B	
Approach Delay (s)	4.5		0.0	16.2		
Approach LOS				C		
Intersection Summary						
Average Delay			4.0			
Intersection Capacity Utilization			53.0%	ICU Level of Service		A
Analysis Period (min)			15			



















Movement	EBL	EBT	WBT	WBR	SBL	SBR
Lane Configurations						
Traffic Volume (veh/h)	58	129	508	111	106	55
Future Volume (Veh/h)	58	129	508	111	106	55
Sign Control		Free	Free		Stop	
Grade		0%	0%		0%	
Peak Hour Factor	1.00	1.00	1.00	1.00	1.00	1.00
Hourly flow rate (vph)	58	129	508	111	106	55
Pedestrians						
Lane Width (m)						
Walking Speed (m/s)						
Percent Blockage						
Right turn flare (veh)						
Median type		None	None			
Median storage (veh)						
Upstream signal (m)						
pX, platoon unblocked						
vC, conflicting volume	619				808	564
vC1, stage 1 conf vol						
vC2, stage 2 conf vol						
vCu, unblocked vol	619				808	564
tC, single (s)	4.1				6.4	6.2
tC, 2 stage (s)						
tF (s)	2.2				3.5	3.3
p0 queue free %	94				67	89
cM capacity (veh/h)	947				325	520
Direction, Lane #						
	EB 1	EB 2	WB 1	SB 1		
Volume Total	58	129	619	161		
Volume Left	58	0	0	106		
Volume Right	0	0	111	55		
cSH	947	1700	1700	373		
Volume to Capacity	0.06	0.08	0.36	0.43		
Queue Length 95th (m)	1.4	0.0	0.0	14.8		
Control Delay (s)	9.0	0.0	0.0	21.8		
Lane LOS	A			C		
Approach Delay (s)	2.8		0.0	21.8		
Approach LOS				C		
Intersection Summary						
Average Delay			4.2			
Intersection Capacity Utilization			58.5%		ICU Level of Service	B
Analysis Period (min)			15			

4055 & 4120 Russell Road
 15: Site 2/Building F & Russell

2023 Total Traffic AM Peak Hour

												
Movement	EBL	EBT	EBR	WBL	WBT	WBR	NBL	NBT	NBR	SBL	SBT	SBR
Lane Configurations												
Traffic Volume (veh/h)	1	85	131	2	607	0	128	2	1	0	1	0
Future Volume (Veh/h)	1	85	131	2	607	0	128	2	1	0	1	0
Sign Control		Free			Free			Stop			Stop	
Grade		0%			0%			0%			0%	
Peak Hour Factor	1.00	1.00	1.00	1.00	1.00	1.00	1.00	1.00	1.00	1.00	1.00	1.00
Hourly flow rate (vph)	1	85	131	2	607	0	128	2	1	0	1	0
Pedestrians												
Lane Width (m)												
Walking Speed (m/s)												
Percent Blockage												
Right turn flare (veh)												
Median type		None			None							
Median storage (veh)												
Upstream signal (m)												
pX, platoon unblocked												
vC, conflicting volume	607			216			764	764	150	766	829	607
vC1, stage 1 conf vol												
vC2, stage 2 conf vol												
vCu, unblocked vol	607			216			764	764	150	766	829	607
tC, single (s)	4.1			4.1			7.1	6.5	6.2	7.1	6.5	6.2
tC, 2 stage (s)												
tF (s)	2.2			2.2			3.5	4.0	3.3	3.5	4.0	3.3
p0 queue free %	100			100			59	99	100	100	100	100
cM capacity (veh/h)	957			1336			315	330	888	314	302	491
Direction, Lane #	EB 1	WB 1	NB 1	SB 1								
Volume Total	217	609	131	1								
Volume Left	1	2	128	0								
Volume Right	131	0	1	0								
cSH	957	1336	317	302								
Volume to Capacity	0.00	0.00	0.41	0.00								
Queue Length 95th (m)	0.0	0.0	13.6	0.1								
Control Delay (s)	0.1	0.0	24.1	17.0								
Lane LOS	A	A	C	C								
Approach Delay (s)	0.1	0.0	24.1	17.0								
Approach LOS			C	C								
Intersection Summary												
Average Delay			3.4									
Intersection Capacity Utilization			56.2%		ICU Level of Service				B			
Analysis Period (min)			15									

												
Movement	EBL	EBT	EBR	WBL	WBT	WBR	NBL	NBT	NBR	SBL	SBT	SBR
Lane Configurations												
Traffic Volume (veh/h)	1	82	3	1	608	0	1	0	0	0	0	0
Future Volume (Veh/h)	1	82	3	1	608	0	1	0	0	0	0	0
Sign Control		Free			Free			Stop			Stop	
Grade		0%			0%			0%			0%	
Peak Hour Factor	1.00	1.00	1.00	1.00	1.00	1.00	1.00	1.00	1.00	1.00	1.00	1.00
Hourly flow rate (vph)	1	82	3	1	608	0	1	0	0	0	0	0
Pedestrians												
Lane Width (m)												
Walking Speed (m/s)												
Percent Blockage												
Right turn flare (veh)												
Median type		None			None							
Median storage (veh)												
Upstream signal (m)												
pX, platoon unblocked												
vC, conflicting volume	608			85			696	696	84	696	697	608
vC1, stage 1 conf vol												
vC2, stage 2 conf vol												
vCu, unblocked vol	608			85			696	696	84	696	697	608
tC, single (s)	4.1			4.1			7.1	6.5	6.2	7.1	6.5	6.2
tC, 2 stage (s)												
tF (s)	2.2			2.2			3.5	4.0	3.3	3.5	4.0	3.3
p0 queue free %	100			100			100	100	100	100	100	100
cM capacity (veh/h)	956			1493			352	361	968	352	360	490
Direction, Lane #	EB 1	WB 1	NB 1	SB 1								
Volume Total	86	609	1	0								
Volume Left	1	1	1	0								
Volume Right	3	0	0	0								
cSH	956	1493	352	1700								
Volume to Capacity	0.00	0.00	0.00	0.00								
Queue Length 95th (m)	0.0	0.0	0.1	0.0								
Control Delay (s)	0.1	0.0	15.3	0.0								
Lane LOS	A	A	C	A								
Approach Delay (s)	0.1	0.0	15.3	0.0								
Approach LOS			C	A								
Intersection Summary												
Average Delay			0.1									
Intersection Capacity Utilization			44.4%		ICU Level of Service				A			
Analysis Period (min)			15									

Intersection	
Intersection Delay, s/veh	23.8
Intersection LOS	C

Movement	WBL	WBR	NBT	NBR	SBL	SBT
Lane Configurations	W		T			T
Traffic Vol, veh/h	308	300	340	53	10	22
Future Vol, veh/h	308	300	340	53	10	22
Peak Hour Factor	1.00	1.00	1.00	1.00	1.00	1.00
Heavy Vehicles, %	4	1	1	15	1	20
Mvmt Flow	308	300	340	53	10	22
Number of Lanes	1	0	1	0	0	1

Approach	WB	NB	SB
Opposing Approach		SB	NB
Opposing Lanes	0	1	1
Conflicting Approach Left	NB		WB
Conflicting Lanes Left	1	0	1
Conflicting Approach Right	SB	WB	
Conflicting Lanes Right	1	1	0
HCM Control Delay	29.1	16.7	9.7
HCM LOS	D	C	A

Lane	NBLn1	WBLn1	SBLn1
Vol Left, %	0%	51%	31%
Vol Thru, %	87%	0%	69%
Vol Right, %	13%	49%	0%
Sign Control	Stop	Stop	Stop
Traffic Vol by Lane	393	608	32
LT Vol	0	308	10
Through Vol	340	0	22
RT Vol	53	300	0
Lane Flow Rate	393	608	32
Geometry Grp	1	1	1
Degree of Util (X)	0.604	0.845	0.056
Departure Headway (Hd)	5.53	5.004	6.31
Convergence, Y/N	Yes	Yes	Yes
Cap	652	724	566
Service Time	3.568	3.038	4.369
HCM Lane V/C Ratio	0.603	0.84	0.057
HCM Control Delay	16.7	29.1	9.7
HCM Lane LOS	C	D	A
HCM 95th-tile Q	4.1	9.6	0.2

Intersection	
Intersection Delay, s/veh	41.7
Intersection LOS	E

Movement	EBL	EBT	EBR	WBL	WBT	WBR	NBL	NBT	NBR	SBL	SBT	SBR
Lane Configurations		↕			↕			↕			↕	
Traffic Vol, veh/h	35	16	20	48	331	118	189	304	6	5	139	153
Future Vol, veh/h	35	16	20	48	331	118	189	304	6	5	139	153
Peak Hour Factor	1.00	1.00	1.00	1.00	1.00	1.00	1.00	1.00	1.00	1.00	1.00	1.00
Heavy Vehicles, %	11	7	1	1	2	3	1	3	17	1	4	2
Mvmt Flow	35	16	20	48	331	118	189	304	6	5	139	153
Number of Lanes	0	1	0	0	1	0	0	1	0	0	1	0

Approach	EB	WB	NB	SB
Opposing Approach	WB	EB	SB	NB
Opposing Lanes	1	1	1	1
Conflicting Approach Left	SB	NB	EB	WB
Conflicting Lanes Left	1	1	1	1
Conflicting Approach Right	NB	SB	WB	EB
Conflicting Lanes Right	1	1	1	1
HCM Control Delay	13.1	48.2	52.8	19
HCM LOS	B	E	F	C

Lane	NBLn1	EBLn1	WBLn1	SBLn1
Vol Left, %		38%	49%	10%
Vol Thru, %		61%	23%	67%
Vol Right, %		1%	28%	24%
Sign Control		Stop	Stop	Stop
Traffic Vol by Lane		499	71	497
LT Vol		189	35	48
Through Vol		304	16	331
RT Vol		6	20	118
Lane Flow Rate		499	71	497
Geometry Grp		1	1	1
Degree of Util (X)		0.945	0.165	0.924
Departure Headway (Hd)		6.816	8.386	6.694
Convergence, Y/N		Yes	Yes	Yes
Cap		534	425	542
Service Time		4.849	6.48	4.723
HCM Lane V/C Ratio		0.934	0.167	0.917
HCM Control Delay		52.8	13.1	48.2
HCM Lane LOS		F	B	E
HCM 95th-tile Q		12	0.6	11.3

4055 & 4120 Russell Road
12: Hunt Club & Access

2023 Total Traffic AM Peak Hour Unsignalized



Movement	EBL	EBT	WBT	WBR	SBL	SBR
Lane Configurations						
Traffic Volume (veh/h)	48	1050	1485	117	92	37
Future Volume (Veh/h)	48	1050	1485	117	92	37
Sign Control		Free	Free		Stop	
Grade		0%	0%		0%	
Peak Hour Factor	1.00	1.00	1.00	1.00	1.00	1.00
Hourly flow rate (vph)	48	1050	1485	117	92	37
Pedestrians						
Lane Width (m)						
Walking Speed (m/s)						
Percent Blockage						
Right turn flare (veh)						
Median type		None	None			
Median storage (veh)						
Upstream signal (m)						
pX, platoon unblocked						
vC, conflicting volume	1602				2164	801
vC1, stage 1 conf vol						
vC2, stage 2 conf vol						
vCu, unblocked vol	1602				2164	801
tC, single (s)	4.2				6.9	7.0
tC, 2 stage (s)						
tF (s)	2.2				3.5	3.3
p0 queue free %	88				0	88
cM capacity (veh/h)	391				34	321
Direction, Lane #	EB 1	EB 2	EB 3	WB 1	WB 2	SB 1
Volume Total	48	525	525	990	612	129
Volume Left	48	0	0	0	0	92
Volume Right	0	0	0	0	117	37
cSH	391	1700	1700	1700	1700	46
Volume to Capacity	0.12	0.31	0.31	0.58	0.36	2.82
Queue Length 95th (m)	2.9	0.0	0.0	0.0	0.0	97.2
Control Delay (s)	15.5	0.0	0.0	0.0	0.0	1011.3
Lane LOS	C					F
Approach Delay (s)	0.7			0.0		1011.3
Approach LOS						F
Intersection Summary						
Average Delay			46.4			
Intersection Capacity Utilization			61.7%		ICU Level of Service	B
Analysis Period (min)			15			

Lane Group	EBL	EBT	EBR	WBL	WBT	WBR	NBL	NBT	NBR	SBL	SBT	SBR
Lane Configurations												
Traffic Volume (vph)	76	486	198	464	1231	64	269	445	568	55	259	135
Future Volume (vph)	76	486	198	464	1231	64	269	445	568	55	259	135
Satd. Flow (prot)	1374	3307	1332	3013	3435	1522	3094	3218	1332	3269	3189	1390
Flt Permitted	0.950			0.950			0.950			0.950		
Satd. Flow (perm)	1372	3307	1332	3013	3435	1490	3083	3218	1314	3264	3189	1365
Satd. Flow (RTOR)			198			134			535			180
Lane Group Flow (vph)	76	486	198	464	1231	64	269	445	568	55	259	135
Turn Type	Prot	NA	Perm	Prot	NA	Perm	Prot	NA	Perm	Prot	NA	Perm
Protected Phases	5	2		1	6		3	8		7	4	
Permitted Phases			2			6			8			4
Total Split (s)	24.4	45.0	45.0	45.0	65.6	65.6	23.0	40.0	40.0	20.0	37.0	37.0
Total Lost Time (s)	6.4	7.3	7.3	6.4	7.3	7.3	7.6	7.4	7.4	7.6	7.4	7.4
Act Effct Green (s)	13.3	52.7	52.7	28.5	68.0	68.0	15.1	34.8	34.8	7.9	24.9	24.9
Actuated g/C Ratio	0.09	0.35	0.35	0.19	0.45	0.45	0.10	0.23	0.23	0.05	0.17	0.17
v/c Ratio	0.63	0.42	0.33	0.81	0.79	0.09	0.86	0.60	0.79	0.32	0.49	0.36
Control Delay	87.4	40.7	6.7	69.4	41.3	0.2	91.8	55.1	14.7	72.9	59.0	4.7
Queue Delay	0.0	0.0	0.0	0.0	0.0	0.0	0.0	0.0	0.0	0.0	0.0	0.0
Total Delay	87.4	40.7	6.7	69.4	41.3	0.2	91.8	55.1	14.7	72.9	59.0	4.7
LOS	F	D	A	E	D	A	F	E	B	E	E	A
Approach Delay		36.5			47.2			44.9			44.4	
Approach LOS		D			D			D			D	
Queue Length 50th (m)	20.4	56.0	0.0	63.5	159.5	0.0	37.9	56.5	7.0	7.6	33.0	0.0
Queue Length 95th (m)	35.5	77.2	18.0	76.9	#207.8	0.0	#59.1	74.6	52.9	14.4	46.0	5.9
Internal Link Dist (m)		485.7			404.4			432.2			296.2	
Turn Bay Length (m)	85.0		225.0	100.0		45.0	140.0		110.0	80.0		55.0
Base Capacity (vph)	164	1162	596	775	1556	748	317	752	717	270	629	413
Starvation Cap Reductn	0	0	0	0	0	0	0	0	0	0	0	0
Spillback Cap Reductn	0	0	0	0	0	0	0	0	0	0	0	0
Storage Cap Reductn	0	0	0	0	0	0	0	0	0	0	0	0
Reduced v/c Ratio	0.46	0.42	0.33	0.60	0.79	0.09	0.85	0.59	0.79	0.20	0.41	0.33

Intersection Summary

Cycle Length: 150

Actuated Cycle Length: 150

Offset: 102 (68%), Referenced to phase 2:EBT and 6:WBT, Start of Green

Control Type: Actuated-Coordinated

Maximum v/c Ratio: 0.86

Intersection Signal Delay: 44.3

Intersection LOS: D

Intersection Capacity Utilization 82.1%

ICU Level of Service E

Analysis Period (min) 15

95th percentile volume exceeds capacity, queue may be longer.

Queue shown is maximum after two cycles.

Splits and Phases: 1: Russell & Walkley

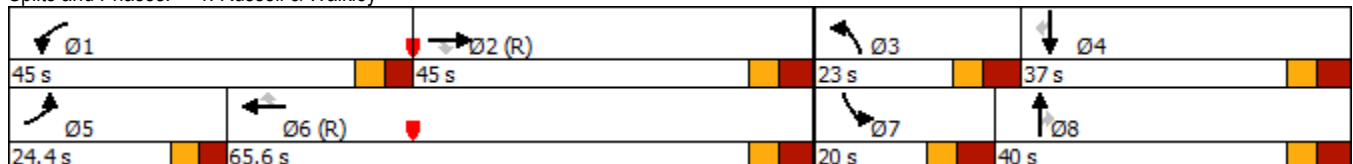

Lane Group	EBL	EBT	EBR	WBL	WBT	WBR	NBL	NBT	NBR	SBL	SBT	SBR
Lane Configurations												
Traffic Volume (vph)	10	0	8	40	10	490	17	891	43	227	548	34
Future Volume (vph)	10	0	8	40	10	490	17	891	43	227	548	34
Satd. Flow (prot)	1276	1278	0	1488	1790	1522	1701	3091	0	1488	2985	0
Flt Permitted	0.751			0.752			0.433			0.195		
Satd. Flow (perm)	1008	1278	0	1178	1790	1522	771	3091	0	306	2985	0
Satd. Flow (RTOR)		331				363		6			13	
Lane Group Flow (vph)	10	8	0	40	10	490	17	934	0	227	582	0
Turn Type	Perm	NA		Perm	NA	Perm	Perm	NA		pm+pt	NA	
Protected Phases		4			8			2		1	6	
Permitted Phases	4			8		8	2			6		
Total Split (s)	29.0	29.0		29.0	29.0	29.0	40.0	40.0		21.0	61.0	
Total Lost Time (s)	5.7	5.7		5.7	5.7	5.7	6.5	6.5		6.3	6.5	
Act Effct Green (s)	17.7	17.7		17.7	17.7	17.7	42.4	42.4		60.3	60.1	
Actuated g/C Ratio	0.20	0.20		0.20	0.20	0.20	0.47	0.47		0.67	0.67	
v/c Ratio	0.05	0.02		0.17	0.03	0.83	0.05	0.64		0.64	0.29	
Control Delay	26.3	0.0		29.1	25.7	21.7	30.0	31.6		16.8	7.3	
Queue Delay	0.0	0.0		0.0	0.0	0.0	0.0	0.0		0.0	0.0	
Total Delay	26.3	0.0		29.1	25.7	21.7	30.0	31.6		16.8	7.3	
LOS	C	A		C	C	C	C	C		B	A	
Approach Delay		14.6			22.3			31.6			10.0	
Approach LOS		B			C			C			A	
Queue Length 50th (m)	1.3	0.0		5.2	1.3	17.4	1.9	67.8		13.3	18.6	
Queue Length 95th (m)	4.8	0.0		12.2	4.7	51.3	m5.1	103.3		29.7	29.6	
Internal Link Dist (m)		63.3			159.0			795.0			432.2	
Turn Bay Length (m)	20.0			40.0		100.0	40.0			60.0		
Base Capacity (vph)	260	576		304	463	663	363	1459		398	1996	
Starvation Cap Reductn	0	0		0	0	0	0	0		0	0	
Spillback Cap Reductn	0	0		0	0	0	0	0		0	0	
Storage Cap Reductn	0	0		0	0	0	0	0		0	0	
Reduced v/c Ratio	0.04	0.01		0.13	0.02	0.74	0.05	0.64		0.57	0.29	

Intersection Summary

Cycle Length: 90
 Actuated Cycle Length: 90
 Offset: 0 (0%), Referenced to phase 2:NBTL and 6:SBTL, Start of Green
 Control Type: Actuated-Coordinated
 Maximum v/c Ratio: 0.83
 Intersection Signal Delay: 21.7
 Intersection LOS: C
 Intersection Capacity Utilization 82.7%
 ICU Level of Service E
 Analysis Period (min) 15
 m Volume for 95th percentile queue is metered by upstream signal.

Splits and Phases: 2: Hawthorne & Russell

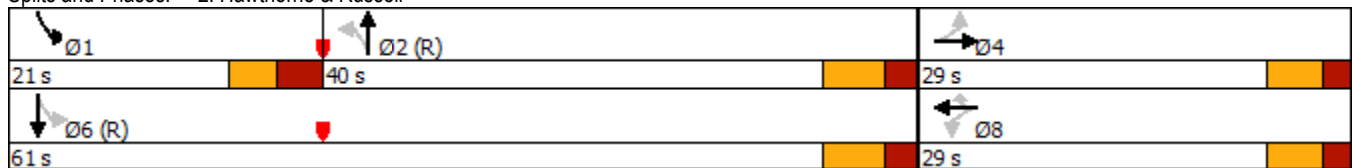

4055 & 4120 Russell Road
3: Hawthorne & Stevenage

2023 Total Traffic AM Peak Hour Mod

Lane Group	EBL	EBT	EBR	WBL	WBT	WBR	NBL	NBT	NBR	SBL	SBT	SBR
Lane Configurations												
Traffic Volume (vph)	134	28	60	58	63	55	208	958	86	52	350	200
Future Volume (vph)	134	28	60	58	63	55	208	958	86	52	350	200
Satd. Flow (prot)	1553	1219	0	1276	1465	0	1669	3096	0	1429	2858	1453
Flt Permitted	0.681			0.700			0.487			0.239		
Satd. Flow (perm)	1113	1219	0	935	1465	0	852	3096	0	359	2858	1414
Satd. Flow (RTOR)		60			52			12				200
Lane Group Flow (vph)	134	88	0	58	118	0	208	1044	0	52	350	200
Turn Type	Perm	NA		Perm	NA		pm+pt	NA		pm+pt	NA	Perm
Protected Phases		4			8		5	2		1	6	
Permitted Phases	4			8			2			6		6
Total Split (s)	35.0	35.0		35.0	35.0		15.0	40.0		15.0	40.0	40.0
Total Lost Time (s)	5.7	5.7		5.7	5.7		5.7	5.5		5.7	5.5	5.5
Act Effct Green (s)	16.9	16.9		16.9	16.9		60.6	54.0		53.0	46.4	46.4
Actuated g/C Ratio	0.19	0.19		0.19	0.19		0.67	0.60		0.59	0.52	0.52
v/c Ratio	0.64	0.32		0.33	0.37		0.31	0.56		0.18	0.24	0.24
Control Delay	46.6	14.8		34.5	20.5		7.5	15.0		7.8	12.6	2.4
Queue Delay	0.0	0.0		0.0	0.0		0.0	0.0		0.0	0.0	0.0
Total Delay	46.6	14.8		34.5	20.5		7.5	15.0		7.8	12.6	2.4
LOS	D	B		C	C		A	B		A	B	A
Approach Delay		34.0			25.1			13.7			8.8	
Approach LOS		C			C			B			A	
Queue Length 50th (m)	20.1	3.8		8.2	9.1		10.0	53.5		2.1	13.7	0.0
Queue Length 95th (m)	33.0	13.4		16.2	20.1		23.8	93.6		7.6	22.2	6.7
Internal Link Dist (m)		201.3			257.1			958.8			795.0	
Turn Bay Length (m)	45.0			25.0			75.0			85.0		85.0
Base Capacity (vph)	362	437		304	512		669	1863		332	1474	826
Starvation Cap Reductn	0	0		0	0		0	0		0	0	0
Spillback Cap Reductn	0	0		0	0		0	0		0	0	0
Storage Cap Reductn	0	0		0	0		0	0		0	0	0
Reduced v/c Ratio	0.37	0.20		0.19	0.23		0.31	0.56		0.16	0.24	0.24

Intersection Summary

Cycle Length: 90
 Actuated Cycle Length: 90
 Offset: 0 (0%), Referenced to phase 2:NBTL and 6:SBTL, Start of Green
 Control Type: Actuated-Coordinated
 Maximum v/c Ratio: 0.64
 Intersection Signal Delay: 15.3
 Intersection LOS: B
 Intersection Capacity Utilization 63.8%
 ICU Level of Service B
 Analysis Period (min) 15

Splits and Phases: 3: Hawthorne & Stevenage

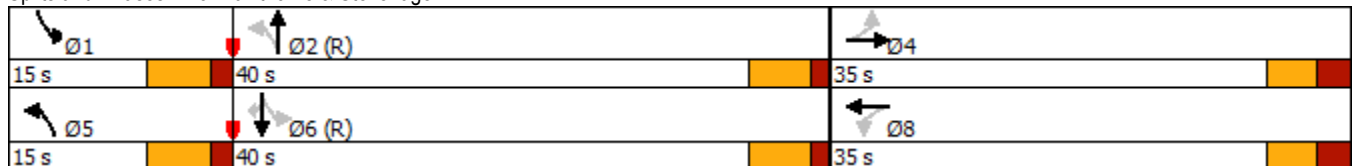

Lane Group	EBL	EBT	EBR	WBL	WBT	WBR	NBL	NBT	NBR	SBL	SBT	SBR
Lane Configurations												
Traffic Volume (vph)	451	673	25	251	715	246	40	412	382	43	147	197
Future Volume (vph)	451	673	25	251	715	246	40	412	382	43	147	197
Satd. Flow (prot)	3179	3337	0	3094	3402	1440	1488	2974	0	1191	2748	1278
Flt Permitted	0.950			0.950			0.659			0.128		
Satd. Flow (perm)	3179	3337	0	3094	3402	1440	1032	2974	0	160	2748	1278
Satd. Flow (RTOR)		2				246		152				197
Lane Group Flow (vph)	451	698	0	251	715	246	40	794	0	43	147	197
Turn Type	Prot	NA		Prot	NA	Perm	pm+pt	NA		pm+pt	NA	Perm
Protected Phases	7	4		3	8		5	2		1	6	
Permitted Phases						8	2			6		6
Total Split (s)	41.4	41.4		41.4	41.4	41.4	21.3	36.3		21.3	36.3	36.3
Total Lost Time (s)	6.4	6.4		6.4	6.4	6.4	6.3	6.3		6.3	6.3	6.3
Act Effct Green (s)	21.8	39.8		14.9	32.9	32.9	36.8	30.5		38.2	31.3	31.3
Actuated g/C Ratio	0.19	0.34		0.13	0.28	0.28	0.32	0.26		0.33	0.27	0.27
v/c Ratio	0.76	0.61		0.63	0.74	0.42	0.11	0.89		0.34	0.20	0.40
Control Delay	54.5	35.5		57.2	44.8	6.8	27.1	48.2		33.9	37.1	8.1
Queue Delay	0.0	0.0		0.0	0.0	0.0	0.0	0.0		0.0	0.0	0.0
Total Delay	54.5	35.5		57.2	44.8	6.8	27.1	48.2		33.9	37.1	8.1
LOS	D	D		E	D	A	C	D		C	D	A
Approach Delay		43.0			39.7			47.2			22.0	
Approach LOS		D			D			D			C	
Queue Length 50th (m)	48.8	65.5		27.3	74.0	0.0	5.6	74.8		6.1	13.3	0.0
Queue Length 95th (m)	67.1	92.6		41.3	105.2	18.7	13.6	#124.3		14.5	23.6	18.0
Internal Link Dist (m)		420.4			459.3			595.0			958.8	
Turn Bay Length (m)	90.0			50.0		80.0	50.0			80.0		80.0
Base Capacity (vph)	973	1174		947	1041	611	427	892		192	737	487
Starvation Cap Reductn	0	0		0	0	0	0	0		0	0	0
Spillback Cap Reductn	0	0		0	0	0	0	0		0	0	0
Storage Cap Reductn	0	0		0	0	0	0	0		0	0	0
Reduced v/c Ratio	0.46	0.59		0.27	0.69	0.40	0.09	0.89		0.22	0.20	0.40

Intersection Summary

Cycle Length: 140.4
 Actuated Cycle Length: 116.4
 Control Type: Semi Act-Uncoord
 Maximum v/c Ratio: 0.89
 Intersection Signal Delay: 40.6
 Intersection LOS: D
 Intersection Capacity Utilization 84.9%
 ICU Level of Service E
 Analysis Period (min) 15
 # 95th percentile volume exceeds capacity, queue may be longer.
 Queue shown is maximum after two cycles.

Splits and Phases: 4: Hawthorne & Hunt Club

Ø3	Ø4	Ø1	Ø2
41.4 s	41.4 s	21.3 s	36.3 s
Ø7	Ø8	Ø5	Ø6
41.4 s	41.4 s	21.3 s	36.3 s



Lane Group	EBL	EBT	WBT	WBR	SBL	SBR
Lane Configurations		↑↑	↑↑		↓	↓
Traffic Volume (vph)	0	731	994	0	23	1039
Future Volume (vph)	0	731	994	0	23	1039
Satd. Flow (prot)	0	3402	3402	0	1701	1522
Flt Permitted					0.950	
Satd. Flow (perm)	0	3402	3402	0	1701	1522
Satd. Flow (RTOR)						371
Lane Group Flow (vph)	0	731	994	0	23	1039
Turn Type		NA	NA		Prot	Free
Protected Phases		4	8		6	
Permitted Phases						Free
Total Split (s)		90.0	90.0		30.0	
Total Lost Time (s)		6.3	6.3		6.3	
Act Effct Green (s)		107.6	107.6		7.2	120.0
Actuated g/C Ratio		0.90	0.90		0.06	1.00
v/c Ratio		0.24	0.33		0.23	0.68
Control Delay		1.8	1.6		58.3	2.5
Queue Delay		0.0	0.0		0.0	0.0
Total Delay		1.8	1.6		58.3	2.5
LOS		A	A		E	A
Approach Delay		1.8	1.6		3.7	
Approach LOS		A	A		A	
Queue Length 50th (m)		13.0	20.5		4.9	0.0
Queue Length 95th (m)		19.4	16.4		12.4	0.0
Internal Link Dist (m)		667.8	354.1		288.6	
Turn Bay Length (m)					100.0	
Base Capacity (vph)		3049	3049		335	1522
Starvation Cap Reductn		0	0		0	0
Spillback Cap Reductn		0	0		0	0
Storage Cap Reductn		0	0		0	0
Reduced v/c Ratio		0.24	0.33		0.07	0.68

Intersection Summary

Cycle Length: 120
 Actuated Cycle Length: 120
 Offset: 0 (0%), Referenced to phase 4:EBT and 8:WBT, Start of Green
 Control Type: Actuated-Coordinated
 Maximum v/c Ratio: 0.68
 Intersection Signal Delay: 2.5
 Intersection LOS: A
 Intersection Capacity Utilization 73.6%
 ICU Level of Service D
 Analysis Period (min) 15

Splits and Phases: 10: Walkley & Hwy 417 SB Off-Ramp

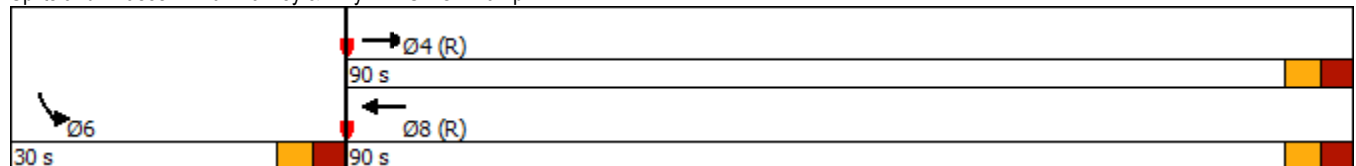

Scheme Summary

Control Data

Control Data and Model Parameters

119124	2023 PHF Flow Profile (veh)
2023 Total Traffic Volumes	7.5 min Time Slice
Rodel-Win1	Queuing Delays (sec)
Right Hand Drive	Daylight conditions
AM Peak Hour	Peak 60/15 min Results
AVERAGE DELAY to Geometry	Output flows: Vehicles
Metric Units (m)	85% Confidence Level

Available Data

Entry Capacity Calibrated	No
Entry Capacity Modified	No
Crosswalks	No
Flows Factored	No
Approach/Exit Road Capacity Calibrated	No
Accidents	No
Accident Costs	No
Bypass Model	No
Bypass Calibration	No
Global Results	Yes

Operational Data

Main Geometry (m)

Geometry and Design Target

Leg	Leg Names	Approach Geometry (m)				Target	Circulating and Exit Geom		
		Bearing (deg)	Grade Sep G	Half Width V	Lanes n	Average Delay (sec/veh)	Inscribed Diameter D	Half Width Vx	Lanes n
1	SB - Anderson	0	0	4.00	1	30	45.00	4.00	1
2	EB - Russell	90	0	4.00	1	30	45.00	4.00	1
3	NB- Anderson	180	0	4.00	1	30	45.00	4.00	1
4	WB - Russell	270	0	4.00	1	30	45.00	4.00	1

Capacity Modifiers and Capacity Calibration (veh/hr)

Leg	Leg Names	Entry Capacity		Entry Calibration		Approach Road			Exit Road		
		Capacity + or -	XWalk Factor	Intercept + or -	Slope Factor	V (m)	Default Capacity	Calib Capacity	V (m)	Default Capacity	Calib Capacity
1	SB - Anderson	0	1.000	0	1.000	6.00	1960	0	4.00	1960	0
2	EB - Russell	0	1.000	0	1.000	6.00	1960	0	4.00	1960	0
3	NB- Anderson	0	1.000	0	1.000	6.00	1960	0	4.00	1960	0
4	WB - Russell	0	1.000	0	1.000	6.00	1960	0	4.00	1960	0

Traffic Flow Data (veh/hr)

2023 AM Peak Peak Hour Flows

Leg	Leg Names	Turning Flows					Flow Modifiers		
		U-Turn	Exit-3	Exit-2	Exit-1	Bypass	Trucks %	Flow Factor	Peak Hour Factor
1	SB - Anderson	0	5	139	153	0	3.0	1.00	0.900
2	EB - Russell	0	35	16	20	0	3.0	1.00	0.900
3	NB- Anderson	0	189	304	6	0	3.0	1.00	0.900
4	WB - Russell	0	48	331	118	0	3.0	1.00	0.900

Operational Results

Geometry for Target Input

Geometry Options for 2023 AM Peak

				Leg 1 - SB - Anderson	
nv	ne	nc	nx	E (m)	L' (m)
1	1	1	1	4.00	0.00

Geometry Options for 2023 AM Peak

				Leg 2 - EB - Russell	
nv	ne	nc	nx	E (m)	L' (m)
1	1	1	1	4.00	0.00

Geometry Options for 2023 AM Peak

				Leg 3 - NB- Anderson	
nv	ne	nc	nx	E (m)	L' (m)
1	1	1	1	4.00	0.00

Geometry Options for 2023 AM Peak

				Leg 4 - WB - Russell	
nv	ne	nc	nx	E (m)	L' (m)
1	1	1	1	4.00	0.00

2023 AM Peak - 60 minutes

Flows and Capacity

Leg	Leg Names	Bypass Type	Flows (veh/hr)				Capacity (veh/hr)			
			Arrival Flow		Opposing Flow		Capacity		Average VCR	
			Entry	Bypass	Entry	Bypass	Entry	Bypass	Entry	Bypass
1	SB - Anderson	None	297		568		457	654		0.4542
2	EB - Russell	None	71		192		673	848		0.0837
3	NB- Anderson	None	499		56		207	918		0.5434
4	WB - Russell	None	497		528		27	674		0.7369

Delays, Queues and Level of Service

Leg	Leg Names	Bypass Type	Average Delay (sec)			95% Queue (veh)		Level of Service		
			Entry	Bypass	Leg	Entry	Bypass	Entry	Bypass	Leg
1	SB - Anderson	None	9.46		9.46	2.65		A		A
2	EB - Russell	None	4.44		4.44	0.26		A		A
3	NB- Anderson	None	7.94		7.94	3.54		A		A
4	WB - Russell	None	18.34		18.34	9.96		C		C

2023 AM Peak - 15 minutes

Flows and Capacity

Leg	Leg Names	Bypass Type	Flows (veh/hr)				Capacity (veh/hr)			
			Arrival Flow		Opposing Flow		Capacity		Average VCR	
			Entry	Bypass	Entry	Bypass	Entry	Bypass	Entry	Bypass
1	SB - Anderson	None	330		625		505	624		0.5285
2	EB - Russell	None	79		212		741	838		0.0942
3	NB- Anderson	None	554		62		229	915		0.6058
4	WB - Russell	None	552		585		30	645		0.8565

Delays, Queues and Level of Service

Leg	Leg Names	Bypass Type	Average Delay (sec)			95% Queue (veh)		Level of Service		
			Entry	Bypass	Leg	Entry	Bypass	Entry	Bypass	Leg
1	SB - Anderson	None	10.20		10.20	2.65		B		B
2	EB - Russell	None	4.37		4.37	0.26		A		A
3	NB- Anderson	None	8.36		8.36	3.54		A		A
4	WB - Russell	None	22.55		22.55	9.96		C		C

Lane Group	EBL	EBT	EBR	WBL	WBT	WBR	NBL	NBT	NBR	SBL	SBT	SBR
Lane Configurations												
Traffic Volume (vph)	96	1360	319	544	681	80	193	308	583	105	481	109
Future Volume (vph)	96	1360	319	544	681	80	193	308	583	105	481	109
Satd. Flow (prot)	1609	3468	1390	3013	3468	1567	3179	3338	1427	3238	3247	1427
Flt Permitted	0.950			0.950			0.950			0.950		
Satd. Flow (perm)	1604	3468	1368	3011	3468	1535	3155	3338	1402	3218	3247	1396
Satd. Flow (RTOR)			262			154			207			207
Lane Group Flow (vph)	96	1360	319	544	681	80	193	308	583	105	481	109
Turn Type	Prot	NA	Perm	Prot	NA	Perm	Prot	NA	Perm	Prot	NA	Perm
Protected Phases	5	2		1	6		3	8		7	4	
Permitted Phases			2			6			8			4
Total Split (s)	12.0	58.0	58.0	20.0	66.0	66.0	17.0	35.0	35.0	17.0	35.0	35.0
Total Lost Time (s)	6.4	7.3	7.3	6.4	7.3	7.3	7.6	7.4	7.4	7.6	7.4	7.4
Act Effct Green (s)	5.6	50.7	50.7	13.6	58.7	58.7	9.4	28.3	28.3	8.7	27.6	27.6
Actuated g/C Ratio	0.04	0.39	0.39	0.10	0.45	0.45	0.07	0.22	0.22	0.07	0.21	0.21
v/c Ratio	1.39	1.01	0.46	1.73	0.44	0.10	0.84	0.42	1.25	0.48	0.70	0.24
Control Delay	287.3	65.5	8.2	374.3	25.4	0.3	89.3	46.2	157.2	66.0	53.6	1.2
Queue Delay	0.0	0.0	0.0	0.0	0.0	0.0	0.0	0.0	0.0	0.0	0.0	0.0
Total Delay	287.3	65.5	8.2	374.3	25.4	0.3	89.3	46.2	157.2	66.0	53.6	1.2
LOS	F	E	A	F	C	A	F	D	F	E	D	A
Approach Delay		67.2			169.3			113.5			47.2	
Approach LOS		E			F			F			D	
Queue Length 50th (m)	~30.1	~169.4	8.5	~97.6	56.6	0.0	23.6	33.4	~132.6	12.4	55.7	0.0
Queue Length 95th (m)	#62.9	#215.3	29.8	#129.7	71.3	0.0	#42.2	46.6	#197.3	21.2	73.2	0.0
Internal Link Dist (m)		485.7			402.0			432.2			296.2	
Turn Bay Length (m)	85.0		225.0	100.0		45.0	140.0		110.0	80.0		55.0
Base Capacity (vph)	69	1352	693	315	1565	777	229	725	466	234	689	459
Starvation Cap Reductn	0	0	0	0	0	0	0	0	0	0	0	0
Spillback Cap Reductn	0	0	0	0	0	0	0	0	0	0	0	0
Storage Cap Reductn	0	0	0	0	0	0	0	0	0	0	0	0
Reduced v/c Ratio	1.39	1.01	0.46	1.73	0.44	0.10	0.84	0.42	1.25	0.45	0.70	0.24

Intersection Summary

Cycle Length: 130

Actuated Cycle Length: 130

Offset: 35 (27%), Referenced to phase 2:EBT and 6:WBT, Start of Green

Control Type: Actuated-Coordinated

Maximum v/c Ratio: 1.73

Intersection Signal Delay: 102.1

Intersection LOS: F

Intersection Capacity Utilization 101.4%

ICU Level of Service G

Analysis Period (min) 15

~ Volume exceeds capacity, queue is theoretically infinite.

Queue shown is maximum after two cycles.

95th percentile volume exceeds capacity, queue may be longer.

Queue shown is maximum after two cycles.

Splits and Phases: 1: Russell & Walkley

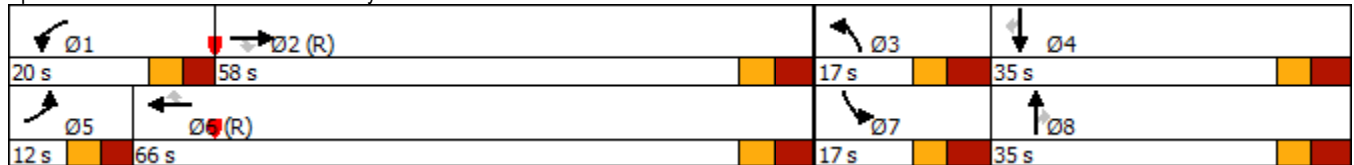

4055 & 4120 Russell Road
2: Hawthorne & Russell

2023 Total Traffic PM Peak Hour

Lane Group	EBL	EBT	EBR	WBL	WBT	WBR	NBL	NBT	NBR	SBL	SBT	SBR
Lane Configurations												
Traffic Volume (vph)	35	7	21	31	3	203	7	716	57	419	869	17
Future Volume (vph)	35	7	21	31	3	203	7	716	57	419	869	17
Satd. Flow (prot)	1624	1466	0	1768	1139	1508	1232	3233	0	1639	3270	0
Flt Permitted	0.756			0.739			0.310			0.355		
Satd. Flow (perm)	1291	1466	0	1376	1139	1488	402	3233	0	612	3270	0
Satd. Flow (RTOR)		21				203		18			4	
Lane Group Flow (vph)	35	28	0	31	3	203	7	773	0	419	886	0
Turn Type	Perm	NA		Perm	NA	Perm	Perm	NA		Perm	NA	
Protected Phases		4			8			2			6	
Permitted Phases	4			8		8	2			6		
Total Split (s)	26.0	26.0		26.0	26.0	26.0	54.0	54.0		54.0	54.0	
Total Lost Time (s)	5.7	5.7		5.7	5.7	5.7	6.5	6.5		6.5	6.5	
Act Effct Green (s)	12.0	12.0		12.0	12.0	12.0	55.8	55.8		55.8	55.8	
Actuated g/C Ratio	0.15	0.15		0.15	0.15	0.15	0.70	0.70		0.70	0.70	
v/c Ratio	0.18	0.12		0.15	0.02	0.51	0.03	0.34		0.98	0.39	
Control Delay	30.3	15.3		29.5	26.3	9.3	5.6	5.7		56.2	6.1	
Queue Delay	0.0	0.0		0.0	0.0	0.0	0.0	0.0		0.0	0.0	
Total Delay	30.3	15.3		29.5	26.3	9.3	5.6	5.7		56.2	6.1	
LOS	C	B		C	C	A	A	A		E	A	
Approach Delay		23.6			12.2			5.7			22.2	
Approach LOS		C			B			A			C	
Queue Length 50th (m)	4.5	0.9		4.0	0.4	0.0	0.2	16.3		42.0	20.1	
Queue Length 95th (m)	10.2	6.1		9.3	2.1	13.9	1.8	36.4		#117.8	43.8	
Internal Link Dist (m)		63.3			159.0			795.0			432.2	
Turn Bay Length (m)	20.0			40.0		100.0	40.0			60.0		
Base Capacity (vph)	327	387		349	289	529	280	2260		427	2281	
Starvation Cap Reductn	0	0		0	0	0	0	0		0	0	
Spillback Cap Reductn	0	0		0	0	0	0	0		0	0	
Storage Cap Reductn	0	0		0	0	0	0	0		0	0	
Reduced v/c Ratio	0.11	0.07		0.09	0.01	0.38	0.03	0.34		0.98	0.39	

Intersection Summary

Cycle Length: 80

Actuated Cycle Length: 80

Offset: 16 (20%), Referenced to phase 2:NBTL and 6:SBTL, Start of Green

Control Type: Actuated-Coordinated

Maximum v/c Ratio: 0.98

Intersection Signal Delay: 15.8

Intersection LOS: B

Intersection Capacity Utilization 71.6%

ICU Level of Service C

Analysis Period (min) 15

95th percentile volume exceeds capacity, queue may be longer.

Queue shown is maximum after two cycles.

Splits and Phases: 2: Hawthorne & Russell

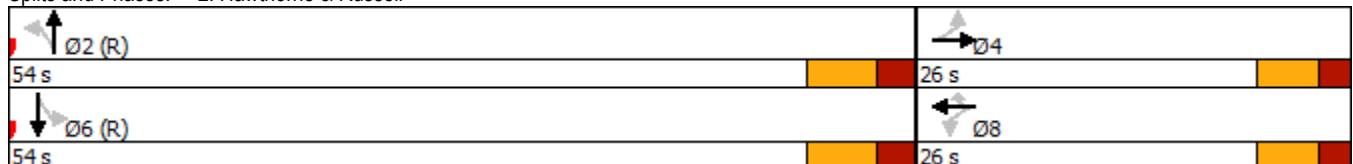

4055 & 4120 Russell Road
3: Hawthorne & Stevenage

2023 Total Traffic PM Peak Hour

Lane Group	EBL	EBT	EBR	WBL	WBT	WBR	NBL	NBT	NBR	SBL	SBT	SBR
Lane Configurations												
Traffic Volume (vph)	201	39	221	100	29	81	82	417	59	45	973	144
Future Volume (vph)	201	39	221	100	29	81	82	417	59	45	973	144
Satd. Flow (prot)	1669	1490	0	1567	1426	0	1323	3077	0	1323	3402	1390
Flt Permitted	0.686			0.426			0.209			0.480		
Satd. Flow (perm)	1202	1490	0	703	1426	0	291	3077	0	668	3402	1352
Satd. Flow (RTOR)		221			81			20				144
Lane Group Flow (vph)	201	260	0	100	110	0	82	476	0	45	973	144
Turn Type	Perm	NA		Perm	NA		pm+pt	NA		pm+pt	NA	Perm
Protected Phases		4			8		5	2		1	6	
Permitted Phases	4			8			2			6		6
Total Split (s)	35.0	35.0		35.0	35.0		15.0	45.0		15.0	45.0	45.0
Total Lost Time (s)	5.7	5.7		5.7	5.7		5.7	5.5		5.7	5.5	5.5
Act Effct Green (s)	22.6	22.6		22.6	22.6		58.2	53.2		55.7	50.1	50.1
Actuated g/C Ratio	0.24	0.24		0.24	0.24		0.61	0.56		0.59	0.53	0.53
v/c Ratio	0.71	0.50		0.60	0.27		0.31	0.27		0.10	0.54	0.18
Control Delay	45.6	9.3		45.8	11.0		11.6	13.5		9.0	18.9	3.7
Queue Delay	0.0	0.0		0.0	0.0		0.0	0.0		0.0	0.0	0.0
Total Delay	45.6	9.3		45.8	11.0		11.6	13.5		9.0	18.9	3.7
LOS	D	A		D	B		B	B		A	B	A
Approach Delay		25.1			27.6			13.2			16.6	
Approach LOS		C			C			B			B	
Queue Length 50th (m)	30.7	5.1		14.8	3.8		4.9	22.5		2.6	59.0	0.0
Queue Length 95th (m)	48.7	21.5		28.3	14.2		12.0	38.0		7.5	89.2	9.8
Internal Link Dist (m)		201.3			257.1			958.8			795.0	
Turn Bay Length (m)	45.0			25.0			75.0			85.0		85.0
Base Capacity (vph)	370	612		216	495		280	1731		466	1792	780
Starvation Cap Reductn	0	0		0	0		0	0		0	0	0
Spillback Cap Reductn	0	0		0	0		0	0		0	0	0
Storage Cap Reductn	0	0		0	0		0	0		0	0	0
Reduced v/c Ratio	0.54	0.42		0.46	0.22		0.29	0.27		0.10	0.54	0.18

Intersection Summary

Cycle Length: 95

Actuated Cycle Length: 95

Offset: 0 (0%), Referenced to phase 2:NBTL and 6:SBTL, Start of Green

Control Type: Actuated-Coordinated

Maximum v/c Ratio: 0.71

Intersection Signal Delay: 18.4

Intersection LOS: B

Intersection Capacity Utilization 76.9%

ICU Level of Service D

Analysis Period (min) 15

Splits and Phases: 3: Hawthorne & Stevenage

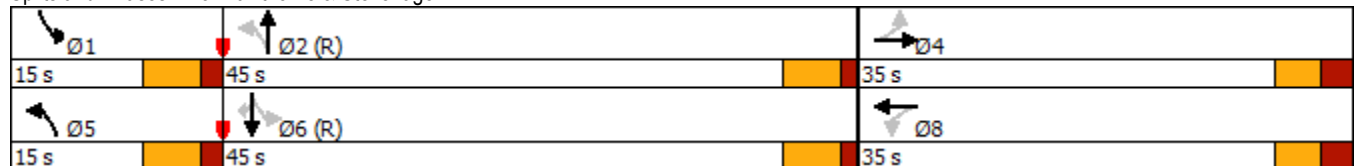

Lane Group	EBL	EBT	EBR	WBL	WBT	WBR	NBL	NBT	NBR	SBL	SBT	SBR
Lane Configurations												
Traffic Volume (vph)	299	858	24	423	906	87	25	193	307	167	494	490
Future Volume (vph)	299	858	24	423	906	87	25	193	307	167	494	490
Satd. Flow (prot)	1595	3422	0	1654	3468	1141	1717	2807	0	1609	3247	1522
Flt Permitted	0.950			0.950			0.424			0.147		
Satd. Flow (perm)	1595	3422	0	1653	3468	1141	766	2807	0	249	3247	1522
Satd. Flow (RTOR)		2				119		242				490
Lane Group Flow (vph)	299	882	0	423	906	87	25	500	0	167	494	490
Turn Type	Prot	NA		Prot	NA	Perm	pm+pt	NA		pm+pt	NA	Perm
Protected Phases	7	4		3	8		5	2		1	6	
Permitted Phases						8	2			6		6
Total Split (s)	36.4	48.4		44.4	56.4	56.4	21.3	32.3		21.3	32.3	32.3
Total Lost Time (s)	6.4	6.4		6.4	6.4	6.4	6.3	6.3		6.3	6.3	6.3
Act Effct Green (s)	28.6	40.2		37.8	49.5	49.5	27.2	20.2		40.7	32.6	32.6
Actuated g/C Ratio	0.21	0.29		0.27	0.36	0.36	0.20	0.15		0.29	0.24	0.24
v/c Ratio	0.91	0.88		0.93	0.73	0.18	0.13	0.81		0.79	0.64	0.67
Control Delay	85.1	58.5		78.6	43.7	2.9	36.7	40.0		64.2	53.3	8.9
Queue Delay	0.0	0.0		0.0	0.0	0.0	0.0	0.0		0.0	0.0	0.0
Total Delay	85.1	58.5		78.6	43.7	2.9	36.7	40.0		64.2	53.3	8.9
LOS	F	E		E	D	A	D	D		E	D	A
Approach Delay		65.2			51.6			39.9			36.0	
Approach LOS		E			D			D			D	
Queue Length 50th (m)	75.6	113.5		107.8	107.4	0.0	4.6	34.9		33.7	63.3	0.0
Queue Length 95th (m)	#128.9	#151.6		#175.8	136.9	5.1	11.1	53.8		#59.4	82.8	30.3
Internal Link Dist (m)		420.4			461.0			595.0			958.8	
Turn Bay Length (m)	90.0			50.0		80.0	50.0			80.0		80.0
Base Capacity (vph)	348	1050		458	1265	491	300	728		222	767	734
Starvation Cap Reductn	0	0		0	0	0	0	0		0	0	0
Spillback Cap Reductn	0	0		0	0	0	0	0		0	0	0
Storage Cap Reductn	0	0		0	0	0	0	0		0	0	0
Reduced v/c Ratio	0.86	0.84		0.92	0.72	0.18	0.08	0.69		0.75	0.64	0.67

Intersection Summary

Cycle Length: 146.4
 Actuated Cycle Length: 138
 Control Type: Semi Act-Uncoord
 Maximum v/c Ratio: 0.93
 Intersection Signal Delay: 49.7
 Intersection LOS: D
 Intersection Capacity Utilization 97.8%
 ICU Level of Service F
 Analysis Period (min) 15
 # 95th percentile volume exceeds capacity, queue may be longer.
 Queue shown is maximum after two cycles.

Splits and Phases: 4: Hawthorne & Hunt Club

Ø3	Ø4	Ø1	Ø2
44.4 s	48.4 s	21.3 s	32.3 s
Ø7	Ø8	Ø5	Ø6
36.4 s	56.4 s	21.3 s	32.3 s



Lane Group	EBL	EBT	WBT	WBR	SBL	SBR
Lane Configurations						
Traffic Volume (vph)	49	1283	1485	123	87	36
Future Volume (vph)	49	1283	1485	123	87	36
Satd. Flow (prot)	1701	3402	3364	0	1660	0
Flt Permitted	0.118				0.966	
Satd. Flow (perm)	211	3402	3364	0	1660	0
Satd. Flow (RTOR)			16		16	
Lane Group Flow (vph)	49	1283	1608	0	123	0
Turn Type	Perm	NA	NA		Prot	
Protected Phases		2	6		4	
Permitted Phases	2					
Total Split (s)	41.4	41.4	41.4		31.8	
Total Lost Time (s)	6.4	6.4	6.4		5.8	
Act Effct Green (s)	54.5	54.5	54.5		10.1	
Actuated g/C Ratio	0.74	0.74	0.74		0.14	
v/c Ratio	0.31	0.51	0.64		0.51	
Control Delay	12.5	6.4	8.1		31.9	
Queue Delay	0.0	0.0	0.0		0.0	
Total Delay	12.5	6.4	8.1		31.9	
LOS	B	A	A		C	
Approach Delay		6.6	8.1		31.9	
Approach LOS		A	A		C	
Queue Length 50th (m)	2.0	34.4	50.7		12.7	
Queue Length 95th (m)	10.6	58.7	87.5		24.7	
Internal Link Dist (m)		461.0	862.2		131.3	
Turn Bay Length (m)	30.0				30.0	
Base Capacity (vph)	157	2532	2507		599	
Starvation Cap Reductn	0	0	0		0	
Spillback Cap Reductn	0	0	0		0	
Storage Cap Reductn	0	0	0		0	
Reduced v/c Ratio	0.31	0.51	0.64		0.21	

Intersection Summary

Cycle Length: 73.2
 Actuated Cycle Length: 73.2
 Offset: 0 (0%), Referenced to phase 2:EBTL and 6:WBT, Start of Green
 Control Type: Actuated-Coordinated
 Maximum v/c Ratio: 0.64
 Intersection Signal Delay: 8.4
 Intersection LOS: A
 Intersection Capacity Utilization 65.0%
 ICU Level of Service C
 Analysis Period (min) 15

Splits and Phases: 12: Hunt Club & Access

Ø2 (R)	Ø4
41.4 s	31.8 s
Ø6 (R)	
41.4 s	

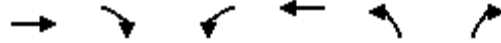

Movement	EBT	EBR	WBL	WBT	NBL	NBR
Lane Configurations						
Traffic Volume (veh/h)	413	29	10	254	27	126
Future Volume (Veh/h)	413	29	10	254	27	126
Sign Control	Free			Free	Stop	
Grade	0%			0%	0%	
Peak Hour Factor	1.00	1.00	1.00	1.00	1.00	1.00
Hourly flow rate (vph)	413	29	10	254	27	126
Pedestrians						
Lane Width (m)						
Walking Speed (m/s)						
Percent Blockage						
Right turn flare (veh)						
Median type	None			None		
Median storage (veh)						
Upstream signal (m)						
pX, platoon unblocked						
vC, conflicting volume				442	702	428
vC1, stage 1 conf vol						
vC2, stage 2 conf vol						
vCu, unblocked vol				442	702	428
tC, single (s)				4.2	6.6	6.2
tC, 2 stage (s)						
tF (s)				2.3	3.7	3.3
p0 queue free %				99	93	80
cM capacity (veh/h)				1077	375	625
Direction, Lane #	EB 1	WB 1	NB 1			
Volume Total	442	264	153			
Volume Left	0	10	27			
Volume Right	29	0	126			
cSH	1700	1077	559			
Volume to Capacity	0.26	0.01	0.27			
Queue Length 95th (m)	0.0	0.2	7.7			
Control Delay (s)	0.0	0.4	13.8			
Lane LOS		A	B			
Approach Delay (s)	0.0	0.4	13.8			
Approach LOS			B			
Intersection Summary						
Average Delay				2.6		
Intersection Capacity Utilization				41.3%	ICU Level of Service	A
Analysis Period (min)				15		



Movement	EBL	EBR	NBL	NBT	SBT	SBR
Lane Configurations						
Traffic Volume (veh/h)	11	1440	0	1125	167	0
Future Volume (Veh/h)	11	1440	0	1125	167	0
Sign Control	Stop			Free	Free	
Grade	0%			0%	0%	
Peak Hour Factor	1.00	1.00	1.00	1.00	1.00	1.00
Hourly flow rate (vph)	11	1440	0	1125	167	0
Pedestrians						
Lane Width (m)						
Walking Speed (m/s)						
Percent Blockage						
Right turn flare (veh)						
Median type				None	None	
Median storage (veh)						
Upstream signal (m)						
pX, platoon unblocked						
vC, conflicting volume	1292	167	167			
vC1, stage 1 conf vol						
vC2, stage 2 conf vol						
vCu, unblocked vol	1292	167	167			
tC, single (s)	6.4	6.3	4.1			
tC, 2 stage (s)						
tF (s)	3.5	3.4	2.2			
p0 queue free %	94	0	100			
cM capacity (veh/h)	181	864	1423			
Direction, Lane #	EB 1	EB 2	NB 1	SB 1		
Volume Total	11	1440	1125	167		
Volume Left	11	0	0	0		
Volume Right	0	1440	0	0		
cSH	181	864	1700	1700		
Volume to Capacity	0.06	1.67	0.66	0.10		
Queue Length 95th (m)	1.3	551.7	0.0	0.0		
Control Delay (s)	26.2	318.9	0.0	0.0		
Lane LOS	D	F				
Approach Delay (s)	316.7		0.0	0.0		
Approach LOS	F					
Intersection Summary						
Average Delay	167.5					
Intersection Capacity Utilization	110.1%			ICU Level of Service	H	
Analysis Period (min)	15					



Movement	EBL	EBR	NBL	NBT	SBT	SBR
Lane Configurations						
Traffic Volume (veh/h)	123	336	57	114	322	40
Future Volume (Veh/h)	123	336	57	114	322	40
Sign Control	Stop			Free	Free	
Grade	0%			0%	0%	
Peak Hour Factor	1.00	1.00	1.00	1.00	1.00	1.00
Hourly flow rate (vph)	123	336	57	114	322	40
Pedestrians						
Lane Width (m)						
Walking Speed (m/s)						
Percent Blockage						
Right turn flare (veh)						
Median type				None	None	
Median storage (veh)						
Upstream signal (m)						
pX, platoon unblocked						
vC, conflicting volume	570	342	362			
vC1, stage 1 conf vol						
vC2, stage 2 conf vol						
vCu, unblocked vol	570	342	362			
tC, single (s)	6.5	6.3	4.2			
tC, 2 stage (s)						
tF (s)	3.6	3.4	2.3			
p0 queue free %	73	51	95			
cM capacity (veh/h)	452	689	1128			
Direction, Lane #	EB 1	NB 1	SB 1			
Volume Total	459	171	362			
Volume Left	123	57	0			
Volume Right	336	0	40			
cSH	604	1128	1700			
Volume to Capacity	0.76	0.05	0.21			
Queue Length 95th (m)	48.1	1.1	0.0			
Control Delay (s)	27.3	3.1	0.0			
Lane LOS	D	A				
Approach Delay (s)	27.3	3.1	0.0			
Approach LOS	D					
Intersection Summary						
Average Delay			13.2			
Intersection Capacity Utilization			69.1%	ICU Level of Service	C	
Analysis Period (min)			15			



Movement	EBL	EBT	WBT	WBR	SBL	SBR
Lane Configurations		↑↑	↑↑		↓	↓
Traffic Volume (veh/h)	0	1622	184	0	174	727
Future Volume (Veh/h)	0	1622	184	0	174	727
Sign Control		Free	Free		Stop	
Grade		0%	0%		0%	
Peak Hour Factor	1.00	1.00	1.00	1.00	1.00	1.00
Hourly flow rate (vph)	0	1622	184	0	174	727
Pedestrians						
Lane Width (m)						
Walking Speed (m/s)						
Percent Blockage						
Right turn flare (veh)						
Median type		None	None			
Median storage (veh)						
Upstream signal (m)						
pX, platoon unblocked						
vC, conflicting volume	184				995	92
vC1, stage 1 conf vol						
vC2, stage 2 conf vol						
vCu, unblocked vol	184				995	92
tC, single (s)	4.2				6.9	7.0
tC, 2 stage (s)						
tF (s)	2.2				3.5	3.3
p0 queue free %	100				26	22
cM capacity (veh/h)	1367				236	938
Direction, Lane #	EB 1	EB 2	WB 1	WB 2	SB 1	SB 2
Volume Total	811	811	92	92	174	727
Volume Left	0	0	0	0	174	0
Volume Right	0	0	0	0	0	727
cSH	1700	1700	1700	1700	236	938
Volume to Capacity	0.48	0.48	0.05	0.05	0.74	0.78
Queue Length 95th (m)	0.0	0.0	0.0	0.0	35.5	55.7
Control Delay (s)	0.0	0.0	0.0	0.0	53.4	20.7
Lane LOS					F	C
Approach Delay (s)	0.0		0.0		27.0	
Approach LOS					D	
Intersection Summary						
Average Delay			9.0			
Intersection Capacity Utilization			64.2%		ICU Level of Service	C
Analysis Period (min)			15			



Movement	EBT	EBR	WBL	WBT	NBL	NBR
Lane Configurations	↑↑			↑↑	↘↘	
Traffic Volume (veh/h)	811	0	0	87	156	24
Future Volume (Veh/h)	811	0	0	87	156	24
Sign Control	Free			Free	Stop	
Grade	0%			0%	0%	
Peak Hour Factor	1.00	1.00	1.00	1.00	1.00	1.00
Hourly flow rate (vph)	811	0	0	87	156	24
Pedestrians						
Lane Width (m)						
Walking Speed (m/s)						
Percent Blockage						
Right turn flare (veh)						
Median type	None			None		
Median storage (veh)						
Upstream signal (m)						
pX, platoon unblocked						
vC, conflicting volume	811			854	406	
vC1, stage 1 conf vol						
vC2, stage 2 conf vol						
vCu, unblocked vol	811			854	406	
tC, single (s)	4.2			6.9	7.0	
tC, 2 stage (s)						
tF (s)	2.2			3.5	3.3	
p0 queue free %	100			47	96	
cM capacity (veh/h)	792			292	586	
Direction, Lane #	EB 1	EB 2	WB 1	WB 2	NB 1	
Volume Total	406	406	44	44	180	
Volume Left	0	0	0	0	156	
Volume Right	0	0	0	0	24	
cSH	1700	1700	1700	1700	313	
Volume to Capacity	0.24	0.24	0.03	0.03	0.58	
Queue Length 95th (m)	0.0	0.0	0.0	0.0	23.7	
Control Delay (s)	0.0	0.0	0.0	0.0	31.0	
Lane LOS						D
Approach Delay (s)	0.0			31.0		
Approach LOS						D
Intersection Summary						
Average Delay	5.2					
Intersection Capacity Utilization	64.2%			ICU Level of Service	C	
Analysis Period (min)	15					



















Movement	EBL	EBT	WBT	WBR	SBL	SBR
Lane Configurations						
Traffic Volume (veh/h)	174	412	116	61	31	89
Future Volume (Veh/h)	174	412	116	61	31	89
Sign Control		Free	Free		Stop	
Grade		0%	0%		0%	
Peak Hour Factor	1.00	1.00	1.00	1.00	1.00	1.00
Hourly flow rate (vph)	174	412	116	61	31	89
Pedestrians						
Lane Width (m)						
Walking Speed (m/s)						
Percent Blockage						
Right turn flare (veh)						
Median type		None	None			
Median storage (veh)						
Upstream signal (m)						
pX, platoon unblocked						
vC, conflicting volume	177				906	146
vC1, stage 1 conf vol						
vC2, stage 2 conf vol						
vCu, unblocked vol	177				906	146
tC, single (s)	4.1				6.4	6.2
tC, 2 stage (s)						
tF (s)	2.2				3.5	3.3
p0 queue free %	87				88	90
cM capacity (veh/h)	1381				264	893
Direction, Lane #	EB 1	EB 2	WB 1	SB 1	SB 2	
Volume Total	174	412	177	31	89	
Volume Left	174	0	0	31	0	
Volume Right	0	0	61	0	89	
cSH	1381	1700	1700	264	893	
Volume to Capacity	0.13	0.24	0.10	0.12	0.10	
Queue Length 95th (m)	3.0	0.0	0.0	2.8	2.3	
Control Delay (s)	8.0	0.0	0.0	20.4	9.5	
Lane LOS	A			C	A	
Approach Delay (s)	2.4		0.0	12.3		
Approach LOS				B		
Intersection Summary						
Average Delay			3.2			
Intersection Capacity Utilization			33.9%	ICU Level of Service		A
Analysis Period (min)			15			



















Movement	EBL	EBT	WBT	WBR	SBL	SBR
Lane Configurations						
Traffic Volume (veh/h)	74	369	139	142	73	38
Future Volume (Veh/h)	74	369	139	142	73	38
Sign Control		Free	Free		Stop	
Grade		0%	0%		0%	
Peak Hour Factor	1.00	1.00	1.00	1.00	1.00	1.00
Hourly flow rate (vph)	74	369	139	142	73	38
Pedestrians						
Lane Width (m)						
Walking Speed (m/s)						
Percent Blockage						
Right turn flare (veh)						
Median type		None	None			
Median storage (veh)						
Upstream signal (m)						
pX, platoon unblocked						
vC, conflicting volume	281				727	210
vC1, stage 1 conf vol						
vC2, stage 2 conf vol						
vCu, unblocked vol	281				727	210
tC, single (s)	4.1				6.4	6.2
tC, 2 stage (s)						
tF (s)	2.2				3.5	3.3
p0 queue free %	94				80	95
cM capacity (veh/h)	1264				364	823
Direction, Lane #						
	EB 1	EB 2	WB 1	SB 1		
Volume Total	74	369	281	111		
Volume Left	74	0	0	73		
Volume Right	0	0	142	38		
cSH	1264	1700	1700	450		
Volume to Capacity	0.06	0.22	0.17	0.25		
Queue Length 95th (m)	1.3	0.0	0.0	6.7		
Control Delay (s)	8.0	0.0	0.0	15.6		
Lane LOS	A			C		
Approach Delay (s)	1.3		0.0	15.6		
Approach LOS				C		
Intersection Summary						
Average Delay			2.8			
Intersection Capacity Utilization			37.9%		ICU Level of Service	A
Analysis Period (min)			15			

4055 & 4120 Russell Road
 15: Site 2/Building F & Russell

2023 Total Traffic PM Peak Hour

												
Movement	EBL	EBT	EBR	WBL	WBT	WBR	NBL	NBT	NBR	SBL	SBT	SBR
Lane Configurations												
Traffic Volume (veh/h)	0	453	86	1	93	0	171	1	2	0	2	1
Future Volume (Veh/h)	0	453	86	1	93	0	171	1	2	0	2	1
Sign Control		Free			Free			Stop			Stop	
Grade		0%			0%			0%			0%	
Peak Hour Factor	1.00	1.00	1.00	1.00	1.00	1.00	1.00	1.00	1.00	1.00	1.00	1.00
Hourly flow rate (vph)	0	453	86	1	93	0	171	1	2	0	2	1
Pedestrians												
Lane Width (m)												
Walking Speed (m/s)												
Percent Blockage												
Right turn flare (veh)												
Median type		None			None							
Median storage (veh)												
Upstream signal (m)												
pX, platoon unblocked												
vC, conflicting volume	93			539			593	591	496	594	634	93
vC1, stage 1 conf vol												
vC2, stage 2 conf vol												
vCu, unblocked vol	93			539			593	591	496	594	634	93
tC, single (s)	4.1			4.1			7.1	6.5	6.2	7.1	6.5	6.2
tC, 2 stage (s)												
tF (s)	2.2			2.2			3.5	4.0	3.3	3.5	4.0	3.3
p0 queue free %	100			100			58	100	100	100	99	100
cM capacity (veh/h)	1483			1014			411	415	568	410	392	956
Direction, Lane #	EB 1	WB 1	NB 1	SB 1								
Volume Total	539	94	174	3								
Volume Left	0	1	171	0								
Volume Right	86	0	2	1								
cSH	1483	1014	412	488								
Volume to Capacity	0.00	0.00	0.42	0.01								
Queue Length 95th (m)	0.0	0.0	14.4	0.1								
Control Delay (s)	0.0	0.1	20.0	12.4								
Lane LOS		A	C	B								
Approach Delay (s)	0.0	0.1	20.0	12.4								
Approach LOS			C	B								
Intersection Summary												
Average Delay			4.4									
Intersection Capacity Utilization			54.2%		ICU Level of Service				A			
Analysis Period (min)			15									

												
Movement	EBL	EBT	EBR	WBL	WBT	WBR	NBL	NBT	NBR	SBL	SBT	SBR
Lane Configurations												
Traffic Volume (veh/h)	0	454	1	1	90	0	3	0	1	0	0	1
Future Volume (Veh/h)	0	454	1	1	90	0	3	0	1	0	0	1
Sign Control		Free			Free			Stop			Stop	
Grade		0%			0%			0%			0%	
Peak Hour Factor	1.00	1.00	1.00	1.00	1.00	1.00	1.00	1.00	1.00	1.00	1.00	1.00
Hourly flow rate (vph)	0	454	1	1	90	0	3	0	1	0	0	1
Pedestrians												
Lane Width (m)												
Walking Speed (m/s)												
Percent Blockage												
Right turn flare (veh)												
Median type		None			None							
Median storage (veh)												
Upstream signal (m)												
pX, platoon unblocked												
vC, conflicting volume	90			455			548	546	454	548	547	90
vC1, stage 1 conf vol												
vC2, stage 2 conf vol												
vCu, unblocked vol	90			455			548	546	454	548	547	90
tC, single (s)	4.1			4.1			7.1	6.5	6.2	7.1	6.5	6.2
tC, 2 stage (s)												
tF (s)	2.2			2.2			3.5	4.0	3.3	3.5	4.0	3.3
p0 queue free %	100			100			99	100	100	100	100	100
cM capacity (veh/h)	1486			1090			442	440	599	442	440	960
Direction, Lane #	EB 1	WB 1	NB 1	SB 1								
Volume Total	455	91	4	1								
Volume Left	0	1	3	0								
Volume Right	1	0	1	1								
cSH	1486	1090	473	960								
Volume to Capacity	0.00	0.00	0.01	0.00								
Queue Length 95th (m)	0.0	0.0	0.2	0.0								
Control Delay (s)	0.0	0.1	12.7	8.8								
Lane LOS		A	B	A								
Approach Delay (s)	0.0	0.1	12.7	8.8								
Approach LOS			B	A								
Intersection Summary												
Average Delay			0.1									
Intersection Capacity Utilization			35.3%		ICU Level of Service				A			
Analysis Period (min)			15									

Intersection	
Intersection Delay, s/veh	11.2
Intersection LOS	B

Movement	WBL	WBR	NBT	NBR	SBL	SBT
Lane Configurations	W		T			T
Traffic Vol, veh/h	83	8	49	203	132	300
Future Vol, veh/h	83	8	49	203	132	300
Peak Hour Factor	1.00	1.00	1.00	1.00	1.00	1.00
Heavy Vehicles, %	10	1	7	4	2	2
Mvmt Flow	83	8	49	203	132	300
Number of Lanes	1	0	1	0	0	1

Approach	WB	NB	SB
Opposing Approach		SB	NB
Opposing Lanes	0	1	1
Conflicting Approach Left	NB		WB
Conflicting Lanes Left	1	0	1
Conflicting Approach Right	SB	WB	
Conflicting Lanes Right	1	1	0
HCM Control Delay	9.7	9.1	12.8
HCM LOS	A	A	B

Lane	NBLn1	WBLn1	SBLn1
Vol Left, %	0%	91%	31%
Vol Thru, %	19%	0%	69%
Vol Right, %	81%	9%	0%
Sign Control	Stop	Stop	Stop
Traffic Vol by Lane	252	91	432
LT Vol	0	83	132
Through Vol	49	0	300
RT Vol	203	8	0
Lane Flow Rate	252	91	432
Geometry Grp	1	1	1
Degree of Util (X)	0.298	0.143	0.542
Departure Headway (Hd)	4.264	5.673	4.513
Convergence, Y/N	Yes	Yes	Yes
Cap	842	629	799
Service Time	2.299	3.734	2.544
HCM Lane V/C Ratio	0.299	0.145	0.541
HCM Control Delay	9.1	9.7	12.8
HCM Lane LOS	A	A	B
HCM 95th-tile Q	1.3	0.5	3.3

Intersection	
Intersection Delay, s/veh	14
Intersection LOS	B

Movement	EBL	EBT	EBR	WBL	WBT	WBR	NBL	NBT	NBR	SBL	SBT	SBR
Lane Configurations		↕			↕			↕			↕	
Traffic Vol, veh/h	77	233	27	12	23	10	30	170	46	61	262	38
Future Vol, veh/h	77	233	27	12	23	10	30	170	46	61	262	38
Peak Hour Factor	1.00	1.00	1.00	1.00	1.00	1.00	1.00	1.00	1.00	1.00	1.00	1.00
Heavy Vehicles, %	2	1	1	1	14	1	1	1	7	2	3	4
Mvmt Flow	77	233	27	12	23	10	30	170	46	61	262	38
Number of Lanes	0	1	0	0	1	0	0	1	0	0	1	0

Approach	EB	WB	NB	SB
Opposing Approach	WB	EB	SB	NB
Opposing Lanes	1	1	1	1
Conflicting Approach Left	SB	NB	EB	WB
Conflicting Lanes Left	1	1	1	1
Conflicting Approach Right	NB	SB	WB	EB
Conflicting Lanes Right	1	1	1	1
HCM Control Delay	15	9.8	12	14.9
HCM LOS	B	A	B	B

Lane	NBLn1	EBLn1	WBLn1	SBLn1
Vol Left, %		12%	23%	27%
Vol Thru, %		69%	69%	51%
Vol Right, %		19%	8%	22%
Sign Control		Stop	Stop	Stop
Traffic Vol by Lane		246	337	45
LT Vol		30	77	12
Through Vol		170	233	23
RT Vol		46	27	10
Lane Flow Rate		246	337	45
Geometry Grp		1	1	1
Degree of Util (X)		0.379	0.53	0.077
Departure Headway (Hd)		5.551	5.66	6.184
Convergence, Y/N		Yes	Yes	Yes
Cap		645	634	575
Service Time		3.61	3.713	4.266
HCM Lane V/C Ratio		0.381	0.532	0.078
HCM Control Delay		12	15	9.8
HCM Lane LOS		B	B	A
HCM 95th-tile Q		1.8	3.1	0.2



Movement	EBL	EBT	WBT	WBR	SBL	SBR
Lane Configurations						
Traffic Volume (veh/h)	49	1283	1485	123	87	36
Future Volume (Veh/h)	49	1283	1485	123	87	36
Sign Control		Free	Free		Stop	
Grade		0%	0%		0%	
Peak Hour Factor	1.00	1.00	1.00	1.00	1.00	1.00
Hourly flow rate (vph)	49	1283	1485	123	87	36
Pedestrians						
Lane Width (m)						
Walking Speed (m/s)						
Percent Blockage						
Right turn flare (veh)						
Median type		None	None			
Median storage (veh)						
Upstream signal (m)						
pX, platoon unblocked						
vC, conflicting volume	1608				2286	804
vC1, stage 1 conf vol						
vC2, stage 2 conf vol						
vCu, unblocked vol	1608				2286	804
tC, single (s)	4.2				6.9	7.0
tC, 2 stage (s)						
tF (s)	2.2				3.5	3.3
p0 queue free %	87				0	89
cM capacity (veh/h)	389				28	320
Direction, Lane #	EB 1	EB 2	EB 3	WB 1	WB 2	SB 1
Volume Total	49	642	642	990	618	123
Volume Left	49	0	0	0	0	87
Volume Right	0	0	0	0	123	36
cSH	389	1700	1700	1700	1700	38
Volume to Capacity	0.13	0.38	0.38	0.58	0.36	3.23
Queue Length 95th (m)	3.0	0.0	0.0	0.0	0.0	Err
Control Delay (s)	15.6	0.0	0.0	0.0	0.0	Err
Lane LOS	C					F
Approach Delay (s)	0.6			0.0		Err
Approach LOS						F
Intersection Summary						
Average Delay			401.8			
Intersection Capacity Utilization			61.5%		ICU Level of Service	B
Analysis Period (min)			15			

Lane Group	EBL	EBT	EBR	WBL	WBT	WBR	NBL	NBT	NBR	SBL	SBT	SBR
Lane Configurations												
Traffic Volume (vph)	96	1240	319	310	681	80	193	308	375	105	481	109
Future Volume (vph)	96	1240	319	310	681	80	193	308	375	105	481	109
Satd. Flow (prot)	1609	3468	1390	3013	3468	1567	3179	3338	1427	3238	3247	1427
Flt Permitted	0.950			0.950			0.950			0.950		
Satd. Flow (perm)	1604	3468	1368	3010	3468	1535	3155	3338	1402	3218	3247	1396
Satd. Flow (RTOR)			258			154			169			154
Lane Group Flow (vph)	96	1240	319	310	681	80	193	308	375	105	481	109
Turn Type	Prot	NA	Perm	Prot	NA	Perm	Prot	NA	Perm	Prot	NA	Perm
Protected Phases	5	2		1	6		3	8		7	4	
Permitted Phases			2			6			8			4
Total Split (s)	15.0	58.0	58.0	20.0	63.0	63.0	17.0	35.0	35.0	17.0	35.0	35.0
Total Lost Time (s)	6.4	7.3	7.3	6.4	7.3	7.3	7.6	7.4	7.4	7.6	7.4	7.4
Act Effct Green (s)	9.4	51.5	51.5	14.9	57.0	57.0	9.4	26.2	26.2	8.7	25.6	25.6
Actuated g/C Ratio	0.07	0.40	0.40	0.11	0.44	0.44	0.07	0.20	0.20	0.07	0.20	0.20
v/c Ratio	0.83	0.90	0.46	0.90	0.45	0.11	0.84	0.46	0.90	0.48	0.75	0.27
Control Delay	106.8	47.4	8.5	85.9	27.0	0.3	89.3	47.8	52.5	66.0	57.2	3.6
Queue Delay	0.0	0.0	0.0	0.0	0.0	0.0	0.0	0.0	0.0	0.0	0.0	0.0
Total Delay	106.8	47.4	8.5	85.9	27.0	0.3	89.3	47.8	52.5	66.0	57.2	3.6
LOS	F	D	A	F	C	A	F	D	D	E	E	A
Approach Delay		43.4			42.1			58.9			50.1	
Approach LOS		D			D			E			D	
Queue Length 50th (m)	22.9	144.8	9.1	38.2	59.2	0.0	23.6	33.4	50.0	12.4	55.7	0.0
Queue Length 95th (m)	#53.8	#184.4	30.7	#65.3	74.6	0.0	#42.2	46.6	#100.9	21.2	73.2	4.8
Internal Link Dist (m)		485.7			402.0			432.2			296.2	
Turn Bay Length (m)	85.0		225.0	100.0		45.0	140.0		110.0	80.0		55.0
Base Capacity (vph)	116	1373	697	344	1519	758	229	708	430	234	689	417
Starvation Cap Reductn	0	0	0	0	0	0	0	0	0	0	0	0
Spillback Cap Reductn	0	0	0	0	0	0	0	0	0	0	0	0
Storage Cap Reductn	0	0	0	0	0	0	0	0	0	0	0	0
Reduced v/c Ratio	0.83	0.90	0.46	0.90	0.45	0.11	0.84	0.44	0.87	0.45	0.70	0.26

Intersection Summary

Cycle Length: 130

Actuated Cycle Length: 130

Offset: 35 (27%), Referenced to phase 2:EBT and 6:WBT, Start of Green

Control Type: Actuated-Coordinated

Maximum v/c Ratio: 0.90

Intersection Signal Delay: 47.3

Intersection LOS: D

Intersection Capacity Utilization 90.8%

ICU Level of Service E

Analysis Period (min) 15

95th percentile volume exceeds capacity, queue may be longer.

Queue shown is maximum after two cycles.

Splits and Phases: 1: Russell & Walkley

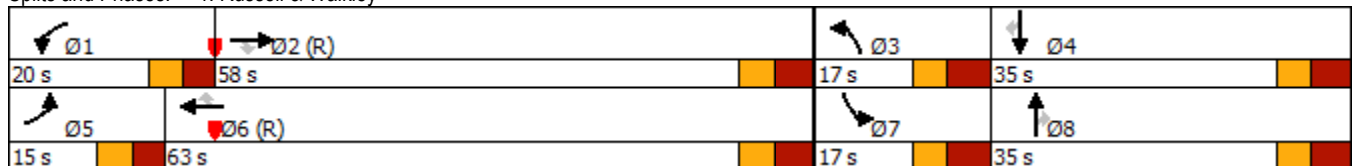

Lane Group	EBL	EBT	EBR	WBL	WBT	WBR	NBL	NBT	NBR	SBL	SBT	SBR
Lane Configurations												
Traffic Volume (vph)	35	7	21	31	3	203	7	716	57	419	869	17
Future Volume (vph)	35	7	21	31	3	203	7	716	57	419	869	17
Satd. Flow (prot)	1624	1466	0	1768	1139	1508	1232	3233	0	1639	3270	0
Flt Permitted	0.756			0.739			0.321			0.222		
Satd. Flow (perm)	1291	1466	0	1376	1139	1488	416	3233	0	383	3270	0
Satd. Flow (RTOR)		21				203		10			4	
Lane Group Flow (vph)	35	28	0	31	3	203	7	773	0	419	886	0
Turn Type	Perm	NA		Perm	NA	Perm	Perm	NA		pm+pt	NA	
Protected Phases		4			8			2		1	6	
Permitted Phases	4			8		8	2			6		
Total Split (s)	26.0	26.0		26.0	26.0	26.0	28.0	28.0		26.0	54.0	
Total Lost Time (s)	5.7	5.7		5.7	5.7	5.7	6.5	6.5		6.3	6.5	
Act Effct Green (s)	12.0	12.0		12.0	12.0	12.0	30.8	30.8		56.0	55.8	
Actuated g/C Ratio	0.15	0.15		0.15	0.15	0.15	0.38	0.38		0.70	0.70	
v/c Ratio	0.18	0.12		0.15	0.02	0.51	0.04	0.62		0.75	0.39	
Control Delay	30.3	15.3		29.5	26.3	9.3	21.0	24.5		18.8	6.1	
Queue Delay	0.0	0.0		0.0	0.0	0.0	0.0	0.0		0.0	0.0	
Total Delay	30.3	15.3		29.5	26.3	9.3	21.0	24.5		18.8	6.1	
LOS	C	B		C	C	A	C	C		B	A	
Approach Delay		23.6			12.2			24.5			10.2	
Approach LOS		C			B			C			B	
Queue Length 50th (m)	4.5	0.9		4.0	0.4	0.0	0.6	44.4		21.1	20.1	
Queue Length 95th (m)	10.2	6.1		9.3	2.1	13.9	3.5	#82.8		#70.9	43.8	
Internal Link Dist (m)		63.3			159.0			795.0			432.2	
Turn Bay Length (m)	20.0			40.0		100.0	40.0			60.0		
Base Capacity (vph)	327	387		349	289	529	160	1252		595	2281	
Starvation Cap Reductn	0	0		0	0	0	0	0		0	0	
Spillback Cap Reductn	0	0		0	0	0	0	0		0	0	
Storage Cap Reductn	0	0		0	0	0	0	0		0	0	
Reduced v/c Ratio	0.11	0.07		0.09	0.01	0.38	0.04	0.62		0.70	0.39	

Intersection Summary

Cycle Length: 80

Actuated Cycle Length: 80

Offset: 0 (0%), Referenced to phase 2:NBTL and 6:SBTL, Start of Green

Control Type: Actuated-Coordinated

Maximum v/c Ratio: 0.75

Intersection Signal Delay: 15.4

Intersection LOS: B

Intersection Capacity Utilization 71.5%

ICU Level of Service C

Analysis Period (min) 15

95th percentile volume exceeds capacity, queue may be longer.

Queue shown is maximum after two cycles.

Splits and Phases: 2: Hawthorne & Russell

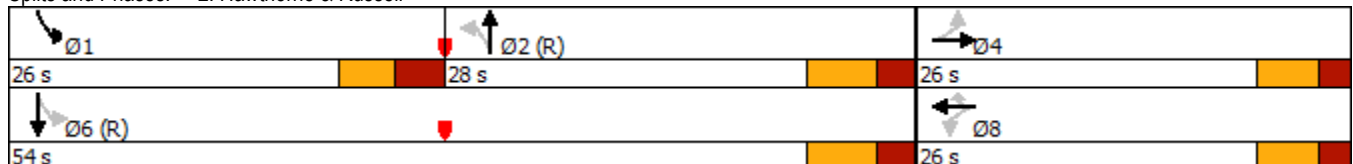

4055 & 4120 Russell Road
 4: Hawthorne & Hunt Club

2023 Total Traffic PM Peak Hour Mod

Lane Group	EBL	EBT	EBR	WBL	WBT	WBR	NBL	NBT	NBR	SBL	SBT	SBR
Lane Configurations												
Traffic Volume (vph)	299	858	24	423	906	87	25	193	307	167	494	490
Future Volume (vph)	299	858	24	423	906	87	25	193	307	167	494	490
Satd. Flow (prot)	3094	3422	0	3208	3468	1141	1717	2807	0	1609	3247	1522
Flt Permitted	0.950			0.950			0.471			0.187		
Satd. Flow (perm)	3094	3422	0	3206	3468	1141	851	2807	0	317	3247	1522
Satd. Flow (RTOR)		2				119		242				490
Lane Group Flow (vph)	299	882	0	423	906	87	25	500	0	167	494	490
Turn Type	Prot	NA		Prot	NA	Perm	pm+pt	NA		pm+pt	NA	Perm
Protected Phases	7	4		3	8		5	2		1	6	
Permitted Phases						8	2			6		6
Total Split (s)	36.4	48.4		44.4	56.4	56.4	21.3	32.3		21.3	32.3	32.3
Total Lost Time (s)	6.4	6.4		6.4	6.4	6.4	6.3	6.3		6.3	6.3	6.3
Act Effct Green (s)	17.3	39.1		21.7	43.4	43.4	25.9	19.0		38.9	31.5	31.5
Actuated g/C Ratio	0.14	0.33		0.18	0.36	0.36	0.22	0.16		0.33	0.26	0.26
v/c Ratio	0.67	0.79		0.73	0.72	0.18	0.11	0.77		0.67	0.58	0.64
Control Delay	58.0	43.4		55.4	37.5	2.9	31.8	33.8		46.2	44.4	8.1
Queue Delay	0.0	0.0		0.0	0.0	0.0	0.0	0.0		0.0	0.0	0.0
Total Delay	58.0	43.4		55.4	37.5	2.9	31.8	33.8		46.2	44.4	8.1
LOS	E	D		E	D	A	C	C		D	D	A
Approach Delay		47.1			40.7			33.7			29.2	
Approach LOS		D			D			C			C	
Queue Length 50th (m)	33.4	92.7		47.0	90.3	0.0	3.8	29.8		28.0	53.8	0.0
Queue Length 95th (m)	50.6	132.4		67.6	128.0	5.0	10.5	51.3		#50.2	78.2	29.4
Internal Link Dist (m)		420.4			461.0			595.0			958.8	
Turn Bay Length (m)	90.0			50.0		80.0	50.0			80.0		80.0
Base Capacity (vph)	800	1267		1051	1495	559	357	817		270	855	761
Starvation Cap Reductn	0	0		0	0	0	0	0		0	0	0
Spillback Cap Reductn	0	0		0	0	0	0	0		0	0	0
Storage Cap Reductn	0	0		0	0	0	0	0		0	0	0
Reduced v/c Ratio	0.37	0.70		0.40	0.61	0.16	0.07	0.61		0.62	0.58	0.64

Intersection Summary

Cycle Length: 146.4
 Actuated Cycle Length: 119.4
 Control Type: Semi Act-Uncoord
 Maximum v/c Ratio: 0.79
 Intersection Signal Delay: 38.5
 Intersection LOS: D
 Intersection Capacity Utilization 85.8%
 ICU Level of Service E
 Analysis Period (min) 15
 # 95th percentile volume exceeds capacity, queue may be longer.
 Queue shown is maximum after two cycles.

Splits and Phases: 4: Hawthorne & Hunt Club

Ø3	Ø4	Ø1	Ø2
44.4 s	48.4 s	21.3 s	32.3 s
Ø7	Ø8	Ø5	Ø6
36.4 s	56.4 s	21.3 s	32.3 s



Lane Group	EBL	EBT	WBT	WBR	SBL	SBR
Lane Configurations		↑↑	↑↑		↓	↓
Traffic Volume (vph)	0	1622	184	0	174	727
Future Volume (vph)	0	1622	184	0	174	727
Satd. Flow (prot)	0	3402	3402	0	1701	1522
Flt Permitted					0.950	
Satd. Flow (perm)	0	3402	3402	0	1701	1522
Satd. Flow (RTOR)						713
Lane Group Flow (vph)	0	1622	184	0	174	727
Turn Type		NA	NA		Prot	Perm
Protected Phases		4	8		6	
Permitted Phases						6
Total Split (s)		56.0	56.0		34.0	34.0
Total Lost Time (s)		6.3	6.3		6.3	6.3
Act Effct Green (s)		60.3	60.3		17.1	17.1
Actuated g/C Ratio		0.67	0.67		0.19	0.19
v/c Ratio		0.71	0.08		0.54	0.84
Control Delay		13.3	6.2		37.6	12.6
Queue Delay		0.0	0.0		0.0	0.0
Total Delay		13.3	6.2		37.6	12.6
LOS		B	A		D	B
Approach Delay		13.3	6.2		17.4	
Approach LOS		B	A		B	
Queue Length 50th (m)		72.7	5.2		25.5	1.9
Queue Length 95th (m)		140.3	8.5		36.7	32.2
Internal Link Dist (m)		664.4	343.7		255.5	
Turn Bay Length (m)					100.0	
Base Capacity (vph)		2280	2280		523	961
Starvation Cap Reductn		0	0		0	0
Spillback Cap Reductn		0	0		0	0
Storage Cap Reductn		0	0		0	0
Reduced v/c Ratio		0.71	0.08		0.33	0.76

Intersection Summary

Cycle Length: 90
 Actuated Cycle Length: 90
 Offset: 0 (0%), Referenced to phase 4:EBT and 8:WBT, Start of Green
 Control Type: Actuated-Coordinated
 Maximum v/c Ratio: 0.84
 Intersection Signal Delay: 14.2
 Intersection LOS: B
 Intersection Capacity Utilization 68.0%
 ICU Level of Service C
 Analysis Period (min) 15

Splits and Phases: 10: Walkley & Hwy 417 SB Off-Ramp

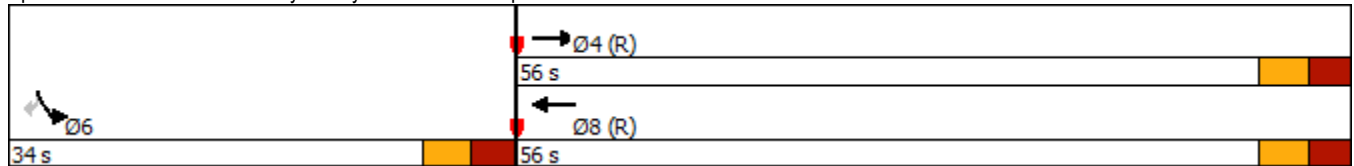

	→	↘	↙	←	↖	↗
Lane Group	EBT	EBR	WBL	WBT	NBL	NBR
Lane Configurations	↑↑			↑↑	↘↗	
Traffic Volume (vph)	811	0	0	87	156	24
Future Volume (vph)	811	0	0	87	156	24
Satd. Flow (prot)	3402	0	0	3402	1684	0
Flt Permitted					0.958	
Satd. Flow (perm)	3402	0	0	3402	1684	0
Satd. Flow (RTOR)					9	
Lane Group Flow (vph)	811	0	0	87	180	0
Turn Type	NA			NA	Prot	
Protected Phases	4			8	2	
Permitted Phases						
Total Split (s)	54.0			54.0	36.0	
Total Lost Time (s)	6.3			6.3	6.3	
Act Effct Green (s)	37.0			37.0	40.4	
Actuated g/C Ratio	0.41			0.41	0.45	
v/c Ratio	0.58			0.06	0.24	
Control Delay	15.5			13.8	18.0	
Queue Delay	0.0			0.0	0.0	
Total Delay	15.5			13.8	18.0	
LOS	B			B	B	
Approach Delay	15.5			13.8	18.0	
Approach LOS	B			B	B	
Queue Length 50th (m)	54.0			4.2	16.2	
Queue Length 95th (m)	26.9			6.4	35.4	
Internal Link Dist (m)	343.7			277.3	355.2	
Turn Bay Length (m)						
Base Capacity (vph)	1803			1803	760	
Starvation Cap Reductn	0			0	0	
Spillback Cap Reductn	0			0	0	
Storage Cap Reductn	0			0	0	
Reduced v/c Ratio	0.45			0.05	0.24	

Intersection Summary

Cycle Length: 90
 Actuated Cycle Length: 90
 Offset: 0 (0%), Referenced to phase 2:NBL and 6:., Start of Green
 Control Type: Actuated-Coordinated
 Maximum v/c Ratio: 0.58
 Intersection Signal Delay: 15.8
 Intersection LOS: B
 Intersection Capacity Utilization 68.0%
 ICU Level of Service C
 Analysis Period (min) 15

Splits and Phases: 11: Hwy 417 NB Off-Ramp & Walkley

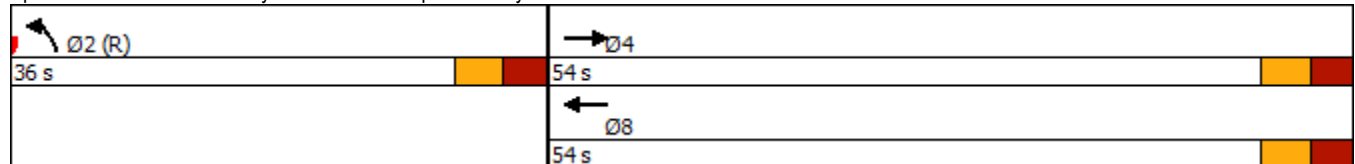

Scheme Summary

Control Data

Control Data and Model Parameters

119124	2023 PHF Flow Profile (veh)
2023 Total Traffic Volumes	7.5 min Time Slice
Rodel-Win1	Queuing Delays (sec)
Right Hand Drive	Daylight conditions
PM Peak Hour	Peak 60/15 min Results
AVERAGE DELAY to Geometry	Output flows: Vehicles
Metric Units (m)	85% Confidence Level

Available Data

Entry Capacity Calibrated	No
Entry Capacity Modified	No
Crosswalks	No
Flows Factored	No
Approach/Exit Road Capacity Calibrated	No
Accidents	No
Accident Costs	No
Bypass Model	No
Bypass Calibration	No
Global Results	Yes

Operational Data

Main Geometry (m)

Geometry and Design Target

Leg	Leg Names	Approach Geometry (m)				Target	Circulating and Exit Geom		
		Bearing (deg)	Grade Sep G	Half Width V	Lanes n	Average Delay (sec/veh)	Inscribed Diameter D	Half Width Vx	Lanes n
1	SB - Anderson	0	0	4.00	1	30	45.00	4.00	1
2	EB - Russell	90	0	4.00	1	30	45.00	4.00	1
3	NB- Anderson	180	0	4.00	1	30	45.00	4.00	1
4	WB - Russell	270	0	4.00	1	30	45.00	4.00	1

Capacity Modifiers and Capacity Calibration (veh/hr)

Leg	Leg Names	Entry Capacity		Entry Calibration		Approach Road			Exit Road		
		Capacity + or -	XWalk Factor	Intercept + or -	Slope Factor	V (m)	Default Capacity	Calib Capacity	V (m)	Default Capacity	Calib Capacity
1	SB - Anderson	0	1.000	0	1.000	6.00	1960	0	4.00	1960	0
2	EB - Russell	0	1.000	0	1.000	6.00	1960	0	4.00	1960	0
3	NB- Anderson	0	1.000	0	1.000	6.00	1960	0	4.00	1960	0
4	WB - Russell	0	1.000	0	1.000	6.00	1960	0	4.00	1960	0

Traffic Flow Data (veh/hr)

2023 PM Peak Peak Hour Flows

Leg	Leg Names	Turning Flows					Flow Modifiers		
		U-Turn	Exit-3	Exit-2	Exit-1	Bypass	Trucks %	Flow Factor	Peak Hour Factor
1	SB - Anderson	0	61	262	38	0	3.0	1.00	1.000
2	EB - Russell	0	77	233	27	0	3.0	1.00	1.000
3	NB- Anderson	0	30	170	46	0	3.0	1.00	1.000
4	WB - Russell	0	12	23	10	0	3.0	1.00	1.000

Operational Results

Geometry for Target Input

Geometry Options for 2023 PM Peak

				Leg 1 - SB - Anderson	
nv	ne	nc	nx	E (m)	L' (m)
1	1	1	1	4.00	0.00

Geometry Options for 2023 PM Peak

				Leg 2 - EB - Russell	
nv	ne	nc	nx	E (m)	L' (m)
1	1	1	1	4.00	0.00

Geometry Options for 2023 PM Peak

				Leg 3 - NB- Anderson	
nv	ne	nc	nx	E (m)	L' (m)
1	1	1	1	4.00	0.00

Geometry Options for 2023 PM Peak

				Leg 4 - WB - Russell	
nv	ne	nc	nx	E (m)	L' (m)
1	1	1	1	4.00	0.00

2023 PM Peak - 60 minutes

Flows and Capacity

Leg	Leg Names	Bypass Type	Flows (veh/hr)				Capacity (veh/hr)			
			Arrival Flow		Opposing Flow		Capacity		Average VCR	
			Entry	Bypass	Entry	Bypass	Entry	Bypass	Entry	Bypass
1	SB - Anderson	None	361		65		257	914		0.3951
2	EB - Russell	None	337		335		91	774		0.4353
3	NB- Anderson	None	246		371		301	755		0.3256
4	WB - Russell	None	45		277		340	804		0.0560

Delays, Queues and Level of Service

Leg	Leg Names	Bypass Type	Average Delay (sec)			95% Queue (veh)		Level of Service		
			Entry	Bypass	Leg	Entry	Bypass	Entry	Bypass	Leg
1	SB - Anderson	None	6.18		6.18	1.61		A		A
2	EB - Russell	None	7.77		7.77	1.89		A		A
3	NB- Anderson	None	6.73		6.73	1.20		A		A
4	WB - Russell	None	4.59		4.59	0.15		A		A

2023 PM Peak - 15 minutes

Flows and Capacity

Leg	Leg Names	Bypass Type	Flows (veh/hr)				Capacity (veh/hr)			
			Arrival Flow		Opposing Flow		Capacity		Average VCR	
			Entry	Bypass	Entry	Bypass	Entry	Bypass	Entry	Bypass
1	SB - Anderson	None	361		65		257	914		0.3951
2	EB - Russell	None	337		335		91	774		0.4353
3	NB- Anderson	None	246		371		301	755		0.3256
4	WB - Russell	None	45		277		340	804		0.0560

Delays, Queues and Level of Service

Leg	Leg Names	Bypass Type	Average Delay (sec)			95% Queue (veh)		Level of Service		
			Entry	Bypass	Leg	Entry	Bypass	Entry	Bypass	Leg
1	SB - Anderson	None	6.19		6.19	1.61		A		A
2	EB - Russell	None	7.79		7.79	1.89		A		A
3	NB- Anderson	None	6.75		6.75	1.20		A		A
4	WB - Russell	None	4.59		4.59	0.15		A		A

4055 & 4120 Russell Road
1: Russell & Walkley

2028 Future Background AM Peak Hour

Lane Group	EBL	EBT	EBR	WBL	WBT	WBR	NBL	NBT	NBR	SBL	SBT	SBR
Lane Configurations												
Traffic Volume (vph)	79	509	141	409	1289	67	226	429	524	57	229	141
Future Volume (vph)	79	509	141	409	1289	67	226	429	524	57	229	141
Satd. Flow (prot)	1374	3307	1332	3013	3435	1522	3094	3218	1332	3269	3189	1390
Flt Permitted	0.950			0.950			0.950			0.950		
Satd. Flow (perm)	1372	3307	1332	3013	3435	1490	3082	3218	1314	3264	3189	1365
Satd. Flow (RTOR)			180			134			524			180
Lane Group Flow (vph)	79	509	141	409	1289	67	226	429	524	57	229	141
Turn Type	Prot	NA	Perm	Prot	NA	Perm	Prot	NA	Perm	Prot	NA	Perm
Protected Phases	5	2		1	6		3	8		7	4	
Permitted Phases			2			6			8			4
Total Split (s)	24.4	45.0	45.0	45.0	65.6	65.6	20.0	40.0	40.0	20.0	40.0	40.0
Total Lost Time (s)	6.4	7.3	7.3	6.4	7.3	7.3	7.6	7.4	7.4	7.6	7.4	7.4
Act Effct Green (s)	13.5	56.9	56.9	25.7	69.1	69.1	12.4	33.4	33.4	8.0	26.3	26.3
Actuated g/C Ratio	0.09	0.38	0.38	0.17	0.46	0.46	0.08	0.22	0.22	0.05	0.18	0.18
v/c Ratio	0.64	0.41	0.23	0.79	0.82	0.09	0.89	0.60	0.75	0.33	0.41	0.36
Control Delay	87.8	37.7	2.8	71.0	41.9	0.2	100.8	56.0	11.3	72.9	55.8	5.1
Queue Delay	0.0	0.0	0.0	0.0	0.0	0.0	0.0	0.0	0.0	0.0	0.0	0.0
Total Delay	87.8	37.7	2.8	71.0	41.9	0.2	100.8	56.0	11.3	72.9	55.8	5.1
LOS	F	D	A	E	D	A	F	E	B	E	E	A
Approach Delay		36.4			47.0			44.7			41.3	
Approach LOS		D			D			D			D	
Queue Length 50th (m)	21.2	56.0	0.0	56.1	167.0	0.0	32.1	55.4	0.0	7.9	28.7	0.0
Queue Length 95th (m)	37.0	78.0	6.6	69.7	#224.9	0.0	#53.9	71.8	34.8	14.6	40.0	7.3
Internal Link Dist (m)		485.7			361.7			432.2			296.2	
Turn Bay Length (m)	85.0		225.0	100.0		45.0	140.0		110.0	80.0		55.0
Base Capacity (vph)	164	1254	616	775	1581	758	255	732	703	270	693	437
Starvation Cap Reductn	0	0	0	0	0	0	0	0	0	0	0	0
Spillback Cap Reductn	0	0	0	0	0	0	0	0	0	0	0	0
Storage Cap Reductn	0	0	0	0	0	0	0	0	0	0	0	0
Reduced v/c Ratio	0.48	0.41	0.23	0.53	0.82	0.09	0.89	0.59	0.75	0.21	0.33	0.32

Intersection Summary

Cycle Length: 150

Actuated Cycle Length: 150

Offset: 102 (68%), Referenced to phase 2:EBT and 6:WBT, Start of Green

Control Type: Actuated-Coordinated

Maximum v/c Ratio: 0.89

Intersection Signal Delay: 43.9

Intersection LOS: D

Intersection Capacity Utilization 83.2%

ICU Level of Service E

Analysis Period (min) 15

95th percentile volume exceeds capacity, queue may be longer.

Queue shown is maximum after two cycles.

Splits and Phases: 1: Russell & Walkley

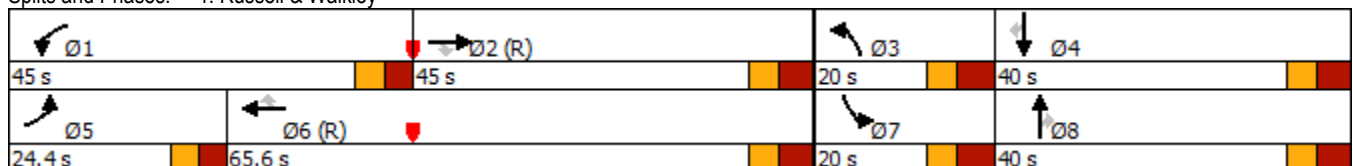

4055 & 4120 Russell Road
2: Hawthorne & Russell

2028 Future Background AM Peak Hour

Lane Group	EBL	EBT	EBR	WBL	WBT	WBR	NBL	NBT	NBR	SBL	SBT	SBR
Lane Configurations												
Traffic Volume (vph)	10	0	8	15	10	350	17	933	9	53	572	34
Future Volume (vph)	10	0	8	15	10	350	17	933	9	53	572	34
Satd. Flow (prot)	1276	1278	0	1488	1790	1522	1701	3104	0	1488	2988	0
Flt Permitted	0.751			0.752			0.423			0.280		
Satd. Flow (perm)	1008	1278	0	1178	1790	1522	754	3104	0	439	2988	0
Satd. Flow (RTOR)		335				160		2			13	
Lane Group Flow (vph)	10	8	0	15	10	350	17	942	0	53	606	0
Turn Type	Perm	NA		Perm	NA	Perm	Perm	NA		Perm	NA	
Protected Phases		4			8			2			6	
Permitted Phases	4			8		8	2			6		
Total Split (s)	26.0	26.0		26.0	26.0	26.0	64.0	64.0		64.0	64.0	
Total Lost Time (s)	5.7	5.7		5.7	5.7	5.7	6.5	6.5		6.5	6.5	
Act Effct Green (s)	17.1	17.1		17.1	17.1	17.1	60.7	60.7		60.7	60.7	
Actuated g/C Ratio	0.19	0.19		0.19	0.19	0.19	0.67	0.67		0.67	0.67	
v/c Ratio	0.05	0.02		0.07	0.03	0.84	0.03	0.45		0.18	0.30	
Control Delay	28.3	0.0		28.5	27.6	36.4	3.7	5.2		8.4	6.8	
Queue Delay	0.0	0.0		0.0	0.0	0.0	0.0	0.0		0.0	0.0	
Total Delay	28.3	0.0		28.5	27.6	36.4	3.7	5.2		8.4	6.8	
LOS	C	A		C	C	D	A	A		A	A	
Approach Delay		15.7			35.8			5.1			6.9	
Approach LOS		B			D			A			A	
Queue Length 50th (m)	1.3	0.0		1.9	1.3	28.3	0.5	13.3		3.1	19.7	
Queue Length 95th (m)	5.0	0.0		6.5	5.0	#64.7	m0.9	16.5		8.1	27.8	
Internal Link Dist (m)		63.3			159.0			795.0			432.2	
Turn Bay Length (m)	20.0			40.0		100.0	40.0			60.0		
Base Capacity (vph)	227	547		265	403	467	508	2092		295	2018	
Starvation Cap Reductn	0	0		0	0	0	0	0		0	0	
Spillback Cap Reductn	0	0		0	0	0	0	0		0	0	
Storage Cap Reductn	0	0		0	0	0	0	0		0	0	
Reduced v/c Ratio	0.04	0.01		0.06	0.02	0.75	0.03	0.45		0.18	0.30	

Intersection Summary

Cycle Length: 90

Actuated Cycle Length: 90

Offset: 23 (26%), Referenced to phase 2:NBT and 6:SBTL, Start of Green

Control Type: Actuated-Coordinated

Maximum v/c Ratio: 0.84

Intersection Signal Delay: 11.5

Intersection LOS: B

Intersection Capacity Utilization 73.7%

ICU Level of Service D

Analysis Period (min) 15

95th percentile volume exceeds capacity, queue may be longer.

Queue shown is maximum after two cycles.

m Volume for 95th percentile queue is metered by upstream signal.

Splits and Phases: 2: Hawthorne & Russell

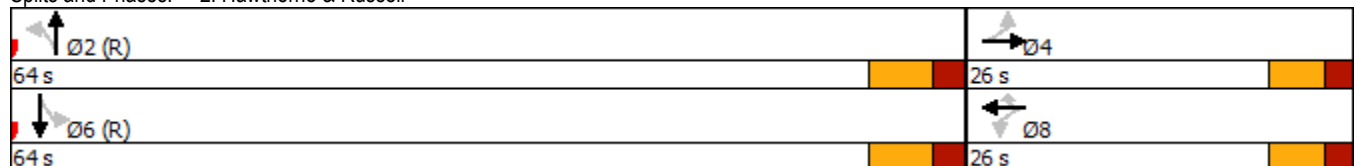

4055 & 4120 Russell Road
3: Hawthorne & Stevenage

2028 Future Background AM Peak Hour



Lane Group	EBL	EBT	EBR	WBL	WBT	WBR	NBL	NBT	NBR	SBL	SBT	SBR
Lane Configurations												
Traffic Volume (vph)	134	28	60	58	63	55	208	966	86	52	330	200
Future Volume (vph)	134	28	60	58	63	55	208	966	86	52	330	200
Satd. Flow (prot)	1553	1219	0	1276	1465	0	1669	3096	0	1429	2858	1453
Flt Permitted	0.681			0.700			0.496			0.236		
Satd. Flow (perm)	1113	1219	0	935	1465	0	868	3096	0	355	2858	1414
Satd. Flow (RTOR)		60			52			12				200
Lane Group Flow (vph)	134	88	0	58	118	0	208	1052	0	52	330	200
Turn Type	Perm	NA		Perm	NA		pm+pt	NA		pm+pt	NA	Perm
Protected Phases		4			8		5	2		1	6	
Permitted Phases	4			8			2			6		6
Total Split (s)	35.0	35.0		35.0	35.0		15.0	40.0		15.0	40.0	40.0
Total Lost Time (s)	5.7	5.7		5.7	5.7		5.7	5.5		5.7	5.5	5.5
Act Effct Green (s)	16.9	16.9		16.9	16.9		60.6	54.0		53.0	46.4	46.4
Actuated g/C Ratio	0.19	0.19		0.19	0.19		0.67	0.60		0.59	0.52	0.52
v/c Ratio	0.64	0.32		0.33	0.37		0.31	0.56		0.18	0.22	0.24
Control Delay	46.6	14.8		34.5	20.5		7.5	15.0		3.8	9.8	6.6
Queue Delay	0.0	0.0		0.0	0.0		0.0	0.0		0.0	0.0	0.0
Total Delay	46.6	14.8		34.5	20.5		7.5	15.0		3.8	9.8	6.6
LOS	D	B		C	C		A	B		A	A	A
Approach Delay		34.0			25.1			13.8			8.2	
Approach LOS		C			C			B			A	
Queue Length 50th (m)	20.1	3.8		8.2	9.1		10.0	54.1		1.6	15.1	6.3
Queue Length 95th (m)	33.0	13.4		16.2	20.1		23.8	94.7		1.1	29.7	25.7
Internal Link Dist (m)		201.3			257.1			958.8			795.0	
Turn Bay Length (m)	45.0			25.0			75.0			85.0		85.0
Base Capacity (vph)	362	437		304	512		678	1863		329	1474	826
Starvation Cap Reductn	0	0		0	0		0	0		0	0	0
Spillback Cap Reductn	0	0		0	0		0	0		0	0	0
Storage Cap Reductn	0	0		0	0		0	0		0	0	0
Reduced v/c Ratio	0.37	0.20		0.19	0.23		0.31	0.56		0.16	0.22	0.24

Intersection Summary

Cycle Length: 90
 Actuated Cycle Length: 90
 Offset: 0 (0%), Referenced to phase 2:NBTL and 6:SBTL, Start of Green
 Control Type: Actuated-Coordinated
 Maximum v/c Ratio: 0.64
 Intersection Signal Delay: 15.2
 Intersection LOS: B
 Intersection Capacity Utilization 64.0%
 ICU Level of Service B
 Analysis Period (min) 15

Splits and Phases: 3: Hawthorne & Stevenage

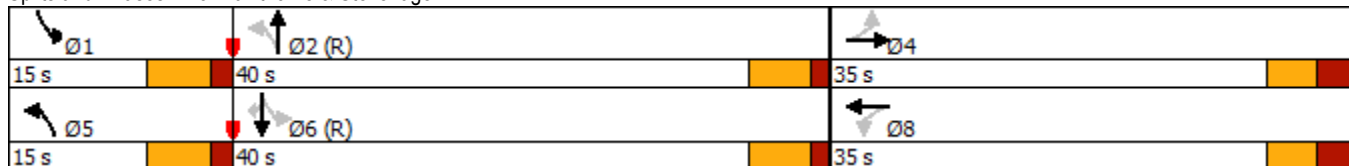

4055 & 4120 Russell Road
4: Hawthorne & Hunt Club

2028 Future Background AM Peak Hour

Lane Group	EBL	EBT	EBR	WBL	WBT	WBR	NBL	NBT	NBR	SBL	SBT	SBR
Lane Configurations												
Traffic Volume (vph)	435	655	26	263	711	257	42	432	400	45	154	171
Future Volume (vph)	435	655	26	263	711	257	42	432	400	45	154	171
Satd. Flow (prot)	1639	3333	0	1595	3402	1440	1488	2974	0	1191	2748	1278
Flt Permitted	0.950			0.950			0.654			0.129		
Satd. Flow (perm)	1639	3333	0	1595	3402	1440	1025	2974	0	162	2748	1278
Satd. Flow (RTOR)		3				257		152				171
Lane Group Flow (vph)	435	681	0	263	711	257	42	832	0	45	154	171
Turn Type	Prot	NA		Prot	NA	Perm	pm+pt	NA		pm+pt	NA	Perm
Protected Phases	7	4		3	8		5	2		1	6	
Permitted Phases						8	2			6		6
Total Split (s)	41.4	41.4		41.4	41.4	41.4	21.3	36.3		21.3	36.3	36.3
Total Lost Time (s)	6.4	6.4		6.4	6.4	6.4	6.3	6.3		6.3	6.3	6.3
Act Effct Green (s)	35.2	42.1		26.3	33.2	33.2	36.9	30.2		38.6	31.1	31.1
Actuated g/C Ratio	0.27	0.32		0.20	0.25	0.25	0.28	0.23		0.30	0.24	0.24
v/c Ratio	0.98	0.63		0.82	0.82	0.46	0.13	1.03		0.38	0.24	0.39
Control Delay	86.8	42.8		70.1	55.2	7.5	31.5	80.6		40.2	42.9	8.9
Queue Delay	0.0	0.0		0.0	0.0	0.0	0.0	0.0		0.0	0.0	0.0
Total Delay	86.8	42.8		70.1	55.2	7.5	31.5	80.6		40.2	42.9	8.9
LOS	F	D		E	E	A	C	F		D	D	A
Approach Delay		60.0			48.5			78.2			26.8	
Approach LOS		E			D			E			C	
Queue Length 50th (m)	~112.3	74.5		61.9	85.8	0.0	7.0	~101.5		7.6	16.2	0.0
Queue Length 95th (m)	#177.9	105.8		87.4	111.0	20.0	14.8	#144.3		15.9	26.0	17.5
Internal Link Dist (m)		420.4			1343.9			595.0			958.8	
Turn Bay Length (m)	90.0			50.0		80.0	50.0			80.0		80.0
Base Capacity (vph)	443	1079		431	920	577	380	806		171	655	435
Starvation Cap Reductn	0	0		0	0	0	0	0		0	0	0
Spillback Cap Reductn	0	0		0	0	0	0	0		0	0	0
Storage Cap Reductn	0	0		0	0	0	0	0		0	0	0
Reduced v/c Ratio	0.98	0.63		0.61	0.77	0.45	0.11	1.03		0.26	0.24	0.39

Intersection Summary

Cycle Length: 140.4
 Actuated Cycle Length: 130.3
 Control Type: Semi Act-Uncoord
 Maximum v/c Ratio: 1.03
 Intersection Signal Delay: 57.1
 Intersection LOS: E
 Intersection Capacity Utilization 97.8%
 ICU Level of Service F
 Analysis Period (min) 15

~ Volume exceeds capacity, queue is theoretically infinite.
 Queue shown is maximum after two cycles.

95th percentile volume exceeds capacity, queue may be longer.
 Queue shown is maximum after two cycles.

Splits and Phases: 4: Hawthorne & Hunt Club

41.4 s	41.4 s	21.3 s	36.3 s
41.4 s	41.4 s	21.3 s	36.3 s

4055 & 4120 Russell Road
5: Belgreen & Russell

2028 Future Background AM Peak Hour

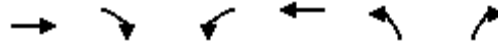

Movement	EBT	EBR	WBL	WBT	NBL	NBR
Lane Configurations						
Traffic Volume (veh/h)	26	42	155	436	39	22
Future Volume (Veh/h)	26	42	155	436	39	22
Sign Control	Free		Free		Stop	
Grade	0%		0%		0%	
Peak Hour Factor	1.00	1.00	1.00	1.00	1.00	1.00
Hourly flow rate (vph)	26	42	155	436	39	22
Pedestrians						
Lane Width (m)						
Walking Speed (m/s)						
Percent Blockage						
Right turn flare (veh)						
Median type	None		None			
Median storage (veh)						
Upstream signal (m)						
pX, platoon unblocked						
vC, conflicting volume			68		793	47
vC1, stage 1 conf vol						
vC2, stage 2 conf vol						
vCu, unblocked vol			68		793	47
tC, single (s)			4.1		6.8	6.5
tC, 2 stage (s)						
tF (s)			2.2		3.9	3.5
p0 queue free %			90		86	98
cM capacity (veh/h)			1527		278	961
Direction, Lane #	EB 1	WB 1	NB 1			
Volume Total	68	591	61			
Volume Left	0	155	39			
Volume Right	42	0	22			
cSH	1700	1527	374			
Volume to Capacity	0.04	0.10	0.16			
Queue Length 95th (m)	0.0	2.4	4.0			
Control Delay (s)	0.0	2.8	16.5			
Lane LOS		A	C			
Approach Delay (s)	0.0	2.8	16.5			
Approach LOS			C			
Intersection Summary						
Average Delay			3.7			
Intersection Capacity Utilization			50.3%	ICU Level of Service	A	
Analysis Period (min)			15			

4055 & 4120 Russell Road
6: Hunt Club & Hwy 417 Offramp

2028 Future Background AM Peak Hour



Movement	EBL	EBR	NBL	NBT	SBT	SBR
Lane Configurations						
Traffic Volume (veh/h)	2	868	0	891	679	0
Future Volume (Veh/h)	2	868	0	891	679	0
Sign Control	Stop			Free	Free	
Grade	0%			0%	0%	
Peak Hour Factor	1.00	1.00	1.00	1.00	1.00	1.00
Hourly flow rate (vph)	2	868	0	891	679	0
Pedestrians						
Lane Width (m)						
Walking Speed (m/s)						
Percent Blockage						
Right turn flare (veh)						
Median type				None	None	
Median storage (veh)						
Upstream signal (m)						
pX, platoon unblocked						
vC, conflicting volume	1570	679	679			
vC1, stage 1 conf vol						
vC2, stage 2 conf vol						
vCu, unblocked vol	1570	679	679			
tC, single (s)	6.4	6.3	4.1			
tC, 2 stage (s)						
tF (s)	3.5	3.4	2.2			
p0 queue free %	98	0	100			
cM capacity (veh/h)	122	440	923			
Direction, Lane #						
	EB 1	EB 2	NB 1	SB 1		
Volume Total	2	868	891	679		
Volume Left	2	0	0	0		
Volume Right	0	868	0	0		
cSH	122	440	1700	1700		
Volume to Capacity	0.02	1.97	0.52	0.40		
Queue Length 95th (m)	0.3	413.3	0.0	0.0		
Control Delay (s)	34.9	467.5	0.0	0.0		
Lane LOS	D	F				
Approach Delay (s)	466.5		0.0	0.0		
Approach LOS	F					
Intersection Summary						
Average Delay			166.3			
Intersection Capacity Utilization			101.1%	ICU Level of Service		G
Analysis Period (min)			15			

4055 & 4120 Russell Road
7: Ramsayville & Russell

2028 Future Background AM Peak Hour



Movement	EBL	EBR	NBL	NBT	SBT	SBR
Lane Configurations						
Traffic Volume (veh/h)	25	21	390	347	145	214
Future Volume (Veh/h)	25	21	390	347	145	214
Sign Control	Stop			Free	Free	
Grade	0%			0%	0%	
Peak Hour Factor	1.00	1.00	1.00	1.00	1.00	1.00
Hourly flow rate (vph)	25	21	390	347	145	214
Pedestrians	2					
Lane Width (m)	4.0					
Walking Speed (m/s)	1.0					
Percent Blockage	0					
Right turn flare (veh)						
Median type				None	None	
Median storage (veh)						
Upstream signal (m)						
pX, platoon unblocked						
vC, conflicting volume	1379	254	359			
vC1, stage 1 conf vol						
vC2, stage 2 conf vol						
vCu, unblocked vol	1379	254	359			
tC, single (s)	6.9	6.4	4.1			
tC, 2 stage (s)						
tF (s)	4.0	3.5	2.2			
p0 queue free %	70	97	67			
cM capacity (veh/h)	85	741	1189			
Direction, Lane #	EB 1	NB 1	SB 1			
Volume Total	46	737	359			
Volume Left	25	390	0			
Volume Right	21	0	214			
cSH	142	1189	1700			
Volume to Capacity	0.32	0.33	0.21			
Queue Length 95th (m)	9.1	10.1	0.0			
Control Delay (s)	42.1	6.9	0.0			
Lane LOS	E	A				
Approach Delay (s)	42.1	6.9	0.0			
Approach LOS	E					
Intersection Summary						
Average Delay	6.1					
Intersection Capacity Utilization	77.9%			ICU Level of Service	D	
Analysis Period (min)	15					

4055 & 4120 Russell Road
10: Walkley & SB off-ramp

2028 Future Background AM Peak Hour



Movement	EBL	EBT	WBT	WBR	SBL	SBR
Lane Configurations		↑↑	↑↑		↓	↓
Traffic Volume (veh/h)	0	485	1041	0	24	1011
Future Volume (Veh/h)	0	485	1041	0	24	1011
Sign Control		Free	Free		Stop	
Grade		0%	0%		0%	
Peak Hour Factor	1.00	1.00	1.00	1.00	1.00	1.00
Hourly flow rate (vph)	0	485	1041	0	24	1011
Pedestrians						
Lane Width (m)						
Walking Speed (m/s)						
Percent Blockage						
Right turn flare (veh)						
Median type		None	None			
Median storage (veh)						
Upstream signal (m)						
pX, platoon unblocked						
vC, conflicting volume	1041				1284	520
vC1, stage 1 conf vol						
vC2, stage 2 conf vol						
vCu, unblocked vol	1041				1284	520
tC, single (s)	4.2				6.9	7.0
tC, 2 stage (s)						
tF (s)	2.2				3.5	3.3
p0 queue free %	100				84	0
cM capacity (veh/h)	646				153	493
Direction, Lane #	EB 1	EB 2	WB 1	WB 2	SB 1	SB 2
Volume Total	242	242	520	520	24	1011
Volume Left	0	0	0	0	24	0
Volume Right	0	0	0	0	0	1011
cSH	1700	1700	1700	1700	153	493
Volume to Capacity	0.14	0.14	0.31	0.31	0.16	2.05
Queue Length 95th (m)	0.0	0.0	0.0	0.0	3.8	491.3
Control Delay (s)	0.0	0.0	0.0	0.0	32.9	499.4
Lane LOS					D	F
Approach Delay (s)	0.0		0.0		488.6	
Approach LOS					F	
Intersection Summary						
Average Delay			197.4			
Intersection Capacity Utilization			103.1%		ICU Level of Service	G
Analysis Period (min)			15			

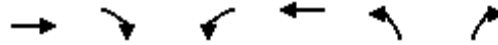

4055 & 4120 Russell Road
11: NB Off-ramp & Walkley

2028 Future Background AM Peak Hour



Movement	EBT	EBR	WBL	WBT	NBL	NBR
Lane Configurations	↑↑			↑↑	↑↑	
Traffic Volume (veh/h)	172	0	0	973	578	60
Future Volume (Veh/h)	172	0	0	973	578	60
Sign Control	Free			Free	Stop	
Grade	0%			0%	0%	
Peak Hour Factor	1.00	1.00	1.00	1.00	1.00	1.00
Hourly flow rate (vph)	172	0	0	973	578	60
Pedestrians						
Lane Width (m)						
Walking Speed (m/s)						
Percent Blockage						
Right turn flare (veh)						
Median type	None			None		
Median storage (veh)						
Upstream signal (m)						
pX, platoon unblocked						
vC, conflicting volume				172	658	86
vC1, stage 1 conf vol						
vC2, stage 2 conf vol						
vCu, unblocked vol				172	658	86
tC, single (s)				4.2	6.9	7.0
tC, 2 stage (s)						
tF (s)				2.2	3.5	3.3
p0 queue free %				100	0	94
cM capacity (veh/h)				1381	390	946
Direction, Lane #	EB 1	EB 2	WB 1	WB 2	NB 1	
Volume Total	86	86	486	486	638	
Volume Left	0	0	0	0	578	
Volume Right	0	0	0	0	60	
cSH	1700	1700	1700	1700	413	
Volume to Capacity	0.05	0.05	0.29	0.29	1.54	
Queue Length 95th (m)	0.0	0.0	0.0	0.0	244.7	
Control Delay (s)	0.0	0.0	0.0	0.0	281.4	
Lane LOS						F
Approach Delay (s)	0.0		0.0		281.4	
Approach LOS						F
Intersection Summary						
Average Delay				100.7		
Intersection Capacity Utilization				103.1%	ICU Level of Service	G
Analysis Period (min)				15		

Intersection	
Intersection Delay, s/veh	23
Intersection LOS	C

Movement	WBL	WBR	NBT	NBR	SBL	SBT
Lane Configurations						
Traffic Vol, veh/h	304	300	340	38	10	22
Future Vol, veh/h	304	300	340	38	10	22
Peak Hour Factor	1.00	1.00	1.00	1.00	1.00	1.00
Heavy Vehicles, %	4	1	1	15	1	20
Mvmt Flow	304	300	340	38	10	22
Number of Lanes	1	0	1	0	0	1

Approach	WB	NB	SB
Opposing Approach		SB	NB
Opposing Lanes	0	1	1
Conflicting Approach Left	NB		WB
Conflicting Lanes Left	1	0	1
Conflicting Approach Right	SB	WB	
Conflicting Lanes Right	1	1	0
HCM Control Delay	28.1	16	9.7
HCM LOS	D	C	A

Lane	NBLn1	WBLn1	SBLn1
Vol Left, %	0%	50%	31%
Vol Thru, %	90%	0%	69%
Vol Right, %	10%	50%	0%
Sign Control	Stop	Stop	Stop
Traffic Vol by Lane	378	604	32
LT Vol	0	304	10
Through Vol	340	0	22
RT Vol	38	300	0
Lane Flow Rate	378	604	32
Geometry Grp	1	1	1
Degree of Util (X)	0.58	0.837	0.056
Departure Headway (Hd)	5.527	4.989	6.257
Convergence, Y/N	Yes	Yes	Yes
Cap	650	731	570
Service Time	3.573	2.989	4.322
HCM Lane V/C Ratio	0.582	0.826	0.056
HCM Control Delay	16	28.1	9.7
HCM Lane LOS	C	D	A
HCM 95th-tile Q	3.7	9.4	0.2

4055 & 4120 Russell Road
9: Anderson & Russell

2028 Future Background AM Peak Hour

Intersection	
Intersection Delay, s/veh	37.2
Intersection LOS	E

Movement	EBL	EBT	EBR	WBL	WBT	WBR	NBL	NBT	NBR	SBL	SBT	SBR
Lane Configurations		↕			↕			↕			↕	
Traffic Vol, veh/h	35	16	3	48	347	118	171	304	6	5	139	153
Future Vol, veh/h	35	16	3	48	347	118	171	304	6	5	139	153
Peak Hour Factor	1.00	1.00	1.00	1.00	1.00	1.00	1.00	1.00	1.00	1.00	1.00	1.00
Heavy Vehicles, %	11	7	1	1	2	3	1	3	17	1	4	2
Mvmt Flow	35	16	3	48	347	118	171	304	6	5	139	153
Number of Lanes	0	1	0	0	1	0	0	1	0	0	1	0
Approach	EB			WB			NB			SB		
Opposing Approach	WB			EB			SB			NB		
Opposing Lanes	1			1			1			1		
Conflicting Approach Left	SB			NB			EB			WB		
Conflicting Lanes Left	1			1			1			1		
Conflicting Approach Right	NB			SB			WB			EB		
Conflicting Lanes Right	1			1			1			1		
HCM Control Delay	12.7			46.2			42.1			18.2		
HCM LOS	B			E			E			C		

Lane	NBLn1	EBLn1	WBLn1	SBLn1
Vol Left, %	36%	65%	9%	2%
Vol Thru, %	63%	30%	68%	47%
Vol Right, %	1%	6%	23%	52%
Sign Control	Stop	Stop	Stop	Stop
Traffic Vol by Lane	481	54	513	297
LT Vol	171	35	48	5
Through Vol	304	16	347	139
RT Vol	6	3	118	153
Lane Flow Rate	481	54	513	297
Geometry Grp	1	1	1	1
Degree of Util (X)	0.887	0.127	0.918	0.562
Departure Headway (Hd)	6.738	8.45	6.444	6.813
Convergence, Y/N	Yes	Yes	Yes	Yes
Cap	544	426	559	532
Service Time	4.738	6.473	4.538	4.813
HCM Lane V/C Ratio	0.884	0.127	0.918	0.558
HCM Control Delay	42.1	12.7	46.2	18.2
HCM Lane LOS	E	B	E	C
HCM 95th-tile Q	10.1	0.4	11.2	3.4

4055 & 4120 Russell Road
1: Russell & Walkley

2028 Future Background AM Peak Hour Mod

Lane Group	EBL	EBT	EBR	WBL	WBT	WBR	NBL	NBT	NBR	SBL	SBT	SBR
Lane Configurations												
Traffic Volume (vph)	79	509	141	409	1289	67	226	429	524	57	229	141
Future Volume (vph)	79	509	141	409	1289	67	226	429	524	57	229	141
Satd. Flow (prot)	1374	3307	1332	3013	3435	1522	3094	3218	1332	3269	3189	1390
Flt Permitted	0.950			0.950			0.950			0.950		
Satd. Flow (perm)	1372	3307	1332	3013	3435	1490	3082	3218	1314	3264	3189	1365
Satd. Flow (RTOR)			180			134			524			180
Lane Group Flow (vph)	79	509	141	409	1289	67	226	429	524	57	229	141
Turn Type	Prot	NA	Perm	Prot	NA	Perm	Prot	NA	Perm	Prot	NA	Perm
Protected Phases	5	2		1	6		3	8		7	4	
Permitted Phases			2			6			8			4
Total Split (s)	24.4	45.0	45.0	45.0	65.6	65.6	20.0	40.0	40.0	20.0	40.0	40.0
Total Lost Time (s)	6.4	7.3	7.3	6.4	7.3	7.3	7.6	7.4	7.4	7.6	7.4	7.4
Act Effct Green (s)	13.5	56.9	56.9	25.7	69.1	69.1	12.4	33.4	33.4	8.0	26.3	26.3
Actuated g/C Ratio	0.09	0.38	0.38	0.17	0.46	0.46	0.08	0.22	0.22	0.05	0.18	0.18
v/c Ratio	0.64	0.41	0.23	0.79	0.82	0.09	0.89	0.60	0.75	0.33	0.41	0.36
Control Delay	87.8	37.7	2.8	71.0	41.9	0.2	100.8	56.0	11.3	72.9	55.8	5.1
Queue Delay	0.0	0.0	0.0	0.0	0.0	0.0	0.0	0.0	0.0	0.0	0.0	0.0
Total Delay	87.8	37.7	2.8	71.0	41.9	0.2	100.8	56.0	11.3	72.9	55.8	5.1
LOS	F	D	A	E	D	A	F	E	B	E	E	A
Approach Delay		36.4			47.0			44.7			41.3	
Approach LOS		D			D			D			D	
Queue Length 50th (m)	21.2	56.0	0.0	56.1	167.0	0.0	32.1	55.4	0.0	7.9	28.7	0.0
Queue Length 95th (m)	37.0	78.0	6.6	69.7	#224.9	0.0	#53.9	71.8	34.8	14.6	40.0	7.3
Internal Link Dist (m)		485.7			361.7			432.2			296.2	
Turn Bay Length (m)	85.0		225.0	100.0		45.0	140.0		110.0	80.0		55.0
Base Capacity (vph)	164	1254	616	775	1581	758	255	732	703	270	693	437
Starvation Cap Reductn	0	0	0	0	0	0	0	0	0	0	0	0
Spillback Cap Reductn	0	0	0	0	0	0	0	0	0	0	0	0
Storage Cap Reductn	0	0	0	0	0	0	0	0	0	0	0	0
Reduced v/c Ratio	0.48	0.41	0.23	0.53	0.82	0.09	0.89	0.59	0.75	0.21	0.33	0.32

Intersection Summary

Cycle Length: 150

Actuated Cycle Length: 150

Offset: 102 (68%), Referenced to phase 2:EBT and 6:WBT, Start of Green

Control Type: Actuated-Coordinated

Maximum v/c Ratio: 0.89

Intersection Signal Delay: 43.9

Intersection LOS: D

Intersection Capacity Utilization 83.2%

ICU Level of Service E

Analysis Period (min) 15

95th percentile volume exceeds capacity, queue may be longer.

Queue shown is maximum after two cycles.

Splits and Phases: 1: Russell & Walkley

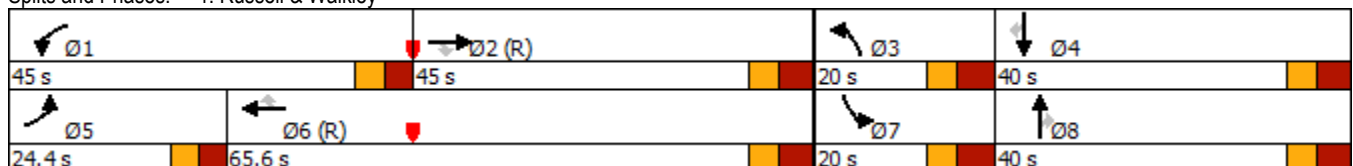

4055 & 4120 Russell Road
2: Hawthorne & Russell

2028 Future Background AM Peak Hour Mod



Lane Group	EBL	EBT	EBR	WBL	WBT	WBR	NBL	NBT	NBR	SBL	SBT	SBR
Lane Configurations												
Traffic Volume (vph)	10	0	8	15	10	350	17	933	9	53	572	34
Future Volume (vph)	10	0	8	15	10	350	17	933	9	53	572	34
Satd. Flow (prot)	1276	1278	0	1488	1790	1522	1701	3104	0	1488	2988	0
Flt Permitted	0.751			0.752			0.423			0.280		
Satd. Flow (perm)	1008	1278	0	1178	1790	1522	754	3104	0	439	2988	0
Satd. Flow (RTOR)		335				160		2			13	
Lane Group Flow (vph)	10	8	0	15	10	350	17	942	0	53	606	0
Turn Type	Perm	NA		Perm	NA	Perm	Perm	NA		Perm	NA	
Protected Phases		4			8			2			6	
Permitted Phases	4			8		8	2			6		
Total Split (s)	26.0	26.0		26.0	26.0	26.0	64.0	64.0		64.0	64.0	
Total Lost Time (s)	5.7	5.7		5.7	5.7	5.7	6.5	6.5		6.5	6.5	
Act Effct Green (s)	17.1	17.1		17.1	17.1	17.1	60.7	60.7		60.7	60.7	
Actuated g/C Ratio	0.19	0.19		0.19	0.19	0.19	0.67	0.67		0.67	0.67	
v/c Ratio	0.05	0.02		0.07	0.03	0.84	0.03	0.45		0.18	0.30	
Control Delay	28.3	0.0		28.5	27.6	36.4	3.7	5.2		8.4	6.8	
Queue Delay	0.0	0.0		0.0	0.0	0.0	0.0	0.0		0.0	0.0	
Total Delay	28.3	0.0		28.5	27.6	36.4	3.7	5.2		8.4	6.8	
LOS	C	A		C	C	D	A	A		A	A	
Approach Delay		15.7			35.8			5.1			6.9	
Approach LOS		B			D			A			A	
Queue Length 50th (m)	1.3	0.0		1.9	1.3	28.3	0.5	13.3		3.1	19.7	
Queue Length 95th (m)	5.0	0.0		6.5	5.0	#64.7	m0.9	16.5		8.1	27.8	
Internal Link Dist (m)		63.3			159.0			795.0			432.2	
Turn Bay Length (m)	20.0			40.0		100.0	40.0			60.0		
Base Capacity (vph)	227	547		265	403	467	508	2092		295	2018	
Starvation Cap Reductn	0	0		0	0	0	0	0		0	0	
Spillback Cap Reductn	0	0		0	0	0	0	0		0	0	
Storage Cap Reductn	0	0		0	0	0	0	0		0	0	
Reduced v/c Ratio	0.04	0.01		0.06	0.02	0.75	0.03	0.45		0.18	0.30	

Intersection Summary

Cycle Length: 90

Actuated Cycle Length: 90

Offset: 23 (26%), Referenced to phase 2:NBT and 6:SBTL, Start of Green

Control Type: Actuated-Coordinated

Maximum v/c Ratio: 0.84

Intersection Signal Delay: 11.5

Intersection LOS: B

Intersection Capacity Utilization 73.7%

ICU Level of Service D

Analysis Period (min) 15

95th percentile volume exceeds capacity, queue may be longer.

Queue shown is maximum after two cycles.

m Volume for 95th percentile queue is metered by upstream signal.

Splits and Phases: 2: Hawthorne & Russell

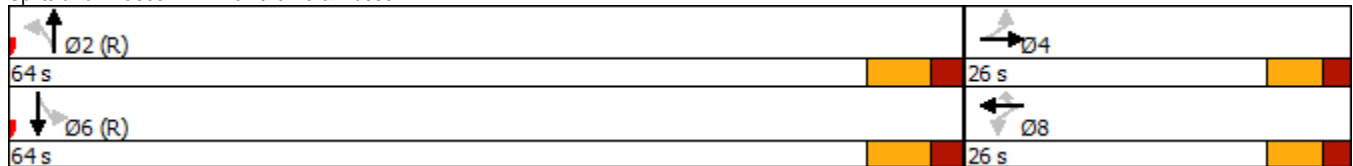

4055 & 4120 Russell Road
3: Hawthorne & Stevenage

2028 Future Background AM Peak Hour Mod



Lane Group	EBL	EBT	EBR	WBL	WBT	WBR	NBL	NBT	NBR	SBL	SBT	SBR
Lane Configurations												
Traffic Volume (vph)	134	28	60	58	63	55	208	966	86	52	330	200
Future Volume (vph)	134	28	60	58	63	55	208	966	86	52	330	200
Satd. Flow (prot)	1553	1219	0	1276	1465	0	1669	3096	0	1429	2858	1453
Flt Permitted	0.681			0.700			0.496			0.236		
Satd. Flow (perm)	1113	1219	0	935	1465	0	868	3096	0	355	2858	1414
Satd. Flow (RTOR)		60			52			12				200
Lane Group Flow (vph)	134	88	0	58	118	0	208	1052	0	52	330	200
Turn Type	Perm	NA		Perm	NA		pm+pt	NA		pm+pt	NA	Perm
Protected Phases		4			8		5	2		1	6	
Permitted Phases	4			8			2			6		6
Total Split (s)	35.0	35.0		35.0	35.0		15.0	40.0		15.0	40.0	40.0
Total Lost Time (s)	5.7	5.7		5.7	5.7		5.7	5.5		5.7	5.5	5.5
Act Effct Green (s)	16.9	16.9		16.9	16.9		60.6	54.0		53.0	46.4	46.4
Actuated g/C Ratio	0.19	0.19		0.19	0.19		0.67	0.60		0.59	0.52	0.52
v/c Ratio	0.64	0.32		0.33	0.37		0.31	0.56		0.18	0.22	0.24
Control Delay	46.6	14.8		34.5	20.5		7.5	15.0		3.8	9.8	6.6
Queue Delay	0.0	0.0		0.0	0.0		0.0	0.0		0.0	0.0	0.0
Total Delay	46.6	14.8		34.5	20.5		7.5	15.0		3.8	9.8	6.6
LOS	D	B		C	C		A	B		A	A	A
Approach Delay		34.0			25.1			13.8			8.2	
Approach LOS		C			C			B			A	
Queue Length 50th (m)	20.1	3.8		8.2	9.1		10.0	54.1		1.6	15.1	6.3
Queue Length 95th (m)	33.0	13.4		16.2	20.1		23.8	94.7		1.1	29.7	25.7
Internal Link Dist (m)		201.3			257.1			958.8			795.0	
Turn Bay Length (m)	45.0			25.0			75.0			85.0		85.0
Base Capacity (vph)	362	437		304	512		678	1863		329	1474	826
Starvation Cap Reductn	0	0		0	0		0	0		0	0	0
Spillback Cap Reductn	0	0		0	0		0	0		0	0	0
Storage Cap Reductn	0	0		0	0		0	0		0	0	0
Reduced v/c Ratio	0.37	0.20		0.19	0.23		0.31	0.56		0.16	0.22	0.24

Intersection Summary

Cycle Length: 90
 Actuated Cycle Length: 90
 Offset: 0 (0%), Referenced to phase 2:NBTL and 6:SBTL, Start of Green
 Control Type: Actuated-Coordinated
 Maximum v/c Ratio: 0.64
 Intersection Signal Delay: 15.2
 Intersection LOS: B
 Intersection Capacity Utilization 64.0%
 ICU Level of Service B
 Analysis Period (min) 15

Splits and Phases: 3: Hawthorne & Stevenage

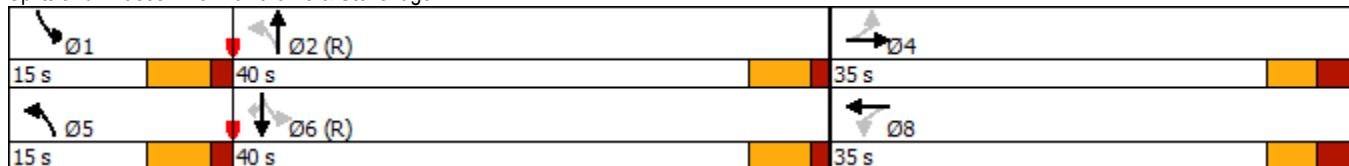

4055 & 4120 Russell Road
4: Hawthorne & Hunt Club

2028 Future Background AM Peak Hour Mod



Lane Group	EBL	EBT	EBR	WBL	WBT	WBR	NBL	NBT	NBR	SBL	SBT	SBR
Lane Configurations												
Traffic Volume (vph)	435	655	26	263	711	257	42	432	400	45	154	171
Future Volume (vph)	435	655	26	263	711	257	42	432	400	45	154	171
Satd. Flow (prot)	3179	3333	0	3094	3402	1440	1488	2974	0	1191	2748	1278
Flt Permitted	0.950			0.950			0.654			0.116		
Satd. Flow (perm)	3179	3333	0	3094	3402	1440	1025	2974	0	145	2748	1278
Satd. Flow (RTOR)		3				257		156				171
Lane Group Flow (vph)	435	681	0	263	711	257	42	832	0	45	154	171
Turn Type	Prot	NA		Prot	NA	Perm	pm+pt	NA		pm+pt	NA	Perm
Protected Phases	7	4		3	8		5	2		1	6	
Permitted Phases						8	2			6		6
Total Split (s)	37.0	42.0		37.0	42.0	42.0	22.0	39.4		22.0	39.4	39.4
Total Lost Time (s)	6.4	6.4		6.4	6.4	6.4	6.3	6.3		6.3	6.3	6.3
Act Effct Green (s)	21.7	39.3		15.7	33.3	33.3	40.0	33.7		41.5	34.4	34.4
Actuated g/C Ratio	0.18	0.33		0.13	0.28	0.28	0.33	0.28		0.35	0.29	0.29
v/c Ratio	0.76	0.62		0.65	0.75	0.44	0.11	0.88		0.36	0.20	0.35
Control Delay	56.6	37.8		59.0	46.8	7.0	26.6	46.8		34.4	36.4	7.7
Queue Delay	0.0	0.0		0.0	0.0	0.0	0.0	0.0		0.0	0.0	0.0
Total Delay	56.6	37.8		59.0	46.8	7.0	26.6	46.8		34.4	36.4	7.7
LOS	E	D		E	D	A	C	D		C	D	A
Approach Delay		45.1			41.1			45.8			22.9	
Approach LOS		D			D			D			C	
Queue Length 50th (m)	48.8	67.0		29.6	76.4	0.0	6.0	80.9		6.5	14.1	0.0
Queue Length 95th (m)	67.0	94.2		44.2	107.7	19.6	14.0	#131.3		15.1	24.6	16.6
Internal Link Dist (m)		420.4			1343.9			595.0			958.8	
Turn Bay Length (m)	90.0			50.0		80.0	50.0			80.0		80.0
Base Capacity (vph)	825	1134		803	1027	614	445	947		194	788	488
Starvation Cap Reductn	0	0		0	0	0	0	0		0	0	0
Spillback Cap Reductn	0	0		0	0	0	0	0		0	0	0
Storage Cap Reductn	0	0		0	0	0	0	0		0	0	0
Reduced v/c Ratio	0.53	0.60		0.33	0.69	0.42	0.09	0.88		0.23	0.20	0.35

Intersection Summary

Cycle Length: 140.4
 Actuated Cycle Length: 120
 Control Type: Semi Act-Uncoord
 Maximum v/c Ratio: 0.88
 Intersection Signal Delay: 41.6
 Intersection LOS: D
 Intersection Capacity Utilization 85.5%
 ICU Level of Service E
 Analysis Period (min) 15
 # 95th percentile volume exceeds capacity, queue may be longer.
 Queue shown is maximum after two cycles.

Splits and Phases: 4: Hawthorne & Hunt Club

Ø3	Ø4	Ø1	Ø2
37 s	42 s	22 s	39.4 s
Ø7	Ø8	Ø5	Ø6
37 s	42 s	22 s	39.4 s

4055 & 4120 Russell Road
10: Walkley & SB off-ramp

2028 Future Background AM Peak Hour Mod



Lane Group	EBL	EBT	WBT	WBR	SBL	SBR
Lane Configurations		↑↑	↑↑		↓	↓
Traffic Volume (vph)	0	485	1041	0	24	1011
Future Volume (vph)	0	485	1041	0	24	1011
Satd. Flow (prot)	0	3402	3402	0	1701	1522
Flt Permitted					0.950	
Satd. Flow (perm)	0	3402	3402	0	1701	1522
Satd. Flow (RTOR)						354
Lane Group Flow (vph)	0	485	1041	0	24	1011
Turn Type		NA	NA		Prot	Free
Protected Phases		4	8		6	
Permitted Phases						Free
Total Split (s)		91.0	91.0		29.0	
Total Lost Time (s)		6.3	6.3		6.3	
Act Effct Green (s)		107.5	107.5		7.3	120.0
Actuated g/C Ratio		0.90	0.90		0.06	1.00
v/c Ratio		0.16	0.34		0.24	0.66
Control Delay		1.6	1.7		58.5	2.3
Queue Delay		0.0	0.0		0.0	0.0
Total Delay		1.6	1.7		58.5	2.3
LOS		A	A		E	A
Approach Delay		1.6	1.7		3.6	
Approach LOS		A	A		A	
Queue Length 50th (m)		7.8	20.7		5.1	0.0
Queue Length 95th (m)		12.3	21.0		12.9	0.0
Internal Link Dist (m)		708.0	344.3		267.0	
Turn Bay Length (m)					100.0	
Base Capacity (vph)		3047	3047		321	1522
Starvation Cap Reductn		0	0		0	0
Spillback Cap Reductn		0	0		0	0
Storage Cap Reductn		0	0		0	0
Reduced v/c Ratio		0.16	0.34		0.07	0.66

Intersection Summary

Cycle Length: 120

Actuated Cycle Length: 120

Offset: 0 (0%), Referenced to phase 4:EBT and 8:WBT, Start of Green

Control Type: Actuated-Coordinated

Maximum v/c Ratio: 0.66

Intersection Signal Delay: 2.5

Intersection LOS: A

Intersection Capacity Utilization 76.5%

ICU Level of Service D

Analysis Period (min) 15

Splits and Phases: 10: Walkley & SB off-ramp

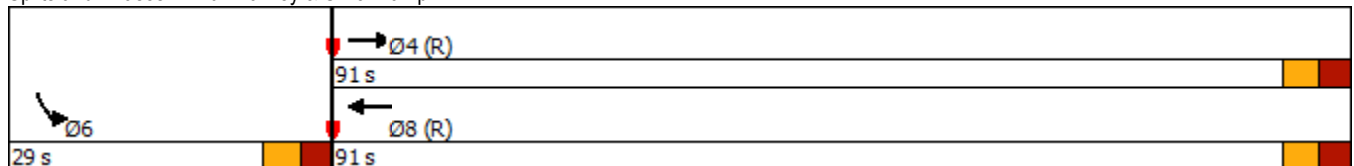

4055 & 4120 Russell Road
11: NB Off-ramp & Walkley

2028 Future Background AM Peak Hour Mod



Lane Group	EBT	EBR	WBL	WBT	NBL	NBR
Lane Configurations	↑↑			↑↑	↔	
Traffic Volume (vph)	172	0	0	973	578	60
Future Volume (vph)	172	0	0	973	578	60
Satd. Flow (prot)	3402	0	0	3402	1691	0
Flt Permitted					0.957	
Satd. Flow (perm)	3402	0	0	3402	1691	0
Satd. Flow (RTOR)					6	
Lane Group Flow (vph)	172	0	0	973	638	0
Turn Type	NA			NA	Prot	
Protected Phases	4			8	2	
Permitted Phases						
Total Split (s)	53.0			53.0	67.0	
Total Lost Time (s)	6.3			6.3	6.3	
Act Effct Green (s)	46.7			46.7	60.7	
Actuated g/C Ratio	0.39			0.39	0.51	
v/c Ratio	0.13			0.74	0.74	
Control Delay	22.6			35.4	29.8	
Queue Delay	0.0			0.0	0.0	
Total Delay	22.6			35.4	29.8	
LOS	C			D	C	
Approach Delay	22.6			35.4	29.8	
Approach LOS	C			D	C	
Queue Length 50th (m)	10.8			93.8	105.1	
Queue Length 95th (m)	16.9			116.5	148.4	
Internal Link Dist (m)	344.3			347.3	355.2	
Turn Bay Length (m)						
Base Capacity (vph)	1323			1323	858	
Starvation Cap Reductn	0			0	0	
Spillback Cap Reductn	0			0	0	
Storage Cap Reductn	0			0	0	
Reduced v/c Ratio	0.13			0.74	0.74	

Intersection Summary

Cycle Length: 120

Actuated Cycle Length: 120

Offset: 0 (0%), Referenced to phase 4:EBT and 8:WBT, Start of Green

Control Type: Actuated-Coordinated

Maximum v/c Ratio: 0.74

Intersection Signal Delay: 32.2

Intersection LOS: C

Intersection Capacity Utilization 76.5%

ICU Level of Service D

Analysis Period (min) 15

Splits and Phases: 11: NB Off-ramp & Walkley



Scheme Summary

Control Data

Control Data and Model Parameters

119124	2028 PHF Flow Profile (veh)
2028 Background Traffic Volumes	7.5 min Time Slice
Rodel-Win1	Queuing Delays (sec)
Right Hand Drive	Daylight conditions
AM Peak Hour	Peak 60/15 min Results
AVERAGE DELAY to Geometry	Output flows: Vehicles
Metric Units (m)	85% Confidence Level

Available Data

Entry Capacity Calibrated	No
Entry Capacity Modified	No
Crosswalks	No
Flows Factored	No
Approach/Exit Road Capacity Calibrated	No
Accidents	No
Accident Costs	No
Bypass Model	No
Bypass Calibration	No
Global Results	Yes

Operational Data

Main Geometry (m)

Geometry and Design Target

Leg	Leg Names	Approach Geometry (m)				Target	Circulating and Exit Geom		
		Bearing (deg)	Grade Sep G	Half Width V	Lanes n	Average Delay (sec/veh)	Inscribed Diameter D	Half Width Vx	Lanes n
1	SB - Anderson	0	0	4.00	1	30	45.00	4.00	1
2	EB - Russell	90	0	4.00	1	30	45.00	4.00	1
3	NB- Anderson	180	0	4.00	1	30	45.00	4.00	1
4	WB- Russell	270	0	4.00	1	30	45.00	4.00	1

Capacity Modifiers and Capacity Calibration (veh/hr)

Leg	Leg Names	Entry Capacity		Entry Calibration		Approach Road			Exit Road		
		Capacity + or -	XWalk Factor	Intercept + or -	Slope Factor	V (m)	Default Capacity	Calib Capacity	V (m)	Default Capacity	Calib Capacity
1	SB - Anderson	0	1.000	0	1.000	6.00	1960	0	4.00	1960	0
2	EB - Russell	0	1.000	0	1.000	6.00	1960	0	4.00	1960	0
3	NB- Anderson	0	1.000	0	1.000	6.00	1960	0	4.00	1960	0
4	WB- Russell	0	1.000	0	1.000	6.00	1960	0	4.00	1960	0

Traffic Flow Data (veh/hr)

2028 AM Peak Peak Hour Flows

Leg	Leg Names	Turning Flows					Flow Modifiers		
		U-Turn	Exit-3	Exit-2	Exit-1	Bypass	Trucks %	Flow Factor	Peak Hour Factor
1	SB - Anderson	0	5	139	153	0	3.0	1.00	0.900
2	EB - Russell	0	35	16	3	0	3.0	1.00	0.900
3	NB- Anderson	0	171	304	6	0	3.0	1.00	0.900
4	WB- Russell	0	48	347	118	0	3.0	1.00	0.900

Operational Results

Geometry for Target Input

Geometry Options for 2028 AM Peak

				Leg 1 - SB - Anderson	
nv	ne	nc	nx	E (m)	L' (m)
1	1	1	1	4.00	0.00

Geometry Options for 2028 AM Peak

				Leg 2 - EB - Russell	
nv	ne	nc	nx	E (m)	L' (m)
1	1	1	1	4.00	0.00

Geometry Options for 2028 AM Peak

				Leg 3 - NB- Anderson	
nv	ne	nc	nx	E (m)	L' (m)
1	1	1	1	4.00	0.00

Geometry Options for 2028 AM Peak

				Leg 4 - WB- Russell	
nv	ne	nc	nx	E (m)	L' (m)
1	1	1	1	4.00	0.00

2028 AM Peak - 60 minutes

Flows and Capacity

Leg	Leg Names	Bypass Type	Flows (veh/hr)				Capacity (veh/hr)			
			Arrival Flow		Opposing Flow		Capacity		Average VCR	
			Entry	Bypass	Entry	Bypass	Entry	Bypass	Entry	Bypass
1	SB - Anderson	None	297		566		457	655		0.4535
2	EB - Russell	None	54		192		671	848		0.0637
3	NB- Anderson	None	481		56		190	918		0.5238
4	WB- Russell	None	513		510		27	684		0.7503

Delays, Queues and Level of Service

Leg	Leg Names	Bypass Type	Average Delay (sec)			95% Queue (veh)		Level of Service		
			Entry	Bypass	Leg	Entry	Bypass	Entry	Bypass	Leg
1	SB - Anderson	None	9.44		9.44	2.64		A		A
2	EB - Russell	None	4.34		4.34	0.20		A		A
3	NB- Anderson	None	7.64		7.64	3.26		A		A
4	WB- Russell	None	18.96		18.96	10.70		C		C

2028 AM Peak - 15 minutes

Flows and Capacity

Leg	Leg Names	Bypass Type	Flows (veh/hr)				Capacity (veh/hr)			
			Arrival Flow		Opposing Flow		Capacity		Average VCR	
			Entry	Bypass	Entry	Bypass	Entry	Bypass	Entry	Bypass
1	SB - Anderson	None	330		622		505	626		0.5273
2	EB - Russell	None	60		212		739	838		0.0716
3	NB- Anderson	None	534		62		210	915		0.5840
4	WB- Russell	None	570		565		30	655		0.8702

Delays, Queues and Level of Service

Leg	Leg Names	Bypass Type	Average Delay (sec)			95% Queue (veh)		Level of Service		
			Entry	Bypass	Leg	Entry	Bypass	Entry	Bypass	Leg
1	SB - Anderson	None	10.15		10.15	2.64		B		B
2	EB - Russell	None	4.28		4.28	0.20		A		A
3	NB- Anderson	None	7.99		7.99	3.26		A		A
4	WB- Russell	None	23.45		23.45	10.70		C		C

Lane Group	EBL	EBT	EBR	WBL	WBT	WBR	NBL	NBT	NBR	SBL	SBT	SBR
Lane Configurations												
Traffic Volume (vph)	101	1424	259	473	714	84	155	292	560	110	454	114
Future Volume (vph)	101	1424	259	473	714	84	155	292	560	110	454	114
Satd. Flow (prot)	1609	3468	1390	3013	3468	1567	3179	3338	1427	3238	3247	1427
Flt Permitted	0.950			0.950			0.950			0.950		
Satd. Flow (perm)	1604	3468	1368	3011	3468	1535	3154	3338	1402	3217	3247	1396
Satd. Flow (RTOR)			259			154			207			207
Lane Group Flow (vph)	101	1424	259	473	714	84	155	292	560	110	454	114
Turn Type	Prot	NA	Perm	Prot	NA	Perm	Prot	NA	Perm	Prot	NA	Perm
Protected Phases	5	2		1	6		3	8		7	4	
Permitted Phases			2			6			8			4
Total Split (s)	12.0	58.0	58.0	20.0	66.0	66.0	17.0	35.0	35.0	17.0	35.0	35.0
Total Lost Time (s)	6.4	7.3	7.3	6.4	7.3	7.3	7.6	7.4	7.4	7.6	7.4	7.4
Act Effct Green (s)	5.6	50.7	50.7	13.6	58.7	58.7	9.2	28.2	28.2	8.8	27.8	27.8
Actuated g/C Ratio	0.04	0.39	0.39	0.10	0.45	0.45	0.07	0.22	0.22	0.07	0.21	0.21
v/c Ratio	1.46	1.05	0.37	1.50	0.46	0.11	0.69	0.40	1.20	0.50	0.65	0.25
Control Delay	313.7	78.4	4.7	280.8	25.8	0.3	75.3	45.8	137.7	66.7	51.9	1.3
Queue Delay	0.0	0.0	0.0	0.0	0.0	0.0	0.0	0.0	0.0	0.0	0.0	0.0
Total Delay	313.7	78.4	4.7	280.8	25.8	0.3	75.3	45.8	137.7	66.7	51.9	1.3
LOS	F	E	A	F	C	A	E	D	F	E	D	A
Approach Delay		81.0			119.0			101.5			45.8	
Approach LOS		F			F			F			D	
Queue Length 50th (m)	~32.5	~192.8	0.0	~79.6	60.1	0.0	18.7	31.5	~121.1	13.0	52.0	0.0
Queue Length 95th (m)	#65.9	#232.1	15.2	#110.5	75.3	0.0	#30.8	44.3	#185.4	22.0	68.7	0.0
Internal Link Dist (m)		485.7			397.0			432.2			296.2	
Turn Bay Length (m)	85.0		225.0	100.0		45.0	140.0		110.0	80.0		55.0
Base Capacity (vph)	69	1352	691	315	1565	777	229	725	466	234	694	461
Starvation Cap Reductn	0	0	0	0	0	0	0	0	0	0	0	0
Spillback Cap Reductn	0	0	0	0	0	0	0	0	0	0	0	0
Storage Cap Reductn	0	0	0	0	0	0	0	0	0	0	0	0
Reduced v/c Ratio	1.46	1.05	0.37	1.50	0.46	0.11	0.68	0.40	1.20	0.47	0.65	0.25

Intersection Summary

Cycle Length: 130

Actuated Cycle Length: 130

Offset: 35 (27%), Referenced to phase 2:EBT and 6:WBT, Start of Green

Control Type: Actuated-Coordinated

Maximum v/c Ratio: 1.50

Intersection Signal Delay: 90.5

Intersection LOS: F

Intersection Capacity Utilization 101.3%

ICU Level of Service G

Analysis Period (min) 15

~ Volume exceeds capacity, queue is theoretically infinite.

Queue shown is maximum after two cycles.

95th percentile volume exceeds capacity, queue may be longer.

Queue shown is maximum after two cycles.

Splits and Phases: 1: Russell & Walkley

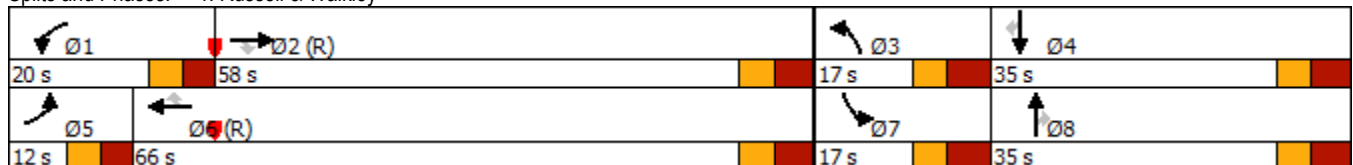

Lane Group	EBL	EBT	EBR	WBL	WBT	WBR	NBL	NBT	NBR	SBL	SBT	SBR
Lane Configurations												
Traffic Volume (vph)	35	7	21	9	3	86	7	749	13	220	910	17
Future Volume (vph)	35	7	21	9	3	86	7	749	13	220	910	17
Satd. Flow (prot)	1624	1466	0	1768	1139	1508	1232	3289	0	1639	3269	0
Flt Permitted	0.756			0.739			0.303			0.363		
Satd. Flow (perm)	1291	1466	0	1376	1139	1488	393	3289	0	626	3269	0
Satd. Flow (RTOR)		21				86		4			4	
Lane Group Flow (vph)	35	28	0	9	3	86	7	762	0	220	927	0
Turn Type	Perm	NA		Perm	NA	Perm	Perm	NA		Perm	NA	
Protected Phases		4			8			2			6	
Permitted Phases	4			8		8	2			6		
Total Split (s)	26.0	26.0		26.0	26.0	26.0	54.0	54.0		54.0	54.0	
Total Lost Time (s)	5.7	5.7		5.7	5.7	5.7	6.5	6.5		6.5	6.5	
Act Effct Green (s)	10.1	10.1		10.1	10.1	10.1	62.1	62.1		62.1	62.1	
Actuated g/C Ratio	0.13	0.13		0.13	0.13	0.13	0.78	0.78		0.78	0.78	
v/c Ratio	0.21	0.14		0.05	0.02	0.33	0.02	0.30		0.45	0.37	
Control Delay	34.9	18.4		31.4	31.0	11.6	3.4	3.9		8.3	4.3	
Queue Delay	0.0	0.0		0.0	0.0	0.0	0.0	0.0		0.0	0.0	
Total Delay	34.9	18.4		31.4	31.0	11.6	3.4	3.9		8.3	4.3	
LOS	C	B		C	C	B	A	A		A	A	
Approach Delay		27.6			14.0			3.9			5.0	
Approach LOS		C			B			A			A	
Queue Length 50th (m)	4.5	0.9		1.1	0.4	0.0	0.2	16.3		10.7	21.4	
Queue Length 95th (m)	11.9	7.2		4.8	2.5	10.8	1.2	23.2		25.3	29.8	
Internal Link Dist (m)		63.3			159.0			795.0			432.2	
Turn Bay Length (m)	20.0			40.0		100.0	40.0			60.0		
Base Capacity (vph)	327	387		349	289	441	304	2554		486	2539	
Starvation Cap Reductn	0	0		0	0	0	0	0		0	0	
Spillback Cap Reductn	0	0		0	0	0	0	0		0	0	
Storage Cap Reductn	0	0		0	0	0	0	0		0	0	
Reduced v/c Ratio	0.11	0.07		0.03	0.01	0.20	0.02	0.30		0.45	0.37	

Intersection Summary

Cycle Length: 80
 Actuated Cycle Length: 80
 Offset: 16 (20%), Referenced to phase 2:NBTL and 6:SBTL, Start of Green
 Control Type: Actuated-Coordinated
 Maximum v/c Ratio: 0.45
 Intersection Signal Delay: 5.7
 Intersection LOS: A
 Intersection Capacity Utilization 59.8%
 ICU Level of Service B
 Analysis Period (min) 15

Splits and Phases: 2: Hawthorne & Russell

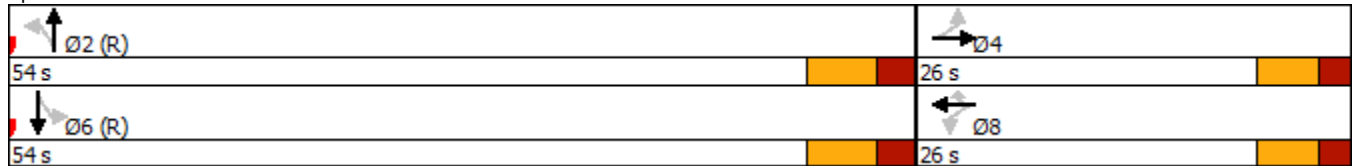

Lane Group	EBL	EBT	EBR	WBL	WBT	WBR	NBL	NBT	NBR	SBL	SBT	SBR
Lane Configurations												
Traffic Volume (vph)	201	39	221	100	29	81	82	390	59	45	993	144
Future Volume (vph)	201	39	221	100	29	81	82	390	59	45	993	144
Satd. Flow (prot)	1669	1490	0	1567	1426	0	1323	3073	0	1323	3402	1390
Flt Permitted	0.686			0.426			0.202			0.492		
Satd. Flow (perm)	1202	1490	0	703	1426	0	281	3073	0	685	3402	1352
Satd. Flow (RTOR)		221			81			22				144
Lane Group Flow (vph)	201	260	0	100	110	0	82	449	0	45	993	144
Turn Type	Perm	NA		Perm	NA		pm+pt	NA		pm+pt	NA	Perm
Protected Phases		4			8		5	2		1	6	
Permitted Phases	4			8			2			6		6
Total Split (s)	35.0	35.0		35.0	35.0		15.0	45.0		15.0	45.0	45.0
Total Lost Time (s)	5.7	5.7		5.7	5.7		5.7	5.5		5.7	5.5	5.5
Act Effct Green (s)	22.6	22.6		22.6	22.6		58.2	53.2		55.7	50.1	50.1
Actuated g/C Ratio	0.24	0.24		0.24	0.24		0.61	0.56		0.59	0.53	0.53
v/c Ratio	0.71	0.50		0.60	0.27		0.32	0.26		0.10	0.55	0.18
Control Delay	45.6	9.3		45.8	11.0		11.7	13.3		9.0	19.1	3.7
Queue Delay	0.0	0.0		0.0	0.0		0.0	0.0		0.0	0.0	0.0
Total Delay	45.6	9.3		45.8	11.0		11.7	13.3		9.0	19.1	3.7
LOS	D	A		D	B		B	B		A	B	A
Approach Delay		25.1			27.6			13.0			16.8	
Approach LOS		C			C			B			B	
Queue Length 50th (m)	30.7	5.1		14.8	3.8		4.9	20.9		2.6	60.8	0.0
Queue Length 95th (m)	48.7	21.5		28.3	14.2		12.0	35.6		7.5	91.6	9.8
Internal Link Dist (m)		201.3			257.1			958.8			795.0	
Turn Bay Length (m)	45.0			25.0			75.0			85.0		85.0
Base Capacity (vph)	370	612		216	495		275	1730		475	1792	780
Starvation Cap Reductn	0	0		0	0		0	0		0	0	0
Spillback Cap Reductn	0	0		0	0		0	0		0	0	0
Storage Cap Reductn	0	0		0	0		0	0		0	0	0
Reduced v/c Ratio	0.54	0.42		0.46	0.22		0.30	0.26		0.09	0.55	0.18

Intersection Summary

Cycle Length: 95

Actuated Cycle Length: 95

Offset: 0 (0%), Referenced to phase 2:NBTL and 6:SBTL, Start of Green

Control Type: Actuated-Coordinated

Maximum v/c Ratio: 0.71

Intersection Signal Delay: 18.5

Intersection LOS: B

Intersection Capacity Utilization 77.5%

ICU Level of Service D

Analysis Period (min) 15

Splits and Phases: 3: Hawthorne & Stevenage

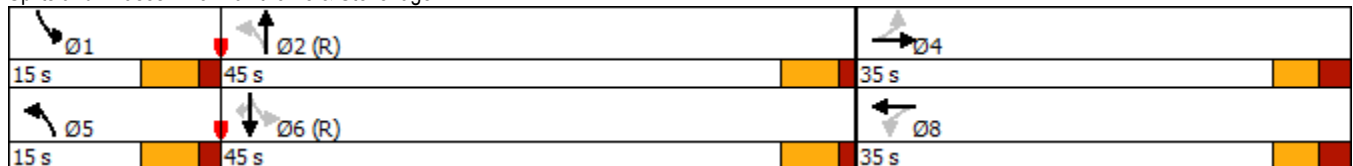

Lane Group	EBL	EBT	EBR	WBL	WBT	WBR	NBL	NBT	NBR	SBL	SBT	SBR
Lane Configurations												
Traffic Volume (vph)	266	847	25	443	912	91	26	202	321	175	517	489
Future Volume (vph)	266	847	25	443	912	91	26	202	321	175	517	489
Satd. Flow (prot)	1595	3422	0	1654	3468	1141	1717	2807	0	1609	3247	1522
Flt Permitted	0.950			0.950			0.400			0.136		
Satd. Flow (perm)	1595	3422	0	1653	3468	1141	723	2807	0	230	3247	1522
Satd. Flow (RTOR)		2				119		240				489
Lane Group Flow (vph)	266	872	0	443	912	91	26	523	0	175	517	489
Turn Type	Prot	NA		Prot	NA	Perm	pm+pt	NA		pm+pt	NA	Perm
Protected Phases	7	4		3	8		5	2		1	6	
Permitted Phases						8	2			6		6
Total Split (s)	36.4	48.4		44.4	56.4	56.4	21.3	32.3		21.3	32.3	32.3
Total Lost Time (s)	6.4	6.4		6.4	6.4	6.4	6.3	6.3		6.3	6.3	6.3
Act Effct Green (s)	26.7	40.2		38.2	51.7	51.7	28.4	21.3		42.0	33.8	33.8
Actuated g/C Ratio	0.19	0.29		0.27	0.37	0.37	0.20	0.15		0.30	0.24	0.24
v/c Ratio	0.87	0.88		0.98	0.71	0.18	0.13	0.83		0.83	0.66	0.66
Control Delay	82.8	59.4		88.4	42.8	3.2	36.7	42.6		69.7	53.6	8.7
Queue Delay	0.0	0.0		0.0	0.0	0.0	0.0	0.0		0.0	0.0	0.0
Total Delay	82.8	59.4		88.4	42.8	3.2	36.7	42.6		69.7	53.6	8.7
LOS	F	E		F	D	A	D	D		E	D	A
Approach Delay		64.9			54.3			42.4			37.4	
Approach LOS		E			D			D			D	
Queue Length 50th (m)	67.1	114.8		~122.6	111.5	0.0	4.8	38.8		35.5	66.9	0.0
Queue Length 95th (m)	#108.4	#148.6		#188.0	137.8	6.0	11.5	58.6		#67.6	87.0	30.0
Internal Link Dist (m)		420.4			1343.9			595.0			958.8	
Turn Bay Length (m)	90.0			50.0		80.0	50.0			80.0		80.0
Base Capacity (vph)	344	1036		452	1284	497	295	720		218	786	739
Starvation Cap Reductn	0	0		0	0	0	0	0		0	0	0
Spillback Cap Reductn	0	0		0	0	0	0	0		0	0	0
Storage Cap Reductn	0	0		0	0	0	0	0		0	0	0
Reduced v/c Ratio	0.77	0.84		0.98	0.71	0.18	0.09	0.73		0.80	0.66	0.66

Intersection Summary

Cycle Length: 146.4
 Actuated Cycle Length: 139.6
 Control Type: Semi Act-Uncoord
 Maximum v/c Ratio: 0.98
 Intersection Signal Delay: 50.9
 Intersection LOS: D
 Intersection Capacity Utilization 99.9%
 ICU Level of Service F
 Analysis Period (min) 15
 ~ Volume exceeds capacity, queue is theoretically infinite.
 Queue shown is maximum after two cycles.
 # 95th percentile volume exceeds capacity, queue may be longer.
 Queue shown is maximum after two cycles.

Splits and Phases: 4: Hawthorne & Hunt Club

44.4 s	48.4 s	21.3 s	32.3 s
36.4 s	56.4 s	21.3 s	32.3 s



Movement	EBT	EBR	WBL	WBT	NBL	NBR
Lane Configurations						
Traffic Volume (veh/h)	317	29	10	36	27	126
Future Volume (Veh/h)	317	29	10	36	27	126
Sign Control	Free			Free	Stop	
Grade	0%			0%	0%	
Peak Hour Factor	1.00	1.00	1.00	1.00	1.00	1.00
Hourly flow rate (vph)	317	29	10	36	27	126
Pedestrians						
Lane Width (m)						
Walking Speed (m/s)						
Percent Blockage						
Right turn flare (veh)						
Median type	None			None		
Median storage (veh)						
Upstream signal (m)						
pX, platoon unblocked						
vC, conflicting volume				346	388	332
vC1, stage 1 conf vol						
vC2, stage 2 conf vol						
vCu, unblocked vol				346	388	332
tC, single (s)				4.2	6.6	6.2
tC, 2 stage (s)						
tF (s)				2.3	3.7	3.3
p0 queue free %				99	95	82
cM capacity (veh/h)				1170	577	708
Direction, Lane #	EB 1	WB 1	NB 1			
Volume Total	346	46	153			
Volume Left	0	10	27			
Volume Right	29	0	126			
cSH	1700	1170	681			
Volume to Capacity	0.20	0.01	0.22			
Queue Length 95th (m)	0.0	0.2	6.0			
Control Delay (s)	0.0	1.8	11.8			
Lane LOS		A	B			
Approach Delay (s)	0.0	1.8	11.8			
Approach LOS			B			
Intersection Summary						
Average Delay				3.5		
Intersection Capacity Utilization				35.9%	ICU Level of Service	A
Analysis Period (min)				15		



Movement	EBL	EBR	NBL	NBT	SBT	SBR
Lane Configurations						
Traffic Volume (veh/h)	11	1407	0	1107	149	0
Future Volume (Veh/h)	11	1407	0	1107	149	0
Sign Control	Stop			Free	Free	
Grade	0%			0%	0%	
Peak Hour Factor	1.00	1.00	1.00	1.00	1.00	1.00
Hourly flow rate (vph)	11	1407	0	1107	149	0
Pedestrians						
Lane Width (m)						
Walking Speed (m/s)						
Percent Blockage						
Right turn flare (veh)						
Median type				None	None	
Median storage (veh)						
Upstream signal (m)						
pX, platoon unblocked						
vC, conflicting volume	1256	149	149			
vC1, stage 1 conf vol						
vC2, stage 2 conf vol						
vCu, unblocked vol	1256	149	149			
tC, single (s)	6.4	6.3	4.1			
tC, 2 stage (s)						
tF (s)	3.5	3.4	2.2			
p0 queue free %	94	0	100			
cM capacity (veh/h)	190	885	1445			
Direction, Lane #	EB 1	EB 2	NB 1	SB 1		
Volume Total	11	1407	1107	149		
Volume Left	11	0	0	0		
Volume Right	0	1407	0	0		
cSH	190	885	1700	1700		
Volume to Capacity	0.06	1.59	0.65	0.09		
Queue Length 95th (m)	1.3	508.0	0.0	0.0		
Control Delay (s)	25.1	285.4	0.0	0.0		
Lane LOS	D	F				
Approach Delay (s)	283.3		0.0	0.0		
Approach LOS	F					
Intersection Summary						
Average Delay			150.3			
Intersection Capacity Utilization			106.9%	ICU Level of Service	G	
Analysis Period (min)			15			



Movement	EBL	EBR	NBL	NBT	SBT	SBR
Lane Configurations						
Traffic Volume (veh/h)	116	321	33	114	322	17
Future Volume (Veh/h)	116	321	33	114	322	17
Sign Control	Stop			Free	Free	
Grade	0%			0%	0%	
Peak Hour Factor	1.00	1.00	1.00	1.00	1.00	1.00
Hourly flow rate (vph)	116	321	33	114	322	17
Pedestrians						
Lane Width (m)						
Walking Speed (m/s)						
Percent Blockage						
Right turn flare (veh)						
Median type				None	None	
Median storage (veh)						
Upstream signal (m)						
pX, platoon unblocked						
vC, conflicting volume	510	330	339			
vC1, stage 1 conf vol						
vC2, stage 2 conf vol						
vCu, unblocked vol	510	330	339			
tC, single (s)	6.5	6.3	4.2			
tC, 2 stage (s)						
tF (s)	3.6	3.4	2.3			
p0 queue free %	77	54	97			
cM capacity (veh/h)	501	700	1151			
Direction, Lane #						
	EB 1	NB 1	SB 1			
Volume Total	437	147	339			
Volume Left	116	33	0			
Volume Right	321	0	17			
cSH	633	1151	1700			
Volume to Capacity	0.69	0.03	0.20			
Queue Length 95th (m)	38.3	0.6	0.0			
Control Delay (s)	22.4	2.0	0.0			
Lane LOS	C	A				
Approach Delay (s)	22.4	2.0	0.0			
Approach LOS	C					
Intersection Summary						
Average Delay			10.9			
Intersection Capacity Utilization			64.9%	ICU Level of Service	C	
Analysis Period (min)			15			



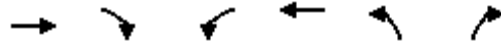

Movement	EBL	EBT	WBT	WBR	SBL	SBR
Lane Configurations		↑↑	↑↑		↓	↓
Traffic Volume (veh/h)	0	1647	193	0	182	665
Future Volume (Veh/h)	0	1647	193	0	182	665
Sign Control		Free	Free		Stop	
Grade		0%	0%		0%	
Peak Hour Factor	1.00	1.00	1.00	1.00	1.00	1.00
Hourly flow rate (vph)	0	1647	193	0	182	665
Pedestrians						
Lane Width (m)						
Walking Speed (m/s)						
Percent Blockage						
Right turn flare (veh)						
Median type		None	None			
Median storage (veh)						
Upstream signal (m)						
pX, platoon unblocked						
vC, conflicting volume	193				1016	96
vC1, stage 1 conf vol						
vC2, stage 2 conf vol						
vCu, unblocked vol	193				1016	96
tC, single (s)	4.2				6.9	7.0
tC, 2 stage (s)						
tF (s)	2.2				3.5	3.3
p0 queue free %	100				20	29
cM capacity (veh/h)	1356				229	931
Direction, Lane #	EB 1	EB 2	WB 1	WB 2	SB 1	SB 2
Volume Total	824	824	96	96	182	665
Volume Left	0	0	0	0	182	0
Volume Right	0	0	0	0	0	665
cSH	1700	1700	1700	1700	229	931
Volume to Capacity	0.48	0.48	0.06	0.06	0.80	0.71
Queue Length 95th (m)	0.0	0.0	0.0	0.0	40.9	44.1
Control Delay (s)	0.0	0.0	0.0	0.0	62.7	17.9
Lane LOS					F	C
Approach Delay (s)	0.0		0.0		27.5	
Approach LOS					D	
Intersection Summary						
Average Delay			8.7			
Intersection Capacity Utilization			65.4%		ICU Level of Service	C
Analysis Period (min)			15			



Movement	EBT	EBR	WBL	WBT	NBL	NBR
Lane Configurations	↑↑			↑↑	↘	
Traffic Volume (veh/h)	849	0	0	92	163	25
Future Volume (Veh/h)	849	0	0	92	163	25
Sign Control	Free			Free	Stop	
Grade	0%			0%	0%	
Peak Hour Factor	1.00	1.00	1.00	1.00	1.00	1.00
Hourly flow rate (vph)	849	0	0	92	163	25
Pedestrians						
Lane Width (m)						
Walking Speed (m/s)						
Percent Blockage						
Right turn flare (veh)						
Median type	None		None			
Median storage (veh)						
Upstream signal (m)						
pX, platoon unblocked						
vC, conflicting volume			849		895	424
vC1, stage 1 conf vol						
vC2, stage 2 conf vol						
vCu, unblocked vol			849		895	424
tC, single (s)			4.2		6.9	7.0
tC, 2 stage (s)						
tF (s)			2.2		3.5	3.3
p0 queue free %			100		41	96
cM capacity (veh/h)			766		275	570
Direction, Lane #						
	EB 1	EB 2	WB 1	WB 2	NB 1	
Volume Total	424	424	46	46	188	
Volume Left	0	0	0	0	163	
Volume Right	0	0	0	0	25	
cSH	1700	1700	1700	1700	295	
Volume to Capacity	0.25	0.25	0.03	0.03	0.64	
Queue Length 95th (m)	0.0	0.0	0.0	0.0	28.3	
Control Delay (s)	0.0	0.0	0.0	0.0	36.4	
Lane LOS					E	
Approach Delay (s)	0.0		0.0		36.4	
Approach LOS					E	
Intersection Summary						
Average Delay			6.1			
Intersection Capacity Utilization			65.4%		ICU Level of Service C	
Analysis Period (min)			15			

Intersection	
Intersection Delay, s/veh	11
Intersection LOS	B

Movement	WBL	WBR	NBT	NBR	SBL	SBT
Lane Configurations						
Traffic Vol, veh/h	63	8	49	199	132	300
Future Vol, veh/h	63	8	49	199	132	300
Peak Hour Factor	1.00	1.00	1.00	1.00	1.00	1.00
Heavy Vehicles, %	10	1	7	4	2	2
Mvmt Flow	63	8	49	199	132	300
Number of Lanes	1	0	1	0	0	1

Approach	WB	NB	SB
Opposing Approach		SB	NB
Opposing Lanes	0	1	1
Conflicting Approach Left	NB		WB
Conflicting Lanes Left	1	0	1
Conflicting Approach Right	SB	WB	
Conflicting Lanes Right	1	1	0
HCM Control Delay	9.4	8.9	12.5
HCM LOS	A	A	B

Lane	NBLn1	WBLn1	SBLn1
Vol Left, %	0%	89%	31%
Vol Thru, %	20%	0%	69%
Vol Right, %	80%	11%	0%
Sign Control	Stop	Stop	Stop
Traffic Vol by Lane	248	71	432
LT Vol	0	63	132
Through Vol	49	0	300
RT Vol	199	8	0
Lane Flow Rate	248	71	432
Geometry Grp	1	1	1
Degree of Util (X)	0.289	0.111	0.533
Departure Headway (Hd)	4.196	5.633	4.444
Convergence, Y/N	Yes	Yes	Yes
Cap	856	635	812
Service Time	2.223	3.684	2.469
HCM Lane V/C Ratio	0.29	0.112	0.532
HCM Control Delay	8.9	9.4	12.5
HCM Lane LOS	A	A	B
HCM 95th-tile Q	1.2	0.4	3.2

Intersection	
Intersection Delay, s/veh	13.7
Intersection LOS	B

Movement	EBL	EBT	EBR	WBL	WBT	WBR	NBL	NBT	NBR	SBL	SBT	SBR
Lane Configurations		↕			↕			↕			↕	
Traffic Vol, veh/h	77	244	14	12	24	10	7	170	46	61	262	38
Future Vol, veh/h	77	244	14	12	24	10	7	170	46	61	262	38
Peak Hour Factor	1.00	1.00	1.00	1.00	1.00	1.00	1.00	1.00	1.00	1.00	1.00	1.00
Heavy Vehicles, %	2	1	1	1	14	1	1	1	7	2	3	4
Mvmt Flow	77	244	14	12	24	10	7	170	46	61	262	38
Number of Lanes	0	1	0	0	1	0	0	1	0	0	1	0

Approach	EB	WB	NB	SB
Opposing Approach	WB	EB	SB	NB
Opposing Lanes	1	1	1	1
Conflicting Approach Left	SB	NB	EB	WB
Conflicting Lanes Left	1	1	1	1
Conflicting Approach Right	NB	SB	WB	EB
Conflicting Lanes Right	1	1	1	1
HCM Control Delay	14.7	9.7	11.4	14.7
HCM LOS	B	A	B	B

Lane	NBLn1	EBLn1	WBLn1	SBLn1
Vol Left, %		3%	23%	26%
Vol Thru, %		76%	73%	52%
Vol Right, %		21%	4%	22%
Sign Control		Stop	Stop	Stop
Traffic Vol by Lane		223	335	46
LT Vol		7	77	12
Through Vol		170	244	24
RT Vol		46	14	10
Lane Flow Rate		223	335	46
Geometry Grp		1	1	1
Degree of Util (X)		0.341	0.523	0.078
Departure Headway (Hd)		5.505	5.617	6.093
Convergence, Y/N		Yes	Yes	Yes
Cap		651	640	584
Service Time		3.561	3.666	4.168
HCM Lane V/C Ratio		0.343	0.523	0.079
HCM Control Delay		11.4	14.7	9.7
HCM Lane LOS		B	B	A
HCM 95th-tile Q		1.5	3	0.3

4055 & 4120 Russell Road
 2: Hawthorne & Russell

2028 Future Background PM Peak Hour Mod

Lane Group	EBL	EBT	EBR	WBL	WBT	WBR	NBL	NBT	NBR	SBL	SBT	SBR
Lane Configurations												
Traffic Volume (vph)	35	7	21	9	3	86	7	749	13	220	910	17
Future Volume (vph)	35	7	21	9	3	86	7	749	13	220	910	17
Satd. Flow (prot)	1624	1466	0	1768	1139	1508	1232	3289	0	1639	3269	0
Flt Permitted	0.756			0.739			0.303			0.363		
Satd. Flow (perm)	1291	1466	0	1376	1139	1488	393	3289	0	626	3269	0
Satd. Flow (RTOR)		21				86		4			4	
Lane Group Flow (vph)	35	28	0	9	3	86	7	762	0	220	927	0
Turn Type	Perm	NA		Perm	NA	Perm	Perm	NA		Perm	NA	
Protected Phases		4			8			2			6	
Permitted Phases	4			8		8	2			6		
Total Split (s)	26.0	26.0		26.0	26.0	26.0	54.0	54.0		54.0	54.0	
Total Lost Time (s)	5.7	5.7		5.7	5.7	5.7	6.5	6.5		6.5	6.5	
Act Effct Green (s)	10.1	10.1		10.1	10.1	10.1	62.1	62.1		62.1	62.1	
Actuated g/C Ratio	0.13	0.13		0.13	0.13	0.13	0.78	0.78		0.78	0.78	
v/c Ratio	0.21	0.14		0.05	0.02	0.33	0.02	0.30		0.45	0.37	
Control Delay	34.9	18.4		31.4	31.0	11.6	3.4	3.9		8.3	4.3	
Queue Delay	0.0	0.0		0.0	0.0	0.0	0.0	0.0		0.0	0.0	
Total Delay	34.9	18.4		31.4	31.0	11.6	3.4	3.9		8.3	4.3	
LOS	C	B		C	C	B	A	A		A	A	
Approach Delay		27.6			14.0			3.9			5.0	
Approach LOS		C			B			A			A	
Queue Length 50th (m)	4.5	0.9		1.1	0.4	0.0	0.2	16.3		10.7	21.4	
Queue Length 95th (m)	11.9	7.2		4.8	2.5	10.8	1.2	23.2		25.3	29.8	
Internal Link Dist (m)		63.3			159.0			795.0			432.2	
Turn Bay Length (m)	20.0			40.0		100.0	40.0			60.0		
Base Capacity (vph)	327	387		349	289	441	304	2554		486	2539	
Starvation Cap Reductn	0	0		0	0	0	0	0		0	0	
Spillback Cap Reductn	0	0		0	0	0	0	0		0	0	
Storage Cap Reductn	0	0		0	0	0	0	0		0	0	
Reduced v/c Ratio	0.11	0.07		0.03	0.01	0.20	0.02	0.30		0.45	0.37	

Intersection Summary

Cycle Length: 80
 Actuated Cycle Length: 80
 Offset: 16 (20%), Referenced to phase 2:NBTL and 6:SBTL, Start of Green
 Control Type: Actuated-Coordinated
 Maximum v/c Ratio: 0.45
 Intersection Signal Delay: 5.7
 Intersection LOS: A
 Intersection Capacity Utilization 59.8%
 ICU Level of Service B
 Analysis Period (min) 15

Splits and Phases: 2: Hawthorne & Russell

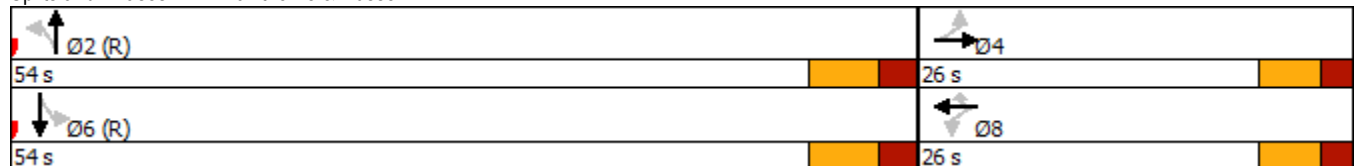

4055 & 4120 Russell Road
3: Hawthorne & Stevenage

2028 Future Background PM Peak Hour Mod

Lane Group	EBL	EBT	EBR	WBL	WBT	WBR	NBL	NBT	NBR	SBL	SBT	SBR
Lane Configurations												
Traffic Volume (vph)	201	39	221	100	29	81	82	390	59	45	993	144
Future Volume (vph)	201	39	221	100	29	81	82	390	59	45	993	144
Satd. Flow (prot)	1669	1490	0	1567	1426	0	1323	3073	0	1323	3402	1390
Flt Permitted	0.686			0.426			0.202			0.492		
Satd. Flow (perm)	1202	1490	0	703	1426	0	281	3073	0	685	3402	1352
Satd. Flow (RTOR)		221			81			22				144
Lane Group Flow (vph)	201	260	0	100	110	0	82	449	0	45	993	144
Turn Type	Perm	NA		Perm	NA		pm+pt	NA		pm+pt	NA	Perm
Protected Phases		4			8		5	2		1	6	
Permitted Phases	4			8			2			6		6
Total Split (s)	35.0	35.0		35.0	35.0		15.0	45.0		15.0	45.0	45.0
Total Lost Time (s)	5.7	5.7		5.7	5.7		5.7	5.5		5.7	5.5	5.5
Act Effct Green (s)	22.6	22.6		22.6	22.6		58.2	53.2		55.7	50.1	50.1
Actuated g/C Ratio	0.24	0.24		0.24	0.24		0.61	0.56		0.59	0.53	0.53
v/c Ratio	0.71	0.50		0.60	0.27		0.32	0.26		0.10	0.55	0.18
Control Delay	45.6	9.3		45.8	11.0		11.7	13.3		9.0	19.1	3.7
Queue Delay	0.0	0.0		0.0	0.0		0.0	0.0		0.0	0.0	0.0
Total Delay	45.6	9.3		45.8	11.0		11.7	13.3		9.0	19.1	3.7
LOS	D	A		D	B		B	B		A	B	A
Approach Delay		25.1			27.6			13.0			16.8	
Approach LOS		C			C			B			B	
Queue Length 50th (m)	30.7	5.1		14.8	3.8		4.9	20.9		2.6	60.8	0.0
Queue Length 95th (m)	48.7	21.5		28.3	14.2		12.0	35.6		7.5	91.6	9.8
Internal Link Dist (m)		201.3			257.1			958.8			795.0	
Turn Bay Length (m)	45.0			25.0			75.0			85.0		85.0
Base Capacity (vph)	370	612		216	495		275	1730		475	1792	780
Starvation Cap Reductn	0	0		0	0		0	0		0	0	0
Spillback Cap Reductn	0	0		0	0		0	0		0	0	0
Storage Cap Reductn	0	0		0	0		0	0		0	0	0
Reduced v/c Ratio	0.54	0.42		0.46	0.22		0.30	0.26		0.09	0.55	0.18

Intersection Summary

Cycle Length: 95

Actuated Cycle Length: 95

Offset: 0 (0%), Referenced to phase 2:NBTL and 6:SBTL, Start of Green

Control Type: Actuated-Coordinated

Maximum v/c Ratio: 0.71

Intersection Signal Delay: 18.5

Intersection LOS: B

Intersection Capacity Utilization 77.5%

ICU Level of Service D

Analysis Period (min) 15

Splits and Phases: 3: Hawthorne & Stevenage

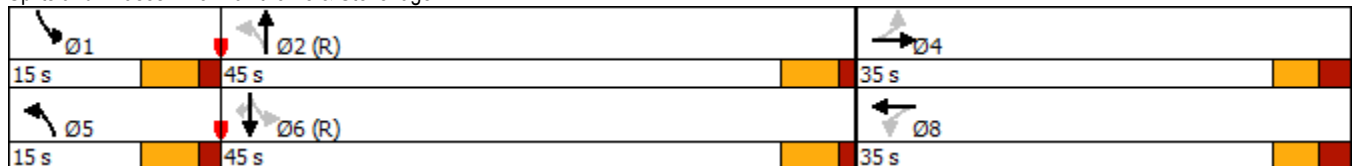

Lane Group	EBL	EBT	EBR	WBL	WBT	WBR	NBL	NBT	NBR	SBL	SBT	SBR
Lane Configurations												
Traffic Volume (vph)	266	847	25	443	912	91	26	202	321	175	517	489
Future Volume (vph)	266	847	25	443	912	91	26	202	321	175	517	489
Satd. Flow (prot)	3094	3422	0	3208	3468	1141	1717	2807	0	1609	3247	1522
Flt Permitted	0.950			0.950			0.459			0.177		
Satd. Flow (perm)	3094	3422	0	3205	3468	1141	830	2807	0	300	3247	1522
Satd. Flow (RTOR)		2				119		240				489
Lane Group Flow (vph)	266	872	0	443	912	91	26	523	0	175	517	489
Turn Type	Prot	NA		Prot	NA	Perm	pm+pt	NA		pm+pt	NA	Perm
Protected Phases	7	4		3	8		5	2		1	6	
Permitted Phases						8	2			6		6
Total Split (s)	36.4	48.4		44.4	56.4	56.4	21.3	32.3		21.3	32.3	32.3
Total Lost Time (s)	6.4	6.4		6.4	6.4	6.4	6.3	6.3		6.3	6.3	6.3
Act Effct Green (s)	16.1	38.4		22.5	44.7	44.7	27.1	20.2		40.4	32.8	32.8
Actuated g/C Ratio	0.13	0.32		0.19	0.37	0.37	0.22	0.17		0.33	0.27	0.27
v/c Ratio	0.65	0.80		0.74	0.71	0.18	0.11	0.78		0.70	0.59	0.64
Control Delay	59.4	45.4		56.0	37.1	3.1	31.2	35.4		47.7	44.1	7.8
Queue Delay	0.0	0.0		0.0	0.0	0.0	0.0	0.0		0.0	0.0	0.0
Total Delay	59.4	45.4		56.0	37.1	3.1	31.2	35.4		47.7	44.1	7.8
LOS	E	D		E	D	A	C	D		D	D	A
Approach Delay		48.7			40.7			35.2			29.6	
Approach LOS		D			D			D			C	
Queue Length 50th (m)	30.6	95.0		50.7	92.2	0.0	4.0	33.6		29.9	57.4	0.0
Queue Length 95th (m)	45.5	131.5		69.3	126.2	5.8	10.6	55.0		#51.5	81.0	29.0
Internal Link Dist (m)		420.4			1343.9			595.0			958.8	
Turn Bay Length (m)	90.0			50.0		80.0	50.0			80.0		80.0
Base Capacity (vph)	787	1224		1034	1472	552	357	806		266	882	769
Starvation Cap Reductn	0	0		0	0	0	0	0		0	0	0
Spillback Cap Reductn	0	0		0	0	0	0	0		0	0	0
Storage Cap Reductn	0	0		0	0	0	0	0		0	0	0
Reduced v/c Ratio	0.34	0.71		0.43	0.62	0.16	0.07	0.65		0.66	0.59	0.64

Intersection Summary

Cycle Length: 146.4
 Actuated Cycle Length: 120.8
 Control Type: Semi Act-Uncoord
 Maximum v/c Ratio: 0.80
 Intersection Signal Delay: 39.1
 Intersection LOS: D
 Intersection Capacity Utilization 87.3%
 ICU Level of Service E
 Analysis Period (min) 15
 # 95th percentile volume exceeds capacity, queue may be longer.
 Queue shown is maximum after two cycles.

Splits and Phases: 4: Hawthorne & Hunt Club

44.4 s	48.4 s	21.3 s	32.3 s
36.4 s	56.4 s	21.3 s	32.3 s



Lane Group	EBL	EBT	WBT	WBR	SBL	SBR
Lane Configurations		↑↑	↑↑		↓	↓
Traffic Volume (vph)	0	1647	193	0	182	665
Future Volume (vph)	0	1647	193	0	182	665
Satd. Flow (prot)	0	3402	3402	0	1701	1522
Flt Permitted					0.950	
Satd. Flow (perm)	0	3402	3402	0	1701	1522
Satd. Flow (RTOR)						665
Lane Group Flow (vph)	0	1647	193	0	182	665
Turn Type		NA	NA		Prot	Free
Protected Phases		4	8		6	
Permitted Phases						Free
Total Split (s)		65.0	65.0		25.0	
Total Lost Time (s)		6.3	6.3		6.3	
Act Effct Green (s)		62.9	62.9		14.5	90.0
Actuated g/C Ratio		0.70	0.70		0.16	1.00
v/c Ratio		0.69	0.08		0.67	0.44
Control Delay		10.5	3.2		47.1	0.9
Queue Delay		0.0	0.0		0.0	0.0
Total Delay		10.5	3.2		47.1	0.9
LOS		B	A		D	A
Approach Delay		10.5	3.2		10.8	
Approach LOS		B	A		B	
Queue Length 50th (m)		70.0	1.3		27.4	0.0
Queue Length 95th (m)		106.6	7.1		44.4	0.0
Internal Link Dist (m)		667.9	357.7		275.3	
Turn Bay Length (m)					100.0	
Base Capacity (vph)		2379	2379		353	1522
Starvation Cap Reductn		0	0		0	0
Spillback Cap Reductn		0	0		0	0
Storage Cap Reductn		0	0		0	0
Reduced v/c Ratio		0.69	0.08		0.52	0.44

Intersection Summary

Cycle Length: 90
 Actuated Cycle Length: 90
 Offset: 0 (0%), Referenced to phase 4:EBT and 8:WBT, Start of Green
 Control Type: Actuated-Coordinated
 Maximum v/c Ratio: 0.69
 Intersection Signal Delay: 10.1
 Intersection LOS: B
 Intersection Capacity Utilization 69.2%
 ICU Level of Service C
 Analysis Period (min) 15

Splits and Phases: 10: Walkley & SB off-ramp

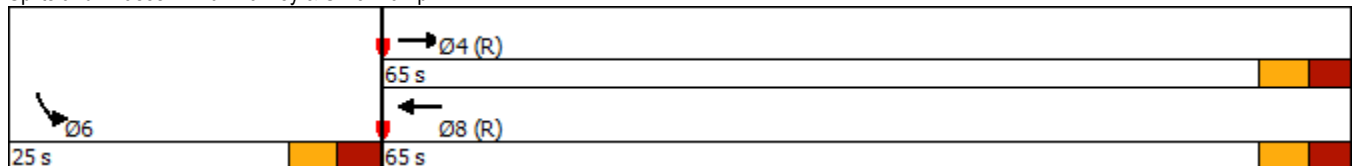

Scheme Summary

Control Data

Control Data and Model Parameters

119124	2028 PHF Flow Profile (veh)
2028 Background Traffic Volumes	7.5 min Time Slice
Rodel-Win1	Queuing Delays (sec)
Right Hand Drive	Daylight conditions
PM Peak Hour	Peak 60/15 min Results
AVERAGE DELAY to Geometry	Output flows: Vehicles
Metric Units (m)	85% Confidence Level

Available Data

Entry Capacity Calibrated	No
Entry Capacity Modified	No
Crosswalks	No
Flows Factored	No
Approach/Exit Road Capacity Calibrated	No
Accidents	No
Accident Costs	No
Bypass Model	No
Bypass Calibration	No
Global Results	Yes

Operational Data

Main Geometry (m)

Geometry and Design Target

Leg	Leg Names	Approach Geometry (m)				Target	Circulating and Exit Geom		
		Bearing (deg)	Grade Sep G	Half Width V	Lanes n	Average Delay (sec/veh)	Inscribed Diameter D	Half Width Vx	Lanes n
1	SB - Anderson	0	0	4.00	1	30	45.00	4.00	1
2	EB - Russell	90	0	4.00	1	30	45.00	4.00	1
3	NB- Anderson	180	0	4.00	1	30	45.00	4.00	1
4	WB- Russell	270	0	4.00	1	30	45.00	4.00	1

Capacity Modifiers and Capacity Calibration (veh/hr)

Leg	Leg Names	Entry Capacity		Entry Calibration		Approach Road			Exit Road		
		Capacity + or -	XWalk Factor	Intercept + or -	Slope Factor	V (m)	Default Capacity	Calib Capacity	V (m)	Default Capacity	Calib Capacity
1	SB - Anderson	0	1.000	0	1.000	6.00	1960	0	4.00	1960	0
2	EB - Russell	0	1.000	0	1.000	6.00	1960	0	4.00	1960	0
3	NB- Anderson	0	1.000	0	1.000	6.00	1960	0	4.00	1960	0
4	WB- Russell	0	1.000	0	1.000	6.00	1960	0	4.00	1960	0

Traffic Flow Data (veh/hr)

2028 PM Peak Peak Hour Flows

Leg	Leg Names	Turning Flows					Flow Modifiers		
		U-Turn	Exit-3	Exit-2	Exit-1	Bypass	Trucks %	Flow Factor	Peak Hour Factor
1	SB - Anderson	0	61	262	38	0	3.0	1.00	1.000
2	EB - Russell	0	77	244	14	0	3.0	1.00	1.000
3	NB- Anderson	0	7	170	46	0	3.0	1.00	1.000
4	WB- Russell	0	12	24	10	0	3.0	1.00	1.000

Operational Results

Geometry for Target Input

Geometry Options for 2028 PM Peak

				Leg 1 - SB - Anderson	
nv	ne	nc	nx	E (m)	L' (m)
1	1	1	1	4.00	0.00

Geometry Options for 2028 PM Peak

				Leg 2 - EB - Russell	
nv	ne	nc	nx	E (m)	L' (m)
1	1	1	1	4.00	0.00

Geometry Options for 2028 PM Peak

				Leg 3 - NB- Anderson	
nv	ne	nc	nx	E (m)	L' (m)
1	1	1	1	4.00	0.00

Geometry Options for 2028 PM Peak

				Leg 4 - WB- Russell	
nv	ne	nc	nx	E (m)	L' (m)
1	1	1	1	4.00	0.00

2028 PM Peak - 60 minutes

Flows and Capacity

Leg	Leg Names	Bypass Type	Flows (veh/hr)				Capacity (veh/hr)			
			Arrival Flow		Opposing Flow		Capacity		Average VCR	
			Entry	Bypass	Entry	Bypass	Entry	Bypass	Entry	Bypass
1	SB - Anderson	None	361		43		257	925		0.3902
2	EB - Russell	None	335		335		69	774		0.4328
3	NB- Anderson	None	223		382		288	750		0.2974
4	WB- Russell	None	46		254		351	816		0.0564

Delays, Queues and Level of Service

Leg	Leg Names	Bypass Type	Average Delay (sec)			95% Queue (veh)		Level of Service		
			Entry	Bypass	Leg	Entry	Bypass	Entry	Bypass	Leg
1	SB - Anderson	None	6.06		6.06	1.58		A		A
2	EB - Russell	None	7.74		7.74	1.87		A		A
3	NB- Anderson	None	6.53		6.53	1.06		A		A
4	WB- Russell	None	4.52		4.52	0.15		A		A

2028 PM Peak - 15 minutes

Flows and Capacity

Leg	Leg Names	Bypass Type	Flows (veh/hr)				Capacity (veh/hr)			
			Arrival Flow		Opposing Flow		Capacity		Average VCR	
			Entry	Bypass	Entry	Bypass	Entry	Bypass	Entry	Bypass
1	SB - Anderson	None	361		43		257	925		0.3902
2	EB - Russell	None	335		335		69	774		0.4328
3	NB- Anderson	None	223		382		288	750		0.2974
4	WB- Russell	None	46		254		351	816		0.0564

Delays, Queues and Level of Service

Leg	Leg Names	Bypass Type	Average Delay (sec)			95% Queue (veh)		Level of Service		
			Entry	Bypass	Leg	Entry	Bypass	Entry	Bypass	Leg
1	SB - Anderson	None	6.07		6.07	1.58		A		A
2	EB - Russell	None	7.76		7.76	1.87		A		A
3	NB- Anderson	None	6.54		6.54	1.06		A		A
4	WB- Russell	None	4.53		4.53	0.15		A		A

Lane Group	EBL	EBT	EBR	WBL	WBT	WBR	NBL	NBT	NBR	SBL	SBT	SBR
Lane Configurations												
Traffic Volume (vph)	79	509	204	482	1289	67	279	465	592	57	269	141
Future Volume (vph)	79	509	204	482	1289	67	279	465	592	57	269	141
Satd. Flow (prot)	1374	3307	1332	3013	3435	1522	3094	3218	1332	3269	3189	1390
Flt Permitted	0.950			0.950			0.950			0.950		
Satd. Flow (perm)	1372	3307	1332	3013	3435	1490	3083	3218	1314	3264	3189	1365
Satd. Flow (RTOR)			204			134			528			180
Lane Group Flow (vph)	79	509	204	482	1289	67	279	465	592	57	269	141
Turn Type	Prot	NA	Perm	Prot	NA	Perm	Prot	NA	Perm	Prot	NA	Perm
Protected Phases	5	2		1	6		3	8		7	4	
Permitted Phases			2			6			8			4
Total Split (s)	24.4	45.0	45.0	45.0	65.6	65.6	20.0	40.0	40.0	20.0	40.0	40.0
Total Lost Time (s)	6.4	7.3	7.3	6.4	7.3	7.3	7.6	7.4	7.4	7.6	7.4	7.4
Act Effct Green (s)	13.5	51.8	51.8	29.4	67.6	67.6	12.4	34.8	34.8	8.0	27.7	27.7
Actuated g/C Ratio	0.09	0.35	0.35	0.20	0.45	0.45	0.08	0.23	0.23	0.05	0.18	0.18
v/c Ratio	0.64	0.45	0.34	0.82	0.83	0.09	1.09	0.62	0.83	0.33	0.46	0.35
Control Delay	87.8	42.0	6.9	69.1	43.6	0.2	145.1	55.8	18.6	72.9	55.9	4.9
Queue Delay	0.0	0.0	0.0	0.0	0.0	0.0	0.0	0.0	0.0	0.0	0.0	0.0
Total Delay	87.8	42.0	6.9	69.1	43.6	0.2	145.1	55.8	18.6	72.9	55.9	4.9
LOS	F	D	A	E	D	A	F	E	B	E	E	A
Approach Delay		37.5			48.7			57.9			42.6	
Approach LOS		D			D			E			D	
Queue Length 50th (m)	21.2	59.7	0.0	65.9	172.3	0.0	-44.2	59.5	14.0	7.9	33.5	0.0
Queue Length 95th (m)	37.0	81.7	18.5	79.4	#224.9	0.0	#71.7	78.1	70.1	14.6	46.3	7.3
Internal Link Dist (m)		485.7			404.4			432.2			296.2	
Turn Bay Length (m)	85.0		225.0	100.0		45.0	140.0		110.0	80.0		55.0
Base Capacity (vph)	164	1141	593	775	1548	745	255	746	710	270	693	437
Starvation Cap Reductn	0	0	0	0	0	0	0	0	0	0	0	0
Spillback Cap Reductn	0	0	0	0	0	0	0	0	0	0	0	0
Storage Cap Reductn	0	0	0	0	0	0	0	0	0	0	0	0
Reduced v/c Ratio	0.48	0.45	0.34	0.62	0.83	0.09	1.09	0.62	0.83	0.21	0.39	0.32

Intersection Summary

Cycle Length: 150

Actuated Cycle Length: 150

Offset: 102 (68%), Referenced to phase 2:EBT and 6:WBT, Start of Green

Control Type: Actuated-Coordinated

Maximum v/c Ratio: 1.09

Intersection Signal Delay: 48.8

Intersection LOS: D

Intersection Capacity Utilization 84.2%

ICU Level of Service E

Analysis Period (min) 15

~ Volume exceeds capacity, queue is theoretically infinite.

Queue shown is maximum after two cycles.

95th percentile volume exceeds capacity, queue may be longer.

Queue shown is maximum after two cycles.

Splits and Phases: 1: Russell & Walkley

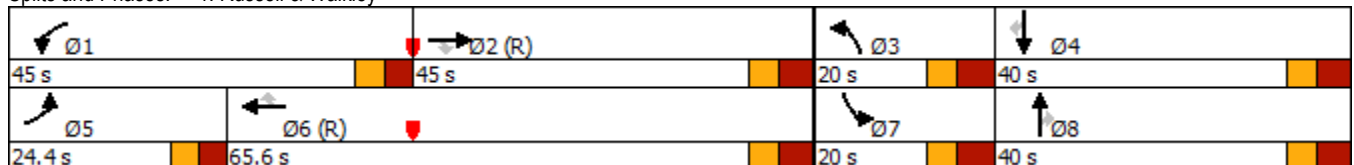

4055 & 4120 Russell Road
3: Hawthorne & Stevenage

2028 Total Traffic AM Peak Hour

Lane Group	EBL	EBT	EBR	WBL	WBT	WBR	NBL	NBT	NBR	SBL	SBT	SBR
Lane Configurations												
Traffic Volume (vph)	134	28	60	58	63	55	208	1001	86	52	364	200
Future Volume (vph)	134	28	60	58	63	55	208	1001	86	52	364	200
Satd. Flow (prot)	1553	1219	0	1276	1465	0	1669	3097	0	1429	2858	1453
Flt Permitted	0.681			0.700			0.480			0.223		
Satd. Flow (perm)	1113	1219	0	935	1465	0	840	3097	0	335	2858	1414
Satd. Flow (RTOR)		60			52			11				200
Lane Group Flow (vph)	134	88	0	58	118	0	208	1087	0	52	364	200
Turn Type	Perm	NA		Perm	NA		pm+pt	NA		pm+pt	NA	Perm
Protected Phases		4			8		5	2		1	6	
Permitted Phases	4			8			2			6		6
Total Split (s)	35.0	35.0		35.0	35.0		15.0	40.0		15.0	40.0	40.0
Total Lost Time (s)	5.7	5.7		5.7	5.7		5.7	5.5		5.7	5.5	5.5
Act Effct Green (s)	16.9	16.9		16.9	16.9		60.6	54.0		53.0	46.4	46.4
Actuated g/C Ratio	0.19	0.19		0.19	0.19		0.67	0.60		0.59	0.52	0.52
v/c Ratio	0.64	0.32		0.33	0.37		0.32	0.58		0.19	0.25	0.24
Control Delay	46.6	14.8		34.5	20.5		7.5	15.4		5.2	10.9	5.9
Queue Delay	0.0	0.0		0.0	0.0		0.0	0.0		0.0	0.0	0.0
Total Delay	46.6	14.8		34.5	20.5		7.5	15.4		5.2	10.9	5.9
LOS	D	B		C	C		A	B		A	B	A
Approach Delay		34.0			25.1			14.1			8.8	
Approach LOS		C			C			B			A	
Queue Length 50th (m)	20.1	3.8		8.2	9.1		10.0	56.8		1.5	17.8	5.6
Queue Length 95th (m)	33.0	13.4		16.2	20.1		23.8	99.5		2.2	33.5	23.3
Internal Link Dist (m)		201.3			257.1			958.8			795.0	
Turn Bay Length (m)	45.0			25.0			75.0			85.0		85.0
Base Capacity (vph)	362	437		304	512		662	1863		319	1474	826
Starvation Cap Reductn	0	0		0	0		0	0		0	0	0
Spillback Cap Reductn	0	0		0	0		0	0		0	0	0
Storage Cap Reductn	0	0		0	0		0	0		0	0	0
Reduced v/c Ratio	0.37	0.20		0.19	0.23		0.31	0.58		0.16	0.25	0.24

Intersection Summary

Cycle Length: 90

Actuated Cycle Length: 90

Offset: 0 (0%), Referenced to phase 2:NBTL and 6:SBTL, Start of Green

Control Type: Actuated-Coordinated

Maximum v/c Ratio: 0.64

Intersection Signal Delay: 15.5

Intersection LOS: B

Intersection Capacity Utilization 65.0%

ICU Level of Service C

Analysis Period (min) 15

Splits and Phases: 3: Hawthorne & Stevenage

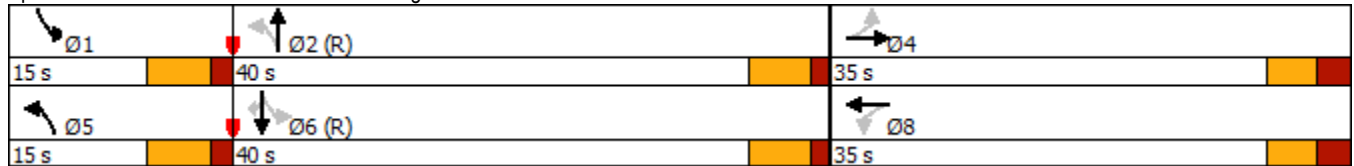

4055 & 4120 Russell Road
4: Hawthorne & Hunt Club

2028 Total Traffic AM Peak Hour

Lane Group	EBL	EBT	EBR	WBL	WBT	WBR	NBL	NBT	NBR	SBL	SBT	SBR
Lane Configurations												
Traffic Volume (vph)	470	703	26	263	748	257	42	432	400	45	154	205
Future Volume (vph)	470	703	26	263	748	257	42	432	400	45	154	205
Satd. Flow (prot)	1639	3337	0	1595	3402	1440	1488	2974	0	1191	2748	1278
Flt Permitted	0.950			0.950			0.654			0.129		
Satd. Flow (perm)	1639	3337	0	1595	3402	1440	1025	2974	0	162	2748	1278
Satd. Flow (RTOR)		2				257		152				205
Lane Group Flow (vph)	470	729	0	263	748	257	42	832	0	45	154	205
Turn Type	Prot	NA		Prot	NA	Perm	pm+pt	NA		pm+pt	NA	Perm
Protected Phases	7	4		3	8		5	2		1	6	
Permitted Phases						8	2			6		6
Total Split (s)	41.4	41.4		41.4	41.4	41.4	21.3	36.3		21.3	36.3	36.3
Total Lost Time (s)	6.4	6.4		6.4	6.4	6.4	6.3	6.3		6.3	6.3	6.3
Act Effct Green (s)	35.2	42.6		26.4	33.8	33.8	36.9	30.2		38.6	31.0	31.0
Actuated g/C Ratio	0.27	0.33		0.20	0.26	0.26	0.28	0.23		0.30	0.24	0.24
v/c Ratio	1.07	0.67		0.82	0.85	0.46	0.13	1.04		0.38	0.24	0.45
Control Delay	107.9	43.9		70.4	57.3	7.5	31.5	82.0		40.2	43.0	8.9
Queue Delay	0.0	0.0		0.0	0.0	0.0	0.0	0.0		0.0	0.0	0.0
Total Delay	107.9	43.9		70.4	57.3	7.5	31.5	82.0		40.2	43.0	8.9
LOS	F	D		E	E	A	C	F		D	D	A
Approach Delay		69.0			49.9			79.6			25.4	
Approach LOS		E			D			E			C	
Queue Length 50th (m)	~130.0	81.4		61.9	91.5	0.0	7.0	~101.5		7.6	16.2	0.0
Queue Length 95th (m)	#197.7	#117.1		87.4	#123.1	20.0	14.8	#144.3		15.9	26.0	19.2
Internal Link Dist (m)		420.4			459.3			595.0			958.8	
Turn Bay Length (m)	90.0			50.0		80.0	50.0			80.0		80.0
Base Capacity (vph)	441	1087		429	915	575	378	802		170	652	459
Starvation Cap Reductn	0	0		0	0	0	0	0		0	0	0
Spillback Cap Reductn	0	0		0	0	0	0	0		0	0	0
Storage Cap Reductn	0	0		0	0	0	0	0		0	0	0
Reduced v/c Ratio	1.07	0.67		0.61	0.82	0.45	0.11	1.04		0.26	0.24	0.45

Intersection Summary

Cycle Length: 140.4
 Actuated Cycle Length: 130.8
 Control Type: Semi Act-Uncoord
 Maximum v/c Ratio: 1.07
 Intersection Signal Delay: 60.3
 Intersection LOS: E
 Intersection Capacity Utilization 101.0%
 ICU Level of Service G
 Analysis Period (min) 15
 ~ Volume exceeds capacity, queue is theoretically infinite.
 Queue shown is maximum after two cycles.
 # 95th percentile volume exceeds capacity, queue may be longer.
 Queue shown is maximum after two cycles.

Splits and Phases: 4: Hawthorne & Hunt Club

Ø3	Ø4	Ø1	Ø2
41.4 s	41.4 s	21.3 s	36.3 s
Ø7	Ø8	Ø5	Ø6
41.4 s	41.4 s	21.3 s	36.3 s



Movement	EBT	EBR	WBL	WBT	NBL	NBR
Lane Configurations						
Traffic Volume (veh/h)	194	42	155	600	39	22
Future Volume (Veh/h)	194	42	155	600	39	22
Sign Control	Free			Free	Stop	
Grade	0%			0%	0%	
Peak Hour Factor	1.00	1.00	1.00	1.00	1.00	1.00
Hourly flow rate (vph)	194	42	155	600	39	22
Pedestrians						
Lane Width (m)						
Walking Speed (m/s)						
Percent Blockage						
Right turn flare (veh)						
Median type	None			None		
Median storage (veh)						
Upstream signal (m)						
pX, platoon unblocked						
vC, conflicting volume			236		1125	215
vC1, stage 1 conf vol						
vC2, stage 2 conf vol						
vCu, unblocked vol			236		1125	215
tC, single (s)			4.1		6.8	6.5
tC, 2 stage (s)						
tF (s)			2.2		3.9	3.5
p0 queue free %			88		77	97
cM capacity (veh/h)			1325		169	770

Direction, Lane #	EB 1	WB 1	NB 1
Volume Total	236	755	61
Volume Left	0	155	39
Volume Right	42	0	22
cSH	1700	1325	236
Volume to Capacity	0.14	0.12	0.26
Queue Length 95th (m)	0.0	2.8	7.0
Control Delay (s)	0.0	2.8	25.5
Lane LOS		A	D
Approach Delay (s)	0.0	2.8	25.5
Approach LOS			D

Intersection Summary			
Average Delay			3.5
Intersection Capacity Utilization	69.6%		ICU Level of Service C
Analysis Period (min)			15



Movement	EBL	EBR	NBL	NBT	SBT	SBR
Lane Configurations						
Traffic Volume (veh/h)	2	961	0	964	702	0
Future Volume (Veh/h)	2	961	0	964	702	0
Sign Control	Stop			Free	Free	
Grade	0%			0%	0%	
Peak Hour Factor	1.00	1.00	1.00	1.00	1.00	1.00
Hourly flow rate (vph)	2	961	0	964	702	0
Pedestrians						
Lane Width (m)						
Walking Speed (m/s)						
Percent Blockage						
Right turn flare (veh)						
Median type				None	None	
Median storage (veh)						
Upstream signal (m)						
pX, platoon unblocked						
vC, conflicting volume	1666	702	702			
vC1, stage 1 conf vol						
vC2, stage 2 conf vol						
vCu, unblocked vol	1666	702	702			
tC, single (s)	6.4	6.3	4.1			
tC, 2 stage (s)						
tF (s)	3.5	3.4	2.2			
p0 queue free %	98	0	100			
cM capacity (veh/h)	107	426	905			
Direction, Lane #						
	EB 1	EB 2	NB 1	SB 1		
Volume Total	2	961	964	702		
Volume Left	2	0	0	0		
Volume Right	0	961	0	0		
cSH	107	426	1700	1700		
Volume to Capacity	0.02	2.25	0.57	0.41		
Queue Length 95th (m)	0.4	502.8	0.0	0.0		
Control Delay (s)	39.3	592.2	0.0	0.0		
Lane LOS	E	F				
Approach Delay (s)	591.1		0.0	0.0		
Approach LOS	F					
Intersection Summary						
Average Delay			216.5			
Intersection Capacity Utilization			108.5%	ICU Level of Service		G
Analysis Period (min)			15			



Movement	EBL	EBR	NBL	NBT	SBT	SBR
Lane Configurations						
Traffic Volume (veh/h)	42	39	411	347	145	232
Future Volume (Veh/h)	42	39	411	347	145	232
Sign Control	Stop			Free	Free	
Grade	0%			0%	0%	
Peak Hour Factor	1.00	1.00	1.00	1.00	1.00	1.00
Hourly flow rate (vph)	42	39	411	347	145	232
Pedestrians	2					
Lane Width (m)	4.0					
Walking Speed (m/s)	1.0					
Percent Blockage	0					
Right turn flare (veh)						
Median type				None	None	
Median storage (veh)						
Upstream signal (m)						
pX, platoon unblocked						
vC, conflicting volume	1430	263	377			
vC1, stage 1 conf vol						
vC2, stage 2 conf vol						
vCu, unblocked vol	1430	263	377			
tC, single (s)	6.9	6.4	4.1			
tC, 2 stage (s)						
tF (s)	4.0	3.5	2.2			
p0 queue free %	44	95	65			
cM capacity (veh/h)	76	732	1171			
Direction, Lane #	EB 1	NB 1	SB 1			
Volume Total	81	758	377			
Volume Left	42	411	0			
Volume Right	39	0	232			
cSH	133	1171	1700			
Volume to Capacity	0.61	0.35	0.22			
Queue Length 95th (m)	22.0	11.2	0.0			
Control Delay (s)	67.1	7.2	0.0			
Lane LOS	F	A				
Approach Delay (s)	67.1	7.2	0.0			
Approach LOS	F					
Intersection Summary						
Average Delay	9.0					
Intersection Capacity Utilization	82.0%			ICU Level of Service	D	
Analysis Period (min)	15					



Movement	EBL	EBT	WBT	WBR	SBL	SBR
Lane Configurations		↑↑	↑↑		↓	↓
Traffic Volume (veh/h)	0	553	1041	0	24	1084
Future Volume (Veh/h)	0	553	1041	0	24	1084
Sign Control		Free	Free		Stop	
Grade		0%	0%		0%	
Peak Hour Factor	1.00	1.00	1.00	1.00	1.00	1.00
Hourly flow rate (vph)	0	553	1041	0	24	1084
Pedestrians						
Lane Width (m)						
Walking Speed (m/s)						
Percent Blockage						
Right turn flare (veh)						
Median type		None	None			
Median storage (veh)						
Upstream signal (m)						
pX, platoon unblocked						
vC, conflicting volume	1041				1318	520
vC1, stage 1 conf vol						
vC2, stage 2 conf vol						
vCu, unblocked vol	1041				1318	520
tC, single (s)	4.2				6.9	7.0
tC, 2 stage (s)						
tF (s)	2.2				3.5	3.3
p0 queue free %	100				83	0
cM capacity (veh/h)	646				145	493
Direction, Lane #	EB 1	EB 2	WB 1	WB 2	SB 1	SB 2
Volume Total	276	276	520	520	24	1084
Volume Left	0	0	0	0	24	0
Volume Right	0	0	0	0	0	1084
cSH	1700	1700	1700	1700	145	493
Volume to Capacity	0.16	0.16	0.31	0.31	0.17	2.20
Queue Length 95th (m)	0.0	0.0	0.0	0.0	4.0	553.3
Control Delay (s)	0.0	0.0	0.0	0.0	34.7	565.3
Lane LOS					D	F
Approach Delay (s)	0.0		0.0		553.8	
Approach LOS					F	
Intersection Summary						
Average Delay			227.1			
Intersection Capacity Utilization			107.9%		ICU Level of Service	G
Analysis Period (min)			15			



Movement	EBT	EBR	WBL	WBT	NBL	NBR
Lane Configurations	↑↑			↑↑	↘	
Traffic Volume (veh/h)	172	0	0	973	578	60
Future Volume (Veh/h)	172	0	0	973	578	60
Sign Control	Free		Free		Stop	
Grade	0%		0%		0%	
Peak Hour Factor	1.00	1.00	1.00	1.00	1.00	1.00
Hourly flow rate (vph)	172	0	0	973	578	60
Pedestrians						
Lane Width (m)						
Walking Speed (m/s)						
Percent Blockage						
Right turn flare (veh)						
Median type	None		None			
Median storage (veh)						
Upstream signal (m)						
pX, platoon unblocked						
vC, conflicting volume			172		658	86
vC1, stage 1 conf vol						
vC2, stage 2 conf vol						
vCu, unblocked vol			172		658	86
tC, single (s)			4.2		6.9	7.0
tC, 2 stage (s)						
tF (s)			2.2		3.5	3.3
p0 queue free %			100		0	94
cM capacity (veh/h)			1381		390	946
Direction, Lane #	EB 1	EB 2	WB 1	WB 2	NB 1	
Volume Total	86	86	486	486	638	
Volume Left	0	0	0	0	578	
Volume Right	0	0	0	0	60	
cSH	1700	1700	1700	1700	413	
Volume to Capacity	0.05	0.05	0.29	0.29	1.54	
Queue Length 95th (m)	0.0	0.0	0.0	0.0	244.7	
Control Delay (s)	0.0	0.0	0.0	0.0	281.4	
Lane LOS						F
Approach Delay (s)	0.0		0.0		281.4	
Approach LOS						F
Intersection Summary						
Average Delay			100.7			
Intersection Capacity Utilization			107.9%	ICU Level of Service	G	
Analysis Period (min)			15			



















Movement	EBL	EBT	WBT	WBR	SBL	SBR
Lane Configurations						
Traffic Volume (veh/h)	136	143	535	48	45	129
Future Volume (Veh/h)	136	143	535	48	45	129
Sign Control		Free	Free		Stop	
Grade		0%	0%		0%	
Peak Hour Factor	1.00	1.00	1.00	1.00	1.00	1.00
Hourly flow rate (vph)	136	143	535	48	45	129
Pedestrians						
Lane Width (m)						
Walking Speed (m/s)						
Percent Blockage						
Right turn flare (veh)						
Median type		None	None			
Median storage (veh)						
Upstream signal (m)						
pX, platoon unblocked						
vC, conflicting volume	583				974	559
vC1, stage 1 conf vol						
vC2, stage 2 conf vol						
vCu, unblocked vol	583				974	559
tC, single (s)	4.1				6.4	6.2
tC, 2 stage (s)						
tF (s)	2.2				3.5	3.3
p0 queue free %	86				81	75
cM capacity (veh/h)	977				237	523
Direction, Lane #	EB 1	EB 2	WB 1	SB 1	SB 2	
Volume Total	136	143	583	45	129	
Volume Left	136	0	0	45	0	
Volume Right	0	0	48	0	129	
cSH	977	1700	1700	237	523	
Volume to Capacity	0.14	0.08	0.34	0.19	0.25	
Queue Length 95th (m)	3.4	0.0	0.0	4.8	6.7	
Control Delay (s)	9.3	0.0	0.0	23.7	14.1	
Lane LOS	A			C	B	
Approach Delay (s)	4.5		0.0	16.6		
Approach LOS				C		
Intersection Summary						
Average Delay			4.0			
Intersection Capacity Utilization			54.1%	ICU Level of Service		A
Analysis Period (min)			15			



















Movement	EBL	EBT	WBT	WBR	SBL	SBR
Lane Configurations						
Traffic Volume (veh/h)	58	130	528	111	106	55
Future Volume (Veh/h)	58	130	528	111	106	55
Sign Control		Free	Free		Stop	
Grade		0%	0%		0%	
Peak Hour Factor	1.00	1.00	1.00	1.00	1.00	1.00
Hourly flow rate (vph)	58	130	528	111	106	55
Pedestrians						
Lane Width (m)						
Walking Speed (m/s)						
Percent Blockage						
Right turn flare (veh)						
Median type		None	None			
Median storage (veh)						
Upstream signal (m)						
pX, platoon unblocked						
vC, conflicting volume	639				830	584
vC1, stage 1 conf vol						
vC2, stage 2 conf vol						
vCu, unblocked vol	639				830	584
tC, single (s)	4.1				6.4	6.2
tC, 2 stage (s)						
tF (s)	2.2				3.5	3.3
p0 queue free %	94				66	89
cM capacity (veh/h)	931				315	506
Direction, Lane #	EB 1	EB 2	WB 1	SB 1		
Volume Total	58	130	639	161		
Volume Left	58	0	0	106		
Volume Right	0	0	111	55		
cSH	931	1700	1700	362		
Volume to Capacity	0.06	0.08	0.38	0.44		
Queue Length 95th (m)	1.4	0.0	0.0	15.5		
Control Delay (s)	9.1	0.0	0.0	22.7		
Lane LOS	A			C		
Approach Delay (s)	2.8		0.0	22.7		
Approach LOS				C		
Intersection Summary						
Average Delay			4.2			
Intersection Capacity Utilization			59.6%		ICU Level of Service	B
Analysis Period (min)			15			

4055 & 4120 Russell Road
 15: Site 2/Building F & Russell

2028 Total Traffic AM Peak Hour

												
Movement	EBL	EBT	EBR	WBL	WBT	WBR	NBL	NBT	NBR	SBL	SBT	SBR
Lane Configurations												
Traffic Volume (veh/h)	1	86	131	2	627	0	128	2	1	0	1	0
Future Volume (Veh/h)	1	86	131	2	627	0	128	2	1	0	1	0
Sign Control		Free			Free			Stop			Stop	
Grade		0%			0%			0%			0%	
Peak Hour Factor	1.00	1.00	1.00	1.00	1.00	1.00	1.00	1.00	1.00	1.00	1.00	1.00
Hourly flow rate (vph)	1	86	131	2	627	0	128	2	1	0	1	0
Pedestrians												
Lane Width (m)												
Walking Speed (m/s)												
Percent Blockage												
Right turn flare (veh)												
Median type		None			None							
Median storage (veh)												
Upstream signal (m)												
pX, platoon unblocked												
vC, conflicting volume	627			217			785	784	152	786	850	627
vC1, stage 1 conf vol												
vC2, stage 2 conf vol												
vCu, unblocked vol	627			217			785	784	152	786	850	627
tC, single (s)	4.1			4.1			7.1	6.5	6.2	7.1	6.5	6.2
tC, 2 stage (s)												
tF (s)	2.2			2.2			3.5	4.0	3.3	3.5	4.0	3.3
p0 queue free %	100			100			58	99	100	100	100	100
cM capacity (veh/h)	940			1335			305	320	887	304	294	478
Direction, Lane #	EB 1	WB 1	NB 1	SB 1								
Volume Total	218	629	131	1								
Volume Left	1	2	128	0								
Volume Right	131	0	1	0								
cSH	940	1335	307	294								
Volume to Capacity	0.00	0.00	0.43	0.00								
Queue Length 95th (m)	0.0	0.0	14.3	0.1								
Control Delay (s)	0.1	0.0	25.2	17.3								
Lane LOS	A	A	D	C								
Approach Delay (s)	0.1	0.0	25.2	17.3								
Approach LOS			D	C								
Intersection Summary												
Average Delay			3.4									
Intersection Capacity Utilization			57.3%		ICU Level of Service				B			
Analysis Period (min)			15									

												
Movement	EBL	EBT	EBR	WBL	WBT	WBR	NBL	NBT	NBR	SBL	SBT	SBR
Lane Configurations												
Traffic Volume (veh/h)	1	83	3	1	628	0	1	0	0	0	0	0
Future Volume (Veh/h)	1	83	3	1	628	0	1	0	0	0	0	0
Sign Control		Free			Free			Stop			Stop	
Grade		0%			0%			0%			0%	
Peak Hour Factor	1.00	1.00	1.00	1.00	1.00	1.00	1.00	1.00	1.00	1.00	1.00	1.00
Hourly flow rate (vph)	1	83	3	1	628	0	1	0	0	0	0	0
Pedestrians												
Lane Width (m)												
Walking Speed (m/s)												
Percent Blockage												
Right turn flare (veh)												
Median type		None			None							
Median storage (veh)												
Upstream signal (m)												
pX, platoon unblocked												
vC, conflicting volume	628			86			716	716	84	716	718	628
vC1, stage 1 conf vol												
vC2, stage 2 conf vol												
vCu, unblocked vol	628			86			716	716	84	716	718	628
tC, single (s)	4.1			4.1			7.1	6.5	6.2	7.1	6.5	6.2
tC, 2 stage (s)												
tF (s)	2.2			2.2			3.5	4.0	3.3	3.5	4.0	3.3
p0 queue free %	100			100			100	100	100	100	100	100
cM capacity (veh/h)	940			1492			341	351	966	341	351	477
Direction, Lane #	EB 1	WB 1	NB 1	SB 1								
Volume Total	87	629	1	0								
Volume Left	1	1	1	0								
Volume Right	3	0	0	0								
cSH	940	1492	341	1700								
Volume to Capacity	0.00	0.00	0.00	0.00								
Queue Length 95th (m)	0.0	0.0	0.1	0.0								
Control Delay (s)	0.1	0.0	15.6	0.0								
Lane LOS	A	A	C	A								
Approach Delay (s)	0.1	0.0	15.6	0.0								
Approach LOS			C	A								
Intersection Summary												
Average Delay			0.1									
Intersection Capacity Utilization			45.5%		ICU Level of Service				A			
Analysis Period (min)			15									

Intersection	
Intersection Delay, s/veh	25.7
Intersection LOS	D

Movement	WBL	WBR	NBT	NBR	SBL	SBT
Lane Configurations	W		T			T
Traffic Vol, veh/h	322	300	340	55	10	22
Future Vol, veh/h	322	300	340	55	10	22
Peak Hour Factor	1.00	1.00	1.00	1.00	1.00	1.00
Heavy Vehicles, %	4	1	1	15	1	20
Mvmt Flow	322	300	340	55	10	22
Number of Lanes	1	0	1	0	0	1

Approach	WB	NB	SB
Opposing Approach		SB	NB
Opposing Lanes	0	1	1
Conflicting Approach Left	NB		WB
Conflicting Lanes Left	1	0	1
Conflicting Approach Right	SB	WB	
Conflicting Lanes Right	1	1	0
HCM Control Delay	32	17.1	9.8
HCM LOS	D	C	A

Lane	NBLn1	WBLn1	SBLn1
Vol Left, %	0%	52%	31%
Vol Thru, %	86%	0%	69%
Vol Right, %	14%	48%	0%
Sign Control	Stop	Stop	Stop
Traffic Vol by Lane	395	622	32
LT Vol	0	322	10
Through Vol	340	0	22
RT Vol	55	300	0
Lane Flow Rate	395	622	32
Geometry Grp	1	1	1
Degree of Util (X)	0.612	0.869	0.057
Departure Headway (Hd)	5.575	5.028	6.369
Convergence, Y/N	Yes	Yes	Yes
Cap	648	722	560
Service Time	3.615	3.064	4.432
HCM Lane V/C Ratio	0.61	0.861	0.057
HCM Control Delay	17.1	32	9.8
HCM Lane LOS	C	D	A
HCM 95th-tile Q	4.2	10.5	0.2

Intersection	
Intersection Delay, s/veh	45.8
Intersection LOS	E

Movement	EBL	EBT	EBR	WBL	WBT	WBR	NBL	NBT	NBR	SBL	SBT	SBR
Lane Configurations		↕			↕			↕			↕	
Traffic Vol, veh/h	35	16	20	48	347	118	189	304	6	5	139	153
Future Vol, veh/h	35	16	20	48	347	118	189	304	6	5	139	153
Peak Hour Factor	1.00	1.00	1.00	1.00	1.00	1.00	1.00	1.00	1.00	1.00	1.00	1.00
Heavy Vehicles, %	11	7	1	1	2	3	1	3	17	1	4	2
Mvmt Flow	35	16	20	48	347	118	189	304	6	5	139	153
Number of Lanes	0	1	0	0	1	0	0	1	0	0	1	0

Approach	EB	WB	NB	SB
Opposing Approach	WB	EB	SB	NB
Opposing Lanes	1	1	1	1
Conflicting Approach Left	SB	NB	EB	WB
Conflicting Lanes Left	1	1	1	1
Conflicting Approach Right	NB	SB	WB	EB
Conflicting Lanes Right	1	1	1	1
HCM Control Delay	13.3	56.4	55.2	19.5
HCM LOS	B	F	F	C

Lane	NBLn1	EBLn1	WBLn1	SBLn1
Vol Left, %		38%	49%	9%
Vol Thru, %		61%	23%	68%
Vol Right, %		1%	28%	23%
Sign Control		Stop	Stop	Stop
Traffic Vol by Lane		499	71	513
LT Vol		189	35	48
Through Vol		304	16	347
RT Vol		6	20	118
Lane Flow Rate		499	71	513
Geometry Grp		1	1	1
Degree of Util (X)		0.954	0.168	0.964
Departure Headway (Hd)		6.886	8.607	6.763
Convergence, Y/N		Yes	Yes	Yes
Cap		524	420	539
Service Time		4.956	6.607	4.763
HCM Lane V/C Ratio		0.952	0.169	0.952
HCM Control Delay		55.2	13.3	56.4
HCM Lane LOS		F	B	F
HCM 95th-tile Q		12.2	0.6	12.7

Lane Group	EBL	EBT	EBR	WBL	WBT	WBR	NBL	NBT	NBR	SBL	SBT	SBR
Lane Configurations												
Traffic Volume (vph)	79	509	204	482	1289	67	279	465	592	57	269	141
Future Volume (vph)	79	509	204	482	1289	67	279	465	592	57	269	141
Satd. Flow (prot)	1374	3307	1332	3013	3435	1522	3094	3218	1332	3269	3189	1390
Flt Permitted	0.950			0.950			0.950			0.950		
Satd. Flow (perm)	1372	3307	1332	3013	3435	1490	3083	3218	1314	3264	3189	1365
Satd. Flow (RTOR)			204			134			528			180
Lane Group Flow (vph)	79	509	204	482	1289	67	279	465	592	57	269	141
Turn Type	Prot	NA	Perm	Prot	NA	Perm	Prot	NA	Perm	Prot	NA	Perm
Protected Phases	5	2		1	6		3	8		7	4	
Permitted Phases			2			6			8			4
Total Split (s)	24.4	45.0	45.0	45.0	65.6	65.6	23.0	40.0	40.0	20.0	37.0	37.0
Total Lost Time (s)	6.4	7.3	7.3	6.4	7.3	7.3	7.6	7.4	7.4	7.6	7.4	7.4
Act Effct Green (s)	13.5	51.3	51.3	29.4	67.1	67.1	15.3	35.3	35.3	8.0	25.3	25.3
Actuated g/C Ratio	0.09	0.34	0.34	0.20	0.45	0.45	0.10	0.24	0.24	0.05	0.17	0.17
v/c Ratio	0.64	0.45	0.35	0.82	0.84	0.09	0.89	0.61	0.83	0.33	0.50	0.37
Control Delay	87.8	42.2	6.9	69.1	44.1	0.2	94.5	55.3	18.3	72.9	59.0	5.3
Queue Delay	0.0	0.0	0.0	0.0	0.0	0.0	0.0	0.0	0.0	0.0	0.0	0.0
Total Delay	87.8	42.2	6.9	69.1	44.1	0.2	94.5	55.3	18.3	72.9	59.0	5.3
LOS	F	D	A	E	D	A	F	E	B	E	E	A
Approach Delay		37.6			49.1			47.1			44.5	
Approach LOS		D			D			D			D	
Queue Length 50th (m)	21.2	59.7	0.0	65.9	172.3	0.0	39.5	59.5	14.0	7.9	34.4	0.0
Queue Length 95th (m)	37.0	81.7	18.5	79.4	#224.9	0.0	#62.6	78.1	70.1	14.6	47.6	7.5
Internal Link Dist (m)		485.7			404.4			432.2			296.2	
Turn Bay Length (m)	85.0		225.0	100.0		45.0	140.0		110.0	80.0		55.0
Base Capacity (vph)	164	1130	589	775	1537	741	317	757	713	270	629	413
Starvation Cap Reductn	0	0	0	0	0	0	0	0	0	0	0	0
Spillback Cap Reductn	0	0	0	0	0	0	0	0	0	0	0	0
Storage Cap Reductn	0	0	0	0	0	0	0	0	0	0	0	0
Reduced v/c Ratio	0.48	0.45	0.35	0.62	0.84	0.09	0.88	0.61	0.83	0.21	0.43	0.34

Intersection Summary

Cycle Length: 150

Actuated Cycle Length: 150

Offset: 102 (68%), Referenced to phase 2:EBT and 6:WBT, Start of Green

Control Type: Actuated-Coordinated

Maximum v/c Ratio: 0.89

Intersection Signal Delay: 46.0

Intersection LOS: D

Intersection Capacity Utilization 84.2%

ICU Level of Service E

Analysis Period (min) 15

95th percentile volume exceeds capacity, queue may be longer.

Queue shown is maximum after two cycles.

Splits and Phases: 1: Russell & Walkley

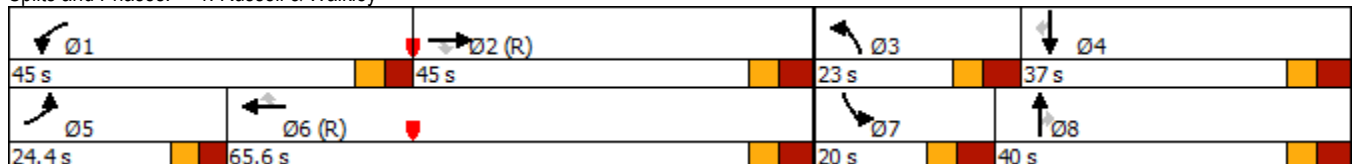

Lane Group	EBL	EBT	EBR	WBL	WBT	WBR	NBL	NBT	NBR	SBL	SBT	SBR
Lane Configurations												
Traffic Volume (vph)	10	0	8	49	10	506	17	933	44	229	572	34
Future Volume (vph)	10	0	8	49	10	506	17	933	44	229	572	34
Satd. Flow (prot)	1276	1278	0	1488	1790	1522	1701	3090	0	1488	2988	0
Flt Permitted	0.751			0.752			0.423			0.178		
Satd. Flow (perm)	1008	1278	0	1178	1790	1522	754	3090	0	279	2988	0
Satd. Flow (RTOR)		328				352		6			13	
Lane Group Flow (vph)	10	8	0	49	10	506	17	977	0	229	606	0
Turn Type	Perm	NA		Perm	NA	Perm	Perm	NA		pm+pt	NA	
Protected Phases		4			8			2		1	6	
Permitted Phases	4			8		8	2			6		
Total Split (s)	27.0	27.0		27.0	27.0	27.0	42.0	42.0		21.0	63.0	
Total Lost Time (s)	5.7	5.7		5.7	5.7	5.7	6.5	6.5		6.3	6.5	
Act Effct Green (s)	17.8	17.8		17.8	17.8	17.8	42.1	42.1		60.2	60.0	
Actuated g/C Ratio	0.20	0.20		0.20	0.20	0.20	0.47	0.47		0.67	0.67	
v/c Ratio	0.05	0.02		0.21	0.03	0.87	0.05	0.67		0.67	0.30	
Control Delay	27.4	0.0		30.6	26.8	26.9	29.2	31.6		18.8	7.2	
Queue Delay	0.0	0.0		0.0	0.0	0.0	0.0	0.0		0.0	0.0	
Total Delay	27.4	0.0		30.6	26.8	26.9	29.2	31.6		18.8	7.2	
LOS	C	A		C	C	C	C	C		B	A	
Approach Delay		15.2			27.3			31.6			10.4	
Approach LOS		B			C			C			B	
Queue Length 50th (m)	1.2	0.0		6.2	1.2	22.0	1.8	66.8		14.4	20.8	
Queue Length 95th (m)	5.0	0.0		14.8	4.9	#70.9	m5.0	107.4		31.3	28.8	
Internal Link Dist (m)		63.3			159.0			795.0			432.2	
Turn Bay Length (m)	20.0			40.0		100.0	40.0			60.0		
Base Capacity (vph)	238	552		278	423	628	352	1448		384	1994	
Starvation Cap Reductn	0	0		0	0	0	0	0		0	0	
Spillback Cap Reductn	0	0		0	0	0	0	0		0	0	
Storage Cap Reductn	0	0		0	0	0	0	0		0	0	
Reduced v/c Ratio	0.04	0.01		0.18	0.02	0.81	0.05	0.67		0.60	0.30	

Intersection Summary

Cycle Length: 90
 Actuated Cycle Length: 90
 Offset: 0 (0%), Referenced to phase 2:NBTL and 6:SBTL, Start of Green
 Control Type: Actuated-Coordinated
 Maximum v/c Ratio: 0.87
 Intersection Signal Delay: 23.1
 Intersection LOS: C
 Intersection Capacity Utilization 85.0%
 ICU Level of Service E
 Analysis Period (min) 15
 # 95th percentile volume exceeds capacity, queue may be longer.
 Queue shown is maximum after two cycles.
 m Volume for 95th percentile queue is metered by upstream signal.

Splits and Phases: 2: Hawthorne & Russell

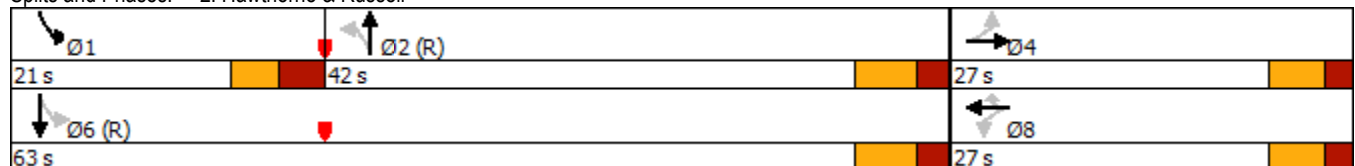

4055 & 4120 Russell Road
 3: Hawthorne & Stevenage

2028 Total Traffic AM Peak Hour Mod

Lane Group	EBL	EBT	EBR	WBL	WBT	WBR	NBL	NBT	NBR	SBL	SBT	SBR
Lane Configurations												
Traffic Volume (vph)	134	28	60	58	63	55	208	1001	86	52	364	200
Future Volume (vph)	134	28	60	58	63	55	208	1001	86	52	364	200
Satd. Flow (prot)	1553	1219	0	1276	1465	0	1669	3097	0	1429	2858	1453
Flt Permitted	0.681			0.700			0.480			0.223		
Satd. Flow (perm)	1113	1219	0	935	1465	0	840	3097	0	335	2858	1414
Satd. Flow (RTOR)		60			52			11				200
Lane Group Flow (vph)	134	88	0	58	118	0	208	1087	0	52	364	200
Turn Type	Perm	NA		Perm	NA		pm+pt	NA		pm+pt	NA	Perm
Protected Phases		4			8		5	2		1	6	
Permitted Phases	4			8			2			6		6
Total Split (s)	35.0	35.0		35.0	35.0		15.0	40.0		15.0	40.0	40.0
Total Lost Time (s)	5.7	5.7		5.7	5.7		5.7	5.5		5.7	5.5	5.5
Act Effct Green (s)	16.9	16.9		16.9	16.9		60.6	54.0		53.0	46.4	46.4
Actuated g/C Ratio	0.19	0.19		0.19	0.19		0.67	0.60		0.59	0.52	0.52
v/c Ratio	0.64	0.32		0.33	0.37		0.32	0.58		0.19	0.25	0.24
Control Delay	46.6	14.8		34.5	20.5		7.5	15.4		8.0	12.7	2.4
Queue Delay	0.0	0.0		0.0	0.0		0.0	0.0		0.0	0.0	0.0
Total Delay	46.6	14.8		34.5	20.5		7.5	15.4		8.0	12.7	2.4
LOS	D	B		C	C		A	B		A	B	A
Approach Delay		34.0			25.1			14.1			9.0	
Approach LOS		C			C			B			A	
Queue Length 50th (m)	20.1	3.8		8.2	9.1		10.0	56.8		2.1	14.3	0.0
Queue Length 95th (m)	33.0	13.4		16.2	20.1		23.8	99.5		7.4	23.8	6.8
Internal Link Dist (m)		201.3			257.1			958.8			795.0	
Turn Bay Length (m)	45.0			25.0			75.0			85.0		85.0
Base Capacity (vph)	362	437		304	512		662	1863		319	1474	826
Starvation Cap Reductn	0	0		0	0		0	0		0	0	0
Spillback Cap Reductn	0	0		0	0		0	0		0	0	0
Storage Cap Reductn	0	0		0	0		0	0		0	0	0
Reduced v/c Ratio	0.37	0.20		0.19	0.23		0.31	0.58		0.16	0.25	0.24

Intersection Summary

Cycle Length: 90
 Actuated Cycle Length: 90
 Offset: 0 (0%), Referenced to phase 2:NBTL and 6:SBTL, Start of Green
 Control Type: Actuated-Coordinated
 Maximum v/c Ratio: 0.64
 Intersection Signal Delay: 15.5
 Intersection LOS: B
 Intersection Capacity Utilization 65.0%
 ICU Level of Service C
 Analysis Period (min) 15

Splits and Phases: 3: Hawthorne & Stevenage

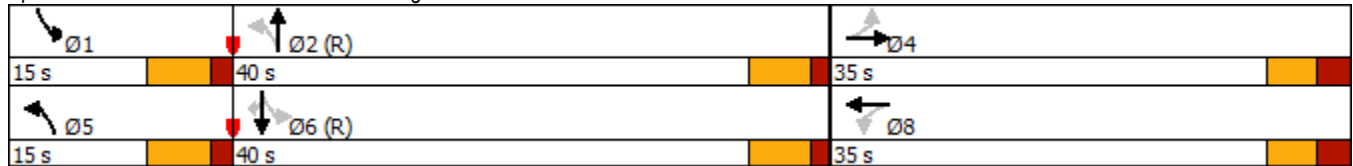

Lane Group	EBL	EBT	EBR	WBL	WBT	WBR	NBL	NBT	NBR	SBL	SBT	SBR
Lane Configurations												
Traffic Volume (vph)	470	703	26	263	748	257	42	432	400	45	154	205
Future Volume (vph)	470	703	26	263	748	257	42	432	400	45	154	205
Satd. Flow (prot)	3179	3337	0	3094	3402	1440	1488	2974	0	1191	2748	1278
Flt Permitted	0.950			0.950			0.654			0.121		
Satd. Flow (perm)	3179	3337	0	3094	3402	1440	1025	2974	0	152	2748	1278
Satd. Flow (RTOR)		2				257		161				205
Lane Group Flow (vph)	470	729	0	263	748	257	42	832	0	45	154	205
Turn Type	Prot	NA		Prot	NA	Perm	pm+pt	NA		pm+pt	NA	Perm
Protected Phases	7	4		3	8		5	2		1	6	
Permitted Phases						8	2			6		6
Total Split (s)	34.7	41.4		34.7	41.4	41.4	21.3	43.0		21.3	43.0	43.0
Total Lost Time (s)	6.4	6.4		6.4	6.4	6.4	6.3	6.3		6.3	6.3	6.3
Act Effct Green (s)	23.2	40.6		16.1	33.5	33.5	41.4	35.1		42.8	35.8	35.8
Actuated g/C Ratio	0.19	0.33		0.13	0.27	0.27	0.34	0.28		0.35	0.29	0.29
v/c Ratio	0.78	0.66		0.65	0.81	0.44	0.11	0.86		0.36	0.19	0.40
Control Delay	59.0	40.4		60.7	51.4	7.3	26.1	45.4		33.8	36.0	7.4
Queue Delay	0.0	0.0		0.0	0.0	0.0	0.0	0.0		0.0	0.0	0.0
Total Delay	59.0	40.4		60.7	51.4	7.3	26.1	45.4		33.8	36.0	7.4
LOS	E	D		E	D	A	C	D		C	D	A
Approach Delay		47.7			44.4			44.5			21.2	
Approach LOS		D			D			D			C	
Queue Length 50th (m)	55.1	77.1		30.9	87.1	0.0	6.1	81.6		6.6	14.4	0.0
Queue Length 95th (m)	74.4	106.1		44.8	#122.2	19.9	13.7	#123.5		14.7	24.1	17.6
Internal Link Dist (m)		420.4			459.3			595.0			958.8	
Turn Bay Length (m)	90.0			50.0		80.0	50.0			80.0		80.0
Base Capacity (vph)	749	1128		729	991	602	440	1021		187	856	539
Starvation Cap Reductn	0	0		0	0	0	0	0		0	0	0
Spillback Cap Reductn	0	0		0	0	0	0	0		0	0	0
Storage Cap Reductn	0	0		0	0	0	0	0		0	0	0
Reduced v/c Ratio	0.63	0.65		0.36	0.75	0.43	0.10	0.81		0.24	0.18	0.38

Intersection Summary

Cycle Length: 140.4
 Actuated Cycle Length: 123.2
 Control Type: Semi Act-Uncoord
 Maximum v/c Ratio: 0.86
 Intersection Signal Delay: 43.0
 Intersection LOS: D
 Intersection Capacity Utilization 87.6%
 ICU Level of Service E
 Analysis Period (min) 15
 # 95th percentile volume exceeds capacity, queue may be longer.
 Queue shown is maximum after two cycles.

Splits and Phases: 4: Hawthorne & Hunt Club

Ø3	Ø4	Ø1	Ø2
34.7 s	41.4 s	21.3 s	43 s
Ø7	Ø8	Ø5	Ø6
34.7 s	41.4 s	21.3 s	43 s

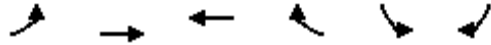

Lane Group	EBL	EBT	WBT	WBR	SBL	SBR
Lane Configurations		↑↑	↑↑		↓	↓
Traffic Volume (vph)	0	553	1041	0	24	1084
Future Volume (vph)	0	553	1041	0	24	1084
Satd. Flow (prot)	0	3402	3402	0	1701	1522
Flt Permitted					0.950	
Satd. Flow (perm)	0	3402	3402	0	1701	1522
Satd. Flow (RTOR)						354
Lane Group Flow (vph)	0	553	1041	0	24	1084
Turn Type		NA	NA		Prot	Free
Protected Phases		4	8		6	
Permitted Phases						Free
Total Split (s)		91.0	91.0		29.0	
Total Lost Time (s)		6.3	6.3		6.3	
Act Effct Green (s)		100.1	100.1		7.3	120.0
Actuated g/C Ratio		0.83	0.83		0.06	1.00
v/c Ratio		0.19	0.37		0.24	0.71
Control Delay		2.2	2.5		58.5	2.9
Queue Delay		0.0	0.0		0.0	0.0
Total Delay		2.2	2.5		58.5	2.9
LOS		A	A		E	A
Approach Delay		2.2	2.5		4.1	
Approach LOS		A	A		A	
Queue Length 50th (m)		9.3	20.7		5.1	0.0
Queue Length 95th (m)		14.2	21.0		12.9	0.0
Internal Link Dist (m)		667.8	354.1		288.6	
Turn Bay Length (m)					100.0	
Base Capacity (vph)		2838	2838		321	1522
Starvation Cap Reductn		0	0		0	0
Spillback Cap Reductn		0	0		0	0
Storage Cap Reductn		0	0		0	0
Reduced v/c Ratio		0.19	0.37		0.07	0.71

Intersection Summary

Cycle Length: 120
 Actuated Cycle Length: 120
 Offset: 0 (0%), Referenced to phase 4:EBT and 8:WBT, Start of Green
 Control Type: Actuated-Coordinated
 Maximum v/c Ratio: 0.71
 Intersection Signal Delay: 3.1
 Intersection LOS: A
 Intersection Capacity Utilization 76.5%
 ICU Level of Service D
 Analysis Period (min) 15

Splits and Phases: 10: Walkley & Hwy 417 SB Off-Ramp

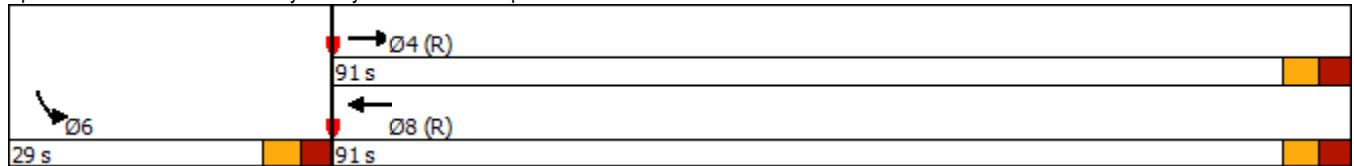

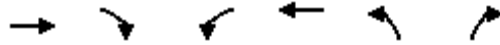

Lane Group	EBT	EBR	WBL	WBT	NBL	NBR
Lane Configurations	↑↑			↑↑	↔	
Traffic Volume (vph)	172	0	0	973	578	60
Future Volume (vph)	172	0	0	973	578	60
Satd. Flow (prot)	3402	0	0	3402	1691	0
Flt Permitted					0.957	
Satd. Flow (perm)	3402	0	0	3402	1691	0
Satd. Flow (RTOR)					6	
Lane Group Flow (vph)	172	0	0	973	638	0
Turn Type	NA			NA	Prot	
Protected Phases	4			8	2	
Permitted Phases						
Total Split (s)	53.0			53.0	67.0	
Total Lost Time (s)	6.3			6.3	6.3	
Act Effct Green (s)	46.7			46.7	60.7	
Actuated g/C Ratio	0.39			0.39	0.51	
v/c Ratio	0.13			0.74	0.74	
Control Delay	22.6			35.4	29.8	
Queue Delay	0.0			0.0	0.0	
Total Delay	22.6			35.4	29.8	
LOS	C			D	C	
Approach Delay	22.6			35.4	29.8	
Approach LOS	C			D	C	
Queue Length 50th (m)	11.0			93.8	105.1	
Queue Length 95th (m)	16.8			116.5	148.4	
Internal Link Dist (m)	354.1			306.3	348.9	
Turn Bay Length (m)						
Base Capacity (vph)	1323			1323	858	
Starvation Cap Reductn	0			0	0	
Spillback Cap Reductn	0			0	0	
Storage Cap Reductn	0			0	0	
Reduced v/c Ratio	0.13			0.74	0.74	

Intersection Summary

Cycle Length: 120
 Actuated Cycle Length: 120
 Offset: 0 (0%), Referenced to phase 4:EBT and 8:WBT, Start of Green
 Control Type: Actuated-Coordinated
 Maximum v/c Ratio: 0.74
 Intersection Signal Delay: 32.2 Intersection LOS: C
 Intersection Capacity Utilization 76.5% ICU Level of Service D
 Analysis Period (min) 15

Splits and Phases: 11: Hwy 417 NB Off-Ramp & Walkley



Scheme Summary

Control Data

Control Data and Model Parameters

119124	2028 PHF Flow Profile (veh)
2028 Total Traffic Volumes	7.5 min Time Slice
Rodel-Win1	Queuing Delays (sec)
Right Hand Drive	Daylight conditions
AM Peak Hour	Peak 60/15 min Results
AVERAGE DELAY to Geometry	Output flows: Vehicles
Metric Units (m)	85% Confidence Level

Available Data

Entry Capacity Calibrated	No
Entry Capacity Modified	No
Crosswalks	No
Flows Factored	No
Approach/Exit Road Capacity Calibrated	No
Accidents	No
Accident Costs	No
Bypass Model	No
Bypass Calibration	No
Global Results	Yes

Operational Data

Main Geometry (m)

Geometry and Design Target

Leg	Leg Names	Approach Geometry (m)				Target	Circulating and Exit Geom		
		Bearing (deg)	Grade Sep G	Half Width V	Lanes n	Average Delay (sec/veh)	Inscribed Diameter D	Half Width Vx	Lanes n
1	SB - Anderson	0	0	4.00	1	30	45.00	4.00	1
2	EB - Russell	90	0	4.00	1	30	45.00	4.00	1
3	NB- Anderson	180	0	4.00	1	30	45.00	4.00	1
4	WB - Russell	270	0	4.00	1	30	45.00	4.00	1

Capacity Modifiers and Capacity Calibration (veh/hr)

Leg	Leg Names	Entry Capacity		Entry Calibration		Approach Road			Exit Road		
		Capacity + or -	XWalk Factor	Intercept + or -	Slope Factor	V (m)	Default Capacity	Calib Capacity	V (m)	Default Capacity	Calib Capacity
1	SB - Anderson	0	1.000	0	1.000	6.00	1960	0	4.00	1960	0
2	EB - Russell	0	1.000	0	1.000	6.00	1960	0	4.00	1960	0
3	NB- Anderson	0	1.000	0	1.000	6.00	1960	0	4.00	1960	0
4	WB - Russell	0	1.000	0	1.000	6.00	1960	0	4.00	1960	0

Traffic Flow Data (veh/hr)

2028 AM Peak Peak Hour Flows

Leg	Leg Names	Turning Flows					Flow Modifiers		
		U-Turn	Exit-3	Exit-2	Exit-1	Bypass	Trucks %	Flow Factor	Peak Hour Factor
1	SB - Anderson	0	5	139	153	0	3.0	1.00	0.900
2	EB - Russell	0	35	16	20	0	3.0	1.00	0.900
3	NB- Anderson	0	189	304	6	0	3.0	1.00	0.900
4	WB - Russell	0	48	347	118	0	3.0	1.00	0.900

Operational Results

Geometry for Target Input

Geometry Options for 2028 AM Peak

				Leg 1 - SB - Anderson	
nv	ne	nc	nx	E (m)	L' (m)
1	1	1	1	4.00	0.00

Geometry Options for 2028 AM Peak

				Leg 2 - EB - Russell	
nv	ne	nc	nx	E (m)	L' (m)
1	1	1	1	4.00	0.00

Geometry Options for 2028 AM Peak

				Leg 3 - NB- Anderson	
nv	ne	nc	nx	E (m)	L' (m)
1	1	1	1	4.00	0.00

Geometry Options for 2028 AM Peak

				Leg 4 - WB - Russell	
nv	ne	nc	nx	E (m)	L' (m)
1	1	1	1	4.00	0.00

2028 AM Peak - 60 minutes

Flows and Capacity

Leg	Leg Names	Bypass Type	Flows (veh/hr)				Capacity (veh/hr)			
			Arrival Flow		Opposing Flow		Capacity		Average VCR	
			Entry	Bypass	Entry	Bypass	Entry	Bypass	Entry	Bypass
1	SB - Anderson	None	297		584		457	646		0.4601
2	EB - Russell	None	71		192		689	848		0.0837
3	NB- Anderson	None	499		56		207	918		0.5434
4	WB - Russell	None	513		528		27	674		0.7607

Delays, Queues and Level of Service

Leg	Leg Names	Bypass Type	Average Delay (sec)			95% Queue (veh)		Level of Service		
			Entry	Bypass	Leg	Entry	Bypass	Entry	Bypass	Leg
1	SB - Anderson	None	9.68		9.68	2.72		A		A
2	EB - Russell	None	4.44		4.44	0.26		A		A
3	NB- Anderson	None	7.94		7.94	3.54		A		A
4	WB - Russell	None	20.01		20.01	11.47		C		C

2028 AM Peak - 15 minutes

Flows and Capacity

Leg	Leg Names	Bypass Type	Flows (veh/hr)				Capacity (veh/hr)			
			Arrival Flow		Opposing Flow		Capacity		Average VCR	
			Entry	Bypass	Entry	Bypass	Entry	Bypass	Entry	Bypass
1	SB - Anderson	None	330		641		505	616		0.5358
2	EB - Russell	None	79		212		758	838		0.0942
3	NB- Anderson	None	554		62		228	915		0.6058
4	WB - Russell	None	570		585		30	645		0.8841

Delays, Queues and Level of Service

Leg	Leg Names	Bypass Type	Average Delay (sec)			95% Queue (veh)		Level of Service		
			Entry	Bypass	Leg	Entry	Bypass	Entry	Bypass	Leg
1	SB - Anderson	None	10.46		10.46	2.72		B		B
2	EB - Russell	None	4.37		4.37	0.26		A		A
3	NB- Anderson	None	8.36		8.36	3.54		A		A
4	WB - Russell	None	25.02		25.02	11.47		D		D

Lane Group	EBL	EBT	EBR	WBL	WBT	WBR	NBL	NBT	NBR	SBL	SBT	SBR
Lane Configurations												
Traffic Volume (vph)	101	1424	330	564	714	84	200	321	608	110	501	114
Future Volume (vph)	101	1424	330	564	714	84	200	321	608	110	501	114
Satd. Flow (prot)	1609	3468	1390	3013	3468	1567	3179	3338	1427	3238	3247	1427
Flt Permitted	0.950			0.950			0.950			0.950		
Satd. Flow (perm)	1604	3468	1368	3011	3468	1535	3156	3338	1402	3218	3247	1396
Satd. Flow (RTOR)			258			154			207			207
Lane Group Flow (vph)	101	1424	330	564	714	84	200	321	608	110	501	114
Turn Type	Prot	NA	Perm	Prot	NA	Perm	Prot	NA	Perm	Prot	NA	Perm
Protected Phases	5	2		1	6		3	8		7	4	
Permitted Phases			2			6			8			4
Total Split (s)	12.0	58.0	58.0	20.0	66.0	66.0	17.0	35.0	35.0	17.0	35.0	35.0
Total Lost Time (s)	6.4	7.3	7.3	6.4	7.3	7.3	7.6	7.4	7.4	7.6	7.4	7.4
Act Effct Green (s)	5.6	50.7	50.7	13.6	58.7	58.7	9.4	28.2	28.2	8.8	27.6	27.6
Actuated g/C Ratio	0.04	0.39	0.39	0.10	0.45	0.45	0.07	0.22	0.22	0.07	0.21	0.21
v/c Ratio	1.46	1.05	0.48	1.79	0.46	0.11	0.87	0.44	1.30	0.50	0.73	0.25
Control Delay	313.7	78.4	9.3	401.2	25.8	0.3	93.6	46.5	179.4	66.7	54.7	1.3
Queue Delay	0.0	0.0	0.0	0.0	0.0	0.0	0.0	0.0	0.0	0.0	0.0	0.0
Total Delay	313.7	78.4	9.3	401.2	25.8	0.3	93.6	46.5	179.4	66.7	54.7	1.3
LOS	F	E	A	F	C	A	F	D	F	E	D	A
Approach Delay		78.9			179.7			126.4			48.1	
Approach LOS		E			F			F			D	
Queue Length 50th (m)	~32.5	~192.8	10.9	~102.6	60.1	0.0	24.4	35.0	~145.0	13.0	58.4	0.0
Queue Length 95th (m)	#65.9	#232.1	33.3	#135.3	75.3	0.0	#44.2	48.4	#210.3	22.0	76.5	0.0
Internal Link Dist (m)		485.7			402.0			432.2			296.2	
Turn Bay Length (m)	85.0		225.0	100.0		45.0	140.0		110.0	80.0		55.0
Base Capacity (vph)	69	1352	690	315	1565	777	229	725	466	234	689	459
Starvation Cap Reductn	0	0	0	0	0	0	0	0	0	0	0	0
Spillback Cap Reductn	0	0	0	0	0	0	0	0	0	0	0	0
Storage Cap Reductn	0	0	0	0	0	0	0	0	0	0	0	0
Reduced v/c Ratio	1.46	1.05	0.48	1.79	0.46	0.11	0.87	0.44	1.30	0.47	0.73	0.25

Intersection Summary

Cycle Length: 130

Actuated Cycle Length: 130

Offset: 35 (27%), Referenced to phase 2:EBT and 6:WBT, Start of Green

Control Type: Actuated-Coordinated

Maximum v/c Ratio: 1.79

Intersection Signal Delay: 112.1

Intersection LOS: F

Intersection Capacity Utilization 104.5%

ICU Level of Service G

Analysis Period (min) 15

~ Volume exceeds capacity, queue is theoretically infinite.

Queue shown is maximum after two cycles.

95th percentile volume exceeds capacity, queue may be longer.

Queue shown is maximum after two cycles.

Splits and Phases: 1: Russell & Walkley

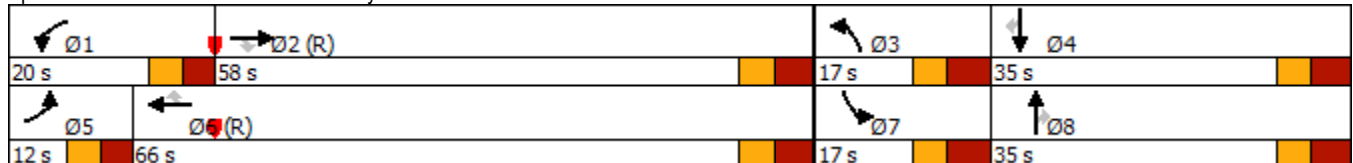

4055 & 4120 Russell Road
2: Hawthorne & Russell

2028 Total Traffic PM Peak Hour

Lane Group	EBL	EBT	EBR	WBL	WBT	WBR	NBL	NBT	NBR	SBL	SBT	SBR
Lane Configurations												
Traffic Volume (vph)	35	7	21	32	3	207	7	749	58	429	910	17
Future Volume (vph)	35	7	21	32	3	207	7	749	58	429	910	17
Satd. Flow (prot)	1624	1466	0	1768	1139	1508	1232	3234	0	1639	3269	0
Flt Permitted	0.756			0.739			0.294			0.341		
Satd. Flow (perm)	1291	1466	0	1376	1139	1488	381	3234	0	588	3269	0
Satd. Flow (RTOR)		21				207		18			4	
Lane Group Flow (vph)	35	28	0	32	3	207	7	807	0	429	927	0
Turn Type	Perm	NA		Perm	NA	Perm	Perm	NA		Perm	NA	
Protected Phases		4			8			2			6	
Permitted Phases	4			8		8	2			6		
Total Split (s)	26.0	26.0		26.0	26.0	26.0	54.0	54.0		54.0	54.0	
Total Lost Time (s)	5.7	5.7		5.7	5.7	5.7	6.5	6.5		6.5	6.5	
Act Effct Green (s)	12.0	12.0		12.0	12.0	12.0	55.8	55.8		55.8	55.8	
Actuated g/C Ratio	0.15	0.15		0.15	0.15	0.15	0.70	0.70		0.70	0.70	
v/c Ratio	0.18	0.12		0.16	0.02	0.52	0.03	0.36		1.05	0.41	
Control Delay	30.3	15.3		29.6	26.3	9.3	5.6	5.8		75.1	6.3	
Queue Delay	0.0	0.0		0.0	0.0	0.0	0.0	0.0		0.0	0.0	
Total Delay	30.3	15.3		29.6	26.3	9.3	5.6	5.8		75.1	6.3	
LOS	C	B		C	C	A	A	A		E	A	
Approach Delay		23.6			12.2			5.8			28.0	
Approach LOS		C			B			A			C	
Queue Length 50th (m)	4.5	0.9		4.1	0.4	0.0	0.2	17.3		~52.0	21.4	
Queue Length 95th (m)	10.2	6.1		9.5	2.1	14.0	1.8	38.4		#74.9	46.5	
Internal Link Dist (m)		63.3			159.0			795.0			432.2	
Turn Bay Length (m)	20.0			40.0		100.0	40.0			60.0		
Base Capacity (vph)	327	387		349	289	532	265	2261		409	2280	
Starvation Cap Reductn	0	0		0	0	0	0	0		0	0	
Spillback Cap Reductn	0	0		0	0	0	0	0		0	0	
Storage Cap Reductn	0	0		0	0	0	0	0		0	0	
Reduced v/c Ratio	0.11	0.07		0.09	0.01	0.39	0.03	0.36		1.05	0.41	

Intersection Summary

Cycle Length: 80

Actuated Cycle Length: 80

Offset: 16 (20%), Referenced to phase 2:NBT and 6:SBTL, Start of Green

Control Type: Actuated-Coordinated

Maximum v/c Ratio: 1.05

Intersection Signal Delay: 19.1

Intersection LOS: B

Intersection Capacity Utilization 73.3%

ICU Level of Service D

Analysis Period (min) 15

~ Volume exceeds capacity, queue is theoretically infinite.

Queue shown is maximum after two cycles.

95th percentile volume exceeds capacity, queue may be longer.

Queue shown is maximum after two cycles.

Splits and Phases: 2: Hawthorne & Russell

	Ø2 (R)		Ø4
54 s		26 s	
	Ø5 (R)		Ø8
54 s		26 s	

4055 & 4120 Russell Road
3: Hawthorne & Stevenage

2028 Total Traffic PM Peak Hour

Lane Group	EBL	EBT	EBR	WBL	WBT	WBR	NBL	NBT	NBR	SBL	SBT	SBR
Lane Configurations												
Traffic Volume (vph)	201	39	221	100	29	81	82	435	59	45	1016	144
Future Volume (vph)	201	39	221	100	29	81	82	435	59	45	1016	144
Satd. Flow (prot)	1669	1490	0	1567	1426	0	1323	3081	0	1323	3402	1390
Flt Permitted	0.686			0.426			0.193			0.471		
Satd. Flow (perm)	1202	1490	0	703	1426	0	268	3081	0	656	3402	1352
Satd. Flow (RTOR)		221			81			19				144
Lane Group Flow (vph)	201	260	0	100	110	0	82	494	0	45	1016	144
Turn Type	Perm	NA		Perm	NA		pm+pt	NA		pm+pt	NA	Perm
Protected Phases		4			8		5	2		1	6	
Permitted Phases	4			8			2			6		6
Total Split (s)	35.0	35.0		35.0	35.0		15.0	45.0		15.0	45.0	45.0
Total Lost Time (s)	5.7	5.7		5.7	5.7		5.7	5.5		5.7	5.5	5.5
Act Effct Green (s)	22.6	22.6		22.6	22.6		58.2	53.2		55.7	50.1	50.1
Actuated g/C Ratio	0.24	0.24		0.24	0.24		0.61	0.56		0.59	0.53	0.53
v/c Ratio	0.71	0.50		0.60	0.27		0.33	0.29		0.10	0.57	0.18
Control Delay	45.6	9.3		45.8	11.0		12.0	13.7		9.0	19.3	3.7
Queue Delay	0.0	0.0		0.0	0.0		0.0	0.0		0.0	0.0	0.0
Total Delay	45.6	9.3		45.8	11.0		12.0	13.7		9.0	19.3	3.7
LOS	D	A		D	B		B	B		A	B	A
Approach Delay		25.1			27.6			13.4			17.1	
Approach LOS		C			C			B			B	
Queue Length 50th (m)	30.7	5.1		14.8	3.8		4.9	23.7		2.6	62.7	0.0
Queue Length 95th (m)	48.7	21.5		28.3	14.2		12.0	39.6		7.5	94.6	9.8
Internal Link Dist (m)		201.3			257.1			958.8			795.0	
Turn Bay Length (m)	45.0			25.0			75.0			85.0		85.0
Base Capacity (vph)	370	612		216	495		268	1732		460	1792	780
Starvation Cap Reductn	0	0		0	0		0	0		0	0	0
Spillback Cap Reductn	0	0		0	0		0	0		0	0	0
Storage Cap Reductn	0	0		0	0		0	0		0	0	0
Reduced v/c Ratio	0.54	0.42		0.46	0.22		0.31	0.29		0.10	0.57	0.18

Intersection Summary

Cycle Length: 95

Actuated Cycle Length: 95

Offset: 0 (0%), Referenced to phase 2:NBTL and 6:SBTL, Start of Green

Control Type: Actuated-Coordinated

Maximum v/c Ratio: 0.71

Intersection Signal Delay: 18.6

Intersection LOS: B

Intersection Capacity Utilization 78.2%

ICU Level of Service D

Analysis Period (min) 15

Splits and Phases: 3: Hawthorne & Stevenage

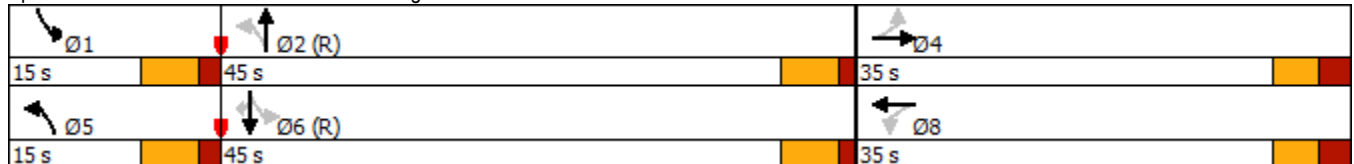

Lane Group	EBL	EBT	EBR	WBL	WBT	WBR	NBL	NBT	NBR	SBL	SBT	SBR
Lane Configurations												
Traffic Volume (vph)	311	896	25	443	948	91	26	202	321	175	517	512
Future Volume (vph)	311	896	25	443	948	91	26	202	321	175	517	512
Satd. Flow (prot)	1595	3422	0	1654	3468	1141	1717	2807	0	1609	3247	1522
Flt Permitted	0.950			0.950			0.397			0.134		
Satd. Flow (perm)	1595	3422	0	1653	3468	1141	718	2807	0	227	3247	1522
Satd. Flow (RTOR)		2				119		240				512
Lane Group Flow (vph)	311	921	0	443	948	91	26	523	0	175	517	512
Turn Type	Prot	NA		Prot	NA	Perm	pm+pt	NA		pm+pt	NA	Perm
Protected Phases	7	4		3	8		5	2		1	6	
Permitted Phases						8	2			6		6
Total Split (s)	36.4	48.4		44.4	56.4	56.4	21.3	32.3		21.3	32.3	32.3
Total Lost Time (s)	6.4	6.4		6.4	6.4	6.4	6.3	6.3		6.3	6.3	6.3
Act Effct Green (s)	29.3	41.2		38.1	50.0	50.0	28.5	21.4		42.1	33.9	33.9
Actuated g/C Ratio	0.21	0.29		0.27	0.36	0.36	0.20	0.15		0.30	0.24	0.24
v/c Ratio	0.94	0.92		0.99	0.77	0.19	0.13	0.83		0.84	0.66	0.68
Control Delay	90.9	62.9		91.1	46.1	3.3	36.7	42.9		70.8	54.0	8.9
Queue Delay	0.0	0.0		0.0	0.0	0.0	0.0	0.0		0.0	0.0	0.0
Total Delay	90.9	62.9		91.1	46.1	3.3	36.7	42.9		70.8	54.0	8.9
LOS	F	E		F	D	A	D	D		E	D	A
Approach Delay		70.0			56.9			42.6			37.3	
Approach LOS		E			E			D			D	
Queue Length 50th (m)	81.3	123.6		~122.6	117.6	0.0	4.8	38.8		35.5	66.9	0.0
Queue Length 95th (m)	#136.6	#163.4		#188.0	144.9	6.0	11.5	58.6		#68.0	87.0	31.0
Internal Link Dist (m)		420.4			461.0			595.0			958.8	
Turn Bay Length (m)	90.0			50.0		80.0	50.0			80.0		80.0
Base Capacity (vph)	341	1026		448	1237	483	292	716		215	783	755
Starvation Cap Reductn	0	0		0	0	0	0	0		0	0	0
Spillback Cap Reductn	0	0		0	0	0	0	0		0	0	0
Storage Cap Reductn	0	0		0	0	0	0	0		0	0	0
Reduced v/c Ratio	0.91	0.90		0.99	0.77	0.19	0.09	0.73		0.81	0.66	0.68

Intersection Summary

Cycle Length: 146.4
 Actuated Cycle Length: 140.6
 Control Type: Semi Act-Uncoord
 Maximum v/c Ratio: 0.99
 Intersection Signal Delay: 53.5
 Intersection Capacity Utilization 101.3%
 Analysis Period (min) 15
 Intersection LOS: D
 ICU Level of Service G

~ Volume exceeds capacity, queue is theoretically infinite.
 Queue shown is maximum after two cycles.

95th percentile volume exceeds capacity, queue may be longer.
 Queue shown is maximum after two cycles.

Splits and Phases: 4: Hawthorne & Hunt Club

44.4 s	48.4 s	21.3 s	32.3 s
36.4 s	56.4 s	21.3 s	32.3 s



Lane Group	EBL	EBT	WBT	WBR	SBL	SBR
Lane Configurations						
Traffic Volume (vph)	49	1343	1556	123	87	36
Future Volume (vph)	49	1343	1556	123	87	36
Satd. Flow (prot)	1701	3402	3364	0	1660	0
Flt Permitted	0.105				0.966	
Satd. Flow (perm)	188	3402	3364	0	1660	0
Satd. Flow (RTOR)			15		13	
Lane Group Flow (vph)	49	1343	1679	0	123	0
Turn Type	Perm	NA	NA		Prot	
Protected Phases		2	6		4	
Permitted Phases	2					
Total Split (s)	41.4	41.4	41.4		31.8	
Total Lost Time (s)	6.4	6.4	6.4		5.8	
Act Effct Green (s)	54.4	54.4	54.4		10.2	
Actuated g/C Ratio	0.74	0.74	0.74		0.14	
v/c Ratio	0.35	0.53	0.67		0.51	
Control Delay	15.2	6.7	8.7		32.5	
Queue Delay	0.0	0.0	0.0		0.0	
Total Delay	15.2	6.7	8.7		32.5	
LOS	B	A	A		C	
Approach Delay		7.0	8.7		32.5	
Approach LOS		A	A		C	
Queue Length 50th (m)	2.1	37.3	55.7		13.1	
Queue Length 95th (m)	12.6	63.8	96.8		25.0	
Internal Link Dist (m)		461.0	862.2		131.3	
Turn Bay Length (m)	30.0				30.0	
Base Capacity (vph)	139	2527	2503		598	
Starvation Cap Reductn	0	0	0		0	
Spillback Cap Reductn	0	0	0		0	
Storage Cap Reductn	0	0	0		0	
Reduced v/c Ratio	0.35	0.53	0.67		0.21	

Intersection Summary

Cycle Length: 73.2
 Actuated Cycle Length: 73.2
 Offset: 0 (0%), Referenced to phase 2:EBTL and 6:WBT, Start of Green
 Control Type: Actuated-Coordinated
 Maximum v/c Ratio: 0.67
 Intersection Signal Delay: 8.9
 Intersection LOS: A
 Intersection Capacity Utilization 67.1%
 ICU Level of Service C
 Analysis Period (min) 15

Splits and Phases: 12: Hunt Club & Access

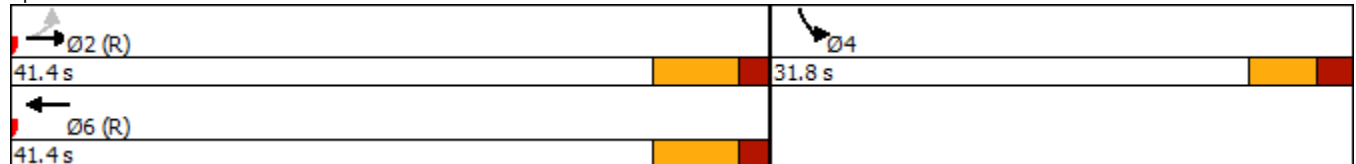



Movement	EBT	EBR	WBL	WBT	NBL	NBR
Lane Configurations						
Traffic Volume (veh/h)	427	29	10	256	27	126
Future Volume (Veh/h)	427	29	10	256	27	126
Sign Control	Free			Free	Stop	
Grade	0%			0%	0%	
Peak Hour Factor	1.00	1.00	1.00	1.00	1.00	1.00
Hourly flow rate (vph)	427	29	10	256	27	126
Pedestrians						
Lane Width (m)						
Walking Speed (m/s)						
Percent Blockage						
Right turn flare (veh)						
Median type	None			None		
Median storage (veh)						
Upstream signal (m)						
pX, platoon unblocked						
vC, conflicting volume				456	718	442
vC1, stage 1 conf vol						
vC2, stage 2 conf vol						
vCu, unblocked vol				456	718	442
tC, single (s)				4.2	6.6	6.2
tC, 2 stage (s)						
tF (s)				2.3	3.7	3.3
p0 queue free %				99	93	79
cM capacity (veh/h)				1064	367	614
Direction, Lane #	EB 1	WB 1	NB 1			
Volume Total	456	266	153			
Volume Left	0	10	27			
Volume Right	29	0	126			
cSH	1700	1064	549			
Volume to Capacity	0.27	0.01	0.28			
Queue Length 95th (m)	0.0	0.2	7.9			
Control Delay (s)	0.0	0.4	14.1			
Lane LOS	A		B			
Approach Delay (s)	0.0	0.4	14.1			
Approach LOS	B					
Intersection Summary						
Average Delay	2.6					
Intersection Capacity Utilization	42.0%			ICU Level of Service	A	
Analysis Period (min)	15					



Movement	EBL	EBR	NBL	NBT	SBT	SBR
Lane Configurations						
Traffic Volume (veh/h)	11	1516	0	1184	174	0
Future Volume (Veh/h)	11	1516	0	1184	174	0
Sign Control	Stop			Free	Free	
Grade	0%			0%	0%	
Peak Hour Factor	1.00	1.00	1.00	1.00	1.00	1.00
Hourly flow rate (vph)	11	1516	0	1184	174	0
Pedestrians						
Lane Width (m)						
Walking Speed (m/s)						
Percent Blockage						
Right turn flare (veh)						
Median type				None	None	
Median storage (veh)						
Upstream signal (m)						
pX, platoon unblocked						
vC, conflicting volume	1358	174	174			
vC1, stage 1 conf vol						
vC2, stage 2 conf vol						
vCu, unblocked vol	1358	174	174			
tC, single (s)	6.4	6.3	4.1			
tC, 2 stage (s)						
tF (s)	3.5	3.4	2.2			
p0 queue free %	93	0	100			
cM capacity (veh/h)	165	857	1415			
Direction, Lane #	EB 1	EB 2	NB 1	SB 1		
Volume Total	11	1516	1184	174		
Volume Left	11	0	0	0		
Volume Right	0	1516	0	0		
cSH	165	857	1700	1700		
Volume to Capacity	0.07	1.77	0.70	0.10		
Queue Length 95th (m)	1.5	621.8	0.0	0.0		
Control Delay (s)	28.4	365.0	0.0	0.0		
Lane LOS	D	F				
Approach Delay (s)	362.6		0.0	0.0		
Approach LOS	F					
Intersection Summary						
Average Delay			191.9			
Intersection Capacity Utilization			115.4%	ICU Level of Service	H	
Analysis Period (min)			15			



Movement	EBL	EBR	NBL	NBT	SBT	SBR
Lane Configurations						
Traffic Volume (veh/h)	129	336	57	114	322	40
Future Volume (Veh/h)	129	336	57	114	322	40
Sign Control	Stop			Free	Free	
Grade	0%			0%	0%	
Peak Hour Factor	1.00	1.00	1.00	1.00	1.00	1.00
Hourly flow rate (vph)	129	336	57	114	322	40
Pedestrians						
Lane Width (m)						
Walking Speed (m/s)						
Percent Blockage						
Right turn flare (veh)						
Median type				None	None	
Median storage (veh)						
Upstream signal (m)						
pX, platoon unblocked						
vC, conflicting volume	570	342	362			
vC1, stage 1 conf vol						
vC2, stage 2 conf vol						
vCu, unblocked vol	570	342	362			
tC, single (s)	6.5	6.3	4.2			
tC, 2 stage (s)						
tF (s)	3.6	3.4	2.3			
p0 queue free %	71	51	95			
cM capacity (veh/h)	452	689	1128			
Direction, Lane #	EB 1	NB 1	SB 1			
Volume Total	465	171	362			
Volume Left	129	57	0			
Volume Right	336	0	40			
cSH	602	1128	1700			
Volume to Capacity	0.77	0.05	0.21			
Queue Length 95th (m)	50.3	1.1	0.0			
Control Delay (s)	28.4	3.1	0.0			
Lane LOS	D	A				
Approach Delay (s)	28.4	3.1	0.0			
Approach LOS	D					
Intersection Summary						
Average Delay			13.7			
Intersection Capacity Utilization			69.5%	ICU Level of Service	C	
Analysis Period (min)			15			



Movement	EBL	EBT	WBT	WBR	SBL	SBR
Lane Configurations		↑↑	↑↑		↓	↓
Traffic Volume (veh/h)	0	1695	193	0	182	756
Future Volume (Veh/h)	0	1695	193	0	182	756
Sign Control		Free	Free		Stop	
Grade		0%	0%		0%	
Peak Hour Factor	1.00	1.00	1.00	1.00	1.00	1.00
Hourly flow rate (vph)	0	1695	193	0	182	756
Pedestrians						
Lane Width (m)						
Walking Speed (m/s)						
Percent Blockage						
Right turn flare (veh)						
Median type		None	None			
Median storage (veh)						
Upstream signal (m)						
pX, platoon unblocked						
vC, conflicting volume	193				1040	96
vC1, stage 1 conf vol						
vC2, stage 2 conf vol						
vCu, unblocked vol	193				1040	96
tC, single (s)	4.2				6.9	7.0
tC, 2 stage (s)						
tF (s)	2.2				3.5	3.3
p0 queue free %	100				18	19
cM capacity (veh/h)	1356				221	931
Direction, Lane #	EB 1	EB 2	WB 1	WB 2	SB 1	SB 2
Volume Total	848	848	96	96	182	756
Volume Left	0	0	0	0	182	0
Volume Right	0	0	0	0	0	756
cSH	1700	1700	1700	1700	221	931
Volume to Capacity	0.50	0.50	0.06	0.06	0.82	0.81
Queue Length 95th (m)	0.0	0.0	0.0	0.0	43.3	63.9
Control Delay (s)	0.0	0.0	0.0	0.0	69.1	23.1
Lane LOS					F	C
Approach Delay (s)	0.0		0.0		32.0	
Approach LOS					D	
Intersection Summary						
Average Delay			10.6			
Intersection Capacity Utilization			66.8%		ICU Level of Service	C
Analysis Period (min)			15			

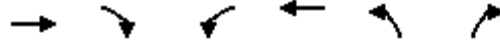

Movement	EBT	EBR	WBL	WBT	NBL	NBR
Lane Configurations	↑↑			↑↑	↘	
Traffic Volume (veh/h)	849	0	0	92	163	25
Future Volume (Veh/h)	849	0	0	92	163	25
Sign Control	Free			Free	Stop	
Grade	0%			0%	0%	
Peak Hour Factor	1.00	1.00	1.00	1.00	1.00	1.00
Hourly flow rate (vph)	849	0	0	92	163	25
Pedestrians						
Lane Width (m)						
Walking Speed (m/s)						
Percent Blockage						
Right turn flare (veh)						
Median type	None			None		
Median storage (veh)						
Upstream signal (m)						
pX, platoon unblocked						
vC, conflicting volume				849	895	424
vC1, stage 1 conf vol						
vC2, stage 2 conf vol						
vCu, unblocked vol				849	895	424
tC, single (s)				4.2	6.9	7.0
tC, 2 stage (s)						
tF (s)				2.2	3.5	3.3
p0 queue free %				100	41	96
cM capacity (veh/h)				766	275	570
Direction, Lane #	EB 1	EB 2	WB 1	WB 2	NB 1	
Volume Total	424	424	46	46	188	
Volume Left	0	0	0	0	163	
Volume Right	0	0	0	0	25	
cSH	1700	1700	1700	1700	295	
Volume to Capacity	0.25	0.25	0.03	0.03	0.64	
Queue Length 95th (m)	0.0	0.0	0.0	0.0	28.3	
Control Delay (s)	0.0	0.0	0.0	0.0	36.4	
Lane LOS						E
Approach Delay (s)	0.0		0.0		36.4	
Approach LOS						E
Intersection Summary						
Average Delay				6.1		
Intersection Capacity Utilization				66.8%	ICU Level of Service	C
Analysis Period (min)				15		



















Movement	EBL	EBT	WBT	WBR	SBL	SBR
Lane Configurations						
Traffic Volume (veh/h)	174	426	118	61	31	89
Future Volume (Veh/h)	174	426	118	61	31	89
Sign Control		Free	Free		Stop	
Grade		0%	0%		0%	
Peak Hour Factor	1.00	1.00	1.00	1.00	1.00	1.00
Hourly flow rate (vph)	174	426	118	61	31	89
Pedestrians						
Lane Width (m)						
Walking Speed (m/s)						
Percent Blockage						
Right turn flare (veh)						
Median type		None	None			
Median storage (veh)						
Upstream signal (m)						
pX, platoon unblocked						
vC, conflicting volume	179				922	148
vC1, stage 1 conf vol						
vC2, stage 2 conf vol						
vCu, unblocked vol	179				922	148
tC, single (s)	4.1				6.4	6.2
tC, 2 stage (s)						
tF (s)	2.2				3.5	3.3
p0 queue free %	87				88	90
cM capacity (veh/h)	1379				259	890
Direction, Lane #	EB 1	EB 2	WB 1	SB 1	SB 2	
Volume Total	174	426	179	31	89	
Volume Left	174	0	0	31	0	
Volume Right	0	0	61	0	89	
cSH	1379	1700	1700	259	890	
Volume to Capacity	0.13	0.25	0.11	0.12	0.10	
Queue Length 95th (m)	3.0	0.0	0.0	2.8	2.3	
Control Delay (s)	8.0	0.0	0.0	20.8	9.5	
Lane LOS	A			C	A	
Approach Delay (s)	2.3		0.0	12.4		
Approach LOS				B		
Intersection Summary						
Average Delay			3.2			
Intersection Capacity Utilization			34.0%		ICU Level of Service	A
Analysis Period (min)			15			



















Movement	EBL	EBT	WBT	WBR	SBL	SBR
Lane Configurations						
Traffic Volume (veh/h)	74	383	141	142	73	38
Future Volume (Veh/h)	74	383	141	142	73	38
Sign Control		Free	Free		Stop	
Grade		0%	0%		0%	
Peak Hour Factor	1.00	1.00	1.00	1.00	1.00	1.00
Hourly flow rate (vph)	74	383	141	142	73	38
Pedestrians						
Lane Width (m)						
Walking Speed (m/s)						
Percent Blockage						
Right turn flare (veh)						
Median type		None	None			
Median storage (veh)						
Upstream signal (m)						
pX, platoon unblocked						
vC, conflicting volume	283				743	212
vC1, stage 1 conf vol						
vC2, stage 2 conf vol						
vCu, unblocked vol	283				743	212
tC, single (s)	4.1				6.4	6.2
tC, 2 stage (s)						
tF (s)	2.2				3.5	3.3
p0 queue free %	94				79	95
cM capacity (veh/h)	1262				356	821
Direction, Lane #	EB 1	EB 2	WB 1	SB 1		
Volume Total	74	383	283	111		
Volume Left	74	0	0	73		
Volume Right	0	0	142	38		
cSH	1262	1700	1700	442		
Volume to Capacity	0.06	0.23	0.17	0.25		
Queue Length 95th (m)	1.3	0.0	0.0	6.9		
Control Delay (s)	8.0	0.0	0.0	15.9		
Lane LOS	A			C		
Approach Delay (s)	1.3		0.0	15.9		
Approach LOS				C		
Intersection Summary						
Average Delay			2.8			
Intersection Capacity Utilization			38.1%		ICU Level of Service	A
Analysis Period (min)			15			

4055 & 4120 Russell Road
 15: Site 2/Building F & Russell

2028 Total Traffic PM Peak Hour

												
Movement	EBL	EBT	EBR	WBL	WBT	WBR	NBL	NBT	NBR	SBL	SBT	SBR
Lane Configurations												
Traffic Volume (veh/h)	0	467	86	1	95	0	171	1	2	0	2	1
Future Volume (Veh/h)	0	467	86	1	95	0	171	1	2	0	2	1
Sign Control		Free			Free			Stop			Stop	
Grade		0%			0%			0%			0%	
Peak Hour Factor	1.00	1.00	1.00	1.00	1.00	1.00	1.00	1.00	1.00	1.00	1.00	1.00
Hourly flow rate (vph)	0	467	86	1	95	0	171	1	2	0	2	1
Pedestrians												
Lane Width (m)												
Walking Speed (m/s)												
Percent Blockage												
Right turn flare (veh)												
Median type		None			None							
Median storage (veh)												
Upstream signal (m)												
pX, platoon unblocked												
vC, conflicting volume	95			553			609	607	510	610	650	95
vC1, stage 1 conf vol												
vC2, stage 2 conf vol												
vCu, unblocked vol	95			553			609	607	510	610	650	95
tC, single (s)	4.1			4.1			7.1	6.5	6.2	7.1	6.5	6.2
tC, 2 stage (s)												
tF (s)	2.2			2.2			3.5	4.0	3.3	3.5	4.0	3.3
p0 queue free %	100			100			57	100	100	100	99	100
cM capacity (veh/h)	1480			1002			401	406	557	400	384	953
Direction, Lane #	EB 1	WB 1	NB 1	SB 1								
Volume Total	553	96	174	3								
Volume Left	0	1	171	0								
Volume Right	86	0	2	1								
cSH	1480	1002	402	479								
Volume to Capacity	0.00	0.00	0.43	0.01								
Queue Length 95th (m)	0.0	0.0	14.9	0.1								
Control Delay (s)	0.0	0.1	20.6	12.6								
Lane LOS		A	C	B								
Approach Delay (s)	0.0	0.1	20.6	12.6								
Approach LOS			C	B								
Intersection Summary												
Average Delay			4.4									
Intersection Capacity Utilization			55.0%		ICU Level of Service				A			
Analysis Period (min)			15									

												
Movement	EBL	EBT	EBR	WBL	WBT	WBR	NBL	NBT	NBR	SBL	SBT	SBR
Lane Configurations												
Traffic Volume (veh/h)	0	468	1	1	92	0	3	0	1	0	0	1
Future Volume (Veh/h)	0	468	1	1	92	0	3	0	1	0	0	1
Sign Control		Free			Free			Stop			Stop	
Grade		0%			0%			0%			0%	
Peak Hour Factor	1.00	1.00	1.00	1.00	1.00	1.00	1.00	1.00	1.00	1.00	1.00	1.00
Hourly flow rate (vph)	0	468	1	1	92	0	3	0	1	0	0	1
Pedestrians												
Lane Width (m)												
Walking Speed (m/s)												
Percent Blockage												
Right turn flare (veh)												
Median type		None			None							
Median storage (veh)												
Upstream signal (m)												
pX, platoon unblocked												
vC, conflicting volume	92			469			564	562	468	564	563	92
vC1, stage 1 conf vol												
vC2, stage 2 conf vol												
vCu, unblocked vol	92			469			564	562	468	564	563	92
tC, single (s)	4.1			4.1			7.1	6.5	6.2	7.1	6.5	6.2
tC, 2 stage (s)												
tF (s)	2.2			2.2			3.5	4.0	3.3	3.5	4.0	3.3
p0 queue free %	100			100			99	100	100	100	100	100
cM capacity (veh/h)	1484			1077			431	431	589	431	431	957
Direction, Lane #	EB 1	WB 1	NB 1	SB 1								
Volume Total	469	93	4	1								
Volume Left	0	1	3	0								
Volume Right	1	0	1	1								
cSH	1484	1077	462	957								
Volume to Capacity	0.00	0.00	0.01	0.00								
Queue Length 95th (m)	0.0	0.0	0.2	0.0								
Control Delay (s)	0.0	0.1	12.9	8.8								
Lane LOS		A	B	A								
Approach Delay (s)	0.0	0.1	12.9	8.8								
Approach LOS			B	A								
Intersection Summary												
Average Delay			0.1									
Intersection Capacity Utilization			36.1%		ICU Level of Service				A			
Analysis Period (min)			15									

Intersection	
Intersection Delay, s/veh	11.3
Intersection LOS	B

Movement	WBL	WBR	NBT	NBR	SBL	SBT
Lane Configurations	W		T			T
Traffic Vol, veh/h	86	8	49	212	132	300
Future Vol, veh/h	86	8	49	212	132	300
Peak Hour Factor	1.00	1.00	1.00	1.00	1.00	1.00
Heavy Vehicles, %	10	1	7	4	2	2
Mvmt Flow	86	8	49	212	132	300
Number of Lanes	1	0	1	0	0	1

Approach	WB	NB	SB
Opposing Approach		SB	NB
Opposing Lanes	0	1	1
Conflicting Approach Left	NB		WB
Conflicting Lanes Left	1	0	1
Conflicting Approach Right	SB	WB	
Conflicting Lanes Right	1	1	0
HCM Control Delay	9.8	9.2	12.9
HCM LOS	A	A	B

Lane	NBLn1	WBLn1	SBLn1
Vol Left, %	0%	91%	31%
Vol Thru, %	19%	0%	69%
Vol Right, %	81%	9%	0%
Sign Control	Stop	Stop	Stop
Traffic Vol by Lane	261	94	432
LT Vol	0	86	132
Through Vol	49	0	300
RT Vol	212	8	0
Lane Flow Rate	261	94	432
Geometry Grp	1	1	1
Degree of Util (X)	0.31	0.149	0.544
Departure Headway (Hd)	4.272	5.695	4.532
Convergence, Y/N	Yes	Yes	Yes
Cap	840	627	795
Service Time	2.31	3.759	2.567
HCM Lane V/C Ratio	0.311	0.15	0.543
HCM Control Delay	9.2	9.8	12.9
HCM Lane LOS	A	A	B
HCM 95th-tile Q	1.3	0.5	3.3

Intersection	
Intersection Delay, s/veh	13.8
Intersection LOS	B

Movement	EBL	EBT	EBR	WBL	WBT	WBR	NBL	NBT	NBR	SBL	SBT	SBR
Lane Configurations		↕			↕			↕			↕	
Traffic Vol, veh/h	77	224	27	12	24	10	30	170	46	61	262	38
Future Vol, veh/h	77	224	27	12	24	10	30	170	46	61	262	38
Peak Hour Factor	1.00	1.00	1.00	1.00	1.00	1.00	1.00	1.00	1.00	1.00	1.00	1.00
Heavy Vehicles, %	2	1	1	1	14	1	1	1	7	2	3	4
Mvmt Flow	77	224	27	12	24	10	30	170	46	61	262	38
Number of Lanes	0	1	0	0	1	0	0	1	0	0	1	0
Approach	EB			WB			NB			SB		
Opposing Approach	WB			EB			SB			NB		
Opposing Lanes	1			1			1			1		
Conflicting Approach Left	SB			NB			EB			WB		
Conflicting Lanes Left	1			1			1			1		
Conflicting Approach Right	NB			SB			WB			EB		
Conflicting Lanes Right	1			1			1			1		
HCM Control Delay	14.6			9.8			11.9			14.8		
HCM LOS	B			A			B			B		

Lane	NBLn1	EBLn1	WBLn1	SBLn1
Vol Left, %		12%	23%	26%
Vol Thru, %		69%	68%	52%
Vol Right, %		19%	8%	22%
Sign Control		Stop	Stop	Stop
Traffic Vol by Lane		246	328	46
LT Vol		30	77	12
Through Vol		170	224	24
RT Vol		46	27	10
Lane Flow Rate		246	328	46
Geometry Grp		1	1	1
Degree of Util (X)		0.377	0.515	0.079
Departure Headway (Hd)		5.521	5.654	6.156
Convergence, Y/N		Yes	Yes	Yes
Cap		649	636	578
Service Time		3.578	3.707	4.236
HCM Lane V/C Ratio		0.379	0.516	0.08
HCM Control Delay		11.9	14.6	9.8
HCM Lane LOS		B	B	A
HCM 95th-tile Q		1.8	3	0.3

Lane Group	EBL	EBT	EBR	WBL	WBT	WBR	NBL	NBT	NBR	SBL	SBT	SBR
Lane Configurations												
Traffic Volume (vph)	35	7	21	32	3	207	7	749	58	429	910	17
Future Volume (vph)	35	7	21	32	3	207	7	749	58	429	910	17
Satd. Flow (prot)	1624	1466	0	1768	1139	1508	1232	3234	0	1639	3269	0
Flt Permitted	0.756			0.739			0.308			0.198		
Satd. Flow (perm)	1291	1466	0	1376	1139	1488	399	3234	0	342	3269	0
Satd. Flow (RTOR)		21				207		10			4	
Lane Group Flow (vph)	35	28	0	32	3	207	7	807	0	429	927	0
Turn Type	Perm	NA		Perm	NA	Perm	Perm	NA		pm+pt	NA	
Protected Phases		4			8			2		1	6	
Permitted Phases	4			8		8	2			6		
Total Split (s)	26.0	26.0		26.0	26.0	26.0	29.0	29.0		25.0	54.0	
Total Lost Time (s)	5.7	5.7		5.7	5.7	5.7	6.5	6.5		6.3	6.5	
Act Effct Green (s)	12.0	12.0		12.0	12.0	12.0	29.5	29.5		56.0	55.8	
Actuated g/C Ratio	0.15	0.15		0.15	0.15	0.15	0.37	0.37		0.70	0.70	
v/c Ratio	0.18	0.12		0.16	0.02	0.52	0.05	0.67		0.76	0.41	
Control Delay	30.3	15.3		29.6	26.3	9.3	21.1	26.3		21.6	6.3	
Queue Delay	0.0	0.0		0.0	0.0	0.0	0.0	0.0		0.0	0.0	
Total Delay	30.3	15.3		29.6	26.3	9.3	21.1	26.3		21.6	6.3	
LOS	C	B		C	C	A	C	C		C	A	
Approach Delay		23.6			12.2			26.3			11.1	
Approach LOS		C			B			C			B	
Queue Length 50th (m)	4.5	0.9		4.1	0.4	0.0	0.6	49.1		26.2	21.4	
Queue Length 95th (m)	10.2	6.1		9.5	2.1	14.0	3.5	#85.3		#80.5	46.5	
Internal Link Dist (m)		63.3			159.0			795.0			432.2	
Turn Bay Length (m)	20.0			40.0		100.0	40.0			60.0		
Base Capacity (vph)	327	387		349	289	532	147	1200		579	2280	
Starvation Cap Reductn	0	0		0	0	0	0	0		0	0	
Spillback Cap Reductn	0	0		0	0	0	0	0		0	0	
Storage Cap Reductn	0	0		0	0	0	0	0		0	0	
Reduced v/c Ratio	0.11	0.07		0.09	0.01	0.39	0.05	0.67		0.74	0.41	

Intersection Summary

Cycle Length: 80
 Actuated Cycle Length: 80
 Offset: 0 (0%), Referenced to phase 2:NBTL and 6:SBTL, Start of Green
 Control Type: Actuated-Coordinated
 Maximum v/c Ratio: 0.76
 Intersection Signal Delay: 16.5
 Intersection LOS: B
 Intersection Capacity Utilization 73.1%
 ICU Level of Service D
 Analysis Period (min) 15
 # 95th percentile volume exceeds capacity, queue may be longer.
 Queue shown is maximum after two cycles.

Splits and Phases: 2: Hawthorne & Russell

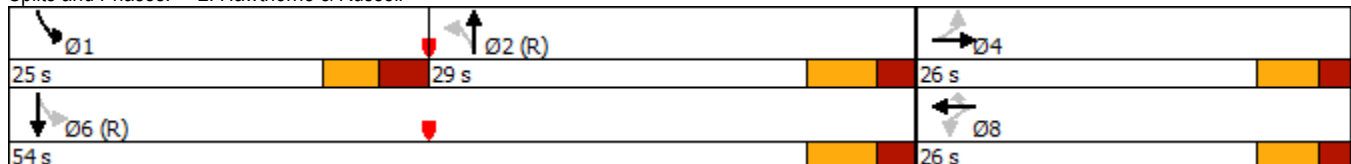

Lane Group	EBL	EBT	EBR	WBL	WBT	WBR	NBL	NBT	NBR	SBL	SBT	SBR
Lane Configurations												
Traffic Volume (vph)	201	39	221	100	29	81	82	424	59	45	990	144
Future Volume (vph)	201	39	221	100	29	81	82	424	59	45	990	144
Satd. Flow (prot)	1669	1490	0	1567	1426	0	1323	3081	0	1323	3402	1390
Flt Permitted	0.686			0.426			0.203			0.476		
Satd. Flow (perm)	1202	1490	0	703	1426	0	282	3081	0	663	3402	1352
Satd. Flow (RTOR)		221			81			20				144
Lane Group Flow (vph)	201	260	0	100	110	0	82	483	0	45	990	144
Turn Type	Perm	NA		Perm	NA		pm+pt	NA		pm+pt	NA	Perm
Protected Phases		4			8		5	2		1	6	
Permitted Phases	4			8			2			6		6
Total Split (s)	35.0	35.0		35.0	35.0		15.0	45.0		15.0	45.0	45.0
Total Lost Time (s)	5.7	5.7		5.7	5.7		5.7	5.5		5.7	5.5	5.5
Act Effct Green (s)	22.6	22.6		22.6	22.6		58.2	53.2		55.7	50.1	50.1
Actuated g/C Ratio	0.24	0.24		0.24	0.24		0.61	0.56		0.59	0.53	0.53
v/c Ratio	0.71	0.50		0.60	0.27		0.32	0.28		0.10	0.55	0.18
Control Delay	45.6	9.3		45.8	11.0		11.7	13.6		9.0	19.0	3.7
Queue Delay	0.0	0.0		0.0	0.0		0.0	0.0		0.0	0.0	0.0
Total Delay	45.6	9.3		45.8	11.0		11.7	13.6		9.0	19.0	3.7
LOS	D	A		D	B		B	B		A	B	A
Approach Delay		25.1			27.6			13.3			16.8	
Approach LOS		C			C			B			B	
Queue Length 50th (m)	30.7	5.1		14.8	3.8		4.9	23.0		2.6	60.5	0.0
Queue Length 95th (m)	48.7	21.5		28.3	14.2		12.0	38.6		7.5	91.3	9.8
Internal Link Dist (m)		201.3			257.1			958.8			795.0	
Turn Bay Length (m)	45.0			25.0			75.0			85.0		85.0
Base Capacity (vph)	370	612		216	495		275	1733		464	1792	780
Starvation Cap Reductn	0	0		0	0		0	0		0	0	0
Spillback Cap Reductn	0	0		0	0		0	0		0	0	0
Storage Cap Reductn	0	0		0	0		0	0		0	0	0
Reduced v/c Ratio	0.54	0.42		0.46	0.22		0.30	0.28		0.10	0.55	0.18

Intersection Summary

Cycle Length: 95
 Actuated Cycle Length: 95
 Offset: 0 (0%), Referenced to phase 2:NBTL and 6:SBTL, Start of Green
 Control Type: Actuated-Coordinated
 Maximum v/c Ratio: 0.71
 Intersection Signal Delay: 18.5
 Intersection LOS: B
 Intersection Capacity Utilization 77.4%
 ICU Level of Service D
 Analysis Period (min) 15

Splits and Phases: 3: Hawthorne & Stevenage

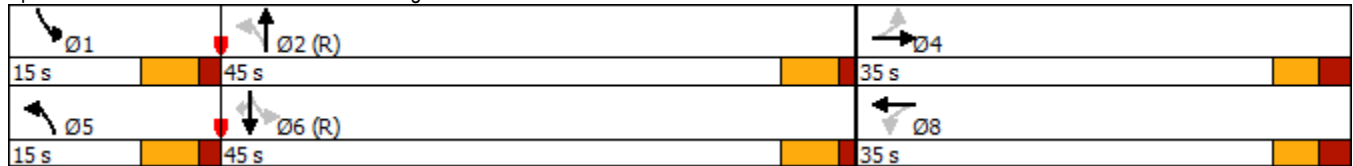

Lane Group	EBL	EBT	EBR	WBL	WBT	WBR	NBL	NBT	NBR	SBL	SBT	SBR
Lane Configurations												
Traffic Volume (vph)	311	896	25	443	948	91	26	202	321	175	517	512
Future Volume (vph)	311	896	25	443	948	91	26	202	321	175	517	512
Satd. Flow (prot)	3094	3422	0	3208	3468	1141	1717	2807	0	1609	3247	1522
Flt Permitted	0.950			0.950			0.448			0.171		
Satd. Flow (perm)	3094	3422	0	3206	3468	1141	810	2807	0	289	3247	1522
Satd. Flow (RTOR)		2				119		240				512
Lane Group Flow (vph)	311	921	0	443	948	91	26	523	0	175	517	512
Turn Type	Prot	NA		Prot	NA	Perm	pm+pt	NA		pm+pt	NA	Perm
Protected Phases	7	4		3	8		5	2		1	6	
Permitted Phases						8	2			6		6
Total Split (s)	36.4	48.4		44.4	56.4	56.4	21.3	32.3		21.3	32.3	32.3
Total Lost Time (s)	6.4	6.4		6.4	6.4	6.4	6.3	6.3		6.3	6.3	6.3
Act Effct Green (s)	18.1	41.1		22.8	45.8	45.8	27.3	20.4		40.7	33.1	33.1
Actuated g/C Ratio	0.15	0.33		0.18	0.37	0.37	0.22	0.16		0.33	0.27	0.27
v/c Ratio	0.69	0.81		0.75	0.74	0.18	0.11	0.79		0.72	0.60	0.66
Control Delay	60.4	45.9		57.8	39.3	3.2	32.3	36.7		50.7	45.7	8.1
Queue Delay	0.0	0.0		0.0	0.0	0.0	0.0	0.0		0.0	0.0	0.0
Total Delay	60.4	45.9		57.8	39.3	3.2	32.3	36.7		50.7	45.7	8.1
LOS	E	D		E	D	A	C	D		D	D	A
Approach Delay		49.5			42.6			36.4			30.4	
Approach LOS		D			D			D			C	
Queue Length 50th (m)	36.4	103.1		51.7	100.4	0.0	4.1	34.3		30.6	58.6	0.0
Queue Length 95th (m)	52.5	141.7		70.4	136.7	5.8	10.8	56.0		#55.3	82.7	30.0
Internal Link Dist (m)		420.4			461.0			595.0			958.8	
Turn Bay Length (m)	90.0			50.0		80.0	50.0			80.0		80.0
Base Capacity (vph)	763	1213		1002	1425	538	344	788		257	865	781
Starvation Cap Reductn	0	0		0	0	0	0	0		0	0	0
Spillback Cap Reductn	0	0		0	0	0	0	0		0	0	0
Storage Cap Reductn	0	0		0	0	0	0	0		0	0	0
Reduced v/c Ratio	0.41	0.76		0.44	0.67	0.17	0.08	0.66		0.68	0.60	0.66

Intersection Summary

Cycle Length: 146.4
 Actuated Cycle Length: 124.1
 Control Type: Semi Act-Uncoord
 Maximum v/c Ratio: 0.81
 Intersection Signal Delay: 40.5
 Intersection LOS: D
 Intersection Capacity Utilization 88.8%
 ICU Level of Service E
 Analysis Period (min) 15
 # 95th percentile volume exceeds capacity, queue may be longer.
 Queue shown is maximum after two cycles.

Splits and Phases: 4: Hawthorne & Hunt Club

Ø3	Ø4	Ø1	Ø2
44.4 s	48.4 s	21.3 s	32.3 s
Ø7	Ø8	Ø5	Ø6
36.4 s	56.4 s	21.3 s	32.3 s



Lane Group	EBL	EBT	WBT	WBR	SBL	SBR
Lane Configurations		↑↑	↑↑		↓	↓
Traffic Volume (vph)	0	1695	193	0	182	756
Future Volume (vph)	0	1695	193	0	182	756
Satd. Flow (prot)	0	3402	3402	0	1701	1522
Flt Permitted					0.950	
Satd. Flow (perm)	0	3402	3402	0	1701	1522
Satd. Flow (RTOR)						756
Lane Group Flow (vph)	0	1695	193	0	182	756
Turn Type		NA	NA		Prot	Free
Protected Phases		4	8		6	
Permitted Phases						Free
Total Split (s)		65.0	65.0		25.0	
Total Lost Time (s)		6.3	6.3		6.3	
Act Effct Green (s)		58.7	58.7		18.7	90.0
Actuated g/C Ratio		0.65	0.65		0.21	1.00
v/c Ratio		0.76	0.09		0.52	0.50
Control Delay		13.8	6.1		37.6	1.2
Queue Delay		0.0	0.0		0.0	0.0
Total Delay		13.8	6.1		37.6	1.2
LOS		B	A		D	A
Approach Delay		13.8	6.1		8.2	
Approach LOS		B	A		A	
Queue Length 50th (m)		87.5	3.7		25.9	0.0
Queue Length 95th (m)		113.1	11.3		44.4	0.0
Internal Link Dist (m)		664.4	343.7		255.5	
Turn Bay Length (m)					100.0	
Base Capacity (vph)		2218	2218		353	1522
Starvation Cap Reductn		0	0		0	0
Spillback Cap Reductn		0	0		0	0
Storage Cap Reductn		0	0		0	0
Reduced v/c Ratio		0.76	0.09		0.52	0.50

Intersection Summary

Cycle Length: 90
 Actuated Cycle Length: 90
 Offset: 33.8 (38%), Referenced to phase 4:EBT and 8:WBT, Start of Green
 Control Type: Actuated-Coordinated
 Maximum v/c Ratio: 0.76
 Intersection Signal Delay: 11.4
 Intersection LOS: B
 Intersection Capacity Utilization 70.6%
 ICU Level of Service C
 Analysis Period (min) 15

Splits and Phases: 10: Walkley & Hwy 417 SB Off-Ramp

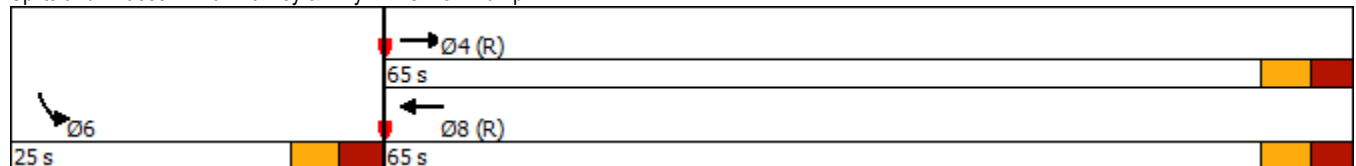



Lane Group	EBT	EBR	WBL	WBT	NBL	NBR
Lane Configurations	↑↑			↑↑	↘↘	
Traffic Volume (vph)	849	0	0	92	163	25
Future Volume (vph)	849	0	0	92	163	25
Satd. Flow (prot)	3402	0	0	3402	1684	0
Flt Permitted					0.958	
Satd. Flow (perm)	3402	0	0	3402	1684	0
Satd. Flow (RTOR)					9	
Lane Group Flow (vph)	849	0	0	92	188	0
Turn Type	NA			NA	Prot	
Protected Phases	4			8	2	
Permitted Phases						
Total Split (s)	56.0			56.0	34.0	
Total Lost Time (s)	6.3			6.3	6.3	
Act Effct Green (s)	62.5			62.5	14.9	
Actuated g/c Ratio	0.69			0.69	0.17	
v/c Ratio	0.36			0.04	0.66	
Control Delay	6.3			5.2	43.8	
Queue Delay	0.0			0.0	0.0	
Total Delay	6.3			5.2	43.8	
LOS	A			A	D	
Approach Delay	6.3			5.2	43.8	
Approach LOS	A			A	D	
Queue Length 50th (m)	32.1			2.1	27.0	
Queue Length 95th (m)	51.3			5.1	43.0	
Internal Link Dist (m)	343.7			277.3	355.2	
Turn Bay Length (m)						
Base Capacity (vph)	2361			2361	524	
Starvation Cap Reductn	0			0	0	
Spillback Cap Reductn	0			0	0	
Storage Cap Reductn	0			0	0	
Reduced v/c Ratio	0.36			0.04	0.36	

Intersection Summary

Cycle Length: 90

Actuated Cycle Length: 90

Offset: 0 (0%), Referenced to phase 4:EBT and 8:WBT, Start of Green

Control Type: Actuated-Coordinated

Maximum v/c Ratio: 0.66

Intersection Signal Delay: 12.4

Intersection LOS: B

Intersection Capacity Utilization 70.6%

ICU Level of Service C

Analysis Period (min) 15

Splits and Phases: 11: Hwy 417 NB Off-Ramp & Walkley

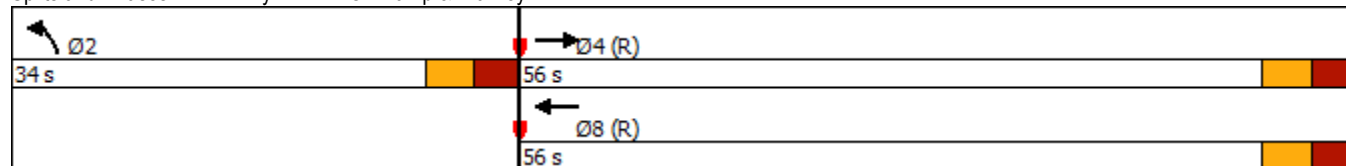

Scheme Summary

Control Data

Control Data and Model Parameters

119124	2028 PHF Flow Profile (veh)
2028 Total Traffic Volumes	7.5 min Time Slice
Rodel-Win1	Queuing Delays (sec)
Right Hand Drive	Daylight conditions
PM Peak Hour	Peak 60/15 min Results
AVERAGE DELAY to Geometry	Output flows: Vehicles
Metric Units (m)	85% Confidence Level

Available Data

Entry Capacity Calibrated	No
Entry Capacity Modified	No
Crosswalks	No
Flows Factored	No
Approach/Exit Road Capacity Calibrated	No
Accidents	No
Accident Costs	No
Bypass Model	No
Bypass Calibration	No
Global Results	Yes

Operational Data

Main Geometry (m)

Geometry and Design Target

Leg	Leg Names	Approach Geometry (m)				Target	Circulating and Exit Geom		
		Bearing (deg)	Grade Sep G	Half Width V	Lanes n	Average Delay (sec/veh)	Inscribed Diameter D	Half Width Vx	Lanes n
1	SB - Anderson	0	0	4.00	1	30	45.00	4.00	1
2	EB - Russell	90	0	4.00	1	30	45.00	4.00	1
3	NB- Anderson	180	0	4.00	1	30	45.00	4.00	1
4	WB - Russell	270	0	4.00	1	30	45.00	4.00	1

Capacity Modifiers and Capacity Calibration (veh/hr)

Leg	Leg Names	Entry Capacity		Entry Calibration		Approach Road			Exit Road		
		Capacity + or -	XWalk Factor	Intercept + or -	Slope Factor	V (m)	Default Capacity	Calib Capacity	V (m)	Default Capacity	Calib Capacity
1	SB - Anderson	0	1.000	0	1.000	6.00	1960	0	4.00	1960	0
2	EB - Russell	0	1.000	0	1.000	6.00	1960	0	4.00	1960	0
3	NB- Anderson	0	1.000	0	1.000	6.00	1960	0	4.00	1960	0
4	WB - Russell	0	1.000	0	1.000	6.00	1960	0	4.00	1960	0

Traffic Flow Data (veh/hr)

2028 PM Peak Peak Hour Flows

Leg	Leg Names	Turning Flows					Flow Modifiers		
		U-Turn	Exit-3	Exit-2	Exit-1	Bypass	Trucks %	Flow Factor	Peak Hour Factor
1	SB - Anderson	0	61	262	38	0	3.0	1.00	1.000
2	EB - Russell	0	77	244	27	0	3.0	1.00	1.000
3	NB- Anderson	0	30	170	46	0	3.0	1.00	1.000
4	WB - Russell	0	12	24	10	0	3.0	1.00	1.000

Operational Results

Geometry for Target Input

Geometry Options for 2028 PM Peak

				Leg 1 - SB - Anderson	
nv	ne	nc	nx	E (m)	L' (m)
1	1	1	1	4.00	0.00

Geometry Options for 2028 PM Peak

				Leg 2 - EB - Russell	
nv	ne	nc	nx	E (m)	L' (m)
1	1	1	1	4.00	0.00

Geometry Options for 2028 PM Peak

				Leg 3 - NB- Anderson	
nv	ne	nc	nx	E (m)	L' (m)
1	1	1	1	4.00	0.00

Geometry Options for 2028 PM Peak

				Leg 4 - WB - Russell	
nv	ne	nc	nx	E (m)	L' (m)
1	1	1	1	4.00	0.00

2028 PM Peak - 60 minutes

Flows and Capacity

Leg	Leg Names	Bypass Type	Flows (veh/hr)				Capacity (veh/hr)			
			Arrival Flow		Opposing Flow		Capacity		Average VCR	
			Entry	Bypass	Entry	Bypass	Entry	Bypass	Entry	Bypass
1	SB - Anderson	None	361		66		257	913		0.3953
2	EB - Russell	None	348		335		92	774		0.4495
3	NB- Anderson	None	246		382		301	750		0.3281
4	WB - Russell	None	46		277		351	804		0.0572

Delays, Queues and Level of Service

Leg	Leg Names	Bypass Type	Average Delay (sec)			95% Queue (veh)		Level of Service		
			Entry	Bypass	Leg	Entry	Bypass	Entry	Bypass	Leg
1	SB - Anderson	None	6.18		6.18	1.61		A		A
2	EB - Russell	None	7.96		7.96	2.00		A		A
3	NB- Anderson	None	6.81		6.81	1.22		A		A
4	WB - Russell	None	4.59		4.59	0.16		A		A

2028 PM Peak - 15 minutes

Flows and Capacity

Leg	Leg Names	Bypass Type	Flows (veh/hr)				Capacity (veh/hr)			
			Arrival Flow		Opposing Flow		Capacity		Average VCR	
			Entry	Bypass	Entry	Bypass	Entry	Bypass	Entry	Bypass
1	SB - Anderson	None	361		66		257	913		0.3953
2	EB - Russell	None	348		335		92	774		0.4495
3	NB- Anderson	None	246		382		301	750		0.3281
4	WB - Russell	None	46		277		351	804		0.0572

Delays, Queues and Level of Service

Leg	Leg Names	Bypass Type	Average Delay (sec)			95% Queue (veh)		Level of Service		
			Entry	Bypass	Leg	Entry	Bypass	Entry	Bypass	Leg
1	SB - Anderson	None	6.20		6.20	1.61		A		A
2	EB - Russell	None	7.98		7.98	2.00		A		A
3	NB- Anderson	None	6.82		6.82	1.22		A		A
4	WB - Russell	None	4.60		4.60	0.16		A		A

4055 & 4120 Russell Road
6: Hunt Club & Hwy 417 Offramp

2033 Future Background AM Peak Hour



Movement	EBL	EBR	NBL	NBT	SBT	SBR
Lane Configurations						
Traffic Volume (veh/h)	2	907	0	931	710	0
Future Volume (Veh/h)	2	907	0	931	710	0
Sign Control	Stop			Free	Free	
Grade	0%			0%	0%	
Peak Hour Factor	1.00	1.00	1.00	1.00	1.00	1.00
Hourly flow rate (vph)	2	907	0	931	710	0
Pedestrians						
Lane Width (m)						
Walking Speed (m/s)						
Percent Blockage						
Right turn flare (veh)						
Median type				None	None	
Median storage (veh)						
Upstream signal (m)						
pX, platoon unblocked						
vC, conflicting volume	1641	710	710			
vC1, stage 1 conf vol						
vC2, stage 2 conf vol						
vCu, unblocked vol	1641	710	710			
tC, single (s)	6.4	6.3	4.1			
tC, 2 stage (s)						
tF (s)	3.5	3.4	2.2			
p0 queue free %	98	0	100			
cM capacity (veh/h)	111	422	899			
Direction, Lane #						
	EB 1	EB 2	NB 1	SB 1		
Volume Total	2	907	931	710		
Volume Left	2	0	0	0		
Volume Right	0	907	0	0		
cSH	111	422	1700	1700		
Volume to Capacity	0.02	2.15	0.55	0.42		
Queue Length 95th (m)	0.4	460.6	0.0	0.0		
Control Delay (s)	38.1	546.3	0.0	0.0		
Lane LOS	E	F				
Approach Delay (s)	545.2		0.0	0.0		
Approach LOS	F					
Intersection Summary						
Average Delay			194.3			
Intersection Capacity Utilization			105.4%	ICU Level of Service		G
Analysis Period (min)			15			

4055 & 4120 Russell Road
10: Walkley & SB off-ramp

2033 Future Background AM Peak Hour



Movement	EBL	EBT	WBT	WBR	SBL	SBR
Lane Configurations		↑↑	↑↑		↓	↓
Traffic Volume (veh/h)	0	507	1088	0	25	1055
Future Volume (Veh/h)	0	507	1088	0	25	1055
Sign Control		Free	Free		Stop	
Grade		0%	0%		0%	
Peak Hour Factor	1.00	1.00	1.00	1.00	1.00	1.00
Hourly flow rate (vph)	0	507	1088	0	25	1055
Pedestrians						
Lane Width (m)						
Walking Speed (m/s)						
Percent Blockage						
Right turn flare (veh)						
Median type		None	None			
Median storage (veh)						
Upstream signal (m)						
pX, platoon unblocked						
vC, conflicting volume	1088				1342	544
vC1, stage 1 conf vol						
vC2, stage 2 conf vol						
vCu, unblocked vol	1088				1342	544
tC, single (s)	4.2				6.9	7.0
tC, 2 stage (s)						
tF (s)	2.2				3.5	3.3
p0 queue free %	100				82	0
cM capacity (veh/h)	620				140	476
Direction, Lane #	EB 1	EB 2	WB 1	WB 2	SB 1	SB 2
Volume Total	254	254	544	544	25	1055
Volume Left	0	0	0	0	25	0
Volume Right	0	0	0	0	0	1055
cSH	1700	1700	1700	1700	140	476
Volume to Capacity	0.15	0.15	0.32	0.32	0.18	2.22
Queue Length 95th (m)	0.0	0.0	0.0	0.0	4.4	542.8
Control Delay (s)	0.0	0.0	0.0	0.0	36.3	574.4
Lane LOS					E	F
Approach Delay (s)	0.0		0.0		561.9	
Approach LOS					F	
Intersection Summary						
Average Delay			226.9			
Intersection Capacity Utilization			107.4%		ICU Level of Service	G
Analysis Period (min)			15			

4055 & 4120 Russell Road
11: NB Off-ramp & Walkley

2033 Future Background AM Peak Hour

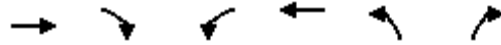

Movement	EBT	EBR	WBL	WBT	NBL	NBR
Lane Configurations	↑↑			↑↑	↘	
Traffic Volume (veh/h)	179	0	0	1016	604	63
Future Volume (Veh/h)	179	0	0	1016	604	63
Sign Control	Free			Free	Stop	
Grade	0%			0%	0%	
Peak Hour Factor	1.00	1.00	1.00	1.00	1.00	1.00
Hourly flow rate (vph)	179	0	0	1016	604	63
Pedestrians						
Lane Width (m)						
Walking Speed (m/s)						
Percent Blockage						
Right turn flare (veh)						
Median type	None			None		
Median storage (veh)						
Upstream signal (m)						
pX, platoon unblocked						
vC, conflicting volume			179		687	90
vC1, stage 1 conf vol						
vC2, stage 2 conf vol						
vCu, unblocked vol			179		687	90
tC, single (s)			4.2		6.9	7.0
tC, 2 stage (s)						
tF (s)			2.2		3.5	3.3
p0 queue free %			100		0	93
cM capacity (veh/h)			1372		374	941
Direction, Lane #	EB 1	EB 2	WB 1	WB 2	NB 1	
Volume Total	90	90	508	508	667	
Volume Left	0	0	0	0	604	
Volume Right	0	0	0	0	63	
cSH	1700	1700	1700	1700	397	
Volume to Capacity	0.05	0.05	0.30	0.30	1.68	
Queue Length 95th (m)	0.0	0.0	0.0	0.0	280.2	
Control Delay (s)	0.0	0.0	0.0	0.0	341.6	
Lane LOS						F
Approach Delay (s)	0.0		0.0		341.6	
Approach LOS						F
Intersection Summary						
Average Delay			122.4			
Intersection Capacity Utilization			107.4%	ICU Level of Service	G	
Analysis Period (min)			15			

4055 & 4120 Russell Road
10: Walkley & SB off-ramp

2033 Future Background AM Peak Hour Mod



Lane Group	EBL	EBT	WBT	WBR	SBL	SBR
Lane Configurations		↑↑	↑↑		↓	↓
Traffic Volume (vph)	0	507	1088	0	25	1055
Future Volume (vph)	0	507	1088	0	25	1055
Satd. Flow (prot)	0	3402	3402	0	1701	1522
Flt Permitted					0.950	
Satd. Flow (perm)	0	3402	3402	0	1701	1522
Satd. Flow (RTOR)						320
Lane Group Flow (vph)	0	507	1088	0	25	1055
Turn Type		NA	NA		Prot	Free
Protected Phases		4	8		6	
Permitted Phases						Free
Total Split (s)		95.0	95.0		25.0	
Total Lost Time (s)		6.3	6.3		6.3	
Act Effct Green (s)		107.5	107.5		7.3	120.0
Actuated g/C Ratio		0.90	0.90		0.06	1.00
v/c Ratio		0.17	0.36		0.24	0.69
Control Delay		1.7	3.8		58.7	2.6
Queue Delay		0.0	0.0		0.0	0.0
Total Delay		1.7	3.8		58.7	2.6
LOS		A	A		E	A
Approach Delay		1.7	3.8		3.9	
Approach LOS		A	A		A	
Queue Length 50th (m)		8.4	36.8		5.3	0.0
Queue Length 95th (m)		13.0	54.0		13.3	0.0
Internal Link Dist (m)		708.0	344.3		267.0	
Turn Bay Length (m)					100.0	
Base Capacity (vph)		3046	3046		265	1522
Starvation Cap Reductn		0	0		0	0
Spillback Cap Reductn		0	0		0	0
Storage Cap Reductn		0	0		0	0
Reduced v/c Ratio		0.17	0.36		0.09	0.69

Intersection Summary

Cycle Length: 120

Actuated Cycle Length: 120

Offset: 26 (22%), Referenced to phase 4:EBT and 8:WBT, Start of Green

Control Type: Actuated-Coordinated

Maximum v/c Ratio: 0.69

Intersection Signal Delay: 3.5

Intersection LOS: A

Intersection Capacity Utilization 79.5%

ICU Level of Service D

Analysis Period (min) 15

Splits and Phases: 10: Walkley & SB off-ramp

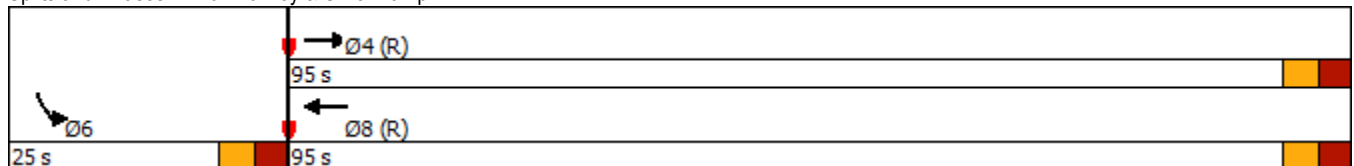

4055 & 4120 Russell Road
11: NB Off-ramp & Walkley

2033 Future Background AM Peak Hour Mod



Lane Group	EBT	EBR	WBL	WBT	NBL	NBR
Lane Configurations	↑↑			↑↑	↘	
Traffic Volume (vph)	179	0	0	1016	604	63
Future Volume (vph)	179	0	0	1016	604	63
Satd. Flow (prot)	3402	0	0	3402	1691	0
Flt Permitted					0.957	
Satd. Flow (perm)	3402	0	0	3402	1691	0
Satd. Flow (RTOR)					6	
Lane Group Flow (vph)	179	0	0	1016	667	0
Turn Type	NA			NA	Prot	
Protected Phases	4			8	2	
Permitted Phases						
Total Split (s)	53.0			53.0	67.0	
Total Lost Time (s)	6.3			6.3	6.3	
Act Effct Green (s)	46.7			46.7	60.7	
Actuated g/C Ratio	0.39			0.39	0.51	
v/c Ratio	0.14			0.77	0.78	
Control Delay	23.3			36.7	31.7	
Queue Delay	0.0			0.0	0.0	
Total Delay	23.3			36.7	31.7	
LOS	C			D	C	
Approach Delay	23.3			36.7	31.7	
Approach LOS	C			D	C	
Queue Length 50th (m)	13.4			99.8	113.0	
Queue Length 95th (m)	20.8			123.3	160.0	
Internal Link Dist (m)	344.3			347.3	355.2	
Turn Bay Length (m)						
Base Capacity (vph)	1323			1323	858	
Starvation Cap Reductn	0			0	0	
Spillback Cap Reductn	0			0	0	
Storage Cap Reductn	0			0	0	
Reduced v/c Ratio	0.14			0.77	0.78	

Intersection Summary

Cycle Length: 120

Actuated Cycle Length: 120

Offset: 69 (58%), Referenced to phase 4:EBT and 8:WBT, Start of Green

Control Type: Actuated-Coordinated

Maximum v/c Ratio: 0.78

Intersection Signal Delay: 33.6

Intersection LOS: C

Intersection Capacity Utilization 79.5%

ICU Level of Service D

Analysis Period (min) 15

Splits and Phases: 11: NB Off-ramp & Walkley





Movement	EBL	EBR	NBL	NBT	SBT	SBR
Lane Configurations						
Traffic Volume (veh/h)	11	1472	0	1158	156	0
Future Volume (Veh/h)	11	1472	0	1158	156	0
Sign Control	Stop			Free	Free	
Grade	0%			0%	0%	
Peak Hour Factor	1.00	1.00	1.00	1.00	1.00	1.00
Hourly flow rate (vph)	11	1472	0	1158	156	0
Pedestrians						
Lane Width (m)						
Walking Speed (m/s)						
Percent Blockage						
Right turn flare (veh)						
Median type				None	None	
Median storage (veh)						
Upstream signal (m)						
pX, platoon unblocked						
vC, conflicting volume	1314	156	156			
vC1, stage 1 conf vol						
vC2, stage 2 conf vol						
vCu, unblocked vol	1314	156	156			
tC, single (s)	6.4	6.3	4.1			
tC, 2 stage (s)						
tF (s)	3.5	3.4	2.2			
p0 queue free %	94	0	100			
cM capacity (veh/h)	175	877	1436			
Direction, Lane #						
	EB 1	EB 2	NB 1	SB 1		
Volume Total	11	1472	1158	156		
Volume Left	11	0	0	0		
Volume Right	0	1472	0	0		
cSH	175	877	1700	1700		
Volume to Capacity	0.06	1.68	0.68	0.09		
Queue Length 95th (m)	1.4	568.5	0.0	0.0		
Control Delay (s)	26.9	324.5	0.0	0.0		
Lane LOS	D	F				
Approach Delay (s)	322.3		0.0	0.0		
Approach LOS	F					
Intersection Summary						
Average Delay			170.9			
Intersection Capacity Utilization			111.5%	ICU Level of Service	H	
Analysis Period (min)			15			



Movement	EBL	EBT	WBT	WBR	SBL	SBR
Lane Configurations		↑↑	↑↑		↘	↗
Traffic Volume (veh/h)	0	1721	201	0	190	695
Future Volume (Veh/h)	0	1721	201	0	190	695
Sign Control		Free	Free		Stop	
Grade		0%	0%		0%	
Peak Hour Factor	1.00	1.00	1.00	1.00	1.00	1.00
Hourly flow rate (vph)	0	1721	201	0	190	695
Pedestrians						
Lane Width (m)						
Walking Speed (m/s)						
Percent Blockage						
Right turn flare (veh)						
Median type		None	None			
Median storage (veh)						
Upstream signal (m)						
pX, platoon unblocked						
vC, conflicting volume	201				1062	100
vC1, stage 1 conf vol						
vC2, stage 2 conf vol						
vCu, unblocked vol	201				1062	100
tC, single (s)	4.2				6.9	7.0
tC, 2 stage (s)						
tF (s)	2.2				3.5	3.3
p0 queue free %	100				11	25
cM capacity (veh/h)	1347				214	926
Direction, Lane #	EB 1	EB 2	WB 1	WB 2	SB 1	SB 2
Volume Total	860	860	100	100	190	695
Volume Left	0	0	0	0	190	0
Volume Right	0	0	0	0	0	695
cSH	1700	1700	1700	1700	214	926
Volume to Capacity	0.51	0.51	0.06	0.06	0.89	0.75
Queue Length 95th (m)	0.0	0.0	0.0	0.0	49.6	50.6
Control Delay (s)	0.0	0.0	0.0	0.0	82.5	19.6
Lane LOS					F	C
Approach Delay (s)	0.0		0.0		33.1	
Approach LOS					D	
Intersection Summary						
Average Delay			10.4			
Intersection Capacity Utilization			68.0%		ICU Level of Service	C
Analysis Period (min)			15			



Movement	EBT	EBR	WBL	WBT	NBL	NBR
Lane Configurations	↑↑			↑↑	↘	
Traffic Volume (veh/h)	886	0	0	96	171	26
Future Volume (Veh/h)	886	0	0	96	171	26
Sign Control	Free			Free	Stop	
Grade	0%			0%	0%	
Peak Hour Factor	1.00	1.00	1.00	1.00	1.00	1.00
Hourly flow rate (vph)	886	0	0	96	171	26
Pedestrians						
Lane Width (m)						
Walking Speed (m/s)						
Percent Blockage						
Right turn flare (veh)						
Median type	None		None			
Median storage (veh)						
Upstream signal (m)						
pX, platoon unblocked						
vC, conflicting volume			886		934	443
vC1, stage 1 conf vol						
vC2, stage 2 conf vol						
vCu, unblocked vol			886		934	443
tC, single (s)			4.2		6.9	7.0
tC, 2 stage (s)						
tF (s)			2.2		3.5	3.3
p0 queue free %			100		34	95
cM capacity (veh/h)			741		259	554
Direction, Lane #	EB 1	EB 2	WB 1	WB 2	NB 1	
Volume Total	443	443	48	48	197	
Volume Left	0	0	0	0	171	
Volume Right	0	0	0	0	26	
cSH	1700	1700	1700	1700	279	
Volume to Capacity	0.26	0.26	0.03	0.03	0.71	
Queue Length 95th (m)	0.0	0.0	0.0	0.0	34.3	
Control Delay (s)	0.0	0.0	0.0	0.0	44.0	
Lane LOS					E	
Approach Delay (s)	0.0		0.0		44.0	
Approach LOS					E	
Intersection Summary						
Average Delay			7.3			
Intersection Capacity Utilization			68.0%		ICU Level of Service	C
Analysis Period (min)			15			



Lane Group	EBL	EBT	WBT	WBR	SBL	SBR
Lane Configurations		↑↑	↑↑		↓	↓
Traffic Volume (vph)	0	1721	201	0	190	695
Future Volume (vph)	0	1721	201	0	190	695
Satd. Flow (prot)	0	3402	3402	0	1701	1522
Flt Permitted					0.950	
Satd. Flow (perm)	0	3402	3402	0	1701	1522
Satd. Flow (RTOR)						695
Lane Group Flow (vph)	0	1721	201	0	190	695
Turn Type		NA	NA		Prot	Free
Protected Phases		4	8		6	
Permitted Phases						Free
Total Split (s)		65.0	65.0		25.0	
Total Lost Time (s)		6.3	6.3		6.3	
Act Effct Green (s)		62.6	62.6		14.8	90.0
Actuated g/C Ratio		0.70	0.70		0.16	1.00
v/c Ratio		0.73	0.08		0.68	0.46
Control Delay		11.4	7.6		47.5	1.0
Queue Delay		0.0	0.0		0.0	0.0
Total Delay		11.4	7.6		47.5	1.0
LOS		B	A		D	A
Approach Delay		11.4	7.6		11.0	
Approach LOS		B	A		B	
Queue Length 50th (m)		77.9	11.5		28.7	0.0
Queue Length 95th (m)		116.7	4.2		46.2	0.0
Internal Link Dist (m)		667.9	357.7		275.3	
Turn Bay Length (m)					100.0	
Base Capacity (vph)		2367	2367		353	1522
Starvation Cap Reductn		0	0		0	0
Spillback Cap Reductn		0	0		0	0
Storage Cap Reductn		0	0		0	0
Reduced v/c Ratio		0.73	0.08		0.54	0.46

Intersection Summary

Cycle Length: 90
 Actuated Cycle Length: 90
 Offset: 0 (0%), Referenced to phase 4:EBT and 8:WBT, Start of Green
 Control Type: Actuated-Coordinated
 Maximum v/c Ratio: 0.73
 Intersection Signal Delay: 11.0
 Intersection LOS: B
 Intersection Capacity Utilization 71.8%
 ICU Level of Service C
 Analysis Period (min) 15

Splits and Phases: 10: Walkley & SB off-ramp

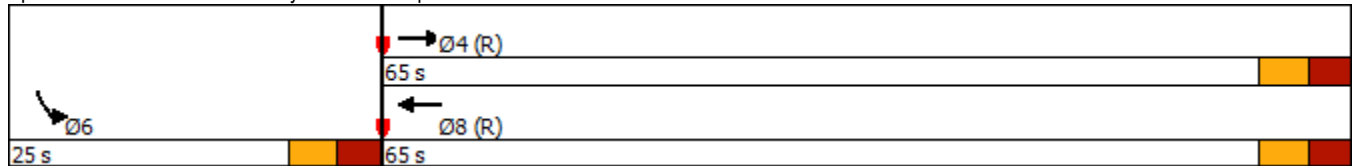

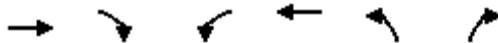

Lane Group	EBT	EBR	WBL	WBT	NBL	NBR
Lane Configurations	↑↑			↑↑	↔	
Traffic Volume (vph)	886	0	0	96	171	26
Future Volume (vph)	886	0	0	96	171	26
Satd. Flow (prot)	3402	0	0	3402	1684	0
Flt Permitted					0.958	
Satd. Flow (perm)	3402	0	0	3402	1684	0
Satd. Flow (RTOR)					9	
Lane Group Flow (vph)	886	0	0	96	197	0
Turn Type	NA			NA	Prot	
Protected Phases	4			8	2	
Permitted Phases						
Total Split (s)	56.0			56.0	34.0	
Total Lost Time (s)	6.3			6.3	6.3	
Act Effct Green (s)	62.0			62.0	15.4	
Actuated g/C Ratio	0.69			0.69	0.17	
v/c Ratio	0.38			0.04	0.67	
Control Delay	11.6			5.4	43.7	
Queue Delay	0.0			0.0	0.0	
Total Delay	11.6			5.4	43.7	
LOS	B			A	D	
Approach Delay	11.6			5.4	43.7	
Approach LOS	B			A	D	
Queue Length 50th (m)	45.2			2.2	28.3	
Queue Length 95th (m)	53.2			5.4	44.6	
Internal Link Dist (m)	357.7			203.8	376.5	
Turn Bay Length (m)						
Base Capacity (vph)	2343			2343	524	
Starvation Cap Reductn	0			0	0	
Spillback Cap Reductn	0			0	0	
Storage Cap Reductn	0			0	0	
Reduced v/c Ratio	0.38			0.04	0.38	

Intersection Summary

Cycle Length: 90

Actuated Cycle Length: 90

Offset: 0 (0%), Referenced to phase 4:EBT and 8:WBT, Start of Green

Control Type: Actuated-Coordinated

Maximum v/c Ratio: 0.67

Intersection Signal Delay: 16.5

Intersection LOS: B

Intersection Capacity Utilization 71.8%

ICU Level of Service C

Analysis Period (min) 15

Splits and Phases: 11: NB Off-ramp & Walkley

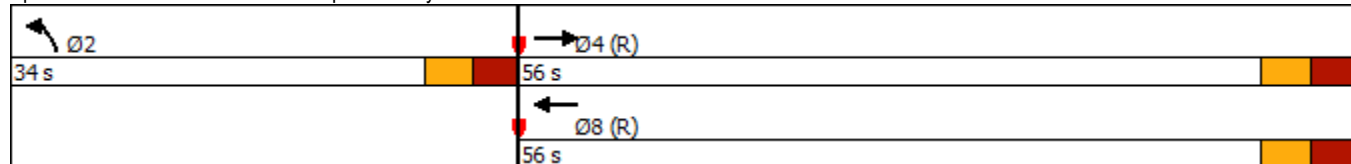



Movement	EBL	EBR	NBL	NBT	SBT	SBR
Lane Configurations						
Traffic Volume (veh/h)	2	1000	0	1004	733	0
Future Volume (Veh/h)	2	1000	0	1004	733	0
Sign Control	Stop			Free	Free	
Grade	0%			0%	0%	
Peak Hour Factor	1.00	1.00	1.00	1.00	1.00	1.00
Hourly flow rate (vph)	2	1000	0	1004	733	0
Pedestrians						
Lane Width (m)						
Walking Speed (m/s)						
Percent Blockage						
Right turn flare (veh)						
Median type				None	None	
Median storage (veh)						
Upstream signal (m)						
pX, platoon unblocked						
vC, conflicting volume	1737	733	733			
vC1, stage 1 conf vol						
vC2, stage 2 conf vol						
vCu, unblocked vol	1737	733	733			
tC, single (s)	6.4	6.3	4.1			
tC, 2 stage (s)						
tF (s)	3.5	3.4	2.2			
p0 queue free %	98	0	100			
cM capacity (veh/h)	97	409	881			
Direction, Lane #	EB 1	EB 2	NB 1	SB 1		
Volume Total	2	1000	1004	733		
Volume Left	2	0	0	0		
Volume Right	0	1000	0	0		
cSH	97	409	1700	1700		
Volume to Capacity	0.02	2.44	0.59	0.43		
Queue Length 95th (m)	0.4	550.3	0.0	0.0		
Control Delay (s)	43.1	677.9	0.0	0.0		
Lane LOS	E	F				
Approach Delay (s)	676.7		0.0	0.0		
Approach LOS	F					
Intersection Summary						
Average Delay			247.5			
Intersection Capacity Utilization			112.7%	ICU Level of Service	H	
Analysis Period (min)			15			



Movement	EBL	EBT	WBT	WBR	SBL	SBR
Lane Configurations		↑↑	↑↑		↓	↓
Traffic Volume (veh/h)	0	575	1088	0	25	1128
Future Volume (Veh/h)	0	575	1088	0	25	1128
Sign Control		Free	Free		Stop	
Grade		0%	0%		0%	
Peak Hour Factor	1.00	1.00	1.00	1.00	1.00	1.00
Hourly flow rate (vph)	0	575	1088	0	25	1128
Pedestrians						
Lane Width (m)						
Walking Speed (m/s)						
Percent Blockage						
Right turn flare (veh)						
Median type		None	None			
Median storage (veh)						
Upstream signal (m)						
pX, platoon unblocked						
vC, conflicting volume	1088				1376	544
vC1, stage 1 conf vol						
vC2, stage 2 conf vol						
vCu, unblocked vol	1088				1376	544
tC, single (s)	4.2				6.9	7.0
tC, 2 stage (s)						
tF (s)	2.2				3.5	3.3
p0 queue free %	100				81	0
cM capacity (veh/h)	620				133	476
Direction, Lane #	EB 1	EB 2	WB 1	WB 2	SB 1	SB 2
Volume Total	288	288	544	544	25	1128
Volume Left	0	0	0	0	25	0
Volume Right	0	0	0	0	0	1128
cSH	1700	1700	1700	1700	133	476
Volume to Capacity	0.17	0.17	0.32	0.32	0.19	2.37
Queue Length 95th (m)	0.0	0.0	0.0	0.0	4.6	605.2
Control Delay (s)	0.0	0.0	0.0	0.0	38.3	642.9
Lane LOS					E	F
Approach Delay (s)	0.0		0.0		629.7	
Approach LOS					F	
Intersection Summary						
Average Delay			257.8			
Intersection Capacity Utilization			112.1%		ICU Level of Service	H
Analysis Period (min)			15			

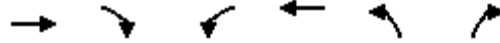

Movement	EBT	EBR	WBL	WBT	NBL	NBR
Lane Configurations	↑↑			↑↑	↘	
Traffic Volume (veh/h)	179	0	0	1016	604	63
Future Volume (Veh/h)	179	0	0	1016	604	63
Sign Control	Free			Free	Stop	
Grade	0%			0%	0%	
Peak Hour Factor	1.00	1.00	1.00	1.00	1.00	1.00
Hourly flow rate (vph)	179	0	0	1016	604	63
Pedestrians						
Lane Width (m)						
Walking Speed (m/s)						
Percent Blockage						
Right turn flare (veh)						
Median type	None			None		
Median storage (veh)						
Upstream signal (m)						
pX, platoon unblocked						
vC, conflicting volume			179			90
vC1, stage 1 conf vol						
vC2, stage 2 conf vol						
vCu, unblocked vol			179			90
tC, single (s)			4.2			7.0
tC, 2 stage (s)						
tF (s)			2.2			3.3
p0 queue free %			100			93
cM capacity (veh/h)			1372			941
Direction, Lane #	EB 1	EB 2	WB 1	WB 2	NB 1	
Volume Total	90	90	508	508	667	
Volume Left	0	0	0	0	604	
Volume Right	0	0	0	0	63	
cSH	1700	1700	1700	1700	397	
Volume to Capacity	0.05	0.05	0.30	0.30	1.68	
Queue Length 95th (m)	0.0	0.0	0.0	0.0	280.2	
Control Delay (s)	0.0	0.0	0.0	0.0	341.6	
Lane LOS						F
Approach Delay (s)	0.0	0.0		341.6		
Approach LOS						F
Intersection Summary						
Average Delay			122.4			
Intersection Capacity Utilization			112.1%		ICU Level of Service	H
Analysis Period (min)	15					

Lane Group	EBT	EBR	WBL	WBT	NBL	NBR
Lane Configurations	↑↑			↑↑	↯	
Traffic Volume (vph)	179	0	0	1016	604	63
Future Volume (vph)	179	0	0	1016	604	63
Satd. Flow (prot)	3402	0	0	3402	1691	0
Flt Permitted					0.957	
Satd. Flow (perm)	3402	0	0	3402	1691	0
Satd. Flow (RTOR)					6	
Lane Group Flow (vph)	179	0	0	1016	667	0
Turn Type	NA			NA	Prot	
Protected Phases	4			8	2	
Permitted Phases						
Total Split (s)	53.0			53.0	67.0	
Total Lost Time (s)	6.3			6.3	6.3	
Act Effct Green (s)	46.7			46.7	60.7	
Actuated g/C Ratio	0.39			0.39	0.51	
v/c Ratio	0.14			0.77	0.78	
Control Delay	20.0			36.7	31.7	
Queue Delay	0.0			0.0	0.0	
Total Delay	20.0			36.7	31.7	
LOS	B			D	C	
Approach Delay	20.0			36.7	31.7	
Approach LOS	B			D	C	
Queue Length 50th (m)	13.4			99.8	113.0	
Queue Length 95th (m)	20.7			123.3	160.0	
Internal Link Dist (m)	354.1			306.3	348.9	
Turn Bay Length (m)						
Base Capacity (vph)	1323			1323	858	
Starvation Cap Reductn	0			0	0	
Spillback Cap Reductn	0			0	0	
Storage Cap Reductn	0			0	0	
Reduced v/c Ratio	0.14			0.77	0.78	

Intersection Summary

Cycle Length: 120
 Actuated Cycle Length: 120
 Offset: 69 (58%), Referenced to phase 4:EBT and 8:WBT, Start of Green
 Control Type: Actuated-Coordinated
 Maximum v/c Ratio: 0.78
 Intersection Signal Delay: 33.3 Intersection LOS: C
 Intersection Capacity Utilization 79.5% ICU Level of Service D
 Analysis Period (min) 15

Splits and Phases: 11: Hwy 417 NB Off-Ramp & Walkley

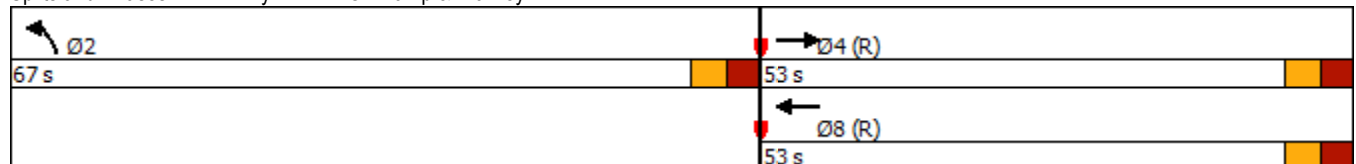



Movement	EBL	EBR	NBL	NBT	SBT	SBR
Lane Configurations						
Traffic Volume (veh/h)	11	1569	0	1226	181	0
Future Volume (Veh/h)	11	1569	0	1226	181	0
Sign Control	Stop			Free	Free	
Grade	0%			0%	0%	
Peak Hour Factor	1.00	1.00	1.00	1.00	1.00	1.00
Hourly flow rate (vph)	11	1569	0	1226	181	0
Pedestrians						
Lane Width (m)						
Walking Speed (m/s)						
Percent Blockage						
Right turn flare (veh)						
Median type				None	None	
Median storage (veh)						
Upstream signal (m)						
pX, platoon unblocked						
vC, conflicting volume	1407	181	181			
vC1, stage 1 conf vol						
vC2, stage 2 conf vol						
vCu, unblocked vol	1407	181	181			
tC, single (s)	6.4	6.3	4.1			
tC, 2 stage (s)						
tF (s)	3.5	3.4	2.2			
p0 queue free %	93	0	100			
cM capacity (veh/h)	154	849	1407			
Direction, Lane #						
	EB 1	EB 2	NB 1	SB 1		
Volume Total	11	1569	1226	181		
Volume Left	11	0	0	0		
Volume Right	0	1569	0	0		
cSH	154	849	1700	1700		
Volume to Capacity	0.07	1.85	0.72	0.11		
Queue Length 95th (m)	1.6	672.9	0.0	0.0		
Control Delay (s)	30.2	400.0	0.0	0.0		
Lane LOS	D	F				
Approach Delay (s)	397.4		0.0	0.0		
Approach LOS	F					
Intersection Summary						
Average Delay			210.2			
Intersection Capacity Utilization			119.3%	ICU Level of Service	H	
Analysis Period (min)			15			



Movement	EBL	EBT	WBT	WBR	SBL	SBR
Lane Configurations		↑↑	↑↑		↓	↓
Traffic Volume (veh/h)	0	1769	201	0	190	786
Future Volume (Veh/h)	0	1769	201	0	190	786
Sign Control		Free	Free		Stop	
Grade		0%	0%		0%	
Peak Hour Factor	1.00	1.00	1.00	1.00	1.00	1.00
Hourly flow rate (vph)	0	1769	201	0	190	786
Pedestrians						
Lane Width (m)						
Walking Speed (m/s)						
Percent Blockage						
Right turn flare (veh)						
Median type		None	None			
Median storage (veh)						
Upstream signal (m)						
pX, platoon unblocked						
vC, conflicting volume	201				1086	100
vC1, stage 1 conf vol						
vC2, stage 2 conf vol						
vCu, unblocked vol	201				1086	100
tC, single (s)	4.2				6.9	7.0
tC, 2 stage (s)						
tF (s)	2.2				3.5	3.3
p0 queue free %	100				8	15
cM capacity (veh/h)	1347				206	926
Direction, Lane #	EB 1	EB 2	WB 1	WB 2	SB 1	SB 2
Volume Total	884	884	100	100	190	786
Volume Left	0	0	0	0	190	0
Volume Right	0	0	0	0	0	786
cSH	1700	1700	1700	1700	206	926
Volume to Capacity	0.52	0.52	0.06	0.06	0.92	0.85
Queue Length 95th (m)	0.0	0.0	0.0	0.0	52.4	73.7
Control Delay (s)	0.0	0.0	0.0	0.0	91.6	26.3
Lane LOS					F	D
Approach Delay (s)	0.0		0.0		39.0	
Approach LOS					E	
Intersection Summary						
Average Delay			12.9			
Intersection Capacity Utilization			69.4%		ICU Level of Service	C
Analysis Period (min)			15			



Movement	EBT	EBR	WBL	WBT	NBL	NBR
Lane Configurations	↑↑			↑↑	↘	
Traffic Volume (veh/h)	886	0	0	96	171	26
Future Volume (Veh/h)	886	0	0	96	171	26
Sign Control	Free			Free	Stop	
Grade	0%			0%	0%	
Peak Hour Factor	1.00	1.00	1.00	1.00	1.00	1.00
Hourly flow rate (vph)	886	0	0	96	171	26
Pedestrians						
Lane Width (m)						
Walking Speed (m/s)						
Percent Blockage						
Right turn flare (veh)						
Median type	None			None		
Median storage (veh)						
Upstream signal (m)						
pX, platoon unblocked						
vC, conflicting volume				886	934	443
vC1, stage 1 conf vol						
vC2, stage 2 conf vol						
vCu, unblocked vol				886	934	443
tC, single (s)				4.2	6.9	7.0
tC, 2 stage (s)						
tF (s)				2.2	3.5	3.3
p0 queue free %				100	34	95
cM capacity (veh/h)				741	259	554
Direction, Lane #	EB 1	EB 2	WB 1	WB 2	NB 1	
Volume Total	443	443	48	48	197	
Volume Left	0	0	0	0	171	
Volume Right	0	0	0	0	26	
cSH	1700	1700	1700	1700	279	
Volume to Capacity	0.26	0.26	0.03	0.03	0.71	
Queue Length 95th (m)	0.0	0.0	0.0	0.0	34.3	
Control Delay (s)	0.0	0.0	0.0	0.0	44.0	
Lane LOS					E	
Approach Delay (s)	0.0		0.0		44.0	
Approach LOS					E	
Intersection Summary						
Average Delay			7.3			
Intersection Capacity Utilization			69.4%		ICU Level of Service C	
Analysis Period (min)			15			



Lane Group	EBL	EBT	WBT	WBR	SBL	SBR
Lane Configurations		↑↑	↑↑		↓	↓
Traffic Volume (vph)	0	1769	201	0	190	786
Future Volume (vph)	0	1769	201	0	190	786
Satd. Flow (prot)	0	3402	3402	0	1701	1522
Flt Permitted					0.950	
Satd. Flow (perm)	0	3402	3402	0	1701	1522
Satd. Flow (RTOR)						786
Lane Group Flow (vph)	0	1769	201	0	190	786
Turn Type		NA	NA		Prot	Free
Protected Phases		4	8		6	
Permitted Phases						Free
Total Split (s)		65.0	65.0		25.0	
Total Lost Time (s)		6.3	6.3		6.3	
Act Effct Green (s)		62.6	62.6		14.8	90.0
Actuated g/C Ratio		0.70	0.70		0.16	1.00
v/c Ratio		0.75	0.08		0.68	0.52
Control Delay		11.9	2.9		47.5	1.3
Queue Delay		0.0	0.0		0.0	0.0
Total Delay		11.9	2.9		47.5	1.3
LOS		B	A		D	A
Approach Delay		11.9	2.9		10.3	
Approach LOS		B	A		B	
Queue Length 50th (m)		82.2	1.4		28.7	0.0
Queue Length 95th (m)		123.6	5.7		46.2	0.0
Internal Link Dist (m)		664.4	343.7		255.5	
Turn Bay Length (m)					100.0	
Base Capacity (vph)		2367	2367		353	1522
Starvation Cap Reductn		0	0		0	0
Spillback Cap Reductn		0	0		0	0
Storage Cap Reductn		0	0		0	0
Reduced v/c Ratio		0.75	0.08		0.54	0.52

Intersection Summary

Cycle Length: 90
 Actuated Cycle Length: 90
 Offset: 0 (0%), Referenced to phase 4:EBT and 8:WBT, Start of Green
 Control Type: Actuated-Coordinated
 Maximum v/c Ratio: 0.75
 Intersection Signal Delay: 10.8
 Intersection LOS: B
 Intersection Capacity Utilization 73.2%
 ICU Level of Service D
 Analysis Period (min) 15

Splits and Phases: 10: Walkley & Hwy 417 SB Off-Ramp

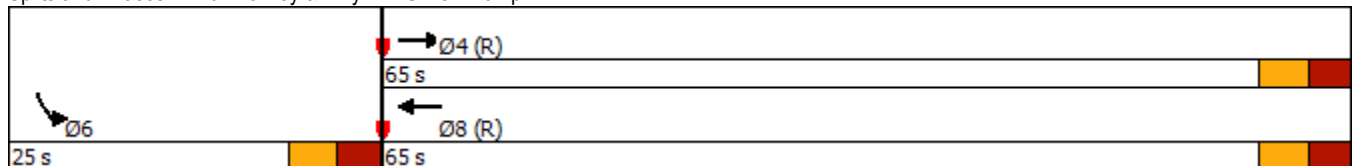

	→	↘	↙	←	↖	↗
Lane Group	EBT	EBR	WBL	WBT	NBL	NBR
Lane Configurations	↑↑			↑↑	↘↗	
Traffic Volume (vph)	886	0	0	96	171	26
Future Volume (vph)	886	0	0	96	171	26
Satd. Flow (prot)	3402	0	0	3402	1684	0
Flt Permitted					0.958	
Satd. Flow (perm)	3402	0	0	3402	1684	0
Satd. Flow (RTOR)					9	
Lane Group Flow (vph)	886	0	0	96	197	0
Turn Type	NA			NA	Prot	
Protected Phases	4			8	2	
Permitted Phases						
Total Split (s)	56.0			56.0	34.0	
Total Lost Time (s)	6.3			6.3	6.3	
Act Effct Green (s)	62.0			62.0	15.4	
Actuated g/c Ratio	0.69			0.69	0.17	
v/c Ratio	0.38			0.04	0.67	
Control Delay	8.4			5.4	43.7	
Queue Delay	0.0			0.0	0.0	
Total Delay	8.4			5.4	43.7	
LOS	A			A	D	
Approach Delay	8.4			5.4	43.7	
Approach LOS	A			A	D	
Queue Length 50th (m)	26.8			2.2	28.3	
Queue Length 95th (m)	53.3			5.4	44.6	
Internal Link Dist (m)	343.7			277.3	355.2	
Turn Bay Length (m)						
Base Capacity (vph)	2343			2343	524	
Starvation Cap Reductn	0			0	0	
Spillback Cap Reductn	0			0	0	
Storage Cap Reductn	0			0	0	
Reduced v/c Ratio	0.38			0.04	0.38	

Intersection Summary

Cycle Length: 90
 Actuated Cycle Length: 90
 Offset: 0 (0%), Referenced to phase 4:EBT and 8:WBT, Start of Green
 Control Type: Actuated-Coordinated
 Maximum v/c Ratio: 0.67
 Intersection Signal Delay: 14.1
 Intersection LOS: B
 Intersection Capacity Utilization 73.2%
 ICU Level of Service D
 Analysis Period (min) 15

Splits and Phases: 11: Hwy 417 NB Off-Ramp & Walkley

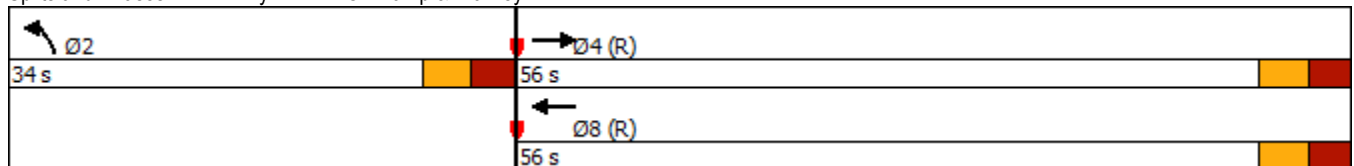

6: Hunt Club & Hwy 417 Offramp Performance by movement

Movement	EBL	EBR	NBT	SBT	All
Denied Del/Veh (s)	3.0	1.1	0.0	0.6	0.6
Total Del/Veh (s)	19.4	3.3	0.4	0.9	1.6

10: Walkley & Hwy 417 SB Off-Ramp Performance by movement

Movement	EBT	WBT	SBL	SBR	All
Denied Del/Veh (s)	0.0	0.0	0.0	0.0	0.0
Total Del/Veh (s)	0.4	1.1	11.7	2.6	1.6

Total Zone Performance

Denied Del/Veh (s)	0.6
Total Del/Veh (s)	13.4

Intersection: 6: Hunt Club & Hwy 417 Offramp

Movement	EB
Directions Served	L
Maximum Queue (m)	9.0
Average Queue (m)	0.9
95th Queue (m)	5.3
Link Distance (m)	
Upstream Blk Time (%)	
Queuing Penalty (veh)	
Storage Bay Dist (m)	85.0
Storage Blk Time (%)	
Queuing Penalty (veh)	

Intersection: 10: Walkley & Hwy 417 SB Off-Ramp

Movement	SB
Directions Served	L
Maximum Queue (m)	17.9
Average Queue (m)	6.8
95th Queue (m)	15.3
Link Distance (m)	227.6
Upstream Blk Time (%)	
Queuing Penalty (veh)	
Storage Bay Dist (m)	
Storage Blk Time (%)	
Queuing Penalty (veh)	

Intersection: 48: Bend

Movement	WB	WB	WB
Directions Served	T	T	
Maximum Queue (m)	13.2	34.8	1.8
Average Queue (m)	0.4	1.3	0.1
95th Queue (m)	9.8	16.3	2.1
Link Distance (m)	157.1	157.1	157.1
Upstream Blk Time (%)			
Queuing Penalty (veh)			
Storage Bay Dist (m)			
Storage Blk Time (%)			
Queuing Penalty (veh)			

Zone Summary

Zone wide Queuing Penalty: 0

6: Hunt Club & Hwy 417 Offramp Performance by movement

Movement	EBL	EBR	NBT	SBT	All
Denied Del/Veh (s)	12.2	11.7	0.0	0.2	6.2
Total Del/Veh (s)	29.7	9.5	0.6	0.6	5.4

10: Walkley & Hwy 417 SB Off-Ramp Performance by movement

Movement	EBT	WBT	SBL	SBR	All
Denied Del/Veh (s)	0.0	0.0	0.0	0.0	0.0
Total Del/Veh (s)	1.6	0.8	61.2	1.5	5.6

Total Zone Performance

Denied Del/Veh (s)	4.0
Total Del/Veh (s)	315.3

Intersection: 6: Hunt Club & Hwy 417 Offramp

Movement	EB
Directions Served	L
Maximum Queue (m)	14.2
Average Queue (m)	3.7
95th Queue (m)	10.8
Link Distance (m)	
Upstream Blk Time (%)	
Queuing Penalty (veh)	
Storage Bay Dist (m)	85.0
Storage Blk Time (%)	
Queuing Penalty (veh)	

Intersection: 10: Walkley & Hwy 417 SB Off-Ramp

Movement	EB	SB
Directions Served	T	L
Maximum Queue (m)	4.2	94.0
Average Queue (m)	0.2	43.9
95th Queue (m)	2.5	87.6
Link Distance (m)	159.4	211.2
Upstream Blk Time (%)		
Queuing Penalty (veh)		
Storage Bay Dist (m)		
Storage Blk Time (%)		
Queuing Penalty (veh)		

Zone Summary

Zone wide Queuing Penalty: 0

6: Hunt Club & Hwy 417 Offramp Performance by movement

Movement	EBL	EBR	NBT	SBT	All
Denied Del/Veh (s)	2.7	1.3	0.0	0.7	0.7
Total Del/Veh (s)	27.3	3.8	0.5	1.0	1.9

10: Walkley & Hwy 417 SB Off-Ramp Performance by movement

Movement	EBT	WBT	SBL	SBR	All
Denied Del/Veh (s)	0.0	0.0	0.0	0.0	0.0
Total Del/Veh (s)	0.4	1.1	12.6	2.9	1.8

Total Zone Performance

Denied Del/Veh (s)	0.7
Total Del/Veh (s)	14.7

Intersection: 6: Hunt Club & Hwy 417 Offramp

Movement	EB
Directions Served	L
Maximum Queue (m)	9.0
Average Queue (m)	0.8
95th Queue (m)	5.0
Link Distance (m)	
Upstream Blk Time (%)	
Queuing Penalty (veh)	
Storage Bay Dist (m)	85.0
Storage Blk Time (%)	
Queuing Penalty (veh)	

Intersection: 10: Walkley & Hwy 417 SB Off-Ramp

Movement	SB
Directions Served	L
Maximum Queue (m)	19.2
Average Queue (m)	7.2
95th Queue (m)	16.5
Link Distance (m)	227.6
Upstream Blk Time (%)	
Queuing Penalty (veh)	
Storage Bay Dist (m)	
Storage Blk Time (%)	
Queuing Penalty (veh)	

Intersection: 48: Bend

Movement	WB	WB	WB
Directions Served	T	T	
Maximum Queue (m)	64.7	67.1	23.4
Average Queue (m)	2.9	4.8	0.8
95th Queue (m)	25.9	35.3	13.2
Link Distance (m)	157.1	157.1	157.1
Upstream Blk Time (%)			
Queuing Penalty (veh)			
Storage Bay Dist (m)			
Storage Blk Time (%)			
Queuing Penalty (veh)			

Zone Summary

Zone wide Queuing Penalty: 0

6: Hunt Club & Hwy 417 Offramp Performance by movement

Movement	EBL	EBR	NBT	SBT	All
Denied Del/Veh (s)	62.1	59.0	0.0	0.2	31.2
Total Del/Veh (s)	39.5	11.7	0.7	0.7	6.6

10: Walkley & Hwy 417 SB Off-Ramp Performance by movement

Movement	EBT	WBT	SBL	SBR	All
Denied Del/Veh (s)	0.0	0.0	0.0	0.0	0.0
Total Del/Veh (s)	1.6	0.8	65.5	1.7	5.8

Total Zone Performance

Denied Del/Veh (s)	19.9
Total Del/Veh (s)	353.2

Intersection: 6: Hunt Club & Hwy 417 Offramp

Movement	EB
Directions Served	L
Maximum Queue (m)	14.2
Average Queue (m)	3.9
95th Queue (m)	11.3
Link Distance (m)	
Upstream Blk Time (%)	
Queuing Penalty (veh)	
Storage Bay Dist (m)	85.0
Storage Blk Time (%)	
Queuing Penalty (veh)	

Intersection: 10: Walkley & Hwy 417 SB Off-Ramp

Movement	EB	WB	SB
Directions Served	T	T	L
Maximum Queue (m)	3.4	1.2	98.4
Average Queue (m)	0.2	0.0	45.6
95th Queue (m)	2.4	0.9	90.6
Link Distance (m)	159.4	360.2	211.2
Upstream Blk Time (%)			
Queuing Penalty (veh)			
Storage Bay Dist (m)			
Storage Blk Time (%)			
Queuing Penalty (veh)			

Zone Summary

Zone wide Queuing Penalty: 0
