

EDWARD J. CUHACI AND ASSOCIATES ARCHITECTS INC.

**ÉCOLE PAUL DESMARAIS SCHOOL
5315 ABBOTT STREET EAST, STITTSVILLE, ON
SERVICING AND STORMWATER
MANAGEMENT REPORT**

MARCH 17, 2023





**ÉCOLE PAUL DESMARAIS SCHOOL
5315 ABBOTT STREET E,
STITTSVILLE, ON**

**SERVICING AND STORMWATER
MANAGEMENT REPORT**

**EDWARD J. CUHACI AND ASSOCIATES
ARCHITECTS INC.**

SITE PLAN APPLICATION

PROJECT NO.: 221-06227-00
DATE: MARCH 2023

WSP CANADA INC.
2611 QUEESVIEW DRIVE, SUITE 300
OTTAWA, ON, CANADA, K2B 8K2

TEL.: +1 613-829-2800

WSP.COM

SIGNATURES

PREPARED BY:



Victoria Teng, P.Eng
Project Engineer

REVIEWED BY:

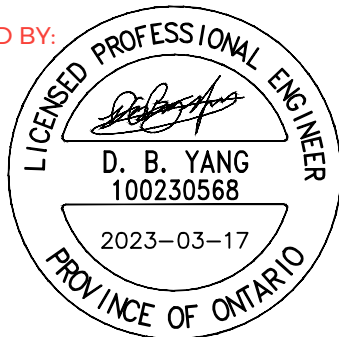

Ding Bang (Winston) Yang, P.Eng
Senior Engineer

This report was prepared by WSP Canada Inc. for the account of EDWARD J. CUHACI AND ASSOCIATES ARCHITECTS INC, in accordance with the professional services agreement. The disclosure of any information contained in this report is the sole responsibility of the intended recipient. The material in it reflects WSP Canada Inc.'s best judgement in light of the information available to it at the time of preparation. Any use which a third party makes of this report, or any reliance on or decisions to be made based on it, are the responsibility of such third parties. WSP Canada Inc. accepts no responsibility for damages, if any, suffered by any third party as a result of decisions made or actions based on this report. This limitations statement is considered part of this report.

The original of the technology-based document sent herewith has been authenticated and will be retained by WSP for a minimum of ten years. Since the file transmitted is now out of WSP's control and its integrity can no longer be ensured, no guarantee may be given with regards to any modifications made to this document.



TABLE OF CONTENTS

| | | |
|----------|---|----------|
| 1 | GENERAL..... | 1 |
| 1.1 | Executive summary | 1 |
| 1.2 | Date and Revision Number | 2 |
| 1.3 | Location Map and Plan | 2 |
| 1.4 | Adherence to zoning and related requirements | 3 |
| 1.5 | Pre-Consultation meetings..... | 4 |
| 1.6 | Higher level studies | 4 |
| 1.7 | Statement of objectives and servicing criteria..... | 4 |
| 1.8 | Available existing and proposed infrastructure | 4 |
| 1.9 | Environmentally significant areas, watercourses and municipal drains | 5 |
| 1.10 | Concept level master grading plan | 5 |
| 1.11 | Impacts on private services | 5 |
| 1.12 | Development phasing | 5 |
| 1.13 | Geotechnical study | 5 |
| 1.14 | Drawing requirement..... | 6 |
| 2 | WATER DISTRIBUTION | 7 |
| 2.1 | Consistency with master servicing study and availability of public infrastructure..... | 7 |
| 2.2 | System constraints and boundary conditions..... | 7 |
| 2.3 | Confirmation of adequate domestic supply and pressure | 7 |
| 2.4 | Confirmation of adequate fire flow protection | 8 |
| 2.5 | Check of high pressure..... | 9 |
| 2.6 | Phasing constraints..... | 9 |
| 2.7 | Reliability requirements | 9 |
| 2.8 | Need for pressure zone boundary modification | 9 |

| | | |
|-------------|--|-----------|
| 2.9 | Capability of major infrastructure to supply sufficient water | 9 |
| 2.10 | Description of proposed water distribution network..... | 9 |
| 2.11 | Off-site requirements | 10 |
| 2.12 | Calculation of water demands | 10 |
| 2.13 | Model Schematic | 10 |
| 3 | WASTEWATER DISPOSAL..... | 11 |
| 3.1 | Design Criteria..... | 11 |
| 3.2 | Consistency with master servicing study | 11 |
| 3.3 | Review of Soil conditions..... | 11 |
| 3.4 | Description of existing sanitary sewer | 12 |
| 3.5 | Verification of available capacity in downstream sewer | 12 |
| 3.6 | Calculations for New sanitary sewer..... | 12 |
| 3.7 | Description of proposed sewer network..... | 12 |
| 3.8 | Environmental constraints | 12 |
| 3.9 | Pumping requirements | 12 |
| 3.10 | Forcemains | 12 |
| 3.11 | Emergency overflows from sanitary pumping stations. | 13 |
| 3.12 | Special considerations..... | 13 |
| 4 | SITE STORM SERVICING..... | 14 |
| 4.1 | Existing condition | 14 |
| 4.2 | Analysis of available capacity in public infrastructure . | 14 |
| 4.3 | Drainage drawing | 14 |
| 4.4 | Water quantity control objective..... | 14 |
| 4.5 | Water quality control objective | 14 |
| 4.6 | Design criteria | 15 |

| | | |
|-------------|--|-----------|
| 4.7 | Proposed minor system..... | 15 |
| 4.8 | Stormwater management | 15 |
| 4.9 | Inlet Controls | 16 |
| 4.10 | On-site detention | 17 |
| 4.11 | Watercourses | 18 |
| 4.12 | Pre and Post development peak flow rates | 18 |
| 4.13 | Diversion of drainage catchment areas | 18 |
| 4.14 | Downstream capacity where quanTity control is not proposed..... | 19 |
| 4.15 | Impacts to receiving watercourses | 19 |
| 4.16 | Municipal drains and related approvals | 19 |
| 4.17 | Means of conveyance and storage capacity | 19 |
| 4.18 | Hydraulic analysis | 19 |
| 4.19 | Identification of floodplains..... | 19 |
| 4.20 | Fill constraints | 19 |
| 5 | SEDIMENT AND EROSION CONTROL | 20 |
| 5.1 | General | 20 |
| 6 | APPROVAL AND PERMIT REQUIREMENTS | 21 |
| 6.1 | General | 21 |
| 7 | CONCLUSION CHECKLIST | 22 |
| 7.1 | Conclusions and recommendations..... | 22 |
| 7.2 | Comments received from review agencies..... | 22 |

TABLES

| | |
|--|----|
| TABLE 2-1: BOUNDARY CONDITIONS..... | 7 |
| TABLE 2-2: SUMMARY OF MINIMUM WATER PRESSURE FOR THE DEVELOPMENT UNDER PEAK HOUR SCENARIO | 8 |
| TABLE 2-3: SUMMARY OF THE RESIDUAL PRESSURE FOR THE DEVELOPMENT UNDER MAX DAY + FIRE SCENARIO..... | 8 |
| TABLE 4-1: ON-SITE STORAGE REQUIREMENTS | 17 |
| TABLE 4-2: ROOF STORAGE – SCHOOL ADDITION..... | 18 |

FIGURES

| | |
|-------------------------------|---|
| FIGURE 1-1 SITE LOCATION..... | 3 |
|-------------------------------|---|

APPENDICES

A

- PRE-CONSULTATION MEETING NOTES
- SERVICING AND STORMWATER MANAGEMENT REPORT, WSP, 2018
- DRAINAGE AREA PLAN C001, WSP, 2018

B

- FIRE UNDERWRITERS SURVEY – FIRE FLOW CALCULATION FOR BUILDING
- FIRE UNDERWRITERS SURVEY – FIRE FLOW CALCULATION FOR PORTABLE CLASSROOM
- WATER DEMAND CALCULATION
- UPDATED BOUNDARY CONDITION

C

- STORM SEWER DESIGN SHEET
- STORM DRAINAGE AREA PLAN C05



- ROOF PLAN
- RESPONSE LETTER – SITE PLAN CONTROL APPLICATION
- FLOW CONTROL ROOF DRAINAGE DECLARATION
- STORMWATER MANAGEMENT CALCULATIONS
- DWG C03 – GRADING PLAN
- DWG C04 - SERVICING PLAN
- D**
- EROSION AND SEDIMENTATION CONTROL PLAN C06
- E**
- SUBMISSION CHECK LIST

1 GENERAL

1.1 EXECUTIVE SUMMARY

WSP was retained by Edward J. Cuhaci and Associates Architects to provide servicing, grading and stormwater management design services for the proposed servicing of an existing sports dome, a proposed pavilion and an addition to Ecole Paul Desmarais School on a 6.0 ha site located at the northwest corner of Abbott Street East and Robert Grant Avenue within the Fernbank subdivision in the Stittsville Community. All services for the school site will be available from Abbott Street East. This report outlines findings and calculations pertaining to the servicing of the proposed building with a gross building area of 548 and 1025 square metres respectively for the pavilion and the addition.

The proposed school addition is a two-storey building with a gross floor area of 2050 square metres and a maximum building height of 10.95m, located on the north-east side of the existing school north of the Abbott Street East and Robert Grant roundabout. To the west of the proposed addition, there will be a bus loop providing access onto Robert Grant Avenue once the roadway has been expanded north of Abbott Street East. Six portable classrooms are proposed north of the addition. To the west of the proposed bus loop and south of the existing sports dome, a pavilion structure is proposed to support the dome. The fire route access to the school, the dome and the pavilion will remain the same; fire trucks will access the dome, and pavilion from the parking lot entrance fronting on Abbott Street East and will access the school from the south entrance located on Abbott Street East. A new fire route access will be provided from the bus loop connected to Robert Grant Avenue for the portable classrooms.

The surrounding neighbourhood and the continuation of the Robert Grant Avenue North is being developed by the City of Ottawa with Novatech Engineers providing engineering design services. Coordination with Novatech regarding this project is ongoing.

Currently the land proposed for the buildings are within the 5315 Abbott Street East site. Currently the reserved land for the proposed addition is grassed. The total study area is considered to be 6.0 hectares in size. The site is located at Lot 28, Concession 11, Geographic Township of Goulbourn in the City of Ottawa. Based on the topographic survey, the site is relatively flat. The current drainage design on the site consists of a piped storm drainage system which outlets on the east side of the site and discharges to a temporary ditch within the right of way of the future Robert Grant Avenue, on route to off-site interim stormwater quantity and quality control facilities designed for the use of the school site. The interim facility will be replaced in the future by a larger communal stormwater treatment facility, which will service the school site as well as other properties within the Fernbank community.

As per Section 4 of the Servicing and Stormwater Management Report prepared in 2018 (refer to Appendix A) for the sports dome within the 5315 Abbott Street East site, the following criteria apply: runoff from all storm events up to and including the 1:100 year event must be restricted to a rate of 850 l/s. Flows exceeding 850 l/s up to the 100-year event must be temporarily stored on site and released at a rate not exceeding 850 l/s. Stormwater quality control is not required for this site. Design of a drainage and stormwater management system in this development must be prepared in accordance with the following documents:

- Sewer Design Guidelines, City of Ottawa, October 2012;

- Stormwater Management Planning and Design Manual, Ministry of the Environment, March 2003; and
- Stormwater Management Facility Design Guidelines, City of Ottawa, April 2012

This report was prepared utilizing servicing design criteria obtained from the City of Ottawa and outlines the design for water, sanitary wastewater, and stormwater facilities, including stormwater management.

The format of this report matches that of the servicing study checklist found in Section 4 of the City of Ottawa's Servicing Study Guidelines for Development Applications, November 2009.

The following municipal services are available at the south property line as recorded from GeoOttawa.

Abbott Street East:

- 750mm diameter sanitary sewer, 375mm storm sewer and 406mm watermain.

It is proposed that:

- On-site stormwater management systems, employing surface storage and roof storage will be provided to attenuate flow rates leaving the school site. Existing drainage patterns, previously established controlled flow rates and storm sewers will be maintained.

1.2 DATE AND REVISION NUMBER

This version of the report is the initial issue, dated September 30, 2022.

1.3 LOCATION MAP AND PLAN

The proposed institutional development is located at 5315 Abbott Street East, Stittsville, Ontario at the location shown in Figure 1-1 below.

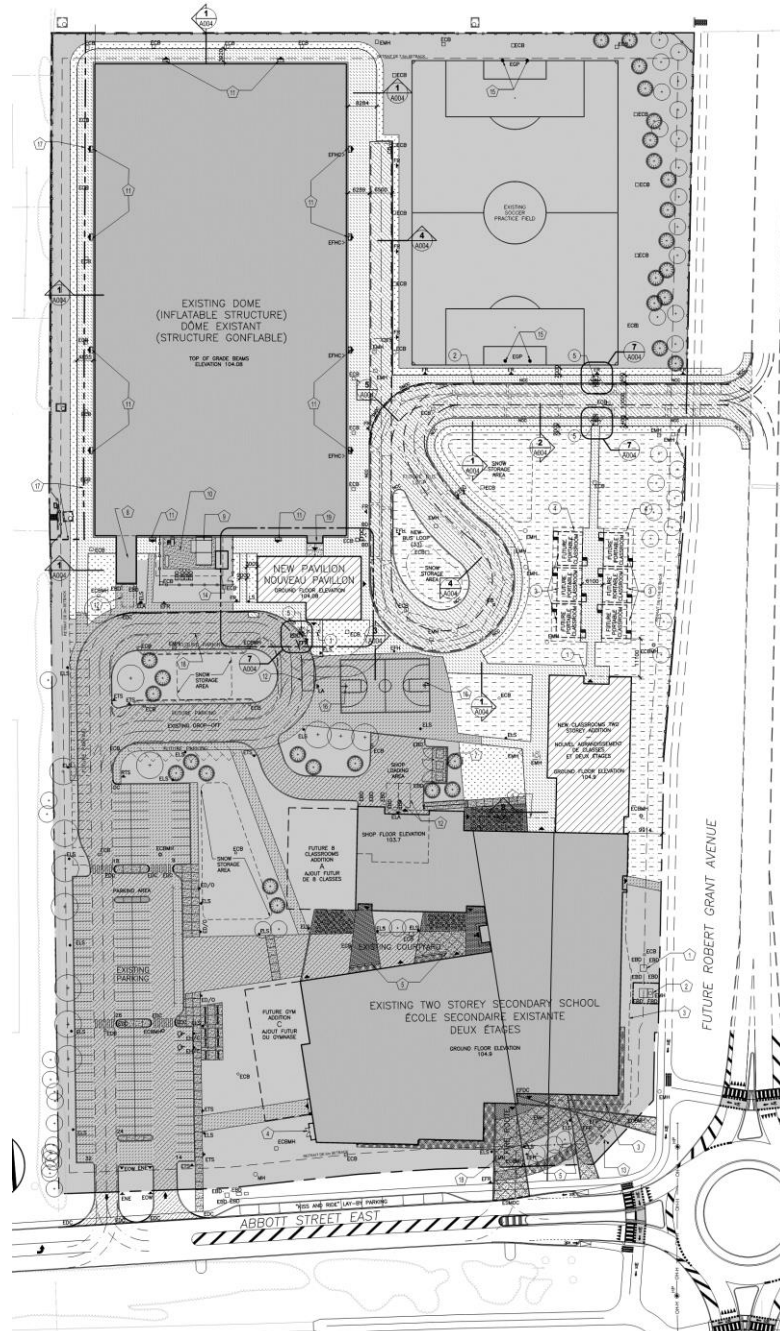

Figure 1-1 Site Location

1.4 ADHERENCE TO ZONING AND RELATED REQUIREMENTS

The proposed property use will be in conformance with zoning and related requirements prior to approval and construction and is understood to be in conformance with current zoning.

1.5 PRE-CONSULTATION MEETINGS

A pre-consultation meeting was held with the City of Ottawa on March 14, 2022. Notes from this meeting are provided in Appendix A.

1.6 HIGHER LEVEL STUDIES

The review for servicing has been undertaken in conformance with, and utilizing information from, the following documents:

- Ottawa Sewer Design Guidelines, Second Edition, Document SDG002, October 2012, City of Ottawa including:
 - Technical Bulletin ISDTB-2012-4 (20 June 2012)
 - Technical Bulletin ISDTB-2014-01 (05 February 2014)
 - Technical Bulletin PIEDTB-2016-01 (September 6, 2018)
 - Technical Bulletin ISDTB-2018-01 (21 March 2018)
 - Technical Bulletin ISDTB-2018-04 (27 June 2018)
 - Ottawa Design Guidelines – Water Distribution, July 2010 (WDG001), including:
 - Technical Bulletin ISDTB-2014-02 (May 27, 2014)
 - Technical Bulletin ISTB-2018-02 (21 March 2018)
 - Stormwater Management Planning and Design Manual, Ontario Ministry of the Environment and Climate Change, March 2003 (SMPDM).
 - Servicing and Stormwater Management Report, WSP, Project 17M-02044-00, revised July 2018. (Includes water, sanitary and storm servicing)
 - Design Guidelines for Drinking-Water Systems, Ontario Ministry of the Environment and Climate Change, 2008 (GDWS).
 - Fire Underwriters Survey, Water Supply for Public Fire Protection (FUS), 2020.
-

1.7 STATEMENT OF OBJECTIVES AND SERVICING CRITERIA

The objective of the site servicing is to meet the requirements for the proposed modification of the site while adhering to the stipulations of the applicable higher-level studies and City of Ottawa servicing design guidelines. The site plan includes a new addition to the main school, a pavilion to support the existing sports dome and a new bus loop from the future street on the east side of the site.

1.8 AVAILABLE EXISTING AND PROPOSED INFRASTRUCTURE

The existing services for the present school will not be altered. The storm sewer network in the north part of the site will be changed to allow for the dome, but the outlet 975mm diameter storm sewer will not be changed. Sanitary and water services for the addition will be provided internally from the existing school. For the pavilion, water will be provided from an existing 100mm water service main. Sanitary service will be provided from an existing 75mm PVC pipe, a combination forcemain and gravity sewer which will convey sanitary sewage from the pavilion to an existing private sanitary maintenance hole at the south-east corner of the site. This manhole discharges to the sanitary trunk sewer on Abbott Street.

Off-site facilities have been provided by the developer for stormwater quantity and quality control, and for conveyance of the stormwater. Presently, the 975 mm discharge pipe outlets to a constructed channel on the future Robert Grant Avenue. A storm sewer on this street is expected in the future. Stormwater quantity control is required on the site, and detention storage will be reconfigured and increased to account for this project.

Site access is presently from Abbott Street. With the construction of the new Robert Grant Avenue north of Abbott Street East, a new bus loop will be constructed to provide access from the future road into the proposed site.

1.9 ENVIRONMENTALLY SIGNIFICANT AREAS, WATERCOURSES AND MUNICIPAL DRAINS

There are no watercourses, municipal drains or environmentally significant areas on the site, but currently there are areas of environment significance on adjacent properties. The proposed changes to the site will not require any additional approvals or amendments to approvals pertaining to environmentally significant areas, watercourses or municipal drains.

1.10 CONCEPT LEVEL MASTER GRADING PLAN

As the design is being submitted for site plan approval, the grading plan has been developed to the final design level. The existing and proposed grading are shown on Drawing C03 - Grading Plan. Existing grading information is based on a topographic survey of the site completed in 2017 and is noted in the background of the Drawing C03. No changes in grading are proposed beyond the site boundaries, and in the vicinity of the existing City storm sewer on the west side of the site. The proposed grading plan confirms the feasibility of the proposed stormwater management system, drainage, soil removal and fills. The geotechnical investigation was completed in 2022 by exp Services Inc. The grading along the east site boundary bordering Robert Grant Avenue is in the process of being coordinated with the City of Ottawa's engineering consultant.

1.11 IMPACTS ON PRIVATE SERVICES

There are no existing domestic private services (septic system and well) located on the site. There are no neighbouring properties using private services.

1.12 DEVELOPMENT PHASING

No development phasing has been detailed for the site. The site plan does indicate possible future portable classrooms. These additional impervious areas have been taken into account in the stormwater management calculations. The future hard surfaces take up a small amount of the green space than the current condition, and therefore were conservatively used in the calculation of runoff.

1.13 GEOTECHNICAL STUDY

A geotechnical investigation report was prepared by exp Services Inc. for the original school construction, and a new draft report was prepared on September 15, 2022. No additional geotechnical information was required for the design of the modified site services, including paving. This geotechnical report will be included with the contract documents to be issued for construction, and the recommendations of the reports will be referenced in the construction specifications. Flexible

joints on piped services at the building walls have also been noted on the civil engineering drawings to allow for possible differential settlement.

1.14 DRAWING REQUIREMENT

The engineering plans submitted for site plan approval will be in compliance with City requirements.

2 WATER DISTRIBUTION

2.1 CONSISTENCY WITH MASTER SERVICING STUDY AND AVAILABILITY OF PUBLIC INFRASTRUCTURE

There is an existing 406mm diameter municipal watermain along Abbott Street East providing water to the property. The new addition will be protected with a supervised automatic fire protection sprinkler system and will be serviced from within the existing school. The fire department connection is located at the front entrance of the existing school building fronting to Abbott Street East. It is 18m away from the existing municipal FH on Abbott Street East. No changes are required to the existing City water distribution system to allow servicing for this property. An existing 200mm watermain extends to the property from Abbott Street in the southeast corner of the site and supplies a private hydrant in that area. The existing school building has a 200mm diameter water service, with a water entry room in the southwest corner. The 200mm diameter water service extends north into the site to provide service for two existing hydrants. The pavilion will be serviced by the existing 200mm diameter watermain extension.

2.2 SYSTEM CONSTRAINTS AND BOUNDARY CONDITIONS

A boundary service request was submitted to the City of Ottawa and boundary conditions have been received and summarized below. A fire flow of 12,000 l/min (200 l/s) was estimated for the existing building with the addition.

Table 2-1: Boundary Conditions

| Boundary Conditions | |
|---------------------|--------------------------|
| SCENARIO | Hydraulic Pressure (kPa) |
| Basic Day (MAX HGL) | 562.6 |
| Peak Hour (MIN HGL) | 519.2 |
| Max Day + Fire Flow | 497.1 |

2.3 CONFIRMATION OF ADEQUATE DOMESTIC SUPPLY AND PRESSURE

Water demands are based on Table 4.2 of the Ottawa Design Guidelines – Water Distribution. As previously noted, the development is considered as institutional development, consisting of sixteen classrooms. A water demand calculation sheet is included in Appendix B, and the total water demands are summarized as follows:

| | WSP |
|-------------|-----------|
| Average Day | 3.75 l/s |
| Maximum Day | 5.62 l/s |
| Peak Hour | 10.12 l/s |

The 2010 City of Ottawa Water Distribution Guidelines stated that the preferred practice for design of a new distribution system is to have normal operating pressures range between 345 kPa (50 psi) and 552 kPa (80 psi) under maximum daily flow conditions. Other pressure criteria identified in the guidelines are as follows:

| | |
|------------------|--|
| Minimum Pressure | Minimum system pressure under peak hour demand conditions shall not be less than 276 kPa (40 psi) |
| Fire Flow | During the period of maximum day demand, the system pressure shall not be less than 140 kPa (20 psi) during a fire flow event. |
| Maximum Pressure | Maximum pressure at any point the distribution system shall not exceed 689 kPa (100 psi). In accordance with the Ontario Building/Plumbing Code, the maximum pressure should not exceed 552 kPa (80 psi). Pressure reduction controls may be required for buildings where it is not possible/feasible to maintain the system pressure below 552 kPa. |

The minimum water pressure inside the building at the connection is determined with the minimum HGL condition, resulting in a pressure of 508.2 kPa and 516.2 kPa respectively at the addition and at the pavilion which exceeds the minimum requirement of 276 kPa per the above guideline.

Table 2-2: Summary of minimum water pressure for the development under peak hour scenario

| Peak Hour @ 156.7m Head | |
|-----------------------------|--------------------------|
| ID | Hydraulic Pressure (kPa) |
| At connection elev = 103.8m | 518.9 |
| At addition FFE = 104.90m | 508.2 |
| At pavilion FFE = 104.08m | 516.2 |

2.4 CONFIRMATION OF ADEQUATE FIRE FLOW PROTECTION

The fire flow rate has been calculated using the Fire Underwriters Survey (FUS) method. The method takes into account the type of building construction, the building occupancy, the use of sprinklers and the exposures to adjacent structures.

For the addition, assuming non-combustible construction and a fully supervised sprinkler system, a fire flow demand of 12,000 l/min (200 l/s) for the existing school and the addition has been calculated. A fire flow rate of 5000 l/min (83 l/s) is calculated for the future portable classrooms. A copy of the FUS calculations is included in Appendix B.

For the pavilion, a single storey structure of wood frame (combustible) construction with low fire hazard contents and no sprinkler system. The estimated fire demand using the FUS method is 10,000 l/min (167 l/s).

The demand of 12,000 l/min for the existing school with the addition can be delivered through three existing municipal fire hydrants. The building is serviced by the 406mm municipal watermain on Abbott Street East and an existing Siamese connection is located on the south side of the building. There is an existing hydrant located 18m from the FDC and is rated at 5800 l/min. There are also two other hydrants located at 63m and 123m from the FDC which are rated at 5800 l/min and 3800 l/min respectively. The three hydrants have a combined total of 15,400 l/min.

The demand of 10,000 l/min for the pavilion can be delivered through the existing fire hydrants, one of which is located east of the sports dome and the second is located south-east of the future pavilion. The 5,000 l/min demand for the portables may also be delivered through the same two hydrants.

The residual pressure is determined as 486.6 kPa and 494.6 kPa respectively at the addition and pavilion finished floor levels which exceeds the minimum residual pressure of 140 kPa. The fire flow requirement is achieved.

Table 2-3: Summary of the residual pressure for the development under max day + fire scenario

| Max day + Fire @ 154.5m Head | |
|------------------------------|--------------------------|
| ID | Hydraulic Pressure (kPa) |

| | |
|---------------------------|-------|
| At building FFE = 104.90m | 486.6 |
| At pavilion FFE = 104.08m | 494.6 |

2.5 CHECK OF HIGH PRESSURE

Using the maximum HGL condition, the maximum pressure inside the building and the pavilion is determined as 552.3 kPa and 560.3 kPa respectively. Based on this result, a pressure control valve will be installed within the pavilion.

Table 2-4: Summary of water pressure for the development under max HGL

| Max HGL @ 161.2m Head | |
|---------------------------|--------------------------|
| ID | Hydraulic Pressure (kPa) |
| At building FFE = 104.90m | 552.3 |
| At pavilion FFE = 104.08m | 560.3 |

2.6 PHASING CONSTRAINTS

No development phasing has been detailed for the site. The site plan does indicate possible future development of additional portable classrooms. The projected occupancy load has been considered in the fire demand and water demand calculations. No phasing constraints exist.

2.7 RELIABILITY REQUIREMENTS

Two shut off valves are provided for the private watermain at the study boundary from Abbott Street East. Another valve is provided south of the future pavilion building.

Water can be supplied both sides of Abbott Street East, west and east and can be isolated.

2.8 NEED FOR PRESSURE ZONE BOUNDARY MODIFICATION

There is no need for a pressure zone boundary modification.

2.9 CAPABILITY OF MAJOR INFRASTRUCTURE TO SUPPLY SUFFICIENT WATER

The current infrastructure is capable of meeting the domestic and fire demand based on City requirements and FUS requirements respectively.

2.10 DESCRIPTION OF PROPOSED WATER DISTRIBUTION NETWORK

The pavilion will be serviced from the existing 203mm private watermain currently serving the two fire hydrants on site. The addition will be connected to the existing school's internal water supply system.

Two private hydrants currently within the site will be protected and maintained.

2.11 OFF-SITE REQUIREMENTS

No off-site improvements to watermains, feeder mains, pumping stations, or other water infrastructure are required to maintain existing conditions and service the adjacent developments.

2.12 CALCULATION OF WATER DEMANDS

Water demands were calculated as described in Sections 2.3 and 2.4 above.

2.13 MODEL SCHEMATIC

The requirement of a model schematic will be determined once boundary conditions are received from the City of Ottawa.

3 WASTEWATER DISPOSAL

3.1 DESIGN CRITERIA

In accordance with the City of Ottawa's Sewer Design Guidelines, the following design criteria have been utilized in order to predict wastewater flows generated by the subject site and complete the sewer design;

| | |
|---|-----------------|
| • Minimum Velocity | 0.6 m/s |
| • Maximum Velocity | 3.0 m/s |
| • Manning Roughness Coefficient | 0.013 |
| • Total est. hectares institutional use | 2.89 |
| • Average sanitary flow for institutional use | 28,000 L/Ha/day |
| • Commercial/Institutional Peaking Factor | 1.5 |
| • Infiltration Allowance (Total) | 0.33 L/Ha/s |
| • Minimum Sewer Slopes – 200 mm diameter | 0.32% |

The area of 6.0 ha represents the lot area of the school. An area of 548m² represents the area of the pavilion. This is the sanitary collection area that is being considered to contribute to the existing 250mm sanitary service connection to the municipal sanitary sewer.

3.2 CONSISTENCY WITH MASTER SERVICING STUDY

The outlet for the sanitary service from the existing building is the 750 mm diameter municipal sewer on Abbott Street East. The Ottawa Sewer Design Guidelines provide estimates of sewage flows based on institutional development.

The criteria to determine anticipated actual peak flow based on site used as described in Ottawa Sewer Design Guidelines Appendix 4-A are as follows;

For the school and the addition:

- Institutional 28000 L/Ha/day = 0.324 L/Ha/s
- Peak flow = (0.324 L/Ha/s x 6.0 ha x 1.5 peaking factor) + 0.33 l/Ha/s x 6.0 ha = 4.90 L/s

For the pavilion:

- Institutional 28000 L/Ha/day = 0.324 L/Ha/s
- Peak flow = (0.324 L/Ha/s x 0.05 ha x 1.5 peaking factor) + 0.33 l/Ha/s x 0.05 ha = 0.04 L/s

The on-site sanitary sewer forcemain servicing the pavilion was designed in accordance with 0.04 L/s as described above. The on-site sanitary sewer network servicing the school has been confirmed to have adequate capacity for the 4.90 L/s as described above.

3.3 REVIEW OF SOIL CONDITIONS

There are no specific local subsurface conditions that suggest the need for a higher extraneous flow allowance.

Soil conditions have been reviewed by EXP Services Inc. Bedding and backfill will be provided as recommended, conventional sewer materials will be utilized, and dewatering will be undertaken as necessary in accordance with the geotechnical recommendations and conditions encountered. The geotechnical report indicates that groundwater table was

observed to be between 100.7 and 101.7 m. The connection between the pavilion sanitary sewer to the existing 75mm forcemain will be above this elevation. It is therefore expected that the groundwater impact on the pavilion sanitary sewer service will be minimal.

3.4 DESCRIPTION OF EXISTING SANITARY SEWER

The outlet sanitary sewer for the addition will be through the existing school. The outlet sanitary sewer for the pavilion will be the existing 75mm forcemain which was previously installed to service the pavilion. Both sewers connect to the existing sanitary maintenance hole located at the south-east corner of the site. From there, a 250mm diameter sanitary sewer ultimately conveys sewage into the 750mm diameter trunk sewer located on Abbott Street East and discharges to the Hazeldean Pump Station.

3.5 VERIFICATION OF AVAILABLE CAPACITY IN DOWNSTREAM SEWER

The existing sanitary service from the site is a 250 mm diameter sewer at a slope of 2%. This size and slope of sewer provides a capacity of 87.7 L/s. The sanitary service from the pavilion will be added to this existing outlet.

For the 6.0 ha site, the sanitary peak flow is calculated at 2.92 l/s with an infiltration flow of 1.98 l/s (based on a peak extraneous flow of 0.33 l/s/ha) for a total flow of 4.90 l/s. The existing sanitary sewer connection, with a capacity of 87.7 l/s is adequate to convey this flow.

No new connections are proposed to the 750mm diameter trunk sewer.

3.6 CALCULATIONS FOR NEW SANITARY SEWER

No new sanitary sewers are proposed for the pavilion or the school addition. The sanitary service for the pavilion will connect to the existing 75mm forcemain already installed for this purpose. The sanitary service for the addition will be through the existing school building.

3.7 DESCRIPTION OF PROPOSED SEWER NETWORK

The proposed sanitary sewer network on site will consist of a service connection to the existing 75mm forcemain.

3.8 ENVIRONMENTAL CONSTRAINTS

There are no previously identified environmental constraints that impact the sanitary servicing design in order to preserve the physical condition of watercourses, vegetation, or soil cover, or to manage water quantity or quality.

3.9 PUMPING REQUIREMENTS

The proposed development will have no impact on existing pumping stations and will not require new pumping facilities other than as part of the plumbing system for the proposed pavilion.

3.10 FORCEMAINS

A 75mm diameter forcemain is located between the new pavilion and the existing SANMH17-2. The sanitary service for the new pavilion will connect to this existing forcemain. The existing 75mm sanitary sewer forcemain has a capacity of

1.22 l/s and is considered adequate to service the pavilion with a flow rate of 0.04 l/s. The pumps within the pavilion have been designed by the mechanical team. A description of the sizing has been included for information in Appendix C. No changes in existing downstream forcemains are required specifically for the proposed additional development on this site.

3.11 EMERGENCY OVERFLOWS FROM SANITARY PUMPING STATIONS

The small sanitary pumping facility proposed for the pavilion building will be a duplex system, with backup power. In the event of failure of the pump station and/or the primary and backup power systems, the facility will be shut down until repairs can be made. No provision is therefore necessary for emergency overflows.

3.12 SPECIAL CONSIDERATIONS

There is no known need for special considerations for sanitary sewer design related to existing site conditions.

4 SITE STORM SERVICING

4.1 EXISTING CONDITION

The subject property is located within the Fernbank Community Development area at the intersection of Abbott Street East and Robert Grant Avenue. Most of the runoff from the institutional land is directed towards an existing 975mm diameter storm sewer on the east boundary of the site. The sewer discharges to an interim channel and treatment facility offsite. It is anticipated that in the future the sewer may discharge to a municipal sewer on Robert Grant Avenue.

The allowable release rate from the site has been set to 850 l/s and remains unchanged from the existing condition. Flow exceeding this amount up to the 100-year storm have to be retained on the site and released at a rate not exceeding 850 l/s.

4.2 ANALYSIS OF AVAILABLE CAPACITY IN PUBLIC INFRASTRUCTURE

As the allowable release rate from the site will be unchanged and was determined in conjunction with the design of the public infrastructure, there are no concerns related to the adequacy and available capacity of the downstream network. Capacity in the minor system is not a concern.

4.3 DRAINAGE DRAWING

Drawing C04 shows the detailed site sewer network. Drawings C03 provides proposed grading and drainage and includes existing grading information. Drawing C05 provides a post-construction drainage sub-area plan, including both site and roof information. Site sub-area information is also provided on the storm sewer design sheet attached in Appendix C. An overall grading plan and Servicing plan have also been attached to Appendix C for reference.

4.4 WATER QUANTITY CONTROL OBJECTIVE

The water quantity objective for the site is to limit the flow release to 850 l/s. Excess flows above this limit for the school site up to those generated by the 100-year storm event are temporarily stored on site.

No provision is required on the school's site to accommodate any flow from the adjacent lands. All flows exceeding the defined minor system capacity and on-site storage capability will enter the major system, with overflow to the City right of way, on the north and east boundaries of the site.

Stormwater storage calculations are shown in Section 4.10 of this report. Detention stormwater storage is presently provided on the school roof and is not being changed in this present site plan amendment. Additional storage is proposed on the school addition. In certain areas, ground surface storage areas provided in the original design have been modified to accommodate the increased flow rate generated by the new impervious surfaces (refer to Appendix C).

4.5 WATER QUALITY CONTROL OBJECTIVE

The site is not required to achieve water quality objectives. Water quality objectives are achieved through downstream works as noted by the MVCA.

4.6 DESIGN CRITERIA

The stormwater system was designed following the principles of dual drainage, making accommodation for both major and minor flow.

Some of the key criteria include the following:

- Design Storm (minor system) 1:2 year return (Ottawa)
- Rational Method Sewer Sizing
- Initial Time of Concentration 10 minutes
- Runoff Coefficients
 - Landscaped Areas C = 0.25
 - Playground Mulch Areas C = 0.40
 - Gravel Areas C = 0.75
 - Asphalt/Concrete C = 0.90
 - Traditional Roof C = 0.90
- Pipe Velocities 0.80 m/s to 6.0 m/s
- Minimum Pipe Size 250 mm diameter
(200 mm CB Leads and service pipes)

4.7 PROPOSED MINOR SYSTEM

The detailed design for this site will maintain the existing storm sewer network to the existing stormwater management facility located east of the site. The drainage system consists of a series of manholes, catchbasins and storm sewers leading to the outlet manhole STMH1 at the east of the site. All drainage areas on the site are collected in the site piped drainage system.

It is also customary for larger buildings to be provided with piped storm services for roof drainage. The roof drains for the building addition are connected to the storm sewer that flows into the sewer in an uncontrolled capacity, ensuring an unobstructed flow for these areas.

Using the above noted criteria, the existing on-site storm sewers were sized accordingly. A detailed storm sewer design sheet and the associated post development storm sewer drainage area plan are included in Appendix C.

4.8 STORMWATER MANAGEMENT

The subject site is currently limited to a release rate of 850 l/s, which is achieved through the existing inlet control devices located within STMH1. There is a second existing inlet control device within CBMH2 which is directly upstream of STMH1.

Flows generated that are in excess of the site's allowable release rate will be stored on site in surface storage areas or by the use of roof top storage and gradually released into the minor system so as not to exceed the site's allocation.

The maximum surface retention depth of the developed areas will be limited to 350mm during a 1:100 year event. Based on Section 4.10 of the Servicing and Stormwater Management Report for the sports dome, the maximum ponding elevation is 103.46m as determined by the overland overflow elevation, which is well below the building ground floor level of 104.08m and 104.90m for the pavilion and addition respectively.

No surface ponding will occur during a 2-year event, and only minimal ponding will occur during a 5-year event.

Overland flow routes will be provided in the grading to permit emergency overland flow from the site. The overflow routes will eliminate any increase in ponding depth for events exceeding 100 years.

At certain locations within the site, the opportunity to store runoff is limited due to grading constraints and building geometry. These locations are located at the perimeter of the site where it is necessary to tie into public boulevards, and it is not always feasible to capture or store stormwater runoff.

The site grading and ponding has been designed to control water generated during the 1:100-year event, with no overflow leaving the site at this control level. Please refer to the SWM Calculations in Appendix C.

4.9 INLET CONTROLS

According to Section 4.0 of the Servicing and Stormwater Management Report for the sports dome, included in Appendix A for reference, the maximum allowable release rate for the 6.0 Ha site is 850 L/s.

As noted in Section 4.8, there are two inlet control devices (ICDs), one located in CBMH2 and the other located downstream in STMH1 which ultimately controls the flow to 850 l/s. While the majority of the storm system is controlled by the ICD located in CBMH2, a portion of the site consisting of catchment areas 5, 9, 11, 12, 13 and 14 will drain directly to STMH1. Out of this portion, catchment areas 5, 13 and 14 are uncontrolled while catchment areas 11 and 12 have rooftop storage controlled by inlet control devices.

The rooftop of the addition (catchment area 11) will be controlled to a release rate of 0.96 l/s (refer to Table 4-2). Catchment area 12, the footprint of the existing school, also has rooftop storage which will release at a controlled rate of 57 l/s (refer to Appendix A). These catchment areas were removed from the calculations shown below.

$$\begin{aligned}
 Q \text{ (uncontrolled)} &= 2.78 \times C \times I_{100\text{yr}} \times A \quad \text{where:} \\
 C &= 0.52 \text{ (Weighted average post-development C)} \\
 I_{100\text{yr}} &= \text{Intensity of 100-year storm event (mm/hr)} \\
 &= 1735.688 / ((T_c + 6.014)^{0.82}); \text{ where } T_c = 10 \text{ minutes} \\
 A &= \text{Area} = 0.453 \text{ Ha}
 \end{aligned}$$

Therefore, the release to the right of way that is not controlled by the ICD located in CBMH2 can be determined as:

| Catchment Area | Control Type Upstream | Release Rate (l/s) |
|----------------|-----------------------|--------------------|
| 5 | N/A | 23 |
| 9 | N/A | 5.48 |
| 11 | Rooftop ICD | 0.96 |
| 12 | Rooftop ICD | 57 |
| 13 | N/A | 2.6 |
| 14 | N/A | 9.86 |
| Total | | 98.9 |

The maximum allowable release rate from the remainder of the site can then be determined as:

$$\begin{aligned}
 Q \text{ (max allowable)} &= Q \text{ (total allowable)} - Q \text{ (uncontrolled)} \\
 &= 850 \text{ L/s} - 98.9 \text{ L/s} \\
 &= \mathbf{751.1 \text{ L/s}}
 \end{aligned}$$

Based on Section 4.10 of the Servicing and Stormwater Management Report included in Appendix A, inlet control devices are provided in maintenance holes STMH1 and CBMH2. The outlet maintenance hole is limited to 850 l/s and the design of the orifice plate is described in the Servicing and Stormwater Management Report for the sports dome prepared in 2018. No

changes to the orifice are proposed in this project and the release rate of 850 l/s will be maintained. Flow restrictions will cause the on-site catchbasins and manholes to surcharge, generating surface ponding in the parking and landscaped areas. Ponding locations and elevations are summarized on the drainage areas plan C05.

4.10 ON-SITE DETENTION

Any excess storm water up to the 100-year event is to be stored on-site in order to not surcharge the downstream municipal storm sewer system. Detention will be provided in parking and landscape areas and building rooftops, where feasible. As previously noted, the volume of storage is dependent on the characteristics of each individual drainage area. It should be noted that greater than 0.30 m of vertical separation has been provided from all maximum ponding elevations to lowest building openings.

Previously, 890.9m³ of surface storage was provided for the 100-year storm event for which 628m³ of storage volume was required (refer to Appendix A). In this current design, a total of 837.2m³ of surface ponding areas have been provided which can hold the required 628m³ of volume required. Further, the uncontrolled discharge rate is reduced from the previous design due to the rooftop storage on top of the addition which will release at a rate of 0.96 l/s at a maximum ponding depth of 150mm. The following Table summarizes the on-site storage requirements during the 1:100-year events.

Table 4-1: On-Site Storage Requirements

| Catchment Area | Outlet Location | Existing Ponding Area (m ²) | Existing Ponding Depth (m) | Existing Ponding Volume (m ³) | Proposed Ponding Area (m ²) | Proposed Ponding Depth (m) | Proposed Ponding Volume (m ³) |
|----------------|-----------------|---|----------------------------|---|---|----------------------------|---|
| 6 | Ex. STMH3 | - | - | - | 164.7 | 0.19 | 10.4 |
| 7 | Ex. CB13 | 399 | 0.27 | 35.9 | 440.9 | 0.33 | 48.5 |
| 8 | Ex. CB1 | - | - | - | 255.3 | 0.24 | 20.4 |
| 10 | Ex. CB14 | - | - | - | 223.6 | 0.33 | 24.6 |
| 10 | CB 101 | - | - | - | 54.4 | 0.13 | 2.4 |
| 18 | CB 102 | - | - | - | 71.6 | 0.10 | 2.4 |
| 20 | Ex. CBMH2 | - | - | - | 98.7 | 0.20 | 6.58 |
| 21 | Ex. CB17-6 | 1010 | 0.3 | 101.0 | 165.0 | 0.30 | 16.5 |
| 24 | Ex. CB11 | 439 | 0.2 | 29.3 | 313.0 | 0.21 | 21.9 |
| 4 | Ex. STMH17-2 | - | - | - | 40.7 | 0.07 | 1.0 |
| 4 | Ex. CBMH17-3 | - | - | - | 5.1 | 0.05 | 0.8 |

| | | | | | | | |
|------------------|---------------------|------|-----|--------------|------|------|------------|
| 5 | Ex. DCB 16 | - | - | - | 69.5 | 0.14 | 3.24 |
| | Ex. CB17-3 | 362 | 0.2 | 24.1 | - | - | - |
| 19 | Ex. CB17-4 | 309 | 0.2 | 20.6 | - | - | - |
| Ex. sports field | Ex. LCB17-14, 17-15 | 6804 | 0.3 | 680 | 6804 | 0.3 | 680 |
| TOTAL | | | | 890.9 | | | 841 |

The storage that is currently designed on the roof of the existing school will not be modified, refer to Section 4.10 of the Servicing and Stormwater Management Report included in Appendix A.

Table 4-2: Roof Storage – School Addition

| Roof Segment | No. of drains | Ponding Area (m ²) | Ponding Depth (m) | Theoretical Rooftop Storage Volume* (m ³) | Storage Volume Required (m ³) | Maximum Flow Rate (l/s) |
|--------------|---------------|--------------------------------|-------------------|---|---|-------------------------|
| R13 | 1 | 341.4 | 0.15 | 13.7 | 11 | 0.32 |
| R14 | 1 | 339.1 | 0.15 | 13.6 | 10.9 | 0.32 |
| R15 | 1 | 338.2 | 0.15 | 13.5 | 10.9 | 0.32 |
| TOTAL | | | | 40.7 | 32.8 | 0.96 |

*Theoretical storage volume is reduced by 20% to account for rooftop equipment

In all instances the required storage is met with surface ponds which retain the stormwater and discharge at the restricted flow rate to the sewer system. Refer to the grading plan for storage information.

4.11 WATERCOURSES

There will be no modification to watercourses as a result of this proposed site plan.

4.12 PRE AND POST DEVELOPMENT PEAK FLOW RATES

The existing site has an allowable release rate of 850 l/s for up to the 100-year storm event. No modifications are proposed to this rate.

4.13 DIVERSION OF DRAINAGE CATCHMENT AREAS

There will be no diversion of existing drainage catchment areas arising from the proposed work described in this report.

4.14 DOWNSTREAM CAPACITY WHERE QUANTITY CONTROL IS NOT PROPOSED

This checklist item is not applicable to this development as quantity control is provided.

4.15 IMPACTS TO RECEIVING WATERCOURSES

No significant negative impact is anticipated to downstream receiving watercourses due to proposed quantity and quality control measures

4.16 MUNICIPAL DRAINS AND RELATED APPROVALS

There are no municipal drains on the site or associated with the drainage from the site.

4.17 MEANS OF CONVEYANCE AND STORAGE CAPACITY

The means of flow conveyance and storage capacity are described in Sections 4.7, 4.8, 4.9 and 4.10 above.

4.18 HYDRAULIC ANALYSIS

Hydraulic calculations for the site storm sewers are provided in the storm sewer design sheet.

4.19 IDENTIFICATION OF FLOODPLAINS

There are no designated floodplains on the site of this development.

4.20 FILL CONSTRAINTS

There are no known fill constraints applicable to this site related to any floodplain. The site is generally being raised higher relative to existing conditions. Fill on the site to not exceed 1m per geotechnical report.

5 SEDIMENT AND EROSION CONTROL

5.1 GENERAL

During construction, existing storm sewer system can be exposed to sediment loadings. A number of construction techniques designed to reduce unnecessary construction sediment loadings will be used including;

- Silt sacks will remain on open surface structures such as manholes and catchbasins until these structures are commissioned and put into use;
- Installation of silt fence, where applicable, around the perimeter of the proposed work area.
- The installation of straw bales within existing drainage features surround the site;
- Bulkhead barriers will be installed in the outlet pipes;

During construction of the services, any trench dewatering using pumps will be fitted with a “filter sock.” Thus, any pumped groundwater will be filtered prior to release to the existing surface runoff. The contractor will inspect and maintain the filter sock as needed including sediment removal and disposal.

All catchbasins, and to a lesser degree, manholes, convey surface water to sewers. Consequently, until the surrounding surface has been completed, these structures will be covered to prevent sediment from entering the minor storm sewer system. These measures will stay in place and be maintained during construction and build-out until it is appropriate to remove them.

During construction of any development both imported and native soils are placed in stockpiles. Mitigative measures and proper management to prevent these materials entering the sewer system are needed.

During construction of the deeper watermains and sewers, imported granular bedding materials are temporarily stockpiled on site. These materials are however quickly used up and generally placed before any catchbasins are installed.

Refer to the Erosion and Sedimentation Control Plan C06 provided in Appendix D.

6 APPROVAL AND PERMIT REQUIREMENTS

6.1 GENERAL

The proposed development is subject to site plan approval and building permit approval.

No approvals related to municipal drains are required.

No permits or approvals are anticipated to be required from the Ontario Ministry of Transportation, National Capital Commission, Parks Canada, Public Works and Government Services Canada, or any other provincial or federal regulatory agency.

7 CONCLUSION CHECKLIST

7.1 CONCLUSIONS AND RECOMMENDATIONS

It is concluded that the proposed development can meet all provided servicing constraints and associated requirements. It is recommended that this report be submitted to the City of Ottawa in support of the application for site plan approval.

7.2 COMMENTS RECEIVED FROM REVIEW AGENCIES

This is a first submission; no comment is available.

APPENDIX

A

- PRE-CONSULTATION MEETING NOTES
- SERVICING AND STORMWATER MANAGEMENT REPORT, WSP, 2018
- DRAINAGE AREA PLAN C001, WSP, 2018

Pre-Application Consultation Meeting Notes

**5315 Abbott Street, Ottawa
11:00 AM to 12:00 PM, Monday, March 14, 2022
Correct Plans received April 14th
MS Teams**

Attendees:

Molly Smith - Planner (File Lead), City of Ottawa
Matthew Ippersiel - Planner (Urban Design), City of Ottawa
Ashvinya Thatchinamoorthy - Student Planner, City of Ottawa

Applicant Team:

Simon Riouz - Architect
Jacques Lavirctoire - Project Manager
Annick Prud'homme - Assistant Project Manager
Luc Poulin - Director of School Board

Regrets:

Mark Richardson - Forestry, City of Ottawa
Josiane Gervais - Transportation, City of Ottawa
Mathew Hayley - Environmental Planning, City of Ottawa
Kersten Nitsche - Planner (Parks), City of Ottawa

Site-Wide Overview:

1. One addition to the school and an addition to the actual Dome itself that will incorporate an extension between the Dome and the School. The objective is to also build a bus loop that will be connected to the extension of Robert Grant Avenue.
2. The addition will provide 18 classrooms and washroom servicing. An additional two portable classrooms will be provided due to growth.
3. There will be a 2-storey addition, the square foot area has not been decided yet.
4. Expansion of area A and C will be eventually built, however, at the current moment it is intended as it is not being funded.

Parks

1. Section 14(1)(f) of Parkland Dedication By-law 2009-95, as amended, exempts schools "where the school provides for the students' outdoor recreational needs on-site at the time of development".

While the proposed development of the two-storey addition does not remove any outdoor recreational areas, it does not increase the outdoor recreational needs for students in line with the student population increase.

Please explain how the increased student population will be accommodate with outdoor recreation space. Please also confirm the status of the outdoor basketball court – the

Site Plan shows that it is within the fire access route for the portables – is it accessible to students? Or has it been removed?

2. Parks and Facilities Planning is currently undertaking a legislated review for the replacement of the Parkland Dedication By-law, with the new by-law to be considered by City Council in early July 2022. To ensure you are aware of parkland dedication requirements for your proposed development, we encourage you to familiarize yourself with the [existing Parkland Dedication By-law](#) and to sign up for project notifications on the [Engage Ottawa project page](#) or by emailing the project lead at Kersten.Nitsche@ottawa.ca

Please contact Kersten Nitsche, Parks Planner, at Kersten.Nitsche@ottawa.ca, if you have any questions or require additional information relating to the comments above.

Urban Design

1. The general massing of the proposed extension and its proposed location on the site is supported.
2. Please reference any relevant design direction in the Fernbank Community Design Plan.
3. Please ensure that sidewalks are continuous across the aperture of the new bus loop.
4. Ensure a continuation of the landscaping treatment along Robert Grant.
5. An Urban Design Brief is required as a part of your submission. This may be combined with your Planning Rationale report. Please refer to the attached Urban Design Brief Terms of Reference to inform the content of the brief.
6. Please note that the proposed property is located in a Design Priority Area and as such, the Official Plan sets an expectation for an elevated level of attention to be paid to design of the building, its materiality, and the treatment of the public realm as a part of development applications.
7. This application is not subject to review by the Urban Design Review Panel.

Please contact Matthew Ippersiel, Urban Design Planner, at Matthew.Ippersiel@ottawa.ca, if you have any questions or require additional information relating to the comments above.

Planning

1. This application is for a Site Plan Control (Complex, subject to public consultation).
2. Please provide the development statistics on the site plan. The detailed requirements for these plans and studies can be found on the City's website [Guide to preparing studies and plans | City of Ottawa](#)
3. In the period between Council approval of the New Official Plan and the Ministry's approval of the New Official Plan, City staff will apply whichever provision, as between the Current and New Official Plan, is more restrictive. However, both of the Official Plan documents must be reviewed in the planning rationale. It should be noted that the Current Official Plan designates the property under '*General Urban Area*'. The New Official Plan designates the property '*Suburban Transect – Evolving Neighbourhood*'. Notwithstanding other sections and policies in the new Official Plan, Section 4.10 – School Facilities apply to the site.
4. Zoning for the site is L1A[2129]
 - a. Exception 2129 states the maximum building height besides the dome as 15m.

- b. Maximum dome height is 23.5m, please label on site plan.
 - c. Please perform a full zoning review for the proposed development prior to submitting any applications; please include a full zoning compliance table on the submitted site plan.
5. How will additional parking be accommodated? In Table 101 the minimum parking rate for a post secondary school is 1 stall per 100 square metres of gross floor area, maximum is 1.5 stalls per 100 GFA.
 6. How will additional bicycle parking be accommodated? Make sure parking stalls and bicycle parking locations are provided in the site plan.
 7. The school addition, the dome and any other zoning complying standards such as the access routes or setback requirements along Robert Grant need to be addressed in your submission. As well, check if any loading spaces are required and if they are, briefly explain how they would be accommodated.
 8. Is the bus loop suppose to allow buses to travel from Robert Grant to Abbott Street?
 9. Impervious paving is becoming the dominant material throughout the site. Please provide trees plantings and realize other opportunities for landscape planting and impervious paving.
 10. Please provide a direct connection from the portables to the extension.
 11. Please provide clarity on what is happening with the basketball court and access route, it appears that the vehicle route is overlapping.
 12. You are encouraged to reach out to the Ward Councillor when you're ready.

Please contact Molly Smith, Planner, at molly.smith@ottawa.ca, if you have any questions or require additional information relating to the comments above.

Environmental Planning

1. Bird-safe Design

Given the proposal to made an addition to the school, they will need to review and incorporate bird safe design elements. Some of the risk factors include glass and related design traps such as corner glass and fly-through conditions, ventilation grates and open pipes, landscaping, light pollution. More guidance and solutions are available in the guidelines which can be found here: <https://ottawa.ca/en/planning-development-and-construction/developing-property/development-application-review-process/development-application-submission/guide-preparing-studies-and-plans> .

2. Urban Heat Island

Please add features that reduce the urban heat island effect (see OP 10.3.3) for the addition and if possible look for easy improvements to the larger site. For example, this impact can be reduced by adding large canopy trees, green roofs or vegetation walls, or constructing the parking lot or building differently.

Please contact Matthew Hayley, Environmental Planner, at Matthew.Hayley@ottawa.ca, if you have any questions or require additional information relating to the comments above.

Forestry

Tree Conservation Report requirements:

- a Tree Conservation Report (TCR) must be supplied for review along with the suite of other plans/reports required by the City
 - a. an approved TCR is a requirement of Site Plan approval.
 - b. The TCR may be combined with the LP provided all information is supplied
- Any removal of privately-owned trees 10cm or larger in diameter, or city-owned trees of any diameter requires a tree permit issued under the Tree Protection Bylaw (Bylaw 2020 – 340); the permit will be based on an approved TCR and made available at or near plan approval.
- The Planning Forester from Planning and Growth Management as well as foresters from Forestry Services will review the submitted TCR
 - a. If tree removal is required, both municipal and privately-owned trees will be addressed in a single permit issued through the Planning Forester
 - b. Compensation may be required for city owned trees – if so, it will need to be paid prior to the release of the tree permit
- the TCR must list all trees on site, as well as off-site trees if the CRZ extends into the developed area, by species, diameter and health condition
- please identify trees by ownership – private onsite, private on adjoining site, city owned, co-owned (trees on a property line)
- If trees are to be removed, the TCR must clearly show where they are, and document the reason they cannot be retained
- All retained trees must be shown, and all retained trees within the area impacted by the development process must be protected as per City guidelines available at [Tree Protection Specification](#) or by searching Ottawa.ca
 - a. the location of tree protection fencing must be shown on the plan
 - b. show the critical root zone of the retained trees
 - c. if excavation will occur within the critical root zone, please show the limits of excavation
- the City encourages the retention of healthy trees; if possible, please seek opportunities for retention of trees that will contribute to the design/function of the site.
- For more information on the process or help with tree retention options, contact Mark Richardson mark.richardson@ottawa.ca or on [City of Ottawa](#)

LP tree planting requirements:

For additional information on the following please contact tracy.smith@Ottawa.ca

Minimum Setbacks

- Maintain 1.5m from sidewalk or MUP/cycle track.
- Maintain 2.5m from curb
- Coniferous species require a minimum 4.5m setback from curb, sidewalk or MUP/cycle track/pathway.
- Maintain 7.5m between large growing trees, and 4m between small growing trees. Park or open space planting should consider 10m spacing, except where otherwise approved in naturalization / afforestation areas. Adhere to Ottawa Hydro's planting guidelines (species and setbacks) when planting around overhead primary conductors.

Tree specifications

- Minimum stock size: 50mm tree caliper for deciduous, 200cm height for coniferous.
- Maximize the use of large deciduous species wherever possible to maximize future canopy coverage
- Tree planting on city property shall be in accordance with the City of Ottawa's Tree Planting Specification; and include watering and warranty as described in the specification (can be provided by Forestry Services).
- Plant native trees whenever possible
- No root barriers, dead-man anchor systems, or planters are permitted.
- No tree stakes unless necessary (and only 1 on the prevailing winds side of the tree)

Hard surface planting

- Curb style planter is highly recommended
- No grates are to be used and if guards are required, City of Ottawa standard (which can be provided) shall be used.
- Trees are to be planted at grade

Soil Volume

- Please ensure adequate soil volumes are met:

| Tree Type/Size | Single Tree Soil Volume (m3) | Multiple Tree Soil Volume (m3/tree) |
|----------------|------------------------------|-------------------------------------|
| Ornamental | 15 | 9 |
| Columnar | 15 | 9 |
| Small | 20 | 12 |
| Medium | 25 | 15 |
| Large | 30 | 18 |
| Conifer | 25 | 15 |

Please note that these soil volumes are not applicable in cases with Sensitive Marine Clay.

Sensitive Marine Clay

- Please follow the City's 2017 Tree Planting in Sensitive Marine Clay guidelines

Tree Canopy Cover

- The landscape plan shall show how the proposed tree planting will replace and increase canopy cover on the site over time, to support the City's 40% urban forest canopy cover target.
- At a site level, efforts shall be made to provide as much canopy cover as possible, through tree planting and tree retention, with an aim of 40% canopy cover at 40 years, as appropriate.
- Indicate on the plan the projected future canopy cover at 40 years for the site.

Please contact Mark Richardson, Planning Forester, at Mark.Richardson@ottawa.ca, if you have any questions or require additional information relating to the comments above.

Transportation

1. Follow Transportation Impact Assessment Guidelines:
 - Indicate on the Screening Form the anticipated additional trips generated by the additions and re-submit to josiane.gervais@ottawa.ca.

- Start this process asap. The application will not be deemed complete until the submission of the draft step 1-4, including the functional draft RMA package (if applicable) and/or monitoring report (if applicable).
 - Request base mapping asap if RMA is required. Contact Engineering Services (<https://ottawa.ca/en/city-hall/planning-and-development/engineering-services>)
 - An update to the *TRANS Trip Generation Manual* has been completed (October 2020). This manual is to be utilized for this TIA. A copy of this document can be provided upon request.
2. Confirm that the emergency connection through the basketball court is required. If so, it should be physically restricted by barriers to avoid this connection being used by non-emergency vehicles.
 3. Clarify who are the intended users of the new access/loop.
 4. Regarding the proposed access onto Robert Grant:
 - Construction of the extension of Robert Grant is anticipated to commence in the fall of 2022.
 - The proposed entrance to the school, although currently shown on the RG detailed design plans, has no status and will require to be reviewed against all current requirements and standards (including, but not limited to transportation concerns, infrastructure and stormwater management).
 - The proposed access should be coordinated with Novatech, who is undertaking the detailed design of the RG corridor.
 - An access at this location, and all infrastructure work associated with it, is not DC eligible and is entirely at the applicant's cost.
 5. As the proposed site is institutional, AODA legislation applies.
 - Ensure all crosswalks located internally on the site provide a TWSI at the depressed curb, per requirements of the Integrated Accessibility Standards Regulation under the AODA.
 - Clearly define accessible parking stalls and ensure they meet AODA standards (include an access aisle next to the parking stall and a pedestrian curb ramp at the end of the access aisle, as required).
 - Please consider using the City's Accessibility Design Standards, which provide a summary of AODA requirements. <https://ottawa.ca/en/city-hall/creating-equal-inclusive-and-diverse-city/accessibility-services/accessibility-design-standards-features#accessibility-design-standards>
 6. On site plan:
 - Ensure the proposed site access meets the City's Private Approach Bylaw.
 - Show all details of the roads abutting the site up to and including the opposite curb; include such items as pavement markings, accesses and/or sidewalks.
 - Turning movement diagrams required for all accesses showing the largest vehicle to access/egress the site.
 - Turning movement diagrams required for internal movements (loading areas, garbage).
 - Show all curb radii measurements; ensure that all curb radii are reduced as much as possible and fall within TAC guidelines (Figure 8.5.1).
 - Show dimensions for site elements (i.e. lane/aisle widths, access width and throat length, parking stalls, sidewalks, pedestrian pathways, etc.)
 - Sidewalk is to be continuous across access as per City Specification 7.1.
 - Grey out any area that will not be impacted by this application.
 7. Noise Impact Study required to address the following:
 - Road
 - Rail

- Stationary, due to the proximity to neighboring exposed mechanical equipment and/or if there will be any exposed mechanical equipment due to the proximity to neighboring noise sensitive land uses.

Please contact Josiane Gervais, Transportation Project Manager, at josiane.gervais@ottawa.ca, if you have any questions or require additional information relating to the comments above.

Infrastructure

Please note the following information regarding the engineering design submission for the above noted site:

1. The Servicing Study Guidelines for Development Applications are available at the following address: <http://ottawa.ca/en/development-application-review-process-0/servicing-study-guidelines-development-applications>
2. Servicing and site works shall be in accordance with the following documents:
 - Ottawa Sewer Design Guidelines (October 2012)
 - Ottawa Design Guidelines – Water Distribution (2010)
 - Geotechnical Investigation and Reporting Guidelines for Development Applications in the City of Ottawa (2007)
 - City of Ottawa Slope Stability Guidelines for Development Applications (revised 2012)
 - City of Ottawa Environmental Noise Control Guidelines (January, 2016)
 - City of Ottawa Park and Pathway Development Manual (2012)
 - City of Ottawa Accessibility Design Standards (2012)
 - Ottawa Standard Tender Documents (latest version)
 - Ontario Provincial Standards for Roads & Public Works (2013)
3. Record drawings and utility plans are also available for purchase from the City (Contact the City's Information Centre by email at InformationCentre@ottawa.ca or by phone at (613) 580-2424 x.44455).
4. The Stormwater Management Criteria is to be governed by previously approved/Fernbank MSS governed stormwater management criteria for the subject site. The engineering design submission should clearly demonstrate the allowable release rate for the site and how it is being respected as well as how additional storage is being provided as a result of the increased hardscape. Runoff in excess of the allowable release rate should be detained on site up to the 100-yr event. The design submission should also demonstrate how any governing quality control or infiltration targets are to be met.
5. Ensure Fernbank MSS designated flow routes across the site are respected with the current proposal.
6. Construction of the extension of Robert Grant is anticipated to commence in the fall of 2022. The proposed entrance to the school, although currently shown on the RG detailed design plans, has no status and will require to be reviewed against all current requirements and standards (including, but not limited to transportation concerns,

infrastructure and stormwater management). The proposed access should be coordinated with Novatech, who is undertaking the detailed design of the RG corridor. An access at this location, and all infrastructure work associated with it, is not DC eligible and is entirely at the applicant's cost. Additionally, the access cannot move forward prior to Robert Grant and until the interim stormwater facility has been decommissioned and replaced by the Robert Grant sewer for conveyance of the site's storm flow to the subdivision pond.

7. It should be demonstrated in the submission how any increased sanitary demand is within previously established Fernbank MSS criteria and is within downstream capacity.
8. Water Boundary condition request must be made to demonstrate the existing infrastructure can support the additional demand proposed while maintaining required residual pressures. Water Boundary condition request to be directed to City Project Manager and should include the location of the service and the expected loads required by the proposed development. Please provide the following information:
 - a. Image (geoOttawa snippet) showing location of service connection to City watermain.
 - b. Type of development and the amount of fire flow required (as per FUS, 1999).
 - c. Average daily demand: ___ l/s.
 - d. Maximum daily demand: ___ l/s.
 - e. Maximum hourly daily demand: ___ l/s.
9. MOECC ECA Requirements
If existing ECA for the site, it shall be amended as necessary.

Next Steps

Please refer to the links to [Guide to preparing studies and plans](#) and [fees](#) for further information. Additional information is available related to [building permits](#), [development charges](#), and the [Accessibility Design Standards](#). Be aware that other fees and permits may be required, outside of the development review process. You may obtain background drawings by contacting informationcentre@ottawa.ca.

These pre-consultation comments are valid for one year. If you submit a development application(s) after this time, you may be required to meet for another pre-consultation meeting and/or the submission requirements may change. You are as well encouraged to contact us for a follow-up meeting if the plan/concept will be further refined.

Please do not hesitate to contact Molly Smith, at molly.smith@ottawa.ca if you have any questions.



**SERVICING AND STORMWATER MANAGEMENT REPORT
École Secondaire Catholique Paul-Desmarais Dome**

5315 Abbott Street, Ottawa, Ontario

This document includes:

- Stormwater Management Report
- Watermain Analysis
- Assessment of Adequacy of Public Services
- Erosion and Sediment Control Brief (Plan Requirements Shown on Drawing C001)

Our File 17M-02044-00

February 5, 2018

Revision 1 – March 6, 2018

Revision 2 – May 4, 2018

Revision 3 – July 20, 2018

**Servicing and Stormwater Management Report
École Secondaire Catholique Paul-Desmarais Dome
5315 Abbott Street, Ottawa, Ontario.**

Revision 3 – July 20, 2018

| TABLE OF CONTENTS (Pages 1 to 3) | | Page |
|---|--|-------------|
| 1. | GENERAL | |
| 1.1 | Executive Summary | 4 |
| 1.2 | Date and Revision Number | 5 |
| 1.3 | Location Map and Plan | 5 |
| 1.4 | Adherence to Zoning and Related Requirements | 5 |
| 1.5 | Pre-Consultation Meetings | 5 |
| 1.6 | Higher Level Studies | 5 |
| 1.7 | Statement of Objectives and Servicing Criteria | 6 |
| 1.8 | Available Existing and Proposed Infrastructure | 6 |
| 1.9 | Environmentally Significant Areas, Watercourses and Municipal Drains | 6 |
| 1.10 | Concept Level Master Grading Plan | 6 |
| 1.11 | Impacts on Private Services | 7 |
| 1.12 | Development Phasing | 7 |
| 1.13 | Geotechnical Study | 7 |
| 1.14 | Drawing Requirement | 7 |
| 2. | WATER SERVICING | |
| 2.1 | Consistency with Master Servicing Study & Availability of Infrastructure | 7 |
| 2.2 | System Constraints and Boundary Conditions | 8 |
| 2.3 | Confirmation of Adequate Domestic Supply and Pressure | 8 |
| 2.4 | Confirmation of Adequate Fire Flow Protection | 9 |
| 2.5 | Check of High Pressure | 9 |
| 2.6 | Water Quality Analysis | 9 |
| 2.7 | Phasing Constraints | 10 |
| 2.8 | Reliability Requirements | 10 |
| 2.9 | Need for Pressure Zone Modification | 10 |
| 2.10 | Capability of Major Infrastructure to Supply Sufficient Water | 10 |
| 2.11 | Description of Proposed Water Distribution Network | 10 |
| 2.12 | Off-site Requirements | 10 |
| 2.13 | Calculation of Water Demands | 10 |
| 2.14 | Model Schematic | 10 |

| | | |
|------|---|----|
| 3. | WASTEWATER SERVICING | |
| 3.1 | Design Criteria | 11 |
| 3.2 | Consistency With Master Servicing Study | 11 |
| 3.3 | Review of Soil Conditions | 12 |
| 3.4 | Description of Existing Sanitary Sewer | 12 |
| 3.5 | Verification of Available Capacity in Downstream Sewer | 12 |
| 3.6 | Calculations for Sanitary Sewers | 12 |
| 3.7 | Description of Proposed Sewer Network | 12 |
| 3.8 | Environmental Constraints | 13 |
| 3.9 | Pumping Requirements | 13 |
| 3.10 | Force-Mains | 13 |
| 3.11 | Emergency Overflows from Sanitary Pumping Stations | 13 |
| 3.12 | Special Considerations | 13 |
| 4. | STORMWATER SERVICING | |
| 4.1 | Description of Drainage Outlets and Downstream Constraints | 13 |
| 4.2 | Analysis of Available Capacity in Existing Public Infrastructure | 14 |
| 4.3 | Drainage Drawing | 14 |
| 4.4 | Water Quantity Control Objective | 14 |
| 4.5 | Water Quality Control Objective | 14 |
| 4.6 | Description of Stormwater Management Concept | 15 |
| 4.7 | Set-Back from Sewage Disposal Systems, Water Courses & Hazard Lands | 15 |
| 4.8 | Pre-Consultation with MOE and CA | 15 |
| 4.9 | Consistency with Higher Level Studies | 15 |
| 4.10 | Storage Requirements and Conveyance Capacity | 16 |
| 4.11 | Watercourses | 23 |
| 4.12 | Pre and Post Development Peak Flow Rates | 23 |
| 4.13 | Diversion of Drainage Catchment Areas | 24 |
| 4.14 | Minor and Major Systems | 24 |
| 4.15 | Downstream Capacity Where Quantity Control is Not Proposed | 24 |
| 4.16 | Impacts to Receiving Watercourses | 24 |
| 4.17 | Municipal Drains and Related Approvals | 25 |
| 4.18 | Means of Conveyance and Storage Capacity | 25 |
| 4.19 | 100 Year Flood Levels and Major Flow Routing | 25 |
| 4.20 | Hydraulic Analysis | 25 |
| 4.21 | Erosion and Sediment Control Plan | 25 |
| 4.22 | Identification of Floodplains | 26 |
| 4.23 | Fill Constraints | 26 |
| 5. | APPROVAL AND PERMIT REQUIREMENTS | 26 |

| | | |
|-----|--|----|
| 6. | CONCLUSION CHECKLIST | |
| 6.1 | Conclusions and Recommendations | 26 |
| 6.2 | Comments Received from Review Agencies | 26 |
| 6.3 | Signature and Professional Stamp | 26 |

LIST OF TABLES

| | | |
|------|--|----|
| 4.1 | 100 YEAR STORAGE REQUIREMENTS | 16 |
| 4.2 | 5 YEAR STORAGE REQUIREMENTS | 17 |
| 4.3 | ROOF STORAGE –AREA, DEPTH AND PHYSICAL VOLUME | 17 |
| 4.4 | ROOF SEGMENT R1 –STORAGE CALCULATED BY FLOW BALANCE | 18 |
| 4.5 | ROOF SEGMENT R2 –STORAGE CALCULATED BY FLOW BALANCE | 18 |
| 4.6 | ROOF SEGMENT R3 –STORAGE CALCULATED BY FLOW BALANCE | 18 |
| 4.7 | ROOF SEGMENT R4 –STORAGE CALCULATED BY FLOW BALANCE | 19 |
| 4.8 | ROOF SEGMENT R5 –STORAGE CALCULATED BY FLOW BALANCE | 19 |
| 4.9 | ROOF SEGMENT R6 –STORAGE CALCULATED BY FLOW BALANCE | 19 |
| 4.10 | ROOF SEGMENT R7 –STORAGE CALCULATED BY FLOW BALANCE | 20 |
| 4.11 | ROOF SEGMENT R8 –STORAGE CALCULATED BY FLOW BALANCE | 20 |
| 4.12 | ROOF SEGMENT R9 –STORAGE CALCULATED BY FLOW BALANCE | 20 |
| 4.13 | ROOF SEGMENT R10 –STORAGE CALCULATED BY FLOW BALANCE | 21 |
| 4.14 | ROOF SEGMENT R11 –STORAGE CALCULATED BY FLOW BALANCE | 21 |
| 4.15 | ROOF SEGMENT R12 –STORAGE CALCULATED BY FLOW BALANCE | 21 |
| 4.16 | 100 YEAR STORAGE REQUIREMENTS UPSTREAM OF CBMH2 | 23 |

APPENDICES

- A. Storm Sewer Design Sheet
Surface Stormwater Storage Calculations
- B. Roof Drainage Area Locations
- C. Correspondence from Mississippi Valley Conservation Authority – Original Development
- D. Water System Boundary Conditions
Water Age Analysis
FUS Fire Demand Calculation
EPANET Watermain Analysis

1. GENERAL

1.1 Executive Summary

This report outlines site servicing criteria and civil engineering calculations pertaining to the servicing of a proposed sports dome and associated pavilion at an existing secondary school constructed in 2015/2016. The report also includes information from the servicing report prepared in 2014 for the original site development. The site is 6 hectares in size, with the present school building located in the southeast corner of the site. The proposed dome facility will be constructed in the northwest corner of the site, north of the existing bus loop, on land presently partly occupied by the main sports field for the school. The site is located within the proposed Fernbank community, located near the eastern limit of the existing community of Stittsville.

Abbott Street was extended to the site in 2015. Water and sanitary mains presently exist within the Abbott Street right of way, and the existing school building is connected to these services. The existing site water service will be extended to service the pavilion, the dome and a new private hydrant. The sanitary service for the pavilion will require pumping. A forcemain will carry sanitary sewage from the pavilion to a manhole near the site driveway entrance, and a gravity sewer will convey the sewage to the existing sanitary manhole SANMH2 at the south east corner of the property. A piped storm drainage outlet on the east side of the site discharges to a temporary ditch within the right of way of the future Robert Grant Avenue, on route to off-site interim stormwater quantity and quality control facilities designed for the use of the school site. The interim facility will be replaced in the future by a larger communal stormwater treatment facility, which will service the school site as well as other properties within the Fernbank community. The developer is responsible for obtaining all required regulatory approvals associated with these facilities.

Modifications will be made to the existing on-site storm sewer system and storm water management system in order to accept the increase in impervious surfaces arising from the dome construction. No change will be made to the storm outlet or allowable flow release rate.

The proposed grading and servicing for the site are shown on civil drawings C002 to C005. Drawing C001 provides a site drainage area plan, sediment and erosion control, and related engineering notes and details.

This report was prepared utilizing servicing design criteria obtained from the original site development, the City of Ottawa, and Novatech Engineering Consultants Ltd. (the consultant for the community developer), and outlines the design for water, sanitary wastewater, and stormwater facilities, including stormwater management.

The format of the report matches that of the development servicing study checklist found in section 4 of the City of Ottawa's Servicing Study Guidelines for Development Applications, November 2009.

1.2 Date and Revision Number

This version of the servicing report is the third revision, incorporating city review comments and site plan modifications, and is dated July 20, 2018.

1.3 Location Map and Plan

The civil engineering drawings C001 to C005 include the municipal address, site boundary, and site layout for grading and servicing. A location plan is shown on Drawing C001. The architectural site plan provides a detailed description of the site layout.

1.4 Adherence to Zoning and Related Requirements

The property and project will be in conformance with zoning and related requirements, subject to confirmation by the City of Ottawa. The dome facility is considered a Recreation and Athletic Facility, which is an acceptable use under the current zoning.

1.5 Pre-Consultation Meetings

A pre-consultation meeting for the dome project were held with representatives of the City of Ottawa, Conseil des Écoles Catholique du Centre-Est, and the consultant design team on February 3, 2017.

1.6 Higher Level Studies

The design for servicing has been undertaken in conformance with, and utilizing information from, the following documents:

- Servicing design information provided by Novatech Engineering, which is based on the Master Servicing Study for the Fernbank Community Design Plan, June 2009. Confirmation was received from Mark Bissett of Novatech Engineering in October 2017 that the water and sanitary sewage demands for the proposed dome project will not have an adverse impact on the neighbourhood servicing design.
- Ottawa Sewer Design Guidelines, October 2012.
- Ottawa Design Guidelines – Water Distribution, July 2010 and Technical Bulletin ISD 2010-02 Revisions to Water Design Guidelines.

1.7 Statement of Objectives and Servicing Criteria

The objective of the site servicing is to meet the ultimate requirements for the development of the school site with the dome project, while adhering to the stipulations of the applicable higher level studies and City of Ottawa servicing design guidelines. The site plan includes allowances for additional parking, expansions to the school building, and a new bus loop from the future street on the east side of the site. The servicing design has allowed for these future site plan modifications, although the presented storm drainage network and ponding is based on the interim condition.

1.8 Available Existing and Proposed Infrastructure

The existing services for the present school will not be altered. The storm sewer network in the north part of the site will be changed to allow for the dome, but the outlet 975mm diameter storm sewer will not be changed. The existing 150mm water service will be replaced with a 200mm private watermain from the south side of the existing building (at the site water entry point) to the new pavilion and dome, and will service a new private hydrant and a 100mm diameter service to the building. Due to the distance of the pavilion from the present site sanitary outlet, a combination forcemain and gravity sewer will be provided to convey sanitary sewage from the pavilion to an existing private sanitary manhole at the southeast corner of the site. This manhole discharges to the sanitary trunk sewer on Abbott Street. Off-site facilities have been provided by the developer for stormwater quantity and quality control, and for conveyance of the stormwater. Presently, the 975 mm discharge pipe outlets to a constructed channel on the future Robert Grant Avenue. A storm sewer on this street is expected in the future. Stormwater quantity control is required on the site, and detention storage will be reconfigured and increased to account for the dome project.

Site access is presently from Abbott Street. A future bus loop connection off of Robert Grant Avenue is anticipated on the site plan, but is not currently scheduled for construction. Additional catch basins and sewer modifications are expected to be necessary for this future change.

1.9 Environmentally Significant Areas, Watercourses and Municipal Drains

The proposed changes to the site will not require any additional approvals or amendments to approvals pertaining to environmentally significant areas, watercourses or municipal drains.

1.10 Concept Level Master Grading Plan

As the design is being submitted for site plan approval, the grading plan has been developed to the final design level. The existing and proposed grading are shown on Drawing C002 - Grading Plan. Existing grading information is based on a topographic survey of the site completed in 2017. No changes in grading are proposed beyond the site boundaries, and in the vicinity of the existing City storm sewer on the west side of the site. The proposed grading plan confirms the feasibility of the proposed stormwater management system, drainage, soil removal and fills.

1.11 Impacts on Private Services

There are no existing domestic private services (septic system and well) located on the site. There are no neighbouring properties using private services.

1.12 Development Phasing

No scheduled development phasing has been detailed for the site. The site plan does indicate possible future development of portable classrooms, a replacement bus loop and building expansions. These additional impervious areas have been taken into account in the stormwater management calculations, assuming the worst case scenario that all future building additions, bus loop, full parking and eight portable classrooms will be in place. During the interim, higher numbers of portable classrooms are expected as noted on the site plan, but these numbers would be reduced when the building expansion takes place. Historically, this School Board has experienced substantial growth at their school sites, and inclusion of larger amounts of potential impervious area is considered a reasonable precaution.

1.13 Geotechnical Study

A geotechnical investigation report was prepared by exp Services Inc. for the original school construction, and a new report has been prepared in 2017 for the dome project. No additional geotechnical information was required for the design of the modified site services, including paving. This geotechnical reports will be included with the contract documents to be issued for construction, and the recommendations of the reports will be referenced in the construction specifications. Flexible joints on piped services at the building walls have also been noted on the civil engineering drawings to allow for possible differential settlement.

1.14 Drawing Requirement

The submitted Site Plan from Edward J. Cuhaci and Associates provides a metric scale, north arrow, location plan, name of Owner, contact information for owner's representative, property limits including bearings and dimensions, existing and proposed structures and parking areas, easements, rights of way, and adjacent street names. Similar information is provided on the engineering plans submitted for site plan amendment.

2. WATER SERVICING

2.1 Consistency with Master Servicing Study and Availability of Public Infrastructure.

No changes are required to the City's water distribution system, either existing or as proposed in the Fernbank Community Design Plan – Master Servicing Study, to allow for water servicing for this property. The 400 mm watermain which services the property, including the proposed buildings, is already in place.

An existing 200mm watermain extends to the property from Abbott Street in the southeast corner of the site, and supplies a private hydrant in that area. The existing school building has a

150mm diameter water service, with a water entry room in the southwest corner. The 150mm water service will be replaced with a 200mm private watermain in order to convey the required fire flow to the pavilion.

There is an option to supply the domestic water needs of the pavilion directly from the existing school water entry room, but this would require both a 75mm diameter domestic supply line and a 150mm private watermain being extended to the pavilion area. It is not anticipated that this arrangement would provide sufficient flow. The proposal is therefore to supply both the domestic supply and fire fighting requirements from the 200mm diameter proposed private watermain extension.

2.2 System Constraints and Boundary Conditions

There are no known system constraints pertaining to the proposed development.

Available system conditions are established based on hydraulic head information provided by the City of Ottawa, as indicated in Appendix D. Hydraulic head values were provided as follows: Peak Hour = 155.6m, Max HGL = 161.3m, and Max Day + Fire = 155.6m. The finished ground elevation at the existing 400mm municipal watermain connection is approximately 104.7m, which at a watermain burial depth of 2.4m results in an elevation head of 102.3m. This results in pressure heads between 53.3m and 59.0m. The proposed floor of the pavilion is at an elevation of 104.8m, and therefore will operate under similar conditions to the present school.

Static pressures in the range of 76 to 84 psi can therefore be expected under the operating heads described above. Minimal head loss will occur in the proposed 200mm private watermain extension due to the relatively low water demands of the pavilion.

2.3 Confirmation of Adequate Domestic Supply and Pressure

The mechanical engineer has suggested a peak domestic water demand of 86 USgpm or 5.4 L/s for the pavilion building. The estimated demand for the school building based on the ultimate demand was 12.9 L/s, but based on 2 years of City of Ottawa water bills provided by the school board, the maximum day demand from the school is only 0.32 L/s. Both demands are relatively low considering the size of the site, and are not expected to be concurrent. The dome will be used during school hours for students, and therefore will not result in an increased population or demand during the daytime. During evening hours and weekends, the dome will be occupied, but the school will generally be empty or used minimally.

The Master Servicing Study was completed for the Fernbank Community Design Plan allowing for the development of a secondary school for the subject parcel of land. The Study did not require any modification in the size of the watermain on Abbott Street even at the ultimate development of the community. It is therefore reasonable to assume that the watermain can supply the expected demand for the school and the dome facility, both of which will be constructed early in the development of the community.

2.4 Confirmation of Adequate Fire Flow Protection

The fire demand for the pavilion is calculated in this report based on the Fire Underwriter's Survey method for a 581 m² building of combustible construction without a sprinkler system. A standpipe system will be provided for the pavilion. A dry standpipe system with freestanding fire cabinets will be provided for the dome.

For the existing school building, a peak fire demand of 23.65 L/s was estimated by the mechanical engineer using OBC requirements. Using the Fire Underwriter's Survey (FUS) method, a recommended fire demand of 9,000 L/min was estimated for the school building in the original site servicing report.

The pavilion will be a single storey structure, of wood frame (combustible) construction, with low fire hazard contents and no sprinkler system. The estimated fire demand using the FUS method is 8,000 L/min (133 L/s), assuming a 20% increase for the proximity of the dome. Calculations are provided in Appendix D. The proposed watermain network was modeled using EPANET software to confirm the system could deliver 8,000 L/min to the new building area. A printout from the model is also provided in Appendix D.

The dome structure will be serviced by an exterior dry standpipe system as determined by the mechanical designer, with a demand of 500 USgpm (1890 L/min). As this demand is lower than the 8,000 L/min demand estimated in the previous paragraph, the demand for the dome structure is easily met by the proposed system.

Section 8.3.2 of the Master Servicing Study indicates that fire flows exceeding 217 L/s (13,020 L/min) are available from the proposed watermain network in the Fernbank community at all locations along the trunk watermain. The Abbott Street watermain is part of the proposed trunk system. Fire flows adequate to meet the FUS and the mechanical engineering calculations (based on Ontario Building Code requirements) are therefore available.

2.5 Check of High Pressures

Section 8.4 of the Master Servicing Study indicates that service areas within the Fernbank Community with ground elevations below 105.7 m will be susceptible to daily pressures exceeding 80 psi (550 kPa). The pavilion elevation is 104.8 m, and therefore pressures exceeding 80 psi can be anticipated, although the length of the private watermain will create some pressure loss. To allow for this condition, a pressure reducing valve is suggested for the mechanical design of the pavilion.

2.6 Water Quality Analysis

A water quality analysis was performed to demonstrate that the age of the water in the water service does not exceed 5 days. Based on the analysis using EPANET and the average day flows to the school and the new pavilion building, the age of the water is much less than the 5 day period. Results of this analysis can be found in Appendix D.

2.7 Phasing Constraints

No phasing constraints exist for the pavilion and dome project.

2.8 Reliability Requirements

The water distribution network for the community will be a looped system, allowing for flow to the site via multiple directions.

2.9 Need for Pressure Zone Boundary Modification

The School Board is not required to implement any modification in pressure zone boundaries.

2.10 Capability of Major Infrastructure to Supply Sufficient Water

The Master Servicing Study was developed assuming the development of a school on the subject site. The construction of the proposed dome and pavilion to not significantly alter the anticipated water demand. As acknowledged by Novatech Engineering, the existing water distribution system is adequate for the site and will not be adversely impacted by the addition of the pavilion and dome.

2.11 Description of Proposed Water Distribution Network

The existing 150mm diameter private watermain serving the school will be replaced and extended using a 200mm diameter private watermain to service the pavilion, the dome and a new private hydrant located southeast of the pavilion.

The single private hydrant proposed meets Ontario Building Code requirements for offset and proximity to the building.

2.12 Off-site Requirements

No off-site improvements to watermains, feeder mains, pumping stations, or other water infrastructure are required to service the project. The Master Servicing Study outlines off-site requirements for the future development of the Fernbank Community.

2.13 Calculation of Water Demands

Water demand calculations are provided in Sections 2.3 and 2.4 above.

2.14 Model Schematic

As the water works consist of a single building service, a model schematic is not required.

3. WASTEWATER SERVICING

3.1 Design Criteria

The City of Ottawa Sewer Design Guidelines recommend that sanitary sewers be designed using a sanitary flow allowance of 50,000 L/ha/day for institutional uses, with a peaking factor of 1.5. The area of the building site is 6 ha. The peak flow allowed for the site calculated using the guidelines is therefore 5.21 L/s. The extraneous flow allowance is 0.28 L/s/ha, raising the peak estimated allowable flow to 6.89 L/s.

The Ottawa Sewer Design Guidelines also provide estimates of sewage flows based on per capita unit rates. The anticipated average flow based on the estimated ultimate population of the school of 1307 persons (at an average rate of 90 L/person/day) is 1.36 L/s. The per capita value is based on a day school containing a gymnasium with showers, and a cafeteria. Applying the peaking factor of 1.5, and adding the extraneous flow, the estimated ultimate peak flow is 3.72 L/s based on the building population. This value is lower than the sewer network design value of 6.89 L/s.

The mechanical engineer has estimated a total of 140 fixture units for the pavilion, which equates to a peak flow of approximately 4.4 L/s using plumbing calculations. As the peak flows for the school and pavilion will not be concurrent, the overall demand is anticipated to be within the parameters allowed for the site.

3.2 Consistency with Master Servicing Study

The use of the subject property for a secondary school was included in the Fernbank Community Design Plan Master Servicing Study. Sanitary sewage from the site will be conveyed to the existing Stittsville Trunk Sewer, which travels easterly along the Abbott Road corridor, and discharges to the Hazeldean Pumping Station, located east of Terry Fox Drive. A new trunk sewer (Fernbank CDP Trunk) will be constructed in the same corridor to augment the capacity of the Stittsville Trunk Sewer, with the new sewer being the outlet for virtually all of the Fernbank area. Some upgrades will be required at the Hazeldean Pumping Station to support the full development of the area.

The MSS indicates that the Stittsville Trunk Sewer is at capacity west of Iber Road, but has some residual capacity in the lower reaches. The minor amount of flow introduced by the school will not have a significant impact on the capacity of this existing 750 mm diameter pipe. The MSS does not specifically indicate that the school lands at 5315 Abbott Street will discharge into the Stittsville Trunk, as this decision was made at a later date by Novatech Engineering Consultants to permit servicing of the school in advance of the construction of the Fernbank CDP Trunk Sewer.

The existing sanitary service from the site is a 250 mm diameter sewer at a slope of 2%. This size and slope of sewer provides a capacity of 87.7 L/s. The sanitary service from the pavilion will be added to this existing outlet. No new connections are proposed to the 750mm diameter trunk sewer.

3.3 Review of Soil Conditions

Soil conditions have been reviewed by exp Services Inc. The geotechnical report indicated that the soil type on site is predominantly wet silty clay, which is susceptible to consolidation and settlement, especially in the event of seismic activity. A flexible pipe joint will be used at the building service connection in order to ensure the sanitary service pipe does not break in the event of settlement.

Bedding and backfill will be provided as recommended, conventional sewer materials will be utilized, and dewatering will be undertaken as necessary in accordance with the geotechnical recommendations and conditions encountered. The lowest top of pipe level for the proposed 100mm forcemain from the pavilion is 101.28m. The geotechnical report indicates that groundwater table was observed to be between 100.8 and 101.8 m. It is therefore expected that the groundwater impact on the forcemain and sewer construction will be minimal. No groundwater control issues were encountered during the construction of the existing development.

3.4 Description of Existing Sanitary Sewer

The outlet sanitary sewer is a 250mm diameter PVC sewer located off of Abbott Street.

3.5 Verification of Available Capacity in Downstream Sewer

The 250mm diameter sanitary sewer provided to the site by the developer has a capacity of 87.7 L/s, which is well in excess of the anticipated peak flows calculated by the methods outlined above. As noted in earlier sections, the receiving Stittsville Trunk Sewer has been deemed to have some additional capacity within this reach, and the flow from this site will have an insignificant impact on this sewer.

3.6 Calculations for Sanitary Sewers

The peak sanitary flow from the pavilion is estimated as 4.4 L/s. The required pumping station is included within the building as part of the mechanical design. A 75mm diameter forcemain, and 150mm diameter gravity sewer, with the latter having slopes of 0.9% and 1.55% in its two segments, will have adequate capacity to convey the pumped flow to the 250mm sanitary outlet sewer.

3.7 Description of Proposed Sewer Network

In addition to the piping described in Section 3.6, two additional 1200mm diameter sanitary manholes, designated as SANMH17-1 and 17-2, will be provided on the new 150mm gravity sewer. A new inlet will be required to existing SANMH2 at the southeast corner of the site.

3.8 Environmental Constraints

There are no previously identified environmental constraints that impact the sanitary servicing design in order to preserve the physical condition of watercourses, vegetation, or soil cover, or to manage water quantity or quality.

3.9 Pumping Requirements

The proposed development will have no impact on existing pumping stations and will not require new pumping facilities, other than as part of the plumbing system for the proposed pavilion. As noted in the Master Servicing Study, some upgrades will be required to the Hazeldean Pumping Station at later stages of development of the Fernbank community.

3.10 Force-Mains

A 75mm diameter force-main is proposed between the new pavilion and new SANMH17-2. This forcemain will generally follow a vertical alignment based on maintaining 2 metres of cover. No changes in existing downstream forcemains are required specifically for the proposed additional development on this site.

3.11 Emergency Overflows from Sanitary Pumping Stations

The small sanitary pumping facility proposed for the pavilion building will be a duplex system, with backup power. In the event of failure of the pump station and/or the primary and backup power systems, the facility will be shut down until repairs can be made. No provision is therefore necessary for emergency overflows.

3.12 Special Considerations

Site investigations have not yielded the need for special considerations for sanitary sewer design related to contamination, corrosive environments, or any other issue. Clay dykes in service trenches, flexible joints at structures, and specific bedding requirements related to soil conditions have been addressed in the design notes and plan on Drawing C003.

4. STORMWATER SERVICING

4.1 Description of Drainage Outlets and Downstream Constraints

The existing piped drainage outlet from the site is a 975 mm diameter storm sewer on the east boundary of the site. The sewer discharges to an interim channel and treatment facility off-site. In the future, it is anticipated that the sewer may discharge to a municipal sewer on Robert Grant Avenue.

The allowable flow release from the site has been set at 850 L/s, and remains unchanged from the existing condition.

Flows exceeding 850 L/s up to the 100 year storm have to be temporarily detained on site and released at a rate not exceeding 850 L/s.

The geotechnical investigation determined that the water table on the site ranged in elevation between 100.8 m and 101.8 m. All proposed subdrains are above 101.8 m. The entire storm sewer network is higher than 100.8 m, but several segments have pipe inverts below 101.8 m. There is the possibility of some groundwater infiltration into the storm sewer network. Standard sewer design methods use an infiltration allowance of 0.28 L/s/ha, which when used for this 6 ha site, would result in a design allowance of 1.68 L/s. As noted on the storm sewer design table in Appendix A, the 5 year design flow for the sewer network is 837.7 L/s. Infiltration is therefore not anticipated to be a significant proportion of the allowable release rate of 850 L/s.

4.2 Analysis of Available Capacity in Existing Public Infrastructure

As the allowable release rate from the site will be unchanged, and was determined in conjunction with the design of the public infrastructure, there are no concerns related to the adequacy and available capacity of the downstream network.

4.3 Drainage Drawing

Drawing C002 provides proposed grading and drainage, and includes existing grading information. Drawing C003 illustrates sections of the existing site storm sewer network that are being removed. Drawing C004 indicates the proposed new sections of the storm sewer network. A drainage sub-area plan is provided on Drawing C001, with a breakdown of subarea information, based on the proposed site plan changes. Sub-area information is also provided on the storm sewer design sheet attached to this report in Appendix A.

4.4 Water Quantity Control Objective

The water quantity objective for the entire site is to limit the flow release to 850 L/s.

Stormwater storage calculations are shown in Section 4.10 of this report. Detention stormwater storage is presently provided on the school roof, and is not being changed in this present site plan amendment. No new additional roof storage is proposed. Ground surface storage areas provided in the original design have been modified to accommodate the increased flow rate generated by the new impervious surfaces.

No quantity control is required on the site to accommodate any flow from the adjacent lands. All flows exceeding the defined minor system capacity and on-site storage capability will enter the major system, with overflow from the site at the northeast corner, consistent with existing conditions.

4.5 Water Quality Control Objective

As established in the original design, stormwater quality control treatment is required for the site based on correspondence provided by MVCA. The required quality treatment is provided in an off-site facility provided by the developer.

4.6 Description of Stormwater Management Concept

The drainage system for the site consists of a series of catch basins, manholes, catch basin manholes, and storm sewers leading to the 975 mm outlet sewer.

The existing school roof is provided with 30 controlled flow roof drains, generating a flow of 1.9 L/s per drain at the maximum storage depth of 150 mm on the roof. The release rate of 1.9 L/s is a design characteristic of the type of roof drain specified. The estimated storage calculations are provided in Section 4.10.

Ground level surface ponding will be provided in 6 ground surface areas, controlled by a flow regulator at the outlet sewer. The maximum depth of surface ponding will be 300 mm. The ponding limits, areas, depths and volumes are noted on Drawing C002.

Calculations for the storage requirements and the outlet flow regulator are provided in subsequent sections.

4.7 Setback from Sewage Disposal Systems, Water Courses, and Hazard Lands

There are no required setbacks from sewage disposal systems, water courses or hazard lands that apply to works on the site.

4.8 Pre-Consultation with Ontario Ministry of the Environment and Conservation Authority

As no changes will be made to off-site flow rates or infrastructure that requires MVCA approval, no pre-consultation has been initiated with the Mississippi Valley Conservation Authority for the proposed site plan amendment. A copy of the response provided by the MVCA for the original school development is provided in Appendix C to this report.

No pre-consultation with the Ottawa District office of the Ontario Ministry of the Environment and Climate Change has been initiated. The original site development did not require an Environmental Compliance Approval (ECA), and the changes being proposed also do not require an ECA.

4.9 Consistency with Higher Level Studies

The stormwater management design for the site is consistent with the requirements established at the time of the original site development. Quality control is provided off-site in the interim in a temporary pond servicing the school site, and at a later date in a communal pond downstream. The quality control design provided by the developer will be required to adhere to all applicable policies and guidelines of the Mississippi Valley Conservation Authority, the City of Ottawa, MOCC and other approvals agencies, as stated in Section 6.1.1 of the Fernbank Community Design Plan Master Servicing Study.

Community quantity control requirements are also listed in Section 6.1.1 of the MSS. The site specific requirements were provided in e-mail correspondence dated November 15, 2013 from

Novatech Engineering Consultants to GENIVAR (now WSP). That correspondence indicated an allowable stormwater release rate of 850 L/s, with storage required up to the 100 year event.

4.10 Storage Requirements and Conveyance Capacity

Detention stormwater storage is required on the site so that the discharge generated by the 6.0176 ha area up to the 100 year event does not exceed the allowable release rate of 850 L/s calculated for the site.

The ultimate development (including the future bus loop, portable classrooms and school additions, plus the proposed dome and pavilion) includes the following areas:

Paved surfaces, pathways and roof areas 3.4808 ha.

Landscaped surfaces 2.4552 ha.

Gravel surface 0.0816 ha for pathways. Interim gravel surfaced fire route will be removed in the ultimate development.

Assigning a runoff coefficient of 0.9 to the impervious areas, a coefficient of 0.7 for the gravel surfaces, and a coefficient of 0.25 to the landscaped area yields a weighted average runoff coefficient of 0.632 for the entire site. Under 100 year conditions, the coefficient for the pervious and gravel areas is increased by 25%, and the impervious area coefficient is increased to 1.0, yielding a weighted average runoff coefficient of 0.718.

The required volume of storage is calculated using the modified Rational Method as indicated in the following tables calculated for the drainage area of 6.0176 ha.

Flows are calculated using the Rational Method with the formula $Q = 2.78 \times C \times I \times A$, where

- Q = flow in litres per second. C = runoff coefficient
- I = rainfall intensity (from City of Ottawa Sewer Design Guidelines)
- A = drainage area in hectares

Required storage is calculated by determining the difference between actual and allowable flow rates for the site, and multiplying by the associated duration.

TABLE 4.1 100 YEAR STORAGE REQUIREMENTS

For 100 year storm event (C = 0.721 and area = 6.0176 ha)

| Duration Minutes | Intensity mm/hr | Q L/s | Q Allowable L/s | Difference L/s | Storage m ³ |
|------------------|-----------------|-------|-----------------|----------------|------------------------|
| 5 | 242.6 | 2914 | 850 | 2064 | 619 |
| 10 | 179.0 | 2150 | 850 | 1300 | 780 |
| 15 | 146.8 | 1763 | 850 | 913 | 822 |
| 20 | 119.95 | 1441 | 850 | 591 | 709 |
| 25 | 103.85 | 1247 | 850 | 397 | 596 |
| 30 | 91.90 | 1104 | 850 | 254 | 457 |
| 35 | 82.58 | 992 | 850 | 142 | 298 |

A required volume of 822 m³ is indicated for the 100 year event.

TABLE 4.2 5 YEAR STORAGE REQUIREMENTS

For 5 year storm event (C = 0.632 and area = 6.0176 ha)

| Duration Minutes | Intensity mm/hr | Q L/s | Q allowed L/s | Difference L/s | Storage m ³ |
|---------------------|--------------------|----------|------------------|-------------------|---------------------------|
| 5 | 140.20 | 1482 | 850 | 632 | 190 |
| 10 | 104.40 | 1104 | 850 | 254 | 152 |
| 15 | 85.60 | 905 | 850 | 55 | 50 |

A required storage volume of 190 m³ is indicated for the 5 year event.

Detention stormwater storage will be provided on-site using roof top and ground surface storage.

Storage on the school roof was calculated only for the initial phase of development. Storage on future roof expansion areas was not assumed. The roof is provided with 30 flow controlled roof drains, each delivering a maximum flow of 1.9 L/s at the maximum ponding depth of 150 mm.

The roof can be divided into 12 separate segments, with each segment being an independent surface. The locations of the roof areas are shown in Figure 1 in Appendix B, copied from the original site servicing report. The areas and number of drains associated with each of these segments is provided in the following table.

TABLE 4.3 ROOF STORAGE – AREA, DEPTH AND PHYSICAL VOLUME

| Roof Segment | No. of Drains | Ponding Area (m ²) | Ponding Depth (m) | Theoretical Storage Volume (m ³) |
|--------------|---------------|--------------------------------|-------------------|--|
| R1 | 1 | 25 | 0.15 | 0.3 |
| R2 | 2 | 349 | 0.15 | 8.7 |
| R3 | 3 | 615 | 0.15 | 29.2 |
| R4 | 2 | 249 | 0.15 | 11.8 |
| R5 | 4 | 1402 | 0.15 | 66.6 |
| R6 | 2 | 188 | 0.15 | 8.9 |
| R7 | 2 | 873 | 0.15 | 41.5 |
| R8 | 6 | 1240 | 0.15 | 52.9 |
| R9 | 2 | 779 | 0.15 | 37.0 |
| R10 | 2 | 806 | 0.15 | 38.3 |
| R11 | 2 | 165 | 0.11 | 5.7 |
| R12 | 2 | 160 | 0.14 | 7.1 |

The theoretical storage volume provided in the table above is based on the physical dimensions of the roof, and is calculated using the formula for an inverted pyramid (Volume = area x depth / 3). The areas shown above were further reduced by 5% to allow for roof top equipment displacing available storage, and for Segment R8, the area of the skylights (126 m²) was also deleted. The 5% reduction is an arbitrary number, but was selected so that the volume of ponding available is not overestimated. The size of roof top equipment will vary, but not to the

extent that it would exceed 5% of the roof space available. As will be noted below the physical storage available on the roof in almost all cases does not govern the storage available, so the 5% value is not of significance in estimating the storage available.

In determining the actual amount of storage that can be achieved, it is necessary to also complete a flow balance analysis, comparing incoming rainfall to the discharge rate from the drains. In some cases, the amount of runoff generated is less than the physical capacity of the storage volume available. The rainfall balance analysis is also completed using the Modified Rational Method, with the incoming flow calculated using the Rational Method, and the outgoing flow determined by the number of drains multiplied by a flow rate of 1.9 L/s per drain. The rainfall balance for each of the roof segments is provided in the tables below for the 100 year condition.

TABLE 4.4 ROOF SEGMENT R1 – STORAGE CALCULATED BY FLOW BALANCE

| Duration Minutes | Intensity mm/hr | Q in L/s | Q out L/s | Difference L/s | Storage m ³ |
|------------------|-----------------|----------|-----------|----------------|------------------------|
| 5 | 242.6 | 1.7 | 1.9 | 0 | 0 |
| 10 | 179.0 | 1.2 | 1.9 | 0 | 0 |

TABLE 4.5 ROOF SEGMENT R2 – STORAGE CALCULATED BY FLOW BALANCE

| Duration Minutes | Intensity mm/hr | Q in L/s | Q out L/s | Difference L/s | Storage m ³ |
|------------------|-----------------|----------|-----------|----------------|------------------------|
| 5 | 242.6 | 23.5 | 3.8 | 19.7 | 5.9 |
| 10 | 179.0 | 17.4 | 3.8 | 13.6 | 8.2 |
| 15 | 146.8 | 14.2 | 3.8 | 10.4 | 9.4 |
| 20 | 119.95 | 11.6 | 3.8 | 7.8 | 9.4 |
| 25 | 103.85 | 10.1 | 3.8 | 6.3 | 9.4 |
| 30 | 91.90 | 8.9 | 3.8 | 5.1 | 9.2 |
| 35 | 82.58 | 8.0 | 3.8 | 4.2 | 8.8 |

TABLE 4.6 ROOF SEGMENT R3 – STORAGE CALCULATED BY FLOW BALANCE

| Duration Minutes | Intensity mm/hr | Q in L/s | Q out L/s | Difference L/s | Storage m ³ |
|------------------|-----------------|----------|-----------|----------------|------------------------|
| 5 | 242.6 | 41.5 | 5.7 | 35.8 | 10.7 |
| 10 | 179.0 | 30.6 | 5.7 | 24.9 | 14.9 |
| 15 | 146.8 | 25.1 | 5.7 | 19.4 | 17.5 |
| 20 | 119.95 | 20.5 | 5.7 | 14.8 | 17.8 |
| 25 | 103.85 | 17.8 | 5.7 | 12.1 | 18.2 |
| 30 | 91.90 | 15.7 | 5.7 | 10.0 | 18.0 |
| 35 | 82.58 | 14.1 | 5.7 | 8.4 | 17.6 |

TABLE 4.7 ROOF SEGMENT R4 – STORAGE CALCULATED BY FLOW BALANCE

| Duration Minutes | Intensity mm/hr | Q in L/s | Q out L/s | Difference L/s | Storage m ³ |
|------------------|-----------------|----------|-----------|----------------|------------------------|
| 5 | 242.6 | 16.8 | 3.8 | 13.0 | 3.9 |
| 10 | 179.0 | 12.4 | 3.8 | 8.6 | 5.2 |
| 15 | 146.8 | 10.2 | 3.8 | 6.4 | 5.8 |
| 20 | 119.95 | 8.3 | 3.8 | 4.5 | 5.4 |
| 25 | 103.85 | 7.2 | 3.8 | 3.4 | 5.1 |
| 30 | 91.90 | 6.4 | 3.8 | 2.6 | 4.7 |
| 35 | 82.58 | 5.7 | 3.8 | 1.9 | 4.0 |

TABLE 4.8 ROOF SEGMENT R5 – STORAGE CALCULATED BY FLOW BALANCE

| Duration Minutes | Intensity mm/hr | Q in L/s | Q out L/s | Difference L/s | Storage m ³ |
|------------------|-----------------|----------|-----------|----------------|------------------------|
| 5 | 242.6 | 94.6 | 7.6 | 87.0 | 26.1 |
| 10 | 179.0 | 69.8 | 7.6 | 62.2 | 37.3 |
| 15 | 146.8 | 57.2 | 7.6 | 49.6 | 44.6 |
| 20 | 119.95 | 46.8 | 7.6 | 39.2 | 47.0 |
| 25 | 103.85 | 40.6 | 7.6 | 33.0 | 49.5 |
| 30 | 91.90 | 36.0 | 7.6 | 28.4 | 51.1 |
| 35 | 82.58 | 32.3 | 7.6 | 24.7 | 51.9 |
| 40 | 75.15 | 29.4 | 7.6 | 21.8 | 52.3 |
| 45 | 69.05 | 27.0 | 7.6 | 19.4 | 52.4 |
| 50 | 63.95 | 25.0 | 7.6 | 17.4 | 52.2 |
| 55 | 59.62 | 23.3 | 7.6 | 15.7 | 51.8 |
| 60 | 53.20 | 20.7 | 7.6 | 13.1 | 47.2 |

TABLE 4.9 ROOF SEGMENT R6 – STORAGE CALCULATED BY FLOW BALANCE

| Duration Minutes | Intensity mm/hr | Q in L/s | Q out L/s | Difference L/s | Storage m ³ |
|------------------|-----------------|----------|-----------|----------------|------------------------|
| 5 | 242.6 | 12.7 | 3.8 | 8.9 | 2.7 |
| 10 | 179.0 | 9.4 | 3.8 | 5.6 | 3.4 |
| 15 | 146.8 | 7.7 | 3.8 | 3.9 | 3.5 |
| 20 | 119.95 | 6.3 | 3.8 | 2.5 | 3.0 |
| 25 | 103.85 | 5.4 | 3.8 | 1.6 | 2.4 |
| 30 | 91.90 | 4.8 | 3.8 | 1.0 | 1.8 |
| 35 | 82.58 | 4.3 | 3.8 | 0.5 | 1.2 |

TABLE 4.10 ROOF SEGMENT R7 – STORAGE CALCULATED BY FLOW BALANCE

| Duration Minutes | Intensity mm/hr | Q in L/s | Q out L/s | Difference L/s | Storage m ³ |
|------------------|-----------------|----------|-----------|----------------|------------------------|
| 5 | 242.6 | 58.8 | 3.8 | 55.0 | 16.5 |
| 10 | 179.0 | 43.4 | 3.8 | 39.6 | 23.8 |
| 15 | 146.8 | 35.6 | 3.8 | 31.8 | 28.6 |
| 20 | 119.95 | 29.1 | 3.8 | 25.3 | 30.4 |
| 25 | 103.85 | 25.2 | 3.8 | 21.4 | 32.1 |
| 30 | 91.90 | 22.3 | 3.8 | 18.5 | 33.3 |
| 35 | 82.58 | 20.0 | 3.8 | 16.2 | 34.0 |
| 40 | 75.15 | 18.2 | 3.8 | 14.4 | 34.6 |
| 45 | 69.05 | 16.8 | 3.8 | 13.0 | 35.1 |
| 50 | 63.95 | 15.5 | 3.8 | 11.7 | 35.1 |
| 55 | 59.62 | 14.5 | 3.8 | 10.7 | 35.3 |
| 60 | 53.20 | 12.9 | 3.8 | 9.1 | 32.8 |

TABLE 4.11 ROOF SEGMENT R8 – STORAGE CALCULATED BY FLOW BALANCE

| Duration Minutes | Intensity mm/hr | Q in L/s | Q out L/s | Difference L/s | Storage m ³ |
|------------------|-----------------|----------|-----------|----------------|------------------------|
| 5 | 242.6 | 83.6 | 11.4 | 72.2 | 21.7 |
| 10 | 179.0 | 61.7 | 11.4 | 50.3 | 30.2 |
| 15 | 146.8 | 50.6 | 11.4 | 39.2 | 35.3 |
| 20 | 119.95 | 41.3 | 11.4 | 29.9 | 35.9 |
| 25 | 103.85 | 35.8 | 11.4 | 24.4 | 36.6 |
| 30 | 91.90 | 31.7 | 11.4 | 20.3 | 36.5 |
| 35 | 82.58 | 28.5 | 11.4 | 17.1 | 35.9 |

TABLE 4.12 ROOF SEGMENT R9 – STORAGE CALCULATED BY FLOW BALANCE

| Duration Minutes | Intensity mm/hr | Q in L/s | Q out L/s | Difference L/s | Storage m ³ |
|------------------|-----------------|----------|-----------|----------------|------------------------|
| 5 | 242.6 | 52.5 | 3.8 | 48.7 | 14.6 |
| 10 | 179.0 | 38.8 | 3.8 | 35.0 | 21.0 |
| 15 | 146.8 | 31.8 | 3.8 | 28.0 | 25.2 |
| 20 | 119.95 | 26.0 | 3.8 | 22.2 | 26.6 |
| 25 | 103.85 | 22.5 | 3.8 | 18.7 | 28.1 |
| 30 | 91.90 | 19.9 | 3.8 | 16.1 | 29.0 |
| 35 | 82.58 | 17.9 | 3.8 | 14.1 | 29.6 |
| 40 | 75.15 | 16.3 | 3.8 | 12.5 | 30.0 |
| 45 | 69.05 | 15.0 | 3.8 | 11.2 | 30.2 |
| 50 | 63.95 | 13.8 | 3.8 | 10.0 | 30.0 |
| 55 | 59.62 | 12.9 | 3.8 | 9.1 | 30.0 |
| 60 | 53.20 | 11.5 | 3.8 | 7.7 | 27.7 |

TABLE 4.13 ROOF SEGMENT R10 – STORAGE CALCULATED BY FLOW BALANCE

| Duration Minutes | Intensity mm/hr | Q in L/s | Q out L/s | Difference L/s | Storage m ³ |
|---------------------|--------------------|-------------|--------------|-------------------|---------------------------|
| 5 | 242.6 | 54.4 | 3.8 | 50.6 | 15.2 |
| 10 | 179.0 | 40.1 | 3.8 | 36.3 | 21.8 |
| 15 | 146.8 | 32.9 | 3.8 | 29.1 | 26.2 |
| 20 | 119.95 | 26.9 | 3.8 | 23.1 | 27.7 |
| 25 | 103.85 | 23.3 | 3.8 | 19.5 | 29.3 |
| 30 | 91.90 | 20.6 | 3.8 | 16.8 | 30.2 |
| 35 | 82.58 | 18.5 | 3.8 | 14.7 | 30.9 |
| 40 | 75.15 | 16.8 | 3.8 | 13.0 | 31.2 |
| 45 | 69.05 | 15.5 | 3.8 | 11.7 | 31.6 |
| 50 | 63.95 | 14.3 | 3.8 | 10.5 | 31.5 |
| 55 | 59.62 | 13.4 | 3.8 | 9.6 | 31.5 |
| 60 | 53.20 | 11.9 | 3.8 | 8.1 | 29.2 |

TABLE 4.14 ROOF SEGMENT R11 – STORAGE CALCULATED BY FLOW BALANCE

| Duration Minutes | Intensity mm/hr | Q in L/s | Q out L/s | Difference L/s | Storage m ³ |
|---------------------|--------------------|-------------|--------------|-------------------|---------------------------|
| 5 | 242.6 | 11.1 | 3.8 | 7.3 | 2.2 |
| 10 | 179.0 | 8.2 | 3.8 | 4.4 | 2.6 |
| 15 | 146.8 | 6.7 | 3.8 | 2.9 | 2.6 |
| 20 | 119.95 | 5.5 | 3.8 | 1.7 | 2.0 |
| 25 | 103.85 | 4.8 | 3.8 | 1.0 | 1.5 |
| 30 | 91.90 | 4.2 | 3.8 | 0.4 | 0.7 |
| 35 | 82.58 | 3.8 | 3.8 | 0 | 0 |

TABLE 4.15 ROOF SEGMENT R12 – STORAGE CALCULATED BY FLOW BALANCE

| Duration Minutes | Intensity mm/hr | Q in L/s | Q out L/s | Difference L/s | Storage m ³ |
|---------------------|--------------------|-------------|--------------|-------------------|---------------------------|
| 5 | 242.6 | 10.8 | 3.8 | 7.0 | 2.1 |
| 10 | 179.0 | 8.0 | 3.8 | 4.2 | 2.5 |
| 15 | 146.8 | 6.5 | 3.8 | 2.7 | 2.4 |
| 20 | 119.95 | 5.3 | 3.8 | 1.5 | 1.8 |
| 25 | 103.85 | 4.6 | 3.8 | 0.8 | 1.2 |
| 30 | 91.90 | 4.1 | 3.8 | 0.3 | 0.5 |
| 35 | 82.58 | 3.7 | 3.8 | 0 | 0 |

For all roof segments other than R2, the rainfall balance calculation yields the storage volume that can be used. For R2, the available rainfall volume exceeds the physical storage available, and therefore the physical storage based on roof geometry governs the amount of storage.

The total roof storage available is the sum of the storage in the 12 segments.

Roof storage = 0 + 8.7 + 18.2 + 5.8 + 52.4 + 3.5 + 35.3 + 36.6 + 30.2 + 31.6 + 2.6 + 2.5 = 227.4 m³.

Ground level storage is available under interim conditions is noted on Drawing C002, and again summarized in Appendix A. Storage available was calculated using the formula for an inverted pyramid, based on the maximum water surface level of 103.46 m, and a depth of 0.3 m. A summary of the surface stormwater storage is provided in Appendix A. The total for all surface stormwater storage is 890.9 m³.

The combination of roof and surface level storage = 227.4 m³ + 890.9 m³ = 1118 m³. This value exceeds the required 100 year storage requirement of 829 m³. There will be adjustments made to the surface ponding volumes if and when the future bus loop is added, but any changes made will still result in sufficient ponding volume being available.

Flow regulation is provided at manholes STMH1 and CBMH2. Flow at STMH1, which is the outlet manhole from the site, is limited to 850 L/s, which is the release rate allowed from the site as stipulated by Novatech Engineering Consultants Ltd. This release rate was determined by Novatech for this site as part of their stormwater design for the Fernbank Community. As noted earlier in this report, this release rate was provided by Novatech to GENIVAR in November 2013.

An orifice plate is used to regulate this flow as shown on Drawing C003. The maximum head of water is dictated by the overland overflow elevation of 103.46 m. The invert of the outlet pipe is 100.91 m. The orifice plate was sized using the orifice equation:

$$Q = 0.61 \times A \times (2 \times g \times H)^{0.5}, \text{ where } Q = \text{discharge rate in m}^3/\text{s},$$

$$\text{Orifice coefficient} = 0.61$$

$$A = \text{area of orifice in m}^2$$

$$g = \text{gravitational constant} = 9.81 \text{ m/s}^2$$

$$H = \text{head of water (m) above the centre of the orifice} = (103.46 - 100.91) - (0.5 \times \text{orifice diameter})$$

An orifice diameter of 514 mm provides the required flow. No change is required at STMH1.

$$Q = .61 \times A \times (2 \times g \times H)^{0.5} = 0.61 \times (\pi \times (0.514/2)^2) \times (2 \times 9.81 \times (2.55 - (0.5 \times 0.514)))^{0.5} = 849 \text{ m}^3/\text{s}$$

The flow limit at CBMH2 is calculated as the difference between the flow limit of 850 L/s and the flow entering STMH1 from the building roof and drainage sub-areas to the south, consisting of sub-areas 5, 9, 11, 12, 13 and 14. It is preferred that the flow from the south be separated from the flow entering the surface ponding areas in order to provide a less restricted flow path. The controlled flow from the roof of 0.7160 ha is limited to 57 L/s based on the use of 30 flow controlled roof drains, with a flow of 1.9 L/s per drain.

The 100 year flow from the remaining south areas is generated from 0.3296 ha of impervious surfaces, 0.0118 ha of gravel surfaces, and 0.2987 ha of landscaped surfaces. This area totals to 0.6401 ha and has a runoff coefficient of 0.593. For 100 year conditions, the runoff coefficient is increased to 0.677. The 100 year uncontrolled runoff from this area can be

estimated using the Rational Method, assuming a time of concentration of 10 minutes, and a corresponding rainfall intensity of 179 mm/hour.

$$Q = 2.78 \times C \times I \times A = 2.78 \times 0.677 \times 179 \times 0.6401 = 215.6 \text{ L/s.}$$

The desired controlled rate of flow leaving CBMH2 is therefore $850 - (57 + 215.6) = 577.4 \text{ L/s}$.

At CBMH2, the maximum head of water is again dictated by the overland overflow elevation of 103.46 m. The invert of the outlet pipe is 101.069 m. The orifice plate was sized using the orifice equation:

$$H = \text{head of water (m) above the centre of the orifice} = (103.46 - 101.069) - (0.5 \times \text{orifice diameter})$$

An orifice diameter of 429 mm provides the required flow. A new orifice plate meeting this requirement will replace the existing orifice plate.

$$Q = .61 \times A \times (2gxH)^{0.5} = 0.61 \times (\pi \times (0.429/2)^2) \times (2 \times 9.81 \times (2.391 - (0.5 \times 0.429)))^{0.5} = 0.5762 \text{ m}^3/\text{s},$$

which is slightly below the maximum release rate of $0.5774 \text{ m}^3/\text{s}$.

The storage required upstream of CBMH2 to restrict the flow to 576.2 L/s can be calculated using the Modified Rational Method. The contributing sub-areas are 1 to 4, 6 to 8, 10, and 15 to 33, with a total area of 4.5039 ha. This area is comprised of 2.4352 ha of impervious area, 0.0698 ha of gravel surface, and 1.9989 ha of landscaped area. The weighted average runoff coefficient is 0.608, which is increased to 0.693 for 100 year conditions.

TABLE 4.16 100 YEAR STORAGE REQUIREMENTS UPSTREAM OF CBMH2

For 100 year storm event (C = 0.693 and area = 4.5039 ha)

| Duration Minutes | Intensity mm/hr | Q L/s | Q Allowable L/s | Difference L/s | Storage m ³ |
|------------------|-----------------|-------|-----------------|----------------|------------------------|
| 5 | 242.6 | 2105 | 576.2 | 1529 | 458.7 |
| 10 | 179.0 | 1554 | 576.2 | 977.8 | 586.7 |
| 15 | 146.8 | 1274 | 576.2 | 697.8 | 628.0 |
| 20 | 119.95 | 1041 | 576.2 | 464.8 | 557.8 |
| 25 | 103.85 | 901 | 576.2 | 324.8 | 487.2 |
| 30 | 91.90 | 797 | 576.2 | 220.8 | 397.4 |
| 35 | 82.58 | 717 | 576.2 | 140.8 | 295.7 |

A required volume of 628 m^3 is indicated for the 100 year event. This volume is easily provided by the upstream surface detention ponding which has an available volume of 890.9 m^3 .

4.11 Watercourses

No alterations to watercourses are required as a result of this proposed site plan amendment.

4.12 Pre and Post Development Peak Flow Rates

The existing site has an allowable release rate of 850 L/s for all storm events up to 100 years. No modification to this rate is proposed for the site plan amendment.

As noted on the storm sewer design sheets for this report and the original servicing report, the 5 year design flow rate from the storm sewer system is increasing from 727.9 L/s to 819.4 L/s without taking into account any flow controls. As the controlled outflow rate from the site is 850 L/s, there will be no surface ponding at 5 year and lesser storm events. Under the proposed conditions for the site plan amendment, the five year flow rate at CBMH2 will be restricted to 576.2 L/s as compared to the original site design 5 year rate at this location of 500.9 L/s.

Post-development peak flow rates under 5 and 100 year conditions are provided in Section 4.10 above for several different return periods as part of the storage calculations.

The drainage area plan on Drawing C001, and the storm sewer design sheet describe the post-development drainage areas and extent of imperviousness.

As noted, peak flows up to the 100 year event will be attenuated to not exceed the allowable release rate of 850 L/s.

4.13 Diversion of Drainage Catchment Areas

There will be no major diversion of on-site drainage catchment areas arising from the proposed work described in this report. Drainage from the site itself is diverted to the off-site treatment facility prior to rejoining with the existing outlet channel. Off-site drainage has been diverted around the west and north perimeter of the site at the time of original site development.

4.14 Minor and Major Systems

Proposed minor and major systems are shown on Drawings C004 and C005, and have been described in previous sections of the report. The minor site storm sewer system is described on the attached storm sewer calculation sheets. The 10 minute minimum inlet time is the standard utilized by the City of Ottawa for the design of municipal storm sewer systems as per clause 5.1.4 of the Sewer Design Guidelines, Second Edition, Document SDG002, October 2012.

The proposed stormwater management facility includes roof top and ground level storage, and flow regulation at the outlet manholes. Quality treatment will be provided off-site by others. Stormwater will back up into the storage areas when incoming flows exceed the allowable system release rate, and will be released over an extended period as incoming flows diminish and cease.

4.15 Downstream Capacity Where Quantity Control Is Not Proposed

This checklist item is not applicable to this development as quantity control is provided.

4.16 Impacts to Receiving Watercourses

The impact to the receiving watercourse has been mitigated through conformance with regulatory requirements for quantity and quality control.

4.17 Municipal Drains and Related Approvals

No municipal drains are located on the site.

4.18 Means of Conveyance and Storage Capacity

The means of flow conveyance and storage capacity are described in Sections 4.6, 4.10 and 4.14 above.

4.19 100 Year Flood Levels and Major Flow Routing

The overflow from the site will be to the north-east of the property in the direction of the existing overland flow.

4.20 Hydraulic Analysis

Hydraulic calculations for the site storm sewers are provided in the storm sewer design sheet. The maximum hydraulic grade line is defined by the maximum stormwater overflow elevation of 103.46 m.

4.21 Erosion and Sediment Control Plan

This document addresses the City of Ottawa's requirement for an Erosion and Sediment Control Plan for the proposed construction.

Drawing C001 includes requirements for the Contractor to implement Best Management Practices to minimize erosion and sediment release during construction activities. Specific measures are dictated including SiltSack from Terrafix or approved alternative filter at catch basins and catch basin manholes, and a temporary silt control fence installed as per OPSD 219.110.

Erosion control measures are also listed on Drawing C001, including the need to minimize areas of disturbed soil, prevent runoff from flowing across disturbed areas, reinstatement or protection of disturbed surfaces as soon as possible, and temporary protection of disturbed areas and stockpiles that have to be in place for extended periods of time.

The Architect, as lead consultant, is responsible for ensuring contractual compliance with the construction specifications, including erosion and sediment control. The Engineer will be retained to provide periodic site observations and will also monitor the condition of the erosion and sediment control measures.

It is anticipated that the measures outlined above will prove adequate for erosion and sediment control. Site inspection personnel will have the authority based on the Contract Documents to require additional control measures as necessary should the contractor's operations result in soil tracking or other offsite transfer of sediment and soil.

4.22 Identification of Floodplains

There are no designated floodplains on the site.

4.23 Fill Constraints

There are no specific fill constraints applicable to this site. The proposed grade raise and finished floor elevation have been considered in the geotechnical engineering report recommendations.

5. APPROVAL AND PERMIT REQUIREMENTS

The proposed development is subject to site plan amendment approval and building permit approval.

No approvals related to municipal drains are required.

No permits or approvals are anticipated to be required for the School Board from the Ontario Ministry of Transportation, National Capital Commission, Parks Canada, Public Works and Government Services Canada, or any other provincial or federal regulatory agency.

6. CONCLUSION CHECKLIST

6.1 Conclusions and Recommendations

It is concluded that the proposed development can meet all provided servicing constraints and associated requirements. It is recommended that this report be submitted to the City of Ottawa in support of the application for site plan approval.

6.2 Comments Received from Review Agencies

The MVCA comments from the original site development are included in Appendix C of this report. No other review agency comments have been submitted, with the exception of engineering review comments from the City of Ottawa.

6.3 Signature and Professional Stamp

| | |
|---|--|
| <p>Report prepared by:</p> <p>WSP Canada</p> <p>James C. Johnston, P.Eng.</p> <p>2611 Queensview Drive, Suite 300 Ottawa, Ontario K2B 8K2</p> |  |
|---|--|

APPENDIX A

STORM SEWER DESIGN SHEET

SURFACE STORMWATER STORAGE CALCULATIONS

Storm Sewer Calculation Sheet (Rational Method) Manning's Coefficient = 0.013 Return Period = 5 years. Minimum Inlet Time = 10 minutes.

| Local Drainage Area | LOCATION | | R = 0.9 | AREA (Ha) | | | | FLOW | | | | | Dia. (mm) | Type | Slope (%) | Length (M) | Capacity (L/s) | Velocity (m/s) | Time of Flow (min.) | Ratio Q/Q full |
|---------------------------|--------------|----------|------------|------------|-------------|---------------|-------------------|-------------------|---------------------|-----------------------|-------------------------|-----|--------------|-------|--------------|---------------|-------------------|-------------------|------------------------------|----------------------|
| | | | | R = 0.7 | R = 0.25 | Total Area | Indiv. 2.78 AC | Accum. 2.78 AC | Time of Conc. | Rainfall Intensity | Peak Flow Q (L/s) | | | | | | | | | |
| | From Node | To Node | | | | | | | | | | | | | | | | | | |
| 14 | CBMH 18 | CBMH 13 | .0423 | | .0437 | .0860 | .1362 | .1362 | 10 | 104.4 | 14.2 | 250 | PVC | 0.432 | 32.2 | 40.8 | 0.8 | 0.67 | 0.35 | |
| 13 | CBMH 13 | CBMH 12 | .0011 | | .0339 | .0350 | .0263 | .1625 | 10.67 | 100.8 | 16.4 | 300 | PVC | 0.34 | 89.9 | 58.4 | 0.8 | 1.87 | 0.28 | |
| 11 | CBMH 12 | CBMH 10 | .0767 | | .0471 | .1238 | .2246 | .3871 | 12.54 | 92.5 | 35.8 | 450 | CON | 0.195 | 49.6 | 131.4 | 0.8 | 1.03 | 0.27 | |
| 5 | DCB 16 | STMH 8 | .1258 | | .0594 | .1852 | .3560 | .3560 | 10 | 104.4 | 37.2 | 300 | PVC | 0.34 | 42.5 | 58.4 | 0.8 | 0.89 | 0.64 | |
| 12 | ROOF | STMH 8 | .7160 | | | .7160 | 1.7914 | 1.7914 | 10 | 104.4 | 187.0* | 450 | CON | 2.75 | 22.5 | 493.2 | 3.0 | 0.12 | 0.38 | |
| - | STMH 8 | STMH 9 | | | | | | 2.1474 | 10.89 | 99.7 | 214.1 | 525 | CON | 0.3 | 33.0 | 245.7 | 1.1 | 0.50 | 0.87 | |
| - | STMH 9 | CBMH 10 | | | | | | 2.1474 | 11.39 | 97.4 | 209.2 | 600 | CON | 0.19 | 30.6 | 279.2 | 0.96 | 0.53 | 0.75 | |
| 9 | CBMH 10 | STMH 1 | .0837 | .0118 | .1146 | .2101 | .3120 | 2.8465 | 13.57 | 88.5 | 251.9 | 675 | CON | 0.15 | 61.0 | 339.6 | 0.92 | 1.10 | 0.74 | |
| 1 | CBMH 17 | CBMH 16 | .0095 | | .1087 | .1182 | .0993 | .0993 | 10 | 104.4 | 10.4 | 250 | PVC | 0.432 | 47.4 | 40.8 | 0.8 | 0.99 | 0.25 | |
| 2 | CBMH 16 | CBMH 15 | .2229 | | .0496 | .2725 | .5922 | .6915 | 10.99 | 99.2 | 68.6 | 375 | PVC | 0.40 | 51.3 | 115.7 | 1.01 | 0.85 | 0.59 | |
| 15, 26 | LCB17-29 | CBMH17-4 | .2058 | .0151 | .0880 | .3089 | .6055 | .6055 | 10 | 104.4 | 63.2 | 300 | HDPE | 0.5 | 74.0 | 71.3 | 0.98 | 1.26 | 0.89 | |
| 16 | CBMH17-4 | CBMH17-2 | .1310 | | .0539 | .1849 | .3652 | .9707 | 11.26 | 98.0 | 95.1 | 375 | PVC | 0.5 | 26.5 | 129.3 | 1.13 | 0.39 | 0.74 | |
| 3, 4 | CBMH15 | CBMH17-2 | .7059 | | .2135 | .9194 | 1.9145 | 2.6060 | 11.84 | 95.4 | 248.6 | 600 | CON | 0.21 | 61.5 | 293.5 | 1.01 | 1.01 | 0.85 | |
| | CBMH17-2 | CBMH17-3 | | | | | | 3.5767 | 12.85 | 91.2 | 326.2 | 600 | CON | 0.26 | 22.0 | 326.6 | 1.12 | 0.33 | 1.00 | |
| 17 | PAVILION | MAIN | .0581 | | | .0581 | .1454 | .1454 | 10 | 104.4 | 15.2 | 200 | PVC | 1.0 | 8.0 | 34.2 | 1.06 | 0.13 | 0.44 | |
| 33 | CBMH17-3 | STMH17-1 | .0184 | | .0139 | .0323 | .0557 | 3.7778 | 13.97 | 87.0 | 328.7 | 600 | CON | 0.29 | 53.0 | 345.1 | 1.18 | 0.75 | 0.95 | |
| 10 | CB 14 | STMH17-1 | .0380 | | .0863 | .1243 | .1551 | .1551 | 10 | 104.4 | 16.2 | 300 | PVC | 0.34 | 45.8 | 58.4 | 0.8 | 0.95 | 0.28 | |
| 6, 18, 19, 21, 25 | STMH17-1 | STMH3 | .2467 | .0040 | .0946 | .3453 | .6908 | 4.6237 | 15.15 | 83.1 | 384.2 | 675 | CON | 0.22 | 33.0 | 411.3 | 1.11 | 0.50 | 0.93 | |
| 27 | LCB17-1 | LCB17-4 | .1912 | .0116 | .0586 | .2614 | .5417 | .5417 | 10 | 104.4 | 56.6 | 300 | HDPE | 0.5 | 60.2 | 71.3 | 0.98 | 1.02 | 0.79 | |
| 28 | LCB17-4 | CBMH6 | .1091 | .0095 | .0454 | .1640 | .3230 | .8647 | 11.02 | 99.1 | 85.7 | 375 | HDPE | 0.5 | 86.0 | 129.3 | 1.13 | 1.27 | 0.66 | |
| 31 | LCB17-14 | CBMH6 | .0069 | .0028 | .0607 | .0704 | .0649 | .0649 | 10 | 104.4 | 6.8 | 250 | HDPE | 0.5 | 40.0 | 43.9 | 0.87 | 0.77 | 0.15 | |
| 29 | CBMH6 | STMH17-4 | .1430 | .0087 | .2602 | .4119 | .5556 | 1.4852 | 12.29 | 93.5 | 138.9 | 450 | CON | 0.222 | 88.0 | 139.5 | 0.85 | 1.73 | 1.00 | |
| 30 | LCB17-12 | STMH17-4 | .1117 | .0072 | .1682 | .2871 | .4104 | .4104 | 10 | 104.4 | 42.8 | 250 | HDPE | 0.5 | 6.0 | 43.9 | 0.87 | 0.03 | 0.97 | |
| | STMH17-4 | STMH5 | | | | | | 1.8956 | 14.02 | 86.9 | 164.7 | 525 | CON | 0.22 | 6.5 | 210.4 | 0.94 | 0.12 | 0.78 | |
| 24, 20 | STMH5 | STMH3 | .1396 | .0047 | .0168 | .1611 | .3701 | 2.2657 | 14.14 | 86.4 | 195.8 | 600 | CON | 0.124 | 48.0 | 225.5 | 0.78 | 1.03 | 0.87 | |
| 7, 22 | STMH3 | CBMH2 | .0492 | | .0890 | .1382 | .1850 | 7.0744 | 15.65 | 81.5 | 576.7 | 825 | CON | 0.168 | 69.7 | 612.3 | 1.11 | 1.05 | 0.94 | |
| 23, 32 | LCB17-15 | CBMH2 | .0326 | | .5053 | .5379 | .4327 | .4327 | 10 | 104.4 | 45.2 | 300 | HDPE /PVC | 0.5 | 113.5 | 71.3 | 0.98 | 1.93 | 0.63 | |
| 8 | CBMH2 | STMH1 | .0156 | .0062 | .0862 | .1080 | .1110 | 7.6181 | 16.70 | 78.4 | 597.3** | 825 | CON | 0.36 | 3.9 | 898.1 | 1.63 | 0.04 | 0.67 | |
| | STMH1 | OUTLET | | | | | | 10.4646 | 16.74 | 78.3 | 819.4*** | 975 | CON | 0.2 | 6.0 | 1046 | 1.36 | 0.07 | 0.78 | |

Definitions:
 Q = 2.78 AIR, where Q = peak Flow in L/s,
 A = Areas in hectares (ha) I = Rainfall Intensity (mm/h)
 R = Runoff Coefficient

Notes:
 *Flow from controlled flow roof drains is limited to 57 L/s.
 **Flow from CBMH2 restricted to 576.2 L/s.
 *** Flow restricted to 850 L/s.

PROJECT:
 École Secondaire Catholique Paul-Desmarais
 Dome
LOCATION: 5315 Abbott Street, Ottawa, ON
File Ref.: 17M-02044-00
Revision Date: 2018-03-06
Sheet No.: 1 of 1

École Secondaire Catholique Paul-Desmarais

5315 Abbott Street, Ottawa, ON.

SURFACE STORMWATER STORAGE – EXISTING AND PROPOSED CONDITIONS – JULY 20, 2018

| Ponding Location | Existing Ponding Area (m ²) | Existing Ponding Depth (m) | Existing Ponding Volume (m ³) | Proposed Ponding Area (m ²) | Proposed Ponding Depth (m) | Proposed Ponding Volume (m ³) |
|------------------|---|----------------------------|---|---|----------------------------|---|
| CB1 | 1244 | 0.23 | 95.4 | | | |
| CB3 | 184 | 0.31 | 19.0 | | | |
| CB4 | 347 | 0.27 | 31.2 | | | |
| CB5 | 143 | 0.25 | 11.9 | | | |
| CB6 | 130 | 0.27 | 11.7 | | | |
| CB7 | 121 | 0.22 | 8.9 | | | |
| CB8 | 79 | 0.25 | 6.6 | | | |
| CB11 | | | | 439 | 0.2 | 29.3 |
| CB13 | 1110 | 0.27 | 99.9 | 399 | 0.27 | 35.9 |
| CB15 | 307 | 0.24 | 24.6 | | | |
| CBMH7 | 1110 | 0.27 | 99.9 | | | |
| CB17-3 | | | | 362 | 0.2 | 24.1 |
| CB17-4 | | | | 309 | 0.2 | 20.6 |
| CB17-6 | | | | 1010 | 0.3 | 101.0 |
| New sports field | | | | 6804 | | 680 |
| | | Total Volume | 409.1 | | Total Volume | 890.9 |

Pond volumes were estimated using the inverted pyramid formula: $\text{Volume} = \text{area} \times \text{depth} / 3$.

APPENDIX B

ROOF DRAINAGE AREA LOCATIONS (FIG. 1)

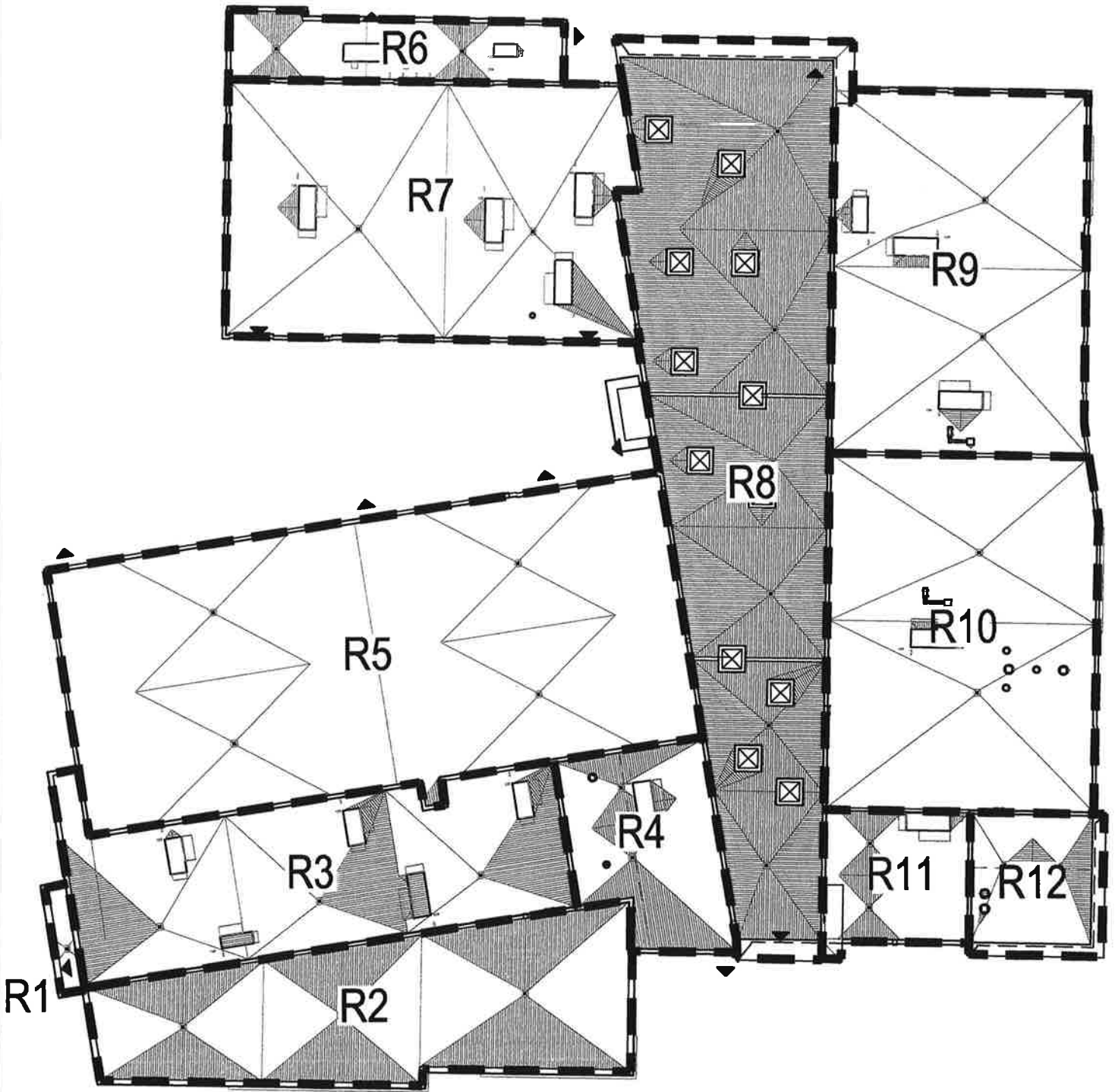

2611 QUEENSVIEW DRIVE, SUITE 300
 OTTAWA (ONTARIO) CANADA K2B 8K2
 TELEPHONE: (613) 829-2800
 FAX: (613) 829-8299

PROJECT:

ÉCOLE SECONDAIRE CATHOLIQUE
 COMMUNAUTÉ DE FERNBANK

5315 ABBOTT STREET
 OTTAWA, ONTARIO.

PROJECT NO.: 121-26221-00

DRAWING NAME:

ROOF AREAS

DATE:
 MAR 07, 2014

SCALE:
 N.T.S.

REVIEWED BY:
 J.J

DESIGNED BY:

J.J

DRAWN BY:

B.N.

SHEET:

FIG.1

APPENDIX C

CORRESPONDENCE FROM MISSISSIPPI VALLEY CONSERVATION AUTHORITY – ORIGINAL SITE

Johnston, James

From: Craig Cunningham <ccunningham@mvc.on.ca>
Sent: Monday, January 07, 2013 4:00 PM
To: James Johnston
Subject: RE: Rép. : RE: Pre-Consultation: New High School in Kanata (CECCE)

Hi Jim,

I forwarded this on to our engineering staff for review, but I'm not certain anyone got back to you directly with preliminary comments. If that is the case, here are some initial comments related to the proposal for your consideration:

- Until the trunk sewer is built, must match post development flows to pre development flows. After it is built, can match post development flows to the design.
- Assume it (swale/watercourse) is fish habitat (because there is fish habitat within 1 km of the site), therefore will need 70% quality treatment.
- An offline pond will be required since it (swale/watercourse) has been assumed to be fish habitat.
 - Development setbacks from watercourse as identified by City OP, Carp River Subwatershed Study, should be discussed.

Excuse the delay, but hope this helps. Let me know if you wish to discuss further.

Regards,

Craig

Craig Cunningham
Environmental Planner
Mississippi Valley Conservation
Tel: (613) 259-2421 x229
Fax: (613) 259-3468

ccunningham@mvc.on.ca

From: James Johnston [<mailto:James.Johnston@genivar.com>]
Sent: December-07-12 8:47 AM
To: ccunningham@mvc.on.ca
Subject: FW: Rép. : RE: Pre-Consultation: New High School in Kanata (CECCE)

Craig,

We are starting work on a new high school project at the east end of Stittsville. The proposed site is highlighted on the attached plans. It appears that drainage will be directed to a future off-site SWM pond located north of the site. There is an existing wet pond on the west side of Iber Road not far west of the site, and the outlet ditch from this pond currently crosses the high school site as it drains to the east and north. We would be interested in receiving any preliminary comments from MVC pertaining to this development and SWM requirements.

*Please take note of our new address / contact info *



James (Jim) Johnston, P.Eng., LEED® AP

GENIVAR INC.

2611 Queensview Drive, Suite 300, Ottawa, Ontario K2B 8K2

T 613.829-2800 x19349 | F 613.829-8299 | C 613.298-5960 | www.genivar.com

CONFIDENTIALITY WARNING:

This message is intended only for the use of the individual or entity to which it is addressed, and may contain information which is privileged, confidential, proprietary or exempt from disclosure under applicable law. If you are not the intended recipient or the person responsible for delivering the message to the intended recipient, you are strictly prohibited from disclosing, distributing, copying or in any way using this message. If you have received this communication in error, please notify the sender, and destroy and delete any copies you may have received.

AVERTISSEMENT:

Ce message est destiné uniquement à la personne ou à l'organisation à laquelle il est adressé et il peut contenir des informations privilégiées, confidentielles ou non divulguables en vertu de la loi. Si vous n'êtes pas le destinataire du présent message ni la personne chargée de remettre le présent message à son destinataire, il vous est strictement interdit de le divulguer, de le distribuer, de le copier ou de l'utiliser de quelque façon que ce soit. Si vous avez reçu la présente communication par erreur, veuillez en aviser l'expéditeur et détruire ou effacer tous les exemplaires que vous avez reçus.

APPENDIX D

WATER SYSTEM BOUNDARY CONDITIONS

WATER AGE ANALYSIS

FUS FIRE DEMAND CALCULATION

EPANET WATERMAIN ANALYSIS

Johnston, James

From: Whittaker, Damien <Damien.Whittaker@ottawa.ca>
Sent: Wednesday, March 12, 2014 8:35 AM
To: Johnston, James
Subject: RE: City File D07-12-13-0234 & D02-02-13-0127 5315 Abbott - Boundary Conditions

Jim,

Please find boundary conditions below:

- PKHR = 155.6m
- Max HGL = 161.3m
- MXDY + Fire = 155.6m

Please feel free to ask for clarification, or further information, on any of the comments above.

Thank you,

Damien Whittaker, P.Eng - Project Manager - Development Review, Suburban West Sub-unit
City of Ottawa - 110 Laurier Avenue West, Ottawa, Ontario K1P 1J1
☎ 613-580-2424 x16968 ✉ damien.whittaker@ottawa.ca 01-14

From: Johnston, James [mailto:James.Johnston@wspgroup.com]
Sent: Wednesday, February 26, 2014 4:48 PM
To: Whittaker, Damien
Subject: FW: City File D07-12-13-0234 & D02-02-13-0127 5315 Abbott - Boundary Conditions

Damien,

Please find attached the requested water demand information to enable establishment of boundary conditions.

Please note that we may be making some changes to the sanitary piping shown on the location sketch, which may result in a minor shift in the site watermain feeding the private hydrant. We do not anticipate any change in the location of the hydrant, the water service entry to the building, or the stub from the street main.



James (Jim) Johnston, P.Eng., LEED® AP ND+C
WSP Canada Inc.

2611 Queensview Drive, Suite 300
Ottawa, Ontario K2B 8K2 Canada
T +1 613-829-2800 #19349 F +1 613-829-8299 C +1 613-298-5960

www.wspgroup.com

We were GENIVAR. We are now WSP.

From: Whittaker, Damien [mailto:Damien.Whittaker@ottawa.ca]
Sent: Friday, February 21, 2014 3:09 PM
To: Johnston, James
Subject: RE: City File D07-12-13-0234 & D02-02-13-0127 5315 Abbott - Boundary Conditions

Jim,

Please provide a location plan, a discussion of the proposed water connection (only for this special application), and the following data

- ▶ Avg. Day = X l/s

- ▶ Max. Day = Y l/s
- ▶ Peak Hour = Z l/s
- ▶ Fire Flow = A l/s

Please note that the fire flow should be calculated as per FUS guidelines and calculations are required with the application.

Please feel free to ask for clarification, or further information, on any of the comments above.

Regards,

Damien Whittaker, P.Eng - Project Manager - Development Review, Suburban West Sub-unit
City of Ottawa - 110 Laurier Avenue West, Ottawa, Ontario K1P 1J1
☎ 613-580-2424 x16968 - ✉ damien.whittaker@ottawa.ca - 01-14

From: Johnston, James [<mailto:James.Johnston@wspgroup.com>]
Sent: Thursday, February 20, 2014 5:38 PM
To: Whittaker, Damien
Subject: City File D07-12-13-0234 & D02-02-13-0127 5315 Abbott - Boundary Conditions

Damien,

We are in the process of responding to the City comments on the initial site plan application. It was noted that we should request boundary conditions for water servicing. I would appreciate if you could assist us in obtaining this information.



James (Jim) Johnston, P.Eng., LEED® AP ND+C
WSP Canada Inc.
2611 Queensview Drive, Suite 300
Ottawa, Ontario K2B 8K2 Canada
T +1 613-829-2800 #19349 F +1 613-829-8299 C +1 613-298-5960
www.wspgroup.com
We were GENIVAR. We are now WSP.

CONFIDENTIALITY WARNING:

This message is intended only for the use of the individual or entity to which it is addressed, and may contain information which is privileged, confidential, proprietary or exempt from disclosure under applicable law. If you are not the intended recipient or the person responsible for delivering the message to the intended recipient, you are strictly prohibited from disclosing, distributing, copying or in any way using this message. If you have received this communication in error, please notify the sender, and destroy and delete any copies you may have received.

AVERTISSEMENT:

Ce message est destiné uniquement à la personne ou à l'organisation à laquelle il est adressé et il peut contenir des informations privilégiées, confidentielles ou non divulguables en vertu de la loi. Si vous n'êtes pas le destinataire du présent message ni la personne chargée de remettre le présent message à son destinataire, il vous est strictement interdit de le divulguer, de le distribuer, de le copier ou de l'utiliser de quelque façon que ce soit. Si vous avez reçu la présente communication par erreur, veuillez en aviser l'expéditeur et détruire ou effacer tous les exemplaires que vous avez reçus.

This e-mail originates from the City of Ottawa e-mail system. Any distribution, use or copying of this e-mail or the information it contains by other than the intended recipient(s) is unauthorized. If you are not the intended recipient, please notify me at the telephone number shown above or by return e-mail and delete this communication and any copy immediately. Thank you.

Le présent courriel a été expédié par le système de courriels de la Ville d'Ottawa. Toute distribution, utilisation ou reproduction du courriel ou des renseignements qui s'y trouvent par une personne autre que son destinataire prévu est interdite. Si vous avez reçu le message par erreur, veuillez m'en aviser par téléphone (au numéro

précité) ou par courriel, puis supprimer sans délai la version originale de la communication ainsi que toutes ses copies. Je vous remercie de votre collaboration.

This e-mail originates from the City of Ottawa e-mail system. Any distribution, use or copying of this e-mail or the information it contains by other than the intended recipient(s) is unauthorized. If you are not the intended recipient, please notify me at the telephone number shown above or by return e-mail and delete this communication and any copy immediately. Thank you.

Le présent courriel a été expédié par le système de courriels de la Ville d'Ottawa. Toute distribution, utilisation ou reproduction du courriel ou des renseignements qui s'y trouvent par une personne autre que son destinataire prévu est interdite. Si vous avez reçu le message par erreur, veuillez m'en aviser par téléphone (au numéro précité) ou par courriel, puis supprimer sans délai la version originale de la communication ainsi que toutes ses copies. Je vous remercie de votre collaboration.

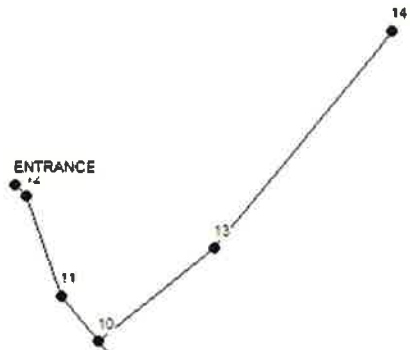

Network Table - Nodes

| Node ID | Demand LPS | Head m | Pressure m | Age hours |
|---------------|------------|--------|------------|-----------|
| Junc Stub | 0.00 | 155.60 | 53.95 | 0.25 |
| Junc 2 | 0.00 | 155.60 | 53.76 | 0.33 |
| Junc 3 | 0.00 | 155.60 | 51.27 | 120.00 |
| Junc 4 | 0.00 | 155.59 | 53.48 | 0.54 |
| Junc SCHOOL | 0.12 | 155.59 | 50.84 | 0.77 |
| Junc 6 | 0.00 | 155.58 | 53.45 | 0.62 |
| Junc 7 | 0.00 | 155.58 | 53.50 | 0.71 |
| Junc 10 | 0.00 | 155.55 | 54.44 | 1.04 |
| Junc 11 | 0.00 | 155.55 | 54.48 | 1.12 |
| Junc 12 | 0.00 | 155.53 | 54.18 | 1.20 |
| Junc ENTRANCE | 2.00 | 155.53 | 51.74 | 1.29 |
| Junc 13 | 0.00 | 155.55 | 54.24 | 120.00 |
| Junc 14 | 0.00 | 155.55 | 51.86 | 120.00 |
| Junc 1 | 0.00 | 155.60 | 53.78 | 0.42 |
| Junc 5 | 0.00 | 155.60 | 53.78 | 120.00 |
| Resvr 8 | -2.12 | 155.60 | 0.00 | 0.00 |

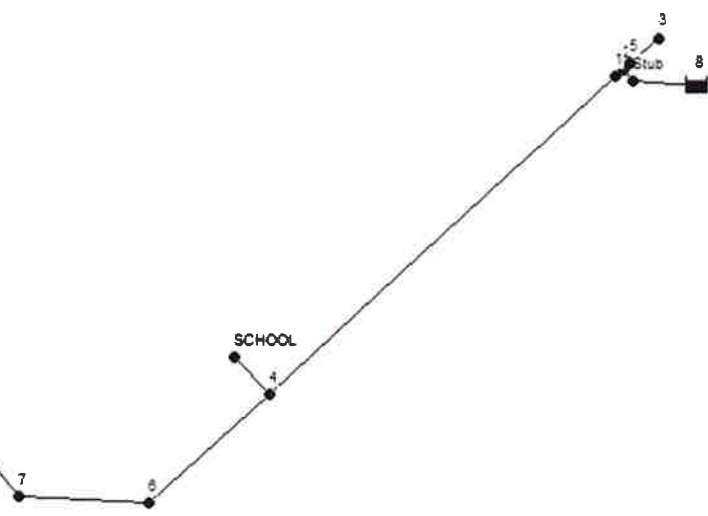

WATER DISTRIBUTION - PROPOSED FIRE FLOW DEMANDS

| |
|----------------------|
| $F = 220 C \sqrt{A}$ |
|----------------------|

| Type of Construction Coefficient: | Coefficient | Comments |
|-----------------------------------|-------------|--|
| Wood Frame | 1.5 | (all structurally combustible) |
| Ordinary | 1.0 | (brick, masonry wall, combustible floor and interior) |
| Non-Combustible | 0.8 | (unprotected metal structural component, masonry or metal walls) |
| Fire Resistive | 0.6 | (fully protected frame, floors and roof) |

| Combustibility: | Coefficient | Comments |
|--|-------------|----------|
| Non-Combustible (Low Hazard Occupancy) | -25% | |
| Limited Combustible | -15% | |
| Combustible | 0% | |
| Free Burning | 15% | |
| Rapid Burning | 25% | |

| Sprinkler Protection: | Coefficient | Comments |
|---|-------------|-------------------|
| Complete Sprinkler System | -50% | (max.) |
| NFPA 13 Conformed | -30% | (max.) |
| If Water Supply Standard for Both System and Fire Lines | -10% | additional (max.) |
| Fully Supervised System | -10% | additional (max.) |
| None | 0% | |

| | | New Pavilion at Sports Dome - Ecole secondaire Paul-Desmarais | |
|------------------------------------|--|---|----------------|
| Type of Construction Coefficient | | Wood Frame | |
| | | 1.5 | |
| Gross Floor Area (m ²) | | 581 | m ² |
| Fire Flow, F (L/min) | | 7,954 | L/min |
| | | 8,000 | L/min |
| Combustibility | | Limited Combustible | |
| | | -15% | |
| F | | 6,800 | L/min |
| Sprinkler Protection | | None | |
| | | 0% | |
| Additional Credit | | None | |
| | | 0% | |
| Exposure Distances | | | |
| North | | 6 m | 20% |
| South | | 46 m | 0% |
| East | | >45 m | 0% |
| West | | >45 m | 0% |
| | | Total = | 20% |
| Total Required Fire Flow, F | | 8,000 | L/min |
| F | | 133 | L/s |

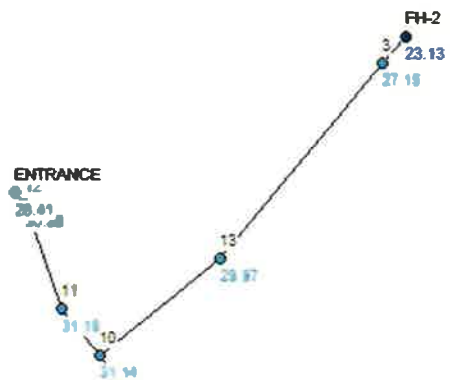

| Node ID | Elevation m | Demand LPS | Head m | Pressure m |
|---------------|-------------|------------|--------|------------|
| Junc Stub | 101.65 | 0.00 | 155.60 | 53.95 |
| Junc 2 | 101.84 | 0.00 | 155.41 | 53.57 |
| Junc FH-1 | 104.33 | 0.00 | 155.41 | 51.08 |
| Junc 4 | 102.11 | 0.00 | 149.85 | 47.74 |
| Junc SCHOOL | 104.75 | 0.18 | 149.85 | 45.10 |
| Junc 6 | 102.13 | 0.00 | 146.95 | 44.82 |
| Junc 7 | 102.08 | 0.00 | 146.22 | 44.14 |
| Junc 10 | 101.11 | 0.00 | 132.25 | 31.14 |
| Junc 11 | 101.07 | 0.00 | 132.25 | 31.18 |
| Junc 12 | 101.35 | 0.00 | 132.21 | 30.86 |
| Junc ENTRANCE | 103.79 | 3.00 | 132.20 | 28.41 |
| Junc 13 | 101.31 | 0.00 | 131.28 | 29.97 |
| Junc FH-2 | 103.69 | 133.00 | 126.82 | 23.13 |
| Junc 1 | 101.82 | 0.00 | 155.28 | 53.46 |
| Junc 5 | 101.82 | 0.00 | 155.41 | 53.59 |
| Junc 3 | 101.23 | 0.00 | 128.38 | 27.15 |
| Resvr 8 | 155.6 | -136.18 | 155.60 | 0.00 |

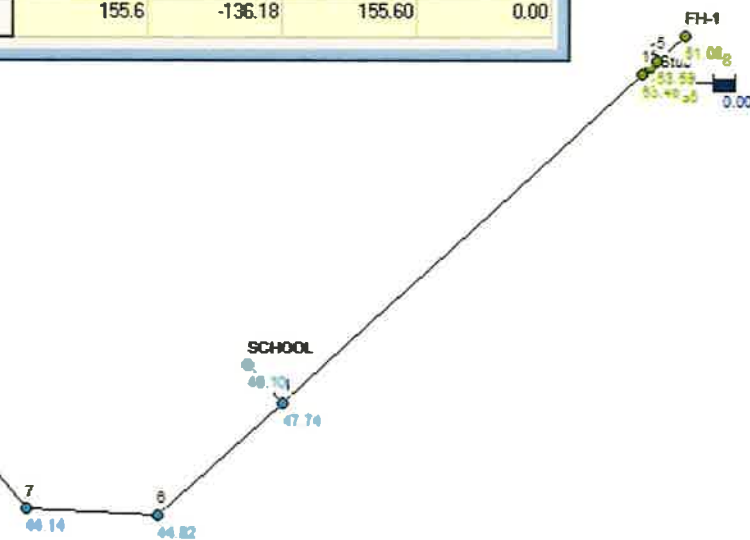

APPENDIX

B

- FIRE UNDERWRITERS SURVEY – FIRE FLOW CALCULATION FOR BUILDING
- FIRE UNDERWRITERS SURVEY – FIRE FLOW CALCULATION FOR PORTABLE CLASSROOM
- WATER DEMAND CALCULATION
- UPDATED BOUNDARY CONDITION



**Existing School and Addition
 Fire Flow Requirements Based on Fire Underwriters Survey (FUS) 2020**

1. An estimate of the Fire Flow required for a given fire area may be estimated by: $F = 220 C \sqrt{A}$

- F = required fire flow in litres per minute
- C = coefficient related to the type of construction
 - 1.5 for **Type V** Wood Frame Construction
 - 0.8 for **Type IV-A** Mass Timber Construction
 - 0.9 for **Type IV-B** Mass Timber Construction
 - 1.0 for **Type IV-C** Mass Timber Construction
 - 1.5 for **Type IV-D** Mass Timber Construction
 - 1.0 for **Type III** Ordinary Construction
 - 0.8 for **Type II** Noncombustible Construction
 - 0.6 for **Type I** Fire resistive Construction

A =2-b) The single largest Floor Area plus 25% of each of the two immediately adjoining floors

A = 9696 m²

C = 0.8

F = 17330.6 L/min

rounded off to 17,000 L/min (min value of 2000 L/min)

2. The value obtained in 1. may be reduced by as much as 25% for occupancies having a low contents fire hazard.

| | |
|---------------------|------|
| Non-combustible | -25% |
| Limited Combustible | -15% |
| Combustible | 0% |
| Free Burning | 15% |
| Rapid Burning | 25% |

Reduction due to low occupancy hazard -15% x 17,000 = 14,450 L/min

3. The value obtained in 2. may be reduced by as much as 50% for buildings equipped with automatic sprinkler protection.

| | |
|---|------|
| Adequate Sprinkler confirms to NFPA13 | -30% |
| Water supply common for sprinklers & fire hoses | -10% |
| Fully supervised system | -10% |
| No Automatic Sprinkler System | 0% |

Reduction due to Sprinkler System -40% x 14,450 = 5,780 L/min

4. The value obtained in 2. is increased for structures exposed within 45 metres by the fire area under consideration.

| <u>Separation</u> | <u>Charge</u> |
|-------------------|---------------|
| 0 to 3 m | 25% |
| 3.1 to 10 m | 20% |
| 10.1 to 20 m | 15% |
| 20.1 to 30 m | 10% |
| 30.1 to 45 m | 0% |

| | | | |
|--------|----|-----|------------|
| Side 1 | 11 | 15% | north side |
| Side 2 | 30 | 10% | east side |
| Side 3 | 68 | 0% | south side |
| Side 4 | 83 | 0% | west side |

25% (Total shall not exceed 75%)

Increase due to separation 25% x 14,450 = 3,613 L/min

5. The flow requirement is the value obtained in 2., minus the reduction in 3., plus the addition in 4.

The fire flow requirement is 12,000 L/min (Rounded to nearest 1000 L/min)
 or **200 L/sec**
 or 3,170 gpm (us)
 or 2,640 gpm (uk)



Existing School
Fire Flow Requirements Based on Fire Underwriters Survey (FUS) 2020

1. An estimate of the Fire Flow required for a given fire area may be estimated by: $F = 220 C \sqrt{A}$

- F = required fire flow in litres per minute
- C = coefficient related to the type of construction
 - 1.5 for **Type V** Wood Frame Construction
 - 0.8 for **Type IV-A** Mass Timber Construction
 - 0.9 for **Type IV-B** Mass Timber Construction
 - 1.0 for **Type IV-C** Mass Timber Construction
 - 1.5 for **Type IV-D** Mass Timber Construction
 - 1.0 for **Type III** Ordinary Construction
 - 0.8 for **Type II** Noncombustible Construction
 - 0.6 for **Type I** Fire resistive Construction

A = 2-b) The single largest Floor Area plus 25% of each of the two immediately adjoining floors

A = **8415** m²

C = **0.8**

F = **16145.1** L/min

rounded off to **16,000** L/min (min value of 2000 L/min)

2. The value obtained in 1. may be reduced by as much as 25% for occupancies having a low contents fire hazard.

| | |
|---------------------|------|
| Non-combustible | -25% |
| Limited Combustible | -15% |
| Combustible | 0% |
| Free Burning | 15% |
| Rapid Burning | 25% |

Reduction due to low occupancy hazard **-15%** x 16,000 = **13,600** L/min

3. The value obtained in 2. may be reduced by as much as 50% for buildings equipped with automatic sprinkler protection.

| | |
|---|------|
| Adequate Sprinkler confirms to NFPA13 | -30% |
| Water supply common for sprinklers & fire hoses | -10% |
| Fully supervised system | -10% |
| No Automatic Sprinkler System | 0% |

Reduction due to Sprinkler System **-40%** x 13,600 = **-5,440** L/min

4. The value obtained in 2. is increased for structures exposed within 45 metres by the fire area under consideration.

| <u>Separation</u> | <u>Charge</u> |
|-------------------|---------------|
| 0 to 3 m | 25% |
| 3.1 to 10 m | 20% |
| 10.1 to 20 m | 15% |
| 20.1 to 30 m | 10% |
| 30.1 to 45 m | 0% |

| | | |
|--------|-----------|---------------|
| Side 1 | 56 | 0% north side |
| Side 2 | 30 | 10% east side |
| Side 3 | 68 | 0% south side |
| Side 4 | 83 | 0% west side |

10% (Total shall not exceed 75%)

Increase due to separation 10% x 13,600 = **1,360** L/min

5. The flow requirement is the value obtained in 2., minus the reduction in 3., plus the addition in 4.

The fire flow requirement is **10,000** L/min (Rounded to nearest 1000 L/min)
 or **167 L/sec**
 or **2,642 gpm (us)**
 or **2,200 gpm (uk)**



Pavilion
Fire Flow Requirements Based on Fire Underwriters Survey (FUS) 2020

1. An estimate of the Fire Flow required for a given fire area may be estimated by: $F = 220 C \sqrt{A}$

- F = required fire flow in litres per minute
- C = coefficient related to the type of construction
 - 1.5 for **Type V** Wood Frame Construction
 - 0.8 for **Type IV-A** Mass Timber Construction
 - 0.9 for **Type IV-B** Mass Timber Construction
 - 1.0 for **Type IV-C** Mass Timber Construction
 - 1.5 for **Type IV-D** Mass Timber Construction
 - 1.0 for **Type III** Ordinary Construction
 - 0.8 for **Type II** Noncombustible Construction
 - 0.6 for **Type I** Fire resistive Construction

A = 2-b) The single largest Floor Area plus 25% of each of the two immediately adjoining floors

A = 611 m²
 C = 1.5
 F = 8158.7 L/min

rounded off to 8,000 L/min (min value of 2000 L/min)

2. The value obtained in 1. may be reduced by as much as 25% for occupancies having a low contents fire hazard.

| | |
|---------------------|------|
| Non-combustible | -25% |
| Limited Combustible | -15% |
| Combustible | 0% |
| Free Burning | 15% |
| Rapid Burning | 25% |

Reduction due to low occupancy hazard -15% x 8,000 = 6,800 L/min

3. The value obtained in 2. may be reduced by as much as 50% for buildings equipped with automatic sprinkler protection.

| | |
|---|------|
| Adequate Sprinkler confirms to NFPA13 | -30% |
| Water supply common for sprinklers & fire hoses | -10% |
| Fully supervised system | -10% |
| No Automatic Sprinkler System | 0% |

Reduction due to Sprinkler System 0% x 6,800 = 0 L/min

4. The value obtained in 2. is increased for structures exposed within 45 metres by the fire area under consideration.

| <u>Separation</u> | <u>Charge</u> |
|-------------------|---------------|
| 0 to 3 m | 25% |
| 3.1 to 10 m | 20% |
| 10.1 to 20 m | 15% |
| 20.1 to 30 m | 10% |
| 30.1 to 45 m | 0% |

| | | | |
|--------|----|-----|------------------------------|
| Side 1 | 5 | 20% | north side |
| Side 2 | 55 | 0% | east side |
| Side 3 | 55 | 0% | south side |
| Side 4 | 8 | 20% | west side |
| | | 40% | (Total shall not exceed 75%) |

Increase due to separation 40% x 6,800 = 2,720 L/min

5. The flow requirement is the value obtained in 2., minus the reduction in 3., plus the addition in 4.

The fire flow requirement is 10,000 L/min (Rounded to nearest 1000 L/min)
 or **167 L/sec**
 or 2,642 gpm (us)
 or 2,200 gpm (uk)

Based on method described in:
 "Water Supply for Public Fire Protection - A Guide to Recommended Practice", 2020
 by Fire Underwriters Survey



Future Portables (6 in 2 rows)
Fire Flow Requirements Based on Fire Underwriters Survey (FUS) 2020

1. An estimate of the Fire Flow required for a given fire area may be estimated by: $F = 220 C \sqrt{A}$

- F = required fire flow in litres per minute
- C = coefficient related to the type of construction
 - 1.5 for **Type V** Wood Frame Construction
 - 0.8 for **Type IV-A** Mass Timber Construction
 - 0.9 for **Type IV-B** Mass Timber Construction
 - 1.0 for **Type IV-C** Mass Timber Construction
 - 1.5 for **Type IV-D** Mass Timber Construction
 - 1.0 for **Type III** Ordinary Construction
 - 0.8 for **Type II** Noncombustible Construction
 - 0.6 for **Type I** Fire resistive Construction

A = 2-b) The single largest Floor Area plus 25% of each of the two immediately adjoining floors

A = 440 m²

C = 1.0

F = 4616.9 L/min

rounded off to 5,000 L/min (min value of 2000 L/min)

2. The value obtained in 1. may be reduced by as much as 25% for occupancies having a low contents fire hazard.

| | |
|---------------------|------|
| Non-combustible | -25% |
| Limited Combustible | -15% |
| Combustible | 0% |
| Free Burning | 15% |
| Rapid Burning | 25% |

Reduction due to low occupancy hazard -15% x 5,000 = 4,250 L/min

3. The value obtained in 2. may be reduced by as much as 50% for buildings equipped with automatic sprinkler protection.

| | |
|---|------|
| Adequate Sprinkler confirms to NFPA13 | -30% |
| Water supply common for sprinklers & fire hoses | -10% |
| Fully supervised system | -10% |
| No Automatic Sprinkler System | 0% |

Reduction due to Sprinkler System 0% x 4,250 = 0 L/min

4. The value obtained in 2. is increased for structures exposed within 45 metres by the fire area under consideration.

| <u>Separation</u> | <u>Charge</u> |
|-------------------|---------------|
| 0 to 3 m | 25% |
| 3.1 to 10 m | 20% |
| 10.1 to 20 m | 15% |
| 20.1 to 30 m | 10% |
| 30.1 to 45 m | 0% |

| | | | |
|--------|-----|-----|------------|
| Side 1 | 150 | 0% | north side |
| Side 2 | 30 | 10% | east side |
| Side 3 | 11 | 15% | south side |
| Side 4 | 56 | 0% | west side |

25% (Total shall not exceed 75%)

Increase due to separation 25% x 4,250 = 1,063 L/min

5. The flow requirement is the value obtained in 2., minus the reduction in 3., plus the addition in 4.

The fire flow requirement is 5,000 L/min (Rounded to nearest 1000 L/min)

- or **83 L/sec**
- or 1,321 gpm (us)
- or 1,100 gpm (uk)

Water Demand Calculation Sheet

Project: Ecole Desmarais Addition
Location: 5315 Abbott Street East
WSP Project No. 221-06227-00

Date: 30/09/2022
Design: VT
Page: 1 of 1



| Proposed Buildings | Residential | | | School per Student | Non-Residential | | | Average Daily Demand (l/s) | | | Maximum Daily Demand (l/s) | | | Maximum Hourly Demand (l/s) | | | Fire Demand (l/min) |
|-----------------------|-------------|-----|----|-----------------------|-----------------|---------------|------------|-------------------------------|-------|------|-------------------------------|-------|------|--------------------------------|-------|------|---------------------------|
| | Units | | | | Industrial | Institutional | Commercial | Demand (l/s) | | | Demand (l/s) | | | Demand (l/s) | | | |
| | SF | APT | ST | (ha) | (ha) | (ha) | Res. | Non-Res. | Total | Res. | Non-Res. | Total | Res. | Non-Res. | Total | | |
| Existing School | | | | 1350 | | 0.84 | | | 3.28 | 3.28 | | 4.92 | 4.92 | | 8.86 | 8.86 | 10,000 |
| Existing and Addition | | | | 1520 | | 0.97 | | | 3.69 | 3.69 | | 5.54 | 5.54 | | 9.98 | 9.98 | 12,000 |
| Pavilion | | | | | | 0.05 | | | 0.05 | 0.05 | | 0.08 | 0.08 | | 0.15 | 0.15 | 10,000 |

Population Densities

| | |
|---------------------|-----------------|
| Single Family | 3.4 person/unit |
| Semi-Detached | 2.7 person/unit |
| Duplex | 2.3 person/unit |
| Townhome (Row) | 2.7 person/unit |
| Bachelor Apartment | 1.4 person/unit |
| 1 Bedroom Apartment | 1.4 person/unit |
| 2 Bedroom Apartment | 2.1 person/unit |
| 3 Bedroom Apartment | 3.1 person/unit |
| 4 Bedroom Apartment | 4.1 person/unit |
| Avg. Apartment | 1.8 person/unit |

Average Daily Demand

| | |
|----------------------------------|------------------|
| Residential | 280 l/cap/day |
| Industrial | 35000 l/ha/day |
| Institutional | 28000 l/ha/day |
| Commercial | 28000 l/ha/day |
| School | 70 l/day/student |
| Assume: 8 hours of operating day | |

Maximum Daily Demand

| | |
|---------------|----------------|
| Residential | 2.5 x avg. day |
| Industrial | 1.5 x avg. day |
| Institutional | 1.5 x avg. day |
| Commercial | 1.5 x avg. day |

Maximum Hourly Demand

| | |
|---------------|----------------|
| Residential | 2.2 x max. day |
| Industrial | 1.8 x max. day |
| Institutional | 1.8 x max. day |
| Commercial | 1.8 x max. day |

Boundary Conditions 5315 Abbott Street

Provided Information

| Scenario | Demand | |
|----------------------|--------|--------|
| | L/min | L/s |
| Average Daily Demand | 225 | 3.75 |
| Maximum Daily Demand | 337 | 5.62 |
| Peak Hour | 607 | 10.12 |
| Fire Flow Demand #1 | 12,000 | 200.00 |

Location

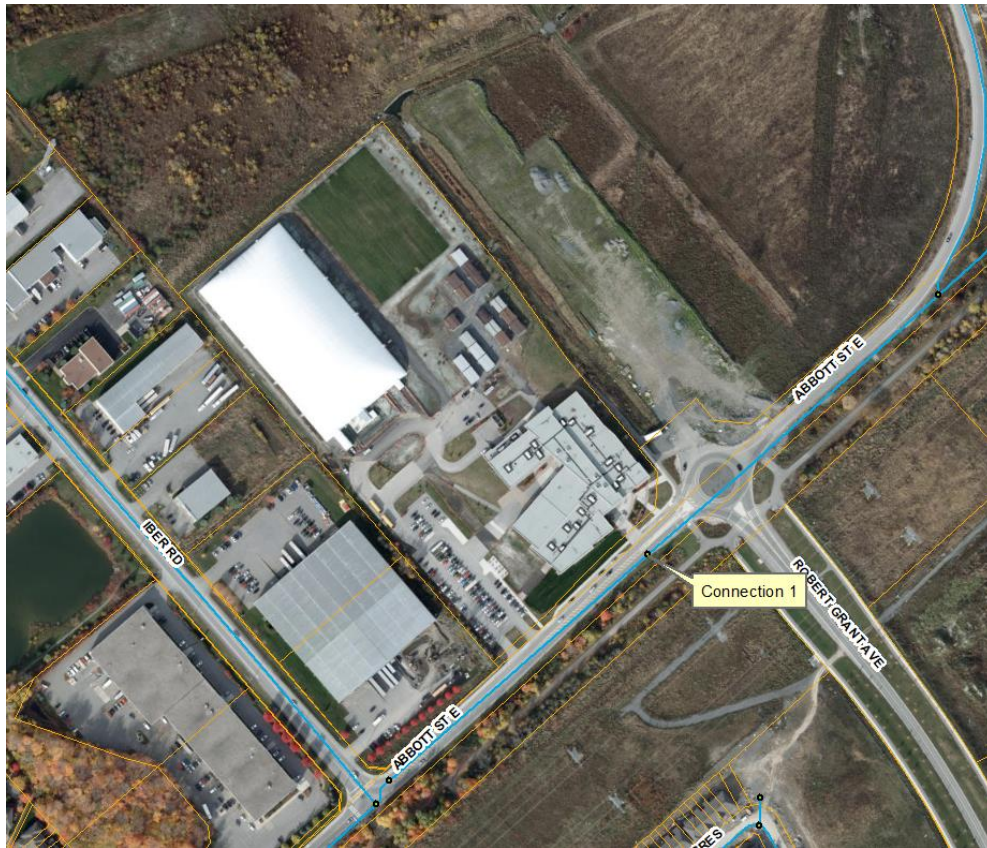

Results

Connection 1 – Abbott St. E

| Demand Scenario | Head (m) | Pressure ¹ (psi) |
|---------------------|----------|-----------------------------|
| Maximum HGL | 161.2 | 81.6 |
| Peak Hour | 156.7 | 75.3 |
| Max Day plus Fire 1 | 154.5 | 72.1 |

Ground Elevation = 103.8 m

Notes

1. A second connection to the watermain, separated by an isolation valve, is required to decrease vulnerability of the water system in case of breaks.
2. As per the Ontario Building Code in areas that may be occupied, the static pressure at any fixture shall not exceed 552 kPa (80 psi.) Pressure control measures to be considered are as follows, in order of preference:
 - a. If possible, systems to be designed to residual pressures of 345 to 552 kPa (50 to 80 psi) in all occupied areas outside of the public right-of-way without special pressure control equipment.
 - b. Pressure reducing valves to be installed immediately downstream of the isolation valve in the home/ building, located downstream of the meter so it is owner maintained.

Disclaimer

The boundary condition information is based on current operation of the city water distribution system. The computer model simulation is based on the best information available at the time. The operation of the water distribution system can change on a regular basis, resulting in a variation in boundary conditions. The physical properties of watermains deteriorate over time, as such must be assumed in the absence of actual field test data. The variation in physical watermain properties can therefore alter the results of the computer model simulation. Fire Flow analysis is a reflection of available flow in the watermain; there may be additional restrictions that occur between the watermain and the hydrant that the model cannot take into account.

APPENDIX

C

- STORM SEWER DESIGN SHEET
- STORM DRAINAGE AREA PLAN C05
- ROOF PLAN
- RESPONSE LETTER - SITE PLAN CONTROL APPLICATION
- FLOW CONTROL ROOF DRAINAGE DECLARATION
- STORMWATER MANAGEMENT CALCULATIONS
- DWG C03 - GRADING PLAN
- DWG C04 - SERVICING PLAN

| | | | |
|---|---|------------|----------------------------|
| 2 | 0 | 2022-12-16 | ISSUED FOR BUILDING PERMIT |
| 1 | 0 | 2022-11-01 | ISSUED FOR SPA |

ISSUE NO. REV. NO. DATE ISSUE

LES IDÉES, CONCEPTS, DISPOSITIONS ET PLANS MONTRÉS OU REPRÉSENTÉS PAR CE DESSIN APPARTIENNENT À EDWARD J. CUHACI AND ASSOCIATES ARCHITECTS INC. ET ONT ÉTÉ CRÉÉS ET DÉVELOPPÉS POUR ÊTRE UTILISÉS DANS LE CADRE DU PRÉSENT PROJET. ILS NE DOIVENT PAS ÊTRE UTILISÉS À D'AUTRES FINS NI COMMUNIQUÉS À QUI QUE CE SOIT SANS LA PERMISSION ÉCRITE DE EDWARD J. CUHACI AND ASSOCIATES ARCHITECTS INC.

L'ARCHITECTE DÉCLINE TOUTE RESPONSABILITÉ DÉCOULANT DE PROBLÈMES FAISANT SUITE AU NON-RESPECT DES PLANS ET DEVIS OU DE L'INTENTION DU CONCEPT QU'ILS TRANSMETTENT OU DE TOUTS PROBLÈMES POUVANT RÉSULTER DU DÉFAUT DE TIERS D'OBTENIR OU DE SUIVRE LES INSTRUCTIONS DE L'ARCHITECTE RELATIVEMENT AUX ERREURS, OMISSIONS, INCOHÉRENCES, AMBIGUITÉS OU CONTRADICTIONS ALLÉGUÉES.

L'ENTREPRENEUR DOIT VÉRIFIER TOUTES LES DIMENSIONS SUR PLACE ET INFORMER L'ARCHITECTE DE TOUT ÉCART AVANT LE DÉBUT DES TRAVAUX. NE PAS MESURER LES DESSINS À L'ÉCHELLE.

ALL IDEAS, DESIGNS, ARRANGEMENTS, AND PLANS INDICATED OR REPRESENTED BY THIS DRAWING ARE OWNED BY AND THE PROPERTY OF EDWARD J. CUHACI AND ASSOCIATES INC. AND WERE CREATED, EVOLVED, AND DEVELOPED FOR USE ON AND IN CONNECTION WITH THE SPECIFIED PROJECT. NONE OF THE IDEAS, DESIGNS, ARRANGEMENTS OR PLANS SHALL BE USED BY OR DISCLOSED TO ANY PERSON, FIRM, OR CORPORATION FOR ANY PURPOSE WHATSOEVER WITHOUT THE WRITTEN PERMISSION OF EDWARD J. CUHACI AND ASSOCIATES INC.

THE ARCHITECT WAIVES ANY AND ALL RESPONSIBILITY AND LIABILITY FOR PROBLEMS WHICH ARISE FROM FAILURE TO FOLLOW THESE PLANS, SPECIFICATIONS, AND THE DESIGN INTENT THEY CONVEY, OR FOR PROBLEMS WHICH ARISE FROM OTHERS' FAILURE TO OBTAIN AND/OR FOLLOW THE ARCHITECT'S GUIDANCE WITH RESPECT TO ANY ERRORS, OMISSIONS, INCONSISTENCIES, AMBIGUITIES OR CONFLICTS WHICH ARE ALLEGED.

CONTRACTOR TO VERIFY ALL DIMENSIONS AND NOTIFY THE ARCHITECT OF ANY DISCREPANCIES BEFORE WORK COMMENCES. DO NOT SCALE DRAWINGS

THE ARCHITECT WAIVES ANY AND ALL RESPONSIBILITY AND LIABILITY FOR PROBLEMS WHICH ARISE FROM FAILURE TO FOLLOW THESE PLANS, SPECIFICATIONS, AND THE DESIGN INTENT THEY CONVEY, OR FOR PROBLEMS WHICH ARISE FROM OTHERS' FAILURE TO OBTAIN AND/OR FOLLOW THE ARCHITECT'S GUIDANCE WITH RESPECT TO ANY ERRORS, OMISSIONS, INCONSISTENCIES, AMBIGUITIES OR CONFLICTS WHICH ARE ALLEGED.

CONTRACTOR TO VERIFY ALL DIMENSIONS AND NOTIFY THE ARCHITECT OF ANY DISCREPANCIES BEFORE WORK COMMENCES. DO NOT SCALE DRAWINGS



TRUE NORTH

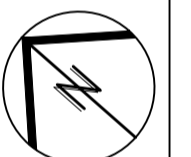

PLAN NORTH



LICENSED PROFESSIONAL ENGINEER
 D. B. YANG
 100230568
 2022-12-16
 PROVINCE OF ONTARIO

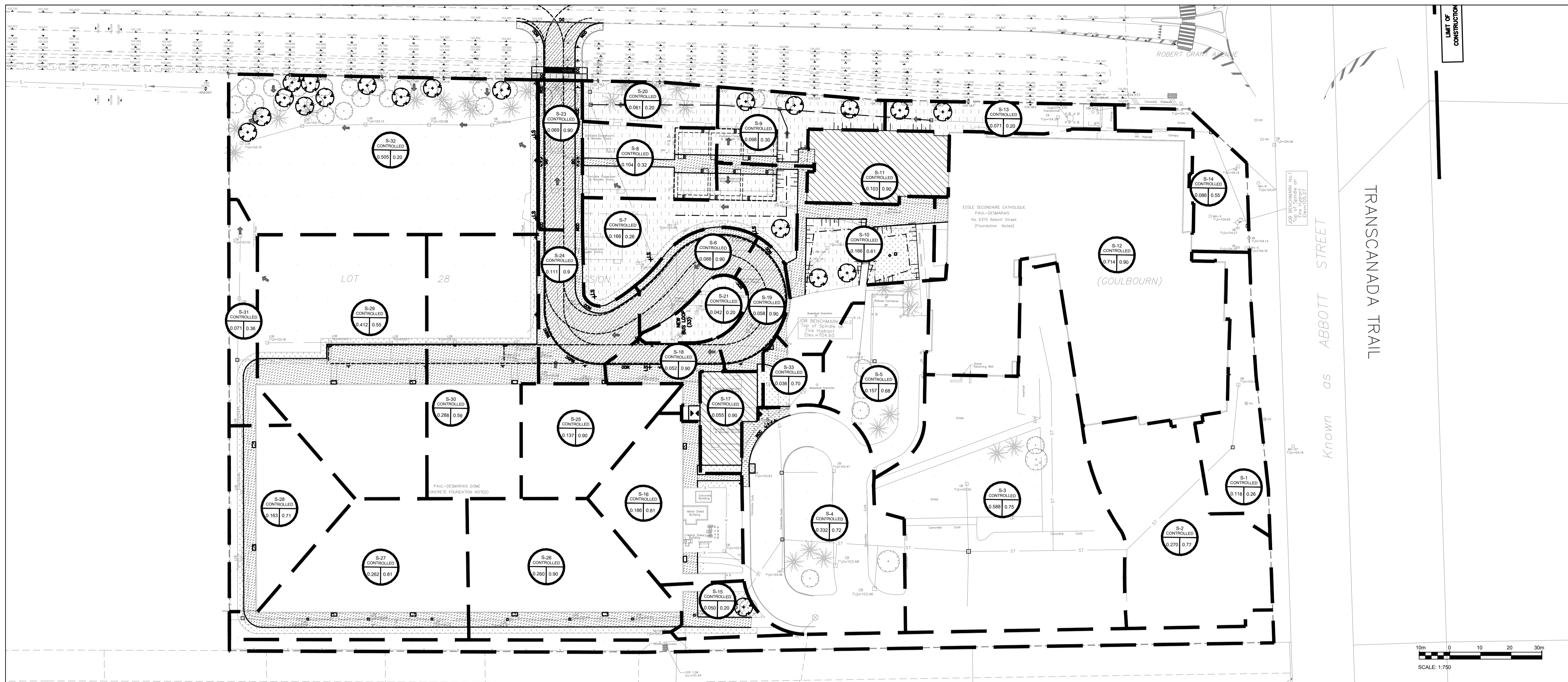
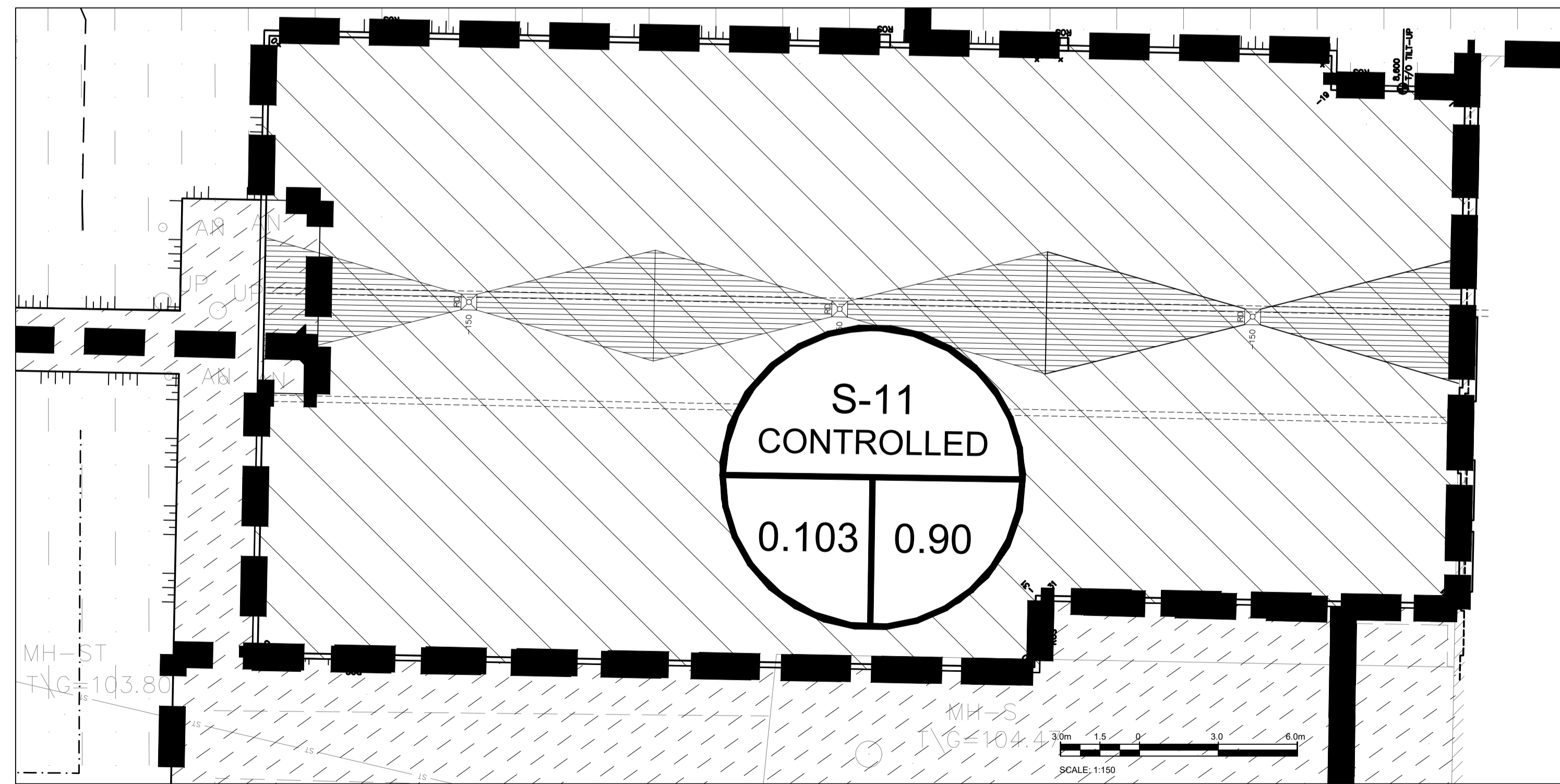
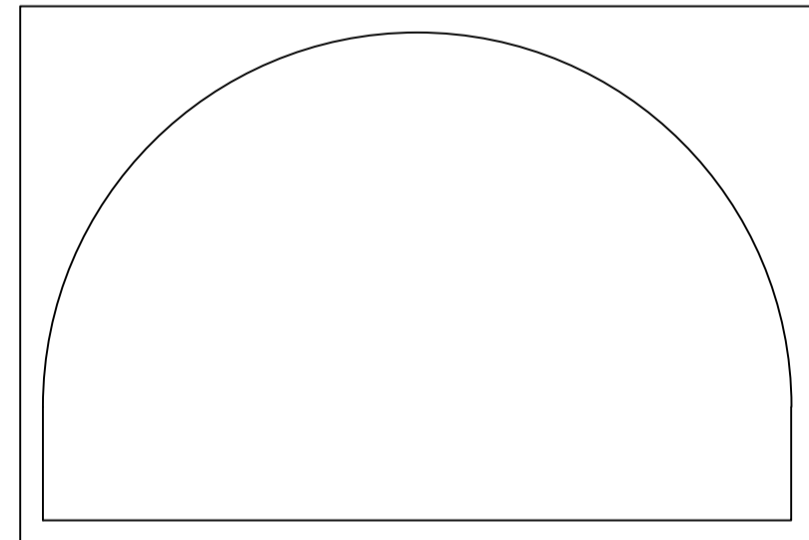

table is missing



1 STORM DRAINAGE AREA PLAN ROOF
 C05 SCALE: 1:150



EDWARD J. CUHACI & ASSOCIATES ARCHITECTS Inc.
 171 Slater St, Suite 100, Ottawa, Ontario, K1P 5H7
 Fax: (613) 236-1944 Telephone: (613) 236-7135 E-mail: info@cuhaci.com

PROJECT TITLE/TITRE DU PROJET
ÉCOLE SECONDAIRE CATHOLIQUE PAUL-DESMARAIS - DOME
 5315 ABBOTT STREET EAST
 OTTAWA, ON
 CONSEIL DES ÉCOLES CATHOLIQUES DU CENTRE-EST
 4000, RUE LABELLE, OTTAWA, ON K1J 1A1

DRAWING TITLE/TITRE DU DESSIN
DRAINAGE AREA PLAN

| | | | | |
|---------------------------|------------|--------------------------|---------------|--------------|
| SCALE ÉCHELLE | 1:750 | PROJ. No 211-06227-00 | ISSUE No 2 | REV. No 0 |
| DRAWN BY DESSINÉ PAR | V.T./J.T. | DRAWING/DESSIN | | |
| CHECKED BY VÉRIFIÉ PAR | D.Y. | C05 | | |
| DATE | 2022-12-16 | FICHIER ACAD FILE: | | |

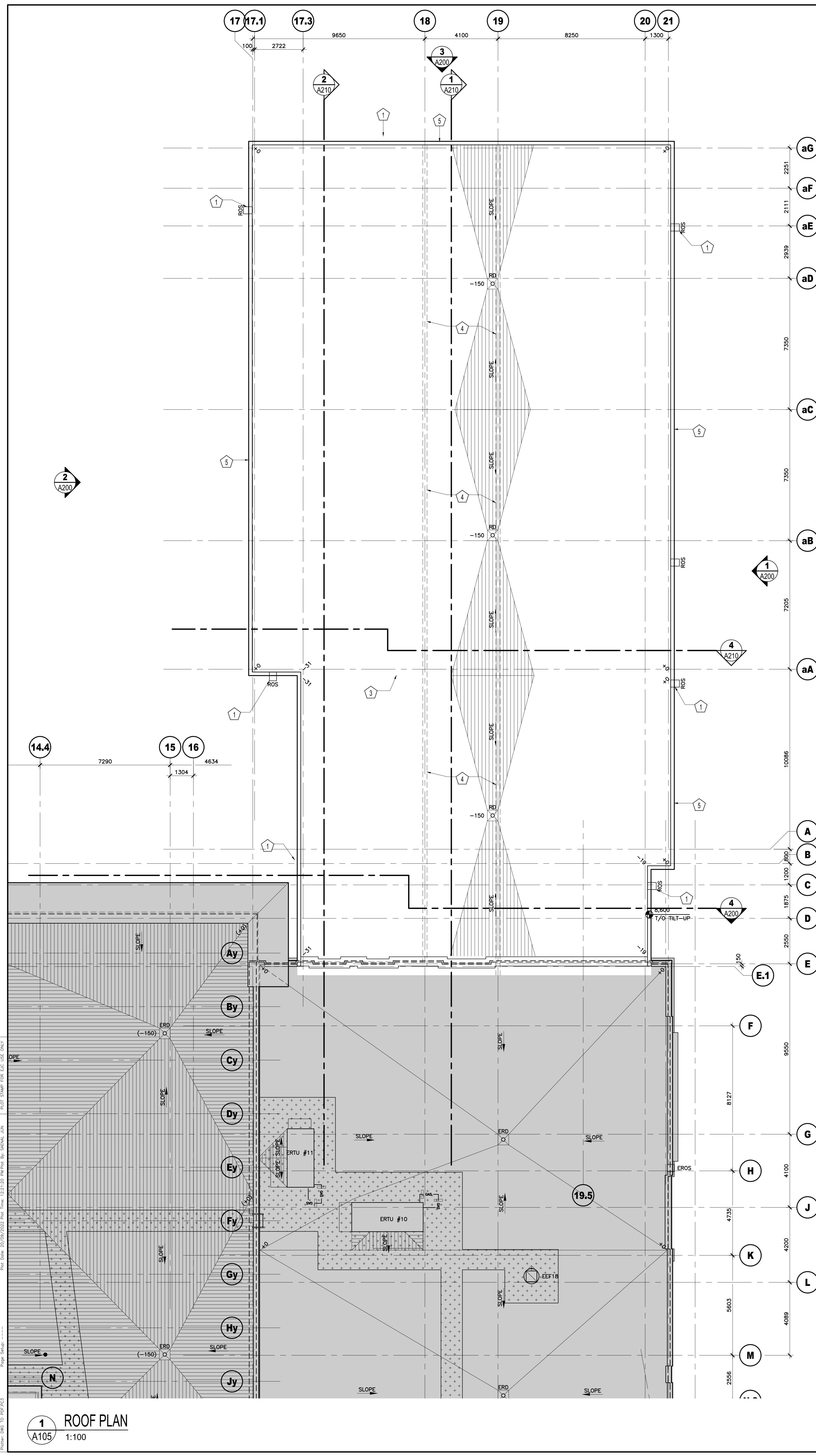

GENERAL ROOF PLAN NOTES

1. ROOFING CONTRACTOR TO PROVIDE TAPERED INSULATION COUNTER SLOPES WHERE SHOWN ON ROOF PLAN, MINIMUM 1200 WIDE, FROM MINIMUM 25 THICK TO 0 THICK, WITH A MIN. FINISHED ROOF SLOPE OF 2%.
2. WHERE THICKNESS OF TAPERED INSULATION IS NOT INDICATED, THE MIN. SLOPE FOR THE ROOFING AT THE TAPERED INSULATION SHALL BE 20mm PER LINEAR METER. ADJUST INSULATION THICKNESS TO SUIT.
3. ROOFING CONTRACTOR TO COORDINATE ALL MECHANICAL AND ELECTRICAL ROOF PENETRATIONS SEE MECHANICAL AND ELECTRICAL DRAWINGS FOR LOCATIONS AND ADDITIONAL INFORMATION.
4. ALL ROOF CURBS SHALL BE LEVEL.
5. FOR FULL EXTENT QUANTITY AND TYPE OF ROOF TOP EQUIPMENT, ROOF PERFORMANCES REFER TO MECHANICAL AND ELECTRICAL DOCUMENTS, COORDINATE SIZES AND SPECIFIC REQUIREMENTS.
6. FOR TYPICAL DETAILS AT ROOF TOP EQUIPMENT AND PENETRATIONS, REFER TO ARCHITECTURAL DETAILS, ALSO REFER TO MECHANICAL AND ELECTRICAL DOCUMENTS. IN THE EVENT OF CONFLICT BETWEEN DRAWINGS, THE MOST STRINGENT SHALL GOVERN.
7. INSTALL ALL MECHANICAL AND ELECTRICAL ROOF PENETRATIONS PRIOR TO ROOF MEMBRANE INSTALLATION.
8. ROOFING CONTRACTOR SHALL PROVIDE FOAM INSULATION ON ROOF SIDE OF METAL DECK FLUTES AT EXT. RECESSED ENTRANCES - INSUL. SHALL EXTEND MIN. 300mm EACH SIDE OF WALL BELOW.
9. IN THE EVENT OF DISCREPANCIES FOR THE LOCATION OF MECHANICAL OR ELECTRICAL ITEMS TO BE INCORPORATED, THE ARCHITECTURAL DRAWINGS SHALL GOVERN.

DRAWING NOTES

- 1 OVERFLOW SCUPPER 200x400 IN TILT-UP PARAPET, SEE DETAIL #/A230
- 2 CONDENSING UNIT SUPPORT ANCHOR, SEE DETAIL 9/A230
- 3 CURB ASSEMBLY CA1, SEE A010
- 4 CORRIDOR WALLS BELOW
- 5 DRIP EDGE FLASHING

ROOF PLAN LEGEND

| | | | |
|--|---|-------|---|
| | EXISTING ROOFING | ERTU# | EXISTING ROOF TOP UNIT # |
| | NEW MODIFIED BITUMINOUS ROOFING | ERD | EXISTING ROOF DRAIN WITH TAPERED 600x600 INSULATION "SUMP" |
| | NEW 1200mm WIDE MODIFIED BITUMEN REINFORCED WALKWAY MEMBRANE | EROS | EXISTING ROOF OVERFLOW SCUPPER |
| | MODIFIED BITUMINOUS ROOFING WITH TAPERED ROOF INSULATION TO PROVIDE A POSITIVE FINISHED SLOPE OF 1.5% MINIMUM | EF# | EXISTING EXHAUST FAN UNIT # |
| | | CJ | CONTROL JOINT, SEE DETAIL 4/A230 |
| | | RTU# | MECHANICAL ROOF TOP UNIT # |
| | | RD | TAPERED 600x600 INSULATION "SUMP" AT ROOF DRAIN COORDINATE W/ MECHANICAL DRAWINGS |
| | | ROS | ROOF OVERFLOW SCUPPER, SEE DETAILS ON DRAWING A230 |
| | | +0 | HIGH POINT (STRUCTURE) |
| | | +(-) | HIGH POINT (INSULATION) |
| | | -## | ELEVATION OF STRUCTURE AT LOW POINT RELATIVE TO HIGH POINT |
| | | ### | ELEVATION OF STRUCTURE AT HIGH POINT RELATIVE TO HIGH POINT |
| | | -### | ELEVATION OF TAPERED INSULATION AT LOW POINT RELATIVE TO INSULATION HIGH POINT |
| | | +### | ELEVATION OF TAPERED INSULATION AT HIGH POINT RELATIVE TO INSULATION HIGH POINT |
| | | EF# | REFER TO MECHANICAL DRAWINGS |
| | | 0.000 | ELEVATION OF NEW ROOF PARAPET MEASURED TO 1/0 STUDS, 1/0 TILT-UP OR 1/0 CURTAINWALL |



| REV. | DATE | ISSUED FOR... |
|------|------|----------------------|
| 1 | 0 | WWW/MR ISSUED FOR... |

LES IDEES, CONCEPTS, DISPOSITIONS ET PLANS MONTRÉS OU REPRÉSENTÉS PAR CE DESSIN APPARTIENNENT À EDWARD J. CUHACI AND ASSOCIATES ARCHITECTS INC. ET ONT ÉTÉ CRÉÉS, ET DÉVELOPPÉS POUR ÊTRE UTILISÉS DANS LE CADRE DU PRÉSENT PROJET. ILS NE DOIVENT PAS ÊTRE UTILISÉS À D'AUTRES FINS NI COMMUNIQUÉS À QUI QUE CE SOIT SANS LA PERMISSION ÉCRITE DE EDWARD J. CUHACI AND ASSOCIATES ARCHITECTS INC.

L'ARCHITECTE DÉCLINE TOUTE RESPONSABILITÉ DÉCOULANT DE PROBLÈMES FAISANT SUITE AU NON RESPECT DES PLANS ET DEVIS OU DE L'INTENTION DU CONCEPT QU'ILS TRANSMITENT, OU DE TOUTES PROBLÈMES POUVANT RÉSULTER DU DÉFAUT DE TIERS D'OBTENIR OU DE SUIVRE LES INSTRUCTIONS DE L'ARCHITECTE RELATIVEMENT AUX ERREURS, OMISSIONS, INCOHÉRENCES, AMBIGUITÉS OU CONTRADICTIONS ALLÉGUÉES.

L'ENTREPRENEUR DOIT VÉRIFIER TOUTES LES DIMENSIONS SUR PLACE ET INFORMER L'ARCHITECTE DE TOUT ÉCART AVANT LE DÉBUT DES TRAVAUX. NE PAS MESURER LES DESSINS À L'ÉCHELLE.

ALL IDEAS, DESIGNS, ARRANGEMENTS, AND PLANS INDICATED OR REPRESENTED BY THIS DRAWING ARE OWNED BY AND THE PROPERTY OF EDWARD J. CUHACI AND ASSOCIATES INC. AND WERE CREATED, EVALUATED, AND DEVELOPED FOR USE ON AND IN CONNECTION WITH THE SPECIFIED PROJECT. NONE OF THE IDEAS, DESIGNS, ARRANGEMENTS OR PLANS SHALL BE USED BY OR DISCLOSED TO ANY PERSON, FIRM, OR CORPORATION FOR ANY PURPOSE WHATSOEVER WITHOUT THE WRITTEN PERMISSION OF EDWARD J. CUHACI AND ASSOCIATES INC.

THE ARCHITECT WAIVES ANY AND ALL RESPONSIBILITY AND LIABILITY FOR PROBLEMS WHICH ARISE FROM FAILURE TO FOLLOW THESE PLANS, SPECIFICATIONS, AND THE DESIGN INTENT THEY CONVEY, OR FOR PROBLEMS WHICH ARISE FROM OTHERS' FAILURE TO OBTAIN AND/OR FOLLOW THE ARCHITECT'S GUIDANCE WITH RESPECT TO ANY ERRORS, OMISSIONS, INCONSISTENCIES, AMBIGUITIES OR CONFLICTS WHICH ARE ALLEGED.

CONTRACTOR TO VERIFY ALL DIMENSIONS AND NOTIFY THE ARCHITECT OF ANY DISCREPANCIES BEFORE WORK COMMENCES. DO NOT SCALE DRAWINGS

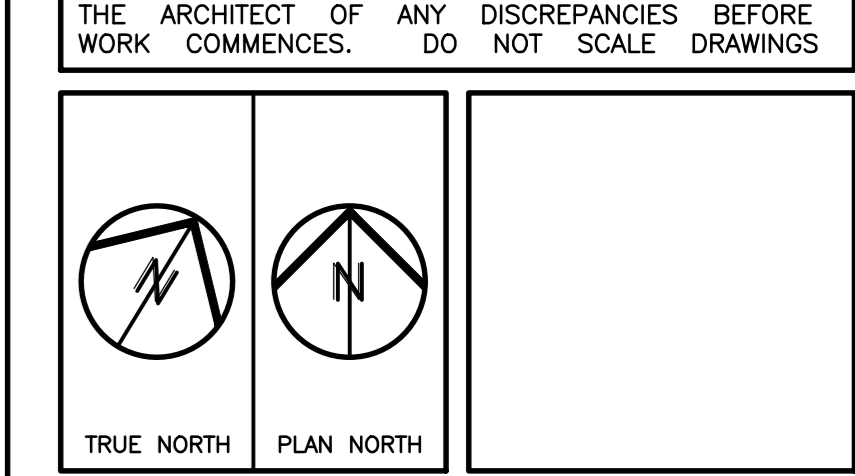

EDWARD J. CUHACI & ASSOCIATES ARCHITECTS INC.
 111 Queen St. Suite 101, Ottawa, Ontario, K1P 6K1
 Fax: (613) 561-1841 Telephone: (613) 238-7125 E-mail: eh@ejc.ca

| | | | |
|-------------------------------|---|-------------|------------|
| PROJECT TITLE/TITRE DU PROJET | ÉCOLE SECONDAIRE CATHOLIQUE PAUL-DESMARAIS - ADDITION | | |
| CLIENT | 5315 ABBOTT STREET EAST OTTAWA, ONTARIO, K2S 0X3 | | |
| SCALE | AS SHOWN | PROJ. NO. | 2219 |
| DATE | 2022 07 26 | ISSUE NO. | 1 |
| DRAWN BY | S.J. | DESIGNER | S.J. |
| CHECKED BY | S.R., J.J. | DATE | 2022 07 26 |
| ROOF PLAN | | A105 | |



Adjustable Accutrol Weir

Tag: _____

Adjustable Flow Control for Roof Drains

ADJUSTABLE ACCUTROL (for Large Sump Roof Drains only)

For more flexibility in controlling flow with heads deeper than 2", Watts Drainage offers the Adjustable Accutrol. The Adjustable Accutrol Weir is designed with a single parabolic opening that can be covered to restrict flow above 2" of head to less than 5 gpm per inch, up to 6" of head. To adjust the flow rate for depths over 2" of head, set the slot in the adjustable upper cone according to the flow rate required. Refer to Table 1 below.
 Note: Flow rates are directly proportional to the amount of weir opening that is exposed.

EXAMPLE:

For example, if the adjustable upper cone is set to cover 1/2 of the weir opening, flow rates above 2" of head will be restricted to 2-1/2 gpm per inch of head.

Therefore, at 3" of head, the flow rate through the Accutrol Weir that has 1/2 the slot exposed will be:
 [5 gpm (per inch of head) x 2 inches of head] + 2-1/2 gpm (for the third inch of head) = 12-1/2 gpm.

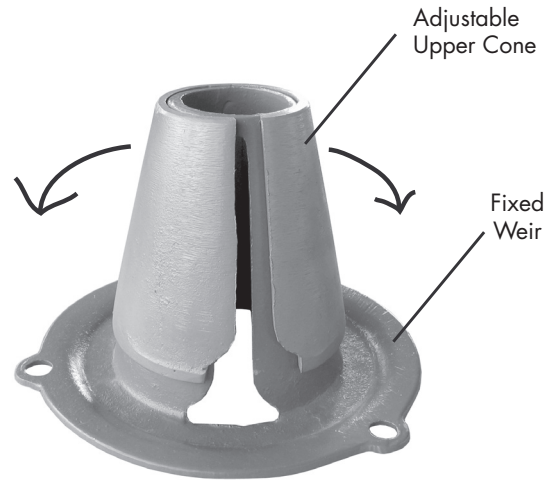
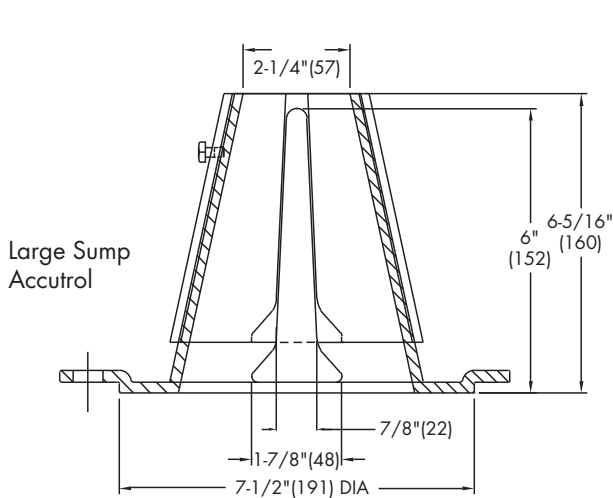

1/2 Weir Opening Exposed Shown Above

TABLE 1. Adjustable Accutrol Flow Rate Settings

| Weir Opening Exposed | 1" | 2" | 3" | 4" | 5" | 6" |
|----------------------|--------------------------------|----|-------|------|-------|----|
| | Flow Rate (gallons per minute) | | | | | |
| Fully Exposed | 5 | 10 | 15 | 20 | 25 | 30 |
| 3/4 | 5 | 10 | 13.75 | 17.5 | 21.25 | 25 |
| 1/2 | 5 | 10 | 12.5 | 15 | 17.5 | 20 |
| 1/4 | 5 | 10 | 11.25 | 12.5 | 13.75 | 15 |
| Closed | 5 | 5 | 5 | 5 | 5 | 5 |

Job Name _____
 Job Location _____
 Engineer _____

Contractor _____
 Contractor's P.O. No. _____
 Representative _____

Watts product specifications in U.S. customary units and metric are approximate and are provided for reference only. For precise measurements, please contact Watts Technical Service. Watts reserves the right to change or modify product design, construction, specifications, or materials without prior notice and without incurring any obligation to make such changes and modifications on Watts products previously or subsequently sold.

USA: Tel: (800) 338-2581 • Fax: (828) 248-3929 • Watts.com
 Canada: Tel: (905) 332-4090 • Fax: (905) 332-7068 • Watts.ca
 Latin America: Tel: (52) 81-1001-8600 • Fax: (52) 81-8000-7091 • Watts.com





GWAL

Goodkey Weedmark & Associates Ltd.

Principal, Partners & Associates
F.W.A. Barr, P.Eng.
R. Lefebvre, P.Eng., LEED® AP
D.R. Vyas, P.Eng., MIEEE
S. Hamilton, P.Eng.
J. Moffat, P.Eng.
E. Pérusse, P.Eng., ing.
R. Bolvin, P.Eng., ing.
R. Leonard, P.Eng.
M. Sarasin, P.Eng.

Executive Consultants
A. Bogdanowicz, P.Eng.
M.G. Carriere, C.E.T.
R.J. McIntyre, P.Eng.

February 23, 2023

Edward J. Cuhaci and Associates Architects Inc.
171 Slater Street, Suite 100
Ottawa, Ontario
K1P 5H7

ATTENTION: SIMON RIOUX, B.ARCH. ARCHITECT, ASSOCIATE PRINCIPAL

**SUBJECT: RESPONSE LETTER – SITE PLAN CONTROL APPLICATION
5315 ABBOTT ST., ÉCOLE SECONDAIRE CATHOLIQUE PAUL-DESMARAIS,
AJOUT DE SALLES DE CLASSE - TILT-UP, CECCE PROJET #2022PDM117
GWAL PROJECT NO. 2022-155**

We have reviewed the City of Ottawa comments regarding the site plan control application first review comments, dated January 11, 2023, and offer the following response to the mechanical items.

Item 1.23: The new pavilion fixture unit load is 98.5 fixture units. Based on table 7.4.10.5 of the OBC, this translates into a maximum probable drainage rate of 53 US GPM. The new pumps are both sized at 32 US GPM. As such, the maximum drainage rate can be addressed with both pumps in operation.

Item 1.31: Flow control roof drains are included in the final design to meet the requirements of the stormwater management strategy. Scuppers are being provided by the architect.

Yours very truly,

GOODKEY, WEEDMARK & ASSOCIATES LTD.

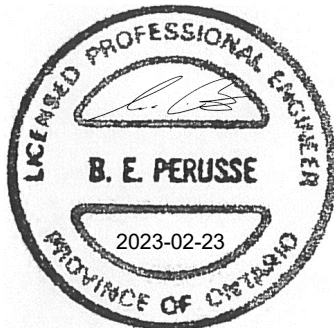

Eric Pérusse, P.Eng., ing. | Partner, Sr. Mechanical Engineer
EP/nh

Enclosure(s): City of Ottawa's letter dated January 11, 2023 – Ten (10) pages

FLOW CONTROL ROOF DRAINAGE DECLARATION

THIS FORM TO BE COMPLETED BY THE MECHANICAL AND STRUCTURAL ENGINEERS RESPONSIBLE FOR DESIGN

Permit Application No.

Project Name:

École Secondaire Catholique Paul-Desmarais - Ajout de Salles de Classe - Tilt-up - CECCE Projet #2022PDM117

Building Location:

5315 Abbott Street East

Municipality:

City of Ottawa

The roof drainage system has been designed in accordance with the following criteria: (please check one of the following).

- M1. Conventionally drained roof (no flow control roof drains used).
- M2. Flow control roof drains meeting the following conditions have been incorporated in this design:
- (a) the maximum drain down time does not exceed 24h,
 - (b) one or more scuppers are installed so that the maximum depth of water on the roof cannot exceed 150mm,
 - (c) drains are located not more than 15m from the edge of roof and not more than 30m from adjacent drains, and
 - (d) there is at least one drain for each 900 sq.m.
- M3. A flow control drainage system that does not meet the minimum drainage criteria described in M2 has been incorporated in this design.

PROFESSIONAL SEAL APPLIED BY:

Practitioner's Name:

Eric Pérusse, P.Eng., ing.

Firm:

Goodkey Weedmark & Associates Ltd

Phone #:

613-229-1273

City:

Ottawa

Province:

Ontario

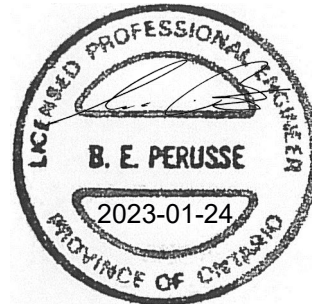

Mechanical Engineer's Seal

- S1. The design parameters incorporated into the overall structural design are consistent with the information provided by the Mechanical Engineer in M2. Loads due to rain are not considered to act simultaneously with loads due to snow as per Sentence 4.1.7.3 (3) OBC.
- S2. The structure has been designed incorporating the additional structural loading due to rain acting simultaneously with the snow load. The design parameters are consistent with the control flow drainage system designed by the mechanical engineer.

PROFESSIONAL SEAL APPLIED BY:

Practitioner's Name:

Terence Cain, P.Eng

Firm:

Cleland Jardine Engineering Ltd

Phone #:

613-591-1533

City:

Kanata

Province:

Ontario



Structural Engineer's Seal

FLOW CONTROL ROOF DRAINAGE DECLARATION

THIS FORM TO BE COMPLETED BY THE MECHANICAL AND STRUCTURAL ENGINEERS RESPONSIBLE FOR DESIGN

Permit Application No.

Project Name:

École secondaire catholique Paul-Desmarais Dome Pavilion

Building Location:

5315 Abbott Street East

Municipality:

City of Ottawa

The roof drainage system has been designed in accordance with the following criteria: (please check one of the following).

- M1. Conventionally drained roof (no flow control roof drains used).
- M2. Flow control roof drains meeting the following conditions have been incorporated in this design:
- (a) the maximum drain down time does not exceed 24h,
 - (b) one or more scuppers are installed so that the maximum depth of water on the roof cannot exceed 150mm,
 - (c) drains are located not more than 15m from the edge of roof and not more than 30m from adjacent drains, and
 - (d) there is at least one drain for each 900 sq.m.
- M3. A flow control drainage system that does not meet the minimum drainage criteria described in M2 has been incorporated in this design.

PROFESSIONAL SEAL APPLIED BY:

Practitioner's Name:

Eric Pérusse, P.Eng., ing.

Firm:

Goodkey, Weedmark & Associates Ltd

Phone #:

613-229-1273

City:

Ottawa

Province:

Ontario



Mechanical Engineer's Seal

- S1. The design parameters incorporated into the overall structural design are consistent with the information provided by the Mechanical Engineer in M2. Loads due to rain are not considered to act simultaneously with loads due to snow as per Sentence 4.1.7.3 (3) OBC.
- S2. The structure has been designed incorporating the additional structural loading due to rain acting simultaneously with the snow load. The design parameters are consistent with the control flow drainage system designed by the mechanical engineer.

PROFESSIONAL SEAL APPLIED BY:

Practitioner's Name:

Richard I. Cunliffe

Firm:

Cunliffe & Associates Inc.

Phone #:

613 729-7242

City:

OTTAWA

Province:

ON

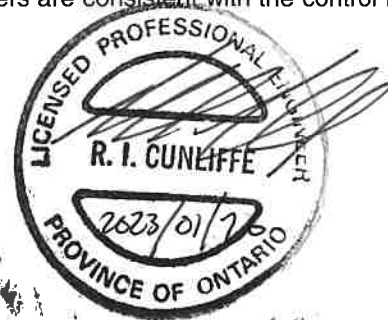

Structural Engineer's Seal

| | | | |
|---|---|------------|----------------------------|
| 2 | 0 | 2022-12-16 | ISSUED FOR BUILDING PERMIT |
| 1 | 0 | 2022-11-01 | ISSUED FOR SPA |

ISSUE NO. REV. NO. DATE ISSUE

LES IDÉES, CONCEPTS, DISPOSITIONS ET PLANS MONTRÉS OU REPRÉSENTÉS PAR CE DESSIN APPARTIENNENT À EDWARD J. CUHACI AND ASSOCIATES ARCHITECTS INC. ET ONT ÉTÉ CRÉÉS ET DÉVELOPPÉS POUR ÊTRE UTILISÉS DANS LE CADRE DU PRÉSENT PROJET. ILS NE DOIVENT PAS ÊTRE UTILISÉS À D'AUTRES FINS NI COMMUNIQUÉS À QUI QUE CE SOIT SANS LA PERMISSION ÉCRITE DE EDWARD J. CUHACI AND ASSOCIATES ARCHITECTS INC.

L'ARCHITECTE DÉCLINE TOUTE RESPONSABILITÉ DÉCOULANT DE PROBLÈMES FAISANT SUITE AU NON-RESPECT DES PLANS ET DEVIS OU DE L'INTENTION DU CONCEPT QU'ILS TRANSMETTENT OU DE TOUTS PROBLÈMES POUVANT RÉSULTER DU DÉFAUT DE TIERS D'OBTENIR OU DE SUIVRE LES INSTRUCTIONS DE L'ARCHITECTE RELATIVEMENT AUX ERREURS, OMISSIONS, INCOHÉRENCES, AMBIGUITÉS OU CONTRADICTIONS ALLÉGUÉES.

L'ENTREPRENEUR DOIT VÉRIFIER TOUTES LES DIMENSIONS SUR PLACE ET INFORMER L'ARCHITECTE DE TOUT ÉCART AVANT LE DÉBUT DES TRAVAUX. NE PAS MESURER LES DESSINS À L'ÉCHELLE.

ALL IDEAS, DESIGNS, ARRANGEMENTS, AND PLANS INDICATED OR REPRESENTED BY THIS DRAWING ARE OWNED BY AND THE PROPERTY OF EDWARD J. CUHACI AND ASSOCIATES INC. ANY AND ALL IDEAS, DESIGNS, ARRANGEMENTS OR PLANS SHALL BE USED BY OR DISCLOSED TO ANY PERSON, FIRM, OR CORPORATION FOR ANY PURPOSE WHATSOEVER WITHOUT THE WRITTEN PERMISSION OF EDWARD J. CUHACI AND ASSOCIATES INC.

THE ARCHITECT WAIVES ANY AND ALL RESPONSIBILITY AND LIABILITY FOR PROBLEMS WHICH ARISE FROM FAILURE TO FOLLOW THESE PLANS, SPECIFICATIONS, AND THE DESIGN INTENT THEY CONVEY, OR FOR PROBLEMS WHICH ARISE FROM OTHERS' FAILURE TO OBTAIN AND/OR FOLLOW THE ARCHITECT'S GUIDANCE WITH RESPECT TO ANY ERRORS, OMISSIONS, INCONSISTENCIES, AMBIGUITIES OR CONFLICTS WHICH ARE ALLEGED.

CONTRACTOR TO VERIFY ALL DIMENSIONS AND NOTIFY THE ARCHITECT OF ANY DISCREPANCIES BEFORE WORK COMMENCES. DO NOT SCALE DRAWINGS



TRUE NORTH

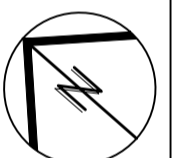

PLAN NORTH

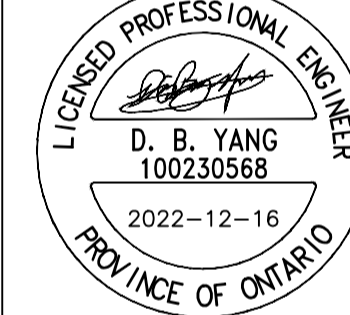

LICENSED PROFESSIONAL ENGINEER
 D. B. YANG
 100230568
 2022-12-16
 PROVINCE OF ONTARIO

EDWARD J. CUHACI & ASSOCIATES ARCHITECTS Inc.
 171 Slater St., Suite 100, Ottawa, Ontario, K1P 5H7
 Fax: (613) 236-1944 Telephone: (613) 236-7135 E-mail: info@cuhaci.com

PROJECT TITLE/TITRE DU PROJET
ÉCOLE SECONDAIRE CATHOLIQUE PAUL-DESMARIS - DOME

5315 ABBOTT STREET EAST
 OTTAWA, ON

CONSEIL DES ÉCOLES CATHOLIQUES DU CENTRE-EST
 4000, RUE LABELLE, OTTAWA, ON K1J 1A1

DRAWING TITLE/TITRE DU DESSIN
GRADING PLAN

| | | | | |
|---------------------------|------------|---------------------------|----------------|---------------|
| SCALE ÉCHELLE | 1:400 | PROJ. No. 211-06227-00 | ISSUE No. 2 | REV. No. 0 |
| DRAWN BY DESSINÉ PAR | V.T./J.T. | DRAWING/DESSIN | | |
| CHECKED BY VÉRIFIÉ PAR | D.Y. | C03 | | |
| DATE | 2022-12-16 | FICHIER ACAD FILE: | | |

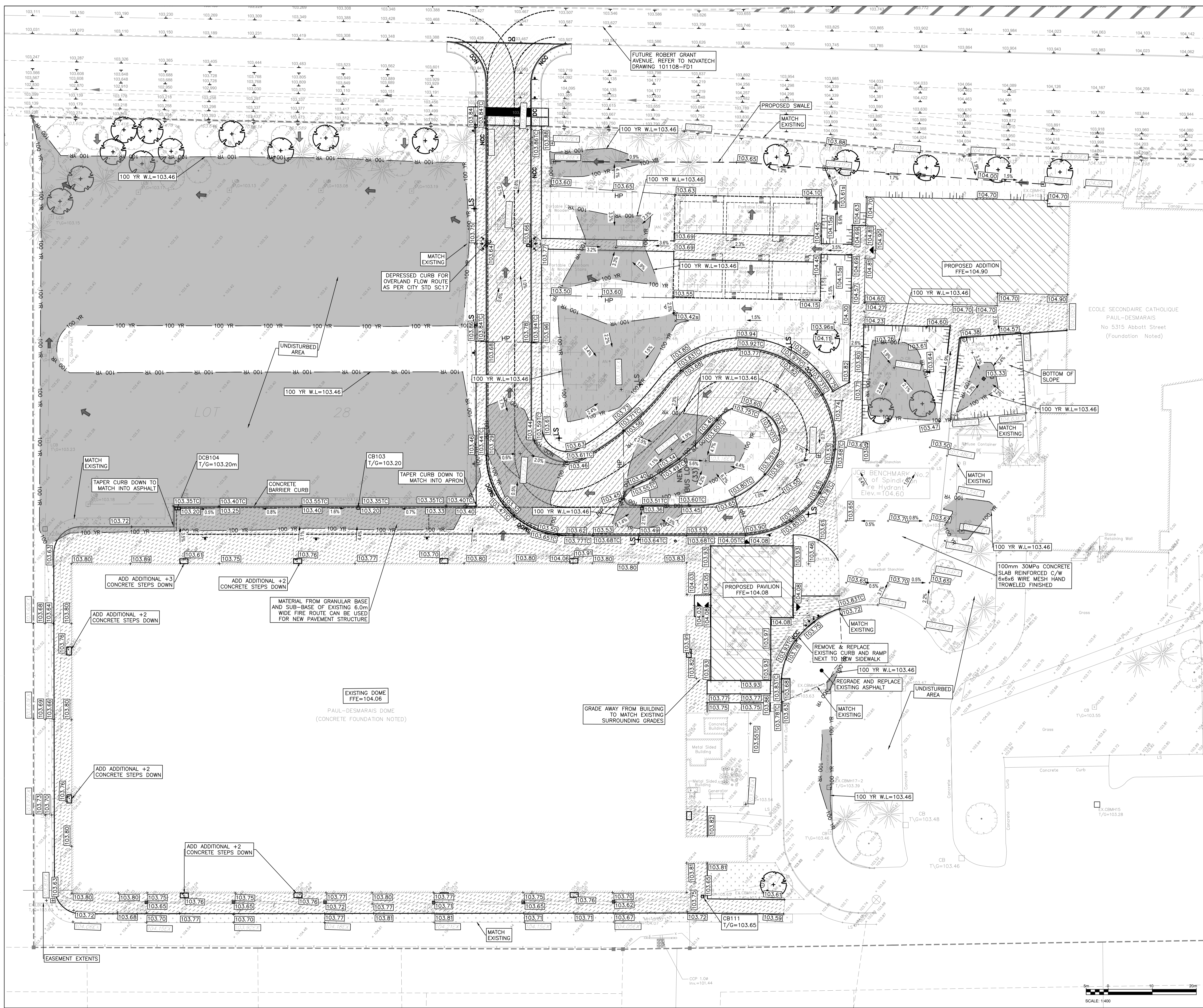

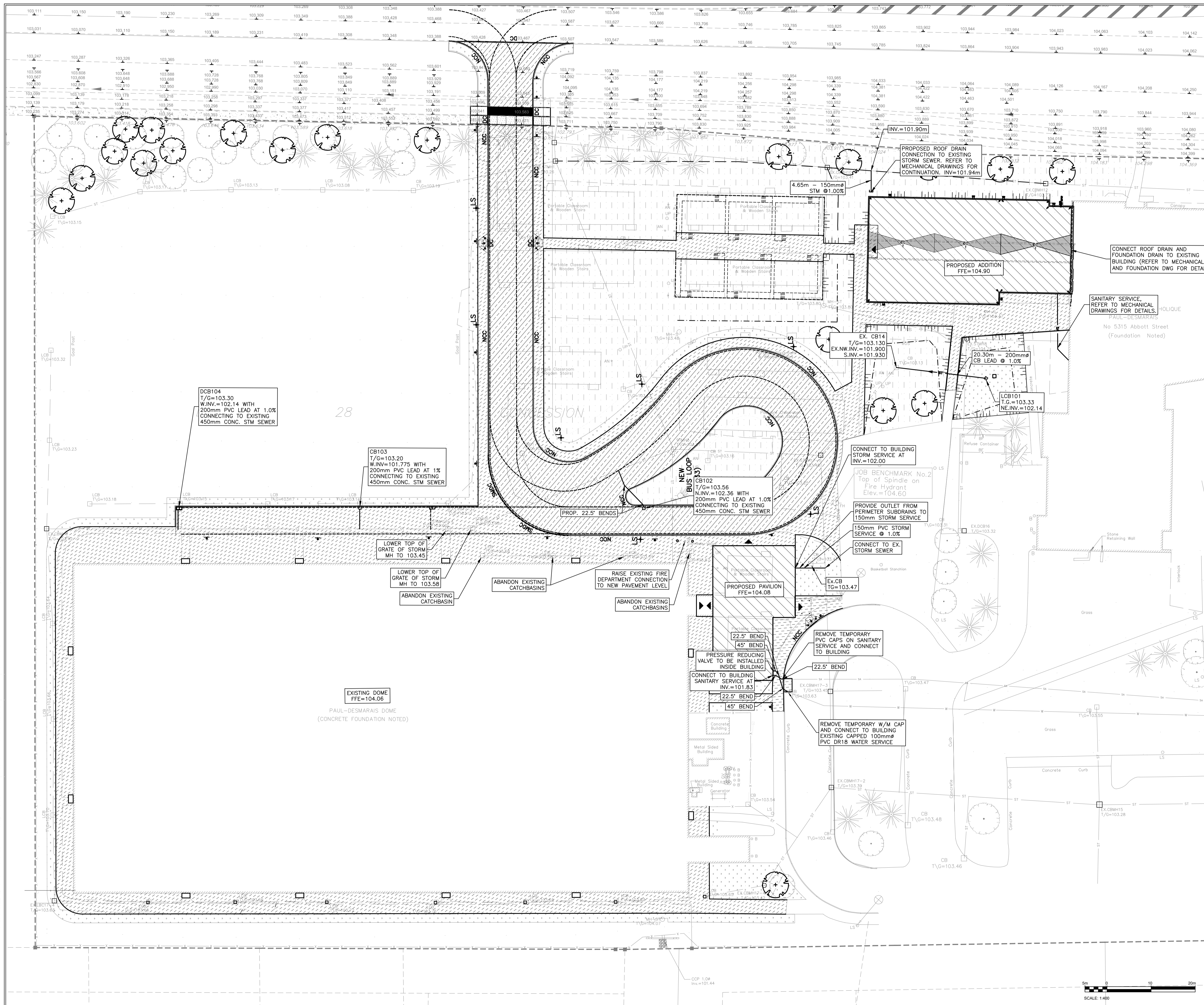

| | | | |
|---|---|------------|----------------------------|
| 2 | 0 | 2022-12-16 | ISSUED FOR BUILDING PERMIT |
| 1 | 0 | 2022-11-01 | ISSUED FOR SPA |

ISSUE NO. REV. NO. DATE BY/ISSUED FOR ISSUE

LES IDEES, CONCEPTS, DISPOSITIONS ET PLANS MONTRÉS OU REPRÉSENTÉS PAR CE DESSIN APPARTIENNENT À EDWARD J. CUHACI AND ASSOCIATES ARCHITECTS INC. ET ONT ÉTÉ CRÉÉS ET DÉVELOPPÉS POUR ÊTRE UTILISÉS DANS LE CADRE DU PRÉSENT PROJET. ILS NE DOIVENT PAS ÊTRE UTILISÉS À D'AUTRES FINS NI COMMUNIQUÉS À QUI QUE CE SOIT SANS LA PERMISSION ÉCRITE DE EDWARD J. CUHACI AND ASSOCIATES ARCHITECTS INC.

L'ARCHITECTE DÉCLINE TOUTE RESPONSABILITÉ DÉCOULANT DE PROBLÈMES FAISANT SUITE AU NON-RESPECT DES PLANS ET DEVIS OU DE L'INTENTION DU CONCEPT QU'ILS TRANSMETTENT OU DE TOUTS PROBLÈMES POUVANT RÉSULTER DU DÉFAUT DE TIERS D'OBTENIR OU DE SUIVRE LES INSTRUCTIONS DE L'ARCHITECTE RELATIVEMENT AUX ERREURS, OMISSIONS, INCOHERENCES, AMBIGUITÉS OU CONTRADICTIONS ALLÉGUÉES.

L'ENTREPRENEUR DOIT VÉRIFIER TOUTES LES DIMENSIONS SUR PLACE ET INFORMER L'ARCHITECTE DE TOUT ÉCART AVANT LE DÉBUT DES TRAVAUX. NE PAS MESURER LES DESSINS À L'ÉCHELLE.

ALL IDEAS, DESIGNS, ARRANGEMENTS, AND PLANS INDICATED OR REPRESENTED BY THIS DRAWING ARE OWNED BY AND THE PROPERTY OF EDWARD J. CUHACI AND ASSOCIATES INC. AND WERE CREATED, EVOLVED, AND DEVELOPED FOR USE ON AND IN CONNECTION WITH THE SPECIFIED PROJECT. NONE OF THE IDEAS, DESIGNS, ARRANGEMENTS OR PLANS SHALL BE USED BY OR DISCLOSED TO ANY PERSON, FIRM, OR CORPORATION FOR ANY PURPOSE WHATSOEVER WITHOUT THE WRITTEN PERMISSION OF EDWARD J. CUHACI AND ASSOCIATES INC.

THE ARCHITECT WAIVES ANY AND ALL RESPONSIBILITY AND LIABILITY FOR PROBLEMS WHICH ARISE FROM FAILURE TO FOLLOW THESE PLANS, SPECIFICATIONS, AND THE DESIGN INTENT THEY CONVEY, OR FOR PROBLEMS WHICH ARISE FROM OTHERS' FAILURE TO OBTAIN AND/OR FOLLOW THE ARCHITECT'S GUIDANCE WITH RESPECT TO ANY ERRORS, OMISSIONS, INCONSISTENCIES, AMBIGUITIES OR CONFLICTS WHICH ARE ALLEGED.

CONTRACTOR TO VERIFY ALL DIMENSIONS AND NOTIFY THE ARCHITECT OF ANY DISCREPANCIES BEFORE WORK COMMENCES. DO NOT SCALE DRAWINGS

TRUE NORTH

PLAN NORTH

LICENSED PROFESSIONAL ENGINEER
 D. B. YANG
 100230568
 2022-12-16
 PROVINCE OF ONTARIO

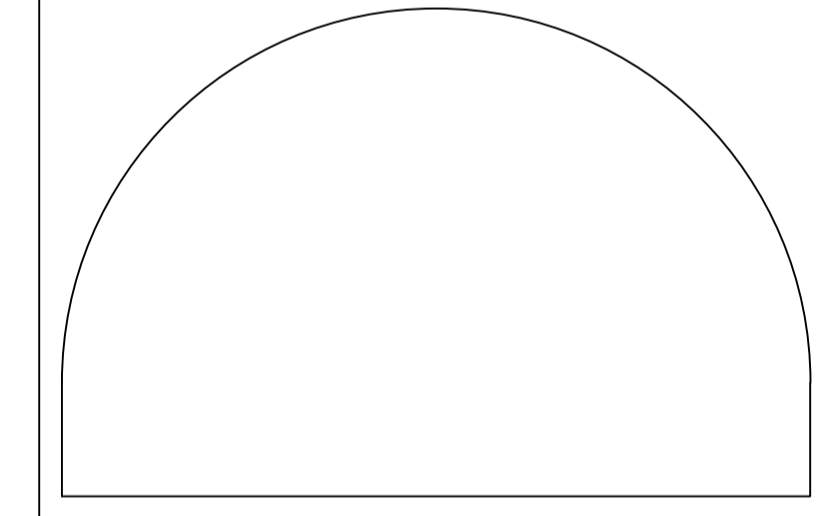

EDWARD J. CUHACI & ASSOCIATES ARCHITECTS Inc.
 171 Slater St., Suite 100, Ottawa, Ontario, K1P 5H7
 Fax: (613) 236-1944 Telephone: (613) 236-7135 E-mail: info@cuhaci.com

PROJECT TITLE/TITRE DU PROJET
ÉCOLE SECONDAIRE CATHOLIQUE PAUL-DESMARAIS - DOME

5315 ABBOTT STREET EAST
 OTTAWA, ON

CONSEIL DES ÉCOLES CATHOLIQUES DU CENTRE-EST
 4000, RUE LABELLE, OTTAWA, ON K1J 1A1

| | | | |
|--|------------|---------------------------|----------------|
| DRAWING TITLE/TITRE DU DESSIN SERVICING PLAN | | | |
| SCALE ÉCHELLE | 1:400 | PROJ. No. 211-06227-00 | ISSUE No. 2 |
| DRAWN BY DESSINÉ PAR | V.T./J.T. | DRAWING/DESSIN | REV. No. 0 |
| CHECKED BY VÉRIFIÉ PAR | D.Y. | C04 | |
| DATE | 2022-12-16 | FICHIER ACAD FILE: | |

APPENDIX

D

- EROSION AND SEDIMENTATION CONTROL
PLAN C06

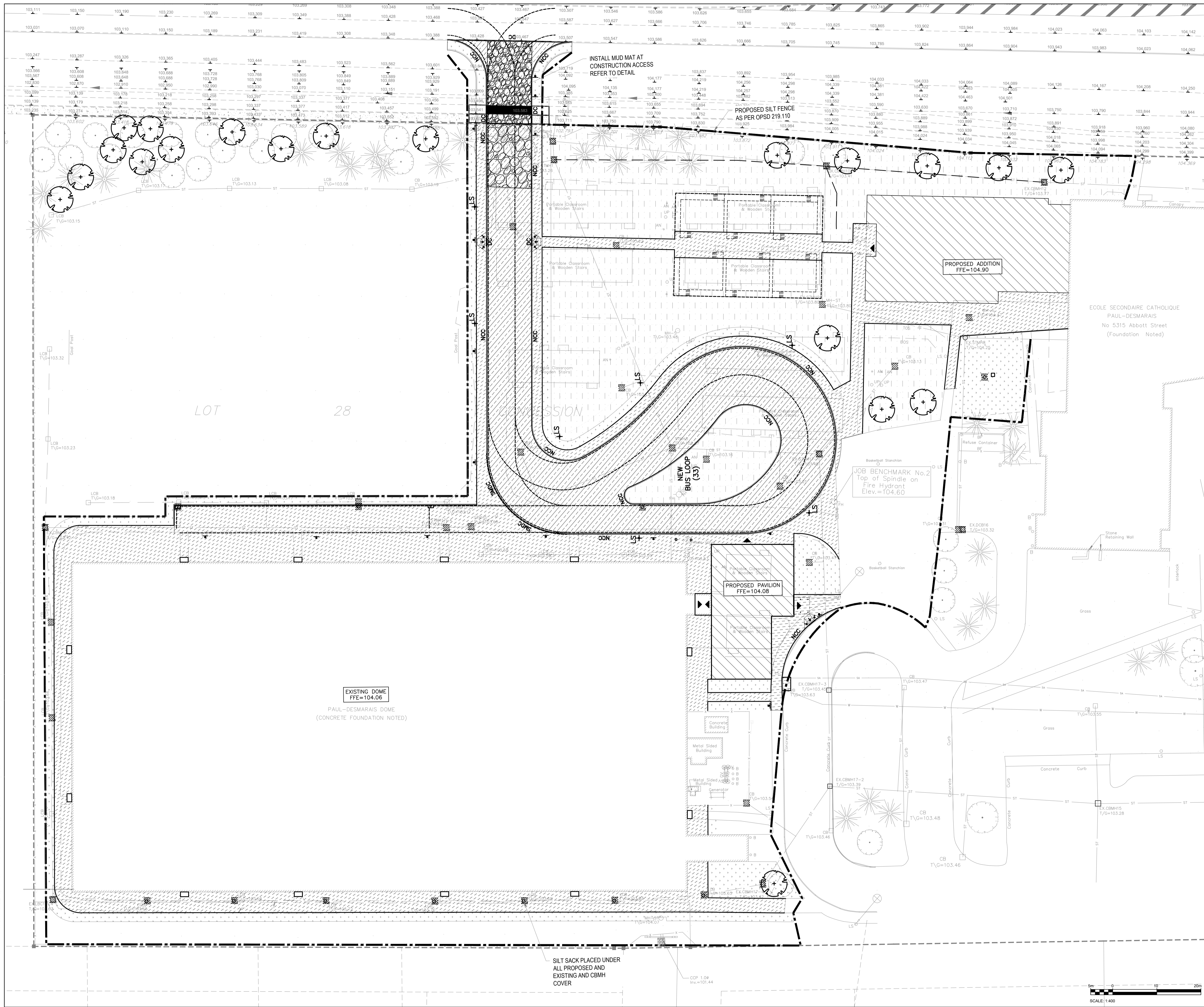

| | | | |
|---|---|------------|----------------------------|
| 2 | 0 | 2022-12-16 | ISSUED FOR BUILDING PERMIT |
| 1 | 0 | 2022-11-01 | ISSUED FOR SPA |

ISSUE NO. REV. NO. DATE ISSUE

LES IDÉES, CONCEPTS, DISPOSITIONS ET PLANS MONTRÉS OU REPRÉSENTÉS PAR CE DESSIN APPARTIENNENT À EDWARD J. CUHACI AND ASSOCIATES ARCHITECTS INC. ET ONT ÉTÉ CRÉÉS ET DÉVELOPPÉS POUR ÊTRE UTILISÉS DANS LE CADRE DU PRÉSENT PROJET. ILS NE DOIVENT PAS ÊTRE UTILISÉS À D'AUTRES FINS NI COMMUNIQUÉS À QUI QUE CE SOIT SANS LA PERMISSION ÉCRITE DE EDWARD J. CUHACI AND ASSOCIATES ARCHITECTS INC.

L'ARCHITECTE DÉCLINE TOUTE RESPONSABILITÉ DÉCOULANT DE PROBLÈMES FAISANT SUITE AU NON-RESPECT DES PLANS ET DEVIS OU DE L'INTENTION DU CONCEPT QU'ILS TRANSMETTENT OU DE TOUTS PROBLÈMES POUVANT RÉSULTER DU DÉFAUT DE TIERS D'OBTENIR OU DE SUIVRE LES INSTRUCTIONS DE L'ARCHITECTE RELATIVEMENT AUX ERREURS, OMISSIONS, INCOHÉRENCES, AMBIGUITÉS OU CONTRADICTIONS ALLÉGUÉES.

L'ENTREPRENEUR DOIT VÉRIFIER TOUTES LES DIMENSIONS SUR PLACE ET INFORMER L'ARCHITECTE DE TOUT ÉCART AVANT LE DÉBUT DES TRAVAUX. NE PAS MESURER LES DESSINS À L'ÉCHELLE.

ALL IDEAS, DESIGNS, ARRANGEMENTS, AND PLANS INDICATED OR REPRESENTED BY THIS DRAWING ARE OWNED BY AND THE PROPERTY OF EDWARD J. CUHACI AND ASSOCIATES INC. AND WERE CREATED, EVOLVED, AND DEVELOPED FOR USE ON AND IN CONNECTION WITH THE SPECIFIED PROJECT. NONE OF THE IDEAS, DESIGNS, ARRANGEMENTS OR PLANS SHALL BE USED BY OR DISCLOSED TO ANY PERSON, FIRM, OR CORPORATION FOR ANY PURPOSE WHATSOEVER WITHOUT THE WRITTEN PERMISSION OF EDWARD J. CUHACI AND ASSOCIATES INC.

THE ARCHITECT WAIVES ANY AND ALL RESPONSIBILITY AND LIABILITY FOR PROBLEMS WHICH ARISE FROM FAILURE TO FOLLOW THESE PLANS, SPECIFICATIONS, AND THE DESIGN INTENT THEY CONVEY, OR FOR PROBLEMS WHICH ARISE FROM OTHERS' FAILURE TO OBTAIN AND/OR FOLLOW THE ARCHITECT'S GUIDANCE WITH RESPECT TO ANY ERRORS, OMISSIONS, INCONSISTENCIES, AMBIGUITIES OR CONFLICTS WHICH ARE ALLEGED.

CONTRACTOR TO VERIFY ALL DIMENSIONS AND NOTIFY THE ARCHITECT OF ANY DISCREPANCIES BEFORE WORK COMMENCES. DO NOT SCALE DRAWINGS

TRUE NORTH

PLAN NORTH

LICENSED PROFESSIONAL ENGINEER
D. B. YANG
100230568
2022-12-16
PROVINCE OF ONTARIO

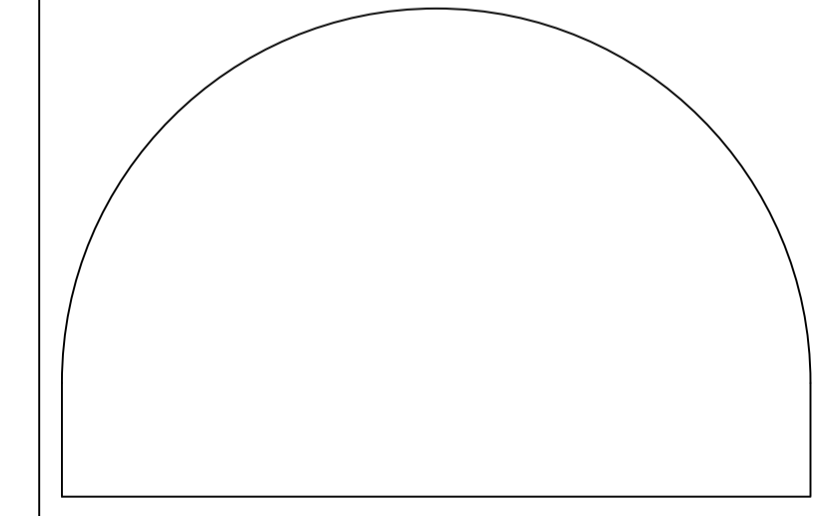

EDWARD J. CUHACI & ASSOCIATES ARCHITECTS Inc.
171 Slater St., Suite 100, Ottawa, Ontario, K1P 5H7
Fax: (613) 236-1944 Telephone: (613) 236-7135 E-mail: info@cuhaci.com

PROJECT TITLE/TITRE DU PROJET
ÉCOLE SECONDAIRE CATHOLIQUE PAUL-DESMARIS - DOME

5315 ABBOTT STREET EAST
OTTAWA, ON

CONSEIL DES ÉCOLES CATHOLIQUES DU CENTRE-EST
4000, RUE LABELLE, OTTAWA, ON K1J 1A1

DRAWING TITLE/TITRE DU DESSIN
EROSION AND SEDIMENTATION CONTROL PLAN

| | | | | |
|---------------------------|------------|---------------------------|----------------|---------------|
| SCALE ÉCHELLE | 1:400 | PROJ. No. 211-06227-00 | ISSUE No. 2 | REV. No. 0 |
| DRAWN BY DESSINÉ PAR | V.T./J.T. | DRAWING/DESSIN | | |
| CHECKED BY VÉRIFIÉ PAR | D.Y. | C06 | | |
| DATE | 2022-12-16 | FICHIER ACAD FILE: | | |

APPENDIX

E

- SUBMISSION CHECK LIST