



**Site Servicing and  
Stormwater Management Report  
266-268 Carruthers Avenue, Ottawa, ON**

**Client:**

McCormick Park Developments Inc.  
P.O. Box 74155 Beechwood Ave  
Ottawa, ON, K1M 2H9

**Submitted for:**

Site Plan Control

**Project Name:**

266-268 Carruthers Avenue

**Project Number:**

OTT-22014656

**Prepared By:**

EXP

2650 Queensview Drive

Ottawa, ON K2B 8H8

t: +1.613.688.1899

f: +1.613.225.7337

**Date Submitted:**

December 15, 2023

## Site Servicing and Stormwater Management Report 266-268 Carruthers Avenue, Ottawa, ON

**Client:**

McCormick Park Developments Inc.  
P.O. Box 74155 Beechwood  
Ottawa, ON, K1M 2H9

**Submitted for:**

Site Plan Control

**Project Name:**

266-268 Carruthers Avenue

**Project Number:**

OTT-22014656

**Prepared By:**

EXP  
2650 Queensview Drive  
Ottawa, ON K2B 8H8  
t: +1.613.688.1899  
f: +1.613.225.7337

**Prepared by:**

**Approved by:**

  
Jason Fitzpatrick, P.Eng.  
Project Engineer

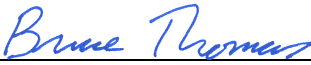

  
Bruce Thomas, P.Eng.  
Senior Project Manager

**Date Submitted:**

December 15, 2023

# Table of Contents

- 1 Introduction ..... 1
  - 1.1 Overview ..... 1
- 2 Existing Conditions..... 2
- 3 Existing Infrastructure..... 2
- 4 Water Servicing..... 3
  - 4.1 Existing Water Servicing..... 3
  - 4.2 Water Servicing Proposal ..... 3
  - 4.3 Water Servicing Design ..... 3
  - 4.4 Water Servicing Design Criteria ..... 4
  - 4.5 Estimated Water Demands ..... 5
  - 4.6 Boundary Conditions..... 5
  - 4.7 Fire Flow Requirements ..... 5
  - 4.8 Review of Hydrant Spacing ..... 6
- 5 Sewage Servicing ..... 7
  - 5.1 Existing Sewage Conditions..... 7
  - 5.2 Proposed Sewage Conditions..... 7
- 6 Storm Servicing & Stormwater Management..... 8
  - 6.1 Design Criteria ..... 8
  - 6.2 Minor System Design Criteria ..... 8
  - 6.3 Major System Design Criteria..... 8
  - 6.4 Time of Concentration ..... 9
  - 6.5 Pre-Development Conditions..... 9
  - 6.6 Allowable Release Rate ..... 9
  - 6.7 Runoff Coefficients..... 9
  - 6.8 Proposed Stormwater System ..... 9
  - 6.9 Flow Attenuation ..... 10
  - 6.10 Storm Sewer Design ..... 11
- 7 Erosion & Sediment Control ..... 12
- 8 Conclusions and Recommendations..... 13
- 9 Legal Notification ..... 14

## List of Figures

Figure 1-1 - Site Location.....	1
Figure A-1 - Pre-Development Drainage Areas .....	A
Figure A-2 - Post-Development Drainage Areas.....	A
Figure A-3 – Hydrant Location Plan.....	A

## List of Tables

Table 4-1 - Summary of Water Supply Design Criteria .....	4
Table 4-2 : Water Demand Summary .....	5
Table 4-3 - Summary of Design Parameters Used in Calculating Required Fire Flows (RFF) Using FUS.....	6
Table 4-4 – Required Fire Flows .....	6
Table 5-1– Summary of Wastewater Design Criteria / Parameters .....	7
Table 5-2 – Summary of Anticipated Sewage Rates .....	8
Table 6-1 – Summary of Pre-Development Flows .....	9
Table 6-2 – Summary of Runoff Coefficients.....	9
Table 6-3 – Summary of Post-Development Flows .....	10
Table 6-4 – Summary of Post-Development Storage .....	11
Table B-1 – Water Demand Chart .....	B
Table B-2 – Fire Flow Requirements Based on Fire Underwriters Survey (FUS) .....	B
Table B-3 – Available Fire Flows Based on Hydrant Spacing .....	B
Table B-4 – Estimated Water Pressure at Proposed Building.....	B
Table C-1 – Sanitary Sewer Design Sheet .....	C
Table D-1 – Estimation of Pre-Development Peak Flows .....	D
Table D-2 – Estimation of Allowable Peak Flows (Based on Max C=0.50 with Tc=10mins) .....	D
Table D-3 – Summary of Post-Development Peak Flows (Uncontrolled and Controlled) .....	D
Table D-4 – Summary of Post-Development Storage.....	D
Table D-5 – Calculation of Available Surface Storage (not provided) .....	D
Table D-6 – Calculation of Available Underground Storage.....	D
Table D-7 – Calculation of Available Underground Infiltration Trench Storage .....	D
Table D-8 – Calculation of Underground Structure Storage.....	D
Table D-9 - 5-year & 100-year Roof Drains Design Sheet - using Flow Controlled Roof Drains .....	D
Table D-10 - Storage Volumes Roof Area #S01-1 (5 Year and 100Year Storms) .....	D
Table D-11 - Storage Volumes Roof Area #S01-2 (5 Year and 100Year Storms) .....	D
Table D-12 - Storage Volumes Roof Area #S01-3 (5 Year and 100Year Storms) .....	D
Table D-13 - Storage Volumes Roof Area #S01-4 (5 Year and 100Year Storms) .....	D
Table D-14 - Storage Volumes Roof Area #S01-5 (5 Year and 100Year Storms) .....	D
Table D-15 - Storage Volumes Roof Area #S01-6 (5 Year and 100Year Storms) .....	D
Table D-16 - Storage Volumes for 2-year, 5-year and 100-year Storms.....	D
Table D-17 – 2-Year Storm Sewer Calculation Sheet.....	D

## List of Appendices

Appendix A - Figures..... A  
Appendix B – Water Servicing Tables..... B  
Appendix C – Sanitary Servicing Tables ..... C  
Appendix D – Stormwater Servicing Tables..... D  
Appendix E – Consultation / Correspondence ..... E  
Appendix F – Background Information.....F  
Appendix G – Checklist.....G  
Appendix H – Drawings ..... H

# 1 Introduction

## 1.1 Overview

EXP Services Inc. (EXP) was retained by McCormick Park Developments Inc. to prepare a Site Servicing and Stormwater Management Report for the proposed redevelopment of 266-268 Carruthers Avenue in support of a Site Plan Application.

The 0.04-hectare site is located 45 m north of the Carruthers Avenue and Armstrong Street intersection, on Carruthers Avenue. **Figure 1-1** illustrates the site location. The site is inside the Greenbelt and situated in Ward 15 (Kitchissippi). The description of the subject properties is noted below:

- Part of Lot 1, Registered Plan 83, in the City of Ottawa, consisting of:
  - PIN 04094-0152 or 266 Carruthers Avenue
- Part of Lot 6, Registered Plan 83, in the City of Ottawa, consisting of:
  - PIN 04094-0152 or 268 Carruthers Avenue (Part of property taken for proposed development)

The proposed site development will consist of an apartment building comprised of 18 units, consisting of a mix of 1-bedroom, and 2-bedroom.

This report discusses the adequacy of the adjacent municipal watermain, sanitary sewers and storm sewers to provide the required water supply, convey the sewage and stormwater flows that will result from the proposed development. This report provides a design brief for submission, along with the engineering drawings, for City approval.

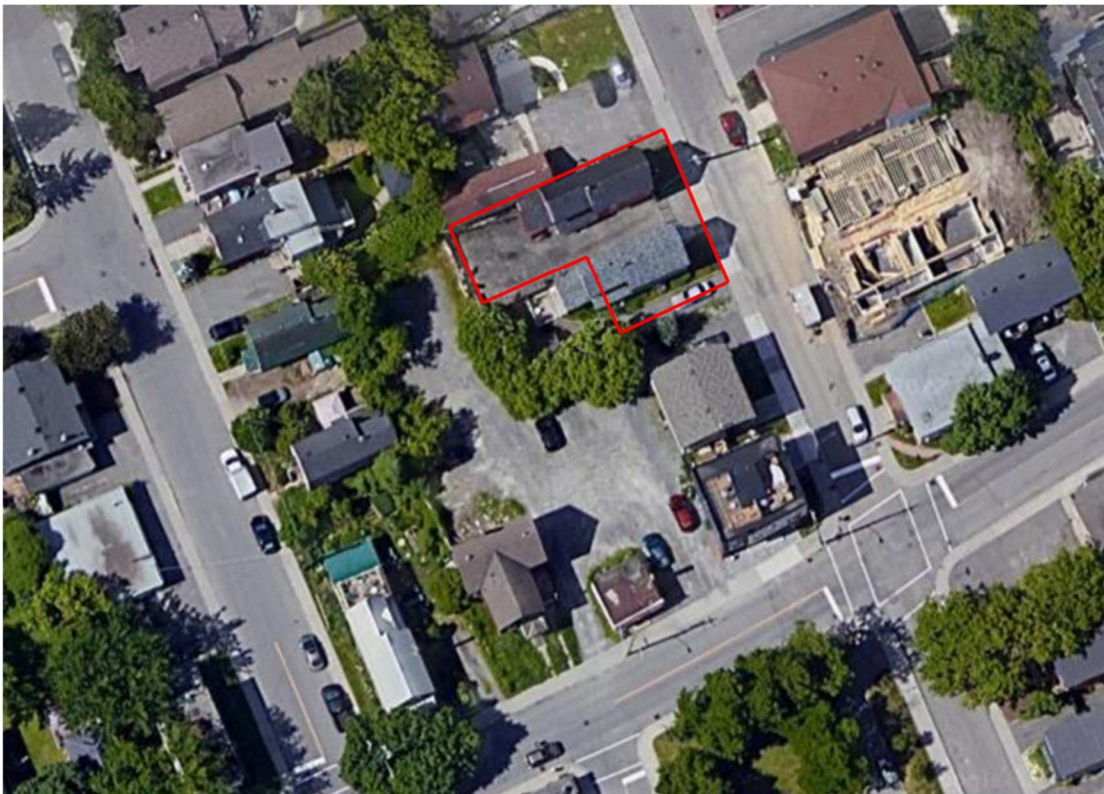

**Figure 1-1 - Site Location**

## 2 Existing Conditions

Within the property, there are two (2) existing buildings. The following summarizes the current land use conditions:

- 266 Carruthers Ave Abandoned single home
- 268 Carruthers Ave Abandoned single home

The existing topography of the subject site falls in an easterly direction along Carruthers Avenue.

## 3 Existing Infrastructure

The site includes two single homes that will be removed during the redevelopment of the site.

From review of the sewer and watermain mapping, as-built drawings and Utility Central Registry (UCC) plans, the following summarizes the onsite and adjacent offsite infrastructure:

### Within property (266-268 Carruthers Avenue)

- Storm, sanitary, and watermain laterals to the property that will be used in the servicing design

### On Carruthers Avenue

- 200mm watermain
- 1200mm sanitary sewer
- 300mm storm sewer
- Gas / Bell / Streetlighting/ Hydro

As-built drawings for Carruthers Avenue were obtained from the City's vault and are included in **Appendix F**.

### 3.1 Pre-Consultation / Permits / Approvals

A pre-consultation meeting was held with the City prior to design commencement. This meeting outlined the submission requirements and provided information to assist with the development proposal.

The proposed site is located within the Rideau Valley Conservation Authority (RVCA) jurisdiction, therefore signoff from the RVCA will be required prior to Site Plan approval. The RVCA has been contacted to confirm the stormwater management quality control requirements. A copy of the correspondence with the RCVA is attached in **Appendix E**.

Generally, an Environmental Compliance Approval (ECA) would be obtained from the Ministry of Environment, Conservation and Parks (MECP), formerly the Ministry of the Environment and Climate Change (MOECC), for any onsite private Sewage Works; however, an Approval Exemption under Ontario Regulation 525/98 can be applied. Under Section 3 of O'Reg 525/98, Section 53 (1) and (3) do not apply to the alteration, extension, replacement, or a change to a stormwater management facility that 1) is designed to service one lot or parcel of land, b) discharges into a storm sewer that is not a combined sewer, c) does not service industrial land or a structure located on industrial land, and finally d) is not located on industrial land. The onsite Sewage Works would generally include the onsite stormwater works such as flow controls, associated stormwater detention, and treatment works.

Based on this exemption, if the parcels noted above are merged into one property parcel, then the Approval Exemptions under O'Reg 525/98, would be satisfied; an ECA would not be required an ECA. The southern portion of the 266 Carruthers Avenue property would have to be merged with the northern portion of the 268 Carruthers Avenue property. Prior to City signoff on the

infrastructure design, a pre-consultation meeting will be held with the local MECP to confirm that the site will not require an ECA.

In addition, various design guidelines were referred to in preparing the current report including:

- Bulletin ISDTB-2012-4 (20 June 2012)
  - Technical Bulletin ISDTB-2014-01 (05 February 2014)
  - Technical Bulletin PIEDTB-2016-01 (September 6, 2016)
  - Technical Bulletin ISDTB-2018-01 (21 March 2018)
  - Technical Bulletin ISDTB-2018-03 (21 March 2018)
  - Technical Bulletin ISDTB-2018-04 (27 June 2018)
  - Technical Bulletin ISDTB-2019-02 (08 July 2019)
- Ottawa Design Guidelines – Water Distribution, July 2010 (WDG001), including:
  - Technical Bulletin ISDTB-2014-02 (May 27, 2014)
  - Technical Bulletin ISTB-2018-02 (21 March 2018)
- Stormwater Management Planning and Design Manual, Ontario Ministry of the Environment and Climate Change, March 2003 (SMPDM).
- Design Guidelines for Drinking-Water Systems, Ontario Ministry of the Environment and Climate Change, 2008 (GDWS).
- Fire Underwriters Survey, Water Supply for Public Fire Protection (FUS), 2020.
- Ontario Building Code 2012, Ministry of Municipal Affairs and Housing.

## 4 Water Servicing

### 4.1 Existing Water Servicing

The subject site is within the City of Ottawa 1W pressure zone. The site is currently serviced by the existing 200mm watermain on Carruthers Avenue. The existing residential buildings within 266-268 Carruthers Avenue are serviced by laterals that will remain during construction.

### 4.2 Water Servicing Proposal

The proposed development at 266-268 Carruthers Avenue will consist of a 3-storey apartment building with 18 units. Architectural site plans are provided in **Appendix H**.

Water supply for the apartment building will be provided by a 50mm water service connecting to the existing watermain. Along with the service, a shutoff valve will be installed at the property line. The proposed servicing plan is provided in drawing C100.

### 4.3 Water Servicing Design

The water servicing requirements for the proposed building is designed in accordance with the City Design Guidelines (July 2010). The following steps indicate the basic methodology that was used in our analysis:

- Estimated water demands under average day, maximum day and peak hour conditions. As the total population estimate was less than 500, residential peaking factors were based on MECP Table 3-3.



- Estimated the required fire flow (RFF) based on the Fire Underwriters Survey (FUS).
- Obtained hydraulic boundary conditions (HGL) from the City, based on the above water demands and required fire flows.
- Boundary condition data and water demands were used to estimate the pressure at the proposed building, and this was compared to the City’s design criteria.

Please refer to **Appendix B** for detailed calculations of the total water demands.

A review of the estimated watermain pressures at the building connection, based on the boundary conditions provided, was completed using a single water service servicing to the building. **Table B-4** in **Appendix B** provides data calculations of anticipated pressures at the building connection based on using a single 50mm water service.

Based on results, a single 50mm service would result in a pressure of ±60.5 psi at the building. A review of pressures on the top floor was also completed and would result in a pressure of ±44.5 psi to the middle of the third floor. This is based on a supply of water from the mechanical room to a unit on the 3<sup>rd</sup> floor, using the average peak demand for one apartment unit on a 25mm internal water supply from the mechanical room. Based on this, pressures on 3<sup>rd</sup> floor exceed the City’s requirement under peak four conditions of 40 psi.

No pressure reducing measures are required as operating pressures are within 50 psi and 80 psi.

#### 4.4 Water Servicing Design Criteria

**Table 4-1** below summarizes the Design Criteria that was used to establish the water demands and the required fire flows, based on the proposed building uses. The design parameters that apply to this project and used for calculations are identified below in **Table 4-1**.

**Table 4-1 - Summary of Water Supply Design Criteria**

Design Parameter	Value	Applies
Population Density – Single-family Home	3.4 persons/unit	
Population Density – Semi-detached Home	2.7 persons/unit	
Population Density – Townhome or Terrace Flat	1.8 persons/unit	
Population Density – Bachelor Apartment (Studio)	1.4 persons/unit	
Population Density – Bachelor + Den Apartment	1.4 persons/unit	
Population Density – One Bedroom Apartment	1.4 persons/unit	✓
Population Density – One Bedroom plus Den Apartment	1.4 persons/unit	
Population Density – Two Bedroom Apartment	2.1 persons/unit	✓
Population Density – Two Bedroom plus Den Apartment	2.1 persons/unit	
Average Day Demands – Residential	280 L/person/day	✓
Average Day Demands – Commercial / Institutional	28,000 L/gross ha/day	
Average Day Demands – Light Industrial / Heavy Industrial	35,000 or 55,000 L/gross ha/day	
Maximum Day Demands – Residential	9.50 x Average Day Demands	✓
Maximum Day Demands – Commercial / Institutional	1.5 x Average Day Demands	
Peak Hour Demands – Residential	14.30 x Average Day Demands	✓
Peak Hour Demands – Commercial / Institutional	2.7 x Average Day Demands	

<b>Fire Flow Requirements Calculation</b>	<b>FUS</b>	✓
<b>Depth of Cover Required</b>	<b>2.4m</b>	✓
<b>Maximum Allowable Pressure</b>	<b>551.6 kPa (80 psi)</b>	✓
<b>Minimum Allowable Pressure</b>	<b>275.8 kPa (40 psi)</b>	✓
<b>Minimum Allowable Pressure during fire flow conditions</b>	<b>137.9 kPa (20 psi)</b>	✓

#### 4.5 Estimated Water Demands

The following **Table 4-2** below summarizes the anticipated water demands for the proposed development based on following:

- The apartment building having 18 units and estimated population of 32.9 persons.

**Table 4-2 : Water Demand Summary**

Water Demand Conditions	Total Water Demands (L/sec)
<b>Average Day</b>	<b>0.09</b>
<b>Max Day</b>	<b>0.88</b>
<b>Peak Hour</b>	<b>1.33</b>

#### 4.6 Boundary Conditions

Hydraulic Grade Line (HGL) boundary conditions were obtained from the City for design purposes. A copy of the correspondence received from the City is provided in **Appendix E**.

The following hydraulic grade line (HGL) boundary conditions were provided:

- Minimum HGL = 107.9 m
- Max Day + Fire Flow = 102.9 m
- Maximum HGL = 115.0 m

Based on a ground elevation of approximately 63.6m at the boundary condition location this results in a system water pressure between ±62.7 psi and ±73.1 psi during peak hour conditions.

#### 4.7 Fire Flow Requirements

Water for fire protection will be available using the proposed fire hydrants located along the adjacent roadways: Carruthers Avenue, Armstrong Street, and Hinchey Avenue. The required fire flows for the proposed buildings were calculated based on typical values as established by the Fire Underwriters Survey 2020 (FUS).

The following equation from the Fire Underwriters document “Water Supply for Public Fire Protection”, 2020, was used for calculation of the on-site supply rates required to be supplied by the hydrants:

$$F = 200 * C * \sqrt{A}$$

where:

- F = Required Fire flow in Litres per minute
- C = Coefficient related to type of Construction
- A = Total Floor Area in square metres

The proceeding **Table 4-3** summarizes the parameters used for estimating the Required Fire Flows (RFF) based on the Fire Underwriters Survey (FUS) and the latest City of Ottawa Technical Bulletins. The RFFs were estimated in accordance with ISTB-2018-02, and based on floor areas provided by the architect, which are illustrates in **Appendix H**.

The following summarizes the parameters used for both proposed buildings.

- Type of Construction                      Wood Frame
- Occupancy                                      Limited combustible
- Sprinkler Protection                      None

**Table 4-3 - Summary of Design Parameters Used in Calculating Required Fire Flows (RFF) Using FUS**

Design Parameter	Value
Coefficient Related to type of Construction C	1.5
Total Floor Area (m <sup>2</sup> )	914.1
Fire Flow prior to reduction (L/min)	10,000
Reduction Due to Occupancy Non-combustible (-25%), Limited Combustible (-15%), Combustible (0%), Free Burning (+15%), Rapid Burning (+25%)	-15%
Reduction due to Sprinkler (Max 50%) Sprinkler Conforming to NFPA 13 (-30%), Standard Water Supply (-10%), Fully Supervised Sprinkler (-10%)	0%
Exposures	+51%
Can the Total Fire Flow be Capped at 10,000 L/min (167 L/sec) based on "TECHNCAL BULLETIN ISTB-2018-02", (yes/no)	No
Total RFF	13,00 L/min (217 L/sec)

The estimated required fire flows (RFF) based on the FUS methods is 217 L/sec for the proposed 3-storey apartment building.

#### 4.8 Review of Hydrant Spacing

A review of the hydrant spacing was completed to ensure compliance with Appendix I of Technical Bulletin ISTB-2018-02. As per Section 3 of Appendix I all hydrants within 150 metres were reviewed to assess the total possible available flow from these contributing hydrants. For each hydrant the distance to the proposed building was determined to arrive at the contribution of fire flow from each. All hydrants are expected to be of Class AA as per Section 5.1 of Appendix I. For each hydrant the straight-line distance, distance measured along a fire route or roadway, whether its location is accessible, and its contribution to the required fire flow.

**Table 4-4 – Required Fire Flows**

Building	Required Fire Flow (L/min)	Available Fireflow Based on Hydrant Spacing as per ISTB-2018-02 (L/min)
266-268 Carruthers Avenue	13,020 (or 217 L/sec)	±17,100

The total available contribution of flow from hydrants was estimated at ±17,100 L/min, whereas the required fire flows (RFF) for the development is 13,020 L/min. Therefore, the available flows from hydrants exceed the developments fire flow requirements as identified in Appendix I of Technical Bulletin ISTB-2018-02. Additional information on the available flows from hydrants is provided in **Table B-3**.

## 5 Sewage Servicing

### 5.1 Existing Sewage Conditions

The existing residential building within the subject property is currently serviced by the existing 1200 mm sanitary sewer on Carruthers Avenue and a 150 mm PVC sanitary lateral. The existing sanitary lateral is to remain and will be used in the redesign of the development.

### 5.2 Proposed Sewage Conditions

It is proposed to use the existing 150 mm PVC sanitary sewer connection from the subject property to the existing sanitary sewer on Carruthers Avenue. The sanitary sewer system was designed based on a population flow with an area-based infiltration allowance. A 150 mm diameter sanitary sewer is proposed with a minimum 2% slope, having a capacity of 20.8 L/sec based on Manning’s Equation under full flow conditions. Based on the OBC, the maximum permitted hydraulic load for a 150 mm pipe at 2% is 2,900 fixture units. **Table 5-1** below summarizes the design parameters used.

**Table 5-1– Summary of Wastewater Design Criteria / Parameters**

Design Parameter	Value	Applies
Population Density – Single-family Home	3.4 persons/unit	
Population Density – Semi-detached Home	2.7 persons/unit	
Population Density – Duplex	2.3 persons/unit	
Population Density – Townhome (row)	2.7 persons/unit	
Population Density – Studio Apartment	1.4 persons/unit	✓
Population Density – Bachelor + Den Apartment	1.4 persons/unit	
Population Density – One Bedroom Apartment	1.4 persons/unit	✓
Population Density – One Bedroom plus Den Apartment	1.4 persons/unit	
Population Density – Two Bedroom Apartment	2.1 persons/unit	✓
Population Density – Two Bedroom plus Den Apartment	2.1 persons/unit	
Average Daily Residential Sewage Flow	280 L/person/day	
Average Daily Commercial / Institutional Flow	28,000 L/gross ha/day	
Average Light / Heavy Industrial Daily Flow	35,000 / 55,000 L/gross ha/day	
Residential Peaking Factor – Harmon Formula (Min = 2.0, Max =4.0, with K=0.8)	$M = 1 + \frac{14}{4 + P^{0.5}} * k$	✓
Commercial Peaking Factor	1.5	
Institutional Peaking Factor	1.5	
Industrial Peaking Factor	As per Table 4-B (SDG002)	
Unit of Peak Extraneous Flow (Dry Weather / Wet Weather)	0.05 or 0.28 L/s/gross ha	
Unit of Peak Extraneous Flow (Total I/I)	0.33 L/s/gross ha	✓

The estimated peak sanitary flow rate from the proposed property at 266-268 Carruthers Avenue is **0.39 L/sec** based on City Design Guidelines. Sewage rates below include a total infiltration allowance of 0.33 L/ha/sec based on the total gross site area.

**Table 5-2 – Summary of Anticipated Sewage Rates**

Sewage Condition	Sanitary Sewage Flow (L/sec)
<b>Peak Residential</b>	<b>0.372</b>
<b>Infiltration Flow</b>	<b>0.015</b>
<b>Peak Design Flow</b>	<b>0.39</b>

The minimum sewer capacity of the last sewer run on Carruthers Avenue (with a slope of 0.42%) has a calculated full flow capacity of 2,127 L/sec. The increase in peak sewage flows up to 0.39 L/sec is minor in comparison to the total capacity of the existing sanitary sewer.

## 6 Storm Servicing & Stormwater Management

The proposed site is located within the Rideau Valley Conservation Authority (RVCA) jurisdiction, stormwater works are therefore subject to both the Rideau Valley Conservation Authority (RVCA) and City of Ottawa (COO) approval. The RVCA was contacted to discuss the stormwater management quality control requirements.

Correspondence from the RVCA is provided in **Appendix F**, states that the RVCA does not have any water quality requirements for the subject site.

### 6.1 Design Criteria

The proposed stormwater system is designed in conformance with the latest version of the City of Ottawa Design Guidelines (October 2012). Section 5 “Storm and Combined Sewer Design” and Section 8 “Stormwater Management”. A summary of the design criteria that relates to this design report is the proceeding sections below.

### 6.2 Minor System Design Criteria

- The storm sewer was sized based on the Rational Method and Manning’s Equation under free flow conditions for the 100-year storm using a 10-minute inlet time.
- Since a detailed site plan was available for the site, including building footprints, calculations of the average runoff coefficients for each drainage area were completed.
- Minimum sewer slopes to be based on minimum velocities for storm sewers of 0.80 m/s.

### 6.3 Major System Design Criteria

- The major system has been designed to accommodate on-site detention with sufficient capacity to attenuate the 100-year design storm. On-site storage is calculated based on the 100-year design storm with on-site detention storage provided on the roof.
- On site storage is provided and calculated for up to the 100-year design storm. There is no surface ponding proposed on the ground surface.
- Overland flow routes are provided.
- The vertical distance from the spill elevation on the street and the ground elevation at the buildings is at least 15cm.

- The emergency overflow spill elevation is at least 30 cm below the lowest building opening.

## 6.4 Time of Concentration

A minimum time of concentration of 10-minutes was used (refer to **Table D-1**).

## 6.5 Pre-Development Conditions

Under pre-development conditions, stormwater runoff from the 0.0468-hectare site drains to the rear of the lot. Only a single drainage area for the entire site was considered, discharging on to Carruthers Avenue. The average run-off coefficient was calculated as 0.83. Based on this runoff coefficient, the pre-development flows were estimated as shown in **Table 6-2** below.

**Table 6-1 – Summary of Pre-Development Flows**

Return Period Storm	Total Peak Flows (L/sec)
2-year	8.3
5-year	11.3
100-year	23.2

## 6.6 Allowable Release Rate

The allowable release rate of 5.0 L/sec from the proposed site was calculated based on a 2-year storm event, a time of concentration ( $T_c$ ) of 10 minutes, and a runoff coefficient of 0.50. **Table D-2** provides detailed calculations on the allowable peak flow.

## 6.7 Runoff Coefficients

Post-development runoff coefficients used were based on areas taken from CAD. The site was divided into three (3) drainage areas: S1, S2, S3. Average runoff coefficients were calculated for each drainage area in excel. The runoff coefficients for the post-development drainage areas are summarized in **Table 6-2** below.

**Table 6-2 – Summary of Runoff Coefficients**

Location	Area (hectares)	Post-Development Runoff Coefficient, $C_{AVG}$
S1	0.0301	0.90
S2	0.0141	0.30
S3	0.0027	0.80

## 6.8 Proposed Stormwater System

Stormwater runoff from the proposed site will drain from a combination of controlled and uncontrolled areas. As a result of the changes onsite the overall post-development runoff coefficient will change over pre-development conditions. This increase / decrease in runoff is the result of changes due to site development (i.e. additional hard surfaces, roof areas and hard landscaping).

A storm drainage plan is illustrated on **Figure A-2**. A total three (3) subcatchments (or drainage areas) within the development site are shown on this drawing with average runoff coefficients calculated for each drainage area. The stormwater works shall consist of the following elements:

- Flow-control roof drains for the building to have a separate storm lateral connection to municipal system.
- Runoff from surface areas will be collected by catchbasin and discharge to the storm lateral.
- Remaining drainage area along the south side of the site to flow uncontrolled to the adjacent property (also owned by the client).

**Table 6-3 – Summary of Post-Development Flows**

Return Period Storm	Unattenuated Peak Flow Rates (L/sec)	Attenuated Peak Flows Rates (L/sec)
<b>2-year</b>	<b>7.1</b>	<b>2.4</b>
<b>5-year</b>	<b>9.7</b>	<b>3.3</b>
<b>100-year</b>	<b>18.9</b>	<b>4.9</b>

To achieve the quantity control requirements and meet the allowable discharge rates as noted in **Section 6.6**, the roof drains will require flow-controlled weirs. Based on the roof areas, an estimate of the number of roof drains required was completed. WATTS ACCUTROL weirs were used to determine the total discharge rates from the roof areas based on the number of drains. In addition, the total cumulative prism volumes on the roofs were calculated at a maximum permitted depth of 150mm. Based on these, a total of six (6) flow-controlled roof drains are proposed with the weir set at CLOSED position. Additional information on the estimated 100-year volumes is provided in **Section 6.9**.

## 6.9 Flow Attenuation

Stormwater flow attenuation will be achieved by using roof storage and stormwater storage in catchbasins and pipes. Using the allowable release rates, the Modified Rational Method was used to determine the 2-year, 5-year, and 100-year volumes that will occur for corresponding release rates.

**Table D-4** provides the summary of storage volumes necessary on the roof and stormwater storage in the catchbasin and pipes to attenuate the controlled release rates with detailed calculations provided in **Table D-5 to D-8**. **Table D-3** summarizes the combined controlled and uncontrolled flows leaving the subject site. A summary of release rates, storage volume requirements, and provided storage volumes are identified in **Table 6-4** below.

**Table 6-4 – Summary of Post-Development Storage**

Area No.	Release Rate (L/s)			Storage Required (m <sup>3</sup> ) (MRM)			Storage Provided (m <sup>3</sup> )					Control Method
	2-yr	5-yr	100-yr	2-yr	5-yr	100-yr	Roof	U/G Pipes	Infiltration Trench	UG CB/MH	Totals	
S01	1.42	1.89	1.89	2.99	4.07	10.53	15.5				13.6	Flow Controlled Roof Drains with Weir Set at Closed Position
S02	0.6	0.8	1.6	0.20	0.27	3.66		0.65	3.58	0.61	4.85	Hydrovex 50VHV-1 ICD
S03	0.5	0.6	1.3	0.0	0.0	0.0					0	Uncontrolled
<b>Totals</b>	<b>2.4</b>	<b>3.3</b>	<b>4.9</b>	<b>3.2</b>	<b>4.3</b>	<b>14.2</b>					<b>18.4</b>	

18.40 m<sup>3</sup> of combined storage will be provided by 13.3 m length of 250 mm dia. Pipes and 3 catchbasin structures. A detailed calculation is provided in **Table D5-D8** in Appendix D.

The inlet control device (ICD) for the underground storm sewer was sized for the allowable rate of 1.64 L/sec at 1.2 m head. This was completed so that the ICD is sized to ensure the required 100-year volume is provided in the underground storm network. A Hydrovex 50-VHV-1 or equivalent will be used to control the discharge rate. Refer to the Hydrovex technical manual attached in Appendix F.

Storm drainage area S03 will discharge uncontrolled towards the neighbouring property (177-179 Armstrong Street), also owned by the applicant for this project. The uncontrolled flowrate towards neighbouring property during 2-year, 5-year and 100-year storm event will be 0.5 L/sec, 0.6L/sec and 1.3 L/sec, respectively. In major storm events, the storm flows from area S03 will follow the overland flow route via 177-179 Armstrong driveway towards Armstrong Street.

## 6.10 Storm Sewer Design

Foundation drains will drain to a separate 150 mm diameter storm lateral that will connect the foundation drains and roof drains. Drainage from the window wells will also be indirectly connected to the foundation drains. A sump pump will be required within the mechanical room to drain the lower-level foundation drain, given the higher invert of the lateral at the property line. Design of a sump pump will be provided by a mechanical consultant. All storm sewers were sized for the 5-year peak flow with no overcapacity.



## 7 Erosion & Sediment Control

During all construction activities, erosion and sedimentation shall be controlled by the following techniques:

- Filter bags shall be installed between the frame and cover of all adjacent catch basins and catch basin manhole structures.
- Heavy duty silt fencing will be used to control runoff around the construction area. Silt fencing locations are identified on the site grading and erosion control plan.
- A mud mat will be installed at the construction entrance to help avoid mud from being transported to offsite roads.
- Visual inspection shall be completed daily on sediment control barriers and any damage repaired immediately. Care will be taken to prevent damage during construction operations.
- In some cases, barriers may be removed temporarily to accommodate the construction operations. The affected barriers will be reinstated at night when construction is completed.
- Sediment control devices will be cleaned of accumulated silt as required. The deposits will be disposed of as per the requirements of the contract.
- During the course of construction, if the engineer believes that additional prevention methods are required to control erosion and sedimentation, the contractor will install additional silt fences or other methods as required to the satisfaction of the engineer.
- Construction and maintenance requirements for erosion and sediment controls are to comply with Ontario Provincial Standard Specification (OPSS) OPSS 805 and City of Ottawa specifications.

## 8 Conclusions and Recommendations

This Functional Servicing & Stormwater Report outlines the rationale which will be used to service the proposed development. The following summarizes the servicing requirements for the site:

### Water

- The existing water service lateral is to remain to service the 3-storey apartment building, as the average day demands do not exceed 50 m<sup>3</sup> per day.
- The Required Fire Flow (RFFs) were estimated at **13,000 L/min** (217 L/sec). The total minimum available flows for firefighting purposes, based on the contribution from hydrants, was estimated at **17,100 L/min**.
- Based on hydraulic boundary conditions (HGL) provided by the City of Ottawa, a system pressure of **±63 psi** under peak hourly demands is anticipated at the building, and **±44.5 psi** at the top floor of the proposed building. This exceeds the City's guidelines of 20 psi.

### Sewage

- Estimated peak sewage flows of **0.39 L/sec** are anticipated. A cursory review of the downstream sanitary sewer system from the site indicates minimum pipe capacity of 20.8 L/sec for a sewer run on Carruthers Ave.

### Stormwater

- For the stormwater system, the allowable capture rate from the entire site was calculated based on a runoff coefficient of 0.50, time of concentration of 10 minutes for a 2-year storm event. The allowable discharge rate for the entire site was calculated to be **5.0 L/sec**. Runoff in excess of this will be detained onsite for up to the 100-year storm.
- The back area surface drainage area will flow uncontrolled to the adjacent property, which is also owned by McCormick Park Developments Inc. The 100-year peak flow from this area was accounted for (i.e. subtracted) in the total runoff rate to establish the allowable rate.
- In order to meet the allowable release rate, total storage volume of **±14.2 m<sup>3</sup>** is required.
- Runoff on the building roofs will be controlled using flow-controlled roof drains. Six (6) roof-drains, each equipped with WATTS ACCUTROL weirs and set at CLOSED position, are proposed. Each drain having maximum discharge rate of 5 gpm at 150mm depth. A maximum discharge rate of **1.89 L/sec** was established for the 100-year event.
- A total 100-year storage volume requirements on the roof were estimated at **10.53 m<sup>3</sup>**, based on the above release rate, using the Modified Rational Method. The volumes available on the roof is **13.6 m<sup>3</sup>**, therefore meeting the required volumes.
- Runoff from rest of the site will be collected and detained using an underground perforated storm sewer network. The volume necessary to detain the 100-year event, is **3.66 m<sup>3</sup>**. The underground sewers will detain a volume of approximately **4.85 m<sup>3</sup>**, which is estimated to hold up the total required volume capacity for a 100-year event.

### Erosion & Sediment Control

- Erosion and sediment control methods will be used during construction to limit erosion potential.

## 9 Legal Notification

This report was prepared by EXP Services Inc. for the account of McCormick Park Developments Inc.

Any use which a third party makes of this report, or any reliance on or decisions to be made based on it, are the responsibility of such third parties. EXP Services Inc. accepts no responsibility for damages, if any, suffered by any third party as a result of decisions made or actions based on this project.

## Appendix A - Figures

**Figure A-1 - Pre-Development Drainage Areas**

**Figure A-2 - Post-Development Drainage Areas**

**Figure A-3 – Hydrant Location Plan**



**Legend**

Land Cover

- Other
- Asphalt
- Grass
- Concrete
- Building\_roof

10 m

**FIGURE A1 - PRE-DEVELOPMENT DRAINAGE AREAS**

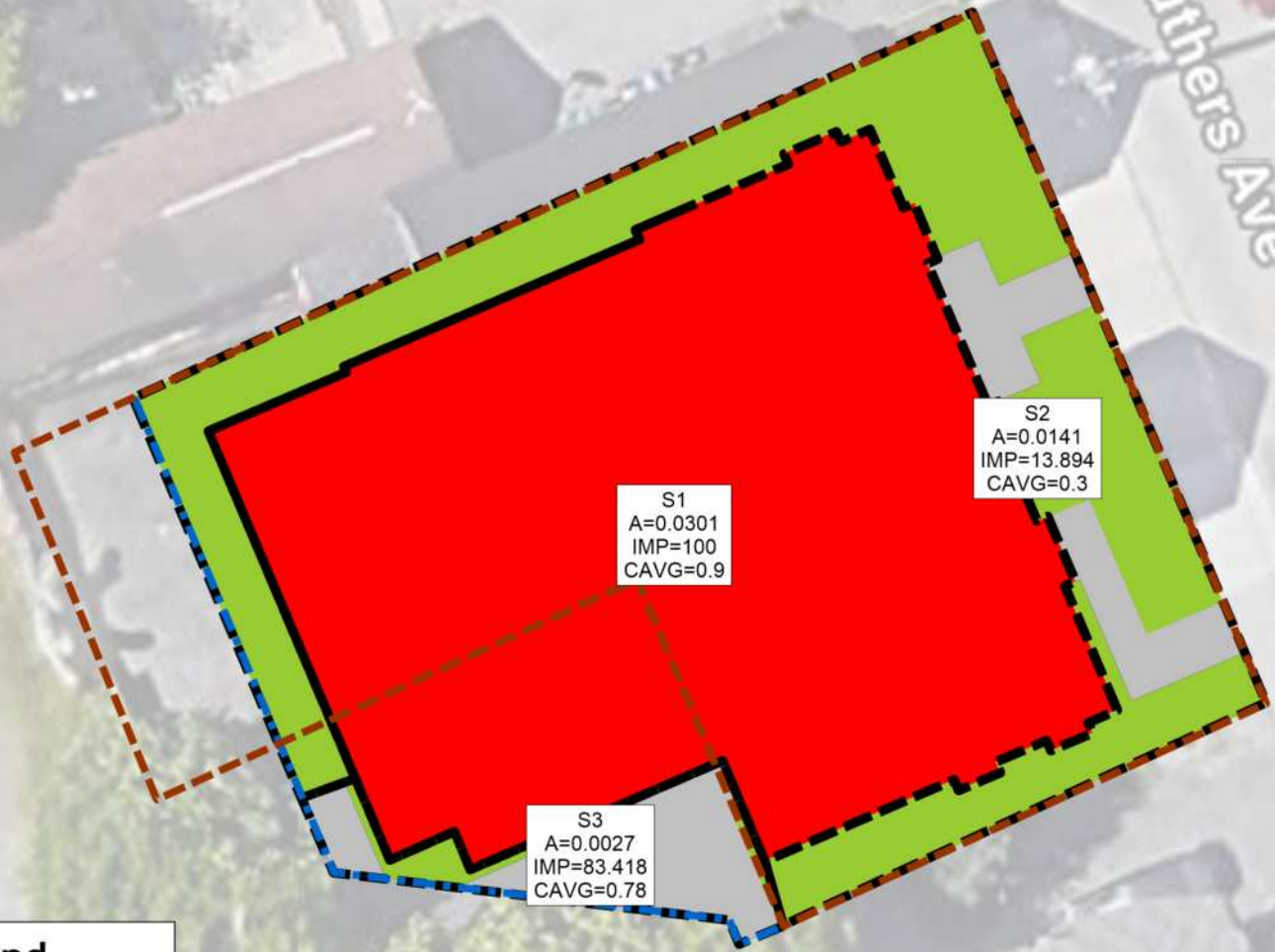

S1  
A=0.0301  
IMP=100  
CAVG=0.9

S2  
A=0.0141  
IMP=13.894  
CAVG=0.3

S3  
A=0.0027  
IMP=83.418  
CAVG=0.78

**Legend**

- Site\_Boundary
- Severance Line
- Landcover\_Post\_Dev\_Rev2

---

- BUILDING
- GRASS
- CONC

10 m

**FIGURE A2 - POST-DEVELOPMENT DRAINAGE AREAS**



Figure A3: Fire hydrant spacing to 266-268 Carruthers Ave.

## Appendix B – Water Servicing Tables

**Table B-1 – Water Demand Chart**

**Table B-2 – Fire Flow Requirements Based on Fire Underwriters Survey (FUS)**

**Table B-3 – Available Fire Flows Based on Hydrant Spacing**

**Table B-4 – Estimated Water Pressure at Proposed Building**



**TABLE B-1: Water Demand Chart**

<b>Location:</b> 266-268 Carruthers Avenue <b>Project No:</b> OTT-22014656 <b>Designed by:</b> J.Fitzpatrick <b>Checked By:</b> B. Thomas <b>Date Revised:</b> November 2023		<b>Population Densities</b> Single Family 3.4 person/unit Semi-Detached 2.7 person/unit Duplex 2.3 person/unit Townhome (Row) 2.7 person/unit Bachelor Apartment 1.4 person/unit 1 Bedroom Apartment 1.4 person/unit 2 Bedroom Apartment 2.1 person/unit 3 Bedroom Apartment 3.1 person/unit 4 Bedroom Apartment 4.1 person/unit Avg. Apartment 1.8 person/unit																									
<b>Water Consumption</b> Residential = 280 L/cap/day Commercial = 5.0 L/m <sup>2</sup> /day																											
Proposed Buildings	No. of Residential Units										Total Persons (pop)	Residential Demands in (L/sec)					Commercial				Total Demands (L/sec)						
	Singles/Semis/Towns				Apartments							Avg. Day Demand (L/day)	Peaking Factors (x Avg Day)		Max Day Demand (L/day)	Peak Hour Demand (L/day)	Area (m <sup>2</sup> )	Avg Demand (L/day)	Peaking Factors (x Avg Day)		Max Day Demand (L/day)	Peak Hour Demand (L/day)	Avg Day (L/s)	Max Day (L/s)	Max Hour (L/s)		
	Single Family	Semi-Detached	Duplex	Townhome	Studio	1 Bedroom	2 Bedroom	3 Bedroom	4 Bedroom	Avg Apt.			Max Day	Peak Hour					Max Day	Peak Hour						Max Day	Peak Hour
Apartment Building						13	5				28.7	8,036	9.50	14.30	76,342	114,915									0.093	0.884	1.330
Total =						13	5				28.7	8,036			76,342	114,915									0.09	0.88	1.33
PEAKING FACTORS FROM MOECC TABLE 3-3 (Peaking Factors for Water Systems Servicing Fewer Than 500 persons)																											
Dwelling Units Serviced	Equiv Pop	Night Min Factor	Maximum Day Factor	Peak Hour Factor																							
10	30	0.10	9.50	14.30																							
50	150	0.10	4.90	7.40																							
100	300	0.20	3.60	5.40																							
150	450	0.30	3.00	4.50																							
167	500	0.40	2.90	4.30																							

**TABLE B-2 FIRE FLOW REQUIREMENTS BASED ON FIRE UNDERWRITERS SURVEY(FUS) 2020  
266-268 Carruthers Ave**

PROJECT: OTT-22014656-A0  
LOCATION: 266-268 Carruthers Avenue



An estimate of the Fire Flow required for a given fire area may be estimated by:

$$F = 220 * C * \text{SQRT}(A)$$

where: F = required fire flow in litres per minute  
A = total floor area in m<sup>2</sup> (including all storeys, but excluding basements at least 50% below grade)  
C = coefficient related to the type of construction

Task	Options	Multiplier	Input				Value Used	Fire Flow Total (L/min)
Choose Building Frame (C)	Wood Frame	1.5	Wood Frame				1.5	
	Ordinary Construction	1						
	Non-combustible Construction	0.8						
	Fire Resistive Construction	0.6						
Input Building Floor Areas (A)			Area	% Used	Area Used	Comment	914.1 m <sup>2</sup>	
	Floor 3		305	100%	304.7			
	Floor 2		305	100%	304.7			
	Floor 1		305	100%	304.7			
	Basement (At least 50% below grade, not included)		305	0%	0.0			
Fire Flow (F)	F = 220 * C * SQRT(A)						9,977	
Fire Flow (F)	Rounded to nearest 1,000							10,000

**Reductions/Increases Due to Factors Effecting Burning**

Task	Options	Multiplier	Input					Value Used	Fire Flow Change (L/min)	Fire Flow Total (L/min)											
Choose Combustibility of Building Contents	Non-combustible	-25%	Limited Combustible					-15%	-1,500	8,500											
	Limited Combustible	-15%																			
	Combustible	0%																			
	Free Burning	15%																			
	Rapid Burning	25%																			
Choose Reduction Due to Sprinkler System	Adequate Sprinkler Conforms to NFPA13	-30%	No Sprinkler					0%	0	8,500											
	No Sprinkler	0%																			
	Standard Water Supply for Fire Department Hose Line and for Sprinkler System	-10%									Not Standard Water Supply or Unavailable					0%	0	8,500			
	Not Standard Water Supply or Unavailable	0%																			
	Fully Supervised Sprinkler System	-10%																	Not Fully Supervised or N/A		
Not Fully Supervised or N/A	0%																				
Choose Structure Exposure Distance	Exposures	Separation Dist (m)	Cond	Separation Condition	Exposed Wall type	Exposed Wall Length					Total Charge (%)	Total Exposure Charge (L/min)									
						Length (m)	No of Storeys	Length-Height Factor	Sub-Condition	Charge (%)											
						Side 1 (north)	3.4	2	3.1 to 10	Type V				16.6	3	49.8	2C	17%	51%	4,335	12,835
						Side 2 (west)	20.2	4	20.1 to 30	Type V				4.0	2	8	4A	0%			
						Side 3 (south)	3	1	0 to 3	Type V				14	3	42	1C	22%			
Side 4 (east)	16.83	3	10.1 to 20	Type V	17	3	51	3C	12%												
Obtain Required Fire Flow	Total Required Fire Flow, Rounded to the Nearest 1,000 L/min =										13,000										
	Total Required Fire Flow, L/s =										217										

**Exposure Charges for Exposing Walls of Wood Frame Construction (from Table G5)**

Type V Wood Frame  
Type IV-III (U) Mass Timber or Ordinary with Unprotected Openings  
Type IV-III (P) Mass Timber or Ordinary with Protected Openings  
Type II-I (U) Noncombustible or Fire Resistive with Unprotected Openings  
Type II-I (P) Noncombustible or Fire Resistive with Protected Openings

**Conditions for Separation**

Separation Dist	Condition
0m to 3m	1
3.1m to 10m	2
10.1m to 20m	3
20.1m to 30m	4
> 30.1m	5

**TABLE B-3: FIRE FLOW CONTRIBUTIONS BASED ON HYDRANT SPACING**

Hydrant #	Location	<sup>1</sup> Distance (m)	<sup>2</sup> Fire Flow Contribution (L/min)	Comment
364029H165	Carruthers Ave	147	3800	
364029H063	Armstrong St	91.7	3800	
364029H166	Carruthers Ave	66.4	5700	
364029H047	Hinchey Ave	131.7	3800	
Total Fireflow Available in L/min (L/sec) or L/sec			17,100 (285)	
FUS RFF in L/min or L/sec			13,020 (217)	
Meets Requirement (Yes/No)			Yes	
<b>Notes:</b> <sup>1</sup> Distance is measured along a road or fire route. <sup>2</sup> Fire Flow Contribution for Class AA Hydrant from Table 1 of Appendix I, ISTB-2018-02 <sup>3</sup> Straight distance from hydrant or closest part of building.				

**TABLE B-4**

**ESTIMATED WATER PRESSURE AT PROPOSED BUILDING**

Description	From	To	Demand (L/sec)	Pipe Length (m)	Pipe Dia (mm)	Dia (m)	Q (m3/sec)	Area (m2)	C	Vel (m/s)	Slope of HGL (m/m)	Head Loss (m)	Elev From (m)	Elev To (m)	*Elev Diff (m)	Pressure From kPa (psi)	Pressure To kPa (psi)	Pressure Drop (psi)	
<b>Avg Day Conditons</b>																			
Single 50mm water service	Main	Building	0.09	12 m	50	0.050	0.0001	0.001963	110	0.0474	0.00013	0.0016	63.82	65.41	-1.6	432.4 (62.7)	416.8 (60.5)	2.3	
Single 25mm water to single Apt on 3rd floor	Building	3rd Floor	0.0052	10 m	25	0.025	0.0000	0.000491	110	0.0105	1.8E-05	0.0002	65.41	76.31	-10.9	416.8 (60.5)	309.9 (44.9)	15.5	
<b>Max Day Conditons</b>																			
Single 100mm watermain	Main	Building	0.88	12 m	50	0.050	0.0009	0.001963	110	0.45	0.00847	0.1057	63.60	65.41	-1.8	432.4 (62.7)	413.6 (60.0)	2.7	
Single 25mm water to single Apt on 3rd floor	Building	3rd Floor	0.0491	10 m	25	0.025	0.0000	0.000491	110	0.1	0.00117	0.0121	65.41	76.31	-10.9	413.6 (60.0)	306.6 (44.5)	15.5	
<b>Peak Hour Conditons</b>																			
Single 100mm watermain	Main	Building	1.33	12 m	50	0.050	0.0013	0.001963	110	0.6774	0.01806	0.2254	63.60	65.41	-1.8	434.6 (63.0)	414.6 (60.1)	2.9	
Single 25mm water to single Apt on 3rd floor	Building	3rd Floor	0.0739	10 m	25	0.025	0.0001	0.000491	110	0.1505	0.0025	0.0258	65.41	76.31	-10.9	414.6 (60.1)	307.4 (44.6)	15.5	
<b>Water Demand Info</b>																			
Average Demand =	0.09	L/sec																	
Max Day Demand =	0.88	L/sec																	
Peak Hr Demand =	1.33	L/sec																	
<b>Pipe Lengths</b>																			
Fireflow Requirement =	217	L/sec																	
Max Day Plus FF Demand =	217.6	L/sec																	
Number of units in building =	18.0	units																	
<b>Boundary Conditon</b>																			
HGL (m)	Min HGL	Max HGL	Peak Hr	Max Day + Fireflow															
Approx Ground Elev (m) =	107.9	115	107.9	102.9	(From City of Ottawa)														
Approx Bldg FF Elev (m) =	63.8	63.6	63.6	63.6															
Pressure (m) =	65.41	65.41	65.41	65.41															
Pressure (Pa) =	44.08	51.4	44.3	39.3															
Pressure (psi) =	432,425	504,234	434,583	385,533															
Pressure (psi) =	62.7	73.1	63.0	55.9															

## Appendix C – Sanitary Servicing Tables

### Table C-1 – Sanitary Sewer Design Sheet



**Table C-1: SANITARY SEWER CALCULATION SHEET**

LOCATION			RESEDENTIAL AREAS AND POPULAITONS										COMMERCIAL				INSTITUTIONAL		INFILTRATION			SEWER DATA											
Street	U/S MH	D/S MH	Area (ha)	NUMBER OF UNITS					POPULATION		Peak Factor	Peak Flow (L/sec)	AREA (m <sup>2</sup> )		Peak Flow (L/sec)	AREA (Ha)	ACCU AREA (Ha)	AREA (ha)		INFILT FLOW (L/s)	TOTAL FLOW (L/s)	Nom Dia (mm)	Actual Dia (mm)	Slope (%)	Length (m)	Capacity (L/sec)	Q/Q <sub>CAP</sub> (%)	Full Velocity (m/s)					
				Singles	Studio	Semi	1-Bed Apt.	2-Bed Apt.	3-Bed Apt.	4-Bed Apt.			INDIV	ACCU				INDIV	ACCU														
Carruthers Ave	bldg	Main	0.0468				13	5			28.7	28.7	4.00	0.372					0.05	0.05	0.015	0.39	150.0	148.0	2.00	8.0	20.8	2%	1.72				
			<b>0.0468</b>	<b>13</b> <b>5</b>					<b>28.7</b>						<b>0.047</b>																		
Residential Avg. Daily Flow, q (L/p/day) =				280		Commercial Peak Factor =				1.5 (when area >20%)		Peak Population Flow, (L/sec) = P*q*M/86.4				Unit Types		PPU		Designed: J. Fitzpatrick, P.Eng							Project: 266-268 Carruther Ave						
Commercial Avg. Daily Flow (L/m <sup>2</sup> /day) =				5.0						1.0 (when area <20%)		Peak Extraneous Flow, (L/sec) = I*Ac				Singles		3.4		Checked: B. Thomas, P.Eng							Location: Ottawa, Ontario						
Institutional Avg. Daily Flow (L/s/ha) =				28,000		Institutional Peak Factor =				1.5 (when area >20%)		Residential Peaking Factor, M = 1 + (14/(4+P^0.5)) * K				Studio		1.4		Checked: B. Thomas, P.Eng							Location: Ottawa, Ontario						
or L/gross ha/sec =				0.324						1.0 (when area <20%)		A <sub>c</sub> = Cumulative Area (hectares)				Semi		2.7		File Reference: 22014656 Sanitary Design Sheet - Nov 2023.xlsx							Page No: 1 of 1						
Light Industrial Flow (L/gross ha/day) =				35,000		Residential Correction Factor, K =				0.80		P = Population (thousands)				1-bed Apt. Unit		1.4															
or L/gross ha/sec =				0.40509		Manning N =				0.013		Sewer Capacity, Q <sub>cap</sub> (L/sec) = 1/N S <sup>1/2</sup> R <sup>2/3</sup> A <sub>c</sub>				2-bed Apt. Unit		2.1															
Light Industrial Flow (L/gross ha/day) =				55,000		Peak extraneous flow, I (L/s/ha) =				0.33 (Total I/I)		(Manning's Equation)				3-bed Apt. Unit		3.1															
or L/gross ha/sec =				0.637												4-bed Apt. Unit		4.1															

## Appendix D – Stormwater Servicing Tables

**Table D-1 – Estimation of Pre-Development Peak Flows**

**Table D-2 – Estimation of Allowable Peak Flows (Based on Max C=0.50 with Tc=10mins)**

**Table D-3 – Summary of Post-Development Peak Flows (Uncontrolled and Controlled)**

**Table D-4 – Summary of Post-Development Storage**

**Table D-5 – Calculation of Available Surface Storage (not provided)**

**Table D-6 – Calculation of Available Underground Storage**

**Table D-7 – Calculation of Available Underground Infiltration Trench Storage**

**Table D-8 – Calculation of Underground Structure Storage**

**Table D-9 - 5-year & 100-year Roof Drains Design Sheet - using Flow Controlled Roof Drains**

**Table D-10 - Storage Volumes Roof Area #S01-1 (5 Year and 100Year Storms)**

**Table D-11 - Storage Volumes Roof Area #S01-2 (5 Year and 100Year Storms)**

**Table D-12 - Storage Volumes Roof Area #S01-3 (5 Year and 100Year Storms)**

**Table D-13 - Storage Volumes Roof Area #S01-4 (5 Year and 100Year Storms)**

**Table D-14 - Storage Volumes Roof Area #S01-5 (5 Year and 100Year Storms)**

**Table D-15 - Storage Volumes Roof Area #S01-6 (5 Year and 100Year Storms)**

**Table D-16 - Storage Volumes for 2-year, 5-year and 100-year Storms**

**Table D-17 – 2-Year Storm Sewer Calculation Sheet**

**TABLE D-1: ESTIMATION OF PRE-DEVELOPMENT PEAK FLOWS**

Catchment No.	Area (ha)	Outlet Location	Time of Conc, Tc (min)	Storm = 2 yr			Storm = 5 yr			Storm = 100 yr		
				I <sub>2</sub> (mm/hr)	Cavg	Q <sub>2PRE</sub> (L/sec)	I <sub>5</sub> (mm/hr)	Cavg	Q <sub>5PRE</sub> (L/sec)	I <sub>100</sub> (mm/hr)	Cavg	Q <sub>100PRE</sub> (L/sec)
Full Site	0.0468	Carruthers Avenue	10.00	76.81	0.83	8.3	104.19	0.83	11.3	178.56	1.00	23.2
<b>Totals</b>	<b>0.0468</b>					<b>8.3</b>			<b>11.3</b>			<b>23.2</b>

**Notes**  
 1) Intensity, I = 732.951/(Tc+6.199)<sup>0.810</sup> (2-year, City of Ottawa)  
 2) Intensity, I = 998.071/(Tc+6.035)<sup>0.814</sup> (5-year, City of Ottawa)  
 3) Intensity, I = 1735.688/(Tc+6.014)<sup>0.820</sup> (100-year, City of Ottawa)  
 4) Cavg for 100-year is increased by 25% to a maximum of 1.0

**Table D-2 ESTIMATION OF ALLOWABLE PEAK FLOWS (Based on Max C=0.50 with Tc=10mins)**

Area (onsite)	Area (ha)	Time of Conc, Tc (min)	Storm = 2 yr			Storm = 5 yr			Storm = 100 yr		
			I <sub>5</sub> (mm/hr)	Cavg	Q <sub>SALLOW</sub> (L/sec)	I <sub>5</sub> (mm/hr)	Cavg	Q <sub>SALLOW</sub> (L/sec)	I <sub>5</sub> (mm/hr)	Cavg	Q <sub>SALLOW</sub> (L/sec)
Full Site	0.0468	10	76.81	0.50	5.0	104.29	0.50	6.8	178.56	0.65	15.1
<b>Totals</b>	<b>0.0468</b>				<b>5.0</b>			<b>6.8</b>			<b>15.1</b>

**Notes**  
 1) Allowable Capture Rate is based on 2-year storm at Tc=10 minutes.

**Allowable Discharge (based on 2-yr storm)**



**TABLE D-3: SUMMARY OF POST-DEVELOPMENT PEAK FLOWS (Uncontrolled and Controlled )**

Area No	Area (ha)	Time of Conc, Tc (min)	Storm = 2 yr				Storm = 5 yr				Storm = 100 yr				Comments
			C <sub>AVG</sub>	I <sub>2</sub> (mm/hr)	Q (L/sec)	Q <sub>CAP</sub> (L/sec)	C <sub>AVG</sub>	I <sub>5</sub> (mm/hr)	Q (L/sec)	Q <sub>CAP</sub> (L/sec)	C <sub>AVG</sub>	I <sub>100</sub> (mm/hr)	Q (L/sec)	Q <sub>CAP</sub> (L/sec)	
S1	0.0301	10	0.90	76.81	5.8	(1.42)	0.90	104.19	7.8	(1.89)	1.00	178.56	14.9	(1.89)	Roof (2 - Closed)
S2	0.0141	10	0.30	76.81	0.9	(0.6)	0.30	104.19	1.2	(0.8)	0.37	178.56	2.6	(1.64)	ICD (50VHV-1)
S3	0.0027	10	0.78	76.81	0.4	0.4	0.78	104.19	0.6	0.6	0.98	178.56	1.3	1.3	side - UNCL
Total =		0.0468			7.1	(2.4)			9.7	(3.3)			18.8	(4.8)	
pre_dev =														5.0	
<p><u>Notes</u>                  2-yr Storm Intensity, <math>I = 732.951 / (Tc + 6.199)^{0.810}</math> (City of Ottawa)                  5-yr Storm Intensity, <math>I = 998.071 / (Tc + 6.035)^{0.814}</math> (City of Ottawa)                  100-yr Storm Intensity, <math>I = 1735.688 / (Tc + 6.014)^{0.820}</math> (City of Ottawa)                  Time of Concentration (min), Tc = <b>10</b>                  For Flows under column Qcap which are shown in brackets <b>(0.0)</b>, denotes flows that are controlled</p>															

**TABLE D-4: SUMMARY OF POST DEVELOPMENT STORAGE**

Area No.	Area (ha)	Release Rate (L/s)			<sup>1</sup> Storage Required (m <sup>3</sup> )			Storage Provided (m <sup>3</sup> )					Control Method		
		2-yr	5-yr	100-yr	2-yr (MRM)	5-yr (MRM)	100-yr (MRM)	Roof	Surface Ponding	UG PIPES	Infiltration Trench	UG CB/MHs		Total	
S1	0.0301	1.42	1.89	1.89	2.99	4.07	10.53	13.6						13.6	Roof Drains
S2	0.0141	0.6	0.8	1.6	0.20	0.27	3.66			0.65	3.58	0.61		4.85	13.3 m x 0.85 m Trench (S29) with ICD in CB02 (IPEX LMF-50)
S3	0.0027	0.4	0.6	1.3	0.0	0.0	0.0							0.0	Un-Controlled
0.0468		2.4	3.3	4.8	3.2	4.3	14.2							18.4	
<p><u>Notes</u>                  1) Storage Required Based on the Modified Rational Method (MRM) for the release rates noted.</p>															

**TABLE D5****CALCULATION OF AVAILABLE SURFACE STORAGE (not provided)**

Drainage Area	Ponding Number	Min W/L or T/G (m)	Indiv Spill Elev (m)	<sup>1</sup> Max Depth (m)	Area (m <sup>2</sup> )	Max Volume (m <sup>3</sup> )
S01						0.0
S02						0.0
S03						0.0
<b>Totals</b>						<b>0.0</b>
<i>Notes:</i>						
<i>The Max Depth is the distance from the Min W/L (T/G) and the lower of the Indiv Spill or System Spill Elev</i>						

**TABLE D6****CALCULATION OF AVAILABLE UNDERGROUND PIPE STORAGE**

Drainage Area	U/S Manhole	D/S Manhole	Pipe Type	Length (m)	Pipe Dia (mm)	Pipe Area (m <sup>2</sup> )	Pipe Volume (m <sup>3</sup> )
S01							
S02	CBE01	CB02	HDPE	6.6	250	0.049	0.32
	CBE03	CB02	HDPE	6.7	250	0.049	0.33
S03							
<b>Totals</b>							<b>0.65</b>

**TABLE D7****CALCULATION OF AVAILABLE UNDERGROUND INFILTRATION TRENCH STORAGE**

Drainage Area	U/S Manhole	D/S Manhole	Trench Width (m)	Trench Length (m)	Trench Height (m)	Pipe Area	Granular Void Ratio	Availabe Storage Area (m <sup>2</sup> )	Pipe Volume (m <sup>3</sup> )
S01									
S02	CBE01	CB02	0.85	6.6	0.85	0.049	0.40	0.269	1.778
	CBE03	CB02	0.85	6.7	0.85	0.049	0.40	0.269	1.805
S03									
<b>Totals</b>									<b>3.58</b>

**TABLE D8****CALCULATION OF UNDERGROUND STRUCTURE STORAGE**

Drainage Area	Structure No.	Size	T/G (m)	Spill Elev (m)	Inv Elev (m)	Sump Elev (m)	<sup>1</sup> Storage Depth (m)	Area (m <sup>2</sup> )	Volume (m <sup>3</sup> )
S01									
S02	CB01	300 dia	63.76	63.76	62.83	62.83	0.93	0.09	0.08
	CB02	610 square	63.83	63.83	62.63	62.63	1.20	0.37	0.45
	CB03	300 dia	63.82	63.82	62.89	62.89	0.93	0.09	0.08
S03									
<b>Totals</b>									<b>0.61</b>
<i>Notes:</i>									
<i>The Storage Depth is the distance from the invert elevation to either the T/G or Spill Elev (whichever is lower)</i>									

**Table D 9: 5-year & 100-year Roof Drains Design Sheet - using Flow Controlled Roof Drains**

Project: 266-268 Carruthers Ave  
 Location: City of Ottawa  
 Date: Nov 2023

Area #	Drain Type	Roof Drain Type	No Drains per Area	No of Weirs per Drain	Weir Position	Runoff Coeff (Cavg)		Drainage Area		5-year Event						100-year Event						Storage Required (MRM)		Maximum Storage Provided at Spill Elevation			
						5-year	100-year	m <sup>2</sup>	ha	Runoff Rate (L/sec)	5yr Ponding Depth (mm)	Roof Drain Capacity Per Weir (gpm)	Roof Drain Capacity Per Drain per weir (gpm)	Roof Drain Capacity Per Drain (L/sec)	Total Flow From Roof Drains (L/sec)	Runoff Rate (L/sec)	100yr Ponding Depth (mm)	Roof Drain Capacity Per Weir (gpm)	Roof Drain Capacity Per Drain per weir (gpm)	Roof Drain Capacity Per Drain (L/sec)	Total Flow From Roof Drains (L/sec)	5-year (m <sup>3</sup> )	100-year (m <sup>3</sup> )	Area Available for Storage (m <sup>2</sup> )	Max Prism Depth (mm)	Max Prism Volume (m <sup>3</sup> )	Total Volume (m <sup>3</sup> )
						S1-01	RD	RD1	1	1	2-Closed	0.90	1.00	38.12	0.0038	0.994	93	5.0	5.0	0.315	0.315	1.892	134	5.0	5.0	0.315	0.315
S1-02	RD	RD1	1	1	2-Closed	0.90	1.00	44.10	0.0044	1.150	96	5.0	5.0	0.315	0.315	2.189	133	5.0	5.0	0.315	0.315	0.55	1.46	41.9	150	2.1	2.09
S1-03	RD	RD1	1	1	2-Closed	0.90	1.00	46.16	0.0046	1.203	97	5.0	5.0	0.315	0.315	2.291	137	5.0	5.0	0.315	0.315	0.60	1.56	43.9	150	2.2	2.19
S1-04	RD	RD1	1	1	2-Closed	0.90	1.00	34.82	0.0035	0.908	90	5.0	5.0	0.315	0.315	1.728	131	5.0	5.0	0.315	0.315	0.36	1.03	33.1	150	1.7	1.65
S1-05	RD	RD1	1	1	2-Closed	0.90	1.00	68.80	0.0069	1.794	104	5.0	5.0	0.315	0.315	3.415	141	5.0	5.0	0.315	0.315	1.10	2.72	65.4	150	3.3	3.27
S1-06	RD	RD1	1	1	2-Closed	0.90	1.00	53.40	0.0053	1.392	100	5.0	5.0	0.315	0.315	2.651	137	5.0	5.0	0.315	0.315	0.75	1.92	50.7	150	2.5	2.54
<b>Totals</b>						0.9	0.9	285	0.0285	7.440		30.00		1.89	1.89	14.17		30.00		1.89	1.89	3.78	9.88	271		13.6	13.6
<b>Min</b>																											
<b>Max</b>																											

**Runoff Based on the Following:**

Storm Frequency (years) = 5 100  
 Time of Conc (mins) = 10 10  
 Storm Intensity (mm/hr) = 104.2 178.6

Qyr(cont) = 1.4  
 V2yr = 2.8

**Roof Drains have Following Flow Rates: WATS Flow Controlled Drain**

Weir Position	Flow (gpm) per depth							Max Flow Rate per Weir
	0	25	50	75	100	125	150	
	0	0.025	0.05	0.075	0.1	0.125	0.15	
1-None	0	0	0	0	0	0	0	0.000
2-Closed	0	5	5	5	5	5	5	0.315
3-1/4 open	0	5	10	11	13	14	15	0.946
4-1/2 open	0	5	10	12	15	18	20	1.262
5-3/4 open	0	5	10	14	18	21	25	1.577
6-Full	0	5	10	15	20	25	30	1.893

**Roof Drain Types**

Drain Type = RD1  
 Max Overflow Depth (mm) 150 mm  
 Flow Controlled (Yes/No) Yes  
 Ponding Yes  
 Weir Desc Accutrol  
 No. Weirs 1

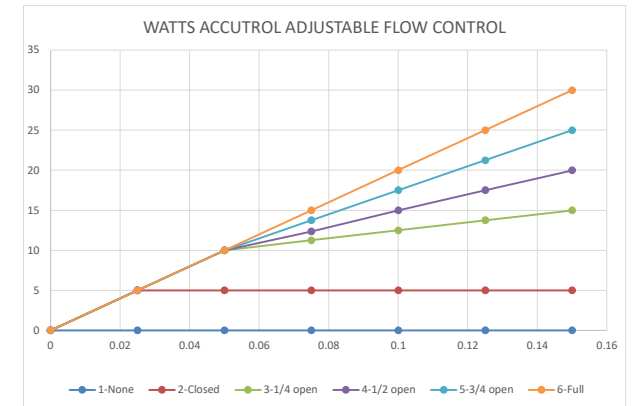

**Table D10 Storage Volumes Roof Area #S01-1 (5 Year and 100Year Storms)**

$C_{AVG} = 0.90$  (dimensionless)

$C_{AVG} = 1.00$

Time Interval = 10 (mins)

Drainage Area = 0.00381 (hectares)

Duration (min)	Release Rate = 0.315 (L/sec) Return Period = 5 (years) IDF Parameters, A = 998.071, B = 0.814 (I = A/(T <sub>c</sub> +C), C = 6.053)					Release Rate = 0.3155 (L/sec) Return Period = 100 (years) IDF Parameters, A = 1735.688, B = 0.820 (I = A/(T <sub>c</sub> +C), C = 6.014)				
	Rainfall Intensity, I (mm/hr)	Peak Flow (L/sec)	Release Rate (L/sec)	Storage Rate (L/sec)	Storage (m <sup>3</sup> )	Rainfall Intensity, I (mm/hr)	Peak Flow (L/sec)	Release Rate (L/sec)	Storage Rate (L/sec)	Storage (m <sup>3</sup> )
0	230.5	2.2	0.32	1.9	0.00	398.6	4.2	0.315	3.9	0.00
10	104.2	1.0	0.32	0.7	0.41	178.6	1.9	0.315	1.6	0.95
20	70.3	0.7	0.32	0.4	0.43	120.0	1.3	0.315	1.0	1.15
30	53.9	0.5	0.32	0.2	0.36	91.9	1.0	0.315	0.7	1.18
40	44.2	0.4	0.32	0.1	0.25	75.1	0.8	0.315	0.5	1.15
50	37.7	0.4	0.32	0.0	0.13	64.0	0.7	0.315	0.4	1.09
60	32.9	0.3	0.32	0.0	0.00	55.9	0.6	0.315	0.3	1.00
70	29.4	0.3	0.32	0.0	-0.15	49.8	0.5	0.315	0.2	0.89
80	26.6	0.3	0.32	-0.1	-0.30	45.0	0.5	0.315	0.2	0.77
90	24.3	0.2	0.32	-0.1	-0.45	41.1	0.4	0.315	0.1	0.65
100	22.4	0.2	0.32	-0.1	-0.61	37.9	0.4	0.315	0.1	0.52
110	20.8	0.2	0.32	-0.1	-0.77	35.2	0.4	0.315	0.1	0.38
120	19.5	0.2	0.32	-0.1	-0.93	32.9	0.3	0.315	0.0	0.24
130	18.3	0.2	0.32	-0.1	-1.10	30.9	0.3	0.315	0.0	0.09
140	17.3	0.2	0.32	-0.2	-1.27	29.2	0.3	0.315	0.0	-0.05
150	16.4	0.2	0.32	-0.2	-1.43	27.6	0.3	0.315	0.0	-0.21
160	15.6	0.1	0.32	-0.2	-1.60	26.2	0.3	0.315	0.0	-0.36
170	14.8	0.1	0.32	-0.2	-1.77	25.0	0.3	0.315	-0.1	-0.51
180	14.2	0.1	0.32	-0.2	-1.95	23.9	0.3	0.315	-0.1	-0.67
190	13.6	0.1	0.32	-0.2	-2.12	22.9	0.2	0.315	-0.1	-0.83
200	13.0	0.1	0.32	-0.2	-2.29	22.0	0.2	0.315	-0.1	-0.99
210	12.6	0.1	0.32	-0.2	-2.47	21.1	0.2	0.315	-0.1	-1.15
220	12.1	0.1	0.32	-0.2	-2.64	20.4	0.2	0.315	-0.1	-1.31
230	11.7	0.1	0.32	-0.2	-2.82	19.7	0.2	0.315	-0.1	-1.48
240	11.3	0.1	0.32	-0.2	-2.99	19.0	0.2	0.315	-0.1	-1.64
Max =	0.43					1.18				

**Notes**

- 1) Peak flow is equal to the product of 2.78 x C x I x A
- 2) Rainfall Intensity, I = A/(T<sub>c</sub>+C)<sup>B</sup>
- 3) Release Rate = Min (Release Rate, Peak Flow)
- 4) Storage Rate = Peak Flow - Release Rate
- 5) Storage = Duration x Storage Rate
- 6) Maximum Storage = Max Storage Over Duration

**Table D11 Storage Volumes Roof Area #S01-2 (5 Year and 100Year Storms)**

$C_{AVG} = 0.90$  (dimensionless)

$C_{AVG} = 1.00$

Time Interval = 10 (mins)

Drainage Area = 0.00441 (hectares)

Duration (min)	Release Rate = <b>0.315</b> (L/sec) Return Period = <b>5</b> (years) IDF Parameters, A = <b>998.071</b> , B = <b>0.814</b> ( $I = A/(T_c+C)$ ), C = <b>6.053</b>					Release Rate = <b>0.3155</b> (L/sec) Return Period = <b>100</b> (years) IDF Parameters, A = <b>1735.688</b> , B = <b>0.820</b> ( $I = A/(T_c+C)$ ), C = <b>6.014</b>				
	Rainfall Intensity, I (mm/hr)	Peak Flow (L/sec)	Release Rate (L/sec)	Storage Rate (L/sec)	Storage (m <sup>3</sup> )	Rainfall Intensity, I (mm/hr)	Peak Flow (L/sec)	Release Rate (L/sec)	Storage Rate (L/sec)	Storage (m <sup>3</sup> )
0	230.5	2.5	0.32	2.2	0.00	398.6	4.9	0.315	4.6	0.00
10	104.2	1.1	0.32	0.8	0.50	178.6	2.2	0.315	1.9	1.12
20	70.3	0.8	0.32	0.5	<b>0.55</b>	120.0	1.5	0.315	1.2	1.39
30	53.9	0.6	0.32	0.3	0.50	91.9	1.1	0.315	0.8	<b>1.46</b>
40	44.2	0.5	0.32	0.2	0.41	75.1	0.9	0.315	0.6	1.45
50	37.7	0.4	0.32	0.1	0.30	64.0	0.8	0.315	0.5	1.41
60	32.9	0.4	0.32	0.0	0.17	55.9	0.7	0.315	0.4	1.33
70	29.4	0.3	0.32	0.0	0.04	49.8	0.6	0.315	0.3	1.24
80	26.6	0.3	0.32	0.0	-0.11	45.0	0.6	0.315	0.2	1.13
90	24.3	0.3	0.32	0.0	-0.26	41.1	0.5	0.315	0.2	1.02
100	22.4	0.2	0.32	-0.1	-0.41	37.9	0.5	0.315	0.1	0.90
110	20.8	0.2	0.32	-0.1	-0.57	35.2	0.4	0.315	0.1	0.77
120	19.5	0.2	0.32	-0.1	-0.72	32.9	0.4	0.315	0.1	0.63
130	18.3	0.2	0.32	-0.1	-0.89	30.9	0.4	0.315	0.1	0.49
140	17.3	0.2	0.32	-0.1	-1.05	29.2	0.4	0.315	0.0	0.35
150	16.4	0.2	0.32	-0.1	-1.21	27.6	0.3	0.315	0.0	0.21
160	15.6	0.2	0.32	-0.1	-1.38	26.2	0.3	0.315	0.0	0.06
170	14.8	0.2	0.32	-0.2	-1.55	25.0	0.3	0.315	0.0	-0.09
180	14.2	0.2	0.32	-0.2	-1.72	23.9	0.3	0.315	0.0	-0.24
190	13.6	0.1	0.32	-0.2	-1.89	22.9	0.3	0.315	0.0	-0.40
200	13.0	0.1	0.32	-0.2	-2.06	22.0	0.3	0.315	0.0	-0.55
210	12.6	0.1	0.32	-0.2	-2.23	21.1	0.3	0.315	-0.1	-0.71
220	12.1	0.1	0.32	-0.2	-2.40	20.4	0.2	0.315	-0.1	-0.87
230	11.7	0.1	0.32	-0.2	-2.57	19.7	0.2	0.315	-0.1	-1.03
240	11.3	0.1	0.32	-0.2	-2.75	19.0	0.2	0.315	-0.1	-1.19
Max =	<b>0.55</b>					<b>1.46</b>				

**Notes**

- 1) Peak flow is equal to the product of  $2.78 \times C \times I \times A$
- 2) Rainfall Intensity,  $I = A/(T_c+C)^B$
- 3) Release Rate = Min (Release Rate, Peak Flow)
- 4) Storage Rate = Peak Flow - Release Rate
- 5) Storage = Duration x Storage Rate
- 6) Maximum Storage = Max Storage Over Duration

**Table D12 Storage Volumes Roof Area #S01-3 (5 Year and 100Year Storms)**

$C_{AVG} = 0.90$  (dimensionless)

$C_{AVG} = 1.00$

Time Interval = 10 (mins)

Drainage Area = 0.00462 (hectares)

Duration (min)	Release Rate = <b>0.315</b> (L/sec) Return Period = <b>5</b> (years) IDF Parameters, A = <b>998.071</b> , B = <b>0.814</b> ( $I = A/(T_c+C)$ ), C = <b>6.053</b>					Release Rate = <b>0.3155</b> (L/sec) Return Period = <b>100</b> (years) IDF Parameters, A = <b>1735.688</b> , B = <b>0.820</b> ( $I = A/(T_c+C)$ ), C = <b>6.014</b>				
	Rainfall Intensity, I (mm/hr)	Peak Flow (L/sec)	Release Rate (L/sec)	Storage Rate (L/sec)	Storage (m <sup>3</sup> )	Rainfall Intensity, I (mm/hr)	Peak Flow (L/sec)	Release Rate (L/sec)	Storage Rate (L/sec)	Storage (m <sup>3</sup> )
0	230.5	2.7	0.32	2.3	0.00	398.6	5.1	0.315	4.8	0.00
10	104.2	1.2	0.32	0.9	0.53	178.6	2.3	0.315	2.0	1.19
20	70.3	0.8	0.32	0.5	<b>0.60</b>	120.0	1.5	0.315	1.2	1.47
30	53.9	0.6	0.32	0.3	0.55	91.9	1.2	0.315	0.9	1.55
40	44.2	0.5	0.32	0.2	0.47	75.1	1.0	0.315	0.6	<b>1.56</b>
50	37.7	0.4	0.32	0.1	0.36	64.0	0.8	0.315	0.5	1.52
60	32.9	0.4	0.32	0.1	0.23	55.9	0.7	0.315	0.4	1.45
70	29.4	0.3	0.32	0.0	0.10	49.8	0.6	0.315	0.3	1.36
80	26.6	0.3	0.32	0.0	-0.04	45.0	0.6	0.315	0.3	1.26
90	24.3	0.3	0.32	0.0	-0.19	41.1	0.5	0.315	0.2	1.15
100	22.4	0.3	0.32	-0.1	-0.34	37.9	0.5	0.315	0.2	1.03
110	20.8	0.2	0.32	-0.1	-0.49	35.2	0.5	0.315	0.1	0.90
120	19.5	0.2	0.32	-0.1	-0.65	32.9	0.4	0.315	0.1	0.77
130	18.3	0.2	0.32	-0.1	-0.81	30.9	0.4	0.315	0.1	0.63
140	17.3	0.2	0.32	-0.1	-0.97	29.2	0.4	0.315	0.1	0.49
150	16.4	0.2	0.32	-0.1	-1.14	27.6	0.4	0.315	0.0	0.35
160	15.6	0.2	0.32	-0.1	-1.30	26.2	0.3	0.315	0.0	0.20
170	14.8	0.2	0.32	-0.1	-1.47	25.0	0.3	0.315	0.0	0.06
180	14.2	0.2	0.32	-0.2	-1.64	23.9	0.3	0.315	0.0	-0.09
190	13.6	0.2	0.32	-0.2	-1.81	22.9	0.3	0.315	0.0	-0.25
200	13.0	0.2	0.32	-0.2	-1.98	22.0	0.3	0.315	0.0	-0.40
210	12.6	0.1	0.32	-0.2	-2.15	21.1	0.3	0.315	0.0	-0.56
220	12.1	0.1	0.32	-0.2	-2.32	20.4	0.3	0.315	-0.1	-0.71
230	11.7	0.1	0.32	-0.2	-2.49	19.7	0.3	0.315	-0.1	-0.87
240	11.3	0.1	0.32	-0.2	-2.66	19.0	0.2	0.315	-0.1	-1.03
Max =	<b>0.60</b>					<b>1.56</b>				

**Notes**

- 1 ) Peak flow is equal to the product of  $2.78 \times C \times I \times A$
- 2) Rainfall Intensity,  $I = A/(T_c+C)^B$
- 3) Release Rate = Min (Release Rate, Peak Flow)
- 4 ) Storage Rate = Peak Flow - Release Rate
- 5) Storage = Duration x Storage Rate
- 6) Maximum Storage = Max Storage Over Duration

**Table D13 Storage Volumes Roof Area #S01-4 (5 Year and 100Year Storms)**

$C_{AVG} = 0.90$  (dimensionless)

$C_{AVG} = 1.00$

Time Interval = 10 (mins)

Drainage Area = 0.00348 (hectares)

Duration (min)	Release Rate = <b>0.315</b> (L/sec) Return Period = <b>5</b> (years) IDF Parameters, A = <b>998.071</b> , B = <b>0.814</b> ( $I = A/(T_c+C)$ ), C = <b>6.053</b>					Release Rate = <b>0.3155</b> (L/sec) Return Period = <b>100</b> (years) IDF Parameters, A = <b>1735.688</b> , B = <b>0.820</b> ( $I = A/(T_c+C)$ ), C = <b>6.014</b>				
	Rainfall Intensity, I (mm/hr)	Peak Flow (L/sec)	Release Rate (L/sec)	Storage Rate (L/sec)	Storage (m <sup>3</sup> )	Rainfall Intensity, I (mm/hr)	Peak Flow (L/sec)	Release Rate (L/sec)	Storage Rate (L/sec)	Storage (m <sup>3</sup> )
0	230.5	2.0	0.32	1.7	0.00	398.6	3.9	0.315	3.5	0.00
10	104.2	0.9	0.32	0.6	0.36	178.6	1.7	0.315	1.4	0.85
20	70.3	0.6	0.32	0.3	<b>0.36</b>	120.0	1.2	0.315	0.8	1.01
30	53.9	0.5	0.32	0.2	0.28	91.9	0.9	0.315	0.6	<b>1.03</b>
40	44.2	0.4	0.32	0.1	0.17	75.1	0.7	0.315	0.4	0.99
50	37.7	0.3	0.32	0.0	0.04	64.0	0.6	0.315	0.3	0.91
60	32.9	0.3	0.32	0.0	-0.10	55.9	0.5	0.315	0.2	0.81
70	29.4	0.3	0.32	-0.1	-0.25	49.8	0.5	0.315	0.2	0.70
80	26.6	0.2	0.32	-0.1	-0.40	45.0	0.4	0.315	0.1	0.58
90	24.3	0.2	0.32	-0.1	-0.56	41.1	0.4	0.315	0.1	0.45
100	22.4	0.2	0.32	-0.1	-0.72	37.9	0.4	0.315	0.1	0.31
110	20.8	0.2	0.32	-0.1	-0.88	35.2	0.3	0.315	0.0	0.17
120	19.5	0.2	0.32	-0.1	-1.05	32.9	0.3	0.315	0.0	0.02
130	18.3	0.2	0.32	-0.2	-1.22	30.9	0.3	0.315	0.0	-0.13
140	17.3	0.2	0.32	-0.2	-1.39	29.2	0.3	0.315	0.0	-0.28
150	16.4	0.1	0.32	-0.2	-1.56	27.6	0.3	0.315	0.0	-0.43
160	15.6	0.1	0.32	-0.2	-1.73	26.2	0.3	0.315	-0.1	-0.59
170	14.8	0.1	0.32	-0.2	-1.90	25.0	0.2	0.315	-0.1	-0.75
180	14.2	0.1	0.32	-0.2	-2.07	23.9	0.2	0.315	-0.1	-0.91
190	13.6	0.1	0.32	-0.2	-2.25	22.9	0.2	0.315	-0.1	-1.07
200	13.0	0.1	0.32	-0.2	-2.42	22.0	0.2	0.315	-0.1	-1.23
210	12.6	0.1	0.32	-0.2	-2.60	21.1	0.2	0.315	-0.1	-1.40
220	12.1	0.1	0.32	-0.2	-2.77	20.4	0.2	0.315	-0.1	-1.56
230	11.7	0.1	0.32	-0.2	-2.95	19.7	0.2	0.315	-0.1	-1.73
240	11.3	0.1	0.32	-0.2	-3.13	19.0	0.2	0.315	-0.1	-1.89
Max =	<b>0.36</b>					<b>1.03</b>				

**Notes**

- 1 ) Peak flow is equal to the product of  $2.78 \times C \times I \times A$
- 2) Rainfall Intensity,  $I = A/(T_c+C)^B$
- 3) Release Rate = Min (Release Rate, Peak Flow)
- 4 ) Storage Rate = Peak Flow - Release Rate
- 5) Storage = Duration x Storage Rate
- 6) Maximum Storage = Max Storage Over Duration

**Table D14 Storage Volumes Roof Area #S01-5 (5 Year and 100Year Storms)**

$C_{AVG} = 0.90$  (dimensionless)

$C_{AVG} = 1.00$

Time Interval = 10 (mins)

Drainage Area = 0.00688 (hectares)

Duration (min)	Release Rate = 0.315 (L/sec) Return Period = 5 (years) IDF Parameters, A = 998.071, B = 0.814 (I = A/(T <sub>c</sub> +C), C = 6.053)					Release Rate = 0.3155 (L/sec) Return Period = 100 (years) IDF Parameters, A = 1735.688, B = 0.820 (I = A/(T <sub>c</sub> +C), C = 6.014)				
	Rainfall Intensity, I (mm/hr)	Peak Flow (L/sec)	Release Rate (L/sec)	Storage Rate (L/sec)	Storage (m <sup>3</sup> )	Rainfall Intensity, I (mm/hr)	Peak Flow (L/sec)	Release Rate (L/sec)	Storage Rate (L/sec)	Storage (m <sup>3</sup> )
0	230.5	4.0	0.32	3.7	0.00	398.6	7.6	0.315	7.3	0.00
10	104.2	1.8	0.32	1.5	0.89	178.6	3.4	0.315	3.1	1.86
20	70.3	1.2	0.32	0.9	1.07	120.0	2.3	0.315	2.0	2.37
30	53.9	0.9	0.32	0.6	1.10	91.9	1.8	0.315	1.4	2.59
40	44.2	0.8	0.32	0.4	1.07	75.1	1.4	0.315	1.1	2.69
50	37.7	0.6	0.32	0.3	1.00	64.0	1.2	0.315	0.9	2.72
60	32.9	0.6	0.32	0.3	0.91	55.9	1.1	0.315	0.8	2.71
70	29.4	0.5	0.32	0.2	0.80	49.8	1.0	0.315	0.6	2.67
80	26.6	0.5	0.32	0.1	0.68	45.0	0.9	0.315	0.5	2.62
90	24.3	0.4	0.32	0.1	0.55	41.1	0.8	0.315	0.5	2.54
100	22.4	0.4	0.32	0.1	0.42	37.9	0.7	0.315	0.4	2.46
110	20.8	0.4	0.32	0.0	0.28	35.2	0.7	0.315	0.4	2.36
120	19.5	0.3	0.32	0.0	0.14	32.9	0.6	0.315	0.3	2.26
130	18.3	0.3	0.32	0.0	0.00	30.9	0.6	0.315	0.3	2.15
140	17.3	0.3	0.32	0.0	-0.15	29.2	0.6	0.315	0.2	2.03
150	16.4	0.3	0.32	0.0	-0.30	27.6	0.5	0.315	0.2	1.91
160	15.6	0.3	0.32	0.0	-0.46	26.2	0.5	0.315	0.2	1.79
170	14.8	0.3	0.32	-0.1	-0.61	25.0	0.5	0.315	0.2	1.66
180	14.2	0.2	0.32	-0.1	-0.77	23.9	0.5	0.315	0.1	1.53
190	13.6	0.2	0.32	-0.1	-0.93	22.9	0.4	0.315	0.1	1.40
200	13.0	0.2	0.32	-0.1	-1.09	22.0	0.4	0.315	0.1	1.26
210	12.6	0.2	0.32	-0.1	-1.25	21.1	0.4	0.315	0.1	1.12
220	12.1	0.2	0.32	-0.1	-1.41	20.4	0.4	0.315	0.1	0.98
230	11.7	0.2	0.32	-0.1	-1.58	19.7	0.4	0.315	0.1	0.84
240	11.3	0.2	0.32	-0.1	-1.74	19.0	0.4	0.315	0.0	0.69
Max =	<b>1.10</b>					<b>2.72</b>				

**Notes**

- 1) Peak flow is equal to the product of 2.78 x C x I x A
- 2) Rainfall Intensity, I = A/(T<sub>c</sub>+C)<sup>B</sup>
- 3) Release Rate = Min (Release Rate, Peak Flow)
- 4) Storage Rate = Peak Flow - Release Rate
- 5) Storage = Duration x Storage Rate
- 6) Maximum Storage = Max Storage Over Duration



**Table D15 Storage Volumes Roof Area #S01-6 (5 Year and 100Year Storms)**

$C_{AVG} = 0.90$  (dimensionless)  
 $C_{AVG} = 1.00$   
 Time Interval = 10 (mins)  
 Drainage Area = 0.00534 (hectares)

Release Rate = 0.315 (L/sec) Return Period = 5 (years) IDF Parameters, A = 998.071, B = 0.814 (I = A/(T <sub>c</sub> +C), C = 6.053)	Release Rate = 0.3155 (L/sec) Return Period = 100 (years) IDF Parameters, A = 1735.688, B = 0.820 (I = A/(T <sub>c</sub> +C), C = 6.014)
---	---

Duration (min)	5 Year Storm					100 Year Storm				
	Rainfall Intensity, I (mm/hr)	Peak Flow (L/sec)	Release Rate (L/sec)	Storage Rate (L/sec)	Storage (m <sup>3</sup> )	Rainfall Intensity, I (mm/hr)	Peak Flow (L/sec)	Release Rate (L/sec)	Storage Rate (L/sec)	Storage (m <sup>3</sup> )
0	230.5	3.1	0.32	2.8	0.00	398.6	5.9	0.315	5.6	0.00
10	104.2	1.4	0.32	1.1	0.65	178.6	2.7	0.315	2.3	1.40
20	70.3	0.9	0.32	0.6	0.75	120.0	1.8	0.315	1.5	1.76
30	53.9	0.7	0.32	0.4	0.73	91.9	1.4	0.315	1.0	1.89
40	44.2	0.6	0.32	0.3	0.66	75.1	1.1	0.315	0.8	1.92
50	37.7	0.5	0.32	0.2	0.56	64.0	0.9	0.315	0.6	1.90
60	32.9	0.4	0.32	0.1	0.45	55.9	0.8	0.315	0.5	1.85
70	29.4	0.4	0.32	0.1	0.32	49.8	0.7	0.315	0.4	1.78
80	26.6	0.4	0.32	0.0	0.19	45.0	0.7	0.315	0.4	1.69
90	24.3	0.3	0.32	0.0	0.05	41.1	0.6	0.315	0.3	1.59
100	22.4	0.3	0.32	0.0	-0.10	37.9	0.6	0.315	0.2	1.48
110	20.8	0.3	0.32	0.0	-0.25	35.2	0.5	0.315	0.2	1.37
120	19.5	0.3	0.32	-0.1	-0.40	32.9	0.5	0.315	0.2	1.24
130	18.3	0.2	0.32	-0.1	-0.55	30.9	0.5	0.315	0.1	1.12
140	17.3	0.2	0.32	-0.1	-0.71	29.2	0.4	0.315	0.1	0.99
150	16.4	0.2	0.32	-0.1	-0.87	27.6	0.4	0.315	0.1	0.85
160	15.6	0.2	0.32	-0.1	-1.03	26.2	0.4	0.315	0.1	0.71
170	14.8	0.2	0.32	-0.1	-1.20	25.0	0.4	0.315	0.1	0.57
180	14.2	0.2	0.32	-0.1	-1.36	23.9	0.4	0.315	0.0	0.43
190	13.6	0.2	0.32	-0.1	-1.53	22.9	0.3	0.315	0.0	0.28
200	13.0	0.2	0.32	-0.1	-1.69	22.0	0.3	0.315	0.0	0.13
210	12.6	0.2	0.32	-0.1	-1.86	21.1	0.3	0.315	0.0	-0.02
220	12.1	0.2	0.32	-0.2	-2.03	20.4	0.3	0.315	0.0	-0.17
230	11.7	0.2	0.32	-0.2	-2.20	19.7	0.3	0.315	0.0	-0.32
240	11.3	0.2	0.32	-0.2	-2.37	19.0	0.3	0.315	0.0	-0.48

Max = 0.75 1.92

**Notes**

- 1 ) Peak flow is equal to the product of 2.78 x C x I x A
- 2 ) Rainfall Intensity, I = A/(T<sub>c</sub>+C)<sup>B</sup>
- 3 ) Release Rate = Min (Release Rate, Peak Flow)
- 4 ) Storage Rate = Peak Flow - Release Rate
- 5 ) Storage = Duration x Storage Rate
- 6 ) Maximum Storage = Max Storage Over Duration

**Table D-16- Storage Volumes for 2-year, 5-Year and 100-Year Storms**

Area No: **S2**  
 $C_{AVG} = 0.30$  (2-yr)  
 $C_{AVG} = 0.30$  (5-yr)  
 $C_{AVG} = 1.00$  (100-yr, Max 1.0)  
 Time Interval = 5.00 (mins)  
 Drainage Area = 0.0141 (hectares)

Duration (min)	Release Rate = <b>0.6</b> (L/sec) Return Period = <b>2</b> (years) IDF Parameters, A = <b>732.951</b> , B = <b>0.810</b> ( $I = A/(T_c+C)$ ), C = <b>6.199</b>					Release Rate = <b>0.77</b> (L/sec) Return Period = <b>5</b> (years) IDF Parameters, A = <b>998.071</b> , B = <b>0.814</b> ( $I = A/(T_c+C)$ ), C = <b>6.053</b>					Release Rate = <b>1.64</b> (L/sec) Return Period = <b>100</b> (years) IDF Parameters, A = <b>1735.688</b> , B = <b>0.820</b> ( $I = A/(T_c+C)$ ), C = <b>6.014</b>				
	Rainfall Intensity, I (mm/hr)	Peak Flow (L/sec)	Release Rate (L/sec)	Storage Rate (L/sec)	Storage (m <sup>3</sup> )	Rainfall Intensity, I (mm/hr)	Peak Flow (L/sec)	Release Rate (L/sec)	Storage Rate (L/sec)	Storage (m <sup>3</sup> )	Rainfall Intensity, I (mm/hr)	Peak Flow (L/sec)	Release Rate (L/sec)	Storage Rate (L/sec)	Storage (m <sup>3</sup> )
0	167.2	2.0	0.56	1.4	0.00	230.5	2.7	0.766	1.9	0.00	398.6	15.6	1.640	14.0	0.00
5	103.6	1.2	0.56	0.6	0.19	141.2	1.7	0.766	0.9	0.27	242.7	9.5	1.640	7.9	2.36
10	76.8	0.9	0.56	0.3	<b>0.20</b>	104.2	1.2	0.766	0.5	<b>0.27</b>	178.6	7.0	1.640	5.3	3.21
15	61.8	0.7	0.56	0.2	0.14	83.6	1.0	0.766	0.2	0.19	142.9	5.6	1.640	4.0	3.56
20	52.0	0.6	0.56	0.0	0.05	70.3	0.8	0.766	0.1	0.07	120.0	4.7	1.640	3.1	<b>3.66</b>
25	45.2	0.5	0.56	0.0	-0.05	60.9	0.7	0.766	-0.1	-0.08	103.8	4.1	1.640	2.4	3.64
30	40.0	0.5	0.56	-0.1	-0.17	53.9	0.6	0.766	-0.1	-0.24	91.9	3.6	1.640	2.0	3.52
35	36.1	0.4	0.56	-0.1	-0.30	48.5	0.6	0.766	-0.2	-0.41	82.6	3.2	1.640	1.6	3.34
40	32.9	0.4	0.56	-0.2	-0.43	44.2	0.5	0.766	-0.2	-0.59	75.1	2.9	1.640	1.3	3.12
45	30.2	0.4	0.56	-0.2	-0.57	40.6	0.5	0.766	-0.3	-0.78	69.1	2.7	1.640	1.1	2.87
50	28.0	0.3	0.56	-0.2	-0.71	37.7	0.4	0.766	-0.3	-0.97	64.0	2.5	1.640	0.9	2.59
55	26.2	0.3	0.56	-0.3	-0.85	35.1	0.4	0.766	-0.4	-1.17	59.6	2.3	1.640	0.7	2.29
60	24.6	0.3	0.56	-0.3	-1.00	32.9	0.4	0.766	-0.4	-1.37	55.9	2.2	1.640	0.5	1.97
65	23.2	0.3	0.56	-0.3	-1.14	31.0	0.4	0.766	-0.4	-1.57	52.6	2.1	1.640	0.4	1.64
70	21.9	0.3	0.56	-0.3	-1.29	29.4	0.3	0.766	-0.4	-1.77	49.8	1.9	1.640	0.3	1.29
75	20.8	0.2	0.56	-0.3	-1.44	27.9	0.3	0.766	-0.4	-1.97	47.3	1.8	1.640	0.2	0.94
80	19.8	0.2	0.56	-0.3	-1.59	26.6	0.3	0.766	-0.5	-2.18	45.0	1.8	1.640	0.1	0.58
85	18.9	0.2	0.56	-0.3	-1.75	25.4	0.3	0.766	-0.5	-2.39	43.0	1.7	1.640	0.0	0.21
90	18.1	0.2	0.56	-0.4	-1.90	24.3	0.3	0.766	-0.5	-2.60	41.1	1.6	1.640	0.0	-0.17
95	17.4	0.2	0.56	-0.4	-2.05	23.3	0.3	0.766	-0.5	-2.81	39.4	1.5	1.640	-0.1	-0.55
100	16.7	0.2	0.56	-0.4	-2.21	22.4	0.3	0.766	-0.5	-3.02	37.9	1.5	1.640	-0.2	-0.94
Max =					<b>0.20</b>					<b>0.27</b>					<b>3.66</b>

- Notes**  
 1) Peak flow is equal to the product of  $2.78 \times C \times I \times A$   
 2) Rainfall Intensity,  $I = A/(T_c+C)^B$   
 3) Release Rate = Min (Release Rate, Peak Flow)  
 4) Storage Rate = Peak Flow - Release Rate  
 5) Storage = Duration x Storage Rate  
 6) Maximum Storage = Max Storage Over Duration  
 7) Parameters a,b,c are for City of Ottawa

**TABLE D17: 2-YEAR STORM SEWER CALCULATION SHEET**



Return Period Storm = **2-year** (2-year, 5-year, 100-year)  
 Default Inlet Time= 10 (minutes)  
 Manning Coefficient = 0.013 (dimensionless)

From Node	To Node	AREA INFO				FLOW (UNRESTRICTED)								INDIV CAP FLOW (L/s)	CUMUL CAP FLOW (L/s)	SEWER DATA									
		Area No.	Area (ha)	Σ Area (ha)	Average R	Indiv. 2.78*A*R	Accum. 2.78*A*R	Tc (mins)	I (mm/h)	Indiv. Flow	Return Period	Q (L/s)	Dia (mm) Actual			Dia (mm) Nominal	Type	Slope (%)	Length (m)	Capacity, Q <sub>CAP</sub> (L/sec)	Velocity (m/s)		Time in Pipe, Tt (min)	Hydraulic Ratios	
																			Vf	Va		Q/Q <sub>CAP</sub>	Va/Vf		
CBE 01	CB 02	S02_1	0.0079	0.0079	0.30	0.0066	0.007	10.00	76.81	0.51	2-year	0.51			250.0	250	HDPE	1.80	6.60	79.78	1.63	0.00	0.07	0.006	0.001
CBE 03	CB 02	S02_2	0.0062	0.0062	0.30	0.0052	0.005	10.00	76.81	0.40	2-year	0.40			250.0	250	HDPE	0.75	6.70	51.50	1.05	0.00	0.11	0.008	0.001
CB 02	STM 01			0.0141			0.012	10.11	76.40		2-year	0.90	1.64	1.64	200.0	200	HDPE	1.00	1.90	32.80	1.04	0.32	0.03	0.027	0.310
BLDG ROOF	STMH 01	S1	0.0301	0.0301	0.90	0.0753	0.0753						1.89	1.89											
STMH 01	MAIN			0.0442			0.0871	10.14	76.28		2-year	6.64		3.53	150.0	150	PVC	1.00	10.40	15.23	0.86	0.61	0.20	0.44	0.71
<b>TOTALS =</b>			<b>0.0442</b>			<b>0.0871</b>				<b>0.90</b>			<b>3.53</b>												
<b>Definitions:</b>														Designed: J.Fitzpatrick, P.Eng.											
Q = 2.78* AIR, where														Project: 266-268 Carruthers Ave											
Q = Peak Flow in Litres per second (L/s)														Checked: B. Thomas, P.Eng.											
A = Watershed Area (hectares)														Location: 266-268 Carruthers Ave											
I = Rainfall Intensity (mm/h)														Dwg Reference: C100 - Site Servicing Plan											
R = Runoff Coefficients (dimensionless)														File Ref:											
														Sheet No: 1 of 1											

Ottawa Rainfall Intensity Values from Sewer Design Guidelines, SDG002

	a	b	c
<b>2-year</b>	732.951	6.199	0.810
<b>5-year</b>	998.071	6.053	0.814
<b>100-year</b>	1735.688	6.014	0.820

## **Appendix E – Consultation / Correspondence**

**City of Ottawa Memo from Pre-Consultation Meeting.**

**Email on Water System Boundary Conditions.**

**Email Received from RCVA on Stormwater Management Requirements.**

Hi Jeff,

Please forward the below information to the applicant regarding a development proposal at **266-268 Carruthers Avenue, Ottawa for a three storey + basement low rise apartment building with approximately 22 units**. Note that the information is considered **preliminary**, and the assigned Development Review Project Manager may modify and/or add additional requirements and conditions upon review of an application if deemed necessary.

**General:**

- It is the sole responsibility of the consultant to investigate the location of existing underground utilities in the proposed servicing area and submit a request for locates to avoid conflict(s). The location of existing utilities and services shall be documented on an **Existing Conditions Plan**.
- Any easements on the subject site shall be identified and respected by any development proposal and shall adhere to the conditions identified in the easement agreement. A **legal survey plan** shall be provided, and all easements shall be shown on the engineering plans.
- **Concern** about sanitary and storm sewer capacity, please provide the new sanitary and storm sewer discharge and we confirm if sanitary sewer main has the capacity. Also provide the size proposed sanitary service.
- An application to consolidate the parcels (266 and 268 Carruthers Avenue) of land will be required otherwise the proposed stormwater works will be servicing more than one parcel of land and thus does not meet the exemption set out in O.Reg. 525/98. This would mean an **ECA would be required** regardless of who owns the parcels.
- Only one service connection is permitted per property parcel. Therefore, if all three properties (266 Carruthers, 268 Carruthers, and 177 Armstrong) are merged as a single property parcel, only one service connection is permitted for the parcel.
  
- Reference documents for information purposes:
  - Ottawa Sewer Design Guidelines (October 2012)
  - Technical Bulletin PIEDTB-2016-01
  - Technical Bulletins ISTB-2018-01, ISTB-2018-02 and ISTB-2018-03.
  - Ottawa Design Guidelines - Water Distribution (2010)
  - Technical Bulletin ISTB-2021-03
  - Geotechnical Investigation and Reporting Guidelines for Development Applications in the City of Ottawa (2007)
  - City of Ottawa Slope Stability Guidelines for Development Applications (revised 2012)
  - City of Ottawa Environmental Noise Control Guidelines (January 2016)
  - City of Ottawa Accessibility Design Standards (2012) (City recommends development be in accordance with these standards on private property)
  - Ottawa Standard Tender Documents (latest version)
  - Ontario Provincial Standards for Roads & Public Works (2013)

- Record drawings and utility plans are also available for purchase from the City (Contact the City's Information Centre by email at [InformationCentre@ottawa.ca](mailto:InformationCentre@ottawa.ca) or by phone at (613) 580-424 x.44455).

Please note that this is the applicant responsibility to refer to the latest applicable guidelines while preparing reports and studies.



**Disclaimer:**

*The City of Ottawa does not guarantee the accuracy or completeness of the data and information contained on the above image(s) and does not assume any responsibility or liability with respect to any damage or loss arising from the use or interpretation of the image(s) provided. This image is for schematic purposes only.*

**Stormwater Management Criteria and Information:**

- Water Quantity Control:** In the absence of area specific SWM criteria please control post-development runoff from the subject site, up to and including the **100-year storm event**, to a **2-year pre-development level**. The pre-development runoff coefficient will need to be determined **as per existing conditions** but in no case more than 0.5. [If 0.5 applies it needs to be clearly demonstrated in the report that the pre-development runoff coefficient is greater than 0.5]. The time of concentration ( $T_c$ ) used to determine the pre-development condition should be calculated.  $T_c$  should not be less than 10 min; since IDF curves become unrealistic at less than 10 min;  $T_c$  of 10 minutes shall be used for all post-development calculations].

- Any storm events greater than the established **2-year allowable** release rate, up to and including the **100-year storm event**, shall be detained on-site. The SWM measures required to avoid impact on downstream sewer system will be subject to review.
- Please note that foundation drainage is to be independently connected to sewer main unless being pumped with appropriate back up power, sufficient sized pump and back flow prevention. **It is recommended that the foundation drainage system be drained by a sump pump connection to the storm sewer to minimize risk of basement flooding as it will provide the best protection from the uncontrolled sewer system compared to relying on the backwater valve.**
- **Water Quality Control:** Please consult with the local conservation authority (RVCA) regarding water quality criteria prior to submission of a Site Plan Control Proposal application to establish any water quality control restrictions, criteria and measures for the site. Correspondence and clearance shall be provided in the Appendix of the report.
- Please note that as per *Technical Bulletin PIEDTB-2016-01 section 8.3.11.1 (p.12 of 14)* **there shall be no surface ponding on private parking areas during the 2-year storm rainfall event.**
- **Underground Storage:** Please note that the Modified Rational Method for storage computation in the Sewer Design Guidelines was originally intended to be used for above ground storage (i.e., parking lot) where the change in head over the orifice varied from 1.5 m to 1.2 m (assuming a 1.2 m deep CB and a max ponding depth of 0.3 m). This change in head was small and hence the release rate fluctuated little, therefore there was no need to use an average release rate.
  - When underground storage is used, the release rate fluctuates from a maximum peak flow based on maximum head down to a release rate of zero. This difference is large and has a significant impact on storage requirements. **We therefore require that an average release rate equal to 50% of the peak allowable rate shall be applied to estimate the required volume. Alternatively, the consultant may choose to use a submersible pump in the design to ensure a constant release rate.**
  - In the event that there is a disagreement from the designer regarding the required storage, The City will require that the designer demonstrate their rationale utilizing dynamic modelling, that will then be reviewed by City modellers in the Water Resources Group.
  - Please provide information on UG storage pipe. Provide required cover over pipe and details, chart of storage values, capacity etc. How will this pipe be cleaned of sediment and debris?
  - Provide information on type of underground storage system including product name and model, number of chambers, chamber configuration, confirm invert of chamber system, top of chamber system, required cover over system and details, interior bottom slope (for self-cleansing), chart of storage values, length, width and height, capacity, entry ports (maintenance) etc.

- Provide a cross section of underground chamber system showing invert and obvert/top, major and minor HWLs, top of ground, system volume provided during major and minor events. UG storage to provide actual 2- and 100-year event storage requirements.
  - Regarding all proposed UG storage, ground water levels (and in particular HGW levels) will need to be reviewed to ensure that the proposed system does not become surcharged and thereby ineffective.
  - Modeling can be provided to ensure capacity for both storm and sanitary sewers for the proposed development by City's Water Distribution Dept. – Modeling Group, through PM and upon request.
- Please note that the minimum orifice dia. for a plug style **ICD is 83mm and the minimum flow rate from a vortex ICD is 6 L/s** in order to reduce the likelihood of plugging.
  - Post-development site grading shall match existing property line grades in order to minimize disruption to the adjacent residential properties. A **topographical plan of survey** shall be provided as part of the submission and a note provided on the plans.
  - Please provide a **Pre-Development Drainage Area Plan** to define the pre-development drainage areas/patterns. **Existing drainage patterns shall be maintained and discussed as part of the proposed SWM solution.**
  - **If rooftop control** and storage is proposed as part of the SWM solutions sufficient details (Cl. 8.3.8.4) shall be discussed and document in the report and on the plans. Roof drains are to be connected downstream of any incorporated ICDs within the SWM system and not to the foundation drain system. Provide a **Roof Drain Plan** as part of the submission.
  - If **Window wells** are proposed, they are to be indirectly connected to the footing drains. A detail of window well with indirect connection is required, as is a note at window well location speaking to indirect connection.
  - There must be at least **15cm of vertical clearance** between the spill elevation and the ground elevation at the building envelope that is in proximity of the flow route or ponding area. The exception in this case would be at reverse sloped loading dock locations. At these locations, a minimum of 15cm of vertical clearance must be provided below loading dock openings. Ensure to provide discussion in report and ensure grading plan matches if applicable.
  - Rear yard on grade parking to be permeable pavement. Refer to City Standard Detail Drawings SC26 (maintenance/temp parking areas), SC27 or permeable asphalt materials. No gravel or stone dust parking areas permitted.

#### **Storm Sewer:**

- A 300mm dia. PVC storm sewer (1996) is available within Carruthers Avenue.
- A 300mm dia. PVC storm sewer (1995) is available within Armstrong Street.

#### **Sanitary Sewer:**

- A 1200 mm dia. CONC Sanitary sewer (1912) is available within Carruthers Avenue.



- A 300 mm dia. PVC Sanitary sewer (1992) is available within Armstrong Street.
- Please provide the new Sanitary sewer discharge and we confirm if sanitary sewer main has the capacity. An analysis and demonstration that there is sufficient/adequate residual capacity to accommodate any increase in wastewater flows in the receiving and downstream wastewater system is required to be provided. Needs to be demonstrated that there is adequate capacity to support any increase in wastewater flow.
- Please apply the wastewater design flow parameters *in Technical Bulletin PIEDTB-2018-01*.
- Sanitary sewer monitoring maintenance hole is required to be installed at the property line (on the private side of the property) as per City of Ottawa Sewer-Use By-Law 2003-514 (14) *Monitoring Devices*.
- A backwater valve is required on the sanitary service for protection.

#### Water:

- A 203 mm dia. PVC watermain (1995) is available within Carruthers Avenue.
- A 203 mm dia. PVC watermain (1992) is available within Armstrong Street.
- Existing residential service to be blanked at the main.
- **Water Supply Redundancy:** Residential buildings with a basic day demand greater than 50m<sup>3</sup>/day (0.57 L/s) are required to be connected to a minimum of two water services separated by an isolation valve to avoid a vulnerable service area as per the *Ottawa Design Guidelines - Water Distribution, WDG001, July 2010 Clause 4.3.1 Configuration*. The basic day demand for this site not expected to exceed 50m<sup>3</sup>/day.
- Please **review Technical Bulletin ISTB-2018-02**, maximum fire flow hydrant capacity is provided in Section 3 Table 1 of Appendix I. A **hydrant coverage figure** shall be provided and **demonstrate there is adequate fire protection for the proposal**. Two or more public hydrants are anticipated to be required to handle fire flow.
- Boundary conditions are required to confirm that the require fire flows can be achieved as well as availability of the domestic water pressure on the City street in front of the development. Use Table 3-3 of the MOE Design Guidelines for Drinking-Water System to determine Maximum Day and Maximum Hour peaking factors for 0 to 500 persons and use Table 4.2 of the Ottawa Design Guidelines, Water Distribution for 501 to 3,000 persons. Please provide the following information to the City of Ottawa via email to request water distribution network boundary conditions for the subject site. Please note that once this information has been provided to the City of Ottawa it takes approximately 5-10 business days to receive boundary conditions.
  - Type of Development and Units
  - Site Address
  - A plan showing the proposed water service connection location.
  - **Average Daily Demand** (L/s)
  - **Maximum Daily Demand** (L/s)
  - **Peak Hour Demand** (L/s)
  - **Fire Flow** (L/min)

[Fire flow demand requirements shall be based on **Fire Underwriters Survey (FUS)** Water Supply for Public Fire Protection 1999]

[Fire flow demand requirements shall be based on ISTB-2021-03]

Note: The OBC method can be used if the fire demand for the private property is less than 9,000 L/min. If the OBC fire demand reaches 9000 L/min, then the FUS method is to be used.

Exposure separation distances shall be defined on a figure to support the FUS calculation and required fore flow (RFF).

- **Hydrant capacity shall be assessed to demonstrate the RFF can be achieved.** Please identify which hydrants are being considered to meet the RFF on a fire hydrant coverage plan as part of the boundary conditions request.

### **Snow Storage:**

- Any portion of the subject property which is intended to be used for permanent or temporary snow storage shall be as shown on the approved site plan and grading plan. Snow storage shall not interfere with approved grading and drainage patterns or servicing. Snow storage areas shall be setback from the property lines, foundations, fencing or landscaping a minimum of 1.5m. Snow storage areas shall not occupy driveways, aisles, required parking spaces or any portion of a road allowance. If snow is to be removed from the site, please indicate this on the plan(s).

### **Trees:**

- Please note that a new Tree By-law is now in effect.



[General Bulletin\\_New  
Tree Protection Bylaw](#)

### **Severance:**

- If severance is planned, this needs to be addressed in servicing to satisfy severance requirements. Where a large parcel with multiple buildings is planned, City will require an ultimate servicing plan to appropriately understand how severance requirements are being met.

### **Gas pressure regulating station**

- A gas pressure regulating station may be required depending on HVAC needs (typically for 12+ units). Be sure to include this on the Grading, Site Servicing, SWM and Landscape plans. This is to ensure that there are no barriers for overland flow routes (SWM) or conflicts with any proposed grading or landscape features with installed structures and has nothing to do with supply and demand of any product.



Gas Pressure  
Regulating Station.pdf

### **Regarding Quantity Estimates:**

- Please note that external Garbage and/or bicycle storage structures are to be added to QE under Landscaping as it is subject to securities. In addition, sump pumps for Sanitary and Storm laterals and/or cisterns are to be added to QE under Hard items as it is subject to securities, even though it is internal and is spoken to under SWM and Site Servicing Report and Plan.

### **CCTV sewer inspection**

- CCTV sewer inspection required for pre and post construction conditions to ensure no damage to City Assets surrounding site.

### **Pre-Construction Survey**

- Pre-Construction (Piling/Hoe Ramming or proximity to City Assets) and/or Pre-Blasting (if applicable) Survey required for any buildings/dwellings in proximity of 75m of site and circulation of notice of vibration/noise to residents within 150 m of site. Conditions for Pre-Construction/ Pre-Blast Survey & Use of Explosives will be applied to agreements. Refer to City's Standard S.P. No. F-1201 entitled Use of Explosives, as amended.

### **Road Reinstatement**

- Where servicing involves three or more service trenches, either a full road width or full lane width 40 mm asphalt overlay will be required, as per amended Road Activity By-Law 2003-445 and City Standard Detail Drawing R10. The amount of overlay will depend on condition of roadway and width of roadway(s).

### **Permits and Approvals:**

- Please note that this project will be subject to an Environmental Compliance Approval (ECA) for Private Sewage Works. (Any connection to a combined Sewer system required the Ministry (MECP) approval)

### **Required Engineering Plans and Studies:**

#### **PLANS:**

- Existing Conditions and Removals Plan
- Site Servicing Plan
- Grade Control and Drainage Plan
- Erosion and Sediment Control Plan
- Roof Drainage Plan
- Foundation Drainage System Detail (if applicable)
- Topographical survey

#### **REPORTS:**

- Site Servicing and Stormwater Management Report

- Geotechnical Study/Investigation (including sensitive marine clays and unstable slopes) is required per section 10.1.4 of OP)
- Slope Stability Assessment Reports (if required, please see requirements below)
- Phase I ESA
- Phase II ESA (Depending on recommendations of Phase I ESA)
- ECA (If the SWM system services two parcels)

Please refer to the **City of Ottawa Guide to Preparing Studies and Plans**

**[Engineering]:**

Specific information has been incorporated into both the [Guide to Preparing Studies and Plans](#) for a site plan. The guide outlines the requirement for a statement to be provided on the plan about where the property boundaries have been derived from.

Added to the general information for servicing and grading plans is a note that an O.L.S. should be engaged when reporting on or relating information to property boundaries or existing conditions. The importance of engaging an O.L.S. for development projects is emphasized.

**Phase One Environmental Site Assessment:**

- A Phase I ESA is required to be completed in accordance with Ontario Regulation 153/04 in support of this development proposal to determine the potential for site contamination. Depending on the Phase I recommendations a Phase II ESA may be required.
- The Phase I ESA shall provide all the required Environmental Source Information as required by O. Reg. 153/04. ERIS records are available to public at a reasonable cost and need to be included in the ESA report to comply with O.Reg. 153/04 and the Official Plan. The City will not be in a position to approve the Phase I ESA without the inclusion of the ERIS reports.
- Official Plan Section 4.8.4:

<https://ottawa.ca/en/city-hall/planning-and-development/official-plan-and-master-plans/official-plan/volume-1-official-plan/section-4-review-development-applications#4-8-protection-health-and-safety>

**ECA application**

- Environmental Compliance Approval (ECA) for stormwater works the services more than one parcel of land.

**Geotechnical Investigation:**

- A Geotechnical Study/Investigation shall be prepared in support of this development proposal.
- Reducing the groundwater level in this area can lead to potential damages to surrounding structures due to excessive differential settlements of the ground. The impact of groundwater lowering on adjacent properties needs to be discussed and investigated to ensure there will be no short term and long-term damages associated with lowering the groundwater in this area.
- Geotechnical Study shall be consistent with the **Geotechnical Investigation and Reporting Guidelines for Development Applications.**

[https://documents.ottawa.ca/sites/documents/files/geotech\\_report\\_en.pdf](https://documents.ottawa.ca/sites/documents/files/geotech_report_en.pdf)

### **Slope Stability Assessment Reports**

- A report addressing the stability of slopes, prepared by a qualified geotechnical engineer licensed in the Province of Ontario, should be provided wherever a site has slopes (existing or proposed) steeper than 5 horizontal to 1 vertical (i.e., 11 degree inclination from horizontal) and/or more than 2 metres in height.
- A report is also required for sites having retaining walls greater than 1 metre high, that addresses the global stability of the proposed retaining walls.  
<https://documents.ottawa.ca/en/document/slope-stability-guidelines-development-applications>

### **Fourth (4<sup>th</sup>) Review Charge:**

Please be advised that additional charges for each review, after the 3<sup>rd</sup> review, will be applicable to each file. There will be no exceptions.

**Construction approach** – Please contact the Right-of-Ways Permit Office [TMconstruction@ottawa.ca](mailto:TMconstruction@ottawa.ca) early in the Site Plan process to determine the ability to construct site and copy File Lead on this request.

Please note that these comments are considered preliminary based on the information available to date and therefore maybe amended as additional details become available and presented to the City. It is the responsibility of the applicant to verify the above information. The applicant may contact me for follow-up questions related to engineering/infrastructure prior to submission of an application if necessary.

If you have any questions or require any clarification, please let me know.

Regards,

**Sarah McLaughlin, P.Eng**

Project Manager

Planning, Real Estate and Economic Development Department / Direction générale de la planification, des biens immobiliers et du développement économique

Development Review - Central Branch

City of Ottawa | Ville d'Ottawa

110 Laurier Avenue West Ottawa, ON, K1P 1J1 | 110, avenue Laurier Ouest, Ottawa, ON, K1P 1J1

613.580.2400 ext./poste 26821, [sarah.mclaughlin@ottawa.ca](mailto:sarah.mclaughlin@ottawa.ca)

**From:** Wessel, Shawn <shawn.wessel@ottawa.ca>  
**Sent:** November 7, 2022 2:30 PM  
**To:** Jason Fitzpatrick  
**Cc:** Bruce Thomas; Alexandria Cushing  
**Subject:** RE: 266-268 Carruthers Ave.  
**Attachments:** [266-268 Carruthers Avenue October 2022.pdf](#)



**CAUTION:** This email originated from outside of the organization. Do not click links or open attachments unless you recognize the sender and know the content is safe.

Good afternoon.

The following are boundary conditions, HGL, for hydraulic analysis at 266-268 Carruthers Avenue (zone 1W) assumed to be connected to the 203 mm watermain on Carruthers Avenue (see attached PDF for location).

Minimum HGL: 107.9 m

Maximum HGL: 115.0 m

Max Day + Fire Flow (217 L/s): 102.9 m

These are for current conditions and are based on computer model simulation.

*Disclaimer: The boundary condition information is based on current operation of the city water distribution system. The computer model simulation is based on the best information available at the time. The operation of the water distribution system can change on a regular basis, resulting in a variation in boundary conditions. The physical properties of watermains deteriorate over time, as such must be assumed in the absence of actual field test data. The variation in physical watermain properties can therefore alter the results of the computer model simulation.*

If you require additional information or clarification, please do not hesitate to contact me anytime.

Thank you

*Regards,*

**Shawn Wessel, A.Sc.T.,rcji**  
**Project Manager - Infrastructure Approvals**

## Gestionnaire de projet – Approbation des demandes d’infrastructures

Development Review Central Branch | Direction de l’examen des projets d’aménagement, Centrale  
Planning, Real Estate and Economic Development Department | Direction générale de la planification des biens immobiliers  
et du développement économique

City of Ottawa | Ville d’Ottawa

110 Laurier Ave. W. | 110, avenue Laurier Ouest, Ottawa ON K1P 1J1

(613) 580 2424 Ext. | Poste 33017

Int. Mail Code | Code de Courrier Interne 01-14

[shawn.wessel@ottawa.ca](mailto:shawn.wessel@ottawa.ca)

 Please consider the environment before printing this email

**\*\*\*Please also note that, while my work hours may be affected by the current situation and am working from home, I still have access to email, video conferencing and telephone. Feel free to schedule video conferences and/or telephone calls, as necessary.\*\*\***

---

**From:** Jason Fitzpatrick <[jason.fitzpatrick@exp.com](mailto:jason.fitzpatrick@exp.com)>

**Sent:** November 07, 2022 8:53 AM

**To:** Wessel, Shawn <[shawn.wessel@ottawa.ca](mailto:shawn.wessel@ottawa.ca)>

**Cc:** Bruce Thomas <[Bruce.Thomas@exp.com](mailto:Bruce.Thomas@exp.com)>; Alexandria Cushing <[Alexandria.Cushing@exp.com](mailto:Alexandria.Cushing@exp.com)>

**Subject:** RE: 266-268 Carruthers Ave.

**CAUTION: This email originated from an External Sender. Please do not click links or open attachments unless you recognize the source.**

**ATTENTION : Ce courriel provient d’un expéditeur externe. Ne cliquez sur aucun lien et n’ouvrez pas de pièce jointe, excepté si vous connaissez l’expéditeur.**

Hi Shawn,

Can you check with Water Resources on an ETA for this request.

Thanks

**Jason Fitzpatrick, P.Eng.**

EXP | Project Engineer

t : +1.613.688.1899, 63258 | m : +1.613.302.7441 | e : [jason.fitzpatrick@exp.com](mailto:jason.fitzpatrick@exp.com)

[exp.com](http://exp.com) | [legal disclaimer](#)

*keep it green, read from the screen*

---

**From:** Jason Fitzpatrick

**Sent:** Monday, October 24, 2022 10:43 AM

**To:** Wessel, Shawn <[shawn.wessel@ottawa.ca](mailto:shawn.wessel@ottawa.ca)>

**Cc:** Bruce Thomas <[bruce.thomas@exp.com](mailto:bruce.thomas@exp.com)>

**Subject:** RE: 266-268 Carruthers Ave.

Hi Shawn,

Appreciate you looking into this. I've updated the FUS calculation based on the new 2020 FUS exposure charges.

Based on this the new RFF is now 217 L/sec (up from 200 L/sec). I've therefore included the new info below along with the updated attachments.

**266-268 Carruthers Ave (18 unit apartment)**

Max Day: 1.0 L/s

Peak Hour: 1.51 L/s

Fire Flow (RFF): 217 L/s

Let me know when you get results back from Water Resources.

Thanks

**Jason Fitzpatrick, P.Eng.**

EXP | Project Engineer

t : +1.613.688.1899, 63258 | m : +1.613.302.7441 | e : [jason.fitzpatrick@exp.com](mailto:jason.fitzpatrick@exp.com)

[exp.com](http://exp.com) | [legal disclaimer](#)

*keep it green, read from the screen*

---

**From:** Wessel, Shawn <[shawn.wessel@ottawa.ca](mailto:shawn.wessel@ottawa.ca)>

**Sent:** Friday, October 21, 2022 10:18 AM

**To:** Jason Fitzpatrick <[jason.fitzpatrick@exp.com](mailto:jason.fitzpatrick@exp.com)>

**Subject:** 266-268 Carruthers Ave.



**CAUTION:** This email originated from outside of the organization. Do not click links or open attachments unless you recognize the sender and know the content is safe.

Hi Jason.

Please ensure you are using 2020 FUS and resubmit.

Thank you.

If you require additional information or clarification, please do not hesitate to contact me anytime.



Thank you

*Regards,*

**Shawn Wessel, A.Sc.T.,rcji**  
**Project Manager - Infrastructure Approvals**  
**Gestionnaire de projet – Approbation des demandes d’infrastructures**

Development Review Central Branch | Direction de l’examen des projets d’aménagement, Centrale  
Planning, Real Estate and Economic Development Department | Direction générale de la planification des biens immobiliers  
et du développement économique  
City of Ottawa | Ville d’Ottawa  
110 Laurier Ave. W. | 110, avenue Laurier Ouest, Ottawa ON K1P 1J1  
(613) 580 2424 Ext. | Poste 33017  
Int. Mail Code | Code de Courrier Interne 01-14  
[shawn.wessel@ottawa.ca](mailto:shawn.wessel@ottawa.ca)

 Please consider the environment before printing this email

**\*\*\*Please also note that, while my work hours may be affected by the current situation and am working from home, I still have access to email, video conferencing and telephone. Feel free to schedule video conferences and/or telephone calls, as necessary.\*\*\***

This e-mail originates from the City of Ottawa e-mail system. Any distribution, use or copying of this e-mail or the information it contains by other than the intended recipient(s) is unauthorized. Thank you.

Le présent courriel a été expédié par le système de courriels de la Ville d’Ottawa. Toute distribution, utilisation ou reproduction du courriel ou des renseignements qui s’y trouvent par une personne autre que son destinataire prévu est interdite. Je vous remercie de votre collaboration.

This e-mail originates from the City of Ottawa e-mail system. Any distribution, use or copying of this e-mail or the information it contains by other than the intended recipient(s) is unauthorized. Thank you.

Le présent courriel a été expédié par le système de courriels de la Ville d’Ottawa. Toute distribution, utilisation ou reproduction du courriel ou des renseignements qui s’y trouvent par une personne autre que son destinataire prévu est interdite. Je vous remercie de votre collaboration.

**From:** Eric Lalande <eric.lalande@rvca.ca>  
**Sent:** October 31, 2022 12:35 PM  
**To:** Jason Fitzpatrick  
**Cc:** Bruce Thomas  
**Subject:** RE: 266, 268 Carruthers, Avenue.



**CAUTION:** This email originated from outside of the organization. Do not click links or open attachments unless you recognize the sender and know the content is safe.

Hi Jason,

The RVCA does not have any water quality control requirements for the project based on the site plan and details provided.

Thank you,

**Eric Lalande, MCIP, RPP**  
Planner, RVCA  
613-692-3571 x1137

---

**From:** Jason Fitzpatrick <[jason.fitzpatrick@exp.com](mailto:jason.fitzpatrick@exp.com)>  
**Sent:** Sunday, October 30, 2022 9:19 PM  
**To:** Eric Lalande <[eric.lalande@rvca.ca](mailto:eric.lalande@rvca.ca)>  
**Cc:** Bruce Thomas <[bruce.thomas@exp.com](mailto:bruce.thomas@exp.com)>  
**Subject:** 266, 268 Carruthers, Avenue.

Hi Eric,

I'm working on a site plan application for the redevelopment of 266 & 268 Carruthers Avenue. This will consist of the demolition of these two lots, and the construction of a new 18-unit 4-storey apartment unit.

As noted in the pre-consultation meeting, we require that the Conservation Authority's confirm the water quality requirements for the proposed development. I've therefore attached the site plan, and highlighted the site.

The site area is 0.0429 ha, and the roof makes up 0.0293 ha, or 68% of the site area. The remaining area is landscaping and walkways, etc. There are no proposed parking areas or driveways. We have a fairly restrictive release rate (Max C=0.50, and control to 2yr storm, so we will be using flow controlled roof drains and a small section of perforated pipes to capture runoff in the front yard. As for quality control, can you confirm if needed. Since there is a small percentage of surface runoff, of which there will be no parking areas, etc., we are hoping that water quality treatment is not required.

Can you confirm the RVCA requirement for this site.

Much appreciated.



**Jason Fitzpatrick, P.Eng.**

EXP | Project Engineer

t : +1.613.688.1899, 63258 | m : +1.613.302.7441 | e : [jason.fitzpatrick@exp.com](mailto:jason.fitzpatrick@exp.com)

2650 Queensview Drive

Suite 100

Ottawa, ON K2B 8H6

CANADA

[exp.com](http://exp.com) | [legal disclaimer](#)

*keep it green, read from the screen*

## **Appendix F – Background Information**

**City of Ottawa Vault Drawings (2 drawings)**

**WATTS ACCUTROL Weir for Roof Drains (1 page)**

**Hydrovex-Technical-Manual (12 pages)**

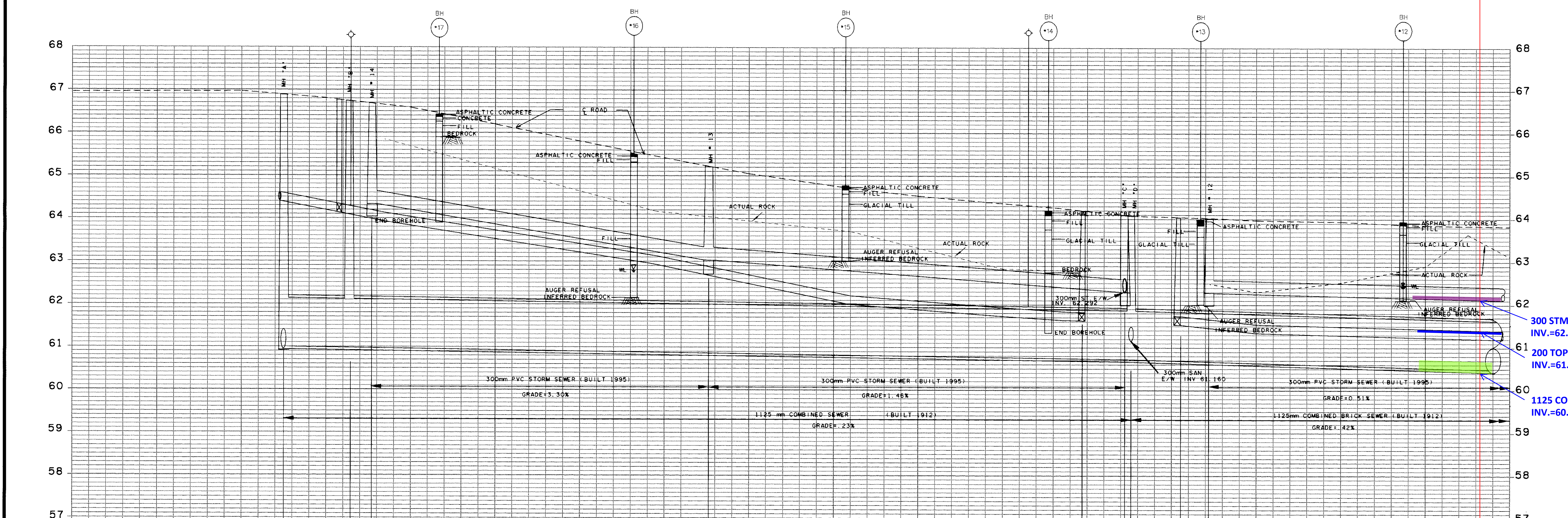
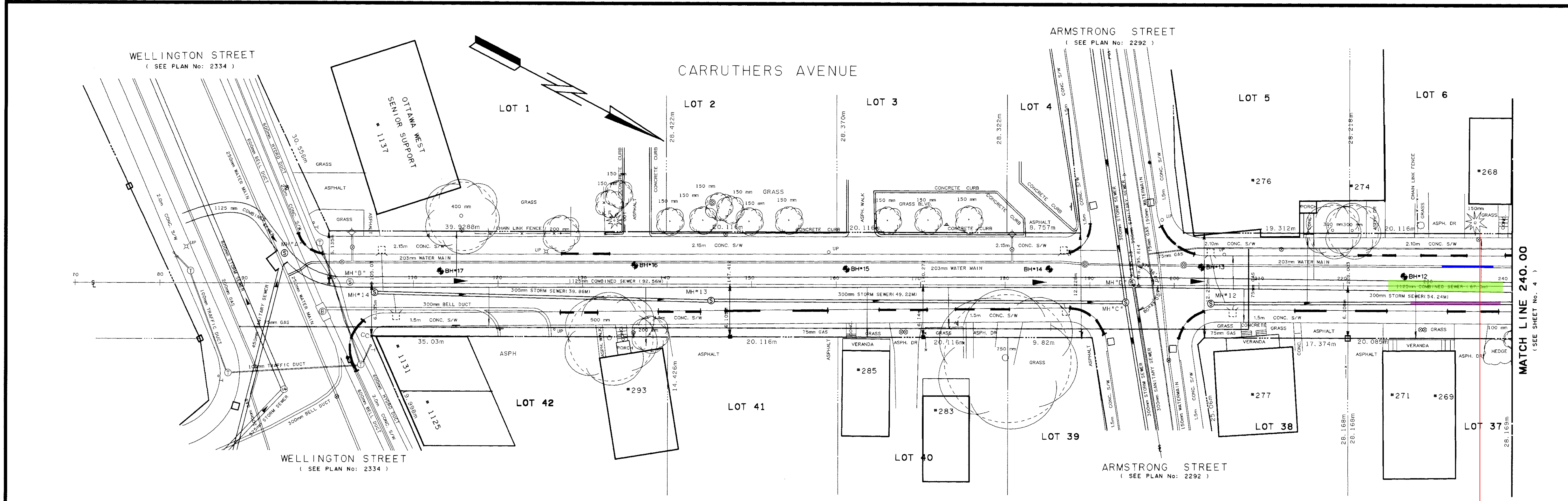

Stations	Top of Watermain	℄ Road	Elevations	Type & Diameter (sewer)	Inverts Existing (sewer)
70					
80					
90	66.970	66.807	24x50' 200mm x 250mm TEE 50.951 450mm SAN. (E) 91.50 100' 200mm SAN. (W/S) 86.50 200mm 45° BEND 97.80 200mm 45° BEND 80.00 200mm 1/4 BEND		
100			105.65 60.889 1125mm SAN. (S) 102.6 102.6 1125mm SAN. (W/S) 105.47 64.337 300mm ST. (N)	200mm VALVE & VALVE BOX 200mm VALVE & VALVE CHAMBER	
110	66.590	66.200			
120					
130	65.810	65.420			
140	65.056	64.770			
150	64.532	64.360			
160	64.001	64.052			
170	63.932	63.972			
180			189.38 200mm VALVE & VALVE CHAMBER 194.55 62.292 300 ST. (S) 199.22 60.686 1125mm SAN. (W/S)	200mm VALVE & VALVE CHAMBER	
190					
200					
210					
220					
230					
240					

Revisions:

No.	Date	Description	Drawn By	Approved By

Design:

Designed By	Date	Checked By	Date
I. BHATIA	JAN./95		
Survey Detail By	Date	Field Checked By	Date
G. BARNEY, T. SCAFFIDI	JULY/94		
Drawing By	Date	Checked By	Date
J. FRANCE, D. GREEN	MAR./95		

Chief Design & Const. Eng.

**H. PASCOE, P.Eng.**

Final Measurements:

Construction Type	Inspector
SEWERS, WATERMAIN, SIDEWALK, ROAD	J. FRANCE
Work Commenced	Project Manager
JULY/95	ISHWAR BHATIA
Work Completed	Field Book #
JUNE/96	5495
Contractor	Date
PEDRO CONST.	1995
Original Revisions	Date
J. FRANCE	NOV./96
	Checked By
	ISHWAR BHATIA

Notes:

- While illustrations and utilities shown are taken from the best available information, they cannot be guaranteed.
- The contractor is requested to check with all utility companies before digging.
- Soil information shown is not guaranteed and contractors are advised to collect additional soils information as deemed necessary.
- The actual rock line was recorded during construction of the existing STORM sewer.
- Soil information taken from : J.D. PATERSON, JAN.16/95
- Reference bench mark : ST. FRANCOIS CHURCH MON.#3606 (ELEV. 67.236)
- Date of television inspection : TAMARACK JAN./91
- This plan supersedes (in whole or in part) plan # 11a
- Registered Plan # : 83
- When reduced, the scale of this drawing is approximately 1:400 horizontally and 1:80 vertically. Do not scale this drawing.

As Built Notes:

- Boreholes prior to construction.
- See typical cross sections for road structure material depths.

Watermain Notes:

- All watermain materials and construction methods shall be in accordance with the latest edition of the R.M.O.C. Standard Specifications and Standard Drawings.
- All connections of new watermains to existing watermains and all blankings of existing mains and services shall be performed by R.M.O.C. staff. The Contractor shall provide excavation, backfilling and reinstatement.
- All copper services (19mm to 51mm) shall be installed by R.M.O.C. staff after the watermain has been successfully disinfected.
- All new water services shall be installed at 2.4m cover.
- All water services that conflict with sanitary and storm sewers at crossings shall be installed under the sewers unless otherwise directed by the REGIONAL PROJECT MANAGER.
- The proposed watermain shall be insulated at specified locations per R.M.O.C. Specification WSD-23.
- A minimum 2.0m separation is required between all new water services and catchbasins or open structures and shall be insulated per R.M.O.C. Specification WSD-23 as applicable.
- A minimum 2.0m separation is required between all new hydrants and catchbasins or open structures and shall be insulated per R.M.O.C. Specification WSD-23 as applicable.
- The Contractor shall be responsible to determine via excavation the exact location and elevation of the existing watermains as required for all connections, relocations and blanking.

**City of Ottawa**  
Ville d'Ottawa

Department Of Engineering And Works  
Engineering Branch  
Design And Construction Division  
111 SUSSEX DRIVE, SUSSEX PAVILION, 7TH FLOOR, OTTAWA, ONTARIO, K1N 5A1

E.M. Robinson  
Commissioner

W.R. Cole, P.Eng.  
Branch Director

**CARRUTHERS AVENUE**

Contract No.	Survey Books	Scales (See note)	Plan No.
95C2825	2825	HOR. 1:250 VERT. 1:50	2825
Sheet			3 of 8

Contract No. 95C2825 Survey Books 2825 Scales (See note) HOR. 1:250 VERT. 1:50 Plan No. 2825 Sheet 3 of 8

This drawing was created using MicroStation 4.0 (2403)

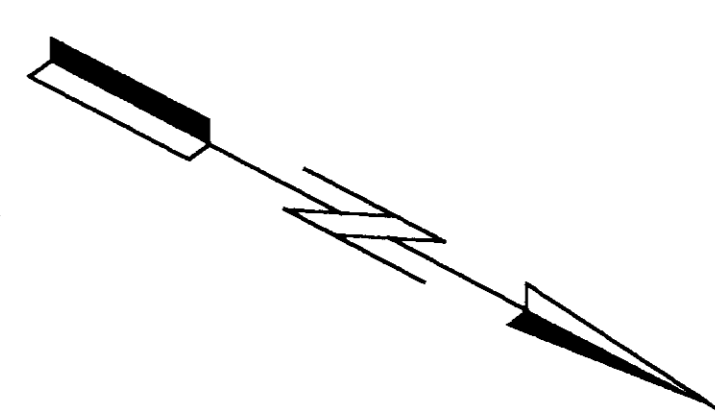
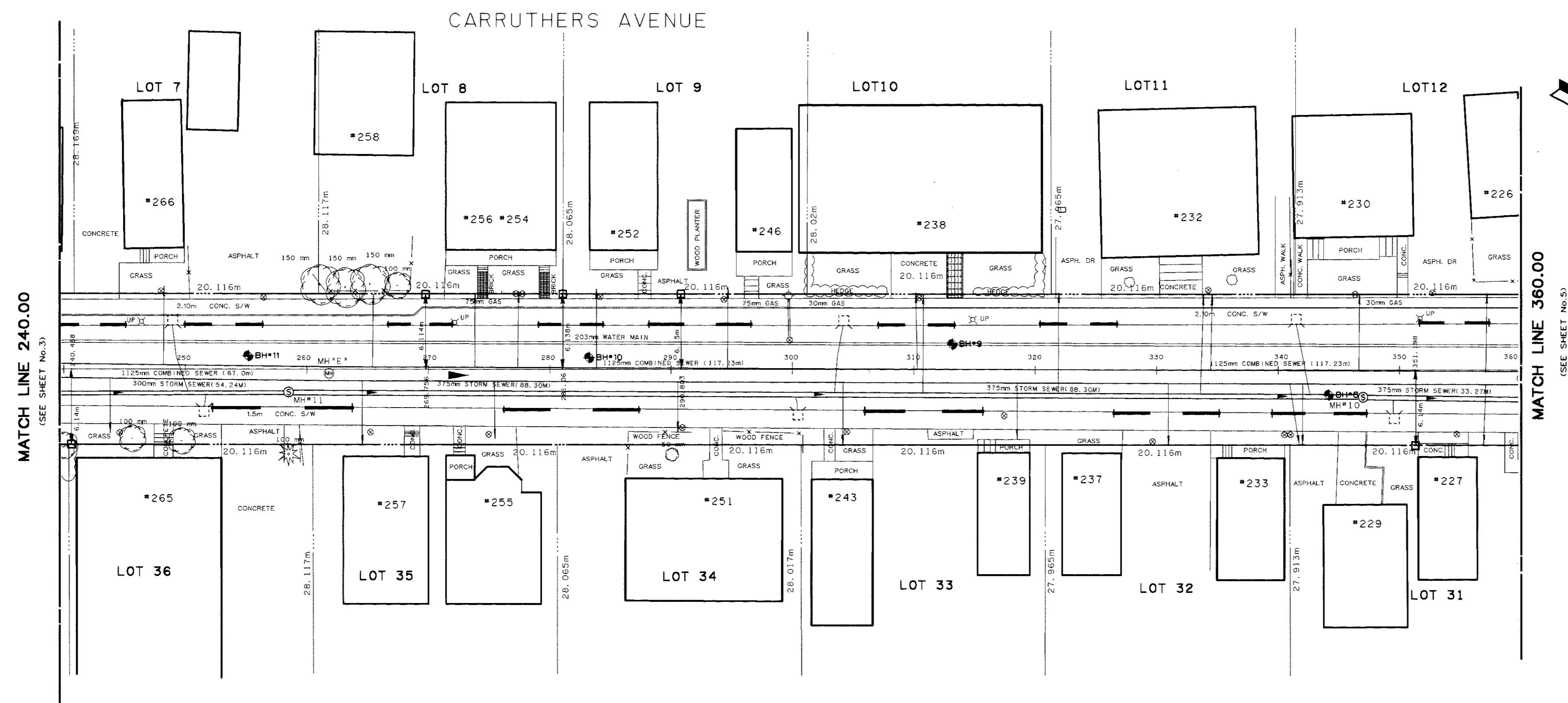

**Revisions:**

No.	Date	Description	Drawn By	Approved By

**Design:**

Designed By	Date	Checked By	Date
J. BHATIA	JAN/95	J. FRANCE	
Survey Detail By	Date	Field Checked By	Date
G. BARNEY, T. SCAFFIDI	JULY/94		
Drafted By	Date	Checked By	Date
J. FRANCE, D. GREEN	MAR./95		

**Chief Design & Const. Eng.**  
**H. PASCOE, P.Eng.**

**Final Measurements:**

Construction Type	Inspector
SEWERS, WATERMAIN, SIDEWALK, ROAD	J. FRANCE
Work Completed	Project Manager
JULY/95	ISHWAR BHATIA
Work Book #	Field Book #
5495	5495
Contractor	Date
PERO CONS. T.	1995
Drafting Revisions	Date
J. FRANCE	NOV/95
Checked By	Date
ISHWAR BHATIA	

- Notes:**
- While illustrations and utilities shown are taken from the best available information, they cannot be guaranteed.
  - The contractor is requested to check with all utility companies before digging.
  - Soil information shown is not guaranteed and contractors are advised to collect additional soils information as deemed necessary.
  - The actual track line was recorded during construction of the existing STORM sewer.
  - Soil information taken from: J.D. PATERSON, JAN.16/95
  - Reference bench mark: ST. FRANCOIS CHURCH MON.#3606 (ELEV. 67.236)
  - Date of television inspection: TAMARACK JAN./91
  - This plan supercedes (in whole or in part) plan # 11a
  - Registered Plan # 83
  - When reduced, the scale of this drawing is approximately 1:400 horizontally and 1:80 vertically. Do not scale this drawing.

- As Built Notes:**
- Boreholes prior to construction.
  - See typical cross sections for road structure material depths.

- Watermain Notes:**
- All watermain materials and construction methods shall be in accordance with the latest edition of the R.M.O.C. Standard Specifications and Standard Drawings.
  - All connections of new watermains to existing watermains and blankings of existing mains and services shall be performed by R.M.O.C. staff. The Contractor shall provide excavation, backfilling and reinstatement.
  - All copper services (19mm to 51mm) shall be installed by R.M.O.C. staff after the watermain has been successfully disinfected.
  - All new water services shall be installed at 2.4m cover.
  - All new water services that conflict with sanitary and storm sewers at crossings shall be installed under the sewers unless otherwise directed by the REGIONAL PROJECT MANAGER.
  - The proposed watermain shall be insulated at specified locations per R.M.O.C. Specification WSD-23.
  - A minimum 2.0m separation is required between all new water services and catchbasins or open structures and shall be insulated per R.M.O.C. Specification WSD-23 as applicable.
  - A minimum 2.0m separation is required between all new hydrants and catchbasins or open structures and shall be insulated per R.M.O.C. Specification WSD-23 as applicable.
- The Contractor shall be responsible to determine via excavation the exact location and elevation of the existing watermains as required for all connections, relocations and blanking.

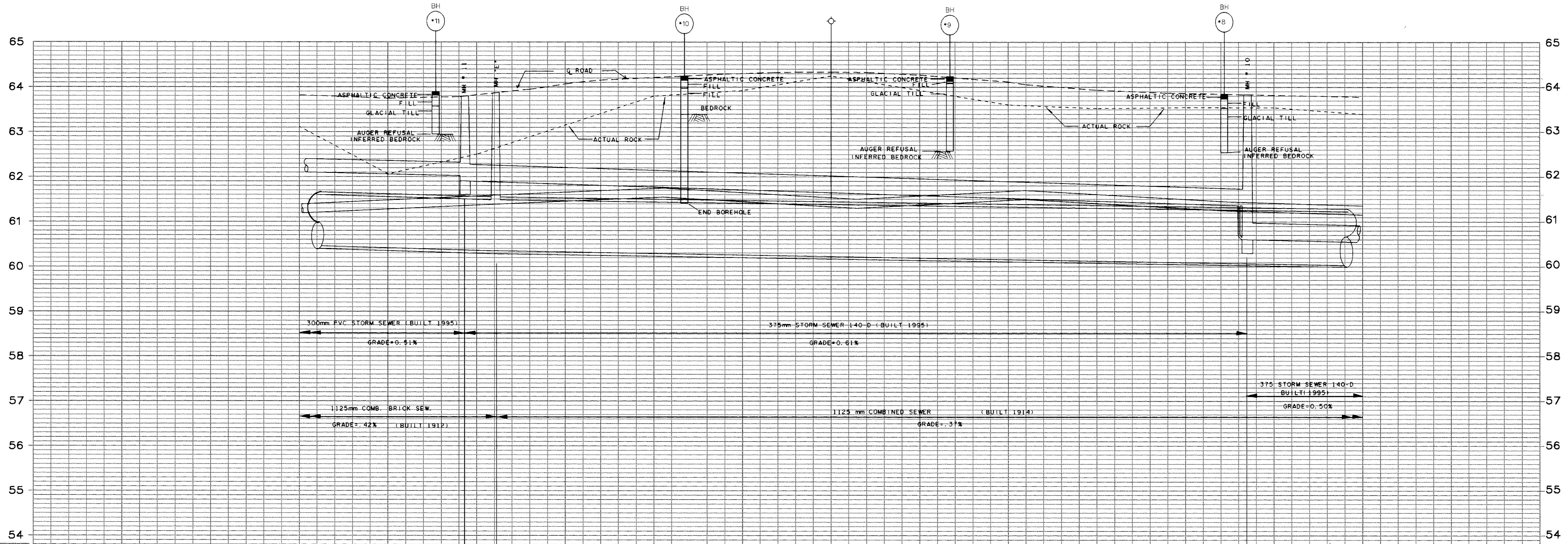

Stations	Top of Watermain	℄ Road	Type & Diameter (sewer)	Inverts Existing (sewer)
240	63.812	63.752	300mm PVC STORM SEWER (BUILT 1995)	61.900 375mm ST.
250	63.817	63.817	1125mm COMB. BRICK SEW. (BUILT 1914)	60.402 1125mm S.M. (V/S)
260	64.086	64.210	375mm STORM SEWER 140-D (BUILT 1995)	61.358 375mm ST.
270	64.310	64.350	1125mm COMBINED SEWER (BUILT 1914)	60.610 375mm ST.
280	64.280	64.116	375 STORM SEWER 140-D (BUILT 1995)	
290	63.940	63.896		
300	63.826	63.786		
310				
320				
330				
340				
350				
360				

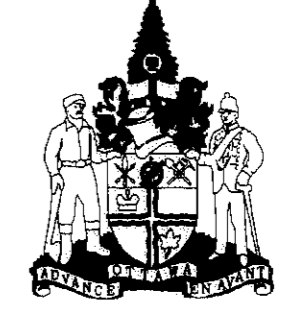
**City of Ottawa**  
 Ville d' Ottawa

**Department Of Engineering And Works**  
 Engineering Branch  
 Design And Construction Division  
 111 SUSSEX DRIVE, SUSSEX PAVILION, 7TH FLOOR, OTTAWA, ONTARIO, K1N 5A1

<b>E.M. Robinson</b> Commissioner	<b>W.R. Cole, P.Eng.</b> Branch Director
--------------------------------------	---

CARRUTHERS AVENUE

Contract No: 95C2825	Survey Books: 2825	Scales: (See note) HOR: 1:250 VERT: 1:50	Plan No: 2825 Sheet 4 of 8
----------------------	--------------------	--	-------------------------------

CAD: F:\11name: 2825a2.dgn

This drawing was created using MicroStation 4.0 (CAD)



# Adjustable Accutrol Weir

Tag: \_\_\_\_\_

## Adjustable Flow Control for Roof Drains

### ADJUSTABLE ACCUTROL (for Large Sump Roof Drains only)

For more flexibility in controlling flow with heads deeper than 2", Watts Drainage offers the Adjustable Accutrol. The Adjustable Accutrol Weir is designed with a single parabolic opening that can be covered to restrict flow above 2" of head to less than 5 gpm per inch, up to 6" of head. To adjust the flow rate for depths over 2" of head, set the slot in the adjustable upper cone according to the flow rate required. Refer to Table 1 below.  
 Note: Flow rates are directly proportional to the amount of weir opening that is exposed.

#### EXAMPLE:

For example, if the adjustable upper cone is set to cover 1/2 of the weir opening, flow rates above 2" of head will be restricted to 2-1/2 gpm per inch of head.

Therefore, at 3" of head, the flow rate through the Accutrol Weir that has 1/2 the slot exposed will be:  
 [5 gpm (per inch of head) x 2 inches of head ] + 2-1/2 gpm (for the third inch of head) = 12-1/2 gpm.

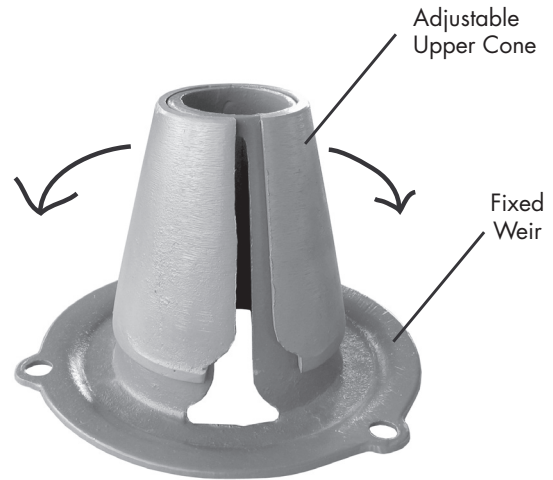
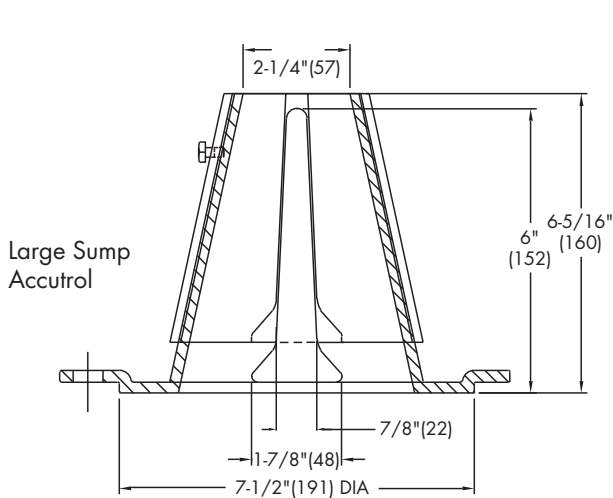

1/2 Weir Opening Exposed Shown Above

TABLE 1. Adjustable Accutrol Flow Rate Settings

Weir Opening Exposed	1"	2"	3"	4"	5"	6"
	Flow Rate (gallons per minute)					
Fully Exposed	5	10	15	20	25	30
3/4	5	10	13.75	17.5	21.25	25
1/2	5	10	12.5	15	17.5	20
1/4	5	10	11.25	12.5	13.75	15
Closed	5	5	5	5	5	5

Job Name \_\_\_\_\_  
 Job Location \_\_\_\_\_  
 Engineer \_\_\_\_\_

Contractor \_\_\_\_\_  
 Contractor's P.O. No. \_\_\_\_\_  
 Representative \_\_\_\_\_

Watts product specifications in U.S. customary units and metric are approximate and are provided for reference only. For precise measurements, please contact Watts Technical Service. Watts reserves the right to change or modify product design, construction, specifications, or materials without prior notice and without incurring any obligation to make such changes and modifications on Watts products previously or subsequently sold.

USA: Tel: (800) 338-2581 • Fax: (828) 248-3929 • Watts.com  
 Canada: Tel: (905) 332-4090 • Fax: (905) 332-7068 • Watts.ca  
 Latin America: Tel: (52) 81-1001-8600 • Fax: (52) 81-8000-7091 • Watts.com



# CSO/STORMWATER MANAGEMENT



**HYDROVEX<sup>®</sup> VHV / SVHV**  
Vertical Vortex Flow Regulator

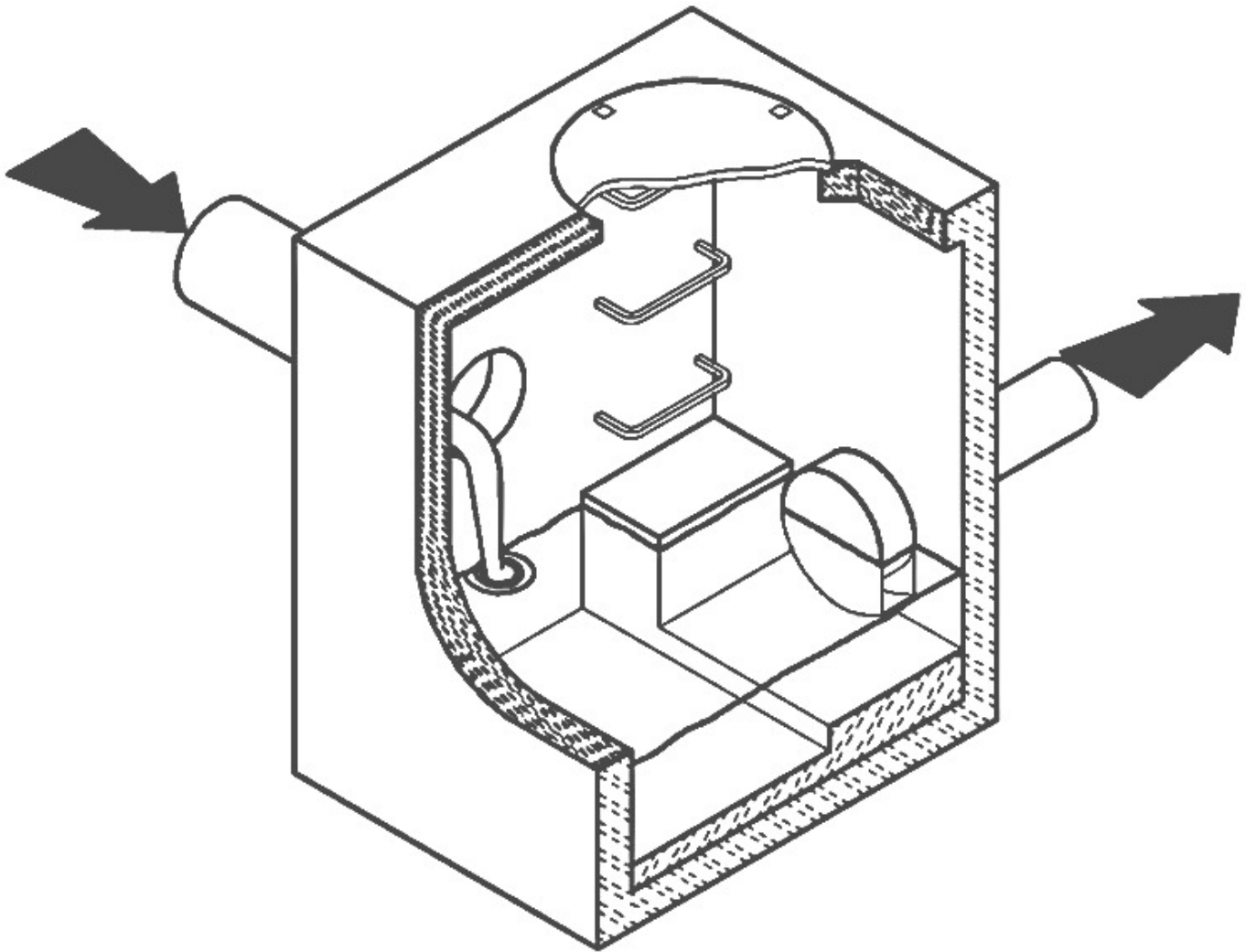

**JOHN MEUNIER**



# HYDROVEX® VHV / SVHV VERTICAL VORTEX FLOW REGULATOR

## APPLICATIONS

One of the major problems of urban wet weather flow management is the runoff generated after a heavy rainfall. During a storm, uncontrolled flows may overload the drainage system and cause flooding. Due to increased velocities, sewer pipe wear is increased dramatically and results in network deterioration. In a combined sewer system, the wastewater treatment plant may also experience significant increases in flows during storms, thereby losing its treatment efficiency.

A simple means of controlling excessive water runoff is by controlling excessive flows at their origin (manholes). **John Meunier Inc.** manufactures the **HYDROVEX® VHV / SVHV** line of vortex flow regulators to control stormwater flows in sewer networks, as well as manholes.

The vortex flow regulator design is based on the fluid mechanics principle of the forced vortex. This grants flow regulation without any moving parts, thus reducing maintenance. The operation of the regulator, depending on the upstream head and discharge, switches between orifice flow (gravity flow) and vortex flow. Although the concept is quite simple, over 12 years of research have been carried out in order to get a high performance.

The **HYDROVEX® VHV / SVHV** Vertical Vortex Flow Regulators (refer to **Figure 1**) are manufactured entirely of stainless steel, and consist of a hollow body (1) (in which flow control takes place) and an outlet orifice (7). Two rubber "O" rings (3) seal and retain the unit inside the outlet pipe. Two stainless steel retaining rings (4) are welded on the outlet sleeve to ensure that there is no shifting of the "O" rings during installation and use.

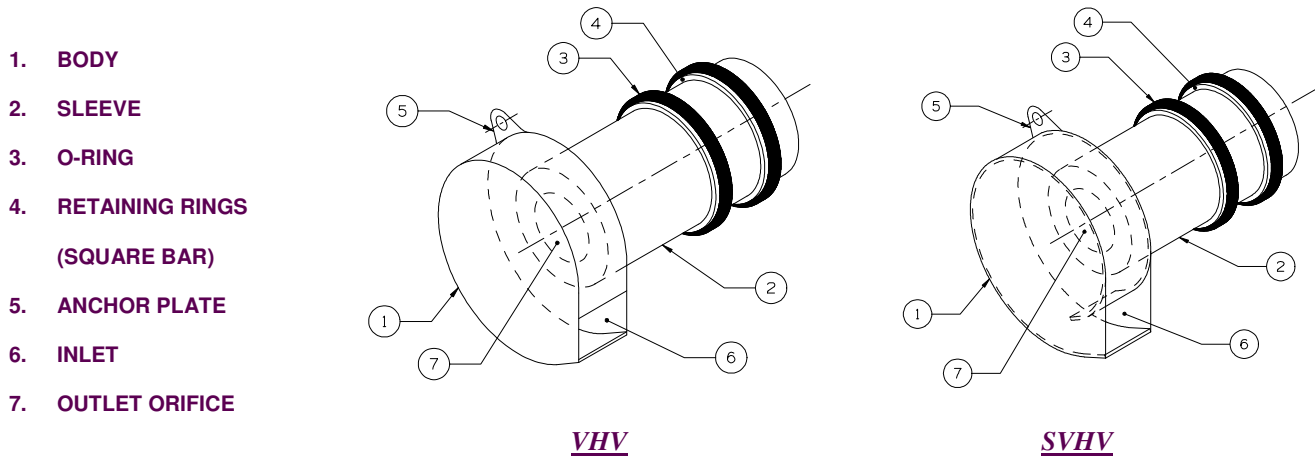

**FIGURE 1: HYDROVEX® VHV-SVHV VERTICAL VORTEX FLOW REGULATORS**

## ADVANTAGES

- The **HYDROVEX® VHV / SVHV** line of flow regulators are manufactured entirely of stainless steel, making them durable and corrosion resistant.
- Having no moving parts, they require minimal maintenance.
- The geometry of the **HYDROVEX® VHV / SVHV** flow regulators allows a control equal to an orifice plate, having a cross section area 4 to 6 times smaller. This decreases the chance of blockage of the regulator, due to sediments and debris found in stormwater flows. **Figure 2** illustrates the comparison between a regulator model 100 SVHV-2 and an equivalent orifice plate. One can see that for the same height of water, the regulator controls a flow approximately four times smaller than an equivalent orifice plate.
- Installation of the **HYDROVEX® VHV / SVHV** flow regulators is quick and straightforward and is performed after all civil works are completed.
- Installation requires no special tools or equipment and may be carried out by any contractor.
- Installation may be carried out in existing structures.

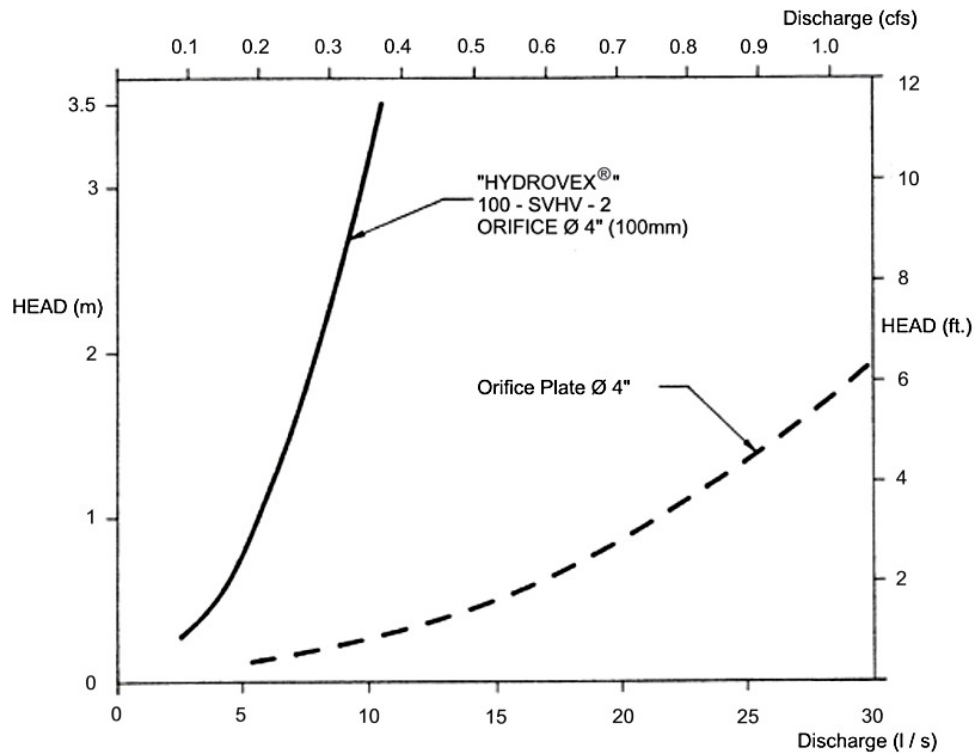

**FIGURE 2: DISCHARGE CURVE SHOWING A HYDROVEX® FLOW REGULATOR VS AN ORIFICE PLATE**

## SELECTION

Selection of a **VHV** or **SVHV** regulator can be easily made using the selection charts found at the back of this brochure (see **Figure 3**). These charts are a graphical representation of the maximum upstream water pressure (head) and the maximum discharge at the manhole outlet. The maximum design head is the difference between the maximum upstream water level and the invert of the outlet pipe. All selections should be verified by John Meunier Inc. personnel prior to fabrication.

### Example:

- ✓ Maximum design head      2m (6.56 ft.)
- ✓ Maximum discharge        6 L/s (0.2 cfs)
- ✓ Using **Figure 3** - VHV      model required is a **75 VHV-1**

## INSTALLATION REQUIREMENTS

All **HYDROVEX®** **VHV** / **SVHV** flow regulators can be installed in circular or square manholes. **Figure 4** gives the various minimum dimensions required for a given regulator. *It is imperative to respect the minimum clearances shown to ensure easy installation and proper functioning of the regulator.*

## SPECIFICATIONS

In order to specify a **HYDROVEX**<sup>®</sup> regulator, the following parameters must be defined:

- The model number (ex: 75-VHV-1)
- The diameter and type of outlet pipe (ex: 6" diam. SDR 35)
- The desired discharge (ex: 6 l/s or 0.21 CFS)
- The upstream head (ex: 2 m or 6.56 ft.) \*
- The manhole diameter (ex: 36" diam.)
- The minimum clearance "H" (ex: 10 inches)
- The material type (ex: 304 s/s, 11 Ga. standard)

\* *Upstream head is defined as the difference in elevation between the maximum upstream water level and the invert of the outlet pipe where the **HYDROVEX**<sup>®</sup> flow regulator is to be installed.*

**PLEASE NOTE THAT WHEN REQUESTING A PROPOSAL, WE SIMPLY REQUIRE THAT YOU PROVIDE US WITH THE FOLLOWING:**

- *project design flow rate*
- *pressure head*
- *chamber's outlet pipe diameter and type*



*Typical VHV model in factory*

# OPTIONS



*FV – SVHV (mounted on sliding plate)*



*VHV-1-O (standard model with odour control inlet)*

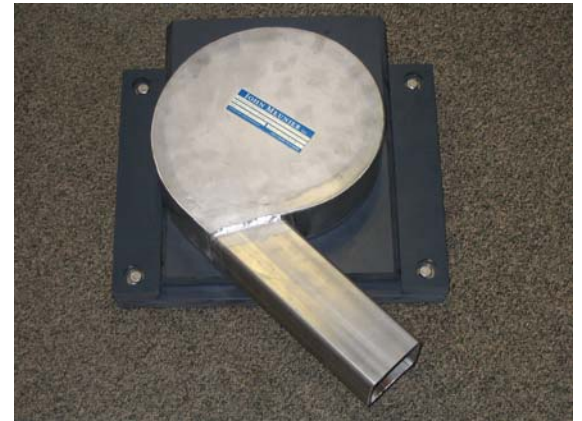

*FV – VHV-O (mounted on sliding plate with odour control inlet)*



*VHV with Gooseneck assembly in existing chamber without minimum release at the bottom*



*VHV with air vent for minimal slopes*



# VHV Vertical Vortex Flow Regulator

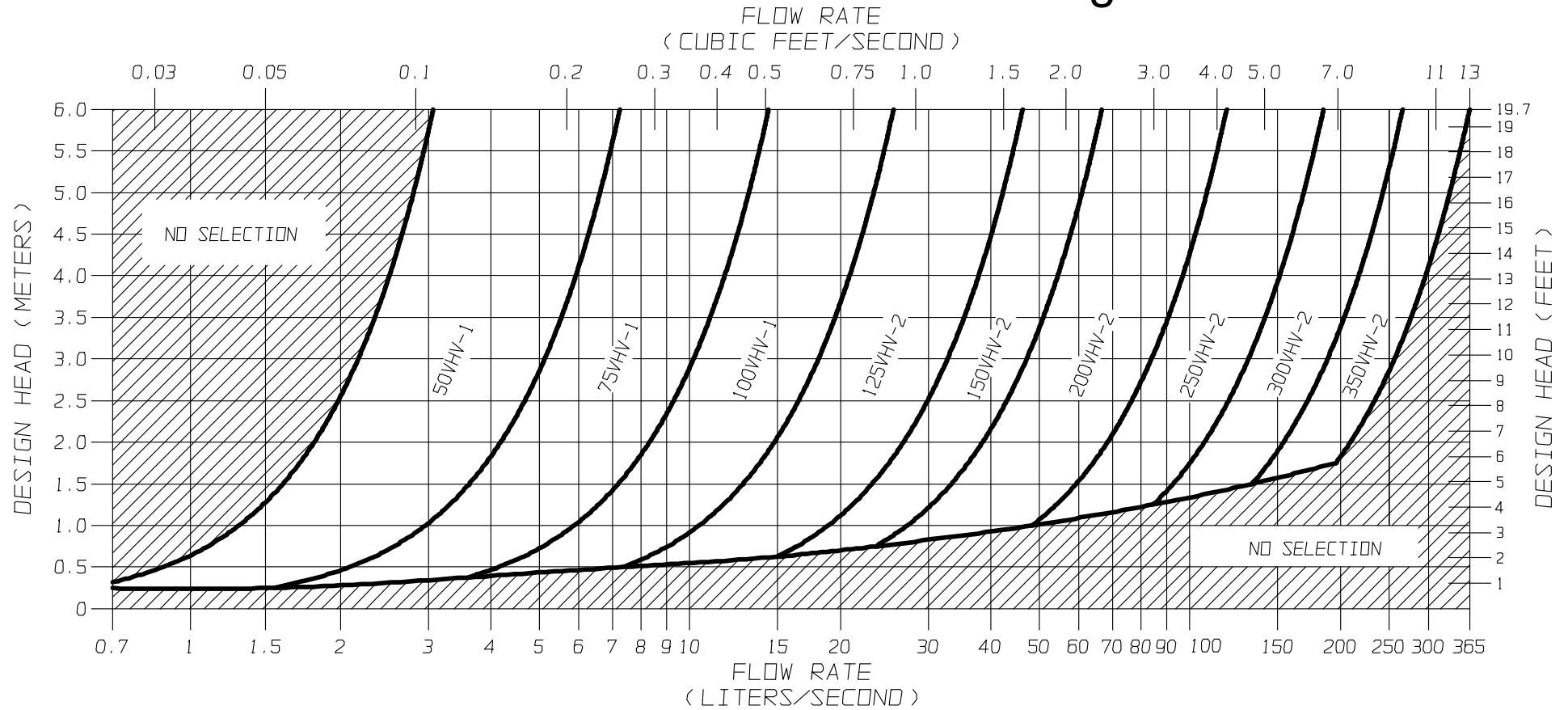

FIGURE 3 - VHV

**JOHN MEUNIER**



# SVHV Vertical Vortex Flow Regulator

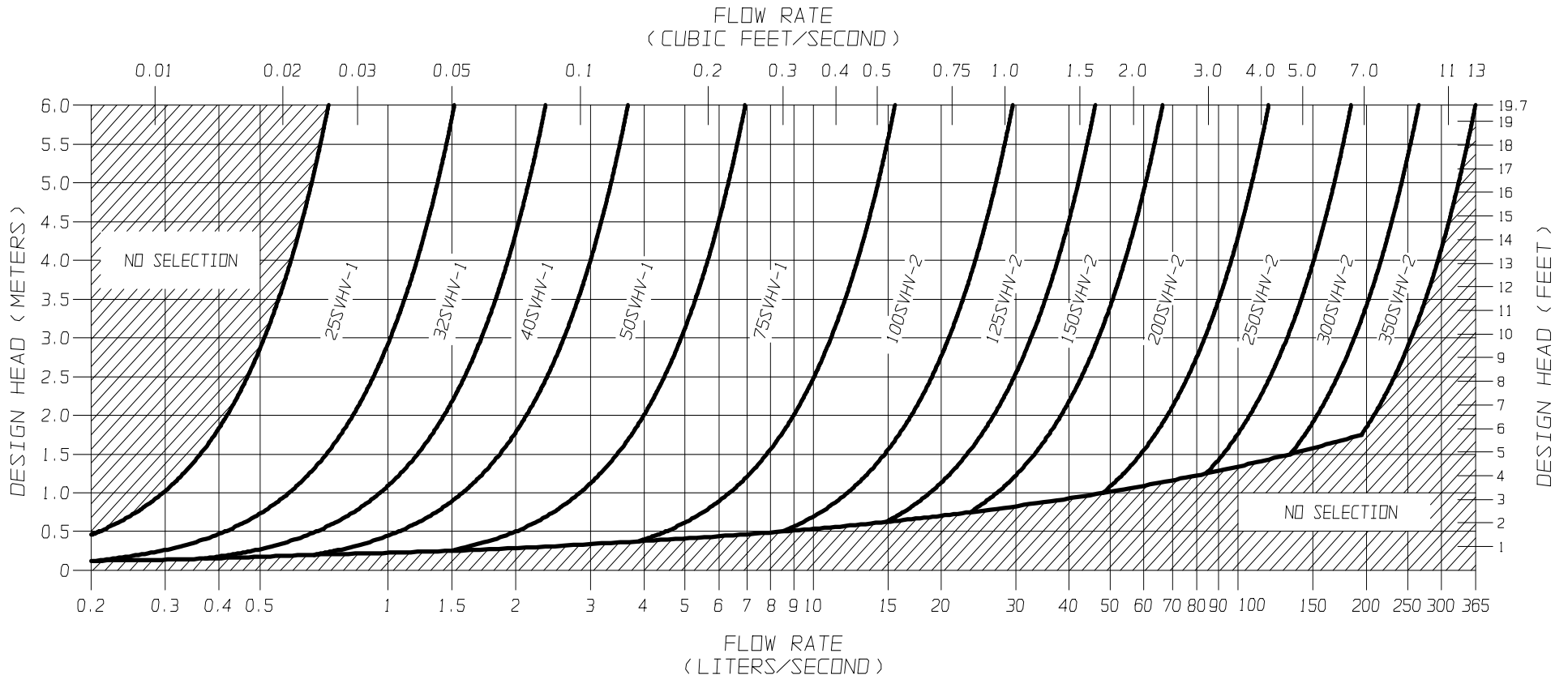
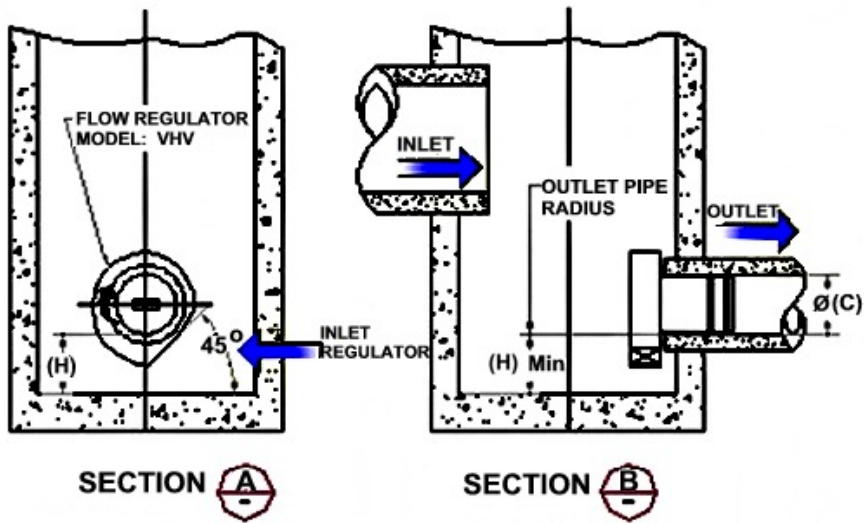
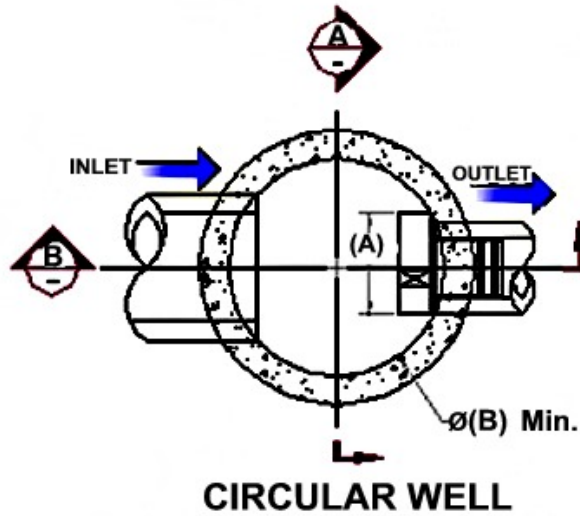

FIGURE 3 - SVHV

**JOHN MEUNIER**

**FLOW REGULATOR TYPICAL INSTALLATION IN CIRCULAR MANHOLE  
FIGURE 4 (MODEL VHV)**

Model Number	Regulator Diameter		Minimum Manhole Diameter		Minimum Outlet Pipe Diameter		Minimum Clearance	
	A (mm)	A (in.)	B (mm)	B (in.)	C (mm)	C (in.)	H (mm)	H (in.)
50VHV-1	150	6	600	24	150	6	150	6
75VHV-1	250	10	600	24	150	6	150	6
100VHV-1	325	13	900	36	150	6	200	8
125VHV-2	275	11	900	36	150	6	200	8
150VHV-2	350	14	900	36	150	6	225	9
200VHV-2	450	18	1200	48	200	8	300	12
250VHV-2	575	23	1200	48	250	10	350	14
300VHV-2	675	27	1600	64	250	10	400	16
350VHV-2	800	32	1800	72	300	12	500	20



**FLOW REGULATOR TYPICAL INSTALLATION IN CIRCULAR MANHOLE**  
**FIGURE 4 (MODEL SVHV)**

Model Number	Regulator Diameter		Minimum Manhole Diameter		Minimum Outlet Pipe Diameter		Minimum Clearance	
	A (mm)	A (in.)	B (mm)	B (in.)	C (mm)	C (in.)	H (mm)	H (in.)
25 SVHV-1	125	5	600	24	150	6	150	6
32 SVHV-1	150	6	600	24	150	6	150	6
40 SVHV-1	200	8	600	24	150	6	150	6
50 SVHV-1	250	10	600	24	150	6	150	6
75 SVHV-1	375	15	900	36	150	6	275	11
100 SVHV-2	275	11	900	36	150	6	250	10
125 SVHV-2	350	14	900	36	150	6	300	12
150 SVHV-2	425	17	1200	48	150	6	350	14
200 SVHV-2	575	23	1600	64	200	8	450	18
250 SVHV-2	700	28	1800	72	250	10	550	22
300 SVHV-2	850	34	2400	96	250	10	650	26
350 SVHV-2	1000	40	2400	96	250	10	700	28

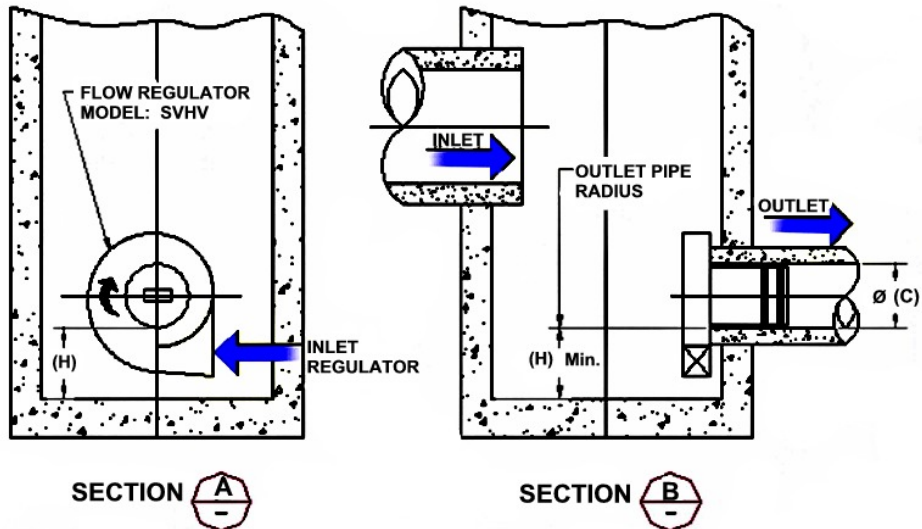
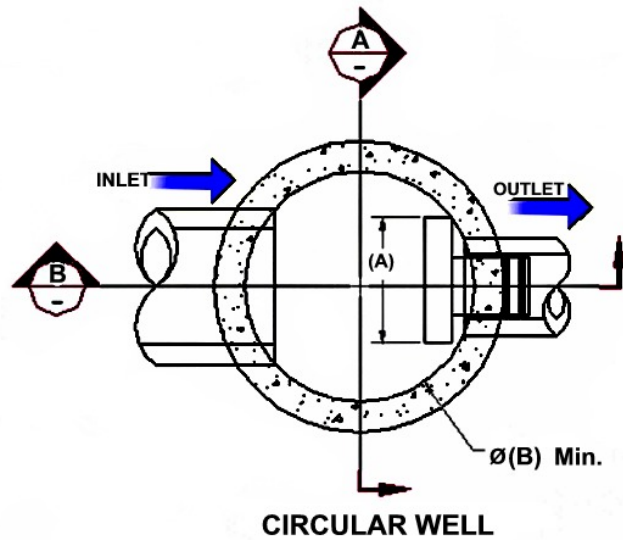



**FLOW REGULATOR TYPICAL INSTALLATION IN SQUARE MANHOLE  
FIGURE 4 (MODEL VHV)**

Model Number	Regulator Diameter		Minimum Chamber Width		Minimum Outlet Pipe Diameter		Minimum Clearance	
	A (mm)	A (in.)	B (mm)	B (in.)	C (mm)	C (in.)	H (mm)	H (in.)
50VHV-1	150	6	600	24	150	6	150	6
75VHV-1	250	10	600	24	150	6	150	6
100VHV-1	325	13	600	24	150	6	200	8
125VHV-2	275	11	600	24	150	6	200	8
150VHV-2	350	14	600	24	150	6	225	9
200VHV-2	450	18	900	36	200	8	300	12
250VHV-2	575	23	900	36	250	10	350	14
300VHV-2	675	27	1200	48	250	10	400	16
350VHV-2	800	32	1200	48	300	12	500	20

**NOTE:** *In the case of a square manhole, the outlet flow pipe must be centered on the wall to ensure enough clearance for the unit.*

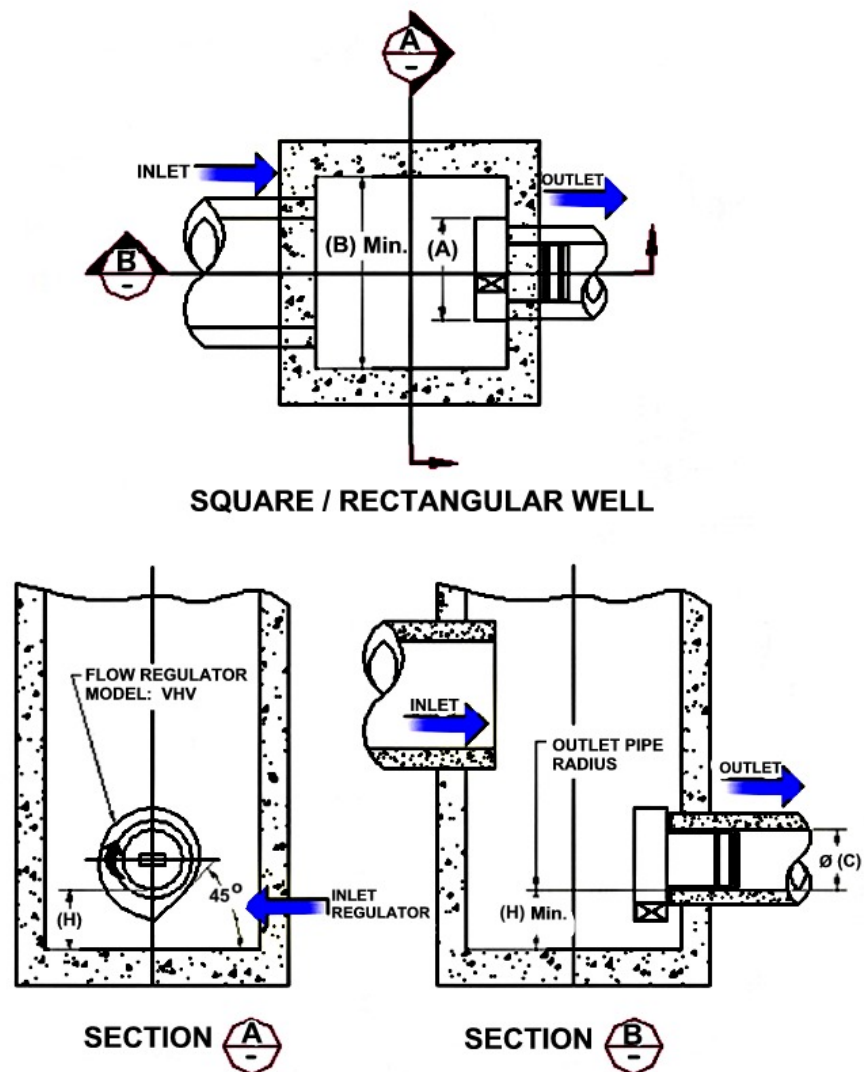

**FLOW REGULATOR TYPICAL INSTALLATION IN SQUARE MANHOLE**  
**FIGURE 4 (MODEL SVHV)**

Model Number	Regulator Diameter		Minimum Chamber Width		Minimum Outlet Pipe Diameter		Minimum Clearance	
	A (mm)	A (in.)	B (mm)	B (in.)	C (mm)	C (in.)	H (mm)	H (in.)
25 SVHV-1	125	5	600	24	150	6	150	6
32 SVHV-1	150	6	600	24	150	6	150	6
40 SVHV-1	200	8	600	24	150	6	150	6
50 SVHV-1	250	10	600	24	150	6	150	6
75 SVHV-1	375	15	600	24	150	6	275	11
100 SVHV-2	275	11	600	24	150	6	250	10
125 SVHV-2	350	14	600	24	150	6	300	12
150 SVHV-2	425	17	600	24	150	6	350	14
200 SVHV-2	575	23	900	36	200	8	450	18
250 SVHV-2	700	28	900	36	250	10	550	22
300 SVHV-2	850	34	1200	48	250	10	650	26
350 SVHV-2	1000	40	1200	48	250	10	700	28

**NOTE:** *In the case of a square manhole, the outlet flow pipe must be centered on the wall to ensure enough clearance for the unit.*

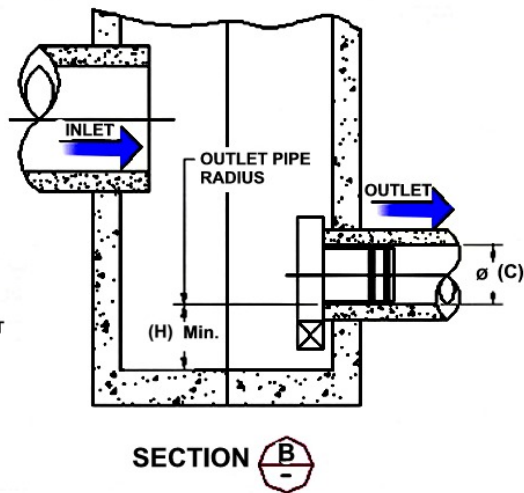
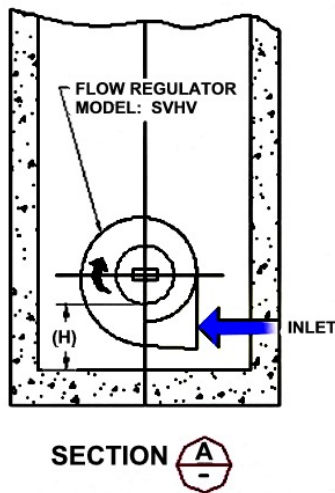
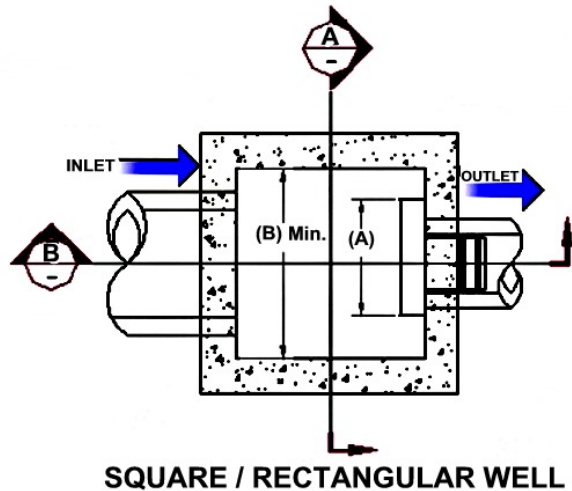

## INSTALLATION

The installation of a **HYDROVEX**<sup>®</sup> regulator may be undertaken once the manhole and piping is in place. Installation consists of simply fitting the regulator into the outlet pipe of the manhole. **John Meunier Inc.** recommends the use of a lubricant on the outlet pipe, in order to facilitate the insertion and orientation of the flow controller.

## MAINTENANCE

**HYDROVEX**<sup>®</sup> regulators are manufactured in such a way as to be maintenance free; however, a periodic inspection (every 3-6 months) is suggested in order to ensure that neither the inlet nor the outlet has become blocked with debris. The manhole should undergo periodically, particularly after major storms, inspection and cleaning as established by the municipality

## GUARANTY

The **HYDROVEX**<sup>®</sup> line of **VHV / SVHV** regulators are guaranteed against both design and manufacturing defects for a period of 5 years. Should a unit be defective, **John Meunier Inc.** is solely responsible for either modification or replacement of the unit.

### **John Meunier Inc.**

ISO 9001 : 2008

#### **Head Office**

4105 Sartelon  
Saint-Laurent (Quebec) Canada H4S 2B3  
Tel.: 514-334-7230 [www.johnmeunier.com](http://www.johnmeunier.com)  
Fax: 514-334-5070 [cs@johnmeunier.com](mailto:cs@johnmeunier.com)

#### **Ontario Office**

2000 Argentia Road, Plaza 4, Unit 430  
Mississauga (Ontario) Canada L5N 1W1  
Tel.: 905-286-4846 [www.johnmeunier.com](http://www.johnmeunier.com)  
Fax: 905-286-0488 [ontario@johnmeunier.com](mailto:ontario@johnmeunier.com)

#### **USA Office**

2209 Menlo Avenue  
Glenside, PA USA 19038  
Tel.: 412-417-6614 [www.johnmeunier.com](http://www.johnmeunier.com)  
Fax: 215-885-4741 [astele@johnmeunier.com](mailto:astele@johnmeunier.com)

## Appendix G – Checklist

GENERAL CONTENT		RESPONSE
<input type="checkbox"/>	Executive Summary (for larger reports only).	Not included
<input checked="" type="checkbox"/>	Date and revision number of the report.	Date of report provided
<input checked="" type="checkbox"/>	Location map and plan showing municipal address, boundary, and layout of proposed development.	Page 1
<input checked="" type="checkbox"/>	Development statistics, land use, density, adherence to zoning and official plan, and reference to applicable subwatershed and watershed plans that provide context to which individual developments must adhere.	Section 2 of report
<input checked="" type="checkbox"/>	Summary of Pre-consultation Meetings with City and other approval agencies.	In Appendix E
<input type="checkbox"/>	Reference and confirm conformance to higher level studies and reports (Master Servicing Studies, Environmental Assessments, Community Design Plans), or in the case where it is not in conformance, the proponent must provide justification and develop a defensible design criteria.	No Master Servicing Studies.
<input checked="" type="checkbox"/>	Statement of objectives and servicing criteria.	Section 1 of report
<input checked="" type="checkbox"/>	Identification of existing and proposed infrastructure available in the immediate area.	Section 2 & 3 of report
<input type="checkbox"/>	Identification of Environmentally Significant Areas, watercourses and Municipal Drains potentially impacted by the proposed development (Reference can be made to the Natural Heritage Studies, if available).	Not applicable
<input type="checkbox"/>	Concept level master grading plan to confirm existing and proposed grades in the development. This is required to confirm the feasibility of proposed stormwater management and drainage, soil removal and fill constraints, and potential impacts to neighbouring properties. This is also required to confirm that the proposed grading will not impede existing major system flow paths.	Not applicable
<input type="checkbox"/>	Identification of potential impacts of proposed piped services on private services (such as wells and septic fields on adjacent lands) and mitigation required to address potential impacts.	Not applicable
<input type="checkbox"/>	Proposed phasing of the development, if applicable.	Not applicable
<input type="checkbox"/>	Reference to geotechnical studies and recommendations concerning servicing.	Not applicable
<input checked="" type="checkbox"/>	All preliminary and formal site plan submissions should have the following information: Metric scale North arrow (including construction North) Key plan name and contact information of applicant and property owner Property limits including bearings and dimensions Existing and proposed structures and parking areas Easements, road widening and rights-of-way Adjacent street names	Functional Report, Civil and Architectural Plans provided all this information.
DEVELOPMENT SERVICING REPORT: WATER		RESPONSE
<input type="checkbox"/>	Confirm consistency with Master Servicing Study, if available Availability of public infrastructure to service proposed development Identification of system constraints	Not applicable
<input checked="" type="checkbox"/>	Identify boundary conditions	Section 4.6
<input checked="" type="checkbox"/>	Confirmation of adequate domestic supply and pressure	Section 4.3
<input checked="" type="checkbox"/>	Confirmation of adequate fire flow protection and confirmation that fire flow is calculated as per the Fire Underwriter's Survey. Output should show available fire flow at locations throughout the development.	Section 4.7
<input checked="" type="checkbox"/>	Provide a check of high pressures. If pressure is found to be high, an assessment is required to confirm the application of pressure reducing valves.	Section 4.6 & Table B-7 Appendix B
<input type="checkbox"/>	Definition of phasing constraints. Hydraulic modeling is required to confirm servicing for all defined phases of the project including the ultimate design	Not applicable
<input checked="" type="checkbox"/>	Address reliability requirements such as appropriate location of shut-off valves Check on the necessity of a pressure zone boundary modification.	Section 4.3
<input checked="" type="checkbox"/>	Reference to water supply analysis to show that major infrastructure is capable of delivering sufficient water for the proposed land use. This includes data that shows that the expected demands under average day, peak hour and fire flow conditions provide water within the required pressure range	Section 4.5 & Table B-4, Table B-5, Appendix B
<input checked="" type="checkbox"/>	Description of the proposed water distribution network, including locations of proposed connections to the existing system, provisions for necessary looping, and appurtenances (valves, pressure reducing valves, valve chambers, and fire hydrants) including special metering provisions.	Section 4.2

<input type="checkbox"/>	Description of off-site required feeder mains, booster pumping stations, and other water infrastructure that will be ultimately required to service proposed development, including financing, interim facilities, and timing of implementation.	Not applicable
<input checked="" type="checkbox"/>	Confirmation that water demands are calculated based on the City of Ottawa Design Guidelines.	Table B-1 Appendix B
<input type="checkbox"/>	Provision of a model schematic showing the boundary conditions locations, streets, parcels, and building locations for reference.	Not applicable
<b>DEVELOPMENT SERVICING REPORT: WASTEWATER</b>		<b>RESPONSE</b>
<input checked="" type="checkbox"/>	Summary of proposed design criteria (Note: Wet-weather flow criteria should not deviate from the City of Ottawa Sewer Design Guidelines. Monitored flow data from relatively new infrastructure cannot be used to justify capacity requirements for proposed infrastructure).	Section 5.1
<input type="checkbox"/>	Confirm consistency with Master Servicing Study and/or justifications for deviations.	Not applicable
<input checked="" type="checkbox"/>	Consideration of local conditions that may contribute to extraneous flows that are higher than the recommended flows in the guidelines. This includes groundwater and soil conditions, and age and condition of sewers.	Section 5.2
<input checked="" type="checkbox"/>	Description of existing sanitary sewer available for discharge of wastewater from proposed development.	Section 5.2
<input type="checkbox"/>	Verify available capacity in downstream sanitary sewer and/or identification of upgrades necessary to service the proposed development. (Reference can be made to previously completed Master Servicing Study if applicable)	Not applicable
<input type="checkbox"/>	Calculations related to dry-weather and wet-weather flow rates from the development in standard MOE sanitary sewer design table (Appendix 'C') format.	Not applicable
<input checked="" type="checkbox"/>	Description of proposed sewer network including sewers, pumping stations, and forcemains.	Section 5.2
<input type="checkbox"/>	Discussion of previously identified environmental constraints and impact on servicing (environmental constraints are related to limitations imposed on the development in order to preserve the physical condition of watercourses, vegetation, soil cover, as well as protecting against water quantity and quality).	Not applicable
<input type="checkbox"/>	Pumping stations: impacts of proposed development on existing pumping stations or requirements for new pumping station to service development.	Not applicable
<input type="checkbox"/>	Forcemain capacity in terms of operational redundancy, surge pressure and maximum flow velocity.	Not applicable
<input type="checkbox"/>	Identification and implementation of the emergency overflow from sanitary pumping stations in relation to the hydraulic grade line to protect against basement flooding.	Not applicable
<input type="checkbox"/>	Special considerations such as contamination, corrosive environment etc.	Not applicable
<b>DEVELOPMENT SERVICING REPORT: STORMWATER CHECKLIST</b>		<b>RESPONSE</b>
<input checked="" type="checkbox"/>	Description of drainage outlets and downstream constraints including legality of outlets (i.e. municipal drain, right-of-way, watercourse, or private property)	Section 6
<input type="checkbox"/>	Analysis of available capacity in existing public infrastructure.	Not applicable
<input type="checkbox"/>	A drawing showing the subject lands, its surroundings, the receiving watercourse, existing drainage patterns, and proposed drainage pattern.	Site is too small to be considered
<input type="checkbox"/>	Water quantity control objective (e.g. controlling post-development peak flows to pre-development level for storm events ranging from the 2 or 5 year event (dependent on the receiving sewer design) to 100 year return period); if other objectives are being applied, a rationale must be included with reference to hydrologic analyses of the potentially affected subwatersheds, taking into account long-term cumulative effects.	Not Applicable
<input type="checkbox"/>	Water Quality control objective (basic, normal or enhanced level of protection based on the sensitivities of the receiving watercourse) and storage requirements.	Not Applicable
<input checked="" type="checkbox"/>	Description of the stormwater management concept with facility locations and descriptions with references and supporting information.	Section 6.2 & 6.3
<input type="checkbox"/>	Set-back from private sewage disposal systems. Watercourse and hazard lands setbacks.	Not Applicable
<input checked="" type="checkbox"/>	Record of pre-consultation with the Ontario Ministry of Environment and the Conservation Authority that has jurisdiction on the affected watershed.	Appendix E
<input type="checkbox"/>	Confirm consistency with sub-watershed and Master Servicing Study, if applicable study exists.	Not Applicable
<input checked="" type="checkbox"/>	Storage requirements (complete with calculations) and conveyance capacity for minor events (1:5 year return period) and major events (1:100 year return period).	Section 6.9 & Table D3-D8 of Appendix D

<input type="checkbox"/>	Identification of watercourses within the proposed development and how watercourses will be protected, or, if necessary, altered by the proposed development with applicable approvals.	Not Applicable
<input checked="" type="checkbox"/>	Calculate pre and post development peak flow rates including a description of existing site conditions and proposed impervious areas and drainage catchments in comparison to existing conditions.	Section 6.6, 6.8 & Table D-1 & D-2 of Appendix D
<input type="checkbox"/>	Any proposed diversion of drainage catchment areas from one outlet to another.	Not Applicable
<input checked="" type="checkbox"/>	Proposed minor and major systems including locations and sizes of stormwater trunk sewers, and stormwater management facilities.	Section 6.8
<input type="checkbox"/>	If quantity control is not proposed, demonstration that downstream system has adequate capacity for the post-development flows up to and including the 100-year return period storm event.	Not Applicable
<input type="checkbox"/>	Identification of potential impacts to receiving watercourses Identification of municipal drains and related approval requirements.	Not Applicable
<input checked="" type="checkbox"/>	Descriptions of how the conveyance and storage capacity will be achieved for the development.	Section 6.9
<input checked="" type="checkbox"/>	100-year flood levels and major flow routing to protect proposed development from flooding for establishing minimum building elevations (MBE) and overall grading.	Site Grading and Erosion and Sediment Plan
<input type="checkbox"/>	Inclusion of hydraulic analysis including hydraulic grade line elevations.	Not Applicable
<input checked="" type="checkbox"/>	Description of approach to erosion and sediment control during construction for the protection of receiving watercourse or drainage corridors.	Section 7
<input type="checkbox"/>	Identification of floodplains – proponent to obtain relevant floodplain information from the appropriate Conservation Authority. The proponent may be required to delineate floodplain elevations to the satisfaction of the Conservation Authority if such information is not available or if information does not match current conditions.	Not Applicable – No requirements from Conservation Authority
<input type="checkbox"/>	Identification of fill constraints related to floodplain and geotechnical investigation.	See geotechnical report
<input checked="" type="checkbox"/>	The Servicing Study shall provide a list of applicable permits and regulatory approvals necessary for the proposed development as well as the relevant issues affecting each approval. The approval and permitting shall include but not be limited to the following:	Appendix E
<input type="checkbox"/>	Conservation Authority as the designated approval agency for modification of floodplain, potential impact on fish habitat, proposed works in or adjacent to a watercourse, cut/fill permits and Approval under Lakes and Rivers Improvement Act. The Conservation Authority is not the approval authority for the Lakes and Rivers Improvement Act. Where there are Conservation Authority regulations in place, approval under the Lakes and Rivers Improvement Act is not required, except in cases of dams as defined in the Act.	Not Applicable
<input type="checkbox"/>	Application for Certificate of Approval (CofA) under the Ontario Water Resources Act.	Not Applicable
<input type="checkbox"/>	Changes to Municipal Drains.	Not Applicable
<input type="checkbox"/>	Other permits (National Capital Commission, Parks Canada, Public Works and Government Services Canada, Ministry of Transportation etc.)	Not Applicable
<b>CONCLUSION CHECKLIST</b>		<b>RESPONSE</b>
<input checked="" type="checkbox"/>	Clearly stated conclusions and recommendations	In Section 8
<input checked="" type="checkbox"/>	Comments received from review agencies including the City of Ottawa and information on how the comments were addressed. Final sign-off from the responsible reviewing agency.	Appendix E
<input checked="" type="checkbox"/>	All draft and final reports shall be signed and stamped by a professional Engineer registered in Ontario	Signed and stamped

## **Appendix H – Drawings**

**Architectural Site Plan (1 page)**

**Notes and Legend Sheet, C000 (Provided Separately)**

**Site Servicing Plan, C100 Rev 4(Provided Separately)**

**Site Grading Plan, C200 Rev 4 (Provided Separately)**

**Erosion and Sedimentation Control Plan, C300 (Provided Separately)**

**Storm Drainage Plan, C400 Rev 4 (Provided Separately)**



**LEGEND**

	NEW OVERHEAD DOOR		BICYCLE PARKING SPACE (1.8Mx0.6M)		NEW SIGN, REFER TO SIGN LEGEND		TWO WAY TRAFFIC		NEW CONSTRUCTION
	NEW DOOR / ENTRANCE		NO PARKING LINES		STREET LIGHT		DEPRESSED CURB (DC)		EXISTING BUILDINGS
	PROPOSED RIVERSTONE MULCH		PROPOSED PRECAST CONCRETE PAVERS		HYDRO POST		PROPERTY LINE		BUILDING MOUNTED LIGHTS REFER TO ELECTRICAL DWGS
	EXISTING VEGETATION REFER TO LANDSCAPE DWGS		PROPOSED SOD - REFER TO LANDSCAPE DWGS		DESIGNATED ACCESSIBLE PARKING SPACE AS PER AODA STANDARDS		EXISTING FENCE		*REFER TO LANDSCAPE DWGS
	NEW SAWCUT CONCRETE SIDEWALK		NEW SAWCUT CONCRETE SIDEWALK		V VISITOR PARKING		MINIMUM SETBACKS (ZONING)		
	PARKING STALL COUNT PER ROW								

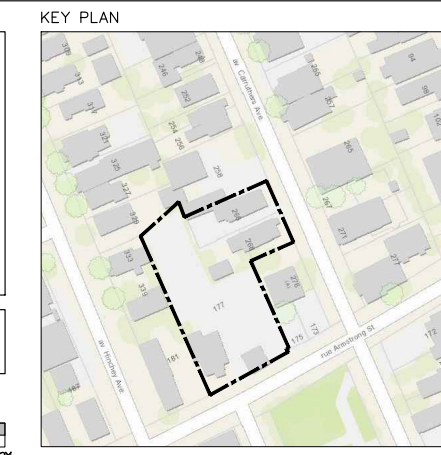

**LEGAL DESCRIPTION:**  
PART OF LOTS 6 & 7, REGISTERED PLAN 83,  
CITY OF OTTAWA,  
FARLEY, SMITH & DENIS SURVEYING LTD.  
COMPLETED ON APRIL 22, 2022

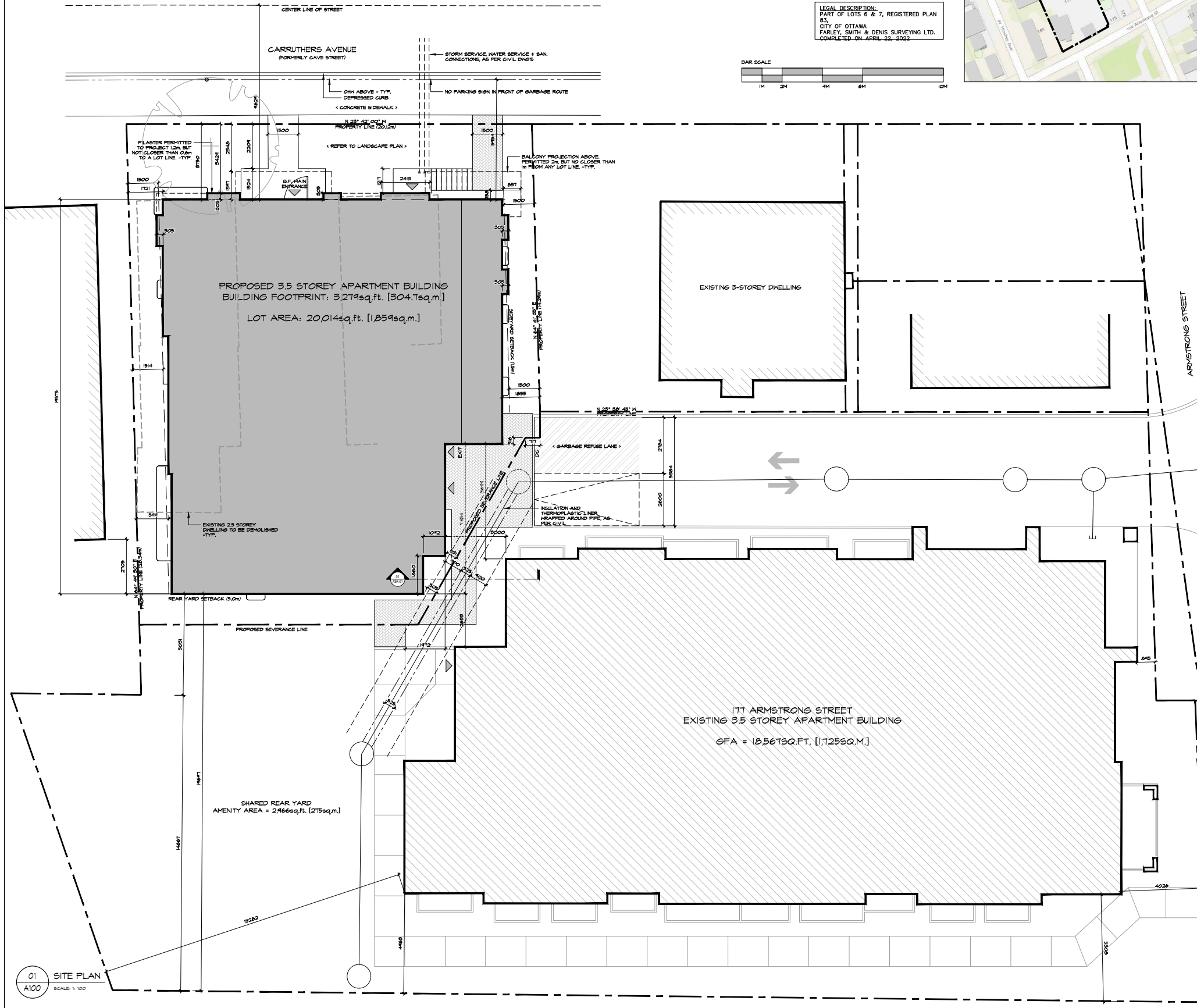
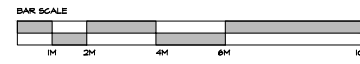

ZONING MECHANISM	RAUB PROVISION (PID)	PROPOSED	COMPLIANCE
MINIMUM LOT WIDTH	N/A	20.12m	
MINIMUM LOT AREA	1,400m²	1,859m²	
MAXIMUM BUILDING HEIGHT	11m	11.30m	X
MINIMUM FRONT YARD SETBACK (SEC. 144)	3.91m (MEASURED FOR 276 CARRUTHERS)	3.75m	X
MINIMUM CORNER SIDE YARD SETBACK	1.5m	3m	
MINIMUM REAR YARD SETBACK SECTION 144 (5)	1.2m	19.7m	
MINIMUM INTERIOR SIDE YARD SETBACK	FOR THE FIRST 18M BACK FROM THE STREET: 1.5m FOR THE REMAINDER: 25% OF THE LOT DEPTH TO A MAXIMUM OF 7.5m	NORTH: 1.5m SOUTH: 1.5m	
INTERIOR YARD AREA SECTION 144 (6)	A MINIMUM INTERIOR YARD IS REQUIRED THAT ABUTS THE REAR YARD AND INTERIOR SIDE YARD BY EXTENDING A PARALLEL LINE FROM THE MINIMUM REQUIRED REAR YARD SETBACK (1.2 M) AFFECTING THE ABUTTING LOT, ACROSS THE LONGEST SHARED COMMON LINE INTO THE AFFECTED SITE FOR A DISTANCE EQUAL TO 30% OF THE AFFECTED LOT'S ACTUAL WIDTH.	NO INTERIOR YARD AREA IS PROPOSED, HOWEVER, A REAR YARD OF 265 M2 IS PROPOSED.	X
MAXIMUM NUMBER OF UNITS FOR A LOW-RISE APARTMENT IN RAUB	12 UNITS	18 UNITS	X
LOW-RISE APARTMENT DWELLINGS IN RAUB ZONE	NO MOTOR VEHICLE PARKING IS PERMITTED ON A LOT LESS THAN 450m²  IN THE CASE OF A LOT OF 450m² OR GREATER: A) AT LEAST 25% OF DWELLING UNITS MUST HAVE AT LEAST 2 BEDROOMS	N/A  28%	N/A
PRINCIPAL ENTRANCE	1 ENTRANCE	1 PRINCIPAL ENTRANCE, BICYCLE STORAGE ENTRANCE, 1 BARRIER-FREE ENTRANCE	
FRONT FACADE	25% WINDOWS	XX% WINDOWS	
FRONT YARD FIXTURES	THE FRONT YARD MUST BE EQUIPPED WITH SOLID, PERMANENT FIXTURES TO PREVENT MOTOR VEHICLE PARKING	TREES ARE PROVIDED WITHIN THE FRONT YARD TO PREVENT VEHICLE PARKING	
BALCONY	1 BALCONY OR PORCH FOR EVERY UNIT THAT FACES A PUBLIC STREET AT OR ABOVE THE FIRST STOREY, AND  TOTAL BALCONY AREA OF 2m² MINIMUM	1 BALCONY FOR EACH UNIT FACING THE STREET ON THE SECOND AND THIRD STOREYS  ALL BALCONIES > 2m² AREA: UNIT 12: 5.3m² UNIT 13: 6.6m²	
LANDSCAPED AREA (TOTAL LOT AREA) (SECTION 161)	30%	38.5% (823.29m²)	
LANDSCAPED AREA, REAR YARD (SECTION 161)	A) ANY PART OF THE REAR YARD NOT OCCUPIED MUST BE SOFTLY LANDSCAPED B) THE MINIMUM AREA OF SOFT LANDSCAPING PER (A) MUST BE AT LEAST 50 SQUARE METERS	REAR YARD IS PROPOSED TO BE SOFTLY LANDSCAPED  REAR YARD = 265 M2 AND PROPOSED TO BE SOFTLY LANDSCAPED	
LANDSCAPED AREA, FRONT YARD (SECTION 161)	40% = 30m²	61% = 46m²	
MINIMUM WIDTH OF A PRIVATE WAY	6m	5.7m	X
MINIMUM SETBACK FOR ANY WALL OF RESIDENTIAL USE BUILDING TO A PRIVATE WAY (SECTION 131)	1.8m	0m (THE BUILDING CANTILEVERS OVER THE PRIVATE WAY)	X
MINIMUM SEPARATION DISTANCE BETWEEN BUILDINGS (SECTION 131)	WHERE THE HEIGHT OF ABUTTING BUILDINGS WITHIN THE PID IS EQUAL TO OR LESS THAN 14.5m: 1.2m	3.0m	
AMENITY AREA (SECTION 137)	RAUB ZONE NOT REQUIRED TO HAVE AMENITY SPACE	PRIVATE: 40m² COMMUNAL: 437m²	
<b>URBAN EXCEPTION 2701</b>			
MAXIMUM NUMBER OF DWELLING UNITS	33	NO CHANGE	EXCEPTION TO REMAIN
RESIDENTIAL PARKING	NOT REQUIRED	NO CHANGE	EXCEPTION TO REMAIN
MINIMUM PARKING SPACE WIDTH	2.4m	NO CHANGE	EXCEPTION TO REMAIN
MINIMUM PARKING SPACE DEPTH	4.6m	NO CHANGE	EXCEPTION TO REMAIN
MINIMUM ROOFTOP ACCESS SETBACK FROM THE FRONT WALL FOR A MAXIMUM OF 6.5m	0m	NO CHANGE	EXCEPTION TO REMAIN
MINIMUM ROOFTOP ACCESS AREA	46.3m²	NO CHANGE	EXCEPTION TO REMAIN
PRINCIPAL ENTRANCE	ONLY ONE PRINCIPAL ENTRANCE IS REQUIRED	NO CHANGE	EXCEPTION TO REMAIN
MAXIMUM LOT AREA	1,430m²	1,859m²	EXCEPTION TO BE REMOVED
<b>URBAN EXCEPTION 2702</b>			
MINIMUM LOT AREA	143.7m²	1,859m²	EXCEPTION TO BE REMOVED
PARKING REQUIREMENTS (SECTION 101, 102, 111)	REQUIREMENTS	PROPOSED	COMPLIANCE
MINIMUM PARKING RATES	DWELLING, LOW-RISE: 0.5 SPACES/UNIT (AFTER THE FIRST 12 UNITS) = 3 SPACES VISITOR: 0.1 SPACES/UNIT (AFTER THE FIRST 12 UNITS) AND UP TO A MAXIMUM OF 30 SPACES PER BUILDING) = 1 SPACE TOTAL: 4 SPACES	0 SPACES	X
MINIMUM PARKING RATES NEAR RAPID TRANSIT (SECTION 103)	AREA B SCHEDULE 1: 1.75 SPACES/UNIT (TOTAL RESIDENT + VISITOR) LOCATED WITHIN 600m OF TUNNEY'S PASTURE	0 SPACES	
PARKING SPACE PROVISIONS (SECTION 106)	MAXIMUM 2.6m x 5.2m MAXIMUM 3.1m x 5.2m PARALLEL PARKING LENGTH: 6.7m	N/A - NO PARKING IS PROPOSED	EXISTING ZONING EXCEPTION TO BE CARRIED FORWARD FOR EXISTING PARKING SPACES
DRIVEWAYS AND DRIVEWAYS (SECTION 107)	DRIVEWAYS: MINIMUM WIDTH: 2.6m	DRIVEWAYS: 5.7m	
PARKING NOT LOCATED IN A PARKING LOT OR PARKING GARAGE 71-90 DEGREE ANGLE OF PARKING	ASIS: MINIMUM WIDTH: 6.7m		
BICYCLE PARKING SPACES (SECTION 111)	0.5 SPACES / DWELLING UNIT = 9 SPACES	18 SPACES	
BICYCLE PARKING SPACE PROVISIONS (SECTION 111)	HORIZONTAL: 0.6m x 1.8m (MINIMUM 50% OF SPACES) VERTICAL: 0.5m x 1.5m STACKED: 0.36m x 1.8m ACCESS AISLE: 1.5m	9 STACKED SPACES (0.6m x 1.8m) ACCESS AISLE: 1.5m	
<b>BUILDING AREAS</b>		<b>CONSTRUCTION AREA (SQ. M)</b>	<b>CONSTRUCTION AREA (SQ. FT)</b>
LOWER LEVEL	304.7 sq.m	3,279 sq.ft	
GROUND FLOOR LEVEL	304.7 sq.m	3,279 sq.ft	
SECOND FLOOR LEVEL	304.7 sq.m	3,279 sq.ft	
THIRD FLOOR LEVEL	304.7 sq.m	3,279 sq.ft	
TOTAL	1,218.8sq.m	13,119 sq.ft	

CLIENT NAME: **THEBERGE HOMES**

NOTES:  
1. ALL WORK TO BE IN COMPLIANCE WITH LOCAL BUILDING CODES, REGULATIONS AND BY-LAWS.  
2. ADDITIONAL DRAWINGS MAY BE ISSUED FOR CLARIFICATION TO ASSIST PROPER EXECUTION OF WORK. SUCH DRAWINGS WILL HAVE THE SAME MEANING AND INTENT AS IF THEY WERE INCLUDED WITH PLANS IN CONTRACT DOCUMENTS.  
3. DO NOT SCALE DRAWINGS.  
4. ALL SUB-CONTRACTORS TO TAKE THEIR OWN ON-SITE MEASUREMENTS AND BE RESPONSIBLE FOR THEIR ACCURACY.  
5. NOTIFY SHAW J. LAWRENCE ARCHITECT FOR ANY ERRORS AND/OR OMISSIONS PRIOR TO START OF WORK.

	SUITES	2 BED	1 BED	STUDIO
LOWER LEVEL	4	1	3	N/A
GROUND FLOOR	4	N/A	4	N/A
SECOND FLOOR	5	2	3	N/A
THIRD FLOOR	5	2	3	N/A
	18	5	13	0
		28%	72%	0%

SEAL:

No.	DATE	REVISION
12	2023.11.20	ISSUED FOR COORDINATION
11	2023.10.27	ISSUED FOR REVIEW
10	2023.09.26	ISSUED FOR REVIEW
09	2023.07.17	ISSUED FOR SPC RESPONSE
08	2023.03.24	REISSUED FOR ZONING & SPC
07	2023.02.24	ISSUED FOR COORDINATION
06	2023.02.13	ISSUED FOR REVIEW
05	2023.01.09	ISSUED FOR OPEN HOUSE
04	2022.11.07	ISSUED FOR RE-ZONING AND SPC
03	2022.11.04	ISSUED FOR COORDINATION
02	2022.08.15	ISSUED FOR COORDINATION
01	2022.07.27	ISSUED FOR REVIEW

S.J. LAWRENCE ARCHITECT INCORPORATED  
18 DEAKIN STREET SUITE 205 OTTAWA, ONTARIO K2E 8B7  
T: (613) 739 7770 F: (613) 739 7703  
www.sjlarchitect.com

THIS DRAWING IS THE SOLE PROPERTY OF S.J. LAWRENCE ARCHITECT INCORPORATED. REPRODUCTION IS NOT PERMITTED.

PROJECT: **CARRUTHERS DEVELOPMENT**  
266 CARRUTHERS, OTTAWA, ON

SHEET TITLE: **SITE PLAN**

DRAWN BY: B.L. CHECKED BY: S.J.L.  
PLOT DATE: 2023.11.20 PROJECT DATE: 2022.06.06  
JOB NUMBER: SL-1077-22 SCALE: AS SHOWN  
SHEET NUMBER: A1.0