

ACCESS PROPERTY DEVELOPMENT

**864 LADY ELLEN PLACE, OTTAWA, ON  
PROPOSED SELF STORAGE  
SERVICING REPORT**

DECEMBER 16, 2022  
1<sup>ST</sup> SUBMISSION

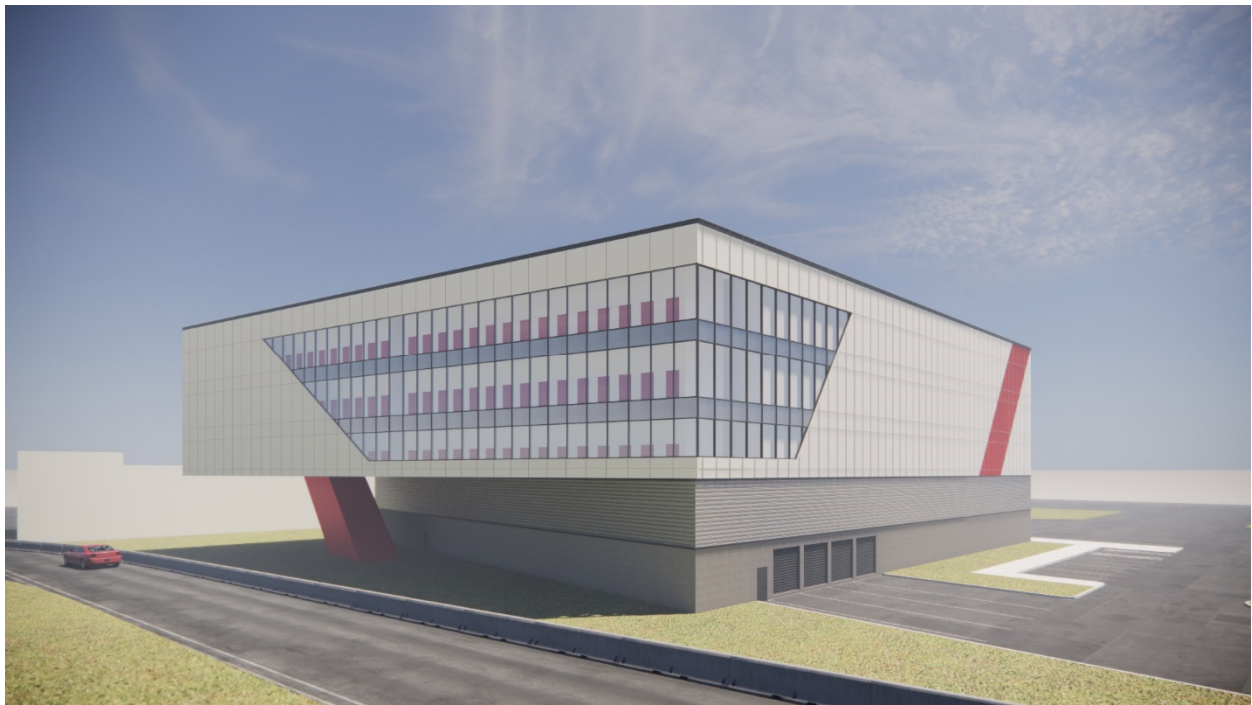





**864 LADY ELLEN PLACE,  
OTTAWA, ON  
PROPOSED SELF STORAGE  
SERVICING REPORT**

**ACCESS PROPERTY DEVELOPMENT**

SITE PLAN APPLICATION  
1ST SUBMISSION

PROJECT NO.: 221-04646-00  
DATE: DECEMBER 2022

WSP CANADA INC  
2611 QUEESVIEW DRIVE, SUITE 300  
OTTAWA, ON, CANADA, K2B 8K2

TEL.: +1 613-829-2800

WSP.COM



---

# SIGNATURES

PREPARED BY



---

**Ding Bang (Winston) Yang, P.Eng., PMP**  
**SENIOR CIVIL ENGINEER**

This report was prepared by WSP Canada Inc. for the account of Access Property Development, in accordance with the professional services agreement. The disclosure of any information contained in this report is the sole responsibility of the intended recipient. The material in it reflects WSP Canada Inc.'s best judgement in light of the information available to it at the time of preparation. Any use which a third party makes of this report, or any reliance on or decisions to be made based on it, are the responsibility of such third parties. WSP Canada Inc. accepts no responsibility for damages, if any, suffered by any third party as a result of decisions made or actions based on this report. This limitations statement is considered part of this report.

The original of the technology-based document sent herewith has been authenticated and will be retained by WSP for a minimum of ten years. Since the file transmitted is now out of WSP's control and its integrity can no longer be ensured, no guarantee may be given with regards to any modifications made to this document.





# TABLE OF CONTENTS

<b>1</b>	<b>GENERAL.....</b>	<b>11</b>
1.1	Executive summary.....	11
1.2	Date and Revision Number .....	12
1.3	Location Map and Plan .....	12
1.4	Adherence to zoning and related requirements .....	13
1.5	Pre-Consultation meetings.....	13
1.6	Higher level studies .....	14
1.7	Statement of objectives and servicing criteria.....	14
1.8	Available existing and proposed infrastructure .....	14
1.9	Environmentally significant areas, watercourses and municipal drains .....	14
1.10	Concept level master grading plan .....	15
1.11	Geotechnical study .....	15
<b>2</b>	<b>WATER DISTRIBUTION .....</b>	<b>16</b>
2.1	Consistency with master servicing study and availability of public infrastructure.....	16
2.2	System constraints and boundary conditions.....	16
2.3	Confirmation of adequate domestic supply and pressure	16
2.4	Confirmation of adequate fire flow protection.....	17
2.5	Check of high pressure.....	18
2.6	Reliability requirements .....	18
2.7	Capability of major infrastructure to supply sufficient water .....	18
2.8	Description of proposed water distribution network.....	18
2.9	Off-site requirements .....	18
2.10	Calculation of water demands .....	18
2.11	Model Schematic .....	18



<b>3</b>	<b>WASTEWATER DISPOSAL.....</b>	<b>19</b>
<b>3.1</b>	<b>Design Criteria.....</b>	<b>19</b>
<b>3.2</b>	<b>Consistency with master servicing study .....</b>	<b>19</b>
<b>3.3</b>	<b>Description of existing sanitary sewer .....</b>	<b>19</b>
<b>3.4</b>	<b>Verification of available capacity in downstream sewer</b>	<b>19</b>
<b>3.5</b>	<b>Description of proposed sewer network.....</b>	<b>19</b>
<b>4</b>	<b>SITE STORM SERVICING.....</b>	<b>20</b>
<b>4.1</b>	<b>Existing condition .....</b>	<b>20</b>
<b>4.2</b>	<b>Analysis of available capacity in public infrastructure</b>	<b>20</b>
<b>4.3</b>	<b>Drainage drawing .....</b>	<b>20</b>
<b>4.4</b>	<b>Water quantity control objective.....</b>	<b>20</b>
<b>4.5</b>	<b>Water quality control objective .....</b>	<b>20</b>
<b>4.6</b>	<b>Design criteria .....</b>	<b>21</b>
<b>4.7</b>	<b>Proposed minor system.....</b>	<b>21</b>
<b>4.8</b>	<b>Watercourses .....</b>	<b>21</b>
<b>4.9</b>	<b>Pre and Post development peak flow rates .....</b>	<b>21</b>
<b>4.10</b>	<b>Diversion of drainage catchment areas .....</b>	<b>22</b>
<b>5</b>	<b>SEDIMENT AND EROSION CONTROL .....</b>	<b>23</b>
<b>5.1</b>	<b>General .....</b>	<b>23</b>
<b>6</b>	<b>APPROVAL AND PERMIT REQUIREMENTS .....</b>	<b>24</b>
<b>6.1</b>	<b>General .....</b>	<b>24</b>
<b>7</b>	<b>CONCLUSION CHECKLIST .....</b>	<b>25</b>
<b>7.1</b>	<b>Conclusions and recommendations.....</b>	<b>25</b>
<b>7.2</b>	<b>Comments received from review agencies .....</b>	<b>25</b>



## TABLES

TABLE 2-1:	BOUNDARY CONDITIONS (CITY OF OTTAWA).....	16
TABLE 2-2:	WATER DEMAND.....	16
TABLE 2-3:	SUMMARY OF THE MINIMUM WATER PRESSURE UNDER PEAK HOUR SCENARIO.....	17
TABLE 2-5:	SUMMARY OF THE AVAILABLE FIRE FLOW UNDER MAX DAY + FIRE SCENARIO.....	17

## FIGURES

FIGURE 1-1	SITE LOCATION.....	12
FIGURE 1-2	SITE PLAN.....	13

## APPENDICES

### A

- PRE-CONSULTATION MEETING NOTES
- TOPOGRAPHIC SURVEY PLAN
- CORESPONDENCE EMAIL FROM CITY
- AS-BUILT DRAWINGS

### B

- WATERMAIN BOUNDARY CONDITIONS FROM CITY OF OTTAWA (TO BE RECIEVED)
- EMAILS FROM CITY OF OTTAWA (TO BE RECIEVED)
- FIRE UNDERWRITERS SURVEY - FIRE FLOW CALCULATION
- WATER DEMAND CALCULATION

### C

- F03 - SANITARY DRAINAGE AREA
- SANITARY SEWER DESIGN SHEET

### D



- STORM SEWER DESIGN SHEET
- F01 - PRE-DEVELOPMENT STORM DRAINAGE AREA
- F02 - ROOF DRAINAGE AREA
- C05 - POST-DEVELOPMENT STORM DRAINAGE AREA PLAN

**E**

- EROSION AND SEDIMENTATION CONTROL PLAN C06

**F**

- SUBMISSION CHECK LIST

# 1 GENERAL

---

## 1.1 EXECUTIVE SUMMARY

WSP was retained by Access Property Development to provide servicing and grading design services for the proposed self storage development including two new commercial buildings, located at 864 Lady Ellen Place, in the light industrial zone, south of Highway 417 and north of Laperriere Ave. This report outlines findings and calculations pertaining to the servicing of the proposed development with a gross lot area of 13,577m<sup>2</sup>.

Currently the land proposed for the residential development is mostly paved parking lot with minor landscaping around the perimeter, with a two storey office building. The total study area for the site is considered to be 1.36 ha in size. The site is bounded by commercial and light industrial development to the east, south and west, and highway 417 to the north.

This site includes lots 9, 10, 11 and 12, part of lot 13 of registered plan 387939 City of Ottawa (refer to Appendix A for the Legal and Topographical Survey Plan by GeoVera (ON) Ltd, July 2022). Based on the topographic survey and existing background data, minor storm runoff is being picked up by the existing on site catchbasins and conveyed to the northeast corner of the site via existing 450mm diameter storm sewer. The major storm runoff is also being conveyed through sheet flow over the impervious asphalt surface towards the northeast corner of the site.

The City of Ottawa required that the design of a drainage and stormwater management system in this development must be prepared in accordance with the following documents:

- Sewer Design Guidelines, City of Ottawa, October 2012;
- Stormwater Management Planning and Design Manual, Ministry of the Environment, March 2003; and
- Stormwater Management Facility Design Guidelines, City of Ottawa, April 2012

This report was prepared utilizing servicing design criteria obtained from available sources, and outlines the design for water, sanitary wastewater, and stormwater facilities.

The format of this report matches that of the servicing study checklist found in Section 4 of the City of Ottawa's Servicing Study Guidelines for Development Applications, November 2009.

The following municipal services are available within 864 Lady Ellen Place as recorded from as-built drawings from City of Ottawa:

864 Lady Ellen Place:

- 450mm storm sewer, 250mm sanitary sewer and 400mm watermain.

It is proposed that:

- On-site stormwater management systems, employing surface and roof storage will be provided to attenuate flow rates. Existing drainage patterns, previously established controlled flow rates and storm sewers will be maintained. Refer to the stormwater management report for details.

- The external overland runoff from the northwest corner of the site will be conveyed via the proposed enhanced grass swale along the north boundary to the northeast corner.
- The external runoff from the south of the site will be picked up by the existing catchbasins at the cul-de-sac. Excess runoff will flow through the site along the sewer easement corridor at the middle of the site to the proposed enhanced grass swale along the north boundary, eventually will be directed to the northeast corner.

---

## 1.2 DATE AND REVISION NUMBER

This version of the report is the first revision, dated December 16, 2022.

---

## 1.3 LOCATION MAP AND PLAN

The proposed residential development is located at 360 Kennedy Lane East, in the City of Ottawa at the location shown in Figure 1-1 below.

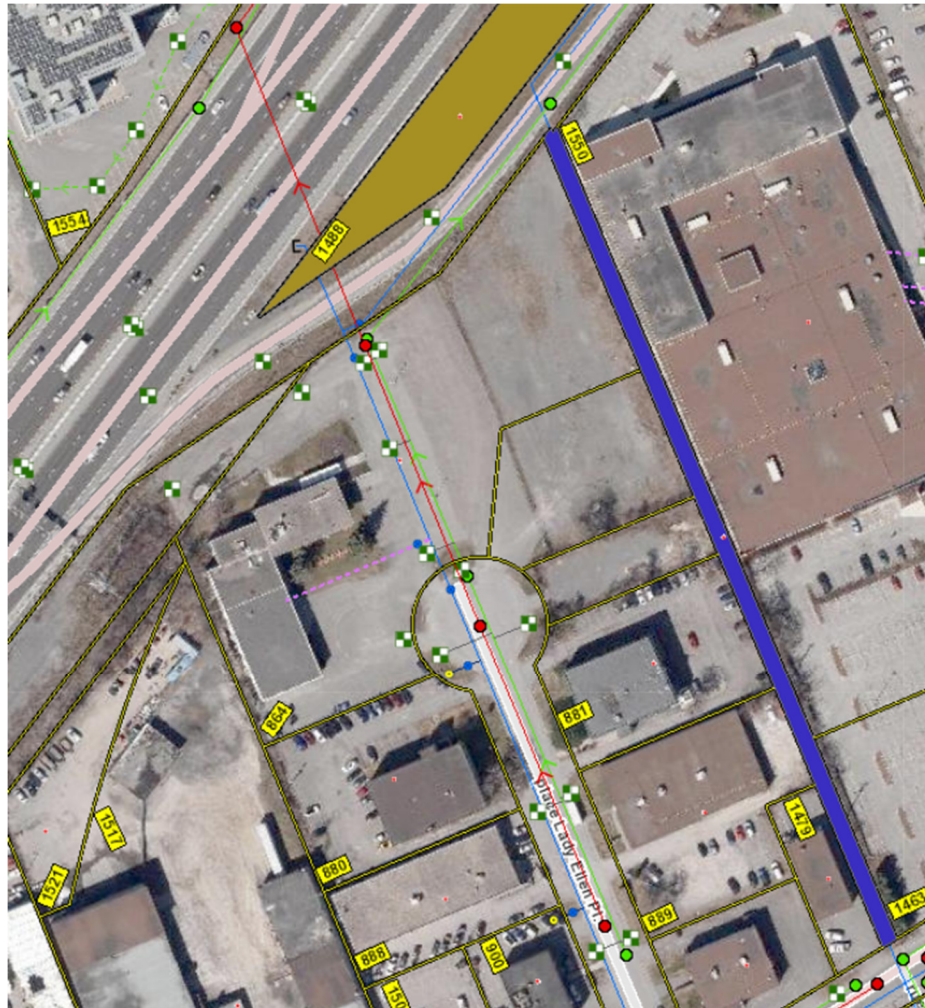

**Figure 1-1 Site Location**

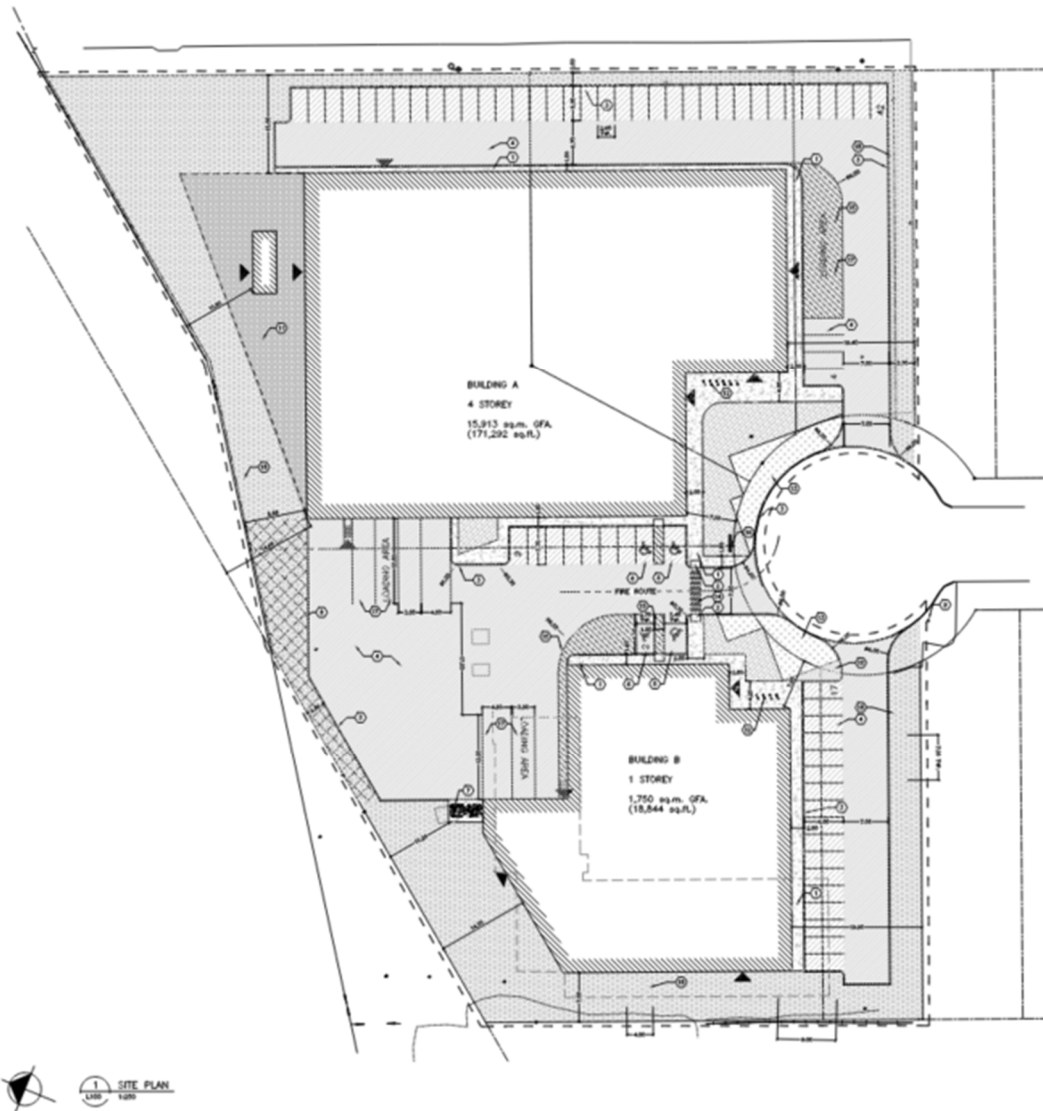

**Figure 1-2 Site Plan**

## 1.4 ADHERENCE TO ZONING AND RELATED REQUIREMENTS

The proposed property use will be in conformance with zoning and related requirements prior to approval and construction and is understood to be in conformance with current zoning.

## 1.5 PRE-CONSULTATION MEETINGS

A pre-consultation meeting was held with the City of Ottawa on November 3, 2022. Notes from this meeting are provided in Appendix A.

---

## 1.6 HIGHER LEVEL STUDIES

The review for servicing has been undertaken in conformance with, and utilizing information from, the following documents:

- Ottawa Sewer Design Guidelines, Second Edition, Document SDG002, October 2012, City of Ottawa including:
  - Technical Bulletin ISDTB-2012-4 (20 June 2012)
  - Technical Bulletin ISDTB-2014-01 (05 February 2014)
  - Technical Bulletin PIEDTB-2016-01 (September 6, 2018)
  - Technical Bulletin ISDTB-2018-01 (21 March 2018)
  - Technical Bulletin ISDTB-2018-04 (27 June 2018)
- Ottawa Design Guidelines – Water Distribution, July 2010 (WDG001), including:
  - Technical Bulletin ISDTB-2014-02 (May 27, 2014)
  - Technical Bulletin ISTB-2018-02 (21 March 2018)
- Stormwater Management Planning and Design Manual, Ontario Ministry of the Environment and Climate Change, March 2003 (SMPDM).
- Design Guidelines for Drinking-Water Systems, Ontario Ministry of the Environment and Climate Change, 2008 (GDWS).
- Fire Underwriters Survey, Water Supply for Public Fire Protection (FUS), 2020.

---

## 1.7 STATEMENT OF OBJECTIVES AND SERVICING CRITERIA

The objective of the site servicing is to meet the requirements for the proposed modification of the site while adhering to the stipulations of the applicable higher-level studies and City of Ottawa servicing design guidelines.

---

## 1.8 AVAILABLE EXISTING AND PROPOSED INFRASTRUCTURE

The existing municipal sanitary sewer, storm sewer and watermain located within the easement for utilities and drainage at 864 Lady Ellen Place will be maintained. New sanitary, storm and water services will be connected to the existing sewers from Building A. Existing sanitary and water services to the existing building will be reused and connected to Building B. A new storm service will also be connected to the existing storm sewer from Building B. Series of catchbasins and catchbasin manholes will be employed at the new parking lot to pick up the surface runoff.

For the redevelopment area, quantity control is required to restrict the discharge for all events up to a 100-year event to the 2-year pre-development flow rate as established in the pre-consultation meeting.

Site access for vehicles will be provided from Lady Ellen Place. The driveways being provided are two-way entrances at the south end.

---

## 1.9 ENVIRONMENTALLY SIGNIFICANT AREAS, WATERCOURSES AND MUNICIPAL DRAINS

The proposed development site is bordered by commercial and light industrial land to the east, south and west, and by Highway 416 to the north. There are no environmentally significant areas, water courses or municipal drains identified at

or in close proximity to the site. The drainage easement within 864 Lady Ellen Place will convey overflow surface drainage from this and the existing south properties to the storm sewer along Lady Ellen Place, but is not classified as a watercourse or municipal drain.

---

## **1.10 CONCEPT LEVEL MASTER GRADING PLAN**

A detailed grading plan has been developed, matching the existing overland flow pattern of direction overland drainage to the northeast corner of the site. The site topographic survey, included in Appendix A, provides evidence of direction of overland flow.

Due to the existing external overland runoff enters from the west of the site, it will be necessary to construct an enhanced grass swale along the west and north boundary of the site to convey the runoff to the northeast corner of the site.

Grading will employ terraced slopes of 3H:1V to provide transitions from the new work areas to existing grades. No significant changes will be made to grades at the property perimeter. Minor changes will be made to confine drainage to the desired overflow routes.

---

## **1.11 GEOTECHNICAL SUTDY**

A geotechnical investigation report has been prepared by Golder Associated Ltd. (Geotechnical Investigation – Access Property Development, December 16, 2022), and its recommendations have been taken into account in developing the engineering specifications.

## 2 WATER DISTRIBUTION

---

### 2.1 CONSISTENCY WITH MASTER SERVICING STUDY AND AVAILABILITY OF PUBLIC INFRASTRUCTURE

There is an existing 400mm diameter public watermain running along the utilities and drainage easement within 864 Lady Ellen Place connecting Laperriere Ave and Carling Ave which will provide water to the development. A 200mm diameter private water service will be connected to the existing 400mm diameter watermain to provide water to proposed Building A. The existing 200mm water service currently servicing the existing building will be reused to service the proposed Building B.

Two existing public fire hydrants on Lady Ellen Road will provide adequate coverage to the proposed buildings. One of the existing public fire hydrants is located within 45m of the Siamese connections for both buildings. No changes are required to the existing City water distribution system to allow servicing for this property.

---

### 2.2 SYSTEM CONSTRAINTS AND BOUNDARY CONDITIONS

Boundary conditions have not yet been obtained from the City of Ottawa at the 400 mm diameter watermain within the easement for the development, and if obtained, will be added to Appendix B. A maximum fire flow demand of 150 l/s (9,000 l/min) has been calculated for the proposed development as indicated in Section 2.4.

**Table 2-1: Boundary Conditions (City of Ottawa)**

BOUNDARY CONDITIONS (to be completed)		
SCENARIO	Head (m)	Pressure (psi)
Maximum HGL		
Minimum HGL (Peak Hour)		
Max Day + Fire Flow		

### 2.3 CONFIRMATION OF ADEQUATE DOMESTIC SUPPLY AND PRESSURE

Water demands are based on Table 4.2 of the Ottawa Design Guidelines – Water Distribution. As previously noted, the development is as light industrial development, consisting of two commercial buildings, one-storey building B and four storey building A. A water demand calculation sheet is included in Appendix C, and the total water demands are summarized as follows:

**Table 2-2: Water Demand**

Domestic Water Demand			
SCENARIO	Avg Daily	Max Daily	Max Hourly
Commercial	0.44	0.66	1.19



The 2010 City of Ottawa Water Distribution Guidelines stated that the preferred practice for design of a new distribution system is to have normal operating pressures range between 345 kPa (50 psi) and 552 kPa (80 psi) under maximum daily flow conditions. Other pressure criteria identified in the guidelines are as follows:

Minimum Pressure	Minimum system pressure under peak hour demand conditions shall not be less than 276 kPa (40 psi)
Fire Flow	During the period of maximum day demand, the system pressure shall not be less than 140 kPa (20 psi) during a fire flow event.
Maximum Pressure	Maximum pressure at any point the distribution system shall not exceed 689 kPa (100 psi). In accordance with the Ontario Building/Plumbing Code, the maximum pressure should not exceed 552 kPa (80 psi). Pressure reduction controls may be required for buildings where it is not possible/feasible to maintain the system pressure below 552 kPa.

Once boundary conditions are obtained from the City of Ottawa, further confirmation can be attained using a water model software.

**Table 2-3: Summary of the minimum water pressure under peak hour scenario**

Peak Hour @ XXXm (TO BE COMPLETED LATER)	
ID	Pressure (kPa)
Building A	
Building B	

## 2.4 CONFIRMATION OF ADEQUATE FIRE FLOW PROTECTION

The fire flow rate has been calculated using the Fire Underwriters Survey (FUS) method. The method takes into account the type of building construction, the building occupancy, the use of sprinklers and the exposures to adjacent structures. A fire flow demand of 150 l/s for the development has been calculated. Calculations are included in Appendix B.

The proposed development can be serviced through the combination of existing municipal fire hydrants. There is one existing fire hydrant on the cul-de-sac just south of the site which is also within 45m of the proposed Siamese connections for both buildings, and the other existing municipal fire hydrant is located 100m south of the site. All the existing hydrants are rated at 5700 l/min.

The proposed buildings A and B on site at 864 Lady Ellen Place will be serviced by laterals off of the existing 400 mm municipal watermain. The sprinkler services will run into the water sprinkler rooms of the proposed buildings. The proposed buildings will be sprinklered and fire protection will be provided with the fire department Siamese connection within 45 m of the existing municipal fire hydrant located south of the site.

The minimum residual pressure will be evaluated once the boundary conditions are obtained from the City of Ottawa.

**Table 2-4: Summary of the available fire flow under Max Day + Fire scenario**

Max Day + Fire @ XXX l/s (TO BE COMPLETED LATER)	
ID	Allowable Fire Flow (l/s)

---

## **2.5 CHECK OF HIGH PRESSURE**

High pressure check will be evaluated once the boundary conditions are obtained from the City of Ottawa.

---

## **2.6 RELIABILITY REQUIREMENTS**

Shot off valves will be provided at each service lateral. There are two existing valve chambers on the existing 400mm watermain, one is located at the south of the site, the other one is located at the north of the site. Water can be supplied to the service laterals from both direction of Lady Ellen Place and can also be isolated. Refer to servicing plan C04 for details.

---

## **2.7 CAPABILITY OF MAJOR INFRASTRUCTURE TO SUPPLY SUFFICIENT WATER**

The current infrastructure is capable of meeting the domestic demand based on City requirements and fire demand as determined by FUS requirements for the proposed residential units.

---

## **2.8 DESCRIPTION OF PROPOSED WATER DISTRIBUTION NETWORK**

One 200mm private water service lateral is proposed to provide domestic and fire demand for the proposed buildings A. Existing 200mm private water service lateral will be reused to service building B.

---

## **2.9 OFF-SITE REQUIREMENTS**

No off-site improvements to watermains, feeder mains, pumping stations, or other water infrastructure are required to maintain existing conditions and service the adjacent buildings, other than the connection of the new private watermain to the City watermain in the south frontage of the site.

---

## **2.10 CALCULATION OF WATER DEMANDS**

Water demands were calculated as described in Sections 2.3 and 2.4 above and is also attached in Appendix B.

---

## **2.11 MODEL SCHEMATIC**

The water works consist of two building services; a model schematic is not required for this development.

## 3 WASTEWATER DISPOSAL

---

### 3.1 DESIGN CRITERIA

In accordance with the City of Ottawa's Sewer Design Guidelines, the following design criteria have been utilized in order to predict wastewater flows generated by the subject site and complete the sewer design.

• Minimum Velocity	0.6 m/s
• Maximum Velocity	3.0 m/s
• Manning Roughness Coefficient	0.013
• Average sanitary flow for residential use	280 L/cap/day
• Average sanitary flow for commercial use	28,000 L/Ha/day
• Commercial/Light Industrial Peaking Factor	1.5
• Infiltration Allowance (Total)	0.33 L/s/Ha
• Minimum Sewer Slopes – 200 mm diameter	0.32%

---

### 3.2 CONSISTENCY WITH MASTER SERVICING STUDY

The outlet for the two private sanitary laterals is the 250 mm diameter municipal sewer within the utilities and drainage easement at 864 Lady Ellen Place.

The Ottawa Sewer Design Guidelines provide estimates of sewage flows based on commercial development. The anticipated average daily flow based on a total development area of 1.36 Ha is 0.44 L/s. Applying the peaking factor of 1.5, and adding the extraneous flow, the estimated ultimate peak flow is 1.11 L/s.

Sanitary demand calculations can be found in Appendix C and an illustration of the proposed sanitary service can be found on the site servicing plan.

---

### 3.3 DESCRIPTION OF EXISTING SANITARY SEWER

The outlet sanitary sewer is the existing 250 mm diameter sewer within the easement. This local sewer outlets to a sanitary trunk sewer, then discharges to a municipal wastewater treatment facility.

---

### 3.4 VERIFICATION OF AVAILABLE CAPACITY IN DOWNSTREAM SEWER

The capacity of the receiving 250 mm diameter sanitary sewer along the easement at 1.80% slope is 25.42 L/s, which is adequate for the flow assumptions from the proposed development. And the flow from the existing sanitary sewer upstream of 864 Lady Ellen Place has a total flow of 1.14 L/s. The downstream sanitary sewer will carry over the discharge from the subjected site and the upstream areas, a total flow of 2.25 L/s is anticipated.

A sanitary sewer design sheet and the sanitary drainage areas F03 are provided for both the subjected site and the upstream areas. See Appendix C for details.

---

### 3.5 DESCRIPTION OF PROPOSED SEWER NETWORK

The proposed sanitary sewer network on site will consist of 200 mm diameter private sanitary sewers with typical sanitary services for the commercial buildings

## 4 SITE STORM SERVICING

---

### 4.1 EXISTING CONDITION

The site currently is dominated by an asphalt parking lot and the existing two storey office building. The site is serviced with a series of storm sewers which collect runoff from the various areas and significant parking lots. Most runoff from the site is ultimately directed to a 450mm diameter storm sewer which runs south to north toward the Highway 417 and is located along the utilities and drainage easement. The 450mm diameter storm sewer ultimately outlets to the Ottawa River via 2100mm diameter trunk sewer along Carling Ave. Drainage in excess of the minor system capacity currently flows overland to the northeast corner of the site.

External overland runoff from the west and south are anticipated draining toward the site. The site currently is used as an overland flow route for those areas.

---

### 4.2 ANALYSIS OF AVAILABLE CAPACITY IN PUBLIC INFRASTRUCTURE

The total controlled area of the site draining toward the existing 450mm diameter storm sewer is 1.047 ha. There is 0.227 ha of uncontrolled area draining toward the proposed ditch along the west and north property line. And 0.080 ha of uncontrolled area draining toward the Lady Ellen Road Cul-De-Sac. The runoff from the controlled areas will discharge to a 450mm storm pipe along the easement which ultimately drains to the Ottawa River via the 2100mm trunk sewer.

On-site attenuation to predevelopment flow is required for the purpose of advancing use of this storm outlet. Using the Rational Method, with coefficient of 0.20 for pervious areas and 0.90 for impervious areas, and a 10-minute time of concentration, results in an estimated 2-year flow of 184.97 L/s from this area. Using utility records from the City, the slope of the existing storm sewer 450 mm diameter running north to south along the easement is 1.90%, which equates to a capacity in excess of 393.39 L/s. As the proposed stormwater management works for the site will reduced the runoff rate to a peak discharge at outlet equal to 106 L/s, capacity in the minor system is not a concern.

As the proposed stormwater management works for the site will restricted the 100-year flow to the pre-development 2-year runoff rate, capacity in the minor system is not a concern.

The allowable release rate for the site is 106 L/s as calculated in the Stormwater Management Report.

---

### 4.3 DRAINAGE DRAWING

Drawing C04 shows the receiving storm sewer and site storm sewer network for the site. Drawing C03 provides proposed grading and drainage and includes existing grading information. Drawing C05 provides a post-construction drainage sub-area plan. Post site sub-area information is also provided on the storm sewer design sheet attached in Appendix D.

---

### 4.4 WATER QUANTITY CONTROL OBJECTIVE

Refer to the Stormwater Management Report for the water quantity objective for the site.

---

### 4.5 WATER QUALITY CONTROL OBJECTIVE

As the proposed modification in use of the site will result in less parking and paved area, and drainage from the proposed

building will be attenuated on the roof and directed to the storm sewer, a conceptual net improvement in stormwater water quality is anticipated.

Water quality control to be confirmed by RVCA.

---

## 4.6 DESIGN CRITERIA

The stormwater system was designed following the principles of dual drainage, making accommodation for both major and minor flow.

Some of the key criteria include the following:

- |                                 |                                                        |
|---------------------------------|--------------------------------------------------------|
| • Design Storm (minor system)   | 1:2-year return (Ottawa)                               |
| • Rational Method Sewer Sizing  |                                                        |
| • Initial Time of Concentration | 10 minutes                                             |
| • Runoff Coefficients           |                                                        |
| Landscaped Areas                | C = 0.20                                               |
| Asphalt/Concrete                | C = 0.90                                               |
| Traditional Roof                | C = 0.90                                               |
| • Pipe Velocities               | 0.80 m/s to 6.0 m/s                                    |
| • Minimum Pipe Size             | 250 mm diameter<br>(200 mm CB Leads and service pipes) |
- 

## 4.7 PROPOSED MINOR SYSTEM

The detailed design for this site will maintain the existing 450mm diameter storm sewer along the utilities and drainage easement within the development site, with the exception of replacement of the existing on site catchbasins. This modification is required to achieve a 2-year discharge rate and proposed site layout, without accounting for the flow reduction being implemented for quantity and quality control. Temporary pumping of storm water will be required during replacement of the existing on-site catchasins.

A limited amount of uncontrolled surface flow will also enter the existing storm sewer network to the south of the site at the Cul-De-Sac, consistent with existing conditions.

Weeping tile from the building is proposed and will be connected to the main sewer without restrictions.

Using the above noted criteria, the proposed on-site storm sewers were sized accordingly. A detailed storm sewer design sheet and the associated pre and post development storm sewer drainage area plan and figure are included in Appendix D.

---

## 4.8 WATERCOURSES

The minor flow will be ultimately directed to the Ottawa River.

---

## 4.9 PRE AND POST DEVELOPMENT PEAK FLOW RATES

Pre and post development peak flow rates for the site have been noted in storm sewer design sheet as well as the Stormwater Management report.

---

## 4.10 DIVERSION OF DRAINAGE CATCHMENT AREAS

With the exception of a small uncontrolled area to the south of the site, the development will be regraded such that all overland flow is directed to the northeast corner of the site as directed by City of Ottawa. A proposed swale along the west and north property line is to be used as the overland flow route for the external overland runoff from the west of the site. And the existing overland flow route draining south to north carrying the external overland runoff from the south of the site will be maintained. All these external overland runoff will be conveyed to the northeast corner of the site via the proposed swale.

## 5 SEDIMENT AND EROSION CONTROL

---

### 5.1 GENERAL

During construction, existing storm sewer system can be exposed to sediment loadings. A number of construction techniques designed to reduce unnecessary construction sediment loadings will be used including:

- The installation of straw bales within existing drainage features surrounding the site.
- Silt Sack will remain on open surface structures such as manholes and catchbasins until these structures are commissioned and put into use.
- Installation of silt fence, where applicable, around the perimeter of the proposed work area.

During construction of the services, any trench dewatering using pumps will be fitted with a “filter sock.” Thus, any pumped groundwater will be filtered prior to release to the existing surface runoff. The contractor will inspect and maintain the filter sock as needed including sediment removal and disposal.

All catchbasins, and to a lesser degree, manholes, convey surface water to sewers. Consequently, until the surrounding surface has been completed, these structures will be covered to prevent sediment from entering the minor storm sewer system. These measures will stay in place and be maintained during construction and build-out until it is appropriate to remove them.

During construction of any development both imported and native soils are placed in stockpiles. Mitigative measures and proper management to prevent these materials entering the sewer system are needed.

During construction of the deeper watermains and sewers, imported granular bedding materials are temporarily stockpiled on site. These materials are however quickly used up and generally placed before any catchbasins are installed.

Refer to the Erosion and Sedimentation Control Plan C06 provided in Appendix E.

## 6 APPROVAL AND PERMIT REQUIREMENTS

---

### 6.1 GENERAL

The proposed development is subject to site plan approval and building permit approval.

No approvals related to municipal drains are required.

No permits or approvals are anticipated to be required from the Ontario Ministry of Transportation, National Capital Commission, Parks Canada, Public Works and Government Services Canada, or any other provincial or federal regulatory agency.



## **7 CONCLUSION CHECKLIST**

---

### **7.1 CONCLUSIONS AND RECOMMENDATIONS**

It is concluded that the proposed development can meet all provided servicing constraints and associated requirements. It is recommended that this report be submitted to the City of Ottawa in support of the application for site plan approval.

---

### **7.2 COMMENTS RECEIVED FROM REVIEW AGENCIES**

This is the first submission, no city comments.



# APPENDIX

## A

- PRE-CONSULTATION MEETING NOTES
- TOPOGRAPHIC SURVEY PLAN
- CORESPONDENCE EMAIL FROM CITY
- AS-BUILT DRAWINGS

## APPLICANT'S STUDY AND PLAN IDENTIFICATION LIST

Legend: **S** indicates that the study or plan is required with application submission.

**A** indicates that the study or plan may be required to satisfy a condition of approval/draft approval.

For information and guidance on preparing required studies and plans refer [here](#):

S/A	ENGINEERING		S/A
S	1. Site Servicing Plan	2. Site Servicing Study / Assessment of Adequacy of Public Services	S
S	3. Grade Control and Drainage Plan	4. Geotechnical Study / Slope Stability Study	S
■	5. Composite Utility Plan	6. Groundwater Impact Study	■
■	7. Servicing Options Report	8. Wellhead Protection Study	■
■	9. Transportation Impact Assessment (TIA)	10. Erosion and Sediment Control Plan / Brief	S
S	11. Storm water Management Report / Brief	12. Hydro geological and Terrain Analysis	■
M	13. Hydraulic Water main Analysis	14. Noise / Vibration Study	■
■	15. Roadway Modification Functional Design	16. Confederation Line Proximity Study	■

S/A	PLANNING / DESIGN / SURVEY		S/A
■	17. Draft Plan of Subdivision	18. Plan Showing Layout of Parking Garage	■
■	19. Draft Plan of Condominium	20. Planning Rationale	S
S	21. Site Plan	22. Minimum Distance Separation (MDS)	■
■	23. Concept Plan Showing Proposed Land Uses and Landscaping	24. Agrology and Soil Capability Study	■
■	25. Concept Plan Showing Ultimate Use of Land	26. Cultural Heritage Impact Statement	■
S	27. Landscape Plan	28. Archaeological Resource Assessment Requirements: <b>S</b> (site plan) <b>A</b> (subdivision, condo)	■
S	29. Survey Plan	30. Shadow Analysis	■
■	31. Architectural Building Elevation Drawings (dimensioned)	32. Design Brief (includes the Design Review Panel Submission Requirements)	■
■	33. Wind Analysis		■

S/A	ENVIRONMENTAL		S/A
S	34. Phase 1 Environmental Site Assessment	35. Impact Assessment of Adjacent Waste Disposal/Former Landfill Site	■
■	36. Phase 2 Environmental Site Assessment (depends on the outcome of Phase 1)	37. Assessment of Landform Features	■
■	38. Record of Site Condition	39. Mineral Resource Impact Assessment	■
■	40. Tree Conservation Report	41. Environmental Impact Statement / Impact Assessment of Endangered Species	■
■	42. Mine Hazard Study / Abandoned Pit or Quarry Study	43. Integrated Environmental Review (Draft, as part of Planning Rationale)	■

S/A	ADDITIONAL REQUIREMENTS		S/A
S	44. Applicant's Public Consultation Strategy (may be provided as part of the Planning Rationale)	45. Tree Conservation Report	S
A	46. Site Lighting Certification Letter	47. Urban Design Brief	S

Meeting Date: Nov 3 2022

Application Type: Site Plan Control

File Lead (Assigned Planner): Craig Hamilton

Infrastructure Approvals Project Manager: Bruce Bramah

Site Address (Municipal Address): 864 Lady Ellen Pl

\*Preliminary Assessment: 1  2  3  4  5

\*One (1) indicates that considerable major revisions are required before a planning application is submitted, while five (5) suggests that proposal appears to meet the City's key land use policies and guidelines. **This assessment is purely advisory and does not consider technical aspects of the proposal or in any way guarantee application approval.**

***It is important to note that the need for additional studies and plans may result during application review. If following the submission of your application, it is determined that material that is not identified in this checklist is required to achieve complete application status, in accordance with the Planning Act and Official Plan requirements, the Planning, Real Estate and Economic Development Department will notify you of outstanding material required within the required 30 day period. Mandatory pre-application consultation will not shorten the City's standard processing timelines, or guarantee that an application will be approved. It is intended to help educate and inform the applicant about submission requirements as well as municipal processes, policies, and key issues in advance of submitting a formal development application. This list is valid for one year following the meeting date. If the application is not submitted within this timeframe the applicant must again pre-consult with the Planning, Real Estate and Economic Development Department.***

## Yang, Winston

---

**From:** MacDonald, Jill  
**Sent:** November 22, 2022 12:33 PM  
**To:** Frank Abrantes; Hind Barnieh; Elisabeth Gebremedhin; Chen, Jie; Bouwman, Andrew; Hirota, Aaron; Yang, Winston; Papazoglou, Jordan  
**Cc:** De Santi, Nadia; Follett, Chris  
**Subject:** FW: Pre-con Follow-up - 864 Lady Ellen Place  
**Attachments:** 864 Lady Ellen - Pre-con Servicing Memo.docx; Pre-con Applicant's Study and Plan Identification List.pdf

Hi everyone,

Hot off the press, please see for the below and attached pre-application consultation minutes and plans/studies list from the City.

As December is fast approaching, we will be looking to set up a standing weekly project check-in till end of this year and Site Plan submission. I will be in touch shortly with the standing evite once I have confirmed availability from APD and the project team.

Thank you,



**Jill MacDonald, MCIP, RPP**  
Project Planner  
Urban and Community Planning  
(she/her)

T+ 1 613-690-3936  
Ottawa, ON

---

**From:** Hamilton, Craig <craig.hamilton@ottawa.ca>  
**Sent:** Tuesday, November 22, 2022 12:11 PM  
**To:** MacDonald, Jill <Jill.MacDonald@wsp.com>; De Santi, Nadia <Nadia.De-Santi@wsp.com>  
**Cc:** Ippersiel, Matthew <Matthew.Ippersiel@ottawa.ca>; Bramah, Bruce <bruce.bramah@ottawa.ca>; Paudel, Neeti <neeti.paudel@ottawa.ca>; Walker, Burl <Burl.Walker@ottawa.ca>; Richardson, Mark <Mark.Richardson@ottawa.ca>  
**Subject:** Pre-con Follow-up - 864 Lady Ellen Place

Hello Ms. Macdonald,

Please refer to the below (and/or attached notes) regarding the Pre-Application Consultation (pre-con) Meeting held on November 3, 2022 for the property 864 Lady Ellen Place for Complex Site Plan Control in order to allow the development of storage and warehousing uses by Access Properties. I have also attached the required Plans & Study List for application submission.

Below (and attached, in some instances) are staff's preliminary comments based on the information available at the time of pre-con meeting:

### Planning

- The property is designated as Mixed Industrial under Schedule 2b of the Official Plan (2021).
- The Mixed Industrial policies are generally supportive of the proposed use and its location with respect to the nearby residential areas.
- Staff do not have significant concerns at this time.
- Please consider providing a landscaping buffer between the large asphalted area serving the loading spaces and the northern property line to reduce unneeded asphalt.
- If possible, provide small tree plantings within the front planting bed where it does not conflict with proposed signage for the building.
- Indicate on the Site Plan the pathway connections of the side and rear doors with pedestrian pathways around the parking lot.
- Ensure that anticipated pedestrian crossings through the parking lot are considered and protected for pedestrian safety.
- The current 'IL' zoning does permit the 'one lot for zoning purposes' provision.

### **Urban Design**

- Note that the adjacent portion of Highway 417 is designated as a Scenic Capital Entry Route in the Official Plan (Schedule C13). As such, adjacent development should contribute to the image of Ottawa as the Capital city through landscape and aesthetic improvements.
  - Ensure that the architecture properly responds to views from the highway by ensuring visual interest, providing animated facades, incorporating glazing, accent lighting, etc.
  - Minimize the visual impact of loading docks, garbage enclosures, utilities, etc.
  - Please incorporate this analysis in the Design Brief.
- Please connect the internal pedestrian pathways to street.
- Explore the possibility of reducing the amount of paved surface in the rear of the site. If this is possible, please use this opportunity to plant additional trees.
- An Urban Design Brief is required as a part of your submission. This may be combined with your Planning Rationale report. Please refer to the attached Urban Design Brief Terms of Reference to inform the content of the brief.
- This application is not subject to review by the Urban Design Review Panel.

### **Heritage**

Heritage has no comments at this time.

### **Engineering**

The attached "Pre-application consultation servicing memo" summarizes engineering design considerations as per our discussion.

Feel free to contact the Infrastructure Project Manager, Bruce Bramah, at [Bruce.bramah@ottawa.ca](mailto:Bruce.bramah@ottawa.ca), for follow-up questions.

### **Transportation**

- Screening form should be updated to include the trip generation for the site. Self storage sites generate less vehicular volumes than other industrial sites. The existing office volume should also be accounted for. Please provide the updated screening form asap to Neeti Paudel at [Neeti.paudel@ottawa.ca](mailto:Neeti.paudel@ottawa.ca) for review. TIA requirement will be based on the review.
- Noise Impact Studies required for the following:
  - Stationary (if there will be any exposed mechanical equipment due to the proximity to neighbouring noise sensitive land uses)
- On site plan:
  - Show all details of the roads abutting the site up to and including the opposite curb; include such items as pavement markings, accesses and/or sidewalks.
  - Show all curb radii measurements; ensure that all curb radii are reduced as much as possible

- Show lane/aisle widths.
- As the proposed site is for the general public use, AODA legislation applies.
  - Clearly define accessible parking stalls and ensure they meet AODA standards (include an access aisle next to the parking stall and a pedestrian curb ramp at the end of the access aisle, as required).
  - Please consider using the City’s Accessibility Design Standards, which provide a summary of AODA requirements. <https://ottawa.ca/en/city-hall/creating-equal-inclusive-and-diverse-city/accessibility-services/accessibility-design-standards-features#accessibility-design-standards>
- Provide direct and safe pedestrian connections from the parking to the buildings.
- Turning movements for the largest vehicle should be assessed at the accesses and within the site.

Feel free to contact the Transportation Project Manager, Neeti Paudel, at [Neeti.paudel@ottawa.ca](mailto:Neeti.paudel@ottawa.ca) (613-580-2424 x22284), for follow-up questions.

**Environmental**

- Environmental Planning has no comments or concerns at this time.
- Consider the [Bird-safe Design Guidelines](#) in the development of the proposed buildings.

**Parkland**

- The applicant is proposing to develop a 4-storey building with a GFA of 15,913 m2 and a 1-storey building with a GFA of 2,171 m2. The total GFA proposed is 18,084 m2. The buildings are proposed to be used as storage warehouses. The existing office building, which has a GFA of 3,530 sq. m, will be demolished. The site has a lot area of 13,576 m2.
- Cash-in-lieu of parkland dedication will be required as a condition of site plan approval because there is a net increase in GFA of a commercial use.
- Based on the information included on the pre-application consultation form and the description of the existing GFA in the property overview sheet provided by Jill MacDonald of WSP on November 4, the following is a draft condition for the cash-in-lieu of parkland dedication requirement:

*The Owner agrees to provide cash-in-lieu of parkland dedication on the subject lands within Ward 16 in accordance with the Planning Act and the City of Ottawa Parkland Dedication By-law No. 2022-280, to the satisfaction of the General Manager, Recreation, Cultural and Facility Services. A land area of 219 m2 has been calculated for the cash-in-lieu of parkland dedication requirement as follows. Parks and Facilities Planning is currently undertaking a legislated replacement of the Parkland Dedication By-law, with the new by-law to be considered by City Council on August 31, 2022. The by-law recommended for approval by Council increases the required parkland conveyance for mid-rise and high-rise residential development, and includes one-year transition policies for in-stream development and building permit applications or those that will be submitted and meet the requirements for completeness by September 1, 2022.*

<b>Proposed Use</b>	<b>Gross Land Area</b>	<b>Cash-in-lieu of Parkland Dedication Rate</b>	<b>Parkland Dedication Area</b>
Commercial	13,576 m2	2%	$\frac{(Proposed\ GFA - Existing\ GFA)}{Proposed\ GFA} \times Gross\ Land\ Area \times 2\%$ $= \frac{(18,084\ m^2 - 3,530\ m^2)}{18,084\ m^2} \times 13,576\ m^2 \times 2\%$ $= 219\ m^2$

The cash-in-lieu of parkland dedication shall be directed 60% towards the Ward 16 cash-in-lieu of parkland reserve (Account 830305) and 40% towards the City-wide cash-in-lieu of parkland reserve (Account 830015).

- Parks and Facilities Planning is currently undertaking a legislated replacement of the Parkland Dedication By-law, with the new by-law to be considered by City Council on August 31, 2022. The by-law recommended for approval by Council increases the required parkland conveyance for mid-rise and high-rise residential development, and includes one-year transition policies for in-stream development and building permit applications or those that will be submitted and meet the requirements for completeness by September 1, 2022.
  - To ensure you are aware of parkland dedication requirements for your proposed development, we encourage you to familiarize yourself with the [staff report](#) and [recommended by-law](#) that were recommended for Council approval by [Planning Committee on July 7, 2022](#). For any questions or information, please contact the project lead at [Kersten.Nitsche@ottawa.ca](mailto:Kersten.Nitsche@ottawa.ca).

### **City Surveyor**

- The determination of property boundaries, minimum setbacks and other regulatory constraints are a critical component of development. An Ontario Land Surveyor (O.L.S.) needs to be consulted at the outset of a project to ensure properties are properly defined and can be used as the geospatial framework for the development.
- Topographic details may also be required for a project and should be either carried out by the O.L.S. that has provided the Legal Survey or done in consultation with the O.L.S. to ensure that the project is integrated to the appropriate control network.

Questions regarding the above requirements can be directed to the City's Surveyor, Bill Harper, at [Bill.Harper@ottawa.ca](mailto:Bill.Harper@ottawa.ca)

### **Forestry**

- a Tree Conservation Report (TCR) must be supplied for review along with the suite of other plans/reports required by the City
  - an approved TCR is a requirement of Site Plan approval.
  - The TCR may be combined with the LP provided all information is supplied
- Any removal of privately-owned trees 10cm or larger in diameter, or city-owned trees of any diameter requires a tree permit issued under the Tree Protection Bylaw (Bylaw 2020 – 340); the permit will be based on an approved TCR and made available at or near plan approval.
- The Planning Forester from Planning and Growth Management as well as foresters from Forestry Services will review the submitted TCR
  - If tree removal is required, both municipal and privately-owned trees will be addressed in a single permit issued through the Planning Forester
  - Compensation may be required for city owned trees – if so, it will need to be paid prior to the release of the tree permit
- The TCR must contain 2 separate plans:
  - Plan/Map 1 - show existing conditions with tree cover information
  - Plan/Map 2 - show proposed development with tree cover information
- Please ensure retained trees are shown on the landscape plan
- the TCR must list all trees on site, as well as off-site trees if the CRZ extends into the developed area, by species, diameter and health condition
- please identify trees by ownership – private onsite, private on adjoining site, city owned, co-owned (trees on a property line)
- If trees are to be removed, the TCR must clearly show where they are, and document the reason they cannot be retained
- All retained trees must be shown, and all retained trees within the area impacted by the development process must be protected as per City guidelines available at [Tree Protection Specification](#) or by searching Ottawa.ca
  - the location of tree protection fencing must be shown on the plan



- show the critical root zone of the retained trees
- the City encourages the retention of healthy trees; if possible, please seek opportunities for retention of trees that will contribute to the design/function of the site.
- For more information on the process or help with tree retention options, contact Mark Richardson [mark.richardson@ottawa.ca](mailto:mark.richardson@ottawa.ca) or on [City of Ottawa](http://City of Ottawa)

LP tree planting requirements:

For additional information on the following please contact [tracy.smith@Ottawa.ca](mailto:tracy.smith@Ottawa.ca)

- Minimum Setbacks
  - Maintain 1.5m from sidewalk or MUP/cycle track or water service laterals.
  - Maintain 2.5m from curb
  - Coniferous species require a minimum 4.5m setback from curb, sidewalk or MUP/cycle track/pathway.
  - Maintain 7.5m between large growing trees, and 4m between small growing trees. Park or open space planting should consider 10m spacing, except where otherwise approved in naturalization / afforestation areas. Adhere to Ottawa Hydro’s planting guidelines (species and setbacks) when planting around overhead primary conductors.
- Tree specifications
  - Minimum stock size: 50mm tree caliper for deciduous, 200cm height for coniferous.
  - Maximize the use of large deciduous species wherever possible to maximize future canopy coverage
  - Tree planting on city property shall be in accordance with the City of Ottawa’s Tree Planting Specification; and include watering and warranty as described in the specification (can be provided by Forestry Services).
  - Plant native trees whenever possible
  - No root barriers, dead-man anchor systems, or planters are permitted.
  - No tree stakes unless necessary (and only 1 on the prevailing winds side of the tree)
- Hard surface planting
  - Curb style planter is highly recommended
  - No grates are to be used and if guards are required, City of Ottawa standard (which can be provided) shall be used.
  - Trees are to be planted at grade

○ Soil Volume

- Please document on the LP that adequate soil volumes can be met:

Tree Type/Size	Single Tree Soil Volume (m3)	Multiple Tree Soil Volume (m3/tree)
Ornamental	15	9
Columnar	15	9
Small	20	12
Medium	25	15
Large	30	18
Conifer	25	15

- Please note that these soil volumes are not applicable in cases with Sensitive Marine Clay.
- Sensitive Marine Clay
  - Please follow the City’s 2017 Tree Planting in Sensitive Marine Clay guidelines

## Tree Canopy Cover

- The landscape plan shall show how the proposed tree planting will replace and increase canopy cover on the site over time, to support the City's 40% urban forest canopy cover target.
- At a site level, efforts shall be made to provide as much canopy cover as possible, through tree planting and tree retention, with an aim of 40% canopy cover at 40 years, as appropriate.
- Indicate on the plan the projected future canopy cover at 40 years for the site.

## **Other**

- Plans are to be standard A1 size (594 mm x 841 mm) or Arch D size (609.6 mm x 914.4 mm) sheets, dimensioned in metric and utilizing an appropriate Metric scale (1:200, 1:250, 1:300, 1:400 or 1:500).
- All PDF submitted documents are to be unlocked and flattened.
- You are encouraged to contact the Ward Councillor, Councillor R. Brockington, at [Riley.brockington@ottawa.ca](mailto:Riley.brockington@ottawa.ca) about the proposal. You may also consider contacting the Carlington Community Association.
- You are encouraged to reach out to the Rideau Valley Conservation Authority.

Please refer to the links to [Guide to preparing studies and plans](#) and [fees](#) for further information. Additional information is available related to [building permits](#), [development charges](#), and the [Accessibility Design Standards](#). Be aware that other fees and permits may be required, outside of the development review process. You may obtain background drawings by contacting [geoinformation@ottawa.ca](mailto:geoinformation@ottawa.ca).

It is anticipated that, as a result of the *More Homes for Everyone Act, 2022*, for applications for site plan approval and zoning by-law amendments, new processes in respect of pre-application consultation will be in place as of January 1, 2023. The new processes are anticipated to require a multiple phase pre-application consultation approach before an application will be deemed complete. Applicants who have not filed a complete application by the effective date may be required to undertake further pre-application consultation(s) consistent with the provincial changes. The by-laws to be amended include By-law 2009-320, the Pre-Consultation By-law, By-law 2022-239, the planning fees by-law and By-law 2022-254, the Information and Materials for Planning Application By-law. The revisions are anticipated to be before Council in the period after the new Council takes office and the end of the year.

These pre-con comments are valid for one year. If you submit a development application(s) after this time, you may be required to meet for another pre-consultation meeting and/or the submission requirements may change. You are as well encouraged to contact us for a follow-up meeting if the plan/concept will be further refined.

Please do not hesitate to contact me if you have any questions.

Regards,

**Craig Hamilton**

**Planner I | *Urbaniste I***

Development Review, Central | *Examen des projets d'aménagement, Central*

Planning, Real Estate and Economic Development Department | Services de la planification, des biens immobiliers et du développement économique

City of Ottawa | *Ville d'Ottawa*

110 Laurier Avenue West. Ottawa, ON | *110, avenue. Laurier Ouest. Ottawa (Ontario) K1P 1J1*

☎ 613.580.2424 ext./poste 23502

[ottawa.ca/planning/](http://ottawa.ca/planning/) / [ottawa.ca/urbanisme](http://ottawa.ca/urbanisme)

This e-mail originates from the City of Ottawa e-mail system. Any distribution, use or copying of this e-mail or the information it contains by other than the intended recipient(s) is unauthorized. Thank you.

Le présent courriel a été expédié par le système de courriels de la Ville d'Ottawa. Toute distribution, utilisation ou reproduction du courriel ou des renseignements qui s'y trouvent par une personne autre que son destinataire prévu est interdite. Je vous remercie de votre collaboration.

# MEMO

Date:

To /  
Destinataire Craig Hamilton, Planner

From /  
Expéditeur Bruce Bramah, Project Manager, Infrastructure  
Approvals

**Pre-Application Consultation**  
**864 Lady Ellen Place, Ward #16**

File No. PC2022-0240

Subject /  
Objet \_\_\_\_\_,  
*Two new storage warehouses are proposed to  
be constructed that are one-storey and 4-  
storeys in height.*

Please note the following information regarding the engineering design submission for the above noted site:

- The original storm sewer within the easement was installed in 1959; no design sheet can be found for this. When the sewer was rehabilitated in 2012, there was no design sheet prepared..
- 1. The Servicing Study Guidelines for Development Applications are available at the following address: <https://ottawa.ca/en/planning-development-and-construction/developing-property/development-application-review-process/development-application-submission/guide-preparing-studies-and-plans#servicing-study-guidelines-development-applications>
- 2. Servicing and site works shall be in accordance with the following documents:
  - ⇒ Ottawa Sewer Design Guidelines (October 2012)
  - ⇒ Ottawa Design Guidelines – Water Distribution (2010)
  - ⇒ Geotechnical Investigation and Reporting Guidelines for Development Applications in the City of Ottawa (2007)
  - ⇒ City of Ottawa Slope Stability Guidelines for Development Applications (revised 2012)
  - ⇒ City of Ottawa Environmental Noise Control Guidelines (January, 2016)

- ⇒ City of Ottawa Park and Pathway Development Manual (2012)
  - ⇒ City of Ottawa Accessibility Design Standards (2012)
  - ⇒ Ottawa Standard Tender Documents (latest version)
  - ⇒ Ontario Provincial Standards for Roads & Public Works (2013)
3. Record drawings and utility plans are also available for purchase from the City (Contact the City's Information Centre by email at [InformationCentre@ottawa.ca](mailto:InformationCentre@ottawa.ca) or by phone at (613) 580-2424 x.44455).
4. The Stormwater Management Criteria, for the subject site, is to be based on the following:
- TSS requirements from the RVCA are pending at this time. Please contact the RVCA and provide the correspondence in the design brief.
  - i. The 2-yr storm event using the IDF information derived from the Meteorological Services of Canada rainfall data, taken from the MacDonald Cartier Airport, collected 1966 to 1997.
  - ii. The pre-development runoff coefficient or a maximum equivalent 'C' of 0.5, whichever is less (§ 8.3.7.3).
  - iii. A calculated time of concentration (Cannot be less than 10 minutes).
  - iv. Flows to the storm sewer in excess of the 2-year pre development storm release rate, up to and including the 100-year post development storm event, must be detained on site.
- Note: There may be area specific SWM Criteria that may apply. Check for any related SWM &/or Sub-watershed studies that may have been completed.
5. Deep Services (Storm, Sanitary & Water Supply)
- i. *Provide information on the monitoring manhole requirements – should be located in an accessible location on private property and outside of the easement (ie. Not in a parking area).*
  - ii. *Review provision of a high-level sewer.*
  - iii. *Provide information on the type of connection permitted*

Sewer connections to be made above the springline of the sewermain as per:

- a. Std Dwg S11.1 for flexible main sewers – *connections made using approved tee or wye fittings.*
  - b. Std Dwg S11 (For rigid main sewers) – *lateral must be less than 50% the diameter of the sewermain,*
  - c. Std Dwg S11.2 (for rigid main sewers using bell end insert method) – *for larger diameter laterals where manufactured inserts are not available; lateral must be less than 50% the diameter of the sewermain,*
  - d. Connections to manholes permitted when the connection is to rigid main sewers where the lateral exceeds 50% the diameter of the sewermain. – Connect obvert to obvert with the outlet pipe unless pipes are a similar size.
  - e. *No submerged outlet connections.*
6. Water Boundary condition requests must include the location of the service and the expected loads required by the proposed development. Please provide the following information:
- i. Location of service
  - ii. Type of development and the amount of fire flow required (as per FUS, 2020).
  - iii. Average daily demand: \_\_\_ l/s.
  - iv. Maximum daily demand: \_\_\_ l/s.
  - v. Maximum hourly daily demand: \_\_\_ l/s.
7. MECP ECA Requirements

An MECP Environmental Compliance Approval (Input Application Type - Industrial Sewage Works or Municipal/Private Sewage Works) may be required for the proposed development based on the industrial zoning and multiple parcels of land. Please contact Ontario Ministry of the Environment and Climate Change, Ottawa District Office to arrange a pre-submission consultation:

For I/C/I applications: Emily Diamond  
 (613) 521-3450, ext. 238

[Emily.Diamond@ontario.ca](mailto:Emily.Diamond@ontario.ca)

8. Phase 1 ESAs and Phase 2 ESAs must conform to clause 4.8.4 of the Official Plan that requires that development applications conform to Ontario Regulation 153/04.

9. Submission Requirements

– SITE PLAN APPLICATION – Municipal servicing

Legend:

The letter **S** indicates that the study or plan is required with application submission.

The letter **M** indicates that the study or plan may be required with application submission.

For information on preparing required studies and plans refer to:

<http://ottawa.ca/en/development-application-review-process-0/guide-preparing-studies-and-plans>

S/A	Number of copies	ENGINEERING		S/A	Number of copies
<b>S</b>	1	1. Site Servicing Plan	2. Assessment of Adequacy of Public Services / Site Servicing Study / Brief	<b>S</b>	1
<b>S</b>	1	3. Grade Control and Drainage Plan	4. Geotechnical Study / Slope Stability Study	<b>S</b>	1
	1	5. Composite Utility Plan	6. Groundwater Impact Study		1
	1	7. Servicing Options Report	8. Wellhead Protection Study		1
	1	9. Community Transportation Study and/or Transportation Impact Study / Brief	10. Erosion and Sediment Control Plan / Brief	<b>S</b>	1
<b>S</b>	1	11. Storm water Management Report / Brief	12. Hydro-geological and Terrain Analysis		1
<b>M</b>	1	13. Water main Analysis	14. Noise / Vibration Study		1
	1	15. Roadway Modification Design Plan	16. Confederation Line Proximity Study		1

Should you have any questions or require additional information, please contact me directly at (613) 580-2424, ext. 29686 or by email at [Bruce.Bramah@ottawa.ca](mailto:Bruce.Bramah@ottawa.ca).

## Yang, Winston

---

**From:** Jadallah, Ayham  
**Sent:** November 17, 2022 8:54 AM  
**To:** Yang, Winston  
**Cc:** Follett, Chris  
**Subject:** FW: 864 Lady Ellen Place: Emergency Overland Flow Outlet

FYI,

Thanks,

**Ayham Jadallah**, P.Eng, M.Eng  
Project Engineer



T+ 1 604-904-4660

---

**From:** Bramah, Bruce <bruce.bramah@ottawa.ca>  
**Sent:** Thursday, November 17, 2022 8:50 AM  
**To:** Jadallah, Ayham <Ayham.Jadallah@wsp.com>  
**Cc:** Hamilton, Craig <craig.hamilton@ottawa.ca>  
**Subject:** RE: 864 Lady Ellen Place: Emergency Overland Flow Outlet

Hi Ayham,

The intent is not to account for these flow in your SWM design, but to make sure it can safely cross the post development property. The image below shows the 24 ha drainage area coming from the west (location A). The drainage area from the South meeting at location B is 2.8 ha. This should be enough to come up with a rough idea of the peak overland flow.

Craig will be sending out all my engineering comments shortly. The quantity control shall be controlled to the 2 year pre development.



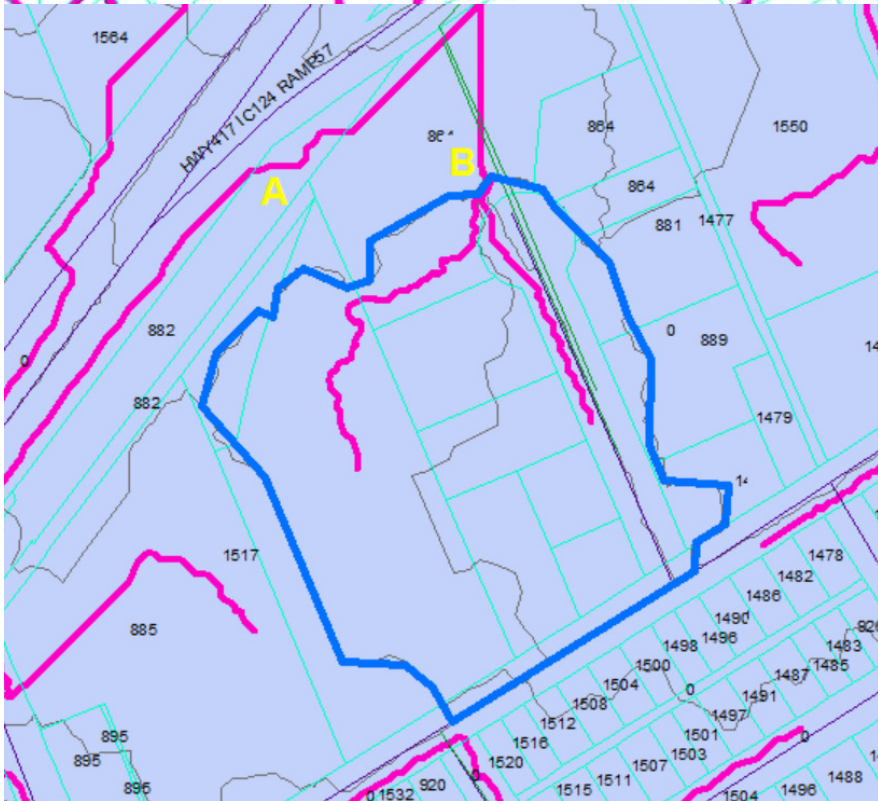
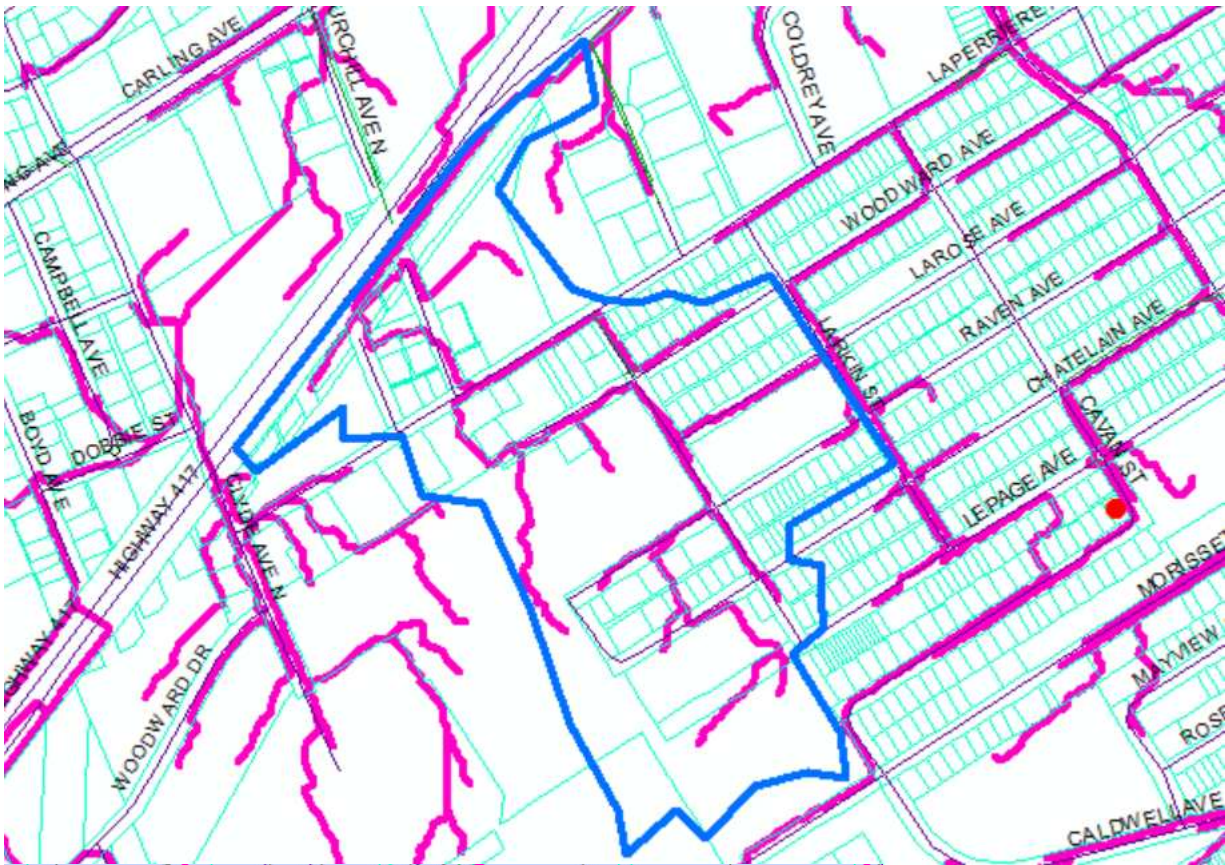

Thank you,

--

**Bruce Bramah, EIT**

Project Manager

Planning, Real Estate and Economic Development Department / Direction générale de la planification, des biens immobiliers et du développement économique

Development Review - South Branch  
City of Ottawa | Ville d'Ottawa  
110 Laurier Avenue West Ottawa, ON | 110, avenue. Laurier Ouest. Ottawa (Ontario) K1P 1J1  
613.580.2424 ext./poste 29686, [Bruce.Bramah@ottawa.ca](mailto:Bruce.Bramah@ottawa.ca)

---

**From:** Jadallah, Ayham <[Ayham.Jadallah@wsp.com](mailto:Ayham.Jadallah@wsp.com)>  
**Sent:** November 15, 2022 9:13 AM  
**To:** Bramah, Bruce <[bruce.bramah@ottawa.ca](mailto:bruce.bramah@ottawa.ca)>  
**Subject:** FW: 864 Lady Ellen Place: Emergency Overland Flow Outlet

**CAUTION: This email originated from an External Sender. Please do not click links or open attachments unless you recognize the source.**

**ATTENTION : Ce courriel provient d'un expéditeur externe. Ne cliquez sur aucun lien et n'ouvrez pas de pièce jointe, excepté si vous connaissez l'expéditeur.**

Hi Bruce,

Just a kind reminder about the below request.

Thanks,

**Ayham Jadallah**, P.Eng, M.Eng  
Project Engineer



T+ 1 604-904-4660

---

**From:** Jadallah, Ayham  
**Sent:** Thursday, November 10, 2022 3:44 PM  
**To:** Bramah, Bruce <[bruce.bramah@ottawa.ca](mailto:bruce.bramah@ottawa.ca)>  
**Cc:** MacDonald, Jill <[Jill.MacDonald@wsp.com](mailto:Jill.MacDonald@wsp.com)>; De Santi, Nadia <[Nadia.De-Santi@wsp.com](mailto:Nadia.De-Santi@wsp.com)>; Follett, Chris <[Chris.Follett@wsp.com](mailto:Chris.Follett@wsp.com)>; Hamilton, Craig <[craig.hamilton@ottawa.ca](mailto:craig.hamilton@ottawa.ca)>; Yang, Winston <[Winston.Yang@wsp.com](mailto:Winston.Yang@wsp.com)>; Hind Barnieh <[hbarnieh@accesspd.ca](mailto:hbarnieh@accesspd.ca)>; Elisabeth Gebremedhin <[egebremedhin@accesspd.ca](mailto:egebremedhin@accesspd.ca)>  
**Subject:** RE: 864 Lady Ellen Place: Emergency Overland Flow Outlet

Hi Bruce,

Per the City's requirements, the contributing upstream parcels have to be considered in the SWM model, but the required datasets to carry out the study are not available, therefore can you provide the following requirements;

- Required study boundary
- Stormwater drainage As-Builts (shapefiles)
- Elevation data (contour or lidar) for the entire study area

Also can you please confirm that quantity control target is 100-yr to 2yr Pre-Development.

Thanks,

**Ayham Jadallah**, P.Eng, M.Eng  
Project Engineer



D+ 1 604-904-4660

---

**From:** Bramah, Bruce <[bruce.bramah@ottawa.ca](mailto:bruce.bramah@ottawa.ca)>  
**Sent:** Thursday, November 10, 2022 9:14 AM  
**To:** Yang, Winston <[Winston.Yang@wsp.com](mailto:Winston.Yang@wsp.com)>  
**Cc:** MacDonald, Jill <[Jill.MacDonald@wsp.com](mailto:Jill.MacDonald@wsp.com)>; De Santi, Nadia <[Nadia.De-Santi@wsp.com](mailto:Nadia.De-Santi@wsp.com)>; Follett, Chris <[Chris.Follett@wsp.com](mailto:Chris.Follett@wsp.com)>; Jadallah, Ayham <[Ayham.Jadallah@wsp.com](mailto:Ayham.Jadallah@wsp.com)>; Hamilton, Craig <[craig.hamilton@ottawa.ca](mailto:craig.hamilton@ottawa.ca)>; Hind Barnieh <[hbarnieh@accesspd.ca](mailto:hbarnieh@accesspd.ca)>; Elisabeth Gebremedhin <[egebremedhin@accesspd.ca](mailto:egebremedhin@accesspd.ca)>  
**Subject:** RE: 864 Lady Ellen Place: Emergency Overland Flow Outlet

Hi Winston,  
The SWM strategy for this site should be for the entirety of the development area. The minor system should be designed with the use of surface storage only. The major system flows from upstream parcels will either drain through the minor system of the proposed site or will overland flow through the site to the northeast corner. The additional flows from adjacent properties do not need to be controlled.

Upon further review of the receiving storm sewers, this site will be controlled to the 2-year pre-development. All the engineering comments will be provided shortly to Craig.

If you have any further questions, I would be happy to set up a team's meeting or phone call to discuss next week.

Thank you,

**Bruce Bramah, EIT**

Project Manager

Planning, Real Estate and Economic Development Department / Direction générale de la planification, des biens immobiliers et du développement économique

Development Review - South Branch

City of Ottawa | Ville d'Ottawa

110 Laurier Avenue West Ottawa, ON | 110, avenue. Laurier Ouest. Ottawa (Ontario) K1P 1J1

613.580.2424 ext./poste 29686, [Bruce.Bramah@ottawa.ca](mailto:Bruce.Bramah@ottawa.ca)

---

**From:** Yang, Winston <[Winston.Yang@wsp.com](mailto:Winston.Yang@wsp.com)>  
**Sent:** November 09, 2022 9:54 AM  
**To:** Bramah, Bruce <[bruce.bramah@ottawa.ca](mailto:bruce.bramah@ottawa.ca)>  
**Cc:** MacDonald, Jill <[Jill.MacDonald@wsp.com](mailto:Jill.MacDonald@wsp.com)>; De Santi, Nadia <[nadia.de-santi@wsp.com](mailto:nadia.de-santi@wsp.com)>; Follett, Chris <[Chris.Follett@wsp.com](mailto:Chris.Follett@wsp.com)>; Jadallah, Ayham <[Ayham.Jadallah@wsp.com](mailto:Ayham.Jadallah@wsp.com)>; Hamilton, Craig <[craig.hamilton@ottawa.ca](mailto:craig.hamilton@ottawa.ca)>; Hind Barnieh <[hbarnieh@accesspd.ca](mailto:hbarnieh@accesspd.ca)>; Elisabeth Gebremedhin <[egebremedhin@accesspd.ca](mailto:egebremedhin@accesspd.ca)>  
**Subject:** RE: 864 Lady Ellen Place: Emergency Overland Flow Outlet  
**Importance:** High

**CAUTION: This email originated from an External Sender. Please do not click links or open attachments unless you recognize the source.**

**ATTENTION : Ce courriel provient d'un expéditeur externe. Ne cliquez sur aucun lien et n'ouvrez pas de pièce jointe, excepté si vous connaissez l'expéditeur.**

Thanks Bruce,

And I still have some concern regarding the SWM strategy for this site.

Since the subjected site is used as the overland flow route to convey the external surface runoff from upstream in multiple directions, Can the SWM study areas be limited to the highlighted in Cyan? Roof storage will be provided.

First, for SWM purpose, it is not feasible for the owner to over control external runoff that drains into the subjected site. The typical pre to post, control post 100 year to pre 5 year is not feasible for the entire site since the external runoff could not be by-passed.

The proposed parking lot and driving aisle will be used and maintained as the overland flow runway for the proposed and existing developments. It is not possible to separate the drainages that go down into the same sewer like existing.

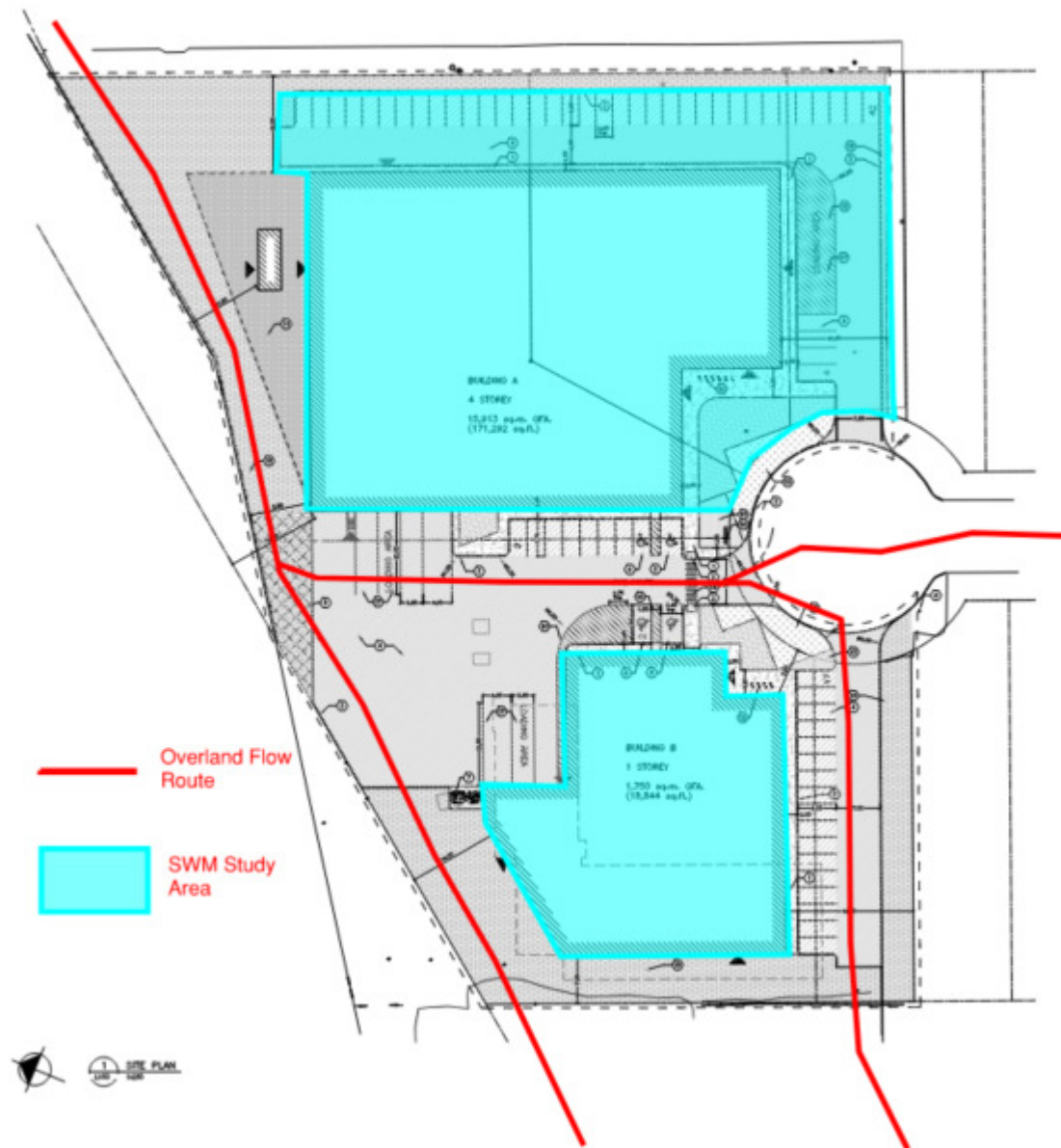

Please take a look and feel free to confirm/comment the SWM study limit and strategy for this site.

Yours truly,

**Ding Bang (Winston) Yang, P.Eng., PMP**  
Senior Civil Engineer  
Infrastructure / Land Development & Municipal Engineering  
Ottawa



T+ 1 613-690-0538  
M+ 1 647-628-8108

WSP Canada Inc.  
2611 Queensview Drive, Suite 300  
Ottawa, Ontario,  
K2B 8K2 Canada

[wsp.com](http://wsp.com)

**From:** Bramah, Bruce <[bruce.bramah@ottawa.ca](mailto:bruce.bramah@ottawa.ca)>  
**Sent:** November 8, 2022 3:42 PM  
**To:** Yang, Winston <[Winston.Yang@wsp.com](mailto:Winston.Yang@wsp.com)>  
**Cc:** MacDonald, Jill <[Jill.MacDonald@wsp.com](mailto:Jill.MacDonald@wsp.com)>; De Santi, Nadia <[Nadia.De-Santi@wsp.com](mailto:Nadia.De-Santi@wsp.com)>; Follett, Chris <[Chris.Follett@wsp.com](mailto:Chris.Follett@wsp.com)>; Jadallah, Ayham <[Ayham.Jadallah@wsp.com](mailto:Ayham.Jadallah@wsp.com)>; Hamilton, Craig <[craig.hamilton@ottawa.ca](mailto:craig.hamilton@ottawa.ca)>; Hind Barnieh <[hbarnieh@accesspd.ca](mailto:hbarnieh@accesspd.ca)>; Elisabeth Gebremedhin <[egbremedhin@accesspd.ca](mailto:egbremedhin@accesspd.ca)>  
**Subject:** RE: 864 Lady Ellen Place: Emergency Overland Flow Outlet

Hi Winston,

I have brought this site up to our surface drainage group last week. The overland flow for the proposed development should match the existing condition which ultimately drains to the north east corner of the site. Please see the yellow below:



The MTO will be circulated upon submission to provide any comments, however, no concerns arose from the MTO circulation from the recently cancelled SPA for this site.

I am still waiting to hear back from our Infrastructure group regarding any future improvements to sewers within the existing easement. All my comments will be in the follow up email from Craig. If you have any further questions in the meantime, please feel free to reach out and we can set up a team meeting.

Thank you,

**Bruce Bramah, EIT**

Project Manager

Planning, Real Estate and Economic Development Department / Direction générale de la planification, des biens immobiliers et du développement économique

Development Review - South Branch

City of Ottawa | Ville d'Ottawa

110 Laurier Avenue West Ottawa, ON | 110, avenue. Laurier Ouest. Ottawa (Ontario) K1P 1J1

613.580.2424 ext./poste 29686, [Bruce.Bramah@ottawa.ca](mailto:Bruce.Bramah@ottawa.ca)

---

**From:** Yang, Winston <[Winston.Yang@wsp.com](mailto:Winston.Yang@wsp.com)>

**Sent:** November 08, 2022 11:48 AM

**To:** Bramah, Bruce <[bruce.bramah@ottawa.ca](mailto:bruce.bramah@ottawa.ca)>

**Cc:** MacDonald, Jill <[Jill.MacDonald@wsp.com](mailto:Jill.MacDonald@wsp.com)>; De Santi, Nadia <[nadia.de-santi@wsp.com](mailto:nadia.de-santi@wsp.com)>; Follett, Chris <[Chris.Follett@wsp.com](mailto:Chris.Follett@wsp.com)>; Jadallah, Ayham <[Ayham.Jadallah@wsp.com](mailto:Ayham.Jadallah@wsp.com)>; Hamilton, Craig <[craig.hamilton@ottawa.ca](mailto:craig.hamilton@ottawa.ca)>;

Hind Barnieh <[hbarnieh@accesspd.ca](mailto:hbarnieh@accesspd.ca)>; Elisabeth Gebremedhin <[egebremedhin@accesspd.ca](mailto:egebremedhin@accesspd.ca)>

**Subject:** RE: 864 Lady Ellen Place: Emergency Overland Flow Outlet

**Importance:** High

**CAUTION: This email originated from an External Sender. Please do not click links or open attachments unless you recognize the source.**

**ATTENTION : Ce courriel provient d'un expéditeur externe. Ne cliquez sur aucun lien et n'ouvrez pas de pièce jointe, excepté si vous connaissez l'expéditeur.**

Hi Bruce,

I would like to follow up with you regarding the emergency overland flow outlet for 864 Lady Ellen Place.

I was on site yesterday try to locate the overland flow drainage outlet. But I could not see any ditches or drainage culvert next to the north boundary adjacent to HWY 417.

And it seems like this site was built the way it is since the 60s while I am looking at the historical aerial image.

Base on the info from the survey and site observation, the overland flow from the upstream parcels will run down to the subjected site and be forced down to the minor system.

See below sketch for your reference. A site photo looking north from the Cul-de-sac is also attached for your reference.

Can you confirm or provide the emergency overland flow outlet for the subjected site? The missing emergency overland flow outlet for this site results in consequential impacts for the new development and existing developments upstream.

If you would like to discuss this issue and schedule a conference meeting, please do not hesitate to contact me.

Yours truly,



← OVERLAND FLOW



**Ding Bang (Winston) Yang, P.Eng., PMP**

Senior Civil Engineer  
Infrastructure / Land Development & Municipal Engineering  
Ottawa

T+ 1 613-690-0538  
M+ 1 647-628-8108

WSP Canada Inc.  
2611 Queensview Drive, Suite 300  
Ottawa, Ontario,  
K2B 8K2 Canada

[wsp.com](http://wsp.com)

NOTICE: This communication and any attachments ("this message") may contain information which is privileged, confidential, proprietary or otherwise subject to restricted disclosure under applicable law. This message is for the sole use of the intended recipient(s). Any unauthorized use, disclosure, viewing, copying, alteration, dissemination or distribution of, or reliance on, this message is strictly prohibited. If you have received this message in error, or you are not an authorized or intended recipient, please notify the sender immediately by replying to this message, delete this message and all copies from your e-mail system and destroy any printed copies. You are receiving this communication because you are listed as a current WSP contact. Should you have any questions regarding WSP's electronic communications policy, please consult our Anti-Spam Commitment at [www.wsp.com/cas/](http://www.wsp.com/cas/). For any concern or if you believe you should not be receiving this message, please forward this message to [caslcompliance@wsp.com](mailto:caslcompliance@wsp.com) so that we can promptly address your request. Note that not all messages sent by WSP qualify as commercial electronic messages.

AVIS : Ce message, incluant tout fichier l'accompagnant (« le message »), peut contenir des renseignements ou de l'information privilégiés, confidentiels, propriétaires ou à divulgation restreinte en vertu de la loi. Ce message est destiné à l'usage exclusif du/des destinataire(s) voulu(s). Toute utilisation non permise, divulgation, lecture, reproduction, modification, diffusion ou distribution est interdite. Si vous avez reçu ce message par erreur, ou que vous n'êtes pas un destinataire autorisé ou voulu, veuillez en aviser l'expéditeur immédiatement et détruire le message et toute copie électronique ou imprimée. Vous recevez cette communication car vous faites partie des contacts de WSP. Si vous avez des questions concernant la politique de communications électroniques de WSP, veuillez consulter notre Engagement anti-pourriel au [www.wsp.com/lcap](http://www.wsp.com/lcap). Pour toute question ou si vous croyez que vous ne devriez pas recevoir ce message, prière de le transférer au [conformitelcap@wsp.com](mailto:conformitelcap@wsp.com) afin que nous puissions rapidement traiter votre demande. Notez que ce ne sont pas tous les messages transmis par WSP qui constituent des messages électroniques commerciaux.

LAEmI-hhHzdJzBITWfa4Hgs7pbKl

This e-mail originates from the City of Ottawa e-mail system. Any distribution, use or copying of this e-mail or the information it contains by other than the intended recipient(s) is unauthorized. Thank you.

Le présent courriel a été expédié par le système de courriels de la Ville d'Ottawa. Toute distribution, utilisation ou reproduction du courriel ou des renseignements qui s'y trouvent par une personne autre que son destinataire prévu est interdite. Je vous remercie de votre collaboration.

This e-mail originates from the City of Ottawa e-mail system. Any distribution, use or copying of this e-mail or the information it contains by other than the intended recipient(s) is unauthorized. Thank you.

Le présent courriel a été expédié par le système de courriels de la Ville d'Ottawa. Toute distribution, utilisation ou reproduction du courriel ou des renseignements qui s'y trouvent par une personne autre que son destinataire prévu est interdite. Je vous remercie de votre collaboration.

This e-mail originates from the City of Ottawa e-mail system. Any distribution, use or copying of this e-mail or the information it contains by other than the intended recipient(s) is unauthorized. Thank you.

Le présent courriel a été expédié par le système de courriels de la Ville d'Ottawa. Toute distribution, utilisation ou reproduction du courriel ou des renseignements qui s'y trouvent par une personne autre que son destinataire prévu est interdite. Je vous remercie de votre collaboration.





**METRIC**

ALL DIMENSIONS SHOWN ARE IN METRES AND/OR MILLIMETRES UNLESS OTHERWISE NOTED.

**LEGEND:**

⊕	DENOTES ANCHOR
⊞	DENOTES CATCH BASIN
⊞	DENOTES CATCH BASIN SIDE INLET
⊞	DENOTES CONFEROUS TREE
⊞	DENOTES DECIDUOUS TREE
⊞	DENOTES ELECTRICAL PLUG
⊞	DENOTES FIRE HYDRANT
⊞	DENOTES FLAG POLE
⊞	DENOTES GATE
⊞	DENOTES LIGHT STANDARD
⊞	DENOTES MANHOLE-SANITARY
⊞	DENOTES MANHOLE-STORM
⊞	DENOTES MANHOLE-WATER
⊞	DENOTES MONITORING WELL
⊞	DENOTES SIGN
⊞	DENOTES UTILITY POLE
⊞	DENOTES WATER VALVE
---	DENOTES BOTTOM OF SLOPE
---	DENOTES CENTER LINE OF BENCH
---	DENOTES EDGE OF VEGETATION
---	DENOTES FENCE
---	DENOTES GUARDRAIL
---	DENOTES MAJOR CONTOUR
---	DENOTES MINOR CONTOUR
---	DENOTES OVERHEAD CABLE
---	DENOTES TOP OF SLOPE
---	DENOTES UNDERGROUND_BELL
---	DENOTES UNDERGROUND_GAS_SERVICE
---	DENOTES UNDERGROUND_HYDRO
---	DENOTES UNDERGROUND_SANITARY_SEWER
---	DENOTES UNDERGROUND_STORM_SEWER
---	DENOTES UNDERGROUND_WATERMAIN

- NOTES:**
1. PROJECTION IS 3° MTM ZONE 9 (CENTRAL MERIDIAN 76°30' WEST LONGITUDE).
  2. COORDINATES SHOWN ON THIS PLAN ARE GRID AND ARE REFERRED TO NAD83 (CSRS 2011) DATUM.
  3. ELEVATIONS ARE ORTHOMETRIC AND ARE REFERRED TO THE CGVD-1928/78 VERTICAL DATUM, BEING DERIVED FROM THE VERTICAL BENCHMARK 001196530217, HAVING A PUBLISHED ELEVATION OF 85.001m.
  4. THE COMBINED SCALE FACTOR FOR THE AREA COVERED BY THIS PLAN IS 0.999952291.
  5. CONTOUR INTERVAL: MAJOR 1.00m, MINOR 0.25m.
  6. THIS PLAN REPRESENTS THE BEST INFORMATION AVAILABLE AT THE TIME OF SURVEY. GEOVERRA AND ITS EMPLOYEES TAKE NO RESPONSIBILITY FOR THE LOCATION OF ANY UNDERGROUND PIPES, CONDUITS, CABLES OR FACILITIES, WHETHER SHOWN ON OR OMITTED FROM THIS PLAN.
  7. DATE OF SURVEY: 2022/04/27 & 2022/05/13

REVISIONS				
REV	DATE	DESCRIPTION	PC	CHK
1	22/05/20	ADDITIONAL SURVEY	A.U.	M.J. A.P.
0	22/05/03	ORIGINAL ISSUE	J.S.	M.J. A.P.

SCALE: 1:200 FULL SIZE ONLY

**TOPOGRAPHIC PLAN OF**  
864 LADY ELLEN PLACE  
OTTAWA, ONTARIO

JOB NO.:	22-01473-000	DWG. NO.:	22-01473-000-TOPO-R	REV.:	1	SHT.:	1
GeoVerra Mississauga (416) 905-8887 www.geoverra.com		GeoVerra Mississauga (416) 905-8887 www.geoverra.com		GeoVerra Mississauga (416) 905-8887 www.geoverra.com			

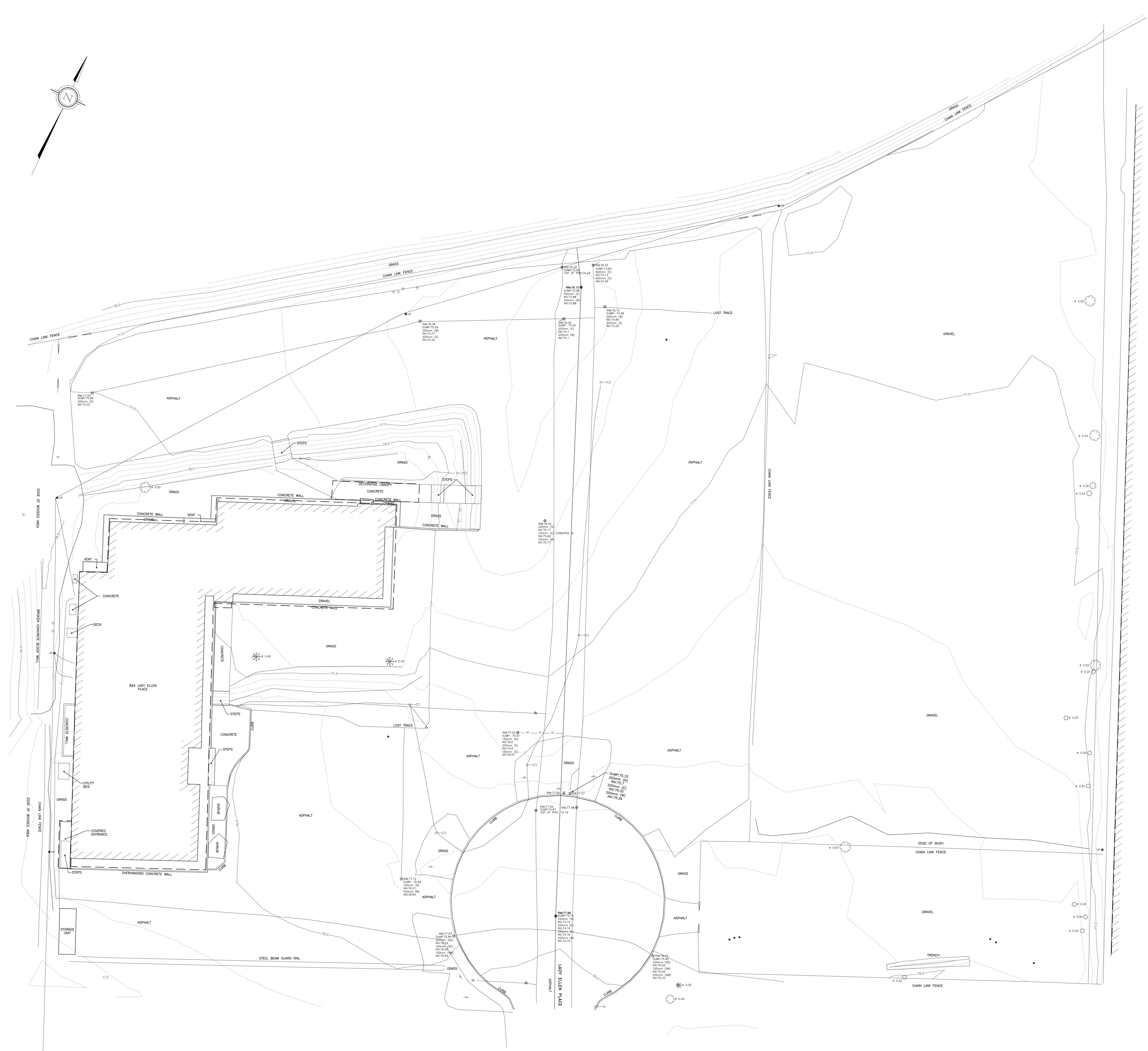

2025/05/13 11:20 AM C:\Users\jmorris\OneDrive\Documents\22-01473-000-TOPO-R (1).dwg

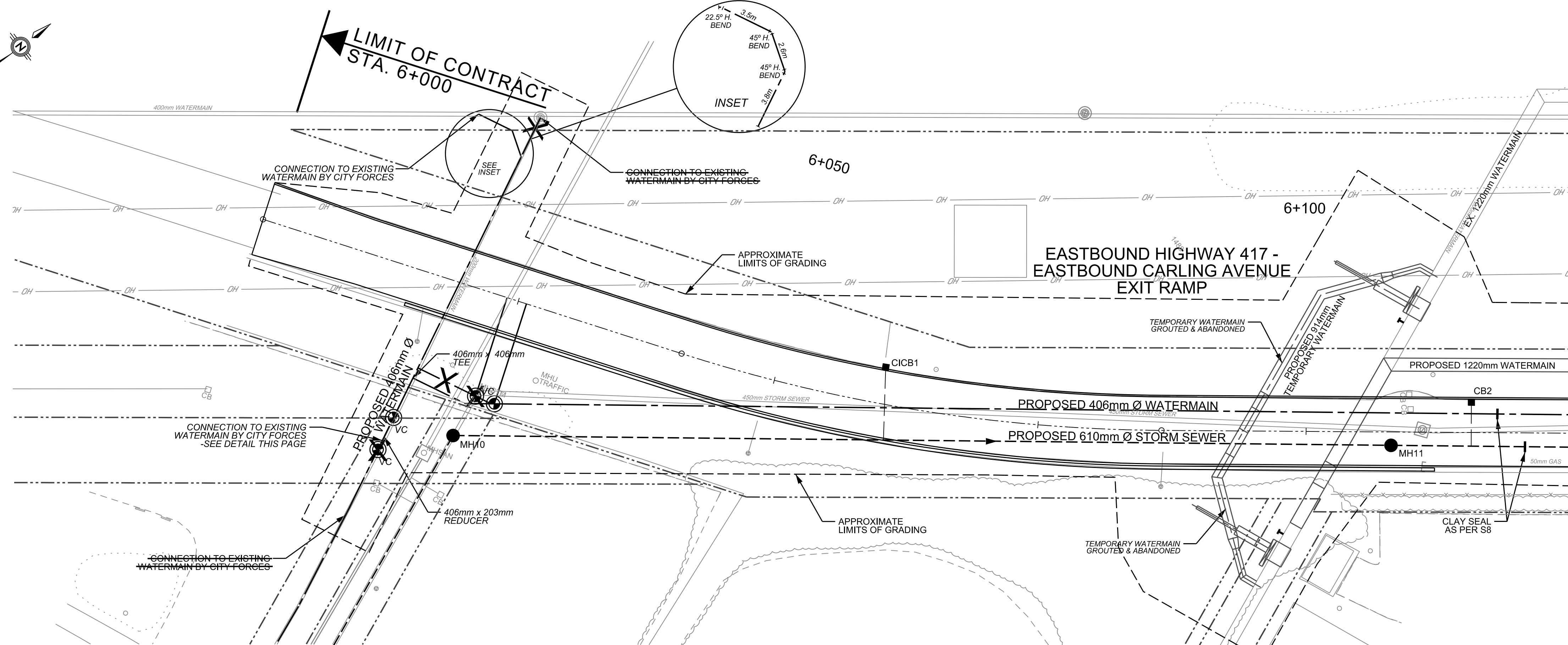
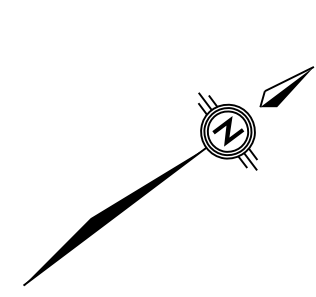

**CARLING AVENUE AND MERIVALE ROAD RECONSTRUCTION**

**GRADING & DRAINAGE EASTBOUND HIGHWAY 417 - EASTBOUND CARLING AVENUE STA. 6+000 TO STA. 6+125**

Contract No. **ISD10-5116** | Draw. No. **031**

Asset No. - | Asset Group: -

Des: RG | Chk'd: DEPI/GB  
Dwn: RV | Chk'd: DEPI/GB  
Utility Circ. No.: - | Index No.: -  
Const. Inspector: -

**AS-BUILT**

RECORD INFORMATION PROVIDED BY CITY OF OTTAWA

ALL NUMERICAL VALUES THAT ARE NOT STROKED OUT AND REPLACED IN ITALICS ON AS-BUILT DRAWINGS ARE CONSIDERED TO BE DESIGN VALUES ONLY AND NOT MEASURED IN THE FIELD.

NOTE: The location of utilities is approximate only, the exact location should be determined by consulting the municipal authorities and utility companies concerned. The contractor shall prove the location of utilities and shall be responsible for adequate protection from damage.

Scale: HORIZONTAL 1:2.5  
VERTICAL 1:1

**Robinson Consultants**

No.	Description	By	Date
1	ISSUED FOR CIRCULATION	K.L.	27.08.10
2	ISSUED FOR FINAL CIRCULATION	G.B.	30.11.10
3	ISSUED FOR TENDER	K.L.	17.12.10
4	ISSUED FOR CONSTRUCTION	K.L.	18.03.11
5	AS BUILT	P.L.	14.12.12

MATCHLINE STA. 6+125 FOR CONTINUATION SEE DWG. 032

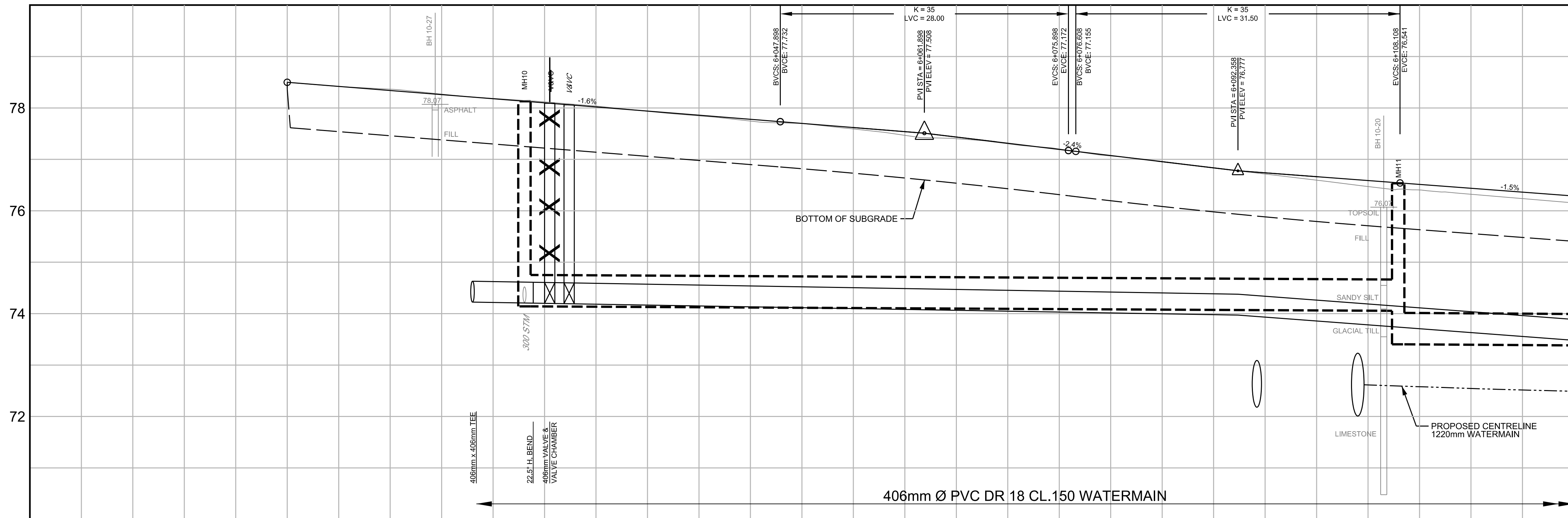

No.	Station	Offset (m)	Type	Grate	Structure	Elevations	Grate to Invert
CIB1	6+060	3.12 L	S22 / S23	S19	705.010	77.49 / 75.64	1.85
CB2	6+115.4	2.83 L	S19	S19	705.010	76.43 / 74.73	1.70

Structure to Structure	Dia.	Type	Length	Invert Elevations	
				Upstream	Downstream
CIB1 TO MAIN	200	PVC	6.8	75.64	74.51
CB2 TO MAIN	200	PVC	3.9	74.73	73.79

No.	Station	Offset (m)	Type	Cover	Elevations	Grate to Invert
MH10	6+024.0	9.34 R	S24.1 / S25	S24.1 / S25	76.90 / 74.14	2.76
MH11	6+107.9	1.25 R	S24.1 / S25	S24.1 / S25	76.559 / 73.404	3.16

400mm WATERMAIN DETAIL @ STA. 6+025.799

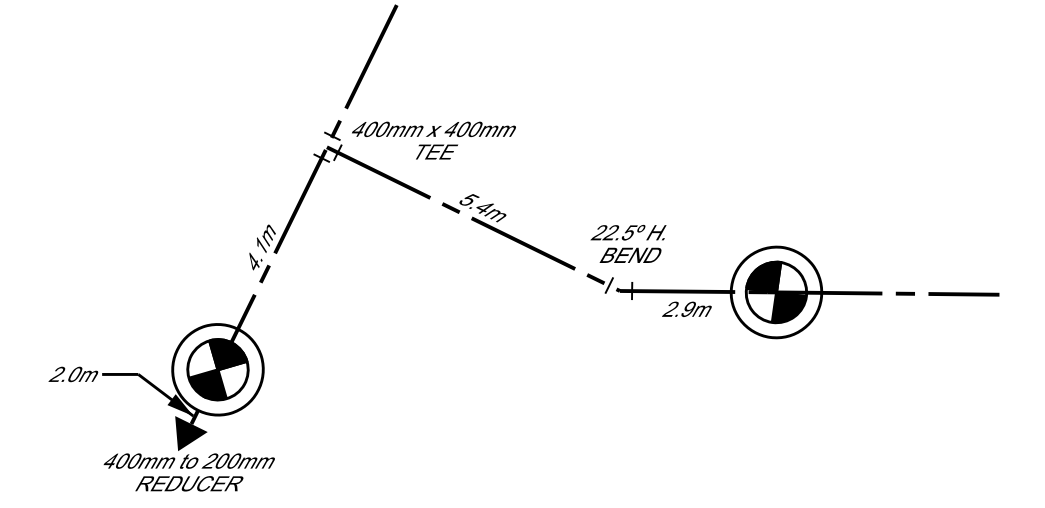

STATION	PROPOSED C PROFILE	TOP OF WATERMAIN	STORM INVERT	SAN. INVERT
6+000.0	78.499			
6+018.0	74.63	74.63		
6+023.9	74.63	74.63		
6+025.799	74.60	74.60		
6+050.0	74.52	74.52	88.45m 87.50m - 610mm Ø PVC SDR 35 STORM @ 0.10%	
6+075.0	74.44	74.44		
6+100.0	74.26	74.26	104.00m 101.00m - 610mm Ø PVC SDR 35 STORM @ 0.13%	
6+125.0	73.89	73.89		

**406mm WATERMAIN REPLACEMENT**  
**SOUTH OF HIGHWAY 417 TO CARLINGTON HEIGHTS RESERVOIR**

**GRADING & DRAINAGE**  
**LADY ELLEN PLACE**  
**STA. 0+900 TO STA. 1+050**

Contract No. **ISD11-3018** Dwg. No. **P1**

Asset No. -  
 Asset Group: -

Des: P.C./D.H. Chk'd: P.L.  
 Dwn: D.H. Chk'd: P.L.  
 Utility Circ. No.: - Index No.: -  
 Const. Inspector: -

**AS-BUILT**

RECORD INFORMATION PROVIDED BY CITY OF OTTAWA

ALL NUMERICAL VALUES THAT ARE NOT STROKED OUT AND REPLACED IN ITALICS ON AS-BUILT DRAWINGS ARE CONSIDERED TO BE DESIGN VALUES ONLY AND NOT MEASURED IN THE FIELD.

Scale: HORIZONTAL 1:250  
 VERTICAL 1:50

**NOTE:**  
 The location of utilities is approximate only, the exact location should be determined by consulting the municipal authorities and utility companies concerned. The contractor shall prove the location of utilities and shall be responsible for adequate protection from damage.



No.	Description	By	Date
1	ISSUED FOR CIRCULATION	P.L./P.C.	12.04.12
2	ISSUED FOR TENDER	P.L./P.C.	29.06.12
3	ISSUED FOR FINAL CIRCULATION	P.L./P.C.	24.07.12
4	ISSUED FOR CONSTRUCTION	P.L./P.C.	08.08.12
5	AS BUILT	P.L./P.C.	23.08.13

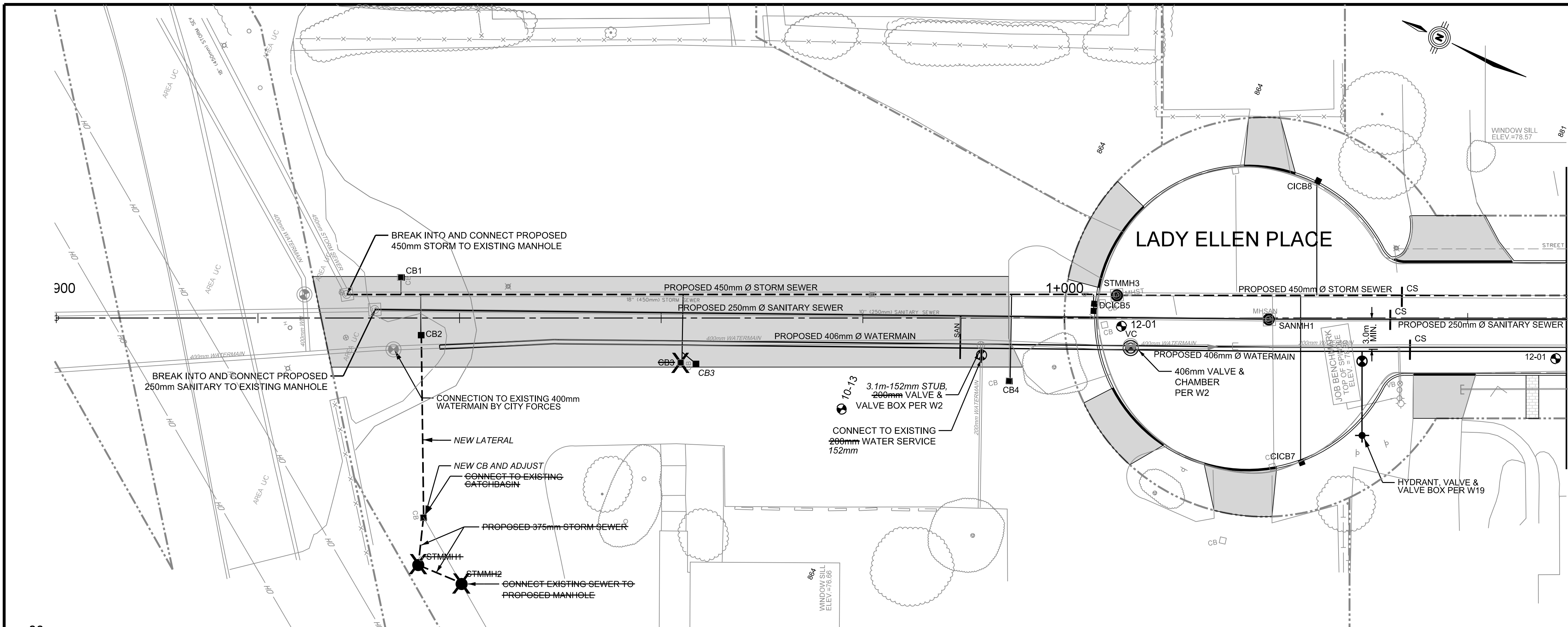

MATCHLINE STA. 1+050  
FOR CONTINUATION SEE DWG. P2

No.	Station	Offset (m)	Structure	Type	Elevations		Grate to Invert
					Grate	Low Inv.	
CB1	0+934.23	4.03L	705.010	S22/S23	76.15	74.45	1.70
CB2	0+936.20	5.48R	705.010	S22/S23	75.97	74.27	1.70
CB3	0+961.95	4.43R	705.010	S22/S23	74.67	72.97	1.70
CB4	0+994.54	6.26R	705.010	S22/S23	77.10	75.40	1.70
DCICB5	1+033.23	1.54L	705.020	S22/S23	77.35	75.60	1.75
CICB7	1+023.43	14.05R	705.010	S22/S23	77.94	76.09	1.85
CICB8	1+025.03	13.34L	705.010	S22/S23	77.96	76.11	1.85

Structure to Structure	Dia.	Type	Length	Invert Elevations	
				Upstream	Downstream
CB1 TO MAIN	200	PVC	1.7	74.45	74.43
CB2 TO MAIN	200	PVC	4.1	74.27	74.23
CB3 TO MAIN	200	PVC	6.7	74.84	74.77
CB4 TO MAIN	200	PVC	8.5	75.40	75.31
CICB5 TO MAIN	250	PVC	1.0	75.60	75.59
CICB7 TO MAIN	200	PVC	16.3	76.09	75.93
CICB8 TO MAIN	200	PVC	11.1	76.11	76.00

No.	Station	Offset (m)	Structure	Type	Cover	Elevations		Grate to Invert
						Grate	Low Inv.	
STMMH1	0+935.91	76.458	701.010	S24/S25	76.46	FIELD DETERMINE		
STMMH2	0+940.20	76.458	701.010	S24/S25	76.46	FIELD DETERMINE		
STMMH3	1+005.21	2.25	701.010	S24/S25	77.43	75.58	1.85	

No.	Station	Offset (m)	Structure	Type	Cover	Elevations		Grate to Invert
						Grate	Low Inv.	
SANMH1	1+020.21	0.1	701.010	S24/S25	77.83	74.62	3.21	

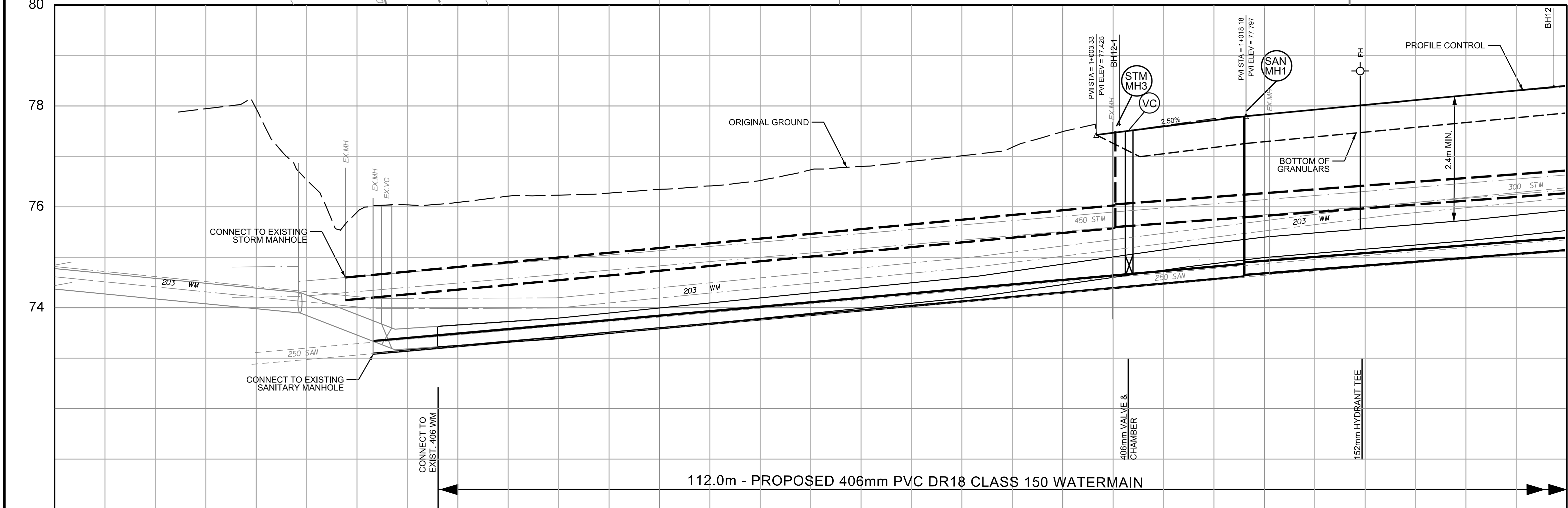

STATION	PROPOSED PROFILE	TOP OF WATERMAIN	STORM INVERT	SAN. INVERT
0+931.5				
0+933.4				
0+938.0				
0+940.0				
0+943.7				
0+949.7				
0+960.0				
0+961.9				
0+968.1				
0+974.2				
0+980.0				
0+980.3				
0+986.4				
0+991.7				
0+992.0				
1+000.0				
1+006.5				
1+012.6				
SAN MH1 1+018.0				
1+020.0				
1+040.0				

ISSUED

# APPENDIX

# APPENDIX

## B

- WATERMAIN BOUNDARY CONDITIONS FROM CITY OF OTTAWA (TO BE RECEIVED)
- EMAILS FROM CITY OF OTTAWA (TO BE RECEIVED)
- FIRE UNDERWRITERS SURVEY – FIRE FLOW CALCULATION
- WATER DEMAND CALCULATION



**Proposed Building A - 4 Storey  
 Fire Flow Requirements Based on Fire Underwriters Survey (FUS) 2020**

1. An estimate of the Fire Flow required for a given fire area may be estimated by:  $F = 220 C \sqrt{A}$

- F = required fire flow in litres per minute
- C = coefficient related to the type of construction
  - 1.5 for **Type V** Wood Frame Construction
  - 0.8 for **Type IV-A** Mass Timber Construction
  - 0.9 for **Type IV-B** Mass Timber Construction
  - 1.0 for **Type IV-C** Mass Timber Construction
  - 1.5 for **Type IV-D** Mass Timber Construction
  - 1.0 for **Type III** Ordinary Construction
  - 0.8 for Type II Noncombustible Construction**
  - 0.6 for **Type I** Fire resistive Construction

A =2-b) The single largest Floor Area plus 25% of each of the two immediately adjoining floors

A = 5578 m<sup>2</sup>

C = 0.8

F = 13144.1 L/min

rounded off to 13,000 L/min (min value of 2000 L/min)

2. The value obtained in 1. may be reduced by as much as 25% for occupancies having a low contents fire hazard.

Non-combustible	-25%
Limited Combustible	-15%
Combustible	0%
Free Burning	15%
Rapid Burning	25%

Reduction due to low occupancy hazard -15% x 13,000 = 11,050 L/min

3. The value obtained in 2. may be reduced by as much as 50% for buildings equipped with automatic sprinkler protection.

Adequate Sprinkler confirms to NFPA13	-30%
Water supply common for sprinklers & fire hoses	-10%
Fully supervised system	-10%
No Automatic Sprinkler System	0%

Reduction due to Sprinkler System -40% x 11,050 = 4,420 L/min

4. The value obtained in 2. is increased for structures exposed within 45 metres by the fire area under consideration.

Separation	Charge
0 to 3 m	25%
3.1 to 10 m	20%
10.1 to 20 m	15%
20.1 to 30 m	10%
30.1 to 45 m	0%

Side 1	110	0% north side
Side 2	20.5	10% east side
Side 3	31	5% south side
Side 4	22	10% west side

25% (Total shall not exceed 75%)

Increase due to separation 25% x 11,050 = 2,763 L/min

5. The flow requirement is the value obtained in 2., minus the reduction in 3., plus the addition in 4.

- The fire flow requirement is 9,000 L/min (Rounded to nearest 1000 L/min)
- or **150 L/sec**
- or 2,378 gpm (us)
- or 1,980 gpm (uk)



**Proposed Building B - 1 Storey**  
**Fire Flow Requirements Based on Fire Underwriters Survey (FUS) 2020**

1. An estimate of the Fire Flow required for a given fire area may be estimated by:  $F = 220 C \sqrt{A}$

- F = required fire flow in litres per minute
- C = coefficient related to the type of construction
  - 1.5 for **Type V** Wood Frame Construction
  - 0.8 for **Type IV-A** Mass Timber Construction
  - 0.9 for **Type IV-B** Mass Timber Construction
  - 1.0 for **Type IV-C** Mass Timber Construction
  - 1.5 for **Type IV-D** Mass Timber Construction
  - 1.0 for **Type III** Ordinary Construction
  - 0.8 for **Type II** Noncombustible Construction
  - 0.6 for **Type I** Fire resistive Construction

A = 2-b) The single largest Floor Area plus 25% of each of the two immediately adjoining floors

A = 1750 m<sup>2</sup>  
 C = 0.8  
 F = 7362.6 L/min

rounded off to 7,000 L/min (min value of 2000 L/min)

2. The value obtained in 1. may be reduced by as much as 25% for occupancies having a low contents fire hazard.

Non-combustible	-25%
Limited Combustible	-15%
Combustible	0%
Free Burning	15%
Rapid Burning	25%

Reduction due to low occupancy hazard  $-15\% \times 7,000 = 5,950$  L/min

3. The value obtained in 2. may be reduced by as much as 50% for buildings equipped with automatic sprinkler protection.

Adequate Sprinkler confirms to NFPA13	-30%
Water supply common for sprinklers & fire hoses	-10%
Fully supervised system	-10%
No Automatic Sprinkler System	0%

Reduction due to Sprinkler System  $-40\% \times 5,950 = -2,380$  L/min

4. The value obtained in 2. is increased for structures exposed within 45 metres by the fire area under consideration.

Separation	Charge
0 to 3 m	25%
3.1 to 10 m	20%
10.1 to 20 m	15%
20.1 to 30 m	10%
30.1 to 45 m	0%

Side 1	130	0% north side
Side 2	22	10% east side
Side 3	38	0% south side
Side 4	33	5% west side

15% (Total shall not exceed 75%)

Increase due to separation  $15\% \times 5,950 = 893$  L/min

5. The flow requirement is the value obtained in 2., minus the reduction in 3., plus the addition in 4.

The fire flow requirement is 4,000 L/min (Rounded to nearest 1000 L/min)  
 or **67 L/sec**  
 or 1,057 gpm (us)  
 or 880 gpm (uk)



**Water Demand Calculation Sheet**

**Project:** 864 Lady Ellen Place  
**Location:** City of Ottawa  
**WSP Project No.** 221-04646-00

**Date:** 2022-11-29  
**Design:** WY  
**Page:** 1 of 1



Proposed Buildings	Residential			Non-Residential			Average Daily			Maximum Daily			Maximum Hourly			Fire
	Units			Industrial (ha)	Institutional (ha)	Commercial (ha)	Demand (l/s)			Demand (l/s)			Demand (l/s)			Demand (l/s)
	SF	APT	ST				Pop.	Res.	Non-Res.	Total	Res.	Non-Res.	Total	Res.	Non-Res.	
<b>Total Lot Area</b>						1.36		0.44	0.44		0.66	0.66		1.19	1.19	150

**Population Densities**

Single Family	3.4 person/unit
Semi-Detached	2.7 person/unit
Duplex	2.3 person/unit
Townhome (Row)	2.7 person/unit
Bachelor Apartment	1.4 person/unit
1 Bedroom Apartment	1.4 person/unit
2 Bedroom Apartment	2.1 person/unit
3 Bedroom Apartment	3.1 person/unit
4 Bedroom Apartment	4.1 person/unit
Avg. Apartment	1.8 person/unit

**Average Daily Demand**

Residential	280 l/cap/day
Industrial	35000 l/ha/day
Institutional	28000 l/ha/day
<b>Commercial</b>	<b>28000 l/ha/day</b>

**Maximum Daily Demand**

Residential	2.5 x avg. day
Industrial	1.5 x avg. day
Institutional	1.5 x avg. day
<b>Commercial</b>	<b>1.5 x avg. day</b>

**Maximum Hourly Demand**

Residential	2.2 x max. day
Industrial	1.8 x max. day
Institutional	1.8 x max. day
<b>Commercial</b>	<b>1.8 x max. day</b>

# APPENDIX

# APPENDIX

## C

- F03 – SANITARY DRAINAGE AREA
- SANITARY SEWER DESIGN SHEET



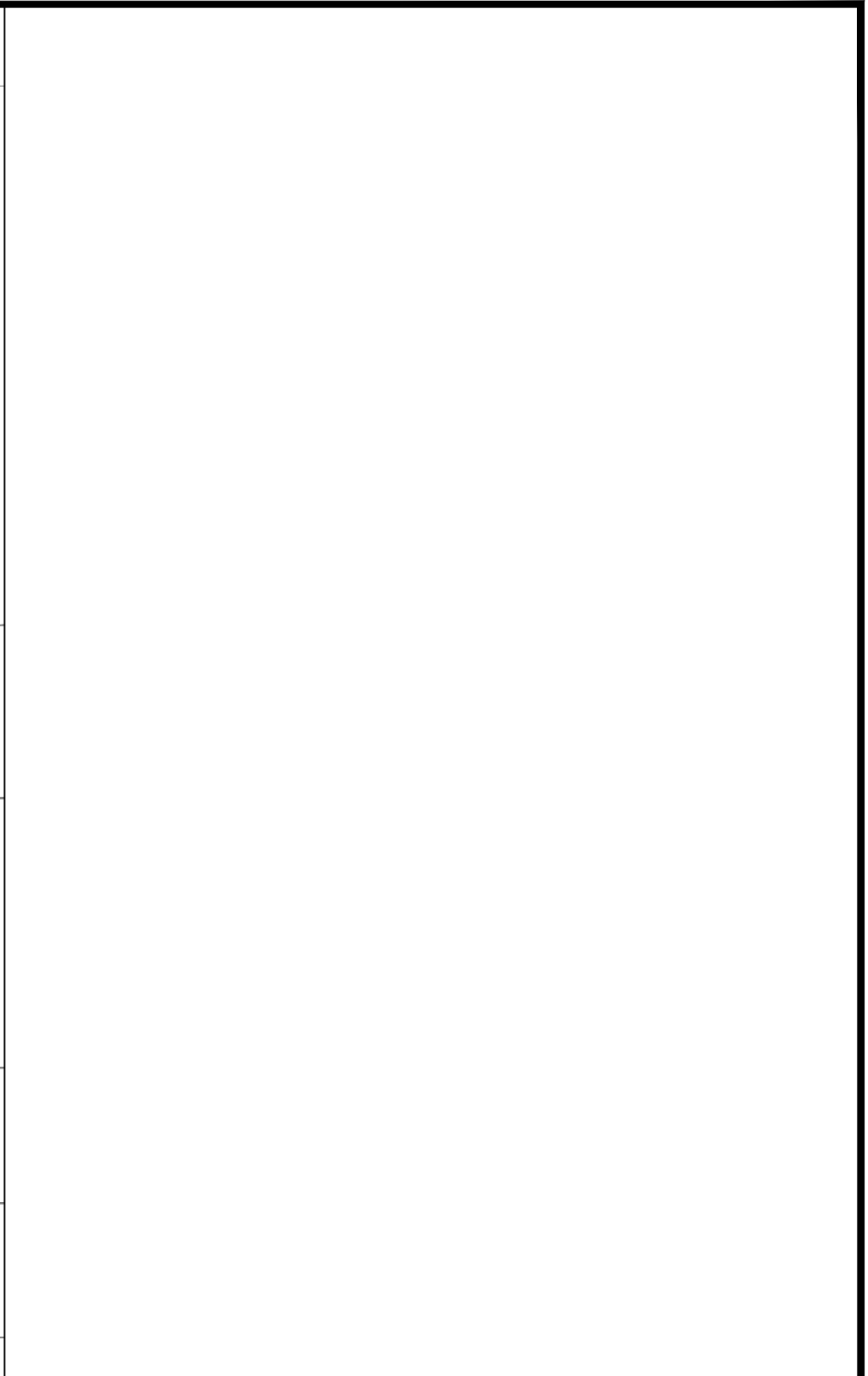
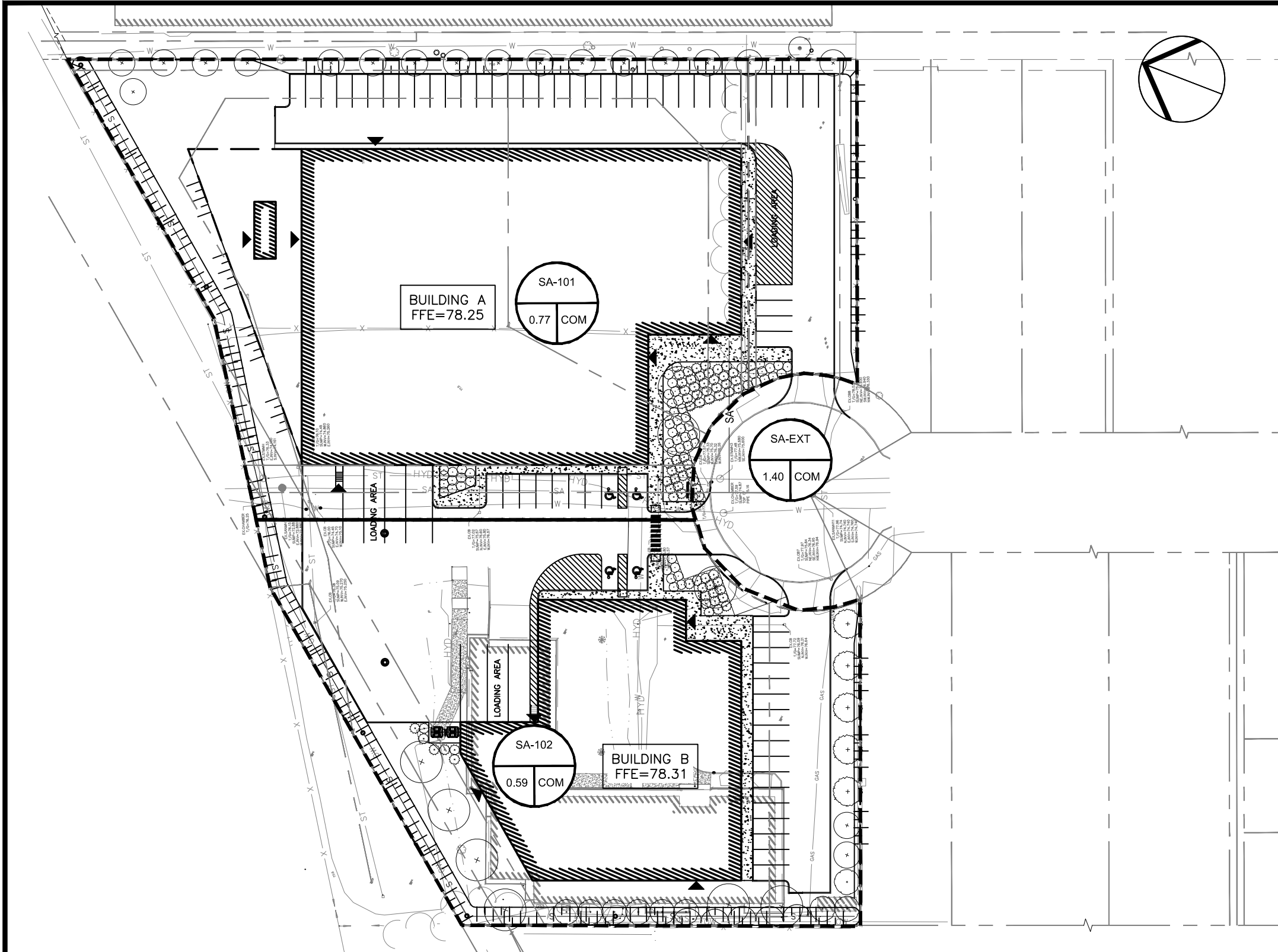

300-2611 QUEENSVIEW DRIVE  
 OTTAWA ONTARIO CANADA K2B 8K2  
 TEL.: 1-613-829-2800 | FAX: 1-613-829-8299 | WWW.WSPGROUP.COM

PROJECT:  
**864 LADY ELLEN PLACE**

ADDRESS:  
**864 LADY ELLEN PLACE,  
 OTTAWA, ONTARIO, K1Z 5M2**

PROJECT NO.:  
 221-0464-00

DRAWING NAME:  
**SANITARY DRAINAGE AREA**

DATE:  
 DEC 16, 2022

SCALE:  
 1 : 750

REVIEWED BY:  
 D.Y.

**LEGEND**

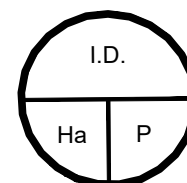

I.D. DENOTES SANITARY DRAINAGE AREA ID  
 Ha DENOTES SANITARY DRAINAGE AREA  
 P DENOTES POPULATION

--- SANITARY DRAINAGE BOUNDARY

DESIGNED BY:  
 D.Y.

DRAWN BY:  
 J.T.

SHEET:  
**F03**

# APPENDIX

# APPENDIX

## D

- STORM SEWER DESIGN SHEET
- F01 - PRE-DEVELOPMENT STORM DRAINAGE AREA
- F02 - ROOF DRAINAGE AREA
- C05 - POST-DEVELOPMENT STORM DRAINAGE AREA PLAN



LOCATION				AREA (Ha)						RATIONAL DESIGN FLOW											PROPOSED SEWER DATA												
LOCATION	AREA ID	FROM	TO	C= 0.20	C= 0.35	C= 0.50	C= 0.60	C= 0.90	C= 1.00	IND 2.78AC	CUM 2.78 AC	INLET (min)	TOTAL (min)	i (2) (mm/hr)	i (5) (mm/hr)	i (100) (mm/hr)	BLDG FLOW (L/s)	2yr PEAK FLOW (L/s)	5yr PEAK FLOW (L/s)	100yr PEAK FLOW (L/s)	ICD FIXED FLOW (L/s)	DESIGN FLOW (L/s)	MODIFIED DESIGN FLOW (L/s)	MATERIAL PIPE	SIZE (mm)	SLOPE (%)	LENGTH (m)	CAPACITY (l/s)	VELOCITY (m/s)	TIME IN PIPE	AVAIL CAP (2yr) (L/s)	AVAIL CAP (%)	
<b>Proposed Site</b>																																	
864 Lady Ellen Place	S-101	CB02	STMH101	0.012				0.073		0.189	0.189	10.00	10.26	76.81	104.19	178.56		14.54					14.54		PVC DR-35	200.0	1.00	16.05	32.83	1.04	0.26	18.29	55.71%
	S-102	CB03	STMH101-STMH102					0.049		0.123	0.123	10.00	10.09	76.81	104.19	178.56		9.42					9.42		PVC DR-35	200.0	1.00	5.60	32.83	1.04	0.09	23.42	71.32%
	S-103	CB04	STMH101-STMH102					0.048		0.120	0.120	10.00	10.09	76.81	104.19	178.56		9.22					9.22		CONC 100-D	200.0	1.00	5.55	32.83	1.04	0.09	23.61	71.91%
			STMH101							0.000	0.432	10.26	11.98	75.83	102.86	176.25							32.76		PVC DR-35	300.0	0.50	100.25	68.45	0.97	1.73	35.69	52.14%
			STMH102							0.000	0.432	11.98	12.11	69.94	94.77	162.26							30.22		PVC DR-35	300.0	0.50	7.15	68.45	0.97	0.12	38.23	55.85%
			STMH103							0.000	0.432	12.11	12.95	69.56	94.24	161.35							30.05		PVC DR-35	300.0	0.50	48.90	68.45	0.97	0.84	38.39	56.09%
			STMH104							0.000	0.432	12.95	13.11	67.07	90.83	155.45							28.98		PVC DR-35	300.0	0.50	9.40	68.45	0.97	0.16	39.47	57.67%
	S-107	CB01	STMH100	0.020				0.062		0.166	0.166	10.00	10.37	76.81	104.19	178.56		12.77					12.77		PVC DR-35	200.0	1.00	23.30	32.83	1.04	0.37	20.06	61.11%
			STMH100							0.000	0.166	10.37	10.76	75.41	102.27	175.23							12.54		PVC DR-35	200.0	1.00	24.30	32.83	1.04	0.39	20.30	61.82%
External	EXT-B, S-110	EX. STMH	EX. STMH3	0.004		2.800				3.894	4.060	10.76	11.67	74.01	100.34	171.90		300.50					300.50		CONC 100-D	450.0	1.50	120.00	349.53	2.20	0.91	49.04	14.03%
Building A	B-BLDG A	BUILDING A	STMH106						0.405	1.126	1.126	10.00	10.11	76.81	104.19	178.56		86.47					86.47		PVC DR-35	300.0	1.30	10.50	110.37	1.56	0.11	23.89	21.65%
			STMH106							0.000	1.126	10.11	11.18	76.38	103.60	177.54							85.99		PVC DR-35	300.0	1.30	100.25	110.37	1.56	1.07	24.37	22.08%
Building B	B-BLDG B	BUILDING B	STMH107						0.175	0.487	0.487	10.00	10.14	76.81	104.19	178.56		37.37					37.37		CONC 100-D	250.0	1.00	10.00	59.53	1.21	0.14	22.16	37.23%
			STMH107							0.000	0.487	10.14	10.27	76.28	103.47	177.31							37.11		PVC DR-35	250.0	1.00	9.60	59.53	1.21	0.13	22.42	37.66%
	S106	CB05	CBMH109					0.035		0.088	0.088	10.00	10.27	76.81	104.19	178.56		6.73					6.73		PVC DR-35	200.0	1.00	16.80	32.83	1.04	0.27	26.11	79.51%
	S-105	CBMH109	CBMH108					0.035		0.088	0.175	10.27	10.75	75.79	102.80	176.14		13.27					13.27		PVC DR-35	200.0	0.50	21.55	23.22	0.74	0.49	9.94	42.82%
	S-104	CBMH108	EX. STMH3-STMH105					0.133		0.333	0.508	10.75	10.92	74.02	100.37	171.94		37.60					37.60		PVC DR-35	250.0	0.65	9.65	47.99	0.98	0.16	10.40	21.66%
	S-111	EX. STMH3	STMH105	0.038				0.038		0.116	6.729	13.11	13.61	66.62	90.20	154.37		448.27					448.27		PVC DR-35	450.0	1.90	74.15	393.39	2.47	0.50	-54.88	-13.95%
			STMH105							0.000	6.729	13.61	13.63	65.25	88.33	151.13		439.08					439.08		PVC DR-35	450.0	1.90	3.10	393.39	2.47	0.02	-45.69	-11.61%
<b>Definition:</b> Q=2.78CiA, where: Q = Peak Flow in Litres per Second (L/s) A = Area in Hectares (Ha) i = Rainfall Intensity in millimeters per hour (mm/hr) i = 732.951/(TC+6.199)^0.810 i = 1174.184/(TC+6.014)^0.816 i = 1735.688/(TC+6.014)^0.820				<b>Notes:</b> 1. Mannings coefficient (n) = 0.013				Time-of-Concentration in the Swale FAA Equation: t (min) = 3.258 [(1.1 - C) L^0.5 / S^0.33] Where: Longest Watercourse Length, L (m). S (%) Runoff Coef. C = 0.00 Impervious										<b>Designed:</b> J.T./D.Y.				<b>No.</b> 1				<b>Revision</b> City Submission No. 1				<b>Date</b> 2022-12-16			
																		<b>Checked:</b> D.Y.															
																		<b>Dwg. Reference:</b> C05															
																						<b>File Reference:</b> 211-01794-00				<b>Date:</b> 2022-12-16				<b>Sheet No:</b> 1 of 1			



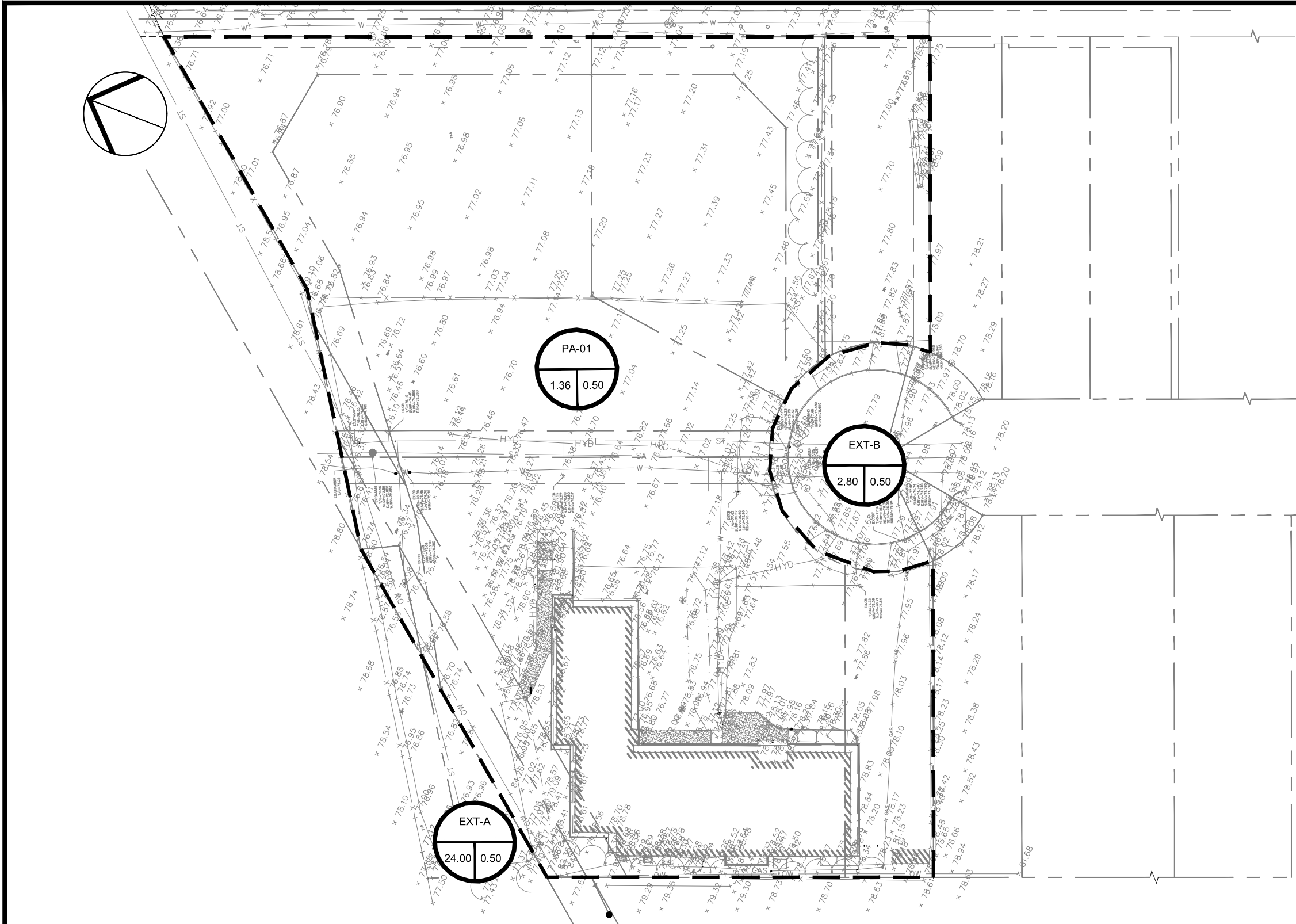
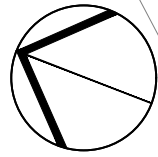

300-2611 QUEENSVIEW DRIVE  
 OTTAWA ONTARIO CANADA K2B 8K2  
 TEL.: 1-613-829-2800 | FAX: 1-613-829-8299 | WWW.WSPGROUP.COM

PROJECT:  
**864 LADY ELLEN PLACE**

ADDRESS:  
**864 LADY ELLEN PLACE,  
 OTTAWA, ONTARIO, K1Z 5M2**

PROJECT NO.:  
 221-0464-00

DRAWING NAME:  
**PRE-DEVELOPMENT  
 STORM DRAINAGE AREA  
 PLAN**

DATE:  
 DEC 16, 2022

SCALE:  
 1 : 500

REVIEWED BY:  
 D.Y.

**LEGEND**

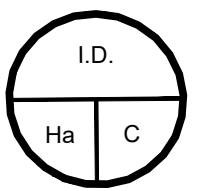

I.D. DENOTES STORM DRAINAGE AREA ID  
 Ha DENOTES STORM DRAINAGE AREA  
 C DENOTES RUNOFF COEFFICIENT

--- STORM DRAINAGE BOUNDARY

DESIGNED BY:  
 D.Y.

DRAWN BY:  
 J.T.

SHEET:  
**F01**

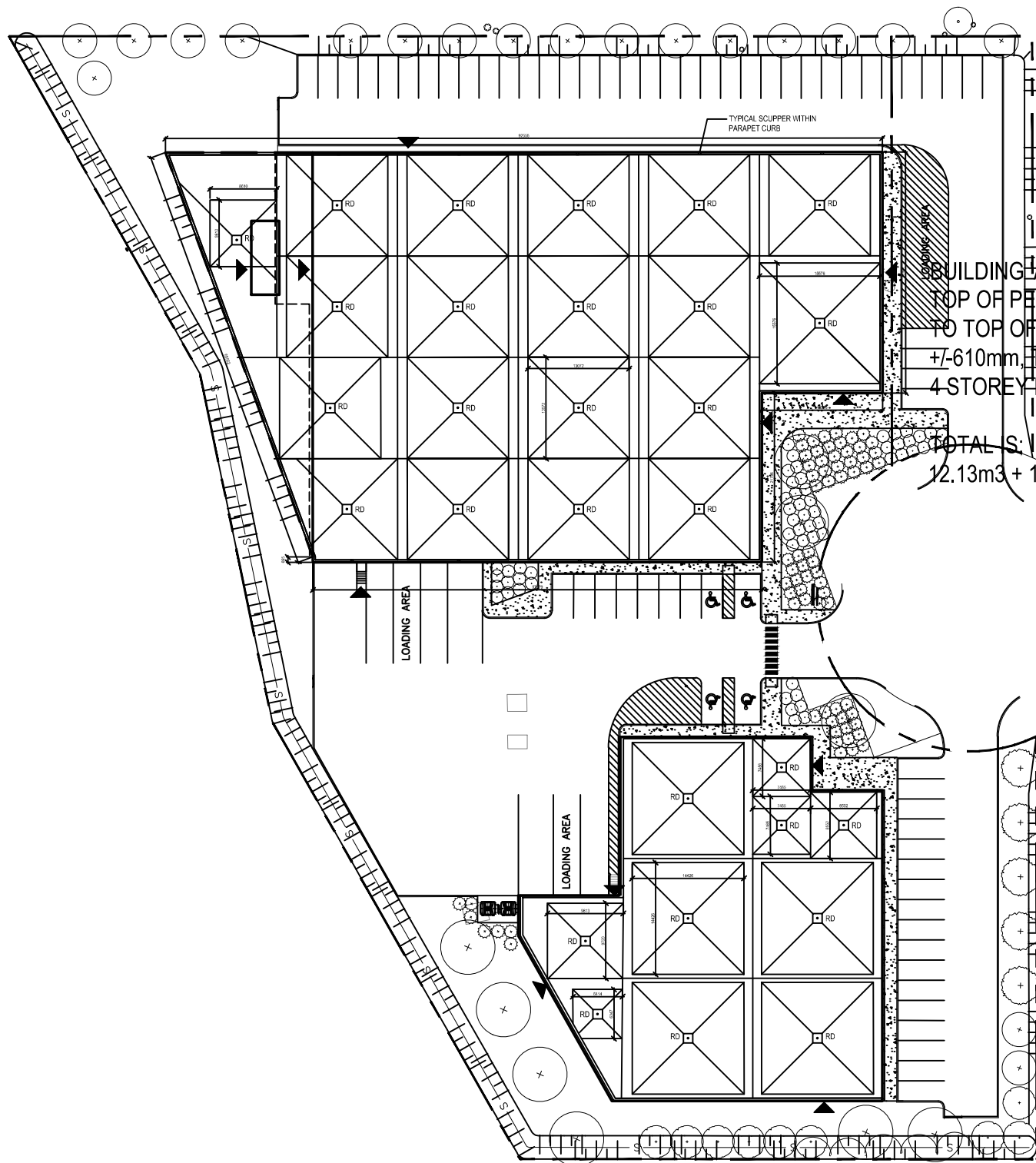

**BUILDING 'A'**  
 TOP OF PERIMETER ROOF PARAPET  
 TO TOP OF FINISHED ROOF IS  
 +/-610mm TYPICAL.  
 4-STOREY BUILDING HEIGHT IS +/-23m  
 TOTAL IS:  
 12.13m<sup>3</sup> + 145.18m<sup>3</sup> + 3.7m<sup>3</sup> = 161m<sup>3</sup>

**BUILDING 'B'**  
 TOP OF PERIMETER ROOF  
 PARAPET TO TOP OF FINISHED  
 ROOF IS 610mm, TYPICAL.  
 1 STOREY-INTERIOR CLEAR  
 BUILDING HEIGHT IS 9.1m

TOTAL IS:  
 2.035m<sup>3</sup> + 4.76m<sup>3</sup> + 2.78m<sup>3</sup> +  
 2.78m<sup>3</sup> + 3.656m<sup>3</sup> + 52m<sup>2</sup> =  
 68m<sup>3</sup>



**Adjustable Accutrol Weir**  
 Tag: \_\_\_\_\_

**Adjustable Flow Control  
 for Roof Drains**

**ADJUSTABLE ACCUTROL (for Large Sump Roof Drains only)**

For more flexibility in controlling flow with heads deeper than 2", Watts Drainage offers the Adjustable Accutrol. The Adjustable Accutrol Weir is designed with a single parabolic opening that can be covered to restrict flow above 2" of head to less than 5 gpm per inch, up to 6" of head. To adjust the flow rate for depths over 2" of head, set the slot in the adjustable upper cone according to the flow rate required. Refer to Table 1 below.  
 Note: Flow rates are directly proportional to the amount of weir opening that is exposed.

**EXAMPLE:**

For example, if the adjustable upper cone is set to cover 1/2 of the weir opening, flow rates above 2" of head will be restricted to 2-1/2 gpm per inch of head.

Therefore, at 3" of head, the flow rate through the Accutrol Weir that has 1/2 the slot exposed will be:  
 [5 gpm (per inch of head) x 2 inches of head] + 2-1/2 gpm (for the third inch of head) = 12-1/2 gpm.

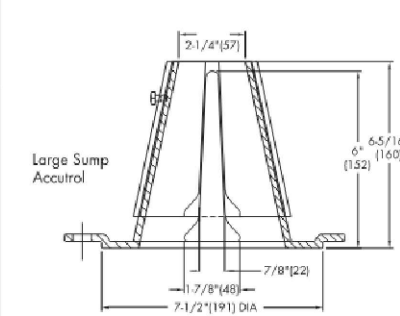

TABLE 1. Adjustable Accutrol Flow Rate Settings

Weir Opening Exposed	Flow Rate (gallons per minute)					
	1"	2"	3"	4"	5"	6"
Fully Exposed	5	10	15	20	25	30
3/4	5	10	13.75	17.5	21.25	25
1/2	5	10	12.5	15	17.5	20
1/4	5	10	11.25	12.5	13.75	15
Closed	5	5	5	5	5	5

Job Name: \_\_\_\_\_ Contractor: \_\_\_\_\_  
 Job Location: \_\_\_\_\_ Contractor's P.O. No.: \_\_\_\_\_  
 Engineer: \_\_\_\_\_ Representative: \_\_\_\_\_

Watts product specifications in U.S. customary units and metric are approximate and are provided for reference only. For precise measurements, please contact Watts Technical Service. Watts reserves the right to change or modify product design, construction, specifications, or materials without prior notice and without incurring any obligation to make such changes and modifications on Watts products previously or subsequently sold.

USA: Tel: (800) 338-2681 • Fax: (828) 248-3929 • Watts.com  
 Canada: Tel: (905) 332-4000 • Fax: (905) 332-7068 • Watts.ca  
 Latin America: Tel: (52) 81-1001-9600 • Fax: (52) 81-9000-7081 • Watts.com



ES-WD-RD-ACCUTROLADJ-CAN 1615

© 2016 Watts



300-2611 QUEENSVIEW DRIVE  
 OTTAWA ONTARIO CANADA K2B 8K2  
 TEL.: 1-613-829-2800 | FAX: 1-613-829-8299 | WWW.WSPGROUP.COM

PROJECT:  
**864 LADY ELLEN PLACE**  
 ADDRESS:  
**864 LADY ELLEN PLACE,  
 OTTAWA, ONTARIO, K1Z 5M2**  
 PROJECT NO.: **221-0464-00**

DRAWING NAME:  
**ROOF DRAINAGE AREA**  
 DATE:  
**DEC 16, 2022**  
 SCALE:  
**1 : 750**  
 REVIEWED BY:  
**D.Y.**

LEGEND

DESIGNED BY:  
 D.Y.  
 DRAWN BY:  
 J.T.  
 SHEET:  
**F02**

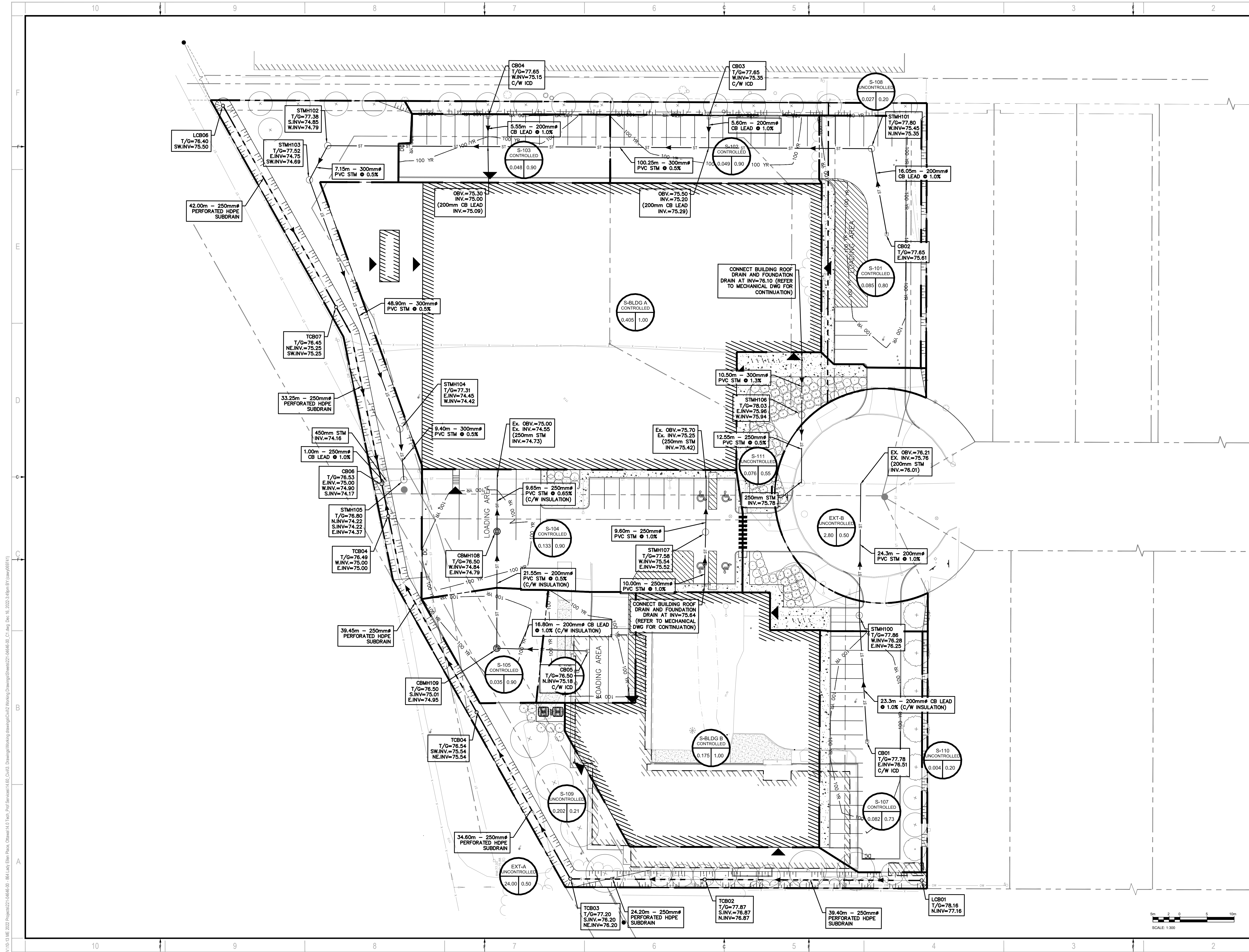

**ARCHITECTURE 49**

1345 ROSSEMOUNT AVENUE  
CORNWALL, ONTARIO, CANADA K6J 3E5  
TEL: 613-933-5602 | FAX: 613-936-0335 | ARCHITECTURE49.COM

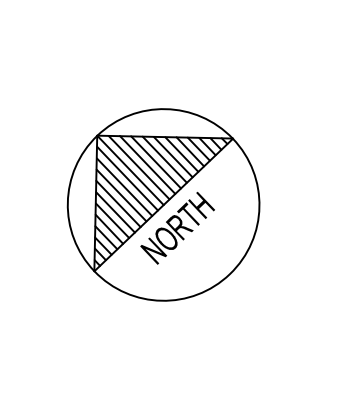
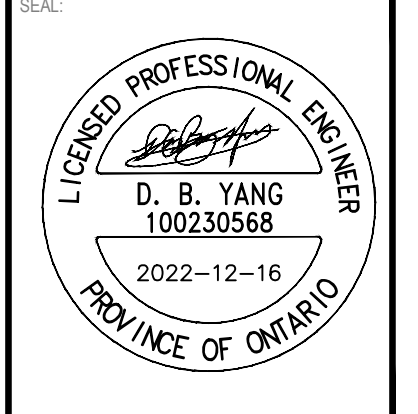

CLIENT: **ACCESS STORAGE**

PROJECT: **864 LADY ELLEN PLACE, OTTAWA**



DISCLAIMER: THIS DRAWING AND DESIGN IS COPYRIGHT PROTECTED WHICH SHALL NOT BE USED, REPRODUCED OR REVISED WITHOUT WRITTEN PERMISSION BY WSP. THE CONTRACTOR SHALL CHECK AND VERIFY ALL DIMENSIONS AND UTILITY LOCATIONS AND REPORT ALL ERRORS AND OMISSIONS PRIOR TO COMMENCING WORK. THIS DRAWING IS NOT TO BE SCALED.

ISSUED FOR REVISION	NO.	DATE	DESCRIPTION
	0	2022-12-16	ISSUED FOR SPA

PROJECT NO:	221-04646-00	DATE:	NOVEMBER 2022
ORIGINAL SCALE:	1:300	IF THIS BAR IS NOT 25mm LONG, ADJUST YOUR PLOTTING SCALE.	
DESIGNED BY:	DY		
DRAWN BY:	JT		
CHECKED BY:	DY		
DISCIPLINE:	CIVIL		

TITLE:	STORM DRAINAGE AREA PLAN		
SHEET NUMBER:	C05		
ISSUE:	ISSUED FOR SPA		
DATE OF:	2022-12-16		
REV #:	0		

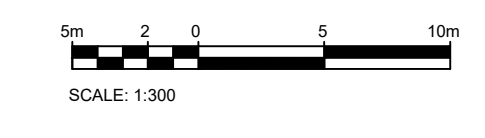

V:\10-13-ME-2022-Projects\221-04646-00 - 864 Lady Ellen Place, Ottawa\14.0 Tech - Prod Services\14.00\_Civil\Drawings\Working Drawings\Civil\221-04646-00\_C1.dwg, Dec 16, 2022, 3:49pm BY (jtan/09914)

#XXXXX  
D07-XX-XX-XXXX

# APPENDIX

# APPENDIX

## E

- EROSION AND SEDIMENTATION CONTROL PLAN C06



# APPENDIX

# APPENDIX

## F

- SUBMISSION CHECK LIST



## 4.1 General Content

- Executive Summary (for larger reports only).

*Comments:* Refer to Servicing Report Section 1.1

- Date and revision number of the report.

*Comments:* Refer to front page of the Report

- Location map and plan showing municipal address, boundary, and layout of proposed development.

*Comments:* Refer to Figure 1.1 Site Location for Location Map and Plan

- Plan showing the site and location of all existing services.

*Comments:* Refer to drawing C04

- Development statistics, land use, density, adherence to zoning and official plan, and reference to applicable subwatershed and watershed plans that provide context to which individual developments must adhere.

*Comments:* Refer to Architectural Site Plan

- Summary of Pre-consultation Meetings with City and other approval agencies.

*Comments:* Refer to Appendix A for Pre-Consultation Meeting Notes

- Reference and confirm conformance to higher level studies and reports (Master Servicing Studies, Environmental Assessments, Community Design Plans), or in the case where it is not in conformance, the proponent must provide justification and develop a defensible design criteria.

*Comments:* N/A

- Statement of objectives and servicing criteria.

*Comments:* Refer to Servicing Report Section 1.7

- Identification of existing and proposed infrastructure available in the immediate area.

*Comments:* Refer to drawing C04

- Identification of Environmentally Significant Areas, watercourses and Municipal Drains potentially impacted by the proposed development (Reference can be made to the Natural Heritage Studies, if available).

Comments:

- Concept level master grading plan to confirm existing and proposed grades in the development. This is required to confirm the feasibility of proposed stormwater management and drainage, soil removal and fill constraints, and potential impacts to neighbouring properties. This is also required to confirm that the proposed grading will not impede existing major system flow paths.

Comments:

- Identification of potential impacts of proposed piped services on private services (such as wells and septic fields on adjacent lands) and mitigation required to address potential impacts.

Comments:

- Proposed phasing of the development, if applicable.

Comments:

- Reference to geotechnical studies and recommendations concerning servicing.

Comments:

- All preliminary and formal site plan submissions should have the following information:

- Metric scale
- North arrow (including construction North)
- Key plan
- Name and contact information of applicant and property owner
- Property limits including bearings and dimensions
- Existing and proposed structures and parking areas
- Easements, road widening and rights-of-way
- Adjacent street names

Comments:

## 4.2 Development Servicing Report: Water

- Confirm consistency with Master Servicing Study, if available  
*Comments:* Refer to Servicing Report Section 2.1
- Availability of public infrastructure to service proposed development  
*Comments:* Refer to Servicing Report Section 2.1
- Identification of system constraints  
*Comments:* N/A
- Identify boundary conditions  
*Comments:* Refer to Servicing Report Section 2.2
- Confirmation of adequate domestic supply and pressure  
*Comments:* Refer to Servicing Report Section 2.3
- Confirmation of adequate fire flow protection and confirmation that fire flow is calculated as per the Fire Underwriter's Survey. Output should show available fire flow at locations throughout the development.  
*Comments:* Refer to Servicing Report Section 2.4
- Provide a check of high pressures. If pressure is found to be high, an assessment is required to confirm the application of pressure reducing valves.  
*Comments:* Refer to Servicing Report Section 2.5
- Definition of phasing constraints. Hydraulic modeling is required to confirm servicing for all defined phases of the project including the ultimate design  
*Comments:* N/A
- Address reliability requirements such as appropriate location of shut-off valves  
*Comments:* Refer to Servicing Report Section 2.6
- Check on the necessity of a pressure zone boundary modification.  
*Comments:* N/A

- Reference to water supply analysis to show that major infrastructure is capable of delivering sufficient water for the proposed land use. This includes data that shows that the expected demands under average day, peak hour and fire flow conditions provide water within the required pressure range

*Comments:* Refer to Servicing Report Section 2.7

- Description of the proposed water distribution network, including locations of proposed connections to the existing system, provisions for necessary looping, and appurtenances (valves, pressure reducing valves, valve chambers, and fire hydrants) including special metering provisions.

*Comments:* Refer to Servicing Report Section 2.8

- Description of off-site required feeder mains, booster pumping stations, and other water infrastructure that will be ultimately required to service proposed development, including financing, interim facilities, and timing of implementation.

*Comments:* Refer to Servicing Report Section 2.9

- Confirmation that water demands are calculated based on the City of Ottawa Design Guidelines.

*Comments:* Refer to Servicing Report Section 2.3 and 2.4

- Provision of a model schematic showing the boundary conditions locations, streets, parcels, and building locations for reference.

*Comments:* N/A

## 4.3 Development Servicing Report: Wastewater

- Summary of proposed design criteria (Note: Wet-weather flow criteria should not deviate from the City of Ottawa Sewer Design Guidelines. Monitored flow data from relatively new infrastructure cannot be used to justify capacity requirements for proposed infrastructure).

*Comments:* Refer to Servicing Report Section 3.1

- Confirm consistency with Master Servicing Study and/or justifications for deviations.

*Comments:* Refer to Servicing Report Section 3.2

- Consideration of local conditions that may contribute to extraneous flows that are higher than the recommended flows in the guidelines. This includes groundwater and soil conditions, and age and condition of sewers.

*Comments:* Refer to Servicing Report Section 3.3

- Description of existing sanitary sewer available for discharge of wastewater from proposed development.

*Comments:* Refer to Servicing Report Section 3.3

- Verify available capacity in downstream sanitary sewer and/or identification of upgrades necessary to service the proposed development. (Reference can be made to previously completed Master Servicing Study if applicable)

*Comments:* Refer to Servicing Report Section 3.4

- Identification and implementation of the emergency overflow from sanitary pumping stations in relation to the hydraulic grade line to protect against basement flooding.

*Comments:* N/A

- Special considerations such as contamination, corrosive environment etc.

*Comments:* N/A

## 4.4 Development Servicing Report: Stormwater

- Description of drainage outlets and downstream constraints including legality of outlets (i.e. municipal drain, right-of-way, watercourse, or private property)

*Comments:* Refer to Servicing Report Section 4.1

- Analysis of available capacity in existing public infrastructure.

*Comments:* Refer to Servicing Report Section 4.2

- A drawing showing the subject lands, its surroundings, the receiving watercourse, existing drainage patterns, and proposed drainage pattern.

*Comments:* Refer to drawing C03

- Water quantity control objective (e.g. controlling post-development peak flows to pre-development level for storm events ranging from the 2 or 5 year event (dependent on the receiving sewer design) to 100 year return period); if other objectives are being applied, a rationale must be included with reference to hydrologic analyses of the potentially affected subwatersheds, taking into account long-term cumulative effects.

*Comments:* Refer to SWM Report

- Water Quality control objective (basic, normal or enhanced level of protection based on the sensitivities of the receiving watercourse) and storage requirements.

*Comments:* Refer to SWM Report

- Description of the stormwater management concept with facility locations and descriptions with references and supporting information.

*Comments:* Refer to SWM Report

- Set-back from private sewage disposal systems.

*Comments:* N/A

- Watercourse and hazard lands setbacks.

*Comments:* N/A

- Record of pre-consultation with the Ontario Ministry of Environment and the Conservation Authority that has jurisdiction on the affected watershed.

*Comments:* N/A

- Confirm consistency with sub-watershed and Master Servicing Study, if applicable study exists.

*Comments:* N/A

- Storage requirements (complete with calculations) and conveyance capacity for minor events (1:5 year return period) and major events (1:100 year return period).

*Comments:* Refer to SWM Report

- Identification of watercourses within the proposed development and how watercourses will be protected, or, if necessary, altered by the proposed development with applicable approvals.

*Comments:* Refer to SWM Report

- Calculate pre and post development peak flow rates including a description of existing site conditions and proposed impervious areas and drainage catchments in comparison to existing conditions.

*Comments:* Refer to SWM Report

- Any proposed diversion of drainage catchment areas from one outlet to another.

*Comments:* Refer to SWM Report

- Proposed minor and major systems including locations and sizes of stormwater trunk sewers, and stormwater management facilities.

*Comments:* Refer to drawing C04 and C05

- If quantity control is not proposed, demonstration that downstream system has adequate capacity for the post-development flows up to and including the 100-year return period storm event.

*Comments:* Refer to SWM Report

- Identification of potential impacts to receiving watercourses

*Comments:* Refer to SWM Report

- Identification of municipal drains and related approval requirements.

*Comments:* Refer to SWM Report

- Descriptions of how the conveyance and storage capacity will be achieved for the development.

*Comments:* Refer to SWM Report

- 100 year flood levels and major flow routing to protect proposed development from flooding for establishing minimum building elevations (MBE) and overall grading.

*Comments:* Refer to drawings C03 and C05

- Inclusion of hydraulic analysis including hydraulic grade line elevations.

*Comments:* Refer to SWM Report

- Description of approach to erosion and sediment control during construction for the protection of receiving watercourse or drainage corridors.

*Comments:* Refer to Servicing Report Section 5.0

- Identification of floodplains - proponent to obtain relevant floodplain information from the appropriate Conservation Authority. The proponent may be required to delineate floodplain elevations to the satisfaction of the Conservation Authority if such information is not available or if information does not match current conditions.

*Comments:* N/A

- Identification of fill constraints related to floodplain and geotechnical investigation.

*Comments:* N/A



## 4.5 Approval and Permit Requirements: Checklist

The Servicing Study shall provide a list of applicable permits and regulatory approvals necessary for the proposed development as well as the relevant issues affecting each approval. The approval and permitting shall include but not be limited to the following:

- Conservation Authority as the designated approval agency for modification of floodplain, potential impact on fish habitat, proposed works in or adjacent to a watercourse, cut/fill permits and Approval under Lakes and Rivers Improvement Act. The Conservation Authority is not the approval authority for the Lakes and Rivers Improvement Act. Where there are Conservation Authority regulations in place, approval under the Lakes and Rivers Improvement Act is not required, except in cases of dams as defined in the Act.

*Comments:*

- Application for Certificate of Approval (CofA) under the Ontario Water Resources Act.

*Comments:*

- Changes to Municipal Drains.

*Comments:*

- Other permits (National Capital Commission, Parks Canada, Public Works and Government Services Canada, Ministry of Transportation etc.)

*Comments:*

## 4.6 Conclusion Checklist

- Clearly stated conclusions and recommendations

*Comments:*

- Comments received from review agencies including the City of Ottawa and information on how the comments were addressed. Final sign-off from the responsible reviewing agency.

*Comments:*

- All draft and final reports shall be signed and stamped by a professional Engineer registered in Ontario

*Comments:*