

SERVICING & STORMWATER MANAGEMENT REPORT

2663 INNES ROAD



Project No.: CCO-23-1884

City File No.: D07-12-22-0182

Prepared for:

IDEA Inc.
595 Byron Avenue
Ottawa, Ontario
K2A 4C4

Prepared by:

McIntosh Perry Consulting Engineers Ltd.
115 Walgreen Road
Carp, ON K0A 1L0

July 7, 2023

Revised: August 30, 2023

McINTOSH PERRY

TABLE OF CONTENTS

1.0	PROJECT DESCRIPTION	1
1.1	<i>Purpose</i>	1
1.2	<i>Site Description</i>	1
1.3	<i>Proposed Development and Statistics.....</i>	2
1.4	<i>Existing Conditions and Infrastructures</i>	2
1.5	<i>Approvals</i>	2
2.0	BACKGROUND STUDIES, STANDARDS, AND REFERENCES.....	3
2.1	<i>Background Reports / Reference Information</i>	3
2.2	<i>Applicable Guidelines and Standards.....</i>	3
3.0	PRE-CONSULTATION SUMMARY	4
4.0	WATERMAIN	5
4.1	<i>Existing Watermain.....</i>	5
4.2	<i>Proposed Watermain</i>	5
5.0	SANITARY DESIGN	7
5.1	<i>Existing Sanitary Sewer</i>	7
5.2	<i>Proposed Sanitary Sewer</i>	7
6.0	STORM SEWER DESIGN.....	9
6.1	<i>Existing Storm Sewers</i>	9
6.2	<i>Proposed Storm Sewers.....</i>	9
7.0	PROPOSED STORMWATER MANAGEMENT	10
7.1	<i>Design Criteria and Methodology</i>	10
7.2	<i>Runoff Calculations</i>	10
7.3	<i>Pre-Development Drainage.....</i>	11
7.4	<i>Post-Development Drainage</i>	11
7.5	<i>Quality Control.....</i>	12
7.6	<i>Low Impact Development (LID).....</i>	13
8.0	EROSION AND SEDIMENT CONTROL.....	14
8.1	<i>Temporary Measures</i>	14

8.2	<i>Permanent Measures</i>	14
9.0	SUMMARY	15
10.0	RECOMMENDATION	16
11.0	STATEMENT OF LIMITATIONS	17

LIST OF TABLES

Table 1: Water Supply Design Criteria	5
Table 2: Boundary Conditions Results	6
Table 3: Fire Protection Confirmation	6
Table 4: Sanitary Design Criteria	7
Table 5: Summary of Estimated Sanitary Flow	7
Table 6: Pre-Development Runoff Summary	11
Table 7: Required Restricted Flow	11
Table 8: Post-Development Runoff Summary	12

APPENDICES

Appendix A: Site Location Plan

Appendix B: Background Documents

Appendix C: Watermain Calculations

Appendix D: Sanitary Calculations

Appendix E: Pre-Development Drainage Plan

Appendix F: Post-Development Drainage Plan

Appendix G: Stormwater Management Calculations

Appendix H: City of Ottawa Design Checklist

1.0 PROJECT DESCRIPTION

1.1 Purpose

McIntosh Perry (MP) has been retained by IDEA Inc. to prepare this Servicing and Stormwater Management Report in support of the Site Plan Control process for the proposed development located at 2663 Innes Road within the City of Ottawa.

The main purpose of this report is to present a servicing and stormwater management design for the development in accordance with the recommendations and guidelines provided by the City of Ottawa (City), the Rideau Valley Conservation Authority (RVCA), and the Ministry of the Environment, Conservation and Parks (MECP). This report will address the water, sanitary and storm sewer servicing for the development, ensuring that existing and available services will adequately service the proposed development.

This report should be read in conjunction with the following drawings:

- CCO-23-1884, C100 – Existing Conditions, Removals, Erosion & Sediment Control Plan
- CCO-23-1884, C101 – Lot Grading and Drainage Plan
- CCO-23-1884, C102 – Site Servicing Plan
- CCO-23-1884, PRE – Pre-Development Drainage Plan (**Appendix E**)
- CCO-23-1884, POST – Post-Development Drainage Plan (**Appendix F**)

1.2 Site Description

Figure 1: Site Map



The subject property, herein referred to as “the site”, is located at 2663 Innes Road within the Innes ward. The site covers approximately **0.16 ha** and is located on Innes Road between Bearbrook Road and Eastpark Drive. The site is zoned for Minor Institutional (I1E H(15)). See Site Location Plan in **Appendix ‘A’** for more details.

1.3 Proposed Development and Statistics

The proposed development consists of the addition of a 4-storey **423 m²** mixed use building, complete with surface parking with street access from Innes Road. The development is proposed within a **0.13 ha** area on site. Refer to **Site Plan** prepared by IDEA and included in **Appendix B** for further details.

1.4 Existing Conditions and Infrastructures

The site is currently developed containing a 1 ½ storey building. The existing building is serviced by the municipal infrastructure within Innes Road.

Sewer and watermain mapping collected from the City of Ottawa indicate that the following services exist across the property frontages within the adjacent municipal rights-of-way(s):

- ❖ Innes Road
 - 406 mm diameter DI watermain, a
 - 350 mm diameter AC sanitary sewer, tributary to the Innes Road Trunk Sewer, and a
 - 675 mm diameter concrete storm sewer

1.5 Approvals

The proposed development is subject to the City of Ottawa site plan control approval process. Site plan control requires the City to review, provided concurrence and approve the engineering design package. Permits to construct can be requested once the City has issued a site plan agreement.

An Environmental Compliance Approval (**ECA**) through the Ministry of Environment, Conservation and Parks (**MECP**) is not anticipated to be required since the proposed storm sewer system services one parcel of land and does not propose industrial use.

2.0 BACKGROUND STUDIES, STANDARDS, AND REFERENCES

2.1 Background Reports / Reference Information

As-built drawings of existing services, provided by the City of Ottawa Information centre, within the vicinity of the proposed site were reviewed in order to identify infrastructure available to service the proposed development.

A topographic survey (22-10-082-00) of the site was completed by J.D. Barnes Limited and dated August 10th, 2022.

The Site Plan (SD6.01) was prepared by IDEA Inc. (*Site Plan*).

2.2 Applicable Guidelines and Standards

City of Ottawa:

- ◆ Ottawa Sewer Design Guidelines, City of Ottawa, SDG002, October 2012. (*Ottawa Sewer Guidelines*)
 - Technical Bulletin ISTB-2014-01 City of Ottawa, February 2014. (*ISTB-2014-01*)
 - Technical Bulletin PIEDTB-2016-01 City of Ottawa, September 2016. (*PIEDTB-2016-01*)
 - Technical Bulletin ISTB-2018-01 City of Ottawa, January 2018. (*ISTB-2018-01*)
 - Technical Bulletin ISTB-2018-04 City of Ottawa, March 2018. (*ISTB-2018-04*)
 - Technical Bulletin ISTB-2019-02 City of Ottawa, February 2019. (*ISTB-2019-02*)
- ◆ Ottawa Design Guidelines – Water Distribution City of Ottawa, July 2010. (*Ottawa Water Guidelines*)
 - Technical Bulletin ISD-2010-2 City of Ottawa, December 15, 2010. (*ISD-2010-2*)
 - Technical Bulletin ISDTB-2014-02 City of Ottawa, May 2014. (*ISDTB-2014-02*)
 - Technical Bulletin ISTB-2018-02 City of Ottawa, March 2018. (*ISTB-2018-02*)
 - Technical Bulletin ISTB-2021-03 City of Ottawa, August 2021. (*ISTB-2021-03*)

Ministry of Environment, Conservation and Parks:

- ◆ Stormwater Planning and Design Manual, Ministry of the Environment, March 2003. (*MECP Stormwater Design Manual*)
- ◆ Design Guidelines for Sewage Works, Ministry of the Environment, 2008. (*MECP Sewer Design Guidelines*)

Other:

- ◆ Water Supply for Public Fire Protection, Fire Underwriters Survey, 2020. (*FUS Guidelines*)

3.0 PRE-CONSULTATION SUMMARY

A pre-consultation meeting was held with City staff on September 8th, 2022 regarding the proposed site servicing. Specific design parameters to be incorporated within this design include the following:

- Pre-development and post-development flows shall be calculated using a time of concentration (T_c) no less than 10 minutes.
- Control 5 through 100-year post-development flows to the 5-year pre-development flow with a combined C value to a maximum of 0.50.
- Any storm events greater than the established 5-year allowable release rate, up to and including the 100-year storm event, shall be detained on-site.

4.0 WATERMAIN

4.1 Existing Watermain

The site is located within the 1E pressure zone, as per the Water Distribution System mapping included in **Appendix C**. There are two municipal fire hydrants on Innes Road available to service the proposed development.

4.2 Proposed Watermain

It is proposed to service the new building with a 150 mm diameter water service connected to the 406 mm diameter water main within Innes Road. The existing service connections to the existing building will be blanked at the main and removed.

Table 1, below, summarizes the water supply design criteria obtained from the **Ottawa Water Guidelines** and utilized for the water analysis.

Table 1: Water Supply Design Criteria

Site Area	0.16 ha
Residential	280 L/day/person
Commercial	28,000 L/gross ha/d
Residential Apartment – 1 Bedroom	1.4 person/unit
Residential Apartment – 2 Bedroom	2.1 person/unit
Max Day Peaking Factor - Residential	9.5 x avg. day
Peak Hour Peaking Factor - Residential	14.3 x avg. day

The OBC and Fire Underwriters Survey 2020 (FUS) methods were utilized to estimate the required fire flow for the proposed building. Fire flow requirements were calculated per City of Ottawa Technical Bulletin **ISTB-2018-02**. The following parameters were utilized for the calculations:

FUS:

- ❖ Type of construction – Ordinary Construction
- ❖ Occupancy Type – Limited Combustible
- ❖ Sprinkler Protection – Standard Sprinkler System

OBC:

- ❖ Type of construction – Combustible Construction
- ❖ Occupancy Type: Group C and D
- ❖ Water Supply Coefficient (K): 18

The results of the FUS calculations yielded a required fire flow of **7,000 L/min** (116.67 L/s), and the results of the OBC calculation yielded a required fire flow of **6,300 L/min** (105 L/s). The detailed calculations for the FUS and OBC can be found in **Appendix C**.

The City provided the estimated water pressures for the average day scenario, peak hour scenario and the max day plus fire flow scenario for the demands indicated by the correspondence in **Appendix C**. The resulting pressures for the boundary conditions results are shown in **Table 2**, below.

Table 2: Boundary Conditions Results

Scenario	Proposed Demands (L/s)	Connection 1 HGL (m H ₂ O)* / kPa
Average Day Demand	0.12	43.8 / 429.7
Maximum Daily + Fire Flow (OBC)	105.00	35.1 / 344.3
Maximum Daily + Fire Flow (FUS)	116.67	33.8 / 331.6
Peak Hourly Demand	1.55	54.4 / 374.7

**Adjusted for an estimated ground elevation of 74.5m above the connection point.*

The normal operating pressure range is anticipated to be 374.7 kPa to 429.7 kPa and will not be less than 275 kPa (40 psi) or exceed 689 kPa (100 psi). The proposed watermains will meet the minimum required 20 psi (140 kPa) from the **Ottawa Water Guidelines** at the ground level under maximum day demand and fire flow conditions.

To confirm the adequacy of fire flow to protect the proposed development, existing hydrants within 150 m of the proposed building were analysed per City of Ottawa **ISTB 2018-02** Appendix I Table 1. The results are summarized below. A hydrant coverage figure can be found in **Appendix C**.

Table 3: Fire Protection Confirmation

Building Location	Fire Flow Demand (L/min.)	Fire Hydrant(s) within 75m (5,700 L/min)	Fire Hydrant(s) within 150m (3,800 L/min)	Fire Flow Contribution (L/min.)
2663 Innes	6,300 (OBC) 7,000 (FUS)	2 Public	-	11,400

5.0 SANITARY DESIGN

5.1 Existing Sanitary Sewer

There is an existing service connection to the 350 mm diameter concrete sanitary sewer located within Innes Road, tributary to the Innes Road trunk sewer.

5.2 Proposed Sanitary Sewer

A new 150 mm diameter gravity sanitary service will be extended from the 350 mm diameter sanitary main within Innes Road to service the proposed building. The existing services will be blanked at the main and removed, or abandoned per City standards. Refer to drawing C102 for a detailed servicing layout.

Table 4, below, summarizes the wastewater design criteria identified by the *Ottawa Sewer Guidelines*.

Table 4: Sanitary Design Criteria

Design Parameter	Value
Site Area	0.16 ha
Residential	280 L/person/day
1 Bedroom Apartment	1.4 persons/unit
2 Bedroom Apartment	2.1 persons/unit
Commercial	2,800 L/(1000m ² /day)
Residential Peaking Factor	3.68
Extraneous Flow Allowance	0.33 L/s/ha
Estimated Population	33 persons

Table 5 below, summarizes the estimated wastewater flow from the proposed building. Refer to *Appendix D* for detailed calculations.

Table 5: Summary of Estimated Sanitary Flow

Design Parameter	Total Flow (L/s)
Total Estimated Average Dry Weather Flow	0.12
Total Estimated Peak Dry Weather Flow	0.41
Total Estimated Peak Wet Weather Flow	0.46

As noted above, the development is proposed to be serviced via a proposed 150 mm sanitary service connection to the 350 mm asbestos concrete sanitary sewer within Innes Road.

The full flowing capacity of a 150 mm diameter service at 1.0% slope is estimated to be **15.89 L/s**. Per **Table 5**, a peak wet weather flow of **0.46 L/s** will be conveyed within the 150 mm diameter service, therefore the proposed system is sufficiently sized for the development. Due to the complexity of the downstream network, it is requested that the City advise of any downstream constraints that may affect development.

6.0 STORM SEWER DESIGN

6.1 Existing Storm Sewers

Stormwater runoff from the existing site flows overland towards the Innes Road right of way, and north towards the adjacent property. An existing swale along the east property line outlets to a ditch inlet near the southeast property corner.

6.2 Proposed Storm Sewers

The proposed development will be serviced through a new 300 mm service connections to the existing 675 mm diameter storm sewer within Innes Road.

Runoff collected on the roof of the proposed building will be stored and controlled internally using seven (7) roof drains. The roof drains will be used to limit the flow from the roof to the specified allowable release rate. Roof drainage will be directed to a 250 mm diameter service connected to the new on-site storm system before discharging into the 675 mm diameter storm sewer within Innes Road. For calculation purposes a Watts Accutrol roof drain was used to estimate a reasonable roof flow. Other products may be specified at detailed building design provided release rates and storage volumes are respected.

Foundation drainage is proposed to be pumped via a sump pump with a backflow preventer per City Standard S14. Foundation and roof drainage will be conveyed via a 250 mm storm service connected to the 375mm service connection, downstream of the proposed ICD.

See CCO-23-1884 - *POST* include in **Appendix F** of this report for more details. The Stormwater Management design for the subject property will be outlined in *Section 7.0* of this report.

7.0 PROPOSED STORMWATER MANAGEMENT

7.1 Design Criteria and Methodology

As per *Section 6.2*, stormwater management for the proposed development will be provided by rooftop and surface storage. The controlled stormwater flow will be directed to the existing 675 mm diameter storm sewer within Innes Road.

In summary, the following design criteria have been employed in developing the stormwater management design for the site as directed by the RVCA and City:

Quality Control

- Based on consultation with the RVCA included in Appendix B, quality controls up to an enhanced level of treatment are required for the development.

Quantity Control

- Any storm events greater than the 5-year, and up to and including the 100-year storm event must be detained on site.
- Post-development flow to be restricted to the 5-year storm event, based on a calculated time of concentration of at least 10 minutes and a combined maximum rational method coefficient of 0.50. Refer to *Section 7.2* for further details.

7.2 Runoff Calculations

Runoff calculations presented in this report are derived using the Rational Method, given as:

$$Q = 2.78CIA \text{ (L/s)}$$

Where:

C	= Runoff coefficient
I	= Rainfall intensity in mm/hr (City of Ottawa IDF curves)
A	= Drainage area in hectares

It is recognized that the Rational Method tends to overestimate runoff rates. As a result, the conservative calculation of runoff ensures that any SWM facility sized using this method is expected to function as intended. The following coefficients were used to develop an average C for each area:

Roofs/Concrete/Asphalt	0.90
Undeveloped and Grass	0.20

As per the *City of Ottawa - Sewer Design Guidelines*, the 5-year balanced 'C' value must be increased by 25% for a 100-year storm event to a maximum of 1.0.

7.3 Pre-Development Drainage

It has been assumed that the development area contains no stormwater management controls for flow attenuation. The estimated pre-development peak flows for 5- and 100-year events are summarized below in **Table 6**. See CCO-23-1884 - PRE in **Appendix E** and **Appendix G** for calculations.

Table 6: Pre-Development Runoff Summary

Drainage Area	Area (ha)	Runoff Coefficient, C		Flow Rate, Q (L/sec)	
		5-Year	100-Year	5-Year	100-Year
A1	0.159	0.32	0.39	14.57	30.68
Total	0.159	-		14.57	30.68

7.4 Post-Development Drainage

To meet the stormwater objectives, the development will contain flow attenuation via rooftop and surface storage. **Table 7**, below, summarizes the required restricted flow.

Table 7: Required Restricted Flow

Drainage Area	Area (ha)	C (5-Year)	Max Q (L/s) (5-Year)
A1	0.159	0.32	14.57

Based on the criteria listed in *Section 7.1*, the development will be required to restrict runoff to the 5-year storm event. It is estimated that the target release rate during the 100-year event will be **14.57 L/s**. See **Appendix G** for calculations.

The proposed site drainage limits are demonstrated on the Post-Development Drainage Area Plan. See CCO-23-1884 - POST in **Appendix F** of this report for more details. A summary of the post-development runoff calculations can be found below.

Table 8: Post-Development Runoff Summary

Drainage Area	Area	Unrestricted Flow (L/S)		Restricted Flow (L/S)		Storage Required (m ³)		Storage Provided (m ³)	
	(ha)	5-year	100-Year	5-Year	100-Year	5-Year	100-Year	5-Year	100-Year
B1A	0.008	1.97	3.75	0.68	0.95	0.78	1.89	0.82	1.90
B1B	0.009	2.45	4.66	0.87	1.48	0.95	1.98	1.07	1.99
B1C	0.004	1.03	1.96	0.63	0.90	0.24	0.64	0.26	0.69
B1D	0.007	1.78	3.38	0.65	0.90	0.68	1.65	0.68	1.67
B1E	0.008	2.12	4.04	0.66	0.90	0.92	2.18	0.99	2.23
B1F	0.014	3.60	6.86	1.01	1.89	1.70	3.26	1.80	3.37
B1G	0.006	1.51	2.88	0.57	0.79	0.57	1.37	0.64	1.42
B2	0.078	19.96	38.02	6.80	7.02	8.00	22.59	8.00	22.63
B3	0.026	2.70	5.42	2.70	5.42	-	-	-	-
Total	0.159	37.12	70.98	14.57	20.25	13.8	35.5	14.3	35.9

Runoff from area B1A-B1G will be controlled and stored on the roof of the proposed building (**B1**) using seven (7) roof drains. The roof drains will be used to limit the flow from the roof to the specified allowable release rate. For calculation purposes a Watts Accutrol roof drain was used to estimate a reasonable roof flow. Other products may be specified at detailed building design provided release rates and storage volumes are respected. It is noted that a portion of the proposed roof structure incorporates the use of a “Green Roof” and as a result, it was assumed that all of the runoff from the green space is directed towards the perimeter drains without any ponding in the green space area. As such, the storage volumes presented in this report account for the total runoff from entire roof which are located along the outer edge of the roof, and do not consider any reduction in runoff coefficients to remain conservative.

Runoff for area B2 will be collected by a proposed catch basin and catch basin maintenance hole. A proposed Tempest LMF85 ICD located at the outlet of CBMH-202 will be used to restrict runoff to the allowable release rate.

Runoff for area B3 will be unrestricted and maintain existing drainage patterns. Foundation and roof drainage is proposed to be conveyed via a 250 mm diameter storm service connection the proposed 375 mm storm service, downstream of the restriction.

7.5 Quality Control

As noted in *Section 7.1*, enhanced treatment will be required based on coordination with the RVCA. Quality controls will be provided by an oil & grit separator (OGS) located downstream of CBMH-202, which will treat all of the captured runoff from the site. The OGS is proposed to be a Hydro First Defence FD-4HC or approved equivalent.

Under the Fine particle size distribution (PSD), the proposed OGS unit can achieve 97% total suspended solids (TSS) removals. The actual TSS removal effectiveness of the OGS units heavily relies on the actual site conditions, nature of the runoff, rain fall event and on-going OGS maintenance. A manufacturer sizing report has been included in **Appendix G** to provide more detail on the OGS selection.

7.6 Low Impact Development (LID)

Due to several constraints such as limited landscaping area, and shallow storm sewers on site, LID measures were not feasible to include within the site development. As a result, the proposed building includes a “Green Roof” design which allows for additional green space on the roof, decreasing the overall impervious surfaces on site. Please refer to the architectural plans and report for more information on the Green Roof design.

8.0 EROSION AND SEDIMENT CONTROL

8.1 Temporary Measures

Before construction begins, temporary silt fence, straw bale or rock flow check dams will be installed at all-natural runoff outlets from the property. It is crucial that these controls be maintained throughout construction and inspection of sediment and erosion control will be facilitated by the Contractor or Contract Administration staff throughout the construction period.

Silt fences will be installed where shown on the final engineering plans, specifically along the downstream property limits. The Contractor, at their discretion or at the instruction of the City, Conservation Authority or the Contract Administrator shall increase the quantity of sediment and erosion controls on-site to ensure that the site is operating as intended and no additional sediment finds its way off site. The rock flow, straw bale & silt fence check dams and barriers shall be inspected weekly and after rainfall events. Care shall be taken to properly remove sediment from the fences and check dams as required. Fibre roll barriers are to be installed at all existing curb inlet catch basins and filter fabric is to be placed under the grates of all existing catch basins and manholes along the frontage of the site and any new structures immediately upon installation. The measures for the existing/proposed structures are to be removed only after all areas have been paved. Care shall be taken at the removal stage to ensure that any silt that has accumulated is properly handled and disposed of. Removal of silt fences without prior removal of the sediments shall not be permitted.

Although not anticipated, work through winter months shall be closely monitored for erosion along sloped areas. Should erosion be noted, the Contractor shall be alerted and shall take all necessary steps to rectify the situation. Should the Contractor's efforts fail at remediating the eroded areas, the Contractor shall contact the City and/or Conservation Authority to review the site conditions and determine the appropriate course of action. As the ground begins to thaw, the Contractor shall place silt fencing at all required locations as soon as ground conditions warrant. Please see the *Site Grading, Drainage and Sediment & Erosion Control Plan* for additional details regarding the temporary measures to be installed and their appropriate OPSD references.

8.2 Permanent Measures

It is expected that the Contractor will promptly ensure that all disturbed areas receive topsoil and seed/sod and that grass be established as soon as possible. Any areas of excess fill shall be removed or levelled as soon as possible and must be located a sufficient distance from any watercourse to ensure that no sediment is washed out into the watercourse. As the vegetation growth within the site provides a key component to the control of sediment for the site, it must be properly maintained once established. Once the construction is complete, it will be up to the landowner to maintain the vegetation and ensure that the vegetation is not overgrown or impeded by foreign objects.

9.0 SUMMARY

- A new 4-storey **423 m²** building is proposed to be constructed at 2663 Innes Road. The development is proposed within **0.13 ha** of the site.
- It is proposed to service the new building through a new 150 mm diameter water service and 150 mm diameter sanitary service. A new 300 mm diameter storm service is proposed to collect and control drainage within the development area.
- It is proposed to blank the existing services at the main and remove them.
- It is proposed to service the development area via roof storage and surface storage. The storm system will connect to the existing 675 mm diameter asbestos concrete storm sewer located within Innes Road.
- Storage for the 5- through 100-year storm events will be provided via rooftop and surface storage.
- Quality controls will be achieved with a Hydro First Defence FD-4HC OGS unit, or approved equivalent.

10.0 RECOMMENDATION

Based on the information presented in this report, we recommend that City of Ottawa approve this Servicing and Stormwater Management report in support of the proposed development at 2663 Innes Road.

This report is respectfully being submitted for approval.

Regards,

McIntosh Perry Consulting Engineers Ltd.



Francis Valenti, E.I.T.
Engineering Intern, Land Development
E: f.valenti@mcintoshperry.com



James Hewson, P.Eng.
Project Engineer, Land Development
E: j.hewson@mcintoshperry.com

11.0 STATEMENT OF LIMITATIONS

This report was produced for the exclusive use of IDEA Inc. The purpose of the report is to assess the existing stormwater management system and provide recommendations and designs for the post-construction scenario that are in compliance with the guidelines and standards from the Ministry of the Environment, Parks and Climate Change, City of Ottawa and local approval agencies. McIntosh Perry reviewed the site information and background documents listed in Section 2.0 of this report. While the previous data was reviewed by McIntosh Perry and site visits were performed, no field verification/measures of any information were conducted.

Any use of this review by a third party, or any reliance on decisions made based on it, without a reliance report is the responsibility of such third parties. McIntosh Perry accepts no responsibility for damages, if any, suffered by any third party as a result of decisions or actions made based on this review.

The findings, conclusions and/or recommendations of this report are only valid as of the date of this report. No assurance is made regarding any changes in conditions subsequent to this date. If additional information is discovered or becomes available at a future date, McIntosh Perry should be requested to re-evaluate the conclusions presented in this report, and provide amendments, if required.

APPENDIX A
KEY PLAN

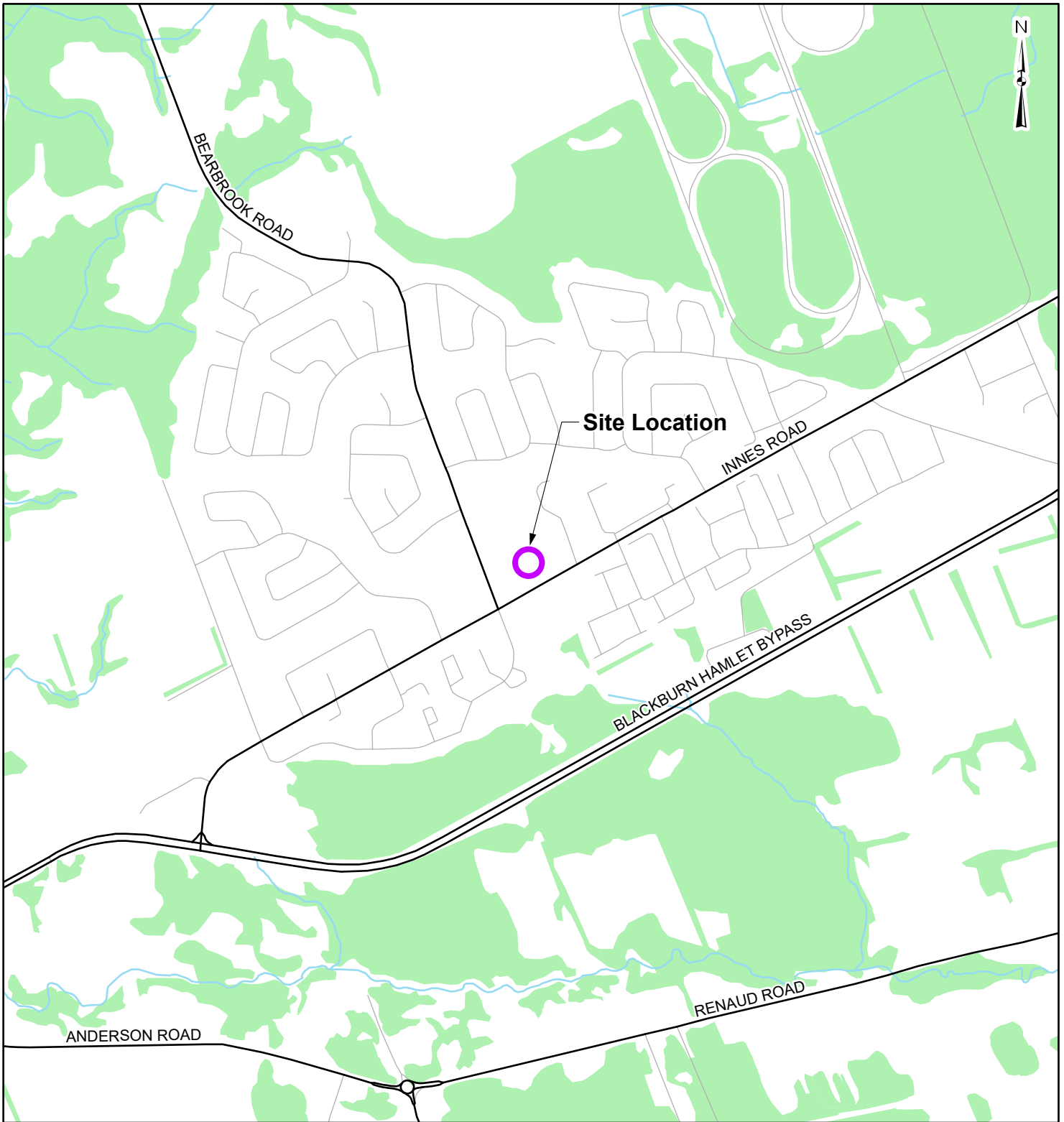

LEGEND

-  Approximate Site Location
-  Local Road
-  Major Road
-  Watercourse
-  Wooded Area

REFERENCE

GIS data provided by the Ontario Ministry of Northern Development, Mines, Natural Resources and Forestry, 2022.



CLIENT:		IDEA INC.	
PROJECT:		2663 INNES ROAD	
TITLE:		SITE LOCATION	
PROJECT NO: CCO-23-1884		FIGURE:	
Date	Oct., 17, 2022	1	
GIS	MG		
Checked By	FV		

McINTOSH PERRY
 115 Walgreen Road, RR3, Carp, ON K0A1L0
 Tel: 613-836-2184 Fax: 613-836-3742
 www.mcintoshperry.com

APPENDIX B
BACKGROUND DOCUMENTS

Francis Valenti

Subject: FW: Pre-con Follow-up - 2663 Innes Road
Attachments: innes, 2663_design brief.pdf; Pre-con Applicant's Study and Plan Identification List.docx

From: Belan, Steve <Steve.Belan@ottawa.ca>
Sent: Wednesday, September 14, 2022 9:46 AM
To: Ryan Crowle <rcrowle@integrateddesign.ca>
Cc: Moise, Christopher <christopher.moise@ottawa.ca>; Castro, Phil <phil.castro@ottawa.ca>; Richardson, Mark <Mark.Richardson@ottawa.ca>; Gervais, Josiane <josiane.gervais@ottawa.ca>; Jhamb, Nishant <nishant.jhamb@ottawa.ca>; Martinov, Amya <amya.martinov@ottawa.ca>; michellelapierre@gmail.com; Leah Guerra <lguerra@integrateddesign.ca>; Sclauzero, Cass <cass.sclauzero@ottawa.ca>
Subject: Pre-con Follow-up - [address]

[EXTERNAL EMAIL WARNING] DO NOT CLICK links or attachments unless you recognize the sender AND can confidently confirm the content is safe. If you are not expecting the email with links or attachments from a known sender, confirm with the sender that the content is safe before opening any links or attachments.

CC: Christopher Moise, Phil Castro, Mark Richardson, Josiane Gervais Nishant Jhamb, Amya Martinov, Michelle Lapierre Leah Guerra, Cass Sclauzero

Hello Mr, Crowle,

Please refer to the below [and/or attached notes] regarding the Pre-Application Consultation (pre-con) Meeting held on Thursday September 8, 2022 for the property at 2663 Innes Road for Site Plan in order to allow the development of a mixed use building consisting of 272 m2 of office space and 18 Residential units by the owner. I have also attached the required Plans & Study List for application submission.

Below [or attached] are staff's preliminary comments based on the information available at the time of pre-con meeting:

Planning

- Policies and provisions – the site is on an Arterial Street as defined in the existing and the new Official Plans. The proposal is consistent with the intent of the policies. There is no CDP for the Blackburn Hamlet.
- Committee of Adjustment / variances required – I realize that the project has been designed to conform to the Zoning By-law. There where a couple of sections that I would like you to review:
 - Section 110 requires that there be a 1.5 m landscaping buffer between the parking area and the property lines.
 - Section 186, 11 (d)(ii) requires that 50% of the street line be occulted by building wall
 - 11(f) buildings greater than 11 metres require that the 1st floor be a min. of 4.5 m high
 - 11(k) requires active doors facing the street
 - 11(l) requires that 50% of the wall facing the street be glazed



I would also like you consider seeking a variance to reduce the parking requirement from 1.2 spaces per residential unit to 1.0 spaces. This will allow you to make some room in the parking area to have some trees. I have brought this to the attention of the Committee of Adjustment Planner if you wish to consult with her, she can be reached at Cass.Sclauzero@ottawa.ca

- Would like a more detailed roof plan showing setbacks from the edge and any permanent fixtures

- Be aware of overhead wires in the right of way and any required setbacks for the building and landscaping under the lines.
- Be aware of the High Performance Development Standards approved by Council.

SITE PLANNING INFO	
LOT AREA	= 1,609 sq.m. (17,319 sq.ft.)
BUILDING AREA	= 527 sq.m. (5,673.ft.)
LANDSCAPED AREA	= 33 % (REQUIRED - 15% OF PARKING AREA)
GROSS FLOOR AREA	= 2,142 sq.m. (23,056 sq.ft.)
APPROXIMATE BUILDING HEIGHT	= 4 STOREYS @ 15m (MAX. BLDG HEIGHT = 30m)
TOTAL PARKING REQUIRED	= 29, PROVIDED = 29
ACCESSIBLE PARKING REQUIRED	= 1, PROVIDED = 1
BICYCLE PARKING REQUIRED	= 10, PROVIDED = 12

Unit Types Schedule	
Name	Area
LEVEL 01	
1-BED	593.02 ft ²
1-BED + DEN	739.41 ft ²
OFFICE #1	956.14 ft ²
OFFICE #2	785.14 ft ²
LEVEL 02	
1-BED	562.72 ft ²
1-BED + DEN	784.87 ft ²
2-BED	907.85 ft ²
2-BED	933.51 ft ²
LAW OFFICE	1195.72 ft ²
LEVEL 03	
1-BED	663.05 ft ²
1-BED	562.46 ft ²
1-BED + DEN	793.04 ft ²
1-BED + DEN	846.52 ft ²
2-BED	933.51 ft ²
2-BED	888.82 ft ²
LEVEL 04	
1-BED	663.05 ft ²
1-BED	562.46 ft ²
1-BED + DEN	846.52 ft ²
1-BED + DEN	793.04 ft ²
2-BED	888.82 ft ²
2-BED	933.51 ft ²
18833.17 ft ²	

UNIT TYPE LEGEND	
	1-BED
	1-BED + DEN
	AMENITY

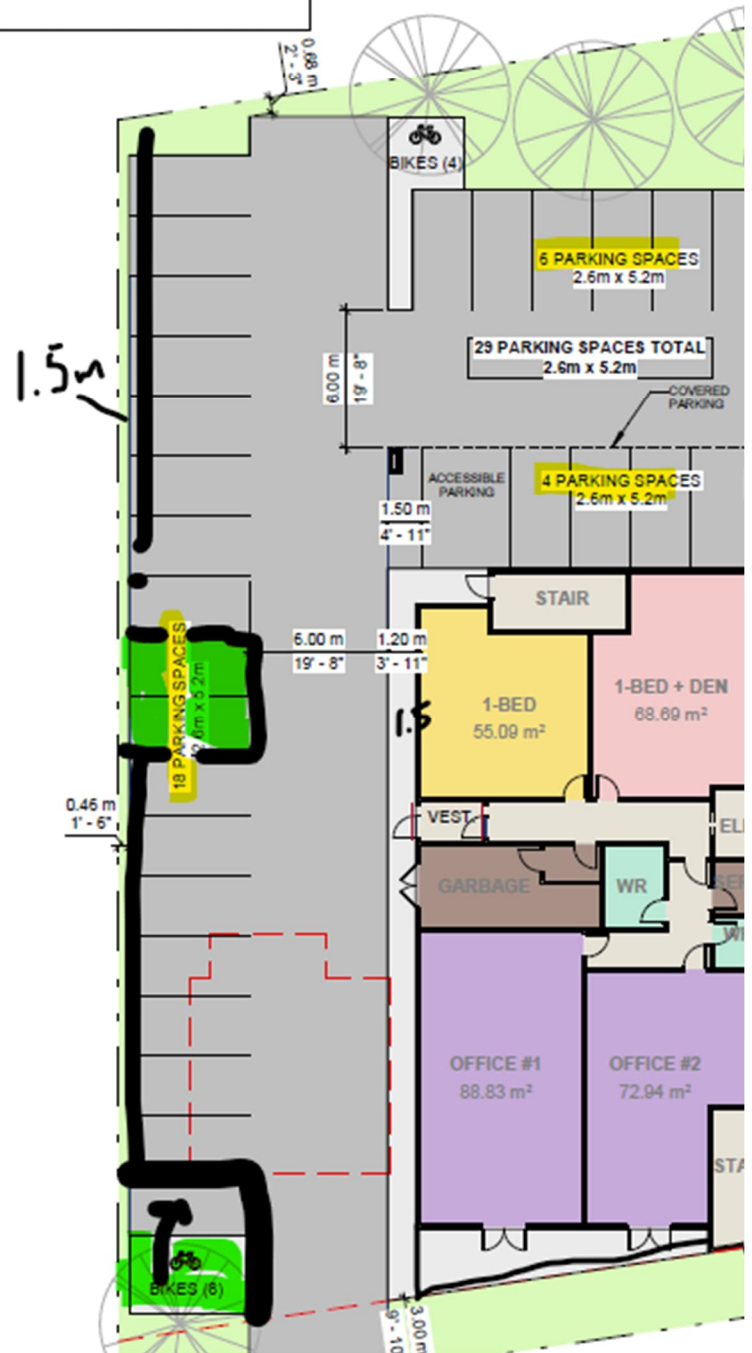

- Landscape requirements
 - Need a 1.5m landscape buffer around the parking area.
- If application is for a Zoning By-law Amendment, Official Plan Amendment or draft plan approval the Applicant must now provide a proposed strategy for public consultation as directed by Bill 73

Urban Design

- This proposal does not meet the threshold in the City's Design Priority Areas and need not attend the City's UDRP. Staff will be responsible for evaluating the proposal and providing design direction;
- We appreciate the drawings submitted and have the following comments/questions about the proposed design:
 - **DPA:** This is a mixed-use development and faces one of the City's Design Priority Areas and demands a higher standard of design quality and materiality;
 - **Internal organization:** Can the floor plan layout be reconsidered and made more efficient? Areas of concern include: poor location of stairwells with large amounts of space dedicated to circulation, dwelling units wrapping around stairwells, stairwells abutting the public right of way (which is a City designated DPA), two stairs to the roof top amenity, etc. If the floor plan was able to be reduced (especially at grade) more space could then be dedicated to landscaping;
 - **Building within 3m of street:** Note the zoning requirement to provide at least 50% of the frontage along the front lot line and corner side lot line must be occupied by building walls located within 3.0 metres of the lot line when developing the elevations;
 - **Ground Floor height:** Note the zoning requirement that the minimum height for the first storey of any building greater than 11 metres in height is 4.5 metres when developing the elevations;
 - **Orientation:** Has a building rotated parallel to the street been investigated? This approach may offer some additional benefits in side yard conditions, addressing the DPA, etc.
 - **Side yard setback:** We recommend this be carefully considered as it may impact the very large wall adjacent to the east lot line;
 - **Landscaped buffer:** Insufficient landscape is provided between the large asphalt parking area and the neighbouring property. We recommend this be increased to be closer to 1.5m to be sensitive to the neighbouring property;
 - **Parking number:** We recommend a reduction in parking if possible to allow for additional landscaping, green space and tree retention;
 - **Bike storage number & location:** We recommend that any bike parking for residents not be located in the front yards and be weather protected. Is it possible to locate the bike parking in the basement? We recommend there be a 1:1 relationship of bike parking to residential units to support the City's multi-modal transportation direction;
 - **Grade landscaping/amenity area:** We recommend the aggregate area proposed be designed with communal facilities to support the office use on the site. I.e benches, picnic tables, etc.;
 - **Trees:** We recommend the retention of as many trees on the site as possible and the planting of new trees where possible;
- A scoped Design Brief is a required submittal for all Site Plan/Re-zoning applications and can be combined with the Planning Rationale. Please see the Design Brief Terms of Reference provided.
 - **Note. The Design Brief submittal should have a section which addresses these pre-consultation comments;**

This is an exciting project in an area full of potential. We look forward to helping you achieve its goals with the highest level of design resolution. We are happy to assist and answer any questions regarding the above. Good luck.

Feel free to contact Architect | Urban Designer, Christopher Moise OAA MRAIC at Christopher.Moise@ottawa.ca , for follow-up questions.

Engineering

Note that the information is considered preliminary and the assigned Development Review Project Manager may modify and/or add additional requirements and conditions upon review of an application if deemed necessary.

General:

- It is the sole responsibility of the consultant to investigate the location of existing underground utilities in the proposed servicing area and submit a request for locates to avoid conflict(s). The location of existing utilities and services shall be documented on an Existing Conditions Plan.
- Any easements on the subject site shall be identified and respected by any development proposal and shall adhere to the conditions identified in the easement agreement. A legal survey plan shall be provided and all easements shall be shown on the engineering plans.
- All underground and above ground building footprints and permanent walls need to be shown on the plans to confirm that any permanent structure does not extend either above or below into the existing property lines and sight triangles.

- Reference documents for information purposes :
 - Ottawa Sewer Design Guidelines (October 2012)
 - Technical Bulletin PIEDTB-2016-01
 - Technical Bulletins ISTB-2018-01, ISTB-2018-02 and ISTB-2018-03.
 - Ottawa Design Guidelines - Water Distribution (2010)
 - Geotechnical Investigation and Reporting Guidelines for Development Applications in the City of Ottawa (2007)
 - City of Ottawa Slope Stability Guidelines for Development Applications (revised 2012)
 - City of Ottawa Environmental Noise Control Guidelines (January 2016)
 - City of Ottawa Accessibility Design Standards (2012) (City recommends development be in accordance with these standards on private property)
 - Ottawa Standard Tender Documents (latest version)
 - Ontario Provincial Standards for Roads & Public Works (2013)
 - Record drawings and utility plans are also available for purchase from the City (Contact the City's Information Centre by email at InformationCentre@ottawa.ca or by phone at (613) 580-424 x.44455).

Please note that this is the applicant responsibility to refer to the latest applicable guidelines while preparing reports and studies.

Stormwater Management Criteria and Information:

- Water Quantity Control: In the absence of area specific SWM criteria please control post-development runoff from the subject site, up to and including the 100-year storm event, to a 5-year pre-development level. The pre-development runoff coefficient of 0.5 is allowed for this particular application. The time of concentration (Tc) used to determine the pre-development condition should be calculated. Tc should not be less than 10 min. since IDF curves become unrealistic at less than 10 min; Tc of 10 minutes shall be used for all post-development calculations].
- Any storm events greater than the established 5-year allowable release rate, up to and including the 100-year storm event, shall be detained on-site. The SWM measures required to avoid impact on downstream sewer system will be subject to review.
- Document how any foundation drainage system will be integrated into the servicing design and show the positive outlet on the plan. Foundation drainage is to be independently connected to sewer main unless being pumped with appropriate back up power, sufficient sized pump and back flow prevention. It is recommended that the foundation drainage system be drained by a sump pump connection to the storm sewer to minimize risk of basement flooding as it will provide the best protection from the uncontrolled sewer system compared to relying on the backwater valve.

- Water Quality Control: Please consult with the local conservation authority regarding water quality criteria prior to submission of a Site Plan Control Proposal application to establish any water quality control restrictions, criteria and measures for the site. Correspondence and clearance shall be provided in the Appendix of the report.
- Please note that as per Technical Bulletin PIEDTB-2016-01 section 8.3.11.1 (p.12 of 14) there shall be no surface ponding on private parking areas during the 5-year storm rainfall event.
- Underground Storage: Please note that the Modified Rational Method for storage computation in the Sewer Design Guidelines was originally intended to be used for above ground storage (i.e. parking lot) where the change in head over the orifice varied from 1.5 m to 1.2 m (assuming a 1.2 m deep CB and a max ponding depth of 0.3 m). This change in head was small and hence the release rate fluctuated little, therefore there was no need to use an average release rate.
 - When underground storage is used, the release rate fluctuates from a maximum peak flow based on maximum head down to a release rate of zero. This difference is large and has a significant impact on storage requirements. We therefore require that an average release rate equal to 50% of the peak allowable rate shall be applied to estimate the required volume. Alternatively, the consultant may choose to use a submersible pump in the design to ensure a constant release rate.
 - In the event that there is a disagreement from the designer regarding the required storage, The City will require that the designer demonstrate their rationale utilizing dynamic modelling, that will then be reviewed by City modellers in the Water Resources Group.
 - Provide information on type of underground storage system including product name and model, number of chambers, chamber configuration, confirm invert of chamber system, top of chamber system, required cover over system and details, interior bottom slope (for self-cleansing), chart of storage values, length, width and height, capacity, entry ports (maintenance) etc. UG storage to provide actual 2- and 100-year event storage requirements.
 - In regard to all proposed UG storage, ground water levels (and in particular HGW levels) will need to be reviewed to ensure that the proposed system does not become surcharged and thereby ineffective.
 - Modeling can be provided to ensure capacity for both storm and sanitary sewers for the proposed development by City's Water Distribution Dept. – Modeling Group, through PM and upon request.
- Post-development site grading shall match existing property line grades in order to minimize disruption to the adjacent residential properties. A topographical plan of survey shall be provided as part of the submission and a note provided on the plans.
- Please provide a Pre-Development Drainage Area Plan to define the pre-development drainage areas/patterns. Existing drainage patterns shall be maintained and discussed as part of the proposed SWM solution.
- If rooftop control and storage is proposed as part of the SWM solutions sufficient details (Cl. 8.3.8.4) shall be discussed and document in the report and on the plans. Roof drains are to be connected downstream of any incorporated ICDs within the SWM system and not to the foundation drain system. Provide a Roof Drain Plan as part of the submission.
- If Window wells are proposed, they are to be indirectly connected to the footing drains. A detail of window well with indirect connection is required, as is a note at window well location speaking to indirect connection.
- There must be at least 15cm of vertical clearance between the spill elevation and the ground elevation at the building envelope that is in proximity of the flow route or ponding area. The

exception in this case would be at reverse sloped loading dock locations. At these locations, a minimum of 15cm of vertical clearance must be provided below loading dock openings. Ensure to provide discussion in report and ensure grading plan matches if applicable.

- Street catchbasins are not to be located at any proposed entrances.

Storm Sewer:

- A 675mm dia. storm sewer (1993) is available within Innes Road.
- A storm sewer monitoring maintenance hole is required to be installed at the property line (on the private side of the property) as per City of Ottawa Sewer-Use By-Law 2003-514 (14) Monitoring Devices.

Sanitary Sewer:

- A 350 mm dia. AC Sanitary sewer (1993) is available within Innes Road.
- Please provide the new Sanitary sewer discharge and we confirm if sanitary sewer main has the capacity.
- Please apply the wastewater design flow parameters in Technical Bulletin PIEDTB-2018-01.
- Sanitary sewer monitoring maintenance hole is required to be installed at the property line (on the private side of the property) as per City of Ottawa Sewer-Use By-Law 2003-514 (14) Monitoring Devices.
- A backwater valve is required on the sanitary service for protection.
- Include correspondence from the Architect within the Appendix of the report confirming the number of residential units per building and a unit type breakdown for each of the buildings to support the calculated building populations.

Water :

- A 460 mm dia. CI watermain (1969) is available within Innes Road.
- Existing residential service to be blanked at the main.
- Water Supply Redundancy: Residential buildings with a basic day demand greater than 50m³/day (0.57 L/s) are required to be connected to a minimum of two water services separated by an isolation valve to avoid a vulnerable service area as per the Ottawa Design Guidelines - Water Distribution, WDG001, July 2010 Clause 4.3.1 Configuration. The basic day demand for this site not expected to exceed 50m³/day.
- Please review Technical Bulletin ISTB-2018-02, maximum fire flow hydrant capacity is provided in Section 3 Table 1 of Appendix I. A hydrant coverage figure shall be provided and demonstrate there is adequate fire protection for the proposal. Two or more public hydrants are anticipated to be required to handle fire flow.
- Boundary conditions are required to confirm that the require fire flows can be achieved as well as availability of the domestic water pressure on the City street in front of the development. Use Table 3-3 of the MOE Design Guidelines for Drinking-Water System to determine Maximum Day and Maximum Hour peaking factors for 0 to 500 persons and use Table 4.2 of the Ottawa Design Guidelines, Water Distribution for 501 to 3,000 persons. Please provide the following information to the City of Ottawa via email to request water distribution network boundary conditions for the subject site. Please note that once this information has been provided to the City of Ottawa it takes approximately 5-10 business days to receive boundary conditions.
 - Type of Development and Units
 - Site Address
 - A plan showing the proposed water service connection location.
 - Average Daily Demand (L/s)

- Maximum Daily Demand (L/s)
- Peak Hour Demand (L/s)
- Fire Flow (L/min)

[Fire flow demand requirements shall be based on ISTB-2021-03]

Exposure separation distances shall be defined on a figure to support the FUS calculation and required fore flow (RFF).

- Hydrant capacity shall be assessed to demonstrate the RFF can be achieved. Please identify which hydrants are being considered to meet the RFF on a fire hydrant coverage plan as part of the boundary conditions request.

Gas pressure regulating station

A gas pressure regulating station may be required depending on HVAC needs (typically for 12+ units). Be sure to include this on the Grading, Site Servicing, SWM and Landscape plans. This is to ensure that there are no barriers for overland flow routes (SWM) or conflicts with any proposed grading or landscape features with installed structures and has nothing to do with supply and demand of any product.



Gas Pressure
Regulating Station.pdf

CCTV sewer inspection

- CCTV sewer inspection required for pre and post construction conditions to ensure no damage to City Assets surrounding site.

Pre-Construction Survey

Pre-Construction (Piling/Hoe Ramming or close proximity to City Assets) and/or Pre-Blasting (if applicable) Survey required for any buildings/dwellings in proximity of 75m of site and circulation of notice of vibration/noise to residents within 150 m of site. Conditions for Pre-Construction/ Pre-Blast Survey & Use of Explosives will be applied to agreements. Refer to City's Standard S.P. No. F-1201 entitled Use of Explosives, as amended.

Road Reinstatement

Please refer to the latest resurfacing policy.

https://documents.ottawa.ca/sites/documents/files/road_cut_policy_scenarios_en.pdf

Required Engineering Plans and Studies:

PLANS:

- Existing Conditions and Removals Plan
- Site Servicing Plan
- Grade Control and Drainage Plan
- Road Reinstatement Plan
- Erosion and Sediment Control Plan
- Roof Drainage Plan
- Foundation Drainage System Detail (if applicable)
- Topographical survey

REPORTS:

- Site Servicing and Stormwater Management Report
- Geotechnical Study/Investigation

- Slope Stability Assessment Reports (if required, please see requirements below)
- Noise Control Study
- Phase I ESA
- Phase II ESA (Depending on recommendations of Phase I ESA)
- Site lighting certificate

Please refer to the City of Ottawa Guide to Preparing Studies and Plans [Engineering]:

Specific information has been incorporated into both the Guide to Preparing Studies and Plans for a site plan. The guide outlines the requirement for a statement to be provided on the plan about where the property boundaries have been derived from.

Added to the general information for servicing and grading plans is a note that an O.L.S. should be engaged when reporting on or relating information to property boundaries or existing conditions. The importance of engaging an O.L.S. for development projects is emphasized.

Phase One Environmental Site Assessment:

- A Phase I ESA is required to be completed in accordance with Ontario Regulation 153/04 in support of this development proposal to determine the potential for site contamination. Depending on the Phase I recommendations a Phase II ESA may be required.
- The Phase I ESA shall provide all the required Environmental Source Information as required by O. Reg. 153/04. ERIS records are available to public at a reasonable cost and need to be included in the ESA report to comply with O.Reg. 153/04 and the Official Plan. The City will not be in a position to approve the Phase I ESA without the inclusion of the ERIS reports.
- Official Plan Section 4.8.4:

<https://ottawa.ca/en/city-hall/planning-and-development/official-plan-and-master-plans/official-plan/volume-1-official-plan/section-4-review-development-applications#4-8-protection-health-and-safety>

Geotechnical Investigation:

- A Geotechnical Study/Investigation shall be prepared in support of this development proposal.
- Reducing the groundwater level in this area can lead to potential damages to surrounding structures due to excessive differential settlements of the ground. The impact of groundwater lowering on adjacent properties needs to be discussed and investigated to ensure there will be no short term and long term damages associated with lowering the groundwater in this area.
- Geotechnical Study shall be consistent with the Geotechnical Investigation and Reporting Guidelines for Development Applications.

<https://documents.ottawa.ca/sites/default/files/documents/cap137602.pdf>

Slope Stability Assessment Reports

- A report addressing the stability of slopes, prepared by a qualified geotechnical engineer licensed in the Province of Ontario, should be provided wherever a site has slopes (existing or proposed) steeper than 5 horizontal to 1 vertical (i.e., 11 degree inclination from horizontal) and/or more than 2 metres in height.
- A report is also required for sites having retaining walls greater than 1 metre high, that addresses the global stability of the proposed retaining walls.

<https://documents.ottawa.ca/en/document/slope-stability-guidelines-development-applications>

Noise Study:

- A Transportation Noise Assessment is required as the subject development is located within 100m proximity of Innes road
- A Stationary Noise Assessment is required in order to assess the noise impact of the proposed sources of stationary noise (mechanical HVAC system/equipment) of the development onto the

surrounding residential area to ensure the noise levels do not exceed allowable limits specified in the City Environmental Noise Control Guidelines.

Exterior Site Lighting:

- Any proposed light fixtures (both pole-mounted and wall mounted) must be part of the approved Site Plan. All external light fixtures must meet the criteria for Full Cut-off Classification as recognized by the Illuminating Engineering Society of North America (IESNA or IES), and must result in minimal light spillage onto adjacent properties (as a guideline, 0.5 fc is normally the maximum allowable spillage). In order to satisfy these criteria, the please provide the City with a Certification (Statement) Letter from an acceptable professional engineer stating that the design is compliant.

Fourth (4th) Review Charge:

Please be advised that a flat fee will be charged for additional reviews , after the 3rd review.

Construction approach – Please contact the Right-of-Ways Permit Office TMconstruction@ottawa.ca early in the Site Plan process to determine the ability to construct site and copy File Lead on this request.

Please note that these comments are considered preliminary based on the information available to date and therefore maybe amended as additional details become available and presented to the City. It is the responsibility of the applicant to verify the above information. The applicant may contact me for follow-up questions related to engineering/infrastructure prior to submission of an application if necessary.

Feel free to contact the Infrastructure Project Manager, Nishant Jhamb, at Nishant.Jhamb@ottawa.ca for follow-up questions.

Transportation

- Follow Transportation Impact Assessment Guidelines:
 - Revise the Screening Form and submit at your earliest convenience to josiane.gervais@ottawa.ca. The proposed driveway is within an auxiliary turning lane and the access is within 150m of two traffic signals. The requirement for a TIA will be confirmed upon review of the Screening Form.
 - Start this process asap. The application will not be deemed complete until the submission of the draft step 1-4, including the functional draft RMA package (if applicable) and/or monitoring report (if applicable).
 - Request base mapping asap if RMA is required. Contact Engineering Services (<https://ottawa.ca/en/city-hall/planning-and-development/engineering-services>)
 - An update to the *TRANS Trip Generation Manual* has been completed (October 2020). This manual is to be utilized for this TIA. A copy of this document can be provided upon request.
- Clear throat requirements on a major collector is 8m. Ensure this length is provided. The clear throat length is measured from the ends of the driveway curb return radii at the roadway and the point of first conflict on-site.
- TMP includes Innes Road identified as a Transit Priority Corridor (Isolated Measures) (2031 Affordable Network)
- As the proposed site is multi-use and for general public use, AODA legislation applies.
 - Ensure all crosswalks located internally on the site provide a TWSI at the depressed curb, per requirements of the Integrated Accessibility Standards Regulation under the AODA.

- Clearly define accessible parking stalls and ensure they meet AODA standards (include an access aisle next to the parking stall and a pedestrian curb ramp at the end of the access aisle, as required).
- Please consider using the City’s Accessibility Design Standards, which provide a summary of AODA requirements. <https://ottawa.ca/en/city-hall/creating-equal-inclusive-and-diverse-city/accessibility-services/accessibility-design-standards-features#accessibility-design-standards>
- On site plan:
 - Ensure site access meets the City’s Private Approach Bylaw. Note that the current access does not meet the PABL due to its width.
 - A 6.7m drive aisle would be required.
 - Walking paths must be 1.5m wide, as per AODA legislation.
 - Show all details of the roads abutting the site up to and including the opposite curb; include such items as pavement markings, accesses and/or sidewalks.
 - Turning movement diagrams required for all accesses showing the largest vehicle to access/egress the site.
 - Turning movement diagrams required for internal movements (loading areas, garbage).
 - Show all curb radii measurements; ensure that all curb radii are reduced as much as possible and fall within TAC guidelines (Figure 8.5.1).
 - Show dimensions for site elements (i.e. lane/aisle widths, access width and throat length, parking stalls, sidewalks, pedestrian pathways, etc.)
 - Sidewalk is to be continuous across access as per City Specification 7.1.
 - Parking stalls at the end of dead-end parking aisles require adequate turning around space
 - Grey out any area that will not be impacted by this application.
- Noise Impact Studies required for the following:
 - Road, as the site is within proximity to Innes Road (major collector). Ensure the rooftop area is assessed as an OLA.
 - Stationary, due to the proximity to neighboring exposed mechanical equipment and/or if there will be any exposed mechanical equipment due to the proximity to neighboring noise sensitive land uses.

Feel free to contact the Transportation Project Manager Josiane Gervais at josiane.gervais@ottawa.ca, for follow-up questions.

Environmental

TCR requirements:

1. a Tree Conservation Report (TCR) must be supplied for review along with the suite of other plans/reports required by the City
 - a. an approved TCR is a requirement of Site Plan approval.
 - b. The TCR may be combined with the LP provided all information is supplied
2. Any removal of privately-owned trees 10cm or larger in diameter, or city-owned trees of any diameter requires a tree permit issued under the Tree Protection Bylaw (Bylaw 2020 – 340); the permit will be based on an approved TCR and made available at or near plan approval.
3. The Planning Forester from Planning and Growth Management as well as foresters from Forestry Services will review the submitted TCR
 - a. If tree removal is required, both municipal and privately-owned trees will be addressed in a single permit issued through the Planning Forester

- b. Compensation may be required for city owned trees – if so, it will need to be paid prior to the release of the tree permit
4. The TCR must contain 2 separate plans:
 - a. Plan/ Map 1 - show existing conditions with tree cover information
 - b. Plan/ Map 2 - show proposed development with tree cover information
 - c. Please ensure retained trees are shown on the landscape plan
5. the TCR must list all trees on site, as well as off-site trees if the CRZ extends into the developed area, by species, diameter and health condition
6. please identify trees by ownership – private onsite, private on adjoining site, city owned, co-owned (trees on a property line)
7. If trees are to be removed, the TCR must clearly show where they are, and document the reason they cannot be retained
8. All retained trees must be shown, and all retained trees within the area impacted by the development process must be protected as per City guidelines available at [Tree Protection Specification](#) or by searching Ottawa.ca
 - a. the location of tree protection fencing must be shown on the plan
 - b. show the critical root zone of the retained trees
9. the City encourages the retention of healthy trees; if possible, please seek opportunities for retention of trees that will contribute to the design/function of the site.
10. For more information on the process or help with tree retention options, contact Mark Richardson mark.richardson@ottawa.ca or on [City of Ottawa](#)

LP tree planting requirements:

For additional information on the following please contact tracy.smith@Ottawa.ca

Minimum Setbacks

- Maintain 1.5m from sidewalk or MUP/cycle track or water service laterals.
- Maintain 2.5m from curb
- Coniferous species require a minimum 4.5m setback from curb, sidewalk or MUP/cycle track/pathway.
- Maintain 7.5m between large growing trees, and 4m between small growing trees. Park or open space planting should consider 10m spacing, except where otherwise approved in naturalization / afforestation areas. Adhere to Ottawa Hydro's planting guidelines (species and setbacks) when planting around overhead primary conductors.

Tree specifications

- Minimum stock size: 50mm tree caliper for deciduous, 200cm height for coniferous.
- Maximize the use of large deciduous species wherever possible to maximize future canopy coverage
- Tree planting on city property shall be in accordance with the City of Ottawa's Tree Planting Specification; and include watering and warranty as described in the specification (can be provided by Forestry Services).
- Plant native trees whenever possible
- No root barriers, dead-man anchor systems, or planters are permitted.
- No tree stakes unless necessary (and only 1 on the prevailing winds side of the tree)

Hard surface planting

- Curb style planter is highly recommended
- No grates are to be used and if guards are required, City of Ottawa standard (which can be provided) shall be used.
- Trees are to be planted at grade

Soil Volume

- Please document on the LP that adequate soil volumes can be met:

Tree Type/Size	Single Tree Soil Volume (m3)	Multiple Tree Soil Volume (m3/tree)
Ornamental	15	9
Columnar	15	9
Small	20	12
Medium	25	15
Large	30	18
Conifer	25	15

Please note that these soil volumes are not applicable in cases with Sensitive Marine Clay.

Sensitive Marine Clay

- Please follow the City's 2017 Tree Planting in Sensitive Marine Clay guidelines

Tree Canopy Cover

- The landscape plan shall show how the proposed tree planting will replace and increase canopy cover on the site over time, to support the City's 40% urban forest canopy cover target.
- At a site level, efforts shall be made to provide as much canopy cover as possible, through tree planting and tree retention, with an aim of 40% canopy cover at 40 years, as appropriate.
- Indicate on the plan the projected future canopy cover at 40 years for the site.

Parkland

- For the proposed 4-storey mixed use building at 2663 Innes the Owner shall pay cash-in-lieu of parkland in accordance with the Parkland Dedication By-law of the City of Ottawa, as well as the fee for appraisal services. The monies are to be paid at the time of execution of the Site Plan Agreement.
- Parks and Facilities Planning is currently undertaking a legislated replacement of the Parkland Dedication By-law, with the new by-law to be considered by City Council on August 31, 2022. The by-law recommended for approval by Council increases the required parkland conveyance for mid-rise and high-rise residential development, and includes one-year transition policies for in-stream development and building permit applications or those that will be submitted and meet the requirements for completeness by September 1, 2022.

- To ensure you are aware of parkland dedication requirements for your proposed development, we encourage you to familiarize yourself with the [staff report](#) and [recommended by-law](#) that were recommended for Council approval by [Planning Committee on July 7, 2022](#). For any questions or information, please contact the project lead at Kersten.Nitsche@ottawa.ca.

City Surveyor

- The determination of property boundaries, minimum setbacks and other regulatory constraints are a critical component of development. An Ontario Land Surveyor (O.L.S.) needs to be consulted at the outset of a project to ensure properties are properly defined and can be used as the geospatial framework for the development.
- Topographic details may also be required for a project and should be either carried out by the O.L.S. that has provided the Legal Survey or done in consultation with the O.L.S. to ensure that the project is integrated to the appropriate control network.

Questions regarding the above requirements can be directed to the City's Surveyor, Bill Harper, at Bill.Harper@ottawa.ca

Waste Services

- New multi-unit residential development, defined as containing six (6) or more units, intending to receive City waste collection services will be required, as of June 1, 2022, to participate in the City's Green Bin program in accordance with Council's approval of the [multi-residential waste diversion strategy](#). The development must include adequate facilities for the proper storage of allocated garbage, recycling, and green bin containers and such facilities built in accordance with the approved site design. Questions regarding this change and requirements can be directed to Andre.Laplante@ottawa.ca.

Conservation Authority

- The Conservation Authority will be circulated
 - Stormwater runoff quality criteria
 - Area specific stormwater runoff criteria

Other

- Plans are to be standard A1 size (594 mm x 841 mm) or Arch D size (609.6 mm x 914.4 mm) sheets, dimensioned in metric and utilizing an appropriate Metric scale (1:200, 1:250, 1:300, 1:400 or 1:500).
- All PDF submitted documents are to be unlocked and flattened.
- You are encouraged to contact the Ward Councillor, Councillor Dudas, at Laura.Dudas@ottawa.ca about the proposal. You may also consider contacting the Blackburn Hamlet Community Association.

Please refer to the links to [Guide to preparing studies and plans](#) and [fees](#) for further information. Additional information is available related to [building permits](#), [development charges](#), and the [Accessibility Design Standards](#). Be aware that other fees and permits may be required, outside of the development review process. You may obtain background drawings by contacting geoinformation@ottawa.ca.

These pre-con comments are valid for one year. If you submit a development application(s) after this time, you may be required to meet for another pre-consultation meeting and/or the submission requirements may change. You are as well encouraged to contact us for a follow-up meeting if the plan/concept will be further refined.

Please do not hesitate to contact me if you have any questions.

Regards,

Steve Belan, MGP, RPP
Planner Planning Services, Development Review Services
Planning, Corporate Real Estate and Economic Development department (PRED)
City of Ottawa / Ville d'Ottawa
110 Laurier Avenue West, 4th Floor / 110, avenue Laurier Ouest, 4e étage
Ottawa, ON K1P 1J1
Telephone / tél.: 613-580-2424 ext./poste 27591
E-mail / courriel: Steve.Belan@ottawa.ca

This e-mail originates from the City of Ottawa e-mail system. Any distribution, use or copying of this e-mail or the information it contains by other than the intended recipient(s) is unauthorized. Thank you.

Le présent courriel a été expédié par le système de courriels de la Ville d'Ottawa. Toute distribution, utilisation ou reproduction du courriel ou des renseignements qui s'y trouvent par une personne autre que son destinataire prévu est interdite. Je vous remercie de votre collaboration.

Francis Valenti

From: Jamie Batchelor <jamie.batchelor@rvca.ca>
Sent: December 16, 2022 2:56 PM
To: Francis Valenti
Subject: 2663 Innes Road Quality Control Requirement

Good Afternoon Francis,

My colleague has forwarded me your inquiry. I took a look at the mapping, and I drew a similar conclusion as you did with respect to where the downstream outlet for this area is. Based on the distance to the presumed downstream outlet being less than 2 km from the site, on-site water quality control of 'enhanced' (80% TSS Removal) would be required. We would also encourage you to implement LIDs where possible as part of the stormwater management strategy.

Jamie Batchelor, MCIP, RPP
Planner, ext. 1191
jamie.batchelor@rvca.ca



3889 Rideau Valley Drive
PO Box 599, Manotick ON K4M 1A5
T 613-692-3571 | 1-800-267-3504 F 613-692-0831 | www.rvca.ca

This message may contain information that is privileged or confidential and is intended to be for the use of the individual(s) or entity named. If you are not the intended recipient of this e-mail, any use, review, revision, retransmission, distribution, dissemination, copying, printing, or taking of any action in reliance upon this e-mail, is strictly prohibited. If you have received this e-mail in error, please contact the sender and any copy of the e-mail and any printout thereof, immediately. Your cooperation is appreciated.

APPENDIX C
WATERMAIN CALCULATIONS

2023-08-30

McIntosh Perry
115 Walgreen Road
Carp, ON K0A 1L0
Mr. James Hewson, P.Eng – Project Engineer, Land Development

RE: 2663 Innes Road, Confirmation of FUS Parameters

Hi James,

As discussed, please find our confirmation of the parameters requested as follows for the new 4-storey mixed use building proposed for 2663 Innes Road, our Project #22541:

FUS Construction Type:

1. Ordinary Construction will be met or exceeded.

FUS Occupancy Type:

2. Limited Combustible is confirmed.

FUS Sprinkler Type:

3. Standard Water Supply Sprinklered confirmed as follows:
 1. Designed in accordance with NFPA 13
 2. Standard water system
 3. Fully supervised system.

Please let us know if you require anything further,

Regards,

IDEA INC.
INTEGRATED DESIGN | ENGINEERING + ARCHITECTURE



Dino Di Sano, OAA, MRAIC, LEED AP
Principal Architect & Director of Architecture



McINTOSH PERRY

000-23-1884 - 2663 Innes Road - Water Demands

Project:	2663 Innes Road
Project No.:	000-23-1884
Designed By:	FV
Checked By:	CJM
Date:	December 16, 2022
Site Area:	0.16 gross ha

Residential	NUMBER OF UNITS	UNIT RATE	
1 Bedroom Apartment	8 units	1.4	persons/unit
2 Bedroom Apartment	10 units	2.1	persons/unit

Total Population 33 persons

Commercial 275 m2

AVERAGE DAILY DEMAND

DEMAND TYPE	AMOUNT	UNITS	
Residential	280	L/c/d	
Industrial - Light	35,000	L/gross ha/d	
Industrial - Heavy	55,000	L/gross ha/d	
Shopping Centres	2,500	L/(1000m ² /d)	
Hospital	900	L/(bed/day)	
Schools	70	L/(Student/d)	
Trailer Park with no Hook-Ups	340	L/(space/d)	
Trailer Park with Hook-Ups	800	L/(space/d)	
Campgrounds	225	L/(campsite/d)	
Mobile Home Parks	1,000	L/(Space/d)	
Motels	150	L/(bed-space/d)	
Hotels	225	L/(bed-space/d)	
Tourist Commercial	28,000	L/gross ha/d	
Other Commercial	28,000	L/gross ha/d	
AVERAGE DAILY DEMAND Residential		0.11	L/s
AVERAGE DAILY DEMAND Commercial/ Industrial/ Institutional		0.01	L/s

MAXIMUM DAILY DEMAND

DEMAND TYPE	AMOUNT	UNITS	
Residential	9.5	x avg. day	L/c/d
Industrial	1.5	x avg. day	L/gross ha/d
Commercial	1.5	x avg. day	L/gross ha/d
Institutional	1.5	x avg. day	L/gross ha/d
MAXIMUM DAILY DEMAND Residential		1.02	L/s
MAXIMUM DAILY DEMAND Commercial/ Industrial/ Institutional		0.01	L/s

MAXIMUM HOUR DEMAND

DEMAND TYPE	AMOUNT	UNITS	
Residential	14.3	x avg. day	L/c/d
Industrial	1.8	x max. day	L/gross ha/d
Commercial	1.8	x max. day	L/gross ha/d
Institutional	1.8	x max. day	L/gross ha/d
MAXIMUM HOUR DEMAND Residential		1.53	L/s
MAXIMUM HOUR DEMAND Commercial/ Industrial/ Institutional		0.02	L/s

WATER DEMAND DESIGN FLOWS PER UNIT COUNT
CITY OF OTTAWA - WATER DISTRIBUTION GUIDELINES, JULY 2010

AVERAGE DAILY DEMAND	0.12	L/s
MAXIMUM DAILY DEMAND	1.03	L/s
MAXIMUM HOUR DEMAND	1.55	L/s

McINTOSH PERRY

000-23-1884 - 2663 Innes Road - OBC Fire Calculations

Project: 2663 Innes Road
 Project No.: 000-23-1884
 Designed By: FV
 Checked By: CJM
 Date: December 16, 2022

Ontario 2006 Building Code Compendium (Div. B - Part 3)

Water Supply for Fire-Fighting - Mixed Use Building

Building is classified as Group : C and D - Residential and Business Occupancies
 Building is of combustible construction with fire separations and fire resistance ratings provided in accordance with Subsection 3.2.2., including loadbearing walls, columns and arches. Noncombustible construction may be used in lieu of fire-resistance rating

From Div. B A-3.2.5.7. of the Ontario Building Code - 3. Building On-Site Water Supply:

(a) $Q = K \times V \times S_{tot}$

where:

Q = minimum supply of water in litres

K = water supply coefficient from Table 1

V = total building volume in cubic metres

S_{tot} = total of spatial coefficient values from the property line exposures on all sides as obtained from the formula:

$S_{tot} = 1.0 + [S_{side1} + S_{side2} + S_{side3} + \dots \text{etc.}]$

K	18	(from Table 1 pg A-31)
V	6,348	(Total building volume in m ³ .)
S _{tot}	2.0	(From figure 1 pg A-32)
Q =	228,533.40 L	

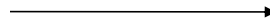

			From Figure 1 (A-32)
S _{north}	19.55	m	0.0
S _{east}	0	m	0.5
S _{south}	5.11	m	0.5
S _{west}	14.53	m	0.0

* approximate distances

From Table 2: Required Minimum Water Supply Flow Rate (L/s)

6300 L/min if Q > 190,000 L and < 270,000 L
 1664 gpm

McINTOSH PERRY

000-23-1884 - 2663 Innes Road - Fire Underwriters Survey

Project: 2663 Innes Road
 Project No.: 000-23-1884
 Designed By: FV
 Checked By: CJM
 Date: December 16, 2022

From the Fire Underwriters Survey (2020)

From Part II – Guide for Determination of Required Fire Flow Copyright I.S.O.:
 City of Ottawa Technical Bulletin ISTB-2018-02 Applied Where Applicable

A. BASE REQUIREMENT (Rounded to the nearest 1000 L/min)

F = 220 x C x √A Where: F = Required fire flow in liters per minute
 C = Coefficient related to the type of construction.
 A = The total floor area in square meters (including all storey's, but excluding basements at least 50 percent below grade) in the building being considered.

Construction Type Ordinary Construction

C 1 A 2,456.0 m²
 Total Floor Area (per the 2020 FUS Page 20 - Total Effective Area) 2,456.0 m²

Calculated Fire Flow 10,902.8 L/min
 11,000.0 L/min

B. REDUCTION FOR OCCUPANCY TYPE (No Rounding)

From Page 24 of the Fire Underwriters Survey:
 Limited Combustible -15%

Fire Flow 9,350.0 L/min

C. REDUCTION FOR SPRINKLER TYPE (No Rounding)

Standard Water Supply Sprinklered -40%

Reduction -3,740.0 L/min

D. INCREASE FOR EXPOSURE (No Rounding)

	Separation Distance (m)	Cons. of Exposed Wall	Length Exposed Adjacent Wall (m)	Height (Stories)	Length-Height Factor	
Exposure 1	Over 30 m	Wood frame	N/A	N/A	N/A	0%
Exposure 2	20.1 to 30	Wood frame	6	1	54.6	4%
Exposure 3	Over 30 m	Wood frame	N/A	N/A	N/A	0%
Exposure 4	10.1 to 20	Wood frame	54.62	3	54.6	12%
					% Increase*	16%

Increase* 1,496.0 L/min

E. Total Fire Flow (Rounded to the Nearest 1000 L/min)

Fire Flow 7,106.0 L/min
 Fire Flow Required** 7,000.0 L/min

* In accordance with Part II, Section 4, the Increase for separation distance is not to exceed 75%

** In accordance with Section 4 the Fire flow is not to exceed 45,000 L/min or be less than 2,000 L/min

McINTOSH PERRY

000-23-1884 - 2663 Innes Road - Boundary Condition Unit Conversion

Project: 2663 Innes Road

Project No.: 000-23-1884

Designed By: FV

Checked By: CJM

Date: December 16, 2022

Boundary Conditions Unit Conversion

Innes Road

Scenario	Height (m)	Elevation (m)	m H ₂ O	PSI	kPa
Avg. DD	116.0	72.2	43.8	62.3	429.7
Max Day + Fire Flow (105 L/s)	107.3	72.2	35.1	49.9	344.3
Max Day + Fire Flow (116.67 L/s)	106.0	72.2	33.8	48.1	331.6
Peak Hour	110.4	72.2	38.2	54.4	374.7

Boundary Conditions 2663 Innes Road

Provided Information

Scenario	Demand	
	L/min	L/s
Average Daily Demand	7	0.12
Maximum Daily Demand	62	1.03
Peak Hour	93	1.55
Fire Flow Demand #1	6,300	105.00
Fire Flow Demand #2	7,000	116.67

Location



Results

Connection 1 – Innes Rd.

Demand Scenario	Head (m)	Pressure ¹ (psi)
Maximum HGL	116.0	59.0
Peak Hour	110.4	51.0
Max Day plus Fire 1	107.3	46.7
Max Day plus Fire 2	106.0	44.8

Ground Elevation = 74.5 m

Disclaimer

The boundary condition information is based on current operation of the city water distribution system. The computer model simulation is based on the best information available at the time. The operation of the water distribution system can change on a regular basis, resulting in a variation in boundary conditions. The physical properties of watermains deteriorate over time, as such must be assumed in the absence of actual field test data. The variation in physical watermain properties can therefore alter the results of the computer model simulation. Fire Flow analysis is a reflection of available flow in the watermain; there may be additional restrictions that occur between the watermain and the hydrant that the model cannot take into account.

2663 Innes Road Pressure Zone Figure

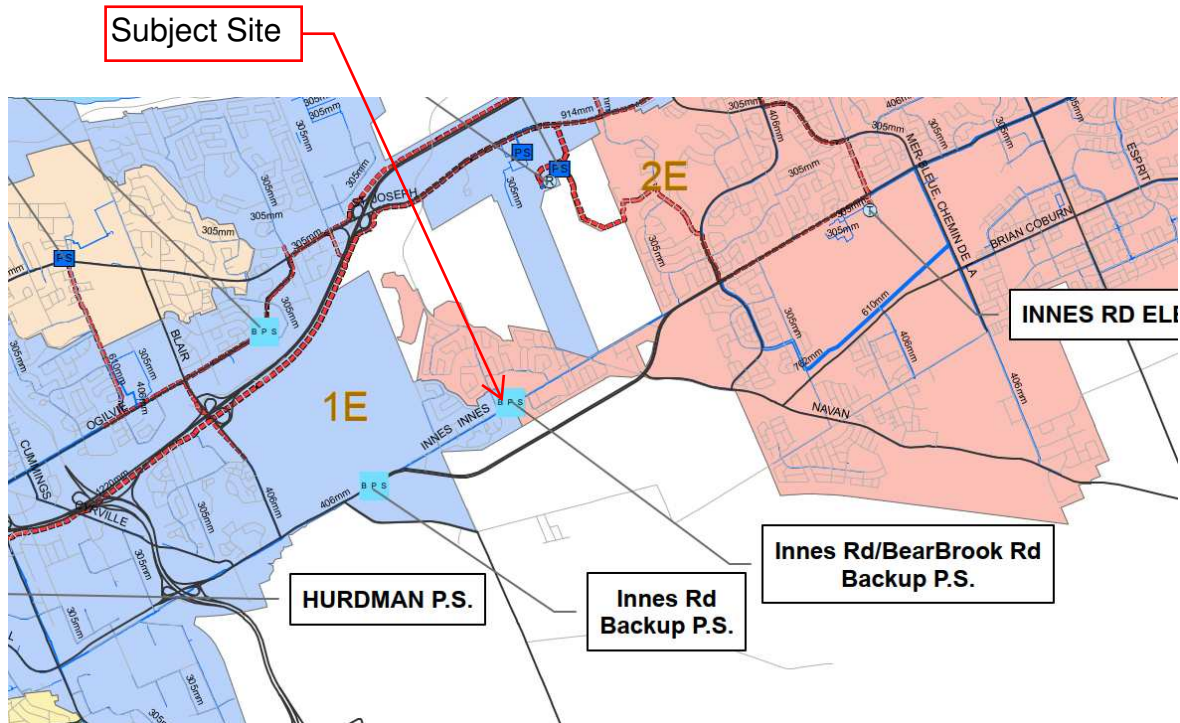

2663 Innes Road

Hydrant Coverage Figure



APPENDIX D
SANITARY CALCULATIONS

McINTOSH PERRY

000-23-1884 - 2663 Innes Road - Sanitary Demands

Project:	2663 Innes Road		
Project No.:	000-23-1884		
Designed By:	FV		
Checked By:	NV		
Date:	Oct-22		
Site Area	0.16	Gross ha	
1 Bedroom	8	1.40	Persons per unit
2 Bedroom	10	2.10	Persons per unit
Total Population	33	Persons	
Commercial Area	275.00	m ²	
Amenity Space	0.00	m ²	

DESIGN PARAMETERS

Institutional/ Commercial Peaking Factor	1	
Residential Peaking Factor	3.68	* Using Harmon Formula = $1+(14/(4+P^{0.5})) \times 0.8$ where P = population in thousands, Harmon's Correction Factor = 0.8
Mannings coefficient (n)	0.013	
Demand (per capita)	280	L/day
Infiltration allowance	0.33	L/s/Ha

EXTRANEOUS FLOW ALLOWANCES

Infiltration / Inflow	Flow (L/s)
Dry	0.01
Wet	0.04
Total	0.05

AVERAGE DAILY DEMAND

DEMAND TYPE	AMOUNT	UNITS	POPULATION / AREA	Flow (L/s)
Residential	280	L/c/d	33	0.11
Industrial - Light**	35,000	L/gross ha/d		0
Industrial - Heavy**	55,000	L/gross ha/d		0
Commercial / Amenity	2,800	L/(1000m ² /d)	275.00	0.01
Hospital	900	L/(bed/day)		0
Schools	70	L/(Student/d)		0
Trailer Parks no Hook-Ups	340	L/(space/d)		0
Trailer Park with Hook-Ups	800	L/(space/d)		0
Campgrounds	225	L/(campsite/d)		0
Mobile Home Parks	1,000	L/(Space/d)		0
Motels	150	L/(bed-space/d)		0
Hotels	225	L/(bed-space/d)		0
Office	75	L/7.0m ² /d		0
Tourist Commercial	28,000	L/gross ha/d		0
Other Commercial	28,000	L/gross ha/d		0

AVERAGE RESIDENTIAL FLOW	0.11	L/s
PEAK RESIDENTIAL FLOW	0.39	L/s
AVERAGE IQ FLOW	0.01	L/s
PEAK INSTITUTIONAL/ COMMERCIAL FLOW	0.01	L/s
PEAK INDUSTRIAL FLOW	0.00	L/s
TOTAL PEAK IQ FLOW	0.01	L/s

TOTAL SANITARY DEMAND

TOTAL ESTIMATED AVERAGE DRY WEATHER FLOW	0.12	L/s
TOTAL ESTIMATED PEAK DRY WEATHER FLOW	0.41	L/s
TOTAL ESTIMATED PEAK WET WEATHER FLOW	0.46	L/s

APPENDIX E
PRE-DEVELOPMENT DRAINAGE PLAN



GENERAL NOTES

- THE ORIGINAL TOPOGRAPHY, GROUND ELEVATION AND SURVEY DATA SHOWN ARE SUPPLIED FOR INFORMATION PURPOSES ONLY, AND IMPLY NO GUARANTEE OF ACCURACY. IT SHALL BE THE RESPONSIBILITY OF THE CONTRACTOR TO VERIFY ALL INFORMATION SHOWN.
- THIS PLAN IS NOT A CADASTRAL SURVEY SHOWING LEGAL PROPERTY BOUNDARIES AND EASEMENTS. THE PROPERTY BOUNDARIES SHOWN HEREON HAVE BEEN DERIVED FROM INFORMATION SUPPLIED BY OR SHOWN ON: (1) BARNES LIMITED DRAWING 22-10-002-00 AND CANNOT BE RELIED UPON TO BE ACCURATE OR COMPLETE. THE PRECISE LOCATION OF THE CURRENT PROPERTY BOUNDARIES AND EASEMENTS CAN ONLY BE DETERMINED BY AN UP-TO-DATE LAND TITLES SEARCH AND A SUBSEQUENT CADASTRAL SURVEY PERFORMED AND CERTIFIED BY AN ONTARIO LAND SURVEYOR.
- THE CONTRACTOR IS TO OBTAIN AND PAY FOR ALL NECESSARY PERMITS AND APPROVALS FROM THE CITY BEFORE COMMENCING CONSTRUCTION.
- THE CONTRACTOR IS RESPONSIBLE FOR ALL LAYOUT.
- THE CONTRACTOR IS TO DETERMINE THE EXACT LOCATION, SIZE, MATERIAL AND ELEVATION OF ALL EXISTING UTILITIES PRIOR TO COMMENCING CONSTRUCTION. PROTECT AND ASSUME ALL RESPONSIBILITY FOR EXISTING UTILITIES WHETHER OR NOT SHOWN ON THESE DRAWINGS. IF THERE IS ANY DISCREPANCY THE CONTRACTOR IS TO NOTIFY THE ENGINEER PROMPTLY.
- RESTORE ALL TRENCHES AND SURFACES OF PUBLIC ROAD ALLOWANCES TO CONDITION EQUAL OR BETTER THAN ORIGINAL CONDITION AND TO THE SATISFACTION OF THE CITY AUTHORITIES.
- EXCAVATE AND DISPOSE OF ALL EXCESS EXCAVATED MATERIAL, SUCH AS ASPHALT, CURBING AND DEBRIS, OFF SITE AS DIRECTED BY THE ENGINEER AND THE CITY.
- TOPSOIL TO BE STRIPPED AND STOCKPILED FOR REHABILITATION. CLEAN FILL TO BE PLACED IN FILL AREAS AND COMPACTED TO 95% STANDARD PROCTOR DENSITY.
- ALL DISTURBED AREAS TO BE RESTORED TO ORIGINAL CONDITION OR BETTER UNLESS OTHERWISE SPECIFIED.
- THE CONTRACTOR SHALL BE RESPONSIBLE FOR ALL TRAFFIC CONTROL AND SAFETY MEASURES DURING THE CONSTRUCTION PERIOD, INCLUDING THE SUPPLY, INSTALLATION, AND REMOVAL OF ALL NECESSARY SIGNAGE, DELINEATORS, MARKERS AND BARRIERS OF THE ENGINEER/CITY.
- DO NOT ALTER GRADING OF THE SITE WITHOUT PRIOR APPROVAL OF THE ENGINEER/CITY.
- ALL ROADWAY, PARKING LOT, AND GRADING WORKS TO BE UNDERTAKEN IN ACCORDANCE WITH CITY STANDARDS AND SPECIFICATIONS. THE CONTRACTOR IS TO PROVIDE POSITIVE DRAINAGE AWAY FROM THE BUILDING.
- CONTACT THE CITY FOR INSPECTION OF ROUGH GRADING OF PARKING LOTS, ROADWAYS AND LANDSCAPED AREAS PRIOR TO PLACEMENT OF ASPHALT AND TOPSOIL. ALL DEFICIENCIES NOTED SHALL BE RECTIFIED TO THE CITY'S SATISFACTION PRIOR TO PLACEMENT OF ANY ASPHALT, TOPSOIL, SEED & MULCH AND/OR SOO.
- ALL DIMENSIONS AND INVERTS MUST BE VERIFIED PRIOR TO CONSTRUCTION, IF THERE IS ANY DISCREPANCY THE CONTRACTOR IS TO NOTIFY THE ENGINEER PROMPTLY.
- ELECTRICAL, GAS, TELEPHONE AND TELEVISION SERVICE LOCATIONS ARE SUBJECT TO THE INDIVIDUAL AGENCY:
 - ELECTRICAL SERVICE - HYDRO ONE,
 - GAS SERVICE - ENBRIDGE,
 - TELEPHONE SERVICE - BELL CANADA,
 - TELEVISION SERVICE - ROGERS.
- INSTALLATION TO BE IN ACCORDANCE WITH CURRENT CODES AND STANDARDS OF APPROVAL AGENCIES HYDRO ONE, BELL AND THE CITY.
- CONTRACTOR TO ENSURE ALL APPLICABLE OPS SPECIFICATIONS ARE FOLLOWED DURING CONSTRUCTION.
- ALL PROPOSED CURBS TO BE CONCRETE BARRIER CURB UNLESS OTHERWISE SPECIFIED.

LEGEND:

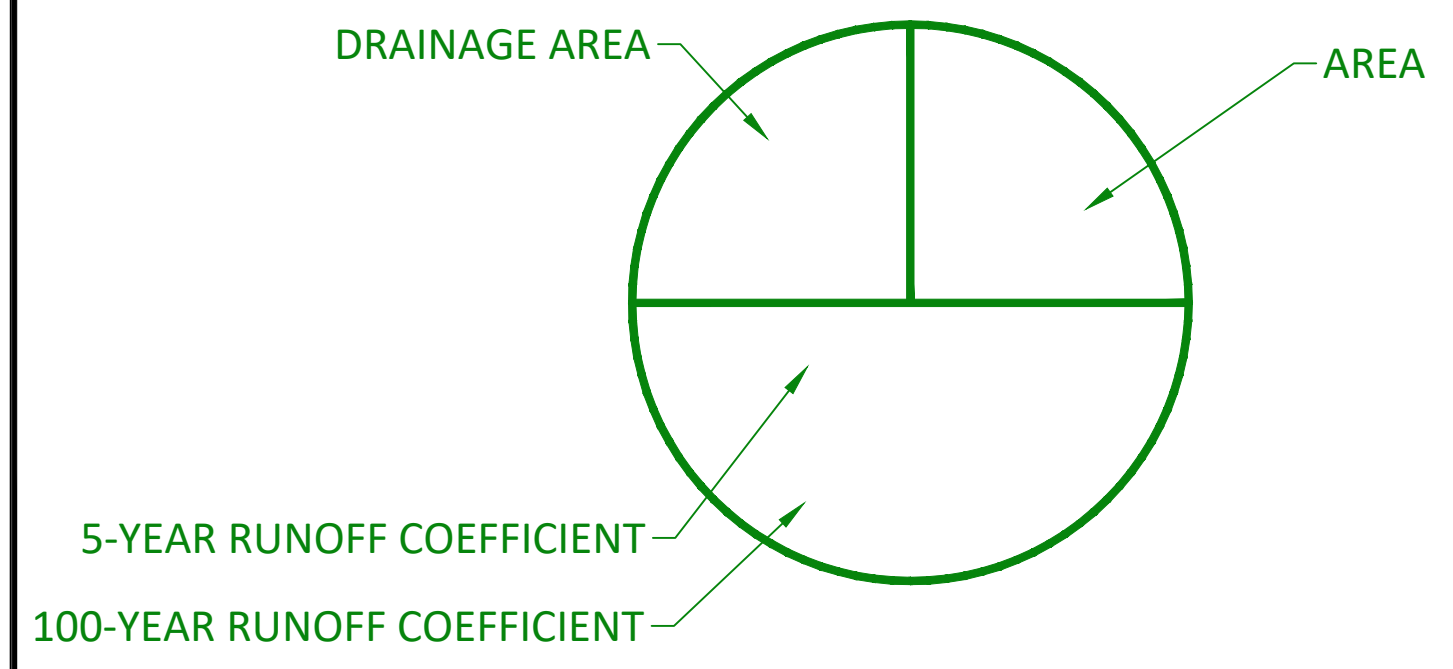

5-YEAR RUNOFF COEFFICIENT
100-YEAR RUNOFF COEFFICIENT

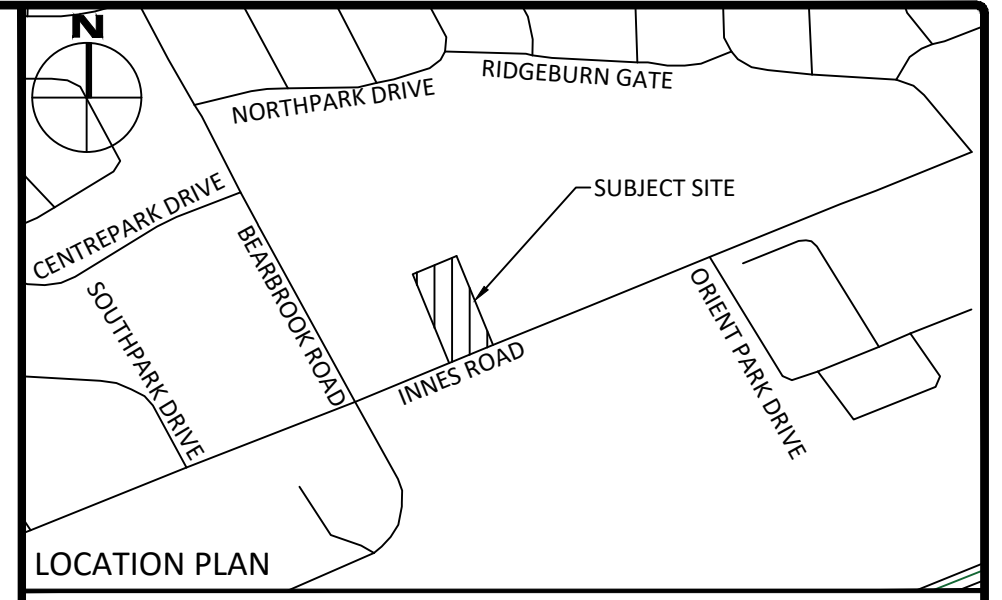

FOR REVIEW ONLY
NOT FOR CONSTRUCTION

No.	Revisions	Date
3	ISSUED FOR SITE PLAN CONTROL	JUL 7, 2023
2	ISSUED FOR SITE PLAN CONTROL	JAN. 20, 2023
1	ISSUED FOR REVIEW	DEC. 16, 2022

Check and verify all dimensions before proceeding with the work. Do not scale drawings.

SCALE 1:150

McINTOSH PERRY
115 Walgreen Road, RR3, Carp, ON K0A 1L0
Tel: 613-836-2184 Fax: 613-836-3742
www.mcintoshperry.com

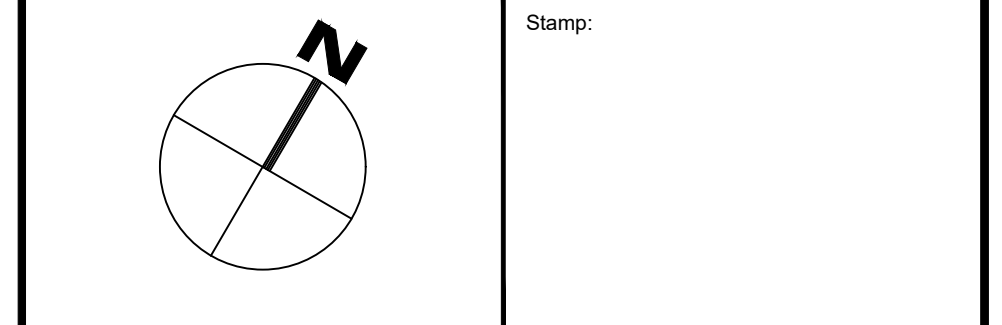

Client: **8743169 Canada Ltd**
595 BYRON AVENUE
OTTAWA, ON K2A 4C4

Project: **MIXED USE BUILDING**
2663 INNES ROAD

Drawing Title: **PRE-DEVELOPMENT DRAINAGE AREA PLAN**

Scale: 1:150	Project Number: CCO-23-1884
Drawn By: FV	Checked By: JH
Designed By: JH	Drawing Number: PRE

FILENAME: U:\Cityworks\01 Projects - Proposed\2023\06\16\CCO-23-1884\0616\Drawings\CCO-23-1884_Presentation.dwg
 USER: JH (JH), DATE: 2023-07-07 10:00:00 AM, LAST SAVED BY: JH (JH)
 LAST PLOTTED: Friday, July 07, 2023 10:00:00 AM

D07-12-22-0182

APPENDIX F
POST-DEVELOPMENT DRAINAGE PLAN

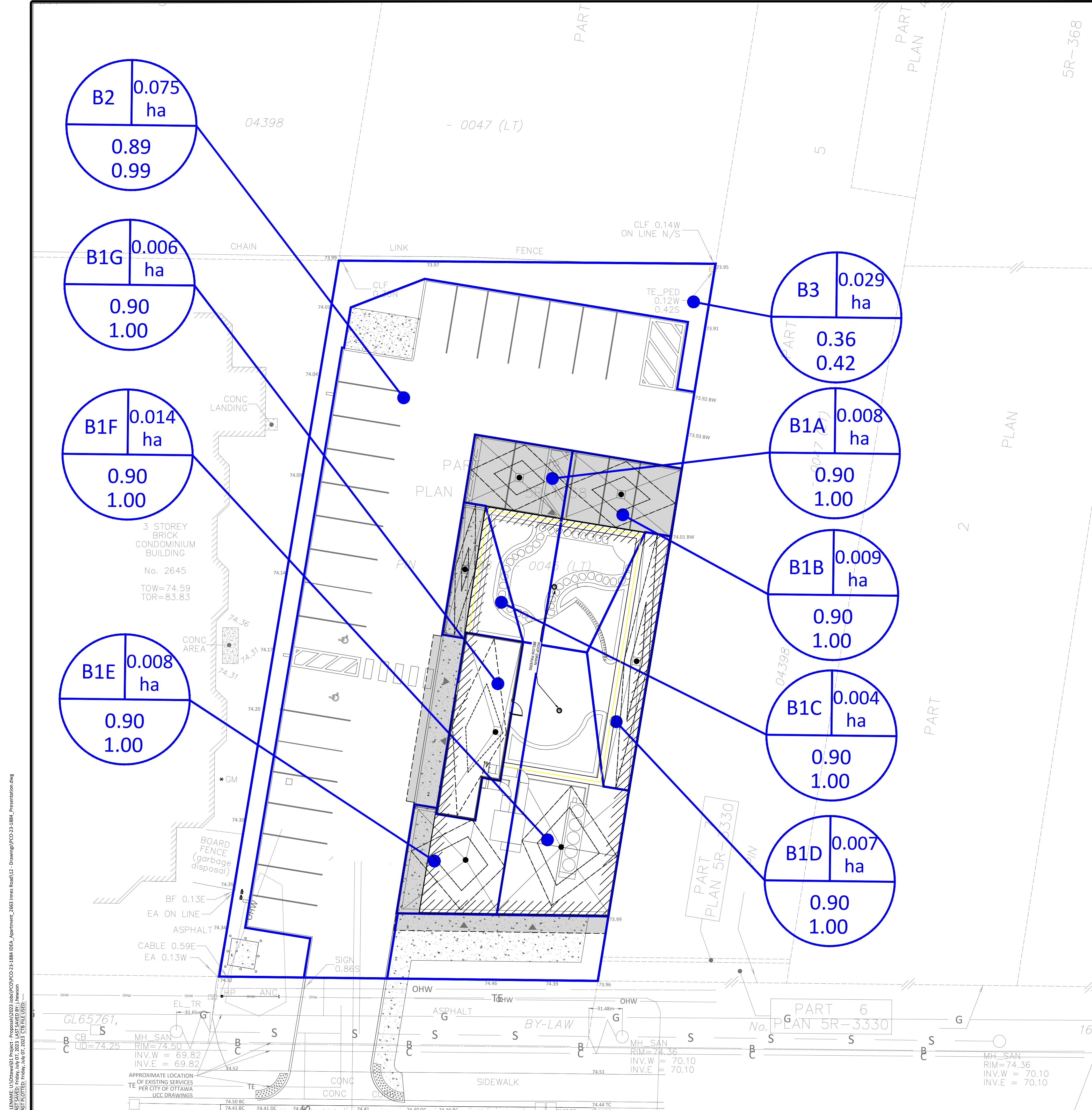

GENERAL NOTES

1. THE ORIGINAL TOPOGRAPHY, GROUND ELEVATION AND SURVEY DATA SHOWN ARE SUPPLIED FOR INFORMATION PURPOSES ONLY, AND IMPLY NO GUARANTEE OF ACCURACY. IT SHALL BE THE RESPONSIBILITY OF THE CONTRACTOR TO VERIFY ALL INFORMATION SHOWN.
2. THIS PLAN IS NOT A CADASTRAL SURVEY SHOWING LEGAL PROPERTY BOUNDARIES AND EASEMENTS. THE PROPERTY BOUNDARIES SHOWN HEREON HAVE BEEN DERIVED FROM INFORMATION SUPPLIED BY (OR SHOWN ON) J.D. BARNES LIMITED DRAWING 22-10-082-00 AND CANNOT BE RELIED UPON TO BE ACCURATE OR COMPLETE. THE PRECISE LOCATION OF THE CURRENT PROPERTY BOUNDARIES AND EASEMENTS CAN ONLY BE DETERMINED BY AN UP-TO-DATE LAND TITLES SEARCH AND A SUBSEQUENT CADASTRAL SURVEY PERFORMED AND CERTIFIED BY AN ONTARIO LAND SURVEYOR.
3. THE CONTRACTOR IS TO OBTAIN AND PAY FOR ALL NECESSARY PERMITS AND APPROVALS FROM THE CITY BEFORE COMMENCING CONSTRUCTION.
4. THE CONTRACTOR IS RESPONSIBLE FOR ALL LAYOUT.
5. THE CONTRACTOR IS TO DETERMINE THE EXACT LOCATION, SIZE, MATERIAL AND ELEVATION OF ALL EXISTING UTILITIES PRIOR TO COMMENCING CONSTRUCTION. PROTECT AND ASSUME ALL RESPONSIBILITY FOR EXISTING UTILITIES WHETHER OR NOT SHOWN ON THESE DRAWINGS. IF THERE IS ANY DISCREPANCY THE CONTRACTOR IS TO NOTIFY THE ENGINEER PROMPTLY.
6. RESTORE ALL TRENCHES AND SURFACES OF PUBLIC ROAD ALLOWANCES TO CONDITION EQUAL OR BETTER THAN ORIGINAL CONDITION AND TO THE SATISFACTION OF THE CITY AUTHORITIES.
7. EXCAVATE AND DISPOSE OF ALL EXCESS EXCAVATED MATERIAL, SUCH AS ASPHALT CURBS AND DEBRIS, OFF SITE AS DIRECTED BY THE ENGINEER AND THE CITY.
8. TOPSOIL TO BE STRIPPED AND STOCKPILED FOR REHABILITATION. CLEAN FILL TO BE PLACED IN FILL AREAS AND COMPACTED TO 95% STANDARD PROCTOR DENSITY.
9. ALL DISTURBED AREAS TO BE RESTORED TO ORIGINAL CONDITION OR BETTER UNLESS OTHERWISE SPECIFIED.
10. THE CONTRACTOR SHALL BE RESPONSIBLE FOR ALL TRAFFIC CONTROL AND SAFETY MEASURES DURING THE CONSTRUCTION PERIOD, INCLUDING THE SUPPLY, INSTALLATION, AND REMOVAL OF ALL NECESSARY SIGNAGE, DELINEATORS, MARKERS AND BARRIERS.
11. DO NOT ALTER GRADING OF THE SITE WITHOUT PRIOR APPROVAL OF THE ENGINEER/CITY.
12. ALL ROADWAY, PARKING LOT, AND GRADING WORKS TO BE UNDERTAKEN IN ACCORDANCE WITH CITY STANDARDS AND SPECIFICATIONS. THE CONTRACTOR IS TO PROVIDE POSITIVE DRAINAGE AWAY FROM THE BUILDING.
13. CONTACT THE CITY FOR INSPECTION OF ROUGH GRADING OF PARKING LOTS, ROADWAYS AND LANDSCAPED AREAS PRIOR TO PLACEMENT OF ASPHALT AND TOPSOIL. ALL DEFICIENCIES NOTED SHALL BE RECTIFIED TO THE CITY'S SATISFACTION PRIOR TO PLACEMENT OF ANY ASPHALT, TOPSOIL, SEED & MULCH AND/OR SOIL.
14. ALL DIMENSIONS AND INVERTS MUST BE VERIFIED PRIOR TO CONSTRUCTION. IF THERE IS ANY DISCREPANCY THE CONTRACTOR IS TO NOTIFY THE ENGINEER PROMPTLY.
15. ELECTRICAL, GAS, TELEPHONE AND TELEVISION SERVICE LOCATIONS ARE SUBJECT TO THE INDIVIDUAL AGENCY:
 - ELECTRICAL SERVICE - HYDRO ONE,
 - GAS SERVICE - ENBRIDGE,
 - TELEPHONE SERVICE - BELL CANADA,
 - TELEVISION SERVICE - ROGERS.
16. INSTALLATION TO BE IN ACCORDANCE WITH CURRENT CODES AND STANDARDS OF APPROVAL AGENCIES HYDRO ONE, BELL AND THE CITY.
17. CONTRACTOR TO ENSURE ALL APPLICABLE OPS SPECIFICATIONS ARE FOLLOWED DURING CONSTRUCTION.
18. ALL PROPOSED CURB TO BE CONCRETE BARRIER CURB UNLESS OTHERWISE SPECIFIED.

LEGEND:

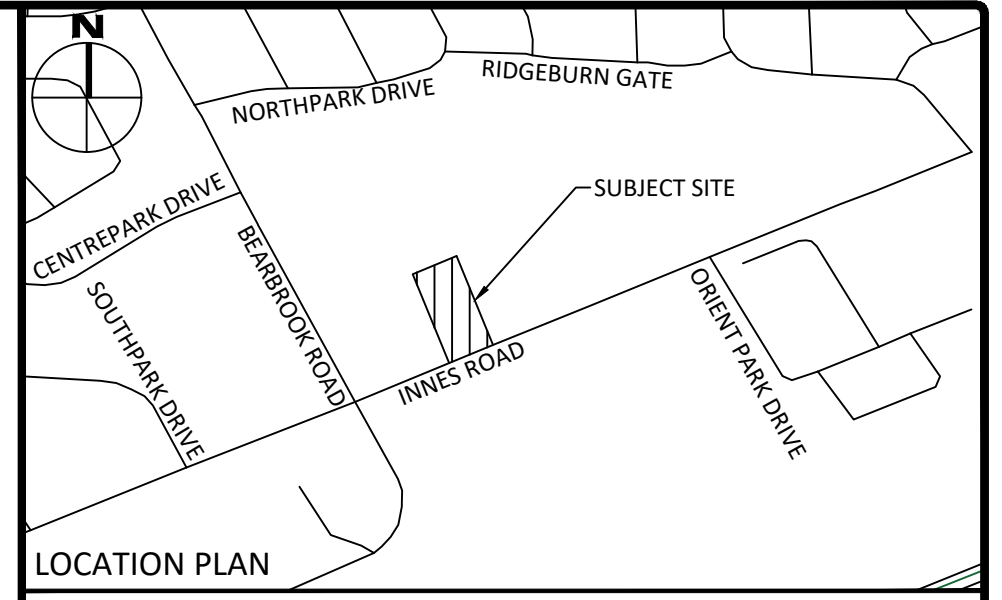
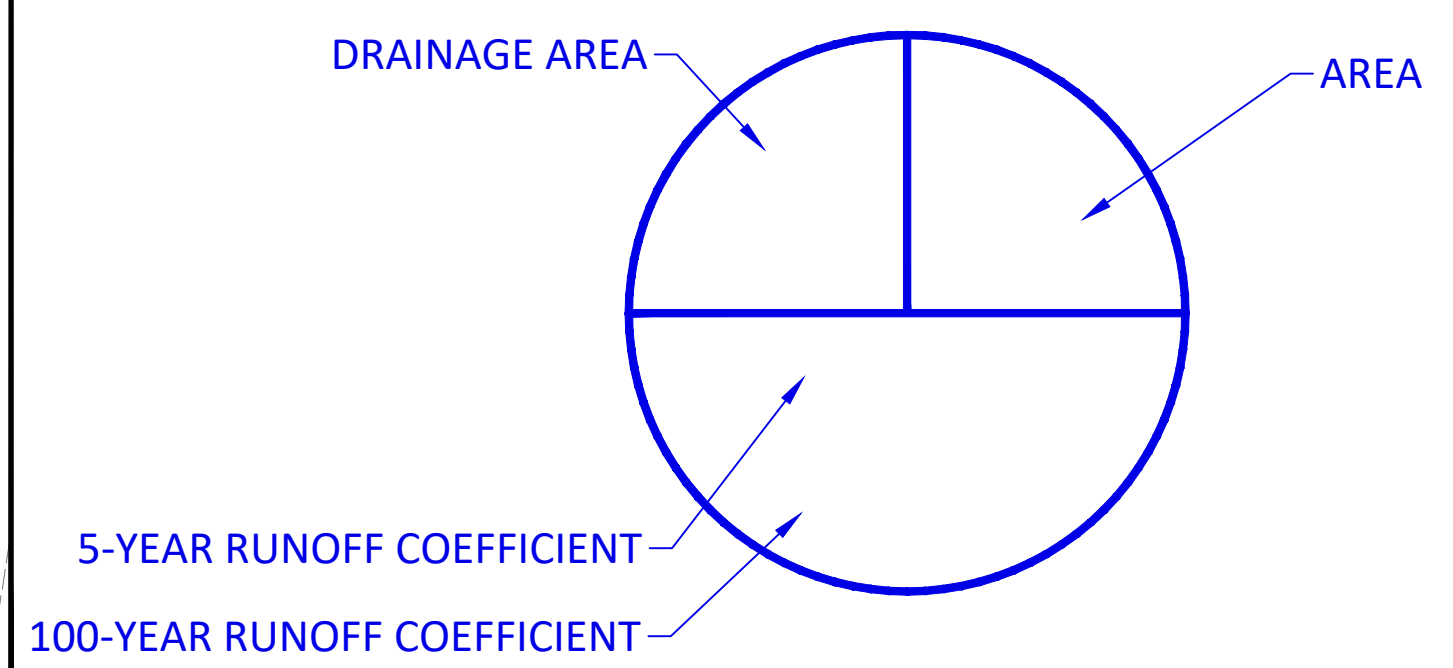

FOR REVIEW ONLY
NOT FOR CONSTRUCTION

No.	Revisions	Date
3	ISSUED FOR SITE PLAN CONTROL	JUL 7, 2023
2	ISSUED FOR SITE PLAN CONTROL	JAN. 20, 2023
1	ISSUED FOR REVIEW	DEC. 16, 2022

Check and verify all dimensions before proceeding with the work. Do not scale drawings.
SCALE 1:150
0 5 10 15 Metres

McINTOSH PERRY
115 Walgreen Road, RR3, Carp, ON K0A 1L0
Tel: 613-836-2184 Fax: 613-836-3742
www.mcintoshperry.com

Client: **8743169 Canada Ltd**
595 BYRON AVENUE
OTTAWA, ON K2A 4C4

Project: **MIXED USE BUILDING**
2663 INNES ROAD

Drawing Title: **POST-DEVELOPMENT DRAINAGE AREA PLAN**

Scale: 1:150	Project Number: CCO-23-1884
Drawn By: FV	Checked By: JH
Designed By: JH	Stamp: POST

DRAWING: C:\Users\jhperry\OneDrive - City of Ottawa\Documents\2023\06\06\CCO-23-1884\06\06\CCO-23-1884_Presentation.dwg
LAST SAVED: Friday, July 07, 2023 1:52:00 PM
LAST PLOTTED: Friday, July 07, 2023 1:52:00 PM

D07-12-22-0182

APPENDIX G
STORMWATER MANAGEMENT CALCULATIONS

McINTOSH PERRY

CCO-23-1884 - 2663 Innes Road

1 of 16

Tc (min)	Intensity (mm/hr)	
	5-Year	100-Year
20	70.3	120.0
10	104.2	178.6

C-Values	
Impervious	0.90
Gravel	0.60
Pervious	0.20

Pre-Development Runoff Coefficient

Drainage Area	Impervious Area (m ²)	Gravel (m ²)	Pervious Area (m ²)	Average C (5-year)	Average C (100-year)
A1	86	311	1,195	0.32	0.39

Pre-Development Runoff Calculations

Drainage Area	Area (ha)	C 5-Year	C 100-Year	Tc (min)	Q (L/s)	
					5-Year	100-Year
A1	0.16	0.32	0.39	10	14.57	30.68
Total	0.159				14.57	30.68

Post-Development Runoff Coefficient

Drainage Area	Impervious Area (m ²)	Gravel (m ²)	Pervious Area (m ²)	Average C (5-year)	Average C (100-year)	
B1A	76	0		0.90	1.00	Roof
B1B	94	0		0.90	1.00	Roof
B1C	40	0		0.90	1.00	Roof
B1D	68	0		0.90	1.00	Roof
B1E	81	0		0.90	1.00	Roof
B1F	138	0		0.90	1.00	Roof
B1G	58	0		0.90	1.00	Roof
B2	762	0	14	0.89	0.99	Surface Controlled
B3	59	0	202	0.36	0.42	Surface Uncontrolled

Post-Development Runoff Calculations

Drainage Area	Area (ha)	C 5-Year	C 100-Year	Tc (min)	Q (L/s)		
					5-Year	100-Year	
B1A	0.008	0.90	1.00	10	1.97	3.75	Roof
B1B	0.009	0.90	1.00	10	2.45	4.66	Roof
B1C	0.004	0.90	1.00	10	1.03	1.96	Roof
B1D	0.007	0.90	1.00	10	1.78	3.38	Roof
B1E	0.008	0.90	1.00	10	2.12	4.04	Roof
B1F	0.014	0.90	1.00	10	3.60	6.86	Roof
B1G	0.006	0.90	1.00	10	1.51	2.88	Roof
B2	0.078	0.89	0.99	10	19.96	38.02	Surface Controlled
B3	0.026	0.36	0.42	10	2.70	5.42	Surface Uncontrolled
Total	0.159				34.42	65.55	

Required Restricted Flow

Drainage Area	Area (ha)	C 5-Year	Tc (min)	Q (L/s)
				5-Year
A1	0.159	0.32	10	14.57

Post-Development Restricted Runoff Calculations

Drainage Area	Unrestricted Flow (L/s)		Restricted Flow (L/s)		Storage Required (m ³)		Storage Provided (m ³)	
	5-year	100-Year	5-Year	100-Year	5-Year	100-Year	5-Year	100-Year
B1A	1.97	3.75	0.68	0.95	0.78	1.89	0.82	1.90
B1B	2.45	4.66	0.87	1.48	0.95	1.98	1.07	1.99
B1C	1.03	1.96	0.63	0.90	0.24	0.64	0.26	0.69
B1D	1.78	3.38	0.65	0.90	0.68	1.65	0.68	1.67
B1E	2.12	4.04	0.66	0.90	0.92	2.18	0.99	2.23
B1F	3.60	6.86	1.01	1.89	1.70	3.26	1.80	3.37
B1G	1.51	2.88	0.57	0.79	0.57	1.37	0.64	1.42
B2	19.96	38.02	6.80	7.02	8.00	22.59	8.00	22.63
B3	2.70	5.42	2.70	5.42				
Total	37.12	70.98	14.57	20.25	13.8	35.5	14.3	35.9

McINTOSH PERRY

CCO-23-1884 - 2663 Innes Road - Roof Storage - B1A

2 of 16

5-Year Storm Event

Tc (min)	I (mm/hr)	Runoff (L/s)	Allowable	Runoff to	Storage
			Outflow (L/s)	be Stored (L/s)	Required (m ³)
10	104.2	1.97	0.68	1.29	0.78
20	70.3	1.33	0.68	0.65	0.78
30	53.9	1.02	0.68	0.34	0.61
40	44.2	0.84	0.68	0.16	0.38
50	37.7	0.71	0.68	0.03	0.10
60	32.9	0.62	0.68	-0.06	-0.20
70	29.4	0.56	0.68	-0.12	-0.51
80	26.6	0.50	0.68	-0.18	-0.84

Maximum Storage Required 5-Year (m ³) =	0.78
---	------

100-Year Storm Event

Tc (min)	I (mm/hr)	Runoff (L/s)	Allowable	Runoff to	Storage
			Outflow (L/s)	be Stored (L/s)	Required (m ³)
10	178.6	3.75	0.95	2.81	1.68
20	120.0	2.52	0.95	1.57	1.89
30	91.9	1.93	0.95	0.98	1.77
40	75.1	1.58	0.95	0.63	1.52
50	64.0	1.34	0.95	0.40	1.19
60	55.9	1.17	0.95	0.23	0.82
70	49.8	1.05	0.95	0.10	0.42
80	45.0	0.95	0.95	0.00	0.00

Maximum Storage Required 100-Year (m ³) =	1.89
---	------

Storage Parameters	
Roof Area (m ²)	37.95
Usable Roof Area (%)	100%
Usable Roof Area (m ²)	37.95

5-Year Storage Summary	
Max. Storage Available (m ³)	0.82
Storage Required (m ³)	0.78
Max. Ponding Depth (m)	0.065

100-Year Storage Summary	
Max. Storage Available (m ³)	1.90
100-Year Storage Required (m ³)	1.89
Max. Ponding Depth (m)	0.150

0

McINTOSH PERRY

CCO-23-1884 - 2663 Innes Road - Roof Storage - B1A

3 of 16

Roof Drains Summary		
Type of Control Device	Watts Drainage - Accutrol Weir	
Number of Roof Drains	1	
Roof Drain Position	1/4 Open	
	5-Year	100-Year
Rooftop Storage Available (m ³)	0.82	1.90
Rooftop Storage Required (m ³)	0.78	1.89
Storage Depth (m)	0.065	0.150
Flow (Per Roof Drain) (L/s)	0.68	0.95
Total Flow (L/s)	0.68	0.95

Flow Rate Vs. Build-Up (Individual Drain)	
Depth (mm)	Flow (L/s)
0	0.00
5	0.06
10	0.13
15	0.19
20	0.25
25	0.32
30	0.38
35	0.44
40	0.50
45	0.57
50	0.63
55	0.65
60	0.66
65	0.68
70	0.69
75	0.71
80	0.73
85	0.74
90	0.76
95	0.77
100	0.79
105	0.80
110	0.82
115	0.84
120	0.85
125	0.87
130	0.88
135	0.90
140	0.91
145	0.93
150	0.95

5-Year

100-Year

Roof Drain Flow		
Individual Flow (l/s)	Storage Depth (mm)	Cumulative Flow (l/s)
0.00	0	0.00
0.06	5	0.06
0.13	10	0.13
0.19	15	0.19
0.25	20	0.25
0.32	25	0.32
0.38	30	0.38
0.44	35	0.44
0.50	40	0.50
0.57	45	0.57
0.63	50	0.63
0.65	55	0.65
0.66	60	0.66
0.68	65	0.68
0.69	70	0.69
0.71	75	0.71
0.73	80	0.73
0.74	85	0.74
0.76	90	0.76
0.77	95	0.77
0.79	100	0.79
0.80	105	0.80
0.82	110	0.82
0.84	115	0.84
0.85	120	0.85
0.87	125	0.87
0.88	130	0.88
0.90	135	0.90
0.91	140	0.91
0.93	145	0.93
0.95	150	0.95

* Roof Drain model to be Accutrol Weirs, See attached sheets
 * Roof Drain Flow information taken from Watts Drainage website

Note: The flow leaving through a restricted roof drain is based on flow vs. head information

McINTOSH PERRY

CCO-23-1884 - 2663 Innes Road - Roof Storage - B1B

4 of 16

5-Year Storm Event

Tc (min)	I (mm/hr)	Runoff (L/s)	Allowable	Runoff to	Storage
			Outflow (L/s)	be Stored (L/s)	Required (m ³)
10	104.2	2.45	0.87	1.58	0.95
20	70.3	1.65	0.87	0.78	0.94
30	53.9	1.27	0.87	0.40	0.72
40	44.2	1.04	0.87	0.17	0.41
50	37.7	0.89	0.87	0.02	0.06
60	32.9	0.77	0.87	-0.09	-0.34
70	29.4	0.69	0.87	-0.18	-0.74
80	26.6	0.63	0.87	-0.24	-1.16

Maximum Storage Required 5-Year (m ³) =	0.95
---	------

100-Year Storm Event

Tc (min)	I (mm/hr)	Runoff (L/s)	Allowable	Runoff to	Storage
			Outflow (L/s)	be Stored (L/s)	Required (m ³)
10	178.6	4.66	1.48	3.18	1.91
20	120.0	3.13	1.48	1.65	1.98
30	91.9	2.40	1.48	0.92	1.65
40	75.1	1.96	1.48	0.48	1.15
50	64.0	1.67	1.48	0.19	0.56
60	55.9	1.46	1.48	-0.02	-0.08
70	49.8	1.30	1.48	-0.18	-0.77
80	45.0	1.17	1.48	-0.31	-1.48

Maximum Storage Required 100-Year (m ³) =	1.98
---	------

Storage Parameters	
Roof Area (m ²)	42.61
Usable Roof Area (%)	100%
Usable Roof Area (m ²)	42.61

5-Year Storage Summary	
Max. Storage Available (m ³)	1.07
Storage Required (m ³)	0.95
Max. Ponding Depth (m)	0.075

100-Year Storage Summary	
Max. Storage Available (m ³)	1.99
100-Year Storage Required (m ³)	1.98
Max. Ponding Depth (m)	0.140

0

McINTOSH PERRY

CCO-23-1884 - 2663 Innes Road - Roof Storage - B1B

5 of 16

Roof Drains Summary		
Type of Control Device	Watts Drainage - Accutrol Weir	
Number of Roof Drains	1	
Roof Drain Position	3/4 Open	
	5-Year	100-Year
Rooftop Storage Available (m ³)	1.07	1.99
Rooftop Storage Required (m ³)	0.95	1.98
Storage Depth (m)	0.075	0.140
Flow (Per Roof Drain) (L/s)	0.87	1.48
Total Flow (L/s)	0.87	1.48

Flow Rate Vs. Build-Up (Individual Drain)	
Depth (mm)	Flow (L/s)
0	0.00
5	0.06
10	0.13
15	0.19
20	0.25
25	0.32
30	0.38
35	0.44
40	0.50
45	0.57
50	0.63
55	0.68
60	0.73
65	0.77
70	0.82
75	0.87
80	0.91
85	0.96
90	1.01
95	1.06
100	1.10
105	1.15
110	1.20
115	1.25
120	1.29
125	1.34
130	1.39
135	1.44
140	1.48
145	1.53
150	1.58

5-Year

100-Year

Roof Drain Flow		
Individual Flow (l/s)	Storage Depth (mm)	Cumulative Flow (l/s)
0.00	0	0.00
0.06	5	0.06
0.13	10	0.13
0.19	15	0.19
0.25	20	0.25
0.32	25	0.32
0.38	30	0.38
0.44	35	0.44
0.50	40	0.50
0.57	45	0.57
0.63	50	0.63
0.68	55	0.68
0.73	60	0.73
0.77	65	0.77
0.82	70	0.82
0.87	75	0.87
0.91	80	0.91
0.96	85	0.96
1.01	90	1.01
1.06	95	1.06
1.10	100	1.10
1.15	105	1.15
1.20	110	1.20
1.25	115	1.25
1.29	120	1.29
1.34	125	1.34
1.39	130	1.39
1.44	135	1.44
1.48	140	1.48
1.53	145	1.53
1.58	150	1.58

* Roof Drain model to be Accutrol Weirs, See attached sheets
 * Roof Drain Flow information taken from Watts Drainage website

Note: The flow leaving through a restricted roof drain is based on flow vs. head information

McINTOSH PERRY

CCO-23-1884 - 2663 Innes Road - Roof Storage - B1C

6 of 16

5-Year Storm Event

Tc (min)	I (mm/hr)	Runoff (L/s)	Allowable	Runoff to	Storage
			Outflow (L/s)	be Stored (L/s)	Required (m ³)
10	104.2	1.03	0.63	0.40	0.24
20	70.3	0.69	0.63	0.06	0.08
30	53.9	0.53	0.63	-0.10	-0.18
40	44.2	0.44	0.63	-0.19	-0.47
50	37.7	0.37	0.63	-0.26	-0.77
60	32.9	0.33	0.63	-0.31	-1.10
70	29.4	0.29	0.63	-0.34	-1.43
80	26.6	0.26	0.63	-0.37	-1.77

Maximum Storage Required 5-Year (m ³) =	0.24
---	------

100-Year Storm Event

Tc (min)	I (mm/hr)	Runoff (L/s)	Allowable	Runoff to	Storage
			Outflow (L/s)	be Stored (L/s)	Required (m ³)
10	178.6	1.96	0.90	1.06	0.64
20	120.0	1.32	0.90	0.42	0.50
30	91.9	1.01	0.90	0.11	0.20
40	75.1	0.83	0.90	-0.07	-0.18
50	64.0	0.70	0.90	-0.20	-0.59
60	55.9	0.61	0.90	-0.29	-1.03
70	49.8	0.55	0.90	-0.35	-1.48
80	45.0	0.49	0.90	-0.40	-1.94

Maximum Storage Required 100-Year (m ³) =	0.64
---	------

Storage Parameters	
Roof Area (m ²)	15.35
Usable Roof Area (%)	100%
Usable Roof Area (m ²)	15.35

5-Year Storage Summary	
Max. Storage Available (m ³)	0.26
Storage Required (m ³)	0.24
Max. Ponding Depth (m)	0.05

100-Year Storage Summary	
Max. Storage Available (m ³)	0.69
100-Year Storage Required (m ³)	0.64
Max. Ponding Depth (m)	0.135

McINTOSH PERRY

CCO-23-1884 - 2663 Innes Road - Roof Storage - B1C

7 of 16

Roof Drains Summary		
Type of Control Device	Watts Drainage - Accutrol Weir	
Number of Roof Drains	1	
Roof Drain Position	1/4 Open	
	5-Year	100-Year
Rooftop Storage Available (m ³)	0.26	0.69
Rooftop Storage Required (m ³)	0.24	0.64
Storage Depth (m)	0.050	0.135
Flow (Per Roof Drain) (L/s)	0.63	0.90
Total Flow (L/s)	0.63	0.90

Flow Rate Vs. Build-Up (Individual Drain)	
Depth (mm)	Flow (L/s)
0	0.00
5	0.06
10	0.13
15	0.19
20	0.25
25	0.32
30	0.38
35	0.44
40	0.50
45	0.57
50	0.63
55	0.65
60	0.66
65	0.68
70	0.69
75	0.71
80	0.73
85	0.74
90	0.76
95	0.77
100	0.79
105	0.80
110	0.82
115	0.84
120	0.85
125	0.87
130	0.88
135	0.90
140	0.91
145	0.93
150	0.95

5-Year

100-Year

Roof Drain Flow		
Individual Flow (l/s)	Storage Depth (mm)	Cumulative Flow (l/s)
0.00	0	0.00
0.06	5	0.06
0.13	10	0.13
0.19	15	0.19
0.25	20	0.25
0.32	25	0.32
0.38	30	0.38
0.44	35	0.44
0.50	40	0.50
0.57	45	0.57
0.63	50	0.63
0.65	55	0.65
0.66	60	0.66
0.68	65	0.68
0.69	70	0.69
0.71	75	0.71
0.73	80	0.73
0.74	85	0.74
0.76	90	0.76
0.77	95	0.77
0.79	100	0.79
0.80	105	0.80
0.82	110	0.82
0.84	115	0.84
0.85	120	0.85
0.87	125	0.87
0.88	130	0.88
0.90	135	0.90
0.91	140	0.91
0.93	145	0.93
0.95	150	0.95

* Roof Drain model to be Accutrol Weirs, See attached sheets
 * Roof Drain Flow information taken from Watts Drainage website

Note: The flow leaving through a restricted roof drain is based on flow vs. head information

McINTOSH PERRY

CCO-23-1884 - 2663 Innes Road - Roof Storage - B1D

8 of 16

5-Year Storm Event

Tc (min)	I (mm/hr)	Runoff (L/s)	Allowable	Runoff to	Storage
			Outflow (L/s)	be Stored (L/s)	Required (m ³)
10	104.2	1.78	0.65	1.13	0.68
20	70.3	1.20	0.65	0.55	0.66
30	53.9	0.92	0.65	0.27	0.49
40	44.2	0.75	0.65	0.11	0.26
50	37.7	0.64	0.65	0.00	-0.01
60	32.9	0.56	0.65	-0.09	-0.31
70	29.4	0.50	0.65	-0.15	-0.61
80	26.6	0.45	0.65	-0.19	-0.93

Maximum Storage Required 5-Year (m ³) =	0.68
---	------

100-Year Storm Event

Tc (min)	I (mm/hr)	Runoff (L/s)	Allowable	Runoff to	Storage
			Outflow (L/s)	be Stored (L/s)	Required (m ³)
10	178.6	3.38	0.90	2.48	1.49
20	120.0	2.27	0.90	1.37	1.65
30	91.9	1.74	0.90	0.84	1.51
40	75.1	1.42	0.90	0.52	1.26
50	64.0	1.21	0.90	0.31	0.93
60	55.9	1.06	0.90	0.16	0.57
70	49.8	0.94	0.90	0.04	0.18
80	45.0	0.85	0.90	-0.05	-0.23

Maximum Storage Required 100-Year (m ³) =	1.65
---	------

Storage Parameters	
Roof Area (m ²)	37.08
Usable Roof Area (%)	100%
Usable Roof Area (m ²)	37.08

5-Year Storage Summary	
Max. Storage Available (m ³)	0.68
Storage Required (m ³)	0.68
Max. Ponding Depth (m)	0.055

100-Year Storage Summary	
Max. Storage Available (m ³)	1.67
100-Year Storage Required (m ³)	1.65
Max. Ponding Depth (m)	0.135

McINTOSH PERRY

CCO-23-1884 - 2663 Innes Road - Roof Storage - B1D

9 of 16

Roof Drains Summary		
Type of Control Device	Watts Drainage - Accutrol Weir	
Number of Roof Drains	1	
Roof Drain Position	1/4 Open	
	5-Year	100-Year
Rooftop Storage Available (m ³)	0.68	1.67
Rooftop Storage Required (m ³)	0.68	1.65
Storage Depth (m)	0.055	0.135
Flow (Per Roof Drain) (L/s)	0.65	0.90
Total Flow (L/s)	0.65	0.90

Flow Rate Vs. Build-Up (Individual Drain)	
Depth (mm)	Flow (L/s)
0	0.00
5	0.06
10	0.13
15	0.19
20	0.25
25	0.32
30	0.38
35	0.44
40	0.50
45	0.57
50	0.63
55	0.65
60	0.66
65	0.68
70	0.69
75	0.71
80	0.73
85	0.74
90	0.76
95	0.77
100	0.79
105	0.80
110	0.82
115	0.84
120	0.85
125	0.87
130	0.88
135	0.90
140	0.91
145	0.93
150	0.95

5-Year

100-Year

Roof Drain Flow		
Individual Flow (l/s)	Storage Depth (mm)	Cumulative Flow (l/s)
0.00	0	0.00
0.06	5	0.06
0.13	10	0.13
0.19	15	0.19
0.25	20	0.25
0.32	25	0.32
0.38	30	0.38
0.44	35	0.44
0.50	40	0.50
0.57	45	0.57
0.63	50	0.63
0.65	55	0.65
0.66	60	0.66
0.68	65	0.68
0.69	70	0.69
0.71	75	0.71
0.73	80	0.73
0.74	85	0.74
0.76	90	0.76
0.77	95	0.77
0.79	100	0.79
0.80	105	0.80
0.82	110	0.82
0.84	115	0.84
0.85	120	0.85
0.87	125	0.87
0.88	130	0.88
0.90	135	0.90
0.91	140	0.91
0.93	145	0.93
0.95	150	0.95

* Roof Drain model to be Accutrol Weirs, See attached sheets
 * Roof Drain Flow information taken from Watts Drainage website

Note: The flow leaving through a restricted roof drain is based on flow vs. head information

McINTOSH PERRY

CCO-23-1884 - 2663 Innes Road - Roof Storage - B1E

10 of 16

5-Year Storm Event

Tc (min)	I (mm/hr)	Runoff (L/s)	Allowable	Runoff to	Storage
			Outflow (L/s)	be Stored (L/s)	Required (m ³)
10	104.2	2.12	0.66	1.46	0.88
20	70.3	1.43	0.66	0.77	0.92
30	53.9	1.10	0.66	0.44	0.78
40	44.2	0.90	0.66	0.24	0.57
50	37.7	0.77	0.66	0.11	0.32
60	32.9	0.67	0.66	0.01	0.03
70	29.4	0.60	0.66	-0.06	-0.27
80	26.6	0.54	0.66	-0.12	-0.58

Maximum Storage Required 5-Year (m ³) =	0.92
---	------

100-Year Storm Event

Tc (min)	I (mm/hr)	Runoff (L/s)	Allowable	Runoff to	Storage
			Outflow (L/s)	be Stored (L/s)	Required (m ³)
10	178.6	4.04	0.90	3.14	1.88
20	120.0	2.71	0.90	1.82	2.18
30	91.9	2.08	0.90	1.18	2.12
40	75.1	1.70	0.90	0.80	1.92
50	64.0	1.45	0.90	0.55	1.64
60	55.9	1.26	0.90	0.37	1.32
70	49.8	1.13	0.90	0.23	0.96
80	45.0	1.02	0.90	0.12	0.57

Maximum Storage Required 100-Year (m ³) =	2.18
---	------

Storage Parameters	
Roof Area (m ²)	62.02
Usable Roof Area (%)	80%
Usable Roof Area (m ²)	49.62

5-Year Storage Summary	
Max. Storage Available (m ³)	0.99
Storage Required (m ³)	0.92
Max. Ponding Depth (m)	0.06

100-Year Storage Summary	
Max. Storage Available (m ³)	2.23
100-Year Storage Required (m ³)	2.18
Max. Ponding Depth (m)	0.135

McINTOSH PERRY

CCO-23-1884 - 2663 Innes Road - Roof Storage - B1E

11 of 16

Roof Drains Summary		
Type of Control Device	Watts Drainage - Accutrol Weir	
Number of Roof Drains	1	
Roof Drain Position	1/4 Open	
	5-Year	100-Year
Rooftop Storage Available (m ³)	0.99	2.23
Rooftop Storage Required (m ³)	0.92	2.18
Storage Depth (m)	0.060	0.135
Flow (Per Roof Drain) (L/s)	0.66	0.90
Total Flow (L/s)	0.66	0.90

Flow Rate Vs. Build-Up (Individual Drain)	
Depth (mm)	Flow (L/s)
0	0.00
5	0.06
10	0.13
15	0.19
20	0.25
25	0.32
30	0.38
35	0.44
40	0.50
45	0.57
50	0.63
55	0.65
60	0.66
65	0.68
70	0.69
75	0.71
80	0.73
85	0.74
90	0.76
95	0.77
100	0.79
105	0.80
110	0.82
115	0.84
120	0.85
125	0.87
130	0.88
135	0.90
140	0.91
145	0.93
150	0.95

5-Year

100-Year

Roof Drain Flow		
Individual Flow (l/s)	Storage Depth (mm)	Cumulative Flow (l/s)
0.00	0	0.00
0.06	5	0.06
0.13	10	0.13
0.19	15	0.19
0.25	20	0.25
0.32	25	0.32
0.38	30	0.38
0.44	35	0.44
0.50	40	0.50
0.57	45	0.57
0.63	50	0.63
0.65	55	0.65
0.66	60	0.66
0.68	65	0.68
0.69	70	0.69
0.71	75	0.71
0.73	80	0.73
0.74	85	0.74
0.76	90	0.76
0.77	95	0.77
0.79	100	0.79
0.80	105	0.80
0.82	110	0.82
0.84	115	0.84
0.85	120	0.85
0.87	125	0.87
0.88	130	0.88
0.90	135	0.90
0.91	140	0.91
0.93	145	0.93
0.95	150	0.95

* Roof Drain model to be Accutrol Weirs, See attached sheets
 * Roof Drain Flow information taken from Watts Drainage website

Note: The flow leaving through a restricted roof drain is based on flow vs. head information

McINTOSH PERRY

CCO-23-1884 - 2663 Innes Road - Roof Storage - B1F

12 of 16

5-Year Storm Event

Tc (min)	I (mm/hr)	Runoff (L/s)	Allowable	Runoff to	Storage
			Outflow (L/s)	be Stored (L/s)	Required (m ³)
10	104.2	3.60	1.01	2.59	1.56
20	70.3	2.43	1.01	1.42	1.70
30	53.9	1.86	1.01	0.85	1.54
40	44.2	1.53	1.01	0.52	1.24
50	37.7	1.30	1.01	0.29	0.88
60	32.9	1.14	1.01	0.13	0.46
70	29.4	1.02	1.01	0.01	0.03
80	26.6	0.92	1.01	-0.09	-0.43

Maximum Storage Required 5-Year (m ³) =	1.70
---	------

100-Year Storm Event

Tc (min)	I (mm/hr)	Runoff (L/s)	Allowable	Runoff to	Storage
			Outflow (L/s)	be Stored (L/s)	Required (m ³)
10	178.6	6.86	1.89	4.97	2.98
20	120.0	4.61	1.89	2.71	3.26
30	91.9	3.53	1.89	1.64	2.94
40	75.1	2.89	1.89	0.99	2.38
50	64.0	2.46	1.89	0.56	1.69
60	55.9	2.15	1.89	0.25	0.91
70	49.8	1.91	1.89	0.02	0.08
80	45.0	1.73	1.89	-0.16	-0.79

Maximum Storage Required 100-Year (m ³) =	3.26
---	------

Storage Parameters	
Roof Area (m ²)	84.25
Usable Roof Area (%)	80%
Usable Roof Area (m ²)	67.40

5-Year Storage Summary	
Max. Storage Available (m ³)	1.80
Storage Required (m ³)	1.70
Max. Ponding Depth (m)	0.08

100-Year Storage Summary	
Max. Storage Available (m ³)	3.37
100-Year Storage Required (m ³)	3.26
Max. Ponding Depth (m)	0.150

0

McINTOSH PERRY

CCO-23-1884 - 2663 Innes Road - Roof Storage - B1F

13 of 16

Roof Drains Summary		
Type of Control Device	Watts Drainage - Accutrol Weir	
Number of Roof Drains	1	
Roof Drain Position	Open	
	5-Year	100-Year
Rooftop Storage Available (m ³)	1.80	3.37
Rooftop Storage Required (m ³)	1.70	3.26
Storage Depth (m)	0.080	0.150
Flow (Per Roof Drain) (L/s)	1.01	1.89
Total Flow (L/s)	1.01	1.89

Flow Rate Vs. Build-Up (Individual Drain)	
Depth (mm)	Flow (L/s)
0	0.00
5	0.06
10	0.13
15	0.19
20	0.25
25	0.32
30	0.38
35	0.44
40	0.50
45	0.57
50	0.63
55	0.69
60	0.76
65	0.82
70	0.88
75	0.95
80	1.01
85	1.07
90	1.14
95	1.20
100	1.26
105	1.32
110	1.39
115	1.45
120	1.51
125	1.58
130	1.64
135	1.70
140	1.77
145	1.83
150	1.89

	Roof Drain Flow		
	Individual Flow (l/s)	Storage Depth (mm)	Cumulative Flow (l/s)
	0.00	0	0.00
	0.06	5	0.06
	0.13	10	0.13
	0.19	15	0.19
	0.25	20	0.25
	0.32	25	0.32
	0.38	30	0.38
	0.44	35	0.44
	0.50	40	0.50
	0.57	45	0.57
	0.63	50	0.63
	0.69	55	0.69
	0.76	60	0.76
	0.82	65	0.82
	0.88	70	0.88
	0.95	75	0.95
5-Year	1.01	80	1.01
	1.07	85	1.07
	1.14	90	1.14
	1.20	95	1.20
	1.26	100	1.26
	1.32	105	1.32
	1.39	110	1.39
	1.45	115	1.45
	1.51	120	1.51
	1.58	125	1.58
	1.64	130	1.64
	1.70	135	1.70
	1.77	140	1.77
	1.83	145	1.83
100-Year	1.89	150	1.89

* Roof Drain model to be Accutrol Weirs, See attached sheets
 * Roof Drain Flow information taken from Watts Drainage website

Note: The flow leaving through a restricted roof drain is based on flow vs. head information

McINTOSH PERRY

CCO-23-1884 - 2663 Innes Road - Roof Storage - B1G

14 of 16

5-Year Storm Event

Tc (min)	I (mm/hr)	Runoff (L/s)	Allowable	Runoff to	Storage
			Outflow (L/s)	be Stored (L/s)	Required (m ³)
10	104.2	1.51	0.57	0.94	0.57
20	70.3	1.02	0.57	0.45	0.54
30	53.9	0.78	0.57	0.21	0.39
40	44.2	0.64	0.57	0.07	0.18
50	37.7	0.55	0.57	-0.02	-0.06
60	32.9	0.48	0.57	-0.09	-0.33
70	29.4	0.43	0.57	-0.14	-0.59
80	26.6	0.39	0.57	-0.18	-0.87

Maximum Storage Required 5-Year (m ³) =	0.57
---	------

100-Year Storm Event

Tc (min)	I (mm/hr)	Runoff (L/s)	Allowable	Runoff to	Storage
			Outflow (L/s)	be Stored (L/s)	Required (m ³)
10	178.6	2.88	0.79	2.09	1.25
20	120.0	1.93	0.79	1.15	1.37
30	91.9	1.48	0.79	0.69	1.25
40	75.1	1.21	0.79	0.42	1.01
50	64.0	1.03	0.79	0.24	0.73
60	55.9	0.90	0.79	0.11	0.40
70	49.8	0.80	0.79	0.01	0.06
80	45.0	0.73	0.79	-0.06	-0.30

Maximum Storage Required 100-Year (m ³) =	1.37
---	------

Storage Parameters	
Roof Area (m ²)	53.34
Usable Roof Area (%)	80%
Usable Roof Area (m ²)	42.67

5-Year Storage Summary	
Max. Storage Available (m ³)	0.64
Storage Required (m ³)	0.57
Max. Ponding Depth (m)	0.045

100-Year Storage Summary	
Max. Storage Available (m ³)	1.42
100-Year Storage Required (m ³)	1.37
Max. Ponding Depth (m)	0.100

McINTOSH PERRY

CCO-23-1884 - 2663 Innes Road - Roof Storage - B1G

15 of 16

Roof Drains Summary		
Type of Control Device	Watts Drainage - Accutrol Weir	
Number of Roof Drains	1	
Roof Drain Position	1/4 Open	
	5-Year	100-Year
Rooftop Storage Available (m ³)	0.64	1.42
Rooftop Storage Required (m ³)	0.57	1.37
Storage Depth (m)	0.045	0.100
Flow (Per Roof Drain) (L/s)	0.57	0.79
Total Flow (L/s)	0.57	0.79

Flow Rate Vs. Build-Up (Individual Drain)	
Depth (mm)	Flow (L/s)
0	0.00
5	0.06
10	0.13
15	0.19
20	0.25
25	0.32
30	0.38
35	0.44
40	0.50
45	0.57
50	0.63
55	0.65
60	0.66
65	0.68
70	0.69
75	0.71
80	0.73
85	0.74
90	0.76
95	0.77
100	0.79
105	0.80
110	0.82
115	0.84
120	0.85
125	0.87
130	0.88
135	0.90
140	0.91
145	0.93
150	0.95

Roof Drain Flow		
Individual Flow (l/s)	Storage Depth (mm)	Cumulative Flow (l/s)
0.00	0	0.00
0.06	5	0.06
0.13	10	0.13
0.19	15	0.19
0.25	20	0.25
0.32	25	0.32
0.38	30	0.38
0.44	35	0.44
0.50	40	0.50
0.57	45	0.57
0.63	50	0.63
0.65	55	0.65
0.66	60	0.66
0.68	65	0.68
0.69	70	0.69
0.71	75	0.71
0.73	80	0.73
0.74	85	0.74
0.76	90	0.76
0.77	95	0.77
0.79	100	0.79
0.80	105	0.80
0.82	110	0.82
0.84	115	0.84
0.85	120	0.85
0.87	125	0.87
0.88	130	0.88
0.90	135	0.90
0.91	140	0.91
0.93	145	0.93
0.95	150	0.95

5-Year

100-Year

* Roof Drain model to be Accutrol Weirs, See attached sheets
 * Roof Drain Flow information taken from Watts Drainage website

Note: The flow leaving through a restricted roof drain is based on flow vs. head information

McINTOSH PERRY

CCO-23-1884 - 2663 Innes Road

16 of 16

Storage Requirements for Area B2

5-Year Storm Event

Tc (min)	I (mm/hr)	Runoff (L/s) B2	Allowable Outflow (L/s)	Runoff to be Stored (L/s)	Storage Required (m ³)
10	104.2	19.96	6.80	13.16	7.89
20	70.3	13.46	6.80	6.66	8.00
30	53.9	10.32	6.80	3.52	6.34
40	44.2	8.47	6.80	1.67	4.00
50	37.7	7.22	6.80	0.42	1.26

Maximum Storage Required 5-year = 8 m³

100-Year Storm Event

Tc (min)	I (mm/hr)	Runoff (L/s) B2	Allowable Outflow (L/s)	Runoff to be Stored (L/s)	Storage Required (m ³)
10	178.6	38.03	7.02	31.01	18.60
20	120.0	25.55	7.02	18.53	22.24
30	91.9	19.57	7.02	12.55	22.59
40	75.1	15.99	7.02	8.97	21.53
50	64.0	13.63	7.02	6.61	19.82
60	55.9	11.90	7.02	4.88	17.58
70	49.8	10.60	7.02	3.58	15.05
80	45.0	9.58	7.02	2.56	12.30
90	41.1	8.75	7.02	1.73	9.35
100	37.9	8.07	7.02	1.05	6.30

Maximum Storage Required 100-year = 23 m³

5-Year Storm Event Storage Summary

		Water Elev. (m) = 74.26				
Location	T/G	INV. (out)	Area (m ²)	Depth (m)	Head (m)	Volume (m ³)
CBMH-202	74.27	72.97	-	-	1.14	-
CB-201	74.08	73.09	136.0	0.18	1.14	8.2

Storage Available (m³) = 8.17 *
Storage Required (m³) = 8.00

100-Year Storm Event Storage Summary

		Water Elev. (m) = 74.33				
Location	T/G	INV. (out)	Area (m ²)	Depth (m)	Head (m)	Volume (m ³)
CBMH-202	74.30	72.97	24.4	0.03	1.21	0.5
CB-201	74.08	73.09	278.9	0.25	1.21	22.2

Storage Available (m³) = 22.63 *
Storage Required (m³) = 22.59

* Available Storage calculated from AutoCAD

STORM SEWER DESIGN SHEET

PROJECT: CCO-23-1884
 LOCATION: 2663 Innes Road
 CLIENT: IDEA



LOCATION				CONTRIBUTING AREA (ha)				RATIONAL DESIGN FLOW								SEWER DATA								
STREET	AREA ID	FROM MH	TO MH	C-VALUE	AREA	INDIV AC	CUMUL AC	INLET (min)	TIME IN PIPE	TOTAL (min)	i (5)	i (10)	i (100)	5yr PEAK FLOW (L/s)	DESIGN FLOW (L/s)	CAPACITY (L/s)	LENGTH (m)	PIPE SIZE (mm)			SLOPE (%)	VELOCITY (m/s)	AVAIL CAP (5yr)	
											(mm/hr)	(mm/hr)	(mm/hr)					DIA	W	H			(L/s)	(%)
Innes Road	B2-A (PARKING)	CB-201	CBMH-202	0.90	0.060	0.05	0.05	10.00	0.65	10.65	104.19	122.14	178.56	15.69	15.69	58.82	31.64	300			0.34	0.806	43.13	73.32%
	B2-B (PARKING)	CBMH2	OGS3	0.90	0.03	0.03	0.08	10.65	0.13	10.78	100.86	118.22	172.79	22.79	22.79	58.82	6.12	300			0.34	0.806	36.04	61.26%
	B1 (ROOF)	OGS3	MAIN	1.00	0.06	0.06	0.14	10.78	0.72	11.50	100.24	117.49	171.72	39.62	39.62	58.82	35.00	300			0.34	0.806	19.20	32.65%
Definitions: Q = 2.78CIA, where: Q = Peak Flow in Litres per Second (L/s) A = Area in Hectares (ha) i = Rainfall Intensity in millimeters per hour (mm/hr) [i = 998.071 / (TC+6.053)^0.814] 5 YEAR [i = 1174.184 / (TC+6.014)^0.816] 10 YEAR [i = 1735.688 / (TC+6.014)^0.820] 100 YEAR				Notes: 1. Mannings coefficient (n) = 0.013				Designed: FV Checked: JH Project No.: CCO-23-1884				No.		Revision				Date						
												1.												
												Date:		2023.07.07				Sheet No:		1 of 1				



Adjustable Accutrol Weir

Tag: _____

Adjustable Flow Control for Roof Drains

ADJUSTABLE ACCUTROL (for Large Sump Roof Drains only)

For more flexibility in controlling flow with heads deeper than 2", Watts Drainage offers the Adjustable Accutrol. The Adjustable Accutrol Weir is designed with a single parabolic opening that can be covered to restrict flow above 2" of head to less than 5 gpm per inch, up to 6" of head. To adjust the flow rate for depths over 2" of head, set the slot in the adjustable upper cone according to the flow rate required. Refer to Table 1 below.
 Note: Flow rates are directly proportional to the amount of weir opening that is exposed.

EXAMPLE:

For example, if the adjustable upper cone is set to cover 1/2 of the weir opening, flow rates above 2" of head will be restricted to 2-1/2 gpm per inch of head.

Therefore, at 3" of head, the flow rate through the Accutrol Weir that has 1/2 the slot exposed will be:
 [5 gpm (per inch of head) x 2 inches of head] + 2-1/2 gpm (for the third inch of head) = 12-1/2 gpm.

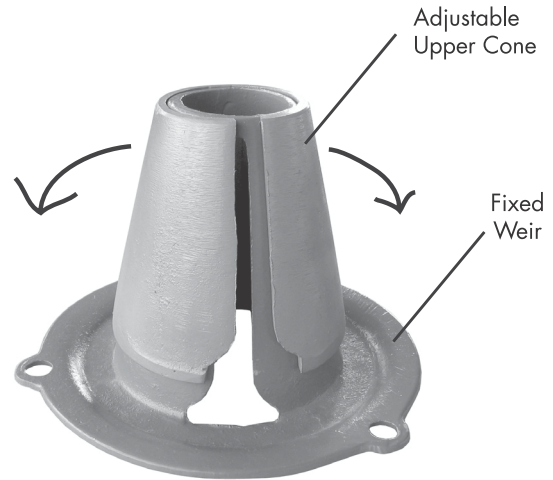
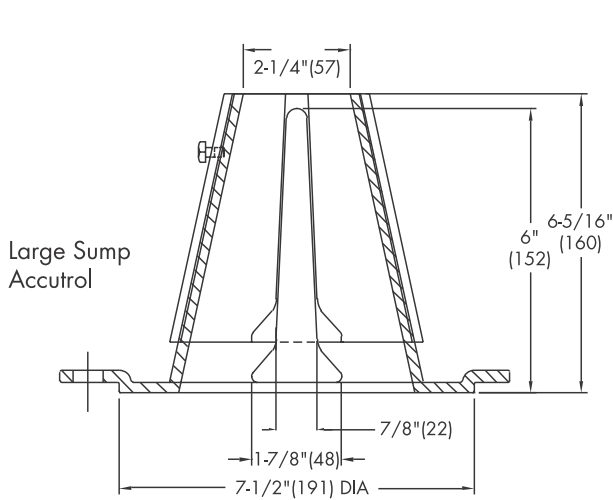

1/2 Weir Opening Exposed Shown Above

TABLE 1. Adjustable Accutrol Flow Rate Settings

Weir Opening Exposed	1"	2"	3"	4"	5"	6"
	Flow Rate (gallons per minute)					
Fully Exposed	5	10	15	20	25	30
3/4	5	10	13.75	17.5	21.25	25
1/2	5	10	12.5	15	17.5	20
1/4	5	10	11.25	12.5	13.75	15
Closed	5	5	5	5	5	5

Job Name _____
 Job Location _____
 Engineer _____

Contractor _____
 Contractor's P.O. No. _____
 Representative _____

Watts product specifications in U.S. customary units and metric are approximate and are provided for reference only. For precise measurements, please contact Watts Technical Service. Watts reserves the right to change or modify product design, construction, specifications, or materials without prior notice and without incurring any obligation to make such changes and modifications on Watts products previously or subsequently sold.

USA: Tel: (800) 338-2581 • Fax: (828) 248-3929 • Watts.com
 Canada: Tel: (905) 332-4090 • Fax: (905) 332-7068 • Watts.ca
 Latin America: Tel: (52) 81-1001-8600 • Fax: (52) 81-8000-7091 • Watts.com



Hydro First Defense® - HC



Rev. 12.7

Project Name: **4-STOREY MIXED USE BUILDING** Report Date: **6/30/2023** Paste
 Street: **2663 INNES ROAD** City: **Ottawa**
 Province: **Ontario** Country: **Canada**
 Designer: **Francis Valenti** email: **NAkbarzadeh@schaeffers.**

Net Annual Removal Model: FD-4HC

Intensity ⁽¹⁾	Fraction of Rainfall ⁽¹⁾	FD-4HC Removal Efficiency ⁽²⁾	Weighted Net Annual Efficiency
(mm/hr)	(%)	(%)	(%)
0.50	0.1%	100.0%	0.1%
1.00	14.1%	100.0%	14.1%
1.50	14.2%	100.0%	14.2%
2.00	14.1%	100.0%	14.1%
2.50	4.2%	100.0%	4.2%
3.00	1.5%	100.0%	1.5%
3.50	8.5%	100.0%	8.5%
4.00	5.4%	100.0%	5.4%
4.50	1.2%	100.0%	1.2%
5.00	5.5%	99.3%	5.5%
6.00	4.3%	97.6%	4.2%
7.00	4.5%	96.2%	4.3%
8.00	3.1%	95.0%	2.9%
9.00	2.3%	94.0%	2.2%
10.00	2.6%	93.1%	2.4%
20.00	9.2%	87.3%	8.1%
30.00	2.6%	84.0%	2.2%
40.00	1.2%	81.8%	1.0%
50.00	0.5%	80.1%	0.4%
100.00	0.7%	75.1%	0.5%
150.00	0.1%	72.3%	0.1%
200.00	0.0%	70.4%	0.0%

Treatment Parameters:

Structure ID: _____
 TSS Goal: **80 % Removal**
 TSS Particle Size: **Fine**
 Area: **0.132 ha**
 Percent Impervious: **100%**
 Rational C value: **0.90** Calc. Cn
 Rainfall Station: **Ottawa, ONT** MAP
 Peak Storm Flow: **65.54 L/s**

RESULTS SUMMARY

Model	TSS	Volume
FD-3HC	95.0%	>90%
FD-4HC	97.0%	>90%
FD-5HC	98.0%	>90%
FD-6HC	99.0%	>90%
FD-8HC	100.0%	>90%
FD-10HC	100.0%	>90%

Model Specification:

Model: **FD-4HC**
 Diameter: **1200 mm**
 Peak Flow Capacity: **510.00 L/s**
 Sediment Storage: **0.54 m³**
 Oil Storage: **723.00 L**

Installation Configuration:

Placement: **Online**
 Outlet Pipe Size: **300 mm OK**
 Inlet Pipe 1 Size: **300 mm OK**
 Inlet Pipe 2 Size: _____ mm OK
 Inlet Pipe 3 Size: _____ mm OK
 Rim Level: **74.480 m** Calc Invs.
 Outlet Pipe Invert: **72.896 m OK**
 Invert Pipe 1: **72.910 m OK**
 Invert Pipe 2: _____ m
 Invert Pipe 3: _____ m

Total Net Annual Removal Efficiency: 97.0%
Total Annual Runoff Volume Treated: >90%

- Rainfall Data: 1960:2007, HLY03, Ottawa, ONT, 6105976 & 6105978.
- Based on third party verified data and approximating the removal of a PSD similar to the STC Fine distribution
- Rainfall adjusted to 5 min peak intensity based on hourly average.

Designer Notes:

Hydro First Defense® - HC

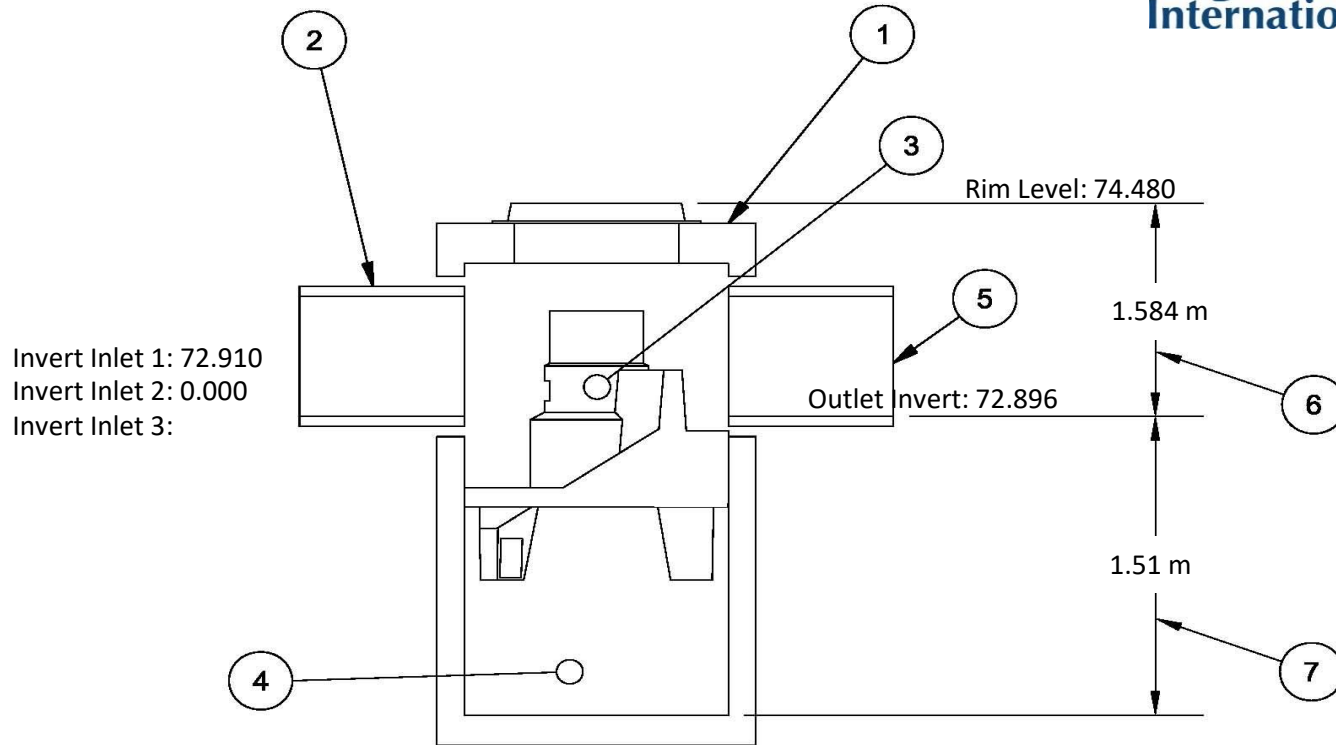

All drawing elevations are metres.

FD-4HC Specification

1	Vortex Chamber Diameter	1200 mm
2	Inlet Pipe Diameter	300 mm
3	Oil Storage Capacity	723.00 L
4	Min. Provided Sediment Storage Capacity	0.54 m ³
5	Outlet Pipe Diameter	300 mm
6	Height(Final Grade to Outlet Invert)	1584 mm
7	Sump Depth(Outlet Invert to Sump)	1510 mm
	Total Depth	3094 mm

Notes:

APPENDIX H
CITY OF OTTAWA DESIGN CHECKLIST

City of Ottawa

4. Development Servicing Study Checklist

The following section describes the checklist of the required content of servicing studies. It is expected that the proponent will address each one of the following items for the study to be deemed complete and ready for review by City of Ottawa Infrastructure Approvals staff.

The level of required detail in the Servicing Study will increase depending on the type of application. For example, for Official Plan amendments and re-zoning applications, the main issues will be to determine the capacity requirements for the proposed change in land use and confirm this against the existing capacity constraint, and to define the solutions, phasing of works and the financing of works to address the capacity constraint. For subdivisions and site plans, the above will be required with additional detailed information supporting the servicing within the development boundary.

4.1 General Content

Criteria	Location (if applicable)
<input type="checkbox"/> Executive Summary (for larger reports only).	N/A
<input type="checkbox"/> Date and revision number of the report.	On Cover
<input type="checkbox"/> Location map and plan showing municipal address, boundary, and layout of proposed development.	Appendix A
<input type="checkbox"/> Plan showing the site and location of all existing services.	Site Servicing Plan (C102)
<input type="checkbox"/> Development statistics, land use, density, adherence to zoning and official plan, and reference to applicable subwatershed and watershed plans that provide context to which individual developments must adhere.	1.1 Purpose 1.2 Site Description 6.0 Stormwater Management
<input type="checkbox"/> Summary of pre-consultation meetings with City and other approval agencies.	Appendix B
<input type="checkbox"/> Reference and confirm conformance to higher level studies and reports (Master Servicing Studies, Environmental Assessments, Community Design Plans), or in the case where it is not in conformance, the proponent must provide justification and develop a defensible design criteria.	1.1 Purpose 1.2 Site Description 6.0 Stormwater Management
<input type="checkbox"/> Statement of objectives and servicing criteria.	3.0 Pre-Consultation Summary

<input type="checkbox"/> Identification of existing and proposed infrastructure available in the immediate area.	N/A
<input type="checkbox"/> Identification of Environmentally Significant Areas, watercourses and Municipal Drains potentially impacted by the proposed development (Reference can be made to the Natural Heritage Studies, if available).	Ste Grading Plan (C101)
<input type="checkbox"/> Concept level master grading plan to confirm existing and proposed grades in the development. This is required to confirm the feasibility of proposed stormwater management and drainage, soil removal and fill constraints, and potential impacts to neighbouring properties. This is also required to confirm that the proposed grading will not impede existing major system flow paths.	Ste Grading Plan (C101)
<input type="checkbox"/> Identification of potential impacts of proposed piped services on private services (such as wells and septic fields on adjacent lands) and mitigation required to address potential impacts.	N/A
<input type="checkbox"/> Proposed phasing of the development, if applicable.	N/A
<input type="checkbox"/> Reference to geotechnical studies and recommendations concerning servicing.	Section 2.0 Background Studies, Standards and References
<input type="checkbox"/> All preliminary and formal site plan submissions should have the following information: <ul style="list-style-type: none"> ○ Metric scale ○ North arrow (including construction North) ○ Key plan ○ Name and contact information of applicant and property owner ○ Property limits including bearings and dimensions ○ Existing and proposed structures and parking areas ○ Easements, road widening and rights-of-way ○ Adjacent street names 	Ste Grading Plan (C101)

4.2 Development Servicing Report: Water

Criteria	Location (if applicable)
<input type="checkbox"/> Confirm consistency with Master Servicing Study, if available	N/A
<input type="checkbox"/> Availability of public infrastructure to service proposed development	N/A
<input type="checkbox"/> Identification of system constraints	N/A
<input type="checkbox"/> Identify boundary conditions	Appendix C
<input type="checkbox"/> Confirmation of adequate domestic supply and pressure	N/A
<input type="checkbox"/> Confirmation of adequate fire flow protection and confirmation that fire flow is calculated as per the Fire Underwriter's Survey. Output should show available fire flow at locations throughout the development.	Appendix C
<input type="checkbox"/> Provide a check of high pressures. If pressure is found to be high, an assessment is required to confirm the application of pressure reducing valves.	N/A
<input type="checkbox"/> Definition of phasing constraints. Hydraulic modeling is required to confirm servicing for all defined phases of the project including the ultimate design	N/A
<input type="checkbox"/> Address reliability requirements such as appropriate location of shut-off valves	N/A
<input type="checkbox"/> Check on the necessity of a pressure zone boundary modification.	N/A
<input type="checkbox"/> Reference to water supply analysis to show that major infrastructure is capable of delivering sufficient water for the proposed land use. This includes data that shows that the expected demands under average day, peak hour and fire flow conditions provide water within the required pressure range	Appendix C, Section 4.2

<input type="checkbox"/> Description of the proposed water distribution network, including locations of proposed connections to the existing system, provisions for necessary looping, and appurtenances (valves, pressure reducing valves, valve chambers, and fire hydrants) including special metering provisions.	Site Servicing Plan (C101)
<input type="checkbox"/> Description of off-site required feeder mains, booster pumping stations, and other water infrastructure that will be ultimately required to service proposed development, including financing, interim facilities, and timing of implementation.	N/A
<input type="checkbox"/> Confirmation that water demands are calculated based on the City of Ottawa Design Guidelines.	Appendix C
<input type="checkbox"/> Provision of a model schematic showing the boundary conditions locations, streets, parcels, and building locations for reference.	N/A

4.3 Development Servicing Report: Wastewater

Criteria	Location (if applicable)
<input type="checkbox"/> Summary of proposed design criteria (Note: Wet-weather flow criteria should not deviate from the City of Ottawa Sewer Design Guidelines. Monitored flow data from relatively new infrastructure cannot be used to justify capacity requirements for proposed infrastructure).	N/A
<input type="checkbox"/> Confirm consistency with Master Servicing Study and/or justifications for deviations.	N/A
<input type="checkbox"/> Consideration of local conditions that may contribute to extraneous flows that are higher than the recommended flows in the guidelines. This includes groundwater and soil conditions, and age and condition of sewers.	N/A
<input type="checkbox"/> Description of existing sanitary sewer available for discharge of wastewater from proposed development.	Section 5.2 Proposed Sanitary Sewer

<input type="checkbox"/> Verify available capacity in downstream sanitary sewer and/or identification of upgrades necessary to service the proposed development. (Reference can be made to previously completed Master Servicing Study if applicable)	Section 5.3 Proposed Sanitary Design
<input type="checkbox"/> Calculations related to dry-weather and wet-weather flow rates from the development in standard MOE sanitary sewer design table (Appendix 'C') format.	N/A
<input type="checkbox"/> Description of proposed sewer network including sewers, pumping stations, and forcemains.	Section 5.2 Proposed Sanitary Sewer
<input type="checkbox"/> Discussion of previously identified environmental constraints and impact on servicing (environmental constraints are related to limitations imposed on the development in order to preserve the physical condition of watercourses, vegetation, soil cover, as well as protecting against water quantity and quality).	N/A
<input type="checkbox"/> Pumping stations: impacts of proposed development on existing pumping stations or requirements for new pumping station to service development.	N/A
<input type="checkbox"/> Forcemain capacity in terms of operational redundancy, surge pressure and maximum flow velocity.	N/A
<input type="checkbox"/> Identification and implementation of the emergency overflow from sanitary pumping stations in relation to the hydraulic grade line to protect against basement flooding.	N/A
<input type="checkbox"/> Special considerations such as contamination, corrosive environment etc.	N/A

4.4 Development Servicing Report: Stormwater Checklist

Criteria	Location (if applicable)
<input type="checkbox"/> Description of drainage outlets and downstream constraints including legality of outlets (i.e. municipal drain, right-of-way, watercourse, or private property)	Section 6.0 Stormwater Sewer Design & Section 7.0 Proposed Stormwater Management
<input type="checkbox"/> Analysis of available capacity in existing public infrastructure.	N/A
<input type="checkbox"/> A drawing showing the subject lands, its surroundings, the receiving watercourse, existing drainage patterns, and proposed drainage pattern.	Pre & Post-Development Plans
<input type="checkbox"/> Water quantity control objective (e.g. controlling post-development peak flows to pre-development level for storm events ranging from the 2 or 5-year event (dependent on the receiving sewer design) to 100-year return period); if other objectives are being applied, a rationale must be included with reference to hydrologic analyses of the potentially affected subwatersheds, taking into account long-term cumulative effects.	Section 6.0 Stormwater Sewer Design & Section 7.0 Proposed Stormwater Management
<input type="checkbox"/> Water Quality control objective (basic, normal or enhanced level of protection based on the sensitivities of the receiving watercourse) and storage requirements.	Section 6.0 Stormwater Sewer Design & Section 7.0 Proposed Stormwater Management
<input type="checkbox"/> Description of the stormwater management concept with facility locations and descriptions with references and supporting information.	Section 6.0 Stormwater Sewer Design & Section 7.0 Proposed Stormwater Management
<input type="checkbox"/> Set-back from private sewage disposal systems.	N/A
<input type="checkbox"/> Watercourse and hazard lands setbacks.	N/A
<input type="checkbox"/> Record of pre-consultation with the Ontario Ministry of Environment and the Conservation Authority that has jurisdiction on the affected watershed.	N/A
<input type="checkbox"/> Confirm consistency with sub-watershed and Master Servicing Study, if applicable study exists.	N/A
<input type="checkbox"/> Storage requirements (complete with calculations) and conveyance capacity for minor events (1:5-year return period) and major events (1:100-year return period).	Appendix G

<input type="checkbox"/> Identification of watercourses within the proposed development and how watercourses will be protected, or, if necessary, altered by the proposed development with applicable approvals.	Site Grading Plan
<input type="checkbox"/> Calculate pre-and post development peak flow rates including a description of existing site conditions and proposed impervious areas and drainage catchments in comparison to existing conditions.	Section 7.0 Proposed Stormwater Management Appendix G
<input type="checkbox"/> Any proposed diversion of drainage catchment areas from one outlet to another.	Section 6.0 Stormwater Sewer Design & Section 7.0 Proposed Stormwater Management
<input type="checkbox"/> Proposed minor and major systems including locations and sizes of stormwater trunk sewers, and stormwater management facilities.	Section 6.0 Stormwater Sewer Design & Section 7.0 Proposed Stormwater Management
<input type="checkbox"/> If quantity control is not proposed, demonstration that downstream system has adequate capacity for the post-development flows up to and including the 100-year return period storm event.	N/A
<input type="checkbox"/> Identification of potential impacts to receiving watercourses	N/A
<input type="checkbox"/> Identification of municipal drains and related approval requirements.	N/A
<input type="checkbox"/> Descriptions of how the conveyance and storage capacity will be achieved for the development.	Section 6.0 Stormwater Sewer Design & Section 7.0 Proposed Stormwater Management
<input type="checkbox"/> 100-year flood levels and major flow routing to protect proposed development from flooding for establishing minimum building elevations (MBE) and overall grading.	Site Grading Plan (C101)
<input type="checkbox"/> Inclusion of hydraulic analysis including hydraulic grade line elevations.	N/A

<input type="checkbox"/> Description of approach to erosion and sediment control during construction for the protection of receiving watercourse or drainage corridors.	Section 8.0 Sediment & Erosion Control
<input type="checkbox"/> Identification of floodplains – proponent to obtain relevant floodplain information from the appropriate Conservation Authority. The proponent may be required to delineate floodplain elevations to the satisfaction of the Conservation Authority if such information is not available or if information does not match current conditions.	N/A
<input type="checkbox"/> Identification of fill constraints related to floodplain and geotechnical investigation.	N/A

4.5 Approval and Permit Requirements: Checklist

The Servicing Study shall provide a list of applicable permits and regulatory approvals necessary for the proposed development as well as the relevant issues affecting each approval. The approval and permitting shall include but not be limited to the following:

Criteria	Location (if applicable)
<input type="checkbox"/> Conservation Authority as the designated approval agency for modification of floodplain, potential impact on fish habitat, proposed works in or adjacent to a watercourse, cut/fill permits and Approval under Lakes and Rivers Improvement Act. The Conservation Authority is not the approval authority for the Lakes and Rivers Improvement Act. Where there are Conservation Authority regulations in place, approval under the Lakes and Rivers Improvement Act is not required, except in cases of dams as defined in the Act.	N/A
<input type="checkbox"/> Application for Certificate of Approval (CofA) under the Ontario Water Resources Act.	N/A
<input type="checkbox"/> Changes to Municipal Drains.	N/A
<input type="checkbox"/> Other permits (National Capital Commission, Parks Canada, Public Works and Government Services Canada, Ministry of Transportation etc.)	N/A

4.6 Conclusion Checklist

Criteria	Location (if applicable)
<input type="checkbox"/> Clearly stated conclusions and recommendations	Section 9.0 Summary Section 10.0 Recommendations
<input type="checkbox"/> Comments received from review agencies including the City of Ottawa and information on how the comments were addressed. Final sign-off from the responsible reviewing agency.	All are stamped
<input type="checkbox"/> All draft and final reports shall be signed and stamped by a professional Engineer registered in Ontario	All are stamped