

# 178 Nepean Street, 219-223 Bank Street Transportation Impact Assessment

Step 1 Screening Report

Step 2 Scoping Report

Step 3 Forecasting Report

Step 4 Strategy Report

Supporting Applications:  
D02-02-22-0127 and D07-12-22- 0188

Prepared for:

Smart Living Properties  
226 Argyle Avenue  
Ottawa ON K2P 1B9

Prepared by:



6 Plaza Court  
Ottawa, ON K2H 7W1

June 2023

PN: 2023-049

## Table of Contents

1	Screening.....	1
2	Existing and Planned Conditions.....	1
2.1	Proposed Development.....	1
2.2	Existing Conditions.....	3
2.2.1	Area Road Network.....	3
2.2.2	Existing Intersections.....	3
2.2.3	Existing Driveways.....	3
2.2.4	Cycling and Pedestrian Facilities.....	3
2.2.5	Existing Transit.....	5
2.2.6	Existing Area Traffic Management Measures.....	7
2.2.7	Existing Peak Hour Travel Demand.....	7
2.2.8	Collision Analysis.....	8
2.3	Planned Conditions.....	10
2.3.1	Changes to the Area Transportation Network.....	10
2.3.2	Other Study Area Developments.....	10
3	Study Area and Time Periods.....	11
3.1	Study Area.....	11
3.2	Time Periods.....	11
3.3	Horizon Years.....	11
4	Exemption Review.....	11
5	Development-Generated Travel Demand.....	12
5.1	Mode Shares.....	12
5.2	Trip Generation.....	12
6	Development Design.....	13
6.1	Design for Sustainable Modes.....	13
6.2	Circulation and Access.....	13
7	Parking.....	13
7.1	Parking Supply.....	13
7.2	Spillover Parking.....	14
8	Boundary Street Design.....	15
9	Transportation Demand Management.....	15
9.1	Context for TDM.....	15
9.2	Need and Opportunity.....	15
9.3	TDM Program.....	15
10	Summary of Improvements Indicated and Modifications Options.....	16
11	Conclusion.....	18

## List of Figures

Figure 1:	Area Context Plan.....	1
Figure 2:	Concept Plan.....	2
Figure 3:	Study Area Pedestrian Facilities.....	4

Figure 4: Study Area Cycling Facilities .....4  
 Figure 5: Existing Pedestrian Volumes .....5  
 Figure 6: Existing Cyclist Volumes .....5  
 Figure 7: Existing Study Area Transit Service.....6  
 Figure 8: Existing Study Area Transit Stops .....6  
 Figure 9: Existing Traffic Counts .....7  
 Figure 10: Study Area Collision Records.....9  
 Figure 11: Study Area On-Street and City Parking..... 14

### Table of Tables

Table 1: Intersection Count Date.....7  
 Table 2: Existing Intersection Operations.....8  
 Table 3: Study Area Collision Summary, 2016-2020 .....8  
 Table 4: Summary of Collision Locations, 2016-2020.....9  
 Table 5: Bank Street at Nepean Street Collision Summary .....9  
 Table 6: Exemption Review ..... 11  
 Table 7: Additional TIA Exemptions..... 12  
 Table 8: TRANS Trip Generation Manual Recommended Mode Shares ..... 12  
 Table 9: Proposed Development Mode Shares ..... 12  
 Table 10: Trip Generation Person Trip Rates by Peak Period..... 13  
 Table 11: Total Residential Person Trip Generation by Peak Period..... 13  
 Table 12: Trip Generation by Mode ..... 13  
 Table 13: Boundary Street MMLOS Analysis..... 15

### List of Appendices

- Appendix A – TIA Screening Form and Certification Form
- Appendix B – Turning Movement Count Data
- Appendix C – Synchro Intersection Worksheets – Existing Conditions
- Appendix D – Collision Data
- Appendix E – MMLOS Analysis
- Appendix F – TDM Checklist

## 1 Screening

This study has been prepared according to the City of Ottawa’s 2017 Transportation Impact Assessment (TIA) Guidelines. Accordingly, a Step 1 Screening Form has been prepared and is included as Appendix A, along with the Certification Form for the TIA Study PM. As shown in the Screening Form, a TIA is required including the Design Review component and the Network Impact Component. This study has been prepared to support a zoning amendment and site plan application (applications D02-02-22-0127 and D07-12-22- 0188). A screening form was submitted for the proposed development recommending no TIA be required based on the site proposing no vehicular access or vehicle parking. Per correspondence with the City’s Transportation Project Manager for this file, a scoped TIA was agreed to as described in Section 4.

## 2 Existing and Planned Conditions

### 2.1 Proposed Development

The existing site, zoned as Traditional Mainstreet (TM H(19)), presently includes a mix of commercial and low-rise residential uses. The proposed development includes the addition of a nine-storey apartment tower comprising 263 dwelling units above the existing commercial uses and heritage-contributing buildings, which are to be retained. The build-out horizon is anticipated to be 2025 with construction occurring in a single phase, and no vehicular access or vehicle parking is to be provided to the site.

Figure 1 illustrates the study area context. Figure 2 illustrates the proposed concept plan.

Figure 1: Area Context Plan

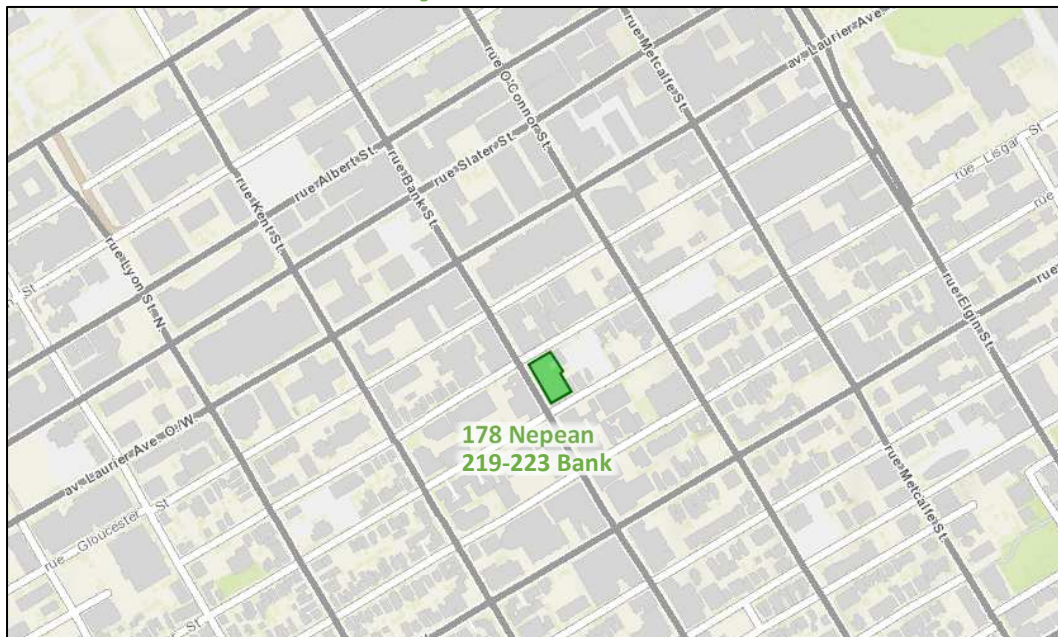

Source: <http://maps.ottawa.ca/geoOttawa/> Accessed: April 17, 2024



## 2.2 Existing Conditions

### 2.2.1 Area Road Network

**Bank Street:** Bank Street is a City of Ottawa arterial road with a two-lane urban cross-section including sidewalks on both sides of the road. Within the study area, on-street parking is permitted on the east side of the road north of Lisgar Street and is permitted on the west side of the road to the south. The posted speed limit is 50 km/h, and Schedule C16 of the Ottawa Official Plan reserves a 20.0-metre right-of-way.

**Nepean Street:** Nepean Street is a City of Ottawa local road with a two-lane urban cross-section including sidewalks on both sides of the road. Within the study area, on-street parking is permitted on both sides of the road except for 70 metres east of Bank Street where angle parking is provided on the south side of the road. The unposted speed limit is assumed to be 50 km/h, the measured right-of-way is 18.5 metres.

**Lisgar Street:** Lisgar Street is a City of Ottawa local road with a two-lane urban cross-section including sidewalks on both sides of the road. West of Bank Street, on-street parking is permitted on the north side of the road, and east of Bank Street, on-street parking is permitted on both sides of the road except for 25 metres east of Bank Street where angle parking is provided on the north side of the road. The unposted speed limit is assumed to be 50 km/h, the measured right-of-way is 18.5 metres.

### 2.2.2 Existing Intersections

The intersections abutting the site property have been summarized below:

#### *Bank Street at Nepean Street*

The intersection of Bank Street at Nepean Street is an unsignalized intersection with stop control on the minor eastbound approach of Nepean Street. The northbound approach consists of a shared through/right-turn lane and the southbound approach consists of a shared left-turn/through lane. The eastbound approach consists of a shared all-movements lane and the east leg is inbound only. No turn restrictions were noted.

#### *Bank Street at Lisgar Street*

The intersection of Bank Street at Lisgar Street is a signalized intersection. The northbound approach consists of a shared left-turn/through lane and the southbound approach consists of a shared through/right-turn lane. The westbound approach consists of a shared all-movements lane and the west leg is inbound only. No turn restrictions were noted.

### 2.2.3 Existing Driveways

As no vehicular site access is proposed, examination of area driveways is not required.

### 2.2.4 Cycling and Pedestrian Facilities

Figure 3 illustrates the pedestrian facilities in the study area and Figure 4 illustrates the cycling facilities.

Sidewalks are provided along both sides of all area roads. Cycling facilities include cycletracks on Bay Street north of Laurier Avenue, a two-way curbed bike lanes on O'Connor Street, curbed bike lanes on Laurier Avenue, and bike lanes on each Lyon Street, Bay Street south of Laurier Avenue, and Percy Street. Laurier Avenue and O'Connor Street are cross-town bikeways, Sparks Street is a neighbourhood bikeway, Metcalfe Street, O'Connor Street, Lyon Street, Bay Street, Percy Street, Somerset Street, Laurier Avenue, Slater Street and Albert Street are spine routes, and Elgin Street, Bank Street, and Queen Street are local routes.



Figure 3: Study Area Pedestrian Facilities

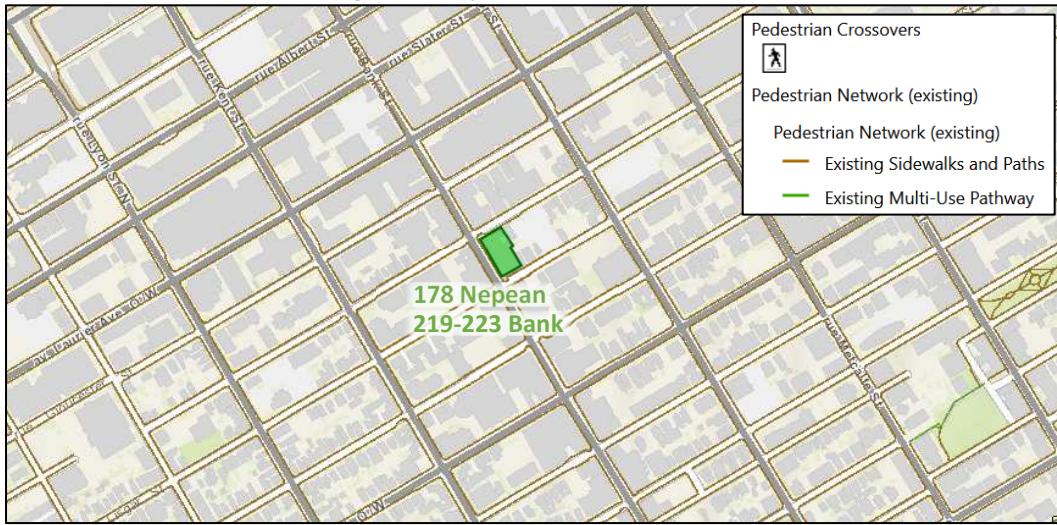

Source: <http://maps.ottawa.ca/geoOttawa/> Accessed: April 17, 2023

Figure 4: Study Area Cycling Facilities



Source: <http://maps.ottawa.ca/geoOttawa/> Accessed: April 17, 2023

Pedestrian and cyclist volumes included in study area intersection counts, presented in Section 2.2.7, have been compiled and are illustrated in Figure 5 and Figure 6, respectively.

Figure 5: Existing Pedestrian Volumes

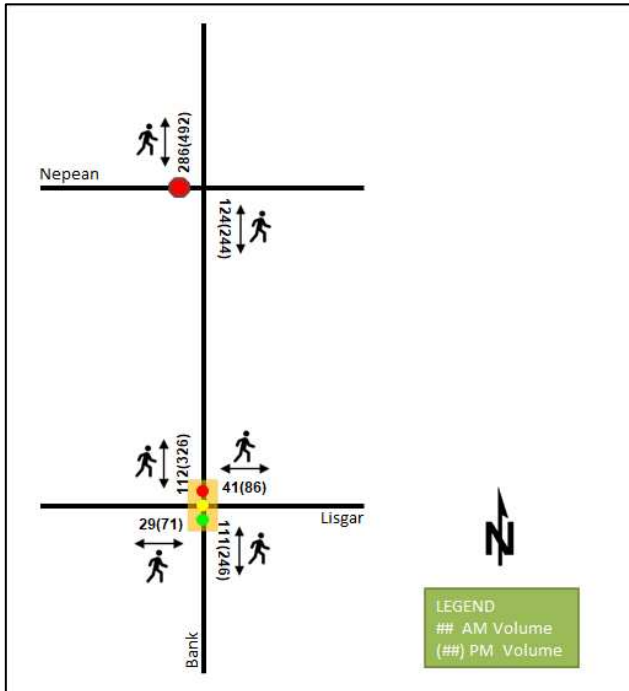
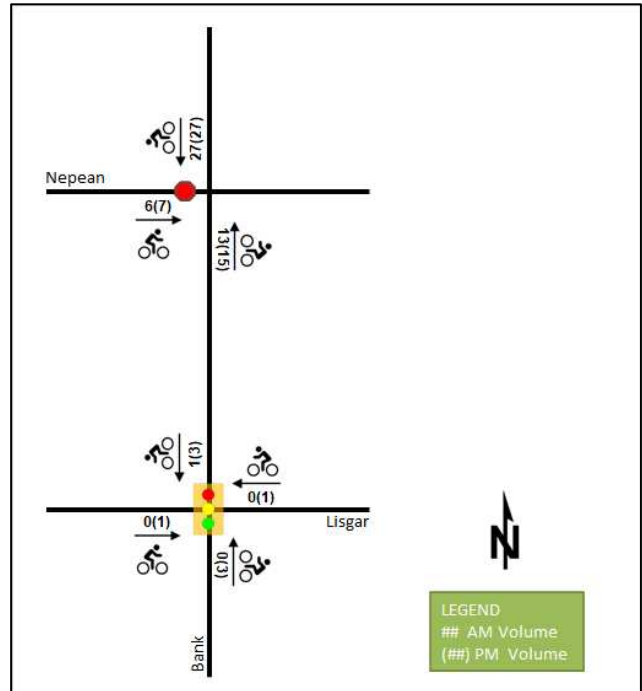

Figure 6: Existing Cyclist Volumes



### 2.2.5 Existing Transit

Figure 7 illustrates the transit system map in the study area and Figure 8 illustrates nearby transit stops. All transit information is from April 17, 2023 and is included for general information purposes and context to the surrounding area.

Within the study area, the routes #6, 7, and 11 travel along Bank Street on the site frontage. The frequency of these routes within proximity of the proposed site based on April 17, 2023 service levels are:

- Route # 6 – 10-minute service in the peak period/direction, 15-minute daytime service, 30-minute service after 7:00 PM
- Route # 7 – 15-minute daytime service, 30-minute service after 7:00 PM
- Route # 11 – 15-minute daytime service, 20-30-minute service after 7:00 PM

The site is also within approximately 550 metres’ walking distance of Parliament Station on the O-Train’s Confederation Line.



Figure 7: Existing Study Area Transit Service

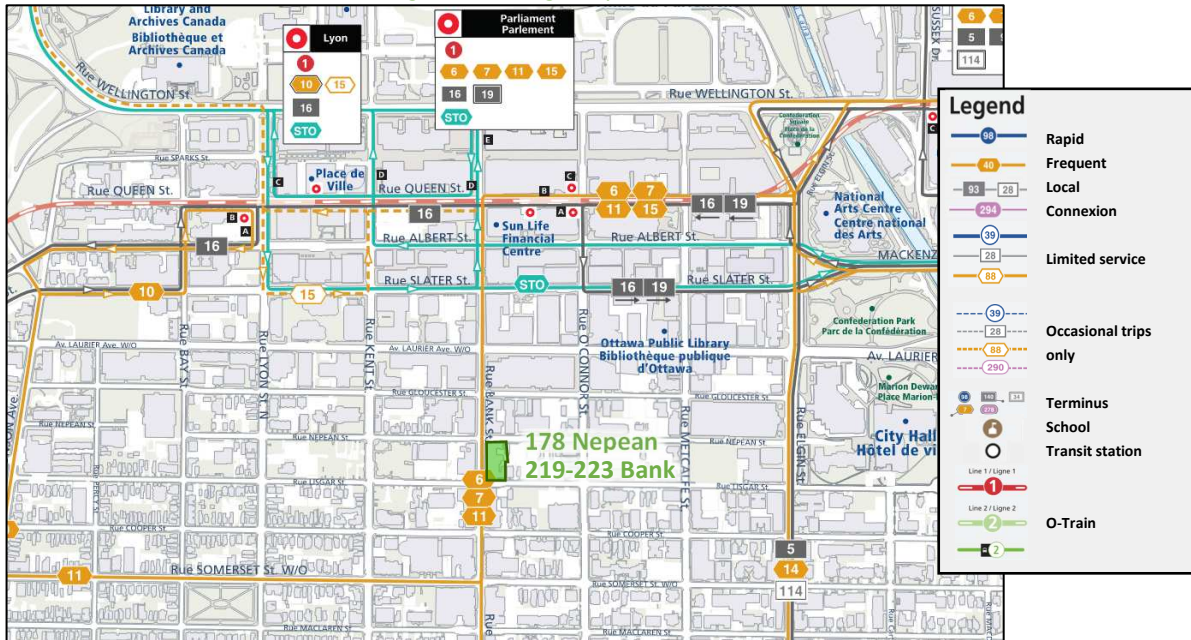

Source: <http://www.octranspo.com/> Accessed: April 17, 2023

Figure 8: Existing Study Area Transit Stops



Source: <http://www.octranspo.com/> Accessed: April 17, 2023

2.2.6 Existing Area Traffic Management Measures

There are no existing area traffic management measures within the study area.

2.2.7 Existing Peak Hour Travel Demand

Existing turning movement counts were acquired from the City of Ottawa and the Traffic Specialist for the existing study area intersections. Table 1 summarizes the intersection count dates and sources.

Table 1: Intersection Count Date

Intersection	Count Date	Count Source
Bank Street at Nepean Street	Thursday, April 27, 2023	The Traffic Specialist
Bank Street at Lisgar Street	Tuesday, March 8, 2022	City of Ottawa

Figure 9 illustrates the existing traffic counts and Table 2 summarizes the existing intersection operations. The level of service for signalized intersections is based on volume to capacity ratio (v/c) calculations for individual lane movements and HCM 2000 v/c calculations for the overall intersection, and average delay for unsignalized intersections. Detailed turning movement count data is included in Appendix B and the Synchro worksheets are provided in Appendix C.

Figure 9: Existing Traffic Counts

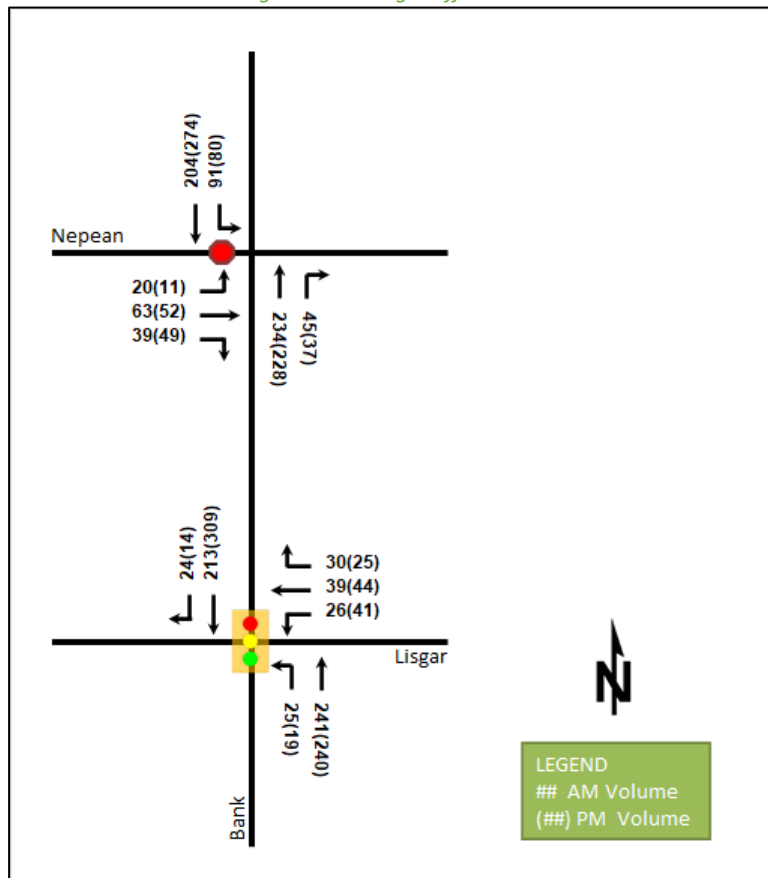

Table 2: Existing Intersection Operations

Intersection	Lane	AM Peak Hour				PM Peak Hour			
		LOS	V/C	Delay (s)	Q (95 <sup>th</sup> )	LOS	V/C	Delay (s)	Q (95 <sup>th</sup> )
<b>Bank St &amp; Nepean St</b> <i>Signalized</i>	EB	B	0.27	14.5	8.3	B	0.23	13.8	6.8
	NBT/R	-	-	-	-	-	-	-	-
	SBL/T	A	0.09	8.5	2.3	A	0.09	8.8	2.3
	<b>Overall</b>	<b>A</b>	<b>-</b>	<b>3.6</b>	<b>-</b>	<b>A</b>	<b>-</b>	<b>3.1</b>	<b>-</b>
<b>Bank St &amp; Lisgar St</b> <i>Signalized</i>	WB	A	0.28	19.7	20.9	A	0.34	23.1	25.8
	NBL/T	A	0.32	7.8	29.6	A	0.29	7.5	28.0
	SBT/R	A	0.28	6.9	24.7	A	0.36	7.9	35.2
	<b>Overall</b>	<b>A</b>	<b>0.30</b>	<b>9.3</b>	<b>-</b>	<b>A</b>	<b>0.34</b>	<b>10.2</b>	<b>-</b>

Notes: Saturation flow rate of 1800 veh/h/lane  
Queue is measured in metres  
Peak Hour Factor = 0.90

Delay = average vehicle delay in seconds  
m = metered queue  
# = volume for the 95th %ile cycle exceeds capacity

During both the AM and PM peak hours, the study area intersection operates well. No capacity issues are noted.

### 2.2.8 Collision Analysis

Collision data have been acquired from the City of Ottawa open data website (data.ottawa.ca) for five years prior to the commencement of this TIA for the surrounding study area road network. Table 3 summarizes the collision types and conditions in the study area, Figure 10 illustrates the intersections and segments analyzed, and Table 4 summarizes the total collisions for each of these locations. Collision data are included in Appendix D.

Table 3: Study Area Collision Summary, 2016-2020

		Number	%
<b>Total Collisions</b>		<b>22</b>	<b>100%</b>
<b>Classification</b>	<b>Fatality</b>	0	0%
	<b>Non-Fatal Injury</b>	6	27%
	<b>Property Damage Only</b>	16	73%
<b>Initial Impact Type</b>	<b>Angle</b>	10	45%
	<b>Rear end</b>	3	14%
	<b>Sideswipe</b>	1	5%
	<b>SMV Unattended</b>	2	9%
	<b>SMV Other</b>	5	23%
	<b>Other</b>	1	5%
<b>Road Surface Condition</b>	<b>Dry</b>	17	77%
	<b>Wet</b>	4	18%
	<b>Loose Snow</b>	1	5%
<b>Pedestrian Involved</b>		4	18%
<b>Cyclists Involved</b>		0	0%

Figure 10: Study Area Collision Records



Table 4: Summary of Collision Locations, 2016-2020

Intersections / Segments	Number	%
<b>Bank St at Nepean St</b>	14	64%
<b>Bank St Btwn Nepean St &amp; Lisgar St</b>	4	18%
<b>Bank St at Lisgar St</b>	4	18%

Within the study area, the intersection of Bank Street at Nepean Street is noted to have experienced higher collisions than other locations. Table 5 summarizes the collision types and conditions for this intersection.

Table 5: Bank Street at Nepean Street Collision Summary

		Number	%
<b>Total Collisions</b>		<b>14</b>	<b>100%</b>
<b>Classification</b>	<b>Fatality</b>	0	0%
	<b>Non-Fatal Injury</b>	5	36%
	<b>Property Damage Only</b>	9	64%
<b>Initial Impact Type</b>	<b>Angle</b>	9	64%
	<b>Rear end</b>	1	7%
	<b>SMV Other</b>	3	21%
	<b>Other</b>	1	7%
<b>Road Surface Condition</b>	<b>Dry</b>	12	86%
	<b>Wet</b>	1	7%
	<b>Loose Snow</b>	1	7%
<b>Pedestrian Involved</b>		3	21%
<b>Cyclists Involved</b>		0	0%

The Bank Street at Nepean Street intersection had a total of 14 collisions during the 2016-2020 time period, with nine involving property damage only and the remaining five having non-fatal injuries. The collision types are most represented by angle with nine collisions, followed by SMV (other) with three collisions all of which involved



pedestrians, and one each as rear end and other. Angle collisions may be associated with the minor stop control where eastbound drivers attempt to push gaps in the north/south traffic stream. With respect to pedestrian collisions, only the east and west legs have pedestrian crossings. Crossings midblock are noted to occur as documented within the detailed traffic counts provided in Appendix B. Ultimately, the pedestrian collisions are a function of high number of pedestrians using these crossings and present along Bank Street. Weather conditions do not affect collisions at this location.

## 2.3 Planned Conditions

### 2.3.1 Changes to the Area Transportation Network

At the time of this report, no changes are noted for the study area within the Transportation Master Plan, the Ottawa Cycling Plan, the Ottawa Pedestrian Plan, or the Planned Construction Projects portal on the City's website.

### 2.3.2 Other Study Area Developments

#### *142-148 Nepean St*

The application includes a zoning amendment and site plan for the construction of a surface parking lot with 30 parking spaces. No TIA is required for this development.

#### *96 Nepean St*

The application includes a site plan for a 27-storey residential building consisting of 201 residential dwelling units. The development is anticipated to generate an additional 59 AM and 57 PM peak hour new two-way auto trips. (Novatech, 2011) The file was last updated in 2012.

#### *230-232 Lisgar St*

The proposed development application includes a site plan for the construction of a nine-storey apartment with 49 units. A screening form indicated that a TIA is required, but none was available for this development at the time of this report.

#### *311 Somerset St W, 234-236 O'Connor St*

The proposed development includes a zoning bylaw amendment and site plan for the construction of an 18-storey, 156-unit apartment/mixed-use building with 2,120 sq. ft. of ground-floor commercial space. The development is anticipated to be built out in a single phase by 2024 and to generate 18 new AM and 21 new PM peak hour two-way auto trips. (CGH, 2022)

#### *359 Kent St, 436-444 MacLaren St*

The application includes official plan amendment and zoning by-law amendment to permit the construction of a 30-storey mixed-use building with a total of 322 apartment units and 4,278 sq. ft. of commercial space. The redevelopment is assumed to be built by 2024 and is forecasted to constitute a reduction of 12 AM and 4 PM peak hour two-way vehicle trips from the existing land use. (Parsons, 2023)

#### *343 Gloucester St*

The proposed development application includes a site plan for the construction of a 21-storey 116-unit apartment building. No TIA is available for this development.

#### *152-160 Bank St, 333 Laurier Ave W*

The proposed development application includes a site plan for the construction of an 18-storey office building with ground floor retail. The file was last updated in 2010 and no TIA is available for this development.



208-212 Slater St

The proposed development application includes a site plan for the construction of a 22-storey, 162-unit mixed use building with ground floor retail. The building was initially anticipated to be built out by 2022 and is forecast to generate 30 AM and 27 M peak hour two-way vehicle trips. (Novatech, 2019)

### 3 Study Area and Time Periods

#### 3.1 Study Area

The study area will include the intersections of Bank Street at Nepean Street and Bank Street at Lisgar Street.

The boundary roads will be Bank Street, Nepean Street, and Lisgar Street, and TRANS screenline SL36 is north of the site but will not be analyzed as part of this study.

#### 3.2 Time Periods

As the proposed development is composed entirely of residential units the AM and PM peak hours have been examined.

#### 3.3 Horizon Years

The anticipated build-out year is 2025. As a result, the full build-out plus five years horizon year is 2030.

### 4 Exemption Review

Table 6 summarizes the exemptions for this TIA.

Table 6: Exemption Review

Module	Element	Explanation	Exempt/Required
<b>Design Review Component</b>			
<b>4.1 Development Design</b>	4.1.2 Circulation and Access	Only required for site plans	Required
	4.1.3 New Street Networks	Only required for plans of subdivision	Exempt
<b>4.2 Parking</b>	4.2.1 Parking Supply	Only required for site plans	Required
	4.2.2 Spillover Parking	Only required for site plans where parking supply is 15% below unconstrained demand	Exempt
<b>Network Impact Component</b>			
<b>4.5 Transportation Demand Management</b>	All Elements	Not required for site plans expected to have fewer than 60 employees and/or students on location at any given time	Required
<b>4.6 Neighbourhood Traffic Management</b>	4.6.1 Adjacent Neighbourhoods	Only required when the development relies on local or collector streets for access and total volumes exceed ATM capacity thresholds	Exempt
<b>4.8 Network Concept</b>		Only required when proposed development generates more than 200 person-trips during the peak hour in excess of equivalent volume permitted by established zoning	Exempt

The scoped TIA was required to contain all Step 2 sections. Table 7 summarizes the additional TIA module and element exemptions provided by the City’s Transportation Project Manager for the Step 3 and Step 4 sections.

Table 7: Additional TIA Exemptions

Module	Element
<b>3.1 Development Generated Travel Demand</b>	3.1.2 Trip Distribution
	3.1.3 Trip Assignment
<b>3.2 Background Network Travel Demand</b>	All Elements
<b>3.3 Demand Rationalization</b>	All Elements
<b>4.4 Access Intersections</b>	All Elements
<b>4.7 Transit</b>	All Elements
<b>4.9 Network Concept</b>	All Elements

## 5 Development-Generated Travel Demand

### 5.1 Mode Shares

The site lies on the south side of Nepean Street within the Ottawa Inner Area TRANS district, where the north side of Nepean Street falls within Ottawa Centre TRANS district. The recommended mode shares for both TRANS districts are summarized in Table 8.

Table 8: TRANS Trip Generation Manual Recommended Mode Shares

Travel Mode	Ottawa Inner Area		Ottawa Centre	
	Multi-Unit (High-Rise)		Multi-Unit (High-Rise)	
	AM	PM	AM	PM
<b>Auto Driver</b>	26%	25%	18%	17%
<b>Auto Passenger</b>	6%	8%	2%	9%
<b>Transit</b>	28%	21%	26%	21%
<b>Cycling</b>	5%	6%	1%	1%
<b>Walking</b>	34%	39%	52%	52%
<b>Total</b>	<b>100%</b>	<b>100%</b>	<b>100%</b>	<b>100%</b>

Based upon the site’s context of being on the boundary of Ottawa Centre and Ottawa Inner Area TRANS districts, being within 550 metres’ walk of the Parliament O-Train station, and providing no parking, modified mode share targets are proposed for the development and are summarized in Table 9. As no vehicle parking is proposed, auto trips are anticipated by taxi and rideshare or deliveries.

Table 9: Proposed Development Mode Shares

Travel Mode	Multi-Unit (High-Rise)	
	AM	PM
<b>Auto Driver</b>	11%	10%
<b>Auto Passenger</b>	1%	5%
<b>Transit</b>	38%	31%
<b>Cycling</b>	6%	7%
<b>Walking</b>	44%	47%
<b>Total</b>	<b>100%</b>	<b>100%</b>

### 5.2 Trip Generation

This TIA has been prepared using the vehicle and person trip rates for the residential dwellings using the TRANS Trip Generation Manual (2020). Table 10 summarizes the person trip rates for the proposed residential land use for each peak period.

Table 10: Trip Generation Person Trip Rates by Peak Period

Land Use	Land Use Code	Peak Period	Person Trip Rates
Multi-Unit High-Rise	221 & 222 (TRANS)	AM	0.80
		PM	0.90

Using the above person trip rates, the total person trip generation has been estimated. Table 11 summarizes the total person trip generation for the residential land use.

Table 11: Total Residential Person Trip Generation by Peak Period

Land Use	Units	AM Peak Period			PM Peak Period		
		In	Out	Total	In	Out	Total
Multi-Unit High-Rise	263	65	145	210	137	100	237

Using the above mode share targets for a subject site and the person trip rates, the person trips by mode have been projected. Trip generation by peak hour has been forecasted using the prescribed peak period conversion factors presented in the TRANS Trip Generation Manual (2020) for the residential component. Table 12 summarizes the residential trip generation by mode and peak hour.

Table 12: Trip Generation by Mode

Travel Mode		AM Peak Hour				PM Peak Hour			
		Mode Share	In	Out	Total	Mode Share	In	Out	Total
Multi-Unit (High-Rise)	Auto Driver	11%	3	8	11	10%	6	4	11
	Auto Passenger	1%	0	0	1	5%	3	2	5
	Transit	38%	14	30	44	31%	20	15	34
	Cycling	6%	2	5	8	7%	5	3	8
	Walking	44%	17	37	53	47%	33	24	58
<b>Total</b>		<b>100%</b>	<b>36</b>	<b>80</b>	<b>117</b>	<b>100%</b>	<b>67</b>	<b>48</b>	<b>116</b>

As shown above, a total of 11 AM and 11 PM new peak hour two-way vehicle trips are projected as a result of the proposed development.

## 6 Development Design

### 6.1 Design for Sustainable Modes

The proposed development is a residential tower with no vehicle access or parking. Bicycle parking is provided internal to the building. Building entrances directly access the sidewalks along Nepean Street and Bank Street. Transit stops for routes noted in Section 2.2.5 are within 400 metres’ walking distance of building entrances, and Parliament Station is within 550 metres’ walking distance.

### 6.2 Circulation and Access

Emergency services are anticipated to access the site via the three public road frontages. Garbage collection will take place on Lisgar Street. Move-in and move-out operations are to take place on Lisgar Street where a move-in access is provided via a hard surface connection to the sidewalk with an existing depressed curb.

## 7 Parking

### 7.1 Parking Supply

The site proposes no vehicle parking for tenants or visitors and proposes 438 bicycle parking spaces internal to the building. From the zoning by-law, for Area Y in which the site is located from Schedule 1A, the minimum visitor

vehicle parking provision is 25 spaces, and the minimum bicycle parking provision is 132 spaces. As the development is a mixed-use building fronting Bank Street, no vehicle parking is required for the residents. The minimum bicycle parking and tenant vehicle parking requirements are satisfied; however the site is not providing the minimum visitor vehicle parking.

## 7.2 Spillover Parking

As the site is 25 spaces below the required parking from the zoning by-law, the potential for spillover parking will be considered. While required rates for visitor parking are identical for “Inner Urban” areas and areas “Near Major LRT Stations” in the zoning by-law, some of the demand for spillover parking is nonetheless considered to be mitigated by the proximity to rapid transit. Residual demand is anticipated to be accommodated by the area parking capacity.

The Centretown Local Area Parking Study was completed by the City’s Public Works Department in March of 2016. The study found that on-street parking was available during all study periods, and occupancy remained below 85% for the duration of the study. Area parking is generally paid parking outside of evenings and weekends, and on-street parking demand was consistent on weekdays when paid parking is in effect, ranging from 45%-56% occupancy. Paid on-street parking and publicly owned parking facilities are illustrated in Figure 11.

Figure 11: Study Area On-Street and City Parking



Source: <http://maps.ottawa.ca/geoOttawa/> Accessed: May 2, 2023

In addition to street parking, publicly owned parking garages and privately owned lots and garages are numerous in the surrounding area. Within one block of the site along Bank Street, Nepean Street or Lisgar Street, at least four privately owned public parking lots, one privately owned public parking garage are present. Additional private and public facilities are present further out from the site. While a low spillover parking demand is anticipated due to the factors discussed above, any demand is anticipated to be accommodated by area parking facilities.

## 8 Boundary Street Design

Table 13 summarizes the MMLOS analysis for the boundary streets of Bank Street, Nepean Street, and Lisgar Street. The existing and future conditions for all streets will be the same and are considered in one row. The boundary street analysis is based on the policy area of “Within 600m of a rapid transit station”. The MMLOS worksheets has been provided in Appendix E.

Table 13: Boundary Street MMLOS Analysis

Segment	Pedestrian LOS		Bicycle LOS		Transit LOS		Truck LOS	
	PLOS	Target	BLOS	Target	TLOS	Target	TrLOS	Target
Bank Street	C	A	E	B	D	D	-	-
Nepean Street	C	A	D	D	-	-	-	-
Lisgar Street	F	A	D	D	-	-	-	-

All boundary streets do not meet the pedestrian LOS targets and Bank Street does not meet cycling LOS targets. To meet pedestrian targets, Bank Street would require two-metre-wide sidewalks with a greater than 2.0-metre boulevard width in concert with the reduction of speeds to 30 km/h. The existing distance between the building face and the roadway edge is approximately three metres, and thus the widened facility cannot be achieved. With respect to pedestrian LOS on Nepean Street, while nominally falling short of the pedestrian LOS target, it is effectively achieved. Per Section 2.2 of the MMLOS addendum, a parking lane should not generally be considered as part of the boulevard width as it is captured elsewhere in the calculation, however given on-street parking on the site frontages of both Nepean Street and Lisgar Street is angle parking, a pedestrian separation from traffic of 4.5-to-5.25 metres is achieved on these frontages. Therefore, the pedestrian exposure to traffic is low and the facilities on Nepean Street are considered adequate. On Lisgar Street, a hydro pole at the site boundary and the presence of a City parking ticketing machine on the site frontage constrain the sidewalk width to 1.5 metres.

To meet cycling LOS, Bank Street would require physically separated facilities, which would not be considered an appropriate treatment for the narrow traditional mainstreet, an no plans exist to implement such a treatment.

No improvements are recommended to be implemented for the area to meet MMLOS targets.

## 9 Transportation Demand Management

### 9.1 Context for TDM

The mode shares used within the TIA represent a shift from auto modes to transit modes, based on the elimination of auto parking and the proximity to Parliament Station on the O-Train Confederation Line. Overall, the modal shares are likely to be achieved and supporting TDM measures should be provided to ensure access to and awareness of area transit and cycling.

Total bedrooms within the development is subject to the final unit breakdown. No age restrictions are noted.

### 9.2 Need and Opportunity

The subject site has been assumed to rely predominantly on transit and walking, and those assumptions have been carried through the trip generation analysis. The elimination of parking will ensure the auto mode share is not exceeded, and thus no impacts on area traffic operations are forecast. The risks associated with not meeting the target mode shares are low.

### 9.3 TDM Program

The “suite of post occupancy TDM measures” has been summarized in the TDM checklists for the residential land uses. The checklist is provided in Appendix F. The key TDM measures recommended include:



- Display local area maps with walking and cycling routes, and transit route information and schedules at major entrances
- Provide a multimodal travel option information package to new residents
- Provide a permanent bike repair station

## 10 Summary of Improvements Indicated and Modifications Options

The following summarizes the analysis and results presented in this TIA report:

### Proposed Site and Screening

- The existing site includes commercial land uses and heritage-contributing buildings, to which a nine-storey apartment tower comprising 263 units is proposed to be added
- No vehicular access or parking are proposed for the site
- The development is proposed to be completed as a single phase by 2025
- A TIA Screening Form was submitted recommending no TIA be conducted for the subject development based on its characteristics and location
- The City's TPM outlined a scoped TIA to satisfy the transportation requirements of the submission
- This scoped TIA is in support of a zoning amendment and site plan application

### Existing Conditions

- Bank Street is an arterial road and Nepean Street and Lisgar Street are local roads comprising the study area
- Sidewalks are provided on both sides of the study area roads
- Cycling facilities include cycletracks on Bay Street north of Laurier Avenue, a two-way curbed bike lanes on O'Connor Street, curbed bike lanes on Laurier Avenue, and bike lanes on each Lyon Street, Bay Street south of Laurier Avenue, and Percy Street
- Laurier Avenue and O'Connor Street are cross-town bikeways, Sparks Street is a neighbourhood bikeway, Metcalfe Street, O'Connor Street, Lyon Street, Bay Street, Percy Street, Somerset Street, Laurier Avenue, Slater Street and Albert Street are spine routes, and Elgin Street, Bank Street, and Queen Street are local routes
- The site is within 550 metres' walk of Parliament Station on the O-Train Confederation Line, and three bus routes operate on Bank Street on the site frontage
- The high volumes of vehicles and pedestrians on Bank Street has produced 14 collisions at the intersection of Bank Street at Nepean Street where the majority of collisions are angle collisions, likely impacted by vehicles pushing gaps in the arterial traffic stream from the minor stop-controlled approach
- Study area intersections operate well during both peak hours

### Development Generated Travel Demand

- The proposed development is forecasted produce 117 two-way people trips during the AM peak hour and 116 two-way people trips during the PM peak hour
- Of the forecasted people trips, 11 two-way trips will be vehicle trips during the AM peak hour and 11 two-way trips will be vehicle trips during the PM peak hour based on a 10-11% auto mode share target
- The site is anticipated to have a low auto mode share due to the elimination of vehicle parking, and enabled by walking and transit access

### **Development Design**

- The bike parking will be located internal to the building
- Pedestrian connections will be made from the entrances on Bank Street and Nepean Street to the sidewalks
- Loading and garbage pickup are anticipated to occur on Lisgar Street, and emergency services are anticipated to access the site via the three public road frontages

### **Parking**

- No vehicle parking is to be provided for the site, and 438 bicycle parking spaces are proposed
- The site is within Area Y of Schedule 1A of the zoning by-law requiring 25 visitor spaces which will not be provided
- Demand for vehicle parking is anticipated to be lower due to proximity to rapid transit
- Area on-street and publicly owned parking facilities have demonstrated capacity and numerous private parking options are also available, and should accommodate residual visitor parking demand

### **Boundary Street Design**

- Bank Street will not meet pedestrian and cycling MMLOS targets due to sidewalk width constraints and operating speeds in excess of 30 km/h
- Nepean Street nominally does not meet pedestrian LOS targets, however functionally does when the presence of angle parking is considered
- Lisgar Street does not meet pedestrian LOS targets due to the presence of two pinch points constraining the sidewalk to 1.5 metres in width

### **TDM**

- Supportive TDM measures to be included within the proposed development should include:
  - Display local area maps with walking and cycling routes, and transit route information and schedules at major entrances
  - Provide a multimodal travel option information package to new residents
  - Provide a permanent bike repair station

## 11 Conclusion

It is recommended that, from a transportation perspective, the proposed development application proceed.

Prepared By:



John Kingsley, EIT  
Transportation Engineering-Intern

Reviewed By:



Andrew Harte, P.Eng.  
Senior Transportation Engineer

# Appendix A

TIA Screening Form and PM Certification Form

City of Ottawa 2017 TIA Guidelines  
Step 1 - Screening Form

Date: 11-Apr-23  
Project Number: 2023-049  
Project Reference: 178 Nepean 219-223 Bank

1.1 Description of Proposed Development	
Municipal Address	178 Nepean St, 219-233 Bank St
Description of Location	Parcel on east side of Bank St, north of Lisgar St and south of Nepean St
Land Use Classification	Traditional Mainstreet - TM H(19)
Development Size	263 high-rise dwelling units
Accesses	No vehicular access provided
Phase of Development	Single
Buildout Year	2025
TIA Requirement	<b>No TIA Recommended</b>

1.2 Trip Generation Trigger	
Land Use Type	Townhomes or apartments
Development Size	263 Units
Trip Generation Trigger	<b>No</b> See attached trip generation

1.3 Location Triggers	
Does the development propose a new driveway to a boundary street that is designated as part of the City's Transit Priority, Rapid Transit or Spine Bicycle Networks?	No
Is the development in a Design Priority Area (DPA) or Transit-oriented Development (TOD) zone?	Yes
Location Trigger	<b>No</b> Considerations relating to the Design Priority Area can be administered through typical site plan review process

1.4. Safety Triggers	
Are posted speed limits on a boundary street 80 km/hr or greater?	No
Are there any horizontal/vertical curvatures on a boundary street limits sight lines at a proposed driveway?	No
Is the proposed driveway within the area of influence of an adjacent traffic signal or roundabout (i.e. within 300 m of intersection in rural conditions, or within 150 m of intersection in urban/ suburban conditions)?	No
Is the proposed driveway within auxiliary lanes of an intersection?	No
Does the proposed driveway make use of an existing median break that serves an existing site?	No
Is there is a documented history of traffic operations or safety concerns on the boundary streets within 500 m of the development?	No
Does the development include a drive-thru facility?	No
Safety Trigger	No



The site lies on the south side of Nepean Street within the Ottawa Inner Area TRANS district, where the north side of Nepean Street falls within Ottawa Centre TRANS district.

*Table 1: TRANS Trip Generation Manual Recommended Mode Shares*

Travel Mode	Ottawa Inner Area		Ottawa Centre	
	Multi-Unit (High-Rise)		Multi-Unit (High-Rise)	
	AM	PM	AM	PM
<b>Auto Driver</b>	26%	25%	18%	17%
<b>Auto Passenger</b>	6%	8%	2%	9%
<b>Transit</b>	28%	21%	26%	21%
<b>Cycling</b>	5%	6%	1%	1%
<b>Walking</b>	34%	39%	52%	52%
<b>Total</b>	<b>100%</b>	<b>100%</b>	<b>100%</b>	<b>100%</b>

Based upon the site’s context of being on the boundary of Ottawa Centre and Ottawa Inner Area TRANS districts, being within 450 metres’ walk of the Parliament O-Train station, and providing no parking, modified mode share targets are proposed for the development and are summarized in Table 2.

*Table 2: Proposed Development Mode Shares*

Travel Mode	Multi-Unit (High-Rise)	
	AM	PM
<b>Auto Driver</b>	11%	10%
<b>Auto Passenger</b>	1%	5%
<b>Transit</b>	38%	31%
<b>Cycling</b>	6%	7%
<b>Walking</b>	44%	47%
<b>Total</b>	<b>100%</b>	<b>100%</b>

*Table 3: Total Residential Person Trip Generation by Peak Period*

Land Use	Units	AM Peak Period			PM Peak Period		
		In	Out	Total	In	Out	Total
<b>Multi-Unit High-Rise</b>	263	65	145	210	137	100	237

*Table 4: Trip Generation by Mode*

Travel Mode		AM Peak Hour				PM Peak Hour			
		Mode Share	In	Out	Total	Mode Share	In	Out	Total
<b>Multi-Unit (High-Rise)</b>	Auto Driver	<b>11%</b>	3	8	11	<b>10%</b>	6	4	11
	Auto Passenger	<b>1%</b>	0	0	1	<b>5%</b>	3	2	5
	Transit	<b>38%</b>	14	30	44	<b>31%</b>	20	15	34
	Cycling	<b>6%</b>	2	5	8	<b>7%</b>	5	3	8
	Walking	<b>44%</b>	17	37	53	<b>47%</b>	33	24	58
<b>Total</b>		<b>100%</b>	<b>36</b>	<b>80</b>	<b>117</b>	<b>100%</b>	<b>67</b>	<b>48</b>	<b>116</b>



## **TIA Plan Reports**

On 14 June 2017, the Council of the City of Ottawa adopted new Transportation Impact Assessment (TIA) Guidelines. In adopting the guidelines, Council established a requirement for those preparing and delivering transportation impact assessments and reports to sign a letter of certification.

Individuals submitting TIA reports will be responsible for all aspects of development-related transportation assessment and reporting, and undertaking such work, in accordance and compliance with the City of Ottawa's Official Plan, the Transportation Master Plan and the Transportation Impact Assessment (2017) Guidelines.

By submitting the attached TIA report (and any associated documents) and signing this document, the individual acknowledges that s/he meets the four criteria listed below.

### **CERTIFICATION**

1. I have reviewed and have a sound understanding of the objectives, needs and requirements of the City of Ottawa's Official Plan, Transportation Master Plan and the Transportation Impact Assessment (2017) Guidelines;
2. I have a sound knowledge of industry standard practice with respect to the preparation of transportation impact assessment reports, including multi modal level of service review;
3. I have substantial experience (more than 5 years) in undertaking and delivering transportation impact studies (analysis, reporting and geometric design) with strong background knowledge in transportation planning, engineering or traffic operations; and
4. I am either a licensed<sup>1</sup> or registered<sup>2</sup> professional in good standing, whose field of expertise [check  appropriate field(s)] is either transportation engineering  or transportation planning .

**1,2 License of registration body that oversees the profession is required to have a code of conduct and ethics guidelines that will ensure appropriate conduct and representation for transportation planning and/or transportation engineering works.**

City Of Ottawa  
Infrastructure Services and Community  
Sustainability  
Planning and Growth Management  
110 Laurier Avenue West, 4th fl.  
Ottawa, ON K1P 1J1  
Tel. : 613-580-2424  
Fax: 613-560-6006

Ville d'Ottawa  
Services d'infrastructure et Viabilité des  
collectivités  
Urbanisme et Gestion de la croissance  
110, avenue Laurier Ouest  
Ottawa (Ontario) K1P 1J1  
Tél. : 613-580-2424  
Télécopieur: 613-560-6006

Dated at Ottawa this 20 day of September, 2018.  
(City)

Name: Andrew Harte  
(Please Print)

Professional Title: Professional Engineer

  
\_\_\_\_\_  
Signature of Individual certifier that s/he meets the above four criteria

<b>Office Contact Information (Please Print)</b>
Address: 6 Plaza Court
City / Postal Code: Ottawa / K2H 7W1
Telephone / Extension: (613) 697-3797
E-Mail Address: Andrew.Harte@CGHTransportation.com



# Appendix B

Turning Movement Counts



## Turning Movement Count Summary Report Including Peak Hours, AADT and Expansion Factors All Vehicles Except Bicycles



### Bank Street & Nepean Street Ottawa, ON

**Survey Date:** Thursday, April 27, 2023      **Start Time:** 0700      **AADT Factor:** 0.9  
**Weather AM:** Mostly Cloudy 4° C      **Survey Duration:** 8 Hrs.      **Survey Hours:** 0700-1000, 1130-1330 & 1500-1800  
**Weather PM:** Mostly Cloudy 12° C      **Surveyor(s):** T. Carmody

Time Period	Nepean St. Eastbound					Nepean St. Westbound					Bank St. Northbound					Bank St. Southbound					Grand Total		
	LT	ST	RT	UT	E/B Tot	LT	ST	RT	UT	W/B Tot	LT	ST	RT	UT	N/B Tot	LT	ST	RT	UT	S/B Tot		Street Total	
	Street Total																						
0700-0800	14	46	24	0	84	0	0	0	0	0	84	0	166	37	0	203	58	143	0	0	201	404	488
0800-0900	22	68	35	0	125	0	0	0	0	0	125	0	219	37	1	257	94	190	0	2	286	543	668
0900-1000	18	45	38	0	101	0	0	0	0	0	101	0	187	35	0	222	58	161	0	0	219	441	542
1130-1230	9	34	54	0	97	0	0	0	0	0	97	0	175	18	2	195	71	190	0	0	261	456	553
1230-1330	21	47	36	0	104	0	0	0	0	0	104	0	160	30	1	191	43	204	0	2	249	440	544
1500-1600	13	35	47	0	95	0	0	0	0	0	95	0	206	30	0	236	97	270	0	0	367	603	698
1600-1700	11	43	52	0	106	0	0	0	0	0	106	0	236	44	1	281	65	250	0	0	315	596	702
1700-1800	13	51	35	0	99	0	0	0	0	0	99	0	226	44	0	270	78	279	0	1	358	628	727
<b>Totals</b>	<b>121</b>	<b>369</b>	<b>321</b>	<b>0</b>	<b>811</b>	<b>0</b>	<b>0</b>	<b>0</b>	<b>0</b>	<b>0</b>	<b>811</b>	<b>0</b>	<b>1575</b>	<b>275</b>	<b>5</b>	<b>1855</b>	<b>564</b>	<b>1687</b>	<b>0</b>	<b>5</b>	<b>2256</b>	<b>4111</b>	<b>4922</b>

**Equivalent 12 & 24-hour Vehicle Volumes Including the Annual Average Daily Traffic (AADT) Factor**  
**Applicable to the Day and Month of the Turning Movement Count**  
**Expansion factors are applied exclusively to standard weekday 8-hour turning movement counts**  
**conducted during the hours of 0700h - 1000h, 1130h - 1330h and 1500h - 1800h**

Equivalent 12-hour vehicle volumes. These volumes are calculated by multiplying the 8-hour totals by the 8 → 12 expansion factor of 1.39																							
Equ. 12 Hr	168	513	446	0	1127	0	0	0	0	0	1127	0	2189	382	7	2578	784	2345	0	7	3136	5714	6842
Average daily 12-hour vehicle volumes. These volumes are calculated by multiplying the equivalent 12-hour totals by the AADT factor of: 0.9																							
AADT 12-hr	151	462	402	0	1015	0	0	0	0	0	1015	0	1970	344	6	2321	706	2110	0	6	2822	5143	6157
24-Hour AADT. These volumes are calculated by multiplying the average daily 12-hour vehicle volumes by the 12 → 24 expansion factor of 1.31																							
AADT 24 Hr	198	605	526	0	1329	0	0	0	0	0	1329	0	2581	451	8	3040	924	2765	0	8	3697	6737	8066

#### AADT and expansion factors provided by the City of Ottawa

AM Peak Hour Factor → 0.96													Highest Hourly Vehicle Volume Between 0700h & 1000h												
AM Peak Hr	LT	ST	RT	UT	Total	LT	ST	RT	UT	Total	Str. Tot.	Gr. Tot.	LT	ST	RT	UT	Total	LT	ST	RT	UT	Total	Str. Tot.	Gr. Tot.	
0815-0915	20	63	39	0	122	0	0	0	0	0	122	0	295	234	45	1	280	91	204	0	0	295	575	697	
OFF Peak Hour Factor → 0.91													Highest Hourly Vehicle Volume Between 1130h & 1330h												
OFF Peak Hr	LT	ST	RT	UT	Total	LT	ST	RT	UT	Total	Str. Tot.	Gr. Tot.	LT	ST	RT	UT	Total	LT	ST	RT	UT	Total	Str. Tot.	Gr. Tot.	
1200-1300	14	40	49	0	103	0	0	0	0	0	103	0	267	159	23	1	183	65	202	0	0	267	450	553	
PM Peak Hour Factor → 0.87													Highest Hourly Vehicle Volume Between 1500h & 1800h												
PM Peak Hr	LT	ST	RT	UT	Total	LT	ST	RT	UT	Total	Str. Tot.	Gr. Tot.	LT	ST	RT	UT	Total	LT	ST	RT	UT	Total	Str. Tot.	Gr. Tot.	
1645-1745	11	52	49	0	112	0	0	0	0	0	112	0	265	228	37	0	265	80	274	0	1	355	620	732	

**Comments:**  
 OC Transpo and Para Transpo buses, private buses and school buses comprise 67.80% of the heavy vehicle traffic. Nepean Street is one way eastbound. The bicycle totals include 23 varieties of personal electric modes - primarily E-scooters (stand up types). The pedestrian totals include 50 with accessibility issues using either a cane, walker or wheelchair.

- Notes:**  
 1. Includes all vehicle types except bicycles, electric bicycles, and electric scooters.  
 2. When expansion and AADT factors are applied, the results will differ slightly due to rounding.



## Turning Movement Count Summary, AM and PM Peak Hour Flow Diagrams All Vehicles Except Bicycles



### Bank Street & Nepean Street Ottawa, ON

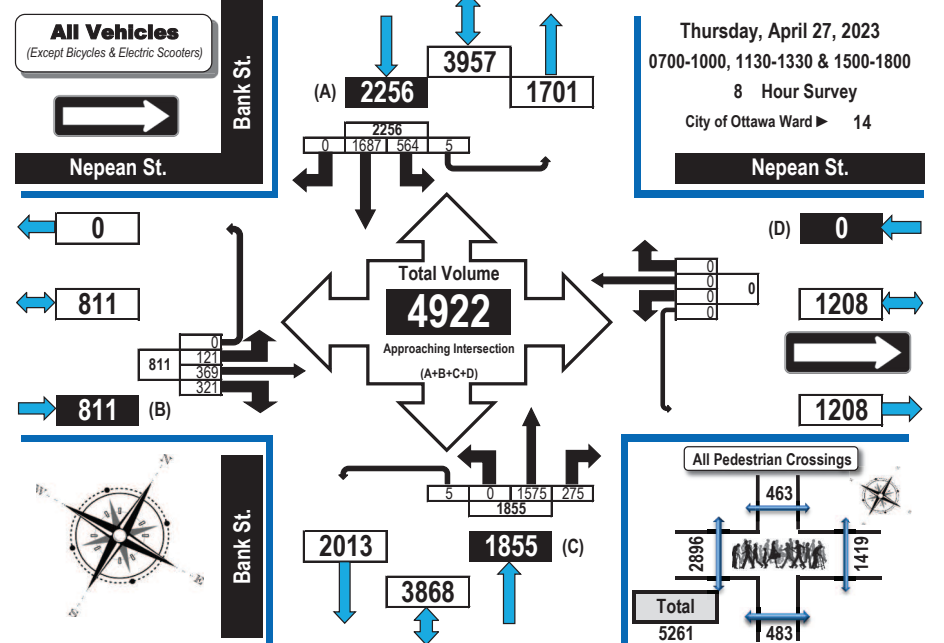

#### AM Peak Hour Flow Diagram PM Peak Hour Flow Diagram

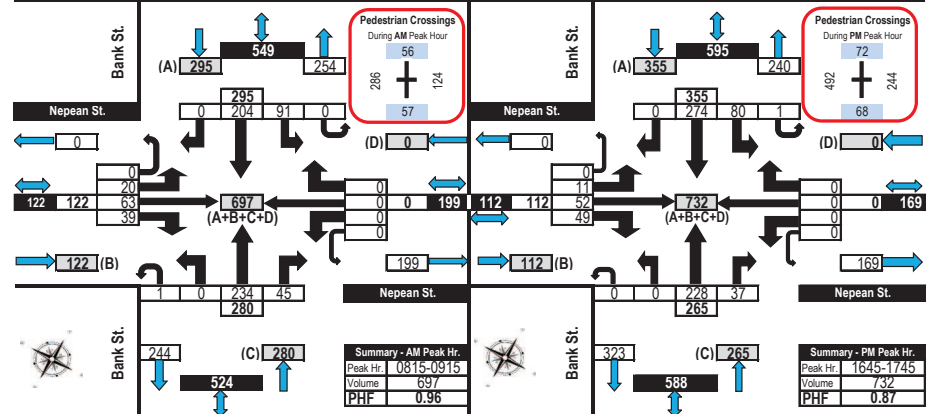





### Turning Movement Count Summary, OFF and EVENING Peak Hour Flow Diagrams All Vehicles Except Bicycles

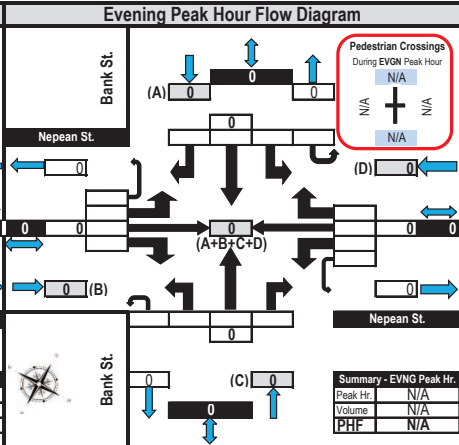
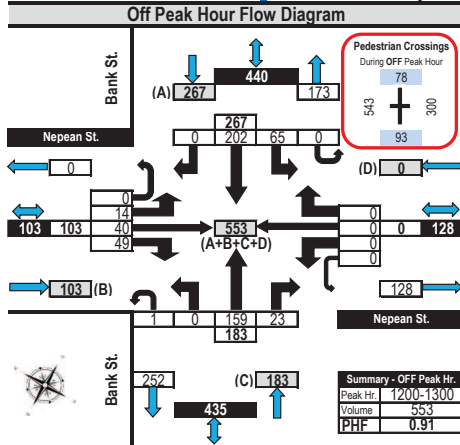
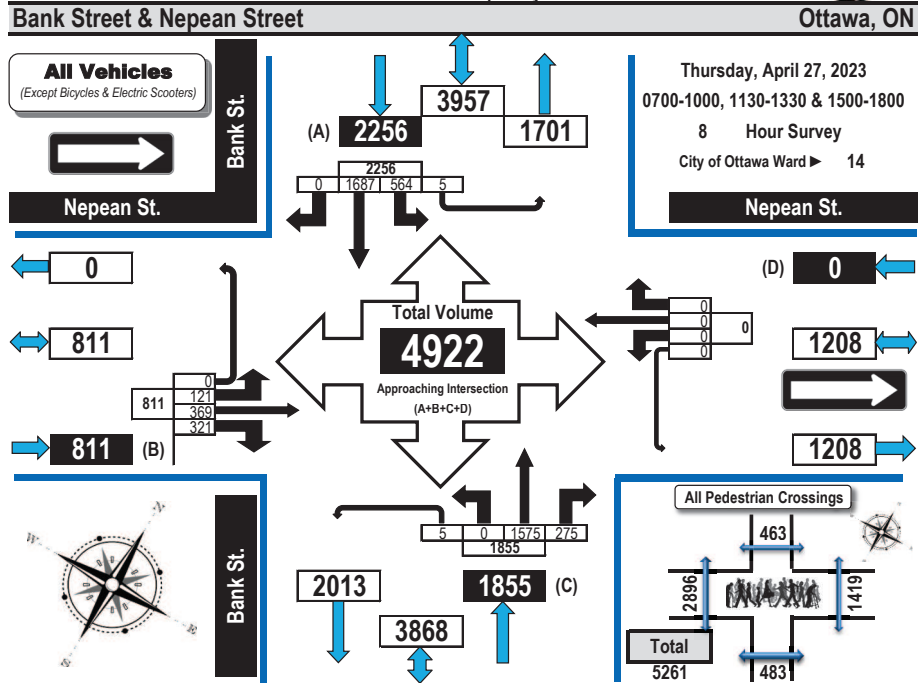

Printed on: 4/30/2023

Prepared by: thetrafficsspecialist@gmail.com

Flow Diagrams: OFF Peak



### Turning Movement Count Heavy Vehicle Summary (FHWA Class 4-13) Flow Diagram

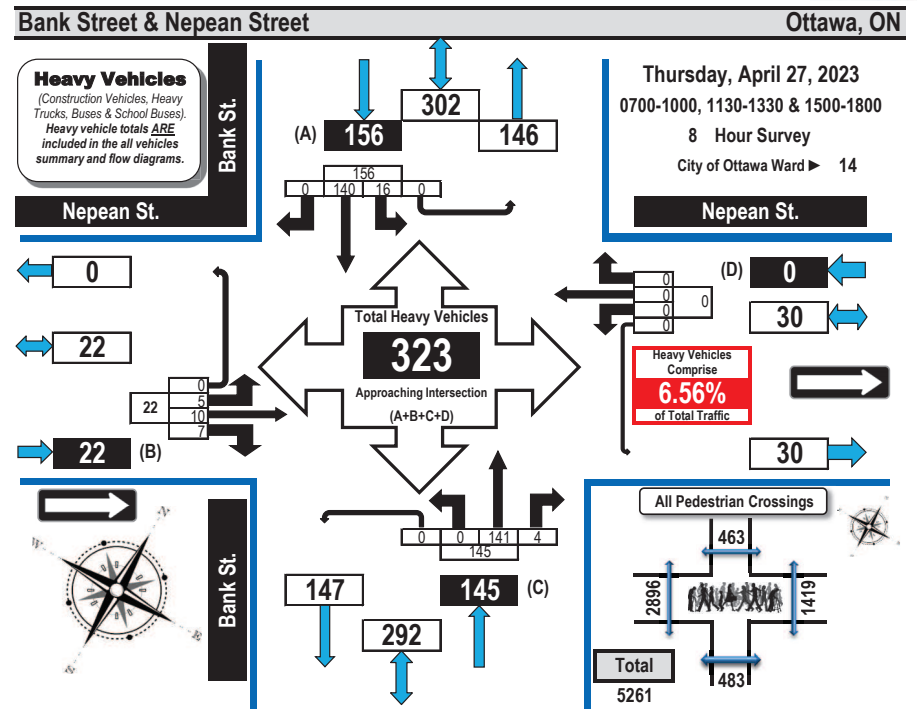

Time Period	Nepean St. Eastbound				Nepean St. Westbound				Bank St. Northbound				Bank St. Southbound				SB Tot	GR Tot			
	LT	ST	RT	UT	EB Tot	LT	ST	RT	UT	WB Tot	LT	ST	RT	UT	NB Tot						
0700-0800	0	2	1	0	3	0	0	0	0	0	0	17	1	0	18	4	13	0	0	17	38
0800-0900	1	2	1	0	4	0	0	0	0	0	0	25	0	0	25	3	18	0	0	21	50
0900-1000	1	0	0	0	1	0	0	0	0	0	0	21	0	0	21	3	26	0	0	29	51
1130-1230	1	0	0	0	1	0	0	0	0	0	0	19	1	0	20	2	20	0	0	22	43
1230-1330	1	3	0	0	4	0	0	0	0	0	0	14	0	0	14	1	18	0	0	19	37
1500-1600	1	0	4	0	5	0	0	0	0	0	0	14	0	0	14	3	13	0	0	16	35
1600-1700	0	1	1	0	2	0	0	0	0	0	0	14	0	0	14	0	15	0	0	15	31
1700-1800	0	2	0	0	2	0	0	0	0	0	0	17	2	0	19	0	17	0	0	17	38
<b>Totals</b>	<b>5</b>	<b>10</b>	<b>7</b>	<b>0</b>	<b>22</b>	<b>0</b>	<b>0</b>	<b>0</b>	<b>0</b>	<b>0</b>	<b>0</b>	<b>141</b>	<b>4</b>	<b>0</b>	<b>145</b>	<b>16</b>	<b>140</b>	<b>0</b>	<b>0</b>	<b>156</b>	<b>323</b>

**Comments:**

OC Transpo and Para Transpo buses, private buses and school buses comprise 67.80% of the heavy vehicle traffic. Nepean Street is one way eastbound. The bicycle totals include 23 varieties of personal electric modes - primarily E-scooters (stand up types). The pedestrian totals include 50 with accessibility issues using either a cane, walker or wheelchair.

Printed on: 4/30/2023

Prepared by: thetrafficsspecialist@gmail.com

Summary: Heavy Vehicles



### Turning Movement Count All Buses Summary (FHWA Class 4 ONLY) Flow Diagram

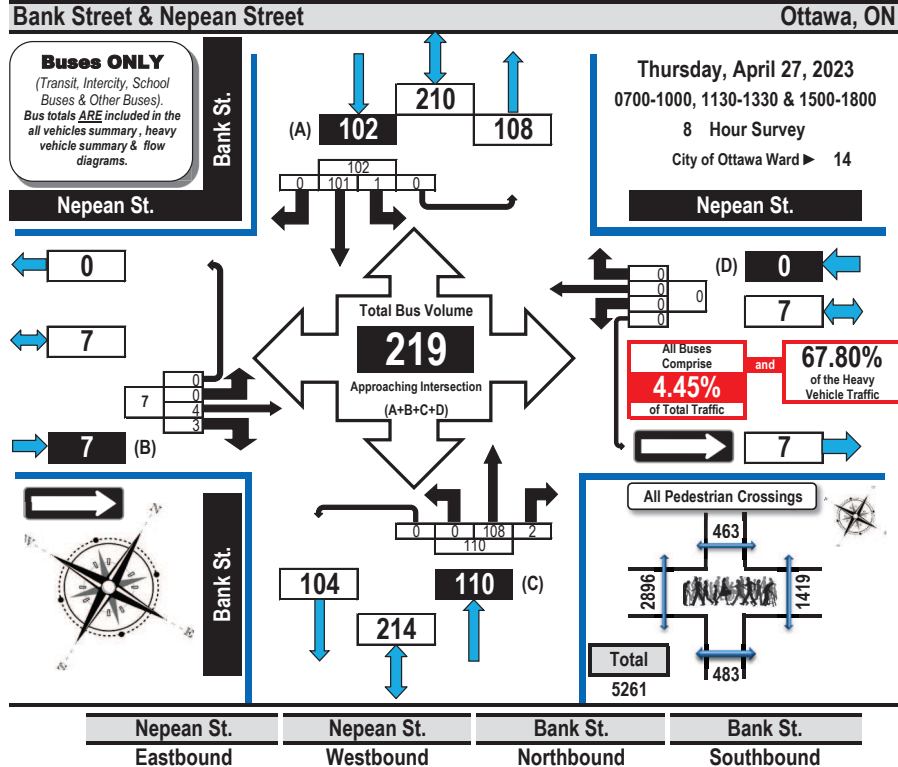

Comments:  
OC Transpo and Para Transpo buses, private buses and school buses comprise 67.80% of the heavy vehicle traffic. Nepean Street is one way eastbound. The bicycle totals include 23 varieties of personal electric modes - primarily E-scooters (stand up types). The pedestrian totals include 50 with accessibility issues using either a cane, walker or wheelchair.



### Turning Movement Count Bicycle Summary Flow Diagram

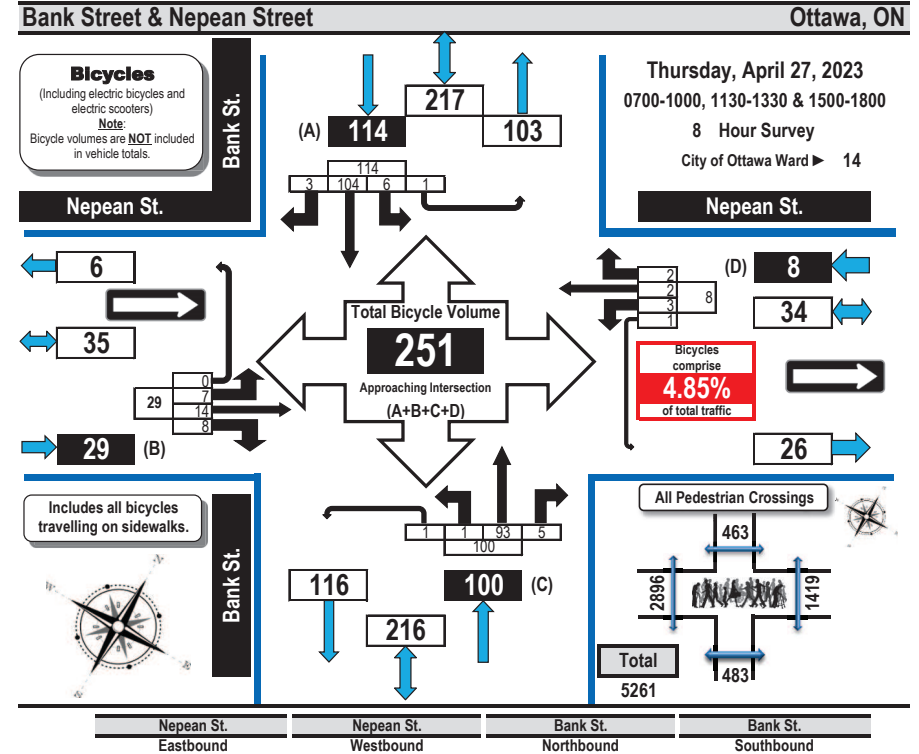

Comments:  
OC Transpo and Para Transpo buses, private buses and school buses comprise 67.80% of the heavy vehicle traffic. Nepean Street is one way eastbound. The bicycle totals include 23 varieties of personal electric modes - primarily E-scooters (stand up types). The pedestrian totals include 50 with accessibility issues using either a cane, walker or wheelchair.



## Turning Movement Count Pedestrian Crossings Summary and Flow Diagram



### Bank Street & Nepean Street Ottawa, ON

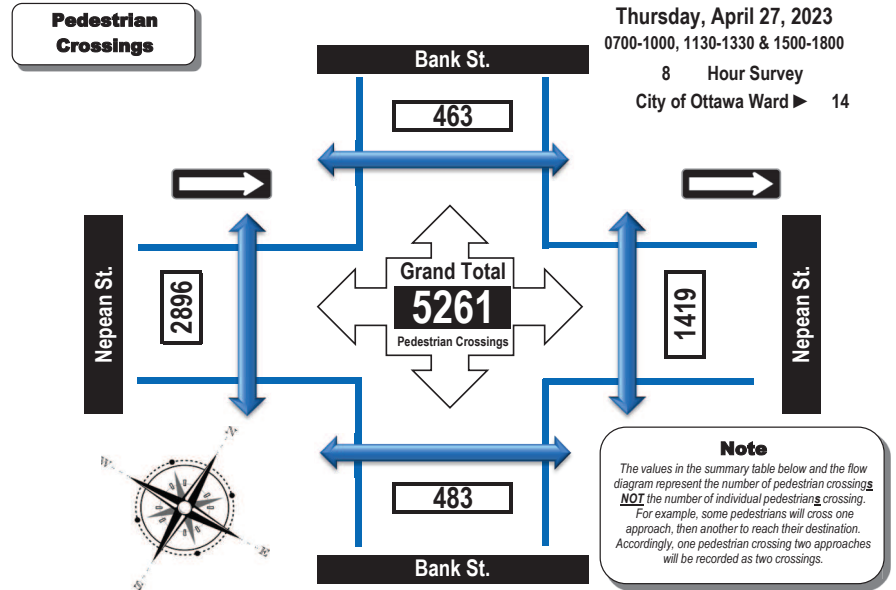

Time Period	West Side Crossing Nepean St.	East Side Crossing Nepean St.	Street Total	South Side Crossing Bank St.	North Side Crossing Bank St.	Street Total	Grand Total
0700-0800	140	71	211	22	29	51	262
0800-0900	276	119	395	59	48	107	502
0900-1000	249	103	352	34	54	88	440
1130-1230	447	226	673	84	86	170	843
1230-1330	534	261	795	54	56	110	905
1500-1600	352	181	533	56	51	107	640
1600-1700	441	218	659	106	70	176	835
1700-1800	457	240	697	68	69	137	834
<b>Totals</b>	<b>2896</b>	<b>1419</b>	<b>4315</b>	<b>483</b>	<b>463</b>	<b>946</b>	<b>5261</b>

**Comments:**  
OC Transpo and Para Transpo buses, private buses and school buses comprise 67.80% of the heavy vehicle traffic. Nepean Street is one way eastbound. The bicycle totals include 23 varieties of personal electric modes - primarily E-scooters (stand up types). The pedestrian totals include 50 with accessibility issues using either a cane, walker or wheelchair.



## Turning Movement Count All Vehicles, Heavy Vehicles, Buses, Bicycles and Pedestrian Summary Bar Graphs



### Bank Street & Nepean Street Ottawa, ON

Survey Day/Date: Thursday, April 27, 2023      Survey Hours: 0700-1000, 1130-1330 & 1500-1800

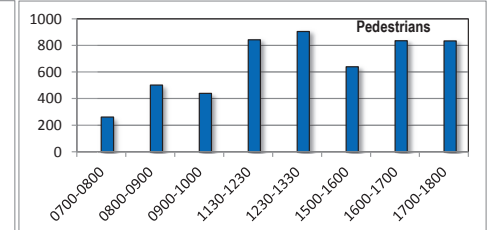
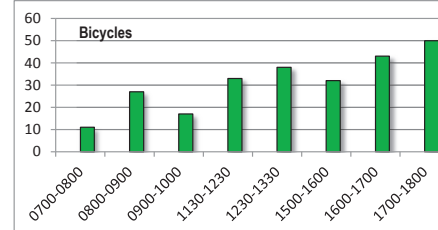
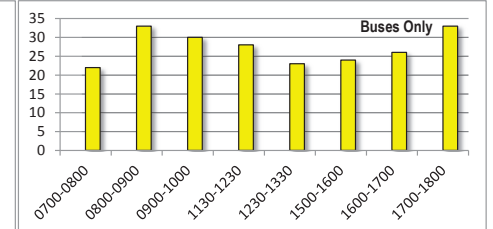
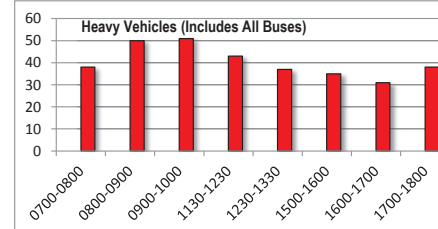
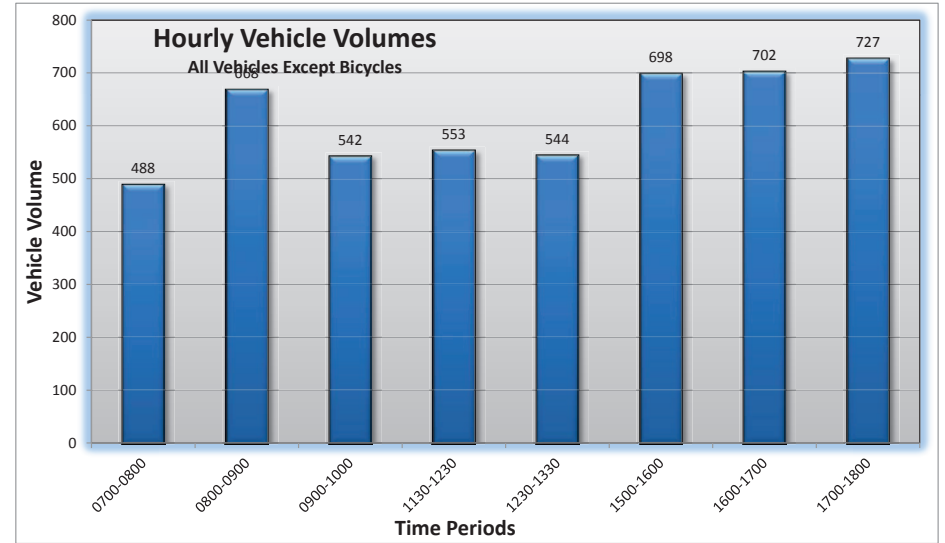



# Transportation Services - Traffic Services

## Turning Movement Count - Study Results

### BANK ST @ LISGAR ST

Survey Date: Tuesday, March 08, 2022

WO No: 40218

Start Time: 07:00

Device: Miovision

#### Full Study Diagram

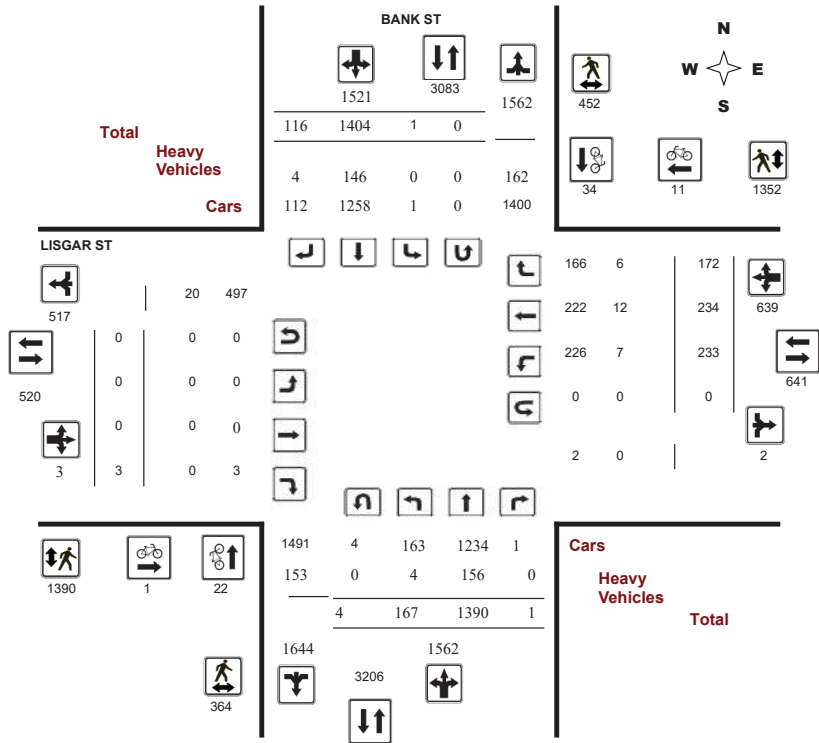

# Transportation Services - Traffic Services

## Turning Movement Count - Study Results

### BANK ST @ LISGAR ST

Survey Date: Tuesday, March 08, 2022

WO No: 40218

Start Time: 07:00

Device: Miovision

#### Full Study Peak Hour Diagram

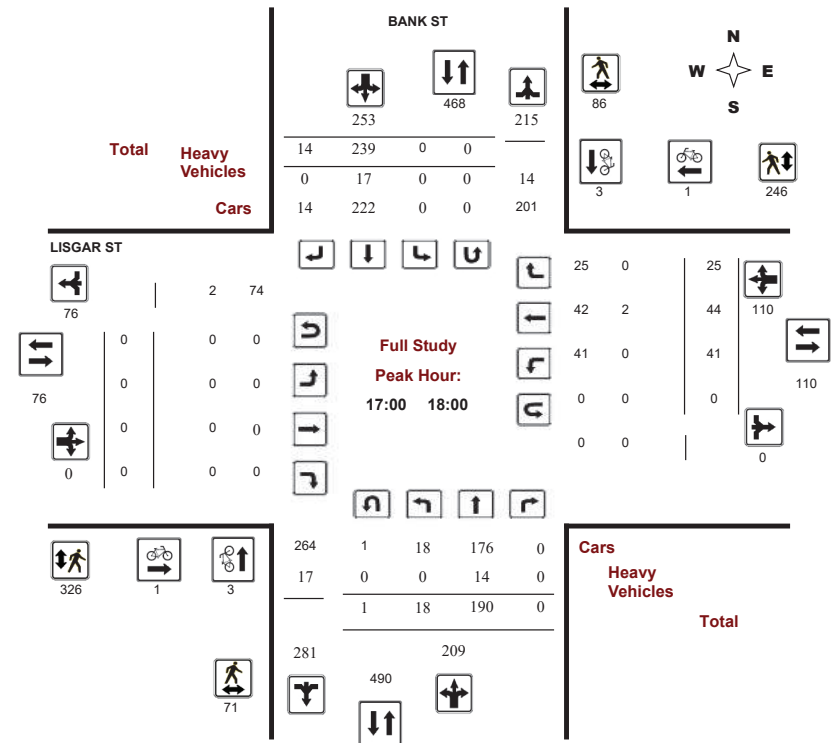









Transportation Services - Traffic Services

Turning Movement Count - Study Results

BANK ST @ LISGAR ST

Survey Date: Tuesday, March 08, 2022

WO No: 40218

Start Time: 07:00

Device: Miovision

Full Study 15 Minute Increments

Table with columns for Time Period, Northbound, Southbound, Eastbound, Westbound, and Grand Total. Rows represent 15-minute intervals from 07:00 to 18:00.

Note: U-Turns are included in Totals.



Transportation Services - Traffic Services

Turning Movement Count - Study Results

BANK ST @ LISGAR ST

Survey Date: Tuesday, March 08, 2022

WO No: 40218

Start Time: 07:00

Device: Miovision

Full Study Cyclist Volume

Table with columns for Time Period, Northbound, Southbound, Street Total, Eastbound, Westbound, Street Total, and Grand Total. Rows represent 15-minute intervals from 07:00 to 18:00.



Transportation Services - Traffic Services

Turning Movement Count - Study Results

BANK ST @ LISGAR ST

Survey Date: Tuesday, March 08, 2022

WO No: 40218

Start Time: 07:00

Device: Miovision

Full Study Pedestrian Volume

Table with columns: Time Period, NB Approach, SB Approach, Total, EB Approach, WB Approach, Grand Total. Rows show pedestrian counts for various time intervals from 07:00 to 17:45.



Transportation Services - Traffic Services

Turning Movement Count - Study Results

BANK ST @ LISGAR ST

Survey Date: Tuesday, March 08, 2022

WO No: 40218

Start Time: 07:00

Device: Miovision

Full Study Heavy Vehicles

Table with columns: Time Period, Northbound (LT, ST, RT, N TOT), Southbound (LT, ST, RT, S TOT), Eastbound (LT, ST, RT, E TOT), Westbound (LT, ST, RT, W TOT), STR TOT, Grand Total. Rows show heavy vehicle counts for various time intervals from 07:00 to 17:45.



**Transportation Services - Traffic Services**

**Turning Movement Count - Study Results**

**BANK ST @ LISGAR ST**

**Survey Date:** Tuesday, March 08, 2022

**WO No:** 40218

**Start Time:** 07:00

**Device:** Miovision

**Full Study 15 Minute U-Turn Total**

BANK ST

LISGAR ST

Time Period	Northbound U-Turn Total	Southbound U-Turn Total	Eastbound U-Turn Total	Westbound U-Turn Total	Total
07:00 - 07:15	0	0	0	0	0
07:15 - 07:30	0	0	0	0	0
07:30 - 07:45	0	0	0	0	0
07:45 - 08:00	0	0	0	0	0
08:00 - 08:15	0	0	0	0	0
08:15 - 08:30	0	0	0	0	0
08:30 - 08:45	0	0	0	0	0
08:45 - 09:00	0	0	0	0	0
09:00 - 09:15	0	0	0	0	0
09:15 - 09:30	0	0	0	0	0
09:30 - 09:45	0	0	0	0	0
09:45 - 10:00	1	0	0	0	1
11:30 - 11:45	0	0	0	0	0
11:45 - 12:00	0	0	0	0	0
12:00 - 12:15	1	0	0	0	1
12:15 - 12:30	0	0	0	0	0
12:30 - 12:45	0	0	0	0	0
12:45 - 13:00	0	0	0	0	0
13:00 - 13:15	0	0	0	0	0
13:15 - 13:30	0	0	0	0	0
15:00 - 15:15	0	0	0	0	0
15:15 - 15:30	0	0	0	0	0
15:30 - 15:45	0	0	0	0	0
15:45 - 16:00	0	0	0	0	0
16:00 - 16:15	0	0	0	0	0
16:15 - 16:30	0	0	0	0	0
16:30 - 16:45	0	0	0	0	0
16:45 - 17:00	1	0	0	0	1
17:00 - 17:15	0	0	0	0	0
17:15 - 17:30	0	0	0	0	0
17:30 - 17:45	1	0	0	0	1
17:45 - 18:00	0	0	0	0	0
<b>Total</b>	<b>4</b>	<b>0</b>	<b>0</b>	<b>0</b>	<b>4</b>

# Appendix C

Synchro Intersection Worksheets – Existing Conditions

Lanes, Volumes, Timings  
1: Bank & Lisgar

Existing AM Peak Hour  
178 Nepean, 219-223 Bank

Lane Group	WBT	NBL	NBT	SBT
Lane Configurations	↕		↕	↕
Traffic Volume (vph)	39	25	241	213
Future Volume (vph)	39	25	241	213
Lane Group Flow (vph)	105	0	296	264
Turn Type	NA	Perm	NA	NA
Protected Phases	8		2	6
Permitted Phases		2		
Detector Phase	8	2	2	6
Switch Phase				
Minimum Initial (s)	10.0	10.0	10.0	10.0
Minimum Split (s)	22.2	20.2	20.2	20.2
Total Split (s)	23.0	52.0	52.0	52.0
Total Split (%)	30.7%	69.3%	69.3%	69.3%
Maximum Green (s)	17.8	46.8	46.8	46.8
Yellow Time (s)	3.3	3.3	3.3	3.3
All-Red Time (s)	1.9	1.9	1.9	1.9
Lost Time Adjust (s)	0.0		0.0	0.0
Total Lost Time (s)	5.2		5.2	5.2
Lead/Lag				
Lead-Lag Optimize?				
Vehicle Extension (s)	3.0	3.0	3.0	3.0
Recall Mode	Max	C-Max	C-Max	C-Max
Walk Time (s)	7.0	7.0	7.0	7.0
Flash Dont Walk (s)	10.0	8.0	8.0	8.0
Pedestrian Calls (#/hr)	41	111	111	112
Act Effct Green (s)	17.8		46.8	46.8
Actuated g/C Ratio	0.24		0.62	0.62
v/c Ratio	0.28		0.32	0.28
Control Delay	19.7		7.8	6.9
Queue Delay	0.0		0.0	0.0
Total Delay	19.7		7.8	6.9
LOS	B		A	A
Approach Delay	19.7		7.8	6.9
Approach LOS	B		A	A
Queue Length 50th (m)	8.7		17.4	14.0
Queue Length 95th (m)	20.9		29.6	24.7
Internal Link Dist (m)	147.0		139.6	52.9
Turn Bay Length (m)				
Base Capacity (vph)	378		926	954
Starvation Cap Reductn	0		0	0
Spillback Cap Reductn	0		0	0
Storage Cap Reductn	0		0	0
Reduced v/c Ratio	0.28		0.32	0.28

Intersection Summary

Cycle Length: 75  
 Actuated Cycle Length: 75  
 Offset: 58 (77%), Referenced to phase 2:NBTL and 6:SBT, Start of Green  
 Natural Cycle: 45

Lanes, Volumes, Timings  
1: Bank & Lisgar

Existing AM Peak Hour  
178 Nepean, 219-223 Bank

Control Type: Actuated-Coordinated	
Maximum v/c Ratio: 0.32	
Intersection Signal Delay: 9.3	Intersection LOS: A
Intersection Capacity Utilization 56.0%	ICU Level of Service B
Analysis Period (min) 15	

Splits and Phases: 1: Bank & Lisgar



HCM 2010 TWSC  
2: Bank & Nepean

Existing AM Peak Hour  
178 Nepean, 219-223 Bank

Intersection													
Int Delay, s/veh	3.6												
Movement	EBL	EBT	EBR	WBL	WBT	WBR	NBL	NBT	NBR	SBL	SBT	SBR	
Lane Configurations	↕							↕			↕		
Traffic Vol, veh/h	20	63	39	0	0	0	0	234	45	91	204	0	
Future Vol, veh/h	20	63	39	0	0	0	0	234	45	91	204	0	
Conflicting Peds, #/hr	56	0	57	57	0	56	286	0	124	124	0	286	
Sign Control	Stop	Stop	Stop	Free	Free	Free	Free	Free	Free	Free	Free	Free	
RT Channelized	-	-	None	-	-	None	-	-	None	-	-	None	
Storage Length	-	-	-	-	-	-	-	-	-	-	-	-	
Veh in Median Storage, #	-	0	-	-	-	-	-	0	-	-	0	-	
Grade, %	-	0	-	-	0	-	-	0	-	-	0	-	
Peak Hour Factor	90	90	90	90	90	90	90	90	90	90	90	90	
Heavy Vehicles, %	5	3	3	2	2	2	2	11	2	3	9	2	
Mvmt Flow	22	70	43	0	0	0	0	260	50	101	227	0	
Major/Minor	Minor2			Major1				Major2					
Conflicting Flow All	770	863	284					-	0	0	434	0	0
Stage 1	429	429	-					-	-	-	-	-	-
Stage 2	341	434	-					-	-	-	-	-	-
Critical Hdwy	6.45	6.53	6.23					-	-	-	4.13	-	-
Critical Hdwy Stg 1	5.45	5.53	-					-	-	-	-	-	-
Critical Hdwy Stg 2	5.45	5.53	-					-	-	-	-	-	-
Follow-up Hdwy	3.545	4.027	3.327					-	-	-	2.227	-	-
Pot Cap-1 Maneuver	365	291	753					0	-	-	1120	-	0
Stage 1	650	582	-					0	-	-	-	-	0
Stage 2	713	579	-					0	-	-	-	-	0
Platoon blocked, %								-	-	-	-	-	-
Mov Cap-1 Maneuver	327	0	720					-	-	-	1120	-	-
Mov Cap-2 Maneuver	327	0	-					-	-	-	-	-	-
Stage 1	650	0	-					-	-	-	-	-	-
Stage 2	640	0	-					-	-	-	-	-	-
Approach	EB			NB				SB					
HCM Control Delay, s	14.5			0				2.6					
HCM LOS	B												
Minor Lane/Major Mvmt	NBT	NBR	EBLn1	SBL	SBT								
Capacity (veh/h)	-	-	512	1120	-								
HCM Lane V/C Ratio	-	-	0.265	0.09	-								
HCM Control Delay (s)	-	-	14.5	8.5	0								
HCM Lane LOS	-	-	B	A	A								
HCM 95th %tile Q(veh)	-	-	1.1	0.3	-								

Lanes, Volumes, Timings  
1: Bank & Lisgar

Existing PM Peak Hour  
178 Nepean, 219-223 Bank

	← ↙ ↑ ↓			
Lane Group	WBT	NBL	NBT	SBT
Lane Configurations	↕		↕	↕
Traffic Volume (vph)	44	19	240	309
Future Volume (vph)	44	19	240	309
Lane Group Flow (vph)	123	0	288	359
Turn Type	NA	Perm	NA	NA
Protected Phases	8		2	6
Permitted Phases	2			
Detector Phase	8	2	2	6
Switch Phase				
Minimum Initial (s)	10.0	10.0	10.0	10.0
Minimum Split (s)	22.2	20.2	20.2	20.2
Total Split (s)	23.0	52.0	52.0	52.0
Total Split (%)	30.7%	69.3%	69.3%	69.3%
Maximum Green (s)	17.8	46.8	46.8	46.8
Yellow Time (s)	3.3	3.3	3.3	3.3
All-Red Time (s)	1.9	1.9	1.9	1.9
Lost Time Adjust (s)	0.0		0.0	0.0
Total Lost Time (s)	5.2		5.2	5.2
Lead/Lag				
Lead-Lag Optimize?				
Vehicle Extension (s)	3.0	3.0	3.0	3.0
Recall Mode	Max	C-Max	C-Max	C-Max
Walk Time (s)	7.0	7.0	7.0	7.0
Flash Dont Walk (s)	10.0	8.0	8.0	8.0
Pedestrian Calls (#/hr)	86	246	246	326
Act Effct Green (s)	17.8		46.8	46.8
Actuated g/C Ratio	0.24		0.62	0.62
v/c Ratio	0.34		0.29	0.36
Control Delay	23.1		7.5	7.9
Queue Delay	0.0		0.0	0.0
Total Delay	23.1		7.5	7.9
LOS	C		A	A
Approach Delay	23.1		7.5	7.9
Approach LOS	C		A	A
Queue Length 50th (m)	12.1		16.6	21.2
Queue Length 95th (m)	25.8		28.0	35.2
Internal Link Dist (m)	147.0		139.6	52.9
Turn Bay Length (m)				
Base Capacity (vph)	363		977	1010
Starvation Cap Reductn	0		0	0
Spillback Cap Reductn	0		0	0
Storage Cap Reductn	0		0	0
Reduced v/c Ratio	0.34		0.29	0.36
Intersection Summary				
Cycle Length: 75				
Actuated Cycle Length: 75				
Offset: 3 (4%), Referenced to phase 2:NBT and 6:SBT, Start of Green				
Natural Cycle: 45				

Lanes, Volumes, Timings  
1: Bank & Lisgar

Existing PM Peak Hour  
178 Nepean, 219-223 Bank

Control Type: Actuated-Coordinated  
Maximum v/c Ratio: 0.36  
Intersection Signal Delay: 10.2  
Intersection Capacity Utilization 52.9%  
Analysis Period (min) 15

Intersection LOS: B  
ICU Level of Service A

Splits and Phases: 1: Bank & Lisgar



HCM 2010 TWSC  
2: Bank & Nepean

Existing PM Peak Hour  
178 Nepean, 219-223 Bank

Intersection

Int Delay, s/veh 3.1

Movement	EBL	EBT	EBR	WBL	WBT	WBR	NBL	NBT	NBR	SBL	SBT	SBR
Lane Configurations		↕						↕			↕	
Traffic Vol, veh/h	11	52	49	0	0	0	0	228	37	80	274	0
Future Vol, veh/h	11	52	49	0	0	0	0	228	37	80	274	0
Conflicting Peds, #/hr	72	0	68	68	0	72	492	0	244	244	0	492
Sign Control	Stop	Stop	Stop	Free	Free	Free	Free	Free	Free	Free	Free	Free
RT Channelized	-	-	None	-	-	None	-	-	None	-	-	None
Storage Length	-	-	-	-	-	-	-	-	-	-	-	-
Veh in Median Storage, #	-	0	-	-	-	-	-	0	-	-	0	-
Grade, %	-	0	-	-	0	-	-	0	-	-	0	-
Peak Hour Factor	90	90	90	90	90	90	90	90	90	90	90	90
Heavy Vehicles, %	2	4	2	2	2	2	2	7	5	2	6	2
Mvmt Flow	12	58	54	0	0	0	0	253	41	89	304	0

Major/Minor	Minor2	Major1	Major2
Conflicting Flow All	828	1020	372
Stage 1	482	482	-
Stage 2	346	538	-
Critical Hdwy	6.42	6.54	6.22
Critical Hdwy Stg 1	5.42	5.54	-
Critical Hdwy Stg 2	5.42	5.54	-
Follow-up Hdwy	3.518	4.036	3.318
Pot Cap-1 Maneuver	341	235	674
Stage 1	621	550	-
Stage 2	716	519	-
Platoon blocked, %	-	-	-
Mov Cap-1 Maneuver	306	0	638
Mov Cap-2 Maneuver	306	0	-
Stage 1	621	0	-
Stage 2	642	0	-

Approach	EB	NB	SB
HCM Control Delay, s	13.8	0	2
HCM LOS	B		

Minor Lane/Major Mvmt	NBT	NBR	EBLn1	SBL	SBT
Capacity (veh/h)	-	-	532	1030	-
HCM Lane V/C Ratio	-	-	0.234	0.086	-
HCM Control Delay (s)	-	-	13.8	8.8	0
HCM Lane LOS	-	-	B	A	A
HCM 95th %tile Q(veh)	-	-	0.9	0.3	-



# Appendix D

Collision Data

Accident Date	Accident Year	Accident Time	Location	Environment Condition	Light	Traffic Control	Traffic Control Condition	Classification Of Accident	Initial Impact Type	Road Surface Condition	# Vehicles	# Motorcycles	# Bicycles	# Pedestrians
2017-10-06	2017	10:30	BANK ST @ LISGAR ST (0006952)	01 - Clear	01 - Daylight	01 - Traffic signal	01 - Functioning	03 - P.D. only	02 - Angle	01 - Dry	2	0	0	0
2018-09-31	2018	12:38	BANK ST @ LISGAR ST (0006952)	01 - Clear	01 - Daylight	01 - Traffic signal	01 - Functioning	03 - P.D. only	07 - SMV other	01 - Dry	2	0	0	0
2019-10-31	2019	19:06	BANK ST @ LISGAR ST (0006952)	02 - Rain	07 - Dark	01 - Traffic signal	01 - Functioning	03 - P.D. only	04 - Sideswipe	02 - Wet	1	0	0	1
2020-09-09	2020	20:28	BANK ST @ LISGAR ST (0006952)	01 - Clear	07 - Dark	01 - Traffic signal	01 - Functioning	02 - Non-fatal injury	03 - Rear end	02 - Wet	1	0	0	0
2016-09-27	2016	19:24	BANK ST btwn NEPEAN ST & LISGAR ST (_3ZA34V)	01 - Clear	07 - Dark	10 - No control	0	03 - P.D. only	03 - Rear end	01 - Dry	2	0	0	0
2018-07-18	2018	11:45	BANK ST btwn NEPEAN ST & LISGAR ST (_3ZA34V)	01 - Clear	01 - Daylight	10 - No control	0	03 - P.D. only	06 - SMV unattended vehicle	01 - Dry	1	0	0	0
2019-01-19	2019	6:05	BANK ST btwn NEPEAN ST & LISGAR ST (_3ZA34V)	01 - Clear	07 - Dark	10 - No control	0	03 - P.D. only	07 - SMV other	02 - Wet	2	0	0	0
2020-12-21	2020	12:41	BANK ST btwn NEPEAN ST & LISGAR ST (_3ZA34V)	01 - Clear	01 - Daylight	10 - No control	0	03 - P.D. only	06 - SMV unattended vehicle	01 - Dry	1	0	0	0
2016-10-15	2016	9:56	NEPEAN ST @ BANK ST (0006938)	01 - Clear	01 - Daylight	02 - Stop sign	01 - Functioning	02 - Non-fatal injury	07 - SMV other	01 - Dry	1	0	0	1
2016-05-06	2016	11:55	NEPEAN ST @ BANK ST (0006938)	01 - Clear	01 - Daylight	02 - Stop sign	01 - Functioning	02 - Non-fatal injury	07 - SMV other	01 - Dry	1	0	0	1
2016-08-03	2016	19:05	NEPEAN ST @ BANK ST (0006938)	01 - Clear	01 - Daylight	02 - Stop sign	01 - Functioning	03 - P.D. only	02 - Angle	01 - Dry	2	0	0	0
2016-08-06	2016	19:24	NEPEAN ST @ BANK ST (0006938)	01 - Clear	01 - Daylight	02 - Stop sign	01 - Functioning	02 - Non-fatal injury	03 - Rear end	01 - Dry	2	0	0	0
2017-12-24	2017	12:07	NEPEAN ST @ BANK ST (0006938)	03 - Snow	01 - Daylight	02 - Stop sign	01 - Functioning	03 - P.D. only	02 - Angle	03 - Loose snow	2	0	0	0
2017-04-13	2017	16:21	NEPEAN ST @ BANK ST (0006938)	01 - Clear	01 - Daylight	02 - Stop sign	01 - Functioning	03 - P.D. only	02 - Angle	01 - Dry	2	0	0	0
2019-08-22	2019	20:34	NEPEAN ST @ BANK ST (0006938)	01 - Clear	05 - Dusk	02 - Stop sign	01 - Functioning	03 - P.D. only	02 - Angle	01 - Dry	2	0	0	0
2019-08-22	2019	20:40	NEPEAN ST @ BANK ST (0006938)	01 - Clear	07 - Dark	02 - Stop sign	01 - Functioning	03 - P.D. only	02 - Angle	01 - Dry	2	0	0	0
2019-11-21	2019	16:45	NEPEAN ST @ BANK ST (0006938)	01 - Clear	05 - Dusk	02 - Stop sign	01 - Functioning	03 - P.D. only	02 - Angle	01 - Dry	2	0	0	0
2019-05-21	2019	15:15	NEPEAN ST @ BANK ST (0006938)	01 - Clear	01 - Daylight	02 - Stop sign	01 - Functioning	03 - P.D. only	02 - Angle	01 - Dry	2	0	0	0
2019-05-13	2019	7:57	NEPEAN ST @ BANK ST (0006938)	01 - Clear	01 - Daylight	02 - Stop sign	01 - Functioning	03 - P.D. only	09 - Other	01 - Dry	2	0	0	0
2019-06-13	2019	18:07	NEPEAN ST @ BANK ST (0006938)	02 - Rain	01 - Daylight	02 - Stop sign	00 - Unknown	03 - P.D. only	02 - Angle	02 - Wet	2	0	0	0
2019-07-24	2019	15:13	NEPEAN ST @ BANK ST (0006938)	01 - Clear	01 - Daylight	02 - Stop sign	01 - Functioning	02 - Non-fatal injury	02 - Angle	01 - Dry	2	1	0	0
2020-02-18	2020	15:58	NEPEAN ST @ BANK ST (0006938)	01 - Clear	01 - Daylight	02 - Stop sign	01 - Functioning	02 - Non-fatal injury	07 - SMV other	01 - Dry	1	0	0	1

# Appendix E

MMLOS Analysis

# Multi-Modal Level of Service - Segments Form

Consultant	CGH Transportation Inc	Project	2023-049
Scenario		Date	2023-05-02
Comments			

SEGMENTS			Bank	Nepean	Lisgar
<b>Pedestrian</b>	Sidewalk Width	<b>-</b>	1.8 m	≥ 2 m	1.5 m
	Boulevard Width		> 2 m	< 0.5	< 0.5 m
	Avg Daily Curb Lane Traffic Volume		> 3000	≤ 3000	≤ 3000
	Operating Speed		> 50 to 60 km/h	> 50 to 60 km/h	> 50 to 60 km/h
	On-Street Parking		yes	yes	yes
	<b>Exposure to Traffic PLoS</b>		<b>C</b>	<b>C</b>	<b>F</b>
	Effective Sidewalk Width				
Pedestrian Volume					
<b>Crowding PLoS</b>	<b>-</b>	<b>-</b>	<b>-</b>		
<b>Level of Service</b>	<b>-</b>	<b>-</b>	<b>-</b>		
<b>Bicycle</b>	Type of Cycling Facility	<b>E</b>	Mixed Traffic	Mixed Traffic	Mixed Traffic
	Number of Travel Lanes		2-3 lanes total	≤ 2 (no centreline)	≤ 2 (no centreline)
	Operating Speed		≥ 50 to 60 km/h	≥ 50 to 60 km/h	≥ 50 to 60 km/h
	<b># of Lanes &amp; Operating Speed LoS</b>		<b>E</b>	<b>D</b>	<b>D</b>
	Bike Lane (+ Parking Lane) Width				
	<b>Bike Lane Width LoS</b>		<b>-</b>	<b>-</b>	<b>-</b>
	Bike Lane Blockages				
	<b>Blockage LoS</b>		<b>-</b>	<b>-</b>	<b>-</b>
	Median Refuge Width (no median = < 1.8 m)		< 1.8 m refuge	< 1.8 m refuge	< 1.8 m refuge
	No. of Lanes at Unsignalized Crossing		≤ 3 lanes	≤ 3 lanes	≤ 3 lanes
	Sidestreet Operating Speed		≤ 40 km/h	≤ 40 km/h	≤ 40 km/h
<b>Unsignalized Crossing - Lowest LoS</b>	<b>A</b>	<b>A</b>	<b>A</b>		
<b>Level of Service</b>	<b>E</b>	<b>D</b>	<b>D</b>		
<b>Transit</b>	Facility Type	<b>D</b>	Mixed Traffic		
	Friction or Ratio Transit:Posted Speed		Vt/Vp ≥ 0.8		
	<b>Level of Service</b>		<b>D</b>	<b>-</b>	<b>-</b>
<b>Truck</b>	Truck Lane Width	<b>-</b>			
	Travel Lanes per Direction				
<b>Level of Service</b>	<b>-</b>	<b>-</b>	<b>-</b>		

# Appendix F

TDM Checklist

**TDM-Supportive Development Design and Infrastructure Checklist:**  
*Residential Developments (multi-family or condominium)*

Legend	
REQUIRED	The Official Plan or Zoning By-law provides related guidance that must be followed
BASIC	The measure is generally feasible and effective, and in most cases would benefit the development and its users
BETTER	The measure could maximize support for users of sustainable modes, and optimize development performance

TDM-supportive design & infrastructure measures: <i>Residential developments</i>		Check if completed & add descriptions, explanations or plan/drawing references
<b>1. WALKING &amp; CYCLING: ROUTES</b>		
<b>1.1 Building location &amp; access points</b>		
BASIC	1.1.1 Locate building close to the street, and do not locate parking areas between the street and building entrances	<input checked="" type="checkbox"/>
BASIC	1.1.2 Locate building entrances in order to minimize walking distances to sidewalks and transit stops/stations	<input checked="" type="checkbox"/>
BASIC	1.1.3 Locate building doors and windows to ensure visibility of pedestrians from the building, for their security and comfort	<input checked="" type="checkbox"/>
<b>1.2 Facilities for walking &amp; cycling</b>		
REQUIRED	1.2.1 Provide convenient, direct access to stations or major stops along rapid transit routes within 600 metres; minimize walking distances from buildings to rapid transit; provide pedestrian-friendly, weather-protected (where possible) environment between rapid transit accesses and building entrances; ensure quality linkages from sidewalks through building entrances to integrated stops/stations (see <i>Official Plan policy 4.3.3</i> )	<input checked="" type="checkbox"/>
REQUIRED	1.2.2 Provide safe, direct and attractive pedestrian access from public sidewalks to building entrances through such measures as: reducing distances between public sidewalks and major building entrances; providing walkways from public streets to major building entrances; within a site, providing walkways along the front of adjoining buildings, between adjacent buildings, and connecting areas where people may congregate, such as courtyards and transit stops; and providing weather protection through canopies, colonnades, and other design elements wherever possible (see <i>Official Plan policy 4.3.12</i> )	<input checked="" type="checkbox"/>

TDM-supportive design & infrastructure measures: <i>Residential developments</i>		Check if completed & add descriptions, explanations or plan/drawing references
REQUIRED	1.2.3 Provide sidewalks of smooth, well-drained walking surfaces of contrasting materials or treatments to differentiate pedestrian areas from vehicle areas, and provide marked pedestrian crosswalks at intersection sidewalks (see <i>Official Plan policy 4.3.10</i> )	<input type="checkbox"/>
REQUIRED	1.2.4 Make sidewalks and open space areas easily accessible through features such as gradual grade transition, depressed curbs at street corners and convenient access to extra-wide parking spaces and ramps (see <i>Official Plan policy 4.3.10</i> )	<input type="checkbox"/>
REQUIRED	1.2.5 Include adequately spaced inter-block/street cycling and pedestrian connections to facilitate travel by active transportation. Provide links to the existing or planned network of public sidewalks, multi-use pathways and on-road cycle routes. Where public sidewalks and multi-use pathways intersect with roads, consider providing traffic control devices to give priority to cyclists and pedestrians (see <i>Official Plan policy 4.3.11</i> )	<input type="checkbox"/>
BASIC	1.2.6 Provide safe, direct and attractive walking routes from building entrances to nearby transit stops	<input checked="" type="checkbox"/>
BASIC	1.2.7 Ensure that walking routes to transit stops are secure, visible, lighted, shaded and wind-protected wherever possible	<input type="checkbox"/>
BASIC	1.2.8 Design roads used for access or circulation by cyclists using a target operating speed of no more than 30 km/h, or provide a separated cycling facility	<input type="checkbox"/>
<b>1.3 Amenities for walking &amp; cycling</b>		
BASIC	1.3.1 Provide lighting, landscaping and benches along walking and cycling routes between building entrances and streets, sidewalks and trails	<input type="checkbox"/>
BASIC	1.3.2 Provide wayfinding signage for site access (where required, e.g. when multiple buildings or entrances exist) and egress (where warranted, such as when directions to reach transit stops/stations, trails or other common destinations are not obvious)	<input type="checkbox"/>

TDM-supportive design & infrastructure measures: <i>Residential developments</i>		Check if completed & add descriptions, explanations or plan/drawing references
<b>2. WALKING &amp; CYCLING: END-OF-TRIP FACILITIES</b>		
<b>2.1 Bicycle parking</b>		
REQUIRED	2.1.1 Provide bicycle parking in highly visible and lighted areas, sheltered from the weather wherever possible (see <i>Official Plan policy 4.3.6</i> )	<input checked="" type="checkbox"/>
REQUIRED	2.1.2 Provide the number of bicycle parking spaces specified for various land uses in different parts of Ottawa; provide convenient access to main entrances or well-used areas (see <i>Zoning By-law Section 111</i> )	<input checked="" type="checkbox"/>
REQUIRED	2.1.3 Ensure that bicycle parking spaces and access aisles meet minimum dimensions; that no more than 50% of spaces are vertical spaces; and that parking racks are securely anchored (see <i>Zoning By-law Section 111</i> )	<input checked="" type="checkbox"/>
BASIC	2.1.4 Provide bicycle parking spaces equivalent to the expected number of resident-owned bicycles, plus the expected peak number of visitor cyclists	<input type="checkbox"/>
<b>2.2 Secure bicycle parking</b>		
REQUIRED	2.2.1 Where more than 50 bicycle parking spaces are provided for a single residential building, locate at least 25% of spaces within a building/structure, a secure area (e.g. supervised parking lot or enclosure) or bicycle lockers (see <i>Zoning By-law Section 111</i> )	<input checked="" type="checkbox"/>
BETTER	2.2.2 Provide secure bicycle parking spaces equivalent to at least the number of units at condominiums or multi-family residential developments	<input checked="" type="checkbox"/>
<b>2.3 Bicycle repair station</b>		
BETTER	2.3.1 Provide a permanent bike repair station, with commonly used tools and an air pump, adjacent to the main bicycle parking area (or secure bicycle parking area, if provided)	<input checked="" type="checkbox"/>
<b>3. TRANSIT</b>		
<b>3.1 Customer amenities</b>		
BASIC	3.1.1 Provide shelters, lighting and benches at any on-site transit stops	<input type="checkbox"/>
BASIC	3.1.2 Where the site abuts an off-site transit stop and insufficient space exists for a transit shelter in the public right-of-way, protect land for a shelter and/or install a shelter	<input type="checkbox"/>
BETTER	3.1.3 Provide a secure and comfortable interior waiting area by integrating any on-site transit stops into the building	<input type="checkbox"/>

TDM-supportive design & infrastructure measures: <i>Residential developments</i>		Check if completed & add descriptions, explanations or plan/drawing references
<b>4. RIDESHARING</b>		
<b>4.1 Pick-up &amp; drop-off facilities</b>		
BASIC	4.1.1 Provide a designated area for carpool drivers (plus taxis and ride-hailing services) to drop off or pick up passengers without using fire lanes or other no-stopping zones	<input type="checkbox"/>
<b>5. CARSHARING &amp; BIKESHARING</b>		
<b>5.1 Carshare parking spaces</b>		
BETTER	5.1.1 Provide up to three carshare parking spaces in an R3, R4 or R5 Zone for specified residential uses (see <i>Zoning By-law Section 94</i> )	<input type="checkbox"/>
<b>5.2 Bikeshare station location</b>		
BETTER	5.2.1 Provide a designated bikeshare station area near a major building entrance, preferably lighted and sheltered with a direct walkway connection	<input type="checkbox"/>
<b>6. PARKING</b>		
<b>6.1 Number of parking spaces</b>		
REQUIRED	6.1.1 Do not provide more parking than permitted by zoning, nor less than required by zoning, unless a variance is being applied for	<input type="checkbox"/>
BASIC	6.1.2 Provide parking for long-term and short-term users that is consistent with mode share targets, considering the potential for visitors to use off-site public parking	<input type="checkbox"/>
BASIC	6.1.3 Where a site features more than one use, provide shared parking and reduce the cumulative number of parking spaces accordingly (see <i>Zoning By-law Section 104</i> )	<input type="checkbox"/>
BETTER	6.1.4 Reduce the minimum number of parking spaces required by zoning by one space for each 13 square metres of gross floor area provided as shower rooms, change rooms, locker rooms and other facilities for cyclists in conjunction with bicycle parking (see <i>Zoning By-law Section 111</i> )	<input type="checkbox"/>
<b>6.2 Separate long-term &amp; short-term parking areas</b>		
BETTER	6.2.1 Provide separate areas for short-term and long-term parking (using signage or physical barriers) to permit access controls and simplify enforcement (i.e. to discourage residents from parking in visitor spaces, and vice versa)	<input type="checkbox"/>



**TDM Measures Checklist:**  
*Residential Developments (multi-family, condominium or subdivision)*

Legend	
<b>BASIC</b>	The measure is generally feasible and effective, and in most cases would benefit the development and its users
<b>BETTER</b>	The measure could maximize support for users of sustainable modes, and optimize development performance
<b>★</b>	The measure is one of the most dependably effective tools to encourage the use of sustainable modes

TDM measures: Residential developments		Check if proposed & add descriptions
<b>1. TDM PROGRAM MANAGEMENT</b>		
<b>1.1 Program coordinator</b>		
<b>BASIC</b> ★	1.1.1 Designate an internal coordinator, or contract with an external coordinator	<input type="checkbox"/>
<b>1.2 Travel surveys</b>		
<b>BETTER</b>	1.2.1 Conduct periodic surveys to identify travel-related behaviours, attitudes, challenges and solutions, and to track progress	<input type="checkbox"/>
<b>2. WALKING AND CYCLING</b>		
<b>2.1 Information on walking/cycling routes &amp; destinations</b>		
<b>BASIC</b>	2.1.1 Display local area maps with walking/cycling access routes and key destinations at major entrances ( <i>multi-family, condominium</i> )	<input checked="" type="checkbox"/>
<b>2.2 Bicycle skills training</b>		
<b>BETTER</b>	2.2.1 Offer on-site cycling courses for residents, or subsidize off-site courses	<input type="checkbox"/>

TDM measures: Residential developments		Check if proposed & add descriptions
<b>3. TRANSIT</b>		
<b>3.1 Transit information</b>		
<b>BASIC</b>	3.1.1 Display relevant transit schedules and route maps at entrances ( <i>multi-family, condominium</i> )	<input checked="" type="checkbox"/>
<b>BETTER</b>	3.1.2 Provide real-time arrival information display at entrances ( <i>multi-family, condominium</i> )	<input type="checkbox"/>
<b>3.2 Transit fare incentives</b>		
<b>BASIC</b> ★	3.2.1 Offer PRESTO cards preloaded with one monthly transit pass on residence purchase/move-in, to encourage residents to use transit	<input type="checkbox"/>
<b>BETTER</b>	3.2.2 Offer at least one year of free monthly transit passes on residence purchase/move-in	<input type="checkbox"/>
<b>3.3 Enhanced public transit service</b>		
<b>BETTER</b> ★	3.3.1 Contract with OC Transpo to provide early transit services until regular services are warranted by occupancy levels ( <i>subdivision</i> )	<input type="checkbox"/>
<b>3.4 Private transit service</b>		
<b>BETTER</b>	3.4.1 Provide shuttle service for seniors homes or lifestyle communities (e.g. scheduled mall or supermarket runs)	<input type="checkbox"/>
<b>4. CARSHARING &amp; BIKESHARING</b>		
<b>4.1 Bikeshare stations &amp; memberships</b>		
<b>BETTER</b>	4.1.1 Contract with provider to install on-site bikeshare station ( <i>multi-family</i> )	<input type="checkbox"/>
<b>BETTER</b>	4.1.2 Provide residents with bikeshare memberships, either free or subsidized ( <i>multi-family</i> )	<input type="checkbox"/>
<b>4.2 Carshare vehicles &amp; memberships</b>		
<b>BETTER</b>	4.2.1 Contract with provider to install on-site carshare vehicles and promote their use by residents	<input type="checkbox"/>
<b>BETTER</b>	4.2.2 Provide residents with carshare memberships, either free or subsidized	<input type="checkbox"/>
<b>5. PARKING</b>		
<b>5.1 Priced parking</b>		
<b>BASIC</b> ★	5.1.1 Unbundle parking cost from purchase price ( <i>condominium</i> )	<input type="checkbox"/>
<b>BASIC</b> ★	5.1.2 Unbundle parking cost from monthly rent ( <i>multi-family</i> )	<input type="checkbox"/>

TDM measures: <i>Residential developments</i>		Check if proposed & add descriptions
<b>6. TDM MARKETING &amp; COMMUNICATIONS</b>		
<b>6.1 Multimodal travel information</b>		
BASIC ★	6.1.1 Provide a multimodal travel option information package to new residents	<input checked="" type="checkbox"/>
<b>6.2 Personalized trip planning</b>		
BETTER ★	6.2.1 Offer personalized trip planning to new residents	<input type="checkbox"/>