

Engineering

- Land/Site Development
- Municipal Infrastructure
- Environmental/Water Resources
- Traffic/Transportation
- Recreational

Planning

- Land/Site Development
- Planning Application Management
- Municipal Planning
- Urban Design
- Expert Witness (LPAT)
- Wireless Industry

Landscape Architecture

- Streetscapes & Public Amenities
- Open Space, Parks & Recreation
- Community & Residential
- Commercial & Institutional
- Environmental Restoration



Proposed Commercial Development 3493-3499 Innes Road, Ottawa Transportation Impact Assessment

**Proposed Commercial Development
3493-3499 Innes Road
Transportation Impact Assessment**

Prepared By:

NOVATECH

Suite 200, 240 Michael Cowpland Drive
Ottawa, Ontario
K2M 1P6

December 2022

Novatech File: 118204
Ref: R-2021-105

December 22, 2022

City of Ottawa
Planning and Growth Management Department
110 Laurier Ave. W., 4th Floor,
Ottawa, Ontario K1P 1J1

Attention: Mr. Mike Giampa
Senior Engineer, Infrastructure Applications

Dear Mr. Giampa:

Reference: 3493-3499 Innes Road
Transportation Impact Assessment
Novatech File No. 118204

We are pleased to submit the following Transportation Impact Assessment, in support of Zoning By-Law Amendment and Site Plan Control applications at 3493-3499 Innes Road, for your review and signoff. The structure and format of this report is in accordance with the City of Ottawa's Transportation Impact Assessment Guidelines (June 2017).

If you have any questions or comments regarding this report, please feel free to contact Jennifer Luong, or the undersigned.

Yours truly,

NOVATECH



Joshua Audia, P.Eng.
Project Engineer | Transportation



TIA Plan Reports

On 14 June 2017, the Council of the City of Ottawa adopted new Transportation Impact Assessment (TIA) Guidelines. In adopting the guidelines, Council established a requirement for those preparing and delivering transportation impact assessments and reports to sign a letter of certification.

Individuals submitting TIA reports will be responsible for all aspects of development-related transportation assessment and reporting, and undertaking such work, in accordance and compliance with the City of Ottawa's Official Plan, the Transportation Master Plan and the Transportation Impact Assessment (2017) Guidelines.

By submitting the attached TIA report (and any associated documents) and signing this document, the individual acknowledges that s/he meets the four criteria listed below.

CERTIFICATION

1. I have reviewed and have a sound understanding of the objectives, needs and requirements of the City of Ottawa's Official Plan, Transportation Master Plan and the Transportation Impact Assessment (2017) Guidelines;
2. I have a sound knowledge of industry standard practice with respect to the preparation of transportation impact assessment reports, including multi modal level of service review;
3. I have substantial experience (more than 5 years) in undertaking and delivering transportation impact studies (analysis, reporting and geometric design) with strong background knowledge in transportation planning, engineering or traffic operations; and
4. I am either a licensed¹ or registered² professional in good standing, whose field of expertise [check appropriate field(s)] is either transportation engineering or transportation planning .

1,2 License of registration body that oversees the profession is required to have a code of conduct and ethics guidelines that will ensure appropriate conduct and representation for transportation planning and/or transportation engineering works.

City Of Ottawa
Infrastructure Services and Community
Sustainability
Planning and Growth Management
110 Laurier Avenue West, 4th fl.
Ottawa, ON K1P 1J1
Tel. : 613-580-2424
Fax: 613-560-6006

Ville d'Ottawa
Services d'infrastructure et Viabilité des
collectivités
Urbanisme et Gestion de la croissance
110, avenue Laurier Ouest
Ottawa (Ontario) K1P 1J1
Tél. : 613-580-2424
Télécopieur: 613-560-6006

Dated at Ottawa this 22nd day of December, 2022.
(City)

Name: Jennifer Luong, P.Eng.
(Please Print)

Professional Title: Senior Project Manager, Transportation



Signature of Individual certifier that s/he meets the above four criteria

Office Contact Information (Please Print)	
Address:	240 Michael Cowpland Drive, Suite 200
City / Postal Code:	Ottawa, ON, K2M 1P6
Telephone / Extension:	613-254-9643 x 254
E-Mail Address:	j.luong@novatech-eng.com

TABLE OF CONTENTS

EXECUTIVE SUMMARYI

1.0 SCREENING.....1

 1.1 INTRODUCTION 1

 1.2 PROPOSED DEVELOPMENT..... 1

 1.3 SCREENING FORM 1

2.0 SCOPING.....2

 2.1 EXISTING CONDITIONS 2

 2.1.1 Roadways.....2

 2.1.2 Intersections4

 2.1.3 Driveways.....6

 2.1.4 Pedestrian and Cycling Facilities6

 2.1.5 Transit6

 2.1.6 Area Traffic Management8

 2.1.7 Existing Traffic Volumes8

 2.1.8 Collision Records.....8

 2.2 PLANNED CONDITIONS 11

 2.2.1 Planned Roadway and Transit Projects11

 2.2.2 Other Area Developments12

 2.3 STUDY AREA AND TIME PERIODS 13

 2.4 EXEMPTIONS REVIEW..... 15

3.0 FORECASTING16

 3.1 DEVELOPMENT-GENERATED TRAVEL DEMAND..... 16

 3.1.1 Trip Generation.....16

 3.1.2 Trip Distribution and Assignment18

 3.2 BACKGROUND TRAFFIC 18

 3.2.1 General Background Growth Rate18

 3.2.2 Other Area Developments19

 3.2.3 Existing Traffic Volume Balancing.....20

 3.3 FUTURE TRAFFIC CONDITIONS..... 20

 3.4 DEMAND RATIONALIZATION..... 24

 3.4.1 Existing Intersection Operations25

 3.4.2 2025 Background Intersection Operations26

 3.4.3 2030 Background Intersection Operations27

4.0 ANALYSIS.....29

 4.1 DEVELOPMENT DESIGN 29

 4.1.1 Design for Sustainable Modes29

 4.1.2 Circulation and Access30

 4.2 PARKING 30

 4.3 BOUNDARY STREETS 35

 4.4 ACCESS INTERSECTIONS..... 35

 4.5 TRANSIT..... 37

 4.6 INTERSECTION DESIGN..... 38

 4.6.1 Intersection MMLOS Review.....38

 4.6.2 2025 Total Intersection Operations39

 4.6.3 2030 Total Intersection Operations40

5.0 CONCLUSIONS AND RECOMMENDATIONS42

Figures

Figure 1: View of the Subject Site 2
 Figure 2: Roadway Network 4
 Figure 3: OC Transpo Bus Stop Locations 7
 Figure 4: Existing Traffic Volumes 8
 Figure 5: Functional Design of Innes Road/Lamarche Avenue Signal 11
 Figure 6: Other Area Developments 14
 Figure 7: Balanced Existing Traffic Volumes 20
 Figure 8: Proposed Site-Generated Primary Traffic Volumes 21
 Figure 9: Proposed Site-Generated Pass-by Traffic Volumes 21
 Figure 10: 2025 Other Area Development-Generated Traffic Volumes 22
 Figure 11: 2030 Other Area Development-Generated Traffic Volumes 22
 Figure 12: 2025 Background Traffic Volumes 23
 Figure 13: 2030 Background Traffic Volumes 23
 Figure 14: 2025 Total Traffic Volumes 24
 Figure 15: 2030 Total Traffic Volumes 24
 Figure 16: MSU Entering Site and Loading Zone A 31
 Figure 17: MSU Exiting Site and Loading Zone A 32
 Figure 18: MSU Entering Site and Loading Zone B 33
 Figure 19: MSU Exiting Site and Loading Zone B 34
 Figure 20: Desirable Cycling Facility Pre-Selection Nomograph 36

Tables

Table 1: OC Transpo Transit Stops 6
 Table 2: OC Transpo Route Information 7
 Table 3: Reported Collisions 9
 Table 4: TIA Exemptions 15
 Table 5: Proposed Development – Peak Hour Trip Generation 16
 Table 6: Proposed Development – Peak Hour Trips by Mode Share 17
 Table 7: Primary and Pass-by Trips 17
 Table 8: Existing Traffic Operations 25
 Table 9: Existing Queues 25
 Table 10: 2025 Background Traffic Operations 26
 Table 11: 2025 Background Queues 26
 Table 12: 2030 Background Traffic Operations 27
 Table 13: 2030 Background Queues 28
 Table 14: Required and Proposed Parking 30
 Table 15: Segment MMLoS Summary 35
 Table 16: Intersection MMLoS Summary 38
 Table 17: 2025 Total Traffic Operations 40
 Table 18: 2025 Total Queues 40
 Table 19: 2030 Total Traffic Operations 41
 Table 20: 2030 Total Queues 41

Appendices

- Appendix A: Preliminary Site Plan
- Appendix B: TIA Screening Form
- Appendix C: OC Transpo Route Maps
- Appendix D: Traffic Count Data
- Appendix E: Collision Records
- Appendix F: Strategic Long-Range Model Snapshots and Excerpt of 2013 TMP
- Appendix G: Other Area Developments
- Appendix H: Signal Timing Plans
- Appendix I: Existing Synchro Analysis
- Appendix J: Background Synchro Analysis
- Appendix K: Transportation Demand Management
- Appendix L: MMLOS Analysis
- Appendix M: Total Synchro Analysis

EXECUTIVE SUMMARY

This Transportation Impact Assessment (TIA) has been prepared for the property located at 3493-3499 Innes Road, in support of Zoning By-Law Amendment and Site Plan Control applications for the site. The subject site is approximately 0.61 hectares in size and is currently occupied by a former sales centre and garage. The subject site is currently served by one driveway to Innes Road.

The subject site is surrounded by the following:

- Residences, followed by Thornecrest Street to the north,
- Innes Road, followed by planned residential development to the south,
- Residences to the east, and
- Commercial uses, followed by Pagé Road to the west.

The proposed development consists of two single-storey commercial buildings, with gross floor areas (GFAs) of 821 m² each (i.e. 1,642 m² GFA in total). A total of 69 surface parking spaces will be provided. Access to the development will be provided through a single full-movement access to Innes Road approximately in the centre of the subject site, which will be restricted to right-in/right-out (RIRO) with the construction of the planned Innes Road/Lamarche Avenue traffic signal and raised median. The development will be constructed in two phases, with buildout years of 2023 for Building A and 2025 for Building B.

The subject site is designated as 'Corridor – Mainstreet (Innes Road)' on Schedule B8 of the City of Ottawa's Official Plan (2022, Ministry Approved). The current zoning for the properties is 'Residential First Density' R1WW, and therefore a rezoning is required to allow for the proposed development. The site is not located within any Community Design Plan or Secondary Plan areas.

The study area for this report includes the boundary roadway Innes Road, as well as the following intersections:

- Innes Road/Orléans Boulevard;
- Innes Road/Pagé Road;
- Innes Road/Lamarche Avenue;
- Innes Road/473m East of Pagé Road.

The selected time periods for the analysis are the weekday AM and PM peak hours, as they represent the 'worst case' combination of site generated traffic and adjacent street traffic. Analysis will be completed for the ultimate buildout year 2025 and the horizon year 2030.

The conclusions and recommendations of this TIA can be summarized as follows:

Roadway Modifications to Innes Road/Lamarche Avenue

- Signalization of the Innes Road/Lamarche Avenue intersection is anticipated to be in place by the buildout year 2025, per discussions with City staff. The functional design of the roadway modifications at Innes Road/Lamarche Avenue includes auxiliary eastbound right turn, westbound left turn, northbound left turn, and northbound right turn lanes.
- Based on the functional design, a raised median will also be constructed on Innes Road between Pagé Road and Lamarche Avenue, and it is this modification that will restrict the proposed access to RIRO in the future. To accommodate accesses on the north side of Innes Road between Pagé Road and Lamarche Avenue, an eastbound U-turn lane at the new signal should be included as part of the roadway modifications at Innes Road/Lamarche Avenue.

Forecasting

- The proposed development is estimated to generate 31 person trips (including 23 vehicle trips) during the AM peak hour, and 80 person trips (including 60 vehicle trips) during the PM peak hour.

Development Design and Parking

- 2.5m-wide pedestrian walkways will connect the front of each proposed building to the existing sidewalk on the north side of Innes Road.
- Four bicycle parking spaces are proposed adjacent to the accessible parking spaces in front of each proposed building, for a total of eight bicycle parking spaces on-site.
- OC Transpo's service design guidelines for peak period service is to provide service within a five-minute (400m) walk of home, work, or school, for 95% of urban residents. The main entrances to each proposed building will be within 400m of stops on Innes Road that are served by OC Route 25.
- Any required Transportation Demand Management-supportive design and infrastructure measures in the TDM checklist for non-residential developments have been met.
- Garbage collection will take place in the loading zones at the back of each proposed building (i.e. at the northern end of the subject site). The fire route for the subject site will be located along Innes Road.
- The minimum parking and loading requirements of the City's *Zoning By-Law* will be met.

Boundary Streets

- Innes Road does not meet the target pedestrian level of service (PLOS) or bicycle level of service (BLOS), and meets the target transit level of service (TLOS) and truck level of service (TkLOS).
- Both sides of Innes Road currently include a 2.0m sidewalk with a boulevard width of approximately 1.5m. The best-possible PLOS D can be achieved by maintaining the current sidewalk width of 2.0m and increasing the boulevard width to a minimum width of 2.0m. This is identified for the City's consideration.
- Both directions of Innes Road currently include curbside bike lanes with an approximate width of 2.0m. For roadways with an operating speed of 70 km/h and AADT volumes greater than 10,000 vehicles per day, the *Ontario Traffic Manual (OTM) – Book 18* identifies that separated facilities are appropriate. This is identified for the City's consideration.

Access Design

- The proposed access meets all relevant provisions of the City's *Private Approach By-Law* (PABL) except for Section 25(u). A waiver to Section 25(u) of the PABL is requested.

- TAC's *Geometric Design Guide* identifies a minimum corner clearance of 70m between a driveway and a signalized intersection, measuring from the nearest edge of a private approach and the nearest edge of the intersecting street. The western edge of the proposed access is approximately 140m from the nearest edge of Pagé Road, meeting this requirement. The eastern edge of the proposed access is approximately 68m from the nearest edge of Lamarche Avenue, which is marginally short of the requirement. Locating the proposed access within 70m of Lamarche Avenue can be justified, as the access will only be downstream of Lamarche Avenue, and the proposed development is not anticipated to generate queues backing onto Innes Road at the access.

Transit

- The proposed development is projected to generate two transit trips during the AM peak hour and four transit trips during the PM peak hour. No capacity issues are anticipated for OC Routes 25, 131, or 231, based on transit trips generated by the proposed development.

Intersection MMLOS

- The results of the intersection MMLOS analysis can be summarized as follows:
 - No signalized intersections meet the target PLOS;
 - No signalized intersections meet the target BLOS;
 - Innes Road/Pagé Road and Innes Road/473m East of Pagé Road meet the target TLOS, while Innes Road/Orléans Boulevard does not;
 - Innes Road/Orléans Boulevard meets the target TkLOS, while Innes Road/Pagé Road and Innes Road/473m East of Pagé Road do not.
- For any approaches that do not meet the target PLOS, there is limited opportunity in improving any approach to the target without reducing the number of travel lanes or restricting turning movements. There is also limited opportunity in improving the delay score for pedestrians crossing Innes Road without incurring major delays for vehicles.
- All approaches of Innes Road/Orléans Boulevard do not achieve the target BLOS, based on both left turn and right turn characteristics. To achieve this target, a protected intersection would be required, and would involve the removal of all right turn channels. This is identified for the City's consideration.
- The east and west approaches at Innes Road/Pagé Road and the south, east, and west approaches at Innes Road/473m East of Pagé Road, do not meet the target BLOS based on left turn characteristics. Two-stage left-turn bike boxes would be required to achieve the target, and would therefore require restriction to right turns on red (RTOR). It is recommended that if bike boxes are pursued, that they are implemented holistically along the Innes Road where applicable, rather than at only select intersections.
- All approaches at Innes Road/Orléans Boulevard do not meet the target TLOS. It is anticipated that transit delays will improve once isolated transit priority measures are implemented on Innes Road.
- The east and west approaches at Innes Road/Pagé Road and the east approach at Innes Road/473m East of Pagé Road do not achieve the target TkLOS. No modifications to the curb radii are recommended, as Pagé Road is primarily a residential street with low truck volumes, and it is anticipated that large trucks do not enter and exit 3615 Innes Road for loading and deliveries, given the layout and size.

Existing Intersection Operations

- During the AM peak hour, the southbound right turn and eastbound left turn movements at Innes Road/Orléans Boulevard operate at a failing vehicular level of service. To meet the target, a reduction of approximately 140 southbound right turning vehicles and 10 eastbound left turning vehicles would be required. The average (50th-percentile) and maximum (95th-percentile) queue lengths of the southbound right turn movement at Innes Road/Orléans Boulevard exceed the storage length provided.
- During the PM peak hour, the eastbound through movement at Innes Road/Orléans Boulevard operate at a failing vehicular level of service. To meet the target, a reduction of approximately 100 eastbound through vehicles would be required. The maximum queue length of the southbound left turn movement at Innes Road/Orléans Boulevard exceeds the storage length provided.

Background Intersection Operations

- During the AM peak hour, the southbound right turn and westbound through movements at Innes Road/Orléans Boulevard operate at a failing vehicular level of service. To meet the target, a reduction of approximately 150 southbound right turning vehicles and 30 westbound through vehicles would be required. The average and maximum queue lengths of the southbound right turn movements exceed the storage length provided.
- During the PM peak hour, the southbound left turn and eastbound through movements at Innes Road/Orléans Boulevard, and the westbound left turn movements at Innes Road/Pagé Road and Innes Road/Lamarche Avenue operate at a failing vehicular level of service. To meet the target, a reduction of approximately 30 southbound right turning vehicles and 280 eastbound through vehicles at Innes Road/Orléans Boulevard would be required. The maximum queue length of the southbound left turn movement at Innes Road/Orléans Boulevard exceeds the storage length provided.
- To mitigate failing movements at Innes Road/Orléans Boulevard, seven seconds of green time for the northbound/southbound phases have been reallocated to the eastbound/westbound through phases in the AM peak hour. For the PM peak hour, the cycle length of all study area intersections has been increased from 110 to 130 seconds, with most or all of this additional green time added to the eastbound/westbound phases.
- To mitigate failing westbound left turn movements at Innes Road/Pagé Road and Innes Road/Lamarche Avenue in the PM peak hour, protected plus permitted left turn phasing is identified for the City's consideration. It is understood that this type of phasing is typically implemented after the City reviews the actual performance of the intersections being studied.

Total Intersection Operations

- The addition of site-generated traffic is anticipated to have a marginal impact to peak hour traffic operations within the study area. During the peak hours, the maximum westbound through queue lengths at Innes Road/Pagé Road do not extend upstream to the proposed site access. The maximum eastbound through queue at Innes Road/Lamarche Avenue extends upstream through the Innes Road/Pagé Road intersection during the PM peak hour.
- Based on the foregoing, the proposed development is recommended from a transportation perspective.

1.0 SCREENING

1.1 Introduction

This Transportation Impact Assessment (TIA) has been prepared for the property located at 3493-3499 Innes Road, in support of Zoning By-Law Amendment and Site Plan Control applications for the site. The subject site is approximately 0.61 hectares in size and is currently occupied by a former sales centre and garage. The subject site is currently served by one driveway to Innes Road.

The subject site is surrounded by the following:

- Residences, followed by Thornecrest Street to the north,
- Innes Road, followed by planned residential development to the south,
- Residences to the east, and
- Commercial uses, followed by Pagé Road to the west.

An aerial of the vicinity around the subject site is provided in **Figure 1**.

1.2 Proposed Development

The proposed development consists of two single-storey commercial buildings, with gross floor areas (GFAs) of 821 m² each (i.e. 1,642 m² GFA in total). A total of 69 surface parking spaces will be provided. Access to the development will be provided through a single full-movement access to Innes Road approximately in the centre of the subject site, which will be restricted to right-in/right-out (RIRO) with the construction of the planned Innes Road/Lamarche Avenue traffic signal and raised median. The development will be constructed in two phases, with buildout years of 2023 for Building A and 2025 for Building B.

The subject site is designated as 'Corridor – Mainstreet (Innes Road)' on Schedule B8 of the City of Ottawa's Official Plan (2022, Ministry Approved). The current zoning for the properties is 'Residential First Density' R1WW, and therefore a rezoning is required to allow for the proposed development. The site is not located within any Community Design Plan or Secondary Plan areas.

A copy of the preliminary site plan is included in **Appendix A**.

1.3 Screening Form

The City's *2017 TIA Guidelines* identify three triggers for completing a TIA report, including trip generation, location, and safety. The criteria for each trigger are outlined in the City's TIA Screening Form, which is included in **Appendix B**. The trigger results are as follows:

- Trip Generation Trigger – The development is expected to generate over 60 peak hour person trips; further assessment is **required** based on this trigger.
- Location Triggers – The development proposes a new access to a transit priority corridor and a spine cycling route, and is located within a Design Priority Area; further assessment is **required** based on this trigger.
- Safety Triggers – The proposed driveway is located within the area of influence of an adjacent traffic signal; further assessment is **required** based on this trigger.

Figure 1: View of the Subject Site

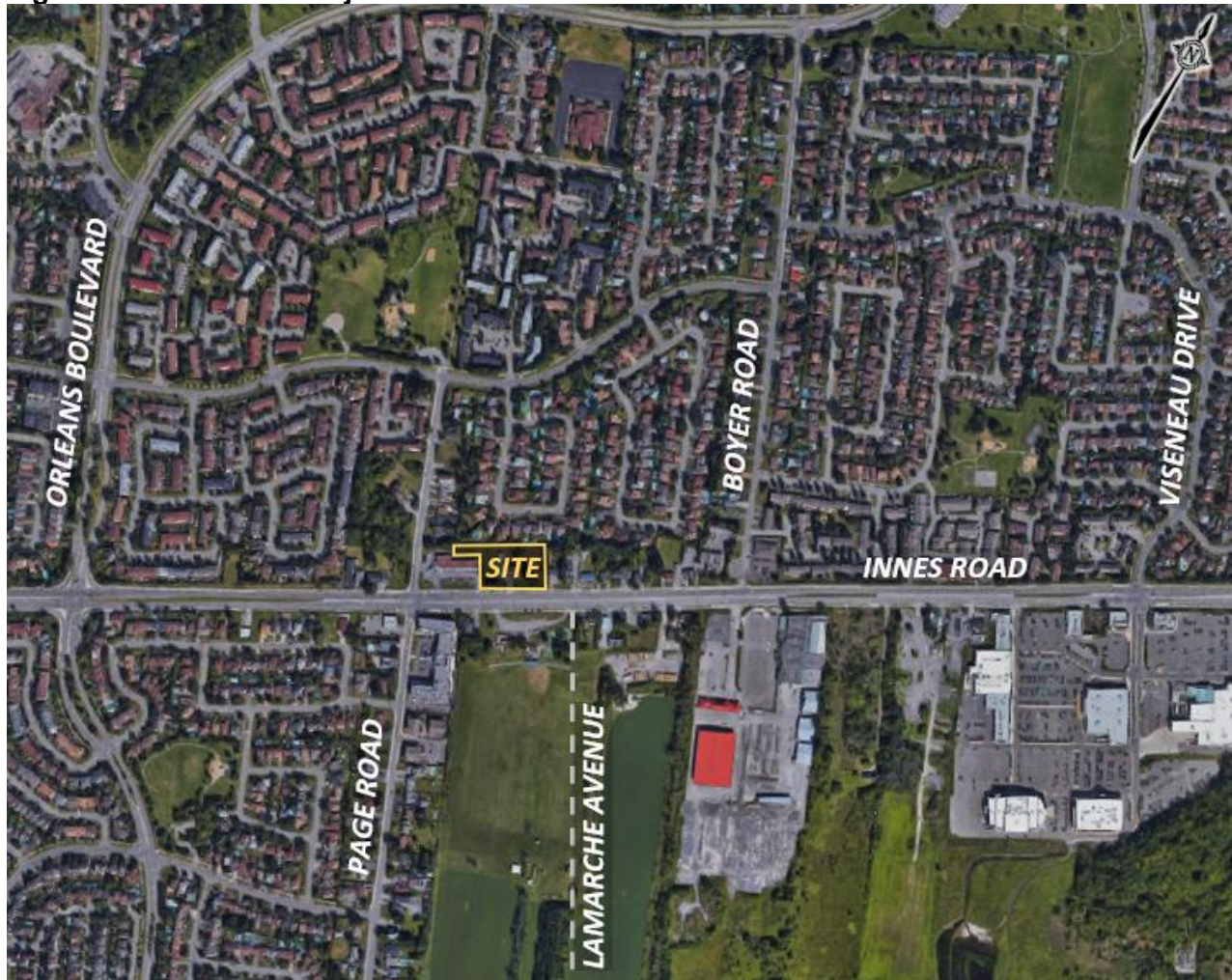

2.0 SCOPING

2.1 Existing Conditions

2.1.1 Roadways

All roadways within the study area fall under the jurisdiction of the City of Ottawa.

Innes Road is an arterial roadway that generally runs on an east-west alignment between St. Laurent Boulevard and Dunning Road. West of St. Laurent Boulevard, the roadway continues as Industrial Avenue. Between the western and eastern intersections with the Blackburn Hamlet Bypass, Innes Road acts as a major collector. Within the study area, Innes Road has a five-lane urban cross-section with a centre two-way left turn lane (TWLTL) between Pagé Road and Frank Bender Street, and a four-lane divided urban cross-section with turn lanes at intersections west of Pagé Road. Bike lanes and sidewalks are provided on both sides of the roadway, and the roadway has a posted speed limit of 60 km/h. Innes Road is classified as a truck route, allowing full loads. Street parking is not permitted. The City of Ottawa's Official Plan identifies a right-of-way (ROW) protection of 37.5m at Innes Road within the study area, and therefore a widening is required along the site frontage.

Orléans Boulevard is an arterial roadway that generally runs on a north-south alignment between St. Joseph Boulevard and Navan Road. North of St. Joseph Boulevard, Orléans Boulevard operates as a major collector, collector, or local roadway. Within the study area, Orléans Boulevard has a four-lane divided urban cross-section, sidewalks on both sides of the roadway, and a posted speed limit of 50 km/h. The speed limit increases to 60 km/h approximately 90m north of Innes Road. Orléans Boulevard is classified as a truck route with restricted loads north of Innes Road, and is not classified as a truck route south of Innes Road. Street parking is not permitted.

Pagé Road runs on a north-south alignment between Innes Road and Renaud Road, and has a posted speed limit of 40 km/h. North of Innes Road, Pagé Road is a local roadway with a two-lane undivided rural cross-section and an at-grade sidewalk on the west side. South of Innes Road, Pagé Road is a collector roadway with a two-lane undivided urban cross-section and sidewalks on both sides of the roadway. Pagé Road is not classified as a truck route. Street parking is permitted on one side of the roadway.

Lamarche Avenue is a local roadway that runs on a north-south alignment between Innes Road and Ponthieu Crescent/Beaugency Street. Within the study area, Lamarche Avenue has a two-lane undivided urban cross-section, a multi-use pathway on the west side, and an unposted speed limit of 50 km/h. Lamarche Avenue is not classified as a truck route. Street parking is permitted on one side of the roadway.

Boyer Road is a local roadway north of Innes Road, and runs on a north-south alignment between Innes Road and Meadowglen Drive. The roadway terminates in a cul-de-sac immediately north of Innes Road. North of Meadowglen Drive, Boyer Road is a collector roadway which runs on a north-south alignment between Meadowglen Drive and Orléans Boulevard. Within the study area, Boyer Road has a two-lane undivided urban cross-section, with no sidewalks, and a posted speed limit of 40 km/h. Boyer Road is not classified as a truck route. Street parking is permitted on one side of the roadway.

The roadway network of the greater area surrounding the subject site is illustrated in **Figure 2**.

Figure 2: Roadway Network



2.1.2 Intersections

Innes Road/Orléans Boulevard

- Signalized four-legged intersection
- North/South Approaches (Orléans Boulevard): one left turn lane, two through lanes, and one channelized right turn lane
- East Approach (Innes Road): one left turn lane, two through lanes, one transit queue jump lane, and one channelized right turn lane
- West Approach (Innes Road): two left turn lanes, two through lanes, and one channelized right turn lane
- Eastbound bike lanes provided on east leg; westbound bike lanes provided on east/west legs



Innes Road/Pagé Road

- Signalized four-legged intersection
- North/South Approaches (Pagé Road): one shared left turn/through/right turn lane
- East/West Approaches (Innes Road): one left turn lane, one through lane, and one shared through/right turn lane
- Bike lanes on east and west approaches



Innes Road/Lamarche Avenue

- Unsignalized three-legged intersection
- South Approach (Lamarche Avenue): one shared left turn/right turn lane
- East Approach (Innes Road): one two-way left turn lane and two through lanes
- West Approach (Innes Road): one two-way left turn lane, one through lane, and one shared through/right turn lane
- Bike lanes on east and west approaches



Innes Road/473m East of Pagé Road

- Signalized four-legged intersection
- North/South Approaches (accesses to 3604-3636 or 3615 Innes Road): one shared left turn/through/right turn lane
- East/West Approaches (Innes Road): one left turn lane, one through lane, and one shared through/right turn lane
- Bike lanes on east and west approaches



2.1.3 Driveways

In accordance with the *2017 TIA Guidelines*, a review of adjacent driveways along the boundary roads are provided as follows:

Innes Road, North Side

- Two driveways to commercial uses and a gas station at 3469 Innes Road
- Ten driveways to residences at 3437, 3443, 3519, 3523, 3533, 3543, 3555, 3565, and 3581 Innes Road

Innes Road, South Side

- Three driveways to residences at 3484, 3554, and 3564 Innes Road
- One driveway to a former driving range at 240 Lamarche Avenue
- Two driveways to commercial uses at 3534 and 3544 Innes Road

2.1.4 Pedestrian and Cycling Facilities

Concrete sidewalks are provided on both sides of Orléans Boulevard, Innes Road east of Orléans Boulevard, and Pagé Road south of Innes Road. Sidewalks are also provided on the west side of Pagé Road north of Innes Road, and on the north side of Innes Road west of Orléans Boulevard. An asphalt multi-use pathway is provided on the west side of Lamarche Avenue. On-street bike lanes are provided in both directions on Innes Road east of Orléans Boulevard. West of Orléans Boulevard, the westbound bike lane on Innes Road continues before connecting to a multi-use pathway west of the study area.

In the City of Ottawa's primary cycling network, Innes Road is designated as both a Spine Route and Crosstown Bikeway, Pagé Road is designated as a Spine Route, and Orléans Boulevard and Boyer Road are designated as Local Routes.

2.1.5 Transit

The locations of bus stops in the vicinity of the subject site are described in **Table 1** and shown in **Figure 3**, and a summary of the routes which serve the study area is included in **Table 2**. Detailed route information and an excerpt from the OC Transpo System Map are included in **Appendix C**.

Table 1: OC Transpo Transit Stops

Stop	Location	Routes Served
#1194	North side of Innes Road, west of Pagé Road	25, 612, 648
#1219	North side of Innes Road, west of Boyer Road	25, 612, 648
#1399	South side of Meadowglen Drive, west of Loranger Court	131, 231, 611, 631, 648
#1401	North side of Meadowglen Drive, west of Loranger Court	131, 231, 611, 631, 648
#7735	South side of Innes Road, east of Pagé Road	25, 612, 648
#7751	South side of Meadowglen Drive, between Pagé Road and Thornecrest Street	131, 231, 611, 631, 648
#7755	North side of Meadowglen Drive, east of Aspenview Way	131, 231, 611, 631, 648
#8129	South side of Innes Road, west of Boyer Road	25, 612, 648

Table 2: OC Transpo Route Information

Route	From ↔ To	Frequency
25	Millennium ↔ La Cité/Blair	All day service, seven days a week; 7- to 30-minute headways
131	Fallingbrook ↔ Chapel Hill	All day service, seven days a week; 30-minute headways
231	Meadowglen ↔ Blair	Peak period service, weekdays only; 30-minute headways in peak direction only
611	Orléans ↔ Gisèle Lalonde H.S.	Service at select times on school days only
612	Renaud ↔ Beatrice Desloges H.S./ Gisèle Lalonde H.S.	Service at select times on school days only
631	Chapel Hill ↔ Colonel By H.S./Gloucester H.S.	Service at select times on school days only
648	Orléans ↔ Louis Riel H.S.	Service at select times on school days only

Figure 3: OC Transpo Bus Stop Locations

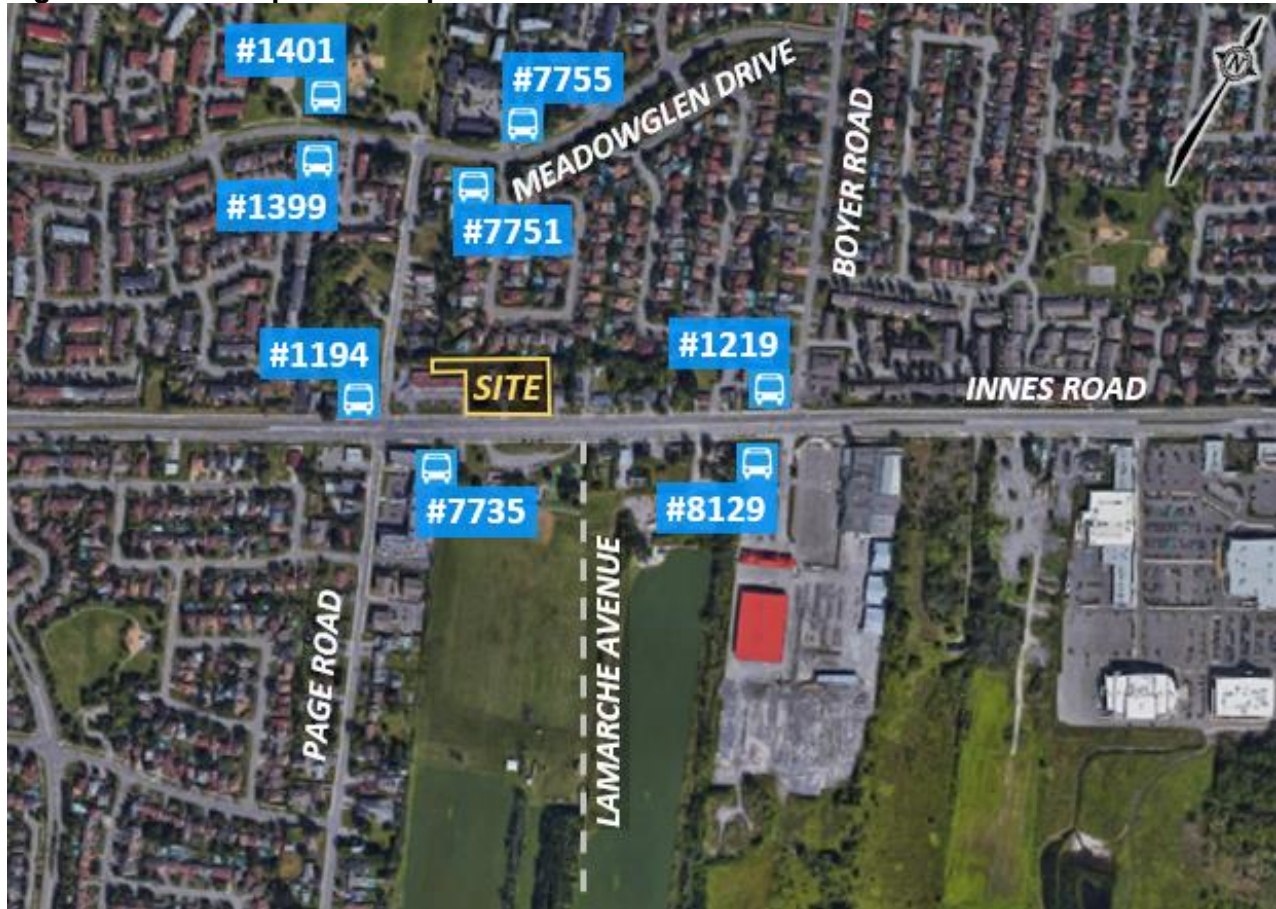

2.1.6 Area Traffic Management

Within the study area, there are no Area Traffic Management (ATM) studies that are in progress.

Additionally, three speed humps have been implemented on Pagé Road between Innes Road and Meadowglen Drive. Signage at each speed bump indicate that vehicles are intended to slow to 30 km/h at those points, where Pagé Road otherwise has a posted speed limit of 40 km/h.

2.1.7 Existing Traffic Volumes

Weekday traffic counts completed by the City or coordinated by Parsons in support of a different development application at 3490 Innes Road, which is discussed further in Section 2.2.2. These counts have been used to determine the existing pedestrian, cyclist, and vehicular traffic volumes at the study area intersections. These counts were completed on the following dates.

- Innes Road/Orléans Boulevard May 3, 2017 (City)
- Innes Road/Pagé Road January 8, 2019 (City)
- Innes Road/Lamarche Avenue August 5, 2021 (Parsons)
- Innes Road/473m East of Pagé Road January 31, 2019 (City)

Traffic count data for the study area intersections are included in **Appendix D**. Peak hour pedestrian, cyclist, and vehicular traffic volumes within the study area are shown in **Figure 4**.

Figure 4: Existing Traffic Volumes

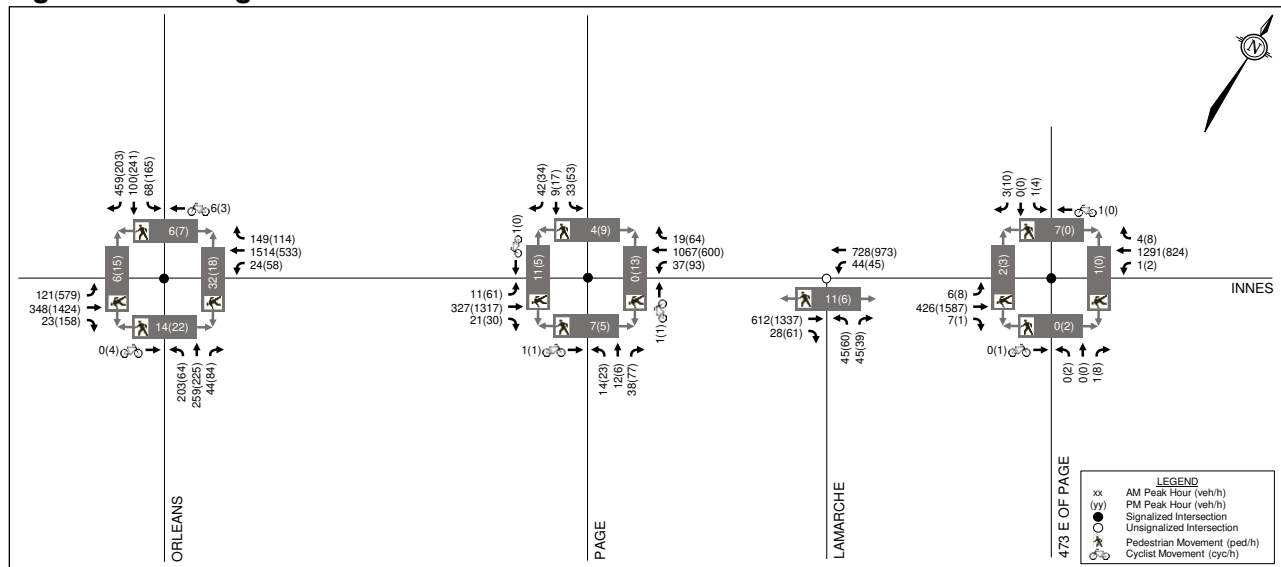

2.1.8 Collision Records

Historical collision data from the last six years available has been obtained from the City’s Public Works and Service Department for the study area. Copies of the collision summary reports are included in **Appendix E**.

The collision data has been evaluated to determine if there are any identifiable collision patterns, which are defined in the City’s 2017 TIA Guidelines as ‘more than six collisions in five years for any one movement.’ Due to the COVID-19 pandemic, it is anticipated that reduced traffic volumes in 2020 resulted in fewer collisions than a typical year. Therefore, the number of collisions at each intersection from January 1, 2015 through December 31, 2020 have been reviewed, and is summarized in **Table 3**.

Table 3: Reported Collisions

Intersection or Street Segment	Impact Types					Total
	Angle	Rear End	Sideswipe	Turn Mvmt	SMV ⁽¹⁾ /Other	
Innes Road/ Orléans Boulevard	7	40	5	18	5	75
Innes Road/ Pagé Road	4	14	2	7	6	33
Innes Road/ Lamarche Avenue	-	-	-	-	-	0
Innes Road/ 473m East of Pagé Road	1	4	-	-	2	7
Innes Road btwn Orléans Boulevard & Pagé Road	-	7	2	-	-	9
Innes Road btwn Pagé Road & 473m East of Pagé Road	5	6	3	1	3	18
Innes Road btwn 473m East of Pagé Road & Viseneau Drive	2	3	2	-	-	7

1. SMV = Single Motor Vehicle

Innes Road/Orléans Boulevard

A total of 75 collisions were reported at this intersection over the last six years, of which there were seven angle impacts, 40 rear-end impacts, five sideswipe impacts, 18 turning movement impacts, and five single vehicle/other impacts. Nineteen collisions resulted in injuries, but none caused fatalities. Thirty-four of the 75 collisions (45%) occurred in poor driving conditions. Three collisions involved pedestrians and no collisions involved cyclists.

Of the seven angle impacts, all involved a southbound vehicle and a westbound vehicle. Five of the seven impacts involved a southbound right-turning vehicle and a westbound through vehicle, and were the result of southbound drivers improperly yielding the right-of-way to westbound drivers.

Of the 40 rear-end impacts, five involved northbound vehicles (one unknown incident and four right-turn incidents), eight involved southbound vehicles (one left-turn incident, three through incidents, and four right-turn incidents), 16 involved eastbound vehicles (three left-turn incidents, 12 through incidents, and one right-turn incident), and 11 involved westbound vehicles (one unknown incident, nine through incidents, and one right-turn incident). The number of rear-end collisions are likely a function of high traffic volumes at this intersection.

Of the 18 turning movement impacts, 11 involved a northbound left-turning vehicle and a southbound through vehicle, five involved a southbound left-turning vehicle and a northbound through vehicle, and two involved a westbound left-turning vehicle and an eastbound through vehicle. The northbound left turn has protected plus permitted phasing during the peak hours, and a fully protected left turn phase would likely reduce this type of collision.

Of the five single vehicle/other impacts, three involved pedestrians. Of these three impacts, two involved a northbound left turning vehicle failing to yield the right-of-way and one involved an eastbound through vehicle disobeying the traffic control.

Innes Road/Pagé Road

A total of 33 collisions were reported at this intersection over the last six years, of which there were four angle impacts, 14 rear-end impacts, two sideswipe impacts, seven turning movement impacts, and six single vehicle/other impacts. Ten collisions resulted in injuries, but none caused fatalities. Twenty of the 33 collisions (61%) occurred in poor driving conditions. Three collisions involved pedestrians and one collision involved a cyclist.

Of the 14 rear-end impacts, five involved eastbound through vehicles and nine involved westbound through vehicles. The number of rear-end collisions are likely a function of high traffic volumes on Innes Road.

Of the six single vehicle/other impacts, three involved pedestrians. Of these three impacts, two involved a northbound left turning vehicle failing to yield the right-of-way and one involved a northbound through vehicle (unknown circumstances).

Innes Road/473m East of Pagé Road

A total of seven collisions were reported at this intersection over the last six years, of which there was one angle impact, four rear-end impacts, and two single vehicle/other impacts. Two collisions resulted in injuries, and none caused fatalities. Two of the seven collisions (28%) occurred in poor driving conditions. One collision involved a pedestrian, and none involved cyclists.

Innes Road between Orléans Boulevard and Pagé Road

A total of nine collisions were reported along this segment over the last six years, of which there were seven rear-end impacts and two sideswipe impacts. One collision resulted in injuries, but none caused fatalities. Three of the nine collisions (33%) occurred in poor driving conditions. No collisions involved pedestrians or cyclists.

Innes Road between Pagé Road and 473m East of Pagé Road

A total of 18 collisions were reported along this segment over the last six years, of which there were five angle impacts, six rear-end impacts, three sideswipe impacts, one turning movement impact, and three single vehicle/other impacts. Four collisions resulted in injuries, but none caused fatalities. Six of the 18 collisions (33%) occurred in poor driving conditions. No collisions involved pedestrians or cyclists.

Innes Road between 473m East of Pagé Road and Viseneau Drive

A total of seven collisions were reported along this segment over the last six years, of which there were two angle impacts, three rear-end impacts, and two sideswipe impacts. Two collisions resulted in injuries, but none caused fatalities. Three of the seven collisions (43%) occurred in poor driving conditions. No collisions involved pedestrians or cyclists.

2.2 Planned Conditions

2.2.1 Planned Roadway and Transit Projects

The City’s 2013 Transportation Master Plan (TMP) identifies future roadway projects within the study area in its Affordable Road Network and Network Concepts. The Network Concept includes a widening of the existing Blackburn Hamlet Bypass from four to six lanes, between the western intersection with Innes Road and Navan Road. In the Affordable Network, the Blackburn Hamlet Bypass Extension was identified as a Phase 2 (2020-2025) project, and would include a new four-lane roadway between Innes Road and Navan Road.

However, due to feasibility concerns, the Environmental Assessment (EA) process was reinitiated for the Brian Coburn Boulevard/Cumberland Transitway Extension. The study produced interim and ultimate conditions for a new alignment of the Brian Coburn Boulevard/Cumberland Transitway Extension. In the interim condition, bus lanes will be provided in both directions on Innes Road at Anderson Road, and in both directions on the Blackburn Hamlet Bypass at the western intersection with Innes Road and at Navan Road. In the ultimate condition, the Brian Coburn Boulevard extension will generally follow the alignment of Renaud Road south of the Blackburn Hamlet Bypass, with the Cumberland Transitway running immediately north of the extension.

Signalization of the Innes Road/Lamarche Avenue intersection is anticipated to be in place by the buildout year 2025, per discussions with City staff. As part of the development at 3490 Innes Road (described in Sections 2.2.2 and 3.2.2), Road Modification Approval (RMA) support documents were submitted for the future Innes Road/Lamarche Avenue signal, which is eligible for funding under the Development Charges By-Law. The functional design of the proposed signalized intersection at Innes Road/Lamarche Avenue includes auxiliary eastbound right turn, westbound left turn, northbound left turn, and northbound right turn lanes. A screenshot of the functional design is included in **Figure 5**.

Figure 5: Functional Design of Innes Road/Lamarche Avenue Signal

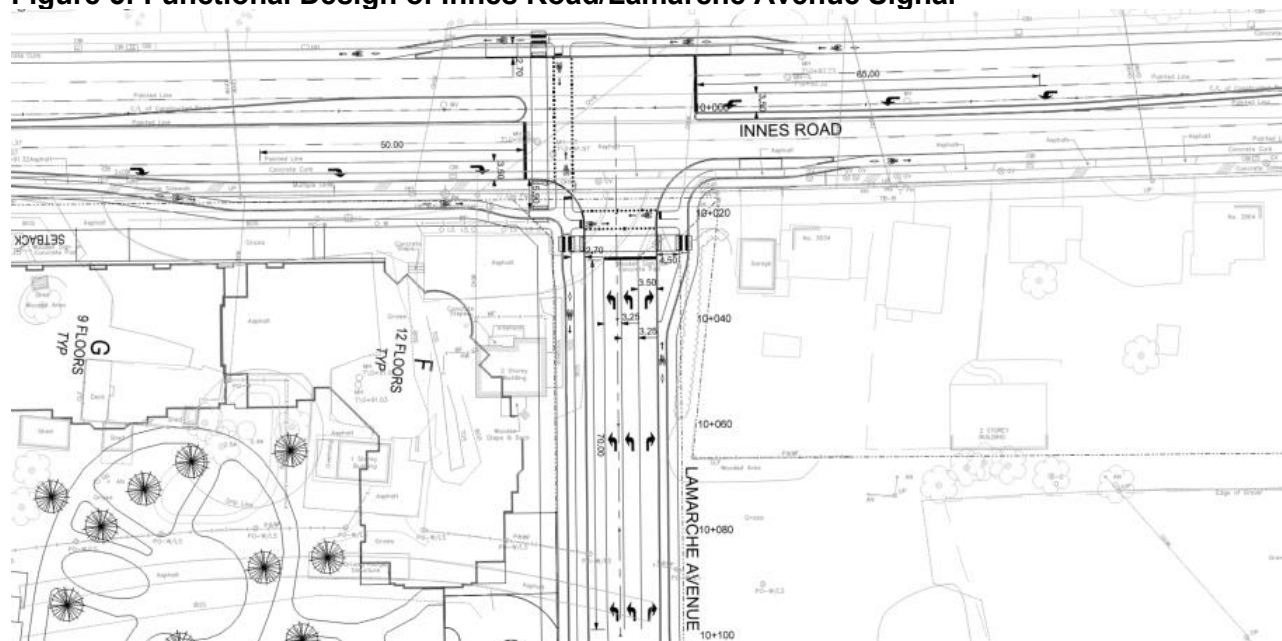

Source: 3490 Innes Road TIA, Appendix L (Parsons, 2021)

The Affordable Rapid Transit and Transit Priority (RTTP) Network identifies Innes Road and Brian Coburn Boulevard west of Tenth Line Road as Transit Priority Corridors with Isolated Measures. Transit signal priority and queue jump lanes will be implemented at select intersections. Peak period bus lanes and transit signal priority are identified for the Blackburn Hamlet Bypass between Innes Road and Brian Coburn Boulevard, which may include the repurposing of general purpose lanes.

The 2031 RTTP Network Concept includes the Cumberland Transitway, which will run between Blair Road and Frank Kenny Road. A corridor for the future transitway has been reserved by the City, immediately north of Brian Coburn Boulevard (south of the study area).

The 2013 Ottawa Cycling Plan identifies a Phase 3 (2026-2031) project north of the study area. The Orléans East-West Neighbourhood Bikeway project will include shared use lanes on Viseneau Drive and Meadowglen Drive. Additionally, a major pathway link between Innes Road and Brian Coburn Boulevard is identified within the East Urban Community, which is anticipated to be constructed beyond the timeline of this study.

The 2013 Ottawa Pedestrian Plan identifies a Phase 3 (2026-2031) project north of the study area. A new sidewalk will be provided along the entire south/west side of Meadowglen Drive between Forest Valley Drive and Boyer Road, in addition to the existing sidewalk on the entire north/east side of Meadowglen Drive.

2.2.2 Other Area Developments

In proximity of the proposed development, there are multiple other developments that have recently been completed, are under construction, approved, or are in the approval process. These developments are summarized as follows.

Orléans Village Subdivision

A Transportation Impact Study (TIS) was prepared by Parsons in December 2016 and later revised in April 2017 and August 2017, in support of a subdivision that will be accessed via Innes Road/Lamarche Avenue. The development consists of 534 residential dwellings. Per the TIS, buildout of Phase 1 of the development was anticipated to occur in 2021, and full buildout was anticipated to occur in 2024. The TIS also recommended signalization of the Innes Road/Lamarche Avenue intersection, as well as a 35m westbound left turn lane and a 50m eastbound right turn lane. It is understood that these improvements will be implemented as their respective warrants are met.

245-275 Lamarche Avenue

A TIA was prepared by CGH Transportation in April 2022, in support of a residential development. The development includes 103 townhouse dwellings and 72 back-to-back dwellings. Per the TIA, buildout of the development is anticipated to occur in 2025.

3437 and 3443 Innes Road

A TIA was prepared by Novatech in April 2022, in support of a mixed-use development. The development includes a single six-storey building, with approximately 5,530 ft² of ground-floor commercial space and 123 residential dwellings. Per the TIA, buildout of the development is anticipated to occur in 2023.

3490 Innes Road

A TIA was prepared by Parsons in October 2021, in support of a mixed-use development. Four options are currently being considered, and the TIA included analysis for the option that would generate the most traffic during the weekday peak hours. This option includes five mid-rise buildings with 525 residential dwellings and approximately 41,300 ft² of ground-floor commercial/retail uses. Buildout of the development is anticipated to occur in three phases, with an ultimate buildout year of 2031.

3598 Innes Road

A TIA was prepared by Tranplan Associates in September 2018, in support of an automatic car wash facility. This facility is now open, but was not completed prior to the traffic counts included in Section 2.1.7.

3610 Innes Road

A TIA was prepared by Novatech in October 2019 and later revised in April 2020, in support of a subdivision. The development consists of 456 residential dwellings. Per the TIA, buildout of the development is anticipated to occur in 2023.

3817-3843 Innes Road

A TIA was prepared by D.J. Halpenny & Associates Ltd. in March 2021, in support of a residential development. The development includes three low- or mid-rise buildings, with a total of 97 residential dwellings. Per the TIA, buildout of the development is anticipated to occur in 2024.

Richcraft Trailsedge North

A TIA was prepared by Castleglenn Consultants in April 2021, in support of a subdivision. The development consists of 2,040 residential dwellings and an employment area that will support approximately 830 jobs. Per the TIA, buildout of the residential portion is anticipated to occur in 2047, and the buildout year of the employment portion is unknown at the time of writing.

A figure outlining the location of all the developments above is included in **Figure 6**.

2.3 Study Area and Time Periods

The study area for this report includes the boundary roadway Innes Road, as well as the following intersections:

- Innes Road/Orléans Boulevard;
- Innes Road/Pagé Road;
- Innes Road/Lamarche Avenue;
- Innes Road/473m East of Pagé Road.

The selected time periods for the analysis are the weekday AM and PM peak hours, as they represent the 'worst case' combination of site generated traffic and adjacent street traffic. Analysis will be completed for the ultimate buildout year 2025 and the horizon year 2030.

Figure 6: Other Area Developments



2.4 Exemptions Review

This module reviews possible exemptions from the final Transportation Impact Assessment, as outlined in the *2017 TIA Guidelines*. The applicable exemptions for this site are shown in **Table 4**.

Table 4: TIA Exemptions

Module	Element	Exemption Criteria	Status
Design Review Component			
4.1 Development Design	4.1.2 Circulation and Access	• Only required for site plans	Not Exempt
	4.1.3 New Street Networks	• Only required for plans of subdivision	Exempt
4.2 Parking	4.2.1 Parking Supply	• Only required for site plans	Not Exempt
	4.2.2 Spillover Parking	• Only required for site plans where parking supply is 15% below unconstrained demand	Exempt
Network Impact Component			
4.5 Transportation Demand Management	<i>All elements</i>	• Not required for non-residential site plans expected to have fewer than 60 employees and/or students on location at any given time	Exempt
4.6 Neighbourhood Traffic Management	4.6.1 Adjacent Neighbourhoods	• Only required when the development relies on local or collector streets for access and total volumes exceed ATM capacity thresholds	Exempt
4.8 Network Concept	<i>All elements</i>	• Only required when proposed development generates more than 200 person-trips during the peak hour in excess of the equivalent volume permitted by the established zoning	Exempt

Based on the foregoing, the following modules will be included in the TIA report:

Design Review Component

- Module 4.1: Development Design
- Module 4.2: Parking
- Module 4.3: Boundary Streets
- Module 4.4: Access Design

Network Impact Component

- Module 4.7: Transit
- Module 4.9: Intersection Design

3.0 FORECASTING

3.1 Development-Generated Travel Demand

3.1.1 Trip Generation

The existing development is conservatively assumed to generate no trips during the weekday peak hours. The proposed development will consist of approximately 17,674 ft² GFA of commercial space (split evenly between two single-storey buildings). Building A is known to be a mattress store, while Building B is anticipated to have office or retail tenants. For the purposes of this review, Building B is assumed to be occupied by one or more retail uses, as this is a higher trip generator than office uses.

Using the *ITE Trip Generation Manual, 11th Edition*, trips generated by Building A have been estimated using the rates corresponding to the Furniture Store land use (code 890), and trips generated by Building B have been estimated using the rates corresponding to the Strip Retail Plaza land use (code 822). Trips have been converted to person trips using an adjustment factor of 1.28, consistent with the City’s *2017 TIA Guidelines*.

The estimated number of person trips generated by the proposed development is summarized in **Table 5**.

Table 5: Proposed Development – Peak Hour Trip Generation

Land Use	ITE Code	GFA	AM Peak Hour (pph)			PM Peak Hour (pph)		
			IN	OUT	TOT	IN	OUT	TOT
Furniture Store	890	8,837 ft ²	3	1	4	3	3	6
Strip Retail Plaza	822	8,837 ft ²	16	11	27	37	37	74
Total			19	12	31	40	40	80

1. pph: Person Trips per Peak Hour

The *TRANS Trip Generation Manual Summary Report*, prepared in October 2020 by WSP, includes peak hour mode share data for commercial trips in the Orléans district. The mode shares during the peak hours for commercial generators in Orléans can be summarized as follows:

- Auto Driver: 77% in AM peak, 71% in PM peak;
- Auto Passenger: 14% in AM peak, 20% in PM peak;
- Transit: 3% in AM peak, 2% in PM peak;
- Cyclist: 0% in AM peak, 1% in PM peak;
- Pedestrian: 6% in AM peak, 6% in PM peak.

The mode shares for the proposed development have been assumed to be equal in both weekday peak hours, but generally follow the observed mode shares described above. Therefore, the assumed peak hour mode shares for trips generated by the proposed development can be summarized as 75% auto driver, 15% auto passenger, 5% transit, 0% cyclist, and 5% pedestrian.

A breakdown of the above person trips by mode share is shown in **Table 6**.

Table 6: Proposed Development – Peak Hour Trips by Mode Share

Travel Mode	Mode Share	AM Peak Hour			PM Peak Hour		
		IN	OUT	TOT	IN	OUT	TOT
Furniture Store Person Trips		3	1	4	3	3	6
Auto Driver	75%	3	-	3	2	2	4
Auto Passenger	15%	-	1	1	1	1	2
Transit	5%	-	-	0	-	-	0
Cyclist	0%	-	-	0	-	-	0
Pedestrian	5%	-	-	0	-	-	0
Retail Person Trips		16	11	27	37	37	74
Auto Driver	75%	12	8	20	28	28	56
Auto Passenger	15%	2	2	4	5	5	10
Transit	5%	1	1	2	2	2	4
Cyclist	0%	-	-	0	-	-	0
Pedestrian	5%	1	-	1	2	2	4
Total Person Trips		19	12	31	40	40	80
Auto Driver		15	8	23	30	30	60
Auto Passenger		2	3	5	6	6	12
Transit		1	1	2	2	2	4
Cyclist		-	-	0	-	-	0
Pedestrian		1	-	1	2	2	4

From the previous table, the proposed development is estimated to generate 31 person trips (including 23 vehicle trips) during the AM peak hour, and 80 person trips (including 60 vehicle trips) during the PM peak hour.

Peak hour pass-by trips have been estimated based on the average rates identified in the *ITE Trip Generation Manual, 11th Edition*. Using these average rates, the assumed pass-by rates for the development are 0% during the AM peak hour for both land uses, and 53% and 40% during the PM peak hour for the furniture store and retail uses respectively. These rates have been applied to the vehicle trips identified above.

The primary and pass-by trip generation for the proposed development is presented in **Table 7**.

Table 7: Primary and Pass-by Trips

Trip Type	AM Peak Hour (vph)			PM Peak Hour (vph)		
	IN	OUT	TOT	IN	OUT	TOT
Furniture Store Trips	3	-	3	2	2	4
Pass-by (0% AM, 53% PM)	-	-	0	1	1	2
Primary Furniture Store Trips	3	-	3	1	1	2
Retail Trips	12	8	20	28	28	56
Pass-by (0% AM, 40% PM)	-	-	0	12	12	24
Primary Retail Trips	12	8	20	16	16	32

From the previous table, the proposed development is estimated to generate 23 primary vehicle trips during the AM peak hour and 34 primary vehicle trips during the PM peak hour.

3.1.2 Trip Distribution and Assignment

The assumed distributions of primary and pass-by trips generated by the proposed development have been derived from existing traffic patterns within the study area. Since the proposed development will be commercial in nature, the two-way midday peak hour volumes have been considered for the primary trip distribution. With the construction of a raised median on Innes Road as part of the Innes Road/Lamarche Avenue roadway modifications, it is assumed that all pass-by trips will arrive from the east and depart to the west, as trips arriving from the west and departing to the east will require U-turn manoeuvres.

Therefore, the assumed trip distributions for the proposed development can be summarized as follows:

Primary Trip Distribution

- To/from the north via Orléans Boulevard: 15%;
- To/from the south via Orléans Boulevard: 10%;
- To/from the east via Innes Road: 35%;
- To/from the west via Innes Road: 40%.

Pass-by Trip Distribution

- Westbound via Innes Road: 100%.

All trips will enter and exit the subject site via the access to Innes Road. Based on the proposed modifications to the Innes Road/Lamarche Avenue intersection shown in **Figure 5**, a raised median will be constructed on Innes Road between Pagé Road and Lamarche Avenue, and it is this modification that will restrict the proposed access to right-in/right-out (RIRO) in the future. To accommodate accesses on the north side of Innes Road between Pagé Road and Lamarche Avenue, an eastbound U-turn lane at the new signal should be included at Innes Road/Lamarche Avenue, and has been assumed in the analysis of this TIA.

Based on the above, for the purposes of this report, it is assumed that trips entering from the west can perform a U-turn at Innes Road/Lamarche Avenue, and trips exiting to the east will perform a U-turn at Innes Road/Pagé Road.

3.2 Background Traffic

3.2.1 General Background Growth Rate

A rate of background growth has been established through a review of the City's 2013 TMP and Strategic Long-Range Model, comparing snapshots of 2011 and 2031 AM peak hour volumes. Section 2.3 of the TMP projects a 33% growth in population for the Orléans area between 2011 and 2031, translating to an annual growth rate of approximately 1.4%. The snapshots indicate traffic volume reductions on Innes Road due to the opening of Brian Coburn Boulevard, which acts as an alternate east-west arterial route. The snapshots do not consistently identify traffic increases or reductions on Orléans Boulevard between 2011 and 2031. To account for potential developments in the area that are not discussed below, a 1% background growth has been applied to the through volumes on the arterial roadways within the study area (i.e. Innes Road and Orléans Boulevard).

Relevant excerpts of the 2013 TMP and Strategic Long-Range Model are included in **Appendix F**.

3.2.2 Other Area Developments

In proximity of the proposed development, there are multiple other developments that have recently been completed, are under construction, approved, or are in the approval process. These developments are summarized as follows. Relevant excerpts of the transportation studies that are considered in the 2025 and 2030 background conditions are included in **Appendix G**.

Orléans Village Subdivision

This subdivision consists of 534 residential dwellings, and is currently under construction. In the TIS, 50% of the development was anticipated to be built out in 2020, and full buildout is anticipated to occur in 2024. Traffic generated by Phase 1 is assumed to have been captured by the existing traffic count at Innes Road/Lamarche Avenue, but not at the other study area intersections. To represent ultimate buildout of this development in the 2025 and 2030 background conditions, projected traffic generated by only Phase 2 has been added to the volumes at Innes Road/Lamarche Avenue and traffic generated by both Phase 1 (observed) and Phase 2 (projected) has been added to the volumes at all other study area intersections.

245-275 Lamarche Avenue

The development includes 103 townhouse dwellings and 72 back-to-back dwellings. Per the TIA, buildout of the development is anticipated to occur in 2025. Therefore, volumes generated by this development have been added to the 2025 and 2030 background conditions.

3437 and 3443 Innes Road

The development includes approximately 5,530 ft² of ground-floor commercial space and 123 residential dwellings. Per the TIA, buildout of the development is anticipated to occur in 2023. Therefore, volumes generated by this development have been added to the 2025 and 2030 background conditions.

3490 Innes Road

Five mid-rise buildings with 525 residential dwellings and approximately 41,300 ft² of ground-floor commercial/retail uses are proposed, and this application is currently in the approval process. Buildout of the development is anticipated to occur in 2031. Traffic generated by this development has conservatively been added to the 2030 background conditions.

3598 Innes Road

An automatic car wash facility is now open, but was not operational prior to the traffic counts included in Section 2.1.7. Traffic generated by this development has been added to the 2025 and 2030 background conditions, based on the TIA prepared by Tranplan Associates.

3610 Innes Road

This proposed development consists of 456 residential dwellings, and this application is currently in the approval process. Per the TIA, buildout of Phase 1 was anticipated to occur in 2021 and buildout of Phase 2 was anticipated to occur in 2023. Therefore, traffic generated by this development has been added to the 2025 and 2030 background conditions.

3817-3843 Innes Road

This proposed development includes three low- or mid-rise buildings with a total of 97 residential dwellings, and this application is currently in the approval process. Per the TIA, buildout of the development is anticipated to occur in 2024. Therefore, traffic generated by this development has been added to the 2025 and 2030 background conditions.

Richcraft Trailsedge North

Approximately 2,040 residential dwellings and an employment area that will support 830 jobs are proposed. Per the TIA, buildout of the residential portion is anticipated to occur in 2047 (with buildout of Phase 1 occurring in 2037), and the buildout year of the employment portion is unknown at the time of writing. Since this buildout year is beyond the horizon year of this study, traffic generated by this development has not been added to the 2025 or 2030 background conditions.

3.2.3 Existing Traffic Volume Balancing

To account for discrepancies in the different traffic counts conducted, the existing through traffic volumes have been balanced throughout the study area for any through movements with discrepancies greater than 10%. The balanced existing traffic volumes are shown in **Figure 7**.

3.3 Future Traffic Conditions

The figures below present the following traffic conditions:

- Proposed site-generated primary traffic volumes are shown in **Figure 8**;
- Proposed site-generated pass-by traffic volumes are shown in **Figure 9**;
- Other area development-generated traffic volumes in 2025 are shown in **Figure 10**;
- Other area development-generated traffic volumes in 2030 are shown in **Figure 11**;
- Background traffic volumes in 2025 are shown in **Figure 12**;
- Background traffic volumes in 2030 are shown in **Figure 13**;
- Total traffic volumes in 2025 are shown in **Figure 14**;
- Total traffic volumes in 2030 are shown in **Figure 15**.

Figure 7: Balanced Existing Traffic Volumes

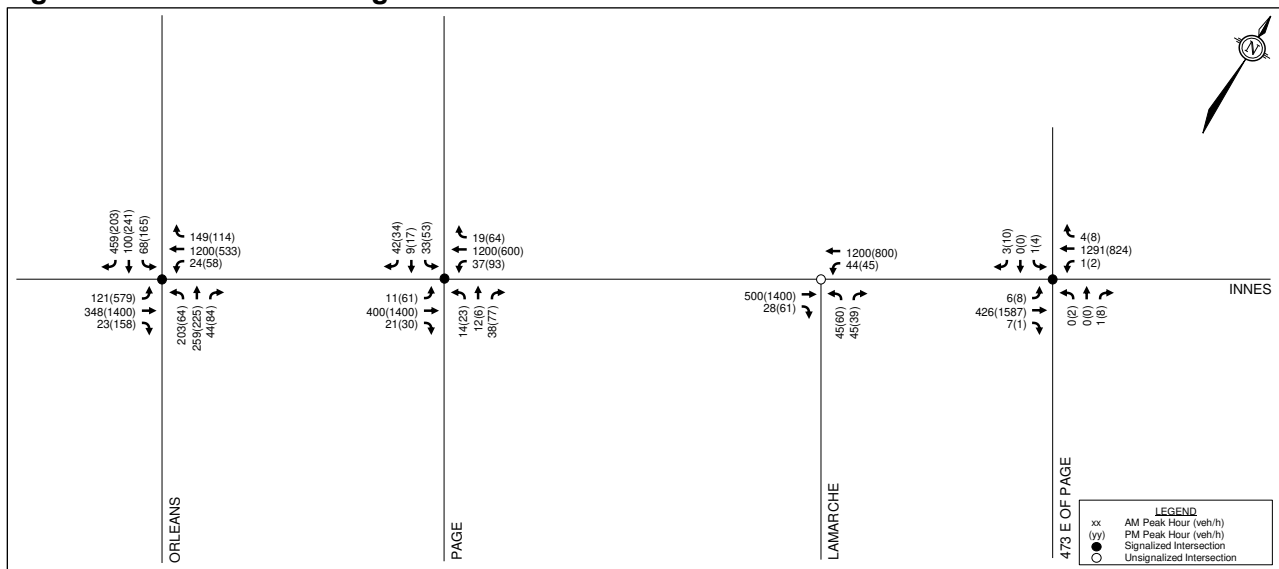

Figure 8: Proposed Site-Generated Primary Traffic Volumes

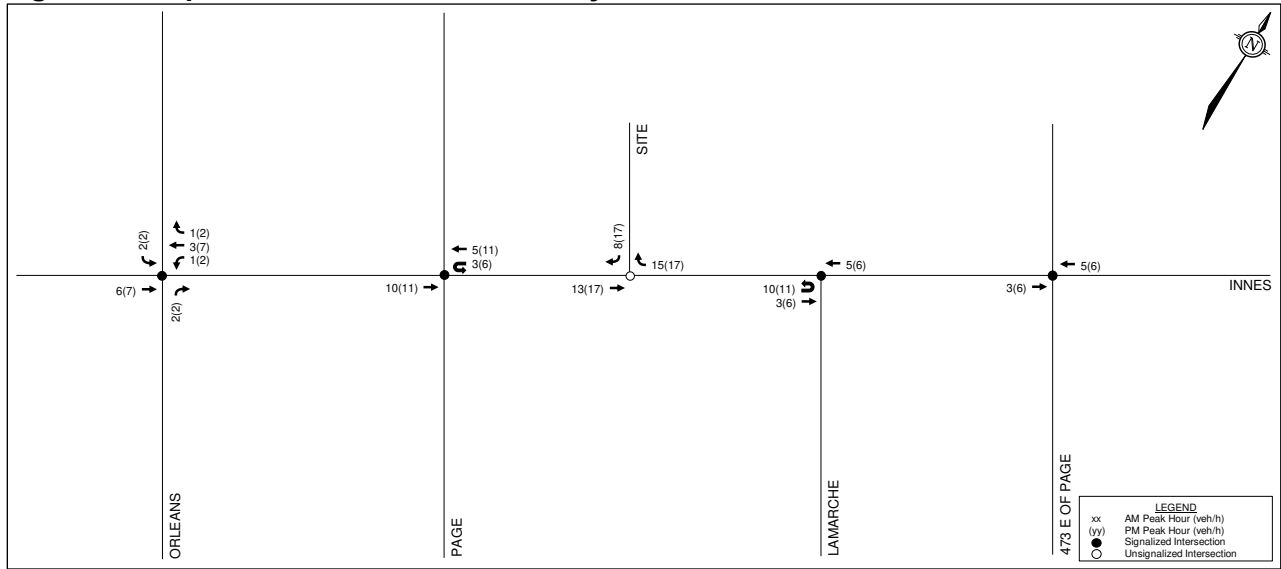

Figure 9: Proposed Site-Generated Pass-by Traffic Volumes

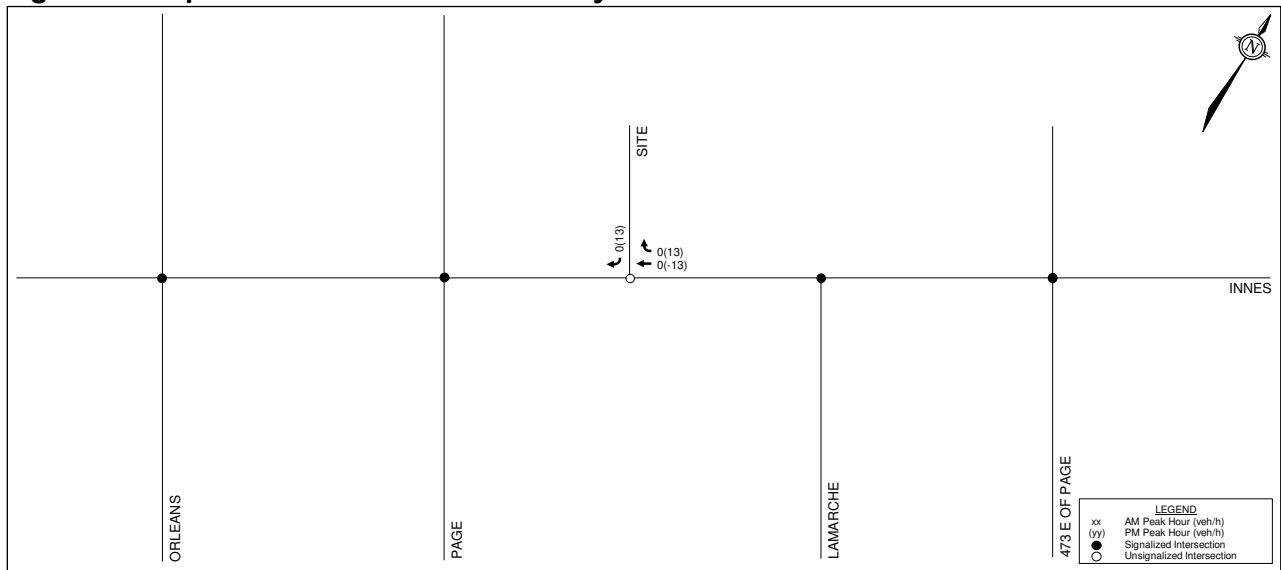

Figure 10: 2025 Other Area Development-Generated Traffic Volumes

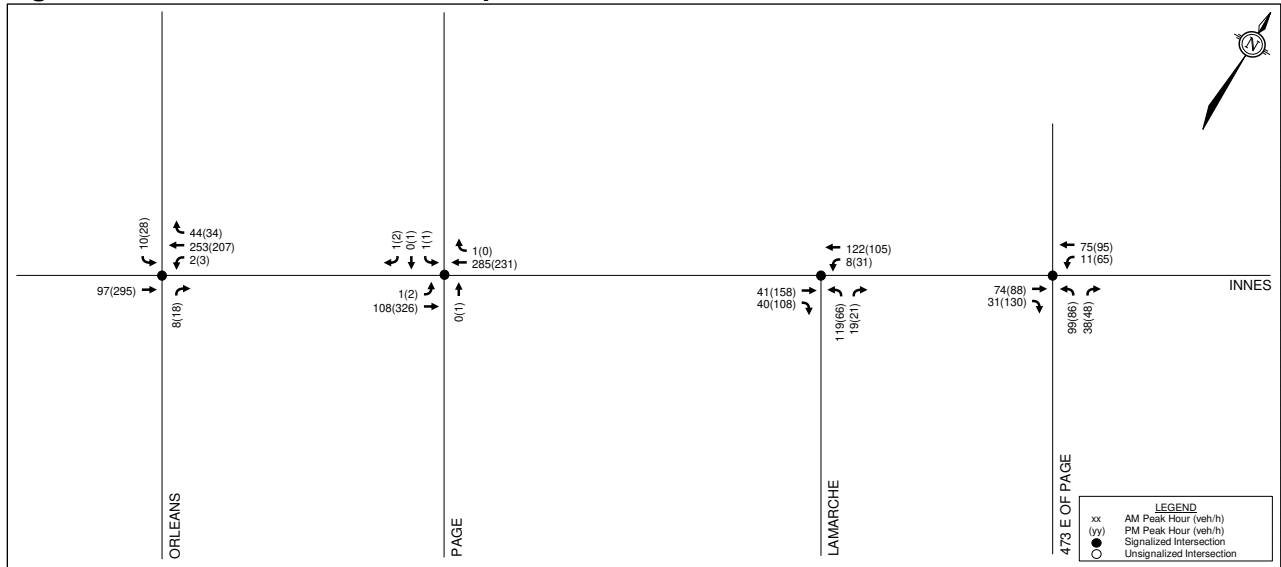

Figure 11: 2030 Other Area Development-Generated Traffic Volumes

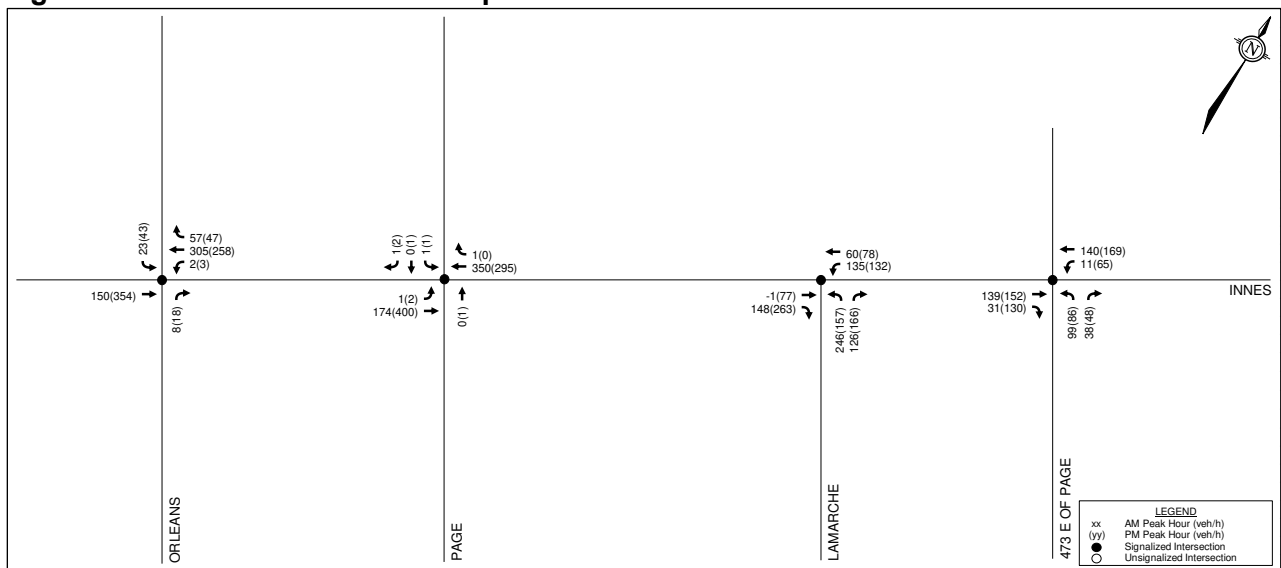

Figure 12: 2025 Background Traffic Volumes

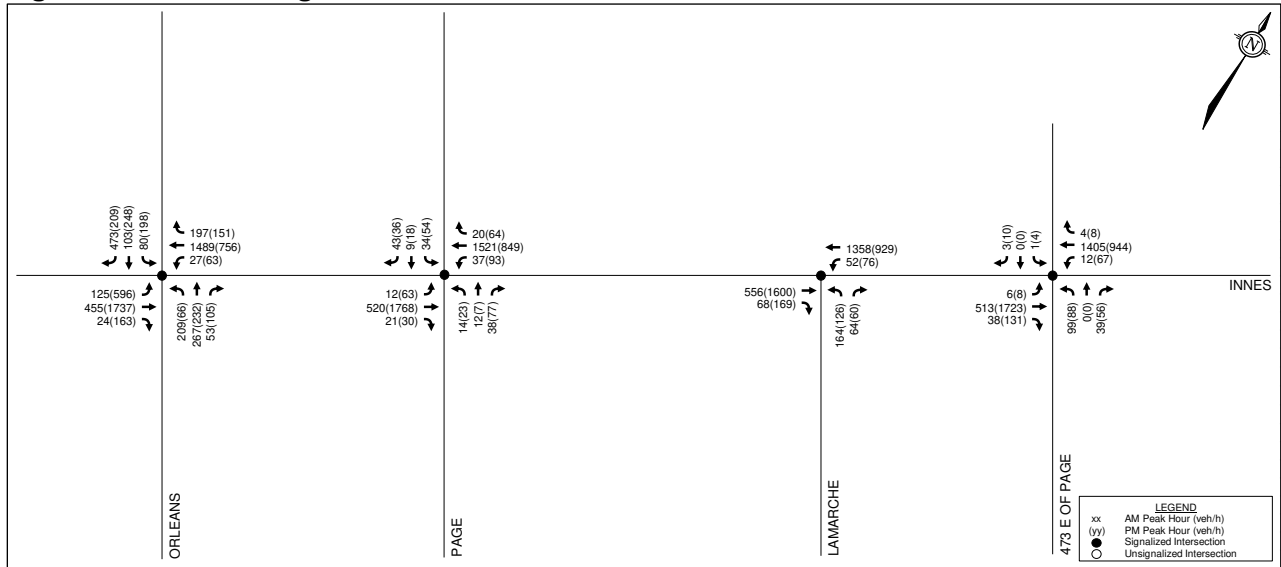

Figure 13: 2030 Background Traffic Volumes

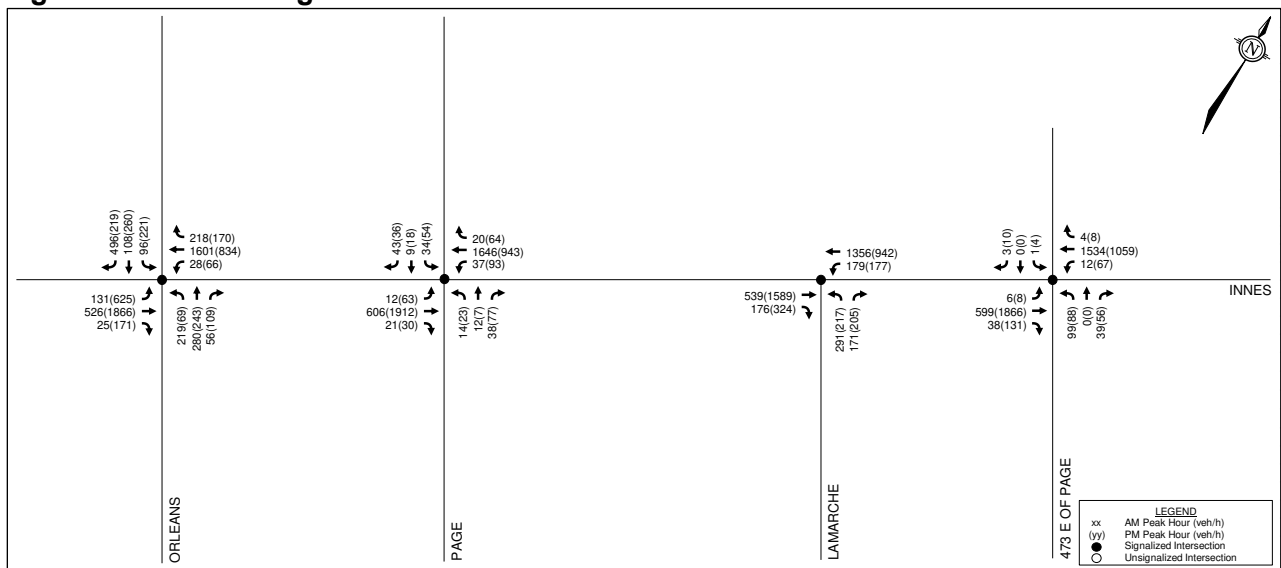

Figure 14: 2025 Total Traffic Volumes

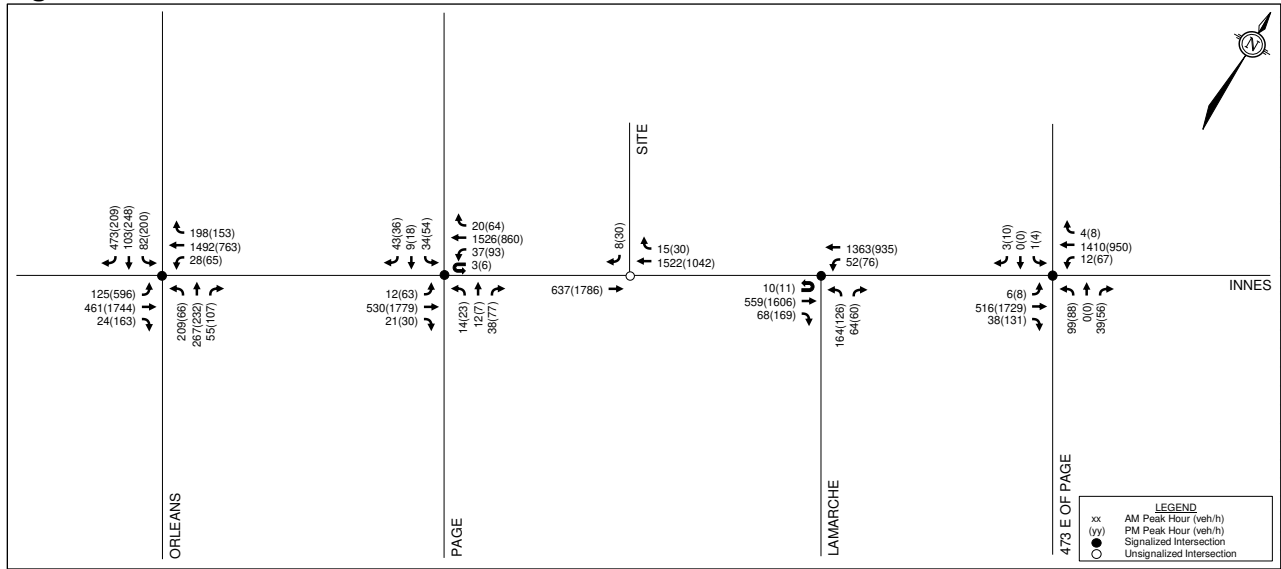
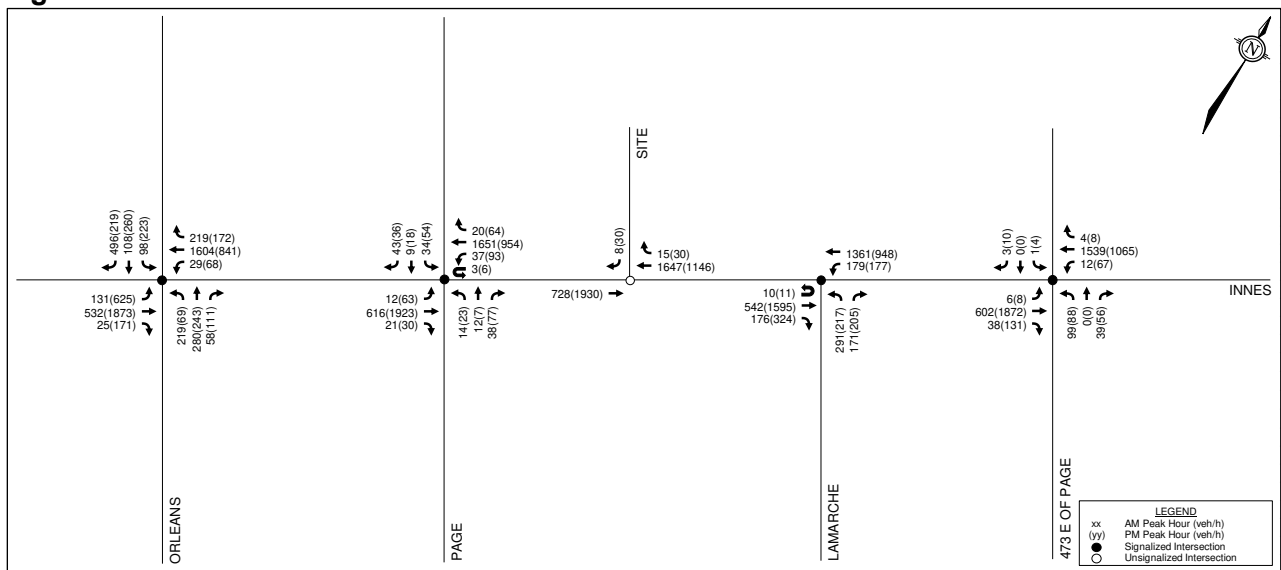

Figure 15: 2030 Total Traffic Volumes



3.4 Demand Rationalization

A review of the existing and background intersection operations has been conducted to determine if/when traffic volumes exceed capacity within the study area. The intersection parameters used in the analysis are consistent with the *2017 TIA Guidelines* (Saturated Flow Rate: 1,800 vphpl, Peak Hour Factor: 0.9 in existing conditions and 1.0 in future conditions). Per Exhibit 22 of the *Multi-Modal Level of Service (MMLOS) Guidelines*, the target vehicular level of service (Auto LOS) at all study area intersections is an Auto LOS D, which equates to a maximum vehicle-to-capacity (v/c) ratio of 0.90. Signal timing plans have been obtained from the City, and are included in **Appendix H**.

3.4.1 Existing Intersection Operations

Intersection capacity analysis has been conducted for the existing traffic conditions. The results of the analysis are summarized in **Table 8** and **Table 9** for the weekday AM and PM peak hours. Detailed Synchro reports are included in **Appendix I**.

Table 8: Existing Traffic Operations

Intersection	AM Peak Hour			PM Peak Hour		
	Max v/c or Delay	LOS	Mvmt	Max v/c or Delay	LOS	Mvmt
Innes Road/ Orléans Boulevard ⁽¹⁾	1.19	F	SBR	1.00	E	EBT
	0.91	E	EBL			
Innes Road/ Pagé Road ⁽¹⁾	0.55	A	WBT/R	0.72	C	WBL
Innes Road/ Lamarche Avenue ⁽²⁾	14 sec	B	NBL/R	27 sec	D	NBL/R
Innes Road/ 473m East of Pagé Road ⁽¹⁾	0.46	A	WBT/R	0.59	A	EBT/R

- 1. Signalized intersection
- 2. Unsignalized intersection

Table 9: Existing Queues

Intersection	Mvmt	Storage/ Spacing ⁽¹⁾	AM Peak			PM Peak		
			v/c [LOS]	50 th % Queue (m)	95 th % Queue (m)	v/c [LOS]	50 th % Queue (m)	95 th % Queue (m)
Innes Road/ Orléans Boulevard	SBL	50m	0.38 [A]	16	30	0.79 [C]	34	#63
	SBR	60m	1.19 [F]	~115	#177	0.45 [A]	0	17
	EBL	140m	0.91 [E]	17	#35	0.90 [D]	64	#91
	EBT	820m	0.25 [A]	29	40	1.00 [E]	~195	#235
	WBT	450m	0.88 [D]	148	178	0.60 [A]	45	82

- 1: Indicates the storage length for auxiliary lanes or the spacing to the nearest upstream intersection/access for through lanes
- #: Volume for the 95th percentile cycle exceeds capacity
- ~: Approach is above capacity

From the previous tables, there are several movements at Innes Road/Orléans Boulevard that exceed the target v/c ratio during the weekday peak hours. During the AM peak hour, the average (50th-percentile) and maximum (95th-percentile) queue lengths of the southbound right turn movement exceed the storage length provided. During the PM peak hour, the maximum queue length of the southbound left turn movement at Innes Road/Orléans Boulevard exceeds the storage length provided.

The approximate required reduction in volumes to meet the target Auto LOS D for each over-capacity movement is included below. Detailed Synchro reports of an alternative scenario with these reduced volumes is included in **Appendix I**.

Innes Road/Orléans Boulevard

- AM Peak Hour
 - Southbound right turn (v/c: 1.19): reduction of 140 vehicles required;
 - Eastbound left turn (v/c: 0.91): reduction of 10 vehicles required.
- PM Peak Hour
 - Eastbound through (v/c: 1.00): reduction of 140 vehicles required.

3.4.2 2025 Background Intersection Operations

Intersection capacity analysis has been conducted for the 2025 background traffic conditions. Signalization of the Innes Road/Lamarche Avenue intersection is anticipated to be in place by the buildout year 2025. This intersection has therefore been modelled as a signal, with auxiliary eastbound right turn, westbound left turn, northbound left turn, and northbound right turn lanes, as shown in **Figure 5**. In addition, an auxiliary eastbound U-turn lane has been included.

The results of the analysis are summarized in **Table 10** and **Table 11** for the weekday AM and PM peak hours. Detailed Synchro reports are included in **Appendix J**.

Table 10: 2025 Background Traffic Operations

Intersection	AM Peak Hour			PM Peak Hour		
	Max v/c or Delay	LOS	Mvmt	Max v/c or Delay	LOS	Mvmt
Innes Road/ Orléans Boulevard ⁽¹⁾	1.10	F	SBR	1.12	F	EBT
	0.98	E	WBT			
Innes Road/ Pagé Road ⁽¹⁾	0.62	B	WBT/R	0.92	E	WBL
Innes Road/ Lamarche Avenue ⁽¹⁾	0.57	A	WBT	0.64	B	EBT
Innes Road/ 473m East of Pagé Road ⁽¹⁾	0.56	A	NBL	0.70	B	EBT/R

- 1. Signalized intersection
- 2. Unsignalized intersection

Table 11: 2025 Background Queues

Intersection	Mvmt	Storage/ Spacing ⁽¹⁾	AM Peak			PM Peak		
			v/c [LOS]	50 th % Queue (m)	95 th % Queue (m)	v/c [LOS]	50 th % Queue (m)	95 th % Queue (m)
Innes Road/ Orléans Boulevard	SBL	50m	0.39 [A]	17	31	0.84 [D]	37	#69
	SBR	60m	1.10 [F]	~96	#157	0.42 [A]	0	14
	EBL	140m	0.85 [D]	15	#32	0.86 [D]	58	#80
	EBT	820m	0.29 [A]	36	47	1.12 [F]	~234	#274
	WBT	450m	0.98 [E]	179	#228	0.75 [C]	63	#112

- 1: Indicates the storage length for auxiliary lanes or the spacing to the nearest upstream intersection/access for through lanes
- #: Volume for the 95th percentile cycle exceeds capacity
- ~: Approach is above capacity

From the previous tables, there are multiple movements within the study area that are not anticipated to meet the target Auto LOS D.

During the AM peak hour, the southbound right turn (v/c: 1.10) and westbound through (v/c: 0.98) at Innes Road/Orléans Boulevard operate at an Auto LOS E or F. The average and maximum queue lengths of the southbound right turn movement exceed the storage length provided.

During the PM peak hour, the eastbound through (v/c: 1.12) at Innes Road/Orléans Boulevard and westbound left turn (v/c: 0.92) at Innes Road/Pagé Road operates at an Auto LOS E or F. The maximum queue length of the southbound left turn movement at Innes Road/Orléans Boulevard exceeds the storage length provided.

An alternate scenario with optimized signal timings at Innes Road/Orléans Boulevard during the AM peak hour, and optimized signal timings and offsets at all study area intersections during the PM peak hour has been generated for the 2025 background conditions.

During the AM peak hour, seven seconds of green time for the northbound/southbound phases have been reallocated to the eastbound/westbound through phases at Innes Road/Orléans Boulevard.

During the PM peak hour, the cycle length of all study area intersections has been increased from 110 seconds to 130 seconds. At Innes Road/Orléans Boulevard, three seconds have been added to the northbound/southbound phases and 17 seconds have been added to the eastbound/westbound phases. At all other intersections, 20 seconds have been added to the eastbound/westbound phases. To mitigate the failing westbound left turn movement at Innes Road/Pagé Road in the PM peak hour, the alternate scenario also includes protected plus permitted westbound left turn phasing at this intersection. The westbound left turn improves to an Auto LOS A, while the opposing eastbound through/right turn movement downgrades from an Auto LOS C (v/c: 0.75) to an Auto LOS D (v/c: 0.82). It is understood that this type of phasing is typically implemented after the City reviews the actual performance of the intersections being studied.

In this scenario, there is still a required reduction in volumes to meet the target Auto LOS D. The required reduction for each over-capacity movement at Innes Road/Orléans Boulevard is included below. Detailed Synchro reports of this alternate scenario is included in **Appendix J**.

Innes Road/Orléans Boulevard

- AM Peak Hour
 - Southbound right turn (v/c: 1.10): reduction of 130 vehicles required.
- PM Peak Hour
 - Eastbound through (v/c: 1.12): reduction of 150 vehicles required.

3.4.3 2030 Background Intersection Operations

Intersection capacity analysis has been conducted for the 2030 background traffic conditions. The adjusted signal timings and offsets as described in the previous section have been assumed for this scenario.

The results of the analysis are summarized in **Table 12** and **Table 13** for the weekday AM and PM peak hours. Detailed Synchro reports are included in **Appendix J**.

Table 12: 2030 Background Traffic Operations

Intersection	AM Peak Hour			PM Peak Hour		
	Max v/c	LOS	Mvmt	Max v/c	LOS	Mvmt
Innes Road/ Orléans Boulevard ⁽¹⁾	1.20	F	SBR	1.09	F	EBT
	0.94	E	WBT	0.95	E	SBL
Innes Road/ Pagé Road ⁽¹⁾	0.67	B	WBT/R	0.88	D	EBT/R
Innes Road/ Lamarche Avenue ⁽¹⁾	0.74	C	NBL	1.37	F	WBL
Innes Road/ 473m East of Pagé Road ⁽¹⁾	0.60	A	WBT/R	0.76	C	EBT/R

1. Signalized intersection

Table 13: 2030 Background Queues

Intersection	Mvmt	Storage/ Spacing ⁽¹⁾	AM Peak			PM Peak		
			v/c [LOS]	50 th % Queue (m)	95 th % Queue (m)	v/c [LOS]	50 th % Queue (m)	95 th % Queue (m)
Innes Road/ Orléans Boulevard	SBL	50m	0.48 [A]	20	37	0.95 [E]	52	#98
	SBR	60m	1.20 [F]	~115	#176	0.44 [A]	0	19
	EBL	140m	0.89 [D]	16	#34	0.90 [D]	74	#101
	EBT	820m	0.31 [A]	38	49	1.09 [F]	~266	#304
	WBT	450m	0.94 [E]	182	#233	0.73 [C]	88	114
Innes Road/ Pagé Road	EBT	450m	0.27 [A]	14	39	0.88 [D]	34	m33
	WBL	100m	0.08 [A]	1	m2	0.65 [B]	7	#36
Innes Road/ Lamarche Avenue	EBT	210m	0.24 [A]	13	21	0.68 [B]	8	12
	WBL	120m max	0.34 [A]	5	23	1.37 [F]	~53	#101
Innes Road/473m East of Pagé Road	EBT	210m	0.27 [A]	14	23	0.76 [C]	29	36
	WBL	40m	0.02 [A]	1	3	0.68 [B]	6	#39

1: Indicates the storage length for auxiliary lanes or the spacing to the nearest upstream intersection/access for through lanes

m: Volume for the 95th percentile queue is metered by an upstream signal

#: Volume for the 95th percentile cycle exceeds capacity

~: Approach is above capacity

From the previous tables, there are multiple movements within the study area that are not anticipated to meet the target Auto LOS D.

During the AM peak hour, the southbound right turn (v/c: 1.20) and westbound through (v/c: 0.94) at Innes Road/Orléans Boulevard operate at an Auto LOS E or F. The average and maximum queue lengths of the southbound right turn movement exceed the storage length provided.

During the PM peak hour, the southbound left turn (v/c: 0.95) and eastbound through (v/c: 1.09) at Innes Road/Orléans Boulevard, and the westbound left turn (v/c: 1.37) at Innes Road/Lamarche Avenue operate at an Auto LOS E or F. The maximum queue length of the southbound left turn movement at Innes Road/Orléans Boulevard exceeds the storage length provided.

To mitigate failing westbound left turn movements at Innes Road/Lamarche Avenue in the PM peak hour, an alternate scenario with protected plus permitted left turn phasing has been conducted. At Innes Road/Lamarche Avenue, the westbound left turn improves to an Auto LOS C (v/c: 0.77), while the opposing eastbound through movement downgrades from an Auto LOS B (v/c: 0.68) to an Auto LOS D (v/c: 0.84). It is understood that this type of phasing is typically implemented after the City reviews the actual performance of the intersections being studied. Detailed Synchro reports of this alternate scenario is included in **Appendix J**.

The approximate required reduction in volumes to meet the target Auto LOS D for each over-capacity movement is included below.

Innes Road/Orléans Boulevard

- AM Peak Hour
 - Southbound right turn (v/c: 1.20): reduction of 150 vehicles required;
 - Westbound through (v/c: 0.94): reduction of 30 vehicles required.
- PM Peak Hour
 - Southbound left turn (v/c: 0.95): reduction of 30 vehicles required;
 - Eastbound through (v/c: 1.09): reduction of 280 vehicles required.

Detailed Synchro reports of an alternative scenario with these reduced volumes is also included in **Appendix J**.

Traffic throughout the study area could be displaced or alleviated through a combination of increased use of non-auto modes of transportation, alternate times of travel for drivers using the study area to make use of off-peak capacity, and alternate routes of travel. Further descriptions of these options are described below.

Increased Use of Non-Auto Modes

As discussed in Section 2.2.1, future improvements to the transit, cyclist, and pedestrian networks are anticipated within proximity of the study area. These improvements will include transit priority measures on Innes Road, Brian Coburn Boulevard, and the Blackburn Hamlet Bypass, the future Cumberland Transitway, and improved cyclist and pedestrian connectivity north of the study area.

Alternate Travel Times

As congestion increases within the study area, some motorists may alter their travel to occur outside of the peak hours. This shift in travel times may result in a reduction of peak hour traffic volumes.

Alternate Travel Routes

As congestion increases within the study area, some motorists may choose alternate routes of travel outside of the study area. North-south routes that are alternative to Orléans Boulevard include Mer Bleue Road/Jeanne d'Arc Boulevard, Tenth Line Road, and Trim Road. East-west routes that are alternative to Innes Road include Ottawa Road 174, St. Joseph Boulevard, and Brian Coburn Boulevard.

4.0 ANALYSIS

4.1 Development Design

4.1.1 Design for Sustainable Modes

Pedestrian walkways will connect the front of each proposed building to the existing sidewalk on the north side of Innes Road. These pathways will be approximately 2.5m in width.

Bicycle parking is proposed adjacent to the accessible parking spaces in front of each proposed building. A total of eight bicycle parking spaces are proposed on-site. A review of the parking requirements per the City's *Zoning By-Law (ZBL)* is included in Section 4.2.

The nearest bus stops to the subject site are discussed in Section 2.1.5. OC Transpo's service design guidelines for peak period service is to provide service within a five-minute (400m) walk of home, work, or school, for 95% of urban residents. The main entrances to each proposed building will be within 400m of stops on Innes Road that are served by OC Route 25.

A review of the City's *Transportation Demand Management (TDM)-Supportive Development Design and Infrastructure Checklist* has been conducted. Any required TDM-supportive design and infrastructure measures in the TDM checklist for non-residential developments have been met. A copy of this checklist is included in **Appendix K**. In addition to the required measures, the proposed development also meets the following 'basic' or 'better' measures as defined in the *TDM-Supportive Development Design and Infrastructure Checklist*.

- Locate buildings close to the street, and do not locate parking areas between the street and building entrances;
- Locate building entrances in order to minimize walking distances to sidewalks and transit stops/stations;
- Locate building doors and windows to ensure visibility of pedestrians from the building, for their security and comfort;
- Provide safe, direct, and attractive walking routes from building entrances to nearby transit stops;
- Provide lighting, landscaping, and benches along walking and cycling routes between building entrances and streets, sidewalks, and trails.

4.1.2 Circulation and Access

Garbage collection will take place in the loading zones at the back of each proposed building (i.e. at the northern end of the subject site). It has been estimated that a Medium Single Unit (MSU) design vehicle will be the largest vehicle to traverse the site. Therefore, truck turning movements for an MSU design vehicle have been prepared to enter and exit the site and each loading zone. The turning movement figures are included in **Figure 16** through **Figure 19**. Minor adjustments to the curbs are required at the loading dock to Building A, as shown in **Figure 16** and **Figure 17**. These revisions will be shown on the Site Plan as part of a subsequent submission.

The fire route for the subject site will be located along Innes Road.

4.2 Parking

The subject site is located in Area C of Schedule 1 and Schedule 1A of the City’s ZBL. Minimum vehicle parking rates, accessible parking rates, bicycle parking rates, and loading space rates for the proposed development are identified in Sections 101, 111, and 113 of the ZBL, and the City’s *Accessibility Design Standards*. The results of this parking review are summarized in **Table 14**.

Table 14: Required and Proposed Parking

Land Use	Rate	Units	Required	Provided
<i>Minimum Vehicle Parking</i>				
Retail Store	3.4 spaces per 100 m ² GFA	1,642 m ²	56	69
<i>Minimum Accessible Parking</i>				
-	3 spaces required when 51 to 75 spaces are provided	69 spaces	3	4
<i>Minimum Bicycle Parking</i>				
Retail Store	1.0 spaces per 250 m ² GFA	1,642 m ²	7	8
<i>Minimum Loading Spaces</i>				
Retail Store	0 spaces required when total GFA is 1,000 to 1,999 m ²	1,642 m ²	0	2

Based on the previous table, the minimum parking/loading requirements will be met.

C:\temp\AcPublish_25944\118204-AT.dwg, Fig 15, Dec 22, 2022 - 11:25am, rhillier

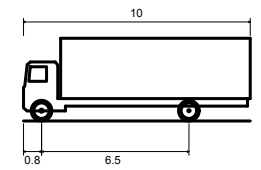
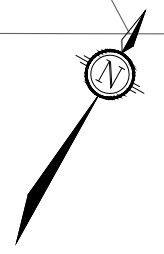
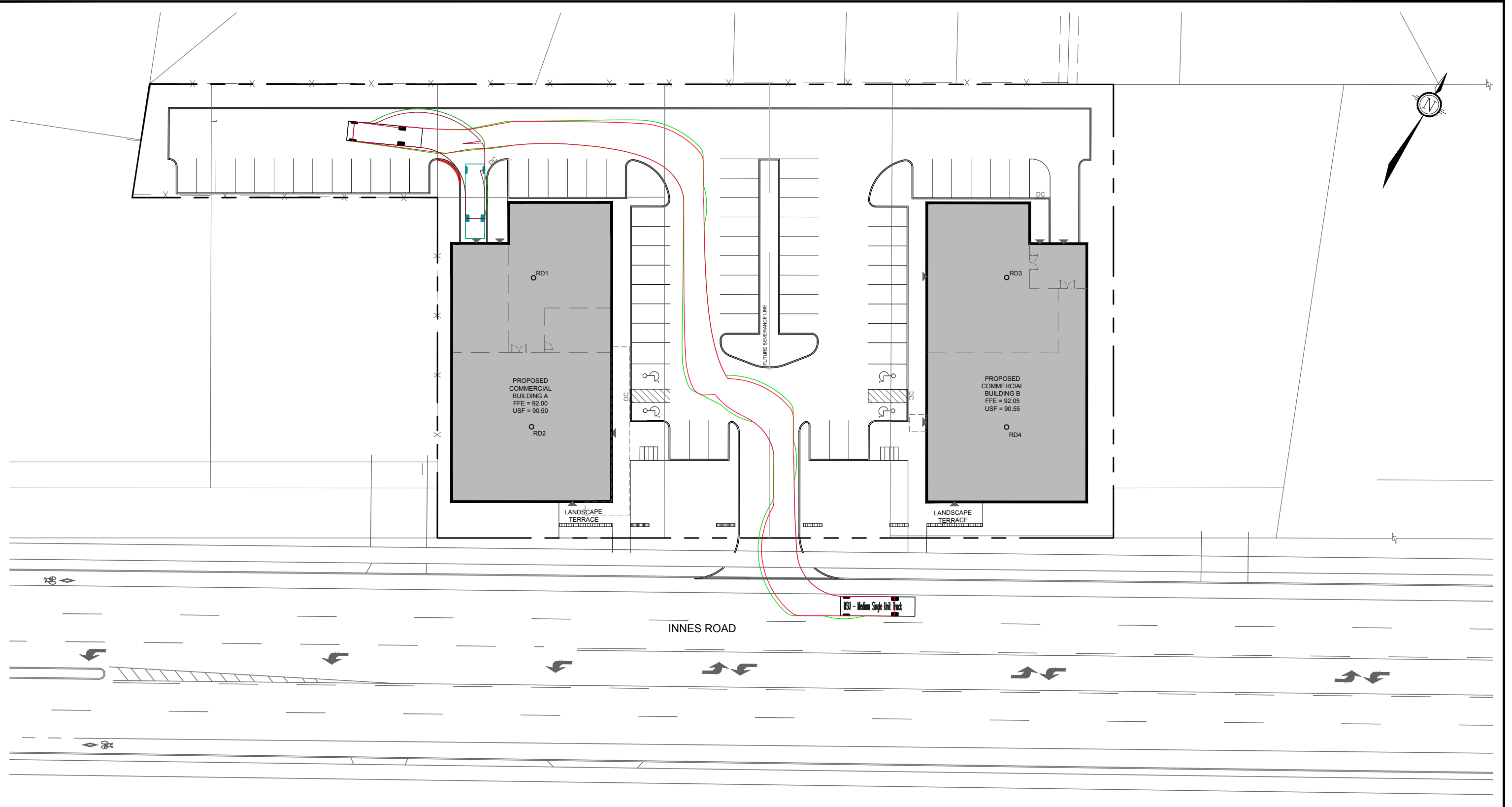

MSU - Medium Single Unit Truck

Overall Length	10.000m
Overall Width	2.600m
Overall Body Height	3.650m
Min Body Ground Clearance	0.445m
Track Width	2.600m
Lock-to-lock time	4.00s
Curb to Curb Turning Radius	11.100m



Engineers, Planners & Landscape Architects
Suite 200, 240 Michael Cowpland Drive
Ottawa, Ontario, Canada K2M 1P6

Telephone (613) 254-9643
Facsimile (613) 254-5867
Website www.novatech-eng.com

3493-3499 INNES

**MSU TURNING MOVEMENT
(INTO BUILDING A LOADING DOCK)**

SCALE 1 : 500

DATE NOV 2022 JOB 118204 FIGURE FIGURE 16

C:\temp\AcPublish_25944\118204-AT.dwg, Fig 16, Dec 22, 2022 - 11:25am, rhillier

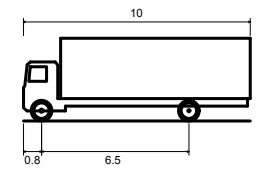
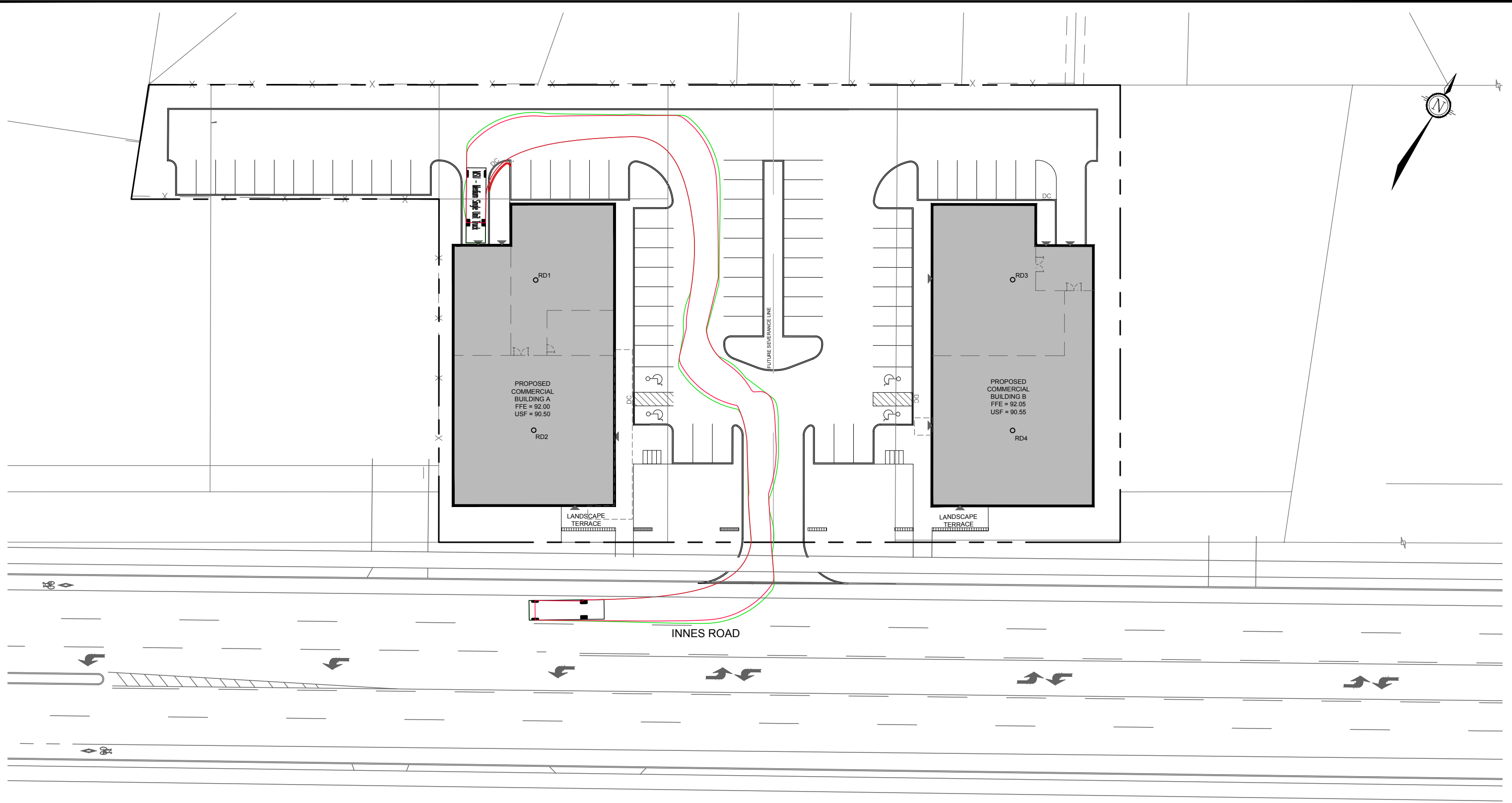

MSU - Medium Single Unit Truck
 Overall Length 10.000m
 Overall Width 2.600m
 Overall Body Height 3.650m
 Min Body Ground Clearance 0.445m
 Track Width 2.600m
 Lock-to-lock time 4.00s
 Curb to Curb Turning Radius 11.100m



Engineers, Planners & Landscape Architects
 Suite 200, 240 Michael Cowpland Drive
 Ottawa, Ontario, Canada K2M 1P6

Telephone (613) 254-9643
 Facsimile (613) 254-5867
 Website www.novatech-eng.com

3493-3499 INNES

MSU TURNING MOVEMENT (OUT OF BUILDING A LOADING DOCK)

SCALE 1 : 500
 0 5m 10m 20m

DATE NOV 2022 JOB 118204 FIGURE FIGURE 17

C:\temp\AcPublish_25944\118204-AT.dwg, Fig17, Dec 22, 2022 - 11:25am, rhillier

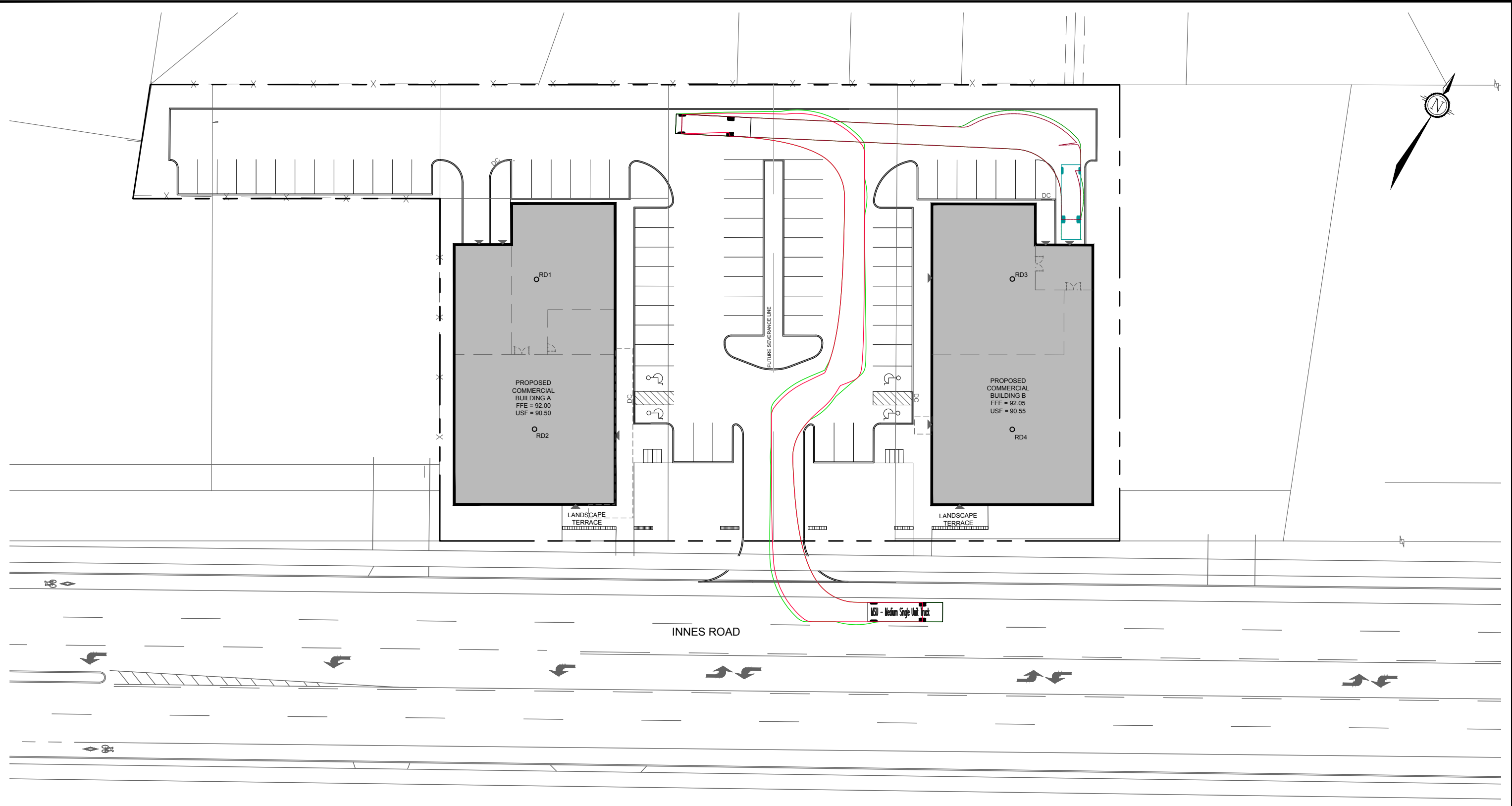

MSU - Medium Single Unit Truck

Overall Length	10.000m
Overall Width	2.600m
Overall Body Height	3.650m
Min Body Ground Clearance	0.445m
Track Width	2.600m
Lock-to-lock time	4.00s
Curb to Curb Turning Radius	11.100m

NOVATECH
 Engineers, Planners & Landscape Architects
 Suite 200, 240 Michael Cowpland Drive
 Ottawa, Ontario, Canada K2M 1P6

Telephone (613) 254-9643
 Facsimile (613) 254-5867
 Website www.novatech-eng.com

3493-3499 INNES

**MSU TURNING MOVEMENT
 (INTO BUILDING B LOADING DOCK)**

SCALE 1 : 500

DATE NOV 2022 JOB 118204 FIGURE FIGURE 18

C:\temp\AcPublish_25944\118204-AT.dwg, Fig 18, Dec 22, 2022 - 11:25am, rhillier

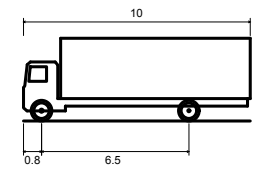
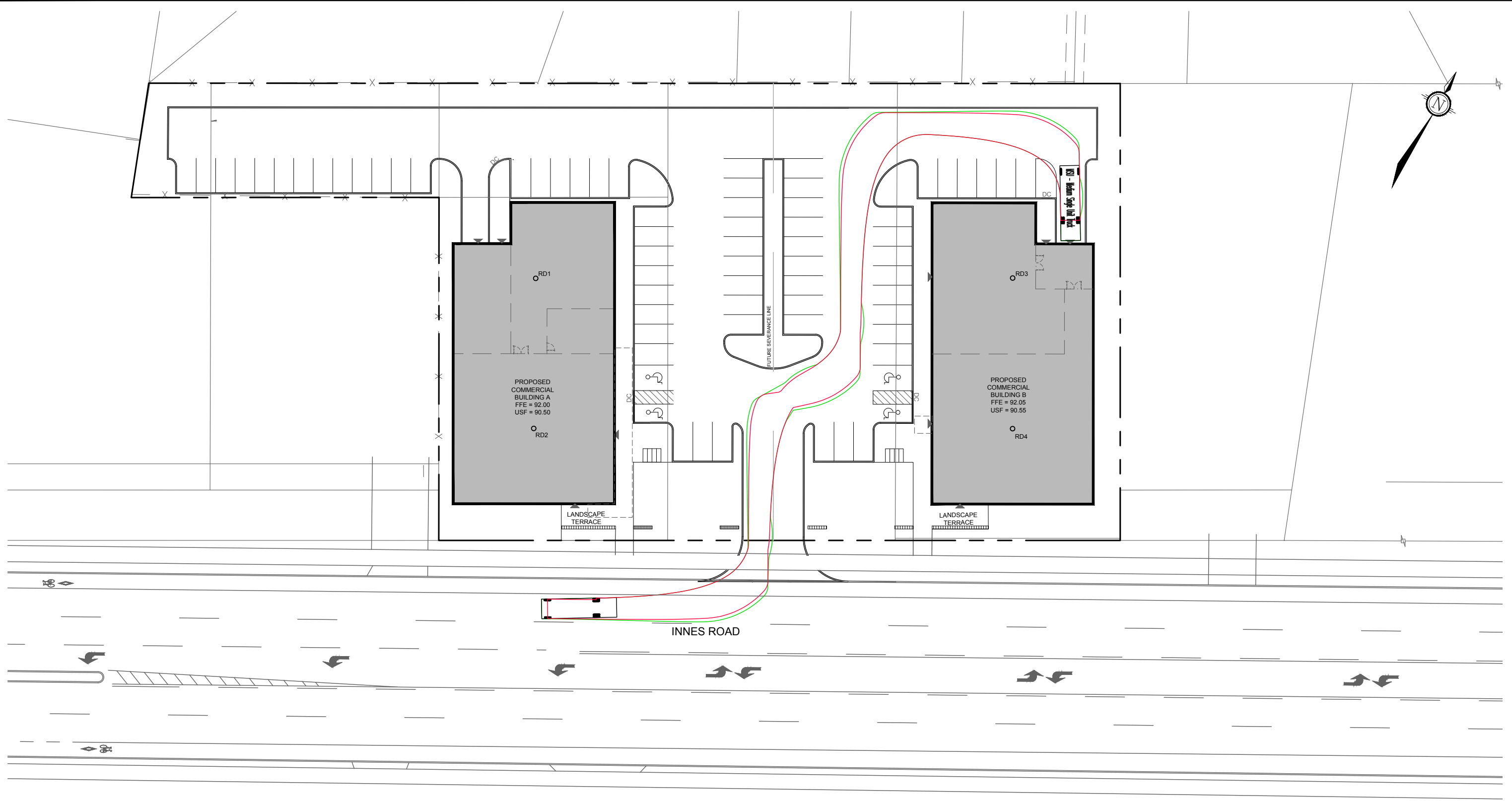

MSU - Medium Single Unit Truck

Overall Length	10.000m
Overall Width	2.600m
Overall Body Height	3.650m
Min Body Ground Clearance	0.445m
Track Width	2.600m
Lock-to-lock time	4.00s
Curb to Curb Turning Radius	11.100m



Engineers, Planners & Landscape Architects
 Suite 200, 240 Michael Cowpland Drive
 Ottawa, Ontario, Canada K2M 1P6

Telephone (613) 254-9643
 Facsimile (613) 254-5867
 Website www.novatech-eng.com

3493-3499 INNES

MSU TURNING MOVEMENT (OUT OF BUILDING B LOADING DOCK)

SCALE 1 : 500

DATE NOV 2022 JOB 118204 FIGURE FIGURE 19

4.3 Boundary Streets

This section provides a review of the boundary street Innes Road, using complete streets principles. The *MMLOS Guidelines*, produced by IBI Group in October 2015, were used to evaluate the levels of service for each alternative mode of transportation, based on existing conditions. Innes Road has been evaluated based on the targets associated with an ‘Arterial Mainstreet’ (as Innes Road is designated as such on Schedule B of the City’s previous Official Plan, which is referenced by the *MMLOS Guidelines*).

A detailed segment MMLOS review of Innes Road is included in **Appendix L**. A summary of the segment MMLOS analysis is provided below in **Table 15**.

Table 15: Segment MMLOS Summary

Segment	PLOS		BLOS		TLOS		TkLOS	
	Actual	Target	Actual	Target	Actual	Target	Actual	Target
Innes Road	E	C	E	B	D	D	A	D

Innes Road does not meet the target pedestrian level of service (PLOS) or bicycle level of service (BLOS).

Both sides of Innes Road currently include a 2.0m sidewalk with a boulevard width of approximately 1.5m. Per Exhibit 4 of the *MMLOS Guidelines*, the target PLOS C cannot be achieved on this segment on Innes Road without reducing the operating speed. The best-possible PLOS D can be achieved by maintaining the current sidewalk width of 2.0m and increasing the boulevard width to a minimum width of 2.0m. This is identified for the City’s consideration.

Both directions of Innes Road currently include curbside bike lanes with an approximate width of 2.0m. Based on Exhibit 11 of the *MMLOS Guidelines*, a physically separated bikeway (such as cycle tracks or multi-use pathways) are required to achieve the target BLOS B for Innes Road, given the current operating speed. The *Ontario Traffic Manual (OTM) – Book 18* includes a desirable cycling facility pre-selection tool, based on the operating speed and AADT of a roadway. For roadways with an operating speed of 70 km/h and AADT volumes greater than 10,000 vehicles per day, OTM Book 18 identifies that separated facilities are appropriate. This is identified for the City’s consideration. The pre-selection tool is included in **Figure 20**.

4.4 Access Intersections

The proposed development includes one full-movement access to Innes Road, which will be restricted to RIRO with the construction of the planned Innes Road/Lamarche Avenue traffic signal and raised median. The access has been evaluated based on the relevant provisions of the City’s *Private Approach By-Law (PABL)* and the Transportation Association of Canada (TAC)’s *Geometric Design Guide for Canadian Roads*.

Section 25(a) of the PABL identifies that a maximum of two two-way private approaches can be provided for a site with 46m to 150m of frontage to a given roadway. Therefore, the single proposed access meets this requirement.

Section 25(c) of the PABL identifies a maximum width of 9m for any two-way private approach, as measured at the street line. The proposed access is approximately 8.3m at the future widened ROW for Innes Road. Therefore, this requirement is met.

Figure 20: Desirable Cycling Facility Pre-Selection Nomograph

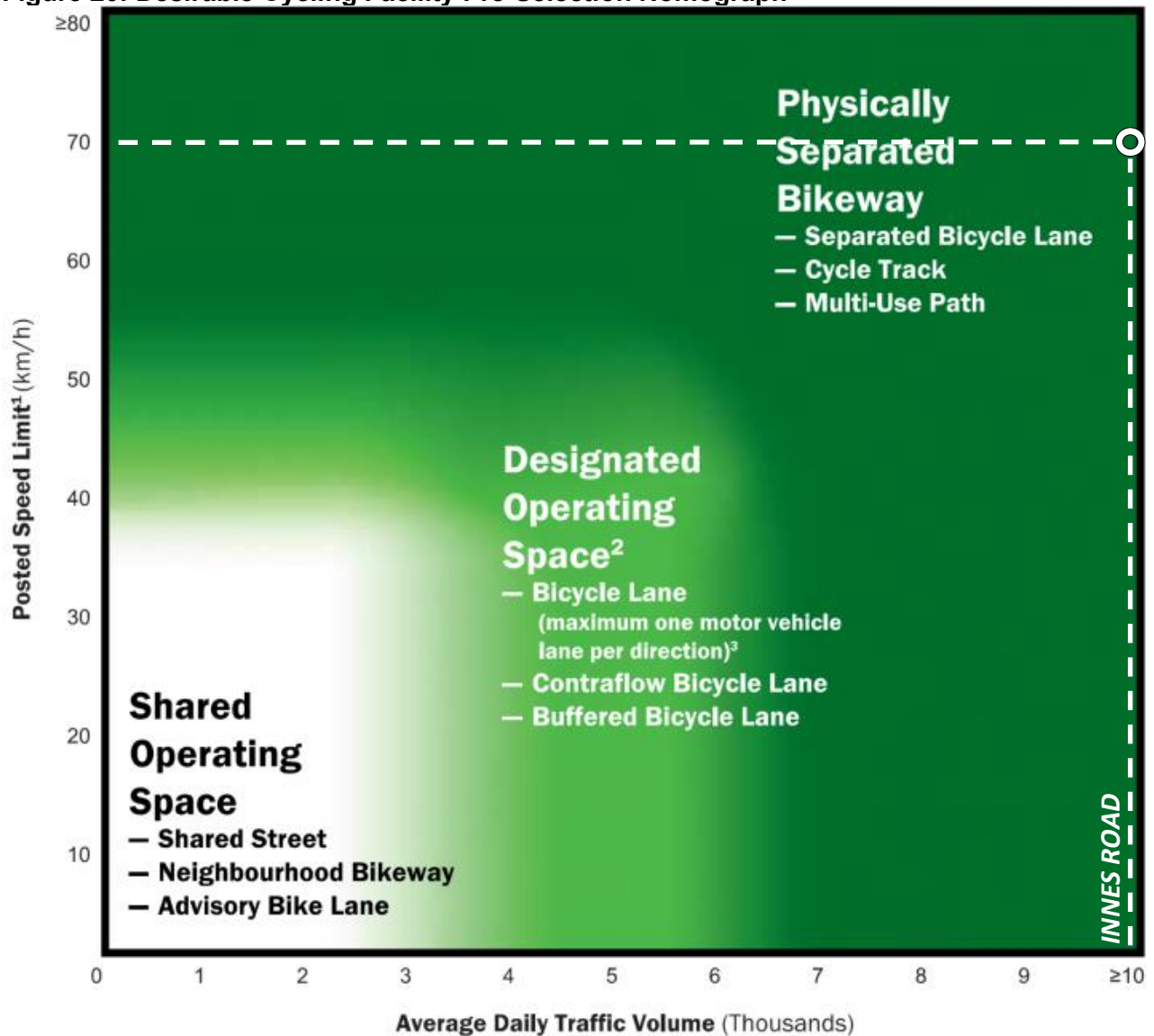

1. Operating speeds are assumed to be similar to posted speeds. If evidence suggests this is not the case, practitioners may consider using 85th percentile speeds or implementing measures to reduce operating speeds.
2. Physically separated bikeways may always be considered in the designated operating space area of the nomograph.
3. On roadways with two or more lanes per direction (including multi-lane one-way roadways), a buffered bicycle lane should be considered the minimum with a typical facility being a physically separated bikeway.

Section 25(m)(i) of the PABL identifies a minimum distance between the nearest edge of a private approach and the nearest intersecting street line, based on the land use and number of parking spaces proposed. Since the proposed development includes a parking lot for the use of customers of a retail or wholesale business, and the total number of parking spaces falls between 50 and 99, this section identifies a minimum distance of 30m between the private approach and the nearest intersecting street line. Since the proposed access is approximately 60m west of the Lamarche Avenue ROW and 135m east of the Pagé Road ROW, this requirement is met.

Section 25(p) of the PABL identifies a minimum distance of 3m between the nearest edge of a private approach and the property line. Since the proposed access is approximately 42m from the eastern property limit and approximately 40m from the western property limit, this requirement is met.

Section 25(u) of the PABL identifies a requirement that any private approach serving a parking area with more than 50 parking spaces shall not have a grade exceeding 2% for the first 9m inside the property line. The proposed access has a maximum grade of 2.8% for the first 9m (descending towards the roadway), which marginally exceeds the requirement. It is anticipated that drivers exiting the subject site will still have adequate sightlines to pedestrians walking along Innes Road. Therefore, it is requested that the requirement of Section 25(u) of the PABL be waived.

For commercial developments that are less than 25,000 m² in size, TAC's *Geometric Design Guide* identifies a minimum clear throat length requirement of 15m for any access to an arterial roadway. This requirement is met by the proposed access.

TAC's *Geometric Design Guide* also identifies a minimum corner clearance of 70m between a driveway and a signalized intersection, measuring from the nearest edge of a private approach and the nearest edge of the intersecting street. The western edge of the proposed access is approximately 140m from the nearest edge of Pagé Road, meeting this requirement. The eastern edge of the proposed access is approximately 68m from the nearest edge of Lamarche Avenue, which is marginally short of the requirement. Locating the proposed access within 70m of Lamarche Avenue can be justified, as the access will only be downstream of Lamarche Avenue and the proposed development is not anticipated to generate queues backing onto Innes Road at the access.

Based on the above, the proposed access meets the clear throat requirement outlined in TAC's *Geometric Design Guide* and all relevant provisions of the City's PABL, except for Section 25(u).

4.5 Transit

Based on the trip generation estimates presented in Section 3.1.1, the proposed development is projected to generate two transit trips during the AM peak hour and four transit trips during the PM peak hour. No capacity issues are anticipated for OC Routes 25, 131, or 231, based on transit trips generated by the proposed development.

4.6 Intersection Design

4.6.1 Intersection MMLOS Review

This section provides a review of the existing signalized study area intersections, using complete streets principles. The MMLOS targets associated with the ‘General Urban Area’ have been used to evaluate Innes Road/Orléans Boulevard, and the MMLOS targets associated with the ‘Arterial Mainstreet’ have been used to evaluate Innes Road/Pagé Road and Innes Road/473m East of Pagé Road. All intersections have been evaluated based on existing conditions.

The full intersection MMLOS analysis is included in **Appendix L**. A summary of the results is shown in **Table 15**.

Table 16: Intersection MMLOS Summary

Intersection	PLOS		BLOS		TLOS		TkLOS	
	Actual	Target	Actual	Target	Actual	Target	Actual	Target
Innes Road/Orléans Boulevard	F		F		F		A	
Innes Road/Pagé Road	F	C	F	B	C	D	E	D
Innes Road/473m East of Pagé Road	F		F		B		F	

The results of the intersection MMLOS analysis can be summarized as follows:

- No signalized intersections meet the target PLOS;
- No signalized intersections meet the target BLOS;
- Innes Road/Pagé Road and Innes Road/473m East of Pagé Road meet the target TLOS, while Innes Road/Orléans Boulevard does not;
- Innes Road/Orléans Boulevard meets the target TkLOS, while Innes Road/Pagé Road and Innes Road/473m East of Pagé Road does not.

Innes Road/Orléans Boulevard

This intersection does not meet the target PLOS C, BLOS B, or TLOS D.

All approaches have a divided cross-section with a width equivalent to ten lanes crossed or more (assuming a lane width equals 3.5m, per the *MMLOS Guidelines*). There is limited opportunity in improving any approach to the target PLOS C without reducing the number of travel lanes or restricting turning movements. All approaches meet the City’s vehicle/pedestrian conflict threshold for zebra-striped crosswalks (greater than 400,000 vehicle/pedestrian conflicts over an eight-hour period), and the east and west approaches have had zebra-striped crosswalks implemented. There is limited opportunity in improving the delay score for pedestrians crossing at the east and west approaches, without incurring major delays for vehicles.

All approaches do not achieve the target BLOS B, based on both left turn and right turn characteristics. To achieve this target, a protected intersection would be required, and would involve the removal of all right turn channels. This is identified for the City’s consideration.

All approaches do not achieve the target TLOS D. It is anticipated that transit delays will improve once the isolated transit priority measures described in Section 2.2.1 are implemented.

Innes Road/Pagé Road

This intersection does not meet the target PLOS C, BLOS B, or TkLOS D.

All approaches have a cross-section with a width equivalent to six lanes crossed or more. There is limited opportunity in improving any approach to the target PLOS C. The east and west approaches meet the City's vehicle/pedestrian conflict threshold for zebra-striped crosswalks, which could be considered to improve the level of comfort for pedestrians. There is limited opportunity in improving the delay score for pedestrians crossing at the east and west approaches, without incurring major delays for vehicles.

The east and west approaches do not achieve the target BLOS B, based on left turn characteristics. Per Exhibit 12 of the *MMLOS Guidelines*, two-stage left-turn bike boxes would be required to achieve the target, and would therefore require a restriction to right turns on red (RTOR) for northbound and southbound vehicles. It is recommended that if bike boxes are pursued, that they are implemented holistically along the Innes Road where applicable, rather than at only select intersections.

The east and west approaches do not achieve the target TkLOS D. Given that Pagé Road is primarily a residential street, and the volume of heavy vehicles turning onto Pagé Road is anticipated to be low, no modifications to the curb radii are recommended.

Innes Road/473m East of Pagé Road

This intersection does not meet the target PLOS C, BLOS B, or TkLOS D.

The south, east, and west approaches have a cross-section with a width equivalent to six lanes crossed or more. There is limited opportunity in improving these approaches to the target PLOS C. The north approach could be improved to the target PLOS C by reducing the width from an equivalent of four lanes crossed to three. No other modifications are identified.

The south, east, and west approaches do not achieve the target BLOS B, based on left turn characteristics. Per Exhibit 12 of the *MMLOS Guidelines*, two-stage left-turn bike boxes would be required to achieve the target, and would therefore require RTOR restrictions for northbound, southbound, and westbound vehicles. It is recommended that if bike boxes are pursued, that they are implemented holistically along the Innes Road where applicable, rather than at select intersections.

The east approach does not achieve the target TkLOS D. Given the layout and size of the commercial site at 3615 Innes Road, it is anticipated that large trucks do not enter and exit the site for loading and deliveries. Therefore, no modifications are recommended.

4.6.2 2025 Total Intersection Operations

Intersection capacity analysis has been conducted for the 2025 total traffic conditions. The optimized signal timings, phasing, and offsets as described in Section 3.4.2 has been assumed for this scenario.

The results of the analysis are summarized in **Table 17** and **Table 18** for the weekday AM and PM peak hours. Detailed Synchro reports are included in **Appendix M**.

Table 17: 2025 Total Traffic Operations

Intersection	AM Peak Hour			PM Peak Hour		
	Max v/c or Delay	LOS	Mvmt	Max v/c or Delay	LOS	Mvmt
Innes Road/Orléans Boulevard ⁽¹⁾	1.15	F	SBR	0.99	E	EBT
Innes Road/Pagé Road ⁽¹⁾	0.63	B	WBT/R	0.83	D	EBT/R
Innes Road/Lamarche Avenue ⁽¹⁾	0.57	A	WBT	0.64	B	EBT
Innes Road/473m East of Pagé Road ⁽¹⁾	0.56	A	NBL	0.71	C	EBT/R
Innes Road/Site Access ⁽²⁾	11 sec	B	SBR	11 sec	B	SBR

- 1. Signalized intersection
- 2. Unsignalized intersection

Table 18: 2025 Total Queues

Intersection	Mvmt	Storage/Spacing ⁽¹⁾	AM Peak			PM Peak		
			v/c [LOS]	50 th % Queue (m)	95 th % Queue (m)	v/c [LOS]	50 th % Queue (m)	95 th % Queue (m)
Innes Road/Orléans Boulevard	SBL	50m	0.41 [A]	17	32	0.90 [D]	46	#85
	SBR	60m	1.15 [F]	~103	#164	0.44 [A]	0	19
	EBL	140m	0.85 [D]	15	#32	0.88 [D]	70	#91
	EBT	820m	0.27 [A]	32	43	0.99 [E]	~234	#273
	WBT	450m	0.88 [D]	160	192	0.64 [B]	78	106

- 1: Indicates the storage length for auxiliary lanes or the spacing to the nearest upstream intersection/access for through lanes
- m: Volume for the 95th percentile queue is metered by an upstream signal
- #: Volume for the 95th percentile cycle exceeds capacity
- ~: Approach is above capacity

Compared to the 2025 background conditions, the addition of site-generated traffic is anticipated to have a marginal impact to peak hour traffic operations within the study area. The maximum westbound through queue lengths at Innes Road/Pagé Road are approximately 13m in the AM peak hour and 26m in the PM peak hour, and therefore do not extend upstream to the proposed site access.

4.6.3 2030 Total Intersection Operations

Intersection capacity analysis has been conducted for the 2030 total traffic conditions. The optimized signal timings, phasing, and offsets as described in Section 3.4.3 has been assumed for this scenario.

The results of the analysis are summarized in **Table 19** and **Table 20** for the weekday AM and PM peak hours. Detailed Synchro reports are included in **Appendix M**.

Table 19: 2030 Total Traffic Operations

Intersection	AM Peak Hour			PM Peak Hour		
	Max v/c	LOS	Mvmt	Max v/c	LOS	Mvmt
Innes Road/ Orléans Boulevard ⁽¹⁾	1.20	F	SBR	1.09	F	EBT
	0.94	E	WBT	0.95	E	SBL
Innes Road/ Pagé Road ⁽¹⁾	0.68	B	WBT/R	0.89	D	EBT/R
Innes Road/ Lamarche Avenue ⁽¹⁾	0.74	C	NBL	0.85	D	EBT
Innes Road/ 473m East of Pagé Road ⁽¹⁾	0.60	A	WBT/R	0.76	C	EBT/R
Innes Road/ Site Access ⁽²⁾	11 sec	B	SBR	11 sec	B	SBR

- 1. Signalized intersection
- 2. Unsignalized intersection

Table 20: 2030 Total Queues

Intersection	Mvmt	Storage/ Spacing ⁽¹⁾	AM Peak			PM Peak		
			v/c [LOS]	50 th % Queue (m)	95 th % Queue (m)	v/c [LOS]	50 th % Queue (m)	95 th % Queue (m)
Innes Road/ Orléans Boulevard	SBL	50m	0.49 [A]	21	38	0.95 [E]	53	#99
	SBR	60m	1.20 [F]	~115	#176	0.44 [A]	0	19
	EBL	140m	0.89 [D]	16	#34	0.90 [D]	74	#101
	EBT	820m	0.31 [A]	38	50	1.09 [F]	~267	#306
	WBT	450m	0.94 [E]	183	#234	0.74 [C]	85	114
Innes Road/ Pagé Road	EBT	450m	0.28 [A]	14	40	0.89 [D]	35	m33
	WBL	100m	0.08 [A]	1	m1	0.68 [B]	8	m#39
Innes Road/ Lamarche Avenue	EBT	210m	0.24 [A]	12	21	0.85 [D]	39	#241
	WBL	120m max	0.34 [A]	5	21	0.78 [C]	27	#75
Innes Road/473m East of Pagé Road	EBT	210m	0.27 [A]	8	16	0.76 [C]	16	30
	WBL	40m	0.02 [A]	1	3	0.68 [B]	6	#39

- 1: Indicates the storage length for auxiliary lanes or the spacing to the nearest upstream intersection/access for through lanes
- m: Volume for the 95th percentile queue is metered by an upstream signal
- #: Volume for the 95th percentile cycle exceeds capacity
- ~: Approach is above capacity

Compared to the 2030 background conditions, the addition of site-generated traffic is anticipated to have a marginal impact to peak hour traffic operations within the study area. The maximum westbound through queue lengths at Innes Road/Pagé Road are approximately 13m in the AM peak hour and 27m in the PM peak hour, and therefore do not extend upstream to the proposed site access. The maximum eastbound through queue length at Innes Road/Lamarche Avenue is approximately 241m, and therefore extends upstream through the Innes Road/Pagé Road intersection during the PM peak hour.

5.0 CONCLUSIONS AND RECOMMENDATIONS

Based on the foregoing, the conclusions and recommendations of this TIA can be summarized as follows:

Roadway Modifications to Innes Road/Lamarche Avenue

- Signalization of the Innes Road/Lamarche Avenue intersection is anticipated to be in place by the buildout year 2025, per discussions with City staff. The functional design of the roadway modifications at Innes Road/Lamarche Avenue includes auxiliary eastbound right turn, westbound left turn, northbound left turn, and northbound right turn lanes.
- Based on the functional design, a raised median will also be constructed on Innes Road between Pagé Road and Lamarche Avenue, and it is this modification that will restrict the proposed access to RIRO in the future. To accommodate accesses on the north side of Innes Road between Pagé Road and Lamarche Avenue, an eastbound U-turn lane at the new signal should be included as part of the roadway modifications at Innes Road/Lamarche Avenue.

Forecasting

- The proposed development is estimated to generate 31 person trips (including 23 vehicle trips) during the AM peak hour, and 80 person trips (including 60 vehicle trips) during the PM peak hour.

Development Design and Parking

- Pedestrian walkways will connect the front of each proposed building to the existing sidewalk on the north side of Innes Road. These pathways will be approximately 2.5m in width.
- Four bicycle parking spaces are proposed adjacent to the accessible parking spaces in front of each proposed building, for a total of eight bicycle parking spaces on-site.
- OC Transpo's service design guidelines for peak period service is to provide service within a five-minute (400m) walk of home, work, or school, for 95% of urban residents. The main entrances to each proposed building will be within 400m of stops on Innes Road that are served by OC Route 25.
- Any required Transportation Demand Management-supportive design and infrastructure measures in the TDM checklist for non-residential developments have been met.
- Garbage collection will take place in the loading zones at the back of each proposed building (i.e. at the northern end of the subject site). The fire route for the subject site will be located along Innes Road.
- The minimum parking and loading requirements of the City's *Zoning By-Law* will be met.

Boundary Streets

- Innes Road does not meet the target pedestrian level of service (PLOS) or bicycle level of service (BLOS), and meets the target transit level of service (TLOS) and truck level of service (TkLOS).

- Both sides of Innes Road currently include a 2.0m sidewalk with a boulevard width of approximately 1.5m. The best-possible PLOS D can be achieved by maintaining the current sidewalk width of 2.0m and increasing the boulevard width to a minimum width of 2.0m. This is identified for the City's consideration.
- Both directions of Innes Road currently include curbside bike lanes with an approximate width of 2.0m. For roadways with an operating speed of 70 km/h and AADT volumes greater than 10,000 vehicles per day, the *Ontario Traffic Manual (OTM) – Book 18* identifies that separated facilities are appropriate. This is identified for the City's consideration.

Access Design

- The proposed access meets all relevant provisions of the City's *Private Approach By-Law (PABL)* except for Section 25(u). A waiver to Section 25(u) of the PABL is requested.
- TAC's *Geometric Design Guide* identifies a minimum corner clearance of 70m between a driveway and a signalized intersection, measuring from the nearest edge of a private approach and the nearest edge of the intersecting street. The western edge of the proposed access is approximately 140m from the nearest edge of Pagé Road, meeting this requirement. The eastern edge of the proposed access is approximately 68m from the nearest edge of Lamarche Avenue, which is marginally short of the requirement. Locating the proposed access within 70m of Lamarche Avenue can be justified, as the access will only be downstream of Lamarche Avenue, and the proposed development is not anticipated to generate queues backing onto Innes Road at the access.

Transit

- The proposed development is projected to generate two transit trips during the AM peak hour and four transit trips during the PM peak hour. No capacity issues are anticipated for OC Routes 25, 131, or 231, based on transit trips generated by the proposed development.

Intersection MMLOS

- The results of the intersection MMLOS analysis can be summarized as follows:
 - No signalized intersections meet the target PLOS;
 - No signalized intersections meet the target BLOS;
 - Innes Road/Pagé Road and Innes Road/473m East of Pagé Road meet the target TLOS, while Innes Road/Orléans Boulevard does not;
 - Innes Road/Orléans Boulevard meets the target TkLOS, while Innes Road/Pagé Road and Innes Road/473m East of Pagé Road do not.
- For any approaches that do not meet the target PLOS, there is limited opportunity in improving any approach to the target without reducing the number of travel lanes or restricting turning movements. There is also limited opportunity in improving the delay score for pedestrians crossing Innes Road without incurring major delays for vehicles.
- All approaches of Innes Road/Orléans Boulevard do not achieve the target BLOS, based on both left turn and right turn characteristics. To achieve this target, a protected intersection would be required, and would involve the removal of all right turn channels. This is identified for the City's consideration.

- The east and west approaches at Innes Road/Pagé Road and the south, east, and west approaches at Innes Road/473m East of Pagé Road, do not meet the target BLOS based on left turn characteristics. Two-stage left-turn bike boxes would be required to achieve the target, and would therefore require restriction to right turns on red (RTOR). It is recommended that if bike boxes are pursued, that they are implemented holistically along the Innes Road where applicable, rather than at only select intersections.
- All approaches at Innes Road/Orléans Boulevard do not meet the target TLOS. It is anticipated that transit delays will improve once isolated transit priority measures are implemented on Innes Road.
- The east and west approaches at Innes Road/Pagé Road and the east approach at Innes Road/473m East of Pagé Road do not achieve the target TkLOS. No modifications to the curb radii are recommended, as Pagé Road is primarily a residential street with low truck volumes, and it is anticipated that large trucks do not enter and exit 3615 Innes Road for loading and deliveries, given the layout and size.

Existing Intersection Operations

- During the AM peak hour, the southbound right turn and eastbound left turn movements at Innes Road/Orléans Boulevard operate at a failing vehicular level of service. To meet the target, a reduction of approximately 140 southbound right turning vehicles and 10 eastbound left turning vehicles would be required. The average (50th-percentile) and maximum (95th-percentile) queue lengths of the southbound right turn movement at Innes Road/Orléans Boulevard exceed the storage length provided.
- During the PM peak hour, the eastbound through movement at Innes Road/Orléans Boulevard operate at a failing vehicular level of service. To meet the target, a reduction of approximately 100 eastbound through vehicles would be required. The maximum queue length of the southbound left turn movement at Innes Road/Orléans Boulevard exceeds the storage length provided.

Background Intersection Operations

- During the AM peak hour, the southbound right turn and westbound through movements at Innes Road/Orléans Boulevard operate at a failing vehicular level of service. To meet the target, a reduction of approximately 150 southbound right turning vehicles and 30 westbound through vehicles would be required. The average and maximum queue lengths of the southbound right turn movements exceed the storage length provided.
- During the PM peak hour, the southbound left turn and eastbound through movements at Innes Road/Orléans Boulevard, and the westbound left turn movements at Innes Road/Pagé Road and Innes Road/Lamarche Avenue operate at a failing vehicular level of service. To meet the target, a reduction of approximately 30 southbound right turning vehicles and 280 eastbound through vehicles at Innes Road/Orléans Boulevard would be required. The maximum queue length of the southbound left turn movement at Innes Road/Orléans Boulevard exceeds the storage length provided.

- To mitigate failing movements at Innes Road/Orléans Boulevard, seven seconds of green time for the northbound/southbound phases have been reallocated to the eastbound/westbound through phases in the AM peak hour. For the PM peak hour, the cycle length of all study area intersections has been increased from 110 to 130 seconds, with most or all of this additional green time added to the eastbound/westbound phases.
- To mitigate failing westbound left turn movements at Innes Road/Pagé Road and Innes Road/Lamarche Avenue in the PM peak hour, protected plus permitted left turn phasing is identified for the City’s consideration. It is understood that this type of phasing is typically implemented after the City reviews the actual performance of the intersections being studied.

Total Intersection Operations

- The addition of site-generated traffic is anticipated to have a marginal impact to peak hour traffic operations within the study area. During the peak hours, the maximum westbound through queue lengths at Innes Road/Pagé Road do not extend upstream to the proposed site access. The maximum eastbound through queue at Innes Road/Lamarche Avenue extends upstream through the Innes Road/Pagé Road intersection during the PM peak hour.

Based on the foregoing, the proposed development is recommended from a transportation perspective.

NOVATECH

Prepared by:

Reviewed by:

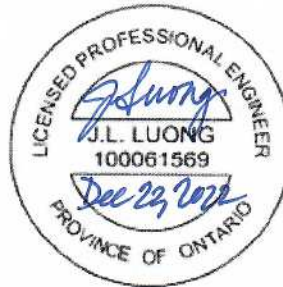

Joshua Audia, P.Eng.
Project Engineer | Transportation

Jennifer Luong, P.Eng.
Senior Project Manager | Transportation

APPENDIX A

Preliminary Site Plan

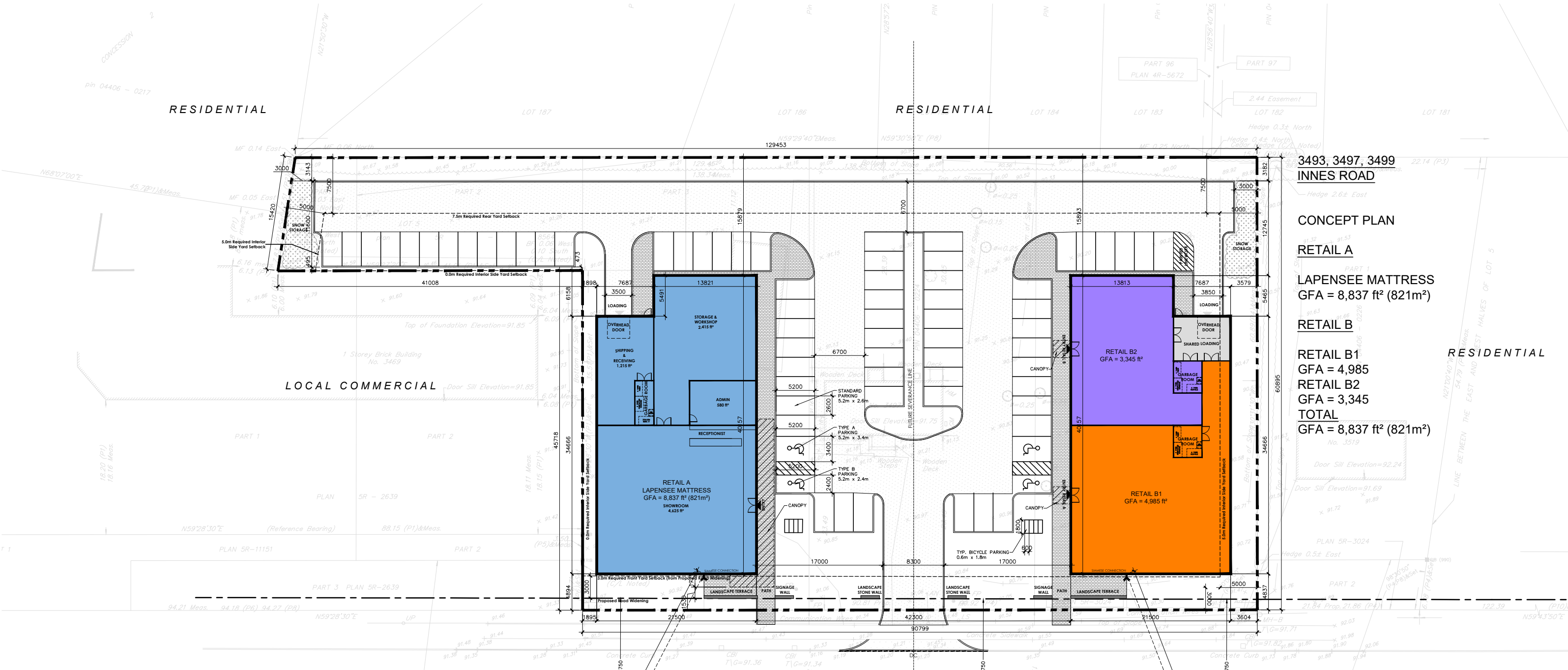

3493, 3497, 3499
INNES ROAD

CONCEPT PLAN

RETAIL A
 LAPENSEE MATTRESS
 GFA = 8,837 ft² (821m²)

RETAIL B
 RETAIL B1
 GFA = 4,985
 RETAIL B2
 GFA = 3,345
TOTAL
 GFA = 8,837 ft² (821m²)

Comprehensive Zoning By-law 2008-250		
LC Zone Provisions (Section 189)	Required	Provided
Minimum Lot Width (m)	No Minimum	90.8
Minimum Lot Area (m ²)	No Minimum	6136
Maximum Building Height (m)	12.5	6.5
Minimum Front Yard Setback (m)	3	3
Minimum Interior Side Yard Setback - Abutting Residential Zone (m) [East Lot Line]	5	3.5
Minimum Interior Side Yard Setback - Other Cases (m) [West Lot Line]	No Minimum	1.8
Minimum Rear Yard Setback (m)	7.5	15.8
Minimum Width of Landscaped Area - Abutting Street (m)	3	4.8
Minimum Width of Landscaped Area - Abutting Residential (m)	3	3
Parking Provisions (Sections 101, 110, 111 & 113)		
	Required	Provided
Minimum Bicycle Parking Rate - Retail Store [1 per 250m ² of GFA]	7 (1642m ² GFA)	8
Minimum Vehicle Parking Rate - Retail Store (Row N79) [3.4 per 100m ² of GFA]	56 (1642m ² GFA)	69
Minimum Loading Space Rate - Retail Store [1000-1999m ² GFA]	0 (1642m ² GFA)	2
Minimum Width of Landscaped Area Around Parking Lot - Abutting a Street (m)	3	10
Minimum Width of Landscaped Area Around Parking Lot - Not Abutting a Street (m)	1.5	0.4

I N N E S R O A D

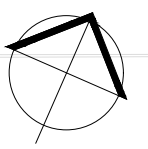

D00-00-00-000

DWG 123456



Lapensée Mattress

GROUND FLOOR

SCALE 1:500
 DEC 21, 2022

APPENDIX B

TIA Screening Form

City of Ottawa 2017 TIA Guidelines Screening Form

1. Description of Proposed Development

Municipal Address	3493, 3497 & 3499 Innes Road
Description of Location	Located on the north side of Innes Road, approximately 90m east of Pagé Road
Land Use Classification	Destination retail
Development Size (units)	-
Development Size (m ²)	1,642 m² (17,674 ft²) GFA
Number of Accesses and Locations	One proposed access to Innes Road
Phase of Development	2
Buildout Year	2023 (Phase 1); 2025 (Phase 2)

If available, **please attach a sketch of the development or site plan** to this form.

2. Trip Generation Trigger

Considering the Development's Land Use type and Size (as filled out in the previous section), please refer to the Trip Generation Trigger checks below.

Land Use Type	Minimum Development Size
Single-family homes	40 units
Townhomes or apartments	90 units
Office	3,500 m ²
Industrial	5,000 m ²
Fast-food restaurant or coffee shop	100 m ²
<i>Destination retail</i>	<i>1,000 m²</i>
Gas station or convenience market	75 m ²

** If the development has a land use type other than what is presented in the table above, estimates of person-trip generation may be made based on average trip generation characteristics represented in the current edition of the Institute of Transportation Engineers (ITE) Trip Generation Manual.*

If the proposed development size is greater than the sizes identified above, the Trip Generation Trigger is satisfied.

3. Location Triggers

	Yes	No
Does the development propose a new driveway to a boundary street that is designated as part of the City's Transit Priority, Rapid Transit or Spine Bicycle Networks?	✓	
Is the development in a Design Priority Area (DPA) or Transit-oriented Development (TOD) zone?*	✓	

*DPA and TOD are identified in the City of Ottawa Official Plan (DPA in Section 2.5.1 and Schedules A and B; TOD in Annex 6). See Chapter 4 for a list of City of Ottawa Planning and Engineering documents that support the completion of TIA).

If any of the above questions were answered with 'Yes,' the Location Trigger is satisfied.

4. Safety Triggers

	Yes	No
Are posted speed limits on a boundary street are 80 km/hr or greater?		✓
Are there any horizontal/vertical curvatures on a boundary street limiting sight lines at a proposed driveway?		✓
Is the proposed driveway within the area of influence of an adjacent traffic signal or roundabout (i.e. within 300 m of intersection in rural conditions, or within 150 m of intersection in urban/suburban conditions)?	✓	
Is the proposed driveway within auxiliary lanes of an intersection?		✓
Does the proposed driveway make use of an existing median break that serves an existing site?		✓
Is there is a documented history of traffic operations or safety concerns on the boundary streets within 500 m of the development?		✓
Does the development include a drive-thru facility?		✓

If any of the above questions were answered with 'Yes,' the Safety Trigger is satisfied.

5. Summary

	Yes	No
Does the development satisfy the Trip Generation Trigger?	✓	
Does the development satisfy the Location Trigger?	✓	
Does the development satisfy the Safety Trigger?	✓	

If none of the triggers are satisfied, the TIA Study is complete. If one or more of the triggers is satisfied, the TIA Study must continue into the next stage (Screening and Scoping).

APPENDIX C

OC Transpo Route Maps



25

MILLENNIUM

LA CITÉ BLAIR

Fréquent

7 days a week / 7 jours par semaine

All day service

Service toute la journée

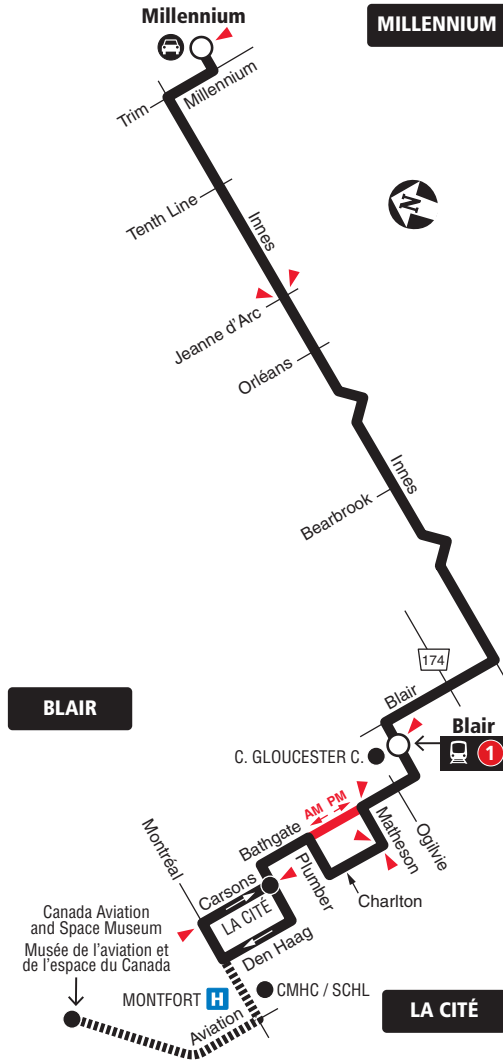

2020.07

 **Schedule / Horaire..... 613-560-1000**
Text / Texto 560560
plus your four digit bus stop number / plus votre numéro d'arrêt à quatre chiffres

Customer Service
 Service à la clientèle 613-741-4390
 Lost and Found / Objets perdus 613-563-4011
 Security / Sécurité 613-741-2478

Effective August 8, 2020
En vigueur 8 août 2020

 **INFO 613-741-4390**
 octranspo.com



131

FALLINGBROOK CHAPEL HILL

Local

7 days a week / 7 jours par semaine
All day service
Service toute la journée

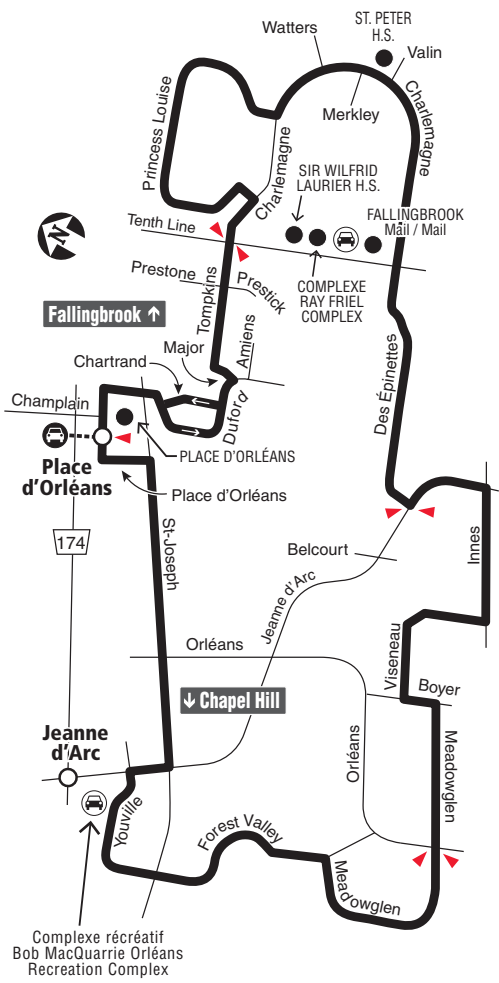

- Station
- Park & Ride / Parc-o-bus
- Timepoint / Heures de passage

2019.06

Schedule / Horaire..... 613-560-1000
Text / Texto560560
plus your four digit bus stop number / plus votre numéro d'arrêt à quatre chiffres

Customer Service
 Service à la clientèle 613-741-4390

Lost and Found / Objets perdus..... 613-563-4011

Security / Sécurité 613-741-2478

Effective September 2, 2018
En vigueur 2 septembre 2018



231

MEADOWGLEN BLAIR

Connexion

Monday to Friday / Lundi au vendredi

Peak periods only

Périodes de pointe seulement

AM
↑
BLAIR

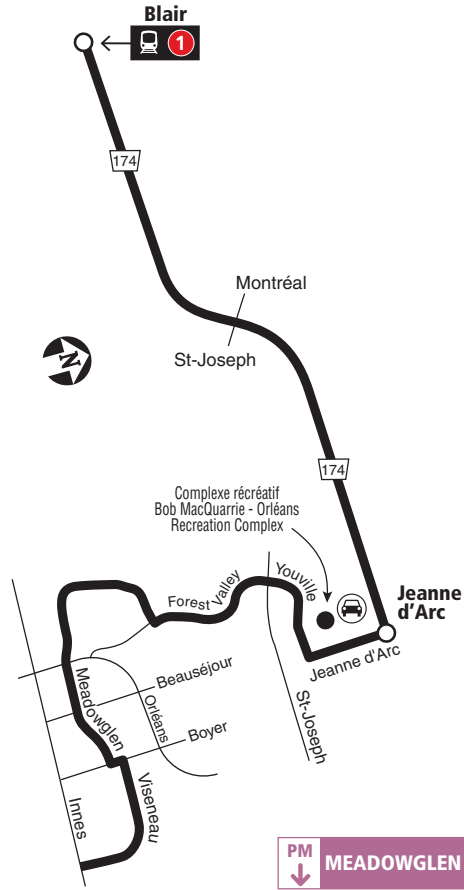

PM
↓
MEADOWGLEN

- Station
- Park & Ride / Parc-o-bus

2019.07



Future route after O-Train Line 1 is open
Trajet du circuit après l'ouverture
de la Ligne 1 de l'O-Train

Lost and Found / Objets perdus..... 613-563-4011

Security / Sécurité..... 613-741-2478



INFO 613-741-4390
octranspo.com

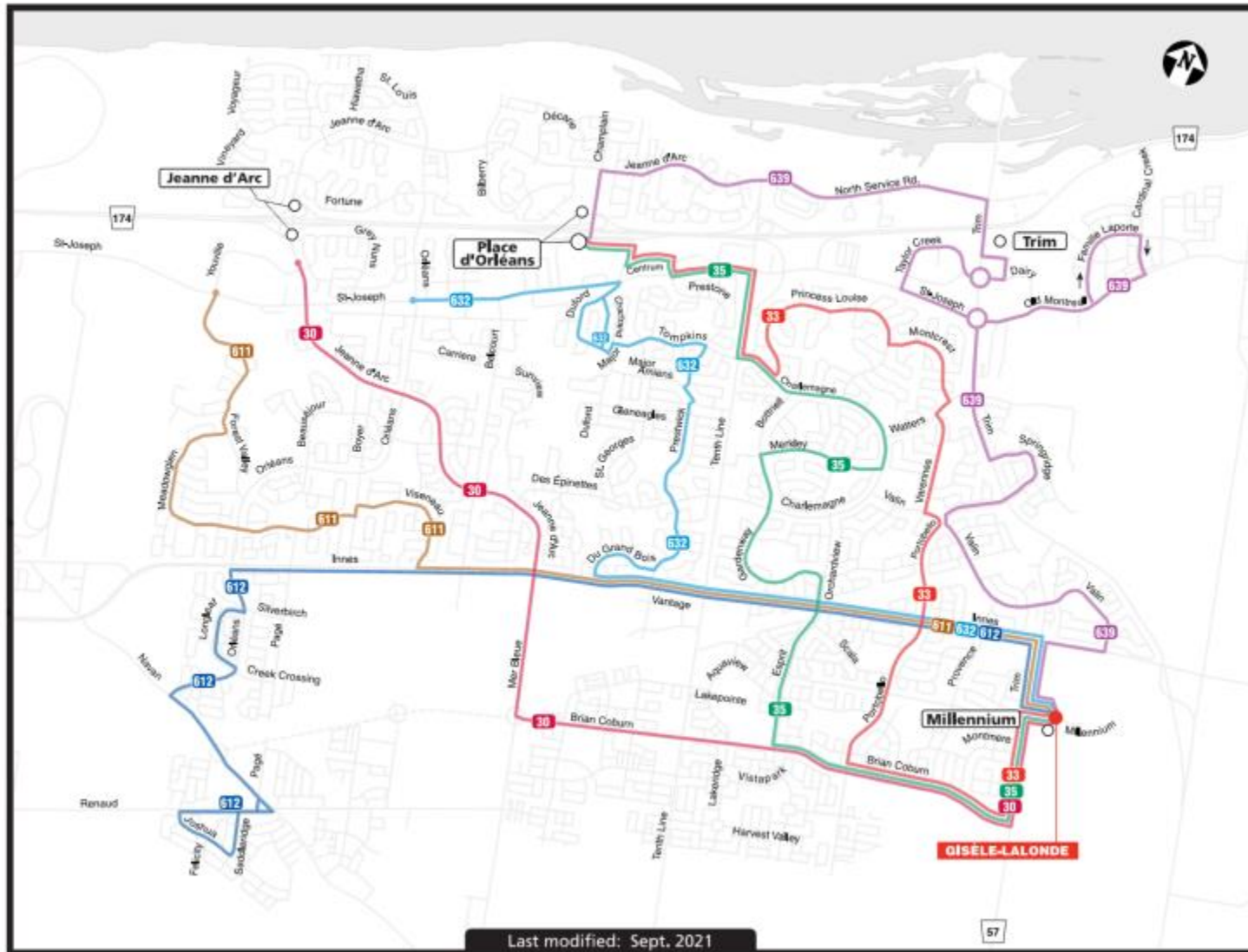

Last modified: Sept. 2021

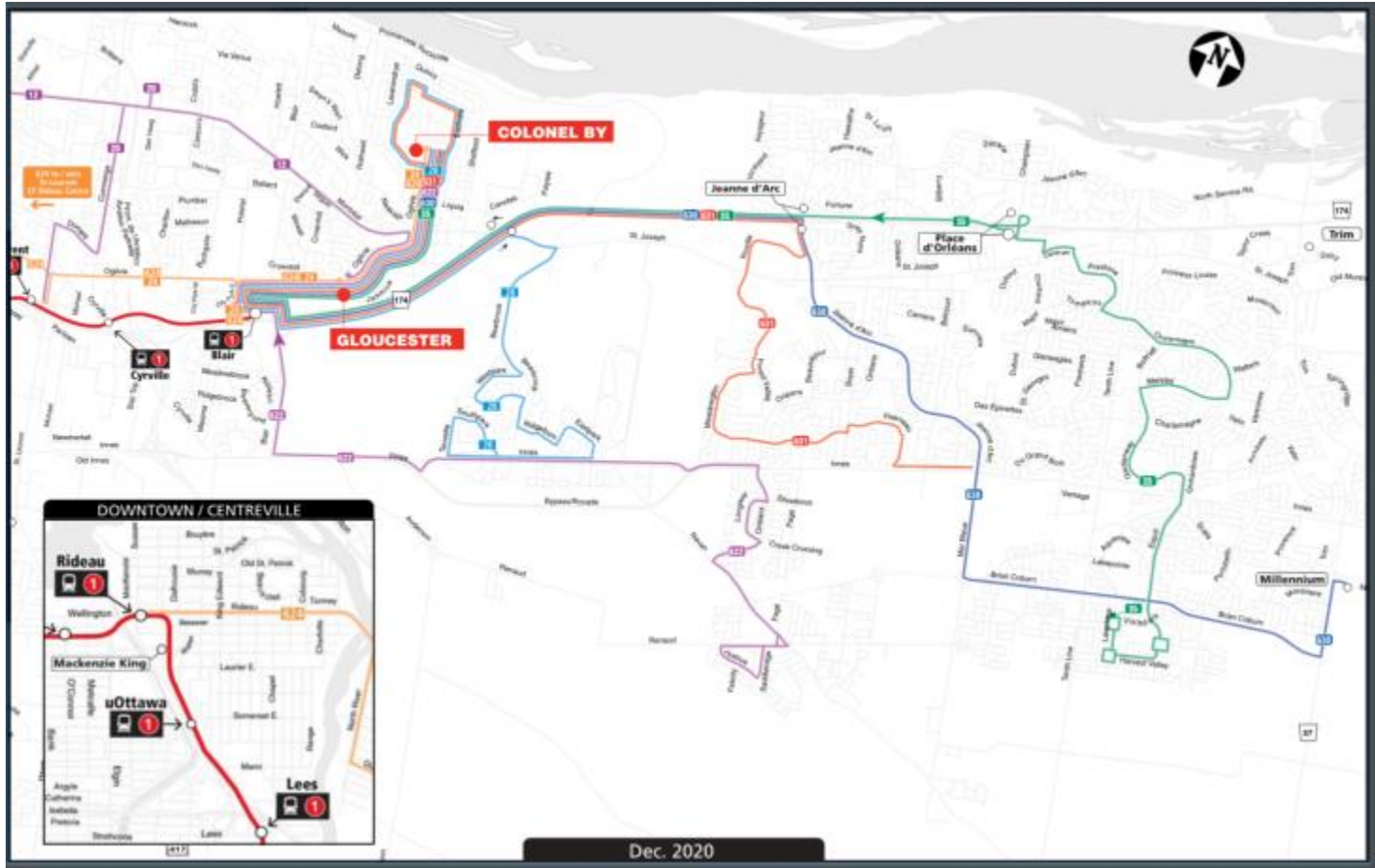

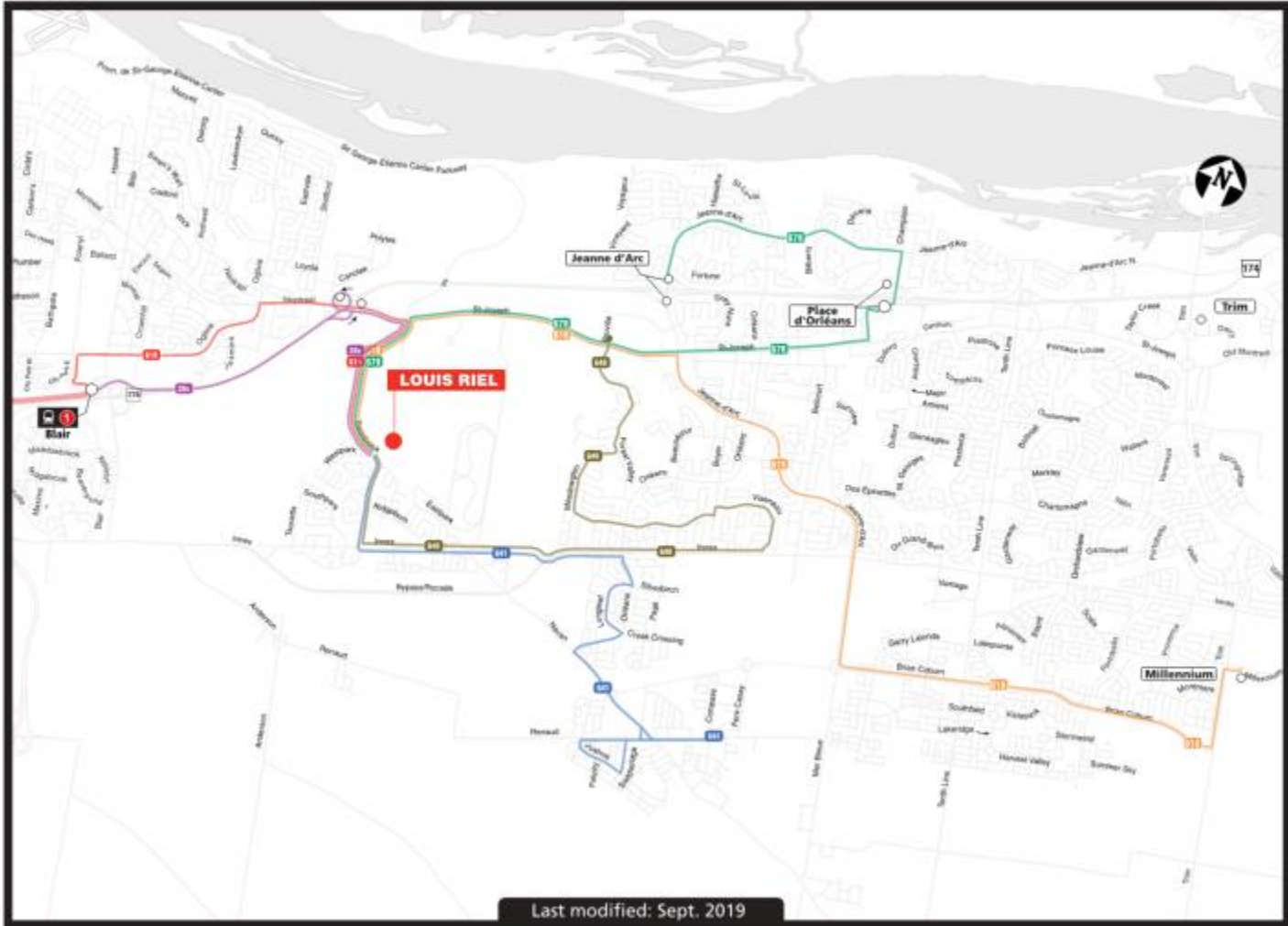

APPENDIX D

Traffic Count Data



Transportation Services - Traffic Services

Turning Movement Count - Peak Hour Diagram

INNES RD @ ORLEANS BLVD

Survey Date: Wednesday, May 03, 2017

Start Time: 07:00

WO No: 36978

Device: Miovision

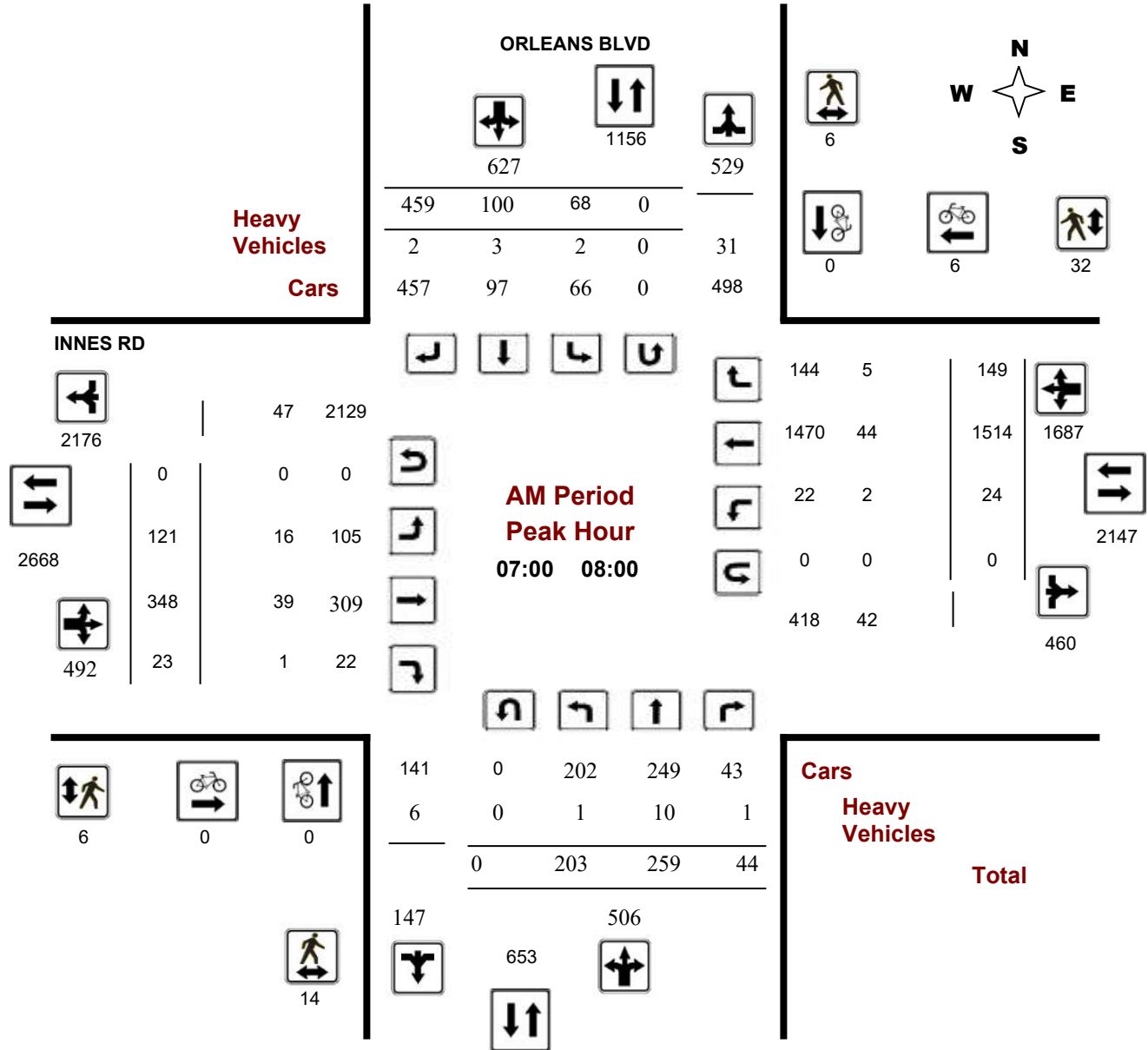



Transportation Services - Traffic Services

Turning Movement Count - Peak Hour Diagram

INNES RD @ ORLEANS BLVD

Survey Date: Wednesday, May 03, 2017

Start Time: 07:00

WO No: 36978

Device: Miovision

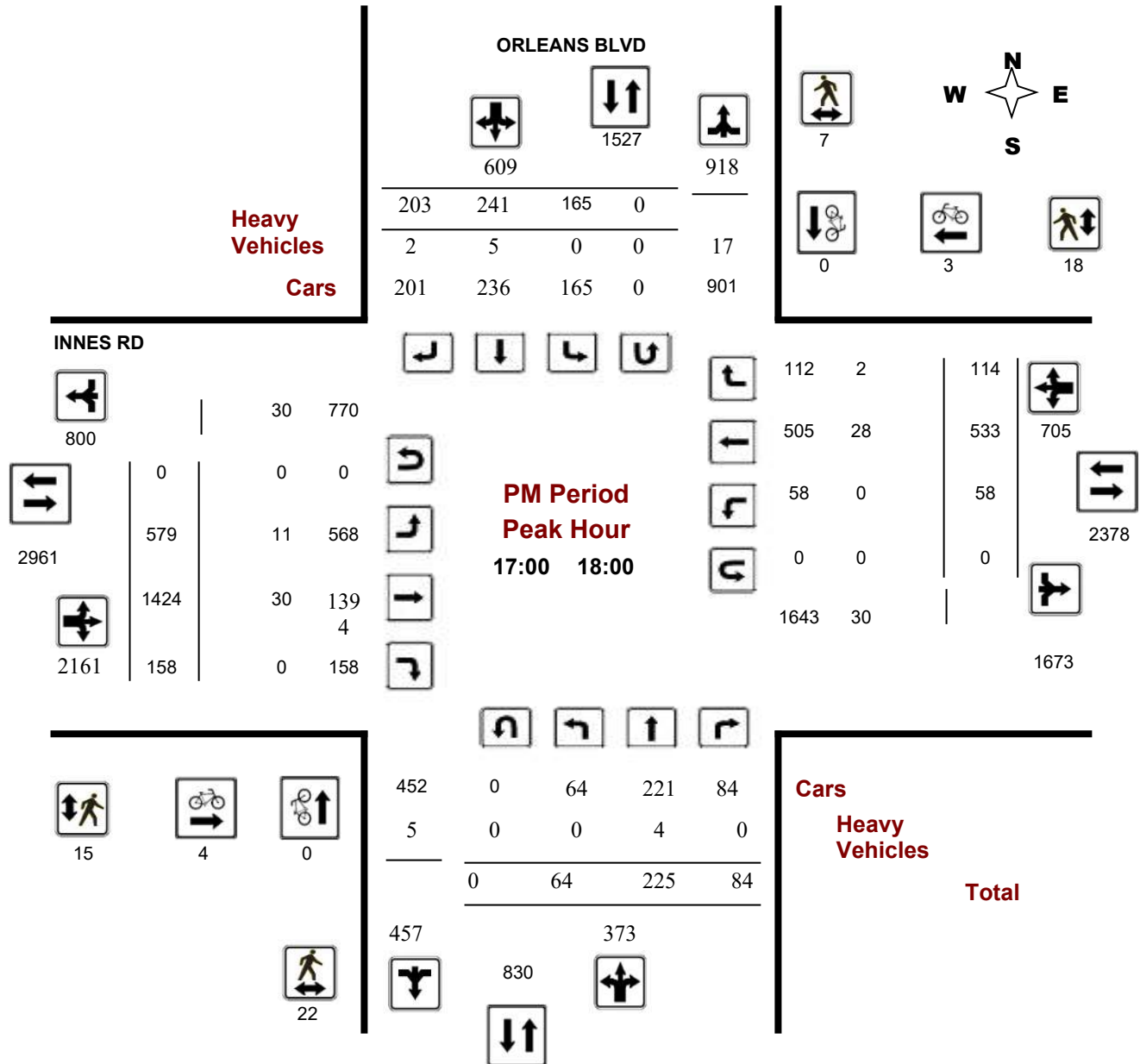

Turning Movement Count - Peak Hour Diagram

INNES RD @ PAGE RD

Survey Date: Tuesday, January 08, 2019

Start Time: 07:00

WO No: 38221

Device: Miovision

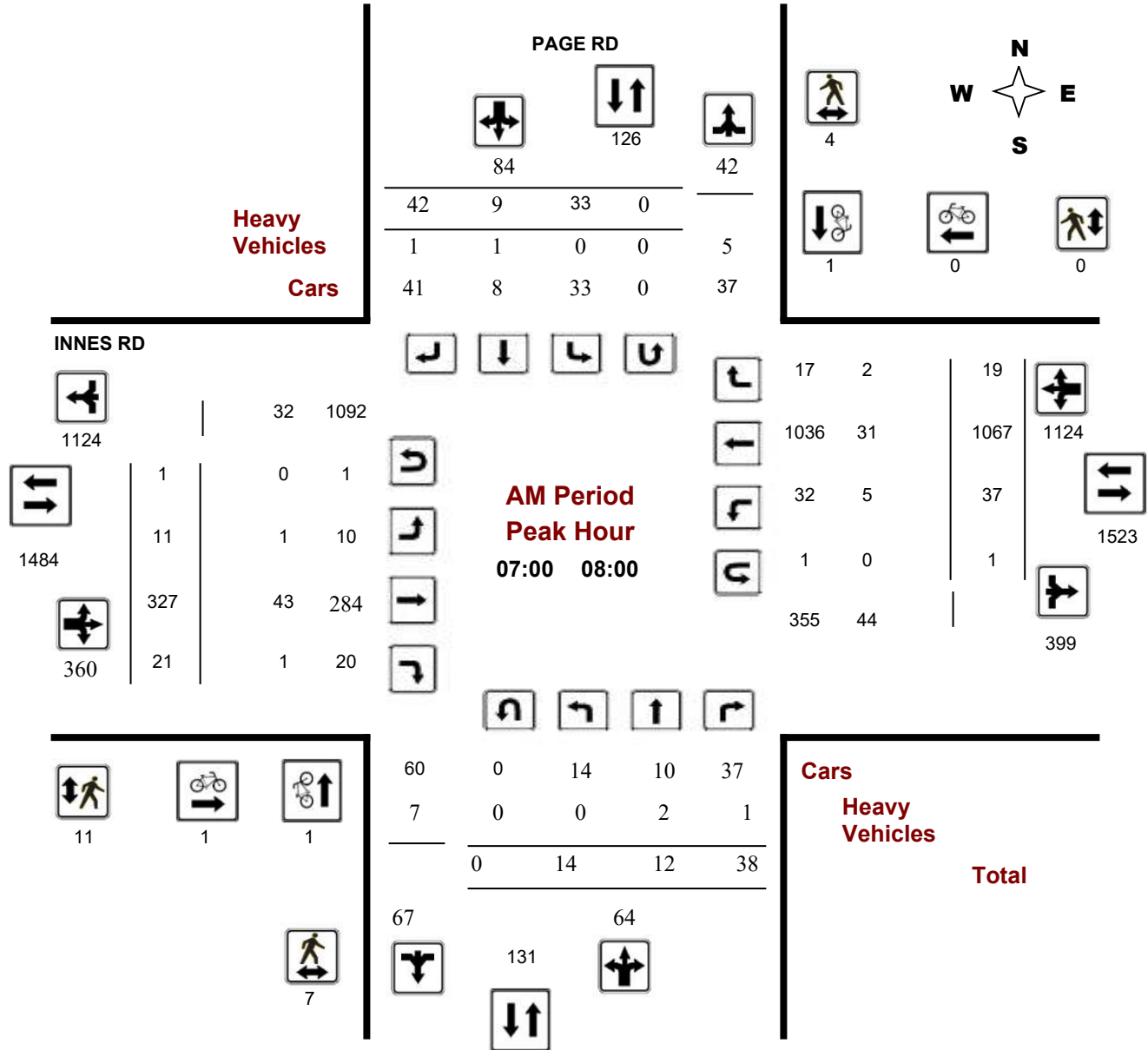

Comments



Transportation Services - Traffic Services

Turning Movement Count - Peak Hour Diagram

INNES RD @ PAGE RD

Survey Date: Tuesday, January 08, 2019

Start Time: 07:00

WO No: 38221

Device: Miovision

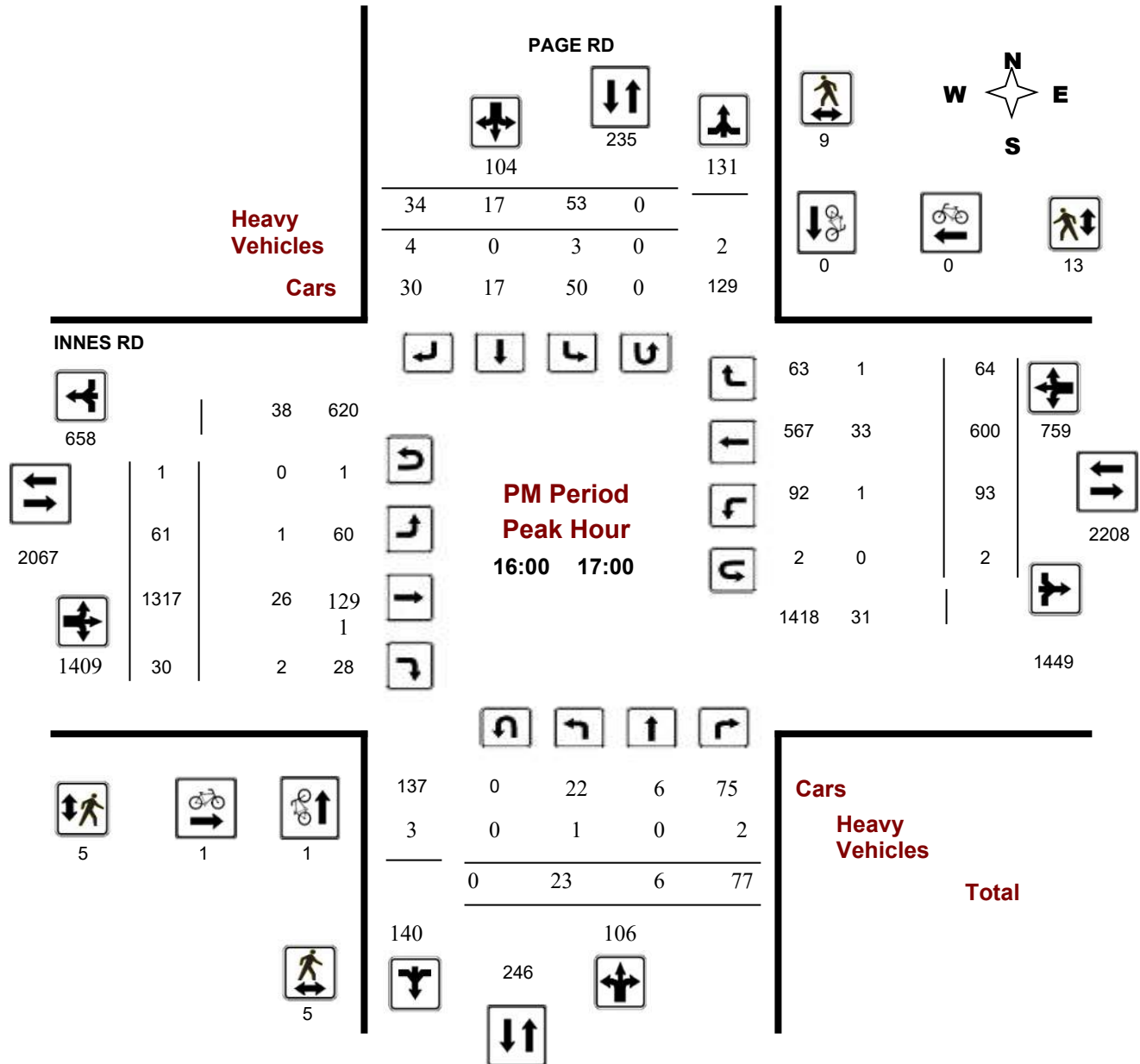



Turning Movement Count

Summary, AM and PM Peak Hour

Flow Diagrams

All Vehicles Except Bicycles



De Lamarche Avenue & Innes Road

Orléans, ON

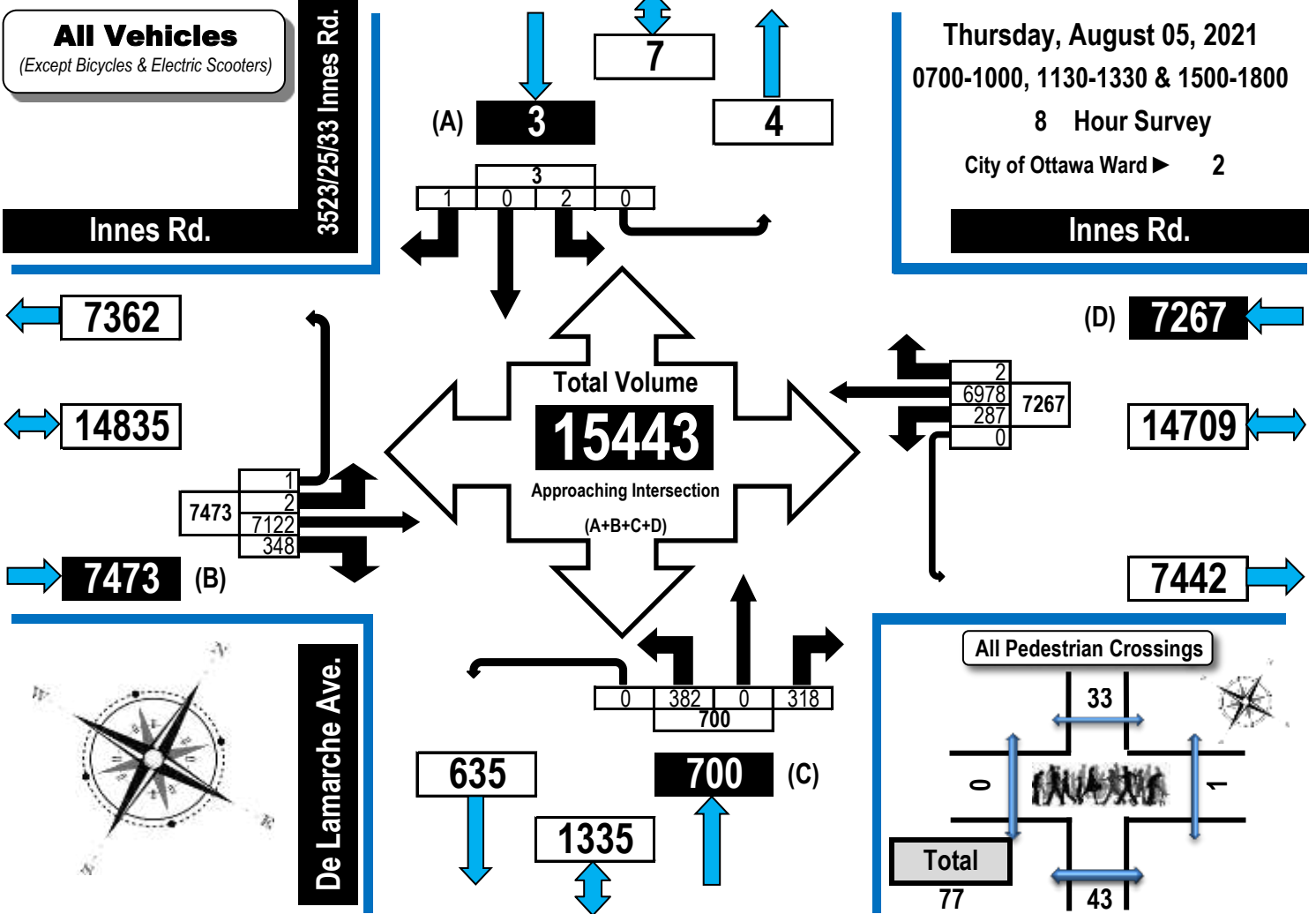

AM Peak Hour Flow Diagram

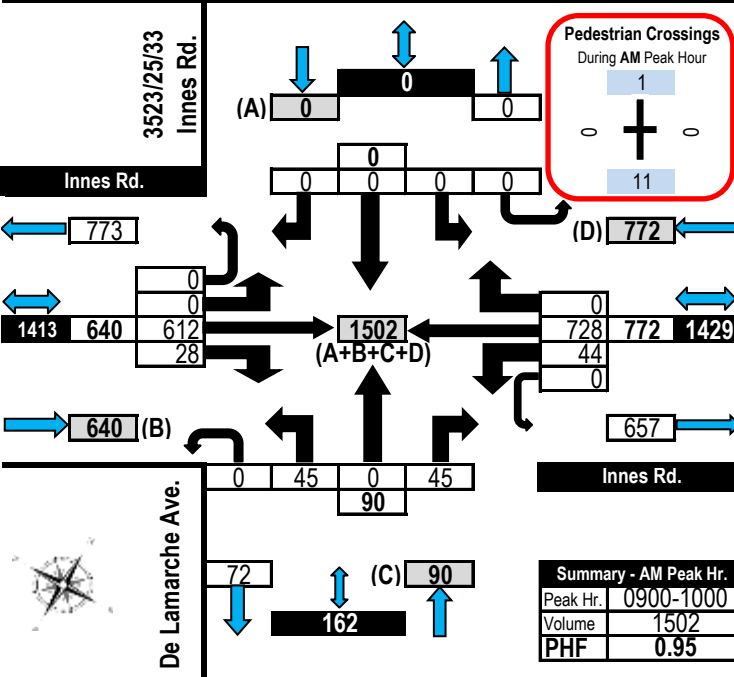

PM Peak Hour Flow Diagram

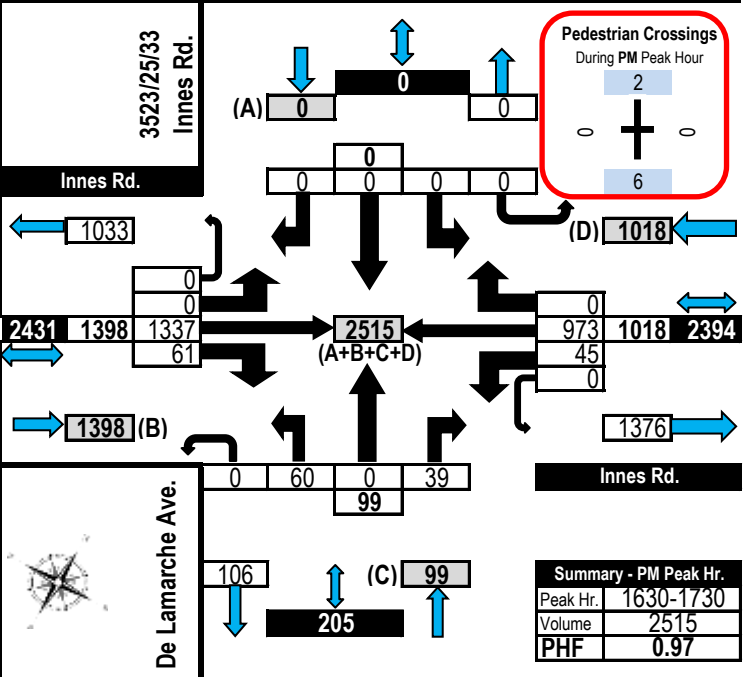

Turning Movement Count - Peak Hour Diagram

INNES RD @ 473 E OF PAGE RD/BUILDERS' WAREHOUSE

Survey Date: Thursday, January 31, 2019

Start Time: 07:00

WO No: 38223

Device: Miovision

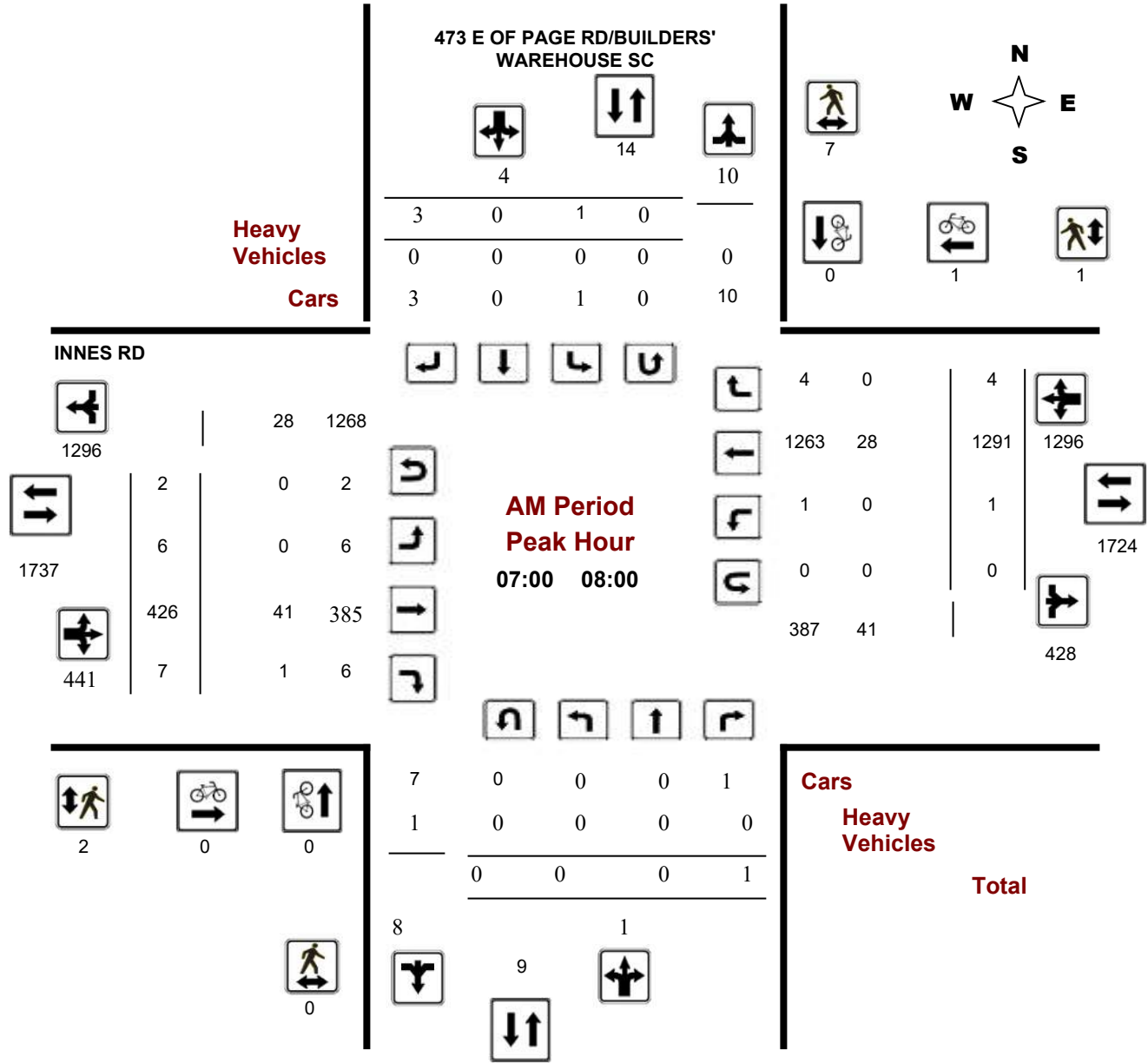

Turning Movement Count - Peak Hour Diagram

INNES RD @ 473 E OF PAGE RD/BUILDERS' WAREHOUSE

Survey Date: Thursday, January 31, 2019

Start Time: 07:00

WO No: 38223

Device: Miovision

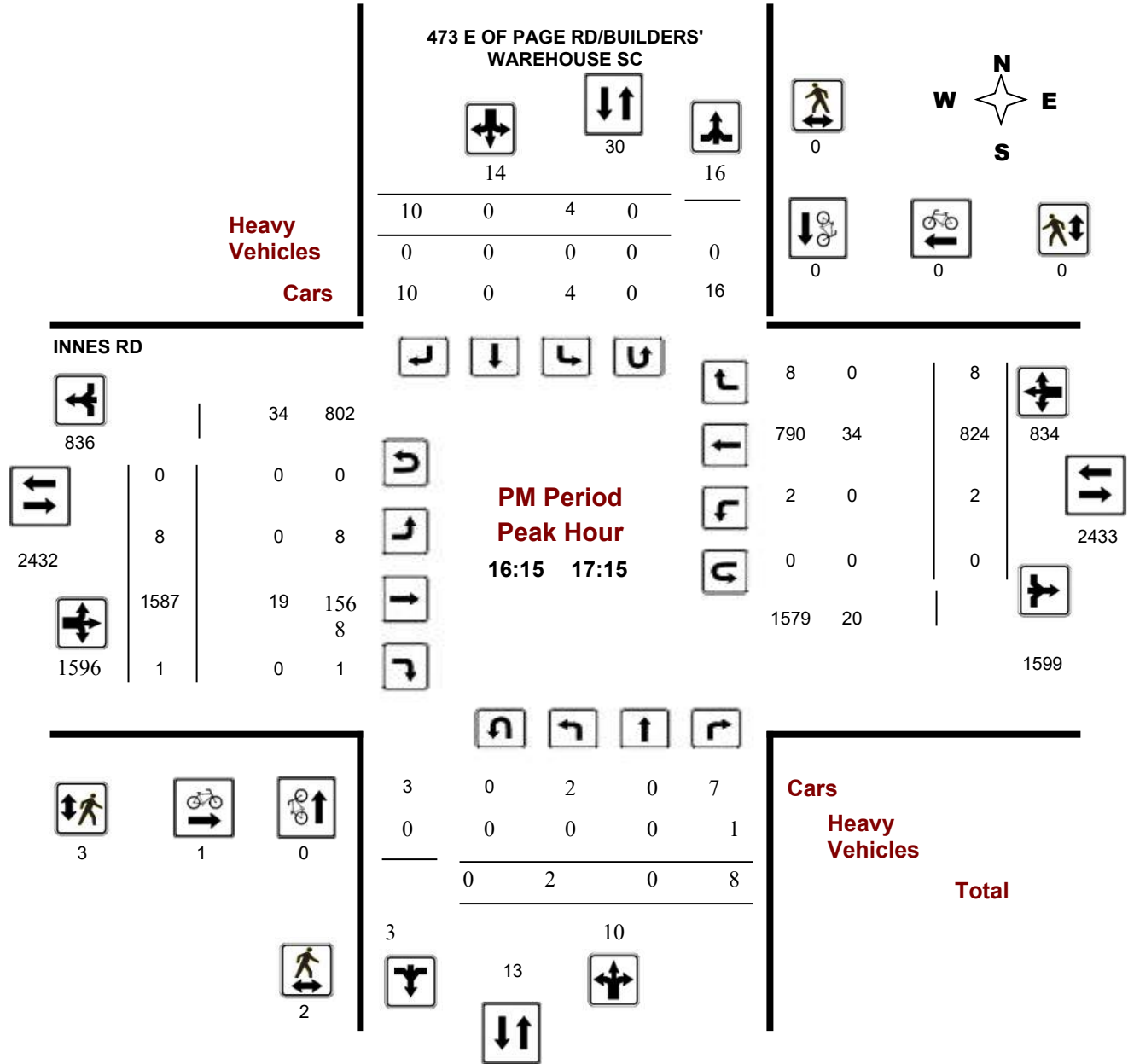

Comments

APPENDIX E

Collision Records



Transportation Services - Traffic Services

Collision Details Report - Public Version

From: January 1, 2015 To: December 31, 2019

Location: INNES RD @ 473 E OF PAGE RD/BUILDERS' WAREHOUS

Traffic Control: Traffic signal

Total Collisions: 5

Date/Day/Time	Environment	Impact Type	Classification	Surface Cond'n	Veh. Dir	Vehicle Manoeuvre	Vehicle type	First Event	No. Ped
2015-Jan-21, Wed,08:18	Rain	Rear end	P.D. only	Wet	West	Slowing or stopping	Pick-up truck	Other motor vehicle	0
					West	Stopped	Passenger van	Other motor vehicle	
2016-Jun-30, Thu,06:35	Clear	Rear end	Non-fatal injury	Dry	West	Slowing or stopping	Motorcycle	Other motor vehicle	0
					West	Going ahead	Automobile, station wagon	Other motor vehicle	
2017-Jul-05, Wed,15:30	Clear	Rear end	P.D. only	Dry	East	Going ahead	Automobile, station wagon	Other motor vehicle	0
					East	Slowing or stopping	Pick-up truck	Other motor vehicle	
2018-Jan-02, Tue,11:15	Snow	SMV other	P.D. only	Ice	East	Making "U" turn	Automobile, station wagon	Snowbank/drift	0
2018-May-28, Mon,12:27	Clear	Angle	P.D. only	Dry	North	Turning left	Pick-up truck	Other motor vehicle	0
					West	Turning left	Automobile, station wagon	Other motor vehicle	

Location: INNES RD @ ORLEANS BLVD

Traffic Control: Traffic signal

Total Collisions: 68

Date/Day/Time	Environment	Impact Type	Classification	Surface Cond'n	Veh. Dir	Vehicle Manoeuvre	Vehicle type	First Event	No. Ped
2015-Jan-06, Tue,08:51	Clear	Rear end	Non-fatal injury	Dry	West	Going ahead	Pick-up truck	Other motor vehicle	0
					West	Slowing or stopping	Automobile, station wagon	Other motor vehicle	
2015-Jan-27, Tue,11:59	Clear	Rear end	P.D. only	Dry	South	Slowing or stopping	Automobile, station wagon	Other motor vehicle	0
					South	Stopped	Automobile, station wagon	Other motor vehicle	
2015-Jan-31, Sat,14:30	Clear	Rear end	P.D. only	Dry	South	Turning right	Automobile, station wagon	Other motor vehicle	0
					South	Turning right	Automobile, station wagon	Other motor vehicle	
2015-May-03, Sun,17:07	Clear	Rear end	P.D. only	Dry	East	Slowing or stopping	Pick-up truck	Other motor vehicle	0
					East	Stopped	Automobile, station wagon	Other motor vehicle	
2015-May-22, Fri,16:27	Clear	Angle	P.D. only	Dry	South	Turning right	Automobile, station wagon	Other motor vehicle	0
					West	Going ahead	Municipal transit bus	Other motor vehicle	



Transportation Services - Traffic Services

Collision Details Report - Public Version

From: January 1, 2015 **To:** December 31, 2019

Location: INNES RD @ ORLEANS BLVD

Traffic Control: Traffic signal

Total Collisions: 68

Date/Day/Time	Environment	Impact Type	Classification	Surface Cond'n	Veh. Dir	Vehicle Manoeuver	Vehicle type	First Event	No. Ped
2015-Jul-09, Thu,17:10	Clear	Rear end	P.D. only	Dry	East	Going ahead	Automobile, station wagon	Other motor vehicle	0
					East	Stopped	Automobile, station wagon	Other motor vehicle	
2015-Jul-14, Tue,08:10	Clear	Rear end	Non-fatal injury	Dry	South	Turning right	Pick-up truck	Other motor vehicle	0
					South	Turning right	Automobile, station wagon	Other motor vehicle	
2015-Aug-27, Thu,18:04	Clear	SMV other	P.D. only	Dry	South	Turning right	Automobile, station wagon	Pole (sign, parking meter)	0
2015-Sep-01, Tue,11:55	Clear	Angle	P.D. only	Dry	South	Turning right	Automobile, station wagon	Other motor vehicle	0
					West	Going ahead	Municipal transit bus	Other motor vehicle	
2015-Oct-18, Sun,09:49	Clear	Angle	P.D. only	Dry	South	Turning right	Pick-up truck	Other motor vehicle	0
					West	Going ahead	Municipal transit bus	Other motor vehicle	
2015-Oct-21, Wed,15:45	Clear	Rear end	P.D. only	Dry	West	Slowing or stopping	Passenger van	Other motor vehicle	0
					West	Stopped	Pick-up truck	Other motor vehicle	
2015-Oct-28, Wed,13:51	Rain	Turning movement	P.D. only	Wet	South	Turning left	Automobile, station wagon	Other motor vehicle	0
					North	Going ahead	Automobile, station wagon	Other motor vehicle	
2016-Jan-19, Tue,18:45	Clear	Rear end	P.D. only	Dry	North	Unknown	Automobile, station wagon	Other motor vehicle	0
					North	Stopped	Pick-up truck	Other motor vehicle	
2016-Jan-25, Mon,18:40	Clear	Rear end	P.D. only	Dry	West	Unknown	Unknown	Other motor vehicle	0
					West	Stopped	Pick-up truck	Other motor vehicle	
2016-Feb-23, Tue,19:59	Clear	Rear end	Non-fatal injury	Packed snow	South	Slowing or stopping	Automobile, station wagon	Other motor vehicle	0
					South	Slowing or stopping	Passenger van	Other motor vehicle	
2016-Mar-12, Sat,21:07	Clear	Angle	P.D. only	Dry	South	Turning right	Automobile, station wagon	Other motor vehicle	0
					West	Going ahead	Pick-up truck	Other motor vehicle	
2016-Apr-12, Tue,18:41	Clear	Rear end	Non-fatal injury	Dry	East	Going ahead	Automobile, station wagon	Other motor vehicle	0
					East	Going ahead	Automobile, station wagon	Other motor vehicle	



Transportation Services - Traffic Services

Collision Details Report - Public Version

From: January 1, 2015 To: December 31, 2019

Location: INNES RD @ ORLEANS BLVD

Traffic Control: Traffic signal

Total Collisions: 68

Date/Day/Time	Environment	Impact Type	Classification	Surface Cond'n	Veh. Dir	Vehicle Manoeuver	Vehicle type	First Event	No. Ped
2016-Apr-28, Thu,10:30	Clear	Turning movement	P.D. only	Dry	North	Turning left	Automobile, station wagon	Other motor vehicle	0
					South	Going ahead	Automobile, station wagon	Other motor vehicle	
2016-May-22, Sun,11:04	Clear	Turning movement	P.D. only	Dry	North	Turning left	Automobile, station wagon	Other motor vehicle	0
					South	Going ahead	Automobile, station wagon	Other motor vehicle	
2016-Jun-09, Thu,19:16	Clear	Rear end	P.D. only	Dry	North	Turning right	Automobile, station wagon	Other motor vehicle	0
					North	Turning right	Passenger van	Other motor vehicle	
2016-Jul-10, Sun,21:52	Clear	Turning movement	P.D. only	Dry	North	Turning left	Automobile, station wagon	Other motor vehicle	0
					South	Going ahead	Pick-up truck	Other motor vehicle	
2016-Jul-21, Thu,13:08	Clear	Rear end	Non-fatal injury	Dry	West	Going ahead	Automobile, station wagon	Other motor vehicle	0
					West	Stopped	Pick-up truck	Other motor vehicle	
					West	Stopped	Pick-up truck	Other motor vehicle	
2016-Jul-28, Thu,16:00	Clear	Rear end	P.D. only	Dry	East	Slowing or stopping	Pick-up truck	Other motor vehicle	0
					East	Slowing or stopping	Pick-up truck	Other motor vehicle	
2016-Oct-13, Thu,09:41	Rain	Turning movement	Non-fatal injury	Wet	North	Turning left	Automobile, station wagon	Other motor vehicle	0
					South	Going ahead	Automobile, station wagon	Other motor vehicle	
2016-Oct-14, Fri,08:16	Clear	Angle	P.D. only	Dry	South	Turning right	Automobile, station wagon	Other motor vehicle	0
					West	Going ahead	Municipal transit bus	Other motor vehicle	
2016-Oct-22, Sat,01:34	Clear	Rear end	P.D. only	Dry	East	Turning left	Automobile, station wagon	Other motor vehicle	0
					East	Turning left	Passenger van	Other motor vehicle	
2016-Oct-26, Wed,11:22	Clear	Turning movement	P.D. only	Dry	North	Turning left	Automobile, station wagon	Other motor vehicle	0
					South	Going ahead	Pick-up truck	Other motor vehicle	



Transportation Services - Traffic Services

Collision Details Report - Public Version

From: January 1, 2015 To: December 31, 2019

Location: INNES RD @ ORLEANS BLVD

Traffic Control: Traffic signal

Total Collisions: 68

Date/Day/Time	Environment	Impact Type	Classification	Surface Cond'n	Veh. Dir	Vehicle Manoeuvre	Vehicle type	First Event	No. Ped
2016-Nov-02, Wed,17:03	Clear	Angle	Non-fatal injury	Dry	West	Going ahead	Automobile, station wagon	Other motor vehicle	0
					South	Going ahead	Automobile, station wagon	Other motor vehicle	
					East	Turning left	Automobile, station wagon	Other motor vehicle	
					East	Turning left	Automobile, station wagon	Other motor vehicle	
					East	Turning left	Pick-up truck	Other motor vehicle	
2016-Dec-08, Thu,19:01	Snow	Turning movement	Non-fatal injury	Slush	North	Going ahead	Automobile, station wagon	Other motor vehicle	0
					South	Turning left	Automobile, station wagon	Other motor vehicle	
2017-Jan-02, Mon,13:43	Clear	Rear end	P.D. only	Dry	West	Turning right	Pick-up truck	Other motor vehicle	0
					West	Turning right	Automobile, station wagon	Other motor vehicle	
2017-Jan-13, Fri,14:41	Clear	Rear end	Non-fatal injury	Dry	East	Turning left	Pick-up truck	Other motor vehicle	0
					East	Turning left	Pick-up truck	Other motor vehicle	
2017-Jan-22, Sun,16:30	Clear	Rear end	P.D. only	Dry	South	Turning right	Automobile, station wagon	Other motor vehicle	0
					South	Turning right	Passenger van	Other motor vehicle	
2017-Feb-15, Wed,09:00	Snow	Rear end	P.D. only	Loose snow	East	Slowing or stopping	Automobile, station wagon	Other motor vehicle	0
					East	Stopped	Automobile, station wagon	Other motor vehicle	
2017-Mar-06, Mon,16:38	Freezing Rain	Turning movement	Non-fatal injury	Wet	South	Turning left	Automobile, station wagon	Other motor vehicle	0
					North	Going ahead	Automobile, station wagon	Other motor vehicle	
2017-Mar-30, Thu,18:22	Clear	Rear end	P.D. only	Dry	East	Going ahead	Automobile, station wagon	Other motor vehicle	0
					East	Going ahead	Automobile, station wagon	Other motor vehicle	
2017-Apr-02, Sun,11:32	Clear	Sideswipe	P.D. only	Dry	South	Changing lanes	Automobile, station wagon	Other motor vehicle	0
					South	Going ahead	Automobile, station wagon	Other motor vehicle	
2017-May-18, Thu,08:47	Clear	SMV other	Non-fatal injury	Dry	East	Going ahead	Pick-up truck	Pedestrian	1
2017-Jun-02, Fri,13:39	Clear	Turning movement	P.D. only	Dry	South	Turning left	Automobile, station wagon	Other motor vehicle	0
					North	Going ahead	Pick-up truck	Other motor vehicle	



Transportation Services - Traffic Services

Collision Details Report - Public Version

From: January 1, 2015 To: December 31, 2019

Location: INNES RD @ ORLEANS BLVD

Traffic Control: Traffic signal

Total Collisions: 68

Date/Day/Time	Environment	Impact Type	Classification	Surface Cond'n	Veh. Dir	Vehicle Manoeuvre	Vehicle type	First Event	No. Ped
2017-Jun-22, Thu,16:30	Clear	Rear end	P.D. only	Dry	West	Going ahead	Automobile, station wagon	Other motor vehicle	0
					West	Stopped	Pick-up truck	Other motor vehicle	
2017-Jun-29, Thu,16:10	Rain	Sideswipe	P.D. only	Wet	East	Changing lanes	Delivery van	Other motor vehicle	0
					East	Turning left	Automobile, station wagon	Other motor vehicle	
2017-Sep-07, Thu,07:24	Rain	Rear end	P.D. only	Wet	West	Slowing or stopping	Automobile, station wagon	Other motor vehicle	0
					West	Slowing or stopping	Automobile, station wagon	Other motor vehicle	
					West	Slowing or stopping	Automobile, station wagon	Other motor vehicle	
2017-Nov-16, Thu,18:28	Rain	Turning movement	P.D. only	Wet	East	Going ahead	Unknown	Other motor vehicle	0
					West	Turning left	Automobile, station wagon	Other motor vehicle	
2017-Nov-22, Wed,16:17	Clear	Angle	Non-fatal injury	Dry	West	Going ahead	Pick-up truck	Other motor vehicle	0
					South	Turning left	Automobile, station wagon	Other motor vehicle	
					South	Stopped	Automobile, station wagon	Other motor vehicle	
2018-Jan-05, Fri,17:49	Clear	Rear end	P.D. only	Dry	East	Slowing or stopping	Automobile, station wagon	Other motor vehicle	0
					East	Stopped	Automobile, station wagon	Other motor vehicle	
2018-Jan-16, Tue,17:54	Freezing Rain	Rear end	P.D. only	Ice	East	Slowing or stopping	Automobile, station wagon	Other motor vehicle	0
					East	Stopped	Automobile, station wagon	Other motor vehicle	
2018-Jan-27, Sat,14:15	Clear	Rear end	Non-fatal injury	Wet	South	Slowing or stopping	Automobile, station wagon	Other motor vehicle	0
					South	Stopped	Automobile, station wagon	Other motor vehicle	
2018-Feb-11, Sun,19:15	Snow	Turning movement	P.D. only	Loose snow	North	Turning left	Automobile, station wagon	Other motor vehicle	0
					South	Going ahead	Automobile, station wagon	Other motor vehicle	
2018-Mar-13, Tue,15:15	Snow	Turning movement	Non-fatal injury	Wet	South	Turning left	Automobile, station wagon	Other motor vehicle	0
					North	Going ahead	Automobile, station wagon	Other motor vehicle	
2018-Jun-15, Fri,16:03	Clear	Rear end	P.D. only	Dry	West	Going ahead	Truck - closed	Other motor vehicle	0
					West	Stopped	Pick-up truck	Other motor vehicle	



Transportation Services - Traffic Services

Collision Details Report - Public Version

From: January 1, 2015 To: December 31, 2019

Location: INNES RD @ ORLEANS BLVD

Traffic Control: Traffic signal

Total Collisions: 68

Date/Day/Time	Environment	Impact Type	Classification	Surface Cond'n	Veh. Dir	Vehicle Manoeuver	Vehicle type	First Event	No. Ped
2018-Sep-23, Sun,19:56	Clear	Sideswipe	P.D. only	Dry	West	Unknown	Unknown	Other motor vehicle	0
					West	Going ahead	Automobile, station wagon	Other motor vehicle	
2018-Sep-25, Tue,12:23	Clear	Sideswipe	P.D. only	Dry	West	Changing lanes	Unknown	Other motor vehicle	0
					West	Going ahead	Automobile, station wagon	Other motor vehicle	
2018-Oct-13, Sat,14:17	Clear	Rear end	P.D. only	Dry	North	Turning right	Automobile, station wagon	Other motor vehicle	0
					North	Turning right	Automobile, station wagon	Other motor vehicle	
2018-Nov-16, Fri,06:26	Snow	Rear end	P.D. only	Loose snow	East	Slowing or stopping	Automobile, station wagon	Other motor vehicle	0
					East	Stopped	Automobile, station wagon	Other motor vehicle	
2018-Dec-02, Sun,15:02	Rain	SMV other	Non-fatal injury	Wet	North	Turning left	Automobile, station wagon	Pedestrian	1
2018-Dec-09, Sun,16:49	Clear	Turning movement	P.D. only	Wet	North	Turning left	Automobile, station wagon	Other motor vehicle	0
					South	Going ahead	Automobile, station wagon	Other motor vehicle	
2018-Dec-29, Sat,17:52	Clear	Rear end	Non-fatal injury	Dry	South	Turning right	Automobile, station wagon	Other motor vehicle	0
					South	Turning right	Automobile, station wagon	Other motor vehicle	
2019-Jan-26, Sat,20:02	Clear	Turning movement	P.D. only	Ice	North	Turning left	Automobile, station wagon	Other motor vehicle	0
					South	Going ahead	Automobile, station wagon	Other motor vehicle	
2019-Jan-31, Thu,15:30	Clear	Rear end	P.D. only	Dry	East	Going ahead	Automobile, station wagon	Other motor vehicle	0
					East	Unknown	Unknown	Other motor vehicle	
					East	Stopped	Automobile, station wagon	Other motor vehicle	
2019-May-02, Thu,09:00	Rain	Rear end	P.D. only	Wet	North	Turning right	Automobile, station wagon	Other motor vehicle	0
					North	Turning right	Automobile, station wagon	Other motor vehicle	
2019-Jun-25, Tue,19:45	Clear	Rear end	P.D. only	Dry	North	Turning right	Automobile, station wagon	Other motor vehicle	0
					North	Turning right	Pick-up truck	Other motor vehicle	
2019-Jul-26, Fri,15:43	Clear	Rear end	P.D. only	Dry	East	Going ahead	Automobile, station wagon	Other motor vehicle	0
					East	Stopped	Automobile, station wagon	Other motor vehicle	



Transportation Services - Traffic Services

Collision Details Report - Public Version

From: January 1, 2015 To: December 31, 2019

Location: INNES RD @ ORLEANS BLVD

Traffic Control: Traffic signal

Total Collisions: 68

Date/Day/Time	Environment	Impact Type	Classification	Surface Cond'n	Veh. Dir	Vehicle Manoeuver	Vehicle type	First Event	No. Ped
2019-Aug-01, Thu,10:20	Clear	Turning movement	P.D. only	Dry	North	Turning left	Passenger van	Other motor vehicle	0
					South	Going ahead	Automobile, station wagon	Other motor vehicle	
2019-Aug-08, Thu,15:02	Clear	Rear end	P.D. only	Dry	East	Going ahead	Pick-up truck	Other motor vehicle	0
					East	Stopped	Delivery van	Other motor vehicle	
					East	Stopped	Automobile, station wagon	Other motor vehicle	
2019-Oct-17, Thu,05:49	Rain	Turning movement	Non-fatal injury	Wet	North	Turning left	Automobile, station wagon	Other motor vehicle	0
					South	Going ahead	Automobile, station wagon	Other motor vehicle	
2019-Nov-03, Sun,16:10	Rain	Turning movement	P.D. only	Wet	North	Turning left	Automobile, station wagon	Other motor vehicle	0
					South	Going ahead	Automobile, station wagon	Other motor vehicle	
2019-Nov-15, Fri,21:26	Clear	Turning movement	Non-fatal injury	Dry	East	Going ahead	Automobile, station wagon	Other motor vehicle	0
					West	Turning left	Automobile, station wagon	Other motor vehicle	
2019-Nov-27, Wed,17:16	Rain	SMV other	Non-fatal injury	Wet	North	Turning left	Automobile, station wagon	Pedestrian	1
2019-Dec-03, Tue,23:30	Clear	Rear end	P.D. only	Dry	West	Slowing or stopping	Automobile, station wagon	Other motor vehicle	0
					West	Going ahead	Unknown	Other motor vehicle	

Location: INNES RD @ PAGE RD

Traffic Control: Traffic signal

Total Collisions: 31

Date/Day/Time	Environment	Impact Type	Classification	Surface Cond'n	Veh. Dir	Vehicle Manoeuver	Vehicle type	First Event	No. Ped
2015-Jan-14, Wed,08:40	Clear	Rear end	P.D. only	Ice	West	Slowing or stopping	Pick-up truck	Other motor vehicle	0
					West	Stopped	Pick-up truck	Other motor vehicle	
2015-Feb-20, Fri,07:15	Clear	Rear end	P.D. only	Loose snow	West	Slowing or stopping	Automobile, station wagon	Other motor vehicle	0
					West	Stopped	Pick-up truck	Other motor vehicle	



Transportation Services - Traffic Services

Collision Details Report - Public Version

From: January 1, 2015 To: December 31, 2019

Location: INNES RD @ PAGE RD

Traffic Control: Traffic signal

Total Collisions: 31

Date/Day/Time	Environment	Impact Type	Classification	Surface Cond'n	Veh. Dir	Vehicle Manoeuvre	Vehicle type	First Event	No. Ped
2015-Jul-14, Tue,18:58	Clear	Rear end	P.D. only	Dry	West	Going ahead	Automobile, station wagon	Other motor vehicle	0
					West	Stopped	Automobile, station wagon	Other motor vehicle	
					West	Stopped	Automobile, station wagon	Other motor vehicle	
2015-Jul-21, Tue,13:20	Clear	Rear end	Non-fatal injury	Dry	East	Slowing or stopping	Pick-up truck	Other motor vehicle	0
					East	Stopped	Automobile, station wagon	Other motor vehicle	
2015-Jul-30, Thu,20:45	Clear	Turning movement	Non-fatal injury	Dry	East	Turning left	Automobile, station wagon	Other motor vehicle	0
					West	Going ahead	Automobile, station wagon	Other motor vehicle	
2015-Sep-28, Mon,08:12	Clear	Angle	P.D. only	Dry	West	Turning right	School bus	Other motor vehicle	0
					North	Stopped	Construction equipment	Other motor vehicle	
2015-Oct-11, Sun,17:24	Clear	Turning movement	Non-fatal injury	Dry	West	Turning left	Automobile, station wagon	Other motor vehicle	0
					East	Going ahead	Automobile, station wagon	Other motor vehicle	
2015-Dec-04, Fri,17:43	Clear	Rear end	Non-fatal injury	Dry	East	Going ahead	Automobile, station wagon	Other motor vehicle	0
					East	Stopped	Pick-up truck	Other motor vehicle	
2016-Mar-23, Wed,10:52	Clear	Rear end	P.D. only	Dry	West	Going ahead	Delivery van	Other motor vehicle	0
					West	Stopped	Truck - closed	Other motor vehicle	
2016-Oct-22, Sat,11:07	Rain	Sideswipe	P.D. only	Wet	East	Changing lanes	Pick-up truck	Other motor vehicle	0
					East	Going ahead	Pick-up truck	Other motor vehicle	
2016-Nov-03, Thu,07:05	Clear	SMV other	Non-fatal injury	Dry	North	Turning left	Pick-up truck	Pedestrian	1
2016-Nov-04, Fri,21:47	Clear	Turning movement	P.D. only	Dry	West	Turning left	Pick-up truck	Other motor vehicle	0
					East	Going ahead	Automobile, station wagon	Other motor vehicle	
2016-Nov-23, Wed,06:45	Clear	Rear end	P.D. only	Dry	West	Going ahead	Automobile, station wagon	Other motor vehicle	0
					West	Stopped	Pick-up truck	Other motor vehicle	
2017-Feb-01, Wed,13:36	Clear	Rear end	P.D. only	Wet	West	Going ahead	Automobile, station wagon	Other motor vehicle	0
					West	Stopped	Automobile, station wagon	Other motor vehicle	



Transportation Services - Traffic Services

Collision Details Report - Public Version

From: January 1, 2015 To: December 31, 2019

Location: INNES RD @ PAGE RD

Traffic Control: Traffic signal

Total Collisions: 31

Date/Day/Time	Environment	Impact Type	Classification	Surface Cond'n	Veh. Dir	Vehicle Manoeuver	Vehicle type	First Event	No. Ped
2017-Jun-01, Thu,12:22	Clear	Turning movement	Non-fatal injury	Dry	North	Turning left	Automobile, station wagon	Cyclist	0
					South	Going ahead	Bicycle	Other motor vehicle	
2017-Nov-03, Fri,18:30	Clear	Rear end	P.D. only	Dry	West	Going ahead	Automobile, station wagon	Other motor vehicle	0
					West	Stopped	Automobile, station wagon	Other motor vehicle	
2017-Nov-20, Mon,08:01	Freezing Rain	Rear end	P.D. only	Ice	East	Going ahead	Automobile, station wagon	Other motor vehicle	0
					East	Slowing or stopping	Automobile, station wagon	Other motor vehicle	
					East	Slowing or stopping	Automobile, station wagon	Other motor vehicle	
2017-Nov-23, Thu,16:52	Snow	Sideswipe	P.D. only	Wet	West	Changing lanes	Automobile, station wagon	Other motor vehicle	0
					West	Slowing or stopping	Automobile, station wagon	Other motor vehicle	
2017-Nov-29, Wed,16:51	Clear	Angle	Non-fatal injury	Dry	West	Going ahead	Pick-up truck	Other motor vehicle	0
					South	Going ahead	Truck - dump	Other motor vehicle	
2018-Jan-26, Fri,16:54	Clear	Turning movement	P.D. only	Dry	North	Turning left	Automobile, station wagon	Other motor vehicle	0
					South	Going ahead	Automobile, station wagon	Other motor vehicle	
2018-May-14, Mon,18:39	Clear	SMV other	Non-fatal injury	Dry	North	Turning left	Automobile, station wagon	Pedestrian	1
2018-Jun-04, Mon,00:00	Clear	SMV other	Non-fatal injury	Dry	North	Going ahead	Unknown	Pedestrian	1
2018-Jul-16, Mon,21:34	Clear	SMV other	P.D. only	Dry	West	Going ahead	Automobile, station wagon	Debris on road	0
2018-Oct-01, Mon,17:10	Clear	Other	P.D. only	Dry	South	Reversing	Pick-up truck	Other motor vehicle	0
					North	Stopped	Automobile, station wagon	Other motor vehicle	
2018-Nov-13, Tue,08:12	Snow	Rear end	P.D. only	Loose snow	West	Slowing or stopping	Automobile, station wagon	Other motor vehicle	0
					West	Stopped	Automobile, station wagon	Other motor vehicle	
2018-Nov-13, Tue,14:54	Rain	Rear end	Non-fatal injury	Wet	East	Going ahead	Automobile, station wagon	Other motor vehicle	0
					East	Slowing or stopping	Automobile, station wagon	Other motor vehicle	



Transportation Services - Traffic Services

Collision Details Report - Public Version

From: January 1, 2015 To: December 31, 2019

Location: INNES RD @ PAGE RD

Traffic Control: Traffic signal

Total Collisions: 31

Date/Day/Time	Environment	Impact Type	Classification	Surface Cond'n	Veh. Dir	Vehicle Manoeuvre	Vehicle type	First Event	No. Ped
2019-Jan-28, Mon,07:30	Clear	Rear end	P.D. only	Packed snow	West	Slowing or stopping	Automobile, station wagon	Other motor vehicle	0
					West	Stopped	Automobile, station wagon	Other motor vehicle	
2019-Mar-08, Fri,20:50	Clear	Turning movement	P.D. only	Dry	West	Turning left	Unknown	Other motor vehicle	0
					East	Going ahead	Automobile, station wagon	Other motor vehicle	
2019-Jun-06, Thu,23:42	Clear	Angle	P.D. only	Dry	West	Turning right	Automobile, station wagon	Other motor vehicle	0
					South	Stopped	Automobile, station wagon	Other motor vehicle	
2019-Jun-18, Tue,06:21	Clear	Rear end	P.D. only	Dry	East	Changing lanes	Automobile, station wagon	Other motor vehicle	0
					East	Stopped	Municipal transit bus	Other motor vehicle	
2019-Sep-13, Fri,19:43	Clear	SMV other	P.D. only	Dry	West	Turning left	Automobile, station wagon	Curb	0

Location: INNES RD @ VISENEAU DR

Traffic Control: Traffic signal

Total Collisions: 41

Date/Day/Time	Environment	Impact Type	Classification	Surface Cond'n	Veh. Dir	Vehicle Manoeuvre	Vehicle type	First Event	No. Ped
2015-Jan-02, Fri,18:19	Clear	Rear end	P.D. only	Dry	West	Turning left	Unknown	Other motor vehicle	0
					West	Turning left	Automobile, station wagon	Other motor vehicle	
2015-Jan-16, Fri,20:09	Clear	Turning movement	P.D. only	Dry	West	Turning left	Automobile, station wagon	Other motor vehicle	0
					East	Going ahead	Pick-up truck	Other motor vehicle	
2015-Jan-30, Fri,19:35	Clear	Rear end	P.D. only	Wet	South	Going ahead	Passenger van	Other motor vehicle	0
					South	Stopped	Pick-up truck	Other motor vehicle	
2015-Apr-30, Thu,14:06	Clear	Turning movement	Non-fatal injury	Dry	West	Turning left	Automobile, station wagon	Other motor vehicle	0
					East	Going ahead	Pick-up truck	Other motor vehicle	
2015-Jun-10, Wed,08:20	Clear	Rear end	Non-fatal injury	Dry	West	Slowing or stopping	Pick-up truck	Other motor vehicle	0
					West	Slowing or stopping	Automobile, station wagon	Other motor vehicle	
					West	Stopped	Automobile, station wagon	Other motor vehicle	



Transportation Services - Traffic Services

Collision Details Report - Public Version

From: January 1, 2015 **To:** December 31, 2019

Location: INNES RD @ VISENEAU DR

Traffic Control: Traffic signal

Total Collisions: 41

Date/Day/Time	Environment	Impact Type	Classification	Surface Cond'n	Veh. Dir	Vehicle Manoeuvre	Vehicle type	First Event	No. Ped
2015-Oct-08, Thu, 15:32	Clear	Turning movement	P.D. only	Dry	West	Turning left	Pick-up truck	Other motor vehicle	0
					East	Going ahead	Automobile, station wagon	Other motor vehicle	
2016-Feb-05, Fri, 18:00	Clear	Other	P.D. only	Dry	Unknown	Unknown	Unknown	Other motor vehicle	0
					West	Slowing or stopping	Pick-up truck	Other motor vehicle	
2016-Feb-27, Sat, 12:30	Clear	Rear end	Non-fatal injury	Dry	East	Turning right	Automobile, station wagon	Other motor vehicle	0
					East	Turning right	Automobile, station wagon	Other motor vehicle	
2016-Apr-04, Mon, 13:34	Clear	Rear end	P.D. only	Dry	East	Going ahead	Pick-up truck	Other motor vehicle	0
					East	Stopped	Automobile, station wagon	Other motor vehicle	
2016-Apr-06, Wed, 20:10	Snow	Angle	P.D. only	Loose snow	West	Turning right	Automobile, station wagon	Other motor vehicle	0
					South	Stopped	Automobile, station wagon	Other motor vehicle	
2016-Apr-30, Sat, 11:41	Clear	Rear end	P.D. only	Dry	East	Slowing or stopping	Automobile, station wagon	Other motor vehicle	0
					East	Stopped	Automobile, station wagon	Other motor vehicle	
2016-Jun-21, Tue, 15:20	Clear	Rear end	P.D. only	Dry	East	Going ahead	Automobile, station wagon	Other motor vehicle	0
					East	Stopped	Pick-up truck	Other motor vehicle	
2016-Aug-24, Wed, 18:35	Clear	Rear end	P.D. only	Dry	West	Slowing or stopping	Automobile, station wagon	Other motor vehicle	0
					West	Stopped	Passenger van	Other motor vehicle	
2016-Nov-01, Tue, 11:00	Clear	Angle	P.D. only	Dry	North	Turning right	Passenger van	Other motor vehicle	0
					East	Going ahead	Pick-up truck	Other motor vehicle	
2016-Nov-26, Sat, 11:30	Clear	Rear end	Non-fatal injury	Dry	East	Slowing or stopping	Automobile, station wagon	Other motor vehicle	0
					East	Stopped	Automobile, station wagon	Other motor vehicle	
2016-Dec-23, Fri, 11:55	Clear	Rear end	P.D. only	Wet	West	Going ahead	Automobile, station wagon	Other motor vehicle	0
					West	Stopped	Automobile, station wagon	Other motor vehicle	
					West	Going ahead	Automobile, station wagon	Other motor vehicle	



Transportation Services - Traffic Services

Collision Details Report - Public Version

From: January 1, 2015 To: December 31, 2019

Location: INNES RD @ VISENEAU DR

Traffic Control: Traffic signal

Total Collisions: 41

Date/Day/Time	Environment	Impact Type	Classification	Surface Cond'n	Veh. Dir	Vehicle Manoeuvre	Vehicle type	First Event	No. Ped
2016-Dec-29, Thu,18:05	Snow	Turning movement	P.D. only	Packed snow	South	Turning right	Municipal transit bus	Other motor vehicle	0
					South	Stopped	Automobile, station wagon	Other motor vehicle	
2017-Jan-04, Wed,18:00	Snow	Turning movement	P.D. only	Slush	West	Turning left	Automobile, station wagon	Other motor vehicle	0
					East	Going ahead	Automobile, station wagon	Other motor vehicle	
2017-Jan-10, Tue,21:06	Freezing Rain	Turning movement	P.D. only	Loose snow	West	Turning right	Automobile, station wagon	Other motor vehicle	0
					West	Going ahead	Automobile, station wagon	Other motor vehicle	
					South	Stopped	Automobile, station wagon	Other motor vehicle	
2017-Mar-20, Mon,10:17	Clear	Turning movement	P.D. only	Dry	West	Turning left	Automobile, station wagon	Other motor vehicle	0
					East	Going ahead	Automobile, station wagon	Other motor vehicle	
2017-Nov-05, Sun,16:39	Rain	Turning movement	P.D. only	Wet	West	Turning left	Automobile, station wagon	Other motor vehicle	0
					East	Going ahead	Automobile, station wagon	Other motor vehicle	
2018-Jan-05, Fri,17:31	Snow	Rear end	P.D. only	Slush	East	Going ahead	Automobile, station wagon	Other motor vehicle	0
					East	Slowing or stopping	Automobile, station wagon	Other motor vehicle	
2018-Jan-15, Mon,15:54	Clear	Sideswipe	P.D. only	Packed snow	East	Going ahead	Automobile, station wagon	Other motor vehicle	0
					East	Going ahead	Bus (other)	Other motor vehicle	
2018-Jan-20, Sat,14:22	Clear	Sideswipe	P.D. only	Wet	East	Changing lanes	Automobile, station wagon	Other motor vehicle	0
					East	Going ahead	Automobile, station wagon	Other motor vehicle	
2018-Mar-19, Mon,17:20	Clear	Rear end	P.D. only	Dry	East	Going ahead	Automobile, station wagon	Other motor vehicle	0
					East	Stopped	Automobile, station wagon	Other motor vehicle	
2018-May-25, Fri,16:41	Clear	Rear end	P.D. only	Dry	West	Going ahead	Automobile, station wagon	Other motor vehicle	0
					West	Stopped	Automobile, station wagon	Other motor vehicle	



Transportation Services - Traffic Services

Collision Details Report - Public Version

From: January 1, 2015 To: December 31, 2019

Location: INNES RD @ VISENEAU DR

Traffic Control: Traffic signal

Total Collisions: 41

Date/Day/Time	Environment	Impact Type	Classification	Surface Cond'n	Veh. Dir	Vehicle Manoeuvre	Vehicle type	First Event	No. Ped
2018-Jun-02, Sat,19:10	Clear	Rear end	P.D. only	Dry	East	Going ahead	Automobile, station wagon	Other motor vehicle	0
					East	Stopped	Automobile, station wagon	Other motor vehicle	
					East	Stopped	Automobile, station wagon	Other motor vehicle	
2018-Jul-17, Tue,16:09	Clear	Rear end	P.D. only	Dry	East	Going ahead	Automobile, station wagon	Other motor vehicle	0
					East	Stopped	Automobile, station wagon	Other motor vehicle	
2018-Oct-10, Wed,14:05	Clear	Rear end	P.D. only	Dry	East	Unknown	Unknown	Other motor vehicle	0
					East	Stopped	Automobile, station wagon	Other motor vehicle	
2018-Oct-12, Fri,09:45	Clear	Sideswipe	P.D. only	Dry	West	Changing lanes	Automobile, station wagon	Other motor vehicle	0
					West	Turning left	Automobile, station wagon	Other motor vehicle	
2019-Jan-21, Mon,12:30	Clear	Rear end	P.D. only	Ice	East	Turning left	Automobile, station wagon	Other motor vehicle	0
					East	Turning left	Automobile, station wagon	Other motor vehicle	
2019-Feb-02, Sat,13:50	Snow	Angle	P.D. only	Loose snow	East	Turning right	Passenger van	Other motor vehicle	0
					North	Stopped	Automobile, station wagon	Other motor vehicle	
2019-Apr-09, Tue,06:39	Snow	SMV other	P.D. only	Ice	West	Slowing or stopping	Automobile, station wagon	Ran off road	0
2019-Jul-05, Fri,23:55	Clear	Angle	P.D. only	Dry	North	Turning right	Automobile, station wagon	Other motor vehicle	0
					East	Pulling onto shoulder or toward curb	Municipal transit bus	Other motor vehicle	
2019-Jul-28, Sun,10:24	Clear	Angle	P.D. only	Dry	West	Going ahead	Automobile, station wagon	Other motor vehicle	0
					North	Turning left	Automobile, station wagon	Other motor vehicle	
2019-Sep-06, Fri,14:00	Clear	Turning movement	P.D. only	Dry	East	Turning right	Automobile, station wagon	Other motor vehicle	0
					West	Turning left	Automobile, station wagon	Other motor vehicle	
2019-Sep-17, Tue,17:00	Clear	Rear end	P.D. only	Dry	East	Going ahead	Pick-up truck	Other motor vehicle	0
					East	Slowing or stopping	Passenger van	Other motor vehicle	



Transportation Services - Traffic Services

Collision Details Report - Public Version

From: January 1, 2015 To: December 31, 2019

Location: INNES RD @ VISENEAU DR

Traffic Control: Traffic signal

Total Collisions: 41

Date/Day/Time	Environment	Impact Type	Classification	Surface Cond'n	Veh. Dir	Vehicle Manoeuver	Vehicle type	First Event	No. Ped
2019-Sep-30, Mon,19:33	Clear	Rear end	P.D. only	Dry	West	Slowing or stopping	Automobile, station wagon	Other motor vehicle	0
					West	Stopped	Unknown	Other motor vehicle	
2019-Oct-01, Tue,21:35	Clear	Angle	P.D. only	Dry	West	Going ahead	Automobile, station wagon	Other motor vehicle	0
					North	Going ahead	Automobile, station wagon	Other motor vehicle	
2019-Nov-27, Wed,17:00	Clear	Rear end	P.D. only	Dry	East	Going ahead	Automobile, station wagon	Other motor vehicle	0
					East	Stopped	Automobile, station wagon	Other motor vehicle	
2019-Dec-13, Fri,17:10	Clear	SMV other	Fatal injury	Dry	West	Going ahead	Automobile, station wagon	Pedestrian	1

Location: INNES RD btwn 473 E OF PAGE RD/BUILDERS' WAREHOUSE SC & GREENVALE LANE

Traffic Control: No control

Total Collisions: 2

Date/Day/Time	Environment	Impact Type	Classification	Surface Cond'n	Veh. Dir	Vehicle Manoeuver	Vehicle type	First Event	No. Ped
2016-May-02, Mon,13:53	Clear	Angle	P.D. only	Dry	North	Turning left	Automobile, station wagon	Other motor vehicle	0
					East	Going ahead	Automobile, station wagon	Other motor vehicle	
2018-Jan-22, Mon,16:37	Snow	Sideswipe	P.D. only	Loose snow	East	Overtaking	Automobile, station wagon	Other motor vehicle	0
					East	Going ahead	Snow plow	Other motor vehicle	

Location: INNES RD btwn GREENVALE LANE & VISENEAU DR

Traffic Control: No control

Total Collisions: 4

Date/Day/Time	Environment	Impact Type	Classification	Surface Cond'n	Veh. Dir	Vehicle Manoeuver	Vehicle type	First Event	No. Ped
2015-Dec-21, Mon,11:07	Freezing Rain	Sideswipe	P.D. only	Ice	West	Changing lanes	Pick-up truck	Skidding/sliding	0
					West	Going ahead	Pick-up truck	Other motor vehicle	
2016-Jun-18, Sat,14:50	Clear	Angle	P.D. only	Dry	North	Turning right	Automobile, station wagon	Other motor vehicle	0
					East	Changing lanes	Passenger van	Other motor vehicle	



Transportation Services - Traffic Services

Collision Details Report - Public Version

From: January 1, 2015 To: December 31, 2019

Location: INNES RD btwn GREENVALE LANE & VISENEAU DR

Traffic Control: No control

Total Collisions: 4

Date/Day/Time	Environment	Impact Type	Classification	Surface Cond'n	Veh. Dir	Vehicle Manoeuvre	Vehicle type	First Event	No. Ped
2016-Aug-26, Fri,17:09	Clear	Rear end	Non-fatal injury	Dry	East	Going ahead	Passenger van	Other motor vehicle	0
					East	Stopped	Automobile, station wagon	Other motor vehicle	
					East	Stopped	Automobile, station wagon	Other motor vehicle	
2019-Feb-17, Sun,22:06	Clear	Rear end	P.D. only	Dry	East	Going ahead	Automobile, station wagon	Other motor vehicle	0
					East	Going ahead	Automobile, station wagon	Other motor vehicle	

Location: INNES RD btwn INNES RD & PAGE RD

Traffic Control: No control

Total Collisions: 8

Date/Day/Time	Environment	Impact Type	Classification	Surface Cond'n	Veh. Dir	Vehicle Manoeuvre	Vehicle type	First Event	No. Ped
2015-Jan-22, Thu,08:53	Clear	Rear end	P.D. only	Dry	West	Going ahead	Automobile, station wagon	Other motor vehicle	0
					West	Stopped	Automobile, station wagon	Other motor vehicle	
2015-May-05, Tue,07:24	Clear	Rear end	P.D. only	Dry	West	Going ahead	Pick-up truck	Other motor vehicle	0
					West	Stopped	Pick-up truck	Other motor vehicle	
					West	Stopped	Pick-up truck	Other motor vehicle	
2015-May-13, Wed,07:45	Clear	Rear end	P.D. only	Dry	West	Unknown	Unknown	Other motor vehicle	0
					West	Going ahead	Pick-up truck	Other motor vehicle	
					West	Going ahead	Pick-up truck	Other motor vehicle	
					West	Going ahead	Automobile, station wagon	Other motor vehicle	
2015-Jul-16, Thu,08:07	Clear	Sideswipe	P.D. only	Dry	East	Unknown	Unknown	Other motor vehicle	0
					East	Stopped	Municipal transit bus	Other motor vehicle	
2015-Oct-03, Sat,15:49	Clear	Sideswipe	P.D. only	Dry	East	Going ahead	Pick-up truck	Other motor vehicle	0
					East	Going ahead	Automobile, station wagon	Other motor vehicle	
2015-Oct-08, Thu,15:19	Clear	Rear end	P.D. only	Dry	East	Slowing or stopping	Pick-up truck	Other motor vehicle	0
					East	Slowing or stopping	Automobile, station wagon	Other motor vehicle	
					East	Changing lanes	Automobile, station wagon	Other motor vehicle	



Transportation Services - Traffic Services

Collision Details Report - Public Version

From: January 1, 2015 To: December 31, 2019

Location: INNES RD btwn INNES RD & PAGE RD

Traffic Control: No control

Total Collisions: 8

Date/Day/Time	Environment	Impact Type	Classification	Surface Cond'n	Veh. Dir	Vehicle Manoeuver	Vehicle type	First Event	No. Ped
2016-Nov-19, Sat,18:49	Clear	Rear end	Non-reportable	Dry	West	Slowing or stopping	Automobile, station wagon	Other motor vehicle	0
					West	Stopped	Automobile, station wagon	Other motor vehicle	
2017-Oct-20, Fri,06:12	Clear	Rear end	Non-fatal injury	Dry	West	Slowing or stopping	Automobile, station wagon	Other motor vehicle	0
					West	Stopped	Pick-up truck	Other motor vehicle	

Location: INNES RD btwn PAGE RD & 473 E OF PAGE RD/BUILDERS' WAREHOUSE SC

Traffic Control: No control

Total Collisions: 15

Date/Day/Time	Environment	Impact Type	Classification	Surface Cond'n	Veh. Dir	Vehicle Manoeuver	Vehicle type	First Event	No. Ped
2015-Jan-14, Wed,09:38	Clear	Rear end	P.D. only	Dry	West	Slowing or stopping	Automobile, station wagon	Other motor vehicle	0
					West	Stopped	Pick-up truck	Other motor vehicle	
2015-Nov-30, Mon,09:51	Clear	Rear end	Non-fatal injury	Dry	East	Going ahead	Automobile, station wagon	Other motor vehicle	0
					East	Stopped	Pick-up truck	Other motor vehicle	
2016-Feb-17, Wed,20:46	Clear	Angle	P.D. only	Packed snow	South	Turning right	Automobile, station wagon	Other motor vehicle	0
					West	Going ahead	Automobile, station wagon	Other motor vehicle	
2016-Apr-20, Wed,16:58	Clear	Sideswipe	P.D. only	Dry	West	Overtaking	Pick-up truck	Other motor vehicle	0
					West	Going ahead	Pick-up truck	Other motor vehicle	
2016-Sep-30, Fri,18:25	Clear	Rear end	Non-fatal injury	Dry	East	Slowing or stopping	Automobile, station wagon	Other motor vehicle	0
					East	Stopped	Passenger van	Other motor vehicle	
2016-Oct-19, Wed,17:00	Clear	Angle	Non-fatal injury	Dry	South	Turning right	Automobile, station wagon	Other motor vehicle	0
					West	Going ahead	Automobile, station wagon	Other motor vehicle	
2017-Jan-31, Tue,16:38	Clear	Sideswipe	P.D. only	Dry	East	Changing lanes	Automobile, station wagon	Other motor vehicle	0
					East	Going ahead	Pick-up truck	Other motor vehicle	
2017-Feb-01, Wed,06:49	Clear	Rear end	P.D. only	Loose snow	West	Slowing or stopping	Automobile, station wagon	Other motor vehicle	0
					West	Stopped	Automobile, station wagon	Other motor vehicle	



Transportation Services - Traffic Services

Collision Details Report - Public Version

From: January 1, 2015 To: December 31, 2019

Location: INNES RD btwn PAGE RD & 473 E OF PAGE RD/BUILDERS' WAREHOUSE SC

Traffic Control: No control

Total Collisions: 15

Date/Day/Time	Environment	Impact Type	Classification	Surface Cond'n	Veh. Dir	Vehicle Manoeuver	Vehicle type	First Event	No. Ped
2017-Jun-01, Thu,01:16	Clear	Sideswipe	P.D. only	Dry	East	Unknown	Unknown	Other motor vehicle	0
					East	Going ahead	Automobile, station wagon	Other motor vehicle	
2017-Nov-14, Tue,16:12	Clear	Rear end	P.D. only	Dry	East	Slowing or stopping	Automobile, station wagon	Other motor vehicle	0
					East	Stopped	Police vehicle	Other motor vehicle	
2018-Apr-26, Thu,18:06	Clear	Turning movement	P.D. only	Dry	East	Going ahead	Pick-up truck	Other motor vehicle	0
					East	Making "U" turn	Automobile, station wagon	Other motor vehicle	
2018-Nov-22, Thu,14:37	Clear	Angle	P.D. only	Dry	South	Turning right	Automobile, station wagon	Other motor vehicle	0
					West	Going ahead	Automobile, station wagon	Other motor vehicle	
2018-Dec-31, Mon,21:30	Snow	Angle	P.D. only	Packed snow	South	Turning right	Automobile, station wagon	Other motor vehicle	0
					West	Going ahead	Automobile, station wagon	Other motor vehicle	
2019-Apr-21, Sun,19:26	Clear	SMV other	P.D. only	Dry	West	Slowing or stopping	Automobile, station wagon	Ran off road	0
2019-Jul-10, Wed,07:15	Clear	Angle	P.D. only	Dry	South	Turning right	Truck - closed	Other motor vehicle	0
					West	Going ahead	Automobile, station wagon	Other motor vehicle	

Location: INNES RD EB btwn ORLEANS BLVD & INNES RD

Traffic Control: No control

Total Collisions: 4

Date/Day/Time	Environment	Impact Type	Classification	Surface Cond'n	Veh. Dir	Vehicle Manoeuver	Vehicle type	First Event	No. Ped
2015-Oct-05, Mon,18:56	Clear	Sideswipe	Non-fatal injury	Dry	East	Changing lanes	Pick-up truck	Other motor vehicle	0
					East	Going ahead	Automobile, station wagon	Other motor vehicle	
2015-Dec-07, Mon,17:05	Clear	Sideswipe	P.D. only	Dry	East	Unknown	Unknown	Other motor vehicle	0
					East	Going ahead	Pick-up truck	Other motor vehicle	
2016-Mar-20, Sun,16:55	Clear	Rear end	P.D. only	Dry	East	Going ahead	Automobile, station wagon	Other motor vehicle	0
					East	Stopped	Pick-up truck	Other motor vehicle	



Transportation Services - Traffic Services

Collision Details Report - Public Version

From: January 1, 2015 To: December 31, 2019

Location: INNES RD EB btwn ORLEANS BLVD & INNES RD

Traffic Control: No control

Total Collisions: 4

Date/Day/Time	Environment	Impact Type	Classification	Surface Cond'n	Veh. Dir	Vehicle Manoeuver	Vehicle type	First Event	No. Ped
2017-Jan-05, Thu,09:44	Clear	Sideswipe	P.D. only	Wet	West	Merging	Automobile, station wagon	Other motor vehicle	0
					West	Going ahead	Municipal transit bus	Other motor vehicle	

Location: INNES RD WB btwn ORLEANS BLVD & INNES RD

Traffic Control: No control

Total Collisions: 5

Date/Day/Time	Environment	Impact Type	Classification	Surface Cond'n	Veh. Dir	Vehicle Manoeuver	Vehicle type	First Event	No. Ped
2016-Jan-19, Tue,18:20	Snow	Rear end	P.D. only	Slush	West	Going ahead	Automobile, station wagon	Other motor vehicle	0
					West	Changing lanes	Pick-up truck	Other motor vehicle	
2016-May-21, Sat,16:15	Clear	Rear end	P.D. only	Dry	West	Slowing or stopping	Automobile, station wagon	Other motor vehicle	0
					West	Slowing or stopping	Pick-up truck	Other motor vehicle	
2016-Dec-04, Sun,06:02	Clear	SMV other	P.D. only	Dry	East	Going ahead	Automobile, station wagon	Ran off road	0
2019-Jan-21, Mon,16:45	Clear	Rear end	P.D. only	Dry	West	Going ahead	Automobile, station wagon	Other motor vehicle	0
					West	Stopped	Automobile, station wagon	Other motor vehicle	
2019-Mar-05, Tue,16:38	Snow	Rear end	P.D. only	Wet	West	Going ahead	Automobile, station wagon	Other motor vehicle	0
					West	Going ahead	Automobile, station wagon	Other motor vehicle	
					West	Going ahead	Automobile, station wagon	Other motor vehicle	



Transportation Services - Traffic Services

Collision Details Report - Public Version

From: January 1, 2020 To: December 31, 2020

Location: INNES RD btwn PAGE RD & 473 E OF PAGE RD/BUILDERS

Traffic Control: No control

Total Collisions: 3

Date/Day/Time	Environment	Impact Type	Classification	Surface Cond'n	Veh. Dir	Vehicle Manoeuver	Vehicle type	First Event	No. Ped
2020-Jan-25, Sat,17:00	Snow	SMV other	P.D. only	Slush	West	Going ahead	Automobile, station wagon	Snowbank/drift	0
2020-Apr-20, Mon,19:59	Clear	Rear end	P.D. only	Dry	West	Slowing or stopping	Pick-up truck	Other motor vehicle	0
					West	Stopped	Pick-up truck	Other motor vehicle	
2020-Jul-06, Mon,07:05	Clear	SMV other	Non-fatal injury	Dry	West	Going ahead	Motorcycle	Skidding/sliding	0

Location: INNES RD @ 473 E OF PAGE RD/BUILDERS' WAREHOUS

Traffic Control: Traffic signal

Total Collisions: 2

Date/Day/Time	Environment	Impact Type	Classification	Surface Cond'n	Veh. Dir	Vehicle Manoeuver	Vehicle type	First Event	No. Ped
2020-Jan-10, Fri,11:00	Clear	Rear end	P.D. only	Dry	West	Unknown	Pick-up truck	Other motor vehicle	0
					West	Stopped	Automobile, station wagon	Other motor vehicle	
2020-Jan-23, Thu,12:57	Clear	SMV other	Non-fatal injury	Wet	South	Turning left	Pick-up truck	Pedestrian	1

Location: INNES RD @ ORLEANS BLVD

Traffic Control: Traffic signal

Total Collisions: 7

Date/Day/Time	Environment	Impact Type	Classification	Surface Cond'n	Veh. Dir	Vehicle Manoeuver	Vehicle type	First Event	No. Ped
2020-Feb-15, Sat,09:29	Clear	Rear end	P.D. only	Slush	South	Turning left	Automobile, station wagon	Other motor vehicle	0
					South	Turning left	Automobile, station wagon	Other motor vehicle	
2020-Feb-25, Tue,11:45	Clear	Rear end	P.D. only	Dry	East	Turning left	Automobile, station wagon	Other motor vehicle	0
					East	Turning left	Automobile, station wagon	Other motor vehicle	
2020-Jun-15, Mon,13:05	Clear	Rear end	P.D. only	Dry	West	Going ahead	Pick-up truck	Other motor vehicle	0
					West	Stopped	Pick-up truck	Other motor vehicle	
2020-Jun-18, Thu,08:52	Clear	Sideswipe	P.D. only	Dry	East	Turning left	Fire vehicle	Other motor vehicle	0
					East	Turning left	Municipal transit bus	Other motor vehicle	
2020-Aug-25, Tue,10:00	Clear	Rear end	P.D. only	Dry	West	Going ahead	Automobile, station wagon	Other motor vehicle	0
					West	Slowing or stopping	Automobile, station wagon	Other motor vehicle	



Transportation Services - Traffic Services

Collision Details Report - Public Version

From: January 1, 2020 To: December 31, 2020

Location: INNES RD @ ORLEANS BLVD

Traffic Control: Traffic signal

Total Collisions: 7

Date/Day/Time	Environment	Impact Type	Classification	Surface Cond'n	Veh. Dir	Vehicle Manoeuver	Vehicle type	First Event	No. Ped
2020-Oct-02, Fri, 10:55	Rain	Rear end	P.D. only	Wet	East	Turning right	Automobile, station wagon	Other motor vehicle	0
					East	Turning right	Pick-up truck	Other motor vehicle	
2020-Nov-22, Sun, 17:45	Snow	SMV other	P.D. only	Ice	South	Turning right	Automobile, station wagon	Skidding/sliding	0

Location: INNES RD @ PAGE RD

Traffic Control: Traffic signal

Total Collisions: 2

Date/Day/Time	Environment	Impact Type	Classification	Surface Cond'n	Veh. Dir	Vehicle Manoeuver	Vehicle type	First Event	No. Ped
2020-Feb-08, Sat, 16:29	Clear	Angle	P.D. only	Wet	West	Going ahead	Automobile, station wagon	Other motor vehicle	0
					South	Turning left	Automobile, station wagon	Other motor vehicle	
2020-May-13, Wed, 00:13	Clear	Turning movement	P.D. only	Dry	East	Turning left	Automobile, station wagon	Other motor vehicle	0
					West	Going ahead	Pick-up truck	Other motor vehicle	

Location: INNES RD @ VISENEAU DR

Traffic Control: Traffic signal

Total Collisions: 3

Date/Day/Time	Environment	Impact Type	Classification	Surface Cond'n	Veh. Dir	Vehicle Manoeuver	Vehicle type	First Event	No. Ped
2020-Feb-24, Mon, 15:46	Clear	Angle	P.D. only	Dry	East	Going ahead	Automobile, station wagon	Other motor vehicle	0
					North	Going ahead	Automobile, station wagon	Other motor vehicle	
2020-Jul-06, Mon, 17:55	Clear	Sideswipe	P.D. only	Dry	South	Turning right	Other school vehicle/bus	Other motor vehicle	0
					South	Turning left	Automobile, station wagon	Other motor vehicle	
2020-Dec-30, Wed, 21:39	Snow	Other	P.D. only	Wet	West	Turning left	Automobile, station wagon	Other motor vehicle	0
					East	Turning left	Pick-up truck	Other motor vehicle	

Location: INNES RD btwn GREENVALE LANE & VISENEAU DR

Traffic Control: No control

Total Collisions: 1

Date/Day/Time	Environment	Impact Type	Classification	Surface Cond'n	Veh. Dir	Vehicle Manoeuver	Vehicle type	First Event	No. Ped
---------------	-------------	-------------	----------------	----------------	----------	-------------------	--------------	-------------	---------



Transportation Services - Traffic Services

Collision Details Report - Public Version

From: January 1, 2020 To: December 31, 2020

Location: INNES RD btwn GREENVALE LANE & VISENEAU DR

Traffic Control: No control

Total Collisions: 1

Date/Day/Time	Environment	Impact Type	Classification	Surface Cond'n	Veh. Dir	Vehicle Manoeuver	Vehicle type	First Event	No. Ped
2020-Nov-08, Sun,13:24	Clear	Rear end	Non-fatal injury	Dry	East	Going ahead	Pick-up truck	Other motor vehicle	0
					East	Slowing or stopping	Pick-up truck	Other motor vehicle	
					East	Going ahead	Pick-up truck	Other motor vehicle	

Location: INNES RD btwn INNES RD & PAGE RD

Traffic Control: No control

Total Collisions: 1

Date/Day/Time	Environment	Impact Type	Classification	Surface Cond'n	Veh. Dir	Vehicle Manoeuver	Vehicle type	First Event	No. Ped
2020-Sep-28, Mon,18:59	Clear	Rear end	P.D. only	Dry	East	Going ahead	Pick-up truck	Other motor vehicle	0
					East	Slowing or stopping	Passenger van	Other motor vehicle	

APPENDIX F

Strategic Long-Range Model Snapshots and Excerpt of 2013 TMP

2.3 Population and Employment in 2031

Where growth will occur. The City has prepared population and employment growth projections for the period from 2011 to 2031 (see Exhibit 2.10). The City expects a 23% increase in population from 922,000 to 1.14 million people, and a 24% increase in employment from 565,000 to 703,000 jobs. Although infill development and intensification are forecast to increase the population of Ottawa’s Inner Area and Inner Suburbs by about 46,000 people over the next 18 years, most growth (about 168,000 people) will occur in the Outer Suburbs. In contrast, 72% of employment growth will occur inside the Greenbelt.

Exhibit 2.10 Population and Employment: 2011 Actual and 2031 Projections

Area	Population			Employment		
	2011	2031	Growth and distribution	2011	2031	Growth & distribution
Inner Area	97,200	116,400	19,200 (9%)	170,600	201,800	31,200 (23%)
Inner Suburbs	432,500	459,300	26,800 (13%)	287,400	355,300	67,900 (49%)
Kanata/Stittsville	105,200	162,000	56,800 (27%)	51,300	62,500	11,200 (8%)
Barrhaven	71,200	107,400	36,200 (17%)	11,100	21,800	10,700 (8%)
Riverside South/Leitrim	15,900	35,800	19,900 (9%)	4,000	7,800	3,800 (3%)
Orléans	108,200	143,400	35,200 (16%)	20,600	33,000	12,400 (9%)
Rural Ottawa	91,400	111,700	20,300 (9%)	20,000	20,900	900 (1%)
Total	922,000	1,135,900	213,900 (100%)	564,900	703,200	138,100 (100%)

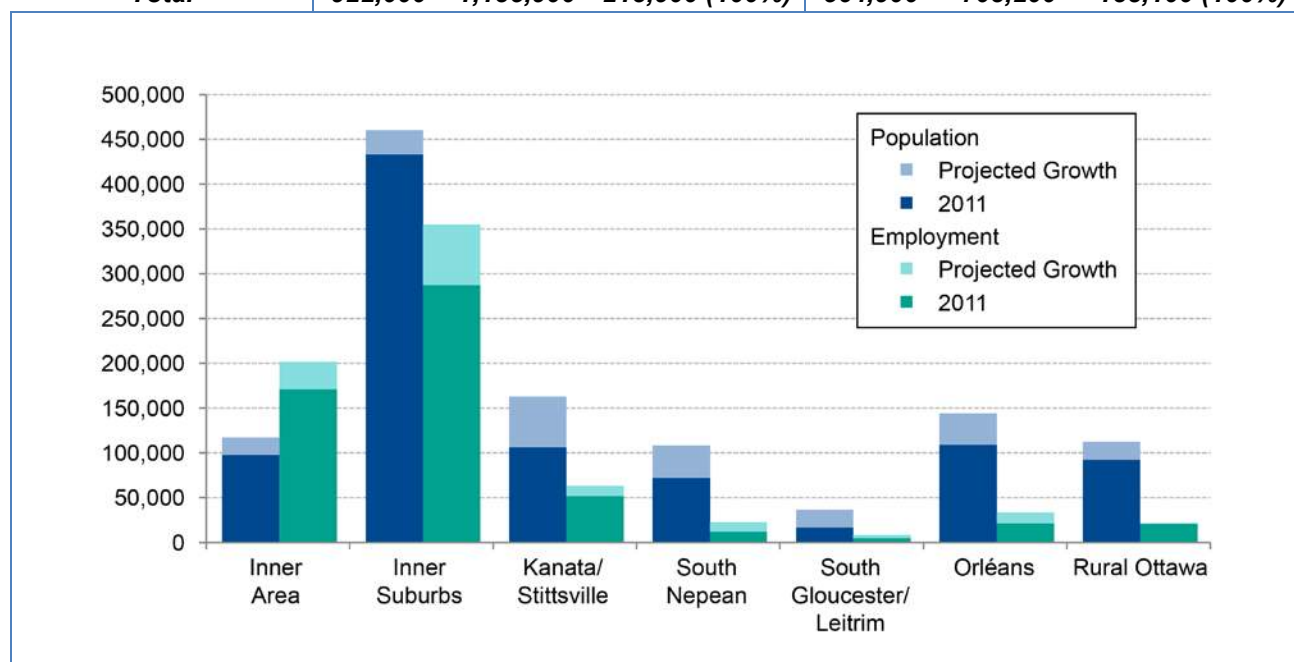

TRANS Regional Model

Version 2.15 - Assigned June 16, 2020

AM Peak Hour Total Traffic Volume

Network Mapping

2011 Model - Base case

N/A

User Initials: TIMW

Plot Prepared: May 31, 2021

EMME Scenario: 21711



Legend

AM Peak Hour Total Traffic Volume

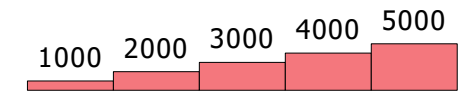

Distance (m)

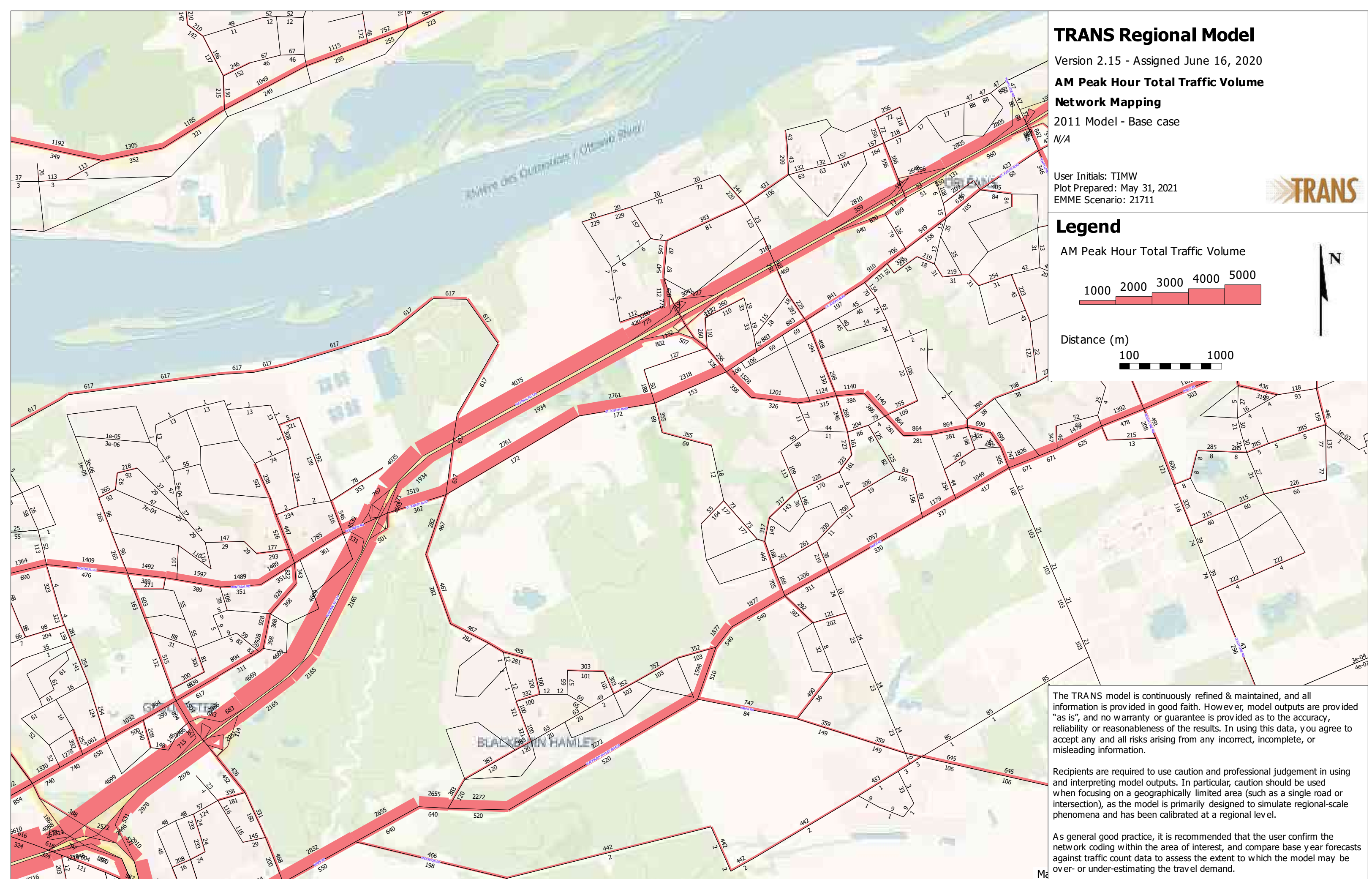

The TRANS model is continuously refined & maintained, and all information is provided in good faith. However, model outputs are provided "as is", and no warranty or guarantee is provided as to the accuracy, reliability or reasonableness of the results. In using this data, you agree to accept any and all risks arising from any incorrect, incomplete, or misleading information.

Recipients are required to use caution and professional judgement in using and interpreting model outputs. In particular, caution should be used when focusing on a geographically limited area (such as a single road or intersection), as the model is primarily designed to simulate regional-scale phenomena and has been calibrated at a regional level.

As general good practice, it is recommended that the user confirm the network coding within the area of interest, and compare base year forecasts against traffic count data to assess the extent to which the model may be over- or under-estimating the travel demand.

TRANS Regional Model

Version 2.15 - Assigned June 16, 2020

AM Peak Hour Total Traffic Volume

Network Mapping

2031 Model - Base case

N/A

User Initials: TIMW

Plot Prepared: May 31, 2021

EMME Scenario: 21711



Legend

AM Peak Hour Total Traffic Volume

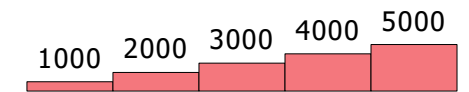

Distance (m)

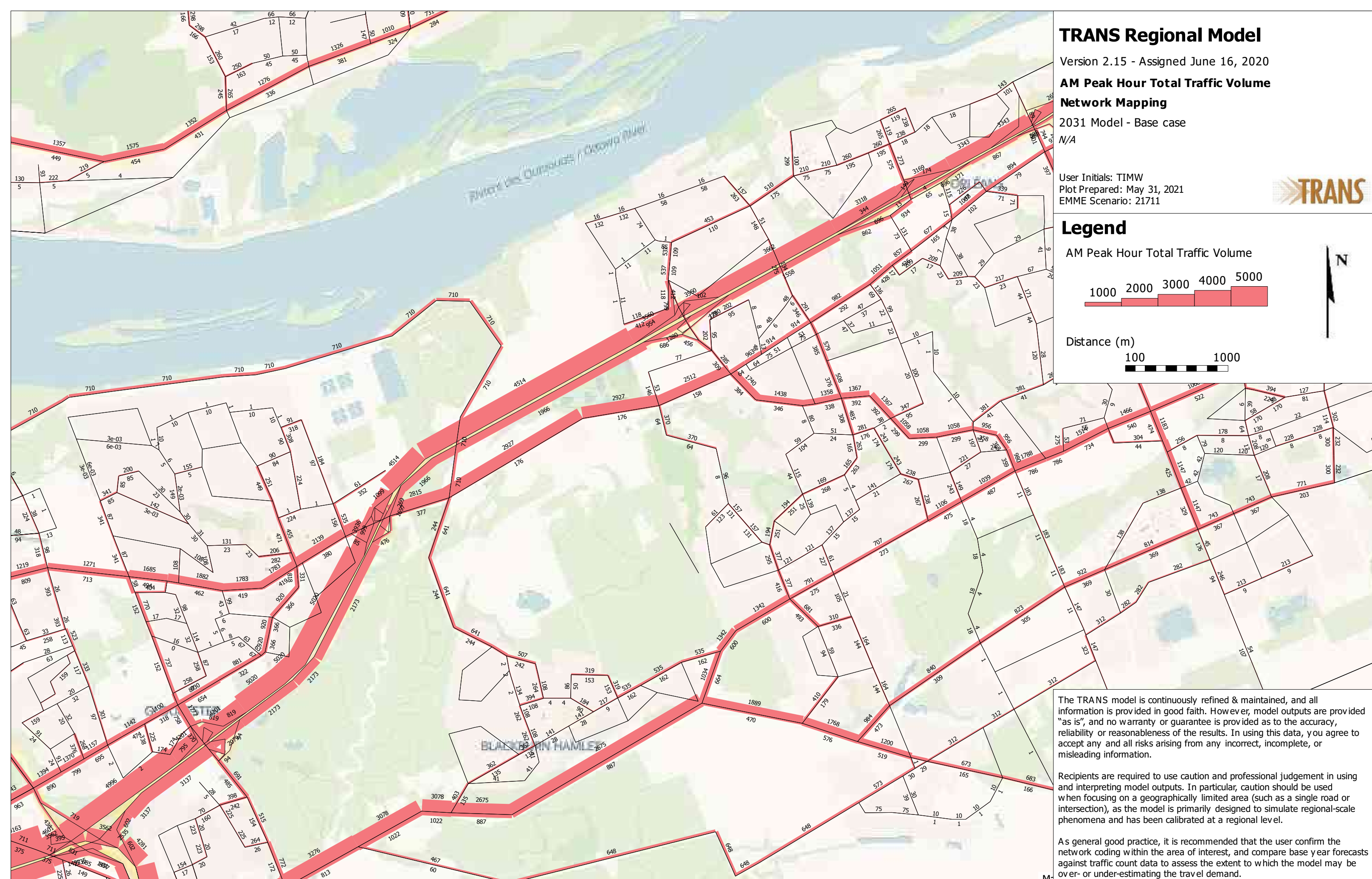

The TRANS model is continuously refined & maintained, and all information is provided in good faith. However, model outputs are provided "as is", and no warranty or guarantee is provided as to the accuracy, reliability or reasonableness of the results. In using this data, you agree to accept any and all risks arising from any incorrect, incomplete, or misleading information.

Recipients are required to use caution and professional judgement in using and interpreting model outputs. In particular, caution should be used when focusing on a geographically limited area (such as a single road or intersection), as the model is primarily designed to simulate regional-scale phenomena and has been calibrated at a regional level.

As general good practice, it is recommended that the user confirm the network coding within the area of interest, and compare base year forecasts against traffic count data to assess the extent to which the model may be over- or under-estimating the travel demand.

APPENDIX G

Other Area Developments

Transportation Impact Study

1 INTRODUCTION

From the information provided, a residential development consisting of approximately 534 residential units (single family homes and town homes) is being proposed on the property municipally known as 3490 Innes Road. These lands are currently zoned for employment land use, therefore a rezoning is required to develop the site as residential. The property in its entirety extends south of Innes Road for approximately 1 km and from approximately 50 to 400 m east of Pagé Road. The land is currently occupied by a golf range/mini-putt and farmland. As shown in Figure 1: Site Context, the proposed residential development is planned on the southern end of the site located approximately 325 m south of Innes Road. Future development is planned on the lands north of the planned residential community, which is not included in the analysis herein. The proposed Site Plan is provided as Figure 2.

Figure 1: Site Context



As part of the Rezoning and Draft Plan of Subdivision Application processes, the City of Ottawa requires submission of a formal Transportation Impact Assessment (TIA) consistent with their guidelines dated October 2006. With respect to these guidelines and through discussions with the City of Ottawa, a Transportation Impact Study (TIS) is considered the appropriate type of study for the subject rezoning.

The proposed development is expected to be constructed in two phases. For the purpose of this assessment, Phase 1 will consist of half of the units (approximately 267 units) and is expected to be built by 2020, and Phase 2, consisting of the remainder of units (267 units) is expected to be constructed by 2024.

Figure 6: Phase 1 'New' Site-Generated Traffic Volumes

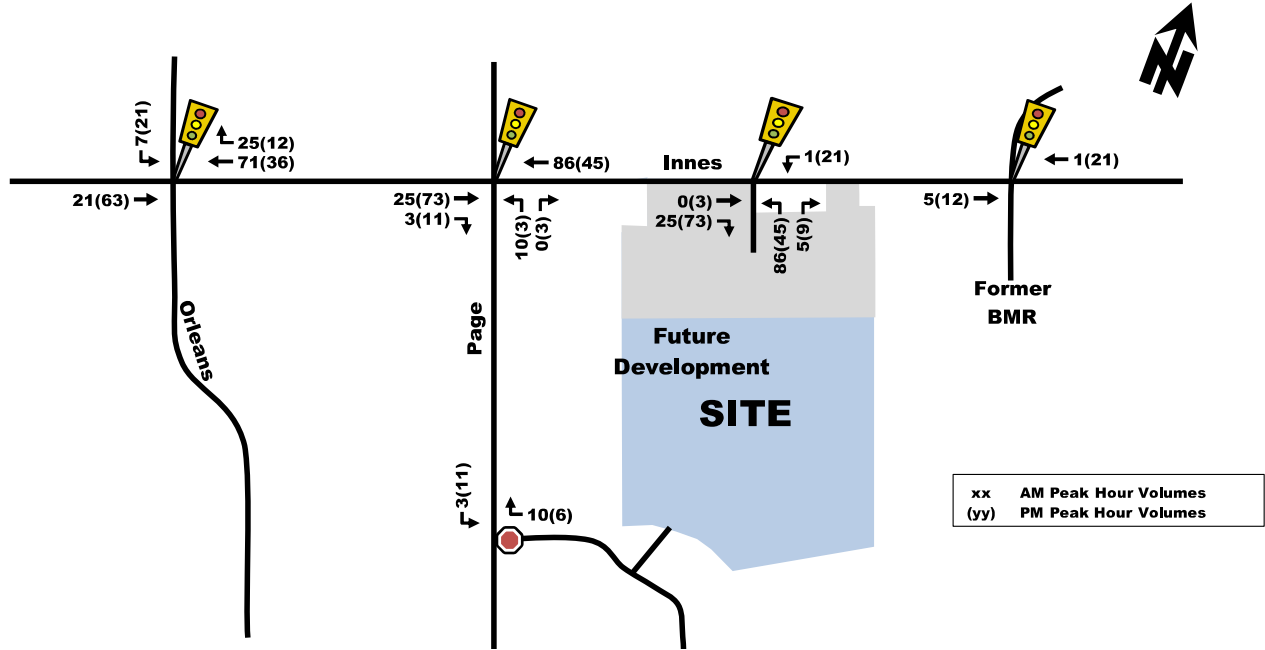
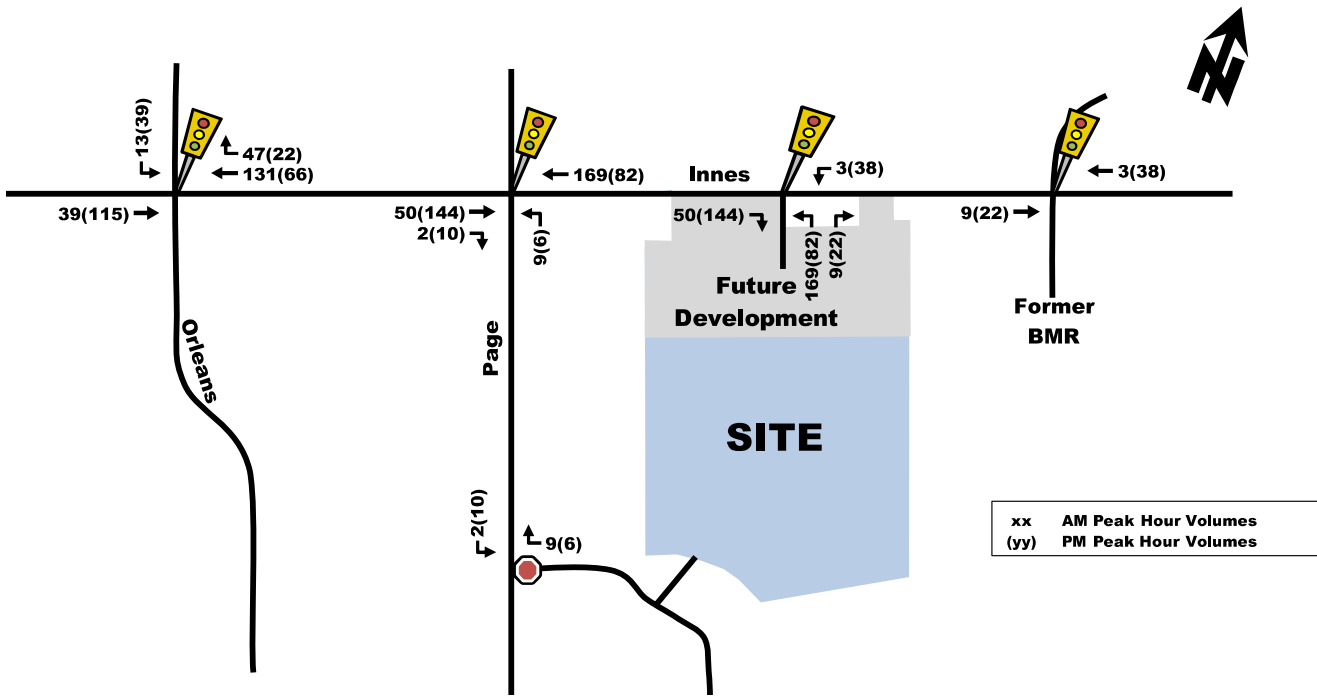

Figure 7: Phases 1 and 2 'New' Site-Generated Traffic Volumes



1 Screening

This study has been prepared according to the City of Ottawa’s 2017 Transportation Impact Assessment (TIA) Guidelines. Accordingly, a Step 1 Screening Form has been prepared and is included as Appendix A, along with the Certification Form for the TIA Study PM. As shown in the Screening Form, a TIA is required including the Design Review component and the Network Impact Component. This study has been prepared to support a zoning by-law amendment and draft plan of subdivision application.

2 Existing and Planned Conditions

2.1 Proposed Development

The existing site, located at 245 and 275 Lamarche Avenue, is zoned as Development Reserve (DR). The proposed development consists of 103 townhomes, 72 back-to-backs dwellings. The new development will constitute the second phase of the Orleans Village subdivision. The concept plan includes two full-movement accesses onto Lamarche Avenue. The anticipated full build-out and occupancy horizon is 2025 with construction occurring in a single phase. The site is located within the Innes Arterial Mainstreet area. Figure 1 illustrates the study area context. Figure 2 illustrates the proposed concept plan.

Figure 1: Area Context Plan

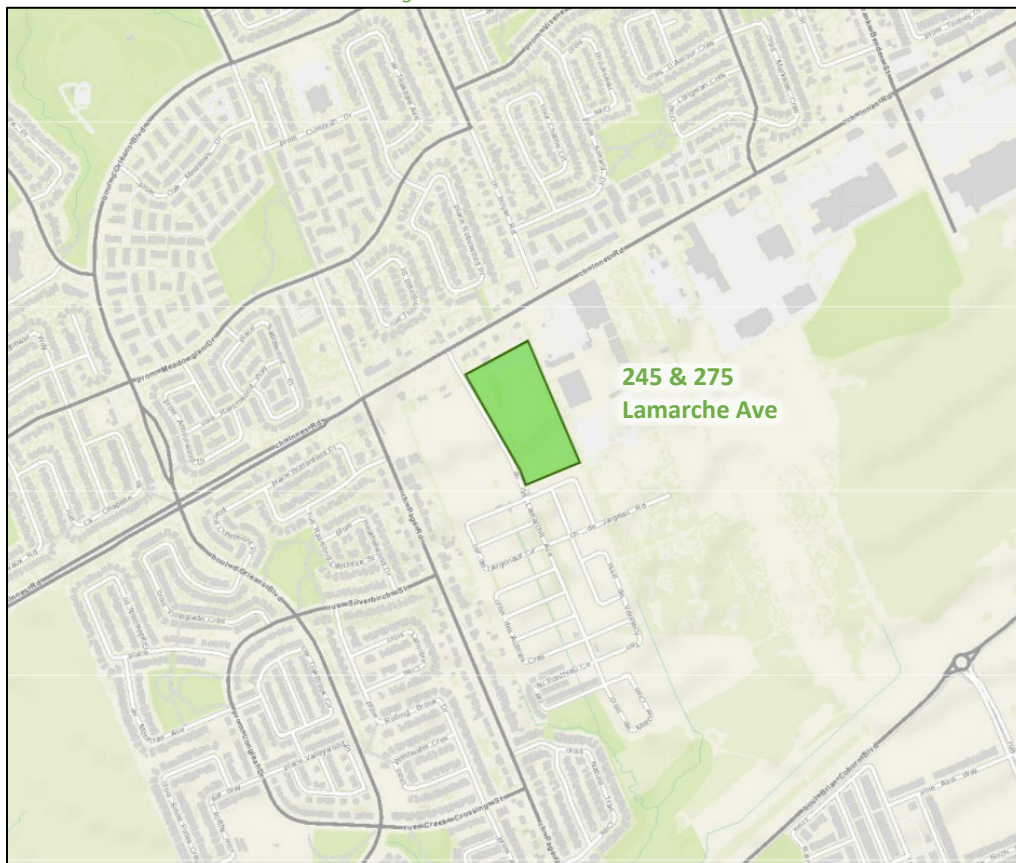

Source: <http://maps.ottawa.ca/geoOttawa/> Accessed: March 21, 2022

Figure 12: New Site Generation Auto Volumes

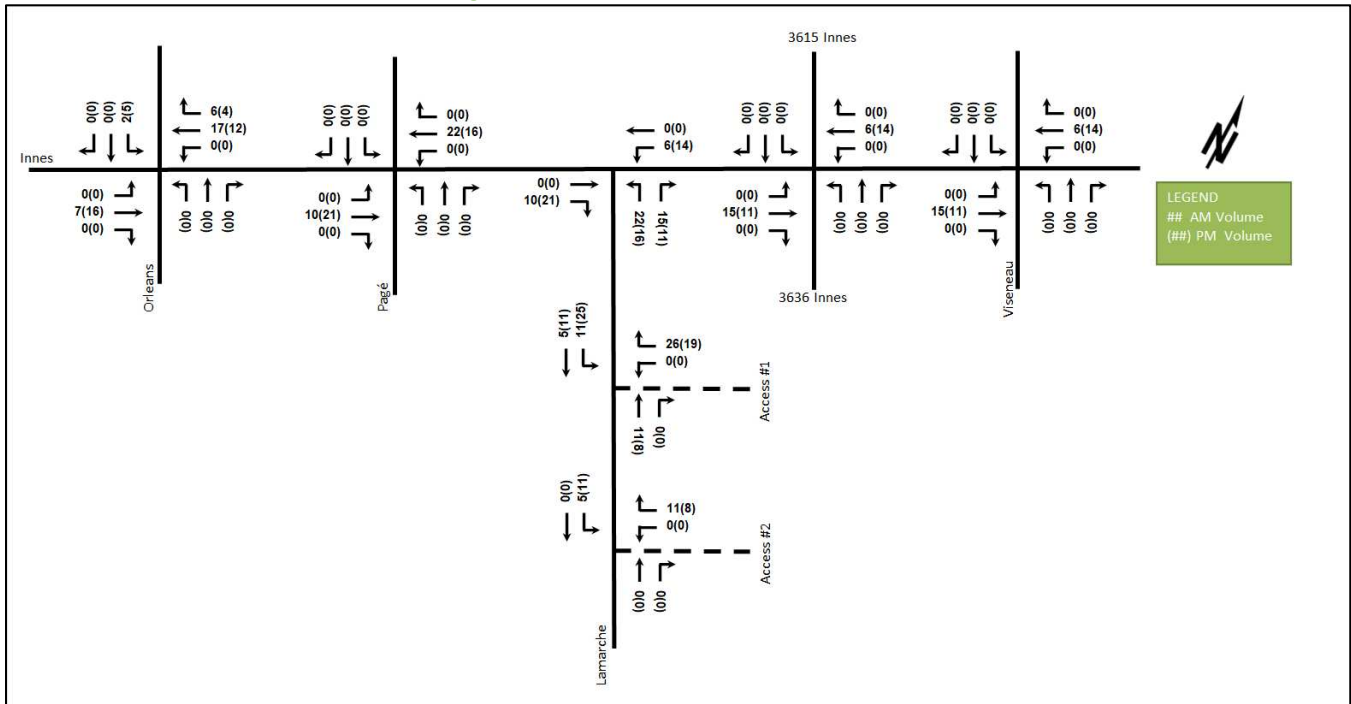

6 Background Network Travel Demands

6.1 Transportation Network Plans

The transportation network plans were discussed in Section 2.3 and no impacts on the study area traffic volumes and travel patterns are anticipated within the study horizons.

6.2 Background Growth

A review of the background projections from the City’s TRANS Regional Model for the 2011 and 2031 horizons was completed to determine the background growth for each of the study area roadways. The background TRANS model growth rates are summarized in Table 11 and the TRANS model plots are provided in Appendix E.

Table 11: TRANS Regional Model Projections – Study Area Growth Rates

Street	TRANS Rate		Existing to 2031	
	Eastbound	Westbound	Eastbound	Westbound
Innes Road	-0.28%	-1.64%	-3.14%	-5.02%
	Northbound	Southbound	Northbound	Southbound
Orleans Boulevard	4.02%	-0.95%	0.45%	1.92%

In general, the growth rates in the study area derived from the two TRANS model horizons are projected to be negative along Innes Road in the eastbound and westbound directions and slightly positive along Orleans Boulevard in the northbound direction. The existing volumes are noted to be exceed the TRANS 2031 model forecasts for Innes Road.

As the continued development is expected in Orleans and result in additional volumes along the area road network, beyond the developments considered in Section 6.3, it is assumed that a 1.00% growth rate will be applied to Innes Road and a 2.00% growth rate will be applied on Orleans Boulevard in peak directions. The modified growth rates have been applied to the study area network, and it is summarized in Table 12.

- Safety Triggers – The proposed access to Innes Road is within the area of influence of a signalized intersection, located within an auxiliary lane for that intersection, and makes use of an existing median break; further assessment is **required** based on this trigger.

Figure 1: View of the Subject Site

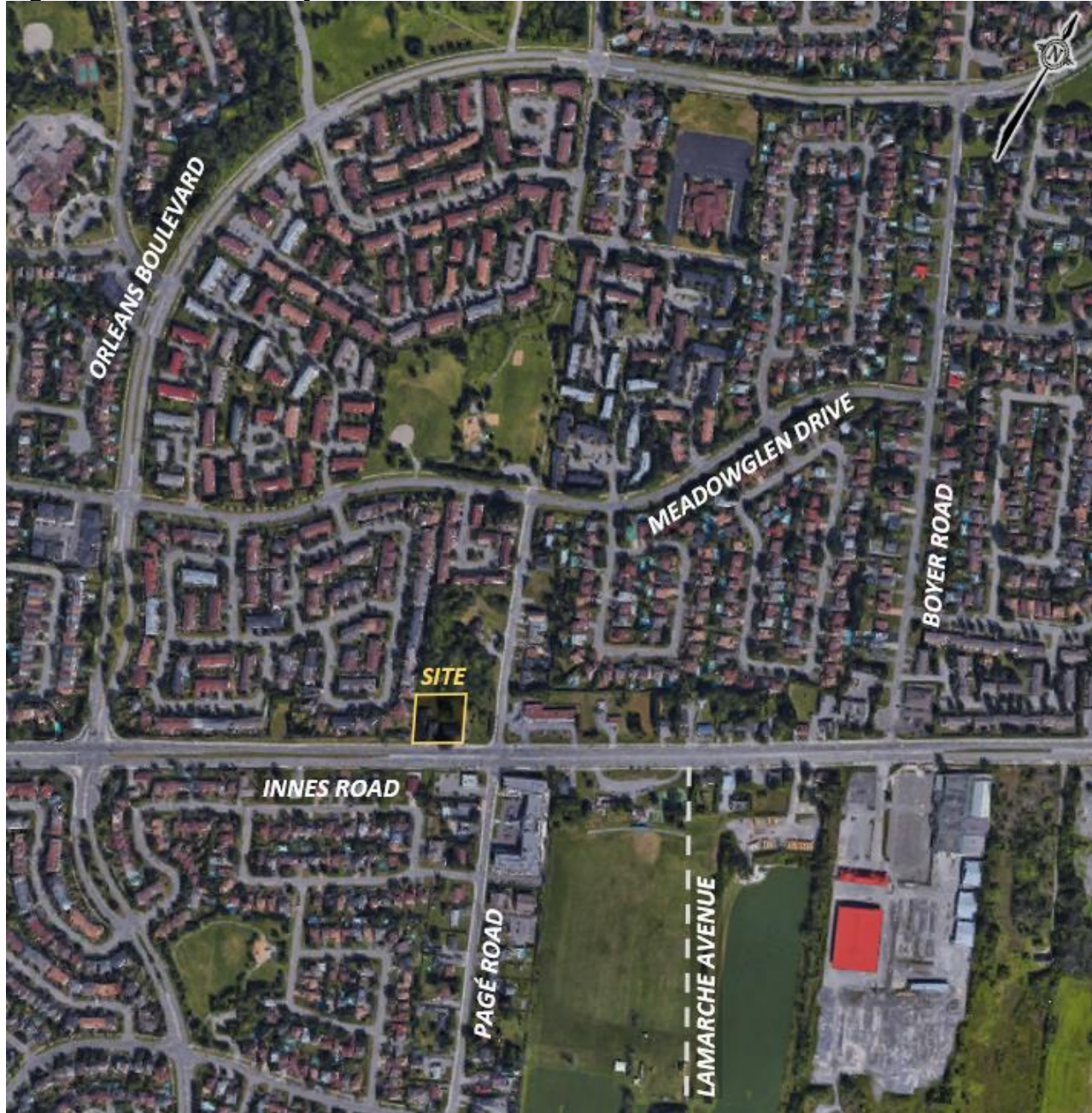

Figure 5: Balanced Existing Traffic Volumes

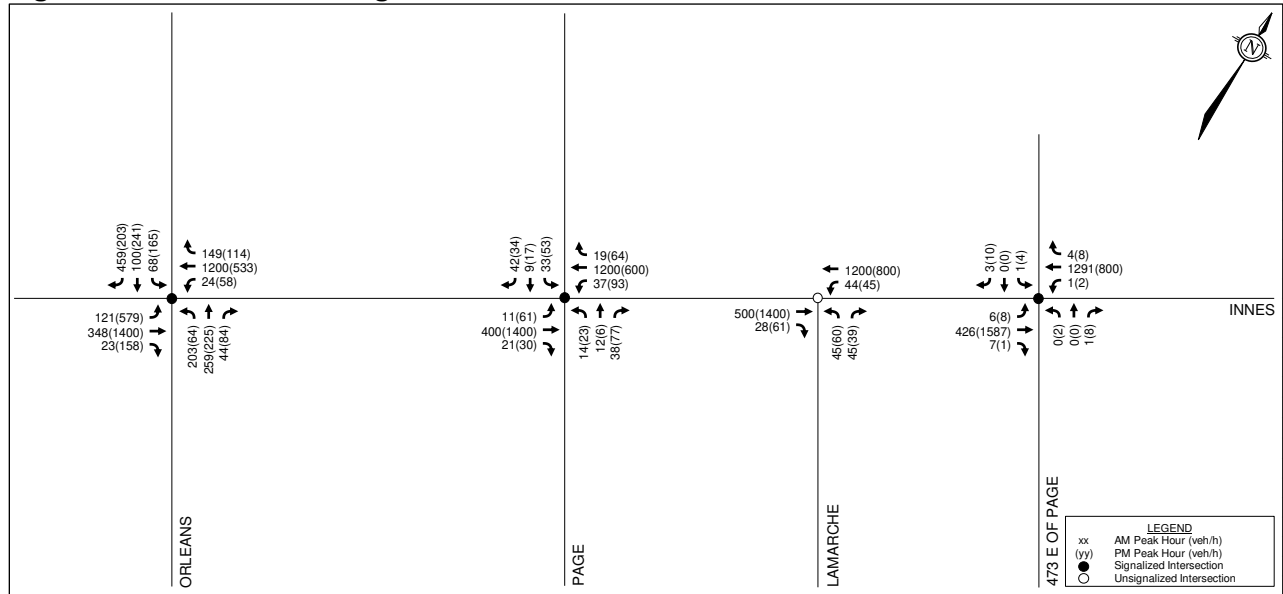
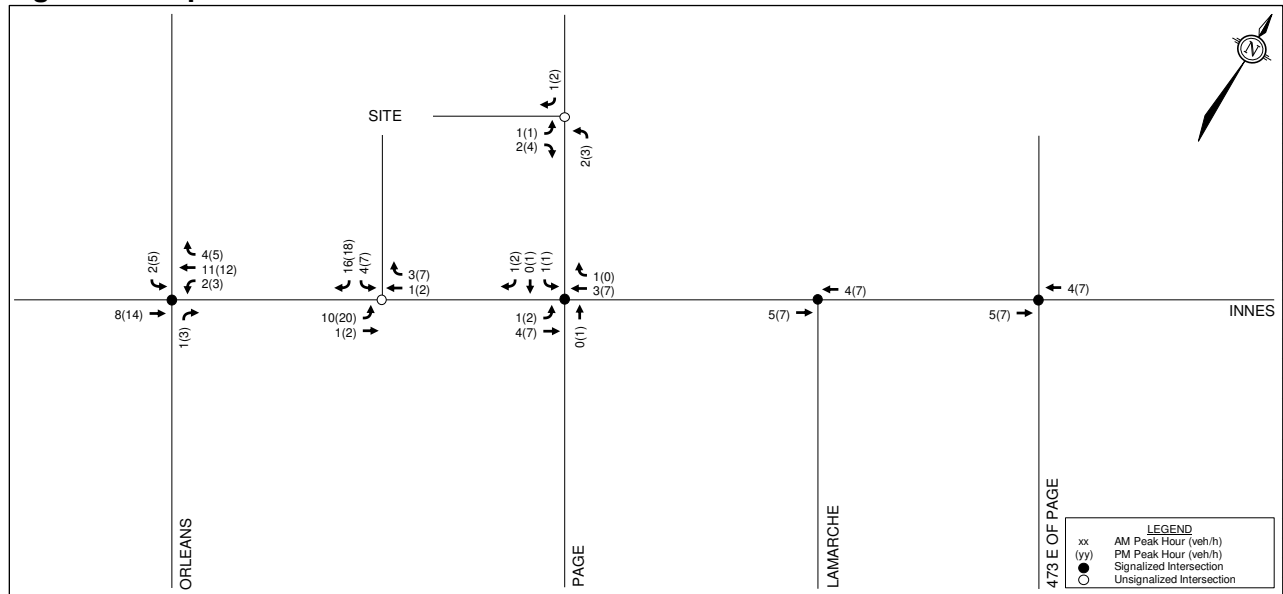

Figure 6: Proposed Site-Generated Traffic Volumes



TIA Strategy Report

Parsons has been retained by Lépine Corp. (Lépine) to prepare a Transportation Impact Assessment (TIA) in support of a Zoning By-Law Amendment (ZBLA) and Plan of Subdivision Application for a new residential focused development located at 3490 Innes Road in the Orléans Ward. This document follows the new TIA process, as outlined in the City Transportation Impact Assessment (TIA) Guidelines (2017).

The applicant previously submitted a TIA in support of a ZBLA on February 13, 2020. Since that time, Lépine has developed four (4) different development proposals that significantly reduce the scale and density to better align with the ultimate vision for the property. This report represents Step 4 – Strategy Report that details the transportation implications related to these potential development proposals by Lépine.

1. Screening Form

The screening form confirmed the need for a TIA Report based on the Trip Generation trigger, given that the proposed development consists of more than 89 residential apartment units; the Location trigger given that the development is located within a future cycling spine route, transit priority corridor with isolated measures and is within the Innes Arterial Mainstreet Design Priority Area (DPA); and the Safety trigger given that the proposed driveway is within the influence of potential future signalized intersection at Lamarche/Innes and one of the development proposals includes a drive-thru facility. The Screening Form has been provided in **Appendix A**.

2. Scoping Report

2.1. Existing and Planned Conditions

2.1.1. PROPOSED DEVELOPMENT

The proposed development is located at the municipal addresses of 3490 Innes Road, on the southwest corner of the Lamarche/Innes intersection. The site is currently occupied by small scale commercial properties, including an insurance company, food truck, mini-put facility and driving range. The proposed study area includes the intersections of Orléans/Innes, Pagé/Innes, Lamarche/Innes, Boyer/Innes and roadway segments adjacent to site or between intersections as shown in **Figure 1**. More details regarding the study area elements can be found in **Section 2.1.2**.

Figure 1: Local Context



Figure 15: 'New' Site-Generated Peak Hour Traffic

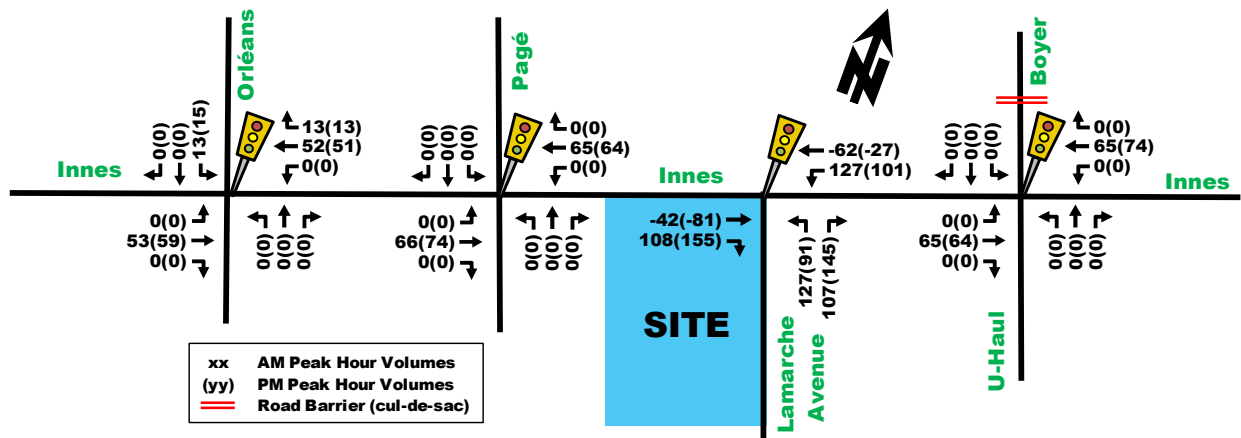

Note that negative trips reflect pass-by deviated trips

3.2. Background Network Travel Demands

3.2.1. TRANSPORTATION NETWORK PLANS

Refer to section 2.1.3 Planned Conditions – Planned Study Area Transportation Network Changes.

3.2.2. BACKGROUND GROWTH

The background traffic growth through the immediate study area, summarized in **Table 22**, was calculated based on historical traffic count data (years 2003, 2004, 2014, and 2017) provided by the City of Ottawa at the Orléans/Innes intersection. Detailed analysis of the background growth is included in **Appendix F**.

Table 22: Orléans/Innes Historical Background Growth (2003 - 2017)

Time Period	Percent Annual Change				
	North Leg	South Leg	East Leg	West Leg	Overall
8 hrs	1.35%	-0.20%	4.38%	2.53%	2.70%
AM Peak	0.69%	0.14%	3.81%	1.75%	2.08%
PM Peak	0.01%	-0.68%	3.45%	1.60%	1.66%

As shown in **Table 22**, in past years Innes Road and Orléans Boulevard has experienced an average annual growth ranging from +1.66% to +2.70%. Overall, minimal growth was observed on north-south movement and growth rates ranging from +1.6% to +4.38% were observed on Innes Road on east-west travel. These high traffic growth rates were a direct result of urban expansion along the Innes corridor towards Trim Road since 2003. Today, there are few undeveloped areas left along Innes Road to fuel significant traffic growth. The few nearby developments that are expected to contribute traffic within the study area were accounted for independently. This process is discussed in further detail in the following section.

Additionally, the City is planning to construct and has already constructed some adjacent road network connections (e.g. to Brian Coburn) and alternate mode infrastructure (e.g. transit priority measures and pedestrian/cycling facilities) to reduce the reliance and traffic pressures on Innes Road. Therefore, a 1% annual growth rate for traffic on Innes Road east-west through movement was considered appropriate to estimate future traffic growth.

3.2.3. OTHER AREA DEVELOPMENTS

Trips generated by other area developments were accounted within the study area. A summary of each development was provided in **Section 2.1.3**.

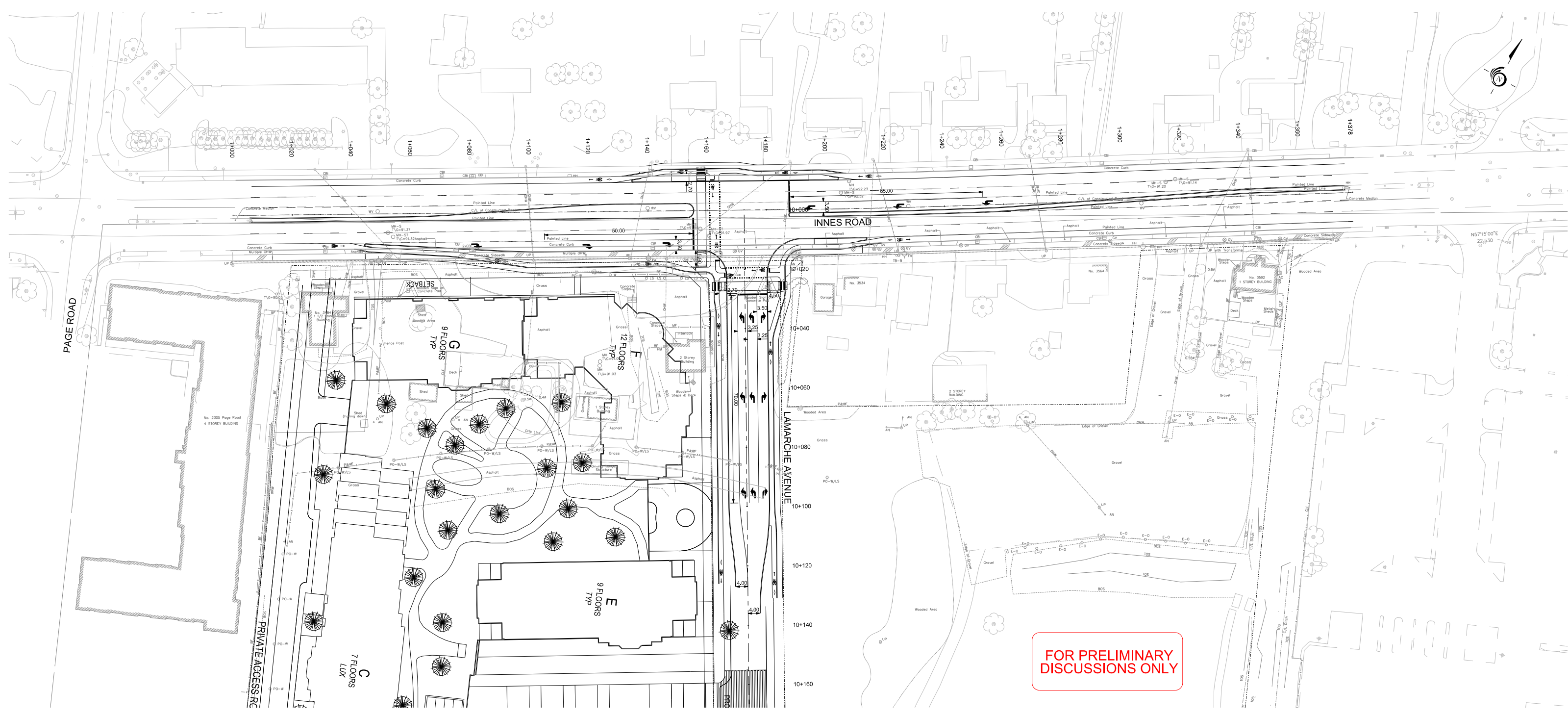

PARSONS

INNES ROAD AND LAMARCHE AVENUE
CONCEPTUAL INTERSECTION DESIGN

NOTE: The location of utilities is approximate only, the exact location should be determined by consulting the municipal authorities and utility companies concerned. The contractor shall prove the location of utilities and shall be responsible for adequate protection from damage.

Client:	Project Number: 478731	Drawn: M.J.P.	Dwg. No. 001
	Date: June 16, 2020	Sheet 1 of 1	
	Scale: HORIZONTAL 0m 5 10 20		

Exhibit 2.1: Existing Traffic Control and Lane Configurations

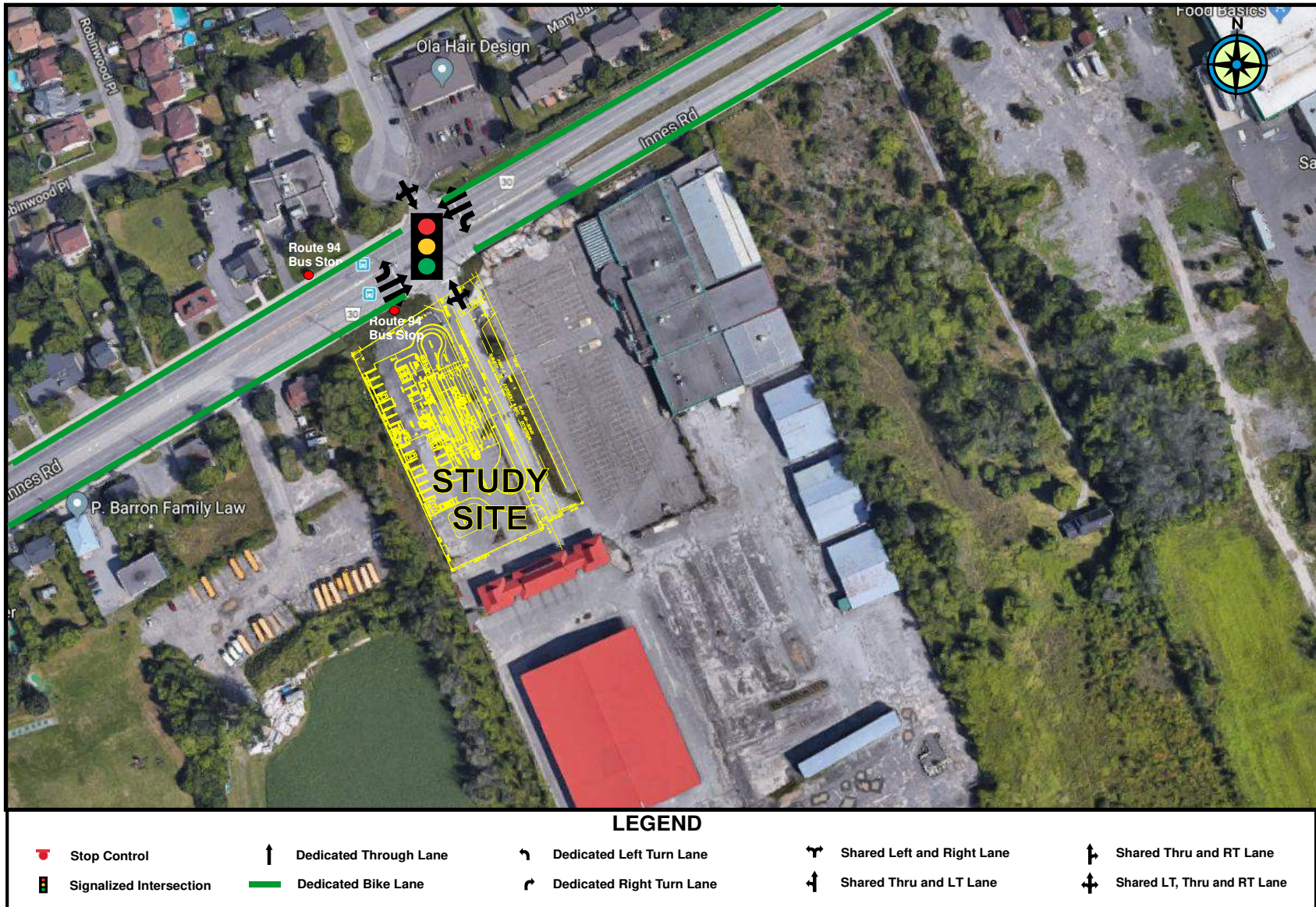

Exhibit 3.1: Site and Total Traffic Volumes

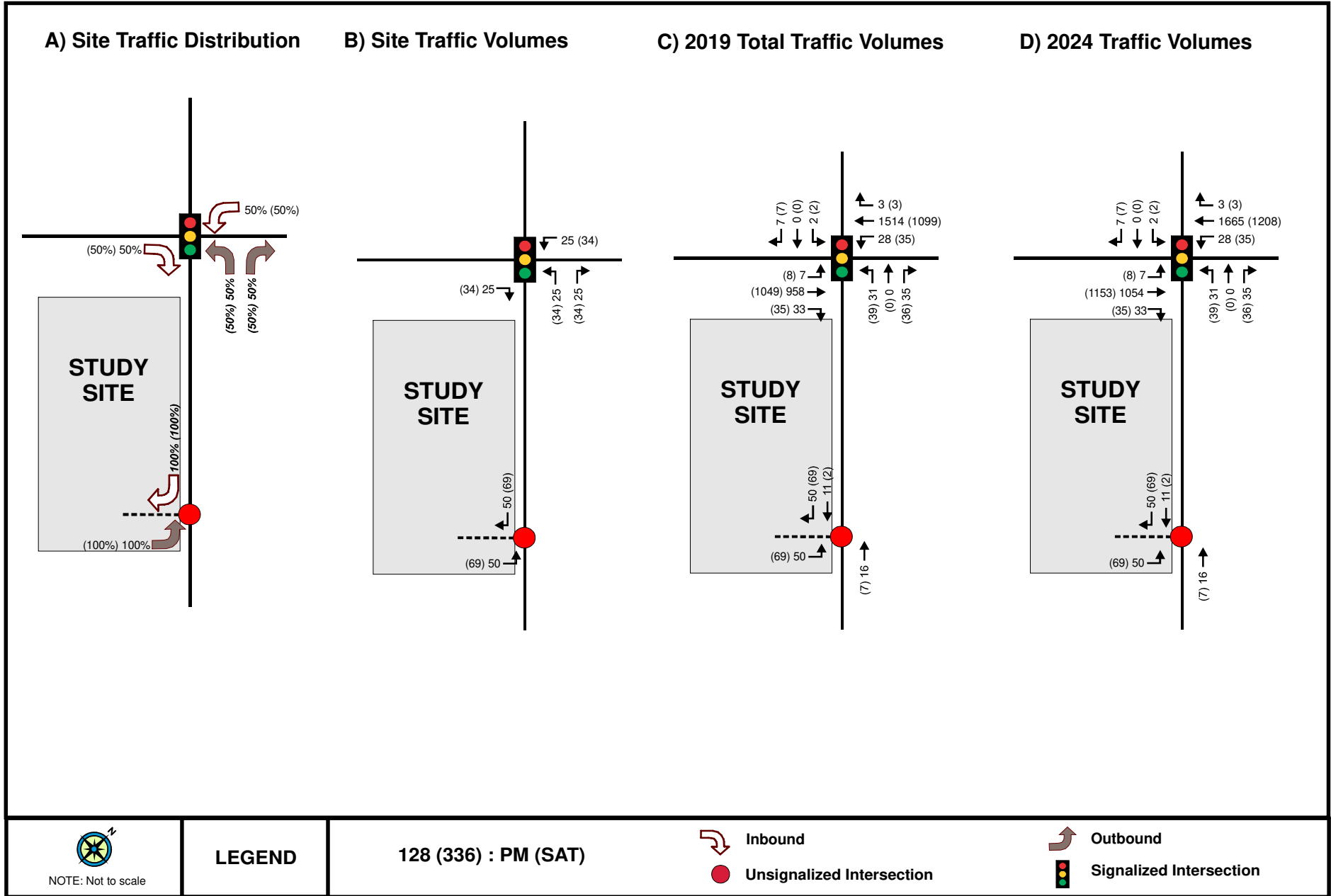

Figure 1: View of the Subject Site



In 2023 and 2028, trips to/from the east generated by the lower-density units and all trips generated by the medium-density units have all been assigned to the Innes Road/473m East of Pagé Road connection. Trips to/from the west generated by the lower-density units have been assigned to the Innes Road/Caivan Access and Innes Road/473m East of Pagé Road connections, with a majority of trips assigned to Innes Road/473m East of Pagé Road. The assumed trip assignment by 2023 and 2028 is described as follows:

Lower-Density Portion

- Innes Road/Caivan Access: 20% of trips to/from the west;
- Innes Road/473m East of Pagé Road: 100% of trips to/from the east and 80% of trips to/from the west.

Medium-Density Portion

- Innes Road/473m East of Pagé Road: 100% of trips to/from the east and west.

The EUC MTS identifies that any lands owned by Richcraft will not be developed by 2031. As such, while a connection to the future Richcraft Subdivision will be constructed, no trips have been assigned to this connection.

The EUC CDP identifies a future conceptual access from the Richcraft Subdivision to Innes Road via a right-in/right-out local connection, as well as a connection to Brian Coburn Boulevard south of the study area, via an extension of Fern Casey Boulevard. These connections are considered in the analysis of the EUC, but are not considered in the analysis of this TIA.

Trips generated by the proposed subdivision in the 2021 Phase 1 year, 2023 buildout year, and 2028 horizon year are shown in **Figure 5** and **Figure 6**.

Figure 5: 2021 Site-Generated Traffic

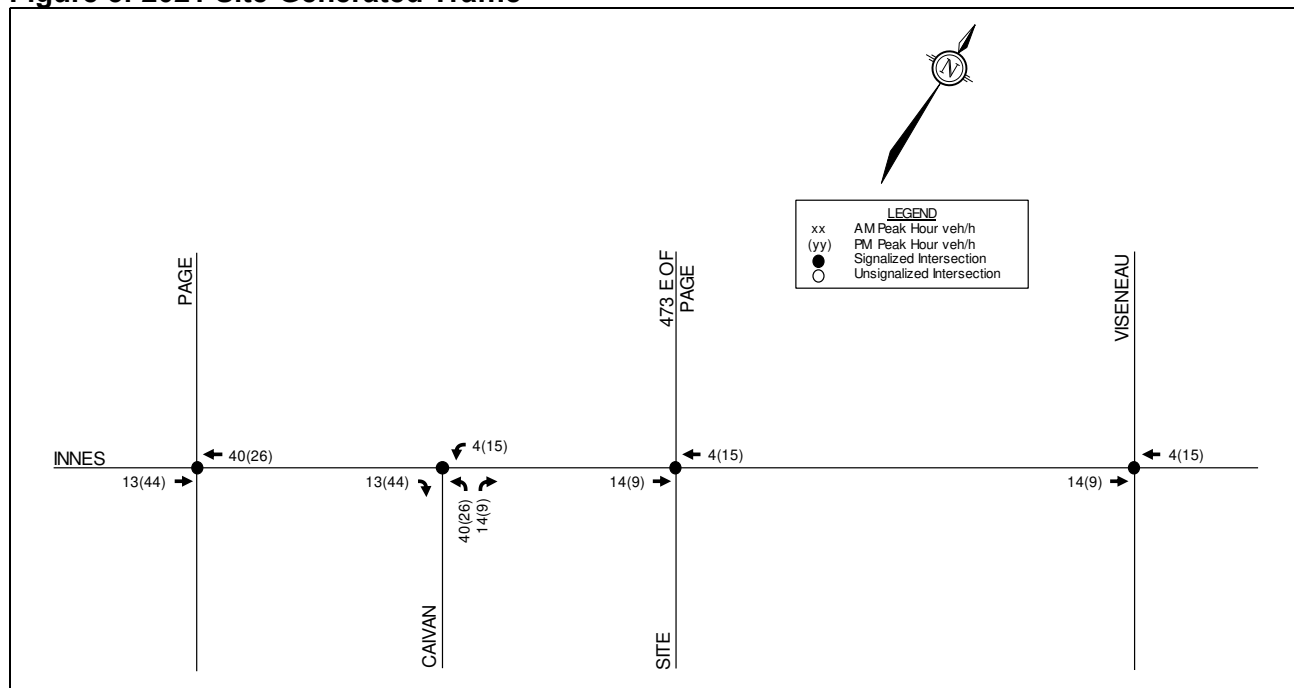
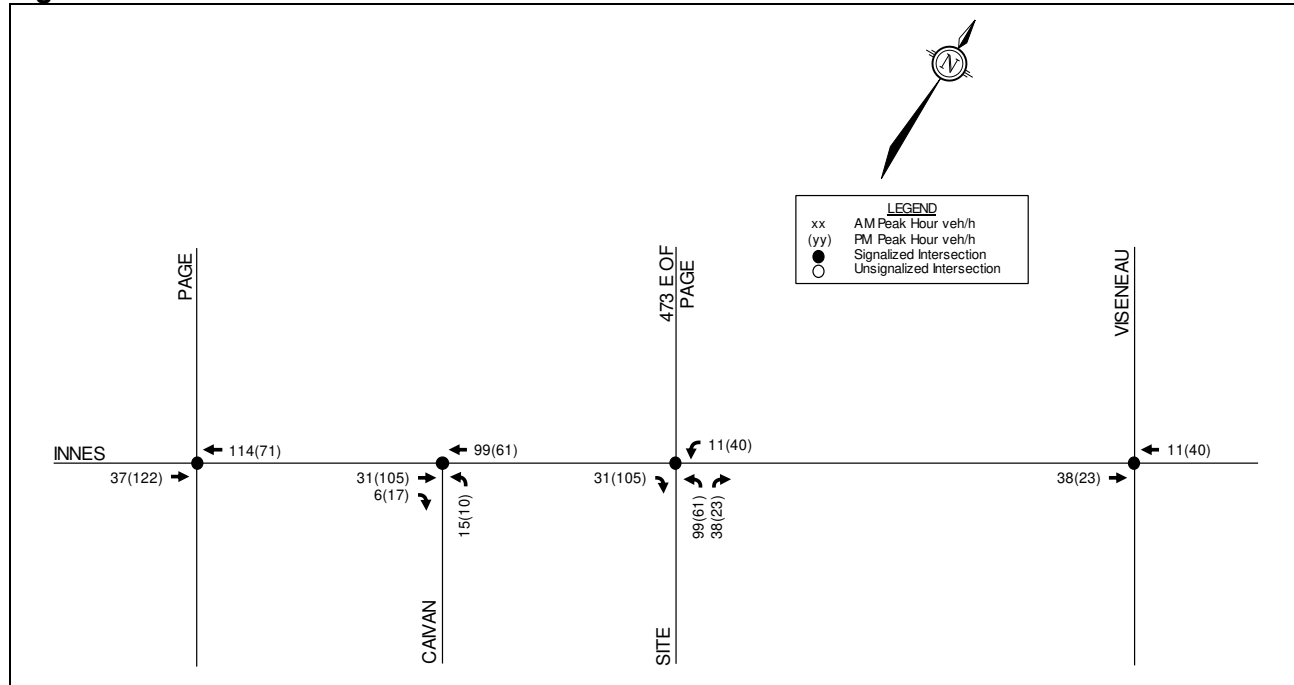

Figure 6: 2023/2028 Site-Generated Traffic



5.2 Background Traffic

5.2.1 General Background Growth Rate

A rate of background growth has been established through a review of the City of Ottawa’s 2013 Transportation Master Plan (TMP) and the City’s Strategic Long Range Model (comparing snapshots of 2011 and 2031 AM peak hour volumes). Section 2.3 of the TMP projects a 33% growth in the population of the Orléans area between 2011 and 2031, which translates to an annual growth rate of approximately 1.4% per annum. The snapshots indicate traffic volume reductions on Innes Road due to the opening of Brian Coburn Boulevard, which acts as an alternate east-west arterial route. To account for potential developments in the area that are not discussed below, a 1% background growth has been applied to the eastbound and westbound through volumes on Innes Road throughout the study area.

5.2.2 Other Area Developments

Within the study area, multiple developments are anticipated or are in the approval process. The following developments will be added to the background traffic to maintain a conservative analysis. Relevant excerpts of the studies associated with the following developments are included in **Appendix F**. Trips generated by the below developments have been assigned based on the trip distributions described in their respective studies, unless otherwise noted.

3443 Innes Road (Six-Storey Mixed-Use Building)

A TIA was prepared by Novatech in December 2017 and later revised in June 2018, in support of a six-storey mixed-use development (Site Plan Application D07-12-17-0169). The development consists of 35 residential units and ground floor commercial units. All trips generated by the development have been added to the background traffic in 2021, 2023, and 2028.

**FIGURE 2.1
SITE LOCATION PLAN**

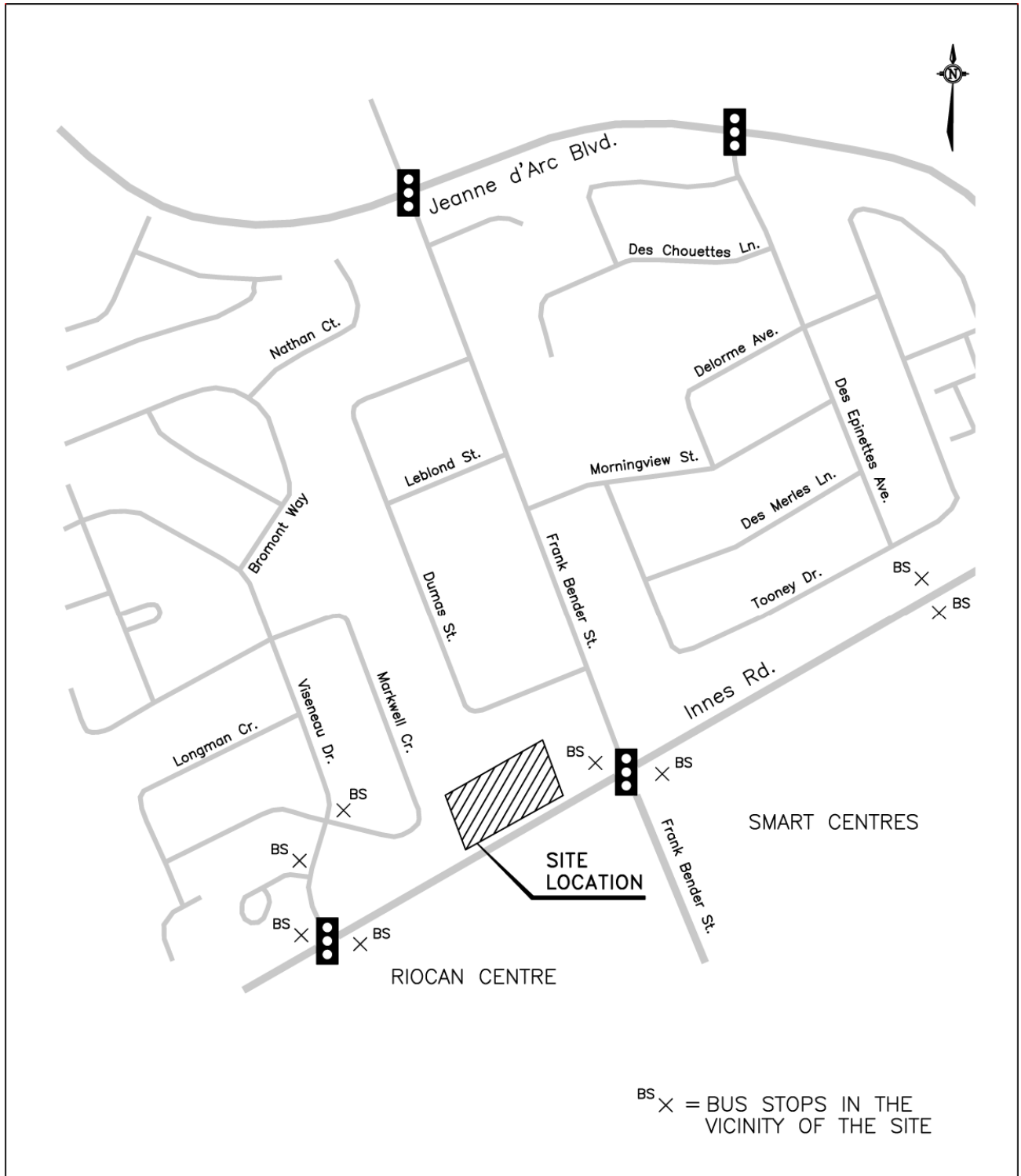

NOT TO SCALE

**FIGURE 3.1
 PEAK AM AND PM HOUR SITE GENERATED TRIPS**

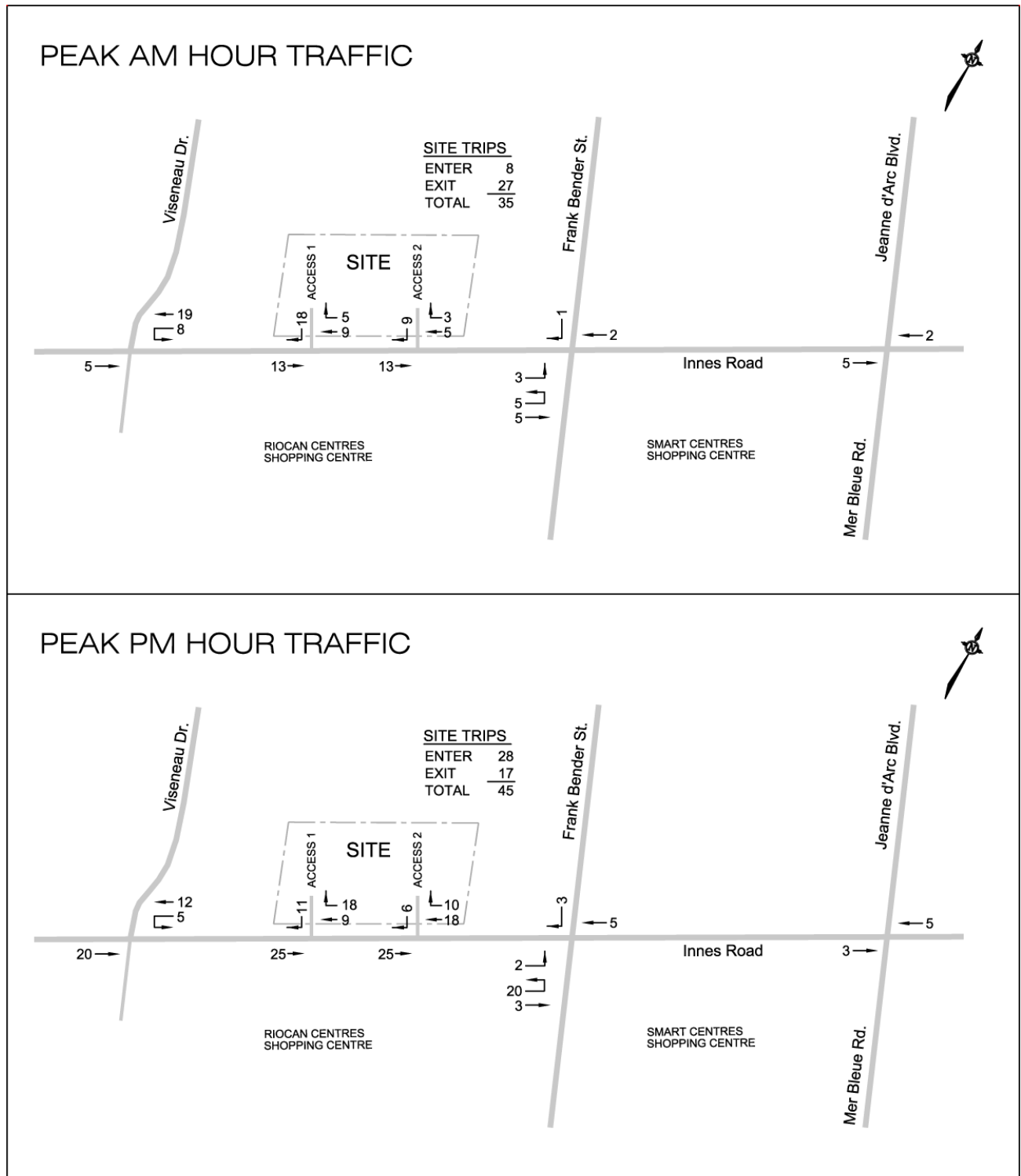

NOT TO SCALE

APPENDIX H

Signal Timing Plans

Traffic Signal Timing

City of Ottawa, Transportation Services Department

Traffic Signal Operations Unit

Intersection:	Main: Innes	Side: Orleans
Controller:	ATC 3	TSD: 5916
Author:	Matthew Anderson	Date: 06-Jul-2021

Existing Timing Plans†

Plan	Ped Minimum Time						Walk	DW	A+R
	AM Peak 1	Off Peak 2	PM Peak 3	Night 4	Weekend 5	AM Heavy 11			
Cycle	110	90	110	80	90	130			
Offset	79	10	0	X	10	99			
EB Thru	45	42	49	29	42	65	7	13	3.7 + 2.5
WB Thru	45	39	34	29	39	65	7	13	3.7 + 2.5
NB Left	19	-	12	-	-	19	-	-	3.3 + 3.4
NB Thru	52	33	45	33	33	52	7	19	3.3 + 3.4
SB Thru	33	33	33	33	33	33	7	19	3.3 + 3.4
EB Left (fp)	13	18	31	18	18	13	-	-	3.7 + 2.9
WB Left (fp)	13	15	16	18	15	13	-	-	3.7 + 2.5

Phasing Sequence‡

Plan: 4

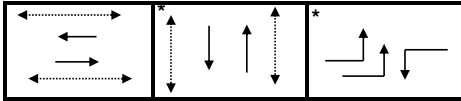

Plan: 2, 5

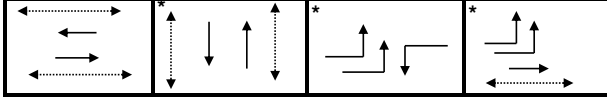

Plan: 3

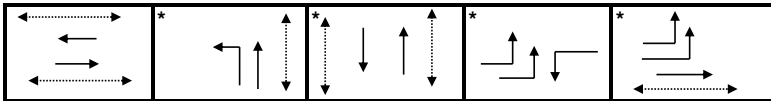

Plan: 1, 11

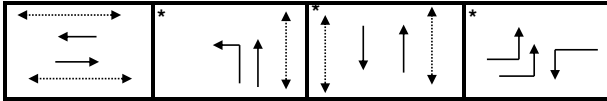

Schedule

Weekday		Saturday		Sunday	
Time	Plan	Time	Plan	Time	Plan
0:10	4	0:10	4	0:10	4
6:00	11	7:00	2	7:00	2
9:00	1	9:00	5	10:00	5
9:30	2	19:00	2	18:00	2
15:00	3	20:00	4	19:00	4
18:30	2				
22:00	4				

Notes

- †: Time for each direction includes amber and all red intervals
- ‡: Start of first phase should be used as reference point for offset
- Asterisk (*) Indicates actuated phase
- (fp): Fully Protected Left Turn
- ◄.....► Pedestrian signal

Cost is \$59.96 (\$53.06 + HST)

Traffic Signal Timing

City of Ottawa, Transportation Services Department

Traffic Signal Operations Unit

Intersection:	Main: Innes	Side: Pagé
Controller:	ATC3	TSD: 6676
Author:	Matthew Anderson	Date: 06-Jul-2021

Existing Timing Plans[†]

	Plan					Ped Minimum Time			
	AM Peak 1	Off Peak 2	PM Peak 3	Night 4	Weekend 5	AM Rush 11	Walk	DW	A+R
Cycle	110	90	110	80	90	120			
Offset	26	43	2	X	43	26			
EB Thru	72	52	72	42	52	82	15	18	3.7 + 2.5
WB Thru	72	52	72	42	52	82	15	18	3.7 + 2.5
NB Thru	38	38	38	38	38	38	7	24	3.0 + 3.8
SB Thru	38	38	38	38	38	38	7	24	3.0 + 3.8

Phasing Sequence[‡]

Plan: All

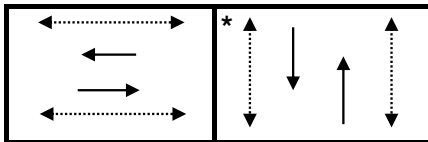

Schedule

Weekday		Saturday		Sunday	
Time	Plan	Time	Plan	Time	Plan
0:10	4	0:10	4	0:10	4
6:00	11	7:00	2	7:00	2
9:00	1	9:00	5	10:00	5
9:30	2	19:00	2	18:00	2
15:00	3	20:00	4	19:00	4
18:30	2				
22:00	4				

Notes

†: Time for each direction includes amber and all red intervals

‡: Start of first phase should be used as reference point for offset

Asterisk (*) Indicates actuated phase

(fp): Fully Protected Left Turn

←.....→ Pedestrian signal

Cost is \$59.96 (\$53.06 + HST)

Traffic Signal Timing

City of Ottawa, Transportation Services Department

Traffic Signal Operations Unit

Intersection:	Main: Innes	Side: Boyer/Builders Warehouse
Controller:	MS-3200	TSD: 6370
Author:	Jon Pach	Date: 05-Dec-2018

Existing Timing Plans†

	Plan						Ped Minimum Time		
	AM Peak 1	Off Peak 2	PM Peak 3	Night 4	Weekend 5	AM Rush 11	Walk	DW	A+R
Cycle	110	90	110	70	90	120			
Offset	0	43	36	X	43	0			
EB Thru	77	57	77	37	57	87	12	14	3.7 + 2.4
WB Thru	77	57	77	37	57	87	12	14	3.7 + 2.4
NB Thru	33	33	33	33	33	33	7	19	3.3 + 3.0
SB Thru	33	33	33	33	33	33	7	19	3.3 + 3.0

Phasing Sequence‡

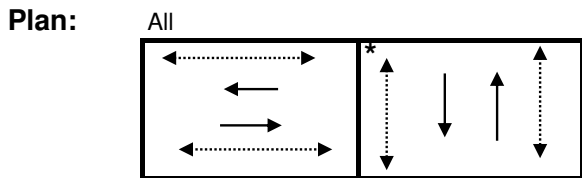

Schedule

Weekday		Saturday		Sunday	
Time	Plan	Time	Plan	Time	Plan
0:10	4	0:10	4	0:10	4
6:00	11	7:00	2	7:00	2
9:00	1	9:00	5	10:00	5
9:30	2	20:00	2	19:00	2
15:00	3	22:00	4	22:00	4
18:30	2				
22:00	4				

Notes

- †: Time for each direction includes amber and all red intervals
- ‡: Start of first phase should be used as reference point for offset
- Asterisk (*) Indicates actuated phase
- (fp): Fully Protected Left Turn
- ◄.....► Pedestrian signal

Cost is \$56.50 (\$50 + HST)

APPENDIX I

Existing Synchro Analysis



Lane Group	EBL	EBT	EBR	WBL	WBT	WBR	NBL	NBT	NBR	SBL	SBT	SBR
Lane Configurations	↖↖	↕↕	↗	↖	↕↕	↗	↖	↕↕	↗	↖	↕↕	↗
Traffic Volume (vph)	121	348	23	24	1200	149	203	259	44	68	100	459
Future Volume (vph)	121	348	23	24	1200	149	203	259	44	68	100	459
Ideal Flow (vphpl)	1800	1800	1800	1800	1800	1800	1800	1800	1800	1800	1800	1800
Storage Length (m)	140.0		80.0	105.0		60.0	50.0		50.0	55.0		60.0
Storage Lanes	2		1	1		1	1		1	1		1
Taper Length (m)	40.0			40.0			10.0			20.0		
Lane Util. Factor	0.97	0.95	1.00	1.00	0.95	1.00	1.00	0.95	1.00	1.00	0.95	1.00
Ped Bike Factor	1.00		0.96	0.98		0.97	0.99		0.94	0.97		0.98
Frt			0.850			0.850			0.850			0.850
Flt Protected	0.950			0.950			0.950			0.950		
Satd. Flow (prot)	2995	3144	1473	1572	3357	1502	1712	3357	1502	1679	3357	1532
Flt Permitted	0.950			0.950			0.543			0.575		
Satd. Flow (perm)	2986	3144	1416	1547	3357	1462	972	3357	1413	983	3357	1500
Right Turn on Red			Yes			Yes			Yes			Yes
Satd. Flow (RTOR)			143			143			82			155
Link Speed (k/h)		60			60			50				50
Link Distance (m)		264.5			491.4			387.7				301.9
Travel Time (s)		15.9			29.5			27.9				21.7
Confl. Peds. (#/hr)	6		14	14		6	6		32	32		6
Confl. Bikes (#/hr)						6						
Peak Hour Factor	0.90	0.90	0.90	0.90	0.90	0.90	0.90	0.90	0.90	0.90	0.90	0.90
Heavy Vehicles (%)	12%	10%	5%	10%	3%	3%	1%	3%	3%	3%	3%	1%
Adj. Flow (vph)	134	387	26	27	1333	166	226	288	49	76	111	510
Shared Lane Traffic (%)												
Lane Group Flow (vph)	134	387	26	27	1333	166	226	288	49	76	111	510
Enter Blocked Intersection	No	No	No	No	No	No	No	No	No	No	No	No
Lane Alignment	L NA	Left	R NA	L NA	Left	R NA	L NA	Left	R NA	L NA	Left	R NA
Median Width(m)		9.0			7.4			6.0				6.0
Link Offset(m)		0.0			0.0			0.0				0.0
Crosswalk Width(m)		5.0			5.0			5.0				5.0
Two way Left Turn Lane												
Headway Factor	1.06	1.06	1.06	1.06	1.06	1.06	1.06	1.06	1.06	1.06	1.06	1.06
Turning Speed (k/h)	24		14	24		14	24		14	24		14
Number of Detectors	1	2	1	1	2	1	1	2	1	1	2	1
Detector Template	Left	Thru	Right	Left	Thru	Right	Left	Thru	Right	Left	Thru	Right
Leading Detector (m)	18.6	93.0	18.6	18.6	93.0	18.6	18.6	93.0	18.6	18.6	93.0	18.6
Trailing Detector (m)	0.0	0.0	0.0	0.0	0.0	0.0	0.0	0.0	0.0	0.0	0.0	0.0
Detector 1 Position(m)	0.0	0.0	0.0	0.0	0.0	0.0	0.0	0.0	0.0	0.0	0.0	0.0
Detector 1 Size(m)	18.6	5.5	18.6	18.6	5.5	18.6	18.6	5.5	18.6	18.6	5.5	18.6
Detector 1 Type	Cl+Ex	Cl+Ex	Cl+Ex	Cl+Ex	Cl+Ex	Cl+Ex	Cl+Ex	Cl+Ex	Cl+Ex	Cl+Ex	Cl+Ex	Cl+Ex
Detector 1 Channel												
Detector 1 Extend (s)	0.0	0.0	0.0	0.0	0.0	0.0	0.0	0.0	0.0	0.0	0.0	0.0
Detector 1 Queue (s)	0.0	0.0	0.0	0.0	0.0	0.0	0.0	0.0	0.0	0.0	0.0	0.0
Detector 1 Delay (s)	0.0	0.0	0.0	0.0	0.0	0.0	0.0	0.0	0.0	0.0	0.0	0.0
Detector 2 Position(m)		87.5			87.5			87.5				87.5
Detector 2 Size(m)		5.5			5.5			5.5				5.5
Detector 2 Type		Cl+Ex			Cl+Ex			Cl+Ex				Cl+Ex
Detector 2 Channel												
Detector 2 Extend (s)		0.0			0.0			0.0				0.0
Turn Type	Prot	NA	Perm	Prot	NA	Perm	pm+pt	NA	Perm	Perm	NA	Perm
Protected Phases	5	2		1	6		3	8			4	
Permitted Phases			2			6	8		8	4		4
Detector Phase	5	2	2	1	6	6	3	8	8	4	4	4

1: Orleans & Innes
AM Peak Hour

3493-3499 Innes Road
2022 Existing Traffic



Lane Group	EBL	EBT	EBR	WBL	WBT	WBR	NBL	NBT	NBR	SBL	SBT	SBR
Switch Phase												
Minimum Initial (s)	5.0	10.0	10.0	5.0	10.0	10.0	5.0	10.0	10.0	10.0	10.0	10.0
Minimum Split (s)	11.6	26.2	26.2	11.2	26.2	26.2	11.7	32.7	32.7	32.7	32.7	32.7
Total Split (s)	13.0	65.0	65.0	13.0	65.0	65.0	19.0	52.0	52.0	33.0	33.0	33.0
Total Split (%)	10.0%	50.0%	50.0%	10.0%	50.0%	50.0%	14.6%	40.0%	40.0%	25.4%	25.4%	25.4%
Maximum Green (s)	6.4	58.8	58.8	6.8	58.8	58.8	12.3	45.3	45.3	26.3	26.3	26.3
Yellow Time (s)	3.7	3.7	3.7	3.7	3.7	3.7	3.3	3.3	3.3	3.3	3.3	3.3
All-Red Time (s)	2.9	2.5	2.5	2.5	2.5	2.5	3.4	3.4	3.4	3.4	3.4	3.4
Lost Time Adjust (s)	0.0	0.0	0.0	0.0	0.0	0.0	0.0	0.0	0.0	0.0	0.0	0.0
Total Lost Time (s)	6.6	6.2	6.2	6.2	6.2	6.2	6.7	6.7	6.7	6.7	6.7	6.7
Lead/Lag	Lead	Lag	Lag	Lead	Lag	Lag	Lead			Lag	Lag	Lag
Lead-Lag Optimize?	Yes	Yes	Yes	Yes	Yes	Yes	Yes			Yes	Yes	Yes
Vehicle Extension (s)	3.0	3.0	3.0	3.0	3.0	3.0	3.0	3.0	3.0	3.0	3.0	3.0
Recall Mode	None	C-Max	C-Max	None	C-Max	C-Max	None	None	None	None	None	None
Walk Time (s)		7.0	7.0		7.0	7.0		7.0	7.0	7.0	7.0	7.0
Flash Dont Walk (s)		13.0	13.0		13.0	13.0		19.0	19.0	19.0	19.0	19.0
Pedestrian Calls (#/hr)		14	14		6	6		32	32	6	6	6
Act Effct Green (s)	6.4	64.0	64.0	6.5	58.8	58.8	45.3	45.3	45.3	26.3	26.3	26.3
Actuated g/C Ratio	0.05	0.49	0.49	0.05	0.45	0.45	0.35	0.35	0.35	0.20	0.20	0.20
v/c Ratio	0.91	0.25	0.03	0.35	0.88	0.22	0.55	0.25	0.09	0.38	0.16	1.19
Control Delay	114.9	20.6	0.1	71.8	40.3	5.5	38.0	30.9	1.9	51.5	43.5	139.2
Queue Delay	0.0	0.0	0.0	0.0	0.0	0.0	0.0	0.0	0.0	0.0	0.0	0.0
Total Delay	114.9	20.6	0.1	71.8	40.3	5.5	38.0	30.9	1.9	51.5	43.5	139.2
LOS	F	C	A	E	D	A	D	C	A	D	D	F
Approach Delay		42.8			37.1			31.2			114.4	
Approach LOS		D			D			C			F	
Queue Length 50th (m)	16.5	29.4	0.0	6.3	147.5	3.0	39.9	25.3	0.0	15.6	11.4	~114.7
Queue Length 95th (m)	#34.6	39.7	0.0	15.5	177.6	14.6	60.2	35.7	2.6	30.0	19.2	#176.9
Internal Link Dist (m)		240.5			467.4			363.7			277.9	
Turn Bay Length (m)	140.0		80.0	105.0		60.0	50.0		50.0	55.0		60.0
Base Capacity (vph)	147	1548	769	82	1518	739	408	1169	545	198	680	427
Starvation Cap Reductn	0	0	0	0	0	0	0	0	0	0	0	0
Spillback Cap Reductn	0	0	0	0	0	0	0	0	0	0	0	0
Storage Cap Reductn	0	0	0	0	0	0	0	0	0	0	0	0
Reduced v/c Ratio	0.91	0.25	0.03	0.33	0.88	0.22	0.55	0.25	0.09	0.38	0.16	1.19

Intersection Summary

Area Type: Other
 Cycle Length: 130
 Actuated Cycle Length: 130
 Offset: 99 (76%), Referenced to phase 2:EBT and 6:WBT, Start of Green
 Natural Cycle: 115
 Control Type: Actuated-Coordinated
 Maximum v/c Ratio: 1.19
 Intersection Signal Delay: 53.2 Intersection LOS: D
 Intersection Capacity Utilization 93.9% ICU Level of Service F
 Analysis Period (min) 15
 ~ Volume exceeds capacity, queue is theoretically infinite.
 Queue shown is maximum after two cycles.
 # 95th percentile volume exceeds capacity, queue may be longer.
 Queue shown is maximum after two cycles.

Splits and Phases: 1: Orleans & Innes

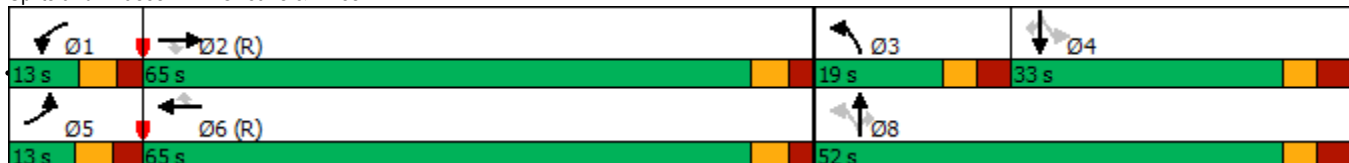



Lane Group	EBL	EBT	EBR	WBL	WBT	WBR	NBL	NBT	NBR	SBL	SBT	SBR
Lane Configurations												
Traffic Volume (vph)	11	400	21	37	1200	19	14	12	38	33	9	42
Future Volume (vph)	11	400	21	37	1200	19	14	12	38	33	9	42
Ideal Flow (vphpl)	1800	1800	1800	1800	1800	1800	1800	1800	1800	1800	1800	1800
Storage Length (m)	100.0		0.0	100.0		0.0	0.0		0.0	0.0		0.0
Storage Lanes	1		0	1		0	0		0	0		0
Taper Length (m)	35.0			0.0			2.5			2.5		
Lane Util. Factor	1.00	0.95	0.95	1.00	0.95	0.95	1.00	1.00	1.00	1.00	1.00	1.00
Ped Bike Factor	1.00	1.00		0.99	1.00			0.99			0.99	
Frt		0.993			0.998			0.920			0.932	
Flt Protected	0.950			0.950				0.989			0.981	
Satd. Flow (prot)	1586	3124	0	1503	3348	0	0	1569	0	0	1596	0
Flt Permitted	0.168			0.484				0.915			0.862	
Satd. Flow (perm)	280	3124	0	761	3348	0	0	1448	0	0	1402	0
Right Turn on Red			Yes			Yes			Yes			Yes
Satd. Flow (RTOR)		8			2			42			41	
Link Speed (k/h)		60			60			40			40	
Link Distance (m)		491.4			236.7			212.5			273.4	
Travel Time (s)		29.5			14.2			19.1			24.6	
Confl. Peds. (#/hr)	4		7	7		4	11					11
Confl. Bikes (#/hr)			1						1			1
Peak Hour Factor	0.90	0.90	0.90	0.90	0.90	0.90	0.90	0.90	0.90	0.90	0.90	0.90
Heavy Vehicles (%)	9%	10%	5%	15%	3%	5%	1%	15%	3%	1%	10%	3%
Adj. Flow (vph)	12	444	23	41	1333	21	16	13	42	37	10	47
Shared Lane Traffic (%)												
Lane Group Flow (vph)	12	467	0	41	1354	0	0	71	0	0	94	0
Enter Blocked Intersection	No	No	No	No	No	No	No	No	No	No	No	No
Lane Alignment	Left	Left	Right	Left	Left	Right	L NA	Left	R NA	L NA	Left	R NA
Median Width(m)		5.0			3.7			0.0			0.0	
Link Offset(m)		0.0			0.0			0.0			0.0	
Crosswalk Width(m)		10.0			10.0			5.0			5.0	
Two way Left Turn Lane					Yes							
Headway Factor	1.06	1.06	1.06	1.06	1.06	1.06	1.06	1.06	1.06	1.06	1.06	1.06
Turning Speed (k/h)	24		14	24		14	24		14	24		14
Number of Detectors	1	2		1	2		1	2		1	2	
Detector Template	Left	Thru		Left	Thru		Left	Thru		Left	Thru	
Leading Detector (m)	18.6	93.0		18.6	93.0		18.6	93.0		18.6	93.0	
Trailing Detector (m)	0.0	0.0		0.0	0.0		0.0	0.0		0.0	0.0	
Detector 1 Position(m)	0.0	0.0		0.0	0.0		0.0	0.0		0.0	0.0	
Detector 1 Size(m)	18.6	5.5		18.6	5.5		18.6	5.5		18.6	5.5	
Detector 1 Type	Cl+Ex	Cl+Ex		Cl+Ex	Cl+Ex		Cl+Ex	Cl+Ex		Cl+Ex	Cl+Ex	
Detector 1 Channel												
Detector 1 Extend (s)	0.0	0.0		0.0	0.0		0.0	0.0		0.0	0.0	
Detector 1 Queue (s)	0.0	0.0		0.0	0.0		0.0	0.0		0.0	0.0	
Detector 1 Delay (s)	0.0	0.0		0.0	0.0		0.0	0.0		0.0	0.0	
Detector 2 Position(m)		87.5			87.5			87.5			87.5	
Detector 2 Size(m)		5.5			5.5			5.5			5.5	
Detector 2 Type		Cl+Ex			Cl+Ex			Cl+Ex			Cl+Ex	
Detector 2 Channel												
Detector 2 Extend (s)		0.0			0.0			0.0			0.0	
Turn Type	Perm	NA		Perm	NA		Perm	NA		Perm	NA	
Protected Phases		2			6			8			4	
Permitted Phases	2			6			8			4		
Detector Phase	2	2		6	6		8	8		4	4	



Lane Group	EBL	EBT	EBR	WBL	WBT	WBR	NBL	NBT	NBR	SBL	SBT	SBR
Switch Phase												
Minimum Initial (s)	10.0	10.0		10.0	10.0		10.0	10.0		10.0	10.0	
Minimum Split (s)	39.2	39.2		39.2	39.2		37.8	37.8		37.8	37.8	
Total Split (s)	82.0	82.0		82.0	82.0		38.0	38.0		38.0	38.0	
Total Split (%)	68.3%	68.3%		68.3%	68.3%		31.7%	31.7%		31.7%	31.7%	
Maximum Green (s)	75.8	75.8		75.8	75.8		31.2	31.2		31.2	31.2	
Yellow Time (s)	3.7	3.7		3.7	3.7		3.0	3.0		3.0	3.0	
All-Red Time (s)	2.5	2.5		2.5	2.5		3.8	3.8		3.8	3.8	
Lost Time Adjust (s)	0.0	0.0		0.0	0.0			0.0			0.0	
Total Lost Time (s)	6.2	6.2		6.2	6.2			6.8			6.8	
Lead/Lag												
Lead-Lag Optimize?												
Vehicle Extension (s)	3.0	3.0		3.0	3.0		3.0	3.0		3.0	3.0	
Recall Mode	C-Max	C-Max		C-Max	C-Max		None	None		None	None	
Walk Time (s)	15.0	15.0		15.0	15.0		7.0	7.0		7.0	7.0	
Flash Dont Walk (s)	18.0	18.0		18.0	18.0		24.0	24.0		24.0	24.0	
Pedestrian Calls (#/hr)	7	7		4	4		1	1		11	11	
Act Effct Green (s)	88.6	88.6		88.6	88.6			18.4			18.4	
Actuated g/C Ratio	0.74	0.74		0.74	0.74			0.15			0.15	
v/c Ratio	0.06	0.20		0.07	0.55			0.28			0.38	
Control Delay	8.3	6.2		4.6	6.7			21.4			28.3	
Queue Delay	0.0	0.0		0.0	0.0			0.0			0.0	
Total Delay	8.3	6.2		4.6	6.7			21.4			28.3	
LOS	A	A		A	A			C			C	
Approach Delay		6.3			6.6			21.4			28.3	
Approach LOS		A			A			C			C	
Queue Length 50th (m)	0.4	9.3		1.5	39.5			6.0			11.1	
Queue Length 95th (m)	3.3	28.2		1.6	14.2			15.5			21.7	
Internal Link Dist (m)		467.4			212.7			188.5			249.4	
Turn Bay Length (m)	100.0			100.0								
Base Capacity (vph)	206	2308		561	2472			407			394	
Starvation Cap Reductn	0	0		0	0			0			0	
Spillback Cap Reductn	0	0		0	0			0			0	
Storage Cap Reductn	0	0		0	0			0			0	
Reduced v/c Ratio	0.06	0.20		0.07	0.55			0.17			0.24	

Intersection Summary

Area Type:	Other
Cycle Length:	120
Actuated Cycle Length:	120
Offset:	26 (22%), Referenced to phase 2:EBTL and 6:WBTL, Start of Green
Natural Cycle:	80
Control Type:	Actuated-Coordinated
Maximum v/c Ratio:	0.55
Intersection Signal Delay:	8.0
Intersection LOS:	A
Intersection Capacity Utilization:	61.0%
ICU Level of Service:	B
Analysis Period (min):	15

Splits and Phases: 2: Page & Innes

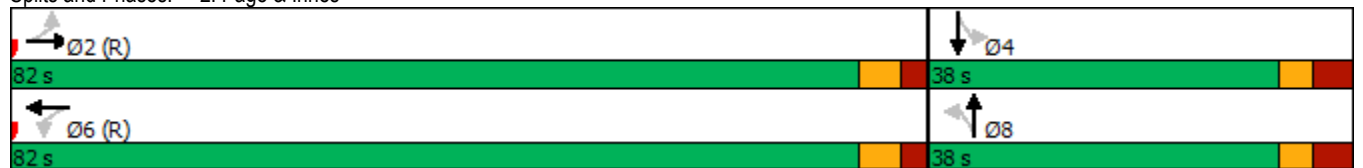



Lane Group	EBT	EBR	WBL	WBT	NBL	NBR
Lane Configurations	↑↑		↙	↑↑	↘	
Traffic Volume (vph)	500	28	44	1200	45	45
Future Volume (vph)	500	28	44	1200	45	45
Ideal Flow (vphpl)	1800	1800	1800	1800	1800	1800
Storage Length (m)		0.0	30.0		0.0	0.0
Storage Lanes		0	1		1	0
Taper Length (m)			20.0		20.0	
Lane Util. Factor	0.95	0.95	1.00	0.95	1.00	1.00
Ped Bike Factor						
Frt	0.992				0.932	
Flt Protected			0.950		0.976	
Satd. Flow (prot)	3330	0	1679	3357	1607	0
Flt Permitted			0.950		0.976	
Satd. Flow (perm)	3330	0	1679	3357	1607	0
Link Speed (k/h)	60			60	50	
Link Distance (m)	236.7			238.7	204.5	
Travel Time (s)	14.2			14.3	14.7	
Confl. Peds. (#/hr)		11	11			
Peak Hour Factor	0.90	0.90	0.90	0.90	0.90	0.90
Adj. Flow (vph)	556	31	49	1333	50	50
Shared Lane Traffic (%)						
Lane Group Flow (vph)	587	0	49	1333	100	0
Enter Blocked Intersection	No	No	No	No	No	No
Lane Alignment	Left	Right	Left	Left	L NA	R NA
Median Width(m)	3.7			3.7	3.7	
Link Offset(m)	0.0			0.0	0.0	
Crosswalk Width(m)	9.0			9.0	9.0	
Two way Left Turn Lane	Yes			Yes		
Headway Factor	1.06	1.06	1.06	1.06	1.06	1.06
Turning Speed (k/h)		14	24		24	14
Sign Control	Free			Free	Stop	

Intersection Summary

Area Type:	Other
Control Type:	Unsignalized
Intersection Capacity Utilization	47.2%
ICU Level of Service	A
Analysis Period (min)	15



Lane Group	EBL	EBT	EBR	WBL	WBT	WBR	NBL	NBT	NBR	SBL	SBT	SBR
Lane Configurations												
Traffic Volume (vph)	6	426	7	1	1291	4	0	0	1	1	0	3
Future Volume (vph)	6	426	7	1	1291	4	0	0	1	1	0	3
Ideal Flow (vphpl)	1800	1800	1800	1800	1800	1800	1800	1800	1800	1800	1800	1800
Storage Length (m)	30.0		0.0	40.0		0.0	0.0		0.0	0.0		0.0
Storage Lanes	1		0	1		0	0		1	0		0
Taper Length (m)	20.0			30.0			20.0			20.0		
Lane Util. Factor	1.00	0.95	0.95	1.00	0.95	0.95	1.00	1.00	1.00	1.00	1.00	1.00
Ped Bike Factor	1.00				1.00				0.99		0.99	
Fr _t		0.998							0.850		0.899	
Fl _t Protected	0.950			0.950							0.988	
Satd. Flow (prot)	1712	3137	0	1712	3357	0	0	1802	1532	0	1583	0
Fl _t Permitted	0.173			0.477							0.914	
Satd. Flow (perm)	311	3137	0	860	3357	0	0	1802	1511	0	1464	0
Right Turn on Red			Yes			Yes			Yes			Yes
Satd. Flow (RTOR)		3							442			28
Link Speed (k/h)		60			60				40			40
Link Distance (m)		238.7			292.8				151.9			62.6
Travel Time (s)		14.3			17.6				13.7			5.6
Confl. Peds. (#/hr)	7					7	2		1	1		2
Confl. Bikes (#/hr)						1						
Peak Hour Factor	0.90	0.90	0.90	0.90	0.90	0.90	0.90	0.90	0.90	0.90	0.90	0.90
Heavy Vehicles (%)	1%	10%	10%	1%	3%	1%	1%	1%	1%	1%	1%	1%
Adj. Flow (vph)	7	473	8	1	1434	4	0	0	1	1	0	3
Shared Lane Traffic (%)												
Lane Group Flow (vph)	7	481	0	1	1438	0	0	0	1	0	4	0
Enter Blocked Intersection	No	No	No	No	No	No	No	No	No	No	No	No
Lane Alignment	L NA	Left	R NA	L NA	Left	R NA	L NA	Left	R NA	L NA	Left	R NA
Median Width(m)		3.7			3.7				0.0			0.0
Link Offset(m)		0.0			0.0				0.0			0.0
Crosswalk Width(m)		9.0			9.0				9.0			9.0
Two way Left Turn Lane		Yes										
Headway Factor	1.06	1.06	1.06	1.06	1.06	1.06	1.06	1.06	1.06	1.06	1.06	1.06
Turning Speed (k/h)	24		14	24		14	24		14	24		14
Number of Detectors	1	2		1	2		1	2	1	1		2
Detector Template	Left	Thru		Left	Thru		Left	Thru	Right	Left		Thru
Leading Detector (m)	18.6	93.0		18.6	93.0		18.6	93.0	18.6	18.6		93.0
Trailing Detector (m)	0.0	0.0		0.0	0.0		0.0	0.0	0.0	0.0		0.0
Detector 1 Position(m)	0.0	0.0		0.0	0.0		0.0	0.0	0.0	0.0		0.0
Detector 1 Size(m)	18.6	5.5		18.6	5.5		18.6	5.5	18.6	18.6		5.5
Detector 1 Type	Cl+Ex	Cl+Ex		Cl+Ex	Cl+Ex		Cl+Ex	Cl+Ex	Cl+Ex	Cl+Ex		Cl+Ex
Detector 1 Channel												
Detector 1 Extend (s)	0.0	0.0		0.0	0.0		0.0	0.0	0.0	0.0		0.0
Detector 1 Queue (s)	0.0	0.0		0.0	0.0		0.0	0.0	0.0	0.0		0.0
Detector 1 Delay (s)	0.0	0.0		0.0	0.0		0.0	0.0	0.0	0.0		0.0
Detector 2 Position(m)		87.5			87.5			87.5				87.5
Detector 2 Size(m)		5.5			5.5			5.5				5.5
Detector 2 Type		Cl+Ex			Cl+Ex			Cl+Ex				Cl+Ex
Detector 2 Channel												
Detector 2 Extend (s)		0.0			0.0			0.0				0.0
Turn Type	Perm	NA		Perm	NA				Perm	Perm		NA
Protected Phases		2			6			8				4
Permitted Phases	2			6			8		8	4		
Detector Phase	2	2		6	6		8	8	8	4		4



Lane Group	EBL	EBT	EBR	WBL	WBT	WBR	NBL	NBT	NBR	SBL	SBT	SBR
Switch Phase												
Minimum Initial (s)	10.0	10.0		10.0	10.0		10.0	10.0	10.0	10.0	10.0	
Minimum Split (s)	32.1	32.1		35.1	35.1		32.3	32.3	32.3	32.3	32.3	
Total Split (s)	87.0	87.0		87.0	87.0		33.0	33.0	33.0	33.0	33.0	
Total Split (%)	72.5%	72.5%		72.5%	72.5%		27.5%	27.5%	27.5%	27.5%	27.5%	
Maximum Green (s)	80.9	80.9		80.9	80.9		26.7	26.7	26.7	26.7	26.7	
Yellow Time (s)	3.7	3.7		3.7	3.7		3.3	3.3	3.3	3.3	3.3	
All-Red Time (s)	2.4	2.4		2.4	2.4		3.0	3.0	3.0	3.0	3.0	
Lost Time Adjust (s)	0.0	0.0		0.0	0.0			0.0	0.0		0.0	
Total Lost Time (s)	6.1	6.1		6.1	6.1			6.3	6.3		6.3	
Lead/Lag												
Lead-Lag Optimize?												
Vehicle Extension (s)	3.0	3.0		3.0	3.0		3.0	3.0	3.0	3.0	3.0	
Recall Mode	C-Max	C-Max		C-Max	C-Max		None	None	None	None	None	
Walk Time (s)	12.0	12.0		12.0	12.0		7.0	7.0	7.0	7.0	7.0	
Flash Dont Walk (s)	14.0	14.0		14.0	14.0		19.0	19.0	19.0	19.0	19.0	
Pedestrian Calls (#/hr)	1	1		7	7		1	1	1	2	2	
Act Effct Green (s)	112.3	112.3		112.3	112.3				13.2		13.2	
Actuated g/C Ratio	0.94	0.94		0.94	0.94				0.11		0.11	
v/c Ratio	0.02	0.16		0.00	0.46				0.00		0.02	
Control Delay	3.7	1.9		4.0	3.4				0.0		0.2	
Queue Delay	0.0	0.0		0.0	0.0				0.0		0.0	
Total Delay	3.7	1.9		4.0	3.4				0.0		0.2	
LOS	A	A		A	A				A		A	
Approach Delay		1.9			3.4							0.3
Approach LOS		A			A							A
Queue Length 50th (m)	0.0	0.0		0.0	0.0				0.0		0.0	
Queue Length 95th (m)	1.7	22.4		0.6	101.7				0.0		0.0	
Internal Link Dist (m)		214.7			268.8			127.9				38.6
Turn Bay Length (m)	30.0			40.0								
Base Capacity (vph)	291	2936		805	3142				679		347	
Starvation Cap Reductn	0	0		0	0				0		0	
Spillback Cap Reductn	0	0		0	0				0		0	
Storage Cap Reductn	0	0		0	0				0		0	
Reduced v/c Ratio	0.02	0.16		0.00	0.46				0.00		0.01	

Intersection Summary

Area Type:	Other
Cycle Length:	120
Actuated Cycle Length:	120
Offset:	0 (0%), Referenced to phase 2:EBTL and 6:WBTL, Start of Green
Natural Cycle:	75
Control Type:	Actuated-Coordinated
Maximum v/c Ratio:	0.46
Intersection Signal Delay:	3.1
Intersection LOS:	A
Intersection Capacity Utilization:	57.3%
ICU Level of Service:	B
Analysis Period (min):	15

Splits and Phases: 4: 473 E of Page & Innes

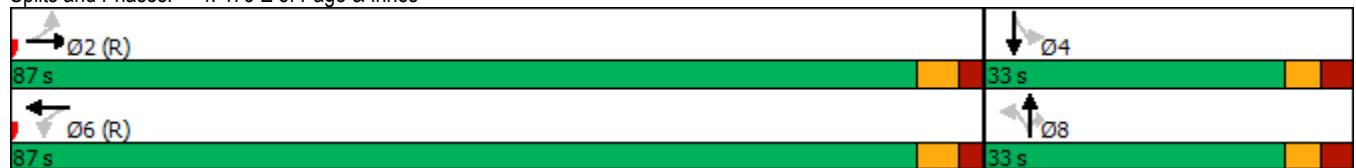

1: Orleans & Innes
AM Peak Hour

3493-3499 Innes Road
2022 Existing Traffic (demand rationalization)



Lane Group	EBL	EBT	EBR	WBL	WBT	WBR	NBL	NBT	NBR	SBL	SBT	SBR
Lane Configurations	↖↖	↗↗	↖	↖	↗↗	↖	↖	↗↗	↖	↖	↗↗	↖
Traffic Volume (vph)	111	348	23	24	1200	149	203	259	44	68	100	319
Future Volume (vph)	111	348	23	24	1200	149	203	259	44	68	100	319
Ideal Flow (vphpl)	1800	1800	1800	1800	1800	1800	1800	1800	1800	1800	1800	1800
Storage Length (m)	140.0		80.0	105.0		60.0	50.0		50.0	55.0		60.0
Storage Lanes	2		1	1		1	1		1	1		1
Taper Length (m)	40.0			40.0			10.0			20.0		
Lane Util. Factor	0.97	0.95	1.00	1.00	0.95	1.00	1.00	0.95	1.00	1.00	0.95	1.00
Ped Bike Factor	1.00		0.96	0.98		0.97	0.99		0.94	0.97		0.98
Fr			0.850			0.850			0.850			0.850
Flt Protected	0.950			0.950			0.950			0.950		
Satd. Flow (prot)	2995	3144	1473	1572	3357	1502	1712	3357	1502	1679	3357	1532
Flt Permitted	0.950			0.950			0.530			0.575		
Satd. Flow (perm)	2986	3144	1416	1547	3357	1462	949	3357	1413	983	3357	1500
Right Turn on Red			Yes			Yes			Yes			Yes
Satd. Flow (RTOR)			143			143			82			154
Link Speed (k/h)		60			60			50				50
Link Distance (m)		264.5			491.4			387.7				301.9
Travel Time (s)		15.9			29.5			27.9				21.7
Confl. Peds. (#/hr)	6		14	14		6	6		32	32		6
Confl. Bikes (#/hr)						6						
Peak Hour Factor	0.90	0.90	0.90	0.90	0.90	0.90	0.90	0.90	0.90	0.90	0.90	0.90
Heavy Vehicles (%)	12%	10%	5%	10%	3%	3%	1%	3%	3%	3%	3%	1%
Adj. Flow (vph)	123	387	26	27	1333	166	226	288	49	76	111	354
Shared Lane Traffic (%)												
Lane Group Flow (vph)	123	387	26	27	1333	166	226	288	49	76	111	354
Enter Blocked Intersection	No	No	No	No	No	No	No	No	No	No	No	No
Lane Alignment	L NA	Left	R NA	L NA	Left	R NA	L NA	Left	R NA	L NA	Left	R NA
Median Width(m)		9.0			7.4			6.0				6.0
Link Offset(m)		0.0			0.0			0.0				0.0
Crosswalk Width(m)		5.0			5.0			5.0				5.0
Two way Left Turn Lane												
Headway Factor	1.06	1.06	1.06	1.06	1.06	1.06	1.06	1.06	1.06	1.06	1.06	1.06
Turning Speed (k/h)	24		14	24		14	24		14	24		14
Number of Detectors	1	2	1	1	2	1	1	2	1	1	2	1
Detector Template	Left	Thru	Right	Left	Thru	Right	Left	Thru	Right	Left	Thru	Right
Leading Detector (m)	18.6	93.0	18.6	18.6	93.0	18.6	18.6	93.0	18.6	18.6	93.0	18.6
Trailing Detector (m)	0.0	0.0	0.0	0.0	0.0	0.0	0.0	0.0	0.0	0.0	0.0	0.0
Detector 1 Position(m)	0.0	0.0	0.0	0.0	0.0	0.0	0.0	0.0	0.0	0.0	0.0	0.0
Detector 1 Size(m)	18.6	5.5	18.6	18.6	5.5	18.6	18.6	5.5	18.6	18.6	5.5	18.6
Detector 1 Type	Cl+Ex	Cl+Ex	Cl+Ex	Cl+Ex	Cl+Ex	Cl+Ex	Cl+Ex	Cl+Ex	Cl+Ex	Cl+Ex	Cl+Ex	Cl+Ex
Detector 1 Channel												
Detector 1 Extend (s)	0.0	0.0	0.0	0.0	0.0	0.0	0.0	0.0	0.0	0.0	0.0	0.0
Detector 1 Queue (s)	0.0	0.0	0.0	0.0	0.0	0.0	0.0	0.0	0.0	0.0	0.0	0.0
Detector 1 Delay (s)	0.0	0.0	0.0	0.0	0.0	0.0	0.0	0.0	0.0	0.0	0.0	0.0
Detector 2 Position(m)		87.5			87.5			87.5				87.5
Detector 2 Size(m)		5.5			5.5			5.5				5.5
Detector 2 Type		Cl+Ex			Cl+Ex			Cl+Ex				Cl+Ex
Detector 2 Channel												
Detector 2 Extend (s)		0.0			0.0			0.0				0.0
Turn Type	Prot	NA	Perm	Prot	NA	Perm	pm+pt	NA	Perm	Perm	NA	Perm
Protected Phases	5	2		1	6		3	8			4	
Permitted Phases			2			6	8		8	4		4
Detector Phase	5	2	2	1	6	6	3	8	8	4	4	4



Lane Group	EBL	EBT	EBR	WBL	WBT	WBR	NBL	NBT	NBR	SBL	SBT	SBR
Switch Phase												
Minimum Initial (s)	5.0	10.0	10.0	5.0	10.0	10.0	5.0	10.0	10.0	10.0	10.0	10.0
Minimum Split (s)	11.6	26.2	26.2	11.2	26.2	26.2	11.7	32.7	32.7	32.7	32.7	32.7
Total Split (s)	13.0	65.0	65.0	13.0	65.0	65.0	19.0	52.0	52.0	33.0	33.0	33.0
Total Split (%)	10.0%	50.0%	50.0%	10.0%	50.0%	50.0%	14.6%	40.0%	40.0%	25.4%	25.4%	25.4%
Maximum Green (s)	6.4	58.8	58.8	6.8	58.8	58.8	12.3	45.3	45.3	26.3	26.3	26.3
Yellow Time (s)	3.7	3.7	3.7	3.7	3.7	3.7	3.3	3.3	3.3	3.3	3.3	3.3
All-Red Time (s)	2.9	2.5	2.5	2.5	2.5	2.5	3.4	3.4	3.4	3.4	3.4	3.4
Lost Time Adjust (s)	0.0	0.0	0.0	0.0	0.0	0.0	0.0	0.0	0.0	0.0	0.0	0.0
Total Lost Time (s)	6.6	6.2	6.2	6.2	6.2	6.2	6.7	6.7	6.7	6.7	6.7	6.7
Lead/Lag	Lead	Lag	Lag	Lead	Lag	Lag	Lead			Lag	Lag	Lag
Lead-Lag Optimize?	Yes	Yes	Yes	Yes	Yes	Yes	Yes			Yes	Yes	Yes
Vehicle Extension (s)	3.0	3.0	3.0	3.0	3.0	3.0	3.0	3.0	3.0	3.0	3.0	3.0
Recall Mode	None	C-Max	C-Max	None	C-Max	C-Max	None	None	None	None	None	None
Walk Time (s)		7.0	7.0		7.0	7.0		7.0	7.0	7.0	7.0	7.0
Flash Dont Walk (s)		13.0	13.0		13.0	13.0		19.0	19.0	19.0	19.0	19.0
Pedestrian Calls (#/hr)		14	14		6	6		32	32	6	6	6
Act Effct Green (s)	7.4	66.9	66.9	6.5	60.8	60.8	42.4	42.4	42.4	23.4	23.4	23.4
Actuated g/C Ratio	0.06	0.51	0.51	0.05	0.47	0.47	0.33	0.33	0.33	0.18	0.18	0.18
v/c Ratio	0.73	0.24	0.03	0.35	0.85	0.22	0.59	0.26	0.10	0.43	0.18	0.89
Control Delay	84.3	19.7	0.1	71.8	37.6	5.5	40.7	32.4	2.0	54.3	44.8	54.1
Queue Delay	0.0	0.0	0.0	0.0	0.0	0.0	0.0	0.0	0.0	0.0	0.0	0.0
Total Delay	84.3	19.7	0.1	71.8	37.6	5.5	40.7	32.4	2.0	54.3	44.8	54.1
LOS	F	B	A	E	D	A	D	C	A	D	D	D
Approach Delay		33.6			34.7			33.1			52.3	
Approach LOS		C			C			C			D	
Queue Length 50th (m)	15.1	29.4	0.0	6.3	147.5	3.0	39.9	25.3	0.0	15.6	11.4	47.4
Queue Length 95th (m)	#31.1	39.7	0.0	15.5	177.6	14.6	60.2	35.7	2.6	30.0	19.2	#92.7
Internal Link Dist (m)		240.5			467.4			363.7			277.9	
Turn Bay Length (m)	140.0		80.0	105.0		60.0	50.0		50.0	55.0		60.0
Base Capacity (vph)	169	1619	798	82	1569	759	381	1169	545	198	679	426
Starvation Cap Reductn	0	0	0	0	0	0	0	0	0	0	0	0
Spillback Cap Reductn	0	0	0	0	0	0	0	0	0	0	0	0
Storage Cap Reductn	0	0	0	0	0	0	0	0	0	0	0	0
Reduced v/c Ratio	0.73	0.24	0.03	0.33	0.85	0.22	0.59	0.25	0.09	0.38	0.16	0.83

Intersection Summary

Area Type: Other
 Cycle Length: 130
 Actuated Cycle Length: 130
 Offset: 99 (76%), Referenced to phase 2:EBT and 6:WBT, Start of Green
 Natural Cycle: 105
 Control Type: Actuated-Coordinated
 Maximum v/c Ratio: 0.89
 Intersection Signal Delay: 37.2 Intersection LOS: D
 Intersection Capacity Utilization 86.4% ICU Level of Service E
 Analysis Period (min) 15
 # 95th percentile volume exceeds capacity, queue may be longer.
 Queue shown is maximum after two cycles.

Splits and Phases: 1: Orleans & Innes





Lane Group	EBL	EBT	EBR	WBL	WBT	WBR	NBL	NBT	NBR	SBL	SBT	SBR
Lane Configurations	↔↔	↕↕	↗	↖	↕↕	↗	↖	↕↕	↗	↖	↕↕	↗
Traffic Volume (vph)	579	1400	158	58	533	114	64	225	84	165	241	203
Future Volume (vph)	579	1400	158	58	533	114	64	225	84	165	241	203
Ideal Flow (vphpl)	1800	1800	1800	1800	1800	1800	1800	1800	1800	1800	1800	1800
Storage Length (m)	140.0		80.0	105.0		60.0	50.0		50.0	55.0		60.0
Storage Lanes	2		1	1		1	1		1	1		1
Taper Length (m)	40.0			40.0			10.0			20.0		
Lane Util. Factor	0.97	0.95	1.00	1.00	0.95	1.00	1.00	0.95	1.00	1.00	0.95	1.00
Ped Bike Factor	0.99		0.95	1.00		0.97	0.99		0.97	0.98		0.97
Fr			0.850			0.850			0.850			0.850
Flt Protected	0.950			0.950			0.950			0.950		
Satd. Flow (prot)	3288	3357	1532	1712	3293	1517	1712	3390	1532	1712	3390	1532
Flt Permitted	0.950			0.950			0.447			0.597		
Satd. Flow (perm)	3261	3357	1456	1705	3293	1477	796	3390	1479	1058	3390	1485
Right Turn on Red			Yes			Yes			Yes			Yes
Satd. Flow (RTOR)			165			230			159			226
Link Speed (k/h)		60			60			50			50	
Link Distance (m)		264.5			491.4			387.7			301.9	
Travel Time (s)		15.9			29.5			27.9			21.7	
Confl. Peds. (#/hr)	7		22	22		7	15		18	18		15
Confl. Bikes (#/hr)			4			3						
Peak Hour Factor	0.90	0.90	0.90	0.90	0.90	0.90	0.90	0.90	0.90	0.90	0.90	0.90
Heavy Vehicles (%)	2%	3%	1%	1%	5%	2%	1%	2%	1%	1%	2%	1%
Adj. Flow (vph)	643	1556	176	64	592	127	71	250	93	183	268	226
Shared Lane Traffic (%)												
Lane Group Flow (vph)	643	1556	176	64	592	127	71	250	93	183	268	226
Enter Blocked Intersection	No	No	No	No	No	No	No	No	No	No	No	No
Lane Alignment	L NA	Left	R NA	L NA	Left	R NA	L NA	Left	R NA	L NA	Left	R NA
Median Width(m)		9.0			7.4			6.0			6.0	
Link Offset(m)		0.0			0.0			0.0			0.0	
Crosswalk Width(m)		5.0			5.0			5.0			5.0	
Two way Left Turn Lane												
Headway Factor	1.06	1.06	1.06	1.06	1.06	1.06	1.06	1.06	1.06	1.06	1.06	1.06
Turning Speed (k/h)	24		14	24		14	24		14	24		14
Number of Detectors	1	2	1	1	2	1	1	2	1	1	2	1
Detector Template	Left	Thru	Right	Left	Thru	Right	Left	Thru	Right	Left	Thru	Right
Leading Detector (m)	18.6	93.0	18.6	18.6	93.0	18.6	18.6	93.0	18.6	18.6	93.0	18.6
Trailing Detector (m)	0.0	0.0	0.0	0.0	0.0	0.0	0.0	0.0	0.0	0.0	0.0	0.0
Detector 1 Position(m)	0.0	0.0	0.0	0.0	0.0	0.0	0.0	0.0	0.0	0.0	0.0	0.0
Detector 1 Size(m)	18.6	5.5	18.6	18.6	5.5	18.6	18.6	5.5	18.6	18.6	5.5	18.6
Detector 1 Type	Cl+Ex	Cl+Ex	Cl+Ex	Cl+Ex	Cl+Ex	Cl+Ex	Cl+Ex	Cl+Ex	Cl+Ex	Cl+Ex	Cl+Ex	Cl+Ex
Detector 1 Channel												
Detector 1 Extend (s)	0.0	0.0	0.0	0.0	0.0	0.0	0.0	0.0	0.0	0.0	0.0	0.0
Detector 1 Queue (s)	0.0	0.0	0.0	0.0	0.0	0.0	0.0	0.0	0.0	0.0	0.0	0.0
Detector 1 Delay (s)	0.0	0.0	0.0	0.0	0.0	0.0	0.0	0.0	0.0	0.0	0.0	0.0
Detector 2 Position(m)		87.5			87.5			87.5			87.5	
Detector 2 Size(m)		5.5			5.5			5.5			5.5	
Detector 2 Type		Cl+Ex			Cl+Ex			Cl+Ex			Cl+Ex	
Detector 2 Channel												
Detector 2 Extend (s)		0.0			0.0			0.0			0.0	
Turn Type	Prot	NA	Perm	Prot	NA	Perm	pm+pt	NA	Perm	Perm	NA	Perm
Protected Phases	5	2		1	6		3	8			4	
Permitted Phases			2			6	8		8	4		4
Detector Phase	5	2	2	1	6	6	3	8	8	4	4	4



Lane Group	EBL	EBT	EBR	WBL	WBT	WBR	NBL	NBT	NBR	SBL	SBT	SBR
Switch Phase												
Minimum Initial (s)	5.0	10.0	10.0	5.0	10.0	10.0	5.0	10.0	10.0	10.0	10.0	10.0
Minimum Split (s)	11.6	26.2	26.2	11.2	26.2	26.2	11.7	32.7	32.7	32.7	32.7	32.7
Total Split (s)	31.0	49.0	49.0	16.0	34.0	34.0	12.0	45.0	45.0	33.0	33.0	33.0
Total Split (%)	28.2%	44.5%	44.5%	14.5%	30.9%	30.9%	10.9%	40.9%	40.9%	30.0%	30.0%	30.0%
Maximum Green (s)	24.4	42.8	42.8	9.8	27.8	27.8	5.3	38.3	38.3	26.3	26.3	26.3
Yellow Time (s)	3.7	3.7	3.7	3.7	3.7	3.7	3.3	3.3	3.3	3.3	3.3	3.3
All-Red Time (s)	2.9	2.5	2.5	2.5	2.5	2.5	3.4	3.4	3.4	3.4	3.4	3.4
Lost Time Adjust (s)	0.0	0.0	0.0	0.0	0.0	0.0	0.0	0.0	0.0	0.0	0.0	0.0
Total Lost Time (s)	6.6	6.2	6.2	6.2	6.2	6.2	6.7	6.7	6.7	6.7	6.7	6.7
Lead/Lag	Lead	Lag	Lag	Lead	Lag	Lag	Lead			Lag	Lag	Lag
Lead-Lag Optimize?	Yes	Yes	Yes	Yes	Yes	Yes	Yes			Yes	Yes	Yes
Vehicle Extension (s)	3.0	3.0	3.0	3.0	3.0	3.0	3.0	3.0	3.0	3.0	3.0	3.0
Recall Mode	None	C-Max	C-Max	None	C-Max	C-Max	None	None	None	None	None	None
Walk Time (s)		7.0	7.0		7.0	7.0		7.0	7.0	7.0	7.0	7.0
Flash Dont Walk (s)		13.0	13.0		13.0	13.0		19.0	19.0	19.0	19.0	19.0
Pedestrian Calls (#/hr)		22	22		7	7		32	32	15	15	15
Act Effct Green (s)	23.9	51.0	51.0	8.6	32.9	32.9	33.7	33.7	33.7	24.1	24.1	24.1
Actuated g/C Ratio	0.22	0.46	0.46	0.08	0.30	0.30	0.31	0.31	0.31	0.22	0.22	0.22
v/c Ratio	0.90	1.00	0.23	0.48	0.60	0.21	0.25	0.24	0.17	0.79	0.36	0.45
Control Delay	58.9	55.6	4.9	56.3	47.0	10.0	27.3	27.9	0.9	64.6	37.3	7.6
Queue Delay	0.0	0.0	0.0	0.0	0.0	0.0	0.0	0.0	0.0	0.0	0.0	0.0
Total Delay	58.9	55.6	4.9	56.3	47.0	10.0	27.3	27.9	0.9	64.6	37.3	7.6
LOS	E	E	A	E	D	B	C	C	A	E	D	A
Approach Delay		52.7			41.8			21.8			34.8	
Approach LOS		D			D			C			C	
Queue Length 50th (m)	63.8	~195.0	1.3	12.5	44.9	0.0	9.5	18.1	0.0	33.5	23.1	0.0
Queue Length 95th (m)	#91.2	#234.6	13.6	26.3	82.3	21.8	18.7	27.0	0.9	#62.9	34.0	16.9
Internal Link Dist (m)		240.5			467.4			363.7			277.9	
Turn Bay Length (m)	140.0		80.0	105.0		60.0	50.0		50.0	55.0		60.0
Base Capacity (vph)	732	1557	763	152	985	603	288	1180	618	252	810	527
Starvation Cap Reductn	0	0	0	0	0	0	0	0	0	0	0	0
Spillback Cap Reductn	0	0	0	0	0	0	0	0	0	0	0	0
Storage Cap Reductn	0	0	0	0	0	0	0	0	0	0	0	0
Reduced v/c Ratio	0.88	1.00	0.23	0.42	0.60	0.21	0.25	0.21	0.15	0.73	0.33	0.43

Intersection Summary

Area Type: Other
 Cycle Length: 110
 Actuated Cycle Length: 110
 Offset: 0 (0%), Referenced to phase 2:EBT and 6:WBT, Start of Green
 Natural Cycle: 115
 Control Type: Actuated-Coordinated
 Maximum v/c Ratio: 1.00
 Intersection Signal Delay: 44.8 Intersection LOS: D
 Intersection Capacity Utilization 90.5% ICU Level of Service E
 Analysis Period (min) 15
 ~ Volume exceeds capacity, queue is theoretically infinite.
 Queue shown is maximum after two cycles.
 # 95th percentile volume exceeds capacity, queue may be longer.
 Queue shown is maximum after two cycles.

Splits and Phases: 1: Orleans & Innes

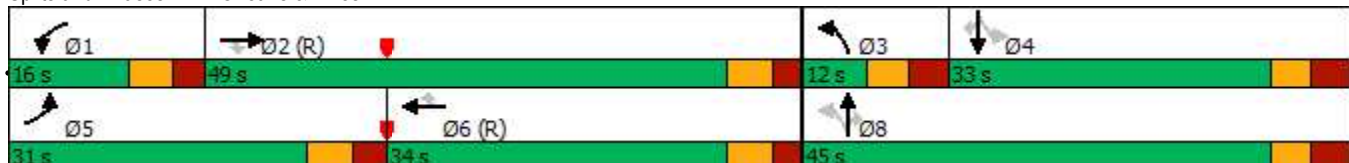



Lane Group	EBL	EBT	EBR	WBL	WBT	WBR	NBL	NBT	NBR	SBL	SBT	SBR
Lane Configurations												
Traffic Volume (vph)	61	1400	30	93	600	64	23	6	77	53	17	34
Future Volume (vph)	61	1400	30	93	600	64	23	6	77	53	17	34
Ideal Flow (vphpl)	1800	1800	1800	1800	1800	1800	1800	1800	1800	1800	1800	1800
Storage Length (m)	100.0		0.0	100.0		0.0	0.0		0.0	0.0		0.0
Storage Lanes	1		0	1		0	0		0	0		0
Taper Length (m)	35.0			0.0			2.5			2.5		
Lane Util. Factor	1.00	0.95	0.95	1.00	0.95	0.95	1.00	1.00	1.00	1.00	1.00	1.00
Ped Bike Factor	1.00	1.00		1.00	1.00			0.98				0.99
Frt		0.997			0.986			0.902				0.956
Flt Protected	0.950			0.950				0.989				0.975
Satd. Flow (prot)	1695	3375	0	1695	3245	0	0	1542	0	0	1579	0
Flt Permitted	0.359			0.114				0.917				0.765
Satd. Flow (perm)	637	3375	0	203	3245	0	0	1428	0	0	1232	0
Right Turn on Red			Yes			Yes			Yes			Yes
Satd. Flow (RTOR)		3			18			32				22
Link Speed (k/h)		60			60			40				40
Link Distance (m)		491.4			236.7			212.5				273.4
Travel Time (s)		29.5			14.2			19.1				24.6
Confl. Peds. (#/hr)	9		5	5		9	5		13	13		5
Confl. Bikes (#/hr)			1						1			
Peak Hour Factor	0.90	0.90	0.90	0.90	0.90	0.90	0.90	0.90	0.90	0.90	0.90	0.90
Heavy Vehicles (%)	2%	2%	6%	2%	5%	2%	5%	1%	3%	6%	1%	11%
Adj. Flow (vph)	68	1556	33	103	667	71	26	7	86	59	19	38
Shared Lane Traffic (%)												
Lane Group Flow (vph)	68	1589	0	103	738	0	0	119	0	0	116	0
Enter Blocked Intersection	No	No	No	No	No	No	No	No	No	No	No	No
Lane Alignment	Left	Left	Right	Left	Left	Right	L NA	Left	R NA	L NA	Left	R NA
Median Width(m)		5.0			3.7			0.0				0.0
Link Offset(m)		0.0			0.0			0.0				0.0
Crosswalk Width(m)		10.0			10.0			5.0				5.0
Two way Left Turn Lane					Yes							
Headway Factor	1.06	1.06	1.06	1.06	1.06	1.06	1.06	1.06	1.06	1.06	1.06	1.06
Turning Speed (k/h)	24		14	24		14	24		14	24		14
Number of Detectors	1	2		1	2		1	2		1		2
Detector Template	Left	Thru		Left	Thru		Left	Thru		Left		Thru
Leading Detector (m)	18.6	93.0		18.6	93.0		18.6	93.0		18.6		93.0
Trailing Detector (m)	0.0	0.0		0.0	0.0		0.0	0.0		0.0		0.0
Detector 1 Position(m)	0.0	0.0		0.0	0.0		0.0	0.0		0.0		0.0
Detector 1 Size(m)	18.6	5.5		18.6	5.5		18.6	5.5		18.6		5.5
Detector 1 Type	Cl+Ex	Cl+Ex		Cl+Ex	Cl+Ex		Cl+Ex	Cl+Ex		Cl+Ex		Cl+Ex
Detector 1 Channel												
Detector 1 Extend (s)	0.0	0.0		0.0	0.0		0.0	0.0		0.0		0.0
Detector 1 Queue (s)	0.0	0.0		0.0	0.0		0.0	0.0		0.0		0.0
Detector 1 Delay (s)	0.0	0.0		0.0	0.0		0.0	0.0		0.0		0.0
Detector 2 Position(m)		87.5			87.5			87.5				87.5
Detector 2 Size(m)		5.5			5.5			5.5				5.5
Detector 2 Type		Cl+Ex			Cl+Ex			Cl+Ex				Cl+Ex
Detector 2 Channel												
Detector 2 Extend (s)		0.0			0.0			0.0				0.0
Turn Type	Perm	NA		Perm	NA		Perm	NA		Perm		NA
Protected Phases		2			6			8				4
Permitted Phases	2			6			8			4		
Detector Phase	2	2		6	6		8	8		4		4



Lane Group	EBL	EBT	EBR	WBL	WBT	WBR	NBL	NBT	NBR	SBL	SBT	SBR
Switch Phase												
Minimum Initial (s)	10.0	10.0		10.0	10.0		10.0	10.0		10.0	10.0	
Minimum Split (s)	39.2	39.2		39.2	39.2		37.8	37.8		37.8	37.8	
Total Split (s)	72.0	72.0		72.0	72.0		38.0	38.0		38.0	38.0	
Total Split (%)	65.5%	65.5%		65.5%	65.5%		34.5%	34.5%		34.5%	34.5%	
Maximum Green (s)	65.8	65.8		65.8	65.8		31.2	31.2		31.2	31.2	
Yellow Time (s)	3.7	3.7		3.7	3.7		3.0	3.0		3.0	3.0	
All-Red Time (s)	2.5	2.5		2.5	2.5		3.8	3.8		3.8	3.8	
Lost Time Adjust (s)	0.0	0.0		0.0	0.0			0.0			0.0	
Total Lost Time (s)	6.2	6.2		6.2	6.2			6.8			6.8	
Lead/Lag												
Lead-Lag Optimize?												
Vehicle Extension (s)	3.0	3.0		3.0	3.0		3.0	3.0		3.0	3.0	
Recall Mode	C-Max	C-Max		C-Max	C-Max		None	None		None	None	
Walk Time (s)	15.0	15.0		15.0	15.0		7.0	7.0		7.0	7.0	
Flash Dont Walk (s)	18.0	18.0		18.0	18.0		24.0	24.0		24.0	24.0	
Pedestrian Calls (#/hr)	5	5		9	9		13	13		5	5	
Act Effct Green (s)	77.8	77.8		77.8	77.8			19.2			19.2	
Actuated g/C Ratio	0.71	0.71		0.71	0.71			0.17			0.17	
v/c Ratio	0.15	0.67		0.72	0.32			0.43			0.50	
Control Delay	2.6	4.9		52.7	11.5			31.5			37.8	
Queue Delay	0.0	0.0		0.0	0.0			0.0			0.0	
Total Delay	2.6	4.9		52.7	11.5			31.5			37.8	
LOS	A	A		D	B			C			D	
Approach Delay		4.8			16.5			31.5			37.8	
Approach LOS		A			B			C			D	
Queue Length 50th (m)	1.2	18.6		8.2	19.4			16.3			18.0	
Queue Length 95th (m)	m1.9	m21.8		#46.9	82.0			27.3			28.9	
Internal Link Dist (m)		467.4			212.7			188.5			249.4	
Turn Bay Length (m)	100.0			100.0								
Base Capacity (vph)	450	2386		143	2299			427			365	
Starvation Cap Reductn	0	0		0	0			0			0	
Spillback Cap Reductn	0	0		0	0			0			0	
Storage Cap Reductn	0	0		0	0			0			0	
Reduced v/c Ratio	0.15	0.67		0.72	0.32			0.28			0.32	

Intersection Summary

Area Type: Other
 Cycle Length: 110
 Actuated Cycle Length: 110
 Offset: 2 (2%), Referenced to phase 2:EBTL and 6:WBTL, Start of Green
 Natural Cycle: 120
 Control Type: Actuated-Coordinated
 Maximum v/c Ratio: 0.72
 Intersection Signal Delay: 11.0 Intersection LOS: B
 Intersection Capacity Utilization 81.2% ICU Level of Service D
 Analysis Period (min) 15
 # 95th percentile volume exceeds capacity, queue may be longer.
 Queue shown is maximum after two cycles.
 m Volume for 95th percentile queue is metered by upstream signal.

Splits and Phases: 2: Page & Innes

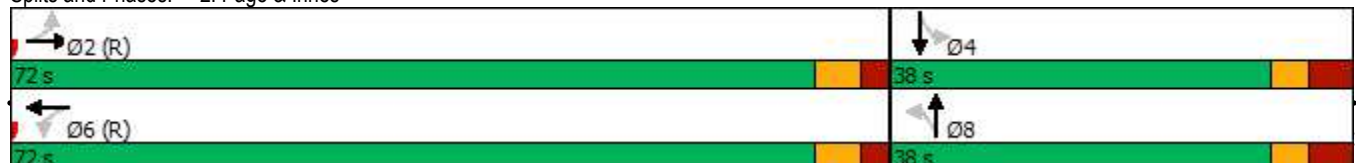



Lane Group	EBT	EBR	WBL	WBT	NBL	NBR
Lane Configurations	↑↑		↙	↑↑	↘	
Traffic Volume (vph)	1400	61	45	800	60	39
Future Volume (vph)	1400	61	45	800	60	39
Ideal Flow (vphpl)	1800	1800	1800	1800	1800	1800
Storage Length (m)		0.0	30.0		0.0	0.0
Storage Lanes		0	1		1	0
Taper Length (m)			20.0		20.0	
Lane Util. Factor	0.95	0.95	1.00	0.95	1.00	1.00
Ped Bike Factor						
Frt	0.994				0.947	
Flt Protected			0.950		0.970	
Satd. Flow (prot)	3337	0	1679	3357	1623	0
Flt Permitted			0.950		0.970	
Satd. Flow (perm)	3337	0	1679	3357	1623	0
Link Speed (k/h)	60			60	50	
Link Distance (m)	236.7			238.7	204.5	
Travel Time (s)	14.2			14.3	14.7	
Confl. Peds. (#/hr)		6	6			
Peak Hour Factor	0.90	0.90	0.90	0.90	0.90	0.90
Adj. Flow (vph)	1556	68	50	889	67	43
Shared Lane Traffic (%)						
Lane Group Flow (vph)	1624	0	50	889	110	0
Enter Blocked Intersection	No	No	No	No	No	No
Lane Alignment	Left	Right	Left	Left	L NA	R NA
Median Width(m)	3.7			3.7	3.7	
Link Offset(m)	0.0			0.0	0.0	
Crosswalk Width(m)	9.0			9.0	9.0	
Two way Left Turn Lane	Yes			Yes		
Headway Factor	1.06	1.06	1.06	1.06	1.06	1.06
Turning Speed (k/h)		14	24		24	14
Sign Control	Free			Free	Stop	

Intersection Summary

Area Type:	Other
Control Type:	Unsignalized
Intersection Capacity Utilization	55.6%
ICU Level of Service	B
Analysis Period (min)	15



Lane Group	EBL	EBT	EBR	WBL	WBT	WBR	NBL	NBT	NBR	SBL	SBT	SBR
Lane Configurations												
Traffic Volume (vph)	8	1587	1	2	824	8	2	0	8	4	0	10
Future Volume (vph)	8	1587	1	2	824	8	2	0	8	4	0	10
Ideal Flow (vphpl)	1800	1800	1800	1800	1800	1800	1800	1800	1800	1800	1800	1800
Storage Length (m)	30.0		0.0	40.0		0.0	0.0		0.0	0.0		0.0
Storage Lanes	1		0	1		0	0		1	0		0
Taper Length (m)	20.0			30.0			20.0			20.0		
Lane Util. Factor	1.00	0.95	0.95	1.00	0.95	0.95	1.00	1.00	1.00	1.00	1.00	1.00
Ped Bike Factor		1.00						1.00				0.99
Fr					0.999				0.850			0.901
Flt Protected	0.950			0.950				0.950				0.987
Satd. Flow (prot)	1712	3390	0	1712	3323	0	0	1712	1381	0	1584	0
Flt Permitted	0.305			0.111				0.748			0.908	
Satd. Flow (perm)	550	3390	0	200	3323	0	0	1343	1381	0	1457	0
Right Turn on Red			Yes			Yes			Yes			Yes
Satd. Flow (RTOR)					2				31			31
Link Speed (k/h)		60			60			40				40
Link Distance (m)		238.7			292.8			151.9				62.6
Travel Time (s)		14.3			17.6			13.7				5.6
Confl. Peds. (#/hr)			2	2			3					3
Confl. Bikes (#/hr)			1									
Peak Hour Factor	0.90	0.90	0.90	0.90	0.90	0.90	0.90	0.90	0.90	0.90	0.90	0.90
Heavy Vehicles (%)	1%	2%	1%	1%	4%	1%	1%	1%	12%	1%	1%	1%
Adj. Flow (vph)	9	1763	1	2	916	9	2	0	9	4	0	11
Shared Lane Traffic (%)												
Lane Group Flow (vph)	9	1764	0	2	925	0	0	2	9	0	15	0
Enter Blocked Intersection	No	No	No	No	No	No	No	No	No	No	No	No
Lane Alignment	L NA	Left	R NA	L NA	Left	R NA	L NA	Left	R NA	L NA	Left	R NA
Median Width(m)		3.7			3.7			0.0				0.0
Link Offset(m)		0.0			0.0			0.0				0.0
Crosswalk Width(m)		9.0			9.0			9.0				9.0
Two way Left Turn Lane		Yes										
Headway Factor	1.06	1.06	1.06	1.06	1.06	1.06	1.06	1.06	1.06	1.06	1.06	1.06
Turning Speed (k/h)	24		14	24		14	24		14	24		14
Number of Detectors	1	2		1	2		1	2	1	1		2
Detector Template	Left	Thru		Left	Thru		Left	Thru	Right	Left		Thru
Leading Detector (m)	18.6	93.0		18.6	93.0		18.6	93.0	18.6	18.6		93.0
Trailing Detector (m)	0.0	0.0		0.0	0.0		0.0	0.0	0.0	0.0		0.0
Detector 1 Position(m)	0.0	0.0		0.0	0.0		0.0	0.0	0.0	0.0		0.0
Detector 1 Size(m)	18.6	5.5		18.6	5.5		18.6	5.5	18.6	18.6		5.5
Detector 1 Type	Cl+Ex	Cl+Ex		Cl+Ex	Cl+Ex		Cl+Ex	Cl+Ex	Cl+Ex	Cl+Ex		Cl+Ex
Detector 1 Channel												
Detector 1 Extend (s)	0.0	0.0		0.0	0.0		0.0	0.0	0.0	0.0		0.0
Detector 1 Queue (s)	0.0	0.0		0.0	0.0		0.0	0.0	0.0	0.0		0.0
Detector 1 Delay (s)	0.0	0.0		0.0	0.0		0.0	0.0	0.0	0.0		0.0
Detector 2 Position(m)		87.5			87.5			87.5				87.5
Detector 2 Size(m)		5.5			5.5			5.5				5.5
Detector 2 Type		Cl+Ex			Cl+Ex			Cl+Ex				Cl+Ex
Detector 2 Channel												
Detector 2 Extend (s)		0.0			0.0			0.0				0.0
Turn Type	Perm	NA		Perm	NA		Perm	NA	Perm	Perm		NA
Protected Phases		2			6			8				4
Permitted Phases	2			6			8		8	4		
Detector Phase	2	2		6	6		8	8	8	4		4



Lane Group	EBL	EBT	EBR	WBL	WBT	WBR	NBL	NBT	NBR	SBL	SBT	SBR
Switch Phase												
Minimum Initial (s)	10.0	10.0		10.0	10.0		10.0	10.0	10.0	10.0	10.0	
Minimum Split (s)	32.1	32.1		35.1	35.1		32.3	32.3	32.3	32.3	32.3	
Total Split (s)	77.0	77.0		77.0	77.0		33.0	33.0	33.0	33.0	33.0	
Total Split (%)	70.0%	70.0%		70.0%	70.0%		30.0%	30.0%	30.0%	30.0%	30.0%	
Maximum Green (s)	70.9	70.9		70.9	70.9		26.7	26.7	26.7	26.7	26.7	
Yellow Time (s)	3.7	3.7		3.7	3.7		3.3	3.3	3.3	3.3	3.3	
All-Red Time (s)	2.4	2.4		2.4	2.4		3.0	3.0	3.0	3.0	3.0	
Lost Time Adjust (s)	0.0	0.0		0.0	0.0			0.0	0.0		0.0	
Total Lost Time (s)	6.1	6.1		6.1	6.1			6.3	6.3		6.3	
Lead/Lag												
Lead-Lag Optimize?												
Vehicle Extension (s)	3.0	3.0		3.0	3.0		3.0	3.0	3.0	3.0	3.0	
Recall Mode	C-Max	C-Max		C-Max	C-Max		None	None	None	None	None	
Walk Time (s)	12.0	12.0		12.0	12.0		7.0	7.0	7.0	7.0	7.0	
Flash Dont Walk (s)	14.0	14.0		14.0	14.0		19.0	19.0	19.0	19.0	19.0	
Pedestrian Calls (#/hr)	2	2		1	1		1	1	1	3	3	
Act Effct Green (s)	97.8	97.8		97.8	97.8			13.2	13.2		13.2	
Actuated g/C Ratio	0.89	0.89		0.89	0.89			0.12	0.12		0.12	
v/c Ratio	0.02	0.59		0.01	0.31			0.01	0.05		0.07	
Control Delay	1.8	2.7		5.0	3.5			38.0	0.5		5.1	
Queue Delay	0.0	0.0		0.0	0.0			0.0	0.0		0.0	
Total Delay	1.8	2.7		5.0	3.5			38.0	0.5		5.1	
LOS	A	A		A	A			D	A		A	
Approach Delay		2.7			3.5			7.3			5.1	
Approach LOS		A			A			A			A	
Queue Length 50th (m)	0.0	0.0		0.0	0.0			0.4	0.0		0.0	
Queue Length 95th (m)	m0.3	44.4		1.0	53.7			2.2	0.3		2.3	
Internal Link Dist (m)		214.7			268.8			127.9			38.6	
Turn Bay Length (m)	30.0			40.0								
Base Capacity (vph)	489	3015		178	2956			325	358		377	
Starvation Cap Reductn	0	0		0	0			0	0		0	
Spillback Cap Reductn	0	0		0	0			0	0		0	
Storage Cap Reductn	0	0		0	0			0	0		0	
Reduced v/c Ratio	0.02	0.59		0.01	0.31			0.01	0.03		0.04	

Intersection Summary

Area Type: Other
 Cycle Length: 110
 Actuated Cycle Length: 110
 Offset: 36 (33%), Referenced to phase 2:EBTL and 6:WBTL, Start of Green
 Natural Cycle: 90
 Control Type: Actuated-Coordinated
 Maximum v/c Ratio: 0.59
 Intersection Signal Delay: 3.0 Intersection LOS: A
 Intersection Capacity Utilization 79.9% ICU Level of Service D
 Analysis Period (min) 15
 m Volume for 95th percentile queue is metered by upstream signal.

Splits and Phases: 4: 473 E of Page & Innes

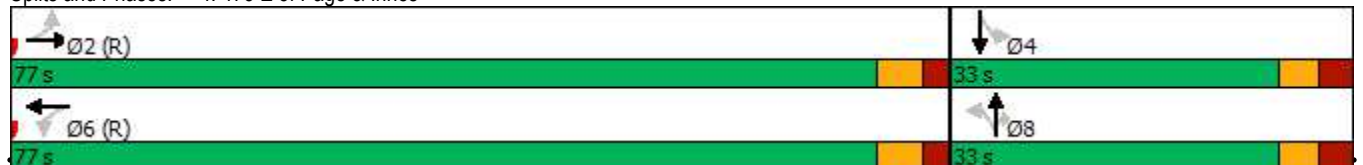

1: Orleans & Innes
PM Peak Hour

3493-3499 Innes Road
2022 Existing Traffic (demand rationalization)



Lane Group	EBL	EBT	EBR	WBL	WBT	WBR	NBL	NBT	NBR	SBL	SBT	SBR
Lane Configurations	↖↖	↕↕	↗	↖	↕↕	↗	↖	↕↕	↗	↖	↕↕	↗
Traffic Volume (vph)	579	1260	158	58	533	114	64	225	84	165	241	203
Future Volume (vph)	579	1260	158	58	533	114	64	225	84	165	241	203
Ideal Flow (vphpl)	1800	1800	1800	1800	1800	1800	1800	1800	1800	1800	1800	1800
Storage Length (m)	140.0		80.0	105.0		60.0	50.0		50.0	55.0		60.0
Storage Lanes	2		1	1		1	1		1	1		1
Taper Length (m)	40.0			40.0			10.0			20.0		
Lane Util. Factor	0.97	0.95	1.00	1.00	0.95	1.00	1.00	0.95	1.00	1.00	0.95	1.00
Ped Bike Factor	0.99		0.95	0.99		0.97	0.99		0.97	0.98		0.97
Fr _t			0.850			0.850			0.850			0.850
Fl _t Protected	0.950			0.950			0.950			0.950		
Satd. Flow (prot)	3288	3357	1532	1712	3293	1517	1712	3390	1532	1712	3390	1532
Fl _t Permitted	0.950			0.950			0.447			0.597		
Satd. Flow (perm)	3261	3357	1456	1703	3293	1477	796	3390	1479	1058	3390	1485
Right Turn on Red			Yes			Yes			Yes			Yes
Satd. Flow (RTOR)			165			230			159			226
Link Speed (k/h)		60			60			50			50	
Link Distance (m)		264.5			491.4			387.7			301.9	
Travel Time (s)		15.9			29.5			27.9			21.7	
Confl. Peds. (#/hr)	7		22	22		7	15		18	18		15
Confl. Bikes (#/hr)			4			3						
Peak Hour Factor	0.90	0.90	0.90	0.90	0.90	0.90	0.90	0.90	0.90	0.90	0.90	0.90
Heavy Vehicles (%)	2%	3%	1%	1%	5%	2%	1%	2%	1%	1%	2%	1%
Adj. Flow (vph)	643	1400	176	64	592	127	71	250	93	183	268	226
Shared Lane Traffic (%)												
Lane Group Flow (vph)	643	1400	176	64	592	127	71	250	93	183	268	226
Enter Blocked Intersection	No	No	No	No	No	No	No	No	No	No	No	No
Lane Alignment	L NA	Left	R NA	L NA	Left	R NA	L NA	Left	R NA	L NA	Left	R NA
Median Width(m)		9.0			7.4			6.0			6.0	
Link Offset(m)		0.0			0.0			0.0			0.0	
Crosswalk Width(m)		5.0			5.0			5.0			5.0	
Two way Left Turn Lane												
Headway Factor	1.06	1.06	1.06	1.06	1.06	1.06	1.06	1.06	1.06	1.06	1.06	1.06
Turning Speed (k/h)	24		14	24		14	24		14	24		14
Number of Detectors	1	2	1	1	2	1	1	2	1	1	2	1
Detector Template	Left	Thru	Right	Left	Thru	Right	Left	Thru	Right	Left	Thru	Right
Leading Detector (m)	18.6	93.0	18.6	18.6	93.0	18.6	18.6	93.0	18.6	18.6	93.0	18.6
Trailing Detector (m)	0.0	0.0	0.0	0.0	0.0	0.0	0.0	0.0	0.0	0.0	0.0	0.0
Detector 1 Position(m)	0.0	0.0	0.0	0.0	0.0	0.0	0.0	0.0	0.0	0.0	0.0	0.0
Detector 1 Size(m)	18.6	5.5	18.6	18.6	5.5	18.6	18.6	5.5	18.6	18.6	5.5	18.6
Detector 1 Type	Cl+Ex	Cl+Ex	Cl+Ex	Cl+Ex	Cl+Ex	Cl+Ex	Cl+Ex	Cl+Ex	Cl+Ex	Cl+Ex	Cl+Ex	Cl+Ex
Detector 1 Channel												
Detector 1 Extend (s)	0.0	0.0	0.0	0.0	0.0	0.0	0.0	0.0	0.0	0.0	0.0	0.0
Detector 1 Queue (s)	0.0	0.0	0.0	0.0	0.0	0.0	0.0	0.0	0.0	0.0	0.0	0.0
Detector 1 Delay (s)	0.0	0.0	0.0	0.0	0.0	0.0	0.0	0.0	0.0	0.0	0.0	0.0
Detector 2 Position(m)		87.5			87.5			87.5			87.5	
Detector 2 Size(m)		5.5			5.5			5.5			5.5	
Detector 2 Type		Cl+Ex			Cl+Ex			Cl+Ex			Cl+Ex	
Detector 2 Channel												
Detector 2 Extend (s)		0.0			0.0			0.0			0.0	
Turn Type	Prot	NA	Perm	Prot	NA	Perm	pm+pt	NA	Perm	Perm	NA	Perm
Protected Phases	5	2		1	6		3	8			4	
Permitted Phases			2			6	8		8	4		4
Detector Phase	5	2	2	1	6	6	3	8	8	4	4	4

1: Orleans & Innes
PM Peak Hour

3493-3499 Innes Road
2022 Existing Traffic (demand rationalization)



Lane Group	EBL	EBT	EBR	WBL	WBT	WBR	NBL	NBT	NBR	SBL	SBT	SBR
Switch Phase												
Minimum Initial (s)	5.0	10.0	10.0	5.0	10.0	10.0	5.0	10.0	10.0	10.0	10.0	10.0
Minimum Split (s)	11.6	26.2	26.2	11.2	26.2	26.2	11.7	32.7	32.7	32.7	32.7	32.7
Total Split (s)	31.0	49.0	49.0	16.0	34.0	34.0	12.0	45.0	45.0	33.0	33.0	33.0
Total Split (%)	28.2%	44.5%	44.5%	14.5%	30.9%	30.9%	10.9%	40.9%	40.9%	30.0%	30.0%	30.0%
Maximum Green (s)	24.4	42.8	42.8	9.8	27.8	27.8	5.3	38.3	38.3	26.3	26.3	26.3
Yellow Time (s)	3.7	3.7	3.7	3.7	3.7	3.7	3.3	3.3	3.3	3.3	3.3	3.3
All-Red Time (s)	2.9	2.5	2.5	2.5	2.5	2.5	3.4	3.4	3.4	3.4	3.4	3.4
Lost Time Adjust (s)	0.0	0.0	0.0	0.0	0.0	0.0	0.0	0.0	0.0	0.0	0.0	0.0
Total Lost Time (s)	6.6	6.2	6.2	6.2	6.2	6.2	6.7	6.7	6.7	6.7	6.7	6.7
Lead/Lag	Lead	Lag	Lag	Lead	Lag	Lag	Lead			Lag	Lag	Lag
Lead-Lag Optimize?	Yes	Yes	Yes	Yes	Yes	Yes	Yes			Yes	Yes	Yes
Vehicle Extension (s)	3.0	3.0	3.0	3.0	3.0	3.0	3.0	3.0	3.0	3.0	3.0	3.0
Recall Mode	None	C-Max	C-Max	None	C-Max	C-Max	None	None	None	None	None	None
Walk Time (s)		7.0	7.0		7.0	7.0		7.0	7.0	7.0	7.0	7.0
Flash Dont Walk (s)		13.0	13.0		13.0	13.0		19.0	19.0	19.0	19.0	19.0
Pedestrian Calls (#/hr)		22	22		7	7		32	32	15	15	15
Act Effct Green (s)	23.9	51.0	51.0	8.6	32.9	32.9	33.7	33.7	33.7	24.1	24.1	24.1
Actuated g/C Ratio	0.22	0.46	0.46	0.08	0.30	0.30	0.31	0.31	0.31	0.22	0.22	0.22
v/c Ratio	0.90	0.90	0.23	0.48	0.60	0.21	0.25	0.24	0.17	0.79	0.36	0.45
Control Delay	58.9	39.7	4.9	56.3	47.0	10.0	27.3	27.9	0.9	64.6	37.3	7.6
Queue Delay	0.0	0.0	0.0	0.0	0.0	0.0	0.0	0.0	0.0	0.0	0.0	0.0
Total Delay	58.9	39.7	4.9	56.3	47.0	10.0	27.3	27.9	0.9	64.6	37.3	7.6
LOS	E	D	A	E	D	B	C	C	A	E	D	A
Approach Delay		42.5			41.8			21.8			34.8	
Approach LOS		D			D			C			C	
Queue Length 50th (m)	63.8	~161.1	1.3	12.5	44.9	0.0	9.5	18.1	0.0	33.5	23.1	0.0
Queue Length 95th (m)	#91.2	#200.5	13.6	26.3	82.3	21.8	18.7	27.0	0.9	#62.9	34.0	16.9
Internal Link Dist (m)		240.5			467.4			363.7			277.9	
Turn Bay Length (m)	140.0		80.0	105.0		60.0	50.0		50.0	55.0		60.0
Base Capacity (vph)	732	1557	763	152	985	603	288	1180	618	252	810	527
Starvation Cap Reductn	0	0	0	0	0	0	0	0	0	0	0	0
Spillback Cap Reductn	0	0	0	0	0	0	0	0	0	0	0	0
Storage Cap Reductn	0	0	0	0	0	0	0	0	0	0	0	0
Reduced v/c Ratio	0.88	0.90	0.23	0.42	0.60	0.21	0.25	0.21	0.15	0.73	0.33	0.43

Intersection Summary

Area Type: Other
 Cycle Length: 110
 Actuated Cycle Length: 110
 Offset: 0 (0%), Referenced to phase 2:EBT and 6:WBT, Start of Green
 Natural Cycle: 105
 Control Type: Actuated-Coordinated
 Maximum v/c Ratio: 0.90
 Intersection Signal Delay: 39.0 Intersection LOS: D
 Intersection Capacity Utilization 86.4% ICU Level of Service E
 Analysis Period (min) 15
 ~ Volume exceeds capacity, queue is theoretically infinite.
 Queue shown is maximum after two cycles.
 # 95th percentile volume exceeds capacity, queue may be longer.
 Queue shown is maximum after two cycles.

Splits and Phases: 1: Orleans & Innes

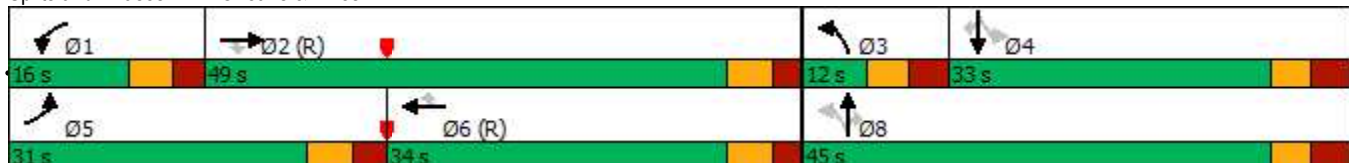

APPENDIX J

Background Synchro Analysis

1: Orleans & Innes
AM Peak Hour

3493-3499 Innes Road
2025 Background Traffic



Lane Group	EBL	EBT	EBR	WBL	WBT	WBR	NBL	NBT	NBR	SBL	SBT	SBR
Lane Configurations	↖↖	↖↖	↖	↖	↖↖	↖	↖	↖↖	↖	↖	↖↖	↖
Traffic Volume (vph)	125	455	24	27	1489	197	209	267	53	80	103	473
Future Volume (vph)	125	455	24	27	1489	197	209	267	53	80	103	473
Ideal Flow (vphpl)	1800	1800	1800	1800	1800	1800	1800	1800	1800	1800	1800	1800
Storage Length (m)	140.0		80.0	105.0		60.0	50.0		50.0	55.0		60.0
Storage Lanes	2		1	1		1	1		1	1		1
Taper Length (m)	40.0			40.0			10.0			20.0		
Lane Util. Factor	0.97	0.95	1.00	1.00	0.95	1.00	1.00	0.95	1.00	1.00	0.95	1.00
Ped Bike Factor	1.00		0.96	0.99		0.97	0.99		0.94	0.97		0.98
Frt			0.850			0.850			0.850			0.850
Flt Protected	0.950			0.950			0.950			0.950		
Satd. Flow (prot)	2995	3144	1473	1572	3357	1502	1712	3357	1502	1679	3357	1532
Flt Permitted	0.950			0.950			0.548			0.587		
Satd. Flow (perm)	2987	3144	1416	1549	3357	1462	981	3357	1413	1003	3357	1500
Right Turn on Red			Yes			Yes			Yes			Yes
Satd. Flow (RTOR)			143			143			82			155
Link Speed (k/h)		60			60			50				50
Link Distance (m)		264.5			491.4			387.7				301.9
Travel Time (s)		15.9			29.5			27.9				21.7
Confl. Peds. (#/hr)	6		14	14		6	6		32	32		6
Confl. Bikes (#/hr)						6						
Peak Hour Factor	1.00	1.00	1.00	1.00	1.00	1.00	1.00	1.00	1.00	1.00	1.00	1.00
Heavy Vehicles (%)	12%	10%	5%	10%	3%	3%	1%	3%	3%	3%	3%	1%
Adj. Flow (vph)	125	455	24	27	1489	197	209	267	53	80	103	473
Shared Lane Traffic (%)												
Lane Group Flow (vph)	125	455	24	27	1489	197	209	267	53	80	103	473
Enter Blocked Intersection	No	No	No	No	No	No	No	No	No	No	No	No
Lane Alignment	L NA	Left	R NA	L NA	Left	R NA	L NA	Left	R NA	L NA	Left	R NA
Median Width(m)		9.0			7.4			6.0				6.0
Link Offset(m)		0.0			0.0			0.0				0.0
Crosswalk Width(m)		5.0			5.0			5.0				5.0
Two way Left Turn Lane												
Headway Factor	1.06	1.06	1.06	1.06	1.06	1.06	1.06	1.06	1.06	1.06	1.06	1.06
Turning Speed (k/h)	24		14	24		14	24		14	24		14
Number of Detectors	1	2	1	1	2	1	1	2	1	1	2	1
Detector Template	Left	Thru	Right	Left	Thru	Right	Left	Thru	Right	Left	Thru	Right
Leading Detector (m)	18.6	93.0	18.6	18.6	93.0	18.6	18.6	93.0	18.6	18.6	93.0	18.6
Trailing Detector (m)	0.0	0.0	0.0	0.0	0.0	0.0	0.0	0.0	0.0	0.0	0.0	0.0
Detector 1 Position(m)	0.0	0.0	0.0	0.0	0.0	0.0	0.0	0.0	0.0	0.0	0.0	0.0
Detector 1 Size(m)	18.6	5.5	18.6	18.6	5.5	18.6	18.6	5.5	18.6	18.6	5.5	18.6
Detector 1 Type	Cl+Ex	Cl+Ex	Cl+Ex	Cl+Ex	Cl+Ex	Cl+Ex	Cl+Ex	Cl+Ex	Cl+Ex	Cl+Ex	Cl+Ex	Cl+Ex
Detector 1 Channel												
Detector 1 Extend (s)	0.0	0.0	0.0	0.0	0.0	0.0	0.0	0.0	0.0	0.0	0.0	0.0
Detector 1 Queue (s)	0.0	0.0	0.0	0.0	0.0	0.0	0.0	0.0	0.0	0.0	0.0	0.0
Detector 1 Delay (s)	0.0	0.0	0.0	0.0	0.0	0.0	0.0	0.0	0.0	0.0	0.0	0.0
Detector 2 Position(m)		87.5			87.5			87.5				87.5
Detector 2 Size(m)		5.5			5.5			5.5				5.5
Detector 2 Type		Cl+Ex			Cl+Ex			Cl+Ex				Cl+Ex
Detector 2 Channel												
Detector 2 Extend (s)		0.0			0.0			0.0				0.0
Turn Type	Prot	NA	Perm	Prot	NA	Perm	pm+pt	NA	Perm	Perm	NA	Perm
Protected Phases	5	2		1	6		3	8			4	
Permitted Phases			2			6	8		8	4		4
Detector Phase	5	2	2	1	6	6	3	8	8	4	4	4



Lane Group	EBL	EBT	EBR	WBL	WBT	WBR	NBL	NBT	NBR	SBL	SBT	SBR
Switch Phase												
Minimum Initial (s)	5.0	10.0	10.0	5.0	10.0	10.0	5.0	10.0	10.0	10.0	10.0	10.0
Minimum Split (s)	11.6	26.2	26.2	11.2	26.2	26.2	11.7	32.7	32.7	32.7	32.7	32.7
Total Split (s)	13.0	65.0	65.0	13.0	65.0	65.0	19.0	52.0	52.0	33.0	33.0	33.0
Total Split (%)	10.0%	50.0%	50.0%	10.0%	50.0%	50.0%	14.6%	40.0%	40.0%	25.4%	25.4%	25.4%
Maximum Green (s)	6.4	58.8	58.8	6.8	58.8	58.8	12.3	45.3	45.3	26.3	26.3	26.3
Yellow Time (s)	3.7	3.7	3.7	3.7	3.7	3.7	3.3	3.3	3.3	3.3	3.3	3.3
All-Red Time (s)	2.9	2.5	2.5	2.5	2.5	2.5	3.4	3.4	3.4	3.4	3.4	3.4
Lost Time Adjust (s)	0.0	0.0	0.0	0.0	0.0	0.0	0.0	0.0	0.0	0.0	0.0	0.0
Total Lost Time (s)	6.6	6.2	6.2	6.2	6.2	6.2	6.7	6.7	6.7	6.7	6.7	6.7
Lead/Lag	Lead	Lag	Lag	Lead	Lag	Lag	Lead			Lag	Lag	Lag
Lead-Lag Optimize?												
Vehicle Extension (s)	3.0	3.0	3.0	3.0	3.0	3.0	3.0	3.0	3.0	3.0	3.0	3.0
Recall Mode	None	C-Max	C-Max	None	C-Max	C-Max	None	None	None	None	None	None
Walk Time (s)		7.0	7.0		7.0	7.0		7.0	7.0	7.0	7.0	7.0
Flash Dont Walk (s)		13.0	13.0		13.0	13.0		19.0	19.0	19.0	19.0	19.0
Pedestrian Calls (#/hr)		14	14		6	6		32	32	6	6	6
Act Effct Green (s)	6.4	64.0	64.0	6.5	58.8	58.8	45.3	45.3	45.3	26.5	26.5	26.5
Actuated g/C Ratio	0.05	0.49	0.49	0.05	0.45	0.45	0.35	0.35	0.35	0.20	0.20	0.20
v/c Ratio	0.85	0.29	0.03	0.35	0.98	0.27	0.51	0.23	0.10	0.39	0.15	1.10
Control Delay	103.8	21.2	0.1	71.9	54.2	7.6	36.7	30.6	2.5	51.6	43.3	106.5
Queue Delay	0.0	0.0	0.0	0.0	0.0	0.0	0.0	0.0	0.0	0.0	0.0	0.0
Total Delay	103.8	21.2	0.1	71.9	54.2	7.6	36.7	30.6	2.5	51.6	43.3	106.5
LOS	F	C	A	E	D	A	D	C	A	D	D	F
Approach Delay		37.5			49.1			30.2			89.9	
Approach LOS		D			D			C			F	
Queue Length 50th (m)	15.3	35.5	0.0	6.3	178.5	7.1	36.4	23.3	0.0	16.5	10.6	-96.3
Queue Length 95th (m)	#31.9	47.0	0.0	15.5	#227.5	20.7	55.9	33.1	3.4	31.2	18.1	#157.0
Internal Link Dist (m)		240.5			467.4			363.7			277.9	
Turn Bay Length (m)	140.0		80.0	105.0		60.0	50.0		50.0	55.0		60.0
Base Capacity (vph)	147	1548	769	82	1518	739	411	1169	545	204	684	429
Starvation Cap Reductn	0	0	0	0	0	0	0	0	0	0	0	0
Spillback Cap Reductn	0	0	0	0	0	0	0	0	0	0	0	0
Storage Cap Reductn	0	0	0	0	0	0	0	0	0	0	0	0
Reduced v/c Ratio	0.85	0.29	0.03	0.33	0.98	0.27	0.51	0.23	0.10	0.39	0.15	1.10

Intersection Summary

Area Type: Other
 Cycle Length: 130
 Actuated Cycle Length: 130
 Offset: 99 (76%), Referenced to phase 2:EBT and 6:WBT, Start of Green
 Natural Cycle: 115
 Control Type: Actuated-Coordinated
 Maximum v/c Ratio: 1.10
 Intersection Signal Delay: 51.9 Intersection LOS: D
 Intersection Capacity Utilization 103.6% ICU Level of Service G
 Analysis Period (min) 15
 ~ Volume exceeds capacity, queue is theoretically infinite.
 Queue shown is maximum after two cycles.
 # 95th percentile volume exceeds capacity, queue may be longer.
 Queue shown is maximum after two cycles.

Splits and Phases: 1: Orleans & Innes

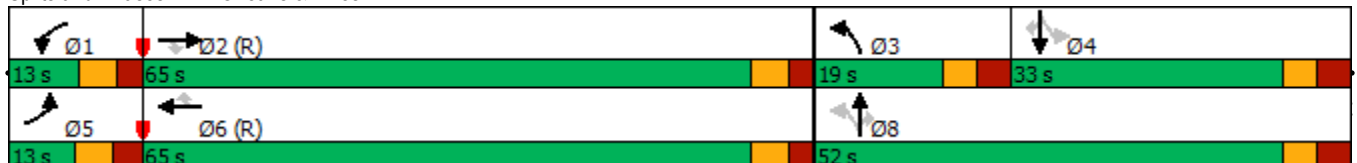



Lane Group	EBL	EBT	EBR	WBL	WBT	WBR	NBL	NBT	NBR	SBL	SBT	SBR
Lane Configurations												
Traffic Volume (vph)	12	520	21	37	1521	20	14	12	38	34	9	43
Future Volume (vph)	12	520	21	37	1521	20	14	12	38	34	9	43
Ideal Flow (vphpl)	1800	1800	1800	1800	1800	1800	1800	1800	1800	1800	1800	1800
Storage Length (m)	100.0		0.0	100.0		0.0	0.0		0.0	0.0		0.0
Storage Lanes	1		0	1		0	0		0	0		0
Taper Length (m)	35.0			25.0			2.5			2.5		
Lane Util. Factor	1.00	0.95	0.95	1.00	0.95	0.95	1.00	1.00	1.00	1.00	1.00	1.00
Ped Bike Factor	1.00	1.00		0.99	1.00			0.99			0.99	
Frt		0.994			0.998			0.920			0.932	
Flt Protected	0.950			0.950				0.989			0.981	
Satd. Flow (prot)	1586	3126	0	1503	3349	0	0	1568	0	0	1596	0
Flt Permitted	0.130			0.450				0.922			0.851	
Satd. Flow (perm)	217	3126	0	708	3349	0	0	1458	0	0	1384	0
Right Turn on Red			Yes			Yes			Yes			Yes
Satd. Flow (RTOR)		6			2			38			41	
Link Speed (k/h)		60			60			40			40	
Link Distance (m)		491.4			236.7			212.5			273.4	
Travel Time (s)		29.5			14.2			19.1			24.6	
Confl. Peds. (#/hr)	4		7	7		4	11					11
Confl. Bikes (#/hr)			1						1			1
Peak Hour Factor	1.00	1.00	1.00	1.00	1.00	1.00	1.00	1.00	1.00	1.00	1.00	1.00
Heavy Vehicles (%)	9%	10%	5%	15%	3%	5%	1%	15%	3%	1%	10%	3%
Adj. Flow (vph)	12	520	21	37	1521	20	14	12	38	34	9	43
Shared Lane Traffic (%)												
Lane Group Flow (vph)	12	541	0	37	1541	0	0	64	0	0	86	0
Enter Blocked Intersection	No	No	No	No	No	No	No	No	No	No	No	No
Lane Alignment	Left	Left	Right	Left	Left	Right	L NA	Left	R NA	L NA	Left	R NA
Median Width(m)		5.0			5.0			0.0			0.0	
Link Offset(m)		0.0			0.0			0.0			0.0	
Crosswalk Width(m)		10.0			10.0			5.0			5.0	
Two way Left Turn Lane												
Headway Factor	1.06	1.06	1.06	1.06	1.06	1.06	1.06	1.06	1.06	1.06	1.06	1.06
Turning Speed (k/h)	24		14	24		14	24		14	24		14
Number of Detectors	1	2		1	2		1	2		1	2	
Detector Template	Left	Thru		Left	Thru		Left	Thru		Left	Thru	
Leading Detector (m)	18.6	93.0		18.6	93.0		18.6	93.0		18.6	93.0	
Trailing Detector (m)	0.0	0.0		0.0	0.0		0.0	0.0		0.0	0.0	
Detector 1 Position(m)	0.0	0.0		0.0	0.0		0.0	0.0		0.0	0.0	
Detector 1 Size(m)	18.6	5.5		18.6	5.5		18.6	5.5		18.6	5.5	
Detector 1 Type	Cl+Ex	Cl+Ex		Cl+Ex	Cl+Ex		Cl+Ex	Cl+Ex		Cl+Ex	Cl+Ex	
Detector 1 Channel												
Detector 1 Extend (s)	0.0	0.0		0.0	0.0		0.0	0.0		0.0	0.0	
Detector 1 Queue (s)	0.0	0.0		0.0	0.0		0.0	0.0		0.0	0.0	
Detector 1 Delay (s)	0.0	0.0		0.0	0.0		0.0	0.0		0.0	0.0	
Detector 2 Position(m)		87.5			87.5			87.5			87.5	
Detector 2 Size(m)		5.5			5.5			5.5			5.5	
Detector 2 Type		Cl+Ex			Cl+Ex			Cl+Ex			Cl+Ex	
Detector 2 Channel												
Detector 2 Extend (s)		0.0			0.0			0.0			0.0	
Turn Type	Perm	NA		Perm	NA		Perm	NA		Perm	NA	
Protected Phases		2			6			8			4	
Permitted Phases	2			6			8			4		
Detector Phase	2	2		6	6		8	8		4	4	

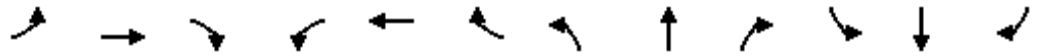

Lane Group	EBL	EBT	EBR	WBL	WBT	WBR	NBL	NBT	NBR	SBL	SBT	SBR
Switch Phase												
Minimum Initial (s)	10.0	10.0		10.0	10.0		10.0	10.0		10.0	10.0	
Minimum Split (s)	39.2	39.2		39.2	39.2		37.8	37.8		37.8	37.8	
Total Split (s)	82.0	82.0		82.0	82.0		38.0	38.0		38.0	38.0	
Total Split (%)	68.3%	68.3%		68.3%	68.3%		31.7%	31.7%		31.7%	31.7%	
Maximum Green (s)	75.8	75.8		75.8	75.8		31.2	31.2		31.2	31.2	
Yellow Time (s)	3.7	3.7		3.7	3.7		3.0	3.0		3.0	3.0	
All-Red Time (s)	2.5	2.5		2.5	2.5		3.8	3.8		3.8	3.8	
Lost Time Adjust (s)	0.0	0.0		0.0	0.0			0.0			0.0	
Total Lost Time (s)	6.2	6.2		6.2	6.2			6.8			6.8	
Lead/Lag												
Lead-Lag Optimize?												
Vehicle Extension (s)	3.0	3.0		3.0	3.0		3.0	3.0		3.0	3.0	
Recall Mode	C-Max	C-Max		C-Max	C-Max		None	None		None	None	
Walk Time (s)	15.0	15.0		15.0	15.0		7.0	7.0		7.0	7.0	
Flash Dont Walk (s)	18.0	18.0		18.0	18.0		24.0	24.0		24.0	24.0	
Pedestrian Calls (#/hr)	7	7		4	4		1	1		11	11	
Act Effct Green (s)	88.6	88.6		88.6	88.6			18.4			18.4	
Actuated g/C Ratio	0.74	0.74		0.74	0.74			0.15			0.15	
v/c Ratio	0.07	0.23		0.07	0.62			0.25			0.35	
Control Delay	8.9	6.5		1.3	3.3			21.2			26.5	
Queue Delay	0.0	0.0		0.0	0.0			0.0			0.0	
Total Delay	8.9	6.5		1.3	3.3			21.2			26.5	
LOS	A	A		A	A			C			C	
Approach Delay		6.5			3.3			21.2			26.5	
Approach LOS		A			A			C			C	
Queue Length 50th (m)	0.4	11.2		0.9	42.7			5.4			9.4	
Queue Length 95th (m)	3.5	33.2		m0.7	24.3			14.4			19.8	
Internal Link Dist (m)		467.4			212.7			188.5			249.4	
Turn Bay Length (m)	100.0			100.0								
Base Capacity (vph)	160	2310		522	2473			407			390	
Starvation Cap Reductn	0	0		0	25			0			0	
Spillback Cap Reductn	0	0		0	0			0			0	
Storage Cap Reductn	0	0		0	0			0			0	
Reduced v/c Ratio	0.07	0.23		0.07	0.63			0.16			0.22	

Intersection Summary

Area Type: Other
 Cycle Length: 120
 Actuated Cycle Length: 120
 Offset: 26 (22%), Referenced to phase 2:EBTL and 6:WBTL, Start of Green
 Natural Cycle: 90
 Control Type: Actuated-Coordinated
 Maximum v/c Ratio: 0.62
 Intersection Signal Delay: 5.4 Intersection LOS: A
 Intersection Capacity Utilization 70.6% ICU Level of Service C
 Analysis Period (min) 15
 m Volume for 95th percentile queue is metered by upstream signal.

Splits and Phases: 2: Page & Innes

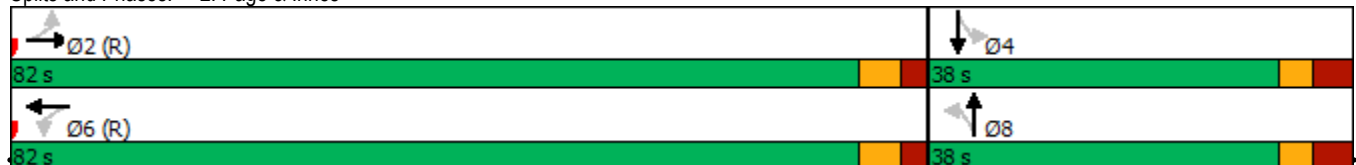



Lane Group	EBU	EBT	EBR	WBL	WBT	NBL	NBR	Ø3
Lane Configurations								
Traffic Volume (vph)	0	556	68	52	1358	164	64	
Future Volume (vph)	0	556	68	52	1358	164	64	
Ideal Flow (vphpl)	1800	1800	1800	1800	1800	1800	1800	
Storage Length (m)	30.0		50.0	65.0		70.0	70.0	
Storage Lanes	1		1	1		1	1	
Taper Length (m)	30.0			80.0		20.0		
Lane Util. Factor	1.00	0.95	1.00	1.00	0.95	0.97	1.00	
Ped Bike Factor			0.95	0.99				
Frt			0.850				0.850	
Flt Protected				0.950		0.950		
Satd. Flow (prot)	1767	3357	1502	1679	3357	3257	1502	
Flt Permitted				0.439		0.950		
Satd. Flow (perm)	1767	3357	1433	767	3357	3257	1502	
Right Turn on Red			Yes				Yes	
Satd. Flow (RTOR)			68				64	
Link Speed (k/h)		60			60	50		
Link Distance (m)		236.7			238.7	204.5		
Travel Time (s)		14.2			14.3	14.7		
Confl. Peds. (#/hr)			11	11				
Peak Hour Factor	1.00	1.00	1.00	1.00	1.00	1.00	1.00	
Adj. Flow (vph)	0	556	68	52	1358	164	64	
Shared Lane Traffic (%)								
Lane Group Flow (vph)	0	556	68	52	1358	164	64	
Enter Blocked Intersection	No	No	No	No	No	No	No	
Lane Alignment	R NA	Left	Right	Left	Left	L NA	R NA	
Median Width(m)		5.0			5.0	7.4		
Link Offset(m)		0.0			0.0	0.0		
Crosswalk Width(m)		9.0			9.0	9.0		
Two way Left Turn Lane								
Headway Factor	1.06	1.06	1.06	1.06	1.06	1.06	1.06	
Turning Speed (k/h)	14		14	24		24	14	
Number of Detectors	1	2	1	1	2	1	1	
Detector Template	Left	Thru	Right	Left	Thru	Left	Right	
Leading Detector (m)	18.6	93.0	18.6	18.6	93.0	18.6	18.6	
Trailing Detector (m)	0.0	0.0	0.0	0.0	0.0	0.0	0.0	
Detector 1 Position(m)	0.0	0.0	0.0	0.0	0.0	0.0	0.0	
Detector 1 Size(m)	18.6	5.5	18.6	18.6	5.5	18.6	18.6	
Detector 1 Type	CI+Ex	CI+Ex	CI+Ex	CI+Ex	CI+Ex	CI+Ex	CI+Ex	
Detector 1 Channel								
Detector 1 Extend (s)	0.0	0.0	0.0	0.0	0.0	0.0	0.0	
Detector 1 Queue (s)	0.0	0.0	0.0	0.0	0.0	0.0	0.0	
Detector 1 Delay (s)	0.0	0.0	0.0	0.0	0.0	0.0	0.0	
Detector 2 Position(m)		87.5			87.5			
Detector 2 Size(m)		5.5			5.5			
Detector 2 Type		CI+Ex			CI+Ex			
Detector 2 Channel								
Detector 2 Extend (s)		0.0			0.0			
Turn Type	Perm	NA	Perm	Perm	NA	Prot	Perm	
Protected Phases		2			6	4		3
Permitted Phases	2		2	6			8	
Detector Phase	2	2	2	6	6	4	8	
Switch Phase								
Minimum Initial (s)	10.0	10.0	10.0	10.0	10.0	5.0	10.0	3.0



Lane Group	EBU	EBT	EBR	WBL	WBT	NBL	NBR	Ø3
Minimum Split (s)	31.2	31.2	31.2	31.2	31.2	11.3	37.3	30.0
Total Split (s)	73.0	73.0	73.0	73.0	73.0	17.0	47.0	30.0
Total Split (%)	60.8%	60.8%	60.8%	60.8%	60.8%	14.2%	39.2%	25%
Maximum Green (s)	66.8	66.8	66.8	66.8	66.8	10.7	40.7	28.0
Yellow Time (s)	3.7	3.7	3.7	3.7	3.7	3.3	3.3	2.0
All-Red Time (s)	2.5	2.5	2.5	2.5	2.5	3.0	3.0	0.0
Lost Time Adjust (s)	0.0	0.0	0.0	0.0	0.0	0.0	0.0	
Total Lost Time (s)	6.2	6.2	6.2	6.2	6.2	6.3	6.3	
Lead/Lag						Lag		Lead
Lead-Lag Optimize?								
Vehicle Extension (s)	3.0	3.0	3.0	3.0	3.0	3.0	3.0	3.0
Recall Mode	C-Max	C-Max	C-Max	C-Max	C-Max	None	None	None
Walk Time (s)	7.0	7.0	7.0	7.0	7.0			7.0
Flash Dont Walk (s)	18.0	18.0	18.0	18.0	18.0			21.0
Pedestrian Calls (#/hr)	10	10	10	10	10			10
Act Effct Green (s)		85.0	85.0	85.0	85.0	10.5	22.5	
Actuated g/C Ratio		0.71	0.71	0.71	0.71	0.09	0.19	
v/c Ratio		0.23	0.07	0.10	0.57	0.57	0.19	
Control Delay		6.9	1.7	5.7	9.0	61.0	8.0	
Queue Delay		0.0	0.0	0.0	0.0	0.0	0.0	
Total Delay		6.9	1.7	5.7	9.0	61.0	8.0	
LOS		A	A	A	A	E	A	
Approach Delay		6.3			8.8	46.1		
Approach LOS		A			A	D		
Queue Length 50th (m)		11.4	0.0	1.2	21.5	17.7	0.0	
Queue Length 95th (m)		26.8	2.4	m4.0	140.4	28.1	8.6	
Internal Link Dist (m)		212.7			214.7	180.5		
Turn Bay Length (m)			50.0	65.0		70.0	70.0	
Base Capacity (vph)		2376	1034	542	2376	293	551	
Starvation Cap Reductn		0	0	0	0	0	0	
Spillback Cap Reductn		0	0	0	0	0	0	
Storage Cap Reductn		0	0	0	0	0	0	
Reduced v/c Ratio		0.23	0.07	0.10	0.57	0.56	0.12	

Intersection Summary

Area Type: Other
 Cycle Length: 120
 Actuated Cycle Length: 120
 Offset: 20 (17%), Referenced to phase 2:EBTU and 6:WBTL, Start of Green
 Natural Cycle: 90
 Control Type: Actuated-Coordinated
 Maximum v/c Ratio: 0.57
 Intersection Signal Delay: 11.9
 Intersection Capacity Utilization 61.0%
 Analysis Period (min) 15
 Intersection LOS: B
 ICU Level of Service B
 m Volume for 95th percentile queue is metered by upstream signal.

Splits and Phases: 3: Lamarche & Innes

<p>Ø2 (R) 73 s</p>	<p>Ø3 30 s</p>	<p>Ø4 17 s</p>
<p>Ø6 (R) 73 s</p>	<p>Ø8 47 s</p>	



Lane Group	EBL	EBT	EBR	WBL	WBT	WBR	NBL	NBT	NBR	SBL	SBT	SBR
Lane Configurations												
Traffic Volume (vph)	6	513	38	12	1405	4	99	0	39	1	0	3
Future Volume (vph)	6	513	38	12	1405	4	99	0	39	1	0	3
Ideal Flow (vphpl)	1800	1800	1800	1800	1800	1800	1800	1800	1800	1800	1800	1800
Storage Length (m)	65.0		0.0	40.0		0.0	0.0		0.0	0.0		0.0
Storage Lanes	1		0	1		0	0		1	0		0
Taper Length (m)	80.0			30.0			20.0			20.0		
Lane Util. Factor	1.00	0.95	0.95	1.00	0.95	0.95	1.00	1.00	1.00	1.00	1.00	1.00
Ped Bike Factor	1.00				1.00			1.00	0.99		0.99	
Fr _t		0.990							0.850		0.899	
Fl _t Protected	0.950			0.950				0.950			0.988	
Satd. Flow (prot)	1712	3112	0	1712	3357	0	0	1712	1532	0	1583	0
Fl _t Permitted	0.162			0.446				0.755			0.942	
Satd. Flow (perm)	292	3112	0	804	3357	0	0	1357	1511	0	1509	0
Right Turn on Red			Yes			Yes			Yes			Yes
Satd. Flow (RTOR)		14							39			28
Link Speed (k/h)		60			60			40				40
Link Distance (m)		238.7			292.8			151.9				62.6
Travel Time (s)		14.3			17.6			13.7				5.6
Confl. Peds. (#/hr)	7					7	2		1	1		2
Confl. Bikes (#/hr)						1						
Peak Hour Factor	1.00	1.00	1.00	1.00	1.00	1.00	1.00	1.00	1.00	1.00	1.00	1.00
Heavy Vehicles (%)	1%	10%	10%	1%	3%	1%	1%	1%	1%	1%	1%	1%
Adj. Flow (vph)	6	513	38	12	1405	4	99	0	39	1	0	3
Shared Lane Traffic (%)												
Lane Group Flow (vph)	6	551	0	12	1409	0	0	99	39	0	4	0
Enter Blocked Intersection	No	No	No	No	No	No	No	No	No	No	No	No
Lane Alignment	L NA	Left	R NA	L NA	Left	R NA	L NA	Left	R NA	L NA	Left	R NA
Median Width(m)		5.0			5.0			0.0			0.0	
Link Offset(m)		0.0			0.0			0.0			0.0	
Crosswalk Width(m)		9.0			9.0			9.0			9.0	
Two way Left Turn Lane												
Headway Factor	1.06	1.06	1.06	1.06	1.06	1.06	1.06	1.06	1.06	1.06	1.06	1.06
Turning Speed (k/h)	24		14	24		14	24		14	24		14
Number of Detectors	1	2		1	2		1	2	1	1		2
Detector Template	Left	Thru		Left	Thru		Left	Thru	Right	Left		Thru
Leading Detector (m)	18.6	93.0		18.6	93.0		18.6	93.0	18.6	18.6		93.0
Trailing Detector (m)	0.0	0.0		0.0	0.0		0.0	0.0	0.0	0.0		0.0
Detector 1 Position(m)	0.0	0.0		0.0	0.0		0.0	0.0	0.0	0.0		0.0
Detector 1 Size(m)	18.6	5.5		18.6	5.5		18.6	5.5	18.6	18.6		5.5
Detector 1 Type	Cl+Ex	Cl+Ex		Cl+Ex	Cl+Ex		Cl+Ex	Cl+Ex	Cl+Ex	Cl+Ex		Cl+Ex
Detector 1 Channel												
Detector 1 Extend (s)	0.0	0.0		0.0	0.0		0.0	0.0	0.0	0.0		0.0
Detector 1 Queue (s)	0.0	0.0		0.0	0.0		0.0	0.0	0.0	0.0		0.0
Detector 1 Delay (s)	0.0	0.0		0.0	0.0		0.0	0.0	0.0	0.0		0.0
Detector 2 Position(m)		87.5			87.5			87.5				87.5
Detector 2 Size(m)		5.5			5.5			5.5				5.5
Detector 2 Type		Cl+Ex			Cl+Ex			Cl+Ex				Cl+Ex
Detector 2 Channel												
Detector 2 Extend (s)		0.0			0.0			0.0				0.0
Turn Type	Perm	NA		Perm	NA		Perm	NA	Perm	Perm		NA
Protected Phases		2			6			8				4
Permitted Phases	2			6			8		8	4		
Detector Phase	2	2		6	6		8	8	8	4		4



Lane Group	EBL	EBT	EBR	WBL	WBT	WBR	NBL	NBT	NBR	SBL	SBT	SBR
Switch Phase												
Minimum Initial (s)	10.0	10.0		10.0	10.0		10.0	10.0	10.0	10.0	10.0	
Minimum Split (s)	32.1	32.1		35.1	35.1		32.3	32.3	32.3	32.3	32.3	
Total Split (s)	87.0	87.0		87.0	87.0		33.0	33.0	33.0	33.0	33.0	
Total Split (%)	72.5%	72.5%		72.5%	72.5%		27.5%	27.5%	27.5%	27.5%	27.5%	
Maximum Green (s)	80.9	80.9		80.9	80.9		26.7	26.7	26.7	26.7	26.7	
Yellow Time (s)	3.7	3.7		3.7	3.7		3.3	3.3	3.3	3.3	3.3	
All-Red Time (s)	2.4	2.4		2.4	2.4		3.0	3.0	3.0	3.0	3.0	
Lost Time Adjust (s)	0.0	0.0		0.0	0.0			0.0	0.0		0.0	
Total Lost Time (s)	6.1	6.1		6.1	6.1			6.3	6.3		6.3	
Lead/Lag												
Lead-Lag Optimize?												
Vehicle Extension (s)	3.0	3.0		3.0	3.0		3.0	3.0	3.0	3.0	3.0	
Recall Mode	C-Max	C-Max		C-Max	C-Max		None	None	None	None	None	
Walk Time (s)	12.0	12.0		12.0	12.0		7.0	7.0	7.0	7.0	7.0	
Flash Dont Walk (s)	14.0	14.0		14.0	14.0		19.0	19.0	19.0	19.0	19.0	
Pedestrian Calls (#/hr)	1	1		7	7		1	1	1	2	2	
Act Effct Green (s)	92.0	92.0		92.0	92.0			15.6	15.6		15.6	
Actuated g/C Ratio	0.77	0.77		0.77	0.77			0.13	0.13		0.13	
v/c Ratio	0.03	0.23		0.02	0.55			0.56	0.17		0.02	
Control Delay	4.3	3.6		4.9	7.4			59.7	14.0		0.2	
Queue Delay	0.0	0.0		0.0	0.0			0.0	0.0		0.0	
Total Delay	4.3	3.6		4.9	7.4			59.7	14.0		0.2	
LOS	A	A		A	A			E	B		A	
Approach Delay		3.6			7.3			46.8			0.3	
Approach LOS		A			A			D			A	
Queue Length 50th (m)	0.2	10.7		0.5	51.0			20.8	0.0		0.0	
Queue Length 95th (m)	1.1	15.6		2.6	98.2			33.3	8.3		0.0	
Internal Link Dist (m)		214.7			268.8			127.9			38.6	
Turn Bay Length (m)	65.0			40.0								
Base Capacity (vph)	223	2387		615	2572			301	366		357	
Starvation Cap Reductn	0	0		0	0			0	0		0	
Spillback Cap Reductn	0	0		0	0			0	0		0	
Storage Cap Reductn	0	0		0	0			0	0		0	
Reduced v/c Ratio	0.03	0.23		0.02	0.55			0.33	0.11		0.01	

Intersection Summary

Area Type:	Other
Cycle Length:	120
Actuated Cycle Length:	120
Offset:	0 (0%), Referenced to phase 2:EBTL and 6:WBTL, Start of Green
Natural Cycle:	70
Control Type:	Actuated-Coordinated
Maximum v/c Ratio:	0.56
Intersection Signal Delay:	8.9
Intersection LOS:	A
Intersection Capacity Utilization:	64.2%
ICU Level of Service:	C
Analysis Period (min):	15

Splits and Phases: 4: 473 E of Page & Innes

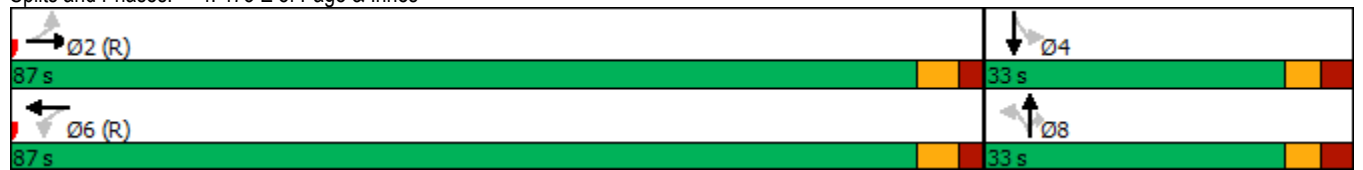

1: Orleans & Innes
AM Peak Hour

3493-3499 Innes Road
2025 Background Traffic (demand rationalization)



Lane Group	EBL	EBT	EBR	WBL	WBT	WBR	NBL	NBT	NBR	SBL	SBT	SBR
Lane Configurations	↖↖	↖↖	↖	↖	↖↖	↖	↖	↖↖	↖	↖	↖↖	↖
Traffic Volume (vph)	125	455	24	27	1489	197	209	267	53	80	103	343
Future Volume (vph)	125	455	24	27	1489	197	209	267	53	80	103	343
Ideal Flow (vphpl)	1800	1800	1800	1800	1800	1800	1800	1800	1800	1800	1800	1800
Storage Length (m)	140.0		80.0	105.0		60.0	50.0		50.0	55.0		60.0
Storage Lanes	2		1	1		1	1		1	1		1
Taper Length (m)	40.0			40.0			10.0			20.0		
Lane Util. Factor	0.97	0.95	1.00	1.00	0.95	1.00	1.00	0.95	1.00	1.00	0.95	1.00
Ped Bike Factor	1.00		0.96	0.99		0.97	0.99		0.94	0.97		0.98
Frt			0.850			0.850			0.850			0.850
Flt Protected	0.950			0.950			0.950			0.950		
Satd. Flow (prot)	2995	3144	1473	1572	3357	1502	1712	3357	1502	1679	3357	1532
Flt Permitted	0.950			0.950			0.535			0.587		
Satd. Flow (perm)	2987	3144	1416	1549	3357	1463	958	3357	1413	1003	3357	1500
Right Turn on Red			Yes			Yes			Yes			Yes
Satd. Flow (RTOR)			143			143			82			138
Link Speed (k/h)		60			60			50				50
Link Distance (m)		264.5			491.4			387.7				301.9
Travel Time (s)		15.9			29.5			27.9				21.7
Confl. Peds. (#/hr)	6		14	14		6	6		32	32		6
Confl. Bikes (#/hr)						6						
Peak Hour Factor	1.00	1.00	1.00	1.00	1.00	1.00	1.00	1.00	1.00	1.00	1.00	1.00
Heavy Vehicles (%)	12%	10%	5%	10%	3%	3%	1%	3%	3%	3%	3%	1%
Adj. Flow (vph)	125	455	24	27	1489	197	209	267	53	80	103	343
Shared Lane Traffic (%)												
Lane Group Flow (vph)	125	455	24	27	1489	197	209	267	53	80	103	343
Enter Blocked Intersection	No	No	No	No	No	No	No	No	No	No	No	No
Lane Alignment	L NA	Left	R NA	L NA	Left	R NA	L NA	Left	R NA	L NA	Left	R NA
Median Width(m)		9.0			7.4			6.0				6.0
Link Offset(m)		0.0			0.0			0.0				0.0
Crosswalk Width(m)		5.0			5.0			5.0				5.0
Two way Left Turn Lane												
Headway Factor	1.06	1.06	1.06	1.06	1.06	1.06	1.06	1.06	1.06	1.06	1.06	1.06
Turning Speed (k/h)	24		14	24		14	24		14	24		14
Number of Detectors	1	2	1	1	2	1	1	2	1	1	2	1
Detector Template	Left	Thru	Right	Left	Thru	Right	Left	Thru	Right	Left	Thru	Right
Leading Detector (m)	18.6	93.0	18.6	18.6	93.0	18.6	18.6	93.0	18.6	18.6	93.0	18.6
Trailing Detector (m)	0.0	0.0	0.0	0.0	0.0	0.0	0.0	0.0	0.0	0.0	0.0	0.0
Detector 1 Position(m)	0.0	0.0	0.0	0.0	0.0	0.0	0.0	0.0	0.0	0.0	0.0	0.0
Detector 1 Size(m)	18.6	5.5	18.6	18.6	5.5	18.6	18.6	5.5	18.6	18.6	5.5	18.6
Detector 1 Type	Cl+Ex	Cl+Ex	Cl+Ex	Cl+Ex	Cl+Ex	Cl+Ex	Cl+Ex	Cl+Ex	Cl+Ex	Cl+Ex	Cl+Ex	Cl+Ex
Detector 1 Channel												
Detector 1 Extend (s)	0.0	0.0	0.0	0.0	0.0	0.0	0.0	0.0	0.0	0.0	0.0	0.0
Detector 1 Queue (s)	0.0	0.0	0.0	0.0	0.0	0.0	0.0	0.0	0.0	0.0	0.0	0.0
Detector 1 Delay (s)	0.0	0.0	0.0	0.0	0.0	0.0	0.0	0.0	0.0	0.0	0.0	0.0
Detector 2 Position(m)		87.5			87.5			87.5				87.5
Detector 2 Size(m)		5.5			5.5			5.5				5.5
Detector 2 Type		Cl+Ex			Cl+Ex			Cl+Ex				Cl+Ex
Detector 2 Channel												
Detector 2 Extend (s)		0.0			0.0			0.0				0.0
Turn Type	Prot	NA	Perm	Prot	NA	Perm	pm+pt	NA	Perm	Perm	NA	Perm
Protected Phases	5	2		1	6		3	8			4	
Permitted Phases			2			6	8		8	4		4
Detector Phase	5	2	2	1	6	6	3	8	8	4	4	4



Lane Group	EBL	EBT	EBR	WBL	WBT	WBR	NBL	NBT	NBR	SBL	SBT	SBR
Switch Phase												
Minimum Initial (s)	5.0	10.0	10.0	5.0	10.0	10.0	5.0	10.0	10.0	10.0	10.0	10.0
Minimum Split (s)	11.6	26.2	26.2	11.2	26.2	26.2	11.7	32.7	32.7	32.7	32.7	32.7
Total Split (s)	13.0	72.0	72.0	13.0	72.0	72.0	12.0	45.0	45.0	33.0	33.0	33.0
Total Split (%)	10.0%	55.4%	55.4%	10.0%	55.4%	55.4%	9.2%	34.6%	34.6%	25.4%	25.4%	25.4%
Maximum Green (s)	6.4	65.8	65.8	6.8	65.8	65.8	5.3	38.3	38.3	26.3	26.3	26.3
Yellow Time (s)	3.7	3.7	3.7	3.7	3.7	3.7	3.3	3.3	3.3	3.3	3.3	3.3
All-Red Time (s)	2.9	2.5	2.5	2.5	2.5	2.5	3.4	3.4	3.4	3.4	3.4	3.4
Lost Time Adjust (s)	0.0	0.0	0.0	0.0	0.0	0.0	0.0	0.0	0.0	0.0	0.0	0.0
Total Lost Time (s)	6.6	6.2	6.2	6.2	6.2	6.2	6.7	6.7	6.7	6.7	6.7	6.7
Lead/Lag	Lead	Lag	Lag	Lead	Lag	Lag	Lead			Lag	Lag	Lag
Lead-Lag Optimize?												
Vehicle Extension (s)	3.0	3.0	3.0	3.0	3.0	3.0	3.0	3.0	3.0	3.0	3.0	3.0
Recall Mode	None	C-Max	C-Max	None	C-Max	C-Max	None	None	None	None	None	None
Walk Time (s)		7.0	7.0		7.0	7.0		7.0	7.0	7.0	7.0	7.0
Flash Dont Walk (s)		13.0	13.0		13.0	13.0		19.0	19.0	19.0	19.0	19.0
Pedestrian Calls (#/hr)		14	14		6	6		32	32	6	6	6
Act Effct Green (s)	7.3	73.7	73.7	6.5	67.6	67.6	35.6	35.6	35.6	23.6	23.6	23.6
Actuated g/C Ratio	0.06	0.57	0.57	0.05	0.52	0.52	0.27	0.27	0.27	0.18	0.18	0.18
v/c Ratio	0.74	0.26	0.03	0.35	0.85	0.24	0.72	0.29	0.12	0.44	0.17	0.89
Control Delay	86.0	16.2	0.0	71.9	33.5	6.1	55.0	37.5	3.0	54.5	44.5	55.9
Queue Delay	0.0	0.0	0.0	0.0	0.0	0.0	0.0	0.0	0.0	0.0	0.0	0.0
Total Delay	86.0	16.2	0.0	71.9	33.5	6.1	55.0	37.5	3.0	54.5	44.5	55.9
LOS	F	B	A	E	C	A	E	D	A	D	D	E
Approach Delay		30.0			30.9			41.0			53.5	
Approach LOS		C			C			D			D	
Queue Length 50th (m)	15.3	31.6	0.0	6.3	159.3	6.4	39.7	25.4	0.0	16.5	10.6	48.4
Queue Length 95th (m)	#31.9	42.0	0.0	15.5	191.2	18.2	60.8	36.1	3.7	31.2	18.1	#93.2
Internal Link Dist (m)		240.5			467.4			363.7			277.9	
Turn Bay Length (m)	140.0		80.0	105.0		60.0	50.0		50.0	55.0		60.0
Base Capacity (vph)	168	1783	865	82	1745	829	292	989	474	202	679	413
Starvation Cap Reductn	0	0	0	0	0	0	0	0	0	0	0	0
Spillback Cap Reductn	0	0	0	0	0	0	0	0	0	0	0	0
Storage Cap Reductn	0	0	0	0	0	0	0	0	0	0	0	0
Reduced v/c Ratio	0.74	0.26	0.03	0.33	0.85	0.24	0.72	0.27	0.11	0.40	0.15	0.83

Intersection Summary

Area Type: Other
 Cycle Length: 130
 Actuated Cycle Length: 130
 Offset: 0 (0%), Referenced to phase 2:EBT and 6:WBT, Start of Green
 Natural Cycle: 105
 Control Type: Actuated-Coordinated
 Maximum v/c Ratio: 0.89
 Intersection Signal Delay: 35.9 Intersection LOS: D
 Intersection Capacity Utilization 95.1% ICU Level of Service F
 Analysis Period (min) 15
 # 95th percentile volume exceeds capacity, queue may be longer.
 Queue shown is maximum after two cycles.

Splits and Phases: 1: Orleans & Innes



1: Orleans & Innes
PM Peak Hour

3493-3499 Innes Road
2025 Background Traffic



Lane Group	EBL	EBT	EBR	WBL	WBT	WBR	NBL	NBT	NBR	SBL	SBT	SBR
Lane Configurations	↖↖	↖↖	↖	↖	↖↖	↖	↖	↖↖	↖	↖	↖↖	↖
Traffic Volume (vph)	596	1737	163	63	756	151	66	232	105	198	248	209
Future Volume (vph)	596	1737	163	63	756	151	66	232	105	198	248	209
Ideal Flow (vphpl)	1800	1800	1800	1800	1800	1800	1800	1800	1800	1800	1800	1800
Storage Length (m)	140.0		80.0	105.0		60.0	50.0		50.0	55.0		60.0
Storage Lanes	2		1	1		1	1		1	1		1
Taper Length (m)	40.0			40.0			10.0			20.0		
Lane Util. Factor	0.97	0.95	1.00	1.00	0.95	1.00	1.00	0.95	1.00	1.00	0.95	1.00
Ped Bike Factor	0.99		0.95	1.00		0.97	0.99		0.97	0.98		0.97
Fr			0.850			0.850			0.850			0.850
Flt Protected	0.950			0.950			0.950			0.950		
Satd. Flow (prot)	3288	3357	1532	1712	3293	1517	1712	3390	1532	1712	3390	1532
Flt Permitted	0.950			0.950			0.469			0.607		
Satd. Flow (perm)	3266	3357	1456	1706	3293	1477	835	3390	1479	1076	3390	1485
Right Turn on Red			Yes			Yes			Yes			Yes
Satd. Flow (RTOR)			165			230			159			225
Link Speed (k/h)		60			60			50				50
Link Distance (m)		264.5			491.4			387.7				301.9
Travel Time (s)		15.9			29.5			27.9				21.7
Confl. Peds. (#/hr)	7		22	22		7	15		18	18		15
Confl. Bikes (#/hr)			4			3						
Peak Hour Factor	1.00	1.00	1.00	1.00	1.00	1.00	1.00	1.00	1.00	1.00	1.00	1.00
Heavy Vehicles (%)	2%	3%	1%	1%	5%	2%	1%	2%	1%	1%	2%	1%
Adj. Flow (vph)	596	1737	163	63	756	151	66	232	105	198	248	209
Shared Lane Traffic (%)												
Lane Group Flow (vph)	596	1737	163	63	756	151	66	232	105	198	248	209
Enter Blocked Intersection	No	No	No	No	No	No	No	No	No	No	No	No
Lane Alignment	L NA	Left	R NA	L NA	Left	R NA	L NA	Left	R NA	L NA	Left	R NA
Median Width(m)		9.0			7.4			6.0				6.0
Link Offset(m)		0.0			0.0			0.0				0.0
Crosswalk Width(m)		5.0			5.0			5.0				5.0
Two way Left Turn Lane												
Headway Factor	1.06	1.06	1.06	1.06	1.06	1.06	1.06	1.06	1.06	1.06	1.06	1.06
Turning Speed (k/h)	24		14	24		14	24		14	24		14
Number of Detectors	1	2	1	1	2	1	1	2	1	1	2	1
Detector Template	Left	Thru	Right	Left	Thru	Right	Left	Thru	Right	Left	Thru	Right
Leading Detector (m)	18.6	93.0	18.6	18.6	93.0	18.6	18.6	93.0	18.6	18.6	93.0	18.6
Trailing Detector (m)	0.0	0.0	0.0	0.0	0.0	0.0	0.0	0.0	0.0	0.0	0.0	0.0
Detector 1 Position(m)	0.0	0.0	0.0	0.0	0.0	0.0	0.0	0.0	0.0	0.0	0.0	0.0
Detector 1 Size(m)	18.6	5.5	18.6	18.6	5.5	18.6	18.6	5.5	18.6	18.6	5.5	18.6
Detector 1 Type	Cl+Ex	Cl+Ex	Cl+Ex	Cl+Ex	Cl+Ex	Cl+Ex	Cl+Ex	Cl+Ex	Cl+Ex	Cl+Ex	Cl+Ex	Cl+Ex
Detector 1 Channel												
Detector 1 Extend (s)	0.0	0.0	0.0	0.0	0.0	0.0	0.0	0.0	0.0	0.0	0.0	0.0
Detector 1 Queue (s)	0.0	0.0	0.0	0.0	0.0	0.0	0.0	0.0	0.0	0.0	0.0	0.0
Detector 1 Delay (s)	0.0	0.0	0.0	0.0	0.0	0.0	0.0	0.0	0.0	0.0	0.0	0.0
Detector 2 Position(m)		87.5			87.5			87.5				87.5
Detector 2 Size(m)		5.5			5.5			5.5				5.5
Detector 2 Type		Cl+Ex			Cl+Ex			Cl+Ex				Cl+Ex
Detector 2 Channel												
Detector 2 Extend (s)		0.0			0.0			0.0				0.0
Turn Type	Prot	NA	Perm	Prot	NA	Perm	pm+pt	NA	Perm	Perm	NA	Perm
Protected Phases	5	2		1	6		3	8			4	
Permitted Phases			2			6	8		8	4		4
Detector Phase	5	2	2	1	6	6	3	8	8	4	4	4



Lane Group	EBL	EBT	EBR	WBL	WBT	WBR	NBL	NBT	NBR	SBL	SBT	SBR
Switch Phase												
Minimum Initial (s)	5.0	10.0	10.0	5.0	10.0	10.0	5.0	10.0	10.0	10.0	10.0	10.0
Minimum Split (s)	11.6	26.2	26.2	11.2	26.2	26.2	11.7	32.7	32.7	32.7	32.7	32.7
Total Split (s)	31.0	49.0	49.0	16.0	34.0	34.0	12.0	45.0	45.0	33.0	33.0	33.0
Total Split (%)	28.2%	44.5%	44.5%	14.5%	30.9%	30.9%	10.9%	40.9%	40.9%	30.0%	30.0%	30.0%
Maximum Green (s)	24.4	42.8	42.8	9.8	27.8	27.8	5.3	38.3	38.3	26.3	26.3	26.3
Yellow Time (s)	3.7	3.7	3.7	3.7	3.7	3.7	3.3	3.3	3.3	3.3	3.3	3.3
All-Red Time (s)	2.9	2.5	2.5	2.5	2.5	2.5	3.4	3.4	3.4	3.4	3.4	3.4
Lost Time Adjust (s)	0.0	0.0	0.0	0.0	0.0	0.0	0.0	0.0	0.0	0.0	0.0	0.0
Total Lost Time (s)	6.6	6.2	6.2	6.2	6.2	6.2	6.7	6.7	6.7	6.7	6.7	6.7
Lead/Lag	Lead	Lag	Lag	Lead	Lag	Lag	Lead			Lag	Lag	Lag
Lead-Lag Optimize?												
Vehicle Extension (s)	3.0	3.0	3.0	3.0	3.0	3.0	3.0	3.0	3.0	3.0	3.0	3.0
Recall Mode	None	C-Max	C-Max	None	C-Max	C-Max	None	None	None	None	None	None
Walk Time (s)		7.0	7.0		7.0	7.0		7.0	7.0	7.0	7.0	7.0
Flash Dont Walk (s)		13.0	13.0		13.0	13.0		19.0	19.0	19.0	19.0	19.0
Pedestrian Calls (#/hr)		22	22		7	7		32	32	15	15	15
Act Effct Green (s)	23.1	50.9	50.9	8.5	33.5	33.5	33.9	33.9	33.9	24.3	24.3	24.3
Actuated g/C Ratio	0.21	0.46	0.46	0.08	0.30	0.30	0.31	0.31	0.31	0.22	0.22	0.22
v/c Ratio	0.86	1.12	0.21	0.48	0.75	0.25	0.22	0.22	0.19	0.84	0.33	0.42
Control Delay	55.5	94.0	4.1	52.5	49.5	11.4	26.7	27.6	1.7	69.2	36.8	6.3
Queue Delay	0.0	0.0	0.0	0.0	0.0	0.0	0.0	0.0	0.0	0.0	0.0	0.0
Total Delay	55.5	94.0	4.1	52.5	49.5	11.4	26.7	27.6	1.7	69.2	36.8	6.3
LOS	E	F	A	D	D	B	C	C	A	E	D	A
Approach Delay		78.9			43.8			20.7			36.9	
Approach LOS		E			D			C			D	
Queue Length 50th (m)	58.0	~233.9	0.0	10.9	59.4	1.3	8.8	16.7	0.0	36.7	21.3	0.0
Queue Length 95th (m)	#80.4	#274.1	11.4	26.5	#111.6	20.5	17.7	25.2	2.9	#69.4	31.6	13.8
Internal Link Dist (m)		240.5			467.4			363.7			277.9	
Turn Bay Length (m)	140.0		80.0	105.0		60.0	50.0		50.0	55.0		60.0
Base Capacity (vph)	729	1552	762	152	1003	610	299	1180	618	257	810	526
Starvation Cap Reductn	0	0	0	0	0	0	0	0	0	0	0	0
Spillback Cap Reductn	0	0	0	0	0	0	0	0	0	0	0	0
Storage Cap Reductn	0	0	0	0	0	0	0	0	0	0	0	0
Reduced v/c Ratio	0.82	1.12	0.21	0.41	0.75	0.25	0.22	0.20	0.17	0.77	0.31	0.40

Intersection Summary

Area Type: Other
 Cycle Length: 110
 Actuated Cycle Length: 110
 Offset: 0 (0%), Referenced to phase 2:EBT and 6:WBT, Start of Green
 Natural Cycle: 125
 Control Type: Actuated-Coordinated
 Maximum v/c Ratio: 1.12
 Intersection Signal Delay: 60.1
 Intersection LOS: E
 Intersection Capacity Utilization 102.3%
 ICU Level of Service G
 Analysis Period (min) 15
 ~ Volume exceeds capacity, queue is theoretically infinite.
 Queue shown is maximum after two cycles.
 # 95th percentile volume exceeds capacity, queue may be longer.
 Queue shown is maximum after two cycles.

Splits and Phases: 1: Orleans & Innes

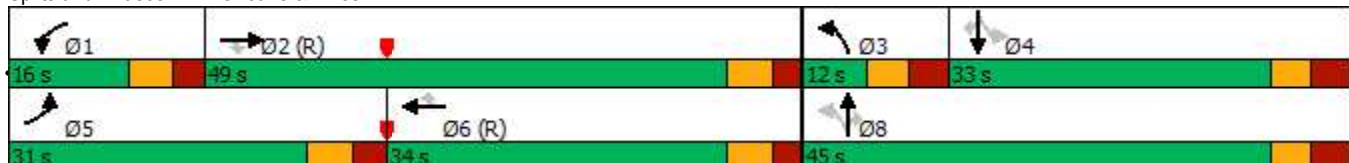



Lane Group	EBL	EBT	EBR	WBL	WBT	WBR	NBL	NBT	NBR	SBL	SBT	SBR
Lane Configurations												
Traffic Volume (vph)	63	1768	30	93	849	64	23	7	77	54	18	36
Future Volume (vph)	63	1768	30	93	849	64	23	7	77	54	18	36
Ideal Flow (vphpl)	1800	1800	1800	1800	1800	1800	1800	1800	1800	1800	1800	1800
Storage Length (m)	100.0		0.0	100.0		0.0	0.0		0.0	0.0		0.0
Storage Lanes	1		0	1		0	0		0	0		0
Taper Length (m)	35.0			25.0			2.5			2.5		
Lane Util. Factor	1.00	0.95	0.95	1.00	0.95	0.95	1.00	1.00	1.00	1.00	1.00	1.00
Ped Bike Factor	1.00	1.00			1.00			0.98				0.99
Frt		0.997			0.989			0.903				0.955
Flt Protected	0.950			0.950				0.989				0.976
Satd. Flow (prot)	1695	3376	0	1695	3256	0	0	1544	0	0	1579	0
Flt Permitted	0.291			0.080				0.918				0.790
Satd. Flow (perm)	517	3376	0	143	3256	0	0	1431	0	0	1270	0
Right Turn on Red			Yes			Yes			Yes			Yes
Satd. Flow (RTOR)		3			13			19				23
Link Speed (k/h)		60			60			40				40
Link Distance (m)		491.4			236.7			212.5				273.4
Travel Time (s)		29.5			14.2			19.1				24.6
Confl. Peds. (#/hr)	9		5	5		9	5		13	13		5
Confl. Bikes (#/hr)			1						1			
Peak Hour Factor	1.00	1.00	1.00	1.00	1.00	1.00	1.00	1.00	1.00	1.00	1.00	1.00
Heavy Vehicles (%)	2%	2%	6%	2%	5%	2%	5%	1%	3%	6%	1%	11%
Adj. Flow (vph)	63	1768	30	93	849	64	23	7	77	54	18	36
Shared Lane Traffic (%)												
Lane Group Flow (vph)	63	1798	0	93	913	0	0	107	0	0	108	0
Enter Blocked Intersection	No	No	No	No	No	No	No	No	No	No	No	No
Lane Alignment	Left	Left	Right	Left	Left	Right	L NA	Left	R NA	L NA	Left	R NA
Median Width(m)		5.0			5.0			0.0				0.0
Link Offset(m)		0.0			0.0			0.0				0.0
Crosswalk Width(m)		10.0			10.0			5.0				5.0
Two way Left Turn Lane												
Headway Factor	1.06	1.06	1.06	1.06	1.06	1.06	1.06	1.06	1.06	1.06	1.06	1.06
Turning Speed (k/h)	24		14	24		14	24		14	24		14
Number of Detectors	1	2		1	2		1	2		1	2	
Detector Template	Left	Thru		Left	Thru		Left	Thru		Left	Thru	
Leading Detector (m)	18.6	93.0		18.6	93.0		18.6	93.0		18.6	93.0	
Trailing Detector (m)	0.0	0.0		0.0	0.0		0.0	0.0		0.0	0.0	
Detector 1 Position(m)	0.0	0.0		0.0	0.0		0.0	0.0		0.0	0.0	
Detector 1 Size(m)	18.6	5.5		18.6	5.5		18.6	5.5		18.6	5.5	
Detector 1 Type	Cl+Ex	Cl+Ex		Cl+Ex	Cl+Ex		Cl+Ex	Cl+Ex		Cl+Ex	Cl+Ex	
Detector 1 Channel												
Detector 1 Extend (s)	0.0	0.0		0.0	0.0		0.0	0.0		0.0	0.0	
Detector 1 Queue (s)	0.0	0.0		0.0	0.0		0.0	0.0		0.0	0.0	
Detector 1 Delay (s)	0.0	0.0		0.0	0.0		0.0	0.0		0.0	0.0	
Detector 2 Position(m)		87.5			87.5			87.5			87.5	
Detector 2 Size(m)		5.5			5.5			5.5			5.5	
Detector 2 Type		Cl+Ex			Cl+Ex			Cl+Ex			Cl+Ex	
Detector 2 Channel												
Detector 2 Extend (s)		0.0			0.0			0.0			0.0	
Turn Type	Perm	NA		Perm	NA		Perm	NA		Perm	NA	
Protected Phases		2			6			8			4	
Permitted Phases	2			6			8			4		
Detector Phase	2	2		6	6		8	8		4	4	



Lane Group	EBL	EBT	EBR	WBL	WBT	WBR	NBL	NBT	NBR	SBL	SBT	SBR
Switch Phase												
Minimum Initial (s)	10.0	10.0		10.0	10.0		10.0	10.0		10.0	10.0	
Minimum Split (s)	39.2	39.2		39.2	39.2		37.8	37.8		37.8	37.8	
Total Split (s)	72.0	72.0		72.0	72.0		38.0	38.0		38.0	38.0	
Total Split (%)	65.5%	65.5%		65.5%	65.5%		34.5%	34.5%		34.5%	34.5%	
Maximum Green (s)	65.8	65.8		65.8	65.8		31.2	31.2		31.2	31.2	
Yellow Time (s)	3.7	3.7		3.7	3.7		3.0	3.0		3.0	3.0	
All-Red Time (s)	2.5	2.5		2.5	2.5		3.8	3.8		3.8	3.8	
Lost Time Adjust (s)	0.0	0.0		0.0	0.0			0.0			0.0	
Total Lost Time (s)	6.2	6.2		6.2	6.2			6.8			6.8	
Lead/Lag												
Lead-Lag Optimize?												
Vehicle Extension (s)	3.0	3.0		3.0	3.0		3.0	3.0		3.0	3.0	
Recall Mode	C-Max	C-Max		C-Max	C-Max		None	None		None	None	
Walk Time (s)	15.0	15.0		15.0	15.0		7.0	7.0		7.0	7.0	
Flash Dont Walk (s)	18.0	18.0		18.0	18.0		24.0	24.0		24.0	24.0	
Pedestrian Calls (#/hr)	5	5		9	9		13	13		5	5	
Act Effct Green (s)	78.1	78.1		78.1	78.1			18.9			18.9	
Actuated g/C Ratio	0.71	0.71		0.71	0.71			0.17			0.17	
v/c Ratio	0.17	0.75		0.92	0.39			0.41			0.46	
Control Delay	2.3	7.8		94.5	8.4			35.0			35.4	
Queue Delay	0.0	0.0		0.0	0.0			0.0			0.0	
Total Delay	2.3	7.8		94.5	8.4			35.0			35.4	
LOS	A	A		F	A			D			D	
Approach Delay		7.6			16.3			35.0			35.4	
Approach LOS		A			B			D			D	
Queue Length 50th (m)	1.0	27.7		13.5	18.7			16.7			16.2	
Queue Length 95th (m)	m1.5	m21.8		#49.8	53.8			26.6			26.6	
Internal Link Dist (m)		467.4			212.7			188.5			249.4	
Turn Bay Length (m)	100.0			100.0								
Base Capacity (vph)	366	2396		101	2314			419			376	
Starvation Cap Reductn	0	0		0	0			0			0	
Spillback Cap Reductn	0	0		0	0			0			0	
Storage Cap Reductn	0	0		0	0			0			0	
Reduced v/c Ratio	0.17	0.75		0.92	0.39			0.26			0.29	

Intersection Summary

Area Type: Other
 Cycle Length: 110
 Actuated Cycle Length: 110
 Offset: 2 (2%), Referenced to phase 2:EBTL and 6:WBTL, Start of Green
 Natural Cycle: 140
 Control Type: Actuated-Coordinated
 Maximum v/c Ratio: 0.92
 Intersection Signal Delay: 12.4 Intersection LOS: B
 Intersection Capacity Utilization 92.2% ICU Level of Service F
 Analysis Period (min) 15
 # 95th percentile volume exceeds capacity, queue may be longer.
 Queue shown is maximum after two cycles.
 m Volume for 95th percentile queue is metered by upstream signal.

Splits and Phases: 2: Page & Innes

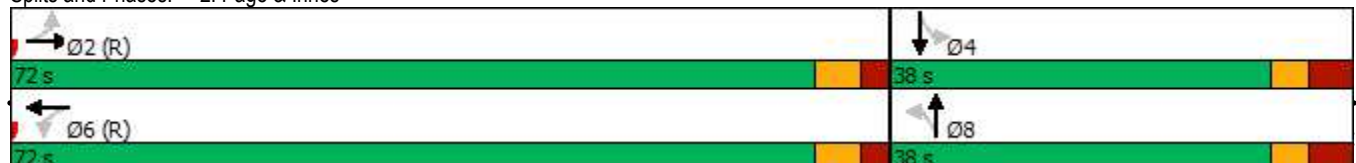



Lane Group	EBU	EBT	EBR	WBL	WBT	NBL	NBR	Ø3
Lane Configurations								
Traffic Volume (vph)	0	1600	169	76	929	126	60	
Future Volume (vph)	0	1600	169	76	929	126	60	
Ideal Flow (vphpl)	1800	1800	1800	1800	1800	1800	1800	
Storage Length (m)	30.0		50.0	65.0		70.0	70.0	
Storage Lanes	1		1	1		1	1	
Taper Length (m)	30.0			80.0		20.0		
Lane Util. Factor	1.00	0.95	1.00	1.00	0.95	0.97	1.00	
Ped Bike Factor			0.97					
Frt			0.850				0.850	
Flt Protected				0.950		0.950		
Satd. Flow (prot)	1767	3357	1502	1679	3357	3257	1502	
Flt Permitted				0.118		0.950		
Satd. Flow (perm)	1767	3357	1452	209	3357	3257	1502	
Right Turn on Red			Yes				Yes	
Satd. Flow (RTOR)			122				22	
Link Speed (k/h)		60			60	50		
Link Distance (m)		236.7			238.7	204.5		
Travel Time (s)		14.2			14.3	14.7		
Confl. Peds. (#/hr)			6	6				
Peak Hour Factor	1.00	1.00	1.00	1.00	1.00	1.00	1.00	
Adj. Flow (vph)	0	1600	169	76	929	126	60	
Shared Lane Traffic (%)								
Lane Group Flow (vph)	0	1600	169	76	929	126	60	
Enter Blocked Intersection	No	No	No	No	No	No	No	
Lane Alignment	R NA	Left	Right	Left	Left	L NA	R NA	
Median Width(m)		5.0			5.0	7.4		
Link Offset(m)		0.0			0.0	0.0		
Crosswalk Width(m)		9.0			9.0	9.0		
Two way Left Turn Lane								
Headway Factor	1.06	1.06	1.06	1.06	1.06	1.06	1.06	
Turning Speed (k/h)	14		14	24		24	14	
Number of Detectors	1	2	1	1	2	1	1	
Detector Template	Left	Thru	Right	Left	Thru	Left	Right	
Leading Detector (m)	18.6	93.0	18.6	18.6	93.0	18.6	18.6	
Trailing Detector (m)	0.0	0.0	0.0	0.0	0.0	0.0	0.0	
Detector 1 Position(m)	0.0	0.0	0.0	0.0	0.0	0.0	0.0	
Detector 1 Size(m)	18.6	5.5	18.6	18.6	5.5	18.6	18.6	
Detector 1 Type	Cl+Ex	Cl+Ex	Cl+Ex	Cl+Ex	Cl+Ex	Cl+Ex	Cl+Ex	
Detector 1 Channel								
Detector 1 Extend (s)	0.0	0.0	0.0	0.0	0.0	0.0	0.0	
Detector 1 Queue (s)	0.0	0.0	0.0	0.0	0.0	0.0	0.0	
Detector 1 Delay (s)	0.0	0.0	0.0	0.0	0.0	0.0	0.0	
Detector 2 Position(m)		87.5			87.5			
Detector 2 Size(m)		5.5			5.5			
Detector 2 Type		Cl+Ex			Cl+Ex			
Detector 2 Channel								
Detector 2 Extend (s)		0.0			0.0			
Turn Type	Perm	NA	Perm	Perm	NA	Prot	Perm	
Protected Phases		2			6	4		3
Permitted Phases	2		2	6			8	
Detector Phase	2	2	2	6	6	4	8	
Switch Phase								
Minimum Initial (s)	10.0	10.0	10.0	10.0	10.0	5.0	10.0	3.0



Lane Group	EBU	EBT	EBR	WBL	WBT	NBL	NBR	Ø3
Minimum Split (s)	31.2	31.2	31.2	31.2	31.2	11.3	37.3	30.0
Total Split (s)	68.0	68.0	68.0	68.0	68.0	12.0	42.0	30.0
Total Split (%)	61.8%	61.8%	61.8%	61.8%	61.8%	10.9%	38.2%	27%
Maximum Green (s)	61.8	61.8	61.8	61.8	61.8	5.7	35.7	28.0
Yellow Time (s)	3.7	3.7	3.7	3.7	3.7	3.3	3.3	2.0
All-Red Time (s)	2.5	2.5	2.5	2.5	2.5	3.0	3.0	0.0
Lost Time Adjust (s)	0.0	0.0	0.0	0.0	0.0	0.0	0.0	0.0
Total Lost Time (s)	6.2	6.2	6.2	6.2	6.2	6.3	6.3	
Lead/Lag						Lag		Lead
Lead-Lag Optimize?								
Vehicle Extension (s)	3.0	3.0	3.0	3.0	3.0	3.0	3.0	3.0
Recall Mode	C-Max	C-Max	C-Max	C-Max	C-Max	None	None	None
Walk Time (s)	7.0	7.0	7.0	7.0	7.0			7.0
Flash Dont Walk (s)	18.0	18.0	18.0	18.0	18.0			21.0
Pedestrian Calls (#/hr)	10	10	10	10	10			10
Act Effct Green (s)		82.2	82.2	82.2	82.2	9.3	15.3	
Actuated g/C Ratio		0.75	0.75	0.75	0.75	0.08	0.14	
v/c Ratio		0.64	0.15	0.49	0.37	0.46	0.26	
Control Delay		3.6	0.3	22.4	5.5	54.5	28.9	
Queue Delay		0.0	0.0	0.0	0.0	0.0	0.0	
Total Delay		3.6	0.3	22.4	5.5	54.5	28.9	
LOS		A	A	C	A	D	C	
Approach Delay		3.3			6.8	46.2		
Approach LOS		A			A	D		
Queue Length 50th (m)		10.5	0.0	3.4	19.3	12.3	7.1	
Queue Length 95th (m)		74.1	m0.0	#34.5	47.8	#26.4	13.9	
Internal Link Dist (m)		212.7			214.7	180.5		
Turn Bay Length (m)			50.0	65.0		70.0	70.0	
Base Capacity (vph)		2507	1115	156	2507	276	502	
Starvation Cap Reductn		0	0	0	0	0	0	
Spillback Cap Reductn		50	0	0	0	0	0	
Storage Cap Reductn		0	0	0	0	0	0	
Reduced v/c Ratio		0.65	0.15	0.49	0.37	0.46	0.12	

Intersection Summary

Area Type: Other

Cycle Length: 110

Actuated Cycle Length: 110

Offset: 22 (20%), Referenced to phase 2:EBTU and 6:WBTL, Start of Green

Natural Cycle: 110

Control Type: Actuated-Coordinated

Maximum v/c Ratio: 0.64

Intersection Signal Delay: 7.2

Intersection LOS: A

Intersection Capacity Utilization 74.8%

ICU Level of Service D

Analysis Period (min) 15

95th percentile volume exceeds capacity, queue may be longer.

Queue shown is maximum after two cycles.

m Volume for 95th percentile queue is metered by upstream signal.

Splits and Phases: 3: Lamarche & Innes

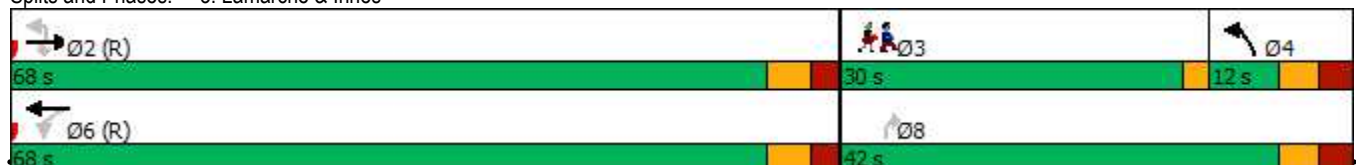



Lane Group	EBL	EBT	EBR	WBL	WBT	WBR	NBL	NBT	NBR	SBL	SBT	SBR
Lane Configurations												
Traffic Volume (vph)	8	1723	131	67	944	8	88	0	56	4	0	10
Future Volume (vph)	8	1723	131	67	944	8	88	0	56	4	0	10
Ideal Flow (vphpl)	1800	1800	1800	1800	1800	1800	1800	1800	1800	1800	1800	1800
Storage Length (m)	65.0		0.0	40.0		0.0	0.0		0.0	0.0		0.0
Storage Lanes	1		0	1		0	0		1	0		0
Taper Length (m)	80.0			30.0			20.0			20.0		
Lane Util. Factor	1.00	0.95	0.95	1.00	0.95	0.95	1.00	1.00	1.00	1.00	1.00	1.00
Ped Bike Factor		1.00						1.00				0.99
Frt		0.989			0.999				0.850			0.904
Flt Protected	0.950			0.950				0.950				0.986
Satd. Flow (prot)	1712	3349	0	1712	3322	0	0	1712	1381	0	1588	0
Flt Permitted	0.288			0.087				0.748				0.911
Satd. Flow (perm)	519	3349	0	157	3322	0	0	1343	1381	0	1467	0
Right Turn on Red			Yes			Yes			Yes			Yes
Satd. Flow (RTOR)		14			1				31			31
Link Speed (k/h)		60			60				40			40
Link Distance (m)		238.7			292.8				151.9			62.6
Travel Time (s)		14.3			17.6				13.7			5.6
Confl. Peds. (#/hr)			2	2			3					3
Confl. Bikes (#/hr)			1									
Peak Hour Factor	1.00	1.00	1.00	1.00	1.00	1.00	1.00	1.00	1.00	1.00	1.00	1.00
Heavy Vehicles (%)	1%	2%	1%	1%	4%	1%	1%	1%	12%	1%	1%	1%
Adj. Flow (vph)	8	1723	131	67	944	8	88	0	56	4	0	10
Shared Lane Traffic (%)												
Lane Group Flow (vph)	8	1854	0	67	952	0	0	88	56	0	14	0
Enter Blocked Intersection	No	No	No	No	No	No	No	No	No	No	No	No
Lane Alignment	L NA	Left	R NA	L NA	Left	R NA	L NA	Left	R NA	L NA	Left	R NA
Median Width(m)		5.0			5.0			0.0			0.0	
Link Offset(m)		0.0			0.0			0.0			0.0	
Crosswalk Width(m)		9.0			9.0			9.0			9.0	
Two way Left Turn Lane												
Headway Factor	1.06	1.06	1.06	1.06	1.06	1.06	1.06	1.06	1.06	1.06	1.06	1.06
Turning Speed (k/h)	24		14	24		14	24		14	24		14
Number of Detectors	1	2		1	2		1	2	1	1		2
Detector Template	Left	Thru		Left	Thru		Left	Thru	Right	Left		Thru
Leading Detector (m)	18.6	93.0		18.6	93.0		18.6	93.0	18.6	18.6		93.0
Trailing Detector (m)	0.0	0.0		0.0	0.0		0.0	0.0	0.0	0.0		0.0
Detector 1 Position(m)	0.0	0.0		0.0	0.0		0.0	0.0	0.0	0.0		0.0
Detector 1 Size(m)	18.6	5.5		18.6	5.5		18.6	5.5	18.6	18.6		5.5
Detector 1 Type	Cl+Ex	Cl+Ex		Cl+Ex	Cl+Ex		Cl+Ex	Cl+Ex	Cl+Ex	Cl+Ex		Cl+Ex
Detector 1 Channel												
Detector 1 Extend (s)	0.0	0.0		0.0	0.0		0.0	0.0	0.0	0.0		0.0
Detector 1 Queue (s)	0.0	0.0		0.0	0.0		0.0	0.0	0.0	0.0		0.0
Detector 1 Delay (s)	0.0	0.0		0.0	0.0		0.0	0.0	0.0	0.0		0.0
Detector 2 Position(m)		87.5			87.5			87.5				87.5
Detector 2 Size(m)		5.5			5.5			5.5				5.5
Detector 2 Type		Cl+Ex			Cl+Ex			Cl+Ex				Cl+Ex
Detector 2 Channel												
Detector 2 Extend (s)		0.0			0.0			0.0				0.0
Turn Type	Perm	NA		Perm	NA		Perm	NA	Perm	Perm		NA
Protected Phases		2			6			8				4
Permitted Phases	2			6			8		8	4		
Detector Phase	2	2		6	6		8	8	8	4		4



Lane Group	EBL	EBT	EBR	WBL	WBT	WBR	NBL	NBT	NBR	SBL	SBT	SBR
Switch Phase												
Minimum Initial (s)	10.0	10.0		10.0	10.0		10.0	10.0	10.0	10.0	10.0	
Minimum Split (s)	32.1	32.1		35.1	35.1		32.3	32.3	32.3	32.3	32.3	
Total Split (s)	77.0	77.0		77.0	77.0		33.0	33.0	33.0	33.0	33.0	
Total Split (%)	70.0%	70.0%		70.0%	70.0%		30.0%	30.0%	30.0%	30.0%	30.0%	
Maximum Green (s)	70.9	70.9		70.9	70.9		26.7	26.7	26.7	26.7	26.7	
Yellow Time (s)	3.7	3.7		3.7	3.7		3.3	3.3	3.3	3.3	3.3	
All-Red Time (s)	2.4	2.4		2.4	2.4		3.0	3.0	3.0	3.0	3.0	
Lost Time Adjust (s)	0.0	0.0		0.0	0.0			0.0	0.0		0.0	
Total Lost Time (s)	6.1	6.1		6.1	6.1			6.3	6.3		6.3	
Lead/Lag												
Lead-Lag Optimize?												
Vehicle Extension (s)	3.0	3.0		3.0	3.0		3.0	3.0	3.0	3.0	3.0	
Recall Mode	C-Max	C-Max		C-Max	C-Max		None	None	None	None	None	
Walk Time (s)	12.0	12.0		12.0	12.0		7.0	7.0	7.0	7.0	7.0	
Flash Dont Walk (s)	14.0	14.0		14.0	14.0		19.0	19.0	19.0	19.0	19.0	
Pedestrian Calls (#/hr)	2	2		1	1		1	1	1	3	3	
Act Effct Green (s)	87.4	87.4		87.4	87.4			14.7	14.7		14.7	
Actuated g/C Ratio	0.79	0.79		0.79	0.79			0.13	0.13		0.13	
v/c Ratio	0.02	0.70		0.54	0.36			0.49	0.27		0.06	
Control Delay	1.4	3.9		29.6	5.4			51.9	24.4		4.4	
Queue Delay	0.0	0.2		0.0	0.0			0.0	0.0		0.0	
Total Delay	1.4	4.1		29.6	5.4			51.9	24.4		4.4	
LOS	A	A		C	A			D	C		A	
Approach Delay		4.1			7.0			41.2			4.4	
Approach LOS		A			A			D			A	
Queue Length 50th (m)	0.2	36.7		4.3	25.7			16.8	4.5		0.0	
Queue Length 95th (m)	m0.2	11.8		#32.5	55.8			27.2	13.2		2.0	
Internal Link Dist (m)		214.7			268.8			127.9			38.6	
Turn Bay Length (m)	65.0			40.0								
Base Capacity (vph)	412	2663		124	2639			325	358		379	
Starvation Cap Reductn	0	214		0	0			0	0		0	
Spillback Cap Reductn	0	0		0	0			0	0		0	
Storage Cap Reductn	0	0		0	0			0	0		0	
Reduced v/c Ratio	0.02	0.76		0.54	0.36			0.27	0.16		0.04	

Intersection Summary

Area Type: Other
 Cycle Length: 110
 Actuated Cycle Length: 110
 Offset: 36 (33%), Referenced to phase 2:EBTL and 6:WBTL, Start of Green
 Natural Cycle: 90
 Control Type: Actuated-Coordinated
 Maximum v/c Ratio: 0.70
 Intersection Signal Delay: 6.8 Intersection LOS: A
 Intersection Capacity Utilization 88.2% ICU Level of Service E
 Analysis Period (min) 15
 # 95th percentile volume exceeds capacity, queue may be longer.
 Queue shown is maximum after two cycles.
 m Volume for 95th percentile queue is metered by upstream signal.

Splits and Phases: 4: 473 E of Page & Innes

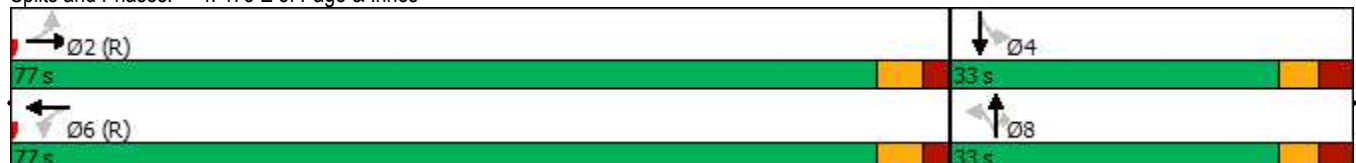

1: Orleans & Innes
PM Peak Hour

3493-3499 Innes Road
2025 Background Traffic (demand rationalization)



Lane Group	EBL	EBT	EBR	WBL	WBT	WBR	NBL	NBT	NBR	SBL	SBT	SBR
Lane Configurations	↖↖	↖↖	↖	↖	↖↖	↖	↖	↖↖	↖	↖	↖↖	↖
Traffic Volume (vph)	596	1587	163	63	756	151	66	232	105	198	248	209
Future Volume (vph)	596	1587	163	63	756	151	66	232	105	198	248	209
Ideal Flow (vphpl)	1800	1800	1800	1800	1800	1800	1800	1800	1800	1800	1800	1800
Storage Length (m)	140.0		80.0	105.0		60.0	50.0		50.0	55.0		60.0
Storage Lanes	2		1	1		1	1		1	1		1
Taper Length (m)	40.0			40.0			10.0			20.0		
Lane Util. Factor	0.97	0.95	1.00	1.00	0.95	1.00	1.00	0.95	1.00	1.00	0.95	1.00
Ped Bike Factor	0.99		0.94	1.00		0.97	0.99		0.96	0.98		0.97
Frt			0.850			0.850			0.850			0.850
Flt Protected	0.950			0.950			0.950			0.950		
Satd. Flow (prot)	3288	3357	1532	1712	3293	1517	1712	3390	1532	1712	3390	1532
Flt Permitted	0.950			0.950			0.456			0.607		
Satd. Flow (perm)	3262	3357	1446	1704	3293	1475	811	3390	1473	1072	3390	1480
Right Turn on Red			Yes			Yes			Yes			Yes
Satd. Flow (RTOR)			139			195			134			209
Link Speed (k/h)		60			60			50				50
Link Distance (m)		264.5			491.4			387.7				301.9
Travel Time (s)		15.9			29.5			27.9				21.7
Confl. Peds. (#/hr)	7		22	22		7	15		18	18		15
Confl. Bikes (#/hr)			4			3						
Peak Hour Factor	1.00	1.00	1.00	1.00	1.00	1.00	1.00	1.00	1.00	1.00	1.00	1.00
Heavy Vehicles (%)	2%	3%	1%	1%	5%	2%	1%	2%	1%	1%	2%	1%
Adj. Flow (vph)	596	1587	163	63	756	151	66	232	105	198	248	209
Shared Lane Traffic (%)												
Lane Group Flow (vph)	596	1587	163	63	756	151	66	232	105	198	248	209
Enter Blocked Intersection	No	No	No	No	No	No	No	No	No	No	No	No
Lane Alignment	L NA	Left	R NA	L NA	Left	R NA	L NA	Left	R NA	L NA	Left	R NA
Median Width(m)		9.0			7.4			6.0				6.0
Link Offset(m)		0.0			0.0			0.0				0.0
Crosswalk Width(m)		5.0			5.0			5.0				5.0
Two way Left Turn Lane												
Headway Factor	1.06	1.06	1.06	1.06	1.06	1.06	1.06	1.06	1.06	1.06	1.06	1.06
Turning Speed (k/h)	24		14	24		14	24		14	24		14
Number of Detectors	1	2	1	1	2	1	1	2	1	1	2	1
Detector Template	Left	Thru	Right	Left	Thru	Right	Left	Thru	Right	Left	Thru	Right
Leading Detector (m)	18.6	93.0	18.6	18.6	93.0	18.6	18.6	93.0	18.6	18.6	93.0	18.6
Trailing Detector (m)	0.0	0.0	0.0	0.0	0.0	0.0	0.0	0.0	0.0	0.0	0.0	0.0
Detector 1 Position(m)	0.0	0.0	0.0	0.0	0.0	0.0	0.0	0.0	0.0	0.0	0.0	0.0
Detector 1 Size(m)	18.6	5.5	18.6	18.6	5.5	18.6	18.6	5.5	18.6	18.6	5.5	18.6
Detector 1 Type	Cl+Ex	Cl+Ex	Cl+Ex	Cl+Ex	Cl+Ex	Cl+Ex	Cl+Ex	Cl+Ex	Cl+Ex	Cl+Ex	Cl+Ex	Cl+Ex
Detector 1 Channel												
Detector 1 Extend (s)	0.0	0.0	0.0	0.0	0.0	0.0	0.0	0.0	0.0	0.0	0.0	0.0
Detector 1 Queue (s)	0.0	0.0	0.0	0.0	0.0	0.0	0.0	0.0	0.0	0.0	0.0	0.0
Detector 1 Delay (s)	0.0	0.0	0.0	0.0	0.0	0.0	0.0	0.0	0.0	0.0	0.0	0.0
Detector 2 Position(m)		87.5			87.5			87.5				87.5
Detector 2 Size(m)		5.5			5.5			5.5				5.5
Detector 2 Type		Cl+Ex			Cl+Ex			Cl+Ex				Cl+Ex
Detector 2 Channel												
Detector 2 Extend (s)		0.0			0.0			0.0				0.0
Turn Type	Prot	NA	Perm	Prot	NA	Perm	pm+pt	NA	Perm	Perm	NA	Perm
Protected Phases	5	2		1	6		3	8			4	
Permitted Phases			2			6	8		8	4		4
Detector Phase	5	2	2	1	6	6	3	8	8	4	4	4



Lane Group	EBL	EBT	EBR	WBL	WBT	WBR	NBL	NBT	NBR	SBL	SBT	SBR
Switch Phase												
Minimum Initial (s)	5.0	10.0	10.0	5.0	10.0	10.0	5.0	10.0	10.0	10.0	10.0	10.0
Minimum Split (s)	11.6	26.2	26.2	11.2	26.2	26.2	11.7	32.7	32.7	32.7	32.7	32.7
Total Split (s)	35.0	71.0	71.0	12.0	48.0	48.0	12.0	47.0	47.0	35.0	35.0	35.0
Total Split (%)	26.9%	54.6%	54.6%	9.2%	36.9%	36.9%	9.2%	36.2%	36.2%	26.9%	26.9%	26.9%
Maximum Green (s)	28.4	64.8	64.8	5.8	41.8	41.8	5.3	40.3	40.3	28.3	28.3	28.3
Yellow Time (s)	3.7	3.7	3.7	3.7	3.7	3.7	3.3	3.3	3.3	3.3	3.3	3.3
All-Red Time (s)	2.9	2.5	2.5	2.5	2.5	2.5	3.4	3.4	3.4	3.4	3.4	3.4
Lost Time Adjust (s)	0.0	0.0	0.0	0.0	0.0	0.0	0.0	0.0	0.0	0.0	0.0	0.0
Total Lost Time (s)	6.6	6.2	6.2	6.2	6.2	6.2	6.7	6.7	6.7	6.7	6.7	6.7
Lead/Lag	Lead	Lag	Lag	Lead	Lag	Lag	Lead			Lag	Lag	Lag
Lead-Lag Optimize?												
Vehicle Extension (s)	3.0	3.0	3.0	3.0	3.0	3.0	3.0	3.0	3.0	3.0	3.0	3.0
Recall Mode	None	C-Max	C-Max	None	C-Max	C-Max	None	None	None	None	None	None
Walk Time (s)		7.0	7.0		7.0	7.0		7.0	7.0	7.0	7.0	7.0
Flash Dont Walk (s)		13.0	13.0		13.0	13.0		19.0	19.0	19.0	19.0	19.0
Pedestrian Calls (#/hr)		22	22		7	7		32	32	15	15	15
Act Effct Green (s)	26.9	68.1	68.1	6.1	47.0	47.0	36.7	36.7	36.7	27.1	27.1	27.1
Actuated g/C Ratio	0.21	0.52	0.52	0.05	0.36	0.36	0.28	0.28	0.28	0.21	0.21	0.21
v/c Ratio	0.88	0.90	0.20	0.79	0.64	0.23	0.25	0.24	0.21	0.89	0.35	0.44
Control Delay	64.9	37.4	4.7	104.7	42.5	10.4	35.4	35.6	3.3	87.3	45.2	8.6
Queue Delay	0.0	0.0	0.0	0.0	0.0	0.0	0.0	0.0	0.0	0.0	0.0	0.0
Total Delay	64.9	37.4	4.7	104.7	42.5	10.4	35.4	35.6	3.3	87.3	45.2	8.6
LOS	E	D	A	F	D	B	D	D	A	F	D	A
Approach Delay		42.1			41.5			27.2			46.2	
Approach LOS		D			D			C			D	
Queue Length 50th (m)	69.7	182.3	2.8	15.2	77.3	1.9	11.2	21.3	0.0	45.2	26.2	0.0
Queue Length 95th (m)	#90.5	#232.7	13.4	#40.1	105.2	18.1	21.4	31.1	6.9	#84.0	37.7	18.5
Internal Link Dist (m)		240.5			467.4			363.7			277.9	
Turn Bay Length (m)	140.0		80.0	105.0		60.0	50.0		50.0	55.0		60.0
Base Capacity (vph)	718	1758	823	80	1189	657	265	1050	549	233	737	485
Starvation Cap Reductn	0	0	0	0	0	0	0	0	0	0	0	0
Spillback Cap Reductn	0	0	0	0	0	0	0	0	0	0	0	0
Storage Cap Reductn	0	0	0	0	0	0	0	0	0	0	0	0
Reduced v/c Ratio	0.83	0.90	0.20	0.79	0.64	0.23	0.25	0.22	0.19	0.85	0.34	0.43

Intersection Summary

Area Type: Other
 Cycle Length: 130
 Actuated Cycle Length: 130
 Offset: 125 (96%), Referenced to phase 2:EBT and 6:WBT, Start of Green
 Natural Cycle: 115
 Control Type: Actuated-Coordinated
 Maximum v/c Ratio: 0.90
 Intersection Signal Delay: 41.2 Intersection LOS: D
 Intersection Capacity Utilization 97.9% ICU Level of Service F
 Analysis Period (min) 15
 # 95th percentile volume exceeds capacity, queue may be longer.
 Queue shown is maximum after two cycles.

Splits and Phases: 1: Orleans & Innes

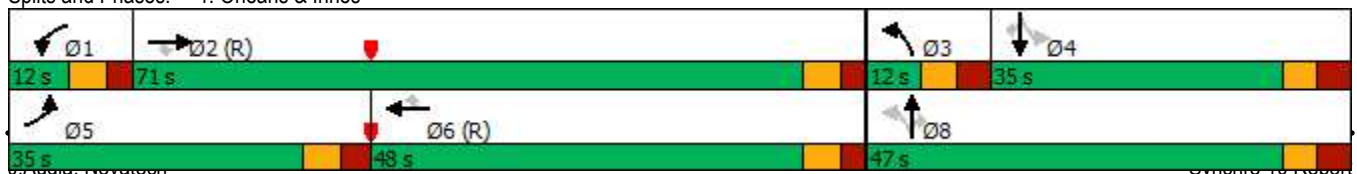



Lane Group	EBL	EBT	EBR	WBL	WBT	WBR	NBL	NBT	NBR	SBL	SBT	SBR
Lane Configurations												
Traffic Volume (vph)	63	1768	30	93	849	64	23	7	77	54	18	36
Future Volume (vph)	63	1768	30	93	849	64	23	7	77	54	18	36
Ideal Flow (vphpl)	1800	1800	1800	1800	1800	1800	1800	1800	1800	1800	1800	1800
Storage Length (m)	100.0		0.0	100.0		0.0	0.0		0.0	0.0		0.0
Storage Lanes	1		0	1		0	0		0	0		0
Taper Length (m)	35.0			25.0			2.5			2.5		
Lane Util. Factor	1.00	0.95	0.95	1.00	0.95	0.95	1.00	1.00	1.00	1.00	1.00	1.00
Ped Bike Factor	1.00	1.00			1.00			0.98			0.99	
Frt		0.997			0.989			0.903			0.955	
Flt Protected	0.950			0.950				0.989			0.976	
Satd. Flow (prot)	1695	3376	0	1695	3255	0	0	1541	0	0	1578	0
Flt Permitted	0.312			0.057				0.917			0.754	
Satd. Flow (perm)	554	3376	0	102	3255	0	0	1427	0	0	1211	0
Right Turn on Red			Yes			Yes			Yes			Yes
Satd. Flow (RTOR)		2			13			77			18	
Link Speed (k/h)		60			60			40			40	
Link Distance (m)		491.4			236.7			212.5			273.4	
Travel Time (s)		29.5			14.2			19.1			24.6	
Confl. Peds. (#/hr)	9		5	5		9	5		13	13		5
Confl. Bikes (#/hr)			1						1			
Peak Hour Factor	1.00	1.00	1.00	1.00	1.00	1.00	1.00	1.00	1.00	1.00	1.00	1.00
Heavy Vehicles (%)	2%	2%	6%	2%	5%	2%	5%	1%	3%	6%	1%	11%
Adj. Flow (vph)	63	1768	30	93	849	64	23	7	77	54	18	36
Shared Lane Traffic (%)												
Lane Group Flow (vph)	63	1798	0	93	913	0	0	107	0	0	108	0
Enter Blocked Intersection	No	No	No	No	No	No	No	No	No	No	No	No
Lane Alignment	Left	Left	Right	Left	Left	Right	L NA	Left	R NA	L NA	Left	R NA
Median Width(m)		5.0			5.0			0.0			0.0	
Link Offset(m)		0.0			0.0			0.0			0.0	
Crosswalk Width(m)		10.0			10.0			5.0			5.0	
Two way Left Turn Lane												
Headway Factor	1.06	1.06	1.06	1.06	1.06	1.06	1.06	1.06	1.06	1.06	1.06	1.06
Turning Speed (k/h)	24		14	24		14	24		14	24		14
Number of Detectors	1	2		1	2		1	2		1	2	
Detector Template	Left	Thru		Left	Thru		Left	Thru		Left	Thru	
Leading Detector (m)	18.6	93.0		18.6	93.0		18.6	93.0		18.6	93.0	
Trailing Detector (m)	0.0	0.0		0.0	0.0		0.0	0.0		0.0	0.0	
Detector 1 Position(m)	0.0	0.0		0.0	0.0		0.0	0.0		0.0	0.0	
Detector 1 Size(m)	18.6	5.5		18.6	5.5		18.6	5.5		18.6	5.5	
Detector 1 Type	Cl+Ex	Cl+Ex		Cl+Ex	Cl+Ex		Cl+Ex	Cl+Ex		Cl+Ex	Cl+Ex	
Detector 1 Channel												
Detector 1 Extend (s)	0.0	0.0		0.0	0.0		0.0	0.0		0.0	0.0	
Detector 1 Queue (s)	0.0	0.0		0.0	0.0		0.0	0.0		0.0	0.0	
Detector 1 Delay (s)	0.0	0.0		0.0	0.0		0.0	0.0		0.0	0.0	
Detector 2 Position(m)		87.5			87.5			87.5			87.5	
Detector 2 Size(m)		5.5			5.5			5.5			5.5	
Detector 2 Type		Cl+Ex			Cl+Ex			Cl+Ex			Cl+Ex	
Detector 2 Channel												
Detector 2 Extend (s)		0.0			0.0			0.0			0.0	
Turn Type	Perm	NA		pm+pt	NA		Perm	NA		Perm	NA	
Protected Phases		2		1	6			8			4	
Permitted Phases	2			6			8			4		
Detector Phase	2	2		1	6		8	8		4	4	



Lane Group	EBL	EBT	EBR	WBL	WBT	WBR	NBL	NBT	NBR	SBL	SBT	SBR
Switch Phase												
Minimum Initial (s)	10.0	10.0		5.0	10.0		10.0	10.0		10.0	10.0	
Minimum Split (s)	39.2	39.2		11.2	39.2		37.8	37.8		37.8	37.8	
Total Split (s)	80.0	80.0		12.0	92.0		38.0	38.0		38.0	38.0	
Total Split (%)	61.5%	61.5%		9.2%	70.8%		29.2%	29.2%		29.2%	29.2%	
Maximum Green (s)	73.8	73.8		5.8	85.8		31.2	31.2		31.2	31.2	
Yellow Time (s)	3.7	3.7		3.7	3.7		3.0	3.0		3.0	3.0	
All-Red Time (s)	2.5	2.5		2.5	2.5		3.8	3.8		3.8	3.8	
Lost Time Adjust (s)	0.0	0.0		0.0	0.0			0.0			0.0	
Total Lost Time (s)	6.2	6.2		6.2	6.2			6.8			6.8	
Lead/Lag	Lag	Lag		Lead								
Lead-Lag Optimize?												
Vehicle Extension (s)	3.0	3.0		3.0	3.0		3.0	3.0		3.0	3.0	
Recall Mode	C-Max	C-Max		None	C-Max		None	None		None	None	
Walk Time (s)	15.0	15.0			15.0		7.0	7.0		7.0	7.0	
Flash Dont Walk (s)	18.0	18.0			18.0		24.0	24.0		24.0	24.0	
Pedestrian Calls (#/hr)	5	5			9		13	13		5	5	
Act Effct Green (s)	84.5	84.5		97.4	97.4			19.6			19.6	
Actuated g/C Ratio	0.65	0.65		0.75	0.75			0.15			0.15	
v/c Ratio	0.17	0.82		0.58	0.37			0.38			0.55	
Control Delay	3.7	6.3		43.6	4.4			18.9			50.4	
Queue Delay	0.0	0.0		0.0	0.0			0.0			0.0	
Total Delay	3.7	6.3		43.6	4.4			18.9			50.4	
LOS	A	A		D	A			B			D	
Approach Delay		6.2			8.1			18.9			50.4	
Approach LOS		A			A			B			D	
Queue Length 50th (m)	1.7	29.9		4.4	20.4			6.5			20.8	
Queue Length 95th (m)	m2.6	#41.6		#28.5	25.1			19.7			33.7	
Internal Link Dist (m)		467.4			212.7			188.5			249.4	
Turn Bay Length (m)	100.0			100.0								
Base Capacity (vph)	360	2194		159	2442			401			304	
Starvation Cap Reductn	0	0		0	0			0			0	
Spillback Cap Reductn	0	0		0	0			0			0	
Storage Cap Reductn	0	0		0	0			0			0	
Reduced v/c Ratio	0.17	0.82		0.58	0.37			0.27			0.36	

Intersection Summary

Area Type: Other
 Cycle Length: 130
 Actuated Cycle Length: 130
 Offset: 122 (94%), Referenced to phase 2:EBTL and 6:WBTL, Start of Green
 Natural Cycle: 110
 Control Type: Actuated-Coordinated
 Maximum v/c Ratio: 0.82
 Intersection Signal Delay: 8.8
 Intersection LOS: A
 Intersection Capacity Utilization 89.3%
 ICU Level of Service E
 Analysis Period (min) 15
 # 95th percentile volume exceeds capacity, queue may be longer.
 Queue shown is maximum after two cycles.
 m Volume for 95th percentile queue is metered by upstream signal.

Splits and Phases: 2: Page & Innes

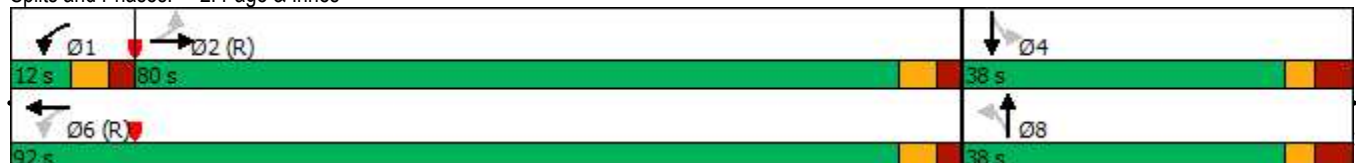

3: Lamarche & Innes
PM Peak Hour

3493-3499 Innes Road
2025 Background Traffic (demand rationalization)



Lane Group	EBU	EBT	EBR	WBL	WBT	NBL	NBR	Ø3
Lane Configurations								
Traffic Volume (vph)	0	1600	169	76	929	126	60	
Future Volume (vph)	0	1600	169	76	929	126	60	
Ideal Flow (vphpl)	1800	1800	1800	1800	1800	1800	1800	
Storage Length (m)	30.0		50.0	65.0		70.0	70.0	
Storage Lanes	1		1	1		1	1	
Taper Length (m)	30.0			80.0		20.0		
Lane Util. Factor	1.00	0.95	1.00	1.00	0.95	0.97	1.00	
Ped Bike Factor			0.96					
Frt			0.850				0.850	
Flt Protected				0.950		0.950		
Satd. Flow (prot)	1767	3357	1502	1679	3357	3257	1502	
Flt Permitted				0.117		0.950		
Satd. Flow (perm)	1767	3357	1449	207	3357	3257	1502	
Right Turn on Red			Yes				Yes	
Satd. Flow (RTOR)			122				34	
Link Speed (k/h)		60			60	50		
Link Distance (m)		236.7			238.7	204.5		
Travel Time (s)		14.2			14.3	14.7		
Confl. Peds. (#/hr)			6	6				
Peak Hour Factor	1.00	1.00	1.00	1.00	1.00	1.00	1.00	
Adj. Flow (vph)	0	1600	169	76	929	126	60	
Shared Lane Traffic (%)								
Lane Group Flow (vph)	0	1600	169	76	929	126	60	
Enter Blocked Intersection	No	No	No	No	No	No	No	
Lane Alignment	R NA	Left	Right	Left	Left	L NA	R NA	
Median Width(m)		5.0			5.0	7.4		
Link Offset(m)		0.0			0.0	0.0		
Crosswalk Width(m)		9.0			9.0	9.0		
Two way Left Turn Lane								
Headway Factor	1.06	1.06	1.06	1.06	1.06	1.06	1.06	
Turning Speed (k/h)	14		14	24		24	14	
Number of Detectors	1	2	1	1	2	1	1	
Detector Template	Left	Thru	Right	Left	Thru	Left	Right	
Leading Detector (m)	18.6	93.0	18.6	18.6	93.0	18.6	18.6	
Trailing Detector (m)	0.0	0.0	0.0	0.0	0.0	0.0	0.0	
Detector 1 Position(m)	0.0	0.0	0.0	0.0	0.0	0.0	0.0	
Detector 1 Size(m)	18.6	5.5	18.6	18.6	5.5	18.6	18.6	
Detector 1 Type	Cl+Ex	Cl+Ex	Cl+Ex	Cl+Ex	Cl+Ex	Cl+Ex	Cl+Ex	
Detector 1 Channel								
Detector 1 Extend (s)	0.0	0.0	0.0	0.0	0.0	0.0	0.0	
Detector 1 Queue (s)	0.0	0.0	0.0	0.0	0.0	0.0	0.0	
Detector 1 Delay (s)	0.0	0.0	0.0	0.0	0.0	0.0	0.0	
Detector 2 Position(m)		87.5			87.5			
Detector 2 Size(m)		5.5			5.5			
Detector 2 Type		Cl+Ex			Cl+Ex			
Detector 2 Channel								
Detector 2 Extend (s)		0.0			0.0			
Turn Type	Perm	NA	Perm	Perm	NA	Prot	Perm	
Protected Phases		2			6	4		3
Permitted Phases	2		2	6			8	
Detector Phase	2	2	2	6	6	4	8	
Switch Phase								
Minimum Initial (s)	10.0	10.0	10.0	10.0	10.0	5.0	10.0	3.0



Lane Group	EBU	EBT	EBR	WBL	WBT	NBL	NBR	Ø3
Minimum Split (s)	31.2	31.2	31.2	31.2	31.2	11.3	37.3	30.0
Total Split (s)	88.0	88.0	88.0	88.0	88.0	12.0	42.0	30.0
Total Split (%)	67.7%	67.7%	67.7%	67.7%	67.7%	9.2%	32.3%	23%
Maximum Green (s)	81.8	81.8	81.8	81.8	81.8	5.7	35.7	28.0
Yellow Time (s)	3.7	3.7	3.7	3.7	3.7	3.3	3.3	2.0
All-Red Time (s)	2.5	2.5	2.5	2.5	2.5	3.0	3.0	0.0
Lost Time Adjust (s)	0.0	0.0	0.0	0.0	0.0	0.0	0.0	
Total Lost Time (s)	6.2	6.2	6.2	6.2	6.2	6.3	6.3	
Lead/Lag						Lag		Lead
Lead-Lag Optimize?								
Vehicle Extension (s)	3.0	3.0	3.0	3.0	3.0	3.0	3.0	3.0
Recall Mode	C-Max	C-Max	C-Max	C-Max	C-Max	None	None	None
Walk Time (s)	7.0	7.0	7.0	7.0	7.0			7.0
Flash Dont Walk (s)	18.0	18.0	18.0	18.0	18.0			21.0
Pedestrian Calls (#/hr)	10	10	10	10	10			10
Act Effct Green (s)		96.9	96.9	96.9	96.9	8.6	20.6	
Actuated g/C Ratio		0.75	0.75	0.75	0.75	0.07	0.16	
v/c Ratio		0.64	0.15	0.49	0.37	0.59	0.23	
Control Delay		1.9	0.2	22.4	6.0	70.5	22.6	
Queue Delay		0.1	0.0	0.0	0.0	0.0	0.0	
Total Delay		2.0	0.2	22.4	6.0	70.5	22.6	
LOS		A	A	C	A	E	C	
Approach Delay		1.8			7.3	55.0		
Approach LOS		A			A	E		
Queue Length 50th (m)		8.6	0.1	3.7	20.9	14.7	5.8	
Queue Length 95th (m)		13.1	m0.0	#34.4	40.4	#32.7	14.5	
Internal Link Dist (m)		212.7			214.7	180.5		
Turn Bay Length (m)			50.0	65.0		70.0	70.0	
Base Capacity (vph)		2501	1110	154	2501	215	437	
Starvation Cap Reductn		149	0	0	0	0	0	
Spillback Cap Reductn		0	0	0	0	0	0	
Storage Cap Reductn		0	0	0	0	0	0	
Reduced v/c Ratio		0.68	0.15	0.49	0.37	0.59	0.14	

Intersection Summary

Area Type: Other
 Cycle Length: 130
 Actuated Cycle Length: 130
 Offset: 129 (99%), Referenced to phase 2:EBTU and 6:WBTL, Start of Green
 Natural Cycle: 110
 Control Type: Actuated-Coordinated
 Maximum v/c Ratio: 0.64
 Intersection Signal Delay: 7.0
 Intersection Capacity Utilization 74.8%
 Analysis Period (min) 15
 # 95th percentile volume exceeds capacity, queue may be longer.
 Queue shown is maximum after two cycles.
 m Volume for 95th percentile queue is metered by upstream signal.

Splits and Phases: 3: Lamarche & Innes

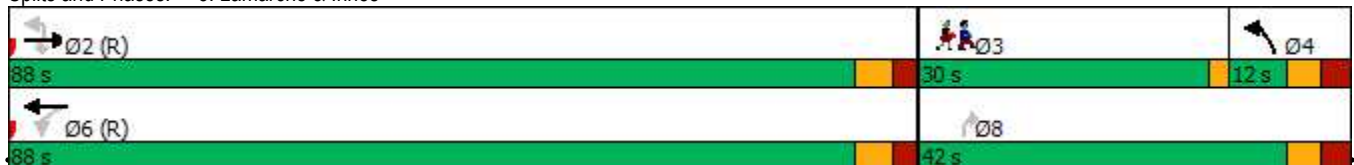



Lane Group	EBL	EBT	EBR	WBL	WBT	WBR	NBL	NBT	NBR	SBL	SBT	SBR
Lane Configurations												
Traffic Volume (vph)	8	1723	131	67	944	8	88	0	56	4	0	10
Future Volume (vph)	8	1723	131	67	944	8	88	0	56	4	0	10
Ideal Flow (vphpl)	1800	1800	1800	1800	1800	1800	1800	1800	1800	1800	1800	1800
Storage Length (m)	65.0		0.0	40.0		0.0	0.0		0.0	0.0		0.0
Storage Lanes	1		0	1		0	0		1	0		0
Taper Length (m)	80.0			30.0			20.0			20.0		
Lane Util. Factor	1.00	0.95	0.95	1.00	0.95	0.95	1.00	1.00	1.00	1.00	1.00	1.00
Ped Bike Factor		1.00						1.00				0.99
Frt		0.989			0.999				0.850			0.904
Flt Protected	0.950			0.950				0.950				0.986
Satd. Flow (prot)	1712	3349	0	1712	3322	0	0	1712	1381	0	1587	0
Flt Permitted	0.287			0.089				0.748				0.920
Satd. Flow (perm)	517	3349	0	160	3322	0	0	1342	1381	0	1481	0
Right Turn on Red			Yes			Yes			Yes			Yes
Satd. Flow (RTOR)		14			1				39			26
Link Speed (k/h)		60			60				40			40
Link Distance (m)		238.7			292.8				151.9			62.6
Travel Time (s)		14.3			17.6				13.7			5.6
Confl. Peds. (#/hr)			2	2			3					3
Confl. Bikes (#/hr)			1									
Peak Hour Factor	1.00	1.00	1.00	1.00	1.00	1.00	1.00	1.00	1.00	1.00	1.00	1.00
Heavy Vehicles (%)	1%	2%	1%	1%	4%	1%	1%	1%	12%	1%	1%	1%
Adj. Flow (vph)	8	1723	131	67	944	8	88	0	56	4	0	10
Shared Lane Traffic (%)												
Lane Group Flow (vph)	8	1854	0	67	952	0	0	88	56	0	14	0
Enter Blocked Intersection	No	No	No	No	No	No	No	No	No	No	No	No
Lane Alignment	L NA	Left	R NA	L NA	Left	R NA	L NA	Left	R NA	L NA	Left	R NA
Median Width(m)		5.0			5.0			0.0			0.0	
Link Offset(m)		0.0			0.0			0.0			0.0	
Crosswalk Width(m)		9.0			9.0			9.0			9.0	
Two way Left Turn Lane												
Headway Factor	1.06	1.06	1.06	1.06	1.06	1.06	1.06	1.06	1.06	1.06	1.06	1.06
Turning Speed (k/h)	24		14	24		14	24		14	24		14
Number of Detectors	1	2		1	2		1	2	1	1		2
Detector Template	Left	Thru		Left	Thru		Left	Thru	Right	Left		Thru
Leading Detector (m)	18.6	93.0		18.6	93.0		18.6	93.0	18.6	18.6		93.0
Trailing Detector (m)	0.0	0.0		0.0	0.0		0.0	0.0	0.0	0.0		0.0
Detector 1 Position(m)	0.0	0.0		0.0	0.0		0.0	0.0	0.0	0.0		0.0
Detector 1 Size(m)	18.6	5.5		18.6	5.5		18.6	5.5	18.6	18.6		5.5
Detector 1 Type	Cl+Ex	Cl+Ex		Cl+Ex	Cl+Ex		Cl+Ex	Cl+Ex	Cl+Ex	Cl+Ex		Cl+Ex
Detector 1 Channel												
Detector 1 Extend (s)	0.0	0.0		0.0	0.0		0.0	0.0	0.0	0.0		0.0
Detector 1 Queue (s)	0.0	0.0		0.0	0.0		0.0	0.0	0.0	0.0		0.0
Detector 1 Delay (s)	0.0	0.0		0.0	0.0		0.0	0.0	0.0	0.0		0.0
Detector 2 Position(m)		87.5			87.5			87.5				87.5
Detector 2 Size(m)		5.5			5.5			5.5				5.5
Detector 2 Type		Cl+Ex			Cl+Ex			Cl+Ex				Cl+Ex
Detector 2 Channel												
Detector 2 Extend (s)		0.0			0.0			0.0				0.0
Turn Type	Perm	NA		Perm	NA		Perm	NA	Perm	Perm		NA
Protected Phases		2			6			8				4
Permitted Phases	2			6			8		8	4		
Detector Phase	2	2		6	6		8	8	8	4		4



Lane Group	EBL	EBT	EBR	WBL	WBT	WBR	NBL	NBT	NBR	SBL	SBT	SBR
Switch Phase												
Minimum Initial (s)	10.0	10.0		10.0	10.0		10.0	10.0	10.0	10.0	10.0	
Minimum Split (s)	32.1	32.1		35.1	35.1		32.3	32.3	32.3	32.3	32.3	
Total Split (s)	97.0	97.0		97.0	97.0		33.0	33.0	33.0	33.0	33.0	
Total Split (%)	74.6%	74.6%		74.6%	74.6%		25.4%	25.4%	25.4%	25.4%	25.4%	
Maximum Green (s)	90.9	90.9		90.9	90.9		26.7	26.7	26.7	26.7	26.7	
Yellow Time (s)	3.7	3.7		3.7	3.7		3.3	3.3	3.3	3.3	3.3	
All-Red Time (s)	2.4	2.4		2.4	2.4		3.0	3.0	3.0	3.0	3.0	
Lost Time Adjust (s)	0.0	0.0		0.0	0.0			0.0	0.0		0.0	
Total Lost Time (s)	6.1	6.1		6.1	6.1			6.3	6.3		6.3	
Lead/Lag												
Lead-Lag Optimize?												
Vehicle Extension (s)	3.0	3.0		3.0	3.0		3.0	3.0	3.0	3.0	3.0	
Recall Mode	C-Max	C-Max		C-Max	C-Max		None	None	None	None	None	
Walk Time (s)	12.0	12.0		12.0	12.0		7.0	7.0	7.0	7.0	7.0	
Flash Dont Walk (s)	14.0	14.0		14.0	14.0		19.0	19.0	19.0	19.0	19.0	
Pedestrian Calls (#/hr)	2	2		1	1		1	1	1	3	3	
Act Effct Green (s)	102.1	102.1		102.1	102.1			15.5	15.5		15.5	
Actuated g/C Ratio	0.79	0.79		0.79	0.79			0.12	0.12		0.12	
v/c Ratio	0.02	0.70		0.54	0.36			0.55	0.28		0.07	
Control Delay	1.1	2.1		26.9	5.2			65.5	24.1		7.4	
Queue Delay	0.0	0.0		0.0	0.0			0.0	0.0		0.0	
Total Delay	1.1	2.1		26.9	5.2			65.5	24.1		7.4	
LOS	A	A		C	A			E	C		A	
Approach Delay		2.1			6.6			49.4			7.4	
Approach LOS		A			A			D			A	
Queue Length 50th (m)	0.1	8.6		4.6	27.5			20.2	3.7		0.0	
Queue Length 95th (m)	m0.2	14.0		#33.2	54.3			32.7	14.1		2.9	
Internal Link Dist (m)		214.7			268.8			127.9			38.6	
Turn Bay Length (m)	65.0			40.0								
Base Capacity (vph)	405	2633		125	2609			275	314		324	
Starvation Cap Reductn	0	0		0	0			0	0		0	
Spillback Cap Reductn	0	0		0	0			0	0		0	
Storage Cap Reductn	0	0		0	0			0	0		0	
Reduced v/c Ratio	0.02	0.70		0.54	0.36			0.32	0.18		0.04	

Intersection Summary

Area Type: Other
 Cycle Length: 130
 Actuated Cycle Length: 130
 Offset: 4 (3%), Referenced to phase 2:EBTL and 6:WBTL, Start of Green
 Natural Cycle: 90
 Control Type: Actuated-Coordinated
 Maximum v/c Ratio: 0.70
 Intersection Signal Delay: 5.9 Intersection LOS: A
 Intersection Capacity Utilization 88.2% ICU Level of Service E
 Analysis Period (min) 15
 # 95th percentile volume exceeds capacity, queue may be longer.
 Queue shown is maximum after two cycles.
 m Volume for 95th percentile queue is metered by upstream signal.

Splits and Phases: 4: 473 E of Page & Innes

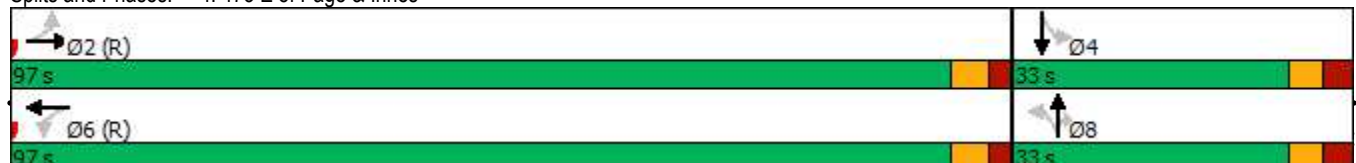



Lane Group	EBL	EBT	EBR	WBL	WBT	WBR	NBL	NBT	NBR	SBL	SBT	SBR
Lane Configurations	↖↖	↗↗	↖	↖	↗↗	↖	↖	↗↗	↖	↖	↗↗	↖
Traffic Volume (vph)	131	526	25	28	1601	218	219	280	56	96	108	496
Future Volume (vph)	131	526	25	28	1601	218	219	280	56	96	108	496
Ideal Flow (vphpl)	1800	1800	1800	1800	1800	1800	1800	1800	1800	1800	1800	1800
Storage Length (m)	140.0		80.0	105.0		60.0	50.0		50.0	55.0		60.0
Storage Lanes	2		1	1		1	1		1	1		1
Taper Length (m)	40.0			40.0			10.0			20.0		
Lane Util. Factor	0.97	0.95	1.00	1.00	0.95	1.00	1.00	0.95	1.00	1.00	0.95	1.00
Ped Bike Factor	1.00		0.96	0.99		0.97	0.99		0.94	0.97		0.98
Frt			0.850			0.850			0.850			0.850
Flt Protected	0.950			0.950			0.950			0.950		
Satd. Flow (prot)	2995	3144	1473	1572	3357	1502	1712	3357	1502	1679	3357	1532
Flt Permitted	0.950			0.950			0.545			0.580		
Satd. Flow (perm)	2989	3144	1416	1551	3357	1463	975	3357	1413	992	3357	1500
Right Turn on Red			Yes			Yes			Yes			Yes
Satd. Flow (RTOR)			143			143			82			138
Link Speed (k/h)		60			60			50				50
Link Distance (m)		264.5			491.4			387.7				301.9
Travel Time (s)		15.9			29.5			27.9				21.7
Confl. Peds. (#/hr)	6		14	14		6	6		32	32		6
Confl. Bikes (#/hr)						6						
Peak Hour Factor	1.00	1.00	1.00	1.00	1.00	1.00	1.00	1.00	1.00	1.00	1.00	1.00
Heavy Vehicles (%)	12%	10%	5%	10%	3%	3%	1%	3%	3%	3%	3%	1%
Adj. Flow (vph)	131	526	25	28	1601	218	219	280	56	96	108	496
Shared Lane Traffic (%)												
Lane Group Flow (vph)	131	526	25	28	1601	218	219	280	56	96	108	496
Enter Blocked Intersection	No	No	No	No	No	No	No	No	No	No	No	No
Lane Alignment	L NA	Left	R NA	L NA	Left	R NA	L NA	Left	R NA	L NA	Left	R NA
Median Width(m)		9.0			7.4			6.0				6.0
Link Offset(m)		0.0			0.0			0.0				0.0
Crosswalk Width(m)		5.0			5.0			5.0				5.0
Two way Left Turn Lane												
Headway Factor	1.06	1.06	1.06	1.06	1.06	1.06	1.06	1.06	1.06	1.06	1.06	1.06
Turning Speed (k/h)	24		14	24		14	24		14	24		14
Number of Detectors	1	2	1	1	2	1	1	2	1	1	2	1
Detector Template	Left	Thru	Right	Left	Thru	Right	Left	Thru	Right	Left	Thru	Right
Leading Detector (m)	18.6	93.0	18.6	18.6	93.0	18.6	18.6	93.0	18.6	18.6	93.0	18.6
Trailing Detector (m)	0.0	0.0	0.0	0.0	0.0	0.0	0.0	0.0	0.0	0.0	0.0	0.0
Detector 1 Position(m)	0.0	0.0	0.0	0.0	0.0	0.0	0.0	0.0	0.0	0.0	0.0	0.0
Detector 1 Size(m)	18.6	5.5	18.6	18.6	5.5	18.6	18.6	5.5	18.6	18.6	5.5	18.6
Detector 1 Type	Cl+Ex	Cl+Ex	Cl+Ex	Cl+Ex	Cl+Ex	Cl+Ex	Cl+Ex	Cl+Ex	Cl+Ex	Cl+Ex	Cl+Ex	Cl+Ex
Detector 1 Channel												
Detector 1 Extend (s)	0.0	0.0	0.0	0.0	0.0	0.0	0.0	0.0	0.0	0.0	0.0	0.0
Detector 1 Queue (s)	0.0	0.0	0.0	0.0	0.0	0.0	0.0	0.0	0.0	0.0	0.0	0.0
Detector 1 Delay (s)	0.0	0.0	0.0	0.0	0.0	0.0	0.0	0.0	0.0	0.0	0.0	0.0
Detector 2 Position(m)		87.5			87.5			87.5				87.5
Detector 2 Size(m)		5.5			5.5			5.5				5.5
Detector 2 Type		Cl+Ex			Cl+Ex			Cl+Ex				Cl+Ex
Detector 2 Channel												
Detector 2 Extend (s)		0.0			0.0			0.0				0.0
Turn Type	Prot	NA	Perm	Prot	NA	Perm	pm+pt	NA	Perm	Perm	NA	Perm
Protected Phases	5	2		1	6		3	8			4	
Permitted Phases			2			6	8		8	4		4
Detector Phase	5	2	2	1	6	6	3	8	8	4	4	4

1: Orleans & Innes
AM Peak Hour

3493-3499 Innes Road
2030 Background Traffic

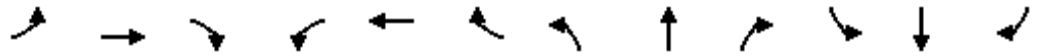

Lane Group	EBL	EBT	EBR	WBL	WBT	WBR	NBL	NBT	NBR	SBL	SBT	SBR
Switch Phase												
Minimum Initial (s)	5.0	10.0	10.0	5.0	10.0	10.0	5.0	10.0	10.0	10.0	10.0	10.0
Minimum Split (s)	11.6	26.2	26.2	11.2	26.2	26.2	11.7	32.7	32.7	32.7	32.7	32.7
Total Split (s)	13.0	72.0	72.0	13.0	72.0	72.0	12.0	45.0	45.0	33.0	33.0	33.0
Total Split (%)	10.0%	55.4%	55.4%	10.0%	55.4%	55.4%	9.2%	34.6%	34.6%	25.4%	25.4%	25.4%
Maximum Green (s)	6.4	65.8	65.8	6.8	65.8	65.8	5.3	38.3	38.3	26.3	26.3	26.3
Yellow Time (s)	3.7	3.7	3.7	3.7	3.7	3.7	3.3	3.3	3.3	3.3	3.3	3.3
All-Red Time (s)	2.9	2.5	2.5	2.5	2.5	2.5	3.4	3.4	3.4	3.4	3.4	3.4
Lost Time Adjust (s)	0.0	0.0	0.0	0.0	0.0	0.0	0.0	0.0	0.0	0.0	0.0	0.0
Total Lost Time (s)	6.6	6.2	6.2	6.2	6.2	6.2	6.7	6.7	6.7	6.7	6.7	6.7
Lead/Lag	Lead	Lag	Lag	Lead	Lag	Lag	Lead			Lag	Lag	Lag
Lead-Lag Optimize?												
Vehicle Extension (s)	3.0	3.0	3.0	3.0	3.0	3.0	3.0	3.0	3.0	3.0	3.0	3.0
Recall Mode	None	C-Max	C-Max	None	C-Max	C-Max	None	None	None	None	None	None
Walk Time (s)		7.0	7.0		7.0	7.0		7.0	7.0	7.0	7.0	7.0
Flash Dont Walk (s)		13.0	13.0		13.0	13.0		19.0	19.0	19.0	19.0	19.0
Pedestrian Calls (#/hr)		14	14		6	6		32	32	6	6	6
Act Effct Green (s)	6.4	71.0	71.0	6.5	65.8	65.8	38.3	38.3	38.3	26.3	26.3	26.3
Actuated g/C Ratio	0.05	0.55	0.55	0.05	0.51	0.51	0.29	0.29	0.29	0.20	0.20	0.20
v/c Ratio	0.89	0.31	0.03	0.36	0.94	0.27	0.69	0.28	0.12	0.48	0.16	1.20
Control Delay	110.9	17.6	0.1	72.6	42.6	7.3	51.9	36.2	3.3	55.0	43.5	143.8
Queue Delay	0.0	0.0	0.0	0.0	0.0	0.0	0.0	0.0	0.0	0.0	0.0	0.0
Total Delay	110.9	17.6	0.1	72.6	42.6	7.3	51.9	36.2	3.3	55.0	43.5	143.8
LOS	F	B	A	E	D	A	D	D	A	E	D	F
Approach Delay		34.8			38.9			39.1			116.2	
Approach LOS		C			D			D			F	
Queue Length 50th (m)	16.1	37.5	0.0	6.5	182.4	9.0	41.8	26.7	0.0	20.2	11.1	~114.6
Queue Length 95th (m)	#33.6	49.1	0.0	16.0	#232.8	22.0	63.6	37.9	4.6	37.0	18.7	#176.3
Internal Link Dist (m)		240.5			467.4			363.7			277.9	
Turn Bay Length (m)	140.0		80.0	105.0		60.0	50.0		50.0	55.0		60.0
Base Capacity (vph)	147	1717	838	82	1699	811	317	989	474	200	679	413
Starvation Cap Reductn	0	0	0	0	0	0	0	0	0	0	0	0
Spillback Cap Reductn	0	0	0	0	0	0	0	0	0	0	0	0
Storage Cap Reductn	0	0	0	0	0	0	0	0	0	0	0	0
Reduced v/c Ratio	0.89	0.31	0.03	0.34	0.94	0.27	0.69	0.28	0.12	0.48	0.16	1.20

Intersection Summary

Area Type: Other
 Cycle Length: 130
 Actuated Cycle Length: 130
 Offset: 0 (0%), Referenced to phase 2:EBT and 6:WBT, Start of Green
 Natural Cycle: 145
 Control Type: Actuated-Coordinated
 Maximum v/c Ratio: 1.20
 Intersection Signal Delay: 52.5 Intersection LOS: D
 Intersection Capacity Utilization 108.9% ICU Level of Service G
 Analysis Period (min) 15
 ~ Volume exceeds capacity, queue is theoretically infinite.
 Queue shown is maximum after two cycles.
 # 95th percentile volume exceeds capacity, queue may be longer.
 Queue shown is maximum after two cycles.

Splits and Phases: 1: Orleans & Innes





Lane Group	EBL	EBT	EBR	WBL	WBT	WBR	NBL	NBT	NBR	SBL	SBT	SBR
Lane Configurations												
Traffic Volume (vph)	12	606	21	37	1646	20	14	12	38	34	9	43
Future Volume (vph)	12	606	21	37	1646	20	14	12	38	34	9	43
Ideal Flow (vphpl)	1800	1800	1800	1800	1800	1800	1800	1800	1800	1800	1800	1800
Storage Length (m)	100.0		0.0	100.0		0.0	0.0		0.0	0.0		0.0
Storage Lanes	1		0	1		0	0		0	0		0
Taper Length (m)	35.0			25.0			2.5			2.5		
Lane Util. Factor	1.00	0.95	0.95	1.00	0.95	0.95	1.00	1.00	1.00	1.00	1.00	1.00
Ped Bike Factor		1.00		0.99	1.00			0.99			0.99	
Frt		0.995			0.998			0.920			0.932	
Flt Protected	0.950			0.950				0.989			0.981	
Satd. Flow (prot)	1586	3129	0	1503	3349	0	0	1568	0	0	1596	0
Flt Permitted	0.107			0.410				0.922			0.851	
Satd. Flow (perm)	179	3129	0	646	3349	0	0	1458	0	0	1384	0
Right Turn on Red			Yes			Yes			Yes			Yes
Satd. Flow (RTOR)		6			2			38			32	
Link Speed (k/h)		60			60			40			40	
Link Distance (m)		491.4			236.7			212.5			273.4	
Travel Time (s)		29.5			14.2			19.1			24.6	
Confl. Peds. (#/hr)	4		7	7		4	11					11
Confl. Bikes (#/hr)			1						1			1
Peak Hour Factor	1.00	1.00	1.00	1.00	1.00	1.00	1.00	1.00	1.00	1.00	1.00	1.00
Heavy Vehicles (%)	9%	10%	5%	15%	3%	5%	1%	15%	3%	1%	10%	3%
Adj. Flow (vph)	12	606	21	37	1646	20	14	12	38	34	9	43
Shared Lane Traffic (%)												
Lane Group Flow (vph)	12	627	0	37	1666	0	0	64	0	0	86	0
Enter Blocked Intersection	No	No	No	No	No	No	No	No	No	No	No	No
Lane Alignment	Left	Left	Right	Left	Left	Right	L NA	Left	R NA	L NA	Left	R NA
Median Width(m)		5.0			5.0			0.0			0.0	
Link Offset(m)		0.0			0.0			0.0			0.0	
Crosswalk Width(m)		10.0			10.0			5.0			5.0	
Two way Left Turn Lane												
Headway Factor	1.06	1.06	1.06	1.06	1.06	1.06	1.06	1.06	1.06	1.06	1.06	1.06
Turning Speed (k/h)	24		14	24		14	24		14	24		14
Number of Detectors	1	2		1	2		1	2		1	2	
Detector Template	Left	Thru		Left	Thru		Left	Thru		Left	Thru	
Leading Detector (m)	18.6	93.0		18.6	93.0		18.6	93.0		18.6	93.0	
Trailing Detector (m)	0.0	0.0		0.0	0.0		0.0	0.0		0.0	0.0	
Detector 1 Position(m)	0.0	0.0		0.0	0.0		0.0	0.0		0.0	0.0	
Detector 1 Size(m)	18.6	5.5		18.6	5.5		18.6	5.5		18.6	5.5	
Detector 1 Type	Cl+Ex	Cl+Ex		Cl+Ex	Cl+Ex		Cl+Ex	Cl+Ex		Cl+Ex	Cl+Ex	
Detector 1 Channel												
Detector 1 Extend (s)	0.0	0.0		0.0	0.0		0.0	0.0		0.0	0.0	
Detector 1 Queue (s)	0.0	0.0		0.0	0.0		0.0	0.0		0.0	0.0	
Detector 1 Delay (s)	0.0	0.0		0.0	0.0		0.0	0.0		0.0	0.0	
Detector 2 Position(m)		87.5			87.5			87.5			87.5	
Detector 2 Size(m)		5.5			5.5			5.5			5.5	
Detector 2 Type		Cl+Ex			Cl+Ex			Cl+Ex			Cl+Ex	
Detector 2 Channel												
Detector 2 Extend (s)		0.0			0.0			0.0			0.0	
Turn Type	Perm	NA		Perm	NA		Perm	NA		Perm	NA	
Protected Phases		2			6			8			4	
Permitted Phases	2			6			8			4		
Detector Phase	2	2		6	6		8	8		4	4	



Lane Group	EBL	EBT	EBR	WBL	WBT	WBR	NBL	NBT	NBR	SBL	SBT	SBR
Switch Phase												
Minimum Initial (s)	10.0	10.0		10.0	10.0		10.0	10.0		10.0	10.0	
Minimum Split (s)	39.2	39.2		39.2	39.2		37.8	37.8		37.8	37.8	
Total Split (s)	82.0	82.0		82.0	82.0		38.0	38.0		38.0	38.0	
Total Split (%)	68.3%	68.3%		68.3%	68.3%		31.7%	31.7%		31.7%	31.7%	
Maximum Green (s)	75.8	75.8		75.8	75.8		31.2	31.2		31.2	31.2	
Yellow Time (s)	3.7	3.7		3.7	3.7		3.0	3.0		3.0	3.0	
All-Red Time (s)	2.5	2.5		2.5	2.5		3.8	3.8		3.8	3.8	
Lost Time Adjust (s)	0.0	0.0		0.0	0.0			0.0			0.0	
Total Lost Time (s)	6.2	6.2		6.2	6.2			6.8			6.8	
Lead/Lag												
Lead-Lag Optimize?												
Vehicle Extension (s)	3.0	3.0		3.0	3.0		3.0	3.0		3.0	3.0	
Recall Mode	C-Max	C-Max		C-Max	C-Max		None	None		None	None	
Walk Time (s)	15.0	15.0		15.0	15.0		7.0	7.0		7.0	7.0	
Flash Dont Walk (s)	18.0	18.0		18.0	18.0		24.0	24.0		24.0	24.0	
Pedestrian Calls (#/hr)	7	7		4	4		1	1		11	11	
Act Effct Green (s)	88.6	88.6		88.6	88.6			18.4			18.4	
Actuated g/C Ratio	0.74	0.74		0.74	0.74			0.15			0.15	
v/c Ratio	0.09	0.27		0.08	0.67			0.25			0.36	
Control Delay	9.7	6.7		2.5	4.4			21.2			30.6	
Queue Delay	0.0	0.0		0.0	0.0			0.0			0.0	
Total Delay	9.7	6.7		2.5	4.4			21.2			30.6	
LOS	A	A		A	A			C			C	
Approach Delay		6.8			4.3			21.2			30.6	
Approach LOS		A			A			C			C	
Queue Length 50th (m)	0.4	13.5		1.0	46.6			5.4			11.4	
Queue Length 95th (m)	3.7	39.3		m0.9	14.0			14.4			21.6	
Internal Link Dist (m)		467.4			212.7			188.5			249.4	
Turn Bay Length (m)	100.0			100.0								
Base Capacity (vph)	132	2311		477	2473			407			383	
Starvation Cap Reductn	0	0		0	3			0			0	
Spillback Cap Reductn	0	0		0	0			0			0	
Storage Cap Reductn	0	0		0	0			0			0	
Reduced v/c Ratio	0.09	0.27		0.08	0.67			0.16			0.22	

Intersection Summary

Area Type: Other
 Cycle Length: 120
 Actuated Cycle Length: 120
 Offset: 22 (18%), Referenced to phase 2:EBTL and 6:WBTL, Start of Green
 Natural Cycle: 90
 Control Type: Actuated-Coordinated
 Maximum v/c Ratio: 0.67
 Intersection Signal Delay: 6.3
 Intersection LOS: A
 Intersection Capacity Utilization 74.3%
 ICU Level of Service D
 Analysis Period (min) 15
 m Volume for 95th percentile queue is metered by upstream signal.

Splits and Phases: 2: Page & Innes

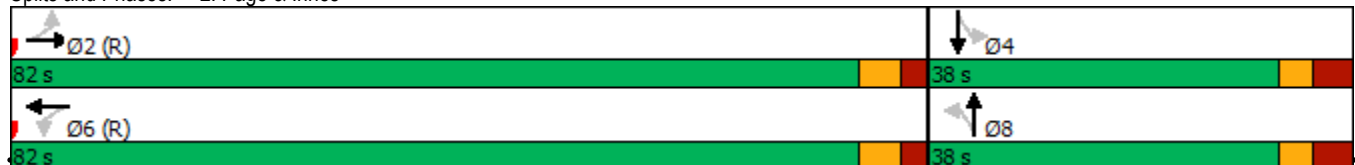

3: Lamarche & Innes
AM Peak Hour

3493-3499 Innes Road
2030 Background Traffic



Lane Group	EBU	EBT	EBR	WBL	WBT	NBL	NBR	Ø3
Lane Configurations								
Traffic Volume (vph)	0	539	176	179	1356	291	171	
Future Volume (vph)	0	539	176	179	1356	291	171	
Ideal Flow (vphpl)	1800	1800	1800	1800	1800	1800	1800	
Storage Length (m)	30.0		50.0	65.0		70.0	70.0	
Storage Lanes	1		1	1		1	1	
Taper Length (m)	30.0			80.0		20.0		
Lane Util. Factor	1.00	0.95	1.00	1.00	0.95	0.97	1.00	
Ped Bike Factor			0.95	0.99		0.97	0.98	
Frt			0.850				0.850	
Flt Protected				0.950		0.950		
Satd. Flow (prot)	1767	3357	1502	1679	3357	3257	1502	
Flt Permitted				0.444		0.950		
Satd. Flow (perm)	1767	3357	1433	775	3357	3165	1477	
Right Turn on Red			Yes				Yes	
Satd. Flow (RTOR)			176				171	
Link Speed (k/h)		60			60	50		
Link Distance (m)		236.7			238.7	204.5		
Travel Time (s)		14.2			14.3	14.7		
Confl. Peds. (#/hr)			11	11		5	5	
Peak Hour Factor	1.00	1.00	1.00	1.00	1.00	1.00	1.00	
Adj. Flow (vph)	0	539	176	179	1356	291	171	
Shared Lane Traffic (%)								
Lane Group Flow (vph)	0	539	176	179	1356	291	171	
Enter Blocked Intersection	No	No	No	No	No	No	No	
Lane Alignment	R NA	Left	Right	Left	Left	L NA	R NA	
Median Width(m)		5.0			5.0	7.4		
Link Offset(m)		0.0			0.0	0.0		
Crosswalk Width(m)		9.0			9.0	9.0		
Two way Left Turn Lane								
Headway Factor	1.06	1.06	1.06	1.06	1.06	1.06	1.06	
Turning Speed (k/h)	14		14	24		24	14	
Number of Detectors	1	2	1	1	2	1	1	
Detector Template	Left	Thru	Right	Left	Thru	Left	Right	
Leading Detector (m)	18.6	93.0	18.6	18.6	93.0	18.6	18.6	
Trailing Detector (m)	0.0	0.0	0.0	0.0	0.0	0.0	0.0	
Detector 1 Position(m)	0.0	0.0	0.0	0.0	0.0	0.0	0.0	
Detector 1 Size(m)	18.6	5.5	18.6	18.6	5.5	18.6	18.6	
Detector 1 Type	Cl+Ex	Cl+Ex	Cl+Ex	Cl+Ex	Cl+Ex	Cl+Ex	Cl+Ex	
Detector 1 Channel								
Detector 1 Extend (s)	0.0	0.0	0.0	0.0	0.0	0.0	0.0	
Detector 1 Queue (s)	0.0	0.0	0.0	0.0	0.0	0.0	0.0	
Detector 1 Delay (s)	0.0	0.0	0.0	0.0	0.0	0.0	0.0	
Detector 2 Position(m)		87.5			87.5			
Detector 2 Size(m)		5.5			5.5			
Detector 2 Type		Cl+Ex			Cl+Ex			
Detector 2 Channel								
Detector 2 Extend (s)		0.0			0.0			
Turn Type	Perm	NA	Perm	Perm	NA	Prot	Perm	
Protected Phases		2			6	4		3
Permitted Phases	2		2	6			8	
Detector Phase	2	2	2	6	6	4	8	
Switch Phase								
Minimum Initial (s)	10.0	10.0	10.0	10.0	10.0	5.0	10.0	5.0



Lane Group	EBU	EBT	EBR	WBL	WBT	NBL	NBR	Ø3
Minimum Split (s)	31.2	31.2	31.2	31.2	31.2	11.3	16.3	30.0
Total Split (s)	73.0	73.0	73.0	73.0	73.0	17.0	47.0	30.0
Total Split (%)	60.8%	60.8%	60.8%	60.8%	60.8%	14.2%	39.2%	25%
Maximum Green (s)	66.8	66.8	66.8	66.8	66.8	10.7	40.7	28.0
Yellow Time (s)	3.7	3.7	3.7	3.7	3.7	3.3	3.3	2.0
All-Red Time (s)	2.5	2.5	2.5	2.5	2.5	3.0	3.0	0.0
Lost Time Adjust (s)	0.0	0.0	0.0	0.0	0.0	0.0	0.0	0.0
Total Lost Time (s)	6.2	6.2	6.2	6.2	6.2	6.3	6.3	
Lead/Lag						Lag		Lead
Lead-Lag Optimize?								
Vehicle Extension (s)	3.0	3.0	3.0	3.0	3.0	3.0	3.0	3.0
Recall Mode	C-Max	C-Max	C-Max	C-Max	C-Max	None	None	None
Walk Time (s)	7.0	7.0	7.0	7.0	7.0			7.0
Flash Dont Walk (s)	18.0	18.0	18.0	18.0	18.0			21.0
Pedestrian Calls (#/hr)	10	10	10	10	10			10
Act Effct Green (s)		81.0	81.0	81.0	81.0	14.5	26.5	
Actuated g/C Ratio		0.68	0.68	0.68	0.68	0.12	0.22	
v/c Ratio		0.24	0.17	0.34	0.60	0.74	0.37	
Control Delay		6.7	0.8	7.9	9.3	63.6	6.5	
Queue Delay		0.0	0.0	0.0	0.0	0.0	0.0	
Total Delay		6.7	0.8	7.9	9.3	63.6	6.5	
LOS		A	A	A	A	E	A	
Approach Delay		5.2			9.2	42.5		
Approach LOS		A			A	D		
Queue Length 50th (m)		13.1	0.0	4.6	18.5	30.7	0.0	
Queue Length 95th (m)		20.7	2.1	23.2	128.3	#59.4	13.5	
Internal Link Dist (m)		212.7			214.7	180.5		
Turn Bay Length (m)			50.0	65.0		70.0	70.0	
Base Capacity (vph)		2264	1023	522	2264	394	613	
Starvation Cap Reductn		0	0	0	0	0	0	
Spillback Cap Reductn		0	0	0	0	0	0	
Storage Cap Reductn		0	0	0	0	0	0	
Reduced v/c Ratio		0.24	0.17	0.34	0.60	0.74	0.28	

Intersection Summary

Area Type: Other
 Cycle Length: 120
 Actuated Cycle Length: 120
 Offset: 25 (21%), Referenced to phase 2:EBTU and 6:WBTL, Start of Green
 Natural Cycle: 90
 Control Type: Actuated-Coordinated
 Maximum v/c Ratio: 0.74
 Intersection Signal Delay: 13.8
 Intersection Capacity Utilization 72.2%
 Analysis Period (min) 15
 # 95th percentile volume exceeds capacity, queue may be longer.
 Queue shown is maximum after two cycles.

Splits and Phases: 3: Lamarche & Innes

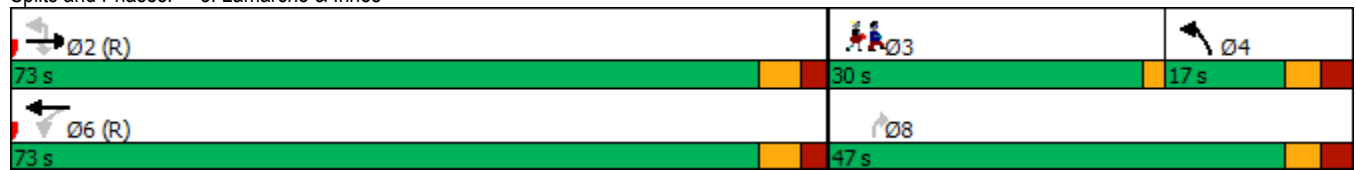



Lane Group	EBL	EBT	EBR	WBL	WBT	WBR	NBL	NBT	NBR	SBL	SBT	SBR
Lane Configurations												
Traffic Volume (vph)	6	599	38	12	1534	4	99	0	39	1	0	3
Future Volume (vph)	6	599	38	12	1534	4	99	0	39	1	0	3
Ideal Flow (vphpl)	1800	1800	1800	1800	1800	1800	1800	1800	1800	1800	1800	1800
Storage Length (m)	65.0		0.0	40.0		0.0	0.0		0.0	0.0		0.0
Storage Lanes	1		0	1		0	0		1	0		0
Taper Length (m)	80.0			30.0			20.0			20.0		
Lane Util. Factor	1.00	0.95	0.95	1.00	0.95	0.95	1.00	1.00	1.00	1.00	1.00	1.00
Ped Bike Factor	1.00				1.00			1.00	0.99		0.99	
Fr _t		0.991							0.850		0.899	
Fl _t Protected	0.950			0.950				0.950			0.988	
Satd. Flow (prot)	1712	3115	0	1712	3357	0	0	1712	1532	0	1583	0
Fl _t Permitted	0.136			0.409				0.755			0.942	
Satd. Flow (perm)	245	3115	0	737	3357	0	0	1357	1511	0	1509	0
Right Turn on Red			Yes			Yes			Yes			Yes
Satd. Flow (RTOR)		12							39			28
Link Speed (k/h)		60			60				40			40
Link Distance (m)		238.7			292.8				151.9			62.6
Travel Time (s)		14.3			17.6				13.7			5.6
Confl. Peds. (#/hr)	7					7	2		1	1		2
Confl. Bikes (#/hr)						1						
Peak Hour Factor	1.00	1.00	1.00	1.00	1.00	1.00	1.00	1.00	1.00	1.00	1.00	1.00
Heavy Vehicles (%)	1%	10%	10%	1%	3%	1%	1%	1%	1%	1%	1%	1%
Adj. Flow (vph)	6	599	38	12	1534	4	99	0	39	1	0	3
Shared Lane Traffic (%)												
Lane Group Flow (vph)	6	637	0	12	1538	0	0	99	39	0	4	0
Enter Blocked Intersection	No	No	No	No	No	No	No	No	No	No	No	No
Lane Alignment	L NA	Left	R NA	L NA	Left	R NA	L NA	Left	R NA	L NA	Left	R NA
Median Width(m)		5.0			3.7			0.0			0.0	
Link Offset(m)		0.0			0.0			0.0			0.0	
Crosswalk Width(m)		9.0			9.0			9.0			9.0	
Two way Left Turn Lane												
Headway Factor	1.06	1.06	1.06	1.06	1.06	1.06	1.06	1.06	1.06	1.06	1.06	1.06
Turning Speed (k/h)	24		14	24		14	24		14	24		14
Number of Detectors	1	2		1	2		1	2	1	1		2
Detector Template	Left	Thru		Left	Thru		Left	Thru	Right	Left		Thru
Leading Detector (m)	18.6	93.0		18.6	93.0		18.6	93.0	18.6	18.6		93.0
Trailing Detector (m)	0.0	0.0		0.0	0.0		0.0	0.0	0.0	0.0		0.0
Detector 1 Position(m)	0.0	0.0		0.0	0.0		0.0	0.0	0.0	0.0		0.0
Detector 1 Size(m)	18.6	5.5		18.6	5.5		18.6	5.5	18.6	18.6		5.5
Detector 1 Type	Cl+Ex	Cl+Ex		Cl+Ex	Cl+Ex		Cl+Ex	Cl+Ex	Cl+Ex	Cl+Ex		Cl+Ex
Detector 1 Channel												
Detector 1 Extend (s)	0.0	0.0		0.0	0.0		0.0	0.0	0.0	0.0		0.0
Detector 1 Queue (s)	0.0	0.0		0.0	0.0		0.0	0.0	0.0	0.0		0.0
Detector 1 Delay (s)	0.0	0.0		0.0	0.0		0.0	0.0	0.0	0.0		0.0
Detector 2 Position(m)		87.5			87.5			87.5				87.5
Detector 2 Size(m)		5.5			5.5			5.5				5.5
Detector 2 Type		Cl+Ex			Cl+Ex			Cl+Ex				Cl+Ex
Detector 2 Channel												
Detector 2 Extend (s)		0.0			0.0			0.0				0.0
Turn Type	Perm	NA		Perm	NA		Perm	NA	Perm	Perm		NA
Protected Phases		2			6			8				4
Permitted Phases	2			6			8		8	4		
Detector Phase	2	2		6	6		8	8	8	4		4



Lane Group	EBL	EBT	EBR	WBL	WBT	WBR	NBL	NBT	NBR	SBL	SBT	SBR
Switch Phase												
Minimum Initial (s)	10.0	10.0		10.0	10.0		10.0	10.0	10.0	10.0	10.0	
Minimum Split (s)	32.1	32.1		35.1	35.1		32.3	32.3	32.3	32.3	32.3	
Total Split (s)	87.0	87.0		87.0	87.0		33.0	33.0	33.0	33.0	33.0	
Total Split (%)	72.5%	72.5%		72.5%	72.5%		27.5%	27.5%	27.5%	27.5%	27.5%	
Maximum Green (s)	80.9	80.9		80.9	80.9		26.7	26.7	26.7	26.7	26.7	
Yellow Time (s)	3.7	3.7		3.7	3.7		3.3	3.3	3.3	3.3	3.3	
All-Red Time (s)	2.4	2.4		2.4	2.4		3.0	3.0	3.0	3.0	3.0	
Lost Time Adjust (s)	0.0	0.0		0.0	0.0			0.0	0.0		0.0	
Total Lost Time (s)	6.1	6.1		6.1	6.1			6.3	6.3		6.3	
Lead/Lag												
Lead-Lag Optimize?												
Vehicle Extension (s)	3.0	3.0		3.0	3.0		3.0	3.0	3.0	3.0	3.0	
Recall Mode	C-Max	C-Max		C-Max	C-Max		None	None	None	None	None	
Walk Time (s)	12.0	12.0		12.0	12.0		7.0	7.0	7.0	7.0	7.0	
Flash Dont Walk (s)	14.0	14.0		14.0	14.0		19.0	19.0	19.0	19.0	19.0	
Pedestrian Calls (#/hr)	1	1		7	7		1	1	1	2	2	
Act Effct Green (s)	92.0	92.0		92.0	92.0			15.6	15.6		15.6	
Actuated g/C Ratio	0.77	0.77		0.77	0.77			0.13	0.13		0.13	
v/c Ratio	0.03	0.27		0.02	0.60			0.56	0.17		0.02	
Control Delay	4.7	4.0		4.9	8.1			59.7	14.0		0.2	
Queue Delay	0.0	0.0		0.0	0.0			0.0	0.0		0.0	
Total Delay	4.7	4.0		4.9	8.1			59.7	14.0		0.2	
LOS	A	A		A	A			E	B		A	
Approach Delay		4.0			8.0			46.8			0.3	
Approach LOS		A			A			D			A	
Queue Length 50th (m)	0.2	14.0		0.5	59.7			20.8	0.0		0.0	
Queue Length 95th (m)	m1.4	23.0		2.6	114.5			33.3	8.3		0.0	
Internal Link Dist (m)		214.7			268.8			127.9			38.6	
Turn Bay Length (m)	65.0			40.0								
Base Capacity (vph)	187	2389		564	2572			301	366		357	
Starvation Cap Reductn	0	0		0	0			0	0		0	
Spillback Cap Reductn	0	0		0	0			0	0		0	
Storage Cap Reductn	0	0		0	0			0	0		0	
Reduced v/c Ratio	0.03	0.27		0.02	0.60			0.33	0.11		0.01	

Intersection Summary

Area Type: Other
 Cycle Length: 120
 Actuated Cycle Length: 120
 Offset: 3 (3%), Referenced to phase 2:EBTL and 6:WBTL, Start of Green
 Natural Cycle: 75
 Control Type: Actuated-Coordinated
 Maximum v/c Ratio: 0.60
 Intersection Signal Delay: 9.2
 Intersection LOS: A
 Intersection Capacity Utilization 68.0%
 ICU Level of Service C
 Analysis Period (min) 15
 m Volume for 95th percentile queue is metered by upstream signal.

Splits and Phases: 4: 473 E of Page & Innes

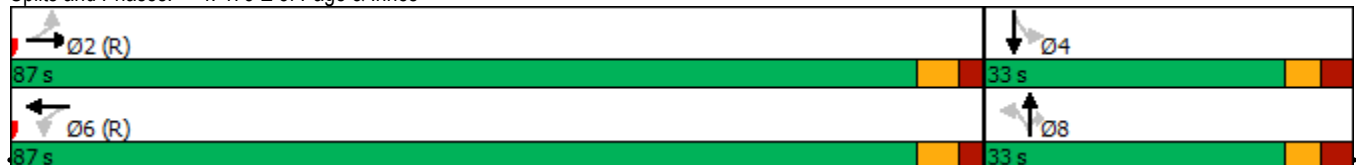

1: Orleans & Innes
AM Peak Hour

3493-3499 Innes Road
2030 Background Traffic (demand rationalization)



Lane Group	EBL	EBT	EBR	WBL	WBT	WBR	NBL	NBT	NBR	SBL	SBT	SBR
Lane Configurations	↖↖	↕	↗	↖	↕	↗	↖	↕	↗	↖	↕	↗
Traffic Volume (vph)	131	526	25	28	1571	218	219	280	56	96	108	346
Future Volume (vph)	131	526	25	28	1571	218	219	280	56	96	108	346
Ideal Flow (vphpl)	1800	1800	1800	1800	1800	1800	1800	1800	1800	1800	1800	1800
Storage Length (m)	140.0		80.0	105.0		60.0	50.0		50.0	55.0		60.0
Storage Lanes	2		1	1		1	1		1	1		1
Taper Length (m)	40.0			40.0			10.0			20.0		
Lane Util. Factor	0.97	0.95	1.00	1.00	0.95	1.00	1.00	0.95	1.00	1.00	0.95	1.00
Ped Bike Factor	1.00		0.96	0.99		0.97	0.99		0.94	0.97		0.98
Fr			0.850			0.850			0.850			0.850
Flt Protected	0.950			0.950			0.950			0.950		
Satd. Flow (prot)	2995	3144	1473	1572	3357	1502	1712	3357	1502	1679	3357	1532
Flt Permitted	0.950			0.950			0.533			0.580		
Satd. Flow (perm)	2988	3144	1416	1551	3357	1463	954	3357	1413	992	3357	1500
Right Turn on Red			Yes			Yes			Yes			Yes
Satd. Flow (RTOR)			143			143			82			138
Link Speed (k/h)		60			60			50				50
Link Distance (m)		264.5			491.4			387.7				301.9
Travel Time (s)		15.9			29.5			27.9				21.7
Confl. Peds. (#/hr)	6		14	14		6	6		32	32		6
Confl. Bikes (#/hr)						6						
Peak Hour Factor	1.00	1.00	1.00	1.00	1.00	1.00	1.00	1.00	1.00	1.00	1.00	1.00
Heavy Vehicles (%)	12%	10%	5%	10%	3%	3%	1%	3%	3%	3%	3%	1%
Adj. Flow (vph)	131	526	25	28	1571	218	219	280	56	96	108	346
Shared Lane Traffic (%)												
Lane Group Flow (vph)	131	526	25	28	1571	218	219	280	56	96	108	346
Enter Blocked Intersection	No	No	No	No	No	No	No	No	No	No	No	No
Lane Alignment	L NA	Left	R NA	L NA	Left	R NA	L NA	Left	R NA	L NA	Left	R NA
Median Width(m)		9.0			7.4			6.0				6.0
Link Offset(m)		0.0			0.0			0.0				0.0
Crosswalk Width(m)		5.0			5.0			5.0				5.0
Two way Left Turn Lane												
Headway Factor	1.06	1.06	1.06	1.06	1.06	1.06	1.06	1.06	1.06	1.06	1.06	1.06
Turning Speed (k/h)	24		14	24		14	24		14	24		14
Number of Detectors	1	2	1	1	2	1	1	2	1	1	2	1
Detector Template	Left	Thru	Right	Left	Thru	Right	Left	Thru	Right	Left	Thru	Right
Leading Detector (m)	18.6	93.0	18.6	18.6	93.0	18.6	18.6	93.0	18.6	18.6	93.0	18.6
Trailing Detector (m)	0.0	0.0	0.0	0.0	0.0	0.0	0.0	0.0	0.0	0.0	0.0	0.0
Detector 1 Position(m)	0.0	0.0	0.0	0.0	0.0	0.0	0.0	0.0	0.0	0.0	0.0	0.0
Detector 1 Size(m)	18.6	5.5	18.6	18.6	5.5	18.6	18.6	5.5	18.6	18.6	5.5	18.6
Detector 1 Type	Cl+Ex	Cl+Ex	Cl+Ex	Cl+Ex	Cl+Ex	Cl+Ex	Cl+Ex	Cl+Ex	Cl+Ex	Cl+Ex	Cl+Ex	Cl+Ex
Detector 1 Channel												
Detector 1 Extend (s)	0.0	0.0	0.0	0.0	0.0	0.0	0.0	0.0	0.0	0.0	0.0	0.0
Detector 1 Queue (s)	0.0	0.0	0.0	0.0	0.0	0.0	0.0	0.0	0.0	0.0	0.0	0.0
Detector 1 Delay (s)	0.0	0.0	0.0	0.0	0.0	0.0	0.0	0.0	0.0	0.0	0.0	0.0
Detector 2 Position(m)		87.5			87.5			87.5				87.5
Detector 2 Size(m)		5.5			5.5			5.5				5.5
Detector 2 Type		Cl+Ex			Cl+Ex			Cl+Ex				Cl+Ex
Detector 2 Channel												
Detector 2 Extend (s)		0.0			0.0			0.0				0.0
Turn Type	Prot	NA	Perm	Prot	NA	Perm	pm+pt	NA	Perm	Perm	NA	Perm
Protected Phases	5	2		1	6		3	8			4	
Permitted Phases			2			6	8		8	4		4
Detector Phase	5	2	2	1	6	6	3	8	8	4	4	4



Lane Group	EBL	EBT	EBR	WBL	WBT	WBR	NBL	NBT	NBR	SBL	SBT	SBR
Switch Phase												
Minimum Initial (s)	5.0	10.0	10.0	5.0	10.0	10.0	5.0	10.0	10.0	10.0	10.0	10.0
Minimum Split (s)	11.6	26.2	26.2	11.2	26.2	26.2	11.7	32.7	32.7	32.7	32.7	32.7
Total Split (s)	13.0	72.0	72.0	13.0	72.0	72.0	12.0	45.0	45.0	33.0	33.0	33.0
Total Split (%)	10.0%	55.4%	55.4%	10.0%	55.4%	55.4%	9.2%	34.6%	34.6%	25.4%	25.4%	25.4%
Maximum Green (s)	6.4	65.8	65.8	6.8	65.8	65.8	5.3	38.3	38.3	26.3	26.3	26.3
Yellow Time (s)	3.7	3.7	3.7	3.7	3.7	3.7	3.3	3.3	3.3	3.3	3.3	3.3
All-Red Time (s)	2.9	2.5	2.5	2.5	2.5	2.5	3.4	3.4	3.4	3.4	3.4	3.4
Lost Time Adjust (s)	0.0	0.0	0.0	0.0	0.0	0.0	0.0	0.0	0.0	0.0	0.0	0.0
Total Lost Time (s)	6.6	6.2	6.2	6.2	6.2	6.2	6.7	6.7	6.7	6.7	6.7	6.7
Lead/Lag	Lead	Lag	Lag	Lead	Lag	Lag	Lead			Lag	Lag	Lag
Lead-Lag Optimize?												
Vehicle Extension (s)	3.0	3.0	3.0	3.0	3.0	3.0	3.0	3.0	3.0	3.0	3.0	3.0
Recall Mode	None	C-Max	C-Max	None	C-Max	C-Max	None	None	None	None	None	None
Walk Time (s)		7.0	7.0		7.0	7.0		7.0	7.0	7.0	7.0	7.0
Flash Dont Walk (s)		13.0	13.0		13.0	13.0		19.0	19.0	19.0	19.0	19.0
Pedestrian Calls (#/hr)		14	14		6	6		32	32	6	6	6
Act Effct Green (s)	7.4	73.6	73.6	6.5	67.4	67.4	35.7	35.7	35.7	23.7	23.7	23.7
Actuated g/C Ratio	0.06	0.57	0.57	0.05	0.52	0.52	0.27	0.27	0.27	0.18	0.18	0.18
v/c Ratio	0.78	0.30	0.03	0.36	0.90	0.26	0.75	0.30	0.12	0.53	0.18	0.90
Control Delay	89.3	16.7	0.1	72.6	37.4	7.2	57.6	37.7	3.4	58.6	44.5	56.6
Queue Delay	0.0	0.0	0.0	0.0	0.0	0.0	0.0	0.0	0.0	0.0	0.0	0.0
Total Delay	89.3	16.7	0.1	72.6	37.4	7.2	57.6	37.7	3.4	58.6	44.5	56.6
LOS	F	B	A	E	D	A	E	D	A	E	D	E
Approach Delay		30.1			34.3			42.1			54.6	
Approach LOS		C			C			D			D	
Queue Length 50th (m)	16.1	37.5	0.0	6.5	176.0	9.0	41.8	26.7	0.0	20.2	11.1	49.2
Queue Length 95th (m)	#33.6	49.1	0.0	16.0	#217.1	22.0	#63.6	37.9	4.6	37.0	18.7	#94.7
Internal Link Dist (m)		240.5			467.4			363.7			277.9	
Turn Bay Length (m)	140.0		80.0	105.0		60.0	50.0		50.0	55.0		60.0
Base Capacity (vph)	169	1779	863	82	1740	827	292	989	474	200	679	413
Starvation Cap Reductn	0	0	0	0	0	0	0	0	0	0	0	0
Spillback Cap Reductn	0	0	0	0	0	0	0	0	0	0	0	0
Storage Cap Reductn	0	0	0	0	0	0	0	0	0	0	0	0
Reduced v/c Ratio	0.78	0.30	0.03	0.34	0.90	0.26	0.75	0.28	0.12	0.48	0.16	0.84

Intersection Summary

Area Type: Other
 Cycle Length: 130
 Actuated Cycle Length: 130
 Offset: 0 (0%), Referenced to phase 2:EBT and 6:WBT, Start of Green
 Natural Cycle: 115
 Control Type: Actuated-Coordinated
 Maximum v/c Ratio: 0.90
 Intersection Signal Delay: 37.8 Intersection LOS: D
 Intersection Capacity Utilization 98.2% ICU Level of Service F
 Analysis Period (min) 15
 # 95th percentile volume exceeds capacity, queue may be longer.
 Queue shown is maximum after two cycles.

Splits and Phases: 1: Orleans & Innes

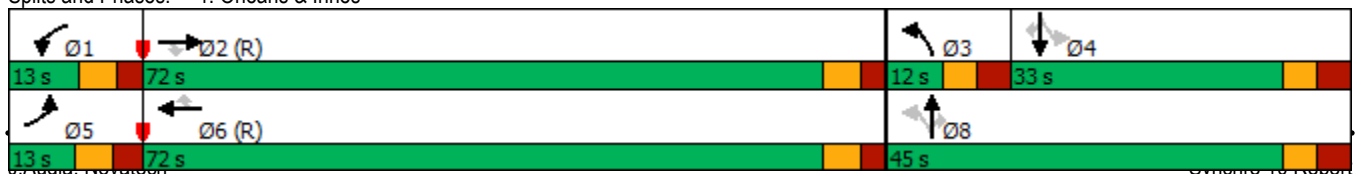



Lane Group	EBL	EBT	EBR	WBL	WBT	WBR	NBL	NBT	NBR	SBL	SBT	SBR
Lane Configurations	↖↖	↖↖	↖	↖	↖↖	↖	↖	↖↖	↖	↖	↖↖	↖
Traffic Volume (vph)	625	1866	171	66	834	170	69	243	109	221	260	219
Future Volume (vph)	625	1866	171	66	834	170	69	243	109	221	260	219
Ideal Flow (vphpl)	1800	1800	1800	1800	1800	1800	1800	1800	1800	1800	1800	1800
Storage Length (m)	140.0		80.0	105.0		60.0	50.0		50.0	55.0		60.0
Storage Lanes	2		1	1		1	1		1	1		1
Taper Length (m)	40.0			40.0			10.0			20.0		
Lane Util. Factor	0.97	0.95	1.00	1.00	0.95	1.00	1.00	0.95	1.00	1.00	0.95	1.00
Ped Bike Factor	0.99		0.94	1.00		0.97	0.99		0.96	0.98		0.97
Fr _t			0.850			0.850			0.850			0.850
Fl _t Protected	0.950			0.950			0.950			0.950		
Satd. Flow (prot)	3288	3357	1532	1712	3293	1517	1712	3390	1532	1712	3390	1532
Fl _t Permitted	0.950			0.950			0.450			0.601		
Satd. Flow (perm)	3265	3357	1446	1706	3293	1475	800	3390	1473	1062	3390	1480
Right Turn on Red			Yes			Yes			Yes			Yes
Satd. Flow (RTOR)			139			195			134			219
Link Speed (k/h)		60			60			50			50	
Link Distance (m)		264.5			491.4			387.7			301.9	
Travel Time (s)		15.9			29.5			27.9			21.7	
Confl. Peds. (#/hr)	7		22	22		7	15		18	18		15
Confl. Bikes (#/hr)			4			3						
Peak Hour Factor	1.00	1.00	1.00	1.00	1.00	1.00	1.00	1.00	1.00	1.00	1.00	1.00
Heavy Vehicles (%)	2%	3%	1%	1%	5%	2%	1%	2%	1%	1%	2%	1%
Adj. Flow (vph)	625	1866	171	66	834	170	69	243	109	221	260	219
Shared Lane Traffic (%)												
Lane Group Flow (vph)	625	1866	171	66	834	170	69	243	109	221	260	219
Enter Blocked Intersection	No	No	No	No	No	No	No	No	No	No	No	No
Lane Alignment	L NA	Left	R NA	L NA	Left	R NA	L NA	Left	R NA	L NA	Left	R NA
Median Width(m)		9.0			7.4			6.0			6.0	
Link Offset(m)		0.0			0.0			0.0			0.0	
Crosswalk Width(m)		5.0			5.0			5.0			5.0	
Two way Left Turn Lane												
Headway Factor	1.06	1.06	1.06	1.06	1.06	1.06	1.06	1.06	1.06	1.06	1.06	1.06
Turning Speed (k/h)	24		14	24		14	24		14	24		14
Number of Detectors	1	2	1	1	2	1	1	2	1	1	2	1
Detector Template	Left	Thru	Right	Left	Thru	Right	Left	Thru	Right	Left	Thru	Right
Leading Detector (m)	18.6	93.0	18.6	18.6	93.0	18.6	18.6	93.0	18.6	18.6	93.0	18.6
Trailing Detector (m)	0.0	0.0	0.0	0.0	0.0	0.0	0.0	0.0	0.0	0.0	0.0	0.0
Detector 1 Position(m)	0.0	0.0	0.0	0.0	0.0	0.0	0.0	0.0	0.0	0.0	0.0	0.0
Detector 1 Size(m)	18.6	5.5	18.6	18.6	5.5	18.6	18.6	5.5	18.6	18.6	5.5	18.6
Detector 1 Type	Cl+Ex	Cl+Ex	Cl+Ex	Cl+Ex	Cl+Ex	Cl+Ex	Cl+Ex	Cl+Ex	Cl+Ex	Cl+Ex	Cl+Ex	Cl+Ex
Detector 1 Channel												
Detector 1 Extend (s)	0.0	0.0	0.0	0.0	0.0	0.0	0.0	0.0	0.0	0.0	0.0	0.0
Detector 1 Queue (s)	0.0	0.0	0.0	0.0	0.0	0.0	0.0	0.0	0.0	0.0	0.0	0.0
Detector 1 Delay (s)	0.0	0.0	0.0	0.0	0.0	0.0	0.0	0.0	0.0	0.0	0.0	0.0
Detector 2 Position(m)		87.5			87.5			87.5			87.5	
Detector 2 Size(m)		5.5			5.5			5.5			5.5	
Detector 2 Type		Cl+Ex			Cl+Ex			Cl+Ex			Cl+Ex	
Detector 2 Channel												
Detector 2 Extend (s)		0.0			0.0			0.0			0.0	
Turn Type	Prot	NA	Perm	Prot	NA	Perm	pm+pt	NA	Perm	Perm	NA	Perm
Protected Phases	5	2		1	6		3	8			4	
Permitted Phases			2			6	8		8	4		4
Detector Phase	5	2	2	1	6	6	3	8	8	4	4	4



Lane Group	EBL	EBT	EBR	WBL	WBT	WBR	NBL	NBT	NBR	SBL	SBT	SBR
Switch Phase												
Minimum Initial (s)	5.0	10.0	10.0	5.0	10.0	10.0	5.0	10.0	10.0	10.0	10.0	10.0
Minimum Split (s)	11.6	26.2	26.2	11.2	26.2	26.2	11.7	32.7	32.7	32.7	32.7	32.7
Total Split (s)	35.0	71.0	71.0	12.0	48.0	48.0	12.0	47.0	47.0	35.0	35.0	35.0
Total Split (%)	26.9%	54.6%	54.6%	9.2%	36.9%	36.9%	9.2%	36.2%	36.2%	26.9%	26.9%	26.9%
Maximum Green (s)	28.4	64.8	64.8	5.8	41.8	41.8	5.3	40.3	40.3	28.3	28.3	28.3
Yellow Time (s)	3.7	3.7	3.7	3.7	3.7	3.7	3.3	3.3	3.3	3.3	3.3	3.3
All-Red Time (s)	2.9	2.5	2.5	2.5	2.5	2.5	3.4	3.4	3.4	3.4	3.4	3.4
Lost Time Adjust (s)	0.0	0.0	0.0	0.0	0.0	0.0	0.0	0.0	0.0	0.0	0.0	0.0
Total Lost Time (s)	6.6	6.2	6.2	6.2	6.2	6.2	6.7	6.7	6.7	6.7	6.7	6.7
Lead/Lag	Lead	Lag	Lag	Lead	Lag	Lag	Lead			Lag	Lag	Lag
Lead-Lag Optimize?												
Vehicle Extension (s)	3.0	3.0	3.0	3.0	3.0	3.0	3.0	3.0	3.0	3.0	3.0	3.0
Recall Mode	None	C-Max	C-Max	None	C-Max	C-Max	None	None	None	None	None	None
Walk Time (s)		7.0	7.0		7.0	7.0		7.0	7.0	7.0	7.0	7.0
Flash Dont Walk (s)		13.0	13.0		13.0	13.0		19.0	19.0	19.0	19.0	19.0
Pedestrian Calls (#/hr)		22	22		7	7		32	32	15	15	15
Act Effct Green (s)	27.4	66.6	66.6	6.3	45.1	45.1	38.0	38.0	38.0	28.4	28.4	28.4
Actuated g/C Ratio	0.21	0.51	0.51	0.05	0.35	0.35	0.29	0.29	0.29	0.22	0.22	0.22
v/c Ratio	0.90	1.09	0.21	0.80	0.73	0.27	0.25	0.25	0.21	0.95	0.35	0.44
Control Delay	67.5	80.2	5.1	107.4	46.6	10.9	35.3	35.1	3.8	98.5	44.6	8.3
Queue Delay	0.0	0.0	0.0	0.0	0.0	0.0	0.0	0.0	0.0	0.0	0.0	0.0
Total Delay	67.5	80.2	5.1	107.4	46.6	10.9	35.3	35.1	3.8	98.5	44.6	8.3
LOS	E	F	A	F	D	B	D	D	A	F	D	A
Approach Delay		72.4			44.7			27.0			50.3	
Approach LOS		E			D			C			D	
Queue Length 50th (m)	73.9	~265.5	3.8	15.9	88.1	2.4	11.7	22.4	0.0	51.9	27.5	0.0
Queue Length 95th (m)	#100.5	#304.2	14.7	#42.2	114.4	20.8	22.3	32.3	7.6	#97.8	39.4	18.7
Internal Link Dist (m)		240.5			467.4			363.7			277.9	
Turn Bay Length (m)	140.0		80.0	105.0		60.0	50.0		50.0	55.0		60.0
Base Capacity (vph)	718	1719	808	82	1142	639	271	1050	549	232	741	494
Starvation Cap Reductn	0	0	0	0	0	0	0	0	0	0	0	0
Spillback Cap Reductn	0	0	0	0	0	0	0	0	0	0	0	0
Storage Cap Reductn	0	0	0	0	0	0	0	0	0	0	0	0
Reduced v/c Ratio	0.87	1.09	0.21	0.80	0.73	0.27	0.25	0.23	0.20	0.95	0.35	0.44

Intersection Summary

Area Type: Other
 Cycle Length: 130
 Actuated Cycle Length: 130
 Offset: 125 (96%), Referenced to phase 2:EBT and 6:WBT, Start of Green
 Natural Cycle: 145
 Control Type: Actuated-Coordinated
 Maximum v/c Ratio: 1.09
 Intersection Signal Delay: 59.2 Intersection LOS: E
 Intersection Capacity Utilization 107.4% ICU Level of Service G
 Analysis Period (min) 15
 ~ Volume exceeds capacity, queue is theoretically infinite.
 Queue shown is maximum after two cycles.
 # 95th percentile volume exceeds capacity, queue may be longer.
 Queue shown is maximum after two cycles.

Splits and Phases: 1: Orleans & Innes

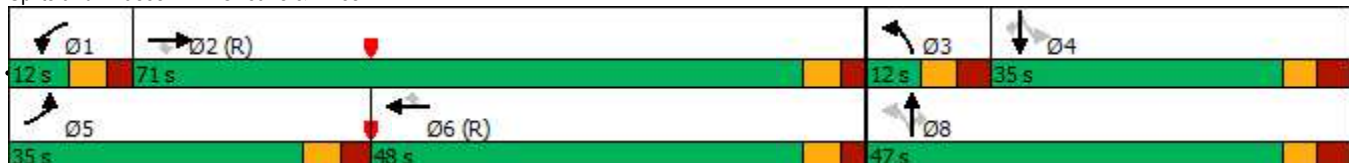



Lane Group	EBL	EBT	EBR	WBL	WBT	WBR	NBL	NBT	NBR	SBL	SBT	SBR
Lane Configurations												
Traffic Volume (vph)	63	1912	30	93	943	64	23	7	77	54	18	36
Future Volume (vph)	63	1912	30	93	943	64	23	7	77	54	18	36
Ideal Flow (vphpl)	1800	1800	1800	1800	1800	1800	1800	1800	1800	1800	1800	1800
Storage Length (m)	100.0		0.0	100.0		0.0	0.0		0.0	0.0		0.0
Storage Lanes	1		0	1		0	0		0	0		0
Taper Length (m)	35.0			25.0			2.5			2.5		
Lane Util. Factor	1.00	0.95	0.95	1.00	0.95	0.95	1.00	1.00	1.00	1.00	1.00	1.00
Ped Bike Factor	1.00	1.00			1.00			0.98				0.99
Frt		0.998			0.990			0.903				0.955
Flt Protected	0.950			0.950				0.989				0.976
Satd. Flow (prot)	1695	3380	0	1695	3259	0	0	1541	0	0	1578	0
Flt Permitted	0.285			0.044				0.917				0.754
Satd. Flow (perm)	506	3380	0	79	3259	0	0	1427	0	0	1211	0
Right Turn on Red			Yes			Yes			Yes			Yes
Satd. Flow (RTOR)		2			11			77				18
Link Speed (k/h)		60			60			40				40
Link Distance (m)		491.4			236.7			212.5				273.4
Travel Time (s)		29.5			14.2			19.1				24.6
Confl. Peds. (#/hr)	9		5	5		9	5		13	13		5
Confl. Bikes (#/hr)			1						1			
Peak Hour Factor	1.00	1.00	1.00	1.00	1.00	1.00	1.00	1.00	1.00	1.00	1.00	1.00
Heavy Vehicles (%)	2%	2%	6%	2%	5%	2%	5%	1%	3%	6%	1%	11%
Adj. Flow (vph)	63	1912	30	93	943	64	23	7	77	54	18	36
Shared Lane Traffic (%)												
Lane Group Flow (vph)	63	1942	0	93	1007	0	0	107	0	0	108	0
Enter Blocked Intersection	No	No	No	No	No	No	No	No	No	No	No	No
Lane Alignment	Left	Left	Right	Left	Left	Right	L NA	Left	R NA	L NA	Left	R NA
Median Width(m)		5.0			5.0			0.0				0.0
Link Offset(m)		0.0			0.0			0.0				0.0
Crosswalk Width(m)		10.0			10.0			5.0				5.0
Two way Left Turn Lane												
Headway Factor	1.06	1.06	1.06	1.06	1.06	1.06	1.06	1.06	1.06	1.06	1.06	1.06
Turning Speed (k/h)	24		14	24		14	24		14	24		14
Number of Detectors	1	2		1	2		1	2		1	2	
Detector Template	Left	Thru		Left	Thru		Left	Thru		Left	Thru	
Leading Detector (m)	18.6	93.0		18.6	93.0		18.6	93.0		18.6	93.0	
Trailing Detector (m)	0.0	0.0		0.0	0.0		0.0	0.0		0.0	0.0	
Detector 1 Position(m)	0.0	0.0		0.0	0.0		0.0	0.0		0.0	0.0	
Detector 1 Size(m)	18.6	5.5		18.6	5.5		18.6	5.5		18.6	5.5	
Detector 1 Type	Cl+Ex	Cl+Ex		Cl+Ex	Cl+Ex		Cl+Ex	Cl+Ex		Cl+Ex	Cl+Ex	
Detector 1 Channel												
Detector 1 Extend (s)	0.0	0.0		0.0	0.0		0.0	0.0		0.0	0.0	
Detector 1 Queue (s)	0.0	0.0		0.0	0.0		0.0	0.0		0.0	0.0	
Detector 1 Delay (s)	0.0	0.0		0.0	0.0		0.0	0.0		0.0	0.0	
Detector 2 Position(m)		87.5			87.5			87.5			87.5	
Detector 2 Size(m)		5.5			5.5			5.5			5.5	
Detector 2 Type		Cl+Ex			Cl+Ex			Cl+Ex			Cl+Ex	
Detector 2 Channel												
Detector 2 Extend (s)		0.0			0.0			0.0			0.0	
Turn Type	Perm	NA		pm+pt	NA		Perm	NA		Perm	NA	
Protected Phases		2		1	6			8			4	
Permitted Phases	2			6			8			4		
Detector Phase	2	2		1	6		8	8		4	4	



Lane Group	EBL	EBT	EBR	WBL	WBT	WBR	NBL	NBT	NBR	SBL	SBT	SBR
Switch Phase												
Minimum Initial (s)	10.0	10.0		5.0	10.0		10.0	10.0		10.0	10.0	
Minimum Split (s)	39.2	39.2		11.2	39.2		37.8	37.8		37.8	37.8	
Total Split (s)	80.0	80.0		12.0	92.0		38.0	38.0		38.0	38.0	
Total Split (%)	61.5%	61.5%		9.2%	70.8%		29.2%	29.2%		29.2%	29.2%	
Maximum Green (s)	73.8	73.8		5.8	85.8		31.2	31.2		31.2	31.2	
Yellow Time (s)	3.7	3.7		3.7	3.7		3.0	3.0		3.0	3.0	
All-Red Time (s)	2.5	2.5		2.5	2.5		3.8	3.8		3.8	3.8	
Lost Time Adjust (s)	0.0	0.0		0.0	0.0			0.0			0.0	
Total Lost Time (s)	6.2	6.2		6.2	6.2			6.8			6.8	
Lead/Lag	Lag	Lag		Lead								
Lead-Lag Optimize?												
Vehicle Extension (s)	3.0	3.0		3.0	3.0		3.0	3.0		3.0	3.0	
Recall Mode	C-Max	C-Max		None	C-Max		None	None		None	None	
Walk Time (s)	15.0	15.0			15.0		7.0	7.0		7.0	7.0	
Flash Dont Walk (s)	18.0	18.0			18.0		24.0	24.0		24.0	24.0	
Pedestrian Calls (#/hr)	5	5			9		13	13		5	5	
Act Effct Green (s)	84.5	84.5		97.4	97.4			19.6			19.6	
Actuated g/C Ratio	0.65	0.65		0.75	0.75			0.15			0.15	
v/c Ratio	0.19	0.88		0.65	0.41			0.38			0.55	
Control Delay	3.1	6.5		56.6	4.4			18.9			50.4	
Queue Delay	0.0	0.0		0.0	0.0			0.0			0.0	
Total Delay	3.1	6.5		56.6	4.4			18.9			50.4	
LOS	A	A		E	A			B			D	
Approach Delay		6.4			8.8			18.9			50.4	
Approach LOS		A			A			B			D	
Queue Length 50th (m)	1.5	33.6		7.1	21.3			6.5			20.8	
Queue Length 95th (m)	m2.1	m33.1		#35.7	25.6			19.7			33.7	
Internal Link Dist (m)		467.4			212.7			188.5			249.4	
Turn Bay Length (m)	100.0			100.0								
Base Capacity (vph)	328	2196		143	2444			401			304	
Starvation Cap Reductn	0	0		0	0			0			0	
Spillback Cap Reductn	0	0		0	0			0			0	
Storage Cap Reductn	0	0		0	0			0			0	
Reduced v/c Ratio	0.19	0.88		0.65	0.41			0.27			0.36	

Intersection Summary

Area Type: Other
 Cycle Length: 130
 Actuated Cycle Length: 130
 Offset: 122 (94%), Referenced to phase 2:EBTL and 6:WBTL, Start of Green
 Natural Cycle: 130
 Control Type: Actuated-Coordinated
 Maximum v/c Ratio: 0.88
 Intersection Signal Delay: 9.0 Intersection LOS: A
 Intersection Capacity Utilization 93.5% ICU Level of Service F
 Analysis Period (min) 15
 # 95th percentile volume exceeds capacity, queue may be longer.
 Queue shown is maximum after two cycles.
 m Volume for 95th percentile queue is metered by upstream signal.

Splits and Phases: 2: Page & Innes

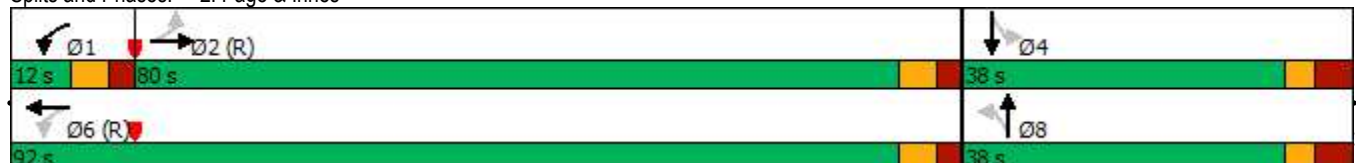

3: Lamarche & Innes
PM Peak Hour

3493-3499 Innes Road
2030 Background Traffic



Lane Group	EBU	EBT	EBR	WBL	WBT	NBL	NBR	Ø3
Lane Configurations								
Traffic Volume (vph)	0	1589	324	177	942	217	205	
Future Volume (vph)	0	1589	324	177	942	217	205	
Ideal Flow (vphpl)	1800	1800	1800	1800	1800	1800	1800	
Storage Length (m)	30.0		50.0	65.0		70.0	70.0	
Storage Lanes	1		1	1		1	1	
Taper Length (m)	30.0			80.0		20.0		
Lane Util. Factor	1.00	0.95	1.00	1.00	0.95	0.97	1.00	
Ped Bike Factor			0.96					
Frt			0.850				0.850	
Flt Protected				0.950		0.950		
Satd. Flow (prot)	1767	3357	1502	1679	3357	3257	1502	
Flt Permitted				0.106		0.950		
Satd. Flow (perm)	1767	3357	1449	187	3357	3257	1502	
Right Turn on Red			Yes				Yes	
Satd. Flow (RTOR)			236				35	
Link Speed (k/h)		60			60	50		
Link Distance (m)		236.7			238.7	204.5		
Travel Time (s)		14.2			14.3	14.7		
Confl. Peds. (#/hr)			6	6				
Peak Hour Factor	1.00	1.00	1.00	1.00	1.00	1.00	1.00	
Adj. Flow (vph)	0	1589	324	177	942	217	205	
Shared Lane Traffic (%)								
Lane Group Flow (vph)	0	1589	324	177	942	217	205	
Enter Blocked Intersection	No	No	No	No	No	No	No	
Lane Alignment	R NA	Left	Right	Left	Left	L NA	R NA	
Median Width(m)		5.0			5.0	7.4		
Link Offset(m)		0.0			0.0	0.0		
Crosswalk Width(m)		9.0			9.0	9.0		
Two way Left Turn Lane								
Headway Factor	1.06	1.06	1.06	1.06	1.06	1.06	1.06	
Turning Speed (k/h)	14		14	24		24	14	
Number of Detectors	1	2	1	1	2	1	1	
Detector Template	Left	Thru	Right	Left	Thru	Left	Right	
Leading Detector (m)	18.6	93.0	18.6	18.6	93.0	18.6	18.6	
Trailing Detector (m)	0.0	0.0	0.0	0.0	0.0	0.0	0.0	
Detector 1 Position(m)	0.0	0.0	0.0	0.0	0.0	0.0	0.0	
Detector 1 Size(m)	18.6	5.5	18.6	18.6	5.5	18.6	18.6	
Detector 1 Type	Cl+Ex	Cl+Ex	Cl+Ex	Cl+Ex	Cl+Ex	Cl+Ex	Cl+Ex	
Detector 1 Channel								
Detector 1 Extend (s)	0.0	0.0	0.0	0.0	0.0	0.0	0.0	
Detector 1 Queue (s)	0.0	0.0	0.0	0.0	0.0	0.0	0.0	
Detector 1 Delay (s)	0.0	0.0	0.0	0.0	0.0	0.0	0.0	
Detector 2 Position(m)		87.5			87.5			
Detector 2 Size(m)		5.5			5.5			
Detector 2 Type		Cl+Ex			Cl+Ex			
Detector 2 Channel								
Detector 2 Extend (s)		0.0			0.0			
Turn Type	Perm	NA	Perm	Perm	NA	Prot	Perm	
Protected Phases		2			6	4		3
Permitted Phases	2		2	6			8	
Detector Phase	2	2	2	6	6	4	8	
Switch Phase								
Minimum Initial (s)	10.0	10.0	10.0	10.0	10.0	5.0	10.0	5.0



Lane Group	EBU	EBT	EBR	WBL	WBT	NBL	NBR	Ø3
Minimum Split (s)	31.2	31.2	31.2	31.2	31.2	11.3	37.3	30.0
Total Split (s)	88.0	88.0	88.0	88.0	88.0	12.0	42.0	30.0
Total Split (%)	67.7%	67.7%	67.7%	67.7%	67.7%	9.2%	32.3%	23%
Maximum Green (s)	81.8	81.8	81.8	81.8	81.8	5.7	35.7	28.0
Yellow Time (s)	3.7	3.7	3.7	3.7	3.7	3.3	3.3	2.0
All-Red Time (s)	2.5	2.5	2.5	2.5	2.5	3.0	3.0	0.0
Lost Time Adjust (s)	0.0	0.0	0.0	0.0	0.0	0.0	0.0	0.0
Total Lost Time (s)	6.2	6.2	6.2	6.2	6.2	6.3	6.3	
Lead/Lag						Lag		Lead
Lead-Lag Optimize?								
Vehicle Extension (s)	3.0	3.0	3.0	3.0	3.0	3.0	3.0	3.0
Recall Mode	C-Max	C-Max	C-Max	C-Max	C-Max	None	None	None
Walk Time (s)	7.0	7.0	7.0	7.0	7.0			7.0
Flash Dont Walk (s)	18.0	18.0	18.0	18.0	18.0			21.0
Pedestrian Calls (#/hr)	10	10	10	10	10			10
Act Effct Green (s)		90.0	90.0	90.0	90.0	15.5	27.5	
Actuated g/C Ratio		0.69	0.69	0.69	0.69	0.12	0.21	
v/c Ratio		0.68	0.30	1.37	0.41	0.56	0.59	
Control Delay		2.2	0.4	229.2	7.5	60.7	44.7	
Queue Delay		0.2	0.0	0.0	0.0	0.0	0.0	
Total Delay		2.4	0.4	229.2	7.5	60.7	44.7	
LOS		A	A	F	A	E	D	
Approach Delay		2.0			42.6	52.9		
Approach LOS		A			D	D		
Queue Length 50th (m)		8.4	0.1	~53.1	25.4	24.1	39.2	
Queue Length 95th (m)		12.1	m0.0	#101.2	39.8	#60.5	55.3	
Internal Link Dist (m)		212.7			214.7	180.5		
Turn Bay Length (m)			50.0	65.0		70.0	70.0	
Base Capacity (vph)		2324	1076	129	2324	387	437	
Starvation Cap Reductn		168	0	0	0	0	0	
Spillback Cap Reductn		0	0	0	0	0	0	
Storage Cap Reductn		0	0	0	0	0	0	
Reduced v/c Ratio		0.74	0.30	1.37	0.41	0.56	0.47	

Intersection Summary

Area Type: Other

Cycle Length: 130

Actuated Cycle Length: 130

Offset: 129 (99%), Referenced to phase 2:EBTU and 6:WBTL, Start of Green

Natural Cycle: 150

Control Type: Actuated-Coordinated

Maximum v/c Ratio: 1.37

Intersection Signal Delay: 21.4

Intersection LOS: C

Intersection Capacity Utilization 78.8%

ICU Level of Service D

Analysis Period (min) 15

~ Volume exceeds capacity, queue is theoretically infinite.

Queue shown is maximum after two cycles.

95th percentile volume exceeds capacity, queue may be longer.

Queue shown is maximum after two cycles.

m Volume for 95th percentile queue is metered by upstream signal.

Splits and Phases: 3: Lamarche & Innes

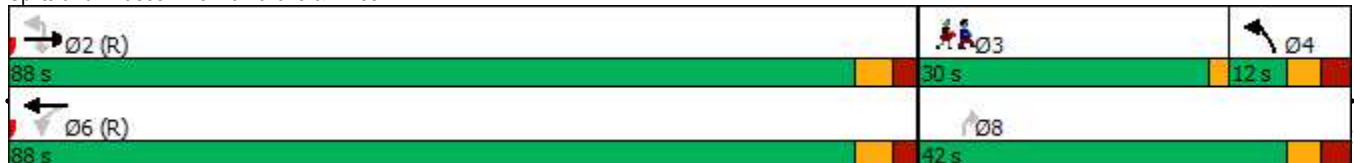



Lane Group	EBL	EBT	EBR	WBL	WBT	WBR	NBL	NBT	NBR	SBL	SBT	SBR
Lane Configurations												
Traffic Volume (vph)	8	1866	131	67	1059	8	88	0	56	4	0	10
Future Volume (vph)	8	1866	131	67	1059	8	88	0	56	4	0	10
Ideal Flow (vphpl)	1800	1800	1800	1800	1800	1800	1800	1800	1800	1800	1800	1800
Storage Length (m)	65.0		0.0	40.0		0.0	0.0		0.0	0.0		0.0
Storage Lanes	1		0	1		0	0		1	0		0
Taper Length (m)	80.0			30.0			20.0			20.0		
Lane Util. Factor	1.00	0.95	0.95	1.00	0.95	0.95	1.00	1.00	1.00	1.00	1.00	1.00
Ped Bike Factor		1.00						1.00				0.99
Frt		0.990			0.999				0.850			0.904
Flt Protected	0.950			0.950				0.950				0.986
Satd. Flow (prot)	1712	3353	0	1712	3322	0	0	1712	1381	0	1587	0
Flt Permitted	0.251			0.070				0.748				0.920
Satd. Flow (perm)	452	3353	0	126	3322	0	0	1342	1381	0	1481	0
Right Turn on Red			Yes			Yes			Yes			Yes
Satd. Flow (RTOR)		13			1				29			26
Link Speed (k/h)		60			60				40			40
Link Distance (m)		238.7			292.8				151.9			62.6
Travel Time (s)		14.3			17.6				13.7			5.6
Confl. Peds. (#/hr)			2	2			3					3
Confl. Bikes (#/hr)			1									
Peak Hour Factor	1.00	1.00	1.00	1.00	1.00	1.00	1.00	1.00	1.00	1.00	1.00	1.00
Heavy Vehicles (%)	1%	2%	1%	1%	4%	1%	1%	1%	12%	1%	1%	1%
Adj. Flow (vph)	8	1866	131	67	1059	8	88	0	56	4	0	10
Shared Lane Traffic (%)												
Lane Group Flow (vph)	8	1997	0	67	1067	0	0	88	56	0	14	0
Enter Blocked Intersection	No	No	No	No	No	No	No	No	No	No	No	No
Lane Alignment	L NA	Left	R NA	L NA	Left	R NA	L NA	Left	R NA	L NA	Left	R NA
Median Width(m)		5.0			3.7			0.0			0.0	
Link Offset(m)		0.0			0.0			0.0			0.0	
Crosswalk Width(m)		9.0			9.0			9.0			9.0	
Two way Left Turn Lane												
Headway Factor	1.06	1.06	1.06	1.06	1.06	1.06	1.06	1.06	1.06	1.06	1.06	1.06
Turning Speed (k/h)	24		14	24		14	24		14	24		14
Number of Detectors	1	2		1	2		1	2	1	1		2
Detector Template	Left	Thru		Left	Thru		Left	Thru	Right	Left		Thru
Leading Detector (m)	18.6	93.0		18.6	93.0		18.6	93.0	18.6	18.6		93.0
Trailing Detector (m)	0.0	0.0		0.0	0.0		0.0	0.0	0.0	0.0		0.0
Detector 1 Position(m)	0.0	0.0		0.0	0.0		0.0	0.0	0.0	0.0		0.0
Detector 1 Size(m)	18.6	5.5		18.6	5.5		18.6	5.5	18.6	18.6		5.5
Detector 1 Type	Cl+Ex	Cl+Ex		Cl+Ex	Cl+Ex		Cl+Ex	Cl+Ex	Cl+Ex	Cl+Ex		Cl+Ex
Detector 1 Channel												
Detector 1 Extend (s)	0.0	0.0		0.0	0.0		0.0	0.0	0.0	0.0		0.0
Detector 1 Queue (s)	0.0	0.0		0.0	0.0		0.0	0.0	0.0	0.0		0.0
Detector 1 Delay (s)	0.0	0.0		0.0	0.0		0.0	0.0	0.0	0.0		0.0
Detector 2 Position(m)		87.5			87.5			87.5				87.5
Detector 2 Size(m)		5.5			5.5			5.5				5.5
Detector 2 Type		Cl+Ex			Cl+Ex			Cl+Ex				Cl+Ex
Detector 2 Channel												
Detector 2 Extend (s)		0.0			0.0			0.0				0.0
Turn Type	Perm	NA		Perm	NA		Perm	NA	Perm	Perm		NA
Protected Phases		2			6			8				4
Permitted Phases	2			6			8		8	4		
Detector Phase	2	2		6	6		8	8	8	4		4



Lane Group	EBL	EBT	EBR	WBL	WBT	WBR	NBL	NBT	NBR	SBL	SBT	SBR
Switch Phase												
Minimum Initial (s)	10.0	10.0		10.0	10.0		10.0	10.0	10.0	10.0	10.0	
Minimum Split (s)	32.1	32.1		35.1	35.1		32.3	32.3	32.3	32.3	32.3	
Total Split (s)	97.0	97.0		97.0	97.0		33.0	33.0	33.0	33.0	33.0	
Total Split (%)	74.6%	74.6%		74.6%	74.6%		25.4%	25.4%	25.4%	25.4%	25.4%	
Maximum Green (s)	90.9	90.9		90.9	90.9		26.7	26.7	26.7	26.7	26.7	
Yellow Time (s)	3.7	3.7		3.7	3.7		3.3	3.3	3.3	3.3	3.3	
All-Red Time (s)	2.4	2.4		2.4	2.4		3.0	3.0	3.0	3.0	3.0	
Lost Time Adjust (s)	0.0	0.0		0.0	0.0			0.0	0.0		0.0	
Total Lost Time (s)	6.1	6.1		6.1	6.1			6.3	6.3		6.3	
Lead/Lag												
Lead-Lag Optimize?												
Vehicle Extension (s)	3.0	3.0		3.0	3.0		3.0	3.0	3.0	3.0	3.0	
Recall Mode	C-Max	C-Max		C-Max	C-Max		None	None	None	None	None	
Walk Time (s)	12.0	12.0		12.0	12.0		7.0	7.0	7.0	7.0	7.0	
Flash Dont Walk (s)	14.0	14.0		14.0	14.0		19.0	19.0	19.0	19.0	19.0	
Pedestrian Calls (#/hr)	2	2		1	1		1	1	1	3	3	
Act Effct Green (s)	102.1	102.1		102.1	102.1			15.5	15.5		15.5	
Actuated g/C Ratio	0.79	0.79		0.79	0.79			0.12	0.12		0.12	
v/c Ratio	0.02	0.76		0.68	0.41			0.55	0.29		0.07	
Control Delay	2.1	3.8		47.6	5.5			65.5	31.1		7.4	
Queue Delay	0.0	0.0		0.0	0.0			0.0	0.0		0.0	
Total Delay	2.1	3.8		47.6	5.5			65.5	31.1		7.4	
LOS	A	A		D	A			E	C		A	
Approach Delay		3.8			8.0			52.1			7.4	
Approach LOS		A			A			D			A	
Queue Length 50th (m)	0.2	29.4		5.6	32.4			20.2	5.9		0.0	
Queue Length 95th (m)	m0.4	36.3		#39.0	63.5			32.7	16.2		2.9	
Internal Link Dist (m)		214.7			268.8			127.9			38.6	
Turn Bay Length (m)	65.0			40.0								
Base Capacity (vph)	355	2636		98	2609			275	306		324	
Starvation Cap Reductn	0	0		0	0			0	0		0	
Spillback Cap Reductn	0	0		0	0			0	0		0	
Storage Cap Reductn	0	0		0	0			0	0		0	
Reduced v/c Ratio	0.02	0.76		0.68	0.41			0.32	0.18		0.04	

Intersection Summary

Area Type: Other
 Cycle Length: 130
 Actuated Cycle Length: 130
 Offset: 4 (3%), Referenced to phase 2:EBTL and 6:WBTL, Start of Green
 Natural Cycle: 90
 Control Type: Actuated-Coordinated
 Maximum v/c Ratio: 0.76
 Intersection Signal Delay: 7.4 Intersection LOS: A
 Intersection Capacity Utilization 92.4% ICU Level of Service F
 Analysis Period (min) 15
 # 95th percentile volume exceeds capacity, queue may be longer.
 Queue shown is maximum after two cycles.
 m Volume for 95th percentile queue is metered by upstream signal.

Splits and Phases: 4: 473 E of Page & Innes

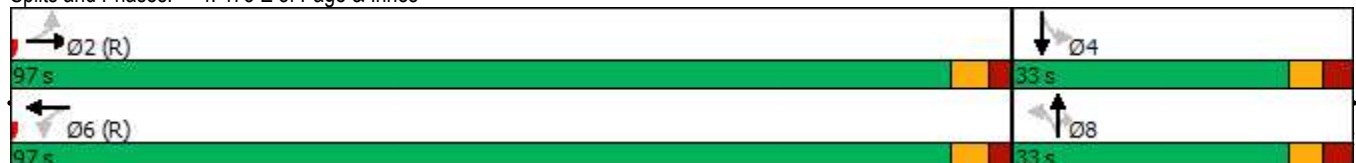

1: Orleans & Innes
PM Peak Hour

3493-3499 Innes Road
2030 Background Traffic (demand rationalization)



Lane Group	EBL	EBT	EBR	WBL	WBT	WBR	NBL	NBT	NBR	SBL	SBT	SBR
Lane Configurations	↔↔	↕↕	↗	↖	↕↕	↗	↖	↕↕	↗	↖	↕↕	↗
Traffic Volume (vph)	625	1586	171	66	834	170	69	243	109	191	260	219
Future Volume (vph)	625	1586	171	66	834	170	69	243	109	191	260	219
Ideal Flow (vphpl)	1800	1800	1800	1800	1800	1800	1800	1800	1800	1800	1800	1800
Storage Length (m)	140.0		80.0	105.0		60.0	50.0		50.0	55.0		60.0
Storage Lanes	2		1	1		1	1		1	1		1
Taper Length (m)	40.0			40.0			10.0			20.0		
Lane Util. Factor	0.97	0.95	1.00	1.00	0.95	1.00	1.00	0.95	1.00	1.00	0.95	1.00
Ped Bike Factor	0.99		0.94	1.00		0.97	0.99		0.96	0.98		0.97
Frt			0.850			0.850			0.850			0.850
Flt Protected	0.950			0.950			0.950			0.950		
Satd. Flow (prot)	3288	3357	1532	1712	3293	1517	1712	3390	1532	1712	3390	1532
Flt Permitted	0.950			0.950			0.442			0.601		
Satd. Flow (perm)	3265	3357	1446	1704	3293	1475	786	3390	1473	1062	3390	1480
Right Turn on Red			Yes			Yes			Yes			Yes
Satd. Flow (RTOR)			141			195			134			219
Link Speed (k/h)		60			60			50			50	
Link Distance (m)		264.5			491.4			387.7			301.9	
Travel Time (s)		15.9			29.5			27.9			21.7	
Confl. Peds. (#/hr)	7		22	22		7	15		18	18		15
Confl. Bikes (#/hr)			4			3						
Peak Hour Factor	1.00	1.00	1.00	1.00	1.00	1.00	1.00	1.00	1.00	1.00	1.00	1.00
Heavy Vehicles (%)	2%	3%	1%	1%	5%	2%	1%	2%	1%	1%	2%	1%
Adj. Flow (vph)	625	1586	171	66	834	170	69	243	109	191	260	219
Shared Lane Traffic (%)												
Lane Group Flow (vph)	625	1586	171	66	834	170	69	243	109	191	260	219
Enter Blocked Intersection	No	No	No	No	No	No	No	No	No	No	No	No
Lane Alignment	L NA	Left	R NA	L NA	Left	R NA	L NA	Left	R NA	L NA	Left	R NA
Median Width(m)		9.0			7.4			6.0			6.0	
Link Offset(m)		0.0			0.0			0.0			0.0	
Crosswalk Width(m)		5.0			5.0			5.0			5.0	
Two way Left Turn Lane												
Headway Factor	1.06	1.06	1.06	1.06	1.06	1.06	1.06	1.06	1.06	1.06	1.06	1.06
Turning Speed (k/h)	24		14	24		14	24		14	24		14
Number of Detectors	1	2	1	1	2	1	1	2	1	1	2	1
Detector Template	Left	Thru	Right	Left	Thru	Right	Left	Thru	Right	Left	Thru	Right
Leading Detector (m)	18.6	93.0	18.6	18.6	93.0	18.6	18.6	93.0	18.6	18.6	93.0	18.6
Trailing Detector (m)	0.0	0.0	0.0	0.0	0.0	0.0	0.0	0.0	0.0	0.0	0.0	0.0
Detector 1 Position(m)	0.0	0.0	0.0	0.0	0.0	0.0	0.0	0.0	0.0	0.0	0.0	0.0
Detector 1 Size(m)	18.6	5.5	18.6	18.6	5.5	18.6	18.6	5.5	18.6	18.6	5.5	18.6
Detector 1 Type	Cl+Ex	Cl+Ex	Cl+Ex	Cl+Ex	Cl+Ex	Cl+Ex	Cl+Ex	Cl+Ex	Cl+Ex	Cl+Ex	Cl+Ex	Cl+Ex
Detector 1 Channel												
Detector 1 Extend (s)	0.0	0.0	0.0	0.0	0.0	0.0	0.0	0.0	0.0	0.0	0.0	0.0
Detector 1 Queue (s)	0.0	0.0	0.0	0.0	0.0	0.0	0.0	0.0	0.0	0.0	0.0	0.0
Detector 1 Delay (s)	0.0	0.0	0.0	0.0	0.0	0.0	0.0	0.0	0.0	0.0	0.0	0.0
Detector 2 Position(m)		87.5			87.5			87.5			87.5	
Detector 2 Size(m)		5.5			5.5			5.5			5.5	
Detector 2 Type		Cl+Ex			Cl+Ex			Cl+Ex			Cl+Ex	
Detector 2 Channel												
Detector 2 Extend (s)		0.0			0.0			0.0			0.0	
Turn Type	Prot	NA	Perm	Prot	NA	Perm	pm+pt	NA	Perm	Perm	NA	Perm
Protected Phases	5	2		1	6		3	8			4	
Permitted Phases			2			6	8		8	4		4
Detector Phase	5	2	2	1	6	6	3	8	8	4	4	4



Lane Group	EBL	EBT	EBR	WBL	WBT	WBR	NBL	NBT	NBR	SBL	SBT	SBR
Switch Phase												
Minimum Initial (s)	5.0	10.0	10.0	5.0	10.0	10.0	5.0	10.0	10.0	10.0	10.0	10.0
Minimum Split (s)	11.6	26.2	26.2	11.2	26.2	26.2	11.7	32.7	32.7	32.7	32.7	32.7
Total Split (s)	35.0	71.0	71.0	12.0	48.0	48.0	12.0	47.0	47.0	35.0	35.0	35.0
Total Split (%)	26.9%	54.6%	54.6%	9.2%	36.9%	36.9%	9.2%	36.2%	36.2%	26.9%	26.9%	26.9%
Maximum Green (s)	28.4	64.8	64.8	5.8	41.8	41.8	5.3	40.3	40.3	28.3	28.3	28.3
Yellow Time (s)	3.7	3.7	3.7	3.7	3.7	3.7	3.3	3.3	3.3	3.3	3.3	3.3
All-Red Time (s)	2.9	2.5	2.5	2.5	2.5	2.5	3.4	3.4	3.4	3.4	3.4	3.4
Lost Time Adjust (s)	0.0	0.0	0.0	0.0	0.0	0.0	0.0	0.0	0.0	0.0	0.0	0.0
Total Lost Time (s)	6.6	6.2	6.2	6.2	6.2	6.2	6.7	6.7	6.7	6.7	6.7	6.7
Lead/Lag	Lead	Lag	Lag	Lead	Lag	Lag	Lead			Lag	Lag	Lag
Lead-Lag Optimize?												
Vehicle Extension (s)	3.0	3.0	3.0	3.0	3.0	3.0	3.0	3.0	3.0	3.0	3.0	3.0
Recall Mode	None	C-Max	C-Max	None	C-Max	C-Max	None	None	None	None	None	None
Walk Time (s)		7.0	7.0		7.0	7.0		7.0	7.0	7.0	7.0	7.0
Flash Dont Walk (s)		13.0	13.0		13.0	13.0		19.0	19.0	19.0	19.0	19.0
Pedestrian Calls (#/hr)		22	22		7	7		32	32	15	15	15
Act Effct Green (s)	27.4	68.2	68.2	6.3	46.7	46.7	36.5	36.5	36.5	26.9	26.9	26.9
Actuated g/C Ratio	0.21	0.52	0.52	0.05	0.36	0.36	0.28	0.28	0.28	0.21	0.21	0.21
v/c Ratio	0.90	0.90	0.21	0.80	0.71	0.26	0.27	0.26	0.21	0.87	0.37	0.46
Control Delay	67.5	37.3	5.0	110.1	38.9	6.1	35.8	36.0	3.8	84.8	45.6	8.6
Queue Delay	0.0	0.0	0.0	0.0	0.0	0.0	0.0	0.0	0.0	0.0	0.0	0.0
Total Delay	67.5	37.3	5.0	110.1	38.9	6.1	35.8	36.0	3.8	84.8	45.6	8.6
LOS	E	D	A	F	D	A	D	D	A	F	D	A
Approach Delay		42.9			38.1			27.6			44.7	
Approach LOS		D			D			C			D	
Queue Length 50th (m)	73.9	182.0	3.5	15.9	102.0	2.4	11.7	22.4	0.0	43.4	27.5	0.0
Queue Length 95th (m)	#100.5	#232.5	14.4	#42.3	107.5	11.9	22.3	32.3	7.6	#80.6	39.4	18.7
Internal Link Dist (m)		240.5			467.4			363.7			277.9	
Turn Bay Length (m)	140.0		80.0	105.0		60.0	50.0		50.0	55.0		60.0
Base Capacity (vph)	718	1760	825	82	1182	654	258	1050	549	231	737	493
Starvation Cap Reductn	0	0	0	0	0	0	0	0	0	0	0	0
Spillback Cap Reductn	0	0	0	0	0	0	0	0	0	0	0	0
Storage Cap Reductn	0	0	0	0	0	0	0	0	0	0	0	0
Reduced v/c Ratio	0.87	0.90	0.21	0.80	0.71	0.26	0.27	0.23	0.20	0.83	0.35	0.44

Intersection Summary

Area Type: Other
 Cycle Length: 130
 Actuated Cycle Length: 130
 Offset: 125 (96%), Referenced to phase 2:EBT and 6:WBT, Start of Green
 Natural Cycle: 115
 Control Type: Actuated-Coordinated
 Maximum v/c Ratio: 0.90
 Intersection Signal Delay: 40.6 Intersection LOS: D
 Intersection Capacity Utilization 97.5% ICU Level of Service F
 Analysis Period (min) 15
 # 95th percentile volume exceeds capacity, queue may be longer.
 Queue shown is maximum after two cycles.

Splits and Phases: 1: Orleans & Innes



3: Lamarche & Innes
PM Peak Hour

3493-3499 Innes Road
2030 Background Traffic (demand rationalization)



Lane Group	EBU	EBT	EBR	WBL	WBT	NBL	NBR	Ø3	Ø8
Lane Configurations									
Traffic Volume (vph)	0	1589	324	177	942	217	205		
Future Volume (vph)	0	1589	324	177	942	217	205		
Ideal Flow (vphpl)	1800	1800	1800	1800	1800	1800	1800		
Storage Length (m)	30.0		50.0	65.0		70.0	70.0		
Storage Lanes	1		1	1		1	1		
Taper Length (m)	30.0			80.0		20.0			
Lane Util. Factor	1.00	0.95	1.00	1.00	0.95	0.97	1.00		
Ped Bike Factor			0.96			0.97			
Frt			0.850				0.850		
Flt Protected				0.950		0.950			
Satd. Flow (prot)	1767	3357	1502	1679	3357	3257	1502		
Flt Permitted				0.056		0.950			
Satd. Flow (perm)	1767	3357	1449	99	3357	3147	1502		
Right Turn on Red			Yes				Yes		
Satd. Flow (RTOR)			167				11		
Link Speed (k/h)		60			60	50			
Link Distance (m)		236.7			238.7	204.5			
Travel Time (s)		14.2			14.3	14.7			
Confl. Peds. (#/hr)			6	6		5	5		
Peak Hour Factor	1.00	1.00	1.00	1.00	1.00	1.00	1.00		
Adj. Flow (vph)	0	1589	324	177	942	217	205		
Shared Lane Traffic (%)									
Lane Group Flow (vph)	0	1589	324	177	942	217	205		
Enter Blocked Intersection	No	No	No	No	No	No	No		
Lane Alignment	R NA	Left	Right	Left	Left	L NA	R NA		
Median Width(m)		5.0			5.0	7.4			
Link Offset(m)		0.0			0.0	0.0			
Crosswalk Width(m)		9.0			9.0	9.0			
Two way Left Turn Lane									
Headway Factor	1.06	1.06	1.06	1.06	1.06	1.06	1.06		
Turning Speed (k/h)	14		14	24		24	14		
Number of Detectors	1	2	1	1	2	1	1		
Detector Template	Left	Thru	Right	Left	Thru	Left	Right		
Leading Detector (m)	18.6	93.0	18.6	18.6	93.0	18.6	18.6		
Trailing Detector (m)	0.0	0.0	0.0	0.0	0.0	0.0	0.0		
Detector 1 Position(m)	0.0	0.0	0.0	0.0	0.0	0.0	0.0		
Detector 1 Size(m)	18.6	5.5	18.6	18.6	5.5	18.6	18.6		
Detector 1 Type	Cl+Ex	Cl+Ex	Cl+Ex	Cl+Ex	Cl+Ex	Cl+Ex	Cl+Ex		
Detector 1 Channel									
Detector 1 Extend (s)	0.0	0.0	0.0	0.0	0.0	0.0	0.0		
Detector 1 Queue (s)	0.0	0.0	0.0	0.0	0.0	0.0	0.0		
Detector 1 Delay (s)	0.0	0.0	0.0	0.0	0.0	0.0	0.0		
Detector 2 Position(m)		87.5			87.5				
Detector 2 Size(m)		5.5			5.5				
Detector 2 Type		Cl+Ex			Cl+Ex				
Detector 2 Channel									
Detector 2 Extend (s)		0.0			0.0				
Turn Type	Perm	NA	Perm	pm+pt	NA	Prot	pt+ov		
Protected Phases		2		1	6	4	18	3	8
Permitted Phases	2		2	6					
Detector Phase	2	2	2	1	6	4	18		
Switch Phase									
Minimum Initial (s)	10.0	10.0	10.0	5.0	10.0	5.0		3.0	10.0



Lane Group	EBU	EBT	EBR	WBL	WBT	NBL	NBR	Ø3	Ø8
Minimum Split (s)	31.2	31.2	31.2	11.2	31.2	11.3		30.0	16.3
Total Split (s)	68.0	68.0	68.0	16.0	84.0	16.0		30.0	46.0
Total Split (%)	52.3%	52.3%	52.3%	12.3%	64.6%	12.3%		23%	35%
Maximum Green (s)	61.8	61.8	61.8	9.8	77.8	9.7		28.0	39.7
Yellow Time (s)	3.7	3.7	3.7	3.7	3.7	3.3		2.0	3.3
All-Red Time (s)	2.5	2.5	2.5	2.5	2.5	3.0		0.0	3.0
Lost Time Adjust (s)	0.0	0.0	0.0	0.0	0.0	0.0			
Total Lost Time (s)	6.2	6.2	6.2	6.2	6.2	6.3			
Lead/Lag	Lag	Lag	Lag	Lead		Lag		Lead	
Lead-Lag Optimize?									
Vehicle Extension (s)	3.0	3.0	3.0	3.0	3.0	3.0		3.0	3.0
Recall Mode	C-Max	C-Max	C-Max	None	C-Max	None		None	None
Walk Time (s)	7.0	7.0	7.0		7.0			7.0	
Flash Dont Walk (s)	18.0	18.0	18.0		18.0			21.0	
Pedestrian Calls (#/hr)	10	10	10		10			10	
Act Effct Green (s)		72.9	72.9	92.2	92.2	13.3	44.7		
Actuated g/C Ratio		0.56	0.56	0.71	0.71	0.10	0.34		
v/c Ratio		0.84	0.37	0.77	0.40	0.65	0.39		
Control Delay		20.5	6.8	58.5	8.4	66.0	31.0		
Queue Delay		0.0	0.0	0.0	0.0	0.0	0.0		
Total Delay		20.5	6.8	58.5	8.4	66.0	31.0		
LOS		C	A	E	A	E	C		
Approach Delay		18.2			16.3	49.0			
Approach LOS		B			B	D			
Queue Length 50th (m)		87.3	12.2	25.8	30.4	24.5	35.7		
Queue Length 95th (m)		#239.6	m16.7	#73.3	55.9	#47.8	46.9		
Internal Link Dist (m)		212.7			214.7	180.5			
Turn Bay Length (m)			50.0	65.0		70.0	70.0		
Base Capacity (vph)		1881	885	229	2379	334	545		
Starvation Cap Reductn		0	0	0	0	0	0		
Spillback Cap Reductn		0	0	0	0	0	0		
Storage Cap Reductn		0	0	0	0	0	0		
Reduced v/c Ratio		0.84	0.37	0.77	0.40	0.65	0.38		

Intersection Summary

Area Type: Other
 Cycle Length: 130
 Actuated Cycle Length: 130
 Offset: 129 (99%), Referenced to phase 2:EBTU and 6:WBTL, Start of Green
 Natural Cycle: 125
 Control Type: Actuated-Coordinated
 Maximum v/c Ratio: 0.84
 Intersection Signal Delay: 21.3
 Intersection Capacity Utilization 78.8%
 Analysis Period (min) 15
 # 95th percentile volume exceeds capacity, queue may be longer.
 Queue shown is maximum after two cycles.
 m Volume for 95th percentile queue is metered by upstream signal.

Splits and Phases: 3: Lamarche & Innes

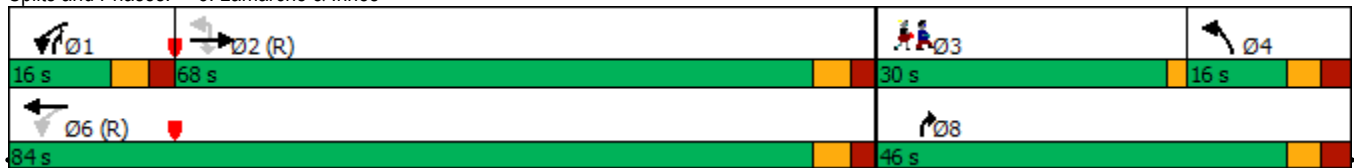

APPENDIX K

Transportation Demand Management

TDM-Supportive Development Design and Infrastructure Checklist:
Non-Residential Developments (office, institutional, retail or industrial)

Legend	
REQUIRED	The Official Plan or Zoning By-law provides related guidance that must be followed
BASIC	The measure is generally feasible and effective, and in most cases would benefit the development and its users
BETTER	The measure could maximize support for users of sustainable modes, and optimize development performance

TDM-supportive design & infrastructure measures: <i>Non-residential developments</i>		Check if completed & add descriptions, explanations or plan/drawing references
1. WALKING & CYCLING: ROUTES		
1.1 Building location & access points		
BASIC	1.1.1 Locate building close to the street, and do not locate parking areas between the street and building entrances	<input checked="" type="checkbox"/>
BASIC	1.1.2 Locate building entrances in order to minimize walking distances to sidewalks and transit stops/stations	<input checked="" type="checkbox"/>
BASIC	1.1.3 Locate building doors and windows to ensure visibility of pedestrians from the building, for their security and comfort	<input checked="" type="checkbox"/>
1.2 Facilities for walking & cycling		
REQUIRED	1.2.1 Provide convenient, direct access to stations or major stops along rapid transit routes within 600 metres; minimize walking distances from buildings to rapid transit; provide pedestrian-friendly, weather-protected (where possible) environment between rapid transit accesses and building entrances; ensure quality linkages from sidewalks through building entrances to integrated stops/stations <i>(see Official Plan policy 4.3.3)</i>	<input type="checkbox"/> - N/A
REQUIRED	1.2.2 Provide safe, direct and attractive pedestrian access from public sidewalks to building entrances through such measures as: reducing distances between public sidewalks and major building entrances; providing walkways from public streets to major building entrances; within a site, providing walkways along the front of adjoining buildings, between adjacent buildings, and connecting areas where people may congregate, such as courtyards and transit stops; and providing weather protection through canopies, colonnades, and other design elements wherever possible <i>(see Official Plan policy 4.3.12)</i>	<input checked="" type="checkbox"/>

TDM-supportive design & infrastructure measures: Non-residential developments		Check if completed & add descriptions, explanations or plan/drawing references
REQUIRED	1.2.3 Provide sidewalks of smooth, well-drained walking surfaces of contrasting materials or treatments to differentiate pedestrian areas from vehicle areas, and provide marked pedestrian crosswalks at intersection sidewalks (<i>see Official Plan policy 4.3.10</i>)	<input checked="" type="checkbox"/>
REQUIRED	1.2.4 Make sidewalks and open space areas easily accessible through features such as gradual grade transition, depressed curbs at street corners and convenient access to extra-wide parking spaces and ramps (<i>see Official Plan policy 4.3.10</i>)	<input checked="" type="checkbox"/>
REQUIRED	1.2.5 Include adequately spaced inter-block/street cycling and pedestrian connections to facilitate travel by active transportation. Provide links to the existing or planned network of public sidewalks, multi-use pathways and on-road cycle routes. Where public sidewalks and multi-use pathways intersect with roads, consider providing traffic control devices to give priority to cyclists and pedestrians (<i>see Official Plan policy 4.3.11</i>)	<input checked="" type="checkbox"/>
BASIC	1.2.6 Provide safe, direct and attractive walking routes from building entrances to nearby transit stops	<input checked="" type="checkbox"/>
BASIC	1.2.7 Ensure that walking routes to transit stops are secure, visible, lighted, shaded and wind-protected wherever possible	<input type="checkbox"/>
BASIC	1.2.8 Design roads used for access or circulation by cyclists using a target operating speed of no more than 30 km/h, or provide a separated cycling facility	<input type="checkbox"/>
1.3 Amenities for walking & cycling		
BASIC	1.3.1 Provide lighting, landscaping and benches along walking and cycling routes between building entrances and streets, sidewalks and trails	<input checked="" type="checkbox"/>
BASIC	1.3.2 Provide wayfinding signage for site access (where required, e.g. when multiple buildings or entrances exist) and egress (where warranted, such as when directions to reach transit stops/stations, trails or other common destinations are not obvious)	<input type="checkbox"/>

TDM-supportive design & infrastructure measures: <i>Non-residential developments</i>		Check if completed & add descriptions, explanations or plan/drawing references
2. WALKING & CYCLING: END-OF-TRIP FACILITIES		
2.1 Bicycle parking		
REQUIRED	2.1.1 Provide bicycle parking in highly visible and lighted areas, sheltered from the weather wherever possible (see <i>Official Plan policy 4.3.6</i>)	<input checked="" type="checkbox"/>
REQUIRED	2.1.2 Provide the number of bicycle parking spaces specified for various land uses in different parts of Ottawa; provide convenient access to main entrances or well-used areas (see <i>Zoning By-law Section 111</i>)	<input checked="" type="checkbox"/>
REQUIRED	2.1.3 Ensure that bicycle parking spaces and access aisles meet minimum dimensions; that no more than 50% of spaces are vertical spaces; and that parking racks are securely anchored (see <i>Zoning By-law Section 111</i>)	<input checked="" type="checkbox"/>
BASIC	2.1.4 Provide bicycle parking spaces equivalent to the expected number of commuter cyclists (assuming the cycling mode share target is met), plus the expected peak number of customer/visitor cyclists	<input type="checkbox"/>
BETTER	2.1.5 Provide bicycle parking spaces equivalent to the expected number of commuter and customer/visitor cyclists, plus an additional buffer (e.g. 25 percent extra) to encourage other cyclists and ensure adequate capacity in peak cycling season	<input type="checkbox"/>
2.2 Secure bicycle parking		
REQUIRED	2.2.1 Where more than 50 bicycle parking spaces are provided for a single office building, locate at least 25% of spaces within a building/structure, a secure area (e.g. supervised parking lot or enclosure) or bicycle lockers (see <i>Zoning By-law Section 111</i>)	<input type="checkbox"/> - N/A
BETTER	2.2.2 Provide secure bicycle parking spaces equivalent to the expected number of commuter cyclists (assuming the cycling mode share target is met)	<input type="checkbox"/>
2.3 Shower & change facilities		
BASIC	2.3.1 Provide shower and change facilities for the use of active commuters	<input type="checkbox"/>
BETTER	2.3.2 In addition to shower and change facilities, provide dedicated lockers, grooming stations, drying racks and laundry facilities for the use of active commuters	<input type="checkbox"/>
2.4 Bicycle repair station		
BETTER	2.4.1 Provide a permanent bike repair station, with commonly used tools and an air pump, adjacent to the main bicycle parking area (or secure bicycle parking area, if provided)	<input type="checkbox"/>

TDM-supportive design & infrastructure measures: <i>Non-residential developments</i>		Check if completed & add descriptions, explanations or plan/drawing references
3. TRANSIT		
3.1 Customer amenities		
BASIC	3.1.1 Provide shelters, lighting and benches at any on-site transit stops	<input type="checkbox"/>
BASIC	3.1.2 Where the site abuts an off-site transit stop and insufficient space exists for a transit shelter in the public right-of-way, protect land for a shelter and/or install a shelter	<input type="checkbox"/>
BETTER	3.1.3 Provide a secure and comfortable interior waiting area by integrating any on-site transit stops into the building	<input type="checkbox"/>
4. RIDESHARING		
4.1 Pick-up & drop-off facilities		
BASIC	4.1.1 Provide a designated area for carpool drivers (plus taxis and ride-hailing services) to drop off or pick up passengers without using fire lanes or other no-stopping zones	<input type="checkbox"/>
4.2 Carpool parking		
BASIC	4.2.1 Provide signed parking spaces for carpools in a priority location close to a major building entrance, sufficient in number to accommodate the mode share target for carpools	<input type="checkbox"/>
BETTER	4.2.2 At large developments, provide spaces for carpools in a separate, access-controlled parking area to simplify enforcement	<input type="checkbox"/>
5. CARSHARING & BIKESHARING		
5.1 Carshare parking spaces		
BETTER	5.1.1 Provide carshare parking spaces in permitted non-residential zones, occupying either required or provided parking spaces (<i>see Zoning By-law Section 94</i>)	<input type="checkbox"/>
5.2 Bikeshare station location		
BETTER	5.2.1 Provide a designated bikeshare station area near a major building entrance, preferably lighted and sheltered with a direct walkway connection	<input type="checkbox"/>

TDM-supportive design & infrastructure measures: <i>Non-residential developments</i>		Check if completed & add descriptions, explanations or plan/drawing references
6. PARKING		
6.1 Number of parking spaces		
REQUIRED	6.1.1 Do not provide more parking than permitted by zoning, nor less than required by zoning, unless a variance is being applied for	<input checked="" type="checkbox"/>
BASIC	6.1.2 Provide parking for long-term and short-term users that is consistent with mode share targets, considering the potential for visitors to use off-site public parking	<input type="checkbox"/>
BASIC	6.1.3 Where a site features more than one use, provide shared parking and reduce the cumulative number of parking spaces accordingly (<i>see Zoning By-law Section 104</i>)	<input type="checkbox"/>
BETTER	6.1.4 Reduce the minimum number of parking spaces required by zoning by one space for each 13 square metres of gross floor area provided as shower rooms, change rooms, locker rooms and other facilities for cyclists in conjunction with bicycle parking (<i>see Zoning By-law Section 111</i>)	<input type="checkbox"/>
6.2 Separate long-term & short-term parking areas		
BETTER	6.2.1 Separate short-term and long-term parking areas using signage or physical barriers, to permit access controls and simplify enforcement (i.e. to discourage employees from parking in visitor spaces, and vice versa)	<input type="checkbox"/>
7. OTHER		
7.1 On-site amenities to minimize off-site trips		
BETTER	7.1.1 Provide on-site amenities to minimize mid-day or mid-commute errands	<input type="checkbox"/>

APPENDIX L

MMLOS Analysis

Segment MMLOS Analysis

This section provides a review of the boundary street Innes Road, using complete streets principles. The *Multi-Modal Level of Service (MMLOS) Guidelines* were used to evaluate the levels of service for each alternative mode of transportation on Innes Road between Pagé Road and Lamarche Avenue. The targets associated with the Arterial Mainstreet designation have been considered.

Exhibit 4 of the *MMLOS Guidelines* has been used to evaluate the segment pedestrian level of service (PLOS) of Innes Road. Exhibit 22 of the *MMLOS Guidelines* identifies a target PLOS C for all Arterial Roadways. The results of the segment PLOS analysis are summarized in **Table 1**.

Exhibit 11 of the *MMLOS Guidelines* has been used to evaluate the segment bicycle level of service (BLOS) of Innes Road. For Arterial Mainstreets, Exhibit 22 of the *MMLOS Guidelines* identifies a target BLOS B for roadways with a Crosstown Bikeway designation. The results of the segment BLOS analysis are summarized in **Table 2**.

Exhibit 15 of the *MMLOS Guidelines* has been used to evaluate the segment transit level of service (TLOS) of Innes Road. For Arterial Mainstreets, Exhibit 22 of the *MMLOS Guidelines* identifies a target TLOS D for roadways with a Transit Priority with Isolated Measures designation. The results of the segment TLOS analysis are summarized in **Table 3**.

Exhibit 20 of the *MMLOS Guidelines* has been used to evaluate the segment truck level of service (TkLOS) of Innes Road. For Arterial Mainstreets, Exhibit 22 of the *MMLOS Guidelines* identifies a target TkLOS D for roadways with a truck route designation. The results of the segment TkLOS analysis are summarized in **Table 4**.

Table 1: PLOS Segment Analysis – Innes Road

Sidewalk Width	Boulevard Width	Avg. Daily Curb Lane Traffic Volume	Presence of On-Street Parking	Operating Speed ⁽¹⁾	PLOS
North side					
≥ 2.0m	0.5m to 2.0m	> 3,000 vpd	No	70 km/h	E
South side					
≥ 2.0m	0.5m to 2.0m	> 3,000 vpd	No	70 km/h	E

1. Operating speed taken as posted speed plus 10 km/h

Table 2: BLOS Segment Analysis – Innes Road

Road Class	Route Type	Bikeway Type	Travel Lanes	Operating Speed	Bike Lane Width	Bike Lane Blockage	BLOS
Arterial	Crosstown Bikeway	Curbside Bike Lane	4	70 km/h	≥ 1.8m	Rare	E

Table 3: TLOS Segment Analysis – Innes Road

Facility Type	Exposure to Congestion Delay, Friction, and Incidents			TLOS
	Congestion	Friction	Incident Potential	
Mixed Traffic – Limited Parking/Driveway Friction	Yes	Low	Medium	D

Table 4: TkLOS Segment Analysis – Innes Road

Curb Lane Width	Number of Travel Lanes Per Direction	TkLOS
≤ 3.5m	2	A

Intersection MMLOS Analysis

The following is a review of the MMLOS of the signalized intersections within the study area, using complete streets principles. All of these intersections have been evaluated based on existing conditions. Innes Road/Orléans Boulevard has been evaluated using the targets for the General Urban Area, and Innes Road/Pagé Road and Innes Road/473m East of Pagé Road have been evaluated using the targets for Arterial Mainstreets.

Exhibit 5 of the *Addendum to the MMLOS Guidelines* has been used to evaluate the existing PLOS at the intersections listed above. Exhibit 22 of the *MMLOS Guidelines* suggest a target PLOS C for Arterial Mainstreets (Innes Road east of Pagé Road) or all roadways within the General Urban Area (Innes Road west of Pagé Road, Orléans Boulevard, Pagé Road, Boyer Road). The results of the intersection PLOS analysis are summarized in **Table 5** through **Table 7**.

Exhibit 12 of the *MMLOS Guidelines* has been used to evaluate the existing BLOS at the intersections listed above. Exhibit 22 of the *MMLOS Guidelines* suggest a target BLOS B for Crosstown Bikeways on Arterial Mainstreets or in the General Urban Area (Innes Road), a target BLOS B for Local Routes in the General Urban Area (Orléans Boulevard, Boyer Road), and a target BLOS C for Spine Routes in the General Urban Area (Pagé Road). The results of the intersection BLOS analysis are summarized in **Table 8**.

Exhibit 16 of the *MMLOS Guidelines* has been used to evaluate the existing TLOS at the intersections listed above. Exhibit 22 of the *MMLOS Guidelines* suggest a target TLOS D for Transit Priority Corridors with Isolated Measures (Innes Road). Orléans Boulevard has also been evaluated for TLOS, as transit service is provided on this roadway. The results of the intersection TLOS analysis are summarized in **Table 9**.

Exhibit 21 of the *MMLOS Guidelines* has been used to evaluate the existing TkLOS at the intersections listed above. Exhibit 22 of the *MMLOS Guidelines* suggest a target TkLOS D for arterial roadways with a truck route designation (Innes Road, Orléans Boulevard north of Innes Road), and a target TkLOS E for arterial roadways without a truck route designation (Orléans Boulevard south of Innes Road). The results of the intersection TkLOS analysis are summarized in **Table 10**.

Table 5: PLOS Intersection Analysis – Innes Road/Orléans Boulevard

CRITERIA	North Approach		South Approach		East Approach		West Approach	
PETSI SCORE								
<i>CROSSING DISTANCE CONDITIONS</i>								
Median > 2.4m in Width	No	-10	No	-10	No	-10	No	-10
Lanes Crossed (3.5m Lane Width)	10 +		10 +		10 +		10 +	
<i>SIGNAL PHASING AND TIMING</i>								
Left Turn Conflict	Protected	0	Protected	0	Permissive	-8	Perm + Prot	-8
Right Turn Conflict	Permissive or Yield	-5	Permissive or Yield	-5	Permissive or Yield	-5	Permissive or Yield	-5
Right Turn on Red	N/A	0	N/A	0	N/A	0	N/A	0
Leading Pedestrian Interval	No	-2	No	-2	No	-2	No	-2
<i>CORNER RADIUS</i>								
Parallel Radius	> 15m to 25m	-8	> 15m to 25m	-8	> 15m to 25m	-8	> 15m to 25m	-8
Parallel Right Turn Channel	Conventional without Receiving	0	Conventional without Receiving	0	Conventional without Receiving	0	Conventional without Receiving	0
Perpendicular Radius	> 15m to 25m	-8	> 15m to 25m	-8	> 15m to 25m	-8	> 15m to 25m	-8
Perpendicular Right Turn Channel	Conventional without Receiving	0	Conventional without Receiving	0	Conventional without Receiving	0	Conventional without Receiving	0
<i>CROSSING TREATMENT</i>								
Treatment	Standard	-7	Standard	-7	Zebra Stripe	-4	Zebra Stripe	-4
	PETSI SCORE	-40		-40		-45		-45
	LOS	F		F		F		F
DELAY SCORE								
Cycle Length		130		130		130		130
Pedestrian Walk Time		45.8		45.8		26.3		7.3
	DELAY SCORE	27.3		27.3		41.4		57.9
	LOS	C		C		E		E
	OVERALL	F		F		F		F

Table 6: PLOS Intersection Analysis – Innes Road/Pagé Road

CRITERIA	North Approach		South Approach		East Approach		West Approach	
PETSI SCORE								
<i>CROSSING DISTANCE CONDITIONS</i>								
Median > 2.4m in Width	No	55	No	55	No	23	No	39
Lanes Crossed (3.5m Lane Width)	6		6		8		7	
<i>SIGNAL PHASING AND TIMING</i>								
Left Turn Conflict	Permissive	-8	Permissive	-8	Permissive	-8	Permissive	-8
Right Turn Conflict	Permissive or Yield	-5	Permissive or Yield	-5	Permissive or Yield	-5	Permissive or Yield	-5
Right Turn on Red	RTOR Allowed	-3	RTOR Allowed	-3	RTOR Allowed	-3	RTOR Allowed	-3
Leading Pedestrian Interval	No	-2	No	-2	No	-2	No	-2
<i>CORNER RADIUS</i>								
Parallel Radius	> 10m to 15m	-6	> 10m to 15m	-6	> 10m to 15m	-6	> 10m to 15m	-6
Parallel Right Turn Channel	No Right Turn Channel	-4	No Right Turn Channel	-4	No Right Turn Channel	-4	No Right Turn Channel	-4
Perpendicular Radius	N/A	0	N/A	0	N/A	0	N/A	0
Perpendicular Right Turn Channel	N/A	0	N/A	0	N/A	0	N/A	0
<i>CROSSING TREATMENT</i>								
Treatment	Standard	-7	Standard	-7	Standard	-7	Standard	-7
	PETSI SCORE	20		20		-12		4
	LOS	F		F		F		F
DELAY SCORE								
Cycle Length		110		110		120		120
Pedestrian Walk Time		47.8		47.8		7.2		7.2
	DELAY SCORE	17.6		17.6		53.0		53.0
	LOS	B		B		E		E
	OVERALL	F		F		F		F

Table 7: PLOS Intersection Analysis – Innes Road/473m East of Pagé Road

CRITERIA	North Approach		South Approach		East Approach		West Approach	
PETSI SCORE								
<i>CROSSING DISTANCE CONDITIONS</i>								
Median > 2.4m in Width	No	88	No	55	No	39	No	39
Lanes Crossed (3.5m Lane Width)	4		6		7		7	
<i>SIGNAL PHASING AND TIMING</i>								
Left Turn Conflict	Permissive	-8	Permissive	-8	Permissive	-8	Permissive	-8
Right Turn Conflict	Permissive or Yield	-5	Permissive or Yield	-5	Permissive or Yield	-5	Permissive or Yield	-5
Right Turn on Red	RTOR Allowed	-3	RTOR Allowed	-3	RTOR Allowed	-3	RTOR Allowed	-3
Leading Pedestrian Interval	No	-2	No	-2	No	-2	No	-2
<i>CORNER RADIUS</i>								
Parallel Radius	> 5m to 10m	-5	> 10m to 15m	-6	> 10m to 15m	-6	> 10m to 15m	-6
Parallel Right Turn Channel	No Right Turn Channel	-4	No Right Turn Channel	-4	No Right Turn Channel	-4	No Right Turn Channel	-4
Perpendicular Radius	N/A	0	N/A	0	N/A	0	N/A	0
Perpendicular Right Turn Channel	N/A	0	N/A	0	N/A	0	N/A	0
<i>CROSSING TREATMENT</i>								
Treatment	Standard	-7	Standard	-7	Standard	-7	Standard	-7
	PETSI SCORE	54		20		4		4
	LOS	D		F		F		F
DELAY SCORE								
Cycle Length		110		110		120		120
Pedestrian Walk Time		56.9		56.9		7.7		7.7
	DELAY SCORE	12.8		12.8		52.5		52.5
	LOS	B		B		E		E
	OVERALL	D		F		F		F

Table 8: BLOS Intersection Analysis

Approach	Facility Type	Criteria	Travel Lanes and/or Speed	BLOS
Innes Road/Orléans Boulevard				
North Approach	Mixed Traffic	Right Turn Lane Characteristics	Right turn lane > 50m	F
		Left Turn Accommodation	Two lanes crossed, ≥ 50 km/h	F
South Approach	Mixed Traffic	Right Turn Lane Characteristics	Right turn lane > 50m	F
		Left Turn Accommodation	Two lanes crossed, ≥ 50 km/h	F
East Approach	Pocket Bike Lane	Right Turn Lane Characteristics	Right turn lane > 50m, turning speed ≤ 30 km/h	D
		Left Turn Accommodation	Two lanes crossed, ≥ 50 km/h	F
West Approach	Mixed Traffic	Right Turn Lane Characteristics	Right turn lane > 50m	F
		Left Turn Accommodation	Dual left turn lanes	F
Innes Road/Pagé Road				
North Approach	Mixed Traffic	Right Turn Lane Characteristics	Shared through/right turn lane	A
		Left Turn Accommodation	No lanes crossed, ≤ 50 km/h	B
South Approach	Mixed Traffic	Right Turn Lane Characteristics	Shared through/right turn lane	A
		Left Turn Accommodation	No lanes crossed, ≤ 50 km/h	B
East Approach	Curbside Bike Lane	Right Turn Lane Characteristics	Shared through/right turn lane	A
		Left Turn Accommodation	Two lanes crossed, ≥ 50 km/h	F
West Approach	Curbside Bike Lane	Right Turn Lane Characteristics	Shared through/right turn lane	A
		Left Turn Accommodation	Two lanes crossed, ≥ 50 km/h	F
Innes Road/473m East of Pagé Road				
North Approach	Mixed Traffic	Right Turn Lane Characteristics	Shared through/right turn lane	A
		Left Turn Accommodation	No lanes crossed, ≤ 50 km/h	B
South Approach	Mixed Traffic	Right Turn Lane Characteristics	Shared through/right turn lane	A
		Left Turn Accommodation	No lanes crossed, ≥ 60 km/h	D
East Approach	Curbside Bike Lane	Right Turn Lane Characteristics	Shared through/right turn lane	A
		Left Turn Accommodation	Two lanes crossed, ≥ 50 km/h	F
West Approach	Curbside Bike Lane	Right Turn Lane Characteristics	Shared through/right turn lane	A
		Left Turn Accommodation	Two lanes crossed, ≥ 50 km/h	F

Table 9: TLOS Intersection Analysis

Approach	Delay ⁽¹⁾		TLOS
	AM Peak	PM Peak	
Innes Road/Orléans Boulevard			
North Approach	114 sec	35 sec	F
South Approach	31 sec	22 sec	E
East Approach	37 sec	42 sec	F
West Approach	43 sec	53 sec	F
Innes Road/Pagé Road			
East Approach	7 sec	17 sec	C
West Approach	6 sec	5 sec	B
Innes Road/473m East of Pagé Road			
East Approach	6 sec	4 sec	B
West Approach	2 sec	3 sec	B

1. Delay based on outputs from Synchro analysis of existing conditions

Table 10: TkLOS Intersection Analysis

Approach	Effective Corner Radius	Number of Receiving Lanes Departing Intersection	TkLOS
Innes Road/Orléans Boulevard			
North Approach	> 15m	3	A
South Approach	> 15m	2	A
East Approach	> 15m	2	A
West Approach	> 15m	2	A
Innes Road/Pagé Road			
East Approach	10m to 15m	1	E
West Approach	10m to 15m	1	E
Innes Road/473m East of Pagé Road			
East Approach	< 10m	1	F
West Approach	> 15m	1	C

APPENDIX M

Total Synchro Analysis



Lane Group	EBL	EBT	EBR	WBL	WBT	WBR	NBL	NBT	NBR	SBL	SBT	SBR
Lane Configurations	↖↖	↖↖	↖	↖	↖↖	↖	↖	↖↖	↖	↖	↖↖	↖
Traffic Volume (vph)	125	461	24	28	1492	198	209	267	55	82	103	473
Future Volume (vph)	125	461	24	28	1492	198	209	267	55	82	103	473
Ideal Flow (vphpl)	1800	1800	1800	1800	1800	1800	1800	1800	1800	1800	1800	1800
Storage Length (m)	140.0		80.0	105.0		60.0	50.0		50.0	55.0		60.0
Storage Lanes	2		1	1		1	1		1	1		1
Taper Length (m)	40.0			40.0			10.0			20.0		
Lane Util. Factor	0.97	0.95	1.00	1.00	0.95	1.00	1.00	0.95	1.00	1.00	0.95	1.00
Ped Bike Factor	1.00		0.96	0.99		0.97	0.99		0.94	0.97		0.98
Fr			0.850			0.850			0.850			0.850
Flt Protected	0.950			0.950			0.950			0.950		
Satd. Flow (prot)	2995	3144	1473	1572	3357	1502	1712	3357	1502	1679	3357	1532
Flt Permitted	0.950			0.950			0.548			0.587		
Satd. Flow (perm)	2988	3144	1416	1549	3357	1463	981	3357	1413	1003	3357	1500
Right Turn on Red			Yes			Yes			Yes			Yes
Satd. Flow (RTOR)			143			143			82			138
Link Speed (k/h)		60			60			50				50
Link Distance (m)		264.5			491.4			387.7				301.9
Travel Time (s)		15.9			29.5			27.9				21.7
Confl. Peds. (#/hr)	6		14	14		6	6		32	32		6
Confl. Bikes (#/hr)						6						
Peak Hour Factor	1.00	1.00	1.00	1.00	1.00	1.00	1.00	1.00	1.00	1.00	1.00	1.00
Heavy Vehicles (%)	12%	10%	5%	10%	3%	3%	1%	3%	3%	3%	3%	1%
Adj. Flow (vph)	125	461	24	28	1492	198	209	267	55	82	103	473
Shared Lane Traffic (%)												
Lane Group Flow (vph)	125	461	24	28	1492	198	209	267	55	82	103	473
Enter Blocked Intersection	No	No	No	No	No	No	No	No	No	No	No	No
Lane Alignment	L NA	Left	R NA	L NA	Left	R NA	L NA	Left	R NA	L NA	Left	R NA
Median Width(m)		9.0			7.4			6.0				6.0
Link Offset(m)		0.0			0.0			0.0				0.0
Crosswalk Width(m)		5.0			5.0			5.0				5.0
Two way Left Turn Lane												
Headway Factor	1.06	1.06	1.06	1.06	1.06	1.06	1.06	1.06	1.06	1.06	1.06	1.06
Turning Speed (k/h)	24		14	24		14	24		14	24		14
Number of Detectors	1	2	1	1	2	1	1	2	1	1	2	1
Detector Template	Left	Thru	Right	Left	Thru	Right	Left	Thru	Right	Left	Thru	Right
Leading Detector (m)	18.6	93.0	18.6	18.6	93.0	18.6	18.6	93.0	18.6	18.6	93.0	18.6
Trailing Detector (m)	0.0	0.0	0.0	0.0	0.0	0.0	0.0	0.0	0.0	0.0	0.0	0.0
Detector 1 Position(m)	0.0	0.0	0.0	0.0	0.0	0.0	0.0	0.0	0.0	0.0	0.0	0.0
Detector 1 Size(m)	18.6	5.5	18.6	18.6	5.5	18.6	18.6	5.5	18.6	18.6	5.5	18.6
Detector 1 Type	Cl+Ex	Cl+Ex	Cl+Ex	Cl+Ex	Cl+Ex	Cl+Ex	Cl+Ex	Cl+Ex	Cl+Ex	Cl+Ex	Cl+Ex	Cl+Ex
Detector 1 Channel												
Detector 1 Extend (s)	0.0	0.0	0.0	0.0	0.0	0.0	0.0	0.0	0.0	0.0	0.0	0.0
Detector 1 Queue (s)	0.0	0.0	0.0	0.0	0.0	0.0	0.0	0.0	0.0	0.0	0.0	0.0
Detector 1 Delay (s)	0.0	0.0	0.0	0.0	0.0	0.0	0.0	0.0	0.0	0.0	0.0	0.0
Detector 2 Position(m)		87.5			87.5			87.5				87.5
Detector 2 Size(m)		5.5			5.5			5.5				5.5
Detector 2 Type		Cl+Ex			Cl+Ex			Cl+Ex				Cl+Ex
Detector 2 Channel												
Detector 2 Extend (s)		0.0			0.0			0.0				0.0
Turn Type	Prot	NA	Perm	Prot	NA	Perm	pm+pt	NA	Perm	Perm	NA	Perm
Protected Phases	5	2		1	6		3	8			4	
Permitted Phases			2			6	8		8	4		4
Detector Phase	5	2	2	1	6	6	3	8	8	4	4	4



Lane Group	EBL	EBT	EBR	WBL	WBT	WBR	NBL	NBT	NBR	SBL	SBT	SBR
Switch Phase												
Minimum Initial (s)	5.0	10.0	10.0	5.0	10.0	10.0	5.0	10.0	10.0	10.0	10.0	10.0
Minimum Split (s)	11.6	26.2	26.2	11.2	26.2	26.2	11.7	32.7	32.7	32.7	32.7	32.7
Total Split (s)	13.0	72.0	72.0	13.0	72.0	72.0	12.0	45.0	45.0	33.0	33.0	33.0
Total Split (%)	10.0%	55.4%	55.4%	10.0%	55.4%	55.4%	9.2%	34.6%	34.6%	25.4%	25.4%	25.4%
Maximum Green (s)	6.4	65.8	65.8	6.8	65.8	65.8	5.3	38.3	38.3	26.3	26.3	26.3
Yellow Time (s)	3.7	3.7	3.7	3.7	3.7	3.7	3.3	3.3	3.3	3.3	3.3	3.3
All-Red Time (s)	2.9	2.5	2.5	2.5	2.5	2.5	3.4	3.4	3.4	3.4	3.4	3.4
Lost Time Adjust (s)	0.0	0.0	0.0	0.0	0.0	0.0	0.0	0.0	0.0	0.0	0.0	0.0
Total Lost Time (s)	6.6	6.2	6.2	6.2	6.2	6.2	6.7	6.7	6.7	6.7	6.7	6.7
Lead/Lag	Lead	Lag	Lag	Lead	Lag	Lag	Lead			Lag	Lag	Lag
Lead-Lag Optimize?												
Vehicle Extension (s)	3.0	3.0	3.0	3.0	3.0	3.0	3.0	3.0	3.0	3.0	3.0	3.0
Recall Mode	None	C-Max	C-Max	None	C-Max	C-Max	None	None	None	None	None	None
Walk Time (s)		7.0	7.0		7.0	7.0		7.0	7.0	7.0	7.0	7.0
Flash Dont Walk (s)		13.0	13.0		13.0	13.0		19.0	19.0	19.0	19.0	19.0
Pedestrian Calls (#/hr)		14	14		6	6		32	32	6	6	6
Act Effct Green (s)	6.4	71.0	71.0	6.5	65.8	65.8	38.3	38.3	38.3	26.3	26.3	26.3
Actuated g/C Ratio	0.05	0.55	0.55	0.05	0.51	0.51	0.29	0.29	0.29	0.20	0.20	0.20
v/c Ratio	0.85	0.27	0.03	0.36	0.88	0.24	0.66	0.27	0.12	0.41	0.15	1.15
Control Delay	103.8	17.1	0.1	72.6	35.9	6.2	49.8	36.0	3.3	52.1	43.4	123.2
Queue Delay	0.0	0.0	0.0	0.0	0.0	0.0	0.0	0.0	0.0	0.0	0.0	0.0
Total Delay	103.8	17.1	0.1	72.6	35.9	6.2	49.8	36.0	3.3	52.1	43.4	123.2
LOS	F	B	A	E	D	A	D	D	A	D	D	F
Approach Delay		34.2			33.0			38.1			101.9	
Approach LOS		C			C			D			F	
Queue Length 50th (m)	15.3	32.2	0.0	6.5	159.9	6.5	39.7	25.4	0.0	17.0	10.6	~103.1
Queue Length 95th (m)	#31.9	42.5	0.0	16.0	191.7	18.4	60.8	36.1	4.2	31.9	18.1	#163.9
Internal Link Dist (m)		240.5			467.4			363.7			277.9	
Turn Bay Length (m)	140.0		80.0	105.0		60.0	50.0		50.0	55.0		60.0
Base Capacity (vph)	147	1717	838	82	1699	811	318	989	474	202	679	413
Starvation Cap Reductn	0	0	0	0	0	0	0	0	0	0	0	0
Spillback Cap Reductn	0	0	0	0	0	0	0	0	0	0	0	0
Storage Cap Reductn	0	0	0	0	0	0	0	0	0	0	0	0
Reduced v/c Ratio	0.85	0.27	0.03	0.34	0.88	0.24	0.66	0.27	0.12	0.41	0.15	1.15

Intersection Summary

Area Type: Other
 Cycle Length: 130
 Actuated Cycle Length: 130
 Offset: 0 (0%), Referenced to phase 2:EBT and 6:WBT, Start of Green
 Natural Cycle: 115
 Control Type: Actuated-Coordinated
 Maximum v/c Ratio: 1.15
 Intersection Signal Delay: 46.9 Intersection LOS: D
 Intersection Capacity Utilization 103.6% ICU Level of Service G
 Analysis Period (min) 15
 ~ Volume exceeds capacity, queue is theoretically infinite.
 Queue shown is maximum after two cycles.
 # 95th percentile volume exceeds capacity, queue may be longer.
 Queue shown is maximum after two cycles.

Splits and Phases: 1: Orleans & Innes



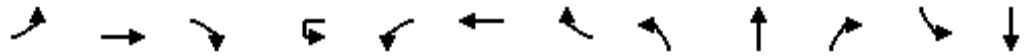

Lane Group	EBL	EBT	EBR	WBU	WBL	WBT	WBR	NBL	NBT	NBR	SBL	SBT
Lane Configurations												
Traffic Volume (vph)	12	530	21	3	37	1526	20	14	12	38	34	9
Future Volume (vph)	12	530	21	3	37	1526	20	14	12	38	34	9
Ideal Flow (vphpl)	1800	1800	1800	1800	1800	1800	1800	1800	1800	1800	1800	1800
Storage Length (m)	100.0		0.0		100.0		0.0	0.0		0.0	0.0	
Storage Lanes	1		0		1		0	0		0	0	
Taper Length (m)	35.0				25.0			2.5			2.5	
Lane Util. Factor	1.00	0.95	0.95	0.95	1.00	0.95	0.95	1.00	1.00	1.00	1.00	1.00
Ped Bike Factor	1.00	1.00			0.99	1.00			0.99			0.99
Frt		0.994				0.998			0.920			0.932
Flt Protected	0.950				0.950				0.989			0.981
Satd. Flow (prot)	1586	3126	0	0	1515	3349	0	0	1568	0	0	1596
Flt Permitted	0.129				0.446				0.922			0.851
Satd. Flow (perm)	215	3126	0	0	707	3349	0	0	1458	0	0	1384
Right Turn on Red			Yes				Yes			Yes		
Satd. Flow (RTOR)		6				2			38			41
Link Speed (k/h)		60				60			40			40
Link Distance (m)		491.4				142.1			212.5			273.4
Travel Time (s)		29.5				8.5			19.1			24.6
Confl. Peds. (#/hr)	4		7		7		4	11				
Confl. Bikes (#/hr)			1							1		
Peak Hour Factor	1.00	1.00	1.00	1.00	1.00	1.00	1.00	1.00	1.00	1.00	1.00	1.00
Heavy Vehicles (%)	9%	10%	5%	3%	15%	3%	5%	1%	15%	3%	1%	10%
Adj. Flow (vph)	12	530	21	3	37	1526	20	14	12	38	34	9
Shared Lane Traffic (%)												
Lane Group Flow (vph)	12	551	0	0	40	1546	0	0	64	0	0	86
Enter Blocked Intersection	No	No	No	No	No	Yes	No	No	No	No	No	No
Lane Alignment	Left	Left	Right	R NA	Left	Left	Right	L NA	Left	R NA	L NA	Left
Median Width(m)		5.0				5.0			0.0			0.0
Link Offset(m)		0.0				0.0			0.0			0.0
Crosswalk Width(m)		10.0				10.0			5.0			5.0
Two way Left Turn Lane												
Headway Factor	1.06	1.06	1.06	1.06	1.06	1.06	1.06	1.06	1.06	1.06	1.06	1.06
Turning Speed (k/h)	24		14	14	24		14	24		14	24	
Number of Detectors	1	2		1	1	2		1	2		1	2
Detector Template	Left	Thru		Left	Left	Thru		Left	Thru		Left	Thru
Leading Detector (m)	18.6	93.0		18.6	18.6	93.0		18.6	93.0		18.6	93.0
Trailing Detector (m)	0.0	0.0		0.0	0.0	0.0		0.0	0.0		0.0	0.0
Detector 1 Position(m)	0.0	0.0		0.0	0.0	0.0		0.0	0.0		0.0	0.0
Detector 1 Size(m)	18.6	5.5		18.6	18.6	5.5		18.6	5.5		18.6	5.5
Detector 1 Type	Cl+Ex	Cl+Ex		Cl+Ex	Cl+Ex	Cl+Ex		Cl+Ex	Cl+Ex		Cl+Ex	Cl+Ex
Detector 1 Channel												
Detector 1 Extend (s)	0.0	0.0		0.0	0.0	0.0		0.0	0.0		0.0	0.0
Detector 1 Queue (s)	0.0	0.0		0.0	0.0	0.0		0.0	0.0		0.0	0.0
Detector 1 Delay (s)	0.0	0.0		0.0	0.0	0.0		0.0	0.0		0.0	0.0
Detector 2 Position(m)		87.5				87.5			87.5			87.5
Detector 2 Size(m)		5.5				5.5			5.5			5.5
Detector 2 Type		Cl+Ex				Cl+Ex			Cl+Ex			Cl+Ex
Detector 2 Channel												
Detector 2 Extend (s)		0.0				0.0			0.0			0.0
Turn Type	Perm	NA		Perm	Perm	NA		Perm	NA		Perm	NA
Protected Phases		2				6			8			4
Permitted Phases	2			6	6			8			4	
Detector Phase	2	2		6	6	6		8	8		4	4

Lane Group	SBR
Lane Configurations	
Traffic Volume (vph)	43
Future Volume (vph)	43
Ideal Flow (vphpl)	1800
Storage Length (m)	0.0
Storage Lanes	0
Taper Length (m)	
Lane Util. Factor	1.00
Ped Bike Factor	
Frt	
Flt Protected	
Satd. Flow (prot)	0
Flt Permitted	
Satd. Flow (perm)	0
Right Turn on Red	Yes
Satd. Flow (RTOR)	
Link Speed (k/h)	
Link Distance (m)	
Travel Time (s)	
Confl. Peds. (#/hr)	11
Confl. Bikes (#/hr)	1
Peak Hour Factor	1.00
Heavy Vehicles (%)	3%
Adj. Flow (vph)	43
Shared Lane Traffic (%)	
Lane Group Flow (vph)	0
Enter Blocked Intersection	No
Lane Alignment	R NA
Median Width(m)	
Link Offset(m)	
Crosswalk Width(m)	
Two way Left Turn Lane	
Headway Factor	1.06
Turning Speed (k/h)	14
Number of Detectors	
Detector Template	
Leading Detector (m)	
Trailing Detector (m)	
Detector 1 Position(m)	
Detector 1 Size(m)	
Detector 1 Type	
Detector 1 Channel	
Detector 1 Extend (s)	
Detector 1 Queue (s)	
Detector 1 Delay (s)	
Detector 2 Position(m)	
Detector 2 Size(m)	
Detector 2 Type	
Detector 2 Channel	
Detector 2 Extend (s)	
Turn Type	
Protected Phases	
Permitted Phases	
Detector Phase	

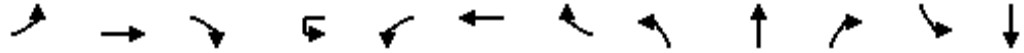

Lane Group	EBL	EBT	EBR	WBU	WBL	WBT	WBR	NBL	NBT	NBR	SBL	SBT
Switch Phase												
Minimum Initial (s)	10.0	10.0		10.0	10.0	10.0		10.0	10.0		10.0	10.0
Minimum Split (s)	39.2	39.2		39.2	39.2	39.2		37.8	37.8		37.8	37.8
Total Split (s)	82.0	82.0		82.0	82.0	82.0		38.0	38.0		38.0	38.0
Total Split (%)	68.3%	68.3%		68.3%	68.3%	68.3%		31.7%	31.7%		31.7%	31.7%
Maximum Green (s)	75.8	75.8		75.8	75.8	75.8		31.2	31.2		31.2	31.2
Yellow Time (s)	3.7	3.7		3.7	3.7	3.7		3.0	3.0		3.0	3.0
All-Red Time (s)	2.5	2.5		2.5	2.5	2.5		3.8	3.8		3.8	3.8
Lost Time Adjust (s)	0.0	0.0			0.0	0.0			0.0			0.0
Total Lost Time (s)	6.2	6.2			6.2	6.2			6.8			6.8
Lead/Lag												
Lead-Lag Optimize?												
Vehicle Extension (s)	3.0	3.0		3.0	3.0	3.0		3.0	3.0		3.0	3.0
Recall Mode	C-Max	C-Max		C-Max	C-Max	C-Max		None	None		None	None
Walk Time (s)	15.0	15.0		15.0	15.0	15.0		7.0	7.0		7.0	7.0
Flash Dont Walk (s)	18.0	18.0		18.0	18.0	18.0		24.0	24.0		24.0	24.0
Pedestrian Calls (#/hr)	7	7		4	4	4		1	1		11	11
Act Effct Green (s)	88.6	88.6			88.6	88.6			18.4			18.4
Actuated g/C Ratio	0.74	0.74			0.74	0.74			0.15			0.15
v/c Ratio	0.08	0.24			0.08	0.63			0.25			0.35
Control Delay	9.0	6.5			2.4	3.7			21.2			26.5
Queue Delay	0.0	0.0			0.0	0.0			0.0			0.0
Total Delay	9.0	6.5			2.4	3.7			21.2			26.5
LOS	A	A			A	A			C			C
Approach Delay		6.5				3.7			21.2			26.5
Approach LOS		A				A			C			C
Queue Length 50th (m)	0.4	11.5			1.2	30.4			5.4			9.4
Queue Length 95th (m)	3.5	33.8			m1.0	13.3			14.4			19.8
Internal Link Dist (m)		467.4					118.1		188.5			249.4
Turn Bay Length (m)	100.0				100.0							
Base Capacity (vph)	158	2310			521	2473			407			390
Starvation Cap Reductn	0	0			0	8			0			0
Spillback Cap Reductn	0	0			0	0			0			0
Storage Cap Reductn	0	0			0	0			0			0
Reduced v/c Ratio	0.08	0.24			0.08	0.63			0.16			0.22

Intersection Summary

Area Type: Other
 Cycle Length: 120
 Actuated Cycle Length: 120
 Offset: 22 (18%), Referenced to phase 2:EBTL and 6:WBTL, Start of Green
 Natural Cycle: 90
 Control Type: Actuated-Coordinated
 Maximum v/c Ratio: 0.63
 Intersection Signal Delay: 5.7
 Intersection LOS: A
 Intersection Capacity Utilization 70.8%
 ICU Level of Service C
 Analysis Period (min) 15
 m Volume for 95th percentile queue is metered by upstream signal.

Splits and Phases: 2: Page & Innes

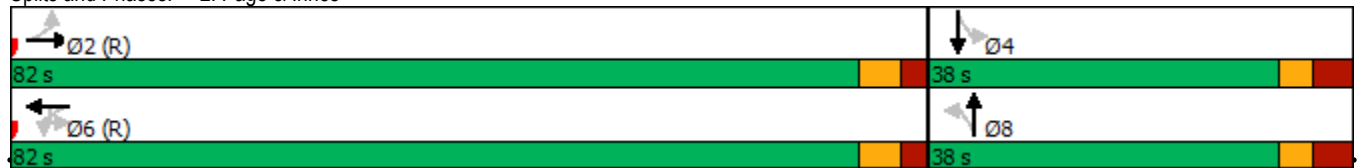

↙

Lane Group	SBR
Switch Phase	
Minimum Initial (s)	
Minimum Split (s)	
Total Split (s)	
Total Split (%)	
Maximum Green (s)	
Yellow Time (s)	
All-Red Time (s)	
Lost Time Adjust (s)	
Total Lost Time (s)	
Lead/Lag	
Lead-Lag Optimize?	
Vehicle Extension (s)	
Recall Mode	
Walk Time (s)	
Flash Dont Walk (s)	
Pedestrian Calls (#/hr)	
Act Effct Green (s)	
Actuated g/C Ratio	
v/c Ratio	
Control Delay	
Queue Delay	
Total Delay	
LOS	
Approach Delay	
Approach LOS	
Queue Length 50th (m)	
Queue Length 95th (m)	
Internal Link Dist (m)	
Turn Bay Length (m)	
Base Capacity (vph)	
Starvation Cap Reductn	
Spillback Cap Reductn	
Storage Cap Reductn	
Reduced v/c Ratio	
Intersection Summary	



Lane Group	EBU	EBT	EBR	WBL	WBT	NBL	NBR	Ø3
Lane Configurations								
Traffic Volume (vph)	10	559	68	52	1363	164	64	
Future Volume (vph)	10	559	68	52	1363	164	64	
Ideal Flow (vphpl)	1800	1800	1800	1800	1800	1800	1800	
Storage Length (m)	30.0		50.0	65.0		70.0	70.0	
Storage Lanes	1		1	1		1	1	
Taper Length (m)	30.0			80.0		20.0		
Lane Util. Factor	1.00	0.95	1.00	1.00	0.95	0.97	1.00	
Ped Bike Factor			0.95	0.99		0.97	0.98	
Frt			0.850				0.850	
Flt Protected	0.950			0.950		0.950		
Satd. Flow (prot)	1679	3357	1502	1679	3357	3257	1502	
Flt Permitted	0.157			0.438		0.950		
Satd. Flow (perm)	277	3357	1433	765	3357	3165	1477	
Right Turn on Red			Yes				Yes	
Satd. Flow (RTOR)			68				64	
Link Speed (k/h)		60			60	50		
Link Distance (m)		94.7			238.7	204.5		
Travel Time (s)		5.7			14.3	14.7		
Confl. Peds. (#/hr)			11	11		5	5	
Peak Hour Factor	1.00	1.00	1.00	1.00	1.00	1.00	1.00	
Adj. Flow (vph)	10	559	68	52	1363	164	64	
Shared Lane Traffic (%)								
Lane Group Flow (vph)	10	559	68	52	1363	164	64	
Enter Blocked Intersection	No	No	No	No	No	No	No	
Lane Alignment	R NA	Left	Right	Left	Left	L NA	R NA	
Median Width(m)		5.0			5.0	7.4		
Link Offset(m)		0.0			0.0	0.0		
Crosswalk Width(m)		9.0			9.0	9.0		
Two way Left Turn Lane								
Headway Factor	1.06	1.06	1.06	1.06	1.06	1.06	1.06	
Turning Speed (k/h)	14		14	24		24	14	
Number of Detectors	1	2	1	1	2	1	1	
Detector Template	Left	Thru	Right	Left	Thru	Left	Right	
Leading Detector (m)	18.6	93.0	18.6	18.6	93.0	18.6	18.6	
Trailing Detector (m)	0.0	0.0	0.0	0.0	0.0	0.0	0.0	
Detector 1 Position(m)	0.0	0.0	0.0	0.0	0.0	0.0	0.0	
Detector 1 Size(m)	18.6	5.5	18.6	18.6	5.5	18.6	18.6	
Detector 1 Type	CI+Ex	CI+Ex	CI+Ex	CI+Ex	CI+Ex	CI+Ex	CI+Ex	
Detector 1 Channel								
Detector 1 Extend (s)	0.0	0.0	0.0	0.0	0.0	0.0	0.0	
Detector 1 Queue (s)	0.0	0.0	0.0	0.0	0.0	0.0	0.0	
Detector 1 Delay (s)	0.0	0.0	0.0	0.0	0.0	0.0	0.0	
Detector 2 Position(m)		87.5			87.5			
Detector 2 Size(m)		5.5			5.5			
Detector 2 Type		CI+Ex			CI+Ex			
Detector 2 Channel								
Detector 2 Extend (s)		0.0			0.0			
Turn Type	Perm	NA	Perm	Perm	NA	Prot	Perm	
Protected Phases		2			6	4		3
Permitted Phases	2		2	6			8	
Detector Phase	2	2	2	6	6	4	8	
Switch Phase								
Minimum Initial (s)	10.0	10.0	10.0	10.0	10.0	5.0	10.0	3.0



Lane Group	EBU	EBT	EBR	WBL	WBT	NBL	NBR	Ø3
Minimum Split (s)	31.2	31.2	31.2	31.2	31.2	11.3	37.3	30.0
Total Split (s)	73.0	73.0	73.0	73.0	73.0	17.0	47.0	30.0
Total Split (%)	60.8%	60.8%	60.8%	60.8%	60.8%	14.2%	39.2%	25%
Maximum Green (s)	66.8	66.8	66.8	66.8	66.8	10.7	40.7	28.0
Yellow Time (s)	3.7	3.7	3.7	3.7	3.7	3.3	3.3	2.0
All-Red Time (s)	2.5	2.5	2.5	2.5	2.5	3.0	3.0	0.0
Lost Time Adjust (s)	0.0	0.0	0.0	0.0	0.0	0.0	0.0	
Total Lost Time (s)	6.2	6.2	6.2	6.2	6.2	6.3	6.3	
Lead/Lag						Lag		Lead
Lead-Lag Optimize?								
Vehicle Extension (s)	3.0	3.0	3.0	3.0	3.0	3.0	3.0	3.0
Recall Mode	C-Max	C-Max	C-Max	C-Max	C-Max	None	None	None
Walk Time (s)	7.0	7.0	7.0	7.0	7.0			7.0
Flash Dont Walk (s)	18.0	18.0	18.0	18.0	18.0			21.0
Pedestrian Calls (#/hr)	10	10	10	10	10			10
Act Effct Green (s)	85.0	85.0	85.0	85.0	85.0	10.5	22.5	
Actuated g/C Ratio	0.71	0.71	0.71	0.71	0.71	0.09	0.19	
v/c Ratio	0.05	0.24	0.07	0.10	0.57	0.57	0.19	
Control Delay	8.9	6.2	1.2	5.7	9.0	61.0	8.0	
Queue Delay	0.0	0.0	0.0	0.0	0.0	0.0	0.0	
Total Delay	8.9	6.2	1.2	5.7	9.0	61.0	8.0	
LOS	A	A	A	A	A	E	A	
Approach Delay		5.7			8.9	46.1		
Approach LOS		A			A	D		
Queue Length 50th (m)	0.3	11.5	0.0	1.2	21.6	17.7	0.0	
Queue Length 95th (m)	2.1	22.6	1.6	m3.9	141.2	28.1	8.6	
Internal Link Dist (m)		70.7			214.7	180.5		
Turn Bay Length (m)	30.0		50.0	65.0		70.0	70.0	
Base Capacity (vph)	196	2376	1034	541	2376	293	543	
Starvation Cap Reductn	0	0	0	0	0	0	0	
Spillback Cap Reductn	0	0	0	0	0	0	0	
Storage Cap Reductn	0	0	0	0	0	0	0	
Reduced v/c Ratio	0.05	0.24	0.07	0.10	0.57	0.56	0.12	

Intersection Summary

Area Type: Other

Cycle Length: 120

Actuated Cycle Length: 120

Offset: 24 (20%), Referenced to phase 2:EBTU and 6:WBTL, Start of Green

Natural Cycle: 90

Control Type: Actuated-Coordinated

Maximum v/c Ratio: 0.57

Intersection Signal Delay: 11.7

Intersection LOS: B

Intersection Capacity Utilization 61.0%

ICU Level of Service B

Analysis Period (min) 15

m Volume for 95th percentile queue is metered by upstream signal.

Splits and Phases: 3: Lamarche & Innes

<p>Ø2 (R) 73 s</p>	<p>Ø3 30 s</p>	<p>Ø4 17 s</p>
<p>Ø6 (R) 73 s</p>	<p>Ø8 47 s</p>	

Lane Group	EBL	EBT	EBR	WBL	WBT	WBR	NBL	NBT	NBR	SBL	SBT	SBR
Lane Configurations												
Traffic Volume (vph)	6	516	38	12	1410	4	99	0	39	1	0	3
Future Volume (vph)	6	516	38	12	1410	4	99	0	39	1	0	3
Ideal Flow (vphpl)	1800	1800	1800	1800	1800	1800	1800	1800	1800	1800	1800	1800
Storage Length (m)	65.0		0.0	40.0		0.0	0.0		0.0	0.0		0.0
Storage Lanes	1		0	1		0	0		1	0		0
Taper Length (m)	80.0			30.0			20.0			20.0		
Lane Util. Factor	1.00	0.95	0.95	1.00	0.95	0.95	1.00	1.00	1.00	1.00	1.00	1.00
Ped Bike Factor	1.00				1.00			1.00	0.99		0.99	
Fr _t		0.990							0.850		0.899	
Fl _t Protected	0.950			0.950				0.950			0.988	
Satd. Flow (prot)	1712	3112	0	1712	3357	0	0	1712	1532	0	1583	0
Fl _t Permitted	0.161			0.445				0.755			0.942	
Satd. Flow (perm)	290	3112	0	802	3357	0	0	1357	1511	0	1509	0
Right Turn on Red			Yes			Yes			Yes			Yes
Satd. Flow (RTOR)		14							39			28
Link Speed (k/h)		60			60				40			40
Link Distance (m)		238.7			292.8				151.9			62.6
Travel Time (s)		14.3			17.6				13.7			5.6
Confl. Peds. (#/hr)	7					7	2		1	1		2
Confl. Bikes (#/hr)						1						
Peak Hour Factor	1.00	1.00	1.00	1.00	1.00	1.00	1.00	1.00	1.00	1.00	1.00	1.00
Heavy Vehicles (%)	1%	10%	10%	1%	3%	1%	1%	1%	1%	1%	1%	1%
Adj. Flow (vph)	6	516	38	12	1410	4	99	0	39	1	0	3
Shared Lane Traffic (%)												
Lane Group Flow (vph)	6	554	0	12	1414	0	0	99	39	0	4	0
Enter Blocked Intersection	No	No	No	No	No	No	No	No	No	No	No	No
Lane Alignment	L NA	Left	R NA	L NA	Left	R NA	L NA	Left	R NA	L NA	Left	R NA
Median Width(m)		5.0			5.0			0.0			0.0	
Link Offset(m)		0.0			0.0			0.0			0.0	
Crosswalk Width(m)		9.0			9.0			9.0			9.0	
Two way Left Turn Lane												
Headway Factor	1.06	1.06	1.06	1.06	1.06	1.06	1.06	1.06	1.06	1.06	1.06	1.06
Turning Speed (k/h)	24		14	24		14	24		14	24		14
Number of Detectors	1	2		1	2		1	2	1	1		2
Detector Template	Left	Thru		Left	Thru		Left	Thru	Right	Left		Thru
Leading Detector (m)	18.6	93.0		18.6	93.0		18.6	93.0	18.6	18.6		93.0
Trailing Detector (m)	0.0	0.0		0.0	0.0		0.0	0.0	0.0	0.0		0.0
Detector 1 Position(m)	0.0	0.0		0.0	0.0		0.0	0.0	0.0	0.0		0.0
Detector 1 Size(m)	18.6	5.5		18.6	5.5		18.6	5.5	18.6	18.6		5.5
Detector 1 Type	Cl+Ex	Cl+Ex		Cl+Ex	Cl+Ex		Cl+Ex	Cl+Ex	Cl+Ex	Cl+Ex		Cl+Ex
Detector 1 Channel												
Detector 1 Extend (s)	0.0	0.0		0.0	0.0		0.0	0.0	0.0	0.0		0.0
Detector 1 Queue (s)	0.0	0.0		0.0	0.0		0.0	0.0	0.0	0.0		0.0
Detector 1 Delay (s)	0.0	0.0		0.0	0.0		0.0	0.0	0.0	0.0		0.0
Detector 2 Position(m)		87.5			87.5			87.5				87.5
Detector 2 Size(m)		5.5			5.5			5.5				5.5
Detector 2 Type		Cl+Ex			Cl+Ex			Cl+Ex				Cl+Ex
Detector 2 Channel												
Detector 2 Extend (s)		0.0			0.0			0.0				0.0
Turn Type	Perm	NA		Perm	NA		Perm	NA	Perm	Perm		NA
Protected Phases		2			6			8				4
Permitted Phases	2			6			8		8	4		
Detector Phase	2	2		6	6		8	8	8	4		4



Lane Group	EBL	EBT	EBR	WBL	WBT	WBR	NBL	NBT	NBR	SBL	SBT	SBR
Switch Phase												
Minimum Initial (s)	10.0	10.0		10.0	10.0		10.0	10.0	10.0	10.0	10.0	
Minimum Split (s)	32.1	32.1		35.1	35.1		32.3	32.3	32.3	32.3	32.3	
Total Split (s)	87.0	87.0		87.0	87.0		33.0	33.0	33.0	33.0	33.0	
Total Split (%)	72.5%	72.5%		72.5%	72.5%		27.5%	27.5%	27.5%	27.5%	27.5%	
Maximum Green (s)	80.9	80.9		80.9	80.9		26.7	26.7	26.7	26.7	26.7	
Yellow Time (s)	3.7	3.7		3.7	3.7		3.3	3.3	3.3	3.3	3.3	
All-Red Time (s)	2.4	2.4		2.4	2.4		3.0	3.0	3.0	3.0	3.0	
Lost Time Adjust (s)	0.0	0.0		0.0	0.0			0.0	0.0		0.0	
Total Lost Time (s)	6.1	6.1		6.1	6.1			6.3	6.3		6.3	
Lead/Lag												
Lead-Lag Optimize?												
Vehicle Extension (s)	3.0	3.0		3.0	3.0		3.0	3.0	3.0	3.0	3.0	
Recall Mode	C-Max	C-Max		C-Max	C-Max		None	None	None	None	None	
Walk Time (s)	12.0	12.0		12.0	12.0		7.0	7.0	7.0	7.0	7.0	
Flash Dont Walk (s)	14.0	14.0		14.0	14.0		19.0	19.0	19.0	19.0	19.0	
Pedestrian Calls (#/hr)	1	1		7	7		1	1	1	2	2	
Act Effct Green (s)	92.0	92.0		92.0	92.0			15.6	15.6		15.6	
Actuated g/C Ratio	0.77	0.77		0.77	0.77			0.13	0.13		0.13	
v/c Ratio	0.03	0.23		0.02	0.55			0.56	0.17		0.02	
Control Delay	4.3	3.6		4.9	7.4			59.7	14.0		0.2	
Queue Delay	0.0	0.0		0.0	0.0			0.0	0.0		0.0	
Total Delay	4.3	3.6		4.9	7.4			59.7	14.0		0.2	
LOS	A	A		A	A			E	B		A	
Approach Delay		3.6			7.4			46.8			0.3	
Approach LOS		A			A			D			A	
Queue Length 50th (m)	0.2	10.8		0.5	51.3			20.8	0.0		0.0	
Queue Length 95th (m)	1.1	15.7		2.6	98.8			33.3	8.3		0.0	
Internal Link Dist (m)		214.7			268.8			127.9			38.6	
Turn Bay Length (m)	65.0			40.0								
Base Capacity (vph)	222	2387		614	2572			301	366		357	
Starvation Cap Reductn	0	0		0	0			0	0		0	
Spillback Cap Reductn	0	0		0	0			0	0		0	
Storage Cap Reductn	0	0		0	0			0	0		0	
Reduced v/c Ratio	0.03	0.23		0.02	0.55			0.33	0.11		0.01	

Intersection Summary

Area Type:	Other
Cycle Length:	120
Actuated Cycle Length:	120
Offset:	4 (3%), Referenced to phase 2:EBTL and 6:WBTL, Start of Green
Natural Cycle:	70
Control Type:	Actuated-Coordinated
Maximum v/c Ratio:	0.56
Intersection Signal Delay:	8.9
Intersection LOS:	A
Intersection Capacity Utilization:	64.4%
ICU Level of Service:	C
Analysis Period (min):	15

Splits and Phases: 4: 473 E of Page & Innes





Lane Group	EBL	EBT	WBT	WBR	SBL	SBR
Lane Configurations		↑↑	↑↑			↗
Traffic Volume (vph)	0	637	1522	15	0	8
Future Volume (vph)	0	637	1522	15	0	8
Ideal Flow (vphpl)	1800	1800	1800	1800	1800	1800
Storage Length (m)	15.0			0.0	0.0	0.0
Storage Lanes	0			0	0	1
Taper Length (m)	0.0				20.0	
Lane Util. Factor	1.00	0.95	0.95	0.95	1.00	1.00
Ped Bike Factor						
Ft			0.999			0.865
Flt Protected						
Satd. Flow (prot)	0	3357	3355	0	0	1559
Flt Permitted						
Satd. Flow (perm)	0	3357	3355	0	0	1559
Link Speed (k/h)		60	60		30	
Link Distance (m)		142.1	94.7		74.6	
Travel Time (s)		8.5	5.7		9.0	
Confl. Peds. (#/hr)	5			5		
Confl. Bikes (#/hr)				1		1
Peak Hour Factor	1.00	1.00	1.00	1.00	1.00	1.00
Heavy Vehicles (%)	1%	3%	3%	1%	1%	1%
Adj. Flow (vph)	0	637	1522	15	0	8
Shared Lane Traffic (%)						
Lane Group Flow (vph)	0	637	1537	0	0	8
Enter Blocked Intersection	No	Yes	Yes	No	No	No
Lane Alignment	L NA	Left	Left	R NA	L NA	R NA
Median Width(m)		5.0	5.0		0.0	
Link Offset(m)		0.0	0.0		0.0	
Crosswalk Width(m)		9.0	9.0		9.0	
Two way Left Turn Lane						
Headway Factor	1.06	1.06	1.06	1.06	1.06	1.06
Turning Speed (k/h)	97			97	97	97
Sign Control		Free	Free		Stop	
Intersection Summary						
Area Type:	Other					
Control Type:	Unsignalized					
Intersection Capacity Utilization	54.9%			ICU Level of Service A		
Analysis Period (min)	15					

1: Orleans & Innes
PM Peak Hour

3493-3499 Innes Road
2025 Total Traffic



Lane Group	EBL	EBT	EBR	WBL	WBT	WBR	NBL	NBT	NBR	SBL	SBT	SBR
Lane Configurations	↖↖	↖↖	↖	↖	↖↖	↖	↖	↖↖	↖	↖	↖↖	↖
Traffic Volume (vph)	596	1744	163	65	763	153	66	232	107	200	248	209
Future Volume (vph)	596	1744	163	65	763	153	66	232	107	200	248	209
Ideal Flow (vphpl)	1800	1800	1800	1800	1800	1800	1800	1800	1800	1800	1800	1800
Storage Length (m)	140.0		80.0	105.0		60.0	50.0		50.0	55.0		60.0
Storage Lanes	2		1	1		1	1		1	1		1
Taper Length (m)	40.0			40.0			10.0			20.0		
Lane Util. Factor	0.97	0.95	1.00	1.00	0.95	1.00	1.00	0.95	1.00	1.00	0.95	1.00
Ped Bike Factor	0.99		0.94	1.00		0.97	0.99		0.96	0.98		0.97
Frt			0.850			0.850			0.850			0.850
Flt Protected	0.950			0.950			0.950			0.950		
Satd. Flow (prot)	3288	3357	1532	1712	3293	1517	1712	3390	1532	1712	3390	1532
Flt Permitted	0.950			0.950			0.456			0.607		
Satd. Flow (perm)	3263	3357	1446	1705	3293	1475	811	3390	1473	1072	3390	1480
Right Turn on Red			Yes			Yes			Yes			Yes
Satd. Flow (RTOR)			139			195			134			209
Link Speed (k/h)		60			60			50			50	
Link Distance (m)		264.5			491.4			387.7			301.9	
Travel Time (s)		15.9			29.5			27.9			21.7	
Confl. Peds. (#/hr)	7		22	22		7	15		18	18		15
Confl. Bikes (#/hr)			4			3						
Peak Hour Factor	1.00	1.00	1.00	1.00	1.00	1.00	1.00	1.00	1.00	1.00	1.00	1.00
Heavy Vehicles (%)	2%	3%	1%	1%	5%	2%	1%	2%	1%	1%	2%	1%
Adj. Flow (vph)	596	1744	163	65	763	153	66	232	107	200	248	209
Shared Lane Traffic (%)												
Lane Group Flow (vph)	596	1744	163	65	763	153	66	232	107	200	248	209
Enter Blocked Intersection	No	No	No	No	No	No	No	No	No	No	No	No
Lane Alignment	L NA	Left	R NA	L NA	Left	R NA	L NA	Left	R NA	L NA	Left	R NA
Median Width(m)		9.0			7.4			6.0			6.0	
Link Offset(m)		0.0			0.0			0.0			0.0	
Crosswalk Width(m)		5.0			5.0			5.0			5.0	
Two way Left Turn Lane												
Headway Factor	1.06	1.06	1.06	1.06	1.06	1.06	1.06	1.06	1.06	1.06	1.06	1.06
Turning Speed (k/h)	24		14	24		14	24		14	24		14
Number of Detectors	1	2	1	1	2	1	1	2	1	1	2	1
Detector Template	Left	Thru	Right	Left	Thru	Right	Left	Thru	Right	Left	Thru	Right
Leading Detector (m)	18.6	93.0	18.6	18.6	93.0	18.6	18.6	93.0	18.6	18.6	93.0	18.6
Trailing Detector (m)	0.0	0.0	0.0	0.0	0.0	0.0	0.0	0.0	0.0	0.0	0.0	0.0
Detector 1 Position(m)	0.0	0.0	0.0	0.0	0.0	0.0	0.0	0.0	0.0	0.0	0.0	0.0
Detector 1 Size(m)	18.6	5.5	18.6	18.6	5.5	18.6	18.6	5.5	18.6	18.6	5.5	18.6
Detector 1 Type	Cl+Ex	Cl+Ex	Cl+Ex	Cl+Ex	Cl+Ex	Cl+Ex	Cl+Ex	Cl+Ex	Cl+Ex	Cl+Ex	Cl+Ex	Cl+Ex
Detector 1 Channel												
Detector 1 Extend (s)	0.0	0.0	0.0	0.0	0.0	0.0	0.0	0.0	0.0	0.0	0.0	0.0
Detector 1 Queue (s)	0.0	0.0	0.0	0.0	0.0	0.0	0.0	0.0	0.0	0.0	0.0	0.0
Detector 1 Delay (s)	0.0	0.0	0.0	0.0	0.0	0.0	0.0	0.0	0.0	0.0	0.0	0.0
Detector 2 Position(m)		87.5			87.5			87.5			87.5	
Detector 2 Size(m)		5.5			5.5			5.5			5.5	
Detector 2 Type		Cl+Ex			Cl+Ex			Cl+Ex			Cl+Ex	
Detector 2 Channel												
Detector 2 Extend (s)		0.0			0.0			0.0			0.0	
Turn Type	Prot	NA	Perm	Prot	NA	Perm	pm+pt	NA	Perm	Perm	NA	Perm
Protected Phases	5	2		1	6		3	8			4	
Permitted Phases			2			6	8		8	4		4
Detector Phase	5	2	2	1	6	6	3	8	8	4	4	4



Lane Group	EBL	EBT	EBR	WBL	WBT	WBR	NBL	NBT	NBR	SBL	SBT	SBR
Switch Phase												
Minimum Initial (s)	5.0	10.0	10.0	5.0	10.0	10.0	5.0	10.0	10.0	10.0	10.0	10.0
Minimum Split (s)	11.6	26.2	26.2	11.2	26.2	26.2	11.7	32.7	32.7	32.7	32.7	32.7
Total Split (s)	35.0	71.0	71.0	12.0	48.0	48.0	12.0	47.0	47.0	35.0	35.0	35.0
Total Split (%)	26.9%	54.6%	54.6%	9.2%	36.9%	36.9%	9.2%	36.2%	36.2%	26.9%	26.9%	26.9%
Maximum Green (s)	28.4	64.8	64.8	5.8	41.8	41.8	5.3	40.3	40.3	28.3	28.3	28.3
Yellow Time (s)	3.7	3.7	3.7	3.7	3.7	3.7	3.3	3.3	3.3	3.3	3.3	3.3
All-Red Time (s)	2.9	2.5	2.5	2.5	2.5	2.5	3.4	3.4	3.4	3.4	3.4	3.4
Lost Time Adjust (s)	0.0	0.0	0.0	0.0	0.0	0.0	0.0	0.0	0.0	0.0	0.0	0.0
Total Lost Time (s)	6.6	6.2	6.2	6.2	6.2	6.2	6.7	6.7	6.7	6.7	6.7	6.7
Lead/Lag	Lead	Lag	Lag	Lead	Lag	Lag	Lead			Lag	Lag	Lag
Lead-Lag Optimize?												
Vehicle Extension (s)	3.0	3.0	3.0	3.0	3.0	3.0	3.0	3.0	3.0	3.0	3.0	3.0
Recall Mode	None	C-Max	C-Max	None	C-Max	C-Max	None	None	None	None	None	None
Walk Time (s)		7.0	7.0		7.0	7.0		7.0	7.0	7.0	7.0	7.0
Flash Dont Walk (s)		13.0	13.0		13.0	13.0		19.0	19.0	19.0	19.0	19.0
Pedestrian Calls (#/hr)		22	22		7	7		32	32	15	15	15
Act Effct Green (s)	26.9	67.9	67.9	6.2	46.9	46.9	36.7	36.7	36.7	27.1	27.1	27.1
Actuated g/C Ratio	0.21	0.52	0.52	0.05	0.36	0.36	0.28	0.28	0.28	0.21	0.21	0.21
v/c Ratio	0.88	0.99	0.20	0.79	0.64	0.23	0.25	0.24	0.21	0.90	0.35	0.44
Control Delay	64.9	51.9	4.7	106.5	42.4	10.1	35.3	35.6	3.6	88.3	45.1	8.6
Queue Delay	0.0	0.0	0.0	0.0	0.0	0.0	0.0	0.0	0.0	0.0	0.0	0.0
Total Delay	64.9	51.9	4.7	106.5	42.4	10.1	35.3	35.6	3.6	88.3	45.1	8.6
LOS	E	D	A	F	D	B	D	D	A	F	D	A
Approach Delay		51.9			41.6			27.1			46.7	
Approach LOS		D			D			C			D	
Queue Length 50th (m)	69.7	~234.1	2.8	15.7	78.3	1.9	11.2	21.3	0.0	45.8	26.2	0.0
Queue Length 95th (m)	#90.5	#273.0	13.4	#41.7	106.3	17.9	21.4	31.1	7.2	#85.0	37.7	18.5
Internal Link Dist (m)		240.5			467.4			363.7			277.9	
Turn Bay Length (m)	140.0		80.0	105.0		60.0	50.0		50.0	55.0		60.0
Base Capacity (vph)	718	1754	822	82	1187	656	266	1050	549	233	737	485
Starvation Cap Reductn	0	0	0	0	0	0	0	0	0	0	0	0
Spillback Cap Reductn	0	0	0	0	0	0	0	0	0	0	0	0
Storage Cap Reductn	0	0	0	0	0	0	0	0	0	0	0	0
Reduced v/c Ratio	0.83	0.99	0.20	0.79	0.64	0.23	0.25	0.22	0.19	0.86	0.34	0.43

Intersection Summary

Area Type: Other
 Cycle Length: 130
 Actuated Cycle Length: 130
 Offset: 125 (96%), Referenced to phase 2:EBT and 6:WBT, Start of Green
 Natural Cycle: 125
 Control Type: Actuated-Coordinated
 Maximum v/c Ratio: 0.99
 Intersection Signal Delay: 46.7 Intersection LOS: D
 Intersection Capacity Utilization 102.6% ICU Level of Service G
 Analysis Period (min) 15
 ~ Volume exceeds capacity, queue is theoretically infinite.
 Queue shown is maximum after two cycles.
 # 95th percentile volume exceeds capacity, queue may be longer.
 Queue shown is maximum after two cycles.

Splits and Phases: 1: Orleans & Innes

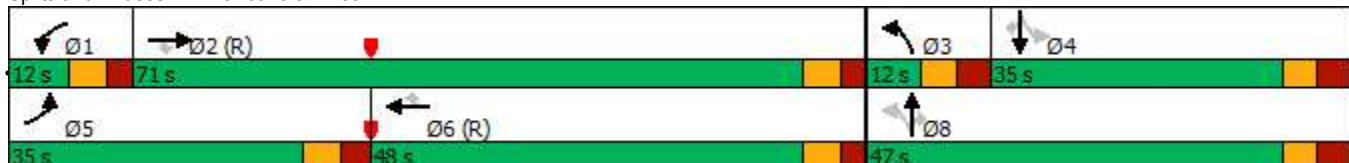

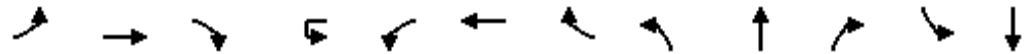

Lane Group	EBL	EBT	EBR	WBU	WBL	WBT	WBR	NBL	NBT	NBR	SBL	SBT
Lane Configurations												
Traffic Volume (vph)	63	1779	30	6	93	860	64	23	7	77	54	18
Future Volume (vph)	63	1779	30	6	93	860	64	23	7	77	54	18
Ideal Flow (vphpl)	1800	1800	1800	1800	1800	1800	1800	1800	1800	1800	1800	1800
Storage Length (m)	100.0		0.0		100.0		0.0	0.0		0.0	0.0	
Storage Lanes	1		0		1		0	0		0	0	
Taper Length (m)	35.0				25.0			2.5			2.5	
Lane Util. Factor	1.00	0.95	0.95	0.95	1.00	0.95	0.95	1.00	1.00	1.00	1.00	1.00
Ped Bike Factor	1.00	1.00				1.00			0.98			0.99
Frt		0.998				0.990			0.903			0.955
Flt Protected	0.950				0.950				0.989			0.976
Satd. Flow (prot)	1695	3380	0	0	1694	3258	0	0	1541	0	0	1578
Flt Permitted	0.309				0.054				0.917			0.754
Satd. Flow (perm)	549	3380	0	0	96	3258	0	0	1427	0	0	1211
Right Turn on Red			Yes				Yes			Yes		
Satd. Flow (RTOR)		2				12			68			18
Link Speed (k/h)		60				60			40			40
Link Distance (m)		491.4				142.1			212.5			273.4
Travel Time (s)		29.5				8.5			19.1			24.6
Confl. Peds. (#/hr)	9		5		5		9	5		13	13	
Confl. Bikes (#/hr)			1							1		
Peak Hour Factor	1.00	1.00	1.00	1.00	1.00	1.00	1.00	1.00	1.00	1.00	1.00	1.00
Heavy Vehicles (%)	2%	2%	6%	3%	2%	5%	2%	5%	1%	3%	6%	1%
Adj. Flow (vph)	63	1779	30	6	93	860	64	23	7	77	54	18
Shared Lane Traffic (%)												
Lane Group Flow (vph)	63	1809	0	0	99	924	0	0	107	0	0	108
Enter Blocked Intersection	No	No	No	No	No	Yes	No	No	No	No	No	No
Lane Alignment	Left	Left	Right	R NA	Left	Left	Right	L NA	Left	R NA	L NA	Left
Median Width(m)		5.0				5.0			0.0			0.0
Link Offset(m)		0.0				0.0			0.0			0.0
Crosswalk Width(m)		10.0				10.0			5.0			5.0
Two way Left Turn Lane												
Headway Factor	1.06	1.06	1.06	1.06	1.06	1.06	1.06	1.06	1.06	1.06	1.06	1.06
Turning Speed (k/h)	24		14	14	24		14	24		14	24	
Number of Detectors	1	2		1	1	2		1	2		1	2
Detector Template	Left	Thru		Left	Left	Thru		Left	Thru		Left	Thru
Leading Detector (m)	18.6	93.0		18.6	18.6	93.0		18.6	93.0		18.6	93.0
Trailing Detector (m)	0.0	0.0		0.0	0.0	0.0		0.0	0.0		0.0	0.0
Detector 1 Position(m)	0.0	0.0		0.0	0.0	0.0		0.0	0.0		0.0	0.0
Detector 1 Size(m)	18.6	5.5		18.6	18.6	5.5		18.6	5.5		18.6	5.5
Detector 1 Type	Cl+Ex	Cl+Ex		Cl+Ex	Cl+Ex	Cl+Ex		Cl+Ex	Cl+Ex		Cl+Ex	Cl+Ex
Detector 1 Channel												
Detector 1 Extend (s)	0.0	0.0		0.0	0.0	0.0		0.0	0.0		0.0	0.0
Detector 1 Queue (s)	0.0	0.0		0.0	0.0	0.0		0.0	0.0		0.0	0.0
Detector 1 Delay (s)	0.0	0.0		0.0	0.0	0.0		0.0	0.0		0.0	0.0
Detector 2 Position(m)		87.5				87.5			87.5			87.5
Detector 2 Size(m)		5.5				5.5			5.5			5.5
Detector 2 Type		Cl+Ex				Cl+Ex			Cl+Ex			Cl+Ex
Detector 2 Channel												
Detector 2 Extend (s)		0.0				0.0			0.0			0.0
Turn Type	Perm	NA		pm+pt	pm+pt	NA		Perm	NA		Perm	NA
Protected Phases		2		1	1	6			8			4
Permitted Phases	2			6	6			8			4	
Detector Phase	2	2		1	1	6		8	8		4	4

Lane Group	SBR
Lane Configurations	
Traffic Volume (vph)	36
Future Volume (vph)	36
Ideal Flow (vphpl)	1800
Storage Length (m)	0.0
Storage Lanes	0
Taper Length (m)	
Lane Util. Factor	1.00
Ped Bike Factor	
Frt	
Flt Protected	
Satd. Flow (prot)	0
Flt Permitted	
Satd. Flow (perm)	0
Right Turn on Red	Yes
Satd. Flow (RTOR)	
Link Speed (k/h)	
Link Distance (m)	
Travel Time (s)	
Confl. Peds. (#/hr)	5
Confl. Bikes (#/hr)	
Peak Hour Factor	1.00
Heavy Vehicles (%)	11%
Adj. Flow (vph)	36
Shared Lane Traffic (%)	
Lane Group Flow (vph)	0
Enter Blocked Intersection	No
Lane Alignment	R NA
Median Width(m)	
Link Offset(m)	
Crosswalk Width(m)	
Two way Left Turn Lane	
Headway Factor	1.06
Turning Speed (k/h)	14
Number of Detectors	
Detector Template	
Leading Detector (m)	
Trailing Detector (m)	
Detector 1 Position(m)	
Detector 1 Size(m)	
Detector 1 Type	
Detector 1 Channel	
Detector 1 Extend (s)	
Detector 1 Queue (s)	
Detector 1 Delay (s)	
Detector 2 Position(m)	
Detector 2 Size(m)	
Detector 2 Type	
Detector 2 Channel	
Detector 2 Extend (s)	
Turn Type	
Protected Phases	
Permitted Phases	
Detector Phase	

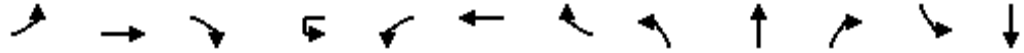

Lane Group	EBL	EBT	EBR	WBU	WBL	WBT	WBR	NBL	NBT	NBR	SBL	SBT
Switch Phase												
Minimum Initial (s)	10.0	10.0		5.0	5.0	10.0		10.0	10.0		10.0	10.0
Minimum Split (s)	39.2	39.2		11.2	11.2	39.2		37.8	37.8		37.8	37.8
Total Split (s)	80.0	80.0		12.0	12.0	92.0		38.0	38.0		38.0	38.0
Total Split (%)	61.5%	61.5%		9.2%	9.2%	70.8%		29.2%	29.2%		29.2%	29.2%
Maximum Green (s)	73.8	73.8		5.8	5.8	85.8		31.2	31.2		31.2	31.2
Yellow Time (s)	3.7	3.7		3.7	3.7	3.7		3.0	3.0		3.0	3.0
All-Red Time (s)	2.5	2.5		2.5	2.5	2.5		3.8	3.8		3.8	3.8
Lost Time Adjust (s)	0.0	0.0			0.0	0.0			0.0			0.0
Total Lost Time (s)	6.2	6.2			6.2	6.2			6.8			6.8
Lead/Lag	Lag	Lag		Lead	Lead							
Lead-Lag Optimize?												
Vehicle Extension (s)	3.0	3.0		3.0	3.0	3.0		3.0	3.0		3.0	3.0
Recall Mode	C-Max	C-Max		None	None	C-Max		None	None		None	None
Walk Time (s)	15.0	15.0				15.0		7.0	7.0		7.0	7.0
Flash Dont Walk (s)	18.0	18.0				18.0		24.0	24.0		24.0	24.0
Pedestrian Calls (#/hr)	5	5				9		13	13		5	5
Act Effct Green (s)	84.2	84.2			97.4	97.4			19.6			19.6
Actuated g/C Ratio	0.65	0.65			0.75	0.75			0.15			0.15
v/c Ratio	0.18	0.83			0.63	0.38			0.39			0.55
Control Delay	3.4	5.6			47.7	4.6			22.5			50.4
Queue Delay	0.0	0.0			0.0	0.0			0.0			0.0
Total Delay	3.4	5.6			47.7	4.6			22.5			50.4
LOS	A	A			D	A			C			D
Approach Delay		5.6				8.7			22.5			50.4
Approach LOS		A				A			C			D
Queue Length 50th (m)	1.6	28.8			6.1	21.1			8.6			20.8
Queue Length 95th (m)	m2.3	m32.8			#34.6	26.2			21.6			33.7
Internal Link Dist (m)		467.4				118.1			188.5			249.4
Turn Bay Length (m)	100.0				100.0							
Base Capacity (vph)	355	2188			158	2444			394			304
Starvation Cap Reductn	0	0			0	0			0			0
Spillback Cap Reductn	0	0			0	0			0			0
Storage Cap Reductn	0	0			0	0			0			0
Reduced v/c Ratio	0.18	0.83			0.63	0.38			0.27			0.36

Intersection Summary

Area Type: Other
 Cycle Length: 130
 Actuated Cycle Length: 130
 Offset: 122 (94%), Referenced to phase 2:EBTL and 6:WBTL, Start of Green
 Natural Cycle: 120
 Control Type: Actuated-Coordinated
 Maximum v/c Ratio: 0.83
 Intersection Signal Delay: 8.7
 Intersection LOS: A
 Intersection Capacity Utilization 90.0%
 ICU Level of Service E
 Analysis Period (min) 15
 # 95th percentile volume exceeds capacity, queue may be longer.
 Queue shown is maximum after two cycles.
 m Volume for 95th percentile queue is metered by upstream signal.

Splits and Phases: 2: Page & Innes

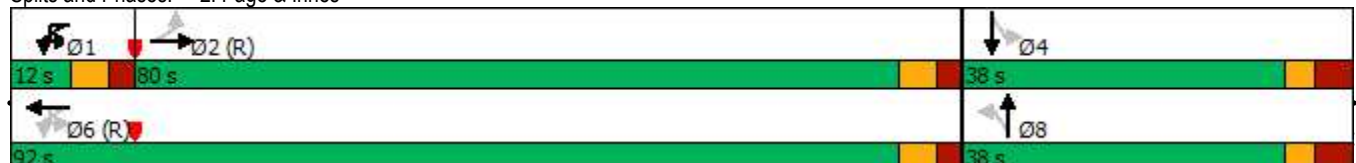

Lane Group	SBR
Switch Phase	
Minimum Initial (s)	
Minimum Split (s)	
Total Split (s)	
Total Split (%)	
Maximum Green (s)	
Yellow Time (s)	
All-Red Time (s)	
Lost Time Adjust (s)	
Total Lost Time (s)	
Lead/Lag	
Lead-Lag Optimize?	
Vehicle Extension (s)	
Recall Mode	
Walk Time (s)	
Flash Dont Walk (s)	
Pedestrian Calls (#/hr)	
Act Effct Green (s)	
Actuated g/C Ratio	
v/c Ratio	
Control Delay	
Queue Delay	
Total Delay	
LOS	
Approach Delay	
Approach LOS	
Queue Length 50th (m)	
Queue Length 95th (m)	
Internal Link Dist (m)	
Turn Bay Length (m)	
Base Capacity (vph)	
Starvation Cap Reductn	
Spillback Cap Reductn	
Storage Cap Reductn	
Reduced v/c Ratio	
Intersection Summary	



Lane Group	EBU	EBT	EBR	WBL	WBT	NBL	NBR	Ø3
Lane Configurations								
Traffic Volume (vph)	11	1606	169	76	935	126	60	
Future Volume (vph)	11	1606	169	76	935	126	60	
Ideal Flow (vphpl)	1800	1800	1800	1800	1800	1800	1800	
Storage Length (m)	30.0		50.0	65.0		70.0	70.0	
Storage Lanes	1		1	1		1	1	
Taper Length (m)	30.0			80.0		20.0		
Lane Util. Factor	1.00	0.95	1.00	1.00	0.95	0.97	1.00	
Ped Bike Factor			0.96			0.94	0.98	
Frt			0.850				0.850	
Flt Protected	0.950			0.950		0.950		
Satd. Flow (prot)	1679	3357	1502	1679	3357	3257	1502	
Flt Permitted	0.284			0.116		0.950		
Satd. Flow (perm)	502	3357	1449	205	3357	3071	1476	
Right Turn on Red			Yes				Yes	
Satd. Flow (RTOR)			122				34	
Link Speed (k/h)		60			60	50		
Link Distance (m)		94.7			238.7	204.5		
Travel Time (s)		5.7			14.3	14.7		
Confl. Peds. (#/hr)			6	6		5	5	
Peak Hour Factor	1.00	1.00	1.00	1.00	1.00	1.00	1.00	
Adj. Flow (vph)	11	1606	169	76	935	126	60	
Shared Lane Traffic (%)								
Lane Group Flow (vph)	11	1606	169	76	935	126	60	
Enter Blocked Intersection	No	No	No	No	No	No	No	
Lane Alignment	R NA	Left	Right	Left	Left	L NA	R NA	
Median Width(m)		5.0			5.0	7.4		
Link Offset(m)		0.0			0.0	0.0		
Crosswalk Width(m)		9.0			9.0	9.0		
Two way Left Turn Lane								
Headway Factor	1.06	1.06	1.06	1.06	1.06	1.06	1.06	
Turning Speed (k/h)	14		14	24		24	14	
Number of Detectors	1	2	1	1	2	1	1	
Detector Template	Left	Thru	Right	Left	Thru	Left	Right	
Leading Detector (m)	18.6	93.0	18.6	18.6	93.0	18.6	18.6	
Trailing Detector (m)	0.0	0.0	0.0	0.0	0.0	0.0	0.0	
Detector 1 Position(m)	0.0	0.0	0.0	0.0	0.0	0.0	0.0	
Detector 1 Size(m)	18.6	5.5	18.6	18.6	5.5	18.6	18.6	
Detector 1 Type	Cl+Ex	Cl+Ex	Cl+Ex	Cl+Ex	Cl+Ex	Cl+Ex	Cl+Ex	
Detector 1 Channel								
Detector 1 Extend (s)	0.0	0.0	0.0	0.0	0.0	0.0	0.0	
Detector 1 Queue (s)	0.0	0.0	0.0	0.0	0.0	0.0	0.0	
Detector 1 Delay (s)	0.0	0.0	0.0	0.0	0.0	0.0	0.0	
Detector 2 Position(m)		87.5			87.5			
Detector 2 Size(m)		5.5			5.5			
Detector 2 Type		Cl+Ex			Cl+Ex			
Detector 2 Channel								
Detector 2 Extend (s)		0.0			0.0			
Turn Type	Perm	NA	Perm	Perm	NA	Prot	Perm	
Protected Phases		2			6	4		3
Permitted Phases	2		2	6			8	
Detector Phase	2	2	2	6	6	4	8	
Switch Phase								
Minimum Initial (s)	10.0	10.0	10.0	10.0	10.0	5.0	10.0	3.0



Lane Group	EBU	EBT	EBR	WBL	WBT	NBL	NBR	Ø3
Minimum Split (s)	31.2	31.2	31.2	31.2	31.2	11.3	37.3	30.0
Total Split (s)	88.0	88.0	88.0	88.0	88.0	12.0	42.0	30.0
Total Split (%)	67.7%	67.7%	67.7%	67.7%	67.7%	9.2%	32.3%	23%
Maximum Green (s)	81.8	81.8	81.8	81.8	81.8	5.7	35.7	28.0
Yellow Time (s)	3.7	3.7	3.7	3.7	3.7	3.3	3.3	2.0
All-Red Time (s)	2.5	2.5	2.5	2.5	2.5	3.0	3.0	0.0
Lost Time Adjust (s)	0.0	0.0	0.0	0.0	0.0	0.0	0.0	
Total Lost Time (s)	6.2	6.2	6.2	6.2	6.2	6.3	6.3	
Lead/Lag						Lag		Lead
Lead-Lag Optimize?								
Vehicle Extension (s)	3.0	3.0	3.0	3.0	3.0	3.0	3.0	3.0
Recall Mode	C-Max	C-Max	C-Max	C-Max	C-Max	None	None	None
Walk Time (s)	7.0	7.0	7.0	7.0	7.0			7.0
Flash Dont Walk (s)	18.0	18.0	18.0	18.0	18.0			21.0
Pedestrian Calls (#/hr)	10	10	10	10	10			10
Act Effct Green (s)	96.9	96.9	96.9	96.9	96.9	8.6	20.6	
Actuated g/C Ratio	0.75	0.75	0.75	0.75	0.75	0.07	0.16	
v/c Ratio	0.03	0.64	0.15	0.50	0.37	0.59	0.23	
Control Delay	1.8	2.0	0.2	22.8	6.0	70.5	22.6	
Queue Delay	0.0	0.1	0.0	0.0	0.0	0.0	0.0	
Total Delay	1.8	2.1	0.2	22.8	6.0	70.5	22.6	
LOS	A	A	A	C	A	E	C	
Approach Delay		1.9			7.3	55.1		
Approach LOS		A			A	E		
Queue Length 50th (m)	0.1	9.3	0.2	3.7	21.1	14.7	5.8	
Queue Length 95th (m)	m0.2	13.6	m0.0	#34.7	40.5	#32.7	14.5	
Internal Link Dist (m)		70.7			214.7	180.5		
Turn Bay Length (m)	30.0		50.0	65.0		70.0	70.0	
Base Capacity (vph)	373	2501	1110	152	2501	215	429	
Starvation Cap Reductn	0	151	0	0	0	0	0	
Spillback Cap Reductn	0	0	0	0	0	0	0	
Storage Cap Reductn	0	0	0	0	0	0	0	
Reduced v/c Ratio	0.03	0.68	0.15	0.50	0.37	0.59	0.14	

Intersection Summary

Area Type: Other
 Cycle Length: 130
 Actuated Cycle Length: 130
 Offset: 129 (99%), Referenced to phase 2:EBTU and 6:WBTL, Start of Green
 Natural Cycle: 110
 Control Type: Actuated-Coordinated
 Maximum v/c Ratio: 0.64
 Intersection Signal Delay: 7.0 Intersection LOS: A
 Intersection Capacity Utilization 74.9% ICU Level of Service D
 Analysis Period (min) 15
 # 95th percentile volume exceeds capacity, queue may be longer.
 Queue shown is maximum after two cycles.
 m Volume for 95th percentile queue is metered by upstream signal.

Splits and Phases: 3: Lamarche & Innes

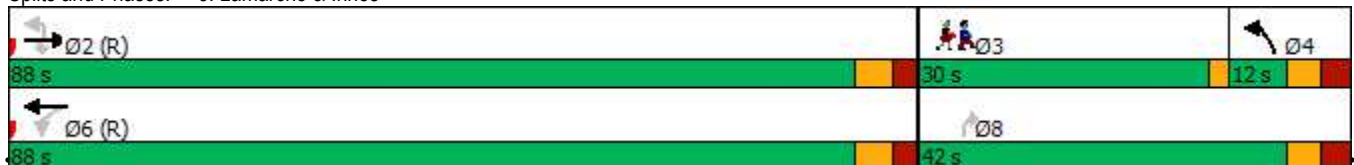



Lane Group	EBL	EBT	EBR	WBL	WBT	WBR	NBL	NBT	NBR	SBL	SBT	SBR
Lane Configurations												
Traffic Volume (vph)	8	1729	131	67	950	8	88	0	56	4	0	10
Future Volume (vph)	8	1729	131	67	950	8	88	0	56	4	0	10
Ideal Flow (vphpl)	1800	1800	1800	1800	1800	1800	1800	1800	1800	1800	1800	1800
Storage Length (m)	65.0		0.0	40.0		0.0	0.0		0.0	0.0		0.0
Storage Lanes	1		0	1		0	0		1	0		0
Taper Length (m)	80.0			30.0			20.0			20.0		
Lane Util. Factor	1.00	0.95	0.95	1.00	0.95	0.95	1.00	1.00	1.00	1.00	1.00	1.00
Ped Bike Factor		1.00						1.00				0.99
Frt		0.989			0.999				0.850			0.904
Flt Protected	0.950			0.950				0.950				0.986
Satd. Flow (prot)	1712	3349	0	1712	3322	0	0	1712	1381	0	1587	0
Flt Permitted	0.285			0.088				0.748				0.920
Satd. Flow (perm)	514	3349	0	159	3322	0	0	1342	1381	0	1481	0
Right Turn on Red			Yes			Yes			Yes			Yes
Satd. Flow (RTOR)		14			1				39			26
Link Speed (k/h)		60			60				40			40
Link Distance (m)		238.7			292.8				151.9			62.6
Travel Time (s)		14.3			17.6				13.7			5.6
Confl. Peds. (#/hr)			2	2			3					3
Confl. Bikes (#/hr)			1									
Peak Hour Factor	1.00	1.00	1.00	1.00	1.00	1.00	1.00	1.00	1.00	1.00	1.00	1.00
Heavy Vehicles (%)	1%	2%	1%	1%	4%	1%	1%	1%	12%	1%	1%	1%
Adj. Flow (vph)	8	1729	131	67	950	8	88	0	56	4	0	10
Shared Lane Traffic (%)												
Lane Group Flow (vph)	8	1860	0	67	958	0	0	88	56	0	14	0
Enter Blocked Intersection	No	No	No	No	No	No	No	No	No	No	No	No
Lane Alignment	L NA	Left	R NA	L NA	Left	R NA	L NA	Left	R NA	L NA	Left	R NA
Median Width(m)		5.0			5.0			0.0			0.0	
Link Offset(m)		0.0			0.0			0.0			0.0	
Crosswalk Width(m)		9.0			9.0			9.0			9.0	
Two way Left Turn Lane												
Headway Factor	1.06	1.06	1.06	1.06	1.06	1.06	1.06	1.06	1.06	1.06	1.06	1.06
Turning Speed (k/h)	24		14	24		14	24		14	24		14
Number of Detectors	1	2		1	2		1	2	1	1		2
Detector Template	Left	Thru		Left	Thru		Left	Thru	Right	Left		Thru
Leading Detector (m)	18.6	93.0		18.6	93.0		18.6	93.0	18.6	18.6		93.0
Trailing Detector (m)	0.0	0.0		0.0	0.0		0.0	0.0	0.0	0.0		0.0
Detector 1 Position(m)	0.0	0.0		0.0	0.0		0.0	0.0	0.0	0.0		0.0
Detector 1 Size(m)	18.6	5.5		18.6	5.5		18.6	5.5	18.6	18.6		5.5
Detector 1 Type	Cl+Ex	Cl+Ex		Cl+Ex	Cl+Ex		Cl+Ex	Cl+Ex	Cl+Ex	Cl+Ex		Cl+Ex
Detector 1 Channel												
Detector 1 Extend (s)	0.0	0.0		0.0	0.0		0.0	0.0	0.0	0.0		0.0
Detector 1 Queue (s)	0.0	0.0		0.0	0.0		0.0	0.0	0.0	0.0		0.0
Detector 1 Delay (s)	0.0	0.0		0.0	0.0		0.0	0.0	0.0	0.0		0.0
Detector 2 Position(m)		87.5			87.5			87.5				87.5
Detector 2 Size(m)		5.5			5.5			5.5				5.5
Detector 2 Type		Cl+Ex			Cl+Ex			Cl+Ex				Cl+Ex
Detector 2 Channel												
Detector 2 Extend (s)		0.0			0.0			0.0				0.0
Turn Type	Perm	NA		Perm	NA		Perm	NA	Perm	Perm		NA
Protected Phases		2			6			8				4
Permitted Phases	2			6			8		8	4		
Detector Phase	2	2		6	6		8	8	8	4		4



Lane Group	EBL	EBT	EBR	WBL	WBT	WBR	NBL	NBT	NBR	SBL	SBT	SBR
Switch Phase												
Minimum Initial (s)	10.0	10.0		10.0	10.0		10.0	10.0	10.0	10.0	10.0	
Minimum Split (s)	32.1	32.1		35.1	35.1		32.3	32.3	32.3	32.3	32.3	
Total Split (s)	97.0	97.0		97.0	97.0		33.0	33.0	33.0	33.0	33.0	
Total Split (%)	74.6%	74.6%		74.6%	74.6%		25.4%	25.4%	25.4%	25.4%	25.4%	
Maximum Green (s)	90.9	90.9		90.9	90.9		26.7	26.7	26.7	26.7	26.7	
Yellow Time (s)	3.7	3.7		3.7	3.7		3.3	3.3	3.3	3.3	3.3	
All-Red Time (s)	2.4	2.4		2.4	2.4		3.0	3.0	3.0	3.0	3.0	
Lost Time Adjust (s)	0.0	0.0		0.0	0.0			0.0	0.0		0.0	
Total Lost Time (s)	6.1	6.1		6.1	6.1			6.3	6.3		6.3	
Lead/Lag												
Lead-Lag Optimize?												
Vehicle Extension (s)	3.0	3.0		3.0	3.0		3.0	3.0	3.0	3.0	3.0	
Recall Mode	C-Max	C-Max		C-Max	C-Max		None	None	None	None	None	
Walk Time (s)	12.0	12.0		12.0	12.0		7.0	7.0	7.0	7.0	7.0	
Flash Dont Walk (s)	14.0	14.0		14.0	14.0		19.0	19.0	19.0	19.0	19.0	
Pedestrian Calls (#/hr)	2	2		1	1		1	1	1	3	3	
Act Effct Green (s)	102.1	102.1		102.1	102.1			15.5	15.5		15.5	
Actuated g/C Ratio	0.79	0.79		0.79	0.79			0.12	0.12		0.12	
v/c Ratio	0.02	0.71		0.54	0.37			0.55	0.28		0.07	
Control Delay	1.1	2.1		27.3	5.2			65.5	24.1		7.4	
Queue Delay	0.0	0.0		0.0	0.0			0.0	0.0		0.0	
Total Delay	1.1	2.1		27.3	5.2			65.5	24.1		7.4	
LOS	A	A		C	A			E	C		A	
Approach Delay		2.1			6.6			49.4			7.4	
Approach LOS		A			A			D			A	
Queue Length 50th (m)	0.1	8.5		4.6	27.8			20.2	3.7		0.0	
Queue Length 95th (m)	m0.2	14.0		#33.3	54.7			32.7	14.1		2.9	
Internal Link Dist (m)		214.7			268.8			127.9			38.6	
Turn Bay Length (m)	65.0			40.0								
Base Capacity (vph)	403	2633		124	2609			275	314		324	
Starvation Cap Reductn	0	0		0	0			0	0		0	
Spillback Cap Reductn	0	0		0	0			0	0		0	
Storage Cap Reductn	0	0		0	0			0	0		0	
Reduced v/c Ratio	0.02	0.71		0.54	0.37			0.32	0.18		0.04	

Intersection Summary

Area Type: Other
 Cycle Length: 130
 Actuated Cycle Length: 130
 Offset: 4 (3%), Referenced to phase 2:EBTL and 6:WBTL, Start of Green
 Natural Cycle: 90
 Control Type: Actuated-Coordinated
 Maximum v/c Ratio: 0.71
 Intersection Signal Delay: 5.9 Intersection LOS: A
 Intersection Capacity Utilization 88.4% ICU Level of Service E
 Analysis Period (min) 15
 # 95th percentile volume exceeds capacity, queue may be longer.
 Queue shown is maximum after two cycles.
 m Volume for 95th percentile queue is metered by upstream signal.

Splits and Phases: 4: 473 E of Page & Innes

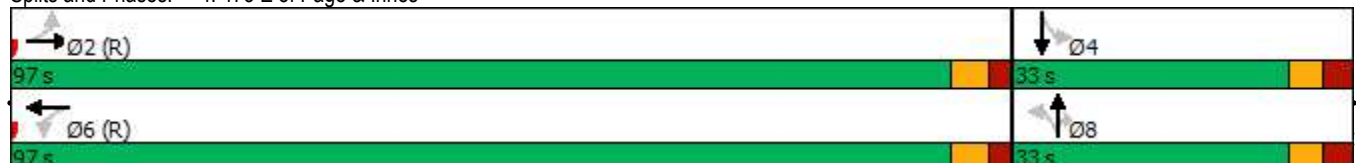



Lane Group	EBL	EBT	WBT	WBR	SBL	SBR
Lane Configurations		↑↑	↑↑			↗
Traffic Volume (vph)	0	1786	1042	30	0	30
Future Volume (vph)	0	1786	1042	30	0	30
Ideal Flow (vphpl)	1800	1800	1800	1800	1800	1800
Storage Length (m)	15.0			0.0	0.0	0.0
Storage Lanes	0			0	0	1
Taper Length (m)	0.0				20.0	
Lane Util. Factor	1.00	0.95	0.95	0.95	1.00	1.00
Ped Bike Factor						
Ft			0.996			0.865
Flt Protected						
Satd. Flow (prot)	0	3357	3346	0	0	1559
Flt Permitted						
Satd. Flow (perm)	0	3357	3346	0	0	1559
Link Speed (k/h)		60	60		30	
Link Distance (m)		142.1	94.7		74.6	
Travel Time (s)		8.5	5.7		9.0	
Confl. Peds. (#/hr)	5			5		
Confl. Bikes (#/hr)				1		1
Peak Hour Factor	1.00	1.00	1.00	1.00	1.00	1.00
Heavy Vehicles (%)	1%	3%	3%	1%	1%	1%
Adj. Flow (vph)	0	1786	1042	30	0	30
Shared Lane Traffic (%)						
Lane Group Flow (vph)	0	1786	1072	0	0	30
Enter Blocked Intersection	No	Yes	Yes	No	No	No
Lane Alignment	L NA	Left	Left	R NA	L NA	R NA
Median Width(m)		5.0	5.0		0.0	
Link Offset(m)		0.0	0.0		0.0	
Crosswalk Width(m)		9.0	9.0		9.0	
Two way Left Turn Lane						
Headway Factor	1.06	1.06	1.06	1.06	1.06	1.06
Turning Speed (k/h)	97			97	97	97
Sign Control		Free	Free		Stop	
Intersection Summary						
Area Type:	Other					
Control Type:	Unsignalized					
Intersection Capacity Utilization	55.4%			ICU Level of Service B		
Analysis Period (min)	15					

1: Orleans & Innes
AM Peak Hour

3493-3499 Innes Road
2030 Total Traffic



Lane Group	EBL	EBT	EBR	WBL	WBT	WBR	NBL	NBT	NBR	SBL	SBT	SBR
Lane Configurations	↖↖	↖↖	↖	↖	↖↖	↖	↖	↖↖	↖	↖	↖↖	↖
Traffic Volume (vph)	131	532	25	29	1604	219	219	280	58	98	108	496
Future Volume (vph)	131	532	25	29	1604	219	219	280	58	98	108	496
Ideal Flow (vphpl)	1800	1800	1800	1800	1800	1800	1800	1800	1800	1800	1800	1800
Storage Length (m)	140.0		80.0	105.0		60.0	50.0		50.0	55.0		60.0
Storage Lanes	2		1	1		1	1		1	1		1
Taper Length (m)	40.0			40.0			10.0			20.0		
Lane Util. Factor	0.97	0.95	1.00	1.00	0.95	1.00	1.00	0.95	1.00	1.00	0.95	1.00
Ped Bike Factor	1.00		0.96	0.99		0.97	0.99		0.94	0.97		0.98
Fr			0.850			0.850			0.850			0.850
Flt Protected	0.950			0.950			0.950			0.950		
Satd. Flow (prot)	2995	3144	1473	1572	3357	1502	1712	3357	1502	1679	3357	1532
Flt Permitted	0.950			0.950			0.545			0.580		
Satd. Flow (perm)	2989	3144	1416	1551	3357	1463	975	3357	1413	992	3357	1500
Right Turn on Red			Yes			Yes			Yes			Yes
Satd. Flow (RTOR)			143			143			82			138
Link Speed (k/h)		60			60			50				50
Link Distance (m)		264.5			491.4			387.7				301.9
Travel Time (s)		15.9			29.5			27.9				21.7
Confl. Peds. (#/hr)	6		14	14		6	6		32	32		6
Confl. Bikes (#/hr)						6						
Peak Hour Factor	1.00	1.00	1.00	1.00	1.00	1.00	1.00	1.00	1.00	1.00	1.00	1.00
Heavy Vehicles (%)	12%	10%	5%	10%	3%	3%	1%	3%	3%	3%	3%	1%
Adj. Flow (vph)	131	532	25	29	1604	219	219	280	58	98	108	496
Shared Lane Traffic (%)												
Lane Group Flow (vph)	131	532	25	29	1604	219	219	280	58	98	108	496
Enter Blocked Intersection	No	No	No	No	No	No	No	No	No	No	No	No
Lane Alignment	L NA	Left	R NA	L NA	Left	R NA	L NA	Left	R NA	L NA	Left	R NA
Median Width(m)		9.0			7.4			6.0				6.0
Link Offset(m)		0.0			0.0			0.0				0.0
Crosswalk Width(m)		5.0			5.0			5.0				5.0
Two way Left Turn Lane												
Headway Factor	1.06	1.06	1.06	1.06	1.06	1.06	1.06	1.06	1.06	1.06	1.06	1.06
Turning Speed (k/h)	24		14	24		14	24		14	24		14
Number of Detectors	1	2	1	1	2	1	1	2	1	1	2	1
Detector Template	Left	Thru	Right	Left	Thru	Right	Left	Thru	Right	Left	Thru	Right
Leading Detector (m)	18.6	93.0	18.6	18.6	93.0	18.6	18.6	93.0	18.6	18.6	93.0	18.6
Trailing Detector (m)	0.0	0.0	0.0	0.0	0.0	0.0	0.0	0.0	0.0	0.0	0.0	0.0
Detector 1 Position(m)	0.0	0.0	0.0	0.0	0.0	0.0	0.0	0.0	0.0	0.0	0.0	0.0
Detector 1 Size(m)	18.6	5.5	18.6	18.6	5.5	18.6	18.6	5.5	18.6	18.6	5.5	18.6
Detector 1 Type	Cl+Ex	Cl+Ex	Cl+Ex	Cl+Ex	Cl+Ex	Cl+Ex	Cl+Ex	Cl+Ex	Cl+Ex	Cl+Ex	Cl+Ex	Cl+Ex
Detector 1 Channel												
Detector 1 Extend (s)	0.0	0.0	0.0	0.0	0.0	0.0	0.0	0.0	0.0	0.0	0.0	0.0
Detector 1 Queue (s)	0.0	0.0	0.0	0.0	0.0	0.0	0.0	0.0	0.0	0.0	0.0	0.0
Detector 1 Delay (s)	0.0	0.0	0.0	0.0	0.0	0.0	0.0	0.0	0.0	0.0	0.0	0.0
Detector 2 Position(m)		87.5			87.5			87.5				87.5
Detector 2 Size(m)		5.5			5.5			5.5				5.5
Detector 2 Type		Cl+Ex			Cl+Ex			Cl+Ex				Cl+Ex
Detector 2 Channel												
Detector 2 Extend (s)		0.0			0.0			0.0				0.0
Turn Type	Prot	NA	Perm	Prot	NA	Perm	pm+pt	NA	Perm	Perm	NA	Perm
Protected Phases	5	2		1	6		3	8			4	
Permitted Phases			2			6	8		8	4		4
Detector Phase	5	2	2	1	6	6	3	8	8	4	4	4

1: Orleans & Innes
AM Peak Hour

3493-3499 Innes Road
2030 Total Traffic



Lane Group	EBL	EBT	EBR	WBL	WBT	WBR	NBL	NBT	NBR	SBL	SBT	SBR
Switch Phase												
Minimum Initial (s)	5.0	10.0	10.0	5.0	10.0	10.0	5.0	10.0	10.0	10.0	10.0	10.0
Minimum Split (s)	11.6	26.2	26.2	11.2	26.2	26.2	11.7	32.7	32.7	32.7	32.7	32.7
Total Split (s)	13.0	72.0	72.0	13.0	72.0	72.0	12.0	45.0	45.0	33.0	33.0	33.0
Total Split (%)	10.0%	55.4%	55.4%	10.0%	55.4%	55.4%	9.2%	34.6%	34.6%	25.4%	25.4%	25.4%
Maximum Green (s)	6.4	65.8	65.8	6.8	65.8	65.8	5.3	38.3	38.3	26.3	26.3	26.3
Yellow Time (s)	3.7	3.7	3.7	3.7	3.7	3.7	3.3	3.3	3.3	3.3	3.3	3.3
All-Red Time (s)	2.9	2.5	2.5	2.5	2.5	2.5	3.4	3.4	3.4	3.4	3.4	3.4
Lost Time Adjust (s)	0.0	0.0	0.0	0.0	0.0	0.0	0.0	0.0	0.0	0.0	0.0	0.0
Total Lost Time (s)	6.6	6.2	6.2	6.2	6.2	6.2	6.7	6.7	6.7	6.7	6.7	6.7
Lead/Lag	Lead	Lag	Lag	Lead	Lag	Lag	Lead			Lag	Lag	Lag
Lead-Lag Optimize?												
Vehicle Extension (s)	3.0	3.0	3.0	3.0	3.0	3.0	3.0	3.0	3.0	3.0	3.0	3.0
Recall Mode	None	C-Max	C-Max	None	C-Max	C-Max	None	None	None	None	None	None
Walk Time (s)		7.0	7.0		7.0	7.0		7.0	7.0	7.0	7.0	7.0
Flash Dont Walk (s)		13.0	13.0		13.0	13.0		19.0	19.0	19.0	19.0	19.0
Pedestrian Calls (#/hr)		14	14		6	6		32	32	6	6	6
Act Effct Green (s)	6.4	71.0	71.0	6.5	65.8	65.8	38.3	38.3	38.3	26.3	26.3	26.3
Actuated g/C Ratio	0.05	0.55	0.55	0.05	0.51	0.51	0.29	0.29	0.29	0.20	0.20	0.20
v/c Ratio	0.89	0.31	0.03	0.37	0.94	0.27	0.69	0.28	0.12	0.49	0.16	1.20
Control Delay	110.9	17.6	0.1	73.2	42.9	7.3	51.9	36.2	3.6	55.4	43.5	143.8
Queue Delay	0.0	0.0	0.0	0.0	0.0	0.0	0.0	0.0	0.0	0.0	0.0	0.0
Total Delay	110.9	17.6	0.1	73.2	42.9	7.3	51.9	36.2	3.6	55.4	43.5	143.8
LOS	F	B	A	E	D	A	D	D	A	E	D	F
Approach Delay		34.7			39.1			39.0			116.0	
Approach LOS		C			D			D			F	
Queue Length 50th (m)	16.1	38.1	0.0	6.7	183.1	9.1	41.8	26.7	0.0	20.6	11.1	~114.6
Queue Length 95th (m)	#33.6	49.6	0.0	16.2	#233.8	22.2	63.6	37.9	5.1	37.9	18.7	#176.3
Internal Link Dist (m)		240.5			467.4			363.7			277.9	
Turn Bay Length (m)	140.0		80.0	105.0		60.0	50.0		50.0	55.0		60.0
Base Capacity (vph)	147	1717	838	82	1699	811	317	989	474	200	679	413
Starvation Cap Reductn	0	0	0	0	0	0	0	0	0	0	0	0
Spillback Cap Reductn	0	0	0	0	0	0	0	0	0	0	0	0
Storage Cap Reductn	0	0	0	0	0	0	0	0	0	0	0	0
Reduced v/c Ratio	0.89	0.31	0.03	0.35	0.94	0.27	0.69	0.28	0.12	0.49	0.16	1.20

Intersection Summary

Area Type: Other
 Cycle Length: 130
 Actuated Cycle Length: 130
 Offset: 0 (0%), Referenced to phase 2:EBT and 6:WBT, Start of Green
 Natural Cycle: 145
 Control Type: Actuated-Coordinated
 Maximum v/c Ratio: 1.20
 Intersection Signal Delay: 52.5 Intersection LOS: D
 Intersection Capacity Utilization 109.0% ICU Level of Service G
 Analysis Period (min) 15
 ~ Volume exceeds capacity, queue is theoretically infinite.
 Queue shown is maximum after two cycles.
 # 95th percentile volume exceeds capacity, queue may be longer.
 Queue shown is maximum after two cycles.

Splits and Phases: 1: Orleans & Innes



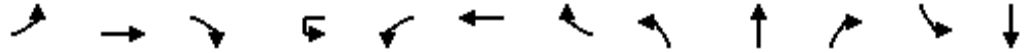

Lane Group	EBL	EBT	EBR	WBU	WBL	WBT	WBR	NBL	NBT	NBR	SBL	SBT
Lane Configurations												
Traffic Volume (vph)	12	616	21	3	37	1651	20	14	12	38	34	9
Future Volume (vph)	12	616	21	3	37	1651	20	14	12	38	34	9
Ideal Flow (vphpl)	1800	1800	1800	1800	1800	1800	1800	1800	1800	1800	1800	1800
Storage Length (m)	100.0		0.0		100.0		0.0	0.0		0.0	0.0	
Storage Lanes	1		0		1		0	0		0	0	
Taper Length (m)	35.0				25.0			2.5			2.5	
Lane Util. Factor	1.00	0.95	0.95	0.95	1.00	0.95	0.95	1.00	1.00	1.00	1.00	1.00
Ped Bike Factor		1.00			1.00	1.00			0.99			0.99
Frt		0.995				0.998			0.920			0.932
Flt Protected	0.950				0.950				0.989			0.981
Satd. Flow (prot)	1586	3129	0	0	1515	3349	0	0	1568	0	0	1596
Flt Permitted	0.107				0.405				0.922			0.851
Satd. Flow (perm)	179	3129	0	0	643	3349	0	0	1458	0	0	1384
Right Turn on Red			Yes				Yes			Yes		
Satd. Flow (RTOR)		5				2			38			31
Link Speed (k/h)		60				60			40			40
Link Distance (m)		491.4				142.1			212.5			273.4
Travel Time (s)		29.5				8.5			19.1			24.6
Confl. Peds. (#/hr)	4		7		7		4	11				
Confl. Bikes (#/hr)			1							1		
Peak Hour Factor	1.00	1.00	1.00	1.00	1.00	1.00	1.00	1.00	1.00	1.00	1.00	1.00
Heavy Vehicles (%)	9%	10%	5%	3%	15%	3%	5%	1%	15%	3%	1%	10%
Adj. Flow (vph)	12	616	21	3	37	1651	20	14	12	38	34	9
Shared Lane Traffic (%)												
Lane Group Flow (vph)	12	637	0	0	40	1671	0	0	64	0	0	86
Enter Blocked Intersection	No	No	No	No	No	Yes	No	No	No	No	No	No
Lane Alignment	Left	Left	Right	R NA	Left	Left	Right	L NA	Left	R NA	L NA	Left
Median Width(m)		5.0				5.0			0.0			0.0
Link Offset(m)		0.0				0.0			0.0			0.0
Crosswalk Width(m)		10.0				10.0			5.0			5.0
Two way Left Turn Lane												
Headway Factor	1.06	1.06	1.06	1.06	1.06	1.06	1.06	1.06	1.06	1.06	1.06	1.06
Turning Speed (k/h)	24		14	14	24		14	24		14	24	
Number of Detectors	1	2		1	1	2		1	2		1	2
Detector Template	Left	Thru		Left	Left	Thru		Left	Thru		Left	Thru
Leading Detector (m)	18.6	93.0		18.6	18.6	93.0		18.6	93.0		18.6	93.0
Trailing Detector (m)	0.0	0.0		0.0	0.0	0.0		0.0	0.0		0.0	0.0
Detector 1 Position(m)	0.0	0.0		0.0	0.0	0.0		0.0	0.0		0.0	0.0
Detector 1 Size(m)	18.6	5.5		18.6	18.6	5.5		18.6	5.5		18.6	5.5
Detector 1 Type	Cl+Ex	Cl+Ex		Cl+Ex	Cl+Ex	Cl+Ex		Cl+Ex	Cl+Ex		Cl+Ex	Cl+Ex
Detector 1 Channel												
Detector 1 Extend (s)	0.0	0.0		0.0	0.0	0.0		0.0	0.0		0.0	0.0
Detector 1 Queue (s)	0.0	0.0		0.0	0.0	0.0		0.0	0.0		0.0	0.0
Detector 1 Delay (s)	0.0	0.0		0.0	0.0	0.0		0.0	0.0		0.0	0.0
Detector 2 Position(m)		87.5				87.5			87.5			87.5
Detector 2 Size(m)		5.5				5.5			5.5			5.5
Detector 2 Type		Cl+Ex				Cl+Ex			Cl+Ex			Cl+Ex
Detector 2 Channel												
Detector 2 Extend (s)		0.0				0.0			0.0			0.0
Turn Type	Perm	NA		Perm	Perm	NA		Perm	NA		Perm	NA
Protected Phases		2				6			8			4
Permitted Phases	2			6	6			8			4	
Detector Phase	2	2		6	6	6		8	8		4	4

Lane Group	SBR
Lane Configurations	
Traffic Volume (vph)	43
Future Volume (vph)	43
Ideal Flow (vphpl)	1800
Storage Length (m)	0.0
Storage Lanes	0
Taper Length (m)	
Lane Util. Factor	1.00
Ped Bike Factor	
Frt	
Flt Protected	
Satd. Flow (prot)	0
Flt Permitted	
Satd. Flow (perm)	0
Right Turn on Red	Yes
Satd. Flow (RTOR)	
Link Speed (k/h)	
Link Distance (m)	
Travel Time (s)	
Confl. Peds. (#/hr)	11
Confl. Bikes (#/hr)	1
Peak Hour Factor	1.00
Heavy Vehicles (%)	3%
Adj. Flow (vph)	43
Shared Lane Traffic (%)	
Lane Group Flow (vph)	0
Enter Blocked Intersection	No
Lane Alignment	R NA
Median Width(m)	
Link Offset(m)	
Crosswalk Width(m)	
Two way Left Turn Lane	
Headway Factor	1.06
Turning Speed (k/h)	14
Number of Detectors	
Detector Template	
Leading Detector (m)	
Trailing Detector (m)	
Detector 1 Position(m)	
Detector 1 Size(m)	
Detector 1 Type	
Detector 1 Channel	
Detector 1 Extend (s)	
Detector 1 Queue (s)	
Detector 1 Delay (s)	
Detector 2 Position(m)	
Detector 2 Size(m)	
Detector 2 Type	
Detector 2 Channel	
Detector 2 Extend (s)	
Turn Type	
Protected Phases	
Permitted Phases	
Detector Phase	

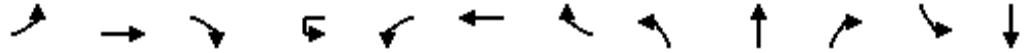

Lane Group	EBL	EBT	EBR	WBU	WBL	WBT	WBR	NBL	NBT	NBR	SBL	SBT
Switch Phase												
Minimum Initial (s)	10.0	10.0		10.0	10.0	10.0		10.0	10.0		10.0	10.0
Minimum Split (s)	39.2	39.2		39.2	39.2	39.2		37.8	37.8		37.8	37.8
Total Split (s)	82.0	82.0		82.0	82.0	82.0		38.0	38.0		38.0	38.0
Total Split (%)	68.3%	68.3%		68.3%	68.3%	68.3%		31.7%	31.7%		31.7%	31.7%
Maximum Green (s)	75.8	75.8		75.8	75.8	75.8		31.2	31.2		31.2	31.2
Yellow Time (s)	3.7	3.7		3.7	3.7	3.7		3.0	3.0		3.0	3.0
All-Red Time (s)	2.5	2.5		2.5	2.5	2.5		3.8	3.8		3.8	3.8
Lost Time Adjust (s)	0.0	0.0			0.0	0.0			0.0			0.0
Total Lost Time (s)	6.2	6.2			6.2	6.2			6.8			6.8
Lead/Lag												
Lead-Lag Optimize?												
Vehicle Extension (s)	3.0	3.0		3.0	3.0	3.0		3.0	3.0		3.0	3.0
Recall Mode	C-Max	C-Max		C-Max	C-Max	C-Max		None	None		None	None
Walk Time (s)	15.0	15.0		15.0	15.0	15.0		7.0	7.0		7.0	7.0
Flash Dont Walk (s)	18.0	18.0		18.0	18.0	18.0		24.0	24.0		24.0	24.0
Pedestrian Calls (#/hr)	7	7		4	4	4		1	1		11	11
Act Effct Green (s)	88.6	88.6			88.6	88.6			18.4			18.4
Actuated g/C Ratio	0.74	0.74			0.74	0.74			0.15			0.15
v/c Ratio	0.09	0.28			0.08	0.68			0.25			0.36
Control Delay	9.7	6.7			2.4	4.4			21.2			31.1
Queue Delay	0.0	0.0			0.0	0.0			0.0			0.0
Total Delay	9.7	6.7			2.4	4.4			21.2			31.1
LOS	A	A			A	A			C			C
Approach Delay		6.8				4.3			21.2			31.1
Approach LOS		A				A			C			C
Queue Length 50th (m)	0.4	13.7			1.2	45.6			5.4			11.6
Queue Length 95th (m)	3.7	39.9			m0.9	13.3			14.4			21.8
Internal Link Dist (m)		467.4				118.1			188.5			249.4
Turn Bay Length (m)	100.0				100.0							
Base Capacity (vph)	132	2311			474	2473			407			382
Starvation Cap Reductn	0	0			0	7			0			0
Spillback Cap Reductn	0	0			0	0			0			0
Storage Cap Reductn	0	0			0	0			0			0
Reduced v/c Ratio	0.09	0.28			0.08	0.68			0.16			0.23

Intersection Summary

Area Type: Other
 Cycle Length: 120
 Actuated Cycle Length: 120
 Offset: 22 (18%), Referenced to phase 2:EBTL and 6:WBTL, Start of Green
 Natural Cycle: 90
 Control Type: Actuated-Coordinated
 Maximum v/c Ratio: 0.68
 Intersection Signal Delay: 6.3 Intersection LOS: A
 Intersection Capacity Utilization 74.4% ICU Level of Service D
 Analysis Period (min) 15
 m Volume for 95th percentile queue is metered by upstream signal.

Splits and Phases: 2: Page & Innes



Lane Group	SBR
Switch Phase	
Minimum Initial (s)	
Minimum Split (s)	
Total Split (s)	
Total Split (%)	
Maximum Green (s)	
Yellow Time (s)	
All-Red Time (s)	
Lost Time Adjust (s)	
Total Lost Time (s)	
Lead/Lag	
Lead-Lag Optimize?	
Vehicle Extension (s)	
Recall Mode	
Walk Time (s)	
Flash Dont Walk (s)	
Pedestrian Calls (#/hr)	
Act Effct Green (s)	
Actuated g/C Ratio	
v/c Ratio	
Control Delay	
Queue Delay	
Total Delay	
LOS	
Approach Delay	
Approach LOS	
Queue Length 50th (m)	
Queue Length 95th (m)	
Internal Link Dist (m)	
Turn Bay Length (m)	
Base Capacity (vph)	
Starvation Cap Reductn	
Spillback Cap Reductn	
Storage Cap Reductn	
Reduced v/c Ratio	
Intersection Summary	

3: Lamarche & Innes
AM Peak Hour

3493-3499 Innes Road
2030 Total Traffic



Lane Group	EBU	EBT	EBR	WBL	WBT	NBL	NBR	Ø3
Lane Configurations								
Traffic Volume (vph)	10	542	176	179	1361	291	171	
Future Volume (vph)	10	542	176	179	1361	291	171	
Ideal Flow (vphpl)	1800	1800	1800	1800	1800	1800	1800	
Storage Length (m)	30.0		50.0	65.0		70.0	70.0	
Storage Lanes	1		1	1		1	1	
Taper Length (m)	30.0			80.0		20.0		
Lane Util. Factor	1.00	0.95	1.00	1.00	0.95	0.97	1.00	
Ped Bike Factor			0.95	0.99		0.97	0.98	
Fr _t			0.850				0.850	
Flt Protected	0.950			0.950		0.950		
Satd. Flow (prot)	1679	3357	1502	1679	3357	3257	1502	
Flt Permitted	0.149			0.442		0.950		
Satd. Flow (perm)	263	3357	1433	772	3357	3165	1477	
Right Turn on Red			Yes				Yes	
Satd. Flow (RTOR)			176				171	
Link Speed (k/h)		60			60	50		
Link Distance (m)		94.7			238.7	204.5		
Travel Time (s)		5.7			14.3	14.7		
Confl. Peds. (#/hr)			11	11		5	5	
Peak Hour Factor	1.00	1.00	1.00	1.00	1.00	1.00	1.00	
Adj. Flow (vph)	10	542	176	179	1361	291	171	
Shared Lane Traffic (%)								
Lane Group Flow (vph)	10	542	176	179	1361	291	171	
Enter Blocked Intersection	No	Yes	No	No	No	No	No	
Lane Alignment	R NA	Left	Right	Left	Left	L NA	R NA	
Median Width(m)		5.0			5.0	7.4		
Link Offset(m)		0.0			0.0	0.0		
Crosswalk Width(m)		9.0			9.0	9.0		
Two way Left Turn Lane								
Headway Factor	1.06	1.06	1.06	1.06	1.06	1.06	1.06	
Turning Speed (k/h)	14		14	24		24	14	
Number of Detectors	1	2	1	1	2	1	1	
Detector Template	Left	Thru	Right	Left	Thru	Left	Right	
Leading Detector (m)	18.6	93.0	18.6	18.6	93.0	18.6	18.6	
Trailing Detector (m)	0.0	0.0	0.0	0.0	0.0	0.0	0.0	
Detector 1 Position(m)	0.0	0.0	0.0	0.0	0.0	0.0	0.0	
Detector 1 Size(m)	18.6	5.5	18.6	18.6	5.5	18.6	18.6	
Detector 1 Type	Cl+Ex	Cl+Ex	Cl+Ex	Cl+Ex	Cl+Ex	Cl+Ex	Cl+Ex	
Detector 1 Channel								
Detector 1 Extend (s)	0.0	0.0	0.0	0.0	0.0	0.0	0.0	
Detector 1 Queue (s)	0.0	0.0	0.0	0.0	0.0	0.0	0.0	
Detector 1 Delay (s)	0.0	0.0	0.0	0.0	0.0	0.0	0.0	
Detector 2 Position(m)		87.5			87.5			
Detector 2 Size(m)		5.5			5.5			
Detector 2 Type		Cl+Ex			Cl+Ex			
Detector 2 Channel								
Detector 2 Extend (s)		0.0			0.0			
Turn Type	Perm	NA	Perm	Perm	NA	Prot	Perm	
Protected Phases		2			6	4		3
Permitted Phases	2		2	6			8	
Detector Phase	2	2	2	6	6	4	8	
Switch Phase								
Minimum Initial (s)	10.0	10.0	10.0	10.0	10.0	5.0	10.0	3.0



Lane Group	EBU	EBT	EBR	WBL	WBT	NBL	NBR	Ø3
Minimum Split (s)	31.2	31.2	31.2	31.2	31.2	11.3	16.3	30.0
Total Split (s)	73.0	73.0	73.0	73.0	73.0	17.0	47.0	30.0
Total Split (%)	60.8%	60.8%	60.8%	60.8%	60.8%	14.2%	39.2%	25%
Maximum Green (s)	66.8	66.8	66.8	66.8	66.8	10.7	40.7	28.0
Yellow Time (s)	3.7	3.7	3.7	3.7	3.7	3.3	3.3	2.0
All-Red Time (s)	2.5	2.5	2.5	2.5	2.5	3.0	3.0	0.0
Lost Time Adjust (s)	0.0	0.0	0.0	0.0	0.0	0.0	0.0	0.0
Total Lost Time (s)	6.2	6.2	6.2	6.2	6.2	6.3	6.3	
Lead/Lag						Lag		Lead
Lead-Lag Optimize?								
Vehicle Extension (s)	3.0	3.0	3.0	3.0	3.0	3.0	3.0	3.0
Recall Mode	C-Max	C-Max	C-Max	C-Max	C-Max	None	None	None
Walk Time (s)	7.0	7.0	7.0	7.0	7.0			7.0
Flash Dont Walk (s)	18.0	18.0	18.0	18.0	18.0			21.0
Pedestrian Calls (#/hr)	10	10	10	10	10			10
Act Effct Green (s)	81.0	81.0	81.0	81.0	81.0	14.5	26.5	
Actuated g/C Ratio	0.68	0.68	0.68	0.68	0.68	0.12	0.22	
v/c Ratio	0.06	0.24	0.17	0.34	0.60	0.74	0.37	
Control Delay	9.1	6.8	0.8	8.0	9.2	63.6	6.5	
Queue Delay	0.0	0.0	0.0	0.0	0.0	0.0	0.0	
Total Delay	9.1	6.8	0.8	8.0	9.2	63.6	6.5	
LOS	A	A	A	A	A	E	A	
Approach Delay		5.4			9.1	42.5		
Approach LOS		A			A	D		
Queue Length 50th (m)	0.4	12.1	0.0	5.3	21.1	30.7	0.0	
Queue Length 95th (m)	2.1	21.4	2.2	20.9	116.8	#59.4	13.5	
Internal Link Dist (m)		70.7			214.7	180.5		
Turn Bay Length (m)	30.0		50.0	65.0		70.0	70.0	
Base Capacity (vph)	177	2264	1023	520	2264	394	613	
Starvation Cap Reductn	0	0	0	0	0	0	0	
Spillback Cap Reductn	0	0	0	0	0	0	0	
Storage Cap Reductn	0	0	0	0	0	0	0	
Reduced v/c Ratio	0.06	0.24	0.17	0.34	0.60	0.74	0.28	

Intersection Summary

Area Type: Other
 Cycle Length: 120
 Actuated Cycle Length: 120
 Offset: 24 (20%), Referenced to phase 2:EBTU and 6:WBTL, Start of Green
 Natural Cycle: 90
 Control Type: Actuated-Coordinated
 Maximum v/c Ratio: 0.74
 Intersection Signal Delay: 13.8
 Intersection Capacity Utilization 72.4%
 Analysis Period (min) 15
 # 95th percentile volume exceeds capacity, queue may be longer.
 Queue shown is maximum after two cycles.

Splits and Phases: 3: Lamarche & Innes

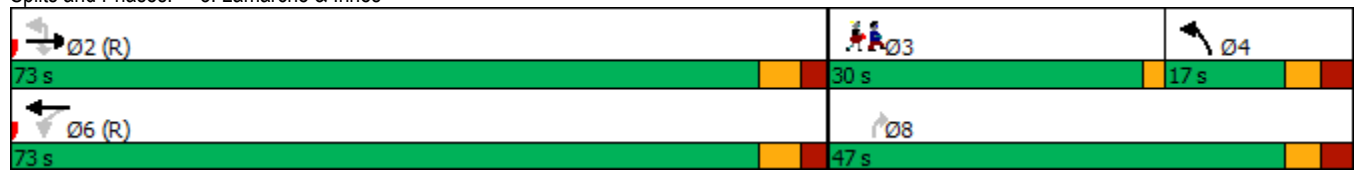



Lane Group	EBL	EBT	EBR	WBL	WBT	WBR	NBL	NBT	NBR	SBL	SBT	SBR
Lane Configurations												
Traffic Volume (vph)	6	602	38	12	1539	4	99	0	39	1	0	3
Future Volume (vph)	6	602	38	12	1539	4	99	0	39	1	0	3
Ideal Flow (vphpl)	1800	1800	1800	1800	1800	1800	1800	1800	1800	1800	1800	1800
Storage Length (m)	65.0		0.0	40.0		0.0	0.0		0.0	0.0		0.0
Storage Lanes	1		0	1		0	0		1	0		0
Taper Length (m)	80.0			30.0			20.0			20.0		
Lane Util. Factor	1.00	0.95	0.95	1.00	0.95	0.95	1.00	1.00	1.00	1.00	1.00	1.00
Ped Bike Factor					1.00			1.00	0.99		0.99	
Fr		0.991							0.850		0.899	
Flt Protected	0.950			0.950				0.950			0.988	
Satd. Flow (prot)	1712	3115	0	1712	3357	0	0	1712	1532	0	1583	0
Flt Permitted	0.135			0.407				0.755			0.942	
Satd. Flow (perm)	243	3115	0	733	3357	0	0	1357	1511	0	1509	0
Right Turn on Red			Yes			Yes			Yes			Yes
Satd. Flow (RTOR)		12							39			28
Link Speed (k/h)		60			60				40			40
Link Distance (m)		238.7			292.8				151.9			62.6
Travel Time (s)		14.3			17.6				13.7			5.6
Confl. Peds. (#/hr)	7					7	2		1	1		2
Confl. Bikes (#/hr)						1						
Peak Hour Factor	1.00	1.00	1.00	1.00	1.00	1.00	1.00	1.00	1.00	1.00	1.00	1.00
Heavy Vehicles (%)	1%	10%	10%	1%	3%	1%	1%	1%	1%	1%	1%	1%
Adj. Flow (vph)	6	602	38	12	1539	4	99	0	39	1	0	3
Shared Lane Traffic (%)												
Lane Group Flow (vph)	6	640	0	12	1543	0	0	99	39	0	4	0
Enter Blocked Intersection	No	No	No	No	No	No	No	No	No	No	No	No
Lane Alignment	L NA	Left	R NA	L NA	Left	R NA	L NA	Left	R NA	L NA	Left	R NA
Median Width(m)		5.0			5.0			0.0			0.0	
Link Offset(m)		0.0			0.0			0.0			0.0	
Crosswalk Width(m)		9.0			9.0			9.0			9.0	
Two way Left Turn Lane												
Headway Factor	1.06	1.06	1.06	1.06	1.06	1.06	1.06	1.06	1.06	1.06	1.06	1.06
Turning Speed (k/h)	24		14	24		14	24		14	24		14
Number of Detectors	1	2		1	2		1	2	1	1		2
Detector Template	Left	Thru		Left	Thru		Left	Thru	Right	Left		Thru
Leading Detector (m)	18.6	93.0		18.6	93.0		18.6	93.0	18.6	18.6		93.0
Trailing Detector (m)	0.0	0.0		0.0	0.0		0.0	0.0	0.0	0.0		0.0
Detector 1 Position(m)	0.0	0.0		0.0	0.0		0.0	0.0	0.0	0.0		0.0
Detector 1 Size(m)	18.6	5.5		18.6	5.5		18.6	5.5	18.6	18.6		5.5
Detector 1 Type	Cl+Ex	Cl+Ex		Cl+Ex	Cl+Ex		Cl+Ex	Cl+Ex	Cl+Ex	Cl+Ex		Cl+Ex
Detector 1 Channel												
Detector 1 Extend (s)	0.0	0.0		0.0	0.0		0.0	0.0	0.0	0.0		0.0
Detector 1 Queue (s)	0.0	0.0		0.0	0.0		0.0	0.0	0.0	0.0		0.0
Detector 1 Delay (s)	0.0	0.0		0.0	0.0		0.0	0.0	0.0	0.0		0.0
Detector 2 Position(m)		87.5			87.5			87.5				87.5
Detector 2 Size(m)		5.5			5.5			5.5				5.5
Detector 2 Type		Cl+Ex			Cl+Ex			Cl+Ex				Cl+Ex
Detector 2 Channel												
Detector 2 Extend (s)		0.0			0.0			0.0				0.0
Turn Type	Perm	NA		Perm	NA		Perm	NA	Perm	Perm		NA
Protected Phases		2			6			8				4
Permitted Phases	2			6			8		8	4		
Detector Phase	2	2		6	6		8	8	8	4		4



Lane Group	EBL	EBT	EBR	WBL	WBT	WBR	NBL	NBT	NBR	SBL	SBT	SBR
Switch Phase												
Minimum Initial (s)	10.0	10.0		10.0	10.0		10.0	10.0	10.0	10.0	10.0	10.0
Minimum Split (s)	32.1	32.1		35.1	35.1		32.3	32.3	32.3	32.3	32.3	32.3
Total Split (s)	87.0	87.0		87.0	87.0		33.0	33.0	33.0	33.0	33.0	33.0
Total Split (%)	72.5%	72.5%		72.5%	72.5%		27.5%	27.5%	27.5%	27.5%	27.5%	27.5%
Maximum Green (s)	80.9	80.9		80.9	80.9		26.7	26.7	26.7	26.7	26.7	26.7
Yellow Time (s)	3.7	3.7		3.7	3.7		3.3	3.3	3.3	3.3	3.3	3.3
All-Red Time (s)	2.4	2.4		2.4	2.4		3.0	3.0	3.0	3.0	3.0	3.0
Lost Time Adjust (s)	0.0	0.0		0.0	0.0			0.0	0.0		0.0	0.0
Total Lost Time (s)	6.1	6.1		6.1	6.1			6.3	6.3		6.3	6.3
Lead/Lag												
Lead-Lag Optimize?												
Vehicle Extension (s)	3.0	3.0		3.0	3.0		3.0	3.0	3.0	3.0	3.0	3.0
Recall Mode	C-Max	C-Max		C-Max	C-Max		None	None	None	None	None	None
Walk Time (s)	12.0	12.0		12.0	12.0		7.0	7.0	7.0	7.0	7.0	7.0
Flash Dont Walk (s)	14.0	14.0		14.0	14.0		19.0	19.0	19.0	19.0	19.0	19.0
Pedestrian Calls (#/hr)	1	1		7	7		1	1	1	2	2	2
Act Effct Green (s)	92.0	92.0		92.0	92.0			15.6	15.6		15.6	15.6
Actuated g/C Ratio	0.77	0.77		0.77	0.77			0.13	0.13		0.13	0.13
v/c Ratio	0.03	0.27		0.02	0.60			0.56	0.17		0.17	0.02
Control Delay	4.7	3.9		5.0	8.1			59.7	14.0		14.0	0.2
Queue Delay	0.0	0.0		0.0	0.0			0.0	0.0		0.0	0.0
Total Delay	4.7	3.9		5.0	8.1			59.7	14.0		14.0	0.2
LOS	A	A		A	A			E	B		B	A
Approach Delay		3.9			8.1			46.8			14.0	0.3
Approach LOS		A			A			D			B	A
Queue Length 50th (m)	0.2	13.1		0.5	59.9			20.8	0.0		0.0	0.0
Queue Length 95th (m)	m1.3	22.1		2.6	115.3			33.3	8.3		0.0	0.0
Internal Link Dist (m)		214.7			268.8			127.9			38.6	
Turn Bay Length (m)	65.0			40.0								
Base Capacity (vph)	186	2389		561	2572			301	366		366	357
Starvation Cap Reductn	0	0		0	0			0	0		0	0
Spillback Cap Reductn	0	0		0	0			0	0		0	0
Storage Cap Reductn	0	0		0	0			0	0		0	0
Reduced v/c Ratio	0.03	0.27		0.02	0.60			0.33	0.11		0.11	0.01

Intersection Summary

Area Type: Other
 Cycle Length: 120
 Actuated Cycle Length: 120
 Offset: 4 (3%), Referenced to phase 2:EBTL and 6:WBTL, Start of Green
 Natural Cycle: 75
 Control Type: Actuated-Coordinated
 Maximum v/c Ratio: 0.60
 Intersection Signal Delay: 9.2
 Intersection LOS: A
 Intersection Capacity Utilization 68.1%
 ICU Level of Service C
 Analysis Period (min) 15
 m Volume for 95th percentile queue is metered by upstream signal.

Splits and Phases: 4: 473 E of Page & Innes

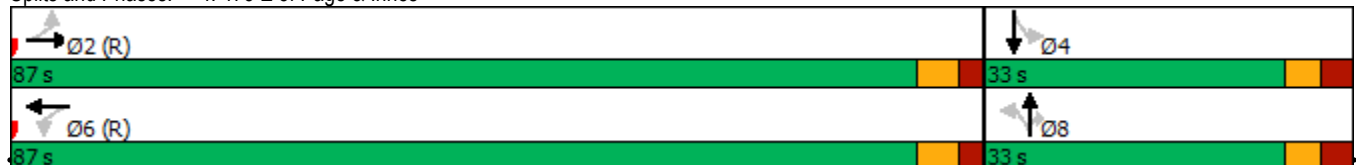



Lane Group	EBL	EBT	WBT	WBR	SBL	SBR
Lane Configurations		↑↑	↑↑			↑
Traffic Volume (vph)	0	728	1647	15	0	8
Future Volume (vph)	0	728	1647	15	0	8
Ideal Flow (vphpl)	1800	1800	1800	1800	1800	1800
Lane Util. Factor	1.00	0.95	0.95	0.95	1.00	1.00
Ped Bike Factor						
Frt			0.999			0.865
Flt Protected						
Satd. Flow (prot)	0	3357	3355	0	0	1559
Flt Permitted						
Satd. Flow (perm)	0	3357	3355	0	0	1559
Link Speed (k/h)		60	60		30	
Link Distance (m)		142.1	94.7		74.6	
Travel Time (s)		8.5	5.7		9.0	
Confl. Peds. (#/hr)	5			5		
Confl. Bikes (#/hr)				1		1
Peak Hour Factor	1.00	1.00	1.00	1.00	1.00	1.00
Heavy Vehicles (%)	1%	3%	3%	1%	1%	1%
Adj. Flow (vph)	0	728	1647	15	0	8
Shared Lane Traffic (%)						
Lane Group Flow (vph)	0	728	1662	0	0	8
Enter Blocked Intersection	No	Yes	Yes	No	No	No
Lane Alignment	L NA	Left	Left	R NA	L NA	R NA
Median Width(m)		3.7	3.7		0.0	
Link Offset(m)		0.0	0.0		0.0	
Crosswalk Width(m)		3.0	3.0		9.0	
Two way Left Turn Lane						
Headway Factor	1.06	1.06	1.06	1.06	1.06	1.06
Turning Speed (k/h)	97			97	97	97
Sign Control		Free	Free		Stop	

Intersection Summary

Area Type: Other

Control Type: Unsignalized

Intersection Capacity Utilization 58.6% ICU Level of Service B

Analysis Period (min) 15



Lane Group	EBL	EBT	EBR	WBL	WBT	WBR	NBL	NBT	NBR	SBL	SBT	SBR
Lane Configurations	↖↖	↖↖	↖	↖	↖↖	↖	↖	↖↖	↖	↖	↖↖	↖
Traffic Volume (vph)	625	1873	171	68	841	172	69	243	111	223	260	219
Future Volume (vph)	625	1873	171	68	841	172	69	243	111	223	260	219
Ideal Flow (vphpl)	1800	1800	1800	1800	1800	1800	1800	1800	1800	1800	1800	1800
Storage Length (m)	140.0		80.0	105.0		60.0	50.0		50.0	55.0		60.0
Storage Lanes	2		1	1		1	1		1	1		1
Taper Length (m)	40.0			40.0			10.0			20.0		
Lane Util. Factor	0.97	0.95	1.00	1.00	0.95	1.00	1.00	0.95	1.00	1.00	0.95	1.00
Ped Bike Factor	0.99		0.94	1.00		0.97	0.99		0.96	0.98		0.97
Frt			0.850			0.850			0.850			0.850
Flt Protected	0.950			0.950			0.950			0.950		
Satd. Flow (prot)	3288	3357	1532	1712	3293	1517	1712	3390	1532	1712	3390	1532
Flt Permitted	0.950			0.950			0.452			0.601		
Satd. Flow (perm)	3265	3357	1446	1706	3293	1475	804	3390	1473	1062	3390	1480
Right Turn on Red			Yes			Yes			Yes			Yes
Satd. Flow (RTOR)			139			195			134			219
Link Speed (k/h)		60			60			50			50	
Link Distance (m)		264.5			491.4			387.7			301.9	
Travel Time (s)		15.9			29.5			27.9			21.7	
Confl. Peds. (#/hr)	7		22	22		7	15		18	18		15
Confl. Bikes (#/hr)			4			3						
Peak Hour Factor	1.00	1.00	1.00	1.00	1.00	1.00	1.00	1.00	1.00	1.00	1.00	1.00
Heavy Vehicles (%)	2%	3%	1%	1%	5%	2%	1%	2%	1%	1%	2%	1%
Adj. Flow (vph)	625	1873	171	68	841	172	69	243	111	223	260	219
Shared Lane Traffic (%)												
Lane Group Flow (vph)	625	1873	171	68	841	172	69	243	111	223	260	219
Enter Blocked Intersection	No	No	No	No	No	No	No	No	No	No	No	No
Lane Alignment	L NA	Left	R NA	L NA	Left	R NA	L NA	Left	R NA	L NA	Left	R NA
Median Width(m)		9.0			7.4			6.0			6.0	
Link Offset(m)		0.0			0.0			0.0			0.0	
Crosswalk Width(m)		5.0			5.0			5.0			5.0	
Two way Left Turn Lane												
Headway Factor	1.06	1.06	1.06	1.06	1.06	1.06	1.06	1.06	1.06	1.06	1.06	1.06
Turning Speed (k/h)	24		14	24		14	24		14	24		14
Number of Detectors	1	2	1	1	2	1	1	2	1	1	2	1
Detector Template	Left	Thru	Right	Left	Thru	Right	Left	Thru	Right	Left	Thru	Right
Leading Detector (m)	18.6	93.0	18.6	18.6	93.0	18.6	18.6	93.0	18.6	18.6	93.0	18.6
Trailing Detector (m)	0.0	0.0	0.0	0.0	0.0	0.0	0.0	0.0	0.0	0.0	0.0	0.0
Detector 1 Position(m)	0.0	0.0	0.0	0.0	0.0	0.0	0.0	0.0	0.0	0.0	0.0	0.0
Detector 1 Size(m)	18.6	5.5	18.6	18.6	5.5	18.6	18.6	5.5	18.6	18.6	5.5	18.6
Detector 1 Type	Cl+Ex	Cl+Ex	Cl+Ex	Cl+Ex	Cl+Ex	Cl+Ex	Cl+Ex	Cl+Ex	Cl+Ex	Cl+Ex	Cl+Ex	Cl+Ex
Detector 1 Channel												
Detector 1 Extend (s)	0.0	0.0	0.0	0.0	0.0	0.0	0.0	0.0	0.0	0.0	0.0	0.0
Detector 1 Queue (s)	0.0	0.0	0.0	0.0	0.0	0.0	0.0	0.0	0.0	0.0	0.0	0.0
Detector 1 Delay (s)	0.0	0.0	0.0	0.0	0.0	0.0	0.0	0.0	0.0	0.0	0.0	0.0
Detector 2 Position(m)		87.5			87.5			87.5			87.5	
Detector 2 Size(m)		5.5			5.5			5.5			5.5	
Detector 2 Type		Cl+Ex			Cl+Ex			Cl+Ex			Cl+Ex	
Detector 2 Channel												
Detector 2 Extend (s)		0.0			0.0			0.0			0.0	
Turn Type	Prot	NA	Perm	Prot	NA	Perm	pm+pt	NA	Perm	Perm	NA	Perm
Protected Phases	5	2		1	6		3	8			4	
Permitted Phases			2			6	8		8	4		4
Detector Phase	5	2	2	1	6	6	3	8	8	4	4	4



Lane Group	EBL	EBT	EBR	WBL	WBT	WBR	NBL	NBT	NBR	SBL	SBT	SBR
Switch Phase												
Minimum Initial (s)	5.0	10.0	10.0	5.0	10.0	10.0	5.0	10.0	10.0	10.0	10.0	10.0
Minimum Split (s)	11.6	26.2	26.2	11.2	26.2	26.2	11.7	32.7	32.7	32.7	32.7	32.7
Total Split (s)	35.0	71.0	71.0	12.0	48.0	48.0	12.0	47.0	47.0	35.0	35.0	35.0
Total Split (%)	26.9%	54.6%	54.6%	9.2%	36.9%	36.9%	9.2%	36.2%	36.2%	26.9%	26.9%	26.9%
Maximum Green (s)	28.4	64.8	64.8	5.8	41.8	41.8	5.3	40.3	40.3	28.3	28.3	28.3
Yellow Time (s)	3.7	3.7	3.7	3.7	3.7	3.7	3.3	3.3	3.3	3.3	3.3	3.3
All-Red Time (s)	2.9	2.5	2.5	2.5	2.5	2.5	3.4	3.4	3.4	3.4	3.4	3.4
Lost Time Adjust (s)	0.0	0.0	0.0	0.0	0.0	0.0	0.0	0.0	0.0	0.0	0.0	0.0
Total Lost Time (s)	6.6	6.2	6.2	6.2	6.2	6.2	6.7	6.7	6.7	6.7	6.7	6.7
Lead/Lag	Lead	Lag	Lag	Lead	Lag	Lag	Lead			Lag	Lag	Lag
Lead-Lag Optimize?												
Vehicle Extension (s)	3.0	3.0	3.0	3.0	3.0	3.0	3.0	3.0	3.0	3.0	3.0	3.0
Recall Mode	None	C-Max	C-Max	None	C-Max	C-Max	None	None	None	None	None	None
Walk Time (s)		7.0	7.0		7.0	7.0		7.0	7.0	7.0	7.0	7.0
Flash Dont Walk (s)		13.0	13.0		13.0	13.0		19.0	19.0	19.0	19.0	19.0
Pedestrian Calls (#/hr)		22	22		7	7		32	32	15	15	15
Act Effct Green (s)	27.4	66.3	66.3	6.3	44.9	44.9	38.3	38.3	38.3	28.7	28.7	28.7
Actuated g/C Ratio	0.21	0.51	0.51	0.05	0.35	0.35	0.29	0.29	0.29	0.22	0.22	0.22
v/c Ratio	0.90	1.09	0.21	0.82	0.74	0.27	0.25	0.24	0.21	0.95	0.35	0.44
Control Delay	67.5	83.7	5.1	109.5	42.7	9.6	35.2	35.0	4.0	98.3	44.5	8.3
Queue Delay	0.0	0.0	0.0	0.0	0.0	0.0	0.0	0.0	0.0	0.0	0.0	0.0
Total Delay	67.5	83.7	5.1	109.5	42.7	9.6	35.2	35.0	4.0	98.3	44.5	8.3
LOS	E	F	A	F	D	A	D	D	A	F	D	A
Approach Delay		74.8			41.6			26.9			50.3	
Approach LOS		E			D			C			D	
Queue Length 50th (m)	73.9	~267.3	3.8	16.4	85.8	2.3	11.7	22.4	0.0	52.5	27.5	0.0
Queue Length 95th (m)	#100.5	#306.0	14.7	#42.2	116.1	19.2	22.3	32.3	8.1	#98.7	39.4	18.7
Internal Link Dist (m)		240.5			467.4			363.7			277.9	
Turn Bay Length (m)	140.0		80.0	105.0		60.0	50.0		50.0	55.0		60.0
Base Capacity (vph)	718	1712	805	83	1136	636	273	1050	549	234	747	497
Starvation Cap Reductn	0	0	0	0	0	0	0	0	0	0	0	0
Spillback Cap Reductn	0	0	0	0	0	0	0	0	0	0	0	0
Storage Cap Reductn	0	0	0	0	0	0	0	0	0	0	0	0
Reduced v/c Ratio	0.87	1.09	0.21	0.82	0.74	0.27	0.25	0.23	0.20	0.95	0.35	0.44

Intersection Summary

Area Type: Other
 Cycle Length: 130
 Actuated Cycle Length: 130
 Offset: 4 (3%), Referenced to phase 2:EBT and 6:WBT, Start of Green
 Natural Cycle: 145
 Control Type: Actuated-Coordinated
 Maximum v/c Ratio: 1.09
 Intersection Signal Delay: 59.8 Intersection LOS: E
 Intersection Capacity Utilization 107.7% ICU Level of Service G
 Analysis Period (min) 15
 ~ Volume exceeds capacity, queue is theoretically infinite.
 Queue shown is maximum after two cycles.
 # 95th percentile volume exceeds capacity, queue may be longer.
 Queue shown is maximum after two cycles.

Splits and Phases: 1: Orleans & Innes

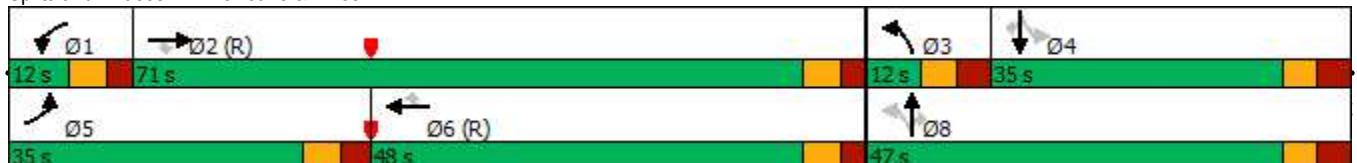

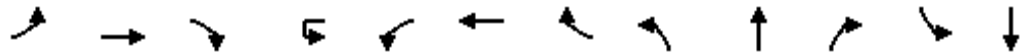

Lane Group	EBL	EBT	EBR	WBU	WBL	WBT	WBR	NBL	NBT	NBR	SBL	SBT
Lane Configurations												
Traffic Volume (vph)	63	1923	30	6	93	954	64	23	7	77	54	18
Future Volume (vph)	63	1923	30	6	93	954	64	23	7	77	54	18
Ideal Flow (vphpl)	1800	1800	1800	1800	1800	1800	1800	1800	1800	1800	1800	1800
Storage Length (m)	100.0		0.0		100.0		0.0	0.0		0.0	0.0	
Storage Lanes	1		0		1		0	0		0	0	
Taper Length (m)	35.0				25.0			2.5			2.5	
Lane Util. Factor	1.00	0.95	0.95	0.95	1.00	0.95	0.95	1.00	1.00	1.00	1.00	1.00
Ped Bike Factor	1.00	1.00				1.00			0.98			0.99
Frt		0.998				0.991			0.903			0.955
Flt Protected	0.950				0.950				0.989			0.976
Satd. Flow (prot)	1695	3380	0	0	1694	3262	0	0	1541	0	0	1578
Flt Permitted	0.282				0.044				0.917			0.754
Satd. Flow (perm)	501	3380	0	0	78	3262	0	0	1427	0	0	1211
Right Turn on Red			Yes				Yes			Yes		
Satd. Flow (RTOR)		2				11			63			18
Link Speed (k/h)		60				60			40			40
Link Distance (m)		491.4				142.1			212.5			273.4
Travel Time (s)		29.5				8.5			19.1			24.6
Confl. Peds. (#/hr)	9		5		5		9	5		13	13	
Confl. Bikes (#/hr)			1							1		
Peak Hour Factor	1.00	1.00	1.00	1.00	1.00	1.00	1.00	1.00	1.00	1.00	1.00	1.00
Heavy Vehicles (%)	2%	2%	6%	3%	2%	5%	2%	5%	1%	3%	6%	1%
Adj. Flow (vph)	63	1923	30	6	93	954	64	23	7	77	54	18
Shared Lane Traffic (%)												
Lane Group Flow (vph)	63	1953	0	0	99	1018	0	0	107	0	0	108
Enter Blocked Intersection	No	No	No	No	No	Yes	No	No	No	No	No	No
Lane Alignment	Left	Left	Right	R NA	Left	Left	Right	L NA	Left	R NA	L NA	Left
Median Width(m)		5.0				5.0			0.0			0.0
Link Offset(m)		0.0				0.0			0.0			0.0
Crosswalk Width(m)		10.0				10.0			5.0			5.0
Two way Left Turn Lane												
Headway Factor	1.06	1.06	1.06	1.06	1.06	1.06	1.06	1.06	1.06	1.06	1.06	1.06
Turning Speed (k/h)	24		14	14	24		14	24		14	24	
Number of Detectors	1	2		1	1	2		1	2		1	2
Detector Template	Left	Thru		Left	Left	Thru		Left	Thru		Left	Thru
Leading Detector (m)	18.6	93.0		18.6	18.6	93.0		18.6	93.0		18.6	93.0
Trailing Detector (m)	0.0	0.0		0.0	0.0	0.0		0.0	0.0		0.0	0.0
Detector 1 Position(m)	0.0	0.0		0.0	0.0	0.0		0.0	0.0		0.0	0.0
Detector 1 Size(m)	18.6	5.5		18.6	18.6	5.5		18.6	5.5		18.6	5.5
Detector 1 Type	Cl+Ex	Cl+Ex		Cl+Ex	Cl+Ex	Cl+Ex		Cl+Ex	Cl+Ex		Cl+Ex	Cl+Ex
Detector 1 Channel												
Detector 1 Extend (s)	0.0	0.0		0.0	0.0	0.0		0.0	0.0		0.0	0.0
Detector 1 Queue (s)	0.0	0.0		0.0	0.0	0.0		0.0	0.0		0.0	0.0
Detector 1 Delay (s)	0.0	0.0		0.0	0.0	0.0		0.0	0.0		0.0	0.0
Detector 2 Position(m)		87.5				87.5			87.5			87.5
Detector 2 Size(m)		5.5				5.5			5.5			5.5
Detector 2 Type		Cl+Ex				Cl+Ex			Cl+Ex			Cl+Ex
Detector 2 Channel												
Detector 2 Extend (s)		0.0				0.0			0.0			0.0
Turn Type	Perm	NA		pm+pt	pm+pt	NA		Perm	NA		Perm	NA
Protected Phases		2		1	1	6			8			4
Permitted Phases	2			6	6			8			4	
Detector Phase	2	2		1	1	6		8	8		4	4

Lane Group	SBR
Lane Configurations	
Traffic Volume (vph)	36
Future Volume (vph)	36
Ideal Flow (vphpl)	1800
Storage Length (m)	0.0
Storage Lanes	0
Taper Length (m)	
Lane Util. Factor	1.00
Ped Bike Factor	
Frt	
Flt Protected	
Satd. Flow (prot)	0
Flt Permitted	
Satd. Flow (perm)	0
Right Turn on Red	Yes
Satd. Flow (RTOR)	
Link Speed (k/h)	
Link Distance (m)	
Travel Time (s)	
Confl. Peds. (#/hr)	5
Confl. Bikes (#/hr)	
Peak Hour Factor	1.00
Heavy Vehicles (%)	11%
Adj. Flow (vph)	36
Shared Lane Traffic (%)	
Lane Group Flow (vph)	0
Enter Blocked Intersection	No
Lane Alignment	R NA
Median Width(m)	
Link Offset(m)	
Crosswalk Width(m)	
Two way Left Turn Lane	
Headway Factor	1.06
Turning Speed (k/h)	14
Number of Detectors	
Detector Template	
Leading Detector (m)	
Trailing Detector (m)	
Detector 1 Position(m)	
Detector 1 Size(m)	
Detector 1 Type	
Detector 1 Channel	
Detector 1 Extend (s)	
Detector 1 Queue (s)	
Detector 1 Delay (s)	
Detector 2 Position(m)	
Detector 2 Size(m)	
Detector 2 Type	
Detector 2 Channel	
Detector 2 Extend (s)	
Turn Type	
Protected Phases	
Permitted Phases	
Detector Phase	

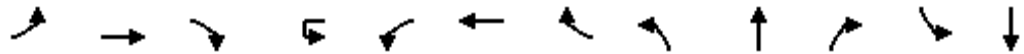

Lane Group	EBL	EBT	EBR	WBU	WBL	WBT	WBR	NBL	NBT	NBR	SBL	SBT
Switch Phase												
Minimum Initial (s)	10.0	10.0		5.0	5.0	10.0		10.0	10.0		10.0	10.0
Minimum Split (s)	39.2	39.2		11.2	11.2	39.2		37.8	37.8		37.8	37.8
Total Split (s)	80.0	80.0		12.0	12.0	92.0		38.0	38.0		38.0	38.0
Total Split (%)	61.5%	61.5%		9.2%	9.2%	70.8%		29.2%	29.2%		29.2%	29.2%
Maximum Green (s)	73.8	73.8		5.8	5.8	85.8		31.2	31.2		31.2	31.2
Yellow Time (s)	3.7	3.7		3.7	3.7	3.7		3.0	3.0		3.0	3.0
All-Red Time (s)	2.5	2.5		2.5	2.5	2.5		3.8	3.8		3.8	3.8
Lost Time Adjust (s)	0.0	0.0			0.0	0.0			0.0			0.0
Total Lost Time (s)	6.2	6.2			6.2	6.2			6.8			6.8
Lead/Lag	Lag	Lag		Lead	Lead							
Lead-Lag Optimize?												
Vehicle Extension (s)	3.0	3.0		3.0	3.0	3.0		3.0	3.0		3.0	3.0
Recall Mode	C-Max	C-Max		None	None	C-Max		None	None		None	None
Walk Time (s)	15.0	15.0				15.0		7.0	7.0		7.0	7.0
Flash Dont Walk (s)	18.0	18.0				18.0		24.0	24.0		24.0	24.0
Pedestrian Calls (#/hr)	5	5				9		13	13		5	5
Act Effct Green (s)	84.2	84.2			97.4	97.4			19.6			19.6
Actuated g/C Ratio	0.65	0.65			0.75	0.75			0.15			0.15
v/c Ratio	0.19	0.89			0.68	0.42			0.40			0.55
Control Delay	3.2	7.6			56.7	4.4			24.5			50.4
Queue Delay	0.0	0.0			0.0	0.0			0.0			0.0
Total Delay	3.2	7.6			56.7	4.4			24.5			50.4
LOS	A	A			E	A			C			D
Approach Delay		7.4				9.1			24.5			50.4
Approach LOS		A				A			C			D
Queue Length 50th (m)	1.6	30.8			8.5	20.5			9.7			20.8
Queue Length 95th (m)	m2.0	m31.8			m#39.0	27.3			22.7			33.7
Internal Link Dist (m)		467.4				118.1			188.5			249.4
Turn Bay Length (m)	100.0				100.0							
Base Capacity (vph)	324	2188			146	2447			390			304
Starvation Cap Reductn	0	0			0	0			0			0
Spillback Cap Reductn	0	0			0	0			0			0
Storage Cap Reductn	0	0			0	0			0			0
Reduced v/c Ratio	0.19	0.89			0.68	0.42			0.27			0.36

Intersection Summary

Area Type: Other
 Cycle Length: 130
 Actuated Cycle Length: 130
 Offset: 4 (3%), Referenced to phase 2:EBTL and 6:WBTL, Start of Green
 Natural Cycle: 130
 Control Type: Actuated-Coordinated
 Maximum v/c Ratio: 0.89
 Intersection Signal Delay: 9.9
 Intersection LOS: A
 Intersection Capacity Utilization 94.2%
 ICU Level of Service F
 Analysis Period (min) 15
 # 95th percentile volume exceeds capacity, queue may be longer.
 Queue shown is maximum after two cycles.
 m Volume for 95th percentile queue is metered by upstream signal.

Splits and Phases: 2: Page & Innes

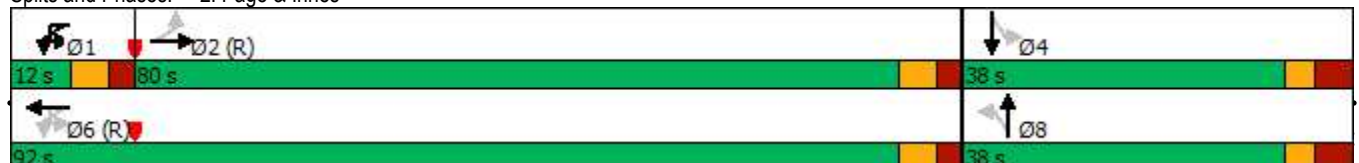

↙

Lane Group	SBR
Switch Phase	
Minimum Initial (s)	
Minimum Split (s)	
Total Split (s)	
Total Split (%)	
Maximum Green (s)	
Yellow Time (s)	
All-Red Time (s)	
Lost Time Adjust (s)	
Total Lost Time (s)	
Lead/Lag	
Lead-Lag Optimize?	
Vehicle Extension (s)	
Recall Mode	
Walk Time (s)	
Flash Dont Walk (s)	
Pedestrian Calls (#/hr)	
Act Effct Green (s)	
Actuated g/C Ratio	
v/c Ratio	
Control Delay	
Queue Delay	
Total Delay	
LOS	
Approach Delay	
Approach LOS	
Queue Length 50th (m)	
Queue Length 95th (m)	
Internal Link Dist (m)	
Turn Bay Length (m)	
Base Capacity (vph)	
Starvation Cap Reductn	
Spillback Cap Reductn	
Storage Cap Reductn	
Reduced v/c Ratio	
Intersection Summary	

3: Lamarche & Innes
PM Peak Hour

3493-3499 Innes Road
2030 Total Traffic



Lane Group	EBU	EBT	EBR	WBL	WBT	NBL	NBR	Ø3	Ø8
Lane Configurations									
Traffic Volume (vph)	11	1595	324	177	948	217	205		
Future Volume (vph)	11	1595	324	177	948	217	205		
Ideal Flow (vphpl)	1800	1800	1800	1800	1800	1800	1800		
Storage Length (m)	30.0		50.0	65.0		70.0	70.0		
Storage Lanes	1		1	1		1	1		
Taper Length (m)	30.0			80.0		20.0			
Lane Util. Factor	1.00	0.95	1.00	1.00	0.95	0.97	1.00		
Ped Bike Factor			0.96			0.97			
Frt			0.850				0.850		
Flt Protected	0.950			0.950		0.950			
Satd. Flow (prot)	1679	3357	1502	1679	3357	3257	1502		
Flt Permitted	0.302			0.053		0.950			
Satd. Flow (perm)	534	3357	1449	94	3357	3147	1502		
Right Turn on Red			Yes				Yes		
Satd. Flow (RTOR)			166				10		
Link Speed (k/h)		60			60	50			
Link Distance (m)		94.7			238.7	204.5			
Travel Time (s)		5.7			14.3	14.7			
Confl. Peds. (#/hr)			6	6		5	5		
Peak Hour Factor	1.00	1.00	1.00	1.00	1.00	1.00	1.00		
Adj. Flow (vph)	11	1595	324	177	948	217	205		
Shared Lane Traffic (%)									
Lane Group Flow (vph)	11	1595	324	177	948	217	205		
Enter Blocked Intersection	No	Yes	No	No	No	No	No		
Lane Alignment	R NA	Left	Right	Left	Left	L NA	R NA		
Median Width(m)		5.0			5.0	7.4			
Link Offset(m)		0.0			0.0	0.0			
Crosswalk Width(m)		9.0			9.0	9.0			
Two way Left Turn Lane									
Headway Factor	1.06	1.06	1.06	1.06	1.06	1.06	1.06		
Turning Speed (k/h)	14		14	24		24	14		
Number of Detectors	1	2	1	1	2	1	1		
Detector Template	Left	Thru	Right	Left	Thru	Left	Right		
Leading Detector (m)	18.6	93.0	18.6	18.6	93.0	18.6	18.6		
Trailing Detector (m)	0.0	0.0	0.0	0.0	0.0	0.0	0.0		
Detector 1 Position(m)	0.0	0.0	0.0	0.0	0.0	0.0	0.0		
Detector 1 Size(m)	18.6	5.5	18.6	18.6	5.5	18.6	18.6		
Detector 1 Type	Cl+Ex	Cl+Ex	Cl+Ex	Cl+Ex	Cl+Ex	Cl+Ex	Cl+Ex		
Detector 1 Channel									
Detector 1 Extend (s)	0.0	0.0	0.0	0.0	0.0	0.0	0.0		
Detector 1 Queue (s)	0.0	0.0	0.0	0.0	0.0	0.0	0.0		
Detector 1 Delay (s)	0.0	0.0	0.0	0.0	0.0	0.0	0.0		
Detector 2 Position(m)		87.5			87.5				
Detector 2 Size(m)		5.5			5.5				
Detector 2 Type		Cl+Ex			Cl+Ex				
Detector 2 Channel									
Detector 2 Extend (s)		0.0			0.0				
Turn Type	Perm	NA	Perm	pm+pt	NA	Prot	pt+ov		
Protected Phases		2		1	6	4	18	3	8
Permitted Phases	2		2	6					
Detector Phase	2	2	2	1	6	4	18		
Switch Phase									
Minimum Initial (s)	10.0	10.0	10.0	5.0	10.0	5.0		3.0	10.0



Lane Group	EBU	EBT	EBR	WBL	WBT	NBL	NBR	Ø3	Ø8
Minimum Split (s)	31.2	31.2	31.2	11.3	31.2	11.3		30.0	16.3
Total Split (s)	68.0	68.0	68.0	16.0	84.0	16.0		30.0	46.0
Total Split (%)	52.3%	52.3%	52.3%	12.3%	64.6%	12.3%		23%	35%
Maximum Green (s)	61.8	61.8	61.8	9.7	77.8	9.7		28.0	39.7
Yellow Time (s)	3.7	3.7	3.7	3.3	3.7	3.3		2.0	3.3
All-Red Time (s)	2.5	2.5	2.5	3.0	2.5	3.0		0.0	3.0
Lost Time Adjust (s)	0.0	0.0	0.0	0.0	0.0	0.0			
Total Lost Time (s)	6.2	6.2	6.2	6.3	6.2	6.3			
Lead/Lag	Lag	Lag	Lag	Lead		Lag		Lead	
Lead-Lag Optimize?									
Vehicle Extension (s)	3.0	3.0	3.0	3.0	3.0	3.0		3.0	3.0
Recall Mode	C-Max	C-Max	C-Max	None	C-Max	None		None	None
Walk Time (s)	7.0	7.0	7.0		7.0			7.0	
Flash Dont Walk (s)	18.0	18.0	18.0		18.0			21.0	
Pedestrian Calls (#/hr)	10	10	10		10			10	
Act Effct Green (s)	72.6	72.6	72.6	92.0	92.1	13.4	44.9		
Actuated g/C Ratio	0.56	0.56	0.56	0.71	0.71	0.10	0.35		
v/c Ratio	0.04	0.85	0.37	0.78	0.40	0.65	0.39		
Control Delay	5.2	11.7	1.3	61.7	8.2	65.9	31.2		
Queue Delay	0.0	0.0	0.0	0.0	0.0	0.0	0.0		
Total Delay	5.2	11.7	1.3	61.7	8.2	65.9	31.2		
LOS	A	B	A	E	A	E	C		
Approach Delay		9.9			16.6	49.0			
Approach LOS		A			B	D			
Queue Length 50th (m)	0.3	36.5	2.9	27.2	30.7	24.5	35.8		
Queue Length 95th (m)	m0.5	#241.0	m4.8	#74.9	54.6	#47.8	47.2		
Internal Link Dist (m)		70.7			214.7	180.5			
Turn Bay Length (m)	30.0		50.0	65.0		70.0	70.0		
Base Capacity (vph)	298	1875	882	227	2379	334	544		
Starvation Cap Reductn	0	0	0	0	0	0	0		
Spillback Cap Reductn	0	0	0	0	0	0	0		
Storage Cap Reductn	0	0	0	0	0	0	0		
Reduced v/c Ratio	0.04	0.85	0.37	0.78	0.40	0.65	0.38		

Intersection Summary

Area Type: Other
 Cycle Length: 130
 Actuated Cycle Length: 130
 Offset: 28 (22%), Referenced to phase 2:EBTU and 6:WBTL, Start of Green
 Natural Cycle: 125
 Control Type: Actuated-Coordinated
 Maximum v/c Ratio: 0.85
 Intersection Signal Delay: 16.8
 Intersection Capacity Utilization 79.1%
 Analysis Period (min) 15
 # 95th percentile volume exceeds capacity, queue may be longer.
 Queue shown is maximum after two cycles.
 m Volume for 95th percentile queue is metered by upstream signal.

Splits and Phases: 3: Lamarche & Innes

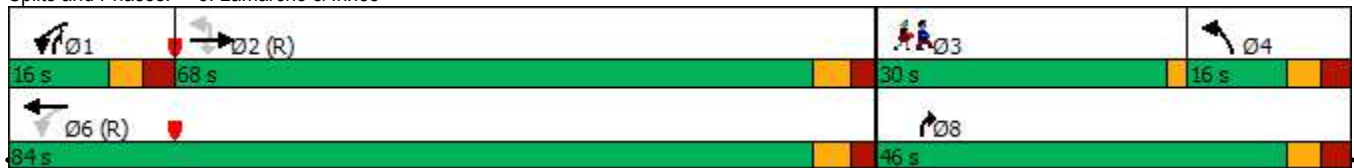



Lane Group	EBL	EBT	EBR	WBL	WBT	WBR	NBL	NBT	NBR	SBL	SBT	SBR
Lane Configurations												
Traffic Volume (vph)	8	1872	131	67	1065	8	88	0	56	4	0	10
Future Volume (vph)	8	1872	131	67	1065	8	88	0	56	4	0	10
Ideal Flow (vphpl)	1800	1800	1800	1800	1800	1800	1800	1800	1800	1800	1800	1800
Storage Length (m)	65.0		0.0	40.0		0.0	0.0		0.0	0.0		0.0
Storage Lanes	1		0	1		0	0		1	0		0
Taper Length (m)	80.0			30.0			20.0			20.0		
Lane Util. Factor	1.00	0.95	0.95	1.00	0.95	0.95	1.00	1.00	1.00	1.00	1.00	1.00
Ped Bike Factor		1.00						1.00				0.99
Frt		0.990			0.999				0.850			0.904
Flt Protected	0.950			0.950				0.950				0.986
Satd. Flow (prot)	1712	3353	0	1712	3322	0	0	1712	1381	0	1587	0
Flt Permitted	0.249			0.070				0.748				0.920
Satd. Flow (perm)	449	3353	0	126	3322	0	0	1342	1381	0	1481	0
Right Turn on Red			Yes			Yes			Yes			Yes
Satd. Flow (RTOR)		13			1				29			26
Link Speed (k/h)		60			60				40			40
Link Distance (m)		238.7			292.8				151.9			62.6
Travel Time (s)		14.3			17.6				13.7			5.6
Confl. Peds. (#/hr)			2	2			3					3
Confl. Bikes (#/hr)			1									
Peak Hour Factor	1.00	1.00	1.00	1.00	1.00	1.00	1.00	1.00	1.00	1.00	1.00	1.00
Heavy Vehicles (%)	1%	2%	1%	1%	4%	1%	1%	1%	12%	1%	1%	1%
Adj. Flow (vph)	8	1872	131	67	1065	8	88	0	56	4	0	10
Shared Lane Traffic (%)												
Lane Group Flow (vph)	8	2003	0	67	1073	0	0	88	56	0	14	0
Enter Blocked Intersection	No	No	No	No	No	No	No	No	No	No	No	No
Lane Alignment	L NA	Left	R NA	L NA	Left	R NA	L NA	Left	R NA	L NA	Left	R NA
Median Width(m)		5.0			5.0			0.0			0.0	
Link Offset(m)		0.0			0.0			0.0			0.0	
Crosswalk Width(m)		9.0			9.0			9.0			9.0	
Two way Left Turn Lane												
Headway Factor	1.06	1.06	1.06	1.06	1.06	1.06	1.06	1.06	1.06	1.06	1.06	1.06
Turning Speed (k/h)	24		14	24		14	24		14	24		14
Number of Detectors	1	2		1	2		1	2	1	1		2
Detector Template	Left	Thru		Left	Thru		Left	Thru	Right	Left		Thru
Leading Detector (m)	18.6	93.0		18.6	93.0		18.6	93.0	18.6	18.6		93.0
Trailing Detector (m)	0.0	0.0		0.0	0.0		0.0	0.0	0.0	0.0		0.0
Detector 1 Position(m)	0.0	0.0		0.0	0.0		0.0	0.0	0.0	0.0		0.0
Detector 1 Size(m)	18.6	5.5		18.6	5.5		18.6	5.5	18.6	18.6		5.5
Detector 1 Type	Cl+Ex	Cl+Ex		Cl+Ex	Cl+Ex		Cl+Ex	Cl+Ex	Cl+Ex	Cl+Ex		Cl+Ex
Detector 1 Channel												
Detector 1 Extend (s)	0.0	0.0		0.0	0.0		0.0	0.0	0.0	0.0		0.0
Detector 1 Queue (s)	0.0	0.0		0.0	0.0		0.0	0.0	0.0	0.0		0.0
Detector 1 Delay (s)	0.0	0.0		0.0	0.0		0.0	0.0	0.0	0.0		0.0
Detector 2 Position(m)		87.5			87.5			87.5				87.5
Detector 2 Size(m)		5.5			5.5			5.5				5.5
Detector 2 Type		Cl+Ex			Cl+Ex			Cl+Ex				Cl+Ex
Detector 2 Channel												
Detector 2 Extend (s)		0.0			0.0			0.0				0.0
Turn Type	Perm	NA		Perm	NA		Perm	NA	Perm	Perm		NA
Protected Phases		2			6			8				4
Permitted Phases	2			6			8		8	4		
Detector Phase	2	2		6	6		8	8	8	4		4



Lane Group	EBL	EBT	EBR	WBL	WBT	WBR	NBL	NBT	NBR	SBL	SBT	SBR
Switch Phase												
Minimum Initial (s)	10.0	10.0		10.0	10.0		10.0	10.0	10.0	10.0	10.0	
Minimum Split (s)	32.1	32.1		35.1	35.1		32.3	32.3	32.3	32.3	32.3	
Total Split (s)	97.0	97.0		97.0	97.0		33.0	33.0	33.0	33.0	33.0	
Total Split (%)	74.6%	74.6%		74.6%	74.6%		25.4%	25.4%	25.4%	25.4%	25.4%	
Maximum Green (s)	90.9	90.9		90.9	90.9		26.7	26.7	26.7	26.7	26.7	
Yellow Time (s)	3.7	3.7		3.7	3.7		3.3	3.3	3.3	3.3	3.3	
All-Red Time (s)	2.4	2.4		2.4	2.4		3.0	3.0	3.0	3.0	3.0	
Lost Time Adjust (s)	0.0	0.0		0.0	0.0			0.0	0.0		0.0	
Total Lost Time (s)	6.1	6.1		6.1	6.1			6.3	6.3		6.3	
Lead/Lag												
Lead-Lag Optimize?												
Vehicle Extension (s)	3.0	3.0		3.0	3.0		3.0	3.0	3.0	3.0	3.0	
Recall Mode	C-Max	C-Max		C-Max	C-Max		None	None	None	None	None	
Walk Time (s)	12.0	12.0		12.0	12.0		7.0	7.0	7.0	7.0	7.0	
Flash Dont Walk (s)	14.0	14.0		14.0	14.0		19.0	19.0	19.0	19.0	19.0	
Pedestrian Calls (#/hr)	2	2		1	1		1	1	1	3	3	
Act Effct Green (s)	102.1	102.1		102.1	102.1			15.5	15.5		15.5	
Actuated g/C Ratio	0.79	0.79		0.79	0.79			0.12	0.12		0.12	
v/c Ratio	0.02	0.76		0.68	0.41			0.55	0.29		0.07	
Control Delay	2.0	5.4		47.6	5.5			65.5	31.1		7.4	
Queue Delay	0.0	0.7		0.0	0.0			0.0	0.0		0.0	
Total Delay	2.0	6.0		47.6	5.5			65.5	31.1		7.4	
LOS	A	A		D	A			E	C		A	
Approach Delay		6.0			8.0			52.1			7.4	
Approach LOS		A			A			D			A	
Queue Length 50th (m)	0.1	16.4		5.6	32.7			20.2	5.9		0.0	
Queue Length 95th (m)	m0.2	30.4		#39.0	64.0			32.7	16.2		2.9	
Internal Link Dist (m)		214.7			268.8			127.9			38.6	
Turn Bay Length (m)	65.0			40.0								
Base Capacity (vph)	352	2636		98	2609			275	306		324	
Starvation Cap Reductn	0	285		0	0			0	0		0	
Spillback Cap Reductn	0	0		0	0			0	0		0	
Storage Cap Reductn	0	0		0	0			0	0		0	
Reduced v/c Ratio	0.02	0.85		0.68	0.41			0.32	0.18		0.04	

Intersection Summary

Area Type: Other
 Cycle Length: 130
 Actuated Cycle Length: 130
 Offset: 28 (22%), Referenced to phase 2:EBTL and 6:WBTL, Start of Green
 Natural Cycle: 90
 Control Type: Actuated-Coordinated
 Maximum v/c Ratio: 0.76
 Intersection Signal Delay: 8.7 Intersection LOS: A
 Intersection Capacity Utilization 92.6% ICU Level of Service F
 Analysis Period (min) 15
 # 95th percentile volume exceeds capacity, queue may be longer.
 Queue shown is maximum after two cycles.
 m Volume for 95th percentile queue is metered by upstream signal.

Splits and Phases: 4: 473 E of Page & Innes

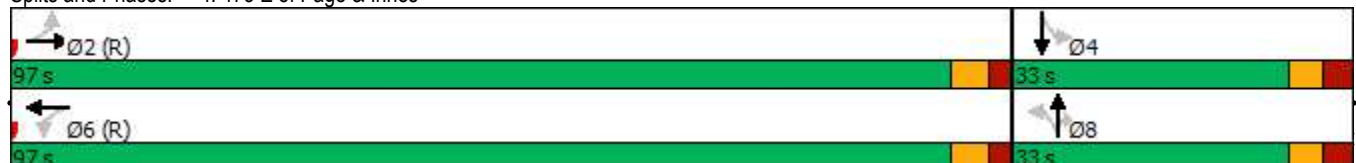



Lane Group	EBL	EBT	WBT	WBR	SBL	SBR
Lane Configurations		↑↑	↑↑			↗
Traffic Volume (vph)	0	1930	1146	30	0	30
Future Volume (vph)	0	1930	1146	30	0	30
Ideal Flow (vphpl)	1800	1800	1800	1800	1800	1800
Lane Util. Factor	1.00	0.95	0.95	0.95	1.00	1.00
Ped Bike Factor						
Frt			0.996			0.865
Flt Protected						
Satd. Flow (prot)	0	3357	3346	0	0	1559
Flt Permitted						
Satd. Flow (perm)	0	3357	3346	0	0	1559
Link Speed (k/h)		60	60		30	
Link Distance (m)		142.1	94.7		74.6	
Travel Time (s)		8.5	5.7		9.0	
Confl. Peds. (#/hr)	5			5		
Confl. Bikes (#/hr)				1		1
Peak Hour Factor	1.00	1.00	1.00	1.00	1.00	1.00
Heavy Vehicles (%)	1%	3%	3%	1%	1%	1%
Adj. Flow (vph)	0	1930	1146	30	0	30
Shared Lane Traffic (%)						
Lane Group Flow (vph)	0	1930	1176	0	0	30
Enter Blocked Intersection	No	Yes	Yes	No	No	No
Lane Alignment	L NA	Left	Left	R NA	L NA	R NA
Median Width(m)		3.7	3.7		0.0	
Link Offset(m)		0.0	0.0		0.0	
Crosswalk Width(m)		3.0	3.0		9.0	
Two way Left Turn Lane						
Headway Factor	1.06	1.06	1.06	1.06	1.06	1.06
Turning Speed (k/h)	97			97	97	97
Sign Control		Free	Free		Stop	

Intersection Summary

Area Type: Other

Control Type: Unsignalized

Intersection Capacity Utilization 59.6%

ICU Level of Service B

Analysis Period (min) 15