



**1806 SCOTT STREET SERVICING AND
STORMWATER MANAGEMENT REPORT**

December 16, 2022

Prepared for:
2851944 Ontario Inc.

Prepared by:
Stantec Consulting Ltd.
300-1331 Clyde Avenue
Ottawa, Ontario
K2C 3G4

Project Number:
160401747

1806 Scott Street Servicing and Stormwater Management Report

December 16, 2022

Revision	Description	Author	Date	Quality Check	Date	Independent Review	Date
0	First Submission	Michael Wu	2022-12-16	Neal Cody	2022-12-16	Sheridan Gillis	2022-11-28



1806 Scott Street Servicing and Stormwater Management Report

The conclusions in the Report titled 1806 Scott Street Servicing and Stormwater Management Report are Stantec’s professional opinion, as of the time of the Report, and concerning the scope described in the Report. The opinions in the document are based on conditions and information existing at the time the scope of work was conducted and do not take into account any subsequent changes. The Report relates solely to the specific project for which Stantec was retained and the stated purpose for which the Report was prepared. The Report is not to be used or relied on for any variation or extension of the project, or for any other project or purpose, and any unauthorized use or reliance is at the recipient’s own risk.

Stantec has assumed all information received from 2851944 Ontario Inc. (the “Client”) and third parties in the preparation of the Report to be correct. While Stantec has exercised a customary level of judgment or due diligence in the use of such information, Stantec assumes no responsibility for the consequences of any error or omission contained therein.

This Report is intended solely for use by the Client in accordance with Stantec’s contract with the Client. While the Report may be provided to applicable authorities having jurisdiction and others for whom the Client is responsible, Stantec does not warrant the services to any third party. The report may not be relied upon by any other party without the express written consent of Stantec, which may be withheld at Stantec’s discretion.

Prepared by: Michael Wu
Signature

Michael Wu, EIT
Printed Name

Reviewed by: Alyssa Gladish
Signature

Alyssa Gladish, EIT
Printed Name

Approved by: Neal Cody
Signature

Neal Cody, P.Eng
Printed Name

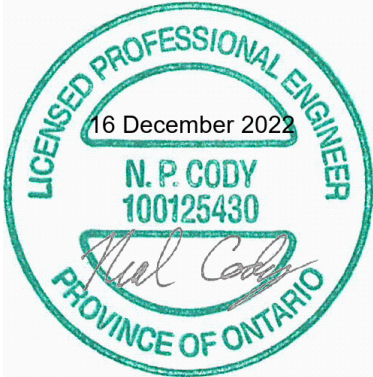

December 16, 2022

Table of Contents

- 1 INTRODUCTION.....1.1**
- 1.1 Objective..... 1.2
- 2 BACKGROUND.....2.1**
- 3 WATER SERVICING3.1**
- 3.1 Background 3.1
- 3.2 Water Demands..... 3.1
- 3.2.1 Potable (Domestic) Water Demands..... 3.1
- 3.2.2 Fire Flow Demands 3.1
- 3.3 Level of Servicing 3.2
- 3.3.1 Boundary Conditions 3.2
- 3.3.2 Allowable Domestic Pressures 3.2
- 3.3.3 Allowable Fire Flow Pressures 3.3
- 3.3.4 Fire Hydrant Coverage 3.3
- 3.4 Proposed Water Servicing..... 3.4
- 4 WASTEWATER SERVICING.....4.1**
- 4.1 Design Criteria 4.1
- 4.2 Wastewater Generation and Servicing Design 4.1
- 4.3 Proposed Sanitary Servicing 4.2
- 5 STORMWATER MANAGEMENT AND SERVICING5.1**
- 5.1 Objectives 5.1
- 5.2 Stormwater Management (SWM) Criteria 5.1
- 5.3 Existing Conditions 5.2
- 5.4 Stormwater Management Design 5.3
- 5.4.1 Allowable Release Rate 5.3
- 5.4.2 Quantity Control: Storage Requirements 5.4
- 5.4.3 Quality Control 5.6
- 5.5 Proposed Stormwater Servicing 5.6
- 6 SITE GRADING6.1**
- 7 UTILITIES7.1**
- 8 APPROVALS.....8.1**
- 9 EROSION AND SEDIMENT CONTROL DURING CONSTRUCTION.....9.1**
- 10 GEOTECHNICAL INVESTIGATION10.1**
- 11 CONCLUSIONS.....11.1**
- 11.1 Water Servicing 11.1
- 11.2 Sanitary Servicing..... 11.1
- 11.3 Stormwater Servicing and Management 11.1
- 11.4 Grading 11.2
- 11.5 Erosion and Sediment Control During Construction 11.2
- 11.6 Geotechnical Investigation 11.2
- 11.7 Utilities 11.2
- 11.8 Approvals..... 11.2



1806 Scott Street Servicing and Stormwater Management Report

December 16, 2022

LIST OF TABLES

Table 3-1: Estimated Water Demands 3.1

Table 3-2: Boundary Conditions 3.2

Table 4-1: Estimated Peak Wastewater Flow 4.1

Table 5-1: Pre-Development Drainage Characteristics 5.2

Table 5-2: Peak Pre-Development Flow Rates 5.3

Table 5-3: Summary of Subcatchment Areas 5.3

Table 5-4: Roof Subcatchment (ROOF-1) Stormwater Management..... 5.4

Table 5-5: Peak Post-Development Discharge Rates from Uncontrolled Areas 5.5

Table 5-6: Summary of Total 5-Year and 100-Year Event Release Rates 5.5

Table 10-1: Pavement Structure 10.1

LIST OF FIGURES

Figure 1: Key Plan of Site 1.1

Figure 2: Fire Hydrant Coverage Sketch 3.3

LIST OF APPENDICES

APPENDIX A WATER DEMANDS 1

A.1 Domestic Water Demands 1

A.2 OFM Fire Flow Calculations 2

A.3 Correspondence with the Architect & Confirmation of Building Construction 3

A.4 Boundary Conditions 4

A.5 Hydraulic Analysis 5

A.6 Fire Hydrant Coverage Calculations 6

APPENDIX B CONCEPTUAL SITE PLAN BY OPA (NOV 23, 2022)..... 7

APPENDIX C SANITARY..... 8

C.1 Sanitary Calculation Sheet 8

C.2 Correspondence with City on Sanitary Sewer Capacity..... 9

APPENDIX D STORMWATER SERVICING..... 10

D.1 Modified Rational Method Sheet 10

D.2 Watts Drainage Adjustable Accutrol Weir Detail (2016)..... 11

D.3 Storm Sewer Design Sheet 12

D.4 Correspondence with the RVCA 13

APPENDIX E BACKGROUND STUDIES..... 14

E.1 Foundation Investigation and Design Report - Draft (by McIntosh-Perry, December 2022) 14

E.2 Topographic Survey Plan (By Farley, Smith & Denis Surveying Ltd., January 2022) 15

APPENDIX F PRECONSULTATION..... 16

APPENDIX G DRAWINGS 17



1806 Scott Street Servicing and Stormwater Management Report

Introduction
December 16, 2022

1 Introduction

Stantec Consulting Ltd. has been commissioned by 2851944 Ontario Inc. to prepare the following Servicing and Stormwater Management Report in support of a Site Plan Control (SPC) application for the proposed development located at 1806 Scott Street in the City of Ottawa.

The 0.063 ha site is situated at the southwest corner of the Scott Street and Rockhurst Road intersection. The site is currently zoned R1MM and contains an existing two-storey residential building with a shed, trees, a timber fence, and surface parking. The site is bounded by Scott Street to the north, Rockhurst Road to the east, and existing residential developments on the west and south, as shown in **Figure 1** below.



Figure 1: Key Plan of Site

The proposed development is a four-storey apartment building with a basement level, consisting of 16 residential units. The proposed building will include nine (9) bachelor units, one 1-bedroom unit, two (2) one-bedroom units with dens, and four (4) two-bedroom units. Open Plan Architects (OPA) has prepared a draft site plan dated November 23, 2022, which defines the proposed development (see **Appendix B**).



1806 Scott Street Servicing and Stormwater Management Report

Introduction
December 16, 2022

1.1 Objective

This site servicing and stormwater management (SWM) report presents a servicing scheme that is free of conflicts, provides on-site servicing in accordance with City of Ottawa Design Guidelines, and uses the existing municipal infrastructure in accordance with any limitations communicated during consultation with the City of Ottawa staff. Details of the existing infrastructure located within the Scott Street and Rockhurst Road right of way (ROW) were obtained from available as-built drawings and site topographic survey.

Criteria and constraints provided by the City of Ottawa have been used as a basis for the detailed servicing design of the proposed development. Specific and potential development constraints to be addressed are as follows:

- Potable Water Servicing
 - Estimated water demands to characterize the proposed feed(s) for the proposed development which will be serviced from either the existing 203 mm diameter watermain within the Scott Street ROW or the 102 mm diameter watermain within the Rockhurst Road ROW or both. There is an existing 1067 mm diameter backbone watermain within the Scott Street ROW, which will not be touched during this project.
 - Watermain servicing for the development is to be able to provide average day and maximum day (including peak hour) demands (i.e., non-emergency conditions) at pressures within the acceptable range of 345 to 552 kPa (50 to 80 psi)
 - Under fire flow (emergency) conditions, the water distribution system is to maintain a minimum pressure greater than 140 kPa (20 psi)
- Wastewater (Sanitary) Servicing
 - Define and size the sanitary service lateral which will be connected to the existing 225 mm diameter sanitary sewer within the Rockhurst Road ROW or the 250 mm diameter sanitary sewer within the Scott Street ROW. There is also a 1650 mm diameter trunk sanitary sewer within the Scott Street ROW, which will not be touched during this project.
- Storm Sewer Servicing
 - Define major and minor conveyance systems in conjunction with the proposed grading plan
 - Determine the stormwater management storage requirements to meet the allowable release rate for the site
 - Define and size the proposed storm service lateral that will be connected to the existing 450 mm diameter municipal storm sewer within the Scott Street ROW.
- Prepare a grading plan in accordance with the proposed site plan and existing grades.

The accompanying drawings included in **Appendix G** of this report illustrate the proposed internal servicing scheme for the site.



1806 Scott Street Servicing and Stormwater Management Report

Background
December 16, 2022

2 Background

Documents referenced in preparing of this stormwater and servicing report for 1806 Scott Street development include:

- *City of Ottawa Sewer Design Guidelines (SDG)*, City of Ottawa, October 2012, including all subsequent technical bulletins
- *City of Ottawa Design Guidelines – Water Distribution*, City of Ottawa, July 2010, including all subsequent technical bulletins
- *Design Guidelines for Drinking Water Systems*, Ministry of the Environment, Conservation, and Parks (MECP), 2008
- *Fire Protection Water Supply Guideline* for Part 3 in the Ontario Building Code, Office of the Fire Marshal (OFM), October 2020
- *Water Supply for Public Fire Protection*, Fire Underwriters Survey (FUS), 2020
- *Multi-Storey Residential Building 1806 Scott Street, Ottawa, ON. Foundation Investigation and Design Report, Draft*, McIntosh Perry, December 2022



3 Water Servicing

3.1 Background

The proposed building is in Pressure Zone 1W of the City of Ottawa's Water Distribution System. The existing dwelling has a water service lateral connection to the existing 203 mm diameter watermain on Scott Street. The existing service which will be blanked at the main by City forces, as shown on the Existing Conditions and Removals Plan (see **Drawing EX-1** in **Appendix G**).

3.2 Water Demands

3.2.1 POTABLE (DOMESTIC) WATER DEMANDS

The proposed four-storey with basement building consists of nine (9) bachelor units, one (1) one-bedroom unit, two (2) one-bedroom with den units, and four (4) two-bedroom units. The City of Ottawa Water Distribution Guidelines (July 2010) and ISTB 2021-03 Technical Bulletin were used to determine water demands based on projected population densities for residential areas. The population was estimated using an occupancy of 1.4 persons per unit for bachelor and one-bedroom apartments, and 2.1 persons per unit for one-bedroom with den and two-bedroom apartments. The proposed residential apartment building was estimated to have a total projected population of 27 persons.

A daily rate of 280 L/cap/day has been used to estimate average daily (AVDY) potable water demand for the residential units. Peaking factors from Table 3-3 of the MECP Design Guidelines for Drinking Water Systems was used to estimate residential water system demands for the site (i.e., residential areas < 30 equivalent population) as follows: maximum day (MXDY) demand was determined by multiplying the AVDY demand by a factor of 9.5 and peak hourly (PKHR) demand was determined by multiplying the AVDY demand by a factor of 14.3 (see **Appendix A.1** for calculations). The estimated demands are summarized in **Table 3-1**.

Table 3-1: Estimated Water Demands

Population	AVDY (L/s)	MXDY (L/s)	PKHR (L/s)
27 persons	0.09	0.82	1.23

3.2.2 FIRE FLOW DEMANDS

The fire flow demand was calculated in accordance with the Office of the Fire Marshal (OFM) fire protection water supply guidelines for the Ontario Building Code (OBC) methodology. The OFM guidelines are acceptable for this private development because no on-site watermains or fire hydrants are proposed and the fire demand for the proposed development is less than 9,000 L/min. The OBC estimate is based on a wood-frame building construction with unprotected building openings, hence the type of construction selected was combustible without fire-resistance ratings. The floor area was estimated as the area of the



1806 Scott Street Servicing and Stormwater Management Report

Water Servicing
December 16, 2022

ground floor and taking into consideration the storeys above and below the ground level for the building volume. It is anticipated that the building will be sprinklered. Correspondence with the architect confirmed that these assumptions for the building construction are conservative (see **Appendix A.3**). Required fire flows were determined to be approximately 5,400 L/min (90.0 L/s). (See calculations in **Appendix A.2**).

3.3 Level of Servicing

3.3.1 BOUNDARY CONDITIONS

The estimated domestic potable water demands and fire flow demands, were used to define the level of servicing required for the proposed development from the municipal watermain and hydrants within the Scott Street ROW. **Table 3-2** outlines the boundary conditions provided by the City of Ottawa on August 15, 2022 (See **Appendix A.4** for correspondence).

Table 3-2: Boundary Conditions

	Connection at Scott Street	Connection at Rockhurst Road
Min. HGL (m)	108.4	
Max. HGL (m)	115.1	
Max. Day + Fire Flow (90.0 L/s) HGL (m)	108.0	98.7

3.3.2 ALLOWABLE DOMESTIC PRESSURES

The desired normal operating pressure range in occupied areas as per the City of Ottawa 2010 Water Distribution Design Guidelines is 345 kPa to 552 kPa (50 psi to 80 psi) under a condition of maximum daily flow and no less than 276 kPa (40 psi) under a condition of maximum hourly demand. Furthermore, the maximum pressure at any point in the water distribution should not exceed 689 kPa (100 psi) as per the Ontario Building/Plumbing Code; pressure reducing measures are required to service areas where pressures greater than 552 kPa (80 psi) are anticipated in occupied areas.

The proposed finished floor elevation of the first floor, 64.4 m, will serve as the ground floor elevation for the calculation of residual pressures at ground level. As per the boundary conditions, the onsite pressures are expected to range from 431.4 kPa to 497.1 kPa (62.6 psi to 72.1 psi) under normal operating conditions. A minimum head loss of about 31.1 kPa (4.5 psi) is estimated for each storey due to the average grade differential between floors. This value does not consider additional pressure losses due to piping frictional losses and appurtenances, etc. It is expected that the upper storey (the fourth floor) will experience maximum pressures in the range of 338.0 kPa to 403.7 kPa (49.0 psi to 58.5 psi).

Calculations of the residual pressures under normal operating conditions have been provided in **Appendix A.5**. On the first floor, these values are within the normal operating pressure objectives as defined by City of Ottawa design guidelines which requires 345 kPa to 552 kPa (50 psi to 80 psi) in occupied areas. However, the minimum residual pressures at the upper stories fall below minimum of 345 kPa (50 psi). Consequently, we anticipate booster pumps may be required to provide adequate water pressure to the top



1806 Scott Street Servicing and Stormwater Management Report

Water Servicing
December 16, 2022

floors of the proposed development. The requirement for booster pumps is to be confirmed by the mechanical consultant.

3.3.3 ALLOWABLE FIRE FLOW PRESSURES

The boundary conditions provided by the City of Ottawa indicate that the 203 mm diameter watermain within Scott Street is expected to maintain a residual pressure of 43.6 m equivalent to 427.5 kPa (62.0 psi) under the required fire flow condition. The existing municipal watermain can provide the required fire flow while maintaining a residual pressure of 138 kPa (20 psi), demonstrating adequacy to support fire suppression for the proposed development.

3.3.4 FIRE HYDRANT COVERAGE

The building will be sprinklered and a Siamese (fire department) connection is to be provided to the right of the main entrance. There are three hydrants in the proximity of the proposed development site, as shown in **Figure 2**. The distance of each hydrant from the proposed building is less than 115 m.

According to the NFPA 1 Table 1835.4.3, a hydrant situated less than 76 m away from a building can supply a maximum capacity of 5,678 L/min. Hence, the required fire flow for this site (5,400 L/min) can be achieved with any one of the hydrants shown. See **Appendix A.6** for fire hydrant coverage table calculations and NFPA Table 18.5.4.3.

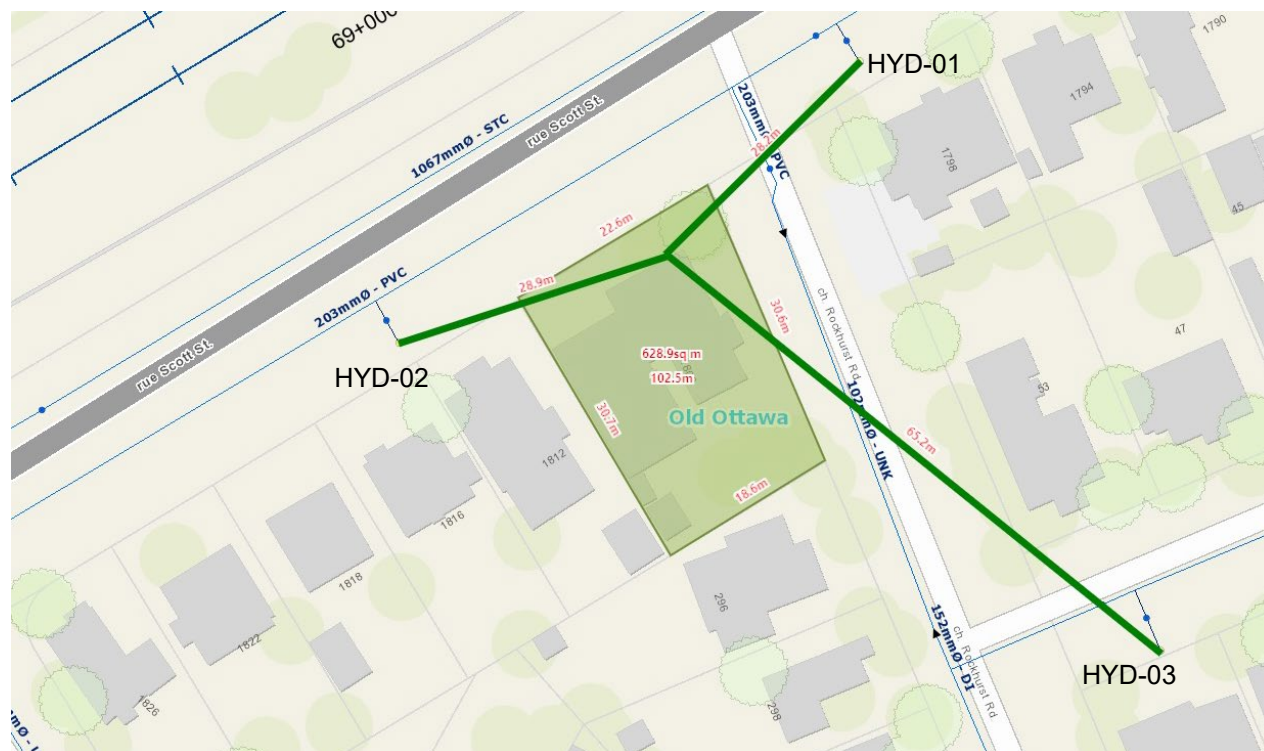

Figure 2: Fire Hydrant Coverage Sketch



1806 Scott Street Servicing and Stormwater Management Report

Water Servicing
December 16, 2022

Both existing fire hydrants along Scott Street (HYD-01 and HYD-02) are located within 45 m of the Siamese connection as per the OBC.

3.4 Proposed Water Servicing

The development will be serviced via a single 150 mm building service connection to the existing 203 mm diameter watermain on Scott Street. The sizing of the service connection is to be confirmed by the mechanical consultant. The proposed water servicing is shown on **Drawing SSP-1 in Appendix G**. Based on City of Ottawa Design Guidelines, the existing 203 mm diameter watermain on Scott Street can provide adequate fire and domestic flows for the subject site. The mechanical consultant or plumbing contractor will ultimately be responsible to confirm building pressures are adequate to meet building code requirements.



4 Wastewater Servicing

The site will be serviced from the existing 250 mm diameter PVC sanitary sewer within the Scott Street ROW. The existing dwelling has a water service lateral connection to the municipal sewer, which will be decommissioned and abandoned as shown in the Existing Conditions and Removals Plan (see **Drawing EX-1** in **Appendix G**).

4.1 Design Criteria

As outlined in the City of Ottawa Sewer Design Guidelines and the MECP Design Guidelines for Sewage Works, the following criteria were used to calculate the estimated wastewater flow rates and to determine the size and location of the sanitary service lateral:

- Minimum velocity = 0.6 m/s (0.8 m/s for upstream sections)
- Maximum velocity = 3.0 m/s
- Manning roughness coefficient for all smooth wall pipes = 0.013
- Minimum size of sanitary sewer service = 135 mm
- Minimum grade of sanitary sewer service = 1.0 % (2.0 % preferred)
- Average wastewater generation = 280 L/person/day (per City Design Guidelines)
- Peak Factor = based on Harmon Equation; maximum of 4.0 (residential)
- Harmon correction factor = 0.8
- Infiltration allowance = 0.33 L/s/ha (per City Design Guidelines)
- Minimum cover for sewer service connections – 2.0 m
- Population density for one-bedroom and bachelor apartments – 1.4 persons/apartment
- Population density for one-bedroom with den and two-bedroom apartments – 2.1 persons/apartment

4.2 Wastewater Generation and Servicing Design

The proposed 0.063 ha development area will consist of a 4-storey plus basement residential apartment building consisting of nine (9) bachelor units, one (1) one-bedroom unit, two (2) one-bedroom with den units, and four (4) two-bedroom units with a total projected population of 27. The anticipated peak residential wastewater flow generated from the proposed development is summarized in **Table 4-1** below:

Table 4-1: Estimated Peak Wastewater Flow

Peak Residential Wastewater Flow				Infiltration Flow (L/s)	Total Peak Flow (L/s)
No. of Units	Population	Peak Factor	Peak Flow (L/s)		
16 units	27	3.49	0.301	0.021	0.322



1806 Scott Street Servicing and Stormwater Management Report

Wastewater Servicing

December 16, 2022

Detailed sanitary sewage calculations are included in **Appendix C.1**. A full port backwater valve will be required for the proposed building in accordance with the Sewer Design Guidelines and will be coordinated with the building mechanical engineers.

The anticipated peak wastewater flows for the proposed development were provided to the City of Ottawa staff to evaluate the adequacy of the receiving municipal sanitary sewer system in the vicinity of the site and downstream network. Confirmation was obtained that there are no concerns with respect to adding the proposed peak flows to the existing sanitary sewer in Scott Street (see correspondence in **Appendix C.2**).

4.3 Proposed Sanitary Servicing

A 150 mm diameter sanitary building service, complete with full port backwater valve as per City standard S14.1 is recommended to service the proposed development. Final sizing of the lateral is to be confirmed by the mechanical consultant.

The depth of the sanitary sewer and watermain in Scott Street make the connection challenging for the sanitary service. A sump pit and pump are required for sanitary servicing of the mechanical room. The sump will lift the sewage to the lateral invert at the building face. The lateral will have a gravity connection from the building to the municipal sewer. The minimum 2.0 m cover has been provided over the sanitary lateral; however, there may not be sufficient clearance between the sanitary lateral and the watermain, and it is likely that insulation will be required between the sewer lateral and the watermain at the crossing location as per City Standard W22. The insulation requirements should be re-evaluated once the contractor has located the top of the watermain at the crossing. The sanitary lateral is to connect to the sewer main with a riser pipe as per City standard S11.1. The proposed sanitary servicing is shown on **Drawing SSP-1** in **Appendix G**.



5 Stormwater Management and Servicing

5.1 Objectives

The goal of this stormwater servicing and stormwater management (SWM) plan is to determine the measures necessary to control the quantity and quality of stormwater released from the proposed development to meet the criteria established during the consultation process with City of Ottawa and Rideau Valley Conservation Authority (RVCA) staff, and to provide sufficient details required for approval.

5.2 Stormwater Management (SWM) Criteria

The Stormwater Management (SWM) criteria were established by combining current design practices outlined by the City of Ottawa Sewer Design Guidelines (SDG) (October 2012), review of project pre-consultation notes with the City of Ottawa, and through consultation with City of Ottawa staff. The following summarizes the criteria, with the source of each criterion indicated in brackets:

General

- Use of the dual drainage principle (City of Ottawa SDG)
- Wherever feasible and practical, site-level measures should be used to reduce and control the volume and rate of runoff (City of Ottawa SDG)
- Assess impact of 100-year event outlined in the City of Ottawa Sewer Design Guidelines on the major and minor drainage systems (City of Ottawa SDG)
- The proposed site is not subject to quality control criteria due to the small site size and proposed land usage of the development; however, best management practices are encouraged to be implemented where possible as part of the overall site design (RVCA **Appendix D.4**).

Storm Sewer & Inlet Controls

- Size storm sewers to convey 5-year storm event under free-flow conditions using City of Ottawa I-D-F parameters (Correspondence with City of Ottawa staff, **Appendix D.5**)
- Roof discharge only for each storm event to be restricted to a 5-year storm event pre-development rate with a maximum pre-development C coefficient of 0.5 (City of Ottawa pre-consultation, **Appendix F.1**)
- Discharge from remainder of site to be uncontrolled if portion is directed towards the Scott Street and Rockhurst Road ROWs. Additional peak flows generated from events greater than the 5-year storm event up to and including the 100-year storm event must be detained on-site. (City of Ottawa pre-consultation, **Appendix F.1**)
- The preferred stormwater system outlet for this site is the 450 mm diameter stormwater sewer within the Scott Street ROW. (City of Ottawa pre-consultation, **Appendix F.1**).



1806 Scott Street Servicing and Stormwater Management Report

Stormwater Management and Servicing
December 16, 2022

- The foundation drainage system is to be independently connected to the storm sewer main unless being pumped with appropriate back up power, sufficient sized pump, and backflow prevention. (City of Ottawa pre-consultation, **Appendix F.1**)
- T_c should be not less than 10 minutes since IDF curves become unrealistic at less than 10 min (City of Ottawa SDG).

Surface Storage & Overland Flow

- Building openings to be a minimum of 0.30 m above the 100-year water level (City of Ottawa SDG)
- Maximum depth of flow under either static or dynamic conditions shall be less than 0.30 m (City of Ottawa SDG)
- Provide adequate emergency overflow conveyance off-site with a minimum vertical clearance of 15 cm between the spill elevation and the ground elevation at the building envelope in the proximity of the flow route or ponding area (City of Ottawa SDG)

5.3 Existing Conditions

The grading and existing drainage from the subject site (0.063 ha) has been delineated into five subcatchment areas, as shown in the Existing Conditions Storm Drainage Plan (see **Appendix G Drawing EXSD-1**). The catchments are characterized by two hard surface areas (EXT-3 and EXT-5), comprising of roofs and asphalt pavement, and three areas of vegetated/soft surface areas (EXT-1, EXT-2 and EXT-4). The subcatchments and surfacing in the EXSD-1 plan was used to establish the overall site pre-development runoff coefficient of $C=0.63$, in which the hard surface areas use a coefficient of 0.90 while soft surface areas have a coefficient of 0.20. Under the existing conditions, the site drains entirely uncontrolled.

Table 5-1: Pre-Development Drainage Characteristics

Subcatchments	Surfacing	C	A (ha)
Uncontrolled Surface (EXT-1)	soft	0.20	0.007
Uncontrolled Surface (EXT-2)	soft	0.20	0.001
Uncontrolled Surface (EXT-3)	hard	0.90	0.038
Uncontrolled Surface (EXT-4)	soft	0.20	0.017
Uncontrolled Surface (EXT-5)	hard	0.90	0.001
Uncontrolled - Total Site		0.63	0.063

The City of Ottawa pre-consultation notes identified a maximum permissible pre-development runoff coefficient of $C=0.5$ for this site. The pre-development runoff coefficient of 0.63 (determined as per existing conditions) exceeds this amount. Hence, a pre-development runoff coefficient of 0.50 has been utilized for the site analysis.



1806 Scott Street Servicing and Stormwater Management Report

Stormwater Management and Servicing
December 16, 2022

The pre-development release rates for the site have been determined using the rational method and the drainage characteristics identified above. A time of concentration for the pre-development area (10 minutes) was assigned based on the small site size and its proximity to the existing drainage outlet. The peak pre-development flow rates shown in **Table 5-2** have been calculated using the rational method as follows:

$$Q = 2.78 (C)(I)(A)$$

Where:

Q = peak flow rate, L/s

C = site runoff coefficient

I = rainfall intensity, mm/hr (per City of Ottawa IDF curves)

A = drainage area, ha

Table 5-2: Peak Pre-Development Flow Rates

Design Storm	Pre-Development Flow Rate (L/s) for C=0.5, A=0.063 ha, t_c = 10min
5-year	9.13
100-year	19.59

5.4 Stormwater Management Design

The Modified Rational Method was employed to assess the rate and volume of runoff anticipated during post-development rainfall runoff events. The site was subdivided into subcatchments (subareas) as defined by the proposed grades and the location, nature, or presence/absence of inlet control devices (ICDs). Each subcatchment was assigned a runoff coefficient based on the proposed finished surface. A summary of subareas and runoff coefficients is provided in **Table 5-3** below. Further details can be found in **Appendix D.1**, while **Drawing SD-1** in **Appendix G** illustrates the proposed subcatchments.

Table 5-3: Summary of Subcatchment Areas

Catchment Areas	C	A (ha)	Flow Type	Outlet
ROOF-1	0.90	0.026	Controlled	Storm sewer
UNC-1	0.59	0.017	Uncontrolled	Storm sewer and ROWs
UNC-2	0.49	0.021	Uncontrolled	Rockhurst ROW
Total Site	0.68	0.063	-	-

5.4.1 ALLOWABLE RELEASE RATE

The pre-development 5-year release rate for the site was determined using the rational method to be 9.13 L/s. Consequently, the target release rate for 1806 Scott Street under all events up to and including the



1806 Scott Street Servicing and Stormwater Management Report

Stormwater Management and Servicing
December 16, 2022

100-year event will be 9.13 L/s. Runoff coefficient values have been increased by 25% for the post-development 100-year storm event based on the City of Ottawa SDG.

5.4.2 QUANTITY CONTROL: STORAGE REQUIREMENTS

The site requires quantity control measures to meet the restrictive stormwater release criteria. It is proposed that rooftop storage via restricted roof release be used to reduce the site peak outflow. A spreadsheet using the Modified Rational Method (MRM) was used to size the roof storage, as shown in **Appendix D.1**.

5.4.2.1 Rooftop Storage

It is proposed to retain stormwater on the building rooftop by installing restricted flow roof drains. The MRM calculations assume the roof will be equipped with two standard Watts model roof drains complete with Adjustable Accutrol Weirs. Discharge from the two controlled roof drains will be routed by the mechanical consultant through the building's internal plumbing to the proposed building storm service lateral on the downstream side of the backwater prevention valve.

Watts Drainage Adjustable Accutrol roof drain weir data (see **Appendix D.2**) and the roof plan (see **Appendix B**) has been used to calculate a practical roof release rate and detention storage volume for the rooftop areas, with 80 % of the roof area assumed to be available for storage. It should be noted that the Accutrol weir has been used as an example only, and that other products may be specified for use, provided that:

- the peak roof drain release rate is restricted to match the maximum rate of release indicated in **Table 5-3**,
- sufficient roof storage is provided to meet (or exceed) the required volume of detained stormwater indicated in **Table 5-3**, and
- the maximum ponding depth of 150 mm is not exceeded during a design storm event.

The proposed drain release rates and storage volumes have been calculated based on both roof drain weirs in at 25 % opened setting. Rooftop storage volumes and controlled release rates are summarized in **Table 5-4**.

Table 5-4: Roof Subcatchment (ROOF-1) Stormwater Management

Design Storm	Storage Depth (mm)	Peak Discharge (L/s)	Volume Stored (m ³)
5-Year (Roof)	103.62	1.60	3.41
100-Year (Roof)	139.54	1.83	8.32

5.4.2.2 Uncontrolled Areas

As per the pre-consultation, shown in **Appendix F**, it has been deemed acceptable to control only the roof portion of the development so long as the remainder of the uncontrolled site is directed towards the



1806 Scott Street Servicing and Stormwater Management Report

Stormwater Management and Servicing
December 16, 2022

Rockhurst Road ROW and Scott Street ROW. These uncontrolled areas have no flow rate restriction component.

There are two uncontrolled subcatchment areas, consisting of UNC-1 and UNC-2. The UNC-2 subcatchment area comprises of the east side and front yard areas, where the former effectively drains east, uncontrolled, to the Rockhurst Road ROW via surface flows, while the front yard effectively drains north, uncontrolled, to the Scott Street ROW via surface flows. The UNC-1 subcatchment area comprises of the west side and the rear yard and drains to the rear (southwest) corner of the site, away from both ROWs under existing conditions.

To reduce the amount of surface drainage towards the west property line as per existing conditions, a swale is proposed to collect the drainage for discharge into both the Scott Street ROW and the storm sewers located within it. The remainder of the site will continue to drain towards the Rockhurst Road ROW as per existing conditions.

Table 5-5: Peak Post-Development Discharge Rates from Uncontrolled Areas

Design Storm	UNC-1 Discharge (L/s)	UNC-2 Discharge (L/s)
5-year	2.84	2.92
100-Year	6.08	6.26

5.4.2.3 Results

The proposed stormwater management plan meets the requirements identified during pre-consultation that it would be acceptable to control the roof portion of the development only. **Table 5-6** provides a summary of the peak design discharge rates calculated from the MRM analysis, shown in **Appendix D.1**. As the table shows, the peak discharge from the uncontrolled areas exceeds the 5-year target rate for control, but for all other areas/design storms the 5-year and 100-year post-development conditions satisfy the design criteria. Compared to the pre-development release rates in **Table 5-2**, the rooftop storage has reduced the peak discharge from the overall site by 19 % for the 5-year event and 20 % for the 100-year event.

Table 5-6: Summary of Total 5-Year and 100-Year Event Release Rates

Drainage areas	5-year Peak Discharge (L/s)	100-Year Peak Discharge (L/s)
Uncontrolled Areas	5.76	12.34
Controlled Areas	1.60	1.83
Target (L/s)	9.13	9.13
Total (L/s)	7.36	14.17



1806 Scott Street Servicing and Stormwater Management Report

Stormwater Management and Servicing
December 16, 2022

5.4.3 QUALITY CONTROL

Through correspondence with the Rideau Valley Conservation Authority (RVCA), it was confirmed that no additional quality control measures are required for the site based on the Site Plan provided. Best management practices are encouraged where possible.

The site is anticipated to have minimal sources of sediment and contaminants that could impact stormwater quality. However, the two proposed at-grade parking spaces on the southeast side of the property presents a potential source of particulates and contaminants. To mitigate this risk, permeable pavement is proposed for the surfacing and no gravel or stone dust parking areas are permitted. Refer to **Appendix D.4** for correspondence with the RVCA.

5.5 Proposed Stormwater Servicing

One 100 mm diameter stormwater building service, complete with full port backwater valve as per City standard S14.1, is proposed for the foundation drain, as per **Drawing SSP-1** in **Appendix G**. A stormwater sump and pump are required for the proposed foundation drain, and the roof drain is to be connected to the service lateral downstream of the sump pump and full port backwater valve.

A 250 mm diameter HDPE subdrain with landscape catch basins (CB "T") is proposed to collect and drain uncontrolled stormwater flows from the rear yard and western side-yard and connect to a proposed catch basin manhole (CBMH). The 100 mm dia. building storm service lateral will also connect to the CBMH. The combined foundation drain, roof drain, and subdrain flows will outlet the CBMH to the north through a 200 mm dia. lead and connect to the existing 450 mm dia. storm sewer within the Scott Street ROW. The lateral is to connect to the main as per City standard S11. The proposed stormwater servicing is shown on **Drawing SSP-1** and **SD-1** in **Appendix G**.

Like the sanitary system, the depth of the stormwater sewer and watermain in Scott Street make the connection challenging for the stormwater service. The 200 mm dia. lead will have a gravity connection from the CBMH to the municipal sewer. The minimum 2.0 m cover has been provided over the stormwater lateral; however, there may not be sufficient vertical clearance between the stormwater lateral and the watermain, and it is likely that insulation will be required between the sewer lateral and the watermain at the crossing location as per City Standard W22. The insulation requirements should be re-evaluated once the contractor has located the top of the watermain at the crossing.



6 Site Grading

The proposed re-development site measures approximately 0.063 ha in area. A detailed grading plan (see **Appendix G, Drawing GP-1**) has been prepared to satisfy the stormwater management requirements described in **Section 5** and to allow for positive drainage away from the face of the building.

The topographic survey plan (by Farley, Smith & Denis Surveying Ltd., see **Appendix E.2**) indicates that the existing site is relatively flat; the west side-yard and front yard drain toward the Scott Street ROW, the east side yard drains east to the Rockhurst Road ROW, and the rear yard drains toward the southwest corner of the site.

The grading plan satisfies the grading and drainage objectives for the proposed development site. The proposed grading respects the existing grades at the property lines, provides an adequate overland flow route, and maintains the existing drainage conditions for the yards. A curb wall (maximum height 0.17 m) has been provided along west side of the property to facilitate the concrete walkway and respect the existing grade at the property line. The basement level does not have direct access to the yard, consequently, the basement windowsills act as the lowest foundation openings. Minimum windowsill elevations have been identified as 63.02 m. The site grading has been designed to drain all non-roof areas uncontrolled to either the Scott Street or Rockhurst Road ROW.



1806 Scott Street Servicing and Stormwater Management Report

Utilities

December 16, 2022

7 Utilities

Overhead (OH) hydro-wires run diagonally from the southwest and southeast corners of the site to the existing building, as well as running parallel to the south and east property lines. All utilities within the work area will require relocation during construction. The existing utility poles are to be protected during construction.

Hydro Ottawa, Bell, Rogers, and Enbridge all have existing utility plants in the area, which will be used to service this site. The exact size, location, and routing of utilities will be finalized after design circulation. Existing overhead wires and utility plants may need to be temporarily moved/reconfigured to allow sufficient clearance for the movement of heavy machinery required for construction. The relocation of existing utilities will be coordinated with the individual utility providers upon design circulation.



1806 Scott Street Servicing and Stormwater Management Report

Approvals
December 16, 2022

8 Approvals

The proposed development lies on a private site under singular ownership; drains to an approved separated sewer outlet; and is not intended to service industrial land or land uses. Therefore, the site is exempt from the Ministry of the Environment, Conservation and Parks (MECP) Environmental Compliance Application (ECA) process under O.Reg. 525/98.

For ground or surface water volumes being pumped during the construction phase, typically between 50,000 to 400,000 L/day, it is required to register on the Environmental Activity and Sector Registry (EASR). It is possible that groundwater may be encountered during the foundation excavation on this site. A minimum of two to four weeks should be allotted for completion of the EASR registration and the preparation of the Water Taking and Discharge Plan by a Qualified Person as stipulated under O.Reg. 63/16. An MECP Permit to Take Water (PTTW), which is required for dewatering volumes exceeding 400,000L/day, is not anticipated for the site.



9 Erosion and Sediment Control During Construction

To protect downstream water quality and prevent sediment build-up in catch basins and storm sewers, erosion and sediment control measures must be implemented during construction. The following recommendations will be included in the contract documents and communicated to the Contractor.

1. Implement best management practices to provide appropriate protection of the existing and proposed drainage system and the receiving water course(s).
2. Limit the extent of the exposed soils at any given time.
3. Re-vegetate exposed areas as soon as possible.
4. Minimize the area to be cleared and grubbed.
5. Protect exposed slopes with geotextiles, geogrid, or synthetic mulches.
6. Install silt barriers/fencing around the perimeter of the site as indicated in **Drawing ECDS-1 in Appendix G** to prevent the migration of sediment offsite.
7. Install trackout control mats (mud mats) at the entrance/egress to prevent migration of sediment into the public ROW.
8. Provide sediment traps and basins during dewatering works.
9. Install sediment traps (such as SiltSack® by Terrafix) between catch basins and frames.
10. Schedule the construction works at times which avoid flooding due to seasonal rains.

The Contractor will also be required to complete inspections and guarantee the proper performance of their erosion and sediment control measures at least after every rainfall. The inspections are to include:

- Verification that water is not flowing under silt barriers.
- Cleaning and changing the sediment traps placed on catch basins.

Refer to **Drawing ECDS-1 in Appendix G** for the proposed location of silt fences, sediment traps, and other erosion control measures.



10 Geotechnical Investigation

A geotechnical investigation for 1806 Scott Street was carried out by McIntosh-Perry in August 2022. Field testing consisted of the advancement of five (5) boreholes throughout the subject site. The borehole locations are presented in the draft geotechnical investigation report included in **Appendix E.1**.

The subject site subsurface layers comprise primarily of granular fill, sand and gravel, and bedrock. The fill material generally consists of sand and gravel with fractions of fine materials of silt and clay, with the sample collected from the fill layer at boreholes BH22-1 and BH22-3 tested and conformed to the USCS Granular B Type I Specification.

The bedrock depth ranged from approximately 0.7 m to 1.4 m below the existing ground surface with confirmation of the core at boreholes BH22-1 and BH22-4 from a depth of 1.3 m to 6.4 m BGS and 1.3 m to 6.5 m BGS respectively. While the top layer of surface weathered rock is recommended for removal, overall, the bedrock is strong and shallow. Based on its quality and strength, the provisions of shallow spread and strip footing are adequate for the proposed building.

Groundwater was not observed during drilling. As water was used as the core-injected coolant for drilling, it was not possible to differentiate from groundwater. A single standpipe piezometer was installed in borehole BH22-4 within the layer of the bedrock. No groundwater was observed in the standpipe well on October 24, 2022; however, groundwater levels are subject to seasonal fluctuations.

The encountered bedrock subgrade is of low frost susceptibility. A minimum of 1.8 m of earth cover or equivalent thermal rigid insulation is required for all perimeter and exterior and interior foundation elements. Slab-on-Grades should be supported on a minimum of 200 mm of Granular A bedding compacted to 100 % SPMDD.

Considering the low traffic volume of lightweight passenger vehicles and the understanding that moving trucks and firetrucks traffic will be limited to the public road, the pavement structure is provided as follows in **Table 10-1**:

Table 10-1: Pavement Structure

Material	Thickness (mm)
Surface – Superpave 12.5 mm, PG 58-34	50
Base – OPSS Granular A	150
Sub-Base – OPSS Granular B Type B	450



11 Conclusions

11.1 Water Servicing

Based on the supplied boundary conditions for existing watermains and calculated domestic and fire flow demands for the subject site, the adjacent watermain on Scott Street has sufficient capacity to sustain both the required domestic and emergency fire flow demands for the development. Booster pump(s) may be required to provide adequate pressures to the building's upper stories. The proposed development requires a 150 mm diameter water service lateral, which will be connected to the existing 203 mm diameter watermain in the Scott Street ROW. Sizing of the water service and requirements for booster pump(s) are to be confirmed by the mechanical consultant.

11.2 Sanitary Servicing

The proposed sanitary sewer service will consist of a 150 mm diameter sanitary service lateral, a sanitary sump pit and sump pump directing wastewater to the existing 250 mm diameter sanitary sewer on Scott Street. Existing connections are to be abandoned and full port backwater valves installed on the proposed sanitary service within the site to prevent any surcharge from the downstream sewer main from impacting the proposed property. A sump pump will be required for sewage discharge from the mechanical room. Sizing of the service lateral, sump pit, and sump pump are to be confirmed by the mechanical consultant.

11.3 Stormwater Servicing and Management

Rooftop storage has been proposed to limit the stormwater discharge rate for all rainfall events up to and including the 100-year event to a peak 5-year predevelopment release rate. The remaining site area drains uncontrolled, with the western side yard and rear yard draining towards the Scott Street ROW via a proposed swale, while the eastern side yard drains towards the Rockhurst Road ROW. The proposed land use and site surfacing is not expected to be a significant source of particulates or pollutants; consequently, quality control is not required for this development.

A single 100 mm diameter storm service lateral is proposed for the building's foundation drain, which is to be mechanically pumped and include a full port backwater valve. The roof drains are to be connected through internal plumbing to the service lateral on the downstream side of the backwater valve. The lateral will enter the proposed catch basin manhole at the property line. The combined foundation, roof, and subdrain flows are to exit the CBMH through a 200 mm diameter catch basin lead connecting to the 450 mm diameter municipal storm sewer in the Scott Street ROW. Sizing of the service lateral, and foundation drain pump are to be confirmed by the mechanical consultant.



1806 Scott Street Servicing and Stormwater Management Report

Conclusions
December 16, 2022

11.4 Grading

Site grading has been designed to provide an adequate emergency overland flow route. The eastern side-yard drains uncontrolled to the Rockhurst Road ROW, while the front and western side-yards drain uncontrolled to the Scott Street ROW.

11.5 Erosion and Sediment Control During Construction

Erosion and sediment control measures and best management practices outlined in this report and included in the drawing set, will be implemented during construction to reduce the impact on adjacent properties, the public ROW, and existing facilities.

11.6 Geotechnical Investigation

Based on the quality and strength of the bedrock on site, the proposed strip-footing and shallow spread is adequate for the building's foundation. While no groundwater is encountered, the groundwater level is subjected to seasonal fluctuations. A minimum 1.8 m of earth cover or the equivalent thermal rigid insulation is recommended for all perimeter and interior and exterior foundational elements.

11.7 Utilities

The site is situated within an established neighbourhood, hence existing utility infrastructure is readily available to service the proposed development. Overhead wires to the existing building will need to be removed. Overhead wires along the east and south boundaries of the site will need to be accommodated during construction.

11.8 Approvals

This site is exempt from the Ministry of the Environment, Conservation and Parks (MECP) Environmental Compliance Application (ECA) process under O.Reg. 525/98. For the expected dewatering needs of 50,000 to 400,000 L/day, the proponent will need to register on the MECP's Environmental Activity and Sector Registry (EASR). A Permit to Take Water, for dewatering needs in excess of 400,000 L/day, is not anticipated for this site.



APPENDICES

Appendix A Water Demands

A.1 Domestic Water Demands



1806 Scott Street, Ottawa, ON - Domestic Water Demand Estimates

Site Plan provided by Open Plan Architects (OPA) Inc.
 Rev. 02 Issued for Client Review/Coordination 30-Mar-2022
 Project No. 160401747

Densities as per City Guidelines:		
Apartment Units		
Bachelor	1.4	ppu
1 Bedroom	1.4	ppu
1 Bedroom + Den	2.1	ppu
2 Bedroom	2.1	ppu



Type of Apartment Unit	No. of Units	Population	Daily Rate of Demand ¹ (L/cap/day)	Avg Day Demand		Max Day Demand ²		Peak Hour Demand ²	
				(L/min)	(L/s)	(L/min)	(L/s)	(L/min)	(L/s)
Bachelor	9	13	280	2.5	0.04	23.3	0.39	35.0	0.58
1 Bedroom	1	1	280	0.3	0.00	2.6	0.04	3.9	0.06
1 Bedroom + Den ³	2	4	280	0.8	0.01	7.8	0.13	11.7	0.19
2 Bedroom	4	8	280	1.6	0.03	15.5	0.26	23.4	0.39
Total Site :	16	27		5.2	0.09	49.1	0.82	74.0	1.23

Notes:

- As per Table 4-2 from the City of Ottawa Water Design Guidelines and Technical Bulletin ISTB-2021-03, the average daily rate of water demand for residential areas: 280 L/cap/day
- As per Table 3-3 from the MECP Water Design Guidelines, the water demand criteria used to estimate peak demand rates for residential areas are as follows:
 maximum day demand rate = 9.5 x average day demand rate
 peak hour demand rate = 14.3 x average day demand rate
- Assumption that "1 bedroom with den" has a density of 2.1 ppu

A.2 OFM Fire Flow Calculations



Fire Flow Calculations as per Ontario Building Code 2006 (Appendix A)

Job# 160401747
Date 28-Jul-22

Designed by: MW
Checked by: AG
Description: 4-storey rental apartment

$$Q = KVS_{tot}$$

Q = Volume of water required (L)

V = Total building volume (m³)

K = Water supply coefficient from Table 1

S_{tot} = Total of spatial coefficient values from property line exposures on all sides as obtained from the formula

$$S_{tot} = 1.0 + [S_{side1} + S_{side2} + S_{side3} + S_{side4}]$$

1	Type of construction	Building Classification		Water Supply Coefficient
	combustible without Fire-Resistance Ratings	A-2, B-1, B-2, B-3, C, D		23
2	Area of one floor (m ²)	number of floors	height of ceiling (m)	Total Building Volume (m ³)
	252.511739	4	3.175	3,207
	233.925659	1	3.2	749
3	Side	Exposure Distance (m)	Spatial Coefficient	Total Spatial Coefficient
	North	3	0.5	2
	East	5	0.5	
	South	7.5	0.25	
	West	3	0.5	
4	Established Fire Safety Plan?	Reduction in Volume (%)		Total Volume Reduction
	no	0%		0%
5	Total Volume 'Q' (L)			
				181,976
			Minimum Required Fire Flow (L/min)	
			5,400	

A.3 Correspondence with the Architect & Confirmation of Building Construction



Gladish, Alyssa

From: Kris Benes - OPA <krisbenes@openplan.ca>
Sent: Tuesday, July 12, 2022 3:28 PM
To: Gladish, Alyssa
Cc: Wu, Michael
Subject: RE: 1806 Scott Street - Seeking Confirmation of Proposed Building Construction

Follow Up Flag: Follow up
Flag Status: Completed

Hi Alyssa,
Please see comments below in blue.
Thanks,

Kristopher Benes
BAS, M.Arch, OAA, MRAIC
Principal Architect

Open Plan Architects Inc.
2305 Hillary Ave.,
Ottawa, ON K1H 7J2
KrisBenes@openplan.ca
613-883-5090

From: Gladish, Alyssa <Alyssa.Gladish@stantec.com>
Sent: July 11, 2022 1:56 PM
To: Kris Benes - OPA <krisbenes@openplan.ca>
Cc: Wu, Michael <Michael.Wu@stantec.com>
Subject: 1806 Scott Street - Seeking Confirmation of Proposed Building Construction

Good day Kris,

Can you please confirm the following information regarding the building construction and provide any additional details that may be pertinent to the building's fire resistivity (i.e., minimum fire-resistance rating of floors/walls/openings, any intentional fire separations) for 1806 Scott Street. This will support our OFM and FUS fire flow requirement calculations.

(KB) the building will have to have a fire alarm, and standpipe, as well as sprinkler in all spaces.

1. Building classification: C - Residential Occupancy, 3-Storey + full basement ***(KB) No, it is actually 4 storeys + full basement.*** it is apartment building with 16 units. (9 x bachelor, 1x 1-bed, 2 x 2-bed + den, 4 x 2-bed). ***(KB) Yes, this breakdown is correct but could theoretically change in detailed design.***
2. Type of construction:
 - i. Type I - Fire Resistive Construction Non-Combustible without Fire-Resistance Ratings
 - ii. Type II - Noncombustible Construction / Type IV-A - Mass Timber Construction
 - iii. Type III - Ordinary Construction / Type IV-C - Mass Timber Construction
 - iv. Type IV-B Mass Timber Construction
 - v. Type V - Wood Frame / Type IV-D - Mass Timber Construction

(KB) I would probably classify it as 3.2.2.45 – Group C, up to 4 storeys, sprinklered.

This means the floors will required 1 hour FRR, as will any supporting structural members. Suites must be separated from each other and any other space w/ at least 1 hour FRR, and exit stairs will also have 1 hour FRR.

We have not yet decided what type of frame this will be. 3.2.2.45 allows both combustible and non-combustible. I would say it is likely to be wood but it will depend on cost and other factors. I would recommend you base it on the most conservative scenario. Would that be wood (i.e. if it changes to concrete then it would become safer from a fire pov)? I don't envision any fire ratings for exterior walls being needed given that we have a healthy limiting distance on all sides. Same goes for windows and door openings generally.

3. The building will not be sprinklered. *(KB) No, it will need to be sprinklered.*
4. Are there any additional details pertinent to the building's fire resistivity? *(KB) not at this stage, it is too early for us to have made very many design decisions.*

Thank you for your time.

Best Regards,
Alyssa

Alyssa Gladish E.I.T.
Project Manager, Community Development

Direct: 780 917-8567
Mobile: 587 721-1241
Alyssa.Gladish@stantec.com

Stantec
300-1331 Clyde Avenue
Ottawa ON K2C 3G4



The content of this email is the confidential property of Stantec and should not be copied, modified, retransmitted, or used for any purpose except with Stantec's written authorization. If you are not the intended recipient, please delete all copies and notify us immediately.

A.4 Boundary Conditions



From: [McLaughlin Seymour, Sarah](#)
To: [Wu, Michael](#)
Cc: [Gladish, Alyssa](#); [Fawzi, Mohammed](#)
Subject: RE: 1806 Scott Street Requests follow-up
Date: Monday, 15 August, 2022 16:04:25
Attachments: [1806 Scott Street August 2022.pdf](#)

Hi Michael,

The following are boundary conditions, HGL, for hydraulic analysis at 1806 Scott Street (zone 1W) assumed to be connected to the 102 mm watermain on Rockhurst Road OR the 203 mm watermain on Scott Street (see attached PDF for location).

Both Connections:

Minimum HGL: 108.4 m

Maximum HGL: 115.1 m

Max Day + Fire Flow (116.7 L/s): 91.5 m (Location 1), 106.7 m (Location 2)

Max Day + Fire Flow (90 L/s): 98.7 m (Location 1), 108.0 m (Location 2)

-

These are for current conditions and are based on computer model simulation.

Disclaimer: The boundary condition information is based on current operation of the city water distribution system. The computer model simulation is based on the best information available at the time. The operation of the water distribution system can change on a regular basis, resulting in a variation in boundary conditions. The physical properties of watermains deteriorate over time, as such must be assumed in the absence of actual field test data. The variation in physical watermain properties can therefore alter the results of the computer model simulation.

Thanks,
Sarah

From: Wu, Michael <Michael.Wu@stantec.com>
Sent: August 09, 2022 2:18 PM
To: McLaughlin Seymour, Sarah <Sarah.McLaughlin@ottawa.ca>
Cc: Gladish, Alyssa <Alyssa.Gladish@stantec.com>; Fawzi, Mohammed <mohammed.fawzi@ottawa.ca>
Subject: RE: 1806 Scott Street Requests follow-up

CAUTION: This email originated from an External Sender. Please do not click links or open attachments unless you recognize the source.

ATTENTION : Ce courriel provient d'un expéditeur externe. Ne cliquez sur aucun lien et n'ouvrez pas

de pièce jointe, excepté si vous connaissez l'expéditeur.

Hi Sarah:

Thanks, we appreciate the update.

Mohammed, could you confirm the status of the sanitary sewer capacity request submitted?

Thanks,

Michael Wu, EIT

Civil Engineering Intern, Community Development

Mobile: (613) 858-0548

michael.wu@stantec.com

Stantec

300 - 1331 Clyde Avenue

Ottawa ON K2C 3G4



The content of this email is the confidential property of Stantec and should not be copied, modified, retransmitted, or used for any purpose except with Stantec's written authorization. If you are not the intended recipient, please delete all copies and notify us immediately.

From: McLaughlin Seymour, Sarah <Sarah.McLaughlin@ottawa.ca>

Sent: Tuesday, 9 August, 2022 14:00

To: Wu, Michael <Michael.Wu@stantec.com>

Cc: Gladish, Alyssa <Alyssa.Gladish@stantec.com>; Fawzi, Mohammed <mohammed.fawzi@ottawa.ca>

Subject: RE: 1806 Scott Street Requests follow-up

Hi Michael,

Mohammed Fawzi (cc'ed on this email) has taken over the file. However, the water boundary conditions were submitted to the modelling group on July 28. I just followed up with them and this one is complete and in review now. It should go out in the next day or two.

Please followup with Mo about the sanitary capacity.

Thanks,

Sarah McLaughlin, P.Eng

Infrastructure Assessment Engineer

Infrastructure & Water Services Dept.

100 Constellation Cres., 6th floor East

Ottawa, ON, K2G 6J8

613-580-2424 x 26821

sarah.mclaughlin@ottawa.ca

From: Wu, Michael <Michael.Wu@stantec.com>
Sent: August 09, 2022 1:15 PM
To: McLaughlin Seymour, Sarah <Sarah.McLaughlin@ottawa.ca>
Cc: Gladish, Alyssa <Alyssa.Gladish@stantec.com>
Subject: 1806 Scott Street Requests follow-up

CAUTION: This email originated from an External Sender. Please do not click links or open attachments unless you recognize the source.

ATTENTION : Ce courriel provient d'un expéditeur externe. Ne cliquez sur aucun lien et n'ouvrez pas de pièce jointe, excepté si vous connaissez l'expéditeur.

Good afternoon, Sarah:

As a quick follow-up for the boundary conditions request and confirmation of sanitary sewer capacity request, I was wondering if you could provide a confirmation of receipt of the two requests and have sent them off for modeling.

Attached are the two initial emails sent containing the requests.

Please let me know if you have any questions or comments.

Thanks,

Michael Wu, EIT

Civil Engineering Intern, Community Development

Mobile: (613) 858-0548
michael.wu@stantec.com

Stantec
300 - 1331 Clyde Avenue
Ottawa ON K2C 3G4



The content of this email is the confidential property of Stantec and should not be copied, modified, retransmitted, or used for any purpose except with Stantec's written authorization. If you are not the intended recipient, please delete all copies and notify us immediately.

This e-mail originates from the City of Ottawa e-mail system. Any distribution, use or copying of this e-mail or the information it contains by other than the intended recipient(s) is unauthorized. Thank you.

Le présent courriel a été expédié par le système de courriels de la Ville d'Ottawa. Toute distribution, utilisation ou reproduction du courriel ou des renseignements qui s'y trouvent par une personne autre que son destinataire prévu est interdite. Je vous remercie de votre

collaboration.

,

This e-mail originates from the City of Ottawa e-mail system. Any distribution, use or copying of this e-mail or the information it contains by other than the intended recipient(s) is unauthorized. Thank you.

Le présent courriel a été expédié par le système de courriels de la Ville d'Ottawa. Toute distribution, utilisation ou reproduction du courriel ou des renseignements qui s'y trouvent par une personne autre que son destinataire prévu est interdite. Je vous remercie de votre collaboration.

,

A.5 Hydraulic Analysis





Project:	1806 Scott Street	No.	160401747
SITE PLAN HYDRAULIC ANALYSIS			
Revision:	01	Prepared By:	MW
Revision Date:	24-Nov-2022	Checked By:	AG

BOUNDARY CONDITIONS (BC)	
Connection at Scott Street	
Site Plan Revision Date	15-Aug-2022
Min. HGL (m)	108.4
Max. HGL (m)	115.1
Max. Day + Fire Flow (90.0 L/s)	108

Ground Floor Elevation (GFE) (Level 01) (m)	64.4
---	------

GROUND FLOOR (GF) PRESSURE RANGE				
	GF HGL (m)	GF Pressure (kPa)	GF Pressure (psi)	Outcome
	= BC HGL (m) - FFE (m)	= GF HGL (m) x 9.804 (kPa/m)	= GF Pressure (kPa) x 0.145 (psi/kPa)	If min <50 psi: booster pump If max >100 psi: pressure reducer
Minimum Normal	44	431.4	62.6	No Booster Pump Required
Maximum Normal	50.7	497.1	72.1	No Pressure Reducer Required

Number of Floors Above Ground	4
Approximate Height of One Storey (m)	3.175
Pressure Drop Per Floor (kPa)	31.1
Pressure Drop Per Floor (psi)	4.5

RESIDUAL PRESSURE RANGE IN MULTI-LEVEL BUILDINGS			
	Residual Pressure (kPa)	Residual Pressure (psi)	Outcome
Top Floor Min	338.0	49.0	Booster Pump Required
Top Floor Max	403.7	58.5	
Maximum Number of Floors Above Ground at Minimum Pressure	4		

RESIDUAL PRESSURE UNDER FIRE FLOW CONDITIONS			
	Residual HGL (m)	Residual Pressure (kPa)	Residual Pressure (psi)
Ground Floor	43.6	427.5	62.0
Top Floor	34.075	334.1	48.4

Pressure Check		
	Pressure (kPa)	Pressure (psi)
Pressure Below Minimum	<276	<40
Pressure Below Normal	276-345	40-50
Pressure Within Normal Range	345-552	50-80
Pressure Above Normal Range	552-690	80-100
Pressure Above Maximum	>690	>100

A.6 Fire Hydrant Coverage Calculations





Project: **1806 Scott Street** 160401747

**TABLE 1:
FIRE HYDRANT COVERAGE TABLE**

Revision: 1 Prepared By: MW

Revision Date: 2022-11-24 Checked By:

Description	Hydrants ¹			Total Available Fire Flow (L/min)	Total Required Fire Flow ² (L/min)
	HYD-01	HYD-02	HYD-03		
1806 Scott Street					
Distance from building (m)	28.2	28.9	65.2	-	-
Maximum fire flow capacity ³ (L/min)	5,678	5,678	5,678	17,034	5,400

NFPA 1 Table 18.5.4.3	
Distance to Building (m)	Maximum Capacity (L/min)
≤ 76	5,678
> 76 and ≤ 152	3,785
> 152 and ≤ 305	2,839

- Notes:
- Hydrant locations as per GeoOttawa accessed November 24, 2022. Refer to fire hydrant coverage sketch (Figure 2).
 - See OBC Calculations, Appendix A.2 for fire flow requirements.
 - See NFPA 1 Table 18.5.4.3 for maximum fire flow capacity of hydrants by distance to building.

Appendix B Conceptual Site Plan by OPA (Nov 23, 2022)



1806 Scott Street, Ottawa

Zoning Data:

Zone: R1MM
 Adjacent zones:
 north: O1
 south: R1MM
 east: R1MM
 west: R1MM

Frontage: 22.87 (Scott Street)

Lot area: 629.87 m²

Proposed building area: 258.5 m²
 taken in accordance w/ OBC definition

Proposed GFA: 828.4 m²
 taken in accordance w/ zoning bylaw definition
 level B 137.6
 level 1 137.6
 level 2 184.4
 level 3 184.4
 level 4 184.4

Proposed use: Apartment Dwelling, Low-Rise

Proposed number of units: 16

unit breakdown:

	bach.	1-bed	1-bed + d	2-bed	total
basement			1	1	2
1 st floor			1	1	2
2 nd floor	3	1			4
3 rd floor	3			1	4
4 th floor	3			1	4
total	9	1	2	4	16

Proposed car parking: 2

Proposed amenity area: 186 m² (96 m² required)
 Communal: 134 m², exterior
 Private: 52 m², balconies

Bikes: 16
 10 stacked in bike room at lobby level
 06 at corner side yard

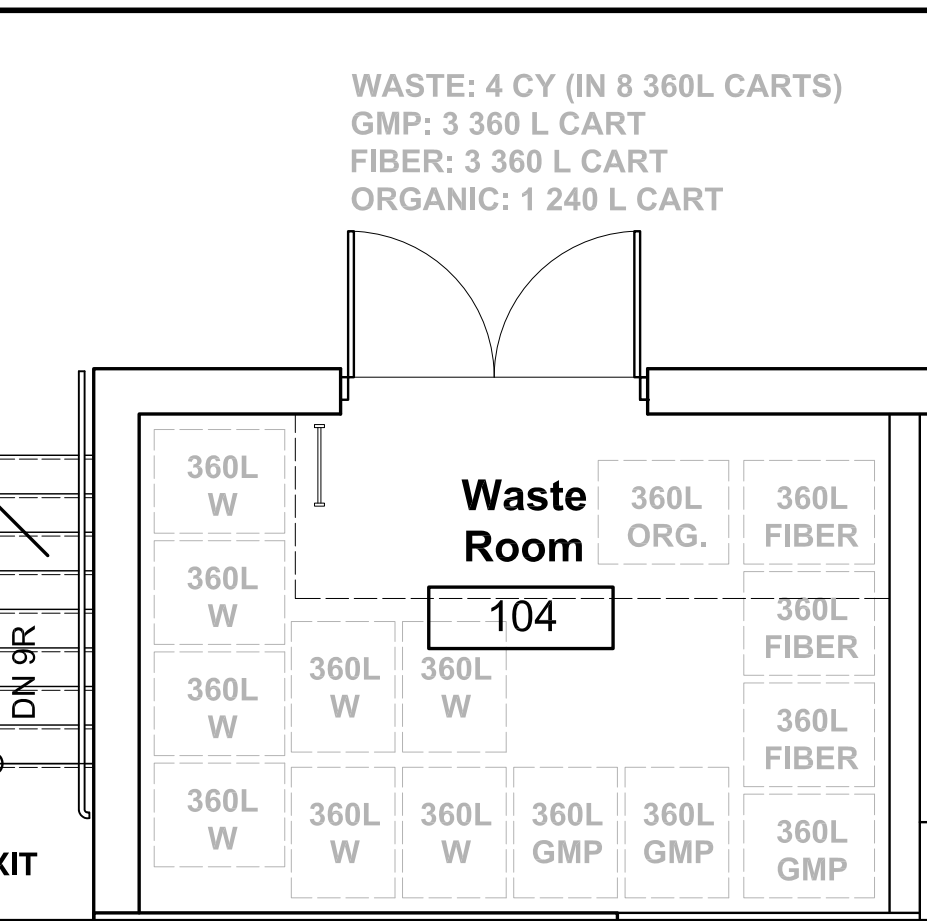

2 GARBAGE ROOM PART PLAN
 A000 1:50

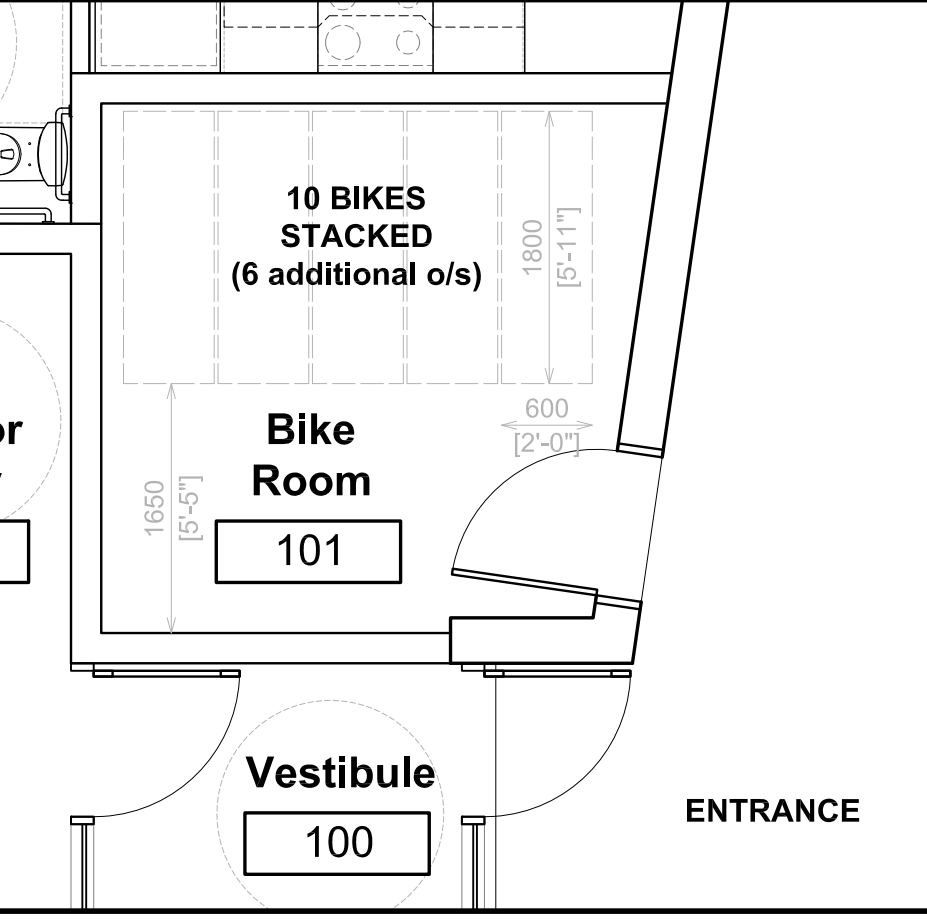

3 BIKE ROOM PART PLAN
 A000 1:50

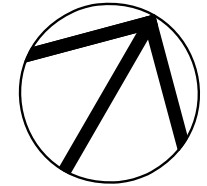

TRUE NORTH

SCALE: 1 : 100

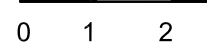

SURVEY INFORMATION TAKEN FROM SURVEY PREPARED FARLEY, SMITH & DENIS SURVEYING LTD., DATED JANUARY 17, 2022, FILE NO. 650-21

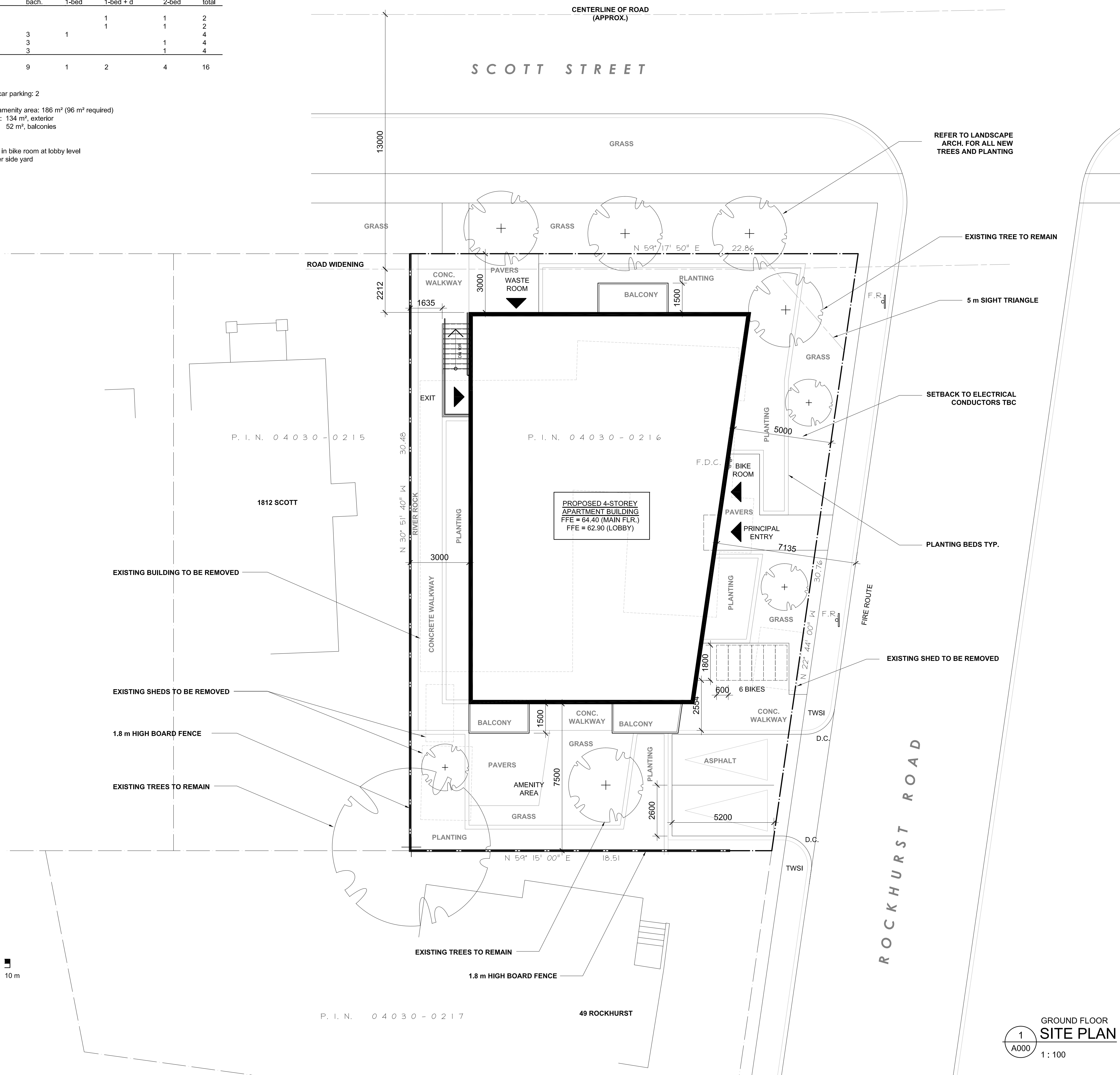

1 GROUND FLOOR SITE PLAN
 A000 1:100

CLIENT / OWNER :
 GABRIELA GODINEZ-LAVERTY
 AND COLIN LAVERTY
 14 BREADNER BOULEVARD,
 TRENTON, ON K8V 1E2
 613-274-2872

STRUCTURAL ENGINEER :
 ALTRA DESIGN AND CONSTRUCTION LTD.
 2445 CLOVER STREET
 OTTAWA, ON K1V 8G4
 613-697-6974

**CONSULTING PLANNER
 & LANDSCAPE ARCHITECT:**
 FOTENN
 396 COOPER STREET, SUITE 300
 OTTAWA, ON K2P 2H7
 613-730-5709

SURVEYOR :
 FARLEY SMITH & DENIS SURVEYING LTD.
 1331 CLYDE AVENUE, SUITE 300
 OTTAWA, ON K2C 3G4
 613-722-4420

CIVIL ENGINEER :
 STANTEC
 30 COLONNADE ROAD, SUITE 275
 OTTAWA, ON K2E 7J6
 613-727-8226

rev. / issue	description	date
01	ISSUED FOR SITE PLAN CONTROL & ZBA	23 NOV. 2022

THE ARCHITECT WAIVES ANY AND ALL RESPONSIBILITY AND LIABILITY FOR PROBLEMS WHICH ARISE FROM FAILURE TO FOLLOW THESE PLANS, SPECIFICATIONS, AND THE DESIGN INTENT THEY CONVEY, OR FOR PROBLEMS WHICH ARISE FROM OTHERS' FAILURE TO OBTAIN AND/OR FOLLOW THE ARCHITECT'S GUIDANCE WITH RESPECT TO ANY ERRORS, OMISSIONS, INCONSISTENCIES, AMBIGUITIES OR CONFLICTS WHICH ARE ALLEGED.

IT IS THE RESPONSIBILITY OF THE APPROPRIATE CONTRACTOR TO CHECK AND VERIFY ALL DIMENSIONS ON SITE AND PROMPTLY REPORT ALL ERRORS AND/OR OMISSIONS TO THE CONSULTANT BEFORE WORK COMMENCES.

ALL WORK IS TO FOLLOW THE OBC 2012 AND ANY OTHER APPLICABLE CODES AND REGULATIONS.

DO NOT SCALE DRAWINGS.

THESE DRAWINGS ARE NOT TO BE USED FOR CONSTRUCTION UNLESS A BUILDING PERMIT IN RESPECT OF THIS PROJECT HAS BEEN GRANTED BY AUTHORITIES AND THEY ARE ISSUED FOR CONSTRUCTION.

COPYRIGHT RESERVED.

professional stamp

project north

Kristopher D. Benes, OAA, MRAIC, LEED AP

OPA open plan architects inc.
 architecture | interiors | concepts

2305 HILLARY AVE. | OTTAWA | ON | K1H 7J2
 613.883.5090 | info@openplan.ca

project

1806 SCOTT STREET, OTTAWA RENTAL APARTMENT BUILDING

drawing

SITE PLAN

drawn	KDB	date	JANUARY 2022
approved	KDB	revision	1
project no.	2120	scale	AS SHOWN

drawing no.

A000

Appendix C Sanitary

C.1 Sanitary Calculation Sheet





SUBDIVISION:
1806 Scott Street
 DATE: 2022-07-28
 REVISION: 1
 DESIGNED BY: MW
 CHECKED BY:

**SANITARY SEWER
 DESIGN SHEET
 (City of Ottawa)**

FILE NUMBER: 160401747

DESIGN PARAMETERS			
MAX PEAK FACTOR (RES.)=	4.0	AVG. DAILY FLOW / PERSON	280 l/p/day
MIN PEAK FACTOR (RES.)=	2.0	COMMERCIAL	28,000 l/ha/day
PEAKING FACTOR (INDUSTRIAL):	2.4	INDUSTRIAL (HEAVY)	55,000 l/ha/day
PEAKING FACTOR (ICI >20%):	1.5	INDUSTRIAL (LIGHT)	35,000 l/ha/day
PERSONS / 1 BEDROOM & BACHELOR	1.4	INSTITUTIONAL	28,000 l/ha/day
PERSONS / 2 BEDROOM & 1 BED+DEN	2.1	INFILTRATION	0.33 l/s/ha
PERSONS / 3 BEDROOM	3.1		
MINIMUM VELOCITY	0.60 m/s		
MAXIMUM VELOCITY	3.00 m/s		
MANNINGS n	0.013		
BEDDING CLASS	B		
MINIMUM COVER	2.50 m		
HARMON CORRECTION FACTOR	0.8		

LOCATION			RESIDENTIAL AREA AND POPULATION										COMMERCIAL		INDUSTRIAL (L)		INDUSTRIAL (H)		INSTITUTIONAL		GREEN / UNUSED		C+I	INFILTRATION			TOTAL	PIPE									
AREA ID NUMBER	FROM M.H.	TO M.H.	AREA (ha)	UNITS	POP.	CUMULATIVE AREA (ha)	POP.	PEAK FACT.	PEAK FLOW (l/s)	AREA (ha)	ACCU. AREA (ha)	AREA (ha)	ACCU. AREA (ha)	AREA (ha)	ACCU. AREA (ha)	AREA (ha)	ACCU. AREA (ha)	AREA (ha)	ACCU. AREA (ha)	PEAK FLOW (l/s)	TOTAL AREA (ha)	ACCU. AREA (ha)	INFILT. FLOW (l/s)	FLOW (l/s)	LENGTH (m)	DIA (mm)	MATERIAL	CLASS	SLOPE (%)	CAP. (FULL) (l/s)	CAP. V PEAK FLOW (%)	VEL. (FULL) (m/s)	VEL. (ACT.) (m/s)				
PROPOSED DEVELOPMENT	BLDG	EX. SAN	0.025	10	2	4	27	0.025	27	3.490	0.301	0.000	0.000	0.000	0.000	0.000	0.000	0.000	0.000	0.000	0.000	0.000	0.000	0.000	0.063	0.063	0.021	0.322	11.200	150	PVC	SDR 35	1.00	15.3	2.10%	0.86	0.30

C.2 Correspondence with City on Sanitary Sewer Capacity



From: [Fawzi, Mohammed](#)
To: [Wu, Michael](#)
Cc: [Gladish, Alyssa](#)
Subject: RE: 1806 Scott Street Requests follow-up
Date: Wednesday, 10 August, 2022 11:35:06

Hi Michael,

This is to confirm that there are no sanitary capacity constraints.

Thank you.

Best Regards,

Mohammed Fawzi, P.Eng.

Project Manager

Planning, Infrastructure and Economic Development Department - Services de la
planification, de l'infrastructure et du développement économique

Development Review - Central Branch

City of Ottawa | Ville d'Ottawa

110 Laurier Avenue West Ottawa, ON | 110, avenue. Laurier Ouest. Ottawa (Ontario) K1P
1J1

613.580.2424 ext./poste 20120, Mohammed.Fawzi@ottawa.ca

****Please note that due to the current situation, I am working remotely. Email is currently the best way to contact me****

From: Wu, Michael <Michael.Wu@stantec.com>
Sent: August 09, 2022 2:20 PM
To: Fawzi, Mohammed <mohammed.fawzi@ottawa.ca>
Cc: Gladish, Alyssa <Alyssa.Gladish@stantec.com>; McLaughlin Seymour, Sarah <Sarah.McLaughlin@ottawa.ca>
Subject: RE: 1806 Scott Street Requests follow-up

CAUTION: This email originated from an External Sender. Please do not click links or open attachments unless you recognize the source.

ATTENTION : Ce courriel provient d'un expéditeur externe. Ne cliquez sur aucun lien et n'ouvrez pas de pièce jointe, excepté si vous connaissez l'expéditeur.

Hi Mohammed:

Thank you for the update. Please let me know if you have any questions or require

any additional information.

Michael Wu, EIT

Civil Engineering Intern, Community Development

Mobile: (613) 858-0548

michael.wu@stantec.com

Stantec

300 - 1331 Clyde Avenue

Ottawa ON K2C 3G4



The content of this email is the confidential property of Stantec and should not be copied, modified, retransmitted, or used for any purpose except with Stantec's written authorization. If you are not the intended recipient, please delete all copies and notify us immediately.

From: Fawzi, Mohammed <mohammed.fawzi@ottawa.ca>

Sent: Tuesday, 9 August, 2022 14:18

To: Wu, Michael <Michael.Wu@stantec.com>

Cc: Gladish, Alyssa <Alyssa.Gladish@stantec.com>; McLaughlin Seymour, Sarah <Sarah.McLaughlin@ottawa.ca>

Subject: RE: 1806 Scott Street Requests follow-up

Hi Michael,

This is to confirm that your request regarding the sanitary capacity was received and is currently being looked at.

Thanks Michael.

Best Regards,

Mohammed Fawzi, P.Eng.

Project Manager

Planning, Infrastructure and Economic Development Department - Services de la planification, de l'infrastructure et du développement économique

Development Review - Central Branch

City of Ottawa | Ville d'Ottawa

110 Laurier Avenue West Ottawa, ON | 110, avenue. Laurier Ouest. Ottawa (Ontario) K1P 1J1

613.580.2424 ext./poste 20120, Mohammed.Fawzi@ottawa.ca

****Please note that due to the current situation, I am working remotely. Email is currently the best way to contact me****

From: McLaughlin Seymour, Sarah <Sarah.McLaughlin@ottawa.ca>
Sent: August 09, 2022 2:00 PM
To: Wu, Michael <Michael.Wu@stantec.com>
Cc: Gladish, Alyssa <Alyssa.Gladish@stantec.com>; Fawzi, Mohammed <mohammed.fawzi@ottawa.ca>
Subject: RE: 1806 Scott Street Requests follow-up

Hi Michael,

Mohammed Fawzi (cc'ed on this email) has taken over the file. However, the water boundary conditions were submitted to the modelling group on July 28. I just followed up with them and this one is complete and in review now. It should go out in the next day or two.

Please followup with Mo about the sanitary capacity.

Thanks,

Sarah McLaughlin, P.Eng

Infrastructure Assessment Engineer
Infrastructure & Water Services Dept.
100 Constellation Cres., 6th floor East
Ottawa, ON, K2G 6J8
613-580-2424 x 26821
sarah.mclaughlin@ottawa.ca

From: Wu, Michael <Michael.Wu@stantec.com>
Sent: August 09, 2022 1:15 PM
To: McLaughlin Seymour, Sarah <Sarah.McLaughlin@ottawa.ca>
Cc: Gladish, Alyssa <Alyssa.Gladish@stantec.com>
Subject: 1806 Scott Street Requests follow-up

CAUTION: This email originated from an External Sender. Please do not click links or open attachments unless you recognize the source.

ATTENTION : Ce courriel provient d'un expéditeur externe. Ne cliquez sur aucun lien et n'ouvrez pas de pièce jointe, excepté si vous connaissez l'expéditeur.

Good afternoon, Sarah:

As a quick follow-up for the boundary conditions request and confirmation of sanitary sewer capacity request, I was wondering if you could provide a confirmation of receipt of the two requests and have sent them off for modeling.

Attached are the two initial emails sent containing the requests.

Please let me know if you have any questions or comments.

Thanks,

Michael Wu, EIT

Civil Engineering Intern, Community Development

Mobile: (613) 858-0548

michael.wu@stantec.com

Stantec

300 - 1331 Clyde Avenue

Ottawa ON K2C 3G4



The content of this email is the confidential property of Stantec and should not be copied, modified, retransmitted, or used for any purpose except with Stantec's written authorization. If you are not the intended recipient, please delete all copies and notify us immediately.

This e-mail originates from the City of Ottawa e-mail system. Any distribution, use or copying of this e-mail or the information it contains by other than the intended recipient(s) is unauthorized. Thank you.

Le présent courriel a été expédié par le système de courriels de la Ville d'Ottawa. Toute distribution, utilisation ou reproduction du courriel ou des renseignements qui s'y trouvent par une personne autre que son destinataire prévu est interdite. Je vous remercie de votre collaboration.

This e-mail originates from the City of Ottawa e-mail system. Any distribution, use or copying of this e-mail or the information it contains by other than the intended recipient(s) is unauthorized. Thank you.

Le présent courriel a été expédié par le système de courriels de la Ville d'Ottawa. Toute distribution, utilisation ou reproduction du courriel ou des renseignements qui s'y trouvent par une personne autre que son destinataire prévu est interdite. Je vous remercie de votre collaboration.

Appendix D Stormwater Servicing

D.1 Modified Rational Method Sheet



Stormwater Management Calculations

Project #160401747, 1806 Scott Street Modified Rational Method Calculators for Storage

5 yr Intensity City of Ottawa	$I = a/(t + b)^c$	a = 998.071	t (min)	I (mm/hr)
		b = 6.053		
		c = 0.814		
			10	104.19
			20	70.25
			30	53.93
			40	44.18
			50	37.65
			60	32.94
			70	29.37
			80	26.56
			90	24.29
			100	22.41
			110	20.82
			120	19.47

5 YEAR Predevelopment Target Release from Portion of Site

Subdrainage Area: Predevelopment Tributary Area to Outlet
 Area (ha): 0.063
 C: 0.50

Typical Time of Concentration

tc (min)	I (5 yr) (mm/hr)	Qtarget (L/s)
10	104.19	9.13

5 YEAR Modified Rational Method for Entire Site

Subdrainage Area: UNC-2 Uncontrolled - Non-Tributary
 Area (ha): 0.02
 C: 0.49

tc (min)	I (5 yr) (mm/hr)	Qactual (L/s)	Qrelease (L/s)	Qstored (L/s)	Vstored (m ³)
5	141.18	3.96	3.96		
10	104.19	2.92	2.92		
15	83.56	2.34	2.34		
20	70.25	1.97	1.97		
25	60.90	1.71	1.71		
30	53.93	1.51	1.51		
35	48.52	1.36	1.36		
40	44.18	1.24	1.24		
45	40.63	1.14	1.14		
50	37.65	1.06	1.06		
55	35.12	0.99	0.99		
60	32.94	0.92	0.92		

Subdrainage Area: UNC-1 Uncontrolled - Non-Tributary
 Area (ha): 0.017
 C: 0.59

tc (min)	I (5 yr) (mm/hr)	Qactual (L/s)	Qrelease (L/s)	Qstored (L/s)	Vstored (m ³)
10	104.19	2.84	2.84		
20	70.25	1.91	1.91		
30	53.93	1.47	1.47		
40	44.18	1.20	1.20		
50	37.65	1.03	1.03		
60	32.94	0.90	0.90		
70	29.37	0.80	0.80		
80	26.56	0.72	0.72		
90	24.29	0.66	0.66		
100	22.41	0.61	0.61		
110	20.82	0.57	0.57		
120	19.47	0.53	0.53		

Subdrainage Area: ROOF-1 Roof
 Area (ha): 0.026 Maximum Storage Depth: 150 mm
 C: 0.90

tc (min)	I (5 yr) (mm/hr)	Qactual (L/s)	Qrelease (L/s)	Qstored (L/s)	Vstored (m ³)	Depth (mm)
10	104.19	6.74	1.58	5.16	3.10	100.3
20	70.25	4.54	1.60	2.94	3.53	104.0
30	53.93	3.49	1.60	1.89	3.41	102.9
40	44.18	2.86	1.58	1.28	3.07	100.1
50	37.65	2.44	1.54	0.89	2.68	94.6
60	32.94	2.13	1.51	0.63	2.25	88.6
70	29.37	1.90	1.47	0.43	1.82	82.5
80	26.56	1.72	1.43	0.29	1.39	76.4
90	24.29	1.57	1.38	0.19	1.05	68.3
100	22.41	1.45	1.32	0.12	0.75	60.0
110	20.82	1.35	1.28	0.07	0.47	52.3
120	19.47	1.26	1.21	0.05	0.36	48.0

Storage: Roof Storage

Depth (mm)	Head (m)	Discharge (L/s)	Vreq (cu. m)	Vavail (cu. m)	Discharge Check
104.00	0.10	1.60	3.53	10.34	0.00

SUMMARY TO OUTLET

	Tributary Area	Required	Available*
	0.026 ha		
Total 5yr Flow to Sewer Target	1.60 L/s 9.13 L/s	3.53	10.34 m ³ Ok
Non-Tributary Area	0.037 ha		
Total 5yr Flow Uncontrolled	6.80 L/s		
Total Area	0.063 ha		
Total 5yr Flow	8.40 L/s		

Project #160401747, 1806 Scott Street Modified Rational Method Calculators for Storage

100 yr Intensity City of Ottawa	$I = a/(t + b)^c$	a = 1735.688	t (min)	I (mm/hr)
		b = 6.014		
		c = 0.820		
			10	178.56
			20	119.95
			30	91.87
			40	75.15
			50	63.95
			60	55.89
			70	49.79
			80	44.99
			90	41.11
			100	37.90
			110	35.20
			120	32.89

100 YEAR Predevelopment Target Release from Portion of Site

Subdrainage Area: Predevelopment Roof Area to Outlet
 Area (ha): 0.026
 C: 0.90

Typical Time of Concentration

tc (min)	I (5 yr) (mm/hr)	Qtarget (L/s)
10	104.19	6.74

100 YEAR Modified Rational Method for Entire Site

Subdrainage Area: UNC-2 Uncontrolled - Non-Tributary
 Area (ha): 0.02
 C: 0.61

tc (min)	I (100 yr) (mm/hr)	Qactual (L/s)	Qrelease (L/s)	Qstored (L/s)	Vstored (m ³)
10	178.56	6.26	6.26		
20	119.95	4.21	4.21		
30	91.87	3.22	3.22		
40	75.15	2.64	2.64		
50	63.95	2.24	2.24		
60	55.89	1.96	1.96		
70	49.79	1.75	1.75		
80	44.99	1.58	1.58		
90	41.11	1.44	1.44		
100	37.90	1.33	1.33		
110	35.20	1.23	1.23		
120	32.89	1.15	1.15		

Subdrainage Area: UNC-1 Uncontrolled - Non-Tributary
 Area (ha): 0.017
 C: 0.74

tc (min)	I (100 yr) (mm/hr)	Qactual (L/s)	Qrelease (L/s)	Qstored (L/s)	Vstored (m ³)
10	178.56	6.08	6.08		
20	119.95	4.08	4.08		
30	91.87	3.13	3.13		
40	75.15	2.56	2.56		
50	63.95	2.18	2.18		
60	55.89	1.90	1.90		
70	49.79	1.69	1.69		
80	44.99	1.53	1.53		
90	41.11	1.40	1.40		
100	37.90	1.29	1.29		
110	35.20	1.20	1.20		
120	32.89	1.12	1.12		

Subdrainage Area: ROOF-1 Roof
 Area (ha): 0.026 Maximum Storage Depth: 150 mm
 C: 1.00

tc (min)	I (100 yr) (mm/hr)	Qactual (L/s)	Qrelease (L/s)	Qstored (L/s)	Vstored (m ³)	Depth (mm)
10	178.56	12.83	1.76	11.08	6.65	128.8
20	119.95	8.62	1.81	6.81	8.17	137.5
30	91.87	6.60	1.83	4.77	8.59	140.0
40	75.15	5.40	1.83	3.57	8.57	139.9
50	63.95	4.60	1.82	2.78	8.33	138.5
60	55.89	4.02	1.81	2.21	7.96	136.3
70	49.79	3.58	1.79	1.79	7.51	133.8
80	44.99	3.23	1.77	1.46	7.02	130.9
90	41.11	2.96	1.75	1.20	6.49	127.9
100	37.90	2.72	1.73	0.99	5.95	124.7
110	35.20	2.53	1.71	0.82	5.44	120.4
120	32.89	2.36	1.68	0.69	4.94	116.1

Storage: Roof Storage

Depth (mm)	Head (m)	Discharge (L/s)	Vreq (cu. m)	Vavail (cu. m)	Discharge Check
139.98	0.14	1.83	8.59	10.34	0.00

SUMMARY TO OUTLET

	Tributary Area	Required	Available*
	0.026 ha		
Total 100yr Flow to Sewer Target	1.83 L/s 9.13 L/s	8.59	10.34 m ³ Ok
Non-Tributary Area	0.037 ha		
Total 100yr Flow Uncontrolled	12.34 L/s		
Total Area	0.063 ha		
Total 100yr Flow	14.17 L/s		

D.2 Watts Drainage Adjustable Accutrol Weir Detail (2016)





Adjustable Accutrol Weir

Tag: _____

Adjustable Flow Control for Roof Drains

ADJUSTABLE ACCUTROL (for Large Sump Roof Drains only)

For more flexibility in controlling flow with heads deeper than 2", Watts Drainage offers the Adjustable Accutrol. The Adjustable Accutrol Weir is designed with a single parabolic opening that can be covered to restrict flow above 2" of head to less than 5 gpm per inch, up to 6" of head. To adjust the flow rate for depths over 2" of head, set the slot in the adjustable upper cone according to the flow rate required. Refer to Table 1 below.
 Note: Flow rates are directly proportional to the amount of weir opening that is exposed.

EXAMPLE:

For example, if the adjustable upper cone is set to cover 1/2 of the weir opening, flow rates above 2" of head will be restricted to 2-1/2 gpm per inch of head.

Therefore, at 3" of head, the flow rate through the Accutrol Weir that has 1/2 the slot exposed will be:
 [5 gpm (per inch of head) x 2 inches of head] + 2-1/2 gpm (for the third inch of head) = 12-1/2 gpm.

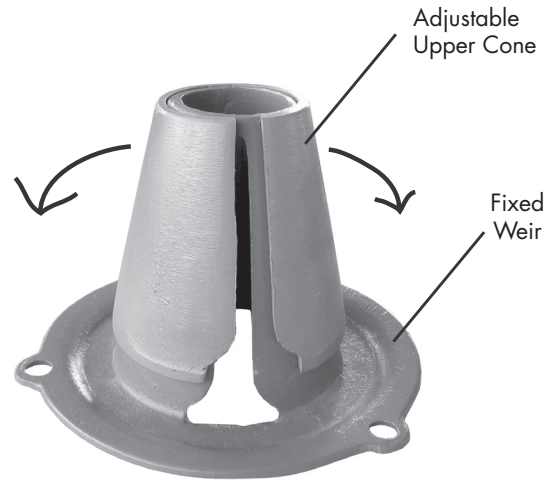
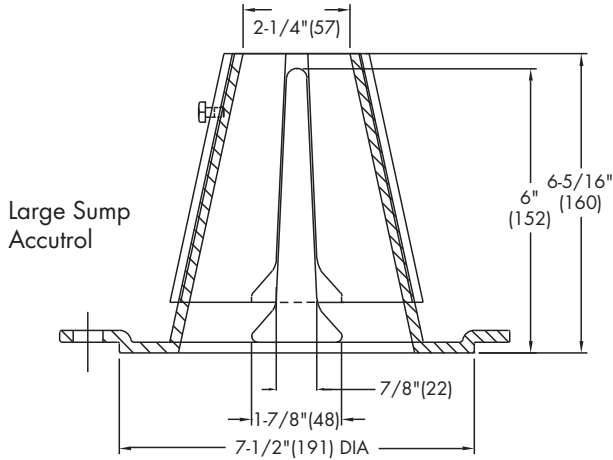

1/2 Weir Opening Exposed Shown Above

TABLE 1. Adjustable Accutrol Flow Rate Settings

Weir Opening Exposed	1"	2"	3"	4"	5"	6"
	Flow Rate (gallons per minute)					
Fully Exposed	5	10	15	20	25	30
3/4	5	10	13.75	17.5	21.25	25
1/2	5	10	12.5	15	17.5	20
1/4	5	10	11.25	12.5	13.75	15
Closed	5	5	5	5	5	5

Job Name _____
 Job Location _____
 Engineer _____

Contractor _____
 Contractor's P.O. No. _____
 Representative _____

Watts product specifications in U.S. customary units and metric are approximate and are provided for reference only. For precise measurements, please contact Watts Technical Service. Watts reserves the right to change or modify product design, construction, specifications, or materials without prior notice and without incurring any obligation to make such changes and modifications on Watts products previously or subsequently sold.

USA: Tel: (800) 338-2581 • Fax: (828) 248-3929 • Watts.com
 Canada: Tel: (905) 332-4090 • Fax: (905) 332-7068 • Watts.ca
 Latin America: Tel: (52) 81-1001-8600 • Fax: (52) 81-8000-7091 • Watts.com



D.3 Storm Sewer Design Sheet





1806 SCOTT STREET

**STORM SEWER
DESIGN SHEET
(City of Ottawa)**

DESIGN PARAMETERS

$I = a / (t+b)^2$ (As per City of Ottawa Guidelines, 2012)

	1:2 yr	1:5 yr	1:10 yr	1:100 yr	
a =	732.951	998.071	1174.184	1735.688	MANNING'S n = 0.013
b =	6.199	6.053	6.014	6.014	MINIMUM COVER: 2.00 m
c =	0.810	0.814	0.816	0.820	TIME OF ENTRY 10 min

BEDDING CLASS = B

FILE NUMBER: 160401747

DATE: 2022-11-28
REVISION: 1
DESIGNED BY: MW
CHECKED BY: AG

LOCATION			DRAINAGE AREA																	PIPE SELECTION																				
AREA ID NUMBER	FROM M.H.	TO M.H.	AREA (2-YEAR) (ha)	AREA (5-YEAR) (ha)	AREA (10-YEAR) (ha)	AREA (100-YEAR) (ha)	AREA (ROOF) (ha)	C (2-YEAR) (-)	C (5-YEAR) (-)	C (10-YEAR) (-)	C (100-YEAR) (-)	A x C (2-YEAR) (ha)	ACCUM AxC (2YR) (ha)	A x C (5-YEAR) (ha)	ACCUM AxC (5YR) (ha)	A x C (10-YEAR) (ha)	ACCUM AxC (10YR) (ha)	A x C (100-YEAR) (ha)	ACCUM AxC (100YR) (ha)	T of C (min)	I _{2-YEAR} (mm/h)	I _{5-YEAR} (mm/h)	I _{10-YEAR} (mm/h)	I _{100-YEAR} (mm/h)	Q _{CONTROL} (L/s)	ACCUM. Q _{CONTROL} (L/s)	Q _{ACT} (CIA/360) (L/s)	LENGTH (m)	PIPE WIDTH OR DIAMETER (mm)	PIPE HEIGHT (mm)	PIPE SHAPE (-)	MATERIAL (-)	CLASS (-)	SLOPE (%)	Q _{CAP} (FULL) (L/s)	% FULL (-)	VEL. (FULL) (m/s)	VEL. (ACT) (m/s)	TIME OF FLOW (min)	
BLG	BLG	CBMH	0.00	0.000	0.00	0.000	0.026	0.00	0.90	0.00	1.13	0.00	0.00	0.00	0.00	0.00	0.00	0.00	0.00	0.00	10.00	76.81	104.19	122.14	178.56	1.830	1.83	1.83	1.00	100	100	CIRCULAR	PVC	-	1.00	5.3	34.55%	0.66	0.51	0.03
UNC-1	SUBDRAIN	CBMH	0.00	0.017	0.00	0.000	0.000	0.00	0.59	0.00	0.74	0.00	0.00	0.01	0.01	0.00	0.00	0.00	0.00	0.00	10.00	76.81	104.19	122.14	178.56	0.000	0.00	2.83	5.80	250	250	CIRCULAR	PVC	-	1.00	60.4	4.69%	1.22	0.52	0.19
SITE	CBMH	EXIST	0.00	0.000	0.00	0.000	0.000	0.00	0.00	0.00	0.00	0.00	0.00	0.00	0.01	0.00	0.00	0.00	0.00	0.00	10.00	76.81	104.19	122.14	178.56	0.000	1.83	4.66	10.00	200	200	CIRCULAR	PVC	-	1.00	33.3	14.00%	1.05	0.61	0.27

D.4 Correspondence with the RVCA



From: [Eric Lalande](#)
To: [Wu, Michael](#)
Cc: [Jamie Batchelor](#); [Gladish, Alyssa](#)
Subject: RE: Follow-up on stormwater quality control criteria request for 1806 Scott Street
Date: Monday, 15 August, 2022 13:46:00

Hi Michael,

Sorry for the delay, based on the site plan provided, the RVCA has no water quality control requirements for the subject lands. Best management practices are encouraged to be implemented where possible as part of the overall site design.

Cheers,

Eric Lalande, MCIP, RPP
Planner, RVCA
613-692-3571 x1137

From: Wu, Michael <Michael.Wu@stantec.com>
Sent: Monday, August 15, 2022 1:43 PM
To: Eric Lalande <eric.lalande@rvca.ca>
Cc: Jamie Batchelor <jamie.batchelor@rvca.ca>; Gladish, Alyssa <Alyssa.Gladish@stantec.com>
Subject: Follow-up on stormwater quality control criteria request for 1806 Scott Street

Good afternoon, Eric:

I am writing to follow up on the request for stormwater quality control criteria for the proposed redevelopment on 1806 Scott Street in the City of Ottawa.

Could you provide a timeline on where we could expect the criteria?

Thanks,

Michael Wu, EIT
Civil Engineering Intern, Community Development

Mobile: (613) 858-0548
michael.wu@stantec.com

Stantec
300 - 1331 Clyde Avenue
Ottawa ON K2C 3G4

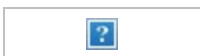

The content of this email is the confidential property of Stantec and should not be copied, modified, retransmitted, or used for any purpose except with Stantec's written authorization. If you are not the intended recipient, please delete all copies and notify us immediately.

Appendix E Background Studies

E.1 Foundation Investigation and Design Report - Draft (by McIntosh-Perry, December 2022)



MULTI-STOREY RESIDENTIAL BUILDING
1806 SCOTT STREET, OTTAWA, ON.
FOUNDATION INVESTIGATION AND DESIGN REPORT

DRAFT

Project No.: CCO-23-1093

Prepared for:

Gabriela Godinez-Laverty
Project Manager
Stantec
Ottawa, ON

Prepared by:

McIntosh Perry
104-215 Menten Place
Ottawa, ON K2H 9C1

December 2022

McINTOSH PERRY

TABLE OF CONTENTS

1.0	INTRODUCTION	1
2.0	PROJECT UNDERSTANDING.....	1
3.0	SITE DESCRIPTION	1
3.1	Site Geology.....	1
4.0	FIELD PROCEDURES.....	2
5.0	LABORATORY TEST PROCEDURES.....	3
6.0	SUBSURFACE CONDITIONS.....	4
6.1	Subsurface.....	4
6.1.1	Fill (Granular).....	4
6.1.2	Sand and Gravel	5
6.1.3	Bedrock	5
6.2	Chemical Analysis	6
6.3	Groundwater	7
7.0	DISCUSSIONS AND RECOMMENDATIONS	7
7.1	General.....	7
7.2	Overview	7
7.3	Site Preparation.....	8
7.4	Foundations.....	9
7.4.1	Rock Anchors.....	10
7.4.2	Frost Protection	11
7.5	Seismic Site Classification.....	11
7.6	Engineered Fill	12
7.7	Slabs-on-Grade.....	12
7.8	Lateral Earth Pressure.....	13
7.9	Flexible Pavement	13
7.10	Sidewalks and Hard Surfacing.....	14
7.11	Cement Type and Corrosion Potential	15

8.0	CONSTRUCTION CONSIDERATIONS.....	15
9.0	GROUNDWATER SEEPAGE.....	16
10.0	SITE SERVICES.....	16
11.0	CLOSURE.....	17
12.0	REFERENCES.....	18

LIST OF TABLES

TABLE 4-1. BOREHOLE INFORMATION SUMMARY.....	3
TABLE 6-1. FILL GRAIN-SIZE DISTRIBUTION SUMMARY.....	4
TABLE 6-2. SAND AND GRAVEL GRAIN-SIZE DISTRIBUTION SUMMARY.....	5
TABLE 6-3. BEDROCK CORE RECOVERY SUMMARY.....	6
TABLE 6-4. BEDROCK STRENGTH SUMMARY.....	6
TABLE 6-5. CHEMICAL ANALYSIS SUMMARY.....	7
TABLE 7-1: ROCK BEARING RESISTANCE.....	10
TABLE 7-2. LATERAL PRESSURE PARAMETERS FOR GRANULAR A AND B AND HORIZONTAL BACKFILL.....	13
TABLE 7-3: HEAVY AND LIGHT DUTY PAVEMENT STRUCTURES.....	13

APPENDICES

- Appendix A – Limitations of Report
- Appendix B – Site Location
- Appendix C – Borehole Records
- Appendix D – Laboratory Test Results
- Appendix E – Seismic Hazard Calculation

Foundation Investigation and Design Recommendation Report 1806 Scott Street, Ottawa – Multi-Storey Residential Building

1.0 INTRODUCTION

This report presents the factual findings of a geotechnical engineering investigation conducted for the proposed development site at 1806 Scott Street, Ottawa, ON. The proposed development involves the construction of a four-storey residential apartment building.

The report involves the methodology and findings of the geotechnical engineering investigation which consists of five (5) exploratory subsurface boreholes, laboratory testing procedures, and subsurface soil stratigraphy of the Proposed Site. The report will also include the anticipated geotechnical engineering conditions influencing the design and construction of the proposed development, and recommendations for the foundation design.

2.0 PROJECT UNDERSTANDING

It is understood that the proposed building would be a four-storey structure with a full basement, and there is no underground parking facility planned. The building plan includes a residential rental apartment.

3.0 SITE DESCRIPTION

The Proposed Site is located at the southwest corner of Scott Street and Rockhurst Road, in The City of Ottawa. Currently, the site contains a two-storey building, paved vehicle parking areas to the north and east, and a fenced-in backyard (lawn). The surrounding area of the building is flat with residential buildings to the south and west, and roads on the north and east of the property site. The Proposed Site location is shown in Figure 1. Appendix A.

3.1 Site Geology

A desk-top study using the published physiography maps of the area (Ontario Geological Survey or OGS) [1] indicates the Site is located on clay plains, and the surficial geology indicates a range from stone-poor, sandy silt to silty sand-textured till on Paleozoic terrain. The bedrock geology of the area consists of sandstone, shale, and dolostone of the Shadow Lake Formation from the Simcoe group.

Based on published physiography maps of the area (Ontario Geological Survey, OGS) [1], the site is located within the Till Plains which is drumlin that is caused by streamlined movement of glacial ice sheets across rock debris, or till. The Surficial geology maps of southern Ontario indicate the site is found on Till Plains comprising of stone-poor, sandy silty to silty sand-textured till on Paleozoic terrain [2].

The Paleozoic geology formation is Gull River of Smcoe Group, with identifying lithology of limestone, dolostone, shale, and sandstone bedding. The bedrock formation within this area is identified as Shadow Lake Formation, containing the Ottawa and Smcoe group with limestone, dolostone, shale, arkose, and sandstone [2].

4.0 FIELD PROCEDURES

The staff of McIntosh Perry Consulting Engineers (McIntosh Perry) conducted a site investigation prior to the planned drill date to mark the proposed borehole locations. Additionally, requisitions were submitted to Ontario One Call (ON1Call) for utility clearance and coordinated with The Client regarding the intended geotechnical exploration drill date.

The geotechnical investigation was continuously supervised and monitored by McIntosh Perry staff in accordance with Ontario Regulations (O. Reg.) [3], and applicable standards and procedures (American Society for Testing and Materials, ASTM) [4]. The drilling operation was performed by Marathon Environmental and Geotechnical drilling Ltd. from Ottawa. The boreholes were drilled using a geo-probe rubber track drill rig: A combination machine that performed both the Standard Penetration Testing (SPT) and rock coring operations. The drill was advanced using a 100 mm casing for wash boring/ rock coring, and a 200 mm hollow stem helical auger during the drilling operation.

Boreholes 22-1, and 4 were drilled using the rock coring method to advance through overburden soil and to core the bedrock, whereas boreholes 22-2, and 5 were terminated at the casing refusal at the inferred surface of the bedrock, and the borehole 22-3 was drilled using the hollow stem helical auger and terminated at auger refusal at the inferred rock surface.

The auger/casing was incrementally advanced below ground surface (bgs), while overburden soil samples were intermittently taken at 0.75 m intervals. Each soil sample was retrieved with a 51 mm outside diameter (OD) Standard Penetration Test (SPT) sampler (SS) in accordance with ASTM D1586, SPT test procedures [4].

The soil samples retrieved from the SS sampler were examined, hermetically sealed in plastic bags, labeled, and packaged for transportation. The rock core samples were examined, measured, labeled, and packaged in protective rock core boxes for transportation to McIntosh Perry Geotechnical laboratory Ottawa (MP Geotech lab) in accordance with ASTM D 4220-95 Preserving and Transporting Soil Samples [4].

The five (5) boreholes BH22-1 to 5 were advanced into the subsurface to depths ranging from 0.7 to 6.5 m below ground surface, the bedrock was cored in boreholes BH22-1 and 4, from a depth of 1.3 to 6.4 m and 1.3 to 6.5 m below ground surface respectively. The borehole information summary is shown in Table 4-1.

Table 4-1. Borehole Information Summary

Borehole ID	Drilled Date	Coordinates (Geodetic)			Borehole		Termination Type
		Latitude	Longitude	Surface E. (m)	Depth (m)	Elevation E. (m)	
BH22-1	2022-08-11	45°23'58.51"N	75°44'37.50"W	62.7	6.4	56.4	Intended
BH22-2	2022-08-11	45°23'58.80"N	75°44'36.99"W	62.7	0.7	62.0	Refusal
BH22-3	2022-08-12	45°23'58.60"N	75°44'36.67"W	62.7	1.3	61.4	Refusal
BH22-4	2022-08-12	45°23'58.15"N	75°44'36.50"W	62.9	6.5	56.5	Intended
BH22-5	2022-08-11	45°23'58.09"N	75°44'36.73"W	62.7	1.4	61.3	Refusal

At the end of the drilling operations, all boreholes were backfilled with auger cuttings, Bentonite hole-plug, and asphalt cold patch as required and restored to their original surface condition. A monitoring standpipe piezometer was installed within borehole BH22-4. The Borehole locations on the proposed property are shown in Figure 2. Appendix A.

5.0 LABORATORY TEST PROCEDURES

All soil and rock core samples received at the MP Geotech lab were logged, and soil descriptions were verified by additional tactile examination in the laboratory. Representative soil and rock core samples from specific soil layers and depths corresponding to the foundation design requirements were identified and submitted to MP Geotech lab for detailed soil and rock core analysis.

Two (2) grain-size distribution sieve analysis and five (5) rock core Unconfined Compressive Strength (UCS) was carried out on representative soil and rock core samples at the MP Geotech lab.

All laboratory tests to determine the index properties were performed in accordance with ASTM test procedures. The relevant test procedures adopted are listed below.

- ASTM C136/LS-602 – Sieve Analysis of Fine and Coarse Aggregates
- ASTM D7012 – Unconfined Compressive Strength of Intact Rock Cores

Analytical and corrosivity testing was conducted on one (1) representative soil sample for the following analysis: pH level, electrical resistivity, chloride, and sulphate concentration levels.

All remaining samples are stored at MP Geotech lab for 90 days after the final report is submitted, thereafter the soil samples are disposed of according to MP Geotech lab policies. Unless The Client notifies MP Geotech lab in writing.

6.0 SUBSURFACE CONDITIONS

6.1 Subsurface

The site stratigraphy consisted of several layers, these layers were identified fill (including asphalt surface), native sand and gravel, and bedrock. The notable subsurface layers encountered in the five (5) boreholes were subdivided into three (3) distinct strata and were identified according to the Unified Soil Classification System (USCS) [3] as;

1. Fill
2. Sand and Gravel
3. Bedrock

The borehole logs show a cross-section view of the subsurface soil stratigraphy of the location. The Borehole logs and bedrock cores are shown in Appendix C, and Appendix D.

6.1.1 Fill (Granular)

A cohesionless fill comprising of granular material was observed in boreholes BH22-1 and 3, which underlie the ≈ 75 mm thick paved asphalt layer. The fill layer consisted of sand and gravel with fractions of fine materials of silt and clay. The soil characteristics of the fill appeared brown, dry to moist, with SPT N-index values for this layer ranging from $\approx 17 - 29$ blows/0.3 m, indicating an approximate compactness condition of compact to a dense layer of fill, according to table 3.1 of the CFEM [3].

One (1) representative sample from the fill layer was subjected to grain size distribution sieve analysis, the fill constituent percentage in weight contained $\approx 47\%$ gravel, 34% Sand, and fractions of fine material of clay and silt. The fill layer's grain-size distribution summary is shown in Table 6-1.

Table 6-1. Fill Grain-Size Distribution Summary

Borehole	Sample	Constituent Materials in percent weight			
		Gravel (%)	Sand (%)	Fines	
				Silt (%)	Clay (%)
BH22-3	GS-1	47	34	19	

The grain-size distribution curve of the fill material was compared to a USCS granular type specifications envelope, and the distribution curves of the tested sample approximately conformed to The USCS Granular B Type I Specification (see Figure 3, Appendix D).

Some organic fill like topsoil and growth medium was encountered at the surface in boreholes BH22-2, BH22-4, and BH22-5.

6.1.2 Sand and Gravel

A cohesionless layer of expectedly native soil comprising sand and gravel material was observed in borehole BH22-5. This layer consisted predominately of sand and gravel with fractions of fine materials of silt and clay. The soil characteristics of the fill appeared brown, dry to moist, with SPT N-index values for this layer $\approx 6 - 56$ blows/0.3 m, indicating an approximate compactness condition of loose to a very dense layer of fill, according to table 3.1 of the CFEM [3].

One (1) representative sample from the sand and gravel layer was subjected to grain size distribution sieve analysis, in which constituent percentage in weight contained $\approx 57\%$ gravel, 34% Sand, and fractions of fine materials of silt and clay. The fill layer's grain-size distribution summary is shown in Table 6-2, and the grain-size distribution curve for the fill material is shown in Figure 4, Appendix D.

Table 6-2. Sand and Gravel Grain-Size Distribution Summary

Borehole	Sample	Constituent Materials in percent weight			
		Gravel (%)	Sand (%)	Fines	
				Silt (%)	Clay (%)
BH22-5	SS-2	57	34	9	

6.1.3 Bedrock

Bedrock was cored in boreholes BH21-1 and 4 and inferred in the remainder at casing/auger refusal. The bedrock depth ranged from $\approx 0.7 - 1.4$ m below the existing ground surface which corresponds to a range of elevations from E. 62.0 m to E 61.3 m.

Confirmation of bedrock was attained by coring boreholes BH22-1, and 4 from a depth of ≈ 1.3 to 6.4 m bgs., and 1.3 to 6.5 m bgs. respectively. The bedrock was identified as a sedimentary rock with horizontal beddings of sandstone, shale, and dolostone with planar joints.

The rock core (RC) samples recovered from bedrock were carefully recorded based on the length of each run and the samples encountered were evaluated for Total Core Recovery (TCR), and Rock Quality Designation (RQD). The rock core sample recovery quantity and quality results are shown in Table 6-3.

Table 6-3. Bedrock Core Recovery Summary

Borehole #	RC Sample #	Depth (m)	Theoretical Length of RC (m)	Length of RC Recovered (m)	Total Core Recovery (%)	RQD (%)
BH22-1	3	1.30	0.81	0.69	94	69
BH22-1	4	2.11	1.25	1.25	100	96
BH22-1	5	3.40	1.50	1.50	100	97
BH22-1	6	4.88	1.52	1.39	97	93
BH22-4	4	1.32	0.10	0.10	100	0
BH22-4	5	1.42	0.71	0.56	84	63
BH22-4	6	2.13	1.47	1.37	97	81
BH22-4	7	3.61	1.12	1.04	89	85
BH22-4	8	4.72	1.60	1.55	100	98

Five (5) samples of bedrock core were tested for UCS at the MP Geotech lab, and the resulting bedrock strength summary is shown in Table 6-4, the laboratory results and bedrock core images are shown in Appendix D.

Table 6-4. Bedrock Strength Summary

Borehole	Core No.	Run No.	Depth (m)	UCS (MPa)
BH22-1	1	1	1.3 - 2.1	257
BH22-1	2	2	2.1 - 3.4	181
BH22-4	3	2	1.3 - 2.1	187
BH22-4	4	3	2.1 - 3.6	203
BH22-4	5	4	3.6 - 4.7	237

6.2 Chemical Analysis

One (1) representative soil sample BH22-5 / SS-2 was sent for soil chemical analysis testing for the following; pH level, resistivity level, chloride, and sulphate concentration. The corresponding test results indicate the following levels and concentrations shown in Table 6-5. The laboratory test result "Certificate of Analysis" is shown in Appendix C.

Table 6-5. Chemical Analysis Summary

BOREHOLE	SAMPLE	DEPTH (m)	Chemical Analysis			
			pH (pH units)	Resistivity (Ohm.cm)	Chloride (ppm)	sulphate (ppm)
BH22-5	SS-2	0.6 - 1.2	7.79	7170	< 5	32

6.3 Groundwater

Groundwater (GW) was not encountered in the open boreholes; however, a single standpipe piezometer was installed in borehole BH22-4 within the layer of the bedrock. The last groundwater measurement was done on October 24, 2022, and no groundwater was observed in the standpipe piezometer. Groundwater level is expected to fluctuate seasonally and may be encountered in the future.

7.0 DISCUSSIONS AND RECOMMENDATIONS

7.1 General

This section of the report provides engineering recommendations on the geotechnical design aspect of the project based on the project requirements and our interpretation of the subsurface soil information. The recommendations presented herein are subject to the limitations noted in Appendix A “Limitations of Report” which forms an integral part of this document.

The foundation engineering recommendations presented in this section have been developed following Part 4 of the 2015 National Building Code of Canada (NBCC) and 2012 Ontario Building Code (OBC) extending the Limit State Design approach.

7.2 Overview

It is understood that the proposed apartment building is a four-storey mid-rise structure with one underground basement level. The finished floor elevation is El. 62.90 based on the site plan issued November 23, 2022.

For the current project, the following list summarizes some key geotechnical details that were considered in the suggested geotechnical recommendations:

- Shallow bedrock is either sampled or inferred across the site. It is concluded provision of shallow spread and strip footing is adequate for the proposed mid-rise structure.

- The proposed structure can be designed using a seismic Site Class C provided that the boundary zones of the shear walls and all column loads are extended to and supported on the bedrock, confirmed by geotechnical staff upon completion of excavation.
- The contractor shall submit the excavation plan for geotechnical review. The plan shall be prepared based on the final site layout, depth of excavation, and offset from adjacent buildings to ensure the protection of those building are considered.
- Based on the observed RQD, if rock excavation is needed hoe ramming and line drilling shall be adequate for leveling the rock surface. Rock blasting is not envisioned based on the proximity of the existing structure. If blasting is required, a blasting plan including health and safety and monitoring programs shall be submitted by the contractor.
- No major issues are expected with groundwater management during construction even if excavations are advanced below the rock surface. One standpipe piezometer was installed in borehole BH22-4 and it was read two months after the initial installation and no water was encountered in the monitoring well. The chance of water seepage into the excavation is low. Based on the current information on design requirements, an application for Permits to Take Water (PTTW) is not required.

7.3 Site Preparation

The expected subgrade is bedrock. All fill, topsoil, and sandy silt overburden shall be removed from the footing subgrade. All loose rock pieces shall be removed, and the subgrade shall be approved by a geotechnical staff. The contractor shall use the information on the rock RQD and unconfined compressive strength to design the proper rock excavation methodology.

Upon completion of the excavation, depending on the subgrade condition, subgrade grouting or poured mud slab may be required. The mud slab shall provide a minimum of 15 MPa compressive strength at 28-day age testing.

The foundation design recommendations provided in this report are based on the assumption of flat subgrade. This report does not support the construction of step footings unless confirmed by the geotechnical engineer upon site review. This condition is put in place to ensure proper subgrade preparation for individual strip or spread footings. This disclaimer does not apply to the construction of elevator pit lower than the other footings.

7.4 Foundations

Bearing resistance is calculated for the bedrock surface.

Provided there are no continuous soil-filled seams or mud seams present at shallow depth in the bedrock below the founding level, footings can be supported on the bedrock surface, or a platform of lean concrete of compressive strength of greater than 15 MPa extending down to the bedrock surface.

The Ultimate Limit States (ULS) factored bearing resistance was estimated using the Rock Mass Rating (RMR) method by Bieniawski (1989). The RMR method was utilized to determine the required parameters for bearing capacity resistance at ULS conditions for the bedrock.

Based on the bedrock cores quality and uniaxial compressive strength tests, the following ratings are estimated:

- The lower bond compressive strength of intact rock rating: The uniaxial compressive strength was taken as 180 MPa, which results in rating = 12,
- RQD rating: The RQD of the rock core is 63 at the surface (falls at the lower boundary value), which results in rating = 13,
- Joint spacing rating: The joint spacing for the rock core samples is occasionally less than 50 mm, which gives an estimated rating = 5,
- Joint condition: The joint condition was observed to be slightly rough, and the rating is estimated to be = 12,
- Groundwater rating: the groundwater elevation was not observed in the monitoring well. Therefore, the estimated rating for water condition = 4; and
- Orientation rating: Horizontal to 25° joints; therefore, a fair to favorable rating was estimated = -2.

The RMR for the rock approximately equals (44) which can be classified to have fair rock quality.

Assuming the above-noted conditions are provided, the estimated factored ULS bearing resistance is 1350 kPa for a minimum of 2 m depth below the existing ground surface which equals to the rock at approximately E. 60.7 m or below the weathered rock surface, whichever is lower. It is understood the elevator pit will be dug over 1.5 m deeper than the rest of the footings.

The provided factored bearing resistance at ULS is based on the uniaxial compressive strength of the rock. The size of the selected footing shall be determined by a structural engineer. The selected size of the footing shall have adequate compressive strength to provide resistance to the structural loads from the building and to avoid failure in concrete material under the applied pressure. Shallow footings shall not be smaller than 0.6 m in their smaller dimension.

Provided the bedrock surface is properly cleaned of soil and weathered material at the time of construction, the settlement of footing size using the above factored bearing resistance should be negligible. The bearing capacities are calculated for a flat subgrade.

Table 7-1: Rock Bearing Resistance

Footing Type	ULS(kPa)
Spread Footings	1,350

The ultimate bearing capacity will govern the design. The serviceability limit state as defined by allowable settlements is not applicable for this project on rock subgrade.

Highly weathered or fractured bedrock, which includes bedrock that can be excavated using hydraulic excavating equipment with only moderate effort, would need to be removed and replaced with concrete.

The rock bearing surface should be inspected by qualified geotechnical personnel of McIntosh Perry to confirm that the surface has been acceptably cleaned of soil, and that weathered, or excessively fractured bedrock has been removed.

7.4.1 Rock Anchors

It is expected that the foundations may be required to resist uplift forces related to unbalanced lateral loads. The uplift forces may be resisted using grouted anchors in the bedrock. The presence of fractured rock conditions and groundwater should be considered carefully by the specialty contractor and may require post-grouting to ensure adequate anchor resistance is obtained.

In designing grouted rock anchors, consideration should be given to four potential anchor failure modes:

1. Failure of the steel tendon or top anchorage;
2. Failure of the grout/tendon bond;
3. Failure of the rock/grout bond; and,
4. Failure within the rock mass, or rock cone bull-out.

Potential failure modes “1 and 2” are structural and are required to be addressed by the structural engineer.

For potential failure mode “3”, a static proof test in tension during construction, as per OBC 2012, will be required to assist the unfactored ULS bond strength at the concrete-rock interface. A resistance factor of 0.4

may be used to estimate the factored ULS. As a general guide, the ULS for limestone ranges between 1.0 to 1.4 MPa as per Post-Tensioning Institution (PTI) Recommendations for Prestressed Rock and Soil Anchors, 1996.

For potential failure mode “4”, the resistance should be calculated based on the buoyant weight of the potential mass of rock that could be mobilized by the anchor. This is typically considered as the mass of rock and surface shear resistance within a cone or wedge for a line of closely spaced anchors having an apex at the tip of the anchor that forms an angle between 60° to 90°. For a group of anchors or for a line of closely spaced anchors, the resistance must consider the potential overlap between the rock masses mobilized by individual anchors.

As stated earlier, proof tests should be performed to confirm the pull-out capacity. The proof tests should be carried out to 1.5 times the anchor service loads, and at least 10 percent of the anchors should be tested. The testing procedure should be in accordance with either OPSS942 or the PTI (1996) for proof testing.

The installation and testing of the anchors should be observed by a geotechnical engineer. Care must be taken during grouting to ensure that the grout is injected from the bottom of the anchor hole to bond the entire length of the grout area. It is also suggested that the anchor holes be thoroughly flushed with water to remove debris, scum/sludge, and rock flour prior to grouting.

7.4.2 Frost Protection

Based on the subsurface investigation results, the encountered bedrock subgrade is of low frost susceptibility. Frost penetration depth is 1.5 m below the surface for the subject site. Frost penetration depth is estimated based on the OPSD 3090.101, Foundation Frost Penetration Depths for Southern Ontario.

All perimeter and exterior foundation elements, or interior foundation elements in unheated areas should be provided with a minimum of 1.8 m of earth cover or equivalent thermal rigid insulation for frost protection purposes.

7.5 Seismic Site Classification

Seismic hazard calculations are provided in Appendix E for a combination of probabilities and spectral responses. The provided values are for reference only and the designers shall verify these values for their design.

Seismic site classification is completed based on NBCC (2015) and OBC (2012) Section 4.1.8.4 and Table 4.1.8.4.A. This classification system is based on the average soil properties in the upper 30 m and accounts for site-specific shear wave velocity of soil and rock, standard penetration resistance, and plasticity parameters of cohesive soils. Based on the investigation results the site can be classified as Seismic Site Class (C) for this bedrock subgrade.

7.6 Engineered Fill

Footings shall be installed on the bedrock. Any over-excavation shall be leveled by lean concrete of a minimum 15 MPa at 28 days strength or matching the strength of the structural footings.

The proposed engineered fill, beyond the footings' influence zone, can be any material conforming to granular criteria as outlined in OPSS 1010. Material conforming to 'Granular' criteria is considered free draining and compactable and can be utilized as the engineered fill. This can apply to the backfill beyond foundation walls and engineered fill in between the footings. The engineered fill shall be compacted to a minimum of 98% SPMDD.

All fill material should be placed in horizontal lifts of uniform thickness of no more than 300 mm before compaction at appropriate moisture content determined by the Proctor test. The requirement for fill material and compaction may be addressed with a note on the structural drawing for foundation or grading drawing, and with a Non-Standard Special Provision (NSSP). Any topsoil, organics, or loose sand should be removed before placing engineered fill material.

The existing fill and/or native soil does not qualify as backfill or grading fill material.

As long as all structural elements are bearing on bedrock subgrade, there is no restriction on grade raise.

7.7 Slabs-on-Grade

Slab-on-grades are considered free-floating (not attached to the foundation walls) and should be supported on a minimum of 200 mm of Granular A bedding compacted to 100% Standard Proctor Maximum Dry Density (SPMDD).

The rest of the fill, above the rock and below the slab can be filled with 'Granular' material as per the OPSS 1010 and compacted to a minimum of 98% SPMDD. If the slab on grade is to carry structural loads, the grading fill shall be Granular B Type II and compacted to a minimum of 100% SPMDD.

Subgrade preparation and compaction efforts shall be approved under the supervision of a geotechnical representative from McIntosh Perry.

If for the design of any portions of the slab-on-grade, the modulus of subgrade reaction (k) is required, the following recommendation can be used for structural modeling. The modulus of the subgrade reaction is a multi-function complex correlation that varies with the subgrade material, grade-raise fill material, and the flexural stiffness of the structural slab. However, simplified assumptions were made to estimate the spring modulus for slab-on-grade on compacted Granular A. To estimate the modulus of subgrade reaction, through a simplistic approach, a 2 m square section of the concrete slab-on-grade under the applied loads. Since the

modulus of subgrade reaction is needed for the ultimate failure design of the slab, it is assumed the failure can occur at a 25 mm deformation. Considering these assumptions, a subgrade reaction modulus of 10,000 kN/m²/m can be used for the design of the interior slab-on-grade. This k-value is only valid for the construction of slab-on-grade on compacted Granular A bedding. This value shall not be used for the native subgrade.

7.8 Lateral Earth Pressure

Free-draining material should be used as backfill material for foundation walls. If proper drainage is provided, “at rest” condition may be assumed for the calculation of earth pressure on foundation walls. The following parameters are recommended for the granular backfill.

Table 7-2. Lateral Pressure parameters for Granular A and B and Horizontal Backfill

Pressure Parameter		Expected Value		
		Granular A	Granular B	Other OPSS1010 'Granular'
Unit Weight (γ) kN/m ³	Above groundwater	22.5	21.7	21.7
	Below groundwater	12.7	11.9	11.9
Angle of Internal Friction (ϕ)		35°	32°	31°
Coefficient of Active Earth Pressure (k_a)		0.27	0.31	0.32
Coefficient of Passive Earth Pressure (k_p)		3.69	3.23	3.12
Coefficient of Earth Pressure at Rest (k_0)		0.43	0.47	0.48

The native sandy silt is not suitable for backfilling foundation walls.

7.9 Flexible Pavement

For most of the site, the pavement structure is most likely to be placed on engineered fill material overlaying the bedrock or the existing fill or the native sand and gravel. All fill and organic material shall be removed from the proposed pavement site and replaced with engineered fill. The existing non-organic material can act as the pavement subgrade if verified by visual confirmation and proof rolling.

The pavement structure proposed in this design considers the very low traffic volume of lightweight passenger vehicles. It is understood moving trucks and firetrucks traffic will be limited to the public road. The light-duty pavement structure design specifications are given in Table 7-3.

Table 7-3: Pavement Structure for the Parking Lot

Material		Thickness (mm)
Surface	Superpave 12.5 mm, PG 58-34	50
Base	OPSS Granular A	150
Sub-base	OPSS Granular B Type II	450

It is understood there is a provision of permeable pavement options. Permeable asphalt or concrete surface course is not recommended due to complications associated with maintenance of such pavement. These pavement options are prone to salt, de-icer, freeze-thaw cycles and requires trained staff for maintenance. The only plausible permeable pavement option recommended in this report are the stone pavers (concrete paver blocks).

To facilitate rapid drainage, a permeable pavement structure is proposed in Table 6-4. Subdrain pipe shall be placed on subdrain trench imbedded within or below the subbase with positive drainage to the storm catch basins. All subdrains shall receive a non-woven sock. Pavers are expected to received periodic maintenance for adjustment and leveling depending on the applied traffic load.

Table 7-4: Permeable Pavement Structure Alternative

Material		Thickness (mm)
Surface	Concrete Paver	min. 80
Bedding	Loose Sand	25
Drainage	OPSS Granular O	100
Base	OPSS Granular A	150
Sub-base	OPSS Granular B Type II	450

The base and sub-base materials, i.e., Granular A for the base and Granular B Type II for the sub-base, shall be in accordance with OPSS.MUNI 1010. Both base and sub-base should be compacted to 100% SPMDD. Asphalt layers should be compacted to comply with OPSS310.

7.10 Sidewalks and Hard Surfacing

The width and extent of the sidewalks will be defined as per the architectural drawings. The designer shall provision adequate slope, based on applicable codes, to provide appropriate runoff discharge. Expansion, construction, and dummy joints shall be spaced as required by the applicable standards. Sidewalks can be categorized under residential/commercial use, and therefore, the concrete sidewalks should have a thickness of 125 mm. Requirements of OPSD 310.010 'Concrete Sidewalk', OPSD 310.020 'Concrete Sidewalks Adjacent to Curb and Gutter', and OPSD 310.030 'Concrete Sidewalk Ramps at the intersection' are recommended for the construction of the concrete sidewalk. A minimum of 150 mm bedding of OPSS Granular A compacted to 100% SPMDD is required for the concrete sidewalk panels.

7.11 Cement Type and Corrosion Potential

One soil sample was submitted to Parcel laboratories for testing of chemical properties relevant to exposure of concrete elements to sulphate attacks as well as potential soil corrosivity effects on buried metallic structural elements. Test results are presented in Table 6-5.

The potential for sulphate attack on concrete structures is moderate to low. Therefore, Type GU Portland cement may be adequate to protect buried concrete elements in the subsurface conditions encountered.

Based on electrical resistivity results and chloride content, the corrosion potential for buried steel elements is within the nonaggressive range.

8.0 CONSTRUCTION CONSIDERATIONS

Any organic material and loose sand of any kind should be removed from the footprint of the footings and all structurally load-bearing elements. Site preparation and requirements of engineered fill placement are noted in previous sections. Refer to relevant sections for material and compaction requirements.

The Occupational Health and Safety Act (OHSA) of Ontario indicated that side slopes in the sandy silt could be classified as Type 4 soil and sloped no steeper than 3H:1V or be shored for any excavation deeper than 1.2 m. If space restrictions exist, the excavations can be carried out within temporary retaining systems, which is fully braced to resist lateral earth pressure.

As noted in the previous sections, all grade adjustments due to over-excavation, within the shallow footing influence zone, shall be done using lean concrete of minimum 15 MPa mature strength.

Foundation walls should be backfilled with free-draining material with granular material conforming to OPSS 1010 Granular criteria. The native soil is not suitable for backfill due to its high fine content.

A geotechnical engineer or technician should attend the site to confirm the native subgrade, type of fill material, and level of compaction. All bearing surfaces should be inspected by experienced geotechnical personnel prior to placing the footings to ensure the excavated subgrade is in the reported and recommended condition.

Rock excavation through blasting is not recommended. At the contractor or owner's discretion, vibration monitoring may be carried out during the excavation and construction phases to ensure that the vibration levels at the existing surrounding structures and utilities are maintained below tolerable levels.

Installation of weeping tiles is necessary below the lowest habitable elevation.

9.0 GROUNDWATER SEEPAGE

The groundwater is expected below the rock excavation depth. However, the weathered rock at higher elevations may collect and outlet the surface runoff after major precipitation events, snow melt, or generally wet seasons with higher groundwater tables. The monitoring well is kept on-site for future reference.

Under the new regulations (O.Reg 63/16 and O.Reg 387/04), a Permit To Take Water (PTTW) is required from the Ministry of the Environment, Conservation, and Parks (MOECP) if a volume of water greater than 400,000 liters per day is pumped from the excavation under normal operation, but less than 50,000 liters per day, the water taking will not require a PTTW, but will need to be registered in the Environmental Activity and Sector Registry (EASR) as a prescribed activity. Since the excavations will likely be above the groundwater level, it is considered unlikely that a PTTW would be required. The site designer shall decide on the permit application based on the expected excavation volume.

The design of the dewatering system should be the responsibility of the contractor. An outlet(s) should be identified, which the contractor can use to dispose of the pumped groundwater and incident precipitation. In order for pumped groundwater to be discharged to a city sewer, the groundwater quality needs to meet the Sewer Use By-law limits, and a separate approval is required.

10.0 SITE SERVICES

At the subject site, the burial depth of water-bearing utility lines is typically 2.2 m below the ground surface. If this depth is not achievable, equivalent thermal insulation should be provided. The contractor should retain a professional engineer to provide detailed drawings for excavation and temporary support of the excavation walls during construction.

Excavation will proceed through the topsoil and native shallow deposits. Excavating of overburden soil shall be performed using conventional hydraulic excavating equipment. Cobbles or boulders larger than 300 mm in diameter, if encountered, should be removed from the side slopes for worker safety.

The Occupational Health and Safety Act (OHSA) of Ontario indicated that side slopes in the sandy silt could be classified as Type 4 soil and sloped no steeper than 3H:1V or be shored. If space restrictions exist, the excavations can be carried out within trench boxes for utility installation, which is fully braced to resist lateral earth pressure.

Due to the potential for long-term settlement of topsoil and organic materials and the effects of this settlement on service lines sensitive to level change, the existing topsoil, and organic materials are not considered suitable for the support of site services. Utilities should be supported on a minimum of 150 mm bedding of Granular A compacted to a minimum of 98% of SPMDD. Utility cover can be Granular A or Granular B type II compacted to

96% SPMDD. All covers are to be compacted to 100% SPMDD if they are intersecting structural elements. The engineer designing utilities shall ensure the proposed utility pipes can tolerate compaction loads.

11.0 CLOSURE

We trust this geotechnical investigation report meets the requirements of your project. The “Limitations of Report” presented in Appendix A are an integral part of this report. Please contact the undersigned should you have any questions or concerns.

McIntosh Perry Consulting Engineers Ltd.

Mizral Hameem, B.Eng. ET.
Engineering Intern
m.hameem@McIntoshPerry.com

N'eem Tavakkoli, M.Eng., P.Eng.
Senior Geotechnical Engineer
n.tavakkoli@mcintoshperry.com

12.0 REFERENCES

- [1] Ontario Geological Survey, The Physiography of Southern Ontario, 3rd Edition, 1984.
- [2] "Google Earth Pro," Google LLC, 2021. [Online]. [Accessed 07 October 2022].
- [3] Government of Ontario, "Ontario Regulation 213/91," 01 January 2022. [Online]. Available: <https://www.ontario.ca/laws/regulation/910213#BK42>. [Accessed 09 May 2022].
- [4] A. International, American Society for Testing and Materials.
- [5] Canadian Geotechnical Society , Canadian Foundation Engineering Manual, Calgary: Queen's Printer, 2006.
- [6] Ontario Ministry of Natural Resources (OMNR), Ontario Geological Survey, Special Volume 2, "The Physiography of Southern Ontario", 3rd Edition, 1984.
- [7] Canadian Standards Association (CSA), Concrete Materials and Methods of Concrete Construction, A23.1, 2009.
- [8] Government of Canada, National Building Code of Canada (NBCC), "Seismic Harard Calculatin" (online),, National Research Council of Canada, 2010.
- [9] Government of Ontario, Ontario Building Code (OBC), (online), 2012.
- [10] Government of Ontario, "Occupational Health and Safety Act," Queen's Printer for Ontario, Toronto, 2021.
- [11] Ontario Provincial Standard Specification, OPSS, 2017.

1806 SCOTT STREET, OTTAWA, ONTARIO.
GEOTECHNICAL AND FOUNDATION REPORT

APPENDIX A
LIMITATIONS OF REPORT

LIMITATIONS OF REPORT

McIntosh Perry Consulting Engineers Ltd. (McIntosh Perry) carried out the field work and prepared the report. This document is an integral part of the Foundation Investigation and Design report presented.

The conclusions and recommendations provided in this report are based on the information obtained at the borehole locations where the tests were conducted. Subsurface and groundwater conditions between and beyond the boreholes may differ from those encountered at the specific locations where tests were conducted and conditions may become apparent during construction, which were not detected and could not be anticipated at the time of the site investigation. The benchmark level used and borehole elevations presented in this report are primarily to establish relative differences in elevations between the borehole locations and should not be used for other purposes such as to establish elevations for grading, depth of excavations or for planning construction.

The recommendations presented in this report for design are applicable only to the intended structure and the project described in the scope of the work, and if constructed in accordance with the details outlined in the report. Unless otherwise noted, the information contained in this report does not reflect on any environmental aspects of either the site or the subsurface conditions.

The comments or recommendation provided in this report on potential construction problems and possible construction methods are intended only to guide the designer. The number of boreholes advanced at this site may not be sufficient or adequate to reveal all the subsurface information or factors that may affect the method and cost of construction. The contractors who are undertaking the construction shall make their own interpretation of the factual data presented in this report and make their conclusions, as to how the subsurface conditions of the site may affect their construction work.

The boundaries between soil strata presented in the report are based on information obtained at the borehole locations. The boundaries of the soil strata between borehole locations are assumed from geological evidences. If differing site conditions are encountered, or if the Client becomes aware of any additional information that differs from or is relevant to the McIntosh Perry findings, the Client agrees to immediately advise McIntosh Perry so that the conclusions presented in this report may be re-evaluated.

Under no circumstances shall the liability of McIntosh Perry for any claim in contract or in tort, related to the services provided and/or the content and recommendations in this report, exceed the extent that such liability is covered by such professional liability insurance from time to time in effect including the deductible therein, and which is available to indemnify McIntosh Perry. Such errors and omissions policies are available for inspection by the Client at all times upon request, and if the Client desires to obtain further insurance to protect it against any risks beyond the coverage provided by such policies, McIntosh Perry will co-operate with the Client to obtain such insurance.





McIntosh Perry prepared this report for the exclusive use of the Client. Any use which a third party makes of this report, or any reliance on or decision to be made based on it, are the responsibility of such third parties. McIntosh Perry accepts no responsibility and will not be liable for damages, if any, suffered by any third party as a result of decisions made or actions taken based on this report.

1806 SCOTT STREET, OTTAWA, ONTARIO.
GEOTECHNICAL AND FOUNDATION REPORT

APPENDIX B
SITE LOCATION



LEGEND

-  Site Location
-  Local Road
-  Major Road
-  Waterbody
-  Wooded Area

REFERENCE

GIS data provided by the Ontario Ministry of Northern Development, Mines, Natural Resources and Forestry, 2022.

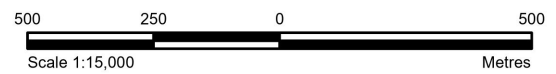

CLIENT:		GABRIELA GODINEZ-LAVERTY	
PROJECT:		GEOTECHNICAL INVESTIGATION 1806 SCOTT STREET	
TITLE:		SITE LOCATION	
PROJECT NO: CCO-23-1093-02		FIGURE:	
Date	Sep., 27, 2022	1	
GIS	AH		
Checked By	MH		

McINTOSH PERRY
 115 Walgreen Road, RR3, Carp, ON K0A1L0
 Tel: 613-836-2184 Fax: 613-836-3742
 www.mcintoshperry.com

C:\Users\hamed\OneDrive\Documents\Projects\2023\CCO-23-1093-1806 Scott Street\GIS - Documents\Projects\2023\CCO-23-1093-02_Geotech.aprx

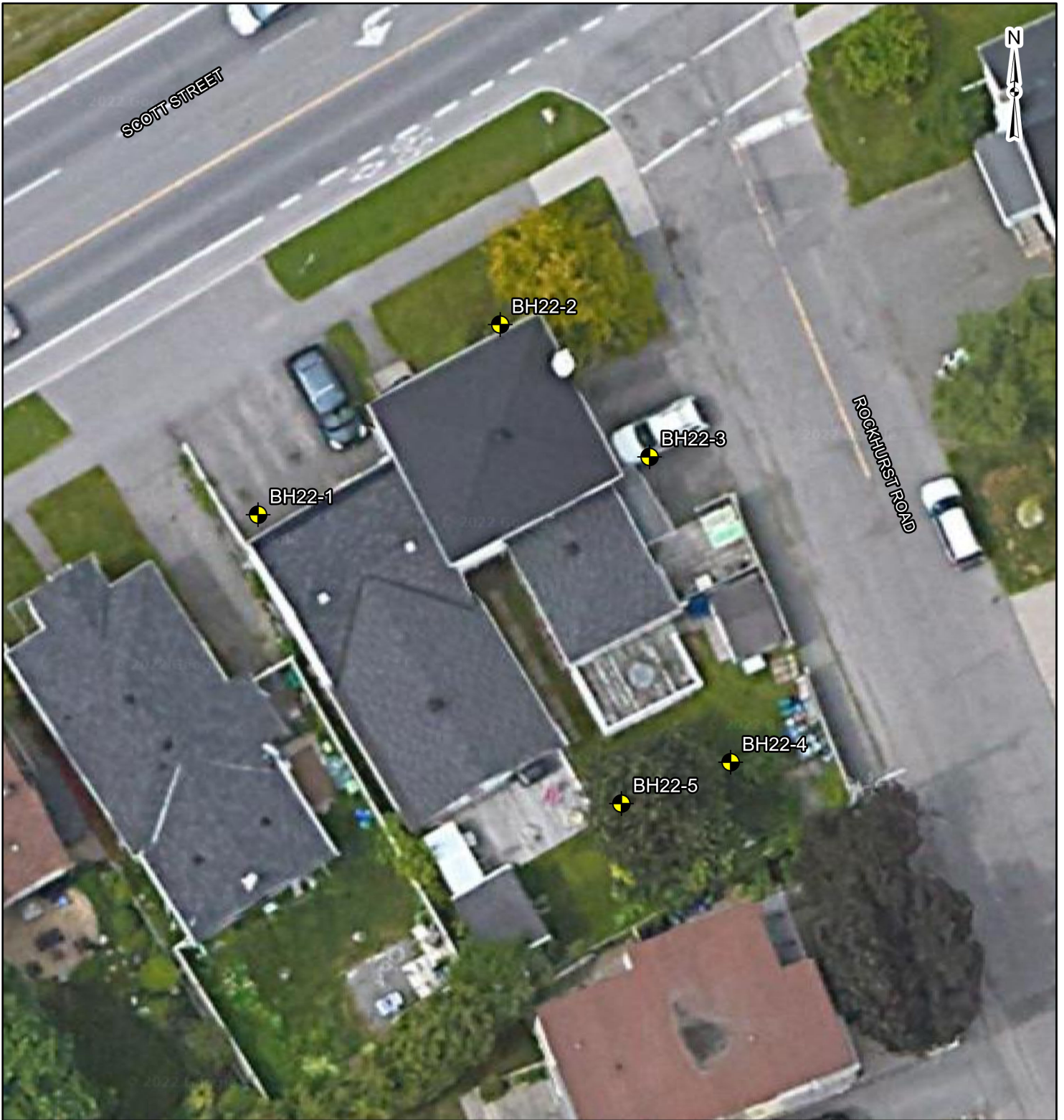

LEGEND

 Borehole Locations

REFERENCE

GIS data provided by the Ontario Ministry of Northern Development, Mines, Natural Resources and Forestry, 2022.

CLIENT:		GABRIELA GODINEZ-LAVERTY	
PROJECT:		GEOTECHNICAL INVESTIGATION 1806 SCOTT STREET	
TITLE:		BOREHOLE LOCATIONS	
McINTOSH PERRY 115 Walgreen Road, RR3, Carp, ON K0A1L0 Tel: 613-836-2184 Fax: 613-836-3742 www.mcintoshperry.com	PROJECT NO: CCO-23-1093-02	FIGURE:	2
	Date	Sep., 27, 2022	
	Checked By	MH	

1806 SCOTT STREET, OTTAWA, ONTARIO.
GEOTECHNICAL AND FOUNDATION REPORT

APPENDIX C
BOREHOLE LOGS

EXPLANATION OF TERMS USED IN REPORT

N-VALUE: THE STANDARD PENETRATION TEST (SPT) N-VALUE IS THE NUMBER OF BLOWS REQUIRED TO CAUSE A STANDARD 51mm O.D SPLIT BARREL SAMPLER TO PENETRATE 0.3m INTO UNDISTURBED GROUND IN A BOREHOLE WHEN DRIVEN BY A HAMMER WITH A MASS OF 63.5 kg, FALLING FREELY A DISTANCE OF 0.76m. FOR PENETRATIONS OF LESS THAN 0.3m N-VALUES ARE INDICATED AS THE NUMBER OF BLOWS FOR THE PENETRATION ACHIEVED. AVERAGE N-VALUE IS DENOTED THUS \bar{N} .

DYNAMIC CONE PENETRATION TEST: CONTINUOUS PENETRATION OF A CONICAL STEEL POINT (51mm O.D. 60° CONE ANGLE) DRIVEN BY 475J IMPACT ENERGY ON 'A' SIZE DRILL RODS. THE RESISTANCE TO CONE PENETRATION IS MEASURED AS THE NUMBER OF BLOWS FOR EACH 0.3m ADVANCE OF THE CONICAL POINT INTO THE UNDISTURBED GROUND.

SOILS ARE DESCRIBED BY THEIR COMPOSITION AND CONSISTENCY OR DENSENESS.

CONSISTENCY: COHESIVE SOILS ARE DESCRIBED ON THE BASIS OF THEIR UNDRAINED SHEAR STRENGTH (c_u) AS FOLLOWS:

C_u (kPa)	0 – 12	12 – 25	25 – 50	50 – 100	100 – 200	>200
	VERY SOFT	SOFT	FIRM	STIFF	VERY STIFF	HARD

DENSENESS: COHESIONLESS SOILS ARE DESCRIBED ON THE BASIS OF DENSENESS AS INDICATED BY SPT N VALUES AS FOLLOWS:

N (BLOWS/0.3m)	0 – 5	5 – 10	10 – 30	30 – 50	>50
	VERY LOOSE	LOOSE	COMPACT	DENSE	VERY DENSE

ROCKS ARE DESCRIBED BY THEIR COMPOSITION AND STRUCTURAL FEATURES AND/OR STRENGTH.

RECOVERY: SUM OF ALL RECOVERED ROCK CORE PIECES FROM A CORING RUN EXPRESSED AS A PERCENT OF THE TOTAL LENGTH OF THE CORING RUN.

MODIFIED RECOVERY: SUM OF THOSE INTACT CORE PIECES, 100mm+ IN LENGTH EXPRESSED AS A PERCENT OF THE LENGTH OF THE CORING RUN. THE ROCK QUALITY DESIGNATION (RQD), FOR MODIFIED RECOVERY IS:

RQD (%)	0 – 25	25 – 50	50 – 75	75 – 90	90 – 100
	VERY POOR	POOR	FAIR	GOOD	EXCELLENT

JOINT AND BEDDING:

SPACING	50mm	50 – 300mm	0.3m – 1m	1m – 3m	>3m
JOINTING	VERY CLOSE	CLOSE	MOD. CLOSE	WIDE	VERY WIDE
BEDDING	VERY THIN	THIN	MEDIUM	THICK	VERY THICK

ABBREVIATIONS AND SYMBOLS

FIELD SAMPLING

SS	SPLIT SPOON	TP	THINWALL PISTON
WS	WASH SAMPLE	OS	OSTERBERG SAMPLE
ST	SLOTTED TUBE SAMPLE	RC	ROCK CORE
BS	BLOCK SAMPLE	PH	TW ADVANCED HYDRAULICALLY
CS	CHUNK SAMPLE	PM	TW ADVANCED MANUALLY
TW	THINWALL OPEN	FS	FOIL SAMPLE

STRESS AND STRAIN

u_w	kPa	PORE WATER PRESSURE
r_u	1	PORE PRESSURE RATIO
σ	kPa	TOTAL NORMAL STRESS
σ'	kPa	EFFECTIVE NORMAL STRESS
τ	kPa	SHEAR STRESS
$\sigma_1, \sigma_2, \sigma_3$	kPa	PRINCIPAL STRESSES
ϵ	%	LINEAR STRAIN
$\epsilon_1, \epsilon_2, \epsilon_3$	%	PRINCIPAL STRAINS
E	kPa	MODULUS OF LINEAR DEFORMATION
G	kPa	MODULUS OF SHEAR DEFORMATION
μ	1	COEFFICIENT OF FRICTION

MECHANICAL PROPERTIES OF SOIL

m_v	kPa^{-1}	COEFFICIENT OF VOLUME CHANGE
c_c	1	COMPRESSION INDEX
c_s	1	SWELLING INDEX
c_a	1	RATE OF SECONDARY CONSOLIDATION
c_v	m^2/s	COEFFICIENT OF CONSOLIDATION
H	m	DRAINAGE PATH
T_v	1	TIME FACTOR
U	%	DEGREE OF CONSOLIDATION
σ'_{v0}	kPa	EFFECTIVE OVERBURDEN PRESSURE
σ'_p	kPa	PRECONSOLIDATION PRESSURE
τ_f	kPa	SHEAR STRENGTH
c'	kPa	EFFECTIVE COHESION INTERCEPT
Φ_i	-°	EFFECTIVE ANGLE OF INTERNAL FRICTION
c_u	kPa	APPARENT COHESION INTERCEPT
Φ_u	-°	APPARENT ANGLE OF INTERNAL FRICTION
τ_R	kPa	RESIDUAL SHEAR STRENGTH
τ_r	kPa	REMOULDED SHEAR STRENGTH
S_t	1	SENSITIVITY = c_u / τ_r

PHYSICAL PROPERTIES OF SOIL

P_s	kg/m^3	DENSITY OF SOLID PARTICLES	e	1, %	VOID RATIO	e_{min}	1, %	VOID RATIO IN DENSEST STATE
γ_s	kN/m^3	UNIT WEIGHT OF SOLID PARTICLES	n	1, %	POROSITY	I_D	1	DENSITY INDEX = $\frac{e_{max} - e}{e_{max} - e_{min}}$
P_w	kg/m^3	DENSITY OF WATER	w	1, %	WATER CONTENT	D	mm	GRAIN DIAMETER
γ_w	kN/m^3	UNIT WEIGHT OF WATER	s_r	%	DEGREE OF SATURATION	D_n	mm	N PERCENT – DIAMETER
P	kg/m^3	DENSITY OF SOIL	w_L	%	LIQUID LIMIT	C_u	1	UNIFORMITY COEFFICIENT
γ	kN/m^3	UNIT WEIGHT OF SOIL	w_p	%	PLASTIC LIMIT	h	m	HYDRAULIC HEAD OR POTENTIAL
P_d	kg/m^3	DENSITY OF DRY SOIL	w_s	%	SHRINKAGE LIMIT	q	m^3/s	RATE OF DISCHARGE
γ_d	kN/m^3	UNIT WEIGHT OF DRY SOIL	I_p	%	PLASTICITY INDEX = $(W_L - W_L)$	v	m/s	DISCHARGE VELOCITY
P_{sat}	kg/m^3	DENSITY OF SATURATED SOIL	I_L	1	LIQUIDITY INDEX = $(W - W_p) / I_p$	i	1	HYDAULIC GRADIENT
γ_{sat}	kN/m^3	UNIT WEIGHT OF SATURATED SOIL	I_c	1	CONSISTENCY INDEX = $(W_L - W) / I_p$	k	m/s	HYDRAULIC CONDUCTIVITY
P'	kg/m^3	DENSITY OF SUBMERGED SOIL	e_{max}	1, %	VOID RATIO IN LOOSEST STATE	j	kN/m^3	SEEPAGE FORCE
γ'	kN/m^3	UNIT WEIGHT OF SUBMERGED SOIL						

PROJECT NO.: **CCO-23-1093**
 PROJECT: Four Storey Building
 CLIENT: Gabriela Godinez-Laverty
 PROJECT LOCATION: 1806 Scott Street, Ottawa, ON.

DRILLING DATA
 Date: Aug-11-2022
 Method: Wash Bore - NQ
 Diameter: 100 mm
 BH Location: N 5029128 E 364006

BH No: **22-1**
 DATUM: MTM Zone 9
 ENCL NO.: 1

SOIL PROFILE		SAMPLES			GROUND WATER CONDITIONS	ELEVATION	DYNAMIC CONE PENETRATION RESISTANCE PLOT				PLASTIC LIMIT W _p	NATURAL MOISTURE CONTENT w	LIQUID LIMIT W _L	Remarks and Grain Size Distribution (%) Unit Weight (kN/m ³) Pocket Penetro. (kPa)
ELEV. / DEPTH	DESCRIPTION	STRATA PLOT	NUMBER	TYPE			"N" BLOWS / 0.3 m	SHEAR STRENGTH (kPa)						
62.7	Paved Driveway													
62.7	ASPHALT: 75mm													
61.1	FILL: Silty Sand and Gravel, brown, dry, compact		1	SS	17									
61.4			2	SS	46									Spoon bouncing @ 1.3 m bgs.
1.3	BEDROCK													
	Sedimentary, horizontal thin laminated bedding, with calcite, mudstone, siltstone, horizontal bedding with moderate joints		3	RC	RQD = 69%									Run 1: TCR = 94%, UCS = 257 MPa
			4	RC	RQD = 96%									Run 2: TCR = 100%, UCS = 181 MPa
			5	RC	RQD = 97%									Run 3: TCR = 100%
			6	RC	RQD = 93%									Run 4: TCR = 97%
56.4	End of Borehole													
6.4	- Borehole terminated at intended depth @ 6.4 m bgs.													

1MP SOIL LOG 1806 SCOTT ST.GPJ MP_OTTAWA_FOUNDATIONS.GDT 22-10-21

GRAPH NOTES
 30 Upper value = Field Vane Shear Strength ○ = 3% Strain at Failure
 3 Lower value = Vane Sensitivity

PROJECT NO.: CCO-23-1093 PROJECT: Four Storey Building CLIENT: Gabriela Godinez-Laverty PROJECT LOCATION: 1806 Scott Street, Ottawa, ON.	DRILLING DATA Date: Aug-11-2022 Method: Wash Bore Diameter: 100 mm BH Location: N 5029137 E 364017	BH No: 22-2 DATUM: MTM Zone 9 ENCL NO.: 2
--	--	--

SOIL PROFILE		SAMPLES			GROUND WATER CONDITIONS	DYNAMIC CONE PENETRATION RESISTANCE PLOT	PLASTIC LIMIT	NATURAL MOISTURE CONTENT	LIQUID LIMIT	Remarks and Grain Size Distribution (%)
ELEV. / DEPTH	DESCRIPTION	STRATA PLOT	NUMBER	TYPE						
0.0	Grass Cover									
0.0	TOPSOIL: Silty Sand with Organic, dark brown, moist, loose									
0.2	FILL: Silty sand with gravel, moist, loose	X	1	SS						
0.2		X	2	SS						
0.7	End of Borehole - Refusal on inferred bedrock									Spoon bouncing @ 0.7 m bgs

1MP SOIL LOG 1806 SCOTT ST.GPJ MP_OTTAWA_FOUNDATIONS.GDT 22-10-21

GRAPH NOTES
 30 Upper value = Field Vane Shear Strength O e=3%
 3 Lower value = Vane Sensitivity Strain at Failure

PROJECT NO.: CCO-23-1093 PROJECT: Four Storey Building CLIENT: Gabriela Godinez-Laverty PROJECT LOCATION: 1806 Scott Street, Ottawa, ON.	DRILLING DATA Date: Aug-12-2022 Method: Hollow Stem Augers Diameter: 200 mm BH Location: N 5029131 E 364024	BH No: 22-3 DATUM: MTM Zone 9 ENCL NO.: 3
--	---	--

SOIL PROFILE		SAMPLES			GROUND WATER CONDITIONS	ELEVATION	DYNAMIC CONE PENETRATION RESISTANCE PLOT	PLASTIC LIMIT	NATURAL MOISTURE CONTENT	LIQUID LIMIT	Remarks and Grain Size Distribution (%)
ELEV. DEPTH	DESCRIPTION	STRATA PLOT	NUMBER	TYPE							
62.7	Paved Driveway										
62.0	ASPHALT: 75 mm										
61.4	FILL: Sandy Gravel , some silt and clay, brown, dry to moist, compact to dense		1	SS	29						47 34 (19)
61.3	End of Borehole - Auger Refusal on inferred bedrock		2	SS	50/100mm						Auger grinding @ 1.3 m bgs.

1MP SOIL LOG 1806 SCOTT ST.GPJ MP_OTTAWA_FOUNDATIONS.GDT 22-10-21

GRAPH NOTES
 30 Upper value = Field Vane Shear Strength ○ e=3%
 3 Lower value = Vane Sensitivity Strain at Failure

PROJECT NO.: **CCO-23-1093**
 PROJECT: Four Storey Building
 CLIENT: Gabriela Godinez-Laverty
 PROJECT LOCATION: 1806 Scott Street, Ottawa, ON.

DRILLING DATA
 Date: Aug-12-2022
 Method: Wash Bore - NQ
 Diameter: 100 mm
 BH Location: N 5029117 E 364028

BH No: **22-4**
 DATUM: MTM Zone 9
 ENCL NO.: 4

SOIL PROFILE		SAMPLES			GROUND WATER CONDITIONS	ELEVATION	DYNAMIC CONE PENETRATION RESISTANCE PLOT				PLASTIC NATURAL LIQUID LIMIT MOISTURE LIMIT			Remarks and Grain Size Distribution (%) Unit Weight (kN/m ³) Pocket Penetro. (kPa)			
ELEV DEPTH	DESCRIPTION	STRATA PLOT	NUMBER	TYPE			"N" BLOWS 0.3 m	SHEAR STRENGTH (kPa)				W _p	w		W _L	GR SA SI CL	
62.9	Grass Cover																
0.0	TOPSOIL: Silty Sand with Organic , dark brown, moist, loose		1	SS	6												
62.3	FILL: Silty Sand and Gravel , grey, moist, very dense		2	SS	63												
61.6	BEDROCK Sedimentary, horizontal thin laminated bedding, with calcite, mudstone, siltstone, horizontal bedding with moderate joints		3	SS	10/											Run 1: TCR = 100%	
1.3			4	RC	0mm/	RQD = 0%											Run 2: TCR = 84%, UCS = 187 MPa
				5	RC		RQD = 63%										
				6	RC		RQD = 81%										Run 3: TCR = 97%, UCS = 203 MPa
				7	RC		RQD = 85%										Run 4: TCR = 89%, UCS = 237 MPa
				8	RC		RQD = 98%										Run 5: TCR = 100%
56.5	End of Borehole - Standpipe installed - Borehole terminated at intended depth @ 6.5 m bgs.																

1MP SOIL LOG 1806 SCOTT ST.GPJ_MP_OTTAWA_FOUNDATIONS.GDT 22-10-21

GRAPH NOTES

30 Upper value = Field Vane Shear Strength ○ s=3%
 3 Lower value = Vane Sensitivity Strain at Failure

PROJECT NO.: CCO-23-1093 PROJECT: Four Storey Building CLIENT: Gabriela Godinez-Laverty PROJECT LOCATION: 1806 Scott Street, Ottawa, ON.	DRILLING DATA Date: Aug-11-2022 Method: Wash Bore Diameter: 100 mm BH Location: N 5029115 E 364023	BH No: 22-5 DATUM: MTM Zone 9 ENCL NO.: 5
--	--	--

SOIL PROFILE		SAMPLES			GROUND WATER CONDITIONS	ELEVATION	DYNAMIC CONE PENETRATION RESISTANCE PLOT				PLASTIC LIMIT NATURAL MOISTURE CONTENT LIQUID LIMIT			Remarks and Grain Size Distribution (%) Unit Weight (kN/m ³) Pocket Penetro. (kPa)	
ELEV. DEPTH	DESCRIPTION	STRATA PLOT	NUMBER	TYPE			"N" BLOWS 0.3 m	SHEAR STRENGTH (kPa)				W _p	w		W _L
0.0	Grass Cover														
0.0	TOPSOIL: Silty Sand with Organic , dark brown, moist, loose														
0.2	Silty Sand , some gravel, dark brown, moist, loose		1	SS	6										
0.2	Silty Sand , some gravel, dark brown, moist, loose														
0.4	Sandy Gravel , trace silty and clay, brown, moist, compact		2	SS	56										57 34 (9)
1.0															
61.3			3	SS	10/										Splitspoon
1.4	End of Borehole Auger refusal on inferred bedrock														bouncing @ 1.4 m bgs.

1MP SOIL LOG 1806 SCOTT ST.GPJ MP_OTTAWA_FOUNDATIONS.GDT 22-10-21

GRAPH NOTES
 30 Upper value = Field Vane Shear Strength ○ s=3%
 3 Lower value = Vane Sensitivity Strain at Failure

1806 SCOTT STREET, OTTAWA, ONTARIO.
GEOTECHNICAL AND FOUNDATION REPORT

APPENDIX D
LABORATORY TEST RESULTS

Unified Soil Classification System (USCS)

CLAY & SILT	SAND			GRAVEL	
	Fine	Medium	Coarse	Fine	Coarse

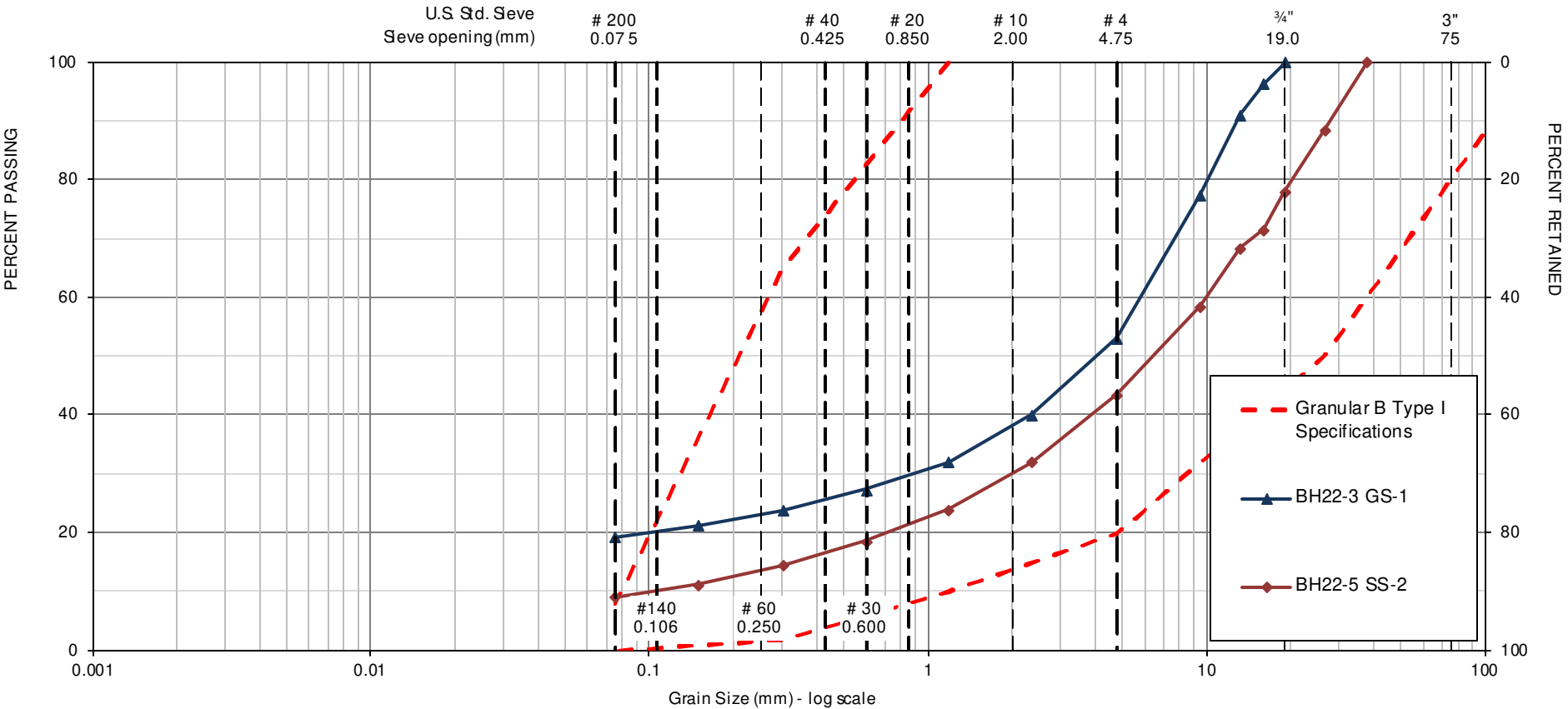

McINTOSH PERRY

Grain-Size Distribution Curve

Fill

1806 Scott Street, Ottawa.

Figure No. 3

COO-23-1093

BH22-1
Rock Core



● Mechanical Breaks

● Joints

McINTOSH PERRY

115 Walgreen Road, RR3, Carp, ON K0A 1L0
Tel: 613-836-2194 Fax: 613-836-3742
www.mcintoshperry.com

Client: Gabriela Godinez-Lavery
Project Name: 1806 Scott St.
Project Location: Ottawa, ON.

Project No.: COO-23-1093

Figure No.: 4

BH22-1
Run 1 (1.3 - 2.1 m)



McINTOSH PERRY

115 Walgreen Road, RR3, Carp, ON K0A 1L0
Tel: 613-836-2194 Fax: 613-836-3742
www.mcintoshperry.com

Client: Gabriela Godinez-Lavery
Project Name: 1806 Scott St.
Project Location: Ottawa, ON.

Project No.: CCO-23-1093

Figure No.: 5

BH22-1
Run 2 (2.1 - 3.4 m)



McINTOSH PERRY



McINTOSH PERRY

McINTOSH PERRY
115 Walgreen Road, RR3, Carp, ON K0A 1L0
Tel: 613-836-2194 Fax: 613-836-3742
www.mcintoshperry.com

Client: Gabriela Godinez-Lavery
Project Name: 1806 Scott St.
Project Location: Ottawa, ON.

Project No.: CCO-23-1093

Figure No.: 6

BH22-4
Rock Core



● Mechanical Breaks

● Joints

McINTOSH PERRY

115 Walgreen Road, RR3, Carp, ON K0A 1L0
Tel: 613-836-2194 Fax: 613-836-3742
www.mcintoshperry.com

Client: Gabriela Godinez-Lavery
Project Name: 1806 Scott St.
Project Location: Ottawa, ON.

Project No.: CCO-23-1093

Figure No.: 7

BH22-4
Run 2 (1.3 - 2.1 m)



McINTOSH PERRY



McINTOSH PERRY

McINTOSH PERRY

115 Walgreen Road, RR3, Carp, ON K0A 1L0
Tel: 613-836-2194 Fax: 613-836-3742
www.mcintoshperry.com

Client: Gabriela Godinez-Lavery
Project Name: 1806 Scott St.
Project Location: Ottawa, ON.

Project No.: COO-23-1093

Figure No.: 8

BH22-4
Run 3 (2.1 - 3.6 m)



McINTOSH PERRY

115 Walgreen Road, RR3, Carp, ON K0A 1L0
Tel: 613-836-2194 Fax: 613-836-3742
www.mcintoshperry.com

Client: Gabriela Godinez-Lavery
Project Name: 1806 Scott St.
Project Location: Ottawa, ON.

Project No.: CCO-23-1093

Figure No.: 9

BH22-4
Run 4 (3.6 - 4.7 m)

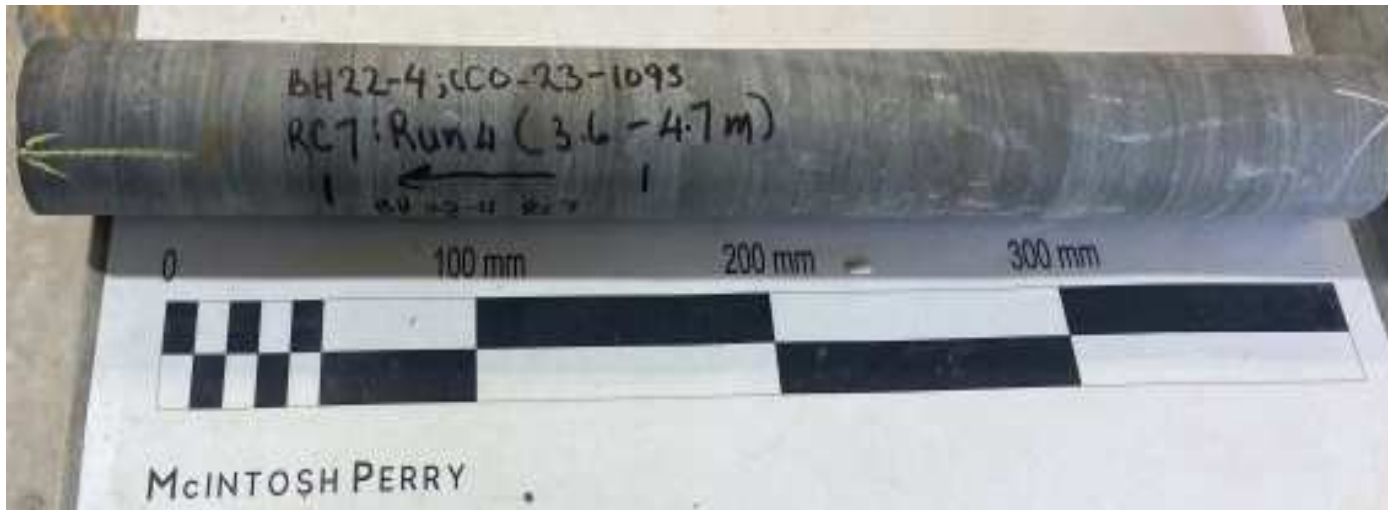

McINTOSH PERRY

115 Walgreen Road, RR3, Carp, ON K0A 1L0
Tel: 613-836-2194 Fax: 613-836-3742
www.mcintoshperry.com

Client: Gabriela Godinez-Lavery
Project Name: 1806 Scott St.
Project Location: Ottawa, ON.

Project No.: COO-23-1093

Figure No.: 10

Unconfined Compressive Strength of Intact Rock Cores ASTM D7012 Method C

Project No.:	CCO23-1093	Date Issued:	Aug 18,2022	
Lab No.:	OL-22070	Report No.:	1 of 2	
Project Name:	1806 Scott St. Ottawa			
Core No.:	1	Moisture Condition:	Dry as received	
Borehole Location:	BH22-1	RC / Run:	RC-3 / Run-1	Depth (ft): 1.3m-2.1m
Date Sampled:	Aug 11,2022	Received:	Aug 12,2022	Tested: Aug 17,2022
Core No.:	2	Moisture Condition:	Dry as received	
Borehole Location:	BH22-1	RC / Run:	RC-4 / Run-2	Depth (ft): 2.1m-3.4m
Date Sampled:	Aug 11,2022	Received:	Aug 12,2022	Tested: Aug 17,2022
Core No.:	3	Moisture Condition:	Dry as received	
Borehole Location:	BH22-4	RC / Run:	RC-5 / Run-2	Depth (ft): 1.3m-2.1m
Date Sampled:	Aug 11,2022	Received:	Aug 12,2022	Tested: Aug 17,2022
Core No. :	1	2	3	
Diameter (mm)	47.4	47.5	47.4	
Thickness/Height (mm)	98.3	97.3	97.3	
Density (Kg/m³)	2752	2709	2687	
Compressive Strength (Mpa)	256.9	180.6	187.3	
Mass of Core (g)	477.38	467.54	465.2	
Description of Failure	2 & 3	2	3	

Remarks: Type 2 - Relatively well-formed cone on one end, vertical cracks running through end, no well formed cone on other end.

Type 3 - Columnar Vertical cracking through both ends, no well-formed cones.

Reviewed By:  **Date:** Aug 18,2022

Jason Hopwood-Jones
Laboratory Manager

Unconfined Compressive Strength of Intact Rock Cores ASTM D7012 Method C

Project No.:	CCO23-1093	Date Issued:	Aug 18,2022
Lab No.:	OL-22070	Report No.:	2 of 2
Project Name:	1806 Scott St. Ottawa		
Core No.:	4	Moisture Condition:	Dry as received
Borehole Location:	BH22-4	RC / Run:	RC-6 / Run-3 Depth (ft): 2.1m-3.6m
Date Sampled:	Aug 11,2022	Received:	Aug 12,2022 Tested: Aug 17,2022
Core No.:	5	Moisture Condition:	Dry as received
Borehole Location:	BH22-4	RC / Run:	RC-7 / Run-4 Depth (ft): 3.6m-4.7m
Date Sampled:	Aug 11,2022	Received:	Aug 12,2022 Tested: Aug 17,2022
Core No.:		Moisture Condition:	
Borehole Location:		RC / Run:	Depth (ft):
Date Sampled:		Received:	Tested:
Core No. :	4	5	
Diameter (mm)	47.6	47.6	
Thickness/Height (mm)	98	98.2	
Density (Kg/m³)	2694	2738	
Compressive Strength (Mpa)	203.3	236.7	
Mass of Core (g)	469.98	477.48	
Description of Failure	3	2 & 3	

Remarks: Type 2 - Relatively well-formed cone on one end, vertical cracks running through end, no well formed cone on other end.

Type 3 - Columnar Vertical cracking through both ends, no well-formed cones.

Reviewed By:  **Date:** Aug 18,2022

Jason Hopwood-Jones
Laboratory Manager

Certificate of Analysis

McIntosh Perry Consulting Eng. (Nepean)

215 Menten Place, Unit 104

Nepean, ON K2H 9C1

Attn: Jason Hopwood-Jones

Client PO: CCO 23-1093

Project: 1806 Scott St.

Custody: 67079

Report Date: 24-Aug-2022

Order Date: 17-Aug-2022

Order #: 2234332

This Certificate of Analysis contains analytical data applicable to the following samples as submitted:

Parcel ID	Client ID
2234332-01	BH22-5 SS-2 2'-4'

Approved By:



Alex Enfield, MSc

Lab Manager

Certificate of Analysis

Report Date: 24-Aug-2022

Client: **McIntosh Perry Consulting Eng. (Nepean)**

Order Date: 17-Aug-2022

Client PO: CCO 23-1093

Project Description: 1806 Scott St.

Analysis Summary Table

Analysis	Method Reference/Description	Extraction Date	Analysis Date
Anions	EPA 300.1 - IC, water extraction	23-Aug-22	24-Aug-22
pH, soil	EPA 150.1 - pH probe @ 25 °C, CaCl buffered ext.	23-Aug-22	23-Aug-22
Resistivity	EPA 120.1 - probe, water extraction	23-Aug-22	23-Aug-22
Solids, %	Gravimetric, calculation	22-Aug-22	22-Aug-22

Certificate of Analysis

Report Date: 24-Aug-2022

Client: **McIntosh Perry Consulting Eng. (Nepean)**

Order Date: 17-Aug-2022

Client PO: CCO 23-1093

Project Description: 1806 Scott St.

Summary of Criteria Exceedances

(If this page is blank then there are no exceedances)

Only those criteria that a sample exceeds will be highlighted in red

Regulatory Comparison:

Paracel Laboratories has provided regulatory guidelines on this report for informational purposes only and makes no representations or warranties that the data is accurate or reflects the current regulatory values. The user is advised to consult with the appropriate official regulations to evaluate compliance. Sample results that are highlighted have exceeded the selected regulatory limit. Calculated uncertainty estimations have not been applied for determining regulatory exceedances.

Sample	Analyte	MDL / Units	Result	-	-
--------	---------	-------------	--------	---	---

Certificate of Analysis

Report Date: 24-Aug-2022

Client: **McIntosh Perry Consulting Eng. (Nepean)**

Order Date: 17-Aug-2022

Client PO: CCO 23-1093

Project Description: 1806 Scott St.

Client ID:	BH22-5 SS-2 2'-4'	-	-	-	-
Sample Date:	11-Aug-22 09:30	-	-	-	-
Sample ID:	2234332-01	-	-	-	-
Matrix:	Soil	-	-	-	-
MDL/Units					

Physical Characteristics

% Solids	0.1 % by Wt.	95.9	-	-	-	-
----------	--------------	------	---	---	---	---

General Inorganics

pH	0.05 pH Units	7.79	-	-	-	-
Resistivity	0.1 Ohm.m	71.7	-	-	-	-

Anions

Chloride	5 ug/g	<5	-	-	-	-
Sulphate	5 ug/g	32	-	-	-	-

Certificate of Analysis

Report Date: 24-Aug-2022

Client: McIntosh Perry Consulting Eng. (Nepean)

Order Date: 17-Aug-2022

Client PO: CCO 23-1093

Project Description: 1806 Scott St.

Method Quality Control: Blank

Analyte	Result	Reporting Limit	Units	%REC	%REC Limit	RPD	RPD Limit	Notes
Anions								
Chloride	ND	5	ug/g					
Sulphate	ND	5	ug/g					
General Inorganics								
Resistivity	ND	0.10	Ohm.m					

Certificate of Analysis

Report Date: 24-Aug-2022

Client: McIntosh Perry Consulting Eng. (Nepean)

Order Date: 17-Aug-2022

Client PO: CCO 23-1093

Project Description: 1806 Scott St.

Method Quality Control: Duplicate

Analyte	Result	Reporting Limit	Units	Source Result	%REC	%REC Limit	RPD	RPD Limit	Notes
Anions									
Chloride	ND	5	ug/g	ND			NC	20	
Sulphate	34.2	5	ug/g	31.5			8.2	20	
General Inorganics									
pH	7.90	0.05	pH Units	7.86			0.5	10	
Resistivity	24.6	0.10	Ohm.m	24.6			0.1	20	
Physical Characteristics									
% Solids	85.9	0.1	% by Wt.	85.7			0.2	25	

Certificate of Analysis

Report Date: 24-Aug-2022

Client: McIntosh Perry Consulting Eng. (Nepean)

Order Date: 17-Aug-2022

Client PO: CCO 23-1093

Project Description: 1806 Scott St.

Method Quality Control: Spike

Analyte	Result	Reporting Limit	Units	Source Result	%REC	%REC Limit	RPD	RPD Limit	Notes
Anions									
Chloride	106	5	ug/g	ND	106	82-118			
Sulphate	129	5	ug/g	31.5	97.8	80-120			

Certificate of Analysis

Report Date: 24-Aug-2022

Client: McIntosh Perry Consulting Eng. (Nepean)

Order Date: 17-Aug-2022

Client PO: CCO 23-1093

Project Description: 1806 Scott St.

Qualifier Notes:

Login Qualifiers :

Received at temperature > 25C

Applies to Samples: BH22-5 SS-2 2'-4'

Sample Data Revisions:

None

Work Order Revisions / Comments:

None

Other Report Notes:

n/a: not applicable

ND: Not Detected

MDL: Method Detection Limit

Source Result: Data used as source for matrix and duplicate samples

%REC: Percent recovery.

RPD: Relative percent difference.

NC: Not Calculated

Soil results are reported on a dry weight basis unless otherwise noted.

Where %Solids is reported, moisture loss includes the loss of volatile hydrocarbons.

Any use of these results implies your agreement that our total liability in connection with this work, however arising, shall be limited to the amount paid by you for this work, and that our employees or agents shall not under any circumstances be liable to you in connection with this work.

1806 SCOTT STREET, OTTAWA, ONTARIO.
GEOTECHNICAL AND FOUNDATION REPORT

APPENDIX E
SEISMIC HAZARD CALCULATION

2010 National Building Code Seismic Hazard Calculation

INFORMATION: Eastern Canada English (613) 995-5548 français (613) 995-0600 Facsimile (613) 992-8836
Western Canada English (250) 363-6500 Facsimile (250) 363-6565

Site: 45.400N 75.744W

User File Reference: 1806 Scott Street

2022-10-05 20:11 UT

Requested by: McIntosh Perry Consulting Engineering Ltd.

Probability of exceedance per annum	0.000404	0.001	0.0021	0.01
Probability of exceedance in 50 years	2 %	5 %	10 %	40 %
Sa (0.2)	0.632	0.384	0.247	0.089
Sa (0.5)	0.307	0.185	0.121	0.043
Sa (1.0)	0.137	0.087	0.055	0.017
Sa (2.0)	0.046	0.028	0.018	0.006
PGA (g)	0.322	0.200	0.122	0.038

Notes: Spectral ($S_a(T)$, where T is the period in seconds) and peak ground acceleration (PGA) values are given in units of g (9.81 m/s^2). Peak ground velocity is given in m/s . Values are for "firm ground" (NBCC2015 Site Class C, average shear wave velocity 450 m/s). NBCC2015 and CSAS6-14 values are highlighted in yellow. Three additional periods are provided - their use is discussed in the NBCC2015 Commentary. Only 2 significant figures are to be used. **These values have been interpolated from a 10-km-spaced grid of points. Depending on the gradient of the nearby points, values at this location calculated directly from the hazard program may vary. More than 95 percent of interpolated values are within 2 percent of the directly calculated values.**

References

National Building Code of Canada 2015 NRCC no. 56190; Appendix C: Table C-3, Seismic Design Data for Selected Locations in Canada

Structural Commentaries (User's Guide - NBC 2015: Part 4 of Division B)
Commentary J: Design for Seismic Effects

Geological Survey of Canada Open File 7893 Fifth Generation Seismic Hazard Model for Canada: Grid values of mean hazard to be used with the 2015 National Building Code of Canada

See the websites www.EarthquakesCanada.ca and www.nationalcodes.ca for more information



Natural Resources
Canada

Ressources naturelles
Canada

E.2 Topographic Survey Plan (By Farley, Smith & Denis Surveying Ltd., January 2022)



LOTS 47 & 48
REGISTERED PLAN 400
CITY OF OTTAWA

FARLEY, SMITH & DENIS SURVEYING LTD. 2022

Scale 1: 100

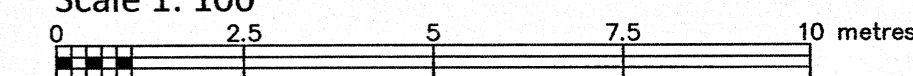

Metric Note

Distances on this plan are in metres and can be converted to feet by dividing by 0.3048.

Bearing Note

Bearings are astronomic and are referred to the westerly limit of Rockhurst Road having a bearing of N 22° 44' 00" W as shown on Registered Plan 400.

For bearing comparisons, a rotation of 0°02'50" clockwise was applied to bearings on P7.

Elevation Notes

- Elevations shown are geodetic and are referred to Geodetic Datum CGVD-1928 :1978. (Monument No. 197534238)
- It is the responsibility of the user of this information to verify that the job benchmark has not been altered or disturbed and that its relative elevation and description agrees with the information shown on this drawing.

Utility Notes

- This drawing cannot be accepted as acknowledging all of the utilities and it will be the responsibility of the user to contact the respective utility authorities for confirmation.
- Only visible surface utilities were located.
- Underground utility data derived from City of Ottawa utility sheet reference: I32d & 18164p&p15.
- Sanitary and storm sewer grades and inverts were compiled from: City of Ottawa Utility Sheets.
- A field location of underground plant by the pertinent utility authority is mandatory before any work involving breaking ground, probing, excavating etc.

Notes & Legend

- Denotes**
- +— Survey Monument Planted
 - +— Survey Monument Found
 - +— Standard Iron Bar
 - +— Short Standard Iron Bar
 - +— Iron Bar
 - +— Round Iron Bar
 - +— Cut Cross
 - +— Witness
 - +— Origin Unknown
 - +— Measured
 - +— Registered Plan 400
 - +— Plan by (857) dated April 29, 1992 (Ref. No. 31-400(NP))
 - +— Plan by (1442) dated September 14, 1994 (Ref. 94-25-260)
 - +— Plan by (1175) dated August 31, 1982 (File No. 82-643)
 - +— Plan by (1319) dated July 26, 1989 (Ref. No. 3-400)
 - +— Plan by (671) dated March 24, 1987 (Job No. 8736)
 - +— Plan by (56) dated November 6, 2020 (Project No. 161614256-110)
- MH-ST Maintenance Hole (Storm)
 - MH-S Maintenance Hole (Sanitary)
 - ST — Underground Storm Sewer
 - S — Underground Sanitary Sewer
 - W — Underground Water
 - OW — Overhead Wires
 - UP — Utility Pole
 - AN — Anchor
 - CB — Catch Basin
 - FH — Fire Hydrant
 - WV — Water Valve
 - GM — Gas Meter
 - B — Bollard
 - △ S — Sign
 - AC — Air Conditioner
 - — Diameter
 - CLF — Chain Link Fence
 - BF — Board Fence
 - PVC — Plastic Vinyl Fence
 - CRW — Concrete Retaining Wall
 - SRW — Stone Retaining Wall
 - Inv — Invert
 - Inv(City) — Invert From City of Ottawa Utility Sheets
 - T/G — Top of Grate
 - U/Eave — Underside of Eave
 - T/Fdn — Top of Foundation
 - C/L — Centreline
 - +65.00 — Location of Elevations
 - +65.00 — Top of Concrete Curb/Retaining Wall Elevation
 - — Property Line
- Deciduous Tree - The symbol shown denotes location and trunk diameter only. Size of its' root system/overhead canopy may be smaller/larger than the symbol size depicted on this plan.

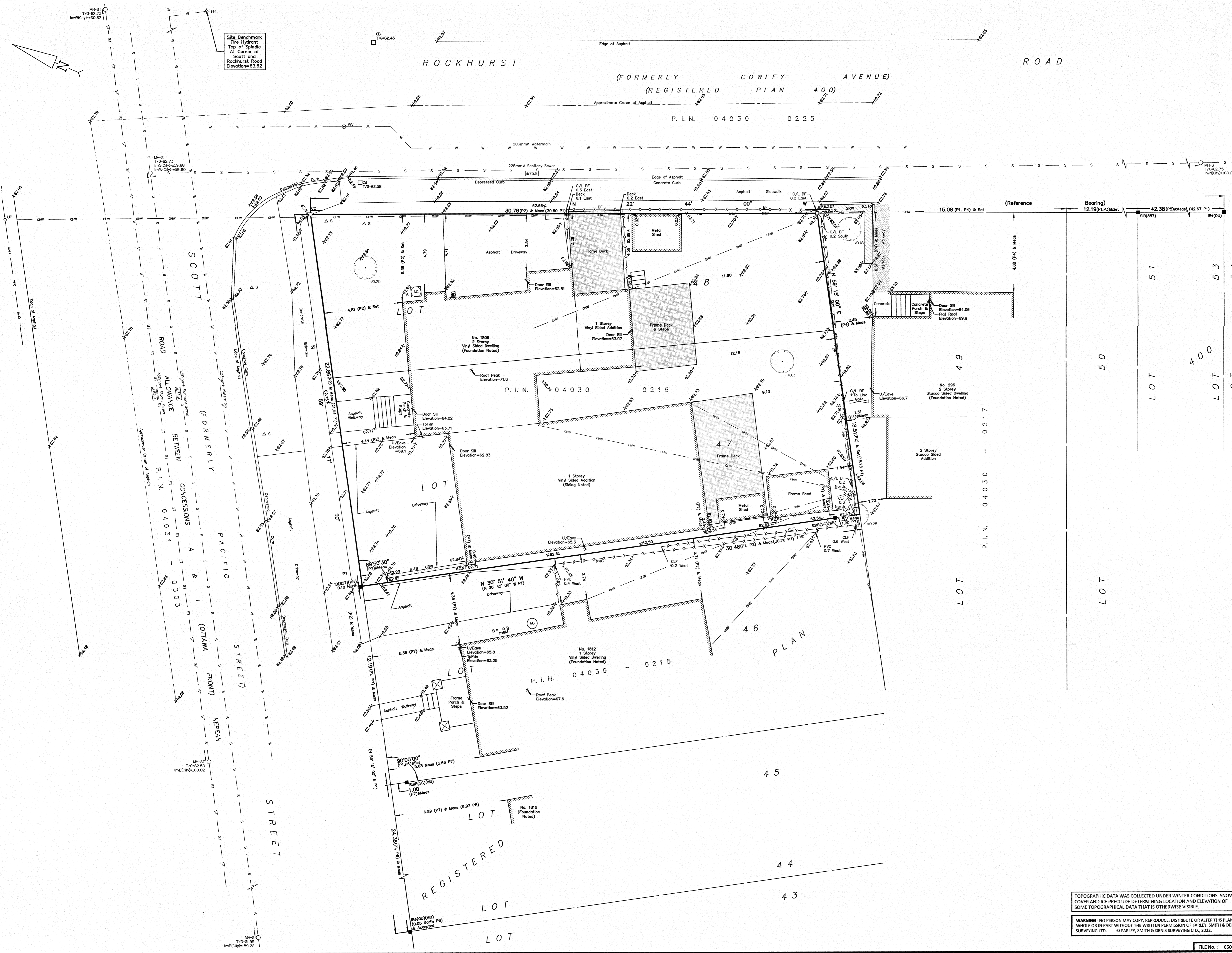

TOPOGRAPHIC DATA WAS COLLECTED UNDER WINTER CONDITIONS. SNOW COVER AND ICE PRECLUDE DETERMINING LOCATION AND ELEVATION OF SOME TOPOGRAPHICAL DATA THAT IS OTHERWISE VISIBLE.

WARNING: NO PERSON MAY COPY, REPRODUCE, DISTRIBUTE OR ALTER THIS PLAN IN WHOLE OR IN PART WITHOUT THE WRITTEN PERMISSION OF FARLEY, SMITH & DENIS SURVEYING LTD. © FARLEY, SMITH & DENIS SURVEYING LTD., 2022.

Surveyor's Certificate

I certify that:

- This survey and plan are correct and in accordance with the Surveys Act, the Surveyors Act and the Regulations made under them.
- The survey was completed on the 4th day of January, 2022.

Date: Jan 17/22
 Signature: Jamie Leslie
 Title: Ontario Land Surveyor

ASSOCIATION OF ONTARIO LAND SURVEYORS
 PLAN SUBMISSION FORM
 V-22659

THIS PLAN IS NOT VALID UNLESS IT IS AN EMBOSSED ORIGINAL COPY ISSUED BY THE SURVEYOR
 In accordance with Regulation 1026, Section 29 (3).

FARLEY, SMITH & DENIS SURVEYING LTD.

ONTARIO LAND SURVEYORS
CANADA LAND SURVEYORS

Unit 275, 30 COLONNADE ROAD, OTTAWA, ONTARIO K2E 7J6
TEL: (613) 727-8226 E-mail: fdsurveys@bellnet.ca

Appendix F Preconsultation



Good afternoon Steve,

Please forward the below information to the applicant regarding a development proposal at **1806 Scott Street, Ottawa for a four-storey mixed-use building with commercial space on main floor and residential dwellings**. Note that the information is considered **preliminary**, and the assigned Development Review Project Manager may modify and/or add additional requirements and conditions upon review of an application if deemed necessary.

General:

- It is the sole responsibility of the consultant to investigate the location of existing underground utilities in the proposed servicing area and submit a request for locates to avoid conflict(s). The location of existing utilities and services shall be documented on an **Existing Conditions Plan**.
- Any easements on the subject site shall be identified and respected by any development proposal and shall adhere to the conditions identified in the easement agreement. A **legal survey plan** shall be provided, and all easements shall be shown on the engineering plans.
- All underground and above ground building footprints and permanent walls need to be shown on the plans to confirm that any permanent structure does not extend either above or below into the existing property lines and sight triangles and/or future road widening protection limits.
- **Concern** about sanitary and storm sewer capacity, please provide the new sanitary and storm sewer discharge and we confirm if sanitary sewer main has the capacity. Also provide the size proposed sanitary and storm service.
- **Concern** about protection of 1067mm watermain. Vibration and settlement monitoring plan will be required. Please note: Connection to the 1067mm dia. backbone watermain is not permitted.
- A deep excavation and dewatering operations have the potential to cause damages to the neighboring adjacent buildings/ City infrastructure. Document that construction activities (excavation, dewatering, vibrations associated with construction, etc.) will not have an impact on any adjacent buildings and infrastructure.
- If existing building services are being reused, a CCTV inspection and report are required to ensure existing services are in good working order and meet current minimum size requirements. Located services to be placed on site servicing plans.

- Reference documents for information purposes:
 - Ottawa Sewer Design Guidelines (October 2012)
 - Technical Bulletin PIEDTB-2016-01
 - Technical Bulletins ISTB-2018-01, ISTB-2018-02 and ISTB-2018-03.
 - Ottawa Design Guidelines - Water Distribution (2010)
 - Technical Bulletin ISTB-2021-03
 - Geotechnical Investigation and Reporting Guidelines for Development Applications in the City of Ottawa (2007)

- City of Ottawa Slope Stability Guidelines for Development Applications (revised 2012)
- City of Ottawa Environmental Noise Control Guidelines (January 2016)
- City of Ottawa Accessibility Design Standards (2012) (City recommends development be in accordance with these standards on private property)
- Ottawa Standard Tender Documents (latest version)
- Ontario Provincial Standards for Roads & Public Works (2013)
- Record drawings and utility plans are also available for purchase from the City (Contact the City's Information Centre by email at InformationCentre@ottawa.ca or by phone at (613) 580-424 x.44455).

Please note that this is the applicant responsibility to refer to the latest applicable guidelines while preparing reports and studies.

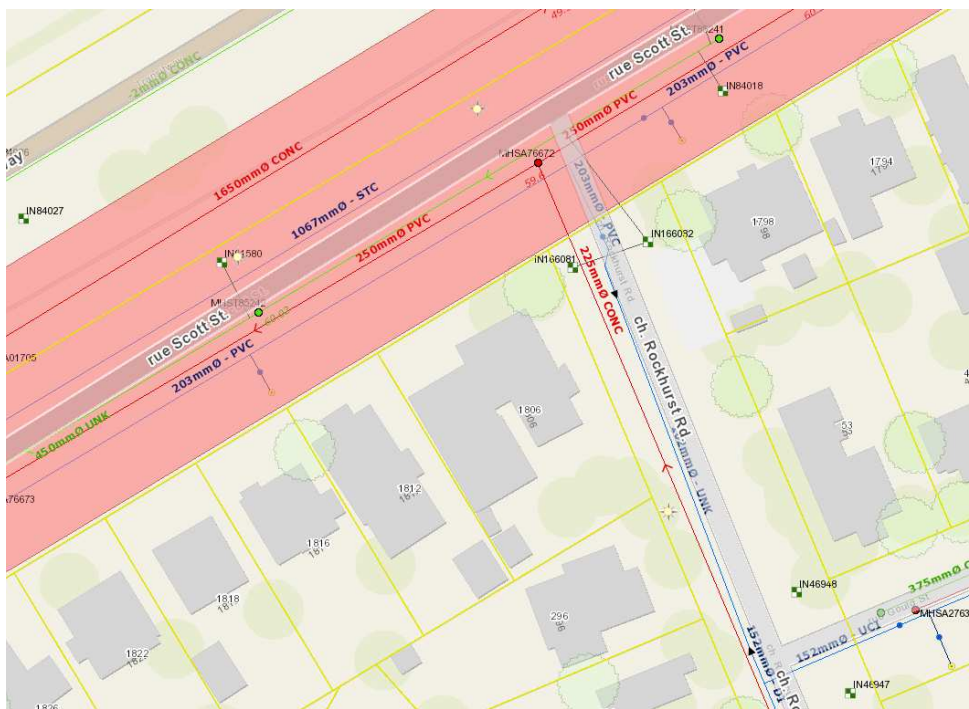

Disclaimer:

The City of Ottawa does not guarantee the accuracy or completeness of the data and information contained on the above image(s) and does not assume any responsibility or liability with respect to any damage or loss arising from the use or interpretation of the image(s) provided. This image is for schematic purposes only.

Stormwater Management Criteria and Information:

- **Water Quantity Control:** Considering the size of the site, it would be acceptable to control the **roof portion only (100-year storm event, to a 5-year pre-development level)** and leave the remainder of the site uncontrol as long as the uncontrolled portion is directed towards the right of way. This approach should be discussed in the SWM report. Also, the grading plan should clearly demonstrate

that the runoff from the uncontrolled portion of the site will be directed towards the ROW and that there are no increased flows draining onto adjacent properties.

- The pre-development runoff coefficient will need to be determined **as per existing conditions** but in no case more than 0.5. **[If 0.5 applies it needs to be clearly demonstrated in the report that the pre-development runoff coefficient is greater than 0.5]**. The time of concentration (T_c) used to determine the pre-development condition should be calculated. *T_c should not be less than 10 min. since IDF curves become unrealistic at less than 10 min; T_c of 10 minutes shall be used for all post-development calculations*.
- SWM measures required to avoid impact on downstream sewer system will be subject to review.
- Please note that foundation drainage is to be independently connected to sewer main unless being pumped with appropriate back up power, sufficient sized pump and back flow prevention. **It is recommended that the foundation drainage system be drained by a sump pump connection to the storm sewer to minimize risk of basement flooding as it will provide the best protection from the uncontrolled sewer system compared to relying on the backwater valve.**
- **Water Quality Control:** Please consult with the local conservation authority (RVCA) regarding water quality criteria prior to submission of a Site Plan Control Proposal application to establish any water quality control restrictions, criteria and measures for the site. Correspondence and clearance shall be provided in the Appendix of the report.
- Please note that as per *Technical Bulletin PIEDTB-2016-01 section 8.3.11.1 (p.12 of 14)* **there shall be no surface ponding on private parking areas during the 2-year storm rainfall event.**
- Post-development site grading shall match existing property line grades in order to minimize disruption to the adjacent residential properties. A **topographical plan of survey** shall be provided as part of the submission and a note provided on the plans.
- Please provide a **Pre-Development Drainage Area Plan** to define the pre-development drainage areas/patterns. **Existing drainage patterns shall be maintained and discussed as part of the proposed SWM solution.**
- **If rooftop control** and storage is proposed as part of the SWM solutions sufficient details (Cl. 8.3.8.4) shall be discussed and document in the report and on the plans. Roof drains are to be connected downstream of any incorporated ICDs within the SWM system and not to the foundation drain system. Provide a **Roof Drain Plan** as part of the submission.
- If **Window wells** are proposed, they are to be indirectly connected to the footing drains. A detail of window well with indirect connection is required, as is a note at window well location speaking to indirect connection.
- There must be at least **15cm of vertical clearance** between the spill elevation and the ground elevation at the building envelope that is in proximity of the flow route or ponding area. The exception in this case would be at reverse sloped loading dock locations. At these locations, a minimum of 15cm of vertical

clearance must be provided below loading dock openings. Ensure to provide discussion in report and ensure grading plan matches if applicable.

- Rear yard on grade parking to be permeable pavement. Refer to City Standard Detail Drawings SC26 (maintenance/temp parking areas), SC27 or permeable asphalt materials. No gravel or stone dust parking areas permitted.

Storm Sewer:

- A 450 mm dia. UNK storm sewer (2020) is available within Scott Street.

Sanitary Sewer:

- A 250 mm dia. PVC Sanitary sewer (2020) is available within Scott Street.
- A 225 mm dia. CONC sanitary sewer (UNK) is available within Rockhurst Road.
- Please provide the new Sanitary sewer discharge and we confirm if sanitary sewer main has the capacity. An analysis and demonstration that there is sufficient/adequate residual capacity to accommodate any increase in wastewater flows in the receiving and downstream wastewater system is required to be provided. Needs to be demonstrated that there is adequate capacity to support any increase in wastewater flow.
- Please apply the wastewater design flow parameters *in Technical Bulletin PIEDTB-2018-01*.
- Sanitary sewer monitoring maintenance hole is required to be installed at the property line (on the private side of the property) as per City of Ottawa Sewer-Use By-Law 2003-514 (14) *Monitoring Devices*.
- A backwater valve is required on the sanitary service for protection.

Water:

- A 203 mm dia. PVC watermain (2020) is available within Scott Street.
- A 102 mm dia. UNK watermain (1938) is available within Rockhurst Road.
- A 1067mm dia. STC watermain (1950) is located within Scott Street; connection not permitted to backbone watermain.
- Existing residential service to be blanked at the main.
- **Water Supply Redundancy:** Residential buildings with a basic day demand greater than 50m³/day (0.57 L/s) are required to be connected to a minimum of two water services separated by an isolation valve to avoid a vulnerable service area as per the *Ottawa Design Guidelines - Water Distribution, WDG001, July 2010 Clause 4.3.1 Configuration*. The basic day demand for this site not expected to exceed 50m³/day.
- Please **review Technical Bulletin ISTB-2018-02**, maximum fire flow hydrant capacity is provided in Section 3 Table 1 of Appendix I. A **hydrant coverage figure** shall be provided and **demonstrate there is adequate fire protection for the proposal**. Two or more public hydrants are anticipated to be required to handle fire flow.
- Boundary conditions are required to confirm that the require fire flows can be achieved as well as availability of the domestic water pressure on the City street in front of the development. Use Table 3-3 of the MOE Design Guidelines for Drinking-Water System to determine Maximum Day and Maximum Hour peaking

factors for 0 to 500 persons and use Table 4.2 of the Ottawa Design Guidelines, Water Distribution for 501 to 3,000 persons. Please provide the following information to the City of Ottawa via email to request water distribution network boundary conditions for the subject site. Please note that once this information has been provided to the City of Ottawa it takes approximately 5-10 business days to receive boundary conditions.

- Type of Development and Units
- Site Address
- A plan showing the proposed water service connection location.
- **Average Daily Demand (L/s)**
- **Maximum Daily Demand (L/s)**
- **Peak Hour Demand (L/s)**
- **Fire Flow (L/min)**

*[Fire flow demand requirements shall be based on **Fire Underwriters Survey (FUS) Water Supply for Public Fire Protection 1999**]*

*[Fire flow demand requirements shall be based on **ISTB-2021-03**]*

Note: The OBC method can be used if the fire demand for the private property is less than 9,000 L/min. If the OBC fire demand reaches 9000 L/min, then the FUS method is to be used.

Exposure separation distances shall be defined on a figure to support the FUS calculation and required fore flow (RFF).

- **Hydrant capacity shall be assessed to demonstrate the RFF can be achieved.** Please identify which hydrants are being considered to meet the RFF on a fire hydrant coverage plan as part of the boundary conditions request.

Snow Storage:

- Any portion of the subject property which is intended to be used for permanent or temporary snow storage shall be as shown on the approved site plan and grading plan. Snow storage shall not interfere with approved grading and drainage patterns or servicing. Snow storage areas shall be setback from the property lines, foundations, fencing or landscaping a minimum of 1.5m. Snow storage areas shall not occupy driveways, aisles, required parking spaces or any portion of a road allowance. If snow is to be removed from the site, please indicate this on the plan(s).

Trees:

- Please note that a new Tree By-law is now in effect.



General Bulletin_New
Tree Protection Bylaw.

Gas pressure regulating station

- A gas pressure regulating station may be required depending on HVAC needs (typically for 12+ units). Be sure to include this on the Grading, Site Servicing,

SWM and Landscape plans. This is to ensure that there are no barriers for overland flow routes (SWM) or conflicts with any proposed grading or landscape features with installed structures and has nothing to do with supply and demand of any product.



Gas Pressure
Regulating Station.pdf

Proximity Study

- Due to proximity of site to Transit Way, applicant to contact City LRT Group regarding required building offset from transitway. Noise study to review vibration conditions within 75m of Transitway. See Rail Guidelines and CPCS Report as well as OP Annex 17, Zones of Influence and Guidelines for Proximity Study.



2013_05_29_Guidelines
s_NewDevelopment_E



CPCS Report
Appendix_F.pdf



annex_17_en.pdf



Trillium ZOI.pdf



Confederation East
ZOI.pdf



Confederation West
ZOI.pdf



Confed Railway Line
Prox. Guidelines.pdf

Regarding Quantity Estimates:

- Please note that external Garbage and/or bicycle storage structures are to be added to QE under Landscaping as it is subject to securities. In addition, sump pumps for Sanitary and Storm laterals and/or cisterns are to be added to QE under Hard items as it is subject to securities, even though it is internal and is spoken to under SWM and Site Servicing Report and Plan.

CCTV sewer inspection

- CCTV sewer inspection required for pre and post construction conditions to ensure no damage to City Assets surrounding site.

Pre-Construction Survey

- Pre-Construction (Piling/Hoe Ramming or proximity to City Assets) and/or Pre-Blasting (if applicable) Survey required for any buildings/dwellings in proximity of 75m of site and circulation of notice of vibration/noise to residents within 150 m of site. Conditions for Pre-Construction/ Pre-Blast Survey & Use of Explosives will be applied to agreements. Refer to City's Standard S.P. No. F-1201 entitled Use of Explosives, as amended.

Road Reinstatement

- Where servicing involves three or more service trenches, either a full road width or full lane width 40 mm asphalt overlay will be required, as per amended Road

Activity By-Law 2003-445 and City Standard Detail Drawing R10. The amount of overlay will depend on condition of roadway and width of roadway(s).

Permits and Approvals:

- Please note that this project will be subject to an Environmental Compliance Approval (ECA) for Private Sewage Works. (Any connection to a combined Sewer system required the Ministry (MECP) approval)

Required Engineering Plans and Studies:

PLANS:

- Existing Conditions and Removals Plan
- Site Servicing Plan
- Grade Control and Drainage Plan
- Erosion and Sediment Control Plan
- Roof Drainage Plan
- Foundation Drainage System Detail (if applicable)
- Topographical survey

REPORTS:

- Site Servicing and Stormwater Management Report
- Geotechnical Study/Investigation (including sensitive marine clays and unstable slopes)
- Slope Stability Assessment Reports (if required, please see requirements below)
- Noise / Vibration Control Study
- Phase I ESA 4) A Phase 1 and, where required, a Phase 2 ESA are required per section 10.1.6 OP
- Phase II ESA (Depending on recommendations of Phase I ESA)
- Vibration and settlement monitoring plan for 1067mm watermain

Please refer to the **City of Ottawa Guide to Preparing Studies and Plans**

[Engineering]:

Specific information has been incorporated into both the [Guide to Preparing Studies and Plans](#) for a site plan. The guide outlines the requirement for a statement to be provided on the plan about where the property boundaries have been derived from.

Added to the general information for servicing and grading plans is a note that an O.L.S. should be engaged when reporting on or relating information to property boundaries or existing conditions. The importance of engaging an O.L.S. for development projects is emphasized.

Phase One Environmental Site Assessment:

- A Phase I ESA is required to be completed in accordance with Ontario Regulation 153/04 in support of this development proposal to determine the potential for site contamination. Depending on the Phase I recommendations a Phase II ESA may be required.
- The Phase I ESA shall provide all the required Environmental Source Information as required by O. Reg. 153/04. ERIS records are available to public at a

reasonable cost and need to be included in the ESA report to comply with O.Reg. 153/04 and the Official Plan. The City will not be in a position to approve the Phase I ESA without the inclusion of the ERIS reports.

- Official Plan Section 4.8.4:
<https://ottawa.ca/en/city-hall/planning-and-development/official-plan-and-master-plans/official-plan/volume-1-official-plan/section-4-review-development-applications#4-8-protection-health-and-safety>

Phase Two Environmental Site Assessment:

- If a Phase II ESA is required and there is indication of contamination present within the site, the site will need to be remediated for the approval.

Geotechnical Investigation:

- A Geotechnical Study/Investigation shall be prepared in support of this development proposal.
- Reducing the groundwater level in this area can lead to potential damages to surrounding structures due to excessive differential settlements of the ground. The impact of groundwater lowering on adjacent properties needs to be discussed and investigated to ensure there will be no short term and long-term damages associated with lowering the groundwater in this area.
- Geotechnical Study shall be consistent with the **Geotechnical Investigation and Reporting Guidelines for Development Applications**.
https://documents.ottawa.ca/sites/documents/files/geotech_report_en.pdf

Slope Stability Assessment Reports

- A report addressing the stability of slopes, prepared by a qualified geotechnical engineer licensed in the Province of Ontario, should be provided wherever a site has slopes (existing or proposed) steeper than 5 horizontal to 1 vertical (i.e., 11 degree inclination from horizontal) and/or more than 2 metres in height.
- A report is also required for sites having retaining walls greater than 1 metre high, that addresses the global stability of the proposed retaining walls.
<https://documents.ottawa.ca/en/document/slope-stability-guidelines-development-applications>

Noise Study:

- A **Transportation Noise Assessment** is required as the subject development is located within 100m proximity of an Arterial Road
- A **Stationary Noise Assessment** is required to assess the noise impact of the proposed sources of stationary noise (mechanical HVAC system/equipment) of the development onto the surrounding residential area to ensure the noise levels do not exceed allowable limits specified in the City Environmental Noise Control Guidelines.
https://documents.ottawa.ca/sites/default/files/documents/enviro_noise_guide_en.pdf

Vibration and settlement monitoring on Backbone Watermain:

- A 1067mm dia. backbone watermain is located within Scott Street. Please note that to ensure the integrity of the nearby watermain the applicant may be required to develop a Vibration and Settlement Monitoring Program. A Vibration and settlement Monitoring Specialist Engineer shall undertake monitoring, develop a vibration and settlement monitoring plan, and prepare a protection plan, an emergency response plan, ensure conformance and shall issue certificates of conformance. The Vibration and settlement Monitoring Specialist Engineer shall be a licensed engineer in the Province of Ontario with a minimum of five years of experience in the field of Vibration and settlement monitoring. Vibration and settlement monitors are to be placed directly on the watermain. The maximum peak particle velocities are to be in accordance with Table 1 of the City of Ottawa Specification F-1201.

Note: In addition to requirement of a vibration specialist engineer required to design and monitor vibration, a certificate of liability insurance shall be submitted to the City wherein the Owner is the named insured, and the City of Ottawa is an additional insured. The limits of the policy shall be in the amount of \$25,000,000 and shall be kept in full force and effect for the term of the construction work.
https://documents.ottawa.ca/sites/default/files/documents/enviro_noise_guide_en.pdf

Exterior Site Lighting:

- Any proposed light fixtures (both pole-mounted and wall mounted) must be part of the approved Site Plan. All external light fixtures must meet the criteria for Full Cut-off Classification as recognized by the Illuminating Engineering Society of North America (IESNA or IES) and must result in minimal light spillage onto adjacent properties (as a guideline, 0.5 fc is normally the maximum allowable spillage). In order to satisfy these criteria, the please provide the City with a **Certification (Statement) Letter** from an acceptable professional engineer stating that the design is compliant.

Fourth (4th) Review Charge:

Please be advised that additional charges for each review, after the 3rd review, will be applicable to each file. There will be no exceptions.

Construction approach – Please contact the Right-of-Ways Permit Office TMconstruction@ottawa.ca early in the Site Plan process to determine the ability to construct site and copy File Lead on this request.

Please note that these comments are considered preliminary based on the information available to date and therefore maybe amended as additional details become available and presented to the City. It is the responsibility of the applicant to verify the above information. The applicant may contact me for follow-up questions related to engineering/infrastructure prior to submission of an application if necessary.

If you have any questions or require any clarification, please let me know.

Regards,

Sarah McLaughlin, P.Eng

Project Manager

Planning, Real Estate and Economic Development Department / Direction générale de la planification, des biens immobiliers et du développement économique

Development Review - Central Branch

City of Ottawa | Ville d'Ottawa

110 Laurier Avenue West Ottawa, ON, K1P 1J1 | 110, avenue Laurier Ouest, Ottawa, ON, K1P 1J1

613.580.2400 ext./poste 26821, sarah.mclaughlin@ottawa.ca

Appendix G Drawings

