



Assessment of Adequacy of Servicing Report

2545 9th Line Road Metcalfe, Ontario

ASB Greenworld Ltd

December 20, 2022



→ The Power of Commitment

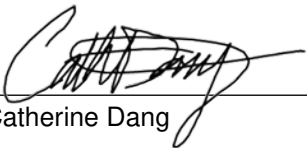

Catherine Dang

Joseph Drader, P. Eng.

Jason Haelzle, P. Eng.

Project name		ASB Greenworld-Metcalf Site					
Document title		Assessment of Adequacy of Servicing Report 2545 9th Line Road Metcalfe, Ontario					
Project number		12586015					
File name		12586015-RPT-3 (Servicing Report)					
Status Code	Revision	Author	Reviewer		Approved for issue		
			Name	Signature	Name	Signature	Date
S3	00	Catherine Dang	Dilan Singaraja, Steve Gagne, Joseph Drader				
S4	01	Catherine Dang, Joseph Drader	Jason Haelzle		Joseph Drader		December 19, 2022

GHD Limited

179 Colonnade Road South, Suite 400

Ottawa, Ontario K2E 7J4, Canada

T +1 613 727 0510 | F +1 613 727 0704 | E info-northamerica@ghd.com | ghd.com

© GHD 2022

This document is and shall remain the property of GHD. The document may only be used for the purpose for which it was commissioned and in accordance with the Terms of Engagement for the commission. Unauthorised use of this document in any form whatsoever is prohibited.

Contents

1. Introduction	1
1.1 Purpose of this Report	1
1.2 Scope and Limitations	1
2. Site Description	1
2.1 Location	1
2.2 Site Characteristics	2
3. Services Capacity	2
3.1 Water Supply	2
3.2 Fire Water Supply	3
3.3 Septic System	3
3.4 Stormwater	4

Figure index

Figure 1	Site Location Map
Figure 2	Site Plan

Appendices

Appendix A	Green Valley Environmental Septic
Appendix B	Ottawa Septic System Office Documents

1. Introduction

1.1 Purpose of this Report

GHD Limited (GHD) was retained by ASB Greenworld Limited (ASB or “the Client”) to complete this Assessment of Adequacy of Servicing Report in support of ASB’s acquisition and future occupation of the property located at 2545 9th Line Road, in Metcalfe, Ontario (Site or Property). This report is required as part of ASB’s Zoning By-law Amendment (ZBLA) application being submitted to the City of Ottawa.

It is understood that ASB initially proposes to use the operational portion of the Site for storage and distribution of garden products. Additional planning and studies may be required based on future development and increased operations to be implemented by ASB, as applicable.

This report presents the various services available at the Site including but not limited to water supply, stormwater management, and septic systems. It is noted that no municipal services are currently provided at the Site. This report summarizes the details from Site inspections and studies/calculations for the services provided at the Site.

1.2 Scope and Limitations

This report: has been prepared by GHD for ASB Greenworld Ltd and may only be used and relied on by ASB Greenworld Ltd for the purpose agreed between GHD and ASB Greenworld Ltd.

GHD otherwise disclaims responsibility to any person other than ASB Greenworld Ltd arising in connection with this report. GHD also excludes implied warranties and conditions, to the extent legally permissible.

The services undertaken by GHD in connection with preparing this report were limited to those specifically detailed in the report and are subject to the scope limitations set out in the report.

The opinions, conclusions and any recommendations in this report are based on conditions encountered and information reviewed at the date of preparation of the report. GHD has no responsibility or obligation to update this report to account for events or changes occurring subsequent to the date that the report was prepared.

The opinions, conclusions and any recommendations in this report are based on assumptions made by GHD described in this report. GHD disclaims liability arising from any of the assumptions being incorrect.

Accessibility of documents

If this report is required to be accessible in any other format, this can be provided by GHD upon request and at an additional cost if necessary.

2. Site Description

2.1 Location

The Site has the municipal address of 2545 9th Line Road and is located roughly 500 metres (m) north of the intersection of Victoria Street and 9th Line Road Street in Metcalfe, Ontario which is within the City of Ottawa limits. The Site fronts onto 9th Line Road on the west side and is surrounded by agricultural and forest lands on all sides. The operational portion of the Site covers an area of approximately 14.3 hectares (ha) and is currently developed with several buildings and warehouses, and asphalt and gravel parking areas. The remainder of the Property is surrounded by agricultural fields and forested areas, for a total property area of approximately 40.1 ha.

A Site Location Map and a Site Plan are provided on **Figure 1** and **Figure 2**, respectively.

2.2 Site Characteristics

The Site is relatively flat with local topography sloping radially outward from the central developed area. Mapping indicates topographic relief is on the order of 10 m across the Site. Based on a review of historical aerial imagery, the built portion of the Site has been present at the Site since prior to 1976 with the majority of the current buildings being developed at that time. Buildings consist of an office building on the west side, vacant mushroom buildings, along the west and several operational buildings in the central part of the Site. Approximately 15 percent impervious cover consists of parking areas, driveway areas, and buildings, with the remainder of the Site consisting of approximately 85 percent pervious cover made up of crop lands, forests, lawns and vegetated fields.

Surface water from the Site is drained by an intermittent tributary to the North Castor River. The north branch of the tributary originates west of 9th line and flows through the north part of the Site, then south and leaves the property at the east part of the property. The south branch of the tributary appears to originate near the south part of the Site and flows east where it confluences with the north branch within an unevaluated wetland prior to flowing north along the east part of the Site.

Along 9th Line Road stormwater generally sheet flows over very gently sloped lawns towards 9th Line Road and is drained by road side vegetated swales north/south to the tributaries. Similarly on the north side stormwater sheetflows over lawn areas to the north branch of the tributary. Along the east side stormwater drains via sheetflow and then via some vegetated swales to the north tributary. Along the south side stormwater sheetflows over lawn areas to forest areas eventually to the south branch of the tributary.

3. Services Capacity

3.1 Water Supply

As part of GHD's Hydrogeological Assessment Report (dated December 8, 2022; also submitted with ZBLA application), GHD observed three drilled water supply wells on the Site to be used for ASB operations. Two drilled wells were located within well pits to the north of the office building (TW-1 and M-1; 0.2 m diameter wells) and one drilled well was located above grade within a pump house near the central storage building (TW-2; 0.15 m diameter well). The location of the three water supply wells is presented on **Figure 2**. A fourth water supply well was located to the east of the Donut Factory building on the northern portion of the Site, but was not assessed as part of this report.

It is understood that ASBs current proposed water usage will be for the office building (kitchen and bathrooms) and warehouse/storage buildings with no processing on-Site that would require water usage. Water usage would therefore be related to general cleaning, washroom or kitchen purposes. Staffing is proposed to consist of 2-5 employees to start with a potential of up to 10-15 employees. In reference to Section 8 of the Ontario Building Code, subsection 8.2.1.3. – Sewage System Design Flows, the water usage for a warehouse with 15 staff, three loading bays and 260 square metres (m²) of office space would be on the order of 2,550 litres per day (L/day). Design flows are conservative in nature with actual daily usage typically two to three times less.

Based on the results of the hydrogeological assessment (GHD, December 2022), the pumped water wells (TW-1 and TW-2) had sufficient water capacity as follows:

- TW-1 | After 6 hours of pumping at a rate of approximately 26.5 litres per minute (L/min), the maximum drawdown was about 2.4 m over the course of the testing with about 37.0 m of available drawdown remaining above the bottom of the well. Approximately 6 percent of the available drawdown was used during the pumping test. Recovery measurements were collected manually for 60 minutes after pumping ceased, with the water level recovering approx. 65 percent in 1 hour and approx. 80 percent in 24 hours. The estimated transmissivity of the pumped water well was 33.6 m²/day based on the drawdown and 12.0 m²/day based on the recovery period and represents a moderate transmissivity. The specific capacity for this well is calculated to be 11.1 L/min/m based upon the pumping test completed.

- TW-2 | After 6 hours of pumping at a rated of approximately 26.5 L/min, the maximum drawdown was about 0.5 m over the course of the testing with about 88.3 m of available drawdown remaining above the bottom of the well. Approximately 0.5 percent of the available drawdown was used during the pumping test. Recovery measurements were collected manually for 60 minutes after pumping ceased, with the water level recovering approximately 76 percent in 1 hour and fully recovered 100 percent in 4 hours and 50 minutes. The estimated transmissivity for TW-2 was 83.9 m²/day based on the drawdown and 186.5 m²/day based on the recovery period and represents a high transmissivity. The specific capacity for this well is calculated to be 52.9 L/min/m based upon the pumping test completed.

3.2 Fire Water Supply

The Site is serviced with an approximately 200 cubic metre (m³) (200,000 L) concrete basin inside the Fire Water Building located in the centre of the Site (refer to Figure 2). Water for the basin is supplied from water supply well TW-2, with an assumed pumping capacity of 75 L/min. Assuming a typical fire truck can spray approximately 950 to 3,785 L/min, the estimated time before the basin would empty is approximately 3.8 to 0.9 hours.

3.3 Septic System

The Site is serviced with existing traditional septic tanks/pump chambers and subsurface disposal beds. It is understood that two septic systems are located on the Site, with one located to the north of the office building and the second located east/southeast of the former mushroom building. The septic systems were inspected by a licensed contractor, Green Valley Environmental (GVE), with their findings presented in a letter report dated October 25, 2022 (refer to **Appendix A**), with applicable notes referenced below. GHD also contacted the Ottawa Septic System Office (OSSO) which provided septic records for the Site (**refer to Appendix B**).

Office Building Septic System

Regarding the Office Building septic system, GVE indicated that the septic bed was in good condition (no bio-mat build up or standing water found), and consisted of four runs of 30 m for a total of 120 m of piping. GVE indicated that the septic tank was found to be approximately 3,600 L in capacity with a significant amount of gravel within the tank as there was a missing lid and that the septic tank needs interior repairs and new lids. A pump chamber with approximately 750 L in capacity was also located near the septic tank and was reported to be in poor condition. GVE could not confirm whether the pump chamber was connected to the septic system.

The following are design considerations for a septic system to support an office/warehouse operation with three loading bays, 10-15 employees, and an office area of 260 m².

Design flow is based on:

Three Loading Bays at 150 L per loading bay: **450 L**

And the greater of:

15 Employees at 75 L per employee (no showers) 1,125 L

or

Office Space 260 m² at 75 L per 9.3 m² **2,100 L**

Resulting in a total design flow of **2,550 L.**

1. Sizing of the septic tank:

Based on a design flow of 2,550 L, a minimum tank size of 7,650 L would be required (tank sizing for non-residential is three times the design flow). The current septic tank size of 3,600 L is undersized, so it is recommended that a 9,000 L tank (commonly manufactured size) be installed to meet the minimum requirements.

2. Sizing of the leaching bed with septic tanks as a treatment unit:

The current septic bed at the Site office building has 120 m of piping and appears to be a raised bed compared to surrounding topography and observations made by GVE. Sizing of the leaching bed is dependent on the percolation rate (T time) of the receiving soils. Based on the OSSO documents received, a Draft "Terrain and Hydrogeological Assessment, Proposed Replacement Septic Sewage Disposal Systems, Continental Mushroom Corp. (1989) LTD" by Golder Associates dated 1996 was reviewed by GHD, with the office building septic bed design considerations including "the fully raised bed will consist of silty sand with an in place, long term percolation rate of approximately 10 minutes per centimetre". Additional information would be required regarding the actual construction of the septic bed to confirm whether it is a fully raised bed and the T time of the underlying imported soils.

Based on a T time of 10 min/centimetre (cm), the bed is slightly undersized:

- $L = QT/200$ assuming $T = 10$ min/cm.
- $L = 2,550 * 10/200 = 127.5$ m.

Should a larger septic bed be required (due to future development, increased staffing, and/or compliance with the Ontario Building Code), the current bed location is restricted due to setbacks from the property boundary and the onsite water supply wells, so an alternative location for a traditional septic bed would need to be considered. The following setback distances need to be considered during any future design of the septic system:

- 15 m from a drilled water supply well, 30 m from a shallow dug well.
- 3 m from property boundary.
- 1.5 m from structure.
- 15 m from lake, pond or stream.

Alternatively, a tertiary treatment system along with a shallow buried trench bed may assist with meeting the setback requirements.

Former Mushroom Building Septic System

The second septic system is dedicated to the former Mushroom Building and consists of two septic tanks to the east of the building (connected to two separate bathrooms) and a septic bed to the southeast of the building. The septic tanks had broken concrete lids and inside walls, and the partition walls were rotted. ASB is not intending to use the Former Mushroom Building and associated bathrooms at this time, and upon future demolition of the building these septic tanks should also be decommissioned. Septic system needs for future development will be planned/approved as required.

3.4 Stormwater

The management of stormwater under current conditions is described in Section 2.2 above. The majority of the site drainage flows over large tracts of pervious lawns/agricultural lands and swales prior to entering intermittent tributaries that flow through the Site. Stormwater drainage patterns and amounts are anticipated to have remained similar to present conditions for several decades. As the majority of the Site is pervious and drainage patterns and stormwater quantity will remain the same as it has for decades and the receiving watercourses flow through several low-lying areas, we anticipate no concerns with stormwater servicing capacities.

Water quality is anticipated to be of good quality as the majority of the operations will involve inside storage of materials. The minor amounts of road wear from trucks and loading equipment is anticipated to be managed with flow over existing lawns and vegetated swales, which will remove the majority of any particulates in the stormwater.

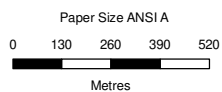
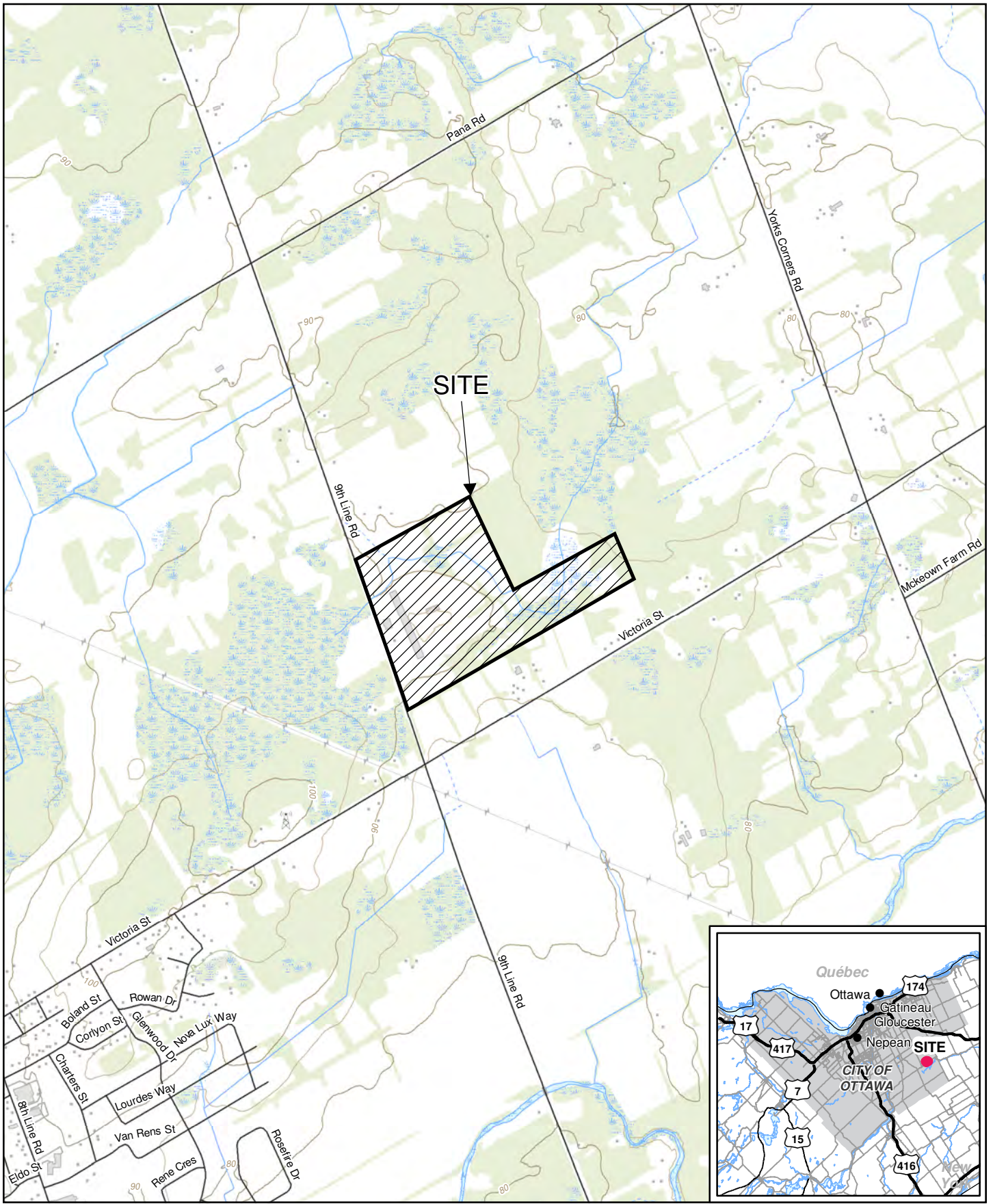

Map Projection: Transverse Mercator
 Horizontal Datum: North American 1983
 Grid: NAD 1983 UTM Zone 18N

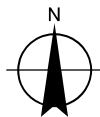

ASB GREENWORD LTD.
 2545 9TH LINE ROAD, METCALFE, ONTARIO

Project No. 12586015
 Revision No. -
 Date Dec 15, 2022

SITE LOCATION MAP

FIGURE 1



Legend

- Well Location
- Site Boundary
- Intermittent Watercourse
- Permanent Watercourse
- Wetland (CWI Database)

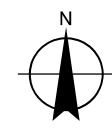
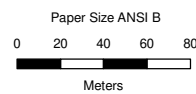

Map Projection: Transverse Mercator
 Horizontal Datum: North American 1983
 Grid: NAD 1983 UTM Zone 18N



ASB GREENWORD LTD.
 2545 9TH LINE ROAD, METCALFE, ONTARIO

Project No. **12586015**
 Revision No. -
 Date **Dec 15, 2022**

SITE PLAN

FIGURE 2

Appendices

Appendix A

**Green Valley Environmental Septic
Inspection**



October 25, 2022

Re: Septic System Inspection Report

Property: 2545 9th Line Rd, Metcalfe, ON K0A 2P0

Dear Joseph Draper,

Further to your request, this firm has carried out septic tank pump-out and an evaluation of the existing sewage systems servicing the Office building and the Mushroom building. The purpose of these work has been to carry out a field investigation to determine the current condition of the sewage systems, to visually inspect the disposal field area, pump chamber, septic tanks and to report on any unsafe conditions and/or signs of any systems failing.

Attached is a report on each of the systems servicing the Office building and Mushroom building. The systems are identified as per attached site layout labeled by GHD. Summary of findings as follows:

Office Building Septic System: Here, septic system consists of septic bed with 4 runs of 30m each, septic tank is 800gal (3600L) and pump chamber (200 gal) with pump. Four test holes were dug on the septic bed and as per our findings, there was no bio-mat build up found and no standing water found which means the septic bed condition is good. Septic tank was pumped-out at the time of inspection and it was filled with gravels on the bottom. Septic tank needs a repair and needs risers/lids. Pump chamber connection to the septic bed is unknown and needs a new pump if it is connected to the septic bed. The existing septic system is not to the current building code as the daily design flow of the Office Building (assuming 15 employees and 1200 sq. m. of floor space) is 9675 L/day and it will need an 11,500 L septic tank along with the treatment unit, pump chamber with pump, distribution box and a shallow buried trench bed with 12 runs of 28.34m each (assuming the soil type is Clay) to meet the building code requirements. See sketch #1 on the inspection report and images of existing septic system attached to it.



Green Valley Environmental Inc.

Mushroom Building: Here, septic system consists of two septic tanks (1000gal and 800gal) and a septic bed. Septic tanks were pumped-out at the time of inspection. Septic tanks had broken concrete lids, inside walls and partition walls are rotted. It is recommended to have the septic tanks replaced with new ones and meet the current building code requirements. Septic bed was not inspected as per the instructions provided at the time of inspection. The daily design flow of the Mushroom Building (assuming 5 water closet and 4 loading bays) is 5350 L/day and it will need a 6000 L (or two 3600L) septic tank/s along with the treatment unit, pump chamber with pump, distribution box and a shallow buried trench bed with 7 runs of 26.16m each (assuming the soil type is Clay) to meet the building code requirements.

Regards,

Davis Patel

Qualified Septic System Designer

(BCIN: 119685)



SKETCH - 2

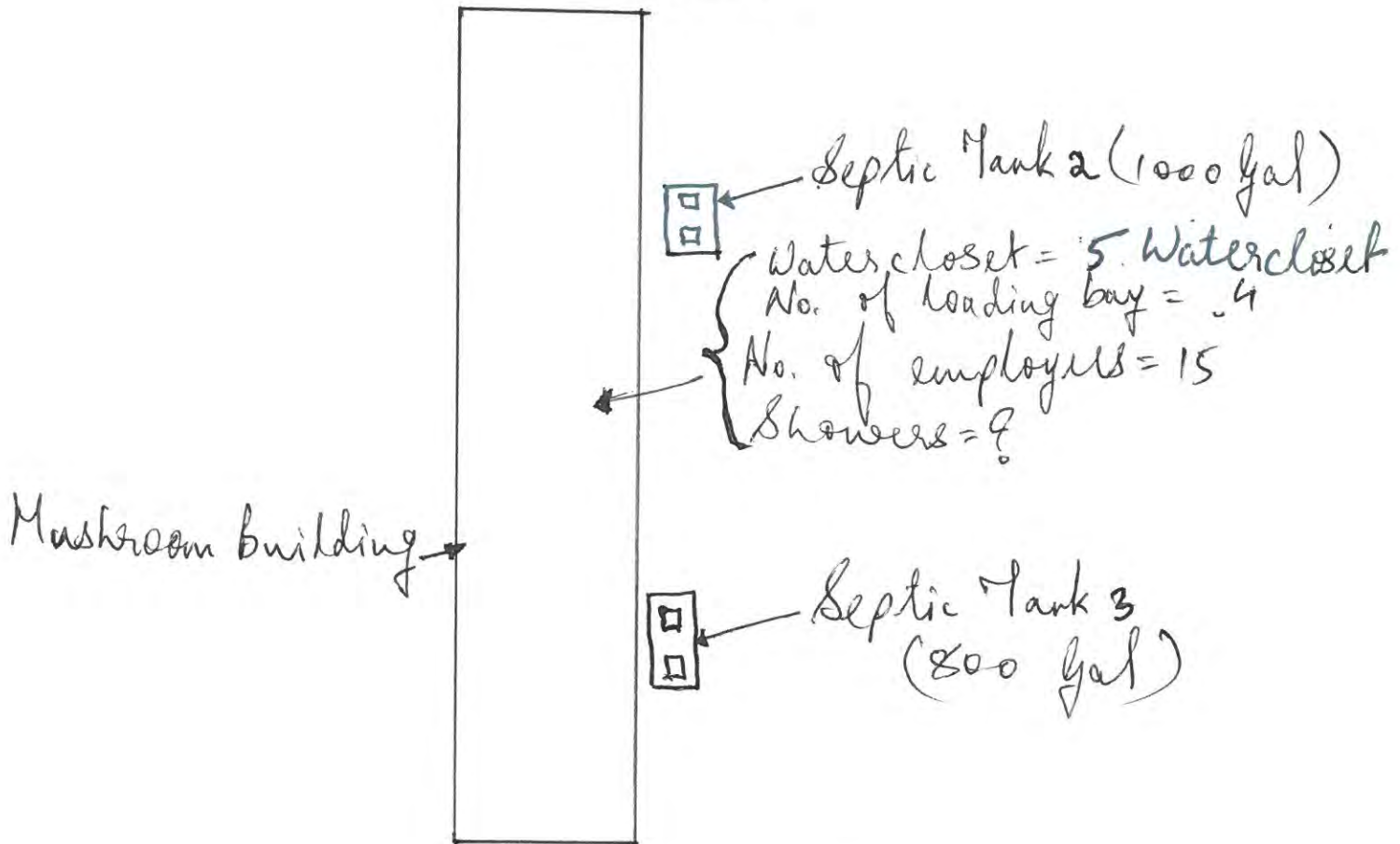

TESTHOLE DESCRIPTION

- * Septic Tanks 1 & 2 : Not good condition.
- * Septic tanks are rotted from inside and broken lids. Needs replacement.



SKETCH - 1

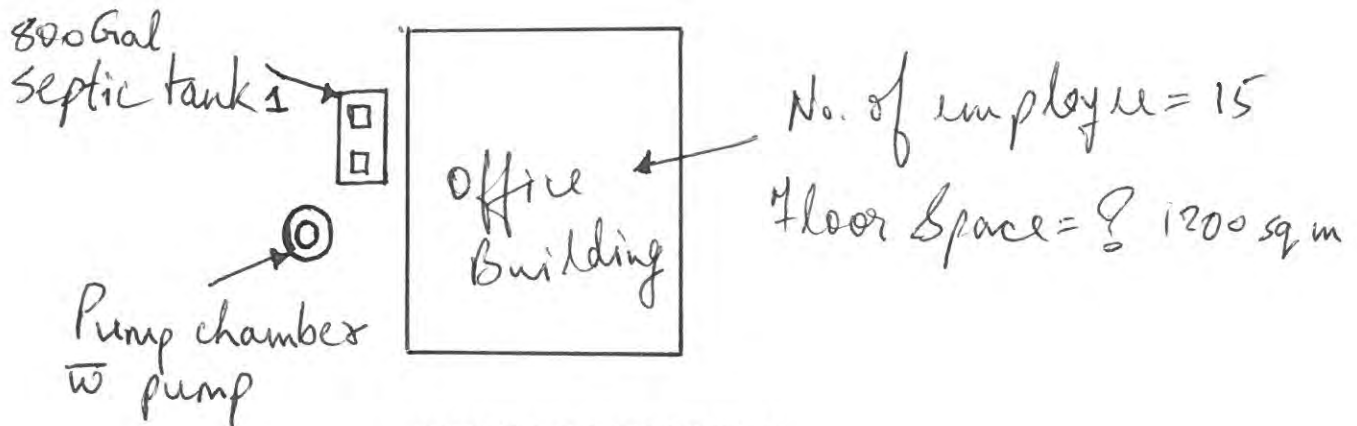
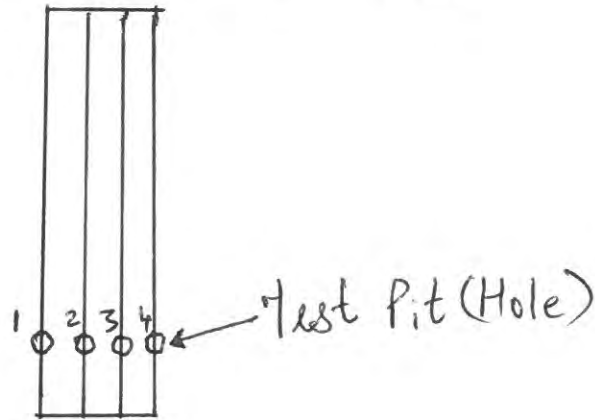

TESTHOLE DESCRIPTION

- * 1, 2, 3, 4 — Test holes looks good. No bio-mat found
- * Septic Tank needs repair on the inside and new risers and lids required.
- * Pump Chambers not in good condition.
Unknown connection of the pump chamber/pump to the septic Bed.



2545 9TH LINE RD

A3

A0

A1

A2

SEPTIC BED

SEPTIC TANK & PUMP CHAMBER

OFFICE BUILDING

MUSHROOM BUILDING

SEPTIC TANK 1000gal

SEPTIC TANK 800gal

373.05m
1284.26m

110.63m
335.72m

463.50m
1530.24m

388.60m
1204.51m

COM 1
LGT 40

COM 2
LGT 40

40m

-8399644.789 5661403.575 Meters

















Appendix B

Ottawa Septic System Office Documents



File Search Reply – Match Found

Information per applicant

To: Steve Gagne **Date:** December 14, 2022
Email: steve.gagne@ghd.com **Phone:** 705-768-6350

From: Ottawa Septic System Office
Phone: 613.692.3571 – Press “4” for the Septic office
Email: septic@rvca.ca

Follow up INQUIRIES Please Reference:		FS-22-169
		Archive file(s) 95-310
Civic Address:		2545 9 th Line Road
Former Township:		Osgoode
Property Owner Last Name:		12586015
Lot 19&20	Con: 9	Part: 2 Plan: 5R3469
	Septic system designed per the attached records for:	Real estate feature listing obtained via the internet:
Bedrooms	0	
Bathrooms	8 Toilets 1 urinal 7 sinks	
Square M	32 workers	

Attachment(s):

- As-Built Drawings
- Permit
- Use Permit (Certificate of Completion)

The foregoing information is given for your convenience only. Supplementary requests are necessary for conformity with other legislation such as flood plain or shoreline works. It should be clearly understood that you must satisfy yourself as to whether the premises and the existing or proposed use thereof is or would be in conformity with all applicable regulations. For further information please contact the Ottawa Septic System Office staff at the number listed above. Thank you for contacting the Ottawa Septic System Office.

Part 8 Inspector: Alex Dekleine

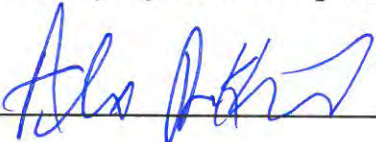

Permit List

Permit

Application Number	Appl Date	Application Type	Permit Number			Issued Date	St#	Street
010624	00- -0000	Construction	OS010624	N	N	20-OCT-1999		2545 9TH LINE
010675	00- -0000	Construction	OS010675	N	N	20-DEC-1999		2545 9TH LINE
011121	01-JAN-2001	Construction	OS011121	N	N	03-JAN-2001		2545 9TH LINE
95-307	02-NOV-1995	Sewage System	95-307	N	N	00- -0000		2545 9TH LINE
95-310	24-MAR-1995	Sewage System	95-310	N	N	26-JUN-1996		2545 9TH LINE
A04-004845	20-MAY-2004	Construction	0404913	N	N	15-JUN-2004		2545 9TH LINE
A04-005712	08-JUN-2004	Construction	0407447	N	N	24-AUG-2004		2545 9TH LINE
A08-001197	11-MAR-2008	Construction	0802107	N	N	17-APR-2008		2545 9TH LINE
ARC21-3792	00- -0000	Road Cut	RC213697	N	N	04-OCT-2021		2545 9TH LINE
FS-18-235	13-NOV-2018	Sewage System	FS-18-235	N	N	00- -0000		2545 9TH LINE
FS-22-169	12-DEC-2022	Sewage System	FS-22-169	N	N	00- -0000		2545 9TH LINE
RC041759	00- -0000	Road Cut	RC041759	N	N	28-FEB-2008		2545 9TH LINE

Municipal Address - 2545 9TH LINE RD - Osgoode - RURAL AREA

Property Address	First Name	
2545 9TH LINE RD	LAND MAN INC	CON 9 PT LOTS 19 & 20 RP,5R-3469 PART 2
2545 9TH LINE RD	HAY MAN INC	CON 9 PT LOTS 19 & 20 RP,5R-3469 PART 2
SEE OWNER	SEE OWNER	

Assessment - 061470005518901

Assessment Roll Number: 061470005518901 Previous Roll Number: 060100005518901

Property / Tenant Address: 2545 9TH LINE RD

Legal Description: CON 9 PT LOTS 19 & 20 RP,5R-3469 PART 2

Unit School Support: P Mailing Address: 8719 VICTORIA ST METCALFE ON KC

Business School Support:

Property Code: 230 Homogeneous Neighbourhood: 666 Equalization: Unit Class:

Municipal Ward: 20 Create Date: 20001020 Realty Tax Class:

Municipal Poll: 10 Number of Structures: 9 Business Tax Class:

Municipal Poll Suffix: 1 Names Per Roll Number: 2 Business Percent:

Mill Rate: Subordinates Per Roll Number: 2 Tenant Tax Liability:

Assessor Neighbourhood: Property Class: Partnership Code:

School Code: Change Date - Subordinate: Publicly Traded:

Change Date - Primary: 20220811 Prime/Subordinate: 0000

Message Text:

Name: LAND MAN INC

Assessment Assessed Values Assessment Summary Municipal Address (Assessment) Parcel (Assessment) Sale Site Soil Structure

Assessment - 061470005518901

Sequence Number	Structure Code	Code Description
6	203	
5	203	
4	204	
3	216	
2	204	
1	509	
7	204	
8	229	
9	508	

Farm - New

Structure Code	203	Height	1.8
Sequence Number	6	Diameter	
Year Built	1975	Doors Square Feet	
Year Built Code	N	Exterior Indicator	CS
Effective Year	1975	Insulation Type	
Condition Indicator	A	Floor Indicator	C
Full Storeys	1	Roof Indicator	G
Ground Floor Area	37654	Doors Type	
Rateable Area	37654		
Farm Operation Code	19		
Structure Quality	5		

Farm - New

Structure Code	203	Height	1.6
Sequence Number	5	Diameter	
Year Built	2000	Doors Square Feet	
Year Built Code	E	Exterior Indicator	CS
Effective Year	2000	Insulation Type	
Condition Indicator	A	Floor Indicator	C
Full Storeys	1	Roof Indicator	G
Ground Floor Area	9600	Doors Type	
Rateable Area	9600		
Farm Operation Code	19		
Structure Quality	5		

Farm - New

Structure Code	204	Height	1.8
Sequence Number	4	Diameter	
Year Built	1973	Doors Square Feet	
Year Built Code	N	Exterior Indicator	CB
Effective Year	1973	Insulation Type	
Condition Indicator	A	Floor Indicator	C
Full Storeys	1	Roof Indicator	F
Ground Floor Area	7881	Doors Type	
Rateable Area	7881		
Farm Operation Code	19		
Structure Quality	6		

Farm - New

Structure Code	216	Height	1.6
Sequence Number	3	Diameter	
Year Built	1973	Doors Square Feet	
Year Built Code	N	Exterior Indicator	CB
Effective Year	1973	Insulation Type	
Condition Indicator	A	Floor Indicator	C
Full Storeys	2	Roof Indicator	G
Ground Floor Area	1677	Doors Type	
Rateable Area	1677		
Farm Operation Code	19		
Structure Quality	6		

Farm - New

Structure Code	204	Height	1.8
Sequence Number	2	Diameter	
Year Built	1973	Doors Square Feet	
Year Built Code	N	Exterior Indicator	CS
Effective Year	1973	Insulation Type	
Condition Indicator	A	Floor Indicator	C
Full Storeys	1	Roof Indicator	S
Ground Floor Area	4177	Doors Type	
Rateable Area	5854		
Farm Operation Code	19		
Structure Quality	6		

Commercial - New

Structure Code	509	Building Height	1.6
Sequence Number	1	Basement Finished Area	
Construction Character		Heat Type Indicator	NO
Quality Indicator	6.5	Air Conditioning Indicator	N
Shape Indicator	A	Effective Year	1986
Year Built	1986	Part Storeys	0
Build Year Code	N	Ground Floor Area	0
Condition Indicator	A	Unit Number	
Full Storeys	1	Basement Area	
Total Area	10560		
Estimated Character Quality			

Farm - New

Structure Code	204	Height	1.4
Sequence Number	7	Diameter	
Year Built	1975	Doors Square Feet	
Year Built Code	N	Exterior Indicator	CS
Effective Year	1975	Insulation Type	
Condition Indicator	A	Floor Indicator	C
Full Storeys	1	Roof Indicator	G
Ground Floor Area	6970	Doors Type	
Rateable Area	6970		
Farm Operation Code	19		
Structure Quality	6		

Farm - New

Structure Code	229	Height	1.6
Sequence Number	8	Diameter	
Year Built	2005	Doors Square Feet	
Year Built Code	N	Exterior Indicator	PC
Effective Year	2005	Insulation Type	
Condition Indicator	A	Floor Indicator	C
Full Storeys		Roof Indicator	S
Ground Floor Area	12800	Doors Type	
Rateable Area			
Farm Operation Code	19		
Structure Quality	2		

Commercial - New

Structure Code	508	Building Height	2.6
Sequence Number	9	Basement Finished Area	
Construction Character		Heat Type Indicator	NO
Quality Indicator	4	Air Conditioning Indicator	N
Shape Indicator	A	Effective Year	2005
Year Built	2005	Part Storeys	0
Build Year Code	N	Ground Floor Area	0
Condition Indicator	A	Unit Number	
Full Storeys		Basement Area	
Total Area	18000		
Estimated Character Quality			

Contraventions - Could not generate description

Seq Number	1
Compliance Date	21-DEC-2012
Reference & Section	18 B.C. A.
Test and Sample Required	Provide letter from structural engineer confirming that settlement of soils supporting structure is within tolerable limits allowed by 2006 ontario building code and that settlement will not be detrimental to building structure. (Refer to soils consultant letter by Golder Associates - project 03-1120-0204 dated Feb. 25, 2009 regarding supporting soils)
Amended Compliance Date 1	00- -0000
Amended Compliance Date 2	00- -0000
Amended Compliance Date 3	00- -0000
Date Complied	00- -0000

Municipal Address - 2545 9TH LINE RD - Osgoode - RURAL AREA

Application Number	Application Type	Date	Brief Description
PC2022-0142	Pre-App Consultation	25-MAY-2022	Proposal to re-use the existing facilities, previously used for a mushroom growing operation, to
PC2018-0107	Pre-App Consultation	18-APR-2018	Production of cannabis fresh, dried and oil, packaging of cannabis, storing cannabis products
05-Jan-005	Compliance	04-JAN-2005	
D06-03-22-0121	Historical Land Use Inv.	07-JUL-2022	HLUI

Application Form And Certificate Of Approval For A Class 2 - 6 Sewage System

Do not complete shaded areas

Application No. 8219620-9/310
Fee Receipt No. 0440
Date Received JUN 24 1995

Personal information contained on this form is collected under the authority of the Environmental Protection Act, Part VIII. It is used to facilitate the issuance of a Certificate of Approval as prescribed in Section 77 of the Act. Questions should be directed to the Ministry's District Office in your area.

1. Name and mailing address (number, street, city, town, etc.) of owner CONTINENTAL MUSHROOM CORP (1994) 2595 9th LINE RD METCALFE, ONT K0A 2P0 Tel. no. (613) - 821 1411 Alternate Tel. no. (613) - 821 1262	2. Name and address (number, street, city, town, etc.) of installer TO BE DETERMINED Tel. no. () -
---	--

3. Propose to INSTALL a Class 4 sewage system to serve FARM OFFICE BLDG.
(construct, install, alter, extend, enlarge) (facility: e.g. single family dwelling, motel, etc.)

4. Property location	Region/County/District OTTAWA	Ward, Township, Town OSGOODE TWP	Lot No. 19+20	Conc. No.	Sub Lot No.	Plan No.	Area of lot (m ²) 100 ACRES
----------------------	---	--	-------------------------	-----------	-------------	----------	---

5. State number of	Bedrooms/motel units	People	Flush toilets	Urinals	Washbasins	Showers & bathtubs	6. Water supply	
		32	8	1	7		<input type="checkbox"/> Proposed or <input checked="" type="checkbox"/> Existing	<input type="checkbox"/> Dug or bored well <input checked="" type="checkbox"/> Drilled well <input type="checkbox"/> Municipal
Total fixture units	Assessment Roll No.							
48.5	0601 000055 18901							

7. Attach completed sketch on Page 2. List other attachments.
GOLDER REPORT 961-2731

8. Relationship to severance (if applicable)	9. Directions to lot (Highway No., secondary roads, signs to follow, etc.)
<input type="checkbox"/> Lot approval pending <input type="checkbox"/> Lot approved, under Severance Application No.	HWY 31 to RR#6 EAST ON RR#6 to 9th LINE RD, NORTH ON 9th LINE FOR 0.5 km - Sign - CONTINENTAL MUSHROOM

10. I certify that the above information is complete and correct and that, if approved, the work will conform with Provincial requirements for sewage systems and local Municipal By-laws.

Name and address of agent (if agent is completing this form) - number, street, city, town, etc.	Signature of owner or agent (if agent is completing this form)
FOR CONTINENTAL MUSHROOM. R. J. Golder 1794 Courtwood Cir. Ottawa Ont.	
Tel. no. (613) 229-5928	Date June 26/96

11. Inspector's Report

Inspection time and date 1:30 <input type="checkbox"/> A.M. <input checked="" type="checkbox"/> P.M. JUNE 3 , 19 96	Sub-surface conditions encountered Rock & G.W.T. Depth (m) Soil type 0 REFER TO 0.25 ENGINEERING 0.50 REPORT: 0.75 GOLDER ASSOCIATES 1.00 FILE: 961-2731 1.25 JUNE 1996 1.50
Weather SUNNY	Representing owner _____ Leaching bed design criteria Depth to rock _____ m. Design H.W.T. _____ m.
Length of distribution pipe 120 metres	Working capacity of septic/holding tank EXISTING litres
Requirements <input checked="" type="checkbox"/> Conditions of approval and reasons (e.g. fill, grading, drainage improvements, design sewage flows) or <input type="checkbox"/> Reasons where proposal not acceptable (add additional pages, if required) SEE APPENDIX "G"	

OFFICE COPY

12. LOT DIAGRAM AND SEWAGE SYSTEM PLAN: Draw to scale indicating north point and showing:
- (a) Location of sewage system components (eg. tanks, leaching bed). Locate and show horizontal distances from system to adjacent existing or proposed buildings, water supplies (including neighbours), existing on-site sewage systems, driveways, property lines, lakes, rivers, water courses, swimming pools.
 - (b) Lot dimensions, topographic features (e.g. swamps, steep slopes) near system.
 - (c) If any part of proposal conforms to specific standard drawing, give reference number(s).

① INSTALL AS PER ENGINEERING DRAWINGS,
 961-2731 (FIGURE 2) MAY 1/96
 961-2731 (FIGURE 3) MAY 1/96
 GOLDBER ASSOCIATES.

② INSTALLATION TO BE SUPERVISED AND CERTIFIED BY A CONSULTING ENGINEER.

A Certificate of Approval for this application is refused for the reasons given in Section 11 Page 1

Inspected and Recommended by	Refused	Date
Director		
CERTIFICATE OF APPROVAL		
Application approved and this Certificate of Approval under Section 77 of the Environmental Protection Act is hereby issued for the proposal outlined on Pages 1 and 2 of the application and its attachments as amended by the requirements and conditions of Section 11 provided that the sewage system shall be completed and a Use Permit issued within 12 months of the issue hereof or such extended period as the Director on application allows. DO NOT OPERATE THE SYSTEM UNTIL A USE PERMIT IS ISSUED.		
Inspected and Recommended by	Issued	Date
Director		

Under Section 139 of the Environmental Protection Act, an applicant may appeal a decision by writing to the Director and to the Environmental Appeal Board, 112 St. Clair Avenue West, Suite 502, Toronto, Ontario, M4V 1N3 within 15 days of receipt of the decision.

APPENDIX "C"

- install as per lot diagram page 2 and typical drawing "___"
- appendix "G" must be completed and returned prior to the installation inspection
- appendix "B" (filter medium) and weight bills must be completed and returned prior to the installation inspection
- Refer to Pumping requirements here attached
- Refer to Holding tank (Class 5) requirements here attached
- Trees within _____ metres of the leaching bed must be removed (Silver Maples, Willows: 8 metres min. → Others: 6 metres min.)
- Inlet and outlet of the septic tank must be sealed properly to ensure a watertight connection.
- After the mandatory installation inspection and prior to the issuance of a Use Permit:
 1. The leaching bed and septic tank must be covered.
 2. The mantles (if required) must be in place and all conditions of the Certificate of Approval must be met.
 3. Three (3) holes, from an outside corner to another (in a diagonal) must be provided. The openings must expose the paper or gravel on top of the distribution pipes.
 4. The four (4) corners of the bed must be staked.
- install as per Engineering Drawing(s) Number

Drawing No.	Date	Company/Consultant
961-2731 (FIG 2)	MAY 1/96	GOLDER ASSOCIATES
961-2731 (FIG 3)	MAY 1/96	GOLDER ASSOCIATES

• installation to be supervised by a consulting engineer with written certification that the system is installed as per Ontario Regulation 358 and the Certificate of Approval (indicate Certificate of Approval N°).

JUNE 26/96
Date

Terry Davidson
Designated Director
Part VIII

APPENDIX "G" PRIVATE SEWAGE DISPOSAL SYSTEM INSTALLER'S AS BUILT REPORT

NOTE: The Use Permit Inspection will not be initiated until the approving Authority receives this report completed in full.

Permit #: 82(19&2079) 310 Applicant's Name: _____

Installed By: _____ Date of Installation: _____

NOTE: The following must be detailed on the back of this sheet as per the example below.

- | | |
|--------------------------|--|
| 1. structure | 6. mantle extension(s) |
| 2. well – dug or drilled | 7. pump chamber & distribution box (if applicable) |
| 3. property lines | 8. elevation of tile obvert (top of tile) at 4 outside corners |
| 4. septic tank | 9. original grade elevation reference on Certificate of Approval (3 areas outside of fill mantle area to be shown) |
| 5. tile bed (show runs) | |

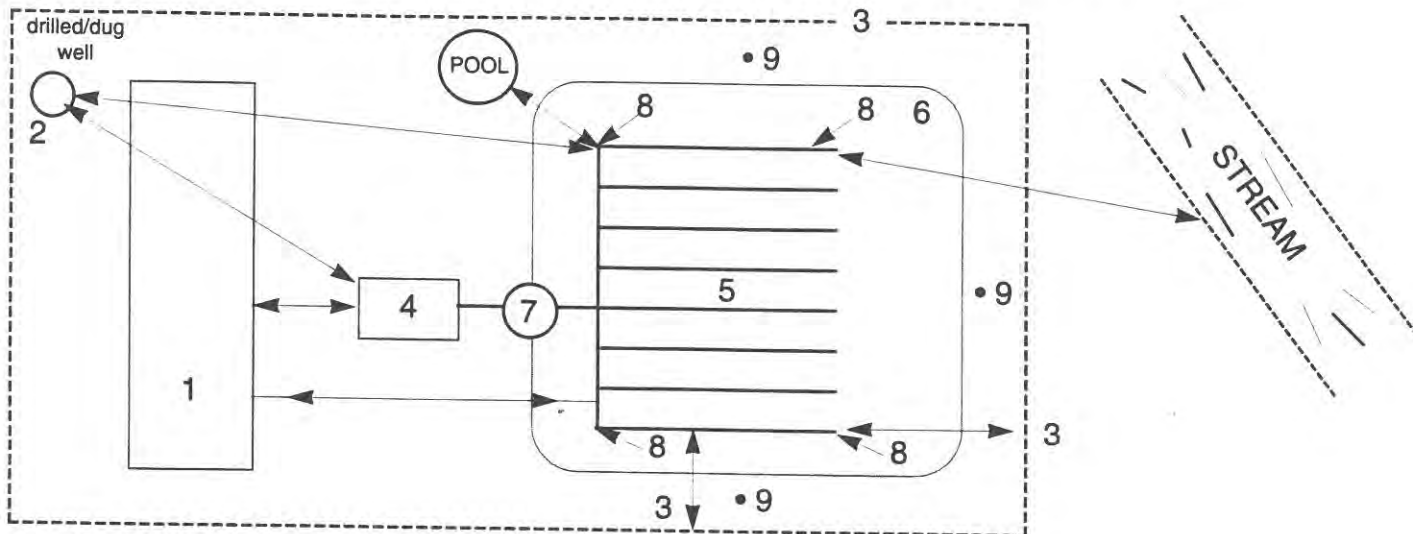

Septic Tank Volume: _____ Litres Diameter of Tile: _____

Septic Tank manufactured by: _____ Runs of _____ Metres each

Estimated "T" time of imported fill _____ min./cm.

The following measured horizontal distances must be shown in metric to the nearest centimetre:

- septic tank & tile bed to any well within 35 metres
- septic tank and tile bed to structure that is being serviced
- tile bed to any structure (including pools, driveways) if less than 10 m.
- tile bed to property lines. If greater than 15 m. show > 15 m.
- tile bed and septic tank to stream/municipal/water body if applicable

NOTE: Before submitting this report, the applicant or agent must ensure the following conditions have been met:

- 1) The well is installed;
- 2) The immediate area surrounding the tile bed or filter bed is free of excavated impermeable material (i.e.) clay, silt);
- 3) The permeable, backfill required between the trenches and the finished grade and the material needed to establish the mantle (if requested) is adjacent to the system.

I hereby certify that the septic tank system as described in this report was installed in accordance with the Regulations and the Certificate of Approval No. _____.

Property Owner's Signature

Installer's Licence #

Installer's Signature

Ottawa-Carleton Septic System Office Bureau des systèmes septiques d'Ottawa-Carleton

Installation Report • Rapport d'installation

Certificate of Approval No: 82(1930-9)310 Weather: SUNNY
 Name of Owner: CONTINENTAL MUSHROOM Representing Owner: _____
 Date: AUGUST 9/96 Time: 11:05 AM Installer: DAW MORRIS

*Well must be installed prior to the issuance of a Use Permit

Section A Class 4 & 4 F.M.	Septic tank/holding tank : <u>EXISTING</u> Make and model: _____ <input type="checkbox"/> steel <input checked="" type="checkbox"/> concrete <input type="checkbox"/> fiberglass <input type="checkbox"/> on-site <input checked="" type="checkbox"/> prefabricated Inlet: _____ Outlet: <u>SEAL</u> Lids: _____ Baffles: _____	Other: _____ Distance: _____ Sketch: (if not installed as per C. of A.) _____
Section B Leaching Bed	Location: <u>SIDE YARD</u> Type: <u>CLASS 4</u> Height: <u>OK</u> Header: <input checked="" type="checkbox"/> level Runs: <u>4</u> Length: <u>30m</u> Gravel Size: <u>3/4</u> Thickness: <u>OK</u> Paper: <input checked="" type="checkbox"/> yes <input type="checkbox"/> no Slopes: _____ Ends capped: <input type="checkbox"/> yes <input type="checkbox"/> no Interconnect <input checked="" type="checkbox"/> <u>NOTE</u> Pipes: Diameter <input checked="" type="checkbox"/> 3 inch <input checked="" type="checkbox"/> 4 inch Make: <u>PVC-ROYAL</u>	Distances: _____ Structure(s): _____ House: _____ Lot Lines: _____ Wells*: <u>OK</u> Watercourses: _____ Tree: _____ Between Trenches: <u>1.6m</u> Mantles: _____ metres in _____ direction(s) thickness: _____ Elevations: (if required) _____ Header: _____ Ends: _____
Section C Class 6 only	Audible & visual failure warning alarm installed <input type="checkbox"/> yes <input type="checkbox"/> no	<input type="checkbox"/> Proprietary aerobic sewage treatment plant: _____
Section D Sections A, B & C	<input type="checkbox"/> pump chamber <input type="checkbox"/> pump present <input type="checkbox"/> floats installed <input type="checkbox"/> electrical wiring <input type="checkbox"/> alarm	<input type="checkbox"/> forced main: <input type="checkbox"/> check valve <input type="checkbox"/> frost protection installed <input type="checkbox"/> joints sealed properly <input type="checkbox"/> other: _____
Section E Section A, B & C	Distribution Box <input type="checkbox"/> sealed joints <input type="checkbox"/> baffle or other <input type="checkbox"/> level <input type="checkbox"/> compacted base <input type="checkbox"/> frost protection number of outlets: _____	Diagram: _____
Section F Class 5 only	Audible & visual failure warning alarm installed <input type="checkbox"/> yes <input type="checkbox"/> no	<input type="checkbox"/> prefabricated <input type="checkbox"/> poured on-site
Section G Class 2 & 3 only	Side wall Construction: _____ Cover Construction: _____	Minimal 0.6 metre of earth for : Sides: <input type="checkbox"/> yes <input type="checkbox"/> no Bottom: <input type="checkbox"/> yes <input type="checkbox"/> no

Picture(s) taken For re-inspection, call 692-0160 or 1-800-459-5975. Please ensure that ALL noted deficiencies have been rectified prior to calling for a re-inspection.
 Passed Not Passed (see remarks)
 Inspected by: TERRY K. DAVIDSON
 Remarks: SEAL OUTLET OF TANK
MANTLE TO BE COMPLETED.

Ottawa-Carleton Septic System Approvals Bureau des systèmes septiques d'Ottawa-Carleton

Final Grading Inspection

OVERCAST

Applicants Name: CONTINENTAL MUSHROOM
 Applicants #: 82(19820-9)310 Date: NOV 1 / 96 Time: 2:50 PM
 Present on site: BRIAN STRATON & DAN MORRIS
 Inspector: TERRY K. DAVIDSON Date: _____

- 1) Is the finished elevation at the correct elevation relative to the reference grade (refer to Bench March on Certificate of Approval)? OK
- 2) Depth of cover measured from the top of the crushed stone layer.
 $X_1 =$ 42 $\text{ cm} \quad X_2 =$ 38 $\text{ cm} \quad X_3 =$ 40 $\text{ cm} \quad \text{Photograph taken: } \underline{\hspace{2cm}}$
- 3) Description of type of earth cover measured from the top of the distribution pipes. SAND + TOPSOIL
- 4) Is the top of the bed shaped to shed water? yes no
- 5) Is the side slope visible? yes no
- 6) Length of Mantle:
 $L_1 =$ _____ $\text{ m} \quad L_2 =$ _____ $\text{ m} \quad L_3 =$ _____ $\text{ m} \quad L_4 =$ _____ m
- 7) Does the depth of mantle (D) exceed .25m? yes no
- 8) Description of mantle material: _____

- 9) If required, was frost protection placed over the

i) septic tank	<input type="checkbox"/> yes	<input type="checkbox"/> no
ii) pumping chamber	<input type="checkbox"/> yes	<input type="checkbox"/> no
iii) distribution box	<input type="checkbox"/> yes	<input type="checkbox"/> no
iv) forced main	<input type="checkbox"/> yes	<input type="checkbox"/> no
- 10) Is all drainage directed away from the tile bed?

- 11) Was a photograph of the complete system taken? yes no
- 12) Inspection accepted yes no
- 13) For re-inspection, call 692-0160 or 1-800-459-5975.
- 14) Comments:

SEAL OUTLET PIPE

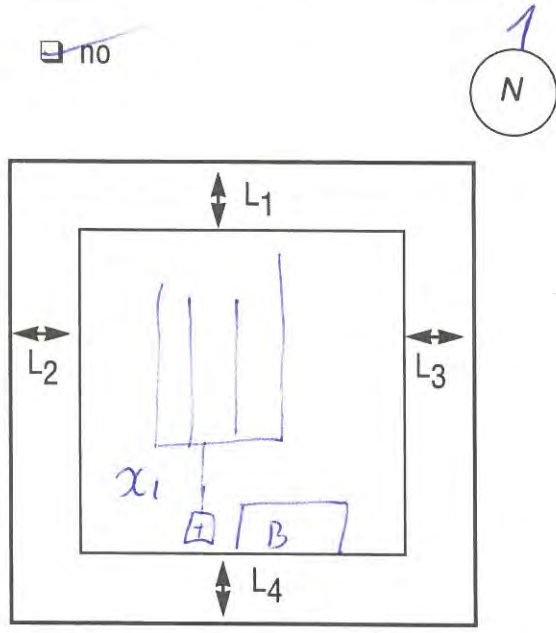

USE PERMIT FOR CLASS 4, 5, 6 SEWAGE SYSTEMS

APPLICATION NO. 82(1998)310

INSPECTION DETAILS	TIME	DATE	WEATHER
	2:50pm	NOV 1/98	OVERCAST
REPRESENTING:	THE OWNER	THE INSTALLER	
	—	DAN MORRIS	

1. Work authorized by the Certificate of Approval has been satisfactorily completed and includes:
 a) Septic tank/holding tank of working capacity of _____ Litres constructed of steel concrete fibreglass on site or prefabricated to serve _____ (no. of bedrooms or units).

MAKE AND MODEL, IF PREFABRICATED TANK EXISTING

b) Leaching bed of total 120 metres of 700 mm (millimetres) diameter distribution pipe of PVC-ROYAL (type and product description e.g. manufacturer(s) and material of which pipe is made) laid in 4 runs and fed by GRAVITY (gravity, siphon, pump).
 c) Proprietary Aerobic System: (Manufacturer) _____ (Model) _____
 d) Other details _____

2. Location
 a) System components installed as shown on application supporting Certificate of Approval
 b) If located other than in (a) use space below for sketch and dimensions from permanent points of reference sufficient to facilitate future location of tank and leaching bed including orientation of pipe runs.

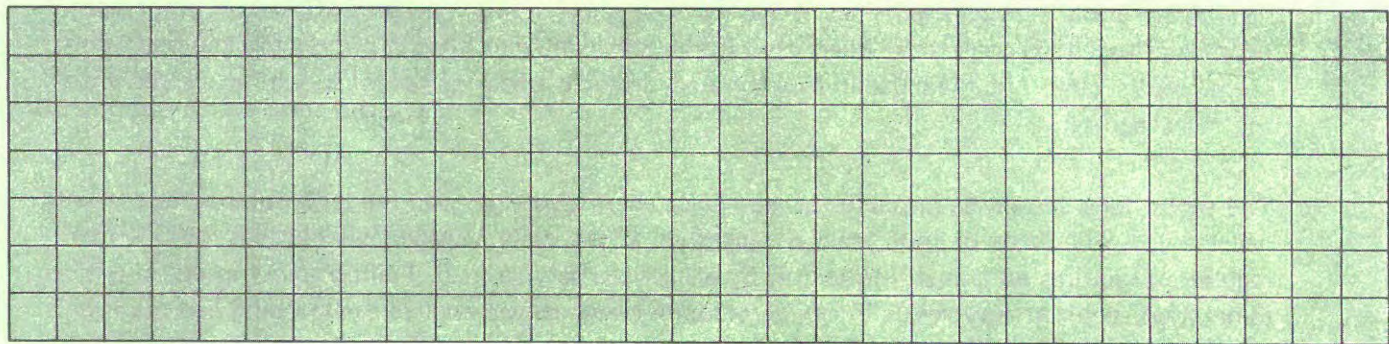

3. The following work remains to be completed:—
 Backfill System and Complete Finish Grading to Shed Run-off and Divert Water Around Leaching Bed
 Stabilize All Sloped Surfaces SEED OR SOD Other

USE PERMIT

Under Section 78 of the Environmental Protection Act, and subject to the provisions of the Act and Regulations a Permit is hereby issued to (Owner) CONTINENTA MUSHROOM CORP for the use and operation of the Class 4 sewage system constructed (installed/enlarged/extended/alterd) pursuant to the Certificate of Approval issued under the above application number in accordance with the application and Certificate of Approval with any changes indicated above and located on Lot PE20 Concession 9 Ward/Township/Municipality OSGOODE Region/District/County R.M.O.C. Plan No. _____ Sub-Lot No. _____

INSPECTED AND RECOMMENDED BY <u>Jerry K. Davidson</u>	PERMIT ISSUED BY <u>Jerry K. Davidson</u> DIRECTOR	DATE ISSUED <u>SEPT 4/98</u>
--	--	---------------------------------

Note: Section 76(a) of the Act provides that no change can be made to any building(s) or structure(s) in connection with which this sewage system is used, if the operation or effectiveness of the sewage system will or is likely to be affected by the change, unless a new Certificate of Approval is obtained.
 Section 139 of the Act provides that an applicant for a permit may appeal a decision to refuse to issue a permit. Written notice of appeal must be forwarded to the Director (who refused to issue the permit) and to the Environmental Appeal Board, 112 St. Clair Avenue West, Suite 502, Toronto, Ontario M4V 1N3 within 15 days of receipt of a permit.
 WARNING: UNDER NO CIRCUMSTANCES SHOULD A HOMEOWNER ENTER A SEPTIC TANK. NOXIOUS GASES WHICH ARE HEAVIER THAN AIR REMAIN IN THE TANK AFTER THE TOP IS REMOVED, AND HAVE CAUSED DEATH BOTH TO THE ORIGINAL VICTIM AND TO THOSE WHO ATTEMPT TO RESCUE HIM FROM THE TANK.

Ottawa-Carleton Septic System Office

Bureau des systèmes septiques d'Ottawa-Carleton



Mississippi
Valley
CONSERVATION
Authority



South Nation River
Conservation Authority
Société d'aménagement
de la rivière Nation-Sud

December 4, 1995
File: P190

Continental Mushroom Corp. (1989) Ltd.
c/o Mr. Lyle Whitham, General Manager
2545 9th Line Road
Metcalf, Ontario
K0A 2P0

**Re: Lot 19 & 20, Concession 9
Township of Osgoode**

Dear Sir,

Thank you for your fax dated on December 4th past, providing information of the soils type and percolation rates. With this information, we have now completed our review of your applications for three (3) Certificates of Approval.

By our calculations, the daily flow for which the sewage systems should be designed (as per the MANUAL OF POLICY, PROCEDURES AND GUIDELINES FOR PRIVATE SEWAGE DISPOSAL SYSTEMS) exceed 4 500 litres/day for two (2) of the three beds (office excluded).

Accordingly the systems are considered to be a non-standard systems and are to be designed and installed according to the M.O.E.E. requirements described in the attached information.

In order to process the Certificates of Approval, we will require that a consulting engineer's report be submitted to demonstrate how the requirements for a non-standard system have been met. We realize that these requirements will further delay the repairs of the malfunctioning systems, but we are obliged, in our capacity as agents for the Ministry of Environment and Energy, to ensure that these requirements are met, so that the systems will function properly without negative impact on the Environment.

The estimated daily average flow for the office will not exceed 4 500 litres therefore it is not considered a non-standard system. Although the proposed size of the replacement system is inadequate and must be re-evaluated. The Ottawa-Carleton Septic System Office is an Approval Agency, not a design consultant, therefore it is the responsibility of the proponent to demonstrate that the system design meets all the requirements of the Act, the Regulations and the Design Manual.

If you have any questions, please contact Denis Longpré or the undersigned. Thank you in advance for your patience and cooperation.

Yours truly,

Terry K. Davidson, P.Eng.
Director Part VIII
Environmental Protection Act

TKD/djl

Golder Associates Ltd.

1796 Courtwood Crescent
Ottawa, Ontario, Canada K2C 2B5
Telephone (613) 224-5864
Fax (613) 224-9928



DRAFT COPY

REPORT ON

TERRAIN AND HYDROGEOLOGICAL
ASSESSMENT

PROPOSED REPLACEMENT SEPTIC
SEWAGE DISPOSAL SYSTEMS

CONTINENTAL MUSHROOM CORP.
(1989) LTD

METCALFE, ONTARIO

Submitted to:

Continental Mushroom Corp. (1989) Ltd.
2545 9th Line Road
Metcalfé, Ontario
K0A 2P0

DISTRIBUTION:

4 copies - Continental Mushroom Corp. (1989) Ltd.
2 copies - Golder Associates Ltd.

May 1996

961-2731

Golder Associates Ltd.

1796 Courtwood Crescent
Ottawa, Ontario, Canada K2C 2B5
Telephone (613) 224-5864
Fax (613) 224-9928



May 14, 1996

961-2731

Continental Mushroom Corp. (1989) Ltd.
2545 9th Line Road
Metcalf, Ontario
K0A 2P0

Attention: Mr. L. Whitham
General Manager

RE: TERRAIN AND HYDROGEOLOGICAL ASSESSMENT
PROPOSED REPLACEMENT SEPTIC SEWAGE SYSTEMS
CONTINENTAL MUSHROOM CORP. (1989) LTD.
METCALFE, ONTARIO

Dear Sirs

This letter reports the results of a terrain and hydrogeological investigation carried out at the above site near Metcalf, Ontario. The purpose of this investigation was to determine the general soil and groundwater conditions in the area of the two proposed septic tile fields and based on an interpretation of the factual information obtained, to provide a design for the two proposed septic systems. Also, the hydrogeological aspects of one of the proposed septic systems was to address the Ontario Ministry of the Environmental and Energy (MOEE) Reasonable Use Criteria for groundwater.

DESCRIPTION OF PROJECT AND SITE

Continental Mushroom operates a mushroom growing facility just east of the Town of Metcalf on 9th Line road (see Key Plan, Figure 1). This facility is near the Town of Metcalf, however the town has no communal water or wastewater servicing, and for this reason, the only practical option for Continental Mushroom is to utilize bedrock wells and septic systems for its on-site water

supply and wastewater handling requirements. Evaluations are, however, presently underway to assess the provision of communal servicing for the town of Metcalfe.

The septic systems presently include three separate tanks and fields servicing two buildings, namely the main office shipping building and production houses building as shown on Figure 2, Site Plan. The location of five bedrock wells is also presented on the Site Plan. Several wells logs for bedrock wells on the Continental Mushroom property from Ontario Ministry of the Environment and Energy data files is presented in Attachment A.

The three septic field systems have failed to varying degree and are to be replaced with two new septic tile bed systems, one for the main office/shipping building in the same general location as the present field and the second to replace the two septic tile bed systems servicing the production houses buildings. The two fields for the production houses are proposed to be combined into one larger tile bed system more at the back of the property (approximately 100 metres southeast of the production houses buildings) in order to be further away from areas of high traffic and activity, shallow bedrock and water supply wells.

Based on available geological information and the results of a previous subsurface investigation for on-site building foundations, it is expected that the site is underlain by an extensive deposit of native silty sand glacial till overlain by fill materials. Geology maps of the area indicate the bedrock underlying the site consists of dolostone of the Oxford formation.

PROCEDURE

The field work for this investigation was carried out on April 18, 1996, at which time 13 test pits were put down within the two areas proposed for the replacement septic system leaching beds using a backhoe supplied and operated by the owner. Test pits TP-1 to TP-5 were excavated near the main office/shipping building with the remaining (TP-6 to TP-13) were excavated back of the production house building as located on the Site Plan, Figure 2. The test pits were advanced to depths of 0.90 to 1.4 metres near the main office/shipping building and 0.3 to 1.8 metres at the back of the property. The soil types encountered in the test pits were classified based on visual and tactile examination of the materials exposed in the walls of the test pits. The groundwater conditions were observed in the test pits during the short period of time that the test pits were left

open at the time of the field work. The field work was supervised by a member of our engineering staff who directed the test pitting operation and logged the subsurface conditions at the test pits. A description of the subsurface conditions encountered in each of the test pits put down during this investigation is given in the Record of Test Pits, Table 1, following the text of this report. The approximate locations of the test pits are shown on the Site Plan, Figure 2.

The ground surface elevations within each of the two areas of the proposed septic system development were determined by Golder Associates Ltd. The elevations of the main office shipping building were referenced to a temporary benchmark (TBM) described as the northwest corner of main office/shipping building foundation. The elevations for the proposed, combined, septic field systems to the southeast of the main production house building was based on a temporary benchmark (100.00) at the southeast corner of the production house building. The temporary benchmarks were assigned an elevation of 100.00 metres as referenced to local datum. The ground surface elevations within the area of the site proposed for the septic system were also determined by Golder Associates Ltd. with reference to the temporary benchmark. A contour plan of the two proposed septic development areas is shown on Figure 2.

SUBSURFACE CONDITIONS

A detailed description of the subsurface conditions encountered in the test pits is given on the Record of Test Pits, Table 1. The test pit logs indicate the subsurface conditions at the specific test locations only. Boundaries between zones on the logs are often not distinct, but rather are transitional and have been interpreted. The following is a summarized account of the subsurface conditions at the site for each of the two proposed septic tile bed replacement areas:

Main Office/Shipping Building

The results of the test pits indicate that the area of the proposed septic system leaching bed (TP-1 to TP-5) are underlain by about a 0.3 to 1.4 metre thickness of silty sand till over dolostone bedrock. The water well records for the existing wells at the site (see Figure 2 and Attachment A) indicate that the wells vary from approximately 30 to 90 metres depth with water bearing zones no shallower than 27.5 metres. A review of a surficial geology map of the site area, available well records for existing water wells in the area of the site as well as the results of previous test pits put

down at proposed septic system location indicates that the silty sand and glacial till deposits are continuous in this area.

The on-site drill logs for the existing wells at the site indicate that the silty sand glacial deposits are underlain by limestone/dolostone and possibly sandstone at depth.

The results of observations within TP-1 to TP-5 indicate that the groundwater level in the area of the proposed septic leaching bed for the main office/shipping building is at a depth of about 1 metre below the existing ground surface with a general flow to the north. For the production houses building, the overburden is thicker to the south with the topography grading to the southeast. The groundwater levels follow the topography with groundwater flow toward the bushed area to the southeast.

PROPOSED EXPANSION OF SEPTIC SEWAGE DISPOSAL SYSTEM

General

This section of the report provides engineering guidelines concerning the geotechnical and hydrogeological aspects of the project, based on our interpretation of the existing test hole data and present project requirements. Contractors bidding on or undertaking the works should examine the factual results of the investigation, satisfy themselves as to the adequacy of the information for construction and make their own interpretation of the factual data as it affects their proposed construction techniques, safety, schedule and equipment capabilities.

The professional services retained for this project include only the geotechnical and hydrogeological aspects of the subsurface conditions at the site. The presence or implications of possible surface and/or subsurface contamination resulting from previous activities or uses of the site and/or resulting from the introduction onto the site of materials from off site sources are outside the terms of reference for this project and have not been investigated or addressed.

Design Considerations

The results of the test pits put down within each of the two proposed septic field development areas indicate very similar soil types based on the field descriptions and on the grain-size distribution of Figure 4. The hydraulic conductivity for these two soils is essentially the same based on estimates from Hazen ($D_{10}^2 = k \text{ cm/sec}$) and Sherard ($0.36D_{15}^2 = k \text{ cm/sec}$) and is in the order of 1×10^{-4} centimetres per second. This hydraulic conductivity is the equivalent of a "T" time of approximately 12 minutes per centimetre.

Main Office/Shipping Building

The concept for the proposed septic leaching bed is to develop a new, fully raised field while utilizing the present septic tank. The old septic field and piping will be totally removed with the waste soil being hauled to the back of the property while the plastic piping will be recycled or landfilled.

Once the old septic bed has been removed, the base of the excavation, namely the native glacial till, will be scarified to ensure a good hydraulic connection between the septic bed materials and native soils. The fully raised bed will consist of silty sand with an in place, long term percolation rate of approximately 10 minutes per centimetre.

It is understood that the proposed leaching bed will serve approximately 32 employees. The maximum volume of septic effluent expected to be handled by the septic system is estimated at 2400 litres per day. Details of the septic effluent volume calculations are given in Attachment B. The classification of this waste is sewage of domestic origin, toilet waste and water sink waste. Based on a design percolation rate of 10 minutes per centimetre for the compacted silty sand fill for the leaching bed, a minimum total leaching bed tile length of 120 metres is required. Further design and construction details are provided in the attached Figures 2 and 4. These figures show the location of the septic tank, the leaching bed and mantle layout, and pertinent site features within the proposed leaching bed area.

Production House Building

The concept for the sanitary wastes from the production house building is to develop one new field away from traffic and building run-off areas to replace the two poorly operating systems, each servicing half of the production house building. The present septic tanks are proposed to be incorporated in the overall design, however, one new pumping chamber near the most southerly septic tank is proposed to distribute the wastewater flows, alternatively to each half of the proposed field.

The design flow for the proposed septic field system is based on measured water consumption of approximately 2600 litres per day (December 1995 to March 1996) for 70 employees in half of the production houses building and this figure was doubled to accommodate the 70 employees in the other, identical half of the structure. Based on a "T" time of 10 minutes per centimetre, the septic field requires 260 metres of tile pipe with 300 metres incorporated into the design.

The design calculations for the pump chambers and septic field system are outlined in Attachment B while the design drawings and layout are presented in Figures 2, 3 and 4, respectively.

Reasonable Use of Groundwater Considerations (Production House Building only)

In terms of the potential off-site impact of the septic waste, MOEE Guideline B-7 (MOEE, 1994b) addresses the level of off-site contaminant impact on groundwater considered acceptable by the MOEE and defines the level of impact on groundwater beyond which some form of migration measure(s) would be warranted.

Under MOEE Guideline B-7, a change in the quality of groundwater on adjacent properties will only be acceptable if the quality is not degraded in excess of 50 percent of the difference between background concentrations and established water quality criteria for aesthetic related parameters, and 25 percent of the difference between background conditions and established water quality criteria for health related parameters.

To obtain a general indication as to the potential impact of septic effluent on the properties adjoining the Continental Mushroom site, a nitrate dilution model was utilized. The water balance method was used to estimate dilution and effects using a net potential infiltration of 220 millimetres per year for the Metcalfe area. A daily effluent loading of 5200 litres per day for the septic system was assumed. The nitrate dilution calculation is provided in Attachment C.

With regard to treatment and dispersal of effluent from the leaching beds, a maximum nitrate concentration of approximately 0.8 milligrams per litre was defined by calculating the theoretical area required to reduce the concentration of nitrate in the effluent from an assumed 40 milligrams per litre (mg/L) (as N) to 2.5 mg/L (as N) or lower at the property boundary by dilution as a result of the infiltration of meteoric water only. The site area of 40 hectares is nearly three times larger than the theoretical minimum area requirements determined using the nitrate dilution model. The nitrate dilution model does not include any nitrate loss from nutrient uptake or denitrification. Therefore, it is concluded that the impact of the proposed development on groundwater at the property lines would be acceptable.

Also the presence of the thicker silty sand glacial deposits to the south will act as a barrier to significant downward migration of the effluent to the underlying bedrock aquifer. The silty sand till is indicated to extend well out beyond the area of the proposed leaching bed. Accordingly, the effluent plume from the septic system will be quite isolated from and is therefore not a significant potential contaminant source to the local water supply. This conclusion is further verified by the present septic systems which have had no measurable impact to the several on site water wells. Consequently, moving the field to greater separation distances would essentially eliminate the potential for well water impact. Furthermore, the water well records for on-site wells (Attachment A) indicate at least 27 metres of lowly permeable bedrock to the shallowest water bearing seams in any of the wells.

CONSTRUCTION CONSIDERATIONS

Construction of the leaching bed and mantle should be carried out using equipment which will not over compact the granular materials and render them relatively impermeable. In this regard, it is suggested that only light, track mounted equipment be used.

In order to ensure that the guidelines in this report have been interpreted as intended by the owner, it is suggested that the owner and/or his contractor contact the geotechnical engineer prior to starting construction to discuss his proposed methodology. It is also considered important that the materials proposed for use for the septic system be approved by the geotechnical engineer before use and that the construction of the leaching bed be inspected by the geotechnical personnel throughout construction.

ADDITIONAL CONSIDERATIONS

This report and the attached Figures 2 and 4 showing details of the design of the proposed septic systems have been prepared for the sole use of the owner. It is understood that the owner, Continental Mushroom Corp. (1989) Ltd. will be constructing the proposed septic system using a local contractor. It is recommended that Golder Associates Ltd. review the proposed construction design with the designated contractor and that a practical field monitoring program be developed for quality control during construction.

We trust this report provides sufficient information for your purposes. If you have any questions concerning this report, please contact our office.

Yours truly,

GOLDER ASSOCIATES LTD.

R.D. Sinclair, P.Eng.
Senior Environmental Engineer

RDS:dc
rpt-001.doc

Attachments

Table X
Figures 1 to 4
Attachments A to C

TABLE X
RECORD OF TEST PITS

Test Pit Number	Depth (metres)	Soil Description
TP1	0.00 - 0.12	TOPSOIL
	0.12 - 0.91	Dark brown SANDY SILT with CLAY and cobbles and GRAVEL (fill)
	0.91 - 1.22	Brown SANDY SILT and GRAVEL
	1.22	End of test pit
		Bucket refused at 1.22 m - bedrock appeared competent, therefore BEDROCK assumed at depth of 1.22 m.
		Water at 1.22 m below ground surface. Sample was taken.
TP2	0.00 - 0.09	TOPSOIL
	0.09 - 0.88	Red brown SILTY SAND with cobbles and GRAVEL (till)
	0.88	End of test pit
		Refusal at 0.88 m in nesting boulders.
		Test pit dry upon completion of excavating.
TP3	0.00 - 0.09	TOPSOIL
	0.09 - 1.07	Brown SILTY SAND with cobbles and small boulders
	1.07	End of test pit
		Nesting of boulders at 1.07 m Less silty from 0.76 m to bottom of test pit
		Refusal occurred at 1.07m in fractured bedrock

Test Pit Number	Depth (metres)	Soil Description
TP4	0.00 - 0.09	TOPSOIL
	0.09 - 1.16	Red brown SILTY SAND with GRAVEL, cobbles and boulders (glacial till)
	1.16 - 1.43	Grey-brown and red-brown SANDY SILT to GRAVEL
	1.43	End of test pit
		Water encountered in test pit
		Uneven surface at bottom of test pit - probably boulders
TP5	0.00 - 0.08	TOPSOIL
	0.08 - 0.52	Fine brown SAND, some GRAVEL
	0.52 - 0.61	Fine grey SAND (fill)
	0.61 - 1.31	Brown SILTY SAND, cobbles, boulders (till)
	1.31	End of test pit (BEDROCK)
		Test pit dry upon completion of excavating
TP6	0.00 - 0.12	TOPSOIL
	0.12 - 0.88	Grey-brown fine-medium SAND with GRAVEL and cobbles (glacial till)
	0.88	End of test pit (BEDROCK)
		Surface runoff, water table not determined.

Test Pit Number	Depth (metres)	Soil Description
TP7	0.00 - 0.08	Organic material
	0.08 - 0.30	Grey-brown fine-medium SAND with GRAVEL and cobbles (glacial till)
	0.30	End of test pit
		Bedrock is composed of badly fractured, generally flat lying limestone or dolomite.
TP8	0.09	BEDROCK encountered
TP9	0.00 - 0.30	TOPSOIL - very organic
	0.30 - 1.22	Grey-brown fine-medium SAND with GRAVEL, cobbles and boulders
	1.22	End of test pit (BEDROCK)
		Test pit dry upon completion of excavation
TP10	0.00 - 1.07	BACKFILL (boulder-sized) mixed with GLACIAL TILL
	1.07 - 1.83	Fine red-brown SILTY SAND with GRAVEL, cobbles, occasional boulder
	1.83	End of test pit

D

R

A

E

Test Pit Number	Depth (metres)	Soil Description
TP11	0.00 - 0.09	TOPSOIL - very organic
	0.09 - 1.34	Fine red-brown SILTY SAND with GRAVEL, cobbles and occasional boulder (till)
	1.34	End of test pit Water encountered at bottom of test pit.
TP12	0.00 - 0.06	TOPSOIL
	0.06 - 1.46	Fine red-brown SILTY SAND with GRAVEL, cobbles and occasional boulder (dry till)
	1.46	End of test pit
TP13	0.00 - 0.15	TOPSOIL - very organic
	0.15 - 1.77	Fine-medium grey-brown SAND with GRAVEL, cobbles and some boulders (till)
	1.77	End of test pit (BEDROCK)

DRAFT

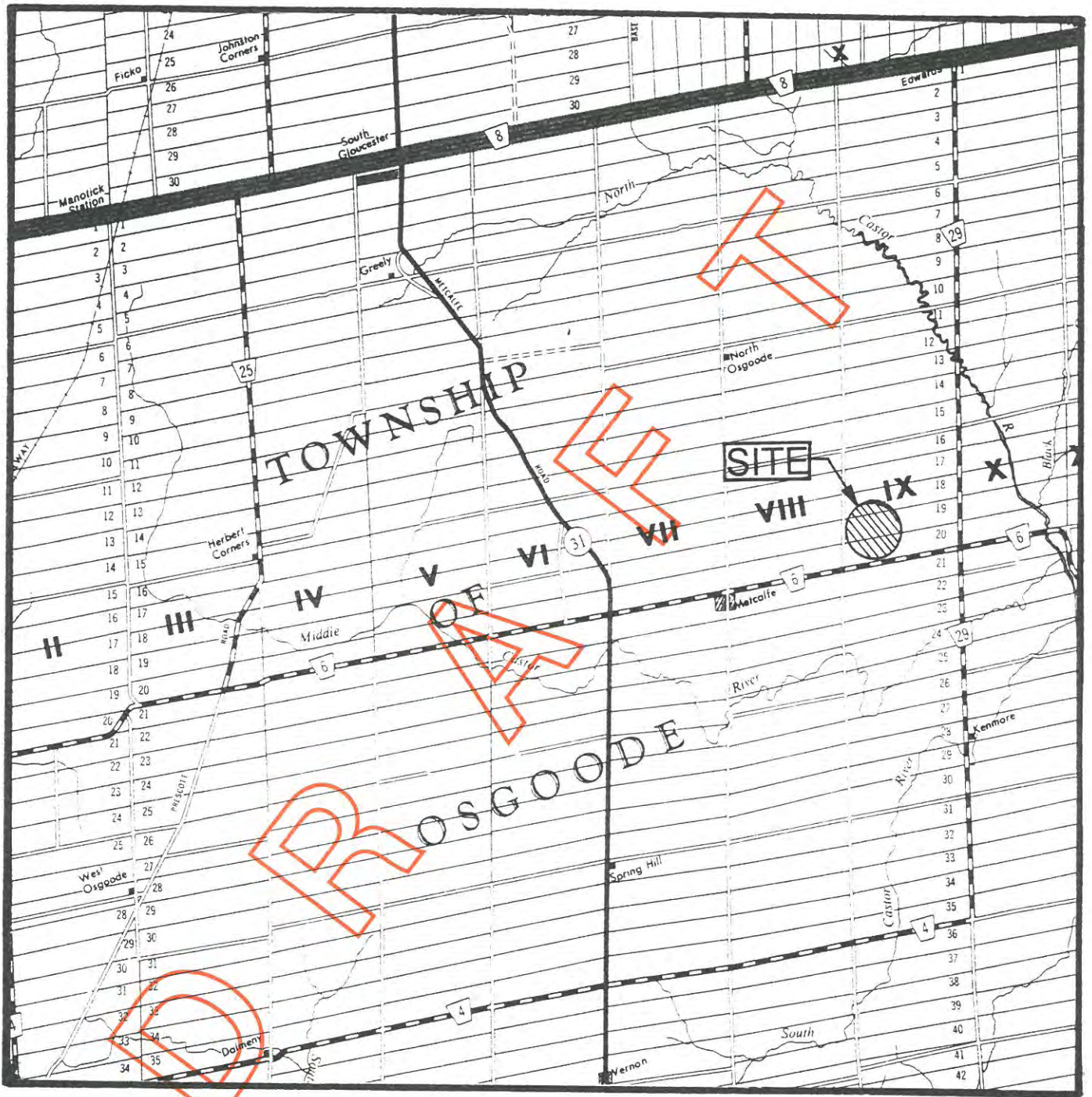

SCALE : 1 : 100,000

SPECIAL NOTE
 THIS DRAWING IS TO BE READ IN CONJUNCTION
 WITH ACCOMPANYING REPORT

Date MAY 03 1996
 Project 961-2731

Golder Associates

Drawn K.M
 Chkd. BS

D
R
A
F
T

ATTACHMENT A

WATER WELL LOGS

CONTINENTAL MUSHROOM CORP. (1989) LTD.
METCALFE, ONTARIO

CON	9	12	15-	463445	280	05/70	1558	5	FR	106	20	30	5	1/00	DO	MOHAUPT H GREY LMSN 0012 GREY LMSN 0090 BRWN LMSN 0108
CON	9	13	15-	464940	245	04/74	1558	6	FR	195	10	50	20	1/00	DO	MCVEY JIM BLCK SAND 0001 BLCK LMSN 0030 BLCK LMSN 0160 GREY SNDS 0198
CON	9	13	15-	465160	240	10/72	1517	5	FR	78	FLW	58	6	1/00	DO	KORTEMEG S BRWN TPSL 0002 BLUE CLAY 0040 BRWN SAND 0053 BRWN LMSN ROCK SHLE 0078
CON	9	13	15-	465199	250	05/81	1517	6	FR	78	10	15	15	1/00	DO	MACKIE P GREY LMSN STNS 0038 BRWN LMSN STNS 0080
CON	9	14	15-	463690	300	08/70	1517	5	FR	120	80	8	8	1/00	DO	MACKIE G BRWN SHLE 0005 BLCK ROCK 0120
CON	9	14	15-	463813	290	08/72	1558	6	FR	120	20	100	5	1/00	DO	ROBERTS RON BRWN TPSL GRVL 0006 GREY LMSN 0051 GREY LMSN 0150
CON	9	14	15-	465200	242	12/76	1558	6	FR	92	7	50	8	2/00	DO	LARCH HOMES LTD BRWN CLAY LOOS 0004 GREY CLAY PCKD 0020 BLUE CLAY SOFT 0031 RED CLAY STNS PCKD 0034 RED HPAN GRVL HARD 0037 RED LMSN VERY SOFT 0045 BLUE LMSN SOFT 0095
CON	9	15	15-	464335	305	06/72	1517	5	FR	94	FLW	70	8	1/30	DO	JOTURCOTTE SNDS 0073 GRNT 0078 SNDS 0100
CON	9	15	15-	465375	245	06/73	3658	6	FR	90	FLW	75	25	2/00	DO	BROWN D J BRWN SAND GRVL FILL 0002 GREY LMSN 0004 GREY LMSN 0164
CON	9	15	15-	465424	245	05/73	1558	6	FR	291	40	120	6	1/00	DO	LARCH HOMES LIMITED GREY SAND GRVL 0048 RED SHLE 0090 GREY LMSN 0294
CON	9	16	15-	464020	305	10/72	1836	6	FR	175	50	120	10	1/00	DO	EMERY J SAND 0003 LMSN 0180
CON	9	16	15-	464299	308	11/82	1558	6	FR	110	58	50	24	1/00	DO	EMERY J BRWN CLAY BLDR SNDY 0005 GREY LMSN MCRD 0150 BLCK LMSN 0167
CON	9	17	15-	464135	300	09/72	1836	6	FR	10	110	120	1/00	DO	WATHALL L P TPSL 0002 GREY LMSN SHLE 0160	
CON	9	17	15-	464190	310	06/62	1505	5	FR	130	28	130	7	1/00	DO	MCCLAREN C CLAY MSND STNS 0004 GREY LMSN 0138
CON	9	17	15-	465660	262	09/71	1517	5	FR	50	10	15	15	1/00	DO	MCDONALD A H GREY CLAY BLDR 0008 GREY SNDS 0051 CONTINENTAL MUSHROOM
CON	9	19	15-	464500	300	08/78	1558	8	FR	45	30	30	30	1/00	CO	CONTINENTAL MUSHROOM BRWN CLAY SAND BLDR 0009 GREY LMSN 0020 GREY LMSN VERY HARD 0050 BLCK LMSN HARD 0065
CON	9	19	15-	464525	302	09/72	1505	6	FR	297	21	120	18	10/00	CO	IN CONTINENTAL MUSHROOM
CON	9	19	15-	464541	300	05/74	1836	6	FR	85	35	85	15	1/00	IN	CONTINENTAL MUSHROOM
CON	9	19	15-	464550	290	01/61	1802	6	FR	57	13	57	3	1/00	DO	BLDR 0003 LMSN 0090 VANDERTILAART W
CON	9	19	15-	464593	300	10/74	1836	6	FR	250	22	230	25	1/00	IN	BLDR CLAY 0010 ROCK LMSN 0075 CONTINENTAL MUSHROOM
CON	9	19	15-	464629	300	10/74	1836	6	FR	DRY						GRVL 0004 LMSN 0220 SNDS 0250 CONTINENTAL MUSHROOM
CON	9	19	15-	465978	265	03/73	1517	5	FR	115	FLW	100	4	1/10	DO	LMSN 0225 CELMS CHARLES
CON	9	20	15-	464505	294	09/72	1505	6	FR	280	18	120	7	10/00	IR	BRWN TPSL 0002 GREY LMSN 0117 CONTINENTAL MUSHROOM
CON	9	20	15-	464505	294	09/72	1505	6	FR	280	18	120	7	10/00	IR	BRWN TPSL SAND 0003 GREY LMSN SNDS 0287

OTTAWA-CARLETON 15

MUNICIPALITY CONCESSION ETC
 UTM WELL EASTING LOT NO
 NORTHING FEET DATE DRILLER INS WATER FEET
 ELEV FEET
 CSG KIND DIA OF INS WATER FEET
 STAT LVL
 PUMP LVL
 TEST RATE
 TEST TIME HR/MN
 WATER USE HR/MN
 DEPTHS IN FEET TO WHICH FORMATIONS EXTEND
 OWNER/LOG/SCREEN

OSGOODE TOWNSHIP (CONTINUED...)

CON	9	20	15-	464508	295	11/72	1836	6	FR	90	20	95	20	1/00	IN	CONT MUSHRM CORP LTD
CON	9	20	15-	464719	290	06/74	2308	5	FR	28	10	30	20	2/00	D0	GREY LMSN 0095
CON	9	20	15-	464890	280	12/55	1526	4	FR	45	9	19	2	2/00	D0	WAYMANN CARL R
CON	9	20	15-	465230	280	04/63	3601	4	FR	46	14	16	6	1/00	D0	HPAN 0008 LMSN 0050
CON	9	20	15-	466220	287	05/70	3504	6	FR	50	15	25	10	1/00	C0 D0	MCKEWN H
CON	9	21	15-	464780	275	07/73	3658	6	FR	30	22	50	40	2/00	D0	TPSL 0002 LMSN 0046
CON	9	21	15-	464799	275	06/73	3658	6	FR	121	28	90	15	2/00	D0	MARION R
CON	9	21	15-	465198	280	10/74	1517	5	FR	267	28	90	15	2/00	D0	CLAY TPSL 0010 LMSN 0051
CON	9	21	15-	465999	295	07/76	3644	6	FR	282	28	90	15	2/00	D0	DILLA BOUGH D W
CON	9	21	15-	466325	289	10/72	3504	6	FR	85	28	90	15	2/00	D0	TPSL CLAY MSND 0005 GREY LMSN 0061
CON	9	22	15-	465560	285	01/68	1802	6	FR	85	28	90	15	2/00	D0	VANNOORT DWIGHT
CON	9	22	15-	465570	285	10/59	1526	4	FR	85	28	90	15	2/00	D0	BRWN CLAY TPSL 0003 GREY LMSN 0260 GREY SNDS 0270
CON	9	22	15-	465920	285	06/60	1802	6	FR	85	28	90	15	2/00	D0	HARBER
CON	9	23	15-	464900	260	07/63	1503	5	FR	85	28	90	15	2/00	D0	BRWN CLAY GRVL SAND 0003 GREY LMSN 0262
CON	9	24	15-	465126	260	02/73	1517	5	FR	85	28	90	15	2/00	D0	GREY SNDS 0284
CON	9	25	15-	465420	255	06/53	2308	4	FR	85	28	90	15	2/00	D0	ROSS HUGH
CON	9	25	15-	466900	260	06/63	3504	6	SU	85	28	90	15	2/00	D0	GREY HPAN 0008 GREY SNDS 0060
CON	9	26	15-	465353	262	10/75	1517	6	FR	85	28	90	15	2/00	D0	DUBORD J
CON	9	26	15-	466070	250	03/61	1526	4	FR	85	28	90	15	2/00	D0	GREY GRVL 0002 GREY LMSN 0084
CON	9	26	15-	466980	255	11/67	3504	6	FR	85	28	90	15	2/00	D0	HAARMA J
CON	9	26	15-	466990	260	06/53	2308	4	FR	85	28	90	15	2/00	D0	BLUE LMSN 0100
CON	9	27	15-	467060	255	12/59	3113	4	FR	85	28	90	15	2/00	D0	ZANBELT JOHN
CON	9	27	15-	5008310	260	02/73	1517	5	FR	85	28	90	15	2/00	D0	PRDR 0100 LMSN 0165
CON	9	27	15-	5008310	260	02/73	1517	5	FR	85	28	90	15	2/00	D0	HARRISON E
CON	9	27	15-	5008310	260	02/73	1517	5	FR	85	28	90	15	2/00	D0	GRVL 0006 RED HPAN 0012 RED SHLE 0060
CON	9	27	15-	5008310	260	02/73	1517	5	FR	85	28	90	15	2/00	D0	WOODS H
CON	9	27	15-	5008310	260	02/73	1517	5	FR	85	28	90	15	2/00	D0	BLUE CLAY 0025 GREY LMSN 0097
CON	9	27	15-	5008310	260	02/73	1517	5	FR	85	28	90	15	2/00	D0	FROLICH R
CON	9	27	15-	5008310	260	02/73	1517	5	FR	85	28	90	15	2/00	D0	CLAY 0020 BLDR GRVL 0024 LMSN 0055
CON	9	27	15-	5008310	260	02/73	1517	5	FR	85	28	90	15	2/00	D0	VANDAM D T
CON	9	27	15-	5008310	260	02/73	1517	5	FR	85	28	90	15	2/00	D0	BRWN TPSL 0002 GREY HPAN 0014 BRWN LMSN 0094
CON	9	27	15-	5008310	260	02/73	1517	5	FR	85	28	90	15	2/00	D0	POAPET E
CON	9	27	15-	5008310	260	02/73	1517	5	FR	85	28	90	15	2/00	D0	GREY HPAN 0030 GRVL 0032
CON	9	27	15-	5008310	260	02/73	1517	5	FR	85	28	90	15	2/00	D0	KINGSBURY K
CON	9	27	15-	5008310	260	02/73	1517	5	FR	85	28	90	15	2/00	D0	MSND BLDR 0016 LMSN 0160
CON	9	27	15-	5008310	260	02/73	1517	5	FR	85	28	90	15	2/00	D0	WYSTEANSKI JOHN
CON	9	27	15-	5008310	260	02/73	1517	5	FR	85	28	90	15	2/00	D0	BRWN HPAN BLDR 0026 BRWN GRVL SAND 0032
CON	9	27	15-	5008310	260	02/73	1517	5	FR	85	28	90	15	2/00	D0	BRWN LMSN 0065
CON	9	27	15-	5008310	260	02/73	1517	5	FR	85	28	90	15	2/00	D0	YANON G
CON	9	27	15-	5008310	260	02/73	1517	5	FR	85	28	90	15	2/00	D0	BLCK TPSL 0007 GREY LMSN 0043
CON	9	27	15-	5008310	260	02/73	1517	5	FR	85	28	90	15	2/00	D0	KINGSBURY K
CON	9	27	15-	5008310	260	02/73	1517	5	FR	85	28	90	15	2/00	D0	BLDR GRVL 0019 LMSN 0084
CON	9	27	15-	5008310	260	02/73	1517	5	FR	85	28	90	15	2/00	D0	BOHMAN G
CON	9	27	15-	5008310	260	02/73	1517	5	FR	85	28	90	15	2/00	D0	GREY CLAY HPAN 0050 GRVL 0055
CON	9	27	15-	5008310	260	02/73	1517	5	FR	85	28	90	15	2/00	D0	MCINTYRE J
CON	9	27	15-	5008310	260	02/73	1517	5	FR	85	28	90	15	2/00	D0	TPSL STNS 0008 HPAN 0037 BLCK LMSN 0054

ATTACHMENT B

DESIGN CALCULATIONS
SEPTIC SEWAGE DISPOSAL SYSTEMS
CONTINENTAL MUSHROOM CORP. (1989) LTD.

- A) MAIN OFFICE/SHIPPING BUILDING SYSTEM
- B) PRODUCTION HOUSE, BUILDING SYSTEM

ATTACHMENT B

ESTIMATED SEWAGE FLOWS

A) MAIN OFFICE/SHIPPING BUILDING

Staff - 35 Persons

Summary of Operations

7 days per week - 1 shift (8 hours)

Flow Calculation

Based on 75 litres per staff person per day

$$32 \times 75 = 2,400 \text{ litres}$$

Total = 2,400 litres per day

Leaching Bed

Capacity required, 2,400 litres per day (Q)

T time selected = 10 minutes per centimetre

$$\text{Total length of tile } L = \frac{QT}{200} = \frac{2,400 (10)}{200} = 120 \text{ metres}$$

Length of tile provided in design = 120 metres

The tile field is to consist of one tile field containing 120 metres of perforated, 100 millimetre diameter tile

Septic Tank

User tank presently in place.
Gravity flow system.

ATTACHMENT B (continued)

B) PRODUCTION HOUSE BUILDING

2 x 70 = 140 employees

Summary of Operations

7 days per week, one shift day (8 hours)

Flow Calculation

Based on measured water consumption

Measured flow (half of building) = 2,600 litres per day (each half of building has identical operation)

Total = 5,200 litres per day

Leaching Bed

Capacity required, 5,200 litres per day (Q)

T time selected = 6 minutes per centimetre

Total length of tile $L = \frac{QT}{200} = \frac{5,200 (10)}{200} = 260$ metres

Length of tile provided in design = 300 metres

The tile field is to consist of two tile fields, each containing 150 metres of 100 millimetre diameter perforated tile.

ATTACHMENT B (continued)

Septic Tank

Using two tanks presently in place

Pumping Station

The effluent will be pumped to each of the leaching beds by a double pumping system complete with pumps, floats and alarm. The pumps will alternate with each cycle, thereby, dosing each half of the bed on successive pumping cycles.

The quantity of effluent discharge from the dosing chamber shall not be less than 3/4 of the total interior volume of the distribution pipe in each of the septic tile fields. The distribution pipe will have a 100 millimetre diameter.

- Length of distribution pipe = 150 metres in each tile field
- Volume of distribution pipe = $\frac{\pi D^2}{4} \times 100 = 1.18 \text{ m}^3 = 1178 \text{ litres}$
- Minimum dosing volume = $0.75 \times 1178 = 885 \text{ litres}$

Therefore, a minimum of 885 litres must be pumped from the dosing chamber with each pumping cycle. Dosing volume selected, 900 litres

Pumps

Pumps will discharge effluent from the chamber for not more than 20 minutes per cycle. Fifteen minutes per pump cycle selected. The pumps will alternate between pumping cycles.

$$\text{Minimum pumping rate} = \frac{900 \text{ litres}}{15 \text{ minutes}} = 60 \text{ litres per minute}$$

$$\text{Pump flow rate} = 60 \text{ litres per minute (14 Imperial gallons per minute)}$$

ATTACHMENT B (continued)

Forcemain

Criteria: Minimum velocity 0.8 metres/second
Maximum velocity 2.5 metres/second

Design: $Q = VA$ Where Q = Flow volume
V = Flow velocity
A = Area of pipe

Flow velocity selected, 1.5 metres/second

$$A = \frac{Q}{V} = \frac{0.001 \text{ m}^3/\text{second}}{1.5 \text{ m/second}} = 0.00067 \text{ m}^2$$

$$A = \frac{\pi D^2}{4} = 0.0067 \text{ m}^2 \text{ where } D = \text{pipe diameter}$$

$$D^2 = \frac{0.0067 \times 4}{\pi} = 0.029 \text{ metres}$$

$$D = 29 \text{ millimetres or } 1.25 \text{ inches}$$

D
R
E
W

ATTACHMENT C

NITRATE DILUTION CALCULATIONS
SEPTIC SYSTEM DESIGN
CONTINENTAL MUSHROOM CORP. (1989) LTD.
METCALFE, ONTARIO

ATTACHMENT C

Nitrate Dilution Calculation

$$\text{NO}_3 \text{ (Boundary mg/L)} = \frac{\text{Total Mass of Nitrate}}{\text{Total Water Volume}} = \frac{\text{Background \& Septic Waste}}{\text{Infiltration \& Septic Waste}}$$

Mass of Nitrate-Nitrogen

Background Nitrate = 0 mg/L (assumed)

Septic Waste = 40 mg/L x 5200 l/day x 365 day/year = 7.6×10^7 mg/L/year

Liquid Volumes

Net Potential Infiltration = 0.22 metres/year (for area)

Total Infiltration = 40 hectares x 0.22 metres/year = 88,000,000 litres per year

Septic Flow = 5200 litres per day x 365 days per year = 1,900,000 litres per year

$$\text{NO}_3 \text{ (Boundary)} = \frac{7.6 \times 10^7 \text{ mg / year}}{9 \times 10^7 \text{ l / year}} = 0.84 \text{ mg / L}$$

Require approximately 14 hectares to provide dilution to 2.5 mg/L or approximately 20 hectares if the main office/shipping building is included.

