

SERVICING & STORMWATER MANAGEMENT REPORT WAREHOUSE – 30 AURIGA DRIVE

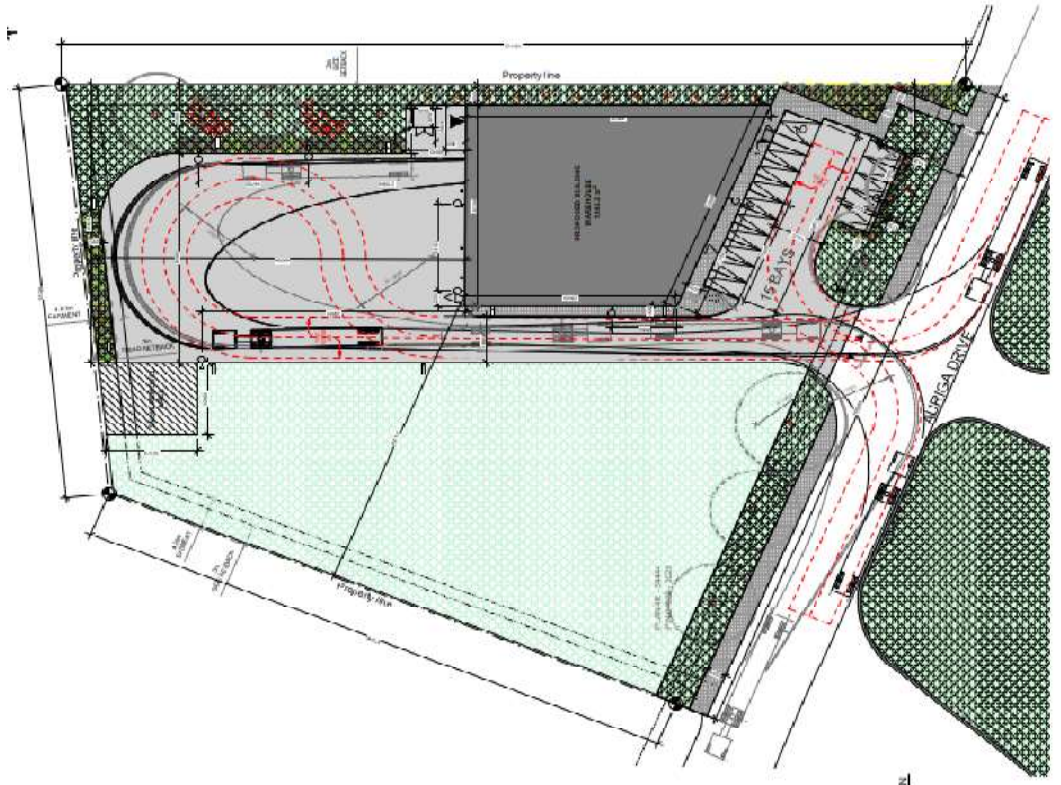

Project No.: CCO-23-0914

City File No.: D07-12-23-0016

Prepared for:

Rossman Architects and Associates Inc.
88 Boulevard Saint-Joseph
Gatineau, Québec J8Y 3W5

Prepared by:

McIntosh Perry Consulting Engineers Ltd.
115 Walgreen Road
Carp, ON K0A 1L0

July 6th, 2023

TABLE OF CONTENTS

1.0	PROJECT DESCRIPTION	1
1.1	<i>Purpose</i>	1
1.2	<i>Site Description</i>	1
1.3	<i>Existing Conditions and Infrastructure.....</i>	2
1.4	<i>Proposed Development and Statistics.....</i>	2
1.5	<i>Approvals</i>	2
2.0	BACKGROUND STUDIES	3
3.0	PRE-CONSULTATION SUMMARY	3
4.0	WATERMAIN	3
4.1	<i>Existing Watermain.....</i>	3
4.2	<i>Proposed Watermain</i>	3
5.0	SANITARY DESIGN	5
5.1	<i>Existing Sanitary Sewer</i>	5
5.2	<i>Proposed Sanitary Sewer</i>	5
6.0	STORM SEWER DESIGN.....	6
6.1	<i>Existing Storm Sewers</i>	6
6.2	<i>Proposed Storm Sewers.....</i>	6
7.0	PROPOSED STORMWATER MANAGEMENT	7
7.1	<i>Design Criteria and Methodology</i>	7
7.2	<i>Runoff Calculations</i>	8
7.3	<i>Pre-Development Drainage.....</i>	8
7.4	<i>Post-Development Drainage</i>	9
7.5	<i>Quantity Control.....</i>	9
7.6	<i>Quality Control.....</i>	11
8.0	EROSION AND SEDIMENT CONTROL.....	12
8.1	<i>Temporary Measures</i>	12
8.2	<i>Permanent Measures.....</i>	13
9.0	SUMMARY	13

10.0 RECOMMENDATION..... 13

11.0 STATEMENT OF LIMITATIONS 15

LIST OF TABLES

Table 1: Water Demands 4

Table 2: Fire Protection Confirmation..... 5

Table 3: Sanitary Design Criteria..... 6

Table 4: Summary of Estimated Sanitary Flow..... 6

Table 5: Pre-Development Runoff Summary 9

Table 6: Post-Development Runoff Summary 9

Table 7: Post-Development Restricted Runoff Summary 10

Table 8: OGS Summary 12

APPENDICES

- Appendix A: Site Location Plan
- Appendix B: City of Ottawa Pre-Consultation Notes
- Appendix C: Watermain Calculations
- Appendix D: Sanitary Calculations
- Appendix E: Pre-Development Drainage Plan
- Appendix F: Post-Development Drainage Plan
- Appendix G: Stormwater Management Calculations
- Appendix H: City of Ottawa Design Checklist

1.0 PROJECT DESCRIPTION

1.1 Purpose

McIntosh Perry (MP) has been retained by Rossman Architects and Associates Inc. to prepare this Servicing and Stormwater Management Report in support of the Site Plan Control process for the proposed Warehouse, located at 30 Auriga Drive within the City of Ottawa.

The main purpose of this report is to present a servicing design for the development in accordance with the recommendations and guidelines provided by the City of Ottawa (City), the Rideau Valley Conservation Authority (RVCA), and the Ministry of the Environment, Conservation and Parks (MECP). This report will address the water, sanitary and storm sewer servicing for the development, ensuring that existing and available services will adequately service the proposed development.

This report should be read in conjunction with the following drawings:

- CCO-23-0914, C101 – Site Grading and Drainage Plan,
- CCO-23-0914, C102 – Site Servicing Plan.
- CCO-23-0914, PRE – Pre-Development Drainage Area Plan (**Appendix 'E'**), and
- CCO-23-0914, POST – Post-Development Drainage Area Plan (**Appendix 'F'**)

1.2 Site Description

The property is located at 30 Auriga Drive and is described as Plan 4R 34444, Part of Lot 36, Concession A (Rideau Front), Geographic Township of Nepean, City of Ottawa. The land in question covers approximately 0.77 ha and is bounded by Auriga Drive and Antares Drive. The site is zoned as a General Industrial Subzone 5, (IG5). See Site Location Plan in **Appendix 'A'** for more details.

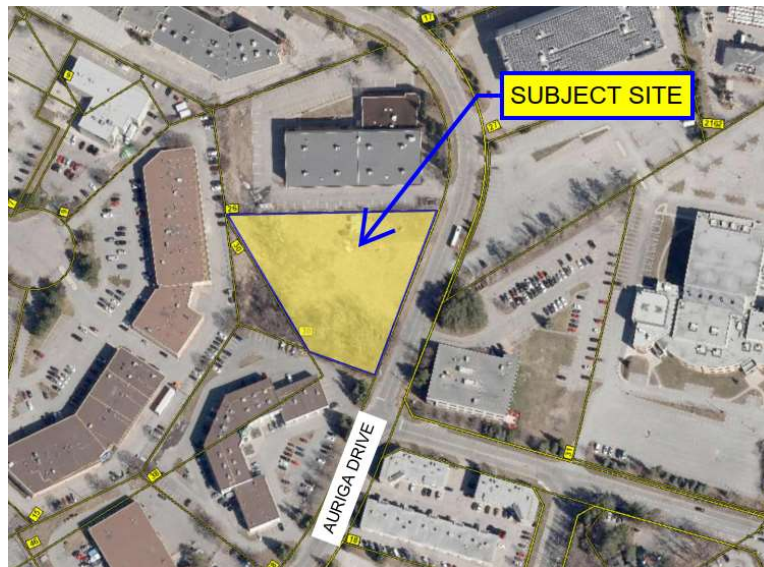

Figure 1: Site Map

1.3 Existing Conditions and Infrastructure

The existing site is currently undeveloped with no existing services. Stormwater runoff on the east side of the site currently flows overland towards the Auriga Drive and is collected by municipal catchbasins. The remainder flows overland towards the adjacent property to the west.

Sewer and watermain mapping collected from the City of Ottawa indicate that the following services exist across the property frontages within the adjacent municipal rights-of-way(s):

- **Auriga Drive**
 - 305mm diameter ductile iron watermain,
 - 250mm diameter PVC sanitary sewer, tributary to the South Ottawa Collector,
 - 1350mm diameter concrete storm sewer, tributary to the Rideau River

1.4 Proposed Development and Statistics

The proposed development consists of a **1042.5m²** light industrial warehouse building complete with office space. Parking will be provided towards the west of the site with a drive aisle extending from the proposed site access on Auriga Drive. Further details are available in the site plan provided by Rossman Architecture in **Appendix 'B'**.

1.5 Approvals

The proposed development is subject to the City of Ottawa site plan control process. Site plan control requires the City to review, provide concurrence and approve the engineering design package. Permits to construct can be requested once the City has issued a site plan agreement.

An Environmental Compliance Approval (ECA) through the Ministry of Environment, Conservation and Parks (MECP) is not anticipated to be required for the development since the development proposes no manufacturing element to its property usage.

2.0 BACKGROUND STUDIES

Background studies that have been completed for the proposed site include City of Ottawa as-built drawings and a topographical survey.

As-built drawings of existing services within the vicinity of the proposed site were reviewed in order to determine accurate servicing and stormwater management schemes for the site.

A topographic survey of the site was completed by Annis, O’Sullivan, Vollebakk LTD., dated November 30, 2022.

3.0 PRE-CONSULTATION SUMMARY

A pre-consultation meeting was conducted on September 26, 2022 regarding the proposed site. Specific design parameters to be incorporated within this design include the following:

- Pre-development and post-development flows shall be determined using a calculated time of concentration (no less than 10 minutes).
- Control 5 through 100-year post-development flows to the 5-year pre-development flows with a combined C value to a maximum of 0.50.
- Quality control is required to be provided for this site (80% TSS Removal) as per RVCA requirements.

The notes from the City of Ottawa can be found in **Appendix ‘B’**.

4.0 WATERMAIN

4.1 Existing Watermain

The site is located within the 2W2C pressure zone, as per the WATER Distribution System mapping included in **Appendix ‘C’**. There is an existing 300mm diameter DI watermain within Auriga Drive. The watermain services the adjacent properties as well as the fire hydrants along the west side of Auriga Drive.

4.2 Proposed Watermain

A new 50mm diameter copper water service is proposed to service the site complete with a water valve located at the property line and will be connected to the existing 300 mm diameter watermain within Auriga Drive. The water service is designed to have a minimum of 2.4m cover and will be insulated where required per City standards.

The Fire Underwriters Survey 2020 (FUS) method and Ontario Building was utilized to determine the required fire flow for the site. The ‘C’ factor (type of construction) for the FUS calculation was determined to be **1.0** (ordinary type construction). The total floor area (‘A’ value) for the FUS calculation was determined to be **1,242 m²**. The results of the calculations yielded a required fire flow of **7,000 L/min**. A fire flow of **4,500 L/min** was calculated using the Ontario Building Code (OBC) requirements. The detailed calculations for the FUS and OBC can be found in **Appendix ‘C’**.

The water demands for the proposed building have been calculated to adhere to the Ottawa Design Guidelines – Water Distribution manual and can be found in **Appendix ‘C’**. The results have been summarized in **Table 1**, below. In accordance with Section 4.3.1 of the guidelines, service areas with a basic day demand greater than 50 m³/day require a dual connection to the municipal system. The basic day demand for the development is estimated to be **26 m³/day**, therefore a dual connection is not required.

Table 1: Water Demands

Site Area	0.77 ha
Industrial - Light	35,000 L/ha/day
Average Day Demand (L/s)	0.31
Maximum Daily Demand (L/s)	0.47
Peak Hourly Demand (L/s)	0.84
OBC Fire Flow Requirement (L/s)	105.00
FUS Fire Flow Requirement (L/s)	116.67

*Refer to **Appendix ‘C’** for detailed calculations.*

Boundary conditions for the site were provided by the City of Ottawa for the average day scenario, peak hour scenario and the maximum day plus fire flow scenario using the demands indicated above, and the results are summarized in below.

	Total HGL (m)	Head Pressure* (m)	Head Pressure* (psi)
Peak Hourly (Minimum HGL)	124.3	35.05	49.84
Average Day (Maximum HGL)	133.4	44.15	62.78
Max Day + Fire Flow (75 L/sec)	127.9	38.65	54.96
Max Day + Fire Flow (116.7 L/sec)	126.2	36.95	52.54

**Adjusted for an estimated ground elevation of 89.25m above the connection point.*

The boundary conditions were used to ensure the normal operating pressures are not less than 275kPa (40psi) or more than 552kPa (80psi), as well as to confirm that there is at least 140kPa (20psi) of pressure during a fire flow scenario. The resultant hydraulic grade line (HGL) shows that the pressures exceed the maximum limit during the average day and peak hour scenarios, however, the 20psi minimum pressure is satisfied during the fire flow scenario.

To confirm the adequacy of fire flow to protect the proposed development, public fire hydrants within 150 m of the proposed building were analysed per City of Ottawa ISTB 2018-02 Appendix I Table 1. Based on City guidelines (ISTB-2018-02), the existing hydrants can provide adequate fire protection to the proposed development. The results are summarized in **Table 2**, below.

Table 2: Fire Protection Confirmation

Building	Fire Flow Demand (L/min.)	Fire Hydrant(s) within 75m	Fire Hydrant(s) within 150m	Combined Fire Flow (L/min.)
30 Auriga Drive	7,000	2	3	22,800

5.0 SANITARY DESIGN

5.1 Existing Sanitary Sewer

There is an existing 250 mm diameter PVC sanitary sewer within Auriga Drive.

5.2 Proposed Sanitary Sewer

A new 150 mm diameter gravity sanitary lateral is proposed be connected to the existing 250 mm diameter sanitary sewer within Auriga Drive. Monitoring for site sanitary flows will occur at the proposed maintenance hole just inside the property line. Refer to drawing **C102** for a detailed servicing layout.

The peak design flows for the proposed building were calculated using criteria from the **Ottawa Sewer Guidelines** and are summarized in **Table 3**, below. Based on the unit occupancy statistics provided by the architect, the proposed site development will generate a flow of **2.46 L/s**. See **Appendix 'D'** of this report for more details.

Table 3: Sanitary Design Criteria

Design Parameter	Value
Site Area	0.77 ha
Industrial - Light	35,000 L/ha/day
Light Industrial Peaking Factor	6.9
Extraneous Flow Allowance	0.33 L/s/ha

Refer to **Appendix 'D'** for detailed calculations.

Table 4: Summary of Estimated Sanitary Flow

Design Parameter	Total Flow (L/s)
Total Estimated Average Dry Weather Flow	0.35
Total Estimated Peak Dry Weather Flow	2.18
Total Estimated Peak Wet Weather Flow	2.40

Refer to **Appendix 'D'** for detailed calculations

6.0 STORM SEWER DESIGN

6.1 Existing Storm Sewers

Water runoff from the site is currently tributary to the Rideau River within the Lower Rideau River sub-watershed. Runoff from the east subject property is currently collected by municipal catch basins within Auriga Drive. Drainage to the north of the site flows overland to the adjacent property where it is collected by a private catch basin. Drainage to the west of the site flows overland to the adjacent western property. Refer to **Appendix 'E'**. There is an existing 1350mm diameter concrete storm sewer within Auriga Drive that is available to service the site.

6.2 Proposed Storm Sewers

A new storm sewer system will be extended from the existing 1350mm diameter storm sewer within Auriga Drive. The new pipe network will collect storm flows and restrict runoff prior to leaving the site. The storm service from the proposed building will be connected to the proposed storm system.

Runoff from the proposed site will be collected in controlled catch basins which will produce surface ponding within the proposed parking area during significant storm events. Catchbasins are

proposed throughout the subject property as well as a catchbasin manhole. The flow will be restricted immediately downstream of CBMH3. The southern section of the property is proposed to drain through sheet flows into a dry retention area which will outlet to a proposed landscape catchbasin. The dry retention area is also to be controlled by CBMH3 resulting in ponding in the retention area. These controls allow for adequate storage within the site. From the ponding areas, the flow is conveyed to the existing 1350mm diameter storm sewer within Auriga Drive. The storm sewers will range from 200 to 300mm in diameter throughout the subject property.

A storm sewer design sheet was created using the rational method and City of Ottawa 5-year storm event. Storm flows will be controlled by an inlet control device (ICD) to limit flows to the specified allowable release rate.

The storm design sheet calculates the proper sizing of the storm pipes within the development. Drainage area information, along with respective pipe slopes and other necessary information was utilized to evaluate the performance of the storm sewer network. The time of concentration calculated for the storm sewer system is based on a 10-minute inlet time at the uppermost sewer run. Within the design sheet, pipe capacities and associated full flow velocities have been calculated. The design flow (peak flow) was checked against the theoretical capacity to ensure that each storm sewer pipe can convey the 5-year unrestricted flow.

See CCO-23-0914 – *POST* and *Storm Sewer Design Sheet* in Appendix 'F' of this report for more details. The Stormwater Management design for the subject property will be outlined in Section 7.0.

7.0 PROPOSED STORMWATER MANAGEMENT

7.1 Design Criteria and Methodology

Stormwater management for the proposed site will be maintained through positive drainage away from the proposed building and into a new underground storm sewer system. The storm system will capture the parking lot and landscape runoff and store water in proposed surface ponding areas within the parking structure as well as a retention area south of the parking area. The restricted flow will then release into the existing 1350mm storm sewer located within Auriga Drive. The emergency overland flow route for the proposed site will be directed east towards Auriga Drive. The quantitative and qualitative properties of the storm runoff for both the pre & post development flows are further detailed below. Stormwater Best Management Practices (SWM BMP's) will be implemented at the "Lot level", "Conveyance" and "End of Pipe" locations. These concepts will be explained further in Section 7.6.

In summary, the following design criteria have been employed in developing the stormwater management design for the site as directed by the RVCA and City:

Quality Control

- The site has been designed to achieve an 80% total suspended solids removal (*enhanced* level) using a proposed oil/grit separator.

Quantity Control

- Post-development flow 5/100-year is to be restricted to match the 5-year pre-development flow with a maximum C value of 0.50.

7.2 Runoff Calculations

Runoff calculations presented in this report are derived using the Rational Method, given as:

$$Q = 2.78CIA \text{ (L/s)}$$

Where	C	= Runoff coefficient
	I	= Rainfall intensity in mm/hr (City of Ottawa IDF curves)
	A	= Drainage area in hectares

It is recognized that the Rational Method tends to overestimate runoff rates. As a result, the conservative calculation of runoff ensures that any SWM facility sized using this method is expected to function as intended.

The following coefficients were used to develop an average C for each area:

Roofs/Concrete/Asphalt	0.90
Gravel	0.60
Undeveloped and Grass	0.20

As per the *City of Ottawa - Sewer Design Guidelines*, the 5-year balanced 'C' value must be increased by 25% for a 100-year storm event to a maximum of 1.0.

As per the pre-consultation meeting with the City of Ottawa the time of concentration (Tc) used for pre-development shall be calculated using a Tc of 20 minutes and post-development flows shall be calculated using a Tc of 10 minutes.

7.3 Pre-Development Drainage

The existing site drainage limits are demonstrated on the Pre-Development Drainage Area Plan. A summary of the Pre-Development Runoff Calculations can be found below.

Table 5: Pre-Development Runoff Summary

Drainage Area	Area (ha)	C 5-Year	C 100-Year	Tc (min)	I (mm/hr)		Q (L/s)	
					5-Year	100-Year	5-Year	100-Year
A1	0.20	0.20	0.25	20	70.3	120.0	7.93	16.93
A2	0.35	0.20	0.25	20	70.3	120.0	13.69	29.21
A3	0.21	0.20	0.25	20	70.3	120.0	8.37	17.86
Total	0.77						29.99	64.00

Refer to **Appendix 'G'** for detailed calculations

7.4 Post-Development Drainage

The proposed site drainage limits are demonstrated on the Post-Development Drainage Area Plan. See CCO-23-0914 – POST in Appendix 'F' of this report for more details. A summary of the Post-Development Runoff Calculations can be found below.

Table 6: Post-Development Runoff Summary

Drainage Area	Area (ha)	C 5-Year	C 100-Year	Tc (min)	I (mm/hr)		Q (L/s)	
					5-Year	100-Year	5-Year	100-Year
B1	0.10	0.90	1.00	10	104.2	178.6	27.18	51.75
B2	0.20	0.75	0.84	10	104.2	178.6	43.61	83.62
B3	0.02	0.90	1.00	10	104.2	178.6	6.30	12.00
B4	0.02	0.90	1.00	10	104.2	178.6	4.49	8.55
B5	0.05	0.90	1.00	10	104.2	178.6	11.97	22.79
B6	0.27	0.20	0.25	10	104.2	178.6	15.67	33.57
B7	0.11	0.29	0.35	10	104.2	178.6	9.02	18.44
Total	0.77						118.24	230.72

Refer to **Appendix 'G'** for detailed calculations

Runoff for areas B1-B6 will be restricted before outletting to the existing storm system within Auriga Drive. The flow will be controlled within roof drains for area B1. Runoff for areas B2-B6 will be restricted and the required storage will be provided within the parking area and retention area. The flow will be controlled by an inlet control device located at the outlet of CBMH3 (LMF 74 ICD). The restriction device will account for the unrestricted flow (Area B7) leaving the site. This quantity and quality control will be further detailed in Sections 7.5 and 7.6.

7.5 Quantity Control

After discussing the stormwater management criteria for the site with City staff, the total post-development runoff for this site has been restricted to match the 5-year pre-development flow rate

with a combined C value of 0.50 or less. (See Appendix ‘B’ for pre-consultation notes). These values create the following allowable release rate and storage volumes for the development site.

See **Appendix ‘G’** for calculations.

Reducing site flows will be achieved using flow restrictions and will create the need for onsite storage. Runoff from areas B1 to B6 will be restricted as shown in the table below.

Table 7: Post-Development Restricted Runoff Summary

Drainage Area	Unrestricted Flow (L/s)		Restricted Flow (L/s)		Storage Required (m ³)		Storage Provided (m ³)	
	5-Year	100-Year	5-Year	100-Year	5-Year	100-Year	5-Year	100-Year
B1	27.18	51.75	2.14	3.66	23.23	39.31	23.62	40.29
B2	82.04	160.53	3.70	7.30	83.81	160.73	89.81	164.50
B3								
B4								
B5								
B6								
B7	9.02	18.44	9.02	18.44	x	x	x	x
Total	118.24	230.72	14.86	29.40	107.05	200.04	113.43	204.79

Refer to **Appendix ‘G’** for detailed calculations

Runoff from Area B1 will be restricted through two (2) roof drains before discharging to STMH 1. The total flow leaving the roof will be 2.14 L/s and 3.66 L/s during the 5 and 100-year storm events, respectively. This will result in ponding depths of 85 and 145 mm for the 5 and 100-year storm events, respectively. All the storage required for this area will be located on the proposed roof, and emergency roof scuppers will be installed to ensure ponding does not exceed the proposed ponding limit of 150mm.

Runoff from Areas B2, B3, B4, B5 and B6 will be restricted at CBMH 3 through an IPEX LMF ICD Vortex-74 (Design Head of 2.28 m). This orifice plug will restrict areas B2, B3, B4, B5 and B6 to 7.3 L/s for 100-year storm events and 3.7 L/s for 5-year events. The restriction creates a water surface elevation (WSEL) of 89.08m for the 5-year storm event and 89.23 m for the 100-year storm event. The storage for this area will be provided above the parking lot structures CB6, and CB2, as well as in the proposed dry retention area south of the parking area. See **Appendix ‘G’** for details of the required and provided storage volumes.

For post development drainage area B6, an effort to preserve the majority of the landscaped areas existing vegetation and trees has been implemented. The proposed storm water management design will rely on existing conditions within the landscaped area to the south to ultimately outlet towards the proposed sewer system. There is a low point with an elevation of 88.66m within the landscaped area in the southeast section of the site, however the retention area free board is

proposed to be lower than any property line grades to ensure during a major storm event water will overtop into the retention area if it does not infiltrate within the existing conditions provided on site.

In the event that there is a rainfall above the 100-year storm event, or a blockage within the storm sewer system, an emergency overland flow route has been provided so that the storm water runoff will be conveyed towards the east entrance at Auriga Drive. A small section of depressed curb is proposed at the entrance driveway to ensure overland flow from the retention area is conveyed towards the right of way.

7.6 Quality Control

The development of this lot will employ Best Management Practices (BMP's) wherever possible. The intent of implementing stormwater BMP's is to ensure that water quality and quantity concerns are addressed at all stages of development. Lot level BMP's typically include temporary retention of the parking lot runoff, minimizing ground slopes and maximizing landscaped areas. Some of these BMP's cannot be provided for this site due to site constraints and development requirements.

A quality treatment unit has been sized to provide a TSS removal rate of 80% as per Rideau Valley Conservation Authority requirements. The OGS (Oil & Grit Separator) unit will provide a water quality of at least 80% TSS. The OGS Unit shall be placed downstream of the restriction unit to provide the required water quality treatment for the site runoff before discharging to the storm sewer within Auriga Drive.

As the proposal of manufactured water quality treatment systems became prevalent in Ontario, scrutiny of such systems was deemed necessary, and a standardized third-party testing protocol called Canadian Environmental Technology Verification (CA-ETV-ISO 14034) was established in Ontario. Irrespective of the manufacturer and model, oil and grit separator units achieve a maximum of 60% TSS removals under the CA ETV testing. Some other acceptable testing protocols include Fine particle size distribution (PSD) and distribution based on the varying particle sizes are commonly accepted testing protocols. Under the Fine PSD, OGS units can achieve > 90 percent TSS removals. Irrespective of the testing protocol selected, the actual TSS removal efficacy of the OGS units heavily relies on the actual site conditions, nature of the runoff and on-going OGS maintenance.

As such, the proposed OGS unit was sized under the CA-ETV particle distribution to achieve the maximum 60 percent TSS removal, which in turn achieves 91 percent TSS removal under the Fine PSD. The following table summarizes the selected OGS unit and its performance under different testing protocols.

Table 8 – OGS Summary

Catchment ID	Area (ha)	Runoff Co-efficient	Testing Protocol	Manufacturer-Model Recommended	Annual TSS Removal (%)	Annual Runoff Volume Capture (%)
(B2-B6)	0.55	0.56	CA ETV	Stormceptor EF-4	61	>90
	0.55	0.56	Fine PSD	Stormceptor EF-4	92	>90

Even though, the proposed OGS unit will not achieve the necessary quality control target based on CAETV testing protocols, based on the limit of construction works and the existing drainage conditions; it will achieve the required Enhanced level of protection under the Fine PSD. A detailed report of the manufacturer’s sizing report is included in **Appendix ‘G’**.

8.0 EROSION AND SEDIMENT CONTROL

8.1 Temporary Measures

Before construction begins, temporary silt fence, straw bale or rock flow check dams will be installed at all natural runoff outlets from the property. It is crucial that these controls be maintained throughout construction and inspection of sediment and erosion control will be facilitated by the Contractor or Contract Administration staff throughout the construction period.

Silt fences will be installed where shown on the final engineering plans, specifically along the downstream property limits. The Contractor, at their discretion or at the instruction of the City, Conservation Authority or the Contract Administrator shall increase the quantity of sediment and erosion controls on-site to ensure that the site is operating as intended and no additional sediment finds its way off site. The rock flow, straw bale & silt fence check dams and barriers shall be inspected weekly and after rainfall events. Care shall be taken to properly remove sediment from the fences and check dams as required. Fibre roll barriers are to be installed at all existing curb inlet catchbasins and filter fabric is to be placed under the grates of all existing catchbasins and manholes along the frontage of the site and any new structures immediately upon installation. The measures for the existing/proposed structures is to be removed only after all areas have been paved. Care shall be taken at the removal stage to ensure that any silt that has accumulated is properly handled and disposed of. Removal of silt fences without prior removal of the sediments shall not be permitted.

Although not anticipated, work through winter months shall be closely monitored for erosion along sloped areas. Should erosion be noted, the Contractor shall be alerted and shall take all necessary steps to rectify the situation. Should the Contractor’s efforts fail at remediating the eroded areas, the Contractor shall contact the City and/or Conservation Authority to review the site conditions and determine the appropriate course of action. As the ground begins to thaw, the Contractor shall place silt fencing at all required locations as soon as ground conditions warrant. Please see the *Site*

Grading, Drainage and Sediment & Erosion Control Plan for additional details regarding the temporary measures to be installed and their appropriate OPSD references.

8.2 Permanent Measures

Rip-rap will be placed at all locations that have the potential for concentrated flow. It is crucial that the Contractor ensure that the geotextile is keyed in properly to ensure runoff does not undermine the rip rapped area. Additional rip rap is to be placed at erosion prone locations as identified by the Contractor / Contract Administrator / City or Conservation Authority.

It is expected that the Contractor will promptly ensure that all disturbed areas receive topsoil and seed/sod and that grass be established as soon as possible. Any areas of excess fill shall be removed or levelled as soon as possible and must be located a sufficient distance from any watercourse to ensure that no sediment is washed out into the watercourse. As the vegetation growth within the site provides a key component to the control of sediment for the site, it must be properly maintained once established. Once the construction is complete, it will be up to the landowner to maintain the vegetation and ensure that the vegetation is not overgrown or impeded by foreign objects.

9.0 SUMMARY

- A new 1,042m² warehouse building is proposed along the east property line at 30 Auriga Drive.
- A new 50mm diameter water service is proposed to service the site, extending from the existing 300mm watermain within Auriga Drive.
- A new 150mm sanitary service is proposed to service the site. The service will extend from a proposed maintenance hole at the existing 250mm sanitary sewer within Auriga Drive.
- The proposed storm sewer, ranging in diameter from 200 mm to 300 mm, will be installed throughout the site and drain to the existing 1350mm storm sewer on Auriga Drive.
- Storage for the 5- through 100-year storm events will be provided within the parking lot areas above the proposed storm structures, on the proposed flat roof and within the dry retention area.
- An OGS downstream of the site restrictions will provide quality control for the proposed storm network.

10.0 RECOMMENDATION

Based on the information presented in this report, we recommend that City of Ottawa approve this Servicing and Stormwater Management Report in support of the proposed warehouse.

This report is respectfully being submitted for approval.

Regards,

McIntosh Perry Consulting Engineers Ltd.



Mitch Raper, B.Eng
Engineering Intern
T: 343.764.2089
E: m.raper@mcintoshperry.com



Andrew Macleod, P.Eng
Senior Engineer
T: 365.527.2696
E: a.macleod@mcintoshperry.com

u:\ottawa\01 project - proposals\2023 jobs\cco\cco-23-0914 rossmann architecture_warehouse_30 auriga drive\03 - servicing\report\co-23-0914_servicing report.docx

11.0 STATEMENT OF LIMITATIONS

This report was produced for the exclusive use of Rossman Architects and Associates Inc. The purpose of the report is to assess the existing stormwater management system and provide recommendations and designs for the post-construction scenario that are in compliance with the guidelines and standards from the Ministry of the Environment, Conservation and Parks, City of Ottawa and local approval agencies. McIntosh Perry reviewed the site information and background documents listed in Section 2.0 of this report. While the previous data was reviewed by McIntosh Perry and site visits were performed, no field verification/measures of any information were conducted.





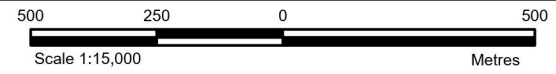
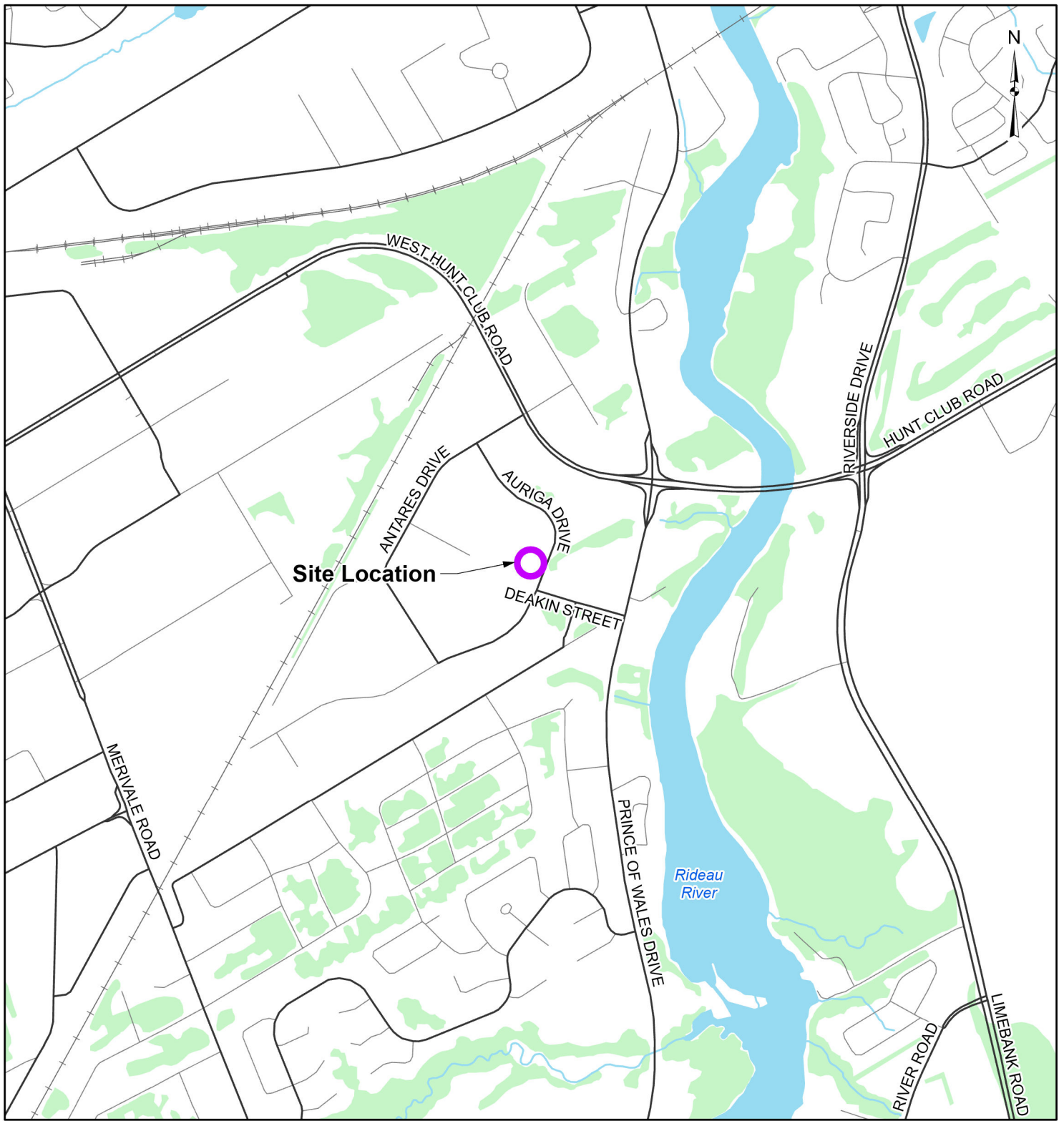

Any use of this review by a third party, or any reliance on decisions made based on it, without a reliance report is the responsibility of such third parties. McIntosh Perry accepts no responsibility for damages, if any, suffered by any third party as a result of decisions or actions made based on this review.

The findings, conclusions and/or recommendations of this report are only valid as of the date of this report. No assurance is made regarding any changes in conditions subsequent to this date. If additional information is discovered or becomes available at a future date, McIntosh Perry should be requested to re-evaluate the conclusions presented in this report, and provide amendments, if required.

APPENDIX A
KEY PLAN



LEGEND

-  Site Location
-  Local Road
-  Major Road
-  Railroad
-  Watercourse
-  Waterbody
-  Wooded Area

REFERENCE

GIS data provided by the Ontario Ministry of Northern Development, Mines, Natural Resources and Forestry, 2022.

CLIENT:		ROSSMAN ARCHITECTS AND ASSOCIATES INC.	
PROJECT:		30 AURIGA DRIVE	
TITLE:		SITE LOCATION	
PROJECT NO: CCO-23-0914		FIGURE:	
Date	Dec., 21, 2022	1	
GIS	MG		
Checked By	RR		

McINTOSH PERRY
 115 Walgreen Road, RR3, Carp, ON K0A1L0
 Tel: 613-836-2184 Fax: 613-836-3742
 www.mcintoshperry.com

C:\Users\M_Grunstra\OneDrive\GIS - Documents\Projects\2023\CCO\CCO-23-0914_Rossmann Architecture Warehouse_30 Auriga Drive.aprx\LandDevelopment\CCO-23-0914_Site_Location\Option D.aprx

APPENDIX B
BACKGROUND DOCUMENTS

Project:

During the meeting, a proposal to redevelop the site with a new 1,042.5 square-metre light industrial building consisting of warehouse and office components was discussed. The new building is proposed to be located on the east portion of the site, and 20 surface parking spaces are proposed to be located on the front portion of the site with truck bays being located to the rear of the site.

Below are staff's preliminary comments:

Policies/Designations of the site

- Official Plan – designated as Urban Employment Zone
- New Official Plan –Mixed Industrial
- Zoning – General Industrial Subzone 5, “IG5”
 - Within Area C for Minimum Parking Requirements (Schedule 1A)

Engineering

Please note the following information regarding the engineering design submission for the above noted site:

1. The Servicing Study Guidelines for Development Applications are available at the following address: <http://ottawa.ca/en/development-application-review-process-0/servicing-study-guidelines-development-applications>
2. Servicing and site works shall be in accordance with the following documents:
 - ⇒ Ottawa Sewer Design Guidelines (October 2012)
 - ⇒ Ottawa Design Guidelines – Water Distribution (2010)
 - ⇒ Geotechnical Investigation and Reporting Guidelines for Development Applications in the City of Ottawa (2007)
 - ⇒ City of Ottawa Slope Stability Guidelines for Development Applications (revised 2012)
 - ⇒ City of Ottawa Environmental Noise Control Guidelines (January, 2016)

- ⇒ City of Ottawa Park and Pathway Development Manual (2012)
 - ⇒ City of Ottawa Accessibility Design Standards (2012)
 - ⇒ Ottawa Standard Tender Documents (latest version)
 - ⇒ Ontario Provincial Standards for Roads & Public Works (2013)
3. Record drawings and utility plans are also available for purchase from the City (Contact the City's Information Centre by email at InformationCentre@ottawa.ca or by phone at (613) 580-2424 x.44455).
 4. The Stormwater Management Criteria, for the subject site, is to be based on the following:
 - i. The 5-yr storm event using the IDF information derived from the Meteorological Services of Canada rainfall data, taken from the MacDonald Cartier Airport, collected 1966 to 1997.
 - ii. The pre-development runoff coefficient or a maximum equivalent 'C' of 0.5, whichever is less (§ 8.3.7.3).
 - iii. A calculated time of concentration (Cannot be less than 10 minutes).
 - iv. Flows to the storm sewer in excess of the 5-year storm release rate, up to and including the 100-year storm event, must be detained on site.
 5. Services (Storm, Sanitary & Water Supply)
 - i. Services should be grouped in a common trench to minimize the number of road cuts.
 - a. 305mm DI watermain in Auriga Drive
 - b. 250mm PVC sanitary sewer in Auriga Drive
 - c. 1350mm CONC storm sewer in Auriga Drive
 - ii. Industrial, commercial, institutional service areas with a basic day demand greater than 50 cubic meters per day shall be connected with a minimum of two watermain connections, separated by an isolation valve.
 - iii. Connections to trunk sewers and easement sewers are typically not permitted.
 - iv. Monitoring maintenance holes to be provided at property line.
 - v. Sewer connections to be made above the springline of the sewermain as per:
 - a. Std Dwg S11.1 for flexible main sewers.
 - b. Std Dwg S11 (For rigid main sewers).

- c. Std Dwg S11.2 (for rigid main sewers using bell end insert method).
- d. Connections to manholes permitted when the connection is to rigid main sewers where the lateral exceeds 50% the diameter of the sewermain. – Connect obvert to obvert with the outlet pipe unless pipes are a similar size.
- e. No submerged outlet connections.

6. Water Boundary condition request to be submitted to the Infrastructure Project Manager and must include the location of the service connection (map or plan with connection location indicated) and the expected loads required by the proposed development, including calculations. Please provide the following information:

- i. Location of service
- ii. Type of development and the amount of fire flow required (as per FUS).
- iii. Average daily demand: ___ l/s.
- iv. Maximum daily demand: ___ l/s.
- v. Maximum hourly daily demand: ___ l/s.

7. MOECC ECA Requirements

An MOECC Environmental Compliance Approval (Input Application Type - Industrial Sewage Works) may be required for the proposed development depending on proposed use. This requirement can be further examined upon formal submission.

8. Phase 1 ESAs and Phase 2 ESAs must conform to clause 4.8.4 of the Official Plan that requires that development applications conform to Ontario Regulation 153/04.

9. Please contact the Transportation Services Department (TMconstruction@ottawa.ca) early in the zoning/site plan process to determine the ability to construct the site within the ROW and copy Sarah.Ezzio@Ottawa.ca on this request.

Should you have any questions or require additional information, please contact me directly at (613) 580-2424, x21746 or by email at Justin.Armstrong@ottawa.ca.

Planning

- Please reduce the amount of asphalt on the site, and include more soft landscaping. We would like to see the building pushed back to incorporate some landscaping at the front of the site, or the inclusion of trees at the rear/sides of the property.

- At time of site plan submission, please provide as many details as possible, including: snow storage locations, dimensions of garbage enclosure, zoning matrix, legend showing surface treatment, etc.
- Please be advised that the city has a 40 % tree canopy cover target.
- Follow the City's [Accessibility Design Standards](#), and note that there must be a depressed curb leading to any accessible parking space.
- Please provide a pedestrian connection to the sidewalk.
- Include Bicycle Parking as per the by-law, and provide dimensions on the site plan.
- The site falls within the Airport Vicinity Development Zone (see Section 4.8.7 of the Official Plan) and [Airport Zoning Regulations](#) apply

Please contact Sarah Ezzio, Planner, at Sarah.Ezzio@ottawa.ca if you have any questions or require additional information relating to the comments above.

Urban Design

- A Design Brief is required. A Terms of Reference for the Design Brief is attached. All the items highlighted in yellow must be addressed.
- The proposed parking in the front of the building is acceptable if there is a substantial landscape treatment along the frontage. This is to include numerous trees and low growing shrubs.
- As noted by numerous staff, as much asphalt at the rear of the site should be removed and replace with soft surface area and generous additional tree planting.
- As noted by the staff Planner, there should be a pedestrian connection from the new building to the future sidewalk along the frontage.
- Please contact Selma Hassan, Selma.Hassan@ottawa.ca, should there be any further comments on the Urban Design comments.

Transportation

- A TIA is not required.
- While a noise impact study is not required, the applicant is encouraged to provide air conditioning for any office use as the development is on the edge of the Airport Operating Influence Zone.
- On site plan:
 - Show all details of the roads abutting the site up to and including the opposite curb; include such items as pavement markings, accesses and/or sidewalks.
 - Turning templates will be required for all accesses showing the largest vehicle to access the site; required for internal movements and at all accesses (the inbound turning movements show that the truck is approach entirely from the left side of Auriga).
 - Show all curb radii measurements; ensure that all curb radii are reduced as much as possible
 - Show lane/aisle widths.
- Auriga has a protected right of way of 24m. Show this on the plan, a widening may be required. Provide a sidewalk connection along the site frontage to connect to the existing sidewalk at the corner of Auriga and Deakin.
- Please contact Patrick McMahon (Patrick.Mcmahon@ottawa.ca) if you have any questions on these transportation comments.

Rideau Valley Conservation Authority

- The subject site appears to outlet through conveyance directly to the Rideau River. As such, on site enhanced water quality protection (80% TSS Removal) is required.
- Please contact Eric Lalande (eric.lalande@rvca.ca) should you have any questions on the Conservation Authority Comments.

Parks & Facilities Planning

The comments from Parks and Facilities Planning Services are as follows:

- PFP will require cash-in-lieu of parkland at the commercial rate of 2% based on the total developable area for this application.
- Please contact Louise Cervený, Louise.Cervený@ottawa.ca, should there be any questions relating to these Parks & Facilities Planning comments.

Forestry & Trees

Project Comments:

1. The staghorn sumac bush bordering the east side of the property appears to be owned by 26 Auriga. If you are proposing removal of these shrubs, you should discuss this with the landowner.
2. Retention of any healthy trees outside of the building area is a priority.

TCR requirements:

1. a Tree Conservation Report (TCR) must be supplied for review along with the suite of other plans/reports required by the City
 - a. an approved TCR is a requirement of Site Plan approval.
 - b. The TCR may be combined with the LP provided all information is supplied
2. Any removal of privately-owned trees 10cm or larger in diameter, or city-owned trees of any diameter requires a tree permit issued under the Tree Protection Bylaw (Bylaw 2020 – 340); the permit will be based on an approved TCR and made available at or near plan approval.
3. The Planning Forester from Planning and Growth Management as well as foresters from Forestry Services will review the submitted TCR
 - a. If tree removal is required, both municipal and privately-owned trees will be addressed in a single permit issued through the Planning Forester
 - b. Compensation may be required for city owned trees – if so, it will need to be paid prior to the release of the tree permit
4. The TCR must contain 2 separate plans:
 - a. Plan/Map 1 - show existing conditions with tree cover information
 - b. Plan/Map 2 - show proposed development with tree cover information
 - c. Please ensure retained trees are shown on the landscape plan
5. the TCR must list all trees on site, as well as off-site trees if the CRZ extends into the developed area, by species, diameter and health condition

- a. please identify trees by ownership – private onsite, private on adjoining site, city owned, boundary (trees on a property line)
- 6. If trees are to be removed, the TCR must clearly show where they are, and document the reason they cannot be retained
- 7. All retained trees must be shown, and all retained trees within the area impacted by the development process must be protected as per City guidelines available at [Tree Protection Specification](#) or by searching Ottawa.ca
 - a. the location of tree protection fencing must be shown on the plan
- 1. the City encourages the retention of healthy trees; if possible, please seek opportunities for retention of trees that will contribute to the design/function of the site.
- 2. For more information on the process or help with tree retention options, contact Hayley Murray hayley.murray@ottawa.ca or on [City of Ottawa](#)

LP tree planting requirements:

For additional information on the following please contact tracy.smith@Ottawa.ca

Minimum Setbacks

- Maintain 1.5m from sidewalk or MUP/cycle track or water service laterals.
- Maintain 2.5m from curb
- Coniferous species require a minimum 4.5m setback from curb, sidewalk or MUP/cycle track/pathway.
- Maintain 7.5m between large growing trees, and 4m between small growing trees. Park or open space planting should consider 10m spacing, except where otherwise approved in naturalization / afforestation areas. Adhere to Ottawa Hydro's planting guidelines (species and setbacks) when planting around overhead primary conductors.

Tree specifications

- Minimum stock size: 50mm tree caliper for deciduous, 200cm height for coniferous.
- Maximize the use of large deciduous species wherever possible to maximize future canopy coverage
- Tree planting on city property shall be in accordance with the City of Ottawa's Tree Planting Specification; and include watering and warranty as described in the specification (can be provided by Forestry Services).
- Plant native trees whenever possible
- No root barriers, dead-man anchor systems, or planters are permitted.
- No tree stakes unless necessary (and only 1 on the prevailing winds side of the tree)

Hard surface planting

- Curb style planter is highly recommended
- No grates are to be used and if guards are required, City of Ottawa standard (which can be provided) shall be used.
- Trees are to be planted at grade

Soil Volume:

- Please document on the LP that adequate soil volumes can be met:

Tree Type/Size	Single Tree Soil Volume (m3)	Multiple Tree Soil Volume (m3/tree)
Ornamental	15	9
Columnar	15	9
Small	20	12
Medium	25	15
Large	30	18
Conifer	25	15

Please note that these soil volumes are not applicable in cases with Sensitive Marine Clay.

- Please follow the City’s 2017 Tree Planting in Sensitive Marine Clay guidelines

Tree Canopy Cover:

- The landscape plan shall show how the proposed tree planting will replace and increase canopy cover on the site over time, to support the City’s 40% urban forest canopy cover target.
- At a site level, efforts shall be made to provide as much canopy cover as possible, through tree planting and tree retention, with an aim of 40% canopy cover at 40 years, as appropriate.
- Indicate on the plan the projected future canopy cover at 40 years for the site.

This proposal is subject to a **Site Plan Control application** (Standard, Staff Approval). The required Plans & Studies is attached.

Please refer to the links to [“Guide to preparing studies and plans”](#) and [fees](#) for general information. Additional information is available related to [building permits](#), [development charges](#), and the [Accessibility Design Standards](#). Be aware that other fees and permits may be required, outside of the development review process. You may obtain background drawings by contacting informationcentre@ottawa.ca.

These pre-con comments are valid for one year. If you submit a development application(s) after this time, you may be required to meet for another pre-consultation meeting and/or the submission requirements may change. You are as well encouraged to contact us for a follow-up meeting if the plan/concept will be further refined.

We are happy to discuss further or answer any follow-up questions.

TOPOGRAPHIC PLAN OF SURVEY OF
PART OF LOT 26
CONCESSION "A" (RIDEAU FRONT)
 GEOGRAPHIC TOWNSHIP OF NEPEAN
 CITY OF OTTAWA
 Surveyed by Annis, O'Sullivan, Vollebakk Ltd.

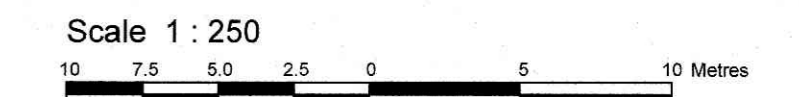

Metric
 DISTANCES SHOWN ON THIS PLAN ARE IN METRES AND
 CAN BE CONVERTED TO FEET BY DIVIDING BY 0.3048

Surveyor's Certificate

- I CERTIFY THAT:
- This survey and plan are correct and in accordance with the Surveys Act and the Surveyors Act and the regulations made under them.
 - The survey was completed on the 17th day of November, 2022.

Nov. 30 2022
 Date
 E. H. Herveyo
 Ontario Land Surveyor

Notes & Legend

—□—	Denotes	Survey Monument Planted
—■—	Denotes	Survey Monument Found
—S—	Denotes	Standard Iron Bar
—SSB—	Denotes	Short Standard Iron Bar
—IB—	Denotes	Iron Bar
(WT)	Denotes	Witness
(AOG)	Denotes	Annis, O'Sullivan, Vollebakk Ltd.
Meas	Denotes	Measured
Acc	Denotes	Accepted
(P1)	Denotes	Plan 5R-12628
(P2)	Denotes	Plan 5R-9094
(P3)	Denotes	Plan 4R-5008
(P4)	Denotes	(AOG) Plan December 17, 2004
(P5)	Denotes	Plan 4R-34444
CLF	Denotes	Chain Link Fence
o UP	Denotes	Utility Pole
• AN	Denotes	Anchor
⊙	Denotes	Deciduous Tree
□ CB	Denotes	Catch Basin
□ CBI	Denotes	Catch Basin Inlet
○ MH-ST	Denotes	Maintenance Hole (Storm Sewer)
○ MH-S	Denotes	Maintenance Hole (Sanitary)
⊕ VC	Denotes	Valve Chamber (Watermain)
— ST —	Denotes	Underground Storm Sewer
— S —	Denotes	Underground Sanitary Sewer
— W —	Denotes	Underground Water
— P —	Denotes	Underground Power
— OW —	Denotes	Overhead Wires
— G —	Denotes	Underground Gas
⊙ FH	Denotes	Fire Hydrant
⊕ WV	Denotes	Water Valve
HT	Denotes	Hydro Transformer
TOS	Denotes	Top of Slope
BOS	Denotes	Bottom of Slope
⊙	Denotes	Diameter
+ 66.00	Denotes	Location of Elevations
+ 66.00	Denotes	Top of Concrete Curb Elevation

Bearings and Distances are per Plan 4R-34444 unless otherwise noted.

Bearings are grid, derived from the westerly limit of Auriga Drive shown to be N20°49'30"E on Plan 5R-12628 and are referred to the Central Meridian of MTM Zone 9 (76°30' West Longitude) NAD-83 (original).

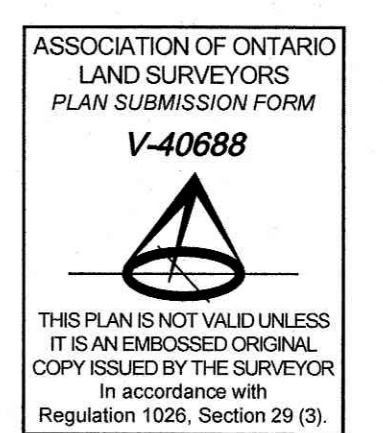

ELEVATION NOTES

- Elevations shown are geodetic and are referred to the CGVD28 geodetic datum, derived from control monument No. 0011964U3685 having an elevation of 89.251 metres.
- It is the responsibility of the user of this information to verify that the job benchmark has not been altered or disturbed and that its relative elevation and description agrees with the information shown on this drawing.

UTILITY NOTES

- This drawing cannot be accepted as acknowledging all of the utilities and it will be the responsibility of the user to contact the respective utility authorities for confirmation.
- Only visible surface utilities were located.
- Underground utility data derived from City of Ottawa utility sheet reference R-06-03C.
- Sanitary and storm sewer grades and inverts were derived from City of Ottawa Plan Reference W.D.M.87 (Drawing No. W.D.M.87-10).
- A field location of underground plant by the pertinent utility authority is mandatory before any work involving breaking ground, probing, excavating etc.

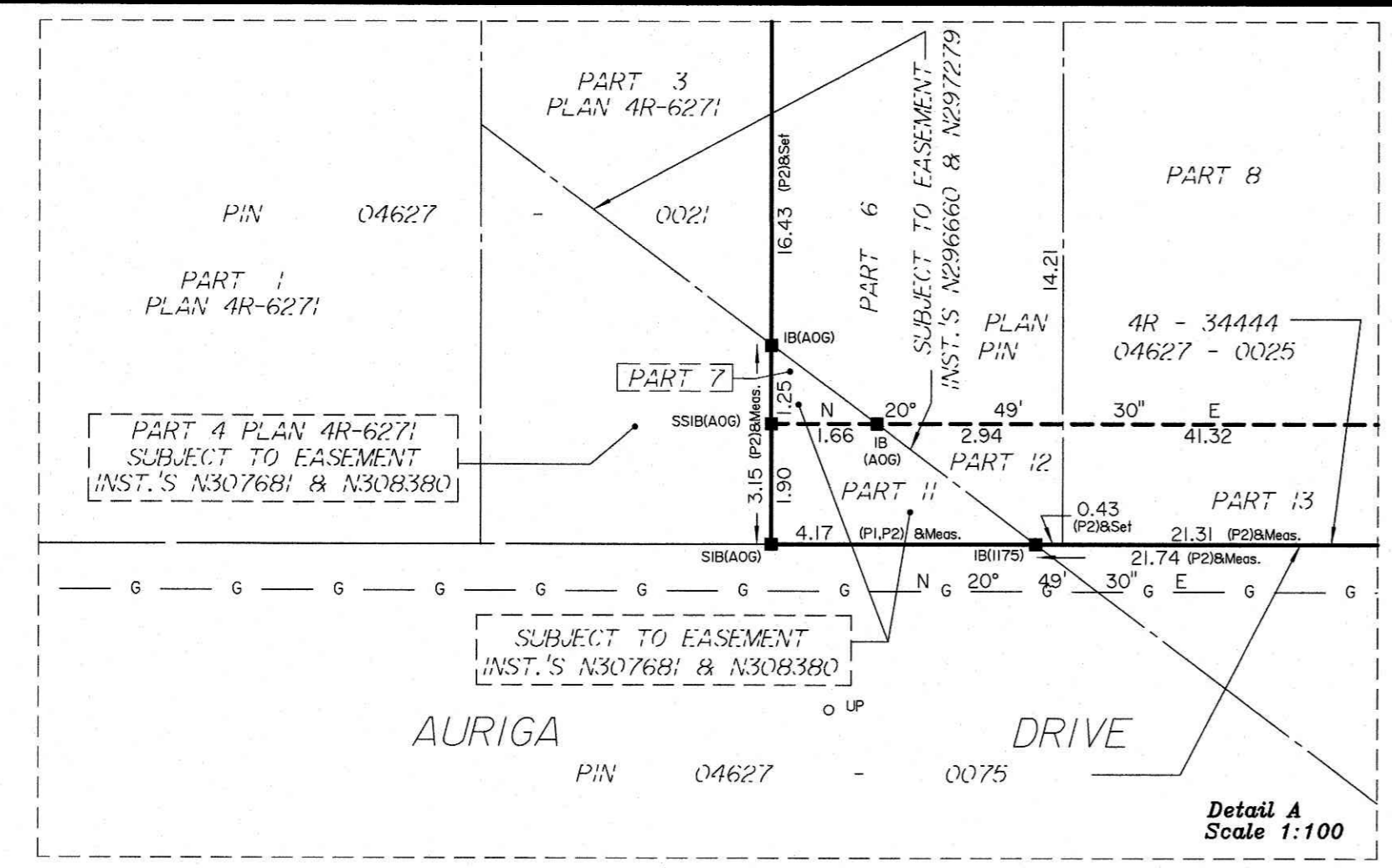

CARLETON CONDOMINIUM PLAN No. 387
 PINS 15387 - 0001 TO 0030

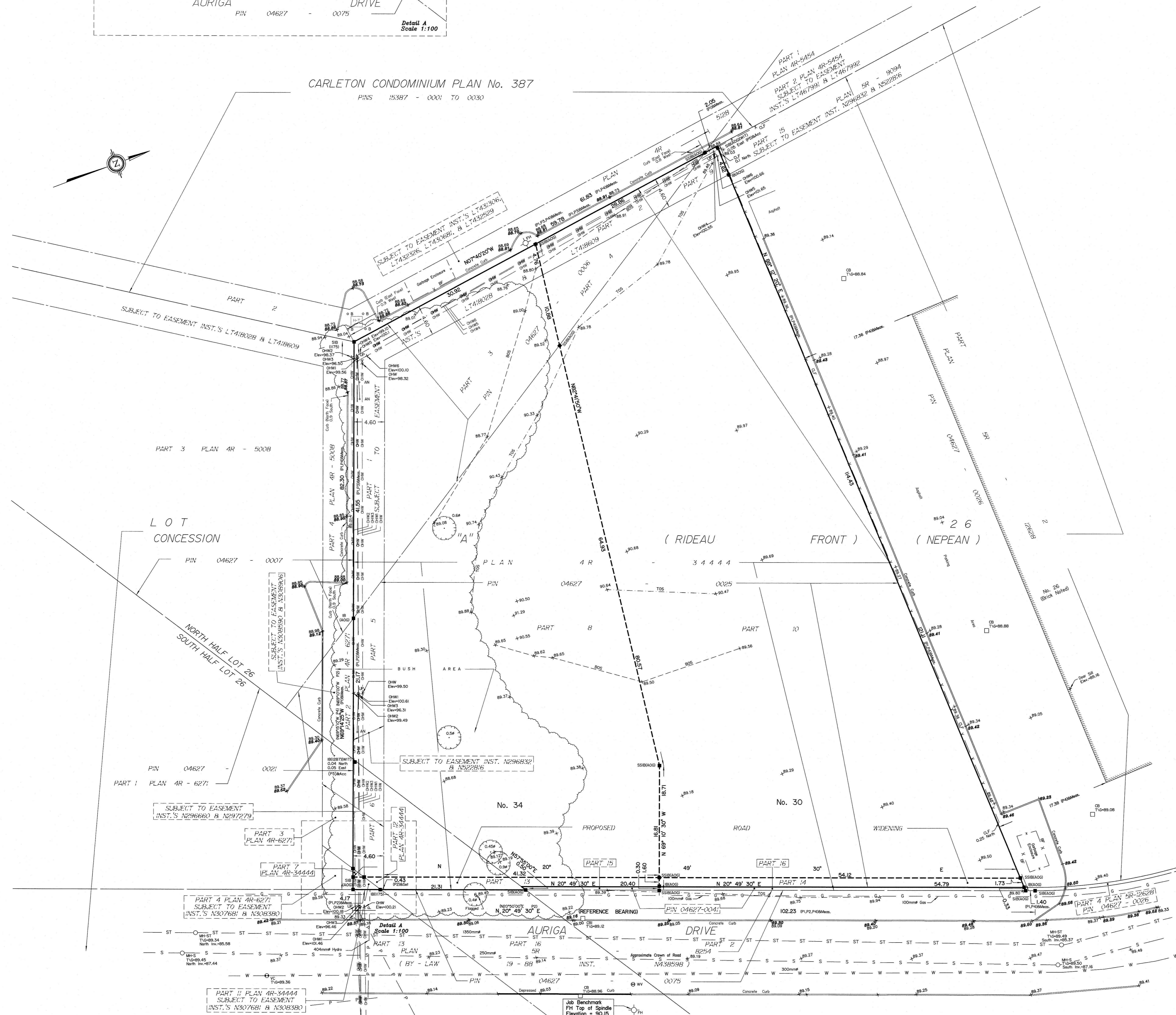

1 SITE PLAN
1 : 250

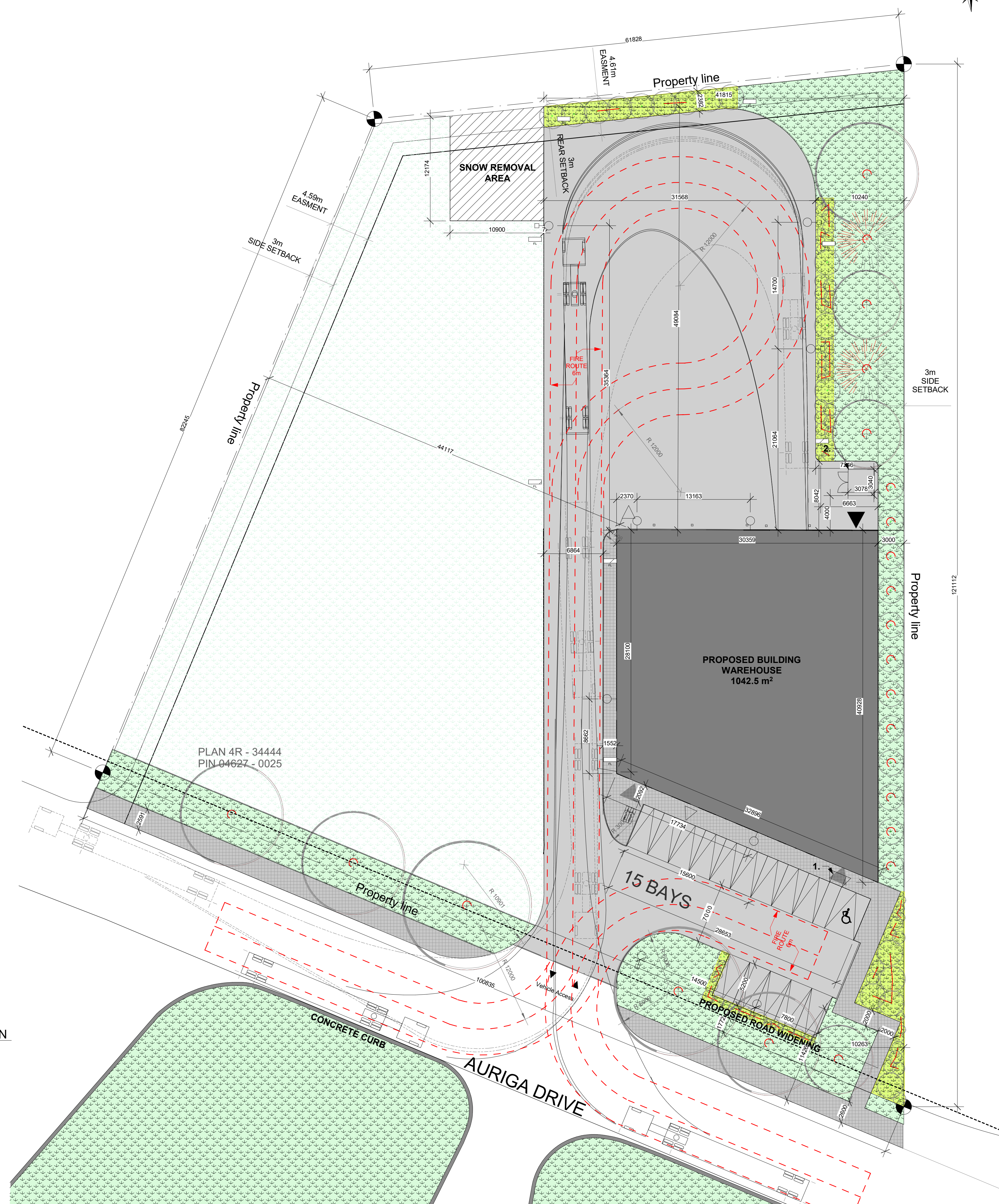

SITE CONTEXT

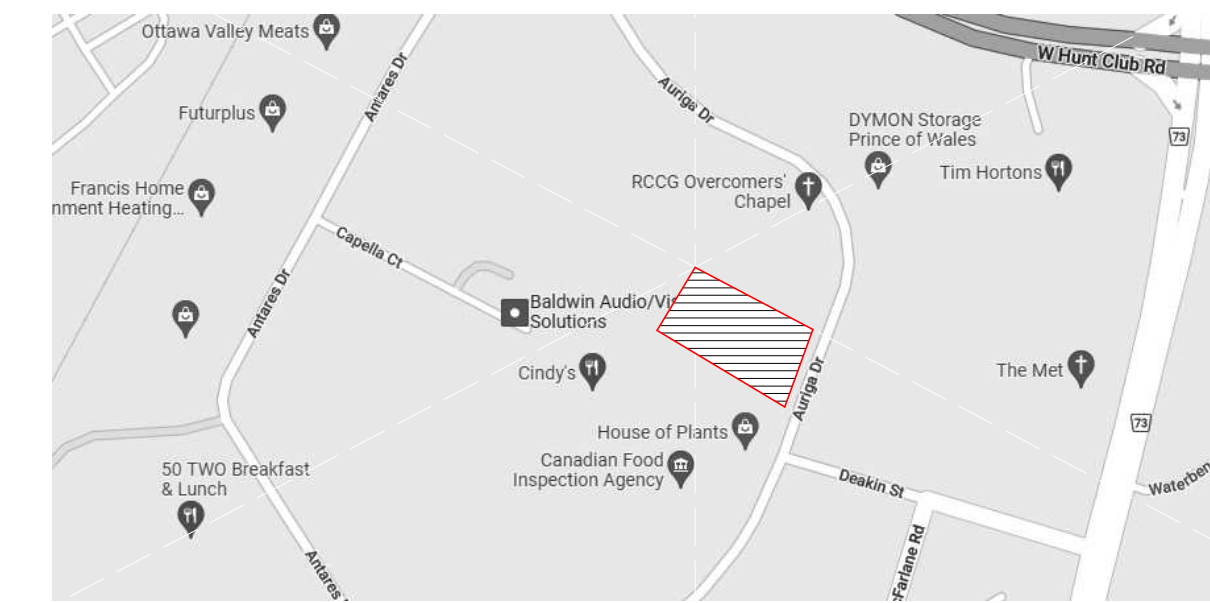

LEGEND

SURFACES

- EXISTING GRASS
- NEW GRASS
- CONCRETE PAVERS
- POURED CONCRETE
- ASPHALT PAVING
- PROPOSED NEW BUILDING
- NEW SNOW REMOVAL AREA

LINES

- FIRE ROUTE
- PROPERTY LINE
- SETBACK LINE
- EXISTING FENCE
- NEW FENCE
- OVERHEAD WIRES

VEGETATION

- TREE: EXISTING TO REMAIN
- TREE: EXISTING TO BE REMOVED
- TREE: NEW PROPOSED
- SHRUB: EXISTING TO REMAIN
- SHRUB: NEW PROPOSED

SYMBOLS

- DIRECTIONAL ARROWS
- BUILDING ACCESS
- BUILDING EGRESS
- SIAMESE CONNECTION
- UTILITY POLE
- FIRE HYDRANT
- CATCH BASIN / MANHOLE
- DEPRESSED CURB
- FIRE LANE SIGN - NO PARKING
- LANDSCAPE LIGHT
- LIGHT POLE
- WALL MOUNTED LIGHT
- EXISTING GRADE ELEVATION
- PROPOSED GRADE ELEVATION
- LOT CORNERS
- PARKING
 - BIKE PARKING
H: HORIZONTAL 0.6M x 1.8M
V: VERTICAL 0.5M x 1.5M
S: STACKED 0.37M x 1.8M
 - CAR PARKING
R: RESIDENTIAL
V: VISITOR
 - BF PARKING (TYPE A)
R: RESIDENTIAL
V: VISITOR
 - BF PARKING (TYPE B)
R: RESIDENTIAL
V: VISITOR

GENERAL NOTES

- NOTE - A :**
- ALL DRAWINGS ARE TO BE READ IN CONJUNCTION WITH ALL OTHER DRAWINGS AND SPECIFICATIONS, INCLUDING OTHER CONSULTANTS DRAWINGS AND SPECIFICATIONS. ANY DISCREPANCIES BETWEEN DRAWINGS WILL BE REPORTED TO THE PROJECT LEAD IMMEDIATELY FOR CLARIFICATION PRIOR TO COMMENCING ANY CONSTRUCTION.
- NOTE - B :**
- ALL GENERAL SITE INFORMATION AND CONDITIONS HAVE BEEN COMPILED FROM EXISTING PLANS AND SURVEYS.
- NOTE - C :**
- CONTRACTOR IS RESPONSIBLE TO CHECK AND VERIFY ALL DIMENSIONS ON SITE AND REPORT ALL ERRORS AND / OR OMISSIONS TO THE ARCHITECT.
- NOTE - D :**
- REFER TO LANDSCAPE PLAN FOR ALL EXTERIOR LANDSCAPING.
- NOTE - E :**
- DO NOT SCALE DRAWINGS.
- NOTE - F :**
- ALL CONTRACTORS MUST COMPLY WITH ALL APPLICABLE CODES AND REGULATIONS.

SURVEY INFO

TOPOGRAPHIC SURVEY OF :
PART OF LOT 26
CONCESSION "A"
(RIDEAU FRONT)
GEOGRAPHIC
TOWNSHIP OF NEPEAN
CITY OF OTTAWA
COMPLETED ON 17TH
OF NOVEMBER 2022.

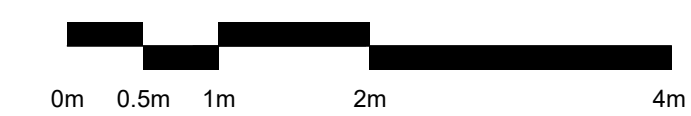
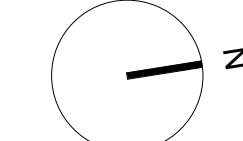

PROJECT INFORMATION

SITE SUMMARY

ADDRESS	30 AURIGA DR
CURRENT ZONING	IGS
SITE AREA	7864.00 m ²
PROPOSED USE	INDUSTRIAL
BUILDING AREA	1042.50 m ²

ZONING SUMMARY

	PERMITTED	PROPOSED
LOT AREA	1000.00 m ²	7864.00 m ²
LOT WIDTH	0.00 m	54.92 m
MIN. LOT WIDTH (RIDEAU FRONT)	0.00 m	0.00 m
MAX. BUILDING HEIGHT	22.00 m	9.00 m
MAX. PARAPET HEIGHT Above building	0.00 m	0.00 m

SET BACKS :

	PERMITTED	PROPOSED
- FRONT YARD	3.00 m (min.) 0.00 m (max.)	23.20 m (min.) 0.00 m (max.)
- CORNER SIDE YARD	0.00 m (min.) 0.00 m (max.)	0.00 m (min.) 0.00 m (max.)
- INTERIOR SIDE YARD	3.00 m (min.) 0.00 m (max.)	3.00 m (min.) 0.00 m (max.)
- REAR YARD	3.00 m (min.) 0.00 m (max.)	50.00 m (min.) 0.00 m (max.)
- ADDITIONAL REQ	0.00 m	0.00 m
MIN LANDSCAPED AREA	0.00 m	3.00 m

VEHICULAR PARKING

	REQUIRED	PROPOSED
MIN PARKING SPACES	0	0
MIN VISITOR PARKING SPACES	8	15
MIN ACCESSIBLE PRKG SPACES	1	1

BIKE PARKING

	REQUIRED	PROPOSED
MIN PARKING SPACES	1	2

DRAWING NOTES:

1. DEPRESSED CURB WITH TACTILE WALKING SURFACE INDICATOR.
2. REFUSE AREA

NOT FOR CONSTRUCTION /
PAS POUR CONSTRUCTION

This document and all information herein is confidential and the intellectual property of Rossmann Architecture Inc. It is disclosed in confidence on terms that it will not be disclosed to any third party, used, sold, loaned, licensed, or reproduced in whole or in any part in any manner or form for manufacturing, rendering or for any other purpose without the written permission of Rossmann Architecture Inc. The copyright is retained by Rossmann Architecture Inc.

Ce document, ainsi que tous renseignements contenus a l'intérieur, est la propriété de Rossmann Architecture Inc. Il est divulgué en confiance sous les termes qu'il ne sera pas divulgué a aucun tiers, utilisé, vendu, prêté, licencié ou reproduit en son entier ou en partie d'aucune manière pour la manufacture, soumission ou pour autres fins sans la permission écrite de Rossmann Architecture Inc. Le droit d'auteur est retenu par Rossmann Architecture Inc.

PROJECT TEAM / ÉQUIPE DU PROJET :

ROSSMANN ARCHITECTURE INC.
ARCHITECT
ROSSMANN ARCHITECTURE INC.
ARCHITECT

ROSSMANN ARCHITECTURE INC.
ARCHITECT
ROSSMANN ARCHITECTURE INC.
ARCHITECT

ROSSMANN ARCHITECTURE INC.
ARCHITECT
ROSSMANN ARCHITECTURE INC.
ARCHITECT

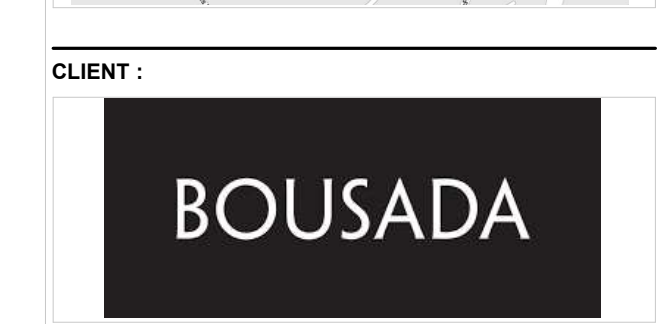
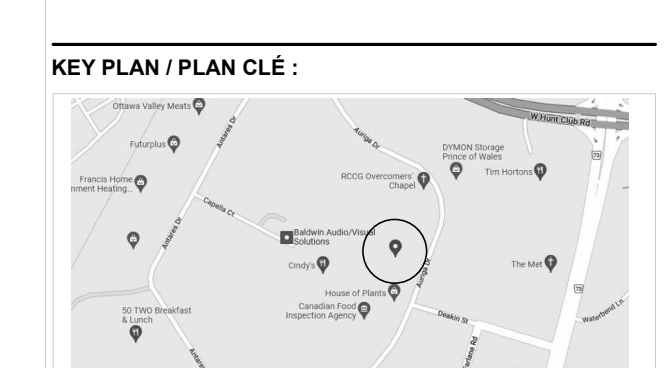

30 Auriga Drive, Nepean, K2E 8B7
Tel : XXX-XXX-XXXX | www.WEBSITE.com

revision	description	date
1.3	ISSUED FOR 99%	23-01-16
1.2	ISSUED FOR 90%	22-12-22
1.1	ISSUED FOR 66%	22-11-29
1.0	ISSUED FOR 33%	22-08-31

PROJECT NAME / NOM DU PROJET :

30 Auriga

DRAWING INFORMATION / INFORMATION DU DESSIN :

PROJECT NO. / NO. DE PROJET : **22096**
DATE : **2022-11-29**
DRAWN BY / DESSINÉ PAR : **MS**
REVIEWED BY / VÉRIFIÉ PAR : **PP**
SCALE / ÉCHELLE : **As indicated**
PROJECT PHASE / PHASE DU PROJET : **2**
DWG NO. / NO. DESSIN : **A050**

REVISION NO. / NO. DE RÉVISION : **1.3**

APPENDIX C
WATERMAIN CALCULATIONS

30 Auriga Drive Pressure Zone Figure

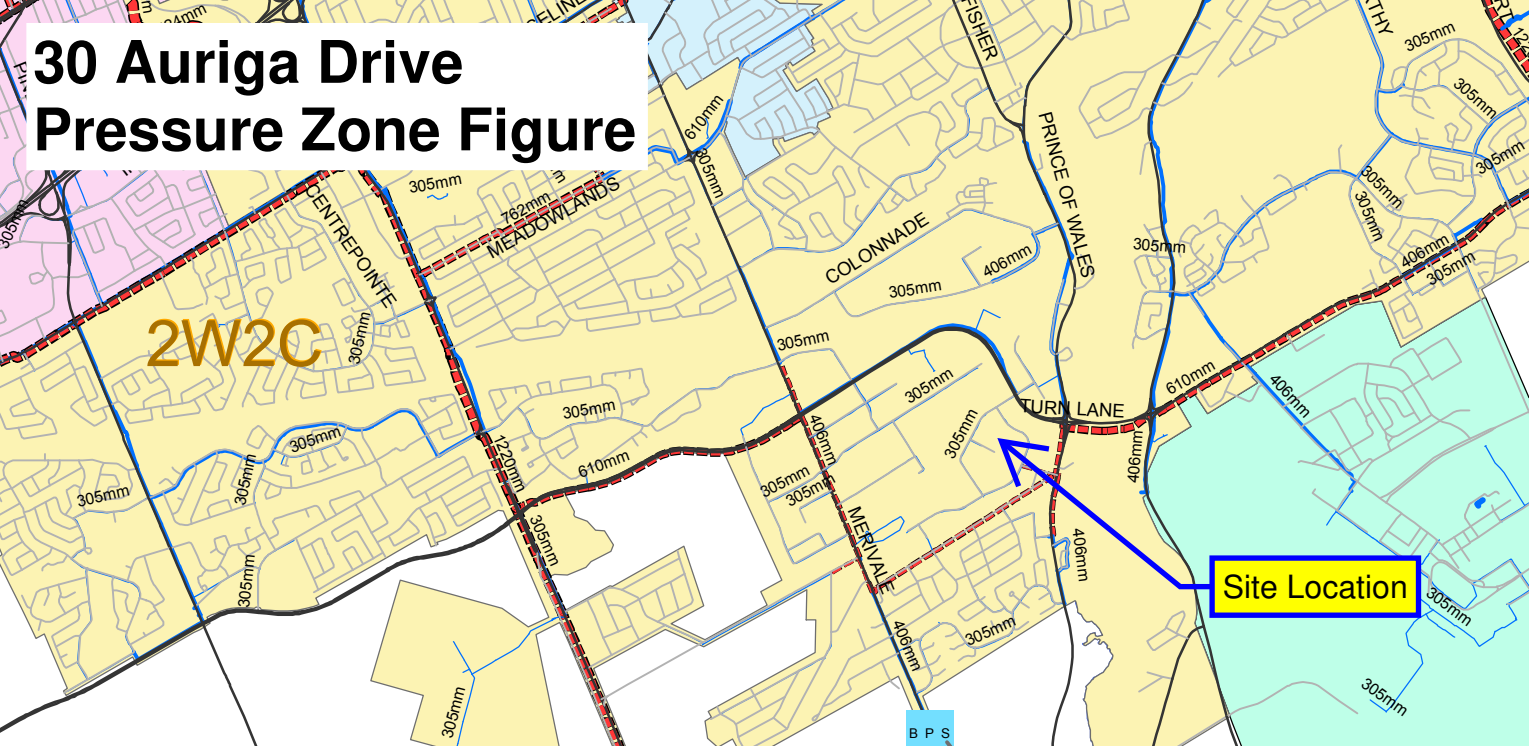

WATER DEMAND CALCULATIONS

PROJECT: 30 Auriga Drive
 LOCATION: 30 Auriga Drive - Warehouse
 CLIENT: Rossmann Architecture

McINTOSH PERRY

LOCATION		INDIVIDUAL								IC AREAS						FLOW									
STREET	JUNCTION	UNIT TYPES				AREA (ha)	POPULATION	PEAKING FACTORS		AREA (ha)			PEAKING FACTORS		AVERAGE DAY FLOW Q(a)		MAX DAY FLOW Q(max)		PEAK HOURLY FLOW Q(h)		FIRE FLOW (FUS)				
		SF	SD	TH	APT			MAX DAY	PEAK HOUR	INSTITUTIONAL	COMMERCIAL	INDUSTRIAL	MAX DAY	PEAK HOUR	(L/s)	(L/min)	(L/s)	(L/min)	(L/s)	(L/min)	(L/s)	(L/min)			
TEMPLATE																									
Auriga	SITE					0	0.0	2.75	4.13					0.77		1.50	1.80	0.31	18.64	0.47	27.96	0.84	50.33	83.00	5,000
TOTALS		0	0	0	0	0	0.0			0.00		0.00		0.77				0.31	18.64	0.47	27.96	0.84	50.33	83.00	5,000
Design Parameters:		Notes: Residential				Notes: Industrial				Designed:															
Single Family	3.4 p/p/u	1. Domestic Flow: 350 L/(cap-day)				1. Industrial - Light 35000 L/(gross ha-day)				MR															
TH/SD	2.7 p/p/u					2. Industrial - Heavy 55000 L/(gross ha-day)				Checked:															
Apartment	1.8 p/p/u	Q (a) = Average Daily Flow				Q (max) = Q(a) * Peaking Factor				NV															
		Q (max) = Maximum Daily Flow				Q (h) = Q(a) * Peaking Factor				Project No.:															
		Q (h) = Peak Hour Flow				Q (min) = Q(a) * Peaking Factor																			
		Q (min) = Night Minimum Hour Flow																							
REF: CITY OF OTTAWA - WATER DISTRIBUTION GUIDELINES, JULY 2010																									

McINTOSH PERRY

Fire Flow Requirements Based on Fire Underwriters Survey (FUS) 2020

Building No. / Type: Industrial

An estimate of the Fire Flow required for a given fire area may be estimated by:

1 of 2

$RRF = 220 \times C \times \sqrt{A}$ Where:

F = Required fire flow in liters per minute

C = Coefficient related to the type of construction.

A = The total floor area in square meters (including all storey's, but excluding basements at least 50 percent below grade) in the building being considered.

A. Determine the Construction Coefficient (C)

Choose the construction type and coefficient to be used in the required fire flow formula:

- = 1.5 Type V Wood Frame Construction
- = 0.8 Type IV-A Mass Timber Construction
- = 0.9 Type IV-B Mass Timber Construction
- = 1.0 Type IV-C Mass Timber Construction
- = 1.5 Type IV-D Mass Timber Construction
- = 1.0 Type III Ordinary Construction
- = 0.8 Type II Noncombustible Construction
- = 0.6 Type I Fire Resistive Construction

Input: C = Type III Ordinary Construction = 1.0

B. Determine Total Effective Floor Area (A)

Input building floor areas:

Floor No.	Area (m ²)	% Used	Area Used (m ²)	Total (m ²)
1	1014	100%	1014	1242
2	228	100%	228	
Input:				

C. Determine Required Fire Flow

$$RRF = 220 \times C \times \sqrt{A} = 7753 \text{ L/min} = 8000 \text{ L/min (Rounded to nearest 1,000 L/min)}$$

D. Determine Increase or Decrease Based on Occupancy Contents Adjustment Factor

Choose the combustibility of building contents:

Option	Factor	Fire Flow Change	Adjusted RFF
Non-Combustible	-25%		
Limited Combustible	-15%		
Combustible	0%		
Free Burning	15%		
Rapid Burning	25%		
Input: Limited Combustible		-15%	-1200 L/min
			6800 L/min

McINTOSH PERRY

Fire Flow Requirements Based on Fire Underwriters Survey (FUS) 2020

2 of 2

E. Determine the Decrease for Automatic Sprinkler Protection, if Applicable

Choose the sprinkler options that apply:

Option		Applicable?	Factor	Fire Flow Change	Adjusted RFF
Automatic sprinkler conforms to NFPA 13	-30%	No	0%	0 L/min	6800 L/min
Standard water supply for system and Fire Department hose line	-10%	No	0%	0 L/min	6800 L/min
Fully supervised system	-10%	No	0%	0 L/min	6800 L/min

F. Determine the Total Increase for Exposures

Choose separation distance and wall lengths:

Subject Side	Separation Distance (m)	Exposed Wall Type	Wall Length (m)	No. of Storeys	Length-Height Factor	Charge (%) (See FUS-Table 6)	Total Charge (%)	Fire Flow Change (L/min)	Adjusted RFF (L/min)
North	20	Type III	40.5	2	81	9%	9%	612	7412
South	NA	(N/A)	0	0	0	0%			
East	NA	(N/A)	0	0	0	0%			
West	NA	(N/A)	0	0	0	0%			
Input:									

G. Determine the Total Required Fire Flow

Total Required Fire Flow, Rounded to the Nearest 1,000 L/min = 7000 L/min

Total Required Fire Flow (L/sec) = 117 L/sec

Does the 10,000 L/min (167 L/sec) RFF limit apply, based on "TECHNICAL BULLETIN ISTB-2018-02"? = No

Resultant Total Required Fire Flow (L/sec) = 117 L/sec

McINTOSH PERRY

Ontario Building Code 2006 - Fire Flow Calculations

Building No. / Type: **Industrial**

1 of 2

Ontario 2006 Building Code Compendium (Div. B - Part 3)
Water Supply for Fire-Fighting

A. Determine the Major Occupancy Classification of the Building

Refer to OBC Table 3.1.2.1:

Input: **F3 Low hazard industrial occupancies**

B. Determine the Construction Type & Water Supply Coefficient

Choose the building construction type:

Input: **2 Building is of noncombustible construction or of heavy timber construction conforming to Article 3.1.4.6. Floor assemblies are fire separations but with no fire-resistance rating. Roof assemblies, mezzanines, loadbearing walls, columns and arches do not have a fire-resistance rating.**

Resulting Water Supply Coefficient (From Table 1):

K = 19

C. Determine Building Volume

Floor No.	Area (m ²)	Floor Height (m)	Floor Volume (m ³)	Total Building Volume (m ³)
1 =	1040	3.6	3744	7488
2 =	1040	3.6	3744	
	Input:			

D. Determine Spatial Coefficient Due to Exposures

From Div. B A-3.2.5.7. of the Ontario Building Code - 3. Building On-Site Water Supply:

Exposure Side	Exposure Distance (m)	Spatial Coefficient	Total Spatial Coefficient $S_{ot} = 1.0 + [S_{north} + S_{south} + S_{east} + S_{west}]$
S_{north} =	20.0	0	1
S_{east} =	50.0	0	
S_{south} =	50.0	0	
S_{west} =	50.0	0	
	Input:		

Ontario Building Code 2006 - Fire Flow Calculations

2 of 2

E. Determine Required On-Site Water Volume

From Div. B A-3.2.5.7. of the Ontario Building Code - 3. Building On-Site Water Supply:

$$Q = K \times V \times S_{\text{tot}}$$

where:

Q = minimum supply of water in litres

K = water supply coefficient from Table 1

V = total building volume in cubic metres

S_{tot} = total of spatial coefficient values from the property line exposures on all sides

Q = 142,272 L

F. Determine Required On-Site Water Flow Rate

Is the building one-storey with building area not exceeding 600m²?

Input:

Minimum Flow Rate (from Table 2) = 4500 L/min (Q > 135,000 L and <= 162,000 L)

30 Auriga Drive Hydrant Coverage Figure

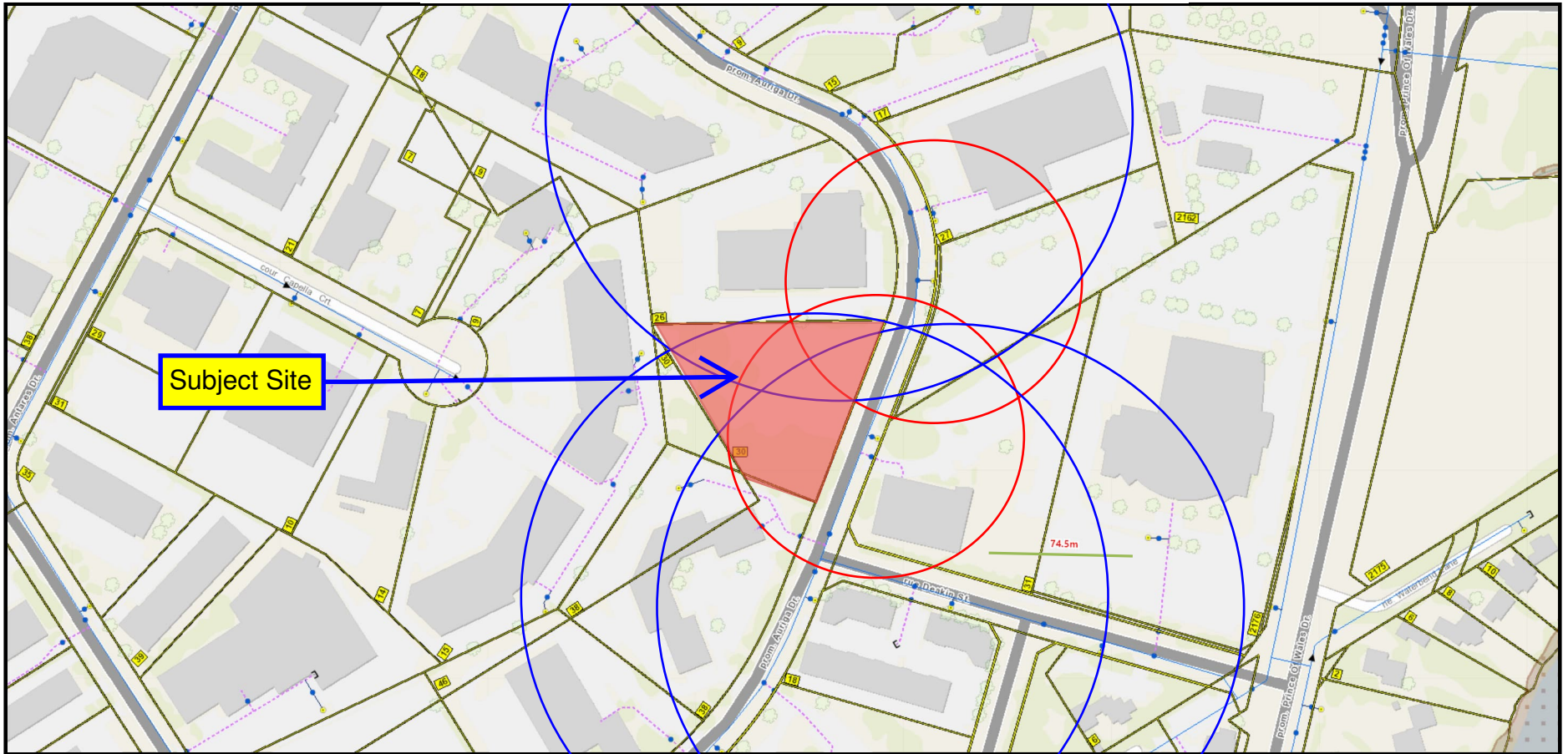

Municipal hydrants within 75m: 2

Municipal hydrants within 150m: 3

APPENDIX D
SANITARY CALCULATIONS

30 Auriga Trunk Sewer Figure

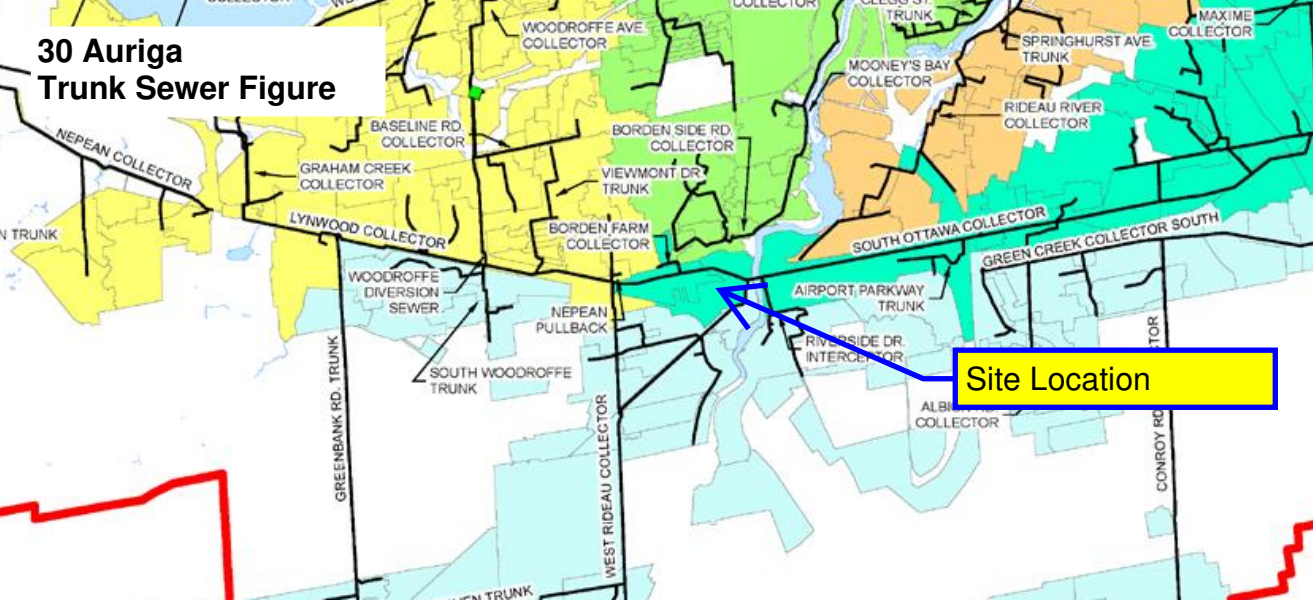

McINTOSH PERRY

CCO-23-0914 - 30 Auriga Drive - Sanitary Demands

Project:	30 Auriga Drive
Project No.:	CCO-23-0914
Designed By:	R.R.R.
Checked By:	C.J.M.
Date:	July 5, 2023

Site Area	0.77	Gross ha		
Duplex	0		0.00	Persons per unit
Apartment	0		0.00	Persons per unit
Total Population	0	Persons		
Commercial Area	0.00	m ²		
Amenity Space	0.00	m ²		

DESIGN PARAMETERS

Light Industrial Peaking Factor	6.9	*Check Ottawa Sewer Design Guidelines Appendix 4B
Institutional/Commercial Peaking Factor	1.5	*Check technical bulleting (Either use 1.0 or 1.5)
Residential Peaking Factor	3.80	* Using Harmon Formula = $1+(14/(4+P^{0.5})) * 0.8$ where P = population in thousands, Harmon's Correction Factor = 0.8
Mannings coefficient (n)	0.013	
Demand (per capita)	280	L/day
Infiltration allowance	0.33	L/s/ha

EXTRANEOUS FLOW ALLOWANCES

Infiltration / Inflow	Flow (L/s)
Dry	0.04
Wet	0.21
Total	0.25

AVERAGE DAILY DEMAND

DEMAND TYPE	AMOUNT	UNITS	POPULATION / AREA	Flow (L/s)
Residential	280	L/c/d	0	0.00
Industrial - Light**	35,000	L/gross ha/d	0.77	0.31
Industrial - Heavy**	55,000	L/gross ha/d		0
Commercial / Amenity	2,800	L/(1000m ² /d)	0.00	0.00
Hospital	900	L/(bed/day)		0
Schools	70	L/(Student/d)		0
Trailer Parks no Hook-Ups	340	L/(space/d)		0
Trailer Park with Hook-Ups	800	L/(space/d)		0
Campgrounds	225	L/(campsite/d)		0
Mobile Home Parks	1,000	L/(Space/d)		0
Motels	150	L/(bed-space/d)		0
Hotels	225	L/(bed-space/d)		0
Office	75	L/7.0m ² /d		0
Tourist Commercial	28,000	L/gross ha/d		0
Other Commercial	28,000	L/gross ha/d		0

McINTOSH PERRY

AVERAGE RESIDENTIAL FLOW	0.00	L/s
PEAK RESIDENTIAL FLOW	0.00	L/s
AVERAGE ICI FLOW	0.00	L/s
PEAK INSTITUTIONAL/COMMERCIAL FLOW	0.00	L/s
PEAK INDUSTRIAL FLOW	2.15	L/s
TOTAL PEAK ICI FLOW	2.15	L/s

TOTAL SANITARY DEMAND

TOTAL ESTIMATED AVERAGE DRY WEATHER FLOW	0.35	L/s
TOTAL ESTIMATED PEAK DRY WEATHER FLOW	2.18	L/s
TOTAL ESTIMATED PEAK WET WEATHER FLOW	2.40	L/s

** PEAK INDUSTRIAL FLOW PER CITY OF OTTAWA SEWER DESIGN GUIDELINES APPENDIX 4B

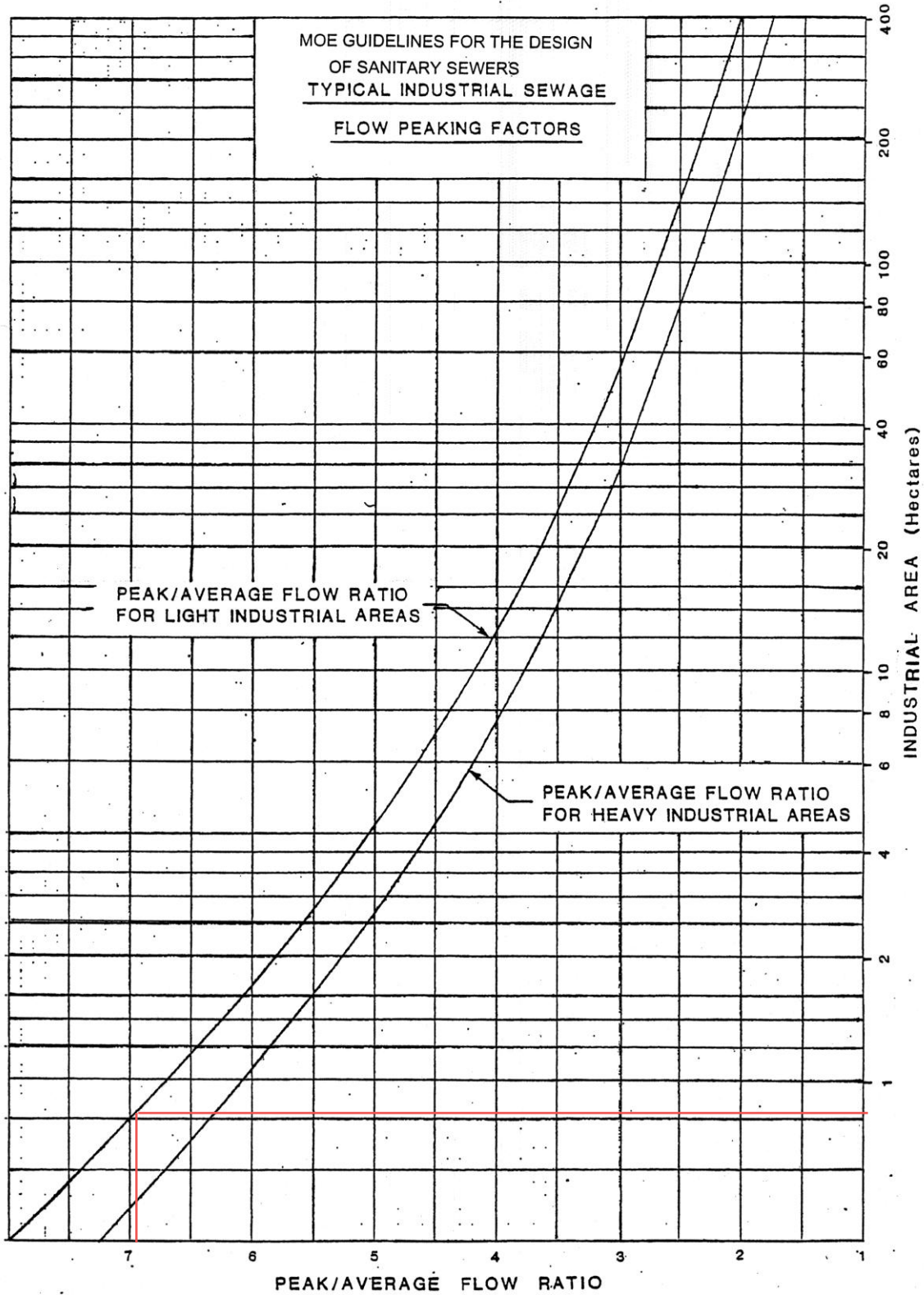

APPENDIX E
PRE-DEVELOPMENT DRAINAGE PLAN

FILENAME: C:\Drawings\01 Project - Proposed\2023\01\01\CCO-23-0914\01\01 - Drainage\01 - Drainage\01 - Presentation.dwg
DATE PLOTTED: Thursday, May 11, 2023 1:30:23 PM
USER: MRP
PLOT DEVICE: HP DesignJet 560c

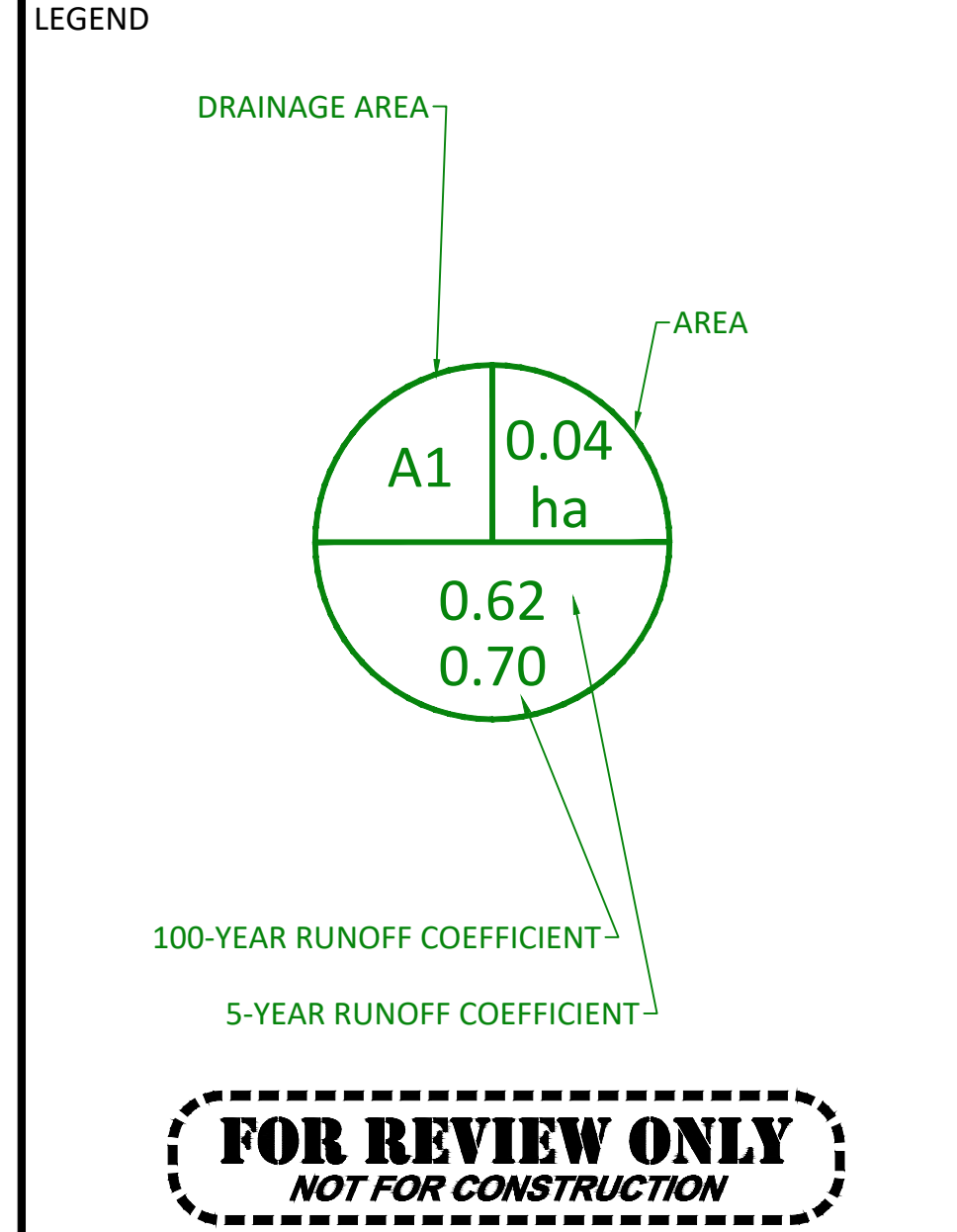
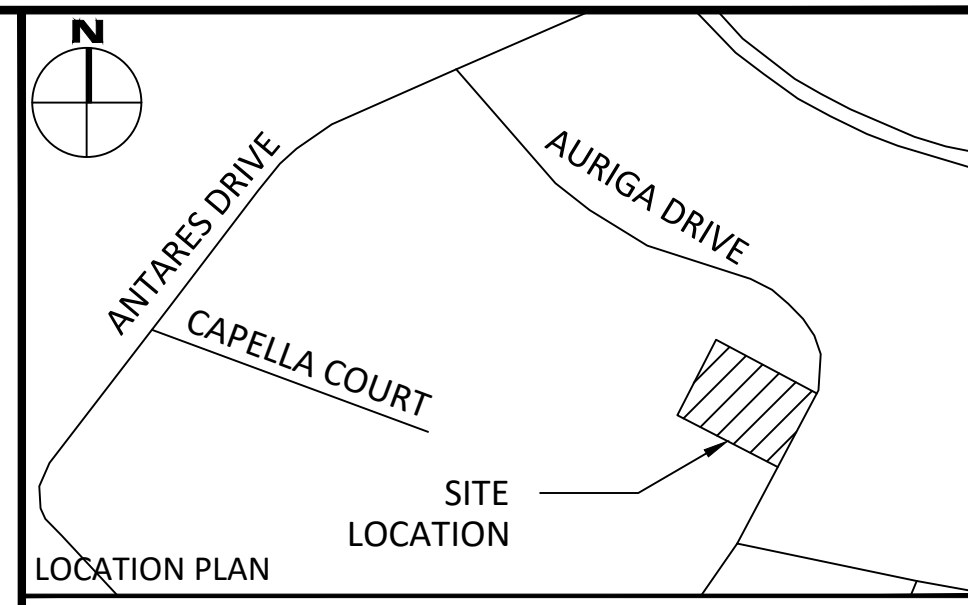
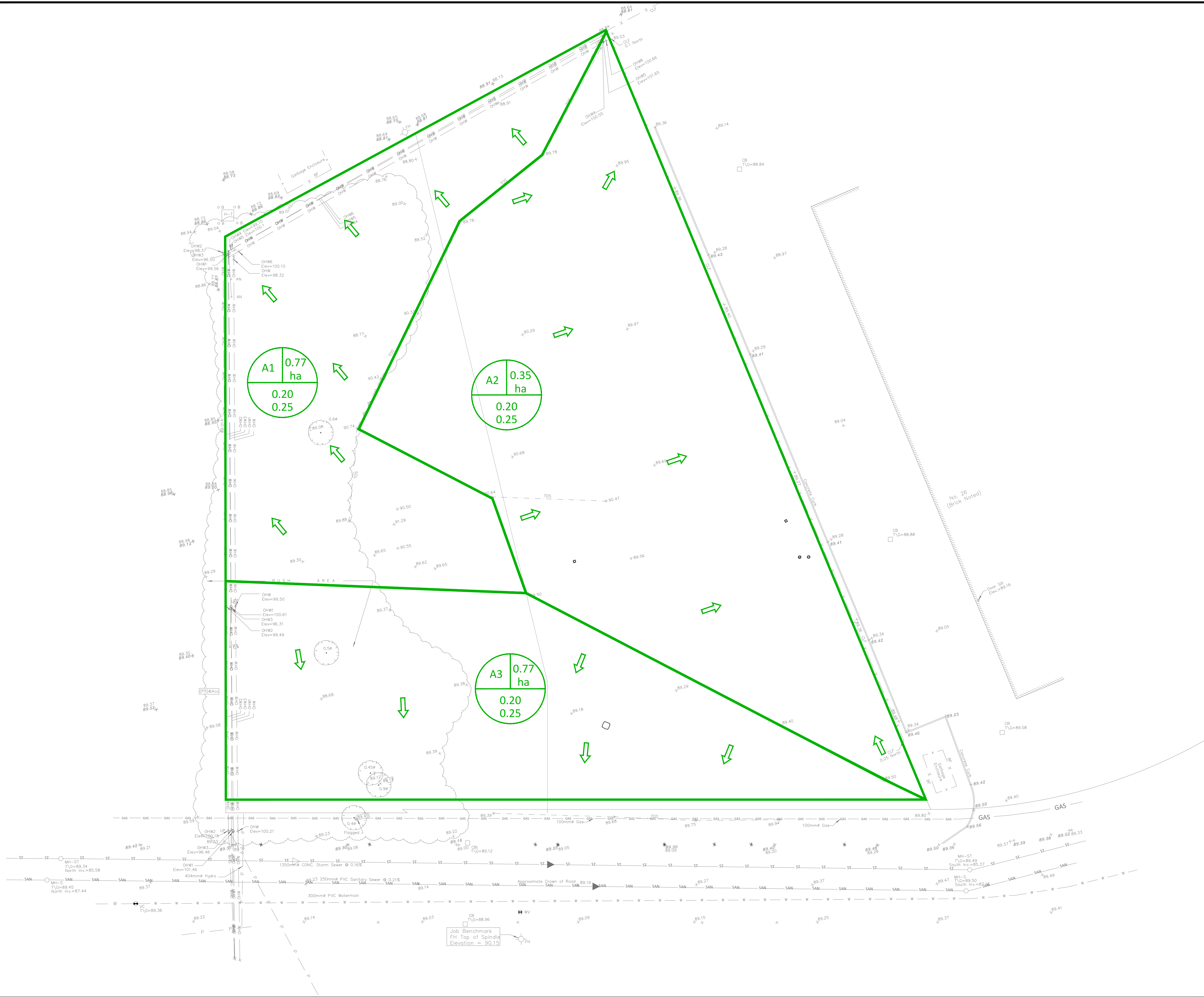

No.	Revisions	Date
2	REVISED PER CITY COMMENTS	2023-05-17
1	ISSUED FOR SITE PLAN APPLICATION	2022-12-22

Check and verify all dimensions before proceeding with the work. Do not scale drawings.
SCALE 1:250
0 5 10 15 20 25 Metres

McINTOSH PERRY
115 Walgreen Road, RR3, Carp, ON K0A 1L0
Tel: 613-836-2184 Fax: 613-836-3742
www.mcintoshperry.com

Client: **ROSSMANN ARCHITECTURE**
86 BOUL. ST-JOSEPH
GATINEAU, QC J8Y 3W5

Project: **PROPOSED WAREHOUSE**
30 AURIGA DRIVE

Drawing Title: **PRE DEVELOPMENT AREA DRAINAGE PLAN**

Scale: 1:250 Project Number: CCO-23-0914

Drawn By: M.R.

Checked By: AM

Designed By: CIM

D07-12-23-0022

C103

XXXXX

APPENDIX F
POST-DEVELOPMENT DRAINAGE PLAN

FILENAME: \\C:\Users\jpt\OneDrive\Documents\Projects\Proposed\2023\0914\Rossmann\Architecture\Warehouse_3D\Auriga\Draw11 - Drainage\CCO-23-0914 - Presentation.dwg
 LAST SAVED: Thursday, July 06, 2023 1:54:58 PM
 LAST PLOTTED: Thursday, July 06, 2023 1:55:15 PM



PROPOSED 2-STOREY WAREHOUSE
 1042.50 m²
 FFE = 89.75 m
 USF = REFER TO STRUCTURAL PLANS FOR DETAILS

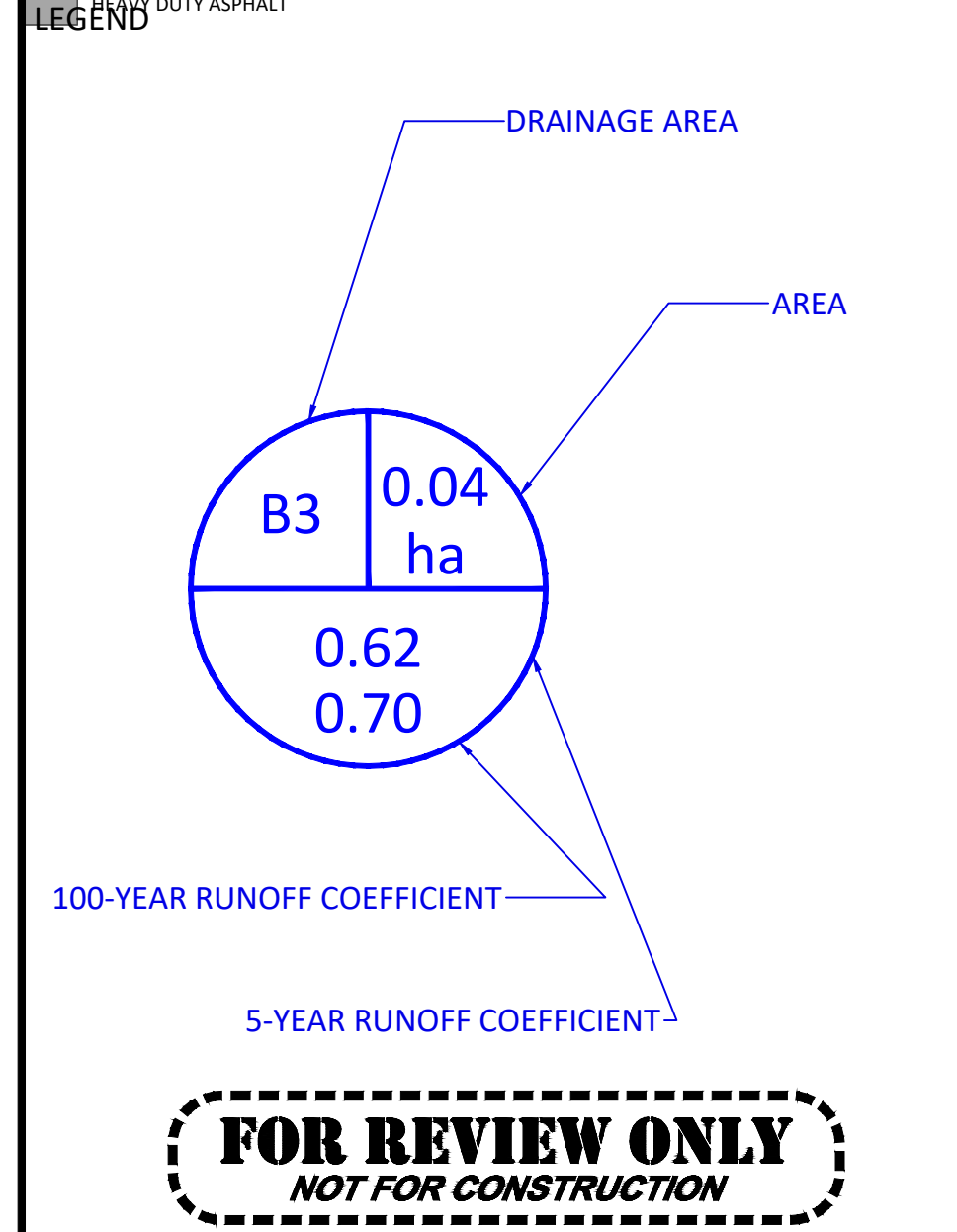
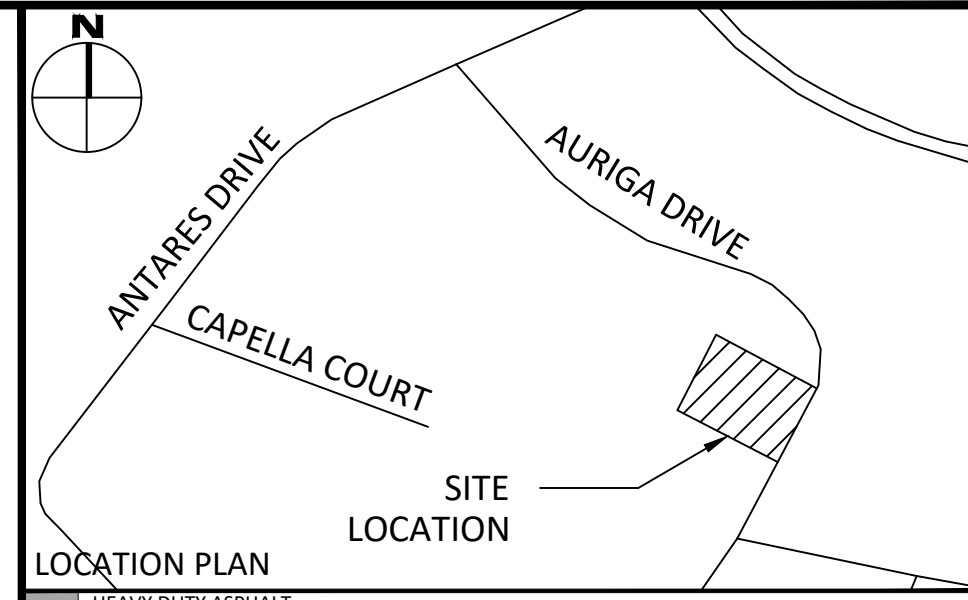

FOR REVIEW ONLY
 NOT FOR CONSTRUCTION

No.	Revisions	Date
3	REVISED PER CITY COMMENTS	2023-07-05
2	REVISED PER CITY COMMENTS	2023-05-17
1	ISSUED FOR SITE PLAN APPLICATION	2022-12-22

Check and verify all dimensions before proceeding with the work. Do not scale drawings.

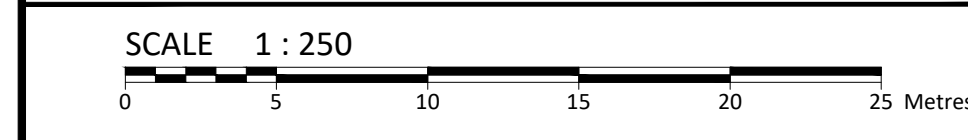

McINTOSH PERRY
 115 Walgreen Road, RR3, Carp, ON K0A 1L0
 Tel: 613-836-2184 Fax: 613-836-3742
 www.mcintoshperry.com

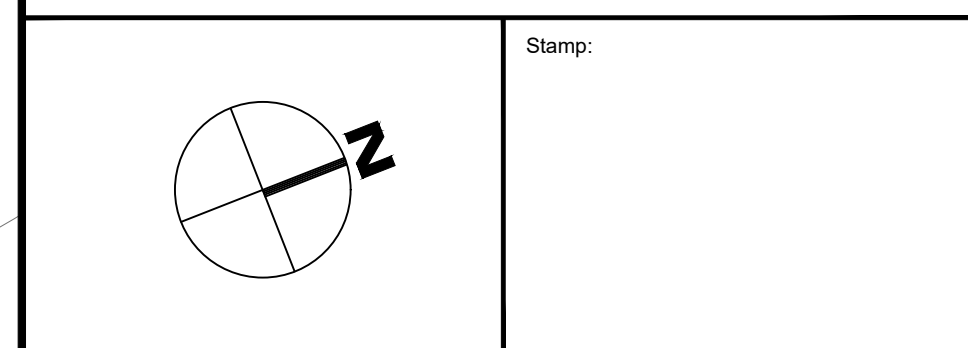

Client: **ROSSMANN ARCHITECTURE**
 86 BOUL. ST-JOSEPH
 GATINEAU, QC J8Y 3W5

Project: **PROPOSED WAREHOUSE**
 30 AURIGA DRIVE

Drawing Title: **POST DEVELOPMENT AREA DRAINAGE PLAN**

Scale:	1:250	Project Number:	CCO-23-0914
Drawn By:	M.R.	Checked By:	AM
Designed By:	CJM	Drawing Number:	C104

D07-12-23-0022

#XXXXX

APPENDIX G
STORMWATER MANAGEMENT CALCULATIONS

McINTOSH PERRY

CCO-23-0914 - 30 Auriga Drive - Runoff Calculations

Pre-Development Runoff Coefficient

Drainage Area	Area (ha)	Impervious	C	Gravel	C	Pervious	C	C _{AVG} 5-Year	C _{AVG} 100-Year
		Area (m ²)		Area (m ²)		Area (m ²)			
A1	0.20	0.00	0.90	0.00	0.60	2,030.46	0.20	0.20	0.25
A2	0.35	0.00	0.90	0.00	0.60	3,503.80	0.20	0.20	0.25
A3	0.21	0.00	0.90	0.00	0.60	2,142.80	0.20	0.20	0.25

Pre-Development Runoff Calculations

Drainage Area	Area (ha)	C 5-Year	C 100-Year	Tc (min)	I (mm/hr)		Q (L/s)	
					5-Year	100-Year	5-Year	100-Year
A1	0.20	0.20	0.25	20	70.3	120.0	7.93	16.93
A2	0.35	0.20	0.25	20	70.3	120.0	13.69	29.21
A3	0.21	0.20	0.25	20	70.3	120.0	8.37	17.86
Total	0.77						29.99	64.00

Post-Development Runoff Coefficient

Drainage Area	Area (ha)	Impervious	C	Gravel	C	Pervious	C	C _{AVG} 5-Year	C _{AVG} 100-Year
		Area (m ²)		Area (m ²)		Area (m ²)			
B1	0.10	1,042.50	0.90	0.00	0.60	0.00	0.20	0.90	1.00
B2	0.20	1,579.48	0.90	0.00	0.60	420.19	0.20	0.75	0.84
B3	0.02	241.79	0.90	0.00	0.60	0.00	0.20	0.90	1.00
B4	0.02	172.34	0.90	0.00	0.60	0.00	0.20	0.90	1.00
B5	0.05	459.04	0.90	0.00	0.60	0.00	0.20	0.90	1.00
B6	0.27	0.00	0.90	0.00	0.60	2,705.00	0.20	0.20	0.25
B7	0.11	143.23	0.90	0.00	0.60	912.83	0.20	0.29	0.35

Roof
Restricted
Restricted
Restricted
Restricted
Restricted
Unrestricted

Post-Development Runoff Calculations

Drainage Area	Area (ha)	C 5-Year	C 100-Year	Tc (min)	I (mm/hr)		Q (L/s)	
					5-Year	100-Year	5-Year	100-Year
B1	0.10	0.90	1.00	10	104.2	178.6	27.18	51.75
B2	0.20	0.75	0.84	10	104.2	178.6	43.61	83.62
B3	0.02	0.90	1.00	10	104.2	178.6	6.30	12.00
B4	0.02	0.90	1.00	10	104.2	178.6	4.49	8.55
B5	0.05	0.90	1.00	10	104.2	178.6	11.97	22.79
B6	0.27	0.20	0.25	10	104.2	178.6	15.67	33.57
B7	0.11	0.29	0.35	10	104.2	178.6	9.02	18.44
Total	0.77						118.24	230.72

Roof
Restricted
Restricted
Restricted
Restricted
Restricted
Unrestricted

Required Restricted Flow

Drainage Area	Area (ha)	C 5-Year	C 100-Year	Tc (min)	I		Q
					5-Year	100-Year	5-Year
A1	0.20	0.20	0.25	20	70.3	120.0	7.93
A2	0.35	0.20	0.25	20	70.3	120.0	13.69
A3	0.21	0.20	0.25	20	70.3	120.0	8.37
Total	0.77						29.99

Drainage Area	Unrestricted Flow (L/s)		Restricted Flow (L/s)		Storage Required (m ³)		Storage Provided (m ³)	
	5-Year	100-Year	5-Year	100-Year	5-Year	100-Year	5-Year	100-Year
B1	27.18	51.75	2.14	3.66	23.23	39.31	23.62	40.29
B2	82.04	160.53	3.70	7.30	83.81	160.73	89.81	164.50
B3								
B4								
B5								
B6								
B7	9.02	18.44	9.02	18.44	x	x	x	x
Total	118.24	230.72	14.86	29.40	107.05	200.04	113.43	204.79

Roof
Restricted by one downstream IPEX LMF 74 ICD
Unrestricted

McINTOSH PERRY

CCO-23-0914 - 30 Auriga Drive - Runoff Calculations

2 of 8

Storage Requirements for Area B1

2-Year Storm Event

Tc (min)	I (mm/hr)	B3 Runoff (L/s)	Allowable Outflow (L/s)	Runoff to be Stored (L/s)	Storage Required (m ³)
10	76.8	4.65	1.50	3.15	1.89
15	61.8	3.74	1.50	2.24	2.01
20	52.0	3.15	1.50	1.65	1.98
25	45.2	2.73	1.50	1.23	1.85
30	40.0	2.42	1.50	0.92	1.66
35	36.1	2.18	1.50	0.68	1.43
40	32.9	1.99	1.50	0.49	1.17
45	30.2	1.83	1.50	0.33	0.89
50	28.0	1.70	1.50	0.20	0.59
55	26.2	1.58	1.50	0.08	0.27

Maximum Storage Required 2-Year (m³) = 2.01

5-Year Storm Event

Tc (min)	I (mm/hr)	B1 Runoff (L/s)	Allowable Outflow (L/s)	Runoff to be Stored (L/s)	Storage Required (m ³)
10	104.2	27.18	2.14	25.04	15.02
15	83.6	21.79	2.14	19.65	17.69
20	70.3	18.32	2.14	16.18	19.42
25	60.9	15.88	2.14	13.74	20.62
30	53.9	14.07	2.14	11.93	21.47
35	48.5	12.65	2.14	10.51	22.08
40	44.2	11.52	2.14	9.38	22.52
45	40.6	10.60	2.14	8.46	22.83
50	37.7	9.82	2.14	7.68	23.04
55	35.1	9.16	2.14	7.02	23.17
60	32.9	8.59	2.14	6.45	23.23
65	31.0	8.10	2.14	5.96	23.23
70	29.4	7.66	2.14	5.52	23.19
75	27.9	7.27	2.14	5.13	23.10

Maximum Storage Required 5-Year (m³) = 23.23

100-Year Storm Event

Tc (min)	I (mm/hr)	B1 Runoff (L/s)	Allowable Outflow (L/s)	Runoff to be Stored (L/s)	Storage Required (m ³)
5	242.7	63.31	3.66	59.65	17.89
10	178.6	46.57	3.66	42.91	25.75
15	142.9	37.27	3.66	33.61	30.25
20	120.0	31.29	3.66	27.63	33.15
25	103.8	27.09	3.66	23.43	35.14
30	91.9	23.96	3.66	20.30	36.54
35	82.6	21.54	3.66	17.88	37.55
40	75.1	19.60	3.66	15.94	38.26
45	69.1	18.01	3.66	14.35	38.75
50	64.0	16.68	3.66	13.02	39.06
55	59.6	15.55	3.66	11.89	39.24
60	55.9	14.58	3.66	10.92	39.31
65	52.6	13.73	3.66	10.07	39.28
70	49.8	12.99	3.66	9.33	39.17
80	45.0	11.74	3.66	8.08	38.76
85	43.0	11.20	3.66	7.54	38.47

Maximum Storage Required 100-Year (m³) = 39.31

Storage Occupied In Area B1

5-Year Storm Event

Roof Storage			
Location	Area*	Depth	Volume (m ³)
Roof	833.60	0.085	23.62
		Total	23.62

Storage Available (m ³) =	23.62
Storage Required (m ³) =	23.23

100-Year Storm Event

Roof Storage			
Location	Area*	Depth	Volume (m ³)
Roof	833.60	0.145	40.29
		Total	40.29

Storage Available (m ³) =	40.29
Storage Required (m ³) =	39.31

*Area is 80% of the total roof area

McINTOSH PERRY

CCO-23-0914 - 30 Auriga Drive - Runoff Calculations

Roof Drain Flow (B1)

Roof Drains Summary		
Type of Control Device	Watts Drainage - Accutrol Weir	
Number of Roof Drains	2	
	5-Year	100-Year
Rooftop Storage (m ³)	23.62	40.29
Storage Depth (m)	0.085	0.145
Flow (Per Roof Drain) (L/s)	1.07	1.83
Total Flow (L/s)	2.14	3.66

Flow Rate Vs. Build-Up (One Weir)	
Depth (mm)	Flow (L/s)
15	0.19
20	0.25
25	0.32
30	0.38
35	0.44
40	0.50
45	0.57
50	0.63
55	0.69

*Roof Drain model to be Adjustable Accutrol Weirs, Fully Exposed

*Roof Drain Flow information taken from Watts Drainage website

CALCULATING ROOF FLOW EXAMPLES

2 roof drains during a 5 year storm

elevation of water = 150mm

Flow leaving 2 roof drains = (2 x 0.36 L/s) = 0.72 L/s

2 roof drains during a 100 year storm

elevation of water = 150mm

Flow leaving 2 roof drains = (2 x 0.54 L/s) = 1.08 L/s

*Storage depth not to exceed 150mm per OBC

Roof Drain Flow		
Flow (l/s)	Storage Depth (mm)	Drains Flow (l/s)
0.19	15	0.38
0.25	20	0.50
0.32	25	0.64
0.38	30	0.76
0.44	35	0.88
0.50	40	1.00
0.57	45	1.14
0.63	50	1.26
0.69	55	1.38
0.76	60	1.52
0.82	65	1.64
0.88	70	1.76
0.95	75	1.90
1.01	80	2.02
1.07	85	2.14
1.13	90	2.26
1.20	95	2.40
1.26	100	2.52
1.32	105	2.64
1.39	110	2.78
1.45	115	2.90
1.51	120	3.02
1.58	125	3.16
1.64	130	3.28
1.70	135	3.40
1.76	140	3.52
1.83	145	3.66
1.89	150	3.78

5-Year

100-Year

Note: The flow leaving through a restricted roof drain is based on flow vs. head information

McINTOSH PERRY

CCO-23-0914 - 30 Auriga Drive - Runoff Calculations

5 of 8

Storage Requirements for Area B2-B6

2-Year Storm Event

Tc (min)	I (mm/hr)	B2-B6 Runoff (L/s)	Allowable Outflow (L/s)	Runoff to be Stored (L/s)	Storage Required (m ³)
10	76.8	60.48	1.23	59.25	35.55
15	61.8	48.64	1.23	47.40	42.66
20	52.0	40.97	1.23	39.74	47.69
25	45.2	35.57	1.23	34.33	51.50
30	40.0	31.53	1.23	30.30	54.54
35	36.1	28.39	1.23	27.16	57.04
40	32.9	25.88	1.23	24.65	59.15
45	30.2	23.81	1.23	22.58	60.96
50	28.0	22.08	1.23	20.85	62.54
55	26.2	20.61	1.23	19.38	63.94
60	24.6	19.34	1.23	18.11	65.18
65	23.2	18.23	1.23	17.00	66.29
70	21.9	17.25	1.23	16.02	67.29
75	20.8	16.39	1.23	15.16	68.20
80	19.8	15.61	1.23	14.38	69.04
85	18.9	14.92	1.23	13.69	69.79
90	18.1	14.29	1.23	13.05	70.49
95	17.4	13.71	1.23	12.48	71.13
100	16.7	13.19	1.23	11.95	71.73
105	16.1	12.70	1.23	11.47	72.27
110	15.6	12.26	1.23	11.03	72.78
115	15.0	11.85	1.23	10.62	73.25
120	14.6	11.47	1.23	10.23	73.69
125	14.1	11.11	1.23	9.88	74.09
130	13.7	10.78	1.23	9.55	74.47
135	13.3	10.47	1.23	9.24	74.82
140	12.9	10.18	1.23	8.95	75.15
145	12.6	9.90	1.23	8.67	75.45
150	12.3	9.65	1.23	8.42	75.74
155	11.9	9.40	1.23	8.17	76.00
160	11.7	9.17	1.23	7.94	76.25
165	11.4	8.96	1.23	7.72	76.47
170	11.1	8.75	1.23	7.52	76.69
175	10.9	8.55	1.23	7.32	76.88
180	10.6	8.37	1.23	7.14	77.06
185	10.4	8.19	1.23	6.96	77.23
190	10.2	8.02	1.23	6.79	77.39
195	10.0	7.86	1.23	6.63	77.53
200	9.8	7.70	1.23	6.47	77.66
205	9.6	7.56	1.23	6.32	77.78
210	9.4	7.41	1.23	6.18	77.89
215	9.2	7.28	1.23	6.05	77.99
220	9.1	7.15	1.23	5.92	78.08
225	8.9	7.02	1.23	5.79	78.16
230	8.8	6.90	1.23	5.67	78.24
235	8.6	6.79	1.23	5.55	78.30
240	8.5	6.67	1.23	5.44	78.35
245	8.3	6.57	1.23	5.33	78.40
250	8.2	6.46	1.23	5.23	78.44
255	8.1	6.36	1.23	5.13	78.48
260	8.0	6.26	1.23	5.03	78.50
265	7.8	6.17	1.23	4.94	78.52
270	7.7	6.08	1.23	4.85	78.54
275	7.6	5.99	1.23	4.76	78.54
280	7.5	5.91	1.23	4.68	78.54
285	7.4	5.82	1.23	4.59	78.54
290	7.3	5.75	1.23	4.51	78.53
Maximum Storage Required 2-Year (m³) =					78.54

5-Year Storm Event

Tc (min)	I (mm/hr)	B2-B6 Runoff (L/s)	Allowable Outflow (L/s)	Runoff to be Stored (L/s)	Storage Required (m ³)
0	230.5	181.48	3.70	177.79	0.00
5	141.2	111.17	3.70	107.47	32.24
10	104.2	82.04	3.70	78.35	47.01
15	83.6	65.79	3.70	62.10	55.89
20	70.3	55.32	3.70	51.62	61.94

McINTOSH PERRY

25	60.9	47.95	3.70	44.25	66.38
30	53.9	42.46	3.70	38.77	69.78
35	48.5	38.20	3.70	34.51	72.46
40	44.2	34.79	3.70	31.09	74.63
45	40.6	31.99	3.70	28.29	76.40
50	37.7	29.65	3.70	25.95	77.86
55	35.1	27.66	3.70	23.96	79.07
60	32.9	25.94	3.70	22.24	80.08
65	31.0	24.44	3.70	20.75	80.91
70	29.4	23.13	3.70	19.43	81.61
75	27.9	21.96	3.70	18.26	82.18
80	26.6	20.92	3.70	17.22	82.65
85	25.4	19.98	3.70	16.28	83.02
90	24.3	19.12	3.70	15.43	83.31
100	22.4	17.64	3.70	13.95	83.68
105	21.6	16.99	3.70	13.30	83.77
110	20.8	16.40	3.70	12.70	83.81
115	20.1	15.84	3.70	12.15	83.80
120	19.5	15.33	3.70	11.63	83.75

Maximum Storage Required 100-Year (m³) = 83.81

100-Year Storm Event

Tc (min)	I (mm/hr)	B2-B6 Runoff (L/s)	Allowable Outflow (L/s)	Runoff to be Stored (L/s)	Storage Required (m ³)
0	398.6	358.37	7.30	351.07	0.00
5	242.7	218.20	7.30	210.90	63.27
10	178.6	160.53	7.30	153.23	91.94
15	142.9	128.47	7.30	121.17	109.05
20	120.0	107.84	7.30	100.54	120.65
25	103.8	93.36	7.30	86.06	129.09
30	91.9	82.59	7.30	75.29	135.53
35	82.6	74.24	7.30	66.94	140.58
40	75.1	67.56	7.30	60.26	144.62
45	69.1	62.08	7.30	54.78	147.90
50	64.0	57.50	7.30	50.20	150.59
55	59.6	53.60	7.30	46.30	152.80
60	55.9	50.25	7.30	42.95	154.62
35	82.6	74.24	7.30	66.94	140.58
40	75.1	67.56	7.30	60.26	144.62
45	69.1	62.08	7.30	54.78	147.90
50	64.0	57.50	7.30	50.20	150.59
55	59.6	53.60	7.30	46.30	152.80
60	55.9	50.25	7.30	42.95	154.62
65	52.6	47.33	7.30	40.03	156.12
70	49.8	44.76	7.30	37.46	157.34
75	47.3	42.48	7.30	35.18	158.33
80	45.0	40.45	7.30	33.15	159.11
85	43.0	38.62	7.30	31.32	159.72
90	41.1	36.96	7.30	29.66	160.17
95	39.4	35.45	7.30	28.15	160.47
100	37.9	34.08	7.30	26.78	160.66
105	36.5	32.81	7.30	25.51	160.73
110	35.2	31.65	7.30	24.35	160.70
115	34.0	30.57	7.30	23.27	160.58

Maximum Storage Required 100-Year (m³) = 160.73

IPEX LMF 74

McINTOSH PERRY

CCO-23-0914 - 30 Auriga Drive - Runoff Calculations

6 of 8

Storage Occupied In Area B2-B6

2-Year Storm Event

Pond Storage			
Location	Area*	Depth	Volume (m ³)
CB6	0.00	0.000	0.00
CB4	0.00	0.000	0.00
CBMH3	0.00	0.000	0.00
CB2	0.00	0.000	0.00
Retention	407.35	0.520	82.33
Pipe Volume (m ³)			3.34
Total			85.67

5-Year Storm Event

Pond Storage			
Location	Area*	Depth	Volume (m ³)
CB6	0.00	0.000	0.00
CB4	0.00	0.000	0.00
CBMH3	0.00	0.000	0.00
CB2	0.00	0.000	0.00
Retention	420.52	0.530	86.47
Pipe Volume (m ³)			3.34
Total			89.81

100-Year Storm Event

Pond Storage			
Location	Area*	Depth	Volume (m ³)
CB6	92.20	0.080	2.60
CB4	0.00	0.000	0.00
CBMH3	0.00	0.000	0.00
CB2	8.89	0.030	0.11
Retention	620.73	0.680	158.45
Pipe Volume (m ³)			3.34
Total			164.50

Upstream Pipe Storage			
Length (m)	Diameter (m)	Area (m ²)	Volume (m ³)
24.50	0.20	0.03	0.77
39.03	0.20	0.03	1.23
10.18	0.25	0.05	0.50
27.00	0.20	0.03	0.85
Total			3.34

Storage Available (m³) =	85.67
Storage Required (m³) =	78.54

*Pond volumes derived in CAD

Storage Available (m³) =	89.81
Storage Required (m³) =	83.81

*Pond volumes derived in CAD

Storage Available (m³) =	164.50
Storage Required (m³) =	160.73

*Pond volumes derived in CAD

STORM SEWER DESIGN SHEET

PROJECT: CCO-23-0194
 LOCATION: 30 Auriga Drive
 CLIENT: Rossmann Architects



LOCATION				CONTRIBUTING AREA (ha)				RATIONAL DESIGN FLOW										SEWER DATA										
1	2	3	4	5	6	7	8	9	10	11	12	13	14	15	16	17	18	19	20	21	22			25	26	27	28	
STREET	AREA ID	FROM MH	TO MH	C-VALUE	AREA	INDIV AC	CUMUL AC	INLET (min)	TIME IN PIPE	TOTAL (min)	i (5) (mm/hr)	i (10) (mm/hr)	i (100) (mm/hr)	5yr PEAK FLOW (L/s)	10yr PEAK FLOW (L/s)	100yr PEAK FLOW (L/s)	FIXED FLOW (L/s)	DESIGN FLOW (L/s)	CAPACITY (L/s)	LENGTH (m)	PIPE SIZE (mm)			SLOPE (%)	VELOCITY (m/s)	AVAIL CAP (5yr)		
																		DIA			W		H					
Wpond	B2	CB 6	STMH 5	0.75	0.10	0.08	0.08	10.00	0.36	10.36	104.19	122.14	178.56	21.72	25.47	37.23		21.72	37.17	24.50	200				1.18	1.146	15.44	41.55%
Wpond	B3	STMH 5	CBMH 3	0.90	0.02	0.02	0.09	10.36	0.64	10.99	102.35	119.97	175.37	26.46	31.02	45.34		26.46	33.17	39.03	200				0.94	1.023	6.71	20.24%
Wpond	B5	CB 2	CBMH3	0.90	0.05	0.05	0.05	10.00	0.41	10.41	104.19	122.14	178.56	13.03	15.28	22.34		13.03	35.23	27.00	200				1.06	1.086	22.19	63.00%
Wpond	B6	LSCB1	CBMH3	0.20	0.27	0.05	0.05	10.00	0.14	10.14	104.19	122.14	178.56	15.64	18.34	26.81		15.64	62.04	10.18	250				1.00	1.224	46.40	74.79%
Wpond	B4	CBMH 3	OGS1	0.90	0.02	0.02	0.21	10.99	0.09	11.08	99.23	116.30	169.97	57.93	67.89	99.23		57.93	127.61	9.20	300				1.60	1.749	69.68	54.60%
Roof	B1	Roof	STMH 1	0.90	0.10	0.09	0.09	10.00	0.28	10.28	104.19	122.14	178.56	26.07	30.56	44.68		26.07	33.87	17.44	200				0.98	1.045	7.80	23.04%
	Total	OGS1	STMH1				0.21	11.08	0.13	11.21	98.82	115.81	169.26	57.69	67.61	98.81		57.69	109.12	11.810	300				1.17	1.495	51.43	47.13%
ROW	Total	STMH1	Ex. 1350mm STM				0.30	11.21	0.09	11.30	98.20	115.09	168.19	81.90	95.98	140.27		81.90	140.15	10.570	300				1.93	1.921	58.25	41.56%
Definitions: Q = 2.78CiA, where: Q = Peak Flow in Litres per Second (L/s) A = Area in Hectares (ha) i = Rainfall intensity in millimeters per hour (mm/hr) [i = 998.071 / (TC+6.053)^0.814] 5 YEAR [i = 1174.184 / (TC+6.014)^0.816] 10 YEAR [i = 1735.688 / (TC+6.014)^0.820] 100 YEAR				Notes: 1. Mannings coefficient (n) = 0.013				Designed: M.R. Checked: A.M. Project No.: CCO-23-0914				No. 1. 2. 3.				Revision Issued for Site Plan Application Revised per city comments Revised per updated servicing				Date 2023.01.12 2023.05.17 2023.06.15								
																Date: 2023.01.12				Sheet No: 1 of 1								

TEMPEST Product Submittal Package R6



Date: June 15, 2023

Customer: McIntosh Perry

Contact: Mitch Raper

Location: - -

Project Name: 30 Auriga Dr



Tempest LMF ICD Rd Shop Drawing

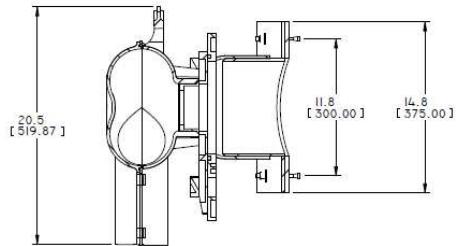
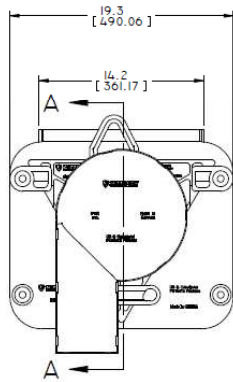
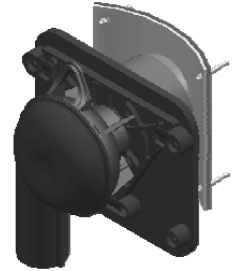
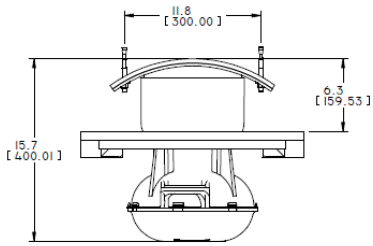

SECTION A-A

Handwritten signature and date: H. M. Martin 2011-07-26

TOLERANCES UNLESS OTHERWISE SPECIFIED: FINISH:		IPEX TECHNOLOGIES INC. PRODUCT DEVELOPMENT DEPARTMENT 12 BUCKLE CREEK DRIVE, SUITE 200 LITTLE ROCK, SOUTH CAROLINA 29112 CONTACT: 803-748-2222 WWW.IPEX.COM	
.125 ±0.002 (D IN MM) .005 ±0.002 (D IN MM) .005 ±0.002 (D IN MM) .005 ±0.002 (D IN MM)	FINISH: IN (MM)	DATE: 2011-07-26 DESIGNED BY: H. M. MARTIN CHECKED BY:	TITLE: LMF ROUND CB ASSEMBLY SIZE: 9 / 16 DRAWING NUMBER: 5017A_FA002R03 SHEET: 1 OF 1 REV: 3

Tempest LMF ICD Flow Curve

Flow: 7.30 L/s

Head: 2.33 m

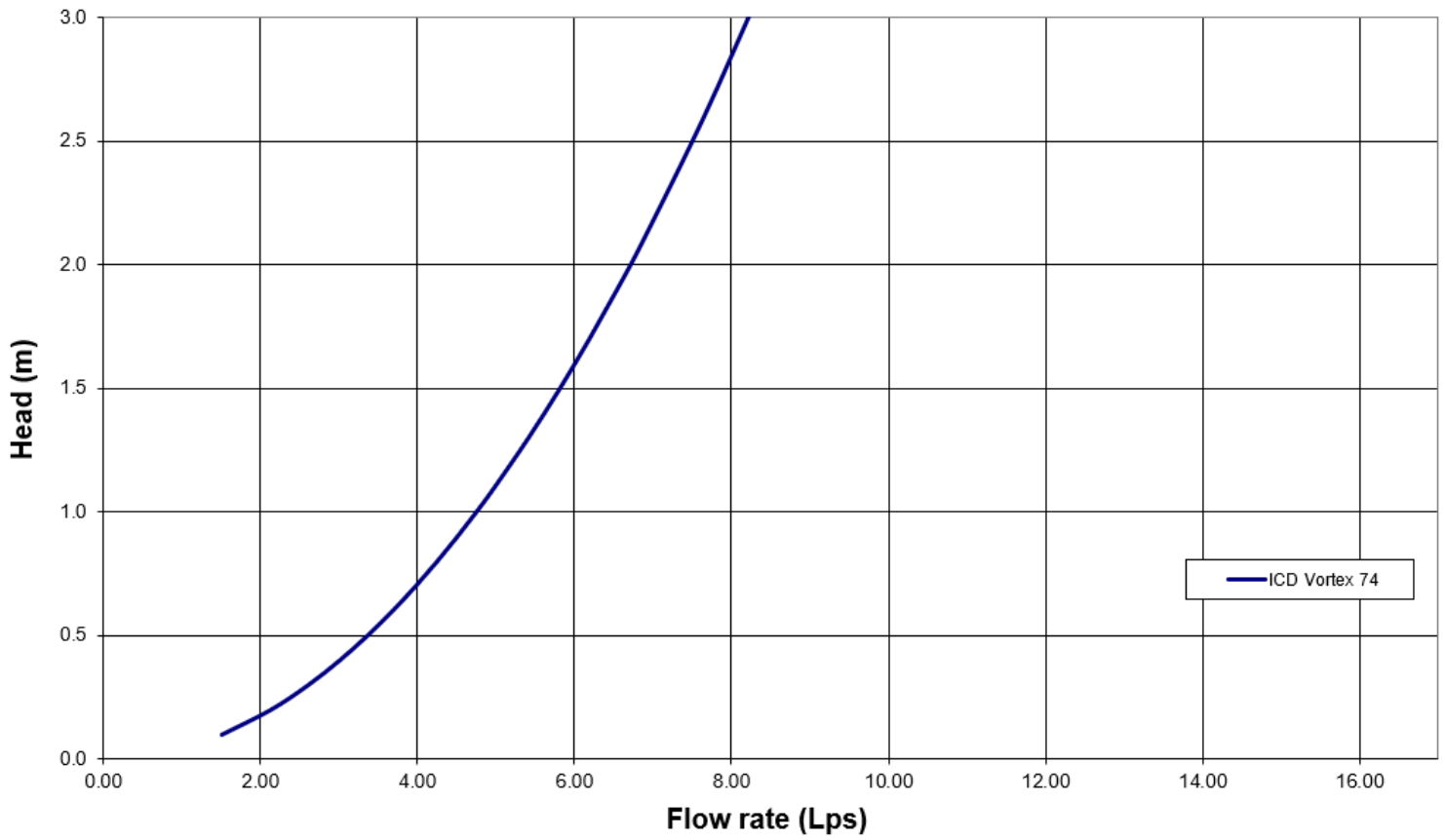

Square CB Installation Notes:

1. Materials and tooling verification:
 - Tooling: impact drill, 3/8'' concrete bit, torque wrench for 9/16'' nut, hand hammer, level, and marker.
 - Material: (4) concrete anchor 3/8x3-1/2, (4) washers, (4) nuts
2. Use the mounting wall plate to locate and mark the hole (4) pattern on the catch basin wall. You should use a level to ensure that the plate is at the horizontal.
3. Use an impact drill with a 3/8'' concrete bit to make the four holes at a minimum of 1-1/2'' depth up to 2-1/2''. Clean the concrete dust from the holes.
4. Install the anchors (4) in the holes by using a hammer. Put the nuts on the top of the anchors to protect the threads when you will hit the anchors with the hammer. Remove the nuts on the ends of the anchors
5. Install the wall mounting plate on the anchors and screw the nut in place with a maximum torque of 40 N.m (30 lbf-ft). There should be no gap between the wall mounting plate and the catch basin wall.
6. From ground above using a reach bar, lower the device by hooking the end of the reach bar to the handle of the LMF device. Align the triangular plate portion into the mounting wall plate. Push down the device to be sure it has centered in to the wall mounting plate and has created a seal.



Round CB Installation Notes: (Refer to square install notes above for steps 1 , 3, & 4)

2. Use spigot catch basin wall plate to locate and mark the hole (4) pattern on the catch basin wall. You should use a level to ensure that the plate is at the horizontal.
5. Install the CB spigot wall plate on the anchors and screw the 4 nuts in place with a maximum torque of 40 N.m (30 lb-ft). There should be no gap between the CB spigot wall plate and the catch basin wall.
6. Apply solvent cement on the hub of the universal mounting plate and the spigot of the spigot CB wall plate. Slide the hub over the spigot. Make sure the universal mounting plate is at the horizontal and its hub is completely inserted onto the spigot. Normally, the corners of the universal mounting plate hub adapter should touch the catch basin wall.
7. From ground above using a reach bar, lower the ICD device by hooking the end of the reach bar to the handle of the ICD device. Align the triangular plate portion into the mounting wall plate. Push down the device to be sure it has centered into the mounting plate and has created a seal.

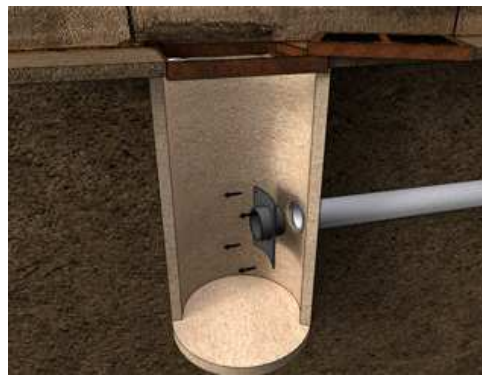

CAUTION/WARNING/DISCLAIM:

- Verify that the inlet(s) pipe(s) is not protruding into the catch basin. If it is, cut it back so that the inlet pipe is flush with the catch basin wall.
- Any required cement in the installation must be approved for PVC.
- The solvent cement should not be used below 0°C (32°F) or in a high humidity environment. Please refer to the IPEX solvent cement guide to confirm required curing times or attend the IPEX [Online Solvent Cement Training Course](#).
- Call your IPEX representative for more information or if you have any questions about our products.

IPEX TEMPEST Inlet Control Devices Technical Specification

General

Inlet control devices (ICD's) are designed to provide flow control at a specified rate for a given water head level and also provide odour and floatable control where specified. All ICD's will be IPEX Tempest or approved equal.

All devices shall be removable from a universal mounting plate. An operator from street level using only a T-bar with a hook will be able to retrieve the device while leaving the universal mounting plate secured to the catch basin wall face. The removal of the TEMPEST devices listed above must not require any unbolting or special manipulation or any special tools.

High Flow (HF) Sump devices will consist of a removable threaded cap which can be accessible from street level with out entry into the catchbasin (CB). The removal of the threaded cap shall not require any special tools other than the operator's hand.

ICD's must have no moving parts.

Materials

ICD's are to be manufactured from Polyvinyl Chloride (PVC) or Polyurethane material, designed to be durable enough to withstand multiple freeze-thaw cycles and exposure to harsh elements.

The inner ring seal will be manufactured using a Buna or Nitrile material with hardness between Duro 50 and Duro 70.

The wall seal is to be comprised of a 3/8" thick Neoprene Closed Cell Sponge gasket which is attached to the back of the wall plate.

All hardware will be made from 304 stainless steel.

Dimensioning

The Low Medium Flow (LMF), High Flow (HF) and the High Flow (HF) Sump shall allow for a minimum outlet pipe diameter of 200mm with a 600mm deep Catch Basin sump.

Installation

Contractor shall be responsible for securing, supporting and connecting the ICD's to the existing influent pipe and catchbasin/manhole structure as specified and designed by the Engineer.



Stormceptor[®] EF Sizing Report

STORMCEPTOR[®] ESTIMATED NET ANNUAL SEDIMENT (TSS) LOAD REDUCTION

05/11/2023

Province:	Ontario
City:	Ottawa
Nearest Rainfall Station:	OTTAWA CDA RCS
Climate Station Id:	6105978
Years of Rainfall Data:	20

Project Name:	30 Auriga Drive
Project Number:	61552
Designer Name:	Mitch Raper
Designer Company:	Mcintosh Perry
Designer Email:	m.raper@mcintoshperry.com
Designer Phone:	613-315-9801
EOR Name:	
EOR Company:	
EOR Email:	
EOR Phone:	

Site Name:	30 Auriga Drive
------------	-----------------

Drainage Area (ha):	0.55
% Imperviousness:	44.24

Runoff Coefficient 'c': 0.56

Particle Size Distribution:	Fine
Target TSS Removal (%):	80.0

Required Water Quality Runoff Volume Capture (%):	90.00
Estimated Water Quality Flow Rate (L/s):	10.04
Oil / Fuel Spill Risk Site?	No
Upstream Flow Control?	Yes
Upstream Orifice Control Flow Rate to Stormceptor (L/s):	6.30
Peak Conveyance (maximum) Flow Rate (L/s):	
Site Sediment Transport Rate (kg/ha/yr):	

Net Annual Sediment (TSS) Load Reduction Sizing Summary	
Stormceptor Model	TSS Removal Provided (%)
EF4	92
EF6	98
EF8	100
EF10	100
EF12	100

Recommended Stormceptor EF Model: EF4
Estimated Net Annual Sediment (TSS) Load Reduction (%): 92
Water Quality Runoff Volume Capture (%): > 90

Stormceptor® EF Sizing Report

THIRD-PARTY TESTING AND VERIFICATION

► **Stormceptor® EF and Stormceptor® EFO** are the latest evolutions in the Stormceptor® oil-grit separator (OGS) technology series, and are designed to remove a wide variety of pollutants from stormwater and snowmelt runoff. These technologies have been third-party tested in accordance with the Canadian ETV **Procedure for Laboratory Testing of Oil-Grit Separators** and performance has been third-party verified in accordance with the **ISO 14034 Environmental Technology Verification (ETV)** protocol.

PERFORMANCE

► **Stormceptor® EF and EFO** remove stormwater pollutants through gravity separation and floatation, and feature a patent-pending design that generates positive removal of total suspended solids (TSS) throughout each storm event, including high-intensity storms. Captured pollutants include sediment, free oils, and sediment-bound pollutants such as nutrients, heavy metals, and petroleum hydrocarbons. Stormceptor is sized to remove a high level of TSS from the frequent rainfall events that contribute the vast majority of annual runoff volume and pollutant load. The technology incorporates an internal bypass to convey excessive stormwater flows from high-intensity storms through the device without resuspension and washout (scour) of previously captured pollutants. Proper routine maintenance ensures high pollutant removal performance and protection of downstream waterways.

PARTICLE SIZE DISTRIBUTION (PSD)

► The **Canadian ETV PSD** shown in the table below was used, or in part, for this sizing. This is the identical PSD that is referenced in the Canadian ETV **Procedure for Laboratory Testing of Oil-Grit Separators** for both sediment removal testing and scour testing. The Canadian ETV PSD contains a wide range of particle sizes in the sand and silt fractions, and is considered reasonably representative of the particle size fractions found in typical urban stormwater runoff.

Particle Size (µm)	Percent Less Than	Particle Size Fraction (µm)	Percent
1000	100	500-1000	5
500	95	250-500	5
250	90	150-250	15
150	75	100-150	15
100	60	75-100	10
75	50	50-75	5
50	45	20-50	10
20	35	8-20	15
8	20	5-8	10
5	10	2-5	5
2	5	<2	5

Stormceptor[®] EF Sizing Report

Upstream Flow Controlled Results

Rainfall Intensity (mm / hr)	Percent Rainfall Volume (%)	Cumulative Rainfall Volume (%)	Flow Rate (L/s)	Flow Rate (L/min)	Surface Loading Rate (L/min/m ²)	Removal Efficiency (%)	Incremental Removal (%)	Cumulative Removal (%)
0.5	8.6	8.6	0.43	26.0	22.0	100	8.6	8.6
1	20.3	29.0	0.86	52.0	43.0	100	20.3	29.0
2	16.2	45.2	1.73	104.0	86.0	98	16.0	44.9
3	12.0	57.2	2.59	156.0	130.0	92	11.0	56.0
4	8.4	65.6	3.46	207.0	173.0	87	7.3	63.3
5	5.9	71.6	4.32	259.0	216.0	83	4.9	68.2
6	28.4	100.0	5.19	311.0	259.0	80	22.8	91.1
7	0.0	100.0	6.00	360.0	300.0	78	0.0	91.1
8	0.0	100.0	6.00	360.0	300.0	78	0.0	91.1
9	0.0	100.0	6.00	360.0	300.0	78	0.0	91.1
10	0.0	100.0	6.00	360.0	300.0	78	0.0	91.1
11	0.0	100.0	6.00	360.0	300.0	78	0.0	91.1
12	0.0	100.0	6.00	360.0	300.0	78	0.0	91.1
13	0.0	100.0	6.00	360.0	300.0	78	0.0	91.1
14	0.0	100.0	6.00	360.0	300.0	78	0.0	91.1
15	0.0	100.0	6.00	360.0	300.0	78	0.0	91.1
16	0.0	100.0	6.00	360.0	300.0	78	0.0	91.1
17	0.0	100.0	6.00	360.0	300.0	78	0.0	91.1
18	0.0	100.0	6.00	360.0	300.0	78	0.0	91.1
19	0.0	100.0	6.00	360.0	300.0	78	0.0	91.1
20	0.0	100.0	6.00	360.0	300.0	78	0.0	91.1
21	0.0	100.0	6.00	360.0	300.0	78	0.0	91.1
22	0.0	100.0	6.00	360.0	300.0	78	0.0	91.1
23	0.0	100.0	6.00	360.0	300.0	78	0.0	91.1
24	0.0	100.0	6.00	360.0	300.0	78	0.0	91.1
25	0.0	100.0	6.00	360.0	300.0	78	0.0	91.1
30	0.0	100.0	6.00	360.0	300.0	78	0.0	91.1
35	0.0	100.0	6.00	360.0	300.0	78	0.0	91.1
40	0.0	100.0	6.00	360.0	300.0	78	0.0	91.1
45	0.0	100.0	6.00	360.0	300.0	78	0.0	91.1
Estimated Net Annual Sediment (TSS) Load Reduction =								91 %

Climate Station ID: 6105978 Years of Rainfall Data: 20

Stormceptor® EF Sizing Report

RAINFALL DATA FROM OTTAWA CDA RCS RAINFALL STATION

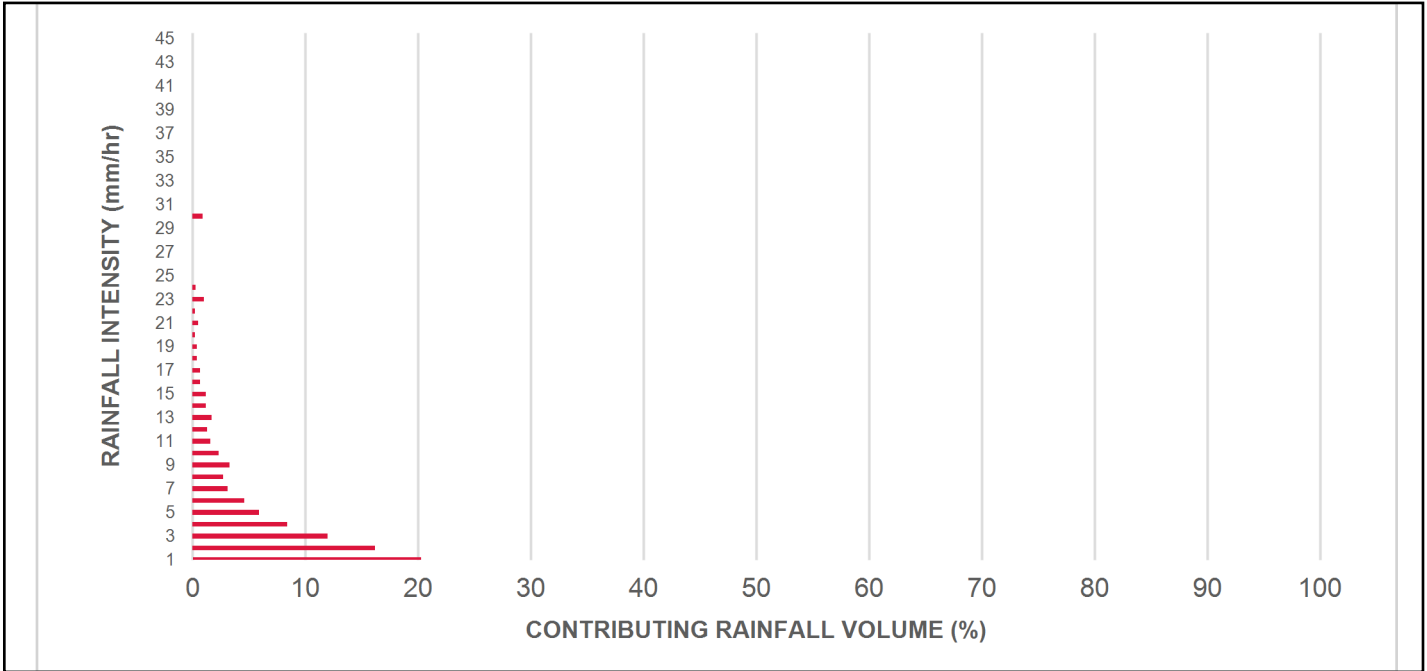

INCREMENTAL AND CUMULATIVE TSS REMOVAL FOR THE RECOMMENDED STORMCEPTOR® MODEL

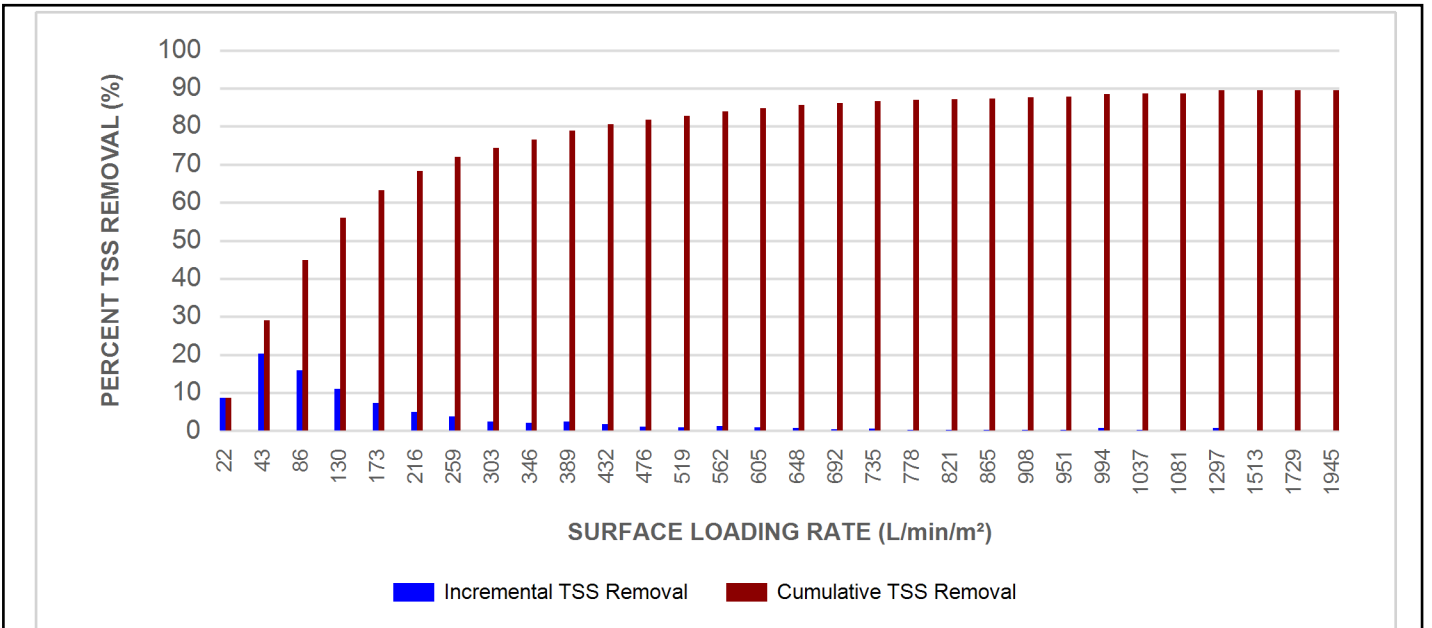

Stormceptor® EF Sizing Report

Maximum Pipe Diameter / Peak Conveyance

Stormceptor EF / EFO	Model Diameter		Min Angle Inlet / Outlet Pipes	Max Inlet Pipe Diameter		Max Outlet Pipe Diameter		Peak Conveyance Flow Rate	
	(m)	(ft)		(mm)	(in)	(mm)	(in)	(L/s)	(cfs)
EF4 / EFO4	1.2	4	90	609	24	609	24	425	15
EF6 / EFO6	1.8	6	90	914	36	914	36	990	35
EF8 / EFO8	2.4	8	90	1219	48	1219	48	1700	60
EF10 / EFO10	3.0	10	90	1828	72	1828	72	2830	100
EF12 / EFO12	3.6	12	90	1828	72	1828	72	2830	100

SCOUR PREVENTION AND ONLINE CONFIGURATION

► **Stormceptor® EF and EFO** feature an internal bypass and superior scour prevention technology that have been demonstrated in third-party testing according to the scour testing provisions of the Canadian ETV **Procedure for Laboratory Testing of Oil-Grit Separators**, and the exceptional scour test performance has been third-party verified in accordance with the ISO 14034 ETV protocol. As a result, Stormceptor EF and EFO are approved for online installation, eliminating the need for costly additional bypass structures, piping, and installation expense.

DESIGN FLEXIBILITY

► **Stormceptor® EF and EFO** offers design flexibility in one simplified platform, accepting stormwater flow from a single inlet pipe or multiple inlet pipes, and/or surface runoff through an inlet grate. The device can also serve as a junction structure, accommodate a 90-degree inlet-to-outlet bend angle, and can be modified to ensure performance in submerged conditions.

OIL CAPTURE AND RETENTION

► While Stormceptor® EF will capture and retain oil from dry weather spills and low intensity runoff, **Stormceptor® EFO** has demonstrated superior oil capture and greater than 99% oil retention in third-party testing according to the light liquid re-entrainment testing provisions of the Canadian ETV **Procedure for Laboratory Testing of Oil-Grit Separators**. Stormceptor EFO is recommended for sites where oil capture and retention is a requirement.

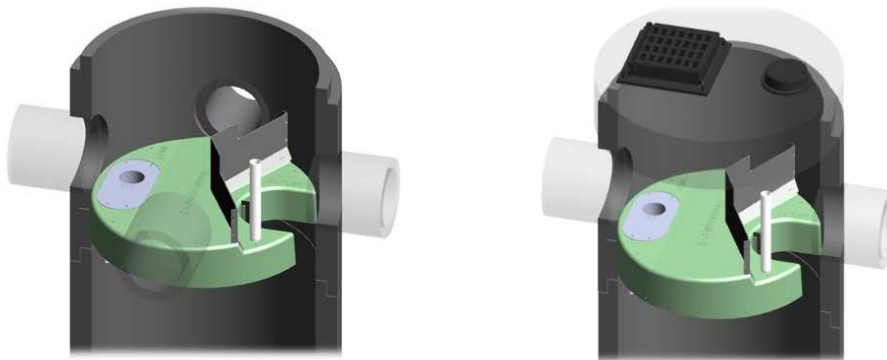

Stormceptor[®] EF Sizing Report

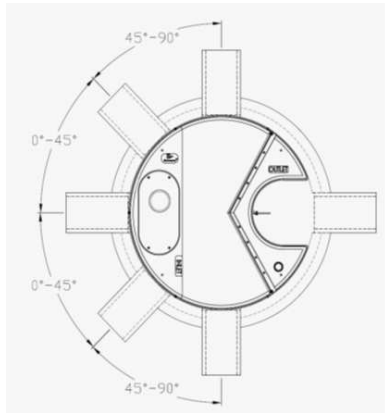

INLET-TO-OUTLET DROP

Elevation differential between inlet and outlet pipe inverts is dictated by the angle at which the inlet pipe(s) enters the unit.

0° - 45° : The inlet pipe is 1-inch (25mm) higher than the outlet pipe.

45° - 90° : The inlet pipe is 2-inches (50mm) higher than the outlet pipe.

HEAD LOSS

The head loss through Stormceptor EF is similar to that of a 60-degree bend structure. The applicable K value for calculating minor losses through the unit is 1.1.

For submerged conditions the applicable K value is 3.0.

Pollutant Capacity

Stormceptor EF / EFO	Model Diameter		Depth (Outlet Pipe Invert to Sump Floor)		Oil Volume		Recommended Sediment Maintenance Depth *		Maximum Sediment Volume *		Maximum Sediment Mass **	
	(m)	(ft)	(m)	(ft)	(L)	(Gal)	(mm)	(in)	(L)	(ft ³)	(kg)	(lb)
EF4 / EFO4	1.2	4	1.52	5.0	265	70	203	8	1190	42	1904	5250
EF6 / EFO6	1.8	6	1.93	6.3	610	160	305	12	3470	123	5552	15375
EF8 / EFO8	2.4	8	2.59	8.5	1070	280	610	24	8780	310	14048	38750
EF10 / EFO10	3.0	10	3.25	10.7	1670	440	610	24	17790	628	28464	78500
EF12 / EFO12	3.6	12	3.89	12.8	2475	655	610	24	31220	1103	49952	137875

*Increased sump depth may be added to increase sediment storage capacity

** Average density of wet packed sediment in sump = 1.6 kg/L (100 lb/ft³)

Feature	Benefit	Feature Appeals To
Patent-pending enhanced flow treatment and scour prevention technology	Superior, verified third-party performance	Regulator, Specifying & Design Engineer
Third-party verified light liquid capture and retention for EFO version	Proven performance for fuel/oil hotspot locations	Regulator, Specifying & Design Engineer, Site Owner
Functions as bend, junction or inlet structure	Design flexibility	Specifying & Design Engineer
Minimal drop between inlet and outlet	Site installation ease	Contractor
Large diameter outlet riser for inspection and maintenance	Easy maintenance access from grade	Maintenance Contractor & Site Owner

STANDARD STORMCEPTOR EF/EFO DRAWINGS

For standard details, please visit <http://www.imbriumsystems.com/stormwater-treatment-solutions/stormceptor-ef>

STANDARD STORMCEPTOR EF/EFO SPECIFICATION

For specifications, please visit <http://www.imbriumsystems.com/stormwater-treatment-solutions/stormceptor-ef>

STANDARD PERFORMANCE SPECIFICATION FOR “OIL GRIT SEPARATOR” (OGS) STORMWATER QUALITY TREATMENT DEVICE

PART 1 – GENERAL

1.1 WORK INCLUDED

This section specifies requirements for selecting, sizing, and designing an underground Oil Grit Separator (OGS) device for stormwater quality treatment, with third-party testing results and a Statement of Verification in accordance with ISO 14034 Environmental Management – Environmental Technology Verification (ETV).

1.2 REFERENCE STANDARDS & PROCEDURES

ISO 14034:2016 Environmental management – Environmental technology verification (ETV)

Canadian Environmental Technology Verification (ETV) Program’s **Procedure for Laboratory Testing of Oil-Grit Separators.**

1.3 SUBMITTALS

1.3.1 All submittals, including sizing reports & shop drawings, shall be submitted upon request with each order to the contractor then forwarded to the Engineer of Record for review and acceptance. Shop drawings shall detail all OGS components, elevations, and sequence of construction.

1.3.2 Alternative devices shall have features identical to or greater than the specified device, including: treatment chamber diameter, treatment chamber wet volume, sediment storage volume, and oil storage volume.

1.3.3 Unless directed otherwise by the Engineer of Record, OGS stormwater quality treatment product substitutions or alternatives submitted within ten days prior to project bid shall not be accepted. All alternatives or substitutions submitted shall be signed and sealed by a local registered Professional Engineer, based on the exact same criteria detailed in Section 3, in entirety, subject to review and approval by the Engineer of Record.

PART 2 – PRODUCTS

2.1 OGS POLLUTANT STORAGE

The OGS device shall include a sump for sediment storage, and a protected volume for the capture and storage of petroleum hydrocarbons and buoyant gross pollutants. The **minimum** sediment & petroleum hydrocarbon storage capacity shall be as follows:

2.1.1	4 ft (1219 mm) Diameter OGS Units:	1.19 m ³ sediment / 265 L oil
	6 ft (1829 mm) Diameter OGS Units:	3.48 m ³ sediment / 609 L oil
	8 ft (2438 mm) Diameter OGS Units:	8.78 m ³ sediment / 1,071 L oil
	10 ft (3048 mm) Diameter OGS Units:	17.78 m ³ sediment / 1,673 L oil
	12 ft (3657 mm) Diameter OGS Units:	31.23 m ³ sediment / 2,476 L oil

PART 3 – PERFORMANCE & DESIGN

3.1 GENERAL

Stormceptor[®] EF Sizing Report

The OGS stormwater quality treatment device shall be verified in accordance with ISO 14034:2016 Environmental management – Environmental technology verification (ETV). The OGS stormwater quality treatment device shall remove oil, sediment and gross pollutants from stormwater runoff during frequent wet weather events, and retain these pollutants during less frequent high flow wet weather events below the insert within the OGS for later removal during maintenance. The Manufacturer shall have at least ten (10) years of local experience, history and success in engineering design, manufacturing and production and supply of OGS stormwater quality treatment device systems, acceptable to the Engineer of Record.

3.2 SIZING METHODOLOGY

The OGS device shall be engineered, designed and sized to provide stormwater quality treatment based on treating a minimum of 90 percent of the average annual runoff volume and a minimum removal of an annual average 60% of the sediment (TSS) load based on the Particle Size Distribution (PSD) specified in the sizing report for the specified device. Sizing of the OGS shall be determined by use of a minimum ten (10) years of local historical rainfall data provided by Environment Canada. Sizing shall also be determined by use of the sediment removal performance data derived from the ISO 14034 ETV third-party verified laboratory testing data from testing conducted in accordance with the Canadian ETV protocol Procedure for Laboratory Testing of Oil-Grit Separators, as follows:

3.2.1 Sediment removal efficiency for a given surface loading rate and its associated flow rate shall be based on sediment removal efficiency demonstrated at the seven (7) tested surface loading rates specified in the protocol, ranging 40 L/min/m² to 1400 L/min/m², and as stated in the ISO 14034 ETV Verification Statement for the OGS device.

3.2.2 Sediment removal efficiency for surface loading rates between 40 L/min/m² and 1400 L/min/m² shall be based on linear interpolation of data between consecutive tested surface loading rates.

3.2.3 Sediment removal efficiency for surface loading rates less than the lowest tested surface loading rate of 40 L/min/m² shall be assumed to be identical to the sediment removal efficiency at 40 L/min/m². No extrapolation shall be allowed that results in a sediment removal efficiency that is greater than that demonstrated at 40 L/min/m².

3.2.4 Sediment removal efficiency for surface loading rates greater than the highest tested surface loading rate of 1400 L/min/m² shall assume zero sediment removal for the portion of flow that exceeds 1400 L/min/m², and shall be calculated using a simple proportioning formula, with 1400 L/min/m² in the numerator and the higher surface loading rate in the denominator, and multiplying the resulting fraction times the sediment removal efficiency at 1400 L/min/m².

The OGS device shall also have sufficient annual sediment storage capacity as specified and calculated in Section 2.1.

3.3 CANADIAN ETV or ISO 14034 ETV VERIFICATION OF SCOUR TESTING

The OGS device shall have Canadian ETV or ISO 14034 ETV Verification of third-party scour testing conducted in accordance with the Canadian ETV Program's **Procedure for Laboratory Testing of Oil-Grit Separators**.

3.3.1 To be acceptable for on-line installation, the OGS device must demonstrate an average scour test effluent concentration less than 10 mg/L at each surface loading rate tested, up to and including 2600 L/min/m².

Stormceptor[®] EF Sizing Report

STORMCEPTOR[®] ESTIMATED NET ANNUAL SEDIMENT (TSS) LOAD REDUCTION

05/11/2023

Province:	Ontario
City:	Ottawa
Nearest Rainfall Station:	OTTAWA CDA RCS
Climate Station Id:	6105978
Years of Rainfall Data:	20

Project Name:	30 Auriga Drive
Project Number:	61552
Designer Name:	Mitch Raper
Designer Company:	Mcintosh Perry
Designer Email:	m.raper@mcintoshperry.com
Designer Phone:	613-315-9801
EOR Name:	
EOR Company:	
EOR Email:	
EOR Phone:	

Site Name:	30 Auriga Drive
------------	-----------------

Drainage Area (ha):	0.55
% Imperviousness:	44.24

Runoff Coefficient 'c': 0.56

Particle Size Distribution:	CA ETV
Target TSS Removal (%):	60.0

Required Water Quality Runoff Volume Capture (%):	90.00
Estimated Water Quality Flow Rate (L/s):	10.04
Oil / Fuel Spill Risk Site?	No
Upstream Flow Control?	Yes
Upstream Orifice Control Flow Rate to Stormceptor (L/s):	6.30
Peak Conveyance (maximum) Flow Rate (L/s):	
Site Sediment Transport Rate (kg/ha/yr):	

Net Annual Sediment (TSS) Load Reduction Sizing Summary	
Stormceptor Model	TSS Removal Provided (%)
EF4	61
EF6	67
EF8	69
EF10	70
EF12	70

Recommended Stormceptor EF Model: EF4
Estimated Net Annual Sediment (TSS) Load Reduction (%): 61
Water Quality Runoff Volume Capture (%): > 90

Stormceptor® EF Sizing Report

THIRD-PARTY TESTING AND VERIFICATION

► **Stormceptor® EF and Stormceptor® EFO** are the latest evolutions in the Stormceptor® oil-grit separator (OGS) technology series, and are designed to remove a wide variety of pollutants from stormwater and snowmelt runoff. These technologies have been third-party tested in accordance with the Canadian ETV **Procedure for Laboratory Testing of Oil-Grit Separators** and performance has been third-party verified in accordance with the **ISO 14034 Environmental Technology Verification (ETV)** protocol.

PERFORMANCE

► **Stormceptor® EF and EFO** remove stormwater pollutants through gravity separation and floatation, and feature a patent-pending design that generates positive removal of total suspended solids (TSS) throughout each storm event, including high-intensity storms. Captured pollutants include sediment, free oils, and sediment-bound pollutants such as nutrients, heavy metals, and petroleum hydrocarbons. Stormceptor is sized to remove a high level of TSS from the frequent rainfall events that contribute the vast majority of annual runoff volume and pollutant load. The technology incorporates an internal bypass to convey excessive stormwater flows from high-intensity storms through the device without resuspension and washout (scour) of previously captured pollutants. Proper routine maintenance ensures high pollutant removal performance and protection of downstream waterways.

PARTICLE SIZE DISTRIBUTION (PSD)

► The **Canadian ETV PSD** shown in the table below was used, or in part, for this sizing. This is the identical PSD that is referenced in the Canadian ETV **Procedure for Laboratory Testing of Oil-Grit Separators** for both sediment removal testing and scour testing. The Canadian ETV PSD contains a wide range of particle sizes in the sand and silt fractions, and is considered reasonably representative of the particle size fractions found in typical urban stormwater runoff.

Particle Size (µm)	Percent Less Than	Particle Size Fraction (µm)	Percent
1000	100	500-1000	5
500	95	250-500	5
250	90	150-250	15
150	75	100-150	15
100	60	75-100	10
75	50	50-75	5
50	45	20-50	10
20	35	8-20	15
8	20	5-8	10
5	10	2-5	5
2	5	<2	5

Stormceptor[®] EF Sizing Report

Upstream Flow Controlled Results

Rainfall Intensity (mm / hr)	Percent Rainfall Volume (%)	Cumulative Rainfall Volume (%)	Flow Rate (L/s)	Flow Rate (L/min)	Surface Loading Rate (L/min/m ²)	Removal Efficiency (%)	Incremental Removal (%)	Cumulative Removal (%)
0.5	8.6	8.6	0.43	26.0	22.0	70	6.1	6.1
1	20.3	29.0	0.86	52.0	43.0	70	14.3	20.4
2	16.2	45.2	1.73	104.0	86.0	64	10.4	30.8
3	12.0	57.2	2.59	156.0	130.0	60	7.2	37.9
4	8.4	65.6	3.46	207.0	173.0	57	4.8	42.7
5	5.9	71.6	4.32	259.0	216.0	54	3.2	45.9
6	28.4	100.0	5.19	311.0	259.0	52	14.8	60.8
7	0.0	100.0	6.00	360.0	300.0	51	0.0	60.8
8	0.0	100.0	6.00	360.0	300.0	51	0.0	60.8
9	0.0	100.0	6.00	360.0	300.0	51	0.0	60.8
10	0.0	100.0	6.00	360.0	300.0	51	0.0	60.8
11	0.0	100.0	6.00	360.0	300.0	51	0.0	60.8
12	0.0	100.0	6.00	360.0	300.0	51	0.0	60.8
13	0.0	100.0	6.00	360.0	300.0	51	0.0	60.8
14	0.0	100.0	6.00	360.0	300.0	51	0.0	60.8
15	0.0	100.0	6.00	360.0	300.0	51	0.0	60.8
16	0.0	100.0	6.00	360.0	300.0	51	0.0	60.8
17	0.0	100.0	6.00	360.0	300.0	51	0.0	60.8
18	0.0	100.0	6.00	360.0	300.0	51	0.0	60.8
19	0.0	100.0	6.00	360.0	300.0	51	0.0	60.8
20	0.0	100.0	6.00	360.0	300.0	51	0.0	60.8
21	0.0	100.0	6.00	360.0	300.0	51	0.0	60.8
22	0.0	100.0	6.00	360.0	300.0	51	0.0	60.8
23	0.0	100.0	6.00	360.0	300.0	51	0.0	60.8
24	0.0	100.0	6.00	360.0	300.0	51	0.0	60.8
25	0.0	100.0	6.00	360.0	300.0	51	0.0	60.8
30	0.0	100.0	6.00	360.0	300.0	51	0.0	60.8
35	0.0	100.0	6.00	360.0	300.0	51	0.0	60.8
40	0.0	100.0	6.00	360.0	300.0	51	0.0	60.8
45	0.0	100.0	6.00	360.0	300.0	51	0.0	60.8
Estimated Net Annual Sediment (TSS) Load Reduction =								61 %

Climate Station ID: 6105978 Years of Rainfall Data: 20



Stormceptor[®] EF Sizing Report

RAINFALL DATA FROM OTTAWA CDA RCS RAINFALL STATION

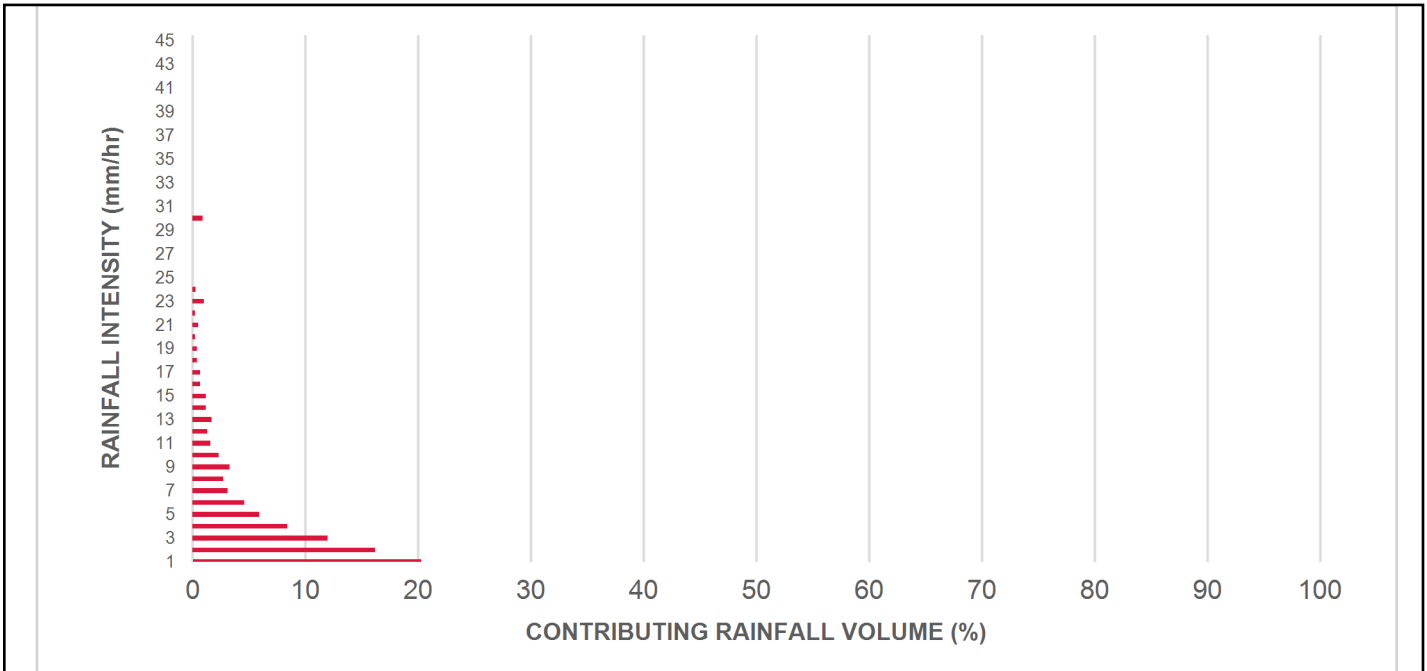

INCREMENTAL AND CUMULATIVE TSS REMOVAL FOR THE RECOMMENDED STORMCEPTOR[®] MODEL

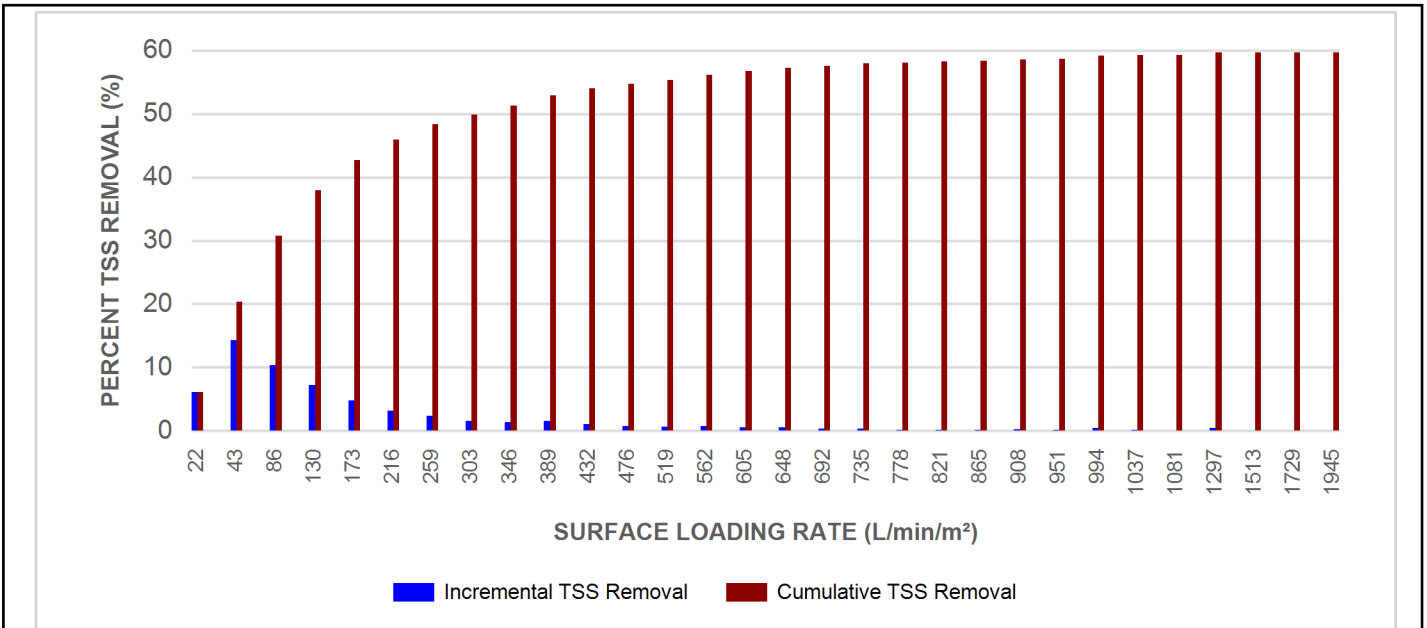

Stormceptor® EF Sizing Report

Maximum Pipe Diameter / Peak Conveyance

Stormceptor EF / EFO	Model Diameter		Min Angle Inlet / Outlet Pipes	Max Inlet Pipe Diameter		Max Outlet Pipe Diameter		Peak Conveyance Flow Rate	
	(m)	(ft)		(mm)	(in)	(mm)	(in)	(L/s)	(cfs)
EF4 / EFO4	1.2	4	90	609	24	609	24	425	15
EF6 / EFO6	1.8	6	90	914	36	914	36	990	35
EF8 / EFO8	2.4	8	90	1219	48	1219	48	1700	60
EF10 / EFO10	3.0	10	90	1828	72	1828	72	2830	100
EF12 / EFO12	3.6	12	90	1828	72	1828	72	2830	100

SCOUR PREVENTION AND ONLINE CONFIGURATION

► **Stormceptor® EF and EFO** feature an internal bypass and superior scour prevention technology that have been demonstrated in third-party testing according to the scour testing provisions of the Canadian ETV **Procedure for Laboratory Testing of Oil-Grit Separators**, and the exceptional scour test performance has been third-party verified in accordance with the ISO 14034 ETV protocol. As a result, Stormceptor EF and EFO are approved for online installation, eliminating the need for costly additional bypass structures, piping, and installation expense.

DESIGN FLEXIBILITY

► **Stormceptor® EF and EFO** offers design flexibility in one simplified platform, accepting stormwater flow from a single inlet pipe or multiple inlet pipes, and/or surface runoff through an inlet grate. The device can also serve as a junction structure, accommodate a 90-degree inlet-to-outlet bend angle, and can be modified to ensure performance in submerged conditions.

OIL CAPTURE AND RETENTION

► While Stormceptor® EF will capture and retain oil from dry weather spills and low intensity runoff, **Stormceptor® EFO** has demonstrated superior oil capture and greater than 99% oil retention in third-party testing according to the light liquid re-entrainment testing provisions of the Canadian ETV **Procedure for Laboratory Testing of Oil-Grit Separators**. Stormceptor EFO is recommended for sites where oil capture and retention is a requirement.

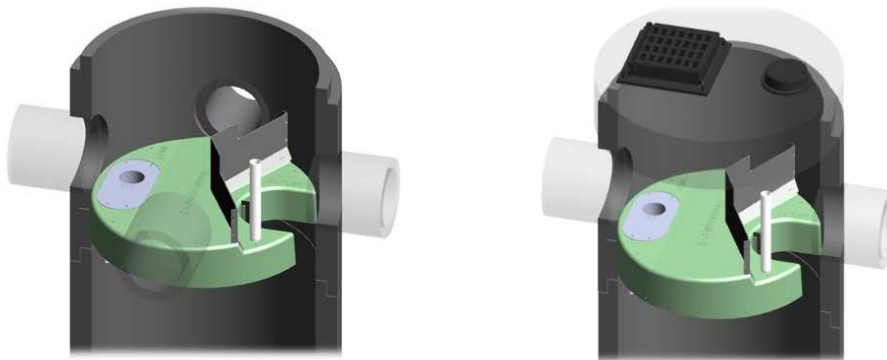

Stormceptor[®] EF Sizing Report

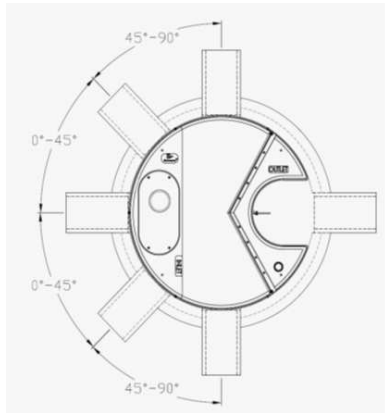

INLET-TO-OUTLET DROP

Elevation differential between inlet and outlet pipe inverts is dictated by the angle at which the inlet pipe(s) enters the unit.

0° - 45° : The inlet pipe is 1-inch (25mm) higher than the outlet pipe.

45° - 90° : The inlet pipe is 2-inches (50mm) higher than the outlet pipe.

HEAD LOSS

The head loss through Stormceptor EF is similar to that of a 60-degree bend structure. The applicable K value for calculating minor losses through the unit is 1.1.

For submerged conditions the applicable K value is 3.0.

Pollutant Capacity

Stormceptor EF / EFO	Model Diameter		Depth (Outlet Pipe Invert to Sump Floor)		Oil Volume		Recommended Sediment Maintenance Depth *		Maximum Sediment Volume *		Maximum Sediment Mass **	
	(m)	(ft)	(m)	(ft)	(L)	(Gal)	(mm)	(in)	(L)	(ft ³)	(kg)	(lb)
EF4 / EFO4	1.2	4	1.52	5.0	265	70	203	8	1190	42	1904	5250
EF6 / EFO6	1.8	6	1.93	6.3	610	160	305	12	3470	123	5552	15375
EF8 / EFO8	2.4	8	2.59	8.5	1070	280	610	24	8780	310	14048	38750
EF10 / EFO10	3.0	10	3.25	10.7	1670	440	610	24	17790	628	28464	78500
EF12 / EFO12	3.6	12	3.89	12.8	2475	655	610	24	31220	1103	49952	137875

*Increased sump depth may be added to increase sediment storage capacity

** Average density of wet packed sediment in sump = 1.6 kg/L (100 lb/ft³)

Feature	Benefit	Feature Appeals To
Patent-pending enhanced flow treatment and scour prevention technology	Superior, verified third-party performance	Regulator, Specifying & Design Engineer
Third-party verified light liquid capture and retention for EFO version	Proven performance for fuel/oil hotspot locations	Regulator, Specifying & Design Engineer, Site Owner
Functions as bend, junction or inlet structure	Design flexibility	Specifying & Design Engineer
Minimal drop between inlet and outlet	Site installation ease	Contractor
Large diameter outlet riser for inspection and maintenance	Easy maintenance access from grade	Maintenance Contractor & Site Owner

STANDARD STORMCEPTOR EF/EFO DRAWINGS

For standard details, please visit <http://www.imbriumsystems.com/stormwater-treatment-solutions/stormceptor-ef>

STANDARD STORMCEPTOR EF/EFO SPECIFICATION

For specifications, please visit <http://www.imbriumsystems.com/stormwater-treatment-solutions/stormceptor-ef>

Stormceptor® EF Sizing Report

**Table of TSS Removal vs Surface Loading Rate Based on Third-Party Test Results
Stormceptor® EF**

SLR (L/min/m ²)	TSS % REMOVAL	SLR (L/min/m ²)	TSS % REMOVAL	SLR (L/min/m ²)	TSS % REMOVAL	SLR (L/min/m ²)	TSS % REMOVAL
1	70	660	46	1320	48	1980	35
30	70	690	46	1350	48	2010	34
60	67	720	45	1380	49	2040	34
90	63	750	45	1410	49	2070	33
120	61	780	45	1440	48	2100	33
150	58	810	45	1470	47	2130	32
180	56	840	45	1500	46	2160	32
210	54	870	45	1530	45	2190	31
240	53	900	45	1560	44	2220	31
270	52	930	44	1590	43	2250	30
300	51	960	44	1620	42	2280	30
330	50	990	44	1650	42	2310	30
360	49	1020	44	1680	41	2340	29
390	48	1050	45	1710	40	2370	29
420	48	1080	45	1740	39	2400	29
450	48	1110	45	1770	39	2430	28
480	47	1140	46	1800	38	2460	28
510	47	1170	46	1830	37	2490	28
540	47	1200	47	1860	37	2520	27
570	46	1230	47	1890	36	2550	27
600	46	1260	47	1920	36	2580	27
630	46	1290	48	1950	35		

Stormceptor[®] EF Sizing Report

STANDARD PERFORMANCE SPECIFICATION FOR “OIL GRIT SEPARATOR” (OGS) STORMWATER QUALITY TREATMENT DEVICE

PART 1 – GENERAL

1.1 WORK INCLUDED

This section specifies requirements for selecting, sizing, and designing an underground Oil Grit Separator (OGS) device for stormwater quality treatment, with third-party testing results and a Statement of Verification in accordance with ISO 14034 Environmental Management – Environmental Technology Verification (ETV).

1.2 REFERENCE STANDARDS & PROCEDURES

ISO 14034:2016 Environmental management – Environmental technology verification (ETV)

Canadian Environmental Technology Verification (ETV) Program’s **Procedure for Laboratory Testing of Oil-Grit Separators.**

1.3 SUBMITTALS

1.3.1 All submittals, including sizing reports & shop drawings, shall be submitted upon request with each order to the contractor then forwarded to the Engineer of Record for review and acceptance. Shop drawings shall detail all OGS components, elevations, and sequence of construction.

1.3.2 Alternative devices shall have features identical to or greater than the specified device, including: treatment chamber diameter, treatment chamber wet volume, sediment storage volume, and oil storage volume.

1.3.3 Unless directed otherwise by the Engineer of Record, OGS stormwater quality treatment product substitutions or alternatives submitted within ten days prior to project bid shall not be accepted. All alternatives or substitutions submitted shall be signed and sealed by a local registered Professional Engineer, based on the exact same criteria detailed in Section 3, in entirety, subject to review and approval by the Engineer of Record.

PART 2 – PRODUCTS

2.1 OGS POLLUTANT STORAGE

The OGS device shall include a sump for sediment storage, and a protected volume for the capture and storage of petroleum hydrocarbons and buoyant gross pollutants. The **minimum** sediment & petroleum hydrocarbon storage capacity shall be as follows:

2.1.1	4 ft (1219 mm) Diameter OGS Units:	1.19 m ³ sediment / 265 L oil
	6 ft (1829 mm) Diameter OGS Units:	3.48 m ³ sediment / 609 L oil
	8 ft (2438 mm) Diameter OGS Units:	8.78 m ³ sediment / 1,071 L oil
	10 ft (3048 mm) Diameter OGS Units:	17.78 m ³ sediment / 1,673 L oil
	12 ft (3657 mm) Diameter OGS Units:	31.23 m ³ sediment / 2,476 L oil

PART 3 – PERFORMANCE & DESIGN

3.1 GENERAL

Stormceptor[®] EF Sizing Report

The OGS stormwater quality treatment device shall be verified in accordance with ISO 14034:2016 Environmental management – Environmental technology verification (ETV). The OGS stormwater quality treatment device shall remove oil, sediment and gross pollutants from stormwater runoff during frequent wet weather events, and retain these pollutants during less frequent high flow wet weather events below the insert within the OGS for later removal during maintenance. The Manufacturer shall have at least ten (10) years of local experience, history and success in engineering design, manufacturing and production and supply of OGS stormwater quality treatment device systems, acceptable to the Engineer of Record.

3.2 SIZING METHODOLOGY

The OGS device shall be engineered, designed and sized to provide stormwater quality treatment based on treating a minimum of 90 percent of the average annual runoff volume and a minimum removal of an annual average 60% of the sediment (TSS) load based on the Particle Size Distribution (PSD) specified in the sizing report for the specified device. Sizing of the OGS shall be determined by use of a minimum ten (10) years of local historical rainfall data provided by Environment Canada. Sizing shall also be determined by use of the sediment removal performance data derived from the ISO 14034 ETV third-party verified laboratory testing data from testing conducted in accordance with the Canadian ETV protocol Procedure for Laboratory Testing of Oil-Grit Separators, as follows:

3.2.1 Sediment removal efficiency for a given surface loading rate and its associated flow rate shall be based on sediment removal efficiency demonstrated at the seven (7) tested surface loading rates specified in the protocol, ranging 40 L/min/m² to 1400 L/min/m², and as stated in the ISO 14034 ETV Verification Statement for the OGS device.

3.2.2 Sediment removal efficiency for surface loading rates between 40 L/min/m² and 1400 L/min/m² shall be based on linear interpolation of data between consecutive tested surface loading rates.

3.2.3 Sediment removal efficiency for surface loading rates less than the lowest tested surface loading rate of 40 L/min/m² shall be assumed to be identical to the sediment removal efficiency at 40 L/min/m². No extrapolation shall be allowed that results in a sediment removal efficiency that is greater than that demonstrated at 40 L/min/m².

3.2.4 Sediment removal efficiency for surface loading rates greater than the highest tested surface loading rate of 1400 L/min/m² shall assume zero sediment removal for the portion of flow that exceeds 1400 L/min/m², and shall be calculated using a simple proportioning formula, with 1400 L/min/m² in the numerator and the higher surface loading rate in the denominator, and multiplying the resulting fraction times the sediment removal efficiency at 1400 L/min/m².

The OGS device shall also have sufficient annual sediment storage capacity as specified and calculated in Section 2.1.

3.3 CANADIAN ETV or ISO 14034 ETV VERIFICATION OF SCOUR TESTING

The OGS device shall have Canadian ETV or ISO 14034 ETV Verification of third-party scour testing conducted in accordance with the Canadian ETV Program's **Procedure for Laboratory Testing of Oil-Grit Separators**.

3.3.1 To be acceptable for on-line installation, the OGS device must demonstrate an average scour test effluent concentration less than 10 mg/L at each surface loading rate tested, up to and including 2600 L/min/m².

APPENDIX H
CITY OF OTTAWA DESIGN CHECKLIST

City of Ottawa

4. Development Servicing Study Checklist

The following section describes the checklist of the required content of servicing studies. It is expected that the proponent will address each one of the following items for the study to be deemed complete and ready for review by City of Ottawa Infrastructure Approvals staff.

The level of required detail in the Servicing Study will increase depending on the type of application. For example, for Official Plan amendments and re-zoning applications, the main issues will be to determine the capacity requirements for the proposed change in land use and confirm this against the existing capacity constraint, and to define the solutions, phasing of works and the financing of works to address the capacity constraint. For subdivisions and site plans, the above will be required with additional detailed information supporting the servicing within the development boundary.

4.1 General Content

Criteria	Location (if applicable)
<input type="checkbox"/> Executive Summary (for larger reports only).	N/A
<input type="checkbox"/> Date and revision number of the report.	On Cover
<input type="checkbox"/> Location map and plan showing municipal address, boundary, and layout of proposed development.	Appendix A
<input type="checkbox"/> Plan showing the site and location of all existing services.	Site Servicing Plan (C102)
<input type="checkbox"/> Development statistics, land use, density, adherence to zoning and official plan, and reference to applicable subwatershed and watershed plans that provide context to which individual developments must adhere.	1.1 Purpose 1.2 Site Description 6.0 Stormwater Management
<input type="checkbox"/> Summary of pre-consultation meetings with City and other approval agencies.	Appendix B
<input type="checkbox"/> Reference and confirm conformance to higher level studies and reports (Master Servicing Studies, Environmental Assessments, Community Design Plans), or in the case where it is not in conformance, the proponent must provide justification and develop a defensible design criteria.	1.1 Purpose 1.2 Site Description 6.0 Stormwater Management
<input type="checkbox"/> Statement of objectives and servicing criteria.	3.0 Pre-Consultation Summary

<input type="checkbox"/> Identification of existing and proposed infrastructure available in the immediate area.	N/A
<input type="checkbox"/> Identification of Environmentally Significant Areas, watercourses and Municipal Drains potentially impacted by the proposed development (Reference can be made to the Natural Heritage Studies, if available).	Ste Grading Plan (C101)
<input type="checkbox"/> Concept level master grading plan to confirm existing and proposed grades in the development. This is required to confirm the feasibility of proposed stormwater management and drainage, soil removal and fill constraints, and potential impacts to neighbouring properties. This is also required to confirm that the proposed grading will not impede existing major system flow paths.	Ste Grading Plan (C101)
<input type="checkbox"/> Identification of potential impacts of proposed piped services on private services (such as wells and septic fields on adjacent lands) and mitigation required to address potential impacts.	N/A
<input type="checkbox"/> Proposed phasing of the development, if applicable.	N/A
<input type="checkbox"/> Reference to geotechnical studies and recommendations concerning servicing.	Section 2.0 Background Studies, Standards and References
<input type="checkbox"/> All preliminary and formal site plan submissions should have the following information: <ul style="list-style-type: none"> ○ Metric scale ○ North arrow (including construction North) ○ Key plan ○ Name and contact information of applicant and property owner ○ Property limits including bearings and dimensions ○ Existing and proposed structures and parking areas ○ Easements, road widening and rights-of-way ○ Adjacent street names 	Ste Grading Plan (C101)

4.2 Development Servicing Report: Water

Criteria	Location (if applicable)
<input type="checkbox"/> Confirm consistency with Master Servicing Study, if available	N/A
<input type="checkbox"/> Availability of public infrastructure to service proposed development	N/A
<input type="checkbox"/> Identification of system constraints	N/A
<input type="checkbox"/> Identify boundary conditions	Appendix C
<input type="checkbox"/> Confirmation of adequate domestic supply and pressure	N/A
<input type="checkbox"/> Confirmation of adequate fire flow protection and confirmation that fire flow is calculated as per the Fire Underwriter's Survey. Output should show available fire flow at locations throughout the development.	Appendix C
<input type="checkbox"/> Provide a check of high pressures. If pressure is found to be high, an assessment is required to confirm the application of pressure reducing valves.	N/A
<input type="checkbox"/> Definition of phasing constraints. Hydraulic modeling is required to confirm servicing for all defined phases of the project including the ultimate design	N/A
<input type="checkbox"/> Address reliability requirements such as appropriate location of shut-off valves	N/A
<input type="checkbox"/> Check on the necessity of a pressure zone boundary modification.	N/A
<input type="checkbox"/> Reference to water supply analysis to show that major infrastructure is capable of delivering sufficient water for the proposed land use. This includes data that shows that the expected demands under average day, peak hour and fire flow conditions provide water within the required pressure range	Appendix C, Section 4.2

<input type="checkbox"/> Description of the proposed water distribution network, including locations of proposed connections to the existing system, provisions for necessary looping, and appurtenances (valves, pressure reducing valves, valve chambers, and fire hydrants) including special metering provisions.	Site Servicing Plan (C101)
<input type="checkbox"/> Description of off-site required feeder mains, booster pumping stations, and other water infrastructure that will be ultimately required to service proposed development, including financing, interim facilities, and timing of implementation.	N/A
<input type="checkbox"/> Confirmation that water demands are calculated based on the City of Ottawa Design Guidelines.	Appendix C
<input type="checkbox"/> Provision of a model schematic showing the boundary conditions locations, streets, parcels, and building locations for reference.	N/A

4.3 Development Servicing Report: Wastewater

Criteria	Location (if applicable)
<input type="checkbox"/> Summary of proposed design criteria (Note: Wet-weather flow criteria should not deviate from the City of Ottawa Sewer Design Guidelines. Monitored flow data from relatively new infrastructure cannot be used to justify capacity requirements for proposed infrastructure).	N/A
<input type="checkbox"/> Confirm consistency with Master Servicing Study and/or justifications for deviations.	N/A
<input type="checkbox"/> Consideration of local conditions that may contribute to extraneous flows that are higher than the recommended flows in the guidelines. This includes groundwater and soil conditions, and age and condition of sewers.	N/A
<input type="checkbox"/> Description of existing sanitary sewer available for discharge of wastewater from proposed development.	Section 5.2 Proposed Sanitary Sewer

<input type="checkbox"/> Verify available capacity in downstream sanitary sewer and/or identification of upgrades necessary to service the proposed development. (Reference can be made to previously completed Master Servicing Study if applicable)	Section 5.3 Proposed Sanitary Design
<input type="checkbox"/> Calculations related to dry-weather and wet-weather flow rates from the development in standard MOE sanitary sewer design table (Appendix 'C') format.	N/A
<input type="checkbox"/> Description of proposed sewer network including sewers, pumping stations, and forcemains.	Section 5.2 Proposed Sanitary Sewer
<input type="checkbox"/> Discussion of previously identified environmental constraints and impact on servicing (environmental constraints are related to limitations imposed on the development in order to preserve the physical condition of watercourses, vegetation, soil cover, as well as protecting against water quantity and quality).	N/A
<input type="checkbox"/> Pumping stations: impacts of proposed development on existing pumping stations or requirements for new pumping station to service development.	N/A
<input type="checkbox"/> Forcemain capacity in terms of operational redundancy, surge pressure and maximum flow velocity.	N/A
<input type="checkbox"/> Identification and implementation of the emergency overflow from sanitary pumping stations in relation to the hydraulic grade line to protect against basement flooding.	N/A
<input type="checkbox"/> Special considerations such as contamination, corrosive environment etc.	N/A

4.4 Development Servicing Report: Stormwater Checklist

Criteria	Location (if applicable)
<input type="checkbox"/> Description of drainage outlets and downstream constraints including legality of outlets (i.e. municipal drain, right-of-way, watercourse, or private property)	Section 6.0 Stormwater Sewer Design & Section 7.0 Proposed Stormwater Management
<input type="checkbox"/> Analysis of available capacity in existing public infrastructure.	N/A
<input type="checkbox"/> A drawing showing the subject lands, its surroundings, the receiving watercourse, existing drainage patterns, and proposed drainage pattern.	Pre & Post-Development Plans
<input type="checkbox"/> Water quantity control objective (e.g. controlling post-development peak flows to pre-development level for storm events ranging from the 2 or 5-year event (dependent on the receiving sewer design) to 100-year return period); if other objectives are being applied, a rationale must be included with reference to hydrologic analyses of the potentially affected subwatersheds, taking into account long-term cumulative effects.	Section 6.0 Stormwater Sewer Design & Section 7.0 Proposed Stormwater Management
<input type="checkbox"/> Water Quality control objective (basic, normal or enhanced level of protection based on the sensitivities of the receiving watercourse) and storage requirements.	Section 6.0 Stormwater Sewer Design & Section 7.0 Proposed Stormwater Management
<input type="checkbox"/> Description of the stormwater management concept with facility locations and descriptions with references and supporting information.	Section 6.0 Stormwater Sewer Design & Section 7.0 Proposed Stormwater Management
<input type="checkbox"/> Set-back from private sewage disposal systems.	N/A
<input type="checkbox"/> Watercourse and hazard lands setbacks.	N/A
<input type="checkbox"/> Record of pre-consultation with the Ontario Ministry of Environment and the Conservation Authority that has jurisdiction on the affected watershed.	N/A
<input type="checkbox"/> Confirm consistency with sub-watershed and Master Servicing Study, if applicable study exists.	N/A
<input type="checkbox"/> Storage requirements (complete with calculations) and conveyance capacity for minor events (1:5-year return period) and major events (1:100-year return period).	Appendix G

<input type="checkbox"/> Identification of watercourses within the proposed development and how watercourses will be protected, or, if necessary, altered by the proposed development with applicable approvals.	Site Grading Plan
<input type="checkbox"/> Calculate pre-and post development peak flow rates including a description of existing site conditions and proposed impervious areas and drainage catchments in comparison to existing conditions.	Section 7.0 Proposed Stormwater Management Appendix G
<input type="checkbox"/> Any proposed diversion of drainage catchment areas from one outlet to another.	Section 6.0 Stormwater Sewer Design & Section 7.0 Proposed Stormwater Management
<input type="checkbox"/> Proposed minor and major systems including locations and sizes of stormwater trunk sewers, and stormwater management facilities.	Section 6.0 Stormwater Sewer Design & Section 7.0 Proposed Stormwater Management
<input type="checkbox"/> If quantity control is not proposed, demonstration that downstream system has adequate capacity for the post-development flows up to and including the 100-year return period storm event.	N/A
<input type="checkbox"/> Identification of potential impacts to receiving watercourses	N/A
<input type="checkbox"/> Identification of municipal drains and related approval requirements.	N/A
<input type="checkbox"/> Descriptions of how the conveyance and storage capacity will be achieved for the development.	Section 6.0 Stormwater Sewer Design & Section 7.0 Proposed Stormwater Management
<input type="checkbox"/> 100-year flood levels and major flow routing to protect proposed development from flooding for establishing minimum building elevations (MBE) and overall grading.	Site Grading Plan (C101)
<input type="checkbox"/> Inclusion of hydraulic analysis including hydraulic grade line elevations.	N/A

<input type="checkbox"/> Description of approach to erosion and sediment control during construction for the protection of receiving watercourse or drainage corridors.	Section 8.0 Sediment & Erosion Control
<input type="checkbox"/> Identification of floodplains – proponent to obtain relevant floodplain information from the appropriate Conservation Authority. The proponent may be required to delineate floodplain elevations to the satisfaction of the Conservation Authority if such information is not available or if information does not match current conditions.	N/A
<input type="checkbox"/> Identification of fill constraints related to floodplain and geotechnical investigation.	N/A

4.5 Approval and Permit Requirements: Checklist

The Servicing Study shall provide a list of applicable permits and regulatory approvals necessary for the proposed development as well as the relevant issues affecting each approval. The approval and permitting shall include but not be limited to the following:

Criteria	Location (if applicable)
<input type="checkbox"/> Conservation Authority as the designated approval agency for modification of floodplain, potential impact on fish habitat, proposed works in or adjacent to a watercourse, cut/fill permits and Approval under Lakes and Rivers Improvement Act. The Conservation Authority is not the approval authority for the Lakes and Rivers Improvement Act. Where there are Conservation Authority regulations in place, approval under the Lakes and Rivers Improvement Act is not required, except in cases of dams as defined in the Act.	N/A
<input type="checkbox"/> Application for Certificate of Approval (CofA) under the Ontario Water Resources Act.	N/A
<input type="checkbox"/> Changes to Municipal Drains.	N/A
<input type="checkbox"/> Other permits (National Capital Commission, Parks Canada, Public Works and Government Services Canada, Ministry of Transportation etc.)	N/A

4.6 Conclusion Checklist

Criteria	Location (if applicable)
<input type="checkbox"/> Clearly stated conclusions and recommendations	Section 9.0 Summary Section 10.0 Recommendations
<input type="checkbox"/> Comments received from review agencies including the City of Ottawa and information on how the comments were addressed. Final sign-off from the responsible reviewing agency.	All are stamped
<input type="checkbox"/> All draft and final reports shall be signed and stamped by a professional Engineer registered in Ontario	All are stamped