



1881 Merivale

Transportation Impact Assessment Report

FINAL

October 2023

1881 Merivale Road

Transportation Impact Assessment Report

prepared for:
Z.V. Holdings Corp.
1801 Woodward Drive
Ottawa, ON
K2J 5N6

prepared by:
 **PARSONS**
1223 Michael Street North
Suite 100
Ottawa, ON K1J 7T2

October 30, 2023

478378-01000

DOCUMENT CONTROL PAGE

CLIENT:	Z.V. Holdings Corp.
PROJECT NAME:	1881 Merivale Road Development
REPORT TITLE:	Transportation Impact Study Report
PARSONS PROJECT NO:	478378 - 01000
APPLICATION TYPE:	Site Plan Application
VERSION:	Final
DIGITAL MASTER:	H:\ISO\478378\1000\DOCS\STEP5-Strategy_SecondSubmission\FINAL - Oct. 30\1881 Merivale Road - Transportaiton Impact Assessment Report 06.06.23.docx
ORIGINATOR	Basel Ansari, P.Eng
REVIEWER:	Jake Berube, P.Eng.
AUTHORIZATION:	
CIRCULATION LIST:	City of Ottawa
HISTORY:	<ul style="list-style-type: none"> - TIA Step 1 Screening Form – August 3, 2022 - TIA Step 2 Scoping Report – August 3, 2022 - TIA Step 3 Forecasting Report – August 24, 2022 - TIA Step 4 Strategy Report – February 21, 2023 - TIA Step 5 Draft Transportation Impact Assessment – June 6, 2023 - TIA Step 5 Final Transportation Impact Assessment – October 30, 2023



Certification Form for TIA Study PM

TIA Plan Reports

On 14 June 2017, the Council of the City of Ottawa adopted new Transportation Impact Assessment (TIA) Guidelines. In adopting the guidelines, Council established a requirement for those preparing and delivering transportation impact assessments and reports to sign a letter of certification.

Individuals submitting TIA reports will be responsible for all aspects of development-related transportation assessment and reporting, and undertaking such work, in accordance and compliance with the City of Ottawa's Official Plan, the Transportation Master Plan and the Transportation Impact Assessment (2017) Guidelines.

By submitting the attached TIA report (and any associated documents) and signing this document, the individual acknowledges that s/he meets the four criteria listed below.

CERTIFICATION

- I have reviewed and have a sound understanding of the objectives, needs and requirements of the City of Ottawa's Official Plan, Transportation Master Plan and the Transportation Impact Assessment (2017) Guidelines;
- I have a sound knowledge of industry standard practice with respect to the preparation of transportation impact assessment reports, including multi modal level of service review;
- I have substantial experience (more than 5 years) in undertaking and delivering transportation impact studies (analysis, reporting and geometric design) with strong background knowledge in transportation planning, engineering or traffic operations; and
- I am either a licensed¹ or registered² professional in good standing, whose field of expertise
 - is either transportation engineering
 - or transportation planning .

^{1,2} License of registration body that oversees the profession is required to have a code of conduct and ethics guidelines that will ensure appropriate conduct and representation for transportation planning and/or transportation engineering works.

Dated at this day of , 20
(City)

Name :

Professional title:

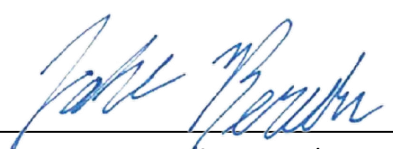

Signature of individual certifier that s/he meets the above criteria

Office Contact Information (Please Print)	
Address:	<input type="text" value="1223 Michael Street North, Suite 100"/>
City / Postal Code:	<input type="text" value="Ottawa, Ontario, K1J 7T2"/>
Telephone / Extension:	<input type="text" value="1-613-738-4160"/>
E-Mail Address:	<input type="text" value="Jake.Berube@Parsons.com"/>

Stamp



TABLE OF CONTENTS

1.0	SCREENING FORM	1
2.0	SCOPING REPORT	1
2.1.	EXISTING AND PLANNED CONDITIONS	1
2.1.1.	PROPOSED DEVELOPMENT.....	1
2.1.2.	EXISTING CONDITIONS.....	3
2.1.3.	PLANNED CONDITIONS	10
2.1.3.1.	Future Transportation Network Changes	10
2.1.3.1	Other Study Area Developments.....	10
2.2.	STUDY AREA AND TIME PERIODS.....	11
2.3.	EXEMPTION REVIEW	12
3.0	FORECASTING	12
3.1.	DEVELOPMENT GENERATED TRAVEL DEMAND	12
3.1.1.	TRIP GENERATION AND MODE SHARES.....	12
3.1.2.	TRIP DISTRIBUTION AND ASSIGNMENT	13
3.2.	BACKGROUND NETWORK TRAFFIC.....	14
3.2.1.	TRANSPORTATION NETWORK PLANS.....	14
3.2.2.	BACKGROUND GROWTH	14
3.2.3.	OTHER DEVELOPMENTS	15
3.3.	DEMAND RATIONALIZATION.....	16
4.0	ANALYSIS	18
4.1.	DEVELOPMENT DESIGN.....	18
4.2.	PARKING	19
4.3.	BOUNDARY STREET DESIGN.....	19
4.4.	ACCESS INTERSECTION DESIGN.....	21
4.4.1.	LOCATION AND DESIGN OF ACCESSES	21
4.4.2.	SIGNALIZED INTERSECTION MMLOS ANALYSIS.....	21
4.5.	TRANSPORTATION DEMAND MANAGEMENT.....	22
4.6.	NEIGHBOURHOOD TRAFFIC MANAGEMENT.....	22
4.7.	TRANSIT	22
4.8.	REVIEW OF NETWORK CONCEPT	22
4.9.	INTERSECTION DESIGN.....	22
4.9.1.	INTERSECTION CONTROL.....	22
4.9.2.	INTERSECTION DESIGN.....	22

5.0 FINDINGS, CONCLUSIONS AND RECOMMENDATIONS.....	25
--	----

LIST OF FIGURES

FIGURE 1: LOCAL CONTEXT	2
FIGURE 2: SITE PLAN (FEBRUARY 2023).....	3
FIGURE 3: ADJACENT DRIVEWAYS WITHIN 200M OF SITE ACCESSES	5
FIGURE 4: STUDY AREA ACTIVE TRANSPORTATION FACILITIES	6
FIGURE 5: AREA TRANSIT NETWORK AND ADJACENT TRANSIT STOPS	7
FIGURE 6: EXISTING PEAK HOUR TRAFFIC VOLUMES	8
FIGURE 7: URBAN AND RURAL TRUCK ROUTE SURROUNDING SITE.....	9
FIGURE 8: STUDY AREA	11
FIGURE 9: SITE-GENERATED TRAFFIC VOLUMES	14
FIGURE 10: 2024 FUTURE BACKGROUND TRAFFIC VOLUMES	15
FIGURE 11: 2029 FUTURE BACKGROUND TRAFFIC VOLUMES	16
FIGURE 12: 2024 TOTAL TRAFFIC VOLUMES	17
FIGURE 13: 2029 TOTAL TRAFFIC VOLUMES	18

LIST OF TABLES

TABLE 1: EXEMPTIONS REVIEW SUMMARY.....	12
TABLE 2: PROPOSED DEVELOPMENT TRIP RATES	12
TABLE 3: WAREHOUSE PEAK HOUR PERSON TRIPS.....	13
TABLE 4: WAREHOUSE PEAK HOUR TRIPS MODE SHARES BREAKDOWN	13
TABLE 5: MMLOS ANALYSIS – MERIVALE ROAD AND JAMIE AVENUE	20
TABLE 6: MMLOS ANALYSIS - SIGNALIZED INTERSECTIONS	21
TABLE 7: EXISTING CONDITIONS INTERSECTION PERFORMANCE	23
TABLE 8: TOTAL FUTURE BACKGROUND 2024 CONDITIONS INTERSECTION PERFORMANCE.....	23
TABLE 9: TOTAL FUTURE BACKGROUND 2029 CONDITIONS TRAFFIC VOLUMES	24
TABLE 10: TOTAL PROJECTED 2024 CONDITIONS TRAFFIC VOLUMES	24
TABLE 11: TOTAL PROJECTED 2029 CONDITIONS TRAFFIC VOLUMES	25

LIST OF APPENDICES

APPENDIX A: SCREENING FORM AND RESPONSE TO CITY COMMENTS
APPENDIX B: TRANSIT ROUTE MAPS
APPENDIX C: TRAFFIC DATA
APPENDIX D: COLLISION DATA
APPENDIX E: TRANS MODEL OUTPUT DATA
APPENDIX F: TDM-SUPPORTIVE DEVELOPMENT DESIGN AND INFRASTRUCTURE CHECKLIST
APPENDIX G: TRUCK TURNING TEMPLATES
APPENDIX H: MMLOS ANALYSIS RESULTS
APPENDIX I: SYNCHRO ANALYSIS RESULTS

TRANSPORTATION IMPACT ASSESSMENT REPORT

Parsons has been retained by Z.V. Holdings Corp. to prepare a TIA in support of a Site Plan Application to re-develop the existing properties located at 1881 Merivale Road, 1883 Merivale Road, 6 Jamie Avenue and 12 Jamie Avenue. This will include removal of the existing school bus parking on Jamie Avenue and the commercial building at 1883 Merivale Road. The proposal would include two, single-storey warehouse buildings of approximately 38,100 ft² and 33,050 ft² (total 71,000 ft²). This document follows the TIA process as outlined in the City Transportation Impact Assessment (TIA) Guidelines (2017). The following report represents the Transportation Impact Assessment Report. The Screening Form has been provided in **Appendix A**.

1.0 SCREENING FORM

The Screening Form confirmed the need for a TIA Report based on the Trip Generation, Location and Safety triggers. The Trip Generation trigger was met as the development is anticipated to generate more than 60 person trips during peak hours. The Safety trigger was met due to the adjacent signalized intersection of Merivale/Bentley. Merivale Road is a future cycling Spine Route and Transit Priority corridor, therefore the Location Trigger was met.

2.0 SCOPING REPORT

2.1. Existing and Planned Conditions

2.1.1. Proposed Development

The proposed development will be located at the municipal addresses of 1881-1883 Merivale Road and 6-12 Jamie Avenue. The 1883 Merivale Road property is currently occupied by a small commercial building with its own access, both of which will be removed. The 6 and 12 Jamie Avenue properties are currently used as school bus parking which will no longer be the case. The combined properties are considered the proposed development site.

The site is currently zoned as IG- General Industrial which allows warehousing as a permitted use. The local context of the site is illustrated in **Figure 1**. The proposed development is anticipated to consist of two, single-storey warehouse buildings of approximately 38,000 ft² and 33,000 ft² (total 71,000 ft²). Large tractor trailer units are anticipated to only access Building A. The proposal includes a right-in right-out access to Merivale Road and a full movement access to Jamie Avenue. Small and mid-sized trucks are anticipated to typically access the site via Jamie Avenue, then exit via either Jamie Ave or Merivale Road, while large tractor trailers should only use Jamie Ave to exit. A total of 87 vehicle parking stalls are anticipated to be provided on-site.

Figure 2 illustrates the proposed site plan which will be constructed as a multi-phase development, likely in consecutive years. However, both accesses will be constructed with the initial phase of development. For the purpose of this TIA analysis, the development has been assumed to be completed in a single phase. Site parking is to be accommodated through a surface parking lot.

Figure 1: Local Context



Figure 2: Site Plan (May 2023)

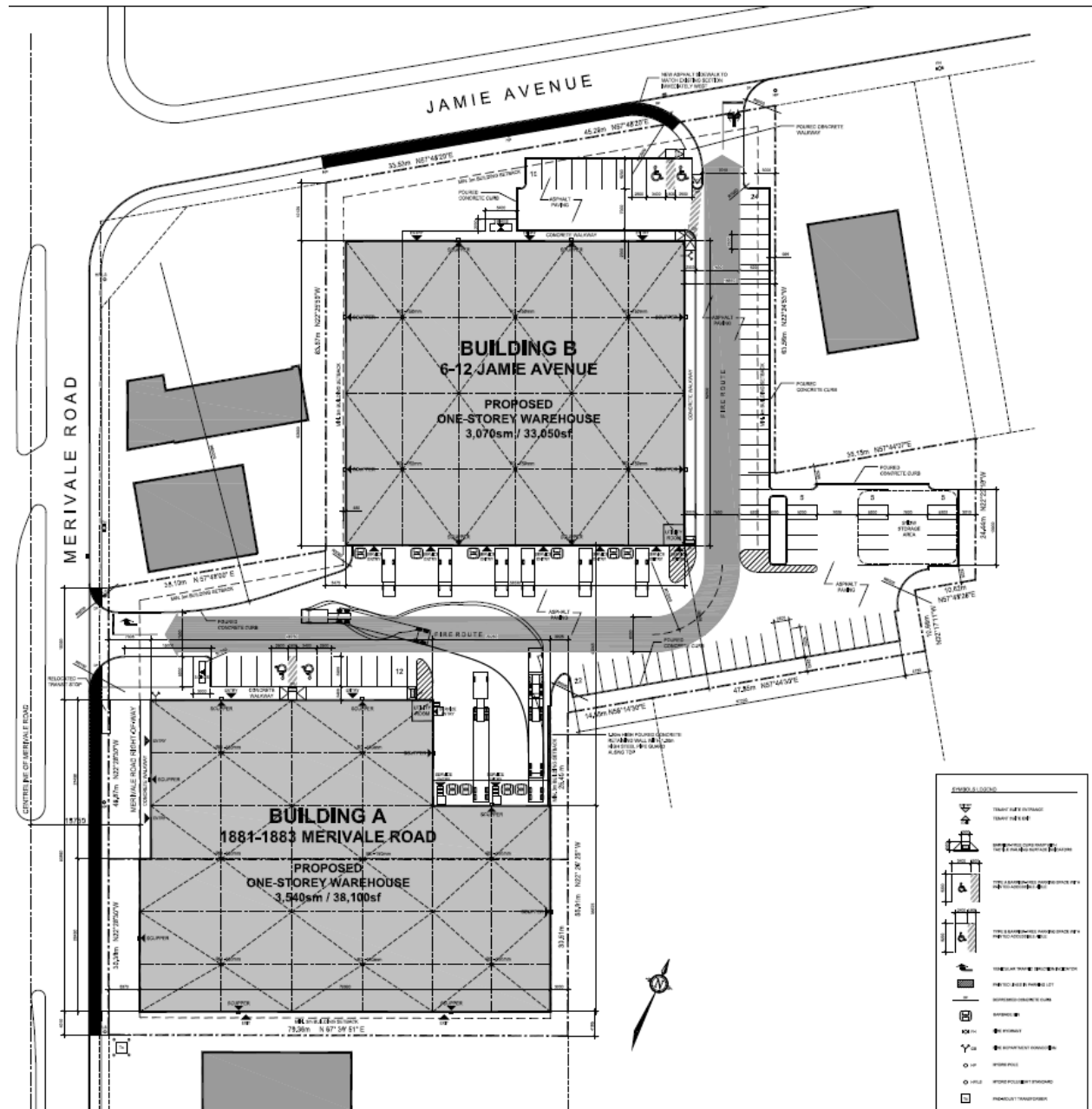

2.1.2. Existing Conditions

Area Road Network

The following roads were included in the TIA. Description for each road within the study area has been provided below.

Merivale Road is a north-south municipal arterial road that extends from Carling Avenue in the north to Fallowfield Road in the south. Fronting the site, Merivale Road has a 4-lane divided urban cross section with a posted speed limit of 60 km/h. It is currently identified as a Full Load urban truck route.

West Hunt Club Road is a major east-west municipal arterial road located north of the development, connecting beyond the Highway 416 in the west to the Highway 417 in the east. It is identified a full load truck route. It is typically a 6-lane divided urban cross-section nearest Merivale Road with a posted 80 km/hr.

Jamie Avenue is an east-west local roadway connecting to Merivale Road while being parallel to Hunt Club Road. It provides for a 2-lane urban cross section without a marked centerline or sidewalks. It is assumed to be posted at 50 km/h.

Bentley Avenue – Camelot Drive is an east-west collector roadway connecting to Cleopatra Drive in the west while being parallel to Hunt Club Road. It provides for a 2-lane urban cross section without a marked centerline or sidewalks for most of its length. It has a posted speed limit of 50 km/h.

Existing Study Area Intersections

Merivale/West Hunt Club

The Merivale/W Hunt Club intersection is a major four-legged signalized intersection. The southbound approach provides for a double left turn, two dedicated through lanes and a channelized right turn lane. The westbound approach provides for a single left turn lane, three through lanes and a channelized right turn. The northbound approach includes a single left turn lane, two dedicated through lanes and a channelized right turn lane. Finally, the eastbound approach provides for a double left turn lane, two through lanes and a channelized right turn lane. Bike lanes are provided on the east-west approach. RTOR and U-Turns are permitted on all approaches.



Merivale/Jamie

The Merivale/Jamie intersection is a three-legged “T” intersection with STOP-control on the minor westbound approach. The major north-south Merivale Road approaches provided for two through lanes and a dedicated southbound left-turn lane. The minor westbound approach flares at the STOP-bar, effectively providing for separate right turn and left turn opportunities.



Merivale/Bentley-Camelot

The Merivale/Bentley intersection is a 4-legged signalized intersection. The major north south Merivale Road approaches provide for a dedicated left turn lane, a dedicated through lane and a shared through/right turn lane. The minor leg approaches accommodate channelized right turn movements, dedicated left turn lanes and a dedicated through movement lane. RTOR and U-Turns are permitted on all approaches.



Existing Driveways to Adjacent Developments

Figure 3 illustrates adjacent accesses (red) within 200m of the proposed site accesses along Merivale Road and Jamie Avenue. In total, 10 accesses along Merivale Road and 4 accesses along Jamie Avenue were identified.

Figure 3: Adjacent Driveways within 200m of Site Accesses



Inspection of **Figure 3** and the existing access arrangements along Merivale indicated that:

- The proposed Merivale Road access will be right-in right-out. The adjacent 1877 Merivale Road property provides for two one-way accesses. Minimal conflicts are anticipated between the proposed site Merivale Road access and the 1877 Merivale Road accesses.
- The Jamie Avenue access is well spaced from Merivale Road and adjacent development accesses.
- The proposal will result in the removal of three existing accesses, two to Merivale Road and one to Jamie Avenue.

Existing Area Traffic Management Measures

No area traffic management measures are deployed within the Study Area. The Study Area is typified by industrial and commercial developments and limited residential activity.

Pedestrian/Cycling Network

Figure 4 illustrates an extract from the City of Ottawa's TMP, Map 1, Cycling Network – Primary Urban. Merivale Road and West Hunt Club Road are designated cycling 'Spine Routes'. West Hunt Club Road provides for cycle lanes in both directions nearest the site. Merivale Road does not offer any cycling facilities.

On the east side, Merivale Road typically provides for a 2.0m asphalt sidewalk while the west side provides for a mixed concrete/asphalt sidewalk. West Hunt Club provides for concrete sidewalks in both directions. Jamie Avenue and Bentley Avenue provide concrete sidewalks nearest Merivale Road and are without cycling facilities.

In review of the August 2022 Jamie Avenue AM and PM peak period counts, approximately 30 pedestrians were observed in the north-south direction while 16 pedestrians crossed the south leg of Merivale/Jamie. This was a notable desire line between the transit stop on the west side of the corridor and the areas on the east side of Merivale. Approximately 30 cyclists were observed in the north-south directions.

Figure 4: Study Area Active Transportation Facilities

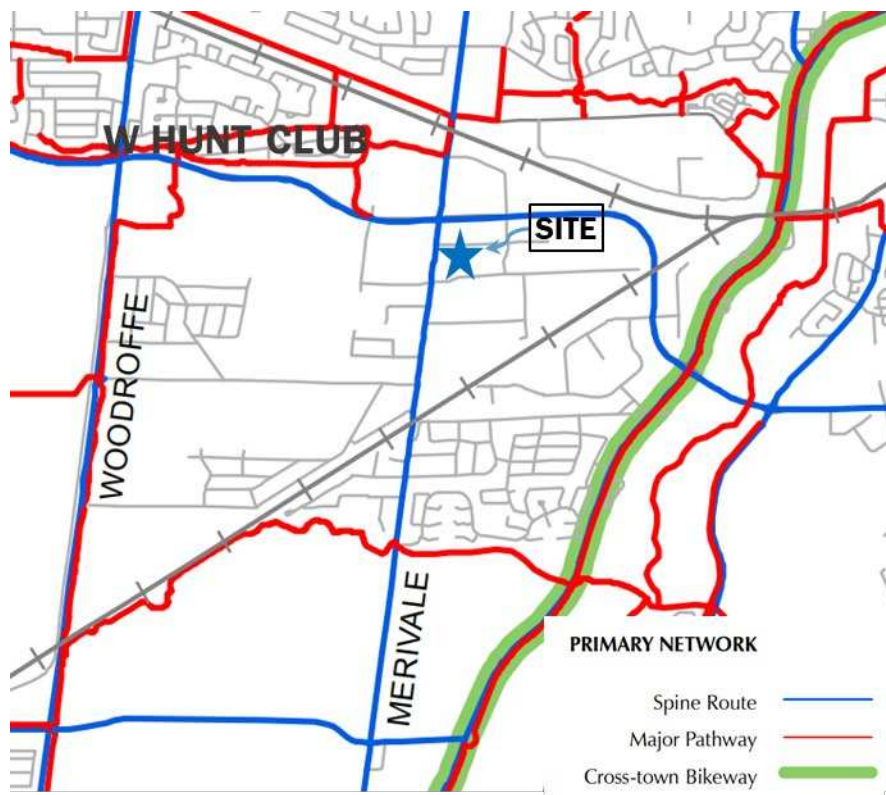

Transit Network

Due to the current circumstances regarding COVID-19, some bus services may have been altered by OC Transpo to operate on a different schedule. The following description of OC Transpo routes are found fronting the site along Merivale Road (Merivale/Jamie bus stop) reflecting current bus operations (July, 2022):

- **Route #80 (Barrhaven Centre <-> Tunney's Pasture):** identified by OC Transpo as a "Frequent Route", this route operates all day, 7 days a week and at an average rate of every 15 or less on weekdays.
- **Route #96 (Greenboro/Hurdman <-> Merivale):** identified by OC Transpo as a "Local Route", this route operates 7 days a week with all day service and at an average headway of 30 minutes during peak periods and 1-hr headways during non-peak periods.
- **Route #186 (Lincoln Fields <-> Merivale/Slack):** identified by OC Transpo as a weekday "Local Route" with service during the peak hours, Monday to Friday.
- **Route #199 (Hurdman <-> Leikin):** identified by OC Transpo as a weekday "Local Route" with service during the peak hours, Monday to Friday.

Figure 5 illustrates the surrounding transit network for the study area and adjacent bus stops to the development. Transit route maps are provided in **Appendix B**.

Figure 5: Area Transit Network and Adjacent Transit Stops

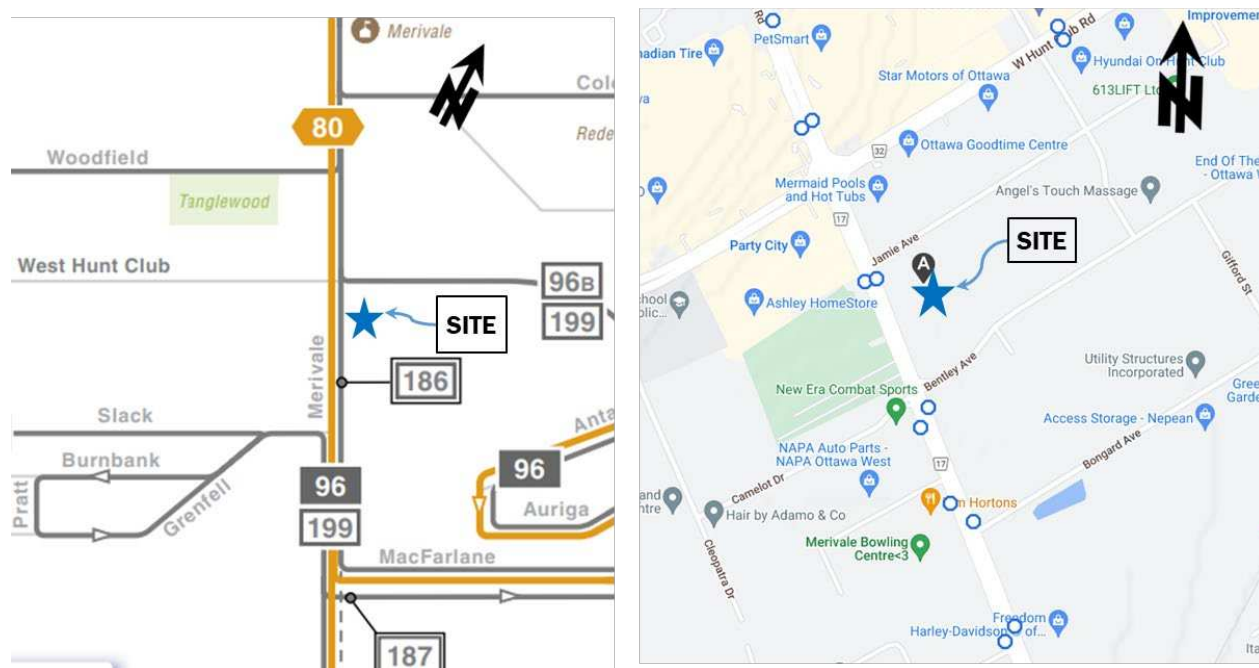

Peak Hour Travel Demands

The existing peak hour traffic volumes at the signalized intersections within the study area were obtained from the City of Ottawa for the following intersections:

- Merivale/West Hunt Club– Conducted Monday, February 10, 2020
- Merivale/Bentley-Camelot – Conducted Tuesday, January 15, 2019

The traffic count at the intersection of Merivale/Jamie was conducted separately on August 2, 2022. The traffic volumes at study area intersections are illustrated in **Figure 6**, with raw traffic count data provided in **Appendix C**. No adjustments such as traffic growth have been applied to the traffic volumes given the study area context in a well-established neighborhood and in a central area of the City of Ottawa. The north-south through movement

at Jamie Avenue was balanced as the average between the Merivale/Hunt Club northbound approach and the Merivale/Bentley northbound egress as the summer counts were noticeably lower.

Figure 6: Existing Peak Hour Traffic Volumes

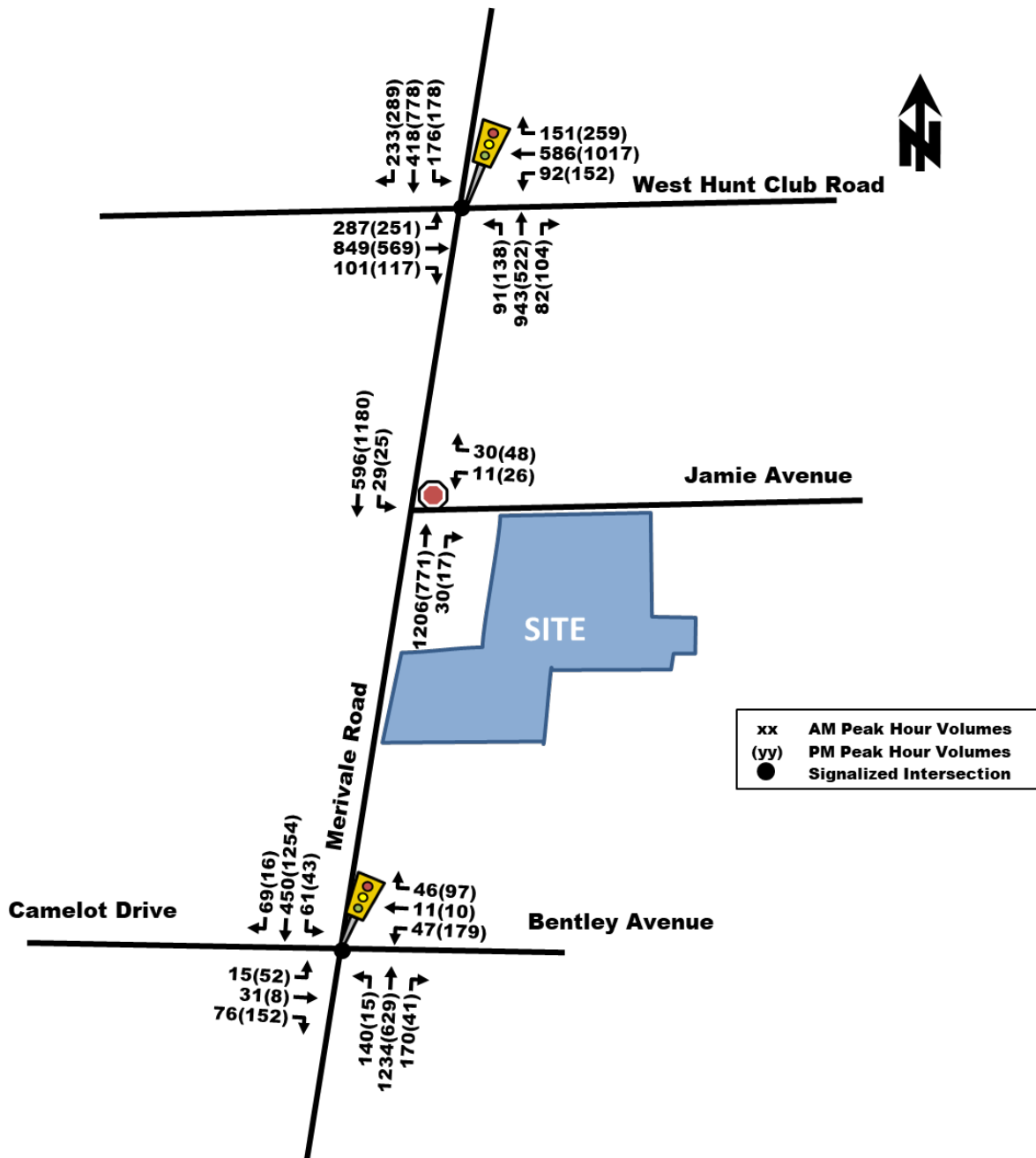

Existing Truck Network

Figure 7 illustrates an extract from the City of Ottawa’s Urban (top half of figure) and Rural (bottom half of figure) Truck Routes (March, 2021) surrounding the development. Notably, Merivale Road and Hunt Club Road provide key north-south and east-west truck connectivity, respectively. Based on the Jamie/Merivale count undertaken in August 2022, Merivale Road truck volumes are higher in the AM peak hour, with 5%-to-6% of north-south traffic, which is similar to the percentage of trucks at the adjacent north and south intersections, although the

truck volumes are slightly higher at the SB movement for the Merivale/Bentley intersection, with 9%. Additionally, the NBL and NBR truck percentages from Merivale Rd onto Hunt Club Rd are 16% and 11%, respectively.

East-west truck volumes are in the range of 4%-to-6% at study area intersections, with higher percentages at the WB approach of the Merivale/Bentley intersection and the EBR and WBL of the Merivale/Hunt Club intersection, ranging between 11% and 18%.

Figure 7: Urban and Rural Truck Route Surrounding Site

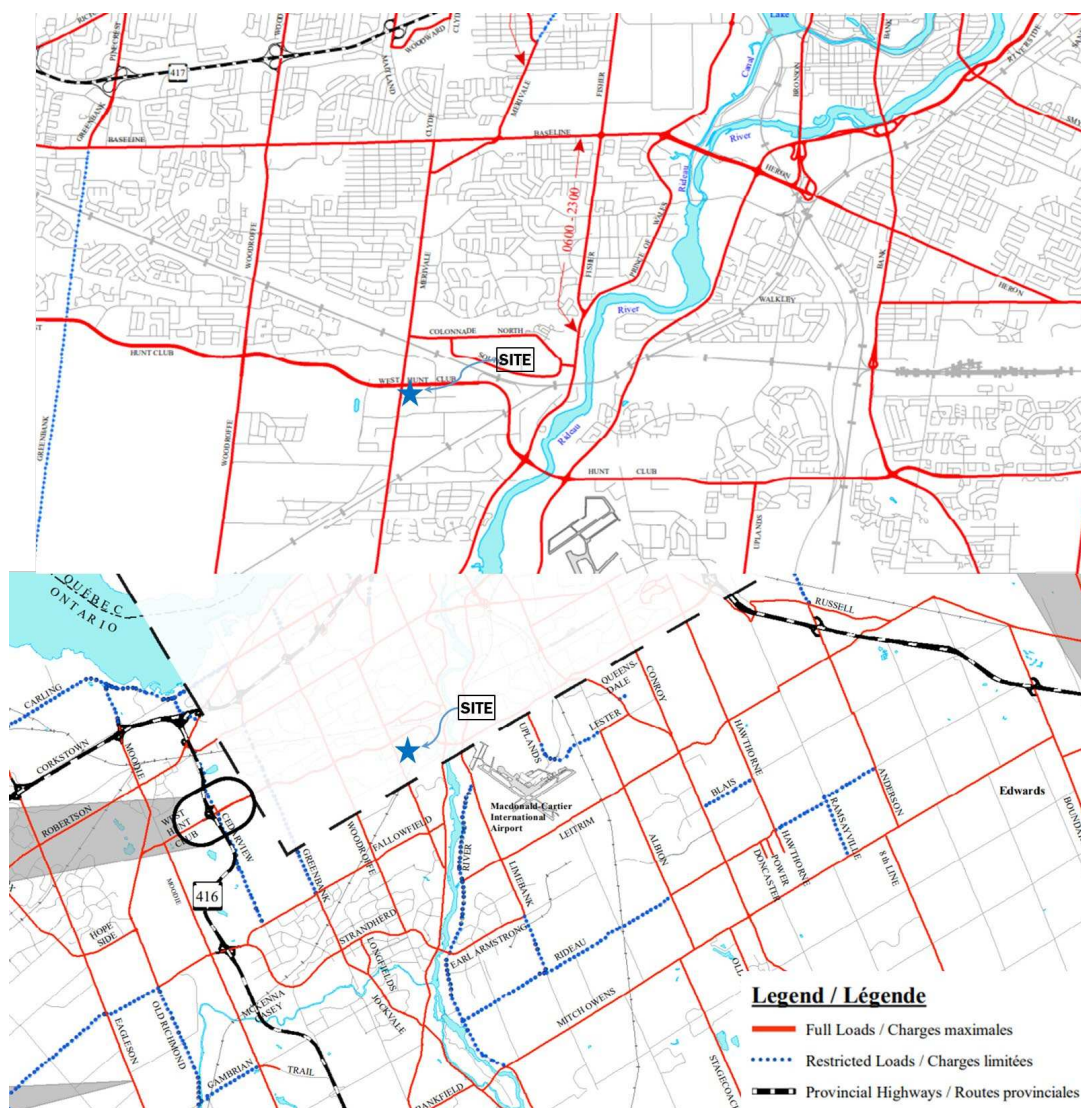

Existing Road Safety Conditions

Five-year collision data (2016-2020, inclusive) was obtained from the City of Ottawa OpenData portal for all intersections and road segments within the study area.

Of the 166 total collisions that occurred, 96 (58%) resulted from rear ends, 41 (25%) from sideswipes, 15 (9%) from turning movements and 14 (8%) from angled collisions. Of the total, 136 collisions were found to occur at Merivale/Hunt Club intersection. Additionally, 149 (86%) collisions of the total collisions were found to result in property-damage only (PDO), representing the majority of collisions, while the remaining 27 (14%) resulted in non-fatal injuries. No collisions resulted in fatalities or involved pedestrians. The source collision data obtained from OpenData Ottawa and detailed analysis results are provided in **Appendix D**.

A standard unit of measure for assessing collisions at an intersection is based on the number of collisions per million entering vehicles (MEV). Intersections with a ratio of 1.0 Collisions/MEV or greater are considered to be at a higher risk for collisions. Based on the City of Ottawa TIA Guidelines (2017), a collision pattern is characterized as a sequence of more than six collisions of the same impact type occurring for a specific movement within a five-year period. At signalized intersections within the study area, reported collisions have historically taken place at a rate of:

- 1.06 Collisions/MEV at the intersection of Merivale/Hunt Club. A total of 136 collisions occurred at this intersection in the five-year period, 84 (64%) were reported as rear-ends while 31 (23%) were reported as sideswipes.
- 0.08 Collisions/MEV at the intersection of Merivale/Jamie. 4 collisions were reported, two related to turning movements and 2 related to angle collisions.
- 0.15 Collisions/MEV at the intersection of Merivale/Bentley-Camelot. A total of 9 collisions were reported, reported as 5 rear-end incidents, 1 sideswipe incident and 3 'other' incidents.

2.1.3. Planned Conditions

2.1.3.1. Future Transportation Network Changes

Merivale Road Secondary Plan

The proposed site is located within the Merivale Road Secondary Plan Area which provides planning direction for the Merivale Main Street corridor. The Plan is founded on the premise that Merivale Road is not a 'greenfield' area and is therefore to be maintained as a retail and service corridor between 'Activity Centres'. The purpose of the Merivale Planning Area is to support ongoing retail function.

The relevant Transportation and streetscape policies from the Merivale Road Secondary Plan include:

- **Pedestrian Realm:** Well furnished, protected and continuous pedestrian sidewalks are to be provided on the frontage of all developments.
- **Transit Network:** Pedestrian routes to and from sidewalks shall connect directly to transit stops.
- **Interconnected Vehicle Access:** where possible, parking aisles and bays shall be linked between sites.

City of Ottawa Transportation Master Plan (2013)

A review of the City of Ottawa Official Plan, Transportation Master Plan, Pedestrian Plan and Cycling Plan has indicated the following:

- Merivale Road is designated a transit priority corridor (continuous lanes) in the TMP Network Concept extending south to Spratt Road. These transit improvements are omitted from the Affordable Concept. To the knowledge of the proponent, no design has been prepared.
- West Hunt Club Road is designated a transit priority corridor (isolated measures) in the TMP Network Concept. These transit improvements are omitted from the Affordable Concept. To the knowledge of the proponent, no design has been prepared that includes transit improvements within the study area.
- Merivale Road is designated a Spine Route in the Ultimate Cycling Network.

2.1.3.1 Other Study Area Developments

Based on the City of Ottawa's Development Applications search tool, several applications have been initiated near the proposed development site which include:

- 1871 Merivale Road: Located at the northeast quadrant of the Merivale/Jamie intersection, this proposal includes an extension on the existing light industrial use by an additional 1,000m². A new access is proposed to Jamie Avenue near the eastern boundary of the 1871 Merivale Road property. A TIA has not been prepared beyond a Screening Form as the development does not meet any TIA triggers.

- 36-40 Jamie Avenue: This infill proposal includes an expansion to the existing automotive services building (approx. 700 m²). A TIA has not been prepared given the small size of the infill development.

The above noted developments are anticipated to have a nominal effect on peak hour traffic along Jamie Avenue and Merivale Road.

2.2. Study Area and Time Periods

It is possible that the development will be constructed in 2 phases, with a short interval of one year or less between the phases. However, for the purpose of this TIA Report, the proposed development is assumed to be constructed in a single phase, by year 2024. The assumed 5-year beyond buildout time horizon (as per TIA Guidelines) will be 2029. Given the proposed site, the AM and PM peak hours are proposed for evaluation.

Proposed study area intersections are listed below and illustrated in **Figure 8**.

- Merivale/Hunt Club (Signalized)
- Merivale/Jamie (Unsignalized)
- Merivale/Bentley-Camelot (Signalized)

Figure 8: Study Area



2.3. Exemption Review

The following modules/elements of the TIA process are recommended to be exempt based on the City's TIA guidelines:

Table 1: Exemptions Review Summary

Module	Element	Exemption Consideration
4.1 Development Design	4.1.3 New Street Networks	This element is only required for applications involving Plan of Subdivision.
4.2 Parking	4.2.2 Spillover Parking	Only required for Site Plans where parking supply is 15% below unconstrained demand.
4.6 Neighborhood Traffic Management	4.6.1 Adjacent Neighbourhoods	Only required when the development relies on local or collector streets for access and total volumes exceed ATM capacity thresholds.
4.8 Network Concept	All	Only required when proposed development generates more than 200 peak hour person-trips in excess of the equivalent volumes permitted by established zoning.

3.0 FORECASTING

3.1. Development Generated Travel Demand

3.1.1. Trip Generation and mode shares

Trip Generation Rates

The proposed development includes two, single-storey warehouse buildings with areas of approximately 38,000 ft² and 33,000 ft² (total 71,000 ft²). The exact tenant, number of employees or delivery schedule are unknown at this time. Therefore, trip generation rates were obtained from the ITE Trip Generation Manual (11th edition), assuming the “Warehouse” land use for the combined floor area, with trip rates for both vehicle and truck trip types. The relevant trip rates for the peak hour of the development are summarized in **Table 2** below.

Table 2: Proposed Development Trip Rates

Land Use	ITE/TRANS Designation	Data Source	Trip Type	Trip Rates	
				AM Peak	PM Peak
Industrial	Warehouse	ITE 150	Vehicle	$T = 0.11(x) + 28.55;$	$T = 0.15(x) + 20.47;$
			Truck	$T = 0.06(x) + 0.99;$	$T = 0.05(x) + 0.82;$

Notes: $T = \frac{\text{Average Vehicle Trip Ends}}{\text{Gross Floor Area (1,000 ft}^2\text{)}}$

Note that while there are existing uses on the proposed property, the traffic generated by these developments are anticipated to be negligible. Therefore, no trip reductions from re-developing the property are considered relevant.

Using the “vehicle” trip rates provided in **Table 2**, the total number of person trips per hour generated by the proposed warehouse are multiplied by a factor of 1.28, as per TIA standards, to account for typical North American auto occupancy values of approximately 1.15 and combined transit and non-motorized modal shares of less than 10%. The resulting total person trips per hour are summarized in **Table 3**.

Note that transit and non-motorized mode share adjustments were not made to the “truck” trip types as they will be composed entirely of delivery and/or transport trucks that are small to mid-sized. Only 2 loading bays are expected to be provided for large tractor trailer vehicles as part of Building A and are expected to operate mainly outside of peak hours. The respective in/out percentages were obtained from the ITE Manual.

Table 3: Warehouse Peak Hour Person Trips

Land Use	GFA (ft ²)	Trip Type	AM Peak (Person Trips/h)			PM Peak (Person Trips/h)		
			In	Out	Total	In	Out	Total
Warehouse	71,000	Person	31	16	47	10	31	41
		Truck	1	4	5	2	2	4
Total			32	20	52	12	33	45

Table 4 summarizes the forecast mode shares and person trips for the proposed warehouse development. Mode share percentages are based on the Employment Generator mode shares for the Merivale district, provided in the City of Ottawa 2020 TRANS Trip Generation Manual. The mode share percentages are the same in both AM and PM peak hours. As the development is located in the Merivale industrial park and is relatively auto-focused, the primary trip mode to and from the development during the peak hours of travel demand is anticipated to be by personal auto vehicle due to employee travel. Including the forecasted truck trips, the site is expected to generate a total of 52 and 45 AM and PM peak hour person trips, respectively, as well as 38 and 32 AM and PM peak hour 'new' vehicle trips, respectively.

Table 4: Warehouse Peak Hour Trips Mode Shares Breakdown

Travel Mode	Mode Share	AM Peak (Person Trips/h)			PM Peak (Person Trips/h)		
		In	Out	Total	In	Out	Total
Auto Driver	70%	22	11	33	7	21	28
Auto Passenger	7%	2	1	3	1	2	3
Transit	16%	5	3	8	2	5	7
Cycling	3%	1	1	2	0	1	1
Pedestrian	4%	1	1	2	0	2	2
Total Person Trips	100%	31	16	47	10	31	41
<i>Plus Truck Trips</i>		1	4	5	2	2	4
Total Person Trips	100%	32	20	52	12	33	45
'New' Auto Driver and Truck Trips		23	15	38	9	23	32

3.1.2. Trip Distribution and Assignment

Based on the 2011 OD Survey (Merivale district) and the location of adjacent arterial roadways and neighbourhoods, the distribution of site-generated traffic volumes was estimated as follows:

- 20% to/from the east via West Hunt Club Road
- 15% to/from the west via West Hunt Club Road
- 45% to/from the north via Merivale-Clyde (Highway 417)
- 20% to/from the south via Merivale Road

The anticipated total 'new' auto trips for the proposed development from **Table 4** were then assigned to the road network as shown in **Figure 9**. Trips via Jamie Avenue are considered somewhat circuitous, there, traffic has not been assigned to Jamie Avenue east of the site access. This also presents a conservative analysis regarding the potential impact to Merivale Road.

Figure 9: Site-Generated Traffic Volumes

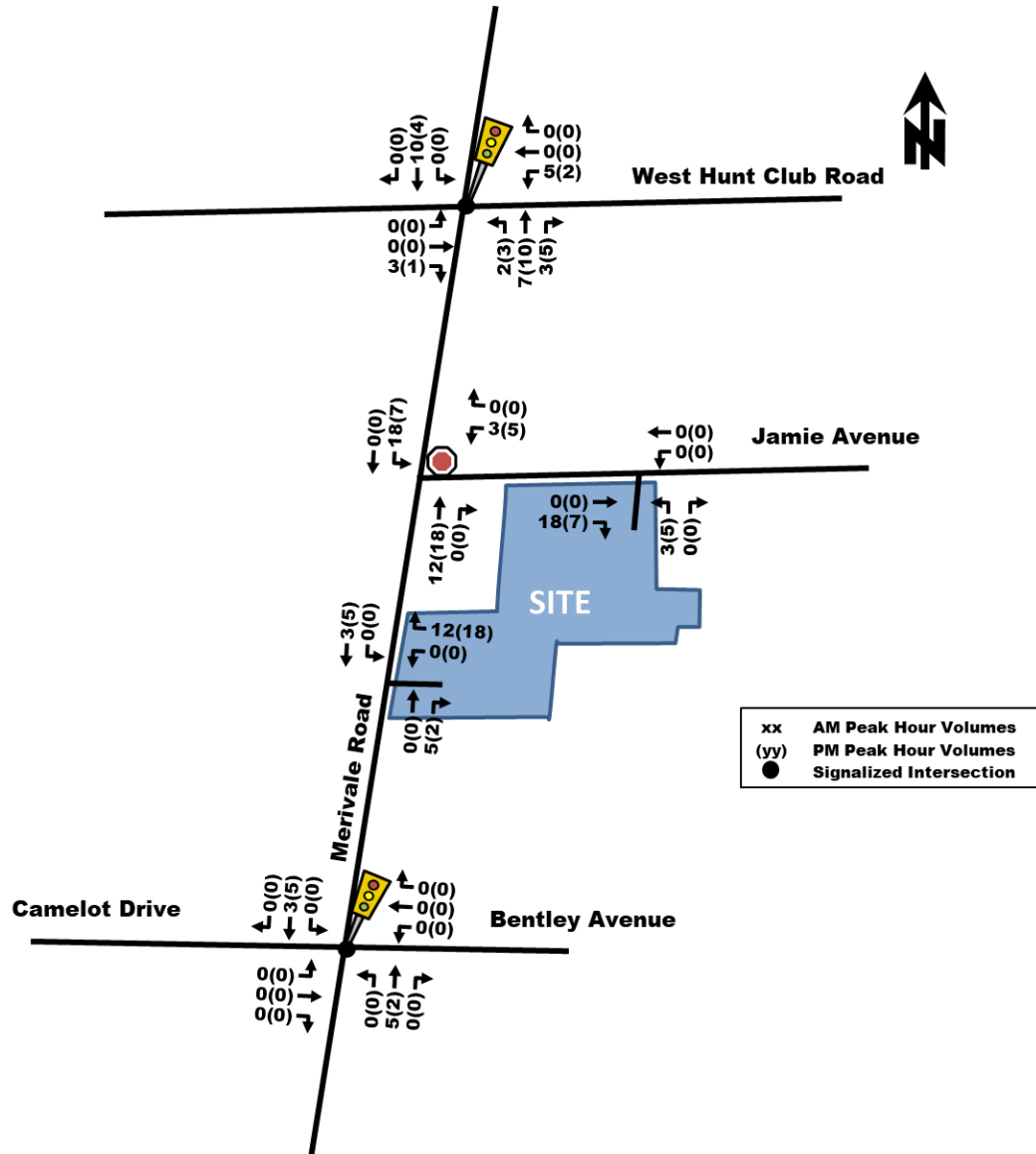

3.2. Background Network Traffic

3.2.1. Transportation network plans

Refer to Section 2.1.3: Planned Conditions.

3.2.2. Background Growth

Appendix E provides 2013 and 2031 TRANS model AM peak hour outputs for the surrounding transportation network. Inspection of the growth rate in the vicinity of the Merivale/West Hunt Club intersection found the following annual growth rates:

- Merivale Northbound: 0.5% to 1.0%
- Merivale Southbound: -0.3% to -0.5%
- West Hunt Club Eastbound: Approx. - 0.07%
- West Hunt Club Westbound: Approx. - 0.35%

In summary, the TRANS model indicates minor north-south growth along Merivale Road and a slight decrease in the east-west directions. Given the surrounding Merivale industrial park is well-developed (reflecting few recent development applications) growth along Merivale Road and West Hunt Club Road is anticipated to be driven by background factors outside of the study area. To remain conservative, a 2% annual growth rate has been applied to north-south Merivale Road and east-west West Hunt Club Road through movements to generate the future 2024 and 2029 background conditions illustrated in **Figure 10** and **Figure 11**, respectively.

Figure 10: 2024 Future Background Traffic Volumes

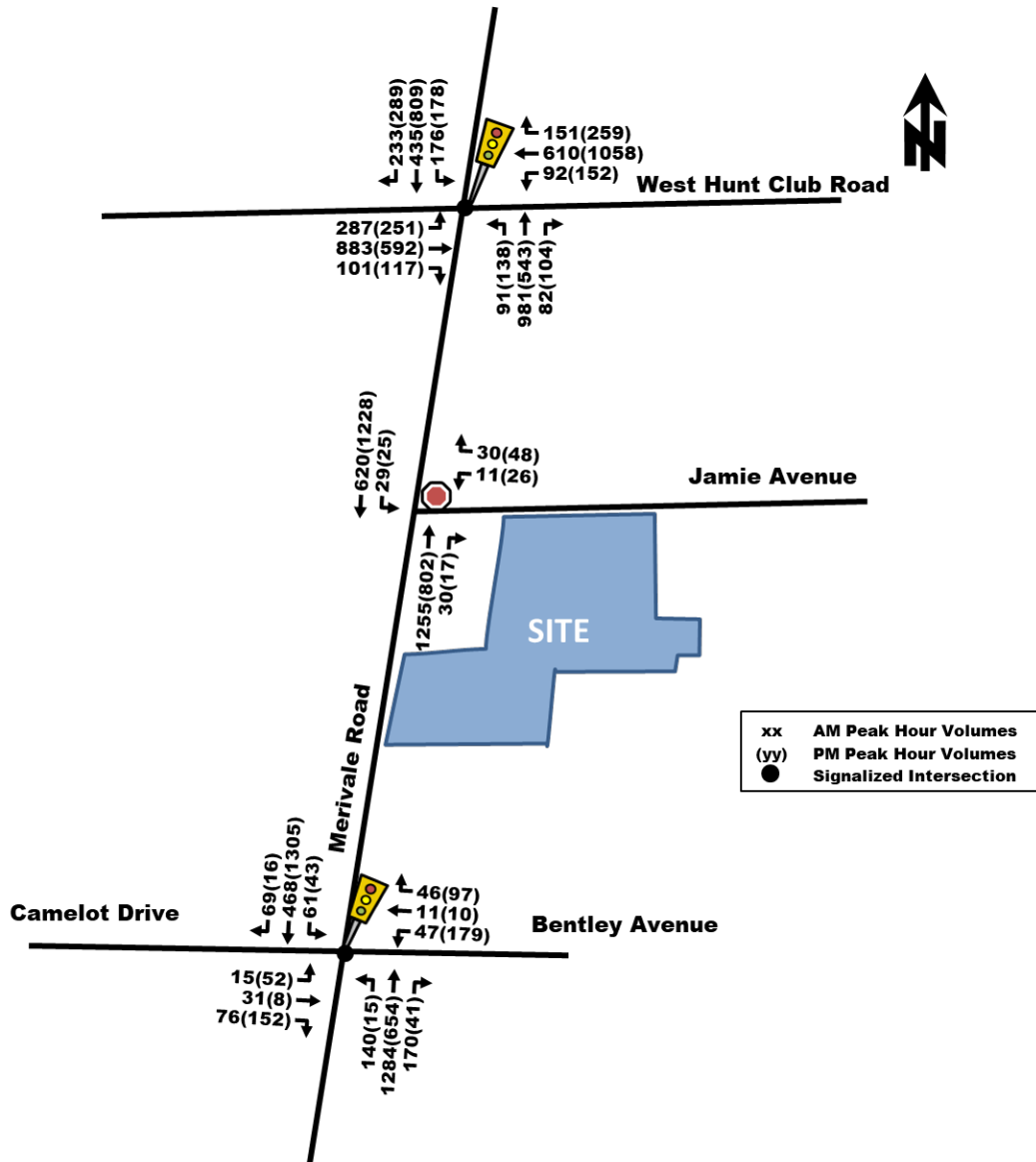

3.2.3. Other Developments

Refer to **Section 2.1.3.1 - Other Study Area Developments**. No other area development included as study area development applications were found to have negligible transportation impacts on the surrounding network. It is recognized that significant development is anticipated to occur outside the study area along Merivale Road. This will likely increase north-south through traffic which has been captured in the annual growth rate.

Figure 11: 2029 Future Background Traffic Volumes

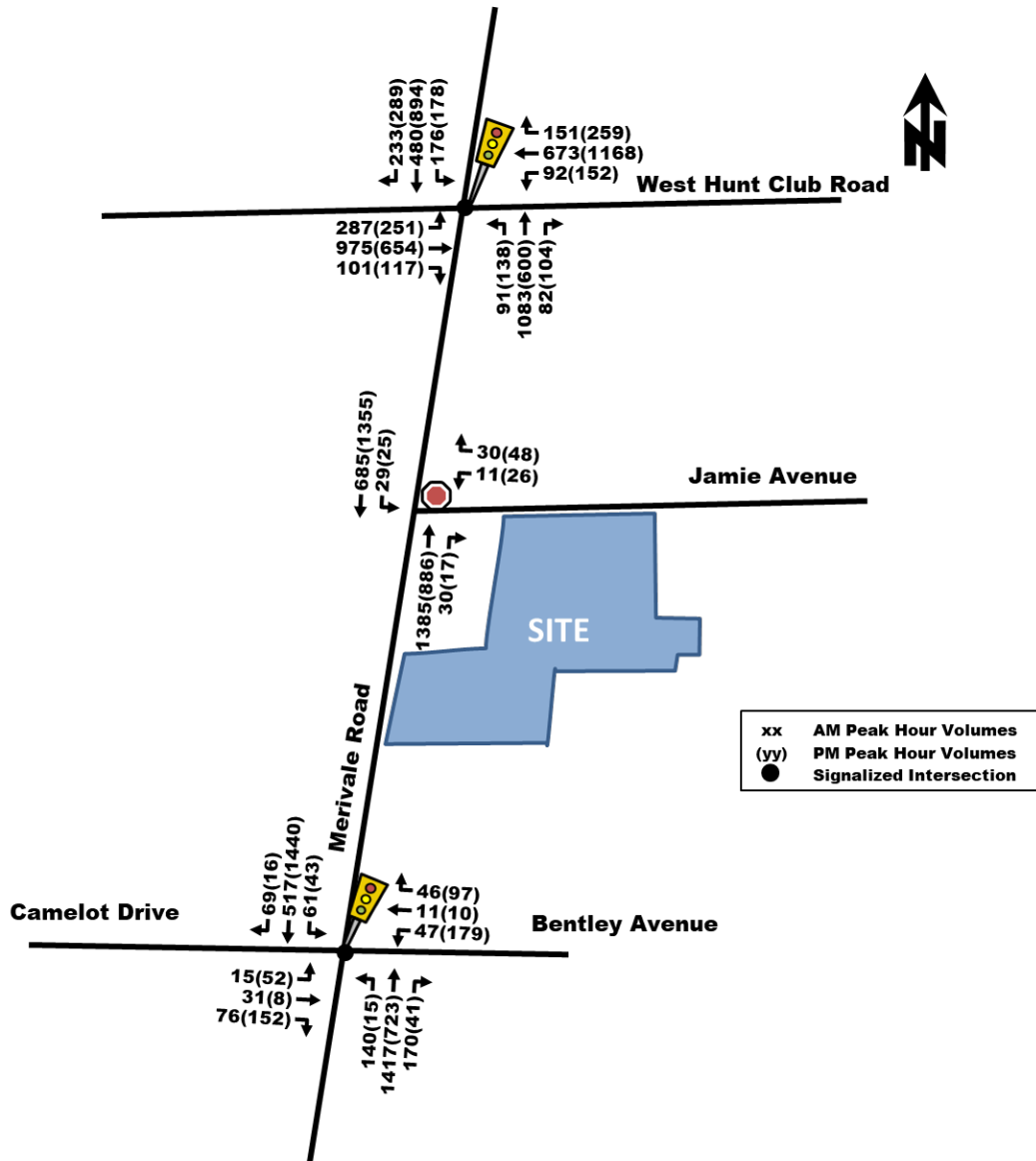

3.3. Demand Rationalization

The total projected future traffic volumes can be determined by superimposing the site-generated traffic volumes in **Figure 9**, onto the future background traffic volumes for the 2024 and 2029 horizon years. The total projected traffic volumes for 2024 and 2029 are illustrated in **Figure 12** and **Figure 13**, respectively.

While Merivale/Hunt Club is expected to operate near capacity during the peak hours, no demand rationalization is proposed as sufficient network capacity is anticipated to accommodate the proposed development and future background growth.

Figure 12: 2024 Total Traffic Volumes

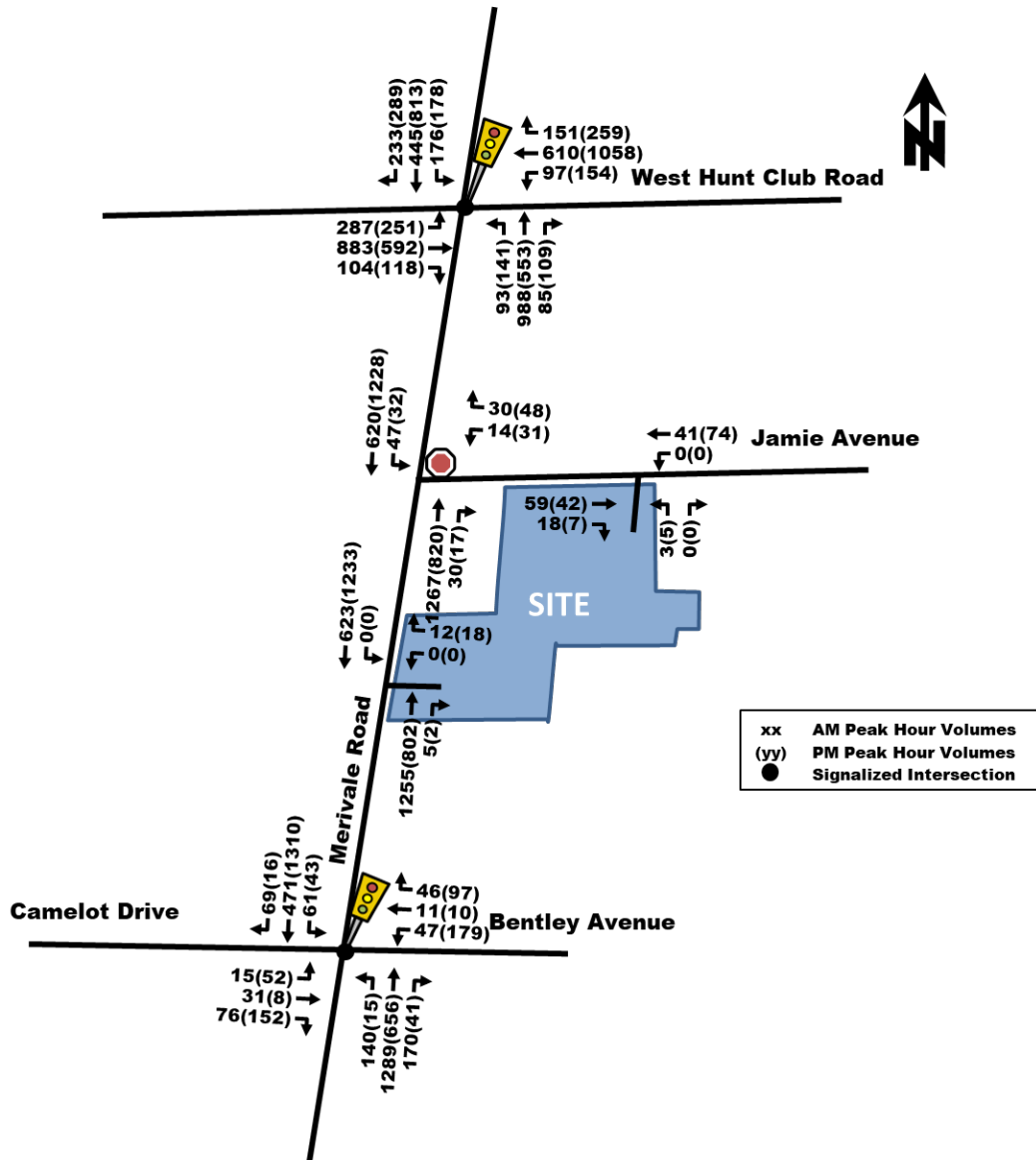
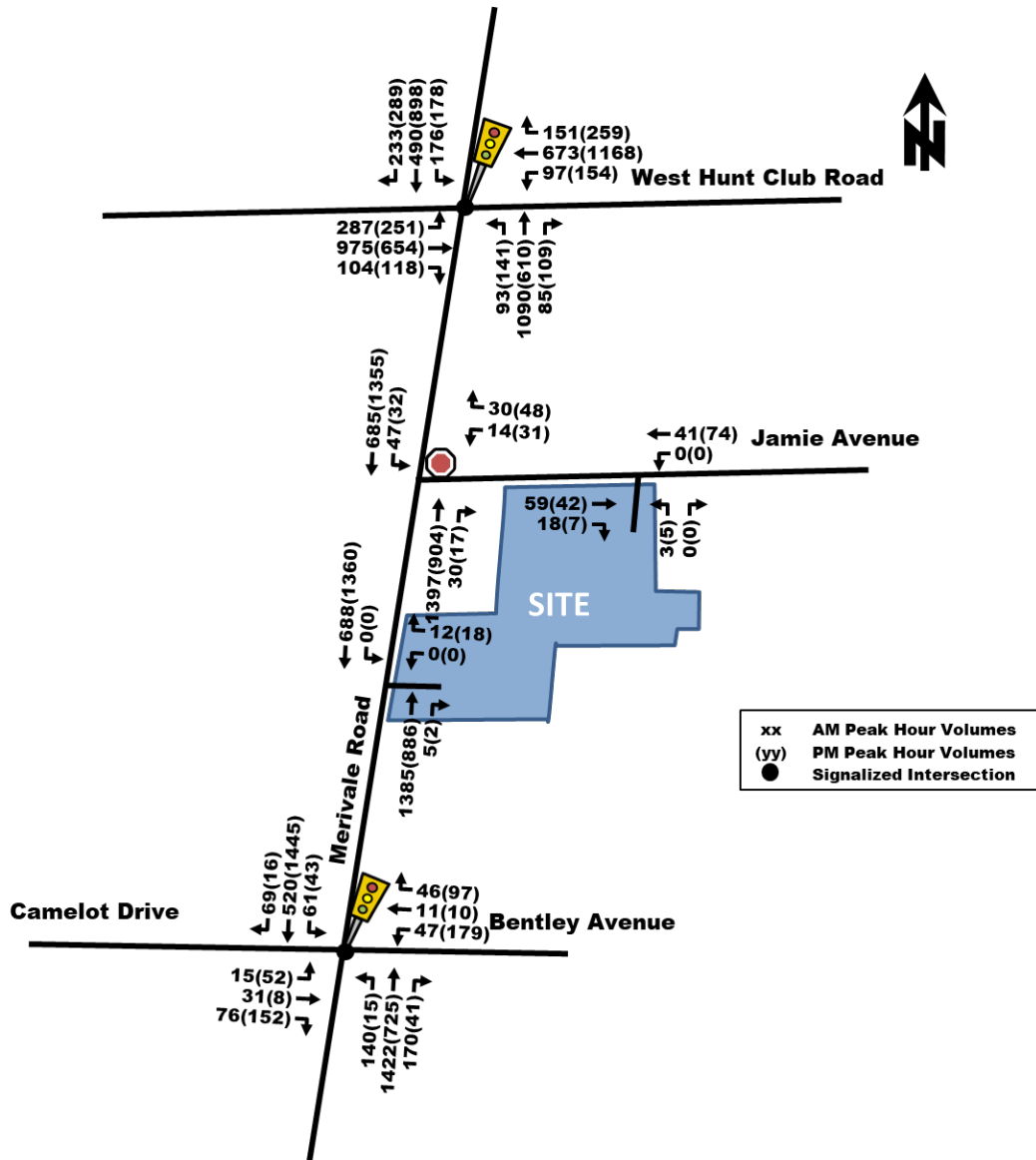

Figure 13: 2029 Total Traffic Volumes



4.0 ANALYSIS

4.1. Development Design

The City of Ottawa’s TDM-supportive Development Design and Infrastructure checklist has been provided in Appendix F.

Auto Parking

Less than 100 surface parking spaces are proposed to be provided within the site, where general spaces will be 2.6m wide by 5.2m long. 4 accessible spaces are required according to the City of Ottawa Accessibility Standards (2015), two Type A (Min. 3.4m wide) and two Type B (Min. 2.4m wide), which are provided fronting each of the two buildings on site.

Pedestrian Facilities

Along the Merivale Road and Jamie Avenue frontages, 2.0-wide asphalt pedestrian sidewalks will be provided. The new Jamie Avenue sidewalk will connect to the adjacent property to the west and be extended on-site to connect to the north building. Within the site, 2.0m or wider concrete walkways will be provided surrounding the buildings.

Transit Amenities

Refer to **Section 2.1.2: Transit Network** for a description of the available transit services in the study area. The nearest bus stop to the site is located on a hydro pole along Merivale Rd, at the northwest corner of the site. Due to possible conflicts with both the proposed future access of the development, as well as the existing access of the building to the north, the bus stop is to be relocated.

Based on discussions with OC Transpo, the bus stop is to be located immediately to the south of the Merivale Road site access. The stop will be built to current accessibility standards by providing a 15m asphalt sidewalk for the length of the bus stop and an accessible loading zone (approximately 3.5m by 5.8m) concrete pad.

Circulation and Access

The warehouse site is designed to allow for WB-20 truck circulation, therefore emergency and waste disposal vehicles are anticipated to access the site without duress. Typically, given the proposed warehouse land use, trucks will also need to access the site to deliver goods. Truck turning templates have been provided in **Appendix G** using WB-20 trucks, which are considered the largest vehicle to access the site. The Appendix illustrates inbound and outbound truck swept path movements at both proposed accesses. Large tractor trailer units are recommended to use the Jamie Ave access to enter and exit the site which facilitates the reverse maneuver into the two bay doors which accommodate tractor trailer units on the north face of the Building A (Building B does not allow for Tractor Trailer Units). Small and mid-sized trucks may use both Jamie Ave and Merivale Rd as an entry/exit location. Truck loading/unloading docks are available on the northeast corner of Building A and the south face of Building B.

4.2. Parking

The development is proposing to provide a total of 6,600 m² (71,000 ft²) of warehouse space, within two one-storey buildings. Based on the City of Ottawa Parking Provisions, the proposed development is located in “Area C”, which consists of the following parking requirements:

- 0.8 spaces per 100 m² for the first 5,000 m² of GFA and 0.4 spaces per m² above 5,000 m² of GFA. This equates to approximately 47 required parking spaces.
- Bicycle parking is required at a rate of 1.0 space per 2,000 m² of GFA, for a total of approximately 3 required spaces.

The development is proposing to provide a total of 83 vehicle surface parking spaces, of which 10 could be occupied by snow during the winter. This includes 4 accessible parking spaces, which meets the minimum requirements of the City of Ottawa’s Parking Provisions and the Accessibility for Ontarians with Disabilities Act (AODA).

6 total bicycle stalls are proposed, which have been located outside of the respective buildings.

4.3. Boundary Street Design

A Multi-Modal Level of Service (MMLoS) analysis was conducted for the two site-adjacent boundary streets, Merivale Rd and Jamie Ave. The existing and future conditions of the two roads are anticipated to be the same, with the exception of providing improved sidewalks along Jamie Ave in the future at the frontage of the development.

Merivale Rd is an arterial road that consists of the following features:

- 2 vehicle travel lanes in each direction,
- 1.5m asphalt sidewalk on the east side (Future: 2.0 m wide asphalt sidewalk),
- No bike lanes,
- Greater than 3,000 average daily curbside lane traffic,
- Posted speed limit of 60 km/h (70 km/h operating speed), and
- Wide travel lanes (greater than 3.7 m).

Jamie Ave is a local road consists of the following features:

- 1 vehicle travel lane in each direction,
- No sidewalks in existing conditions (Future: 2.0 m wide asphalt sidewalk on south side),
- No bike lanes,
- Less than 3,000 average daily curbside lane traffic,
- Posted speed limit of 50 km/h (60 km/h operating speed), and
- Wide travel lanes (greater than 3.7 m).

The multi-modal level of service analysis for the adjacent road segments of Merivale Rd and Jamie Ave is summarized in **Table 5**, with detailed analysis provided in **Appendix H**. The table also identifies the target LOS, with respect to each mode, based on the land-use designation and road classification of the development site and the boundary streets. The Transportation Master Plan (TMP) of the City of Ottawa identifies the land-use designation of the development site as an Urban Employment Area. The road classifications of each of the boundary streets were noted in the descriptions of features above.

Table 5: MMLoS Analysis – Merivale Road and Jamie Avenue

Road Segment	Level of Service							
	Pedestrian (PLOS)		Bicycle (BLOS)		Transit (TLOS)		Truck (TkLOS)	
	PLOS	Target	BLOS	Target	TLOS	Target	TkLOS	Target
Merivale Rd	F/F*	C	F	C	D	N/A	A	B
Jamie Ave	F/C*	C	F	No target	N/A	N/A	B	E

Note: Blue letters in the table above indicate that the LOS result meets its respective minimum desirable LOS target set by the MMLoS Guidelines, while red letters indicate that the LOS target was not met.

*Assuming 2.0m future sidewalks are implemented along Jamie Ave and Merivale Rd at the frontage of the proposed development.

For Merivale Rd, the pedestrian LOS minimum desirable target is not met due to the high operating speed (70 km/h), the high curbside daily traffic volume (>3,000) and the lack of a boulevard/on-street parking. Installation of a boulevard would be incongruent with the surrounding sidewalks while reducing operating speeds on a 4-lane arterial is also considered unrealistic without significant interventions.

The bicycle LOS target is not met due to the lack of cycling facilities. For Jamie Ave, the pedestrian LOS minimum desirable target is not met in existing conditions due to the lack of pedestrian facilities along the road. However, inclusion of a 2.0m sidewalk will improve the PLOS to the target 'C'

However, there are no anticipated concerns for either pedestrians or cyclists travelling to/from the site, as they account for a negligible number of site-generated person trips.

Based on the MMLoS Guidelines, there are no minimum desirable LOS targets for transit along both road segments as there are no transit corridor or transit priority area designations.

4.4. Access Intersection Design

4.4.1. Location and Design of Accesses

Access to the proposed development will be provided via an internal driveway that connects Merivale Rd and Jamie Ave. The Merivale Rd access will be located approximately 70m south of Jamie Ave and permits only right-in/right-out movements, while Jamie Ave access will be located approximately 105m east of Merivale Rd and permit full in/out movements. Note the following design elements:

- Both accesses exceed a width of 9m, which is considered permitted due to the proposed warehouse land use providing for loading facilities, according to the Private Approach By-Law.
- Both accesses are expected to provide a minimum 0.3m distance from adjoining property lines and adjacent accesses, as permitted by the Private Approach By-Law. The presence of the Merivale Road and Jamie Avenue access are not anticipated to create an undue hazard for adjacent accesses or for thru-traffic on their respective roadway facilities.
- Neither access is provided in the location of an existing median opening.
- Both accesses are more than 18m away from the nearest respective intersecting street-line, as required by the Private Approach By-Law.
- The clear throat length at the Merivale Rd access to its nearest parking space is 15m, as per the suggestions of the TAC Guidelines Table 8.9.3.
- The City of Ottawa Official Plan indicates a protected future Right of Way (ROW) of 36.5m (or 18.75m from road centreline) along this section of Merivale Rd. The proposed development is anticipated to provide the needed 18.75m distance between the centreline and Building A, which has been indicated on the site plan.

Based on the above, the proposed locations and designs of the site accesses are acceptable, given the requirements of the Private Approach By-Law and the suggestions of the TAC Guidelines.

4.4.2. Signalized Intersection MMLoS Analysis

MMLoS analysis was conducted at the signalized intersections of Merivale/Hunt Club and Merivale/Bentley/Camelot. **Table 6** summarizes the analysis results for different travel modes and provides the minimal desirable LOS targets based on the City of Ottawa MMLoS Guidelines. For the Merivale/Hunt Club intersection, the targets are reflective of a “General Urban Area” land use designation and an arterial road classification. For the Merivale/Bentley/Camelot intersection, the targets are reflective of an “Employment Area” land use designation and an arterial road classification. The detailed analysis sheet is provided in **Appendix H**.

Table 6: MMLoS Analysis - Signalized Intersections

Signalized Intersection	Level of Service							
	Pedestrian (PLOS)		Bicycle (BLOS)		Transit (TLOS)		Truck (TkLOS)	
	PLOS	Target	BLOS	Target	TLOS	Target	TkLOS	Target
Merivale/Hunt Club	F	C	F	C	F	N/A	A	D
Merivale/Bentley/Camelot	F	C	F	C	F	N/A	C	B

Note: Blue letters in the table above indicate that the LOS result meets its respective minimum desirable LOS target set by the MMLoS Guidelines, while red letters indicate that the LOS target was not met.

As shown in **Table 6**, the pedestrian and bicycle LOS do not meet the respective minimum desirable targets at the intersections. For pedestrians, this is primarily due to the number of lanes that pedestrians must cross on each leg of the intersection, which reduces the level of comfort for pedestrians. Given the function of this intersection and the intersecting roadways, reducing the number of lanes would not be ideal. However, some measures identified in the City of Ottawa’s Protected Intersection Design Guide may help to somewhat improve level of comfort for pedestrians, including protected vehicle turning movement phases, prohibited right-turns-on-red, leading pedestrian signal intervals, and raised crosswalks.

For cyclists, the minimum desirable LOS target is not met due to cyclists having to operate in mixed along Merivale Rd, alongside high vehicle operating speeds and the number of lanes a cyclist would need to cross to complete a left-turn. Providing dedicated cycling facilities would help to improve operations at the intersections.

There are no minimum desirable LOS targets for transit at both intersections as there are no transit corridor or transit priority area designations.

The truck LOS is not met at the intersection of Merivale/Bentley/Camelot due to having only one receiving lanes along Bentley Ave and Camelot Dr. However, it should be noted that these roads are not designated as truck routes and trucks may only access them occasionally.

4.5. Transportation Demand Management

Given the proposed development's land use as a warehouse and the low anticipated trips generated during peak hours (less than 60), there are no relevant TDM Measures anticipated to be provided as part of the TDM Measures Checklist.

4.6. Neighbourhood Traffic Management

This module compares the maximum two-way traffic of a local or collector road during morning and afternoon peak hours, to the respective thresholds suggested by the City of Ottawa TIA Guidelines.

Site-generated traffic of the proposed development are expected to use local road Jamie Ave as part of their access route to/from the proposed development. The thresholds suggested in the TIA Guidelines indicate an ideal two-way traffic volume of 120 veh/h for local roads during peak hours. Based on the total projected 2029 traffic volumes in **Figure 13**, future two-way peak hour traffic volumes along Jamie Ave are 121 veh/h in the AM and 128 veh/h in the PM. Although the volumes slightly exceed the ideal threshold of 120 veh/h, they are not expected to result in any undue hazard or increase significantly in the future. Furthermore, Jamie Avenue supports local industry and employment uses which are typically less sensitive to traffic volumes as residential roadways, but can be affected by traffic calming measurements significantly. As such, there are no concerns with regards to traffic volumes along Jamie Ave.

4.7. Transit

As shown in **Table 4**, the proposed development is expected to result in a negligible 8 or less person trips for transit related to employee travel to and from the site. As such, there are no anticipated concerns with regards to capacity of existing transit services.

4.8. Review of Network Concept

Exempt – see **Table 1**.

4.9. Intersection Design

4.9.1. Intersection Control

Stop control will be provided for vehicles exiting the site at each of the Merivale Rd and Jamie Ave accesses. Merivale Rd access will permit right-in/right-out movements only, while Jamie Ave access will permit full movements in/out of site. All other off-site intersection controls in the study area will continue to operate as in existing conditions.

4.9.2. Intersection Design

Synchro 11 Trafficware was used to analyze intersection performance of intersections within the study area. Critical movements at each of the intersections were assessed based on either the movement with the highest

volume-to-capacity ratio (for signalized intersections), or the movement experiencing the highest average delay (for unsignalized intersections). It should be noted that, as per the TIA Guidelines, the Peak Hour Factor (PHF) used for analysis was 0.90 in existing conditions and 1.0 in all future scenario conditions. All detailed Synchro reports for existing and future conditions have been provided in **Appendix I**.

Existing Conditions

Table 7 below summarizes the intersection performance of study area intersections, based on existing conditions traffic volumes illustrated in **Figure 6**.

Table 7: Existing Conditions Intersection Performance

Intersection	Weekday AM Peak (PM Peak)					
	Critical Movement			Intersection 'As a Whole'		
	LOS	max. v/c or avg. delay (s)	Movement	Delay (s)	LOS	v/c
Merivale Rd/W Hunt Club Rd (S)	F(E)	1.24(0.97)	SBL(WBT)	61.8(56.2)	E(E)	0.99(0.93)
Merivale Rd/Bentley Ave/Camelot Dr (S)	B(E)	0.70(0.93)	NBT(WBL)	12.5(18.8)	B(B)	0.66(0.63)
Merivale Rd/Jamie Ave (U)	C(C)	21(22)	WBL(WBL)	0.4(0.6)	A(A)	-
Note: Analysis of signalized intersections assumes a PHF of 0.9 and a saturation flow rate of 1800 veh/h/lane. (S) – Signalized intersection, movement with highest v/c ratio identified as critical movement. (U) – Unsignalized intersection, movement with highest average delay identified as critical movement.						

As shown in **Table 7**, the Merivale/Hunt Club intersection 'as a whole' operate essentially at-capacity during both peak hours, with the critical SBL operating at capacity during the morning peak hour and the WBT operating near capacity during the afternoon peak hour. The critical WBL movement at the intersection of Merivale/Bentley/Camelot operates near capacity during the afternoon peak hour.

Upon reflection of the need for Demand Rationalization, the Hunt Club/Merivale Road intersection is considered to have reasonably sufficient capacity to accommodate the number of vehicle trips forecasted by this development proposal.

Critical movements at the unsignalized intersection of Merivale/Jamie operate at an acceptable LOS 'C' during both peak hours.

Total Future Background 2024

Table 8 below summarizes the Synchro traffic operations at study area intersections, based on future background 2024 traffic volumes illustrated in **Figure 10**. The analysis maintains existing signal timing and splits.

Table 8: Total Future Background 2024 Conditions Intersection Performance

Intersection	Weekday AM Peak (PM Peak)					
	Critical Movement			Intersection 'As a Whole'		
	LOS	max. v/c or avg. delay (s)	Movement	Delay (s)	LOS	v/c
Merivale Rd/W Hunt Club Rd (S)	F(D)	1.11(0.87)	SBL(WBT)	52.9(49.6)	E(D)	0.91(0.86)
Merivale Rd/Bentley Ave/Camelot Dr (S)	B(D)	0.63(0.88)	NBT(WBL)	11.0(16.6)	A(A)	0.60(0.59)
Merivale Rd/Jamie Ave (U)	C(C)	20(21)	WBL(WBL)	0.4(0.6)	A(A)	-
Note: Analysis of signalized intersections assumes a PHF of 1.0 and a saturation flow rate of 1800 veh/h/lane. (S) – Signalized intersection, movement with highest v/c ratio identified as critical movement. (U) – Unsignalized intersection, movement with highest average delay identified as critical movement.						

As shown in **Table 8**, operations are slightly better than existing conditions due to increasing the PHF to 1.0. However, the critical SBL movement at the intersection of Merivale/Hunt Club continues to operate at capacity during the morning peak hour.

Total Future Background 2029

Table 9 below summarizes the Synchro traffic operations at study area intersections, based on future background 2029 traffic volumes illustrated in **Figure 11**. The analysis maintains existing signal timing and splits.

Table 9: Total Future Background 2029 Conditions Traffic Volumes

Intersection	Weekday AM Peak (PM Peak)					
	Critical Movement			Intersection 'As a Whole'		
	LOS	max. v/c or avg. delay (s)	Movement	Delay (s)	LOS	v/c
Merivale Rd/W Hunt Club Rd (S)	F(E)	1.11(0.97)	SBL(WBT)	61.7(55.4)	E(E)	1.00(0.93)
Merivale Rd/Bentley Ave/Camelot Dr (S)	C(D)	0.71(0.88)	NBT(WBL)	12.0(17.0)	B(B)	0.67(0.63)
Merivale Rd/Jamie Ave (U)	C(C)	21(22)	WBL(WBL)	0.4(0.6)	A(A)	-

Note: Analysis of signalized intersections assumes a PHF of 1.0 and a saturation flow rate of 1800 veh/h/lane.
(S) - Signalized intersection, movement with highest v/c ratio identified as critical movement.
(U) - Unsignalized intersection, movement with highest average delay identified as critical movement.

As shown in **Table 9**, operations at the signalized intersections are anticipated to deteriorate slightly compared to total future background 2024 due to higher congestions and delays.

Total Projected 2024

Table 10 below summarizes the Synchro traffic operations at study area intersections, based on total projected 2024 traffic volumes illustrated in **Figure 12**. The analysis reflects optimized signal timing and splits to reflect changes in future traffic patterns.

Table 10: Total Projected 2024 Conditions Traffic Volumes

Intersection	Weekday AM Peak (PM Peak)					
	Critical Movement			Intersection 'As a Whole'		
	LOS	max. v/c or avg. delay (s)	Movement	Delay (s)	LOS	v/c
Merivale Rd/W Hunt Club Rd (S)	E(D)	0.94(0.90)	NBT(SBT)	51.0(50.1)	D(D)	0.90(0.86)
Merivale Rd/Bentley Ave/Camelot Dr (S)	B(D)	0.65(0.85)	NBT(WBL)	11.2(17.0)	B(A)	0.62(0.58)
Merivale Rd/Jamie Ave (U)	C(C)	22(22)	WBL(WBL)	0.6(0.7)	A(A)	-
Merivale Rd/Site Access (U)	A(B)	9(10)	WBR(WBR)	0.1(0.1)	A(A)	-
Jamie Ave/Site Access (U)	A(A)	9(9)	NB(NB)	0.2(0.4)	A(A)	-

Note: Analysis of signalized intersections assumes a PHF of 1.0 and a saturation flow rate of 1800 veh/h/lane.
(S) - Signalized intersection, movement with highest v/c ratio identified as critical movement.
(U) - Unsignalized intersection, movement with highest average delay identified as critical movement.

As shown in **Table 10**, the signalized intersections 'as a whole' are expected to operate at LOS 'D' or better with critical movements operating at acceptable LOS 'E' or better during peak hours. This improvement in operations is attributed to the optimization of the phase times at the intersections in Synchro.

Unsignalized intersections are expected to also operate acceptably, with the outbound movements at the site accesses operating at LOS 'B' or better and the WBL at Merivale/Jamie operating at LOS 'C' during both peak hours.

Total Projected 2029

Table 11 below summarizes the Synchro traffic operations at study area intersections, based on total projected 2029 traffic volumes illustrated in **Figure 13**. The analysis reflects optimized signal timing and splits to reflect changes in future traffic patterns.

As shown in **Table 11**, operations are similar to total projected 2024 operations, with higher delays and v/c ratios. The intersection of Merivale/Hunt Club 'as a whole' operates near capacity during the morning peak hour, with critical NBT and WBL operating near capacity during the morning and afternoon peak hours, respectively. The intersection of Merivale/Bentley/Camelot 'as a whole' operates at LOS 'B' during both peak hours, with

critical movements operating at LOS 'D' or better. Unsignalized intersections operate similar to total projected 2024 conditions.

Table 11: Total Projected 2029 Conditions Traffic Volumes

Intersection	Weekday AM Peak (PM Peak)					
	Critical Movement			Intersection 'As a Whole'		
	LOS	max. v/c or avg. delay (s)	Movement	Delay (s)	LOS	v/c
Merivale Rd/W Hunt Club Rd (S)	E(E)	0.99(0.97)	NBT(WBL)	57.6(54.7)	E(D)	0.97(0.88)
Merivale Rd/Bentley Ave/Camelot Dr (S)	C(D)	0.71(0.85)	NBT(WBL)	12.1(17.4)	B(B)	0.67(0.63)
Merivale Rd/Jamie Ave (U)	C(C)	24(24)	WBL(WBL)	0.5(0.7)	A(A)	-
Merivale Rd/Site Access (U)	A(B)	9(10)	WBR(WBR)	0.1(0.1)	A(A)	-
Jamie Ave/Site Access (U)	A(A)	9(9)	NB(NB)	0.2(0.4)	A(A)	-
Note: Analysis of signalized intersections assumes a PHF of 1.0 and a saturation flow rate of 1800 veh/h/lane. (S) - Signalized intersection, movement with highest v/c ratio identified as critical movement. (U) - Unsignalized intersection, movement with highest average delay identified as critical movement.						

5.0 FINDINGS, CONCLUSIONS AND RECOMMENDATIONS

Based on the results summarized herein, the following transportation related conclusions are offered:

Proposed Development

- Z.V. Holdings Corp is proposing a warehouse development at the municipal addresses of 1881-1883 Merivale Road and 6-12 Jamie Avenue in Ottawa, replacing minor existing uses. The development is assumed to be constructed in consecutive years as a multi-phased approach where likely the first phase completed in 2024.
- The development will consist of two one-storey warehouse building with areas of approximately 38,000 ft² and 33,000 ft² (total 71,000 ft²). Only 2 loading bay areas are provided for large tractor trailer units which are anticipated to access Building A only. Other heavy vehicles are expected to be mostly small to mid-sized delivery and commercial vehicles.
- The development proposes to re-instate a 2.0m wide asphalt sidewalk along Merivale Road. A 2.0m asphalt sidewalk will also be extended along the Jamie Street site frontage to the site access.
- 83 vehicle parking spaces are proposed to be provided on a surface parking lot, including 4 accessible parking spaces, thereby meeting the requirements of the City of Ottawa's Parking Provisions and the Accessibility for Ontarians with Disabilities Act (AODA).
- Two site accesses will be provided, one access along Merivale Rd approximately 70m south of Jamie Ave and permits only right-in/right-out movements, and a second access along Jamie approximately 105m east of Merivale Rd and permits full in/out movements. The access locations were found to meet the requirements of the City of Ottawa's Private Approach By-Law and TAC Guidelines. Truck turning templates indicate that large WB-20 trucks will have no issues entering and exiting the site via the Jamie Ave access. Small and mid-sized trucks may use both Merivale Rd and Jamie Ave to exit site.
- The existing OC Transpo bus stop will be relocated to immediately south of the Merivale Road access. It will be designed according to current accessibility standards, including a 2.0m asphalt sidewalk along its 15m length and an accessible loading area (3.5m by 5.8m) concrete pad.
- The development is anticipated to generate up to approximately 52 person trips during peak hours, which includes 33 general vehicle trips, 5 truck trips, 3 passenger trips, 8 transit trips and 4 active transport (walking and cycling) trips.

Existing and Future Background Conditions

- In existing conditions, the Merivale/Hunt Club intersection 'as a whole' operates near capacity during both peak hours, with the critical SBL operating at capacity during the morning peak hour and the WBT operating near capacity during the afternoon peak hour. The critical WBL movement at the intersection of Merivale/Bentley/Camelot operates near capacity during the afternoon peak hour.
- A review of the TRANS model indicates minor north-south traffic growth along Merivale Road and a slight decrease in the east-west directions along Hunt Club Road. To remain conservative, a 2% annual growth rate has been applied to north-south Merivale Road and east-west West Hunt Club Road through movements at future horizon years.
- MMLOS analysis for boundary roads Merivale Rd and Jamie Ave was conducted. It is anticipated that geometric features along the 2 roads will remain the same in future conditions, with the exception of providing 2m wide sidewalks. The analysis indicates that the pedestrian LOS minimum desirable target is not met for both segments in existing conditions, along with the bicycle LOS for Merivale Rd. In future conditions, the PLOS is anticipated to be met. All other MMLOS results are acceptable or not applicable.
- MMLOS analysis for signalized intersections for Merivale/Hunt Club and Merivale/Bentley/Camelot was conducted. The intersections are anticipated to remain the same in both existing and future conditions. The analysis indicates that the pedestrian and bicycle LOS do not meet the respective minimum desirable targets at the intersections. The truck LOS does not meet the target at the Merivale/Bentley/Camelot intersection.
- Both the total future background 2024 and 2029 conditions indicate that overall study area intersections are anticipated to operate similar to existing conditions. Note that the Peak Hour Factor (PHF) was increased to 1.0 for all future scenarios in Synchro, as per the requirements of the TIA Guidelines, which results in somewhat improved operations relative to existing conditions.

Projected Conditions

- With regards to neighbourhood traffic management, the two-way traffic volumes along Jamie Ave N slightly exceeds the 120 veh/h ideal threshold of a local road, with up to 128 veh/h during the afternoon peak hour of total projected 2029 conditions. Nonetheless, there are no concerns with regards to traffic volumes along Jamie Ave.
- In total projected 2024 and 2029 conditions, traffic operations are anticipated to operate similar to the respective total future background conditions, with improvements to operations at the signalized intersections due to Synchro phase time adjustments. Signalized intersections and their critical movements are expected to operate at LOS 'E' or better during peak hours. Unsignalized intersections are expected to also operate acceptably, with the outbound movements at the site accesses operating at LOS 'B' or better and the WBL at Merivale/Jamie operating at LOS 'C' during both peak hours.

Based on the proposed land use, the site context, the low traffic volumes anticipated to be generated by the proposed development and the analysis conducted, the proposed development will have minimal impact to the study area and is recommended to proceed from a transportation perspective.

Prepared By:



Basel Ansari, P. Eng.

Reviewed By:



Jake Berube, P.Eng.

Appendix A:

Screening Form and Response to City Comments



03 LOCATION PLAN
SP-A01 NTS

SITE INFORMATION

SITE AREA: 13,999 m²

BUILDING DATA

AREA CALCULATIONS:

Gross Floor Area:	
Building A:	3,540sm (38,100sf)
Building B:	3,070sm (33,050sf)
Total:	6,610sm (71,150sf)

ZONING

DESIGNATION: IG - GENERAL INDUSTRIAL ZONE

PERMITTED NON RESIDENTIAL USES SECTION 199:

- Light Industrial Uses
- Medical Facility
- Office
- Parking Garage
- Parking Lot
- Research and Development Centre
- Service and Repair Shop
- Storage Yard
- Technology Industry
- Training Centre
- Warehouse

NOTE: Accessory display and sales areas within the same building must not exceed 25% of the gross floor area.

Uses Permitted up to 300sm each without exceeding 2,999sm total:

- Animal care establishment
- Automotive dealership or rental establishment
- Automotive service station gas bar or car wash
- Bank or bank machine
- Bar
- Convenience store
- Instructional facility
- Payday loan establishment
- Personal services business
- Post office
- Recreational and athletic facility
- Restaurant

FSI - TABLE 199:

Maximum Permitted:	2.0 (28,226sm / 303,820sf)
Provided:	0.5 (6,610sm / 71,150sf)

SETBACKS - TABLE 199:

Front & Corner Yard:	3.0m
Interior Side Yard:	3.0m
Rear Side Yard:	3.0m

BUILDING HEIGHT - TABLE 199:

Maximum Permitted:	22.0m
Provided:	9.6m

MINIMUM WIDTH OF LANDSCAPED AREA TABLE 199:

Abutting a Street:	3.0m
Abutting a Residential Zone:	3.0m
All Other Cases:	No minimum

PARKING Section 101

MINIMUM REQUIRED:	53
(WAREHOUSE .8/100sm OF GFA)	
PROVIDED:	83 (INCL. 4 BARR-FREE)

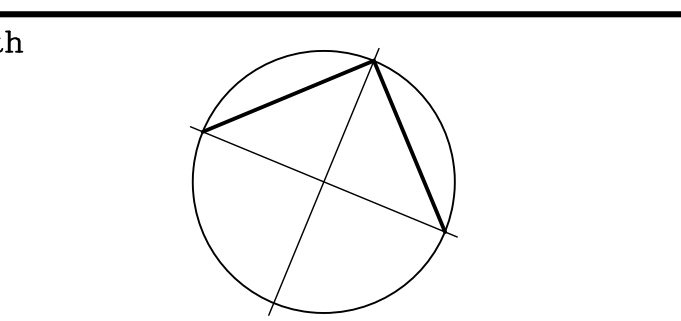

Revisions

No.	By	Description	Date
01	NH	ISSUED FOR COORDINATION	2022/09/09
02	NH	REV. FOR COORDINATION	2022/10/06
03	NH	REV. FOR COORDINATION	2022/12/08
04	NH	REV. FOR COORDINATION	2023/01/27
05	NH	ISSUED FOR SPA	2023/02/15
06	NH	REVISED FOR SPA	2023/05/09
08	NH	REVISED FOR SPA	2023/05/16
07	NH	REVISED FOR SPA	2023/05/24

Project

MERIVALE ROAD INDUSTRIAL DEVELOPMENT

1881-1883 MERIVALE ROAD
6-12 JAMIE AVENUE

Drawing

SITE PLAN

Scale AS NOTED Stamp

Drawn JAS

Checked

Project No. 19-120 Drawing No.

Date SEPT. 2022 **SP-A01**

PLAN NO.

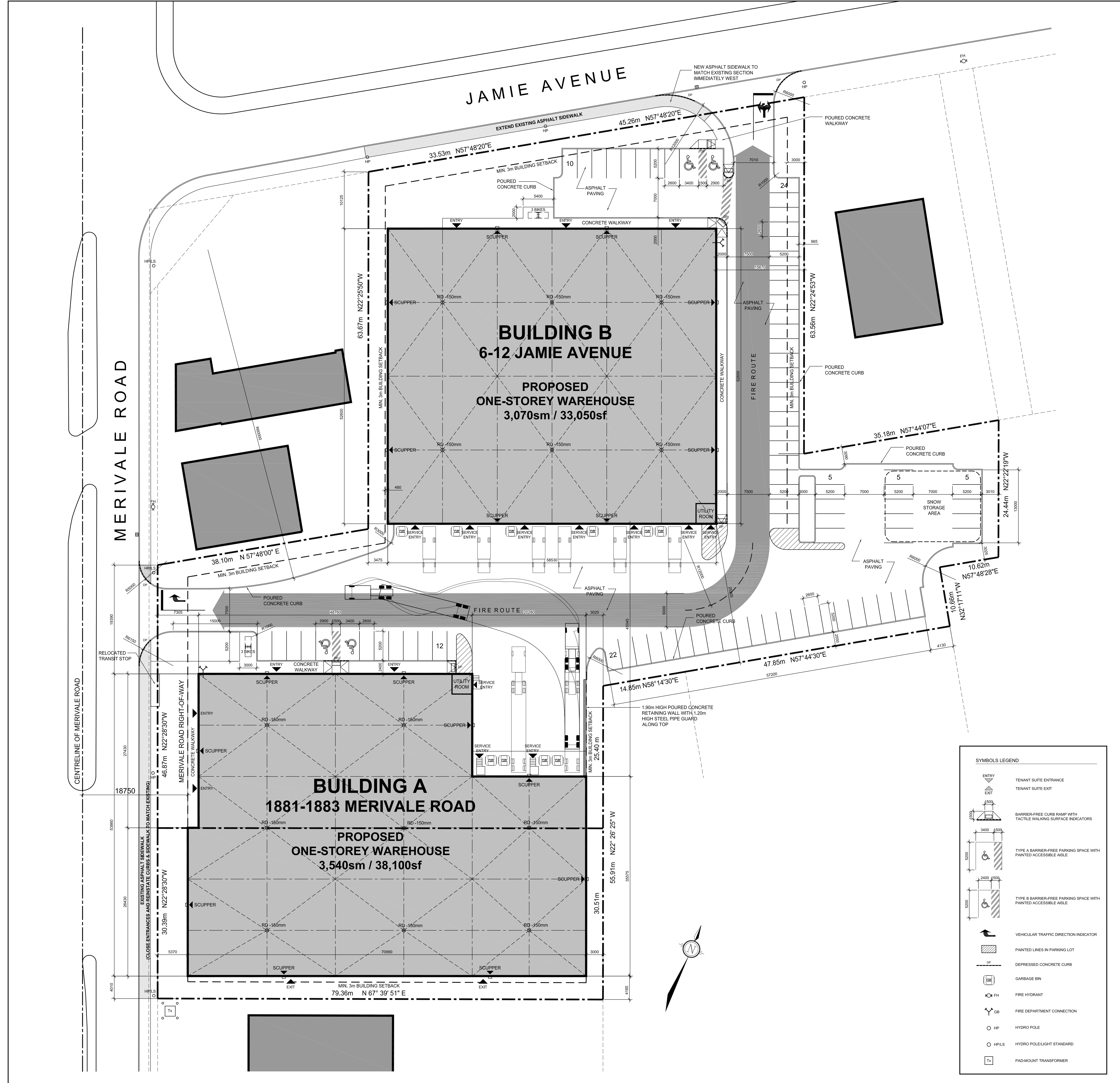

01 SITE PLAN
SP-A01 1:300

02 SITE INFORMATION/BUILDING DATA/ZONING
SP-A01 NTS

City of Ottawa 2017 TIA Guidelines

Date 02.21.2023

TIA Screening Form

Project 1881-1883 Merivale Road

Project Number 438378-01000

Results of Screening	Yes/No
Development Satisfies the Trip Generation Trigger	Yes
Development Satisfies the Location Trigger	Yes
Development Satisfies the Safety Trigger	Yes

Module 1.1 - Description of Proposed Development

Municipal Address	1881-1883 Merivale, 6-12 Jamie Avenue
Description of location	Property located east of Merivale and south of Jamie Avenue with frontage along both municipal streets. The 1883 Merivale lands are currently occupied by a commercial building.
Land Use	Warehouse
Development Size	71,150 sq.ft. / 6,610m ²
Number of Accesses and Locations	One right in/right out access to Merivale Full access to Jamie Avenue Remove existing Merivale accesses (2) and Jame access (1)
Development Phasing	One phase
Buildout Year	2024
Sketch Plan / Site Plan	See attached

Module 1.2 - Trip Generation Trigger

Land Use Type	Industrial
Development Size	6610 sq. m
Trip Generation Trigger Met?	Yes

Module 1.3 - Location Triggers

Development Proposes a new driveway to a boundary street that is designated as part of the City's Transit Priority, Rapid Transit, or Spine Bicycle Networks (See Sheet 3)	Yes	Merivale designated a Spine Route, long term transit route
Development is in a Design Priority Area (DPA) or Transit-oriented Development (TOD) zone. (See Sheet 3)	No	
Location Trigger Met?	Yes	

Module 1.4 - Safety Triggers

Posted Speed Limit on any boundary road	<80	km/h
Horizontal / Vertical Curvature on a boundary street limits sight lines at a proposed driveway	No	
A proposed driveway is within the area of influence of an adjacent traffic signal or roundabout (i.e. within 300 m of intersection in rural conditions, or within 150 m of intersection in urban/ suburban conditions) or within auxiliary lanes of an intersection;	Yes	150m to Merivale/Bentley
A proposed driveway makes use of an existing median break that serves an existing site	No	Median to be maintained.
There is a documented history of traffic operations or safety concerns on the boundary streets within 500 m of the development	No	
The development includes a drive-thru facility	No	
Safety Trigger Met?	Yes	

6 June 2023

City of Ottawa
Development Review Services
110 Laurier Avenue West
Ottawa, ON K1P 1J1

Attention: Patrick McMahon, Project Manager, Infrastructure Approvals

Dear Patrick:

Re: 1881-1883 Merivale Road TIA
Step 4 – Response to 1st SPC Review

The following document has been prepared in response to City of Ottawa comments received on April 27, 2023. Comments have been noted in black with the corresponding responses from Parsons in Green.

Transportation – Site Plan

- 2.1. Site Plan - Clearly label and indicate dimensions of Merivale Road ROW widening/dedication.
Merivale Road has a protected right-of-way of 37.5m, this has been shown on the site plan.
- 2.2. Site Plan - Building A is directly adjacent to the new Merivale Road property line, meaning that no setback can be provided with this site layout.
Noted.
- 2.3. Site Plan - The site plan labels the Jamie Avenue sidewalk as “extend existing asphalt sidewalk”. Adjust this label to clearly indicate that the extended sidewalk will be constructed as a 2.0m-wide concrete sidewalk per City of Ottawa standards.
The proponent proposes to re-instate the existing asphalt sidewalk along Merivale Road.
- 2.4. Site Plan - The site plan labels the Merivale Road sidewalk as “existing concrete sidewalk (close entrances and reinstate curbs & sidewalk)”. Adjust this label to clearly indicate that the existing Merivale Road asphalt sidewalk along the site frontage will be reconstructed as a 2.0m-wide concrete sidewalk per City of Ottawa standards.
The proponent proposes to re-instate the existing asphalt sidewalk along Merivale Road.

Transportation – Traffic Impact Assessment

- 2.5. Section 4.1 Development Design and Section 4.3 Boundary Street Design: Please indicate the proposed location of the bus stop on the site plan and provide any necessary modifications to the Merivale Road site frontage to meet accessible bus stop standards.
Proposed location for the bus stop has been shown on the site plan following communications with OC Transpo. The bus stop will be located immediately south of the Merivale Road access. A 2.0m asphalt sidewalk runs the 15m length of the bus stop, and an accessible loading zone has been provided (approximately 3.5m by 5.8m).
- 2.6. Bicycle parking is not visible on the site plan. Please label the bicycle parking and specify its location within Section 4.2 of the TIA.
Bicycle parking has been included on the north side of Buildings A & B. The TIA has been updated.
- 2.7. The clear throat length of the Merivale Road access is not 15m as claimed in Section 4.4.1 of the TIA. The clear throat length is measured from the ends of the driveway curb return radii at the roadway and the point of first conflict on-site. Refer to Figure 8.52 in the Transportation Association of Canada Geometric Design Guide (TAC GDG). By this measurement, the clear throat length provided is 6m. Increase clear throat length per TAC GDG minimum.
Noted, measuring from the end of the curb return, a 15.0m clear throat length has been provided.
- 2.8. Depressed curbs should not extend across the concrete sidewalk at the accesses (i.e., concrete sidewalk should be completely flush). Refer to City of Ottawa standard drawing SC7.1.
The proponent proposes an asphalt sidewalk which will include depressed curbs across the access.

Transit Services:

- 2.9. The reinstated bus stop will need to be built to current specification to meet accessibility standards.
Noted, see response to Comment 2.5.

Development Review:

- 2.10. Two of the four accessible parking spaces must meet Type A (3.4m) width requirements, the other two can be anything greater than 2.4m.
Noted, four accessible spaces are provided, two of which are Type A spaces fronting each building. Dimensions for the Type A and Type B accessible parking spaces have been added to the revised Site Plan.

Appendix B:

Transit Route Maps



80

BARRHAVEN CENTRE TUNNEY'S PASTURE

Fréquent

7 days a week / 7 jours par semaine
All day service
Service toute la journée

TUNNEY'S PASTURE

Tunney's Pasture
 1

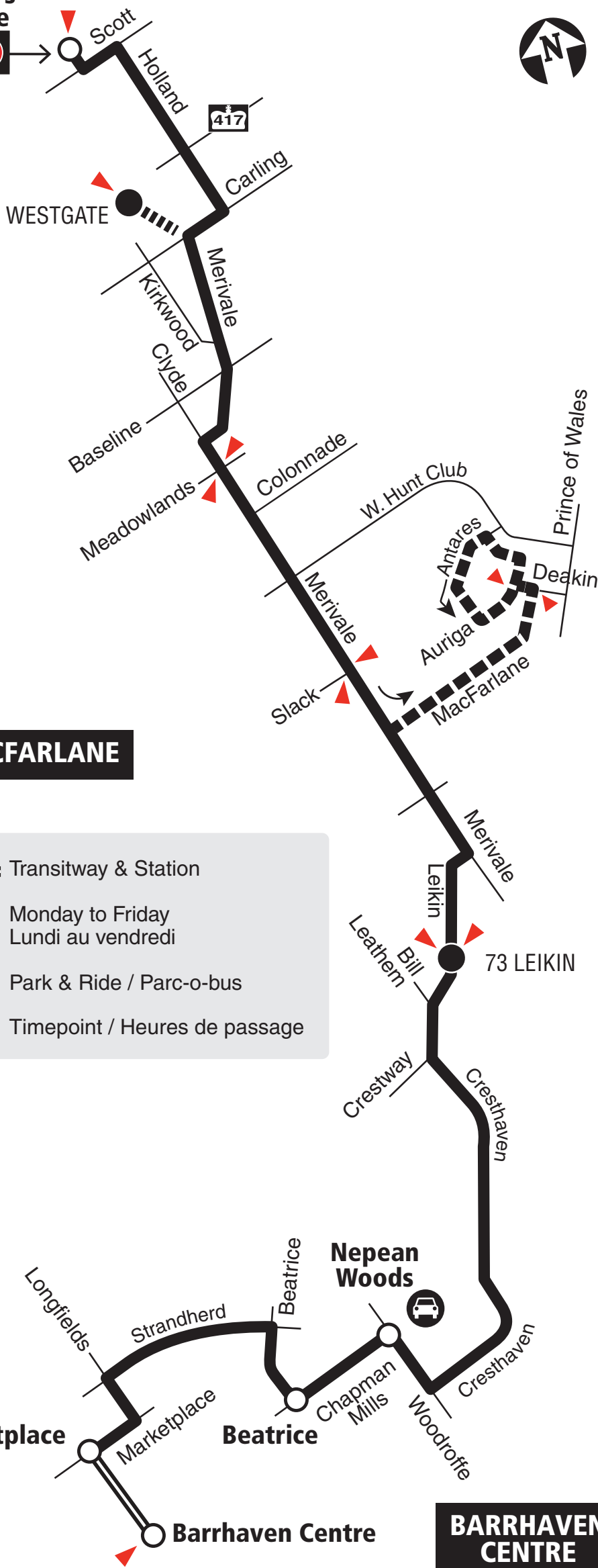

MACFARLANE

- Transitway & Station
- Monday to Friday
Lundi au vendredi
- Park & Ride / Parc-o-bus
- Timepoint / Heures de passage

2018.12



Schedule / Horaire.....613-560-1000

Text / Texto560560

plus your four digit bus stop number / plus votre numéro d'arrêt à quatre chiffres

Customer Relations
Service à la clientèle **613-842-3600**

Lost and Found / Objets perdus..... **613-563-4011**

Security / Sécurité **613-741-2478**

**Effective June 24, 2018
En vigueur 24 juin 2018**



**INFO 613-741-4390
octranspo.com**



96

MERIVALE GREENBORO HURDMAN

Local

7 days a week / 7 jours par semaine

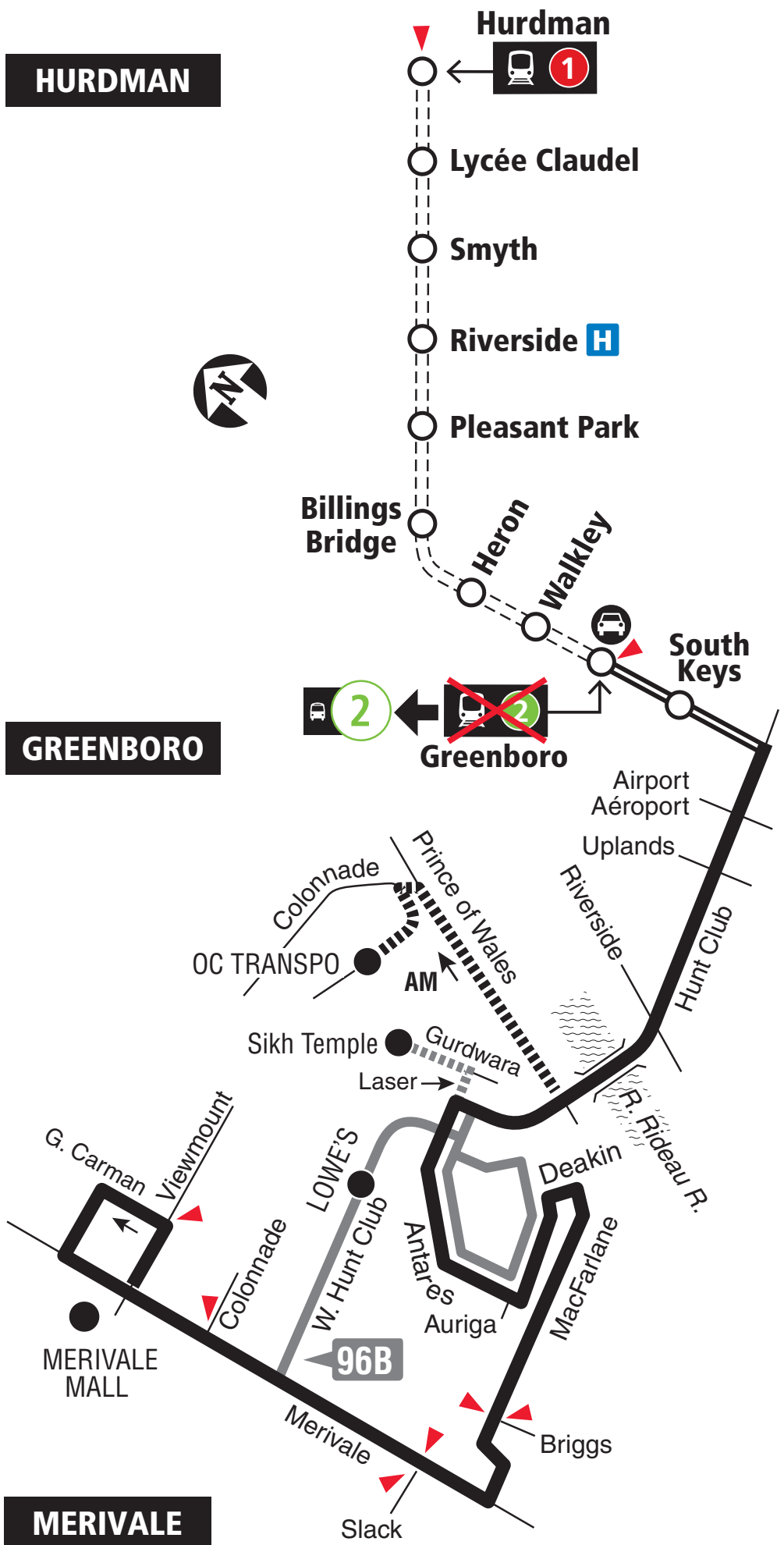

- Transitway & Station
- Transitway & Station (Peak periods only / Périodes de pointe seulement)
- 96B
- 96B Some trips / 96B Quelques trajets
- Some trips / Quelques trajets
- Park & Ride / Parc-o-bus
- Timepoint / Heures de passage

2019.06



Schedule / Horaire 613-560-1000

Text / Texto 560560

plus your four digit bus stop number / plus votre numéro d'arrêt à quatre chiffres

Customer Service

Service à la clientèle **613-741-4390**

Lost and Found / Objets perdus **613-563-4011**

Security / Sécurité **613-741-2478**

Effective May 3, 2020

En vigueur 3 mai 2020



INFO 613-741-4390
octranspo.com



186

LINCOLN FIELDS MERIVALE

Local

Monday to Friday / Lundi au vendredi
Peak periods only
Périodes de pointe seulement

PM
↑
LINCOLN FIELDS

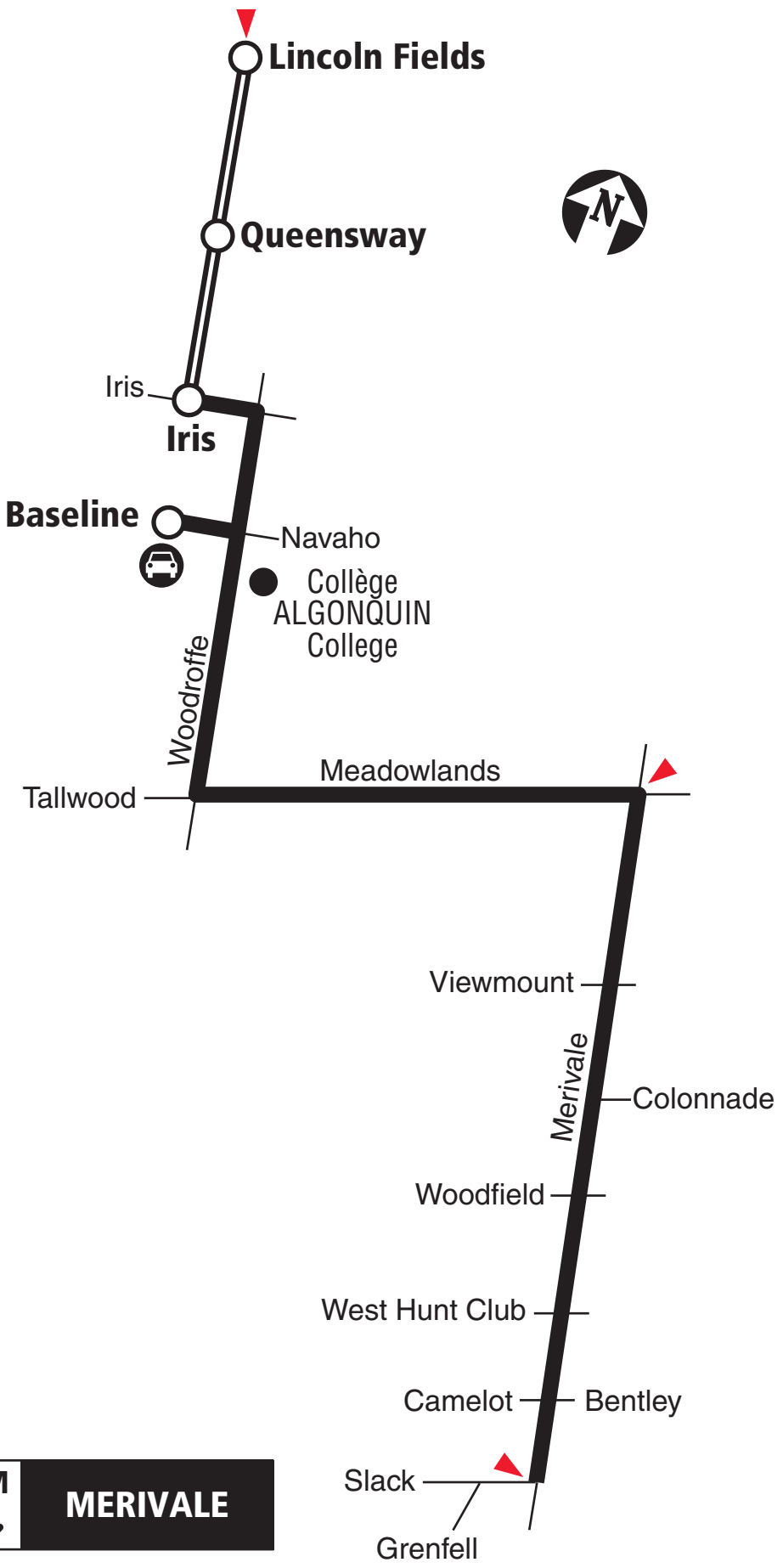

AM
↓
MERIVALE

- Transitway & Station
- Park & Ride / Parc-o-bus
- Timepoint / Heures de passage

2022.06



Schedule / Horaire 613-560-1000

Text / Texto* 560560

plus your four digit bus stop number / plus votre numéro d'arrêt à quatre chiffres

*Standard message rates may apply / Les tarifs réguliers de messagerie texte peuvent s'appliquer

Customer Service
Service à la clientèle **613-560-5000**

Lost and Found / Objets perdus..... **613-563-4011**

Security / Sécurité **613-741-2478**

Effective June 26, 2022

En vigueur 26 juin 2022



INFO 613-560-5000
octranspo.com

199

LEIKIN HURDMAN

Local

Monday to Friday / Lundi au vendredi
Peak periods only
Périodes de pointe seulement

PM
↑
HURDMAN

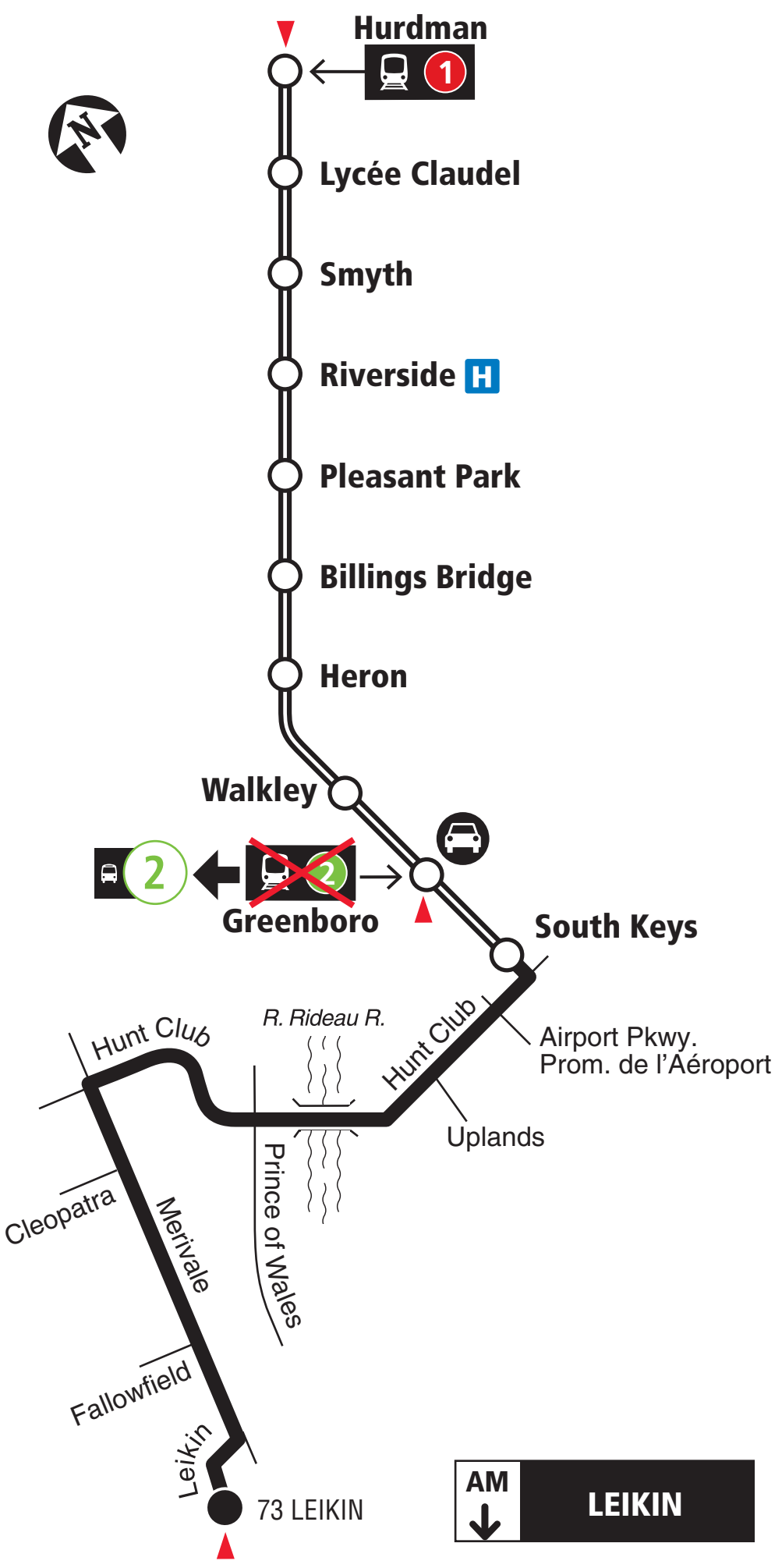

-  Transitway & Station
-  Park & Ride / Parc-o-bus
-  Timepoint / Heures de passage

2020.04

 **Schedule / Horaire.....613-560-1000**
Text / Texto560560
plus your four digit bus stop number / plus votre numéro d'arrêt à quatre chiffres

Customer Service
Service à la clientèle 613-741-4390
Lost and Found / Objets perdus..... 613-563-4011
Security / Sécurité 613-741-2478

Effective May 3, 2020
En vigueur 3 mai 2020

 **INFO 613-741-4390**
octranspo.com

Appendix C:

Traffic Data



Turning Movement Count

Summary Report

Including AM and PM Peak Hours

All Vehicles Except Bicycles



Jamie Avenue & Merivale Road Nepean, ON

Survey Date: Tuesday, August 02, 2022 **Start Time:** 0700 **AADT Factor:** 0.9
Weather AM: Mostly Cloudy 22° C **Survey Duration:** 4 Hrs. **Survey Hours:** 0700-0900 & 1600-1800
Weather PM: Clear & Sunny 25° C **Surveyor(s):** T. Carmody

Time Period	St. John's Church					Jamie Ave.					Merivale Rd.					Merivale Rd.					Street Total	Grand Total	
	Eastbound					Westbound					Northbound					Southbound							
	LT	ST	RT	UT	E/B Tot	LT	ST	RT	UT	W/B Tot	LT	ST	RT	UT	N/B Tot	LT	ST	RT	UT	S/B Tot			
0700-0800	0	0	0	0	0	6	0	21	0	27	27	0	574	33	1	608	52	534	0	2	588	1196	1223
0800-0900	0	0	0	0	0	11	0	30	0	41	41	0	740	30	0	770	29	574	0	8	611	1381	1422
1600-1700	0	0	1	0	1	22	0	40	0	62	63	0	916	16	1	933	20	1015	0	10	1045	1978	2041
1700-1800	0	0	1	0	1	26	0	42	0	68	69	0	771	17	2	790	14	882	1	4	901	1691	1760
Totals	0	0	2	0	2	65	0	133	0	198	200	0	3001	96	4	3101	115	3005	1	24	3145	6246	6446

Equivalent 12 & 24-hour Vehicle Volumes Including the Annual Average Daily Traffic (AADT) Factor
Applicable to the Day and Month of the Turning Movement Count

Expansion factors are applied exclusively to standard weekday 8-hour turning movement counts conducted during the hours of 0700h - 1000h, 1130h - 1330h and 1500h - 1800h

Equivalent 12-hour vehicle volumes. These volumes are calculated by multiplying the 8-hour totals by the 8 → 12 expansion factor of 1.39																						
Equ. 12 Hr	n/a	n/a	n/a	n/a	n/a	n/a	n/a	n/a	n/a	n/a	n/a	n/a	n/a	n/a	n/a	n/a	n/a	n/a	n/a	n/a	n/a	n/a
Average daily 12-hour vehicle volumes. These volumes are calculated by multiplying the equivalent 12-hour totals by the AADT factor of: 0.9																						
AADT 12-hr	n/a	n/a	n/a	n/a	n/a	n/a	n/a	n/a	n/a	n/a	n/a	n/a	n/a	n/a	n/a	n/a	n/a	n/a	n/a	n/a	n/a	n/a
24-Hour AADT. These volumes are calculated by multiplying the average daily 12-hour vehicle volumes by the 12 → 24 expansion factor of 1.31																						
AADT 24 Hr	n/a	n/a	n/a	n/a	n/a	n/a	n/a	n/a	n/a	n/a	n/a	n/a	n/a	n/a	n/a	n/a	n/a	n/a	n/a	n/a	n/a	n/a

AADT and expansion factors provided by the City of Ottawa

AM Peak Hour Factor → 0.88											Highest Hourly Vehicle Volume Between 0700h & 0900h												
AM Peak Hr	LT	ST	RT	UT	Total	LT	ST	RT	UT	Total	Str. Tot.	LT	ST	RT	UT	Total	LT	ST	RT	UT	Total	Str. Tot.	Gr. Tot.
0800-0900	0	0	0	0	0	11	0	30	0	41	41	0	740	30	0	770	29	574	0	8	611	1381	1422
PM Peak Hour Factor → 0.96											Highest Hourly Vehicle Volume Between 1600h & 1800h												
PM Peak Hr	LT	ST	RT	UT	Total	LT	ST	RT	UT	Total	Str. Tot.	LT	ST	RT	UT	Total	LT	ST	RT	UT	Total	Str. Tot.	Gr. Tot.
1615-1715	0	0	1	0	1	26	0	48	0	74	75	0	946	17	1	964	25	1020	1	9	1055	2019	2094

Comments:

OC Transpo and Para Transpo buses together with 1 school bus comprise 14.44% of the heavy vehicle traffic. The bicycle totals include 3 E-scooters (stand-up type). Northbound traffic backed up to Jamie Avenue from West Hunt Club Road twice - at 1642H & 1704H - but cleared on the next cycle.

Notes:

- Includes all vehicle types except bicycles, electric bicycles, and electric scooters.
- When expansion and AADT factors are applied, the results will differ slightly due to rounding.



Turning Movement Count

Summary, AM and PM Peak Hour

Flow Diagrams

All Vehicles Except Bicycles



Jamie Avenue & Merivale Road **Nepean, ON**

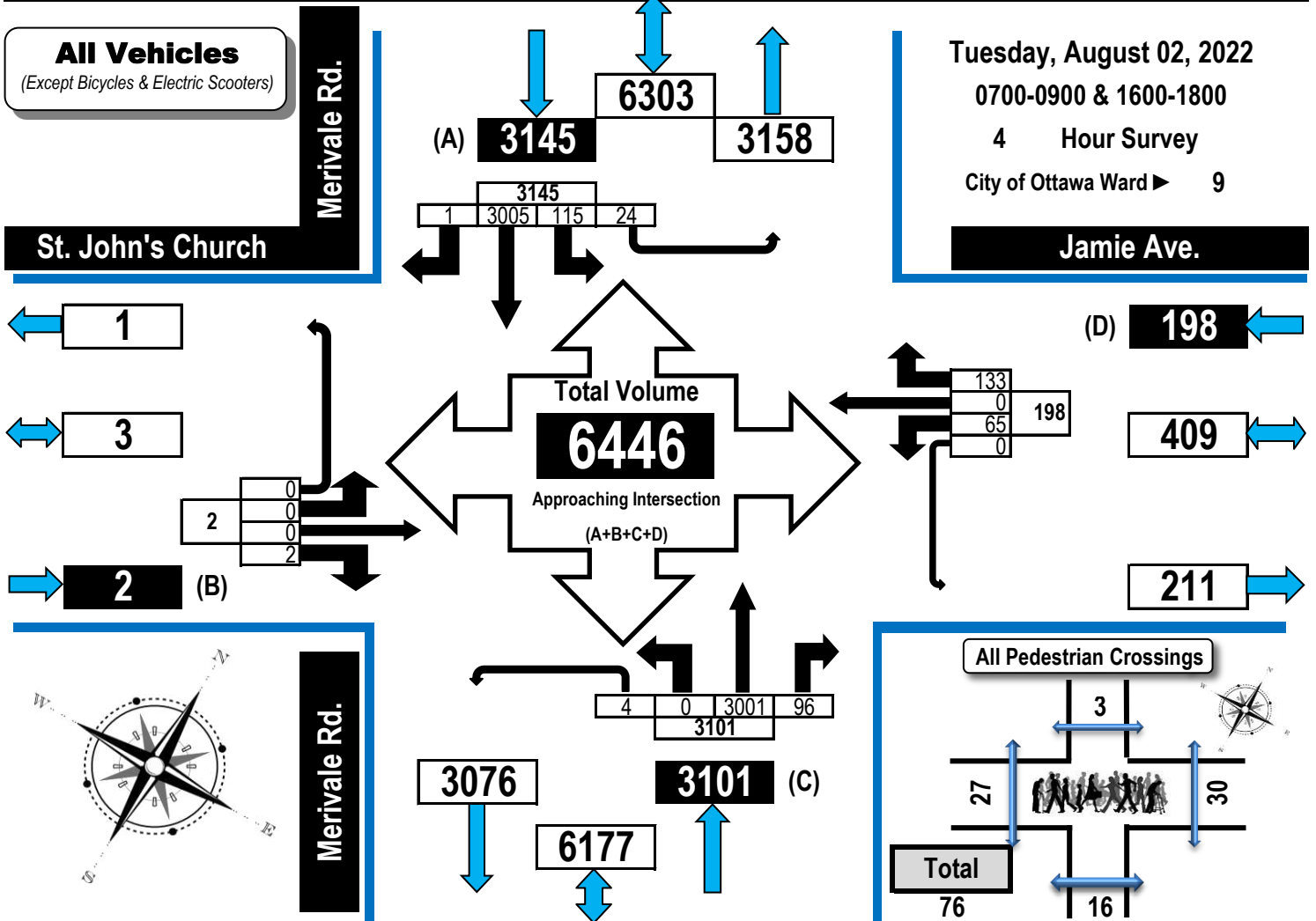

AM Peak Hour Flow Diagram **PM Peak Hour Flow Diagram**

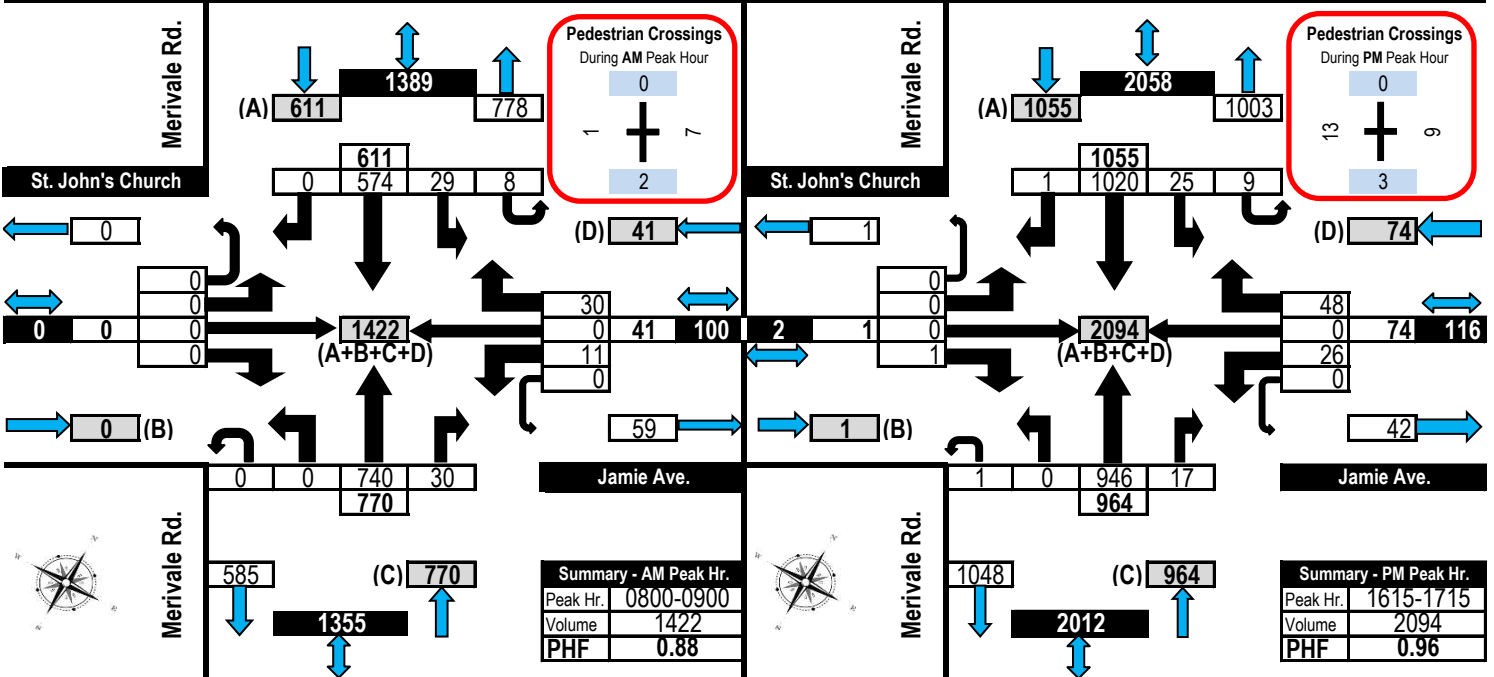



Turning Movement Count Heavy Vehicle Summary (FHWA Class 4-13) Flow Diagram



Jamie Avenue & Merivale Road Nepean, ON

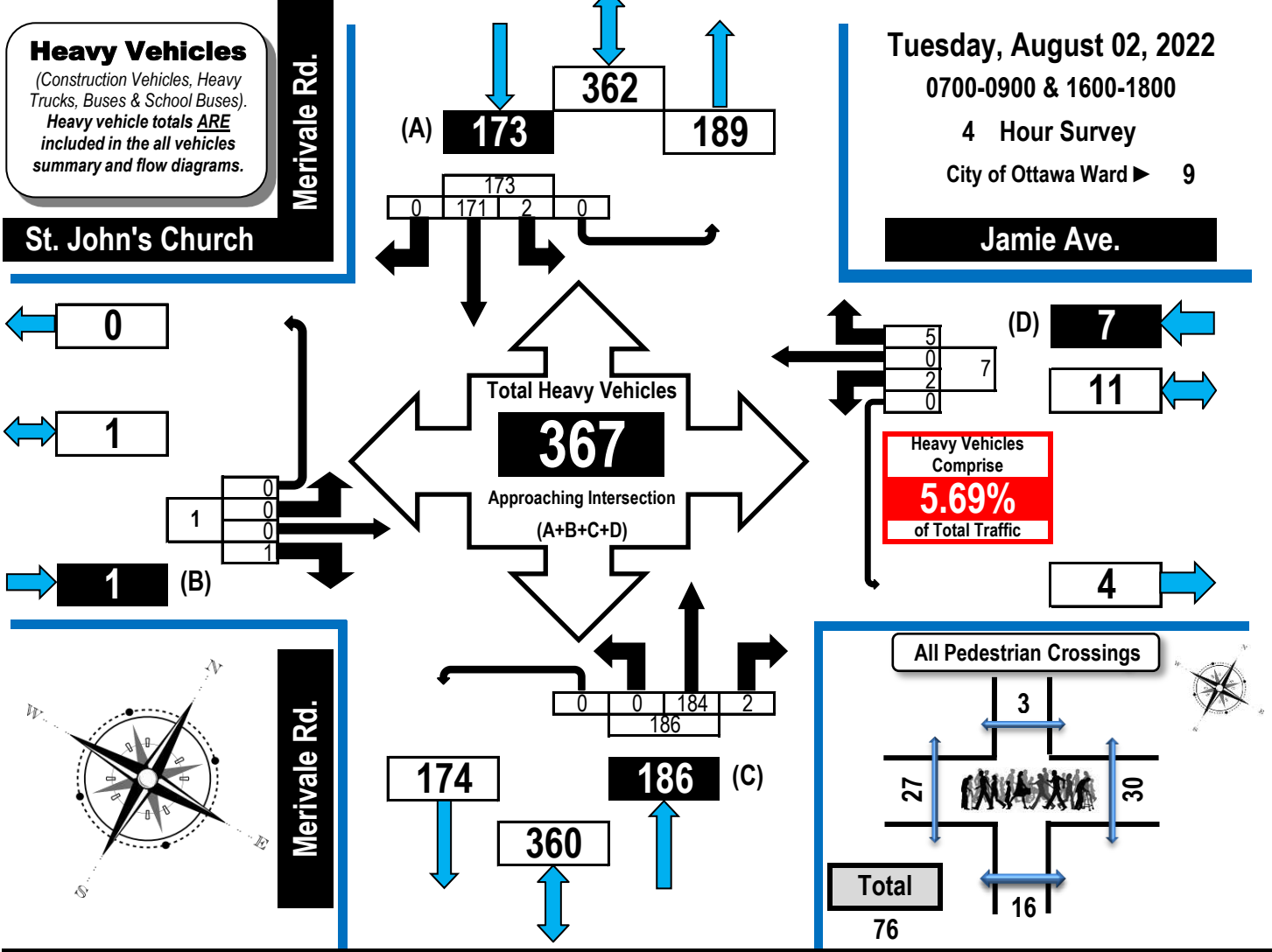

Time Period	St. John's Church Eastbound					Jamie Ave. Westbound					Merivale Rd. Northbound					Merivale Rd. Southbound					SB Tot	GR Tot
	LT	ST	RT	UT	EB Tot	LT	ST	RT	UT	WB Tot	LT	ST	RT	UT	NB Tot	LT	ST	RT	UT			
0700-0800	0	0	0	0	0	0	0	2	0	2	0	69	1	0	70	0	45	0	0	45	117	
0800-0900	0	0	0	0	0	2	0	1	0	3	0	62	1	0	63	1	40	0	0	41	107	
1600-1700	0	0	1	0	1	0	0	2	0	2	0	34	0	0	34	0	42	0	0	42	79	
1700-1800	0	0	0	0	0	0	0	0	0	0	0	19	0	0	19	1	44	0	0	45	64	
Totals	0	0	1	0	1	2	0	5	0	7	0	184	2	0	186	2	171	0	0	173	367	

Comments:
OC Transpo and Para Transpo buses together with 1 school bus comprise 14.44% of the heavy vehicle traffic. The bicycle totals include 3 E-scooters (stand-up type). Northbound traffic backed up to Jamie Avenue from West Hunt Club Road twice - at 1642H & 1704H - but cleared on the next cycle.

Turning Movement Count Bicycle Summary Flow Diagram



Jamie Avenue & Merivale Road Nepean, ON

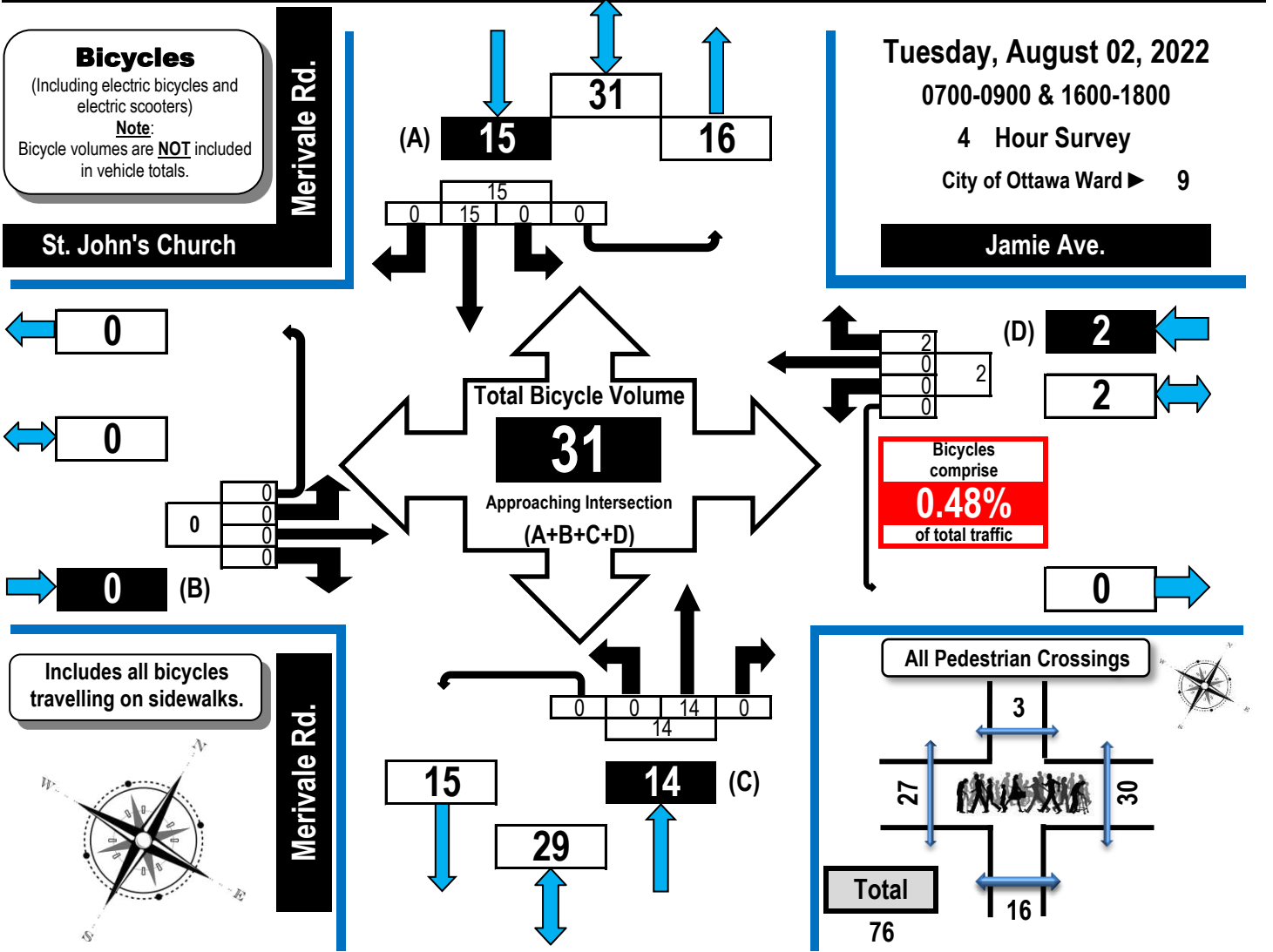

Time Period	St. John's Church Eastbound					Jamie Ave. Westbound					Merivale Rd. Northbound					Merivale Rd. Southbound				
	LT	ST	RT	UT	EB Tot	LT	ST	RT	UT	WB Tot	LT	ST	RT	UT	NB Tot	LT	ST	RT	UT	SB Tot

Time Period	St. John's Church Eastbound					Jamie Ave. Westbound					Merivale Rd. Northbound					Merivale Rd. Southbound						
	LT	ST	RT	UT	EB Tot	LT	ST	RT	UT	WB Tot	LT	ST	RT	UT	NB Tot	LT	ST	RT	UT	SB Tot	GR Tot	
0700-0800	0	0	0	0	0	0	0	0	0	0	0	0	0	0	0	0	0	3	0	0	3	3
0800-0900	0	0	0	0	0	0	0	0	0	0	0	1	0	0	1	0	5	0	0	0	5	6
1600-1700	0	0	0	0	0	0	0	1	0	1	0	4	0	0	4	0	4	0	0	0	4	9
1700-1800	0	0	0	0	0	0	0	1	0	1	0	9	0	0	9	0	3	0	0	0	3	13
Totals	0	0	0	0	0	0	0	2	0	2	0	14	0	0	14	0	15	0	0	0	15	31

Comments:

OC Transpo and Para Transpo buses together with 1 school bus comprise 14.44% of the heavy vehicle traffic. The bicycle totals include 3 E-scooters (stand-up type). Northbound traffic backed up to Jamie Avenue from West Hunt Club Road twice - at 1642H & 1704H - but cleared on the next cycle.



Turning Movement Count Pedestrian Crossings Summary and Flow Diagram



Jamie Avenue & Merivale Road

Nepean, ON

**Pedestrian
Crossings**

Tuesday, August 02, 2022

0700-0900 & 1600-1800

4 Hour Survey

City of Ottawa Ward ▶ 9

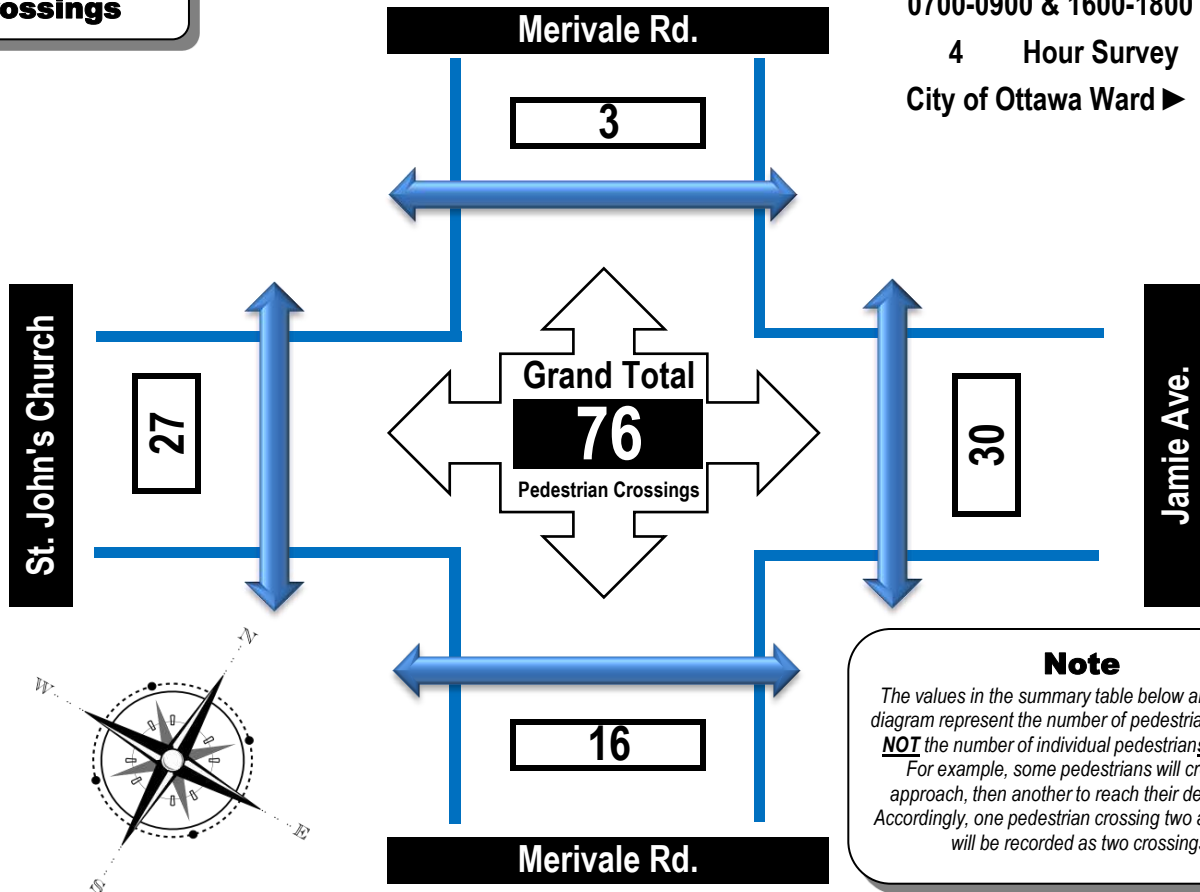

Note
The values in the summary table below and the flow diagram represent the number of pedestrian crossings NOT the number of individual pedestrians crossing. For example, some pedestrians will cross one approach, then another to reach their destination. Accordingly, one pedestrian crossing two approaches will be recorded as two crossings.

Time Period	West Side Crossing St. John's Church	East Side Crossing Jamie Ave.	Street Total	South Side Crossing Merivale Rd.	North Side Crossing Merivale Rd.	Street Total	Grand Total
0700-0800	3	7	10	7	0	7	17
0800-0900	1	7	8	2	0	2	10
1600-1700	13	8	21	3	1	4	25
1700-1800	10	8	18	4	2	6	24
Totals	27	30	57	16	3	19	76

Comments:

OC Transpo and Para Transpo buses together with 1 school bus comprise 14.44% of the heavy vehicle traffic. The bicycle totals include 3 E-scooters (stand-up type). Northbound traffic backed up to Jamie Avenue from West Hunt Club Road twice - at 1642H & 1704H - but cleared on the next cycle.

Turning Movement Count - Study Results

MERIVALE RD @ BENTLEY AVE/CAMELOT DR

Survey Date: Tuesday, January 15, 2019

WO No: 38254

Start Time: 07:00

Device: Miovision

Full Study Diagram

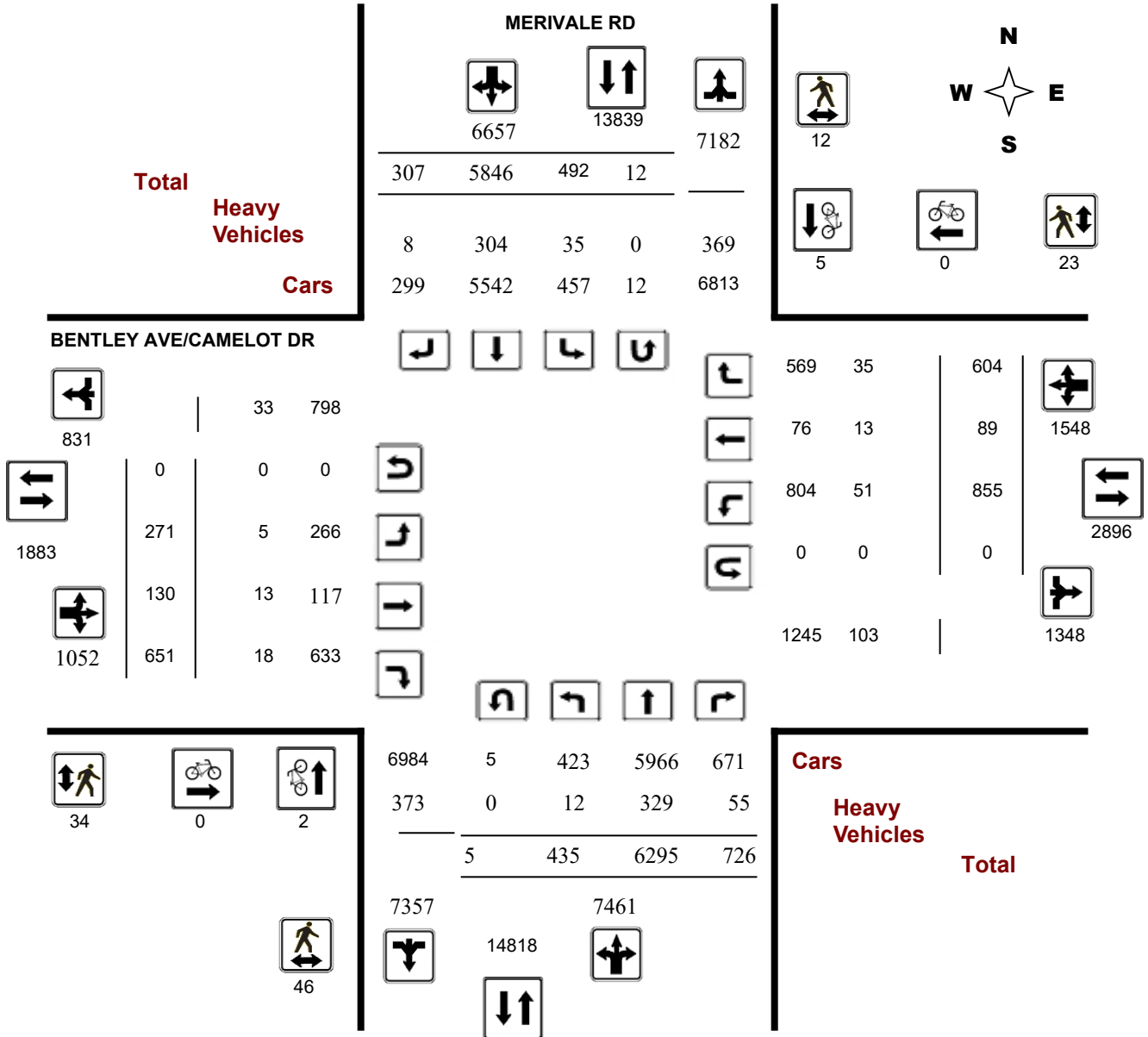

Turning Movement Count - Study Results

MERIVALE RD @ BENTLEY AVE/CAMELOT DR

Survey Date: Tuesday, January 15, 2019

WO No: 38254

Start Time: 07:00

Device: Miovision

Full Study Peak Hour Diagram

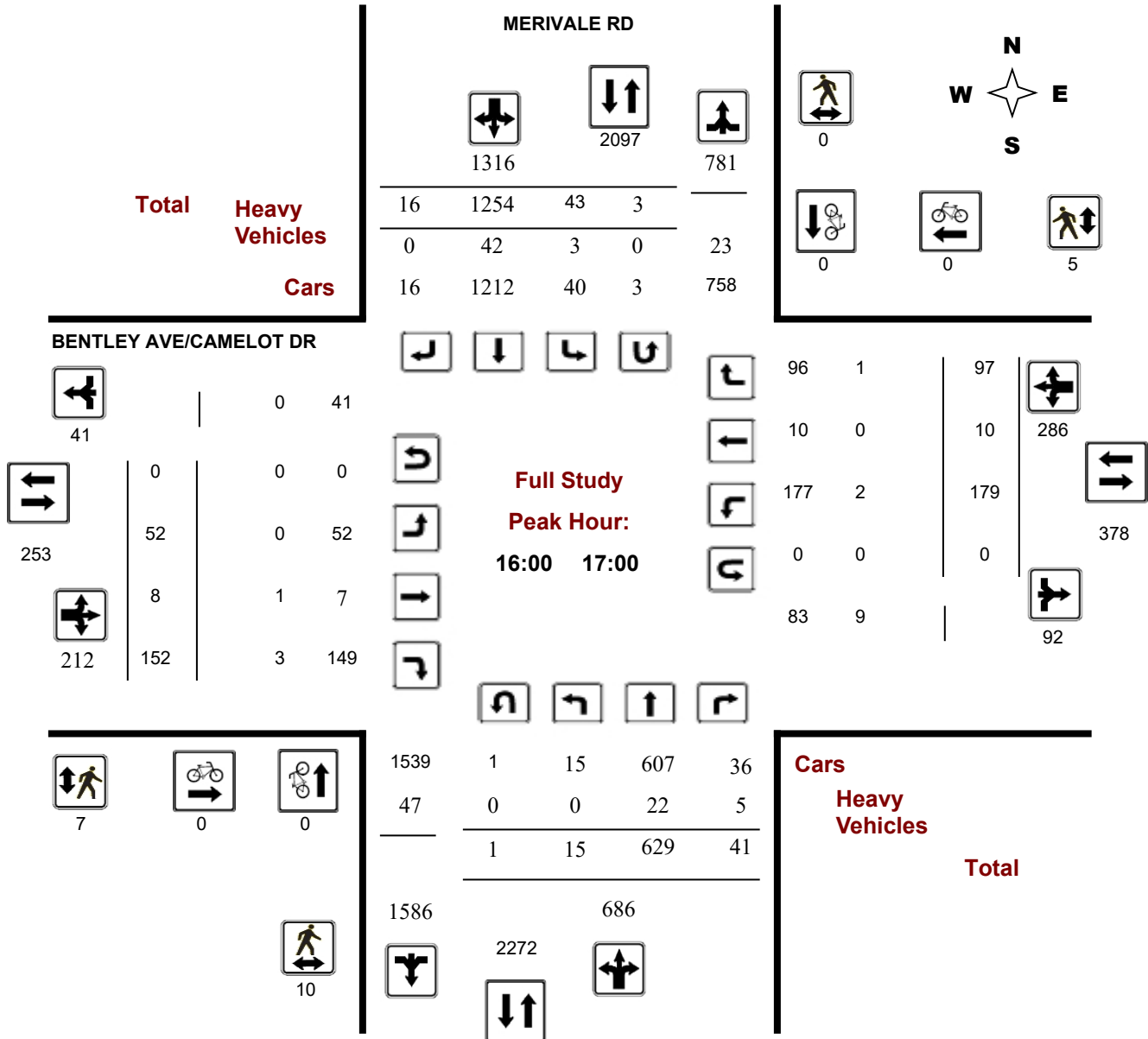

Turning Movement Count - Peak Hour Diagram MERIVALE RD @ BENTLEY AVE/CAMELOT DR

Survey Date: Tuesday, January 15, 2019

Start Time: 07:00

WO No: 38254

Device: Miovision

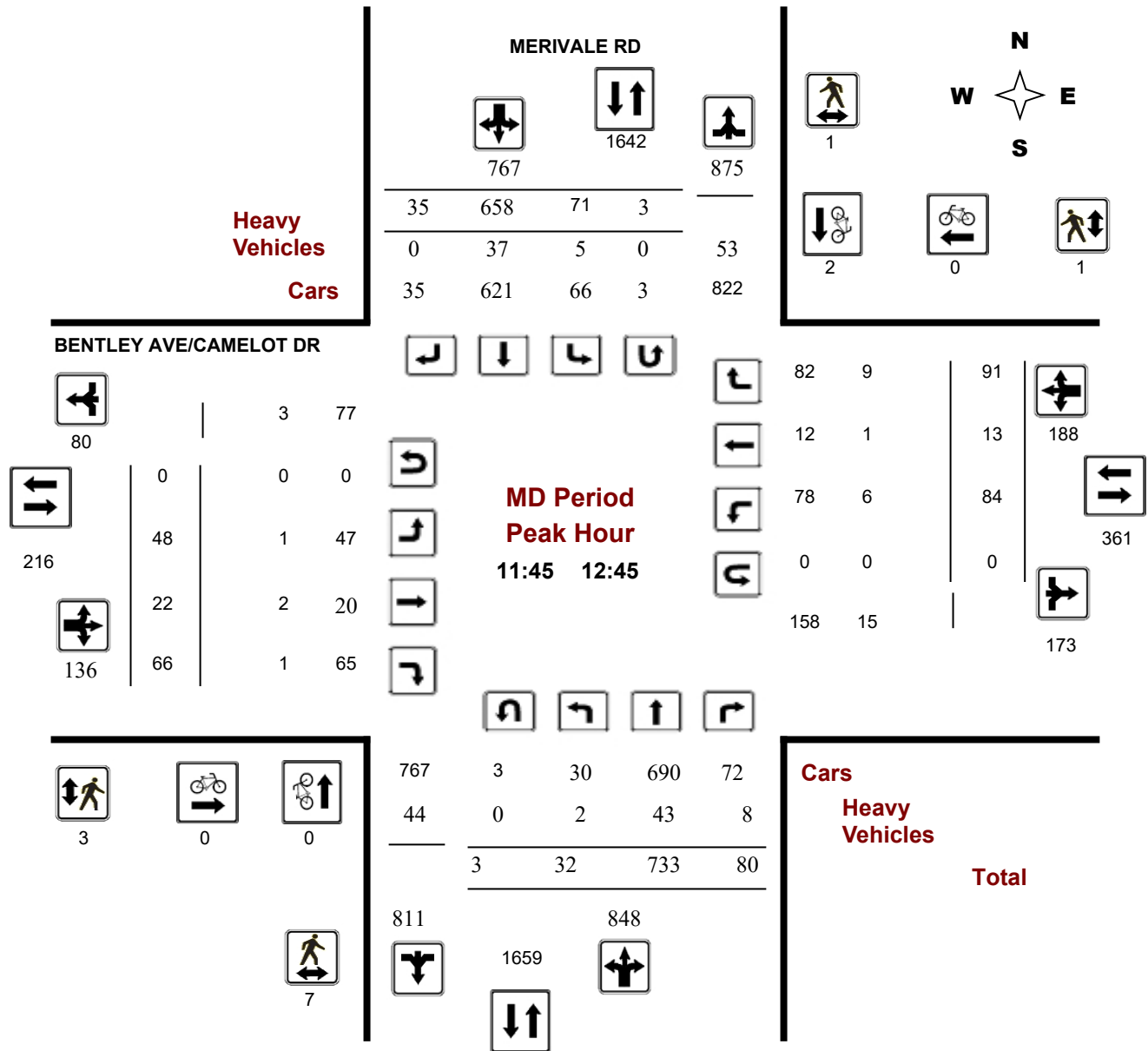

Turning Movement Count - Peak Hour Diagram MERIVALE RD @ BENTLEY AVE/CAMELOT DR

Survey Date: Tuesday, January 15, 2019

Start Time: 07:00

WO No: 38254

Device: Miovision

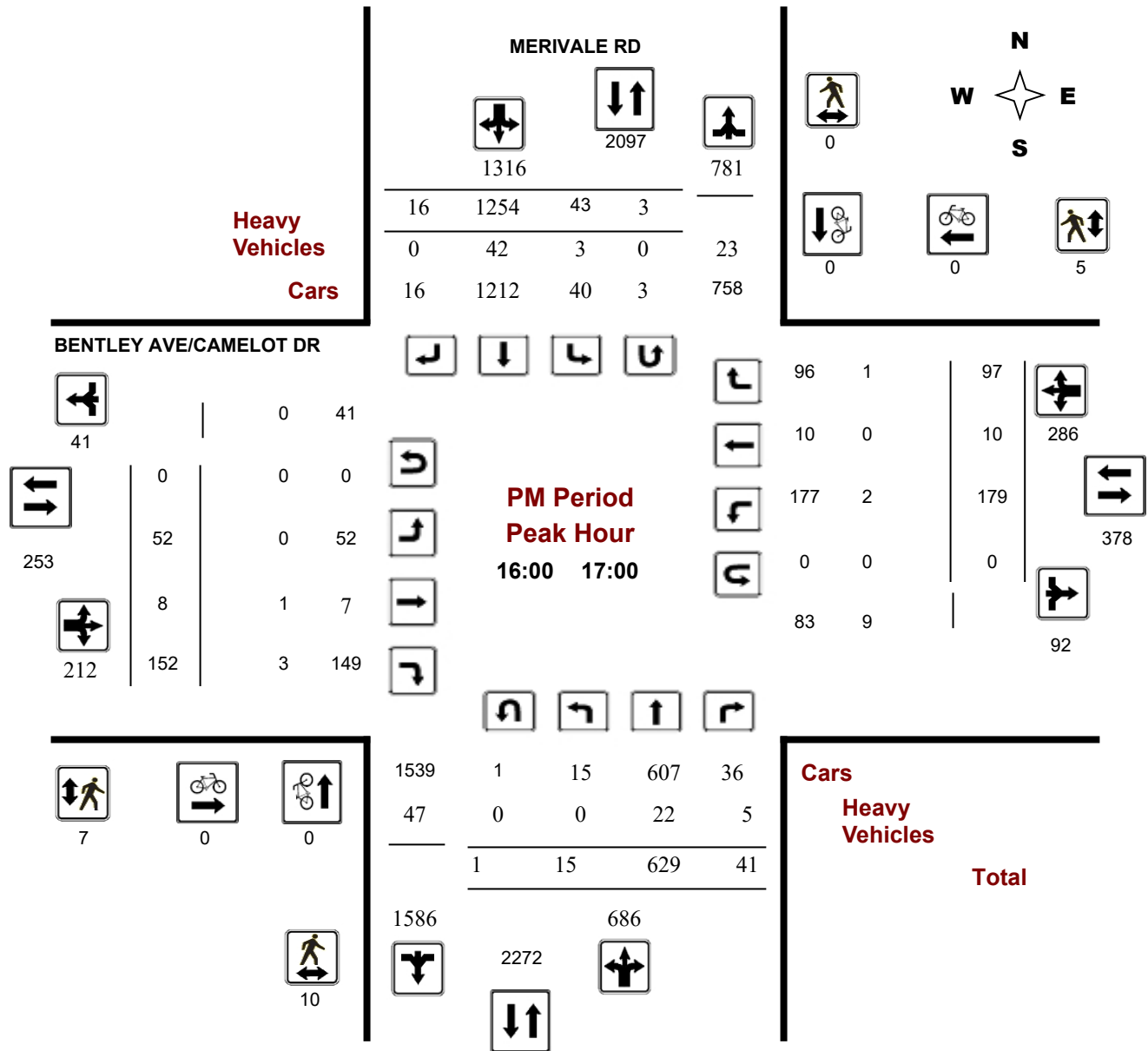



Transportation Services - Traffic Services

Turning Movement Count - Study Results

MERIVALE RD @ BENTLEY AVE/CAMELOT DR

Survey Date: Tuesday, January 15, 2019

WO No: 38254

Start Time: 07:00

Device: Miovision

Full Study Summary (8 HR Standard)

Survey Date: Tuesday, January 15, 2019

Total Observed U-Turns

AADT Factor

Northbound: 5 Southbound: 12
 Eastbound: 0 Westbound: 0

1.10

MERIVALE RD

BENTLEY AVE/CAMELOT DR

Period	Northbound					Southbound					Eastbound				Westbound			STR TOT	Grand Total
	LT	ST	RT	NB TOT	STR TOT	LT	ST	RT	SB TOT	STR TOT	LT	ST	RT	EB TOT	WB TOT				
07:00 08:00	103	1153	153	1409	66	384	50	500	1909	10	17	70	97	49	4	39	92	189	2098
08:00 09:00	159	1116	145	1420	67	444	79	590	2010	26	28	74	128	60	15	48	123	251	2261
09:00 10:00	65	805	98	968	68	450	42	560	1528	25	24	52	101	73	13	77	163	264	1792
11:30 12:30	32	746	78	856	74	629	35	738	1594	39	24	61	124	90	11	86	187	311	1905
12:30 13:30	30	623	97	750	83	689	53	825	1575	38	14	52	104	80	15	79	174	278	1853
15:00 16:00	16	667	67	750	60	866	15	941	1691	31	12	104	147	135	11	91	237	384	2075
16:00 17:00	15	629	41	685	43	1254	16	1313	1998	52	8	152	212	179	10	97	286	498	2496
17:00 18:00	15	556	47	618	31	1130	17	1178	1796	50	3	86	139	189	10	87	286	425	2221
Sub Total	435	6295	726	7456	492	5846	307	6645	14101	271	130	651	1052	855	89	604	1548	2600	16701
U Turns	5			5	12			12	17	0			0	0			0	0	17
Total	440	6295	726	7461	504	5846	307	6657	14118	271	130	651	1052	855	89	604	1548	2600	16718

EQ 12Hr 612 8750 1009 10371 701 8126 427 9254 19625 377 181 905 1463 1188 124 840 2152 3615 23240
 Note: These values are calculated by multiplying the totals by the appropriate expansion factor. **1.39**

AVG 12Hr 673 9625 1110 11408 771 8939 470 10180 21588 415 199 996 1610 1307 136 924 2367 3977 25565
 Note: These volumes are calculated by multiplying the Equivalent 12 hr. totals by the AADT factor. **1.10**

AVG 24Hr 882 12609 1454 14945 1010 11710 616 13336 28281 544 261 1305 2110 1712 178 1210 3100 5210 33491
 Note: These volumes are calculated by multiplying the Average Daily 12 hr. totals by 12 to 24 expansion factor. **1.31**

Note: U-Turns provided for approach totals. Refer to 'U-Turn' Report for specific breakdown.



Transportation Services - Traffic Services

Turning Movement Count - Study Results

MERIVALE RD @ BENTLEY AVE/CAMELOT DR

Survey Date: Tuesday, January 15, 2019

WO No: 38254

Start Time: 07:00

Device: Miovision

Full Study Cyclist Volume

MERIVALE RD

BENTLEY AVE/CAMELOT DR

Time Period	Northbound	Southbound	Street Total	Eastbound	Westbound	Street Total	Grand Total
07:00 07:15	0	0	0	0	0	0	0
07:15 07:30	0	0	0	0	0	0	0
07:30 07:45	0	0	0	0	0	0	0
07:45 08:00	0	0	0	0	0	0	0
08:00 08:15	0	1	1	0	0	0	1
08:15 08:30	1	0	1	0	0	0	1
08:30 08:45	0	0	0	0	0	0	0
08:45 09:00	0	0	0	0	0	0	0
09:00 09:15	0	1	1	0	0	0	1
09:15 09:30	0	0	0	0	0	0	0
09:30 09:45	0	0	0	0	0	0	0
09:45 10:00	0	0	0	0	0	0	0
11:30 11:45	0	0	0	0	0	0	0
11:45 12:00	0	0	0	0	0	0	0
12:00 12:15	0	1	1	0	0	0	1
12:15 12:30	0	1	1	0	0	0	1
12:30 12:45	0	0	0	0	0	0	0
12:45 13:00	0	0	0	0	0	0	0
13:00 13:15	0	0	0	0	0	0	0
13:15 13:30	0	0	0	0	0	0	0
15:00 15:15	0	0	0	0	0	0	0
15:15 15:30	0	0	0	0	0	0	0
15:30 15:45	0	0	0	0	0	0	0
15:45 16:00	0	0	0	0	0	0	0
16:00 16:15	0	0	0	0	0	0	0
16:15 16:30	0	0	0	0	0	0	0
16:30 16:45	0	0	0	0	0	0	0
16:45 17:00	0	0	0	0	0	0	0
17:00 17:15	0	0	0	0	0	0	0
17:15 17:30	1	0	1	0	0	0	1
17:30 17:45	0	1	1	0	0	0	1
17:45 18:00	0	0	0	0	0	0	0
Total	2	5	7	0	0	0	7



Transportation Services - Traffic Services

Turning Movement Count - Study Results

MERIVALE RD @ BENTLEY AVE/CAMELOT DR

Survey Date: Tuesday, January 15, 2019

WO No: 38254

Start Time: 07:00

Device: Miovision

Full Study Pedestrian Volume

MERIVALE RD

BENTLEY AVE/CAMELOT DR

Time Period	NB Approach (E or W Crossing)	SB Approach (E or W Crossing)	Total	EB Approach (N or S Crossing)	WB Approach (N or S Crossing)	Total	Grand Total
07:00 07:15	1	0	1	1	0	1	2
07:15 07:30	0	1	1	1	0	1	2
07:30 07:45	0	4	4	2	5	7	11
07:45 08:00	0	0	0	2	0	2	2
08:00 08:15	1	0	1	2	0	2	3
08:15 08:30	1	1	2	0	1	1	3
08:30 08:45	2	1	3	0	2	2	5
08:45 09:00	2	0	2	0	0	0	2
09:00 09:15	1	0	1	1	0	1	2
09:15 09:30	1	0	1	0	0	0	1
09:30 09:45	1	1	2	2	1	3	5
09:45 10:00	1	0	1	0	1	1	2
11:30 11:45	0	0	0	1	0	1	1
11:45 12:00	0	0	0	1	0	1	1
12:00 12:15	1	0	1	0	0	0	1
12:15 12:30	1	0	1	0	0	0	1
12:30 12:45	5	1	6	2	1	3	9
12:45 13:00	0	0	0	0	0	0	0
13:00 13:15	3	0	3	5	0	5	8
13:15 13:30	0	0	0	3	1	4	4
15:00 15:15	4	0	4	1	3	4	8
15:15 15:30	0	1	1	1	0	1	2
15:30 15:45	6	0	6	0	1	1	7
15:45 16:00	1	1	2	0	0	0	2
16:00 16:15	5	0	5	3	1	4	9
16:15 16:30	1	0	1	1	0	1	2
16:30 16:45	1	0	1	2	2	4	5
16:45 17:00	3	0	3	1	2	3	6
17:00 17:15	1	0	1	0	1	1	2
17:15 17:30	2	1	3	1	1	2	5
17:30 17:45	1	0	1	0	0	0	1
17:45 18:00	0	0	0	1	0	1	1
Total	46	12	58	34	23	57	115



Transportation Services - Traffic Services

Turning Movement Count - Study Results

MERIVALE RD @ BENTLEY AVE/CAMELOT DR

Survey Date: Tuesday, January 15, 2019

WO No: 38254

Start Time: 07:00

Device: Miovision

Full Study Heavy Vehicles

MERIVALE RD

BENTLEY AVE/CAMELOT DR

Northbound

Southbound

Eastbound

Westbound

Time Period	Northbound				Southbound				Eastbound				Westbound				Grand Total		
	LT	ST	RT	N TOT	LT	ST	RT	S TOT	STR TOT	LT	ST	RT	E TOT	LT	ST	RT		W TOT	STR TOT
07:00 07:15	0	23	0		1	10	0		34	1	0	0		4	0	0		5	39
07:15 07:30	0	10	2		2	7	0		21	0	0	0		6	0	2		8	29
07:30 07:45	0	15	2		0	8	0		25	0	0	0		2	1	2		5	30
07:45 08:00	0	16	1		0	12	0		29	0	0	0		1	0	1		2	31
08:00 08:15	3	13	3		1	7	1		28	0	0	1		1	0	1		3	31
08:15 08:30	2	21	1		1	13	0		38	0	2	1		2	1	1		7	45
08:30 08:45	0	13	0		4	11	1		29	0	0	2		3	2	0		7	36
08:45 09:00	0	16	2		0	12	0		30	0	0	1		0	0	2		3	33
09:00 09:15	0	14	1		0	16	0		31	0	0	0		0	1	1		2	33
09:15 09:30	2	14	0		1	14	1		32	0	0	1		2	0	1		4	36
09:30 09:45	0	12	5		3	11	0		31	1	0	0		5	0	4		10	41
09:45 10:00	0	13	3		0	10	0		26	1	0	0		2	1	6		10	36
11:30 11:45	0	12	2		2	10	2		28	0	0	3		2	0	0		5	33
11:45 12:00	1	13	3		2	12	0		31	0	0	1		1	0	2		4	35
12:00 12:15	1	14	1		2	9	0		27	0	0	0		4	0	1		5	32
12:15 12:30	0	6	1		0	5	0		12	1	2	0		0	0	4		7	19
12:30 12:45	0	10	3		1	11	0		25	0	0	0		1	1	2		4	29
12:45 13:00	0	10	4		1	5	0		20	0	1	0		1	1	0		3	23
13:00 13:15	1	12	4		1	13	0		31	1	1	1		1	1	2		7	38
13:15 13:30	0	7	0		4	11	0		22	0	1	0		1	0	1		3	25
15:00 15:15	1	4	3		1	10	0		19	0	0	0		3	2	0		5	24
15:15 15:30	0	4	0		0	13	2		19	0	2	0		1	0	0		3	22
15:30 15:45	0	11	2		2	7	0		22	0	0	0		3	0	1		4	26
15:45 16:00	1	9	3		1	9	1		24	0	1	3		1	0	0		5	29
16:00 16:15	0	5	0		1	11	0		17	0	1	2		1	0	0		4	21
16:15 16:30	0	9	2		0	12	0		23	0	0	0		0	0	0		0	23
16:30 16:45	0	2	1		1	11	0		15	0	0	1		1	0	1		3	18
16:45 17:00	0	6	2		1	8	0		17	0	0	0		0	0	0		0	17
17:00 17:15	0	2	0		1	5	0		8	0	1	0		0	0	0		1	9
17:15 17:30	0	5	3		0	6	0		14	0	0	1		1	2	0		4	18
17:30 17:45	0	7	1		1	2	0		11	0	1	0		0	0	0		1	12
17:45 18:00	0	1	0		0	3	0		4	0	0	0		1	0	0		1	5
Total: None	12	329	55	0	35	304	8	0	743	5	13	18	0	51	13	35	0	135	878



Transportation Services - Traffic Services

Turning Movement Count - Study Results

MERIVALE RD @ BENTLEY AVE/CAMELOT DR

Survey Date: Tuesday, January 15, 2019

WO No: 38254

Start Time: 07:00

Device: Miovision

Full Study 15 Minute U-Turn Total

MERIVALE RD

BENTLEY AVE/CAMELOT DR

Time Period		Northbound U-Turn Total	Southbound U-Turn Total	Eastbound U-Turn Total	Westbound U-Turn Total	Total
07:00	07:15	0	2	0	0	2
07:15	07:30	0	0	0	0	0
07:30	07:45	0	0	0	0	0
07:45	08:00	0	0	0	0	0
08:00	08:15	0	0	0	0	0
08:15	08:30	0	0	0	0	0
08:30	08:45	0	0	0	0	0
08:45	09:00	1	1	0	0	2
09:00	09:15	0	1	0	0	1
09:15	09:30	0	0	0	0	0
09:30	09:45	0	0	0	0	0
09:45	10:00	0	0	0	0	0
11:30	11:45	0	0	0	0	0
11:45	12:00	1	1	0	0	2
12:00	12:15	1	0	0	0	1
12:15	12:30	0	1	0	0	1
12:30	12:45	1	1	0	0	2
12:45	13:00	0	0	0	0	0
13:00	13:15	0	1	0	0	1
13:15	13:30	0	0	0	0	0
15:00	15:15	0	0	0	0	0
15:15	15:30	0	0	0	0	0
15:30	15:45	0	0	0	0	0
15:45	16:00	0	0	0	0	0
16:00	16:15	0	0	0	0	0
16:15	16:30	0	3	0	0	3
16:30	16:45	1	0	0	0	1
16:45	17:00	0	0	0	0	0
17:00	17:15	0	1	0	0	1
17:15	17:30	0	0	0	0	0
17:30	17:45	0	0	0	0	0
17:45	18:00	0	0	0	0	0
Total		5	12	0	0	17

Turning Movement Count - Study Results

MERIVALE RD @ WEST HUNT CLUB RD

Survey Date: Monday, February 10, 2020

WO No: 39439

Start Time: 07:00

Device: Miovision

Full Study Diagram

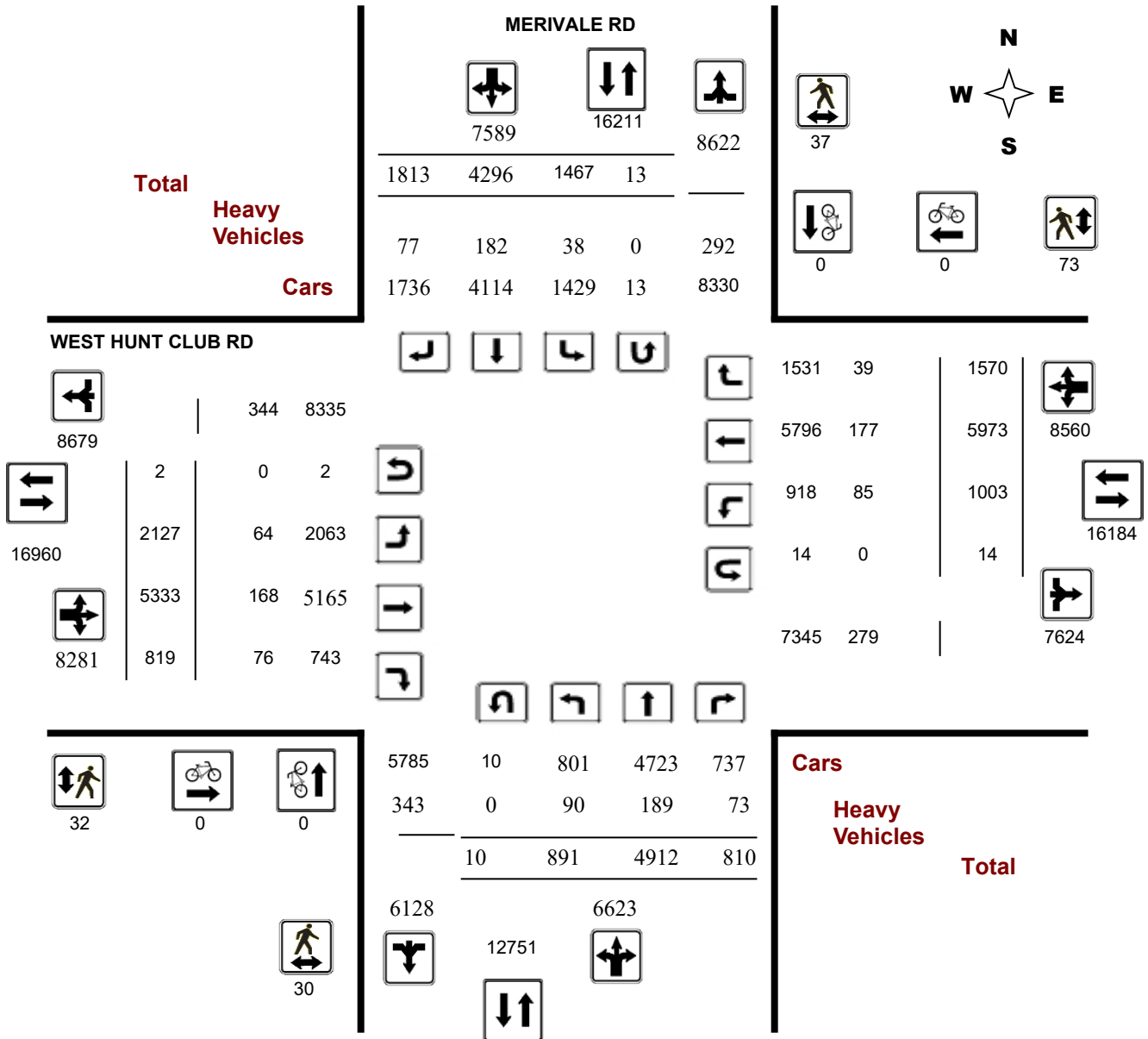

Turning Movement Count - Study Results

MERIVALE RD @ WEST HUNT CLUB RD

Survey Date: Monday, February 10, 2020

WO No: 39439

Start Time: 07:00

Device: Miovision

Full Study Peak Hour Diagram

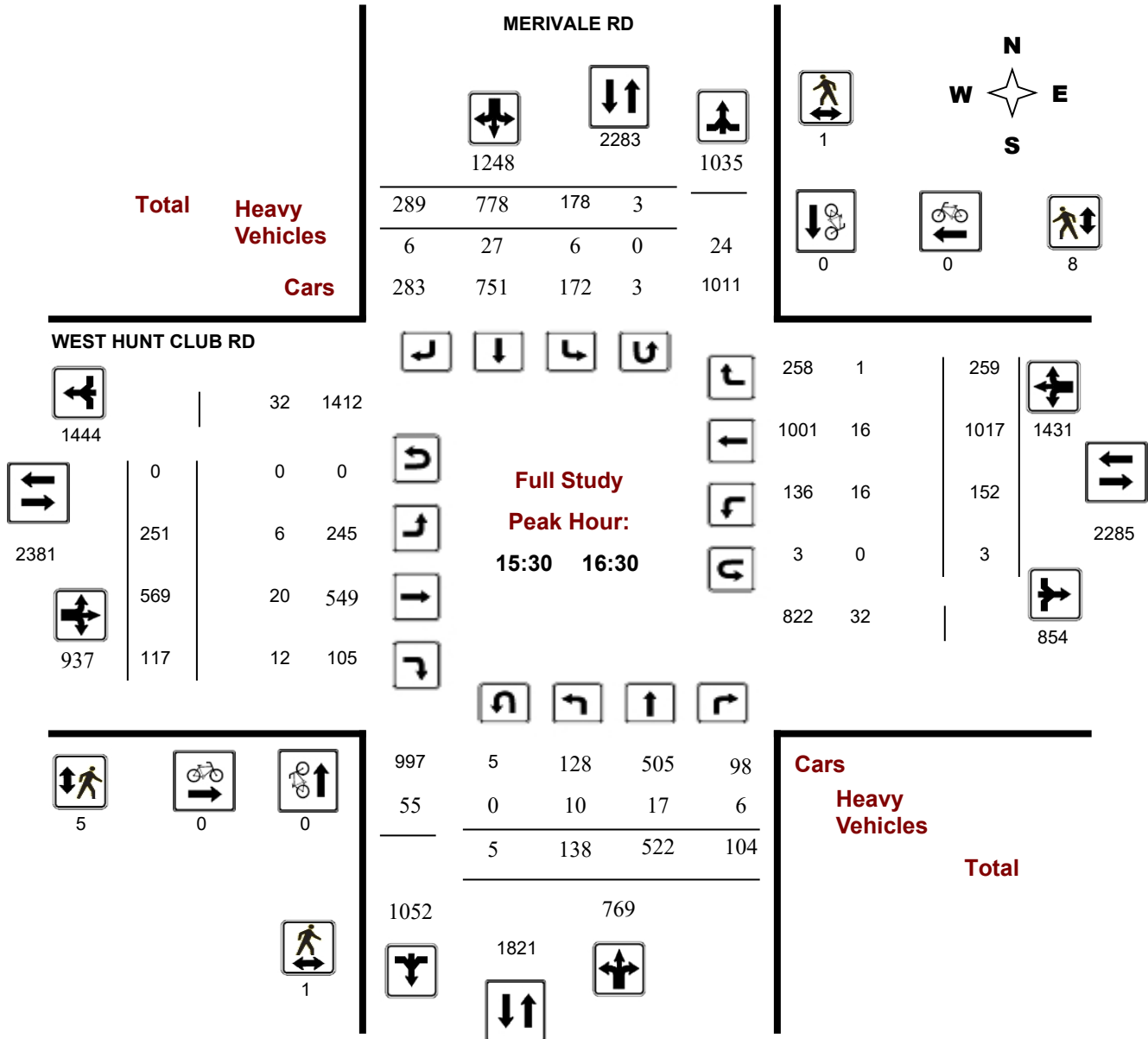

Turning Movement Count - Peak Hour Diagram

MERIVALE RD @ WEST HUNT CLUB RD

Survey Date: Monday, February 10, 2020

Start Time: 07:00

WO No: 39439

Device: Miovision

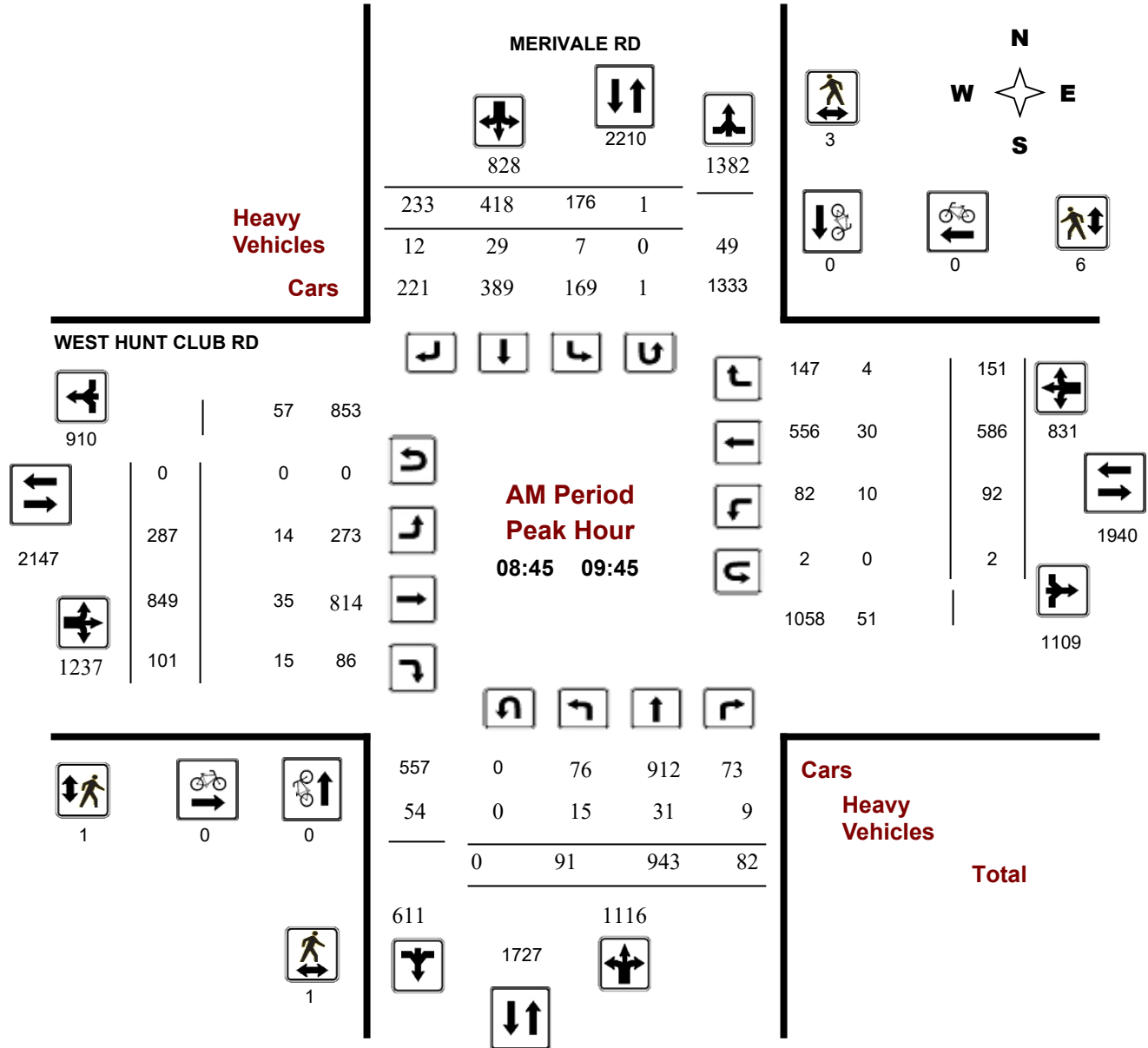

Turning Movement Count - Peak Hour Diagram

MERIVALE RD @ WEST HUNT CLUB RD

Survey Date: Monday, February 10, 2020

Start Time: 07:00

WO No: 39439

Device: Miovision

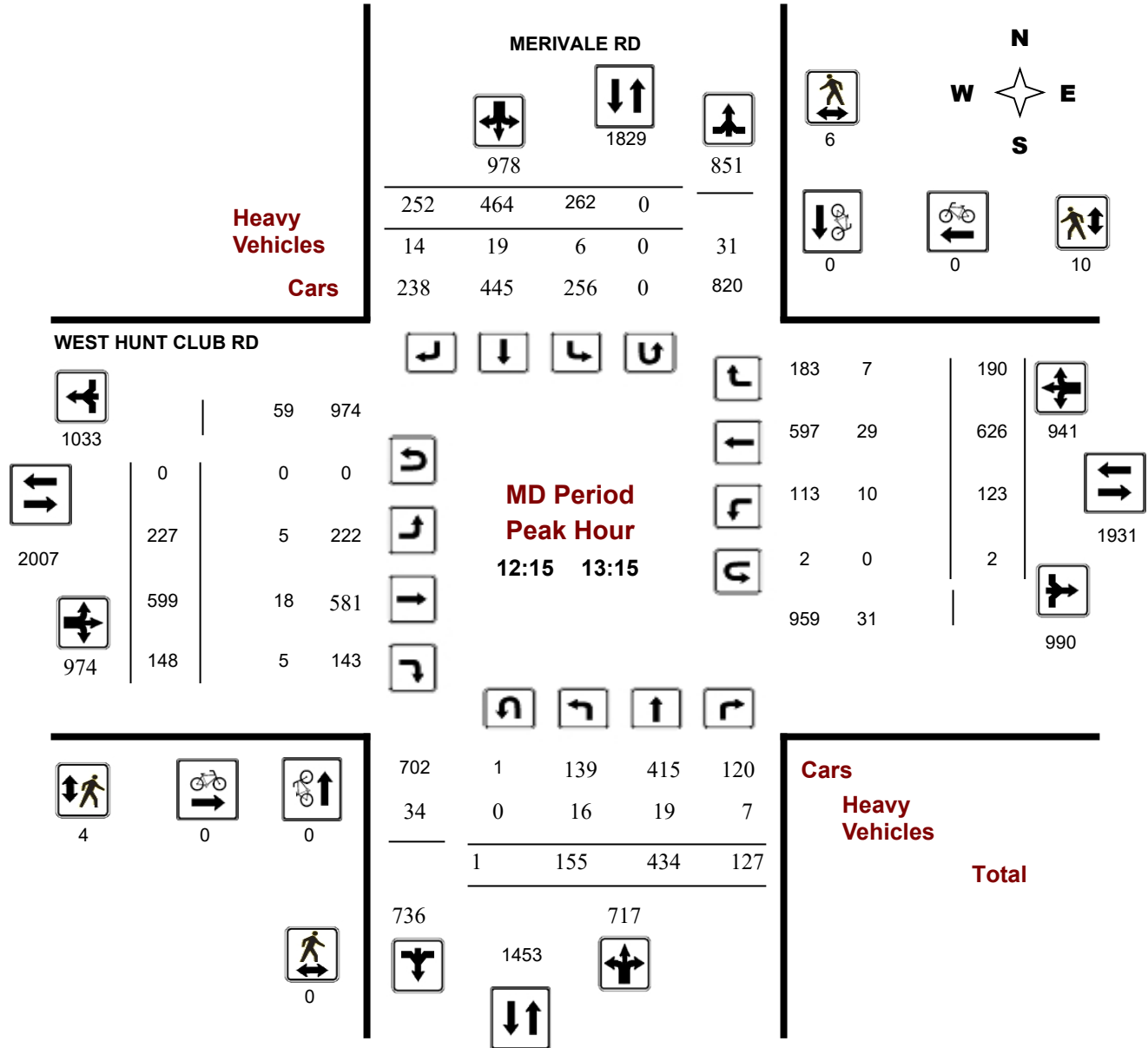

Turning Movement Count - Peak Hour Diagram

MERIVALE RD @ WEST HUNT CLUB RD

Survey Date: Monday, February 10, 2020

Start Time: 07:00

WO No: 39439

Device: Miovision

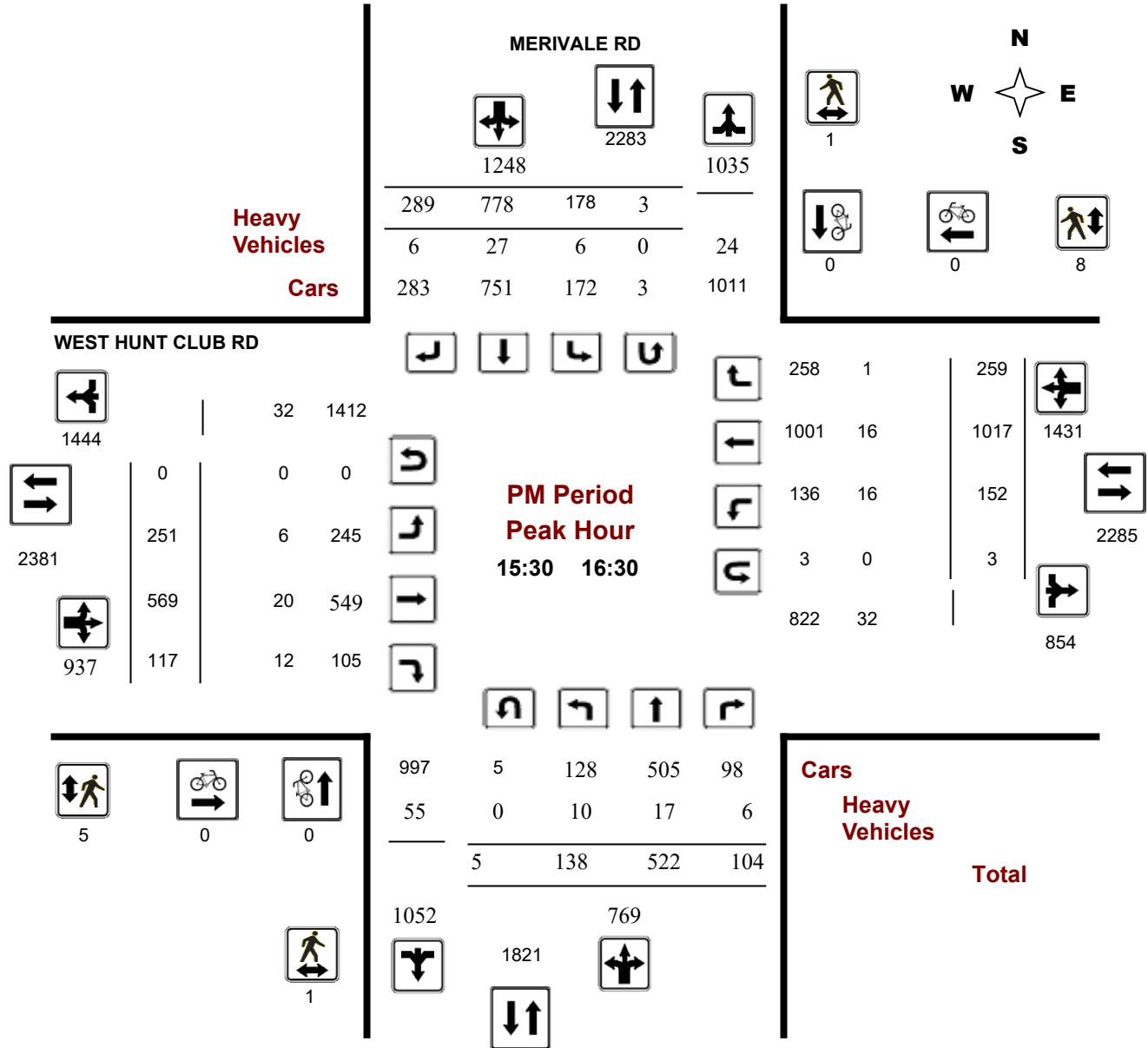



Transportation Services - Traffic Services

Turning Movement Count - Study Results

MERIVALE RD @ WEST HUNT CLUB RD

Survey Date: Monday, February 10, 2020

WO No: 39439

Start Time: 07:00

Device: Miovision

Full Study Summary (8 HR Standard)

Survey Date: Monday, February 10, 2020

Total Observed U-Turns

AADT Factor

Northbound: 10 Southbound: 13

1.00

Eastbound: 2 Westbound: 14

MERIVALE RD

WEST HUNT CLUB RD

Period	Northbound					Southbound					Eastbound				Westbound			STR TOT	Grand Total
	LT	ST	RT	NB TOT	LT	ST	RT	SB TOT	STR TOT	LT	ST	RT	EB TOT	LT	ST	RT	WB TOT		
07:00 08:00	68	838	100	1006	147	346	143	636	1642	363	846	86	1295	84	572	97	753	2048	3690
08:00 09:00	50	758	79	887	182	395	184	761	1648	275	925	64	1264	89	651	136	876	2140	3788
09:00 10:00	109	912	93	1114	176	379	199	754	1868	303	852	101	1256	111	593	143	847	2103	3971
11:30 12:30	139	425	131	695	220	441	231	892	1587	250	551	129	930	101	603	214	918	1848	3435
12:30 13:30	155	425	141	721	249	458	237	944	1665	206	579	145	930	131	603	187	921	1851	3516
15:00 16:00	122	474	116	712	198	674	302	1174	1886	232	618	96	946	121	1023	235	1379	2325	4211
16:00 17:00	145	560	77	782	144	825	250	1219	2001	256	485	111	852	174	949	282	1405	2257	4258
17:00 18:00	103	520	73	696	151	778	267	1196	1892	242	477	87	806	192	979	276	1447	2253	4145
Sub Total	891	4912	810	6613	1467	4296	1813	7576	14189	2127	5333	819	8279	1003	5973	1570	8546	16825	31014
U Turns	10			10	13			13	23	2			2	14			14	16	39
Total	901	4912	810	6623	1480	4296	1813	7589	14212	2129	5333	819	8281	1017	5973	1570	8560	16841	31053

EQ 12Hr 1252 6828 1126 9206 2057 5971 2520 10548 19754 2959 7413 1138 11510 1414 8302 2182 11898 23408 43162

Note: These values are calculated by multiplying the totals by the appropriate expansion factor.

1.39

AVG 12Hr 1252 6828 1126 9206 2057 5971 2520 10548 19754 2959 7413 1138 11510 1414 8302 2182 11898 23408 43162

Note: These volumes are calculated by multiplying the Equivalent 12 hr. totals by the AADT factor.

1.00

AVG 24Hr 1640 8945 1475 12060 2695 7822 3301 13818 25878 3876 9711 1491 15078 1852 10876 2858 15586 30664 56542

Note: These volumes are calculated by multiplying the Average Daily 12 hr. totals by 12 to 24 expansion factor.

1.31

Note: U-Turns provided for approach totals. Refer to 'U-Turn' Report for specific breakdown.



Transportation Services - Traffic Services

Turning Movement Count - Study Results

MERIVALE RD @ WEST HUNT CLUB RD

Survey Date: Monday, February 10, 2020

WO No: 39439

Start Time: 07:00

Device: Miovision

Full Study Cyclist Volume

MERIVALE RD

WEST HUNT CLUB RD

Time Period	Northbound	Southbound	Street Total	Eastbound	Westbound	Street Total	Grand Total
07:00 07:15	0	0	0	0	0	0	0
07:15 07:30	0	0	0	0	0	0	0
07:30 07:45	0	0	0	0	0	0	0
07:45 08:00	0	0	0	0	0	0	0
08:00 08:15	0	0	0	0	0	0	0
08:15 08:30	0	0	0	0	0	0	0
08:30 08:45	0	0	0	0	0	0	0
08:45 09:00	0	0	0	0	0	0	0
09:00 09:15	0	0	0	0	0	0	0
09:15 09:30	0	0	0	0	0	0	0
09:30 09:45	0	0	0	0	0	0	0
09:45 10:00	0	0	0	0	0	0	0
11:30 11:45	0	0	0	0	0	0	0
11:45 12:00	0	0	0	0	0	0	0
12:00 12:15	0	0	0	0	0	0	0
12:15 12:30	0	0	0	0	0	0	0
12:30 12:45	0	0	0	0	0	0	0
12:45 13:00	0	0	0	0	0	0	0
13:00 13:15	0	0	0	0	0	0	0
13:15 13:30	0	0	0	0	0	0	0
15:00 15:15	0	0	0	0	0	0	0
15:15 15:30	0	0	0	0	0	0	0
15:30 15:45	0	0	0	0	0	0	0
15:45 16:00	0	0	0	0	0	0	0
16:00 16:15	0	0	0	0	0	0	0
16:15 16:30	0	0	0	0	0	0	0
16:30 16:45	0	0	0	0	0	0	0
16:45 17:00	0	0	0	0	0	0	0
17:00 17:15	0	0	0	0	0	0	0
17:15 17:30	0	0	0	0	0	0	0
17:30 17:45	0	0	0	0	0	0	0
17:45 18:00	0	0	0	0	0	0	0
Total	0	0	0	0	0	0	0



Transportation Services - Traffic Services

Turning Movement Count - Study Results

MERIVALE RD @ WEST HUNT CLUB RD

Survey Date: Monday, February 10, 2020

WO No: 39439

Start Time: 07:00

Device: Miovision

Full Study Pedestrian Volume

MERIVALE RD

WEST HUNT CLUB RD

Time Period	NB Approach (E or W Crossing)	SB Approach (E or W Crossing)	Total	EB Approach (N or S Crossing)	WB Approach (N or S Crossing)	Total	Grand Total
07:00 07:15	0	0	0	0	2	2	2
07:15 07:30	0	1	1	0	1	1	2
07:30 07:45	0	1	1	1	1	2	3
07:45 08:00	2	2	4	3	4	7	11
08:00 08:15	2	0	2	2	1	3	5
08:15 08:30	0	1	1	1	2	3	4
08:30 08:45	1	1	2	1	2	3	5
08:45 09:00	0	1	1	0	0	0	1
09:00 09:15	1	0	1	0	1	1	2
09:15 09:30	0	1	1	0	4	4	5
09:30 09:45	0	1	1	1	1	2	3
09:45 10:00	1	1	2	1	1	2	4
11:30 11:45	1	0	1	2	2	4	5
11:45 12:00	1	3	4	0	2	2	6
12:00 12:15	1	0	1	0	1	1	2
12:15 12:30	0	1	1	0	2	2	3
12:30 12:45	0	3	3	2	1	3	6
12:45 13:00	0	0	0	0	6	6	6
13:00 13:15	0	2	2	2	1	3	5
13:15 13:30	0	1	1	1	2	3	4
15:00 15:15	3	0	3	1	2	3	6
15:15 15:30	2	3	5	0	4	4	9
15:30 15:45	1	0	1	3	0	3	4
15:45 16:00	0	0	0	0	1	1	1
16:00 16:15	0	1	1	2	4	6	7
16:15 16:30	0	0	0	0	3	3	3
16:30 16:45	0	3	3	1	6	7	10
16:45 17:00	6	0	6	3	4	7	13
17:00 17:15	4	4	8	4	6	10	18
17:15 17:30	0	1	1	0	1	1	2
17:30 17:45	4	4	8	1	4	5	13
17:45 18:00	0	1	1	0	1	1	2
Total	30	37	67	32	73	105	172



Transportation Services - Traffic Services

Turning Movement Count - Study Results

MERIVALE RD @ WEST HUNT CLUB RD

Survey Date: Monday, February 10, 2020

WO No: 39439

Start Time: 07:00

Device: Miovision

Full Study Heavy Vehicles

MERIVALE RD

WEST HUNT CLUB RD

Northbound

Southbound

Eastbound

Westbound

Time Period	Northbound				Southbound				Eastbound				Westbound				Grand Total		
	LT	ST	RT	N TOT	LT	ST	RT	S TOT	STR TOT	LT	ST	RT	E TOT	LT	ST	RT		W TOT	STR TOT
07:00 07:15	10	10	1		0	3	7		31	0	5	2		3	8	0		18	49
07:15 07:30	1	13	2		1	5	8		30	3	0	1		1	7	2		14	44
07:30 07:45	6	7	7		1	2	9		32	0	5	0		3	7	2		17	49
07:45 08:00	0	16	2		1	9	2		30	2	3	0		3	7	1		16	46
08:00 08:15	3	4	2		1	6	2		18	5	2	0		4	10	1		22	40
08:15 08:30	1	8	2		0	6	2		19	1	6	2		3	5	3		20	39
08:30 08:45	0	6	4		0	5	0		15	0	10	3		1	6	6		26	41
08:45 09:00	4	10	1		1	7	3		26	1	8	4		1	10	1		25	51
09:00 09:15	3	7	1		1	7	3		22	2	11	4		3	6	1		27	49
09:15 09:30	3	7	5		2	7	3		27	5	9	4		5	9	0		32	59
09:30 09:45	5	7	2		3	8	3		28	6	7	3		1	5	2		24	52
09:45 10:00	3	6	1		0	7	5		22	1	8	4		6	6	2		27	49
11:30 11:45	3	8	1		1	3	0		16	2	9	3		5	8	3		30	46
11:45 12:00	5	5	6		1	6	2		25	5	7	5		3	6	0		26	51
12:00 12:15	0	3	3		3	5	2		16	2	5	4		1	3	2		17	33
12:15 12:30	3	3	2		3	3	3		17	2	7	1		2	3	2		17	34
12:30 12:45	5	2	1		0	5	3		16	1	1	1		2	8	0		13	29
12:45 13:00	4	7	1		1	8	4		25	0	3	0		3	8	2		16	41
13:00 13:15	4	7	3		2	3	4		23	2	7	3		3	10	3		28	51
13:15 13:30	1	3	4		3	5	2		18	0	9	3		2	10	1		25	43
15:00 15:15	4	4	1		0	11	1		21	1	9	1		2	3	1		17	38
15:15 15:30	4	6	5		1	7	1		24	1	6	2		1	8	0		18	42
15:30 15:45	3	4	1		1	5	0		14	1	3	3		6	1	0		14	28
15:45 16:00	3	2	1		4	7	2		19	1	5	1		3	7	0		17	36
16:00 16:15	3	6	1		0	7	3		20	1	10	4		6	7	1		29	49
16:15 16:30	1	5	3		1	8	1		19	3	2	4		1	1	0		11	30
16:30 16:45	2	5	2		0	6	0		15	2	2	2		1	0	0		7	22
16:45 17:00	1	3	3		0	5	2		14	2	3	3		4	3	1		16	30
17:00 17:15	0	6	2		2	5	0		15	2	2	2		0	2	0		8	23
17:15 17:30	2	5	1		1	3	0		12	4	1	2		3	1	0		11	23
17:30 17:45	2	2	0		2	5	0		11	4	1	3		0	2	2		12	23
17:45 18:00	1	2	2		1	3	0		9	2	2	2		3	0	0		9	18
Total: None	90	189	73	0	38	182	77	0	649	64	168	76	0	85	177	39	0	609	1,258



Transportation Services - Traffic Services

Turning Movement Count - Study Results

MERIVALE RD @ WEST HUNT CLUB RD

Survey Date: Monday, February 10, 2020

WO No: 39439

Start Time: 07:00

Device: Miovision

Full Study 15 Minute U-Turn Total

MERIVALE RD

WEST HUNT CLUB RD

Time Period		Northbound U-Turn Total	Southbound U-Turn Total	Eastbound U-Turn Total	Westbound U-Turn Total	Total
07:00	07:15	0	2	0	0	2
07:15	07:30	0	0	0	0	0
07:30	07:45	1	1	0	1	3
07:45	08:00	0	1	0	0	1
08:00	08:15	0	0	0	0	0
08:15	08:30	0	1	0	0	1
08:30	08:45	0	0	0	1	1
08:45	09:00	0	1	0	1	2
09:00	09:15	0	0	0	0	0
09:15	09:30	0	0	0	1	1
09:30	09:45	0	0	0	0	0
09:45	10:00	0	2	0	0	2
11:30	11:45	0	1	0	0	1
11:45	12:00	0	0	1	0	1
12:00	12:15	0	0	0	2	2
12:15	12:30	0	0	0	0	0
12:30	12:45	0	0	0	1	1
12:45	13:00	1	0	0	0	1
13:00	13:15	0	0	0	1	1
13:15	13:30	1	0	1	2	4
15:00	15:15	0	0	0	0	0
15:15	15:30	1	0	0	1	2
15:30	15:45	2	1	0	1	4
15:45	16:00	1	1	0	0	2
16:00	16:15	1	0	0	1	2
16:15	16:30	1	1	0	1	3
16:30	16:45	1	0	0	0	1
16:45	17:00	0	0	0	0	0
17:00	17:15	0	0	0	0	0
17:15	17:30	0	0	0	0	0
17:30	17:45	0	0	0	0	0
17:45	18:00	0	1	0	0	1
Total		10	13	2	14	39

Appendix D:

Collision Data

Accident Year	Accident Date	Accident Time	Location	Vehicle 1 Type	Vehicle 2 Type	Environment/Condition	Light	Classification of Accident	Initial Impact Type	No. of Pedestrians	Road Surface Condition	Traffic Control	Traffic Control Condition	No. of Vehicles	No. of Bicycles	No. of Motorcycles	Max Injury	No. of Injuries	No. of Minimal	No. of Minor	No. of Major	No. of Fatal
2016	10/13/2016	09:09 AM	MERVALE RD @ WOODFIELD DR/ROYDON PL (0009776)	Clear	Clear	Clear	01 - Daylight	01 - Non-fatal injury	03 - Rear end	0	02 - Wet	02 - Stop sign	01 - Functioning	4	0	0	0	0	0	0	0	0
2016	10/13/2016	09:09 AM	MERVALE RD @ BONGARD AVE (000588)	Clear	Clear	Clear	01 - Daylight	02 - Non-fatal injury	05 - Turning movement	0	02 - Wet	02 - Stop sign	01 - Functioning	2	0	0	0	0	0	0	0	0
2016	10/4/2016	9:45 AM	MERVALE RD @ WEST HUNT CLUB RD (0000584)	Clear	Clear	Clear	01 - Daylight	02 - Non-fatal injury	03 - Rear end	0	01 - Dry	01 - Traffic signal	01 - Functioning	3	0	0	0	0	0	0	0	0
2016	9/28/2016	5:35 PM	BENTLEY AVE @ SUNDERLAND ST (0005117)	Clear	Clear	Clear	01 - Daylight	03 - P.D. only	02 - Angle	0	02 - Wet	02 - Stop sign	01 - Functioning	2	0	0	0	0	0	0	0	0
2016	10/18/2016	10:03 PM	ENTREPRE AVE @ MERVALE RD (0000589)	Clear	Clear	Clear	07 - Dark	03 - P.D. only	05 - Turning movement	0	01 - Dry	01 - Traffic signal	01 - Functioning	2	0	0	0	0	0	0	0	0
2016	1/22/2016	8:11 AM	MERVALE RD @ WOODFIELD DR/ROYDON PL (0009776)	Clear	Clear	Clear	01 - Daylight	02 - Non-fatal injury	07 - SMV other	1	01 - Dry	01 - Traffic signal	01 - Functioning	1	0	0	0	0	0	0	0	0
2016	11/3/2016	3:58 PM	MERVALE RD @ WEST HUNT CLUB RD (0000584)	Clear	Clear	Clear	01 - Daylight	03 - P.D. only	03 - Rear end	0	01 - Dry	01 - Traffic signal	01 - Functioning	2	0	0	0	0	0	0	0	0
2016	11/8/2016	1:02 PM	MERVALE RD @ WOODFIELD DR/ROYDON PL (0009776)	Clear	Clear	Clear	01 - Daylight	03 - P.D. only	04 - Sideswipe	0	01 - Dry	01 - Traffic signal	01 - Functioning	2	0	0	0	0	0	0	0	0
2016	11/8/2016	12:15 PM	MERVALE RD @ WOODFIELD DR/ROYDON PL (0009776)	Clear	Clear	Clear	01 - Daylight	03 - P.D. only	04 - Sideswipe	0	01 - Dry	01 - Traffic signal	01 - Functioning	2	0	0	0	0	0	0	0	0
2016	11/13/2016	2:55 PM	MERVALE RD @ BENTLEY AVE & JAMIE AVE (L_3280G2)	Clear	Clear	Clear	01 - Daylight	03 - P.D. only	02 - Angle	0	01 - Dry	10 - No control	0	2	0	0	0	0	0	0	0	0
2016	11/14/2016	2:01 PM	MERVALE RD @ WEST HUNT CLUB RD (0000584)	Clear	Clear	Clear	01 - Daylight	03 - P.D. only	04 - Sideswipe	0	01 - Dry	01 - Traffic signal	01 - Functioning	2	0	0	0	0	0	0	0	0
2016	10/23/2016	1:15 PM	MERVALE RD @ WOODFIELD DR/ROYDON PL (0009776)	Clear	Clear	Clear	01 - Daylight	03 - P.D. only	04 - Sideswipe	0	01 - Dry	01 - Traffic signal	00 - Unknown	2	0	0	0	0	0	0	0	0
2016	11/30/2016	8:00 AM	MERVALE RD @ BENTLEY AVE & JAMIE AVE (L_3280G2)	Clear	Clear	Clear	07 - Fog, mist, smoke, dust	01 - Daylight	02 - Non-fatal injury	04 - Sideswipe	0	02 - Wet	10 - No control	2	0	0	0	0	0	0	0	0
2016	11/23/2016	12:02 PM	BENTLEY AVE @ SUNDERLAND ST & CAMELOT DR (L_32A33R)	Clear	Clear	Clear	01 - Daylight	03 - P.D. only	02 - Angle	0	02 - Wet	10 - No control	0	2	0	0	0	0	0	0	0	0
2016	11/29/2016	8:28 PM	MERVALE RD @ WOODFIELD DR/ROYDON PL (0009776)	Clear	Clear	Clear	01 - Daylight	02 - Non-fatal injury	03 - Rear end	0	01 - Dry	01 - Traffic signal	01 - Functioning	2	0	0	0	0	0	0	0	0
2016	12/13/2016	11:05 AM	MERVALE RD @ WOODFIELD DR/ROYDON PL (0009776)	Clear	Clear	Clear	01 - Daylight	03 - P.D. only	03 - Rear end	0	01 - Loose snow	01 - Traffic signal	01 - Functioning	2	0	0	0	0	0	0	0	0
2016	12/18/2016	4:07 PM	MERVALE RD @ WOODFIELD DR/ROYDON PL (0009776)	Clear	Clear	Clear	01 - Snow	05 - Dark	03 - P.D. only	03 - Rear end	0	02 - Wet	01 - Traffic signal	01 - Functioning	2	0	0	0	0	0	0	0
2016	12/14/2016	5:43 AM	MERVALE RD @ WOODFIELD DR/ROYDON PL (0009776)	Clear	Clear	Clear	01 - Snow	07 - Dark	02 - Non-fatal injury	99 - Other	0	05 - Packed snow	01 - Traffic signal	01 - Functioning	2	0	0	0	0	0	0	0
2016	1/29/2016	4:49 PM	MERVALE RD @ WOODFIELD DR/ROYDON PL (0009776)	Clear	Clear	Clear	01 - Clear	05 - Dark	03 - P.D. only	03 - Rear end	0	04 - Slush	01 - Traffic signal	01 - Functioning	2	0	0	0	0	0	0	0
2016	2/10/2016	2:54 PM	MERVALE RD @ WEST HUNT CLUB RD (0000584)	Clear	Clear	Clear	01 - Clear	01 - Daylight	03 - P.D. only	01 - Dry	01 - Clear	01 - Traffic signal	01 - Functioning	2	0	0	0	0	0	0	0	0
2016	12/27/2016	7:08 PM	MERVALE RD @ WEST HUNT CLUB RD (0000584)	Clear	Clear	Clear	04 - Freezing Rain	07 - Dark	03 - P.D. only	03 - Rear end	0	02 - Wet	01 - Traffic signal	01 - Functioning	3	0	0	0	0	0	0	0
2016	2/6/2016	1:41 PM	MERVALE RD @ WOODFIELD DR/ROYDON PL (0009776)	Clear	Clear	Clear	01 - Clear	01 - Daylight	03 - P.D. only	03 - Rear end	0	01 - Dry	01 - Traffic signal	01 - Functioning	2	0	0	0	0	0	0	0
2016	12/29/2016	12:15 PM	MERVALE RD @ WEST HUNT CLUB RD (0000584)	Clear	Clear	Clear	01 - Snow	01 - Daylight	03 - P.D. only	03 - Rear end	0	06 - Ice	01 - Traffic signal	01 - Functioning	2	0	0	0	0	0	0	0
2016	12/21/2016	2:02 PM	MERVALE RD @ WOODFIELD DR/ROYDON PL (0009776)	Clear	Clear	Clear	01 - Clear	01 - Daylight	03 - P.D. only	03 - Rear end	0	02 - Wet	01 - Traffic signal	01 - Functioning	3	0	0	0	0	0	0	0
2016	12/21/2016	6:15 PM	MERVALE RD @ CLEOPATRA DR (000112)	Clear	Clear	Clear	01 - Clear	07 - Dark	03 - P.D. only	04 - Sideswipe	0	02 - Wet	01 - Traffic signal	00 - Unknown	2	0	0	0	0	0	0	0
2016	1/6/2016	4:15 PM	MERVALE RD @ WEST HUNT CLUB RD (0000584)	Clear	Clear	Clear	01 - Clear	01 - Daylight	03 - P.D. only	03 - Rear end	0	01 - Dry	01 - Traffic signal	01 - Functioning	2	0	0	0	0	0	0	0
2016	2/18/2016	2:00 PM	MERVALE RD @ CLEOPATRA DR (000112)	Clear	Clear	Clear	01 - Clear	01 - Daylight	03 - P.D. only	05 - Turning movement	0	02 - Wet	01 - Traffic signal	01 - Functioning	2	0	0	0	0	0	0	0
2016	2/17/2016	6:24 PM	MERVALE RD @ SUNDERLAND ST & 170 N OF WEST HUNT CLUB RD/COSTCO SC (L_32A33DA)	Clear	Clear	Clear	01 - Snow	07 - Dark	03 - P.D. only	04 - Sideswipe	0	10 - No control	0	2	0	0	0	0	0	0	0	0
2016	2/26/2016	11:53 AM	MERVALE RD @ WEST HUNT CLUB RD (0000584)	Clear	Clear	Clear	02 - Rain	01 - Daylight	03 - P.D. only	03 - Rear end	0	02 - Wet	01 - Traffic signal	01 - Functioning	2	0	0	0	0	0	0	0
2016	3/15/2016	12:07 PM	MERVALE RD @ BENTLEY AVE & ENTREPRE AVE (L_32A34)	Clear	Clear	Clear	02 - Rain	01 - Daylight	03 - P.D. only	04 - Sideswipe	0	02 - Wet	10 - No control	2	0	0	0	0	0	0	0	0
2016	3/14/2016	10:40 AM	MERVALE RD @ SUNDERLAND ST & 170 N OF WEST HUNT CLUB RD/COSTCO SC (L_32A33DA)	Clear	Clear	Clear	01 - Clear	01 - Daylight	03 - P.D. only	03 - Rear end	0	01 - Dry	10 - No control	2	0	0	0	0	0	0	0	0
2016	3/11/2016	11:21 AM	MERVALE RD @ WEST HUNT CLUB RD (0000584)	Clear	Clear	Clear	01 - Clear	01 - Daylight	03 - P.D. only	03 - Rear end	0	01 - Dry	01 - Traffic signal	01 - Functioning	2	0	0	0	0	0	0	0
2016	3/26/2016	12:12 PM	MERVALE RD @ BENTLEY AVE & ENTREPRE AVE (L_32A34)	Clear	Clear	Clear	01 - Clear	01 - Daylight	02 - Non-fatal injury	03 - Rear end	0	01 - Dry	10 - No control	2	0	0	0	0	0	0	0	0
2016	4/24/2016	12:27 PM	MERVALE RD @ WEST HUNT CLUB RD (0000584)	Clear	Clear	Clear	01 - Freezing Rain	07 - Dark	02 - Non-fatal injury	01 - SMV other	0	01 - Slush	01 - Traffic signal	01 - Functioning	2	0	0	0	0	0	0	0
2016	4/7/2016	11:54 AM	MERVALE RD @ WEST HUNT CLUB RD (0000584)	Clear	Clear	Clear	01 - Clear	07 - Dark	02 - Non-fatal injury	03 - SMV other	0	02 - Wet	01 - Traffic signal	01 - Functioning	1	0	0	0	0	0	0	0
2016	4/29/2016	12:39 PM	MERVALE RD @ WEST HUNT CLUB RD (0000584)	Clear	Clear	Clear	01 - Clear	05 - Dark	02 - Non-fatal injury	01 - Dry	01 - Dry	01 - Traffic signal	01 - Functioning	2	0	0	0	0	0	0	0	0
2016	4/29/2016	5:46 PM	MERVALE RD @ 170 N OF HUNTCUB RD/COSTCO CANA (0004681)	Clear	Clear	Clear	01 - Clear	01 - Daylight	03 - P.D. only	03 - Rear end	0	01 - Dry	01 - Traffic signal	01 - Functioning	2	0	0	0	0	0	0	0
2016	4/21/2016	11:43 AM	MERVALE RD @ WEST HUNT CLUB RD (0000584)	Clear	Clear	Clear	01 - Clear	01 - Daylight	03 - P.D. only	03 - Rear end	0	01 - Dry	01 - Traffic signal	01 - Functioning	2	0	0	0	0	0	0	0
2016	4/21/2016	11:45 AM	MERVALE RD @ WEST HUNT CLUB RD & JAMIE AVE (L_32A33J)	Clear	Clear	Clear	01 - Clear	01 - Daylight	03 - P.D. only	01 - Dry	01 - No control	0	0	2	0	0	0	0	0	0	0	
2016	6/3/2016	3:24 PM	MERVALE RD @ 170 N OF HUNTCUB RD/COSTCO CANA (0004681)	Clear	Clear	Clear	01 - Clear	01 - Daylight	03 - P.D. only	03 - Rear end	0	01 - Dry	01 - Traffic signal	01 - Functioning	3	0	0	0	0	0	0	0
2016	5/30/2016	12:45 PM	MERVALE RD @ WEST HUNT CLUB RD (0000584)	Clear	Clear	Clear	01 - Clear	01 - Daylight	02 - Non-fatal injury	03 - Rear end	0	01 - Dry	01 - Traffic signal	01 - Functioning	2	0	0	0	0	0	0	0
2016	5/23/2016	7:47 PM	MERVALE RD @ WEST HUNT CLUB RD (0000584)	Clear	Clear	Clear	02 - Rain	01 - Daylight	02 - Non-fatal injury	03 - Rear end	0	02 - Wet	01 - Traffic signal	01 - Functioning	3	0	0	0	0	0	0	0
2016	6/2/2016	7:48 AM	MERVALE RD @ WEST HUNT CLUB RD (0000584)	Clear	Clear	Clear	01 - Clear	01 - Daylight	02 - Non-fatal injury	03 - Rear end	0	02 - Wet	01 - Traffic signal	01 - Functioning	3	0	0	0	0	0	0	0
2016	11/4/2016	5:27 PM	MERVALE RD @ WOODFIELD DR/ROYDON PL (0009776)	Clear	Clear	Clear	01 - Clear	07 - Dark	03 - P.D. only	03 - Rear end	0	01 - Slush	01 - Traffic signal	01 - Functioning	2	0	0	0	0	0	0	0
2016	6/17/2016	11:14 AM	MERVALE RD @ WEST HUNT CLUB RD/COSTCO SC & WEST HUNT CLUB (L_32A330B)	Clear	Clear	Clear	01 - Clear	07 - Dark	03 - P.D. only	04 - Sideswipe	0	01 - Dry	10 - No control	2	0	0	0	0	0	0	0	
2016	6/18/2016	11:05 AM	BENTLEY AVE @ SUNDERLAND ST & CAMELOT DR (L_32A33R)	Clear	Clear	Clear	01 - Clear	01 - Daylight	03 - P.D. only	99 - Other	0	01 - Dry	10 - No control	2	0	0	0	0	0	0	0	
2016	6/12/2016	6:12 PM	MERVALE RD @ WEST HUNT CLUB RD (0000584)	Clear	Clear	Clear	01 - Clear	01 - Daylight	03 - P.D. only	03 - Rear end	0	01 - Dry	01 - Traffic signal	01 - Functioning	2	0	0	0	0	0	0	0
2016	7/2/2016	2:30 PM	MERVALE RD @ WEST HUNT CLUB RD (0000584)	Clear	Clear	Clear	01 - Clear	01 - Daylight	03 - P.D. only	03 - Rear end	0	01 - Dry	01 - Traffic signal	01 - Functioning	2	0	0	0	0	0	0	0
2016	7/13/2016	8:45 AM	MERVALE RD @ WEST HUNT CLUB RD (0000584)	Clear	Clear	Clear	01 - Clear	01 - Daylight	03 - P.D. only	03 - Rear end	0	01 - Dry	01 - Traffic signal	01 - Functioning	2	0	0	0	0	0	0	0
2016	7/22/2016	9:58 AM	MERVALE RD @ WEST HUNT CLUB RD (0000584)	Clear	Clear	Clear	01 - Clear	01 - Daylight	03 - P.D. only	03 - Rear end	0	01 - Dry	01 - Traffic signal	01 - Functioning	2	0	0	0	0	0	0	0
2016	7/20/2016	10:15 AM	MERVALE RD @ SUNDERLAND ST & CLEOPATRA DR (L_32A33K)	Clear	Clear	Clear	01 - Clear	01 - Daylight	03 - P.D. only	04 - Sideswipe	0	01 - Dry	10 - No control	2	0	0	0	0	0	0	0	
2016	7/18/2016	2:45 PM	MERVALE RD @ WEST HUNT CLUB RD (0000584)	Clear	Clear	Clear	01 - Clear	01 - Daylight	03 - P.D. only	03 - Rear end	0	01 - Dry	01 - Traffic signal	01 - Functioning	2	0	0	0	0	0	0	0
2016	8/15/2016	9:20 PM	MERVALE RD @ 170 N OF HUNTCUB RD/COSTCO CANA (0004681)	Clear	Clear	Clear	01 - Clear	01 - Daylight	03 - P.D. only	03 - Rear end	0	01 - Dry	01 - Traffic signal	01 - Functioning								

2020	5/27/2020	9:30 AM MERVALE RD @ WEST HUNT CLUB RD (0000584)	01 - Clear	01 - Daylight	03 - P.D. only	04 - Sideswipe	0	01 - Dry	01 - Traffic signal	01 - Functioning	2	0	0	0
2020	5/28/2020	9:05 AM MERVALE RD @ WEST HUNT CLUB RD (0000584)	01 - Clear	01 - Daylight	03 - P.D. only	03 - Rear-end	0	01 - Dry	01 - Traffic signal	01 - Functioning	2	0	0	0
2020	5/30/2020	7:59 PM MERVALE RD @ WEST HUNT CLUB RD (0000584)	01 - Clear	05 - Dusk	03 - P.D. only	03 - Rear-end	0	01 - Dry	01 - Traffic signal	00 - Unknown	2	0	0	0
2020	6/12/2020	1:28 PM MERVALE RD @ WEST HUNT CLUB RD (0000584)	01 - Clear	01 - Daylight	03 - P.D. only	03 - Rear-end	0	01 - Dry	01 - Traffic signal	01 - Functioning	2	0	0	0
2020	6/15/2020	10:36 AM MERVALE RD @ WEST HUNT CLUB RD (0000584)	01 - Clear	01 - Daylight	03 - P.D. only	04 - Sideswipe	0	01 - Dry	01 - Traffic signal	01 - Functioning	2	0	0	0
2020	6/30/2020	5:42 PM MERVALE RD @ WOODFIELD DR/ROYDON FL (0009776)	01 - Clear	01 - Daylight	02 - Non-fatal injury	03 - Rear-end	0	01 - Dry	01 - Traffic signal	01 - Functioning	2	0	0	01 - Minimal
2020	6/18/2020	11:06 PM MERVALE RD @ CLEOPATRA DR (0000112)	01 - Clear	01 - Daylight	03 - P.D. only	03 - Rear-end	0	01 - Dry	01 - Traffic signal	01 - Functioning	2	0	0	1
2020	7/6/2020	3:29 PM BENTLEY AVE SWW SUNDERLAND ST & CAMELOT DR (_32A53R)	01 - Clear	01 - Daylight	03 - P.D. only	02 - Angle	0	01 - Dry	10 - No control		2	0	0	0
2020	8/9/2020	8:00 PM MERVALE RD @ WEST HUNT CLUB RD (0000584)	01 - Clear	05 - Dusk	03 - P.D. only	02 - Angle	0	02 - Wet	01 - Traffic signal	01 - Functioning	2	0	0	0
2020	7/12/2020	4:22 PM MERVALE RD @ 170 N OF HUNTCLUB RD/COSTCO/CANA (0004681)	01 - Clear	01 - Daylight	03 - P.D. only	02 - Angle	0	01 - Dry	01 - Traffic signal	01 - Functioning	2	0	0	0
2020	6/11/2020	5:13 PM MERVALE RD @ WOODFIELD DR/ROYDON FL (0009776)	01 - Clear	01 - Daylight	03 - P.D. only	03 - Rear-end	0	01 - Dry	01 - Traffic signal	01 - Functioning	2	0	0	0
2020	8/26/2020	8:00 PM MERVALE RD btwn 170 N OF WEST HUNT CLUB RD/COSTCO SC & WEST HUNT CLUB (_32A330E)	01 - Clear	05 - Dusk	03 - P.D. only	05 - Turning movement	0	01 - Dry	10 - No control		2	0	0	0
2020	9/16/2020	7:20 PM MERVALE RD @ WEST HUNT CLUB RD (0000584)	01 - Clear	05 - Dusk	03 - P.D. only	03 - Rear-end	0	01 - Dry	01 - Traffic signal	01 - Functioning	2	0	0	0
2020	9/6/2020	3:00 PM MERVALE RD @ WEST HUNT CLUB RD (0000584)	01 - Clear	01 - Daylight	03 - P.D. only	03 - Rear-end	0	01 - Dry	01 - Traffic signal	01 - Functioning	3	0	0	0
2020	9/21/2020	2:21 PM MERVALE RD @ WOODFIELD DR/ROYDON FL (0009776)	01 - Clear	01 - Daylight	03 - P.D. only	02 - Angle	0	01 - Dry	01 - Traffic signal	01 - Functioning	2	0	0	0
2020	9/20/2020	9:14 PM MERVALE RD @ WEST HUNT CLUB RD (0000584)	01 - Clear	07 - Dark	03 - P.D. only	03 - Rear-end	0	01 - Dry	01 - Traffic signal	01 - Functioning	2	0	0	0
2020	10/7/2020	11:00 AM MERVALE RD @ 170 N OF HUNTCLUB RD/COSTCO/CANA (0004681)	02 - Rain	01 - Daylight	03 - P.D. only	05 - Turning movement	0	02 - Wet	01 - Traffic signal	01 - Functioning	2	0	0	0
2020	9/27/2020	5:15 PM MERVALE RD @ WOODFIELD DR/ROYDON FL (0009776)	01 - Clear	01 - Daylight	03 - P.D. only	03 - Rear-end	0	01 - Dry	01 - Traffic signal	01 - Functioning	2	0	0	0
2020	10/21/2020	10:24 AM MERVALE RD @ WOODFIELD DR/ROYDON FL (0009776)	02 - Rain	01 - Daylight	02 - Non-fatal injury	07 - SMV other	1	02 - Wet	01 - Traffic signal	01 - Functioning	1	0	0	02 - Minor
2020	10/13/2020	5:11 PM MERVALE RD @ WEST HUNT CLUB RD (0000584)	01 - Clear	05 - Dusk	03 - P.D. only	03 - Rear-end	0	02 - Wet	01 - Traffic signal	01 - Functioning	2	0	0	0
2020	10/14/2020	1:00 PM MERVALE RD @ WEST HUNT CLUB RD (0000584)	01 - Clear	01 - Daylight	03 - P.D. only	03 - Rear-end	0	01 - Dry	01 - Traffic signal	01 - Functioning	2	0	0	0
2020	11/4/2020	1:05 PM MERVALE RD @ WEST HUNT CLUB RD (0000584)	01 - Clear	01 - Daylight	03 - P.D. only	04 - Sideswipe	0	01 - Dry	01 - Traffic signal	01 - Functioning	2	0	0	0
2020	1/18/2020	3:00 PM MERVALE RD @ WEST HUNT CLUB RD (0000584)	01 - Clear	01 - Daylight	03 - P.D. only	02 - Angle	0	01 - Dry	01 - Traffic signal	01 - Functioning	2	0	0	0
2020	10/11/2020	3:00 PM MERVALE RD @ WEST HUNT CLUB RD (0000584)	01 - Clear	01 - Daylight	03 - P.D. only	03 - Rear-end	0	01 - Dry	01 - Traffic signal	00 - Unknown	2	0	0	0
2020	12/16/2020	11:20 AM MERVALE RD @ 170 N OF HUNTCLUB RD/COSTCO/CANA (0004681)	01 - Clear	01 - Daylight	02 - Non-fatal injury	03 - Rear-end	0	01 - Dry	01 - Traffic signal	01 - Functioning	2	0	0	01 - Minimal
2020	11/28/2020	2:16 PM MERVALE RD @ WEST HUNT CLUB RD (0000584)	01 - Clear	01 - Daylight	03 - P.D. only	03 - Rear-end	0	01 - Dry	01 - Traffic signal	01 - Functioning	2	0	0	0
2020	12/7/2020	5:18 PM MERVALE RD @ WOODFIELD DR/ROYDON FL (0009776)	01 - Clear	07 - Dark	02 - Non-fatal injury	03 - Rear-end	0	02 - Wet	01 - Traffic signal	01 - Functioning	3	0	0	02 - Minor
2020	12/11/2020	7:30 AM MERVALE RD @ CLEOPATRA DR (0000112)	01 - Clear	03 - Dawn	03 - P.D. only	07 - SMV other	0	01 - Dry	01 - Traffic signal	01 - Functioning	1	0	0	0

Appendix E:

TRANS Model Output Data

TRANS Regional Model

Version 2.15 - Assigned June 16, 2020

AM Peak Hour Total Traffic Volume

Roydon/Slack

2011 Model - Basecase

N/A

User Initials: KN

Plot Prepared: Aug 17, 2022

EMME Scenario: 21713



Legend

AM Peak Hour Total Traffic Volume

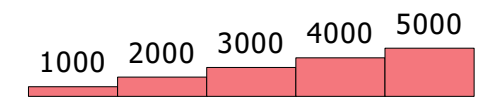

Distance (m)

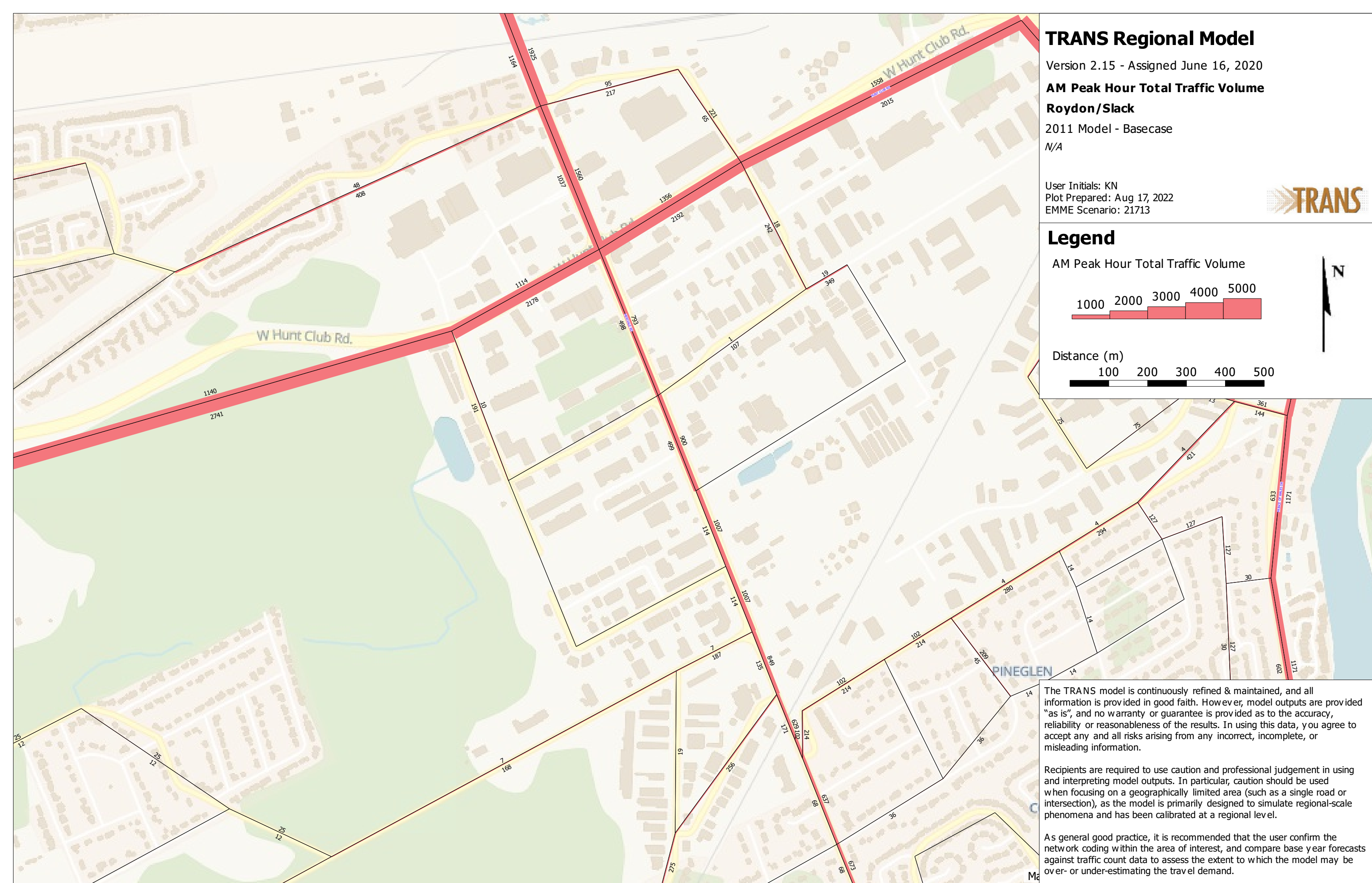

The TRANS model is continuously refined & maintained, and all information is provided in good faith. However, model outputs are provided "as is", and no warranty or guarantee is provided as to the accuracy, reliability or reasonableness of the results. In using this data, you agree to accept any and all risks arising from any incorrect, incomplete, or misleading information.

Recipients are required to use caution and professional judgement in using and interpreting model outputs. In particular, caution should be used when focusing on a geographically limited area (such as a single road or intersection), as the model is primarily designed to simulate regional-scale phenomena and has been calibrated at a regional level.

As general good practice, it is recommended that the user confirm the network coding within the area of interest, and compare base year forecasts against traffic count data to assess the extent to which the model may be over- or under-estimating the travel demand.

Appendix F:

TDM-supportive Development Design and Infrastructure Checklist

TDM-Supportive Development Design and Infrastructure Checklist:
Non-Residential Developments (office, institutional, retail or industrial)

Legend	
REQUIRED	The Official Plan or Zoning By-law provides related guidance that must be followed
BASIC	The measure is generally feasible and effective, and in most cases would benefit the development and its users
BETTER	The measure could maximize support for users of sustainable modes, and optimize development performance

TDM-supportive design & infrastructure measures: <i>Non-residential developments</i>		Check if completed & add descriptions, explanations or plan/drawing references
1. WALKING & CYCLING: ROUTES		
1.1 Building location & access points		
BASIC	1.1.1 Locate building close to the street, and do not locate parking areas between the street and building entrances	<input type="checkbox"/>
BASIC	1.1.2 Locate building entrances in order to minimize walking distances to sidewalks and transit stops/stations	<input checked="" type="checkbox"/>
BASIC	1.1.3 Locate building doors and windows to ensure visibility of pedestrians from the building, for their security and comfort	<input checked="" type="checkbox"/>
1.2 Facilities for walking & cycling		
REQUIRED	1.2.1 Provide convenient, direct access to stations or major stops along rapid transit routes within 600 metres; minimize walking distances from buildings to rapid transit; provide pedestrian-friendly, weather-protected (where possible) environment between rapid transit accesses and building entrances; ensure quality linkages from sidewalks through building entrances to integrated stops/stations (see <i>Official Plan policy 4.3.3</i>)	<input checked="" type="checkbox"/>
REQUIRED	1.2.2 Provide safe, direct and attractive pedestrian access from public sidewalks to building entrances through such measures as: reducing distances between public sidewalks and major building entrances; providing walkways from public streets to major building entrances; within a site, providing walkways along the front of adjoining buildings, between adjacent buildings, and connecting areas where people may congregate, such as courtyards and transit stops; and providing weather protection through canopies, colonnades, and other design elements wherever possible (see <i>Official Plan policy 4.3.12</i>)	<input checked="" type="checkbox"/>

TDM-supportive design & infrastructure measures: <i>Non-residential developments</i>		Check if completed & add descriptions, explanations or plan/drawing references
REQUIRED	1.2.3 Provide sidewalks of smooth, well-drained walking surfaces of contrasting materials or treatments to differentiate pedestrian areas from vehicle areas, and provide marked pedestrian crosswalks at intersection sidewalks (see <i>Official Plan policy 4.3.10</i>)	<input checked="" type="checkbox"/>
REQUIRED	1.2.4 Make sidewalks and open space areas easily accessible through features such as gradual grade transition, depressed curbs at street corners and convenient access to extra-wide parking spaces and ramps (see <i>Official Plan policy 4.3.10</i>)	<input checked="" type="checkbox"/>
REQUIRED	1.2.5 Include adequately spaced inter-block/street cycling and pedestrian connections to facilitate travel by active transportation. Provide links to the existing or planned network of public sidewalks, multi-use pathways and on-road cycle routes. Where public sidewalks and multi-use pathways intersect with roads, consider providing traffic control devices to give priority to cyclists and pedestrians (see <i>Official Plan policy 4.3.11</i>)	<input checked="" type="checkbox"/>
BASIC	1.2.6 Provide safe, direct and attractive walking routes from building entrances to nearby transit stops	<input checked="" type="checkbox"/>
BASIC	1.2.7 Ensure that walking routes to transit stops are secure, visible, lighted, shaded and wind-protected wherever possible	<input type="checkbox"/>
BASIC	1.2.8 Design roads used for access or circulation by cyclists using a target operating speed of no more than 30 km/h, or provide a separated cycling facility	<input type="checkbox"/>
1.3 Amenities for walking & cycling		
BASIC	1.3.1 Provide lighting, landscaping and benches along walking and cycling routes between building entrances and streets, sidewalks and trails	<input type="checkbox"/>
BASIC	1.3.2 Provide wayfinding signage for site access (where required, e.g. when multiple buildings or entrances exist) and egress (where warranted, such as when directions to reach transit stops/stations, trails or other common destinations are not obvious)	<input checked="" type="checkbox"/>

TDM-supportive design & infrastructure measures: <i>Non-residential developments</i>		Check if completed & add descriptions, explanations or plan/drawing references
2. WALKING & CYCLING: END-OF-TRIP FACILITIES		
2.1 Bicycle parking		
REQUIRED	2.1.1 Provide bicycle parking in highly visible and lighted areas, sheltered from the weather wherever possible (see <i>Official Plan policy 4.3.6</i>)	<input checked="" type="checkbox"/>
REQUIRED	2.1.2 Provide the number of bicycle parking spaces specified for various land uses in different parts of Ottawa; provide convenient access to main entrances or well-used areas (see <i>Zoning By-law Section 111</i>)	<input checked="" type="checkbox"/>
REQUIRED	2.1.3 Ensure that bicycle parking spaces and access aisles meet minimum dimensions; that no more than 50% of spaces are vertical spaces; and that parking racks are securely anchored (see <i>Zoning By-law Section 111</i>)	<input checked="" type="checkbox"/>
BASIC	2.1.4 Provide bicycle parking spaces equivalent to the expected number of commuter cyclists (assuming the cycling mode share target is met), plus the expected peak number of customer/visitor cyclists	<input type="checkbox"/>
BETTER	2.1.5 Provide bicycle parking spaces equivalent to the expected number of commuter and customer/visitor cyclists, plus an additional buffer (e.g. 25 percent extra) to encourage other cyclists and ensure adequate capacity in peak cycling season	<input type="checkbox"/>
2.2 Secure bicycle parking		
REQUIRED	2.2.1 Where more than 50 bicycle parking spaces are provided for a single office building, locate at least 25% of spaces within a building/structure, a secure area (e.g. supervised parking lot or enclosure) or bicycle lockers (see <i>Zoning By-law Section 111</i>)	<input type="checkbox"/>
BETTER	2.2.2 Provide secure bicycle parking spaces equivalent to the expected number of commuter cyclists (assuming the cycling mode share target is met)	<input type="checkbox"/>
2.3 Shower & change facilities		
BASIC	2.3.1 Provide shower and change facilities for the use of active commuters	<input type="checkbox"/>
BETTER	2.3.2 In addition to shower and change facilities, provide dedicated lockers, grooming stations, drying racks and laundry facilities for the use of active commuters	<input type="checkbox"/>
2.4 Bicycle repair station		
BETTER	2.4.1 Provide a permanent bike repair station, with commonly used tools and an air pump, adjacent to the main bicycle parking area (or secure bicycle parking area, if provided)	<input type="checkbox"/>

TDM-supportive design & infrastructure measures: <i>Non-residential developments</i>		Check if completed & add descriptions, explanations or plan/drawing references
3. TRANSIT		
3.1 Customer amenities		
BASIC	3.1.1 Provide shelters, lighting and benches at any on-site transit stops	<input type="checkbox"/>
BASIC	3.1.2 Where the site abuts an off-site transit stop and insufficient space exists for a transit shelter in the public right-of-way, protect land for a shelter and/or install a shelter	<input type="checkbox"/>
BETTER	3.1.3 Provide a secure and comfortable interior waiting area by integrating any on-site transit stops into the building	<input type="checkbox"/>
4. RIDESHARING		
4.1 Pick-up & drop-off facilities		
BASIC	4.1.1 Provide a designated area for carpool drivers (plus taxis and ride-hailing services) to drop off or pick up passengers without using fire lanes or other no-stopping zones	<input type="checkbox"/>
4.2 Carpool parking		
BASIC	4.2.1 Provide signed parking spaces for carpools in a priority location close to a major building entrance, sufficient in number to accommodate the mode share target for carpools	<input type="checkbox"/>
BETTER	4.2.2 At large developments, provide spaces for carpools in a separate, access-controlled parking area to simplify enforcement	<input type="checkbox"/>
5. CARSHARING & BIKESHARING		
5.1 Carshare parking spaces		
BETTER	5.1.1 Provide carshare parking spaces in permitted non-residential zones, occupying either required or provided parking spaces (<i>see Zoning By-law Section 94</i>)	<input type="checkbox"/>
5.2 Bikeshare station location		
BETTER	5.2.1 Provide a designated bikeshare station area near a major building entrance, preferably lighted and sheltered with a direct walkway connection	<input type="checkbox"/>

TDM-supportive design & infrastructure measures: <i>Non-residential developments</i>		Check if completed & add descriptions, explanations or plan/drawing references
6. PARKING		
6.1 Number of parking spaces		
REQUIRED	6.1.1 Do not provide more parking than permitted by zoning, nor less than required by zoning, unless a variance is being applied for	<input checked="" type="checkbox"/>
BASIC	6.1.2 Provide parking for long-term and short-term users that is consistent with mode share targets, considering the potential for visitors to use off-site public parking	<input type="checkbox"/>
BASIC	6.1.3 Where a site features more than one use, provide shared parking and reduce the cumulative number of parking spaces accordingly (<i>see Zoning By-law Section 104</i>)	<input type="checkbox"/>
BETTER	6.1.4 Reduce the minimum number of parking spaces required by zoning by one space for each 13 square metres of gross floor area provided as shower rooms, change rooms, locker rooms and other facilities for cyclists in conjunction with bicycle parking (<i>see Zoning By-law Section 111</i>)	<input type="checkbox"/>
6.2 Separate long-term & short-term parking areas		
BETTER	6.2.1 Separate short-term and long-term parking areas using signage or physical barriers, to permit access controls and simplify enforcement (i.e. to discourage employees from parking in visitor spaces, and vice versa)	<input type="checkbox"/>
7. OTHER		
7.1 On-site amenities to minimize off-site trips		
BETTER	7.1.1 Provide on-site amenities to minimize mid-day or mid-commute errands	<input type="checkbox"/>

Appendix G:

Truck Turning Templates

IN ALTERNATION OR DISTRIBUTION OF
IN CONFORMANCE OF PARALLEL ADAPTATION
TBD

MERIVALE ROAD

JAMIE AVENUE

BUILDING B
PROPOSED
ONE-STORY WAREHOUSE
3,070sm / 33,050sf

BUILDING A



Legend

Not to Scale

Drawing Description		WB-20 IN	
Client	Date	Feb 21, 2023	Figure Number
Project Number	478378	Project Description	1881-1883 Merivale Rd
		001	



NOTE: The location of utilities is approximate only, the exact location should be determined by consulting the municipal authorities and utility companies concerned. The contractor shall prove the location of utilities and shall be responsible for adequate protection from damage.

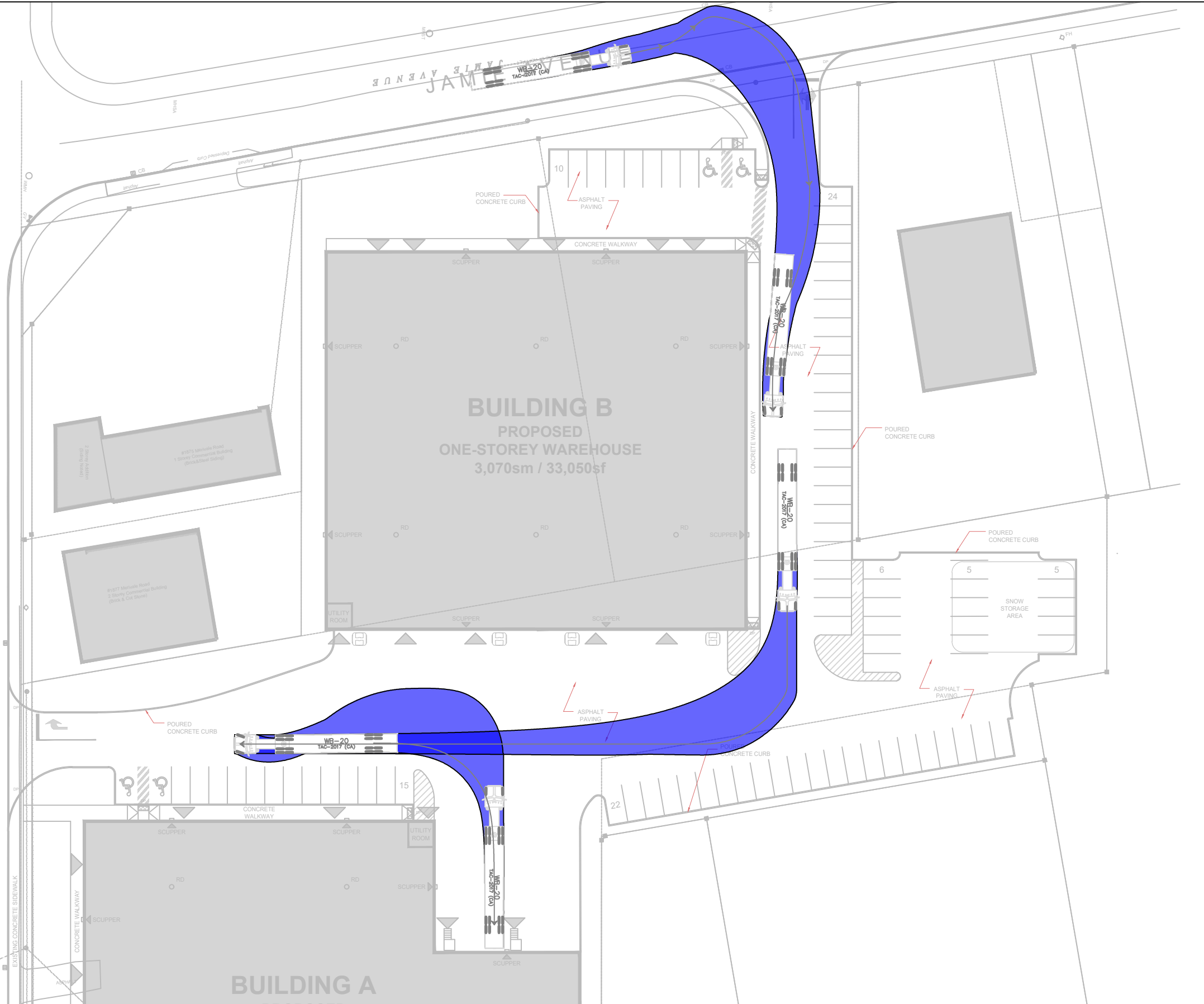

IN ALTERNATION OR DISTRIBUTION OF
IN CONSENT OF PARALLEL OFFICER
TBD

MERIVALE ROAD

JAMIE AVENUE

BUILDING B
PROPOSED
ONE-STORY WAREHOUSE
3,070sm / 33,050sf

BUILDING A



Legend

Drawing Description

WB-20 OUT

Client

Date

Feb 21, 2023

Figure Number

002

Project Number

478378

Project Description

1881-1883 Merivale Rd

Not to Scale

NOTE: The location of utilities is approximate only, the exact location should be determined by consulting the municipal authorities and utility companies concerned. The contractor shall prove the location of utilities and shall be responsible for adequate protection from damage.



Appendix H:

MMLOS Analysis Results

Multi-Modal Level of Service - Segments Form

Consultant Scenario Comments	Parsons	Project Date	478378-01000
	Existing and Future		22-Sep-22

SEGMENTS		Street A	Merivale Rd 1	Jamie Ave 2	Jamie Ave (Future) 3
Pedestrian	Sidewalk Width	-	≥ 2 m	no sidewalk	≥ 2 m
	Boulevard Width		< 0.5	n/a	< 0.5
	Avg Daily Curb Lane Traffic Volume		> 3000	≤ 3000	≤ 3000
	Operating Speed		> 60 km/h	> 50 to 60 km/h	> 50 to 60 km/h
	On-Street Parking		no	no	no
	Exposure to Traffic PLoS		F	F	C
	Effective Sidewalk Width				
Pedestrian Volume					
Crowding PLoS	-	-	-		
Level of Service	-	-	-		
Bicycle	Type of Cycling Facility	F	Mixed Traffic	Mixed Traffic	
	Number of Travel Lanes		≤ 2 (no centreline)	4-5 lanes total	
	Operating Speed		≥ 60 km/h	≥ 60 km/h	
	# of Lanes & Operating Speed LoS		F	F	-
	Bike Lane (+ Parking Lane) Width				
	Bike Lane Width LoS		-	-	-
	Bike Lane Blockages				
	Blockage LoS		-	-	-
	Median Refuge Width (no median = < 1.8 m)		≥ 1.8 m refuge	< 1.8 m refuge	
	No. of Lanes at Unsignalized Crossing		≤ 3 lanes	≤ 3 lanes	
Sidestreet Operating Speed	>40 to 50 km/h	>40 to 50 km/h			
Unsignalized Crossing - Lowest LoS	A	B	-		
Level of Service	F	F	-		
Transit	Facility Type	D	Mixed Traffic		
	Friction or Ratio Transit:Posted Speed		Vt/Vp ≥ 0.8		
	Level of Service		D	-	-
Truck	Truck Lane Width	B	> 3.7 m	> 3.7 m	
	Travel Lanes per Direction		> 1	1	
	Level of Service		A	B	-

Multi-Modal Level of Service - Intersections Form

Consultant
Scenario
Comments

Parsons
Existing

Project
Date

478378-01000
23-Sep-22

INTERSECTIONS		Merivale / Hunt Club				Merivale / Bentley / Camelot			
Crossing Side		NORTH	SOUTH	EAST	WEST	NORTH	SOUTH	EAST	WEST
Pedestrian	Lanes	10+	10+	10+	10+	10+	10+	7	8
	Median	No Median - 2.4 m	No Median - 2.4 m	No Median - 2.4 m	No Median - 2.4 m	No Median - 2.4 m	No Median - 2.4 m	No Median - 2.4 m	Median > 2.4 m
	Conflicting Left Turns	Protected	Protected	Protected	Protected	Permissive	Permissive	Permissive	Permissive
	Conflicting Right Turns	Permissive or yield control	Permissive or yield control	Permissive or yield control	Permissive or yield control	Permissive or yield control	Permissive or yield control	Permissive or yield control	Permissive or yield control
	Right Turns on Red (RTOR) ?	RTOR allowed	RTOR allowed	RTOR allowed	RTOR allowed	RTOR allowed	RTOR allowed	RTOR allowed	RTOR allowed
	Ped Signal Leading Interval?	No	No	No	No	No	No	No	No
	Right Turn Channel	Conv'tl without Receiving Lane	Conventional with Receiving Lane	Conventional with Receiving Lane	Conventional with Receiving Lane	No Channel	No Channel	Conv'tl without Receiving Lane	Conv'tl without Receiving Lane
	Corner Radius	>25m	15-25m	15-25m	15-25m	15-25m	15-25m	15-25m	15-25m
	Crosswalk Type	Std transverse markings	Std transverse markings	Std transverse markings	Std transverse markings	Std transverse markings	Std transverse markings	Std transverse markings	Std transverse markings
	PETSI Score	-36	-38	-38	-38	-47	-47	6	-3
	Ped. Exposure to Traffic LoS	#N/A	#N/A	#N/A	#N/A	#N/A	#N/A	F	F
	Cycle Length	130	130	130	130	110	110	110	110
	Effective Walk Time	18	12	13	13	58	43	7	7
	Average Pedestrian Delay	48	54	53	53	12	20	48	48
Pedestrian Delay LoS	E	E	E	E	B	C	E	E	
Level of Service	#N/A	#N/A	#N/A	#N/A	#N/A	#N/A	F	F	
		#N/A				#N/A			
Approach From		NORTH	SOUTH	EAST	WEST	NORTH	SOUTH	EAST	WEST
Bicycle	Bicycle Lane Arrangement on Approach	Mixed Traffic	Mixed Traffic	Pocket Bike Lane	Pocket Bike Lane	Mixed Traffic	Mixed Traffic	Mixed Traffic	Mixed Traffic
	Right Turn Lane Configuration	> 50 m	> 50 m	≤ 50 m Introduced right turn lane	≤ 50 m Introduced right turn lane	≤ 50 m	≤ 50 m	≤ 50 m	≤ 50 m
	Right Turning Speed	≤ 25 km/h	≤ 25 km/h	≤ 25 km/h	≤ 25 km/h	≤ 25 km/h	≤ 25 km/h	≤ 25 km/h	≤ 25 km/h
	Cyclist relative to RT motorists	F	F	B	B	D	D	D	D
	Separated or Mixed Traffic	Mixed Traffic	Mixed Traffic	Separated	Separated	Mixed Traffic	Mixed Traffic	Mixed Traffic	Mixed Traffic
	Left Turn Approach	≥ 2 lanes crossed	≥ 2 lanes crossed	1 lane crossed	1 lane crossed	One lane crossed	One lane crossed	No lane crossed	No lane crossed
	Operating Speed	≥ 60 km/h	≥ 60 km/h	≥ 60 km/h	≥ 60 km/h	≥ 60 km/h	≥ 60 km/h	≥ 60 km/h	≥ 60 km/h
Left Turning Cyclist	F	F	E	E	F	F	C	C	
Level of Service	F	F	E	E	F	F	D	D	
		F				F			
Transit	Average Signal Delay	> 40 sec	> 40 sec	> 40 sec		≤ 20 sec	≤ 20 sec	> 40 sec	≤ 40 sec
	Level of Service	F	F	F	-	C	C	F	E
		F				F			
Truck	Effective Corner Radius	> 15 m	> 15 m	> 15 m	> 15 m	> 15 m	> 15 m	> 15 m	> 15 m
	Number of Receiving Lanes on Departure from Intersection	≥ 2	≥ 2	≥ 2	≥ 2	1	1	≥ 2	≥ 2
Level of Service	A	A	A	A	C	C	A	A	
		A				C			
Auto	Volume to Capacity Ratio	0.91 - 1.00				0.61 - 0.70			
	Level of Service	E				B			

Appendix I:

Synchro Analysis Results

Existing Conditions

Lanes, Volumes, Timings
1: Merivale Rd & West Hunt Club Rd

09/21/2022



Lane Group	EBL	EBT	WBL	WBT	NBL	NBT	NBR	SBL	SBT	SBR
Lane Configurations										
Traffic Volume (vph)	287	849	92	586	91	943	82	176	418	233
Future Volume (vph)	287	849	92	586	91	943	82	176	418	233
Lane Group Flow (vph)	319	1055	102	819	101	1048	91	196	464	259
Turn Type	Prot	NA	Prot	NA	Prot	NA	Perm	Prot	NA	Perm
Protected Phases	7	4	3	8	5	2		1	6	
Permitted Phases							2			6
Detector Phase	7	4	3	8	5	2	2	1	6	6
Switch Phase										
Minimum Initial (s)	5.0	10.0	5.0	10.0	5.0	10.0	10.0	5.0	10.0	10.0
Minimum Split (s)	12.0	33.6	12.0	33.6	11.6	38.6	38.6	11.6	38.6	38.6
Total Split (s)	29.0	45.0	20.0	36.0	23.0	52.0	52.0	13.0	42.0	42.0
Total Split (%)	22.3%	34.6%	15.4%	27.7%	17.7%	40.0%	40.0%	10.0%	32.3%	32.3%
Yellow Time (s)	4.6	4.6	4.6	4.6	3.7	3.7	3.7	3.7	3.7	3.7
All-Red Time (s)	2.4	2.0	2.4	2.0	2.9	2.9	2.9	2.9	2.9	2.9
Lost Time Adjust (s)	0.0	0.0	0.0	0.0	0.0	0.0	0.0	0.0	0.0	0.0
Total Lost Time (s)	7.0	6.6	7.0	6.6	6.6	6.6	6.6	6.6	6.6	6.6
Lead/Lag	Lead	Lag	Lead	Lag	Lead	Lag	Lag	Lead	Lag	Lag
Lead-Lag Optimize?	Yes	Yes	Yes	Yes	Yes	Yes	Yes	Yes	Yes	Yes
Recall Mode	None	C-Max	None	C-Max	None	None	None	None	None	None
Act Effct Green (s)	18.0	40.6	11.9	34.5	13.4	44.3	44.3	6.4	37.3	37.3
Actuated g/C Ratio	0.14	0.31	0.09	0.27	0.10	0.34	0.34	0.05	0.29	0.29
v/c Ratio	0.72	1.04	0.72	0.65	0.66	0.92	0.15	1.24	0.50	0.43
Control Delay	63.1	81.8	84.6	43.7	75.8	54.0	0.5	199.8	41.1	6.6
Queue Delay	0.0	0.0	0.0	0.0	0.0	0.0	0.0	0.0	0.0	0.0
Total Delay	63.1	81.8	84.6	43.7	75.8	54.0	0.5	199.8	41.1	6.6
LOS	E	F	F	D	E	D	A	F	D	A
Approach Delay		77.5		48.2		51.9			65.3	
Approach LOS		E		D		D			E	
Queue Length 50th (m)	40.8	~160.2	25.6	65.8	25.1	133.0	0.0	~32.0	51.9	0.0
Queue Length 95th (m)	54.7	#202.1	#49.0	84.2	43.3	#170.5	0.0	#56.3	70.3	20.3
Internal Link Dist (m)		173.3		390.9		150.6			154.0	
Turn Bay Length (m)	90.0		70.0		65.0		130.0	60.0		125.0
Base Capacity (vph)	540	1017	155	1251	188	1172	609	158	927	602
Starvation Cap Reductn	0	0	0	0	0	0	0	0	0	0
Spillback Cap Reductn	0	0	0	0	0	0	0	0	0	0
Storage Cap Reductn	0	0	0	0	0	0	0	0	0	0
Reduced v/c Ratio	0.59	1.04	0.66	0.65	0.54	0.89	0.15	1.24	0.50	0.43

Intersection Summary

Cycle Length: 130
 Actuated Cycle Length: 130
 Offset: 102 (78%), Referenced to phase 4:EBT and 8:WBT, Start of Green
 Natural Cycle: 120
 Control Type: Actuated-Coordinated
 Maximum v/c Ratio: 1.24
 Intersection Signal Delay: 61.8
 Intersection Capacity Utilization 88.7%
 Analysis Period (min) 15
 ~ Volume exceeds capacity, queue is theoretically infinite.
 Queue shown is maximum after two cycles.
 # 95th percentile volume exceeds capacity, queue may be longer.
 Queue shown is maximum after two cycles.

Splits and Phases: 1: Merivale Rd & West Hunt Club Rd

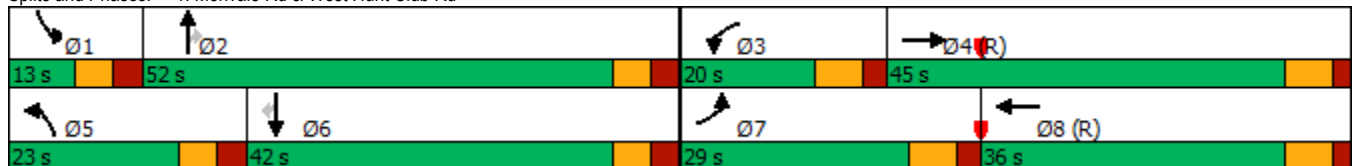

Lanes, Volumes, Timings 2:
 Merivale Rd & Jamie Ave

09/21/2022



Lane Group	WBL	WBR	NBT	SBL	SBT
Lane Configurations					
Traffic Volume (vph)	11	30	1206	29	596
Future Volume (vph)	11	30	1206	29	596
Lane Group Flow (vph)	12	33	1373	32	662
Sign Control	Stop		Free		Free
Intersection Summary					
Control Type: Unsignalized					
Intersection Capacity Utilization 46.2%			ICU Level of Service A		
Analysis Period (min) 15					

HCM Unsignalized Intersection Capacity Analysis
 2: Merivale Rd & Jamie Ave

09/21/2022



Movement	WBL	WBR	NBT	NBR	SBL	SBT	
Lane Configurations							
Traffic Volume (veh/h)	11	30	1206	30	29	596	
Future Volume (Veh/h)	11	30	1206	30	29	596	
Sign Control	Stop		Free		Free		
Grade	0%		0%		0%		
Peak Hour Factor	0.90	0.90	0.90	0.90	0.90	0.90	
Hourly flow rate (vph)	12	33	1340	33	32	662	
Pedestrians	7		2				
Lane Width (m)	3.7		3.7				
Walking Speed (m/s)	1.0		1.0				
Percent Blockage	1		0				
Right turn flare (veh)			None		None		
Median type			None		None		
Median storage (veh)							
Upstream signal (m)			233		175		
pX, platoon unblocked	0.78	0.72			0.72		
vC, conflicting volume	1760	694			1380		
vC1, stage 1 conf vol							
vC2, stage 2 conf vol							
vCu, unblocked vol	784	0			758		
tC, single (s)	6.8	7.0			4.2		
tC, 2 stage (s)							
tF (s)	3.5	3.4			2.2		
p0 queue free %	95	96			95		
cM capacity (veh/h)	240	766			604		
Direction, Lane #	WB 1	WB 2	NB 1	NB 2	SB 1	SB 2	SB 3
Volume Total	12	33	893	480	32	331	331
Volume Left	12	0	0	0	32	0	0
Volume Right	0	33	0	33	0	0	0
cSH	240	766	1700	1700	604	1700	1700
Volume to Capacity	0.05	0.04	0.53	0.28	0.05	0.19	0.19
Queue Length 95th (m)	1.2	1.0	0.0	0.0	1.3	0.0	0.0
Control Delay (s)	20.8	9.9	0.0	0.0	11.3	0.0	0.0
Lane LOS	C	A			B		
Approach Delay (s)	12.8		0.0		0.5		
Approach LOS	B						
Intersection Summary							
Average Delay			0.4				
Intersection Capacity Utilization			46.2%		ICU Level of Service		A
Analysis Period (min)			15				

Lanes, Volumes, Timings
5: Merivale Rd & Camelot Dr/Bentley Ave

09/21/2022



Lane Group	EBL	EBT	WBL	WBT	WBR	NBL	NBT	SBL	SBT
Lane Configurations									
Traffic Volume (vph)	15	31	47	11	46	140	1234	61	450
Future Volume (vph)	15	31	47	11	46	140	1234	61	450
Lane Group Flow (vph)	17	118	52	12	51	156	1560	68	577
Turn Type	Perm	NA	Perm	NA	Perm	Perm	NA	pm+pt	NA
Protected Phases		4		8			2	1	6
Permitted Phases	4		8		8	2		6	
Detector Phase	4	4	8	8	8	2	2	1	6
Switch Phase									
Minimum Initial (s)	10.0	10.0	10.0	10.0	10.0	10.0	10.0	5.0	10.0
Minimum Split (s)	31.3	31.3	31.3	31.3	31.3	35.9	35.9	10.8	35.9
Total Split (s)	31.0	31.0	31.0	31.0	31.0	64.0	64.0	15.0	79.0
Total Split (%)	28.2%	28.2%	28.2%	28.2%	28.2%	58.2%	58.2%	13.6%	71.8%
Yellow Time (s)	3.3	3.3	3.3	3.3	3.3	3.7	3.7	3.7	3.7
All-Red Time (s)	3.0	3.0	3.0	3.0	3.0	2.2	2.2	2.1	2.2
Lost Time Adjust (s)	0.0	0.0	0.0	0.0	0.0	0.0	0.0	0.0	0.0
Total Lost Time (s)	6.3	6.3	6.3	6.3	6.3	5.9	5.9	5.8	5.9
Lead/Lag						Lag	Lag	Lead	
Lead-Lag Optimize?						Yes	Yes	Yes	
Recall Mode	None	None	None	None	None	C-Max	C-Max	None	C-Max
Act Effct Green (s)	11.8	11.8	11.8	11.8	11.8	75.7	75.7	86.1	86.0
Actuated g/C Ratio	0.11	0.11	0.11	0.11	0.11	0.69	0.69	0.78	0.78
v/c Ratio	0.12	0.49	0.46	0.07	0.23	0.30	0.70	0.29	0.24
Control Delay	44.9	23.2	59.3	43.6	5.1	10.1	13.6	6.2	3.4
Queue Delay	0.0	0.0	0.0	0.0	0.0	0.0	0.0	0.0	0.0
Total Delay	44.9	23.2	59.3	43.6	5.1	10.1	13.6	6.2	3.4
LOS	D	C	E	D	A	B	B	A	A
Approach Delay		25.9		33.6			13.3		3.7
Approach LOS		C		C			B		A
Queue Length 50th (m)	3.4	6.9	10.8	2.4	0.0	12.0	95.8	2.5	12.3
Queue Length 95th (m)	9.7	23.1	22.5	7.8	3.8	28.4	151.5	6.6	21.6
Internal Link Dist (m)		412.3		581.1			116.9		209.2
Turn Bay Length (m)	35.0		35.0		25.0	40.0		80.0	
Base Capacity (vph)	298	412	233	346	373	521	2225	267	2447
Starvation Cap Reductn	0	0	0	0	0	0	0	0	0
Spillback Cap Reductn	0	0	0	0	0	0	0	0	0
Storage Cap Reductn	0	0	0	0	0	0	0	0	0
Reduced v/c Ratio	0.06	0.29	0.22	0.03	0.14	0.30	0.70	0.25	0.24

Intersection Summary

Cycle Length: 110
 Actuated Cycle Length: 110
 Offset: 103 (94%), Referenced to phase 2:NBT and 6:SBTL, Start of Green
 Natural Cycle: 90
 Control Type: Actuated-Coordinated
 Maximum v/c Ratio: 0.70
 Intersection Signal Delay: 12.5
 Intersection Capacity Utilization 75.8%
 Analysis Period (min) 15

Intersection LOS: B
 ICU Level of Service D

Splits and Phases: 5: Merivale Rd & Camelot Dr/Bentley Ave



Lanes, Volumes, Timings
1: Merivale Rd & West Hunt Club Rd

09/21/2022



Lane Group	EBL	EBT	WBL	WBT	NBL	NBT	NBR	SBL	SBT	SBR
Lane Configurations										
Traffic Volume (vph)	251	569	152	1017	138	522	104	178	778	289
Future Volume (vph)	251	569	152	1017	138	522	104	178	778	289
Lane Group Flow (vph)	279	762	169	1418	153	580	116	198	864	321
Turn Type	Prot	NA	Prot	NA	Prot	NA	Perm	Prot	NA	Perm
Protected Phases	7	4	3	8	5	2		1	6	
Permitted Phases							2			6
Detector Phase	7	4	3	8	5	2	2	1	6	6
Switch Phase										
Minimum Initial (s)	5.0	10.0	5.0	10.0	5.0	10.0	10.0	5.0	10.0	10.0
Minimum Split (s)	12.0	33.6	12.0	33.6	11.6	38.6	38.6	11.6	38.6	38.6
Total Split (s)	20.0	39.0	26.0	45.0	20.0	45.0	45.0	20.0	45.0	45.0
Total Split (%)	15.4%	30.0%	20.0%	34.6%	15.4%	34.6%	34.6%	15.4%	34.6%	34.6%
Yellow Time (s)	4.6	4.6	4.6	4.6	3.7	3.7	3.7	3.7	3.7	3.7
All-Red Time (s)	2.4	2.0	2.4	2.0	2.9	2.9	2.9	2.9	2.9	2.9
Lost Time Adjust (s)	0.0	0.0	0.0	0.0	0.0	0.0	0.0	0.0	0.0	0.0
Total Lost Time (s)	7.0	6.6	7.0	6.6	6.6	6.6	6.6	6.6	6.6	6.6
Lead/Lag	Lead	Lag	Lead	Lag	Lead	Lag	Lag	Lead	Lag	Lag
Lead-Lag Optimize?	Yes	Yes	Yes	Yes	Yes	Yes	Yes	Yes	Yes	Yes
Recall Mode	None	C-Max	None	C-Max	None	None	None	None	None	None
Act Effct Green (s)	12.9	35.0	17.3	39.3	13.4	38.7	38.7	12.2	37.5	37.5
Actuated g/C Ratio	0.10	0.27	0.13	0.30	0.10	0.30	0.30	0.09	0.29	0.29
v/c Ratio	0.85	0.87	0.82	0.97	0.92	0.58	0.22	0.65	0.89	0.51
Control Delay	81.4	56.9	83.4	61.1	109.5	41.6	3.7	66.9	56.7	9.6
Queue Delay	0.0	0.0	0.0	0.0	0.0	0.0	0.0	0.0	0.0	0.0
Total Delay	81.4	56.9	83.4	61.1	109.5	41.6	3.7	66.9	56.7	9.6
LOS	F	E	F	E	F	D	A	E	E	A
Approach Delay		63.4		63.4		48.6			47.2	
Approach LOS		E		E		D			D	
Queue Length 50th (m)	36.8	99.1	42.1	129.3	39.5	66.5	0.0	25.4	110.6	7.8
Queue Length 95th (m)	#59.6	#137.2	#74.6	#163.9	#80.2	85.5	8.2	38.0	#139.5	32.8
Internal Link Dist (m)		173.3		390.9		150.6			154.0	
Turn Bay Length (m)	90.0		70.0		65.0		130.0	60.0		125.0
Base Capacity (vph)	328	873	227	1460	166	1001	527	335	991	636
Starvation Cap Reductn	0	0	0	0	0	0	0	0	0	0
Spillback Cap Reductn	0	0	0	0	0	0	0	0	0	0
Storage Cap Reductn	0	0	0	0	0	0	0	0	0	0
Reduced v/c Ratio	0.85	0.87	0.74	0.97	0.92	0.58	0.22	0.59	0.87	0.50

Intersection Summary

Cycle Length: 130
 Actuated Cycle Length: 130
 Offset: 28 (22%), Referenced to phase 4:EBT and 8:WBT, Start of Green
 Natural Cycle: 110
 Control Type: Actuated-Coordinated
 Maximum v/c Ratio: 0.97
 Intersection Signal Delay: 56.2
 Intersection Capacity Utilization 88.1%
 Analysis Period (min) 15
 # 95th percentile volume exceeds capacity, queue may be longer.
 Queue shown is maximum after two cycles.

Intersection LOS: E
 ICU Level of Service E

Splits and Phases: 1: Merivale Rd & West Hunt Club Rd

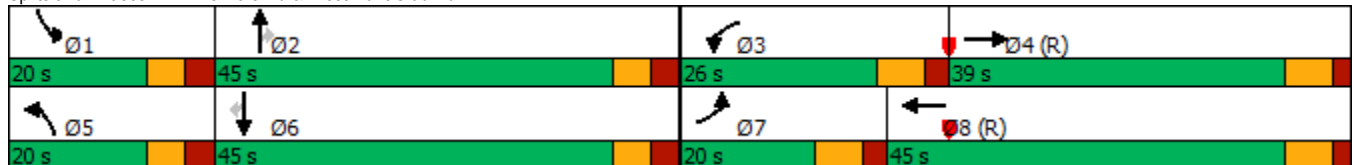

Lanes, Volumes, Timings 2:
Merivale Rd & Jamie Ave

09/21/2022



Lane Group	WBL	WBR	NBT	SBL	SBT
Lane Configurations					
Traffic Volume (vph)	26	48	771	25	1180
Future Volume (vph)	26	48	771	25	1180
Lane Group Flow (vph)	29	53	876	28	1311
Sign Control	Stop		Free		Free
Intersection Summary					
Control Type: Unsignalized					
Intersection Capacity Utilization 44.4%			ICU Level of Service A		
Analysis Period (min) 15					

HCM Unsignalized Intersection Capacity Analysis
 2: Merivale Rd & Jamie Ave

09/21/2022



Movement	WBL	WBR	NBT	NBR	SBL	SBT	
Lane Configurations							
Traffic Volume (veh/h)	26	48	771	17	25	1180	
Future Volume (Veh/h)	26	48	771	17	25	1180	
Sign Control	Stop		Free			Free	
Grade	0%		0%			0%	
Peak Hour Factor	0.90	0.90	0.90	0.90	0.90	0.90	
Hourly flow rate (vph)	29	53	857	19	28	1311	
Pedestrians	9		3				
Lane Width (m)	3.7		3.7				
Walking Speed (m/s)	1.0		1.0				
Percent Blockage	1		0				
Right turn flare (veh)							
Median type			None			None	
Median storage (veh)							
Upstream signal (m)			233			175	
pX, platoon unblocked	0.80	0.92			0.92		
vC, conflicting volume	1590	447			885		
vC1, stage 1 conf vol							
vC2, stage 2 conf vol							
vCu, unblocked vol	796	235			709		
tC, single (s)	6.8	7.0			4.1		
tC, 2 stage (s)							
tF (s)	3.5	3.3			2.2		
p0 queue free %	88	92			97		
cM capacity (veh/h)	246	696			810		
Direction, Lane #	WB 1	WB 2	NB 1	NB 2	SB 1	SB 2	SB 3
Volume Total	29	53	571	305	28	656	656
Volume Left	29	0	0	0	28	0	0
Volume Right	0	53	0	19	0	0	0
cSH	246	696	1700	1700	810	1700	1700
Volume to Capacity	0.12	0.08	0.34	0.18	0.03	0.39	0.39
Queue Length 95th (m)	3.0	1.9	0.0	0.0	0.8	0.0	0.0
Control Delay (s)	21.6	10.6	0.0	0.0	9.6	0.0	0.0
Lane LOS	C	B			A		
Approach Delay (s)	14.5		0.0		0.2		
Approach LOS	B						
Intersection Summary							
Average Delay			0.6				
Intersection Capacity Utilization			44.4%		ICU Level of Service		A
Analysis Period (min)			15				

Lanes, Volumes, Timings
5: Merivale Rd & Camelot Dr/Bentley Ave

09/21/2022



Lane Group	EBL	EBT	WBL	WBT	WBR	NBL	NBT	SBL	SBT
Lane Configurations									
Traffic Volume (vph)	52	8	179	10	97	15	629	43	1254
Future Volume (vph)	52	8	179	10	97	15	629	43	1254
Lane Group Flow (vph)	58	178	199	11	108	17	745	48	1411
Turn Type	Perm	NA	Perm	NA	Perm	Perm	NA	Perm	NA
Protected Phases		4		8			2		6
Permitted Phases	4		8		8	2		6	
Detector Phase	4	4	8	8	8	2	2	6	6
Switch Phase									
Minimum Initial (s)	10.0	10.0	10.0	10.0	10.0	10.0	10.0	10.0	10.0
Minimum Split (s)	31.3	31.3	31.3	31.3	31.3	35.9	35.9	35.9	35.9
Total Split (s)	35.0	35.0	35.0	35.0	35.0	85.0	85.0	85.0	85.0
Total Split (%)	29.2%	29.2%	29.2%	29.2%	29.2%	70.8%	70.8%	70.8%	70.8%
Yellow Time (s)	3.3	3.3	3.3	3.3	3.3	3.7	3.7	3.7	3.7
All-Red Time (s)	3.0	3.0	3.0	3.0	3.0	2.2	2.2	2.2	2.2
Lost Time Adjust (s)	0.0	0.0	0.0	0.0	0.0	0.0	0.0	0.0	0.0
Total Lost Time (s)	6.3	6.3	6.3	6.3	6.3	5.9	5.9	5.9	5.9
Lead/Lag									
Lead-Lag Optimize?									
Recall Mode	None	None	None	None	None	C-Max	C-Max	C-Max	C-Max
Act Effct Green (s)	26.6	26.6	26.6	26.6	26.6	81.2	81.2	81.2	81.2
Actuated g/C Ratio	0.22	0.22	0.22	0.22	0.22	0.68	0.68	0.68	0.68
v/c Ratio	0.20	0.47	0.93	0.03	0.26	0.10	0.33	0.12	0.62
Control Delay	38.8	29.6	91.6	35.4	8.4	9.3	8.7	8.5	12.7
Queue Delay	0.0	0.0	0.0	0.0	0.0	0.0	0.0	0.0	0.0
Total Delay	38.8	29.6	91.6	35.4	8.4	9.3	8.7	8.5	12.7
LOS	D	C	F	D	A	A	A	A	B
Approach Delay		31.8		61.4			8.7		12.6
Approach LOS		C		E			A		B
Queue Length 50th (m)	10.9	22.6	45.1	2.0	0.0	1.4	36.6	3.9	94.3
Queue Length 95th (m)	22.5	44.1	#86.8	6.8	14.0	4.5	46.6	8.8	115.1
Internal Link Dist (m)		412.3		581.1			116.9		209.2
Turn Bay Length (m)	35.0		35.0		25.0	40.0		80.0	
Base Capacity (vph)	320	403	231	426	444	168	2239	397	2267
Starvation Cap Reductn	0	0	0	0	0	0	0	0	0
Spillback Cap Reductn	0	0	0	0	0	0	0	0	0
Storage Cap Reductn	0	0	0	0	0	0	0	0	0
Reduced v/c Ratio	0.18	0.44	0.86	0.03	0.24	0.10	0.33	0.12	0.62

Intersection Summary

Cycle Length: 120
 Actuated Cycle Length: 120
 Offset: 16 (13%), Referenced to phase 2:NBT and 6:SBTL, Start of Green
 Natural Cycle: 70
 Control Type: Actuated-Coordinated
 Maximum v/c Ratio: 0.93
 Intersection Signal Delay: 18.8
 Intersection Capacity Utilization 77.6%
 Analysis Period (min) 15
 # 95th percentile volume exceeds capacity, queue may be longer.
 Queue shown is maximum after two cycles.

Intersection LOS: B
 ICU Level of Service D

Splits and Phases: 5: Merivale Rd & Camelot Dr/Bentley Ave

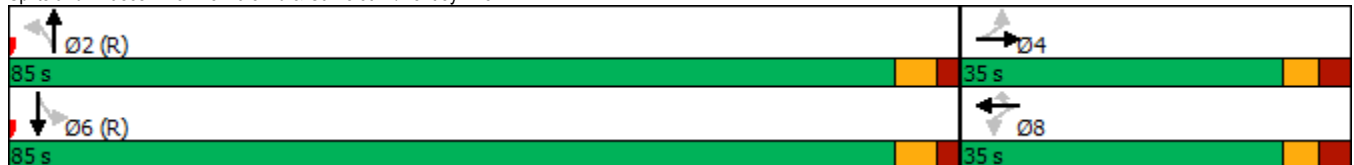

Future Background 2024

Lanes, Volumes, Timings

1: Merivale Rd & West Hunt Club Rd

10/19/2022



Lane Group	EBL	EBT	WBL	WBT	NBL	NBT	NBR	SBL	SBT	SBR
Lane Configurations										
Traffic Volume (vph)	287	883	92	610	91	981	82	176	435	233
Future Volume (vph)	287	883	92	610	91	981	82	176	435	233
Lane Group Flow (vph)	287	984	92	761	91	981	82	176	435	233
Turn Type	Prot	NA	Prot	NA	Prot	NA	Perm	Prot	NA	Perm
Protected Phases	7	4	3	8	5	2		1	6	
Permitted Phases							2			6
Detector Phase	7	4	3	8	5	2	2	1	6	6
Switch Phase										
Minimum Initial (s)	5.0	10.0	5.0	10.0	5.0	10.0	10.0	5.0	10.0	10.0
Minimum Split (s)	12.0	33.6	12.0	33.6	11.6	38.6	38.6	11.6	38.6	38.6
Total Split (s)	29.0	45.0	20.0	36.0	23.0	52.0	52.0	13.0	42.0	42.0
Total Split (%)	22.3%	34.6%	15.4%	27.7%	17.7%	40.0%	40.0%	10.0%	32.3%	32.3%
Yellow Time (s)	4.6	4.6	4.6	4.6	3.7	3.7	3.7	3.7	3.7	3.7
All-Red Time (s)	2.4	2.0	2.4	2.0	2.9	2.9	2.9	2.9	2.9	2.9
Lost Time Adjust (s)	0.0	0.0	0.0	0.0	0.0	0.0	0.0	0.0	0.0	0.0
Total Lost Time (s)	7.0	6.6	7.0	6.6	6.6	6.6	6.6	6.6	6.6	6.6
Lead/Lag	Lead	Lag	Lead	Lag	Lead	Lag	Lag	Lead	Lag	Lag
Lead-Lag Optimize?	Yes	Yes	Yes	Yes	Yes	Yes	Yes	Yes	Yes	Yes
Recall Mode	None	C-Max	None	C-Max	None	None	None	None	None	None
Act Effct Green (s)	16.9	42.2	11.5	36.8	12.8	43.1	43.1	6.4	36.7	36.7
Actuated g/C Ratio	0.13	0.32	0.09	0.28	0.10	0.33	0.33	0.05	0.28	0.28
v/c Ratio	0.69	0.93	0.67	0.57	0.62	0.88	0.14	1.11	0.48	0.39
Control Delay	62.8	58.4	80.3	40.7	74.1	51.2	0.5	160.4	40.8	4.9
Queue Delay	0.0	0.0	0.0	0.0	0.0	0.0	0.0	0.0	0.0	0.0
Total Delay	62.8	58.4	80.3	40.7	74.1	51.2	0.5	160.4	40.8	4.9
LOS	E	E	F	D	E	D	A	F	D	A
Approach Delay		59.4		44.9		49.4			55.8	
Approach LOS		E		D		D			E	
Queue Length 50th (m)	36.7	~139.8	22.9	59.4	22.7	121.1	0.0	~26.4	47.7	0.0
Queue Length 95th (m)	49.7	#181.4	#41.9	77.3	39.9	148.2	0.0	#50.1	65.8	14.0
Internal Link Dist (m)		173.3		390.9		150.6			154.0	
Turn Bay Length (m)	90.0		70.0		65.0		130.0	60.0		125.0
Base Capacity (vph)	540	1056	155	1330	188	1172	609	158	913	595
Starvation Cap Reductn	0	0	0	0	0	0	0	0	0	0
Spillback Cap Reductn	0	0	0	0	0	0	0	0	0	0
Storage Cap Reductn	0	0	0	0	0	0	0	0	0	0
Reduced v/c Ratio	0.53	0.93	0.59	0.57	0.48	0.84	0.13	1.11	0.48	0.39

Intersection Summary

Cycle Length: 130

Actuated Cycle Length: 130

Offset: 102 (78%), Referenced to phase 4:EBT and 8:WBT, Start of Green

Natural Cycle: 100

Control Type: Actuated-Coordinated

Maximum v/c Ratio: 1.11

Intersection Signal Delay: 52.9

Intersection LOS: D

Intersection Capacity Utilization 90.8%

ICU Level of Service E

Analysis Period (min) 15

~ Volume exceeds capacity, queue is theoretically infinite.

Queue shown is maximum after two cycles.

95th percentile volume exceeds capacity, queue may be longer.

Queue shown is maximum after two cycles.

Splits and Phases: 1: Merivale Rd & West Hunt Club Rd

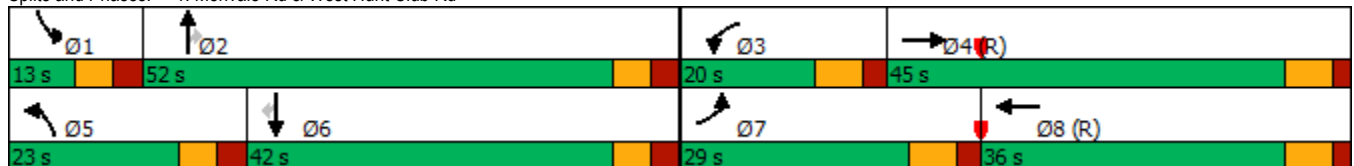

Lanes, Volumes, Timings 2:
Merivale Rd & Jamie Ave

10/19/2022



Lane Group	WBL	WBR	NBT	SBL	SBT
Lane Configurations					
Traffic Volume (vph)	11	30	1255	29	620
Future Volume (vph)	11	30	1255	29	620
Lane Group Flow (vph)	11	30	1285	29	620
Sign Control	Stop		Free		Free
Intersection Summary					
Control Type: Unsignalized					
Intersection Capacity Utilization 47.6%			ICU Level of Service A		
Analysis Period (min) 15					

HCM Unsignalized Intersection Capacity Analysis

2: Merivale Rd & Jamie Ave

10/19/2022



Movement	WBL	WBR	NBT	NBR	SBL	SBT	
Lane Configurations							
Traffic Volume (veh/h)	11	30	1255	30	29	620	
Future Volume (Veh/h)	11	30	1255	30	29	620	
Sign Control	Stop		Free		Free		
Grade	0%		0%		0%		
Peak Hour Factor	1.00	1.00	1.00	1.00	1.00	1.00	
Hourly flow rate (vph)	11	30	1255	30	29	620	
Pedestrians	7		2				
Lane Width (m)	3.7		3.7				
Walking Speed (m/s)	1.0		1.0				
Percent Blockage	1		0				
Right turn flare (veh)							
Median type			None		None		
Median storage (veh)							
Upstream signal (m)			233		175		
pX, platoon unblocked	0.82	0.77			0.77		
vC, conflicting volume	1647	650			1292		
vC1, stage 1 conf vol							
vC2, stage 2 conf vol							
vCu, unblocked vol	817	0			792		
tC, single (s)	6.8	7.0			4.2		
tC, 2 stage (s)							
tF (s)	3.5	3.4			2.2		
p0 queue free %	95	96			95		
cM capacity (veh/h)	244	821			628		
Direction, Lane #	WB 1	WB 2	NB 1	NB 2	SB 1	SB 2	SB 3
Volume Total	11	30	837	448	29	310	310
Volume Left	11	0	0	0	29	0	0
Volume Right	0	30	0	30	0	0	0
cSH	244	821	1700	1700	628	1700	1700
Volume to Capacity	0.05	0.04	0.49	0.26	0.05	0.18	0.18
Queue Length 95th (m)	1.1	0.9	0.0	0.0	1.1	0.0	0.0
Control Delay (s)	20.4	9.6	0.0	0.0	11.0	0.0	0.0
Lane LOS	C	A			B		
Approach Delay (s)	12.5		0.0		0.5		
Approach LOS	B						
Intersection Summary							
Average Delay			0.4				
Intersection Capacity Utilization			47.6%		ICU Level of Service		A
Analysis Period (min)			15				

Lanes, Volumes, Timings
5: Merivale Rd & Camelot Dr/Bentley Ave

10/19/2022



Lane Group	EBL	EBT	WBL	WBT	WBR	NBL	NBT	SBL	SBT
Lane Configurations									
Traffic Volume (vph)	15	31	47	11	46	140	1248	61	468
Future Volume (vph)	15	31	47	11	46	140	1248	61	468
Lane Group Flow (vph)	15	107	47	11	46	140	1418	61	537
Turn Type	Perm	NA	Perm	NA	Perm	Perm	NA	pm+pt	NA
Protected Phases		4		8			2	1	6
Permitted Phases	4		8		8	2		6	
Detector Phase	4	4	8	8	8	2	2	1	6
Switch Phase									
Minimum Initial (s)	10.0	10.0	10.0	10.0	10.0	10.0	10.0	5.0	10.0
Minimum Split (s)	31.3	31.3	31.3	31.3	31.3	35.9	35.9	10.8	35.9
Total Split (s)	31.0	31.0	31.0	31.0	31.0	64.0	64.0	15.0	79.0
Total Split (%)	28.2%	28.2%	28.2%	28.2%	28.2%	58.2%	58.2%	13.6%	71.8%
Yellow Time (s)	3.3	3.3	3.3	3.3	3.3	3.7	3.7	3.7	3.7
All-Red Time (s)	3.0	3.0	3.0	3.0	3.0	2.2	2.2	2.1	2.2
Lost Time Adjust (s)	0.0	0.0	0.0	0.0	0.0	0.0	0.0	0.0	0.0
Total Lost Time (s)	6.3	6.3	6.3	6.3	6.3	5.9	5.9	5.8	5.9
Lead/Lag						Lag	Lag	Lead	
Lead-Lag Optimize?						Yes	Yes	Yes	
Recall Mode	None	None	None	None	None	C-Max	C-Max	None	C-Max
Act Effct Green (s)	11.4	11.4	11.4	11.4	11.4	76.5	76.5	86.5	86.4
Actuated g/C Ratio	0.10	0.10	0.10	0.10	0.10	0.70	0.70	0.79	0.79
v/c Ratio	0.11	0.47	0.41	0.07	0.21	0.26	0.63	0.23	0.22
Control Delay	45.3	23.6	56.7	44.2	4.0	8.9	11.5	4.9	3.2
Queue Delay	0.0	0.0	0.0	0.0	0.0	0.0	0.0	0.0	0.0
Total Delay	45.3	23.6	56.7	44.2	4.0	8.9	11.5	4.9	3.2
LOS	D	C	E	D	A	A	B	A	A
Approach Delay		26.3		32.1			11.3		3.4
Approach LOS		C		C			B		A
Queue Length 50th (m)	3.0	6.3	9.7	2.2	0.0	10.2	78.4	2.2	10.8
Queue Length 95th (m)	9.0	22.0	20.9	7.4	2.5	23.0	119.0	5.8	19.2
Internal Link Dist (m)		412.3		581.1			116.9		209.2
Turn Bay Length (m)	35.0		35.0		25.0	40.0		80.0	
Base Capacity (vph)	298	406	248	346	373	546	2248	304	2462
Starvation Cap Reductn	0	0	0	0	0	0	0	0	0
Spillback Cap Reductn	0	0	0	0	0	0	0	0	0
Storage Cap Reductn	0	0	0	0	0	0	0	0	0
Reduced v/c Ratio	0.05	0.26	0.19	0.03	0.12	0.26	0.63	0.20	0.22

Intersection Summary

Cycle Length: 110
 Actuated Cycle Length: 110
 Offset: 103 (94%), Referenced to phase 2:NBT and 6:SBTL, Start of Green
 Natural Cycle: 90
 Control Type: Actuated-Coordinated
 Maximum v/c Ratio: 0.63
 Intersection Signal Delay: 11.0
 Intersection Capacity Utilization 76.2%
 Analysis Period (min) 15

Intersection LOS: B
 ICU Level of Service D

Splits and Phases: 5: Merivale Rd & Camelot Dr/Bentley Ave



Lanes, Volumes, Timings
1: Merivale Rd & West Hunt Club Rd

10/19/2022



Lane Group	EBL	EBT	WBL	WBT	NBL	NBT	NBR	SBL	SBT	SBR
Lane Configurations										
Traffic Volume (vph)	251	592	152	1058	138	543	104	178	809	289
Future Volume (vph)	251	592	152	1058	138	543	104	178	809	289
Lane Group Flow (vph)	251	709	152	1317	138	543	104	178	809	289
Turn Type	Prot	NA	Prot	NA	Prot	NA	Perm	Prot	NA	Perm
Protected Phases	7	4	3	8	5	2		1	6	
Permitted Phases							2			6
Detector Phase	7	4	3	8	5	2	2	1	6	6
Switch Phase										
Minimum Initial (s)	5.0	10.0	5.0	10.0	5.0	10.0	10.0	5.0	10.0	10.0
Minimum Split (s)	12.0	33.6	12.0	33.6	11.6	38.6	38.6	11.6	38.6	38.6
Total Split (s)	20.0	39.0	26.0	45.0	20.0	45.0	45.0	20.0	45.0	45.0
Total Split (%)	15.4%	30.0%	20.0%	34.6%	15.4%	34.6%	34.6%	15.4%	34.6%	34.6%
Yellow Time (s)	4.6	4.6	4.6	4.6	3.7	3.7	3.7	3.7	3.7	3.7
All-Red Time (s)	2.4	2.0	2.4	2.0	2.9	2.9	2.9	2.9	2.9	2.9
Lost Time Adjust (s)	0.0	0.0	0.0	0.0	0.0	0.0	0.0	0.0	0.0	0.0
Total Lost Time (s)	7.0	6.6	7.0	6.6	6.6	6.6	6.6	6.6	6.6	6.6
Lead/Lag	Lead	Lag	Lead	Lag	Lead	Lag	Lag	Lead	Lag	Lag
Lead-Lag Optimize?	Yes	Yes	Yes	Yes	Yes	Yes	Yes	Yes	Yes	Yes
Recall Mode	None	C-Max	None	C-Max	None	None	None	None	None	None
Act Effct Green (s)	12.8	37.3	16.5	41.0	13.0	37.6	37.6	11.8	36.4	36.4
Actuated g/C Ratio	0.10	0.29	0.13	0.32	0.10	0.29	0.29	0.09	0.28	0.28
v/c Ratio	0.78	0.76	0.77	0.87	0.85	0.56	0.20	0.60	0.86	0.46
Control Delay	74.0	48.7	79.3	48.2	98.0	41.6	2.7	65.5	54.7	6.5
Queue Delay	0.0	0.0	0.0	0.0	0.0	0.0	0.0	0.0	0.0	0.0
Total Delay	74.0	48.7	79.3	48.2	98.0	41.6	2.7	65.5	54.7	6.5
LOS	E	D	E	D	F	D	A	E	D	A
Approach Delay		55.3		51.4		46.3			45.3	
Approach LOS		E		D		D			D	
Queue Length 50th (m)	32.8	89.2	37.7	116.4	35.2	60.8	0.0	22.8	101.3	0.2
Queue Length 95th (m)	#50.6	#121.3	#63.4	#144.1	#70.6	79.7	5.4	34.5	126.1	20.6
Internal Link Dist (m)		173.3		390.9		150.6			154.0	
Turn Bay Length (m)	90.0		70.0		65.0		130.0	60.0		125.0
Base Capacity (vph)	332	930	227	1518	166	996	525	335	991	642
Starvation Cap Reductn	0	0	0	0	0	0	0	0	0	0
Spillback Cap Reductn	0	0	0	0	0	0	0	0	0	0
Storage Cap Reductn	0	0	0	0	0	0	0	0	0	0
Reduced v/c Ratio	0.76	0.76	0.67	0.87	0.83	0.55	0.20	0.53	0.82	0.45

Intersection Summary

Cycle Length: 130
 Actuated Cycle Length: 130
 Offset: 28 (22%), Referenced to phase 4:EBT and 8:WBT, Start of Green
 Natural Cycle: 100
 Control Type: Actuated-Coordinated
 Maximum v/c Ratio: 0.87
 Intersection Signal Delay: 49.6
 Intersection Capacity Utilization 89.7%
 Analysis Period (min) 15
 # 95th percentile volume exceeds capacity, queue may be longer.
 Queue shown is maximum after two cycles.

Intersection LOS: D
 ICU Level of Service E

Splits and Phases: 1: Merivale Rd & West Hunt Club Rd

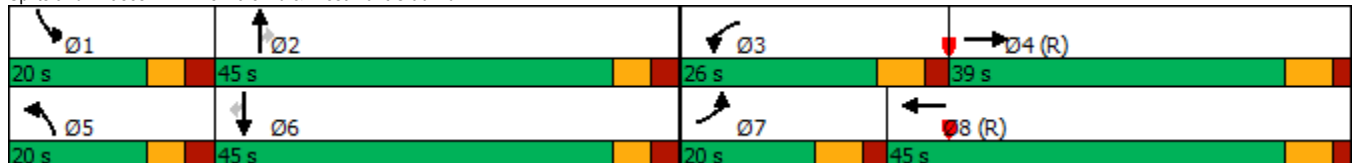

Lanes, Volumes, Timings 2:
Merivale Rd & Jamie Ave

10/19/2022



Lane Group	WBL	WBR	NBT	SBL	SBT
Lane Configurations					
Traffic Volume (vph)	26	48	802	25	1228
Future Volume (vph)	26	48	802	25	1228
Lane Group Flow (vph)	26	48	819	25	1228
Sign Control	Stop		Free		Free
Intersection Summary					
Control Type: Unsignalized					
Intersection Capacity Utilization 45.8%			ICU Level of Service A		
Analysis Period (min) 15					

HCM Unsignalized Intersection Capacity Analysis
 2: Merivale Rd & Jamie Ave

10/19/2022



Movement	WBL	WBR	NBT	NBR	SBL	SBT	
Lane Configurations							
Traffic Volume (veh/h)	26	48	802	17	25	1228	
Future Volume (Veh/h)	26	48	802	17	25	1228	
Sign Control	Stop		Free			Free	
Grade	0%		0%			0%	
Peak Hour Factor	1.00	1.00	1.00	1.00	1.00	1.00	
Hourly flow rate (vph)	26	48	802	17	25	1228	
Pedestrians	9		3				
Lane Width (m)	3.7		3.7				
Walking Speed (m/s)	1.0		1.0				
Percent Blockage	1		0				
Right turn flare (veh)							
Median type			None			None	
Median storage (veh)							
Upstream signal (m)			233			175	
pX, platoon unblocked	0.81	0.94			0.94		
vC, conflicting volume	1486	418			828		
vC1, stage 1 conf vol							
vC2, stage 2 conf vol							
vCu, unblocked vol	781	249			685		
tC, single (s)	6.8	7.0			4.1		
tC, 2 stage (s)							
tF (s)	3.5	3.3			2.2		
p0 queue free %	90	93			97		
cM capacity (veh/h)	256	693			841		
Direction, Lane #	WB 1	WB 2	NB 1	NB 2	SB 1	SB 2	SB 3
Volume Total	26	48	535	284	25	614	614
Volume Left	26	0	0	0	25	0	0
Volume Right	0	48	0	17	0	0	0
cSH	256	693	1700	1700	841	1700	1700
Volume to Capacity	0.10	0.07	0.31	0.17	0.03	0.36	0.36
Queue Length 95th (m)	2.5	1.7	0.0	0.0	0.7	0.0	0.0
Control Delay (s)	20.6	10.6	0.0	0.0	9.4	0.0	0.0
Lane LOS	C	B			A		
Approach Delay (s)	14.1		0.0		0.2		
Approach LOS	B						
Intersection Summary							
Average Delay			0.6				
Intersection Capacity Utilization			45.8%		ICU Level of Service		A
Analysis Period (min)			15				

Lanes, Volumes, Timings
5: Merivale Rd & Camelot Dr/Bentley Ave

10/19/2022



Lane Group	EBL	EBT	WBL	WBT	WBR	NBL	NBT	SBL	SBT
Lane Configurations									
Traffic Volume (vph)	52	8	179	10	97	15	654	43	1305
Future Volume (vph)	52	8	179	10	97	15	654	43	1305
Lane Group Flow (vph)	52	160	179	10	97	15	695	43	1321
Turn Type	Perm	NA	Perm	NA	Perm	Perm	NA	Perm	NA
Protected Phases		4		8			2		6
Permitted Phases	4		8		8	2		6	
Detector Phase	4	4	8	8	8	2	2	6	6
Switch Phase									
Minimum Initial (s)	10.0	10.0	10.0	10.0	10.0	10.0	10.0	10.0	10.0
Minimum Split (s)	31.3	31.3	31.3	31.3	31.3	35.9	35.9	35.9	35.9
Total Split (s)	35.0	35.0	35.0	35.0	35.0	85.0	85.0	85.0	85.0
Total Split (%)	29.2%	29.2%	29.2%	29.2%	29.2%	70.8%	70.8%	70.8%	70.8%
Yellow Time (s)	3.3	3.3	3.3	3.3	3.3	3.7	3.7	3.7	3.7
All-Red Time (s)	3.0	3.0	3.0	3.0	3.0	2.2	2.2	2.2	2.2
Lost Time Adjust (s)	0.0	0.0	0.0	0.0	0.0	0.0	0.0	0.0	0.0
Total Lost Time (s)	6.3	6.3	6.3	6.3	6.3	5.9	5.9	5.9	5.9
Lead/Lag									
Lead-Lag Optimize?									
Recall Mode	None	None	None	None	None	C-Max	C-Max	C-Max	C-Max
Act Effct Green (s)	24.2	24.2	24.2	24.2	24.2	83.6	83.6	83.6	83.6
Actuated g/C Ratio	0.20	0.20	0.20	0.20	0.20	0.70	0.70	0.70	0.70
v/c Ratio	0.19	0.45	0.88	0.03	0.25	0.07	0.30	0.10	0.57
Control Delay	39.5	24.8	84.3	35.7	8.8	8.2	7.8	7.8	10.9
Queue Delay	0.0	0.0	0.0	0.0	0.0	0.0	0.0	0.0	0.0
Total Delay	39.5	24.8	84.3	35.7	8.8	8.2	7.8	7.8	10.9
LOS	D	C	F	D	A	A	A	A	B
Approach Delay		28.4		57.0			7.8		10.8
Approach LOS		C		E			A		B
Queue Length 50th (m)	10.1	16.5	40.4	1.9	0.0	1.1	31.0	3.1	78.0
Queue Length 95th (m)	20.5	35.8	#73.1	6.3	13.2	3.9	43.0	8.0	103.1
Internal Link Dist (m)		412.3		581.1			116.9		209.2
Turn Bay Length (m)	35.0		35.0		25.0	40.0		80.0	
Base Capacity (vph)	320	412	241	426	436	206	2305	439	2334
Starvation Cap Reductn	0	0	0	0	0	0	0	0	0
Spillback Cap Reductn	0	0	0	0	0	0	0	0	0
Storage Cap Reductn	0	0	0	0	0	0	0	0	0
Reduced v/c Ratio	0.16	0.39	0.74	0.02	0.22	0.07	0.30	0.10	0.57

Intersection Summary

Cycle Length: 120
 Actuated Cycle Length: 120
 Offset: 16 (13%), Referenced to phase 2:NBTL and 6:SBTL, Start of Green
 Natural Cycle: 70
 Control Type: Actuated-Coordinated
 Maximum v/c Ratio: 0.88
 Intersection Signal Delay: 16.6
 Intersection Capacity Utilization 78.5%
 Analysis Period (min) 15
 # 95th percentile volume exceeds capacity, queue may be longer.
 Queue shown is maximum after two cycles.

Splits and Phases: 5: Merivale Rd & Camelot Dr/Bentley Ave



Future Background 2029

Lanes, Volumes, Timings
1: Merivale Rd & West Hunt Club Rd

10/19/2022



Lane Group	EBL	EBT	WBL	WBT	NBL	NBT	NBR	SBL	SBT	SBR
Lane Configurations										
Traffic Volume (vph)	287	975	92	673	91	1083	82	176	480	233
Future Volume (vph)	287	975	92	673	91	1083	82	176	480	233
Lane Group Flow (vph)	287	1076	92	824	91	1083	82	176	480	233
Turn Type	Prot	NA	Prot	NA	Prot	NA	Perm	Prot	NA	Perm
Protected Phases	7	4	3	8	5	2		1	6	
Permitted Phases							2			6
Detector Phase	7	4	3	8	5	2	2	1	6	6
Switch Phase										
Minimum Initial (s)	5.0	10.0	5.0	10.0	5.0	10.0	10.0	5.0	10.0	10.0
Minimum Split (s)	12.0	33.6	12.0	33.6	11.6	38.6	38.6	11.6	38.6	38.6
Total Split (s)	29.0	45.0	20.0	36.0	23.0	52.0	52.0	13.0	42.0	42.0
Total Split (%)	22.3%	34.6%	15.4%	27.7%	17.7%	40.0%	40.0%	10.0%	32.3%	32.3%
Yellow Time (s)	4.6	4.6	4.6	4.6	3.7	3.7	3.7	3.7	3.7	3.7
All-Red Time (s)	2.4	2.0	2.4	2.0	2.9	2.9	2.9	2.9	2.9	2.9
Lost Time Adjust (s)	0.0	0.0	0.0	0.0	0.0	0.0	0.0	0.0	0.0	0.0
Total Lost Time (s)	7.0	6.6	7.0	6.6	6.6	6.6	6.6	6.6	6.6	6.6
Lead/Lag	Lead	Lag	Lead	Lag	Lead	Lag	Lag	Lead	Lag	Lag
Lead-Lag Optimize?	Yes	Yes	Yes	Yes	Yes	Yes	Yes	Yes	Yes	Yes
Recall Mode	None	C-Max	None	C-Max	None	None	None	None	None	None
Act Effct Green (s)	16.9	40.5	11.5	35.1	12.8	44.8	44.8	6.4	38.4	38.4
Actuated g/C Ratio	0.13	0.31	0.09	0.27	0.10	0.34	0.34	0.05	0.30	0.30
v/c Ratio	0.69	1.06	0.67	0.65	0.62	0.94	0.14	1.11	0.50	0.38
Control Delay	62.8	88.3	80.3	43.6	74.1	56.4	0.5	160.4	40.6	4.8
Queue Delay	0.0	0.0	0.0	0.0	0.0	0.0	0.0	0.0	0.0	0.0
Total Delay	62.8	88.3	80.3	43.6	74.1	56.4	0.5	160.4	40.6	4.8
LOS	E	F	F	D	E	E	A	F	D	A
Approach Delay		82.9		47.3		54.1			54.9	
Approach LOS		F		D		D			D	
Queue Length 50th (m)	36.7	~165.9	22.9	66.1	22.7	139.6	0.0	~26.4	53.5	0.0
Queue Length 95th (m)	49.7	#208.0	#41.9	85.2	39.9	#180.6	0.0	#50.1	72.9	14.0
Internal Link Dist (m)		173.3		390.9		150.6			154.0	
Turn Bay Length (m)	90.0		70.0		65.0		130.0	60.0		125.0
Base Capacity (vph)	540	1015	155	1270	188	1172	609	158	955	611
Starvation Cap Reductn	0	0	0	0	0	0	0	0	0	0
Spillback Cap Reductn	0	0	0	0	0	0	0	0	0	0
Storage Cap Reductn	0	0	0	0	0	0	0	0	0	0
Reduced v/c Ratio	0.53	1.06	0.59	0.65	0.48	0.92	0.13	1.11	0.50	0.38

Intersection Summary

Cycle Length: 130
 Actuated Cycle Length: 130
 Offset: 102 (78%), Referenced to phase 4:EBT and 8:WBT, Start of Green
 Natural Cycle: 120
 Control Type: Actuated-Coordinated
 Maximum v/c Ratio: 1.11
 Intersection Signal Delay: 61.7
 Intersection Capacity Utilization 96.5%
 Analysis Period (min) 15
 ~ Volume exceeds capacity, queue is theoretically infinite.
 Queue shown is maximum after two cycles.
 # 95th percentile volume exceeds capacity, queue may be longer.
 Queue shown is maximum after two cycles.

Intersection LOS: E
 ICU Level of Service F

Splits and Phases: 1: Merivale Rd & West Hunt Club Rd

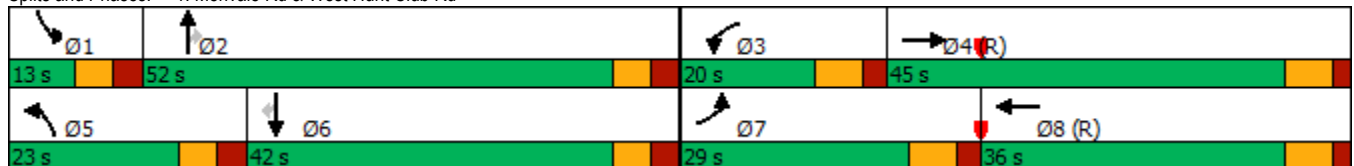

Lanes, Volumes, Timings 2:
Merivale Rd & Jamie Ave

10/19/2022



Lane Group	WBL	WBR	NBT	SBL	SBT
Lane Configurations					
Traffic Volume (vph)	11	30	1385	29	685
Future Volume (vph)	11	30	1385	29	685
Lane Group Flow (vph)	11	30	1415	29	685
Sign Control	Stop		Free		Free
Intersection Summary					
Control Type: Unsignalized					
Intersection Capacity Utilization 51.4%			ICU Level of Service A		
Analysis Period (min) 15					

HCM Unsignalized Intersection Capacity Analysis
 2: Merivale Rd & Jamie Ave

10/19/2022



Movement	WBL	WBR	NBT	NBR	SBL	SBT	
Lane Configurations							
Traffic Volume (veh/h)	11	30	1385	30	29	685	
Future Volume (Veh/h)	11	30	1385	30	29	685	
Sign Control	Stop		Free		Free		
Grade	0%		0%		0%		
Peak Hour Factor	1.00	1.00	1.00	1.00	1.00	1.00	
Hourly flow rate (vph)	11	30	1385	30	29	685	
Pedestrians	7		2				
Lane Width (m)	3.7		3.7				
Walking Speed (m/s)	1.0		1.0				
Percent Blockage	1		0				
Right turn flare (veh)							
Median type	None			None			
Median storage (veh)							
Upstream signal (m)	233			175			
pX, platoon unblocked	0.77	0.71			0.71		
vC, conflicting volume	1810	714			1422		
vC1, stage 1 conf vol							
vC2, stage 2 conf vol							
vCu, unblocked vol	805	0			789		
tC, single (s)	6.8	7.0			4.2		
tC, 2 stage (s)							
tF (s)	3.5	3.4			2.2		
p0 queue free %	95	96			95		
cM capacity (veh/h)	232	757			581		
Direction, Lane #	WB 1	WB 2	NB 1	NB 2	SB 1	SB 2	SB 3
Volume Total	11	30	923	492	29	342	342
Volume Left	11	0	0	0	29	0	0
Volume Right	0	30	0	30	0	0	0
cSH	232	757	1700	1700	581	1700	1700
Volume to Capacity	0.05	0.04	0.54	0.29	0.05	0.20	0.20
Queue Length 95th (m)	1.1	0.9	0.0	0.0	1.2	0.0	0.0
Control Delay (s)	21.3	10.0	0.0	0.0	11.5	0.0	0.0
Lane LOS	C	A			B		
Approach Delay (s)	13.0		0.0		0.5		
Approach LOS	B						
Intersection Summary							
Average Delay			0.4				
Intersection Capacity Utilization			51.4%		ICU Level of Service		A
Analysis Period (min)			15				

Lanes, Volumes, Timings
5: Merivale Rd & Camelot Dr/Bentley Ave

10/19/2022



Lane Group	EBL	EBT	WBL	WBT	WBR	NBL	NBT	SBL	SBT
Lane Configurations									
Traffic Volume (vph)	15	31	47	11	46	140	1417	61	517
Future Volume (vph)	15	31	47	11	46	140	1417	61	517
Lane Group Flow (vph)	15	107	47	11	46	140	1587	61	586
Turn Type	Perm	NA	Perm	NA	Perm	Perm	NA	pm+pt	NA
Protected Phases		4		8			2	1	6
Permitted Phases	4		8		8	2		6	
Detector Phase	4	4	8	8	8	2	2	1	6
Switch Phase									
Minimum Initial (s)	10.0	10.0	10.0	10.0	10.0	10.0	10.0	5.0	10.0
Minimum Split (s)	31.3	31.3	31.3	31.3	31.3	35.9	35.9	10.8	35.9
Total Split (s)	31.0	31.0	31.0	31.0	31.0	64.0	64.0	15.0	79.0
Total Split (%)	28.2%	28.2%	28.2%	28.2%	28.2%	58.2%	58.2%	13.6%	71.8%
Yellow Time (s)	3.3	3.3	3.3	3.3	3.3	3.7	3.7	3.7	3.7
All-Red Time (s)	3.0	3.0	3.0	3.0	3.0	2.2	2.2	2.1	2.2
Lost Time Adjust (s)	0.0	0.0	0.0	0.0	0.0	0.0	0.0	0.0	0.0
Total Lost Time (s)	6.3	6.3	6.3	6.3	6.3	5.9	5.9	5.8	5.9
Lead/Lag						Lag	Lag	Lead	
Lead-Lag Optimize?						Yes	Yes	Yes	
Recall Mode	None	None	None	None	None	C-Max	C-Max	None	C-Max
Act Effct Green (s)	11.4	11.4	11.4	11.4	11.4	76.3	76.3	86.5	86.4
Actuated g/C Ratio	0.10	0.10	0.10	0.10	0.10	0.69	0.69	0.79	0.79
v/c Ratio	0.11	0.47	0.41	0.07	0.21	0.27	0.71	0.27	0.24
Control Delay	45.3	23.6	56.7	44.2	4.0	9.2	13.3	5.8	3.3
Queue Delay	0.0	0.0	0.0	0.0	0.0	0.0	0.0	0.0	0.0
Total Delay	45.3	23.6	56.7	44.2	4.0	9.2	13.3	5.8	3.3
LOS	D	C	E	D	A	A	B	A	A
Approach Delay		26.3		32.1			13.0		3.6
Approach LOS		C		C			B		A
Queue Length 50th (m)	3.0	6.3	9.7	2.2	0.0	10.3	96.7	2.2	12.2
Queue Length 95th (m)	9.0	22.0	20.9	7.4	2.5	23.9	149.5	5.8	21.3
Internal Link Dist (m)		412.3		581.1			116.9		209.2
Turn Bay Length (m)	35.0		35.0		25.0	40.0		80.0	
Base Capacity (vph)	298	406	248	346	373	521	2249	265	2463
Starvation Cap Reductn	0	0	0	0	0	0	0	0	0
Spillback Cap Reductn	0	0	0	0	0	0	0	0	0
Storage Cap Reductn	0	0	0	0	0	0	0	0	0
Reduced v/c Ratio	0.05	0.26	0.19	0.03	0.12	0.27	0.71	0.23	0.24

Intersection Summary

Cycle Length: 110
 Actuated Cycle Length: 110
 Offset: 103 (94%), Referenced to phase 2:NBT and 6:SBTL, Start of Green
 Natural Cycle: 90
 Control Type: Actuated-Coordinated
 Maximum v/c Ratio: 0.71
 Intersection Signal Delay: 12.0
 Intersection Capacity Utilization 81.1%
 Analysis Period (min) 15

Intersection LOS: B
 ICU Level of Service D

Splits and Phases: 5: Merivale Rd & Camelot Dr/Bentley Ave



Lanes, Volumes, Timings

1: Merivale Rd & West Hunt Club Rd

10/19/2022



Lane Group	EBL	EBT	WBL	WBT	NBL	NBT	NBR	SBL	SBT	SBR
Lane Configurations										
Traffic Volume (vph)	251	654	152	1168	138	600	104	178	894	289
Future Volume (vph)	251	654	152	1168	138	600	104	178	894	289
Lane Group Flow (vph)	251	771	152	1427	138	600	104	178	894	289
Turn Type	Prot	NA	Prot	NA	Prot	NA	Perm	Prot	NA	Perm
Protected Phases	7	4	3	8	5	2		1	6	
Permitted Phases							2			6
Detector Phase	7	4	3	8	5	2	2	1	6	6
Switch Phase										
Minimum Initial (s)	5.0	10.0	5.0	10.0	5.0	10.0	10.0	5.0	10.0	10.0
Minimum Split (s)	12.0	33.6	12.0	33.6	11.6	38.6	38.6	11.6	38.6	38.6
Total Split (s)	20.0	39.0	26.0	45.0	20.0	45.0	45.0	20.0	45.0	45.0
Total Split (%)	15.4%	30.0%	20.0%	34.6%	15.4%	34.6%	34.6%	15.4%	34.6%	34.6%
Yellow Time (s)	4.6	4.6	4.6	4.6	3.7	3.7	3.7	3.7	3.7	3.7
All-Red Time (s)	2.4	2.0	2.4	2.0	2.9	2.9	2.9	2.9	2.9	2.9
Lost Time Adjust (s)	0.0	0.0	0.0	0.0	0.0	0.0	0.0	0.0	0.0	0.0
Total Lost Time (s)	7.0	6.6	7.0	6.6	6.6	6.6	6.6	6.6	6.6	6.6
Lead/Lag	Lead	Lag	Lead	Lag	Lead	Lag	Lag	Lead	Lag	Lag
Lead-Lag Optimize?	Yes	Yes	Yes	Yes	Yes	Yes	Yes	Yes	Yes	Yes
Recall Mode	None	C-Max	None	C-Max	None	None	None	None	None	None
Act Effct Green (s)	12.7	35.8	16.5	39.7	13.0	39.0	39.0	11.8	37.8	37.8
Actuated g/C Ratio	0.10	0.28	0.13	0.31	0.10	0.30	0.30	0.09	0.29	0.29
v/c Ratio	0.79	0.86	0.77	0.97	0.85	0.60	0.20	0.60	0.92	0.46
Control Delay	75.0	55.4	79.3	60.9	98.0	41.8	2.7	65.5	59.3	6.5
Queue Delay	0.0	0.0	0.0	0.0	0.0	0.0	0.0	0.0	0.0	0.0
Total Delay	75.0	55.4	79.3	60.9	98.0	41.8	2.7	65.5	59.3	6.5
LOS	E	E	E	E	F	D	A	E	E	A
Approach Delay		60.2		62.7		46.1			48.9	
Approach LOS		E		E		D			D	
Queue Length 50th (m)	32.8	99.9	37.7	~131.8	35.2	68.6	0.0	22.8	116.0	0.6
Queue Length 95th (m)	#50.6	#139.9	#63.4	#166.7	#70.6	88.8	5.4	34.5	#151.8	21.1
Internal Link Dist (m)		173.3		390.9		150.6			154.0	
Turn Bay Length (m)	90.0		70.0		65.0		130.0	60.0		125.0
Base Capacity (vph)	328	896	227	1471	166	1009	530	335	991	641
Starvation Cap Reductn	0	0	0	0	0	0	0	0	0	0
Spillback Cap Reductn	0	0	0	0	0	0	0	0	0	0
Storage Cap Reductn	0	0	0	0	0	0	0	0	0	0
Reduced v/c Ratio	0.77	0.86	0.67	0.97	0.83	0.59	0.20	0.53	0.90	0.45

Intersection Summary

Cycle Length: 130

Actuated Cycle Length: 130

Offset: 28 (22%), Referenced to phase 4:EBT and 8:WBT, Start of Green

Natural Cycle: 110

Control Type: Actuated-Coordinated

Maximum v/c Ratio: 0.97

Intersection Signal Delay: 55.4

Intersection LOS: E

Intersection Capacity Utilization 94.1%

ICU Level of Service F

Analysis Period (min) 15

~ Volume exceeds capacity, queue is theoretically infinite.

Queue shown is maximum after two cycles.

95th percentile volume exceeds capacity, queue may be longer.

Queue shown is maximum after two cycles.

Splits and Phases: 1: Merivale Rd & West Hunt Club Rd

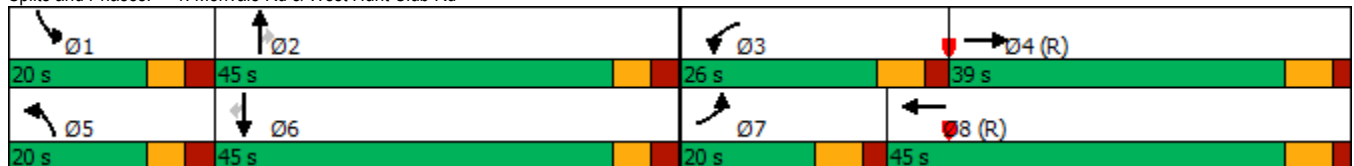

Lanes, Volumes, Timings 2:
Merivale Rd & Jamie Ave

10/19/2022



Lane Group	WBL	WBR	NBT	SBL	SBT
Lane Configurations					
Traffic Volume (vph)	26	48	886	25	1355
Future Volume (vph)	26	48	886	25	1355
Lane Group Flow (vph)	26	48	903	25	1355
Sign Control	Stop		Free		Free
Intersection Summary					
Control Type: Unsignalized					
Intersection Capacity Utilization 49.5%			ICU Level of Service A		
Analysis Period (min) 15					

HCM Unsignalized Intersection Capacity Analysis
 2: Merivale Rd & Jamie Ave

10/19/2022



Movement	WBL	WBR	NBT	NBR	SBL	SBT	
Lane Configurations							
Traffic Volume (veh/h)	26	48	886	17	25	1355	
Future Volume (Veh/h)	26	48	886	17	25	1355	
Sign Control	Stop		Free			Free	
Grade	0%		0%			0%	
Peak Hour Factor	1.00	1.00	1.00	1.00	1.00	1.00	
Hourly flow rate (vph)	26	48	886	17	25	1355	
Pedestrians	9		3				
Lane Width (m)	3.7		3.7				
Walking Speed (m/s)	1.0		1.0				
Percent Blockage	1		0				
Right turn flare (veh)							
Median type			None			None	
Median storage (veh)							
Upstream signal (m)			233			175	
pX, platoon unblocked	0.78	0.93			0.93		
vC, conflicting volume	1634	460			912		
vC1, stage 1 conf vol							
vC2, stage 2 conf vol							
vCu, unblocked vol	829	256			744		
tC, single (s)	6.8	7.0			4.1		
tC, 2 stage (s)							
tF (s)	3.5	3.3			2.2		
p0 queue free %	89	93			97		
cM capacity (veh/h)	232	676			788		
Direction, Lane #	WB 1	WB 2	NB 1	NB 2	SB 1	SB 2	SB 3
Volume Total	26	48	591	312	25	678	678
Volume Left	26	0	0	0	25	0	0
Volume Right	0	48	0	17	0	0	0
cSH	232	676	1700	1700	788	1700	1700
Volume to Capacity	0.11	0.07	0.35	0.18	0.03	0.40	0.40
Queue Length 95th (m)	2.8	1.7	0.0	0.0	0.7	0.0	0.0
Control Delay (s)	22.5	10.7	0.0	0.0	9.7	0.0	0.0
Lane LOS	C	B			A		
Approach Delay (s)	14.9		0.0		0.2		
Approach LOS	B						
Intersection Summary							
Average Delay			0.6				
Intersection Capacity Utilization			49.5%		ICU Level of Service		A
Analysis Period (min)			15				

Lanes, Volumes, Timings
5: Merivale Rd & Camelot Dr/Bentley Ave

10/19/2022



Lane Group	EBL	EBT	WBL	WBT	WBR	NBL	NBT	SBL	SBT
Lane Configurations									
Traffic Volume (vph)	52	8	179	10	97	15	723	43	1440
Future Volume (vph)	52	8	179	10	97	15	723	43	1440
Lane Group Flow (vph)	52	160	179	10	97	15	764	43	1456
Turn Type	Perm	NA	Perm	NA	Perm	Perm	NA	Perm	NA
Protected Phases		4		8			2		6
Permitted Phases	4		8		8	2		6	
Detector Phase	4	4	8	8	8	2	2	6	6
Switch Phase									
Minimum Initial (s)	10.0	10.0	10.0	10.0	10.0	10.0	10.0	10.0	10.0
Minimum Split (s)	31.3	31.3	31.3	31.3	31.3	35.9	35.9	35.9	35.9
Total Split (s)	35.0	35.0	35.0	35.0	35.0	85.0	85.0	85.0	85.0
Total Split (%)	29.2%	29.2%	29.2%	29.2%	29.2%	70.8%	70.8%	70.8%	70.8%
Yellow Time (s)	3.3	3.3	3.3	3.3	3.3	3.7	3.7	3.7	3.7
All-Red Time (s)	3.0	3.0	3.0	3.0	3.0	2.2	2.2	2.2	2.2
Lost Time Adjust (s)	0.0	0.0	0.0	0.0	0.0	0.0	0.0	0.0	0.0
Total Lost Time (s)	6.3	6.3	6.3	6.3	6.3	5.9	5.9	5.9	5.9
Lead/Lag									
Lead-Lag Optimize?									
Recall Mode	None	None	None	None	None	C-Max	C-Max	C-Max	C-Max
Act Effct Green (s)	24.2	24.2	24.2	24.2	24.2	83.6	83.6	83.6	83.6
Actuated g/C Ratio	0.20	0.20	0.20	0.20	0.20	0.70	0.70	0.70	0.70
v/c Ratio	0.19	0.47	0.88	0.03	0.25	0.09	0.33	0.11	0.62
Control Delay	39.5	30.2	84.3	35.7	8.8	8.8	8.0	8.0	11.9
Queue Delay	0.0	0.0	0.0	0.0	0.0	0.0	0.0	0.0	0.0
Total Delay	39.5	30.2	84.3	35.7	8.8	8.8	8.0	8.0	11.9
LOS	D	C	F	D	A	A	A	A	B
Approach Delay		32.5		57.0			8.1		11.8
Approach LOS		C		E			A		B
Queue Length 50th (m)	10.1	20.6	40.4	1.9	0.0	1.1	35.1	3.2	92.3
Queue Length 95th (m)	20.5	40.2	#73.1	6.3	13.2	4.1	48.2	8.1	121.6
Internal Link Dist (m)		412.3		581.1			116.9		209.2
Turn Bay Length (m)	35.0		35.0		25.0	40.0		80.0	
Base Capacity (vph)	320	398	241	426	436	168	2309	404	2334
Starvation Cap Reductn	0	0	0	0	0	0	0	0	0
Spillback Cap Reductn	0	0	0	0	0	0	0	0	0
Storage Cap Reductn	0	0	0	0	0	0	0	0	0
Reduced v/c Ratio	0.16	0.40	0.74	0.02	0.22	0.09	0.33	0.11	0.62

Intersection Summary

Cycle Length: 120
 Actuated Cycle Length: 120
 Offset: 16 (13%), Referenced to phase 2:NBTL and 6:SBTL, Start of Green
 Natural Cycle: 70
 Control Type: Actuated-Coordinated
 Maximum v/c Ratio: 0.88
 Intersection Signal Delay: 17.0
 Intersection Capacity Utilization 82.5%
 Analysis Period (min) 15
 # 95th percentile volume exceeds capacity, queue may be longer.
 Queue shown is maximum after two cycles.

Intersection LOS: B
 ICU Level of Service E

Splits and Phases: 5: Merivale Rd & Camelot Dr/Bentley Ave



Total Projected 2024

Lanes, Volumes, Timings
1: Merivale Rd & West Hunt Club Rd

10/19/2022



Lane Group	EBL	EBT	WBL	WBT	NBL	NBT	NBR	SBL	SBT	SBR
Lane Configurations										
Traffic Volume (vph)	287	883	97	610	93	988	85	176	445	233
Future Volume (vph)	287	883	97	610	93	988	85	176	445	233
Lane Group Flow (vph)	287	987	97	761	93	988	85	176	445	233
Turn Type	Prot	NA	Prot	NA	Prot	NA	Perm	Prot	NA	Perm
Protected Phases	7	4	3	8	5	2		1	6	
Permitted Phases							2			6
Detector Phase	7	4	3	8	5	2	2	1	6	6
Switch Phase										
Minimum Initial (s)	5.0	10.0	5.0	10.0	5.0	10.0	10.0	5.0	10.0	10.0
Minimum Split (s)	12.0	33.6	12.0	33.6	11.6	38.6	38.6	11.6	38.6	38.6
Total Split (s)	24.0	51.0	16.0	43.0	22.2	48.0	48.0	15.0	40.8	40.8
Total Split (%)	18.5%	39.2%	12.3%	33.1%	17.1%	36.9%	36.9%	11.5%	31.4%	31.4%
Yellow Time (s)	4.6	4.6	4.6	4.6	3.7	3.7	3.7	3.7	3.7	3.7
All-Red Time (s)	2.4	2.0	2.4	2.0	2.9	2.9	2.9	2.9	2.9	2.9
Lost Time Adjust (s)	0.0	0.0	0.0	0.0	0.0	0.0	0.0	0.0	0.0	0.0
Total Lost Time (s)	7.0	6.6	7.0	6.6	6.6	6.6	6.6	6.6	6.6	6.6
Lead/Lag	Lead	Lag	Lead	Lag	Lead	Lag	Lag	Lead	Lag	Lag
Lead-Lag Optimize?	Yes	Yes	Yes	Yes	Yes	Yes	Yes	Yes	Yes	Yes
Recall Mode	None	C-Max	None	C-Max	None	None	None	None	None	None
Act Effct Green (s)	15.6	44.7	9.3	38.4	12.7	40.8	40.8	8.4	36.5	36.5
Actuated g/C Ratio	0.12	0.34	0.07	0.30	0.10	0.31	0.31	0.06	0.28	0.28
v/c Ratio	0.75	0.88	0.87	0.55	0.64	0.94	0.15	0.85	0.49	0.39
Control Delay	67.8	50.4	116.2	38.3	75.8	59.8	0.6	92.6	41.6	5.0
Queue Delay	0.0	0.0	0.0	0.0	0.0	0.0	0.0	0.0	0.0	0.0
Total Delay	67.8	50.4	116.2	38.3	75.8	59.8	0.6	92.6	41.6	5.0
LOS	E	D	F	D	E	E	A	F	D	A
Approach Delay		54.3		47.1		56.8			42.1	
Approach LOS		D		D		E			D	
Queue Length 50th (m)	36.7	124.2	25.1	57.8	23.2	128.5	0.0	23.4	50.2	0.0
Queue Length 95th (m)	51.9	#160.8	#58.6	71.7	40.4	#167.9	0.0	#43.2	68.3	14.2
Internal Link Dist (m)		173.3		390.9		150.6			154.0	
Turn Bay Length (m)	90.0		70.0		65.0		130.0	60.0		125.0
Base Capacity (vph)	417	1117	111	1386	178	1069	573	208	907	593
Starvation Cap Reductn	0	0	0	0	0	0	0	0	0	0
Spillback Cap Reductn	0	0	0	0	0	0	0	0	0	0
Storage Cap Reductn	0	0	0	0	0	0	0	0	0	0
Reduced v/c Ratio	0.69	0.88	0.87	0.55	0.52	0.92	0.15	0.85	0.49	0.39

Intersection Summary

Cycle Length: 130
 Actuated Cycle Length: 130
 Offset: 102 (78%), Referenced to phase 4:EBT and 8:WBT, Start of Green
 Natural Cycle: 100
 Control Type: Actuated-Coordinated
 Maximum v/c Ratio: 0.94
 Intersection Signal Delay: 51.0
 Intersection Capacity Utilization 91.4%
 Analysis Period (min) 15
 # 95th percentile volume exceeds capacity, queue may be longer.
 Queue shown is maximum after two cycles.

Splits and Phases: 1: Merivale Rd & West Hunt Club Rd

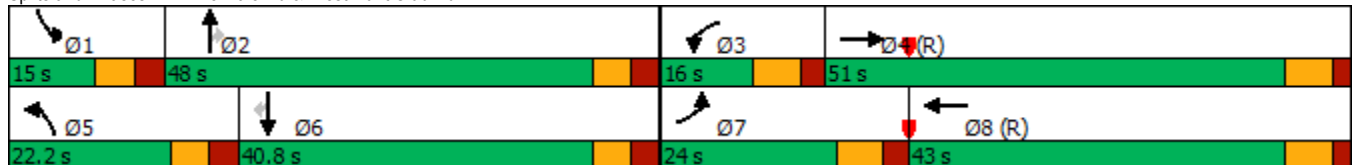

Lanes, Volumes, Timings 2:
Merivale Rd & Jamie Ave

10/19/2022



Lane Group	WBL	WBR	NBT	SBL	SBT
Lane Configurations					
Traffic Volume (vph)	13	30	1267	47	620
Future Volume (vph)	13	30	1267	47	620
Lane Group Flow (vph)	13	30	1297	47	620
Sign Control	Stop		Free		Free
Intersection Summary					
Control Type: Unsignalized					
Intersection Capacity Utilization 51.2%			ICU Level of Service A		
Analysis Period (min) 15					

HCM Unsignalized Intersection Capacity Analysis

2: Merivale Rd & Jamie Ave

10/19/2022



Movement	WBL	WBR	NBT	NBR	SBL	SBT	
Lane Configurations							
Traffic Volume (veh/h)	13	30	1267	30	47	620	
Future Volume (Veh/h)	13	30	1267	30	47	620	
Sign Control	Stop		Free		Free		
Grade	0%		0%		0%		
Peak Hour Factor	1.00	1.00	1.00	1.00	1.00	1.00	
Hourly flow rate (vph)	13	30	1267	30	47	620	
Pedestrians	7		2				
Lane Width (m)	3.7		3.7				
Walking Speed (m/s)	1.0		1.0				
Percent Blockage	1		0				
Right turn flare (veh)							
Median type			None		None		
Median storage (veh)							
Upstream signal (m)			233		175		
pX, platoon unblocked	0.82	0.77			0.77		
vC, conflicting volume	1695	656			1304		
vC1, stage 1 conf vol							
vC2, stage 2 conf vol							
vCu, unblocked vol	862	0			798		
tC, single (s)	6.8	7.0			4.2		
tC, 2 stage (s)							
tF (s)	3.5	3.4			2.2		
p0 queue free %	94	96			92		
cM capacity (veh/h)	221	817			622		
Direction, Lane #	WB 1	WB 2	NB 1	NB 2	SB 1	SB 2	SB 3
Volume Total	13	30	845	452	47	310	310
Volume Left	13	0	0	0	47	0	0
Volume Right	0	30	0	30	0	0	0
cSH	221	817	1700	1700	622	1700	1700
Volume to Capacity	0.06	0.04	0.50	0.27	0.08	0.18	0.18
Queue Length 95th (m)	1.4	0.9	0.0	0.0	1.9	0.0	0.0
Control Delay (s)	22.3	9.6	0.0	0.0	11.3	0.0	0.0
Lane LOS	C	A			B		
Approach Delay (s)	13.4		0.0		0.8		
Approach LOS	B						
Intersection Summary							
Average Delay			0.6				
Intersection Capacity Utilization			51.2%		ICU Level of Service		A
Analysis Period (min)			15				

Lanes, Volumes, Timings
 3: Merivale Rd & Merivale Access

10/19/2022



Lane Group	WBR	NBT	SBT
Lane Configurations			
Traffic Volume (vph)	12	1255	623
Future Volume (vph)	12	1255	623
Lane Group Flow (vph)	12	1260	623
Sign Control		Free	Free
Intersection Summary			
Control Type: Unsignalized			
Intersection Capacity Utilization 46.8%		ICU Level of Service A	
Analysis Period (min) 15			

HCM Unsignalized Intersection Capacity Analysis
 3: Merivale Rd & Merivale Access

10/19/2022



Movement	WBL	WBR	NBT	NBR	SBL	SBT
Lane Configurations						
Traffic Volume (veh/h)	0	12	1255	5	0	623
Future Volume (Veh/h)	0	12	1255	5	0	623
Sign Control	Stop		Free			Free
Grade	0%		0%			0%
Peak Hour Factor	1.00	1.00	1.00	1.00	1.00	1.00
Hourly flow rate (vph)	0	12	1255	5	0	623
Pedestrians						
Lane Width (m)						
Walking Speed (m/s)						
Percent Blockage						
Right turn flare (veh)						
Median type			None			None
Median storage (veh)						
Upstream signal (m)			159			249
pX, platoon unblocked	0.81	0.76			0.76	
vC, conflicting volume	1569	630			1260	
vC1, stage 1 conf vol						
vC2, stage 2 conf vol						
vCu, unblocked vol	716	0			713	
tC, single (s)	6.8	6.9			4.1	
tC, 2 stage (s)						
tF (s)	3.5	3.3			2.2	
p0 queue free %	100	99			100	
cM capacity (veh/h)	294	825			672	
Direction, Lane #	WB 1	NB 1	NB 2	SB 1	SB 2	
Volume Total	12	837	423	312	312	
Volume Left	0	0	0	0	0	
Volume Right	12	0	5	0	0	
cSH	825	1700	1700	1700	1700	
Volume to Capacity	0.01	0.49	0.25	0.18	0.18	
Queue Length 95th (m)	0.3	0.0	0.0	0.0	0.0	
Control Delay (s)	9.4	0.0	0.0	0.0	0.0	
Lane LOS	A					
Approach Delay (s)	9.4	0.0		0.0		
Approach LOS	A					
Intersection Summary						
Average Delay			0.1			
Intersection Capacity Utilization			46.8%		ICU Level of Service	A
Analysis Period (min)			15			

Lanes, Volumes, Timings

4: Jamie Access & Jamie Ave

10/19/2022

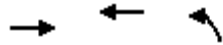

Lane Group	EBT	WBT	NBL
Lane Configurations			
Traffic Volume (vph)	59	41	3
Future Volume (vph)	59	41	3
Lane Group Flow (vph)	77	41	3
Sign Control	Free	Free	Stop
Intersection Summary			
Control Type: Unsignalized			
Intersection Capacity Utilization 14.4%		ICU Level of Service A	
Analysis Period (min) 15			

HCM Unsignalized Intersection Capacity Analysis
 4: Jamie Access & Jamie Ave

10/19/2022

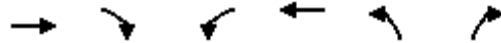

Movement	EBT	EBR	WBL	WBT	NBL	NBR
Lane Configurations						
Traffic Volume (veh/h)	59	18	0	41	3	0
Future Volume (Veh/h)	59	18	0	41	3	0
Sign Control	Free			Free	Stop	
Grade	0%			0%	0%	
Peak Hour Factor	1.00	1.00	1.00	1.00	1.00	1.00
Hourly flow rate (vph)	59	18	0	41	3	0
Pedestrians						
Lane Width (m)						
Walking Speed (m/s)						
Percent Blockage						
Right turn flare (veh)						
Median type	None			None		
Median storage (veh)						
Upstream signal (m)						
pX, platoon unblocked						
vC, conflicting volume			77		109	68
vC1, stage 1 conf vol						
vC2, stage 2 conf vol						
vCu, unblocked vol			77		109	68
tC, single (s)			4.1		6.4	6.2
tC, 2 stage (s)						
tF (s)			2.2		3.5	3.3
p0 queue free %			100		100	100
cM capacity (veh/h)			1522		888	995
Direction, Lane #	EB 1	WB 1	NB 1			
Volume Total	77	41	3			
Volume Left	0	0	3			
Volume Right	18	0	0			
cSH	1700	1522	888			
Volume to Capacity	0.05	0.00	0.00			
Queue Length 95th (m)	0.0	0.0	0.1			
Control Delay (s)	0.0	0.0	9.1			
Lane LOS				A		
Approach Delay (s)	0.0	0.0	9.1			
Approach LOS				A		
Intersection Summary						
Average Delay			0.2			
Intersection Capacity Utilization			14.4%	ICU Level of Service	A	
Analysis Period (min)			15			

Lanes, Volumes, Timings
5: Merivale Rd & Camelot Dr/Bentley Ave

10/19/2022



Lane Group	EBL	EBT	WBL	WBT	WBR	NBL	NBT	SBL	SBT
Lane Configurations									
Traffic Volume (vph)	15	31	47	11	46	140	1289	61	471
Future Volume (vph)	15	31	47	11	46	140	1289	61	471
Lane Group Flow (vph)	15	107	47	11	46	140	1459	61	540
Turn Type	Perm	NA	Perm	NA	Perm	Perm	NA	pm+pt	NA
Protected Phases		4		8			2	1	6
Permitted Phases	4		8		8	2		6	
Detector Phase	4	4	8	8	8	2	2	1	6
Switch Phase									
Minimum Initial (s)	10.0	10.0	10.0	10.0	10.0	10.0	10.0	5.0	10.0
Minimum Split (s)	31.3	31.3	31.3	31.3	31.3	35.9	35.9	10.8	35.9
Total Split (s)	31.6	31.6	31.6	31.6	31.6	66.4	66.4	12.0	78.4
Total Split (%)	28.7%	28.7%	28.7%	28.7%	28.7%	60.4%	60.4%	10.9%	71.3%
Yellow Time (s)	3.3	3.3	3.3	3.3	3.3	3.7	3.7	3.7	3.7
All-Red Time (s)	3.0	3.0	3.0	3.0	3.0	2.2	2.2	2.1	2.2
Lost Time Adjust (s)	0.0	0.0	0.0	0.0	0.0	0.0	0.0	0.0	0.0
Total Lost Time (s)	6.3	6.3	6.3	6.3	6.3	5.9	5.9	5.8	5.9
Lead/Lag						Lag	Lag	Lead	
Lead-Lag Optimize?						Yes	Yes	Yes	
Recall Mode	None	None	None	None	None	C-Max	C-Max	None	C-Max
Act Effct Green (s)	11.4	11.4	11.4	11.4	11.4	76.5	76.5	86.5	86.4
Actuated g/C Ratio	0.10	0.10	0.10	0.10	0.10	0.70	0.70	0.79	0.79
v/c Ratio	0.11	0.47	0.41	0.07	0.21	0.26	0.65	0.24	0.22
Control Delay	45.3	23.6	56.7	44.2	4.0	8.9	11.8	5.1	3.2
Queue Delay	0.0	0.0	0.0	0.0	0.0	0.0	0.0	0.0	0.0
Total Delay	45.3	23.6	56.7	44.2	4.0	8.9	11.8	5.1	3.2
LOS	D	C	E	D	A	A	B	A	A
Approach Delay		26.3		32.1			11.6		3.4
Approach LOS		C		C			B		A
Queue Length 50th (m)	3.0	6.3	9.7	2.2	0.0	10.2	82.2	2.2	10.9
Queue Length 95th (m)	9.0	22.0	20.9	7.4	2.5	23.1	124.9	5.8	19.3
Internal Link Dist (m)		412.3		581.1			116.9		135.0
Turn Bay Length (m)	35.0		35.0		25.0	40.0		80.0	
Base Capacity (vph)	305	414	254	354	380	545	2250	258	2462
Starvation Cap Reductn	0	0	0	0	0	0	0	0	0
Spillback Cap Reductn	0	0	0	0	0	0	0	0	0
Storage Cap Reductn	0	0	0	0	0	0	0	0	0
Reduced v/c Ratio	0.05	0.26	0.19	0.03	0.12	0.26	0.65	0.24	0.22

Intersection Summary

Cycle Length: 110
 Actuated Cycle Length: 110
 Offset: 103 (94%), Referenced to phase 2:NBT and 6:SBTL, Start of Green
 Natural Cycle: 90
 Control Type: Actuated-Coordinated
 Maximum v/c Ratio: 0.65
 Intersection Signal Delay: 11.2
 Intersection Capacity Utilization 77.4%
 Analysis Period (min) 15

Intersection LOS: B
 ICU Level of Service D

Splits and Phases: 5: Merivale Rd & Camelot Dr/Bentley Ave



Lanes, Volumes, Timings

1: Merivale Rd & West Hunt Club Rd

10/19/2022



Lane Group	EBL	EBT	WBL	WBT	NBL	NBT	NBR	SBL	SBT	SBR
Lane Configurations										
Traffic Volume (vph)	251	592	154	1058	141	553	109	178	813	289
Future Volume (vph)	251	592	154	1058	141	553	109	178	813	289
Lane Group Flow (vph)	251	710	154	1317	141	553	109	178	813	289
Turn Type	Prot	NA	Prot	NA	Prot	NA	Perm	Prot	NA	Perm
Protected Phases	7	4	3	8	5	2		1	6	
Permitted Phases							2			6
Detector Phase	7	4	3	8	5	2	2	1	6	6
Switch Phase										
Minimum Initial (s)	5.0	10.0	5.0	10.0	5.0	10.0	10.0	5.0	10.0	10.0
Minimum Split (s)	12.0	33.6	12.0	33.6	11.6	38.6	38.6	11.6	38.6	38.6
Total Split (s)	19.0	41.7	24.0	46.7	22.0	45.4	45.4	18.9	42.3	42.3
Total Split (%)	14.6%	32.1%	18.5%	35.9%	16.9%	34.9%	34.9%	14.5%	32.5%	32.5%
Yellow Time (s)	4.6	4.6	4.6	4.6	3.7	3.7	3.7	3.7	3.7	3.7
All-Red Time (s)	2.4	2.0	2.4	2.0	2.9	2.9	2.9	2.9	2.9	2.9
Lost Time Adjust (s)	0.0	0.0	0.0	0.0	0.0	0.0	0.0	0.0	0.0	0.0
Total Lost Time (s)	7.0	6.6	7.0	6.6	6.6	6.6	6.6	6.6	6.6	6.6
Lead/Lag	Lead	Lag	Lead	Lag	Lead	Lag	Lag	Lead	Lag	Lag
Lead-Lag Optimize?	Yes	Yes	Yes	Yes	Yes	Yes	Yes	Yes	Yes	Yes
Recall Mode	None	C-Max	None	C-Max	None	None	None	None	None	None
Act Effct Green (s)	12.0	38.1	15.8	41.9	14.3	38.0	38.0	11.4	35.0	35.0
Actuated g/C Ratio	0.09	0.29	0.12	0.32	0.11	0.29	0.29	0.09	0.27	0.27
v/c Ratio	0.83	0.75	0.82	0.85	0.79	0.56	0.21	0.63	0.90	0.48
Control Delay	80.5	47.2	86.7	46.3	86.0	41.4	3.0	67.3	59.7	8.1
Queue Delay	0.0	0.0	0.0	0.0	0.0	0.0	0.0	0.0	0.0	0.0
Total Delay	80.5	47.2	86.7	46.3	86.0	41.4	3.0	67.3	59.7	8.1
LOS	F	D	F	D	F	D	A	E	E	A
Approach Delay		55.9		50.5		44.1			49.1	
Approach LOS		E		D		D			D	
Queue Length 50th (m)	33.1	87.7	38.6	113.9	35.4	62.6	0.0	22.8	105.2	2.8
Queue Length 95th (m)	#54.1	111.3	#70.9	133.5	#66.1	80.9	6.5	34.8	#138.1	25.2
Internal Link Dist (m)		173.3		390.9		150.6			154.0	
Turn Bay Length (m)	90.0		70.0		65.0		130.0	60.0		125.0
Base Capacity (vph)	305	951	203	1552	191	1006	529	308	924	608
Starvation Cap Reductn	0	0	0	0	0	0	0	0	0	0
Spillback Cap Reductn	0	0	0	0	0	0	0	0	0	0
Storage Cap Reductn	0	0	0	0	0	0	0	0	0	0
Reduced v/c Ratio	0.82	0.75	0.76	0.85	0.74	0.55	0.21	0.58	0.88	0.48

Intersection Summary

Cycle Length: 130
 Actuated Cycle Length: 130
 Offset: 28 (22%), Referenced to phase 4:EBT and 8:WBT, Start of Green
 Natural Cycle: 100
 Control Type: Actuated-Coordinated
 Maximum v/c Ratio: 0.90
 Intersection Signal Delay: 50.1
 Intersection Capacity Utilization 90.0%
 Analysis Period (min) 15
 # 95th percentile volume exceeds capacity, queue may be longer.
 Queue shown is maximum after two cycles.

Intersection LOS: D
 ICU Level of Service E

Splits and Phases: 1: Merivale Rd & West Hunt Club Rd

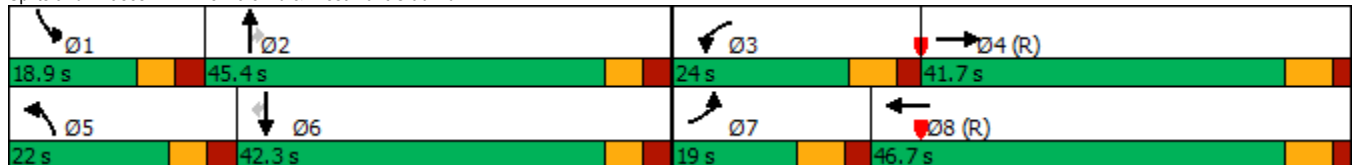

Lanes, Volumes, Timings 2:
Merivale Rd & Jamie Ave

10/19/2022



Lane Group	WBL	WBR	NBT	SBL	SBT
Lane Configurations					
Traffic Volume (vph)	31	48	820	32	1228
Future Volume (vph)	31	48	820	32	1228
Lane Group Flow (vph)	31	48	837	32	1228
Sign Control	Stop		Free		Free
Intersection Summary					
Control Type: Unsignalized					
Intersection Capacity Utilization 45.8%			ICU Level of Service A		
Analysis Period (min) 15					

HCM Unsignalized Intersection Capacity Analysis
 2: Merivale Rd & Jamie Ave

10/19/2022



Movement	WBL	WBR	NBT	NBR	SBL	SBT	
Lane Configurations							
Traffic Volume (veh/h)	31	48	820	17	32	1228	
Future Volume (Veh/h)	31	48	820	17	32	1228	
Sign Control	Stop		Free			Free	
Grade	0%		0%			0%	
Peak Hour Factor	1.00	1.00	1.00	1.00	1.00	1.00	
Hourly flow rate (vph)	31	48	820	17	32	1228	
Pedestrians	9		3				
Lane Width (m)	3.7		3.7				
Walking Speed (m/s)	1.0		1.0				
Percent Blockage	1		0				
Right turn flare (veh)							
Median type			None			None	
Median storage (veh)							
Upstream signal (m)			233			175	
pX, platoon unblocked	0.80	0.94			0.94		
vC, conflicting volume	1518	428			846		
vC1, stage 1 conf vol							
vC2, stage 2 conf vol							
vCu, unblocked vol	824	268			713		
tC, single (s)	6.8	7.0			4.1		
tC, 2 stage (s)							
tF (s)	3.5	3.3			2.2		
p0 queue free %	87	93			96		
cM capacity (veh/h)	237	675			824		
Direction, Lane #	WB 1	WB 2	NB 1	NB 2	SB 1	SB 2	SB 3
Volume Total	31	48	547	290	32	614	614
Volume Left	31	0	0	0	32	0	0
Volume Right	0	48	0	17	0	0	0
cSH	237	675	1700	1700	824	1700	1700
Volume to Capacity	0.13	0.07	0.32	0.17	0.04	0.36	0.36
Queue Length 95th (m)	3.4	1.7	0.0	0.0	0.9	0.0	0.0
Control Delay (s)	22.5	10.7	0.0	0.0	9.5	0.0	0.0
Lane LOS	C	B			A		
Approach Delay (s)	15.3		0.0		0.2		
Approach LOS	C						
Intersection Summary							
Average Delay			0.7				
Intersection Capacity Utilization			45.8%		ICU Level of Service		A
Analysis Period (min)			15				

Lanes, Volumes, Timings
 3: Merivale Rd & Merivale Access

10/19/2022



Lane Group	WBR	NBT	SBT
Lane Configurations			
Traffic Volume (vph)	18	802	1233
Future Volume (vph)	18	802	1233
Lane Group Flow (vph)	18	804	1233
Sign Control		Free	Free
Intersection Summary			
Control Type: Unsignalized			
Intersection Capacity Utilization 39.3%		ICU Level of Service A	
Analysis Period (min) 15			

HCM Unsignalized Intersection Capacity Analysis
 3: Merivale Rd & Merivale Access

10/19/2022



Movement	WBL	WBR	NBT	NBR	SBL	SBT
Lane Configurations						
Traffic Volume (veh/h)	0	18	802	2	0	1233
Future Volume (Veh/h)	0	18	802	2	0	1233
Sign Control	Stop		Free			Free
Grade	0%		0%			0%
Peak Hour Factor	1.00	1.00	1.00	1.00	1.00	1.00
Hourly flow rate (vph)	0	18	802	2	0	1233
Pedestrians						
Lane Width (m)						
Walking Speed (m/s)						
Percent Blockage						
Right turn flare (veh)						
Median type			None			None
Median storage (veh)						
Upstream signal (m)			159			249
pX, platoon unblocked	0.81	0.93			0.93	
vC, conflicting volume	1420	402			804	
vC1, stage 1 conf vol						
vC2, stage 2 conf vol						
vCu, unblocked vol	678	215			646	
tC, single (s)	6.8	6.9			4.1	
tC, 2 stage (s)						
tF (s)	3.5	3.3			2.2	
p0 queue free %	100	98			100	
cM capacity (veh/h)	313	737			873	
Direction, Lane #	WB 1	NB 1	NB 2	SB 1	SB 2	
Volume Total	18	535	269	616	616	
Volume Left	0	0	0	0	0	
Volume Right	18	0	2	0	0	
cSH	737	1700	1700	1700	1700	
Volume to Capacity	0.02	0.31	0.16	0.36	0.36	
Queue Length 95th (m)	0.6	0.0	0.0	0.0	0.0	
Control Delay (s)	10.0	0.0	0.0	0.0	0.0	
Lane LOS	B					
Approach Delay (s)	10.0	0.0		0.0		
Approach LOS	B					
Intersection Summary						
Average Delay			0.1			
Intersection Capacity Utilization			39.3%		ICU Level of Service	A
Analysis Period (min)			15			

Lanes, Volumes, Timings

4: Jamie Access & Jamie Ave

10/19/2022

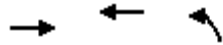

Lane Group	EBT	WBT	NBL
Lane Configurations			
Traffic Volume (vph)	42	74	5
Future Volume (vph)	42	74	5
Lane Group Flow (vph)	49	74	5
Sign Control	Free	Free	Stop

Intersection Summary	
Control Type: Unsignalized	
Intersection Capacity Utilization 14.1%	ICU Level of Service A
Analysis Period (min) 15	

HCM Unsignalized Intersection Capacity Analysis
 4: Jamie Access & Jamie Ave

10/19/2022

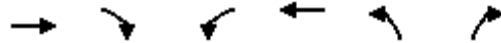

Movement	EBT	EBR	WBL	WBT	NBL	NBR
Lane Configurations						
Traffic Volume (veh/h)	42	7	0	74	5	0
Future Volume (Veh/h)	42	7	0	74	5	0
Sign Control	Free			Free	Stop	
Grade	0%			0%	0%	
Peak Hour Factor	1.00	1.00	1.00	1.00	1.00	1.00
Hourly flow rate (vph)	42	7	0	74	5	0
Pedestrians						
Lane Width (m)						
Walking Speed (m/s)						
Percent Blockage						
Right turn flare (veh)						
Median type	None			None		
Median storage (veh)						
Upstream signal (m)						
pX, platoon unblocked						
vC, conflicting volume			49		120	46
vC1, stage 1 conf vol						
vC2, stage 2 conf vol						
vCu, unblocked vol			49		120	46
tC, single (s)			4.1		6.4	6.2
tC, 2 stage (s)						
tF (s)			2.2		3.5	3.3
p0 queue free %			100		99	100
cM capacity (veh/h)			1558		876	1024
Direction, Lane #	EB 1	WB 1	NB 1			
Volume Total	49	74	5			
Volume Left	0	0	5			
Volume Right	7	0	0			
cSH	1700	1558	876			
Volume to Capacity	0.03	0.00	0.01			
Queue Length 95th (m)	0.0	0.0	0.1			
Control Delay (s)	0.0	0.0	9.1			
Lane LOS	A					
Approach Delay (s)	0.0	0.0	9.1			
Approach LOS	A					
Intersection Summary						
Average Delay			0.4			
Intersection Capacity Utilization			14.1%	ICU Level of Service	A	
Analysis Period (min)			15			

Lanes, Volumes, Timings
5: Merivale Rd & Camelot Dr/Bentley Ave

10/19/2022



Lane Group	EBL	EBT	WBL	WBT	WBR	NBL	NBT	SBL	SBT
Lane Configurations									
Traffic Volume (vph)	52	8	179	10	97	15	656	43	1310
Future Volume (vph)	52	8	179	10	97	15	656	43	1310
Lane Group Flow (vph)	52	160	179	10	97	15	697	43	1326
Turn Type	Perm	NA	Perm	NA	Perm	Perm	NA	Perm	NA
Protected Phases		4		8			2		6
Permitted Phases	4		8		8	2		6	
Detector Phase	4	4	8	8	8	2	2	6	6
Switch Phase									
Minimum Initial (s)	10.0	10.0	10.0	10.0	10.0	10.0	10.0	10.0	10.0
Minimum Split (s)	31.3	31.3	31.3	31.3	31.3	35.9	35.9	35.9	35.9
Total Split (s)	44.0	44.0	44.0	44.0	44.0	76.0	76.0	76.0	76.0
Total Split (%)	36.7%	36.7%	36.7%	36.7%	36.7%	63.3%	63.3%	63.3%	63.3%
Yellow Time (s)	3.3	3.3	3.3	3.3	3.3	3.7	3.7	3.7	3.7
All-Red Time (s)	3.0	3.0	3.0	3.0	3.0	2.2	2.2	2.2	2.2
Lost Time Adjust (s)	0.0	0.0	0.0	0.0	0.0	0.0	0.0	0.0	0.0
Total Lost Time (s)	6.3	6.3	6.3	6.3	6.3	5.9	5.9	5.9	5.9
Lead/Lag									
Lead-Lag Optimize?									
Recall Mode	None	None	None	None	None	C-Max	C-Max	C-Max	C-Max
Act Effct Green (s)	24.8	24.8	24.8	24.8	24.8	83.0	83.0	83.0	83.0
Actuated g/C Ratio	0.21	0.21	0.21	0.21	0.21	0.69	0.69	0.69	0.69
v/c Ratio	0.19	0.46	0.85	0.03	0.25	0.07	0.30	0.10	0.57
Control Delay	37.8	30.4	77.9	33.5	8.1	9.5	8.4	8.8	11.7
Queue Delay	0.0	0.0	0.0	0.0	0.0	0.0	0.0	0.0	0.0
Total Delay	37.8	30.4	77.9	33.5	8.1	9.5	8.4	8.8	11.7
LOS	D	C	E	C	A	A	A	A	B
Approach Delay		32.2		52.7			8.4		11.6
Approach LOS		C		D			A		B
Queue Length 50th (m)	10.2	22.0	40.8	1.9	0.0	1.0	30.0	3.0	75.7
Queue Length 95th (m)	19.1	38.4	61.5	5.8	12.3	4.6	50.7	9.3	121.5
Internal Link Dist (m)		412.3		581.1			116.9		135.0
Turn Bay Length (m)	35.0		35.0		25.0	40.0		80.0	
Base Capacity (vph)	420	501	319	560	543	200	2288	433	2318
Starvation Cap Reductn	0	0	0	0	0	0	0	0	0
Spillback Cap Reductn	0	0	0	0	0	0	0	0	0
Storage Cap Reductn	0	0	0	0	0	0	0	0	0
Reduced v/c Ratio	0.12	0.32	0.56	0.02	0.18	0.07	0.30	0.10	0.57

Intersection Summary
 Cycle Length: 120
 Actuated Cycle Length: 120
 Offset: 16 (13%), Referenced to phase 2:NBT and 6:SBTL, Start of Green
 Natural Cycle: 70
 Control Type: Actuated-Coordinated
 Maximum v/c Ratio: 0.85
 Intersection Signal Delay: 17.0
 Intersection Capacity Utilization 78.7%
 Analysis Period (min) 15
 Intersection LOS: B
 ICU Level of Service D

Splits and Phases: 5: Merivale Rd & Camelot Dr/Bentley Ave



Total Projected 2029

Lanes, Volumes, Timings

1: Merivale Rd & West Hunt Club Rd

10/19/2022



Lane Group	EBL	EBT	WBL	WBT	NBL	NBT	NBR	SBL	SBT	SBR
Lane Configurations										
Traffic Volume (vph)	287	975	97	673	93	1090	85	176	490	233
Future Volume (vph)	287	975	97	673	93	1090	85	176	490	233
Lane Group Flow (vph)	287	1079	97	824	93	1090	85	176	490	233
Turn Type	Prot	NA	Prot	NA	Prot	NA	Perm	Prot	NA	Perm
Protected Phases	7	4	3	8	5	2		1	6	
Permitted Phases							2			6
Detector Phase	7	4	3	8	5	2	2	1	6	6
Switch Phase										
Minimum Initial (s)	5.0	10.0	5.0	10.0	5.0	10.0	10.0	5.0	10.0	10.0
Minimum Split (s)	12.0	33.6	12.0	33.6	11.6	38.6	38.6	11.6	38.6	38.6
Total Split (s)	24.0	51.4	15.0	42.4	22.2	49.0	49.0	14.6	41.4	41.4
Total Split (%)	18.5%	39.5%	11.5%	32.6%	17.1%	37.7%	37.7%	11.2%	31.8%	31.8%
Yellow Time (s)	4.6	4.6	4.6	4.6	3.7	3.7	3.7	3.7	3.7	3.7
All-Red Time (s)	2.4	2.0	2.4	2.0	2.9	2.9	2.9	2.9	2.9	2.9
Lost Time Adjust (s)	0.0	0.0	0.0	0.0	0.0	0.0	0.0	0.0	0.0	0.0
Total Lost Time (s)	7.0	6.6	7.0	6.6	6.6	6.6	6.6	6.6	6.6	6.6
Lead/Lag	Lead	Lag	Lead	Lag	Lead	Lag	Lag	Lead	Lag	Lag
Lead-Lag Optimize?	Yes	Yes	Yes	Yes	Yes	Yes	Yes	Yes	Yes	Yes
Recall Mode	None	C-Max	None	C-Max	None	None	None	None	None	None
Act Effct Green (s)	15.6	44.8	8.0	37.2	12.7	42.4	42.4	8.0	37.7	37.7
Actuated g/C Ratio	0.12	0.34	0.06	0.29	0.10	0.33	0.33	0.06	0.29	0.29
v/c Ratio	0.75	0.96	1.02	0.61	0.64	1.00	0.15	0.89	0.52	0.39
Control Delay	67.8	60.7	157.4	40.8	75.8	70.1	0.5	100.7	41.7	4.9
Queue Delay	0.0	0.0	0.0	0.0	0.0	0.0	0.0	0.0	0.0	0.0
Total Delay	67.8	60.7	157.4	40.8	75.8	70.1	0.5	100.7	41.7	4.9
LOS	E	E	F	D	E	E	A	F	D	A
Approach Delay		62.2		53.1		65.8			43.7	
Approach LOS		E		D		E			D	
Queue Length 50th (m)	36.7	141.0	~25.7	65.0	23.2	146.3	0.0	23.5	55.8	0.0
Queue Length 95th (m)	51.9	#186.0	#61.8	79.7	40.4	#193.4	0.0	#44.6	75.1	14.1
Internal Link Dist (m)		173.3		390.9		150.6			154.0	
Turn Bay Length (m)	90.0		70.0		65.0		130.0	60.0		125.0
Base Capacity (vph)	417	1122	95	1344	178	1094	582	198	937	604
Starvation Cap Reductn	0	0	0	0	0	0	0	0	0	0
Spillback Cap Reductn	0	0	0	0	0	0	0	0	0	0
Storage Cap Reductn	0	0	0	0	0	0	0	0	0	0
Reduced v/c Ratio	0.69	0.96	1.02	0.61	0.52	1.00	0.15	0.89	0.52	0.39

Intersection Summary

Cycle Length: 130

Actuated Cycle Length: 130

Offset: 102 (78%), Referenced to phase 4:EBT and 8:WBT, Start of Green

Natural Cycle: 120

Control Type: Actuated-Coordinated

Maximum v/c Ratio: 1.02

Intersection Signal Delay: 57.6

Intersection LOS: E

Intersection Capacity Utilization 97.1%

ICU Level of Service F

Analysis Period (min) 15

~ Volume exceeds capacity, queue is theoretically infinite.

Queue shown is maximum after two cycles.

95th percentile volume exceeds capacity, queue may be longer.

Queue shown is maximum after two cycles.

Splits and Phases: 1: Merivale Rd & West Hunt Club Rd

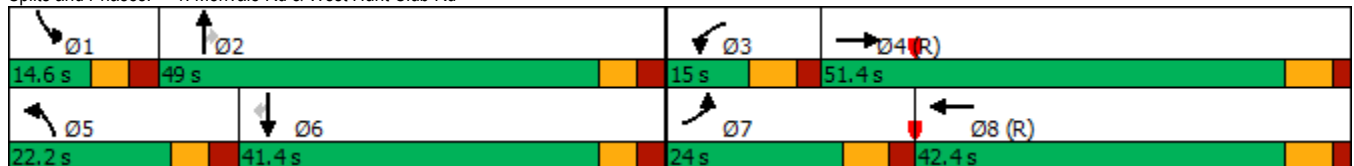

Lanes, Volumes, Timings 2:
Merivale Rd & Jamie Ave

10/19/2022



Lane Group	WBL	WBR	NBT	SBL	SBT
Lane Configurations					
Traffic Volume (vph)	14	30	1397	47	685
Future Volume (vph)	14	30	1397	47	685
Lane Group Flow (vph)	14	30	1427	47	685
Sign Control	Stop		Free		Free
Intersection Summary					
Control Type: Unsignalized					
Intersection Capacity Utilization 51.8%			ICU Level of Service A		
Analysis Period (min) 15					

HCM Unsignalized Intersection Capacity Analysis
 2: Merivale Rd & Jamie Ave

10/19/2022



Movement	WBL	WBR	NBT	NBR	SBL	SBT	
Lane Configurations							
Traffic Volume (veh/h)	14	30	1397	30	47	685	
Future Volume (Veh/h)	14	30	1397	30	47	685	
Sign Control	Stop		Free		Free		
Grade	0%		0%		0%		
Peak Hour Factor	1.00	1.00	1.00	1.00	1.00	1.00	
Hourly flow rate (vph)	14	30	1397	30	47	685	
Pedestrians	7		2				
Lane Width (m)	3.7		3.7				
Walking Speed (m/s)	1.0		1.0				
Percent Blockage	1		0				
Right turn flare (veh)							
Median type			None		None		
Median storage (veh)							
Upstream signal (m)			233		175		
pX, platoon unblocked	0.77	0.72			0.72		
vC, conflicting volume	1858	720			1434		
vC1, stage 1 conf vol							
vC2, stage 2 conf vol							
vCu, unblocked vol	865	0			813		
tC, single (s)	6.8	7.0			4.2		
tC, 2 stage (s)							
tF (s)	3.5	3.4			2.2		
p0 queue free %	93	96			92		
cM capacity (veh/h)	206	760			571		
Direction, Lane #	WB 1	WB 2	NB 1	NB 2	SB 1	SB 2	SB 3
Volume Total	14	30	931	496	47	342	342
Volume Left	14	0	0	0	47	0	0
Volume Right	0	30	0	30	0	0	0
cSH	206	760	1700	1700	571	1700	1700
Volume to Capacity	0.07	0.04	0.55	0.29	0.08	0.20	0.20
Queue Length 95th (m)	1.6	0.9	0.0	0.0	2.0	0.0	0.0
Control Delay (s)	23.8	9.9	0.0	0.0	11.9	0.0	0.0
Lane LOS	C	A			B		
Approach Delay (s)	14.3		0.0		0.8		
Approach LOS	B						
Intersection Summary							
Average Delay			0.5				
Intersection Capacity Utilization			51.8%		ICU Level of Service		A
Analysis Period (min)			15				

Lanes, Volumes, Timings
 3: Merivale Rd & Merivale Access

10/19/2022



Lane Group	WBR	NBT	SBT
Lane Configurations			
Traffic Volume (vph)	12	1385	688
Future Volume (vph)	12	1385	688
Lane Group Flow (vph)	12	1390	688
Sign Control		Free	Free
Intersection Summary			
Control Type: Unsignalized			
Intersection Capacity Utilization 50.6%		ICU Level of Service A	
Analysis Period (min) 15			

HCM Unsignalized Intersection Capacity Analysis

3: Merivale Rd & Merivale Access

10/19/2022



Movement	WBL	WBR	NBT	NBR	SBL	SBT
Lane Configurations						
Traffic Volume (veh/h)	0	12	1385	5	0	688
Future Volume (Veh/h)	0	12	1385	5	0	688
Sign Control	Stop		Free			Free
Grade	0%		0%			0%
Peak Hour Factor	1.00	1.00	1.00	1.00	1.00	1.00
Hourly flow rate (vph)	0	12	1385	5	0	688
Pedestrians						
Lane Width (m)						
Walking Speed (m/s)						
Percent Blockage						
Right turn flare (veh)						
Median type			None			None
Median storage (veh)						
Upstream signal (m)			159			249
pX, platoon unblocked	0.76	0.71			0.71	
vC, conflicting volume	1732	695			1390	
vC1, stage 1 conf vol						
vC2, stage 2 conf vol						
vCu, unblocked vol	713	0			728	
tC, single (s)	6.8	6.9			4.1	
tC, 2 stage (s)						
tF (s)	3.5	3.3			2.2	
p0 queue free %	100	98			100	
cM capacity (veh/h)	279	769			617	
Direction, Lane #	WB 1	NB 1	NB 2	SB 1	SB 2	
Volume Total	12	923	467	344	344	
Volume Left	0	0	0	0	0	
Volume Right	12	0	5	0	0	
cSH	769	1700	1700	1700	1700	
Volume to Capacity	0.02	0.54	0.27	0.20	0.20	
Queue Length 95th (m)	0.4	0.0	0.0	0.0	0.0	
Control Delay (s)	9.8	0.0	0.0	0.0	0.0	
Lane LOS	A					
Approach Delay (s)	9.8	0.0		0.0		
Approach LOS	A					
Intersection Summary						
Average Delay			0.1			
Intersection Capacity Utilization			50.6%		ICU Level of Service	A
Analysis Period (min)			15			

Lanes, Volumes, Timings

4: Jamie Access & Jamie Ave

10/19/2022

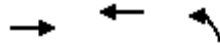

Lane Group	EBT	WBT	NBL
Lane Configurations			
Traffic Volume (vph)	59	41	3
Future Volume (vph)	59	41	3
Lane Group Flow (vph)	77	41	3
Sign Control	Free	Free	Stop
Intersection Summary			
Control Type: Unsignalized			
Intersection Capacity Utilization 14.4%		ICU Level of Service A	
Analysis Period (min) 15			

HCM Unsignalized Intersection Capacity Analysis
 4: Jamie Access & Jamie Ave

10/19/2022

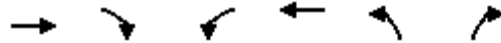

Movement	EBT	EBR	WBL	WBT	NBL	NBR
Lane Configurations						
Traffic Volume (veh/h)	59	18	0	41	3	0
Future Volume (Veh/h)	59	18	0	41	3	0
Sign Control	Free			Free	Stop	
Grade	0%			0%	0%	
Peak Hour Factor	1.00	1.00	1.00	1.00	1.00	1.00
Hourly flow rate (vph)	59	18	0	41	3	0
Pedestrians						
Lane Width (m)						
Walking Speed (m/s)						
Percent Blockage						
Right turn flare (veh)						
Median type	None		None			
Median storage (veh)						
Upstream signal (m)						
pX, platoon unblocked						
vC, conflicting volume			77		109	68
vC1, stage 1 conf vol						
vC2, stage 2 conf vol						
vCu, unblocked vol			77		109	68
tC, single (s)			4.1		6.4	6.2
tC, 2 stage (s)						
tF (s)			2.2		3.5	3.3
p0 queue free %			100		100	100
cM capacity (veh/h)			1522		888	995
Direction, Lane #	EB 1	WB 1	NB 1			
Volume Total	77	41	3			
Volume Left	0	0	3			
Volume Right	18	0	0			
cSH	1700	1522	888			
Volume to Capacity	0.05	0.00	0.00			
Queue Length 95th (m)	0.0	0.0	0.1			
Control Delay (s)	0.0	0.0	9.1			
Lane LOS				A		
Approach Delay (s)	0.0	0.0	9.1			
Approach LOS				A		
Intersection Summary						
Average Delay			0.2			
Intersection Capacity Utilization			14.4%	ICU Level of Service	A	
Analysis Period (min)			15			

Lanes, Volumes, Timings
5: Merivale Rd & Camelot Dr/Bentley Ave

10/19/2022



Lane Group	EBL	EBT	WBL	WBT	WBR	NBL	NBT	SBL	SBT
Lane Configurations									
Traffic Volume (vph)	15	31	47	11	46	140	1422	61	520
Future Volume (vph)	15	31	47	11	46	140	1422	61	520
Lane Group Flow (vph)	15	107	47	11	46	140	1592	61	589
Turn Type	Perm	NA	Perm	NA	Perm	Perm	NA	pm+pt	NA
Protected Phases		4		8			2	1	6
Permitted Phases	4		8		8	2		6	
Detector Phase	4	4	8	8	8	2	2	1	6
Switch Phase									
Minimum Initial (s)	10.0	10.0	10.0	10.0	10.0	10.0	10.0	5.0	10.0
Minimum Split (s)	31.3	31.3	31.3	31.3	31.3	35.9	35.9	10.8	35.9
Total Split (s)	31.4	31.4	31.4	31.4	31.4	67.5	67.5	11.1	78.6
Total Split (%)	28.5%	28.5%	28.5%	28.5%	28.5%	61.4%	61.4%	10.1%	71.5%
Yellow Time (s)	3.3	3.3	3.3	3.3	3.3	3.7	3.7	3.7	3.7
All-Red Time (s)	3.0	3.0	3.0	3.0	3.0	2.2	2.2	2.1	2.2
Lost Time Adjust (s)	0.0	0.0	0.0	0.0	0.0	0.0	0.0	0.0	0.0
Total Lost Time (s)	6.3	6.3	6.3	6.3	6.3	5.9	5.9	5.8	5.9
Lead/Lag						Lag	Lag	Lead	
Lead-Lag Optimize?						Yes	Yes	Yes	
Recall Mode	None	None	None	None	None	C-Max	C-Max	None	C-Max
Act Effct Green (s)	11.4	11.4	11.4	11.4	11.4	76.3	76.3	86.5	86.4
Actuated g/C Ratio	0.10	0.10	0.10	0.10	0.10	0.69	0.69	0.79	0.79
v/c Ratio	0.11	0.47	0.41	0.07	0.21	0.27	0.71	0.27	0.24
Control Delay	45.3	23.6	56.7	44.2	4.0	9.3	13.4	5.8	3.3
Queue Delay	0.0	0.0	0.0	0.0	0.0	0.0	0.0	0.0	0.0
Total Delay	45.3	23.6	56.7	44.2	4.0	9.3	13.4	5.8	3.3
LOS	D	C	E	D	A	A	B	A	A
Approach Delay		26.3		32.1			13.1		3.6
Approach LOS		C		C			B		A
Queue Length 50th (m)	3.0	6.3	9.7	2.2	0.0	10.3	97.3	2.2	12.3
Queue Length 95th (m)	9.0	22.0	20.9	7.4	2.5	24.2	151.6	5.8	21.4
Internal Link Dist (m)		412.3		581.1			116.9		135.0
Turn Bay Length (m)	35.0		35.0		25.0	40.0		80.0	
Base Capacity (vph)	303	412	252	351	378	519	2247	227	2463
Starvation Cap Reductn	0	0	0	0	0	0	0	0	0
Spillback Cap Reductn	0	0	0	0	0	0	0	0	0
Storage Cap Reductn	0	0	0	0	0	0	0	0	0
Reduced v/c Ratio	0.05	0.26	0.19	0.03	0.12	0.27	0.71	0.27	0.24

Intersection Summary

Cycle Length: 110
 Actuated Cycle Length: 110
 Offset: 103 (94%), Referenced to phase 2:NBT and 6:SBTL, Start of Green
 Natural Cycle: 90
 Control Type: Actuated-Coordinated
 Maximum v/c Ratio: 0.71
 Intersection Signal Delay: 12.1
 Intersection Capacity Utilization 81.3%
 Analysis Period (min) 15

Intersection LOS: B
 ICU Level of Service D

Splits and Phases: 5: Merivale Rd & Camelot Dr/Bentley Ave



Lanes, Volumes, Timings
1: Merivale Rd & West Hunt Club Rd

10/19/2022



Lane Group	EBL	EBT	WBL	WBT	NBL	NBT	NBR	SBL	SBT	SBR
Lane Configurations										
Traffic Volume (vph)	251	654	154	1168	141	610	109	178	898	289
Future Volume (vph)	251	654	154	1168	141	610	109	178	898	289
Lane Group Flow (vph)	251	772	154	1427	141	610	109	178	898	289
Turn Type	Prot	NA	Prot	NA	Prot	NA	Perm	Prot	NA	Perm
Protected Phases	7	4	3	8	5	2		1	6	
Permitted Phases							2			6
Detector Phase	7	4	3	8	5	2	2	1	6	6
Switch Phase										
Minimum Initial (s)	5.0	10.0	5.0	10.0	5.0	10.0	10.0	5.0	10.0	10.0
Minimum Split (s)	12.0	33.6	12.0	33.6	11.6	38.6	38.6	11.6	38.6	38.6
Total Split (s)	18.0	46.8	20.0	48.8	20.0	44.3	44.3	18.9	43.2	43.2
Total Split (%)	13.8%	36.0%	15.4%	37.5%	15.4%	34.1%	34.1%	14.5%	33.2%	33.2%
Yellow Time (s)	4.6	4.6	4.6	4.6	3.7	3.7	3.7	3.7	3.7	3.7
All-Red Time (s)	2.4	2.0	2.4	2.0	2.9	2.9	2.9	2.9	2.9	2.9
Lost Time Adjust (s)	0.0	0.0	0.0	0.0	0.0	0.0	0.0	0.0	0.0	0.0
Total Lost Time (s)	7.0	6.6	7.0	6.6	6.6	6.6	6.6	6.6	6.6	6.6
Lead/Lag	Lead	Lag	Lead	Lag	Lead	Lag	Lag	Lead	Lag	Lag
Lead-Lag Optimize?	Yes	Yes	Yes	Yes	Yes	Yes	Yes	Yes	Yes	Yes
Recall Mode	None	C-Max	None	C-Max	None	None	None	None	None	None
Act Effct Green (s)	11.2	40.2	13.2	42.2	13.1	38.4	38.4	11.4	36.7	36.7
Actuated g/C Ratio	0.09	0.31	0.10	0.32	0.10	0.30	0.30	0.09	0.28	0.28
v/c Ratio	0.88	0.77	0.97	0.91	0.87	0.62	0.21	0.63	0.95	0.49
Control Delay	89.2	45.9	123.3	51.0	100.4	42.8	3.1	67.3	65.1	12.2
Queue Delay	0.0	0.0	0.0	0.0	0.0	0.0	0.0	0.0	0.0	0.0
Total Delay	89.2	45.9	123.3	51.0	100.4	42.8	3.1	67.3	65.1	12.2
LOS	F	D	F	D	F	D	A	E	E	B
Approach Delay		56.5		58.0		47.2			54.2	
Approach LOS		E		E		D			D	
Queue Length 50th (m)	33.4	92.5	40.1	125.3	36.1	71.4	0.0	22.8	119.1	11.5
Queue Length 95th (m)	#57.5	116.3	#83.6	#148.6	#72.8	91.3	6.5	34.8	#159.2	36.9
Internal Link Dist (m)		173.3		390.9		150.6			154.0	
Turn Bay Length (m)	90.0		70.0		65.0		130.0	60.0		125.0
Base Capacity (vph)	284	1004	158	1561	166	991	523	308	946	584
Starvation Cap Reductn	0	0	0	0	0	0	0	0	0	0
Spillback Cap Reductn	0	0	0	0	0	0	0	0	0	0
Storage Cap Reductn	0	0	0	0	0	0	0	0	0	0
Reduced v/c Ratio	0.88	0.77	0.97	0.91	0.85	0.62	0.21	0.58	0.95	0.49

Intersection Summary

Cycle Length: 130
 Actuated Cycle Length: 130
 Offset: 28 (22%), Referenced to phase 4:EBT and 8:WBT, Start of Green
 Natural Cycle: 110
 Control Type: Actuated-Coordinated
 Maximum v/c Ratio: 0.97
 Intersection Signal Delay: 54.7
 Intersection Capacity Utilization 94.3%
 Analysis Period (min) 15
 # 95th percentile volume exceeds capacity, queue may be longer.
 Queue shown is maximum after two cycles.

Intersection LOS: D
 ICU Level of Service F

Splits and Phases: 1: Merivale Rd & West Hunt Club Rd

Ø1 18.9 s	Ø2 44.3 s	Ø3 20 s	Ø4 (R) 46.8 s
Ø5 20 s	Ø6 43.2 s	Ø7 18 s	Ø8 (R) 48.8 s

Lanes, Volumes, Timings 2:
Merivale Rd & Jamie Ave

10/19/2022



Lane Group	WBL	WBR	NBT	SBL	SBT
Lane Configurations					
Traffic Volume (vph)	31	48	904	32	1355
Future Volume (vph)	31	48	904	32	1355
Lane Group Flow (vph)	31	48	921	32	1355
Sign Control	Stop		Free		Free
Intersection Summary					
Control Type: Unsignalized					
Intersection Capacity Utilization 49.5%			ICU Level of Service A		
Analysis Period (min) 15					

HCM Unsignalized Intersection Capacity Analysis

2: Merivale Rd & Jamie Ave

10/19/2022



Movement	WBL	WBR	NBT	NBR	SBL	SBT	
Lane Configurations							
Traffic Volume (veh/h)	31	48	904	17	32	1355	
Future Volume (Veh/h)	31	48	904	17	32	1355	
Sign Control	Stop		Free			Free	
Grade	0%		0%			0%	
Peak Hour Factor	1.00	1.00	1.00	1.00	1.00	1.00	
Hourly flow rate (vph)	31	48	904	17	32	1355	
Pedestrians	9		3				
Lane Width (m)	3.7		3.7				
Walking Speed (m/s)	1.0		1.0				
Percent Blockage	1		0				
Right turn flare (veh)							
Median type			None			None	
Median storage (veh)							
Upstream signal (m)			233			175	
pX, platoon unblocked	0.78	0.93			0.93		
vC, conflicting volume	1666	470			930		
vC1, stage 1 conf vol							
vC2, stage 2 conf vol							
vCu, unblocked vol	867	271			768		
tC, single (s)	6.8	7.0			4.1		
tC, 2 stage (s)							
tF (s)	3.5	3.3			2.2		
p0 queue free %	86	93			96		
cM capacity (veh/h)	215	662			773		
Direction, Lane #	WB 1	WB 2	NB 1	NB 2	SB 1	SB 2	SB 3
Volume Total	31	48	603	318	32	678	678
Volume Left	31	0	0	0	32	0	0
Volume Right	0	48	0	17	0	0	0
cSH	215	662	1700	1700	773	1700	1700
Volume to Capacity	0.14	0.07	0.35	0.19	0.04	0.40	0.40
Queue Length 95th (m)	3.8	1.8	0.0	0.0	1.0	0.0	0.0
Control Delay (s)	24.5	10.9	0.0	0.0	9.9	0.0	0.0
Lane LOS	C	B			A		
Approach Delay (s)	16.2		0.0		0.2		
Approach LOS	C						
Intersection Summary							
Average Delay			0.7				
Intersection Capacity Utilization			49.5%		ICU Level of Service		A
Analysis Period (min)			15				

Lanes, Volumes, Timings
 3: Merivale Rd & Merivale Access

10/19/2022



Lane Group	WBR	NBT	SBT
Lane Configurations			
Traffic Volume (vph)	18	886	1360
Future Volume (vph)	18	886	1360
Lane Group Flow (vph)	18	888	1360
Sign Control		Free	Free
Intersection Summary			
Control Type: Unsignalized			
Intersection Capacity Utilization 43.0%		ICU Level of Service A	
Analysis Period (min) 15			

HCM Unsignalized Intersection Capacity Analysis
 3: Merivale Rd & Merivale Access

10/19/2022



Movement	WBL	WBR	NBT	NBR	SBL	SBT
Lane Configurations						
Traffic Volume (veh/h)	0	18	886	2	0	1360
Future Volume (Veh/h)	0	18	886	2	0	1360
Sign Control	Stop		Free			Free
Grade	0%		0%			0%
Peak Hour Factor	1.00	1.00	1.00	1.00	1.00	1.00
Hourly flow rate (vph)	0	18	886	2	0	1360
Pedestrians						
Lane Width (m)						
Walking Speed (m/s)						
Percent Blockage						
Right turn flare (veh)						
Median type			None			None
Median storage (veh)						
Upstream signal (m)			159			249
pX, platoon unblocked	0.79	0.92			0.92	
vC, conflicting volume	1567	444			888	
vC1, stage 1 conf vol						
vC2, stage 2 conf vol						
vCu, unblocked vol	728	222			704	
tC, single (s)	6.8	6.9			4.1	
tC, 2 stage (s)						
tF (s)	3.5	3.3			2.2	
p0 queue free %	100	97			100	
cM capacity (veh/h)	283	719			818	
Direction, Lane #	WB 1	NB 1	NB 2	SB 1	SB 2	
Volume Total	18	591	297	680	680	
Volume Left	0	0	0	0	0	
Volume Right	18	0	2	0	0	
cSH	719	1700	1700	1700	1700	
Volume to Capacity	0.03	0.35	0.17	0.40	0.40	
Queue Length 95th (m)	0.6	0.0	0.0	0.0	0.0	
Control Delay (s)	10.1	0.0	0.0	0.0	0.0	
Lane LOS	B					
Approach Delay (s)	10.1	0.0		0.0		
Approach LOS	B					
Intersection Summary						
Average Delay			0.1			
Intersection Capacity Utilization			43.0%		ICU Level of Service	A
Analysis Period (min)			15			

Lanes, Volumes, Timings

4: Jamie Access & Jamie Ave

10/19/2022

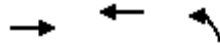

Lane Group	EBT	WBT	NBL
Lane Configurations			
Traffic Volume (vph)	42	74	5
Future Volume (vph)	42	74	5
Lane Group Flow (vph)	49	74	5
Sign Control	Free	Free	Stop
Intersection Summary			
Control Type: Unsignalized			
Intersection Capacity Utilization 14.1%		ICU Level of Service A	
Analysis Period (min) 15			

HCM Unsignalized Intersection Capacity Analysis
 4: Jamie Access & Jamie Ave

10/19/2022

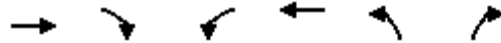

Movement	EBT	EBR	WBL	WBT	NBL	NBR
Lane Configurations						
Traffic Volume (veh/h)	42	7	0	74	5	0
Future Volume (Veh/h)	42	7	0	74	5	0
Sign Control	Free			Free	Stop	
Grade	0%			0%	0%	
Peak Hour Factor	1.00	1.00	1.00	1.00	1.00	1.00
Hourly flow rate (vph)	42	7	0	74	5	0
Pedestrians						
Lane Width (m)						
Walking Speed (m/s)						
Percent Blockage						
Right turn flare (veh)						
Median type	None			None		
Median storage (veh)						
Upstream signal (m)						
pX, platoon unblocked						
vC, conflicting volume			49		120	46
vC1, stage 1 conf vol						
vC2, stage 2 conf vol						
vCu, unblocked vol			49		120	46
tC, single (s)			4.1		6.4	6.2
tC, 2 stage (s)						
tF (s)			2.2		3.5	3.3
p0 queue free %			100		99	100
cM capacity (veh/h)			1558		876	1024
Direction, Lane #	EB 1	WB 1	NB 1			
Volume Total	49	74	5			
Volume Left	0	0	5			
Volume Right	7	0	0			
cSH	1700	1558	876			
Volume to Capacity	0.03	0.00	0.01			
Queue Length 95th (m)	0.0	0.0	0.1			
Control Delay (s)	0.0	0.0	9.1			
Lane LOS				A		
Approach Delay (s)	0.0	0.0	9.1			
Approach LOS				A		
Intersection Summary						
Average Delay			0.4			
Intersection Capacity Utilization			14.1%	ICU Level of Service	A	
Analysis Period (min)			15			

Lanes, Volumes, Timings
5: Merivale Rd & Camelot Dr/Bentley Ave

10/19/2022



Lane Group	EBL	EBT	WBL	WBT	WBR	NBL	NBT	SBL	SBT
Lane Configurations									
Traffic Volume (vph)	52	8	179	10	97	15	725	43	1445
Future Volume (vph)	52	8	179	10	97	15	725	43	1445
Lane Group Flow (vph)	52	160	179	10	97	15	766	43	1461
Turn Type	Perm	NA	Perm	NA	Perm	Perm	NA	Perm	NA
Protected Phases		4		8			2		6
Permitted Phases	4		8		8	2		6	
Detector Phase	4	4	8	8	8	2	2	6	6
Switch Phase									
Minimum Initial (s)	10.0	10.0	10.0	10.0	10.0	10.0	10.0	10.0	10.0
Minimum Split (s)	31.3	31.3	31.3	31.3	31.3	35.9	35.9	35.9	35.9
Total Split (s)	42.0	42.0	42.0	42.0	42.0	78.0	78.0	78.0	78.0
Total Split (%)	35.0%	35.0%	35.0%	35.0%	35.0%	65.0%	65.0%	65.0%	65.0%
Yellow Time (s)	3.3	3.3	3.3	3.3	3.3	3.7	3.7	3.7	3.7
All-Red Time (s)	3.0	3.0	3.0	3.0	3.0	2.2	2.2	2.2	2.2
Lost Time Adjust (s)	0.0	0.0	0.0	0.0	0.0	0.0	0.0	0.0	0.0
Total Lost Time (s)	6.3	6.3	6.3	6.3	6.3	5.9	5.9	5.9	5.9
Lead/Lag									
Lead-Lag Optimize?									
Recall Mode	None	None	None	None	None	C-Max	C-Max	C-Max	C-Max
Act Effct Green (s)	24.9	24.9	24.9	24.9	24.9	82.9	82.9	82.9	82.9
Actuated g/C Ratio	0.21	0.21	0.21	0.21	0.21	0.69	0.69	0.69	0.69
v/c Ratio	0.19	0.47	0.85	0.03	0.25	0.09	0.33	0.11	0.63
Control Delay	37.7	33.6	77.1	33.4	8.1	10.2	8.7	9.0	12.9
Queue Delay	0.0	0.0	0.0	0.0	0.0	0.0	0.0	0.0	0.0
Total Delay	37.7	33.6	77.1	33.4	8.1	10.2	8.7	9.0	12.9
LOS	D	C	E	C	A	B	A	A	B
Approach Delay		34.6		52.2			8.7		12.8
Approach LOS		C		D			A		B
Queue Length 50th (m)	10.2	24.5	40.8	1.9	0.0	1.1	34.0	3.1	89.7
Queue Length 95th (m)	19.1	40.7	61.4	5.8	12.3	4.8	56.9	9.5	143.7
Internal Link Dist (m)		412.3		581.1			116.9		135.0
Turn Bay Length (m)	35.0		35.0		25.0	40.0		80.0	
Base Capacity (vph)	398	470	302	530	519	163	2289	398	2314
Starvation Cap Reductn	0	0	0	0	0	0	0	0	0
Spillback Cap Reductn	0	0	0	0	0	0	0	0	0
Storage Cap Reductn	0	0	0	0	0	0	0	0	0
Reduced v/c Ratio	0.13	0.34	0.59	0.02	0.19	0.09	0.33	0.11	0.63

Intersection Summary

Cycle Length: 120
 Actuated Cycle Length: 120
 Offset: 16 (13%), Referenced to phase 2:NBT and 6:SBTL, Start of Green
 Natural Cycle: 70
 Control Type: Actuated-Coordinated
 Maximum v/c Ratio: 0.85
 Intersection Signal Delay: 17.4
 Intersection Capacity Utilization 82.6%
 Analysis Period (min) 15

Intersection LOS: B
 ICU Level of Service E

Splits and Phases: 5: Merivale Rd & Camelot Dr/Bentley Ave

