

1050 TAWADINA ROAD

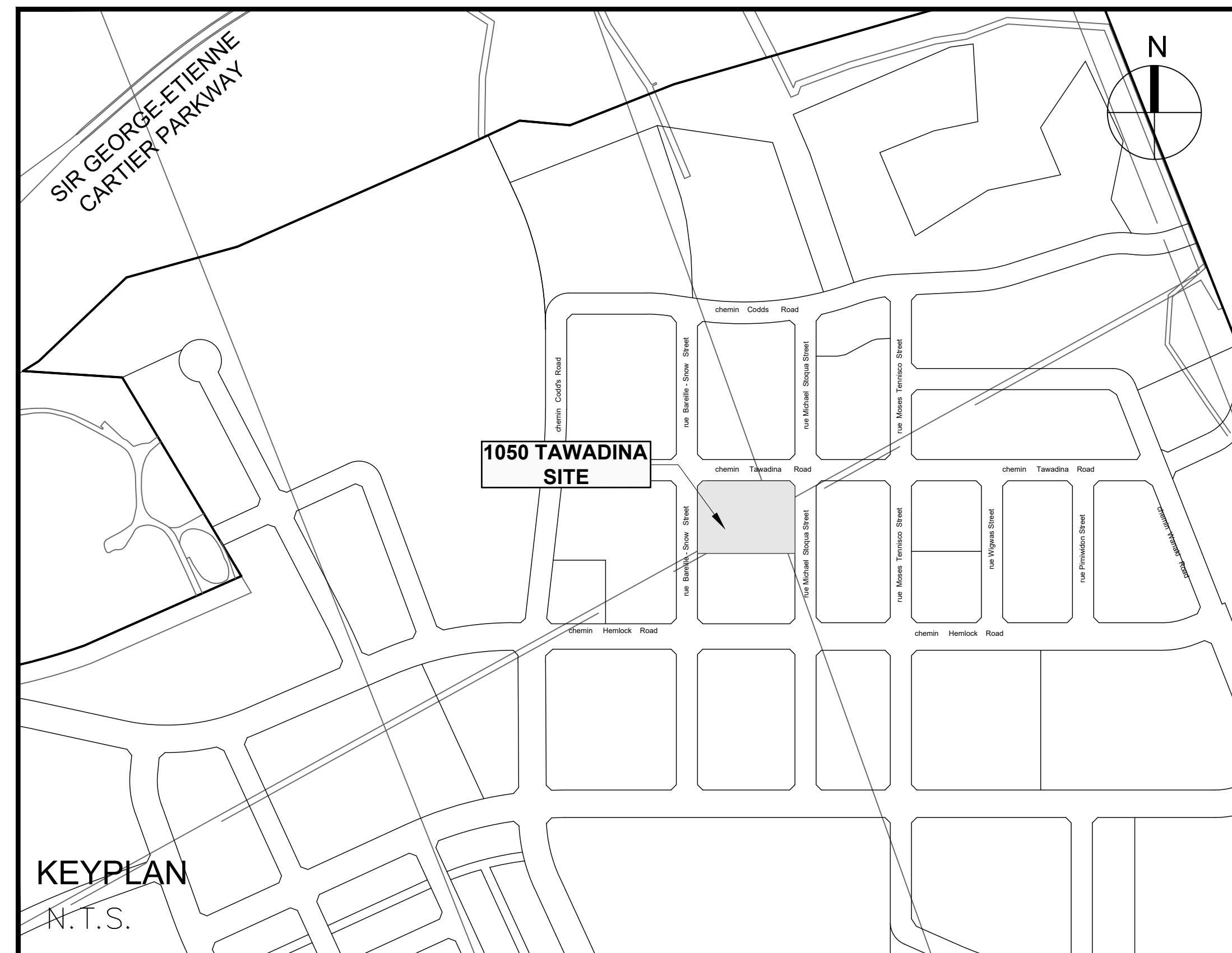

333 Preston Street - Suite 500
Ottawa ON K1S 5N4 Canada
tel 613 225 1311
www.arcadis.com



Sheet List Table	
Sheet Number	Sheet Title
C-000	Cover
C-001	SITE SERVICING PLAN
C-200	SITE GRADING PLAN
C-500	STORM DRAINAGE AREA PLAN
C-900	SITE EROSION AND SEDIMENT CONTROL PLAN
C-REM	REMOVALS
GP-1	GENERAL PLAN
ESC-1	EROSION AND SEDIMENT CONTROL PLAN
L-1	MODULE LAYOUT
CD-1	TYPICAL CONSTRUCTION DETAILS
CD-2	TYPICAL PIPE PENETRATION DETAILS
CD-3	TYPICAL ISOLATOR ROW DETAILS
CD-4	SUPPLEMENTARY NOTES (1 OF 2)
CD-5	SUPPLEMENTARY NOTES (2 OF 2)

CONTRACT NO. 142609

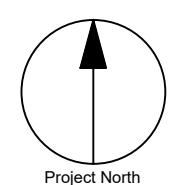
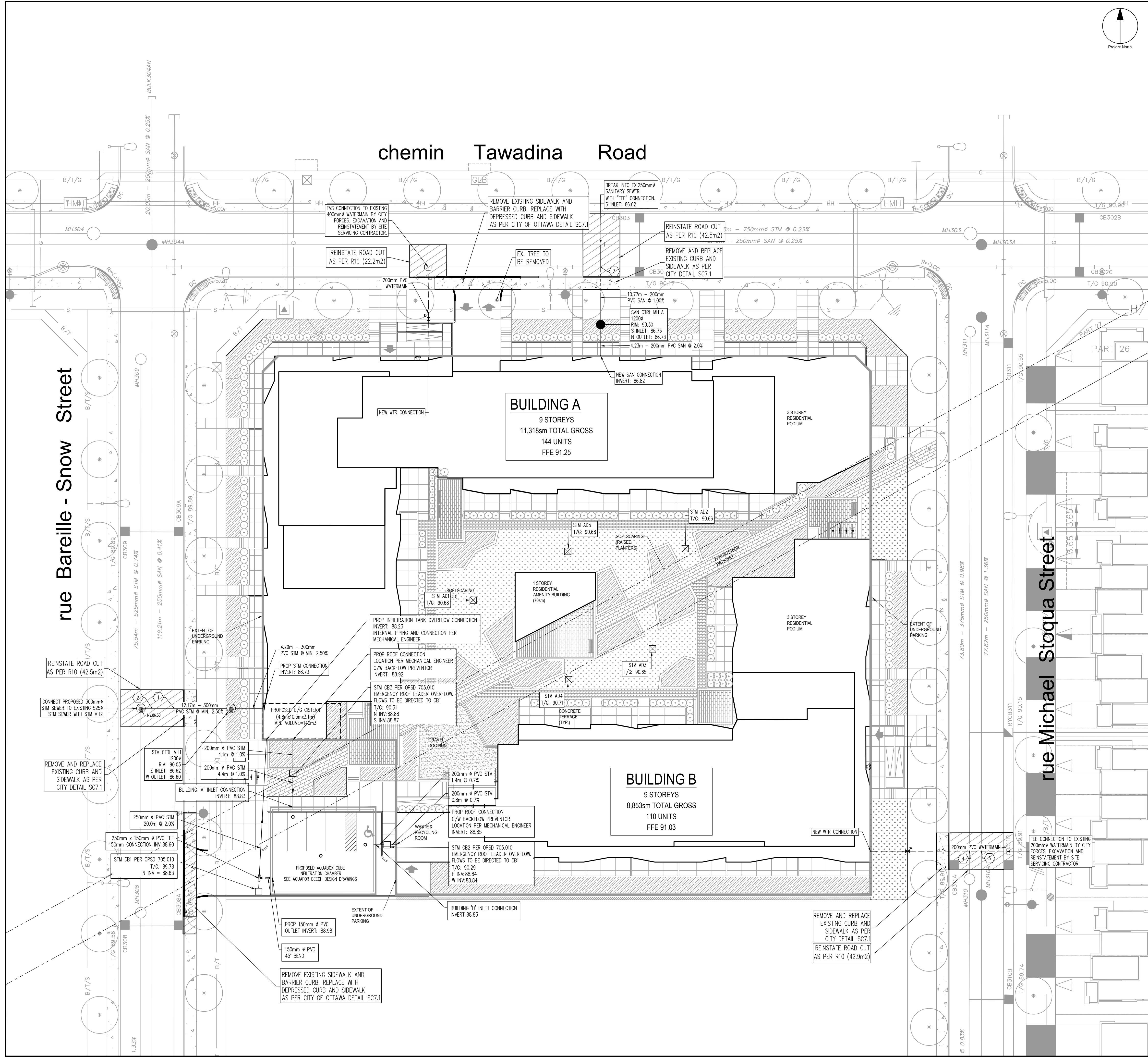

LEGEND:

	PROPOSED	EXISTING
STORM SEWER		
WATER LINE		
SANITARY SEWER		
PIPE FLOW DIRECTION		
STORM MANHOLE		
AREA DRAIN		
CATCH BASIN		
DOUBLE CATCH BASIN		
TRENCH DRAIN		
PIPE INSULATION		
SANITARY MANHOLE		
OBSERVATION PORT		
WATER HYDRANT		
WATER VALVE		
90° BEND		
45° BEND		
TEE FITTING		
PIPE CROSSING NUMBER		
BUILDING		
RETAINING WALL		
CONSTRUCTION LIMIT		
PROPERTY LINE		
R/W PLAN		

LABEL LEGEND:

T/G = TOP OF GRATE	
CB = CATCH BASIN	
DCB = DOUBLE CATCH BASIN	
MH = MANHOLE	
AD = AREA DRAIN	
UTILITY LEGEND:	
	EX. TRANSFORMER
	EX. HYDR. MANHOLE
	EX. BELL PEDESTAL
	EX. BELL GRADE LEVEL BOX
	EX. ROGERS PEDESTAL
	EX. STREET LIGHT
	EX. STREET LIGHT GROUNDING
	EX. JOINT UTILITY TRENCH
	EX. HYDR. CABLE AND DUCTS
	EX. BELL CABLE
	EX. ROGERS CABLE
	EX. GAS
	EX. STREET LIGHT CABLE
	EX. UTILITY DROP LOCATIONS
	EX. CONCRETE ENCASED DUCT BANK
	EX. TREE LOCATION

- NOTES:**
- IT IS THE RESPONSIBILITY OF THE APPLICANT/CONSULTANT TO ENSURE COMPLIANCE WITH ALL APPLICABLE PROVINCIAL STANDARDS AND TO OBTAIN ALL PROVINCIAL APPROVALS, INCLUDING BUT NOT LIMITED TO ENVIRONMENTAL COMPLIANCE APPROVALS.
 - THE CONTRACTOR SHALL ENSURE ALL MATERIAL AND CONSTRUCTION IS IN ACCORDANCE WITH THE CITY OF OTTAWA STANDARD DRAWINGS AND SPECIFICATIONS. DRAWINGS AND SPECIFICATIONS FROM OPSS & OPSD, SHALL BE USED WHERE THERE IS NO EQUIVALENT FROM CITY STANDARDS.
 - THE CONTRACTOR SHALL VERIFY ALL SURVEY STAKE LAYOUT POINTS AND DIMENSIONS AND ANY DISCREPANCIES SHALL BE REPORTED TO THE CONSULTANT PRIOR TO CONSTRUCTION. ANY DISCREPANCIES ARE TO BE IMMEDIATELY REPORTED TO THE CONSULTANT.
 - ALL EXISTING UTILITIES SHOWN ON DRAWINGS (PLAN AND PROFILE) ARE FOR REFERENCE PURPOSES ONLY. THE CONTRACTOR SHALL SATISFY THEMSELVES AS TO THE ACTUAL LOCATION AND DEPTH OF ANY UTILITY AND SHALL BE LIABLE FOR ALL OR ANY DAMAGES.
 - THE POSITION OF ALL STATIC STRUCTURES, SMALL UTILITIES, DEEP UTILITIES, AND ANY OTHER ABOVEGROUND OR UNDERGROUND UTILITIES STRUCTURES AND APPURTENANCES SHALL BE FIELD VERIFIED BY THE CONTRACTOR TO SATISFY HIMSELF AND SHALL ASSUME LIABILITY FOR ANY DAMAGES TO THEM DURING CONSTRUCTION. ANY DAMAGES ARE TO BE RECTIFIED TO THE SATISFACTION OF THE CITY INSPECTOR OR FRANCHISE UTILITY OWNERS.
 - REFER TO THE PRELIMINARY GEOTECHNICAL INVESTIGATION REPORT COMPLETED BY ENGLOBE ON OCTOBER 11TH, 2022 FOR GEOTECHNICAL INFORMATION.
 - ALL SEWER AND WATERMAIN PIPES SHALL BE INSTALLED AT A MINIMUM FROST COVER OF 2.4m.
 - ALL WATERMAIN CONNECTIONS WITHIN MUNICIPAL R.O.W.'S TO BE INSTALLED BY CITY FORCES AT THE OWNER'S EXPENSE.

Pipe Clearance Table

Crossing No.	Bottom of Pipe	Top of Pipe	Clearance
1	87.50 WTR	87.00 STM	0.50
2	86.62 STM	85.24 SAN	1.38
3	87.40 WTR	86.87 SAN	0.53
4	87.40 WTR	86.87 STM	0.53
5	87.40 WTR	85.77 SAN	0.63

CLIENT

WestUrban
Developments Ltd.

COPYRIGHT

This drawing has been prepared solely for the intended use, thus any reproduction or distribution for any purpose other than authorized by Arcadis is forbidden. Written dimensions shall have precedence over scaled dimensions. Contractors shall verify and be responsible for all dimensions and conditions on the job, and Arcadis shall be informed of any variations from the dimensions and conditions shown on the drawing. Shop drawings shall be submitted to Arcadis for general conformance before proceeding with fabrication.

ISSUES

No.	DESCRIPTION	DATE
1	ISSUED FOR CLC SUBMISSION	2023-01-11
2	SUBMISSION NO 2 FOR CITY REVIEW	2023-09-13
3		
4		
5		
6		
7		
8		

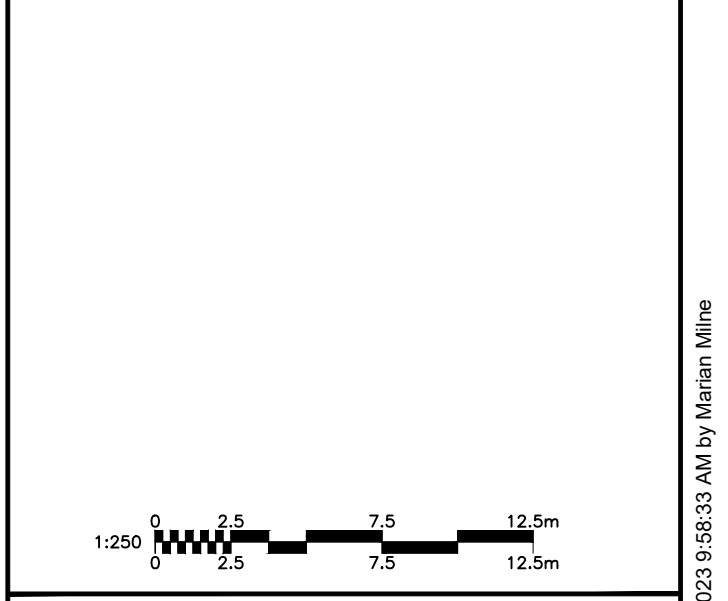
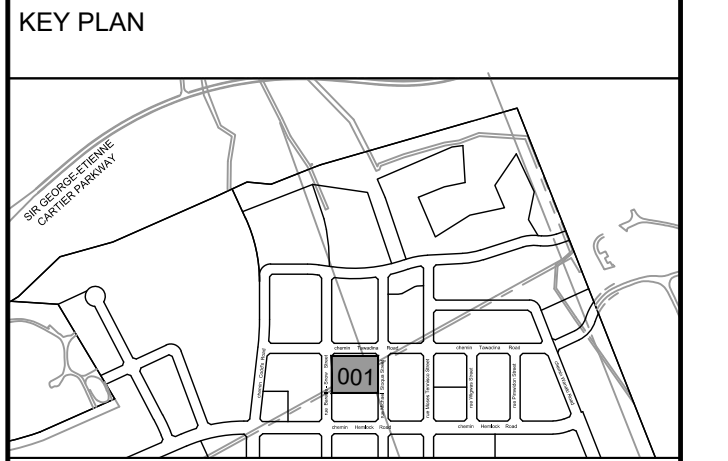

SEAL

ARCADIS

333 Preston Street - Suite 500
Ottawa ON K1S 5N4 Canada
Tel 613 225 1311
www.arcadis.com

PROJECT

1050 Tawadina Road

WATERIDGE VILLAGE PHASE 2

PROJECT NO: 142609

DRAWN BY: M.M.

PROJECT MGR: S.L.

CHECKED BY: J.I.M.

APPROVED BY: A.C.

SHEET TITLE

SITE SERVICING PLAN

SHEET NUMBER C-001

ISSUE 2

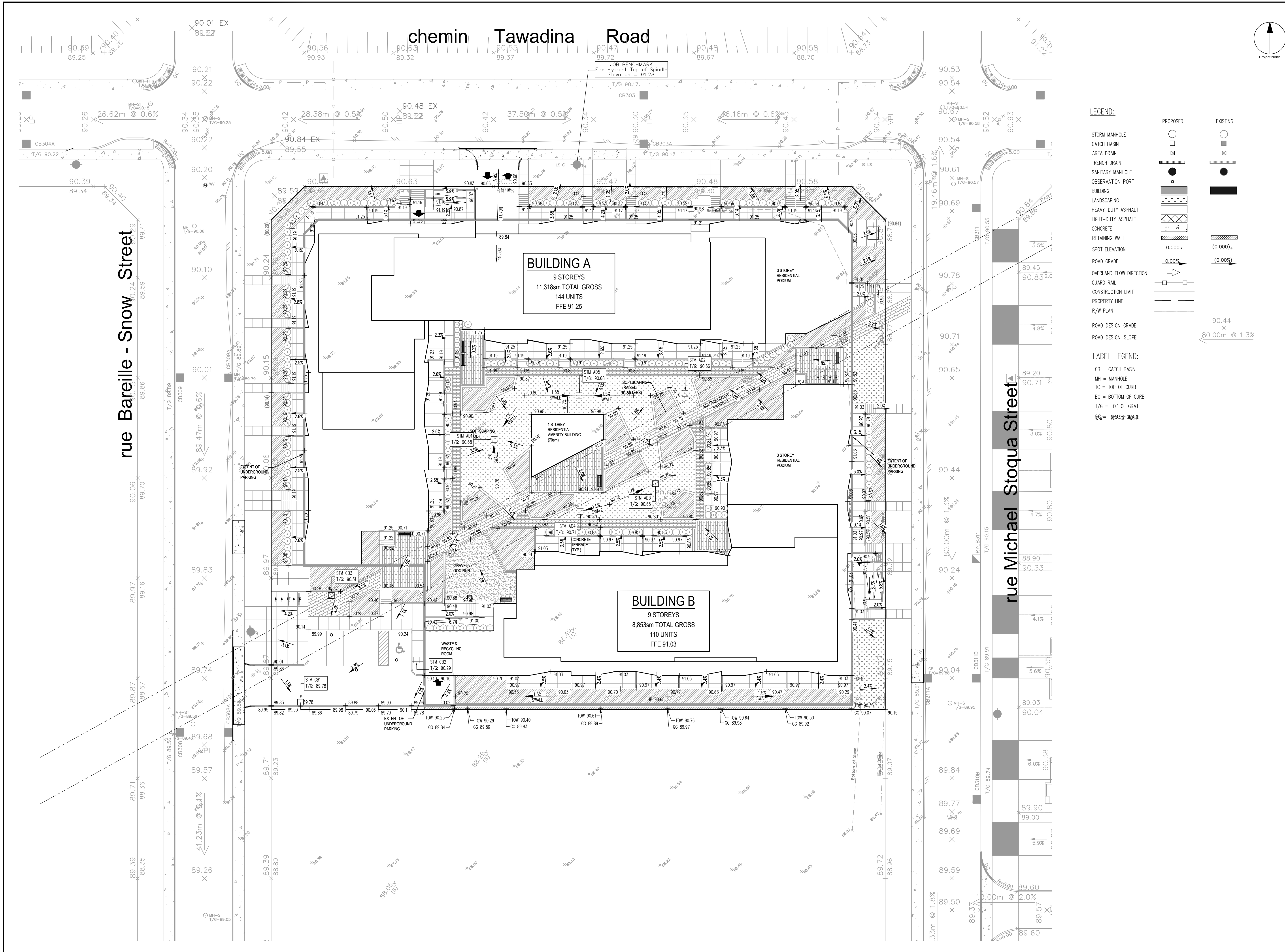

LEGEND:

- STORM MANHOLE
- CATCH BASIN
- AREA DRAIN
- TRENCH DRAIN
- SANITARY MANHOLE
- OBSERVATION PORT
- BUILDING
- LANDSCAPING
- HEAVY-DUTY ASPHALT
- LIGHT-DUTY ASPHALT
- CONCRETE
- RETAINING WALL
- SPOT ELEVATION
- ROAD GRADE
- OVERLAND FLOW DIRECTION
- GUARD RAIL
- CONSTRUCTION LIMIT
- PROPERTY LINE
- R/W PLAN
- ROAD DESIGN GRADE
- ROAD DESIGN SLOPE

LABEL LEGEND:

- CB = CATCH BASIN
- MH = MANHOLE
- TC = TOP OF CURB
- BC = BOTTOM OF CURB
- T/G = TOP OF GRATE
- R/W = ROAD SIDE GRADE

CLIENT

WestUrban
Developments Ltd.

COPYRIGHT

This drawing has been prepared solely for the intended use, thus any reproduction or distribution for any purpose other than authorized by Arcadis is forbidden. Written dimensions shall have precedence over scaled dimensions. Contractors shall verify and be responsible for all dimensions and conditions on the job, and Arcadis shall be informed of any variations from the dimensions and conditions shown on the drawing. Shop drawings shall be submitted to Arcadis for general conformance before proceeding with fabrication.

ISSUES

No.	DESCRIPTION	DATE
1	ISSUED FOR CLC SUBMISSION	2023-01-11
2	SUBMISSION NO 2 FOR CITY REVIEW	2023-09-13
3		
4		
5		
6		
7		
8		

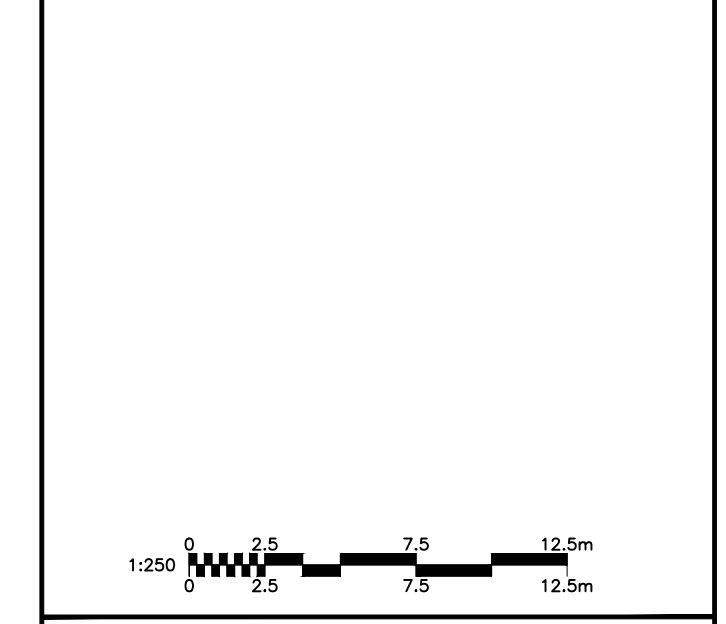
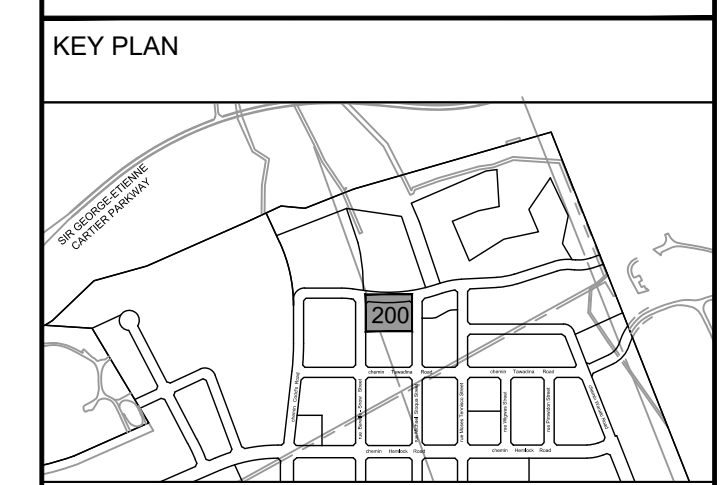

SEAL

A. CHETIAR
100528180
2023/09/13
PROVINCE OF ONTARIO

ARCADIS

333 Preston Street - Suite 500
Ottawa ON K1S 5N4 Canada
tel 613 225 1311
www.arcadis.com

PROJECT

1050 Tawadina Road

WATERIDGE VILLAGE PHASE 2

PROJECT NO: 142609

DRAWN BY: M.M. **CHECKED BY:** J.I.M.

PROJECT MGR: S.L. **APPROVED BY:** A.C.

SHEET TITLE

SITE GRADING PLAN

SHEET NUMBER C-200 **ISSUE** 2

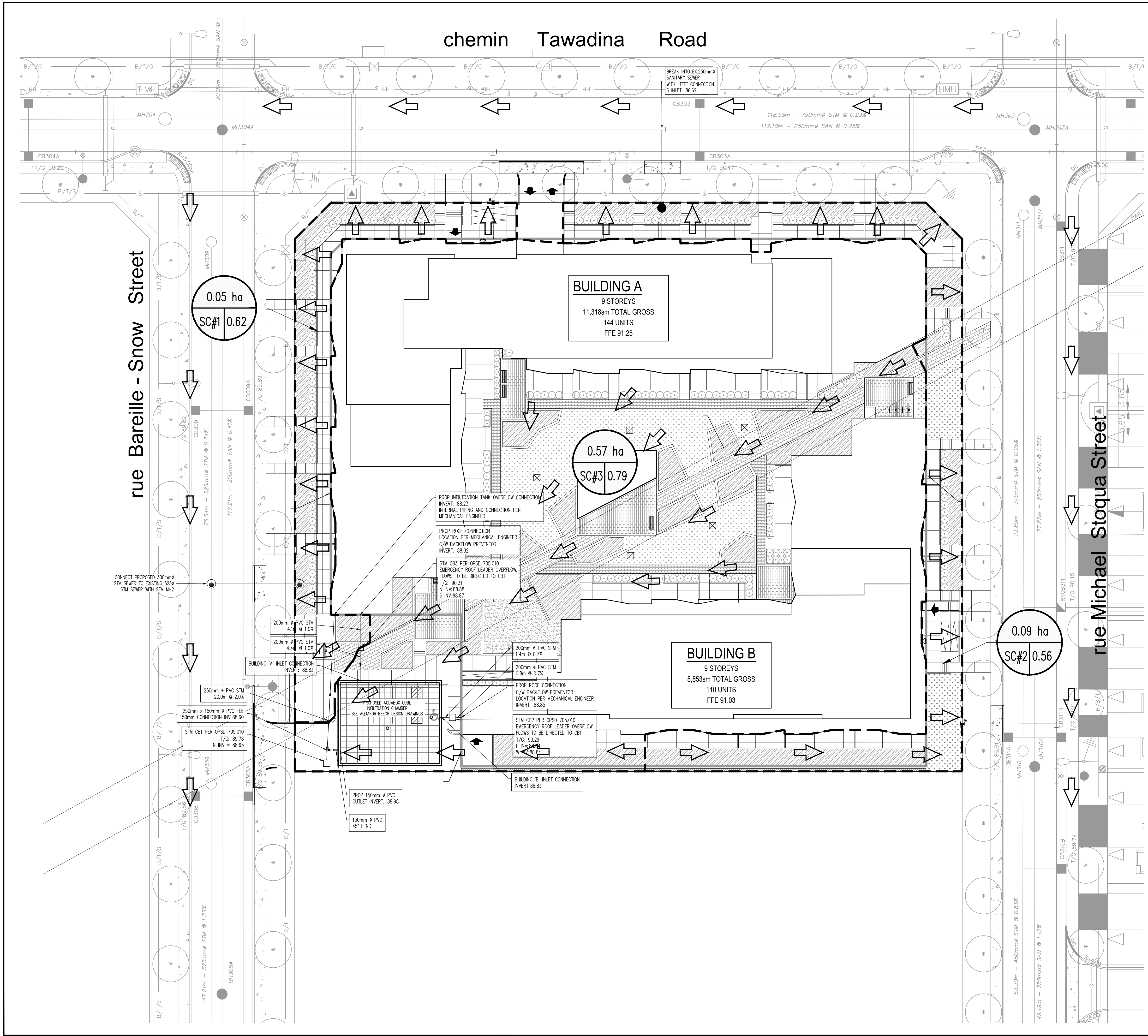

LEGEND:

- STORM SEWER
- WATER LINE
- SANITARY SEWER
- PIPE FLOW DIRECTION
- STORM MANHOLE
- AREA DRAIN
- CATCH BASIN
- DOUBLE CATCH BASIN
- TRENCH DRAIN
- PIPE INSULATION
- SANITARY MANHOLE
- WATER HYDRANT
- WATER VALVE
- 90° BEND
- 45° BEND
- TEE FITTING
- PIPE CROSSING NUMBER
- BUILDING
- RETAINING WALL
- CONSTRUCTION LIMIT
- PROPERTY LINE
- R/W PLAN

LABEL LEGEND:

- T/G = TOP OF GRATE
- CB = CATCH BASIN
- DCB = DOUBLE CATCH BASIN
- MH = MANHOLE
- WTR = WATER SERVICE
- FWTR = FIRE WATER SERVICE
- AD = AREA DRAIN

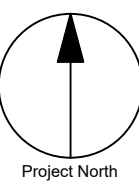
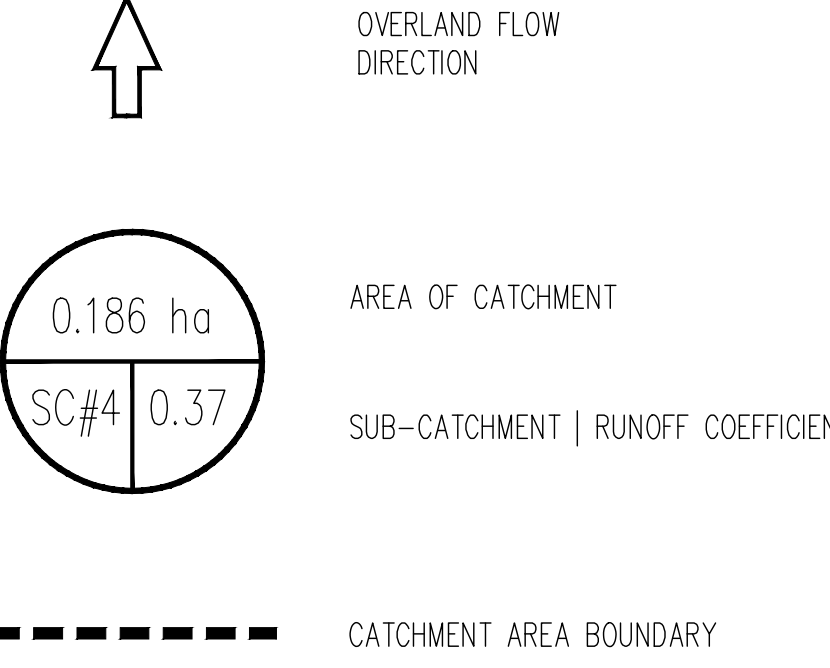

CLIENT
WestUrban
Developments Ltd.

COPYRIGHT
This drawing has been prepared solely for the intended use, thus any reproduction or distribution for any purpose other than authorized by Arcadis is forbidden. Written dimensions shall have precedence over scaled dimensions. Contractors shall verify and be responsible for all dimensions and conditions on the job, and Arcadis shall be informed of any variations from the dimensions and conditions shown on the drawing. Shop drawings shall be submitted to Arcadis for general conformance before proceeding with fabrication.

ISSUES

No.	DESCRIPTION	DATE
1	ISSUED FOR CLC SUBMISSION	2023-01-11
2	SUBMISSION NO 2 FOR CITY REVIEW	2023-09-13
3		
4		
5		
6		
7		
8		

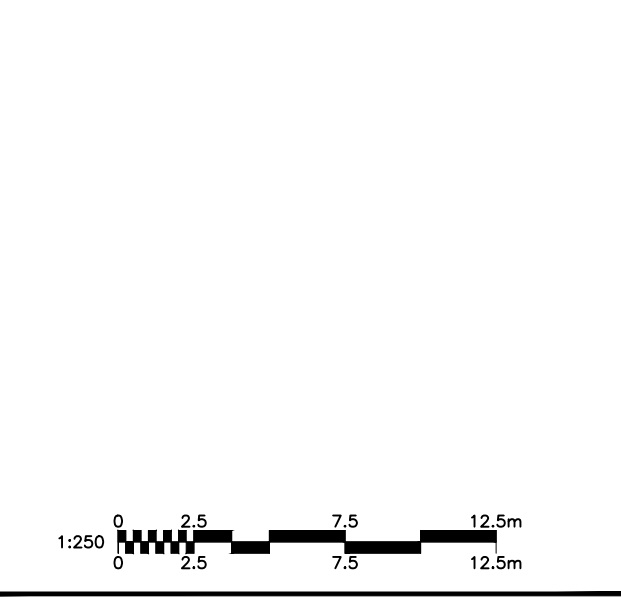
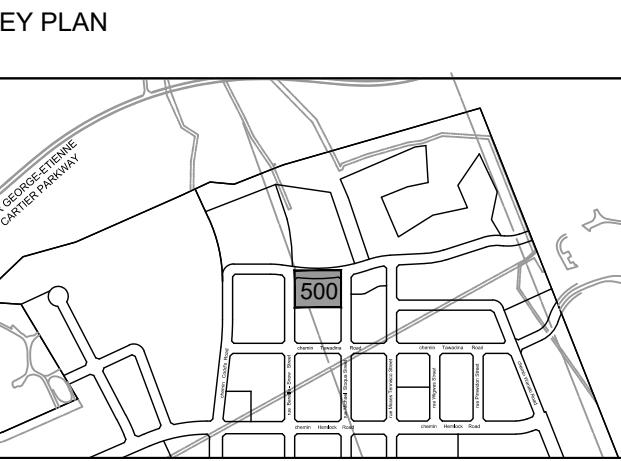

SEAL

ARCADIS
333 Preston Street - Suite 500
Ottawa ON K1S 5N4 Canada
tel 613 225 1311
www.arcadis.com

PROJECT
1050 Tawadina Road
WATERIDGE VILLAGE PHASE 2

PROJECT NO: 142609
DRAWN BY: M.M. CHECKED BY: J.I.M.
PROJECT MGR: S.L. APPROVED BY: A.C.

SHEET TITLE
STORM DRAINAGE AREA PLAN

SHEET NUMBER: C-500 ISSUE: 2

CITY FILE No. D07-12-22-0023 CITY PLAN No. 18977
Last Saved: September 6, 2023, by M.Milne Plotted: Tuesday, September 12, 2023 10:03:46 AM by Marian Milne

chemin Tawadina Road

rue Bareille - Snow Street

rue Michael Stogua Street

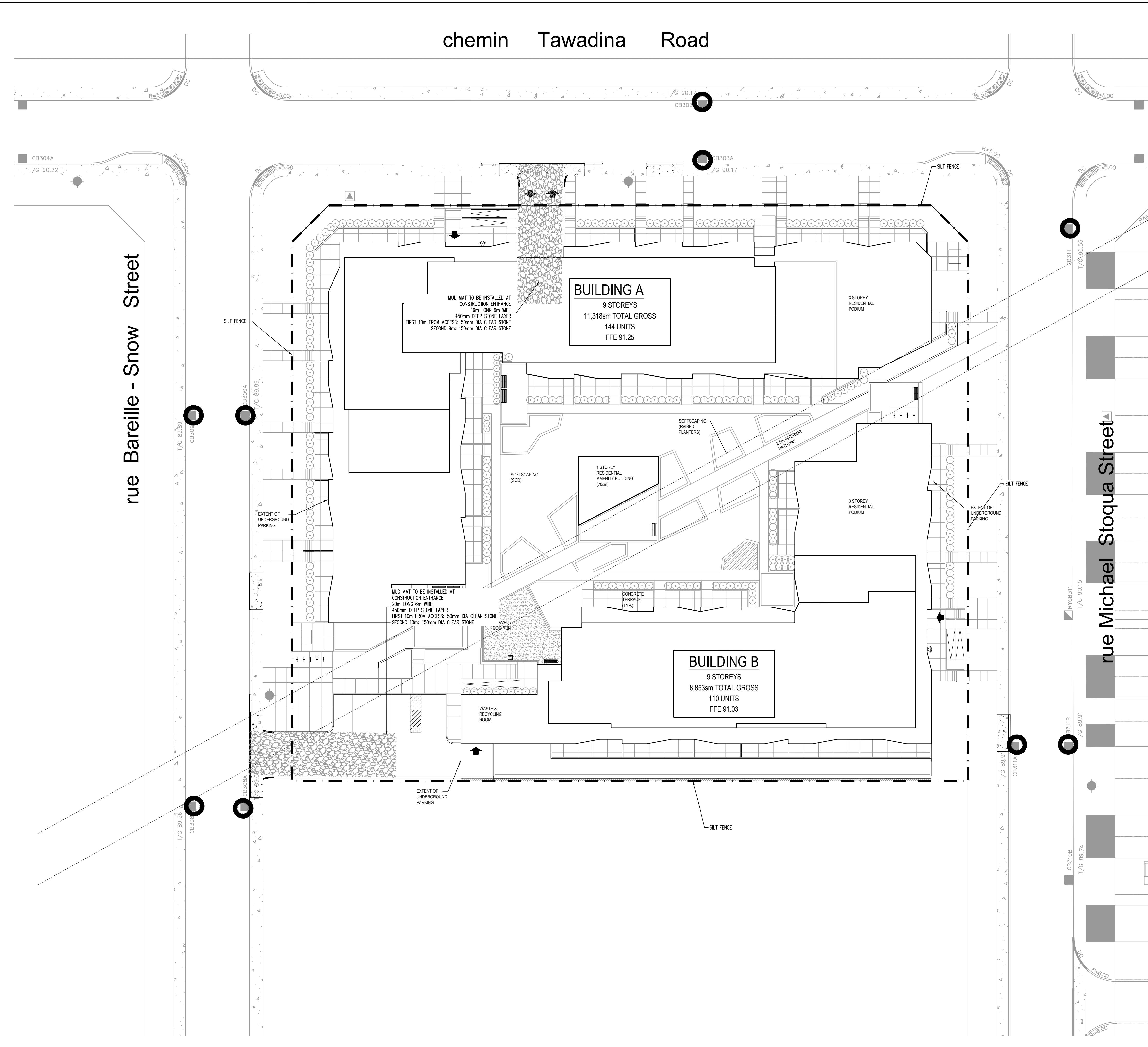

LEGEND:

	PROPOSED	EXISTING
STORM SEWER		
WATER LINE		
SANITARY SEWER		
PIPE FLOW DIRECTION		
STORM MANHOLE		
AREA DRAIN		
CATCH BASIN		
DOUBLE CATCH BASIN		
TRENCH DRAIN		
PIPE INSULATION		
SANITARY MANHOLE		
WATER HYDRANT		
WATER VALVE		
90° BEND		
45° BEND		
TEE FITTING		
PIPE CROSSING NUMBER		
BUILDING		
RETAINING WALL		
CONSTRUCTION LIMIT		
PROPERTY LINE		
R/W PLAN		

LABEL LEGEND:

T/G = TOP OF GRATE
CB = CATCH BASIN
DCB = DOUBLE CATCH BASIN
MH = MANHOLE
AD = AREA DRAIN

LEGEND:

	SILT FENCING
	CB INLET PROTECTION REQUIRED
	MUD MAT

NOTES:

- IT IS THE RESPONSIBILITY OF THE APPLICANT/CONSULTANT TO ENSURE COMPLIANCE WITH ALL APPLICABLE PROVINCIAL STANDARDS AND TO OBTAIN ALL PROVINCIAL APPROVALS, INCLUDING BUT NOT LIMITED ENVIRONMENTAL COMPLIANCE APPROVALS.
- EROSION AND SEDIMENT CONTROL (ESC) MEASURES WILL BE IMPLEMENTED PRIOR TO, AND MAINTAINED, DURING CONSTRUCTION PHASES TO PREVENT ENTRY OF SEDIMENT INTO THE WATER. ALL DAMAGED ESC MEASURES SHOULD BE REPAIRED AND/OR REPLACED WITHIN 48 HOURS OF INSPECTION.
- ALL DISTURBED AREAS WILL BE MINIMIZED TO THE EXTENT POSSIBLE AND TEMPORARILY OR PERMANENTLY STABILIZED OR RESTORED AS WORK PROGRESSES. THE ESC STRATEGIES OUTLINED IN THE REPORTS AND IN THESE NOTES ARE NOT STATIC AND MAY NEED TO BE UPGRADED/AMENDED AS SITE CONDITIONS CHANGE TO MINIMIZE SEDIMENT LADEN RUNOFF FROM LEAVING THE WORK AREA. IF THE PRESCRIBED MEASURES IN THE REPORTS AND NOTES ARE NOT EFFECTIVE IN PREVENTING THE RELEASE OF DELETERIOUS SUBSTANCE, THEN ALTERNATIVE MEASURES MUST BE IMPLEMENTED IMMEDIATELY TO MINIMIZE POTENTIAL ECOLOGICAL IMPACTS AND A TORONTO REGION CONSERVATION AUTHORITY ENFORCEMENT OFFICE SHOULD BE IMMEDIATELY CONTACTED. ADDITIONAL ESC MEASURES TO BE KEPT ON SITE AND USED AS NECESSARY.
- ALL ACTIVITIES, INCLUDING MAINTENANCE PROCEDURES, WILL BE CONTROLLED TO PREVENT THE ENTRY OF PETROLEUM PRODUCTS, DEBRIS, RUBBLE, CONCRETE, OR OTHER DELETERIOUS SUBSTANCES INTO THE WATER. VEHICULAR REFUELING AND MAINTENANCE WILL BE CONDUCTED A MINIMUM OF 30m FROM ANY ONSITE WATER BODY OR DRAINAGE WAY.
- FILTER FABRIC TO BE PLACED UNDER GRATES ON ALL CATCH BASINS SURROUNDING THE SITE, TO TRAP SEDIMENT. SILT TRAPS ARE TO BE CLEANED REGULARLY AND ARE NOT TO BE REMOVED UNTIL SUCH TIME AS THE CONSTRUCTION IS COMPLETE AND THE LANDSCAPING IS GRADED AND SODED. FILTER FABRIC FOR SILT CONTROL TO BE TERRA FIX 270R OR APPROVED EQUIVALENT.
- ALL EROSION AND SEDIMENT CONTROL MEASURES SHALL MEET THE REQUIREMENTS SET OUT IN OPSS 804, OPSS 805, CITY OF OTTAWA CONSTRUCTION SPECIFICATION 01 57 13, CITY OF OTTAWA STANDARD SPECIFICATION SP F-1004 AND CITY OF OTTAWA STANDARD SPECIFICATION SP F-804.

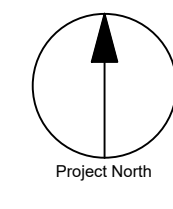

CLIENT

WestUrban
Developments Ltd.

COPYRIGHT
This drawing has been prepared solely for the intended use, thus any reproduction or distribution for any purpose other than authorized by Arcadis is forbidden. Written dimensions shall have precedence over scaled dimensions. Contractors shall verify and be responsible for all dimensions and conditions on the job, and Arcadis shall be informed of any variations from the dimensions and conditions shown on the drawing. Shop drawings shall be submitted to Arcadis for general conformance before proceeding with fabrication.

ISSUES

No.	DESCRIPTION	DATE
1	ISSUED FOR CLC SUBMISSION	2023-01-11
2	SUBMISSION NO 2 FOR CITY REVIEW	2023-09-13
3		
4		
5		
6		
7		
8		

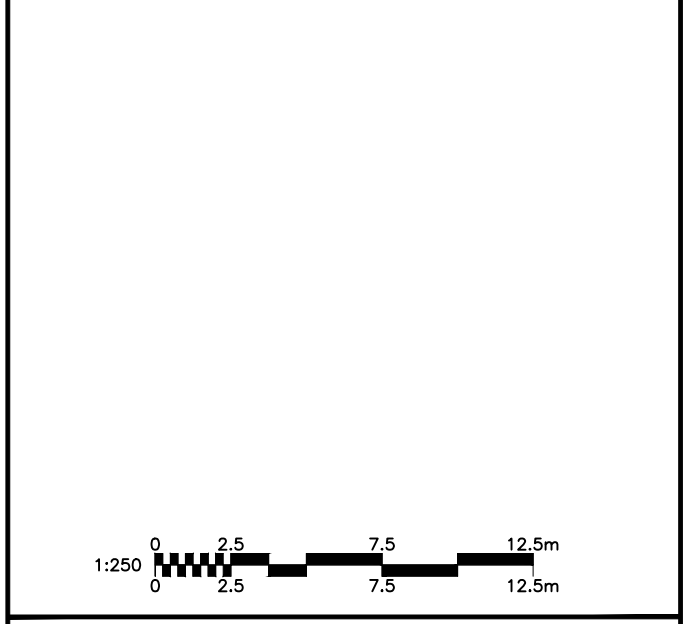
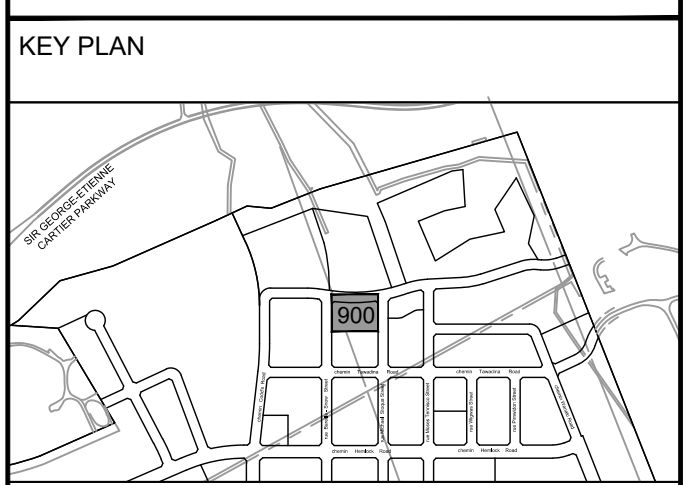

SEAL

ARCADIS

333 Preston Street - Suite 500
Ottawa ON K1S 5N4 Canada
tel 613 225 1311
www.arcadis.com

PROJECT
1050 Tawadina Road
WATERIDGE VILLAGE PHASE 2

PROJECT NO: 142609
DRAWN BY: M.M.
PROJECT MGR: S.L.

CHECKED BY: J.I.M.
APPROVED BY: A.C.

SHEET TITLE
SITE EROSION AND SEDIMENT CONTROL PLAN

SHEET NUMBER C-900 **ISSUE** 2

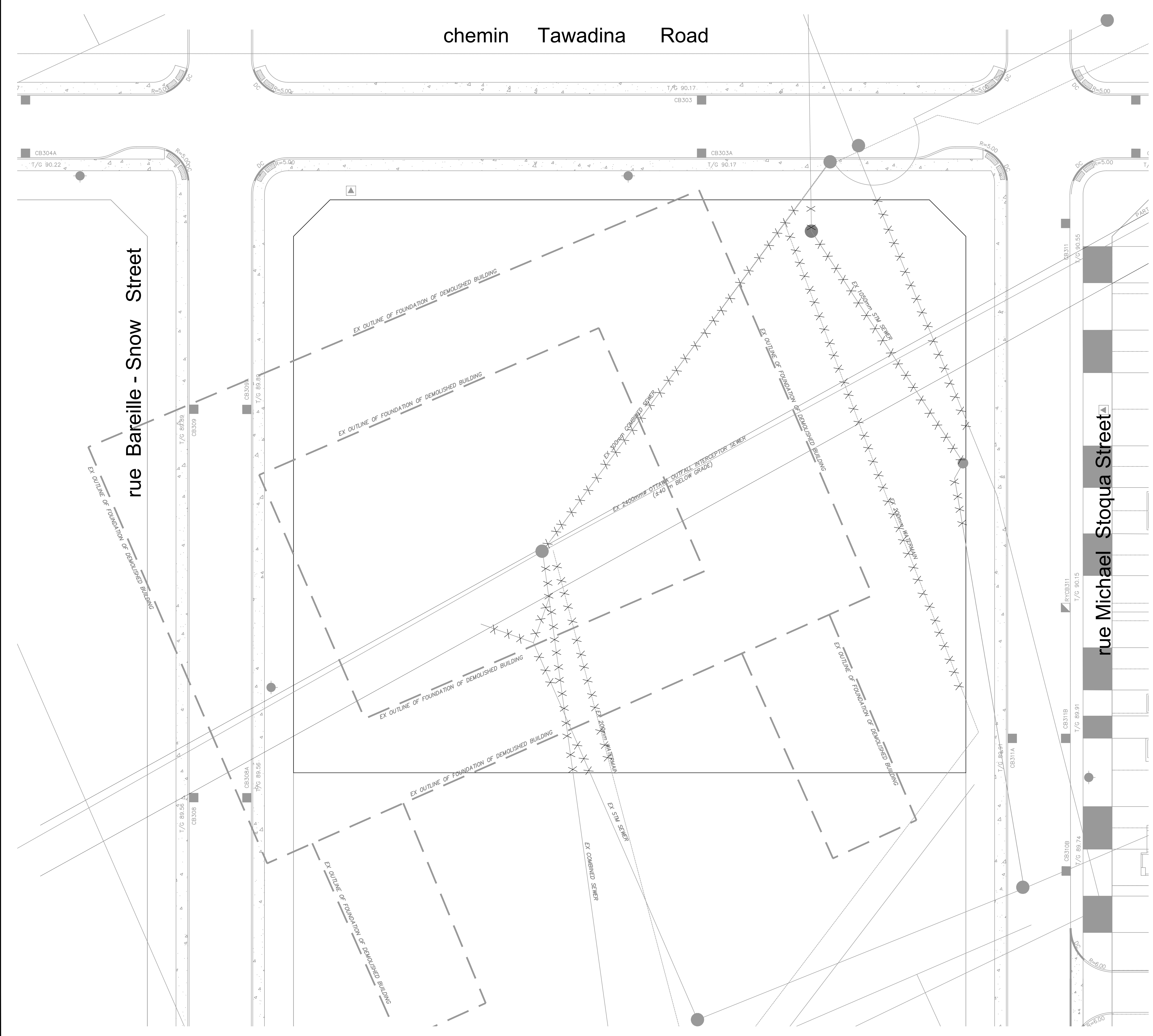

LEGEND:

STORM SEWER		
WATER LINE		
SANITARY SEWER		
PIPE FLOW DIRECTION		
STORM MANHOLE		
AREA DRAIN		
CATCH BASIN		
DOUBLE CATCH BASIN		
TRENCH DRAIN		
PIPE INSULATION		
SANITARY MANHOLE		
WATER HYDRANT		
WATER VALVE		
90° BEND		
45° BEND		
TEE FITTING		
PIPE CROSSING NUMBER		
BUILDING		
RETAINING WALL		
CONSTRUCTION LIMIT		
PROPERTY LINE		
R/W PLAN		

LABEL LEGEND:

- T/G = TOP OF GRATE
- CB = CATCH BASIN
- DOB = DOUBLE CATCH BASIN
- MH = MANHOLE
- AD = AREA DRAIN

LEGEND:

UTILITY/SERVICE LINE TO BE REMOVED

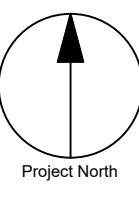

CLIENT

WestUrban
Developments Ltd.

COPYRIGHT

This drawing has been prepared solely for the intended use, thus any reproduction or distribution for any purpose other than authorized by Arcadis is forbidden. Written dimensions shall have precedence over scaled dimensions. Contractors shall verify and be responsible for all dimensions and conditions on the job, and Arcadis shall be informed of any variations from the dimensions and conditions shown on the drawing. Shop drawings shall be submitted to Arcadis for general conformance before proceeding with fabrication.

ISSUES

No.	DESCRIPTION	DATE
1	ISSUED FOR CLC SUBMISSION	2023-01-11
2	SUBMISSION NO 2 FOR CITY REVIEW	2023-09-13
3		
4		
5		
6		
7		
8		

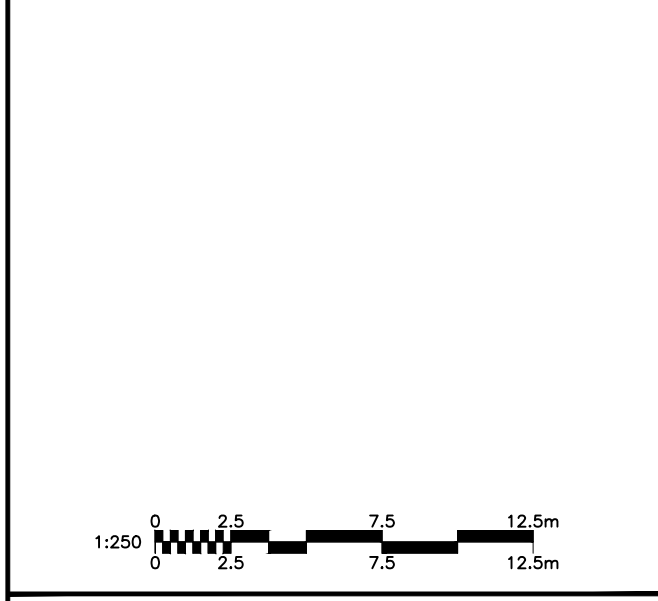
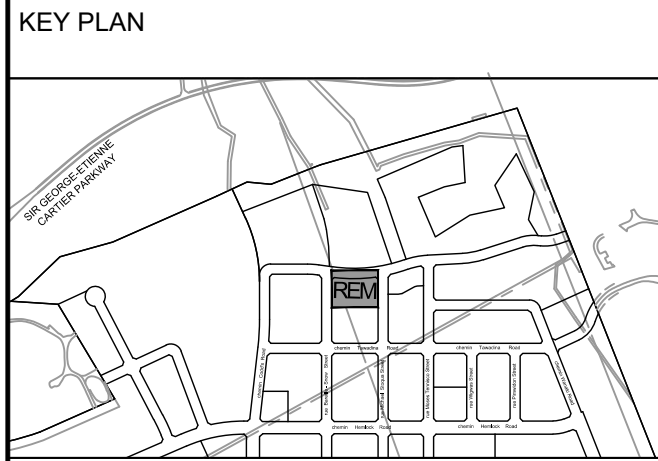

SEAL

ARCADIS

333 Preston Street - Suite 500
Ottawa ON K1S 5N4 Canada
tel 613 225 1311
www.arcadis.com

PROJECT

1050 Tawadina Road

WATERIDGE VILLAGE PHASE 2

PROJECT NO:
142609

DRAWN BY:
M.M.

CHECKED BY:
J.I.M.

PROJECT MGR:
S.L.

APPROVED BY:
A.C.

SHEET TITLE

REMOVALS

SHEET NUMBER

C-REM

ISSUE

2

THESE DRAWINGS WERE PREPARED BY AQUAFOR BEECH LTD FOR THE ACCOUNT OF THE CITY OF OTTAWA. THE MATERIAL CONTAINED HEREIN REPRESENTS AQUAFOR BEECH LTD'S BEST JUDGMENT IN LIGHT OF THE INFORMATION AVAILABLE TO IT AT THE TIME OF PREPARATION. ANY USE OTHER THAN THAT AUTHORIZED BY AQUAFOR BEECH LTD ACCEPTS NO RESPONSIBILITY FOR DAMAGES, ANY, SUFFERED BY ANY THIRD PARTY AS A RESULT OF DECISIONS MADE OR ACTIONS BASED ON THESE DRAWINGS. THIRD PARTY USE OF THESE DRAWINGS WITHOUT THE WRITTEN CONSENT OF AQUAFOR BEECH LTD IS STRICTLY PROHIBITED. THE INTENDED USE OF THESE DRAWINGS ARE STRICTLY LIMITED TO THE PURPOSES AS LISTED WITHIN THE ISSUED FOOT AND REVISIONS TITLE BLOCK OF THESE DRAWINGS. AQUAFOR BEECH LTD ACCEPTS NO RESPONSIBILITY FOR DAMAGES, IF ANY, SUFFERED AS A RESULT OF THE USE OF THESE DRAWINGS OUTSIDE THE INTENDED USE AND AFORESAID LIMITATIONS.

- GENERAL NOTES:**
- ALL ELEVATIONS ARE IN METRES AND REFERENCED TO LOCAL DATUM.
 - ALL DIMENSIONS ARE IN METRIC UNITS.
 - THE CONTRACTOR SHALL BE RESPONSIBLE FOR LAYOUT AND SURVEY CONTROL DURING CONSTRUCTION.
 - THE CONTRACTOR IS RESPONSIBLE FOR LOCATION OF ALL EXISTING UTILITIES PRIOR TO CONSTRUCTION.
 - ON-SITE PRIOR TO THE START OF WORK AND SHALL CONTINUE OPERATIONS WITHIN THE DEFINED AREA. ALL ACTIVITIES, INCLUDING MAINTENANCE PROCEDURES, WILL BE CONTROLLED TO PREVENT ENTRY OF PETROLEUM PRODUCTS, DEBRIS, RUBBLE, CONCRETE OR OTHER DELETERIOUS SUBSTANCES INTO ANY WATER/WATERCOURSE/WETLAND MATERIAL FEATURES, STORM SEWER OR SANITARY SEWER.
 - EROSION AND SEDIMENT CONTROL MEASURES (AND TREE/SHRUB PROTECTION BARRIERS) WILL BE IMPLEMENTED PRIOR TO AND MAINTAINED DURING THE CONSTRUCTION PHASES TO PREVENT ENTRY OF SEDIMENT INTO THE INFILTRATION FACILITY. THESE EROSION AND SEDIMENT CONTROL MEASURES WILL BE REMOVED FOLLOWING CONSTRUCTION COMPLETION AND WHEN DISTURBED AREAS HAVE BEEN STABILIZED AND VEGETATION ESTABLISHED.
 - ALL AREAS WHICH REMAIN DISTURBED FOR MORE THAN 30 DAYS MUST BE STABILIZED TO THE SATISFACTION OF THE RELEVANT AGENCIES, THE CLIENT AND/OR THE SITE ENGINEER.
 - ALL SITE RESTORATION TO BE IN ACCORDANCE WITH THE LANDSCAPE REHABILITATION PLANS AND DETAILS.
 - THE CONTRACTOR IS RESPONSIBLE FOR REMOVAL AND DISPOSAL OF ALL DEBRIS.
 - ALL SEDIMENT AND EROSION CONTROL MEASURES SHALL BE INSPECTED DAILY TO ENSURE THAT THEY ARE FUNCTIONING PROPERLY AND ARE MAINTAINED AND/OR UPGRADED AS REQUIRED.

THE POSITION OF THE POLE LINES, CONDUITS, WATERMANS, SEWERS, AND OTHER UTILITIES AND STRUCTURES ARE NOT NECESSARILY SHOWN ON THE CONTRACT DRAWINGS, AND WHERE SHOWN, THE ACCURACY OF THE POSITION OF SUCH UTILITIES AND STRUCTURES IS NOT GUARANTEED.

BEFORE STARTING WORK, THE CONTRACTOR SHALL CONFIRM THE POSITION AND EXACT LOCATION OF ALL SUCH UTILITIES, AND SHALL ASSUME ALL LIABILITY FOR ANY DAMAGE TO THEM MADE DURING THE COURSE OF THE CONTRACT WORK.

- LEGEND:**
- HEAVY DUTY SILT FENCE
 - SEDIMENT LOG
 - AQUABOX CUBE INFILTRATION FACILITY
 - SEWER PIPE
 - CATCHBASIN
 - CONSTRUCTION ACCESS
 - 375mm Ø OBSERVATION PORT

No.	REVISIONS	By	Date
6			
5			
4			
3			
2			
1	SUBMISSION No.1 FOR ISSUED REVIEW	JM	09/11/23



Project Title
**1050 TAWADINA ROAD
STORMWATER MANAGEMENT
INFILTRATION FACILITY DESIGN**

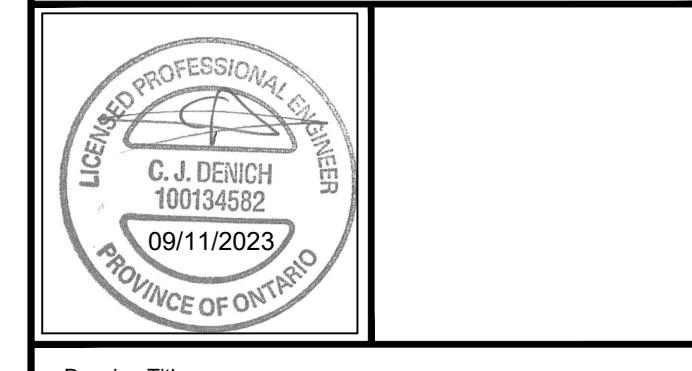

Drawing Title
GENERAL PLAN

Scale
1:150

Design J.M. Date 09/11/2023

Drawn J.M. Checked

Project No. XXXXXX Drawing No. GP-1

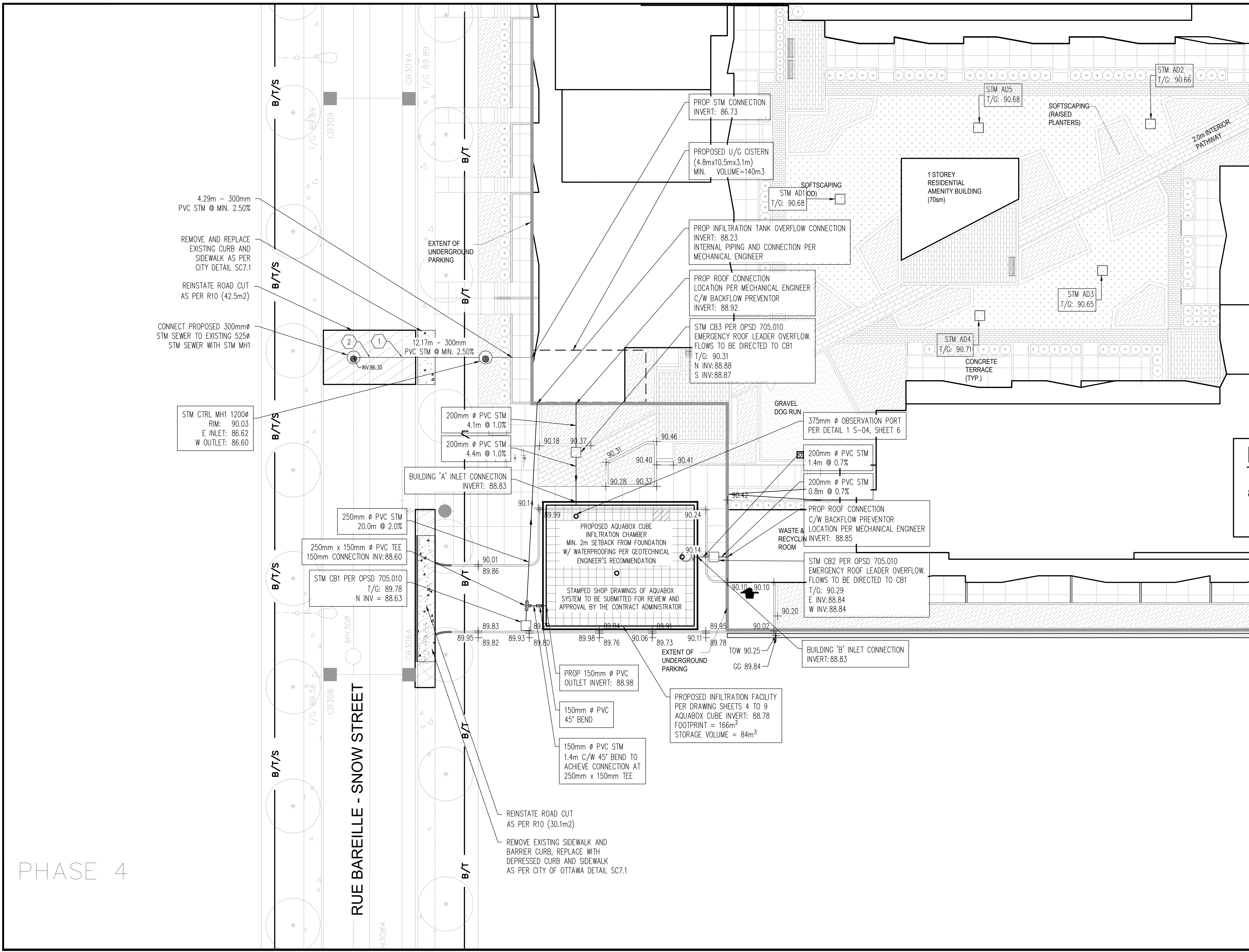

PHASE 4

RUE BAREILLE - SNOW STREET

D07-12-23-0023

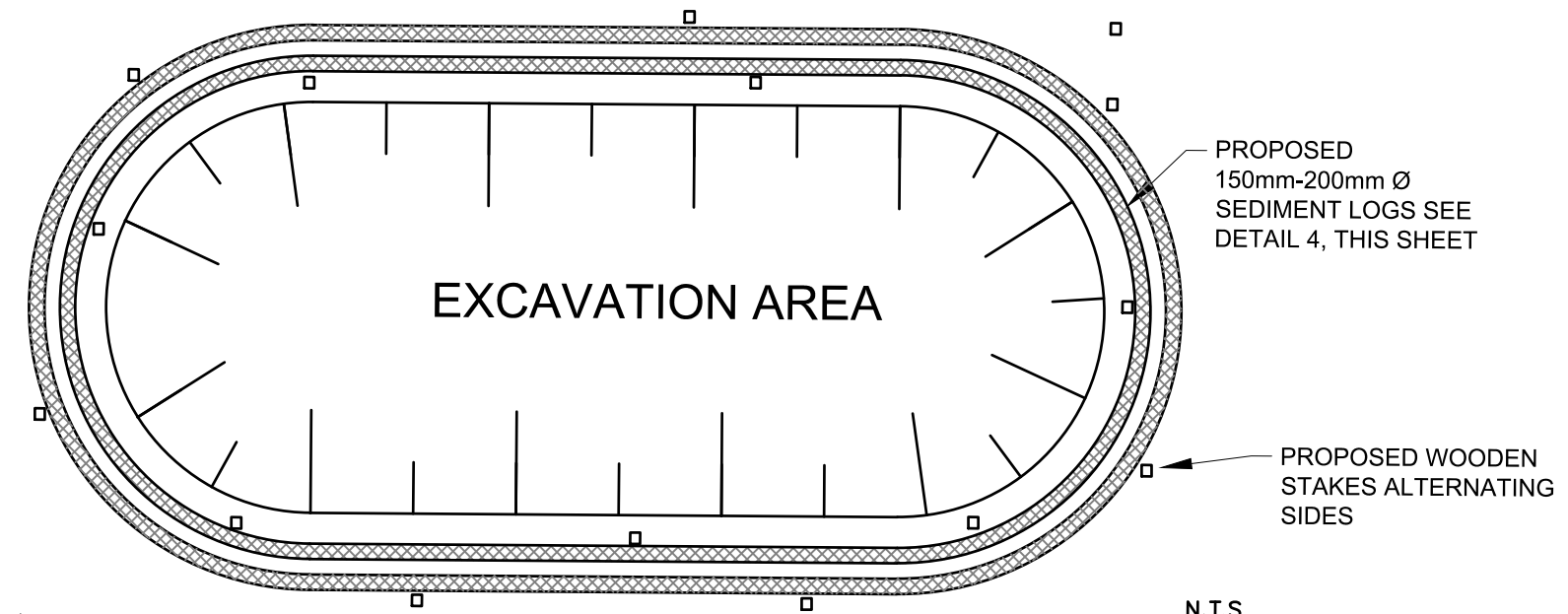

- Notes:**
1. SEDIMENT LOGS SHALL BE INSTALLED AROUND THE PERIMETER OF THE EXCAVATION AREA IDENTIFIED IN THE PLANS.
 2. SEDIMENT LOGS DAMAGED DURING CONSTRUCTION ACTIVITIES SHALL BE REMOVED AND REPLACED PRIOR TO CONTINUING THE WORKS.
 3. SEDIMENT LOGS SHALL BE STAKED IN PLACE USING WEDGE STAKES OR WEIGHTED BARRIERS SUCH AS SAND BAGS OR BRICKS SUCH THAT THE BOTTOM ROWS OF SEDIMENT LOGS ARE SECURED TO GROUND SURFACE. STAKES SHALL NOT BE INSTALLED THROUGH THE SEDIMENT LOGS.
 4. WHERE PLACED ON PVIOUS SURFACES, SEDIMENT LOGS TO BE TRENCHED INTO NATIVE SOIL MIN. 50mm DEPTH.

DTL 01 SEDIMENT LOG DETAIL

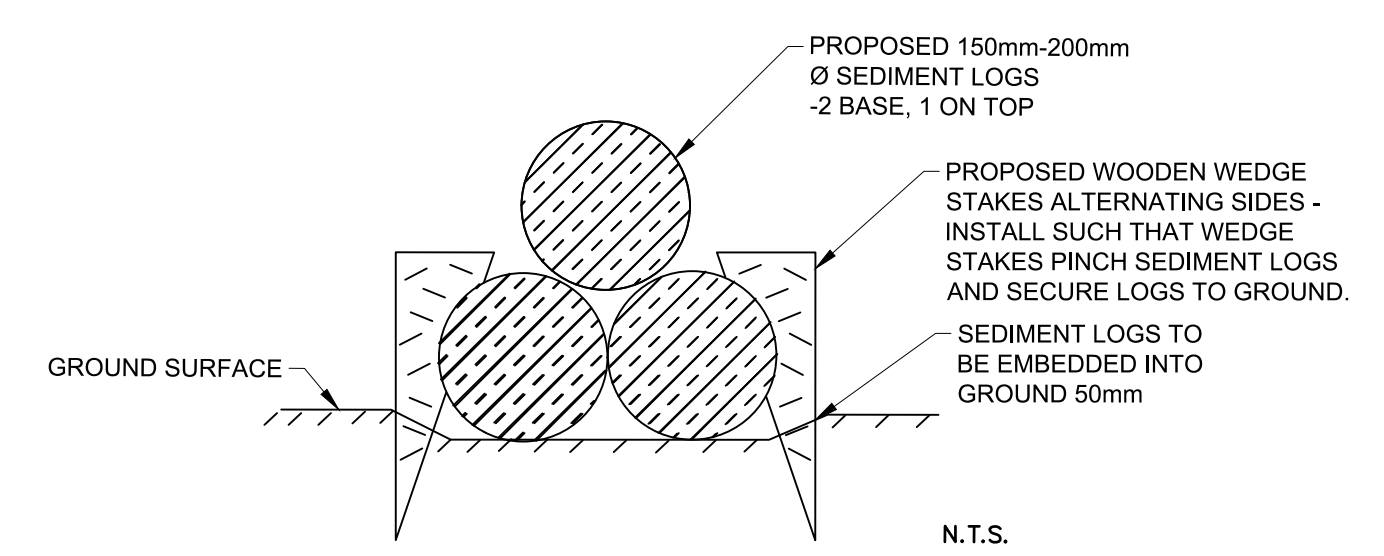

DTL 02 SEDIMENT LOG CONFIGURATION DETAIL

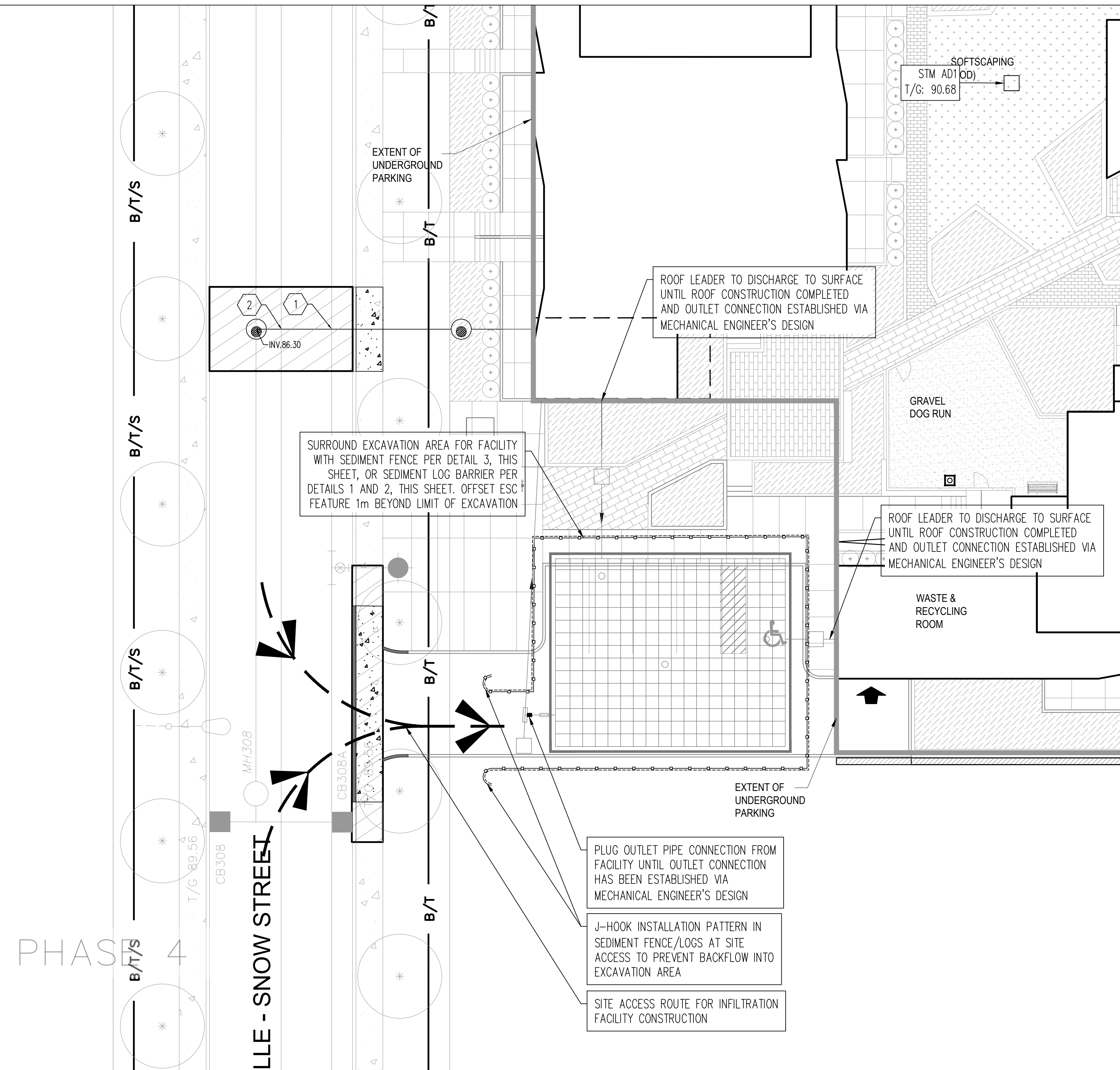

INFILTRATION FACILITY ESC NOTES

1. DURING CONSTRUCTION, PROVISIONS SHALL BE MADE FOR PROPER WATER MANAGEMENT AND DRAINAGE OF THE SITE. THIS SHALL INCLUDE ALL APPLICABLE SILT TRAPS, ALL EROSION CONTROL MEASURES, TEMPORARY WATER COLLECTION DITCHES AND OVERFLOW STRUCTURES DENOTED WITHIN THIS ESC PLAN, AS WELL AS THE PROPER MAINTENANCE OF SUCH THROUGHOUT THE CONSTRUCTION PERIOD. AT NO TIME SHALL SEDIMENT LADEN WATER BE ALLOWED TO ENTER THE EXCAVATED/BACKFILLED OR COMPLETED INFILTRATION CHAMBER AREA. PRIOR TO THE COMPLETION OF ROOFTOP AREAS FOR BUILDING 'A' AND BUILDING 'B', AS WELL AS CONNECTION OF THE OUTLET TO THE UNDERGROUND CISTERN, NO SITE DRAINAGE AND/OR STORM DRAINAGE IS TO ENTER THE PROPOSED INFILTRATION CHAMBER AREA. SHOULD SEDIMENT ENTER THE FACILITY PRIOR TO RECEIVING APPROVAL FROM FIELD ENGINEER, THE INFILTRATION RATE OF THE CONTAMINATED AREA SHOULD BE TESTED USING THE GUELPH PERMEAMETER TEST OR DOUBLE-RING INFILTRATION TEST, TO CONFIRM NO LOSS IN INFILTRATION POTENTIAL. SHOULD A LOSS OF INFILTRATION CAPACITY BE CONFIRMED, THE CONTRACTOR WILL BE RESPONSIBLE FOR THE REPAIR/ REMEDIATION OF THE CONTAMINATED AREA TO THE SATISFACTION OF THE CLIENT/ ENGINEER/ LANDSCAPE ARCHITECT, USING APPROVED MEASURES/ MATERIALS AND PRACTICES.
2. THE EROSION AND SEDIMENT CONTROL STRATEGIES OUTLINED ON THE PLANS ARE NOT STATIC AND MAY NEED TO BE UPGRADED / AMENDED AS SITE CONDITIONS CHANGE TO MINIMIZE SEDIMENT LADEN RUNOFF FROM LEAVING THE WORK AREAS. IF THE PRESCRIBED MEASURES ON THE PLANS ARE NOT EFFECTIVE IN PREVENTING THE RELEASE OF A DELETERIOUS SUBSTANCE, THEN ALTERNATIVE MEASURES SHOULD BE IMPLEMENTED IMMEDIATELY TO MINIMIZE POTENTIAL ECOLOGICAL IMPACTS.
3. ADHERENCE TO CONSTRUCTION SEQUENCING IS REQUIRED AS PART OF THE ESC PLAN. CONSTRUCTION SEQUENCING IS AN INTEGRAL COMPONENT OF ESC PROCEDURES/ PRACTICES AND HAS BEEN DESIGNED IN ORDER TO ENSURE THAT NO CONTAMINATION/ REDUCTION IN INFILTRATION CAPACITY TAKES PLACE AS A RESULT OF CONSTRUCTION ACTIVITIES.
4. TEMPORARY SEDIMENT CONTROLS TO BE INSTALLED PRIOR TO, AND MAINTAINED DURING THE CONSTRUCTION PHASES. ALL DAMAGED EROSION AND SEDIMENT CONTROL MEASURES SHOULD BE REPAIRED WITHIN 48 HOURS OF THE INSPECTION.
5. SEDIMENT LOGS/SOCKS, HEAVY DUTY SEDIMENT FENCE, OR APPROVED EQUIVALENT SHALL BE INSTALLED ALONG THE PERIMETER OF THE EXCAVATION AREA OF THE INFILTRATION CHAMBER WITH A 1.0m SETBACK PRIOR TO FACILITY CONSTRUCTION TO PREVENT SEDIMENT ENTRY INTO THE INFILTRATION CHAMBER.
6. ANY AND ALL ACCUMULATED AND/OR STORED WATER WITHIN THE EXCAVATED AREAS SHALL BE ALLOTTED SUFFICIENT TIME TO SETTLE OUT SUSPENDED SEDIMENTS AS DETERMINED BY THE FIELD ENGINEER PRIOR TO PUMPING/DISCHARGE TO A DESIGNATED AREA AND SEDIMENT BAG.
7. AFTER THE COMMENCEMENT OF EXCAVATION, SHOULD A SIGNIFICANT STORM EVENT OCCUR THAT FILLS OR PARTIALLY FILLS THE EXCAVATED AREA/CONSTRUCTION SITE, PUMPING SHOULD BE UNDERTAKEN AS PER NOTE 6.
8. NO RUNOFF FROM THE EXCAVATED AREA AND UNVEGETATED AREAS SHALL BE DISCHARGED OFF SITE INTO ACTIVE AND/OR INACTIVE STORM SEWERS. SEE NOTE 6 ABOVE.
9. CONTRACTOR IS RESPONSIBLE FOR ANY REMEDIATION/REPAIR OF INFILTRATION FACILITIES DAMAGED AS A RESULT OF INADEQUATE OR IMPROPER SEDIMENT CONTROL.
10. THE CONTRACTOR SHALL DELINEATE THE REQUIRED WORKING AREA ON-SITE PRIOR TO THE START OF WORK AND SHALL CONFINE OPERATIONS WITHIN THE DEFINED AREA.
11. TEMPORARY TOPSOIL AND/OR FILL MATERIAL STOCKPILE AREAS TO BE ENCLOSED WITH SILTATION CONTROL FENCE. MATERIALS ARE NOT TO BE STOCKPILED UPSTREAM OF PROPOSED FACILITY.
12. LOCATION OF STOCKPILE AREAS TO BE DETERMINED ON-SITE PRIOR TO CONSTRUCTION AND APPROVED BY THE ENGINEER.
13. WORKING AREAS, ACCESS REQUIREMENTS, AND TEMPORARY MATERIAL STORAGE AREAS TO BE MAINTAINED IN GOOD CONDITION BY THE CONTRACTOR AT ALL TIMES. AREAS AFFECTED BY THE CONTRACTOR'S ACTIVITIES TO BE REINSTATED TO THE EXISTING CONDITIONS OR BETTER.
14. NO RUNOFF FROM EXCAVATED OR UNVEGETATED AREAS SHALL BE DISCHARGED OFF SITE INTO ACTIVE AND/OR INACTIVE STORM SEWERS OR WATERCOURSES.
15. ALL ACCUMULATED SEDIMENTS TO BE REMOVED PRIOR TO THE REMOVAL OF CONTROLS AND DISPOSED OF IN AN APPROVED ON-SITE LOCATION BY THE CONTRACTOR (LOCATION TO BE DETERMINED IN THE FIELD).
16. ON-SITE EQUIPMENT REFUELING AND MAINTENANCE TO BE ONLY COMPLETED IN DESIGNATED AREAS.
17. SEDIMENT CONTROLS TO BE INSPECTED DAILY AND AFTER EACH RAINFALL EVENT. SEDIMENT CONTROLS TO BE MAINTAINED AND REPAIRED BY THE CONTRACTOR UNTIL COMPLETION OF CONSTRUCTION AND SITE RESTORATION.
18. ANY DAMAGE TO EXISTING FEATURES OR SURFACES DUE TO CONSTRUCTION ACTIVITY SHALL BE REINSTATED TO EXISTING CONDITIONS OR BETTER PRIOR TO COMPLETION OF CONSTRUCTION ACTIVITIES ON SITE TO THE SATISFACTION OF THE RELEVANT AGENCIES, THE CLIENT, AND/OR THE SITE ENGINEER.
19. ALL ROADWAYS TO BE CLEANED OF SEDIMENTS RESULTING FROM CONSTRUCTION TRAFFIC FROM THE SITE EACH DAY.
20. EROSION PROTECTION TO BE PROVIDED AROUND ALL EXISTING STORM AND SANITARY MHS, DICs AND CBs PRIOR TO CONSTRUCTION.
21. REMOVE TEMPORARY SEDIMENT CONTROLS FOLLOWING COMPLETION OF CONSTRUCTION AND SITE RESTORATION, AND REINSTATE AFFECTED AREAS TO EXISTING CONDITIONS OR BETTER TO THE SATISFACTION OF THE RELEVANT AGENCIES, THE CLIENT, AND/OR THE SITE ENGINEER.

INFILTRATION FACILITY CONSTRUCTION SEQUENCING NOTES

1. EROSION AND SEDIMENTATION PROTECTION MEASURES ARE REQUIRED PRIOR TO THE COMMENCEMENT OF ANY AND ALL EXCAVATION ACTIVITIES.
2. ROUGH EXCAVATION OF THE INFILTRATION FACILITY IS PERMITTED TO A MAXIMUM 100mm OF FINAL GRADE AT INVERT OF 19mm LEVELING COURSE ANGULAR STONE. FINAL GRADE OF THE INFILTRATION FACILITY TO BE EXCAVATED IMMEDIATELY PRIOR TO BACKFILLING WITH SPECIFIED AGGREGATE. AVOID PREMATURE FACILITY CLOGGING.
3. EXCAVATION, 19mm ANGULAR STONE BACKFILLING AND CHAMBER INSTALLATION IS ONLY TO OCCUR AFTER THE CONTRIBUTING DRAINAGE AREA HAS BEEN STABILIZED.
4. EXCAVATION OF FINAL 100mm OF NATIVE MATERIAL TO FINAL FACILITY INVERT AS PER DESIGN DRAWINGS. SURFACE OF EXCAVATION SHALL BE SCARIFIED PRIOR TO INSTALLATION OF BACKFILL MATERIALS.
5. INSTALL AQUABOX CHAMBER COMPONENTS TO SPECIFIED LOCATIONS AND DEPTHS AS MARKED ON THE ASSOCIATED DESIGN DRAWINGS. MAKE ALL REQUIRED PIPE CONNECTIONS.
6. APPLY 19mm ANGULAR STONE IN 300mm LIFTS UNTIL DESIRED ELEVATION IS ACHIEVED.
7. SURFACE INSTALLATION:
 - A. APPLY AND COMPACT BACKFILL MATERIAL/PARKING LOT SUB BASE MATERIALS APPROVED BY THE CONTRACT ADMINISTRATOR TO MINIMUM 300mm THICKNESS.
 - B. INSTALL PROPOSED IMPVIOUS SURFACE MATERIAL ABOVE INFILTRATION FACILITY AREA AS PER DESIGN DRAWING.

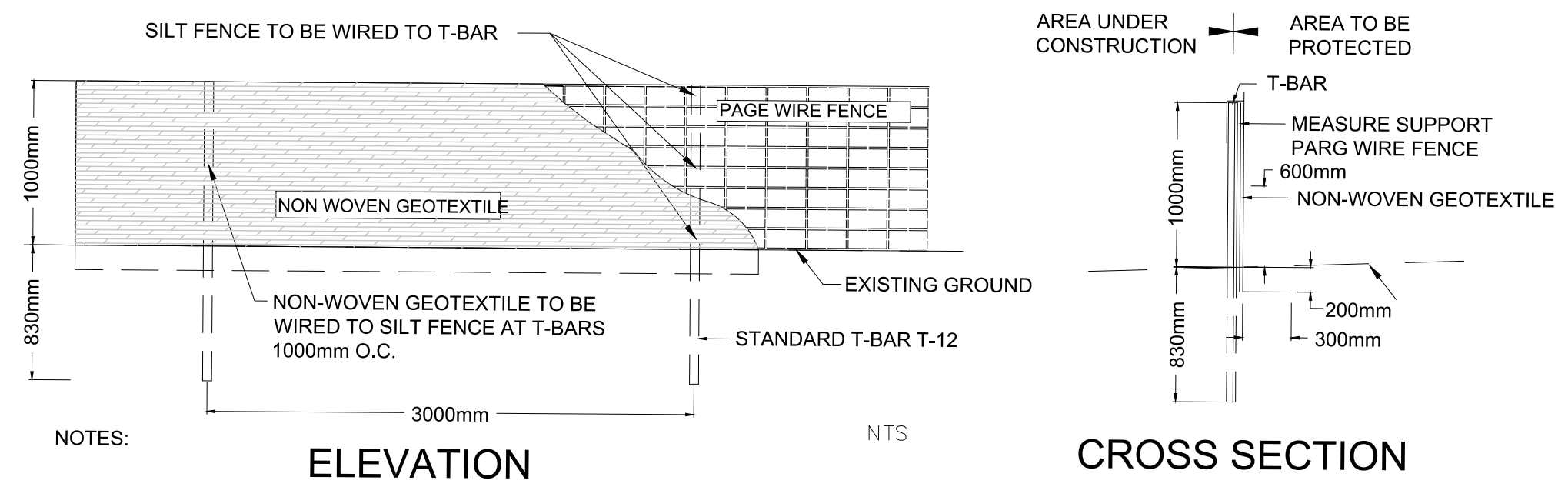

- NOTES:**
- SILTATION CONTROL FENCE TO BE TERRAFIX TERRAFENCE, OR EQUIVALENT, OR CONSTRUCTED AS INDICATED BELOW.
 - GEOTEXTILE TO BE NON-WOVEN WITH A MINIMUM EQUIVALENT OPENING SIZE OF 0.15mm AND A MAXIMUM EQUIVALENT OPENING SIZE OF 0.25mm
 - NON-WOVEN GEOTEXTILE TO HAVE A HORIZONTAL OVERLAP OF 1 METER AT JOINTS.
 - SILT FENCE TO BE UV STABILIZED HIGH DENSITY POLYETHYLENE OR APPROVED EQUAL.

DTL 03 HEAVY DUTY SEDIMENT FENCE DETAIL

REVIEWED BY
DEVELOPMENT REVIEW SERVICES BRANCH

Signed _____
Date _____ 2023
Plan Number _____

THESE DRAWINGS WERE PREPARED BY AQUAFOR BEECH LTD FOR THE ACCOUNT OF THE CITY OF STONING. THE MATERIAL CONTAINED HEREIN BELONGS TO AQUAFOR BEECH LTD. BEST JUDGMENT IN LIGHT OF THE INFORMATION AVAILABLE TO IT AT THE TIME OF PREPARATION. THESE DRAWINGS ARE INTENDED FOR THE USE OF THE CLIENT AND/OR CONTRACTOR. ANY USE OF THESE DRAWINGS BY ANY OTHER PARTY IS THE RESPONSIBILITY OF SUCH THIRD PARTY. AQUAFOR BEECH LTD ACCEPTS NO RESPONSIBILITY FOR ANY DAMAGE OR LOSS OF PROFITS OR BUSINESS OR OTHER ADVERSE CONSEQUENCES OF ANY KIND, INCLUDING REPUTATIONAL DAMAGE, ARISING FROM THE USE OF THESE DRAWINGS. AQUAFOR BEECH LTD IS STRICTLY PROHIBITED FROM THE INTENDED USE OF THESE DRAWINGS. SHOULD ANY SUCH DAMAGE OR LOSS OF PROFITS OR BUSINESS OR OTHER ADVERSE CONSEQUENCES BE SUFFERED BY ANY PARTY AS A RESULT OF THE USE OF THESE DRAWINGS, THE USER SHALL BE RESPONSIBLE FOR THE REPAIR/ REMEDIATION OF THE CONTAMINATED AREA TO THE SATISFACTION OF THE CLIENT/ ENGINEER/ LANDSCAPE ARCHITECT, USING APPROVED MEASURES/ MATERIALS AND PRACTICES.

GENERAL NOTES:

1. ALL ELEVATIONS ARE IN METRES AND REFERENCED TO LOCAL DATUM.
2. ALL DIMENSIONS ARE IN METRIC UNITS.
3. THE CONTRACTOR SHALL BE RESPONSIBLE FOR LAYOUT AND EXISTING UTILITIES PRIOR TO CONSTRUCTION.
4. THE CONTRACTOR SHALL DELINEATE THE REQUIRED WORKING AREA ON-SITE PRIOR TO THE START OF WORK AND SHALL CONFINE OPERATIONS WITHIN THE DEFINED AREA. ALL ACTIVITIES, INCLUDING MAINTENANCE PROCEDURES, WILL BE CONTROLLED TO PREVENT ENTRY OF PETROLEUM PRODUCTS, DEBRIS, RUBBLE, CONCRETE OR OTHER DELETERIOUS SUBSTANCES INTO ANY WATER/WATERCOURSE/WETLAND/NATURAL FEATURES, STORM SEWER OR SANITARY SEWER.
5. EROSION AND SEDIMENT CONTROL MEASURES (AND TREE/SHRUB PROTECTION BARRIERS) WILL BE IMPLEMENTED PRIOR TO AND MAINTAINED DURING THE CONSTRUCTION PHASES TO PREVENT ENTRY OF SEDIMENT INTO THE INFILTRATION FACILITY. THESE EROSION AND SEDIMENT CONTROL MEASURES WILL BE REMOVED FOLLOWING CONSTRUCTION COMPLETION AND WHEN DISTURBED AREAS HAVE BEEN STABILIZED AND VEGETATION ESTABLISHED.
6. ALL AREAS WHICH REMAIN DISTURBED FOR MORE THAN 30 DAYS MUST BE STABILIZED TO THE SATISFACTION OF THE RELEVANT AGENCIES, THE CLIENT AND/OR THE SITE ENGINEER.
7. ALL SITE RESTORATION TO BE IN ACCORDANCE WITH THE LANDSCAPE REHABILITATION PLANS AND DETAILS.
8. THE CONTRACTOR IS RESPONSIBLE FOR REMOVAL AND DISPOSAL OF ALL DEBRIS.
9. ALL SEDIMENT AND EROSION CONTROL MEASURES SHALL BE INSPECTED DAILY TO ENSURE THAT THEY ARE FUNCTIONING PROPERLY AND ARE MAINTAINED AND/OR UPGRADED AS REQUIRED.

THE POSITION OF THE POLE LINES, CONDUITS, WATERMANS, SEWERS, AND OTHER UTILITIES AND STRUCTURES ARE NOT NECESSARILY SHOWN ON THE CONTRACT DRAWINGS, AND WHERE SHOWN, THE ACCURACY OF THE POSITION OF SUCH UTILITIES AND STRUCTURES IS NOT GUARANTEED.

BEFORE STARTING WORK, THE CONTRACTOR SHALL CONFIRM THE POSITION AND EXACT LOCATION OF ALL SUCH UTILITIES, AND SHALL ASSUME ALL LIABILITY FOR ANY DAMAGE TO THEM MADE DURING THE COURSE OF THE CONTRACT WORK.

LEGEND:

- HEAVY DUTY SILT FENCE
- - - SEDIMENT LOG
- ▨ AQUABOX CUBE INFILTRATION FACILITY
- SEWER PIPE
- CATCHBASIN
- ➔ CONSTRUCTION ACCESS
- 375mm Ø OBSERVATION PORT

6			
5			
4			
3			
2			
1	SUBMISSION No.1 FOR ISSUED REVIEW	JM	09/11/23
No.	REVISIONS	By	Date



Project Title
1050 TAWADINA ROAD STORMWATER MANAGEMENT INFILTRATION FACILITY DESIGN

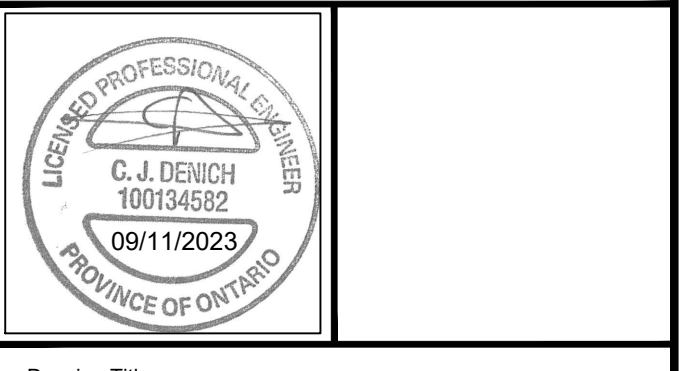

Drawing Title
EROSION & SEDIMENT CONTROL PLAN

Scale
1:150

Design	J.M.	Date	09/11/2023
Drawn	J.M.	Checked	
Project No.	XXXXXX	Drawing No.	ESC-1

1 NOTES
S-02

- NOTES:
- a. All dimensions are measured in meters unless noted otherwise.
 - b. Reference Aquabox standard drawings and notes for detailed information.
 - c. Reference current Aquabox Module installation instructions for proper installation practices.
<https://www.geoplastglobal.com/en/downloads/aquabox>
 - d. Engineer of record to confirm conformance to manufacturer's allowable proximity to other structures and slopes.
 - e. All inlet and pipe locations and designs by others.
 - f. The sub-grade and side backfill needs to be compacted to 97%, unless noted otherwise.
 - g. During and after installation, the AquaBox Module area should be clearly marked and roped off to prevent unauthorized construction and equipment trafficking over the modules.
 - h. Top of Ground water is to be maintained 610 mm (2 ft) below the module to prevent buoyancy, unless otherwise noted by engineer.
 - i. The quantities related to stone and geosynthetics are estimated values as the roll size, overlaps, waste, ect. may vary.
 - j. Materials must be stored in a manner to prevent prolonged exposure to UV light.
 - k. Materials shall not be handled in temperatures lower than 4.4 °C to prevent damage.
 - l. Storm tank system is not considered complete until all backfill is installed to the minimum depth shown on Detail 5 Typical System Cross-Section. The installer **MUST** insure that the project site remains dry and free of water (both surface and groundwater) until the installation is complete, including the backfill as noted, to avoid damage to the tank system due to buoyancy.

Material Quantity (AQUABOX HP)		Material Quantity (AQUABOX CUBE HP)	
AquaBox HP	0	AquaBox Cube HP	532
Sidewall Grid HP	0	Sidewall Grid Cube HP	76
Top Cap HP	1064	Circular Cap D400 HP	529
Single Joint	998	Surface Grate	3
Double Joint	0		

Elevations

Leveling Stone Bottom	90.09
Module Invert	90.19
Top of Module	90.59
Top of Stone Backfill	90.90
Minimum Finished Grade	91.20
*Must consider frost line, varies by region	
Maximum Finished Grade	92.49

Contractor to confirm that quantities shipped to site match those listed above. Please report any discrepancy or damage to Layfield immediately.

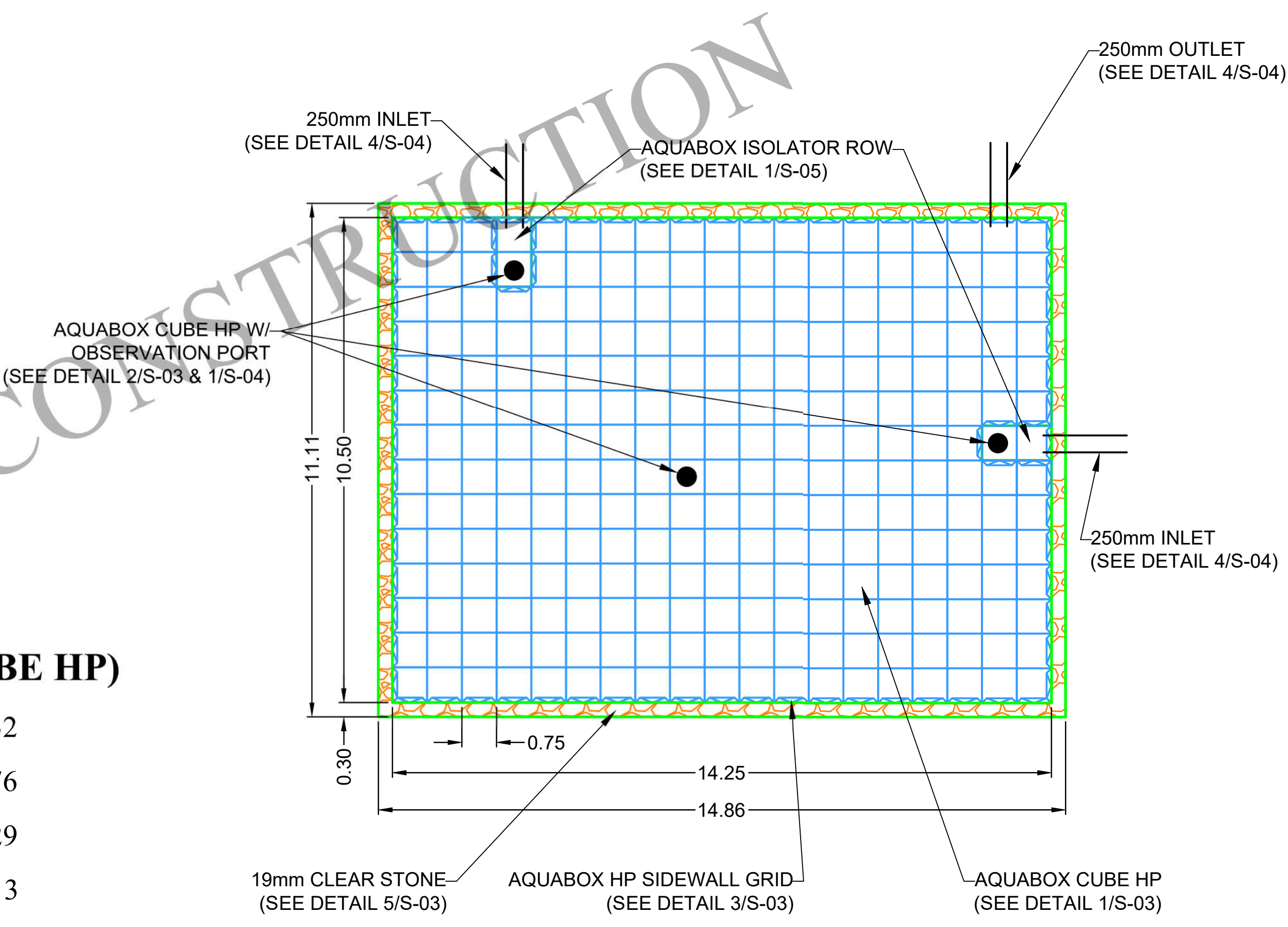

2 MODULE LAYOUT
S-02 SCALE: NTS

THIS DRAWING AND THE INFORMATION CONTAINED HEREIN ARE CONFIDENTIAL AND PROPRIETARY AND SHALL NOT BE COPIED NOR USED IN ANY MANNER WITHOUT WRITTEN AUTHORIZATION FROM LAYFIELD CANADA LTD.

Total Storage Volume		85.30 m ³
Module Storage Volume		55.99 m ³
Stone Storage Volume		29.31 m ³
System Footprint		165.10 m ²
Estimated Geotextile Fabric	NuBarrier	883 m ²
Estimated Geotextile Fabric	LP8	---- m ²
Estimated Liner		---- m ²
Estimated GeoGrid		---- m ²
Estimated Stone Volume		73.27 m ³
Excavation Required		183.44 m ³
Minimum Excavation Depth		1.11 m
Stone Type		19mm Clear Stone
Stone Void Space		40%
Number of Module Layers		0.5
Allowable Loading		HS-25
Surface	Paved Surface	Vegetated/ Unpaved
Minimum Top Cover	0.60 m	0.80 m
Maximum Tank Depth	2.30 m	2.20 m

1050 TAWADINA
Ottawa, ON

REV	Record of Changes	Date	By
△	Preliminary Drawing	09-04-2023	PE

Project Number: OP2023-7273	
Page Name:	Module Layout (L-1)
Drawn by: PE	Checked By: JF
Scale: NTS	Date: 09-04-2023

THIS LAYOUT DRAWING WAS PREPARED TO SUPPORT THE ENGINEER OF RECORD FOR THE PROPOSED SYSTEM. IT IS THE RESPONSIBILITY OF THE ENGINEER OF RECORD TO REVIEW THE INFORMATION AND ENSURE THAT THE LAYOUT AND DESIGN IS IN FULL COMPLIANCE WITH ALL APPLICABLE LAWS AND REGULATIONS AND THAT THE AQUABOX SYSTEM HAS BEEN DESIGNED IN ACCORDANCE WITH GEOPLAST'S REQUIREMENTS. LAYFIELD DOES NOT REVIEW OR APPROVE PLANS, SIZING OR DESIGNS.

Sheet: **04 OF 09**

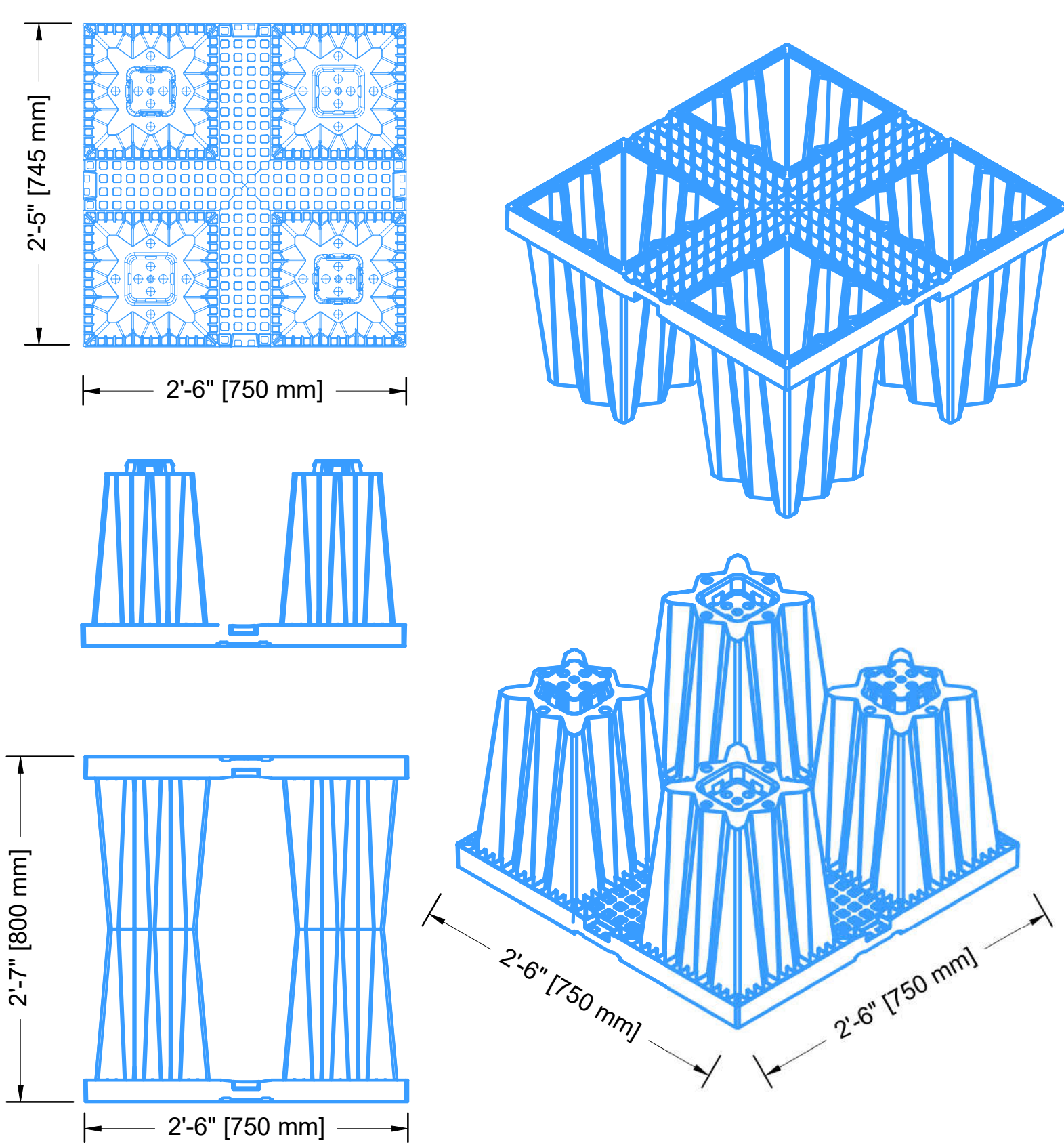

1 AQUABOX HP
S-03

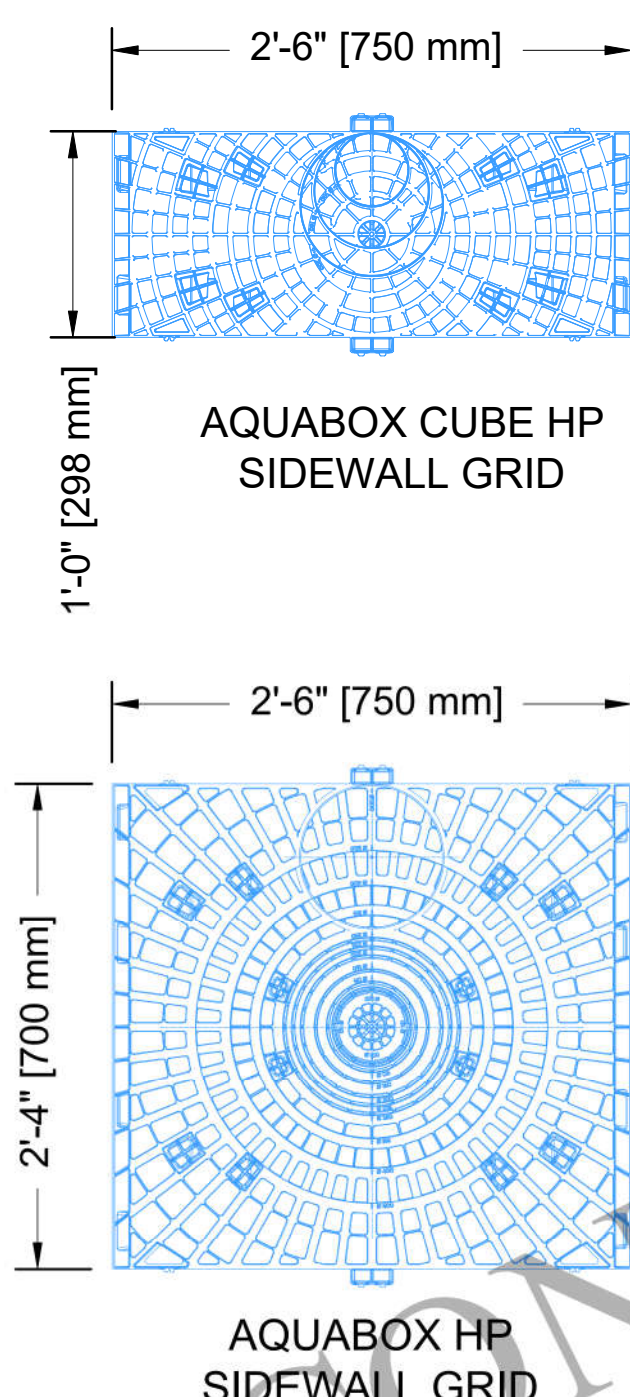

3 AQUABOX SIDEWALL GRID
S-03

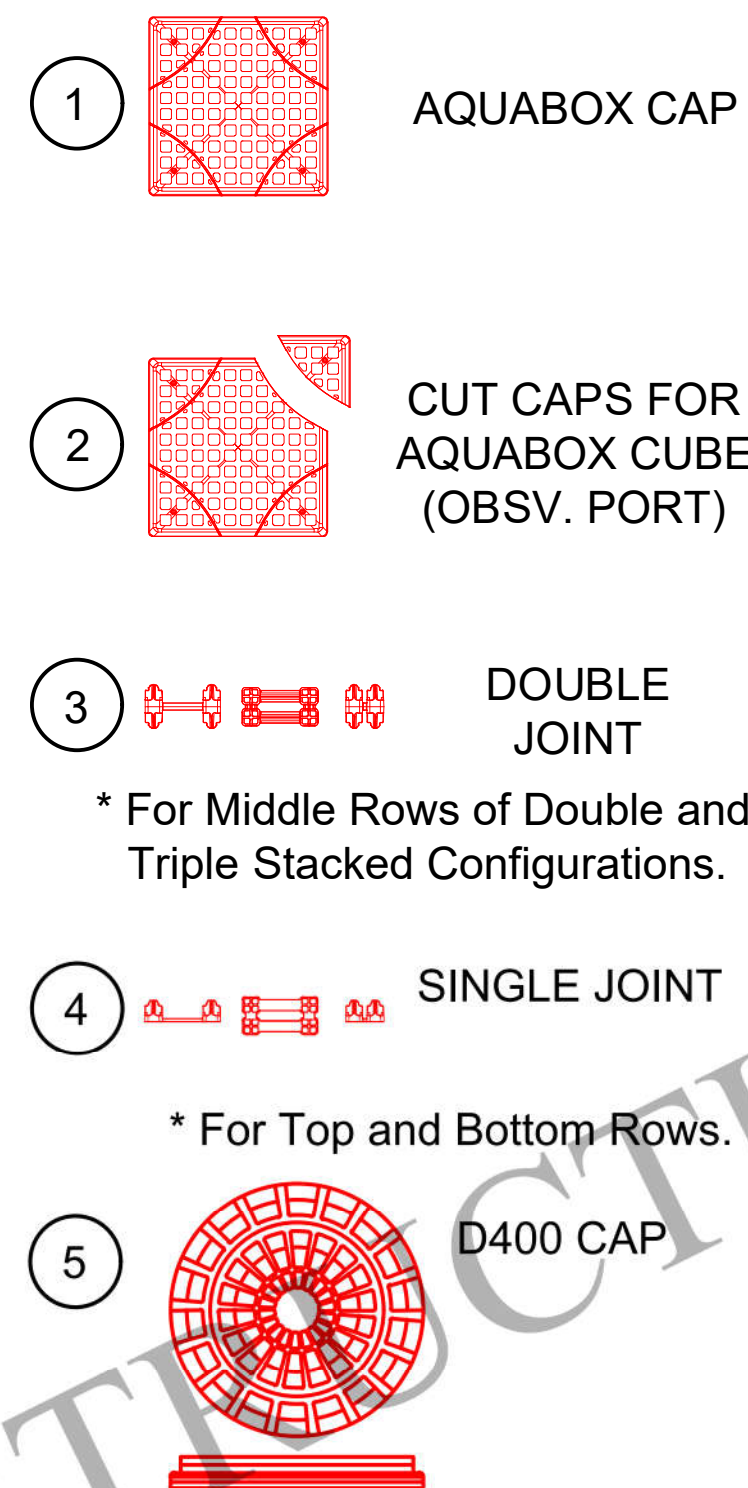

NOTE: THIS DETAIL DEPICTS ONLY THE LOCATION OF AQUABOX ACCESSORIES (CAPS/ CONNECTORS) AND DOES NOT REPRESENT THE PROJECT-SPECIFIC STACKING CONFIGURATION. REFER TO DETAIL 5/S-03 FOR STACKING CONFIGURATION AND CROSS-SECTIONAL DETAILS.

4 AQUABOX ACCESSORIES CAPS AND JOINTS
S-03

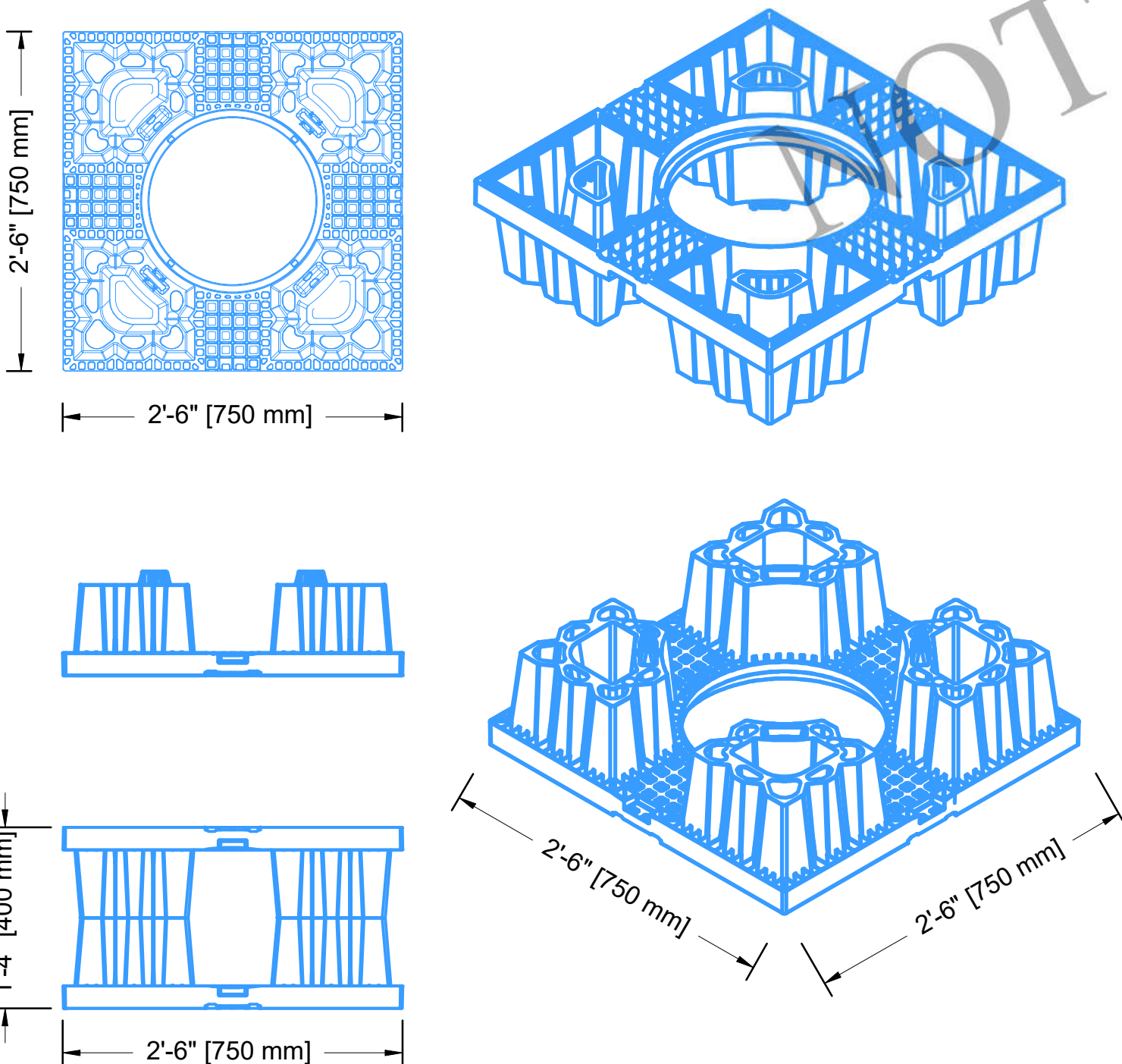
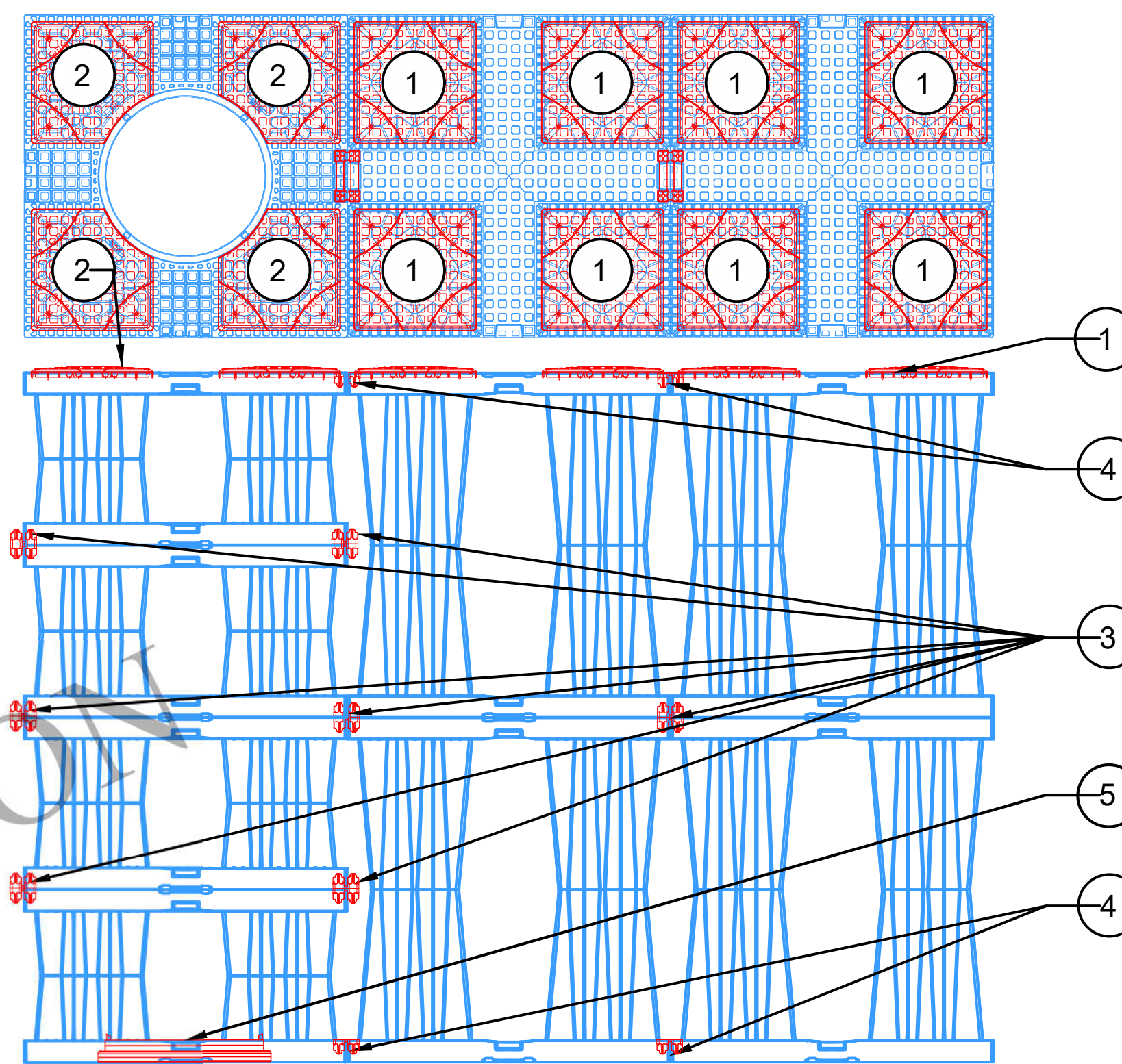

2 AQUABOX CUBE HP
S-03

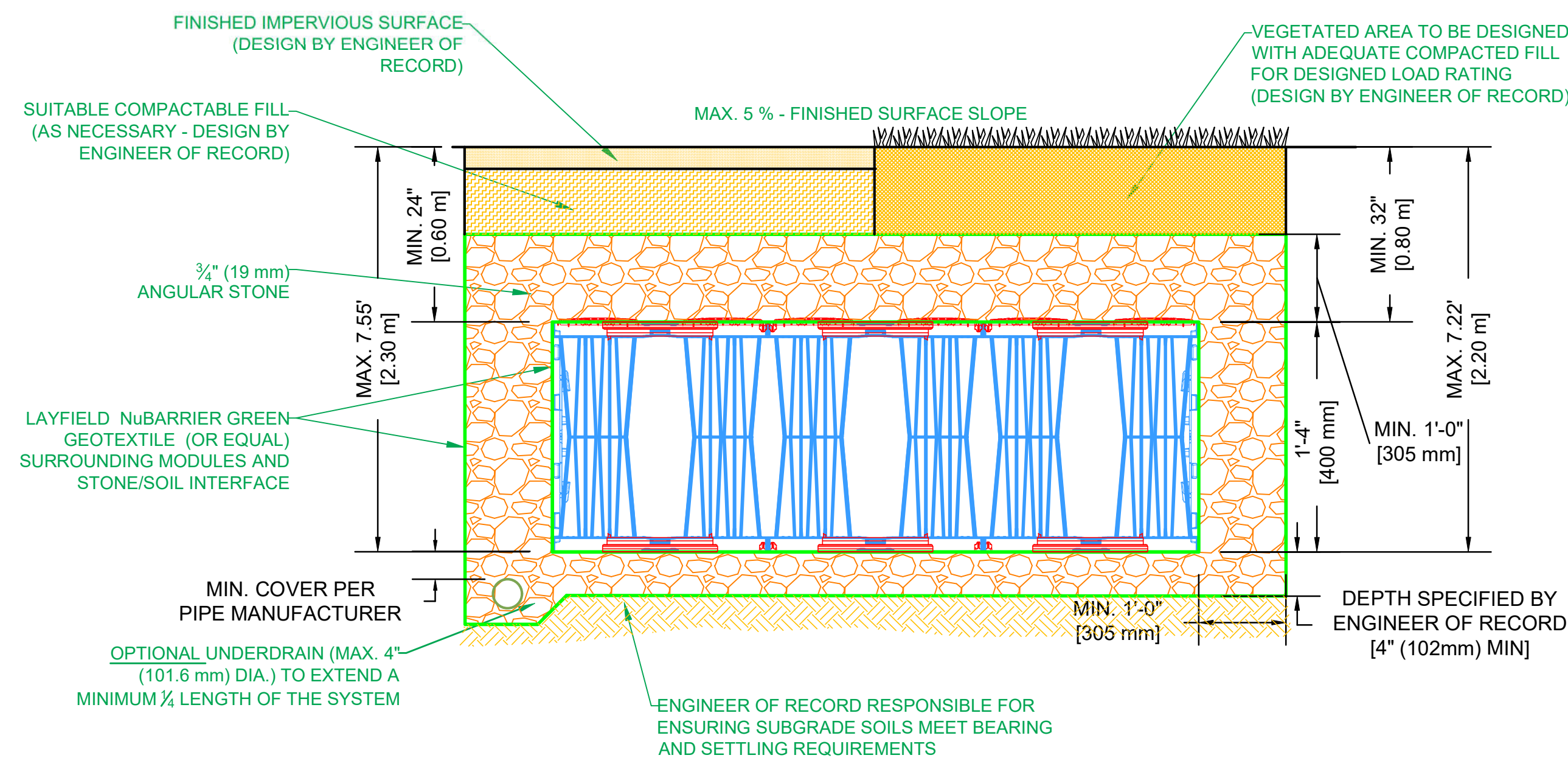

5 TYPICAL SYSTEM CROSS SECTION
S-03

Total Storage Volume	85.30 m ³	
Module Storage Volume	55.99 m ³	
Stone Storage Volume	29.31 m ³	
System Footprint	165.10 m ²	
Estimated Geotextile Fabric	NuBarrier 883 m ²	
Estimated Geotextile Fabric	LP8 ---- m ²	
Estimated Liner	---- m ²	
Estimated GeoGrid	---- m ²	
Estimated Stone Volume	73.27 m ³	
Excavation Required	183.44 m ³	
Minimum Excavation Depth	1.11 m	
Stone Type	19mm Clear Stone	
Stone Void Space	40%	
Number of Module Layers	0.5	
Allowable Loading	HS-25	
Surface	Paved Surface	Vegetated/ Unpaved
Minimum Top Cover	0.60 m	0.80 m
Maximum Tank Depth	2.30 m	2.20 m

1050 TAWADINA
Ottawa, ON

REV	Record of Changes	Date	By
△	Preliminary Drawing	09-04-2023	PE

Project Number:	OP2023-7273		
Page Name:	TYP. Construction Details (CD-1)		
Drawn by:	PE	Checked By:	JF
Scale:	NTS	Date:	09-04-2023

THIS LAYOUT DRAWING WAS PREPARED TO SUPPORT THE ENGINEER OF RECORD FOR THE PROPOSED SYSTEM. IT IS THE RESPONSIBILITY OF THE ENGINEER OF RECORD TO REVIEW THE INFORMATION AND ENSURE THAT THE LAYOUT AND DESIGN IS IN FULL COMPLIANCE WITH ALL APPLICABLE LAWS AND REGULATIONS AND THAT THE AQUABOX SYSTEM HAS BEEN DESIGNED IN ACCORDANCE WITH GEOPLAST'S REQUIREMENTS. LAYFIELD DOES NOT REVIEW OR APPROVE PLANS, SIZING OR DESIGNS.

THIS DRAWING AND THE INFORMATION CONTAINED HEREIN ARE CONFIDENTIAL AND PROPRIETARY AND SHALL NOT BE COPIED NOR USED IN ANY MANNER WITHOUT WRITTEN AUTHORIZATION FROM LAYFIELD CANADA LTD.

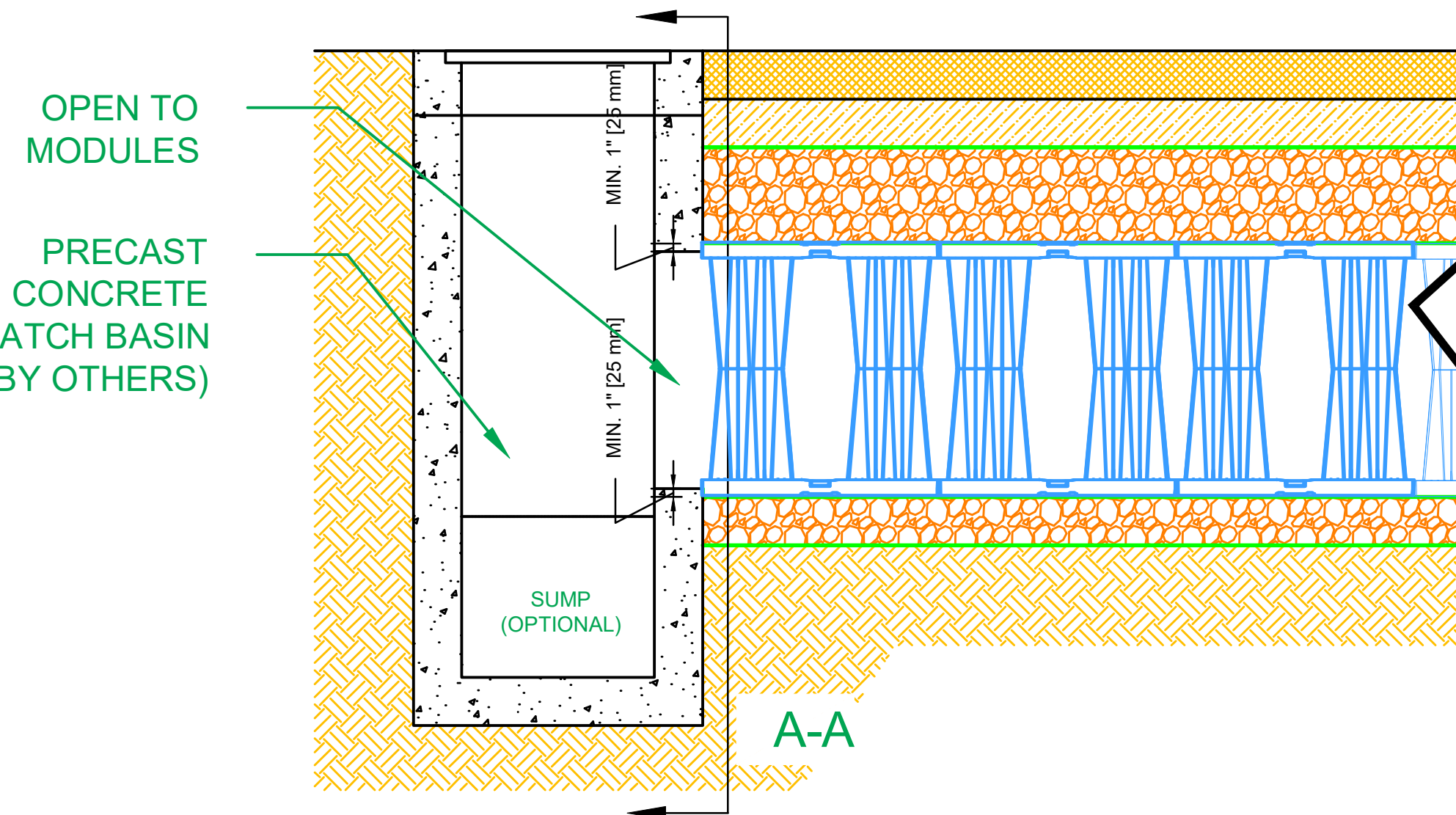
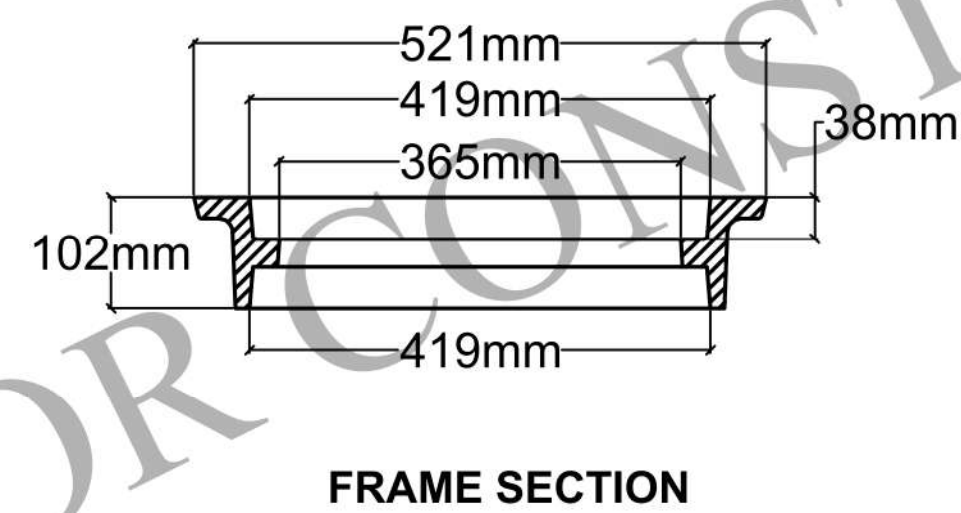
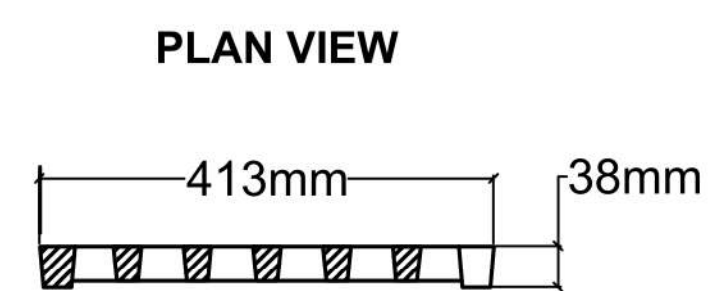
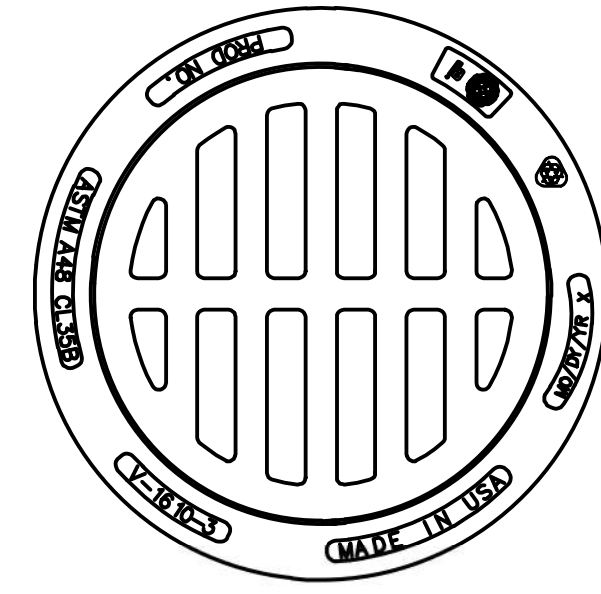
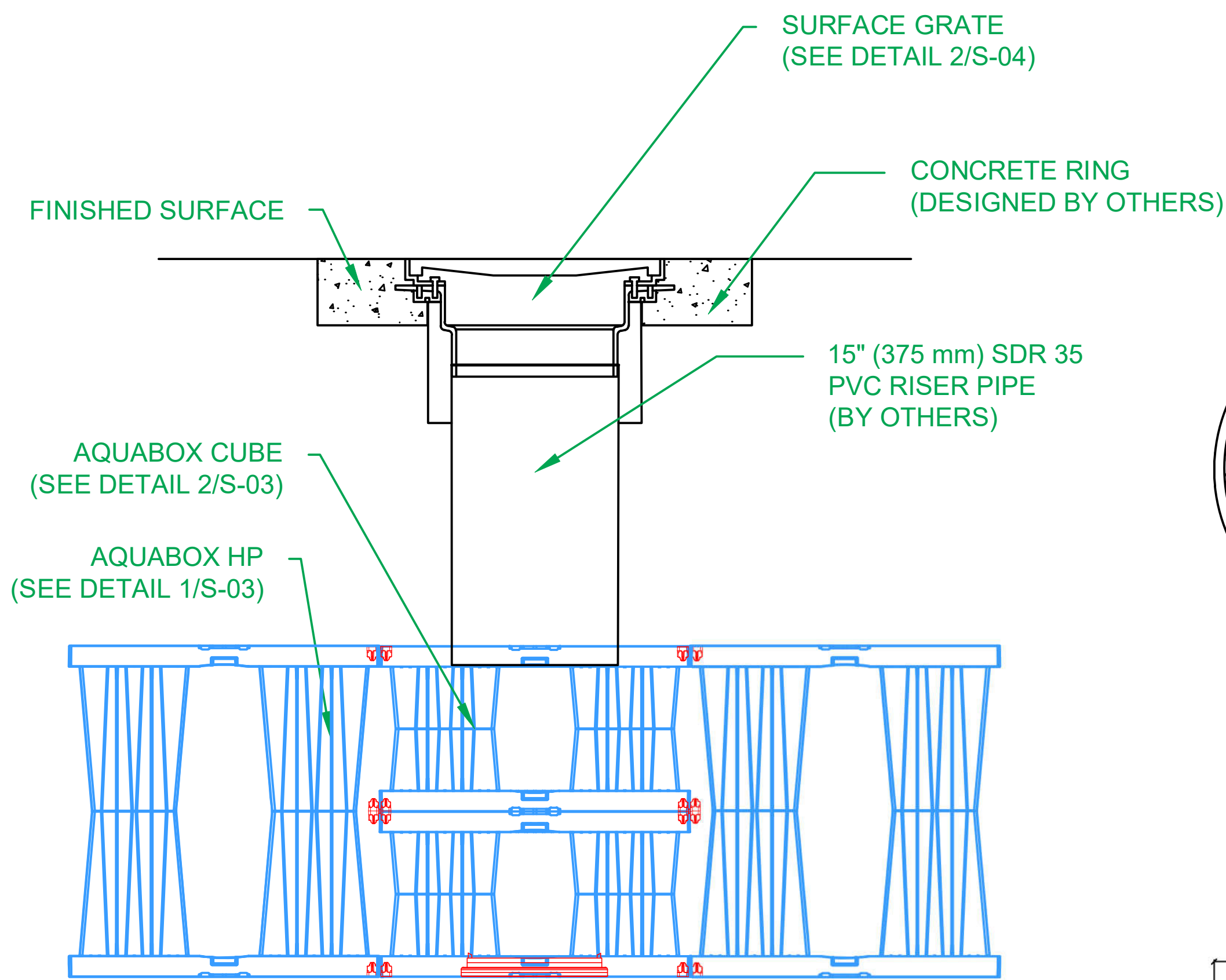

SIDE PANELS ARE NOT REQUIRED ON MODULES DIRECTLY ABUTTING THE CATCH BASIN

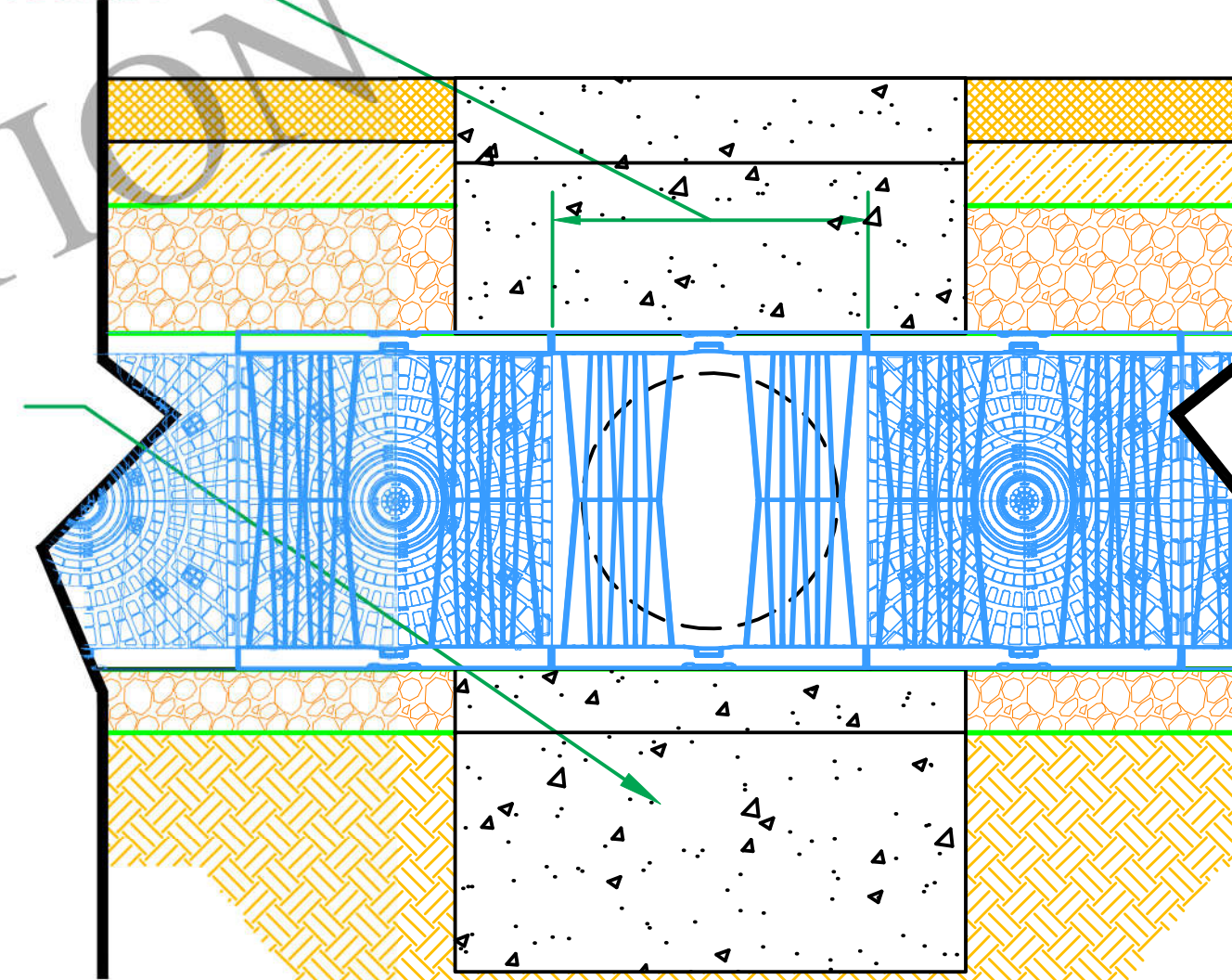

1 S-04 AQUABOX OBSERVATION PORT

2 S-04 OBSERVATION PORT SURFACE GRATE

3 S-04 AQUABOX CATCHBASIN ABUTMENT (IF APPLICABLE)

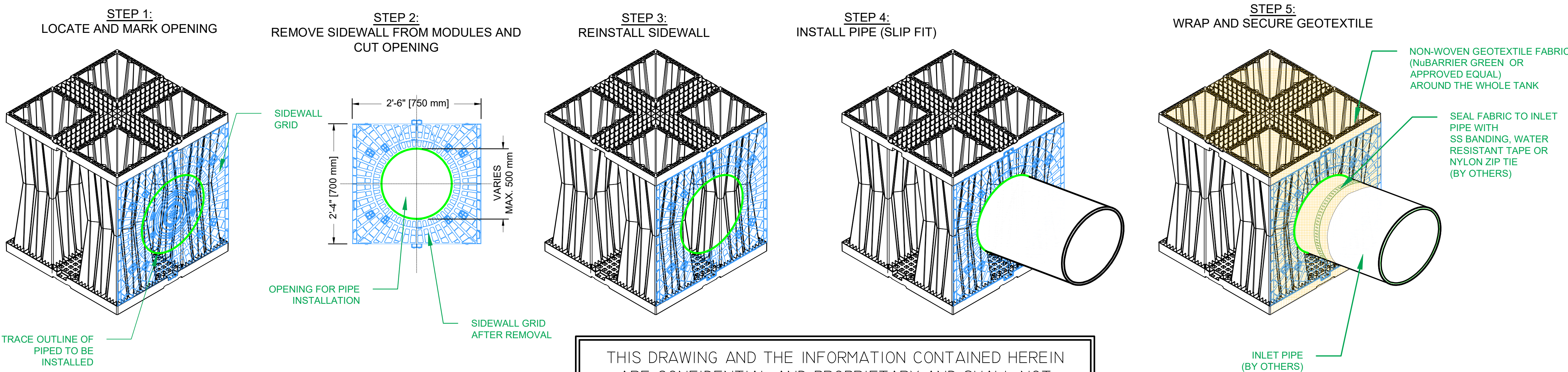

4 S-04 PIPE CONNECTION DETAIL

THIS DRAWING AND THE INFORMATION CONTAINED HEREIN ARE CONFIDENTIAL AND PROPRIETARY AND SHALL NOT BE COPIED NOR USED IN ANY MANNER WITHOUT WRITTEN AUTHORIZATION FROM LAYFIELD CANADA LTD.

Total Storage Volume	85.30 m ³	
Module Storage Volume	55.99 m ³	
Stone Storage Volume	29.31 m ³	
System Footprint	165.10 m ²	
Estimated Geotextile Fabric	NuBarrier	883 m ²
Estimated Geotextile Fabric	LP8	---- m ²
Estimated Liner	---- m ²	
Estimated GeoGrid	---- m ²	
Estimated Stone Volume	73.27 m ³	
Excavation Required	183.44 m ³	
Minimum Excavation Depth	1.11 m	
Stone Type	19mm Clear Stone	
Stone Void Space	40%	
Number of Module Layers	0.5	
Allowable Loading	HS-25	
Surface	Paved Surface	Vegetated/ Unpaved
Minimum Top Cover	0.60 m	0.80 m
Maximum Tank Depth	2.30 m	2.20 m

1050 TAWADINA
Ottawa, ON

REV	Record of Changes	Date	By
△	Preliminary Drawing	09-04-2023	PE

Project Number: OP2023-7273

Page Name: TYP. Pipe Penetration Details (CD-2)

Drawn by: PE	Checked By: JF
Scale: NTS	Date: 09-04-2023

THIS LAYOUT DRAWING WAS PREPARED TO SUPPORT THE ENGINEER OF RECORD FOR THE PROPOSED SYSTEM. IT IS THE RESPONSIBILITY OF THE ENGINEER OF RECORD TO REVIEW THE INFORMATION AND ENSURE THAT THE LAYOUT AND DESIGN IS IN FULL COMPLIANCE WITH ALL APPLICABLE LAWS AND REGULATIONS AND THAT THE AQUABOX SYSTEM HAS BEEN DESIGNED IN ACCORDANCE WITH GEOPLAST'S REQUIREMENTS. LAYFIELD DOES NOT REVIEW OR APPROVE PLANS, SIZING OR DESIGNS.

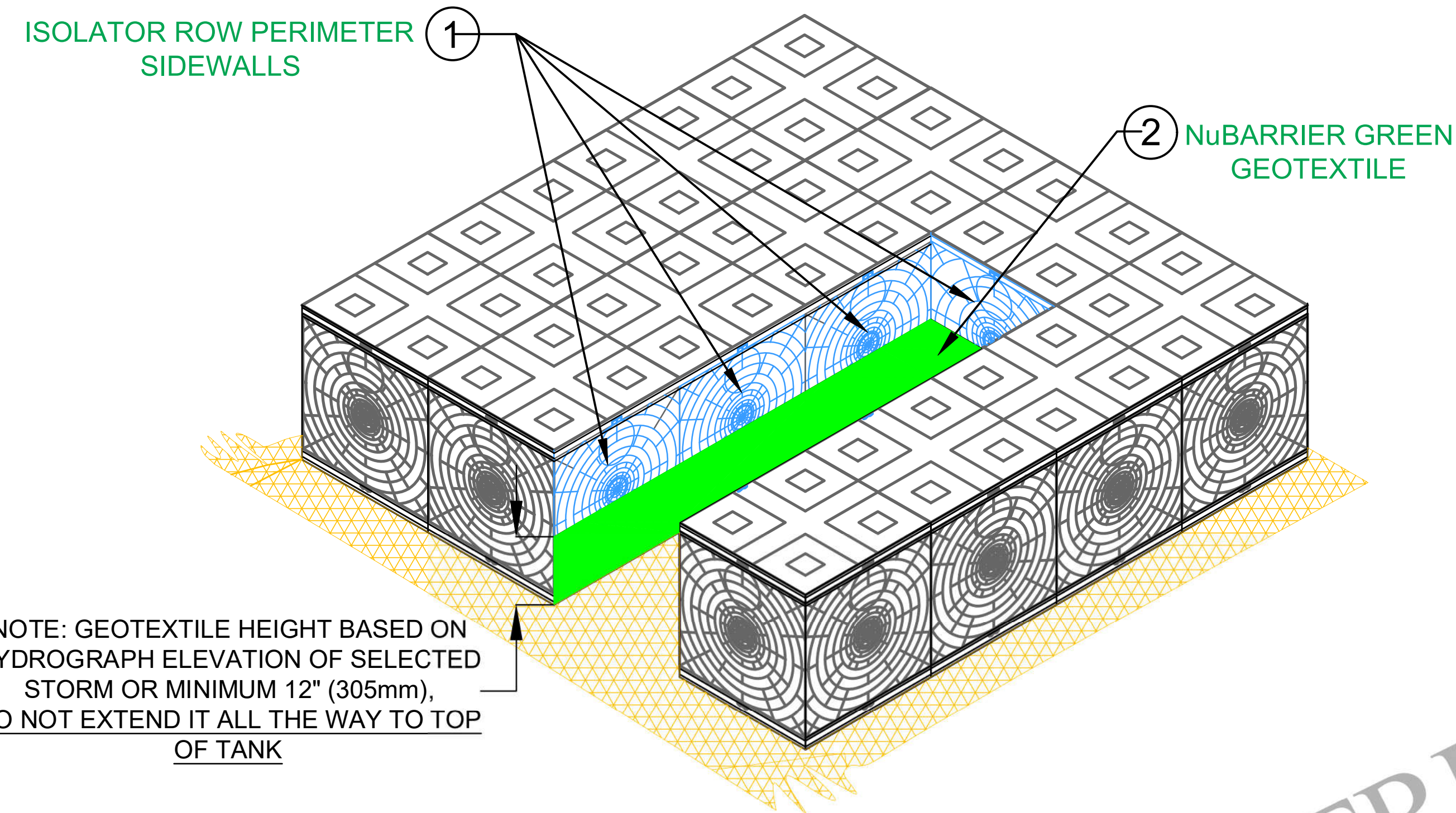

STEP 1:
INSTALL ISOLATER ROW PERIMETER SIDEWALLS AND ATTACH GEOTEXTILE TO THEM.

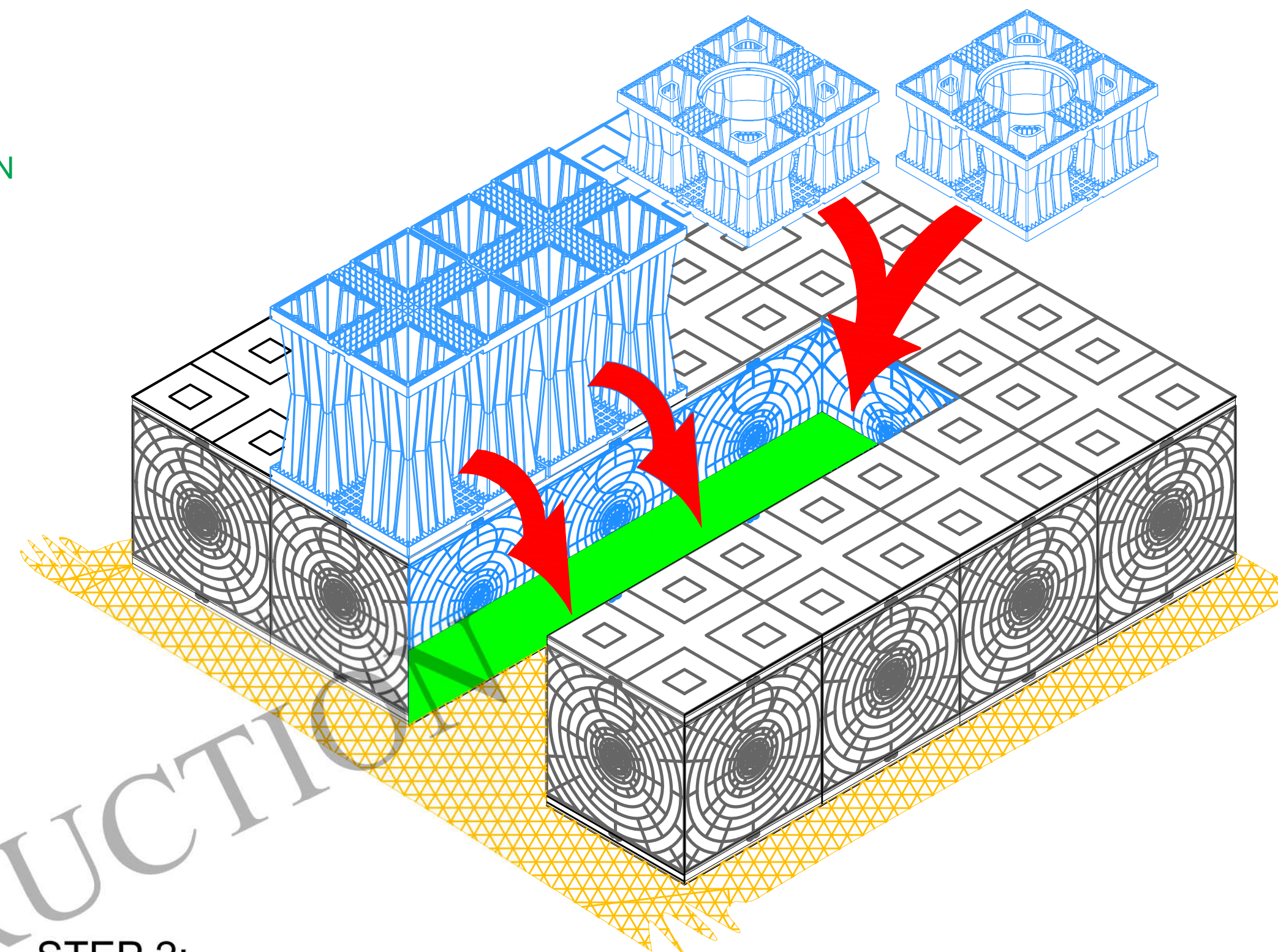

STEP 2:
PLACE AQUABOX HP AND AQUABOX HP CUBE MODULES IN THE ISOLATER ROW AS PER MODULE LAYOUT 2/S-02

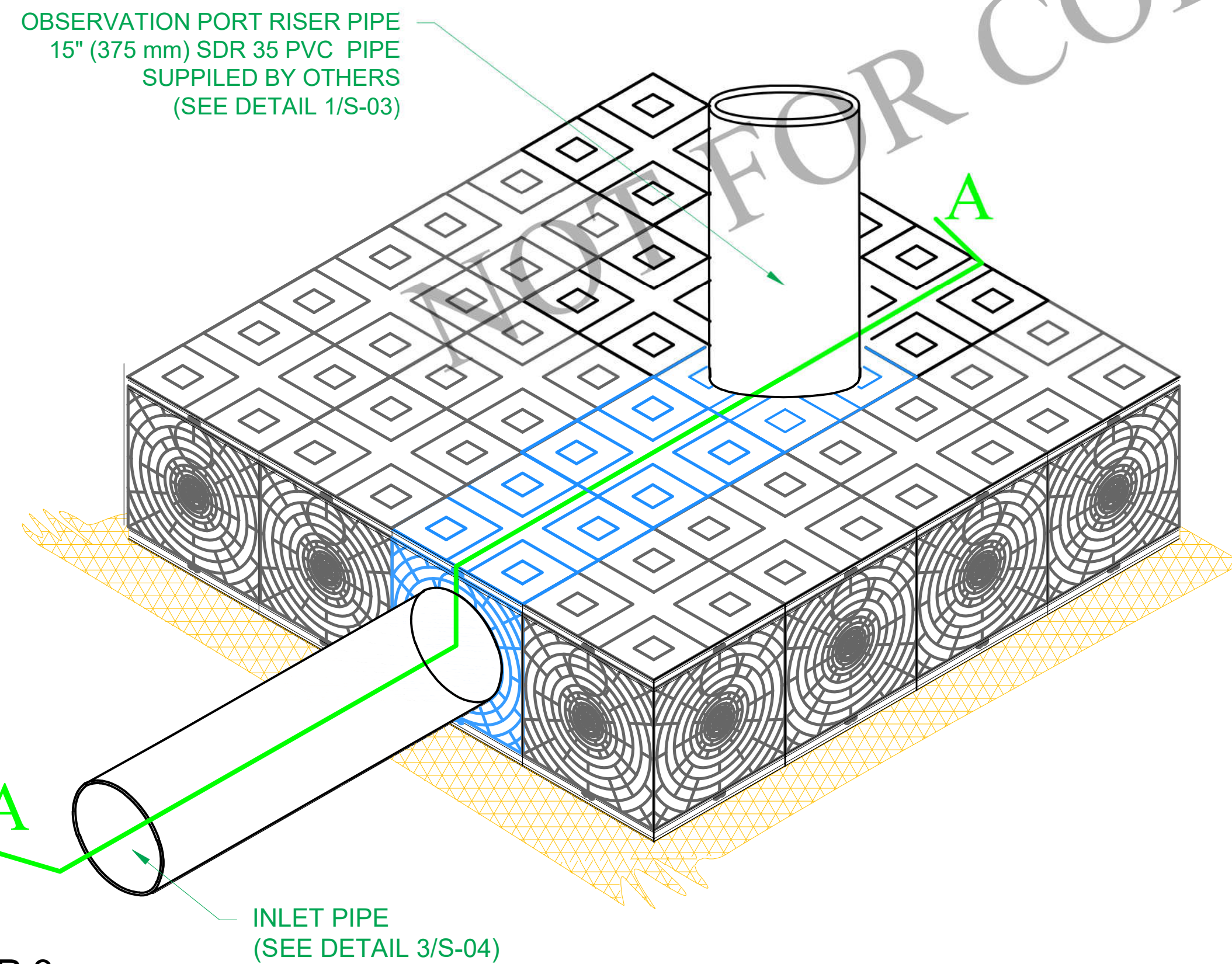

STEP 3:
INSTALL INLET PIPE AS PER DETAIL 4/S-04 AND CONNECTOR PIPE FOR OBSERVATION PORT AS PER DETAIL 1/S-04

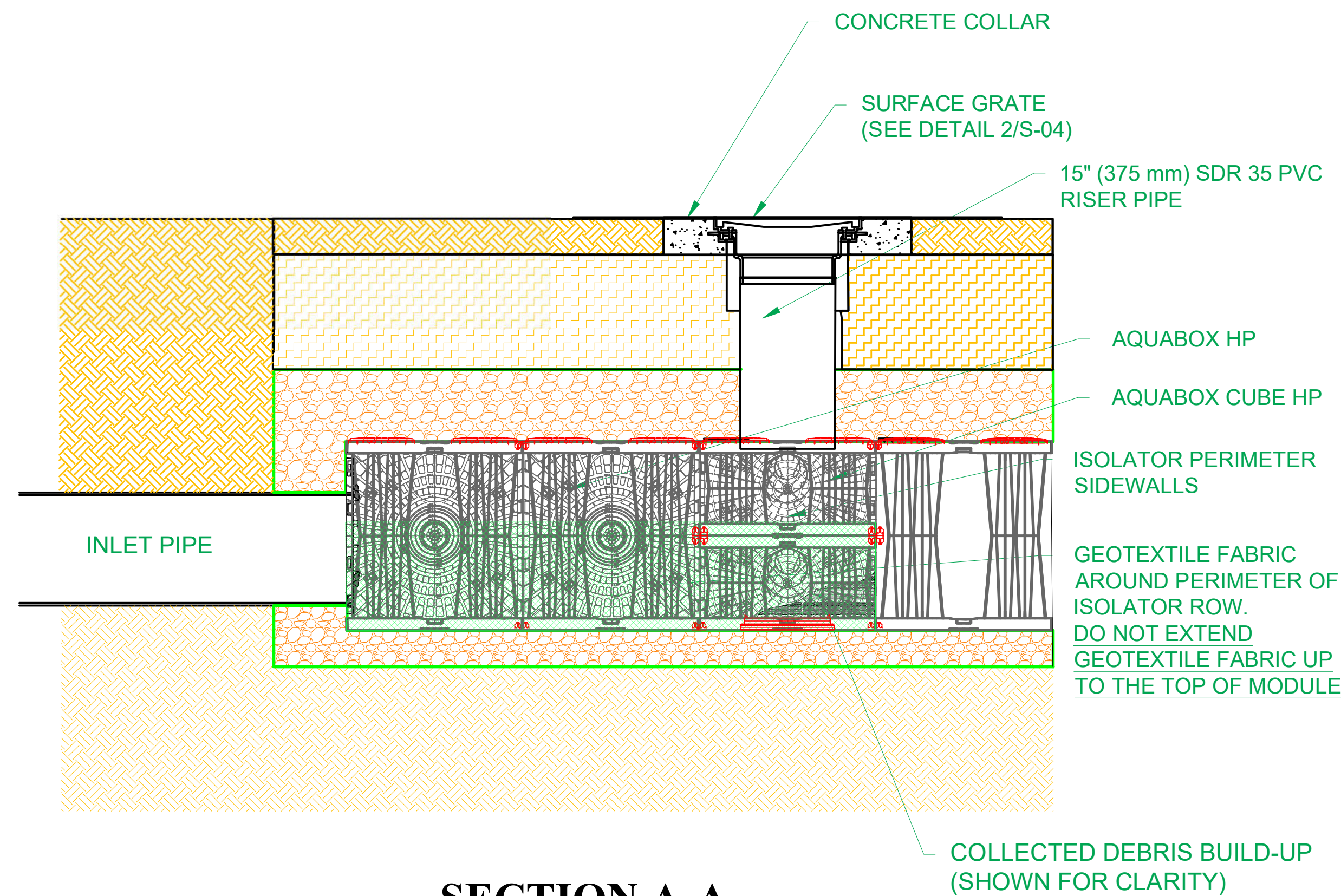

1 S-05 ISOLATER ROW INSTALLATION DETAIL

THIS DRAWING AND THE INFORMATION CONTAINED HEREIN ARE CONFIDENTIAL AND PROPRIETARY AND SHALL NOT BE COPIED NOR USED IN ANY MANNER WITHOUT WRITTEN AUTHORIZATION FROM LAYFIELD CANADA LTD.

Total Storage Volume	85.30 m ³	
Module Storage Volume	55.99 m ³	
Stone Storage Volume	29.31 m ³	
System Footprint	165.10 m ²	
Estimated Geotextile Fabric	NuBarrier	883 m ²
Estimated Geotextile Fabric	LP8	---- m ²
Estimated Liner	---- m ²	
Estimated GeoGrid	---- m ²	
Estimated Stone Volume	73.27 m ³	
Excavation Required	183.44 m ³	
Minimum Excavation Depth	1.11 m	
Stone Type	19mm Clear Stone	
Stone Void Space	40%	
Number of Module Layers	0.5	
Allowable Loading	HS-25	
Surface	Paved Surface	Vegetated/ Unpaved
Minimum Top Cover	0.60 m	0.80 m
Maximum Tank Depth	2.30 m	2.20 m

1050 TAWADINA
Ottawa, ON

REV	Record of Changes	Date	By
△	Preliminary Drawing	09-04-2023	PE

Project Number: OP2023-7273

Page Name: TYP. Isolater Row Details (CD-3)

Drawn by: PE	Checked By: JF
Scale: NTS	Date: 09-04-2023

THIS LAYOUT DRAWING WAS PREPARED TO SUPPORT THE ENGINEER OF RECORD FOR THE PROPOSED SYSTEM. IT IS THE RESPONSIBILITY OF THE ENGINEER OF RECORD TO REVIEW THE INFORMATION AND ENSURE THAT THE LAYOUT AND DESIGN IS IN FULL COMPLIANCE WITH ALL APPLICABLE LAWS AND REGULATIONS AND THAT THE AQUABOX SYSTEM HAS BEEN DESIGNED IN ACCORDANCE WITH GEOPLAST'S REQUIREMENTS. LAYFIELD DOES NOT REVIEW OR APPROVE PLANS, SIZING OR DESIGNS.

Sheet: **07 OF 09**

General Conditions

- Review installation procedures and coordinate the installation with other construction activities, such as grading, excavation, utilities, construction access, erosion control, etc.
- Engineered Contract Drawings supersede all provided documentation, as the information furnished in this document is based on a typical installation.
- Coordinate the installation with the manufacturer's representative/distributor to be on-site to review start-up procedures and installation instructions.
- Components shall be unloaded, handled and stored in an area protected from traffic and in a manner to prevent damage.
- Assembled modules may be walked on, but vehicular traffic is prohibited until backfilled per the Manufacturer's requirements. Protect the installation against damage with highly visible construction tape, fencing, or other means until construction is complete.
- Ensure all construction occurs in accordance with Federal, Provincial and Local Laws, Ordinances, Regulations, and Safety Requirements.
- Extra care and caution should be taken when temperatures are at or below -5.0° C.

NOT FOR CONSTRUCTION

These drawings shall not be used for construction until they have been reviewed for all design aspects (structural, geotechnical, stormwater) and approved by the Engineer of Record for the Project.

It is the Buyer's responsibility to ensure that the design into which the Product will be used has been approved by the Engineer of Record (not Layfield) with a review that may include, but not be limited to, Inlet and outlet configurations including inverts and pipe connections, storage volume, system footprint, Aquabox elevations including cover soil requirements, buoyancy and groundwater conditions, and proximity to structures and slopes.

Site design/engineering elements may include but not be limited to the following:

- Review elevations and if necessary adjust grading to ensure the chamber cover requirements are met.
- Evaluating site-specific information on soil conditions and/or bearing capacity.
- Assessing the bearing resistance (allowable bearing capacity) of the subgrade soils and the depth of foundation stone with consideration for the range of expected soil moisture conditions.

1.0 Basin Excavation

1. Stake out and excavate to elevations per approved plans. Excavation Requirements:
 - a. Sub-grade excavation must be a minimum of 4" (102 mm) below the designed AquaBox Module

invert.

- b. The excavation should extend a minimum of 12" (305 mm) beyond the AquaBox dimensions in each length and width (an additional 24" [610 mm] in total length and total width) to allow for adequate placement of side backfill material.
- c. Remove objectionable material encountered within the excavation, including protruding material from the walls.
- d. Furnish, install, monitor, and maintain excavation support (e.g., shoring, bracing, trench boxes, etc.) as required by Federal, Provincial and Local Laws, Ordinances, Regulations, and Safety Requirements.

2.0 Sub-Grade Requirements

1. Sub-grade shall be unfrozen, level (plus or minus 1%), and free of lumps, or debris with no standing water, mud or muck. Do not use materials nor mix with materials that are frozen and/or coated with ice or frost.
2. Unstable, unsuitable, and/or compromised areas should be brought to the Engineer's attention and mitigating efforts determined prior to compacting the sub-grade.
3. Sub-grade must be compacted to 97% Standard Proctor Density or as approved by the Engineer of Record. If code requirements restrict subgrade compaction, it is the requirement of the geotechnical engineer to verify that the bearing capacity and settlement criteria for support of the system are met.

* The Engineer of Record shall confirm minimum soil bearing capacity required based on Load Rating and top cover depth. Minimum soil bearing capacity is required so that settlements are less than 1" through the entire sub-grade and do not exceed long-term 1/2" differential settlement between any two adjacent units within the system. Sub-grade must be designed to ensure soil bearing capacity is maintained throughout all soil saturation levels.

3.0 Leveling Bed Installation

1. Install geotextile fabric and/or liner material, as specified.
 - a. Geotextile fabric shall be placed per the manufacturer's recommendations.
 - b. Additional material to be utilized for wrapping above the system must be protected from damage until use.
2. After the geotextile is secured, place a minimum 4" (102 mm) Leveling Bed.
 - a. Material should be a 3/4" (19 mm) angular stone meeting AASTHO #56, 57, 67, 68 Material specifications.
 - b. Material should be raked free of voids, lumps, debris, sharp objects, and plate vibrated to a level

with a maximum 1% slope.

3. Correct any unsatisfactory conditions.

4.0 AquaBox Module Assembly and Placement

1.0 AquaBox Assembly

AquaBox modules are delivered to the site as palletized components requiring simple assembly. No special equipment, tools or bonding agents are required; only a rubber mallet. The modules can be pre-assembled either inside or outside the trench. The pre-assembled modules must then be organized according to the design specifications.

ASSEMBLY INSTRUCTIONS:

1. Each AquaBox features plug and socket connections which makes assembling the modules quick and easy. Simply lay one element on the ground and join it to another by applying some pressure on the top.

GENERAL NOTES:

- Remove packaging material and check for any damage. Report any damaged components to an AquaBox Distributor or Layfield personnel.
- AquaBox components are backed by a 50 year warranty when installed per the manufacturer's recommendations.

2.0 AquaBox Placement

1. Install geotextile fabric and/or liner material, as specified.
 - a. Geotextile fabric shall be placed per the manufacturer's recommendations.
 - b. Additional material to be utilized for wrapping above the system must be protected from damage until use.
2. Mark the footprint of the modules for placement.
 - a. Ensure module perimeter outline is square or similar prior to Module placement.
 - b. Care should be taken to note any connections, ports or other irregular units to be placed.
3. Install the individual modules by hand, as detailed below.
 - a. The modules should be installed as shown in the AquaBox submittal drawings. Place AquaBox Cubes at the location of observation ports.
 - b. Modules are connected horizontally to adjacent modules with Single or Double Joints.
 - c. Use Single Joints for Bottom and Top rows while Double Joints are used for middle rows in Double or Triple stacking configuration.
 - d. For double/ triple stack configurations:
 - i. Use the Single Joints for the first bottom row.
 - ii. Install Double Joints on all the middle rows.
 - iii. Place the upper module directly on top of the bottom module in the same direction.



117 Basaltic Rd,
Concord, ON L4K 1G4 Canada
Ph: (905) 761-9123
www.layfieldgroup.com

Total Storage Volume	85.30 m ³	
Module Storage Volume	55.99 m ³	
Stone Storage Volume	29.31 m ³	
System Footprint	165.10 m ²	
Estimated Geotextile Fabric	NuBarrier	883 m ²
Estimated Geotextile Fabric	LP8	---- m ²
Estimated Liner	---- m ²	
Estimated GeoGrid	---- m ²	
Estimated Stone Volume	73.27 m ³	
Excavation Required	183.44 m ³	
Minimum Excavation Depth	1.11 m	
Stone Type	19mm Clear Stone	
Stone Void Space	40%	
Number of Module Layers	0.5	
Allowable Loading	HS-25	
Surface	Paved Surface	Vegetated/ Unpaved
Minimum Top Cover	0.60 m	0.80 m
Maximum Tank Depth	2.30 m	2.20 m

1050 TAWADINA
Ottawa, ON

REV	Record of Changes	Date	By
△	Preliminary Drawing	09-04-2023	PE

Project Number: OP2023-7273	
Page Name:	Supplementary Notes (CD-4)
Drawn by: PE	Checked By: JF
Scale: NTS	Date: 09-04-2023

THIS LAYOUT DRAWING WAS PREPARED TO SUPPORT THE ENGINEER OF RECORD FOR THE PROPOSED SYSTEM. IT IS THE RESPONSIBILITY OF THE ENGINEER OF RECORD TO REVIEW THE INFORMATION AND ENSURE THAT THE LAYOUT AND DESIGN IS IN FULL COMPLIANCE WITH ALL APPLICABLE LAWS AND REGULATIONS AND THAT THE AQUABOX SYSTEM HAS BEEN DESIGNED IN ACCORDANCE WITH GEOPLAST'S REQUIREMENTS. LAYFIELD DOES NOT REVIEW OR APPROVE PLANS, SIZING OR DESIGNS.

4. Install the modules to completion, taking care to avoid damage to the geotextile and/or liner material.
5. Once all the modules have been placed, Install SIDEWALLS on the perimeter and CAPS on the top.
6. Locate any ports or other penetration of the AquaBox.
 - a. Install ports/penetrations in accordance with the approved submittals, contract documents, and manufacturer's recommendations.
6. Upon completion of module installation, wrap the modules in geotextile fabric and/or liner.
 - a. Geotextile fabric shall be wrapped and secured per the manufacturer's recommendations.
 - b. Seal any ports/penetrations per the Manufacturer's requirements

Notes:

- If damage occurs to the geotextile fabric or impermeable liner, repair the material in accordance with the geotextile/liner Manufacturer's recommendations

6.0 Side Backfill

1. Inspect all geotextiles, ensuring that no voids or damage exists; which will allow sediment into the AquaBox system.
2. Adjust the stone/soil interface geotextile along the side of the native soil to ensure the geotextile is taught to the native soil.
3. Once the geotextile is secured, begin to place the Side Backfill.
 - a. Material should be a 3/4" (19 mm) angular stone meeting AASTHO #56, 57, 67, 68 Material specifications.
 - b. Backfill sides "evenly" around the perimeter without exceeding single 12" (305 mm) lifts.
 - c. Place material utilizing an excavator, dozer, or conveyor boom.
 - d. Utilize a plate vibrator to settle the stone and provide uniform distribution.

Notes:

- Do not apply vehicular load to the modules during placement of side backfill. All material placement should occur with equipment located on the native soil surrounding the system.
- If damage occurs to the geotextile fabric or impermeable liner, repair the material in accordance with the geotextile/liner Manufacturer's recommendations

7.0 Top Backfill (Stone)

1. Begin to place the Top Backfill.
 - a. Material should be a 3/4" (19 mm) angular stone meeting AASTHO #56, 57, 67, 68 Material specifications.

- b. Place material utilizing an excavator, dozer, or conveyor boom and use a walk-behind plate vibrator to settle the stone and provide even distribution.

DO NOT DRIVE ON THE MODULES WITHOUT REQUIRED MINIMUM COVER.

2. Upon completion of Top Backfilling, wrap the system in geotextile fabric and/or liner per the manufacturer's recommendations.
3. Install metallic tape around the perimeter of the system to mark the area for future utility detection.

Notes:

- If damage occurs to the geotextile fabric or impermeable liner, repair the material in accordance with the geotextile/liner Manufacturer's recommendations.
- Only Low Ground Pressure tracked equipment can be used during construction with at least 300 mm suitably compacted covering created over the AquaBox System. Abrupt maneuvers such as steering should be avoided at this stage.
- The passage of heavy goods vehicles with a wheel load of more than 50 kN over the basin is possible if the thickness of the covering is adequately compacted and not less than 600 mm. When dumping the backfill material, the load per wheel shall not exceed 50 kN.

8.0 Suitable Compactable Fill

Following Top Backfill placement and geotextile fabric wrapping; complete the installation as noted below.

Vegetated Area

1. Place fill onto the geotextile.
 - a. Maximum 12" (305 mm) lifts, compacted with a vibratory plate or walk behind roller to a minimum of 90% Standard Proctor Density.
 - b. The minimum top cover/backfill to finished grade must not be less than that shown on Detail 5 Typical System Cross Section, and the maximum depth from final grade to the bottom of the lowest module should not exceed that shown on Detail 5.
2. Finish to the surface and complete with vegetative cover.

Impervious Area

1. Place fill onto the geotextile.
 - a. Maximum 12" (305 mm) lifts, compacted with a vibratory plate or walk behind roller to a minimum of 90% Standard Proctor Density.
 - b. The minimum top cover/backfill to finished grade must not be less than that shown on Detail 5 Typical System Cross Section, and

the maximum depth from final grade to the bottom of the lowest module should not exceed that shown on Detail 5.

2. Finish to the surface and complete with asphalt, concrete, etc.

Notes:

- Adequate cover for frost protection must be considered, this will vary by Region.
- A vibratory roller may only be utilized after a minimum cover has been placed or for the installation of the asphalt wearing course.
- If damage occurs to the geotextile fabric, repair the material in accordance with the geotextile Manufacturer's recommendations.
- For most recent installation guidelines visit: <https://www.geoplastglobal.com/en/downloads/aquabox>

9.0 Inspection and Maintenance

If the following inspections and maintenance procedures are not followed as specified below then the end-user is responsible for the performance of the modules. This maintenance procedure must be performed after termination of site operations, heavy rainfall, flooding, or any incident that will vary the flow of water drastically.

Inspection

1. Inspect all observation ports, inflow, and outflow connection and the discharge area
2. Identify and log any sediment and debris accumulation, system backup, or discharge rate changes.
3. If there is a sufficient need for a cleanout, contact a local cleaning company for assistance.
4. Inspect module for any damaged components, movement, or other irregularities and replace immediately.

Cleaning:

1. If a pre-treatment device is installed, follow manufacturer recommendations.
2. Using a vacuum pump truck, evacuate debris from the inflow and outflow points.
3. Flush the system with clean water, forcing debris from the system.
4. Repeat steps 2 and 3 until no debris is evident

Notes:

- For spray probe cleaning, the use of a 90° rotating nozzle with a 45° water jet is recommended. The nozzles used should have a pressure of 80 to 120 bar; higher pressures may damage the geotextile.

THIS DRAWING AND THE INFORMATION CONTAINED HEREIN ARE CONFIDENTIAL AND PROPRIETARY AND SHALL NOT BE COPIED NOR USED IN ANY MANNER WITHOUT WRITTEN AUTHORIZATION FROM LAYFIELD CANADA LTD.



117 Basaltic Rd,
Concord, ON L4K 1G4 Canada
Ph: (905) 761-9123
www.layfieldgroup.com

Total Storage Volume	85.30 m ³	
Module Storage Volume	55.99 m ³	
Stone Storage Volume	29.31 m ³	
System Footprint	165.10 m ²	
Estimated Geotextile Fabric	NuBarrier	883 m ²
Estimated Geotextile Fabric	LP8	---- m ²
Estimated Liner	---- m ²	
Estimated GeoGrid	---- m ²	
Estimated Stone Volume	73.27 m ³	
Excavation Required	183.44 m ³	
Minimum Excavation Depth	1.11 m	
Stone Type	19mm Clear Stone	
Stone Void Space	40%	
Number of Module Layers	0.5	
Allowable Loading	HS-25	
Surface	Paved Surface	Vegetated/ Unpaved
Minimum Top Cover	0.60 m	0.80 m
Maximum Tank Depth	2.30 m	2.20 m

1050 TAWADINA
Ottawa, ON

REV	Record of Changes	Date	By
△	Preliminary Drawing	09-04-2023	PE

Project Number: OP2023-7273	
Page Name:	Supplementary Notes (CD-5)
Drawn by: PE	Checked By: JF
Scale: NTS	Date: 09-04-2023

THIS LAYOUT DRAWING WAS PREPARED TO SUPPORT THE ENGINEER OF RECORD FOR THE PROPOSED SYSTEM. IT IS THE RESPONSIBILITY OF THE ENGINEER OF RECORD TO REVIEW THE INFORMATION AND ENSURE THAT THE LAYOUT AND DESIGN IS IN FULL COMPLIANCE WITH ALL APPLICABLE LAWS AND REGULATIONS AND THAT THE AQUABOX SYSTEM HAS BEEN DESIGNED IN ACCORDANCE WITH GEOPLAST'S REQUIREMENTS. LAYFIELD DOES NOT REVIEW OR APPROVE PLANS, SIZING OR DESIGNS.

Sheet: 09 OF 09