

MONTGOMERY SISAM ARCHITECTS

EXTENDICARE (CANADA) INC. -
ORLEANS LTC HOME
STORMWATER MANAGEMENT REPORT

JUNE 07, 2023





EXTENDICARE
(CANADA) INC. -
ORLEANS LTC HOME
STORMWATER
MANAGEMENT REPORT
MONTGOMERY SISAM ARCHITECTS

2ND SUBMISSION

PROJECT NO.: 221-12376-00
CLIENT REF:
DATE: JUNE 07, 2023

WSP
SUITE 300
2611 QUEENSVIEW DRIVE
OTTAWA, ON, CANADA K2B 8K2

T: +1 613 829-2800
F: +1 613 829-8299
WSP.COM

REVISION HISTORY

FIRST ISSUE

March 20 th , 2023	Draft SWM Report			
Prepared by	Reviewed by	Approved By		
KK	AJ	WY		
SECIND ISSUE				
June 7 th , 2023	Revised SWM Report			
Prepared by	Reviewed by	Approved By		
KK	WY	WY		

SIGNATURES

PREPARED BY



Kathryn Kerker, M.A.Sc.
Designer, Water Resources

June 7th, 2023

Date

APPROVED¹ BY



Winston Yang, P.Eng., PMP
Senior Engineer, Land Development

June 7th, 2023

Date

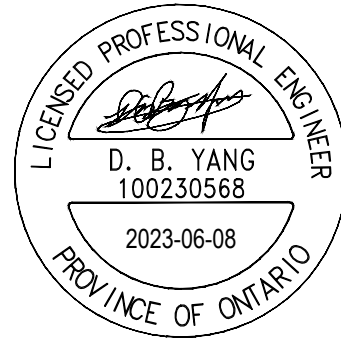

WSP Canada Inc. ("WSP") prepared this report solely for the use of the intended recipient, MONTGOMERY SISAM ARCHITECTS, in accordance with the professional services agreement. The intended recipient is solely responsible for the disclosure of any information contained in this report. The content and opinions contained in the present report are based on the observations and/or information available to WSP at the time of preparation. If a third party makes use of, relies on, or makes decisions in accordance with this report, said third party is solely responsible for such use, reliance or decisions. WSP does not accept responsibility for damages, if any, suffered by any third party as a result of decisions made or actions taken by said third party based on this report. This limitations statement is considered an integral part of this report.

The original of this digital file will be conserved by WSP for a period of not less than 10 years. As the digital file transmitted to the intended recipient is no longer under the control of WSP, its integrity cannot be assured. As such, WSP does not guarantee any modifications made to this digital file subsequent to its transmission to the intended recipient.

¹ Approval of this document is an administrative function indicating readiness for release and does not impart legal liability on to the Approver for any technical content contained herein. Technical accuracy and fit-for-purpose of this content is obtained through the review process. The Approver shall ensure the applicable review process has occurred prior to signing the document.

CONTRIBUTORS

CLIENT

Montgomery Sisam Architects

WSP

Water Resources, Designer Kathryn Kerker

Water Resources, Project Engineer Ayham Jadallah

Land Development, Senior Engineer Winston Yang



TABLE OF CONTENTS

1	INTRODUCTION	1
1.1	Scope	1
1.2	Site Location	1
1.3	Stormwater Management Plan Objectives	2
1.4	Design Criteria	2
1.5	Rainfall Information	2
2	PRE-DEVELOPMENT CONDITIONS	3
2.1	General	3
2.2	Allowable Flow Rates	3
3	POST-DEVELOPMENT CONDITIONS	4
3.1	General	4
3.2	Water Quantity	5
3.2.1	Emergency Overflow	6
3.2.2	Uncontrolled Drainage Areas	7
3.3	Water Quality	7
4	CONCLUSIONS	8

TABLES

TABLE 3-1: AREA BREAKDOWN	4
TABLE 3-2: FLOW CONTROL – HYDROVEX PARAMETERS	5
TABLE 3-3: SUMMARY OF PCSWMM MODELLING RESULTS – STORAGE AND PEAK FLOW.....	5
TABLE 3-4: SUMMARY PCSWMM MODELLING RESULTS – PONDING DEPTHS.....	6
TABLE 3-5: UNCONTROLLED DRAINAGE AREAS.....	7

FIGURES

FIGURE 1: SITE LOCATION	1
FIGURE 2: EAST BILBERRY CREEK WATERSHED	3

APPENDICES

A	PRE-CONSULTATION MEETING MINUTES AND TECHNICAL COMMENTS
B	EXHIBITS
C	PCSWMM OUTPUT
D	SUPPORTING DOCUMENTS

1 INTRODUCTION

1.1 SCOPE

WSP Canada Inc. was retained by Montgomery Sisam Architects to prepare a Stormwater Management (SWM) report for the proposed development at 1001 Noella Leclair Way in Orleans, Ontario. This SWM report examines the potential water quality and quantity impacts of the proposed long-term care development and summarizes how each will be addressed in accordance with applicable guidelines.

1.2 SITE LOCATION

The site of the proposed development is located at 1001 Noella Leclair Way, Orleans, Ontario. The subject site is bounded by commercial development. The site is accessed via Noella Leclair Way on the west side of the property. The site location is shown in Figure 1.



Figure 1: Site Location

1.3 STORMWATER MANAGEMENT PLAN OBJECTIVES

The objectives of the stormwater management plan are as follows:

- Collect and review background information
- Determine the site-specific stormwater management requirements to ensure that the proposals are in conformance with the applicable Provincial, Municipal and Conservation Authority stormwater management and development guidelines.
- Evaluate various stormwater management practices that meet the applicable SWM and development requirements and recommend a preferred strategy.
- Prepare a stormwater management report documenting the strategy along with the technical information necessary for the justification and sizing of the proposed stormwater management facilities.

1.4 DESIGN CRITERIA

Design criteria were obtained through the Site Plan Pre-Application Consultation Notes provided by the City of Ottawa on November 14th, 2022 (pre consultation notes in **Appendix A**). Criteria for 1001 Noella Leclair way are as follows:

- **Stormwater Quantity**
 - Minor system inflow to be restricted for all contributing areas to 50 L/s/ha.
 - Ensure no overland flow for all storms up to and including the 100-year event. Provide adequate emergency overflow conveyance off-site.
- **Stormwater Quality**
 - Enhanced level of protection is required (80% TSS Removal) as the site is within the Bilberry Creek watershed.

1.5 RAINFALL INFORMATION

The rainfall intensity is calculated in accordance with Section 5.4.2 of the Ottawa Sewer Design Guidelines (October, 2012):

Where;

$$i = \left[\frac{A}{(Td + C)^B} \right]$$

- A, B, C = regression constants for each return period (defined in section 5.4.2)
- i = rainfall intensity (mm/hour)
- Td = storm duration (minutes)

The IDF parameters/regression constants are per the Ottawa Sewer Design Guidelines (October, 2012). The 3-hour Chicago design storm was used for all calculations within this report.

2 PRE-DEVELOPMENT CONDITIONS

2.1 GENERAL

The subject site is a 1.62 ha parcel of land comprised of undeveloped grass area. Under existing conditions, the property drains north and eventually drains to Bilberry Creek (Figure 2).

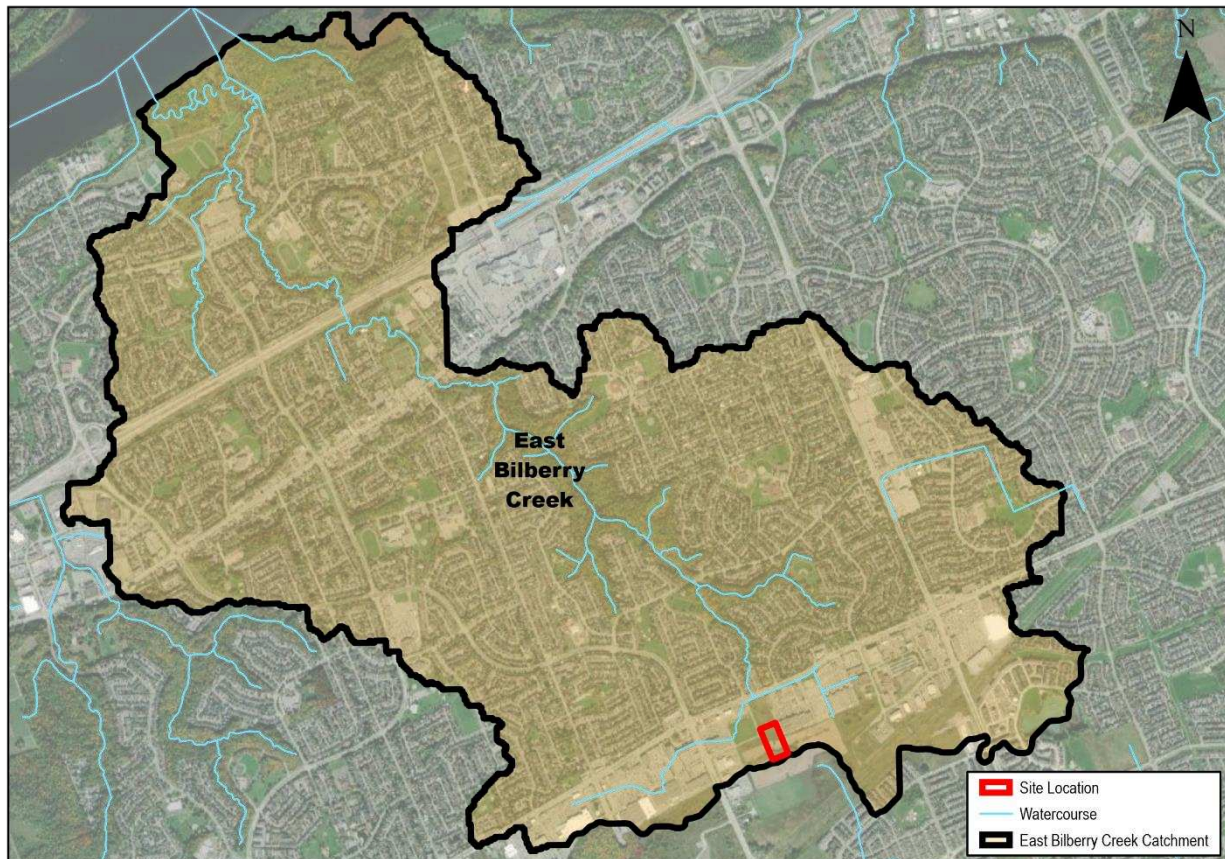

Figure 2: East Bilberry Creek Watershed

2.2 ALLOWABLE FLOW RATES

As noted in section 1.4, the peak allowable discharge rate from the site is 50 L/s/ha. This release rate was identified in the *Site Servicing and Stormwater Management Report – Orleans II Draft Plan of Subdivision* (April 12, 2018). As the total site area is 1.62 ha, the maximum release rate during the 100-year event is 81 L/s. Additionally, no overland flow may leave the site during the 100-year event.

An existing conditions drainage area plan is shown in the civil drawing set (C005) and discussed in Section 3.2.2

3 POST-DEVELOPMENT CONDITIONS

3.1 GENERAL

The proposed Noella Leclair Way project is a long-term care (LTC) home development in Orleans. Post development conditions drainage areas and runoff coefficients are shown in the Drainage Area Plan (C004) and summarized in Table 3-1.

The proposed development includes the construction of the LTC home and surface parking on the approximately 1.62 ha parcel of land. Vehicular access to the site will be via new entrances off the extended Noella Leclair Way and new Lady Pellatt Street. All stormwater runoff will ultimately discharge to the existing storm sewer on Noella Leclair Way, except for a strip along the site boundary.

An estimated area breakdown for the new layout is provided in Table 3-1.

Table 3-1: Area Breakdown

Catchment ID	Area (ha)	% Coverage of Project Area	Pervious Area (ha)	Impervious Area (ha)	% Imperv.	Runoff Coefficient	Peak 100-year Uncontrolled Runoff (m ³ /s)
Controlled Drainage Areas							
S101	0.072	4.4%	0.024	0.048	68.3	0.68	0.033
S102	0.078	4.8%	0.033	0.045	59.8	0.63	0.033
S103	0.084	5.2%	0.031	0.053	64.9	0.66	0.038
S104	0.090	5.6%	0.040	0.050	57.8	0.61	0.037
S105	0.099	6.1%	0.035	0.064	66.4	0.67	0.045
S106	0.088	5.4%	0.039	0.049	57.9	0.61	0.037
S107	0.061	3.8%	0.015	0.046	76.6	0.74	0.028
S108	0.192	11.9%	0.106	0.086	47.6	0.54	0.071
S109	0.161	9.9%	0.111	0.050	34.5	0.45	0.052
SBLDG	0.340	21.0%	0.000	0.340	100.0	1.00	0.169
Uncontrolled Drainage Areas							
S110	0.081	5.0%	0.071	0.010	16.7	0.33	0.009
S111	0.022	1.4%	0.016	0.006	30.9	0.43	0.006
S112	0.028	1.7%	0.028	0.000	5.0	0.25	0.002
S113	0.036	2.2%	0.036	0.000	5.0	0.25	0.003
SBLDG-CY	0.187	11.6%	0.187	0.000	5.0	0.25	0.016
Total Project Area	1.619	100.0%			54.7	0.61	

3.2 WATER QUANTITY

As noted previously, it is required that the 100-year post-development discharge rate from the site not exceed 81 L/s. Proposed features to achieve these targets include;

- Surface storage and pipe storage with inlet control device (ICD) (HYDROVEX VHV or equivalent)
- Rooftop storage with controlled roof drains (WATTS Adjustable Accutrol or equivalent).

PCSWMM software was used to model the behaviour of the proposed SWM system. A schematic of the PCSWMM model is included in **Appendix B**.

Surface ponding has been proposed on the parking lot at each catch basin low point, and within the proposed storm sewer. To determine peak surface ponding depths and volumes, reference has been made to model output at each respective storage node where surface storage is utilized. Ponding depths have been simulated in the model by routing runoff from the contributing sub-catchment area to a storage node defined with a stage-storage relationship describing the ponding volume available on the surface (based on proposed grading and calculated using PCSWMM storage creator tool). Flow into each catch basin is modelled using the head-discharge relationship from MTO Design Chart 4.19 for a single CB at a sag. Primary flow control is provided by a downstream Hydrovex VHV ICD, which is modelled using the supplier's head-discharge rating curve on the outlet of CBMH105. The specified Hydrovex model shown in Table 3-2. Supporting documentation for the Hydrovex ICD is included in **Appendix D**.

Storage on the roof was defined by the available roof area. Outflow from the roof was defined using the supplier head-discharge curve for fully closed roof drains, multiplied by the number of roof drains (19). Supporting documentation for the Accutrol roof drains is included in **Appendix D**.

Drainage from the building courtyard is routed uncontrolled through the building's mechanical system to the outlet. Other areas are overcontrolled to account for this uncontrolled area.

Table 3-2: Flow Control – HYDROVEX Parameters

Location	ICD	Peak Head (m)	Peak Flow (m ³ /s)
CBMH105	125-VHV-2	5.09	0.039

A summary of modeling results is provided in Table 3-3 and Table 3-4, with detailed modelling output included in **Appendix C**.

Table 3-3: Summary of PCSWMM Modelling Results – Storage and Peak Flow

Location	Return Period					
	2-Year	5-Year	10-Year	25-Year	50-Year	100-Year
Peak Discharge OF1 – to storm sewer (m ³ /s)	0.037	0.046	0.052	0.058	0.064	0.070
Peak Discharge OF2 – to ROW South (m ³ /s)	0.001	0.002	0.003	0.004	0.005	0.006
Peak Discharge OF3 – to adjacent property north and east (m ³ /s)	0.001	0.001	0.003	0.003	0.004	0.005
Storage Utilized at CB01 (m ³)	0	1	3	7	13	18
Storage Utilized at CB02 (m ³)	0	1	8	13	20	27
Storage Utilized at CB03 (m ³)	0	0	4	23	32	41

Location	Return Period					
	2-Year	5-Year	10-Year	25-Year	50-Year	100-Year
Storage Utilized at CB04 (m ³)	0	1	1	17	25	34
Storage Utilized at CB05 (m ³)	0	0	0	5	10	15
Storage Utilized at CB06 (m ³)	0	0	2	2	6	9
Storage Utilized at CB07 (m ³)	1	1	0	2	4	8
Storage Utilized at CBMH101 (m ³)	0	0	1	1	2	4
Storage Utilized at CBMH105 (m ³)	0	1	116	1	2	2
Roof Storage (m ³)	65	95	116	142	162	184

Table 3-4: Summary PCSWMM Modelling Results – Ponding Depths

Location	Return Period					
	2-Year	5-Year	10-Year	25-Year	50-Year	100-Year
Ponding depth CB01 (m)	0.04	0.05	0.08	0.15	0.19	0.21
Ponding depth CB02 (m)	0.05	0.06	0.11	0.18	0.22	0.24
Ponding depth CB03 (m)	0.05	0.06	0.16	0.23	0.26	0.29
Ponding depth CB04 (m)	0.05	0.06	0.12	0.20	0.23	0.25
Ponding depth CB05 (m)	0.05	0.06	0.08	0.15	0.18	0.21
Ponding depth CB06 (m)	0.04	0.05	0.06	0.11	0.14	0.17
Ponding depth CB07 (m)	0.06	0.07	0.08	0.09	0.11	0.14
Ponding depth CBMH101 (m)	0.04	0.05	0.06	0.08	0.11	0.14
Ponding depth CBMH105 (m)	0.05	0.06	0.07	0.07	0.09	0.10
Roof ponding depth (m)	0.08	0.09	0.10	0.11	0.12	0.13

The ICD at CBMH105 was selected to ensure peak ponding remains below 0.3 m during the 100-year event, the target release rate is met, and ponding is avoided during the 2-year event. In both the 2-year and the 5-year events there is no surcharge from the storm sewer system, and the low ponding depths that are shown in Table 3-4 are due to the head required to pass the flow through the CB grates as per MTO design chart 4.19. A profile showing the 2-year HGL is included in **Appendix C**.

As shown in Table 3-4, the peak surface ponding depth is 0.29 m. This corresponds to a peak ponding elevation of 88.61 m, which provides sufficient freeboard (0.57 m) to the finish floor elevation of the proposed development (89.18 m). The peak ponding depth on the roof is 0.13 m, which is below the maximum allowable roof ponding depth of 0.15 m. The peak overall 100-year discharge rate is 0.081 m³/s, which meets the target release rate of 0.081 m³/s.

3.2.1 EMERGENCY OVERFLOW

The site was designed so that in extreme events greater than the 100-year return period event, flow will spill overland to Lady Pellatt Street. The spill elevation is set so that spill will occur well below the finished floor elevation. High points between parking surface storage zones are set so that spill between zones occurs at or before ponding depths reach 0.30 m.

3.2.2 UNCONTROLLED DRAINAGE AREAS

As shown in Section 3.1, Subcatchments S110 and S111 drain uncontrolled to the right-of-way (ROW), while Subcatchments 112 and 113 drain to adjacent property. Table 3-5 shows a summary of the uncontrolled areas by discharge location under existing and proposed conditions. An existing conditions PCSWMM model was created to determine the existing conditions flows shown in Table 3-5.

Table 3-5: Uncontrolled Drainage Areas

Discharge Location	Existing				Proposed			
	Catchment ID	Area (ha)	C	100-year Flows (m ³ /s)	Catchment ID	Area (ha)	C	100-year Flows (m ³ /s)
North to undeveloped land	P1	0.049	0.25	0.012	S112	0.028	0.25	0.002
East to Existing Parking Area	P2	1.439	0.25	0.117	S113	0.036	0.25	0.003
South to ROW	P3	0.132	0.25	0.016	S111	0.022	0.43	0.006
West to ROW	N/A	N/A	N/A	N/A	S110	0.081	0.33	0.009

As shown, under existing conditions the majority of the site drains uncontrolled east toward the existing parking area. Under proposed conditions this area is significantly reduced and remains entirely pervious as in existing conditions. The same is true of the area draining north to the undeveloped land. The flows to adjacent property are significantly reduced, from 0.117 m³/s to 0.003 m³/s to the east and from 0.012 m³/s to 0.002 m³/s to the north. Based on this, there is expected to be an overall improvement to the drainage conditions of the adjacent parking area.

3.3 WATER QUALITY

As outlined in Section 1.4, it is required that post development runoff be treated to achieve 80% TSS removal.

Proposed features to achieve these targets include:

- Suitably sized oil and grit separator (OGS) unit (Stormceptor EFO4 or equivalent)

As noted previously, a single outlet location into the Noella Leclair Way storm sewer is proposed. A suitably sized OGS unit is proposed to achieve a minimum 80% TSS removal. A Stormceptor EFO4 (or equivalent) is proposed to meet the requirements, and details on the proposed unit can be found in **Appendix D**.

The OGS unit will be located downstream of the final parking lot catch basin, but upstream of the roof drainage sewer connection (at STMH106). Roof drainage does not require treatment as it is free from sediment and hydrocarbon-generating activities.

4 CONCLUSIONS

A stormwater management report has been prepared to support the proposed development at 1001 Noella Leclair Way in the City of Orleans. The key points are summarized below.

WATER QUALITY

An OGS unit (Stormceptor EFO4, or equivalent) is proposed near the outlet to the Noella Leclair Way sewer to meet MOE Enhanced treatment standards (80% TSS removal).

WATER QUANTITY

Runoff will be controlled by surface storage on the parking lot and rooftop storage on the building. Flow from the parking area will be controlled with an ICD, and roof drainage will be controlled with adjustable roof drains.

APPENDIX

A

PRE-CONSULTATION
MEETING MINUTES
AND TECHNICAL
COMMENTS

Pre-Application Consultation – Preliminary Comments

1001 Noella Leclair Way & 4200 Innes Road | File No. PC2022-0290 | Meeting held on 14 November 2022

Contents

Summary of Application.....	1
Planning	1
Urban Design.....	5
Infrastructure Engineering.....	5
Transportation Engineering	10
Forester	Error! Bookmark not defined.

Summary of Application

The following summary notes and attachments are provided as a follow-up to the pre-application consultation meeting held on 14 November 2022. They are regarding a future proposed site plan control application for two vacant parcels of land addressed 1001 Noella Leclair Way and 4200 Innes Road. The proposed application is to enable the applicant to implement a 3 storey plus partial basement long - term care home, containing a total of 192 residential unit. The proposed development is planned to be placed in between 1001 Noella Leclair Way and 4200 Innes Road, at the intersection of Roger Pharand Road. The site will have access from future Vangaurd Drive. A total of 207 at-grade parking spaces are proposed on the northern, eastern, and southern portions of the lot.

Also attached is the list of required plans and studies in support of applications for site plan control approval should your client choose to formally submit them.

The following City staff preliminary comments are based upon the attached information that was made available at the time of the pre-application consultation.

Planning

Contact: Steve Belan – Planner II | Steve.Belan@ottawa.ca

Official Plan and Zoning

- The use is consistent with the OP and ZBL. The concept plan seems to conform with the ZBL but will be reviewed as part of the planning review.

Site Plan

- I realize that this building is highly designed for efficiencies in the care of the residents. But I have concerns that it is designed has no regard to its relationship to its surroundings. The entrance faces into the parking lot has separated the building from the intersection and the street. There is a long side wall facing the street with no active doors. Parking seems to be excessive and there seems to be a lot of congestion of uses at the southeast corner of the building. I know that you provided more explanations of what was happening in the building, but more information (ground floor plan) and elevations would have been more helpful at the meeting. The following are suggestions to improve the building's relationship with the surrounding and street:
 - Introduce a couple of access points onto Noella Leclair. The southern access can be within 15 metres of the intersection. The northern access can be in the intersection or 15 m from the intersection. The fire route can go from the existing access to the new south access on Noella Leclair and try and bring the building up to the intersection more. Have the north access connect with the northern parking lot.

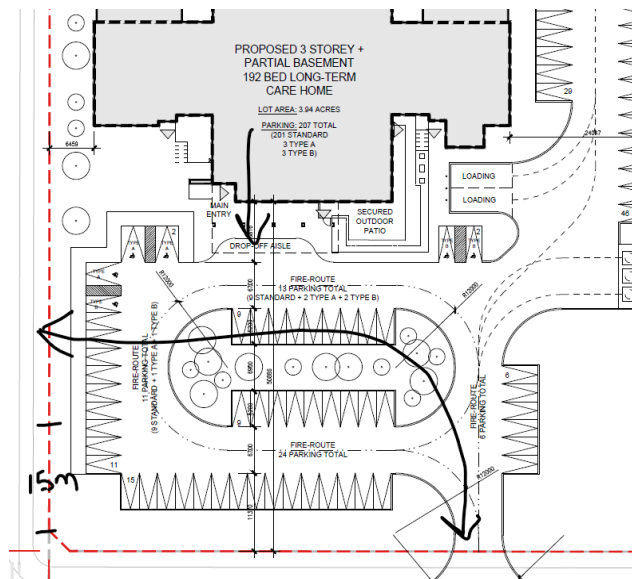

- Can the west side of the building be articulated with some units pushed back to break up a long straight wall? Or can exterior materials be employed to break up the mass or a combination of both? There will be a row of street trees on Noella Leclair. I like the idea that you plant a second row to match on your property to have a fully treed boulevard.

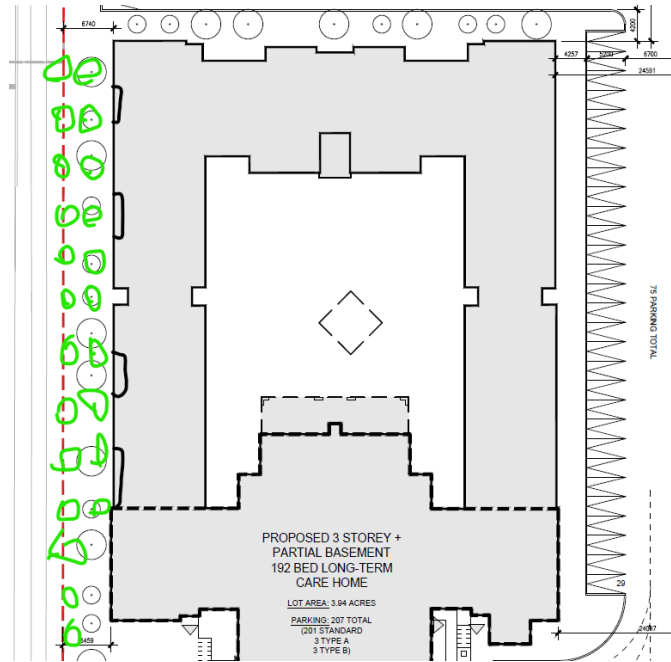

- Would it be possible to move the massing of the central building towards Noella Leclair and have is present as a more prominent architectural feature of the building? The secured outdoor patio can face the street (A) the covered drop off can extend into the parking (B) and there would be more room to provide loading and utility areas (C) away from the other areas and reduce congestion with access to the employee parking areas.

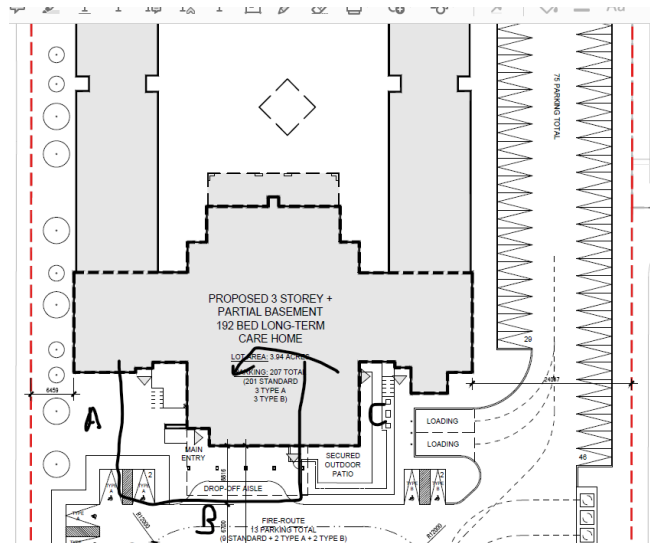

- Breaking up the long lines of parking space by introducing some trees in the parking area to provide some shade.

Other

- Will you be considering LEED building or the [HPDS Overview for Applicants](#) and [HPDS Example Checklist](#) ?
- The Assessable Parking Standards are here [ADS Site Plan Checklist](#);
- Plans are to be standard A1 size (594 mm x 841 mm) or Arch D size (609.6 mm x 914.4 mm) sheets, dimensioned in metric and utilizing an appropriate Metric scale (1:200, 1:250, 1:300, 1:400 or 1:500).
- All PDF submitted documents are to be unlocked and flattened.
- A Waste Reduction Workplan Summary is required for the construction project as required by O.Reg. 102/94, being “Waste Audits and Waste Reduction Work Plans” made under the Environmental Protection Act, RSO 1990, c E.19, as amended.
- You are encouraged to contact the Ward Councillor, Councillor Kitts, at Catherine.Kitts@ottawa.ca about the proposal.

Please refer to the links to [Guide to preparing studies and plans](#) and [fees](#) for further information. Additional information is available related to [building permits, development charges, and the Accessibility Design Standards](#). Be aware that other fees and permits may be required, outside of the development review process. You may obtain background drawings by contacting geoinformation@ottawa.ca.

It is anticipated that, as a result of the More Homes for Everyone Act, 2022, for applications for site plan approval and zoning by-law amendments, new processes in respect of pre-application consultation will be in place as of January 1, 2023. The new processes are anticipated to require a multiple phase pre-application consultation approach before an application will be deemed complete. Applicants who have not filed a complete application by the effective date may be required to undertake further pre-application consultation(s) consistent with the provincial changes. The by-laws to be amended include By-law 2009-320, the Pre-Consultation By-law, By-law 2022-239, the planning fees by-law and By-law 2022-254, the Information and Materials for Planning Application By-law. The revisions are anticipated to be before Council in the period after the new Council takes office and the end of the year.

These pre-con comments are valid for one year. If you submit a development application(s) after this time, you may be required to meet for another pre-consultation meeting and/or the submission requirements may change. You are as well encouraged to contact us for a follow-up meeting if the plan/concept will be further refined.

Urban Design

Selma Hassan – Planner II | Selma.Hassan@ottawa.ca

1. A Design Brief is required with the Site Plan submission. A Terms of Reference for the Design Brief is attached; all items highlighted in yellow must be provided with the application.
2. Complete floor plan and elevation drawings are required with the application.
3. The property is **not** subject to review by the City's Urban Design Review Panel (UDRP).
4. The Site Plan needs to show:
 - a. pedestrian walkways from the public sidewalks, on both streets, to the building
 - b. pedestrian walkways from the parking areas to building entries (for the safety of staff and visitors)
 - c. Substantial landscaping to screen the parking and commercial uses to the east
 - d. Continuous tree planting along Noelle LeClair (currently, the planting stops at the north and south ends of the building)
 - e. Continuous tree planting at the southern frontage / property line

Infrastructure Engineering

Alex Polyak – Infrastructure Project Manager | Alex.Polyak@ottawa.ca

Note the following Development charges which are applicable to the site:

- Outer Greenbelt development charge

List of Reports and Plans (Site Plan Control):

1. Site Plan
2. Topographical Plan of Survey Plan with a published Bench Mark
3. Removals Plan
4. Site Servicing Plan
5. Site Grading and Ponding Plan
6. Erosion and Sediment Control Plan
7. Existing Condition Storm Drainage Plan
8. Post Development Storm Drainage Plan
9. Stormwater Management and Site Servicing Report
10. Geotechnical Investigation Report

Please note the following information regarding the engineering design submissions for the above noted site:

1. The Servicing Study Guidelines for Development Applications are available at the following address:
<https://ottawa.ca/en/city-hall/planning-and-development/how-develop-property/development-application-review-process-2/guide-preparing-studies-and-plans>
2. Servicing and site works shall be in accordance with the following documents:

- Ottawa Sewer Design Guidelines, Second Edition, (October 2012), including Technical Bulletins, ISDTB-2014-01, PIEDTB-2016-01, ISTB 2018-01, ISTB-2018-04, and ISTB-2019-02
 - Ottawa Design Guidelines – Water Distribution, First Edition, (July 2010), including Technical Bulletins ISD-2010-2, ISDTB-2014-02, ISTB-2018-02, and ISTB-2021-03
 - Geotechnical Investigation and Reporting Guidelines for Development Applications in the City of Ottawa (Revised 2008)
 - City of Ottawa Slope Stability Guidelines for Development Applications (Revised 2012)
 - City of Ottawa Environmental Noise Control Guidelines (January, 2016)
 - City of Ottawa Hydrogeological and Terrain Analysis Guidelines (March 2021)
 - City of Ottawa Park and Pathway Development Manual (2012)
 - City of Ottawa Accessibility Design Standards (2012)
 - Ottawa Standard Tender Documents (latest version)
 - Ontario Provincial Standards for Roads & Public Works (2013)
3. Record drawings and utility plans are also available for purchase from the City (Contact the City's Information Centre by email at InformationCentre@ottawa.ca or by phone at (613) 580-2424 x 44455
4. The Stormwater Management Criteria for the subject site is to be based on the approved detailed subdivision design for allowable release rates
- Minor system inflow to be restricted for all contributing areas to 50L/s/ha.
 - Ensure no overland flow for all storms up to and including the 100-year event. Provide adequate emergency overflow conveyance off-site
 - Quality control requirements to be provided by Rideau Valley Conservation Authority (RVCA).
 - This property is located within the Bilberry Creek subwatershed. Please verify any subwatershed specific SWM criteria with the RVCA.
5. Deep Services:

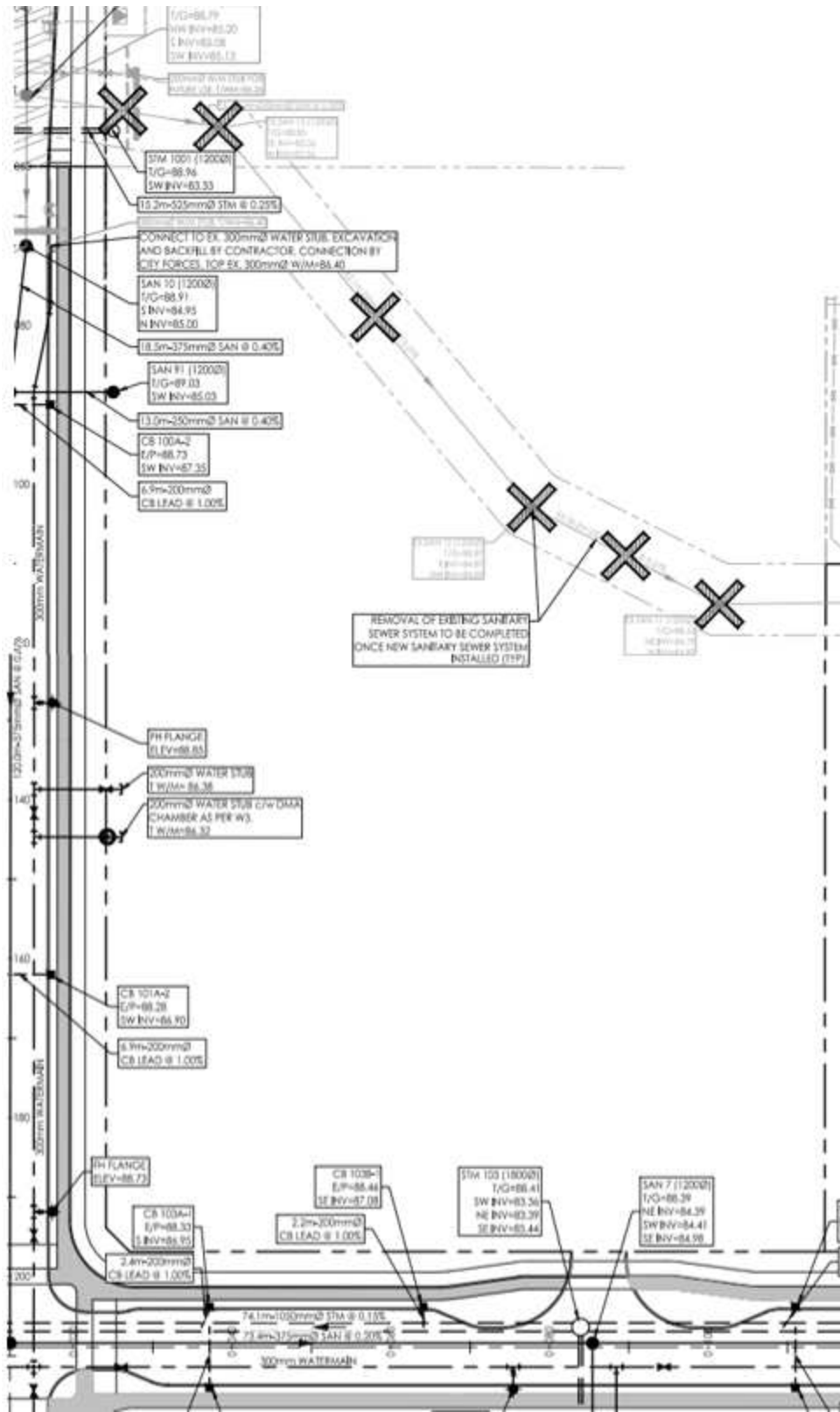

- i. A plan view of the approximate services may be seen above from the future services to be installed as part of the subdivision plan. Services should ideally be grouped in a common trench to minimize the number of road cuts. The sizing of available future services is:
 - a. Connections (Noella Leclair):
 - i. 200 mm dia. future water service stub to be dropped at the West of the property.
 - ii. 250 mm dia. future sanitary service stub to be dropped at the West of the property.
 - iii. 525 mm dia. future storm service stub to be dropped at the North-West of the property
 - b. Note: Existing sanitary system running through the property is to be removed once new sanitary system has been installed*
- ii. Provide existing servicing information and the recommended location for the proposed connections. Services should ideally be grouped in a common trench to minimize the number of road cuts.*
- iii. Provide information on the monitoring manhole requirements – should be located in an accessible location on private property near the property line (ie. Not in a parking area).*
- iv. Provide information on the type of connection permitted*

Sewer connections to be made above the springline of the sewermain as per:

- a. Std Dwg S11.1 for flexible main sewers – *connections made using approved tee or wye fittings.*
- b. Std Dwg S11 (For rigid main sewers) – *lateral must be less than 50% the diameter of the sewermain,*
- c. Std Dwg S11.2 (for rigid main sewers using bell end insert method) – *for larger diameter laterals where manufactured inserts are not available; lateral must be less than 50% the diameter of the sewermain,*
- d. Connections to manholes permitted when the connection is to rigid main sewers where the lateral exceeds 50% the diameter of the sewermain. – Connect obvert to obvert with the outlet pipe unless pipes are a similar size.
- e. *No submerged outlet connections.*

- v. *The capacity of the existing system should be evaluated when estimating the peak sanitary flow rates.*
6. Civil consultant must request boundary conditions from the City's assigned Project Manager prior to first submission. Water Boundary condition requests must include the location of the service and the expected loads required by the proposed development. Please provide the following information:
- i. Location of service(s)
 - ii. Type of development and the amount of fire flow required (as per FUS, 2020).
 - iii. Average daily demand: ___ l/s.
 - iv. Maximum daily demand: ___ l/s.
 - v. Maximum hourly daily demand: ___ l/s.
 - vi. Hydrant location and spacing to meet City's Water Design guidelines.
 - vii. Water supply redundancy will be required for more than 50 m³/day water demand.

Please note that a boundary condition request should be made to the City as early as possible, in order to identify any water supply constraints (if any exist). Please also provide the estimated sanitary flows with the design, so the City can confirm that there aren't any capacity constraints downstream.

7. Phase 1 ESAs and Phase 2 ESAs must conform to clause 4.8.4 of the Official Plan that requires that development applications conform to Ontario Regulation 153/04.
8. All development applications should be considered for an Environmental Compliance Approval (ECA) by the Ministry of the Environment, Conservation, and Parks (MECP);
- a. The consultants determine if an approval for sewage works under Section 53 of OWRA is required and determines what type of application. The City's project manager may help confirm and coordinate with the MECP as required.
 - b. The project will be either transfer of review (standard), transfer of review (additional), direct submission, or exempt as per O. Reg. 525/98.
 - c. Pre-consultation is not required if applying for standard or additional works (Schedule A of the Agreement) under Transfer Review.

- d. Pre-consultation with local District office of MECP is recommended for direct submission.
- e. Consultant completes an MECP request form for a pre-consultation. Send request to moeccottawasewage@ontario.ca
- f. ECA applications are required to be submitted online through the MECP portal. A business account required to submit ECA application. For more information visit <https://www.ontario.ca/page/environmental-compliance-approval>

NOTE: Site Plan Approval, or Draft Approval, is required before an application is sent to the MECP.

9. General Engineering Submission requirements:

- a. As per section 53 of the Professional Engineers Act, O. Reg 941/40, R.S.O. 1990, all documents prepared by engineers must be signed and dated on the seal.
- b. All required plans are to be submitted on standard A1 size sheets (594mm x 841mm) sheets, utilizing a reasonable and appropriate metric scale as per City of Ottawa Servicing and Grading Plan Requirements: title blocks are to be placed on the right of the sheets and not along the bottom. Engineering plans may be combined, but the Site Plans must be provided separately. Plans shall include the survey monument used to confirm datum. Information shall be provided to enable a non-surveyor to locate the survey monument presented by the consultant.
- c. All required plans & reports are to be provided in *.pdf format (at application submission and for any, and all, re-submissions)

Should you have any questions or require additional information, please contact me directly at alex.polyak@ottawa.ca

Minimum Drawing and File Requirements- All Plans

Plans are to be submitted on standard **A1 size** (594mm x 841mm) sheets, utilizing an appropriate Metric scale (1:200, 1:250, 1:300, 1:400, or 1:500).

With all submitted hard copies provide individual PDF of the DWGs and for reports please provide one PDF file of the reports. **All PDF documents are to be unlocked and flattened.**

Transportation Engineering

Mike Giampa – Senior Transportation Engineer | Mike.Giampa@ottawa.ca

- Submit a TIA screening form.

- If a TIA is warranted proceed to scoping. The guidelines are available on the City website: <https://ottawa.ca/en/transportation-impact-assessment-guidelines>
- The application will not be deemed complete until the submission of the draft step 2-4, including the functional draft RMA package (if applicable) and/or monitoring report (if applicable). Although a full review of the TIA Strategy report (Step 4) is not required prior to an application, it is strongly recommended.
- Synchro files are required at Step 4.
- Corner sight triangle: 5m x 5m
- A Road Noise Impact Study is required

Forestry

Mark Richardson - Forester | Mark.Richardson@ottawa.ca

1. a Tree Conservation Report (TCR) must be supplied for review along with the suite of other plans/reports required by the City
 - a. an approved TCR is a requirement of Site Plan approval.
 - b. The TCR may be combined with the LP provided all information is supplied
2. Any removal of privately-owned trees 10cm or larger in diameter, or city-owned trees of any diameter requires a tree permit issued under the Tree Protection Bylaw (Bylaw 2020 – 340); the permit will be based on an approved TCR and made available at or near plan approval.
3. The Planning Forester from Planning and Growth Management as well as foresters from Forestry Services will review the submitted TCR
 - a. If tree removal is required, both municipal and privately-owned trees will be addressed in a single permit issued through the Planning Forester
 - b. Compensation may be required for city owned trees – if so, it will need to be paid prior to the release of the tree permit
4. The TCR must contain 2 separate plans:
 - a. Plan/Map 1 - show existing conditions with tree cover information
 - b. Plan/Map 2 - show proposed development with tree cover information
 - c. Please ensure retained trees are shown on the landscape plan
5. the TCR must list all trees on site, as well as off-site trees if the CRZ extends into the developed area, by species, diameter and health condition
6. please identify trees by ownership – private onsite, private on adjoining site, city owned, co-owned (trees on a property line)
7. If trees are to be removed, the TCR must clearly show where they are, and document the reason they cannot be retained
8. All retained trees must be shown, and all retained trees within the area impacted by the development process must be protected as per City guidelines available at [Tree Protection Specification](#) or by searching Ottawa.ca
 - a. the location of tree protection fencing must be shown on the plan
 - b. show the critical root zone of the retained trees
9. the City encourages the retention of healthy trees; if possible, please seek opportunities for retention of trees that will contribute to the design/function of the site.

10. For more information on the process or help with tree retention options, contact Mark Richardson mark.richardson@ottawa.ca or on [City of Ottawa](https://www.cityofottawa.ca)

LP tree planting requirements:

For additional information on the following please contact tracy.smith@Ottawa.ca

Minimum Setbacks

- Maintain 1.5m from sidewalk or MUP/cycle track or water service laterals.
- Maintain 2.5m from curb
- Coniferous species require a minimum 4.5m setback from curb, sidewalk or MUP/cycle track/pathway.
- Maintain 7.5m between large growing trees, and 4m between small growing trees. Park or open space planting should consider 10m spacing, except where otherwise approved in naturalization / afforestation areas. Adhere to Ottawa Hydro’s planting guidelines (species and setbacks) when planting around overhead primary conductors.

Tree specifications

- Minimum stock size: 50mm tree caliper for deciduous, 200cm height for coniferous.
- Maximize the use of large deciduous species wherever possible to maximize future canopy coverage
- Tree planting on city property shall be in accordance with the City of Ottawa’s Tree Planting Specification; and include watering and warranty as described in the specification (can be provided by Forestry Services).
- Plant native trees whenever possible
- No root barriers, dead-man anchor systems, or planters are permitted.
- No tree stakes unless necessary (and only 1 on the prevailing winds side of the tree)

Hard surface planting

- Curb style planter is highly recommended
- No grates are to be used and if guards are required, City of Ottawa standard (which can be provided) shall be used.
- Trees are to be planted at grade

Soil Volume

- Please document on the LP that adequate soil volumes can be met:

Tree Type/Size	Single Tree Soil Volume (m3)	Multiple Tree Soil Volume (m3/tree)
Ornamental	15	9
Columnar	15	9
Small	20	12
Medium	25	15
Large	30	18

Conifer	25	15
---------	----	----

Please note that these soil volumes are not applicable in cases with Sensitive Marine Clay.

Sensitive Marine Clay

- Please follow the City's 2017 Tree Planting in Sensitive Marine Clay guidelines

Tree Canopy Cover

- The landscape plan shall show how the proposed tree planting will replace and increase canopy cover on the site over time, to support the City's 40% urban forest canopy cover target.
- At a site level, efforts shall be made to provide as much canopy cover as possible, through tree planting and tree retention, with an aim of 40% canopy cover at 40 years, as appropriate.
- Indicate on the plan the projected future canopy cover at 40 years for the site.

Environmental Planning

Sami Rehman – Environmental Planner II | Sami.Rehamn@ottawa.ca

- Please review and incorporate design elements from the City's Bird Safe Design Guidelines to eliminate bird collisions.
 - [Bird-Safe Design Guidelines | City of Ottawa](#)

Parkland

Jessica Button – Parks & Facilities Planner II | Jessica.Button@ottawa.ca

- Please note that Parks and Facilities Planning has recently undertaken a legislated replacement of the Parkland Dedication By-law, with the new by-law approved by City Council on August 31, 2022. To ensure you are aware of parkland dedication requirements for your proposed development, we encourage you to familiarize yourself with the staff report and By-Law that were approved by Council on August 31, 2022.
- The southern portion of the proposed development is part of a subdivision (D07-16-18-0006) and has met its parkland dedication requirement under the former Parkland dedication by-law.
- The northern portion of the proposed development is located outside of the above noted subdivision. Cash-in-lieu of Parkland dedication, along with the fee for appraisal services, will be required in accordance with the By-law. The Cash-in-lieu of Parkland will be finalized as the Site Plan Control Agreement is being prepared. The monies are to be paid at the time of execution of the Site Plan Agreement. If the proposed land use or By-law changes, then the parkland dedication will be recalculated accordingly.
- Please provide Parks & Facilities Planning with a surveyor's note (or equivalent) which specifies the gross land area of the property with your application.

APPENDIX

B EXHIBITS



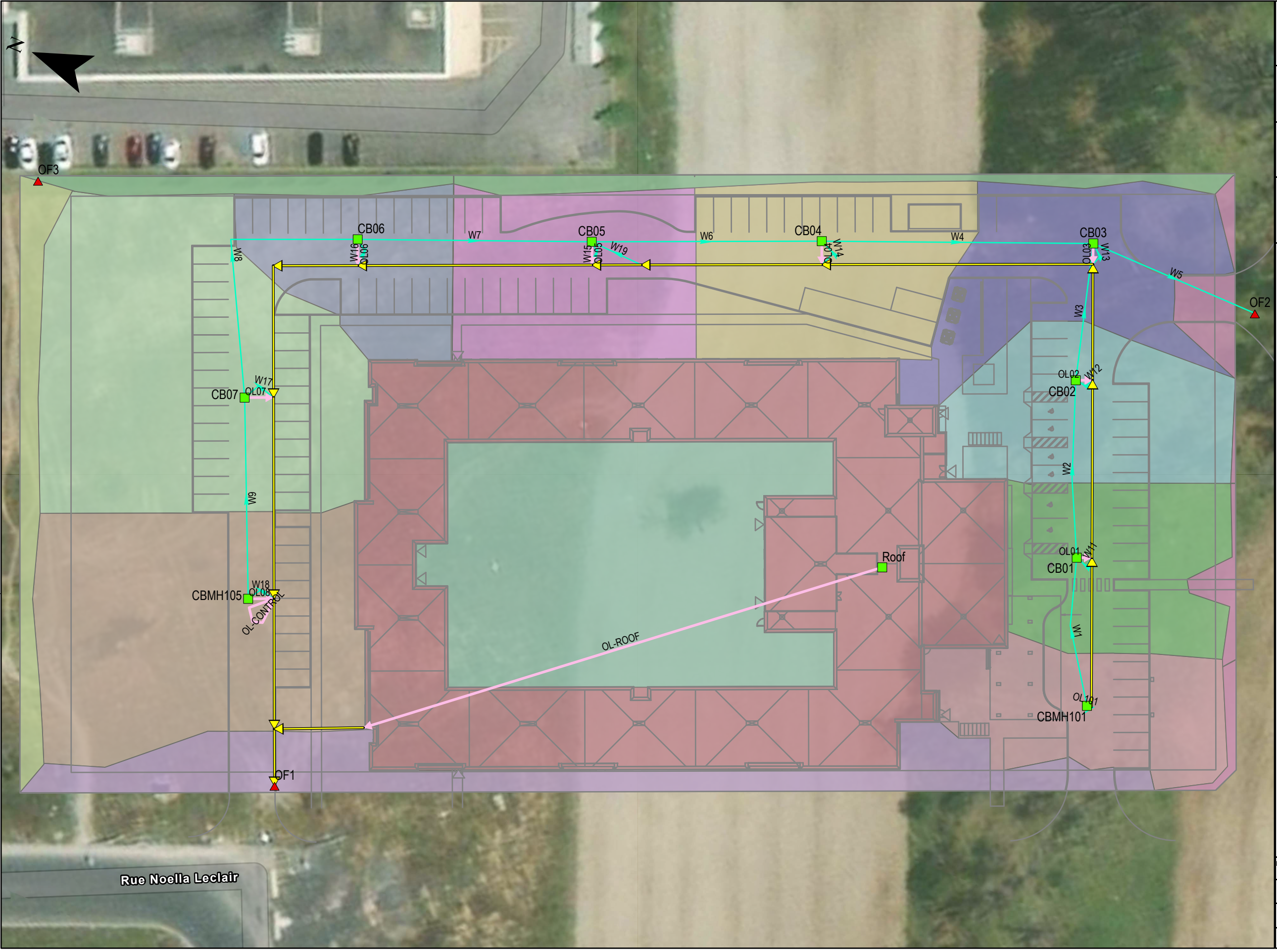

CLIENT
MONTGOMERY SISAM ARCHITECTS INC.

PROJECT
EXTENDICARE - ORLEANS LTC

TITLE
EXHIBIT 1
PCSWMM MODEL SCHEMATIC

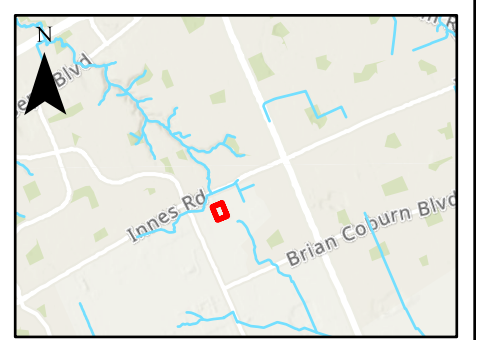

LEGEND

- Proposed Storm
- Storage Areas

Subcatchments

- S101
- S102
- S103
- S104
- S105
- S106
- S107
- S108
- S109
- S110
- S111
- SBLDG_CY
- SBLDG_roof
- S112
- S113

- Outlets
- Weirs
- Outfalls

0 0.01 0.01 km

DRAWN BY KK	CHECKED BY AJ
March 2023	
NAD 1983 MTM 9	
1:550	

Document Path: C:\Users\CAK\72000\Documents\221-12376-00_Extendicare Inc\GIS\Extendicare.aprx

Rue Noella Leclair

APPENDIX

C PCSWMM OUTPUT



PCSWMM Results

Minor System Outflow

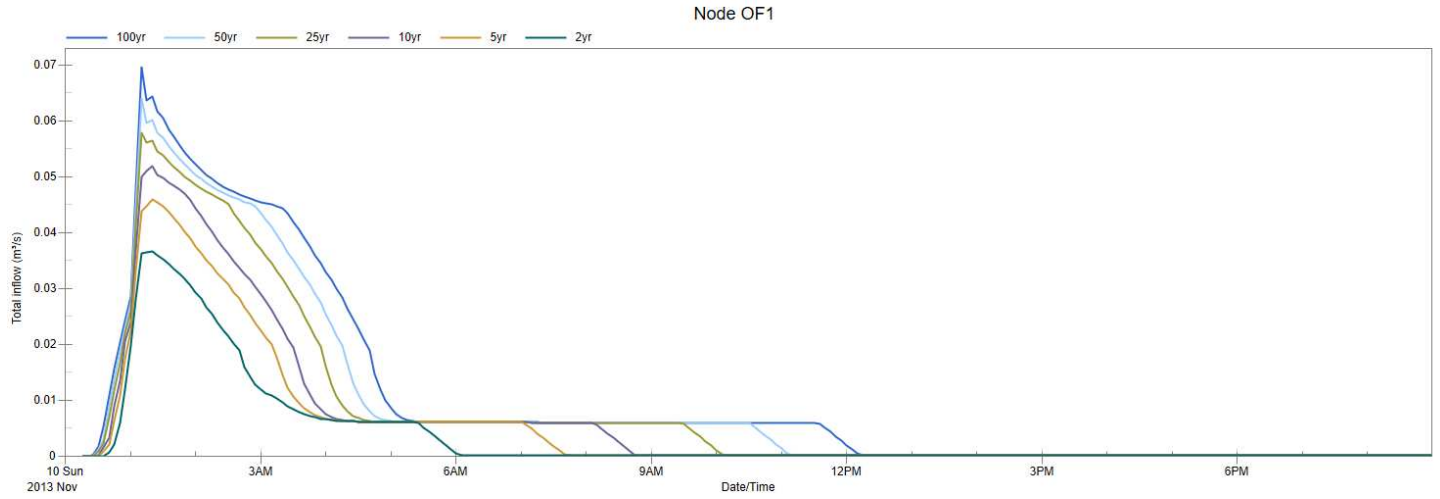

Roof Storage Depth and Volume

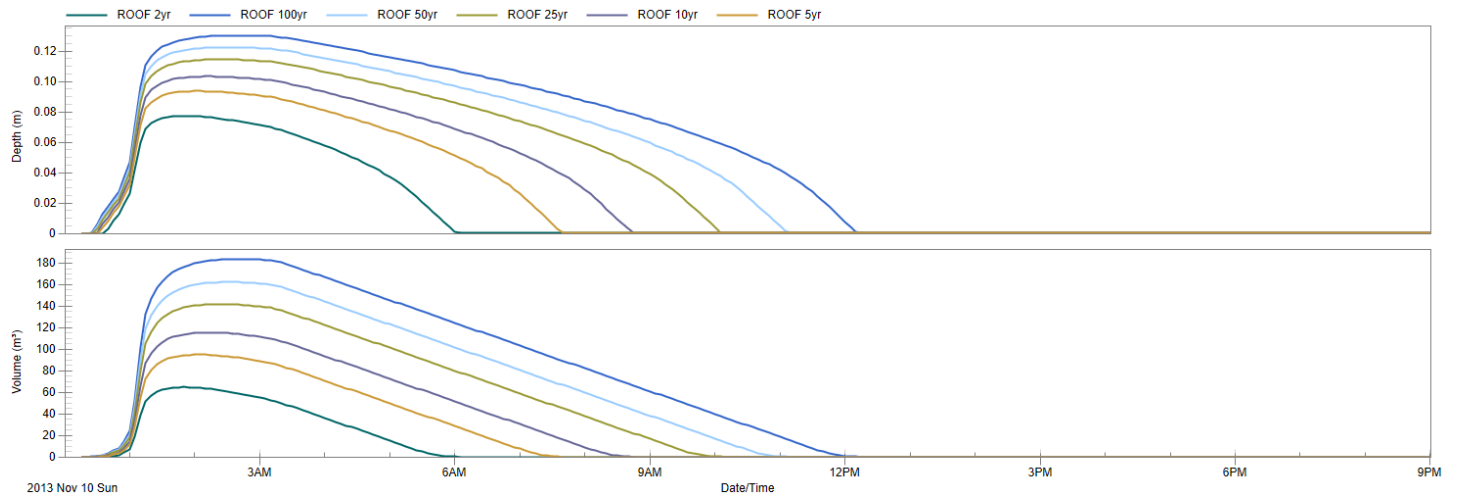

2-Year 3-Hour Chicago Storm Event

Parking Lot Surface Storage Depth and Volume

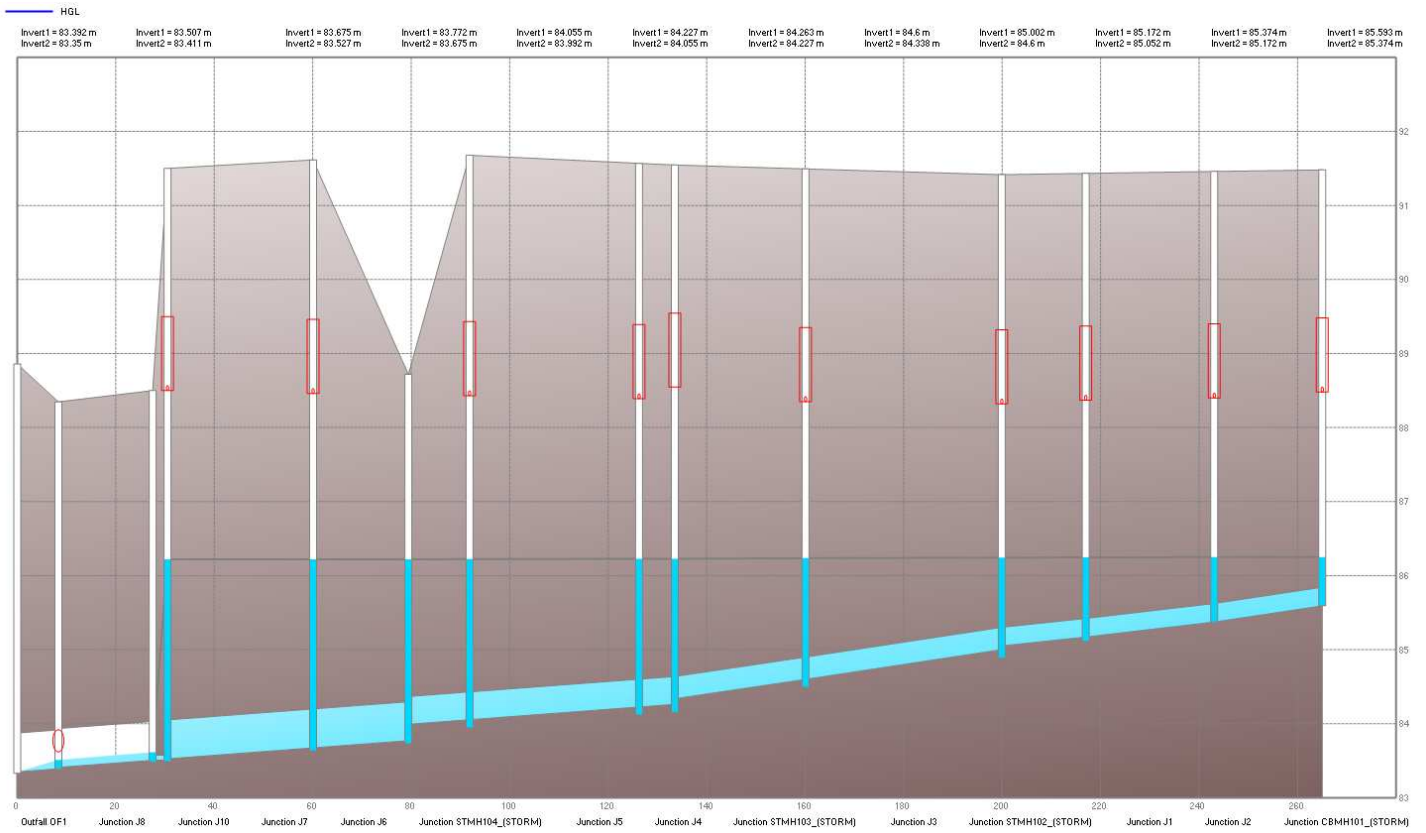
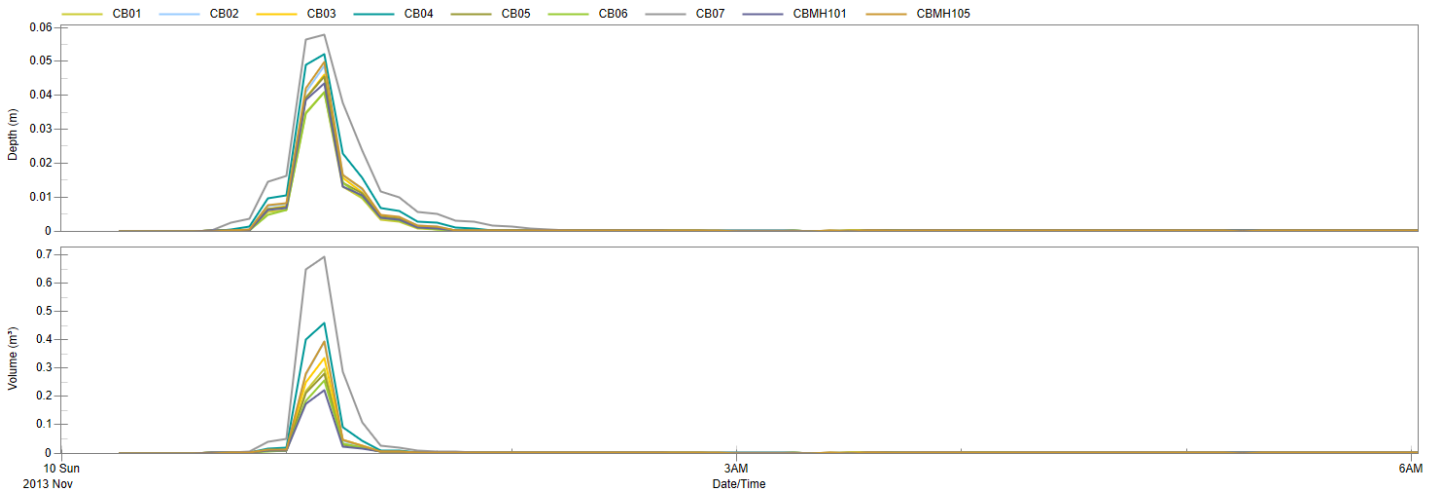

WARNING 03: negative offset ignored for Link Pipe_-(23)_ (STORM)_3
 WARNING 03: negative offset ignored for Link Pipe_-(23)_ (STORM)_3
 WARNING 03: negative offset ignored for Link Pipe_-(23)_ (STORM)_4

 Element Count

 Number of rain gages 17
 Number of subcatchments ... 15
 Number of nodes 28
 Number of links 43
 Number of pollutants 0
 Number of land uses 0

 Raingage Summary

Name	Data Source	Data Type	Recording Interval
100yr_3hr_Chicago	100yr_3hr_Chicago	INTENSITY	10 min.
100yr_3hr_Chicago_Climate_Change	100yr_3hr_Chicago_Increase_20percent	INTENSITY	10 min.
100yr_6hr_Chicago	100yr_6hr_Chicago	INTENSITY	10 min.
100yr_6hr_Chicago_Climate_Change	100yr_6hr_Chicago_Increase_20percent	INTENSITY	10 min.
10yr_3hr_Chicago	10yr_3hr_Chicago	INTENSITY	10 min.
10yr_6hr_Chicago	10yr_6hr_Chicago	INTENSITY	10 min.
25mm_3hr_Chicago	25mm_3hr_Chicago	INTENSITY	10 min.
25mm_4hr_Chicago	25mm_4hr_Chicago	INTENSITY	10 min.
25yr_3hr_Chicago	25yr_3hr_Chicago	INTENSITY	10 min.
25yr_6hr_Chicago	25yr_6hr_Chicago	INTENSITY	10 min.
2yr	2yr	INTENSITY	10 min.
2yr_3hr_Chicago	2yr_3hr_Chicago	INTENSITY	10 min.
2yr_6hr_Chicago	2yr_6hr_Chicago	INTENSITY	10 min.
50yr_3hr_Chicago	50yr_3hr_Chicago	INTENSITY	10 min.
50yr_6hr_Chicago	50yr_6hr_Chicago	INTENSITY	10 min.
5yr_3hr_Chicago	5yr_3hr_Chicago	INTENSITY	10 min.
5yr_6hr_Chicago	5yr_6hr_Chicago	INTENSITY	10 min.

 Subcatchment Summary

Name	Area	Width	%Imperv	%Slope	Rain Gage	Outlet
S101	0.07	27.77	68.30	2.1000	2yr	CBMH101
S102	0.08	28.93	59.80	2.0000	2yr	CB01
S103	0.08	31.11	64.90	2.5000	2yr	CB02
S104	0.09	25.00	57.80	2.2000	2yr	CB03
S105	0.10	40.49	66.40	1.8000	2yr	CB04
S106	0.09	33.36	57.90	1.5000	2yr	CB05
S107	0.06	14.60	76.60	2.0000	2yr	CB06
S108	0.19	51.95	47.60	2.0000	2yr	CB07
S109	0.16	42.40	34.50	2.2000	2yr	CBMH105
S110	0.08	4.83	16.70	0.8000	2yr	OF1
S111	0.02	4.78	30.90	1.5000	2yr	OF2
S112	0.03	3.34	5.00	0.8000	2yr	OF3
S113	0.04	4.12	5.00	0.8500	2yr	OF3
SBLDG_CY	0.19	28.30	5.00	0.5000	2yr	J9
SBLDG_roof	0.34	261.54	100.00	0.5000	2yr	ROOF

 Node Summary

Name	Type	Invert Elev.	Max. Depth	Ponded Area	External Inflow
CBMH101_(STORM)	JUNCTION	85.59	5.89	0.0	
J1	JUNCTION	85.11	6.32	0.0	
J10	JUNCTION	83.49	5.01	0.0	
J2	JUNCTION	85.37	6.08	0.0	
J3	JUNCTION	84.49	7.00	0.0	
J4	JUNCTION	84.12	7.45	0.0	
J5	JUNCTION	83.94	7.73	0.0	
J6	JUNCTION	83.64	7.98	0.0	
J7	JUNCTION	83.49	8.01	0.0	
J8	JUNCTION	83.39	4.96	0.0	
J9	JUNCTION	83.76	5.23	0.0	
STM_CAP_02_(STORM)	JUNCTION	84.65	4.34	0.0	
STMH102_(STORM)	JUNCTION	84.89	6.52	0.0	
STMH103_(STORM)	JUNCTION	84.15	7.39	0.0	
STMH104_(STORM)	JUNCTION	83.73	4.99	0.0	
OF1	OUTFALL	83.33	0.54	0.0	
OF2	OUTFALL	0.00	0.00	0.0	
OF3	OUTFALL	0.00	0.00	0.0	
CB01	STORAGE	88.40	0.41	0.0	
CB02	STORAGE	88.37	0.40	0.0	
CB03	STORAGE	88.32	0.51	0.0	
CB04	STORAGE	88.35	0.47	0.0	
CB05	STORAGE	88.39	0.45	0.0	
CB06	STORAGE	88.43	0.38	0.0	
CB07	STORAGE	88.46	0.44	0.0	
CBMH101	STORAGE	88.48	0.35	0.0	
CBMH105	STORAGE	88.50	0.46	0.0	
ROOF	STORAGE	100.00	6.00	0.0	

 Link Summary

```

*****
Name          From Node      To Node      Type          Length    %Slope  Roughness
-----
C1            J9              J8           CONDUIT       13.1      1.1050  0.0130
Pipe_-(23)_(STORM)_2 J1           STMH102_(STORM) CONDUIT       17.1      0.7035  0.0130
Pipe_-(23)_(STORM)_3 CBMH101_(STORM) J2           CONDUIT       21.9      0.9983  0.0130
Pipe_-(23)_(STORM)_4 J2           J1           CONDUIT       26.1      0.7744  0.0130
Pipe_-(24)_(1)_(STORM)_1 STMH102_(STORM) J3           CONDUIT       39.9      1.0084  0.0130
Pipe_-(24)_(1)_(STORM)_2 J3           STMH103_(STORM) CONDUIT       26.5      0.9873  0.0130
Pipe_-(25)_(STORM)_1 STMH103_(STORM) J4           CONDUIT        7.3      0.4962  0.0130
Pipe_-(25)_(STORM)_3 J4           J5           CONDUIT       34.4      0.4996  0.0130
Pipe_-(25)_(STORM)_4 J5           STMH104_(STORM) CONDUIT       12.4      0.5071  0.0130
Pipe_-(26)_(STORM)_1 STMH104_(STORM) J6           CONDUIT       19.4      0.5010  0.0130
Pipe_-(26)_(STORM)_3 J6           J7           CONDUIT       29.6      0.5009  0.0130
Pipe_-(26)_(STORM)_5 J8           OF1          CONDUIT        8.3      0.5040  0.0130
Pipe_-(26)_(STORM)_6 J10          J8           CONDUIT       19.2      0.5013  0.0130
W1            CBMH101         CB01         WEIR
W10           CBMH101_(STORM) CBM101       WEIR
W11           J2              CB01         WEIR
W12           J1              CB02         WEIR
W13           STMH102_(STORM) CB03         WEIR
W14           J3              CB04         WEIR
W15           J4              CB05         WEIR
W16           J5              CB06         WEIR
W17           J6              CB07         WEIR
W18           J7              CBMH105      WEIR
W19           STMH103_(STORM) CB05         WEIR
W2            CB01            CB02         WEIR
W3            CB02            CB03         WEIR
W4            CB04            CB03         WEIR
W5            CB03            OF2          WEIR
W6            CB05            CB04         WEIR
W7            CB06            CB05         WEIR
W8            CB07            CB06         WEIR
W9            CBMH105         CB07         WEIR
OL01          CB01            J2           OUTLET
OL02          CB02            J1           OUTLET
OL03          CB03            STMH102_(STORM) OUTLET
OL04          CB04            J3           OUTLET
OL05          CB05            J4           OUTLET
OL06          CB06            J5           OUTLET
OL07          CB07            J6           OUTLET
OL08          CBMH105         J7           OUTLET
OL101         CBMH101         CBMH101_(STORM) OUTLET
OL-CONTROL   J7              J10          OUTLET
OL-ROOF      ROOF            J9           OUTLET

```

Cross Section Summary

Conduit	Shape	Full Depth	Full Area	Hyd. Rad.	Max. Width	No. of Barrels	Full Flow
C1	CIRCULAR	0.30	0.07	0.07	0.30	1	0.10
Pipe_-(23)_(STORM)_2	CIRCULAR	0.25	0.05	0.05	0.25	1	0.05
Pipe_-(23)_(STORM)_3	CIRCULAR	0.25	0.05	0.05	0.25	1	0.06
Pipe_-(23)_(STORM)_4	CIRCULAR	0.25	0.05	0.05	0.25	1	0.05
Pipe_-(24)_(1)_(STORM)_1	CIRCULAR	0.30	0.07	0.07	0.30	1	0.10
Pipe_-(24)_(1)_(STORM)_2	CIRCULAR	0.30	0.07	0.07	0.30	1	0.10
Pipe_-(25)_(STORM)_1	CIRCULAR	0.38	0.11	0.09	0.38	1	0.12
Pipe_-(25)_(STORM)_3	CIRCULAR	0.38	0.11	0.09	0.38	1	0.12
Pipe_-(25)_(STORM)_4	CIRCULAR	0.38	0.11	0.09	0.38	1	0.12
Pipe_-(26)_(STORM)_1	CIRCULAR	0.53	0.22	0.13	0.53	1	0.30
Pipe_-(26)_(STORM)_3	CIRCULAR	0.53	0.22	0.13	0.53	1	0.30
Pipe_-(26)_(STORM)_5	CIRCULAR	0.53	0.22	0.13	0.53	1	0.31
Pipe_-(26)_(STORM)_6	CIRCULAR	0.53	0.22	0.13	0.53	1	0.30

NOTE: The summary statistics displayed in this report are based on results found at every computational time step, not just on results from each reporting time step.

Analysis Options

```

Flow Units ..... CMS
Process Models:
  Rainfall/Runoff ..... YES
  RDII ..... NO
  Snowmelt ..... NO
  Groundwater ..... NO
  Flow Routing ..... YES
  Ponding Allowed ..... YES
  Water Quality ..... NO
Infiltration Method ..... HORTON
Flow Routing Method ..... DYNWAVE
Surcharge Method ..... EXTRAN
Starting Date ..... 11/10/2013 00:10:00
Ending Date ..... 11/11/2013 03:00:00
Antecedent Dry Days ..... 0.0
Report Time Step ..... 00:05:00
Wet Time Step ..... 00:05:00
Dry Time Step ..... 00:05:00
Routing Time Step ..... 1.00 sec
Variable Time Step ..... YES
Maximum Trials ..... 20
Number of Threads ..... 2
Head Tolerance ..... 0.001500 m

```

***** Volume Depth

```

Runoff Quantity Continuity      hectare-m      mm
-----
Total Precipitation .....      0.052      31.860
Evaporation Loss .....          0.000          0.000
Infiltration Loss .....          0.023      14.406
Surface Runoff .....            0.027      16.712
Final Storage .....             0.001          0.860
Continuity Error (%) .....      -0.369

```

```

*****
Flow Routing Continuity      Volume      Volume
      hectare-m      10^6 ltr
-----
Dry Weather Inflow .....          0.000          0.000
Wet Weather Inflow .....          0.027          0.271
Groundwater Inflow .....          0.000          0.000
RDII Inflow .....              0.000          0.000
External Inflow .....           0.000          0.000
External Outflow .....           0.028          0.276
Flooding Loss .....             0.000          0.000
Evaporation Loss .....           0.000          0.000
Exfiltration Loss .....          0.000          0.000
Initial Stored Volume .....      0.000          0.000
Final Stored Volume .....        0.000          0.000
Continuity Error (%) .....      -1.896

```

```

*****
Highest Continuity Errors
*****
Node CB06 (-7.09%)
Node CB01 (-5.74%)
Node CBM101 (-5.23%)
Node CB03 (-4.98%)
Node CB05 (-4.95%)

```

```

*****
Time-Step Critical Elements
*****
None

```

```

*****
Highest Flow Instability Indexes
*****
Link OL07 (5)
Link OL06 (5)
Link OL04 (5)
Link OL03 (4)
Link OL05 (4)

```

```

*****
Routing Time Step Summary
*****
Minimum Time Step : 0.81 sec
Average Time Step : 1.00 sec
Maximum Time Step : 1.00 sec
Percent in Steady State : 0.00
Average Iterations per Step : 2.00
Percent Not Converging : 0.00
Time Step Frequencies :
1.000 - 0.871 sec : 100.00 %
0.871 - 0.758 sec : 0.00 %
0.758 - 0.660 sec : 0.00 %
0.660 - 0.574 sec : 0.00 %
0.574 - 0.500 sec : 0.00 %

```

```

*****
Subcatchment Runoff Summary
*****

```

Subcatchment	Total Precip mm	Total Runon mm	Total Evap mm	Total Infil mm	Imperv Runoff mm	Perv Runoff mm	Total Runoff mm	Total Runoff 10^6 ltr	Peak Runoff CMS	Runoff Coeff
S101	31.86	0.00	0.00	10.08	20.81	0.04	20.85	0.02	0.01	0.654
S102	31.86	0.00	0.00	12.79	18.21	0.04	18.25	0.01	0.01	0.573
S103	31.86	0.00	0.00	11.16	19.76	0.05	19.81	0.02	0.01	0.622
S104	31.86	0.00	0.00	13.43	17.62	0.03	17.65	0.02	0.01	0.554
S105	31.86	0.00	0.00	10.68	20.23	0.04	20.27	0.02	0.01	0.636
S106	31.86	0.00	0.00	13.39	17.64	0.04	17.68	0.02	0.01	0.555
S107	31.86	0.00	0.00	7.44	23.39	0.03	23.41	0.01	0.01	0.735
S108	31.86	0.00	0.00	16.68	14.50	0.03	14.53	0.03	0.02	0.456
S109	31.86	0.00	0.00	20.85	10.50	0.03	10.53	0.02	0.01	0.331
S110	31.86	0.00	0.00	26.54	5.10	0.00	5.11	0.00	0.00	0.160
S111	31.86	0.00	0.00	22.00	9.41	0.02	9.43	0.00	0.00	0.296
S112	31.86	0.00	0.00	30.26	1.52	0.01	1.53	0.00	0.00	0.048
S113	31.86	0.00	0.00	30.26	1.52	0.01	1.53	0.00	0.00	0.048
SBLDG_CY	31.86	0.00	0.00	30.26	1.52	0.01	1.53	0.00	0.00	0.048
SBLDG_roof	31.86	0.00	0.00	0.00	30.51	0.00	30.51	0.10	0.07	0.958

```

*****
Node Depth Summary
*****

```

Node	Type	Average Depth Meters	Maximum Depth Meters	Maximum HGL Meters	Time of Max Occurrence days hr:min	Reported Max Depth Meters

CBMH101_(STORM)	JUNCTION	0.01	0.70	86.29	0	01:11	0.69
J1	JUNCTION	0.08	1.17	86.29	0	01:11	1.16
J10	JUNCTION	0.03	0.13	83.62	0	01:12	0.13
J2	JUNCTION	0.02	0.92	86.29	0	01:11	0.91
J3	JUNCTION	0.15	1.79	86.28	0	01:11	1.77
J4	JUNCTION	0.18	2.16	86.27	0	01:12	2.14
J5	JUNCTION	0.19	2.32	86.27	0	01:12	2.31
J6	JUNCTION	0.15	2.63	86.27	0	01:12	2.62
J7	JUNCTION	0.19	2.78	86.27	0	01:12	2.77
J8	JUNCTION	0.02	0.12	83.51	0	01:10	0.12
J9	JUNCTION	0.01	0.06	83.82	0	01:00	0.06
STM_CAP_02_(STORM)	JUNCTION	0.00	0.00	84.65	0	00:00	0.00
STMH102_(STORM)	JUNCTION	0.14	1.39	86.28	0	01:11	1.38
STMH103_(STORM)	JUNCTION	0.17	2.12	86.27	0	01:12	2.11
STMH104_(STORM)	JUNCTION	0.14	2.54	86.27	0	01:12	2.52
OF1	OUTFALL	0.00	0.00	83.33	0	00:00	0.00
OF2	OUTFALL	0.00	0.00	0.00	0	00:00	0.00
OF3	OUTFALL	0.00	0.00	0.00	0	00:00	0.00
CB01	STORAGE	0.00	0.04	88.44	0	01:00	0.04
CB02	STORAGE	0.00	0.05	88.42	0	01:00	0.05
CB03	STORAGE	0.00	0.05	88.37	0	01:00	0.05
CB04	STORAGE	0.00	0.05	88.40	0	01:00	0.05
CB05	STORAGE	0.00	0.05	88.44	0	01:00	0.05
CB06	STORAGE	0.00	0.04	88.47	0	01:00	0.04
CB07	STORAGE	0.00	0.06	88.52	0	01:00	0.06
CBMH101	STORAGE	0.00	0.04	88.52	0	01:00	0.04
CBMH105	STORAGE	0.00	0.05	88.55	0	01:00	0.05
ROOF	STORAGE	0.01	0.08	100.08	0	01:40	0.08

Node Inflow Summary

Node	Type	Maximum		Time of Max Occurrence days hr:min	Lateral Inflow Volume 10^6 ltr	Total Inflow Volume 10^6 ltr	Flow Balance Error Percent
		Lateral Inflow CMS	Maximum Inflow CMS				
CBMH101_(STORM)	JUNCTION	0.000	0.011	0 01:00	0	0.0158	1.288
J1	JUNCTION	0.000	0.032	0 00:58	0	0.0478	0.843
J10	JUNCTION	0.000	0.029	0 01:12	0	0.162	0.070
J2	JUNCTION	0.000	0.021	0 00:59	0	0.0307	0.827
J3	JUNCTION	0.000	0.055	0 00:56	0	0.0846	-0.092
J4	JUNCTION	0.000	0.044	0 00:55	0	0.101	0.314
J5	JUNCTION	0.000	0.042	0 00:55	0	0.116	0.401
J6	JUNCTION	0.000	0.049	0 00:55	0	0.145	0.034
J7	JUNCTION	0.000	0.037	0 00:57	0	0.162	0.095
J8	JUNCTION	0.000	0.036	0 01:10	0	0.268	-0.035
J9	JUNCTION	0.002	0.008	0 01:00	0.00286	0.107	0.010
STM_CAP_02_(STORM)	JUNCTION	0.000	0.000	0 00:00	0	0	0.000 ltr
STMH102_(STORM)	JUNCTION	0.000	0.042	0 00:57	0	0.0641	0.192
STMH103_(STORM)	JUNCTION	0.000	0.044	0 00:55	0	0.0847	-0.263
STMH104_(STORM)	JUNCTION	0.000	0.031	0 00:55	0	0.116	-0.190
OF1	OUTFALL	0.003	0.037	0 01:03	0.00415	0.273	0.000
OF2	OUTFALL	0.001	0.001	0 01:00	0.00203	0.00203	0.000
OF3	OUTFALL	0.001	0.001	0 01:00	0.000962	0.000962	0.000
CB01	STORAGE	0.010	0.010	0 01:00	0.0143	0.0143	-5.432
CB02	STORAGE	0.012	0.012	0 01:00	0.0166	0.0166	-3.911
CB03	STORAGE	0.011	0.011	0 01:00	0.0159	0.0159	-4.744
CB04	STORAGE	0.014	0.014	0 01:00	0.0201	0.0201	-2.761
CB05	STORAGE	0.011	0.011	0 01:00	0.0156	0.0156	-4.712
CB06	STORAGE	0.010	0.010	0 01:00	0.0144	0.0144	-6.617
CB07	STORAGE	0.020	0.020	0 01:00	0.0279	0.0279	-1.969
CBMH101	STORAGE	0.011	0.011	0 01:00	0.0151	0.0151	-4.974
CBMH105	STORAGE	0.012	0.012	0 01:00	0.017	0.017	-3.410
ROOF	STORAGE	0.073	0.073	0 01:00	0.104	0.104	0.001

Node Surcharge Summary

Surcharging occurs when water rises above the top of the highest conduit.

Node	Type	Hours Surcharged	Max. Height	Min. Depth
			Above Crown Meters	Below Rim Meters
STM_CAP_02_(STORM)	JUNCTION	26.83	0.000	4.343
STMH104_(STORM)	JUNCTION	1.40	1.900	2.450

Node Flooding Summary

No nodes were flooded.

Storage Volume Summary

Storage Unit	Average Volume 1000 m3	Avg Pcnt Full	Evap Pcnt Loss	Exfil Pcnt Loss	Maximum Volume 1000 m3	Max Pcnt Full	Time of Max Occurrence days hr:min	Maximum Outflow CMS
CB02	0.000	0	0	0	0.000	1	0 01:00	0.012
CB03	0.000	0	0	0	0.000	0	0 01:00	0.011
CB04	0.000	0	0	0	0.000	0	0 01:00	0.014
CB05	0.000	0	0	0	0.000	0	0 01:00	0.011

CB06	0.000	0	0	0	0.000	0	0	01:00	0.010
CB07	0.000	0	0	0	0.001	1	0	01:00	0.020
CBMH101	0.000	0	0	0	0.000	1	0	01:00	0.011
CBMH105	0.000	0	0	0	0.000	0	0	01:00	0.012
ROOF	0.007	0	0	0	0.065	0	0	01:40	0.006

 Outfall Loading Summary

Outfall Node	Flow Freq Pcnt	Avg Flow CMS	Max Flow CMS	Total Volume 10^6 ltr
OF1	37.04	0.008	0.037	0.273
OF2	9.54	0.000	0.001	0.002
OF3	6.89	0.000	0.001	0.001
System	17.82	0.008	0.038	0.276

 Link Flow Summary

Link	Type	Maximum Flow CMS	Time of Max Occurrence days hr:min	Maximum Veloc m/sec	Max/ Full Flow	Max/ Full Depth
C1	CONDUIT	0.008	0 01:00	0.86	0.08	0.19
Pipe_-(23)-(STORM)_2	CONDUIT	0.031	0 00:57	1.07	0.63	1.00
Pipe_-(23)-(STORM)_3	CONDUIT	0.011	0 00:59	0.66	0.18	1.00
Pipe_-(23)-(STORM)_4	CONDUIT	0.020	0 00:58	0.82	0.39	1.00
Pipe_-(24)-(1)-(STORM)_1	CONDUIT	0.041	0 00:56	1.14	0.42	1.00
Pipe_-(24)-(1)-(STORM)_2	CONDUIT	0.044	0 00:55	1.25	0.45	1.00
Pipe_-(25)-(STORM)_1	CONDUIT	0.034	0 00:55	0.83	0.28	1.00
Pipe_-(25)-(STORM)_3	CONDUIT	0.033	0 00:55	0.74	0.27	1.00
Pipe_-(25)-(STORM)_4	CONDUIT	0.031	0 00:55	0.81	0.24	1.00
Pipe_-(26)-(STORM)_1	CONDUIT	0.030	0 00:55	0.51	0.10	1.00
Pipe_-(26)-(STORM)_3	CONDUIT	0.026	0 01:11	0.17	0.09	1.00
Pipe_-(26)-(STORM)_5	CONDUIT	0.036	0 01:10	0.94	0.12	0.23
Pipe_-(26)-(STORM)_6	CONDUIT	0.029	0 01:12	0.89	0.10	0.21
W1	WEIR	0.000	0 00:00			0.00
W10	WEIR	0.000	0 00:00			0.00
W11	WEIR	0.000	0 00:00			0.00
W12	WEIR	0.000	0 00:00			0.00
W13	WEIR	0.000	0 00:00			0.00
W14	WEIR	0.000	0 00:00			0.00
W15	WEIR	0.000	0 00:00			0.00
W16	WEIR	0.000	0 00:00			0.00
W17	WEIR	0.000	0 00:00			0.00
W18	WEIR	0.000	0 00:00			0.00
W19	WEIR	0.000	0 00:00			0.00
W2	WEIR	0.000	0 00:00			0.00
W3	WEIR	0.000	0 00:00			0.00
W4	WEIR	0.000	0 00:00			0.00
W5	WEIR	0.000	0 00:00			0.00
W6	WEIR	0.000	0 00:00			0.00
W7	WEIR	0.000	0 00:00			0.00
W8	WEIR	0.000	0 00:00			0.00
W9	WEIR	0.000	0 00:00			0.00
OL01	DUMMY	0.010	0 01:00			
OL02	DUMMY	0.012	0 01:00			
OL03	DUMMY	0.011	0 01:00			
OL04	DUMMY	0.014	0 01:00			
OL05	DUMMY	0.011	0 01:00			
OL06	DUMMY	0.010	0 01:00			
OL07	DUMMY	0.020	0 01:00			
OL08	DUMMY	0.012	0 01:00			
OL101	DUMMY	0.011	0 01:00			
OL-CONTROL	DUMMY	0.029	0 01:12			
OL-ROOF	DUMMY	0.006	0 00:49			

 Flow Classification Summary

Conduit	Adjusted /Actual Length	Fraction of Time in Flow Class								
		Dry	Up Dry	Down Dry	Sub Crit	Sup Crit	Up Crit	Down Crit	Norm Ltd	Inlet Ctrl
C1	1.00	0.02	0.00	0.00	0.00	0.00	0.00	0.98	0.00	0.00
Pipe_-(23)-(STORM)_2	1.00	0.02	0.00	0.00	0.04	0.00	0.00	0.95	0.00	0.00
Pipe_-(23)-(STORM)_3	1.00	0.02	0.00	0.00	0.98	0.00	0.00	0.00	0.91	0.00
Pipe_-(23)-(STORM)_4	1.00	0.02	0.06	0.00	0.93	0.00	0.00	0.00	0.95	0.00
Pipe_-(24)-(1)-(STORM)_1	1.00	0.02	0.03	0.00	0.90	0.05	0.00	0.00	0.94	0.00
Pipe_-(24)-(1)-(STORM)_2	1.00	0.02	0.00	0.00	0.05	0.00	0.00	0.93	0.01	0.00
Pipe_-(25)-(STORM)_1	1.00	0.02	0.00	0.00	0.83	0.00	0.00	0.15	0.64	0.00
Pipe_-(25)-(STORM)_3	1.00	0.02	0.15	0.00	0.83	0.00	0.00	0.00	0.92	0.00
Pipe_-(25)-(STORM)_4	1.00	0.02	0.00	0.00	0.06	0.00	0.00	0.91	0.00	0.00
Pipe_-(26)-(STORM)_1	1.00	0.02	0.07	0.00	0.91	0.00	0.00	0.00	0.88	0.00
Pipe_-(26)-(STORM)_3	1.00	0.02	0.00	0.00	0.43	0.00	0.00	0.55	0.20	0.00
Pipe_-(26)-(STORM)_5	1.00	0.02	0.00	0.00	0.00	0.00	0.00	0.98	0.00	0.00
Pipe_-(26)-(STORM)_6	1.00	0.02	0.00	0.00	0.12	0.00	0.00	0.86	0.11	0.00

 Conduit Surge Summary

Conduit	Hours Full			Hours	Hours
	Both Ends	Upstream	Dnstream	Above Full Normal Flow	Capacity Limited
Pipe_-(23)_-(STORM)_2	0.76	0.76	0.83	0.01	0.01
Pipe_-(23)_-(STORM)_3	0.49	0.49	0.63	0.01	0.01
Pipe_-(23)_-(STORM)_4	0.63	0.63	0.76	0.01	0.01
Pipe_-(24)_-(1)_-(STORM)_1	0.83	0.83	1.06	0.01	0.01
Pipe_-(24)_-(1)_-(STORM)_2	1.06	1.06	1.22	0.01	0.01
Pipe_-(25)_-(STORM)_1	1.22	1.22	1.24	0.01	0.01
Pipe_-(25)_-(STORM)_3	1.24	1.24	1.35	0.01	0.01
Pipe_-(25)_-(STORM)_4	1.35	1.35	1.40	0.01	0.01
Pipe_-(26)_-(STORM)_1	1.46	1.46	1.55	0.01	0.01
Pipe_-(26)_-(STORM)_3	1.55	1.55	1.72	0.01	0.01

Analysis begun on: Mon Mar 20 15:01:25 2023
 Analysis ended on: Mon Mar 20 15:01:32 2023
 Total elapsed time: 00:00:07

5-Year 3-Hour Chicago Storm Event

Parking Lot Surface Storage Depth and Volume

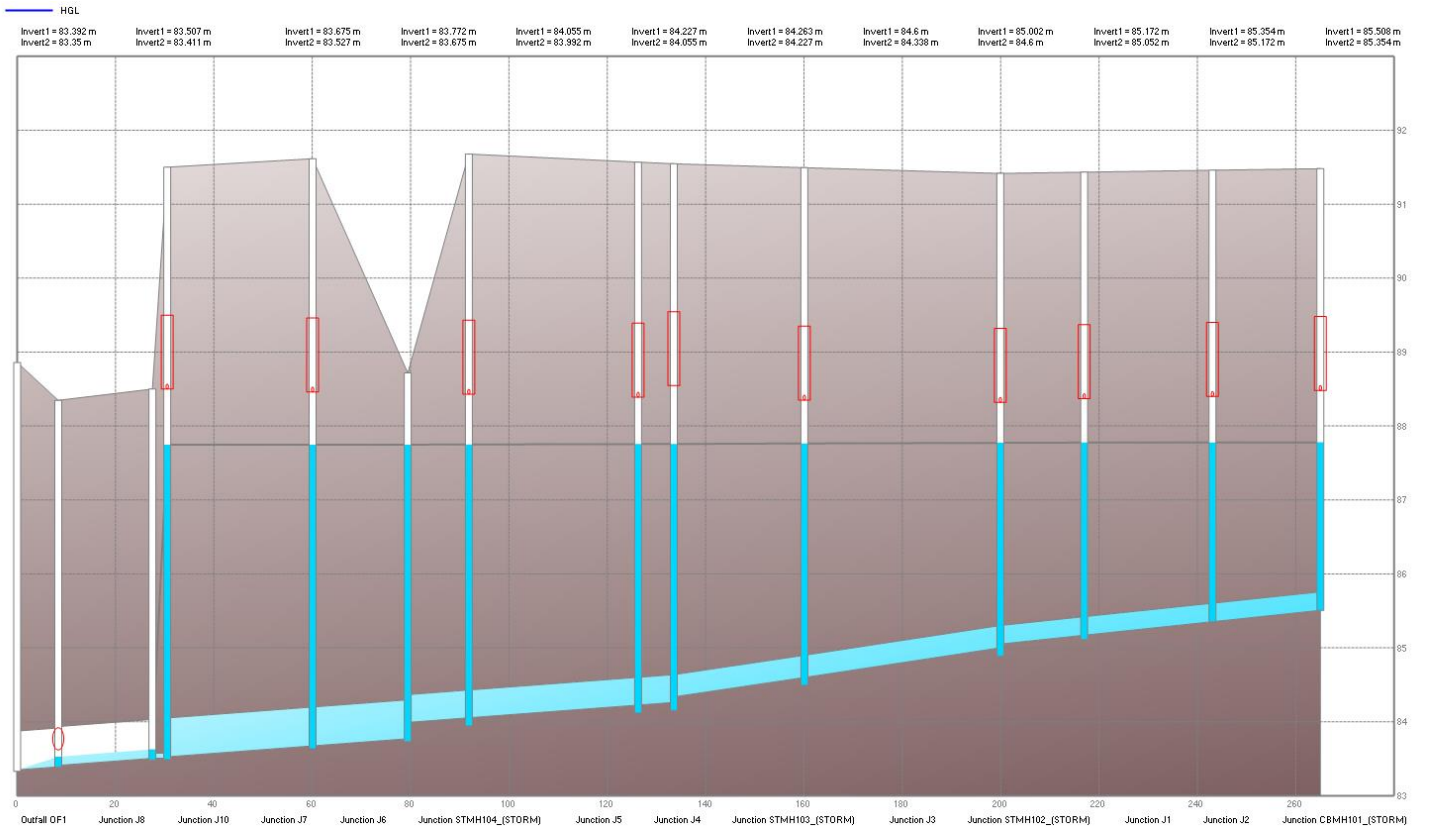
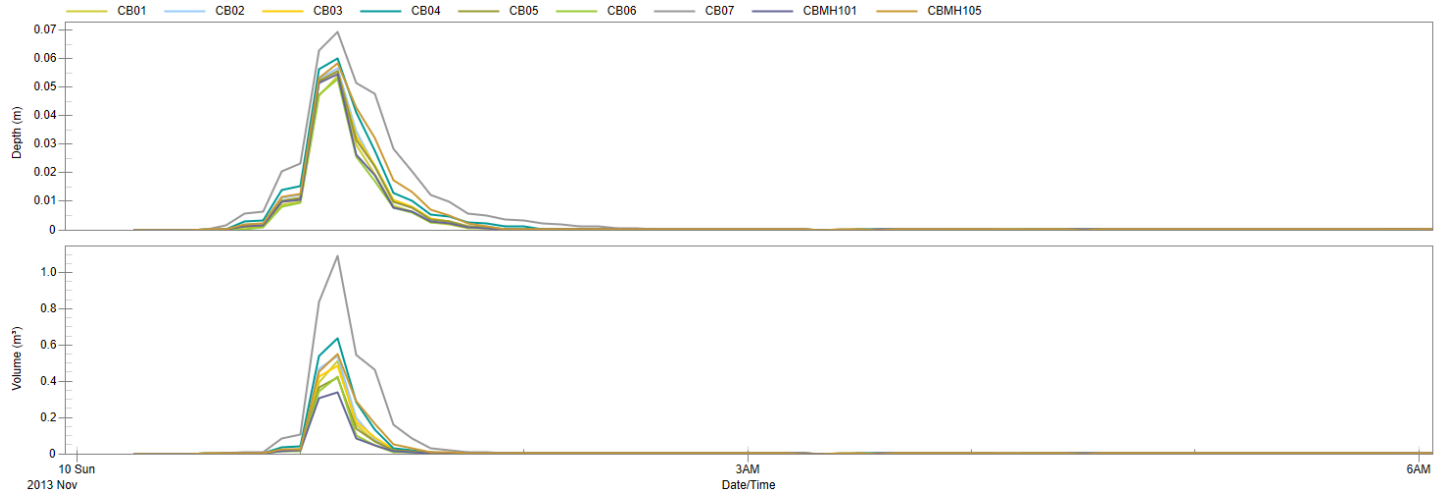

EPA STORM WATER MANAGEMENT MODEL - VERSION 5.1 (Build 5.1.015)

```

*****
Element Count
*****
Number of rain gages ..... 17
Number of subcatchments ... 15
Number of nodes ..... 28
Number of links ..... 43
Number of pollutants ..... 0
Number of land uses ..... 0
    
```

Raingage Summary

Name	Data Source	Data Type	Recording Interval
------	-------------	-----------	--------------------

100yr_3hr_Chicago	100yr_3hr_Chicago	INTENSITY	10 min.
100yr_3hr_Chicago_Climate_Change	100yr_3hr_Chicago_Increase_20percent	INTENSITY	10 min.
100yr_6hr_Chicago	100yr_6hr_Chicago	INTENSITY	10 min.
100yr_6hr_Chicago_Climate_Change	100yr_6hr_Chicago_Increase_20percent	INTENSITY	10 min.
10yr_3hr_Chicago	10yr_3hr_Chicago	INTENSITY	10 min.
10yr_6hr_Chicago	10yr_6hr_Chicago	INTENSITY	10 min.
25mm_3hr_Chicago	25mm_3hr_Chicago	INTENSITY	10 min.
25mm_4hr_Chicago	25mm_4hr_Chicago	INTENSITY	10 min.
25yr_3hr_Chicago	25yr_3hr_Chicago	INTENSITY	10 min.
25yr_6hr_Chicago	25yr_6hr_Chicago	INTENSITY	10 min.
2yr_3hr_Chicago	2yr_3hr_Chicago	INTENSITY	10 min.
2yr_6hr_Chicago	2yr_6hr_Chicago	INTENSITY	10 min.
50yr_3hr_Chicago	50yr_3hr_Chicago	INTENSITY	10 min.
50yr_6hr_Chicago	50yr_6hr_Chicago	INTENSITY	10 min.
5yr	5yr	INTENSITY	10 min.
5yr_3hr_Chicago	5yr_3hr_Chicago	INTENSITY	10 min.
5yr_6hr_Chicago	5yr_6hr_Chicago	INTENSITY	10 min.

Subcatchment Summary

Name	Area	Width	%Imperv	%Slope	Rain	Gage	Outlet
S101	0.07	27.77	68.30	2.1000	5yr		CBMH101
S102	0.08	28.93	59.80	2.0000	5yr		CB01
S103	0.08	31.11	64.90	2.5000	5yr		CB02
S104	0.09	25.00	57.80	2.2000	5yr		CB03
S105	0.10	40.49	66.40	1.8000	5yr		CB04
S106	0.09	33.36	57.90	1.5000	5yr		CB05
S107	0.06	14.60	76.60	2.0000	5yr		CB06
S108	0.19	51.95	47.60	2.0000	5yr		CB07
S109	0.16	42.40	34.50	2.2000	5yr		CBMH105
S110	0.08	4.83	16.70	0.8000	5yr		OF1
S111	0.02	4.78	30.90	1.5000	5yr		OF2
S112	0.03	3.34	5.00	0.8000	5yr		OF3
S113	0.04	4.12	5.00	0.8500	5yr		OF3
SBLDG_CY	0.19	28.30	5.00	0.5000	5yr		J9
SBLDG_roof	0.34	261.54	100.00	0.5000	5yr		ROOF

Node Summary

Name	Type	Invert Elev.	Max. Depth	Ponded Area	External Inflow
CBMH101_(STORM)	JUNCTION	85.59	5.89	0.0	
J1	JUNCTION	85.11	6.32	0.0	
J10	JUNCTION	83.49	5.01	0.0	
J2	JUNCTION	85.37	6.08	0.0	
J3	JUNCTION	84.49	7.00	0.0	
J4	JUNCTION	84.12	7.45	0.0	
J5	JUNCTION	83.94	7.73	0.0	
J6	JUNCTION	83.64	7.98	0.0	
J7	JUNCTION	83.49	8.01	0.0	
J8	JUNCTION	83.39	4.96	0.0	
J9	JUNCTION	83.76	5.23	0.0	
STM_CAP_02_(STORM)	JUNCTION	84.65	4.34	0.0	
STMH102_(STORM)	JUNCTION	84.89	6.52	0.0	
STMH103_(STORM)	JUNCTION	84.15	7.39	0.0	
STMH104_(STORM)	JUNCTION	83.73	4.99	0.0	
OF1	OUTFALL	83.33	0.54	0.0	
OF2	OUTFALL	0.00	0.00	0.0	
OF3	OUTFALL	0.00	0.00	0.0	
CB01	STORAGE	88.40	0.41	0.0	
CB02	STORAGE	88.37	0.40	0.0	
CB03	STORAGE	88.32	0.51	0.0	
CB04	STORAGE	88.35	0.47	0.0	
CB05	STORAGE	88.39	0.45	0.0	
CB06	STORAGE	88.43	0.38	0.0	
CB07	STORAGE	88.46	0.44	0.0	
CBMH101	STORAGE	88.48	0.35	0.0	
CBMH105	STORAGE	88.50	0.46	0.0	
ROOF	STORAGE	100.00	6.00	0.0	

Link Summary

Name	From Node	To Node	Type	Length	%Slope	Roughness
C1	J9	J8	CONDUIT	13.1	1.1050	0.0130
Pipe_-(23)_(STORM)_2	J1	STMH102_(STORM)	CONDUIT	17.1	0.7035	0.0130
Pipe_-(23)_(STORM)_3	CBMH101_(STORM)	J2	CONDUIT	21.9	0.9983	0.0130
Pipe_-(23)_(STORM)_4	J2	J1	CONDUIT	26.1	0.7744	0.0130
Pipe_-(24)_(1)_(STORM)_1	STMH102_(STORM)	J3	CONDUIT	39.9	1.0084	0.0130
Pipe_-(24)_(1)_(STORM)_2	J3	STMH103_(STORM)	CONDUIT	26.5	0.9873	0.0130
Pipe_-(25)_(STORM)_1	STMH103_(STORM)	J4	CONDUIT	7.3	0.4962	0.0130
Pipe_-(25)_(STORM)_3	J4	J5	CONDUIT	34.4	0.4996	0.0130
Pipe_-(25)_(STORM)_4	J5	STMH104_(STORM)	CONDUIT	12.4	0.5071	0.0130
Pipe_-(26)_(STORM)_1	STMH104_(STORM)	J6	CONDUIT	19.4	0.5010	0.0130
Pipe_-(26)_(STORM)_3	J6	J7	CONDUIT	29.6	0.5009	0.0130
Pipe_-(26)_(STORM)_5	J8	OF1	CONDUIT	8.3	0.5040	0.0130
Pipe_-(26)_(STORM)_6	J10	J8	CONDUIT	19.2	0.5013	0.0130
W1	CBMH101	CB01	WEIR			
W10	CBMH101_(STORM)	CBMH101	WEIR			
W11	J2	CB01	WEIR			
W12	J1	CB02	WEIR			
W13	STMH102_(STORM)	CB03	WEIR			
W14	J3	CB04	WEIR			
W15	J4	CB05	WEIR			
W16	J5	CB06	WEIR			
W17	J6	CB07	WEIR			
W18	J7	CBMH105	WEIR			

W19	STMH103_(STORM)	CB05	WEIR
W2	CB01	CB02	WEIR
W3	CB02	CB03	WEIR
W4	CB04	CB03	WEIR
W5	CB03	OF2	WEIR
W6	CB05	CB04	WEIR
W7	CB06	CB05	WEIR
W8	CB07	CB06	WEIR
W9	CBMH105	CB07	WEIR
OL01	CB01	J2	OUTLET
OL02	CB02	J1	OUTLET
OL03	CB03	STMH102_(STORM)	OUTLET
OL04	CB04	J3	OUTLET
OL05	CB05	J4	OUTLET
OL06	CB06	J5	OUTLET
OL07	CB07	J6	OUTLET
OL08	CBMH105	J7	OUTLET
OL101	CBMH101	CBMH101_(STORM)	OUTLET
OL-CONTROL	J7	J10	OUTLET
OL-ROOF	ROOF	J9	OUTLET

Cross Section Summary

Conduit	Shape	Full Depth	Full Area	Hyd. Rad.	Max. Width	No. of Barrels	Full Flow
C1	CIRCULAR	0.30	0.07	0.07	0.30	1	0.10
Pipe_(23)_(STORM)_2	CIRCULAR	0.25	0.05	0.06	0.25	1	0.05
Pipe_(23)_(STORM)_3	CIRCULAR	0.25	0.05	0.06	0.25	1	0.06
Pipe_(23)_(STORM)_4	CIRCULAR	0.25	0.05	0.06	0.25	1	0.05
Pipe_(24)_(1)_(STORM)_1	CIRCULAR	0.30	0.07	0.07	0.30	1	0.10
Pipe_(24)_(1)_(STORM)_2	CIRCULAR	0.30	0.07	0.07	0.30	1	0.10
Pipe_(25)_(STORM)_1	CIRCULAR	0.38	0.11	0.09	0.38	1	0.12
Pipe_(25)_(STORM)_3	CIRCULAR	0.38	0.11	0.09	0.38	1	0.12
Pipe_(25)_(STORM)_4	CIRCULAR	0.38	0.11	0.09	0.38	1	0.12
Pipe_(26)_(STORM)_1	CIRCULAR	0.53	0.22	0.13	0.53	1	0.30
Pipe_(26)_(STORM)_3	CIRCULAR	0.53	0.22	0.13	0.53	1	0.30
Pipe_(26)_(STORM)_5	CIRCULAR	0.53	0.22	0.13	0.53	1	0.31
Pipe_(26)_(STORM)_6	CIRCULAR	0.53	0.22	0.13	0.53	1	0.30

NOTE: The summary statistics displayed in this report are based on results found at every computational time step, not just on results from each reporting time step.

Analysis Options

Flow Units CMS
Process Models:
 Rainfall/Runoff YES
 RDII NO
 Snowmelt NO
 Groundwater NO
 Flow Routing YES
 Ponding Allowed YES
 Water Quality NO
Infiltration Method HORTON
Flow Routing Method DYNWAVE
Surcharge Method EXTRAN
Starting Date 11/10/2013 00:10:00
Ending Date 11/11/2013 03:00:00
Antecedent Dry Days 0.0
Report Time Step 00:05:00
Wet Time Step 00:05:00
Dry Time Step 00:05:00
Routing Time Step 1.00 sec
Variable Time Step YES
Maximum Trials 20
Number of Threads 2
Head Tolerance 0.001500 m

	Volume hectare-m	Depth mm
Runoff Quantity Continuity		

Total Precipitation	0.069	42.514
Evaporation Loss	0.000	0.000
Infiltration Loss	0.029	17.673
Surface Runoff	0.039	24.176
Final Storage	0.001	0.860
Continuity Error (%)	-0.458	

	Volume hectare-m	Volume 10^6 ltr
Flow Routing Continuity		

Dry Weather Inflow	0.000	0.000
Wet Weather Inflow	0.039	0.391
Groundwater Inflow	0.000	0.000
RDII Inflow	0.000	0.000
External Inflow	0.000	0.000
External Outflow	0.040	0.396
Flooding Loss	0.000	0.000
Evaporation Loss	0.000	0.000
Exfiltration Loss	0.000	0.000
Initial Stored Volume	0.000	0.000
Final Stored Volume	0.000	0.000
Continuity Error (%)	-1.246	

Highest Continuity Errors

Node CB06 (-3.80%)
Node CB01 (-2.62%)
Node CBMH101 (-2.36%)
Node CB03 (-2.30%)
Node CB05 (-2.25%)

Time-Step Critical Elements

None

Highest Flow Instability Indexes

Link OL06 (5)
Link OL04 (5)
Link OL07 (5)
Link OL03 (5)
Link OL05 (4)

Routing Time Step Summary

Minimum Time Step : 0.46 sec
Average Time Step : 1.00 sec
Maximum Time Step : 1.00 sec
Percent in Steady State : 0.00
Average Iterations per Step : 2.01
Percent Not Converging : 0.00
Time Step Frequencies :
1.000 - 0.871 sec : 100.00 %
0.871 - 0.758 sec : 0.00 %
0.758 - 0.660 sec : 0.00 %
0.660 - 0.574 sec : 0.00 %
0.574 - 0.500 sec : 0.00 %

Subcatchment Runoff Summary

Subcatchment	Total Precip mm	Total Runon mm	Total Evap mm	Total Infil mm	Imperv Runoff mm	Perv Runoff mm	Total Runoff mm	Total Runoff 10 ⁶ ltr	Peak Runoff CMS	Runoff Coeff
S101	42.51	0.00	0.00	11.73	28.10	1.87	29.97	0.02	0.02	0.705
S102	42.51	0.00	0.00	15.00	24.60	2.22	26.82	0.02	0.02	0.631
S103	42.51	0.00	0.00	13.00	26.69	2.05	28.74	0.02	0.02	0.676
S104	42.51	0.00	0.00	15.89	23.79	2.16	25.95	0.02	0.02	0.610
S105	42.51	0.00	0.00	12.46	27.32	1.95	29.27	0.03	0.02	0.688
S106	42.51	0.00	0.00	15.79	23.82	2.22	26.05	0.02	0.02	0.613
S107	42.51	0.00	0.00	8.70	31.59	1.32	32.91	0.02	0.01	0.774
S108	42.51	0.00	0.00	19.93	19.59	2.45	22.04	0.04	0.03	0.518
S109	42.51	0.00	0.00	25.09	14.18	2.86	17.04	0.03	0.02	0.401
S110	42.51	0.00	0.00	34.43	6.89	1.00	7.89	0.01	0.00	0.186
S111	42.51	0.00	0.00	26.89	12.71	2.56	15.27	0.00	0.00	0.359
S112	42.51	0.00	0.00	38.69	2.06	1.73	3.79	0.00	0.00	0.089
S113	42.51	0.00	0.00	38.67	2.06	1.75	3.81	0.00	0.00	0.090
SBLDG_CY	42.51	0.00	0.00	38.68	2.06	1.74	3.79	0.01	0.00	0.089
SBLDG_roof	42.51	0.00	0.00	0.00	41.20	0.00	41.20	0.14	0.10	0.969

Node Depth Summary

Node	Type	Average Depth Meters	Maximum Depth Meters	Maximum HGL Meters	Time of Max Occurrence days hr:min	Reported Max Depth Meters
CBMH101_(STORM)	JUNCTION	0.07	2.26	87.85	0 01:14	2.26
J1	JUNCTION	0.15	2.74	87.85	0 01:14	2.74
J10	JUNCTION	0.03	0.14	83.63	0 01:14	0.14
J2	JUNCTION	0.08	2.48	87.85	0 01:14	2.48
J3	JUNCTION	0.23	3.35	87.84	0 01:14	3.35
J4	JUNCTION	0.26	3.71	87.83	0 01:14	3.71
J5	JUNCTION	0.27	3.88	87.83	0 01:14	3.88
J6	JUNCTION	0.24	4.19	87.82	0 01:14	4.19
J7	JUNCTION	0.28	4.34	87.82	0 01:14	4.33
J8	JUNCTION	0.02	0.14	83.53	0 01:12	0.14
J9	JUNCTION	0.02	0.07	83.83	0 01:00	0.07
STM_CAP_02_(STORM)	JUNCTION	0.00	0.00	84.65	0 00:00	0.00
STMH102_(STORM)	JUNCTION	0.21	2.96	87.85	0 01:14	2.95
STMH103_(STORM)	JUNCTION	0.26	3.68	87.83	0 01:14	3.68
STMH104_(STORM)	JUNCTION	0.23	4.09	87.82	0 01:14	4.09
OF1	OUTFALL	0.00	0.00	83.33	0 00:00	0.00
OF2	OUTFALL	0.00	0.00	0.00	0 00:00	0.00
OF3	OUTFALL	0.00	0.00	0.00	0 00:00	0.00
CB01	STORAGE	0.00	0.05	88.45	0 01:00	0.05
CB02	STORAGE	0.00	0.06	88.43	0 01:00	0.06
CB03	STORAGE	0.00	0.06	88.38	0 01:00	0.06
CB04	STORAGE	0.00	0.06	88.41	0 01:00	0.06
CB05	STORAGE	0.00	0.06	88.45	0 01:00	0.06
CB06	STORAGE	0.00	0.05	88.48	0 01:00	0.05
CB07	STORAGE	0.00	0.07	88.53	0 01:00	0.07
CBMH101	STORAGE	0.00	0.05	88.53	0 01:00	0.05

CBMH105 STORAGE 0.00 0.06 88.56 0 01:00 0.06
 ROOF STORAGE 0.02 0.09 100.09 0 01:53 0.09

 Node Inflow Summary

Node	Type	Maximum Lateral Inflow CMS	Maximum Total Inflow CMS	Time of Max Occurrence days hr:min	Lateral Inflow Volume 10^6 ltr	Total Inflow Volume 10^6 ltr	Flow Balance Error Percent
CBMH101_(STORM)	JUNCTION	0.000	0.016	0 01:00	0	0.0221	-0.322
J1	JUNCTION	0.000	0.044	0 00:56	0	0.0683	0.344
J10	JUNCTION	0.000	0.036	0 01:14	0	0.237	0.048
J2	JUNCTION	0.000	0.029	0 00:57	0	0.0437	0.023
J3	JUNCTION	0.000	0.060	0 00:54	0	0.122	-0.154
J4	JUNCTION	0.000	0.045	0 00:55	0	0.145	0.061
J5	JUNCTION	0.000	0.045	0 00:55	0	0.166	0.163
J6	JUNCTION	0.000	0.053	0 00:55	0	0.209	0.055
J7	JUNCTION	0.000	0.045	0 01:00	0	0.237	-0.014
J8	JUNCTION	0.000	0.044	0 01:12	0	0.384	-0.025
J9	JUNCTION	0.004	0.010	0 01:00	0.00708	0.147	0.007
STM_CAP_02_(STORM)	JUNCTION	0.000	0.000	0 00:00	0	0	0.000 ltr
STMH102_(STORM)	JUNCTION	0.000	0.053	0 00:55	0	0.0919	-0.166
STMH103_(STORM)	JUNCTION	0.000	0.040	0 00:53	0	0.122	-0.101
STMH104_(STORM)	JUNCTION	0.000	0.028	0 00:55	0	0.166	-0.233
OF1	OUTFALL	0.004	0.046	0 01:10	0.00641	0.391	0.000
OF2	OUTFALL	0.002	0.002	0 01:00	0.00328	0.00328	0.000
OF3	OUTFALL	0.001	0.001	0 01:00	0.00239	0.00239	0.000
CB01	STORAGE	0.016	0.016	0 01:00	0.0209	0.0209	-2.552
CB02	STORAGE	0.018	0.018	0 01:00	0.0241	0.0241	-1.772
CB03	STORAGE	0.017	0.017	0 01:00	0.0234	0.0234	-2.251
CB04	STORAGE	0.022	0.022	0 01:00	0.029	0.029	-1.509
CB05	STORAGE	0.017	0.017	0 01:00	0.023	0.023	-2.203
CB06	STORAGE	0.015	0.015	0 01:00	0.0202	0.0202	-3.660
CB07	STORAGE	0.031	0.031	0 01:00	0.0424	0.0424	-1.236
CBMH101	STORAGE	0.016	0.016	0 01:00	0.0216	0.0216	-2.301
CBMH105	STORAGE	0.020	0.020	0 01:00	0.0275	0.0275	-1.372
ROOF	STORAGE	0.098	0.098	0 01:00	0.14	0.14	0.005

 Node Surcharge Summary

Surcharging occurs when water rises above the top of the highest conduit.

Node	Type	Hours Surcharged	Max. Height Above Crown Meters	Min. Depth Below Rim Meters
STM_CAP_02_(STORM)	JUNCTION	26.83	0.000	4.343
STMH104_(STORM)	JUNCTION	2.01	3.458	0.892

 Node Flooding Summary

No nodes were flooded.

 Storage Volume Summary

Storage Unit	Average Volume 1000 m3	Avg Pcnt Full	Evap Pcnt Loss	Exfil Pcnt Loss	Maximum Volume 1000 m3	Max Pcnt Full	Time of Max Occurrence days hr:min	Maximum Outflow CMS
CB01	0.000	0	0	0	0.001	1	0 01:00	0.016
CB02	0.000	0	0	0	0.001	1	0 01:00	0.018
CB03	0.000	0	0	0	0.000	0	0 01:00	0.017
CB04	0.000	0	0	0	0.001	0	0 01:00	0.022
CB05	0.000	0	0	0	0.000	0	0 01:00	0.017
CB06	0.000	0	0	0	0.000	1	0 01:00	0.015
CB07	0.000	0	0	0	0.001	1	0 01:00	0.031
CBMH101	0.000	0	0	0	0.000	1	0 01:00	0.016
CBMH105	0.000	0	0	0	0.001	1	0 01:00	0.020
ROOF	0.014	0	0	0	0.095	0	0 01:53	0.006

 Outfall Loading Summary

Outfall Node	Flow Freq Pcnt	Avg Flow CMS	Max Flow CMS	Total Volume 10^6 ltr
OF1	37.44	0.011	0.046	0.391
OF2	9.98	0.000	0.002	0.003
OF3	8.79	0.000	0.001	0.002
System	18.74	0.011	0.048	0.396

 Link Flow Summary

Link	Type	Maximum Flow CMS	Time of Max Occurrence days hr:min	Maximum Veloc m/sec	Max/ Full Flow	Max/ Full Depth
C1	CONDUIT	0.010	0 01:00	0.92	0.10	0.21
Pipe_-(23)-(STORM)_2	CONDUIT	0.038	0 00:55	1.12	0.76	1.00
Pipe_-(23)-(STORM)_3	CONDUIT	0.015	0 00:57	0.75	0.25	1.00
Pipe_-(23)-(STORM)_4	CONDUIT	0.028	0 00:56	0.85	0.53	1.00
Pipe_-(24)-(1)-(STORM)_1	CONDUIT	0.043	0 00:54	1.11	0.44	1.00
Pipe_-(24)-(1)-(STORM)_2	CONDUIT	0.040	0 00:53	1.12	0.41	1.00
Pipe_-(25)-(STORM)_1	CONDUIT	0.031	0 00:53	0.73	0.25	1.00
Pipe_-(25)-(STORM)_3	CONDUIT	0.033	0 00:55	0.79	0.27	1.00
Pipe_-(25)-(STORM)_4	CONDUIT	0.028	0 00:55	0.84	0.22	1.00
Pipe_-(26)-(STORM)_1	CONDUIT	0.028	0 00:55	0.49	0.09	1.00
Pipe_-(26)-(STORM)_3	CONDUIT	0.031	0 01:17	0.18	0.10	1.00
Pipe_-(26)-(STORM)_5	CONDUIT	0.044	0 01:12	1.01	0.15	0.26
Pipe_-(26)-(STORM)_6	CONDUIT	0.036	0 01:14	0.95	0.12	0.23
W1	WEIR	0.000	0 00:00			0.00
W10	WEIR	0.000	0 00:00			0.00
W11	WEIR	0.000	0 00:00			0.00
W12	WEIR	0.000	0 00:00			0.00
W13	WEIR	0.000	0 00:00			0.00
W14	WEIR	0.000	0 00:00			0.00
W15	WEIR	0.000	0 00:00			0.00
W16	WEIR	0.000	0 00:00			0.00
W17	WEIR	0.000	0 00:00			0.00
W18	WEIR	0.000	0 00:00			0.00
W19	WEIR	0.000	0 00:00			0.00
W2	WEIR	0.000	0 00:00			0.00
W3	WEIR	0.000	0 00:00			0.00
W4	WEIR	0.000	0 00:00			0.00
W5	WEIR	0.000	0 00:00			0.00
W6	WEIR	0.000	0 00:00			0.00
W7	WEIR	0.000	0 00:00			0.00
W8	WEIR	0.000	0 00:00			0.00
W9	WEIR	0.000	0 00:00			0.00
OL01	DUMMY	0.016	0 01:00			
OL02	DUMMY	0.018	0 01:00			
OL03	DUMMY	0.017	0 01:00			
OL04	DUMMY	0.022	0 01:00			
OL05	DUMMY	0.017	0 01:00			
OL06	DUMMY	0.015	0 01:00			
OL07	DUMMY	0.031	0 01:00			
OL08	DUMMY	0.020	0 01:00			
OL101	DUMMY	0.016	0 01:00			
OL-CONTROL	DUMMY	0.036	0 01:14			
OL-ROOF	DUMMY	0.006	0 00:45			

Flow Classification Summary

Conduit	Adjusted /Actual Length	----- Fraction of Time in Flow Class -----								
		Up Dry	Down Dry	Sub Dry	Sup Crit	Up Crit	Down Crit	Norm Ltd	Inlet Ctrl	
C1	1.00	0.01	0.00	0.00	0.00	0.00	0.99	0.00	0.00	
Pipe_-(23)-(STORM)_2	1.00	0.01	0.00	0.00	0.06	0.00	0.93	0.00	0.00	
Pipe_-(23)-(STORM)_3	1.00	0.01	0.00	0.00	0.99	0.00	0.00	0.78	0.00	
Pipe_-(23)-(STORM)_4	1.00	0.01	0.09	0.00	0.90	0.00	0.00	0.93	0.00	
Pipe_-(24)-(1)-(STORM)_1	1.00	0.02	0.10	0.00	0.85	0.03	0.00	0.92	0.00	
Pipe_-(24)-(1)-(STORM)_2	1.00	0.02	0.00	0.00	0.07	0.00	0.00	0.91	0.01	
Pipe_-(25)-(STORM)_1	1.00	0.02	0.00	0.00	0.85	0.00	0.00	0.13	0.59	
Pipe_-(25)-(STORM)_3	1.00	0.02	0.13	0.00	0.85	0.00	0.00	0.90	0.00	
Pipe_-(25)-(STORM)_4	1.00	0.02	0.00	0.00	0.09	0.00	0.00	0.90	0.00	
Pipe_-(26)-(STORM)_1	1.00	0.01	0.12	0.00	0.87	0.00	0.00	0.87	0.00	
Pipe_-(26)-(STORM)_3	1.00	0.01	0.00	0.00	0.43	0.00	0.00	0.55	0.20	
Pipe_-(26)-(STORM)_5	1.00	0.01	0.00	0.00	0.00	0.00	0.99	0.00	0.00	
Pipe_-(26)-(STORM)_6	1.00	0.02	0.00	0.00	0.16	0.00	0.82	0.15	0.00	

Conduit Surcharge Summary

Conduit	----- Both Ends	----- Hours -----			----- Normal Flow	----- Capacity Limited
		Hours Full Upstream	----- Dnstream	Hours Above Full		
Pipe_-(23)-(STORM)_2	1.40	1.40	1.46	0.01	0.01	
Pipe_-(23)-(STORM)_3	1.18	1.18	1.29	0.01	0.01	
Pipe_-(23)-(STORM)_4	1.29	1.29	1.40	0.01	0.01	
Pipe_-(24)-(1)-(STORM)_1	1.46	1.46	1.67	0.01	0.01	
Pipe_-(24)-(1)-(STORM)_2	1.67	1.67	1.83	0.01	0.01	
Pipe_-(25)-(STORM)_1	1.83	1.83	1.84	0.01	0.01	
Pipe_-(25)-(STORM)_3	1.84	1.84	1.96	0.01	0.01	
Pipe_-(25)-(STORM)_4	1.96	1.96	2.01	0.01	0.01	
Pipe_-(26)-(STORM)_1	2.09	2.09	2.18	0.01	0.01	
Pipe_-(26)-(STORM)_3	2.18	2.18	2.34	0.01	0.01	

Analysis begun on: Mon Mar 20 15:01:25 2023
Analysis ended on: Mon Mar 20 15:01:32 2023
Total elapsed time: 00:00:07

100-Year 3-Hour Chicago Storm Event

Parking Lot Surface Storage Depth and Volume

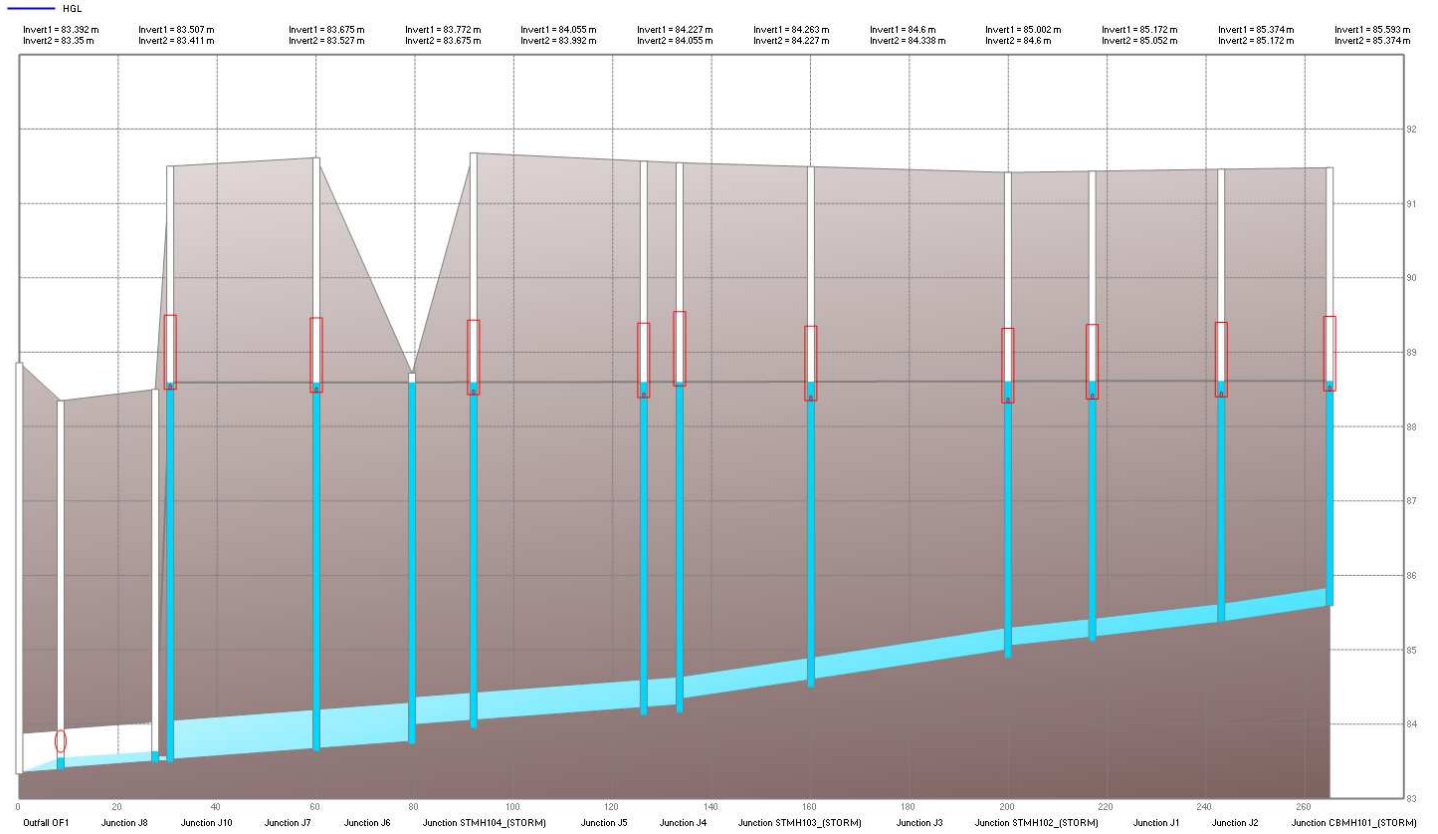
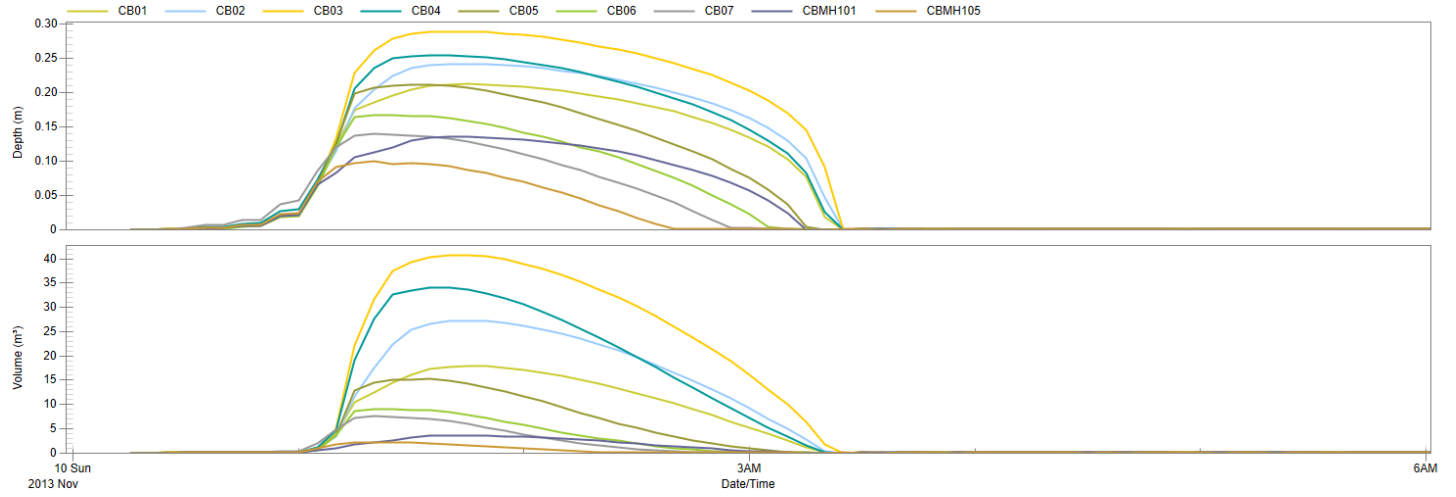

WARNING 03: negative offset ignored for Link Pipe_-(23)_ (STORM)_3
 WARNING 03: negative offset ignored for Link Pipe_-(23)_ (STORM)_3
 WARNING 03: negative offset ignored for Link Pipe_-(23)_ (STORM)_4

 Element Count

 Number of rain gages 17
 Number of subcatchments ... 15
 Number of nodes 28
 Number of links 43
 Number of pollutants 0
 Number of land uses 0

 Raingage Summary

Name	Data Source	Data Type	Recording Interval
100yr	100yr	INTENSITY	10 min.
100yr_3hr_Chicago	100yr_3hr_Chicago	INTENSITY	10 min.
100yr_3hr_Chicago_Climate_Change	100yr_3hr_Chicago_Increase_20percent	INTENSITY	10 min.
100yr_6hr_Chicago	100yr_6hr_Chicago	INTENSITY	10 min.
100yr_6hr_Chicago_Climate_Change	100yr_6hr_Chicago_Increase_20percent	INTENSITY	10 min.
10yr_3hr_Chicago	10yr_3hr_Chicago	INTENSITY	10 min.
10yr_6hr_Chicago	10yr_6hr_Chicago	INTENSITY	10 min.
25mm_3hr_Chicago	25mm_3hr_Chicago	INTENSITY	10 min.
25mm_4hr_Chicago	25mm_4hr_Chicago	INTENSITY	10 min.
25yr_3hr_Chicago	25yr_3hr_Chicago	INTENSITY	10 min.
25yr_6hr_Chicago	25yr_6hr_Chicago	INTENSITY	10 min.
2yr_3hr_Chicago	2yr_3hr_Chicago	INTENSITY	10 min.
2yr_6hr_Chicago	2yr_6hr_Chicago	INTENSITY	10 min.
50yr_3hr_Chicago	50yr_3hr_Chicago	INTENSITY	10 min.
50yr_6hr_Chicago	50yr_6hr_Chicago	INTENSITY	10 min.
5yr_3hr_Chicago	5yr_3hr_Chicago	INTENSITY	10 min.
5yr_6hr_Chicago	5yr_6hr_Chicago	INTENSITY	10 min.

 Subcatchment Summary

Name	Area	Width	%Imperv	%Slope	Rain Gage	Outlet
S101	0.07	27.77	68.30	2.1000	100yr	CBMH101
S102	0.08	28.93	59.80	2.0000	100yr	CB01
S103	0.08	31.11	64.90	2.5000	100yr	CB02
S104	0.09	25.00	57.80	2.2000	100yr	CB03
S105	0.10	40.49	66.40	1.8000	100yr	CB04
S106	0.09	33.36	57.90	1.5000	100yr	CB05
S107	0.06	14.60	76.60	2.0000	100yr	CB06
S108	0.19	51.95	47.60	2.0000	100yr	CB07
S109	0.16	42.40	34.50	2.2000	100yr	CBMH105
S110	0.08	4.83	16.70	0.8000	100yr	OF1
S111	0.02	4.78	30.90	1.5000	100yr	OF2
S112	0.03	3.34	5.00	0.8000	100yr	OF3
S113	0.04	4.12	5.00	0.8500	100yr	OF3
SBLDG_CY	0.19	28.30	5.00	0.5000	100yr	J9
SBLDG_roof	0.34	261.54	100.00	0.5000	100yr	ROOF

 Node Summary

Name	Type	Invert Elev.	Max. Depth	Ponded Area	External Inflow
CBMH101_ (STORM)	JUNCTION	85.59	5.89	0.0	
J1	JUNCTION	85.11	6.32	0.0	
J10	JUNCTION	83.49	5.01	0.0	
J2	JUNCTION	85.37	6.08	0.0	
J3	JUNCTION	84.49	7.00	0.0	
J4	JUNCTION	84.12	7.45	0.0	
J5	JUNCTION	83.94	7.73	0.0	
J6	JUNCTION	83.64	7.98	0.0	
J7	JUNCTION	83.49	8.01	0.0	
J8	JUNCTION	83.39	4.96	0.0	
J9	JUNCTION	83.76	5.23	0.0	
STM_CAP_02_ (STORM)	JUNCTION	84.65	4.34	0.0	
STMH102_ (STORM)	JUNCTION	84.89	6.52	0.0	
STMH103_ (STORM)	JUNCTION	84.15	7.39	0.0	
STMH104_ (STORM)	JUNCTION	83.73	4.99	0.0	
OF1	OUTFALL	83.33	0.54	0.0	
OF2	OUTFALL	0.00	0.00	0.0	
OF3	OUTFALL	0.00	0.00	0.0	
CB01	STORAGE	88.40	0.41	0.0	
CB02	STORAGE	88.37	0.40	0.0	
CB03	STORAGE	88.32	0.51	0.0	
CB04	STORAGE	88.35	0.47	0.0	
CB05	STORAGE	88.39	0.45	0.0	
CB06	STORAGE	88.43	0.38	0.0	
CB07	STORAGE	88.46	0.44	0.0	
CBMH101	STORAGE	88.48	0.35	0.0	
CBMH105	STORAGE	88.50	0.46	0.0	
ROOF	STORAGE	100.00	6.00	0.0	

 Link Summary

Name	From Node	To Node	Type	Length	%Slope	Roughness	
C1	J9	J8	CONDUIT	13.1	1.1050	0.0130	
Pipe_-(23)_(STORM)_2	J1	STMH102_(STORM)	J2	CONDUIT	17.1	0.7035	0.0130
Pipe_-(23)_(STORM)_3	CBMH101_(STORM)	J2	CONDUIT	21.9	0.9983	0.0130	
Pipe_-(23)_(STORM)_4	J2	J1	CONDUIT	26.1	0.7744	0.0130	
Pipe_-(24)_(1)_(STORM)_1	STMH102_(STORM)	J3	CONDUIT	39.9	1.0084	0.0130	
Pipe_-(24)_(1)_(STORM)_2	J3	STMH103_(STORM)	CONDUIT	26.5	0.9873	0.0130	
Pipe_-(25)_(STORM)_1	STMH103_(STORM)	J4	CONDUIT	7.3	0.4962	0.0130	
Pipe_-(25)_(STORM)_3	J4	J5	CONDUIT	34.4	0.4996	0.0130	
Pipe_-(25)_(STORM)_4	J5	STMH104_(STORM)	CONDUIT	12.4	0.5071	0.0130	
Pipe_-(26)_(STORM)_1	STMH104_(STORM)	J6	CONDUIT	19.4	0.5010	0.0130	
Pipe_-(26)_(STORM)_3	J6	J7	CONDUIT	29.6	0.5009	0.0130	
Pipe_-(26)_(STORM)_5	J8	OF1	CONDUIT	8.3	0.5040	0.0130	
Pipe_-(26)_(STORM)_6	J10	J8	CONDUIT	19.2	0.5013	0.0130	
W1	CBMH101	CB01	WEIR				
W10	CBMH101_(STORM)	CBMH101	WEIR				
W11	J2	CB01	WEIR				
W12	J1	CB02	WEIR				
W13	STMH102_(STORM)	CB03	WEIR				
W14	J3	CB04	WEIR				
W15	J4	CB05	WEIR				
W16	J5	CB06	WEIR				
W17	J6	CB07	WEIR				
W18	J7	CBMH105	WEIR				
W19	STMH103_(STORM)	CB05	WEIR				
W2	CB01	CB02	WEIR				
W3	CB02	CB03	WEIR				
W4	CB04	CB03	WEIR				
W5	CB03	OF2	WEIR				
W6	CB05	CB04	WEIR				
W7	CB06	CB05	WEIR				
W8	CB07	CB06	WEIR				
W9	CBMH105	CB07	WEIR				
OL01	CB01	J2	OUTLET				
OL02	CB02	J1	OUTLET				
OL03	CB03	STMH102_(STORM)	OUTLET				
OL04	CB04	J3	OUTLET				
OL05	CB05	J4	OUTLET				
OL06	CB06	J5	OUTLET				
OL07	CB07	J6	OUTLET				
OL08	CBMH105	J7	OUTLET				
OL101	CBMH101	CBMH101_(STORM)	OUTLET				
OL-CONTROL	J7	J10	OUTLET				
OL-ROOF	ROOF	J9	OUTLET				

 Cross Section Summary

Conduit	Shape	Full Depth	Full Area	Hyd. Rad.	Max. Width	No. of Barrels	Full Flow
C1	CIRCULAR	0.30	0.07	0.07	0.30	1	0.10
Pipe_-(23)_(STORM)_2	CIRCULAR	0.25	0.05	0.05	0.25	1	0.05
Pipe_-(23)_(STORM)_3	CIRCULAR	0.25	0.05	0.05	0.25	1	0.06
Pipe_-(23)_(STORM)_4	CIRCULAR	0.25	0.05	0.05	0.25	1	0.05
Pipe_-(24)_(1)_(STORM)_1	CIRCULAR	0.30	0.07	0.07	0.30	1	0.10
Pipe_-(24)_(1)_(STORM)_2	CIRCULAR	0.30	0.07	0.07	0.30	1	0.10
Pipe_-(25)_(STORM)_1	CIRCULAR	0.38	0.11	0.09	0.38	1	0.12
Pipe_-(25)_(STORM)_3	CIRCULAR	0.38	0.11	0.09	0.38	1	0.12
Pipe_-(25)_(STORM)_4	CIRCULAR	0.38	0.11	0.09	0.38	1	0.12
Pipe_-(26)_(STORM)_1	CIRCULAR	0.53	0.22	0.13	0.53	1	0.30
Pipe_-(26)_(STORM)_3	CIRCULAR	0.53	0.22	0.13	0.53	1	0.30
Pipe_-(26)_(STORM)_5	CIRCULAR	0.53	0.22	0.13	0.53	1	0.31
Pipe_-(26)_(STORM)_6	CIRCULAR	0.53	0.22	0.13	0.53	1	0.30

 NOTE: The summary statistics displayed in this report are based on results found at every computational time step, not just on results from each reporting time step.

Analysis Options

Flow Units CMS

Process Models:

Rainfall/Runoff YES

RDII NO

Snowmelt NO

Groundwater NO

Flow Routing YES

Ponding Allowed YES

Water Quality NO

Infiltration Method HORTON

Flow Routing Method DYNWAVE

Surcharge Method EXTRAN

Starting Date 11/10/2013 00:10:00

Ending Date 11/11/2013 03:00:00

Antecedent Dry Days 0.0

Report Time Step 00:05:00

Wet Time Step 00:05:00

Dry Time Step 00:05:00

Routing Time Step 1.00 sec

Variable Time Step YES

Maximum Trials 20

Number of Threads 2

Head Tolerance 0.001500 m

```

*****
Volume      Depth
Runoff Quantity Continuity  hectare-m      mm
*****
Total Precipitation .....  0.116      71.677
Evaporation Loss .....    0.000      0.000
Infiltration Loss .....   0.035      21.859
Surface Runoff .....      0.080      49.428
Final Storage .....       0.001      0.860
Continuity Error (%) ..... -0.656

```

```

*****
Volume      Volume
Flow Routing Continuity    hectare-m      10^6 ltr
*****
Dry Weather Inflow .....   0.000      0.000
Wet Weather Inflow .....   0.080      0.800
Groundwater Inflow .....   0.000      0.000
RDII Inflow .....         0.000      0.000
External Inflow .....      0.000      0.000
External Outflow .....     0.080      0.803
Flooding Loss .....        0.000      0.000
Evaporation Loss .....     0.000      0.000
Exfiltration Loss .....    0.000      0.000
Initial Stored Volume ....  0.000      0.000
Final Stored Volume .....  0.000      0.000
Continuity Error (%) ..... -0.357

```

```

*****
Highest Continuity Errors
*****
Node CBMH101 (STORM) (-14.73%)
Node CBMH101 (12.59%)

```

```

*****
Time-Step Critical Elements
*****
None

```

```

*****
Highest Flow Instability Indexes
*****
Link OL101 (8)
Link OL06 (7)
Link OL08 (7)
Link OL07 (6)
Link W10 (6)

```

```

*****
Routing Time Step Summary
*****
Minimum Time Step : 0.50 sec
Average Time Step : 1.00 sec
Maximum Time Step : 1.00 sec
Percent in Steady State : 0.00
Average Iterations per Step : 2.91
Percent Not Converging : 4.69
Time Step Frequencies :
1.000 - 0.871 sec : 100.00 %
0.871 - 0.758 sec : 0.00 %
0.758 - 0.660 sec : 0.00 %
0.660 - 0.574 sec : 0.00 %
0.574 - 0.500 sec : 0.00 %

```

```

*****
Subcatchment Runoff Summary
*****

```

Subcatchment	Total Precip mm	Total Runon mm	Total Evap mm	Total Infil mm	Imperv mm	Perv Runoff mm	Total Runoff mm	Total Runoff 10^6 ltr	Peak Runoff CMS	Runoff Coeff
S101	71.68	0.00	0.00	14.10	48.01	9.19	57.20	0.04	0.03	0.798
S102	71.68	0.00	0.00	18.00	42.02	11.41	53.43	0.04	0.03	0.745
S103	71.68	0.00	0.00	15.63	45.60	10.14	55.74	0.05	0.04	0.778
S104	71.68	0.00	0.00	19.03	40.64	11.72	52.36	0.05	0.04	0.731
S105	71.68	0.00	0.00	14.97	46.67	9.69	56.36	0.06	0.04	0.786
S106	71.68	0.00	0.00	18.92	40.70	11.80	52.50	0.05	0.04	0.732
S107	71.68	0.00	0.00	10.45	53.97	6.69	60.66	0.04	0.03	0.846
S108	71.68	0.00	0.00	23.86	33.46	14.20	47.66	0.09	0.07	0.665
S109	71.68	0.00	0.00	30.07	24.23	17.42	41.65	0.07	0.05	0.581
S110	71.68	0.00	0.00	45.86	11.78	13.94	25.72	0.02	0.01	0.359
S111	71.68	0.00	0.00	32.39	21.71	17.54	39.26	0.01	0.01	0.548
S112	71.68	0.00	0.00	49.23	3.51	19.05	22.56	0.01	0.00	0.315
S113	71.68	0.00	0.00	49.16	3.51	19.12	22.63	0.01	0.00	0.316
SBLDG_CY	71.68	0.00	0.00	49.22	3.51	19.06	22.56	0.04	0.02	0.315
SBLDG_roof	71.68	0.00	0.00	0.00	70.39	0.00	70.39	0.24	0.17	0.982

```

*****
Node Depth Summary
*****

```

Node	Type	Average Depth Meters	Maximum Depth Meters	Maximum HGL Meters	Time of Max Occurrence days hr:min	Reported Max Depth Meters
CBMH101_ (STORM)	JUNCTION	0.29	3.02	88.62	0 01:33	3.02

J1	JUNCTION	0.39	3.50	88.62	0	01:33	3.50
J10	JUNCTION	0.04	0.15	83.64	0	00:59	0.15
J2	JUNCTION	0.31	3.24	88.62	0	01:33	3.24
J3	JUNCTION	0.51	4.12	88.61	0	01:16	4.12
J4	JUNCTION	0.56	4.49	88.60	0	01:23	4.49
J5	JUNCTION	0.59	4.66	88.60	0	01:12	4.66
J6	JUNCTION	0.58	4.97	88.60	0	01:10	4.96
J7	JUNCTION	0.62	5.11	88.60	0	01:11	5.11
J8	JUNCTION	0.03	0.16	83.55	0	01:00	0.16
J9	JUNCTION	0.03	0.10	83.86	0	01:00	0.10
STM_CAP_02_(STORM)	JUNCTION	0.00	0.00	84.65	0	00:00	0.00
STMH102_(STORM)	JUNCTION	0.46	3.72	88.61	0	01:32	3.72
STMH103_(STORM)	JUNCTION	0.56	4.45	88.60	0	01:22	4.45
STMH104_(STORM)	JUNCTION	0.56	4.89	88.62	0	01:07	4.88
OF1	OUTFALL	0.00	0.00	83.33	0	00:00	0.00
OF2	OUTFALL	0.00	0.00	0.00	0	00:00	0.00
OF3	OUTFALL	0.00	0.00	0.00	0	00:00	0.00
CB01	STORAGE	0.01	0.21	88.61	0	01:34	0.21
CB02	STORAGE	0.02	0.24	88.61	0	01:34	0.24
CB03	STORAGE	0.02	0.29	88.61	0	01:32	0.29
CB04	STORAGE	0.02	0.25	88.60	0	01:28	0.25
CB05	STORAGE	0.01	0.21	88.60	0	01:24	0.21
CB06	STORAGE	0.01	0.17	88.60	0	01:12	0.17
CB07	STORAGE	0.01	0.14	88.60	0	01:11	0.14
CBMH101	STORAGE	0.01	0.14	88.62	0	01:32	0.14
CBMH105	STORAGE	0.00	0.10	88.60	0	01:11	0.10
ROOF	STORAGE	0.04	0.13	100.13	0	02:31	0.13

Node Inflow Summary

Node	Type	Maximum Lateral Inflow CMS	Maximum Total Inflow CMS	Time of Max Occurrence days hr:min	Lateral Inflow Volume 10^6 ltr	Total Inflow Volume 10^6 ltr	Flow Balance Error Percent
CBMH101_(STORM)	JUNCTION	0.000	0.062	0 01:11	0	0.132	-12.840
J1	JUNCTION	0.000	0.061	0 00:58	0	0.402	0.042
J10	JUNCTION	0.000	0.039	0 01:11	0	0.478	-0.003
J2	JUNCTION	0.000	0.094	0 01:03	0	0.32	0.070
J3	JUNCTION	0.000	0.106	0 01:16	0	0.505	0.061
J4	JUNCTION	0.000	0.121	0 01:05	0	0.496	0.081
J5	JUNCTION	0.000	0.087	0 01:00	0	0.475	0.072
J6	JUNCTION	0.000	0.104	0 01:01	0	0.486	0.070
J7	JUNCTION	0.000	0.071	0 00:59	0	0.501	0.030
J8	JUNCTION	0.000	0.061	0 01:00	0	0.76	0.004
J9	JUNCTION	0.016	0.022	0 01:00	0.0422	0.281	0.003
STM_CAP_02_(STORM)	JUNCTION	0.000	0.000	0 00:00	0	0	0.000 ltr
STMH102_(STORM)	JUNCTION	0.000	0.117	0 01:14	0	0.481	-0.058
STMH103_(STORM)	JUNCTION	0.000	0.042	0 00:58	0	0.285	-0.056
STMH104_(STORM)	JUNCTION	0.000	0.065	0 01:00	0	0.355	-0.125
OF1	OUTFALL	0.009	0.070	0 01:00	0.0209	0.78	0.000
OF2	OUTFALL	0.006	0.006	0 01:00	0.00844	0.00844	0.000
OF3	OUTFALL	0.005	0.005	0 01:00	0.0142	0.0142	0.000
CB01	STORAGE	0.034	0.061	0 01:03	0.0417	0.278	-0.161
CB02	STORAGE	0.038	0.060	0 01:10	0.0468	0.317	-0.052
CB03	STORAGE	0.037	0.085	0 01:14	0.0471	0.338	-0.029
CB04	STORAGE	0.045	0.069	0 01:16	0.0559	0.29	-0.177
CB05	STORAGE	0.037	0.068	0 01:00	0.0464	0.231	-0.271
CB06	STORAGE	0.028	0.057	0 00:59	0.0372	0.153	-0.374
CB07	STORAGE	0.071	0.084	0 00:59	0.0916	0.146	-0.481
CBMH101	STORAGE	0.033	0.043	0 01:01	0.0413	0.151	14.408
CBMH105	STORAGE	0.052	0.054	0 00:59	0.0671	0.0888	-0.450
ROOF	STORAGE	0.169	0.169	0 01:00	0.239	0.239	0.015

Node Surcharge Summary

Surcharging occurs when water rises above the top of the highest conduit.

Node	Type	Hours Surcharged	Max. Height Above Crown Meters	Min. Depth Below Rim Meters
STM_CAP_02_(STORM)	JUNCTION	26.83	0.000	4.343
STMH104_(STORM)	JUNCTION	3.62	4.254	0.096

Node Flooding Summary

No nodes were flooded.

Storage Volume Summary

Storage Unit	Average Volume 1000 m3	Avg Pcnt Full	Evap Loss	Exfil Pcnt Loss	Maximum Volume 1000 m3	Max Pcnt Full	Time of Max Occurrence days hr:min	Maximum Outflow CMS
CB01	0.001	1	0	0	0.018	24	0 01:34	0.076
CB02	0.001	2	0	0	0.027	36	0 01:34	0.044
CB03	0.002	2	0	0	0.041	33	0 01:32	0.109
CB04	0.002	1	0	0	0.034	24	0 01:28	0.104
CB05	0.001	1	0	0	0.015	17	0 01:24	0.091
CB06	0.000	1	0	0	0.009	14	0 01:12	0.034

CB07	0.000	0	0	0	0.008	6	0	01:11	0.100
CBMH101	0.000	0	0	0	0.004	10	0	01:32	0.062
CBMH105	0.000	0	0	0	0.002	3	0	01:11	0.057
ROOF	0.043	0	0	0	0.184	0	0	02:31	0.006

 Outfall Loading Summary

Outfall Node	Flow Freq Pcnt	Avg Flow CMS	Max Flow CMS	Total Volume 10^6 ltr
OF1	44.12	0.018	0.070	0.780
OF2	10.47	0.001	0.006	0.008
OF3	10.25	0.001	0.005	0.014
System	21.61	0.021	0.081	0.803

 Link Flow Summary

Link	Type	Maximum Flow CMS	Time of Max Occurrence days hr:min	Maximum Veloc m/sec	Max/ Full Flow	Max/ Full Depth
C1	CONDUIT	0.022	0 01:00	1.14	0.21	0.31
Pipe_-(23)_(STORM)_2	CONDUIT	0.039	0 00:58	1.01	0.78	1.00
Pipe_-(23)_(STORM)_3	CONDUIT	0.030	0 00:59	0.79	0.51	1.00
Pipe_-(23)_(STORM)_4	CONDUIT	0.026	0 00:52	0.82	0.50	1.00
Pipe_-(24)_(1)_(STORM)_1	CONDUIT	0.040	0 00:58	1.00	0.41	1.00
Pipe_-(24)_(1)_(STORM)_2	CONDUIT	0.042	0 00:58	1.15	0.44	1.00
Pipe_-(25)_(STORM)_1	CONDUIT	0.039	0 01:00	0.77	0.31	1.00
Pipe_-(25)_(STORM)_3	CONDUIT	0.050	0 01:00	0.71	0.40	1.00
Pipe_-(25)_(STORM)_4	CONDUIT	0.065	0 01:00	0.78	0.52	1.00
Pipe_-(26)_(STORM)_1	CONDUIT	0.065	0 01:00	0.53	0.21	1.00
Pipe_-(26)_(STORM)_3	CONDUIT	0.038	0 02:34	0.18	0.13	1.00
Pipe_-(26)_(STORM)_5	CONDUIT	0.061	0 01:00	1.10	0.20	0.30
Pipe_-(26)_(STORM)_6	CONDUIT	0.039	0 00:59	0.97	0.13	0.26
W1	WEIR	0.000	0 00:00			0.00
W10	WEIR	0.034	0 01:11			0.14
W11	WEIR	0.042	0 01:19			0.22
W12	WEIR	0.050	0 01:15			0.25
W13	WEIR	0.078	0 01:14			0.29
W14	WEIR	0.062	0 01:16			0.26
W15	WEIR	0.049	0 01:05			0.21
W16	WEIR	0.030	0 01:21			0.17
W17	WEIR	0.020	0 01:03			0.14
W18	WEIR	0.012	0 01:11			0.10
W19	WEIR	0.009	0 01:22			0.06
W2	WEIR	0.000	0 00:00			0.00
W3	WEIR	0.000	0 00:00			0.00
W4	WEIR	0.000	0 00:00			0.00
W5	WEIR	0.000	0 00:00			0.00
W6	WEIR	0.000	0 00:00			0.00
W7	WEIR	0.000	0 00:00			0.00
W8	WEIR	0.000	0 00:00			0.00
W9	WEIR	0.000	0 00:00			0.00
OL01	DUMMY	0.076	0 01:03			
OL02	DUMMY	0.044	0 01:34			
OL03	DUMMY	0.109	0 01:14			
OL04	DUMMY	0.104	0 01:16			
OL05	DUMMY	0.091	0 01:05			
OL06	DUMMY	0.034	0 01:12			
OL07	DUMMY	0.100	0 01:02			
OL08	DUMMY	0.057	0 01:03			
OL101	DUMMY	0.062	0 01:11			
OL-CONTROL	DUMMY	0.039	0 01:11			
OL-ROOF	DUMMY	0.006	0 00:37			

 Flow Classification Summary

Conduit	Adjusted /Actual Length	Fraction of Time in Flow Class									
		Up Dry	Down Dry	Sub Dry	Sup Crit	Up Crit	Down Crit	Norm Crit	Inlet Ltd	Ctrl	
C1	1.00	0.01	0.00	0.00	0.00	0.00	0.99	0.00	0.00	0.00	
Pipe_-(23)_(STORM)_2	1.00	0.01	0.00	0.00	0.12	0.00	0.00	0.87	0.00	0.00	
Pipe_-(23)_(STORM)_3	1.00	0.01	0.00	0.00	0.99	0.00	0.00	0.00	0.74	0.00	
Pipe_-(23)_(STORM)_4	1.00	0.01	0.20	0.00	0.79	0.00	0.00	0.00	0.87	0.00	
Pipe_-(24)_(1)_(STORM)_1	1.00	0.01	0.06	0.00	0.91	0.02	0.00	0.00	0.86	0.00	
Pipe_-(24)_(1)_(STORM)_2	1.00	0.01	0.00	0.00	0.13	0.00	0.00	0.85	0.01	0.00	
Pipe_-(25)_(STORM)_1	1.00	0.01	0.00	0.00	0.80	0.00	0.00	0.18	0.60	0.00	
Pipe_-(25)_(STORM)_3	1.00	0.01	0.18	0.00	0.80	0.00	0.00	0.00	0.84	0.00	
Pipe_-(25)_(STORM)_4	1.00	0.01	0.00	0.00	0.15	0.00	0.00	0.84	0.00	0.00	
Pipe_-(26)_(STORM)_1	1.00	0.01	0.09	0.00	0.90	0.00	0.00	0.00	0.82	0.00	
Pipe_-(26)_(STORM)_3	1.00	0.01	0.00	0.00	0.44	0.00	0.00	0.55	0.20	0.00	
Pipe_-(26)_(STORM)_5	1.00	0.01	0.00	0.00	0.00	0.00	0.00	0.99	0.00	0.00	
Pipe_-(26)_(STORM)_6	1.00	0.01	0.00	0.00	0.30	0.01	0.00	0.68	0.27	0.00	

 Conduit Surge Summary

Conduit	Hours Full			Hours	
	Both Ends	Upstream	Dnstream	Above Full Normal Flow	Capacity Limited
Pipe_-(23)_-(STORM)_2	3.10	3.10	3.15	0.01	0.01
Pipe_-(23)_-(STORM)_3	2.94	2.94	3.02	0.01	0.01
Pipe_-(23)_-(STORM)_4	3.02	3.02	3.10	0.01	0.01
Pipe_-(24)_-(1)_-(STORM)_1	3.15	3.15	3.33	0.01	0.01
Pipe_-(24)_-(1)_-(STORM)_2	3.33	3.33	3.47	0.01	0.01
Pipe_-(25)_-(STORM)_1	3.47	3.47	3.49	0.01	0.01
Pipe_-(25)_-(STORM)_3	3.49	3.49	3.58	0.01	0.01
Pipe_-(25)_-(STORM)_4	3.58	3.58	3.62	0.01	0.01
Pipe_-(26)_-(STORM)_1	3.68	3.68	3.75	0.01	0.01
Pipe_-(26)_-(STORM)_3	3.75	3.75	3.92	0.01	0.01

Analysis begun on: Mon Mar 20 15:01:25 2023
 Analysis ended on: Mon Mar 20 15:01:32 2023
 Total elapsed time: 00:00:07

PCSWMM Results – Existing Conditions



100-Year 3-Hour Chicago Storm Event

EPA STORM WATER MANAGEMENT MODEL - VERSION 5.1 (Build 5.1.015)

```

*****
Element Count
*****
Number of rain gages ..... 16
Number of subcatchments ... 3
Number of nodes ..... 3
Number of links ..... 0
Number of pollutants ..... 0
Number of land uses ..... 0
    
```

```

*****
Raingage Summary
*****
    
```

Name	Data Source	Data Type	Recording Interval
100yr_3hr_Chicago	100yr_3hr_Chicago	INTENSITY	10 min.
100yr_3hr_Chicago_Climate_Change	100yr_3hr_Chicago_Increase_20percent	INTENSITY	10 min.
100yr_6hr_Chicago	100yr_6hr_Chicago	INTENSITY	10 min.
100yr_6hr_Chicago_Climate_Change	100yr_6hr_Chicago_Increase_20percent	INTENSITY	10 min.
10yr_3hr_Chicago	10yr_3hr_Chicago	INTENSITY	10 min.
10yr_6hr_Chicago	10yr_6hr_Chicago	INTENSITY	10 min.
25mm_3hr_Chicago	25mm_3hr_Chicago	INTENSITY	10 min.
25mm_4hr_Chicago	25mm_4hr_Chicago	INTENSITY	10 min.
25yr_3hr_Chicago	25yr_3hr_Chicago	INTENSITY	10 min.
25yr_6hr_Chicago	25yr_6hr_Chicago	INTENSITY	10 min.
2yr_3hr_Chicago	2yr_3hr_Chicago	INTENSITY	10 min.
2yr_6hr_Chicago	2yr_6hr_Chicago	INTENSITY	10 min.
50yr_3hr_Chicago	50yr_3hr_Chicago	INTENSITY	10 min.
50yr_6hr_Chicago	50yr_6hr_Chicago	INTENSITY	10 min.
5yr_3hr_Chicago	5yr_3hr_Chicago	INTENSITY	10 min.

Subcatchment Summary

Name	Area	Width	%Imperv	%Slope	Rain Gage	Outlet
P1	0.05	32.53	5.00	0.8000	100yr_3hr_Chicago	OF-North
P2	1.44	163.39	5.00	0.8000	100yr_3hr_Chicago	OF-East
P3	0.13	28.11	5.00	0.8000	100yr_3hr_Chicago	OF-South

Node Summary

Name	Type	Invert Elev.	Max. Depth	Ponded Area	External Inflow
OF-East	OUTFALL	0.00	0.00	0.0	
OF-North	OUTFALL	0.00	0.00	0.0	
OF-South	OUTFALL	0.00	0.00	0.0	

NOTE: The summary statistics displayed in this report are based on results found at every computational time step, not just on results from each reporting time step.

Analysis Options

Flow Units CMS
Process Models:
 Rainfall/Runoff YES
 RDII NO
 Snowmelt NO
 Groundwater NO
 Flow Routing NO
 Water Quality NO
Infiltration Method HORTON
Surcharge Method EXTRAN
Starting Date 11/10/2013 00:00:00
Ending Date 11/10/2013 06:00:00
Antecedent Dry Days 0.0
Report Time Step 00:05:00
Wet Time Step 00:05:00
Dry Time Step 00:05:00

	Volume hectare-m	Depth mm
Runoff Quantity Continuity		
Total Precipitation	0.116	71.677
Evaporation Loss	0.000	0.000
Infiltration Loss	0.079	49.075
Surface Runoff	0.037	22.732
Final Storage	0.000	0.079
Continuity Error (%)	-0.290	

	Volume hectare-m	Volume 10^6 ltr
Flow Routing Continuity		
Dry Weather Inflow	0.000	0.000
Wet Weather Inflow	0.037	0.368
Groundwater Inflow	0.000	0.000
RDII Inflow	0.000	0.000
External Inflow	0.000	0.000
External Outflow	0.037	0.368
Flooding Loss	0.000	0.000
Evaporation Loss	0.000	0.000
Exfiltration Loss	0.000	0.000
Initial Stored Volume	0.000	0.000
Final Stored Volume	0.000	0.000
Continuity Error (%)	0.000	

Subcatchment Runoff Summary

Subcatchment	Total Precip mm	Total Runon mm	Total Evap mm	Total Infil mm	Imperv Runoff mm	Perv Runoff mm	Total Runoff mm	Total Runoff 10^6 ltr	Peak Runoff CMS	Runoff Coeff
P1	71.68	0.00	0.00	43.52	3.51	25.39	28.90	0.01	0.01	0.403
P2	71.68	0.00	0.00	49.48	3.51	18.78	22.29	0.32	0.12	0.311
P3	71.68	0.00	0.00	46.69	3.51	21.71	25.22	0.03	0.02	0.352

Analysis begun on: Tue Jun 6 09:36:20 2023
Analysis ended on: Tue Jun 6 09:36:20 2023
Total elapsed time: < 1 sec

APPENDIX

D SUPPORTING DOCUMENTS



Stormceptor[®] EF Sizing Report

STORMCEPTOR[®] ESTIMATED NET ANNUAL SEDIMENT (TSS) LOAD REDUCTION

02/07/2023

Province:	Ontario
City:	Orleans
Nearest Rainfall Station:	OTTAWA CDA RCS
Climate Station Id:	6105978
Years of Rainfall Data:	20

Project Name:	Extencicare - Orleans LTC
Project Number:	221-12376-00
Designer Name:	Kathryn Kerker
Designer Company:	WSP
Designer Email:	kathryn.kerker@wsp.com
Designer Phone:	613-690-1206
EOR Name:	
EOR Company:	
EOR Email:	
EOR Phone:	

Site Name:	OGS
------------	-----

Drainage Area (ha):	0.94
---------------------	------

% Imperviousness:	54.00
-------------------	-------

Runoff Coefficient 'c': 0.62

Particle Size Distribution:	Fine
-----------------------------	------

Target TSS Removal (%):	80.0
-------------------------	------

Required Water Quality Runoff Volume Capture (%):	90.00
---	-------

Estimated Water Quality Flow Rate (L/s):	18.93
--	-------

Oil / Fuel Spill Risk Site?	Yes
-----------------------------	-----

Upstream Flow Control?	Yes
------------------------	-----

Upstream Orifice Control Flow Rate to Stormceptor (L/s):	81.00
--	-------

Peak Conveyance (maximum) Flow Rate (L/s):	
--	--

Site Sediment Transport Rate (kg/ha/yr):	
--	--

Net Annual Sediment (TSS) Load Reduction Sizing Summary

Stormceptor Model	TSS Removal Provided (%)
EFO4	81
EFO6	90
EFO8	95
EFO10	97
EFO12	99

Recommended Stormceptor EFO Model: EFO4

Estimated Net Annual Sediment (TSS) Load Reduction (%): 81

Water Quality Runoff Volume Capture (%): > 90

Stormceptor® EF Sizing Report

THIRD-PARTY TESTING AND VERIFICATION

► **Stormceptor® EF and Stormceptor® EFO** are the latest evolutions in the Stormceptor® oil-grit separator (OGS) technology series, and are designed to remove a wide variety of pollutants from stormwater and snowmelt runoff. These technologies have been third-party tested in accordance with the Canadian ETV **Procedure for Laboratory Testing of Oil-Grit Separators** and performance has been third-party verified in accordance with the **ISO 14034 Environmental Technology Verification (ETV)** protocol.

PERFORMANCE

► **Stormceptor® EF and EFO** remove stormwater pollutants through gravity separation and floatation, and feature a patent-pending design that generates positive removal of total suspended solids (TSS) throughout each storm event, including high-intensity storms. Captured pollutants include sediment, free oils, and sediment-bound pollutants such as nutrients, heavy metals, and petroleum hydrocarbons. Stormceptor is sized to remove a high level of TSS from the frequent rainfall events that contribute the vast majority of annual runoff volume and pollutant load. The technology incorporates an internal bypass to convey excessive stormwater flows from high-intensity storms through the device without resuspension and washout (scour) of previously captured pollutants. Proper routine maintenance ensures high pollutant removal performance and protection of downstream waterways.

PARTICLE SIZE DISTRIBUTION (PSD)

► The **Canadian ETV PSD** shown in the table below was used, or in part, for this sizing. This is the identical PSD that is referenced in the Canadian ETV **Procedure for Laboratory Testing of Oil-Grit Separators** for both sediment removal testing and scour testing. The Canadian ETV PSD contains a wide range of particle sizes in the sand and silt fractions, and is considered reasonably representative of the particle size fractions found in typical urban stormwater runoff.

Particle Size (µm)	Percent Less Than	Particle Size Fraction (µm)	Percent
1000	100	500-1000	5
500	95	250-500	5
250	90	150-250	15
150	75	100-150	15
100	60	75-100	10
75	50	50-75	5
50	45	20-50	10
20	35	8-20	15
8	20	5-8	10
5	10	2-5	5
2	5	<2	5

Stormceptor[®] EF Sizing Report

Upstream Flow Controlled Results

Rainfall Intensity (mm / hr)	Percent Rainfall Volume (%)	Cumulative Rainfall Volume (%)	Flow Rate (L/s)	Flow Rate (L/min)	Surface Loading Rate (L/min/m ²)	Removal Efficiency (%)	Incremental Removal (%)	Cumulative Removal (%)
0.5	8.6	8.6	0.82	49.0	41.0	100	8.6	8.6
1	20.3	29.0	1.63	98.0	82.0	98	20.0	28.6
2	16.2	45.2	3.26	196.0	163.0	88	14.3	43.0
3	12.0	57.2	4.89	294.0	245.0	81	9.7	52.7
4	8.4	65.6	6.52	391.0	326.0	78	6.5	59.2
5	5.9	71.6	8.15	489.0	408.0	74	4.4	63.6
6	4.6	76.2	9.78	587.0	489.0	70	3.2	66.9
7	3.1	79.3	11.41	685.0	571.0	66	2.0	68.9
8	2.7	82.0	13.05	783.0	652.0	64	1.8	70.6
9	3.3	85.3	14.68	881.0	734.0	64	2.1	72.8
10	2.3	87.6	16.31	978.0	815.0	63	1.4	74.2
11	1.6	89.2	17.94	1076.0	897.0	62	1.0	75.2
12	1.3	90.5	19.57	1174.0	978.0	62	0.8	76.0
13	1.7	92.2	21.20	1272.0	1060.0	60	1.0	77.0
14	1.2	93.5	22.83	1370.0	1141.0	58	0.7	77.8
15	1.2	94.6	24.46	1468.0	1223.0	56	0.7	78.4
16	0.7	95.3	26.09	1565.0	1305.0	55	0.4	78.8
17	0.7	96.1	27.72	1663.0	1386.0	53	0.4	79.2
18	0.4	96.5	29.35	1761.0	1468.0	50	0.2	79.4
19	0.4	96.9	30.98	1859.0	1549.0	47	0.2	79.6
20	0.2	97.1	32.61	1957.0	1631.0	45	0.1	79.7
21	0.5	97.5	34.24	2055.0	1712.0	43	0.2	79.9
22	0.2	97.8	35.87	2152.0	1794.0	41	0.1	80.0
23	1.0	98.8	37.50	2250.0	1875.0	39	0.4	80.4
24	0.3	99.1	39.14	2348.0	1957.0	38	0.1	80.5
25	0.9	100.0	40.77	2446.0	2038.0	36	0.3	80.8
30	0.9	100.9	48.92	2935.0	2446.0	30	0.3	81.1
35	-0.9	100.0	57.07	3424.0	2854.0	26	N/A	80.8
40	0.0	100.0	65.23	3914.0	3261.0	23	0.0	80.8
45	0.0	100.0	73.38	4403.0	3669.0	20	0.0	80.8
Estimated Net Annual Sediment (TSS) Load Reduction =								81 %

Climate Station ID: 6105978 Years of Rainfall Data: 20

Stormceptor[®] EF Sizing Report

RAINFALL DATA FROM OTTAWA CDA RCS RAINFALL STATION

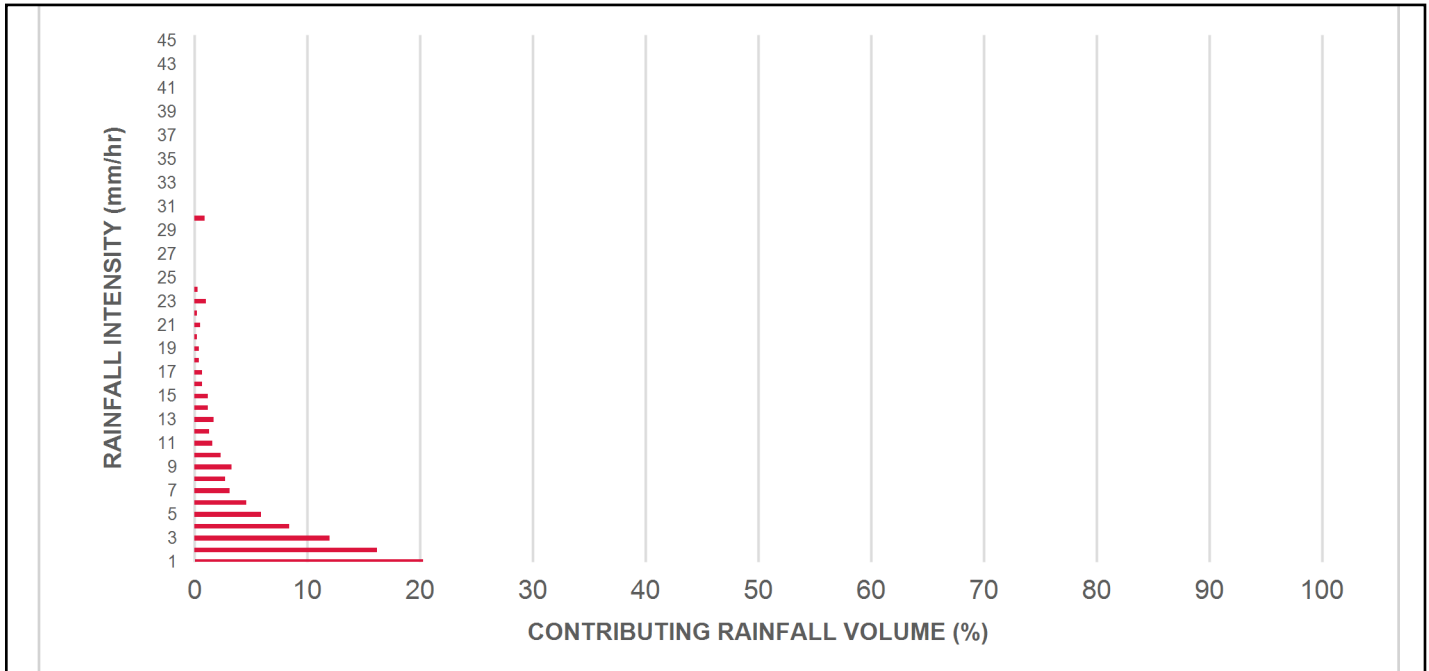

INCREMENTAL AND CUMULATIVE TSS REMOVAL FOR THE RECOMMENDED STORMCEPTOR[®] MODEL

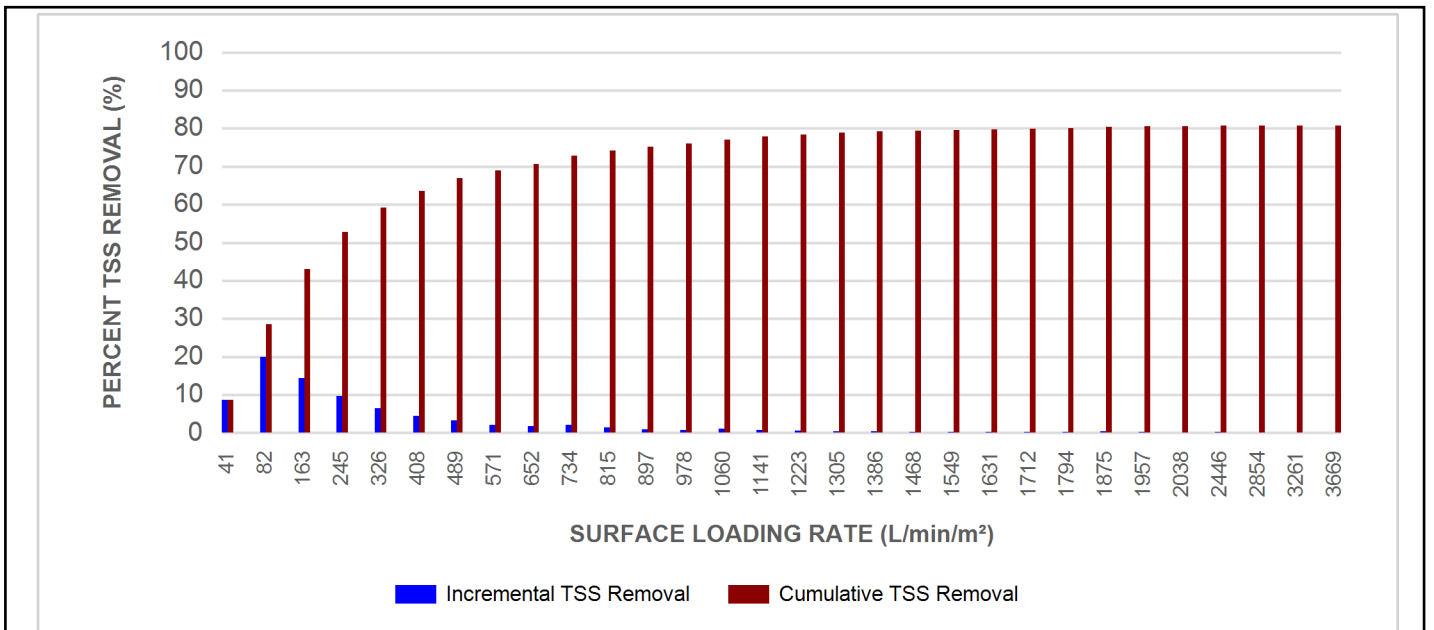

Stormceptor® EF Sizing Report

Maximum Pipe Diameter / Peak Conveyance

Stormceptor EF / EFO	Model Diameter		Min Angle Inlet / Outlet Pipes	Max Inlet Pipe Diameter		Max Outlet Pipe Diameter		Peak Conveyance Flow Rate	
	(m)	(ft)		(mm)	(in)	(mm)	(in)	(L/s)	(cfs)
EF4 / EFO4	1.2	4	90	609	24	609	24	425	15
EF6 / EFO6	1.8	6	90	914	36	914	36	990	35
EF8 / EFO8	2.4	8	90	1219	48	1219	48	1700	60
EF10 / EFO10	3.0	10	90	1828	72	1828	72	2830	100
EF12 / EFO12	3.6	12	90	1828	72	1828	72	2830	100

SCOUR PREVENTION AND ONLINE CONFIGURATION

► Stormceptor® EF and EFO feature an internal bypass and superior scour prevention technology that have been demonstrated in third-party testing according to the scour testing provisions of the Canadian ETV **Procedure for Laboratory Testing of Oil-Grit Separators**, and the exceptional scour test performance has been third-party verified in accordance with the ISO 14034 ETV protocol. As a result, Stormceptor EF and EFO are approved for online installation, eliminating the need for costly additional bypass structures, piping, and installation expense.

DESIGN FLEXIBILITY

► Stormceptor® EF and EFO offers design flexibility in one simplified platform, accepting stormwater flow from a single inlet pipe or multiple inlet pipes, and/or surface runoff through an inlet grate. The device can also serve as a junction structure, accommodate a 90-degree inlet-to-outlet bend angle, and can be modified to ensure performance in submerged conditions.

OIL CAPTURE AND RETENTION

► While Stormceptor® EF will capture and retain oil from dry weather spills and low intensity runoff, Stormceptor® EFO has demonstrated superior oil capture and greater than 99% oil retention in third-party testing according to the light liquid re-entrainment testing provisions of the Canadian ETV **Procedure for Laboratory Testing of Oil-Grit Separators**. Stormceptor EFO is recommended for sites where oil capture and retention is a requirement.

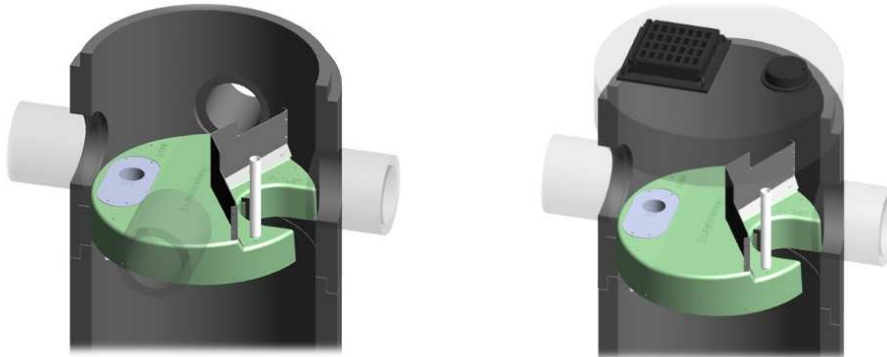

Stormceptor® EF Sizing Report

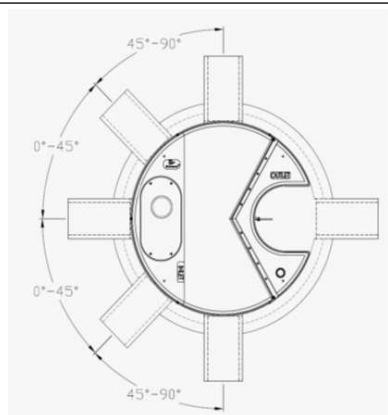

INLET-TO-OUTLET DROP

Elevation differential between inlet and outlet pipe inverts is dictated by the angle at which the inlet pipe(s) enters the unit.

0° - 45° : The inlet pipe is 1-inch (25mm) higher than the outlet pipe.

45° - 90° : The inlet pipe is 2-inches (50mm) higher than the outlet pipe.

HEAD LOSS

The head loss through Stormceptor EF is similar to that of a 60-degree bend structure. The applicable K value for calculating minor losses through the unit is 1.1.

For submerged conditions the applicable K value is 3.0.

Pollutant Capacity

Stormceptor EF / EFO	Model Diameter		Depth (Outlet Pipe Invert to Sump Floor)		Oil Volume		Recommended Sediment Maintenance Depth *		Maximum Sediment Volume *		Maximum Sediment Mass **	
	(m)	(ft)	(m)	(ft)	(L)	(Gal)	(mm)	(in)	(L)	(ft ³)	(kg)	(lb)
EF4 / EFO4	1.2	4	1.52	5.0	265	70	203	8	1190	42	1904	5250
EF6 / EFO6	1.8	6	1.93	6.3	610	160	305	12	3470	123	5552	15375
EF8 / EFO8	2.4	8	2.59	8.5	1070	280	610	24	8780	310	14048	38750
EF10 / EFO10	3.0	10	3.25	10.7	1670	440	610	24	17790	628	28464	78500
EF12 / EFO12	3.6	12	3.89	12.8	2475	655	610	24	31220	1103	49952	137875

*Increased sump depth may be added to increase sediment storage capacity

** Average density of wet packed sediment in sump = 1.6 kg/L (100 lb/ft³)

Feature	Benefit	Feature Appeals To
Patent-pending enhanced flow treatment and scour prevention technology	Superior, verified third-party performance	Regulator, Specifying & Design Engineer
Third-party verified light liquid capture and retention for EFO version	Proven performance for fuel/oil hotspot locations	Regulator, Specifying & Design Engineer, Site Owner
Functions as bend, junction or inlet structure	Design flexibility	Specifying & Design Engineer
Minimal drop between inlet and outlet	Site installation ease	Contractor
Large diameter outlet riser for inspection and maintenance	Easy maintenance access from grade	Maintenance Contractor & Site Owner

STANDARD STORMCEPTOR EF/EFO DRAWINGS

For standard details, please visit <http://www.imbriumsystems.com/stormwater-treatment-solutions/stormceptor-ef>

STANDARD STORMCEPTOR EF/EFO SPECIFICATION

For specifications, please visit <http://www.imbriumsystems.com/stormwater-treatment-solutions/stormceptor-ef>

Stormceptor[®] EF Sizing Report

STANDARD PERFORMANCE SPECIFICATION FOR “OIL GRIT SEPARATOR” (OGS) STORMWATER QUALITY TREATMENT DEVICE

PART 1 – GENERAL

1.1 WORK INCLUDED

This section specifies requirements for selecting, sizing, and designing an underground Oil Grit Separator (OGS) device for stormwater quality treatment, with third-party testing results and a Statement of Verification in accordance with ISO 14034 Environmental Management – Environmental Technology Verification (ETV).

1.2 REFERENCE STANDARDS & PROCEDURES

ISO 14034:2016 Environmental management – Environmental technology verification (ETV)

Canadian Environmental Technology Verification (ETV) Program’s **Procedure for Laboratory Testing of Oil-Grit Separators**

1.3 SUBMITTALS

1.3.1 All submittals, including sizing reports & shop drawings, shall be submitted upon request with each order to the contractor then forwarded to the Engineer of Record for review and acceptance. Shop drawings shall detail all OGS components, elevations, and sequence of construction.

1.3.2 Alternative devices shall have features identical to or greater than the specified device, including: treatment chamber diameter, treatment chamber wet volume, sediment storage volume, and oil storage volume.

1.3.3 Unless directed otherwise by the Engineer of Record, OGS stormwater quality treatment product substitutions or alternatives submitted within ten days prior to project bid shall not be accepted. All alternatives or substitutions submitted shall be signed and sealed by a local registered Professional Engineer, based on the exact same criteria detailed in Section 3, in entirety, subject to review and approval by the Engineer of Record.

PART 2 – PRODUCTS

2.1 OGS POLLUTANT STORAGE

The OGS device shall include a sump for sediment storage, and a protected volume for the capture and storage of petroleum hydrocarbons and buoyant gross pollutants. The minimum sediment & petroleum hydrocarbon storage capacity shall be as follows:

2.1.1	4 ft (1219 mm) Diameter OGS Units:	1.19 m ³ sediment / 265 L oil
	6 ft (1829 mm) Diameter OGS Units:	3.48 m ³ sediment / 609 L oil
	8 ft (2438 mm) Diameter OGS Units:	8.78 m ³ sediment / 1,071 L oil
	10 ft (3048 mm) Diameter OGS Units:	17.78 m ³ sediment / 1,673 L oil
	12 ft (3657 mm) Diameter OGS Units:	31.23 m ³ sediment / 2,476 L oil

PART 3 – PERFORMANCE & DESIGN

3.1 GENERAL

The OGS stormwater quality treatment device shall be verified in accordance with ISO 14034:2016 Environmental management – Environmental technology verification (ETV). The OGS stormwater quality treatment device shall

Stormceptor[®] EF Sizing Report

remove oil, sediment and gross pollutants from stormwater runoff during frequent wet weather events, and retain these pollutants during less frequent high flow wet weather events below the insert within the OGS for later removal during maintenance. The Manufacturer shall have at least ten (10) years of local experience, history and success in engineering design, manufacturing and production and supply of OGS stormwater quality treatment device systems, acceptable to the Engineer of Record.

3.2 SIZING METHODOLOGY

The OGS device shall be engineered, designed and sized to provide stormwater quality treatment based on treating a minimum of 90 percent of the average annual runoff volume and a minimum removal of an annual average 60% of the sediment (TSS) load based on the Particle Size Distribution (PSD) specified in the sizing report for the specified device. Sizing of the OGS shall be determined by use of a minimum ten (10) years of local historical rainfall data provided by Environment Canada. Sizing shall also be determined by use of the sediment removal performance data derived from the ISO 14034 ETV third-party verified laboratory testing data from testing conducted in accordance with the Canadian ETV protocol Procedure for Laboratory Testing of Oil-Grit Separators, as follows:

3.2.1 Sediment removal efficiency for a given surface loading rate and its associated flow rate shall be based on sediment removal efficiency demonstrated at the seven (7) tested surface loading rates specified in the protocol, ranging 40 L/min/m² to 1400 L/min/m², and as stated in the ISO 14034 ETV Verification Statement for the OGS device.

3.2.2 Sediment removal efficiency for surface loading rates between 40 L/min/m² and 1400 L/min/m² shall be based on linear interpolation of data between consecutive tested surface loading rates.

3.2.3 Sediment removal efficiency for surface loading rates less than the lowest tested surface loading rate of 40 L/min/m² shall be assumed to be identical to the sediment removal efficiency at 40 L/min/m². No extrapolation shall be allowed that results in a sediment removal efficiency that is greater than that demonstrated at 40 L/min/m².

3.2.4 Sediment removal efficiency for surface loading rates greater than the highest tested surface loading rate of 1400 L/min/m² shall assume zero sediment removal for the portion of flow that exceeds 1400 L/min/m², and shall be calculated using a simple proportioning formula, with 1400 L/min/m² in the numerator and the higher surface loading rate in the denominator, and multiplying the resulting fraction times the sediment removal efficiency at 1400 L/min/m².

The OGS device shall also have sufficient annual sediment storage capacity as specified and calculated in Section 2.1.

3.3 CANADIAN ETV or ISO 14034 ETV VERIFICATION OF SCOUR TESTING

The OGS device shall have Canadian ETV or ISO 14034 ETV Verification of third-party scour testing conducted in accordance with the Canadian ETV Program's **Procedure for Laboratory Testing of Oil-Grit Separators**.

3.3.1 To be acceptable for on-line installation, the OGS device must demonstrate an average scour test effluent concentration less than 10 mg/L at each surface loading rate tested, up to and including 2600 L/min/m².

3.4 LIGHT LIQUID RE-ENTRAINMENT SIMULATION TESTING

The OGS device shall have Canadian ETV or ISO 14034 ETV Verification of completed third-party Light Liquid Re-entrainment Simulation Testing in accordance with the Canadian ETV **Program's Procedure for Laboratory Testing of Oil-Grit Separators**, with results reported within the Canadian ETV or ISO 14034 ETV verification. This re-entrainment testing is conducted with the device pre-loaded with low density polyethylene (LDPE) plastic beads as a surrogate for light liquids such as oil and fuel. Testing is conducted on the same OGS unit tested for sediment removal to

Stormceptor[®] EF Sizing Report

assess whether light liquids captured after a spill are effectively retained at high flow rates.

3.4.1 For an OGS device to be an acceptable stormwater treatment device on a site where vehicular traffic occurs and the potential for an oil or fuel spill exists, the OGS device must have reported verified performance results of greater than 99% cumulative retention of LDPE plastic beads for the five specified surface loading rates (ranging 200 L/min/m² to 2600 L/min/m²) in accordance with the Light Liquid Re-entrainment Simulation Testing within the Canadian ETV Program's **Procedure for Laboratory Testing of Oil-Grit Separators**. However, an OGS device shall not be allowed if the Light Liquid Re-entrainment Simulation Testing was performed with screening components within the OGS device that are effective at retaining the LDPE plastic beads, but would not be expected to retain light liquids such as oil and fuel.

CSO/STORMWATER MANAGEMENT



HYDROVEX[®] VHV / SVHV
Vertical Vortex Flow Regulator

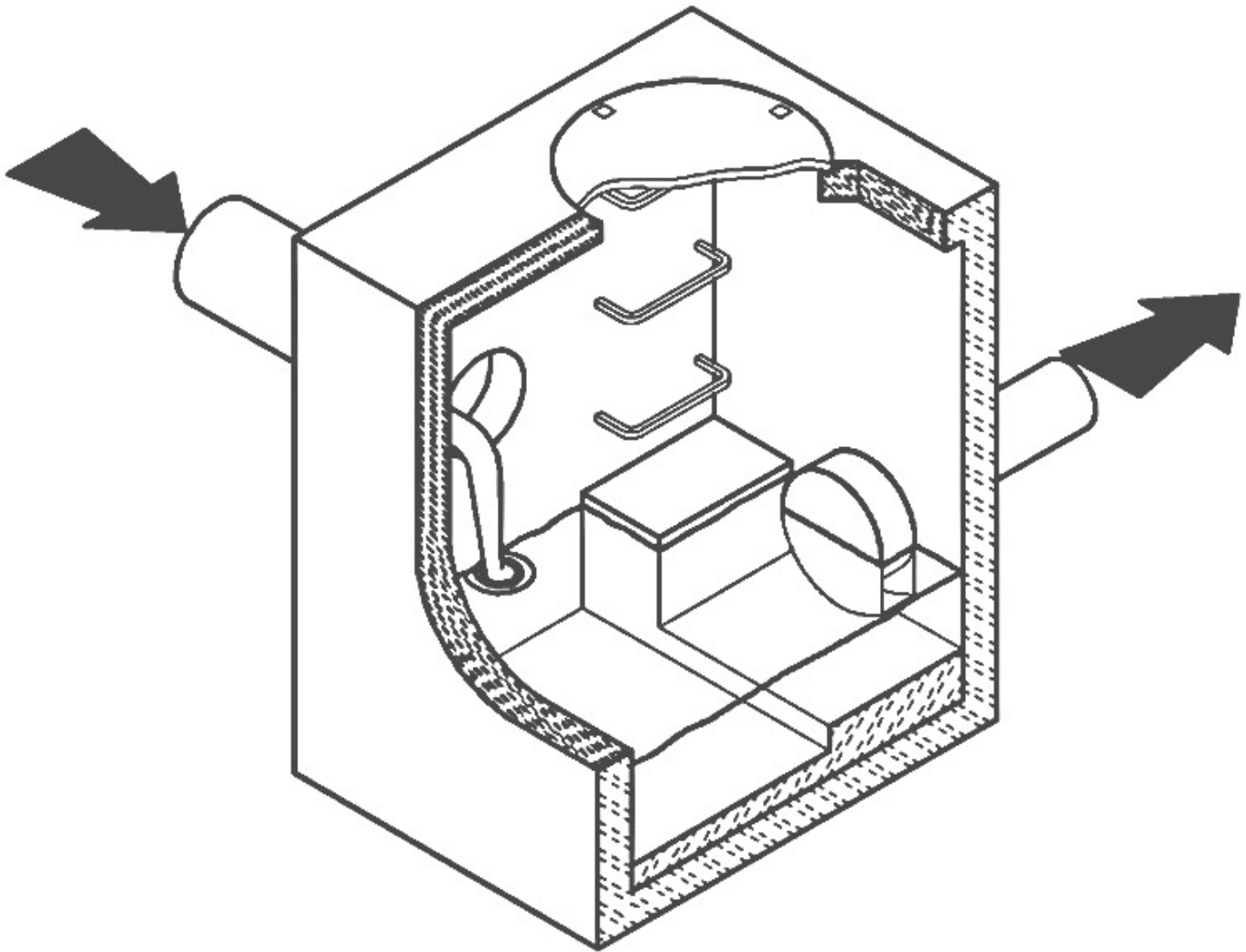

JOHN MEUNIER

HYDROVEX® VHV / SVHV VERTICAL VORTEX FLOW REGULATOR

APPLICATIONS

One of the major problems of urban wet weather flow management is the runoff generated after a heavy rainfall. During a storm, uncontrolled flows may overload the drainage system and cause flooding. Due to increased velocities, sewer pipe wear is increased dramatically and results in network deterioration. In a combined sewer system, the wastewater treatment plant may also experience significant increases in flows during storms, thereby losing its treatment efficiency.

A simple means of controlling excessive water runoff is by controlling excessive flows at their origin (manholes). **John Meunier Inc.** manufactures the **HYDROVEX® VHV / SVHV** line of vortex flow regulators to control stormwater flows in sewer networks, as well as manholes.

The vortex flow regulator design is based on the fluid mechanics principle of the forced vortex. This grants flow regulation without any moving parts, thus reducing maintenance. The operation of the regulator, depending on the upstream head and discharge, switches between orifice flow (gravity flow) and vortex flow. Although the concept is quite simple, over 12 years of research have been carried out in order to get a high performance.

The **HYDROVEX® VHV / SVHV** Vertical Vortex Flow Regulators (refer to **Figure 1**) are manufactured entirely of stainless steel, and consist of a hollow body (1) (in which flow control takes place) and an outlet orifice (7). Two rubber "O" rings (3) seal and retain the unit inside the outlet pipe. Two stainless steel retaining rings (4) are welded on the outlet sleeve to ensure that there is no shifting of the "O" rings during installation and use.

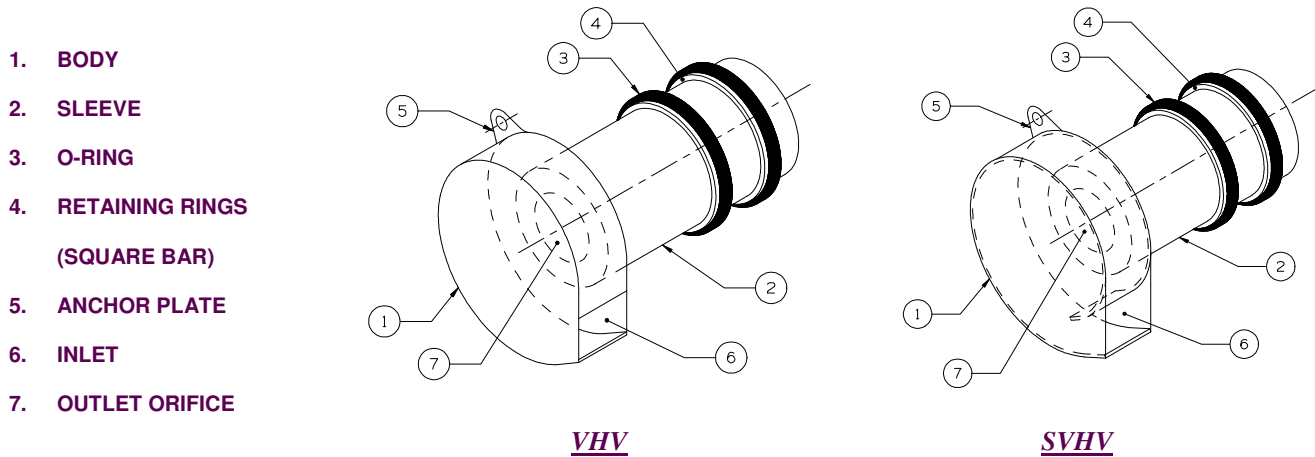

FIGURE 1: HYDROVEX® VHV-SVHV VERTICAL VORTEX FLOW REGULATORS

ADVANTAGES

- The **HYDROVEX® VHV / SVHV** line of flow regulators are manufactured entirely of stainless steel, making them durable and corrosion resistant.
- Having no moving parts, they require minimal maintenance.
- The geometry of the **HYDROVEX® VHV / SVHV** flow regulators allows a control equal to an orifice plate, having a cross section area 4 to 6 times smaller. This decreases the chance of blockage of the regulator, due to sediments and debris found in stormwater flows. **Figure 2** illustrates the comparison between a regulator model 100 SVHV-2 and an equivalent orifice plate. One can see that for the same height of water, the regulator controls a flow approximately four times smaller than an equivalent orifice plate.
- Installation of the **HYDROVEX® VHV / SVHV** flow regulators is quick and straightforward and is performed after all civil works are completed.
- Installation requires no special tools or equipment and may be carried out by any contractor.
- Installation may be carried out in existing structures.

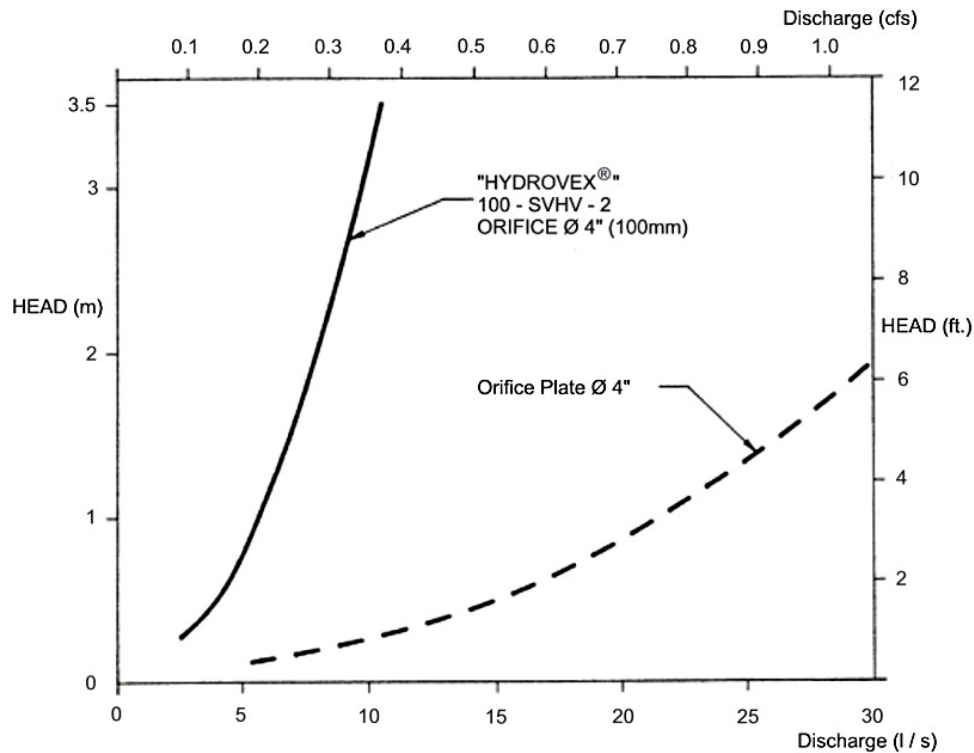

FIGURE 2: DISCHARGE CURVE SHOWING A HYDROVEX® FLOW REGULATOR VS AN ORIFICE PLATE

SELECTION

Selection of a **VHV** or **SVHV** regulator can be easily made using the selection charts found at the back of this brochure (see **Figure 3**). These charts are a graphical representation of the maximum upstream water pressure (head) and the maximum discharge at the manhole outlet. The maximum design head is the difference between the maximum upstream water level and the invert of the outlet pipe. All selections should be verified by John Meunier Inc. personnel prior to fabrication.

Example:

- ✓ Maximum design head 2m (6.56 ft.)
- ✓ Maximum discharge 6 L/s (0.2 cfs)
- ✓ Using **Figure 3** - VHV model required is a **75 VHV-1**

INSTALLATION REQUIREMENTS

All **HYDROVEX®** **VHV** / **SVHV** flow regulators can be installed in circular or square manholes. **Figure 4** gives the various minimum dimensions required for a given regulator. *It is imperative to respect the minimum clearances shown to ensure easy installation and proper functioning of the regulator.*

SPECIFICATIONS

In order to specify a **HYDROVEX**[®] regulator, the following parameters must be defined:

- The model number (ex: 75-VHV-1)
- The diameter and type of outlet pipe (ex: 6" diam. SDR 35)
- The desired discharge (ex: 6 l/s or 0.21 CFS)
- The upstream head (ex: 2 m or 6.56 ft.) *
- The manhole diameter (ex: 36" diam.)
- The minimum clearance "H" (ex: 10 inches)
- The material type (ex: 304 s/s, 11 Ga. standard)

* *Upstream head is defined as the difference in elevation between the maximum upstream water level and the invert of the outlet pipe where the **HYDROVEX**[®] flow regulator is to be installed.*

PLEASE NOTE THAT WHEN REQUESTING A PROPOSAL, WE SIMPLY REQUIRE THAT YOU PROVIDE US WITH THE FOLLOWING:

- *project design flow rate*
- *pressure head*
- *chamber's outlet pipe diameter and type*



Typical VHV model in factory

OPTIONS



FV – SVHV (mounted on sliding plate)



VHV-1-O (standard model with odour control inlet)

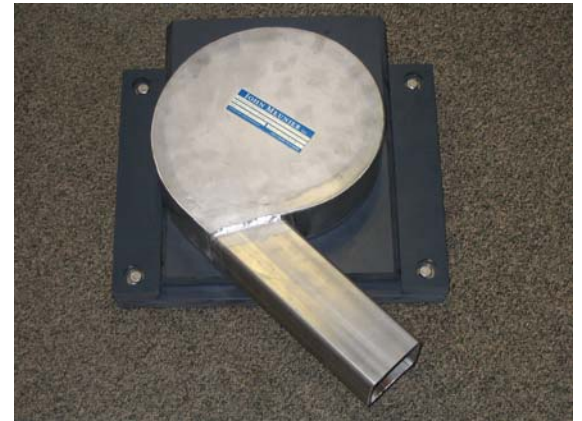

FV – VHV-O (mounted on sliding plate with odour control inlet)



VHV with Gooseneck assembly in existing chamber without minimum release at the bottom



VHV with air vent for minimal slopes



VHV Vertical Vortex Flow Regulator

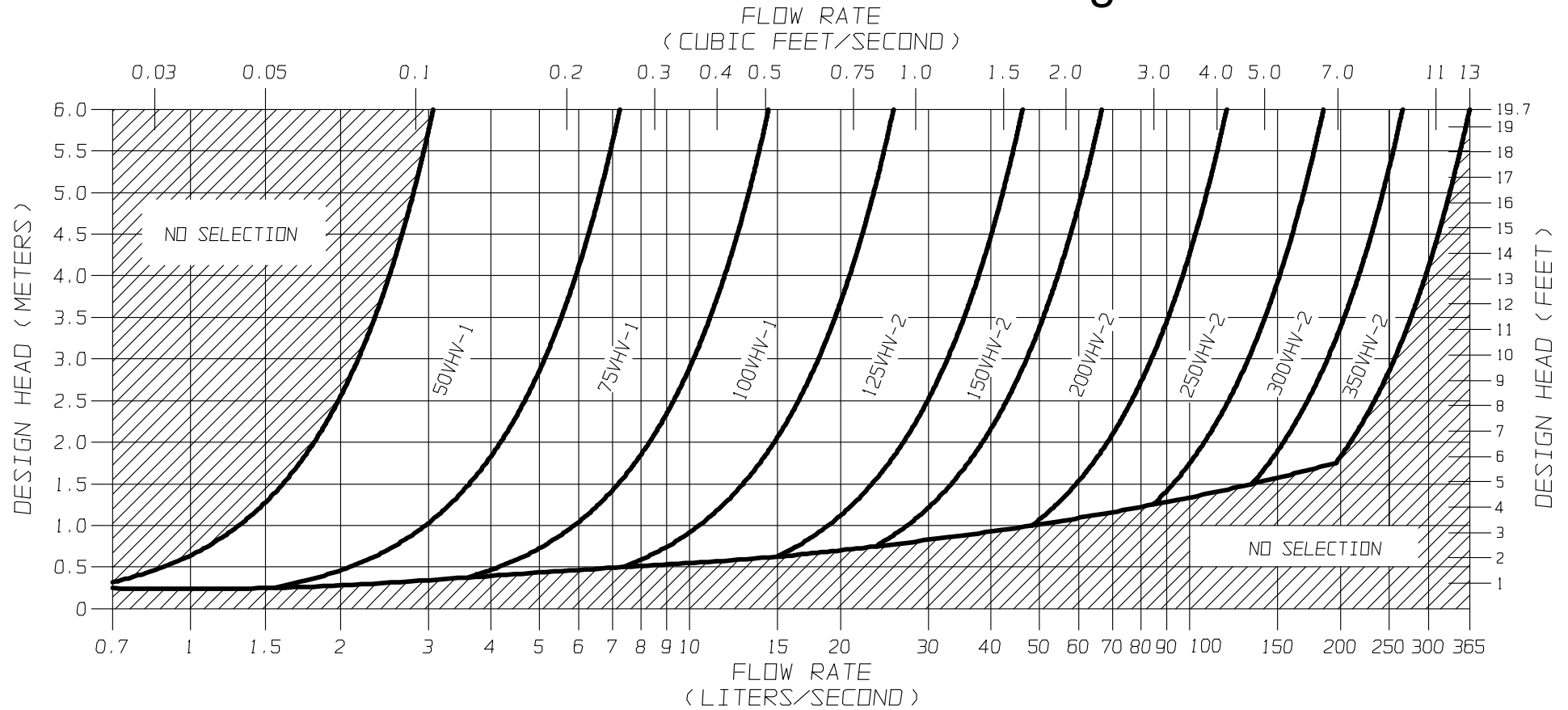

FIGURE 3 - VHV

JOHN MEUNIER



SVHV Vertical Vortex Flow Regulator

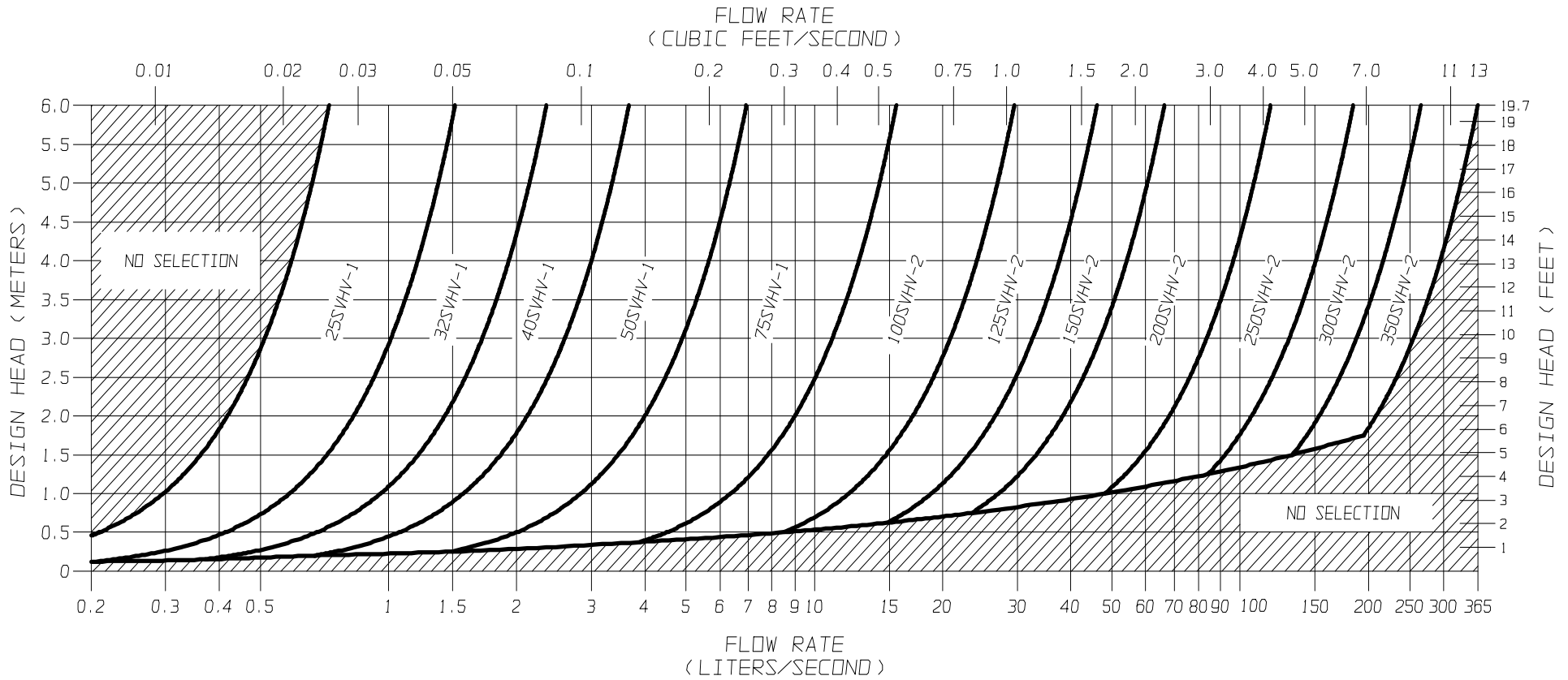
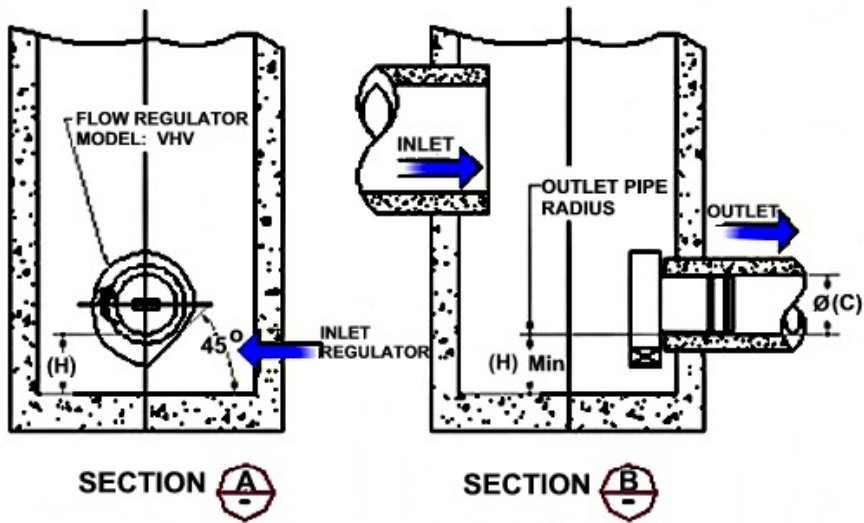
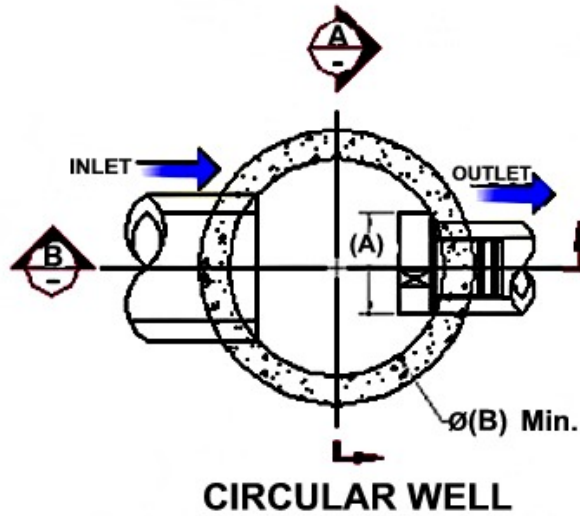

FIGURE 3 - SVHV

JOHN MEUNIER

**FLOW REGULATOR TYPICAL INSTALLATION IN CIRCULAR MANHOLE
FIGURE 4 (MODEL VHV)**

Model Number	Regulator Diameter		Minimum Manhole Diameter		Minimum Outlet Pipe Diameter		Minimum Clearance	
	A (mm)	A (in.)	B (mm)	B (in.)	C (mm)	C (in.)	H (mm)	H (in.)
50VHV-1	150	6	600	24	150	6	150	6
75VHV-1	250	10	600	24	150	6	150	6
100VHV-1	325	13	900	36	150	6	200	8
125VHV-2	275	11	900	36	150	6	200	8
150VHV-2	350	14	900	36	150	6	225	9
200VHV-2	450	18	1200	48	200	8	300	12
250VHV-2	575	23	1200	48	250	10	350	14
300VHV-2	675	27	1600	64	250	10	400	16
350VHV-2	800	32	1800	72	300	12	500	20



FLOW REGULATOR TYPICAL INSTALLATION IN CIRCULAR MANHOLE
FIGURE 4 (MODEL SVHV)

Model Number	Regulator Diameter		Minimum Manhole Diameter		Minimum Outlet Pipe Diameter		Minimum Clearance	
	A (mm)	A (in.)	B (mm)	B (in.)	C (mm)	C (in.)	H (mm)	H (in.)
25 SVHV-1	125	5	600	24	150	6	150	6
32 SVHV-1	150	6	600	24	150	6	150	6
40 SVHV-1	200	8	600	24	150	6	150	6
50 SVHV-1	250	10	600	24	150	6	150	6
75 SVHV-1	375	15	900	36	150	6	275	11
100 SVHV-2	275	11	900	36	150	6	250	10
125 SVHV-2	350	14	900	36	150	6	300	12
150 SVHV-2	425	17	1200	48	150	6	350	14
200 SVHV-2	575	23	1600	64	200	8	450	18
250 SVHV-2	700	28	1800	72	250	10	550	22
300 SVHV-2	850	34	2400	96	250	10	650	26
350 SVHV-2	1000	40	2400	96	250	10	700	28

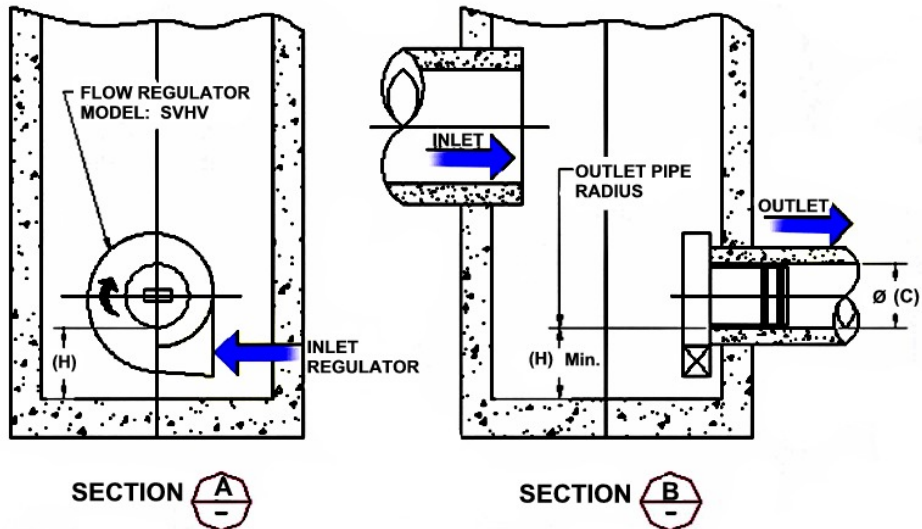
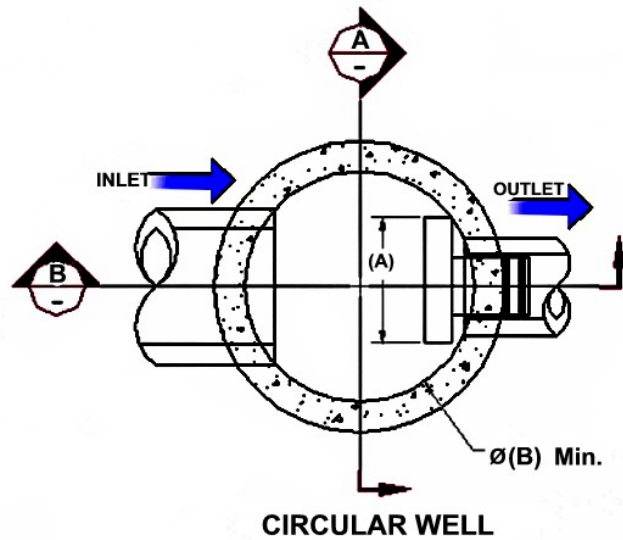

**FLOW REGULATOR TYPICAL INSTALLATION IN SQUARE MANHOLE
FIGURE 4 (MODEL VHV)**

Model Number	Regulator Diameter		Minimum Chamber Width		Minimum Outlet Pipe Diameter		Minimum Clearance	
	A (mm)	A (in.)	B (mm)	B (in.)	C (mm)	C (in.)	H (mm)	H (in.)
50VHV-1	150	6	600	24	150	6	150	6
75VHV-1	250	10	600	24	150	6	150	6
100VHV-1	325	13	600	24	150	6	200	8
125VHV-2	275	11	600	24	150	6	200	8
150VHV-2	350	14	600	24	150	6	225	9
200VHV-2	450	18	900	36	200	8	300	12
250VHV-2	575	23	900	36	250	10	350	14
300VHV-2	675	27	1200	48	250	10	400	16
350VHV-2	800	32	1200	48	300	12	500	20

NOTE: *In the case of a square manhole, the outlet flow pipe must be centered on the wall to ensure enough clearance for the unit.*

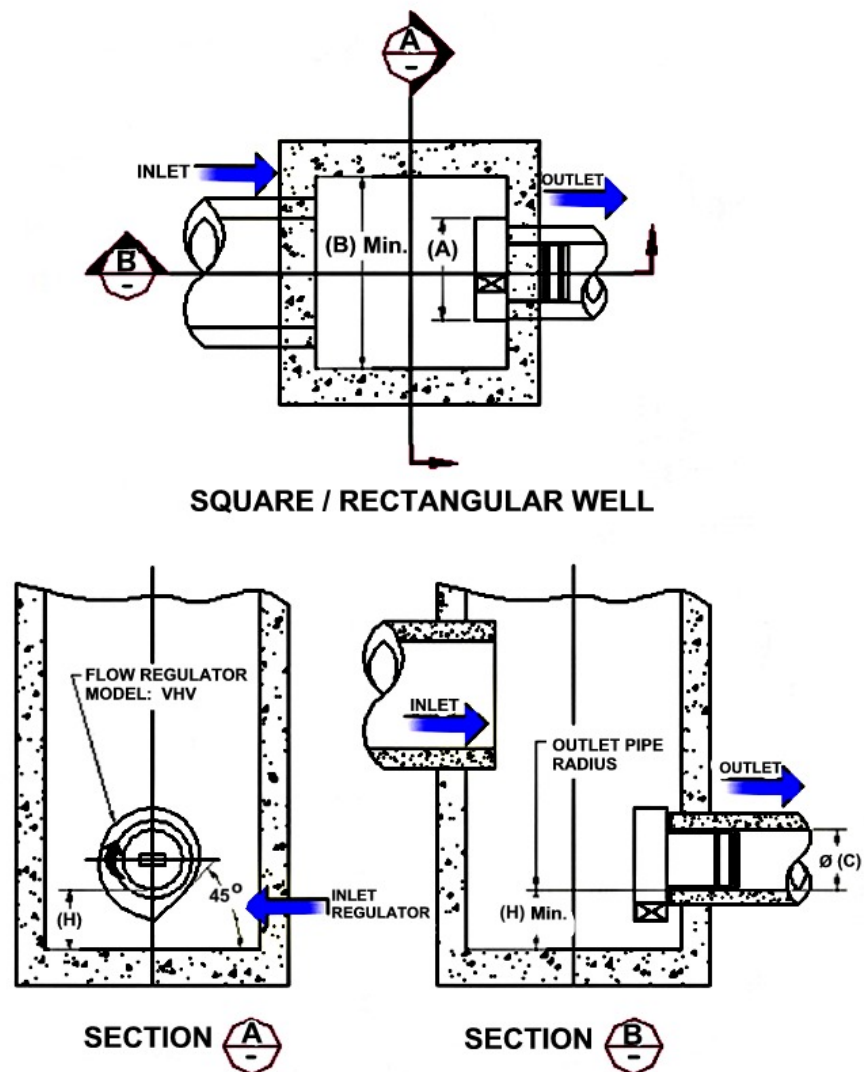

FLOW REGULATOR TYPICAL INSTALLATION IN SQUARE MANHOLE
FIGURE 4 (MODEL SVHV)

Model Number	Regulator Diameter		Minimum Chamber Width		Minimum Outlet Pipe Diameter		Minimum Clearance	
	A (mm)	A (in.)	B (mm)	B (in.)	C (mm)	C (in.)	H (mm)	H (in.)
25 SVHV-1	125	5	600	24	150	6	150	6
32 SVHV-1	150	6	600	24	150	6	150	6
40 SVHV-1	200	8	600	24	150	6	150	6
50 SVHV-1	250	10	600	24	150	6	150	6
75 SVHV-1	375	15	600	24	150	6	275	11
100 SVHV-2	275	11	600	24	150	6	250	10
125 SVHV-2	350	14	600	24	150	6	300	12
150 SVHV-2	425	17	600	24	150	6	350	14
200 SVHV-2	575	23	900	36	200	8	450	18
250 SVHV-2	700	28	900	36	250	10	550	22
300 SVHV-2	850	34	1200	48	250	10	650	26
350 SVHV-2	1000	40	1200	48	250	10	700	28

NOTE: *In the case of a square manhole, the outlet flow pipe must be centered on the wall to ensure enough clearance for the unit.*

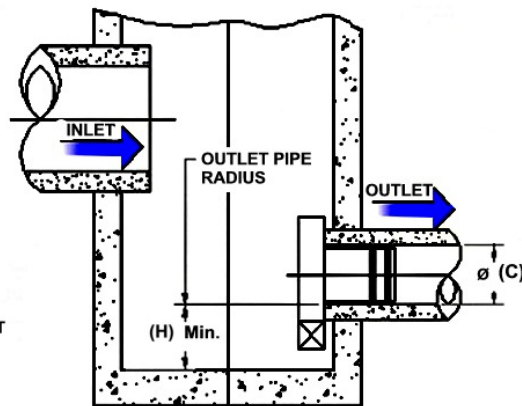
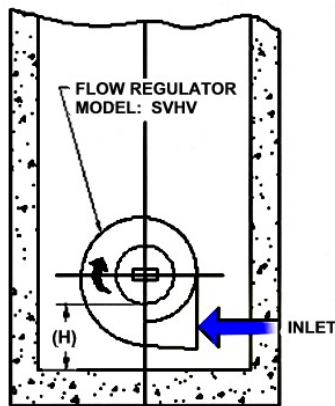
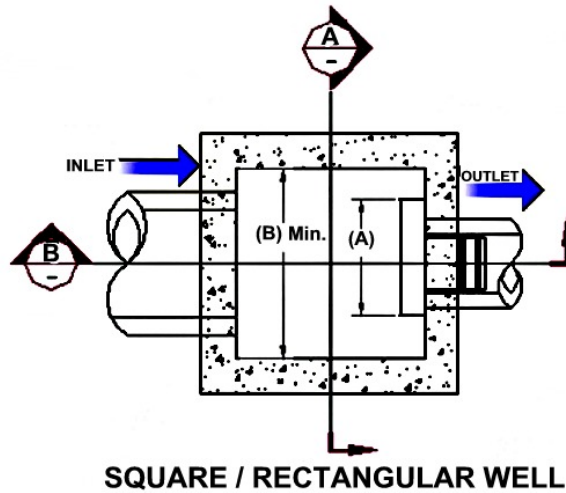

INSTALLATION

The installation of a **HYDROVEX**[®] regulator may be undertaken once the manhole and piping is in place. Installation consists of simply fitting the regulator into the outlet pipe of the manhole. **John Meunier Inc.** recommends the use of a lubricant on the outlet pipe, in order to facilitate the insertion and orientation of the flow controller.

MAINTENANCE

HYDROVEX[®] regulators are manufactured in such a way as to be maintenance free; however, a periodic inspection (every 3-6 months) is suggested in order to ensure that neither the inlet nor the outlet has become blocked with debris. The manhole should undergo periodically, particularly after major storms, inspection and cleaning as established by the municipality

GUARANTY

The **HYDROVEX**[®] line of **VHV / SVHV** regulators are guaranteed against both design and manufacturing defects for a period of 5 years. Should a unit be defective, **John Meunier Inc.** is solely responsible for either modification or replacement of the unit.

John Meunier Inc.

ISO 9001 : 2008

Head Office

4105 Sartelon

Saint-Laurent (Quebec) Canada H4S 2B3

Tel.: 514-334-7230 www.johnmeunier.com

Fax: 514-334-5070 cs@johnmeunier.com

Ontario Office

2000 Argentia Road, Plaza 4, Unit 430

Mississauga (Ontario) Canada L5N 1W1

Tel.: 905-286-4846 www.johnmeunier.com

Fax: 905-286-0488 ontario@johnmeunier.com

USA Office

2209 Menlo Avenue

Glenside, PA USA 19038

Tel.: 412-417-6614 www.johnmeunier.com

Fax: 215-885-4741 astele@johnmeunier.com



Adjustable Accutrol Weir
 Tag: _____

**Adjustable Flow Control
 for Roof Drains**

ADJUSTABLE ACCUTROL (for Large Sump Roof Drains only)

For more flexibility in controlling flow with heads deeper than 2", Watts Drainage offers the Adjustable Accutrol. The Adjustable Accutrol Weir is designed with a single parabolic opening that can be covered to restrict flow above 2" of head to less than 5 gpm per inch, up to 6" of head. To adjust the flow rate for depths over 2" of head, set the slot in the adjustable upper cone according to the flow rate required. Refer to Table 1 below.
 Note: Flow rates are directly proportional to the amount of weir opening that is exposed.

EXAMPLE:

For example, if the adjustable upper cone is set to cover 1/2 of the weir opening, flow rates above 2" of head will be restricted to 2-1/2 gpm per inch of head.

Therefore, at 3" of head, the flow rate through the Accutrol Weir that has 1/2 the slot exposed will be:
 [5 gpm (per inch of head) x 2 inches of head] + 2-1/2 gpm (for the third inch of head) = 12-1/2 gpm.

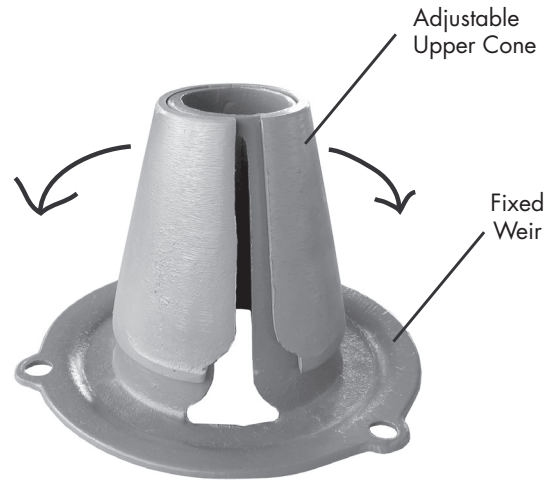
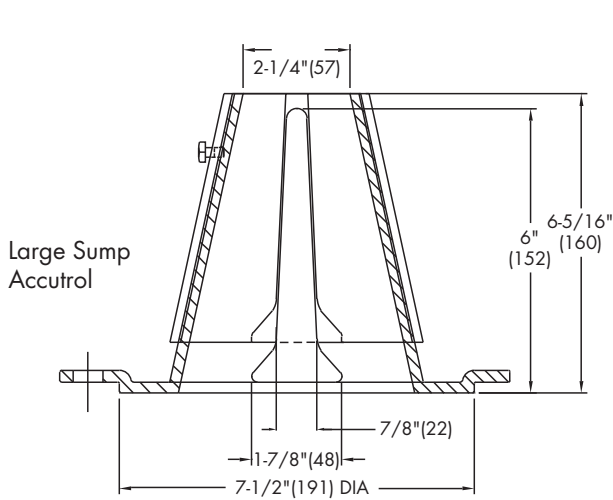

1/2 Weir Opening Exposed Shown Above

TABLE 1. Adjustable Accutrol Flow Rate Settings

Weir Opening Exposed	1"	2"	3"	4"	5"	6"
	Flow Rate (gallons per minute)					
Fully Exposed	5	10	15	20	25	30
3/4	5	10	13.75	17.5	21.25	25
1/2	5	10	12.5	15	17.5	20
1/4	5	10	11.25	12.5	13.75	15
Closed	5	5	5	5	5	5

Job Name _____
 Job Location _____
 Engineer _____

Contractor _____
 Contractor's P.O. No. _____
 Representative _____

Watts product specifications in U.S. customary units and metric are approximate and are provided for reference only. For precise measurements, please contact Watts Technical Service. Watts reserves the right to change or modify product design, construction, specifications, or materials without prior notice and without incurring any obligation to make such changes and modifications on Watts products previously or subsequently sold.

USA: Tel: (800) 338-2581 • Fax: (828) 248-3929 • Watts.com
 Canada: Tel: (905) 332-4090 • Fax: (905) 332-7068 • Watts.ca
 Latin America: Tel: (52) 81-1001-8600 • Fax: (52) 81-8000-7091 • Watts.com



FLOW CONTROL ROOF DRAINAGE DECLARATION

THIS FORM TO BE COMPLETED BY THE MECHANICAL AND STRUCTURAL ENGINEERS RESPONSIBLE FOR DESIGN

Permit Application No.

Project Name:

Extendicare Orleans

Building Location:

1045 Noella Leclair Street

Municipality:

Ottawa

The roof drainage system has been designed in accordance with the following criteria: (please check one of the following).

- M1. Conventionally drained roof (no flow control roof drains used).
- M2. Flow control roof drains meeting the following conditions have been incorporated in this design:
- (a) the maximum drain down time does not exceed 24h,
 - (b) one or more scuppers are installed so that the maximum depth of water on the roof cannot exceed 150mm,
 - (c) drains are located not more than 15m from the edge of roof and not more than 30m from adjacent drains, and
 - (d) there is at least one drain for each 900 sq.m.
- M3. A flow control drainage system that does not meet the minimum drainage criteria described in M2 has been incorporated in this design.

PROFESSIONAL SEAL APPLIED BY:

Practitioner's Name:

Walter D'Souza

Firm:

EXP Inc

Phone #:

(289) 860-1409

City:

Stoney Creek

Province:

Ontario



Mechanical Engineer's Seal

- S1. The design parameters incorporated into the overall structural design are consistent with the information provided by the Mechanical Engineer in M2. Loads due to rain are not considered to act simultaneously with loads due to snow as per Sentence 4.1.7.3 (3) OBC.
- S2. The structure has been designed incorporating the additional structural loading due to rain acting simultaneously with the snow load. The design parameters are consistent with the control flow drainage system designed by the mechanical engineer.

PROFESSIONAL SEAL APPLIED BY:

Practitioner's Name:

Li Ming Tang

Firm:

EXP Services Inc.

Phone #:

905-695-3217

City:

Markham

Province:

Ontario



Structural Engineer's Seal