

## Engineering

- Land/Site Development
- Municipal Infrastructure
- Environmental/Water Resources
- Traffic/Transportation
- Recreational

## Planning

- Land/Site Development
- Planning Application Management
- Municipal Planning
- Urban Design
- Expert Witness (LPAT)
- Wireless Industry

## Landscape Architecture

- Streetscapes & Public Amenities
- Open Space, Parks & Recreation
- Community & Residential
- Commercial & Institutional
- Environmental Restoration



## Lynwood Retail Plaza 1826 Robertson Road, Ottawa Transportation Impact Assessment

**Lynwood Retail Plaza  
1826 Robertson Road**

**Transportation Impact Assessment**

Prepared By:

**NOVATECH**

Suite 200, 240 Michael Cowpland Drive  
Ottawa, Ontario  
K2M 1P6

Dated: March 2023

*Revised: November 2023*

Novatech File: 106134

Ref: R-2020-046

November 17, 2023

City of Ottawa  
Planning, Real Estate, and Economic Development Department  
110 Laurier Ave. W., 4<sup>th</sup> Floor,  
Ottawa, Ontario K1P 1J1

**Attention: Ms. Josiane Gervais**  
**Project Manager, Infrastructure Approvals**

Dear Ms. Gervais:

**Reference: 1826 Robertson Road**  
**Revised Transportation Impact Assessment**  
**Novatech File No. 106134**

---

We are pleased to submit the following Transportation Impact Assessment (TIA) in support of a Site Plan Control application for the property located at 1826 Robertson Road, for your review and signoff. The structure and format of this report is in accordance with the City of Ottawa's *Transportation Impact Assessment Guidelines (June 2017)*.

This TIA was originally submitted in March 2023, and has since been updated to address City comments and reflect changes to the proposed site plan.

If you have any questions or comments regarding this report, please feel free to contact Jennifer Luong, or the undersigned.

Yours truly,

**NOVATECH**



Joshua Audia, P.Eng.  
Project Engineer | Transportation



## Certification Form for Transportation Impact Assessment (TIA) Study Program Manager

### TIA Plan Reports

On April 14, 2022, the Province's Bill 109 received Royal Assent providing legislative direction to implement the More Homes for Everyone Act, 2022 aiming to increase the supply of a range of housing options to make housing more affordable. Revisions have been made to the TIA guidelines to comply with Bill 109 and streamline the process for applicants and staff.

Individuals submitting TIA reports will be responsible for all aspects of development-related transportation assessment and reporting, and undertaking such work, in accordance and compliance with the City of Ottawa's Official Plan, the Transportation Master Plan and the Transportation Impact Assessment (2017) Guidelines.

By submitting the attached TIA report (and any associated documents) and signing this document, the individual acknowledges that they meet the four criteria listed below.

### Certification

- I have reviewed and have a sound understanding of the objectives, needs and requirements of the City of Ottawa's Official Plan, Transportation Master Plan and the Transportation Impact Assessment (2017) Guidelines (Update Effective July 2023);
- I have a sound knowledge of industry standard practice with respect to the preparation of transportation impact assessment reports, including multi modal level of service review;
- I have substantial experience (more than 5 years) in undertaking and delivering transportation impact studies (analysis, reporting and geometric design) with strong background knowledge in transportation planning, engineering or traffic operations; and

City of Ottawa  
Transportation Engineering Services  
Planning, Real Estate and Economic Development  
110 Laurier Avenue West, 4th fl.  
Ottawa, ON K1P 1J1  
Tel. : 613-580-2424  
Fax: 613-560-6006

**Revision Date: June, 2023**

## Transportation Impact Assessment Guidelines

I am either a licensed or registered<sup>1</sup> professional in good standing, whose field of expertise [check  appropriate field(s)]:

is either transportation engineering

or transportation planning.

Dated at  this  day of , 20.

(City)

Name:

Professional Title:

---

Signature of Individual certifier that they meet the above four criteria

<b>Office Contact Information (Please Print)</b>	
Address:	240 Michael Cowpland Drive, Suite 200
City / Postal Code:	Ottawa, ON K2M 1P6
Telephone / Extension:	613-254-9643 x 254
E-Mail Address:	j.luong@novatech-eng.com

### Stamp



---

<sup>1</sup> License of registration body that oversees the profession is required to have a code of conduct and ethics guidelines that will ensure appropriate conduct and representation for transportation planning and/or transportation engineering works.

**TABLE OF CONTENTS**

**EXECUTIVE SUMMARY ..... I**

**1.0 SCREENING.....1**

    1.1 INTRODUCTION ..... 1

    1.2 PROPOSED DEVELOPMENT ..... 1

    1.3 SCREENING ..... 1

**2.0 SCOPING.....2**

    2.1 EXISTING CONDITIONS ..... 2

        2.1.1 Roadways.....2

        2.1.2 Intersections .....4

        2.1.3 Driveways.....6

        2.1.4 Pedestrian and Cycling Facilities .....6

        2.1.5 Area Traffic Management .....6

        2.1.6 Transit .....6

        2.1.7 Existing Traffic Volumes .....9

        2.1.8 Collision Records.....10

    2.2 PLANNED CONDITIONS ..... 11

        2.2.1 Planned Transportation Projects.....11

        2.2.2 Other Area Developments .....12

    2.3 STUDY AREA AND TIME PERIODS ..... 12

    2.4 EXEMPTIONS REVIEW..... 13

**3.0 FORECASTING .....14**

    3.1 DEVELOPMENT-GENERATED TRAFFIC ..... 14

        3.1.1 Trip Generation.....14

        3.1.2 Trip Distribution.....17

        3.1.3 Trip Assignment.....18

    3.2 BACKGROUND TRAFFIC ..... 22

        3.2.1 Other Area Development .....22

        3.2.2 General Background Growth Rate.....22

    3.3 FUTURE TRAFFIC CONDITIONS..... 23

    3.4 DEMAND RATIONALIZATION..... 26

        3.4.1 Existing Intersection Operations .....26

        3.4.2 2024 Background Intersection Operations .....27

        3.4.3 2029 Background Intersection Operations .....28

**4.0 ANALYSIS.....29**

    4.1 DEVELOPMENT DESIGN ..... 29

        4.1.1 Design for Sustainable Modes .....29

        4.1.2 Circulation and Access .....30

    4.2 PARKING ..... 35

    4.3 BOUNDARY STREETS ..... 35

    4.4 ACCESS DESIGN ..... 37

    4.5 TRANSIT ..... 38

    4.6 INTERSECTION DESIGN..... 38

        4.6.1 Intersection MMLOS .....38

        4.6.2 2024 Total Traffic Operations.....41

        4.6.3 2029 Total Traffic Operations.....42

**5.0 CONCLUSIONS AND RECOMMENDATIONS .....42**

**Figures**

Figure 1: View of the Subject Site ..... 2

Figure 2: Roadway Network ..... 4

Figure 3: Existing Pedestrian and Cycling Infrastructure ..... 7

Figure 4: OC Transpo Bus Stop Locations ..... 8

Figure 5: Existing Network Traffic Volumes ..... 9

Figure 6: Site-Generated Primary Traffic (pre-expansion) ..... 19

Figure 7: Site-Generated Pass-By Traffic (pre-expansion) ..... 19

Figure 8: Site-Generated Primary Traffic (post-expansion) ..... 20

Figure 9: Site-Generated Pass-By Traffic (post-expansion) ..... 20

Figure 10: Net Additional Site-Generated Primary Traffic ..... 21

Figure 11: Net Additional Site-Generated Pass-By Traffic ..... 21

Figure 12: 2024 Other Area Development-Generated Volumes ..... 23

Figure 13: 2029 Other Area Development-Generated Volumes ..... 24

Figure 14: 2024 Background Traffic Volumes ..... 24

Figure 15: 2029 Background Traffic Volumes ..... 25

Figure 16: 2024 Total Traffic Volumes ..... 25

Figure 17: 2029 Total Traffic Volumes ..... 26

Figure 18: Fire Truck – Entering ..... 31

Figure 19: Fire Truck – Exiting ..... 32

Figure 20: Delivery/Garbage Truck – Entering ..... 33

Figure 21: Delivery/Garbage Truck – Exiting ..... 34

Figure 22: Desirable Cycling Facility Pre-Selection Nomograph ..... 37

**Tables**

Table 1: OC Transpo Transit Stops ..... 7

Table 2: OC Transpo Route Information ..... 8

Table 3: Reported Collisions ..... 10

Table 4: TIA Exemptions ..... 13

Table 5: Person Trip Generation ..... 15

Table 6: Person Trips by Modal Share ..... 15

Table 7: Internally Captured Trips – Proposed Development ..... 16

Table 8: Primary and Pass-by Trips – Existing Development Only ..... 17

Table 9: Primary and Pass-by Trips – Existing plus Proposed Development ..... 17

Table 10: Existing Traffic Operations ..... 27

Table 11: Existing Queues ..... 27

Table 12: 2024 Background Intersection Operations ..... 28

Table 13: 2024 Background Queues ..... 28

Table 14: 2029 Background Intersection Operations ..... 29

Table 15: 2029 Background Queues ..... 29

Table 16: Parking Requirements Per Zoning By-Law ..... 35

Table 17: Segment MMLOS Summary ..... 36

Table 18: Intersection MMLOS Summary ..... 38

Table 19: 2024 Total Intersection Operations ..... 41

Table 20: 2024 Total Queues ..... 41

Table 21: 2029 Total Intersection Operations ..... 42

Table 22: 2029 Total Queues ..... 42

**Appendices**

- Appendix A: Site Plan
- Appendix B: TIA Screening Form
- Appendix C: OC Transpo Route Maps
- Appendix D: Traffic Count Data
- Appendix E: Collision Records
- Appendix F: Internal Capture Worksheets
- Appendix G: Other Area Developments
- Appendix H: Long-Range Model and Intersection Traffic Growth Rates
- Appendix I: Signal Timing Plans
- Appendix J: Existing Synchro Analysis
- Appendix K: Background Synchro Analysis
- Appendix L: Transportation Demand Management
- Appendix M: MMLOS Analysis
- Appendix N: Total Synchro Analysis



## EXECUTIVE SUMMARY

This Transportation Impact Assessment (TIA) has been prepared in support of a Site Plan Control application for the property located at 1826 Robertson Road. The site is currently occupied by a shopping centre (referred to as 'Lynwood Centre').

The subject site is surrounded by the following:

- Robertson Road and Northside Road, followed by a shopping centre to the north;
- A retirement residence, followed by Eaton Street to the south;
- Larkspur Drive, followed by commercial and residential uses to the east;
- Lynhar Road, Virgil Road, and Ellery Crescent, followed by commercial and residential uses to the west.

The proposed development is a single-storey retail pad, and will include 2,370 ft<sup>2</sup> (220 m<sup>2</sup>) gross floor area (GFA) of drive-through restaurant space and 6,135 ft<sup>2</sup> (570 m<sup>2</sup>) GFA of retail space at the northwest corner of the subject site. No changes to the existing Lynwood Centre building or its accesses are proposed. At full buildout, a total of 208 parking spaces will be provided on the entire site. Access to the proposed development will be provided via the existing Lynwood Centre accesses to Lynhar Road and Larkspur Drive. It is anticipated that the development will be constructed in a single phase, with full occupancy in 2024.

The proposed development is located within the Outer Urban Transect, and is designated as 'Corridor – Mainstreet' (Robertson Road) in Schedule B3 of the City of Ottawa's Official Plan. The existing zoning for the subject site is 'Arterial Mainstreet' (AM). The proposed drive-through restaurant and retail uses are permitted under the existing AM zoning.

The study area for this report will include the boundary roadways Robertson Road, Northside Road West, Lynhar Road, and Larkspur Drive, as well as the following intersections:

- Robertson Road/Stinson Avenue;
- Robertson Road/Lynhar Road/Stafford Road;
- Robertson Road/Northside Road East;
- Northside Road/Larkspur Drive;
- Existing site accesses to Lynhar Road and Larkspur Drive.

The selected time periods for the analysis are the weekday AM, weekday PM, and Saturday peak hours, as they represent the 'worst case' combination of site generated traffic and adjacent street traffic. The proposed development is expected to be completed in one phase, opening in 2024. Therefore, this TIA will perform analysis for the weekday AM, weekday PM, and Saturday peak periods in the buildout year 2024, and the horizon year 2029.

The conclusions and recommendations of this TIA can be summarized as follows:

### Forecasting

- The existing shopping plaza is estimated to generate 115 person trips (including 75 vehicle trips) during the AM peak hour, 346 person trips (including 225 vehicle trips) during the PM peak hour, and 389 person trips (including 253 vehicle trips) during the Saturday peak hour.

- With the proposed expansion, the shopping plaza is estimated to generate 265 person trips (including 173 vehicle trips) during the AM peak hour, 487 person trips (including 317 vehicle trips) during the PM peak hour, and 619 person trips (including 402 vehicle trips) during the Saturday peak hour.

#### Development Design and Parking

- Pedestrian facilities will be provided between the proposed retail pad and the existing shopping plaza. A pedestrian walkway will be provided around the north, south and east sides of the proposed drive-through restaurant and retail pad. Existing sidewalks on the north side of the shopping plaza provide connectivity to both Lynhar Road and Larkspur Drive.
- Ten bicycle parking spaces are currently located near the southeastern corner of the existing shopping plaza (i.e. at the back of the building). Four new bicycle parking spaces will be provided adjacent to the proposed drive-through aisle.
- The walking distance from the main entrance of the existing development to the stops listed above is approximately 110m to OC Transpo stop #5294 and 210m to OC Transpo stop #0937.
- All required TDM-supportive design and infrastructure measures in the TDM checklist are met.
- For restaurants with a drive-through window and an order board preceding the window, the City's *Zoning By-Law* (ZBL) identifies a minimum of seven queueing spaces prior to the board and a minimum total of eleven queueing spaces overall. This minimum requirement will be met, as the proposed development will include seven spaces leading to the order board, and eleven spaces overall.
- The fire route is located along the north side of the existing shopping plaza, as well as the drive aisle east of the proposed retail pad. Garbage collection will be located west of the proposed retail pad, within the loop formed by the drive-through aisle.
- The minimum number of on-site vehicular parking spaces, bicycle parking spaces, and loading spaces as outlined in the City's ZBL will be met upon buildout of the proposed development.
- A total of eight accessible spaces will be provided on-site, meeting the minimum requirements outlined in the City's *Accessibility Design Standards*.
- The proposed expansion will be served by the existing Lynwood Centre accesses via Lynhar Road and Larkspur Drive. No changes to the existing accesses are proposed.

### Boundary Streets

- Based on the results of the segment multi-modal level of service (MMLOS) analysis:
  - No boundary streets meet the target pedestrian level of service (PLOS);
  - Northside Road West and Larkspur Drive meet the target bicycle level of service (BLOS), while Robertson Road and Lynhar Road do not;
  - Robertson Road meets the target transit level of service (TLOS);
  - Robertson Road meets the target truck level of service (TkLOS).
- The best possible PLOS for Robertson Road is a PLOS D. This corresponds to a sidewalk with a minimum width of 2.0m and a minimum boulevard width of 2.0m. Implementing segregated cycling facilities will improve the level of comfort by providing a boulevard between the roadway and pedestrians. No further recommendations have been made in improving the PLOS of Robertson Road.
- A sidewalk with a width of 1.8m are provided on one side on Lynhar Road, achieving a PLOS D. This sidewalk is provided along the frontage of the subject site. The target PLOS C can be met by providing a 2.0m-wide sidewalk with no boulevard or a 1.8m-wide sidewalk with a minimum boulevard width of 0.5m. This is identified for the City's consideration.
- Sidewalks with a width of 1.8m are provided on one side of Northside Road West and Larkspur Drive, both of which meet the target PLOS C. These sidewalks are provided along the frontage of the subject site. Therefore, providing 1.8m sidewalks on the opposite side of these roadways is identified for the City's consideration.
- Robertson Road does not meet the target BLOS B. The *Ontario Traffic Manual (OTM) – Book 18* states that a 'separated facility' is appropriate, based on the operating speed and average annual daily traffic (AADT) volumes. Implementation of separated cycling facilities based on OTM Book 18 and the City's 2013 Cycling Plan will improve Robertson Road to a BLOS A. No further modifications are recommended.
- Lynhar Road does not meet the target BLOS B. *OTM Book 18* states that a 'designated operating space' for cyclists is appropriate, based on the operating speed and AADT volumes. This can include curbside bicycle lanes. This is identified for the City's consideration.

### Transit

- The proposed development is estimated to generate 12 transit trips during the AM peak hour (seven alighting, five boarding), 21 transit trips during the PM peak hour (11 alighting, 10 boarding), and 25 transit trips during the Saturday peak hour (13 alighting, 12 boarding). No capacity problems are anticipated on any of the bus routes or either stop included above.

### Intersection MMLOS

- The results of the intersection MMLOS analysis are summarized as follows:
  - No study area intersections meet the target PLOS;
  - No study area intersections meet the target BLOS;
  - Robertson Road/Stinson Avenue and Robertson Road/Northside Road East meet the target TLOS, while Robertson Road/Lynhar Road/Stafford Road does not;
  - Robertson Road/Northside Road East meets the target TkLOS, while Robertson Road/Stinson Avenue and Robertson Road/Lynhar Road/Stafford Road do not.

- Every approach at each study area intersection do not meet the target PLOS, and cannot achieve the target PLOS without significantly reducing the number of lanes and restricting turning movements. Approaches crossing Robertson Road or Stafford Road meet the City's vehicle/pedestrian conflict threshold for zebra-striped crosswalks (greater than 400,000 vehicle/pedestrian conflicts over an eight-hour period), which could be considered to improve the level of comfort for pedestrians. This is identified for the City's consideration. No other modifications are recommended.
- The east and west approaches of Robertson Road/Stinson Avenue, all approaches of Robertson Road/Lynhar Road/Stafford Road, and the north, east, and west approaches of Robertson Road/Northside Road East do not meet the target BLOS, based on left turn characteristics. The target BLOS can be achieved through the implementation of two-stage left-turn bike boxes for eastbound and westbound cyclists. From a traffic operations perspective, this implementation would require a restriction of right turns on red (RTOR) at select approaches, resulting in additional vehicle delay. Bike boxes for eastbound and westbound cyclists are identified for the City's consideration, in addition to the future segregated cycling facilities that are anticipated on Robertson Road. It is recommended that if bike boxes are to be implemented, that they are not implemented in a 'piecemeal' manner at select intersections, but rather holistically along the Robertson Road corridor where applicable.
- The north, south, and west approaches of Robertson Road/Lynhar Road/Stafford Road and the north, south, and east approaches of Robertson Road/Northside Road East do not achieve the target BLOS based on right turn characteristics. Segregated cycling facilities are identified as a future improvement for Robertson Road, and as this will achieve the target BLOS, no further recommendations have been made for the west approach at Stafford Road and the east approach at Northside Road East. Providing pocket bike lanes and right turn lanes shorter than 50m would allow the north and south approaches at both intersections to achieve the target BLOS. As the north approach at Robertson Road/Northside Road East is on private property, this improvement on the south approach is identified for the City's consideration during the implementation of improved cycling facilities on Robertson Road. The ROW on Lynhar Road and Stafford Road is constrained based on the current cross-section, and capacity analysis suggests that shared through/right turn lanes may be sufficient, improving the BLOS. This is identified for the City's consideration.
- The west approach of Robertson Road/Lynhar Road/Stafford Road does not achieve the target TLOS during the PM peak hour. Since the 2013 Transportation Master Plan identifies transit signal priority or queue jump lanes on Robertson Road at select intersections between Eagleson Road and Holly Acres Road, implementing a transit priority measure at Robertson Road/Lynhar Road/Stafford Road is identified for the City's consideration.
- The east and west approaches of Robertson Road/Stinson Avenue do not meet the target TkLOS. These approaches represent heavy vehicles turning right into the campus at 1891 Robertson Road or onto Stinson Avenue. These roadways are anticipated to continue having low overall vehicular volume, as well as low volumes of heavy vehicles at both approaches. Therefore, no modifications to the curb radii are recommended.

- The west approach of Robertson Road/Lynhar Road/Stafford Road (i.e. turning right onto Lynhar Road from Robertson Road) does not achieve the target TKLOS. As the corner radius measures approximately 13m, and a wide receiving lane is provided before tapering south of the intersection, no recommendations have been made.

*Existing Traffic Operations*

- All study area intersections and the subject site accesses meet the target vehicular level of service (Auto LOS).
- During the AM peak hour, the 95<sup>th</sup>-percentile (maximum) queue lengths of the eastbound through movement at Robertson Road/Lynhar Road/Stafford Road extend through the upstream intersection at Robertson Road/Stinson Avenue, a distance of 270m to the west.

*Background Traffic Operations*

- Compared to existing traffic conditions, marginal changes to the v/c ratios, queue lengths, and delays are anticipated as a result of background growth within the study area.

*Total Traffic Operations*

- Compared to background traffic conditions, marginal changes to the v/c ratios, queue lengths, and delays within the study area are anticipated as a result of traffic generated by the proposed development.
- Based on the foregoing, the proposed development is recommended from a transportation perspective.

## 1.0 SCREENING

### 1.1 Introduction

This Transportation Impact Assessment (TIA) has been prepared in support of a Site Plan Control application for the property located at 1826 Robertson Road. The site is currently occupied by a shopping centre (referred to as 'Lynwood Centre').

The subject site is surrounded by the following:

- Robertson Road and Northside Road, followed by a shopping centre to the north;
- A retirement residence, followed by Eaton Street to the south;
- Larkspur Drive, followed by commercial and residential uses to the east;
- Lynhar Road, Virgil Road, and Ellery Crescent, followed by commercial and residential uses to the west.

A view of the subject site is provided in **Figure 1**.

### 1.2 Proposed Development

The proposed development is a single-storey retail pad, and will include 2,370 ft<sup>2</sup> (220 m<sup>2</sup>) gross floor area (GFA) of drive-through restaurant space and 6,135 ft<sup>2</sup> (570 m<sup>2</sup>) GFA of retail space at the northwest corner of the subject site. No changes to the existing Lynwood Centre building or its accesses are proposed. At full buildout, a total of 208 parking spaces will be provided on the entire site. Access to the proposed development will be provided via the existing Lynwood Centre accesses to Lynhar Road and Larkspur Drive. It is anticipated that the development will be constructed in a single phase, with full occupancy in 2024.

The proposed development is located within the Outer Urban Transect, and is designated as 'Corridor – Mainstreet' (Robertson Road) in Schedule B3 of the City of Ottawa's Official Plan. The existing zoning for the subject site is 'Arterial Mainstreet' (AM). The proposed drive-through restaurant and retail uses are permitted under the existing AM zoning.

A copy of the site plan is included in **Appendix A**.

### 1.3 Screening

The City's *2023 Revised TIA Guidelines* identify three triggers for completing a TIA report, including trip generation, location, and safety. The criteria for each trigger are outlined in the City's TIA Screening Form (included in **Appendix B**). The trigger results are as follows:

- Trip Generation Trigger – The development is anticipated to generate over 60 peak hour person trips; further assessment is **required** based on this trigger.
- Location Triggers – The development is located within a Design Priority Area; further assessment is **required** based on this trigger.
- Safety Triggers – The proposed development includes a drive-through facility; further assessment is **required** based on this trigger.

Figure 1: View of the Subject Site



## 2.0 SCOPING

### 2.1 Existing Conditions

#### 2.1.1 Roadways

All roadways within the study area fall under the jurisdiction of the City of Ottawa.

Robertson Road is an arterial roadway that generally runs on an east-west alignment between Eagleson Road and Baseline Road. West of Eagleson Road, this roadway continues as Hazeldean Road. East of Baseline Road, this roadway continues as Richmond Road. Robertson Road has a five-lane undivided urban cross-section with a two-way left turn lane (TWLTL) from the western limit of the study area to approximately 90m west of the intersection of Robertson Road/Lynhar Road/Stafford Road. East of this point, Robertson Road has a four-lane divided urban cross-section until the eastern limit of the study area. Within the entire study area, Robertson Road has sidewalks on both sides of the roadway and a posted speed limit of 60 km/h. Robertson Road is classified as a truck route, allowing full loads. Street parking is not permitted. The City's Official Plan identifies a ROW protection of 37.5m for Robertson Road through the study area. A required ROW widening is anticipated as a part of this application.

Stinson Avenue is a collector roadway that runs on a north-south alignment between Robertson Road and Ridgefield Crescent. South of Ridgefield Crescent, Stinson Avenue continues as a local roadway. Within the study area, Stinson Avenue has a two-lane undivided cross-section, sidewalks on the western side of the roadway north of Ridgefield Crescent, and a posted speed limit of 40 km/h. Stinson Avenue is not classified as a truck route. Street parking is permitted.

Lynhar Road is a collector roadway that runs on a north-south alignment between Robertson Road and Eaton Street. North of Robertson Road, the roadway continues as Stafford Road. South of Eaton Street, Lynhar Road continues as a local roadway. Within the study area, Lynhar Road has a two-lane undivided cross-section, sidewalks on the eastern side of the roadway, and a posted speed limit of 40 km/h. Lynhar Road is not classified as a truck route. Street parking is permitted. The City's Official Plan identifies a ROW protection of 24m for Lynhar Road between Robertson Road and Eaton Street, and the existing ROW width is approximately 20m along the subject site's frontage. Therefore, a widening is proposed along the subject site's frontage between Robertson Road and the northerly site access to Lynhar Road.

Stafford Road is a collector roadway that runs on a north-south alignment between Robertson Road and Bexley Place. South of Robertson Road, the roadway continues as Lynhar Road. At the intersection with Bexley Place, both the west and south approaches are considered Stafford Road. Within the study area, Stafford Road has a two-lane undivided urban cross-section, sidewalks on both sides of the roadway, and an unposted regulatory speed limit of 50 km/h under the Highway Traffic Act. Stafford Road is not classified as a truck route. Street parking is permitted.

Northside Road is a collector roadway that generally runs on an east-west alignment between Robertson Road and Cassidy Road. Northside Road and Cassidy Road are one continuous roadway that changes names at a 90-degree corner. Northside Road originates as an eastbound-only roadway off of Robertson Road, approximately 50m east of Lynhar Road. In this study, this section is considered to be Northside Road West. Northside Road becomes a two-way roadway east of Larkspur Drive, and is considered to be Northside Road East. Along the frontage of the subject site, Northside Road has a one-lane urban cross-section, sidewalks on the southern side of the roadway, and a posted speed limit of 40 km/h. In the remainder of the study area (i.e. east of Larkspur Drive), Northside Road has a two-lane cross-section, sidewalks on the southern side of the roadway, and a posted speed limit of 40 km/h. Northside Road is not classified as a truck route. Street parking is not permitted.

Larkspur Drive is a collector or local roadway that generally runs on a north-south alignment within the study area. Overall, it is a crescent loop with two intersections to Northside Road approximately 270m apart. The roadway is classified as a collector roadway between the western intersection with Northside Road and Eaton Street, and a local roadway between Eaton Street and the eastern intersection with Northside Road. Within the study area, Larkspur Drive has a two-lane undivided cross-section, sidewalks on the western side of the roadway, and a posted speed limit of 40 km/h. Larkspur Drive is not classified as a truck route. Street parking is not permitted. The City's Official Plan identifies a ROW protection of 24m for Larkspur Drive between Northside Road and Eaton Street, and the existing ROW width is approximately 20m along the subject site's frontage.

The roadway network of the greater area surrounding the subject site is illustrated in **Figure 2**.



Figure 2: Roadway Network

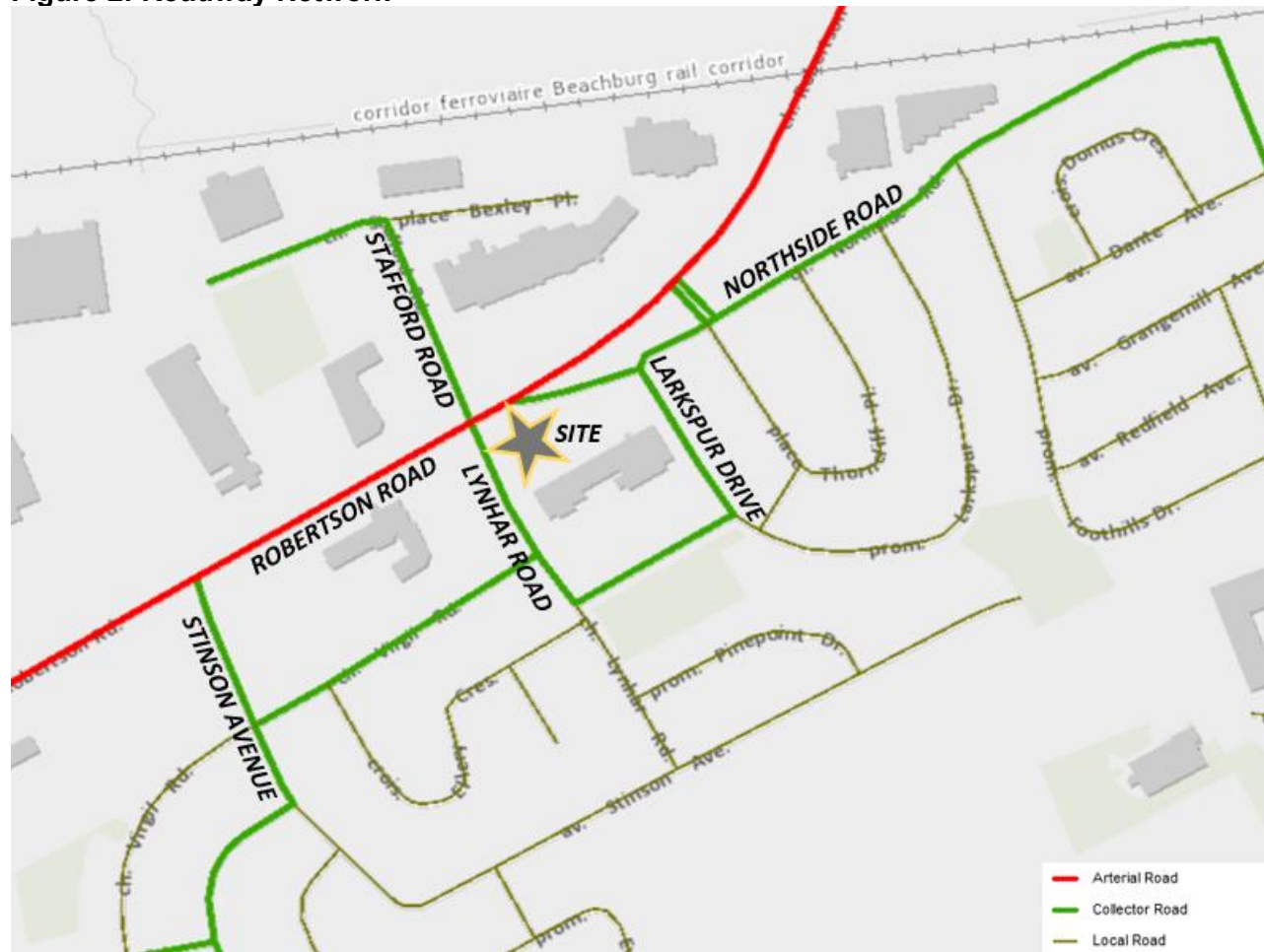

2.1.2 Intersections

Robertson Road/Stinson Avenue

- Signalized four-legged intersection
- North Approach (access to 1891 Robertson Rd): one shared left turn/through/right turn lane
- South Approach (Stinson Avenue): one shared left turn/through/right turn lane
- East/West Approaches (Robertson Road): one left turn lane, one through lane, and one shared through/right turn lane



Robertson Road/Lynhar Road/Stafford Road

- Signalized four-legged intersection
- North Approach (Stafford Road): one left turn lane, one through lane, and one channelized right turn lane
- South Approach (Lynhar Road): one left turn lane, one through lane, and one right turn lane
- East Approach (Robertson Road): one left turn lane, one through lane, and one shared through/right turn lane
- West Approach (Robertson Road): one left turn lane, two through lanes, and one right turn lane



Robertson Road/Northside Road East

- Signalized four-legged intersection
- North Approach (access to 1811 Robertson Rd): one left turn lane, one through lane, and one channelized right turn lane
- South Approach (Northside Road): one left turn lane and one shared through/right turn lane
- East Approach (Robertson Road): one left turn lane, two through lanes, and one right turn lane
- West Approach (Robertson Road): one left turn lane, one through lane, and one shared through/right turn lane



Northside Road/Larkspur Drive

- Unsignalized three-legged intersection
- All-way stop controlled
- South Approach (Larkspur Drive): one right turn lane
- East Approach (Northside Road): one left turn lane
- West Approach (Northside Road): one shared through/right turn lane (*approach is one way eastbound*)



### 2.1.3 Driveways

The City of Ottawa's 2017 TIA Guidelines requires a review of driveways on the boundary streets within 200m of any site access, which can be described as follows. The subject site has two existing accesses to Lynhar Road and two existing accesses to Larkspur Drive.

#### Lynhar Road/Stafford Road, West Side:

- Two driveways to a shopping centre at 1861 Robertson Road
- One driveway to commercial uses at 1850 Robertson Road
- Five driveways to residences at 10, 12, 14, 18 & 20 Lynhar Road

#### Larkspur Drive, West Side:

- Five driveways to residences at 41, 43, 45, 47 & 49 Larkspur Drive

#### Lynhar Road/Stafford Road, East Side:

- Two driveways to a shopping centre at 1811 Robertson Road

#### Larkspur Drive, East Side:

- Six driveways to residences at 42, 44, 46, 50, 52 & 54 Larkspur Drive
- Three driveways to commercial uses at 56 & 60 Larkspur Drive, and 48 Northside Road

### 2.1.4 Pedestrian and Cycling Facilities

Concrete sidewalks are provided on both sides of Robertson Road and the majority of Stafford Road. Concrete sidewalks are provided on one side of Stinson Avenue, Lynhar Road, Larkspur Drive, and Northside Road, wherever these roadways are classified as collectors. No cycling facilities are provided within the study area.

Robertson Road is classified as a Crosstown Bikeway and a Spine Route in the City's primary cycling network, while Lynhar Road and Stinson Avenue east of Delta Street are classified as Local Routes. Stinson Avenue between Robertson Road and Delta Street, Stafford Road, Larkspur Drive, and Northside Road have no cycling route designations.

The existing pedestrian and cycling infrastructure provided in the greater area surrounding the subject site is illustrated in **Figure 3**.

### 2.1.5 Area Traffic Management

There are no Area Traffic Management (ATM) studies within the study area that have been completed, or are currently in progress.

### 2.1.6 Transit

The locations of OC Transpo bus stops in the vicinity of the subject site are described in **Table 1** and shown in **Figure 4**, and a summary of the various routes which serve the study area is included in **Table 2**. Detailed route information and an excerpt from the OC Transpo System Map are included in **Appendix C**.

Figure 3: Existing Pedestrian and Cycling Infrastructure

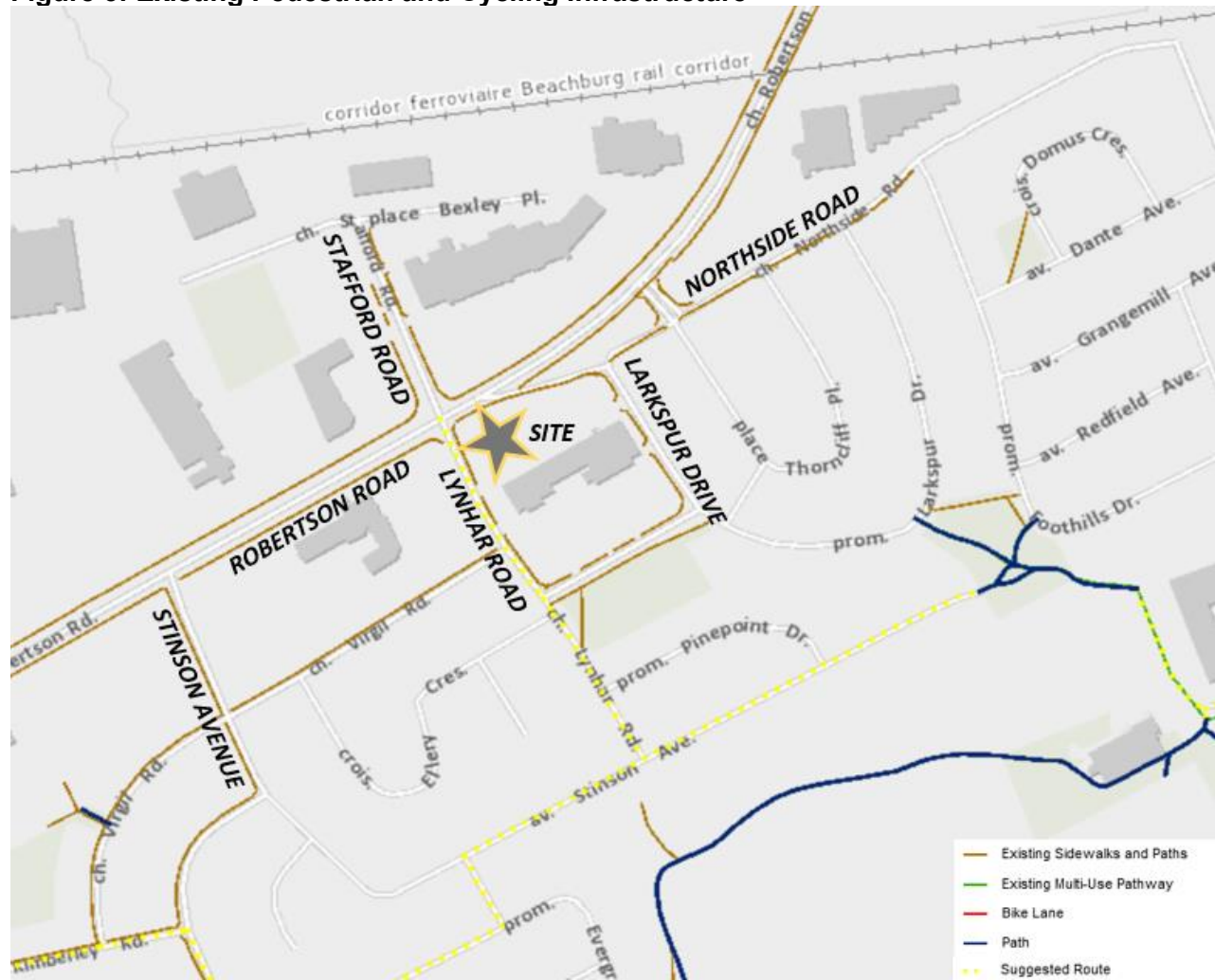

Table 1: OC Transpo Transit Stops

Stop	Location	Routes Served
#0937	North side of Robertson Road, west of Stafford Road	57, 88, 665, 675, 681, 688
#0939	South side of Northside Road, east of Thorncliff Place East	665, 681
#0940	North side of Northside Road, east of Thorncliff Place East	665, 675, 681
#2872	North side of Northside Road, east of Thorncliff Place West	665, 681
#4902	West side of Larkspur Drive, south of Northside Road	665, 675, 681
#5291	North side of Robertson Road, east of Stinson Avenue	57, 88, 665, 675, 681, 688
#5292	South side of Robertson Road, east of Stinson Avenue	57, 88, 665, 681, 688
#5293	North side of Robertson Road, midblock between Stafford Road and Stafford Centre Access	57, 88, 688

Stop	Location	Routes Served
#5294	South side of Robertson Road, east of Lynhar Road	57, 88, 665, 681, 688
#5301	North side of Eaton Street, east of Lynhar Road	665, 675, 681
#6493	South side of Robertson Road, west of Stafford Centre Access	57, 88, 688

Table 2: OC Transpo Route Information

Route	From ↔ To	Frequency
57	Tunney's Pasture & N Rideau ↔ Crystal Bay	All day and limited overnight service, 7 days a week; 15- to 30-minute headways
88	Hurdman ↔ Terry Fox	All day service, 7 days a week; 10- to 30-minute headways
665	Kanata ↔ Bell H.S.	Service at select times on school days only
675	Minto Rec Centre ↔ Bell H.S.	Service at select times on school days only
681	Kanata ↔ Bell H.S.	Service at select times on school days only
688	Terry Fox ↔ Merivale H.S.	Service at select times on school days only

Figure 4: OC Transpo Bus Stop Locations

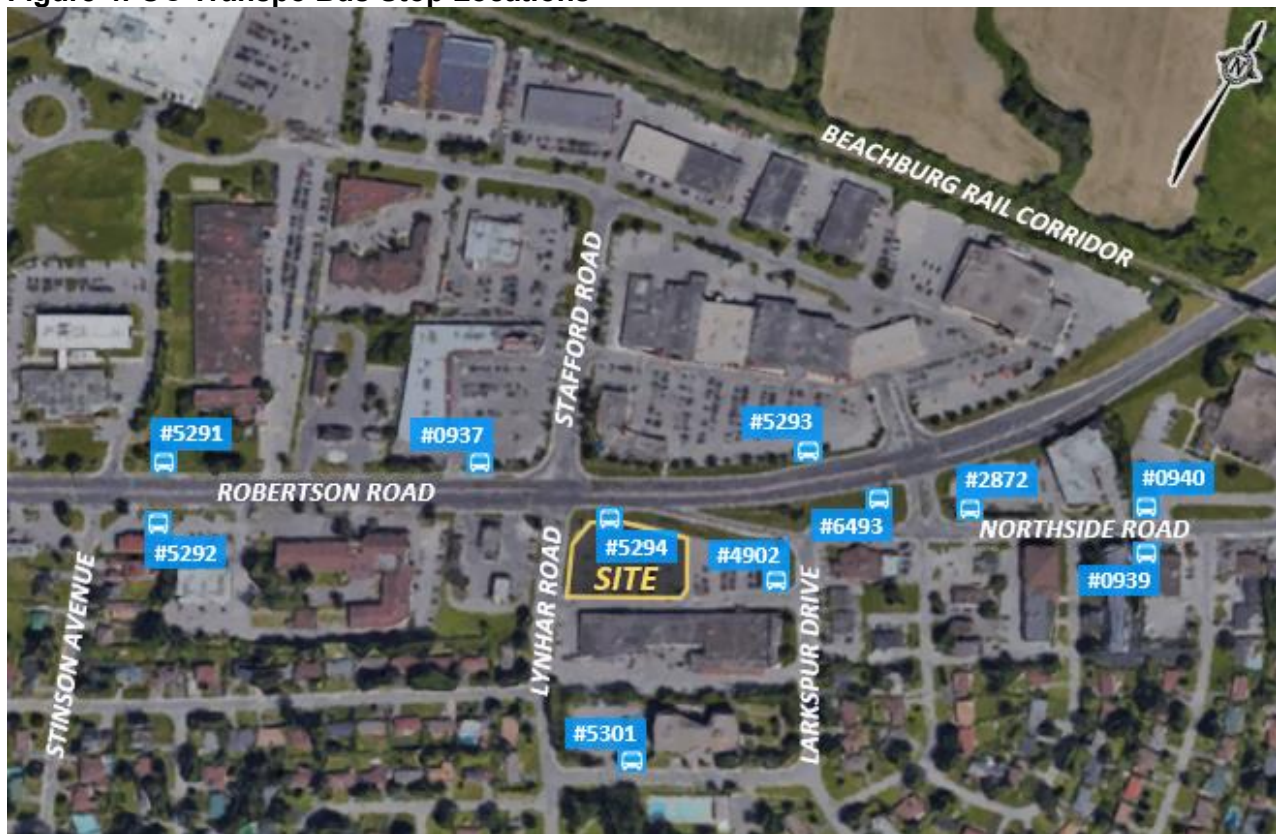

### 2.1.7 Existing Traffic Volumes

Weekday and Saturday traffic counts completed by the City of Ottawa or Novatech have been used to determine the existing pedestrian, cyclist, and vehicular traffic volumes at the study area intersections. The traffic counts were completed on the following dates:

- Robertson Road/Stinson Avenue Wed, March 8, 2017 and Sat, Sept 17, 2022
- Robertson Road/Lynhar Road/Stafford Road Wed, March 8, 2017 and Sat, Sept 17, 2022
- Robertson Road/Northside Road East Thu, June 13, 2019 and Sat, Sept 24, 2022
- Northside Road/Larkspur Drive Wed, Sept 21, 2022 and Sat, Sept 24, 2022

Traffic count data from the dates listed above is included in **Appendix D**. Traffic volumes within the study area are shown in **Figure 5**.

Figure 5: Existing Network Traffic Volumes

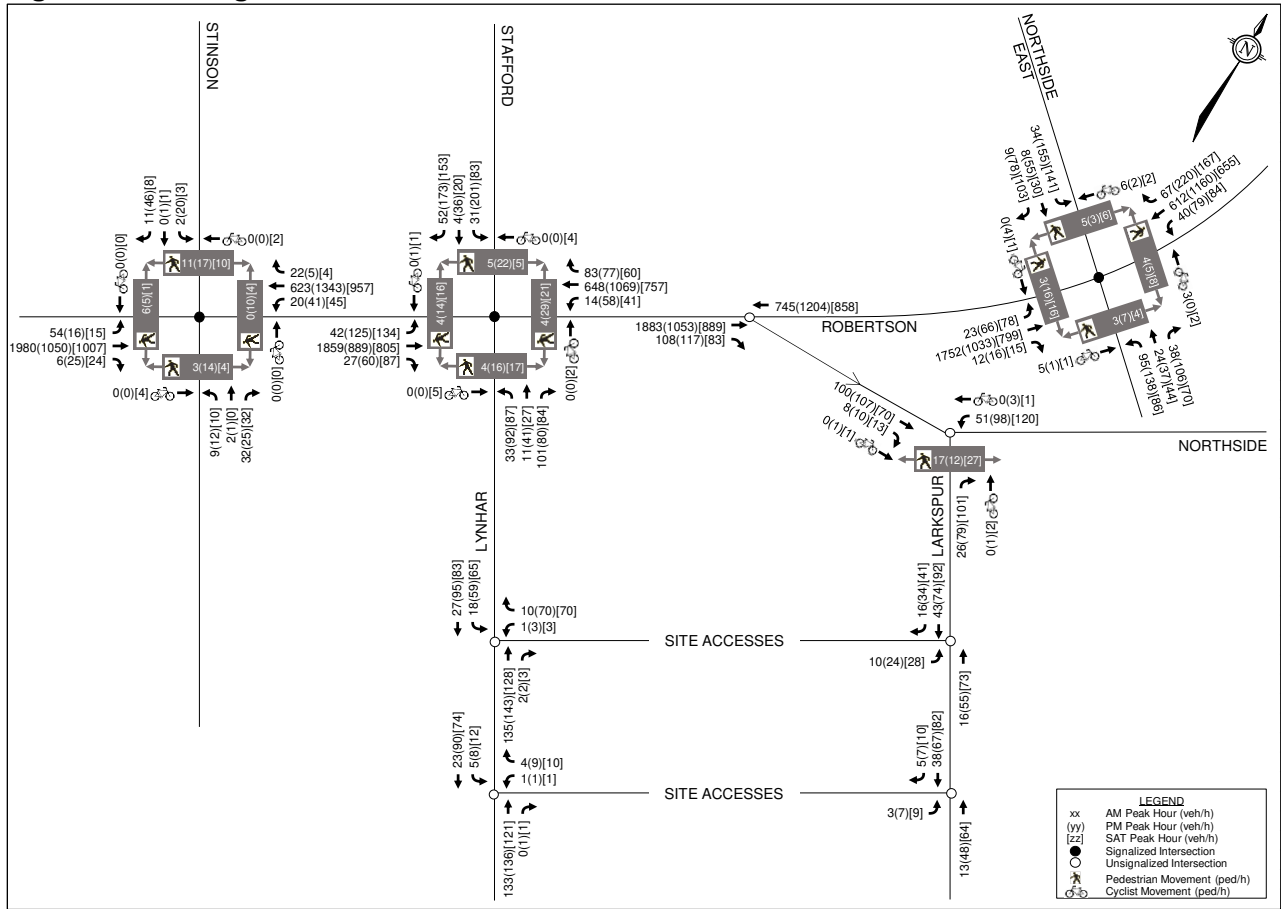

Based on the weekday counts at Robertson Road/Lynhar Road/Stafford Road and Northside Road/Larkspur Drive, the approximate average annual daily traffic (AADT) on each boundary street can be summarized as follows (in vehicles per day, or vpd):

- Robertson Road: 29,270 vpd
- Lynhar Road: 3,700 vpd
- Northside Road West: 1,340 vpd
- Larkspur Drive: 1,960 vpd

### 2.1.8 Collision Records

Historical collision data from the last five years was obtained from the City’s Public Works and Service Department at the study area intersections. Copies of the collision summary reports are included in **Appendix E**.

The collision data has been evaluated to determine if there are any identifiable collision patterns, which are defined in the City’s *2017 TIA Guidelines* as ‘more than six collisions in five years for any one movement.’ The number of collisions at each location in the past five years is summarized in **Table 3**.

**Table 3: Reported Collisions**

Location	Impact Type					Total
	Angle	Rear End	Sideswipe	Turning	SMV <sup>(1)</sup> /Other	
Robertson Road/ Stinson Avenue	-	4	2	1	1	8
Robertson Road/ Lynhar Road/Stafford Road	5	22	8	3	4	42
Robertson Road/ Northside Road East	5	6	-	5	2	18
Northside Road/ Larkspur Drive	-	-	-	-	-	0
Robertson Road btwn Stinson Avenue & Stafford Road	11	6	1	3	1	22
Robertson Road btwn Stafford Road and Northside Road East	-	2	3	1	1	7
Lynhar Road btwn Robertson Road & Virgil Road	2	-	-	-	-	2
Larkspur Drive btwn Northside Road & Eaton Street	-	-	-	-	-	0

1. SMV: Single Motor Vehicle

#### Robertson Road/Stinson Avenue

A total of eight collisions were reported at this intersection over the last five years, of which there were four rear-end impacts, two sideswipe impacts, one turning movement impact, and one single vehicle/other impact. Two of the collisions caused injuries, but none caused fatalities. Three of the eight collisions occurred in poor driving conditions. No collisions involved cyclists or pedestrians.

#### Robertson Road/Lynhar Road/Stafford Road

A total of 42 collisions were reported at this intersection over the last five years, of which there were five angle impacts, 22 rear-end impacts, eight sideswipe impacts, three turning movement impacts, and four single vehicle/other impacts. Eleven of the collisions caused injuries, but none caused fatalities. Thirteen of the 42 collisions occurred in poor driving conditions. No collisions involved cyclists or pedestrians.

Of the 22 rear-end impacts, five occurred at the southbound approach (one through and four right turn incidents), 12 occurred at the eastbound approach (all through incidents), and five occurred at the westbound approach (all through incidents).

Rear ends at the eastbound approach exceeds the threshold to be considered a collision pattern. High traffic volumes on Robertson Road and the multiple existing commercial driveways (including three within 100m of the intersection) on the south side of Robertson Road are potential factors in these collisions.

Of the eight sideswipe impacts, one occurred at the northbound approach, one occurred at the southbound approach, three occurred at the eastbound approach, and three occurred at the westbound approach.

#### Robertson Road/Northside Road East

A total of 18 collisions were reported at this intersection over the last five years, of which there were five angle impacts, six rear-end impacts, five turning movement impacts, and two single vehicle/other impacts. One of the collisions caused injuries, and no collisions caused fatalities. Ten of the 18 collisions occurred in poor driving conditions. No collisions involved cyclists, and one collision involved a pedestrian.

#### Robertson Road between Stinson Avenue and Lynhar Road/Stafford Road

A total of 22 collisions were reported along this segment over the last five years, of which there were 11 angle impacts, six rear-end impacts, five turning movement impacts, and two single vehicle/other impacts. Four of the collisions caused injuries, but none caused fatalities. Six of the 22 collisions occurred in poor driving conditions. No collisions involved cyclists or pedestrians.

Of the 11 angle impacts, five involved a northbound left-turning vehicle and an eastbound through vehicle, two involved a southbound left-turning vehicle and a westbound through vehicle, and four involved a southbound right-turning vehicle and a westbound through vehicle.

#### Robertson Road between Lynhar Road/Stafford Road and Northside Road East

A total of seven collisions were reported along this segment over the last five years, including four collisions at Robertson Road/Northside Road West. The seven collisions consisted of two rear-end impacts, three sideswipe impacts, one turning movement impact, and one single vehicle/other impact. None of the collisions caused injuries or occurred in poor driving conditions. No collisions involved cyclists or pedestrians.

#### Lynhar Road between Robertson Road and Virgil Road

A total of two collisions were reported along this segment over the last five years. Both collisions were angle impacts, did not result in injury, and occurred in fair driving conditions. Neither collision involved cyclists or pedestrians.

## **2.2 Planned Conditions**

### **2.2.1 Planned Transportation Projects**

The City of Ottawa's 2013 Transportation Master Plan (TMP) does not identify any upcoming roadway projects within the study area in its 2031 Affordable Road Network.

The Rapid Transit and Transit Priority (RTTP) Network identifies transit improvements in its 2031 Affordable Network for Robertson Road. Transit signal priority and queue jump lanes will be provided on Robertson Road between Eagleson Road and Holly Acres Road.



East of the study area, the Baseline/Heron/Walkley/St. Laurent Bus Rapid Transit (BRT) project will provide high-quality transit access to employment, commercial, and institutional land uses along the corridor. In the 2031 Affordable Network, at-grade BRT is planned to run from Baseline Station to Heron Station. In the 2031 Network Concept, at-grade BRT will connect from Bayshore Station to St. Laurent Station. The 2031 Network Concept will not be implemented prior to 2031.

The City's 2013 Cycling Plan identifies a Phase 2 (2020-2025) cycling infrastructure project within the study area. As Robertson Road is designated as a crosstown bikeway, the 2013 Cycling Plan identifies that segregated cycling facilities will be provided on Robertson Road between Moodie Drive and Baseline Road. The City's 2013 Pedestrian Plan does not identify any planned infrastructure projects within the study area.

The City's Draft 2024 TMP does not identify any planned pedestrian or cycling infrastructure projects within the study area.

## 2.2.2 Other Area Developments

A review of the City's Development Application search tool identifies the following developments within the study area that are being constructed, are approved, or are in the approval process.

### 42 Northside Road

The proposed development will consist of one five-storey apartment building, with a total of 51 dwellings. A TIA was prepared by Stantec in May 2022, in support of a Site Plan Control application. Per the TIA, the anticipated buildout year is 2023.

### 1987 Robertson Road and 295 Moodie Drive

The proposed development will consist of eight high-rise buildings and one mid-rise building, with a total of 1,925 dwellings and approximately 41,657 ft<sup>2</sup> GFA of commercial space. A TIA was prepared by CGH in September 2021, in support of Official Plan Amendment and Zoning By-Law Amendment applications. Per the TIA, the development will be built in five phases, with an ultimate buildout year is 2029.

### 2165 Robertson Road

The proposed development will consist of a single-storey warehouse and a single-storey building with three restaurant units. In total, the development will include approximately 11,757 ft<sup>2</sup> GFA of warehouse space and 6,017 ft<sup>2</sup> GFA of restaurant space. A TIA and subsequent addendum was prepared by Parsons in December 2018 and December 2020, respectively, in support of a Site Plan Control application. The TIA had originally anticipated a buildout year of 2019.

## 2.3 Study Area and Time Periods

The study area for this report will include the boundary roadways Robertson Road, Northside Road West, Lynhar Road, and Larkspur Drive, as well as the following intersections:

- Robertson Road/Stinson Avenue;
- Robertson Road/Lynhar Road/Stafford Road;
- Robertson Road/Northside Road East;
- Northside Road/Larkspur Drive;
- Existing site accesses to Lynhar Road and Larkspur Drive.

The intersection at Robertson Road/Old Richmond Road has not been included in this assessment. Based on the size of the proposed development, it is anticipated that the site-generated traffic impacts on Robertson Road west of the subject site will be adequately captured by the assessment of Robertson Road/Stinson Avenue and Robertson Road/Lynhar Road/Stafford Road. Site-generated traffic is estimated to account for approximately 2% of volumes at these two intersections, and therefore, development-related impacts at Robertson Road/Old Richmond Road are anticipated to be similarly minimal.

The selected time periods for the analysis are the weekday AM, weekday PM, and Saturday peak hours, as they represent the ‘worst case’ combination of site generated traffic and adjacent street traffic. The proposed development is expected to be completed in one phase, opening in 2024. Therefore, this TIA will perform analysis for the weekday AM, weekday PM, and Saturday peak periods in the buildout year 2024, and the horizon year 2029.

## 2.4 Exemptions Review

This module reviews possible exemptions from the final Transportation Impact Assessment, as outlined in the *TIA Guidelines*. The applicable exemptions for this site are shown in **Table 4**.

**Table 4: TIA Exemptions**

Module	Element	Exemption Criteria	Status
<b>Design Review Component</b>			
<b>4.1</b> Development Design	4.1.2 Circulation and Access	<ul style="list-style-type: none"> <li>Required for site plans</li> </ul>	Not Exempt
	4.1.3 New Street Networks	<ul style="list-style-type: none"> <li>Required for plans of subdivision</li> </ul>	Exempt
<b>4.2</b> Parking	4.2.1 Parking Supply	<ul style="list-style-type: none"> <li>Required for site plans</li> </ul>	Not Exempt
<b>Network Impact Component</b>			
<b>4.5</b> Transportation Demand Management	<i>All elements</i>	<ul style="list-style-type: none"> <li>Not required for non-residential site plans expected to have fewer than 60 employees and/or students on-location at any given time</li> </ul>	Exempt
<b>4.6</b> Neighbourhood Traffic Calming	4.6.1 Adjacent Neighbourhoods	Required if the development meets all of the following criteria: <ol style="list-style-type: none"> <li>Access to Collector or Local;</li> <li>“Significant sensitive land use presence” exists, where there is at least two of the following adjacent to the subject street segment:                             <ul style="list-style-type: none"> <li>School (within 250m walking distance);</li> <li>Park;</li> <li>Retirement / Older Adult Facility (i.e. long-term care and retirement homes);</li> <li>Licensed Child Care Centre;</li> <li>Community Centre; or</li> <li>50%, or greater, of adjacent property along the route(s) is occupied by residential lands and a minimum of 10 occupied residential units are present on the route.</li> </ul> </li> </ol>	Exempt

Module	Element	Exemption Criteria	Status
		3. Application is for Zoning By-Law Amendment or Draft Plan of Subdivision; 4. At least 75 site-generated auto trips; 5. Site Trip Infiltration is expected. Site traffic will increase peak hour vehicle volumes along the route by 50% or more.	
4.8 Network Concept	All elements	<ul style="list-style-type: none"> <li>Only required when proposed development generates more than 200 person-trips during the peak hour in excess of the equivalent volume permitted by the established zoning</li> </ul>	Exempt

Module 4.5: Transportation Demand Management is exempt from further analysis, as fewer than 60 employees are anticipated to be at the retail pad at any given time. Based on the foregoing, the following modules will be included in the TIA report.

**Design Review Component**

- Module 4.1: Development Design
- Module 4.2: Parking
- Module 4.3: Boundary Streets
- Module 4.4: Access Design

**Network Impact Component**

- Module 4.7: Transit
- Module 4.9: Intersection Design

**3.0 FORECASTING**

**3.1 Development-Generated Traffic**

**3.1.1 Trip Generation**

Traffic generated by the existing shopping plaza and proposed expansion has been estimated using the *ITE Trip Generation Manual, 11<sup>th</sup> Edition*. Currently, the subject site is occupied by a shopping plaza with approximately 52,000 ft<sup>2</sup> GFA. Traffic generated by the existing shopping plaza have been estimated based on the trip generation rates associated with the Shopping Plaza land use (code 821). The proposed development adds an approximately 6,135 ft<sup>2</sup> GFA retail pad and 2,370 ft<sup>2</sup> GFA fast-food restaurant with drive-through window. Therefore, trips generated by the retail pad have been estimated using the rates associated with the Shopping Plaza land use (consistent with the existing Lynwood Centre), and trips generated by the restaurant have been estimated using the rates associated with the Fast-Food Restaurant with Drive-Through Window (code 934).

The person trip generation estimates for the subject site in existing conditions and post-expansion, are shown in **Table 5**.

The modal shares for the existing development and proposed expansion are anticipated to be generally consistent with the modal shares outlined in the *TRANS Trip Generation Manual Summary Report* (prepared in October 2020 by WSP), specific to the Bayshore/Cedarview region. The modal share values applied to the trip generation estimates can therefore be summarized as 65% auto driver, 20% auto passenger, 5% transit, 0% cyclist, and 10% pedestrian.

A full breakdown of the projected trips generated by mode are shown in **Table 6**.

**Table 5: Person Trip Generation**

Land Use	Code	GFA	AM Peak (pph <sup>(1)</sup> )			PM Peak (pph <sup>(1)</sup> )			SAT Peak (pph <sup>(1)</sup> )		
			IN	OUT	TOT	IN	OUT	TOT	IN	OUT	TOT
<b>Pre-Expansion</b>											
Shopping Plaza (no supermarket)	821	52,000 ft <sup>2</sup>	71	44	115	170	176	346	202	187	389
<b>Post-Expansion</b>											
Shopping Plaza (no supermarket)	821	58,135 ft <sup>2</sup>	80	49	129	190	197	387	235	216	451
Fast-Food Restaurant with Drive-Through	934	2,370 ft <sup>2</sup>	69	67	136	52	48	100	86	82	168
<b>Proposed Total</b>			<b>149</b>	<b>116</b>	<b>265</b>	<b>242</b>	<b>245</b>	<b>487</b>	<b>321</b>	<b>298</b>	<b>619</b>
<b>Difference</b>			<b>+78</b>	<b>+72</b>	<b>+150</b>	<b>+72</b>	<b>+69</b>	<b>+141</b>	<b>+119</b>	<b>+111</b>	<b>+230</b>

1. pph = Persons Per Hour – Calculated using an ITE Trip to Person Trip factor of 1.28, consistent with the 2017 TIA Guidelines

**Table 6: Person Trips by Modal Share**

Travel Mode	Modal Share	AM Peak			PM Peak			SAT Peak		
		IN	OUT	TOT	IN	OUT	TOT	IN	OUT	TOT
<b>Pre-Expansion</b>										
<b>Retail Person Trips</b>		<b>71</b>	<b>44</b>	<b>115</b>	<b>170</b>	<b>176</b>	<b>346</b>	<b>202</b>	<b>187</b>	<b>389</b>
Auto Driver	65%	46	29	75	111	114	225	132	121	253
Auto Passenger	20%	14	9	23	34	35	69	40	38	78
Transit	5%	4	2	6	8	9	17	10	9	19
Cyclist	0%	-	-	0	-	-	0	-	-	0
Pedestrian	10%	7	4	11	17	18	35	20	19	39
<b>Post-Expansion</b>										
<b>Retail Person Trips</b>		<b>80</b>	<b>49</b>	<b>129</b>	<b>190</b>	<b>197</b>	<b>387</b>	<b>235</b>	<b>216</b>	<b>451</b>
Auto Driver	65%	52	32	84	124	128	252	153	140	293
Auto Passenger	20%	16	10	26	38	39	77	47	43	90
Transit	5%	4	2	6	9	10	19	12	11	23
Cyclist	0%	-	-	0	-	-	0	-	-	0
Pedestrian	10%	8	5	13	19	20	39	23	22	45
<b>Restaurant Person Trips</b>		<b>69</b>	<b>67</b>	<b>136</b>	<b>52</b>	<b>48</b>	<b>100</b>	<b>86</b>	<b>82</b>	<b>168</b>
Auto Driver	65%	45	44	89	34	31	65	56	53	109
Auto Passenger	20%	14	13	27	10	10	20	17	17	34
Transit	5%	3	3	6	3	2	5	4	4	8
Cyclist	0%	-	-	0	-	-	0	-	-	0
Pedestrian	10%	7	7	14	5	5	10	9	8	17
<b>Total Person Trips</b>		<b>149</b>	<b>116</b>	<b>265</b>	<b>242</b>	<b>245</b>	<b>487</b>	<b>321</b>	<b>298</b>	<b>619</b>
Auto Driver		97	76	173	158	159	317	209	193	402
Auto Passenger		30	23	53	48	49	97	64	60	124
Transit		7	5	12	12	12	24	16	15	31
Cyclist		-	-	0	-	-	0	-	-	0
Pedestrian		15	12	27	24	25	49	32	30	62
<b>Net Additional Person Trips</b>		<b>78</b>	<b>72</b>	<b>150</b>	<b>72</b>	<b>69</b>	<b>141</b>	<b>119</b>	<b>111</b>	<b>230</b>
Auto Driver		51	47	98	47	45	92	77	72	149
Auto Passenger		16	14	30	14	14	28	24	22	46
Transit		3	3	6	4	3	7	6	6	12
Cyclist		-	-	0	-	-	0	-	-	0
Pedestrian		8	8	16	7	7	14	12	11	23

Based on the previous tables, the existing shopping plaza is estimated to generate 115 person trips (including 75 vehicle trips) during the AM peak hour, 346 person trips (including 225 vehicle trips)

during the PM peak hour, and 389 person trips (including 253 vehicle trips) during the Saturday peak hour. With the proposed expansion, the shopping plaza is estimated to generate 265 person trips (including 173 vehicle trips) during the AM peak hour, 487 person trips (including 317 vehicle trips) during the PM peak hour, and 619 person trips (including 402 vehicle trips) during the Saturday peak hour.

Therefore, the proposed retail pad and drive-through restaurant are estimated to generate a net additional:

- 150 person trips, including 98 vehicle trips during the AM peak hour;
- 141 person trips, including 92 vehicle trips during the PM peak hour;
- 230 person trips, including 149 vehicle trips during the Saturday peak hour.

As the subject site will contain multiple land uses, it is anticipated that some trips may be internally captured (i.e. customers of the drive-through restaurant travelling to/from the retail pad or existing shopping plaza). Since the Shopping Plaza land use rates in the *ITE Trip Generation Manual* account for multiple retail uses in one plaza, no reduction to account for internally captured trips has been applied to the existing development.

The *ITE Trip Generation Handbook* identifies internal trip rates between retail and restaurant land uses, and these rates have been used to estimate the number of internally captured trips at buildout of the proposed expansion. Internally captured trips between the proposed land uses have been estimated using the methodology outlined in the *ITE Trip Generation Handbook* and the *NCHRP Report 684 Estimator* spreadsheet tool (developed by the Texas A&M Transportation Institute in 2010). Person trips have been entered directly into the spreadsheet where required, as the tool’s method of estimating person trips is incompatible with the results shown in **Table 5** and **Table 6**. The internal capture worksheets are included in **Appendix F**.

Internally captured trip estimates by the proposed development is presented in **Table 7**.

**Table 7: Internally Captured Trips – Proposed Development**

Trip Type		AM Peak Hour			PM Peak Hour			SAT Peak Hour		
		IN	OUT	TOT	IN	OUT	TOT	IN	OUT	TOT
Retail Trips	Vehicle	52	32	84	124	128	252	153	140	293
	Transit	4	2	6	9	10	19	12	11	23
	Non-Auto	8	5	13	19	20	39	23	22	45
Internal Adjustment	Vehicle	-5	-5	-10	-17	-13	-30	-29	-21	-50
	Transit	-	-	0	-	-1	-1	-2	-1	-3
	Non-Auto	-1	-1	-2	-2	-2	-4	-3	-3	-6
External Trips	Vehicle	47	27	74	107	115	222	124	119	243
	Transit	4	2	6	9	9	18	10	10	20
	Non-Auto	7	4	11	17	18	35	20	19	39
Restaurant Trips	Vehicle	45	44	89	34	31	65	56	53	109
	Transit	3	3	6	3	2	5	4	4	8
	Non-Auto	7	7	14	5	5	10	9	8	17
Internal Adjustment	Vehicle	-5	-5	-10	-13	-17	-30	-21	-29	-50
	Transit	-	-	0	-1	-1	-2	-1	-2	-3
	Non-Auto	-1	-1	-2	-1	-2	-3	-3	-3	-6
External Trips	Vehicle	40	39	79	21	14	35	35	24	59
	Transit	3	3	6	2	1	3	3	2	5
	Non-Auto	6	6	12	4	3	7	6	5	11

The existing and proposed land uses are also expected to generate two types of external peak hour trips: primary and pass-by trips. Primary trips are made for the specific purpose of visiting the site, while pass-by trips are made as intermediate stops on the way to another destination.

For the shopping and restaurant uses, peak hour pass-by trips have been estimated based on the average rates identified in the *ITE Trip Generation Manual, 11<sup>th</sup> Edition*. Using these average rates, the assumed pass-by rates for the shopping uses are 0% during the AM peak hour, 40% during the PM peak hour, and 31% during the Saturday peak hour, and the assumed pass-by rates for the restaurant use are 50% during the AM peak hour, 55% during the PM peak hour, and 55% during the Saturday peak hour. These rates have been applied to the external trips identified above.

The primary and pass-by trip generation for the existing development only is presented in **Table 8**. The primary and pass-by trip generation for the proposed development as a whole is presented in **Table 9**.

**Table 8: Primary and Pass-by Trips – Existing Development Only**

Trip Type	AM Peak (vph)			PM Peak (vph)			SAT Peak (vph)		
	IN	OUT	TOT	IN	OUT	TOT	IN	OUT	TOT
Existing Retail Trips	46	29	75	111	114	225	132	121	253
Pass-by (0% AM, 40% PM, 31% SAT)	-	-	0	45	45	90	39	39	78
<b>Primary Trips</b>	<b>46</b>	<b>29</b>	<b>75</b>	<b>66</b>	<b>69</b>	<b>135</b>	<b>93</b>	<b>82</b>	<b>175</b>

**Table 9: Primary and Pass-by Trips – Existing plus Proposed Development**

Trip Type	AM Peak (vph)			PM Peak (vph)			SAT Peak (vph)		
	IN	OUT	TOT	IN	OUT	TOT	IN	OUT	TOT
Retail External Trips	47	27	74	107	115	222	124	119	243
Pass-by (0% AM, 40% PM, 31% SAT)	-	-	0	45	45	90	38	38	76
<b>Primary</b>	<b>47</b>	<b>27</b>	<b>74</b>	<b>62</b>	<b>70</b>	<b>132</b>	<b>86</b>	<b>81</b>	<b>167</b>
Restaurant External Trips	40	39	79	21	14	35	35	24	59
Pass-by (50% AM, 55% PM, 55% SAT)	20	20	40	9	9	18	16	16	32
<b>Primary</b>	<b>20</b>	<b>19</b>	<b>39</b>	<b>12</b>	<b>5</b>	<b>17</b>	<b>19</b>	<b>8</b>	<b>27</b>
<b>Primary Total</b>	<b>67</b>	<b>46</b>	<b>113</b>	<b>74</b>	<b>75</b>	<b>149</b>	<b>105</b>	<b>89</b>	<b>194</b>

### 3.1.2 Trip Distribution

The assumed distribution of primary trips generated by the existing and proposed land uses has been derived from existing traffic patterns within the study area, and can be described as follows:

- 5% to/from the north via Stafford Road;
- 5% to/from the south via Lynhar Road;
- 45% to/from the east via Robertson Road;
- 45% to/from the west via Robertson Road.

The distribution of pass-by trips generated by the existing and proposed land uses have been estimated based on the existing traffic patterns of the study area, and all pass-by trips are assumed to originate from Robertson Road. This can be described as follows:

- Eastbound via Robertson Road: 70% during AM peak and 50% during PM and SAT peaks;
- Westbound via Robertson Road: 30% during AM peak and 50% during PM and SAT peaks.

### 3.1.3 Trip Assignment

There are two existing site accesses to Lynhar Road and two existing site accesses to Larkspur Drive. Based on the total number of existing parking spaces, approximately 25% of the parking supply is south of the shopping plaza building and is accessed via the southern accesses to Lynhar Road and Larkspur Drive, while the remaining 75% is accessed via the northern accesses. Trips generated by the existing shopping plaza and proposed retail pad are assumed to follow this ratio, and have been assigned to the accesses accordingly. All trips generated by the proposed restaurant have been assigned to the northerly accesses to Lynhar Road and Larkspur Drive.

It is estimated that all pass-by trips from the west will enter and exit the site via the northerly access to Lynhar Road. Due to the layout of the roadways surrounding the subject site, it is estimated that pass-by trips from the east will enter the site equally between the northerly accesses to Lynhar Road and Larkspur Drive, but all trips will exit the site via the northerly access to Lynhar Road.

A full breakdown of the trip assignment for the existing shopping plaza and proposed expansion can be described as follows:

#### Northerly Access – Lynhar Road

- 75% of **primary retail trips** and 100% of **primary restaurant trips** arriving/departing to the north via Stafford Road, the south via Lynhar Road, and the west via Robertson Road;
- 100% of **pass-by trips** (entering from and exiting to) the west via Robertson Road;
- 50% of **pass-by trips** (entering only) from the east via Robertson Road;
- 100% of **pass-by trips** (exiting only) to the east via Robertson Road.

#### Southerly Access – Lynhar Road

- 25% of **primary retail trips** arriving/departing to the north via Stafford Road, the south via Lynhar Road, and the west via Robertson Road.

#### Northerly Access – Larkspur Drive

- 75% of **primary retail trips** and 100% of **primary restaurant trips** arriving/departing to the east via Robertson Road;
- 50% of **pass-by trips** (entering only) from the east via Robertson Road.

#### Southerly Access – Larkspur Drive

- 25% of **primary retail trips** arriving/departing to the east via Robertson Road.

Traffic volume figures for trips generated by the shopping plaza (divided into primary trips and pass-by trips) are shown in the following conditions:

- Trips generated by the existing development are shown in **Figure 6** and **Figure 7**;
- Trips generated by the development post-expansion are shown in **Figure 8** and **Figure 9**;
- The net additional trips generated by the proposed expansion are shown in **Figure 10** and **Figure 11**.

Figure 6: Site-Generated Primary Traffic (pre-expansion)

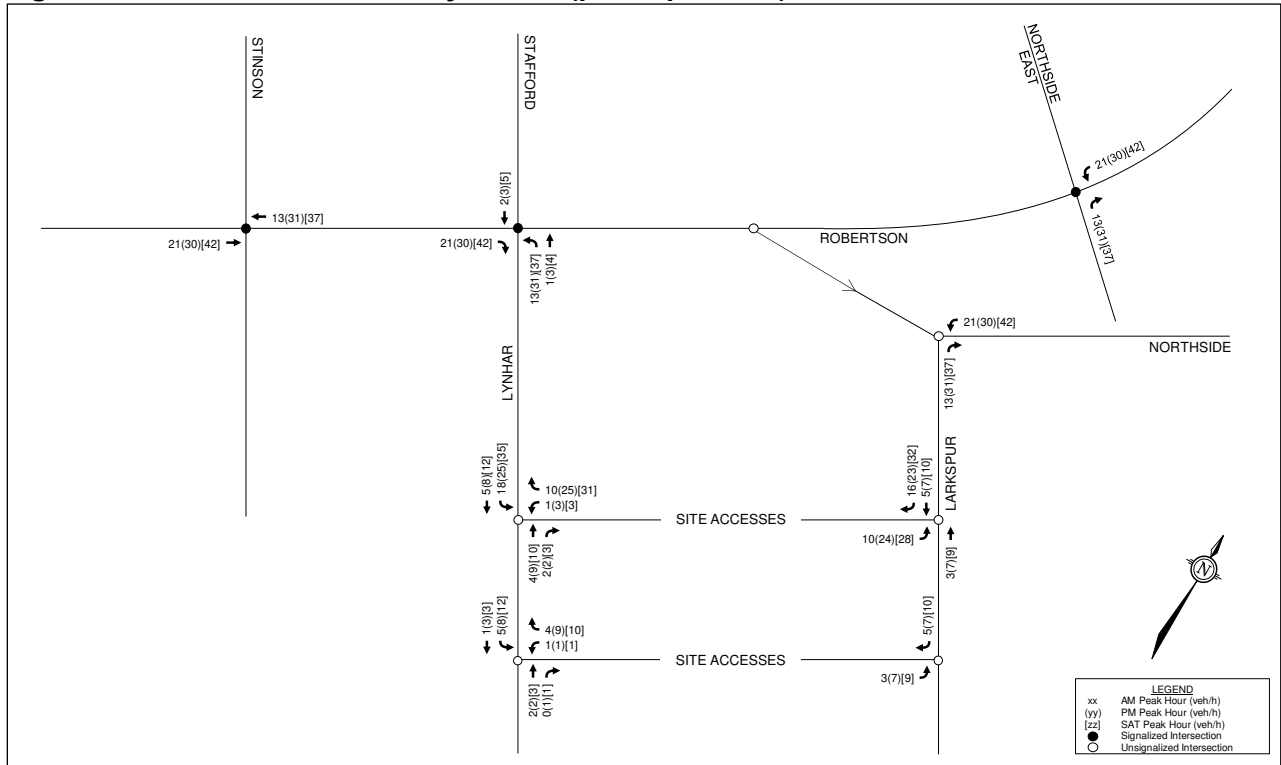

Figure 7: Site-Generated Pass-By Traffic (pre-expansion)

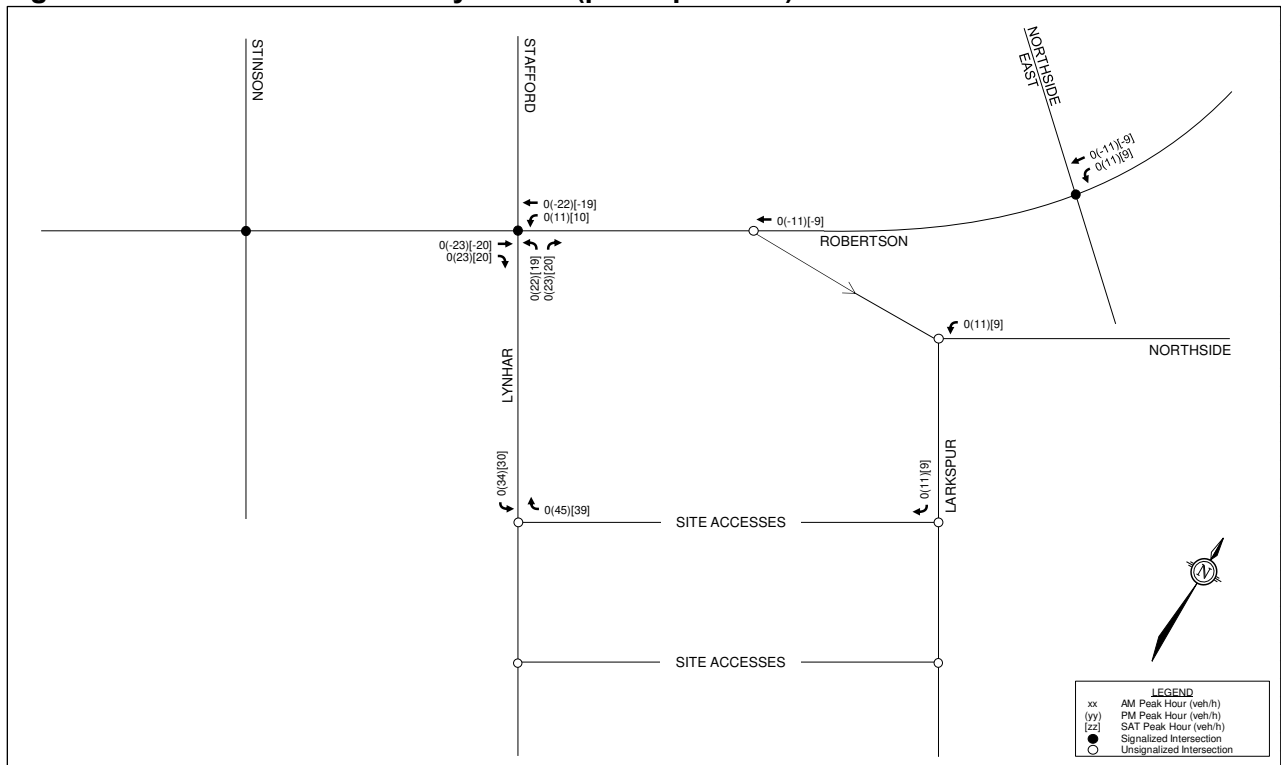



Figure 8: Site-Generated Primary Traffic (post-expansion)

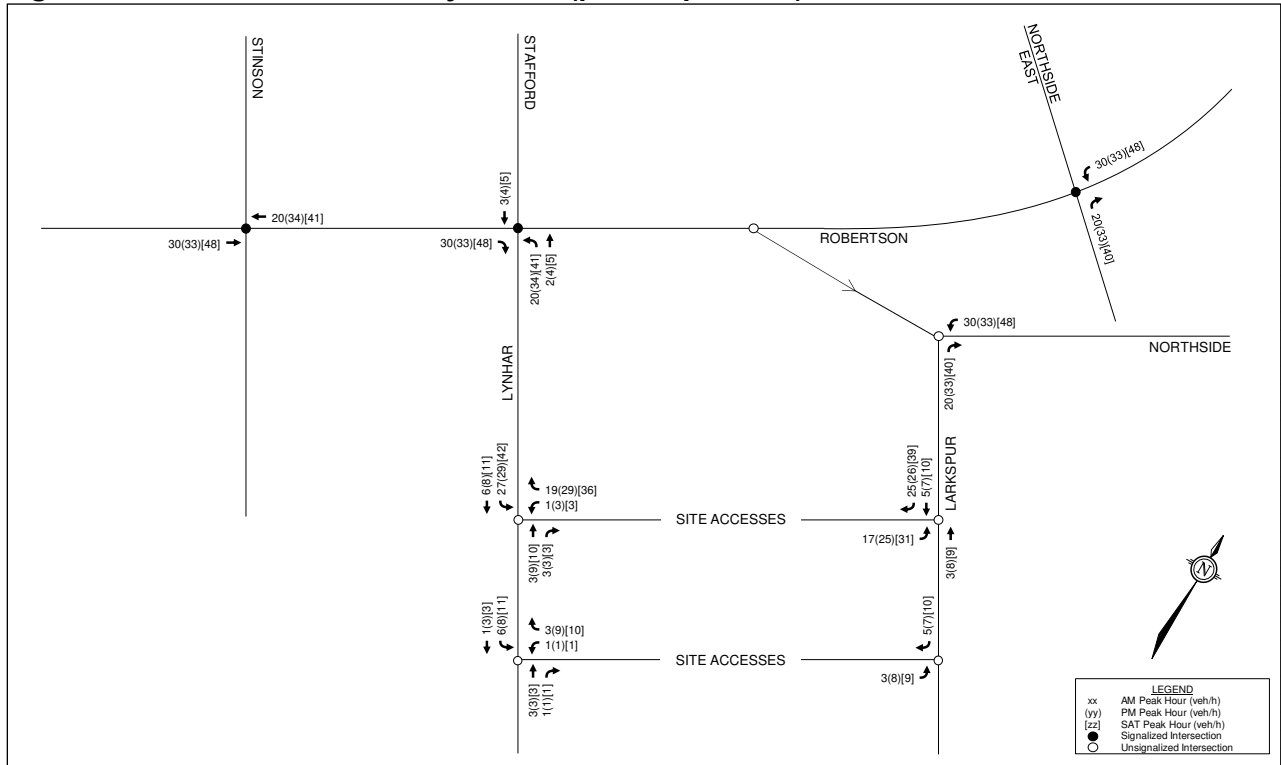

Figure 9: Site-Generated Pass-By Traffic (post-expansion)

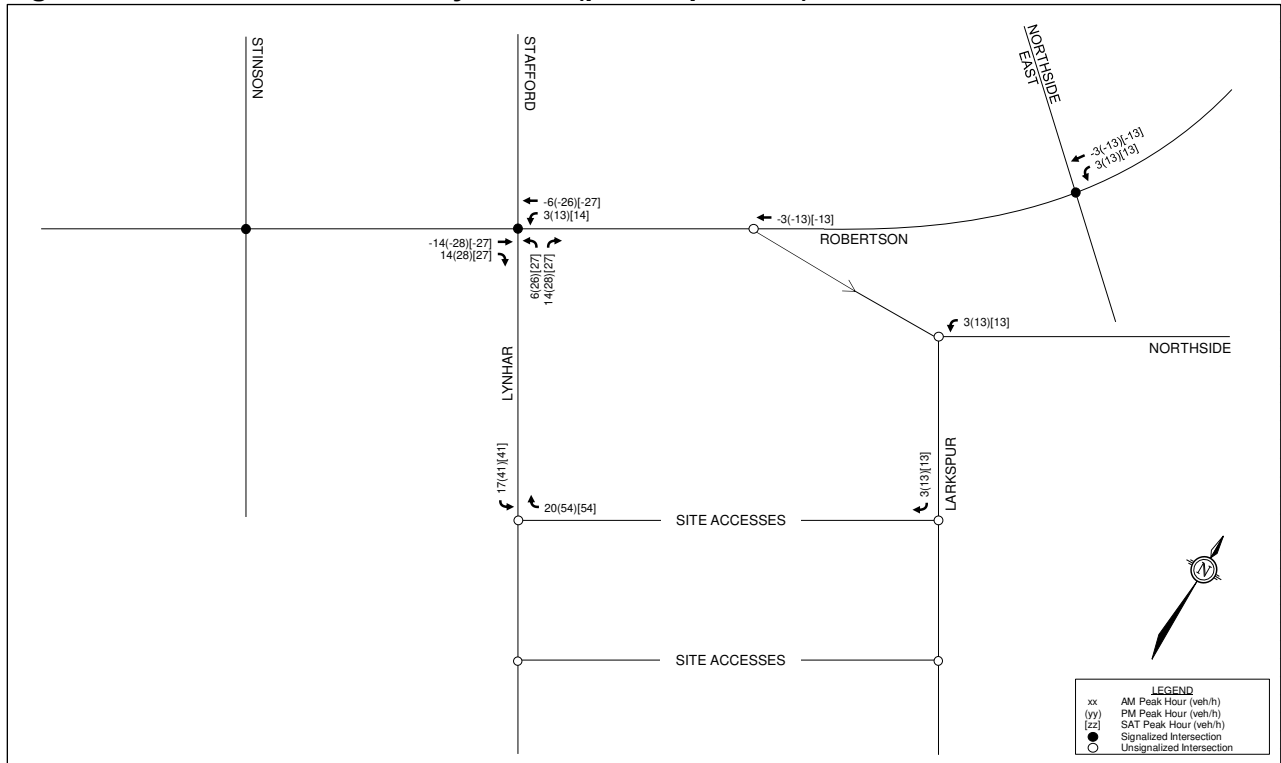

Figure 10: Net Additional Site-Generated Primary Traffic

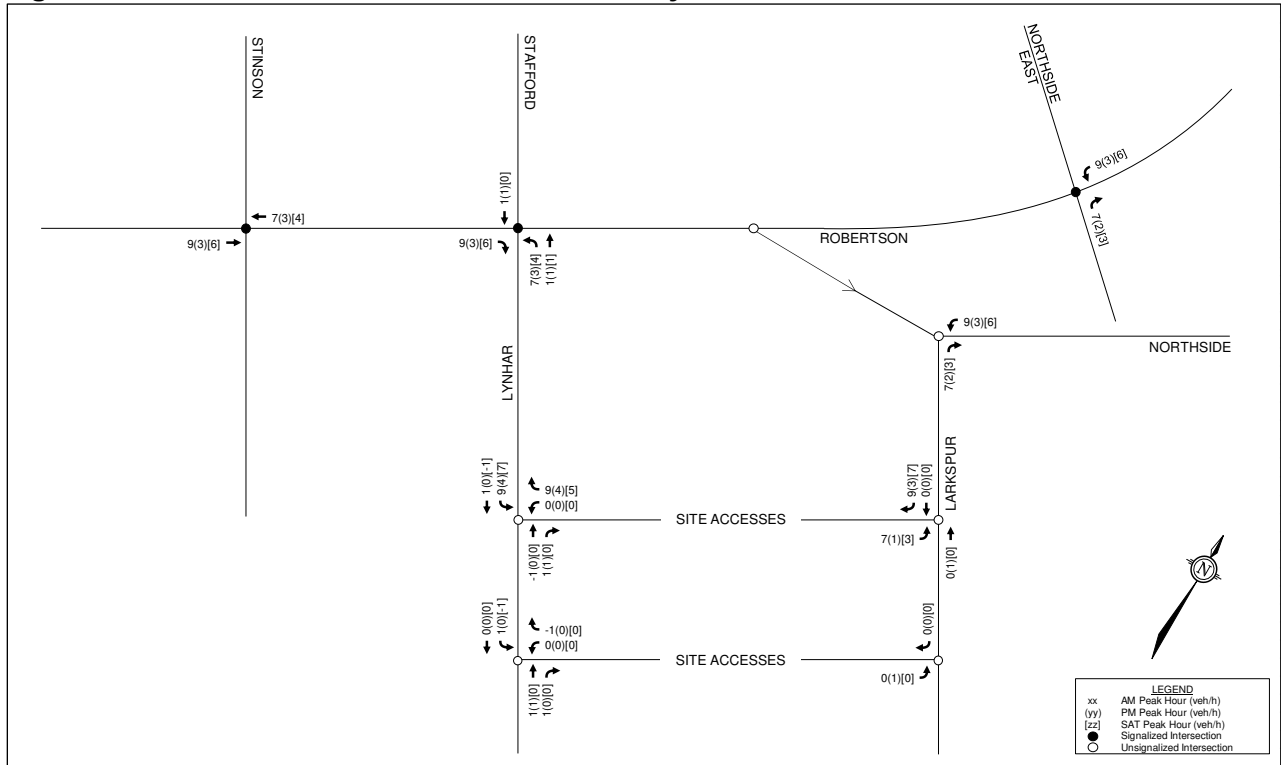
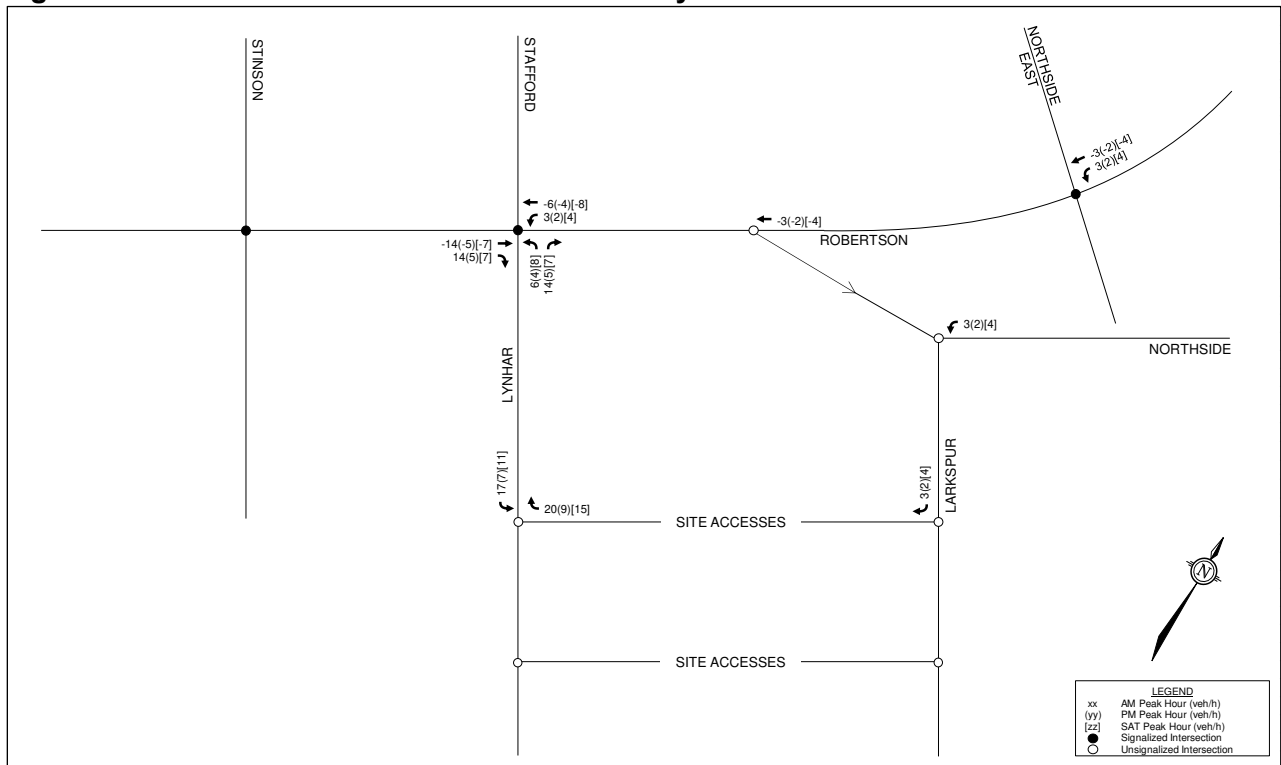

Figure 11: Net Additional Site-Generated Pass-By Traffic



## 3.2 Background Traffic

### 3.2.1 Other Area Development

Of the other area developments outlined in Section 2.2.2, the following developments included traffic projections that have been added to the background volumes for the purposes of this TIA. Relevant excerpts in support of the development applications below are included in **Appendix G**.

#### 1987 Robertson Road and 295 Moodie Drive

The proposed development will include 1,925 dwellings and approximately 41,657 ft<sup>2</sup> GFA of commercial space. Per the 2021 TIA prepared by CGH, the development will have an ultimate buildout year of 2029. Therefore, traffic generated by this development has been added to the 2029 background volumes.

As the study did not include traffic projections for the Saturday peak hour, the PM peak hour projections have been multiplied by a factor of 1.125 to represent Saturday peak hour volumes. This PM-to-Saturday factor is based on the average trip generation rates for the PM and Saturday peak hours included in the *ITE Trip Generation Manual, 11<sup>th</sup> Edition*, corresponding to the High-Rise Multifamily Housing land use (0.32 trips per dwelling in the PM peak, 0.36 trips per dwelling in the Saturday peak). Only the residential trip generation rates were considered in determining the PM-to-Saturday factor, as the commercial component was estimated to account for approximately 3% to 12% of the total traffic generated by this development during the weekday peak hours.

#### 2165 Robertson Road

The proposed development will include approximately 11,757 ft<sup>2</sup> GFA of warehouse space and 6,017 ft<sup>2</sup> GFA of restaurant space. The 2018 TIA prepared by Parsons originally anticipated a buildout year of 2019, and a TIA Addendum was prepared by Parsons in 2020. For the purposes of this TIA, traffic generated by this development has been added to the 2024 and 2029 background volumes.

### 3.2.2 General Background Growth Rate

A rate of background growth has been established through a review of snapshots of the City's Strategic Long-Range Model (comparing 2011 and 2031 AM peak volumes) and Intersection Traffic Growth Rate maps (which establish AM and PM peak growth rates from counts conducted between 2000 and 2016). The snapshots and growth rate maps are included in **Appendix H**.

The snapshots suggest growth on Robertson Road up to 0.5% per annum west of Stinson Avenue, and suggests negative growth on Robertson Road east of Stinson Avenue. The intersection traffic growth maps generally indicate growth between 0.2% and 2% per annum along the Robertson Road corridor (between Eagleson Road and Baseline Road) during the AM peak hour, and generally indicate growth between -0.2% and -2% per annum along the Robertson Road corridor during the PM peak hour. In the interest of maintaining a conservative analysis, a growth rate of 0.5% has been assumed along Robertson Road. A growth rate of 0% has been applied to all other roadways within the study area.

### 3.3 Future Traffic Conditions

The figures listed below present the following conditions:

- Other area development-generated volumes in 2024 are shown in **Figure 12**;
- Other area development-generated volumes in 2029 are shown in **Figure 13**;
- Background traffic volumes for the 2024 buildout year are shown in **Figure 14**;
- Background traffic volumes for the 2029 horizon year are shown in **Figure 15**;
- Total traffic volumes for the 2024 buildout year are shown in **Figure 16**;
- Total traffic volumes for the 2029 horizon year are shown in **Figure 17**.

**Figure 12: 2024 Other Area Development-Generated Volumes**

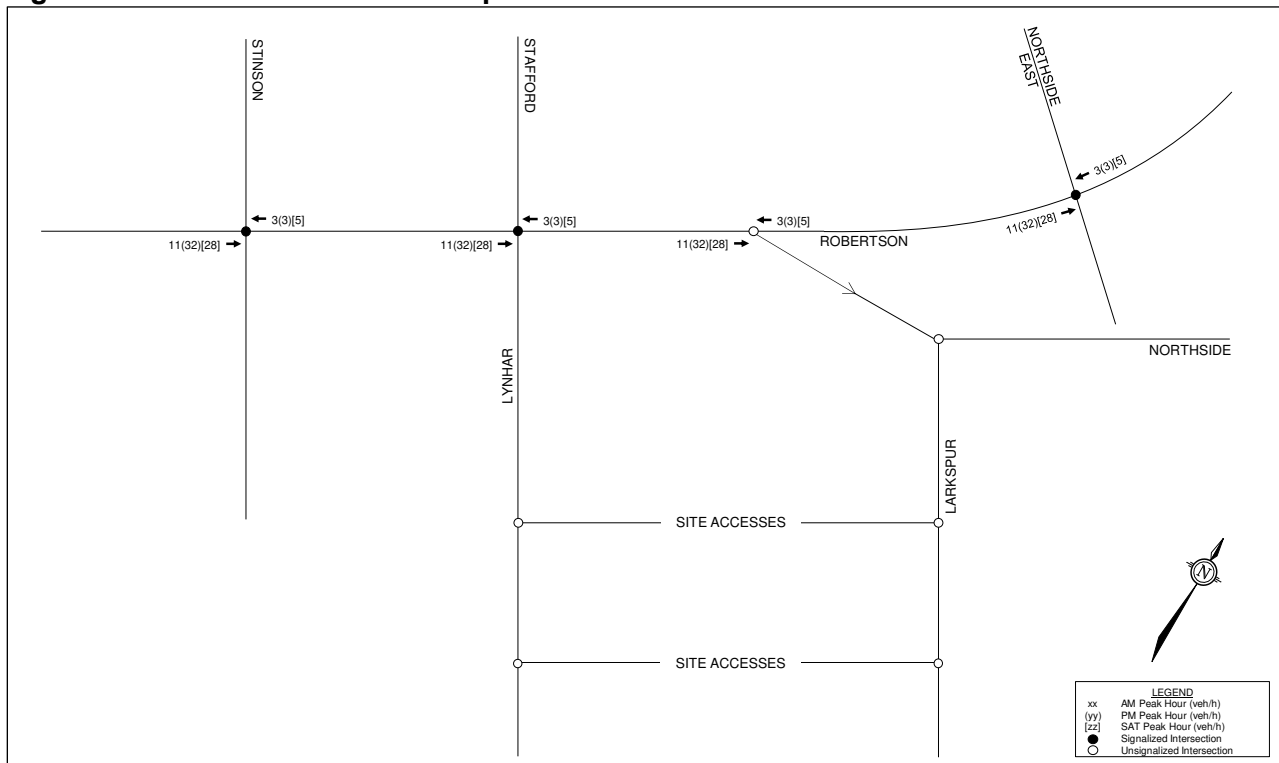

Figure 13: 2029 Other Area Development-Generated Volumes

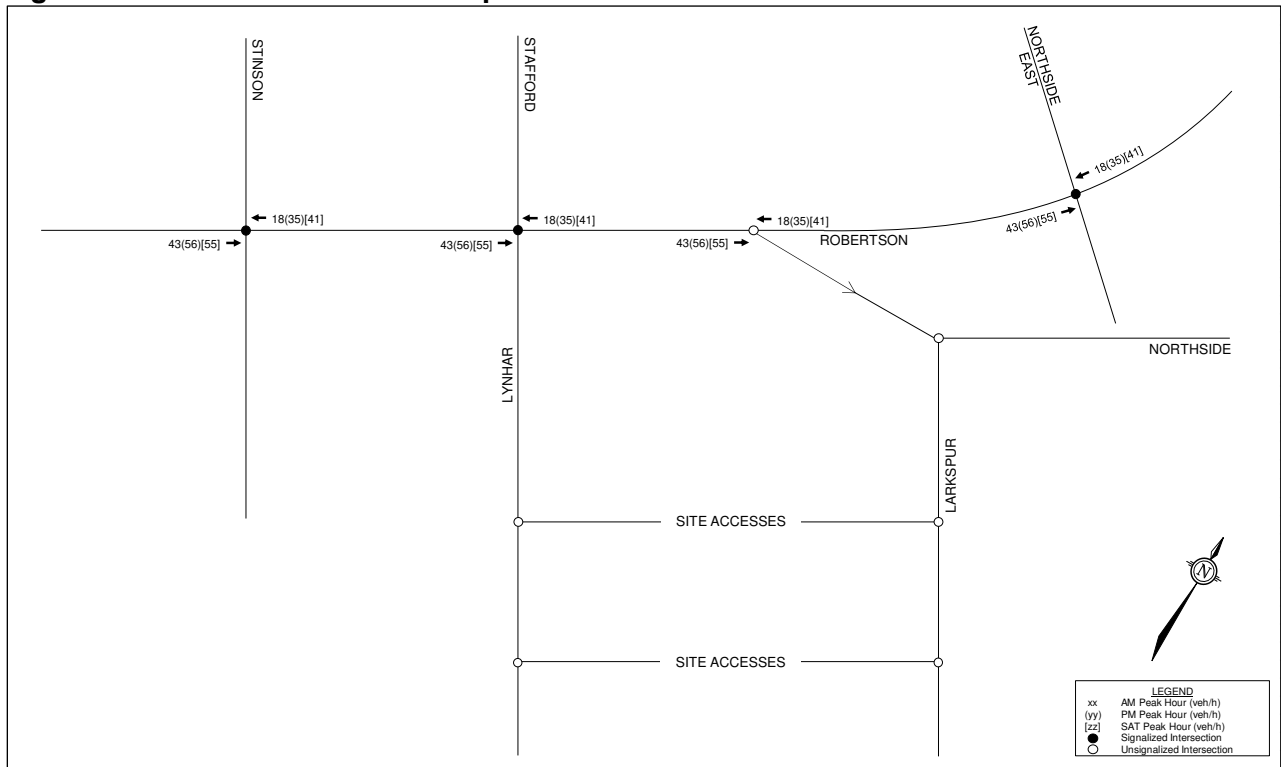

Figure 14: 2024 Background Traffic Volumes

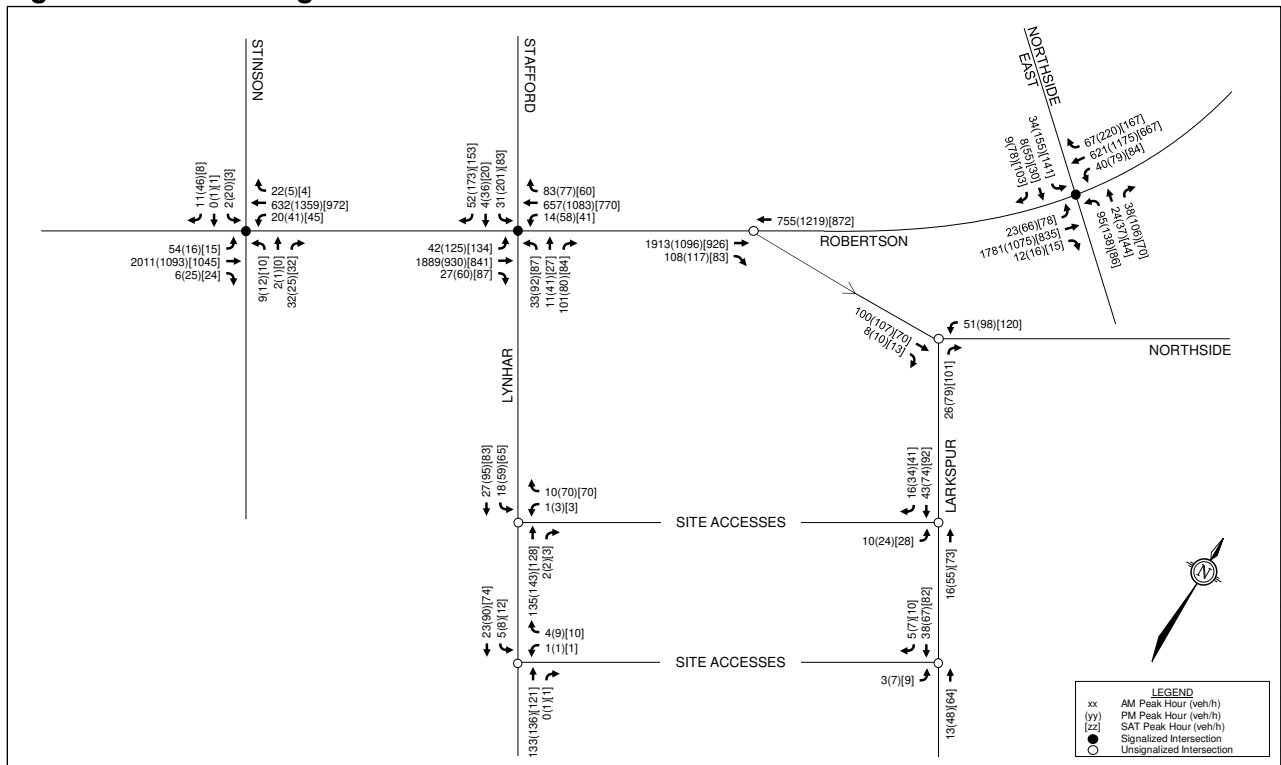

Figure 15: 2029 Background Traffic Volumes

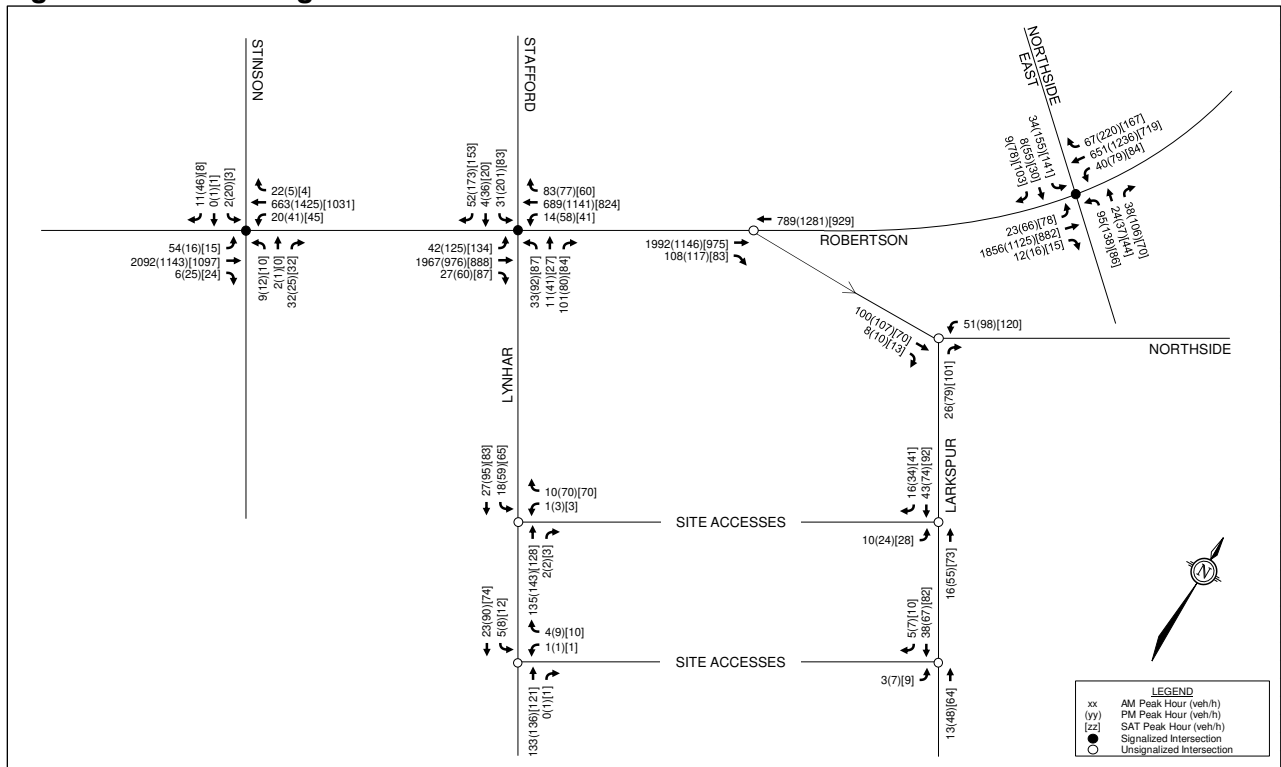

Figure 16: 2024 Total Traffic Volumes

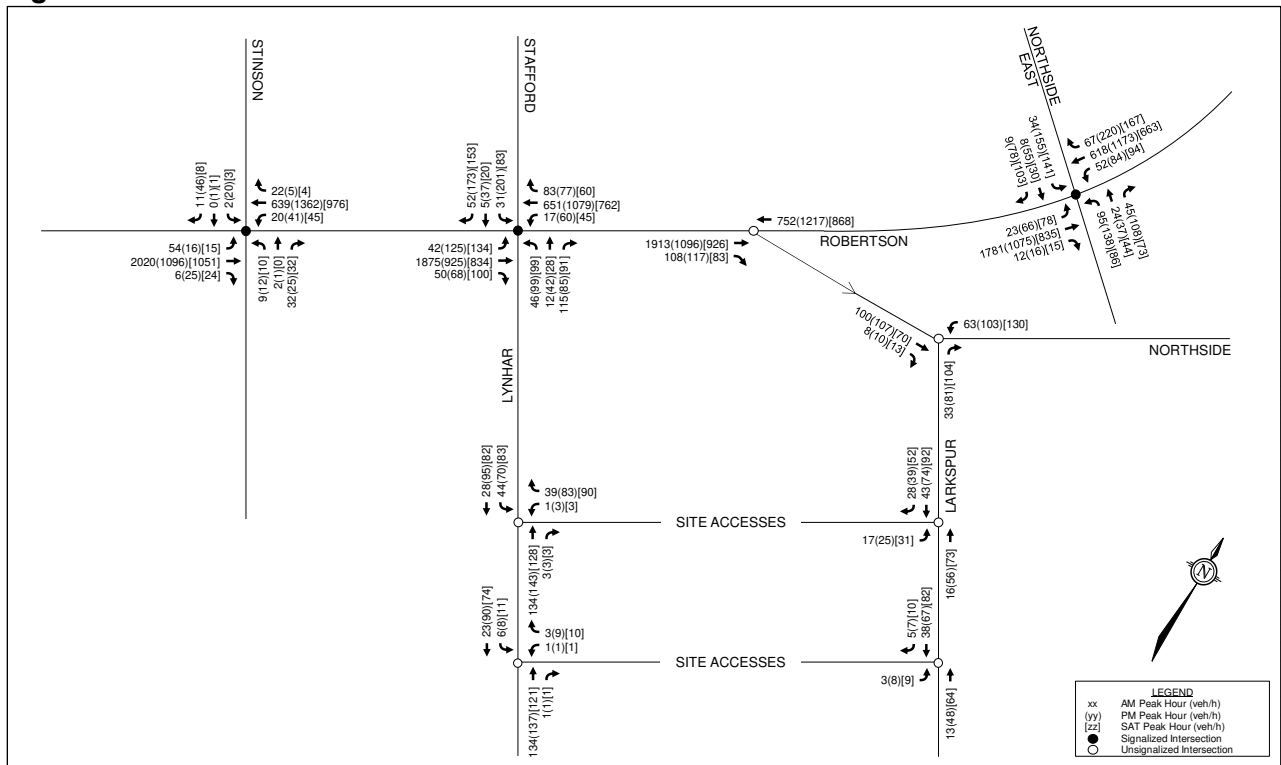
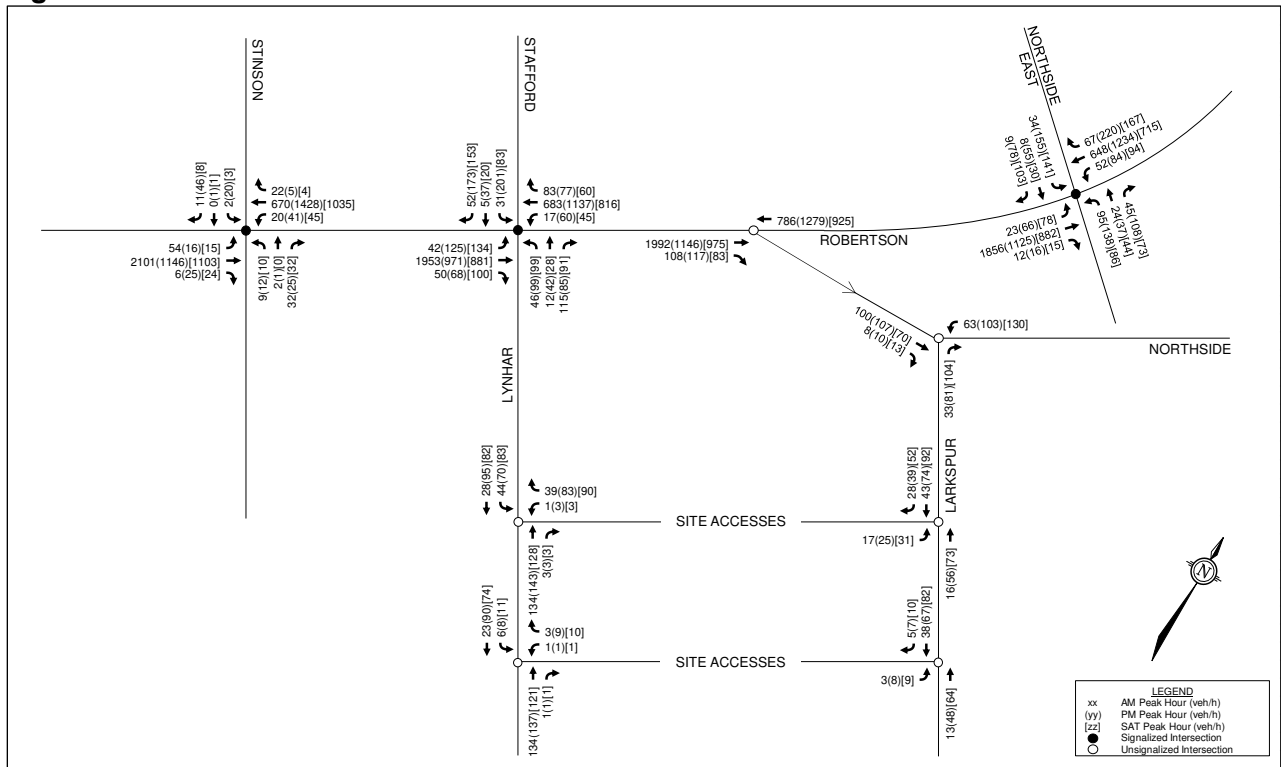

Figure 17: 2029 Total Traffic Volumes



### 3.4 Demand Rationalization

A review of the existing and background intersection operations has been conducted using Synchro 11, to determine if and when traffic volumes exceed capacity within the study area. The intersection parameters used in the analysis are consistent with the *2017 TIA Guidelines* (Saturated Flow Rate: 1,800 vphpl, Peak Hour Factor: 0.9 in existing conditions and 1.0 in future conditions).

Per Exhibit 22 of the *Multi-Modal Level of Service (MMLOS) Guidelines*, the target vehicular level of service (Auto LOS) is an Auto LOS E at Robertson Road/Stinson Avenue (as it is within 300m of a school), and an Auto LOS D at Robertson Road/Lynhar Road/Stafford Road, Robertson Road/Northside Road East, Northside Road/Larkspur Drive, and all site accesses. An Auto LOS D equates to a maximum vehicle-to-capacity (v/c) ratio of 0.90 at signalized intersections and a maximum delay of 35 seconds at unsignalized intersections. An Auto LOS E equates to a maximum v/c ratio of 1.00 at signalized intersections.

Signal timing plans were obtained from the City, and are included in **Appendix I**.

#### 3.4.1 Existing Intersection Operations

Intersection capacity analysis has been conducted for the existing traffic conditions. The results of the analysis are summarized in **Table 10** and **Table 11** for the AM, PM, and Saturday peak hours. Detailed Synchro reports are included in **Appendix J**.

**Table 10: Existing Traffic Operations**

Intersection	AM Peak			PM Peak			SAT Peak		
	Max v/c or Delay	LOS	Mvmt	Max v/c or Delay	LOS	Mvmt	Max v/c or Delay	LOS	Mvmt
Robertson Road/ Stinson Avenue	0.78	C	EBT/R	0.54	A	WBT/R	0.41	A	EBT/R
Robertson Road/ Lynhar Road/Stafford Road	0.82	D	EBT	0.86	D	WBT/R	0.72	C	EBL
Robertson Road/ Northside Road East	0.75	C	EBT/R	0.77	C	SBL	0.76	C	SBL
Northside Road/ Larkspur Drive	8 sec	A	WBL	8 sec	A	WBL	8 sec	A	EBT/R
Lynhar Road/ North Site Access	9 sec	A	WBL/R	9 sec	A	WBL/R	9 sec	A	WBL/R
Lynhar Road/ South Site Access	9 sec	A	WBL/R	9 sec	A	WBL/R	9 sec	A	WBL/R
Larkspur Drive/ North Site Access	10 sec	A	EBL/R	10 sec	A	EBL/R	10 sec	A	EBL/R
Larkspur Drive/ South Site Access	9 sec	A	EBL/R	9 sec	A	EBL/R	9 sec	A	EBL/R

**Table 11: Existing Queues**

Intersection	Mvmt	AM Peak			PM Peak			SAT Peak		
		v/c [LOS]	50 <sup>th</sup> % Queue (m)	95 <sup>th</sup> % Queue (m)	v/c [LOS]	50 <sup>th</sup> % Queue (m)	95 <sup>th</sup> % Queue (m)	v/c [LOS]	50 <sup>th</sup> % Queue (m)	95 <sup>th</sup> % Queue (m)
Robertson/ Lynhar/ Stafford	SBL	0.25 [A]	8	15	0.69 [B]	35	55	0.28 [A]	13	24
	EBL	0.44 [A]	11	m13	0.72 [C]	31	#68	0.72 [C]	~35	#74
	EBT	0.82 [D]	14	#332	0.59 [A]	79	126	0.52 [A]	71	114
	WBT	0.36 [A]	28	34	0.86 [D]	142	#179	0.63 [B]	87	110
Robertson/ Northside E	NBL	0.65 [B]	24	40	0.59 [A]	30	48	0.42 [A]	19	31
	WBL	0.44 [A]	4	#23	0.35 [A]	10	25	0.28 [A]	9	23

~: volume for the 50<sup>th</sup> percentile queue exceeds capacity  
 #: volume for the 95<sup>th</sup> percentile queue exceeds capacity  
 m: volume for the 95<sup>th</sup> percentile queue is metered by an upstream signal

From the previous tables, all study area intersections and the subject site accesses meet the target Auto LOS.

During the AM peak hour, the 95<sup>th</sup>-percentile (maximum) queue lengths of the eastbound through movement at Robertson Road/Lynhar Road/Stafford Road extend through the upstream intersection at Robertson Road/Stinson Avenue, a distance of 270m to the west.

**3.4.2 2024 Background Intersection Operations**

Intersection capacity analysis has been conducted for the 2024 background traffic conditions. The results of the analysis are summarized in **Table 12** and **Table 13** for the AM, PM, and Saturday peak hours. Detailed Synchro reports are included in **Appendix K**.



**Table 12: 2024 Background Intersection Operations**

Intersection	AM Peak			PM Peak			SAT Peak		
	Max v/c or Delay	LOS	Mvmt	Max v/c or Delay	LOS	Mvmt	Max v/c or Delay	LOS	Mvmt
Robertson Road/ Stinson Avenue	0.72	C	EBT/R	0.49	A	WBT/R	0.38	A	EBT/R
Robertson Road/ Lynhar Road/Stafford Road	0.75	C	EBT	0.77	C	WBT/R	0.73	C	EBL
Robertson Road/ Northside Road East	0.68	B	EBT/R	0.77	C	SBL	0.72	C	SBL
Northside Road/ Larkspur Drive	8 sec	A	WBL	8 sec	A	WBL	8 sec	A	EBT/R
Lynhar Road/ North Site Access	9 sec	A	WBL/R	9 sec	A	WBL/R	9 sec	A	WBL/R
Lynhar Road/ South Site Access	9 sec	A	WBL/R	9 sec	A	WBL/R	9 sec	A	WBL/R
Larkspur Drive/ North Site Access	9 sec	A	EBL/R	9 sec	A	EBL/R	10 sec	A	EBL/R
Larkspur Drive/ South Site Access	9 sec	A	EBL/R	9 sec	A	EBL/R	9 sec	A	EBL/R

**Table 13: 2024 Background Queues**

Intersection	Mvmt	AM Peak			PM Peak			SAT Peak		
		v/c [LOS]	50 <sup>th</sup> % Queue (m)	95 <sup>th</sup> % Queue (m)	v/c [LOS]	50 <sup>th</sup> % Queue (m)	95 <sup>th</sup> % Queue (m)	v/c [LOS]	50 <sup>th</sup> % Queue (m)	95 <sup>th</sup> % Queue (m)
Robertson/ Lynhar/ Stafford	SBL	0.23 [A]	7	14	0.63 [B]	31	49	0.25 [A]	12	22
	EBL	0.40 [A]	10	m13	0.73 [C]	27	#59	0.73 [C]	29	#65
	EBT	0.75 [C]	12	#289	0.55 [A]	74	118	0.49 [A]	67	107
	WBT	0.32 [A]	25	31	0.77 [C]	123	133	0.56 [A]	78	99
Robertson/ Northside E	NBL	0.61 [B]	22	36	0.60 [A]	28	44	0.42 [A]	17	29
	WBL	0.30 [A]	3	13	0.27 [A]	8	21	0.22 [A]	7	19

#: volume for the 95<sup>th</sup> percentile queue exceeds capacity  
 m: volume for the 95<sup>th</sup> percentile queue is metered by an upstream signal

Based on the previous tables, marginal changes to the v/c ratios, queue lengths, and delays are anticipated as a result of background growth within the study area. Certain movements appear to improve compared to existing conditions, due to differences in the peak hour factor parameter (0.90 in existing conditions versus 1.0 in future conditions, per the *2017 TIA Guidelines*).

**3.4.3 2029 Background Intersection Operations**

Intersection capacity analysis has been conducted for the 2029 background traffic conditions. The results of the analysis are summarized in **Table 14** and **Table 15** for the AM, PM, and Saturday peak hours. Detailed Synchro reports are included in **Appendix K**.

**Table 14: 2029 Background Intersection Operations**

Intersection	AM Peak			PM Peak			SAT Peak		
	Max v/c or Delay	LOS	Mvmt	Max v/c or Delay	LOS	Mvmt	Max v/c or Delay	LOS	Mvmt
Robertson Road/ Stinson Avenue	0.75	C	EBT/R	0.52	A	WBT/R	0.40	A	EBT/R
Robertson Road/ Lynhar Road/Stafford Road	0.78	C	EBT	0.80	C	WBT/R	0.73	C	EBL
Robertson Road/ Northside Road East	0.71	C	EBT/R	0.77	C	SBL	0.72	C	SBL
Northside Road/ Larkspur Drive	8 sec	A	WBL	8 sec	A	WBL	8 sec	A	EBT/R
Lynhar Road/ North Site Access	9 sec	A	WBL/R	9 sec	A	WBL/R	9 sec	A	WBL/R
Lynhar Road/ South Site Access	9 sec	A	WBL/R	9 sec	A	WBL/R	9 sec	A	WBL/R
Larkspur Drive/ North Site Access	9 sec	A	EBL/R	9 sec	A	EBL/R	10 sec	A	EBL/R
Larkspur Drive/ South Site Access	9 sec	A	EBL/R	9 sec	A	EBL/R	9 sec	A	EBL/R

**Table 15: 2029 Background Queues**

Intersection	Mvmt	AM Peak			PM Peak			SAT Peak		
		v/c [LOS]	50 <sup>th</sup> % Queue (m)	95 <sup>th</sup> % Queue (m)	v/c [LOS]	50 <sup>th</sup> % Queue (m)	95 <sup>th</sup> % Queue (m)	v/c [LOS]	50 <sup>th</sup> % Queue (m)	95 <sup>th</sup> % Queue (m)
Robertson/ Lynhar/ Stafford	SBL	0.23 [A]	7	14	0.63 [B]	31	49	0.25 [A]	12	22
	EBL	0.40 [A]	10	m12	0.73 [C]	27	#59	0.73 [C]	29	#65
	EBT	0.78 [C]	13	#306	0.58 [A]	78	124	0.51 [A]	71	113
	WBT	0.34 [A]	26	31	0.80 [C]	132	#170	0.59 [A]	84	106
Robertson/ Northside E	NBL	0.61 [B]	22	36	0.60 [A]	28	44	0.42 [A]	17	29
	WBL	0.34 [A]	3	15	0.29 [A]	8	21	0.23 [A]	8	20

#: volume for the 95<sup>th</sup> percentile queue exceeds capacity  
 m: volume for the 95<sup>th</sup> percentile queue is metered by an upstream signal

Based on the previous tables and compared to the 2024 background traffic conditions, marginal changes to the v/c ratios, queue lengths, and delays are anticipated as a result of background growth within the study area.

#### 4.0 ANALYSIS

#### 4.1 Development Design

#### 4.1.1 Design for Sustainable Modes

Pedestrian facilities will be provided between the proposed retail pad and the existing shopping plaza. A concrete sidewalk will be provided around the north, south, and east sides of the proposed drive-through restaurant and retail pad. Existing sidewalks on the north side of the shopping plaza provide connectivity to both Lynhar Road and Larkspur Drive.

Bicycle parking for the entire site will be in accordance with the minimum requirement of the City's Zoning By-law (ZBL), as described in Section 4.2. Ten bicycle parking spaces are currently located near the southeastern corner of the existing shopping plaza (i.e. at the back of the building). Four new bicycle parking spaces will be provided adjacent to the proposed drive-through aisle.

Locations of OC Transpo stops #0937 and #5294 are included in Section 2.1.6. These stops represent the closest bus stops that are not exclusively served by school routes. OC Transpo's service design guidelines for peak period service within a five minute walk of home, school, or work for 95% of urban residents, which is approximated using a walking distance of 400m. The walking distance from the main entrance of the existing development to the bus stops listed above is approximately 110m to stop #5294 and 210m to stop #0937.

A review of the Transportation Demand Management (TDM) – *Supportive Development Design and Infrastructure Checklist* has been conducted. A copy of the TDM checklist is included in **Appendix L**. All required TDM-supportive design and infrastructure measures in the TDM checklist are met. In addition to the required measures, the proposed development also meets the 'basic' measure of locating building doors and windows to ensure visibility of pedestrians from the proposed new building, for their security and comfort.

#### 4.1.2 Circulation and Access

No changes are proposed to the existing site accesses.

The Transportation Association of Canada (TAC)'s *Geometric Design Guide for Canadian Roads* identifies minimum clear throat length requirements for driveways, based on the classification of roadway, land use, and size of development. For driveways to collector roadways, TAC's *Geometric Design Guide* identifies minimum clear throat length requirements of 8m for shopping centres with less than 25,000 m<sup>2</sup> GFA and 15m for fast-food restaurants with greater than 200 m<sup>2</sup> GFA. Therefore, the 15m requirement governs. Measured from the end of the curb radii, the northerly Lynhar Road access is proposed to provide 15m of clear throat length, meeting the requirement.

Section 112(1) of the City's ZBL identifies minimum queueing space required for drive-through operations. For restaurants with a drive-through window and an order board preceding the window, the ZBL identifies a minimum of seven queueing spaces prior to the board and a minimum total of eleven queueing spaces overall. This minimum requirement will be met, as the proposed development will include seven spaces leading to the order board, and eleven spaces overall.

The fire route is located along the north side of the existing shopping plaza, as well as the drive aisle east of the proposed retail pad. Garbage collection will be located west of the proposed retail pad, within the loop formed by the drive-through aisle.

Truck turning movement figures have been prepared for the following conditions:

- A fire truck entering and exiting the fire route, represented by a Heavy Single Unit (HSU) vehicle: shown in **Figure 18** and **Figure 19**;
- A delivery truck/front-loading garbage truck driving forward in and reversing out from the loading area/garbage bins, represented by a Medium Single Unit (MSU) vehicle: shown in **Figure 20** and **Figure 21**.

C:\temp\publish\_79601106134-TM.dwg, Fig18, Nov 06, 2023 - 4:36pm, rhiller

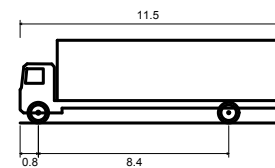
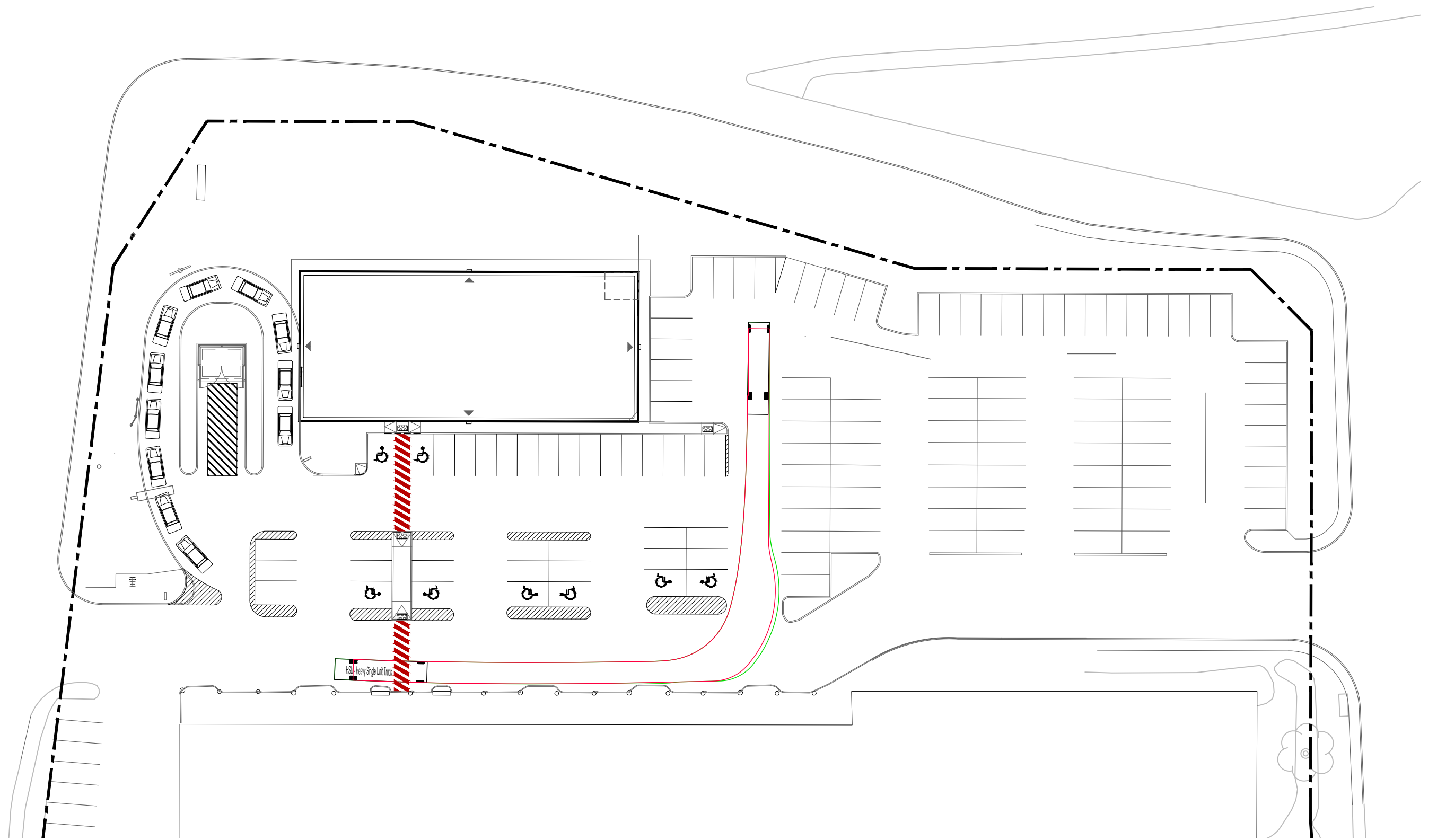

**HSU - Heavy Single Unit Truck**  
 Overall Length 11.500m  
 Overall Width 2.600m  
 Overall Body Height 3.650m  
 Min Body Ground Clearance 0.445m  
 Track Width 2.600m  
 Lock-to-lock time 4.00s  
 Curb to Curb Turning Radius 14.100m



Engineers, Planners & Landscape Architects  
 Suite 200, 240 Michael Cowpland Drive  
 Ottawa, Ontario, Canada K2M 1P6

Telephone (613) 254-9643  
 Facsimile (613) 254-5867  
 Website www.novatech-eng.com

1826 ROBERTSON ROAD

**TURNING MOVEMENT  
 (HSU / FIRE TRUCK)**

SCALE 1 : 500

DATE FEB 2023 JOB 106134 FIGURE FIGURE 18

C:\temp\AcPublish\_79601106134-TM.dwg, Fig19, Nov 06, 2023 - 4:36pm, rhiller

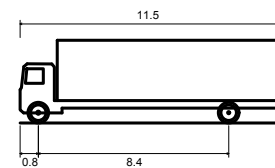
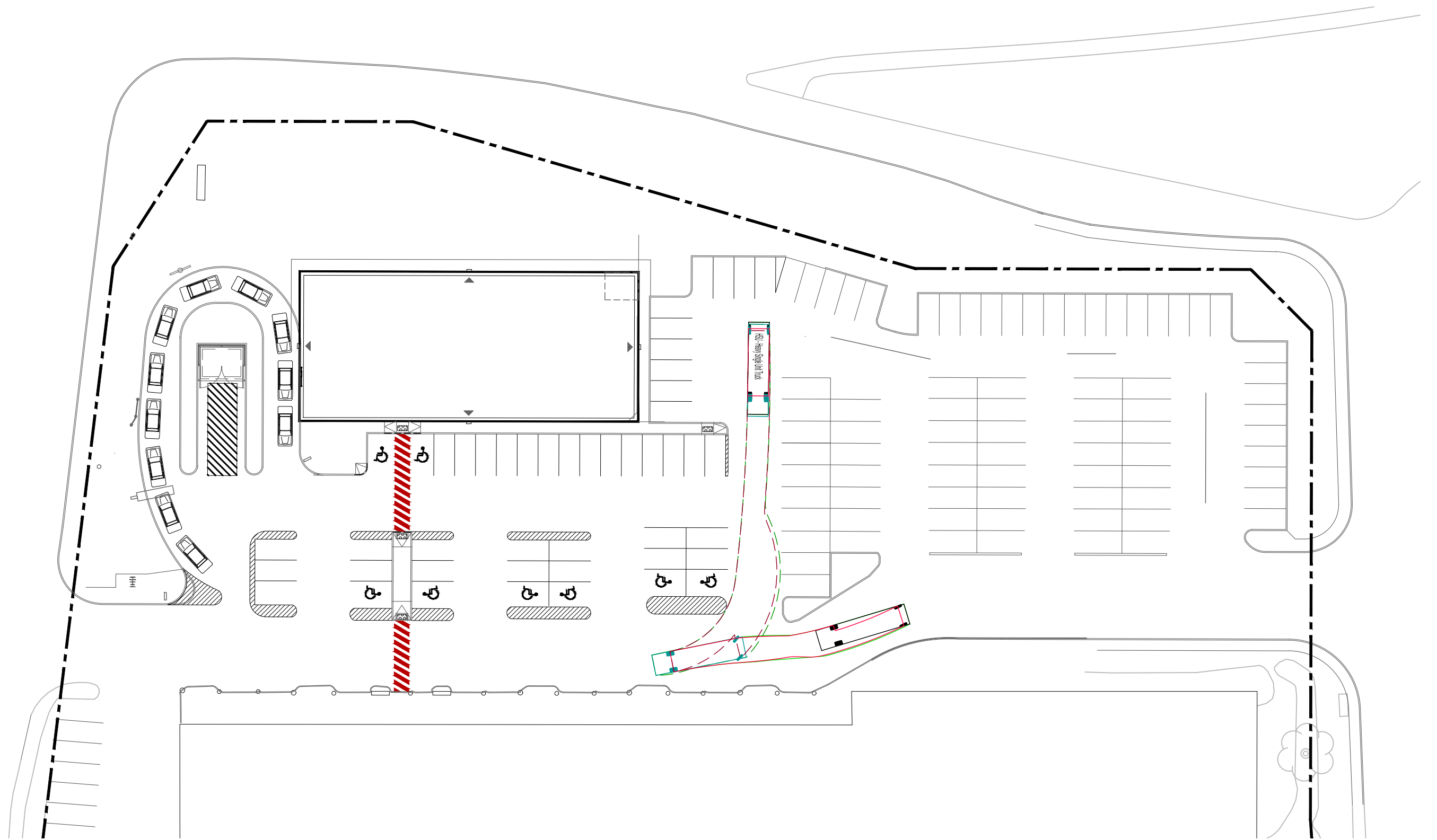

HSU - Heavy Single Unit Truck

Overall Length	11.500m
Overall Width	2.600m
Overall Body Height	3.650m
Min Body Ground Clearance	0.445m
Track Width	2.600m
Lock-to-lock time	4.00s
Curb to Curb Turning Radius	14.100m



Engineers, Planners & Landscape Architects  
 Suite 200, 240 Michael Cowpland Drive  
 Ottawa, Ontario, Canada K2M 1P6

Telephone (613) 254-9643  
 Facsimile (613) 254-5867  
 Website www.novatech-eng.com

1826 ROBERTSON ROAD

TURNING MOVEMENT (HSU / FIRE TRUCK)

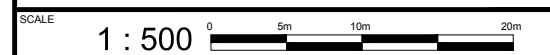

DATE	JOB	FIGURE
FEB 2023	106134	FIGURE 19

C:\temp\AcPublish\_79601106134-TM.dwg, Fig20, Nov 06, 2023 - 4:36pm, rhiller

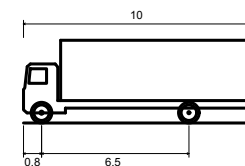
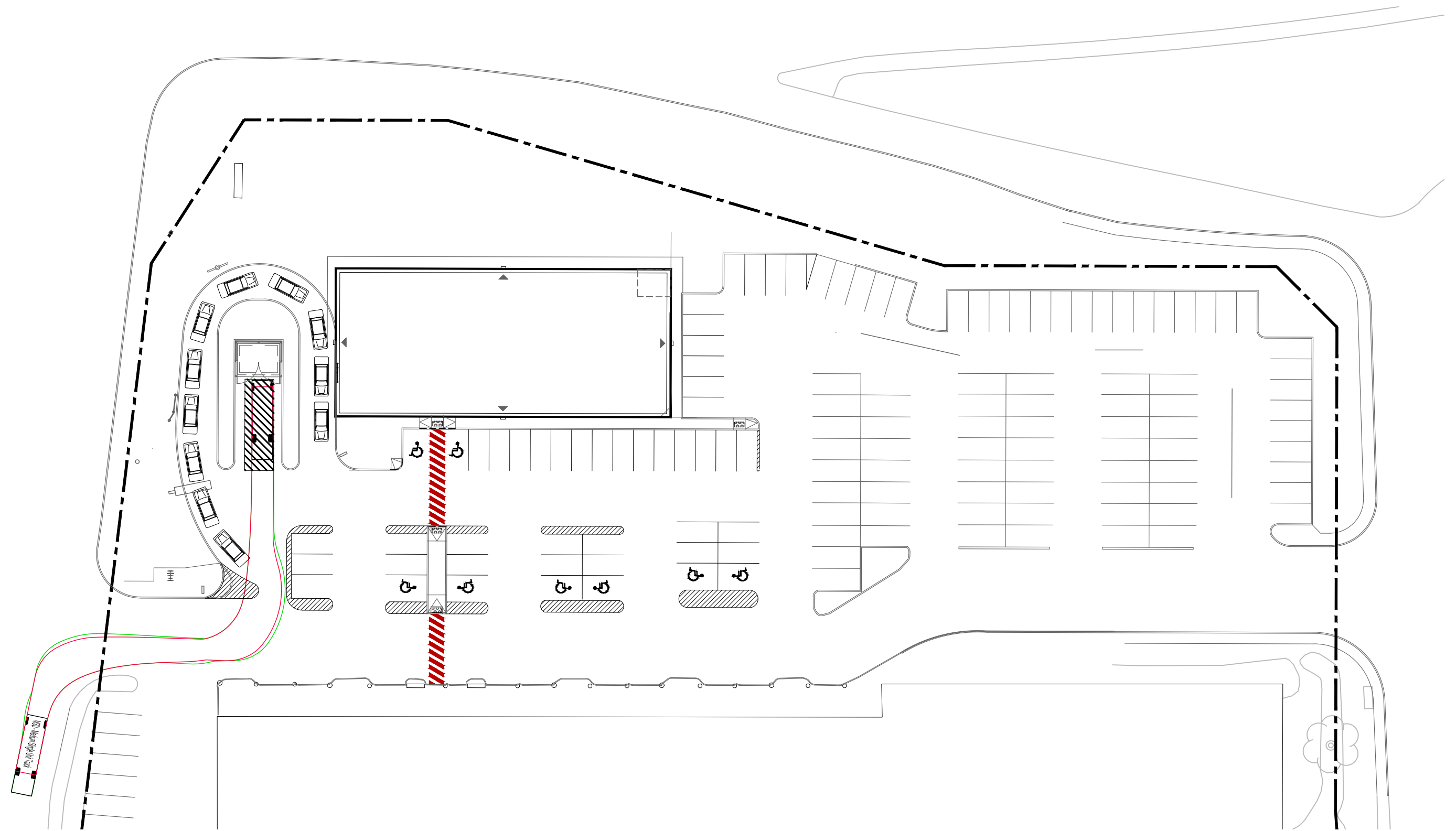

MSU - Medium Single Unit Truck

Overall Length	10.000m
Overall Width	2.600m
Overall Body Height	3.650m
Min Body Ground Clearance	0.445m
Track Width	2.600m
Lock-to-lock time	4.00s
Curb to Curb Turning Radius	11.100m



Engineers, Planners & Landscape Architects  
Suite 200, 240 Michael Cowpland Drive  
Ottawa, Ontario, Canada K2M 1P6

Telephone (613) 254-9643  
Facsimile (613) 254-5867  
Website www.novatech-eng.com

1826 ROBERTSON ROAD

TURNING MOVEMENT  
(MSU / GARBAGE TRUCK)

SCALE 1 : 500

DATE FEB 2023 JOB 106134 FIGURE FIGURE 20

C:\temp\AcPublish\_79601106134-TM.dwg, Fig21, Nov 06, 2023 - 4:36pm, rhiller

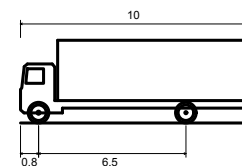
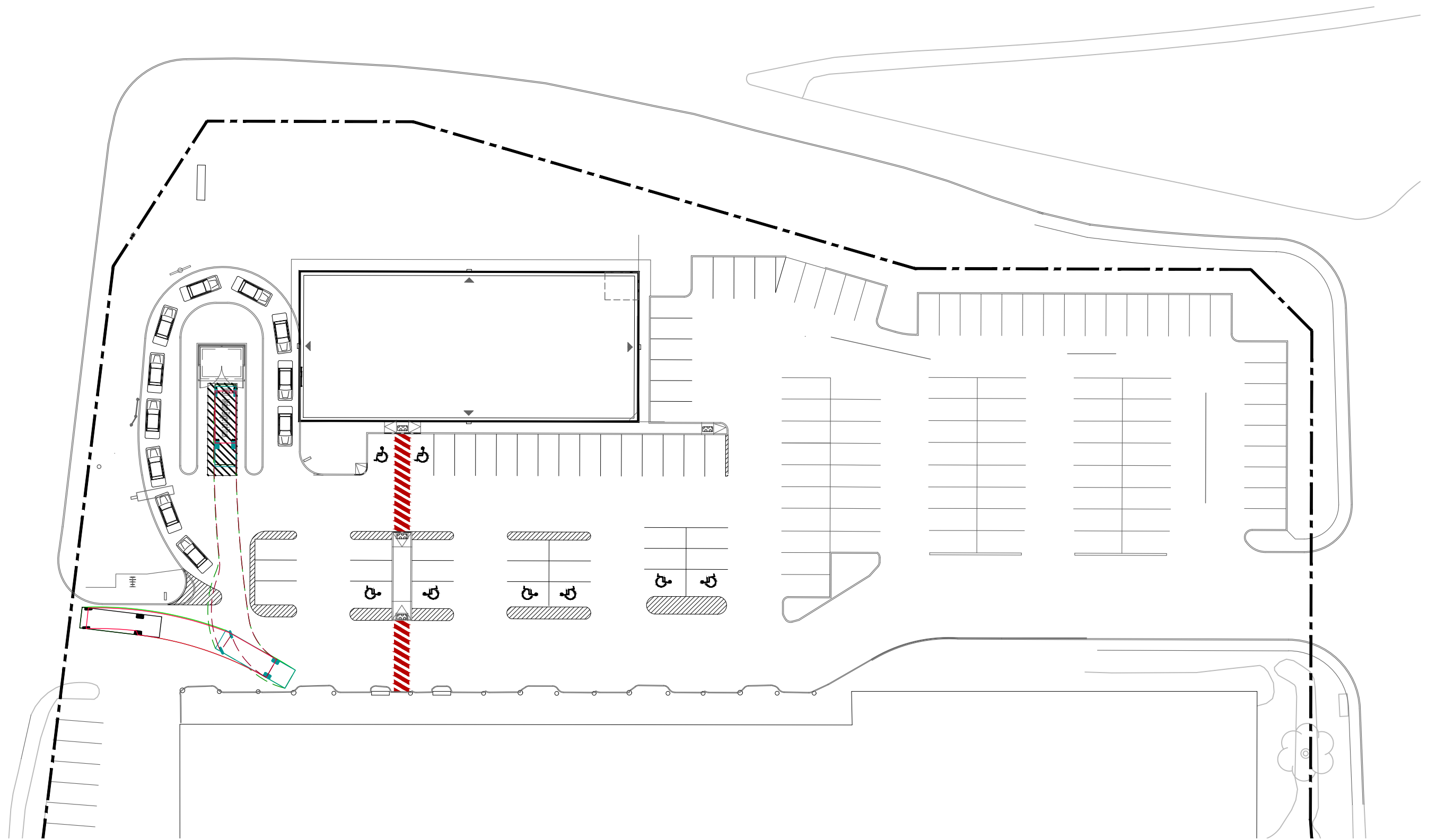

MSU - Medium Single Unit Truck

Overall Length	10.000m
Overall Width	2.600m
Overall Body Height	3.650m
Min Body Ground Clearance	0.445m
Track Width	2.600m
Lock-to-lock time	4.00s
Curb to Curb Turning Radius	11.100m



Engineers, Planners & Landscape Architects  
 Suite 200, 240 Michael Cowpland Drive  
 Ottawa, Ontario, Canada K2M 1P6

Telephone (613) 254-9643  
 Facsimile (613) 254-5867  
 Website www.novatech-eng.com

1826 ROBERTSON ROAD

**TURNING MOVEMENT  
 (MSU / GARBAGE TRUCK)**



DATE	JOB	FIGURE
FEB 2023	106134	FIGURE 21

## 4.2 Parking

The subject site is located in Area C on Schedule 1 and Schedule 1A of the City's ZBL. Minimum vehicular and bicycle parking rates for the existing and proposed uses are identified in the ZBL and are summarized in **Table 16**.

**Table 16: Parking Requirements Per Zoning By-Law**

Land Use	Rate	GLA <sup>(1)</sup>	Required	Proposed
<b>Vehicle Parking</b>				
Shopping Centre (existing)	3.6 per 100 m <sup>2</sup> GLA	4,831 m <sup>2</sup>	174	161
Shopping Centre (proposed)	3.6 per 100 m <sup>2</sup> GLA	790 m <sup>2</sup>	28	47
<b>Total</b>			<b>202</b>	<b>208</b>
<b>Bicycle Parking</b>				
Shopping Centre (existing)	1 per 500 m <sup>2</sup> GLA	4,831 m <sup>2</sup>	10	10
Shopping Centre (proposed)	1 per 500 m <sup>2</sup> GLA	790 m <sup>2</sup>	2	9
<b>Total</b>			<b>12</b>	<b>19</b>

1. GLA: Gross Leasable Floor Area

Based on the previous table, the minimum number of on-site vehicular parking spaces and bicycle parking spaces will be met upon buildout of the proposed development.

For instances where the total supply of parking falls between 167 and 250 spaces, the City's *Accessibility Design Standards* identifies a minimum requirement of seven accessible parking spaces to be provided (including three Type A spaces with a minimum width of 3.4m and four Type B spaces with a minimum width of 2.4m). All spaces must be adjacent to a 1.5m-wide access aisle. Based on the proposed plan, two accessible spaces (one Type A and one Type B) will share an access aisle adjacent to the retail pad. Six other accessible spaces (four Type A and two Type B) will be provided adjacent to the main drive aisle of the existing shopping centre. In total, eight accessible spaces will be provided on-site, and will therefore meet the requirement.

One loading space is proposed west of the retail pad and one loading space is currently provided at the southwest corner of the existing shopping centre. This meets the minimum loading space requirements outlined in Section 113 of the ZBL, which states that shopping centres with a gross floor area between 5,000 m<sup>2</sup> and 9,999 m<sup>2</sup> require a minimum of two loading spaces.

## 4.3 Boundary Streets

This section provides a review of the boundary streets using complete streets principles. The *Multi-Modal Level of Service (MMLOS) Guidelines* produced by IBI Group in October 2015 were used to evaluate the levels of service for the boundary roadways for each mode of transportation. Targets for the pedestrian level of service (PLOS), bicycle level of service (BLOS), transit level of service (TLOS), and truck level of service (TkLOS) adhere to those outlined in Exhibit 22 of the *MMLOS Guidelines*. The boundary streets review evaluates the MMLOS for all boundary streets based on existing conditions. A summary of the MMLOS review is included in **Table 17**, and the detailed MMLOS review is included in **Appendix M**.



**Table 17: Segment MMLOS Summary**

Segment	PLOS		BLOS		TLOS		TKLOS	
	Actual	Target	Actual	Target	Actual	Target	Actual	Target
Robertson Road <sup>(1)</sup>	F	C	F	B	D	D	A	D
Lynhar Road <sup>(2)</sup>	F		D		-	-	C	-
Northside Road West <sup>(3)</sup>	F		B	D	-	-	B	-
Larkspur Drive <sup>(4)</sup>	F		B		-	-	B	-

1. Robertson Road – Arterial Main Street, Crosstown Bikeway, Transit Priority Corridor with Isolated Measures, Truck Route
2. Lynhar Road – General Urban Area, Local Cycling Route, no transit or truck route designations
3. Northside Road West – General Urban Area, no cycling, transit, or truck route designations
4. Larkspur Drive – General Urban Area, no cycling, transit, or truck route designations

Based on the results of the segment MMLOS analysis:

- No boundary streets meet the target PLOS;
- Northside Road West and Larkspur Drive meet the target BLOS, while Robertson Road and Lynhar Road do not;
- Robertson Road meets the target TLOS;
- Robertson Road meets the target TkLOS.

Pedestrian Level of Service

No boundary streets meet the target PLOS C. Per Exhibit 4 of the *MMLOS Guidelines*, the best possible PLOS for roadways with an operating speed greater than 60 km/h and a curb lane AADT greater than 3,000 vehicles per day is a PLOS D. This corresponds to a sidewalk with a minimum width of 2.0m and a minimum boulevard width of 2.0m. As stated in Section 2.2.1, the City’s 2013 Cycling Plan identifies a Phase 2 (2020-2025) cycling infrastructure project along Robertson Road between Moodie Drive and Baseline Road, and will include separated cycling facilities. Implementing segregated cycling facilities will improve the level of comfort by providing a boulevard between the roadway and pedestrians. No further recommendations have been made in improving the PLOS of Robertson Road.

A sidewalk with a width of 1.8m are provided on one side on Lynhar Road, achieving a PLOS D. This sidewalk is provided along the frontage of the subject site. Per Exhibit 4 of the *MMLOS Guidelines*, the target PLOS C can be met by providing a 2.0m-wide sidewalk with no boulevard or a 1.8m-wide sidewalk with a minimum boulevard width of 0.5m. This is identified for the City’s consideration.

Sidewalks with a width of 1.8m are provided on one side of Northside Road West and Larkspur Drive, both of which meet the target PLOS. These sidewalks are provided along the frontage of the subject site. Therefore, providing 1.8m sidewalks on the opposite side of these roadways is identified for the City’s consideration.

Bicycle Level of Service

Robertson Road does not meet the target BLOS B. For roadways with an AADT greater than 10,000 vpd and an operating speed of 70 km/h, the *Ontario Traffic Manual (OTM) – Book 18* states that a ‘separated facility’ is appropriate (per the selection tool included in *OTM Book 18*). The selection tool used in *OTM Book 18* is shown in **Figure 22**. Implementation of separated cycling facilities as noted in the selection tool and the 2013 Cycling Plan will improve Robertson Road to a BLOS A. No further modifications are recommended.

Figure 22: Desirable Cycling Facility Pre-Selection Nomograph

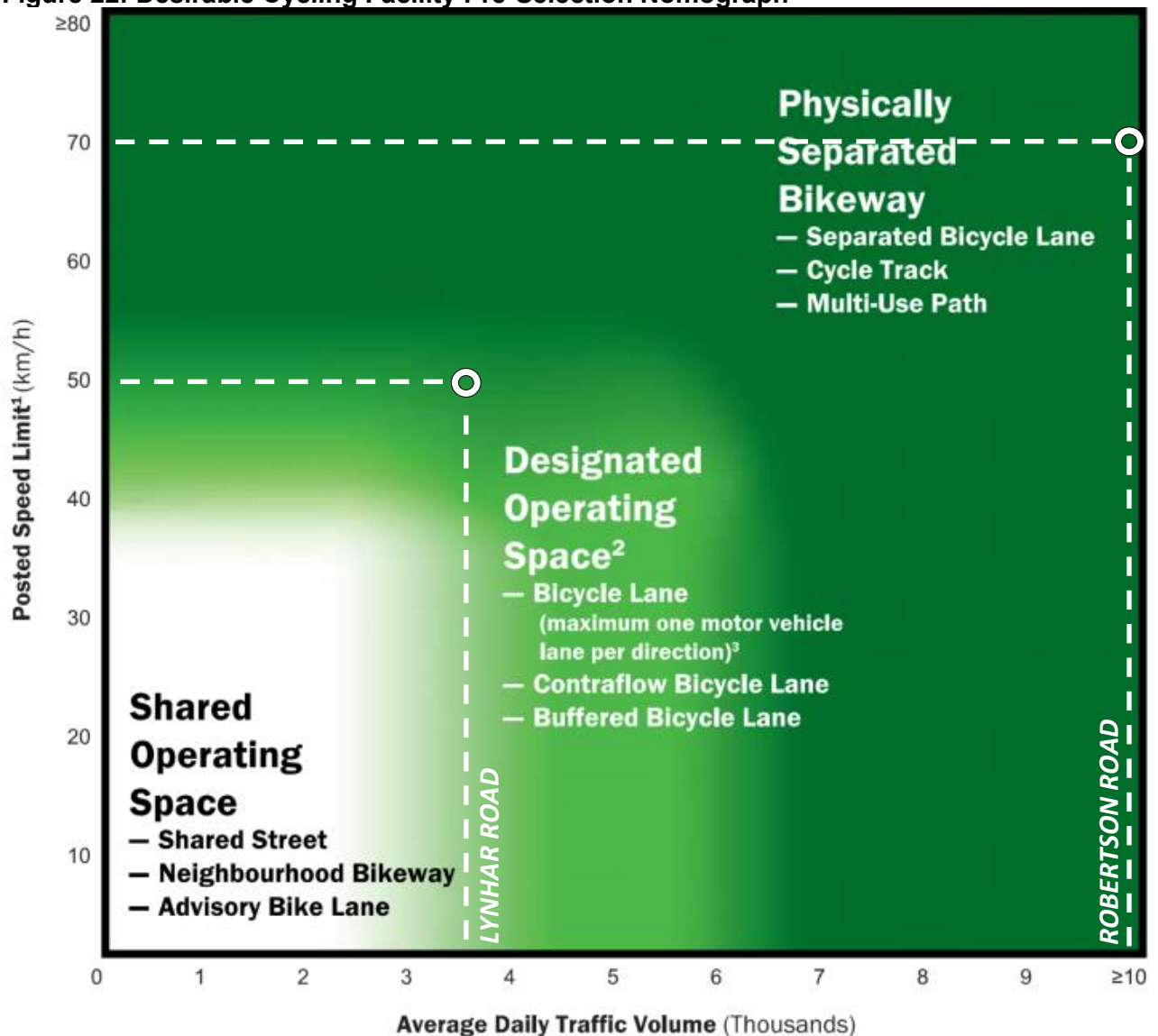

1 Operating speeds are assumed to be similar to posted speeds. If evidence suggests this is not the case, practitioners may consider using 85th percentile speeds or implementing measures to reduce operating speeds.

Lynhar Road does not meet the target BLOS B. For roadways with an AADT of approximately 3,700 vpd and an operating speed of 50 km/h, *OTM Book 18* states that a ‘designated operating space’ for cyclists is appropriate. This can include curbside bicycle lanes. This is identified for the City’s consideration.

#### 4.4 Access Design

The proposed expansion will be served by the existing Lynwood Centre accesses via Lynhar Road and Larkspur Drive. No changes to the existing accesses are proposed.

## 4.5 Transit

Based on the external trip generation estimates shown in **Table 7**, the proposed development is estimated to generate 12 transit trips during the AM peak hour (seven alighting, five boarding), 21 transit trips during the PM peak hour (11 alighting, 10 boarding), and 25 transit trips during the Saturday peak hour (13 alighting, 12 boarding). The trip distribution of these transit trips are assumed to follow the trip distribution assumptions described in Section 3.1.2. Due to their proximity to the proposed expansion, all new transit trips are assumed to arrive and depart at stops #0937 (for trips arriving from the east and departing to the west) and #5294 (for trips arriving from the west and departing to the east). These trips can be summarized as follows:

### AM Peak Hour

- 6 passengers (4 alighting, 2 boarding) at stop #0937 for OC Routes 57 and 88;
- 6 passengers (3 alighting, 3 boarding) at stop #5294 for OC Routes 57 and 88.

### PM Peak Hour

- 10 passengers (5 alighting, 5 boarding) at stop #0937 for OC Routes 57 and 88;
- 11 passengers (6 alighting, 5 boarding) at stop #5294 for OC Routes 57 and 88.

### SAT Peak Hour

- 13 passengers (7 alighting, 6 boarding) at stop #0937 for OC Routes 57 and 88;
- 12 passengers (6 alighting, 6 boarding) at stop #5294 for OC Routes 57 and 88.

Based on the projected number of transit trips generated by the development, no capacity problems are anticipated on any of the bus routes or either stop included above.

## 4.6 Intersection Design

### 4.6.1 Intersection MMLOS

This section provides a review of the study area intersections using complete streets principles. The *MMLOS Guidelines* were used to evaluate the MMLOS for each signalized intersection in the study area. The MMLOS targets applied to Robertson Road/Stinson Avenue are based on the policy area ‘Within 300m of a School,’ while all other study area intersections have been evaluated based on the MMLOS targets associated with the ‘General Urban Area.’ A summary of the results is shown in **Table 18**. Detailed review of the MMLOS at all intersections is included in **Appendix M**.

**Table 18: Intersection MMLOS Summary**

Intersection	PLOS		BLOS		TLOS		TkLOS	
	Actual	Target	Actual	Target	Actual	Target	Actual	Target
Robertson Road/Stinson Avenue	F	A	F	A	B	D	E	D
Robertson Road/Lynhar Road/Stafford Road	F	C	F	B	E		E	
Robertson Road/Northside Road East	F		F		C		D	

Based on the results of the intersection MMLOS analysis:

- No study area intersections meet the target PLOS;
- No study area intersections meet the target BLOS;
- Robertson Road/Stinson Avenue and Robertson Road/Northside Road East meet the target TLOS, while Robertson Road/Lynhar Road/Stafford Road does not;

- Robertson Road/Northside Road East meets the target TkLOS, while Robertson Road/Stinson Avenue and Robertson Road/Lynhar Road/Stafford Road do not.

The following sections outline further discussions for each intersection.

### Robertson Road/Stinson Avenue

Robertson Road/Stinson Avenue does not meet the target PLOS A, BLOS A, or TkLOS D.

All approaches of Robertson Road/Stinson Avenue do not meet the target PLOS, and cannot achieve the target PLOS without significantly reducing the number of lanes and restricting turning movements. The east and west approaches meet the City's vehicle/pedestrian conflict threshold for zebra-striped crosswalks (greater than 400,000 vehicle/pedestrian conflicts over an eight-hour period), which could be considered to improve the level of comfort for pedestrians. This is identified for the City's consideration. No other modifications are recommended.

The east and west approaches of Robertson Road/Stinson Avenue do not meet the target BLOS, based on left turn characteristics. The target BLOS can be achieved through the implementation of two-stage left-turn bike boxes for eastbound and westbound cyclists. From a traffic operations perspective, this implementation would require a restriction of right turns on red (RTOR) at the north and south approaches. As shown in **Appendix M**, the vehicular level of service at these approaches would be marginally affected by the RTOR restriction, however vehicle delays are anticipated to increase more significantly. Bike boxes for eastbound and westbound cyclists are identified for the City's consideration, in addition to the future segregated cycling facilities that are anticipated on Robertson Road (as described in Sections 2.2.1 and 4.3).

Bike boxes are identified at each signalized intersection as a possible mitigation for left turning cyclists. It is recommended that if bike boxes are to be implemented, that they are not implemented in a 'piecemeal' manner at select intersections, but rather holistically along the Robertson Road corridor where applicable.

The east and west approaches of Robertson Road/Stinson Avenue do not meet the target TkLOS. These approaches represent heavy vehicles turning right into the campus at 1891 Robertson Road or onto Stinson Avenue. These roadways are anticipated to continue having low overall vehicular volume, as well as low volumes of heavy vehicles at both approaches. Therefore, no modifications to the curb radii are recommended.

### Robertson Road/Lynhar Road/Stafford Road

Robertson Road/Lynhar Road/Stafford Road does not meet the target PLOS C, BLOS B, TLOS D, or TkLOS D.

All approaches of Robertson Road/Lynhar Road/Stafford Road do not meet the target PLOS, and cannot achieve the target PLOS without significantly reducing the number of lanes and restricting turning movements. The north, east, and west approaches meet the City's vehicle/pedestrian conflict threshold for zebra-striped crosswalks, which could be considered to improve the level of comfort for pedestrians. This is identified for the City's consideration. No other modifications are recommended.

All approaches of Robertson Road/Lynhar Road/Stafford Road do not achieve the target BLOS based on left turn characteristics. The target BLOS can be achieved for left turn movements through

the implementation of two-stage left-turn bike boxes, as described in the previous section. Implementing bike boxes for cyclists would require a RTOR restriction at the east approach, as this restriction is only required when a dedicated right turn lane is not provided. As shown in **Appendix M**, queueing and delays are anticipated to increase marginally at the east approach with a RTOR restriction implemented.

The north, south, and west approaches of Robertson Road/Lynhar Road/Stafford Road do not achieve the target BLOS based on right turn characteristics. Segregated cycling facilities are identified as a future improvement for Robertson Road, and as this will achieve the target BLOS, no further recommendations have been made for the west approach. Per Exhibit 12 of the *MMLOS Guidelines*, providing pocket bike lanes and right turn lanes shorter than 50m would allow the north and south approaches to achieve the target BLOS. However, the ROW on Lynhar Road and Stafford Road is constrained based on the current cross-section. Intersection capacity analysis suggests that the northbound/southbound right turn lanes may not be required. Shared through/right turn lanes would achieve a BLOS A and meet the target. This is identified for the City's consideration during the implementation of improved cycling facilities on Robertson Road.

The west approach of Robertson Road/Lynhar Road/Stafford Road does not achieve the target TLOS during the PM peak hour. Since the 2013 TMP identifies transit signal priority or queue jump lanes on Robertson Road at select intersections between Eagleson Road and Holly Acres Road, implementing a transit priority measure at Robertson Road/Lynhar Road/Stafford Road is identified for the City's consideration.

The west approach of Robertson Road/Lynhar Road/Stafford Road (i.e. turning right onto Lynhar Road from Robertson Road) does not achieve the target TkLOS. Per Exhibit 20 of the *MMLOS Guidelines*, for roadways with one receiving lane after a right turn, a minimum corner radius of 15m is required. As the corner radius measures approximately 13m, and a wide receiving lane is provided before tapering south of the intersection, no recommendations have been made in improving the truck level of service at this intersection.

### Robertson Road/Northside Road East

Robertson Road/Northside Road East does not meet the target PLOS C or BLOS B.

All approaches of Robertson Road/Northside Road East do not meet the target PLOS, and cannot achieve the target PLOS without significantly reducing the number of lanes and restricting turning movements. The east and west approaches meet the City's vehicle/pedestrian conflict threshold for zebra-striped crosswalks, which could be considered to improve the level of comfort for pedestrians. This is identified for the City's consideration. No other modifications are recommended.

The north, east, and west approaches of Robertson Road/Northside Road East do not achieve the target BLOS based on left turn characteristics. The target BLOS can be achieved through the implementation of two-stage left-turn bike boxes, as described in the previous section. Implementing bike boxes for cyclists requires a RTOR restriction at the south and west approaches. As shown in **Appendix M**, the vehicular level of service at these approaches would be marginally affected by the RTOR restriction, however vehicle delays at the south approach are anticipated to increase more significantly.

The north, south, and east approaches of Robertson Road/Northside Road East do not achieve the target BLOS based on right turn characteristics. Segregated cycling facilities are identified as a future improvement for Robertson Road, and as this will achieve the target BLOS, no further

recommendations have been made for the east approach. Per Exhibit 12 of the *MMLOS Guidelines*, providing bike lanes and right turn lanes shorter than 50m would allow the north and south approaches to achieve the target BLOS. As the north approach is on private property, this improvement on the south approach is identified for the City’s consideration during the implementation of improved cycling facilities on Robertson Road.

#### 4.6.2 2024 Total Traffic Operations

Intersection capacity analysis has been conducted for the 2024 total traffic conditions. The results of the analysis are summarized in **Table 19** and **Table 20** for the AM, PM, and Saturday peak hours. Detailed Synchro reports are included in **Appendix N**.

**Table 19: 2024 Total Intersection Operations**

Intersection	AM Peak			PM Peak			SAT Peak		
	Max v/c or Delay	LOS	Mvmt	Max v/c or Delay	LOS	Mvmt	Max v/c or Delay	LOS	Mvmt
Robertson Road/ Stinson Avenue	0.72	C	EBT/R	0.49	A	WBT/R	0.38	A	EBT/R
Robertson Road/ Lynhar Road/Stafford Road	0.75	C	EBT	0.76	C	WBT/R	0.73	C	EBL
Robertson Road/ Northside Road East	0.68	B	EBT/R	0.78	C	SBL	0.73	C	SBL
Northside Road/ Larkspur Drive	8 sec	A	WBL	8 sec	A	WBL	8 sec	A	WBL
Lynhar Road/ North Site Access	9 sec	A	WBL/R	9 sec	A	WBL/R	9 sec	A	WBL/R
Lynhar Road/ South Site Access	9 sec	A	WBL/R	9 sec	A	WBL/R	9 sec	A	WBL/R
Larkspur Drive/ North Site Access	9 sec	A	EBL/R	9 sec	A	EBL/R	10 sec	A	EBL/R
Larkspur Drive/ South Site Access	9 sec	A	EBL/R	9 sec	A	EBL/R	9 sec	A	EBL/R

**Table 20: 2024 Total Queues**

Intersection	Mvmt	AM Peak			PM Peak			SAT Peak		
		v/c [LOS]	50 <sup>th</sup> % Queue (m)	95 <sup>th</sup> % Queue (m)	v/c [LOS]	50 <sup>th</sup> % Queue (m)	95 <sup>th</sup> % Queue (m)	v/c [LOS]	50 <sup>th</sup> % Queue (m)	95 <sup>th</sup> % Queue (m)
Robertson/ Lynhar/ Stafford	SBL	0.22 [A]	7	14	0.63 [B]	31	49	0.25 [A]	12	22
	EBL	0.40 [A]	10	m13	0.73 [C]	27	#59	0.73 [C]	29	#65
	EBT	0.75 [C]	12	#285	0.55 [A]	74	118	0.48 [A]	66	106
	WBT	0.32 [A]	25	30	0.76 [C]	122	132	0.55 [A]	77	97
Robertson/ Northside E	NBL	0.61 [B]	22	36	0.60 [A]	28	44	0.42 [A]	17	29
	WBL	0.39 [A]	5	19	0.29 [A]	8	22	0.25 [A]	9	22

~: volume for the 50<sup>th</sup> percentile queue exceeds capacity  
 #: volume for the 95<sup>th</sup> percentile queue exceeds capacity  
 m: volume for the 95<sup>th</sup> percentile queue is metered by an upstream signal

Based on the previous tables and compared to the 2024 background traffic conditions, marginal changes to the v/c ratios, queue lengths, and delays within the study area are anticipated as a result of traffic generated by the proposed development.

### 4.6.3 2029 Total Traffic Operations

Intersection capacity analysis has been conducted for the 2029 total traffic conditions. The results of the analysis are summarized in **Table 21** and **Table 22** for the AM, PM, and Saturday peak hours. Detailed Synchro reports are included in **Appendix N**.

**Table 21: 2029 Total Intersection Operations**

Intersection	AM Peak			PM Peak			SAT Peak		
	Max v/c or Delay	LOS	Mvmt	Max v/c or Delay	LOS	Mvmt	Max v/c or Delay	LOS	Mvmt
Robertson Road/ Stinson Avenue	0.75	C	EBT/R	0.52	A	WBT/R	0.40	A	EBT/R
Robertson Road/ Lynhar Road/Stafford Road	0.78	C	EBT	0.80	C	WBT/R	0.73	C	EBL
Robertson Road/ Northside Road East	0.71	C	EBT/R	0.78	C	SBL	0.73	C	SBL
Northside Road/ Larkspur Drive	8 sec	A	WBL	8 sec	A	WBL	8 sec	A	WBL
Lynhar Road/ North Site Access	9 sec	A	WBL/R	9 sec	A	WBL/R	9 sec	A	WBL/R
Lynhar Road/ South Site Access	9 sec	A	WBL/R	9 sec	A	WBL/R	9 sec	A	WBL/R
Larkspur Drive/ North Site Access	9 sec	A	EBL/R	9 sec	A	EBL/R	10 sec	A	EBL/R
Larkspur Drive/ South Site Access	9 sec	A	EBL/R	9 sec	A	EBL/R	9 sec	A	EBL/R

**Table 22: 2029 Total Queues**

Intersection	Mvmt	AM Peak			PM Peak			SAT Peak		
		v/c [LOS]	50 <sup>th</sup> % Queue (m)	95 <sup>th</sup> % Queue (m)	v/c [LOS]	50 <sup>th</sup> % Queue (m)	95 <sup>th</sup> % Queue (m)	v/c [LOS]	50 <sup>th</sup> % Queue (m)	95 <sup>th</sup> % Queue (m)
Robertson/ Lynhar/ Stafford	SBL	0.22 [A]	7	14	0.63 [B]	31	49	0.25 [A]	12	22
	EBL	0.40 [A]	10	m12	0.73 [C]	27	#59	0.73 [C]	29	#65
	EBT	0.78 [C]	13	#304	0.58 [A]	78	123	0.51 [A]	70	112
	WBT	0.34 [A]	26	31	0.80 [C]	131	#169	0.59 [A]	83	105
Robertson/ Northside E	NBL	0.61 [B]	22	36	0.60 [A]	28	44	0.42 [A]	17	29
	WBL	0.44 [A]	5	23	0.30 [A]	9	23	0.26 [A]	9	22

~: volume for the 50<sup>th</sup> percentile queue exceeds capacity  
 #: volume for the 95<sup>th</sup> percentile queue exceeds capacity  
 m: volume for the 95<sup>th</sup> percentile queue is metered by an upstream signal

Based on the previous tables and compared to the 2029 background traffic conditions, marginal changes to the v/c ratios, queue lengths, and delays within the study area are anticipated as a result of traffic generated by the proposed development.

## 5.0 CONCLUSIONS AND RECOMMENDATIONS

The conclusions and recommendations of the foregoing TIA can be summarized as follows:

### Forecasting

- The existing shopping plaza is estimated to generate 115 person trips (including 75 vehicle trips) during the AM peak hour, 346 person trips (including 225 vehicle trips) during the PM peak hour, and 389 person trips (including 253 vehicle trips) during the Saturday peak hour.
- With the proposed expansion, the shopping plaza is estimated to generate 265 person trips (including 173 vehicle trips) during the AM peak hour, 487 person trips (including 317 vehicle trips) during the PM peak hour, and 619 person trips (including 402 vehicle trips) during the Saturday peak hour.

### Development Design and Parking

- Pedestrian facilities will be provided between the proposed retail pad and the existing shopping plaza. A concrete sidewalk will be provided around the north, south, and east sides of the proposed drive-through restaurant and retail pad. Existing sidewalks on the north side of the shopping plaza provide connectivity to both Lynhar Road and Larkspur Drive.
- Ten bicycle parking spaces are currently located near the southeastern corner of the existing shopping plaza (i.e. at the back of the building). Four new bicycle parking spaces will be provided adjacent to the proposed drive-through aisle.
- The walking distance from the main entrance of the existing development to the stops listed above is approximately 110m to OC Transpo stop #5294 and 210m to OC Transpo stop #0937.
- All required transportation demand management (TDM)-supportive design and infrastructure measures in the TDM checklist are met.
- For driveways to collector roadways, the Transportation Association of Canada (TAC)'s *Geometric Design Guide for Canadian Roads* identifies minimum clear throat length requirements of 8m for shopping centres with less than 25,000 m<sup>2</sup> GFA and 15m for fast-food restaurants with greater than 200 m<sup>2</sup> GFA. Therefore, the 15m requirement governs. Measured from the end of the curb radii, the northerly Lynhar Road access is proposed to provide 15m of clear throat length, meeting the requirement.
- For restaurants with a drive-through window and an order board preceding the window, the City's *Zoning By-Law* (ZBL) identifies a minimum of seven queueing spaces prior to the board and a minimum total of eleven queueing spaces overall. This minimum requirement will be met, as the proposed development will include seven spaces leading to the order board, and eleven spaces overall.
- The fire route is located along the north side of the existing shopping plaza, as well as the drive aisle east of the proposed retail pad. Garbage collection will be located west of the proposed retail pad, within the loop formed by the drive-through aisle.
- The minimum number of on-site vehicular parking spaces, bicycle parking spaces, and loading spaces as outlined in the City's ZBL will be met upon buildout of the proposed development.
- A total of eight accessible spaces will be provided on-site, meeting the minimum requirements outlined in the City's *Accessibility Design Standards*.



- The proposed expansion will be served by the existing Lynwood Centre accesses via Lynhar Road and Larkspur Drive. No changes to the existing accesses are proposed.

### Boundary Streets

- Based on the results of the segment multi-modal level of service (MMLOS) analysis:
  - No boundary streets meet the target pedestrian level of service (PLOS);
  - Northside Road West and Larkspur Drive meet the target bicycle level of service (BLOS), while Robertson Road and Lynhar Road do not;
  - Robertson Road meets the target transit level of service (TLOS);
  - Robertson Road meets the target truck level of service (TkLOS).
- The best possible PLOS for Robertson Road is a PLOS D. This corresponds to a sidewalk with a minimum width of 2.0m and a minimum boulevard width of 2.0m. Implementing segregated cycling facilities will improve the level of comfort by providing a boulevard between the roadway and pedestrians. No further recommendations have been made in improving the PLOS of Robertson Road.
- A sidewalk with a width of 1.8m are provided on one side on Lynhar Road, achieving a PLOS D. This sidewalk is provided along the frontage of the subject site. The target PLOS C can be met by providing a 2.0m-wide sidewalk with no boulevard or a 1.8m-wide sidewalk with a minimum boulevard width of 0.5m. This is identified for the City's consideration.
- Sidewalks with a width of 1.8m are provided on one side of Northside Road West and Larkspur Drive, both of which meet the target PLOS C. These sidewalks are provided along the frontage of the subject site. Therefore, providing 1.8m sidewalks on the opposite side of these roadways is identified for the City's consideration.
- Robertson Road does not meet the target BLOS B. The *Ontario Traffic Manual (OTM) – Book 18* states that a 'separated facility' is appropriate, based on the operating speed and average annual daily traffic (AADT) volumes. Implementation of separated cycling facilities based on OTM Book 18 and the City's 2013 Cycling Plan will improve Robertson Road to a BLOS A. No further modifications are recommended.
- Lynhar Road does not meet the target BLOS B. *OTM Book 18* states that a 'designated operating space' for cyclists is appropriate, based on the operating speed and AADT volumes. This can include curbside bicycle lanes. This is identified for the City's consideration.

### Transit

- The proposed development is estimated to generate 12 transit trips during the AM peak hour (seven alighting, five boarding), 21 transit trips during the PM peak hour (11 alighting, 10 boarding), and 25 transit trips during the Saturday peak hour (13 alighting, 12 boarding). No capacity problems are anticipated on any of the bus routes or either stop included above.

### Intersection MMLOS

- The results of the intersection MMLOS analysis are summarized as follows:
  - No study area intersections meet the target PLOS;
  - No study area intersections meet the target BLOS;

- Robertson Road/Stinson Avenue and Robertson Road/Northside Road East meet the target TLOS, while Robertson Road/Lynhar Road/Stafford Road does not;
  - Robertson Road/Northside Road East meets the target TkLOS, while Robertson Road/Stinson Avenue and Robertson Road/Lynhar Road/Stafford Road do not.
- Every approach at each study area intersection do not meet the target PLOS, and cannot achieve the target PLOS without significantly reducing the number of lanes and restricting turning movements. Approaches crossing Robertson Road or Stafford Road meet the City's vehicle/pedestrian conflict threshold for zebra-striped crosswalks (greater than 400,000 vehicle/pedestrian conflicts over an eight-hour period), which could be considered to improve the level of comfort for pedestrians. This is identified for the City's consideration. No other modifications are recommended.
  - The east and west approaches of Robertson Road/Stinson Avenue, all approaches of Robertson Road/Lynhar Road/Stafford Road, and the north, east, and west approaches of Robertson Road/Northside Road East do not meet the target BLOS, based on left turn characteristics. The target BLOS can be achieved through the implementation of two-stage left-turn bike boxes for eastbound and westbound cyclists. From a traffic operations perspective, this implementation would require a restriction of right turns on red (RTOR) at select approaches, resulting in additional vehicle delay. Bike boxes for eastbound and westbound cyclists are identified for the City's consideration, in addition to the future segregated cycling facilities that are anticipated on Robertson Road. It is recommended that if bike boxes are to be implemented, that they are not implemented in a 'piecemeal' manner at select intersections, but rather holistically along the Robertson Road corridor where applicable.
  - The north, south, and west approaches of Robertson Road/Lynhar Road/Stafford Road and the north, south, and east approaches of Robertson Road/Northside Road East do not achieve the target BLOS based on right turn characteristics. Segregated cycling facilities are identified as a future improvement for Robertson Road, and as this will achieve the target BLOS, no further recommendations have been made for the west approach at Stafford Road and the east approach at Northside Road East. Providing pocket bike lanes and right turn lanes shorter than 50m would allow the north and south approaches at both intersections to achieve the target BLOS. As the north approach at Robertson Road/Northside Road East is on private property, this improvement on the south approach is identified for the City's consideration during the implementation of improved cycling facilities on Robertson Road. The ROW on Lynhar Road and Stafford Road is constrained based on the current cross-section, and capacity analysis suggests that shared through/right turn lanes may be sufficient, improving the BLOS. This is identified for the City's consideration.
  - The west approach of Robertson Road/Lynhar Road/Stafford Road does not achieve the target TLOS during the PM peak hour. Since the 2013 Transportation Master Plan identifies transit signal priority or queue jump lanes on Robertson Road at select intersections between Eagleson Road and Holly Acres Road, implementing a transit priority measure at Robertson Road/Lynhar Road/Stafford Road is identified for the City's consideration.
  - The east and west approaches of Robertson Road/Stinson Avenue do not meet the target TkLOS. These approaches represent heavy vehicles turning right into the campus at 1891 Robertson Road or onto Stinson Avenue. These roadways are anticipated to continue having

low overall vehicular volume, as well as low volumes of heavy vehicles at both approaches. Therefore, no modifications to the curb radii are recommended.

- The west approach of Robertson Road/Lynhar Road/Stafford Road (i.e. turning right onto Lynhar Road from Robertson Road) does not achieve the target TkLOS. As the corner radius measures approximately 13m, and a wide receiving lane is provided before tapering south of the intersection, no recommendations have been made.

#### Existing Traffic Operations

- All study area intersections and the subject site accesses meet the target vehicular level of service (Auto LOS).
- During the AM peak hour, the 95<sup>th</sup>-percentile (maximum) queue lengths of the eastbound through movement at Robertson Road/Lynhar Road/Stafford Road extend through the upstream intersection at Robertson Road/Stinson Avenue, a distance of 270m to the west.

#### Background Traffic Operations

- Compared to existing traffic conditions, marginal changes to the v/c ratios, queue lengths, and delays are anticipated as a result of background growth within the study area.

#### Total Traffic Operations

- Compared to background traffic conditions, marginal changes to the v/c ratios, queue lengths, and delays within the study area are anticipated as a result of traffic generated by the proposed development.

Based on the foregoing, the proposed development is recommended from a transportation perspective.

## NOVATECH

Prepared by:

Reviewed by:



Joshua Audia, P.Eng.  
Project Engineer | Transportation

Jennifer Luong, P.Eng.  
Senior Project Manager | Transportation

## **APPENDIX A**

---

Site Plan



## **APPENDIX B**

---

TIA Screening Form

City of Ottawa 2017 TIA Guidelines TIA Screening

1. Description of Proposed Development

Municipal Address	1826 Robertson Road
Description of Location	Southeast of Robertson/Lynhar
Land Use Classification	Drive-Through Restaurant and Retail
Development Size (units)	
Development Size square metre (m <sup>2</sup> )	220 sq.m. DT Rest. & 570 sq.m. Retail
Number of Accesses and Locations	Two ex. to Lynhar & two ex. to Larkspur
Phase of Development	1
Buildout Year	2024

If available, please attach a sketch of the development or site plan to this form.

2. Trip Generation Trigger

Considering the Development’s Land Use type and Size (as filled out in the previous section), please refer to the Trip Generation Trigger checks below.

Table notes:

1. Table 2, Table 3 & Table 4 TRANS Trip Generation Manual
2. Institute of Transportation Engineers (ITE) Trip Generation Manual 11.1 Ed.

Land Use Type	Minimum Development Size
Single-family homes	60 units
Multi-Use Family (Low-Rise) <sup>1</sup>	90 units
Multi-Use Family (High-Rise) <sup>1</sup>	150 units
Office <sup>2</sup>	1,400 m <sup>2</sup>
Industrial <sup>2</sup>	7,000 m <sup>2</sup>
Fast-food restaurant or coffee shop <sup>2</sup>	110 m <sup>2</sup>
Destination retail <sup>2</sup>	1,800 m <sup>2</sup>
Gas station or convenience market <sup>2</sup>	90 m <sup>2</sup>

If the proposed development size is equal to or greater than the sizes identified above, the Trip Generation Trigger is satisfied.

### 3. Location Triggers

	Yes	No
Does the development propose a new driveway to a boundary street that is designated as part of the Transit Priority Network, Rapid Transit network or Cross-Town Bikeways?	<input type="checkbox"/>	<input checked="" type="checkbox"/>
Is the development in a Hub, a Protected Major Transit Station Area (PMTSA), or a Design Priority Area (DPA)? <sup>2</sup>	<input checked="" type="checkbox"/>	<input type="checkbox"/>

If any of the above questions were answered with ‘Yes,’ the Location Trigger is satisfied.

### 4. Safety Triggers

	Yes	No
Are posted speed limits on a boundary street are 80 kilometers per hour (km/h) or greater?	<input type="checkbox"/>	<input checked="" type="checkbox"/>
Are there any horizontal/vertical curvatures on a boundary street limits sight lines at a proposed driveway?	<input type="checkbox"/>	<input checked="" type="checkbox"/>
Is the proposed driveway within the area of influence of an adjacent traffic signal or roundabout (i.e. within 300 metre [m] of intersection in rural conditions, or within 150 m of intersection in urban/ suburban conditions)?	<input type="checkbox"/>	<input checked="" type="checkbox"/>
Is the proposed driveway within auxiliary lanes of an intersection?	<input type="checkbox"/>	<input checked="" type="checkbox"/>
Does the proposed driveway make use of an existing median break that serves an existing site?	<input type="checkbox"/>	<input checked="" type="checkbox"/>

<sup>2</sup> Hubs are identified in Schedules B1 to B8 of the City of Ottawa Official Plan. PMTSAs are identified in Schedule C1 of the Official Plan. DPAs are identified in Schedule C7A and C7B of the Official. See Chapter 4 for a list of City of Ottawa Planning and Engineering documents that support the completion of TIA.



## Transportation Impact Assessment Guidelines

	Yes	No
Is there is a documented history of traffic operations or safety concerns on the boundary streets within 500 m of the development?	<input type="checkbox"/>	<input checked="" type="checkbox"/>
Does the development include a drive-thru facility?	<input checked="" type="checkbox"/>	<input type="checkbox"/>

**If any of the above questions were answered with ‘Yes,’ the Safety Trigger is satisfied.**

### 5. Summary

Results of Screening	Yes	No
Does the development satisfy the Trip Generation Trigger?	<input checked="" type="checkbox"/>	<input type="checkbox"/>
Does the development satisfy the Location Trigger?	<input checked="" type="checkbox"/>	<input type="checkbox"/>
Does the development satisfy the Safety Trigger?	<input checked="" type="checkbox"/>	<input type="checkbox"/>

**If none of the triggers are satisfied, the TIA Study is complete. If one or more of the triggers is satisfied, the TIA Study must continue into the next stage (Screening and Scoping).**

## **APPENDIX C**

---

OC Transpo Route Maps



**BAYSHORE  
CRYSTAL BAY  
TUNNEY'S PASTURE**

**Rapid**

**7 days a week / 7 jours par semaine**

All day and limited overnight service  
Service toute la journée et limité la nuit

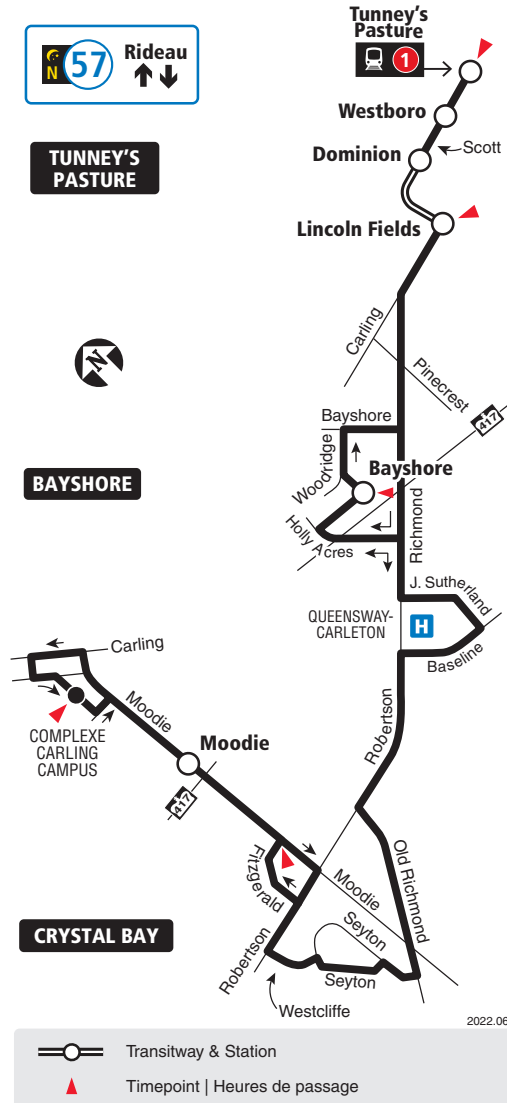

**TUNNEY'S PASTURE**

**BAYSHORE**

**CRYSTAL BAY**

**57** When O-Train Line 1 is not running overnight, Route 57 will be extended downtown to Rideau Station. / Lorsque la Ligne 1 de l'O-Train ne circule pas la nuit, le circuit 57 sera prolongée au centre-ville jusqu'à la station Rideau.

2022.06

2022.06

**Schedule / Horaire ..... 613-560-1000**  
**Text / Texto\* ..... 560560**  
*plus your four digit bus stop number / plus votre numéro d'arrêt à quatre chiffres*  
\*Standard message rates may apply / Les tarifs réguliers de messagerie texte peuvent s'appliquer

Customer Service  
Service à la clientèle ..... **613-560-5000**  
 Lost and Found / Objets perdus..... **613-563-4011**  
 Security / Sécurité ..... **613-741-2478**

**Effective June 26, 2022**  
**En vigueur 26 juin 2022**

# 88

## HURDMAN TERRY FOX

Fréquent

7 days a week / 7 jours par semaine

All day service  
Service toute la journée

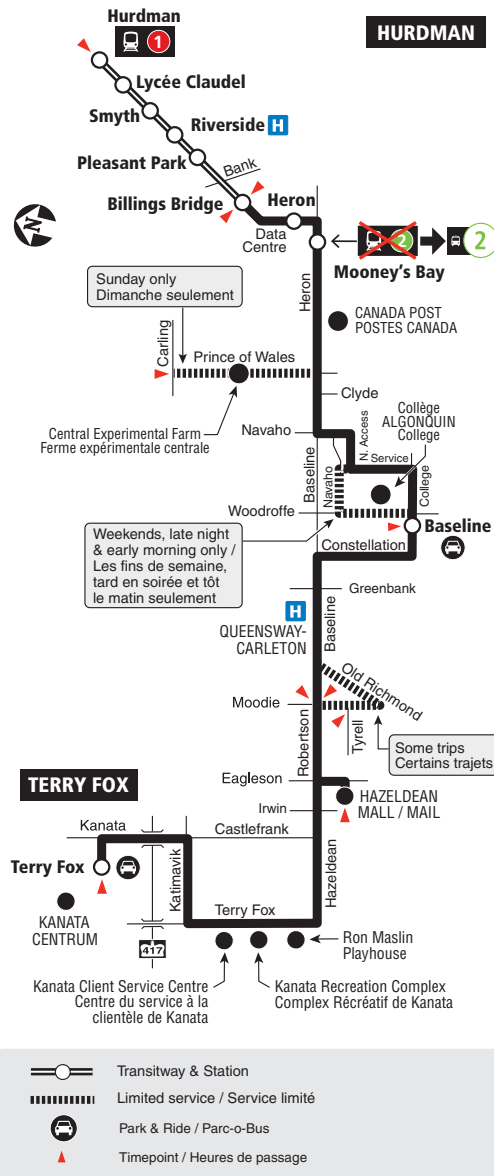

2020.05



Schedule / Horaire ..... 613-560-1000

Text / Texto ..... 560560

plus your four digit bus stop number / plus votre numéro d'arrêt à quatre chiffres

Customer Service  
Service à la clientèle ..... 613-741-4390

Lost and Found / Objets perdus ..... 613-563-4011

Security / Sécurité ..... 613-741-2478

Effective May 3, 2020

En vigueur 3 mai 2020



INFO 613-741-4390  
octranspo.com

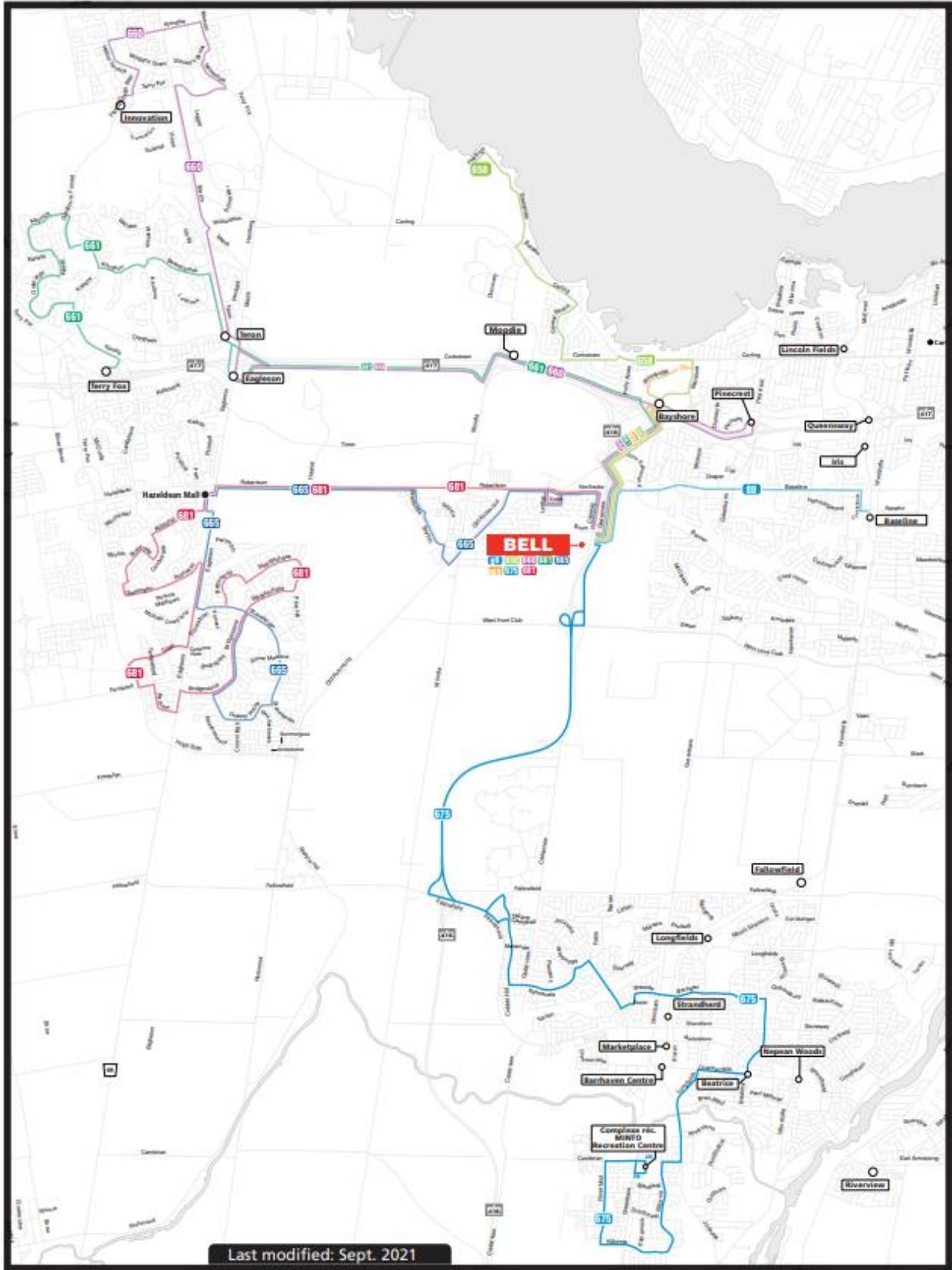

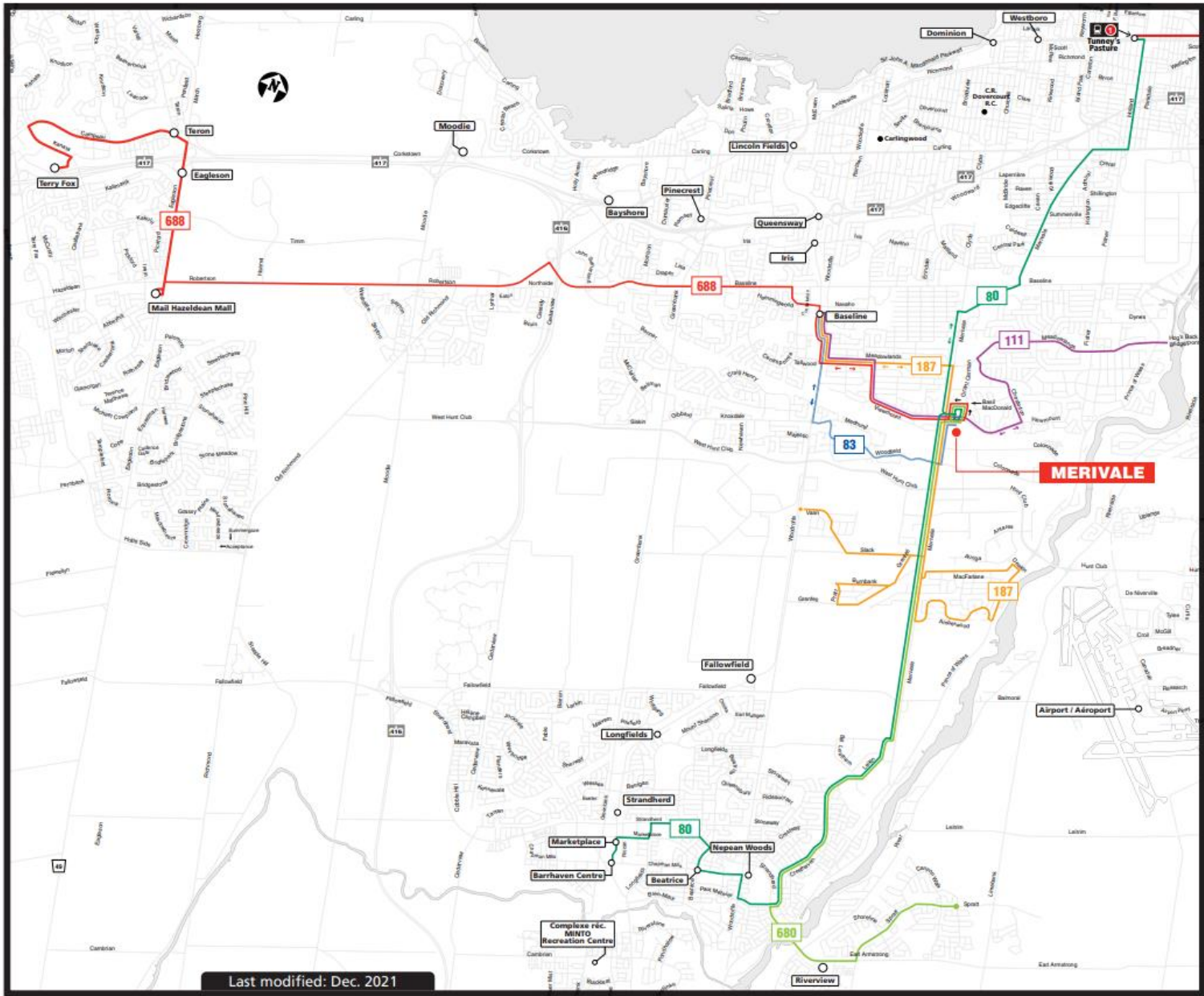

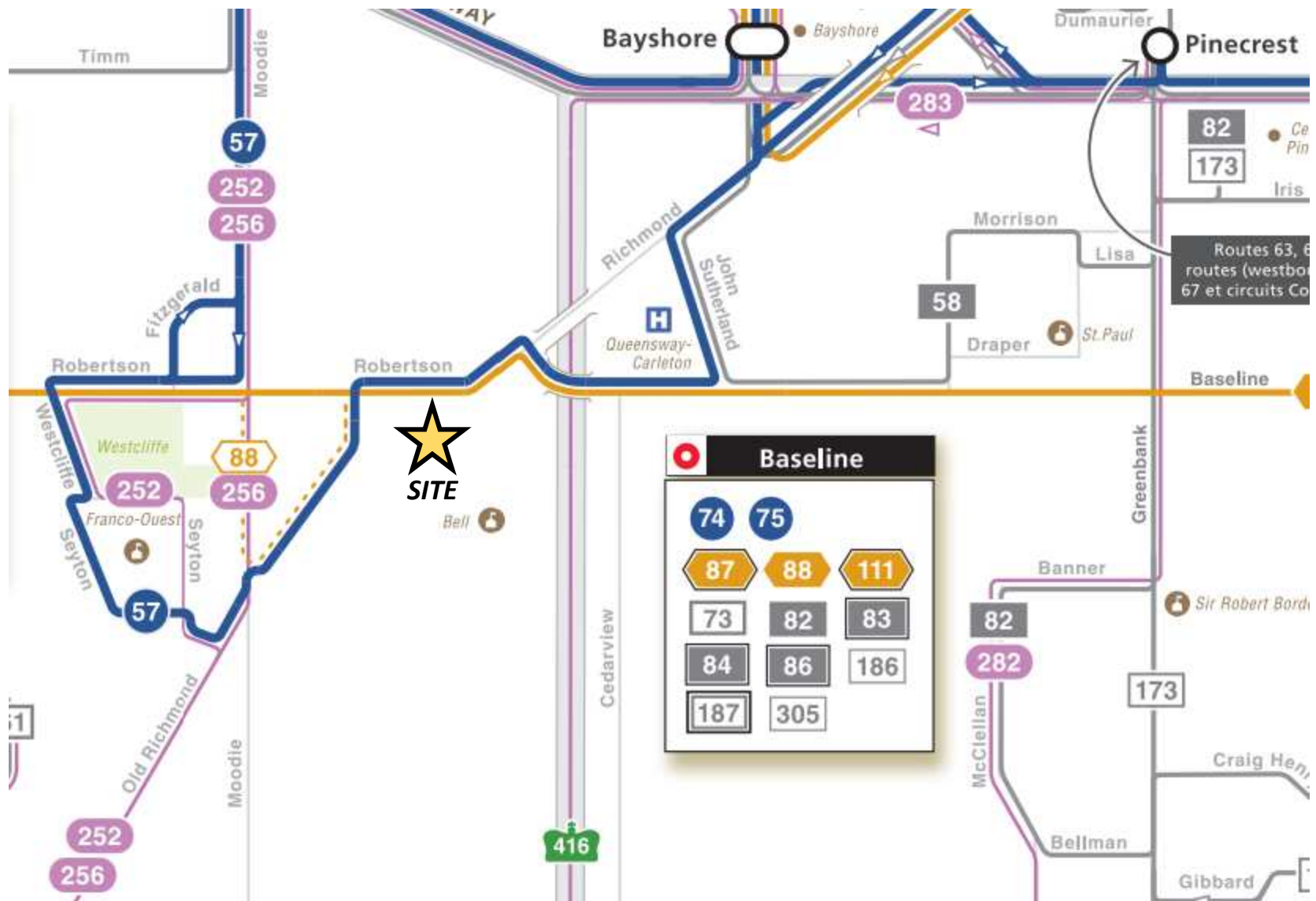

## **APPENDIX D**

---

Traffic Count Data





# Transportation Services - Traffic Services

## Turning Movement Count - Peak Hour Diagram

### RICHMOND RD @ STINSON AVE

**Survey Date:** Wednesday, March 08, 2017

**Start Time:** 07:00

**WO No:** 36747

**Device:** Miovision

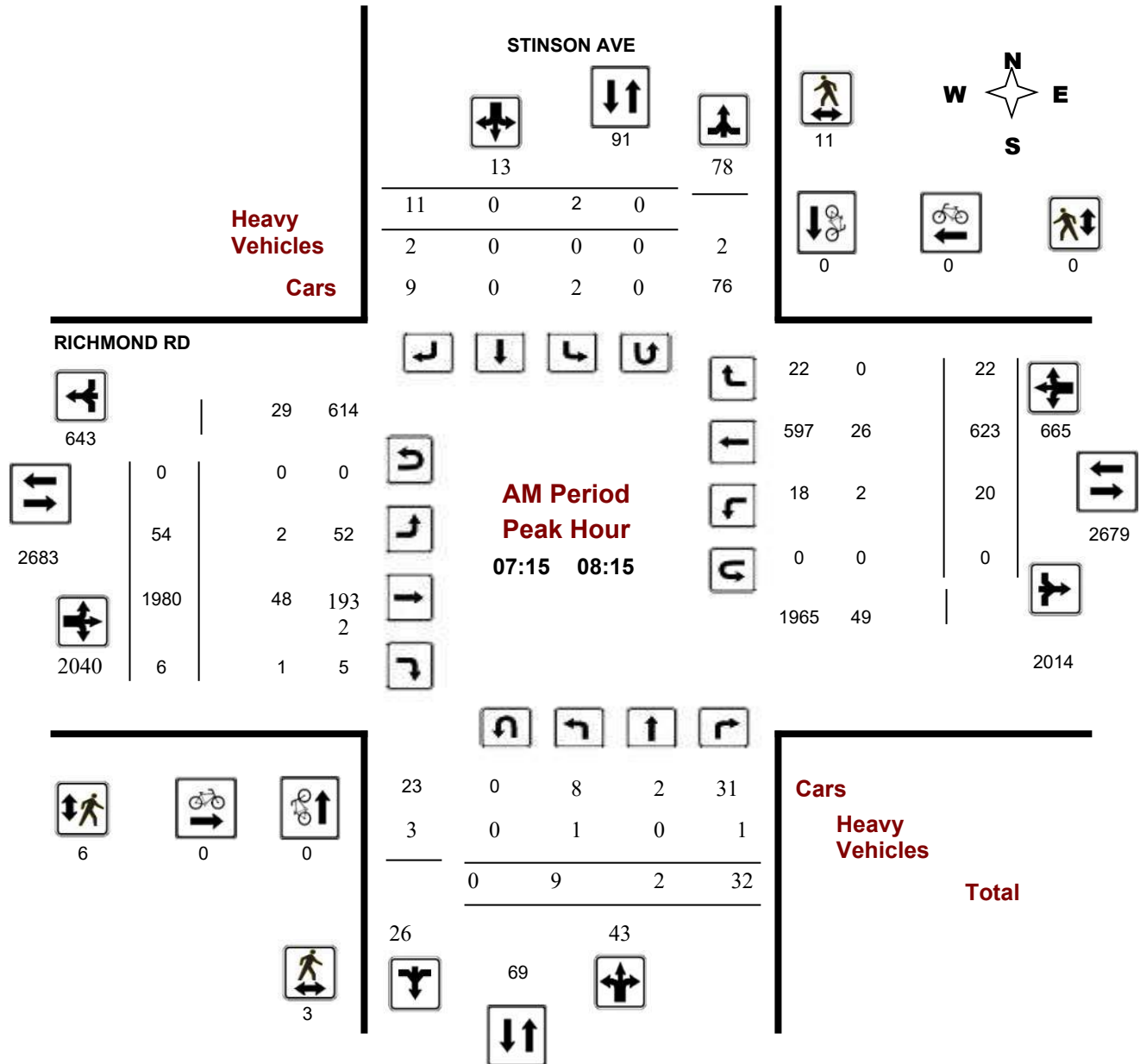



# Transportation Services - Traffic Services

## Turning Movement Count - Peak Hour Diagram

### RICHMOND RD @ STINSON AVE

**Survey Date:** Wednesday, March 08, 2017

**Start Time:** 07:00

**WO No:** 36747

**Device:** Miovision

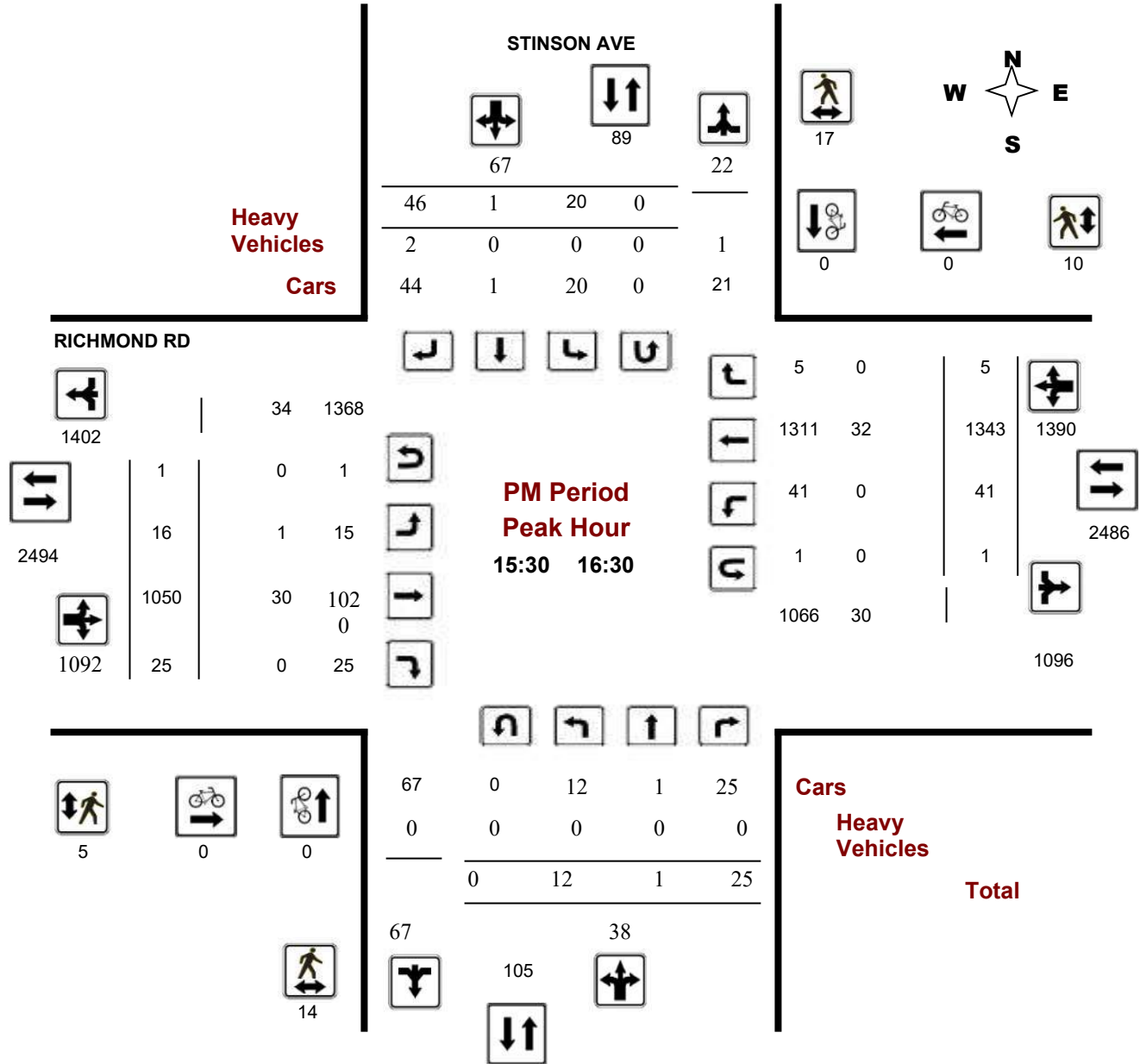



# Turning Movement Count

## Summary, OFF and PM Peak Hour

### Flow Diagrams

All Vehicles Except Bicycles



### Robertson Road & Stinson Avenue

### Bells Corners, ON

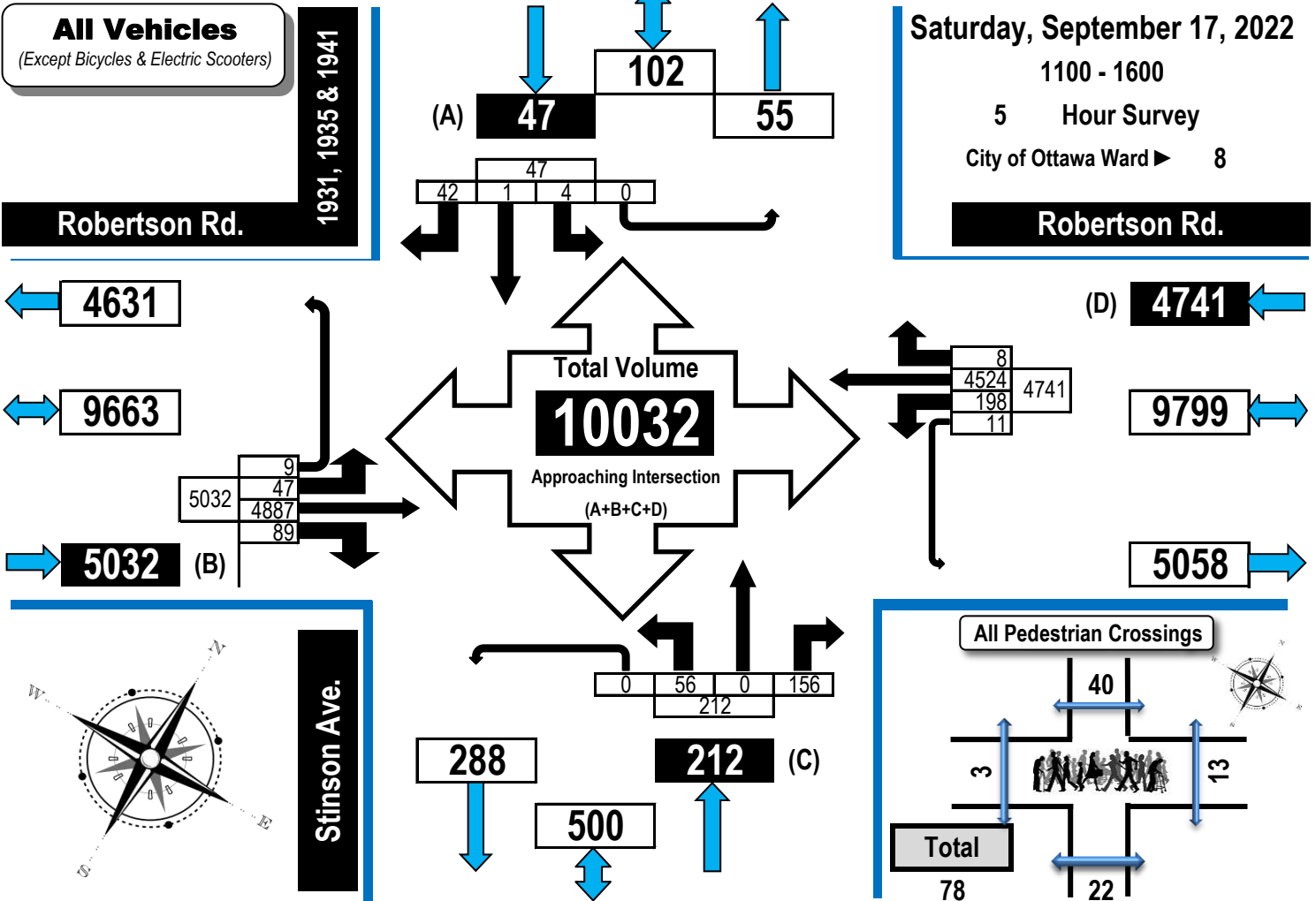

#### Off Peak Hour Flow Diagram

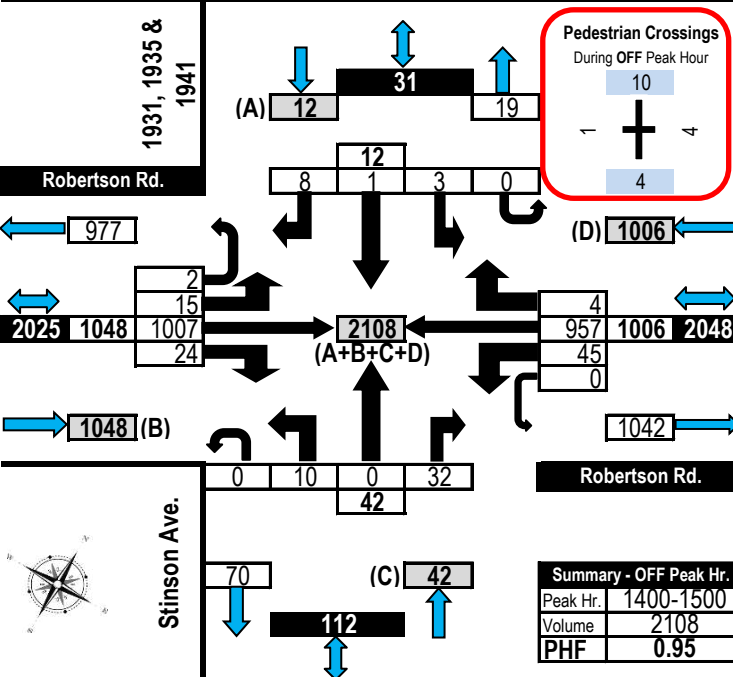

#### PM Peak Hour Flow Diagram

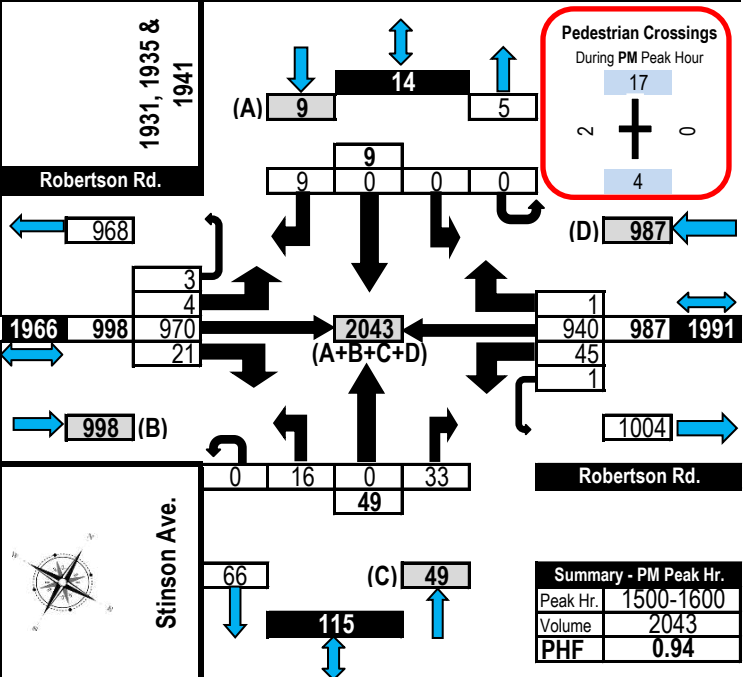



# Transportation Services - Traffic Services

## Turning Movement Count - Study Results

### RICHMOND RD @ LYNHAR RD/STAFFORD RD

**Survey Date:** Wednesday, March 08, 2017

**WO No:** 36587

**Start Time:** 07:00

**Device:** Miovision

### Full Study Summary (8 HR Standard)

**Survey Date:** Wednesday, March 08, 2017

**Total Observed U-Turns**

**AADT Factor**

Northbound: 2      Southbound: 0  
 Eastbound: 6      Westbound: 1

1.00

**LYNHAR RD/STAFFORD RD**

**RICHMOND RD**

Period	Northbound					Southbound					Eastbound					Westbound					Grand Total
	LT	ST	RT	NB TOT	STR TOT	LT	ST	RT	SB TOT	STR TOT	LT	ST	RT	EB TOT	STR TOT	LT	ST	RT	WB TOT	STR TOT	
07:00 08:00	28	10	107	145	205	20	2	38	60	205	40	1893	21	1954	14	599	75	688	2642	2847	
08:00 09:00	42	16	75	133	257	38	11	75	124	257	67	1364	40	1471	24	762	83	869	2340	2597	
09:00 10:00	45	26	64	135	297	60	12	90	162	297	111	867	63	1041	15	658	98	771	1812	2109	
11:30 12:30	70	37	51	158	456	120	18	160	298	456	198	718	49	965	38	681	90	809	1774	2230	
12:30 13:30	79	33	52	164	484	97	18	205	320	484	143	669	49	861	37	732	100	869	1730	2214	
15:00 16:00	88	33	77	198	543	155	39	151	345	543	137	842	67	1046	43	1006	81	1130	2176	2719	
16:00 17:00	93	49	72	214	635	221	28	172	421	635	117	851	57	1025	66	1081	73	1220	2245	2880	
17:00 18:00	89	20	72	181	580	197	32	170	399	580	118	875	47	1040	38	1019	85	1142	2182	2762	
<b>Sub Total</b>	534	224	570	1328	3457	908	160	1061	2129	3457	931	8079	393	9403	275	6538	685	7498	16901	20358	
<b>U Turns</b>				2					0	2				6				1	7	9	
<b>Total</b>	534	224	570	1330	3459	908	160	1061	2129	3459	931	8079	393	9409	275	6538	685	7499	16908	20367	
<b>EQ 12Hr</b>	742	311	792	1849	4808	1262	222	1475	2959	4808	1294	11230	546	13079	382	9088	952	10424	23502	28310	
Note: These values are calculated by multiplying the totals by the appropriate expansion factor.																	<b>1.39</b>				
<b>AVG 12Hr</b>	700	293	747	1742	4808	1189	210	1390	2789	4808	1220	10583	515	12326	360	8565	897	9824	23502	28310	
Note: These volumes are calculated by multiplying the Equivalent 12 hr. totals by the AADT factor.																	<b>1</b>				
<b>AVG 24Hr</b>	916	384	978	2282	5936	1558	275	1821	3654	5936	1598	13864	674	16147	472	11220	1176	12869	29016	34952	
Note: These volumes are calculated by multiplying the Average Daily 12 hr. totals by 12 to 24 expansion factor.																	<b>1.31</b>				

Note: U-Turns provided for approach totals. Refer to 'U-Turn' Report for specific breakdown.



# Transportation Services - Traffic Services

## Turning Movement Count - Peak Hour Diagram RICHMOND RD @ LYNHAR RD/STAFFORD RD

**Survey Date:** Wednesday, March 08, 2017

**Start Time:** 07:00

**WO No:** 36587

**Device:** Miovision

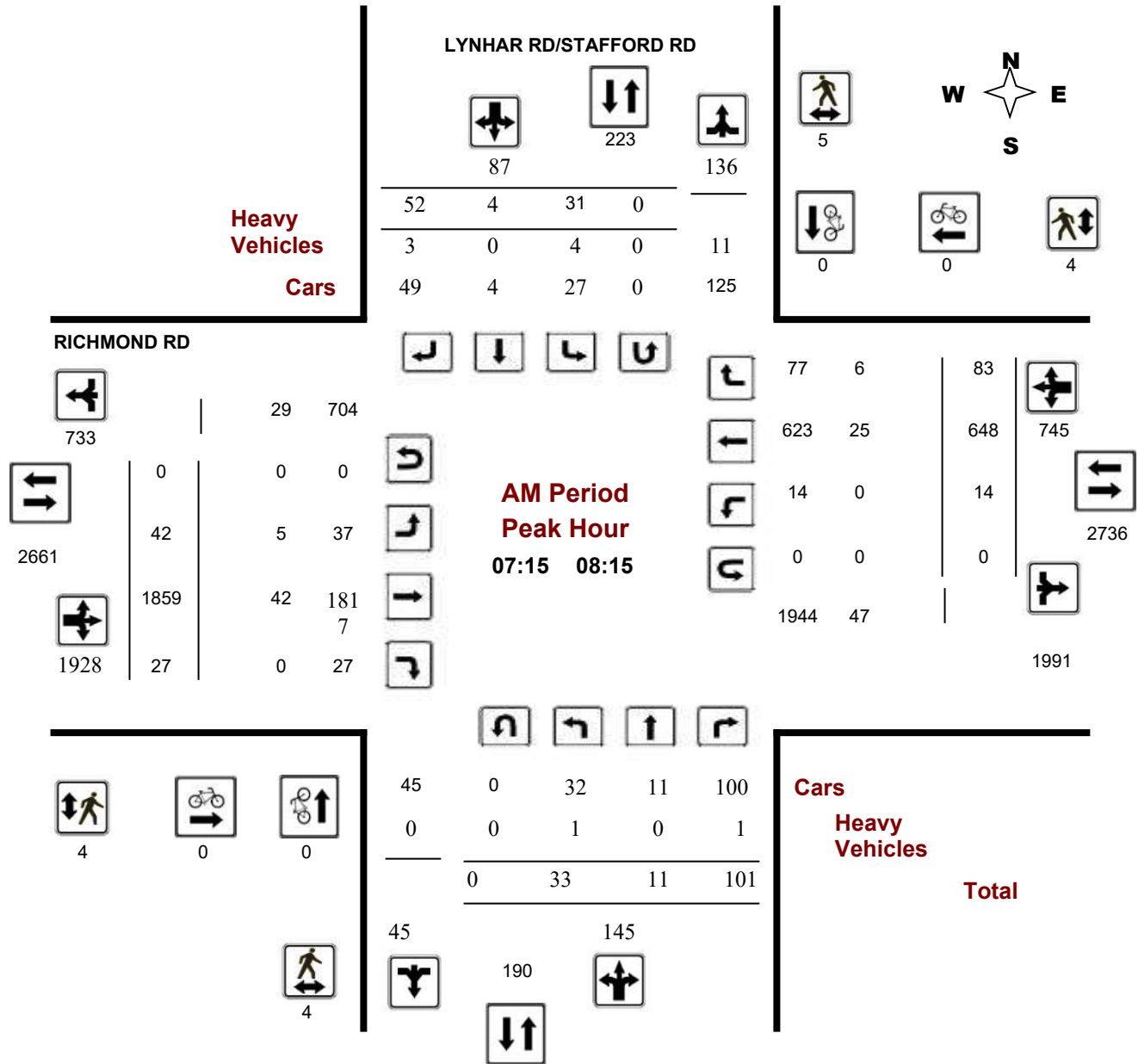



# Transportation Services - Traffic Services

## Turning Movement Count - Peak Hour Diagram RICHMOND RD @ LYNHAR RD/STAFFORD RD

**Survey Date:** Wednesday, March 08, 2017

**Start Time:** 07:00

**WO No:** 36587

**Device:** Miovision

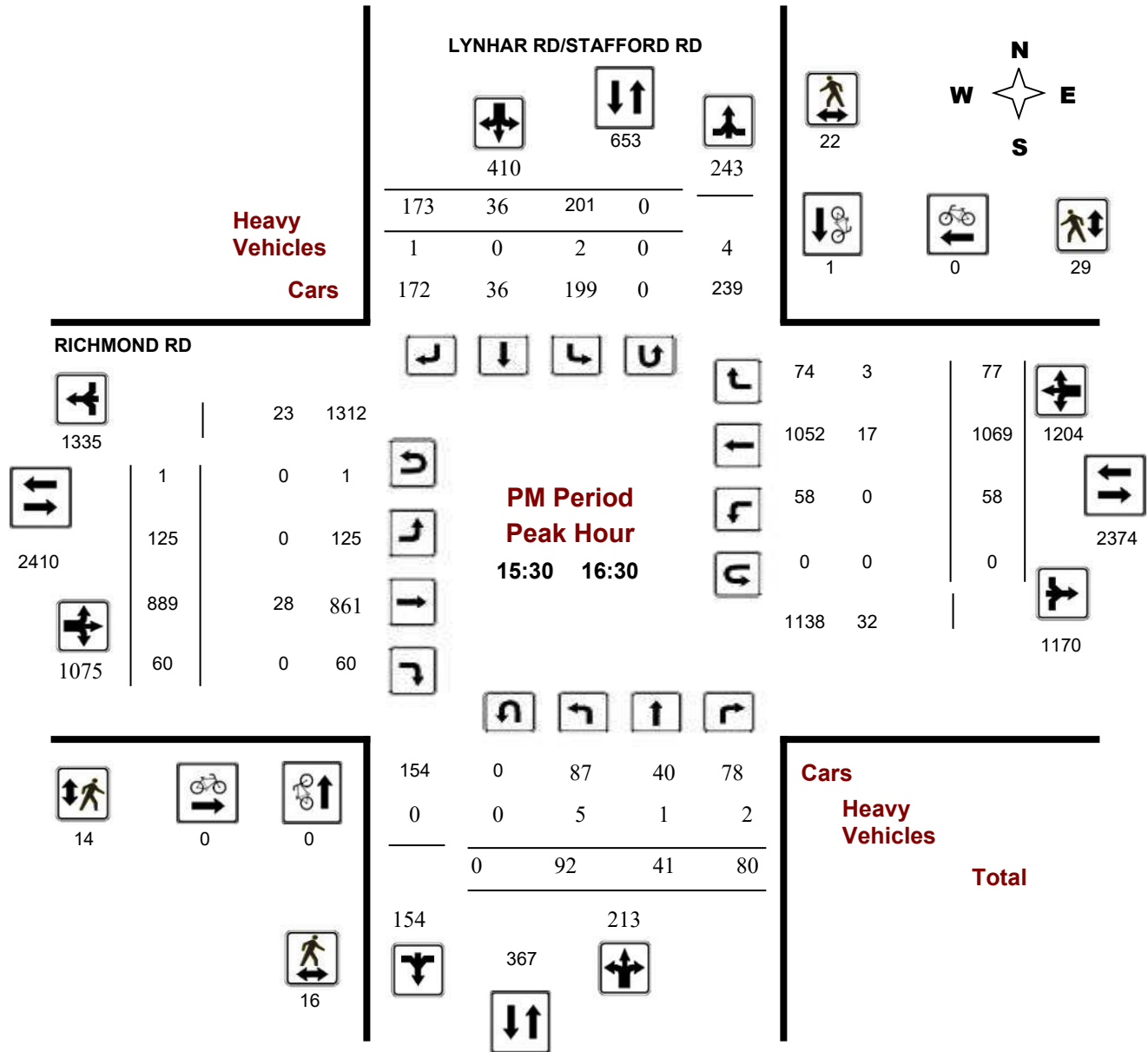

**Comments**



# Turning Movement Count

## Summary, OFF and PM Peak Hour

### Flow Diagrams

All Vehicles Except Bicycles



## Lynhar Road/Stafford Road & Robertson Road Bells Corners, ON

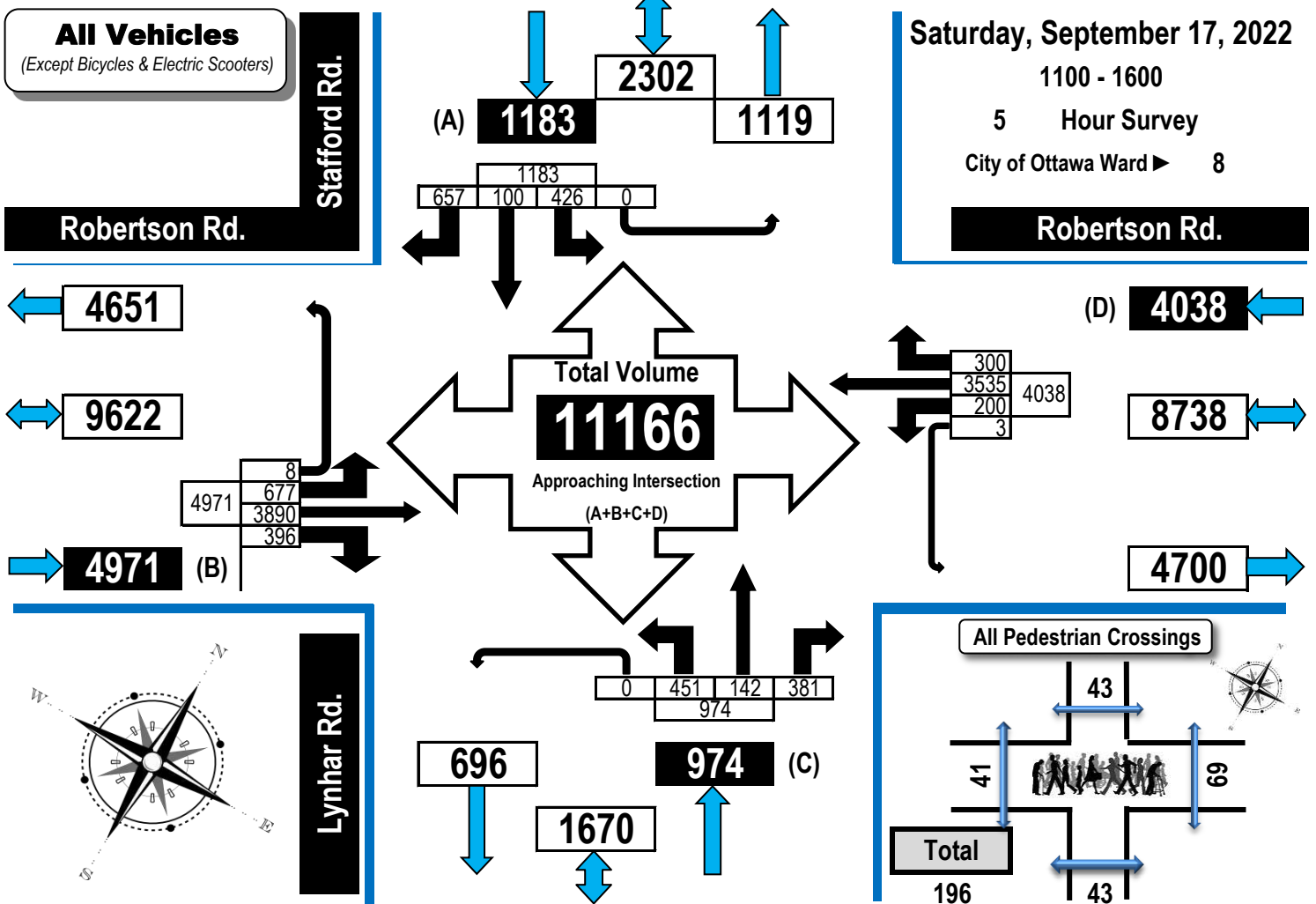

### Off Peak Hour Flow Diagram PM Peak Hour Flow Diagram

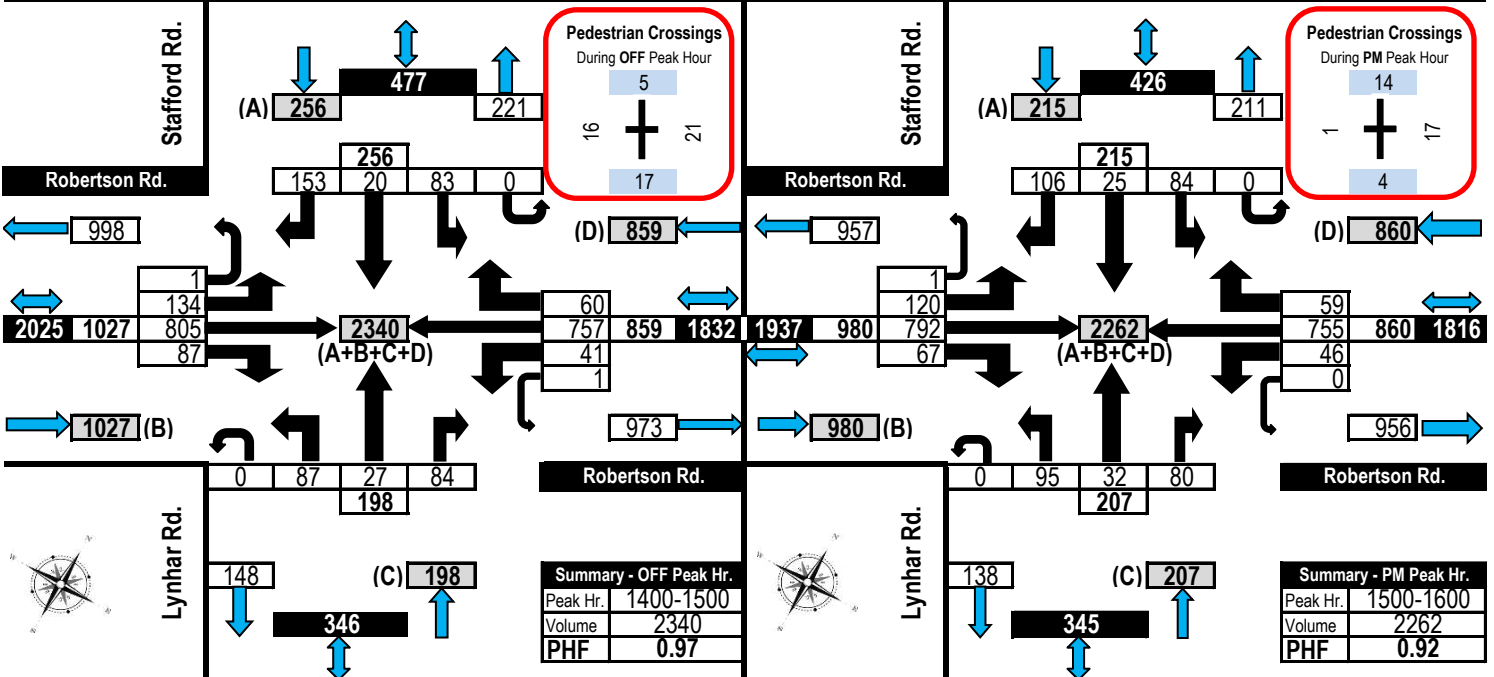



# Transportation Services - Traffic Services

## Turning Movement Count - Peak Hour Diagram

### RICHMOND RD @ NORTHSIDE RD E

**Survey Date:** Thursday, June 13, 2019

**Start Time:** 07:00

**WO No:** 38647

**Device:** Miovision

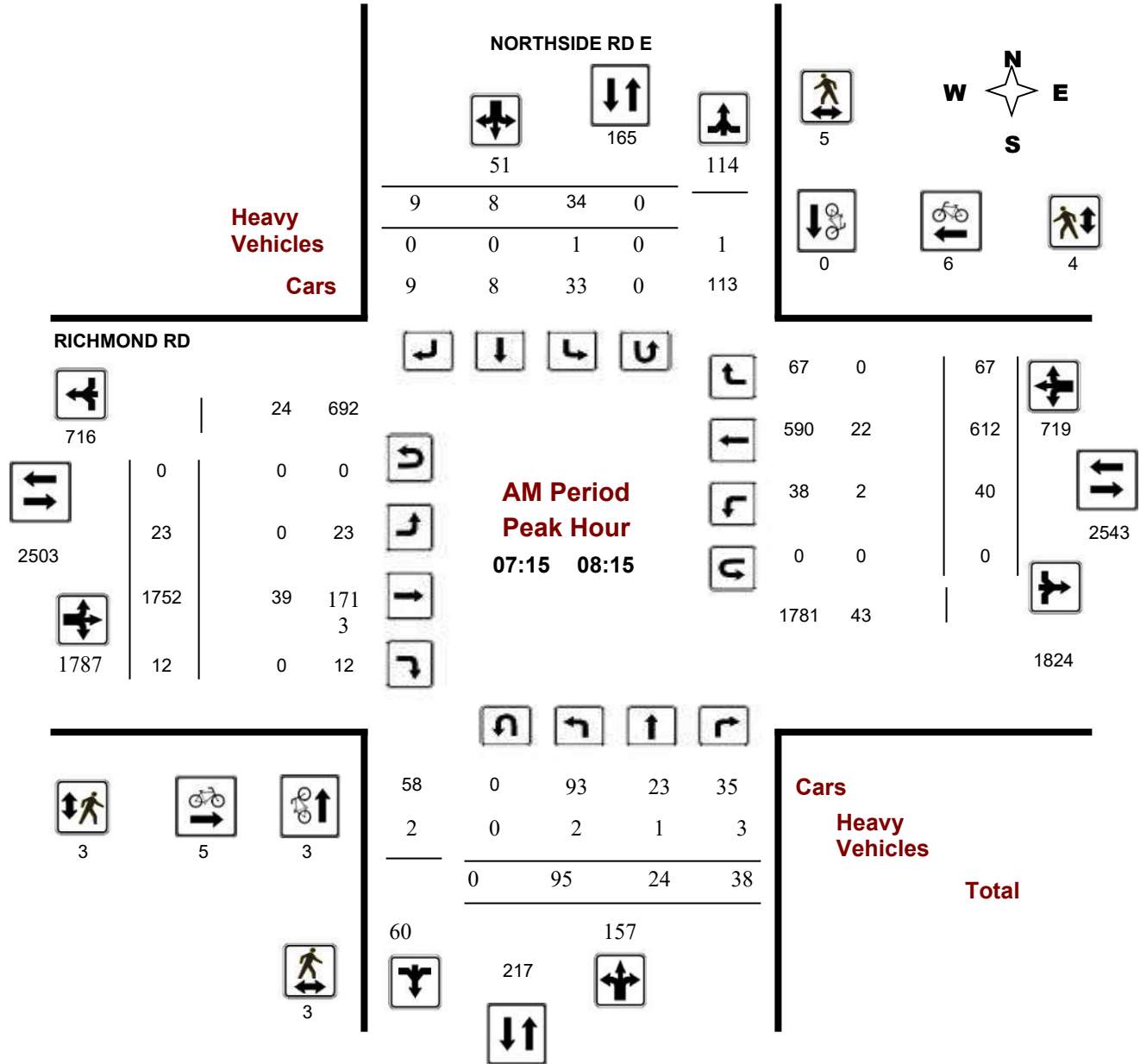





# Transportation Services - Traffic Services

## Turning Movement Count - Peak Hour Diagram

### RICHMOND RD @ NORTHSIDE RD E

**Survey Date:** Thursday, June 13, 2019

**Start Time:** 07:00

**WO No:** 38647

**Device:** Miovision

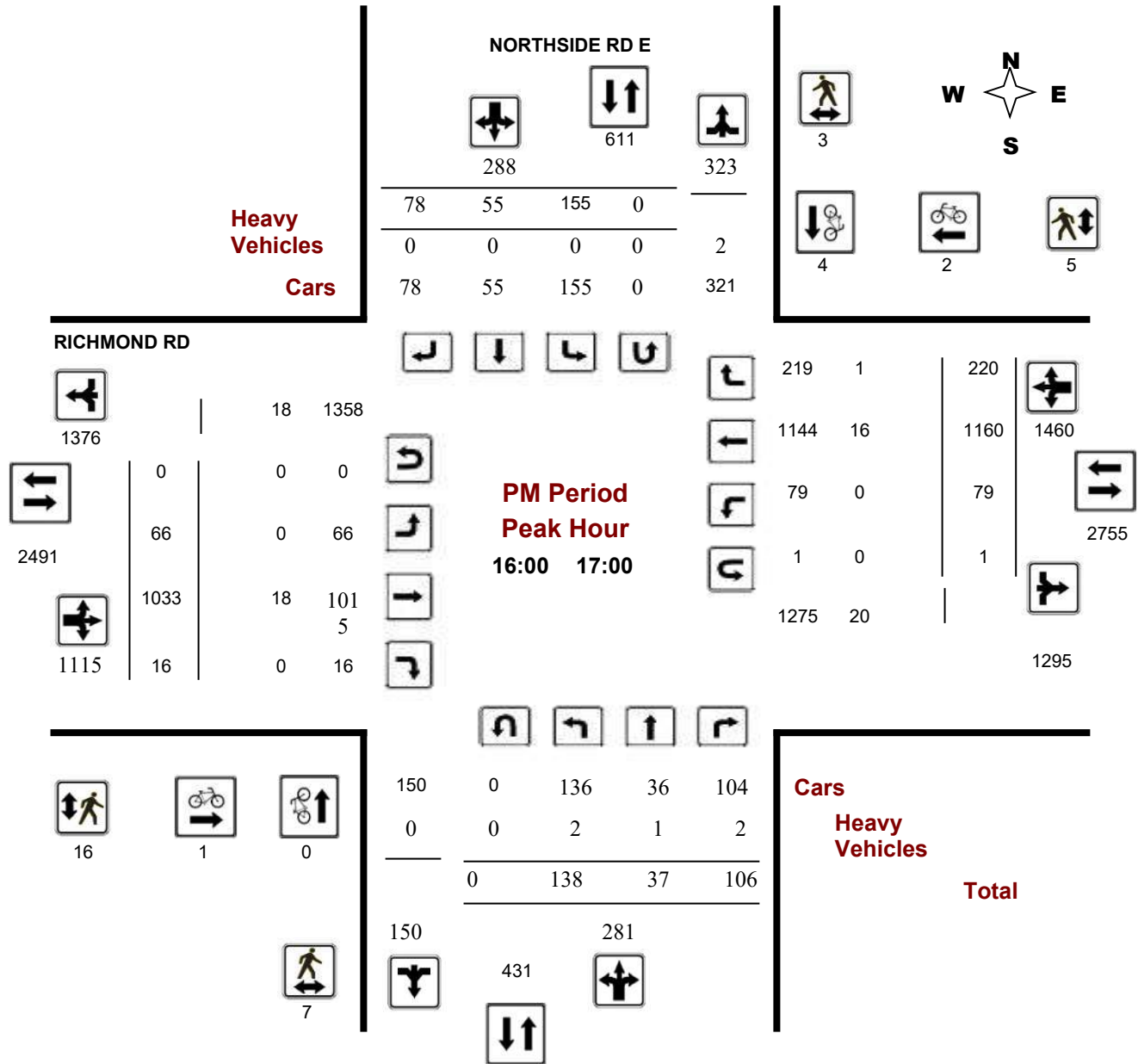



# Turning Movement Count

## Summary, OFF and PM Peak Hour

### Flow Diagrams

All Vehicles Except Bicycles



## Northside Road/Stafford Centre & Robertson Road Bells Corners, ON

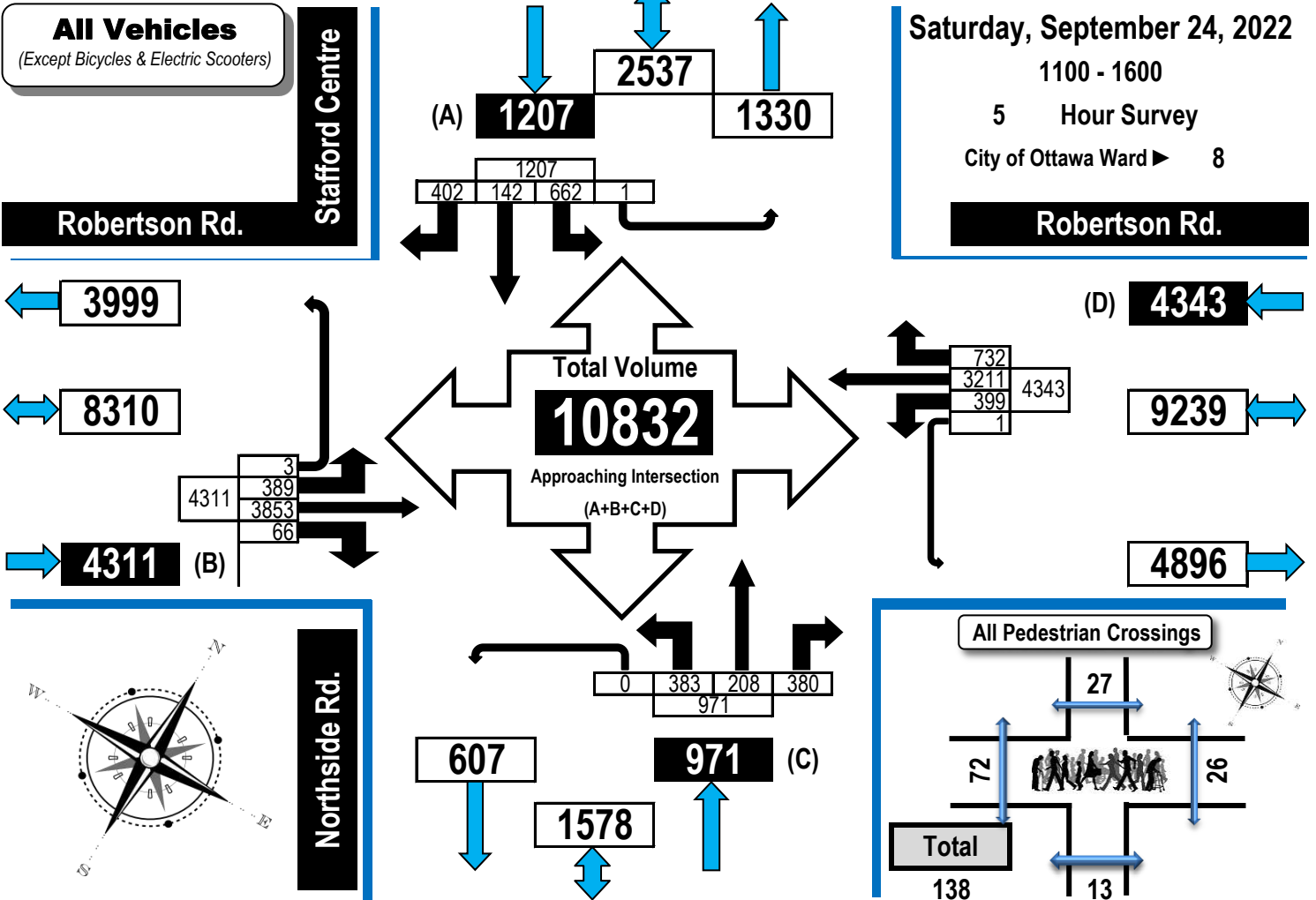

### Off Peak Hour Flow Diagram PM Peak Hour Flow Diagram

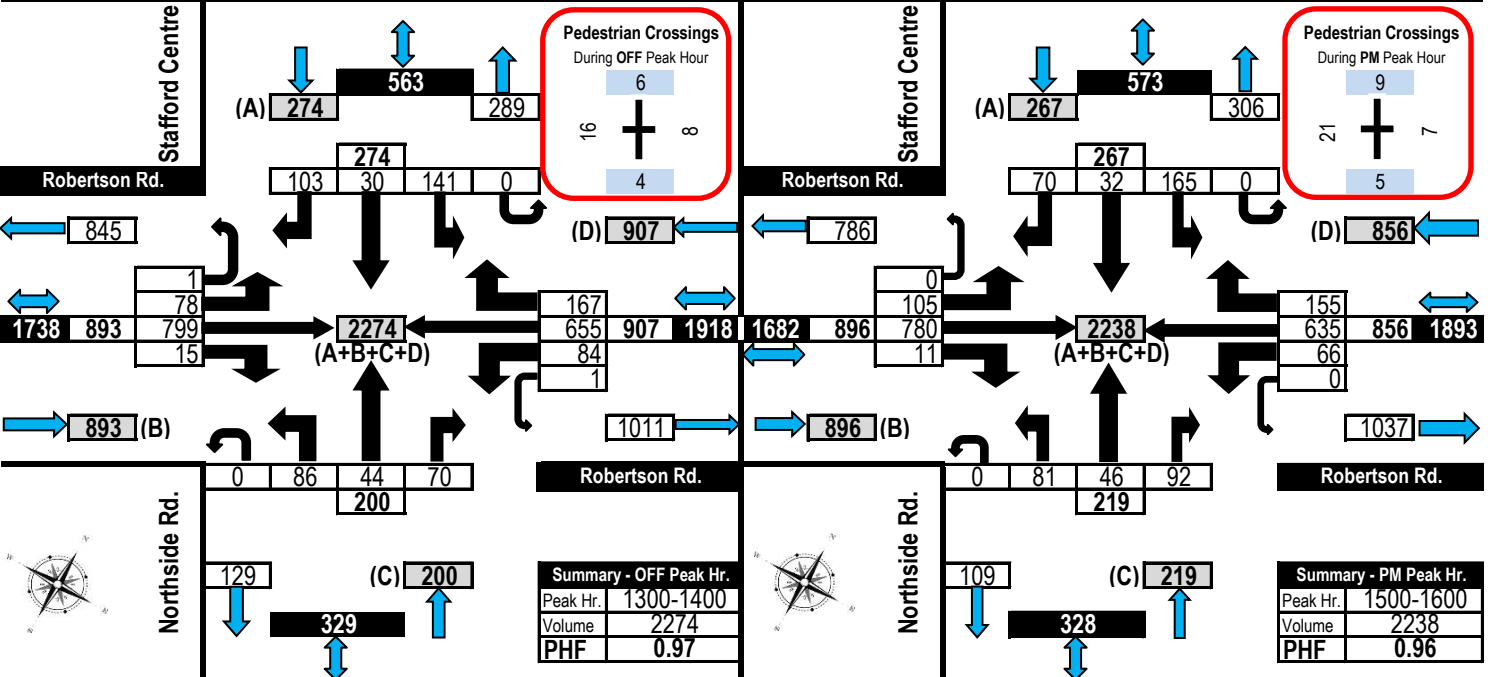



# Turning Movement Count

## Summary Report Including Peak Hours, AADT and Expansion Factors

All Vehicles Except Bicycles



### Larkspur Drive & Northside RoadBells Corners, ON

**Survey Date:** Wednesday, September 21, 2022      **Start Time:** 0700      **AADT Factor:** 1.0  
**Weather AM:** Overcast 12° C      **Survey Duration:** 8 Hrs.      **Survey Hours:** 0700-1000, 1130-1330 & 1500-1800  
**Weather PM:** Mostly Sunny 20° C      **Surveyor(s):** M. Brazeau

Northside Rd.					Northside Rd.					Larkspur Dr.					N/A				
Eastbound					Westbound					Northbound					Southbound				

Time Period	LT	ST	RT	UT	E/B Tot	LT	ST	RT	UT	W/B Tot	Street Total	LT	ST	RT	UT	N/B Tot	LT	ST	RT	UT	S/B Tot	Street Total	Grand Total
0700-0800		63	8	0	71	25			0	25	96			24	0	24						24	120
0800-0900		91	11	0	102	43			0	43	145			24	0	24						24	169
0900-1000		65	4	0	69	47			0	47	116			23	0	23						23	139
1130-1230		90	13	0	103	81			0	81	184			82	0	82						82	266
1230-1330		70	10	0	80	86			0	86	166			86	0	86						86	252
1500-1600		112	9	0	121	92			0	92	213			77	0	77						77	290
1600-1700		100	9	0	109	76			0	76	185			83	0	83						83	268
1700-1800		71	9	0	80	74			0	74	154			78	0	78						78	232
<b>Totals</b>		<b>662</b>	<b>73</b>	<b>0</b>	<b>735</b>	<b>524</b>			<b>0</b>	<b>524</b>	<b>1259</b>			<b>477</b>	<b>0</b>	<b>477</b>						<b>477</b>	<b>1736</b>

**Equivalent 12 & 24-hour Vehicle Volumes Including the Annual Average Daily Traffic (AADT) Factor**  
**Applicable to the Day and Month of the Turning Movement Count**

**Expansion factors are applied exclusively to standard weekday 8-hour turning movement counts conducted during the hours of 0700h - 1000h, 1130h - 1330h and 1500h - 1800h**

Equivalent 12-hour vehicle volumes. These volumes are calculated by multiplying the 8-hour totals by the 8 → 12 expansion factor of 1.39

Equ. 12 Hr	0	920	101	0	1022	728	0	0	0	728	1750	0	0	663	0	663	0	0	0	0	0	0	663	2413
------------	---	-----	-----	---	------	-----	---	---	---	-----	------	---	---	-----	---	-----	---	---	---	---	---	---	-----	------

Average daily 12-hour vehicle volumes. These volumes are calculated by multiplying the equivalent 12-hour totals by the AADT factor of: 1.0

AADT 12-hr	0	920	101	0	1022	728	0	0	0	728	1750	0	0	663	0	663	0	0	0	0	0	0	663	2413
------------	---	-----	-----	---	------	-----	---	---	---	-----	------	---	---	-----	---	-----	---	---	---	---	---	---	-----	------

24-Hour AADT. These volumes are calculated by multiplying the average daily 12-hour vehicle volumes by the 12 → 24 expansion factor of 1.31

AADT 24 Hr	0	1205	133	0	1338	954	0	0	0	954	2293	0	0	869	0	869	0	0	0	0	0	0	869	3161
------------	---	------	-----	---	------	-----	---	---	---	-----	------	---	---	-----	---	-----	---	---	---	---	---	---	-----	------

**AADT and expansion factors provided by the City of Ottawa**

<b>AM Peak Hour Factor → 0.72</b>											<b>Highest Hourly Vehicle Volume Between 0700h &amp; 1000h</b>													
<b>AM Peak Hr</b>	LT	ST	RT	UT	Total	LT	ST	RT	UT	Total	Str. Tot.	LT	ST	RT	UT	Total	LT	ST	RT	UT	Total	Str. Tot.	Gr. Tot.	
0815-0915	0	100	8	0	108	51	0	0	0	51	159	0	0	26	0	26	0	0	0	0	0	0	26	185
<b>OFF Peak Hour Factor → 0.91</b>											<b>Highest Hourly Vehicle Volume Between 1130h &amp; 1330h</b>													
<b>OFF Peak Hr</b>	LT	ST	RT	UT	Total	LT	ST	RT	UT	Total	Str. Tot.	LT	ST	RT	UT	Total	LT	ST	RT	UT	Total	Str. Tot.	Gr. Tot.	
1215-1315	0	85	11	0	96	89	0	0	0	89	185	0	0	92	0	92	0	0	0	0	0	0	92	277
<b>PM Peak Hour Factor → 0.97</b>											<b>Highest Hourly Vehicle Volume Between 1500h &amp; 1800h</b>													
<b>PM Peak Hr</b>	LT	ST	RT	UT	Total	LT	ST	RT	UT	Total	Str. Tot.	LT	ST	RT	UT	Total	LT	ST	RT	UT	Total	Str. Tot.	Gr. Tot.	
1515-1615	0	107	10	0	117	98	0	0	0	98	215	0	0	79	0	79	0	0	0	0	0	0	79	294

**Comments:**

OC Transpo and school buses comprise 27.87% of the heavy vehicle traffic. Many drivers completely ignore the stop control. One northbound driver attempted to turn left to Northside Drive, realized it was a one way eastbound, and almost backed into a northbound vehicle before finally turning right to Northside, eastbound. The pedestrian crossings total includes one with accessibility issues using a wheelchair.

**Notes:**

1. Includes all vehicle types except bicycles, electric bicycles, and electric scooters.
2. When expansion and AADT factors are applied, the results will differ slightly due to rounding.



# Turning Movement Count

## Summary, AM and PM Peak Hour

### Flow Diagrams

All Vehicles Except Bicycles



## Larkspur Drive & Northside Road Bells Corners, ON

**All Vehicles**  
(Except Bicycles & Electric Scooters)



Total vehicle volume, all approaches.  
(B + C + D)

Wednesday, September 21, 2022

0700-1000, 1130-1330 & 1500-1800

8 Hour Survey

City of Ottawa Ward 8

### Northside Rd.

### Northside Rd.

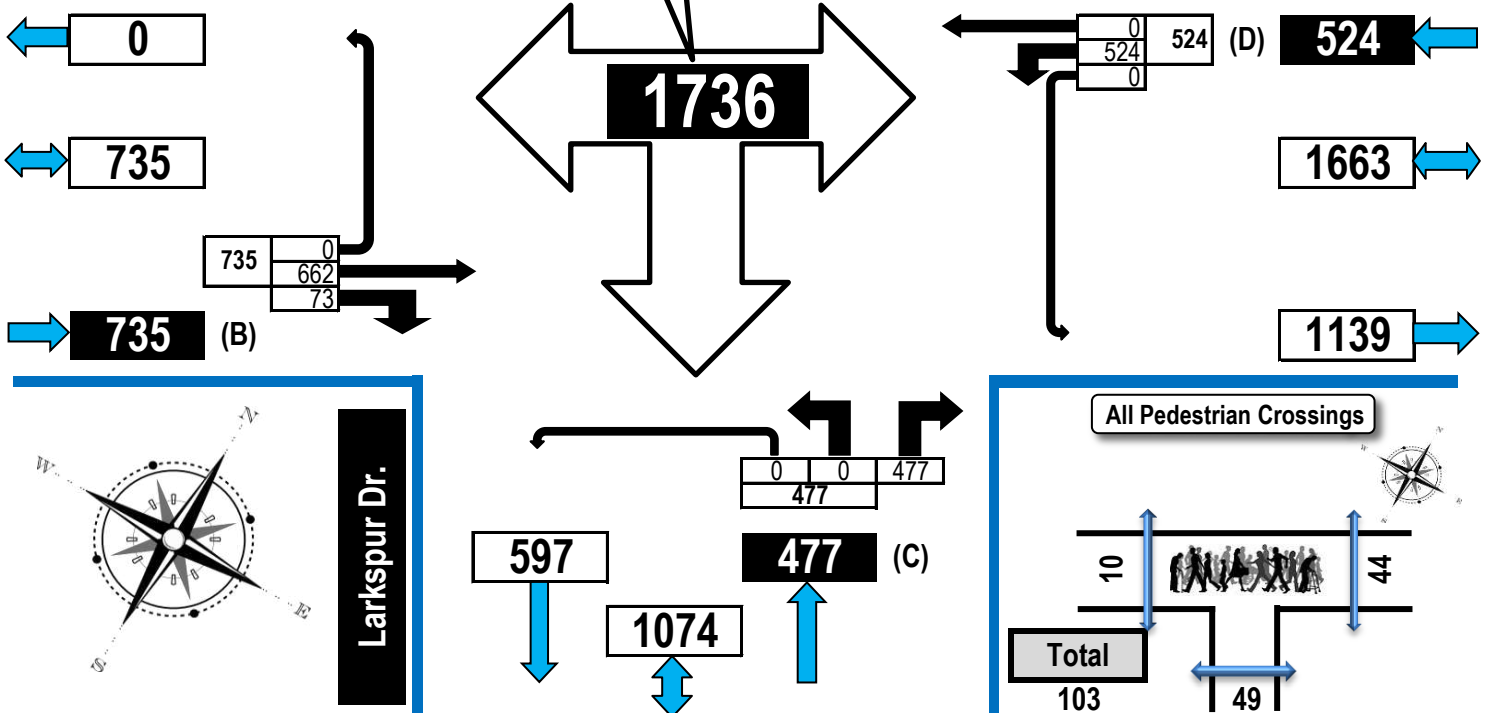

### AM Peak Hour Flow Diagram

### PM Peak Hour Flow Diagram

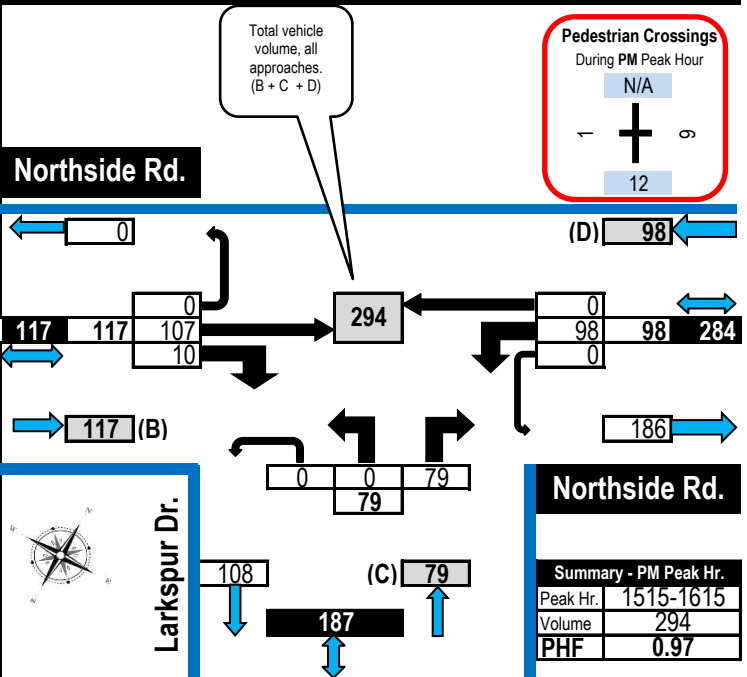
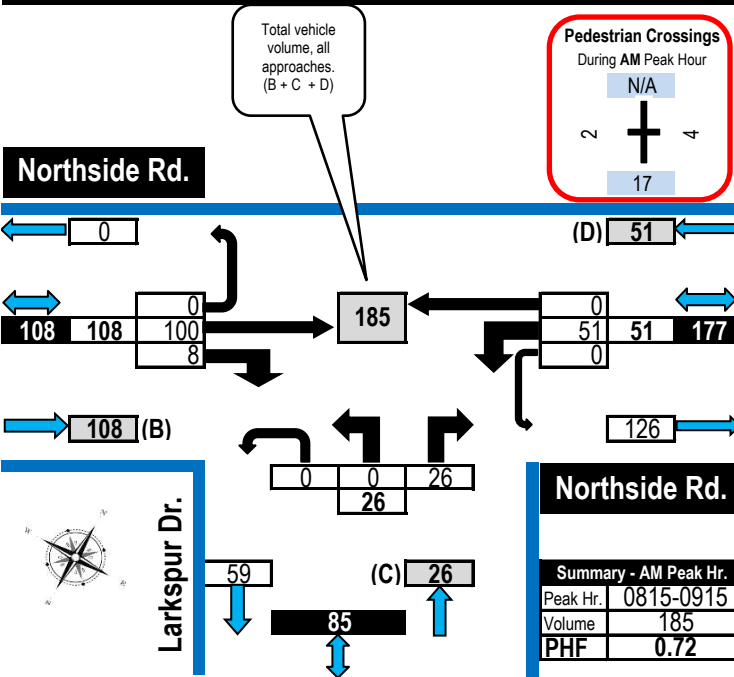



# Turning Movement Count

## Summary, OFF and EVENING Peak Hour

### Flow Diagrams

All Vehicles Except Bicycles



## Larkspur Drive & Northside Road

## Bells Corners, ON

**All Vehicles**  
(Except Bicycles & Electric Scooters)

Total vehicle volume, all approaches.  
(B + C + D)

Saturday, September 24, 2022  
1100-1600  
5 Hour Survey  
City of Ottawa Ward 8

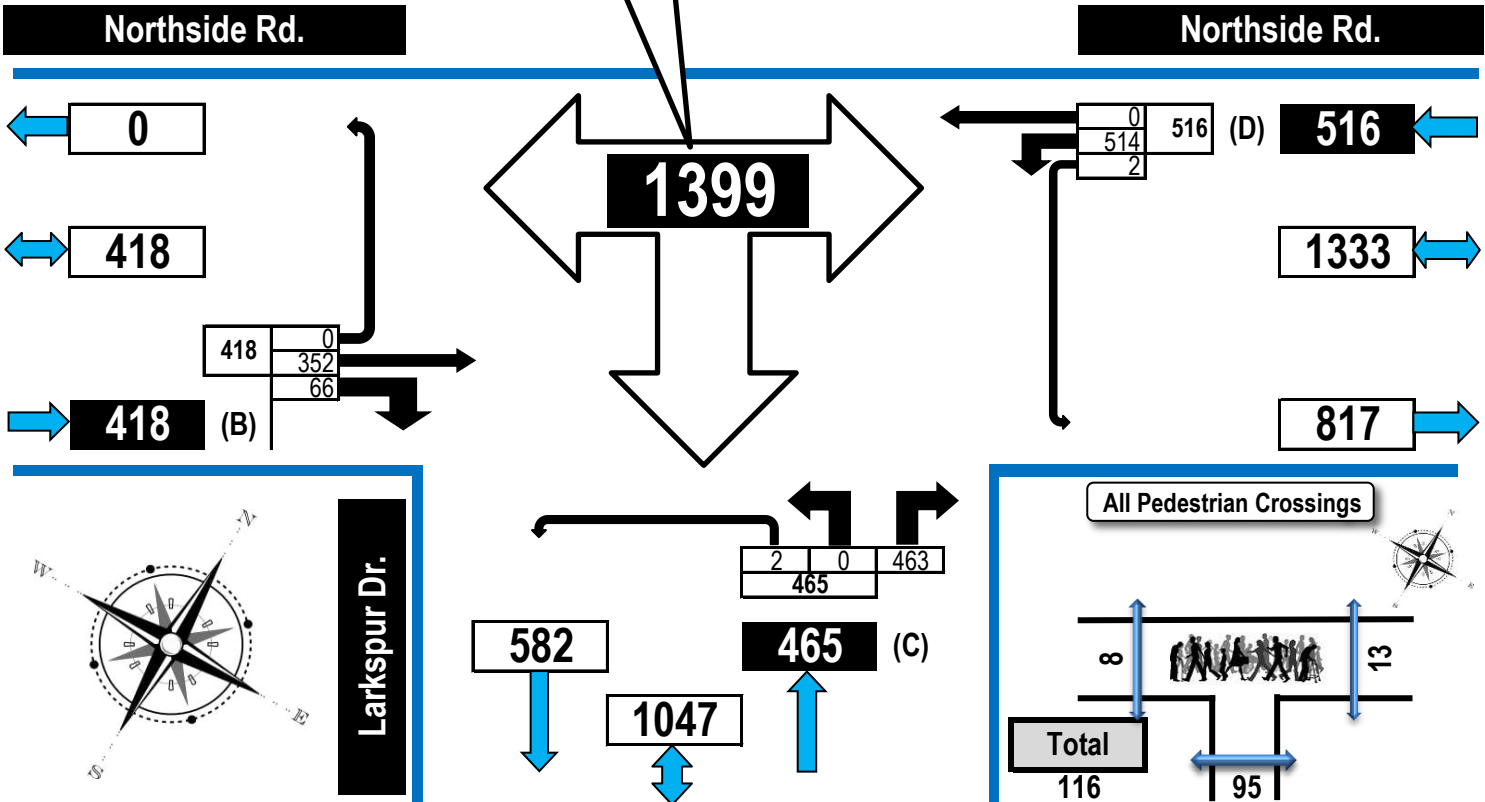

### Off Peak Hour Flow Diagram

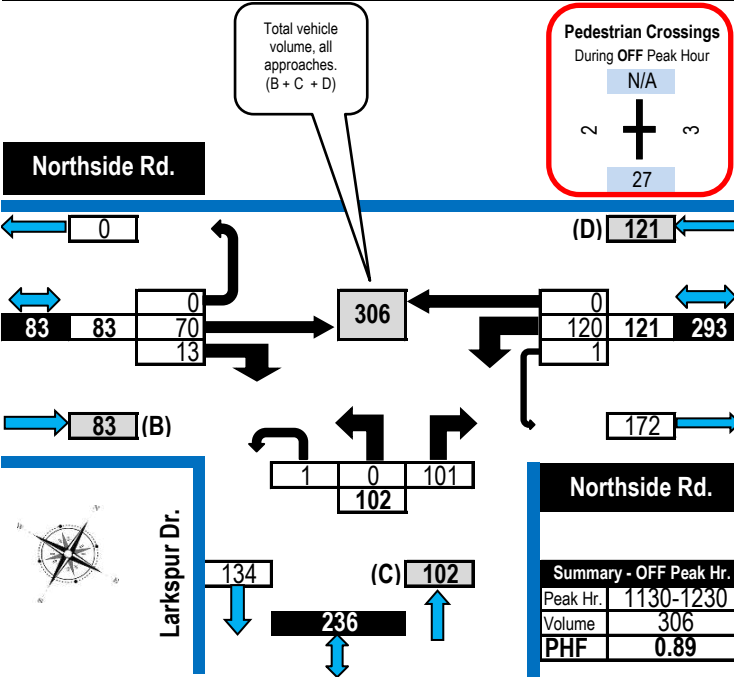

### Evening Peak Hour Flow Diagram

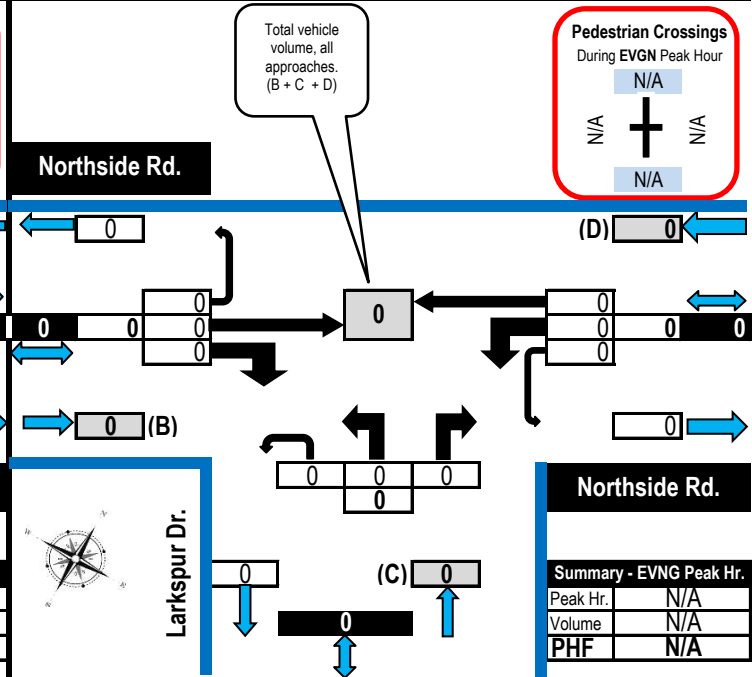

## **APPENDIX E**

---

Collision Records



# Transportation Services - Traffic Services

## Collision Details Report - Public Version

From: January 1, 2016 To: December 31, 2020

**Location:** LYNHAR RD btwn STAFFORD RD & VIRGIL RD

**Traffic Control:** No control

**Total Collisions:** 2

Date/Day/Time	Environment	Impact Type	Classification	Surface Cond'n	Veh. Dir	Vehicle Manoeuver	Vehicle type	First Event	No. Ped
2016-Jan-08, Fri,08:57	Clear	Angle	P.D. only	Dry	West	Turning left	Pick-up truck	Other motor vehicle	0
					North	Going ahead	Automobile, station wagon	Other motor vehicle	
2020-Feb-14, Fri,09:15	Clear	Angle	P.D. only	Dry	East	Turning left	Automobile, station wagon	Other motor vehicle	0
					North	Going ahead	Truck - closed	Other motor vehicle	

**Location:** NORTHSIDE RD W @ RICHMOND RD

**Traffic Control:** No control

**Total Collisions:** 4

Date/Day/Time	Environment	Impact Type	Classification	Surface Cond'n	Veh. Dir	Vehicle Manoeuver	Vehicle type	First Event	No. Ped
2017-Sep-20, Wed,17:19	Clear	Rear end	P.D. only	Dry	East	Going ahead	Automobile, station wagon	Other motor vehicle	0
					East	Slowing or stopping	Automobile, station wagon	Other motor vehicle	
2018-Jan-25, Thu,10:00	Clear	Sideswipe	P.D. only	Dry	East	Going ahead	Automobile, station wagon	Other motor vehicle	0
					East	Stopped	Automobile, station wagon	Other motor vehicle	
					East	Stopped	Automobile, station wagon	Other motor vehicle	
2018-Jun-29, Fri,17:15	Clear	SMV other	P.D. only	Dry	East	Going ahead	Automobile, station wagon	Pole (utility, power)	0
2018-Oct-24, Wed,16:45	Clear	Turning movement	P.D. only	Dry	East	Turning right	Pick-up truck	Other motor vehicle	0
					East	Turning left	Automobile, station wagon	Other motor vehicle	

**Location:** RICHMOND RD @ LYNHAR RD/STAFFORD RD

**Traffic Control:** Traffic signal

**Total Collisions:** 42

Date/Day/Time	Environment	Impact Type	Classification	Surface Cond'n	Veh. Dir	Vehicle Manoeuver	Vehicle type	First Event	No. Ped
2016-Feb-22, Mon,09:33	Clear	Angle	P.D. only	Dry	East	Turning right	Automobile, station wagon	Other motor vehicle	0
					North	Turning left	Pick-up truck	Other motor vehicle	
2016-Feb-24, Wed,12:47	Snow	Angle	P.D. only	Loose snow	South	Going ahead	Unknown	Other motor vehicle	0
					West	Going ahead	Automobile, station wagon	Other motor vehicle	



# Transportation Services - Traffic Services

## Collision Details Report - Public Version

From: January 1, 2016 To: December 31, 2020

**Location:** RICHMOND RD @ LYNHAR RD/STAFFORD RD

**Traffic Control:** Traffic signal

**Total Collisions:** 42

Date/Day/Time	Environment	Impact Type	Classification	Surface Cond'n	Veh. Dir	Vehicle Manoeuvre	Vehicle type	First Event	No. Ped
2016-Apr-07, Thu,19:27	Clear	Rear end	P.D. only	Dry	East	Going ahead	Automobile, station wagon	Other motor vehicle	0
					East	Stopped	Pick-up truck	Other motor vehicle	
2016-Apr-20, Wed,14:26	Clear	Rear end	P.D. only	Dry	South	Turning right	Automobile, station wagon	Other motor vehicle	0
					South	Turning right	Unknown	Other motor vehicle	
2016-May-11, Wed,14:36	Clear	Rear end	P.D. only	Dry	East	Slowing or stopping	Pick-up truck	Other motor vehicle	0
					East	Stopped	Automobile, station wagon	Other motor vehicle	
2016-Jun-04, Sat,18:04	Clear	Sideswipe	P.D. only	Dry	West	Changing lanes	Automobile, station wagon	Other motor vehicle	0
					West	Going ahead	Automobile, station wagon	Other motor vehicle	
2016-Jun-22, Wed,15:29	Clear	Rear end	Non-fatal injury	Dry	East	Going ahead	Automobile, station wagon	Other motor vehicle	0
					East	Stopped	Passenger van	Other motor vehicle	
					East	Going ahead	Automobile, station wagon	Other motor vehicle	
2016-Aug-11, Thu,17:54	Clear	Rear end	P.D. only	Dry	West	Slowing or stopping	Automobile, station wagon	Other motor vehicle	0
					West	Stopped	Automobile, station wagon	Other motor vehicle	
2016-Dec-28, Wed,12:01	Clear	Sideswipe	P.D. only	Dry	East	Changing lanes	Automobile, station wagon	Other motor vehicle	0
					East	Going ahead	Automobile, station wagon	Other motor vehicle	
2016-Dec-29, Thu,14:41	Clear	Rear end	P.D. only	Packed snow	East	Going ahead	Pick-up truck	Other motor vehicle	0
					East	Stopped	Pick-up truck	Other motor vehicle	
2017-May-19, Fri,09:40	Clear	Angle	P.D. only	Dry	South	Turning right	Automobile, station wagon	Other motor vehicle	0
					West	Unknown	Passenger van	Other motor vehicle	
2017-Nov-08, Wed,16:43	Clear	Turning movement	P.D. only	Dry	South	Turning left	Automobile, station wagon	Other motor vehicle	0
					South	Going ahead	Automobile, station wagon	Other motor vehicle	
2017-Nov-18, Sat,01:30	Freezing Rain	SMV other	P.D. only	Ice	East	Going ahead	Automobile, station wagon	Skidding/sliding	0
2017-Nov-19, Sun,01:14	Freezing Rain	SMV other	P.D. only	Ice	East	Going ahead	Automobile, station wagon	Skidding/sliding	0





# Transportation Services - Traffic Services

## Collision Details Report - Public Version

From: January 1, 2016 To: December 31, 2020

**Location:** RICHMOND RD @ LYNHAR RD/STAFFORD RD

**Traffic Control:** Traffic signal

**Total Collisions:** 42

Date/Day/Time	Environment	Impact Type	Classification	Surface Cond'n	Veh. Dir	Vehicle Manoeuvre	Vehicle type	First Event	No. Ped
2017-Dec-13, Wed,13:03	Clear	Sideswipe	P.D. only	Dry	East	Changing lanes	Automobile, station wagon	Other motor vehicle	0
					East	Going ahead	Automobile, station wagon	Other motor vehicle	
2017-Dec-19, Tue,06:48	Snow	SMV other	P.D. only	Loose snow	East	Going ahead	Automobile, station wagon	Pole (utility, power)	0
2018-Jan-16, Tue,08:38	Snow	Sideswipe	P.D. only	Loose snow	West	Changing lanes	Automobile, station wagon	Other motor vehicle	0
					West	Going ahead	Automobile, station wagon	Other motor vehicle	
2018-Feb-26, Mon,14:43	Clear	Turning movement	Non-fatal injury	Dry	East	Turning left	Automobile, station wagon	Other motor vehicle	0
					West	Going ahead	Automobile, station wagon	Other motor vehicle	
2018-Mar-19, Mon,10:37	Clear	Rear end	P.D. only	Dry	East	Going ahead	Passenger van	Other motor vehicle	0
					East	Stopped	Truck - closed	Other motor vehicle	
2018-May-09, Wed,05:27	Clear	SMV other	P.D. only	Dry	South	Turning left	Truck - tractor	Pole (utility, power)	0
2018-Jun-16, Sat,14:51	Clear	Rear end	Non-fatal injury	Dry	East	Slowing or stopping	Passenger van	Other motor vehicle	0
					East	Stopped	Automobile, station wagon	Other motor vehicle	
					East	Stopped	Automobile, station wagon	Other motor vehicle	
2018-Jun-27, Wed,07:25	Clear	Rear end	P.D. only	Dry	East	Going ahead	Automobile, station wagon	Other motor vehicle	0
					East	Stopped	Automobile, station wagon	Other motor vehicle	
2018-Jul-16, Mon,10:15	Clear	Sideswipe	P.D. only	Dry	West	Changing lanes	Automobile, station wagon	Other motor vehicle	0
					West	Going ahead	Automobile, station wagon	Other motor vehicle	
2018-Sep-01, Sat,15:24	Clear	Rear end	P.D. only	Dry	West	Going ahead	Automobile, station wagon	Other motor vehicle	0
					West	Stopped	Automobile, station wagon	Other motor vehicle	
2018-Oct-01, Mon,14:48	Clear	Rear end	Non-fatal injury	Dry	West	Going ahead	Automobile, station wagon	Other motor vehicle	0
					West	Stopped	Automobile, station wagon	Other motor vehicle	
2018-Nov-13, Tue,14:04	Snow	Rear end	P.D. only	Wet	South	Turning right	Automobile, station wagon	Other motor vehicle	0
					South	Turning right	Automobile, station wagon	Other motor vehicle	



# Transportation Services - Traffic Services

## Collision Details Report - Public Version

From: January 1, 2016 To: December 31, 2020

**Location:** RICHMOND RD @ LYNHAR RD/STAFFORD RD

**Traffic Control:** Traffic signal

**Total Collisions:** 42

Date/Day/Time	Environment	Impact Type	Classification	Surface Cond'n	Veh. Dir	Vehicle Manoeuvre	Vehicle type	First Event	No. Ped
2019-Jan-16, Wed,16:41	Clear	Rear end	P.D. only	Dry	West	Going ahead	Automobile, station wagon	Other motor vehicle	0
					West	Stopped	Automobile, station wagon	Other motor vehicle	
					West	Stopped	Automobile, station wagon	Other motor vehicle	
2019-Feb-01, Fri,11:30	Clear	Angle	P.D. only	Dry	East	Going ahead	Unknown	Other motor vehicle	0
					North	Turning left	Automobile, station wagon	Other motor vehicle	
2019-Feb-09, Sat,13:56	Clear	Angle	Non-fatal injury	Dry	East	Going ahead	Automobile, station wagon	Other motor vehicle	0
					South	Going ahead	Automobile, station wagon	Other motor vehicle	
2019-Feb-26, Tue,21:45	Clear	Sideswipe	P.D. only	Dry	South	Turning left	Automobile, station wagon	Other motor vehicle	0
					South	Turning left	Truck - dump	Other motor vehicle	
2019-Apr-24, Wed,20:45	Clear	Rear end	P.D. only	Dry	East	Slowing or stopping	Pick-up truck	Other motor vehicle	0
					East	Stopped	Automobile, station wagon	Other motor vehicle	
2019-May-23, Thu,09:40	Clear	Rear end	P.D. only	Dry	South	Turning right	Truck - closed	Other motor vehicle	0
					South	Turning right	Automobile, station wagon	Other motor vehicle	
2019-Jun-28, Fri,17:00	Clear	Sideswipe	P.D. only	Wet	East	Changing lanes	Automobile, station wagon	Other motor vehicle	0
					East	Going ahead	Automobile, station wagon	Other motor vehicle	
2019-Jul-17, Wed,09:50	Clear	Turning movement	Non-fatal injury	Dry	East	Turning right	Automobile, station wagon	Other motor vehicle	0
					West	Turning left	Automobile, station wagon	Other motor vehicle	
2019-Aug-01, Thu,07:37	Clear	Sideswipe	Non-fatal injury	Dry	North	Changing lanes	Pick-up truck	Other motor vehicle	0
					North	Turning right	Automobile, station wagon	Other motor vehicle	
2019-Oct-19, Sat,18:06	Clear	Rear end	Non-fatal injury	Dry	East	Going ahead	Automobile, station wagon	Other motor vehicle	0
					East	Stopped	Automobile, station wagon	Other motor vehicle	
2019-Nov-10, Sun,14:34	Clear	Rear end	Non-fatal injury	Dry	East	Going ahead	Passenger van	Other motor vehicle	0
					East	Stopped	Automobile, station wagon	Other motor vehicle	



# Transportation Services - Traffic Services

## Collision Details Report - Public Version

From: January 1, 2016 To: December 31, 2020

**Location:** RICHMOND RD @ LYNHAR RD/STAFFORD RD

**Traffic Control:** Traffic signal

**Total Collisions:** 42

Date/Day/Time	Environment	Impact Type	Classification	Surface Cond'n	Veh. Dir	Vehicle Manoeuvre	Vehicle type	First Event	No. Ped
2019-Dec-19, Thu,15:23	Clear	Rear end	P.D. only	Ice	East	Slowing or stopping	Automobile, station wagon	Skidding/sliding	0
					East	Stopped	Automobile, station wagon	Other motor vehicle	
2020-Aug-06, Thu,17:10	Clear	Rear end	Non-fatal injury	Dry	East	Slowing or stopping	Automobile, station wagon	Other motor vehicle	0
					East	Stopped	Pick-up truck	Other motor vehicle	
2020-Nov-03, Tue,10:01	Snow	Rear end	P.D. only	Ice	South	Going ahead	Automobile, station wagon	Skidding/sliding	0
					South	Slowing or stopping	Pick-up truck	Other motor vehicle	
2020-Nov-09, Mon,11:49	Clear	Rear end	P.D. only	Dry	West	Slowing or stopping	Pick-up truck	Other motor vehicle	0
					West	Stopped	Pick-up truck	Other motor vehicle	
2020-Nov-18, Wed,14:39	Clear	Rear end	Non-fatal injury	Dry	South	Turning right	Automobile, station wagon	Other motor vehicle	0
					South	Turning right	Pick-up truck	Other motor vehicle	

**Location:** RICHMOND RD @ NORTHSIDE RD E

**Traffic Control:** Traffic signal

**Total Collisions:** 18

Date/Day/Time	Environment	Impact Type	Classification	Surface Cond'n	Veh. Dir	Vehicle Manoeuvre	Vehicle type	First Event	No. Ped
2016-Feb-02, Tue,18:36	Clear	Angle	P.D. only	Dry	South	Turning right	Automobile, station wagon	Other motor vehicle	0
					West	Changing lanes	Municipal transit bus	Other motor vehicle	
2016-Mar-23, Wed,09:55	Clear	Rear end	P.D. only	Dry	East	Slowing or stopping	Pick-up truck	Other motor vehicle	0
					East	Stopped	Automobile, station wagon	Other motor vehicle	
					East	Stopped	Automobile, station wagon	Other motor vehicle	
2016-Aug-17, Wed,04:58	Rain	SMV other	P.D. only	Wet	South	Going ahead	Pick-up truck	Ran off road	0
2016-Oct-21, Fri,21:36	Rain	Angle	P.D. only	Wet	East	Going ahead	Automobile, station wagon	Other motor vehicle	0
					South	Going ahead	Automobile, station wagon	Other motor vehicle	
2017-Mar-28, Tue,10:06	Clear	Angle	P.D. only	Wet	West	Going ahead	Passenger van	Other motor vehicle	0
					South	Turning left	Pick-up truck	Other motor vehicle	



# Transportation Services - Traffic Services

## Collision Details Report - Public Version

From: January 1, 2016 To: December 31, 2020

**Location:** RICHMOND RD @ NORTHSIDE RD E

**Traffic Control:** Traffic signal

**Total Collisions:** 18

Date/Day/Time	Environment	Impact Type	Classification	Surface Cond'n	Veh. Dir	Vehicle Manoeuvre	Vehicle type	First Event	No. Ped
2017-Nov-21, Tue,13:34	Clear	Angle	P.D. only	Wet	West	Unknown	Municipal transit bus	Other motor vehicle	0
					South	Unknown	Pick-up truck	Other motor vehicle	
2018-Sep-22, Sat,09:45	Clear	Rear end	P.D. only	Dry	East	Going ahead	Automobile, station wagon	Other motor vehicle	0
					East	Stopped	Automobile, station wagon	Other motor vehicle	
2018-Nov-09, Fri,14:48	Rain	Rear end	P.D. only	Wet	North	Going ahead	Automobile, station wagon	Other motor vehicle	0
					North	Stopped	Automobile, station wagon	Other motor vehicle	
2018-Dec-22, Sat,16:05	Snow	Rear end	P.D. only	Wet	South	Turning right	Automobile, station wagon	Other motor vehicle	0
					South	Turning right	Automobile, station wagon	Other motor vehicle	
2019-Feb-01, Fri,17:41	Clear	Angle	P.D. only	Dry	East	Going ahead	Automobile, station wagon	Other motor vehicle	0
					South	Going ahead	Automobile, station wagon	Other motor vehicle	
					North	Stopped	Automobile, station wagon	Other motor vehicle	
2019-Feb-02, Sat,17:30	Snow	Turning movement	P.D. only	Loose snow	East	Turning left	Unknown	Other motor vehicle	0
					West	Going ahead	Automobile, station wagon	Other motor vehicle	
2019-Mar-07, Thu,20:04	Clear	Turning movement	P.D. only	Dry	North	Turning left	Automobile, station wagon	Other motor vehicle	0
					South	Going ahead	Automobile, station wagon	Other motor vehicle	
2019-Oct-01, Tue,08:55	Rain	Turning movement	P.D. only	Wet	West	Turning left	Automobile, station wagon	Other motor vehicle	0
					East	Going ahead	Automobile, station wagon	Other motor vehicle	
2019-Oct-05, Sat,16:02	Clear	Turning movement	P.D. only	Dry	East	Turning left	Automobile, station wagon	Other motor vehicle	0
					West	Going ahead	Automobile, station wagon	Other motor vehicle	
2019-Oct-16, Wed,10:45	Clear	Rear end	P.D. only	Dry	South	Turning left	Automobile, station wagon	Other motor vehicle	0
					South	Turning left	Automobile, station wagon	Other motor vehicle	
2020-Jan-28, Tue,07:30	Freezing Rain	Turning movement	P.D. only	Ice	East	Going ahead	Automobile, station wagon	Other motor vehicle	0
					West	Turning left	Automobile, station wagon	Skidding/sliding	
					North	Turning left	Automobile, station wagon	Other motor vehicle	



# Transportation Services - Traffic Services

## Collision Details Report - Public Version

From: January 1, 2016 To: December 31, 2020

**Location:** RICHMOND RD @ NORTHSIDE RD E

**Traffic Control:** Traffic signal

**Total Collisions:** 18

Date/Day/Time	Environment	Impact Type	Classification	Surface Cond'n	Veh. Dir	Vehicle Manoeuver	Vehicle type	First Event	No. Ped
2020-Sep-22, Tue,12:42	Clear	SMV other	Non-fatal injury	Dry	South	Turning right	Automobile, station wagon	Pedestrian	1
2020-Sep-22, Tue,13:10	Clear	Rear end	P.D. only	Dry	East	Slowing or stopping	Automobile, station wagon	Other motor vehicle	0
					East	Stopped	Pick-up truck	Other motor vehicle	

**Location:** RICHMOND RD @ STINSON AVE

**Traffic Control:** Traffic signal

**Total Collisions:** 8

Date/Day/Time	Environment	Impact Type	Classification	Surface Cond'n	Veh. Dir	Vehicle Manoeuver	Vehicle type	First Event	No. Ped
2016-Aug-13, Sat,23:44	Rain	SMV other	P.D. only	Wet	West	Going ahead	Automobile, station wagon	Pole (utility, power)	0
2017-Apr-27, Thu,22:23	Clear	Rear end	P.D. only	Dry	East	Going ahead	Passenger van	Other motor vehicle	0
					East	Slowing or stopping	Automobile, station wagon	Other motor vehicle	
2018-Jan-08, Mon,11:04	Snow	Rear end	P.D. only	Loose snow	East	Going ahead	Automobile, station wagon	Skidding/sliding	0
					East	Stopped	Automobile, station wagon	Other motor vehicle	
2018-May-24, Thu,11:55	Clear	Sideswipe	P.D. only	Dry	East	Changing lanes	Automobile, station wagon	Other motor vehicle	0
					East	Stopped	Automobile, station wagon	Other motor vehicle	
2019-Jul-11, Thu,10:20	Clear	Rear end	P.D. only	Dry	East	Going ahead	Automobile, station wagon	Other motor vehicle	0
					East	Stopped	Automobile, station wagon	Other motor vehicle	
					East	Stopped	Automobile, station wagon	Other motor vehicle	
2019-Oct-15, Tue,12:33	Clear	Turning movement	Non-fatal injury	Dry	East	Turning left	Automobile, station wagon	Other motor vehicle	0
					West	Going ahead	Automobile, station wagon	Other motor vehicle	
2020-Mar-25, Wed,11:35	Clear	Rear end	Non-fatal injury	Dry	East	Going ahead	Automobile, station wagon	Other motor vehicle	0
					East	Slowing or stopping	Automobile, station wagon	Other motor vehicle	
2020-Aug-15, Sat,16:20	Clear	Sideswipe	P.D. only	Dry	West	Changing lanes	Automobile, station wagon	Other motor vehicle	0
					West	Slowing or stopping	Pick-up truck	Other motor vehicle	



# Transportation Services - Traffic Services

## Collision Details Report - Public Version

From: January 1, 2016 To: December 31, 2020

**Location:** RICHMOND RD btwn NORTHSIDE RD & NORTHSIDE RD (2)

**Traffic Control:** No control

**Total Collisions:** 2

Date/Day/Time	Environment	Impact Type	Classification	Surface Cond'n	Veh. Dir	Vehicle Manoeuvre	Vehicle type	First Event	No. Ped
2016-Oct-26, Wed,14:52	Clear	Sideswipe	P.D. only	Dry	East	Changing lanes	Automobile, station wagon	Other motor vehicle	0
					East	Stopped	Automobile, station wagon	Other motor vehicle	
2017-Jun-22, Thu,18:58	Clear	Sideswipe	P.D. only	Dry	East	Merging	Automobile, station wagon	Other motor vehicle	0
					East	Going ahead	Pick-up truck	Other motor vehicle	

**Location:** RICHMOND RD btwn NORTHSIDE RD & STAFFORD RD

**Traffic Control:** No control

**Total Collisions:** 1

Date/Day/Time	Environment	Impact Type	Classification	Surface Cond'n	Veh. Dir	Vehicle Manoeuvre	Vehicle type	First Event	No. Ped
2016-Oct-14, Fri,12:33	Clear	Rear end	P.D. only	Dry	East	Changing lanes	Passenger van	Other motor vehicle	0
					East	Stopped	Municipal transit bus	Other motor vehicle	

**Location:** RICHMOND RD btwn STAFFORD RD & STINSON AVE

**Traffic Control:** No control

**Total Collisions:** 22

Date/Day/Time	Environment	Impact Type	Classification	Surface Cond'n	Veh. Dir	Vehicle Manoeuvre	Vehicle type	First Event	No. Ped
2016-May-15, Sun,22:29	Clear	Rear end	Non-fatal injury	Dry	East	Going ahead	Pick-up truck	Other motor vehicle	0
					East	Stopped	Municipal transit bus	Other motor vehicle	
2016-May-26, Thu,17:43	Clear	Rear end	P.D. only	Dry	East	Going ahead	Automobile, station wagon	Other motor vehicle	0
					East	Stopped	Automobile, station wagon	Other motor vehicle	
2016-Aug-24, Wed,12:32	Clear	Angle	P.D. only	Dry	South	Turning left	Passenger van	Other motor vehicle	0
					West	Going ahead	Automobile, station wagon	Other motor vehicle	
2016-Nov-21, Mon,18:21	Snow	Rear end	P.D. only	Wet	East	Going ahead	Automobile, station wagon	Other motor vehicle	0
					East	Stopped	Automobile, station wagon	Other motor vehicle	
2017-Jan-28, Sat,17:21	Clear	Sideswipe	P.D. only	Dry	East	Changing lanes	Automobile, station wagon	Other motor vehicle	0
					East	Going ahead	Automobile, station wagon	Other motor vehicle	



# Transportation Services - Traffic Services

## Collision Details Report - Public Version

From: January 1, 2016 To: December 31, 2020

**Location:** RICHMOND RD btwn STAFFORD RD & STINSON AVE

**Traffic Control:** No control

**Total Collisions:** 22

Date/Day/Time	Environment	Impact Type	Classification	Surface Cond'n	Veh. Dir	Vehicle Manoeuvre	Vehicle type	First Event	No. Ped
2017-Feb-14, Tue,07:10	Clear	Angle	P.D. only	Dry	North	Turning left	Automobile, station wagon	Other motor vehicle	0
					East	Going ahead	Passenger van	Other motor vehicle	
2017-Mar-12, Sun,10:15	Clear	SMV other	P.D. only	Dry	North	Turning left	Pick-up truck	Curb	0
2018-Mar-22, Thu,15:30	Clear	Angle	P.D. only	Dry	South	Turning right	Automobile, station wagon	Other motor vehicle	0
					West	Going ahead	Automobile, station wagon	Other motor vehicle	
2018-May-19, Sat,08:48	Clear	Angle	P.D. only	Dry	South	Turning left	Automobile, station wagon	Other motor vehicle	0
					West	Going ahead	Automobile, station wagon	Other motor vehicle	
2018-Jul-17, Tue,09:29	Clear	Turning movement	P.D. only	Dry	West	Going ahead	Automobile, station wagon	Other motor vehicle	0
					West	Turning right	Truck - tractor	Other motor vehicle	
2018-Oct-22, Mon,19:02	Clear	Turning movement	P.D. only	Dry	West	Going ahead	Automobile, station wagon	Other motor vehicle	0
					West	Turning right	Automobile, station wagon	Other motor vehicle	
2019-Jan-03, Thu,16:38	Clear	Turning movement	Non-fatal injury	Wet	East	Turning left	Automobile, station wagon	Other motor vehicle	0
					West	Going ahead	Automobile, station wagon	Other motor vehicle	
2019-Feb-22, Fri,10:22	Clear	Angle	P.D. only	Wet	North	Turning left	Pick-up truck	Other motor vehicle	0
					East	Going ahead	Automobile, station wagon	Other motor vehicle	
2019-Mar-08, Fri,15:00	Clear	Angle	P.D. only	Dry	South	Turning right	Automobile, station wagon	Other motor vehicle	0
					West	Going ahead	Automobile, station wagon	Other motor vehicle	
2019-Mar-15, Fri,08:55	Clear	Angle	P.D. only	Wet	North	Turning left	Automobile, station wagon	Other motor vehicle	0
					East	Going ahead	Automobile, station wagon	Other motor vehicle	
					West	Stopped	Automobile, station wagon	Other motor vehicle	
2019-Jul-15, Mon,15:09	Clear	Angle	P.D. only	Dry	North	Turning left	Pick-up truck	Other motor vehicle	0
					East	Going ahead	Automobile, station wagon	Other motor vehicle	
2019-Aug-01, Thu,18:14	Clear	Rear end	Non-fatal injury	Dry	West	Going ahead	Automobile, station wagon	Other motor vehicle	0
					West	Slowing or stopping	Automobile, station wagon	Other motor vehicle	



# Transportation Services - Traffic Services

## Collision Details Report - Public Version

From: January 1, 2016 To: December 31, 2020

**Location:** RICHMOND RD btwn STAFFORD RD & STINSON AVE

**Traffic Control:** No control

**Total Collisions:** 22

Date/Day/Time	Environment	Impact Type	Classification	Surface Cond'n	Veh. Dir	Vehicle Manoeuvre	Vehicle type	First Event	No. Ped
2019-Aug-08, Thu,15:55	Clear	Angle	P.D. only	Dry	North	Turning left	Delivery van	Other motor vehicle	0
					East	Stopped	Passenger van	Other motor vehicle	
2019-Aug-19, Mon,08:50	Clear	Angle	P.D. only	Dry	South	Turning right	Automobile, station wagon	Other motor vehicle	0
					West	Going ahead	Automobile, station wagon	Other motor vehicle	
2019-Oct-24, Thu,12:31	Clear	Rear end	Non-fatal injury	Dry	East	Going ahead	Automobile, station wagon	Other motor vehicle	0
					East	Slowing or stopping	Automobile, station wagon	Other motor vehicle	
					East	Slowing or stopping	Automobile, station wagon	Other motor vehicle	
2019-Nov-01, Fri,15:10	Clear	Rear end	P.D. only	Dry	West	Slowing or stopping	Automobile, station wagon	Other motor vehicle	0
					West	Stopped	Automobile, station wagon	Other motor vehicle	
2020-Feb-26, Wed,19:53	Snow	Angle	P.D. only	Slush	South	Turning right	Automobile, station wagon	Other motor vehicle	0
					West	Going ahead	Automobile, station wagon	Other motor vehicle	



## **APPENDIX F**

---

Internal Capture Worksheets

NCHRP 684 Internal Trip Capture Estimation Tool			
<b>Project Name:</b>	Lynwood Centre Expansion	<b>Organization:</b>	Novatech
<b>Project Location:</b>	1826 Robertson Road	<b>Performed By:</b>	J. Audia
<b>Scenario Description:</b>	Full Site Development	<b>Date:</b>	11/1/2022
<b>Analysis Year:</b>	2024 Buildout	<b>Checked By:</b>	
<b>Analysis Period:</b>	AM Street Peak Hour	<b>Date:</b>	

Table 1-A: Base Vehicle-Trip Generation Estimates (Single-Use Site Estimate)						
Land Use	Development Data (For Information Only)			Estimated Vehicle-Trips <sup>3</sup>		
	ITE LUCs <sup>1</sup>	Quantity	Units	Total	Entering	Exiting
Office				0		
Retail				84	52	32
Restaurant				80	41	39
Cinema/Entertainment				0		
Residential				0		
Hotel				0		
All Other Land Uses <sup>2</sup>				0		
				164	93	71

Table 2-A: Mode Split and Vehicle Occupancy Estimates						
Land Use	Entering Trips			Exiting Trips		
	Veh. Occ. <sup>4</sup>	% Transit	% Non-Motorized	Veh. Occ. <sup>4</sup>	% Transit	% Non-Motorized
Office						
Retail		5%	10%		5%	10%
Restaurant		5%	10%		5%	10%
Cinema/Entertainment						
Residential						
Hotel						
All Other Land Uses <sup>2</sup>						

Table 3-A: Average Land Use Interchange Distances (Feet Walking Distance)						
Origin (From)	Destination (To)					
	Office	Retail	Restaurant	Cinema/Entertainment	Residential	Hotel
Office						
Retail						
Restaurant						
Cinema/Entertainment						
Residential						
Hotel						

Table 4-A: Internal Person-Trip Origin-Destination Matrix*						
Origin (From)	Destination (To)					
	Office	Retail	Restaurant	Cinema/Entertainment	Residential	Hotel
Office						
Retail	0		6	0	0	0
Restaurant	0	6		0	0	0
Cinema/Entertainment	0	0	0		0	0
Residential	0	0	0	0		0
Hotel	0	0	0	0	0	

Table 5-A: Computations Summary			
	Total	Entering	Exiting
All Person-Trips	252	143	109
Internal Capture Percentage	10%	8%	11%
External Vehicle-Trips <sup>5</sup>	144	83	61
External Transit-Trips <sup>6</sup>	12	7	5
External Non-Motorized Trips <sup>6</sup>	22	13	9

Table 6-A: Internal Trip Capture Percentages by Land Use		
Land Use	Entering Trips	Exiting Trips
Office	N/A	N/A
Retail	8%	12%
Restaurant	10%	10%
Cinema/Entertainment	N/A	N/A
Residential	N/A	N/A
Hotel	N/A	N/A

<sup>1</sup>Land Use Codes (LUCs) from *Trip Generation Manual*, published by the Institute of Transportation Engineers.

<sup>2</sup>Total estimate for all other land uses at mixed-use development site is not subject to internal trip capture computations in this estimator.

<sup>3</sup>Enter trips assuming no transit or non-motorized trips (as assumed in *ITE Trip Generation Manual*).

<sup>4</sup>Enter vehicle occupancy assumed in Table 1-A vehicle trips. If vehicle occupancy changes for proposed mixed-use project, manual adjustments must be made to Tables 5-A, 9-A (O and D). Enter transit, non-motorized percentages that will result with proposed mixed-use project complete.

<sup>5</sup>Vehicle-trips computed using the mode split and vehicle occupancy values provided in Table 2-A.

<sup>6</sup>Person-Trips

\*Indicates computation that has been rounded to the nearest whole number.

Estimation Tool Developed by the Texas A&M Transportation Institute - Version 2013.1

<b>Project Name:</b>	Lynwood Centre Expansion
<b>Analysis Period:</b>	AM Street Peak Hour

Land Use	Table 7-A (D): Entering Trips		Table 7-A (O): Exiting Trips	
	Vehicle-Trips	Person-Trips*	Vehicle-Trips	Person-Trips*
Office	0	0	0	0
Retail	52	80	32	49
Restaurant	41	63	39	60
Cinema/Entertainment	0	0	0	0
Residential	0	0	0	0
Hotel	0	0	0	0

Origin (From)	Destination (To)					
	Office	Retail	Restaurant	Cinema/Entertainment	Residential	Hotel
Office		0	0	0	0	0
Retail	14		6	0	7	0
Restaurant	19	8		0	2	2
Cinema/Entertainment	0	0	0		0	0
Residential	0	0	0	0		0
Hotel	0	0	0	0	0	

Origin (From)	Destination (To)					
	Office	Retail	Restaurant	Cinema/Entertainment	Residential	Hotel
Office		26	14	0	0	0
Retail	0		32	0	0	0
Restaurant	0	6		0	0	0
Cinema/Entertainment	0	0	0		0	0
Residential	0	14	13	0		0
Hotel	0	3	4	0	0	

Destination Land Use	Person-Trip Estimates			External Trips by Mode*		
	Internal	External	Total	Vehicles <sup>1</sup>	Transit <sup>2</sup>	Non-Motorized <sup>2</sup>
Office	0	0	0	0	0	0
Retail	6	74	80	47	4	7
Restaurant	6	57	63	36	3	6
Cinema/Entertainment	0	0	0	0	0	0
Residential	0	0	0	0	0	0
Hotel	0	0	0	0	0	0
All Other Land Uses <sup>3</sup>	0	0	0	0	0	0

Origin Land Use	Person-Trip Estimates			External Trips by Mode*		
	Internal	External	Total	Vehicles <sup>1</sup>	Transit <sup>2</sup>	Non-Motorized <sup>2</sup>
Office	0	0	0	0	0	0
Retail	6	43	49	27	2	4
Restaurant	6	54	60	34	3	5
Cinema/Entertainment	0	0	0	0	0	0
Residential	0	0	0	0	0	0
Hotel	0	0	0	0	0	0
All Other Land Uses <sup>3</sup>	0	0	0	0	0	0

<sup>1</sup>Vehicle-trips computed using the mode split and vehicle occupancy values provided in Table 2-A  
<sup>2</sup>Person-Trips  
<sup>3</sup>Total estimate for all other land uses at mixed-use development site is not subject to internal trip capture computations in this estimator  
\*Indicates computation that has been rounded to the nearest whole number.

NCHRP 684 Internal Trip Capture Estimation Tool			
<b>Project Name:</b>	Lynwood Centre Expansion	<b>Organization:</b>	Novatech
<b>Project Location:</b>	1826 Robertson Road	<b>Performed By:</b>	J. Audia
<b>Scenario Description:</b>	Full Site Development	<b>Date:</b>	11/1/2022
<b>Analysis Year:</b>	2024 Buildout	<b>Checked By:</b>	
<b>Analysis Period:</b>	PM Street Peak Hour	<b>Date:</b>	

Table 1-P: Base Vehicle-Trip Generation Estimates (Single-Use Site Estimate)						
Land Use	Development Data (For Information Only)			Estimated Vehicle-Trips <sup>3</sup>		
	ITE LUCs <sup>1</sup>	Quantity	Units	Total	Entering	Exiting
Office				0		
Retail				252	124	128
Restaurant				60	31	29
Cinema/Entertainment				0		
Residential				0		
Hotel				0		
All Other Land Uses <sup>2</sup>				0		
				312	155	157

Table 2-P: Mode Split and Vehicle Occupancy Estimates						
Land Use	Entering Trips			Exiting Trips		
	Veh. Occ. <sup>4</sup>	% Transit	% Non-Motorized	Veh. Occ. <sup>4</sup>	% Transit	% Non-Motorized
Office						
Retail		5%	10%		5%	10%
Restaurant		5%	10%		5%	10%
Cinema/Entertainment						
Residential						
Hotel						
All Other Land Uses <sup>2</sup>						

Table 3-P: Average Land Use Interchange Distances (Feet Walking Distance)						
Origin (From)	Destination (To)					
	Office	Retail	Restaurant	Cinema/Entertainment	Residential	Hotel
Office						
Retail						
Restaurant						
Cinema/Entertainment						
Residential						
Hotel						

Table 4-P: Internal Person-Trip Origin-Destination Matrix*						
Origin (From)	Destination (To)					
	Office	Retail	Restaurant	Cinema/Entertainment	Residential	Hotel
Office		0	0	0	0	0
Retail	0		14	0	0	0
Restaurant	0	18		0	0	0
Cinema/Entertainment	0	0	0		0	0
Residential	0	0	0	0		0
Hotel	0	0	0	0	0	

Table 5-P: Computations Summary			
	Total	Entering	Exiting
All Person-Trips	478	237	241
Internal Capture Percentage	13%	14%	13%
External Vehicle-Trips <sup>5</sup>	258	128	130
External Transit-Trips <sup>6</sup>	21	11	10
External Non-Motorized Trips <sup>6</sup>	41	20	21

Table 6-P: Internal Trip Capture Percentages by Land Use		
Land Use	Entering Trips	Exiting Trips
Office	N/A	N/A
Retail	9%	7%
Restaurant	30%	41%
Cinema/Entertainment	N/A	N/A
Residential	N/A	N/A
Hotel	N/A	N/A

<sup>1</sup>Land Use Codes (LUCs) from *Trip Generation Manual*, published by the Institute of Transportation Engineers.

<sup>2</sup>Total estimate for all other land uses at mixed-use development site is not subject to internal trip capture computations in this estimator.

<sup>3</sup>Enter trips assuming no transit or non-motorized trips (as assumed in *ITE Trip Generation Manual*).

<sup>4</sup>Enter vehicle occupancy assumed in Table 1-P vehicle trips. If vehicle occupancy changes for proposed mixed-use project, manual adjustments must be made.

<sup>5</sup>Vehicle-trips computed using the mode split and vehicle occupancy values provided in Table 2-P.

<sup>6</sup>Person-Trips

\*Indicates computation that has been rounded to the nearest whole number.

Estimation Tool Developed by the Texas A&M Transportation Institute - Version 2013.1

<b>Project Name:</b>	Lynwood Centre Expansion
<b>Analysis Period:</b>	PM Street Peak Hour

Land Use	Table 7-P (D): Entering Trips		Table 7-P (O): Exiting Trips	
	Vehicle-Trips	Person-Trips*	Vehicle-Trips	Person-Trips*
Office	0	0	0	0
Retail	124	190	128	197
Restaurant	31	47	29	44
Cinema/Entertainment	0	0	0	0
Residential	0	0	0	0
Hotel	0	0	0	0

Origin (From)	Destination (To)					
	Office	Retail	Restaurant	Cinema/Entertainment	Residential	Hotel
Office	0	0	0	0	0	0
Retail	4	57	8	51	10	
Restaurant	1	18	4	8	3	
Cinema/Entertainment	0	0	0	0	0	
Residential	0	0	0	0	0	
Hotel	0	0	0	0	0	

Origin (From)	Destination (To)					
	Office	Retail	Restaurant	Cinema/Entertainment	Residential	Hotel
Office	15	1	0	0	0	0
Retail	0	14	0	0	0	0
Restaurant	0	95	0	0	0	0
Cinema/Entertainment	0	8	1	0	0	0
Residential	0	19	7	0	0	0
Hotel	0	4	2	0	0	0

Destination Land Use	Person-Trip Estimates			External Trips by Mode*		
	Internal	External	Total	Vehicles <sup>1</sup>	Transit <sup>2</sup>	Non-Motorized <sup>2</sup>
Office	0	0	0	0	0	0
Retail	18	172	190	109	9	17
Restaurant	14	33	47	19	2	3
Cinema/Entertainment	0	0	0	0	0	0
Residential	0	0	0	0	0	0
Hotel	0	0	0	0	0	0
All Other Land Uses <sup>3</sup>	0	0	0	0	0	0

Origin Land Use	Person-Trip Estimates			External Trips by Mode*		
	Internal	External	Total	Vehicles <sup>1</sup>	Transit <sup>2</sup>	Non-Motorized <sup>2</sup>
Office	0	0	0	0	0	0
Retail	14	183	197	116	9	18
Restaurant	18	26	44	14	1	3
Cinema/Entertainment	0	0	0	0	0	0
Residential	0	0	0	0	0	0
Hotel	0	0	0	0	0	0
All Other Land Uses <sup>3</sup>	0	0	0	0	0	0

<sup>1</sup>Vehicle-trips computed using the mode split and vehicle occupancy values provided in Table 2-P  
<sup>2</sup>Person-Trips  
<sup>3</sup>Total estimate for all other land uses at mixed-use development site is not subject to internal trip capture computations in this estimator  
\*Indicates computation that has been rounded to the nearest whole number.

NCHRP 684 Internal Trip Capture Estimation Tool			
Project Name:	Lynwood Centre Expansion	Organization:	Novatech
Project Location:	1826 Robertson Road	Performed By:	J. Audia
Scenario Description:	Full Site Development	Date:	11/1/2022
Analysis Year:	2024 Buildout	Checked By:	
Analysis Period:	SAT Street Peak Hour	Date:	

Table 1-P: Base Vehicle-Trip Generation Estimates (Single-Use Site Estimate)						
Land Use	Development Data (For Information Only)			Estimated Vehicle-Trips <sup>3</sup>		
	ITE LUCs <sup>1</sup>	Quantity	Units	Total	Entering	Exiting
Office				0		
Retail				293	153	140
Restaurant				99	51	48
Cinema/Entertainment				0		
Residential				0		
Hotel				0		
All Other Land Uses <sup>2</sup>				0		
				392	204	188

Table 2-P: Mode Split and Vehicle Occupancy Estimates						
Land Use	Entering Trips			Exiting Trips		
	Veh. Occ. <sup>4</sup>	% Transit	% Non-Motorized	Veh. Occ. <sup>4</sup>	% Transit	% Non-Motorized
Office						
Retail		5%	10%		5%	10%
Restaurant		5%	10%		5%	10%
Cinema/Entertainment						
Residential						
Hotel						
All Other Land Uses <sup>2</sup>						

Table 3-P: Average Land Use Interchange Distances (Feet Walking Distance)						
Origin (From)	Destination (To)					
	Office	Retail	Restaurant	Cinema/Entertainment	Residential	Hotel
Office						
Retail						
Restaurant						
Cinema/Entertainment						
Residential						
Hotel						

Table 4-P: Internal Person-Trip Origin-Destination Matrix*						
Origin (From)	Destination (To)					
	Office	Retail	Restaurant	Cinema/Entertainment	Residential	Hotel
Office		0	0	0	0	0
Retail	0		23	0	0	0
Restaurant	0	30		0	0	0
Cinema/Entertainment	0	0	0		0	0
Residential	0	0	0	0		0
Hotel	0	0	0	0	0	

Table 5-P: Computations Summary			
	Total	Entering	Exiting
All Person-Trips	603	313	290
Internal Capture Percentage	18%	17%	18%
External Vehicle-Trips <sup>5</sup>	302	159	143
External Transit-Trips <sup>6</sup>	25	13	12
External Non-Motorized Trips <sup>6</sup>	50	27	23

Table 6-P: Internal Trip Capture Percentages by Land Use		
Land Use	Entering Trips	Exiting Trips
Office	N/A	N/A
Retail	13%	11%
Restaurant	29%	41%
Cinema/Entertainment	N/A	N/A
Residential	N/A	N/A
Hotel	N/A	N/A

<sup>1</sup>Land Use Codes (LUCs) from *Trip Generation Manual*, published by the Institute of Transportation Engineers.

<sup>2</sup>Total estimate for all other land uses at mixed-use development site is not subject to internal trip capture computations in this estimator.

<sup>3</sup>Enter trips assuming no transit or non-motorized trips (as assumed in *ITE Trip Generation Manual*).

<sup>4</sup>Enter vehicle occupancy assumed in Table 1-P vehicle trips. If vehicle occupancy changes for proposed mixed-use project, manual adjustments must be made.

<sup>5</sup>Vehicle-trips computed using the mode split and vehicle occupancy values provided in Table 2-P.

<sup>6</sup>Person-Trips

\*Indicates computation that has been rounded to the nearest whole number.

Estimation Tool Developed by the Texas A&M Transportation Institute - Version 2013.1

<b>Project Name:</b>	Lynwood Centre Expansion
<b>Analysis Period:</b>	SAT Street Peak Hour

Land Use	Table 7-P (D): Entering Trips		Table 7-P (O): Exiting Trips	
	Vehicle-Trips	Person-Trips*	Vehicle-Trips	Person-Trips*
Office	0	0	0	0
Retail	153	235	140	216
Restaurant	51	78	48	74
Cinema/Entertainment	0	0	0	0
Residential	0	0	0	0
Hotel	0	0	0	0

Origin (From)	Destination (To)					
	Office	Retail	Restaurant	Cinema/Entertainment	Residential	Hotel
Office	0	0	0	0	0	0
Retail	4	63	9	56	11	
Restaurant	2	30	6	13	5	
Cinema/Entertainment	0	0	0	0	0	
Residential	0	0	0	0	0	
Hotel	0	0	0	0	0	

Origin (From)	Destination (To)					
	Office	Retail	Restaurant	Cinema/Entertainment	Residential	Hotel
Office	19	2	0	0	0	
Retail	0	23	0	0	0	
Restaurant	0	118	0	0	0	
Cinema/Entertainment	0	9	2	0	0	
Residential	0	24	11	0	0	
Hotel	0	5	4	0	0	

Destination Land Use	Person-Trip Estimates			External Trips by Mode*		
	Internal	External	Total	Vehicles <sup>1</sup>	Transit <sup>2</sup>	Non-Motorized <sup>2</sup>
Office	0	0	0	0	0	0
Retail	30	205	235	128	10	21
Restaurant	23	55	78	31	3	6
Cinema/Entertainment	0	0	0	0	0	0
Residential	0	0	0	0	0	0
Hotel	0	0	0	0	0	0
All Other Land Uses <sup>3</sup>	0	0	0	0	0	0

Origin Land Use	Person-Trip Estimates			External Trips by Mode*		
	Internal	External	Total	Vehicles <sup>1</sup>	Transit <sup>2</sup>	Non-Motorized <sup>2</sup>
Office	0	0	0	0	0	0
Retail	23	193	216	120	10	19
Restaurant	30	44	74	23	2	4
Cinema/Entertainment	0	0	0	0	0	0
Residential	0	0	0	0	0	0
Hotel	0	0	0	0	0	0
All Other Land Uses <sup>3</sup>	0	0	0	0	0	0

<sup>1</sup>Vehicle-trips computed using the mode split and vehicle occupancy values provided in Table 2-P  
<sup>2</sup>Person-Trips  
<sup>3</sup>Total estimate for all other land uses at mixed-use development site is not subject to internal trip capture computations in this estimator  
\*Indicates computation that has been rounded to the nearest whole number.

## **APPENDIX G**

---

Other Area Developments



## 1 Screening

This study has been prepared according to the City of Ottawa’s 2017 Transportation Impact Assessment (TIA) Guidelines. Accordingly, a Step 1 Screening Form has been prepared and is included as Appendix A, along with the Certification Form for the TIA Study PM. As shown in the Screening Form, a TIA is required including the Design Review component and the Network Impact Component. This report is part of an Official Plan amendment/zoning by-law amendment.

## 2 Existing and Planned Conditions

### 2.1 Proposed Development

The existing site, zoned primarily as Business Park Industrial Zone (IP2 with minor portions as IP[1530], IPS)) and with minor portions of the site area zoned as Agricultural (AG), General Mixed Use (GM18 F(1.0) H(34)), and Arterial Mainstreet (AM) currently consists of a warehouse and industrial yard, and includes an electrical utility transmission corridor and decommissioned rail corridor. The proposed development includes eight high-rise buildings on six-storey podiums and one six-storey building comprising a total of 1,925 units and 41,657 ft<sup>2</sup> of commercial space, all to be built-out in five phases by 2029. The site is proposed as accessing Moodie Drive via a new east leg of the intersection with Timm Drive, and proposes 1,778 vehicle parking spaces. A MUP is also proposed along the eastern channel of the site connecting to the pedestrian facilities on Robertson Road.

Figure 1 illustrates the study area context. Figure 2 illustrates the proposed concept plan.

Figure 1: Area Context Plan

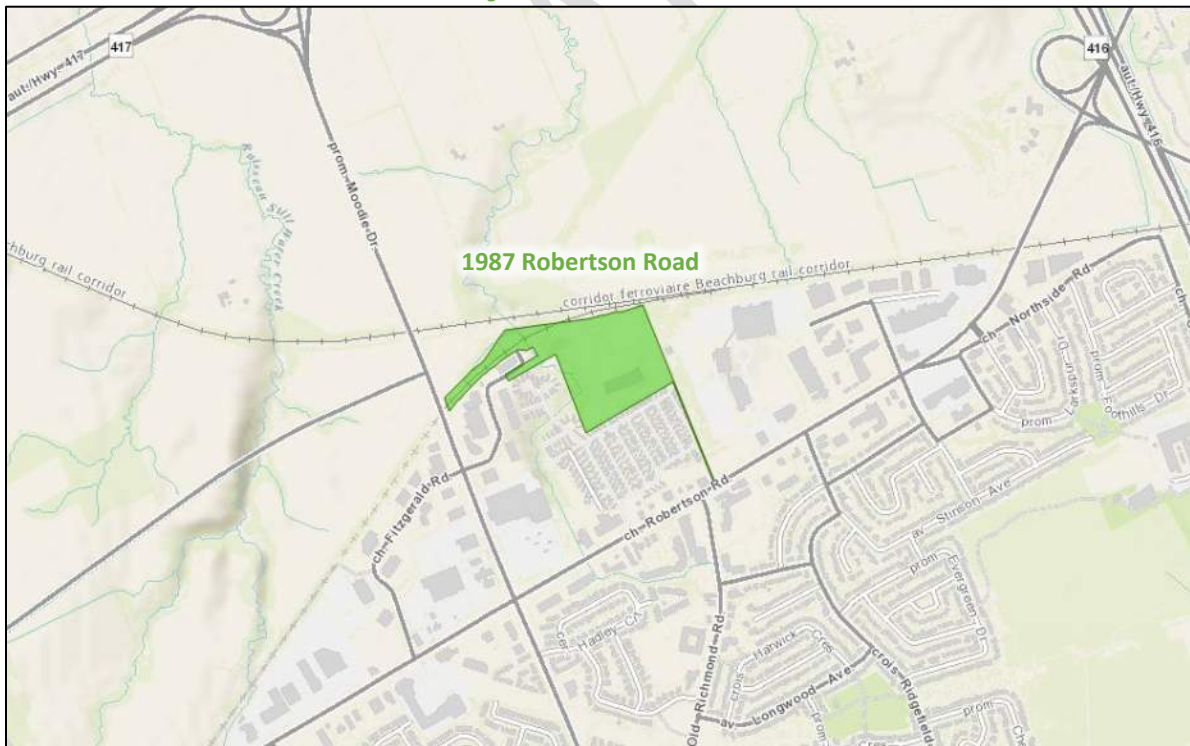

Source: <http://maps.ottawa.ca/geoOttawa/> Accessed: March 12, 2021

Figure 12: New and Pass-By Site Generation Auto Volumes

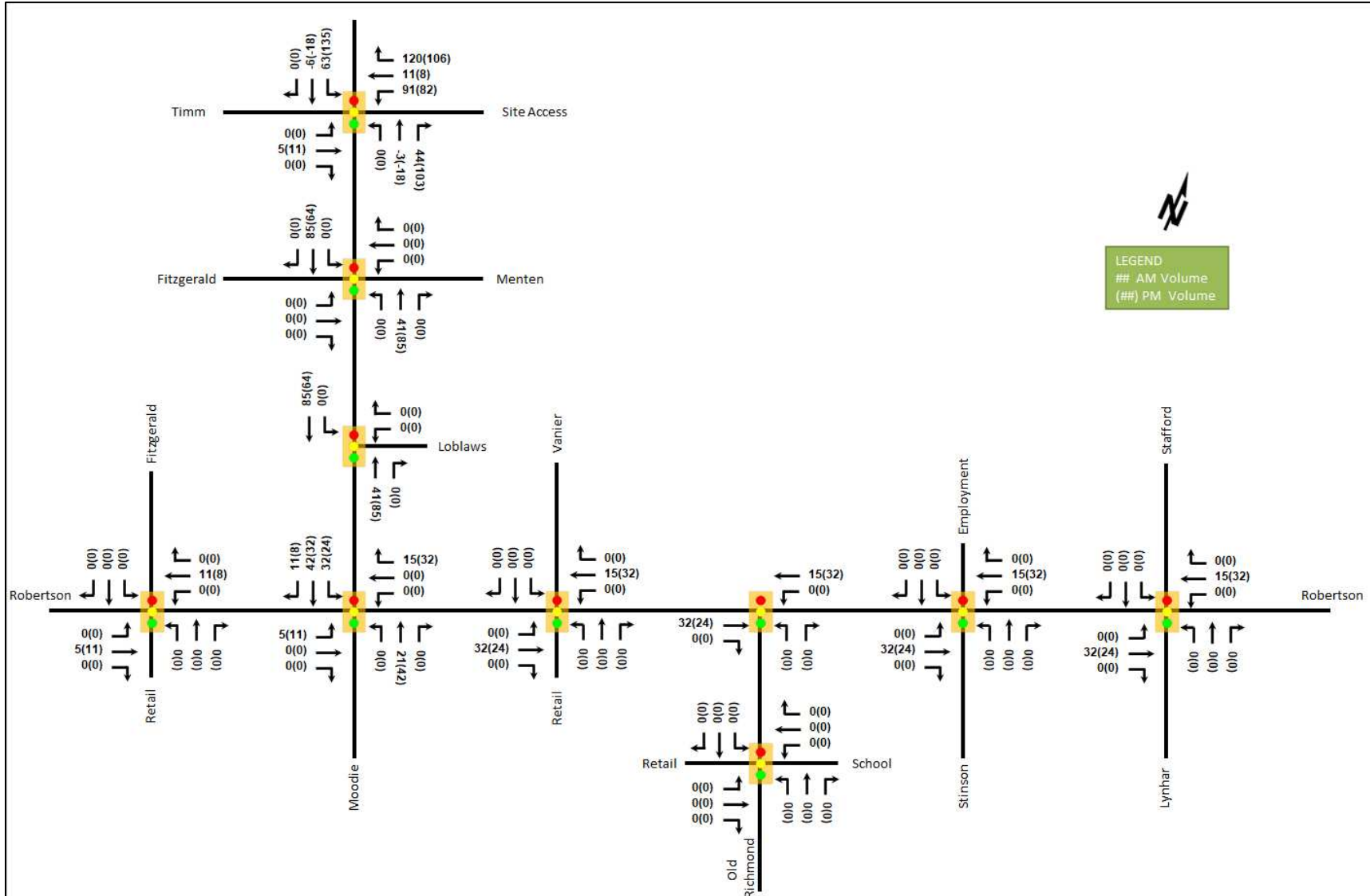

# TIA Screening and Scoping Report

## 1. SCREENING FORM

The Screening Form, in conjunction with the Scoping Report for the subject development, was submitted to the City of Ottawa staff for review and confirmation of the need for a Transportation Impact Assessment (TIA). Trip Generation triggers were met based on the type and size of the development. The Location triggers were met based on the site’s location in the Robertson Arterial Mainstreet Design Priority Area (DPA) and fronting a designated Cycling Spine Route. The Safety trigger was met based on the proposed drive through facility and also on the site’s proposed driveway location, which is within close proximity to Robertson/Fitzgerald signalized intersection. The Screening Form is provided as Appendix A.

## 2. SCOPING REPORT

### 2.1. EXISTING AND PLANNED CONDITIONS

#### 2.1.1. PROPOSED DEVELOPMENT

Based on the Site Plan provided by Lawrence Architect Incorporated, it is our understanding that the proponent is proposing a retail/warehouse complex at the rear of the site with drive-thru restaurant at the front of the site located at 2165 Robertson Road. The expected date of occupancy is 2019. The proposed single-phase development will consist of a 1,092 m<sup>2</sup> of Warehouse (ITE 150), a 232 m<sup>2</sup> of Fast-Food Restaurant with drive-thru (ITE 934) and 74 surface parking spaces. Of these spaces, 39 are for the warehouse and 35 are for the restaurant. . Access to the site is proposed via two one-way driveways on Robertson Road. The restaurant building has been located forward on the site with the parking and drive through at the rear of the building. The site is currently occupied by warehousing and parking, which has one 8.0m wide two-way driveway connection to Robertson Road. It is zoned as AM – Arterial Mainstreet Zone. The local context of the site is provided as Figure 1 and the proposed Site Plan is provided as Figure 2.

Figure 1: Local Context



December 23, 2020

Huntington Construction and Development Inc.  
 1306 Wellington Street, Suite 200  
 Ottawa, ON, K1Y 3B2

**By Email:** mdesjardins@huntingtonpropertiers.ca  
**Reference:** 476734 - 01000

**Attention: Mathieu Desjardins, Development Coordinator**

**Re: 2165 Robertson Road Ottawa, ON, Transportation Impact Study: Addendum #1**

Dear Mathieu,

This Addendum #1 to the above-noted Transportation Impact Study has been prepared to support an updated site plan. The attached revised site plan includes changes that affect the transportation analysis as follows:

- No notable changes proposed to Building B (Retail/Warehouse).
- Total onsite vehicle parking increased to 87 spaces.
- Building A's footprint is increased to 559 m<sup>2</sup> (6,020 ft<sup>2</sup>) as shown in Figure 2 from 232 m<sup>2</sup> (2,500 ft<sup>2</sup>) as displayed in Figure 1 and adds two additional restaurant/retail units. For the purpose of this study, the following land uses and daily operations per unit are assumed:
  1. ~184 m<sup>2</sup> of drive through restaurant providing all day service for the southernmost unit;
  2. ~180 m<sup>2</sup> of Fast casual restaurant with operating hours between 10AM to 9PM for the middle unit; and,
  3. ~195 m<sup>2</sup> of Fast casual restaurant with operating hours between 10AM to 9PM for the northernmost unit.

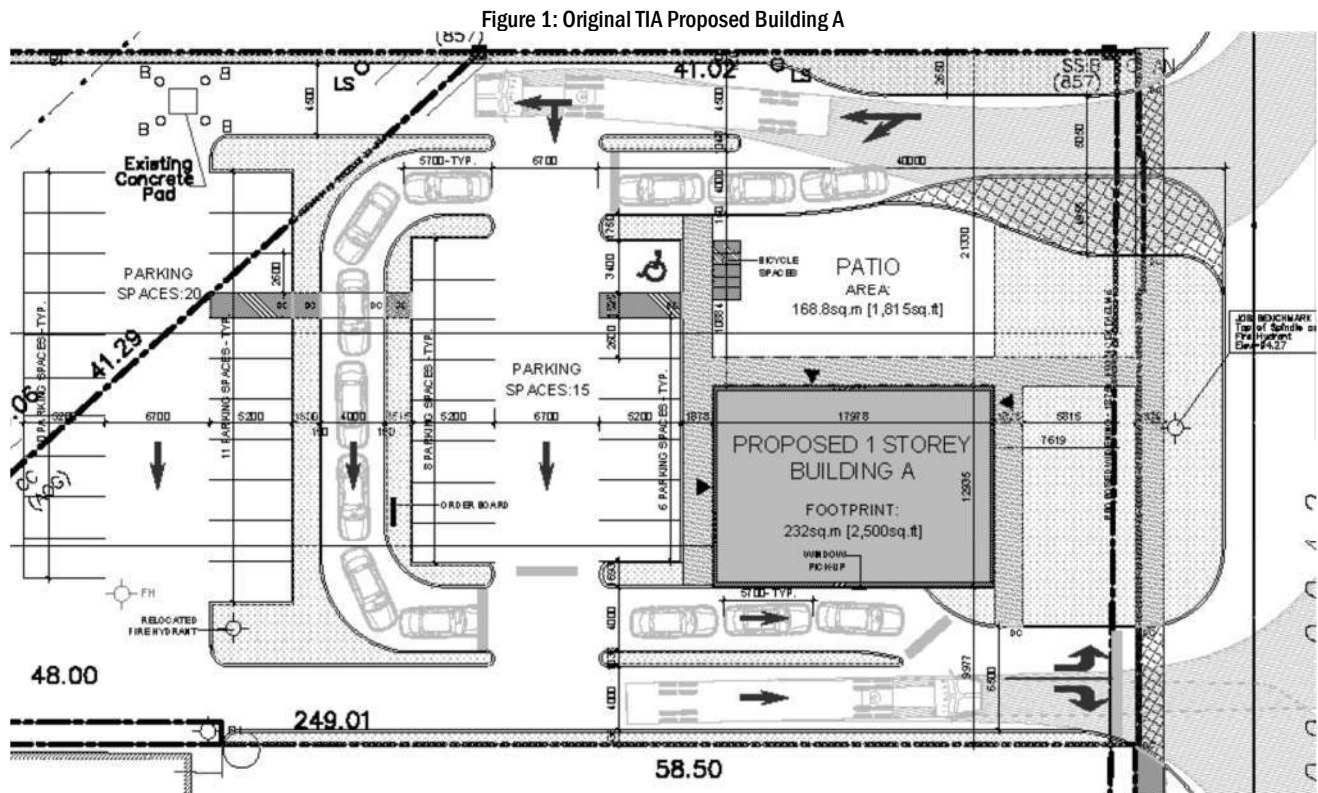

The updated total site generated traffic volumes including pass-by trips and the multi-purpose trip reduction is summarized in Table 4 and the subsequent network distribution is displayed in Figure 4.

Table 4: Updated Total Site Vehicle Trip Generation

Land Use	AM Peak (veh/h)			PM Peak (veh/h)			SAT Peak (veh/h)		
	In	Out	Total	In	Out	Total	In	Out	Total
Fast-Food w/Drive-Through Trip Generation	32	30	62	26	24	50	42	42	84
Fast Casual Restaurant Trip Generation	0	0	0	24	21	45	59	49	108
Retail/Warehousing Trip Generation	16	6	22	6	17	23	0	1	1
Fast-Food w/ Drive-Through Pass-by (50%)	-16	-16	-32	-13	-13	-26	-21	-21	-42
Fast Casual Restaurant Pass-by (50%)	0	0	0	-11	-11	-22	-27	-27	-54
Retail/Warehousing Pass-by (0%)	0	0	0	0	0	0	0	0	0
Multi-purpose Trips (10%)	-3	-2	-5	-3	-4	-7	-6	-4	-10
<b>Total 'New' Auto Trips</b>	<b>29</b>	<b>18</b>	<b>47</b>	<b>29</b>	<b>34</b>	<b>63</b>	<b>47</b>	<b>40</b>	<b>87</b>

Figure 4: 'New', 'Pass-by' and Multi-Purpose Site-Generated Traffic

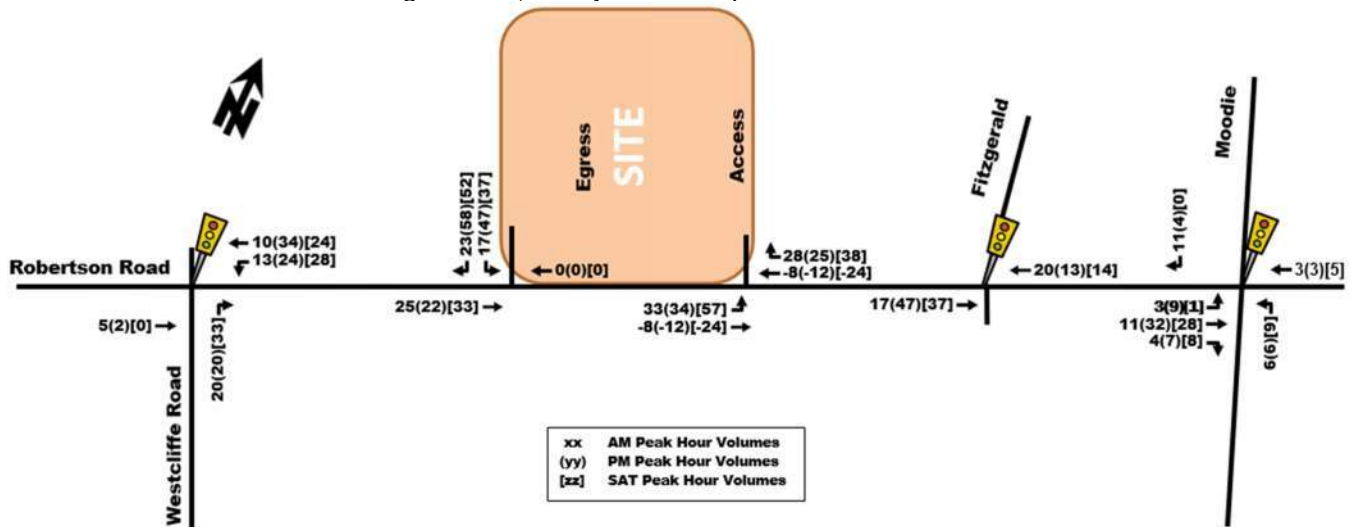

As displayed in Figure 4, each of projected turning movements are approximately 60 veh/h or less during the peak hours, which on averages equates to 1 vehicle every minute. The site provides ~45m of throat length, ~90m of internal drive-through queueing space, and that there is a shared center right-turn/left-turn lane on Robertson Road for eastbound left turning vehicles to wait for breaks in oncoming traffic to enter. As described within the foregoing, the impacts of the increase in traffic volumes produced by the additional restaurant floor area when compared to the original TIA, are anticipated to be minor.

## **APPENDIX H**

---

Long-Range Model and Intersection Traffic Growth Rates

# TRANS Regional Model

Version 2.13 - Assigned December 11, 2019

## AM Peak Hour Total Traffic Volume

### Bells Corners

2011 Model - Base Scenario

No Modifications from Base Version

User Initials: MM  
Plot Prepared: March 23, 2020  
EMME Scenario: 21311



## Legend

AM Peak Hour Total Traffic Volume

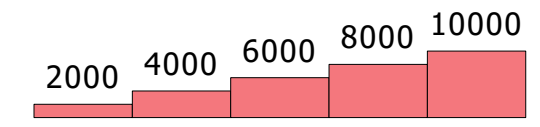

Distance (m)



The TRANS model is continuously refined & maintained, and all information is provided in good faith. However, model outputs are provided "as is", and no warranty or guarantee is provided as to the accuracy, reliability or reasonableness of the results. In using this data, you agree to accept any and all risks arising from any incorrect, incomplete, or misleading information.

Recipients are required to use caution and professional judgement in using and interpreting model outputs. In particular, caution should be used when focusing on a geographically limited area (such as a single road or intersection), as the model is primarily designed to simulate regional-scale phenomena and has been calibrated at a regional level.

As general good practice, it is recommended that the user confirm the network coding within the area of interest, and compare base year forecasts against traffic count data to assess the extent to which the model may be over- or under-estimating the travel demand.

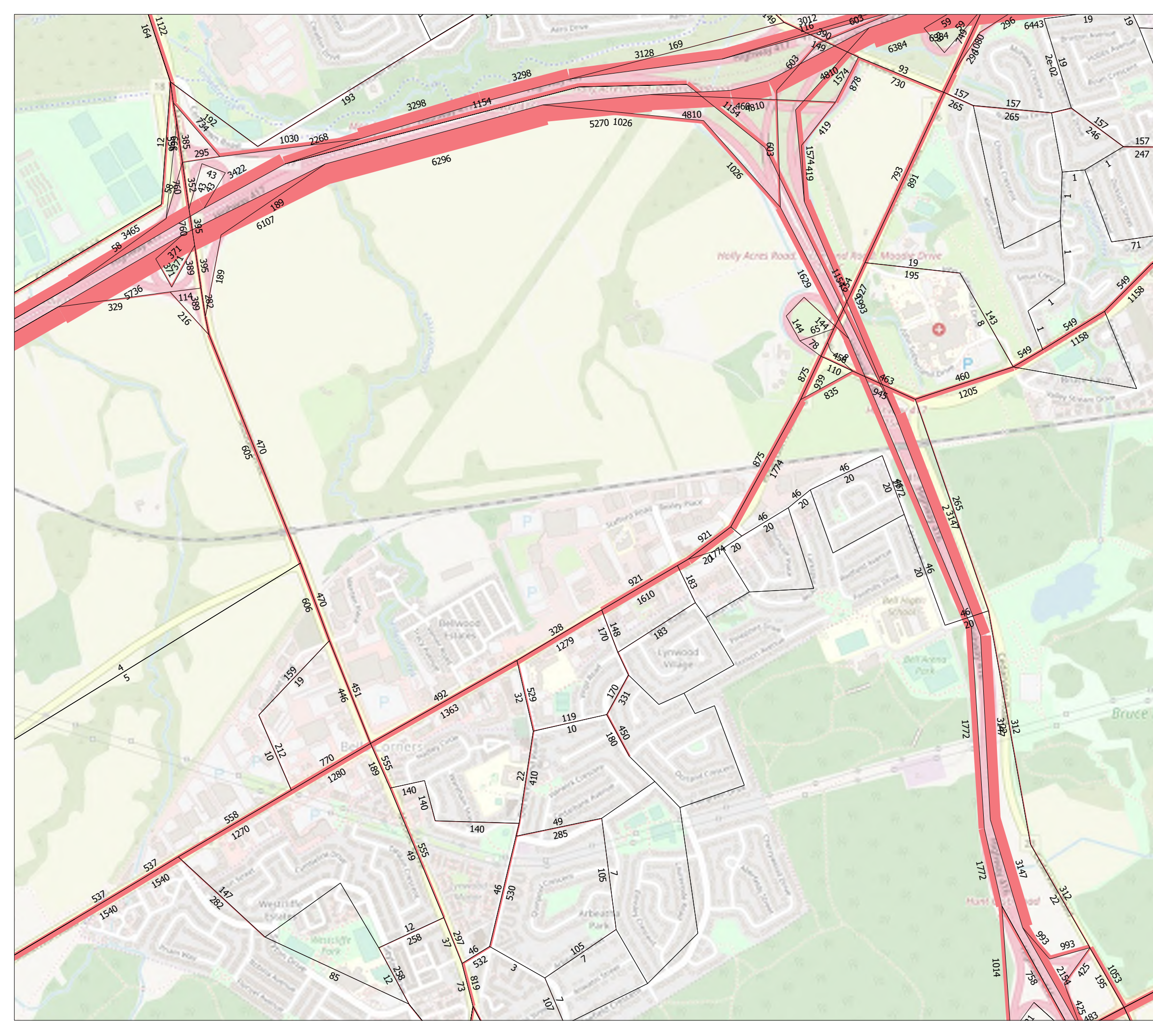

# TRANS Regional Model

Version 2.11 - Assigned February 19, 2020

## AM Peak Hour Total Traffic Volume

### Bells Corners

2031 Model - Affordable Road & Transit Network

No Modifications from Base Version

User Initials: MM  
Plot Prepared: March 23, 2020  
EMME Scenario: 21131



## Legend

AM Peak Hour Total Traffic Volume

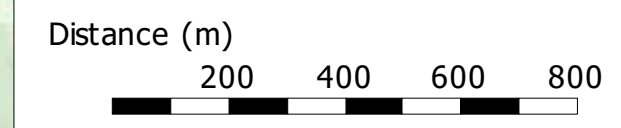
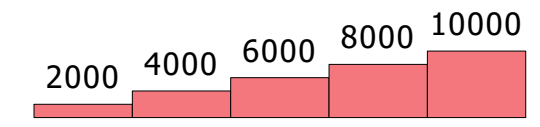

The TRANS model is continuously refined & maintained, and all information is provided in good faith. However, model outputs are provided "as is", and no warranty or guarantee is provided as to the accuracy, reliability or reasonableness of the results. In using this data, you agree to accept any and all risks arising from any incorrect, incomplete, or misleading information.

Recipients are required to use caution and professional judgement in using and interpreting model outputs. In particular, caution should be used when focusing on a geographically limited area (such as a single road or intersection), as the model is primarily designed to simulate regional-scale phenomena and has been calibrated at a regional level.

As general good practice, it is recommended that the user confirm the network coding within the area of interest, and compare base year forecasts against traffic count data to assess the extent to which the model may be over- or under-estimating the travel demand.

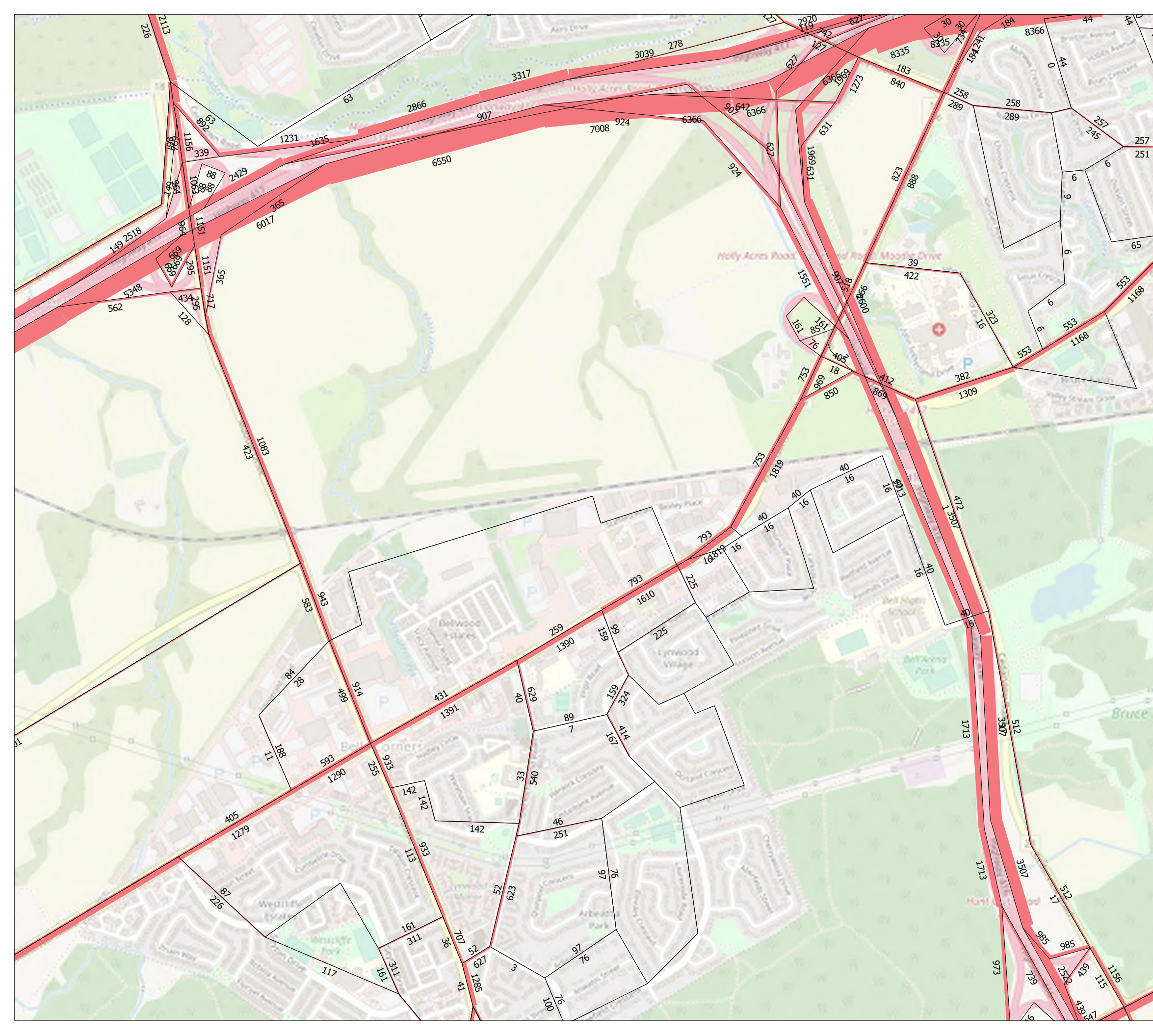



# INTERSECTION TRAFFIC GROWTH RATE, AM PEAK PERIOD

Total Vehicular Volume Entering the Intersection, 2000 to 2016

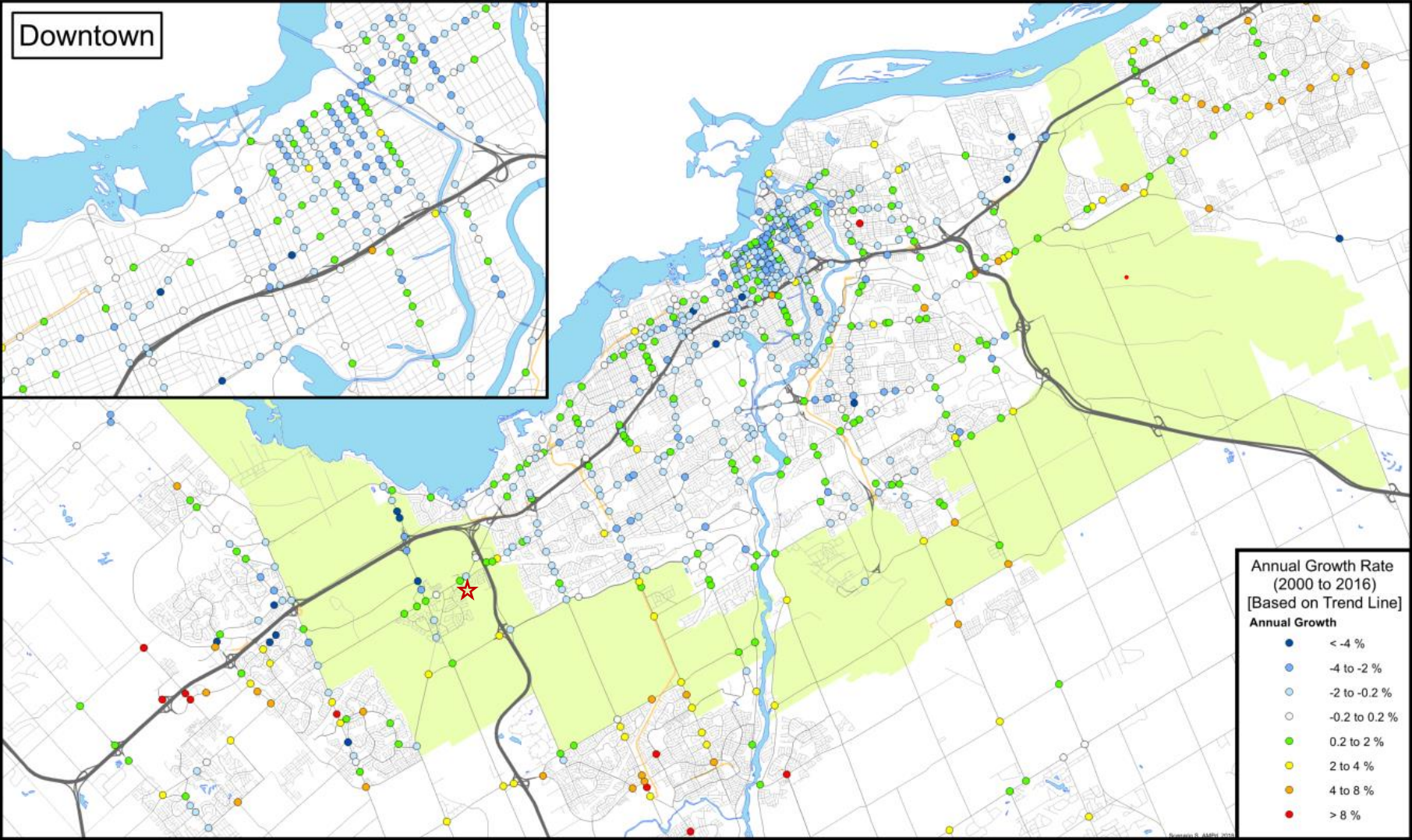

# INTERSECTION TRAFFIC GROWTH RATE, PM PEAK PERIOD

Total Vehicular Volume Entering the Intersection, 2000 to 2016

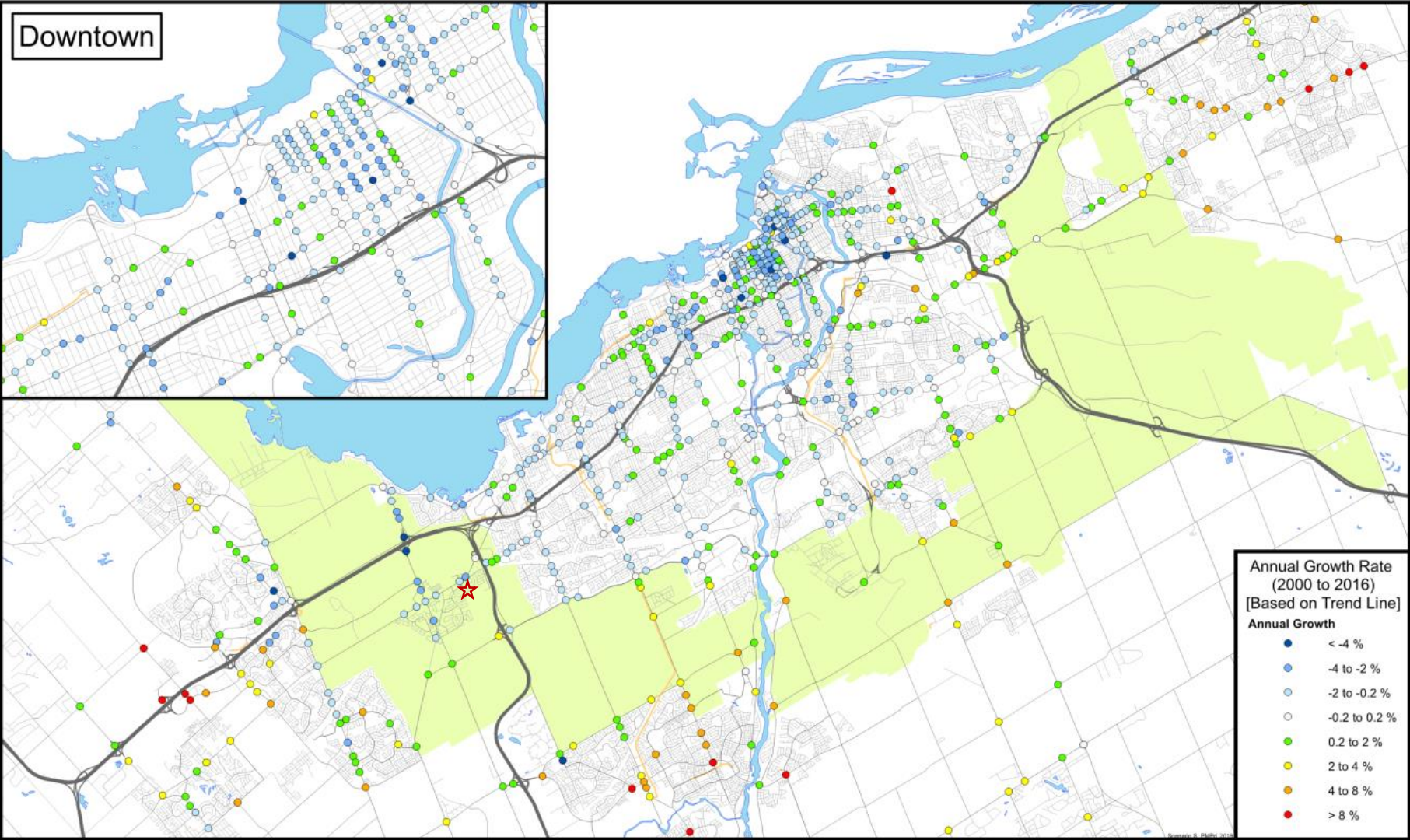

## **APPENDIX I**

---

### Signal Timing Plans

# Traffic Signal Timing

City of Ottawa, Transportation Services Department

## Traffic Signal Operations Unit

<b>Intersection:</b>	<i>Main:</i> Robertson	<i>Side:</i> Stinson
<b>Controller:</b>	<b>MS 3200</b>	<b>TSD: 5660</b>
<b>Author:</b>	Matthew Anderson	<b>Date:</b> 15/Apr/2020

## Existing Timing Plans†

	Plan				Ped Minimum Time		
	AM Peak 1	Off Peak 2	PM Peak 3	Night 4	Walk	DW	A+R
<b>Cycle</b>	130	110	120	70			
<b>Offset</b>	129	30	31	X			
EB Thru	98	78	88	38	7	14	3.7+2.1
WB Thru	98	78	88	38	7	14	3.7+2.1
NB Thru	32	32	32	32	7	18	3.0+3.6
SB Thru	32	32	32	32	7	18	3.0+3.6

## Phasing Sequence‡

Plan: All

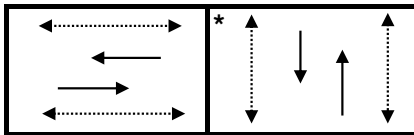

**Note:** 1) The NB Thru, EB Left, and WB Right movements are prohibited weekdays, from 1630-1700

## Schedule

Weekday		Saturday		Sunday	
Time	Plan	Time	Plan	Time	Plan
0:15	4	0:15	4	0:15	4
6:30	1	9:00	3	9:00	2
9:30	2	18:00	2	19:00	4
15:00	3	22:00	4		
18:30	2				
21:30	4				

## Notes

†: Time for each direction includes amber and all red intervals

‡: Start of first phase should be used as reference point for offset

Asterisk (\*) Indicates actuated phase

(fp): Fully Protected Left Turn

◄.....► Pedestrian signal

Cost is \$58.78 (\$52.02 + HST)

# Traffic Signal Timing

City of Ottawa, Transportation Services Department

## Traffic Signal Operations Unit

<b>Intersection:</b>	<i>Main:</i> Robertson	<i>Side:</i> Lynhar / Stafford
<b>Controller:</b>	<b>ATC 3</b>	<b>TSD: 5644</b>
<b>Author:</b>	Matthew Anderson	<b>Date:</b> 15/Apr/2020

### Existing Timing Plans<sup>†</sup>

	Plan				Ped Minimum Time		
	AM Peak 1	Off Peak 2	PM Peak 3	Night 4	Walk	DW	A+R
<b>Cycle</b>	130	110	120	85			
<b>Offset</b>	36	18	7	X			
EB Thru	75	33	54	34	7	18	3.7+2.6
WB Thru	75	33	54	34	7	18	3.7+2.6
NB Left	-	14	12	-	-	-	3.0+3.2
SB Left	-	14	12	-	-	-	3.0+3.2
NB Thru	39	39	39	39	12	19	3.0+3.7
SB Thru	39	39	39	39	12	19	3.0+3.7
EB Left (fp)	16	24	15	12	-	-	3.7+2.4
WB Left (fp)	16	24	15	12	-	-	3.7+2.4

### Phasing Sequence<sup>‡</sup>

Plan: 1,4

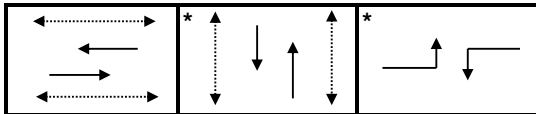

Plan: 2,3

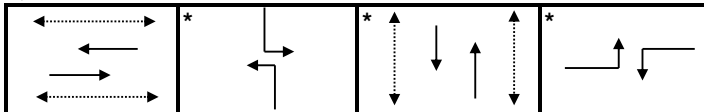

### Schedule

Weekday		Saturday		Sunday	
Time	Plan	Time	Plan	Time	Plan
0:15	4	0:15	4	0:15	4
6:30	1	9:00	3	9:00	2
9:30	2	18:00	2	19:00	4
15:00	3	22:00	4		
18:30	2				
21:30	4				

### Notes

- †: Time for each direction includes amber and all red intervals
- ‡: Start of first phase should be used as reference point for offset
- Asterisk (\*) Indicates actuated phase
- (fp): Fully Protected Left Turn
- ◄.....► Pedestrian signal

Cost is \$58.78 (\$52.02 + HST)

# Traffic Signal Timing

City of Ottawa, Transportation Services Department

## Traffic Signal Operations Unit

<b>Intersection:</b>	<i>Main:</i> Robertson	<i>Side:</i> Northside
<b>Controller:</b>	<b>ATC 3</b>	<b>TSD: 6247</b>
<b>Author:</b>	Matthew Anderson	<b>Date:</b> 15/Apr/2020

### Existing Timing Plans<sup>†</sup>

	Plan				Ped Minimum Time		
	AM Peak 1	Off Peak 2	PM Peak 3	Night 4	Walk	DW	A+R
<b>Cycle</b>	130	110	120	80			
<b>Offset</b>	37	18	111	X			
<b>EB Thru</b>	78	57	68	33	7	17	3.7+2.4
<b>WB Thru</b>	78	57	68	33	7	17	3.7+2.4
<b>NB Thru</b>	36	37	37	36	7	22	3.0+3.8
<b>SB Thru</b>	36	37	37	36	7	22	3.0+3.8
<i>EB Left</i>	16	16	15	11	-	-	3.7+2.3

### Phasing Sequence<sup>‡</sup>

Plan: All

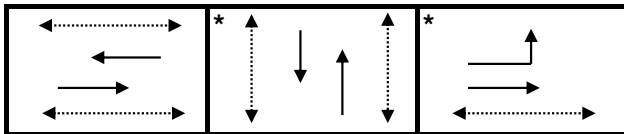

### Schedule

Weekday		Saturday		Sunday	
Time	Plan	Time	Plan	Time	Plan
0:15	4	0:15	4	0:15	4
6:30	1	9:00	3	9:00	2
9:30	2	18:00	2	19:00	4
15:00	3	22:00	4		
18:30	2				
21:30	4				

### Notes

- †: Time for each direction includes amber and all red intervals
- ‡: Start of first phase should be used as reference point for offset
- Asterisk (\*) Indicates actuated phase
- (fp): Fully Protected Left Turn
- ◀.....▶ Pedestrian signal

Cost is \$58.78 (\$52.02 + HST)























## **APPENDIX J**

---

Existing Synchro Analysis

1: Stinson Avenue & Robertson Road  
AM Peak Hour

1826 Robertson Road  
Existing Traffic

													
Lane Group	EBL	EBT	EBR	WBL	WBT	WBR	NBL	NBT	NBR	SBL	SBT	SBR	
Lane Configurations		 			 			 				 	
Traffic Volume (vph)	54	1980	6	20	623	22	9	2	32	2	0	11	
Future Volume (vph)	54	1980	6	20	623	22	9	2	32	2	0	11	
Ideal Flow (vphpl)	1800	1800	1800	1800	1800	1800	1800	1800	1800	1800	1800	1800	
Storage Length (m)	75.0		0.0	45.0		0.0	0.0		0.0	0.0		0.0	
Storage Lanes	1		0	1		0	0		0	0		0	
Taper Length (m)	10.0			10.0			10.0			10.0			
Lane Util. Factor	1.00	0.95	0.95	1.00	0.95	0.95	1.00	1.00	1.00	1.00	1.00	1.00	
Ped Bike Factor	0.99	1.00			1.00			1.00				0.98	
Frt					0.995			0.899				0.884	
Flt Protected	0.950			0.950				0.990				0.993	
Satd. Flow (prot)	1662	3356	0	1572	3308	0	0	1552	0	0	1443	0	
Flt Permitted	0.378			0.055				0.927			0.955		
Satd. Flow (perm)	654	3356	0	91	3308	0	0	1450	0	0	1388	0	
Right Turn on Red			Yes			Yes			Yes			Yes	
Satd. Flow (RTOR)		1			6			16			23		
Link Speed (k/h)		60			60			40			40		
Link Distance (m)		198.0			310.7			254.0			246.4		
Travel Time (s)		11.9			18.6			22.9			22.2		
Confl. Peds. (#/hr)	11		3	11		3	6					6	
Peak Hour Factor	0.90	0.90	0.90	0.90	0.90	0.90	0.90	0.90	0.90	0.90	0.90	0.90	
Heavy Vehicles (%)	4%	3%	10%	10%	4%	1%	10%	1%	3%	1%	1%	10%	
Adj. Flow (vph)	60	2200	7	22	692	24	10	2	36	2	0	12	
Shared Lane Traffic (%)													
Lane Group Flow (vph)	60	2207	0	22	716	0	0	48	0	0	14	0	
Enter Blocked Intersection	No	No	No	No	No	No	No	No	No	No	No	No	
Lane Alignment	L NA	Left	R NA	L NA	Left	R NA	L NA	Left	R NA	L NA	Left	R NA	
Median Width(m)		3.7			3.7			0.0			0.0		
Link Offset(m)		0.0			0.0			0.0			0.0		
Crosswalk Width(m)		5.0			5.0			5.0			5.0		
Two way Left Turn Lane		Yes			Yes								
Headway Factor	1.06	1.06	1.06	1.06	1.06	1.06	1.06	1.06	1.06	1.06	1.06	1.06	
Turning Speed (k/h)	24		14	24		14	24		14	24		14	
Number of Detectors	1	2		1	2		1	2		1	2		
Detector Template	Left	Thru		Left	Thru		Left	Thru		Left	Thru		
Leading Detector (m)	6.1	30.5		6.1	30.5		6.1	30.5		6.1	30.5		
Trailing Detector (m)	0.0	0.0		0.0	0.0		0.0	0.0		0.0	0.0		
Detector 1 Position(m)	0.0	0.0		0.0	0.0		0.0	0.0		0.0	0.0		
Detector 1 Size(m)	6.1	1.8		6.1	1.8		6.1	1.8		6.1	1.8		
Detector 1 Type	Cl+Ex	Cl+Ex		Cl+Ex	Cl+Ex		Cl+Ex	Cl+Ex		Cl+Ex	Cl+Ex		
Detector 1 Channel													
Detector 1 Extend (s)	0.0	0.0		0.0	0.0		0.0	0.0		0.0	0.0		
Detector 1 Queue (s)	0.0	0.0		0.0	0.0		0.0	0.0		0.0	0.0		
Detector 1 Delay (s)	0.0	0.0		0.0	0.0		0.0	0.0		0.0	0.0		
Detector 2 Position(m)		28.7			28.7			28.7			28.7		
Detector 2 Size(m)		1.8			1.8			1.8			1.8		
Detector 2 Type		Cl+Ex			Cl+Ex			Cl+Ex			Cl+Ex		
Detector 2 Channel													
Detector 2 Extend (s)		0.0			0.0			0.0			0.0		
Turn Type	Perm	NA		Perm	NA		Perm	NA		Perm	NA		
Protected Phases		2			6			8			4		
Permitted Phases	2			6			8			4			
Detector Phase	2	2		6	6		8	8		4	4		
Switch Phase													



1: Stinson Avenue & Robertson Road  
AM Peak Hour

1826 Robertson Road  
Existing Traffic

Lane Group	EBL	EBT	EBR	WBL	WBT	WBR	NBL	NBT	NBR	SBL	SBT	SBR
Minimum Initial (s)	10.0	10.0		10.0	10.0		10.0	10.0		10.0	10.0	
Minimum Split (s)	26.8	26.8		26.8	26.8		31.6	31.6		31.6	31.6	
Total Split (s)	98.0	98.0		98.0	98.0		32.0	32.0		32.0	32.0	
Total Split (%)	75.4%	75.4%		75.4%	75.4%		24.6%	24.6%		24.6%	24.6%	
Maximum Green (s)	92.2	92.2		92.2	92.2		25.4	25.4		25.4	25.4	
Yellow Time (s)	3.7	3.7		3.7	3.7		3.0	3.0		3.0	3.0	
All-Red Time (s)	2.1	2.1		2.1	2.1		3.6	3.6		3.6	3.6	
Lost Time Adjust (s)	0.0	0.0		0.0	0.0			0.0			0.0	
Total Lost Time (s)	5.8	5.8		5.8	5.8			6.6			6.6	
Lead/Lag												
Lead-Lag Optimize?												
Vehicle Extension (s)	3.0	3.0		3.0	3.0		3.0	3.0		3.0	3.0	
Recall Mode	C-Max	C-Max		C-Max	C-Max		None	None		None	None	
Walk Time (s)	7.0	7.0		7.0	7.0		7.0	7.0		7.0	7.0	
Flash Dont Walk (s)	14.0	14.0		14.0	14.0		18.0	18.0		18.0	18.0	
Pedestrian Calls (#/hr)	3	3		11	11		1	1		6	6	
Act Effct Green (s)	109.1	109.1		109.1	109.1			13.0			13.0	
Actuated g/C Ratio	0.84	0.84		0.84	0.84			0.10			0.10	
v/c Ratio	0.11	0.78		0.29	0.26			0.30			0.09	
Control Delay	4.1	10.5		23.6	2.7			42.4			10.2	
Queue Delay	0.0	0.0		0.0	0.0			0.0			0.0	
Total Delay	4.1	10.5		23.6	2.7			42.4			10.2	
LOS	A	B		C	A			D			B	
Approach Delay		10.3			3.4			42.4			10.2	
Approach LOS		B			A			D			B	
Queue Length 50th (m)	2.1	108.5		0.8	12.3			7.3			0.0	
Queue Length 95th (m)	8.4	253.4		7.8	23.2			16.5			3.5	
Internal Link Dist (m)		174.0			286.7			230.0			222.4	
Turn Bay Length (m)	75.0			45.0								
Base Capacity (vph)	548	2815		76	2777			296			289	
Starvation Cap Reductn	0	0		0	0			0			0	
Spillback Cap Reductn	0	0		0	0			0			0	
Storage Cap Reductn	0	0		0	0			0			0	
Reduced v/c Ratio	0.11	0.78		0.29	0.26			0.16			0.05	

Intersection Summary























Area Type: Other  
 Cycle Length: 130  
 Actuated Cycle Length: 130  
 Offset: 129 (99%), Referenced to phase 2:EBTL and 6:WBTL, Start of Green  
 Natural Cycle: 110  
 Control Type: Actuated-Coordinated  
 Maximum v/c Ratio: 0.78  
 Intersection Signal Delay: 9.1  
 Intersection Capacity Utilization 78.9%  
 Analysis Period (min) 15  
 Intersection LOS: A  
 ICU Level of Service D

Splits and Phases: 1: Stinson Avenue & Robertson Road



2: Lynhar Road/Stafford Road & Robertson Road  
AM Peak Hour

1826 Robertson Road  
Existing Traffic

												
Lane Group	EBL	EBT	EBR	WBL	WBT	WBR	NBL	NBT	NBR	SBL	SBT	SBR
Lane Configurations												
Traffic Volume (vph)	42	1859	27	14	648	83	33	11	101	31	4	52
Future Volume (vph)	42	1859	27	14	648	83	33	11	101	31	4	52
Ideal Flow (vphpl)	1800	1800	1800	1800	1800	1800	1800	1800	1800	1800	1800	1800
Storage Length (m)	85.0		40.0	0.0		0.0	0.0		30.0	45.0		75.0
Storage Lanes	1		1	1		0	1		1	1		1
Taper Length (m)	10.0			10.0			10.0			30.0		
Lane Util. Factor	1.00	0.95	1.00	1.00	0.95	0.95	1.00	1.00	1.00	1.00	1.00	1.00
Ped Bike Factor	1.00		0.97	1.00	1.00		0.99		0.98	1.00		0.98
Frt			0.850		0.983				0.850			0.850
Flt Protected	0.950			0.950			0.950			0.950		
Satd. Flow (prot)	1572	3357	1532	1712	3275	0	1679	1802	1532	1572	1802	1459
Flt Permitted	0.950			0.950			0.755			0.750		
Satd. Flow (perm)	1568	3357	1485	1711	3275	0	1327	1802	1506	1235	1802	1435
Right Turn on Red			Yes			Yes			Yes			Yes
Satd. Flow (RTOR)			82		16				112			79
Link Speed (k/h)		60			60			40			40	
Link Distance (m)		310.7			66.2			81.0			107.6	
Travel Time (s)		18.6			4.0			7.3			9.7	
Confl. Peds. (#/hr)	5		4	4		5	4		4	4		4
Peak Hour Factor	0.90	0.90	0.90	0.90	0.90	0.90	0.90	0.90	0.90	0.90	0.90	0.90
Heavy Vehicles (%)	10%	3%	1%	1%	3%	8%	3%	1%	1%	10%	1%	6%
Adj. Flow (vph)	47	2066	30	16	720	92	37	12	112	34	4	58
Shared Lane Traffic (%)												
Lane Group Flow (vph)	47	2066	30	16	812	0	37	12	112	34	4	58
Enter Blocked Intersection	No	No	No	No	No	No	No	No	No	No	No	No
Lane Alignment	L NA	Left	R NA	L NA	Left	R NA	L NA	L NA	R NA	L NA	Left	R NA
Median Width(m)		3.7			7.4			7.4			7.4	
Link Offset(m)		0.0			0.0			0.0			0.0	
Crosswalk Width(m)		5.0			5.0			5.0			5.0	
Two way Left Turn Lane		Yes										
Headway Factor	1.06	1.06	1.06	1.06	1.06	1.06	1.06	1.06	1.06	1.06	1.06	1.06
Turning Speed (k/h)	24		14	24		14	24		14	24		14
Number of Detectors	1	2	1	1	2		1	2	1	1	2	1
Detector Template	Left	Thru	Right	Left	Thru		Left	Thru	Right	Left	Thru	Right
Leading Detector (m)	6.1	30.5	6.1	6.1	30.5		6.1	30.5	6.1	6.1	30.5	6.1
Trailing Detector (m)	0.0	0.0	0.0	0.0	0.0		0.0	0.0	0.0	0.0	0.0	0.0
Detector 1 Position(m)	0.0	0.0	0.0	0.0	0.0		0.0	0.0	0.0	0.0	0.0	0.0
Detector 1 Size(m)	6.1	1.8	6.1	6.1	1.8		6.1	1.8	6.1	6.1	1.8	6.1
Detector 1 Type	CI+Ex	CI+Ex	CI+Ex	CI+Ex	CI+Ex		CI+Ex	CI+Ex	CI+Ex	CI+Ex	CI+Ex	CI+Ex
Detector 1 Channel												
Detector 1 Extend (s)	0.0	0.0	0.0	0.0	0.0		0.0	0.0	0.0	0.0	0.0	0.0
Detector 1 Queue (s)	0.0	0.0	0.0	0.0	0.0		0.0	0.0	0.0	0.0	0.0	0.0
Detector 1 Delay (s)	0.0	0.0	0.0	0.0	0.0		0.0	0.0	0.0	0.0	0.0	0.0
Detector 2 Position(m)		28.7			28.7			28.7			28.7	
Detector 2 Size(m)		1.8			1.8			1.8			1.8	
Detector 2 Type		CI+Ex			CI+Ex			CI+Ex			CI+Ex	
Detector 2 Channel												
Detector 2 Extend (s)		0.0			0.0			0.0			0.0	
Turn Type	Prot	NA	Perm	Prot	NA		Perm	NA	Perm	Perm	NA	Perm
Protected Phases	5	2		1	6			8			4	
Permitted Phases			2				8		8	4		4
Detector Phase	5	2	2	1	6		8	8	8	4	4	4
Switch Phase												

Lane Group	EBL	EBT	EBR	WBL	WBT	WBR	NBL	NBT	NBR	SBL	SBT	SBR
Minimum Initial (s)	5.0	10.0	10.0	5.0	10.0		10.0	10.0	10.0	10.0	10.0	10.0
Minimum Split (s)	11.1	31.3	31.3	11.1	31.3		37.7	37.7	37.7	37.7	37.7	37.7
Total Split (s)	16.0	75.0	75.0	16.0	75.0		39.0	39.0	39.0	39.0	39.0	39.0
Total Split (%)	12.3%	57.7%	57.7%	12.3%	57.7%		30.0%	30.0%	30.0%	30.0%	30.0%	30.0%
Maximum Green (s)	9.9	68.7	68.7	9.9	68.7		32.3	32.3	32.3	32.3	32.3	32.3
Yellow Time (s)	3.7	3.7	3.7	3.7	3.7		3.0	3.0	3.0	3.0	3.0	3.0
All-Red Time (s)	2.4	2.6	2.6	2.4	2.6		3.7	3.7	3.7	3.7	3.7	3.7
Lost Time Adjust (s)	0.0	0.0	0.0	0.0	0.0		0.0	0.0	0.0	0.0	0.0	0.0
Total Lost Time (s)	6.1	6.3	6.3	6.1	6.3		6.7	6.7	6.7	6.7	6.7	6.7
Lead/Lag	Lead	Lag	Lag	Lead	Lag							
Lead-Lag Optimize?	Yes	Yes	Yes	Yes	Yes							
Vehicle Extension (s)	3.0	3.0	3.0	3.0	3.0		3.0	3.0	3.0	3.0	3.0	3.0
Recall Mode	None	C-Max	C-Max	None	C-Max		None	None	None	None	None	None
Walk Time (s)		7.0	7.0		7.0		12.0	12.0	12.0	12.0	12.0	12.0
Flash Dont Walk (s)		18.0	18.0		18.0		19.0	19.0	19.0	19.0	19.0	19.0
Pedestrian Calls (#/hr)		4	4		5		4	4	4	4	4	4
Act Effct Green (s)	8.9	97.0	97.0	6.8	90.0		14.3	14.3	14.3	14.3	14.3	14.3
Actuated g/C Ratio	0.07	0.75	0.75	0.05	0.69		0.11	0.11	0.11	0.11	0.11	0.11
v/c Ratio	0.44	0.82	0.03	0.18	0.36		0.25	0.06	0.42	0.25	0.02	0.25
Control Delay	79.3	10.7	0.1	71.5	7.6		54.1	47.7	12.8	54.2	46.0	6.7
Queue Delay	0.0	0.0	0.0	0.0	0.0		0.0	0.0	0.0	0.0	0.0	0.0
Total Delay	79.3	10.7	0.1	71.5	7.6		54.1	47.7	12.8	54.2	46.0	6.7
LOS	E	B	A	E	A		D	D	B	D	D	A
Approach Delay		12.1			8.8			24.9			25.1	
Approach LOS		B			A			C			C	
Queue Length 50th (m)	11.1	13.8	0.0	3.8	27.8		8.4	2.7	0.0	7.8	0.9	0.0
Queue Length 95th (m)	m13.3	#331.8	m0.0	m11.7	33.6		15.6	7.0	13.7	14.6	3.5	6.1
Internal Link Dist (m)		286.7			42.2			57.0			83.6	
Turn Bay Length (m)	85.0		40.0						30.0	45.0		75.0
Base Capacity (vph)	124	2505	1128	130	2272		329	447	458	306	447	415
Starvation Cap Reductn	0	0	0	0	0		0	0	0	0	0	0
Spillback Cap Reductn	0	0	0	0	0		0	0	0	0	0	0
Storage Cap Reductn	0	0	0	0	0		0	0	0	0	0	0
Reduced v/c Ratio	0.38	0.82	0.03	0.12	0.36		0.11	0.03	0.24	0.11	0.01	0.14

Intersection Summary

Area Type: Other  
 Cycle Length: 130  
 Actuated Cycle Length: 130  
 Offset: 36 (28%), Referenced to phase 2:EBT and 6:WBT, Start of Green  
 Natural Cycle: 145  
 Control Type: Actuated-Coordinated  
 Maximum v/c Ratio: 0.82  
 Intersection Signal Delay: 12.3      Intersection LOS: B  
 Intersection Capacity Utilization 89.5%      ICU Level of Service E  
 Analysis Period (min) 15  
 # 95th percentile volume exceeds capacity, queue may be longer.  
 Queue shown is maximum after two cycles.  
 m Volume for 95th percentile queue is metered by upstream signal.

Splits and Phases: 2: Lynhar Road/Stafford Road & Robertson Road

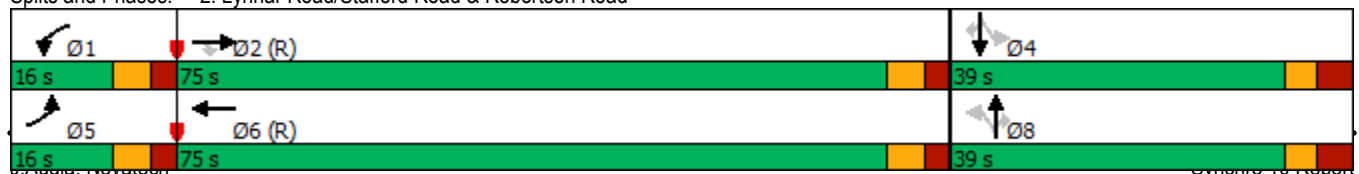

3: Northside Road East & Robertson Road  
AM Peak Hour

1826 Robertson Road  
Existing Traffic

Lane Group	EBL	EBT	EBR	WBL	WBT	WBR	NBL	NBT	NBR	SBL	SBT	SBR
Lane Configurations												
Traffic Volume (vph)	23	1752	12	40	612	67	95	24	38	34	8	9
Future Volume (vph)	23	1752	12	40	612	67	95	24	38	34	8	9
Ideal Flow (vphpl)	1800	1800	1800	1800	1800	1800	1800	1800	1800	1800	1800	1800
Storage Length (m)	55.0		0.0	75.0		80.0	0.0		0.0	0.0		0.0
Storage Lanes	1		0	1		1	1		0	1		1
Taper Length (m)	30.0			15.0			10.0			10.0		
Lane Util. Factor	1.00	0.95	0.95	1.00	0.95	1.00	1.00	1.00	1.00	1.00	1.00	1.00
Ped Bike Factor	1.00	1.00				0.96	0.99	0.99		0.99		0.98
Frt		0.999				0.850		0.909				0.850
Flt Protected	0.950			0.950			0.950			0.950		
Satd. Flow (prot)	1712	3354	0	1647	3325	1532	1679	1519	0	1679	1802	1532
Flt Permitted	0.355			0.081			0.752			0.712		
Satd. Flow (perm)	637	3354	0	140	3325	1475	1322	1519	0	1250	1802	1506
Right Turn on Red			Yes			Yes			Yes			Yes
Satd. Flow (RTOR)		1				99		42				93
Link Speed (k/h)		60			60			40				40
Link Distance (m)		105.4			310.9			87.0				90.9
Travel Time (s)		6.3			18.7			7.8				8.2
Confl. Peds. (#/hr)	5		3	3		5	3		4	4		3
Confl. Bikes (#/hr)			5			6			3			
Peak Hour Factor	0.90	0.90	0.90	0.90	0.90	0.90	0.90	0.90	0.90	0.90	0.90	0.90
Heavy Vehicles (%)	1%	3%	1%	5%	4%	1%	3%	5%	9%	3%	1%	1%
Adj. Flow (vph)	26	1947	13	44	680	74	106	27	42	38	9	10
Shared Lane Traffic (%)												
Lane Group Flow (vph)	26	1960	0	44	680	74	106	69	0	38	9	10
Enter Blocked Intersection	No	No	No	No	No	No	No	No	No	No	No	No
Lane Alignment	L NA	Left	R NA	L NA	Left	R NA	L NA	Left	R NA	L NA	Left	R NA
Median Width(m)		5.5			5.5			3.7				3.7
Link Offset(m)		0.0			0.0			0.0				0.0
Crosswalk Width(m)		5.0			5.0			5.0				5.0
Two way Left Turn Lane												
Headway Factor	1.06	1.06	1.06	1.06	1.06	1.06	1.06	1.06	1.06	1.06	1.06	1.06
Turning Speed (k/h)	24		14	24		14	24		14	24		14
Number of Detectors	1	2		1	2		1	1	2		1	2
Detector Template	Left	Thru		Left	Thru	Right	Left	Thru		Left	Thru	Right
Leading Detector (m)	6.1	30.5		6.1	30.5	6.1	6.1	30.5		6.1	30.5	6.1
Trailing Detector (m)	0.0	0.0		0.0	0.0	0.0	0.0	0.0		0.0	0.0	0.0
Detector 1 Position(m)	0.0	0.0		0.0	0.0	0.0	0.0	0.0		0.0	0.0	0.0
Detector 1 Size(m)	6.1	1.8		6.1	1.8	6.1	6.1	1.8		6.1	1.8	6.1
Detector 1 Type	Cl+Ex	Cl+Ex		Cl+Ex	Cl+Ex	Cl+Ex	Cl+Ex	Cl+Ex		Cl+Ex	Cl+Ex	Cl+Ex
Detector 1 Channel												
Detector 1 Extend (s)	0.0	0.0		0.0	0.0	0.0	0.0	0.0		0.0	0.0	0.0
Detector 1 Queue (s)	0.0	0.0		0.0	0.0	0.0	0.0	0.0		0.0	0.0	0.0
Detector 1 Delay (s)	0.0	0.0		0.0	0.0	0.0	0.0	0.0		0.0	0.0	0.0
Detector 2 Position(m)		28.7			28.7			28.7				28.7
Detector 2 Size(m)		1.8			1.8			1.8				1.8
Detector 2 Type		Cl+Ex			Cl+Ex			Cl+Ex				Cl+Ex
Detector 2 Channel												
Detector 2 Extend (s)		0.0			0.0			0.0				0.0
Turn Type	pm+pt	NA		Perm	NA	Perm	Perm	NA		Perm	NA	Perm
Protected Phases	5	2			6			8				4
Permitted Phases	2			6		6	8			4		4
Detector Phase	5	2		6	6	6	8	8		4	4	4

Lane Group	Ø3	Ø7
Lane Configurations		
Traffic Volume (vph)		
Future Volume (vph)		
Ideal Flow (vphpl)		
Storage Length (m)		
Storage Lanes		
Taper Length (m)		
Lane Util. Factor		
Ped Bike Factor		
Frt		
Flt Protected		
Satd. Flow (prot)		
Flt Permitted		
Satd. Flow (perm)		
Right Turn on Red		
Satd. Flow (RTOR)		
Link Speed (k/h)		
Link Distance (m)		
Travel Time (s)		
Confl. Peds. (#/hr)		
Confl. Bikes (#/hr)		
Peak Hour Factor		
Heavy Vehicles (%)		
Adj. Flow (vph)		
Shared Lane Traffic (%)		
Lane Group Flow (vph)		
Enter Blocked Intersection		
Lane Alignment		
Median Width(m)		
Link Offset(m)		
Crosswalk Width(m)		
Two way Left Turn Lane		
Headway Factor		
Turning Speed (k/h)		
Number of Detectors		
Detector Template		
Leading Detector (m)		
Trailing Detector (m)		
Detector 1 Position(m)		
Detector 1 Size(m)		
Detector 1 Type		
Detector 1 Channel		
Detector 1 Extend (s)		
Detector 1 Queue (s)		
Detector 1 Delay (s)		
Detector 2 Position(m)		
Detector 2 Size(m)		
Detector 2 Type		
Detector 2 Channel		
Detector 2 Extend (s)		
Turn Type		
Protected Phases	3	7
Permitted Phases		
Detector Phase		

3: Northside Road East & Robertson Road  
AM Peak Hour

1826 Robertson Road  
Existing Traffic



Lane Group	EBL	EBT	EBR	WBL	WBT	WBR	NBL	NBT	NBR	SBL	SBT	SBR
Switch Phase												
Minimum Initial (s)	5.0	10.0		10.0	10.0	10.0	10.0	10.0		10.0	10.0	10.0
Minimum Split (s)	11.7	30.7		30.7	30.7	30.7	29.8	29.8		29.8	29.8	29.8
Total Split (s)	16.0	94.0		78.0	78.0	78.0	30.0	30.0		30.0	30.0	30.0
Total Split (%)	12.3%	72.3%		60.0%	60.0%	60.0%	23.1%	23.1%		23.1%	23.1%	23.1%
Maximum Green (s)	10.0	87.9		71.9	71.9	71.9	23.2	23.2		23.2	23.2	23.2
Yellow Time (s)	3.7	3.7		3.7	3.7	3.7	3.0	3.0		3.0	3.0	3.0
All-Red Time (s)	2.3	2.4		2.4	2.4	2.4	3.8	3.8		3.8	3.8	3.8
Lost Time Adjust (s)	0.0	0.0		0.0	0.0	0.0	0.0	0.0		0.0	0.0	0.0
Total Lost Time (s)	6.0	6.1		6.1	6.1	6.1	6.8	6.8		6.8	6.8	6.8
Lead/Lag	Lead			Lag	Lag	Lag	Lag	Lag		Lag	Lag	Lag
Lead-Lag Optimize?	Yes			Yes	Yes	Yes	Yes	Yes		Yes	Yes	Yes
Vehicle Extension (s)	3.0	3.0		3.0	3.0	3.0	3.0	3.0		3.0	3.0	3.0
Recall Mode	None	C-Max		C-Max	C-Max	C-Max	None	None		None	None	None
Walk Time (s)		7.0		7.0	7.0	7.0	1.0	1.0		1.0	1.0	1.0
Flash Dont Walk (s)		17.0		17.0	17.0	17.0	22.0	22.0		22.0	22.0	22.0
Pedestrian Calls (#/hr)		3		5	5	5	4	4		3	3	3
Act Effct Green (s)	101.2	101.1		93.7	93.7	93.7	16.0	16.0		16.0	16.0	16.0
Actuated g/C Ratio	0.78	0.78		0.72	0.72	0.72	0.12	0.12		0.12	0.12	0.12
v/c Ratio	0.05	0.75		0.44	0.28	0.07	0.65	0.31		0.25	0.04	0.04
Control Delay	3.5	6.9		29.1	8.0	1.0	72.0	26.6		53.4	47.2	0.2
Queue Delay	0.0	0.1		0.0	0.0	0.0	0.0	0.0		0.0	0.0	0.0
Total Delay	3.5	7.0		29.1	8.0	1.0	72.0	26.6		53.4	47.2	0.2
LOS	A	A		C	A	A	E	C		D	D	A
Approach Delay		6.9			8.5			54.1			43.1	
Approach LOS		A			A			D			D	
Queue Length 50th (m)	0.6	26.3		4.3	30.2	0.0	24.3	5.8		8.3	1.9	0.0
Queue Length 95th (m)	m1.5	70.4		#23.2	47.2	2.9	39.9	17.7		17.2	6.4	0.0
Internal Link Dist (m)		81.4			286.9			63.0			66.9	
Turn Bay Length (m)	55.0			75.0		80.0						
Base Capacity (vph)	578	2608		101	2396	1090	235	305		223	321	345
Starvation Cap Reductn	0	73		0	0	0	0	0		0	0	0
Spillback Cap Reductn	0	0		0	0	0	0	0		0	0	0
Storage Cap Reductn	0	0		0	0	0	0	0		0	0	0
Reduced v/c Ratio	0.04	0.77		0.44	0.28	0.07	0.45	0.23		0.17	0.03	0.03

Intersection Summary

Area Type: Other  
 Cycle Length: 130  
 Actuated Cycle Length: 130  
 Offset: 37 (28%), Referenced to phase 2:EBTL and 6:WBTL, Start of Green  
 Natural Cycle: 100  
 Control Type: Actuated-Coordinated  
 Maximum v/c Ratio: 0.75  
 Intersection Signal Delay: 10.8 Intersection LOS: B  
 Intersection Capacity Utilization 75.4% ICU Level of Service D  
 Analysis Period (min) 15  
 # 95th percentile volume exceeds capacity, queue may be longer.  
 Queue shown is maximum after two cycles.  
 m Volume for 95th percentile queue is metered by upstream signal.

Splits and Phases: 3: Northside Road East & Robertson Road



Lane Group	Ø3	Ø7
Switch Phase		
Minimum Initial (s)	4.0	4.0
Minimum Split (s)	6.0	6.0
Total Split (s)	6.0	6.0
Total Split (%)	5%	5%
Maximum Green (s)	4.0	4.0
Yellow Time (s)	2.0	2.0
All-Red Time (s)	0.0	0.0
Lost Time Adjust (s)		
Total Lost Time (s)		
Lead/Lag	Lead	Lead
Lead-Lag Optimize?	Yes	Yes
Vehicle Extension (s)	3.0	3.0
Recall Mode	None	None
Walk Time (s)		
Flash Dont Walk (s)		
Pedestrian Calls (#/hr)		
Act Effct Green (s)		
Actuated g/C Ratio		
v/c Ratio		
Control Delay		
Queue Delay		
Total Delay		
LOS		
Approach Delay		
Approach LOS		
Queue Length 50th (m)		
Queue Length 95th (m)		
Internal Link Dist (m)		
Turn Bay Length (m)		
Base Capacity (vph)		
Starvation Cap Reductn		
Spillback Cap Reductn		
Storage Cap Reductn		
Reduced v/c Ratio		
Intersection Summary		

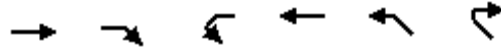

Lane Group	EBT	EBR	WBL	WBT	NWL	NWR
Lane Configurations	↑↑			↑↑↑		
Traffic Volume (vph)	1883	108	0	745	0	0
Future Volume (vph)	1883	108	0	745	0	0
Ideal Flow (vphpl)	1800	1800	1800	1800	1800	1800
Storage Length (m)		0.0	25.0		0.0	0.0
Storage Lanes		0	1		0	0
Taper Length (m)			25.0		10.0	
Lane Util. Factor	0.95	0.95	1.00	0.91	1.00	1.00
Fr <sub>t</sub>	0.992					
<b>Flt Protected</b>						
Satd. Flow (prot)	3356	0	0	4871	0	0
<b>Flt Permitted</b>						
Satd. Flow (perm)	3356	0	0	4871	0	0
Link Speed (k/h)	60			60	50	
Link Distance (m)	66.2			72.0	100.3	
Travel Time (s)	4.0			4.3	7.2	
Peak Hour Factor	0.90	0.90	0.90	0.90	0.90	0.90
Heavy Vehicles (%)	2%	6%	1%	2%	1%	1%
Adj. Flow (vph)	2092	120	0	828	0	0
<b>Shared Lane Traffic (%)</b>						
Lane Group Flow (vph)	2212	0	0	828	0	0
Enter Blocked Intersection	Yes	Yes	Yes	Yes	No	No
Lane Alignment	Left	Right	Left	Left	Left	Right
Median Width(m)	3.7			3.7	0.0	
Link Offset(m)	0.0			0.0	0.0	
Crosswalk Width(m)	0.0			0.0	0.0	
<b>Two way Left Turn Lane</b>						
Headway Factor	1.06	1.06	1.06	1.06	1.06	1.06
Turning Speed (k/h)		50	24		24	14
Sign Control	Free			Free	Free	

**Intersection Summary**

Area Type: Other

Control Type: Unsignalized

Intersection Capacity Utilization 61.9% ICU Level of Service B

Analysis Period (min) 15

























Lane Group	EBT	EBR	WBL	WBT	NBL	NBR
Lane Configurations						
Traffic Volume (vph)	100	8	51	0	0	26
Future Volume (vph)	100	8	51	0	0	26
Ideal Flow (vphpl)	1800	1800	1800	1800	1800	1800
Lane Util. Factor	1.00	1.00	1.00	1.00	1.00	1.00
Ped Bike Factor						
Frt	0.990					0.865
Flt Protected			0.950			
Satd. Flow (prot)	1706	0	1572	0	0	1458
Flt Permitted			0.950			
Satd. Flow (perm)	1706	0	1572	0	0	1458
Link Speed (k/h)	50			40	40	
Link Distance (m)	100.3			62.0	54.2	
Travel Time (s)	7.2			5.6	4.9	
Confl. Peds. (#/hr)		17	17			
Peak Hour Factor	0.90	0.90	0.90	0.90	0.90	0.90
Heavy Vehicles (%)	6%	1%	10%	1%	1%	8%
Adj. Flow (vph)	111	9	57	0	0	29
Shared Lane Traffic (%)						
Lane Group Flow (vph)	120	0	57	0	0	29
Enter Blocked Intersection	No	No	No	No	No	No
Lane Alignment	L NA	R NA	L NA	R NA	Left	R NA
Median Width(m)	3.7			3.7	0.0	
Link Offset(m)	3.0			3.0	0.0	
Crosswalk Width(m)	5.0			5.0	5.0	
Two way Left Turn Lane						
Headway Factor	1.06	1.06	1.06	1.06	1.06	1.06
Turning Speed (k/h)		14	24		24	14
Sign Control	Stop			Stop	Stop	

**Intersection Summary**

Area Type:	Other
Control Type:	Unsignalized
Intersection Capacity Utilization 19.3%	ICU Level of Service A
Analysis Period (min)	15

						
Lane Group	WBL	WBR	NBT	NBR	SBL	SBT
Lane Configurations			 			
Traffic Volume (vph)	1	10	135	2	18	27
Future Volume (vph)	1	10	135	2	18	27
Ideal Flow (vphpl)	1800	1800	1800	1800	1800	1800
Storage Length (m)	0.0	0.0		45.0	15.0	
Storage Lanes	1	0		0	1	
Taper Length (m)	10.0				20.0	
Lane Util. Factor	1.00	1.00	0.95	0.95	1.00	1.00
Frt	0.876		0.998			
Flt Protected	0.996				0.950	
Satd. Flow (prot)	1572	0	3384	0	1712	1784
Flt Permitted	0.996				0.950	
Satd. Flow (perm)	1572	0	3384	0	1712	1784
Link Speed (k/h)	40		40		40	
Link Distance (m)	173.4		68.2		81.0	
Travel Time (s)	15.6		6.1		7.3	
Peak Hour Factor	0.90	0.90	0.90	0.90	0.90	0.90
Heavy Vehicles (%)	1%	1%	2%	1%	1%	2%
Adj. Flow (vph)	1	11	150	2	20	30
Shared Lane Traffic (%)						
Lane Group Flow (vph)	12	0	152	0	20	30
Enter Blocked Intersection	No	No	No	No	No	No
Lane Alignment	Left	Right	Left	Right	Left	Left
Median Width(m)	3.7		3.7		3.7	
Link Offset(m)	0.0		0.0		0.0	
Crosswalk Width(m)	5.0		5.0		5.0	
Two way Left Turn Lane						
Headway Factor	1.06	1.06	1.06	1.06	1.06	1.06
Turning Speed (k/h)	24	14		14	24	
Sign Control	Stop		Free			Free
<b>Intersection Summary</b>						
Area Type:	Other					
Control Type:	Unsignalized					
Intersection Capacity Utilization 20.7%	ICU Level of Service A					
Analysis Period (min) 15						

						
Lane Group	WBL	WBR	NBT	NBR	SBL	SBT
Lane Configurations						
Traffic Volume (vph)	1	4	133	0	5	23
Future Volume (vph)	1	4	133	0	5	23
Ideal Flow (vphpl)	1800	1800	1800	1800	1800	1800
Lane Util. Factor	1.00	1.00	1.00	1.00	1.00	1.00
Frt	0.892					
Frt Protected	0.990					0.991
Satd. Flow (prot)	1591	0	1784	0	0	1772
Frt Permitted	0.990					0.991
Satd. Flow (perm)	1591	0	1784	0	0	1772
Link Speed (k/h)	50		50			50
Link Distance (m)	178.0		82.4			68.2
Travel Time (s)	12.8		5.9			4.9
Peak Hour Factor	0.90	0.90	0.90	0.90	0.90	0.90
Heavy Vehicles (%)	1%	1%	2%	1%	1%	2%
Adj. Flow (vph)	1	4	148	0	6	26
Shared Lane Traffic (%)						
Lane Group Flow (vph)	5	0	148	0	0	32
Enter Blocked Intersection	No	No	No	No	No	No
Lane Alignment	L NA	R NA	Left	Right	Left	Left
Median Width(m)	3.7		0.0			0.0
Link Offset(m)	0.0		0.0			0.0
Crosswalk Width(m)	5.0		5.0			5.0
Two way Left Turn Lane						
Headway Factor	1.06	1.06	1.06	1.06	1.06	1.06
Turning Speed (k/h)	97	97		97	97	
Sign Control	Stop		Free			Free
<b>Intersection Summary</b>						
Area Type:	Other					
Control Type:	Unsignalized					
Intersection Capacity Utilization	17.4%			ICU Level of Service A		
Analysis Period (min)	15					



Lane Group	EBL	EBR	NBL	NBT	SBT	SBR
Lane Configurations						
Traffic Volume (vph)	10	0	0	16	43	16
Future Volume (vph)	10	0	0	16	43	16
Ideal Flow (vphpl)	1800	1800	1800	1800	1800	1800
Lane Util. Factor	1.00	1.00	1.00	1.00	1.00	1.00
Frt					0.963	
Frt Protected	0.950					
Satd. Flow (prot)	1712	0	0	1802	1735	0
Frt Permitted	0.950					
Satd. Flow (perm)	1712	0	0	1802	1735	0
Link Speed (k/h)	40			40	40	
Link Distance (m)	173.4			67.2	54.2	
Travel Time (s)	15.6			6.0	4.9	
Peak Hour Factor	0.90	0.90	0.90	0.90	0.90	0.90
Heavy Vehicles (%)	1%	1%	1%	1%	1%	1%
Adj. Flow (vph)	11	0	0	18	48	18
Shared Lane Traffic (%)						
Lane Group Flow (vph)	11	0	0	18	66	0
Enter Blocked Intersection	No	No	No	No	No	No
Lane Alignment	Left	Right	Left	Left	Left	Right
Median Width(m)	3.7			0.0	0.0	
Link Offset(m)	0.0			0.0	0.0	
Crosswalk Width(m)	5.0			5.0	5.0	
Two way Left Turn Lane						
Headway Factor	1.06	1.06	1.06	1.06	1.06	1.06
Turning Speed (k/h)	24	14	24			14
Sign Control	Stop			Free	Free	

**Intersection Summary**

Area Type:	Other
Control Type:	Unsignalized
Intersection Capacity Utilization	13.4%
Analysis Period (min)	15
	ICU Level of Service A



Lane Group	EBL	EBR	NBL	NBT	SBT	SBR
Lane Configurations						
Traffic Volume (vph)	3	0	0	13	38	5
Future Volume (vph)	3	0	0	13	38	5
Ideal Flow (vphpl)	1800	1800	1800	1800	1800	1800
Lane Util. Factor	1.00	1.00	1.00	1.00	1.00	1.00
Friction	0.983					
Fit Protected	0.950					
Satd. Flow (prot)	1712	0	0	1802	1771	0
Fit Permitted	0.950					
Satd. Flow (perm)	1712	0	0	1802	1771	0
Link Speed (k/h)	50			50	50	
Link Distance (m)	178.0			106.1	67.2	
Travel Time (s)	12.8			7.6	4.8	
Peak Hour Factor	0.90	0.90	0.90	0.90	0.90	0.90
Heavy Vehicles (%)	1%	1%	1%	1%	1%	1%
Adj. Flow (vph)	3	0	0	14	42	6
Shared Lane Traffic (%)						
Lane Group Flow (vph)	3	0	0	14	48	0
Enter Blocked Intersection	No	No	No	No	No	No
Lane Alignment	L NA	R NA	Left	Left	Left	Right
Median Width(m)	3.7			0.0	0.0	
Link Offset(m)	0.0			0.0	0.0	
Crosswalk Width(m)	5.0			5.0	5.0	
Two way Left Turn Lane						
Headway Factor	1.06	1.06	1.06	1.06	1.06	1.06
Turning Speed (k/h)	97	97	97			97
Sign Control	Stop			Free	Free	

Intersection Summary	
Area Type:	Other
Control Type:	Unsignalized
Intersection Capacity Utilization	13.3%
Analysis Period (min)	15
	ICU Level of Service A

1: Stinson Avenue & Robertson Road  
PM Peak Hour

1826 Robertson Road  
Existing Traffic

Lane Group	EBL	EBT	EBR	WBL	WBT	WBR	NBL	NBT	NBR	SBL	SBT	SBR
Lane Configurations												
Traffic Volume (vph)	16	1050	25	41	1343	5	12	1	25	20	1	46
Future Volume (vph)	16	1050	25	41	1343	5	12	1	25	20	1	46
Ideal Flow (vphpl)	1800	1800	1800	1800	1800	1800	1800	1800	1800	1800	1800	1800
Storage Length (m)	75.0		0.0	45.0		0.0	0.0		0.0	0.0		0.0
Storage Lanes	1		0	1		0	0		0	0		0
Taper Length (m)	10.0			10.0			10.0			10.0		
Lane Util. Factor	1.00	0.95	0.95	1.00	0.95	0.95	1.00	1.00	1.00	1.00	1.00	1.00
Ped Bike Factor		1.00		1.00	1.00			0.98			0.98	
Frt		0.996			0.999			0.910			0.907	
Flt Protected	0.950			0.950				0.985			0.985	
Satd. Flow (prot)	1647	3341	0	1712	3353	0	0	1587	0	0	1547	0
Flt Permitted	0.151			0.219				0.889			0.885	
Satd. Flow (perm)	262	3341	0	393	3353	0	0	1430	0	0	1384	0
Right Turn on Red			Yes			Yes			Yes			Yes
Satd. Flow (RTOR)		4			1			28			51	
Link Speed (k/h)		60			60			40			40	
Link Distance (m)		198.0			310.7			254.0			246.4	
Travel Time (s)		11.9			18.6			22.9			22.2	
Confl. Peds. (#/hr)	17		14	14		17	5		10	10		5
Peak Hour Factor	0.90	0.90	0.90	0.90	0.90	0.90	0.90	0.90	0.90	0.90	0.90	0.90
Heavy Vehicles (%)	5%	3%	1%	1%	3%	1%	1%	1%	1%	1%	1%	5%
Adj. Flow (vph)	18	1167	28	46	1492	6	13	1	28	22	1	51
Shared Lane Traffic (%)												
Lane Group Flow (vph)	18	1195	0	46	1498	0	0	42	0	0	74	0
Enter Blocked Intersection	No	No	No	No	No	No	No	No	No	No	No	No
Lane Alignment	L NA	Left	R NA	L NA	Left	R NA	L NA	Left	R NA	L NA	Left	R NA
Median Width(m)		3.7			3.7			0.0			0.0	
Link Offset(m)		0.0			0.0			0.0			0.0	
Crosswalk Width(m)		5.0			5.0			5.0			5.0	
Two way Left Turn Lane		Yes			Yes							
Headway Factor	1.06	1.06	1.06	1.06	1.06	1.06	1.06	1.06	1.06	1.06	1.06	1.06
Turning Speed (k/h)	24		14	24		14	24		14	24		14
Number of Detectors	1	2		1	2		1	2		1	2	
Detector Template	Left	Thru		Left	Thru		Left	Thru		Left	Thru	
Leading Detector (m)	6.1	30.5		6.1	30.5		6.1	30.5		6.1	30.5	
Trailing Detector (m)	0.0	0.0		0.0	0.0		0.0	0.0		0.0	0.0	
Detector 1 Position(m)	0.0	0.0		0.0	0.0		0.0	0.0		0.0	0.0	
Detector 1 Size(m)	6.1	1.8		6.1	1.8		6.1	1.8		6.1	1.8	
Detector 1 Type	Cl+Ex	Cl+Ex		Cl+Ex	Cl+Ex		Cl+Ex	Cl+Ex		Cl+Ex	Cl+Ex	
Detector 1 Channel												
Detector 1 Extend (s)	0.0	0.0		0.0	0.0		0.0	0.0		0.0	0.0	
Detector 1 Queue (s)	0.0	0.0		0.0	0.0		0.0	0.0		0.0	0.0	
Detector 1 Delay (s)	0.0	0.0		0.0	0.0		0.0	0.0		0.0	0.0	
Detector 2 Position(m)		28.7			28.7			28.7			28.7	
Detector 2 Size(m)		1.8			1.8			1.8			1.8	
Detector 2 Type		Cl+Ex			Cl+Ex			Cl+Ex			Cl+Ex	
Detector 2 Channel												
Detector 2 Extend (s)		0.0			0.0			0.0			0.0	
Turn Type	Perm	NA		Perm	NA		Perm	NA		Perm	NA	
Protected Phases		2			6			8			4	
Permitted Phases	2			6			8			4		
Detector Phase	2	2		6	6		8	8		4	4	
Switch Phase												



Lane Group	EBL	EBT	EBR	WBL	WBT	WBR	NBL	NBT	NBR	SBL	SBT	SBR
Minimum Initial (s)	10.0	10.0		10.0	10.0		10.0	10.0		10.0	10.0	
Minimum Split (s)	26.8	26.8		26.8	26.8		31.6	31.6		31.6	31.6	
Total Split (s)	88.0	88.0		88.0	88.0		32.0	32.0		32.0	32.0	
Total Split (%)	73.3%	73.3%		73.3%	73.3%		26.7%	26.7%		26.7%	26.7%	
Maximum Green (s)	82.2	82.2		82.2	82.2		25.4	25.4		25.4	25.4	
Yellow Time (s)	3.7	3.7		3.7	3.7		3.0	3.0		3.0	3.0	
All-Red Time (s)	2.1	2.1		2.1	2.1		3.6	3.6		3.6	3.6	
Lost Time Adjust (s)	0.0	0.0		0.0	0.0			0.0			0.0	
Total Lost Time (s)	5.8	5.8		5.8	5.8			6.6			6.6	
Lead/Lag												
Lead-Lag Optimize?												
Vehicle Extension (s)	3.0	3.0		3.0	3.0		3.0	3.0		3.0	3.0	
Recall Mode	C-Max	C-Max		C-Max	C-Max		None	None		None	None	
Walk Time (s)	7.0	7.0		7.0	7.0		7.0	7.0		7.0	7.0	
Flash Dont Walk (s)	14.0	14.0		14.0	14.0		18.0	18.0		18.0	18.0	
Pedestrian Calls (#/hr)	14	14		17	17		10	10		5	5	
Act Effct Green (s)	99.1	99.1		99.1	99.1			13.0			13.0	
Actuated g/C Ratio	0.83	0.83		0.83	0.83			0.11			0.11	
v/c Ratio	0.08	0.43		0.14	0.54			0.23			0.38	
Control Delay	5.3	4.9		1.6	3.5			25.3			24.5	
Queue Delay	0.0	0.0		0.0	0.0			0.0			0.0	
Total Delay	5.3	4.9		1.6	3.5			25.3			24.5	
LOS	A	A		A	A			C			C	
Approach Delay		4.9			3.4			25.3			24.5	
Approach LOS		A			A			C			C	
Queue Length 50th (m)	0.6	31.1		0.3	5.6			2.9			4.7	
Queue Length 95th (m)	3.8	73.0		m0.6	176.1			11.2			15.9	
Internal Link Dist (m)		174.0			286.7			230.0			222.4	
Turn Bay Length (m)	75.0			45.0								
Base Capacity (vph)	216	2759		324	2768			324			333	
Starvation Cap Reductn	0	0		0	0			0			0	
Spillback Cap Reductn	0	0		0	0			0			0	
Storage Cap Reductn	0	0		0	0			0			0	
Reduced v/c Ratio	0.08	0.43		0.14	0.54			0.13			0.22	

Intersection Summary





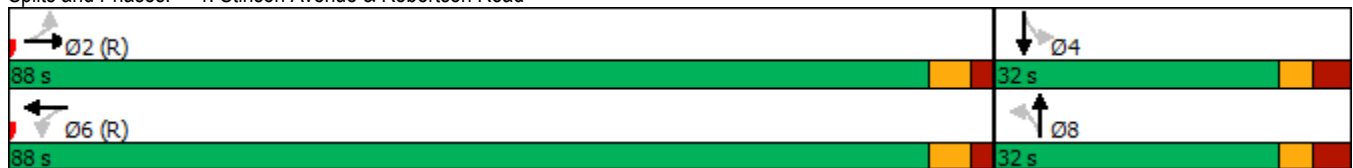



















Area Type: Other  
 Cycle Length: 120  
 Actuated Cycle Length: 120  
 Offset: 31 (26%), Referenced to phase 2:EBTL and 6:WBTL, Start of Green  
 Natural Cycle: 75  
 Control Type: Actuated-Coordinated  
 Maximum v/c Ratio: 0.54  
 Intersection Signal Delay: 4.9  
 Intersection Capacity Utilization 61.6%  
 Analysis Period (min) 15  
 m Volume for 95th percentile queue is metered by upstream signal.

Splits and Phases: 1: Stinson Avenue & Robertson Road



2: Lynhar Road/Stafford Road & Robertson Road  
PM Peak Hour

1826 Robertson Road  
Existing Traffic

												
Lane Group	EBL	EBT	EBR	WBL	WBT	WBR	NBL	NBT	NBR	SBL	SBT	SBR
Lane Configurations												
Traffic Volume (vph)	125	889	60	58	1069	77	92	41	80	201	36	173
Future Volume (vph)	125	889	60	58	1069	77	92	41	80	201	36	173
Ideal Flow (vphpl)	1800	1800	1800	1800	1800	1800	1800	1800	1800	1800	1800	1800
Storage Length (m)	85.0		40.0	0.0		0.0	0.0		30.0	45.0		75.0
Storage Lanes	1		1	1		0	1		1	1		1
Taper Length (m)	10.0			10.0			10.0			30.0		
Lane Util. Factor	1.00	0.95	1.00	1.00	0.95	0.95	1.00	1.00	1.00	1.00	1.00	1.00
Ped Bike Factor	0.99		0.94	0.99	1.00		0.98		0.95	0.97		0.97
Frt			0.850		0.990				0.850			0.850
Flt Protected	0.950			0.950			0.950			0.950		
Satd. Flow (prot)	1712	3357	1532	1712	3342	0	1631	1767	1502	1695	1802	1532
Flt Permitted	0.950			0.950			0.731			0.727		
Satd. Flow (perm)	1703	3357	1443	1695	3342	0	1236	1767	1434	1256	1802	1488
Right Turn on Red			Yes			Yes			Yes			Yes
Satd. Flow (RTOR)			145		7				142			192
Link Speed (k/h)		60			60			40				40
Link Distance (m)		310.7			66.2			81.0				107.6
Travel Time (s)		18.6			4.0			7.3				9.7
Confl. Peds. (#/hr)	22		16	16		22	14		29	29		14
Confl. Bikes (#/hr)												1
Peak Hour Factor	0.90	0.90	0.90	0.90	0.90	0.90	0.90	0.90	0.90	0.90	0.90	0.90
Heavy Vehicles (%)	1%	3%	1%	1%	2%	4%	6%	3%	3%	2%	1%	1%
Adj. Flow (vph)	139	988	67	64	1188	86	102	46	89	223	40	192
Shared Lane Traffic (%)												
Lane Group Flow (vph)	139	988	67	64	1274	0	102	46	89	223	40	192
Enter Blocked Intersection	No	No	No	No	No	No	No	No	No	No	No	No
Lane Alignment	L NA	Left	R NA	L NA	Left	R NA	L NA	L NA	R NA	L NA	Left	R NA
Median Width(m)		3.7			7.4			7.4				7.4
Link Offset(m)		0.0			0.0			0.0				0.0
Crosswalk Width(m)		5.0			5.0			5.0				5.0
Two way Left Turn Lane		Yes										
Headway Factor	1.06	1.06	1.06	1.06	1.06	1.06	1.06	1.06	1.06	1.06	1.06	1.06
Turning Speed (k/h)	24		14	24		14	24		14	24		14
Number of Detectors	1	2	1	1	2		1	2	1	1	2	1
Detector Template	Left	Thru	Right	Left	Thru		Left	Thru	Right	Left	Thru	Right
Leading Detector (m)	6.1	30.5	6.1	6.1	30.5		6.1	30.5	6.1	6.1	30.5	6.1
Trailing Detector (m)	0.0	0.0	0.0	0.0	0.0		0.0	0.0	0.0	0.0	0.0	0.0
Detector 1 Position(m)	0.0	0.0	0.0	0.0	0.0		0.0	0.0	0.0	0.0	0.0	0.0
Detector 1 Size(m)	6.1	1.8	6.1	6.1	1.8		6.1	1.8	6.1	6.1	1.8	6.1
Detector 1 Type	Cl+Ex	Cl+Ex	Cl+Ex	Cl+Ex	Cl+Ex		Cl+Ex	Cl+Ex	Cl+Ex	Cl+Ex	Cl+Ex	Cl+Ex
Detector 1 Channel												
Detector 1 Extend (s)	0.0	0.0	0.0	0.0	0.0		0.0	0.0	0.0	0.0	0.0	0.0
Detector 1 Queue (s)	0.0	0.0	0.0	0.0	0.0		0.0	0.0	0.0	0.0	0.0	0.0
Detector 1 Delay (s)	0.0	0.0	0.0	0.0	0.0		0.0	0.0	0.0	0.0	0.0	0.0
Detector 2 Position(m)		28.7			28.7			28.7				28.7
Detector 2 Size(m)		1.8			1.8			1.8				1.8
Detector 2 Type		Cl+Ex			Cl+Ex			Cl+Ex				Cl+Ex
Detector 2 Channel												
Detector 2 Extend (s)		0.0			0.0			0.0				0.0
Turn Type	Prot	NA	Perm	Prot	NA		pm+pt	NA	Perm	pm+pt	NA	Perm
Protected Phases	5	2		1	6		3	8		7	4	
Permitted Phases			2				8		8	4		4
Detector Phase	5	2	2	1	6		3	8	8	7	4	4



2: Lynhar Road/Stafford Road & Robertson Road  
PM Peak Hour

1826 Robertson Road  
Existing Traffic



Lane Group	EBL	EBT	EBR	WBL	WBT	WBR	NBL	NBT	NBR	SBL	SBT	SBR
Switch Phase												
Minimum Initial (s)	5.0	10.0	10.0	5.0	10.0		5.0	10.0	10.0	5.0	10.0	10.0
Minimum Split (s)	11.1	31.3	31.3	11.1	31.3		11.2	37.7	37.7	11.2	37.7	37.7
Total Split (s)	15.0	54.0	54.0	15.0	54.0		12.0	39.0	39.0	12.0	39.0	39.0
Total Split (%)	12.5%	45.0%	45.0%	12.5%	45.0%		10.0%	32.5%	32.5%	10.0%	32.5%	32.5%
Maximum Green (s)	8.9	47.7	47.7	8.9	47.7		5.8	32.3	32.3	5.8	32.3	32.3
Yellow Time (s)	3.7	3.7	3.7	3.7	3.7		3.0	3.0	3.0	3.0	3.0	3.0
All-Red Time (s)	2.4	2.6	2.6	2.4	2.6		3.2	3.7	3.7	3.2	3.7	3.7
Lost Time Adjust (s)	0.0	0.0	0.0	0.0	0.0		0.0	0.0	0.0	0.0	0.0	0.0
Total Lost Time (s)	6.1	6.3	6.3	6.1	6.3		6.2	6.7	6.7	6.2	6.7	6.7
Lead/Lag	Lead	Lag	Lag	Lead	Lag		Lead	Lag	Lag	Lead	Lag	Lag
Lead-Lag Optimize?	Yes	Yes	Yes	Yes	Yes		Yes	Yes	Yes	Yes	Yes	Yes
Vehicle Extension (s)	3.0	3.0	3.0	3.0	3.0		3.0	3.0	3.0	3.0	3.0	3.0
Recall Mode	None	C-Max	C-Max	None	C-Max		None	None	None	None	None	None
Walk Time (s)		7.0	7.0		7.0			12.0	12.0		12.0	12.0
Flash Dont Walk (s)		18.0	18.0		18.0			19.0	19.0		19.0	19.0
Pedestrian Calls (#/hr)		16	16		22			29	29		14	14
Act Effct Green (s)	13.5	59.8	59.8	8.9	52.8		28.9	22.6	22.6	28.9	22.6	22.6
Actuated g/C Ratio	0.11	0.50	0.50	0.07	0.44		0.24	0.19	0.19	0.24	0.19	0.19
v/c Ratio	0.72	0.59	0.08	0.51	0.86		0.32	0.14	0.23	0.69	0.12	0.44
Control Delay	70.0	29.9	4.1	85.8	26.0		33.3	37.2	2.4	48.3	36.8	8.2
Queue Delay	0.0	0.0	0.0	0.0	0.0		0.0	0.0	0.0	0.0	0.0	0.0
Total Delay	70.0	29.9	4.1	85.8	26.0		33.3	37.2	2.4	48.3	36.8	8.2
LOS	E	C	A	F	C		C	D	A	D	D	A
Approach Delay		33.1			28.9			22.4			30.4	
Approach LOS		C			C			C			C	
Queue Length 50th (m)	30.5	78.9	0.0	14.8	141.4		14.9	7.6	0.0	35.2	6.6	0.0
Queue Length 95th (m)	#67.9	125.7	5.0	m24.0	#179.1		26.7	16.4	2.5	54.5	14.8	16.0
Internal Link Dist (m)		286.7			42.2			57.0			83.6	
Turn Bay Length (m)	85.0		40.0						30.0	45.0		75.0
Base Capacity (vph)	192	1673	791	136	1474		316	475	489	323	485	540
Starvation Cap Reductn	0	0	0	0	0		0	0	0	0	0	0
Spillback Cap Reductn	0	0	0	0	0		0	0	0	0	0	0
Storage Cap Reductn	0	0	0	0	0		0	0	0	0	0	0
Reduced v/c Ratio	0.72	0.59	0.08	0.47	0.86		0.32	0.10	0.18	0.69	0.08	0.36

Intersection Summary





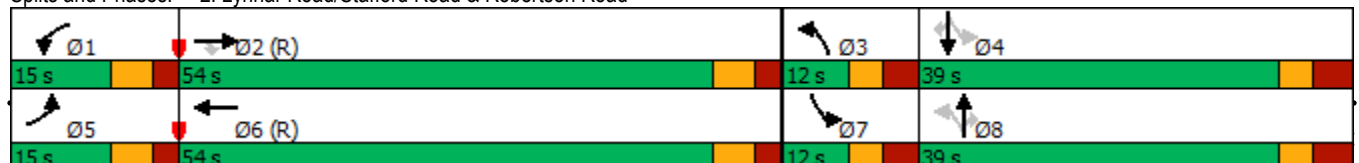

















Area Type: Other  
 Cycle Length: 120  
 Actuated Cycle Length: 120  
 Offset: 7 (6%), Referenced to phase 2:EBT and 6:WBT, Start of Green  
 Natural Cycle: 115  
 Control Type: Actuated-Coordinated  
 Maximum v/c Ratio: 0.86  
 Intersection Signal Delay: 30.2 Intersection LOS: C  
 Intersection Capacity Utilization 78.3% ICU Level of Service D  
 Analysis Period (min) 15  
 # 95th percentile volume exceeds capacity, queue may be longer.  
 Queue shown is maximum after two cycles.  
 m Volume for 95th percentile queue is metered by upstream signal.

Splits and Phases: 2: Lynhar Road/Stafford Road & Robertson Road



3: Northside Road East & Robertson Road  
PM Peak Hour

1826 Robertson Road  
Existing Traffic

												
Lane Group	EBL	EBT	EBR	WBL	WBT	WBR	NBL	NBT	NBR	SBL	SBT	SBR
Lane Configurations												
Traffic Volume (vph)	66	1033	16	79	1160	220	138	37	106	155	55	78
Future Volume (vph)	66	1033	16	79	1160	220	138	37	106	155	55	78
Ideal Flow (vphpl)	1800	1800	1800	1800	1800	1800	1800	1800	1800	1800	1800	1800
Storage Length (m)	55.0		0.0	75.0		80.0	0.0		0.0	0.0		0.0
Storage Lanes	1		0	1		1	1		0	1		1
Taper Length (m)	30.0			15.0			10.0			10.0		
Lane Util. Factor	1.00	0.95	0.95	1.00	0.95	1.00	1.00	1.00	1.00	1.00	1.00	1.00
Ped Bike Factor		1.00		1.00		0.97	0.98	0.99		0.99		0.96
Frt		0.998				0.850		0.889				0.850
Flt Protected	0.950			0.950			0.950			0.950		
Satd. Flow (prot)	1712	3383	0	1712	3390	1532	1695	1559	0	1712	1802	1532
Flt Permitted	0.129			0.238			0.717			0.594		
Satd. Flow (perm)	232	3383	0	428	3390	1488	1250	1559	0	1064	1802	1469
Right Turn on Red			Yes			Yes			Yes			Yes
Satd. Flow (RTOR)		3				244		108				101
Link Speed (k/h)		60			60			40				40
Link Distance (m)		105.4			310.9			87.0				90.9
Travel Time (s)		6.3			18.7			7.8				8.2
Confl. Peds. (#/hr)	3		7	7		3	16		5	5		16
Confl. Bikes (#/hr)			1			2						4
Peak Hour Factor	0.90	0.90	0.90	0.90	0.90	0.90	0.90	0.90	0.90	0.90	0.90	0.90
Heavy Vehicles (%)	1%	2%	1%	1%	2%	1%	2%	3%	2%	1%	1%	1%
Adj. Flow (vph)	73	1148	18	88	1289	244	153	41	118	172	61	87
Shared Lane Traffic (%)												
Lane Group Flow (vph)	73	1166	0	88	1289	244	153	159	0	172	61	87
Enter Blocked Intersection	No	No	No	No	No	No	No	No	No	No	No	No
Lane Alignment	L NA	Left	R NA	L NA	Left	R NA	L NA	Left	R NA	L NA	Left	R NA
Median Width(m)		5.5			5.5			3.7				3.7
Link Offset(m)		0.0			0.0			0.0				0.0
Crosswalk Width(m)		5.0			5.0			5.0				5.0
Two way Left Turn Lane												
Headway Factor	1.06	1.06	1.06	1.06	1.06	1.06	1.06	1.06	1.06	1.06	1.06	1.06
Turning Speed (k/h)	24		14	24		14	24		14	24		14
Number of Detectors	1	2		1	2		1	1	2		1	2
Detector Template	Left	Thru		Left	Thru	Right	Left	Thru		Left	Thru	Right
Leading Detector (m)	6.1	30.5		6.1	30.5	6.1	6.1	30.5		6.1	30.5	6.1
Trailing Detector (m)	0.0	0.0		0.0	0.0	0.0	0.0	0.0		0.0	0.0	0.0
Detector 1 Position(m)	0.0	0.0		0.0	0.0	0.0	0.0	0.0		0.0	0.0	0.0
Detector 1 Size(m)	6.1	1.8		6.1	1.8	6.1	6.1	1.8		6.1	1.8	6.1
Detector 1 Type	Cl+Ex	Cl+Ex		Cl+Ex	Cl+Ex	Cl+Ex	Cl+Ex	Cl+Ex		Cl+Ex	Cl+Ex	Cl+Ex
Detector 1 Channel												
Detector 1 Extend (s)	0.0	0.0		0.0	0.0	0.0	0.0	0.0		0.0	0.0	0.0
Detector 1 Queue (s)	0.0	0.0		0.0	0.0	0.0	0.0	0.0		0.0	0.0	0.0
Detector 1 Delay (s)	0.0	0.0		0.0	0.0	0.0	0.0	0.0		0.0	0.0	0.0
Detector 2 Position(m)		28.7			28.7			28.7				28.7
Detector 2 Size(m)		1.8			1.8			1.8				1.8
Detector 2 Type		Cl+Ex			Cl+Ex			Cl+Ex				Cl+Ex
Detector 2 Channel												
Detector 2 Extend (s)		0.0			0.0			0.0				0.0
Turn Type	pm+pt	NA		Perm	NA	Perm	Perm	NA		Perm	NA	Perm
Protected Phases	5	2			6			8				4
Permitted Phases	2			6		6	8			4		4
Detector Phase	5	2		6	6	6	8	8		4	4	4

Lane Group	Ø3	Ø7
Lane Configurations		
Traffic Volume (vph)		
Future Volume (vph)		
Ideal Flow (vphpl)		
Storage Length (m)		
Storage Lanes		
Taper Length (m)		
Lane Util. Factor		
Ped Bike Factor		
Frt		
Flt Protected		
Satd. Flow (prot)		
Flt Permitted		
Satd. Flow (perm)		
Right Turn on Red		
Satd. Flow (RTOR)		
Link Speed (k/h)		
Link Distance (m)		
Travel Time (s)		
Confl. Peds. (#/hr)		
Confl. Bikes (#/hr)		
Peak Hour Factor		
Heavy Vehicles (%)		
Adj. Flow (vph)		
Shared Lane Traffic (%)		
Lane Group Flow (vph)		
Enter Blocked Intersection		
Lane Alignment		
Median Width(m)		
Link Offset(m)		
Crosswalk Width(m)		
Two way Left Turn Lane		
Headway Factor		
Turning Speed (k/h)		
Number of Detectors		
Detector Template		
Leading Detector (m)		
Trailing Detector (m)		
Detector 1 Position(m)		
Detector 1 Size(m)		
Detector 1 Type		
Detector 1 Channel		
Detector 1 Extend (s)		
Detector 1 Queue (s)		
Detector 1 Delay (s)		
Detector 2 Position(m)		
Detector 2 Size(m)		
Detector 2 Type		
Detector 2 Channel		
Detector 2 Extend (s)		
Turn Type		
Protected Phases	3	7
Permitted Phases		
Detector Phase		

3: Northside Road East & Robertson Road  
PM Peak Hour

1826 Robertson Road  
Existing Traffic



Lane Group	EBL	EBT	EBR	WBL	WBT	WBR	NBL	NBT	NBR	SBL	SBT	SBR
Switch Phase												
Minimum Initial (s)	5.0	10.0		10.0	10.0	10.0	10.0	10.0		10.0	10.0	10.0
Minimum Split (s)	11.7	30.7		30.7	30.7	30.7	29.8	29.8		29.8	29.8	29.8
Total Split (s)	15.0	83.0		68.0	68.0	68.0	31.0	31.0		31.0	31.0	31.0
Total Split (%)	12.5%	69.2%		56.7%	56.7%	56.7%	25.8%	25.8%		25.8%	25.8%	25.8%
Maximum Green (s)	9.0	76.9		61.9	61.9	61.9	24.2	24.2		24.2	24.2	24.2
Yellow Time (s)	3.7	3.7		3.7	3.7	3.7	3.0	3.0		3.0	3.0	3.0
All-Red Time (s)	2.3	2.4		2.4	2.4	2.4	3.8	3.8		3.8	3.8	3.8
Lost Time Adjust (s)	0.0	0.0		0.0	0.0	0.0	0.0	0.0		0.0	0.0	0.0
Total Lost Time (s)	6.0	6.1		6.1	6.1	6.1	6.8	6.8		6.8	6.8	6.8
Lead/Lag	Lead			Lag	Lag	Lag	Lag	Lag		Lag	Lag	Lag
Lead-Lag Optimize?	Yes			Yes	Yes	Yes	Yes	Yes		Yes	Yes	Yes
Vehicle Extension (s)	3.0	3.0		3.0	3.0	3.0	3.0	3.0		3.0	3.0	3.0
Recall Mode	None	C-Max		C-Max	C-Max	C-Max	None	None		None	None	None
Walk Time (s)		7.0		7.0	7.0	7.0	1.0	1.0		1.0	1.0	1.0
Flash Dont Walk (s)		17.0		17.0	17.0	17.0	22.0	22.0		22.0	22.0	22.0
Pedestrian Calls (#/hr)		7		3	3	3	5	5		16	16	16
Act Effct Green (s)	82.1	82.0		71.1	71.1	71.1	25.1	25.1		25.1	25.1	25.1
Actuated g/C Ratio	0.68	0.68		0.59	0.59	0.59	0.21	0.21		0.21	0.21	0.21
v/c Ratio	0.29	0.50		0.35	0.64	0.25	0.59	0.39		0.77	0.16	0.23
Control Delay	13.1	10.6		20.9	19.9	2.5	51.3	16.4		67.2	37.8	6.4
Queue Delay	0.0	0.0		0.0	0.0	0.0	0.0	0.0		0.0	0.0	0.0
Total Delay	13.1	10.6		20.9	19.9	2.5	51.3	16.4		67.2	37.8	6.4
LOS	B	B		C	B	A	D	B		E	D	A
Approach Delay		10.7			17.4			33.5			45.1	
Approach LOS		B			B			C			D	
Queue Length 50th (m)	4.7	52.7		10.0	98.7	0.0	29.7	9.0		35.0	10.8	0.0
Queue Length 95th (m)	m10.6	65.8		24.9	135.3	11.2	47.9	25.2		56.4	20.6	9.0
Internal Link Dist (m)		81.4			286.9			63.0			66.9	
Turn Bay Length (m)	55.0			75.0		80.0						
Base Capacity (vph)	269	2313		253	2008	980	281	434		239	405	408
Starvation Cap Reductn	0	0		0	0	0	0	0		0	0	0
Spillback Cap Reductn	0	0		0	0	0	0	0		0	0	0
Storage Cap Reductn	0	0		0	0	0	0	0		0	0	0
Reduced v/c Ratio	0.27	0.50		0.35	0.64	0.25	0.54	0.37		0.72	0.15	0.21

Intersection Summary

Area Type: Other  
 Cycle Length: 120  
 Actuated Cycle Length: 120  
 Offset: 111 (93%), Referenced to phase 2:EBTL and 6:WBTL, Start of Green  
 Natural Cycle: 90  
 Control Type: Actuated-Coordinated  
 Maximum v/c Ratio: 0.77  
 Intersection Signal Delay: 19.0 Intersection LOS: B  
 Intersection Capacity Utilization 81.7% ICU Level of Service D  
 Analysis Period (min) 15  
 m Volume for 95th percentile queue is metered by upstream signal.

Splits and Phases: 3: Northside Road East & Robertson Road

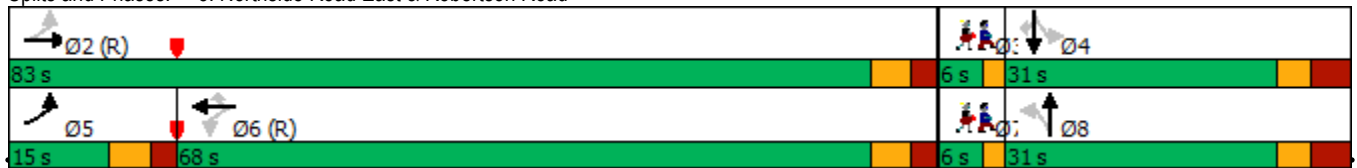

Lane Group	Ø3	Ø7
Switch Phase		
Minimum Initial (s)	4.0	4.0
Minimum Split (s)	6.0	6.0
Total Split (s)	6.0	6.0
Total Split (%)	5%	5%
Maximum Green (s)	4.0	4.0
Yellow Time (s)	2.0	2.0
All-Red Time (s)	0.0	0.0
Lost Time Adjust (s)		
Total Lost Time (s)		
Lead/Lag	Lead	Lead
Lead-Lag Optimize?	Yes	Yes
Vehicle Extension (s)	3.0	3.0
Recall Mode	None	None
Walk Time (s)		
Flash Dont Walk (s)		
Pedestrian Calls (#/hr)		
Act Effct Green (s)		
Actuated g/C Ratio		
v/c Ratio		
Control Delay		
Queue Delay		
Total Delay		
LOS		
Approach Delay		
Approach LOS		
Queue Length 50th (m)		
Queue Length 95th (m)		
Internal Link Dist (m)		
Turn Bay Length (m)		
Base Capacity (vph)		
Starvation Cap Reductn		
Spillback Cap Reductn		
Storage Cap Reductn		
Reduced v/c Ratio		
Intersection Summary		

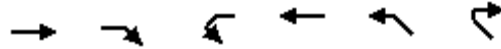

Lane Group	EBT	EBR	WBL	WBT	NWL	NWR
Lane Configurations	↑↑			↑↑↑		
Traffic Volume (vph)	1053	117	0	1204	0	0
Future Volume (vph)	1053	117	0	1204	0	0
Ideal Flow (vphpl)	1800	1800	1800	1800	1800	1800
Storage Length (m)		0.0	25.0		0.0	0.0
Storage Lanes		0	1		0	0
Taper Length (m)			25.0		10.0	
Lane Util. Factor	0.95	0.95	1.00	0.91	1.00	1.00
Frt	0.985					
Flt Protected						
Satd. Flow (prot)	3326	0	0	4871	0	0
Flt Permitted						
Satd. Flow (perm)	3326	0	0	4871	0	0
Link Speed (k/h)	60			60	50	
Link Distance (m)	66.2			72.0	100.3	
Travel Time (s)	4.0			4.3	7.2	
Peak Hour Factor	0.90	0.90	0.90	0.90	0.90	0.90
Heavy Vehicles (%)	2%	6%	1%	2%	1%	1%
Adj. Flow (vph)	1170	130	0	1338	0	0
Shared Lane Traffic (%)						
Lane Group Flow (vph)	1300	0	0	1338	0	0
Enter Blocked Intersection	Yes	Yes	Yes	Yes	No	No
Lane Alignment	Left	Right	Left	Left	Left	Right
Median Width(m)	3.7			3.7	0.0	
Link Offset(m)	0.0			0.0	0.0	
Crosswalk Width(m)	0.0			0.0	0.0	
Two way Left Turn Lane						
Headway Factor	1.06	1.06	1.06	1.06	1.06	1.06
Turning Speed (k/h)		50	24		24	14
Sign Control	Free			Free	Free	

**Intersection Summary**

Area Type: Other

Control Type: Unsignalized

Intersection Capacity Utilization 38.0% ICU Level of Service A











Analysis Period (min) 15











Lane Group	EBT	EBR	WBL	WBT	NBL	NBR
Lane Configurations						
Traffic Volume (vph)	107	10	98	0	0	79
Future Volume (vph)	107	10	98	0	0	79
Ideal Flow (vphpl)	1800	1800	1800	1800	1800	1800
Lane Util. Factor	1.00	1.00	1.00	1.00	1.00	1.00
Ped Bike Factor						
Frt	0.989					0.865
Flt Protected			0.950			
Satd. Flow (prot)	1690	0	1631	0	0	1514
Flt Permitted			0.950			
Satd. Flow (perm)	1690	0	1631	0	0	1514
Link Speed (k/h)	50			40	40	
Link Distance (m)	100.3			62.0	54.2	
Travel Time (s)	7.2			5.6	4.9	
Confl. Peds. (#/hr)		12	12			
Confl. Bikes (#/hr)		1				1
Peak Hour Factor	0.90	0.90	0.90	0.90	0.90	0.90
Heavy Vehicles (%)	7%	1%	6%	1%	1%	4%
Adj. Flow (vph)	119	11	109	0	0	88
Shared Lane Traffic (%)						
Lane Group Flow (vph)	130	0	109	0	0	88
Enter Blocked Intersection	No	No	No	No	No	No
Lane Alignment	L NA	R NA	L NA	R NA	Left	R NA
Median Width(m)	3.7			3.7	0.0	
Link Offset(m)	3.0			3.0	0.0	
Crosswalk Width(m)	5.0			5.0	5.0	
Two way Left Turn Lane						
Headway Factor	1.06	1.06	1.06	1.06	1.06	1.06
Turning Speed (k/h)		14	24		24	14
Sign Control	Stop			Stop	Stop	

**Intersection Summary**

Area Type:	Other
Control Type:	Unsignalized
Intersection Capacity Utilization	20.7%
ICU Level of Service	A
Analysis Period (min)	15

						
Lane Group	WBL	WBR	NBT	NBR	SBL	SBT
Lane Configurations						
Traffic Volume (vph)	3	70	143	2	59	95
Future Volume (vph)	3	70	143	2	59	95
Ideal Flow (vphpl)	1800	1800	1800	1800	1800	1800
Storage Length (m)	0.0	0.0		45.0	15.0	
Storage Lanes	1	0		0	1	
Taper Length (m)	10.0				20.0	
Lane Util. Factor	1.00	1.00	0.95	0.95	1.00	1.00
Frt	0.870		0.998			
Flt Protected	0.998				0.950	
Satd. Flow (prot)	1565	0	3384	0	1712	1784
Flt Permitted	0.998				0.950	
Satd. Flow (perm)	1565	0	3384	0	1712	1784
Link Speed (k/h)	40		40			40
Link Distance (m)	173.4		68.2			81.0
Travel Time (s)	15.6		6.1			7.3
Peak Hour Factor	0.90	0.90	0.90	0.90	0.90	0.90
Heavy Vehicles (%)	1%	1%	2%	1%	1%	2%
Adj. Flow (vph)	3	78	159	2	66	106
Shared Lane Traffic (%)						
Lane Group Flow (vph)	81	0	161	0	66	106
Enter Blocked Intersection	No	No	No	No	No	No
Lane Alignment	Left	Right	Left	Right	Left	Left
Median Width(m)	3.7		3.7			3.7
Link Offset(m)	0.0		0.0			0.0
Crosswalk Width(m)	5.0		5.0			5.0
Two way Left Turn Lane						
Headway Factor	1.06	1.06	1.06	1.06	1.06	1.06
Turning Speed (k/h)	24	14		14	24	
Sign Control	Stop		Free			Free
<b>Intersection Summary</b>						
Area Type:	Other					
Control Type:	Unsignalized					
Intersection Capacity Utilization	22.4%			ICU Level of Service A		
Analysis Period (min)	15					



						
Lane Group	WBL	WBR	NBT	NBR	SBL	SBT
Lane Configurations						
Traffic Volume (vph)	1	9	136	1	8	90
Future Volume (vph)	1	9	136	1	8	90
Ideal Flow (vphpl)	1800	1800	1800	1800	1800	1800
Lane Util. Factor	1.00	1.00	1.00	1.00	1.00	1.00
Frt	0.877		0.999			
Flt Protected	0.995					0.996
Satd. Flow (prot)	1572	0	1783	0	0	1779
Flt Permitted	0.995					0.996
Satd. Flow (perm)	1572	0	1783	0	0	1779
Link Speed (k/h)	50		50			50
Link Distance (m)	178.0		82.4			68.2
Travel Time (s)	12.8		5.9			4.9
Peak Hour Factor	0.90	0.90	0.90	0.90	0.90	0.90
Heavy Vehicles (%)	1%	1%	2%	1%	1%	2%
Adj. Flow (vph)	1	10	151	1	9	100
Shared Lane Traffic (%)						
Lane Group Flow (vph)	11	0	152	0	0	109
Enter Blocked Intersection	No	No	No	No	No	No
Lane Alignment	L NA	R NA	Left	Right	Left	Left
Median Width(m)	3.7		0.0			0.0
Link Offset(m)	0.0		0.0			0.0
Crosswalk Width(m)	5.0		5.0			5.0
Two way Left Turn Lane						
Headway Factor	1.06	1.06	1.06	1.06	1.06	1.06
Turning Speed (k/h)	97	97		97	97	
Sign Control	Stop		Free			Free
<b>Intersection Summary</b>						
Area Type:	Other					
Control Type:	Unsignalized					
Intersection Capacity Utilization	22.0%			ICU Level of Service A		
Analysis Period (min)	15					



Lane Group	EBL	EBR	NBL	NBT	SBT	SBR
Lane Configurations						
Traffic Volume (vph)	24	0	0	55	74	34
Future Volume (vph)	24	0	0	55	74	34
Ideal Flow (vphpl)	1800	1800	1800	1800	1800	1800
Lane Util. Factor	1.00	1.00	1.00	1.00	1.00	1.00
Frt					0.957	
Frt Protected	0.950					
Satd. Flow (prot)	1712	0	0	1802	1719	0
Frt Permitted	0.950					
Satd. Flow (perm)	1712	0	0	1802	1719	0
Link Speed (k/h)	40			40	40	
Link Distance (m)	173.4			67.2	54.2	
Travel Time (s)	15.6			6.0	4.9	
Peak Hour Factor	0.90	0.90	0.90	0.90	0.90	0.90
Heavy Vehicles (%)	1%	1%	1%	1%	1%	2%
Adj. Flow (vph)	27	0	0	61	82	38
Shared Lane Traffic (%)						
Lane Group Flow (vph)	27	0	0	61	120	0
Enter Blocked Intersection	No	No	No	No	No	No
Lane Alignment	Left	Right	Left	Left	Left	Right
Median Width(m)	3.7			0.0	0.0	
Link Offset(m)	0.0			0.0	0.0	
Crosswalk Width(m)	5.0			5.0	5.0	
Two way Left Turn Lane						
Headway Factor	1.06	1.06	1.06	1.06	1.06	1.06
Turning Speed (k/h)	24	14	24			14
Sign Control	Stop			Free	Free	

**Intersection Summary**

Area Type:	Other
Control Type:	Unsignalized
Intersection Capacity Utilization	16.3%
Analysis Period (min)	15
	ICU Level of Service A



Lane Group	EBL	EBR	NBL	NBT	SBT	SBR
Lane Configurations						
Traffic Volume (vph)	7	0	0	48	67	7
Future Volume (vph)	7	0	0	48	67	7
Ideal Flow (vphpl)	1800	1800	1800	1800	1800	1800
Lane Util. Factor	1.00	1.00	1.00	1.00	1.00	1.00
Frt					0.987	
Frt Protected	0.950					
Satd. Flow (prot)	1712	0	0	1802	1779	0
Frt Permitted	0.950					
Satd. Flow (perm)	1712	0	0	1802	1779	0
Link Speed (k/h)	50			50	50	
Link Distance (m)	178.0			106.1	67.2	
Travel Time (s)	12.8			7.6	4.8	
Peak Hour Factor	0.90	0.90	0.90	0.90	0.90	0.90
Heavy Vehicles (%)	1%	1%	1%	1%	1%	1%
Adj. Flow (vph)	8	0	0	53	74	8
Shared Lane Traffic (%)						
Lane Group Flow (vph)	8	0	0	53	82	0
Enter Blocked Intersection	No	No	No	No	No	No
Lane Alignment	L NA	R NA	Left	Left	Left	Right
Median Width(m)	3.7			0.0	0.0	
Link Offset(m)	0.0			0.0	0.0	
Crosswalk Width(m)	5.0			5.0	5.0	
Two way Left Turn Lane						
Headway Factor	1.06	1.06	1.06	1.06	1.06	1.06
Turning Speed (k/h)	97	97	97			97
Sign Control	Stop			Free	Free	

**Intersection Summary**

Area Type:	Other
Control Type:	Unsignalized
Intersection Capacity Utilization	14.2%
Analysis Period (min)	15
	ICU Level of Service A













1: Stinson Avenue & Robertson Road  
SAT Peak Hour

1826 Robertson Road  
Existing Traffic

Lane Group	EBL	EBT	EBR	WBL	WBT	WBR	NBL	NBT	NBR	SBL	SBT	SBR
Lane Configurations												
Traffic Volume (vph)	15	1007	24	45	957	4	10	0	32	3	1	8
Future Volume (vph)	15	1007	24	45	957	4	10	0	32	3	1	8
Ideal Flow (vphpl)	1800	1800	1800	1800	1800	1800	1800	1800	1800	1800	1800	1800
Storage Length (m)	75.0		0.0	45.0		0.0	0.0		0.0	0.0		0.0
Storage Lanes	1		0	1		0	0		0	0		0
Taper Length (m)	10.0			10.0			10.0			10.0		
Lane Util. Factor	1.00	0.95	0.95	1.00	0.95	0.95	1.00	1.00	1.00	1.00	1.00	1.00
Ped Bike Factor	1.00	1.00		1.00	1.00			0.99			0.99	
Frt		0.996			0.999			0.897			0.907	
Flt Protected	0.950			0.950				0.988			0.989	
Satd. Flow (prot)	1712	3405	0	1712	3420	0	0	1575	0	0	1601	0
Flt Permitted	0.255			0.232				0.918			0.927	
Satd. Flow (perm)	457	3405	0	417	3420	0	0	1463	0	0	1499	0
Right Turn on Red			Yes			Yes			Yes			Yes
Satd. Flow (RTOR)		4			1			36			9	
Link Speed (k/h)		60			60			40			40	
Link Distance (m)		198.0			310.7			254.0			246.4	
Travel Time (s)		11.9			18.6			22.9			22.2	
Confl. Peds. (#/hr)	10		4	4		10	1		4	4		1
Confl. Bikes (#/hr)			4			2						
Peak Hour Factor	0.90	0.90	0.90	0.90	0.90	0.90	0.90	0.90	0.90	0.90	0.90	0.90
Heavy Vehicles (%)	1%	1%	4%	1%	1%	1%	1%	1%	1%	1%	1%	1%
Adj. Flow (vph)	17	1119	27	50	1063	4	11	0	36	3	1	9
Shared Lane Traffic (%)												
Lane Group Flow (vph)	17	1146	0	50	1067	0	0	47	0	0	13	0
Enter Blocked Intersection	No	No	No	No	No	No	No	No	No	No	No	No
Lane Alignment	L NA	Left	R NA	L NA	Left	R NA	L NA	Left	R NA	L NA	Left	R NA
Median Width(m)		3.7			3.7			0.0			0.0	
Link Offset(m)		0.0			0.0			0.0			0.0	
Crosswalk Width(m)		5.0			5.0			5.0			5.0	
Two way Left Turn Lane		Yes			Yes							
Headway Factor	1.06	1.06	1.06	1.06	1.06	1.06	1.06	1.06	1.06	1.06	1.06	1.06
Turning Speed (k/h)	24		14	24		14	24		14	24		14
Number of Detectors	1	2		1	2		1	2		1	2	
Detector Template	Left	Thru		Left	Thru		Left	Thru		Left	Thru	
Leading Detector (m)	6.1	30.5		6.1	30.5		6.1	30.5		6.1	30.5	
Trailing Detector (m)	0.0	0.0		0.0	0.0		0.0	0.0		0.0	0.0	
Detector 1 Position(m)	0.0	0.0		0.0	0.0		0.0	0.0		0.0	0.0	
Detector 1 Size(m)	6.1	1.8		6.1	1.8		6.1	1.8		6.1	1.8	
Detector 1 Type	Cl+Ex	Cl+Ex		Cl+Ex	Cl+Ex		Cl+Ex	Cl+Ex		Cl+Ex	Cl+Ex	
Detector 1 Channel												
Detector 1 Extend (s)	0.0	0.0		0.0	0.0		0.0	0.0		0.0	0.0	
Detector 1 Queue (s)	0.0	0.0		0.0	0.0		0.0	0.0		0.0	0.0	
Detector 1 Delay (s)	0.0	0.0		0.0	0.0		0.0	0.0		0.0	0.0	
Detector 2 Position(m)		28.7			28.7			28.7			28.7	
Detector 2 Size(m)		1.8			1.8			1.8			1.8	
Detector 2 Type		Cl+Ex			Cl+Ex			Cl+Ex			Cl+Ex	
Detector 2 Channel												
Detector 2 Extend (s)		0.0			0.0			0.0			0.0	
Turn Type	Perm	NA		Perm	NA		Perm	NA		Perm	NA	
Protected Phases		2			6			8			4	
Permitted Phases	2			6			8			4		
Detector Phase	2	2		6	6		8	8		4	4	

1: Stinson Avenue & Robertson Road  
SAT Peak Hour

1826 Robertson Road  
Existing Traffic

												
Lane Group	EBL	EBT	EBR	WBL	WBT	WBR	NBL	NBT	NBR	SBL	SBT	SBR
Switch Phase												
Minimum Initial (s)	10.0	10.0		10.0	10.0		10.0	10.0		10.0	10.0	
Minimum Split (s)	26.8	26.8		26.8	26.8		31.6	31.6		31.6	31.6	
Total Split (s)	88.0	88.0		88.0	88.0		32.0	32.0		32.0	32.0	
Total Split (%)	73.3%	73.3%		73.3%	73.3%		26.7%	26.7%		26.7%	26.7%	
Maximum Green (s)	82.2	82.2		82.2	82.2		25.4	25.4		25.4	25.4	
Yellow Time (s)	3.7	3.7		3.7	3.7		3.0	3.0		3.0	3.0	
All-Red Time (s)	2.1	2.1		2.1	2.1		3.6	3.6		3.6	3.6	
Lost Time Adjust (s)	0.0	0.0		0.0	0.0			0.0			0.0	
Total Lost Time (s)	5.8	5.8		5.8	5.8			6.6			6.6	
Lead/Lag												
Lead-Lag Optimize?												
Vehicle Extension (s)	3.0	3.0		3.0	3.0		3.0	3.0		3.0	3.0	
Recall Mode	C-Max	C-Max		C-Max	C-Max		None	None		None	None	
Walk Time (s)	7.0	7.0		7.0	7.0		7.0	7.0		7.0	7.0	
Flash Dont Walk (s)	14.0	14.0		14.0	14.0		18.0	18.0		18.0	18.0	
Pedestrian Calls (#/hr)	4	4		10	10		4	4		1	1	
Act Effct Green (s)	99.1	99.1		99.1	99.1			13.0			13.0	
Actuated g/C Ratio	0.83	0.83		0.83	0.83			0.11			0.11	
v/c Ratio	0.05	0.41		0.15	0.38			0.25			0.08	
Control Delay	4.5	4.7		1.8	1.9			22.0			27.2	
Queue Delay	0.0	0.0		0.0	0.0			0.0			0.0	
Total Delay	4.5	4.7		1.8	1.9			22.0			27.2	
LOS	A	A		A	A			C			C	
Approach Delay		4.7			1.9			22.0			27.2	
Approach LOS		A			A			C			C	
Queue Length 50th (m)	0.6	28.9		0.4	4.1			2.2			0.8	
Queue Length 95th (m)	3.4	67.7		m1.0	22.6			11.2			5.7	
Internal Link Dist (m)		174.0			286.7			230.0			222.4	
Turn Bay Length (m)	75.0			45.0								
Base Capacity (vph)	377	2812		344	2823			338			324	
Starvation Cap Reductn	0	0		0	0			0			0	
Spillback Cap Reductn	0	0		0	0			0			0	
Storage Cap Reductn	0	0		0	0			0			0	
Reduced v/c Ratio	0.05	0.41		0.15	0.38			0.14			0.04	

Intersection Summary





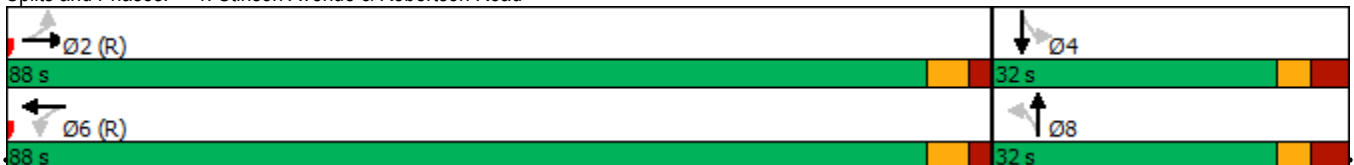

















Area Type: Other  
 Cycle Length: 120  
 Actuated Cycle Length: 120  
 Offset: 31 (26%), Referenced to phase 2:EBTL and 6:WBTL, Start of Green  
 Natural Cycle: 60  
 Control Type: Actuated-Coordinated  
 Maximum v/c Ratio: 0.41  
 Intersection Signal Delay: 3.8 Intersection LOS: A  
 Intersection Capacity Utilization 59.7% ICU Level of Service B  
 Analysis Period (min) 15  
 m Volume for 95th percentile queue is metered by upstream signal.

Splits and Phases: 1: Stinson Avenue & Robertson Road



2: Lynhar Road/Stafford Road & Robertson Road  
SAT Peak Hour

1826 Robertson Road  
Existing Traffic

												
Lane Group	EBL	EBT	EBR	WBL	WBT	WBR	NBL	NBT	NBR	SBL	SBT	SBR
Lane Configurations												
Traffic Volume (vph)	134	805	87	41	757	60	87	27	84	83	20	153
Future Volume (vph)	134	805	87	41	757	60	87	27	84	83	20	153
Ideal Flow (vphpl)	1800	1800	1800	1800	1800	1800	1800	1800	1800	1800	1800	1800
Storage Length (m)	85.0		40.0	0.0		0.0	0.0		30.0	45.0		75.0
Storage Lanes	1		1	1		0	1		1	1		1
Taper Length (m)	10.0			10.0			10.0			30.0		
Lane Util. Factor	1.00	0.95	1.00	1.00	0.95	0.95	1.00	1.00	1.00	1.00	1.00	1.00
Ped Bike Factor	1.00		0.94	0.99	1.00		0.98		0.96	0.98		0.97
Frt			0.850		0.989				0.850			0.850
Flt Protected	0.950			0.950			0.950			0.950		
Satd. Flow (prot)	1695	3424	1517	1712	3350	0	1712	1802	1532	1695	1802	1532
Flt Permitted	0.950			0.950			0.707			0.738		
Satd. Flow (perm)	1692	3424	1419	1692	3350	0	1251	1802	1474	1286	1802	1484
Right Turn on Red			Yes			Yes			Yes			Yes
Satd. Flow (RTOR)			145		8				142			170
Link Speed (k/h)		60			60			40			40	
Link Distance (m)		310.7			66.2			81.0			107.6	
Travel Time (s)		18.6			4.0			7.3			9.7	
Confl. Peds. (#/hr)	5		17	17		5	16		21	21		16
Confl. Bikes (#/hr)			5			4			2			1
Peak Hour Factor	0.90	0.90	0.90	0.90	0.90	0.90	0.90	0.90	0.90	0.90	0.90	0.90
Heavy Vehicles (%)	2%	1%	2%	1%	2%	1%	1%	1%	1%	2%	1%	1%
Adj. Flow (vph)	149	894	97	46	841	67	97	30	93	92	22	170
Shared Lane Traffic (%)												
Lane Group Flow (vph)	149	894	97	46	908	0	97	30	93	92	22	170
Enter Blocked Intersection	No	No	No	No	No	No	No	No	No	No	No	No
Lane Alignment	L NA	Left	R NA	L NA	Left	R NA	L NA	L NA	R NA	L NA	Left	R NA
Median Width(m)		3.7			7.4			7.4			7.4	
Link Offset(m)		0.0			0.0			0.0			0.0	
Crosswalk Width(m)		5.0			5.0			5.0			5.0	
Two way Left Turn Lane		Yes										
Headway Factor	1.06	1.06	1.06	1.06	1.06	1.06	1.06	1.06	1.06	1.06	1.06	1.06
Turning Speed (k/h)	24		14	24		14	24		14	24		14
Number of Detectors	1	2	1	1	2		1	2	1	1	2	1
Detector Template	Left	Thru	Right	Left	Thru		Left	Thru	Right	Left	Thru	Right
Leading Detector (m)	6.1	30.5	6.1	6.1	30.5		6.1	30.5	6.1	6.1	30.5	6.1
Trailing Detector (m)	0.0	0.0	0.0	0.0	0.0		0.0	0.0	0.0	0.0	0.0	0.0
Detector 1 Position(m)	0.0	0.0	0.0	0.0	0.0		0.0	0.0	0.0	0.0	0.0	0.0
Detector 1 Size(m)	6.1	1.8	6.1	6.1	1.8		6.1	1.8	6.1	6.1	1.8	6.1
Detector 1 Type	Cl+Ex	Cl+Ex	Cl+Ex	Cl+Ex	Cl+Ex		Cl+Ex	Cl+Ex	Cl+Ex	Cl+Ex	Cl+Ex	Cl+Ex
Detector 1 Channel												
Detector 1 Extend (s)	0.0	0.0	0.0	0.0	0.0		0.0	0.0	0.0	0.0	0.0	0.0
Detector 1 Queue (s)	0.0	0.0	0.0	0.0	0.0		0.0	0.0	0.0	0.0	0.0	0.0
Detector 1 Delay (s)	0.0	0.0	0.0	0.0	0.0		0.0	0.0	0.0	0.0	0.0	0.0
Detector 2 Position(m)		28.7			28.7			28.7			28.7	
Detector 2 Size(m)		1.8			1.8			1.8			1.8	
Detector 2 Type		Cl+Ex			Cl+Ex			Cl+Ex			Cl+Ex	
Detector 2 Channel												
Detector 2 Extend (s)		0.0			0.0			0.0			0.0	
Turn Type	Prot	NA	Perm	Prot	NA		pm+pt	NA	Perm	pm+pt	NA	Perm
Protected Phases	5	2		1	6		3	8		7	4	
Permitted Phases			2				8		8	4		4
Detector Phase	5	2	2	1	6		3	8	8	7	4	4

2: Lynhar Road/Stafford Road & Robertson Road  
SAT Peak Hour

1826 Robertson Road  
Existing Traffic



Lane Group	EBL	EBT	EBR	WBL	WBT	WBR	NBL	NBT	NBR	SBL	SBT	SBR
Switch Phase												
Minimum Initial (s)	5.0	10.0	10.0	5.0	10.0		5.0	10.0	10.0	5.0	10.0	10.0
Minimum Split (s)	11.1	31.3	31.3	11.1	31.3		11.2	37.7	37.7	11.2	37.7	37.7
Total Split (s)	15.0	54.0	54.0	15.0	54.0		12.0	39.0	39.0	12.0	39.0	39.0
Total Split (%)	12.5%	45.0%	45.0%	12.5%	45.0%		10.0%	32.5%	32.5%	10.0%	32.5%	32.5%
Maximum Green (s)	8.9	47.7	47.7	8.9	47.7		5.8	32.3	32.3	5.8	32.3	32.3
Yellow Time (s)	3.7	3.7	3.7	3.7	3.7		3.0	3.0	3.0	3.0	3.0	3.0
All-Red Time (s)	2.4	2.6	2.6	2.4	2.6		3.2	3.7	3.7	3.2	3.7	3.7
Lost Time Adjust (s)	0.0	0.0	0.0	0.0	0.0		0.0	0.0	0.0	0.0	0.0	0.0
Total Lost Time (s)	6.1	6.3	6.3	6.1	6.3		6.2	6.7	6.7	6.2	6.7	6.7
Lead/Lag	Lead	Lag	Lag	Lead	Lag		Lead	Lag	Lag	Lead	Lag	Lag
Lead-Lag Optimize?	Yes	Yes	Yes	Yes	Yes		Yes	Yes	Yes	Yes	Yes	Yes
Vehicle Extension (s)	3.0	3.0	3.0	3.0	3.0		3.0	3.0	3.0	3.0	3.0	3.0
Recall Mode	None	C-Max	C-Max	None	C-Max		None	None	None	None	None	None
Walk Time (s)		7.0	7.0		7.0			12.0	12.0		12.0	12.0
Flash Dont Walk (s)		18.0	18.0		18.0			19.0	19.0		19.0	19.0
Pedestrian Calls (#/hr)		17	17		5			21	21		16	16
Act Effct Green (s)	14.7	60.3	60.3	8.3	51.6		30.1	25.0	25.0	28.9	22.6	22.6
Actuated g/C Ratio	0.12	0.50	0.50	0.07	0.43		0.25	0.21	0.21	0.24	0.19	0.19
v/c Ratio	0.72	0.52	0.12	0.39	0.63		0.29	0.08	0.22	0.28	0.06	0.41
Control Delay	68.3	28.5	6.4	82.5	23.5		32.2	35.9	2.6	31.9	35.4	8.3
Queue Delay	0.0	0.0	0.0	0.0	0.0		0.0	0.0	0.0	0.0	0.0	0.0
Total Delay	68.3	28.5	6.4	82.5	23.5		32.2	35.9	2.6	31.9	35.4	8.3
LOS	E	C	A	F	C		C	D	A	C	D	A
Approach Delay		31.8			26.3			20.2			18.0	
Approach LOS		C			C			C			B	
Queue Length 50th (m)	~34.8	71.1	0.0	9.1	87.4		14.1	4.9	0.0	13.3	3.6	0.0
Queue Length 95th (m)	#73.6	114.2	11.6	22.3	109.8		25.4	11.9	3.3	24.2	9.7	15.1
Internal Link Dist (m)		286.7			42.2			57.0			83.6	
Turn Bay Length (m)	85.0		40.0						30.0	45.0		75.0
Base Capacity (vph)	207	1721	785	133	1445		336	485	500	329	485	523
Starvation Cap Reductn	0	0	0	0	0		0	0	0	0	0	0
Spillback Cap Reductn	0	0	0	0	0		0	0	0	0	0	0
Storage Cap Reductn	0	0	0	0	0		0	0	0	0	0	0
Reduced v/c Ratio	0.72	0.52	0.12	0.35	0.63		0.29	0.06	0.19	0.28	0.05	0.33

Intersection Summary

Area Type: Other  
 Cycle Length: 120  
 Actuated Cycle Length: 120  
 Offset: 7 (6%), Referenced to phase 2:EBT and 6:WBT, Start of Green  
 Natural Cycle: 95  
 Control Type: Actuated-Coordinated  
 Maximum v/c Ratio: 0.72  
 Intersection Signal Delay: 27.3      Intersection LOS: C  
 Intersection Capacity Utilization 66.7%      ICU Level of Service C  
 Analysis Period (min) 15  
 ~ Volume exceeds capacity, queue is theoretically infinite.  
 Queue shown is maximum after two cycles.  
 # 95th percentile volume exceeds capacity, queue may be longer.  
 Queue shown is maximum after two cycles.

Splits and Phases: 2: Lynhar Road/Stafford Road & Robertson Road

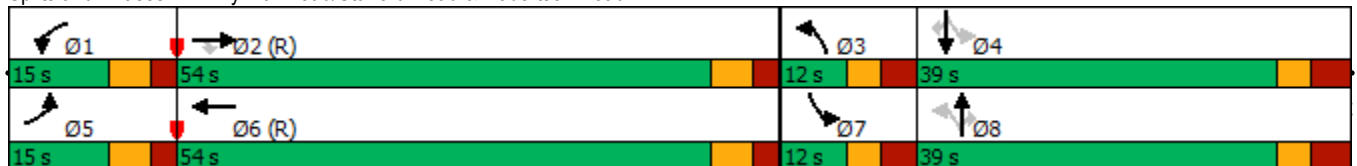

3: Northside Road East & Robertson Road  
SAT Peak Hour

1826 Robertson Road  
Existing Traffic

Lane Group	EBL	EBT	EBR	WBL	WBT	WBR	NBL	NBT	NBR	SBL	SBT	SBR
Lane Configurations												
Traffic Volume (vph)	78	799	15	84	655	167	86	44	70	141	30	103
Future Volume (vph)	78	799	15	84	655	167	86	44	70	141	30	103
Ideal Flow (vphpl)	1800	1800	1800	1800	1800	1800	1800	1800	1800	1800	1800	1800
Storage Length (m)	55.0		0.0	75.0		80.0	0.0		0.0	0.0		0.0
Storage Lanes	1		0	1		1	1		0	1		1
Taper Length (m)	30.0			15.0			10.0			10.0		
Lane Util. Factor	1.00	0.95	0.95	1.00	0.95	1.00	1.00	1.00	1.00	1.00	1.00	1.00
Ped Bike Factor	1.00	1.00		1.00		0.96	0.98	0.98		0.99		0.96
Frt		0.997				0.850		0.908				0.850
Flt Protected	0.950			0.950			0.950			0.950		
Satd. Flow (prot)	1712	3412	0	1695	3390	1532	1695	1610	0	1712	1802	1532
Flt Permitted	0.314			0.315			0.736			0.654		
Satd. Flow (perm)	564	3412	0	561	3390	1476	1282	1610	0	1166	1802	1474
Right Turn on Red			Yes			Yes			Yes			Yes
Satd. Flow (RTOR)		3				186		60				114
Link Speed (k/h)		60			60			40			40	
Link Distance (m)		105.4			310.9			87.0			90.9	
Travel Time (s)		6.3			18.7			7.8			8.2	
Confl. Peds. (#/hr)	6		4	4		6	16		8	8		16
Confl. Bikes (#/hr)			1			2			2			1
Peak Hour Factor	0.90	0.90	0.90	0.90	0.90	0.90	0.90	0.90	0.90	0.90	0.90	0.90
Heavy Vehicles (%)	1%	1%	1%	2%	2%	1%	2%	1%	1%	1%	1%	1%
Adj. Flow (vph)	87	888	17	93	728	186	96	49	78	157	33	114
Shared Lane Traffic (%)												
Lane Group Flow (vph)	87	905	0	93	728	186	96	127	0	157	33	114
Enter Blocked Intersection	No	No	No	No	No	No	No	No	No	No	No	No
Lane Alignment	L NA	Left	R NA	L NA	Left	R NA	L NA	Left	R NA	L NA	Left	R NA
Median Width(m)		5.5			5.5			3.7			3.7	
Link Offset(m)		0.0			0.0			0.0			0.0	
Crosswalk Width(m)		5.0			5.0			5.0			5.0	
Two way Left Turn Lane												
Headway Factor	1.06	1.06	1.06	1.06	1.06	1.06	1.06	1.06	1.06	1.06	1.06	1.06
Turning Speed (k/h)	24		14	24		14	24		14	24		14
Number of Detectors	1	2		1	2	1	1	2		1	2	1
Detector Template	Left	Thru		Left	Thru	Right	Left	Thru		Left	Thru	Right
Leading Detector (m)	6.1	30.5		6.1	30.5	6.1	6.1	30.5		6.1	30.5	6.1
Trailing Detector (m)	0.0	0.0		0.0	0.0	0.0	0.0	0.0		0.0	0.0	0.0
Detector 1 Position(m)	0.0	0.0		0.0	0.0	0.0	0.0	0.0		0.0	0.0	0.0
Detector 1 Size(m)	6.1	1.8		6.1	1.8	6.1	6.1	1.8		6.1	1.8	6.1
Detector 1 Type	Cl+Ex	Cl+Ex		Cl+Ex	Cl+Ex	Cl+Ex	Cl+Ex	Cl+Ex		Cl+Ex	Cl+Ex	Cl+Ex
Detector 1 Channel												
Detector 1 Extend (s)	0.0	0.0		0.0	0.0	0.0	0.0	0.0		0.0	0.0	0.0
Detector 1 Queue (s)	0.0	0.0		0.0	0.0	0.0	0.0	0.0		0.0	0.0	0.0
Detector 1 Delay (s)	0.0	0.0		0.0	0.0	0.0	0.0	0.0		0.0	0.0	0.0
Detector 2 Position(m)		28.7			28.7			28.7			28.7	
Detector 2 Size(m)		1.8			1.8			1.8			1.8	
Detector 2 Type		Cl+Ex			Cl+Ex			Cl+Ex			Cl+Ex	
Detector 2 Channel												
Detector 2 Extend (s)		0.0			0.0			0.0			0.0	
Turn Type	pm+pt	NA		Perm	NA	Perm	Perm	NA		Perm	NA	Perm
Protected Phases	5	2			6			8			4	
Permitted Phases	2			6		6	8			4		4
Detector Phase	5	2		6	6	6	8	8		4	4	4



Lane Group	Ø3	Ø7
Lane Configurations		
Traffic Volume (vph)		
Future Volume (vph)		
Ideal Flow (vphpl)		
Storage Length (m)		
Storage Lanes		
Taper Length (m)		
Lane Util. Factor		
Ped Bike Factor		
Frt		
Flt Protected		
Satd. Flow (prot)		
Flt Permitted		
Satd. Flow (perm)		
Right Turn on Red		
Satd. Flow (RTOR)		
Link Speed (k/h)		
Link Distance (m)		
Travel Time (s)		
Confl. Peds. (#/hr)		
Confl. Bikes (#/hr)		
Peak Hour Factor		
Heavy Vehicles (%)		
Adj. Flow (vph)		
Shared Lane Traffic (%)		
Lane Group Flow (vph)		
Enter Blocked Intersection		
Lane Alignment		
Median Width(m)		
Link Offset(m)		
Crosswalk Width(m)		
Two way Left Turn Lane		
Headway Factor		
Turning Speed (k/h)		
Number of Detectors		
Detector Template		
Leading Detector (m)		
Trailing Detector (m)		
Detector 1 Position(m)		
Detector 1 Size(m)		
Detector 1 Type		
Detector 1 Channel		
Detector 1 Extend (s)		
Detector 1 Queue (s)		
Detector 1 Delay (s)		
Detector 2 Position(m)		
Detector 2 Size(m)		
Detector 2 Type		
Detector 2 Channel		
Detector 2 Extend (s)		
Turn Type		
Protected Phases	3	7
Permitted Phases		
Detector Phase		

3: Northside Road East & Robertson Road  
SAT Peak Hour

1826 Robertson Road  
Existing Traffic



Lane Group	EBL	EBT	EBR	WBL	WBT	WBR	NBL	NBT	NBR	SBL	SBT	SBR
Switch Phase												
Minimum Initial (s)	5.0	10.0		10.0	10.0	10.0	10.0	10.0		10.0	10.0	10.0
Minimum Split (s)	11.7	30.7		30.7	30.7	30.7	29.8	29.8		29.8	29.8	29.8
Total Split (s)	15.0	83.0		68.0	68.0	68.0	31.0	31.0		31.0	31.0	31.0
Total Split (%)	12.5%	69.2%		56.7%	56.7%	56.7%	25.8%	25.8%		25.8%	25.8%	25.8%
Maximum Green (s)	9.0	76.9		61.9	61.9	61.9	24.2	24.2		24.2	24.2	24.2
Yellow Time (s)	3.7	3.7		3.7	3.7	3.7	3.0	3.0		3.0	3.0	3.0
All-Red Time (s)	2.3	2.4		2.4	2.4	2.4	3.8	3.8		3.8	3.8	3.8
Lost Time Adjust (s)	0.0	0.0		0.0	0.0	0.0	0.0	0.0		0.0	0.0	0.0
Total Lost Time (s)	6.0	6.1		6.1	6.1	6.1	6.8	6.8		6.8	6.8	6.8
Lead/Lag	Lead			Lag	Lag	Lag	Lag	Lag		Lag	Lag	Lag
Lead-Lag Optimize?	Yes			Yes	Yes	Yes	Yes	Yes		Yes	Yes	Yes
Vehicle Extension (s)	3.0	3.0		3.0	3.0	3.0	3.0	3.0		3.0	3.0	3.0
Recall Mode	None	C-Max		C-Max	C-Max	C-Max	None	None		None	None	None
Walk Time (s)		7.0		7.0	7.0	7.0	1.0	1.0		1.0	1.0	1.0
Flash Dont Walk (s)		17.0		17.0	17.0	17.0	22.0	22.0		22.0	22.0	22.0
Pedestrian Calls (#/hr)		4		6	6	6	8	8		16	16	16
Act Effct Green (s)	85.9	85.8		72.5	72.5	72.5	21.3	21.3		21.3	21.3	21.3
Actuated g/C Ratio	0.72	0.72		0.60	0.60	0.60	0.18	0.18		0.18	0.18	0.18
v/c Ratio	0.18	0.37		0.28	0.36	0.19	0.42	0.38		0.76	0.10	0.32
Control Delay	7.8	7.9		16.3	13.7	2.5	47.8	25.0		68.7	38.8	9.2
Queue Delay	0.0	0.0		0.0	0.0	0.0	0.0	0.0		0.0	0.0	0.0
Total Delay	7.8	7.9		16.3	13.7	2.5	47.8	25.0		68.7	38.8	9.2
LOS	A	A		B	B	A	D	C		E	D	A
Approach Delay		7.9			11.9			34.8			43.2	
Approach LOS		A			B			C			D	
Queue Length 50th (m)	5.7	33.1		9.0	39.3	0.0	18.7	12.6		32.7	6.1	0.0
Queue Length 95th (m)	9.2	34.7		23.1	62.7	10.0	31.1	26.5		50.0	13.1	12.9
Internal Link Dist (m)		81.4			286.9			63.0			66.9	
Turn Bay Length (m)	55.0			75.0		80.0						
Base Capacity (vph)	489	2440		338	2047	965	272	389		248	382	403
Starvation Cap Reductn	0	0		0	0	0	0	0		0	0	0
Spillback Cap Reductn	0	0		0	0	0	0	0		0	0	0
Storage Cap Reductn	0	0		0	0	0	0	0		0	0	0
Reduced v/c Ratio	0.18	0.37		0.28	0.36	0.19	0.35	0.33		0.63	0.09	0.28

**Intersection Summary**  
 Area Type: Other  
 Cycle Length: 120  
 Actuated Cycle Length: 120  
 Offset: 111 (93%), Referenced to phase 2:EBTL and 6:WBTL, Start of Green  
 Natural Cycle: 80  
 Control Type: Actuated-Coordinated  
 Maximum v/c Ratio: 0.76  
 Intersection Signal Delay: 16.1      Intersection LOS: B  
 Intersection Capacity Utilization 64.7%      ICU Level of Service C  
 Analysis Period (min) 15

Splits and Phases: 3: Northside Road East & Robertson Road



Lane Group	Ø3	Ø7
Switch Phase		
Minimum Initial (s)	4.0	4.0
Minimum Split (s)	6.0	6.0
Total Split (s)	6.0	6.0
Total Split (%)	5%	5%
Maximum Green (s)	4.0	4.0
Yellow Time (s)	2.0	2.0
All-Red Time (s)	0.0	0.0
Lost Time Adjust (s)		
Total Lost Time (s)		
Lead/Lag	Lead	Lead
Lead-Lag Optimize?	Yes	Yes
Vehicle Extension (s)	3.0	3.0
Recall Mode	None	None
Walk Time (s)		
Flash Dont Walk (s)		
Pedestrian Calls (#/hr)		
Act Effct Green (s)		
Actuated g/C Ratio		
v/c Ratio		
Control Delay		
Queue Delay		
Total Delay		
LOS		
Approach Delay		
Approach LOS		
Queue Length 50th (m)		
Queue Length 95th (m)		
Internal Link Dist (m)		
Turn Bay Length (m)		
Base Capacity (vph)		
Starvation Cap Reductn		
Spillback Cap Reductn		
Storage Cap Reductn		
Reduced v/c Ratio		
Intersection Summary		

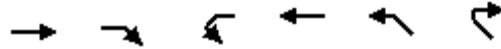

Lane Group	EBT	EBR	WBL	WBT	NWL	NWR
Lane Configurations	↑↑			↑↑↑		
Traffic Volume (vph)	889	83	0	858	0	0
Future Volume (vph)	889	83	0	858	0	0
Ideal Flow (vphpl)	1800	1800	1800	1800	1800	1800
Storage Length (m)		0.0	25.0		0.0	0.0
Storage Lanes		0	1		0	0
Taper Length (m)			25.0		10.0	
Lane Util. Factor	0.95	0.95	1.00	0.91	1.00	1.00
Frt	0.987					
<b>Flt Protected</b>						
Satd. Flow (prot)	3376	0	0	4919	0	0
<b>Flt Permitted</b>						
Satd. Flow (perm)	3376	0	0	4919	0	0
Link Speed (k/h)	60			60	50	
Link Distance (m)	66.2			72.0	100.3	
Travel Time (s)	4.0			4.3	7.2	
Peak Hour Factor	0.90	0.90	0.90	0.90	0.90	0.90
Heavy Vehicles (%)	1%	2%	1%	1%	1%	1%
Adj. Flow (vph)	988	92	0	953	0	0
<b>Shared Lane Traffic (%)</b>						
Lane Group Flow (vph)	1080	0	0	953	0	0
Enter Blocked Intersection	Yes	Yes	Yes	Yes	No	No
Lane Alignment	Left	Right	Left	Left	Left	Right
Median Width(m)	3.7			3.7	0.0	
Link Offset(m)	0.0			0.0	0.0	
Crosswalk Width(m)	0.0			0.0	0.0	
<b>Two way Left Turn Lane</b>						
Headway Factor	1.06	1.06	1.06	1.06	1.06	1.06
Turning Speed (k/h)		50	24		24	14
Sign Control	Free			Free	Free	

**Intersection Summary**

Area Type: Other

Control Type: Unsignalized

Intersection Capacity Utilization 32.1% ICU Level of Service A











Analysis Period (min) 15











Lane Group	EBT	EBR	WBL	WBT	NBL	NBR
Lane Configurations						
Traffic Volume (vph)	70	13	120	0	0	101
Future Volume (vph)	70	13	120	0	0	101
Ideal Flow (vphpl)	1800	1800	1800	1800	1800	1800
Lane Util. Factor	1.00	1.00	1.00	1.00	1.00	1.00
Ped Bike Factor						
Frt	0.979					0.865
Flt Protected			0.950			
Satd. Flow (prot)	1749	0	1712	0	0	1559
Flt Permitted			0.950			
Satd. Flow (perm)	1749	0	1712	0	0	1559
Link Speed (k/h)	50			40	40	
Link Distance (m)	100.3			62.0	54.2	
Travel Time (s)	7.2			5.6	4.9	
Confl. Peds. (#/hr)		27	27			
Confl. Bikes (#/hr)		1				2
Peak Hour Factor	0.90	0.90	0.90	0.90	0.90	0.90
Heavy Vehicles (%)	2%	1%	1%	1%	1%	1%
Adj. Flow (vph)	78	14	133	0	0	112
Shared Lane Traffic (%)						
Lane Group Flow (vph)	92	0	133	0	0	112
Enter Blocked Intersection	No	No	No	No	No	No
Lane Alignment	L NA	R NA	L NA	R NA	Left	R NA
Median Width(m)	3.7			3.7	0.0	
Link Offset(m)	3.0			3.0	0.0	
Crosswalk Width(m)	5.0			5.0	5.0	
Two way Left Turn Lane						
Headway Factor	1.06	1.06	1.06	1.06	1.06	1.06
Turning Speed (k/h)		14	24		24	14
Sign Control	Stop			Stop	Stop	

**Intersection Summary**

Area Type:	Other
Control Type:	Unsignalized
Intersection Capacity Utilization	23.3%
ICU Level of Service	A
Analysis Period (min)	15

						
Lane Group	WBL	WBR	NBT	NBR	SBL	SBT
Lane Configurations						
Traffic Volume (vph)	3	70	128	3	65	83
Future Volume (vph)	3	70	128	3	65	83
Ideal Flow (vphpl)	1800	1800	1800	1800	1800	1800
Storage Length (m)	0.0	0.0		45.0	15.0	
Storage Lanes	1	0		0	1	
Taper Length (m)	10.0				20.0	
Lane Util. Factor	1.00	1.00	0.95	0.95	1.00	1.00
Frt	0.870		0.997			
Flt Protected	0.998				0.950	
Satd. Flow (prot)	1565	0	3381	0	1712	1784
Flt Permitted	0.998				0.950	
Satd. Flow (perm)	1565	0	3381	0	1712	1784
Link Speed (k/h)	40		40			40
Link Distance (m)	173.4		68.2			81.0
Travel Time (s)	15.6		6.1			7.3
Peak Hour Factor	0.90	0.90	0.90	0.90	0.90	0.90
Heavy Vehicles (%)	1%	1%	2%	1%	1%	2%
Adj. Flow (vph)	3	78	142	3	72	92
Shared Lane Traffic (%)						
Lane Group Flow (vph)	81	0	145	0	72	92
Enter Blocked Intersection	No	No	No	No	No	No
Lane Alignment	Left	Right	Left	Right	Left	Left
Median Width(m)	3.7		3.7			3.7
Link Offset(m)	0.0		0.0			0.0
Crosswalk Width(m)	5.0		5.0			5.0
Two way Left Turn Lane						
Headway Factor	1.06	1.06	1.06	1.06	1.06	1.06
Turning Speed (k/h)	24	14		14	24	
Sign Control	Stop		Free			Free
<b>Intersection Summary</b>						
Area Type:	Other					
Control Type:	Unsignalized					
Intersection Capacity Utilization	22.4%			ICU Level of Service A		
Analysis Period (min)	15					

						
Lane Group	WBL	WBR	NBT	NBR	SBL	SBT
Lane Configurations						
Traffic Volume (vph)	1	10	121	1	12	74
Future Volume (vph)	1	10	121	1	12	74
Ideal Flow (vphpl)	1800	1800	1800	1800	1800	1800
Lane Util. Factor	1.00	1.00	1.00	1.00	1.00	1.00
Frt	0.876		0.999			
Flt Protected	0.996					0.993
Satd. Flow (prot)	1572	0	1783	0	0	1774
Flt Permitted	0.996					0.993
Satd. Flow (perm)	1572	0	1783	0	0	1774
Link Speed (k/h)	50		40			50
Link Distance (m)	178.0		82.4			68.2
Travel Time (s)	12.8		7.4			4.9
Peak Hour Factor	0.90	0.90	0.90	0.90	0.90	0.90
Heavy Vehicles (%)	1%	1%	2%	1%	1%	2%
Adj. Flow (vph)	1	11	134	1	13	82
Shared Lane Traffic (%)						
Lane Group Flow (vph)	12	0	135	0	0	95
Enter Blocked Intersection	No	No	No	No	No	No
Lane Alignment	L NA	R NA	Left	Right	Left	Left
Median Width(m)	3.7		0.0			0.0
Link Offset(m)	0.0		0.0			0.0
Crosswalk Width(m)	5.0		5.0			5.0
Two way Left Turn Lane						
Headway Factor	1.06	1.06	1.06	1.06	1.06	1.06
Turning Speed (k/h)	24	14		14	24	
Sign Control	Stop		Free			Free
<b>Intersection Summary</b>						
Area Type:	Other					
Control Type:	Unsignalized					
Intersection Capacity Utilization	24.8%			ICU Level of Service A		
Analysis Period (min)	15					



Lane Group	EBL	EBR	NBL	NBT	SBT	SBR
Lane Configurations						
Traffic Volume (vph)	28	0	0	73	92	41
Future Volume (vph)	28	0	0	73	92	41
Ideal Flow (vphpl)	1800	1800	1800	1800	1800	1800
Lane Util. Factor	1.00	1.00	1.00	1.00	1.00	1.00
Frt					0.958	
Frt Protected	0.950					
Satd. Flow (prot)	1712	0	0	1802	1726	0
Frt Permitted	0.950					
Satd. Flow (perm)	1712	0	0	1802	1726	0
Link Speed (k/h)	40			40	40	
Link Distance (m)	173.4			67.2	54.2	
Travel Time (s)	15.6			6.0	4.9	
Peak Hour Factor	0.90	0.90	0.90	0.90	0.90	0.90
Heavy Vehicles (%)	1%	1%	1%	1%	1%	1%
Adj. Flow (vph)	31	0	0	81	102	46
Shared Lane Traffic (%)						
Lane Group Flow (vph)	31	0	0	81	148	0
Enter Blocked Intersection	No	No	No	No	No	No
Lane Alignment	Left	Right	Left	Left	Left	Right
Median Width(m)	3.7			0.0	0.0	
Link Offset(m)	0.0			0.0	0.0	
Crosswalk Width(m)	5.0			5.0	5.0	
Two way Left Turn Lane						
Headway Factor	1.06	1.06	1.06	1.06	1.06	1.06
Turning Speed (k/h)	24	14	24			14
Sign Control	Stop			Free	Free	

**Intersection Summary**

Area Type:	Other
Control Type:	Unsignalized
Intersection Capacity Utilization	17.7%
Analysis Period (min)	15
	ICU Level of Service A





Lane Group	EBL	EBR	NBL	NBT	SBT	SBR
Lane Configurations						
Traffic Volume (vph)	9	0	0	64	82	10
Future Volume (vph)	9	0	0	64	82	10
Ideal Flow (vphpl)	1800	1800	1800	1800	1800	1800
Lane Util. Factor	1.00	1.00	1.00	1.00	1.00	1.00
Fr <sub>t</sub>					0.985	
Fl <sub>t</sub> Protected	0.950					
Satd. Flow (prot)	1712	0	0	1802	1775	0
Fl <sub>t</sub> Permitted	0.950					
Satd. Flow (perm)	1712	0	0	1802	1775	0
Link Speed (k/h)	50			40	50	
Link Distance (m)	178.0			106.1	67.2	
Travel Time (s)	12.8			9.5	4.8	
Peak Hour Factor	0.90	0.90	0.90	0.90	0.90	0.90
Heavy Vehicles (%)	1%	1%	1%	1%	1%	1%
Adj. Flow (vph)	10	0	0	71	91	11
Shared Lane Traffic (%)						
Lane Group Flow (vph)	10	0	0	71	102	0
Enter Blocked Intersection	No	No	No	No	No	No
Lane Alignment	L NA	R NA	Left	Left	Left	Right
Median Width(m)	3.7			0.0	0.0	
Link Offset(m)	0.0			0.0	0.0	
Crosswalk Width(m)	5.0			5.0	5.0	
Two way Left Turn Lane						
Headway Factor	1.06	1.06	1.06	1.06	1.06	1.06
Turning Speed (k/h)	24	14	24			14
Sign Control	Stop			Free	Free	

**Intersection Summary**

Area Type:	Other
Control Type:	Unsignalized
Intersection Capacity Utilization	15.2%
Analysis Period (min)	15
	ICU Level of Service A

## **APPENDIX K**

---

### Background Synchro Analysis

1: Stinson Avenue & Robertson Road  
AM Peak Hour

1826 Robertson Road  
2024 Background Traffic

Lane Group	EBL	EBT	EBR	WBL	WBT	WBR	NBL	NBT	NBR	SBL	SBT	SBR
Lane Configurations												
Traffic Volume (vph)	54	2011	6	20	632	22	9	2	32	2	0	11
Future Volume (vph)	54	2011	6	20	632	22	9	2	32	2	0	11
Ideal Flow (vphpl)	1800	1800	1800	1800	1800	1800	1800	1800	1800	1800	1800	1800
Storage Length (m)	75.0		0.0	45.0		0.0	0.0		0.0	0.0		0.0
Storage Lanes	1		0	1		0	0		0	0		0
Taper Length (m)	10.0			10.0			10.0			10.0		
Lane Util. Factor	1.00	0.95	0.95	1.00	0.95	0.95	1.00	1.00	1.00	1.00	1.00	1.00
Ped Bike Factor	0.99	1.00			1.00			1.00				0.98
Frt					0.995			0.900				0.886
Flt Protected	0.950			0.950				0.990				0.992
Satd. Flow (prot)	1662	3356	0	1572	3308	0	0	1554	0	0	1446	0
Flt Permitted	0.403			0.075				0.928			0.952	
Satd. Flow (perm)	696	3356	0	124	3308	0	0	1454	0	0	1388	0
Right Turn on Red			Yes			Yes			Yes			Yes
Satd. Flow (RTOR)		1			7			23			23	
Link Speed (k/h)		60			60			40			40	
Link Distance (m)		198.0			310.7			254.0			246.4	
Travel Time (s)		11.9			18.6			22.9			22.2	
Confl. Peds. (#/hr)	11		3	11		3	6					6
Peak Hour Factor	1.00	1.00	1.00	1.00	1.00	1.00	1.00	1.00	1.00	1.00	1.00	1.00
Heavy Vehicles (%)	4%	3%	10%	10%	4%	1%	10%	1%	3%	1%	1%	10%
Adj. Flow (vph)	54	2011	6	20	632	22	9	2	32	2	0	11
Shared Lane Traffic (%)												
Lane Group Flow (vph)	54	2017	0	20	654	0	0	43	0	0	13	0
Enter Blocked Intersection	No	No	No	No	No	No	No	No	No	No	No	No
Lane Alignment	L NA	Left	R NA	L NA	Left	R NA	L NA	Left	R NA	L NA	Left	R NA
Median Width(m)		3.7			3.7			0.0			0.0	
Link Offset(m)		0.0			0.0			0.0			0.0	
Crosswalk Width(m)		5.0			5.0			5.0			5.0	
Two way Left Turn Lane		Yes			Yes							
Headway Factor	1.06	1.06	1.06	1.06	1.06	1.06	1.06	1.06	1.06	1.06	1.06	1.06
Turning Speed (k/h)	24		14	24		14	24		14	24		14
Number of Detectors	1	2		1	2		1	2		1	2	
Detector Template	Left	Thru		Left	Thru		Left	Thru		Left	Thru	
Leading Detector (m)	6.1	30.5		6.1	30.5		6.1	30.5		6.1	30.5	
Trailing Detector (m)	0.0	0.0		0.0	0.0		0.0	0.0		0.0	0.0	
Detector 1 Position(m)	0.0	0.0		0.0	0.0		0.0	0.0		0.0	0.0	
Detector 1 Size(m)	6.1	1.8		6.1	1.8		6.1	1.8		6.1	1.8	
Detector 1 Type	Cl+Ex	Cl+Ex		Cl+Ex	Cl+Ex		Cl+Ex	Cl+Ex		Cl+Ex	Cl+Ex	
Detector 1 Channel												
Detector 1 Extend (s)	0.0	0.0		0.0	0.0		0.0	0.0		0.0	0.0	
Detector 1 Queue (s)	0.0	0.0		0.0	0.0		0.0	0.0		0.0	0.0	
Detector 1 Delay (s)	0.0	0.0		0.0	0.0		0.0	0.0		0.0	0.0	
Detector 2 Position(m)		28.7			28.7			28.7			28.7	
Detector 2 Size(m)		1.8			1.8			1.8			1.8	
Detector 2 Type		Cl+Ex			Cl+Ex			Cl+Ex			Cl+Ex	
Detector 2 Channel												
Detector 2 Extend (s)		0.0			0.0			0.0			0.0	
Turn Type	Perm	NA		Perm	NA		Perm	NA		Perm	NA	
Protected Phases		2			6			8			4	
Permitted Phases	2			6			8			4		
Detector Phase	2	2		6	6		8	8		4	4	
Switch Phase												



Lane Group	EBL	EBT	EBR	WBL	WBT	WBR	NBL	NBT	NBR	SBL	SBT	SBR
Minimum Initial (s)	10.0	10.0		10.0	10.0		10.0	10.0		10.0	10.0	
Minimum Split (s)	26.8	26.8		26.8	26.8		31.6	31.6		31.6	31.6	
Total Split (s)	98.0	98.0		98.0	98.0		32.0	32.0		32.0	32.0	
Total Split (%)	75.4%	75.4%		75.4%	75.4%		24.6%	24.6%		24.6%	24.6%	
Maximum Green (s)	92.2	92.2		92.2	92.2		25.4	25.4		25.4	25.4	
Yellow Time (s)	3.7	3.7		3.7	3.7		3.0	3.0		3.0	3.0	
All-Red Time (s)	2.1	2.1		2.1	2.1		3.6	3.6		3.6	3.6	
Lost Time Adjust (s)	0.0	0.0		0.0	0.0			0.0			0.0	
Total Lost Time (s)	5.8	5.8		5.8	5.8			6.6			6.6	
Lead/Lag												
Lead-Lag Optimize?												
Vehicle Extension (s)	3.0	3.0		3.0	3.0		3.0	3.0		3.0	3.0	
Recall Mode	C-Max	C-Max		C-Max	C-Max		None	None		None	None	
Walk Time (s)	7.0	7.0		7.0	7.0		7.0	7.0		7.0	7.0	
Flash Dont Walk (s)	14.0	14.0		14.0	14.0		18.0	18.0		18.0	18.0	
Pedestrian Calls (#/hr)	3	3		11	11		1	1		6	6	
Act Effct Green (s)	109.1	109.1		109.1	109.1			13.0			13.0	
Actuated g/c Ratio	0.84	0.84		0.84	0.84			0.10			0.10	
v/c Ratio	0.09	0.72		0.19	0.24			0.26			0.08	
Control Delay	4.0	8.5		9.3	2.7			32.6			8.8	
Queue Delay	0.0	0.0		0.0	0.0			0.0			0.0	
Total Delay	4.0	8.5		9.3	2.7			32.6			8.8	
LOS	A	A		A	A			C			A	
Approach Delay		8.4			2.9			32.6			8.8	
Approach LOS		A			A			C			A	
Queue Length 50th (m)	1.9	85.1		0.6	11.0			4.5			0.0	
Queue Length 95th (m)	7.6	196.1		4.1	21.6			13.5			3.3	
Internal Link Dist (m)		174.0			286.7			230.0			222.4	
Turn Bay Length (m)	75.0			45.0								
Base Capacity (vph)	584	2815		104	2777			302			289	
Starvation Cap Reductn	0	0		0	0			0			0	
Spillback Cap Reductn	0	0		0	0			0			0	
Storage Cap Reductn	0	0		0	0			0			0	
Reduced v/c Ratio	0.09	0.72		0.19	0.24			0.14			0.04	

Intersection Summary

Area Type: Other  
 Cycle Length: 130  
 Actuated Cycle Length: 130  
 Offset: 129 (99%), Referenced to phase 2:EBTL and 6:WBTL, Start of Green  
 Natural Cycle: 90  
 Control Type: Actuated-Coordinated  
 Maximum v/c Ratio: 0.72  
 Intersection Signal Delay: 7.5  
 Intersection Capacity Utilization 79.8%  
 Analysis Period (min) 15  
 Intersection LOS: A  
 ICU Level of Service D

Splits and Phases: 1: Stinson Avenue & Robertson Road



2: Lynhar Road/Stafford Road & Robertson Road  
AM Peak Hour

1826 Robertson Road  
2024 Background Traffic



Lane Group	EBL	EBT	EBR	WBL	WBT	WBR	NBL	NBT	NBR	SBL	SBT	SBR
Lane Configurations												
Traffic Volume (vph)	42	1889	27	14	657	83	33	11	101	31	4	52
Future Volume (vph)	42	1889	27	14	657	83	33	11	101	31	4	52
Ideal Flow (vphpl)	1800	1800	1800	1800	1800	1800	1800	1800	1800	1800	1800	1800
Storage Length (m)	85.0		40.0	0.0		0.0	0.0		30.0	45.0		75.0
Storage Lanes	1		1	1		0	1		1	1		1
Taper Length (m)	10.0			10.0			10.0			30.0		
Lane Util. Factor	1.00	0.95	1.00	1.00	0.95	0.95	1.00	1.00	1.00	1.00	1.00	1.00
Ped Bike Factor	1.00		0.97	1.00	1.00		0.99		0.98	1.00		0.98
Frt			0.850		0.983				0.850			0.850
Flt Protected	0.950			0.950			0.950			0.950		
Satd. Flow (prot)	1572	3357	1532	1712	3275	0	1679	1802	1532	1572	1802	1459
Flt Permitted	0.950			0.950			0.755			0.750		
Satd. Flow (perm)	1567	3357	1485	1711	3275	0	1327	1802	1506	1235	1802	1435
Right Turn on Red			Yes			Yes			Yes			Yes
Satd. Flow (RTOR)			82		16				101			79
Link Speed (k/h)		60			60			40			40	
Link Distance (m)		310.7			66.2			81.0			107.6	
Travel Time (s)		18.6			4.0			7.3			9.7	
Confl. Peds. (#/hr)	5		4	4		5	4		4	4		4
Peak Hour Factor	1.00	1.00	1.00	1.00	1.00	1.00	1.00	1.00	1.00	1.00	1.00	1.00
Heavy Vehicles (%)	10%	3%	1%	1%	3%	8%	3%	1%	1%	10%	1%	6%
Adj. Flow (vph)	42	1889	27	14	657	83	33	11	101	31	4	52
Shared Lane Traffic (%)												
Lane Group Flow (vph)	42	1889	27	14	740	0	33	11	101	31	4	52
Enter Blocked Intersection	No	No	No	No	No	No	No	No	No	No	No	No
Lane Alignment	L NA	Left	R NA	L NA	Left	R NA	L NA	L NA	R NA	L NA	Left	R NA
Median Width(m)		3.7			7.4			7.4			7.4	
Link Offset(m)		0.0			0.0			0.0			0.0	
Crosswalk Width(m)		5.0			5.0			5.0			5.0	
Two way Left Turn Lane		Yes										
Headway Factor	1.06	1.06	1.06	1.06	1.06	1.06	1.06	1.06	1.06	1.06	1.06	1.06
Turning Speed (k/h)	24		14	24		14	24		14	24		14
Number of Detectors	1	2	1	1	2		1	2	1	1	2	1
Detector Template	Left	Thru	Right	Left	Thru		Left	Thru	Right	Left	Thru	Right
Leading Detector (m)	6.1	30.5	6.1	6.1	30.5		6.1	30.5	6.1	6.1	30.5	6.1
Trailing Detector (m)	0.0	0.0	0.0	0.0	0.0		0.0	0.0	0.0	0.0	0.0	0.0
Detector 1 Position(m)	0.0	0.0	0.0	0.0	0.0		0.0	0.0	0.0	0.0	0.0	0.0
Detector 1 Size(m)	6.1	1.8	6.1	6.1	1.8		6.1	1.8	6.1	6.1	1.8	6.1
Detector 1 Type	CI+Ex	CI+Ex	CI+Ex	CI+Ex	CI+Ex		CI+Ex	CI+Ex	CI+Ex	CI+Ex	CI+Ex	CI+Ex
Detector 1 Channel												
Detector 1 Extend (s)	0.0	0.0	0.0	0.0	0.0		0.0	0.0	0.0	0.0	0.0	0.0
Detector 1 Queue (s)	0.0	0.0	0.0	0.0	0.0		0.0	0.0	0.0	0.0	0.0	0.0
Detector 1 Delay (s)	0.0	0.0	0.0	0.0	0.0		0.0	0.0	0.0	0.0	0.0	0.0
Detector 2 Position(m)		28.7			28.7			28.7			28.7	
Detector 2 Size(m)		1.8			1.8			1.8			1.8	
Detector 2 Type		CI+Ex			CI+Ex			CI+Ex			CI+Ex	
Detector 2 Channel												
Detector 2 Extend (s)		0.0			0.0			0.0			0.0	
Turn Type	Prot	NA	Perm	Prot	NA		Perm	NA	Perm	Perm	NA	Perm
Protected Phases	5	2		1	6			8			4	
Permitted Phases			2				8		8	4		4
Detector Phase	5	2	2	1	6		8	8	8	4	4	4
Switch Phase												



Lane Group	EBL	EBT	EBR	WBL	WBT	WBR	NBL	NBT	NBR	SBL	SBT	SBR
Minimum Initial (s)	5.0	10.0	10.0	5.0	10.0		10.0	10.0	10.0	10.0	10.0	10.0
Minimum Split (s)	11.1	31.3	31.3	11.1	31.3		37.7	37.7	37.7	37.7	37.7	37.7
Total Split (s)	16.0	75.0	75.0	16.0	75.0		39.0	39.0	39.0	39.0	39.0	39.0
Total Split (%)	12.3%	57.7%	57.7%	12.3%	57.7%		30.0%	30.0%	30.0%	30.0%	30.0%	30.0%
Maximum Green (s)	9.9	68.7	68.7	9.9	68.7		32.3	32.3	32.3	32.3	32.3	32.3
Yellow Time (s)	3.7	3.7	3.7	3.7	3.7		3.0	3.0	3.0	3.0	3.0	3.0
All-Red Time (s)	2.4	2.6	2.6	2.4	2.6		3.7	3.7	3.7	3.7	3.7	3.7
Lost Time Adjust (s)	0.0	0.0	0.0	0.0	0.0		0.0	0.0	0.0	0.0	0.0	0.0
Total Lost Time (s)	6.1	6.3	6.3	6.1	6.3		6.7	6.7	6.7	6.7	6.7	6.7
Lead/Lag	Lead	Lag	Lag	Lead	Lag							
Lead-Lag Optimize?	Yes	Yes	Yes	Yes	Yes							
Vehicle Extension (s)	3.0	3.0	3.0	3.0	3.0		3.0	3.0	3.0	3.0	3.0	3.0
Recall Mode	None	C-Max	C-Max	None	C-Max		None	None	None	None	None	None
Walk Time (s)		7.0	7.0		7.0		12.0	12.0	12.0	12.0	12.0	12.0
Flash Dont Walk (s)		18.0	18.0		18.0		19.0	19.0	19.0	19.0	19.0	19.0
Pedestrian Calls (#/hr)		4	4		5		4	4	4	4	4	4
Act Effct Green (s)	8.6	97.2	97.2	6.6	90.3		14.2	14.2	14.2	14.2	14.2	14.2
Actuated g/C Ratio	0.07	0.75	0.75	0.05	0.69		0.11	0.11	0.11	0.11	0.11	0.11
v/c Ratio	0.40	0.75	0.02	0.16	0.32		0.23	0.06	0.40	0.23	0.02	0.23
Control Delay	80.4	8.8	0.1	71.6	7.3		53.3	47.6	13.0	53.6	46.2	5.6
Queue Delay	0.0	0.0	0.0	0.0	0.0		0.0	0.0	0.0	0.0	0.0	0.0
Total Delay	80.4	8.8	0.1	71.6	7.3		53.3	47.6	13.0	53.6	46.2	5.6
LOS	F	A	A	E	A		D	D	B	D	D	A
Approach Delay		10.2			8.5			24.8			24.6	
Approach LOS		B			A			C			C	
Queue Length 50th (m)	9.9	11.9	0.0	3.4	25.1		7.5	2.5	0.0	7.1	0.9	0.0
Queue Length 95th (m)	m12.8	#288.6	m0.0	m10.0	30.6		14.4	6.7	12.9	13.6	3.5	4.4
Internal Link Dist (m)		286.7			42.2			57.0			83.6	
Turn Bay Length (m)	85.0		40.0						30.0	45.0		75.0
Base Capacity (vph)	123	2510	1131	130	2280		329	447	450	306	447	415
Starvation Cap Reductn	0	0	0	0	0		0	0	0	0	0	0
Spillback Cap Reductn	0	0	0	0	0		0	0	0	0	0	0
Storage Cap Reductn	0	0	0	0	0		0	0	0	0	0	0
Reduced v/c Ratio	0.34	0.75	0.02	0.11	0.32		0.10	0.02	0.22	0.10	0.01	0.13

Intersection Summary

Area Type: Other  
 Cycle Length: 130  
 Actuated Cycle Length: 130  
 Offset: 36 (28%), Referenced to phase 2:EBT and 6:WBT, Start of Green  
 Natural Cycle: 125  
 Control Type: Actuated-Coordinated  
 Maximum v/c Ratio: 0.75  
 Intersection Signal Delay: 10.9 Intersection LOS: B  
 Intersection Capacity Utilization 90.4% ICU Level of Service E  
 Analysis Period (min) 15  
 # 95th percentile volume exceeds capacity, queue may be longer.  
 Queue shown is maximum after two cycles.  
 m Volume for 95th percentile queue is metered by upstream signal.

Splits and Phases: 2: Lynhar Road/Stafford Road & Robertson Road

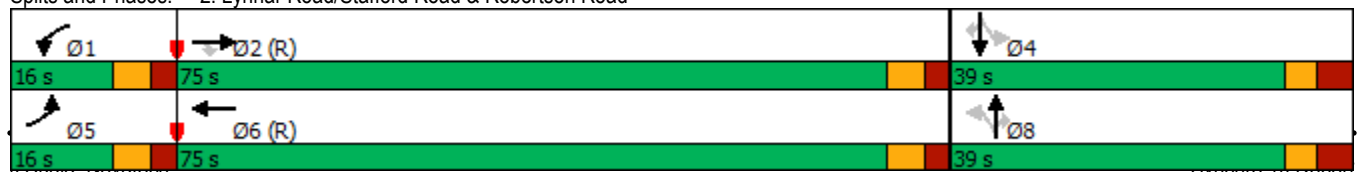

3: Northside Road East & Robertson Road  
AM Peak Hour

1826 Robertson Road  
2024 Background Traffic















Lane Group	EBL	EBT	EBR	WBL	WBT	WBR	NBL	NBT	NBR	SBL	SBT	SBR
Lane Configurations												
Traffic Volume (vph)	23	1781	12	40	621	67	95	24	38	34	8	9
Future Volume (vph)	23	1781	12	40	621	67	95	24	38	34	8	9
Ideal Flow (vphpl)	1800	1800	1800	1800	1800	1800	1800	1800	1800	1800	1800	1800
Storage Length (m)	55.0		0.0	75.0		80.0	0.0		0.0	0.0		0.0
Storage Lanes	1		0	1		1	1		0	1		1
Taper Length (m)	30.0			15.0			10.0			10.0		
Lane Util. Factor	1.00	0.95	0.95	1.00	0.95	1.00	1.00	1.00	1.00	1.00	1.00	1.00
Ped Bike Factor	1.00	1.00				0.96	0.99	0.99		0.99		0.98
Frt		0.999				0.850		0.908				0.850
Flt Protected	0.950			0.950			0.950			0.950		
Satd. Flow (prot)	1712	3354	0	1647	3325	1532	1679	1517	0	1679	1802	1532
Flt Permitted	0.381			0.107			0.752			0.717		
Satd. Flow (perm)	684	3354	0	185	3325	1475	1322	1517	0	1259	1802	1506
Right Turn on Red			Yes			Yes			Yes			Yes
Satd. Flow (RTOR)		1				99		38				93
Link Speed (k/h)		60			60			40			40	
Link Distance (m)		105.4			310.9			87.0			90.9	
Travel Time (s)		6.3			18.7			7.8			8.2	
Confl. Peds. (#/hr)	5		3	3		5	3		4	4		3
Confl. Bikes (#/hr)			5			6			3			
Peak Hour Factor	1.00	1.00	1.00	1.00	1.00	1.00	1.00	1.00	1.00	1.00	1.00	1.00
Heavy Vehicles (%)	1%	3%	1%	5%	4%	1%	3%	5%	9%	3%	1%	1%
Adj. Flow (vph)	23	1781	12	40	621	67	95	24	38	34	8	9
Shared Lane Traffic (%)												
Lane Group Flow (vph)	23	1793	0	40	621	67	95	62	0	34	8	9
Enter Blocked Intersection	No	No	No	No	No	No	No	No	No	No	No	No
Lane Alignment	L NA	Left	R NA	L NA	Left	R NA	L NA	Left	R NA	L NA	Left	R NA
Median Width(m)		5.5			5.5			3.7			3.7	
Link Offset(m)		0.0			0.0			0.0			0.0	
Crosswalk Width(m)		5.0			5.0			5.0			5.0	
Two way Left Turn Lane												
Headway Factor	1.06	1.06	1.06	1.06	1.06	1.06	1.06	1.06	1.06	1.06	1.06	1.06
Turning Speed (k/h)	24		14	24		14	24		14	24		14
Number of Detectors	1	2		1	2		1	1	2		1	2
Detector Template	Left	Thru		Left	Thru	Right	Left	Thru		Left	Thru	Right
Leading Detector (m)	6.1	30.5		6.1	30.5	6.1	6.1	30.5		6.1	30.5	6.1
Trailing Detector (m)	0.0	0.0		0.0	0.0	0.0	0.0	0.0		0.0	0.0	0.0
Detector 1 Position(m)	0.0	0.0		0.0	0.0	0.0	0.0	0.0		0.0	0.0	0.0
Detector 1 Size(m)	6.1	1.8		6.1	1.8	6.1	6.1	1.8		6.1	1.8	6.1
Detector 1 Type	Cl+Ex	Cl+Ex		Cl+Ex	Cl+Ex	Cl+Ex	Cl+Ex	Cl+Ex		Cl+Ex	Cl+Ex	Cl+Ex
Detector 1 Channel												
Detector 1 Extend (s)	0.0	0.0		0.0	0.0	0.0	0.0	0.0		0.0	0.0	0.0
Detector 1 Queue (s)	0.0	0.0		0.0	0.0	0.0	0.0	0.0		0.0	0.0	0.0
Detector 1 Delay (s)	0.0	0.0		0.0	0.0	0.0	0.0	0.0		0.0	0.0	0.0
Detector 2 Position(m)		28.7			28.7			28.7			28.7	
Detector 2 Size(m)		1.8			1.8			1.8			1.8	
Detector 2 Type		Cl+Ex			Cl+Ex			Cl+Ex			Cl+Ex	
Detector 2 Channel												
Detector 2 Extend (s)		0.0			0.0			0.0			0.0	
Turn Type	pm+pt	NA		Perm	NA	Perm	Perm	NA		Perm	NA	Perm
Protected Phases	5	2			6			8			4	
Permitted Phases	2			6		6	8			4		4
Detector Phase	5	2		6	6	6	8	8		4	4	4

Lane Group	Ø3	Ø7
Lane Configurations		
Traffic Volume (vph)		
Future Volume (vph)		
Ideal Flow (vphpl)		
Storage Length (m)		
Storage Lanes		
Taper Length (m)		
Lane Util. Factor		
Ped Bike Factor		
Frt		
Flt Protected		
Satd. Flow (prot)		
Flt Permitted		
Satd. Flow (perm)		
Right Turn on Red		
Satd. Flow (RTOR)		
Link Speed (k/h)		
Link Distance (m)		
Travel Time (s)		
Confl. Peds. (#/hr)		
Confl. Bikes (#/hr)		
Peak Hour Factor		
Heavy Vehicles (%)		
Adj. Flow (vph)		
Shared Lane Traffic (%)		
Lane Group Flow (vph)		
Enter Blocked Intersection		
Lane Alignment		
Median Width(m)		
Link Offset(m)		
Crosswalk Width(m)		
Two way Left Turn Lane		
Headway Factor		
Turning Speed (k/h)		
Number of Detectors		
Detector Template		
Leading Detector (m)		
Trailing Detector (m)		
Detector 1 Position(m)		
Detector 1 Size(m)		
Detector 1 Type		
Detector 1 Channel		
Detector 1 Extend (s)		
Detector 1 Queue (s)		
Detector 1 Delay (s)		
Detector 2 Position(m)		
Detector 2 Size(m)		
Detector 2 Type		
Detector 2 Channel		
Detector 2 Extend (s)		
Turn Type		
Protected Phases	3	7
Permitted Phases		
Detector Phase		



3: Northside Road East & Robertson Road  
AM Peak Hour

1826 Robertson Road  
2024 Background Traffic

												
Lane Group	EBL	EBT	EBR	WBL	WBT	WBR	NBL	NBT	NBR	SBL	SBT	SBR
Switch Phase												
Minimum Initial (s)	5.0	10.0		10.0	10.0	10.0	10.0	10.0		10.0	10.0	10.0
Minimum Split (s)	11.0	30.1		30.1	30.1	30.1	29.8	29.8		29.8	29.8	29.8
Total Split (s)	16.0	94.0		78.0	78.0	78.0	30.0	30.0		30.0	30.0	30.0
Total Split (%)	12.3%	72.3%		60.0%	60.0%	60.0%	23.1%	23.1%		23.1%	23.1%	23.1%
Maximum Green (s)	10.0	87.9		71.9	71.9	71.9	23.2	23.2		23.2	23.2	23.2
Yellow Time (s)	3.7	3.7		3.7	3.7	3.7	3.0	3.0		3.0	3.0	3.0
All-Red Time (s)	2.3	2.4		2.4	2.4	2.4	3.8	3.8		3.8	3.8	3.8
Lost Time Adjust (s)	0.0	0.0		0.0	0.0	0.0	0.0	0.0		0.0	0.0	0.0
Total Lost Time (s)	6.0	6.1		6.1	6.1	6.1	6.8	6.8		6.8	6.8	6.8
Lead/Lag	Lead			Lag	Lag	Lag	Lag	Lag		Lag	Lag	Lag
Lead-Lag Optimize?	Yes			Yes	Yes	Yes	Yes	Yes		Yes	Yes	Yes
Vehicle Extension (s)	3.0	3.0		3.0	3.0	3.0	3.0	3.0		3.0	3.0	3.0
Recall Mode	None	C-Max		C-Max	C-Max	C-Max	None	None		None	None	None
Walk Time (s)		7.0		7.0	7.0	7.0	1.0	1.0		1.0	1.0	1.0
Flash Dont Walk (s)		17.0		17.0	17.0	17.0	22.0	22.0		22.0	22.0	22.0
Pedestrian Calls (#/hr)		3		5	5	5	4	4		3	3	3
Act Effct Green (s)	101.8	101.7		94.4	94.4	94.4	15.4	15.4		15.4	15.4	15.4
Actuated g/C Ratio	0.78	0.78		0.73	0.73	0.73	0.12	0.12		0.12	0.12	0.12
v/c Ratio	0.04	0.68		0.30	0.26	0.06	0.61	0.29		0.23	0.04	0.03
Control Delay	3.4	5.2		16.9	7.5	0.7	70.0	26.9		53.4	47.6	0.2
Queue Delay	0.0	0.1		0.0	0.0	0.0	0.0	0.0		0.0	0.0	0.0
Total Delay	3.4	5.2		16.9	7.5	0.7	70.0	26.9		53.4	47.6	0.2
LOS	A	A		B	A	A	E	C		D	D	A
Approach Delay		5.2			7.4			52.9			43.1	
Approach LOS		A			A			D			D	
Queue Length 50th (m)	0.6	24.0		3.3	26.0	0.0	21.8	5.2		7.4	1.7	0.0
Queue Length 95th (m)	m1.5	46.8		13.3	42.3	2.1	36.0	16.4		15.9	5.8	0.0
Internal Link Dist (m)		81.4			286.9			63.0			66.9	
Turn Bay Length (m)	55.0			75.0		80.0						
Base Capacity (vph)	614	2625		134	2415	1098	235	301		224	321	345
Starvation Cap Reductn	0	77		0	0	0	0	0		0	0	0
Spillback Cap Reductn	0	0		0	0	0	0	0		0	0	0
Storage Cap Reductn	0	0		0	0	0	0	0		0	0	0
Reduced v/c Ratio	0.04	0.70		0.30	0.26	0.06	0.40	0.21		0.15	0.02	0.03

Intersection Summary

Area Type: Other  
 Cycle Length: 130  
 Actuated Cycle Length: 130  
 Offset: 37 (28%), Referenced to phase 2:EBTL and 6:WBTL, Start of Green  
 Natural Cycle: 90  
 Control Type: Actuated-Coordinated  
 Maximum v/c Ratio: 0.68  
 Intersection Signal Delay: 9.2 Intersection LOS: A  
 Intersection Capacity Utilization 76.2% ICU Level of Service D  
 Analysis Period (min) 15  
 m Volume for 95th percentile queue is metered by upstream signal.

Splits and Phases: 3: Northside Road East & Robertson Road

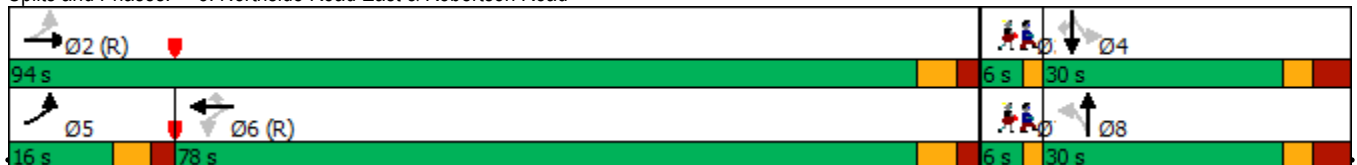

Lane Group	Ø3	Ø7
Switch Phase		
Minimum Initial (s)	4.0	4.0
Minimum Split (s)	6.0	6.0
Total Split (s)	6.0	6.0
Total Split (%)	5%	5%
Maximum Green (s)	4.0	4.0
Yellow Time (s)	2.0	2.0
All-Red Time (s)	0.0	0.0
Lost Time Adjust (s)		
Total Lost Time (s)		
Lead/Lag	Lead	Lead
Lead-Lag Optimize?	Yes	Yes
Vehicle Extension (s)	3.0	3.0
Recall Mode	None	None
Walk Time (s)		
Flash Dont Walk (s)		
Pedestrian Calls (#/hr)		
Act Effct Green (s)		
Actuated g/C Ratio		
v/c Ratio		
Control Delay		
Queue Delay		
Total Delay		
LOS		
Approach Delay		
Approach LOS		
Queue Length 50th (m)		
Queue Length 95th (m)		
Internal Link Dist (m)		
Turn Bay Length (m)		
Base Capacity (vph)		
Starvation Cap Reductn		
Spillback Cap Reductn		
Storage Cap Reductn		
Reduced v/c Ratio		
Intersection Summary		

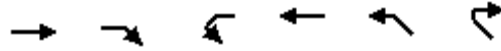

Lane Group	EBT	EBR	WBL	WBT	NWL	NWR
Lane Configurations	↑↑			↑↑↑		
Traffic Volume (vph)	1913	108	0	755	0	0
Future Volume (vph)	1913	108	0	755	0	0
Ideal Flow (vphpl)	1800	1800	1800	1800	1800	1800
Storage Length (m)		0.0	25.0		0.0	0.0
Storage Lanes		0	1		0	0
Taper Length (m)			25.0		10.0	
Lane Util. Factor	0.95	0.95	1.00	0.91	1.00	1.00
Flt	0.992					
Flt Protected						
Satd. Flow (prot)	3356	0	0	4871	0	0
Flt Permitted						
Satd. Flow (perm)	3356	0	0	4871	0	0
Link Speed (k/h)	60			60	50	
Link Distance (m)	66.2			72.0	100.3	
Travel Time (s)	4.0			4.3	7.2	
Peak Hour Factor	1.00	1.00	1.00	1.00	1.00	1.00
Heavy Vehicles (%)	2%	6%	1%	2%	1%	1%
Adj. Flow (vph)	1913	108	0	755	0	0
Shared Lane Traffic (%)						
Lane Group Flow (vph)	2021	0	0	755	0	0
Enter Blocked Intersection	Yes	Yes	Yes	Yes	No	No
Lane Alignment	Left	Right	Left	Left	Left	Right
Median Width(m)	3.7			3.7	0.0	
Link Offset(m)	0.0			0.0	0.0	
Crosswalk Width(m)	0.0			0.0	0.0	
Two way Left Turn Lane						
Headway Factor	1.06	1.06	1.06	1.06	1.06	1.06
Turning Speed (k/h)		50	24		24	14
Sign Control	Free			Free	Free	

**Intersection Summary**

Area Type: Other

Control Type: Unsignalized











Intersection Capacity Utilization 62.8% ICU Level of Service B









Analysis Period (min) 15



Lane Group	EBT	EBR	WBL	WBT	NBL	NBR
Lane Configurations						
Traffic Volume (vph)	100	8	51	0	0	26
Future Volume (vph)	100	8	51	0	0	26
Ideal Flow (vphpl)	1800	1800	1800	1800	1800	1800
Lane Util. Factor	1.00	1.00	1.00	1.00	1.00	1.00
Ped Bike Factor						
Frt	0.990					0.865
Flt Protected			0.950			
Satd. Flow (prot)	1706	0	1572	0	0	1458
Flt Permitted			0.950			
Satd. Flow (perm)	1706	0	1572	0	0	1458
Link Speed (k/h)	50			40	40	
Link Distance (m)	100.3			62.0	54.2	
Travel Time (s)	7.2			5.6	4.9	
Confl. Peds. (#/hr)		17	17			
Peak Hour Factor	1.00	1.00	1.00	1.00	1.00	1.00
Heavy Vehicles (%)	6%	1%	10%	1%	1%	8%
Adj. Flow (vph)	100	8	51	0	0	26
Shared Lane Traffic (%)						
Lane Group Flow (vph)	108	0	51	0	0	26
Enter Blocked Intersection	No	No	No	No	No	No
Lane Alignment	L NA	R NA	L NA	R NA	Left	R NA
Median Width(m)	3.7			3.7	0.0	
Link Offset(m)	3.0			3.0	0.0	
Crosswalk Width(m)	5.0			5.0	5.0	
Two way Left Turn Lane						
Headway Factor	1.06	1.06	1.06	1.06	1.06	1.06
Turning Speed (k/h)		14	24		24	14
Sign Control	Stop			Stop	Stop	

Intersection Summary	
Area Type:	Other
Control Type:	Unsignalized
Intersection Capacity Utilization 19.3%	ICU Level of Service A
Analysis Period (min)	15

						
Lane Group	WBL	WBR	NBT	NBR	SBL	SBT
Lane Configurations						
Traffic Volume (vph)	1	10	135	2	18	27
Future Volume (vph)	1	10	135	2	18	27
Ideal Flow (vphpl)	1800	1800	1800	1800	1800	1800
Storage Length (m)	0.0	0.0		45.0	15.0	
Storage Lanes	1	0		0	1	
Taper Length (m)	10.0				20.0	
Lane Util. Factor	1.00	1.00	0.95	0.95	1.00	1.00
Frt	0.877		0.998			
Flt Protected	0.995				0.950	
Satd. Flow (prot)	1572	0	3384	0	1712	1784
Flt Permitted	0.995				0.950	
Satd. Flow (perm)	1572	0	3384	0	1712	1784
Link Speed (k/h)	40		40		40	
Link Distance (m)	173.4		68.2		81.0	
Travel Time (s)	15.6		6.1		7.3	
Peak Hour Factor	1.00	1.00	1.00	1.00	1.00	1.00
Heavy Vehicles (%)	1%	1%	2%	1%	1%	2%
Adj. Flow (vph)	1	10	135	2	18	27
Shared Lane Traffic (%)						
Lane Group Flow (vph)	11	0	137	0	18	27
Enter Blocked Intersection	No	No	No	No	No	No
Lane Alignment	Left	Right	Left	Right	Left	Left
Median Width(m)	3.7		3.7		3.7	
Link Offset(m)	0.0		0.0		0.0	
Crosswalk Width(m)	5.0		5.0		5.0	
Two way Left Turn Lane						
Headway Factor	1.06	1.06	1.06	1.06	1.06	1.06
Turning Speed (k/h)	24	14		14	24	
Sign Control	Stop		Free			Free
<b>Intersection Summary</b>						
Area Type:	Other					
Control Type:	Unsignalized					
Intersection Capacity Utilization 20.7%	ICU Level of Service A					
Analysis Period (min) 15						

						
Lane Group	WBL	WBR	NBT	NBR	SBL	SBT
Lane Configurations						
Traffic Volume (vph)	1	4	133	0	5	23
Future Volume (vph)	1	4	133	0	5	23
Ideal Flow (vphpl)	1800	1800	1800	1800	1800	1800
Lane Util. Factor	1.00	1.00	1.00	1.00	1.00	1.00
Frt	0.892					
Flt Protected	0.990					
Satd. Flow (prot)	1591	0	1784	0	0	1771
Flt Permitted	0.990					
Satd. Flow (perm)	1591	0	1784	0	0	1771
Link Speed (k/h)	50		50		50	
Link Distance (m)	178.0		82.4		68.2	
Travel Time (s)	12.8		5.9		4.9	
Peak Hour Factor	1.00	1.00	1.00	1.00	1.00	1.00
Heavy Vehicles (%)	1%	1%	2%	1%	1%	2%
Adj. Flow (vph)	1	4	133	0	5	23
Shared Lane Traffic (%)						
Lane Group Flow (vph)	5	0	133	0	0	28
Enter Blocked Intersection	No	No	No	No	No	No
Lane Alignment	L NA	R NA	Left	Right	Left	Left
Median Width(m)	3.7		0.0		0.0	
Link Offset(m)	0.0		0.0		0.0	
Crosswalk Width(m)	5.0		5.0		5.0	
Two way Left Turn Lane						
Headway Factor	1.06	1.06	1.06	1.06	1.06	1.06
Turning Speed (k/h)	97	97		97	97	
Sign Control	Stop		Free		Free	
<b>Intersection Summary</b>						
Area Type:	Other					
Control Type:	Unsignalized					
Intersection Capacity Utilization	17.4%			ICU Level of Service A		
Analysis Period (min)	15					



Lane Group	EBL	EBR	NBL	NBT	SBT	SBR
Lane Configurations						
Traffic Volume (vph)	10	0	0	16	43	16
Future Volume (vph)	10	0	0	16	43	16
Ideal Flow (vphpl)	1800	1800	1800	1800	1800	1800
Lane Util. Factor	1.00	1.00	1.00	1.00	1.00	1.00
Frt					0.963	
Frt Protected	0.950					
Satd. Flow (prot)	1712	0	0	1802	1735	0
Frt Permitted	0.950					
Satd. Flow (perm)	1712	0	0	1802	1735	0
Link Speed (k/h)	40			40	40	
Link Distance (m)	173.4			67.2	54.2	
Travel Time (s)	15.6			6.0	4.9	
Peak Hour Factor	1.00	1.00	1.00	1.00	1.00	1.00
Heavy Vehicles (%)	1%	1%	1%	1%	1%	1%
Adj. Flow (vph)	10	0	0	16	43	16
Shared Lane Traffic (%)						
Lane Group Flow (vph)	10	0	0	16	59	0
Enter Blocked Intersection	No	No	No	No	No	No
Lane Alignment	Left	Right	Left	Left	Left	Right
Median Width(m)	3.7			0.0	0.0	
Link Offset(m)	0.0			0.0	0.0	
Crosswalk Width(m)	5.0			5.0	5.0	
Two way Left Turn Lane						
Headway Factor	1.06	1.06	1.06	1.06	1.06	1.06
Turning Speed (k/h)	24	14	24			14
Sign Control	Stop			Free	Free	

**Intersection Summary**

Area Type:	Other
Control Type:	Unsignalized
Intersection Capacity Utilization	13.4%
Analysis Period (min)	15
	ICU Level of Service A



Lane Group	EBL	EBR	NBL	NBT	SBT	SBR
Lane Configurations						
Traffic Volume (vph)	3	0	0	13	38	5
Future Volume (vph)	3	0	0	13	38	5
Ideal Flow (vphpl)	1800	1800	1800	1800	1800	1800
Lane Util. Factor	1.00	1.00	1.00	1.00	1.00	1.00
Frt					0.984	
Flt Protected	0.950					
Satd. Flow (prot)	1712	0	0	1802	1773	0
Flt Permitted	0.950					
Satd. Flow (perm)	1712	0	0	1802	1773	0
Link Speed (k/h)	50			50	50	
Link Distance (m)	178.0			106.1	67.2	
Travel Time (s)	12.8			7.6	4.8	
Peak Hour Factor	1.00	1.00	1.00	1.00	1.00	1.00
Heavy Vehicles (%)	1%	1%	1%	1%	1%	1%
Adj. Flow (vph)	3	0	0	13	38	5
Shared Lane Traffic (%)						
Lane Group Flow (vph)	3	0	0	13	43	0
Enter Blocked Intersection	No	No	No	No	No	No
Lane Alignment	L NA	R NA	Left	Left	Left	Right
Median Width(m)	3.7			0.0	0.0	
Link Offset(m)	0.0			0.0	0.0	
Crosswalk Width(m)	5.0			5.0	5.0	
Two way Left Turn Lane						
Headway Factor	1.06	1.06	1.06	1.06	1.06	1.06
Turning Speed (k/h)	97	97	97			97
Sign Control	Stop			Free	Free	

**Intersection Summary**

Area Type:	Other
Control Type:	Unsignalized
Intersection Capacity Utilization	13.3%
ICU Level of Service	A
Analysis Period (min)	15



1: Stinson Avenue & Robertson Road  
PM Peak Hour

1826 Robertson Road  
2024 Background Traffic

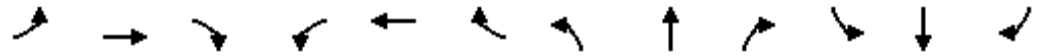

Lane Group	EBL	EBT	EBR	WBL	WBT	WBR	NBL	NBT	NBR	SBL	SBT	SBR
Lane Configurations												
Traffic Volume (vph)	16	1093	25	41	1359	5	12	1	25	20	1	46
Future Volume (vph)	16	1093	25	41	1359	5	12	1	25	20	1	46
Ideal Flow (vphpl)	1800	1800	1800	1800	1800	1800	1800	1800	1800	1800	1800	1800
Storage Length (m)	75.0		0.0	45.0		0.0	0.0		0.0	0.0		0.0
Storage Lanes	1		0	1		0	0		0	0		0
Taper Length (m)	10.0			10.0			10.0			10.0		
Lane Util. Factor	1.00	0.95	0.95	1.00	0.95	0.95	1.00	1.00	1.00	1.00	1.00	1.00
Ped Bike Factor	1.00	1.00		0.99	1.00			0.98			0.98	
Frt		0.997			0.999			0.911			0.907	
Flt Protected	0.950			0.950				0.984			0.985	
Satd. Flow (prot)	1647	3344	0	1712	3353	0	0	1588	0	0	1547	0
Flt Permitted	0.179			0.240				0.899			0.886	
Satd. Flow (perm)	309	3344	0	430	3353	0	0	1447	0	0	1386	0
Right Turn on Red			Yes			Yes			Yes			Yes
Satd. Flow (RTOR)		4			1			25			46	
Link Speed (k/h)		60			60			40			40	
Link Distance (m)		198.0			310.7			254.0			246.4	
Travel Time (s)		11.9			18.6			22.9			22.2	
Confl. Peds. (#/hr)	17		14	14		17	5		10	10		5
Peak Hour Factor	1.00	1.00	1.00	1.00	1.00	1.00	1.00	1.00	1.00	1.00	1.00	1.00
Heavy Vehicles (%)	5%	3%	1%	1%	3%	1%	1%	1%	1%	1%	1%	5%
Adj. Flow (vph)	16	1093	25	41	1359	5	12	1	25	20	1	46
Shared Lane Traffic (%)												
Lane Group Flow (vph)	16	1118	0	41	1364	0	0	38	0	0	67	0
Enter Blocked Intersection	No	No	No	No	No	No	No	No	No	No	No	No
Lane Alignment	L NA	Left	R NA	L NA	Left	R NA	L NA	Left	R NA	L NA	Left	R NA
Median Width(m)		3.7			3.7			0.0			0.0	
Link Offset(m)		0.0			0.0			0.0			0.0	
Crosswalk Width(m)		5.0			5.0			5.0			5.0	
Two way Left Turn Lane		Yes			Yes							
Headway Factor	1.06	1.06	1.06	1.06	1.06	1.06	1.06	1.06	1.06	1.06	1.06	1.06
Turning Speed (k/h)	24		14	24		14	24		14	24		14
Number of Detectors	1	2		1	2		1	2		1	2	
Detector Template	Left	Thru		Left	Thru		Left	Thru		Left	Thru	
Leading Detector (m)	6.1	30.5		6.1	30.5		6.1	30.5		6.1	30.5	
Trailing Detector (m)	0.0	0.0		0.0	0.0		0.0	0.0		0.0	0.0	
Detector 1 Position(m)	0.0	0.0		0.0	0.0		0.0	0.0		0.0	0.0	
Detector 1 Size(m)	6.1	1.8		6.1	1.8		6.1	1.8		6.1	1.8	
Detector 1 Type	Cl+Ex	Cl+Ex		Cl+Ex	Cl+Ex		Cl+Ex	Cl+Ex		Cl+Ex	Cl+Ex	
Detector 1 Channel												
Detector 1 Extend (s)	0.0	0.0		0.0	0.0		0.0	0.0		0.0	0.0	
Detector 1 Queue (s)	0.0	0.0		0.0	0.0		0.0	0.0		0.0	0.0	
Detector 1 Delay (s)	0.0	0.0		0.0	0.0		0.0	0.0		0.0	0.0	
Detector 2 Position(m)		28.7			28.7			28.7			28.7	
Detector 2 Size(m)		1.8			1.8			1.8			1.8	
Detector 2 Type		Cl+Ex			Cl+Ex			Cl+Ex			Cl+Ex	
Detector 2 Channel												
Detector 2 Extend (s)		0.0			0.0			0.0			0.0	
Turn Type	Perm	NA		Perm	NA		Perm	NA		Perm	NA	
Protected Phases		2			6			8			4	
Permitted Phases	2			6			8			4		
Detector Phase	2	2		6	6		8	8		4	4	
Switch Phase												



Lane Group	EBL	EBT	EBR	WBL	WBT	WBR	NBL	NBT	NBR	SBL	SBT	SBR
Minimum Initial (s)	10.0	10.0		10.0	10.0		10.0	10.0		10.0	10.0	
Minimum Split (s)	26.8	26.8		26.8	26.8		31.6	31.6		31.6	31.6	
Total Split (s)	88.0	88.0		88.0	88.0		32.0	32.0		32.0	32.0	
Total Split (%)	73.3%	73.3%		73.3%	73.3%		26.7%	26.7%		26.7%	26.7%	
Maximum Green (s)	82.2	82.2		82.2	82.2		25.4	25.4		25.4	25.4	
Yellow Time (s)	3.7	3.7		3.7	3.7		3.0	3.0		3.0	3.0	
All-Red Time (s)	2.1	2.1		2.1	2.1		3.6	3.6		3.6	3.6	
Lost Time Adjust (s)	0.0	0.0		0.0	0.0			0.0			0.0	
Total Lost Time (s)	5.8	5.8		5.8	5.8			6.6			6.6	
Lead/Lag												
Lead-Lag Optimize?												
Vehicle Extension (s)	3.0	3.0		3.0	3.0		3.0	3.0		3.0	3.0	
Recall Mode	C-Max	C-Max		C-Max	C-Max		None	None		None	None	
Walk Time (s)	7.0	7.0		7.0	7.0		7.0	7.0		7.0	7.0	
Flash Dont Walk (s)	14.0	14.0		14.0	14.0		18.0	18.0		18.0	18.0	
Pedestrian Calls (#/hr)	14	14		17	17		10	10		5	5	
Act Effct Green (s)	99.1	99.1		99.1	99.1			13.0			13.0	
Actuated g/C Ratio	0.83	0.83		0.83	0.83			0.11			0.11	
v/c Ratio	0.06	0.40		0.12	0.49			0.21			0.35	
Control Delay	4.9	4.7		1.4	3.2			25.5			24.5	
Queue Delay	0.0	0.0		0.0	0.0			0.0			0.0	
Total Delay	4.9	4.7		1.4	3.2			25.5			24.5	
LOS	A	A		A	A			C			C	
Approach Delay		4.7			3.1			25.5			24.5	
Approach LOS		A			A			C			C	
Queue Length 50th (m)	0.6	28.1		0.3	5.1			2.7			4.3	
Queue Length 95th (m)	3.4	66.3		m0.6	79.2			10.8			14.9	
Internal Link Dist (m)		174.0			286.7			230.0			222.4	
Turn Bay Length (m)	75.0			45.0								
Base Capacity (vph)	255	2761		354	2768			325			329	
Starvation Cap Reductn	0	0		0	0			0			0	
Spillback Cap Reductn	0	0		0	0			0			0	
Storage Cap Reductn	0	0		0	0			0			0	
Reduced v/c Ratio	0.06	0.40		0.12	0.49			0.12			0.20	

Intersection Summary

Area Type: Other  
 Cycle Length: 120  
 Actuated Cycle Length: 120  
 Offset: 31 (26%), Referenced to phase 2:EBTL and 6:WBTL, Start of Green  
 Natural Cycle: 70  
 Control Type: Actuated-Coordinated  
 Maximum v/c Ratio: 0.49  
 Intersection Signal Delay: 4.7  
 Intersection LOS: A  
 Intersection Capacity Utilization 62.0%  
 ICU Level of Service B  
 Analysis Period (min) 15  
 m Volume for 95th percentile queue is metered by upstream signal.

Splits and Phases: 1: Stinson Avenue & Robertson Road

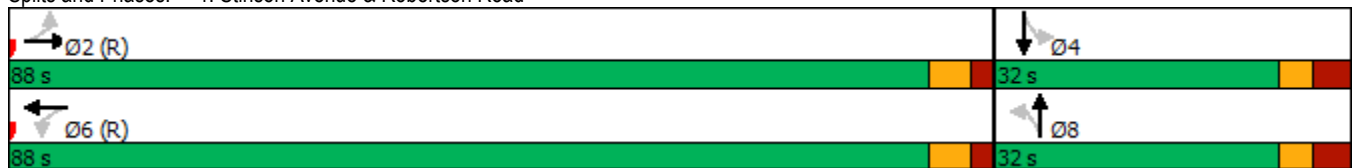

2: Lynhar Road/Stafford Road & Robertson Road  
PM Peak Hour

1826 Robertson Road  
2024 Background Traffic

Lane Group	EBL	EBT	EBR	WBL	WBT	WBR	NBL	NBT	NBR	SBL	SBT	SBR
Lane Configurations												
Traffic Volume (vph)	125	930	60	58	1083	77	92	41	80	201	36	173
Future Volume (vph)	125	930	60	58	1083	77	92	41	80	201	36	173
Ideal Flow (vphpl)	1800	1800	1800	1800	1800	1800	1800	1800	1800	1800	1800	1800
Storage Length (m)	85.0		40.0	0.0		0.0	0.0		30.0	45.0		75.0
Storage Lanes	1		1	1		0	1		1	1		1
Taper Length (m)	10.0			10.0			10.0			30.0		
Lane Util. Factor	1.00	0.95	1.00	1.00	0.95	0.95	1.00	1.00	1.00	1.00	1.00	1.00
Ped Bike Factor	0.99		0.94	0.99	1.00		0.98		0.95	0.97		0.97
Frt			0.850		0.990				0.850			0.850
Flt Protected	0.950			0.950			0.950			0.950		
Satd. Flow (prot)	1712	3357	1532	1712	3342	0	1631	1767	1502	1695	1802	1532
Flt Permitted	0.950			0.950			0.734			0.629		
Satd. Flow (perm)	1701	3357	1443	1694	3342	0	1241	1767	1434	1087	1802	1488
Right Turn on Red			Yes			Yes			Yes			Yes
Satd. Flow (RTOR)			145		7				142			173
Link Speed (k/h)		60			60			40			40	
Link Distance (m)		310.7			66.2			81.0			107.6	
Travel Time (s)		18.6			4.0			7.3			9.7	
Confl. Peds. (#/hr)	22		16	16		22	14		29	29		14
Confl. Bikes (#/hr)												1
Peak Hour Factor	1.00	1.00	1.00	1.00	1.00	1.00	1.00	1.00	1.00	1.00	1.00	1.00
Heavy Vehicles (%)	1%	3%	1%	1%	2%	4%	6%	3%	3%	2%	1%	1%
Adj. Flow (vph)	125	930	60	58	1083	77	92	41	80	201	36	173
Shared Lane Traffic (%)												
Lane Group Flow (vph)	125	930	60	58	1160	0	92	41	80	201	36	173
Enter Blocked Intersection	No	No	No	No	No	No	No	No	No	No	No	No
Lane Alignment	L NA	Left	R NA	L NA	Left	R NA	L NA	L NA	R NA	L NA	Left	R NA
Median Width(m)		3.7			7.4			7.4			7.4	
Link Offset(m)		0.0			0.0			0.0			0.0	
Crosswalk Width(m)		5.0			5.0			5.0			5.0	
Two way Left Turn Lane		Yes										
Headway Factor	1.06	1.06	1.06	1.06	1.06	1.06	1.06	1.06	1.06	1.06	1.06	1.06
Turning Speed (k/h)	24		14	24		14	24		14	24		14
Number of Detectors	1	2	1	1	2		1	2	1	1	2	1
Detector Template	Left	Thru	Right	Left	Thru		Left	Thru	Right	Left	Thru	Right
Leading Detector (m)	6.1	30.5	6.1	6.1	30.5		6.1	30.5	6.1	6.1	30.5	6.1
Trailing Detector (m)	0.0	0.0	0.0	0.0	0.0		0.0	0.0	0.0	0.0	0.0	0.0
Detector 1 Position(m)	0.0	0.0	0.0	0.0	0.0		0.0	0.0	0.0	0.0	0.0	0.0
Detector 1 Size(m)	6.1	1.8	6.1	6.1	1.8		6.1	1.8	6.1	6.1	1.8	6.1
Detector 1 Type	Cl+Ex	Cl+Ex	Cl+Ex	Cl+Ex	Cl+Ex		Cl+Ex	Cl+Ex	Cl+Ex	Cl+Ex	Cl+Ex	Cl+Ex
Detector 1 Channel												
Detector 1 Extend (s)	0.0	0.0	0.0	0.0	0.0		0.0	0.0	0.0	0.0	0.0	0.0
Detector 1 Queue (s)	0.0	0.0	0.0	0.0	0.0		0.0	0.0	0.0	0.0	0.0	0.0
Detector 1 Delay (s)	0.0	0.0	0.0	0.0	0.0		0.0	0.0	0.0	0.0	0.0	0.0
Detector 2 Position(m)		28.7			28.7			28.7			28.7	
Detector 2 Size(m)		1.8			1.8			1.8			1.8	
Detector 2 Type		Cl+Ex			Cl+Ex			Cl+Ex			Cl+Ex	
Detector 2 Channel												
Detector 2 Extend (s)		0.0			0.0			0.0			0.0	
Turn Type	Prot	NA	Perm	Prot	NA		pm+pt	NA	Perm	pm+pt	NA	Perm
Protected Phases	5	2		1	6		3	8		7	4	
Permitted Phases			2				8		8	4		4
Detector Phase	5	2	2	1	6		3	8	8	7	4	4



Lane Group	EBL	EBT	EBR	WBL	WBT	WBR	NBL	NBT	NBR	SBL	SBT	SBR
Switch Phase												
Minimum Initial (s)	5.0	10.0	10.0	5.0	10.0		5.0	10.0	10.0	5.0	10.0	10.0
Minimum Split (s)	11.1	31.3	31.3	11.1	31.3		11.2	37.7	37.7	11.2	37.7	37.7
Total Split (s)	15.0	54.0	54.0	15.0	54.0		12.0	39.0	39.0	12.0	39.0	39.0
Total Split (%)	12.5%	45.0%	45.0%	12.5%	45.0%		10.0%	32.5%	32.5%	10.0%	32.5%	32.5%
Maximum Green (s)	8.9	47.7	47.7	8.9	47.7		5.8	32.3	32.3	5.8	32.3	32.3
Yellow Time (s)	3.7	3.7	3.7	3.7	3.7		3.0	3.0	3.0	3.0	3.0	3.0
All-Red Time (s)	2.4	2.6	2.6	2.4	2.6		3.2	3.7	3.7	3.2	3.7	3.7
Lost Time Adjust (s)	0.0	0.0	0.0	0.0	0.0		0.0	0.0	0.0	0.0	0.0	0.0
Total Lost Time (s)	6.1	6.3	6.3	6.1	6.3		6.2	6.7	6.7	6.2	6.7	6.7
Lead/Lag	Lead	Lag	Lag	Lead	Lag		Lead	Lag	Lag	Lead	Lag	Lag
Lead-Lag Optimize?	Yes	Yes	Yes	Yes	Yes		Yes	Yes	Yes	Yes	Yes	Yes
Vehicle Extension (s)	3.0	3.0	3.0	3.0	3.0		3.0	3.0	3.0	3.0	3.0	3.0
Recall Mode	None	C-Max	C-Max	None	C-Max		None	None	None	None	None	None
Walk Time (s)		7.0	7.0		7.0			12.0	12.0		12.0	12.0
Flash Dont Walk (s)		18.0	18.0		18.0			19.0	19.0		19.0	19.0
Pedestrian Calls (#/hr)		16	16		22			29	29		14	14
Act Effct Green (s)	12.0	60.0	60.0	8.7	54.3		26.8	22.6	22.6	30.1	22.6	22.6
Actuated g/C Ratio	0.10	0.50	0.50	0.07	0.45		0.22	0.19	0.19	0.25	0.19	0.19
v/c Ratio	0.73	0.55	0.08	0.47	0.77		0.31	0.12	0.21	0.63	0.11	0.41
Control Delay	73.2	29.1	3.3	85.6	23.1		33.5	36.9	1.3	45.2	36.5	8.2
Queue Delay	0.0	0.0	0.0	0.0	0.0		0.0	0.0	0.0	0.0	0.0	0.0
Total Delay	73.2	29.1	3.3	85.6	23.1		33.5	36.9	1.3	45.2	36.5	8.2
LOS	E	C	A	F	C		C	D	A	D	D	A
Approach Delay		32.7			26.0			22.1			28.8	
Approach LOS		C			C			C			C	
Queue Length 50th (m)	27.4	74.2	0.0	12.2	123.1		13.4	6.8	0.0	31.3	5.9	0.0
Queue Length 95th (m)	#59.1	118.3	4.0	m24.4	132.4		24.4	15.1	0.5	49.2	13.7	15.5
Internal Link Dist (m)		286.7			42.2			57.0			83.6	
Turn Bay Length (m)	85.0		40.0						30.0	45.0		75.0
Base Capacity (vph)	171	1677	793	135	1516		295	475	489	319	485	526
Starvation Cap Reductn	0	0	0	0	0		0	0	0	0	0	0
Spillback Cap Reductn	0	0	0	0	0		0	0	0	0	0	0
Storage Cap Reductn	0	0	0	0	0		0	0	0	0	0	0
Reduced v/c Ratio	0.73	0.55	0.08	0.43	0.77		0.31	0.09	0.16	0.63	0.07	0.33

**Intersection Summary**

Area Type: Other

Cycle Length: 120

Actuated Cycle Length: 120

Offset: 7 (6%), Referenced to phase 2:EBT and 6:WBT, Start of Green

Natural Cycle: 105

Control Type: Actuated-Coordinated

Maximum v/c Ratio: 0.77

Intersection Signal Delay: 28.6      Intersection LOS: C

Intersection Capacity Utilization 78.7%      ICU Level of Service D

Analysis Period (min) 15

# 95th percentile volume exceeds capacity, queue may be longer.  
Queue shown is maximum after two cycles.





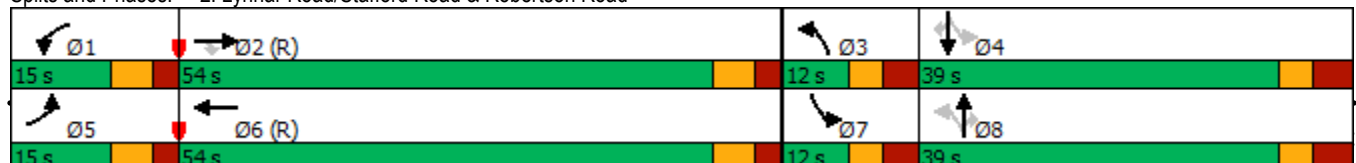

















m Volume for 95th percentile queue is metered by upstream signal.

Splits and Phases: 2: Lynhar Road/Stafford Road & Robertson Road



3: Northside Road East & Robertson Road  
PM Peak Hour

1826 Robertson Road  
2024 Background Traffic

												
Lane Group	EBL	EBT	EBR	WBL	WBT	WBR	NBL	NBT	NBR	SBL	SBT	SBR
Lane Configurations												
Traffic Volume (vph)	66	1075	16	79	1175	220	138	37	106	155	55	78
Future Volume (vph)	66	1075	16	79	1175	220	138	37	106	155	55	78
Ideal Flow (vphpl)	1800	1800	1800	1800	1800	1800	1800	1800	1800	1800	1800	1800
Storage Length (m)	55.0		0.0	75.0		80.0	0.0		0.0	0.0		0.0
Storage Lanes	1		0	1		1	1		0	1		1
Taper Length (m)	30.0			15.0			10.0			10.0		
Lane Util. Factor	1.00	0.95	0.95	1.00	0.95	1.00	1.00	1.00	1.00	1.00	1.00	1.00
Ped Bike Factor		1.00		1.00		0.97	0.98	0.99		0.99		0.96
Frt		0.998				0.850		0.889				0.850
Flt Protected	0.950			0.950			0.950			0.950		
Satd. Flow (prot)	1712	3383	0	1712	3390	1532	1695	1559	0	1712	1802	1532
Flt Permitted	0.167			0.262			0.721			0.615		
Satd. Flow (perm)	301	3383	0	471	3390	1488	1257	1559	0	1101	1802	1469
Right Turn on Red			Yes			Yes			Yes			Yes
Satd. Flow (RTOR)		2				220		106				101
Link Speed (k/h)		60			60			40				40
Link Distance (m)		105.4			310.9			87.0				90.9
Travel Time (s)		6.3			18.7			7.8				8.2
Confl. Peds. (#/hr)	3		7	7		3	16		5	5		16
Confl. Bikes (#/hr)			1			2						4
Peak Hour Factor	1.00	1.00	1.00	1.00	1.00	1.00	1.00	1.00	1.00	1.00	1.00	1.00
Heavy Vehicles (%)	1%	2%	1%	1%	2%	1%	2%	3%	2%	1%	1%	1%
Adj. Flow (vph)	66	1075	16	79	1175	220	138	37	106	155	55	78
Shared Lane Traffic (%)												
Lane Group Flow (vph)	66	1091	0	79	1175	220	138	143	0	155	55	78
Enter Blocked Intersection	No	No	No	No	No	No	No	No	No	No	No	No
Lane Alignment	L NA	Left	R NA	L NA	Left	R NA	L NA	Left	R NA	L NA	Left	R NA
Median Width(m)		5.5			5.5			3.7				3.7
Link Offset(m)		0.0			0.0			0.0				0.0
Crosswalk Width(m)		5.0			5.0			5.0				5.0
Two way Left Turn Lane												
Headway Factor	1.06	1.06	1.06	1.06	1.06	1.06	1.06	1.06	1.06	1.06	1.06	1.06
Turning Speed (k/h)	24		14	24		14	24		14	24		14
Number of Detectors	1	2		1	2	1	1	2		1	2	1
Detector Template	Left	Thru		Left	Thru	Right	Left	Thru		Left	Thru	Right
Leading Detector (m)	6.1	30.5		6.1	30.5	6.1	6.1	30.5		6.1	30.5	6.1
Trailing Detector (m)	0.0	0.0		0.0	0.0	0.0	0.0	0.0		0.0	0.0	0.0
Detector 1 Position(m)	0.0	0.0		0.0	0.0	0.0	0.0	0.0		0.0	0.0	0.0
Detector 1 Size(m)	6.1	1.8		6.1	1.8	6.1	6.1	1.8		6.1	1.8	6.1
Detector 1 Type	Cl+Ex	Cl+Ex		Cl+Ex	Cl+Ex	Cl+Ex	Cl+Ex	Cl+Ex		Cl+Ex	Cl+Ex	Cl+Ex
Detector 1 Channel												
Detector 1 Extend (s)	0.0	0.0		0.0	0.0	0.0	0.0	0.0		0.0	0.0	0.0
Detector 1 Queue (s)	0.0	0.0		0.0	0.0	0.0	0.0	0.0		0.0	0.0	0.0
Detector 1 Delay (s)	0.0	0.0		0.0	0.0	0.0	0.0	0.0		0.0	0.0	0.0
Detector 2 Position(m)		28.7			28.7			28.7				28.7
Detector 2 Size(m)		1.8			1.8			1.8				1.8
Detector 2 Type		Cl+Ex			Cl+Ex			Cl+Ex				Cl+Ex
Detector 2 Channel												
Detector 2 Extend (s)		0.0			0.0			0.0				0.0
Turn Type	pm+pt	NA		Perm	NA	Perm	Perm	NA		Perm	NA	Perm
Protected Phases	5	2			6			8				4
Permitted Phases	2			6		6	8			4		4
Detector Phase	5	2		6	6	6	8	8		4	4	4

Lane Group	Ø3	Ø7
Lane Configurations		
Traffic Volume (vph)		
Future Volume (vph)		
Ideal Flow (vphpl)		
Storage Length (m)		
Storage Lanes		
Taper Length (m)		
Lane Util. Factor		
Ped Bike Factor		
Frt		
Flt Protected		
Satd. Flow (prot)		
Flt Permitted		
Satd. Flow (perm)		
Right Turn on Red		
Satd. Flow (RTOR)		
Link Speed (k/h)		
Link Distance (m)		
Travel Time (s)		
Confl. Peds. (#/hr)		
Confl. Bikes (#/hr)		
Peak Hour Factor		
Heavy Vehicles (%)		
Adj. Flow (vph)		
Shared Lane Traffic (%)		
Lane Group Flow (vph)		
Enter Blocked Intersection		
Lane Alignment		
Median Width(m)		
Link Offset(m)		
Crosswalk Width(m)		
Two way Left Turn Lane		
Headway Factor		
Turning Speed (k/h)		
Number of Detectors		
Detector Template		
Leading Detector (m)		
Trailing Detector (m)		
Detector 1 Position(m)		
Detector 1 Size(m)		
Detector 1 Type		
Detector 1 Channel		
Detector 1 Extend (s)		
Detector 1 Queue (s)		
Detector 1 Delay (s)		
Detector 2 Position(m)		
Detector 2 Size(m)		
Detector 2 Type		
Detector 2 Channel		
Detector 2 Extend (s)		
Turn Type		
Protected Phases	3	7
Permitted Phases		
Detector Phase		

3: Northside Road East & Robertson Road  
PM Peak Hour

1826 Robertson Road  
2024 Background Traffic



Lane Group	EBL	EBT	EBR	WBL	WBT	WBR	NBL	NBT	NBR	SBL	SBT	SBR
Switch Phase												
Minimum Initial (s)	5.0	10.0		10.0	10.0	10.0	10.0	10.0		10.0	10.0	10.0
Minimum Split (s)	11.0	30.1		30.1	30.1	30.1	29.8	29.8		29.8	29.8	29.8
Total Split (s)	15.0	83.0		68.0	68.0	68.0	31.0	31.0		31.0	31.0	31.0
Total Split (%)	12.5%	69.2%		56.7%	56.7%	56.7%	25.8%	25.8%		25.8%	25.8%	25.8%
Maximum Green (s)	9.0	76.9		61.9	61.9	61.9	24.2	24.2		24.2	24.2	24.2
Yellow Time (s)	3.7	3.7		3.7	3.7	3.7	3.0	3.0		3.0	3.0	3.0
All-Red Time (s)	2.3	2.4		2.4	2.4	2.4	3.8	3.8		3.8	3.8	3.8
Lost Time Adjust (s)	0.0	0.0		0.0	0.0	0.0	0.0	0.0		0.0	0.0	0.0
Total Lost Time (s)	6.0	6.1		6.1	6.1	6.1	6.8	6.8		6.8	6.8	6.8
Lead/Lag	Lead			Lag	Lag	Lag	Lag	Lag		Lag	Lag	Lag
Lead-Lag Optimize?	Yes			Yes	Yes	Yes	Yes	Yes		Yes	Yes	Yes
Vehicle Extension (s)	3.0	3.0		3.0	3.0	3.0	3.0	3.0		3.0	3.0	3.0
Recall Mode	None	C-Max		C-Max	C-Max	C-Max	None	None		None	None	None
Walk Time (s)		7.0		7.0	7.0	7.0	1.0	1.0		1.0	1.0	1.0
Flash Dont Walk (s)		17.0		17.0	17.0	17.0	22.0	22.0		22.0	22.0	22.0
Pedestrian Calls (#/hr)		7		3	3	3	5	5		16	16	16
Act Effct Green (s)	85.3	85.2		74.4	74.4	74.4	21.9	21.9		21.9	21.9	21.9
Actuated g/C Ratio	0.71	0.71		0.62	0.62	0.62	0.18	0.18		0.18	0.18	0.18
v/c Ratio	0.22	0.45		0.27	0.56	0.22	0.60	0.39		0.77	0.17	0.22
Control Delay	8.8	8.8		16.9	16.5	2.4	54.9	15.4		70.1	39.8	5.1
Queue Delay	0.0	0.0		0.0	0.0	0.0	0.0	0.0		0.0	0.0	0.0
Total Delay	8.8	8.8		16.9	16.5	2.4	54.9	15.4		70.1	39.8	5.1
LOS	A	A		B	B	A	D	B		E	D	A
Approach Delay		8.8			14.4			34.8			46.7	
Approach LOS		A			B			C			D	
Queue Length 50th (m)	4.2	45.4		7.8	77.3	0.0	27.7	6.8		32.2	10.1	0.0
Queue Length 95th (m)	m7.4	53.6		20.7	117.2	10.7	43.5	21.4		50.0	19.1	6.9
Internal Link Dist (m)		81.4			286.9			63.0			66.9	
Turn Bay Length (m)	55.0			75.0		80.0						
Base Capacity (vph)	319	2401		291	2103	1006	269	417		236	386	394
Starvation Cap Reductn	0	0		0	0	0	0	0		0	0	0
Spillback Cap Reductn	0	0		0	0	0	0	0		0	0	0
Storage Cap Reductn	0	0		0	0	0	0	0		0	0	0
Reduced v/c Ratio	0.21	0.45		0.27	0.56	0.22	0.51	0.34		0.66	0.14	0.20

Intersection Summary

Area Type: Other  
 Cycle Length: 120  
 Actuated Cycle Length: 120  
 Offset: 111 (93%), Referenced to phase 2:EBTL and 6:WBTL, Start of Green  
 Natural Cycle: 80  
 Control Type: Actuated-Coordinated  
 Maximum v/c Ratio: 0.77  
 Intersection Signal Delay: 17.1      Intersection LOS: B  
 Intersection Capacity Utilization 82.9%      ICU Level of Service E  
 Analysis Period (min) 15  
 m Volume for 95th percentile queue is metered by upstream signal.

Splits and Phases: 3: Northside Road East & Robertson Road

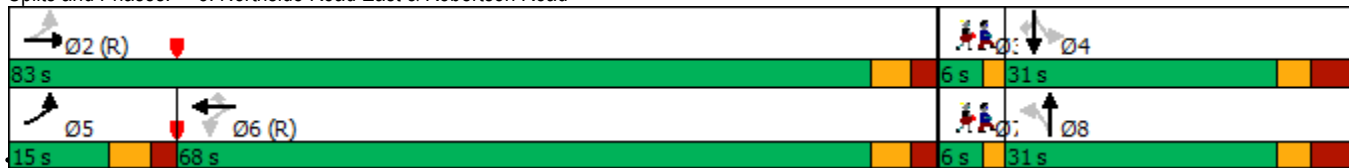

Lane Group	Ø3	Ø7
Switch Phase		
Minimum Initial (s)	4.0	4.0
Minimum Split (s)	6.0	6.0
Total Split (s)	6.0	6.0
Total Split (%)	5%	5%
Maximum Green (s)	4.0	4.0
Yellow Time (s)	2.0	2.0
All-Red Time (s)	0.0	0.0
Lost Time Adjust (s)		
Total Lost Time (s)		
Lead/Lag	Lead	Lead
Lead-Lag Optimize?	Yes	Yes
Vehicle Extension (s)	3.0	3.0
Recall Mode	None	None
Walk Time (s)		
Flash Dont Walk (s)		
Pedestrian Calls (#/hr)		
Act Effct Green (s)		
Actuated g/C Ratio		
v/c Ratio		
Control Delay		
Queue Delay		
Total Delay		
LOS		
Approach Delay		
Approach LOS		
Queue Length 50th (m)		
Queue Length 95th (m)		
Internal Link Dist (m)		
Turn Bay Length (m)		
Base Capacity (vph)		
Starvation Cap Reductn		
Spillback Cap Reductn		
Storage Cap Reductn		
Reduced v/c Ratio		
Intersection Summary		



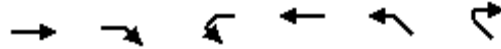

Lane Group	EBT	EBR	WBL	WBT	NWL	NWR
Lane Configurations	↑↑			↑↑↑		
Traffic Volume (vph)	1096	117	0	1219	0	0
Future Volume (vph)	1096	117	0	1219	0	0
Ideal Flow (vphpl)	1800	1800	1800	1800	1800	1800
Storage Length (m)		0.0	25.0		0.0	0.0
Storage Lanes		0	1		0	0
Taper Length (m)			25.0		10.0	
Lane Util. Factor	0.95	0.95	1.00	0.91	1.00	1.00
Fr <sub>t</sub>	0.986					
<b>Flt Protected</b>						
Satd. Flow (prot)	3330	0	0	4871	0	0
<b>Flt Permitted</b>						
Satd. Flow (perm)	3330	0	0	4871	0	0
Link Speed (k/h)	60			60	50	
Link Distance (m)	66.2			72.0	100.3	
Travel Time (s)	4.0			4.3	7.2	
Peak Hour Factor	1.00	1.00	1.00	1.00	1.00	1.00
Heavy Vehicles (%)	2%	6%	1%	2%	1%	1%
Adj. Flow (vph)	1096	117	0	1219	0	0
<b>Shared Lane Traffic (%)</b>						
Lane Group Flow (vph)	1213	0	0	1219	0	0
Enter Blocked Intersection	Yes	Yes	Yes	Yes	No	No
Lane Alignment	Left	Right	Left	Left	Left	Right
Median Width(m)	3.7			3.7	0.0	
Link Offset(m)	0.0			0.0	0.0	
Crosswalk Width(m)	0.0			0.0	0.0	
<b>Two way Left Turn Lane</b>						
Headway Factor	1.06	1.06	1.06	1.06	1.06	1.06
Turning Speed (k/h)		50	24		24	14
Sign Control	Free			Free	Free	

**Intersection Summary**

Area Type: Other

Control Type: Unsignalized

Intersection Capacity Utilization 39.2% ICU Level of Service A











Analysis Period (min) 15











Lane Group	EBT	EBR	WBL	WBT	NBL	NBR
Lane Configurations						
Traffic Volume (vph)	107	10	98	0	0	79
Future Volume (vph)	107	10	98	0	0	79
Ideal Flow (vphpl)	1800	1800	1800	1800	1800	1800
Lane Util. Factor	1.00	1.00	1.00	1.00	1.00	1.00
Ped Bike Factor						
Frt	0.988					0.865
Flt Protected			0.950			
Satd. Flow (prot)	1689	0	1631	0	0	1514
Flt Permitted			0.950			
Satd. Flow (perm)	1689	0	1631	0	0	1514
Link Speed (k/h)	50			40	40	
Link Distance (m)	100.3			62.0	54.2	
Travel Time (s)	7.2			5.6	4.9	
Confl. Peds. (#/hr)		12	12			
Confl. Bikes (#/hr)		1				1
Peak Hour Factor	1.00	1.00	1.00	1.00	1.00	1.00
Heavy Vehicles (%)	7%	1%	6%	1%	1%	4%
Adj. Flow (vph)	107	10	98	0	0	79
Shared Lane Traffic (%)						
Lane Group Flow (vph)	117	0	98	0	0	79
Enter Blocked Intersection	No	No	No	No	No	No
Lane Alignment	L NA	R NA	L NA	R NA	Left	R NA
Median Width(m)	3.7			3.7	0.0	
Link Offset(m)	3.0			3.0	0.0	
Crosswalk Width(m)	5.0			5.0	5.0	
Two way Left Turn Lane						
Headway Factor	1.06	1.06	1.06	1.06	1.06	1.06
Turning Speed (k/h)		14	24		24	14
Sign Control	Stop			Stop	Stop	

**Intersection Summary**

Area Type:	Other
Control Type:	Unsignalized
Intersection Capacity Utilization 20.7%	ICU Level of Service A
Analysis Period (min)	15

						
Lane Group	WBL	WBR	NBT	NBR	SBL	SBT
Lane Configurations						
Traffic Volume (vph)	3	70	143	2	59	95
Future Volume (vph)	3	70	143	2	59	95
Ideal Flow (vphpl)	1800	1800	1800	1800	1800	1800
Storage Length (m)	0.0	0.0		45.0	15.0	
Storage Lanes	1	0		0	1	
Taper Length (m)	10.0				20.0	
Lane Util. Factor	1.00	1.00	0.95	0.95	1.00	1.00
Frt	0.871		0.998			
Flt Protected	0.998				0.950	
Satd. Flow (prot)	1566	0	3384	0	1712	1784
Flt Permitted	0.998				0.950	
Satd. Flow (perm)	1566	0	3384	0	1712	1784
Link Speed (k/h)	40		40			40
Link Distance (m)	173.4		68.2			81.0
Travel Time (s)	15.6		6.1			7.3
Peak Hour Factor	1.00	1.00	1.00	1.00	1.00	1.00
Heavy Vehicles (%)	1%	1%	2%	1%	1%	2%
Adj. Flow (vph)	3	70	143	2	59	95
Shared Lane Traffic (%)						
Lane Group Flow (vph)	73	0	145	0	59	95
Enter Blocked Intersection	No	No	No	No	No	No
Lane Alignment	Left	Right	Left	Right	Left	Left
Median Width(m)	3.7		3.7			3.7
Link Offset(m)	0.0		0.0			0.0
Crosswalk Width(m)	5.0		5.0			5.0
Two way Left Turn Lane						
Headway Factor	1.06	1.06	1.06	1.06	1.06	1.06
Turning Speed (k/h)	24	14		14	24	
Sign Control	Stop		Free			Free
<b>Intersection Summary</b>						
Area Type:	Other					
Control Type:	Unsignalized					
Intersection Capacity Utilization	22.4%			ICU Level of Service A		
Analysis Period (min)	15					

						
Lane Group	WBL	WBR	NBT	NBR	SBL	SBT
Lane Configurations						
Traffic Volume (vph)	1	9	136	1	8	90
Future Volume (vph)	1	9	136	1	8	90
Ideal Flow (vphpl)	1800	1800	1800	1800	1800	1800
Lane Util. Factor	1.00	1.00	1.00	1.00	1.00	1.00
Frt	0.878		0.999			
Flt Protected	0.995					0.996
Satd. Flow (prot)	1574	0	1783	0	0	1779
Flt Permitted	0.995					0.996
Satd. Flow (perm)	1574	0	1783	0	0	1779
Link Speed (k/h)	50		50			50
Link Distance (m)	178.0		82.4			68.2
Travel Time (s)	12.8		5.9			4.9
Peak Hour Factor	1.00	1.00	1.00	1.00	1.00	1.00
Heavy Vehicles (%)	1%	1%	2%	1%	1%	2%
Adj. Flow (vph)	1	9	136	1	8	90
Shared Lane Traffic (%)						
Lane Group Flow (vph)	10	0	137	0	0	98
Enter Blocked Intersection	No	No	No	No	No	No
Lane Alignment	L NA	R NA	Left	Right	Left	Left
Median Width(m)	3.7		0.0			0.0
Link Offset(m)	0.0		0.0			0.0
Crosswalk Width(m)	5.0		5.0			5.0
Two way Left Turn Lane						
Headway Factor	1.06	1.06	1.06	1.06	1.06	1.06
Turning Speed (k/h)	97	97		97	97	
Sign Control	Stop		Free			Free
<b>Intersection Summary</b>						
Area Type:	Other					
Control Type:	Unsignalized					
Intersection Capacity Utilization	22.0%			ICU Level of Service A		
Analysis Period (min)	15					



Lane Group	EBL	EBR	NBL	NBT	SBT	SBR
Lane Configurations						
Traffic Volume (vph)	24	0	0	55	74	34
Future Volume (vph)	24	0	0	55	74	34
Ideal Flow (vphpl)	1800	1800	1800	1800	1800	1800
Lane Util. Factor	1.00	1.00	1.00	1.00	1.00	1.00
Frt					0.957	
Frt Protected	0.950					
Satd. Flow (prot)	1712	0	0	1802	1719	0
Frt Permitted	0.950					
Satd. Flow (perm)	1712	0	0	1802	1719	0
Link Speed (k/h)	40			40	40	
Link Distance (m)	173.4			67.2	54.2	
Travel Time (s)	15.6			6.0	4.9	
Peak Hour Factor	1.00	1.00	1.00	1.00	1.00	1.00
Heavy Vehicles (%)	1%	1%	1%	1%	1%	2%
Adj. Flow (vph)	24	0	0	55	74	34
Shared Lane Traffic (%)						
Lane Group Flow (vph)	24	0	0	55	108	0
Enter Blocked Intersection	No	No	No	No	No	No
Lane Alignment	Left	Right	Left	Left	Left	Right
Median Width(m)	3.7			0.0	0.0	
Link Offset(m)	0.0			0.0	0.0	
Crosswalk Width(m)	5.0			5.0	5.0	
Two way Left Turn Lane						
Headway Factor	1.06	1.06	1.06	1.06	1.06	1.06
Turning Speed (k/h)	24	14	24			14
Sign Control	Stop			Free	Free	

**Intersection Summary**

Area Type:	Other
Control Type:	Unsignalized
Intersection Capacity Utilization	16.3%
Analysis Period (min)	15
	ICU Level of Service A



Lane Group	EBL	EBR	NBL	NBT	SBT	SBR
Lane Configurations						
Traffic Volume (vph)	7	0	0	48	67	7
Future Volume (vph)	7	0	0	48	67	7
Ideal Flow (vphpl)	1800	1800	1800	1800	1800	1800
Lane Util. Factor	1.00	1.00	1.00	1.00	1.00	1.00
Frt					0.987	
Frt Protected	0.950					
Satd. Flow (prot)	1712	0	0	1802	1779	0
Frt Permitted	0.950					
Satd. Flow (perm)	1712	0	0	1802	1779	0
Link Speed (k/h)	50			50	50	
Link Distance (m)	178.0			106.1	67.2	
Travel Time (s)	12.8			7.6	4.8	
Peak Hour Factor	1.00	1.00	1.00	1.00	1.00	1.00
Heavy Vehicles (%)	1%	1%	1%	1%	1%	1%
Adj. Flow (vph)	7	0	0	48	67	7
Shared Lane Traffic (%)						
Lane Group Flow (vph)	7	0	0	48	74	0
Enter Blocked Intersection	No	No	No	No	No	No
Lane Alignment	L NA	R NA	Left	Left	Left	Right
Median Width(m)	3.7			0.0	0.0	
Link Offset(m)	0.0			0.0	0.0	
Crosswalk Width(m)	5.0			5.0	5.0	
Two way Left Turn Lane						
Headway Factor	1.06	1.06	1.06	1.06	1.06	1.06
Turning Speed (k/h)	97	97	97			97
Sign Control	Stop			Free	Free	

**Intersection Summary**

Area Type:	Other
Control Type:	Unsignalized
Intersection Capacity Utilization	14.2%
ICU Level of Service	A
Analysis Period (min)	15

1: Stinson Avenue & Robertson Road  
SAT Peak Hour

1826 Robertson Road  
2024 Background Traffic



Lane Group	EBL	EBT	EBR	WBL	WBT	WBR	NBL	NBT	NBR	SBL	SBT	SBR
Lane Configurations												
Traffic Volume (vph)	15	1045	24	45	972	4	10	0	32	3	1	8
Future Volume (vph)	15	1045	24	45	972	4	10	0	32	3	1	8
Ideal Flow (vphpl)	1800	1800	1800	1800	1800	1800	1800	1800	1800	1800	1800	1800
Storage Length (m)	75.0		0.0	45.0		0.0	0.0		0.0	0.0		0.0
Storage Lanes	1		0	1		0	0		0	0		0
Taper Length (m)	10.0			10.0			10.0			10.0		
Lane Util. Factor	1.00	0.95	0.95	1.00	0.95	0.95	1.00	1.00	1.00	1.00	1.00	1.00
Ped Bike Factor	0.99	1.00		1.00	1.00			0.99			0.99	
Frt		0.997			0.999			0.897			0.910	
Flt Protected	0.950			0.950				0.988			0.988	
Satd. Flow (prot)	1712	3409	0	1712	3420	0	0	1576	0	0	1606	0
Flt Permitted	0.283			0.254				0.919			0.923	
Satd. Flow (perm)	507	3409	0	457	3420	0	0	1465	0	0	1498	0
Right Turn on Red			Yes			Yes			Yes			Yes
Satd. Flow (RTOR)		4			1			32			8	
Link Speed (k/h)		60			60			40			40	
Link Distance (m)		198.0			310.7			254.0			246.4	
Travel Time (s)		11.9			18.6			22.9			22.2	
Confl. Peds. (#/hr)	10		4	4		10	1		4	4		1
Confl. Bikes (#/hr)			4			2						
Peak Hour Factor	1.00	1.00	1.00	1.00	1.00	1.00	1.00	1.00	1.00	1.00	1.00	1.00
Heavy Vehicles (%)	1%	1%	4%	1%	1%	1%	1%	1%	1%	1%	1%	1%
Adj. Flow (vph)	15	1045	24	45	972	4	10	0	32	3	1	8
Shared Lane Traffic (%)												
Lane Group Flow (vph)	15	1069	0	45	976	0	0	42	0	0	12	0
Enter Blocked Intersection	No	No	No	No	No	No	No	No	No	No	No	No
Lane Alignment	L NA	Left	R NA	L NA	Left	R NA	L NA	Left	R NA	L NA	Left	R NA
Median Width(m)		3.7			3.7			0.0			0.0	
Link Offset(m)		0.0			0.0			0.0			0.0	
Crosswalk Width(m)		5.0			5.0			5.0			5.0	
Two way Left Turn Lane		Yes			Yes							
Headway Factor	1.06	1.06	1.06	1.06	1.06	1.06	1.06	1.06	1.06	1.06	1.06	1.06
Turning Speed (k/h)	24		14	24		14	24		14	24		14
Number of Detectors	1	2		1	2		1	2		1	2	
Detector Template	Left	Thru		Left	Thru		Left	Thru		Left	Thru	
Leading Detector (m)	6.1	30.5		6.1	30.5		6.1	30.5		6.1	30.5	
Trailing Detector (m)	0.0	0.0		0.0	0.0		0.0	0.0		0.0	0.0	
Detector 1 Position(m)	0.0	0.0		0.0	0.0		0.0	0.0		0.0	0.0	
Detector 1 Size(m)	6.1	1.8		6.1	1.8		6.1	1.8		6.1	1.8	
Detector 1 Type	Cl+Ex	Cl+Ex		Cl+Ex	Cl+Ex		Cl+Ex	Cl+Ex		Cl+Ex	Cl+Ex	
Detector 1 Channel												
Detector 1 Extend (s)	0.0	0.0		0.0	0.0		0.0	0.0		0.0	0.0	
Detector 1 Queue (s)	0.0	0.0		0.0	0.0		0.0	0.0		0.0	0.0	
Detector 1 Delay (s)	0.0	0.0		0.0	0.0		0.0	0.0		0.0	0.0	
Detector 2 Position(m)		28.7			28.7			28.7			28.7	
Detector 2 Size(m)		1.8			1.8			1.8			1.8	
Detector 2 Type		Cl+Ex			Cl+Ex			Cl+Ex			Cl+Ex	
Detector 2 Channel												
Detector 2 Extend (s)		0.0			0.0			0.0			0.0	
Turn Type	Perm	NA		Perm	NA		Perm	NA		Perm	NA	
Protected Phases		2			6			8			4	
Permitted Phases	2			6			8			4		
Detector Phase	2	2		6	6		8	8		4	4	



Lane Group	EBL	EBT	EBR	WBL	WBT	WBR	NBL	NBT	NBR	SBL	SBT	SBR
Switch Phase												
Minimum Initial (s)	10.0	10.0		10.0	10.0		10.0	10.0		10.0	10.0	
Minimum Split (s)	26.8	26.8		26.8	26.8		31.6	31.6		31.6	31.6	
Total Split (s)	88.0	88.0		88.0	88.0		32.0	32.0		32.0	32.0	
Total Split (%)	73.3%	73.3%		73.3%	73.3%		26.7%	26.7%		26.7%	26.7%	
Maximum Green (s)	82.2	82.2		82.2	82.2		25.4	25.4		25.4	25.4	
Yellow Time (s)	3.7	3.7		3.7	3.7		3.0	3.0		3.0	3.0	
All-Red Time (s)	2.1	2.1		2.1	2.1		3.6	3.6		3.6	3.6	
Lost Time Adjust (s)	0.0	0.0		0.0	0.0			0.0			0.0	
Total Lost Time (s)	5.8	5.8		5.8	5.8			6.6			6.6	
Lead/Lag												
Lead-Lag Optimize?												
Vehicle Extension (s)	3.0	3.0		3.0	3.0		3.0	3.0		3.0	3.0	
Recall Mode	C-Max	C-Max		C-Max	C-Max		None	None		None	None	
Walk Time (s)	7.0	7.0		7.0	7.0		7.0	7.0		7.0	7.0	
Flash Dont Walk (s)	14.0	14.0		14.0	14.0		18.0	18.0		18.0	18.0	
Pedestrian Calls (#/hr)	4	4		10	10		4	4		1	1	
Act Effct Green (s)	99.1	99.1		99.1	99.1			13.0			13.0	
Actuated g/C Ratio	0.83	0.83		0.83	0.83			0.11			0.11	
v/c Ratio	0.04	0.38		0.12	0.35			0.22			0.07	
Control Delay	4.3	4.5		1.6	2.1			22.3			28.4	
Queue Delay	0.0	0.0		0.0	0.0			0.0			0.0	
Total Delay	4.3	4.5		1.6	2.1			22.3			28.4	
LOS	A	A		A	A			C			C	
Approach Delay		4.5			2.0			22.3			28.4	
Approach LOS		A			A			C			C	
Queue Length 50th (m)	0.5	26.0		0.3	3.7			2.0			0.8	
Queue Length 95th (m)	3.0	61.4		m0.8	19.2			10.5			5.5	
Internal Link Dist (m)		174.0			286.7			230.0			222.4	
Turn Bay Length (m)	75.0			45.0								
Base Capacity (vph)	418	2815		377	2823			335			323	
Starvation Cap Reductn	0	0		0	0			0			0	
Spillback Cap Reductn	0	0		0	0			0			0	
Storage Cap Reductn	0	0		0	0			0			0	
Reduced v/c Ratio	0.04	0.38		0.12	0.35			0.13			0.04	

Intersection Summary

Area Type: Other  
 Cycle Length: 120  
 Actuated Cycle Length: 120  
 Offset: 31 (26%), Referenced to phase 2:EBTL and 6:WBTL, Start of Green  
 Natural Cycle: 60  
 Control Type: Actuated-Coordinated  
 Maximum v/c Ratio: 0.38  
 Intersection Signal Delay: 3.8 Intersection LOS: A  
 Intersection Capacity Utilization 59.7% ICU Level of Service B  
 Analysis Period (min) 15  
 m Volume for 95th percentile queue is metered by upstream signal.

Splits and Phases: 1: Stinson Avenue & Robertson Road





2: Lynhar Road/Stafford Road & Robertson Road  
SAT Peak Hour

1826 Robertson Road  
2024 Background Traffic

Lane Group	EBL	EBT	EBR	WBL	WBT	WBR	NBL	NBT	NBR	SBL	SBT	SBR
Lane Configurations												
Traffic Volume (vph)	134	841	87	41	770	60	87	27	84	83	20	153
Future Volume (vph)	134	841	87	41	770	60	87	27	84	83	20	153
Ideal Flow (vphpl)	1800	1800	1800	1800	1800	1800	1800	1800	1800	1800	1800	1800
Storage Length (m)	85.0		40.0	0.0		0.0	0.0		30.0	45.0		75.0
Storage Lanes	1		1	1		0	1		1	1		1
Taper Length (m)	10.0			10.0			10.0			30.0		
Lane Util. Factor	1.00	0.95	1.00	1.00	0.95	0.95	1.00	1.00	1.00	1.00	1.00	1.00
Ped Bike Factor	1.00		0.94	0.99	1.00		0.98		0.96	0.98		0.97
Frt			0.850		0.989				0.850			0.850
Flt Protected	0.950			0.950			0.950			0.950		
Satd. Flow (prot)	1695	3424	1517	1712	3350	0	1712	1802	1532	1695	1802	1532
Flt Permitted	0.950			0.950			0.709			0.740		
Satd. Flow (perm)	1691	3424	1419	1690	3350	0	1255	1802	1474	1289	1802	1484
Right Turn on Red			Yes			Yes			Yes			Yes
Satd. Flow (RTOR)			145		8				142			153
Link Speed (k/h)		60			60			40			40	
Link Distance (m)		310.7			66.2			81.0			107.6	
Travel Time (s)		18.6			4.0			7.3			9.7	
Confl. Peds. (#/hr)	5		17	17		5	16		21	21		16
Confl. Bikes (#/hr)			5			4			2			1
Peak Hour Factor	1.00	1.00	1.00	1.00	1.00	1.00	1.00	1.00	1.00	1.00	1.00	1.00
Heavy Vehicles (%)	2%	1%	2%	1%	2%	1%	1%	1%	1%	2%	1%	1%
Adj. Flow (vph)	134	841	87	41	770	60	87	27	84	83	20	153
Shared Lane Traffic (%)												
Lane Group Flow (vph)	134	841	87	41	830	0	87	27	84	83	20	153
Enter Blocked Intersection	No	No	No	No	No	No	No	No	No	No	No	No
Lane Alignment	L NA	Left	R NA	L NA	Left	R NA	L NA	L NA	R NA	L NA	Left	R NA
Median Width(m)		3.7			7.4			7.4			7.4	
Link Offset(m)		0.0			0.0			0.0			0.0	
Crosswalk Width(m)		5.0			5.0			5.0			5.0	
Two way Left Turn Lane		Yes										
Headway Factor	1.06	1.06	1.06	1.06	1.06	1.06	1.06	1.06	1.06	1.06	1.06	1.06
Turning Speed (k/h)	24		14	24		14	24		14	24		14
Number of Detectors	1	2	1	1	2		1	2	1	1	2	1
Detector Template	Left	Thru	Right	Left	Thru		Left	Thru	Right	Left	Thru	Right
Leading Detector (m)	6.1	30.5	6.1	6.1	30.5		6.1	30.5	6.1	6.1	30.5	6.1
Trailing Detector (m)	0.0	0.0	0.0	0.0	0.0		0.0	0.0	0.0	0.0	0.0	0.0
Detector 1 Position(m)	0.0	0.0	0.0	0.0	0.0		0.0	0.0	0.0	0.0	0.0	0.0
Detector 1 Size(m)	6.1	1.8	6.1	6.1	1.8		6.1	1.8	6.1	6.1	1.8	6.1
Detector 1 Type	Cl+Ex	Cl+Ex	Cl+Ex	Cl+Ex	Cl+Ex		Cl+Ex	Cl+Ex	Cl+Ex	Cl+Ex	Cl+Ex	Cl+Ex
Detector 1 Channel												
Detector 1 Extend (s)	0.0	0.0	0.0	0.0	0.0		0.0	0.0	0.0	0.0	0.0	0.0
Detector 1 Queue (s)	0.0	0.0	0.0	0.0	0.0		0.0	0.0	0.0	0.0	0.0	0.0
Detector 1 Delay (s)	0.0	0.0	0.0	0.0	0.0		0.0	0.0	0.0	0.0	0.0	0.0
Detector 2 Position(m)		28.7			28.7			28.7			28.7	
Detector 2 Size(m)		1.8			1.8			1.8			1.8	
Detector 2 Type		Cl+Ex			Cl+Ex			Cl+Ex			Cl+Ex	
Detector 2 Channel												
Detector 2 Extend (s)		0.0			0.0			0.0			0.0	
Turn Type	Prot	NA	Perm	Prot	NA		pm+pt	NA	Perm	pm+pt	NA	Perm
Protected Phases	5	2		1	6		3	8		7	4	
Permitted Phases			2				8		8	4		4
Detector Phase	5	2	2	1	6		3	8	8	7	4	4



Lane Group	EBL	EBT	EBR	WBL	WBT	WBR	NBL	NBT	NBR	SBL	SBT	SBR
Switch Phase												
Minimum Initial (s)	5.0	10.0	10.0	5.0	10.0		5.0	10.0	10.0	5.0	10.0	10.0
Minimum Split (s)	11.1	31.3	31.3	11.1	31.3		11.2	37.7	37.7	11.2	37.7	37.7
Total Split (s)	15.0	54.0	54.0	15.0	54.0		12.0	39.0	39.0	12.0	39.0	39.0
Total Split (%)	12.5%	45.0%	45.0%	12.5%	45.0%		10.0%	32.5%	32.5%	10.0%	32.5%	32.5%
Maximum Green (s)	8.9	47.7	47.7	8.9	47.7		5.8	32.3	32.3	5.8	32.3	32.3
Yellow Time (s)	3.7	3.7	3.7	3.7	3.7		3.0	3.0	3.0	3.0	3.0	3.0
All-Red Time (s)	2.4	2.6	2.6	2.4	2.6		3.2	3.7	3.7	3.2	3.7	3.7
Lost Time Adjust (s)	0.0	0.0	0.0	0.0	0.0		0.0	0.0	0.0	0.0	0.0	0.0
Total Lost Time (s)	6.1	6.3	6.3	6.1	6.3		6.2	6.7	6.7	6.2	6.7	6.7
Lead/Lag	Lead	Lag	Lag	Lead	Lag		Lead	Lag	Lag	Lead	Lag	Lag
Lead-Lag Optimize?	Yes	Yes	Yes	Yes	Yes		Yes	Yes	Yes	Yes	Yes	Yes
Vehicle Extension (s)	3.0	3.0	3.0	3.0	3.0		3.0	3.0	3.0	3.0	3.0	3.0
Recall Mode	None	C-Max	C-Max	None	C-Max		None	None	None	None	None	None
Walk Time (s)		7.0	7.0		7.0			12.0	12.0		12.0	12.0
Flash Dont Walk (s)		18.0	18.0		18.0			19.0	19.0		19.0	19.0
Pedestrian Calls (#/hr)		17	17		5			21	21		16	16
Act Effct Green (s)	13.1	60.5	60.5	8.1	53.2		30.1	25.0	25.0	28.9	22.6	22.6
Actuated g/C Ratio	0.11	0.50	0.50	0.07	0.44		0.25	0.21	0.21	0.24	0.19	0.19
v/c Ratio	0.73	0.49	0.11	0.36	0.56		0.26	0.07	0.20	0.25	0.06	0.38
Control Delay	71.2	27.8	5.7	78.8	22.6		31.4	35.7	1.5	31.2	35.1	8.3
Queue Delay	0.0	0.0	0.0	0.0	0.0		0.0	0.0	0.0	0.0	0.0	0.0
Total Delay	71.2	27.8	5.7	78.8	22.6		31.4	35.7	1.5	31.2	35.1	8.3
LOS	E	C	A	E	C		C	D	A	C	D	A
Approach Delay		31.5			25.3			19.3			17.8	
Approach LOS		C			C			B			B	
Queue Length 50th (m)	29.3	66.6	0.0	7.5	77.6		12.6	4.4	0.0	12.0	3.3	0.0
Queue Length 95th (m)	#64.7	107.1	9.0	21.0	98.6		23.2	11.2	1.3	22.4	9.0	14.6
Internal Link Dist (m)		286.7			42.2			57.0			83.6	
Turn Bay Length (m)	85.0		40.0						30.0	45.0		75.0
Base Capacity (vph)	184	1727	787	132	1490		337	485	500	330	485	511
Starvation Cap Reductn	0	0	0	0	0		0	0	0	0	0	0
Spillback Cap Reductn	0	0	0	0	0		0	0	0	0	0	0
Storage Cap Reductn	0	0	0	0	0		0	0	0	0	0	0
Reduced v/c Ratio	0.73	0.49	0.11	0.31	0.56		0.26	0.06	0.17	0.25	0.04	0.30

Intersection Summary

Area Type: Other  
 Cycle Length: 120  
 Actuated Cycle Length: 120  
 Offset: 7 (6%), Referenced to phase 2:EBT and 6:WBT, Start of Green  
 Natural Cycle: 95  
 Control Type: Actuated-Coordinated  
 Maximum v/c Ratio: 0.73  
 Intersection Signal Delay: 26.7 Intersection LOS: C  
 Intersection Capacity Utilization 67.1% ICU Level of Service C  
 Analysis Period (min) 15  
 # 95th percentile volume exceeds capacity, queue may be longer.  
 Queue shown is maximum after two cycles.

Splits and Phases: 2: Lynhar Road/Stafford Road & Robertson Road



3: Northside Road East & Robertson Road  
SAT Peak Hour

1826 Robertson Road  
2024 Background Traffic



Lane Group	EBL	EBT	EBR	WBL	WBT	WBR	NBL	NBT	NBR	SBL	SBT	SBR
Lane Configurations												
Traffic Volume (vph)	78	835	15	84	667	167	86	44	70	141	30	103
Future Volume (vph)	78	835	15	84	667	167	86	44	70	141	30	103
Ideal Flow (vphpl)	1800	1800	1800	1800	1800	1800	1800	1800	1800	1800	1800	1800
Storage Length (m)	55.0		0.0	75.0		80.0	0.0		0.0	0.0		0.0
Storage Lanes	1		0	1		1	1		0	1		1
Taper Length (m)	30.0			15.0			10.0			10.0		
Lane Util. Factor	1.00	0.95	0.95	1.00	0.95	1.00	1.00	1.00	1.00	1.00	1.00	1.00
Ped Bike Factor	1.00	1.00		1.00		0.96	0.98	0.98		0.99		0.96
Frt		0.997				0.850		0.908				0.850
Flt Protected	0.950			0.950			0.950			0.950		
Satd. Flow (prot)	1712	3412	0	1695	3390	1532	1695	1610	0	1712	1802	1532
Flt Permitted	0.347			0.333			0.738			0.683		
Satd. Flow (perm)	623	3412	0	593	3390	1476	1285	1610	0	1218	1802	1474
Right Turn on Red			Yes			Yes			Yes			Yes
Satd. Flow (RTOR)		3				167		60				103
Link Speed (k/h)		60			60			40			40	
Link Distance (m)		105.4			310.9			87.0			90.9	
Travel Time (s)		6.3			18.7			7.8			8.2	
Confl. Peds. (#/hr)	6		4	4		6	16		8	8		16
Confl. Bikes (#/hr)			1			2			2			1
Peak Hour Factor	1.00	1.00	1.00	1.00	1.00	1.00	1.00	1.00	1.00	1.00	1.00	1.00
Heavy Vehicles (%)	1%	1%	1%	2%	2%	1%	2%	1%	1%	1%	1%	1%
Adj. Flow (vph)	78	835	15	84	667	167	86	44	70	141	30	103
Shared Lane Traffic (%)												
Lane Group Flow (vph)	78	850	0	84	667	167	86	114	0	141	30	103
Enter Blocked Intersection	No	No	No	No	No	No	No	No	No	No	No	No
Lane Alignment	L NA	Left	R NA	L NA	Left	R NA	L NA	Left	R NA	L NA	Left	R NA
Median Width(m)		5.5			5.5			3.7			3.7	
Link Offset(m)		0.0			0.0			0.0			0.0	
Crosswalk Width(m)		5.0			5.0			5.0			5.0	
Two way Left Turn Lane												
Headway Factor	1.06	1.06	1.06	1.06	1.06	1.06	1.06	1.06	1.06	1.06	1.06	1.06
Turning Speed (k/h)	24		14	24		14	24		14	24		14
Number of Detectors	1	2		1	2		1	1	2		1	2
Detector Template	Left	Thru		Left	Thru	Right	Left	Thru		Left	Thru	Right
Leading Detector (m)	6.1	30.5		6.1	30.5	6.1	6.1	30.5		6.1	30.5	6.1
Trailing Detector (m)	0.0	0.0		0.0	0.0	0.0	0.0	0.0		0.0	0.0	0.0
Detector 1 Position(m)	0.0	0.0		0.0	0.0	0.0	0.0	0.0		0.0	0.0	0.0
Detector 1 Size(m)	6.1	1.8		6.1	1.8	6.1	6.1	1.8		6.1	1.8	6.1
Detector 1 Type	Cl+Ex	Cl+Ex		Cl+Ex	Cl+Ex	Cl+Ex	Cl+Ex	Cl+Ex		Cl+Ex	Cl+Ex	Cl+Ex
Detector 1 Channel												
Detector 1 Extend (s)	0.0	0.0		0.0	0.0	0.0	0.0	0.0		0.0	0.0	0.0
Detector 1 Queue (s)	0.0	0.0		0.0	0.0	0.0	0.0	0.0		0.0	0.0	0.0
Detector 1 Delay (s)	0.0	0.0		0.0	0.0	0.0	0.0	0.0		0.0	0.0	0.0
Detector 2 Position(m)		28.7			28.7			28.7			28.7	
Detector 2 Size(m)		1.8			1.8			1.8			1.8	
Detector 2 Type		Cl+Ex			Cl+Ex			Cl+Ex			Cl+Ex	
Detector 2 Channel												
Detector 2 Extend (s)		0.0			0.0			0.0			0.0	
Turn Type	pm+pt	NA		Perm	NA	Perm	Perm	NA		Perm	NA	Perm
Protected Phases	5	2			6			8			4	
Permitted Phases	2			6		6	8			4		4
Detector Phase	5	2		6	6	6	8	8		4	4	4

Lane Group	Ø3	Ø7
Lane Configurations		
Traffic Volume (vph)		
Future Volume (vph)		
Ideal Flow (vphpl)		
Storage Length (m)		
Storage Lanes		
Taper Length (m)		
Lane Util. Factor		
Ped Bike Factor		
Frt		
Flt Protected		
Satd. Flow (prot)		
Flt Permitted		
Satd. Flow (perm)		
Right Turn on Red		
Satd. Flow (RTOR)		
Link Speed (k/h)		
Link Distance (m)		
Travel Time (s)		
Confl. Peds. (#/hr)		
Confl. Bikes (#/hr)		
Peak Hour Factor		
Heavy Vehicles (%)		
Adj. Flow (vph)		
Shared Lane Traffic (%)		
Lane Group Flow (vph)		
Enter Blocked Intersection		
Lane Alignment		
Median Width(m)		
Link Offset(m)		
Crosswalk Width(m)		
Two way Left Turn Lane		
Headway Factor		
Turning Speed (k/h)		
Number of Detectors		
Detector Template		
Leading Detector (m)		
Trailing Detector (m)		
Detector 1 Position(m)		
Detector 1 Size(m)		
Detector 1 Type		
Detector 1 Channel		
Detector 1 Extend (s)		
Detector 1 Queue (s)		
Detector 1 Delay (s)		
Detector 2 Position(m)		
Detector 2 Size(m)		
Detector 2 Type		
Detector 2 Channel		
Detector 2 Extend (s)		
Turn Type		
Protected Phases	3	7
Permitted Phases		
Detector Phase		

3: Northside Road East & Robertson Road  
SAT Peak Hour

1826 Robertson Road  
2024 Background Traffic



Lane Group	EBL	EBT	EBR	WBL	WBT	WBR	NBL	NBT	NBR	SBL	SBT	SBR
Switch Phase												
Minimum Initial (s)	5.0	10.0		10.0	10.0	10.0	10.0	10.0		10.0	10.0	10.0
Minimum Split (s)	11.0	30.1		30.1	30.1	30.1	29.8	29.8		29.8	29.8	29.8
Total Split (s)	15.0	83.0		68.0	68.0	68.0	31.0	31.0		31.0	31.0	31.0
Total Split (%)	12.5%	69.2%		56.7%	56.7%	56.7%	25.8%	25.8%		25.8%	25.8%	25.8%
Maximum Green (s)	9.0	76.9		61.9	61.9	61.9	24.2	24.2		24.2	24.2	24.2
Yellow Time (s)	3.7	3.7		3.7	3.7	3.7	3.0	3.0		3.0	3.0	3.0
All-Red Time (s)	2.3	2.4		2.4	2.4	2.4	3.8	3.8		3.8	3.8	3.8
Lost Time Adjust (s)	0.0	0.0		0.0	0.0	0.0	0.0	0.0		0.0	0.0	0.0
Total Lost Time (s)	6.0	6.1		6.1	6.1	6.1	6.8	6.8		6.8	6.8	6.8
Lead/Lag	Lead			Lag	Lag	Lag	Lag	Lag		Lag	Lag	Lag
Lead-Lag Optimize?	Yes			Yes	Yes	Yes	Yes	Yes		Yes	Yes	Yes
Vehicle Extension (s)	3.0	3.0		3.0	3.0	3.0	3.0	3.0		3.0	3.0	3.0
Recall Mode	None	C-Max		C-Max	C-Max	C-Max	None	None		None	None	None
Walk Time (s)		7.0		7.0	7.0	7.0	1.0	1.0		1.0	1.0	1.0
Flash Dont Walk (s)		17.0		17.0	17.0	17.0	22.0	22.0		22.0	22.0	22.0
Pedestrian Calls (#/hr)		4		6	6	6	8	8		16	16	16
Act Effct Green (s)	87.9	87.8		77.0	77.0	77.0	19.3	19.3		19.3	19.3	19.3
Actuated g/C Ratio	0.73	0.73		0.64	0.64	0.64	0.16	0.16		0.16	0.16	0.16
v/c Ratio	0.15	0.34		0.22	0.31	0.17	0.42	0.37		0.72	0.10	0.32
Control Delay	6.4	6.6		13.8	11.7	2.3	49.6	24.3		67.0	40.6	10.0
Queue Delay	0.0	0.0		0.0	0.0	0.0	0.0	0.0		0.0	0.0	0.0
Total Delay	6.4	6.6		13.8	11.7	2.3	49.6	24.3		67.0	40.6	10.0
LOS	A	A		B	B	A	D	C		E	D	A
Approach Delay		6.6			10.2			35.2			42.7	
Approach LOS		A			B			D			D	
Queue Length 50th (m)	5.0	29.4		7.4	33.1	0.0	17.0	10.3		29.4	5.6	0.0
Queue Length 95th (m)	6.6	26.5		19.3	53.9	9.0	29.2	23.8		45.9	12.4	12.7
Internal Link Dist (m)		81.4			286.9			63.0			66.9	
Turn Bay Length (m)	55.0			75.0		80.0						
Base Capacity (vph)	537	2496		380	2174	1006	266	381		252	373	387
Starvation Cap Reductn	0	0		0	0	0	0	0		0	0	0
Spillback Cap Reductn	0	0		0	0	0	0	0		0	0	0
Storage Cap Reductn	0	0		0	0	0	0	0		0	0	0
Reduced v/c Ratio	0.15	0.34		0.22	0.31	0.17	0.32	0.30		0.56	0.08	0.27

Intersection Summary

Area Type: Other  
 Cycle Length: 120  
 Actuated Cycle Length: 120  
 Offset: 111 (93%), Referenced to phase 2:EBTL and 6:WBTL, Start of Green  
 Natural Cycle: 80  
 Control Type: Actuated-Coordinated  
 Maximum v/c Ratio: 0.72  
 Intersection Signal Delay: 14.7      Intersection LOS: B  
 Intersection Capacity Utilization 65.7%      ICU Level of Service C  
 Analysis Period (min) 15

Splits and Phases: 3: Northside Road East & Robertson Road



Lane Group	Ø3	Ø7
Switch Phase		
Minimum Initial (s)	4.0	4.0
Minimum Split (s)	6.0	6.0
Total Split (s)	6.0	6.0
Total Split (%)	5%	5%
Maximum Green (s)	4.0	4.0
Yellow Time (s)	2.0	2.0
All-Red Time (s)	0.0	0.0
Lost Time Adjust (s)		
Total Lost Time (s)		
Lead/Lag	Lead	Lead
Lead-Lag Optimize?	Yes	Yes
Vehicle Extension (s)	3.0	3.0
Recall Mode	None	None
Walk Time (s)		
Flash Dont Walk (s)		
Pedestrian Calls (#/hr)		
Act Effct Green (s)		
Actuated g/C Ratio		
v/c Ratio		
Control Delay		
Queue Delay		
Total Delay		
LOS		
Approach Delay		
Approach LOS		
Queue Length 50th (m)		
Queue Length 95th (m)		
Internal Link Dist (m)		
Turn Bay Length (m)		
Base Capacity (vph)		
Starvation Cap Reductn		
Spillback Cap Reductn		
Storage Cap Reductn		
Reduced v/c Ratio		
Intersection Summary		

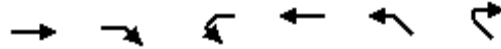

Lane Group	EBT	EBR	WBL	WBT	NWL	NWR
Lane Configurations	↑↑			↑↑↑		
Traffic Volume (vph)	926	83	0	872	0	0
Future Volume (vph)	926	83	0	872	0	0
Ideal Flow (vphpl)	1800	1800	1800	1800	1800	1800
Storage Length (m)		0.0	25.0		0.0	0.0
Storage Lanes		0	1		0	0
Taper Length (m)			25.0		10.0	
Lane Util. Factor	0.95	0.95	1.00	0.91	1.00	1.00
Fr <sub>t</sub>	0.988					
<b>Flt Protected</b>						
Satd. Flow (prot)	3380	0	0	4919	0	0
<b>Flt Permitted</b>						
Satd. Flow (perm)	3380	0	0	4919	0	0
Link Speed (k/h)	60			60	50	
Link Distance (m)	66.2			72.0	100.3	
Travel Time (s)	4.0			4.3	7.2	
Peak Hour Factor	1.00	1.00	1.00	1.00	1.00	1.00
Heavy Vehicles (%)	1%	2%	1%	1%	1%	1%
Adj. Flow (vph)	926	83	0	872	0	0
<b>Shared Lane Traffic (%)</b>						
Lane Group Flow (vph)	1009	0	0	872	0	0
Enter Blocked Intersection	Yes	Yes	Yes	Yes	No	No
Lane Alignment	Left	Right	Left	Left	Left	Right
Median Width(m)	3.7			3.7	0.0	
Link Offset(m)	0.0			0.0	0.0	
Crosswalk Width(m)	0.0			0.0	0.0	
<b>Two way Left Turn Lane</b>						
Headway Factor	1.06	1.06	1.06	1.06	1.06	1.06
Turning Speed (k/h)		50	24		24	14
Sign Control	Free			Free	Free	

**Intersection Summary**

Area Type: Other

Control Type: Unsignalized

Intersection Capacity Utilization 33.1% ICU Level of Service A

Analysis Period (min) 15



Lane Group	EBT	EBR	WBL	WBT	NBL	NBR
Lane Configurations						
Traffic Volume (vph)	70	13	120	0	0	101
Future Volume (vph)	70	13	120	0	0	101
Ideal Flow (vphpl)	1800	1800	1800	1800	1800	1800
Lane Util. Factor	1.00	1.00	1.00	1.00	1.00	1.00
Ped Bike Factor						
Frt	0.979				0.865	
Flt Protected			0.950			
Satd. Flow (prot)	1750	0	1712	0	0	1559
Flt Permitted	0.950					
Satd. Flow (perm)	1750	0	1712	0	0	1559
Link Speed (k/h)	50			40	40	
Link Distance (m)	100.3			62.0	54.2	
Travel Time (s)	7.2			5.6	4.9	
Confl. Peds. (#/hr)	27		27			
Confl. Bikes (#/hr)	1		2			
Peak Hour Factor	1.00	1.00	1.00	1.00	1.00	1.00
Heavy Vehicles (%)	2%	1%	1%	1%	1%	1%
Adj. Flow (vph)	70	13	120	0	0	101
Shared Lane Traffic (%)						
Lane Group Flow (vph)	83	0	120	0	0	101
Enter Blocked Intersection	No	No	No	No	No	No
Lane Alignment	L NA	R NA	L NA	R NA	Left	R NA
Median Width(m)	3.7			3.7	0.0	
Link Offset(m)	3.0			3.0	0.0	
Crosswalk Width(m)	5.0			5.0	5.0	
Two way Left Turn Lane						
Headway Factor	1.06	1.06	1.06	1.06	1.06	1.06
Turning Speed (k/h)	14		24		24	14
Sign Control	Stop			Stop	Stop	

**Intersection Summary**











Area Type: Other









Control Type: Unsignalized

Intersection Capacity Utilization 23.3% ICU Level of Service A

Analysis Period (min) 15



						
Lane Group	WBL	WBR	NBT	NBR	SBL	SBT
Lane Configurations						
Traffic Volume (vph)	3	70	128	3	65	83
Future Volume (vph)	3	70	128	3	65	83
Ideal Flow (vphpl)	1800	1800	1800	1800	1800	1800
Storage Length (m)	0.0	0.0		45.0	15.0	
Storage Lanes	1	0		0	1	
Taper Length (m)	10.0				20.0	
Lane Util. Factor	1.00	1.00	0.95	0.95	1.00	1.00
Frt	0.871		0.997			
Flt Protected	0.998				0.950	
Satd. Flow (prot)	1566	0	3381	0	1712	1784
Flt Permitted	0.998				0.950	
Satd. Flow (perm)	1566	0	3381	0	1712	1784
Link Speed (k/h)	40		40		40	
Link Distance (m)	173.4		68.2		81.0	
Travel Time (s)	15.6		6.1		7.3	
Peak Hour Factor	1.00	1.00	1.00	1.00	1.00	1.00
Heavy Vehicles (%)	1%	1%	2%	1%	1%	2%
Adj. Flow (vph)	3	70	128	3	65	83
Shared Lane Traffic (%)						
Lane Group Flow (vph)	73	0	131	0	65	83
Enter Blocked Intersection	No	No	No	No	No	No
Lane Alignment	Left	Right	Left	Right	Left	Left
Median Width(m)	3.7		3.7		3.7	
Link Offset(m)	0.0		0.0		0.0	
Crosswalk Width(m)	5.0		5.0		5.0	
Two way Left Turn Lane						
Headway Factor	1.06	1.06	1.06	1.06	1.06	1.06
Turning Speed (k/h)	24	14		14	24	
Sign Control	Stop		Free			Free
<b>Intersection Summary</b>						
Area Type:	Other					
Control Type:	Unsignalized					
Intersection Capacity Utilization	22.4%			ICU Level of Service A		
Analysis Period (min)	15					

						
Lane Group	WBL	WBR	NBT	NBR	SBL	SBT
Lane Configurations						
Traffic Volume (vph)	1	10	121	1	12	74
Future Volume (vph)	1	10	121	1	12	74
Ideal Flow (vphpl)	1800	1800	1800	1800	1800	1800
Lane Util. Factor	1.00	1.00	1.00	1.00	1.00	1.00
Frt	0.877		0.999			
Flt Protected	0.995					0.993
Satd. Flow (prot)	1572	0	1783	0	0	1774
Flt Permitted	0.995					0.993
Satd. Flow (perm)	1572	0	1783	0	0	1774
Link Speed (k/h)	50		40			50
Link Distance (m)	178.0		82.4			68.2
Travel Time (s)	12.8		7.4			4.9
Peak Hour Factor	1.00	1.00	1.00	1.00	1.00	1.00
Heavy Vehicles (%)	1%	1%	2%	1%	1%	2%
Adj. Flow (vph)	1	10	121	1	12	74
Shared Lane Traffic (%)						
Lane Group Flow (vph)	11	0	122	0	0	86
Enter Blocked Intersection	No	No	No	No	No	No
Lane Alignment	L NA	R NA	Left	Right	Left	Left
Median Width(m)	3.7		0.0			0.0
Link Offset(m)	0.0		0.0			0.0
Crosswalk Width(m)	5.0		5.0			5.0
Two way Left Turn Lane						
Headway Factor	1.06	1.06	1.06	1.06	1.06	1.06
Turning Speed (k/h)	24	14		14	24	
Sign Control	Stop		Free			Free
<b>Intersection Summary</b>						
Area Type:	Other					
Control Type:	Unsignalized					
Intersection Capacity Utilization	24.8%			ICU Level of Service A		
Analysis Period (min)	15					



Lane Group	EBL	EBR	NBL	NBT	SBT	SBR
Lane Configurations						
Traffic Volume (vph)	28	0	0	73	92	41
Future Volume (vph)	28	0	0	73	92	41
Ideal Flow (vphpl)	1800	1800	1800	1800	1800	1800
Lane Util. Factor	1.00	1.00	1.00	1.00	1.00	1.00
Fr <sub>t</sub>						0.958
Flt Protected	0.950					
Satd. Flow (prot)	1712	0	0	1802	1726	0
Flt Permitted	0.950					
Satd. Flow (perm)	1712	0	0	1802	1726	0
Link Speed (k/h)	40			40	40	
Link Distance (m)	173.4			67.2	54.2	
Travel Time (s)	15.6			6.0	4.9	
Peak Hour Factor	1.00	1.00	1.00	1.00	1.00	1.00
Heavy Vehicles (%)	1%	1%	1%	1%	1%	1%
Adj. Flow (vph)	28	0	0	73	92	41
Shared Lane Traffic (%)						
Lane Group Flow (vph)	28	0	0	73	133	0
Enter Blocked Intersection	No	No	No	No	No	No
Lane Alignment	Left	Right	Left	Left	Left	Right
Median Width(m)	3.7			0.0	0.0	
Link Offset(m)	0.0			0.0	0.0	
Crosswalk Width(m)	5.0			5.0	5.0	
Two way Left Turn Lane						
Headway Factor	1.06	1.06	1.06	1.06	1.06	1.06
Turning Speed (k/h)	24	14	24			14
Sign Control	Stop			Free	Free	

**Intersection Summary**

Area Type:	Other
Control Type:	Unsignalized
Intersection Capacity Utilization	17.7%
Analysis Period (min)	15
	ICU Level of Service A



Lane Group	EBL	EBR	NBL	NBT	SBT	SBR
Lane Configurations						
Traffic Volume (vph)	9	0	0	64	82	10
Future Volume (vph)	9	0	0	64	82	10
Ideal Flow (vphpl)	1800	1800	1800	1800	1800	1800
Lane Util. Factor	1.00	1.00	1.00	1.00	1.00	1.00
Frt					0.985	
Frt Protected	0.950					
Satd. Flow (prot)	1712	0	0	1802	1775	0
Frt Permitted	0.950					
Satd. Flow (perm)	1712	0	0	1802	1775	0
Link Speed (k/h)	50			40	50	
Link Distance (m)	178.0			106.1	67.2	
Travel Time (s)	12.8			9.5	4.8	
Peak Hour Factor	1.00	1.00	1.00	1.00	1.00	1.00
Heavy Vehicles (%)	1%	1%	1%	1%	1%	1%
Adj. Flow (vph)	9	0	0	64	82	10
Shared Lane Traffic (%)						
Lane Group Flow (vph)	9	0	0	64	92	0
Enter Blocked Intersection	No	No	No	No	No	No
Lane Alignment	L NA	R NA	Left	Left	Left	Right
Median Width(m)	3.7			0.0	0.0	
Link Offset(m)	0.0			0.0	0.0	
Crosswalk Width(m)	5.0			5.0	5.0	
Two way Left Turn Lane						
Headway Factor	1.06	1.06	1.06	1.06	1.06	1.06
Turning Speed (k/h)	24	14	24			14
Sign Control	Stop			Free	Free	

**Intersection Summary**

Area Type:	Other
Control Type:	Unsignalized
Intersection Capacity Utilization	15.2%
ICU Level of Service	A
Analysis Period (min)	15



Lane Group	EBL	EBT	EBR	WBL	WBT	WBR	NBL	NBT	NBR	SBL	SBT	SBR
Lane Configurations												
Traffic Volume (vph)	54	2092	6	20	663	22	9	2	32	2	0	11
Future Volume (vph)	54	2092	6	20	663	22	9	2	32	2	0	11
Ideal Flow (vphpl)	1800	1800	1800	1800	1800	1800	1800	1800	1800	1800	1800	1800
Storage Length (m)	75.0		0.0	45.0		0.0	0.0		0.0	0.0		0.0
Storage Lanes	1		0	1		0	0		0	0		0
Taper Length (m)	10.0			10.0			10.0			10.0		
Lane Util. Factor	1.00	0.95	0.95	1.00	0.95	0.95	1.00	1.00	1.00	1.00	1.00	1.00
Ped Bike Factor	0.99	1.00			1.00			1.00				0.98
Frt					0.995			0.900				0.886
Flt Protected	0.950			0.950				0.990				0.992
Satd. Flow (prot)	1662	3356	0	1572	3308	0	0	1554	0	0	1446	0
Flt Permitted	0.391			0.066				0.928			0.952	
Satd. Flow (perm)	676	3356	0	109	3308	0	0	1454	0	0	1388	0
Right Turn on Red			Yes			Yes			Yes			Yes
Satd. Flow (RTOR)		1			6			19			23	
Link Speed (k/h)		60			60			40			40	
Link Distance (m)		198.0			310.7			254.0			246.4	
Travel Time (s)		11.9			18.6			22.9			22.2	
Confl. Peds. (#/hr)	11		3	11		3	6					6
Peak Hour Factor	1.00	1.00	1.00	1.00	1.00	1.00	1.00	1.00	1.00	1.00	1.00	1.00
Heavy Vehicles (%)	4%	3%	10%	10%	4%	1%	10%	1%	3%	1%	1%	10%
Adj. Flow (vph)	54	2092	6	20	663	22	9	2	32	2	0	11
Shared Lane Traffic (%)												
Lane Group Flow (vph)	54	2098	0	20	685	0	0	43	0	0	13	0
Enter Blocked Intersection	No	No	No	No	No	No	No	No	No	No	No	No
Lane Alignment	L NA	Left	R NA	L NA	Left	R NA	L NA	Left	R NA	L NA	Left	R NA
Median Width(m)		3.7			3.7			0.0			0.0	
Link Offset(m)		0.0			0.0			0.0			0.0	
Crosswalk Width(m)		5.0			5.0			5.0			5.0	
Two way Left Turn Lane		Yes			Yes							
Headway Factor	1.06	1.06	1.06	1.06	1.06	1.06	1.06	1.06	1.06	1.06	1.06	1.06
Turning Speed (k/h)	24		14	24		14	24		14	24		14
Number of Detectors	1	2		1	2		1	2		1	2	
Detector Template	Left	Thru		Left	Thru		Left	Thru		Left	Thru	
Leading Detector (m)	6.1	30.5		6.1	30.5		6.1	30.5		6.1	30.5	
Trailing Detector (m)	0.0	0.0		0.0	0.0		0.0	0.0		0.0	0.0	
Detector 1 Position(m)	0.0	0.0		0.0	0.0		0.0	0.0		0.0	0.0	
Detector 1 Size(m)	6.1	1.8		6.1	1.8		6.1	1.8		6.1	1.8	
Detector 1 Type	Cl+Ex	Cl+Ex		Cl+Ex	Cl+Ex		Cl+Ex	Cl+Ex		Cl+Ex	Cl+Ex	
Detector 1 Channel												
Detector 1 Extend (s)	0.0	0.0		0.0	0.0		0.0	0.0		0.0	0.0	
Detector 1 Queue (s)	0.0	0.0		0.0	0.0		0.0	0.0		0.0	0.0	
Detector 1 Delay (s)	0.0	0.0		0.0	0.0		0.0	0.0		0.0	0.0	
Detector 2 Position(m)		28.7			28.7			28.7			28.7	
Detector 2 Size(m)		1.8			1.8			1.8			1.8	
Detector 2 Type		Cl+Ex			Cl+Ex			Cl+Ex			Cl+Ex	
Detector 2 Channel												
Detector 2 Extend (s)		0.0			0.0			0.0			0.0	
Turn Type	Perm	NA		Perm	NA		Perm	NA		Perm	NA	
Protected Phases		2			6			8			4	
Permitted Phases	2			6			8			4		
Detector Phase	2	2		6	6		8	8		4	4	
Switch Phase												



Lane Group	EBL	EBT	EBR	WBL	WBT	WBR	NBL	NBT	NBR	SBL	SBT	SBR
Minimum Initial (s)	10.0	10.0		10.0	10.0		10.0	10.0		10.0	10.0	
Minimum Split (s)	26.8	26.8		26.8	26.8		31.6	31.6		31.6	31.6	
Total Split (s)	98.0	98.0		98.0	98.0		32.0	32.0		32.0	32.0	
Total Split (%)	75.4%	75.4%		75.4%	75.4%		24.6%	24.6%		24.6%	24.6%	
Maximum Green (s)	92.2	92.2		92.2	92.2		25.4	25.4		25.4	25.4	
Yellow Time (s)	3.7	3.7		3.7	3.7		3.0	3.0		3.0	3.0	
All-Red Time (s)	2.1	2.1		2.1	2.1		3.6	3.6		3.6	3.6	
Lost Time Adjust (s)	0.0	0.0		0.0	0.0			0.0			0.0	
Total Lost Time (s)	5.8	5.8		5.8	5.8			6.6			6.6	
Lead/Lag												
Lead-Lag Optimize?												
Vehicle Extension (s)	3.0	3.0		3.0	3.0		3.0	3.0		3.0	3.0	
Recall Mode	C-Max	C-Max		C-Max	C-Max		None	None		None	None	
Walk Time (s)	7.0	7.0		7.0	7.0		7.0	7.0		7.0	7.0	
Flash Dont Walk (s)	14.0	14.0		14.0	14.0		18.0	18.0		18.0	18.0	
Pedestrian Calls (#/hr)	3	3		11	11		1	1		6	6	
Act Effct Green (s)	109.1	109.1		109.1	109.1			13.0			13.0	
Actuated g/C Ratio	0.84	0.84		0.84	0.84			0.10			0.10	
v/c Ratio	0.10	0.75		0.22	0.25			0.27			0.08	
Control Delay	4.1	9.3		13.6	2.7			36.9			8.8	
Queue Delay	0.0	0.0		0.0	0.0			0.0			0.0	
Total Delay	4.1	9.3		13.6	2.7			36.9			8.8	
LOS	A	A		B	A			D			A	
Approach Delay		9.2			3.0			36.9			8.8	
Approach LOS		A			A			D			A	
Queue Length 50th (m)	1.9	94.1		0.7	11.7			5.4			0.0	
Queue Length 95th (m)	7.7	218.4		5.4	22.7			14.4			3.3	
Internal Link Dist (m)		174.0			286.7			230.0			222.4	
Turn Bay Length (m)	75.0			45.0								
Base Capacity (vph)	567	2815		91	2777			299			289	
Starvation Cap Reductn	0	0		0	0			0			0	
Spillback Cap Reductn	0	0		0	0			0			0	
Storage Cap Reductn	0	0		0	0			0			0	
Reduced v/c Ratio	0.10	0.75		0.22	0.25			0.14			0.04	

Intersection Summary

Area Type: Other  
 Cycle Length: 130  
 Actuated Cycle Length: 130  
 Offset: 129 (99%), Referenced to phase 2:EBTL and 6:WBTL, Start of Green  
 Natural Cycle: 100  
 Control Type: Actuated-Coordinated  
 Maximum v/c Ratio: 0.75  
 Intersection Signal Delay: 8.1  
 Intersection Capacity Utilization 82.2%  
 Analysis Period (min) 15  
 Intersection LOS: A  
 ICU Level of Service E

Splits and Phases: 1: Stinson Avenue & Robertson Road



2: Lynhar Road/Stafford Road & Robertson Road  
AM Peak Hour

1826 Robertson Road  
2029 Background Traffic



Lane Group	EBL	EBT	EBR	WBL	WBT	WBR	NBL	NBT	NBR	SBL	SBT	SBR
Lane Configurations												
Traffic Volume (vph)	42	1967	27	14	689	83	33	11	101	31	4	52
Future Volume (vph)	42	1967	27	14	689	83	33	11	101	31	4	52
Ideal Flow (vphpl)	1800	1800	1800	1800	1800	1800	1800	1800	1800	1800	1800	1800
Storage Length (m)	85.0		40.0	0.0		0.0	0.0		30.0	45.0		75.0
Storage Lanes	1		1	1		0	1		1	1		1
Taper Length (m)	10.0			10.0			10.0			30.0		
Lane Util. Factor	1.00	0.95	1.00	1.00	0.95	0.95	1.00	1.00	1.00	1.00	1.00	1.00
Ped Bike Factor	1.00		0.97	1.00	1.00		0.99		0.98	1.00		0.98
Frt			0.850		0.984				0.850			0.850
Flt Protected	0.950			0.950			0.950			0.950		
Satd. Flow (prot)	1572	3357	1532	1712	3279	0	1679	1802	1532	1572	1802	1459
Flt Permitted	0.950			0.950			0.755			0.750		
Satd. Flow (perm)	1568	3357	1485	1711	3279	0	1327	1802	1506	1235	1802	1435
Right Turn on Red			Yes			Yes			Yes			Yes
Satd. Flow (RTOR)			82		15				101			79
Link Speed (k/h)		60			60			40				40
Link Distance (m)		310.7			66.2			81.0				107.6
Travel Time (s)		18.6			4.0			7.3				9.7
Confl. Peds. (#/hr)	5		4	4		5	4		4	4		4
Peak Hour Factor	1.00	1.00	1.00	1.00	1.00	1.00	1.00	1.00	1.00	1.00	1.00	1.00
Heavy Vehicles (%)	10%	3%	1%	1%	3%	8%	3%	1%	1%	10%	1%	6%
Adj. Flow (vph)	42	1967	27	14	689	83	33	11	101	31	4	52
Shared Lane Traffic (%)												
Lane Group Flow (vph)	42	1967	27	14	772	0	33	11	101	31	4	52
Enter Blocked Intersection	No	No	No	No	No	No	No	No	No	No	No	No
Lane Alignment	L NA	Left	R NA	L NA	Left	R NA	L NA	L NA	R NA	L NA	Left	R NA
Median Width(m)		3.7			7.4			7.4				7.4
Link Offset(m)		0.0			0.0			0.0				0.0
Crosswalk Width(m)		5.0			5.0			5.0				5.0
Two way Left Turn Lane		Yes										
Headway Factor	1.06	1.06	1.06	1.06	1.06	1.06	1.06	1.06	1.06	1.06	1.06	1.06
Turning Speed (k/h)	24		14	24		14	24		14	24		14
Number of Detectors	1	2	1	1	2		1	2	1	1	2	1
Detector Template	Left	Thru	Right	Left	Thru		Left	Thru	Right	Left	Thru	Right
Leading Detector (m)	6.1	30.5	6.1	6.1	30.5		6.1	30.5	6.1	6.1	30.5	6.1
Trailing Detector (m)	0.0	0.0	0.0	0.0	0.0		0.0	0.0	0.0	0.0	0.0	0.0
Detector 1 Position(m)	0.0	0.0	0.0	0.0	0.0		0.0	0.0	0.0	0.0	0.0	0.0
Detector 1 Size(m)	6.1	1.8	6.1	6.1	1.8		6.1	1.8	6.1	6.1	1.8	6.1
Detector 1 Type	CI+Ex	CI+Ex	CI+Ex	CI+Ex	CI+Ex		CI+Ex	CI+Ex	CI+Ex	CI+Ex	CI+Ex	CI+Ex
Detector 1 Channel												
Detector 1 Extend (s)	0.0	0.0	0.0	0.0	0.0		0.0	0.0	0.0	0.0	0.0	0.0
Detector 1 Queue (s)	0.0	0.0	0.0	0.0	0.0		0.0	0.0	0.0	0.0	0.0	0.0
Detector 1 Delay (s)	0.0	0.0	0.0	0.0	0.0		0.0	0.0	0.0	0.0	0.0	0.0
Detector 2 Position(m)		28.7			28.7			28.7				28.7
Detector 2 Size(m)		1.8			1.8			1.8				1.8
Detector 2 Type		CI+Ex			CI+Ex			CI+Ex				CI+Ex
Detector 2 Channel												
Detector 2 Extend (s)		0.0			0.0			0.0				0.0
Turn Type	Prot	NA	Perm	Prot	NA		Perm	NA	Perm	Perm	NA	Perm
Protected Phases	5	2		1	6			8				4
Permitted Phases			2				8		8	4		4
Detector Phase	5	2	2	1	6		8	8	8	4	4	4
Switch Phase												



Lane Group	EBL	EBT	EBR	WBL	WBT	WBR	NBL	NBT	NBR	SBL	SBT	SBR
Minimum Initial (s)	5.0	10.0	10.0	5.0	10.0		10.0	10.0	10.0	10.0	10.0	10.0
Minimum Split (s)	11.1	31.3	31.3	11.1	31.3		37.7	37.7	37.7	37.7	37.7	37.7
Total Split (s)	16.0	75.0	75.0	16.0	75.0		39.0	39.0	39.0	39.0	39.0	39.0
Total Split (%)	12.3%	57.7%	57.7%	12.3%	57.7%		30.0%	30.0%	30.0%	30.0%	30.0%	30.0%
Maximum Green (s)	9.9	68.7	68.7	9.9	68.7		32.3	32.3	32.3	32.3	32.3	32.3
Yellow Time (s)	3.7	3.7	3.7	3.7	3.7		3.0	3.0	3.0	3.0	3.0	3.0
All-Red Time (s)	2.4	2.6	2.6	2.4	2.6		3.7	3.7	3.7	3.7	3.7	3.7
Lost Time Adjust (s)	0.0	0.0	0.0	0.0	0.0		0.0	0.0	0.0	0.0	0.0	0.0
Total Lost Time (s)	6.1	6.3	6.3	6.1	6.3		6.7	6.7	6.7	6.7	6.7	6.7
Lead/Lag	Lead	Lag	Lag	Lead	Lag							
Lead-Lag Optimize?	Yes	Yes	Yes	Yes	Yes							
Vehicle Extension (s)	3.0	3.0	3.0	3.0	3.0		3.0	3.0	3.0	3.0	3.0	3.0
Recall Mode	None	C-Max	C-Max	None	C-Max		None	None	None	None	None	None
Walk Time (s)		7.0	7.0		7.0		12.0	12.0	12.0	12.0	12.0	12.0
Flash Dont Walk (s)		18.0	18.0		18.0		19.0	19.0	19.0	19.0	19.0	19.0
Pedestrian Calls (#/hr)		4	4		5		4	4	4	4	4	4
Act Effct Green (s)	8.6	97.2	97.2	6.6	90.3		14.2	14.2	14.2	14.2	14.2	14.2
Actuated g/C Ratio	0.07	0.75	0.75	0.05	0.69		0.11	0.11	0.11	0.11	0.11	0.11
v/c Ratio	0.40	0.78	0.02	0.16	0.34		0.23	0.06	0.40	0.23	0.02	0.23
Control Delay	79.7	9.6	0.0	72.1	7.3		53.3	47.6	13.0	53.6	46.2	5.6
Queue Delay	0.0	0.0	0.0	0.0	0.0		0.0	0.0	0.0	0.0	0.0	0.0
Total Delay	79.7	9.6	0.0	72.1	7.3		53.3	47.6	13.0	53.6	46.2	5.6
LOS	E	A	A	E	A		D	D	B	D	D	A
Approach Delay		10.9			8.5			24.8			24.6	
Approach LOS		B			A			C			C	
Queue Length 50th (m)	9.9	12.6	0.0	3.4	25.8		7.5	2.5	0.0	7.1	0.9	0.0
Queue Length 95th (m)	m12.2	#305.5	m0.0	m10.0	31.4		14.4	6.7	12.9	13.6	3.5	4.4
Internal Link Dist (m)		286.7			42.2			57.0			83.6	
Turn Bay Length (m)	85.0		40.0						30.0	45.0		75.0
Base Capacity (vph)	123	2510	1131	130	2283		329	447	450	306	447	415
Starvation Cap Reductn	0	0	0	0	0		0	0	0	0	0	0
Spillback Cap Reductn	0	0	0	0	0		0	0	0	0	0	0
Storage Cap Reductn	0	0	0	0	0		0	0	0	0	0	0
Reduced v/c Ratio	0.34	0.78	0.02	0.11	0.34		0.10	0.02	0.22	0.10	0.01	0.13

Intersection Summary

Area Type: Other  
 Cycle Length: 130  
 Actuated Cycle Length: 130  
 Offset: 36 (28%), Referenced to phase 2:EBT and 6:WBT, Start of Green  
 Natural Cycle: 135  
 Control Type: Actuated-Coordinated  
 Maximum v/c Ratio: 0.78  
 Intersection Signal Delay: 11.3      Intersection LOS: B  
 Intersection Capacity Utilization 92.7%      ICU Level of Service F  
 Analysis Period (min) 15  
 # 95th percentile volume exceeds capacity, queue may be longer.  
 Queue shown is maximum after two cycles.  
 m Volume for 95th percentile queue is metered by upstream signal.

Splits and Phases: 2: Lynhar Road/Stafford Road & Robertson Road

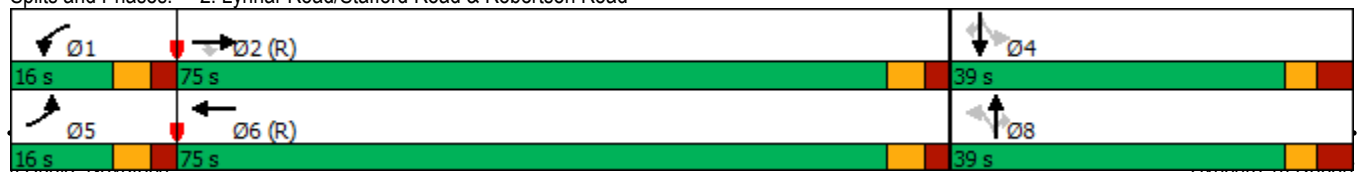



3: Northside Road East & Robertson Road  
AM Peak Hour

1826 Robertson Road  
2029 Background Traffic



Lane Group	EBL	EBT	EBR	WBL	WBT	WBR	NBL	NBT	NBR	SBL	SBT	SBR
Lane Configurations												
Traffic Volume (vph)	23	1856	12	40	651	67	95	24	38	34	8	9
Future Volume (vph)	23	1856	12	40	651	67	95	24	38	34	8	9
Ideal Flow (vphpl)	1800	1800	1800	1800	1800	1800	1800	1800	1800	1800	1800	1800
Storage Length (m)	55.0		0.0	75.0		80.0	0.0		0.0	0.0		0.0
Storage Lanes	1		0	1		1	1		0	1		1
Taper Length (m)	30.0			15.0			10.0			10.0		
Lane Util. Factor	1.00	0.95	0.95	1.00	0.95	1.00	1.00	1.00	1.00	1.00	1.00	1.00
Ped Bike Factor	1.00	1.00				0.96	0.99	0.99		0.99		0.98
Frt		0.999				0.850		0.908				0.850
Flt Protected	0.950			0.950			0.950			0.950		
Satd. Flow (prot)	1712	3354	0	1647	3325	1532	1679	1517	0	1679	1802	1532
Flt Permitted	0.368			0.095			0.752			0.717		
Satd. Flow (perm)	661	3354	0	165	3325	1475	1322	1517	0	1259	1802	1506
Right Turn on Red			Yes			Yes			Yes			Yes
Satd. Flow (RTOR)		1				99		38				93
Link Speed (k/h)		60			60			40				40
Link Distance (m)		105.4			310.9			87.0				90.9
Travel Time (s)		6.3			18.7			7.8				8.2
Confl. Peds. (#/hr)	5		3	3		5	3		4	4		3
Confl. Bikes (#/hr)			5			6			3			
Peak Hour Factor	1.00	1.00	1.00	1.00	1.00	1.00	1.00	1.00	1.00	1.00	1.00	1.00
Heavy Vehicles (%)	1%	3%	1%	5%	4%	1%	3%	5%	9%	3%	1%	1%
Adj. Flow (vph)	23	1856	12	40	651	67	95	24	38	34	8	9
Shared Lane Traffic (%)												
Lane Group Flow (vph)	23	1868	0	40	651	67	95	62	0	34	8	9
Enter Blocked Intersection	No	No	No	No	No	No	No	No	No	No	No	No
Lane Alignment	L NA	Left	R NA	L NA	Left	R NA	L NA	Left	R NA	L NA	Left	R NA
Median Width(m)		5.5			5.5			3.7				3.7
Link Offset(m)		0.0			0.0			0.0				0.0
Crosswalk Width(m)		5.0			5.0			5.0				5.0
Two way Left Turn Lane												
Headway Factor	1.06	1.06	1.06	1.06	1.06	1.06	1.06	1.06	1.06	1.06	1.06	1.06
Turning Speed (k/h)	24		14	24		14	24		14	24		14
Number of Detectors	1	2		1	2		1	1	2		1	2
Detector Template	Left	Thru		Left	Thru	Right	Left	Thru		Left	Thru	Right
Leading Detector (m)	6.1	30.5		6.1	30.5	6.1	6.1	30.5		6.1	30.5	6.1
Trailing Detector (m)	0.0	0.0		0.0	0.0	0.0	0.0	0.0		0.0	0.0	0.0
Detector 1 Position(m)	0.0	0.0		0.0	0.0	0.0	0.0	0.0		0.0	0.0	0.0
Detector 1 Size(m)	6.1	1.8		6.1	1.8	6.1	6.1	1.8		6.1	1.8	6.1
Detector 1 Type	Cl+Ex	Cl+Ex		Cl+Ex	Cl+Ex	Cl+Ex	Cl+Ex	Cl+Ex		Cl+Ex	Cl+Ex	Cl+Ex
Detector 1 Channel												
Detector 1 Extend (s)	0.0	0.0		0.0	0.0	0.0	0.0	0.0		0.0	0.0	0.0
Detector 1 Queue (s)	0.0	0.0		0.0	0.0	0.0	0.0	0.0		0.0	0.0	0.0
Detector 1 Delay (s)	0.0	0.0		0.0	0.0	0.0	0.0	0.0		0.0	0.0	0.0
Detector 2 Position(m)		28.7			28.7			28.7				28.7
Detector 2 Size(m)		1.8			1.8			1.8				1.8
Detector 2 Type		Cl+Ex			Cl+Ex			Cl+Ex				Cl+Ex
Detector 2 Channel												
Detector 2 Extend (s)		0.0			0.0			0.0				0.0
Turn Type	pm+pt	NA		Perm	NA	Perm	Perm	NA		Perm	NA	Perm
Protected Phases	5	2			6			8				4
Permitted Phases	2			6		6	8			4		4
Detector Phase	5	2		6	6	6	8	8		4	4	4

Lane Group	Ø3	Ø7
Lane Configurations		
Traffic Volume (vph)		
Future Volume (vph)		
Ideal Flow (vphpl)		
Storage Length (m)		
Storage Lanes		
Taper Length (m)		
Lane Util. Factor		
Ped Bike Factor		
Frt		
Flt Protected		
Satd. Flow (prot)		
Flt Permitted		
Satd. Flow (perm)		
Right Turn on Red		
Satd. Flow (RTOR)		
Link Speed (k/h)		
Link Distance (m)		
Travel Time (s)		
Confl. Peds. (#/hr)		
Confl. Bikes (#/hr)		
Peak Hour Factor		
Heavy Vehicles (%)		
Adj. Flow (vph)		
Shared Lane Traffic (%)		
Lane Group Flow (vph)		
Enter Blocked Intersection		
Lane Alignment		
Median Width(m)		
Link Offset(m)		
Crosswalk Width(m)		
Two way Left Turn Lane		
Headway Factor		
Turning Speed (k/h)		
Number of Detectors		
Detector Template		
Leading Detector (m)		
Trailing Detector (m)		
Detector 1 Position(m)		
Detector 1 Size(m)		
Detector 1 Type		
Detector 1 Channel		
Detector 1 Extend (s)		
Detector 1 Queue (s)		
Detector 1 Delay (s)		
Detector 2 Position(m)		
Detector 2 Size(m)		
Detector 2 Type		
Detector 2 Channel		
Detector 2 Extend (s)		
Turn Type		
Protected Phases	3	7
Permitted Phases		
Detector Phase		

3: Northside Road East & Robertson Road  
AM Peak Hour

1826 Robertson Road  
2029 Background Traffic



Lane Group	EBL	EBT	EBR	WBL	WBT	WBR	NBL	NBT	NBR	SBL	SBT	SBR
Switch Phase												
Minimum Initial (s)	5.0	10.0		10.0	10.0	10.0	10.0	10.0		10.0	10.0	10.0
Minimum Split (s)	11.0	30.1		30.1	30.1	30.1	29.8	29.8		29.8	29.8	29.8
Total Split (s)	16.0	94.0		78.0	78.0	78.0	30.0	30.0		30.0	30.0	30.0
Total Split (%)	12.3%	72.3%		60.0%	60.0%	60.0%	23.1%	23.1%		23.1%	23.1%	23.1%
Maximum Green (s)	10.0	87.9		71.9	71.9	71.9	23.2	23.2		23.2	23.2	23.2
Yellow Time (s)	3.7	3.7		3.7	3.7	3.7	3.0	3.0		3.0	3.0	3.0
All-Red Time (s)	2.3	2.4		2.4	2.4	2.4	3.8	3.8		3.8	3.8	3.8
Lost Time Adjust (s)	0.0	0.0		0.0	0.0	0.0	0.0	0.0		0.0	0.0	0.0
Total Lost Time (s)	6.0	6.1		6.1	6.1	6.1	6.8	6.8		6.8	6.8	6.8
Lead/Lag	Lead			Lag	Lag	Lag	Lag	Lag		Lag	Lag	Lag
Lead-Lag Optimize?	Yes			Yes	Yes	Yes	Yes	Yes		Yes	Yes	Yes
Vehicle Extension (s)	3.0	3.0		3.0	3.0	3.0	3.0	3.0		3.0	3.0	3.0
Recall Mode	None	C-Max		C-Max	C-Max	C-Max	None	None		None	None	None
Walk Time (s)		7.0		7.0	7.0	7.0	1.0	1.0		1.0	1.0	1.0
Flash Dont Walk (s)		17.0		17.0	17.0	17.0	22.0	22.0		22.0	22.0	22.0
Pedestrian Calls (#/hr)		3		5	5	5	4	4		3	3	3
Act Effct Green (s)	101.8	101.7		94.4	94.4	94.4	15.4	15.4		15.4	15.4	15.4
Actuated g/C Ratio	0.78	0.78		0.73	0.73	0.73	0.12	0.12		0.12	0.12	0.12
v/c Ratio	0.04	0.71		0.34	0.27	0.06	0.61	0.29		0.23	0.04	0.03
Control Delay	3.4	5.9		19.6	7.6	0.7	70.0	26.9		53.4	47.6	0.2
Queue Delay	0.0	0.1		0.0	0.0	0.0	0.0	0.0		0.0	0.0	0.0
Total Delay	3.4	5.9		19.6	7.6	0.7	70.0	26.9		53.4	47.6	0.2
LOS	A	A		B	A	A	E	C		D	D	A
Approach Delay		5.9			7.6			52.9			43.1	
Approach LOS		A			A			D			D	
Queue Length 50th (m)	0.6	24.8		3.4	27.6	0.0	21.8	5.2		7.4	1.7	0.0
Queue Length 95th (m)	m1.3	57.0		14.8	44.6	2.1	36.0	16.4		15.9	5.8	0.0
Internal Link Dist (m)		81.4			286.9			63.0			66.9	
Turn Bay Length (m)	55.0			75.0		80.0						
Base Capacity (vph)	598	2625		119	2415	1098	235	301		224	321	345
Starvation Cap Reductn	0	75		0	0	0	0	0		0	0	0
Spillback Cap Reductn	0	0		0	0	0	0	0		0	0	0
Storage Cap Reductn	0	0		0	0	0	0	0		0	0	0
Reduced v/c Ratio	0.04	0.73		0.34	0.27	0.06	0.40	0.21		0.15	0.02	0.03

Intersection Summary

Area Type: Other  
 Cycle Length: 130  
 Actuated Cycle Length: 130  
 Offset: 37 (28%), Referenced to phase 2:EBTL and 6:WBTL, Start of Green  
 Natural Cycle: 90  
 Control Type: Actuated-Coordinated  
 Maximum v/c Ratio: 0.71  
 Intersection Signal Delay: 9.6 Intersection LOS: A  
 Intersection Capacity Utilization 78.4% ICU Level of Service D  
 Analysis Period (min) 15  
 m Volume for 95th percentile queue is metered by upstream signal.

Splits and Phases: 3: Northside Road East & Robertson Road

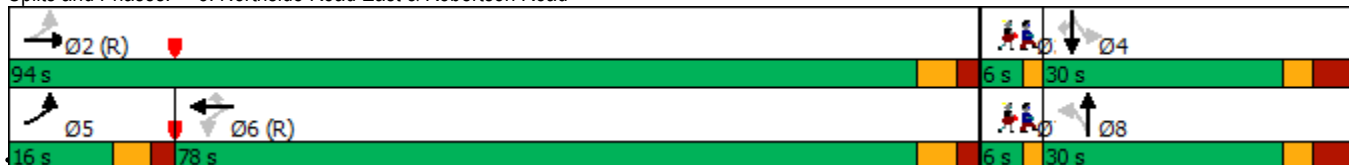

Lane Group	Ø3	Ø7
Switch Phase		
Minimum Initial (s)	4.0	4.0
Minimum Split (s)	6.0	6.0
Total Split (s)	6.0	6.0
Total Split (%)	5%	5%
Maximum Green (s)	4.0	4.0
Yellow Time (s)	2.0	2.0
All-Red Time (s)	0.0	0.0
Lost Time Adjust (s)		
Total Lost Time (s)		
Lead/Lag	Lead	Lead
Lead-Lag Optimize?	Yes	Yes
Vehicle Extension (s)	3.0	3.0
Recall Mode	None	None
Walk Time (s)		
Flash Dont Walk (s)		
Pedestrian Calls (#/hr)		
Act Effct Green (s)		
Actuated g/C Ratio		
v/c Ratio		
Control Delay		
Queue Delay		
Total Delay		
LOS		
Approach Delay		
Approach LOS		
Queue Length 50th (m)		
Queue Length 95th (m)		
Internal Link Dist (m)		
Turn Bay Length (m)		
Base Capacity (vph)		
Starvation Cap Reductn		
Spillback Cap Reductn		
Storage Cap Reductn		
Reduced v/c Ratio		
Intersection Summary		

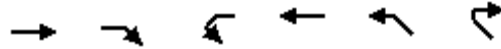

Lane Group	EBT	EBR	WBL	WBT	NWL	NWR
Lane Configurations	↑↑			↑↑↑		
Traffic Volume (vph)	1992	108	0	789	0	0
Future Volume (vph)	1992	108	0	789	0	0
Ideal Flow (vphpl)	1800	1800	1800	1800	1800	1800
Storage Length (m)		0.0	25.0		0.0	0.0
Storage Lanes		0	1		0	0
Taper Length (m)			25.0		10.0	
Lane Util. Factor	0.95	0.95	1.00	0.91	1.00	1.00
Fr <sub>t</sub>	0.992					
Flt Protected						
Satd. Flow (prot)	3356	0	0	4871	0	0
Flt Permitted						
Satd. Flow (perm)	3356	0	0	4871	0	0
Link Speed (k/h)	60			60	50	
Link Distance (m)	66.2			72.0	100.3	
Travel Time (s)	4.0			4.3	7.2	
Peak Hour Factor	1.00	1.00	1.00	1.00	1.00	1.00
Heavy Vehicles (%)	2%	6%	1%	2%	1%	1%
Adj. Flow (vph)	1992	108	0	789	0	0
Shared Lane Traffic (%)						
Lane Group Flow (vph)	2100	0	0	789	0	0
Enter Blocked Intersection	Yes	Yes	Yes	Yes	No	No
Lane Alignment	Left	Right	Left	Left	Left	Right
Median Width(m)	3.7			3.7	0.0	
Link Offset(m)	0.0			0.0	0.0	
Crosswalk Width(m)	0.0			0.0	0.0	
Two way Left Turn Lane						
Headway Factor	1.06	1.06	1.06	1.06	1.06	1.06
Turning Speed (k/h)		50	24		24	14
Sign Control	Free			Free	Free	

**Intersection Summary**

Area Type: Other

Control Type: Unsignalized











Intersection Capacity Utilization 65.1% ICU Level of Service C









Analysis Period (min) 15



Lane Group	EBT	EBR	WBL	WBT	NBL	NBR
Lane Configurations						
Traffic Volume (vph)	100	8	51	0	0	26
Future Volume (vph)	100	8	51	0	0	26
Ideal Flow (vphpl)	1800	1800	1800	1800	1800	1800
Lane Util. Factor	1.00	1.00	1.00	1.00	1.00	1.00
Ped Bike Factor						
Frt	0.990					0.865
Flt Protected			0.950			
Satd. Flow (prot)	1706	0	1572	0	0	1458
Flt Permitted			0.950			
Satd. Flow (perm)	1706	0	1572	0	0	1458
Link Speed (k/h)	50			40	40	
Link Distance (m)	100.3			62.0	54.2	
Travel Time (s)	7.2			5.6	4.9	
Confl. Peds. (#/hr)		17	17			
Peak Hour Factor	1.00	1.00	1.00	1.00	1.00	1.00
Heavy Vehicles (%)	6%	1%	10%	1%	1%	8%
Adj. Flow (vph)	100	8	51	0	0	26
Shared Lane Traffic (%)						
Lane Group Flow (vph)	108	0	51	0	0	26
Enter Blocked Intersection	No	No	No	No	No	No
Lane Alignment	L NA	R NA	L NA	R NA	Left	R NA
Median Width(m)	3.7			3.7	0.0	
Link Offset(m)	3.0			3.0	0.0	
Crosswalk Width(m)	5.0			5.0	5.0	
Two way Left Turn Lane						
Headway Factor	1.06	1.06	1.06	1.06	1.06	1.06
Turning Speed (k/h)		14	24		24	14
Sign Control	Stop			Stop	Stop	

Intersection Summary	
Area Type:	Other
Control Type:	Unsignalized
Intersection Capacity Utilization	19.3%
	ICU Level of Service A
Analysis Period (min)	15

						
Lane Group	WBL	WBR	NBT	NBR	SBL	SBT
Lane Configurations						
Traffic Volume (vph)	1	10	135	2	18	27
Future Volume (vph)	1	10	135	2	18	27
Ideal Flow (vphpl)	1800	1800	1800	1800	1800	1800
Storage Length (m)	0.0	0.0		45.0	15.0	
Storage Lanes	1	0		0	1	
Taper Length (m)	10.0				20.0	
Lane Util. Factor	1.00	1.00	0.95	0.95	1.00	1.00
Frt	0.877		0.998			
Flt Protected	0.995				0.950	
Satd. Flow (prot)	1572	0	3384	0	1712	1784
Flt Permitted	0.995				0.950	
Satd. Flow (perm)	1572	0	3384	0	1712	1784
Link Speed (k/h)	40		40		40	
Link Distance (m)	173.4		68.2		81.0	
Travel Time (s)	15.6		6.1		7.3	
Peak Hour Factor	1.00	1.00	1.00	1.00	1.00	1.00
Heavy Vehicles (%)	1%	1%	2%	1%	1%	2%
Adj. Flow (vph)	1	10	135	2	18	27
Shared Lane Traffic (%)						
Lane Group Flow (vph)	11	0	137	0	18	27
Enter Blocked Intersection	No	No	No	No	No	No
Lane Alignment	Left	Right	Left	Right	Left	Left
Median Width(m)	3.7		3.7		3.7	
Link Offset(m)	0.0		0.0		0.0	
Crosswalk Width(m)	5.0		5.0		5.0	
Two way Left Turn Lane						
Headway Factor	1.06	1.06	1.06	1.06	1.06	1.06
Turning Speed (k/h)	24	14		14	24	
Sign Control	Stop		Free			Free
<b>Intersection Summary</b>						
Area Type:	Other					
Control Type:	Unsignalized					
Intersection Capacity Utilization 20.7%	ICU Level of Service A					
Analysis Period (min) 15						

						
Lane Group	WBL	WBR	NBT	NBR	SBL	SBT
Lane Configurations						
Traffic Volume (vph)	1	4	133	0	5	23
Future Volume (vph)	1	4	133	0	5	23
Ideal Flow (vphpl)	1800	1800	1800	1800	1800	1800
Lane Util. Factor	1.00	1.00	1.00	1.00	1.00	1.00
Frt	0.892					
Flt Protected	0.990					0.991
Satd. Flow (prot)	1591	0	1784	0	0	1771
Flt Permitted	0.990					0.991
Satd. Flow (perm)	1591	0	1784	0	0	1771
Link Speed (k/h)	50		50			50
Link Distance (m)	178.0		82.4			68.2
Travel Time (s)	12.8		5.9			4.9
Peak Hour Factor	1.00	1.00	1.00	1.00	1.00	1.00
Heavy Vehicles (%)	1%	1%	2%	1%	1%	2%
Adj. Flow (vph)	1	4	133	0	5	23
Shared Lane Traffic (%)						
Lane Group Flow (vph)	5	0	133	0	0	28
Enter Blocked Intersection	No	No	No	No	No	No
Lane Alignment	L NA	R NA	Left	Right	Left	Left
Median Width(m)	3.7		0.0			0.0
Link Offset(m)	0.0		0.0			0.0
Crosswalk Width(m)	5.0		5.0			5.0
Two way Left Turn Lane						
Headway Factor	1.06	1.06	1.06	1.06	1.06	1.06
Turning Speed (k/h)	97	97		97	97	
Sign Control	Stop		Free			Free
<b>Intersection Summary</b>						
Area Type:	Other					
Control Type:	Unsignalized					
Intersection Capacity Utilization	17.4%			ICU Level of Service A		
Analysis Period (min)	15					





Lane Group	EBL	EBR	NBL	NBT	SBT	SBR
Lane Configurations						
Traffic Volume (vph)	10	0	0	16	43	16
Future Volume (vph)	10	0	0	16	43	16
Ideal Flow (vphpl)	1800	1800	1800	1800	1800	1800
Lane Util. Factor	1.00	1.00	1.00	1.00	1.00	1.00
Frt					0.963	
Frt Protected	0.950					
Satd. Flow (prot)	1712	0	0	1802	1735	0
Frt Permitted	0.950					
Satd. Flow (perm)	1712	0	0	1802	1735	0
Link Speed (k/h)	40			40	40	
Link Distance (m)	173.4			67.2	54.2	
Travel Time (s)	15.6			6.0	4.9	
Peak Hour Factor	1.00	1.00	1.00	1.00	1.00	1.00
Heavy Vehicles (%)	1%	1%	1%	1%	1%	1%
Adj. Flow (vph)	10	0	0	16	43	16
Shared Lane Traffic (%)						
Lane Group Flow (vph)	10	0	0	16	59	0
Enter Blocked Intersection	No	No	No	No	No	No
Lane Alignment	Left	Right	Left	Left	Left	Right
Median Width(m)	3.7			0.0	0.0	
Link Offset(m)	0.0			0.0	0.0	
Crosswalk Width(m)	5.0			5.0	5.0	
Two way Left Turn Lane						
Headway Factor	1.06	1.06	1.06	1.06	1.06	1.06
Turning Speed (k/h)	24	14	24			14
Sign Control	Stop			Free	Free	

**Intersection Summary**

Area Type:	Other
Control Type:	Unsignalized
Intersection Capacity Utilization	13.4%
Analysis Period (min)	15
	ICU Level of Service A



Lane Group	EBL	EBR	NBL	NBT	SBT	SBR
Lane Configurations						
Traffic Volume (vph)	3	0	0	13	38	5
Future Volume (vph)	3	0	0	13	38	5
Ideal Flow (vphpl)	1800	1800	1800	1800	1800	1800
Lane Util. Factor	1.00	1.00	1.00	1.00	1.00	1.00
Frt					0.984	
Flt Protected	0.950					
Satd. Flow (prot)	1712	0	0	1802	1773	0
Flt Permitted	0.950					
Satd. Flow (perm)	1712	0	0	1802	1773	0
Link Speed (k/h)	50			50	50	
Link Distance (m)	178.0			106.1	67.2	
Travel Time (s)	12.8			7.6	4.8	
Peak Hour Factor	1.00	1.00	1.00	1.00	1.00	1.00
Heavy Vehicles (%)	1%	1%	1%	1%	1%	1%
Adj. Flow (vph)	3	0	0	13	38	5
Shared Lane Traffic (%)						
Lane Group Flow (vph)	3	0	0	13	43	0
Enter Blocked Intersection	No	No	No	No	No	No
Lane Alignment	L NA	R NA	Left	Left	Left	Right
Median Width(m)	3.7			0.0	0.0	
Link Offset(m)	0.0			0.0	0.0	
Crosswalk Width(m)	5.0			5.0	5.0	
Two way Left Turn Lane						
Headway Factor	1.06	1.06	1.06	1.06	1.06	1.06
Turning Speed (k/h)	97	97	97			97
Sign Control	Stop			Free	Free	

**Intersection Summary**

Area Type:	Other
Control Type:	Unsignalized
Intersection Capacity Utilization	13.3%
Analysis Period (min)	15
	ICU Level of Service A



Lane Group	EBL	EBT	EBR	WBL	WBT	WBR	NBL	NBT	NBR	SBL	SBT	SBR
Lane Configurations												
Traffic Volume (vph)	16	1143	25	41	1425	5	12	1	25	20	1	46
Future Volume (vph)	16	1143	25	41	1425	5	12	1	25	20	1	46
Ideal Flow (vphpl)	1800	1800	1800	1800	1800	1800	1800	1800	1800	1800	1800	1800
Storage Length (m)	75.0		0.0	45.0		0.0	0.0		0.0	0.0		0.0
Storage Lanes	1		0	1		0	0		0	0		0
Taper Length (m)	10.0			10.0			10.0			10.0		
Lane Util. Factor	1.00	0.95	0.95	1.00	0.95	0.95	1.00	1.00	1.00	1.00	1.00	1.00
Ped Bike Factor		1.00		0.99	1.00			0.98			0.98	
Frt		0.997		0.999				0.911			0.907	
Flt Protected	0.950			0.950				0.984			0.985	
Satd. Flow (prot)	1647	3344	0	1712	3353	0	0	1588	0	0	1547	0
Flt Permitted	0.165			0.226				0.899			0.886	
Satd. Flow (perm)	286	3344	0	405	3353	0	0	1447	0	0	1386	0
Right Turn on Red			Yes			Yes			Yes			Yes
Satd. Flow (RTOR)		4			1			25			46	
Link Speed (k/h)		60			60			40			40	
Link Distance (m)		198.0			310.7			254.0			246.4	
Travel Time (s)		11.9			18.6			22.9			22.2	
Confl. Peds. (#/hr)	17		14	14		17	5		10	10		5
Peak Hour Factor	1.00	1.00	1.00	1.00	1.00	1.00	1.00	1.00	1.00	1.00	1.00	1.00
Heavy Vehicles (%)	5%	3%	1%	1%	3%	1%	1%	1%	1%	1%	1%	5%
Adj. Flow (vph)	16	1143	25	41	1425	5	12	1	25	20	1	46
Shared Lane Traffic (%)												
Lane Group Flow (vph)	16	1168	0	41	1430	0	0	38	0	0	67	0
Enter Blocked Intersection	No	No	No	No	No	No	No	No	No	No	No	No
Lane Alignment	L NA	Left	R NA	L NA	Left	R NA	L NA	Left	R NA	L NA	Left	R NA
Median Width(m)		3.7			3.7			0.0			0.0	
Link Offset(m)		0.0			0.0			0.0			0.0	
Crosswalk Width(m)		5.0			5.0			5.0			5.0	
Two way Left Turn Lane		Yes			Yes							
Headway Factor	1.06	1.06	1.06	1.06	1.06	1.06	1.06	1.06	1.06	1.06	1.06	1.06
Turning Speed (k/h)	24		14	24		14	24		14	24		14
Number of Detectors	1	2		1	2		1	2		1	2	
Detector Template	Left	Thru		Left	Thru		Left	Thru		Left	Thru	
Leading Detector (m)	6.1	30.5		6.1	30.5		6.1	30.5		6.1	30.5	
Trailing Detector (m)	0.0	0.0		0.0	0.0		0.0	0.0		0.0	0.0	
Detector 1 Position(m)	0.0	0.0		0.0	0.0		0.0	0.0		0.0	0.0	
Detector 1 Size(m)	6.1	1.8		6.1	1.8		6.1	1.8		6.1	1.8	
Detector 1 Type	Cl+Ex	Cl+Ex		Cl+Ex	Cl+Ex		Cl+Ex	Cl+Ex		Cl+Ex	Cl+Ex	
Detector 1 Channel												
Detector 1 Extend (s)	0.0	0.0		0.0	0.0		0.0	0.0		0.0	0.0	
Detector 1 Queue (s)	0.0	0.0		0.0	0.0		0.0	0.0		0.0	0.0	
Detector 1 Delay (s)	0.0	0.0		0.0	0.0		0.0	0.0		0.0	0.0	
Detector 2 Position(m)		28.7			28.7			28.7			28.7	
Detector 2 Size(m)		1.8			1.8			1.8			1.8	
Detector 2 Type		Cl+Ex			Cl+Ex			Cl+Ex			Cl+Ex	
Detector 2 Channel												
Detector 2 Extend (s)		0.0			0.0			0.0			0.0	
Turn Type	Perm	NA		Perm	NA		Perm	NA		Perm	NA	
Protected Phases		2			6			8			4	
Permitted Phases	2			6			8			4		
Detector Phase	2	2		6	6		8	8		4	4	
Switch Phase												



Lane Group	EBL	EBT	EBR	WBL	WBT	WBR	NBL	NBT	NBR	SBL	SBT	SBR
Minimum Initial (s)	10.0	10.0		10.0	10.0		10.0	10.0		10.0	10.0	
Minimum Split (s)	26.8	26.8		26.8	26.8		31.6	31.6		31.6	31.6	
Total Split (s)	88.0	88.0		88.0	88.0		32.0	32.0		32.0	32.0	
Total Split (%)	73.3%	73.3%		73.3%	73.3%		26.7%	26.7%		26.7%	26.7%	
Maximum Green (s)	82.2	82.2		82.2	82.2		25.4	25.4		25.4	25.4	
Yellow Time (s)	3.7	3.7		3.7	3.7		3.0	3.0		3.0	3.0	
All-Red Time (s)	2.1	2.1		2.1	2.1		3.6	3.6		3.6	3.6	
Lost Time Adjust (s)	0.0	0.0		0.0	0.0			0.0			0.0	
Total Lost Time (s)	5.8	5.8		5.8	5.8			6.6			6.6	
Lead/Lag												
Lead-Lag Optimize?												
Vehicle Extension (s)	3.0	3.0		3.0	3.0		3.0	3.0		3.0	3.0	
Recall Mode	C-Max	C-Max		C-Max	C-Max		None	None		None	None	
Walk Time (s)	7.0	7.0		7.0	7.0		7.0	7.0		7.0	7.0	
Flash Dont Walk (s)	14.0	14.0		14.0	14.0		18.0	18.0		18.0	18.0	
Pedestrian Calls (#/hr)	14	14		17	17		10	10		5	5	
Act Effct Green (s)	99.1	99.1		99.1	99.1			13.0			13.0	
Actuated g/C Ratio	0.83	0.83		0.83	0.83			0.11			0.11	
v/c Ratio	0.07	0.42		0.12	0.52			0.21			0.35	
Control Delay	5.0	4.8		1.5	3.5			25.5			24.5	
Queue Delay	0.0	0.0		0.0	0.0			0.0			0.0	
Total Delay	5.0	4.8		1.5	3.5			25.5			24.5	
LOS	A	A		A	A			C			C	
Approach Delay		4.8			3.4			25.5			24.5	
Approach LOS		A			A			C			C	
Queue Length 50th (m)	0.6	30.0		0.3	5.2			2.7			4.3	
Queue Length 95th (m)	3.4	70.5		m0.6	169.0			10.8			14.9	
Internal Link Dist (m)		174.0			286.7			230.0			222.4	
Turn Bay Length (m)	75.0			45.0								
Base Capacity (vph)	236	2761		334	2768			325			329	
Starvation Cap Reductn	0	0		0	0			0			0	
Spillback Cap Reductn	0	0		0	0			0			0	
Storage Cap Reductn	0	0		0	0			0			0	
Reduced v/c Ratio	0.07	0.42		0.12	0.52			0.12			0.20	

Intersection Summary

Area Type: Other  
 Cycle Length: 120  
 Actuated Cycle Length: 120  
 Offset: 31 (26%), Referenced to phase 2:EBTL and 6:WBTL, Start of Green  
 Natural Cycle: 70  
 Control Type: Actuated-Coordinated  
 Maximum v/c Ratio: 0.52  
 Intersection Signal Delay: 4.8  
 Intersection Capacity Utilization 64.0%  
 Analysis Period (min) 15  
 m Volume for 95th percentile queue is metered by upstream signal.

Splits and Phases: 1: Stinson Avenue & Robertson Road

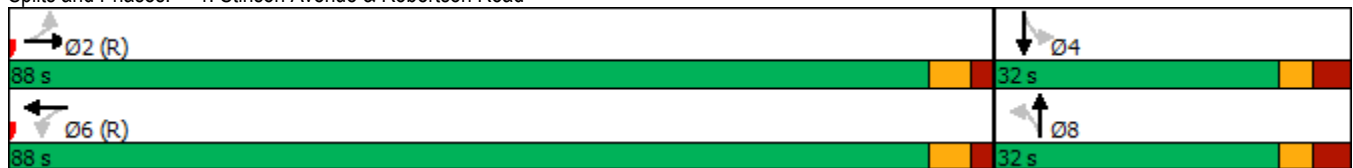

2: Lynhar Road/Stafford Road & Robertson Road  
PM Peak Hour

1826 Robertson Road  
2029 Background Traffic

Lane Group	EBL	EBT	EBR	WBL	WBT	WBR	NBL	NBT	NBR	SBL	SBT	SBR
Lane Configurations												
Traffic Volume (vph)	125	976	60	58	1141	77	92	41	80	201	36	173
Future Volume (vph)	125	976	60	58	1141	77	92	41	80	201	36	173
Ideal Flow (vphpl)	1800	1800	1800	1800	1800	1800	1800	1800	1800	1800	1800	1800
Storage Length (m)	85.0		40.0	0.0		0.0	0.0		30.0	45.0		75.0
Storage Lanes	1		1	1		0	1		1	1		1
Taper Length (m)	10.0			10.0			10.0			30.0		
Lane Util. Factor	1.00	0.95	1.00	1.00	0.95	0.95	1.00	1.00	1.00	1.00	1.00	1.00
Ped Bike Factor	0.99		0.94	0.99	1.00		0.98		0.95	0.97		0.97
Frt			0.850		0.991				0.850			0.850
Flt Protected	0.950			0.950			0.950			0.950		
Satd. Flow (prot)	1712	3357	1532	1712	3346	0	1631	1767	1502	1695	1802	1532
Flt Permitted	0.950			0.950			0.734			0.629		
Satd. Flow (perm)	1702	3357	1443	1695	3346	0	1241	1767	1434	1087	1802	1488
Right Turn on Red			Yes			Yes			Yes			Yes
Satd. Flow (RTOR)			145		7				142			173
Link Speed (k/h)		60			60			40			40	
Link Distance (m)		310.7			66.2			81.0			107.6	
Travel Time (s)		18.6			4.0			7.3			9.7	
Confl. Peds. (#/hr)	22		16	16		22	14		29	29		14
Confl. Bikes (#/hr)												1
Peak Hour Factor	1.00	1.00	1.00	1.00	1.00	1.00	1.00	1.00	1.00	1.00	1.00	1.00
Heavy Vehicles (%)	1%	3%	1%	1%	2%	4%	6%	3%	3%	2%	1%	1%
Adj. Flow (vph)	125	976	60	58	1141	77	92	41	80	201	36	173
Shared Lane Traffic (%)												
Lane Group Flow (vph)	125	976	60	58	1218	0	92	41	80	201	36	173
Enter Blocked Intersection	No	No	No	No	No	No	No	No	No	No	No	No
Lane Alignment	L NA	Left	R NA	L NA	Left	R NA	L NA	L NA	R NA	L NA	Left	R NA
Median Width(m)		3.7			7.4			7.4			7.4	
Link Offset(m)		0.0			0.0			0.0			0.0	
Crosswalk Width(m)		5.0			5.0			5.0			5.0	
Two way Left Turn Lane		Yes										
Headway Factor	1.06	1.06	1.06	1.06	1.06	1.06	1.06	1.06	1.06	1.06	1.06	1.06
Turning Speed (k/h)	24		14	24		14	24		14	24		14
Number of Detectors	1	2	1	1	2		1	2	1	1	2	1
Detector Template	Left	Thru	Right	Left	Thru		Left	Thru	Right	Left	Thru	Right
Leading Detector (m)	6.1	30.5	6.1	6.1	30.5		6.1	30.5	6.1	6.1	30.5	6.1
Trailing Detector (m)	0.0	0.0	0.0	0.0	0.0		0.0	0.0	0.0	0.0	0.0	0.0
Detector 1 Position(m)	0.0	0.0	0.0	0.0	0.0		0.0	0.0	0.0	0.0	0.0	0.0
Detector 1 Size(m)	6.1	1.8	6.1	6.1	1.8		6.1	1.8	6.1	6.1	1.8	6.1
Detector 1 Type	Cl+Ex	Cl+Ex	Cl+Ex	Cl+Ex	Cl+Ex		Cl+Ex	Cl+Ex	Cl+Ex	Cl+Ex	Cl+Ex	Cl+Ex
Detector 1 Channel												
Detector 1 Extend (s)	0.0	0.0	0.0	0.0	0.0		0.0	0.0	0.0	0.0	0.0	0.0
Detector 1 Queue (s)	0.0	0.0	0.0	0.0	0.0		0.0	0.0	0.0	0.0	0.0	0.0
Detector 1 Delay (s)	0.0	0.0	0.0	0.0	0.0		0.0	0.0	0.0	0.0	0.0	0.0
Detector 2 Position(m)		28.7			28.7			28.7			28.7	
Detector 2 Size(m)		1.8			1.8			1.8			1.8	
Detector 2 Type		Cl+Ex			Cl+Ex			Cl+Ex			Cl+Ex	
Detector 2 Channel												
Detector 2 Extend (s)		0.0			0.0			0.0			0.0	
Turn Type	Prot	NA	Perm	Prot	NA		pm+pt	NA	Perm	pm+pt	NA	Perm
Protected Phases	5	2		1	6		3	8		7	4	
Permitted Phases			2				8		8	4		4
Detector Phase	5	2	2	1	6		3	8	8	7	4	4



3: Northside Road East & Robertson Road  
PM Peak Hour

1826 Robertson Road  
2029 Background Traffic

Lane Group	EBL	EBT	EBR	WBL	WBT	WBR	NBL	NBT	NBR	SBL	SBT	SBR
Lane Configurations												
Traffic Volume (vph)	66	1125	16	79	1236	220	138	37	106	155	55	78
Future Volume (vph)	66	1125	16	79	1236	220	138	37	106	155	55	78
Ideal Flow (vphpl)	1800	1800	1800	1800	1800	1800	1800	1800	1800	1800	1800	1800
Storage Length (m)	55.0		0.0	75.0		80.0	0.0		0.0	0.0		0.0
Storage Lanes	1		0	1		1	1		0	1		1
Taper Length (m)	30.0			15.0			10.0			10.0		
Lane Util. Factor	1.00	0.95	0.95	1.00	0.95	1.00	1.00	1.00	1.00	1.00	1.00	1.00
Ped Bike Factor		1.00		1.00		0.97	0.98	0.99		0.99		0.96
Frt		0.998				0.850		0.889				0.850
Flt Protected	0.950			0.950			0.950			0.950		
Satd. Flow (prot)	1712	3383	0	1712	3390	1532	1695	1559	0	1712	1802	1532
Flt Permitted	0.151			0.249			0.721			0.615		
Satd. Flow (perm)	272	3383	0	448	3390	1488	1257	1559	0	1101	1802	1469
Right Turn on Red			Yes			Yes			Yes			Yes
Satd. Flow (RTOR)		2				220		106				101
Link Speed (k/h)		60			60			40				40
Link Distance (m)		105.4			310.9			87.0				90.9
Travel Time (s)		6.3			18.7			7.8				8.2
Confl. Peds. (#/hr)	3		7	7		3	16		5	5		16
Confl. Bikes (#/hr)			1			2						4
Peak Hour Factor	1.00	1.00	1.00	1.00	1.00	1.00	1.00	1.00	1.00	1.00	1.00	1.00
Heavy Vehicles (%)	1%	2%	1%	1%	2%	1%	2%	3%	2%	1%	1%	1%
Adj. Flow (vph)	66	1125	16	79	1236	220	138	37	106	155	55	78
Shared Lane Traffic (%)												
Lane Group Flow (vph)	66	1141	0	79	1236	220	138	143	0	155	55	78
Enter Blocked Intersection	No	No	No	No	No	No	No	No	No	No	No	No
Lane Alignment	L NA	Left	R NA	L NA	Left	R NA	L NA	Left	R NA	L NA	Left	R NA
Median Width(m)		5.5			5.5			3.7				3.7
Link Offset(m)		0.0			0.0			0.0				0.0
Crosswalk Width(m)		5.0			5.0			5.0				5.0
Two way Left Turn Lane												
Headway Factor	1.06	1.06	1.06	1.06	1.06	1.06	1.06	1.06	1.06	1.06	1.06	1.06
Turning Speed (k/h)	24		14	24		14	24		14	24		14
Number of Detectors	1	2		1	2	1	1	2		1	2	1
Detector Template	Left	Thru		Left	Thru	Right	Left	Thru		Left	Thru	Right
Leading Detector (m)	6.1	30.5		6.1	30.5	6.1	6.1	30.5		6.1	30.5	6.1
Trailing Detector (m)	0.0	0.0		0.0	0.0	0.0	0.0	0.0		0.0	0.0	0.0
Detector 1 Position(m)	0.0	0.0		0.0	0.0	0.0	0.0	0.0		0.0	0.0	0.0
Detector 1 Size(m)	6.1	1.8		6.1	1.8	6.1	6.1	1.8		6.1	1.8	6.1
Detector 1 Type	Cl+Ex	Cl+Ex		Cl+Ex	Cl+Ex	Cl+Ex	Cl+Ex	Cl+Ex		Cl+Ex	Cl+Ex	Cl+Ex
Detector 1 Channel												
Detector 1 Extend (s)	0.0	0.0		0.0	0.0	0.0	0.0	0.0		0.0	0.0	0.0
Detector 1 Queue (s)	0.0	0.0		0.0	0.0	0.0	0.0	0.0		0.0	0.0	0.0
Detector 1 Delay (s)	0.0	0.0		0.0	0.0	0.0	0.0	0.0		0.0	0.0	0.0
Detector 2 Position(m)		28.7			28.7			28.7				28.7
Detector 2 Size(m)		1.8			1.8			1.8				1.8
Detector 2 Type		Cl+Ex			Cl+Ex			Cl+Ex				Cl+Ex
Detector 2 Channel												
Detector 2 Extend (s)		0.0			0.0			0.0				0.0
Turn Type	pm+pt	NA		Perm	NA	Perm	Perm	NA		Perm	NA	Perm
Protected Phases	5	2			6			8				4
Permitted Phases	2			6		6	8			4		4
Detector Phase	5	2		6	6	6	8	8		4	4	4

Lane Group	Ø3	Ø7
Lane Configurations		
Traffic Volume (vph)		
Future Volume (vph)		
Ideal Flow (vphpl)		
Storage Length (m)		
Storage Lanes		
Taper Length (m)		
Lane Util. Factor		
Ped Bike Factor		
Frt		
Flt Protected		
Satd. Flow (prot)		
Flt Permitted		
Satd. Flow (perm)		
Right Turn on Red		
Satd. Flow (RTOR)		
Link Speed (k/h)		
Link Distance (m)		
Travel Time (s)		
Confl. Peds. (#/hr)		
Confl. Bikes (#/hr)		
Peak Hour Factor		
Heavy Vehicles (%)		
Adj. Flow (vph)		
Shared Lane Traffic (%)		
Lane Group Flow (vph)		
Enter Blocked Intersection		
Lane Alignment		
Median Width(m)		
Link Offset(m)		
Crosswalk Width(m)		
Two way Left Turn Lane		
Headway Factor		
Turning Speed (k/h)		
Number of Detectors		
Detector Template		
Leading Detector (m)		
Trailing Detector (m)		
Detector 1 Position(m)		
Detector 1 Size(m)		
Detector 1 Type		
Detector 1 Channel		
Detector 1 Extend (s)		
Detector 1 Queue (s)		
Detector 1 Delay (s)		
Detector 2 Position(m)		
Detector 2 Size(m)		
Detector 2 Type		
Detector 2 Channel		
Detector 2 Extend (s)		
Turn Type		
Protected Phases	3	7
Permitted Phases		
Detector Phase		



3: Northside Road East & Robertson Road  
PM Peak Hour

1826 Robertson Road  
2029 Background Traffic



Lane Group	EBL	EBT	EBR	WBL	WBT	WBR	NBL	NBT	NBR	SBL	SBT	SBR
Switch Phase												
Minimum Initial (s)	5.0	10.0		10.0	10.0	10.0	10.0	10.0		10.0	10.0	10.0
Minimum Split (s)	11.0	30.1		30.1	30.1	30.1	29.8	29.8		29.8	29.8	29.8
Total Split (s)	15.0	83.0		68.0	68.0	68.0	31.0	31.0		31.0	31.0	31.0
Total Split (%)	12.5%	69.2%		56.7%	56.7%	56.7%	25.8%	25.8%		25.8%	25.8%	25.8%
Maximum Green (s)	9.0	76.9		61.9	61.9	61.9	24.2	24.2		24.2	24.2	24.2
Yellow Time (s)	3.7	3.7		3.7	3.7	3.7	3.0	3.0		3.0	3.0	3.0
All-Red Time (s)	2.3	2.4		2.4	2.4	2.4	3.8	3.8		3.8	3.8	3.8
Lost Time Adjust (s)	0.0	0.0		0.0	0.0	0.0	0.0	0.0		0.0	0.0	0.0
Total Lost Time (s)	6.0	6.1		6.1	6.1	6.1	6.8	6.8		6.8	6.8	6.8
Lead/Lag	Lead			Lag	Lag	Lag	Lag	Lag		Lag	Lag	Lag
Lead-Lag Optimize?	Yes			Yes	Yes	Yes	Yes	Yes		Yes	Yes	Yes
Vehicle Extension (s)	3.0	3.0		3.0	3.0	3.0	3.0	3.0		3.0	3.0	3.0
Recall Mode	None	C-Max		C-Max	C-Max	C-Max	None	None		None	None	None
Walk Time (s)		7.0		7.0	7.0	7.0	1.0	1.0		1.0	1.0	1.0
Flash Dont Walk (s)		17.0		17.0	17.0	17.0	22.0	22.0		22.0	22.0	22.0
Pedestrian Calls (#/hr)		7		3	3	3	5	5		16	16	16
Act Effct Green (s)	85.3	85.2		74.4	74.4	74.4	21.9	21.9		21.9	21.9	21.9
Actuated g/C Ratio	0.71	0.71		0.62	0.62	0.62	0.18	0.18		0.18	0.18	0.18
v/c Ratio	0.24	0.48		0.29	0.59	0.22	0.60	0.39		0.77	0.17	0.22
Control Delay	9.4	9.3		17.5	17.1	2.4	54.9	15.4		70.1	39.8	5.1
Queue Delay	0.0	0.0		0.0	0.0	0.0	0.0	0.0		0.0	0.0	0.0
Total Delay	9.4	9.3		17.5	17.1	2.4	54.9	15.4		70.1	39.8	5.1
LOS	A	A		B	B	A	D	B		E	D	A
Approach Delay		9.3			15.0			34.8			46.7	
Approach LOS		A			B			C			D	
Queue Length 50th (m)	4.3	48.3		7.8	83.6	0.0	27.7	6.8		32.2	10.1	0.0
Queue Length 95th (m)	m7.8	60.9		21.2	126.5	10.7	43.5	21.4		50.0	19.1	6.9
Internal Link Dist (m)		81.4			286.9			63.0			66.9	
Turn Bay Length (m)	55.0			75.0		80.0						
Base Capacity (vph)	301	2401		277	2103	1006	269	417		236	386	394
Starvation Cap Reductn	0	0		0	0	0	0	0		0	0	0
Spillback Cap Reductn	0	0		0	0	0	0	0		0	0	0
Storage Cap Reductn	0	0		0	0	0	0	0		0	0	0
Reduced v/c Ratio	0.22	0.48		0.29	0.59	0.22	0.51	0.34		0.66	0.14	0.20

Intersection Summary

Area Type: Other  
 Cycle Length: 120  
 Actuated Cycle Length: 120  
 Offset: 111 (93%), Referenced to phase 2:EBTL and 6:WBTL, Start of Green  
 Natural Cycle: 90  
 Control Type: Actuated-Coordinated  
 Maximum v/c Ratio: 0.77  
 Intersection Signal Delay: 17.4 Intersection LOS: B  
 Intersection Capacity Utilization 84.4% ICU Level of Service E  
 Analysis Period (min) 15  
 m Volume for 95th percentile queue is metered by upstream signal.

Splits and Phases: 3: Northside Road East & Robertson Road

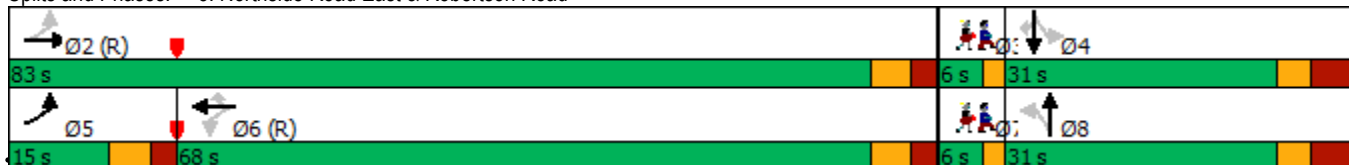

Lane Group	Ø3	Ø7
Switch Phase		
Minimum Initial (s)	4.0	4.0
Minimum Split (s)	6.0	6.0
Total Split (s)	6.0	6.0
Total Split (%)	5%	5%
Maximum Green (s)	4.0	4.0
Yellow Time (s)	2.0	2.0
All-Red Time (s)	0.0	0.0
Lost Time Adjust (s)		
Total Lost Time (s)		
Lead/Lag	Lead	Lead
Lead-Lag Optimize?	Yes	Yes
Vehicle Extension (s)	3.0	3.0
Recall Mode	None	None
Walk Time (s)		
Flash Dont Walk (s)		
Pedestrian Calls (#/hr)		
Act Effct Green (s)		
Actuated g/C Ratio		
v/c Ratio		
Control Delay		
Queue Delay		
Total Delay		
LOS		
Approach Delay		
Approach LOS		
Queue Length 50th (m)		
Queue Length 95th (m)		
Internal Link Dist (m)		
Turn Bay Length (m)		
Base Capacity (vph)		
Starvation Cap Reductn		
Spillback Cap Reductn		
Storage Cap Reductn		
Reduced v/c Ratio		
Intersection Summary		

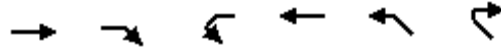

Lane Group	EBT	EBR	WBL	WBT	NWL	NWR
Lane Configurations	↑↑			↑↑↑		
Traffic Volume (vph)	1146	117	0	1281	0	0
Future Volume (vph)	1146	117	0	1281	0	0
Ideal Flow (vphpl)	1800	1800	1800	1800	1800	1800
Storage Length (m)		0.0	25.0		0.0	0.0
Storage Lanes		0	1		0	0
Taper Length (m)			25.0		10.0	
Lane Util. Factor	0.95	0.95	1.00	0.91	1.00	1.00
Frt	0.986					
Flt Protected						
Satd. Flow (prot)	3331	0	0	4871	0	0
Flt Permitted						
Satd. Flow (perm)	3331	0	0	4871	0	0
Link Speed (k/h)	60			60	50	
Link Distance (m)	66.2			72.0	100.3	
Travel Time (s)	4.0			4.3	7.2	
Peak Hour Factor	1.00	1.00	1.00	1.00	1.00	1.00
Heavy Vehicles (%)	2%	6%	1%	2%	1%	1%
Adj. Flow (vph)	1146	117	0	1281	0	0
Shared Lane Traffic (%)						
Lane Group Flow (vph)	1263	0	0	1281	0	0
Enter Blocked Intersection	Yes	Yes	Yes	Yes	No	No
Lane Alignment	Left	Right	Left	Left	Left	Right
Median Width(m)	3.7			3.7	0.0	
Link Offset(m)	0.0			0.0	0.0	
Crosswalk Width(m)	0.0			0.0	0.0	
Two way Left Turn Lane						
Headway Factor	1.06	1.06	1.06	1.06	1.06	1.06
Turning Speed (k/h)		50	24		24	14
Sign Control	Free			Free	Free	

**Intersection Summary**

Area Type: Other

Control Type: Unsignalized

Intersection Capacity Utilization 40.7% ICU Level of Service A











Analysis Period (min) 15











Lane Group	EBT	EBR	WBL	WBT	NBL	NBR
Lane Configurations						
Traffic Volume (vph)	107	10	98	0	0	79
Future Volume (vph)	107	10	98	0	0	79
Ideal Flow (vphpl)	1800	1800	1800	1800	1800	1800
Lane Util. Factor	1.00	1.00	1.00	1.00	1.00	1.00
Ped Bike Factor						
Frt	0.988					0.865
Flt Protected			0.950			
Satd. Flow (prot)	1689	0	1631	0	0	1514
Flt Permitted			0.950			
Satd. Flow (perm)	1689	0	1631	0	0	1514
Link Speed (k/h)	50			40	40	
Link Distance (m)	100.3			62.0	54.2	
Travel Time (s)	7.2			5.6	4.9	
Confl. Peds. (#/hr)		12	12			
Confl. Bikes (#/hr)		1				1
Peak Hour Factor	1.00	1.00	1.00	1.00	1.00	1.00
Heavy Vehicles (%)	7%	1%	6%	1%	1%	4%
Adj. Flow (vph)	107	10	98	0	0	79
Shared Lane Traffic (%)						
Lane Group Flow (vph)	117	0	98	0	0	79
Enter Blocked Intersection	No	No	No	No	No	No
Lane Alignment	L NA	R NA	L NA	R NA	Left	R NA
Median Width(m)	3.7			3.7	0.0	
Link Offset(m)	3.0			3.0	0.0	
Crosswalk Width(m)	5.0			5.0	5.0	
Two way Left Turn Lane						
Headway Factor	1.06	1.06	1.06	1.06	1.06	1.06
Turning Speed (k/h)		14	24		24	14
Sign Control	Stop			Stop	Stop	

**Intersection Summary**

Area Type:	Other
Control Type:	Unsignalized
Intersection Capacity Utilization 20.7%	ICU Level of Service A
Analysis Period (min)	15

						
Lane Group	WBL	WBR	NBT	NBR	SBL	SBT
Lane Configurations						
Traffic Volume (vph)	3	70	143	2	59	95
Future Volume (vph)	3	70	143	2	59	95
Ideal Flow (vphpl)	1800	1800	1800	1800	1800	1800
Storage Length (m)	0.0	0.0		45.0	15.0	
Storage Lanes	1	0		0	1	
Taper Length (m)	10.0				20.0	
Lane Util. Factor	1.00	1.00	0.95	0.95	1.00	1.00
Frt	0.871		0.998			
Flt Protected	0.998				0.950	
Satd. Flow (prot)	1566	0	3384	0	1712	1784
Flt Permitted	0.998				0.950	
Satd. Flow (perm)	1566	0	3384	0	1712	1784
Link Speed (k/h)	40		40			40
Link Distance (m)	173.4		68.2			81.0
Travel Time (s)	15.6		6.1			7.3
Peak Hour Factor	1.00	1.00	1.00	1.00	1.00	1.00
Heavy Vehicles (%)	1%	1%	2%	1%	1%	2%
Adj. Flow (vph)	3	70	143	2	59	95
Shared Lane Traffic (%)						
Lane Group Flow (vph)	73	0	145	0	59	95
Enter Blocked Intersection	No	No	No	No	No	No
Lane Alignment	Left	Right	Left	Right	Left	Left
Median Width(m)	3.7		3.7			3.7
Link Offset(m)	0.0		0.0			0.0
Crosswalk Width(m)	5.0		5.0			5.0
Two way Left Turn Lane						
Headway Factor	1.06	1.06	1.06	1.06	1.06	1.06
Turning Speed (k/h)	24	14		14	24	
Sign Control	Stop		Free			Free
<b>Intersection Summary</b>						
Area Type:	Other					
Control Type:	Unsignalized					
Intersection Capacity Utilization	22.4%			ICU Level of Service A		
Analysis Period (min)	15					

						
Lane Group	WBL	WBR	NBT	NBR	SBL	SBT
Lane Configurations						
Traffic Volume (vph)	1	9	136	1	8	90
Future Volume (vph)	1	9	136	1	8	90
Ideal Flow (vphpl)	1800	1800	1800	1800	1800	1800
Lane Util. Factor	1.00	1.00	1.00	1.00	1.00	1.00
Frt	0.878		0.999			
Flt Protected	0.995					0.996
Satd. Flow (prot)	1574	0	1783	0	0	1779
Flt Permitted	0.995					0.996
Satd. Flow (perm)	1574	0	1783	0	0	1779
Link Speed (k/h)	50		50			50
Link Distance (m)	178.0		82.4			68.2
Travel Time (s)	12.8		5.9			4.9
Peak Hour Factor	1.00	1.00	1.00	1.00	1.00	1.00
Heavy Vehicles (%)	1%	1%	2%	1%	1%	2%
Adj. Flow (vph)	1	9	136	1	8	90
Shared Lane Traffic (%)						
Lane Group Flow (vph)	10	0	137	0	0	98
Enter Blocked Intersection	No	No	No	No	No	No
Lane Alignment	L NA	R NA	Left	Right	Left	Left
Median Width(m)	3.7		0.0			0.0
Link Offset(m)	0.0		0.0			0.0
Crosswalk Width(m)	5.0		5.0			5.0
Two way Left Turn Lane						
Headway Factor	1.06	1.06	1.06	1.06	1.06	1.06
Turning Speed (k/h)	97	97		97	97	
Sign Control	Stop		Free			Free
<b>Intersection Summary</b>						
Area Type:	Other					
Control Type:	Unsignalized					
Intersection Capacity Utilization	22.0%			ICU Level of Service A		
Analysis Period (min)	15					



Lane Group	EBL	EBR	NBL	NBT	SBT	SBR
Lane Configurations						
Traffic Volume (vph)	24	0	0	55	74	34
Future Volume (vph)	24	0	0	55	74	34
Ideal Flow (vphpl)	1800	1800	1800	1800	1800	1800
Lane Util. Factor	1.00	1.00	1.00	1.00	1.00	1.00
Fr <sub>t</sub>					0.957	
Fl <sub>t</sub> Protected	0.950					
Satd. Flow (prot)	1712	0	0	1802	1719	0
Fl <sub>t</sub> Permitted	0.950					
Satd. Flow (perm)	1712	0	0	1802	1719	0
Link Speed (k/h)	40			40	40	
Link Distance (m)	173.4			67.2	54.2	
Travel Time (s)	15.6			6.0	4.9	
Peak Hour Factor	1.00	1.00	1.00	1.00	1.00	1.00
Heavy Vehicles (%)	1%	1%	1%	1%	1%	2%
Adj. Flow (vph)	24	0	0	55	74	34
Shared Lane Traffic (%)						
Lane Group Flow (vph)	24	0	0	55	108	0
Enter Blocked Intersection	No	No	No	No	No	No
Lane Alignment	Left	Right	Left	Left	Left	Right
Median Width(m)	3.7			0.0	0.0	
Link Offset(m)	0.0			0.0	0.0	
Crosswalk Width(m)	5.0			5.0	5.0	
Two way Left Turn Lane						
Headway Factor	1.06	1.06	1.06	1.06	1.06	1.06
Turning Speed (k/h)	24	14	24			14
Sign Control	Stop			Free	Free	

**Intersection Summary**

Area Type:	Other
Control Type:	Unsignalized
Intersection Capacity Utilization	16.3%
Analysis Period (min)	15
	ICU Level of Service A



Lane Group	EBL	EBR	NBL	NBT	SBT	SBR
Lane Configurations						
Traffic Volume (vph)	7	0	0	48	67	7
Future Volume (vph)	7	0	0	48	67	7
Ideal Flow (vphpl)	1800	1800	1800	1800	1800	1800
Lane Util. Factor	1.00	1.00	1.00	1.00	1.00	1.00
Frt					0.987	
Frt Protected	0.950					
Satd. Flow (prot)	1712	0	0	1802	1779	0
Frt Permitted	0.950					
Satd. Flow (perm)	1712	0	0	1802	1779	0
Link Speed (k/h)	50			50	50	
Link Distance (m)	178.0			106.1	67.2	
Travel Time (s)	12.8			7.6	4.8	
Peak Hour Factor	1.00	1.00	1.00	1.00	1.00	1.00
Heavy Vehicles (%)	1%	1%	1%	1%	1%	1%
Adj. Flow (vph)	7	0	0	48	67	7
Shared Lane Traffic (%)						
Lane Group Flow (vph)	7	0	0	48	74	0
Enter Blocked Intersection	No	No	No	No	No	No
Lane Alignment	L NA	R NA	Left	Left	Left	Right
Median Width(m)	3.7			0.0	0.0	
Link Offset(m)	0.0			0.0	0.0	
Crosswalk Width(m)	5.0			5.0	5.0	
Two way Left Turn Lane						
Headway Factor	1.06	1.06	1.06	1.06	1.06	1.06
Turning Speed (k/h)	97	97	97			97
Sign Control	Stop			Free	Free	

**Intersection Summary**

Area Type:	Other
Control Type:	Unsignalized
Intersection Capacity Utilization	14.2%
ICU Level of Service	A
Analysis Period (min)	15



1: Stinson Avenue & Robertson Road  
SAT Peak Hour

1826 Robertson Road  
2029 Background Traffic



Lane Group	EBL	EBT	EBR	WBL	WBT	WBR	NBL	NBT	NBR	SBL	SBT	SBR
Lane Configurations												
Traffic Volume (vph)	15	1097	24	45	1031	4	10	0	32	3	1	8
Future Volume (vph)	15	1097	24	45	1031	4	10	0	32	3	1	8
Ideal Flow (vphpl)	1800	1800	1800	1800	1800	1800	1800	1800	1800	1800	1800	1800
Storage Length (m)	75.0		0.0	45.0		0.0	0.0		0.0	0.0		0.0
Storage Lanes	1		0	1		0	0		0	0		0
Taper Length (m)	10.0			10.0			10.0			10.0		
Lane Util. Factor	1.00	0.95	0.95	1.00	0.95	0.95	1.00	1.00	1.00	1.00	1.00	1.00
Ped Bike Factor	0.99	1.00		1.00	1.00			0.99			0.99	
Frt		0.997			0.999			0.897			0.910	
Flt Protected	0.950			0.950				0.988			0.988	
Satd. Flow (prot)	1712	3409	0	1712	3420	0	0	1576	0	0	1606	0
Flt Permitted	0.264			0.239				0.919			0.923	
Satd. Flow (perm)	473	3409	0	430	3420	0	0	1465	0	0	1498	0
Right Turn on Red			Yes			Yes			Yes			Yes
Satd. Flow (RTOR)		4			1			32			8	
Link Speed (k/h)		60			60			40			40	
Link Distance (m)		198.0			310.7			254.0			246.4	
Travel Time (s)		11.9			18.6			22.9			22.2	
Confl. Peds. (#/hr)	10		4	4		10	1		4	4		1
Confl. Bikes (#/hr)			4			2						
Peak Hour Factor	1.00	1.00	1.00	1.00	1.00	1.00	1.00	1.00	1.00	1.00	1.00	1.00
Heavy Vehicles (%)	1%	1%	4%	1%	1%	1%	1%	1%	1%	1%	1%	1%
Adj. Flow (vph)	15	1097	24	45	1031	4	10	0	32	3	1	8
Shared Lane Traffic (%)												
Lane Group Flow (vph)	15	1121	0	45	1035	0	0	42	0	0	12	0
Enter Blocked Intersection	No	No	No	No	No	No	No	No	No	No	No	No
Lane Alignment	L NA	Left	R NA	L NA	Left	R NA	L NA	Left	R NA	L NA	Left	R NA
Median Width(m)		3.7			3.7			0.0			0.0	
Link Offset(m)		0.0			0.0			0.0			0.0	
Crosswalk Width(m)		5.0			5.0			5.0			5.0	
Two way Left Turn Lane		Yes			Yes							
Headway Factor	1.06	1.06	1.06	1.06	1.06	1.06	1.06	1.06	1.06	1.06	1.06	1.06
Turning Speed (k/h)	24		14	24		14	24		14	24		14
Number of Detectors	1	2		1	2		1	2		1	2	
Detector Template	Left	Thru		Left	Thru		Left	Thru		Left	Thru	
Leading Detector (m)	6.1	30.5		6.1	30.5		6.1	30.5		6.1	30.5	
Trailing Detector (m)	0.0	0.0		0.0	0.0		0.0	0.0		0.0	0.0	
Detector 1 Position(m)	0.0	0.0		0.0	0.0		0.0	0.0		0.0	0.0	
Detector 1 Size(m)	6.1	1.8		6.1	1.8		6.1	1.8		6.1	1.8	
Detector 1 Type	Cl+Ex	Cl+Ex		Cl+Ex	Cl+Ex		Cl+Ex	Cl+Ex		Cl+Ex	Cl+Ex	
Detector 1 Channel												
Detector 1 Extend (s)	0.0	0.0		0.0	0.0		0.0	0.0		0.0	0.0	
Detector 1 Queue (s)	0.0	0.0		0.0	0.0		0.0	0.0		0.0	0.0	
Detector 1 Delay (s)	0.0	0.0		0.0	0.0		0.0	0.0		0.0	0.0	
Detector 2 Position(m)		28.7			28.7			28.7			28.7	
Detector 2 Size(m)		1.8			1.8			1.8			1.8	
Detector 2 Type		Cl+Ex			Cl+Ex			Cl+Ex			Cl+Ex	
Detector 2 Channel												
Detector 2 Extend (s)		0.0			0.0			0.0			0.0	
Turn Type	Perm	NA		Perm	NA		Perm	NA		Perm	NA	
Protected Phases		2			6			8			4	
Permitted Phases	2			6			8			4		
Detector Phase	2	2		6	6		8	8		4	4	



Lane Group	EBL	EBT	EBR	WBL	WBT	WBR	NBL	NBT	NBR	SBL	SBT	SBR
Switch Phase												
Minimum Initial (s)	10.0	10.0		10.0	10.0		10.0	10.0		10.0	10.0	
Minimum Split (s)	26.8	26.8		26.8	26.8		31.6	31.6		31.6	31.6	
Total Split (s)	88.0	88.0		88.0	88.0		32.0	32.0		32.0	32.0	
Total Split (%)	73.3%	73.3%		73.3%	73.3%		26.7%	26.7%		26.7%	26.7%	
Maximum Green (s)	82.2	82.2		82.2	82.2		25.4	25.4		25.4	25.4	
Yellow Time (s)	3.7	3.7		3.7	3.7		3.0	3.0		3.0	3.0	
All-Red Time (s)	2.1	2.1		2.1	2.1		3.6	3.6		3.6	3.6	
Lost Time Adjust (s)	0.0	0.0		0.0	0.0			0.0			0.0	
Total Lost Time (s)	5.8	5.8		5.8	5.8			6.6			6.6	
Lead/Lag												
Lead-Lag Optimize?												
Vehicle Extension (s)	3.0	3.0		3.0	3.0		3.0	3.0		3.0	3.0	
Recall Mode	C-Max	C-Max		C-Max	C-Max		None	None		None	None	
Walk Time (s)	7.0	7.0		7.0	7.0		7.0	7.0		7.0	7.0	
Flash Dont Walk (s)	14.0	14.0		14.0	14.0		18.0	18.0		18.0	18.0	
Pedestrian Calls (#/hr)	4	4		10	10		4	4		1	1	
Act Effct Green (s)	99.1	99.1		99.1	99.1			13.0			13.0	
Actuated g/C Ratio	0.83	0.83		0.83	0.83			0.11			0.11	
v/c Ratio	0.04	0.40		0.13	0.37			0.22			0.07	
Control Delay	4.4	4.6		1.6	2.1			22.3			28.4	
Queue Delay	0.0	0.0		0.0	0.0			0.0			0.0	
Total Delay	4.4	4.6		1.6	2.1			22.3			28.4	
LOS	A	A		A	A			C			C	
Approach Delay		4.6			2.1			22.3			28.4	
Approach LOS		A			A			C			C	
Queue Length 50th (m)	0.5	27.9		0.3	3.8			2.0			0.8	
Queue Length 95th (m)	3.0	65.7		m0.7	21.3			10.5			5.5	
Internal Link Dist (m)		174.0			286.7			230.0			222.4	
Turn Bay Length (m)	75.0			45.0								
Base Capacity (vph)	390	2815		354	2823			335			323	
Starvation Cap Reductn	0	0		0	0			0			0	
Spillback Cap Reductn	0	0		0	0			0			0	
Storage Cap Reductn	0	0		0	0			0			0	
Reduced v/c Ratio	0.04	0.40		0.13	0.37			0.13			0.04	

Intersection Summary

Area Type: Other  
 Cycle Length: 120  
 Actuated Cycle Length: 120  
 Offset: 31 (26%), Referenced to phase 2:EBTL and 6:WBTL, Start of Green  
 Natural Cycle: 60  
 Control Type: Actuated-Coordinated  
 Maximum v/c Ratio: 0.40  
 Intersection Signal Delay: 3.9 Intersection LOS: A  
 Intersection Capacity Utilization 59.7% ICU Level of Service B  
 Analysis Period (min) 15  
 m Volume for 95th percentile queue is metered by upstream signal.

Splits and Phases: 1: Stinson Avenue & Robertson Road

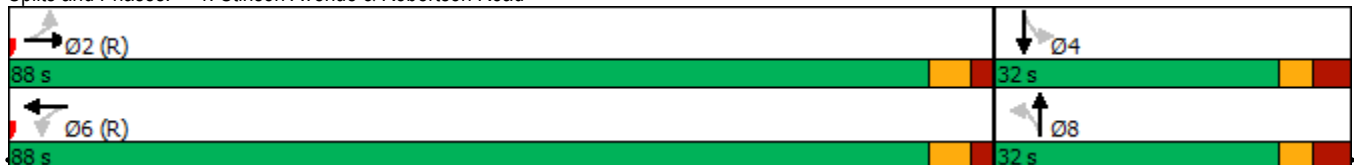

2: Lynhar Road/Stafford Road & Robertson Road  
SAT Peak Hour

1826 Robertson Road  
2029 Background Traffic



Lane Group	EBL	EBT	EBR	WBL	WBT	WBR	NBL	NBT	NBR	SBL	SBT	SBR
Lane Configurations												
Traffic Volume (vph)	134	888	87	41	824	60	87	27	84	83	20	153
Future Volume (vph)	134	888	87	41	824	60	87	27	84	83	20	153
Ideal Flow (vphpl)	1800	1800	1800	1800	1800	1800	1800	1800	1800	1800	1800	1800
Storage Length (m)	85.0		40.0	0.0		0.0	0.0		30.0	45.0		75.0
Storage Lanes	1		1	1		0	1		1	1		1
Taper Length (m)	10.0			10.0			10.0			30.0		
Lane Util. Factor	1.00	0.95	1.00	1.00	0.95	0.95	1.00	1.00	1.00	1.00	1.00	1.00
Ped Bike Factor	1.00		0.94	0.99	1.00		0.98		0.96	0.98		0.97
Frt			0.850		0.990				0.850			0.850
Flt Protected	0.950			0.950			0.950			0.950		
Satd. Flow (prot)	1695	3424	1517	1712	3354	0	1712	1802	1532	1695	1802	1532
Flt Permitted	0.950			0.950			0.709			0.740		
Satd. Flow (perm)	1692	3424	1419	1692	3354	0	1255	1802	1474	1289	1802	1484
Right Turn on Red			Yes			Yes			Yes			Yes
Satd. Flow (RTOR)			145		7				142			153
Link Speed (k/h)		60			60			40			40	
Link Distance (m)		310.7			66.2			81.0			107.6	
Travel Time (s)		18.6			4.0			7.3			9.7	
Confl. Peds. (#/hr)	5		17	17		5	16		21	21		16
Confl. Bikes (#/hr)			5			4			2			1
Peak Hour Factor	1.00	1.00	1.00	1.00	1.00	1.00	1.00	1.00	1.00	1.00	1.00	1.00
Heavy Vehicles (%)	2%	1%	2%	1%	2%	1%	1%	1%	1%	2%	1%	1%
Adj. Flow (vph)	134	888	87	41	824	60	87	27	84	83	20	153
Shared Lane Traffic (%)												
Lane Group Flow (vph)	134	888	87	41	884	0	87	27	84	83	20	153
Enter Blocked Intersection	No	No	No	No	No	No	No	No	No	No	No	No
Lane Alignment	L NA	Left	R NA	L NA	Left	R NA	L NA	L NA	R NA	L NA	Left	R NA
Median Width(m)		3.7			7.4			7.4			7.4	
Link Offset(m)		0.0			0.0			0.0			0.0	
Crosswalk Width(m)		5.0			5.0			5.0			5.0	
Two way Left Turn Lane		Yes										
Headway Factor	1.06	1.06	1.06	1.06	1.06	1.06	1.06	1.06	1.06	1.06	1.06	1.06
Turning Speed (k/h)	24		14	24		14	24		14	24		14
Number of Detectors	1	2	1	1	2		1	2	1	1	2	1
Detector Template	Left	Thru	Right	Left	Thru		Left	Thru	Right	Left	Thru	Right
Leading Detector (m)	6.1	30.5	6.1	6.1	30.5		6.1	30.5	6.1	6.1	30.5	6.1
Trailing Detector (m)	0.0	0.0	0.0	0.0	0.0		0.0	0.0	0.0	0.0	0.0	0.0
Detector 1 Position(m)	0.0	0.0	0.0	0.0	0.0		0.0	0.0	0.0	0.0	0.0	0.0
Detector 1 Size(m)	6.1	1.8	6.1	6.1	1.8		6.1	1.8	6.1	6.1	1.8	6.1
Detector 1 Type	Cl+Ex	Cl+Ex	Cl+Ex	Cl+Ex	Cl+Ex		Cl+Ex	Cl+Ex	Cl+Ex	Cl+Ex	Cl+Ex	Cl+Ex
Detector 1 Channel												
Detector 1 Extend (s)	0.0	0.0	0.0	0.0	0.0		0.0	0.0	0.0	0.0	0.0	0.0
Detector 1 Queue (s)	0.0	0.0	0.0	0.0	0.0		0.0	0.0	0.0	0.0	0.0	0.0
Detector 1 Delay (s)	0.0	0.0	0.0	0.0	0.0		0.0	0.0	0.0	0.0	0.0	0.0
Detector 2 Position(m)		28.7			28.7			28.7			28.7	
Detector 2 Size(m)		1.8			1.8			1.8			1.8	
Detector 2 Type		Cl+Ex			Cl+Ex			Cl+Ex			Cl+Ex	
Detector 2 Channel												
Detector 2 Extend (s)		0.0			0.0			0.0			0.0	
Turn Type	Prot	NA	Perm	Prot	NA		pm+pt	NA	Perm	pm+pt	NA	Perm
Protected Phases	5	2		1	6		3	8		7	4	
Permitted Phases			2				8		8	4		4
Detector Phase	5	2	2	1	6		3	8	8	7	4	4



Lane Group	EBL	EBT	EBR	WBL	WBT	WBR	NBL	NBT	NBR	SBL	SBT	SBR
Switch Phase												
Minimum Initial (s)	5.0	10.0	10.0	5.0	10.0		5.0	10.0	10.0	5.0	10.0	10.0
Minimum Split (s)	11.1	31.3	31.3	11.1	31.3		11.2	37.7	37.7	11.2	37.7	37.7
Total Split (s)	15.0	54.0	54.0	15.0	54.0		12.0	39.0	39.0	12.0	39.0	39.0
Total Split (%)	12.5%	45.0%	45.0%	12.5%	45.0%		10.0%	32.5%	32.5%	10.0%	32.5%	32.5%
Maximum Green (s)	8.9	47.7	47.7	8.9	47.7		5.8	32.3	32.3	5.8	32.3	32.3
Yellow Time (s)	3.7	3.7	3.7	3.7	3.7		3.0	3.0	3.0	3.0	3.0	3.0
All-Red Time (s)	2.4	2.6	2.6	2.4	2.6		3.2	3.7	3.7	3.2	3.7	3.7
Lost Time Adjust (s)	0.0	0.0	0.0	0.0	0.0		0.0	0.0	0.0	0.0	0.0	0.0
Total Lost Time (s)	6.1	6.3	6.3	6.1	6.3		6.2	6.7	6.7	6.2	6.7	6.7
Lead/Lag	Lead	Lag	Lag	Lead	Lag		Lead	Lag	Lag	Lead	Lag	Lag
Lead-Lag Optimize?	Yes	Yes	Yes	Yes	Yes		Yes	Yes	Yes	Yes	Yes	Yes
Vehicle Extension (s)	3.0	3.0	3.0	3.0	3.0		3.0	3.0	3.0	3.0	3.0	3.0
Recall Mode	None	C-Max	C-Max	None	C-Max		None	None	None	None	None	None
Walk Time (s)		7.0	7.0		7.0			12.0	12.0		12.0	12.0
Flash Dont Walk (s)		18.0	18.0		18.0			19.0	19.0		19.0	19.0
Pedestrian Calls (#/hr)		17	17		5			21	21		16	16
Act Effct Green (s)	13.1	60.5	60.5	8.1	53.2		30.1	25.0	25.0	28.9	22.6	22.6
Actuated g/C Ratio	0.11	0.50	0.50	0.07	0.44		0.25	0.21	0.21	0.24	0.19	0.19
v/c Ratio	0.73	0.51	0.11	0.36	0.59		0.26	0.07	0.20	0.25	0.06	0.38
Control Delay	71.1	28.3	5.8	79.8	23.0		31.4	35.7	1.5	31.2	35.1	8.3
Queue Delay	0.0	0.0	0.0	0.0	0.0		0.0	0.0	0.0	0.0	0.0	0.0
Total Delay	71.1	28.3	5.8	79.8	23.0		31.4	35.7	1.5	31.2	35.1	8.3
LOS	E	C	A	E	C		C	D	A	C	D	A
Approach Delay		31.7			25.5			19.3			17.8	
Approach LOS		C			C			B			B	
Queue Length 50th (m)	29.3	70.5	0.0	7.7	84.2		12.6	4.4	0.0	12.0	3.3	0.0
Queue Length 95th (m)	#65.0	113.0	9.0	20.7	106.0		23.2	11.2	1.3	22.4	9.0	14.6
Internal Link Dist (m)		286.7			42.2			57.0			83.6	
Turn Bay Length (m)	85.0		40.0						30.0	45.0		75.0
Base Capacity (vph)	184	1727	787	132	1491		337	485	500	330	485	511
Starvation Cap Reductn	0	0	0	0	0		0	0	0	0	0	0
Spillback Cap Reductn	0	0	0	0	0		0	0	0	0	0	0
Storage Cap Reductn	0	0	0	0	0		0	0	0	0	0	0
Reduced v/c Ratio	0.73	0.51	0.11	0.31	0.59		0.26	0.06	0.17	0.25	0.04	0.30

Intersection Summary

Area Type: Other  
 Cycle Length: 120  
 Actuated Cycle Length: 120  
 Offset: 7 (6%), Referenced to phase 2:EBT and 6:WBT, Start of Green  
 Natural Cycle: 95  
 Control Type: Actuated-Coordinated  
 Maximum v/c Ratio: 0.73  
 Intersection Signal Delay: 27.0 Intersection LOS: C  
 Intersection Capacity Utilization 68.7% ICU Level of Service C  
 Analysis Period (min) 15  
 # 95th percentile volume exceeds capacity, queue may be longer.  
 Queue shown is maximum after two cycles.

Splits and Phases: 2: Lynhar Road/Stafford Road & Robertson Road

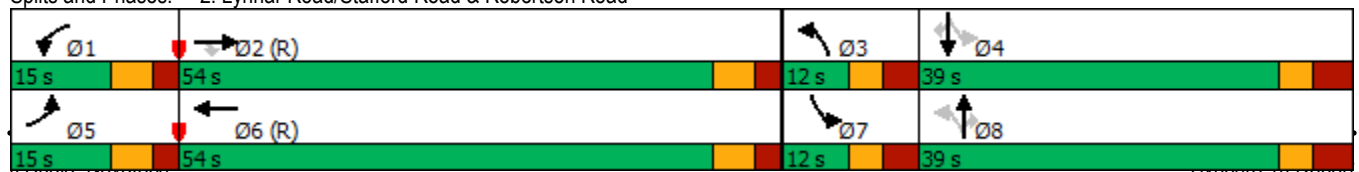

3: Northside Road East & Robertson Road  
SAT Peak Hour

1826 Robertson Road  
2029 Background Traffic

Lane Group	EBL	EBT	EBR	WBL	WBT	WBR	NBL	NBT	NBR	SBL	SBT	SBR
Lane Configurations												
Traffic Volume (vph)	78	882	15	84	719	167	86	44	70	141	30	103
Future Volume (vph)	78	882	15	84	719	167	86	44	70	141	30	103
Ideal Flow (vphpl)	1800	1800	1800	1800	1800	1800	1800	1800	1800	1800	1800	1800
Storage Length (m)	55.0		0.0	75.0		80.0	0.0		0.0	0.0		0.0
Storage Lanes	1		0	1		1	1		0	1		1
Taper Length (m)	30.0			15.0			10.0			10.0		
Lane Util. Factor	1.00	0.95	0.95	1.00	0.95	1.00	1.00	1.00	1.00	1.00	1.00	1.00
Ped Bike Factor	1.00	1.00		1.00		0.96	0.98	0.98		0.99		0.96
Frt		0.997				0.850		0.908				0.850
Flt Protected	0.950			0.950			0.950			0.950		
Satd. Flow (prot)	1712	3412	0	1695	3390	1532	1695	1610	0	1712	1802	1532
Flt Permitted	0.324			0.317			0.738			0.683		
Satd. Flow (perm)	582	3412	0	565	3390	1476	1285	1610	0	1218	1802	1474
Right Turn on Red			Yes			Yes			Yes			Yes
Satd. Flow (RTOR)		3				167		60				103
Link Speed (k/h)		60			60			40			40	
Link Distance (m)		105.4			310.9			87.0			90.9	
Travel Time (s)		6.3			18.7			7.8			8.2	
Confl. Peds. (#/hr)	6		4	4		6	16		8	8		16
Confl. Bikes (#/hr)			1			2			2			1
Peak Hour Factor	1.00	1.00	1.00	1.00	1.00	1.00	1.00	1.00	1.00	1.00	1.00	1.00
Heavy Vehicles (%)	1%	1%	1%	2%	2%	1%	2%	1%	1%	1%	1%	1%
Adj. Flow (vph)	78	882	15	84	719	167	86	44	70	141	30	103
Shared Lane Traffic (%)												
Lane Group Flow (vph)	78	897	0	84	719	167	86	114	0	141	30	103
Enter Blocked Intersection	No	No	No	No	No	No	No	No	No	No	No	No
Lane Alignment	L NA	Left	R NA	L NA	Left	R NA	L NA	Left	R NA	L NA	Left	R NA
Median Width(m)		5.5			5.5			3.7			3.7	
Link Offset(m)		0.0			0.0			0.0			0.0	
Crosswalk Width(m)		5.0			5.0			5.0			5.0	
Two way Left Turn Lane												
Headway Factor	1.06	1.06	1.06	1.06	1.06	1.06	1.06	1.06	1.06	1.06	1.06	1.06
Turning Speed (k/h)	24		14	24		14	24		14	24		14
Number of Detectors	1	2		1	2		1	1	2		1	2
Detector Template	Left	Thru		Left	Thru	Right	Left	Thru		Left	Thru	Right
Leading Detector (m)	6.1	30.5		6.1	30.5	6.1	6.1	30.5		6.1	30.5	6.1
Trailing Detector (m)	0.0	0.0		0.0	0.0	0.0	0.0	0.0		0.0	0.0	0.0
Detector 1 Position(m)	0.0	0.0		0.0	0.0	0.0	0.0	0.0		0.0	0.0	0.0
Detector 1 Size(m)	6.1	1.8		6.1	1.8	6.1	6.1	1.8		6.1	1.8	6.1
Detector 1 Type	Cl+Ex	Cl+Ex		Cl+Ex	Cl+Ex	Cl+Ex	Cl+Ex	Cl+Ex		Cl+Ex	Cl+Ex	Cl+Ex
Detector 1 Channel												
Detector 1 Extend (s)	0.0	0.0		0.0	0.0	0.0	0.0	0.0		0.0	0.0	0.0
Detector 1 Queue (s)	0.0	0.0		0.0	0.0	0.0	0.0	0.0		0.0	0.0	0.0
Detector 1 Delay (s)	0.0	0.0		0.0	0.0	0.0	0.0	0.0		0.0	0.0	0.0
Detector 2 Position(m)		28.7			28.7			28.7			28.7	
Detector 2 Size(m)		1.8			1.8			1.8			1.8	
Detector 2 Type		Cl+Ex			Cl+Ex			Cl+Ex			Cl+Ex	
Detector 2 Channel												
Detector 2 Extend (s)		0.0			0.0			0.0			0.0	
Turn Type	pm+pt	NA		Perm	NA	Perm	Perm	NA		Perm	NA	Perm
Protected Phases	5	2			6			8			4	
Permitted Phases	2			6		6	8			4		4
Detector Phase	5	2		6	6	6	8	8		4	4	4

Lane Group	Ø3	Ø7
Lane Configurations		
Traffic Volume (vph)		
Future Volume (vph)		
Ideal Flow (vphpl)		
Storage Length (m)		
Storage Lanes		
Taper Length (m)		
Lane Util. Factor		
Ped Bike Factor		
Frt		
Flt Protected		
Satd. Flow (prot)		
Flt Permitted		
Satd. Flow (perm)		
Right Turn on Red		
Satd. Flow (RTOR)		
Link Speed (k/h)		
Link Distance (m)		
Travel Time (s)		
Confl. Peds. (#/hr)		
Confl. Bikes (#/hr)		
Peak Hour Factor		
Heavy Vehicles (%)		
Adj. Flow (vph)		
Shared Lane Traffic (%)		
Lane Group Flow (vph)		
Enter Blocked Intersection		
Lane Alignment		
Median Width(m)		
Link Offset(m)		
Crosswalk Width(m)		
Two way Left Turn Lane		
Headway Factor		
Turning Speed (k/h)		
Number of Detectors		
Detector Template		
Leading Detector (m)		
Trailing Detector (m)		
Detector 1 Position(m)		
Detector 1 Size(m)		
Detector 1 Type		
Detector 1 Channel		
Detector 1 Extend (s)		
Detector 1 Queue (s)		
Detector 1 Delay (s)		
Detector 2 Position(m)		
Detector 2 Size(m)		
Detector 2 Type		
Detector 2 Channel		
Detector 2 Extend (s)		
Turn Type		
Protected Phases	3	7
Permitted Phases		
Detector Phase		

3: Northside Road East & Robertson Road  
SAT Peak Hour

1826 Robertson Road  
2029 Background Traffic



Lane Group	EBL	EBT	EBR	WBL	WBT	WBR	NBL	NBT	NBR	SBL	SBT	SBR
Switch Phase												
Minimum Initial (s)	5.0	10.0		10.0	10.0	10.0	10.0	10.0		10.0	10.0	10.0
Minimum Split (s)	11.0	30.1		30.1	30.1	30.1	29.8	29.8		29.8	29.8	29.8
Total Split (s)	15.0	83.0		68.0	68.0	68.0	31.0	31.0		31.0	31.0	31.0
Total Split (%)	12.5%	69.2%		56.7%	56.7%	56.7%	25.8%	25.8%		25.8%	25.8%	25.8%
Maximum Green (s)	9.0	76.9		61.9	61.9	61.9	24.2	24.2		24.2	24.2	24.2
Yellow Time (s)	3.7	3.7		3.7	3.7	3.7	3.0	3.0		3.0	3.0	3.0
All-Red Time (s)	2.3	2.4		2.4	2.4	2.4	3.8	3.8		3.8	3.8	3.8
Lost Time Adjust (s)	0.0	0.0		0.0	0.0	0.0	0.0	0.0		0.0	0.0	0.0
Total Lost Time (s)	6.0	6.1		6.1	6.1	6.1	6.8	6.8		6.8	6.8	6.8
Lead/Lag	Lead			Lag	Lag	Lag	Lag	Lag		Lag	Lag	Lag
Lead-Lag Optimize?	Yes			Yes	Yes	Yes	Yes	Yes		Yes	Yes	Yes
Vehicle Extension (s)	3.0	3.0		3.0	3.0	3.0	3.0	3.0		3.0	3.0	3.0
Recall Mode	None	C-Max		C-Max	C-Max	C-Max	None	None		None	None	None
Walk Time (s)		7.0		7.0	7.0	7.0	1.0	1.0		1.0	1.0	1.0
Flash Dont Walk (s)		17.0		17.0	17.0	17.0	22.0	22.0		22.0	22.0	22.0
Pedestrian Calls (#/hr)		4		6	6	6	8	8		16	16	16
Act Effct Green (s)	87.9	87.8		77.0	77.0	77.0	19.3	19.3		19.3	19.3	19.3
Actuated g/C Ratio	0.73	0.73		0.64	0.64	0.64	0.16	0.16		0.16	0.16	0.16
v/c Ratio	0.16	0.36		0.23	0.33	0.17	0.42	0.37		0.72	0.10	0.32
Control Delay	7.0	7.2		14.1	11.9	2.3	49.6	24.3		67.0	40.6	10.0
Queue Delay	0.0	0.0		0.0	0.0	0.0	0.0	0.0		0.0	0.0	0.0
Total Delay	7.0	7.2		14.1	11.9	2.3	49.6	24.3		67.0	40.6	10.0
LOS	A	A		B	B	A	D	C		E	D	A
Approach Delay		7.2			10.4			35.2			42.7	
Approach LOS		A			B			D			D	
Queue Length 50th (m)	5.0	31.9		7.5	36.4	0.0	17.0	10.3		29.4	5.6	0.0
Queue Length 95th (m)	7.8	32.1		19.7	58.8	9.0	29.2	23.8		45.9	12.4	12.7
Internal Link Dist (m)		81.4			286.9			63.0			66.9	
Turn Bay Length (m)	55.0			75.0		80.0						
Base Capacity (vph)	511	2496		362	2174	1006	266	381		252	373	387
Starvation Cap Reductn	0	0		0	0	0	0	0		0	0	0
Spillback Cap Reductn	0	0		0	0	0	0	0		0	0	0
Storage Cap Reductn	0	0		0	0	0	0	0		0	0	0
Reduced v/c Ratio	0.15	0.36		0.23	0.33	0.17	0.32	0.30		0.56	0.08	0.27

Intersection Summary

Area Type: Other  
 Cycle Length: 120  
 Actuated Cycle Length: 120  
 Offset: 111 (93%), Referenced to phase 2:EBTL and 6:WBTL, Start of Green  
 Natural Cycle: 80  
 Control Type: Actuated-Coordinated  
 Maximum v/c Ratio: 0.72  
 Intersection Signal Delay: 14.8  
 Intersection LOS: B  
 Intersection Capacity Utilization 67.1%  
 ICU Level of Service C  
 Analysis Period (min) 15

Splits and Phases: 3: Northside Road East & Robertson Road

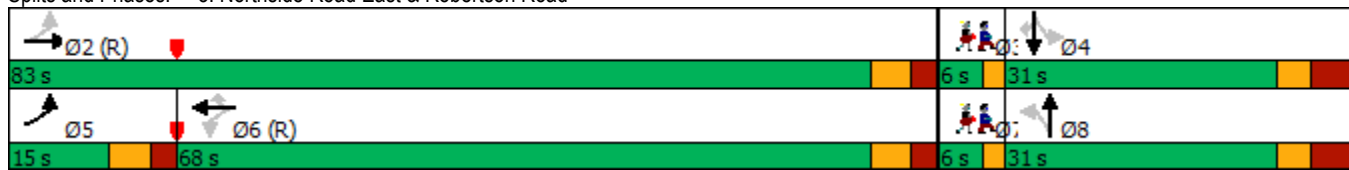

Lane Group	Ø3	Ø7
Switch Phase		
Minimum Initial (s)	4.0	4.0
Minimum Split (s)	6.0	6.0
Total Split (s)	6.0	6.0
Total Split (%)	5%	5%
Maximum Green (s)	4.0	4.0
Yellow Time (s)	2.0	2.0
All-Red Time (s)	0.0	0.0
Lost Time Adjust (s)		
Total Lost Time (s)		
Lead/Lag	Lead	Lead
Lead-Lag Optimize?	Yes	Yes
Vehicle Extension (s)	3.0	3.0
Recall Mode	None	None
Walk Time (s)		
Flash Dont Walk (s)		
Pedestrian Calls (#/hr)		
Act Effct Green (s)		
Actuated g/C Ratio		
v/c Ratio		
Control Delay		
Queue Delay		
Total Delay		
LOS		
Approach Delay		
Approach LOS		
Queue Length 50th (m)		
Queue Length 95th (m)		
Internal Link Dist (m)		
Turn Bay Length (m)		
Base Capacity (vph)		
Starvation Cap Reductn		
Spillback Cap Reductn		
Storage Cap Reductn		
Reduced v/c Ratio		
Intersection Summary		



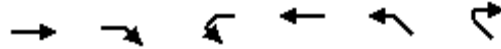

Lane Group	EBT	EBR	WBL	WBT	NWL	NWR
Lane Configurations	↑↑			↑↑↑		
Traffic Volume (vph)	975	83	0	929	0	0
Future Volume (vph)	975	83	0	929	0	0
Ideal Flow (vphpl)	1800	1800	1800	1800	1800	1800
Storage Length (m)		0.0	25.0		0.0	0.0
Storage Lanes		0	1		0	0
Taper Length (m)			25.0		10.0	
Lane Util. Factor	0.95	0.95	1.00	0.91	1.00	1.00
Frt	0.988					
Flt Protected						
Satd. Flow (prot)	3380	0	0	4919	0	0
Flt Permitted						
Satd. Flow (perm)	3380	0	0	4919	0	0
Link Speed (k/h)	60			60	50	
Link Distance (m)	66.2			72.0	100.3	
Travel Time (s)	4.0			4.3	7.2	
Peak Hour Factor	1.00	1.00	1.00	1.00	1.00	1.00
Heavy Vehicles (%)	1%	2%	1%	1%	1%	1%
Adj. Flow (vph)	975	83	0	929	0	0
Shared Lane Traffic (%)						
Lane Group Flow (vph)	1058	0	0	929	0	0
Enter Blocked Intersection	Yes	Yes	Yes	Yes	No	No
Lane Alignment	Left	Right	Left	Left	Left	Right
Median Width(m)	3.7			3.7	0.0	
Link Offset(m)	0.0			0.0	0.0	
Crosswalk Width(m)	0.0			0.0	0.0	
Two way Left Turn Lane						
Headway Factor	1.06	1.06	1.06	1.06	1.06	1.06
Turning Speed (k/h)		50	24		24	14
Sign Control	Free			Free	Free	

**Intersection Summary**

Area Type: Other

Control Type: Unsignalized

Intersection Capacity Utilization 34.6% ICU Level of Service A

Analysis Period (min) 15



Lane Group	EBT	EBR	WBL	WBT	NBL	NBR
Lane Configurations						
Traffic Volume (vph)	70	13	120	0	0	101
Future Volume (vph)	70	13	120	0	0	101
Ideal Flow (vphpl)	1800	1800	1800	1800	1800	1800
Lane Util. Factor	1.00	1.00	1.00	1.00	1.00	1.00
Ped Bike Factor						
Frt	0.979				0.865	
Flt Protected			0.950			
Satd. Flow (prot)	1750	0	1712	0	0	1559
Flt Permitted	0.950					
Satd. Flow (perm)	1750	0	1712	0	0	1559
Link Speed (k/h)	50			40	40	
Link Distance (m)	100.3			62.0	54.2	
Travel Time (s)	7.2			5.6	4.9	
Confl. Peds. (#/hr)	27		27			
Confl. Bikes (#/hr)	1		2			
Peak Hour Factor	1.00	1.00	1.00	1.00	1.00	1.00
Heavy Vehicles (%)	2%	1%	1%	1%	1%	1%
Adj. Flow (vph)	70	13	120	0	0	101
Shared Lane Traffic (%)						
Lane Group Flow (vph)	83	0	120	0	0	101
Enter Blocked Intersection	No	No	No	No	No	No
Lane Alignment	L NA	R NA	L NA	R NA	Left	R NA
Median Width(m)	3.7			3.7	0.0	
Link Offset(m)	3.0			3.0	0.0	
Crosswalk Width(m)	5.0			5.0	5.0	
Two way Left Turn Lane						
Headway Factor	1.06	1.06	1.06	1.06	1.06	1.06
Turning Speed (k/h)	14		24		24	14
Sign Control	Stop			Stop	Stop	











**Intersection Summary**









Area Type: Other

Control Type: Unsignalized

Intersection Capacity Utilization 23.3% ICU Level of Service A

Analysis Period (min) 15

						
Lane Group	WBL	WBR	NBT	NBR	SBL	SBT
Lane Configurations						
Traffic Volume (vph)	3	70	128	3	65	83
Future Volume (vph)	3	70	128	3	65	83
Ideal Flow (vphpl)	1800	1800	1800	1800	1800	1800
Storage Length (m)	0.0	0.0		45.0	15.0	
Storage Lanes	1	0		0	1	
Taper Length (m)	10.0				20.0	
Lane Util. Factor	1.00	1.00	0.95	0.95	1.00	1.00
Frt	0.871		0.997			
Flt Protected	0.998				0.950	
Satd. Flow (prot)	1566	0	3381	0	1712	1784
Flt Permitted	0.998				0.950	
Satd. Flow (perm)	1566	0	3381	0	1712	1784
Link Speed (k/h)	40		40		40	
Link Distance (m)	173.4		68.2		81.0	
Travel Time (s)	15.6		6.1		7.3	
Peak Hour Factor	1.00	1.00	1.00	1.00	1.00	1.00
Heavy Vehicles (%)	1%	1%	2%	1%	1%	2%
Adj. Flow (vph)	3	70	128	3	65	83
Shared Lane Traffic (%)						
Lane Group Flow (vph)	73	0	131	0	65	83
Enter Blocked Intersection	No	No	No	No	No	No
Lane Alignment	Left	Right	Left	Right	Left	Left
Median Width(m)	3.7		3.7		3.7	
Link Offset(m)	0.0		0.0		0.0	
Crosswalk Width(m)	5.0		5.0		5.0	
Two way Left Turn Lane						
Headway Factor	1.06	1.06	1.06	1.06	1.06	1.06
Turning Speed (k/h)	24	14		14	24	
Sign Control	Stop		Free			Free
<b>Intersection Summary</b>						
Area Type:	Other					
Control Type:	Unsignalized					
Intersection Capacity Utilization	22.4%			ICU Level of Service A		
Analysis Period (min)	15					

						
Lane Group	WBL	WBR	NBT	NBR	SBL	SBT
Lane Configurations						
Traffic Volume (vph)	1	10	121	1	12	74
Future Volume (vph)	1	10	121	1	12	74
Ideal Flow (vphpl)	1800	1800	1800	1800	1800	1800
Lane Util. Factor	1.00	1.00	1.00	1.00	1.00	1.00
Frt	0.877		0.999			
Flt Protected	0.995					0.993
Satd. Flow (prot)	1572	0	1783	0	0	1774
Flt Permitted	0.995					0.993
Satd. Flow (perm)	1572	0	1783	0	0	1774
Link Speed (k/h)	50		40			50
Link Distance (m)	178.0		82.4			68.2
Travel Time (s)	12.8		7.4			4.9
Peak Hour Factor	1.00	1.00	1.00	1.00	1.00	1.00
Heavy Vehicles (%)	1%	1%	2%	1%	1%	2%
Adj. Flow (vph)	1	10	121	1	12	74
Shared Lane Traffic (%)						
Lane Group Flow (vph)	11	0	122	0	0	86
Enter Blocked Intersection	No	No	No	No	No	No
Lane Alignment	L NA	R NA	Left	Right	Left	Left
Median Width(m)	3.7		0.0			0.0
Link Offset(m)	0.0		0.0			0.0
Crosswalk Width(m)	5.0		5.0			5.0
Two way Left Turn Lane						
Headway Factor	1.06	1.06	1.06	1.06	1.06	1.06
Turning Speed (k/h)	24	14		14	24	
Sign Control	Stop		Free			Free
<b>Intersection Summary</b>						
Area Type:	Other					
Control Type:	Unsignalized					
Intersection Capacity Utilization	24.8%			ICU Level of Service A		
Analysis Period (min)	15					



Lane Group	EBL	EBR	NBL	NBT	SBT	SBR
Lane Configurations						
Traffic Volume (vph)	28	0	0	73	92	41
Future Volume (vph)	28	0	0	73	92	41
Ideal Flow (vphpl)	1800	1800	1800	1800	1800	1800
Lane Util. Factor	1.00	1.00	1.00	1.00	1.00	1.00
Fr <sub>t</sub>						0.958
Flt Protected	0.950					
Satd. Flow (prot)	1712	0	0	1802	1726	0
Flt Permitted	0.950					
Satd. Flow (perm)	1712	0	0	1802	1726	0
Link Speed (k/h)	40			40	40	
Link Distance (m)	173.4			67.2	54.2	
Travel Time (s)	15.6			6.0	4.9	
Peak Hour Factor	1.00	1.00	1.00	1.00	1.00	1.00
Heavy Vehicles (%)	1%	1%	1%	1%	1%	1%
Adj. Flow (vph)	28	0	0	73	92	41
Shared Lane Traffic (%)						
Lane Group Flow (vph)	28	0	0	73	133	0
Enter Blocked Intersection	No	No	No	No	No	No
Lane Alignment	Left	Right	Left	Left	Left	Right
Median Width(m)	3.7			0.0	0.0	
Link Offset(m)	0.0			0.0	0.0	
Crosswalk Width(m)	5.0			5.0	5.0	
Two way Left Turn Lane						
Headway Factor	1.06	1.06	1.06	1.06	1.06	1.06
Turning Speed (k/h)	24	14	24			14
Sign Control	Stop			Free	Free	

**Intersection Summary**

Area Type:	Other
Control Type:	Unsignalized
Intersection Capacity Utilization	17.7%
ICU Level of Service	A
Analysis Period (min)	15



Lane Group	EBL	EBR	NBL	NBT	SBT	SBR
Lane Configurations						
Traffic Volume (vph)	9	0	0	64	82	10
Future Volume (vph)	9	0	0	64	82	10
Ideal Flow (vphpl)	1800	1800	1800	1800	1800	1800
Lane Util. Factor	1.00	1.00	1.00	1.00	1.00	1.00
Friction						0.985
Fit Protected	0.950					
Satd. Flow (prot)	1712	0	0	1802	1775	0
Fit Permitted	0.950					
Satd. Flow (perm)	1712	0	0	1802	1775	0
Link Speed (k/h)	50			40	50	
Link Distance (m)	178.0			106.1	67.2	
Travel Time (s)	12.8			9.5	4.8	
Peak Hour Factor	1.00	1.00	1.00	1.00	1.00	1.00
Heavy Vehicles (%)	1%	1%	1%	1%	1%	1%
Adj. Flow (vph)	9	0	0	64	82	10
Shared Lane Traffic (%)						
Lane Group Flow (vph)	9	0	0	64	92	0
Enter Blocked Intersection	No	No	No	No	No	No
Lane Alignment	L NA	R NA	Left	Left	Left	Right
Median Width(m)	3.7			0.0	0.0	
Link Offset(m)	0.0			0.0	0.0	
Crosswalk Width(m)	5.0			5.0	5.0	
Two way Left Turn Lane						
Headway Factor	1.06	1.06	1.06	1.06	1.06	1.06
Turning Speed (k/h)	24	14	24			14
Sign Control	Stop			Free	Free	

**Intersection Summary**

Area Type:	Other
Control Type:	Unsignalized
Intersection Capacity Utilization	15.2%
ICU Level of Service	A
Analysis Period (min)	15

## **APPENDIX L**

---

### Transportation Demand Management

**TDM-Supportive Development Design and Infrastructure Checklist:**  
*Non-Residential Developments (office, institutional, retail or industrial)*

<b>Legend</b>	
<b>REQUIRED</b>	The Official Plan or Zoning By-law provides related guidance that must be followed
<b>BASIC</b>	The measure is generally feasible and effective, and in most cases would benefit the development and its users
<b>BETTER</b>	The measure could maximize support for users of sustainable modes, and optimize development performance

TDM-supportive design & infrastructure measures: <i>Non-residential developments</i>		Check if completed & add descriptions, explanations or plan/drawing references
<b>1. WALKING &amp; CYCLING: ROUTES</b>		
<b>1.1 Building location &amp; access points</b>		
BASIC	1.1.1 Locate building close to the street, and do not locate parking areas between the street and building entrances	<input type="checkbox"/>
BASIC	1.1.2 Locate building entrances in order to minimize walking distances to sidewalks and transit stops/stations	<input type="checkbox"/>
BASIC	1.1.3 Locate building doors and windows to ensure visibility of pedestrians from the building, for their security and comfort	<input checked="" type="checkbox"/>
<b>1.2 Facilities for walking &amp; cycling</b>		
REQUIRED	1.2.1 Provide convenient, direct access to stations or major stops along rapid transit routes within 600 metres; minimize walking distances from buildings to rapid transit; provide pedestrian-friendly, weather-protected (where possible) environment between rapid transit accesses and building entrances; ensure quality linkages from sidewalks through building entrances to integrated stops/stations <i>(see Official Plan policy 4.3.3)</i>	<input type="checkbox"/> - N/A, no rapid transit stations within 600m
REQUIRED	1.2.2 Provide safe, direct and attractive pedestrian access from public sidewalks to building entrances through such measures as: reducing distances between public sidewalks and major building entrances; providing walkways from public streets to major building entrances; within a site, providing walkways along the front of adjoining buildings, between adjacent buildings, and connecting areas where people may congregate, such as courtyards and transit stops; and providing weather protection through canopies, colonnades, and other design elements wherever possible <i>(see Official Plan policy 4.3.12)</i>	<input checked="" type="checkbox"/>



<b>TDM-supportive design &amp; infrastructure measures: Non-residential developments</b>		<b>Check if completed &amp; add descriptions, explanations or plan/drawing references</b>
<b>REQUIRED</b>	1.2.3 Provide sidewalks of smooth, well-drained walking surfaces of contrasting materials or treatments to differentiate pedestrian areas from vehicle areas, and provide marked pedestrian crosswalks at intersection sidewalks ( <i>see Official Plan policy 4.3.10</i> )	<input checked="" type="checkbox"/>
<b>REQUIRED</b>	1.2.4 Make sidewalks and open space areas easily accessible through features such as gradual grade transition, depressed curbs at street corners and convenient access to extra-wide parking spaces and ramps ( <i>see Official Plan policy 4.3.10</i> )	<input checked="" type="checkbox"/>
<b>REQUIRED</b>	1.2.5 Include adequately spaced inter-block/street cycling and pedestrian connections to facilitate travel by active transportation. Provide links to the existing or planned network of public sidewalks, multi-use pathways and on-road cycle routes. Where public sidewalks and multi-use pathways intersect with roads, consider providing traffic control devices to give priority to cyclists and pedestrians ( <i>see Official Plan policy 4.3.11</i> )	<input checked="" type="checkbox"/>
<b>BASIC</b>	1.2.6 Provide safe, direct and attractive walking routes from building entrances to nearby transit stops	<input type="checkbox"/>
<b>BASIC</b>	1.2.7 Ensure that walking routes to transit stops are secure, visible, lighted, shaded and wind-protected wherever possible	<input type="checkbox"/>
<b>BASIC</b>	1.2.8 Design roads used for access or circulation by cyclists using a target operating speed of no more than 30 km/h, or provide a separated cycling facility	<input type="checkbox"/>
<b>1.3 Amenities for walking &amp; cycling</b>		
<b>BASIC</b>	1.3.1 Provide lighting, landscaping and benches along walking and cycling routes between building entrances and streets, sidewalks and trails	<input type="checkbox"/>
<b>BASIC</b>	1.3.2 Provide wayfinding signage for site access (where required, e.g. when multiple buildings or entrances exist) and egress (where warranted, such as when directions to reach transit stops/stations, trails or other common destinations are not obvious)	<input type="checkbox"/>

TDM-supportive design & infrastructure measures: <i>Non-residential developments</i>		Check if completed & add descriptions, explanations or plan/drawing references
<b>2. WALKING &amp; CYCLING: END-OF-TRIP FACILITIES</b>		
<b>2.1 Bicycle parking</b>		
REQUIRED	2.1.1 Provide bicycle parking in highly visible and lighted areas, sheltered from the weather wherever possible ( <i>see Official Plan policy 4.3.6</i> )	<input checked="" type="checkbox"/>
REQUIRED	2.1.2 Provide the number of bicycle parking spaces specified for various land uses in different parts of Ottawa; provide convenient access to main entrances or well-used areas ( <i>see Zoning By-law Section 111</i> )	<input checked="" type="checkbox"/>
REQUIRED	2.1.3 Ensure that bicycle parking spaces and access aisles meet minimum dimensions; that no more than 50% of spaces are vertical spaces; and that parking racks are securely anchored ( <i>see Zoning By-law Section 111</i> )	<input checked="" type="checkbox"/>
BASIC	2.1.4 Provide bicycle parking spaces equivalent to the expected number of commuter cyclists (assuming the cycling mode share target is met), plus the expected peak number of customer/visitor cyclists	<input type="checkbox"/>
BETTER	2.1.5 Provide bicycle parking spaces equivalent to the expected number of commuter and customer/visitor cyclists, plus an additional buffer (e.g. 25 percent extra) to encourage other cyclists and ensure adequate capacity in peak cycling season	<input type="checkbox"/>
<b>2.2 Secure bicycle parking</b>		
REQUIRED	2.2.1 Where more than 50 bicycle parking spaces are provided for a single office building, locate at least 25% of spaces within a building/structure, a secure area (e.g. supervised parking lot or enclosure) or bicycle lockers ( <i>see Zoning By-law Section 111</i> )	<input type="checkbox"/> - N/A
BETTER	2.2.2 Provide secure bicycle parking spaces equivalent to the expected number of commuter cyclists (assuming the cycling mode share target is met)	<input type="checkbox"/>
<b>2.3 Shower &amp; change facilities</b>		
BASIC	2.3.1 Provide shower and change facilities for the use of active commuters	<input type="checkbox"/>
BETTER	2.3.2 In addition to shower and change facilities, provide dedicated lockers, grooming stations, drying racks and laundry facilities for the use of active commuters	<input type="checkbox"/>
<b>2.4 Bicycle repair station</b>		
BETTER	2.4.1 Provide a permanent bike repair station, with commonly used tools and an air pump, adjacent to the main bicycle parking area (or secure bicycle parking area, if provided)	<input type="checkbox"/>

<b>TDM-supportive design &amp; infrastructure measures: <i>Non-residential developments</i></b>		<b>Check if completed &amp; add descriptions, explanations or plan/drawing references</b>
<b>3. TRANSIT</b>		
<b>3.1 Customer amenities</b>		
<b>BASIC</b>	3.1.1 Provide shelters, lighting and benches at any on-site transit stops	<input type="checkbox"/>
<b>BASIC</b>	3.1.2 Where the site abuts an off-site transit stop and insufficient space exists for a transit shelter in the public right-of-way, protect land for a shelter and/or install a shelter	<input type="checkbox"/>
<b>BETTER</b>	3.1.3 Provide a secure and comfortable interior waiting area by integrating any on-site transit stops into the building	<input type="checkbox"/>
<b>4. RIDESHARING</b>		
<b>4.1 Pick-up &amp; drop-off facilities</b>		
<b>BASIC</b>	4.1.1 Provide a designated area for carpool drivers (plus taxis and ride-hailing services) to drop off or pick up passengers without using fire lanes or other no-stopping zones	<input type="checkbox"/>
<b>4.2 Carpool parking</b>		
<b>BASIC</b>	4.2.1 Provide signed parking spaces for carpools in a priority location close to a major building entrance, sufficient in number to accommodate the mode share target for carpools	<input type="checkbox"/>
<b>BETTER</b>	4.2.2 At large developments, provide spaces for carpools in a separate, access-controlled parking area to simplify enforcement	<input type="checkbox"/>
<b>5. CARSHARING &amp; BIKESHARING</b>		
<b>5.1 Carshare parking spaces</b>		
<b>BETTER</b>	5.1.1 Provide carshare parking spaces in permitted non-residential zones, occupying either required or provided parking spaces ( <i>see Zoning By-law Section 94</i> )	<input type="checkbox"/>
<b>5.2 Bikeshare station location</b>		
<b>BETTER</b>	5.2.1 Provide a designated bikeshare station area near a major building entrance, preferably lighted and sheltered with a direct walkway connection	<input type="checkbox"/>

TDM-supportive design & infrastructure measures: <i>Non-residential developments</i>		Check if completed & add descriptions, explanations or plan/drawing references
<b>6. PARKING</b>		
<b>6.1 Number of parking spaces</b>		
<b>REQUIRED</b>	6.1.1 Do not provide more parking than permitted by zoning, nor less than required by zoning, unless a variance is being applied for	<input checked="" type="checkbox"/>
<b>BASIC</b>	6.1.2 Provide parking for long-term and short-term users that is consistent with mode share targets, considering the potential for visitors to use off-site public parking	<input type="checkbox"/>
<b>BASIC</b>	6.1.3 Where a site features more than one use, provide shared parking and reduce the cumulative number of parking spaces accordingly ( <i>see Zoning By-law Section 104</i> )	<input type="checkbox"/>
<b>BETTER</b>	6.1.4 Reduce the minimum number of parking spaces required by zoning by one space for each 13 square metres of gross floor area provided as shower rooms, change rooms, locker rooms and other facilities for cyclists in conjunction with bicycle parking ( <i>see Zoning By-law Section 111</i> )	<input type="checkbox"/>
<b>6.2 Separate long-term &amp; short-term parking areas</b>		
<b>BETTER</b>	6.2.1 Separate short-term and long-term parking areas using signage or physical barriers, to permit access controls and simplify enforcement (i.e. to discourage employees from parking in visitor spaces, and vice versa)	<input type="checkbox"/>
<b>7. OTHER</b>		
<b>7.1 On-site amenities to minimize off-site trips</b>		
<b>BETTER</b>	7.1.1 Provide on-site amenities to minimize mid-day or mid-commute errands	<input type="checkbox"/>

## **APPENDIX M**

---

MMLOS Analysis

## Segment MMLOS Analysis

Exhibit 4 of the *MMLOS Guidelines* has been used to evaluate the existing segment PLOS of the boundary streets. Exhibit 22 of the *MMLOS Guidelines* suggests a target PLOS C for Arterial Main Streets (Robertson Road) and all roadways within the General Urban Area (Lynhar Road, Northside Road West, Larkspur Drive). The results of the segment PLOS analysis are summarized in **Table 1**.

Exhibit 12 of the *MMLOS Guidelines* has been used to evaluate the existing segment BLOS of the boundary streets. Exhibit 22 of the *MMLOS Guidelines* suggests a target BLOS B for Crosstown Bikeways on Arterial Main Streets (Robertson Road) and Local Routes within the General Urban Area (Lynhar Road), and a target BLOS D for roadways with no cycling designations within the General Urban Area (Northside Road West, Larkspur Drive). The results of the segment BLOS analysis are summarized in **Table 2**.

Exhibit 15 of the *MMLOS Guidelines* has been used to evaluate the existing segment TLOS of Robertson Road. Exhibit 22 of the *MMLOS Guidelines* identifies a target TLOS D for Transit Priority Corridors with Isolated Measures (Robertson Road), and no target for roadways that are not designated in the Rapid Transit and Transit Priority networks (Lynhar Road, Northside Road West, Larkspur Drive). Therefore, only Robertson Road has been evaluated. The results of the segment TLOS analysis are summarized in **Table 3**.

Exhibit 20 of the *MMLOS Guidelines* has been used to evaluate the existing segment TkLOS of the boundary streets. Exhibit 22 of the *MMLOS Guidelines* identifies a target TkLOS D for truck routes on Arterial Main Streets (Robertson Road), and no target for collectors that are not truck routes within the General Urban Area (Lynhar Road, Northside Road West, Larkspur Drive). As the on-site loading zones can be accessed via Lynhar Road or Larkspur Drive, all study area roadways have been evaluated. The results of the segment TkLOS analysis are summarized in **Table 4**.

**Table 1: PLOS Segment Analysis**

Sidewalk Width	Boulevard Width	Avg. Daily Curb Lane Traffic Volume	Presence of On-Street Parking	Operating Speed <sup>(1)</sup>	PLOS
<b>Robertson Road (north side)</b>					
1.8m	0m	> 3,000 vpd	No	70 km/h	F
<b>Robertson Road (south side)<sup>(2)</sup></b>					
1.8m	0m	> 3,000 vpd	No	70 km/h	F
<b>Lynhar Road (east side)<sup>(2)</sup></b>					
1.8m	0m	> 3,000 vpd	No	50 km/h	D
<b>Lynhar Road (west side)</b>					
No sidewalk		> 3,000 vpd	No	50 km/h	F
<b>Northside Road West (north side)</b>					
No sidewalk		≤ 3,000 vpd	No	50 km/h	F
<b>Northside Road West (south side)<sup>(2)</sup></b>					
1.8m	0m	≤ 3,000 vpd	No	50 km/h	B
<b>Larkspur Drive (east side)</b>					
No sidewalk		≤ 3,000 vpd	No	50 km/h	F
<b>Larkspur Drive (west side)<sup>(2)</sup></b>					
1.8m	0m	≤ 3,000 vpd	No	50 km/h	B

1. Operating speed taken as 10 km/h over the posted speed limit

2. Borders subject site frontage

Table 2: BLOS Segment Analysis

Road Class	Bike Route	Type of Bikeway	Travel Lanes	Centerline Type	Operating Speed	BLOS
<b>Robertson Road (Lynhar Road/Stafford Road to Northside Road East)</b>						
Arterial	Crosstown Bikeway	Mixed Traffic	4 to 5	Raised Median	70 km/h	<b>F</b>
<b>Lynhar Road (Robertson Road to Eaton Street)</b>						
Collector	Local Route	Mixed Traffic	2 to 3	Marked Centerline	50 km/h	<b>D</b>
<b>Northside Road West (Robertson Road to Larkspur Drive)</b>						
Collector	No Class	Mixed Traffic	1	N/A	50 km/h	<b>B</b>
<b>Larkspur Drive (Northside Road to Eaton Street)</b>						
Collector	No Class	Mixed Traffic	2	Unmarked Centerline	50 km/h	<b>B</b>

Table 3: TLOS Segment Analysis

Facility Type	Level of Congestion Delay, Friction and Incidents			TLOS
	Congestion	Friction	Incident Potential	
<b>Robertson Road (Lynhar Road/Stafford Road to Northside Road East)</b>				
Mixed Traffic – Limited Parking/Driveway Friction	Yes	Low	Medium	<b>D</b>

Table 4: TkLOS Segment Analysis

Curb Lane Width	Number of Travel Lanes Per Direction	TkLOS
<b>Robertson Road (Lynhar Road/Stafford Road to Northside Road East)</b>		
< 3.5m	2	<b>A</b>
<b>Lynhar Road (Robertson Road to Eaton Street)</b>		
< 3.5m	1	<b>C</b>
<b>Northside Road West (Robertson Road to Larkspur Drive)</b>		
> 3.7m	1	<b>B</b>
<b>Larkspur Drive (Northside Road to Eaton Street)</b>		
> 3.7m	1	<b>B</b>

## Intersection MMLOS Analysis

Exhibit 5 of the Addendum to the *MMLOS Guidelines* has been used to evaluate the existing PLOS at all signalized intersections within the study area. Exhibit 22 of the *MMLOS Guidelines* suggests a target PLOS A for all roadways within 300m of a school (Robertson Road/Stinson Avenue), and a target PLOS C for Arterial Main Streets and all roadways within the General Urban Area (Robertson Road/Lynhar Road/Stafford Road and Robertson Road/Northside Road East). The results of the intersection PLOS analysis are summarized in **Table 5** through **Table 7**.

Exhibit 12 of the *MMLOS Guidelines* has been used to evaluate the existing BLOS at all signalized intersections within the study area. Exhibit 22 of the *MMLOS Guidelines* suggests a target BLOS A for Crosstown Bikeways within 300m of a school (Robertson Road/Stinson Avenue), and a target BLOS B for Crosstown Bikeways on Arterial Main Streets (Robertson Road/Lynhar Road/Stafford Road and Robertson Road/Northside Road East). The results of the intersection BLOS analysis are summarized in **Table 8**.

Exhibit 16 of the *MMLOS Guidelines* has been used to evaluate the existing TLOS at all intersections within the study area. Exhibit 22 of the *MMLOS Guidelines* suggests a target TLOS D for Transit Priority Corridors with Isolated Measures (Robertson Road). All study area roadways intersecting Robertson Road have no rapid transit or transit priority designation. Therefore, only the approaches of Robertson Road at each intersection has been evaluated for TLOS. The results of the intersection TLOS analysis are summarized in **Table 9**.

Exhibit 21 of the *MMLOS Guidelines* has been used to evaluate the existing TkLOS at all signalized intersections within the study area. Exhibit 22 of the *MMLOS Guidelines* suggest a target TkLOS D for truck routes on Arterial Main Streets (Robertson Road). The results of the intersection TkLOS analysis are summarized in **Table 10**.

Consideration of bike boxes for cyclists at each signalized intersection along Robertson Road has been included, with the results shown in **Table 11**. This scenario restricts right turns on red (RTOR) at the north and south approaches of Robertson Road/Stinson Avenue, the east approach of Robertson Road/Lynhar Road/Stafford Road, and the south and west approaches of Robertson Road/Northside Road East.



**Table 5: PLOS Intersection Analysis – Robertson Road/Stinson Avenue**

CRITERIA	North Approach		South Approach		East Approach		West Approach	
<b>PETSI SCORE</b>								
<i>CROSSING DISTANCE CONDITIONS</i>								
Median > 2.4m in Width	No	72	No	72	No	39	No	39
Lanes Crossed (3.5m Lane Width)	5		5		7		7	
<i>SIGNAL PHASING AND TIMING</i>								
Left Turn Conflict	Permissive	-8	Permissive	-8	Permissive	-8	Permissive	-8
Right Turn Conflict	Permissive or Yield	-5	Permissive or Yield	-5	Permissive or Yield	-5	Permissive or Yield	-5
Right Turn on Red	RTOR Allowed	-3	RTOR Allowed	-3	RTOR Allowed	-3	RTOR Allowed	-3
Leading Pedestrian Interval	No	-2	No	-2	No	-2	No	-2
<i>CORNER RADIUS</i>								
Parallel Radius	> 10m to 15m	-6	> 10m to 15m	-6	> 10m to 15m	-6	> 10m to 15m	-6
Parallel Right Turn Channel	No Right Turn Channel	-4	No Right Turn Channel	-4	No Right Turn Channel	-4	No Right Turn Channel	-4
Perpendicular Radius	N/A	0	N/A	0	N/A	0	N/A	0
Perpendicular Right Turn Channel	N/A	0	N/A	0	N/A	0	N/A	0
<i>CROSSING TREATMENT</i>								
Treatment	Standard	-7	Standard	-7	Standard	-7	Standard	-7
	<b>PETSI SCORE</b>	<b>37</b>		<b>37</b>		<b>4</b>		<b>4</b>
	<b>LOS</b>	<b>E</b>		<b>E</b>		<b>F</b>		<b>F</b>
<b>DELAY SCORE</b>								
Cycle Length	120		120		130		130	
Pedestrian Walk Time	68.2		68.2		7.4		7.4	
	<b>DELAY SCORE</b>	<b>11.2</b>		<b>11.2</b>		<b>57.8</b>		<b>57.8</b>
	<b>LOS</b>	<b>B</b>		<b>B</b>		<b>E</b>		<b>E</b>
	<b>OVERALL</b>	<b>E</b>		<b>E</b>		<b>F</b>		<b>F</b>

**Table 6: PLOS Intersection Analysis – Robertson Road/Lynhar Road/Stafford Road**

CRITERIA	North Approach		South Approach		East Approach		West Approach	
<b>PETSI SCORE</b>								
<i>CROSSING DISTANCE CONDITIONS</i>								
Median > 2.4m in Width	No	6	No	39	No	39	No	-10
Lanes Crossed (3.5m Lane Width)	9		7		7		10 +	
<i>SIGNAL PHASING AND TIMING</i>								
Left Turn Conflict	Protected	0	Protected	0	Perm + Prot	-8	Perm + Prot	-8
Right Turn Conflict	Permissive or Yield	-5	Permissive or Yield	-5	Permissive or Yield	-5	Permissive or Yield	-5
Right Turn on Red	N/A	0	RTOR Allowed	-3	RTOR Allowed	-3	RTOR Allowed	-3
Leading Pedestrian Interval	No	-2	No	-2	No	-2	No	-2
<i>CORNER RADIUS</i>								
Parallel Radius	> 15m to 25m	-8	> 10m to 15m	-6	> 10m to 15m	-6	> 15m to 25m	-8
Parallel Right Turn Channel	No Right Turn Channel	-4	No Right Turn Channel	-4	No Right Turn Channel	-4	Conventional without Receiving	0
Perpendicular Radius	> 15m to 25m	-8	N/A	0	N/A	0	N/A	0
Perpendicular Right Turn Channel	Conventional without Receiving	0	N/A	0	N/A	0	N/A	0
<i>CROSSING TREATMENT</i>								
Treatment	Standard	-7	Standard	-7	Standard	-7	Standard	-7
	<b>PETSI SCORE</b>	<b>-28</b>		<b>12</b>		<b>4</b>		<b>-43</b>
	<b>LOS</b>	<b>F</b>		<b>F</b>		<b>F</b>		<b>F</b>
<b>DELAY SCORE</b>								
Cycle Length	120		120		130		130	
Pedestrian Walk Time	29.7		29.7		13.3		13.3	
	<b>DELAY SCORE</b>	<b>34.0</b>		<b>34.0</b>		<b>52.4</b>		<b>52.4</b>
	<b>LOS</b>	<b>D</b>		<b>D</b>		<b>E</b>		<b>E</b>
	<b>OVERALL</b>	<b>F</b>		<b>F</b>		<b>F</b>		<b>F</b>

**Table 7: PLOS Intersection Analysis – Robertson Road/Northside Road East**

CRITERIA	North Approach		South Approach		East Approach		West Approach	
<b>PETSI SCORE</b>								
<i>CROSSING DISTANCE CONDITIONS</i>								
Median > 2.4m in Width	No	6	No	55	No	23	No	6
Lanes Crossed (3.5m Lane Width)	9		6		8		9	
<i>SIGNAL PHASING AND TIMING</i>								
Left Turn Conflict	Perm + Prot	-8	Permissive	-8	Permissive	-8	Permissive	-8
Right Turn Conflict	Permissive or Yield	-5	Permissive or Yield	-5	Permissive or Yield	-5	Permissive or Yield	-5
Right Turn on Red	N/A	0	RTOR Allowed	-3	RTOR Allowed	-3	RTOR Allowed	-3
Leading Pedestrian Interval	No	-2	No	-2	Yes	0	Yes	0
<i>CORNER RADIUS</i>								
Parallel Radius	> 15m to 25m	-8	> 5m to 10m	-5	> 10m to 15m	-6	> 10m to 15m	-6
Parallel Right Turn Channel	No Right Turn Channel	-4	No Right Turn Channel	-4	No Right Turn Channel	-4	Conventional with Receiving	-3
Perpendicular Radius	> 15m to 25m	-8	N/A	0	N/A	0	N/A	0
Perpendicular Right Turn Channel	Conventional with Receiving	-3	N/A	0	N/A	0	N/A	0
<i>CROSSING TREATMENT</i>								
Treatment	Standard	-7	Standard	-7	Standard	-7	Standard	-7
	<b>PETSI SCORE</b>	<b>-39</b>		<b>21</b>		<b>-10</b>		<b>-26</b>
	<b>LOS</b>	<b>F</b>		<b>F</b>		<b>F</b>		<b>F</b>
<b>DELAY SCORE</b>								
Cycle Length		120		120		130		130
Pedestrian Walk Time		44.9		44.9		7.2		7.2
	<b>DELAY SCORE</b>	<b>23.5</b>		<b>23.5</b>		<b>58.0</b>		<b>58.0</b>
	<b>LOS</b>	<b>C</b>		<b>C</b>		<b>E</b>		<b>E</b>
	<b>OVERALL</b>	<b>F</b>		<b>F</b>		<b>F</b>		<b>F</b>

Table 8: BLOS Intersection Analysis

Approach	Bikeway Type	Criteria	Travel Lanes and/or Speed	BLOS
<b>Robertson Road/Stinson Avenue</b>				
North Approach	Mixed Traffic	Right Turn Lane Characteristics	Shared left/through/right lane	A
		Left Turn Accommodation	No lane crossed; $\leq 50$ km/h	B
South Approach	Mixed Traffic	Right Turn Lane Characteristics	Shared left/through/right lane	A
		Left Turn Accommodation	No lane crossed; $\leq 50$ km/h	B
East Approach	Mixed Traffic	Right Turn Lane Characteristics	Shared through/right turn lane	A
		Left Turn Accommodation	Two lanes crossed; $\geq 50$ km/h	F
West Approach	Mixed Traffic	Right Turn Lane Characteristics	Shared through/right turn lane	A
		Left Turn Accommodation	Two lanes crossed; $\geq 50$ km/h	F
<b>Robertson Road/Lynhar Road/Stafford Road</b>				
North Approach	Mixed Traffic	Right Turn Lane Characteristics	Right turn lane $> 50$ m	F
		Left Turn Accommodation	One lane crossed; $\geq 60$ km/h	F
South Approach	Mixed Traffic	Right Turn Lane Characteristics	Right turn lane $< 50$ m, slow turning speed	D
		Left Turn Accommodation	One lane crossed; 50 km/h	D
East Approach	Mixed Traffic	Right Turn Lane Characteristics	Shared through/right turn lane	A
		Left Turn Accommodation	Two lanes crossed; $\geq 50$ km/h	F
West Approach	Mixed Traffic	Right Turn Lane Characteristics	Right turn lane $< 50$ m, slow turning speed	D
		Left Turn Accommodation	Two lanes crossed; $\geq 50$ km/h	F
<b>Robertson Road/Northside Road East</b>				
North Approach	Mixed Traffic	Right Turn Lane Characteristics	Right turn lane $< 50$ m, slow turning speed	D
		Left Turn Accommodation	One lane crossed; 50 km/h	D
South Approach	Mixed Traffic	Right Turn Lane Characteristics	Right turn lane $< 50$ m, slow turning speed	D
		Left Turn Accommodation	No lanes crossed; $\leq 50$ km/h	B
East Approach	Mixed Traffic	Right Turn Lane Characteristics	Right turn lane $> 50$ m	F
		Left Turn Accommodation	Two lanes crossed; $\geq 50$ km/h	F
West Approach	Mixed Traffic	Right Turn Lane Characteristics	Shared through/right turn lane	A
		Left Turn Accommodation	Two lanes crossed; $\geq 50$ km/h	F

Table 9: TLOS Intersection Analysis

Approach	Approach Delay <sup>(1)</sup>			TLOS
	AM Peak	PM Peak	SAT Peak	
<b>Robertson Road/Stinson Avenue</b>				
East Approach	3 sec	3 sec	2 sec	B
West Approach	10 sec	5 sec	5 sec	B
<b>Robertson Road/Lynhar Road/Stafford Road</b>				
East Approach	8 sec	30 sec	26 sec	D
West Approach	12 sec	33 sec	32 sec	E
<b>Robertson Road/Northside Road East</b>				
East Approach	10 sec	16 sec	12 sec	C
West Approach	7 sec	10 sec	8 sec	B

1. Delay based on outputs from Synchro analysis of existing conditions

Table 10: TkLOS Intersection Analysis

Approach	Effective Corner Radius	Number of Receiving Lanes Departing Intersection	TkLOS
<b>Robertson Road/Stinson Avenue</b>			
North Approach	10m to 15m	2	B
South Approach	10m to 15m	2	B
East Approach	10m to 15m	1	E
West Approach	10m to 15m	1	E
<b>Robertson Road/Lynhar Road/Stafford Road</b>			
North Approach	> 15m	2	A
South Approach	10m to 15m	2	B
East Approach	> 15m	2	A
West Approach	10m to 15m	1	E
<b>Robertson Road/Northside Road East</b>			
North Approach	10m to 15m	3	B
South Approach	10m to 15m	2	B
East Approach	> 15m	1	C
West Approach	< 10m	2	D

Table 11: Auto LOS Intersection Analysis – EB/WB Bike Boxes Implemented

Intersection	Mvmt [Scenario]	AM Peak			PM Peak			SAT Peak		
		v/c [Delay]	50 <sup>th</sup> % Queue (m)	95 <sup>th</sup> % Queue (m)	v/c [Delay]	50 <sup>th</sup> % Queue (m)	95 <sup>th</sup> % Queue (m)	v/c [Delay]	50 <sup>th</sup> % Queue (m)	95 <sup>th</sup> % Queue (m)
Robertson/ Stinson	NBL/T/R [Existing]	0.30 [42 s]	7	17	0.23 [25 s]	3	11	0.19 [26 s]	2	10
	NBL/T/R [Bike Box]	0.33 [58 s]	11	20	0.25 [49 s]	9	17	0.29 [52 s]	10	18
	SBL/T/R [Existing]	0.09 [10 s]	0	4	0.38 [25 s]	5	16	0.32 [24 s]	4	14
	SBL/T/R [Bike Box]	0.10 [51 s]	3	8	0.46 [57 s]	16	26	0.08 [46 s]	3	7
Robertson/ Lynhar/ Stafford	WBT/R [Existing]	0.36 [7 s]	28	34	0.86 [27 s]	142	#179	0.63 [23 s]	87	110
	WBT/R [Bike Box]	0.36 [7 s]	28	35	0.87 [27 s]	142	#180	0.63 [23 s]	88	111
Robertson/ Northside E	NBT/R [Existing]	0.31 [27 s]	6	18	0.39 [16 s]	9	25	0.38 [25 s]	13	27
	NBT/R [Bike Box]	0.37 [56 s]	15	27	0.49 [46 s]	30	48	0.45 [48 s]	25	39
	EBT/R [Existing]	0.75 [7 s]	26	70	0.50 [11 s]	53	66	0.37 [8 s]	33	35
	EBT/R [Bike Box]	0.75 [7 s]	26	71	0.50 [11 s]	57	66	0.37 [8 s]	33	35

1: Stinson Avenue & Robertson Road  
AM Peak Hour

1826 Robertson Road  
Existing Traffic (RTOR restrictions)

Lane Group	EBL	EBT	EBR	WBL	WBT	WBR	NBL	NBT	NBR	SBL	SBT	SBR
Lane Configurations												
Traffic Volume (vph)	54	1980	6	20	623	22	9	2	32	2	0	11
Future Volume (vph)	54	1980	6	20	623	22	9	2	32	2	0	11
Ideal Flow (vphpl)	1800	1800	1800	1800	1800	1800	1800	1800	1800	1800	1800	1800
Storage Length (m)	75.0		0.0	45.0		0.0	0.0		0.0	0.0		0.0
Storage Lanes	1		0	1		0	0		0	0		0
Taper Length (m)	10.0			10.0			10.0			10.0		
Lane Util. Factor	1.00	0.95	0.95	1.00	0.95	0.95	1.00	1.00	1.00	1.00	1.00	1.00
Ped Bike Factor	0.99	1.00			1.00			1.00				0.98
Frt					0.995			0.899				0.884
Flt Protected	0.950			0.950				0.990				0.993
Satd. Flow (prot)	1662	3356	0	1572	3308	0	0	1552	0	0	1443	0
Flt Permitted	0.378			0.054				0.927				0.955
Satd. Flow (perm)	654	3356	0	89	3308	0	0	1450	0	0	1388	0
Right Turn on Red			Yes			Yes			No			No
Satd. Flow (RTOR)		1			6							
Link Speed (k/h)		60			60			40				40
Link Distance (m)		198.0			310.7			254.0				246.4
Travel Time (s)		11.9			18.6			22.9				22.2
Confl. Peds. (#/hr)	11		3	11		3	6					6
Peak Hour Factor	0.90	0.90	0.90	0.90	0.90	0.90	0.90	0.90	0.90	0.90	0.90	0.90
Heavy Vehicles (%)	4%	3%	10%	10%	4%	1%	10%	1%	3%	1%	1%	10%
Adj. Flow (vph)	60	2200	7	22	692	24	10	2	36	2	0	12
Shared Lane Traffic (%)												
Lane Group Flow (vph)	60	2207	0	22	716	0	0	48	0	0	14	0
Enter Blocked Intersection	No	No	No	No	No	No	No	No	No	No	No	No
Lane Alignment	L NA	Left	R NA	L NA	Left	R NA	L NA	Left	R NA	L NA	Left	R NA
Median Width(m)		3.7			3.7			0.0				0.0
Link Offset(m)		0.0			0.0			0.0				0.0
Crosswalk Width(m)		5.0			5.0			5.0				5.0
Two way Left Turn Lane		Yes			Yes							
Headway Factor	1.06	1.06	1.06	1.06	1.06	1.06	1.06	1.06	1.06	1.06	1.06	1.06
Turning Speed (k/h)	24		14	24		14	24		14	24		14
Number of Detectors	1	2		1	2		1	2		1	2	
Detector Template	Left	Thru		Left	Thru		Left	Thru		Left	Thru	
Leading Detector (m)	6.1	30.5		6.1	30.5		6.1	30.5		6.1	30.5	
Trailing Detector (m)	0.0	0.0		0.0	0.0		0.0	0.0		0.0	0.0	
Detector 1 Position(m)	0.0	0.0		0.0	0.0		0.0	0.0		0.0	0.0	
Detector 1 Size(m)	6.1	1.8		6.1	1.8		6.1	1.8		6.1	1.8	
Detector 1 Type	Cl+Ex	Cl+Ex		Cl+Ex	Cl+Ex		Cl+Ex	Cl+Ex		Cl+Ex	Cl+Ex	
Detector 1 Channel												
Detector 1 Extend (s)	0.0	0.0		0.0	0.0		0.0	0.0		0.0	0.0	
Detector 1 Queue (s)	0.0	0.0		0.0	0.0		0.0	0.0		0.0	0.0	
Detector 1 Delay (s)	0.0	0.0		0.0	0.0		0.0	0.0		0.0	0.0	
Detector 2 Position(m)		28.7			28.7			28.7			28.7	
Detector 2 Size(m)		1.8			1.8			1.8			1.8	
Detector 2 Type		Cl+Ex			Cl+Ex			Cl+Ex			Cl+Ex	
Detector 2 Channel												
Detector 2 Extend (s)		0.0			0.0			0.0			0.0	
Turn Type	Perm	NA		Perm	NA		Perm	NA		Perm	NA	
Protected Phases		2			6			8			4	
Permitted Phases	2			6			8			4		
Detector Phase	2	2		6	6		8	8		4	4	
Switch Phase												

1: Stinson Avenue & Robertson Road  
AM Peak Hour

1826 Robertson Road  
Existing Traffic (RTOR restrictions)



Lane Group	EBL	EBT	EBR	WBL	WBT	WBR	NBL	NBT	NBR	SBL	SBT	SBR
Minimum Initial (s)	10.0	10.0		10.0	10.0		10.0	10.0		10.0	10.0	
Minimum Split (s)	26.8	26.8		26.8	26.8		31.6	31.6		31.6	31.6	
Total Split (s)	98.0	98.0		98.0	98.0		32.0	32.0		32.0	32.0	
Total Split (%)	75.4%	75.4%		75.4%	75.4%		24.6%	24.6%		24.6%	24.6%	
Maximum Green (s)	92.2	92.2		92.2	92.2		25.4	25.4		25.4	25.4	
Yellow Time (s)	3.7	3.7		3.7	3.7		3.0	3.0		3.0	3.0	
All-Red Time (s)	2.1	2.1		2.1	2.1		3.6	3.6		3.6	3.6	
Lost Time Adjust (s)	0.0	0.0		0.0	0.0			0.0			0.0	
Total Lost Time (s)	5.8	5.8		5.8	5.8			6.6			6.6	
Lead/Lag												
Lead-Lag Optimize?												
Vehicle Extension (s)	3.0	3.0		3.0	3.0		3.0	3.0		3.0	3.0	
Recall Mode	C-Max	C-Max		C-Max	C-Max		None	None		None	None	
Walk Time (s)	7.0	7.0		7.0	7.0		7.0	7.0		7.0	7.0	
Flash Dont Walk (s)	14.0	14.0		14.0	14.0		18.0	18.0		18.0	18.0	
Pedestrian Calls (#/hr)	3	3		11	11		1	1		6	6	
Act Effct Green (s)	108.8	108.8		108.8	108.8			13.2			13.2	
Actuated g/C Ratio	0.84	0.84		0.84	0.84			0.10			0.10	
v/c Ratio	0.11	0.79		0.30	0.26			0.33			0.10	
Control Delay	4.2	10.6		25.0	2.8			58.2			51.2	
Queue Delay	0.0	0.0		0.0	0.0			0.0			0.0	
Total Delay	4.2	10.6		25.0	2.8			58.2			51.2	
LOS	A	B		C	A			E			D	
Approach Delay		10.5			3.4			58.2			51.2	
Approach LOS		B			A			E			D	
Queue Length 50th (m)	2.1	108.5		0.8	12.3			11.0			3.1	
Queue Length 95th (m)	8.4	253.4		8.1	23.1			20.0			8.1	
Internal Link Dist (m)		174.0			286.7			230.0			222.4	
Turn Bay Length (m)	75.0			45.0								
Base Capacity (vph)	547	2809		74	2770			283			271	
Starvation Cap Reductn	0	0		0	0			0			0	
Spillback Cap Reductn	0	0		0	0			0			0	
Storage Cap Reductn	0	0		0	0			0			0	
Reduced v/c Ratio	0.11	0.79		0.30	0.26			0.17			0.05	

Intersection Summary

Area Type: Other  
 Cycle Length: 130  
 Actuated Cycle Length: 130  
 Offset: 129 (99%), Referenced to phase 2:EBTL and 6:WBTL, Start of Green  
 Natural Cycle: 110  
 Control Type: Actuated-Coordinated  
 Maximum v/c Ratio: 0.79  
 Intersection Signal Delay: 9.7  
 Intersection Capacity Utilization 78.9%  
 Analysis Period (min) 15  
 Intersection LOS: A  
 ICU Level of Service D

Splits and Phases: 1: Stinson Avenue & Robertson Road



2: Lynhar Road/Stafford Road & Robertson Road  
AM Peak Hour

1826 Robertson Road  
Existing Traffic (RTOR restrictions)

Lane Group	EBL	EBT	EBR	WBL	WBT	WBR	NBL	NBT	NBR	SBL	SBT	SBR
Lane Configurations												
Traffic Volume (vph)	42	1859	27	14	648	83	33	11	101	31	4	52
Future Volume (vph)	42	1859	27	14	648	83	33	11	101	31	4	52
Ideal Flow (vphpl)	1800	1800	1800	1800	1800	1800	1800	1800	1800	1800	1800	1800
Storage Length (m)	85.0		40.0	0.0		0.0	0.0		30.0	45.0		75.0
Storage Lanes	1		1	1		0	1		1	1		1
Taper Length (m)	10.0			10.0			10.0			30.0		
Lane Util. Factor	1.00	0.95	1.00	1.00	0.95	0.95	1.00	1.00	1.00	1.00	1.00	1.00
Ped Bike Factor	1.00		0.97	1.00	1.00		0.99		0.98	1.00		0.98
Frt			0.850		0.983				0.850			0.850
Flt Protected	0.950			0.950			0.950			0.950		
Satd. Flow (prot)	1572	3357	1532	1712	3275	0	1679	1802	1532	1572	1802	1459
Flt Permitted	0.950			0.950			0.755			0.750		
Satd. Flow (perm)	1568	3357	1485	1711	3275	0	1327	1802	1506	1235	1802	1435
Right Turn on Red			Yes			No			Yes			Yes
Satd. Flow (RTOR)			82						112			79
Link Speed (k/h)		60			60			40				40
Link Distance (m)		310.7			66.2			81.0				107.6
Travel Time (s)		18.6			4.0			7.3				9.7
Confl. Peds. (#/hr)	5		4	4		5	4		4	4		4
Peak Hour Factor	0.90	0.90	0.90	0.90	0.90	0.90	0.90	0.90	0.90	0.90	0.90	0.90
Heavy Vehicles (%)	10%	3%	1%	1%	3%	8%	3%	1%	1%	10%	1%	6%
Adj. Flow (vph)	47	2066	30	16	720	92	37	12	112	34	4	58
Shared Lane Traffic (%)												
Lane Group Flow (vph)	47	2066	30	16	812	0	37	12	112	34	4	58
Enter Blocked Intersection	No	No	No	No	No	No	No	No	No	No	No	No
Lane Alignment	L NA	Left	R NA	L NA	Left	R NA	L NA	L NA	R NA	L NA	Left	R NA
Median Width(m)		3.7			7.4			7.4				7.4
Link Offset(m)		0.0			0.0			0.0				0.0
Crosswalk Width(m)		5.0			5.0			5.0				5.0
Two way Left Turn Lane		Yes										
Headway Factor	1.06	1.06	1.06	1.06	1.06	1.06	1.06	1.06	1.06	1.06	1.06	1.06
Turning Speed (k/h)	24		14	24		14	24		14	24		14
Number of Detectors	1	2	1	1	2		1	2	1	1	2	1
Detector Template	Left	Thru	Right	Left	Thru		Left	Thru	Right	Left	Thru	Right
Leading Detector (m)	6.1	30.5	6.1	6.1	30.5		6.1	30.5	6.1	6.1	30.5	6.1
Trailing Detector (m)	0.0	0.0	0.0	0.0	0.0		0.0	0.0	0.0	0.0	0.0	0.0
Detector 1 Position(m)	0.0	0.0	0.0	0.0	0.0		0.0	0.0	0.0	0.0	0.0	0.0
Detector 1 Size(m)	6.1	1.8	6.1	6.1	1.8		6.1	1.8	6.1	6.1	1.8	6.1
Detector 1 Type	Cl+Ex	Cl+Ex	Cl+Ex	Cl+Ex	Cl+Ex		Cl+Ex	Cl+Ex	Cl+Ex	Cl+Ex	Cl+Ex	Cl+Ex
Detector 1 Channel												
Detector 1 Extend (s)	0.0	0.0	0.0	0.0	0.0		0.0	0.0	0.0	0.0	0.0	0.0
Detector 1 Queue (s)	0.0	0.0	0.0	0.0	0.0		0.0	0.0	0.0	0.0	0.0	0.0
Detector 1 Delay (s)	0.0	0.0	0.0	0.0	0.0		0.0	0.0	0.0	0.0	0.0	0.0
Detector 2 Position(m)		28.7			28.7			28.7				28.7
Detector 2 Size(m)		1.8			1.8			1.8				1.8
Detector 2 Type		Cl+Ex			Cl+Ex			Cl+Ex				Cl+Ex
Detector 2 Channel												
Detector 2 Extend (s)		0.0			0.0			0.0				0.0
Turn Type	Prot	NA	Perm	Prot	NA		Perm	NA	Perm	Perm	NA	Perm
Protected Phases	5	2		1	6			8				4
Permitted Phases			2				8		8	4		4
Detector Phase	5	2	2	1	6		8	8	8	4	4	4
Switch Phase												



Lane Group	EBL	EBT	EBR	WBL	WBT	WBR	NBL	NBT	NBR	SBL	SBT	SBR
Minimum Initial (s)	5.0	10.0	10.0	5.0	10.0		10.0	10.0	10.0	10.0	10.0	10.0
Minimum Split (s)	11.1	31.3	31.3	11.1	31.3		37.7	37.7	37.7	37.7	37.7	37.7
Total Split (s)	16.0	75.0	75.0	16.0	75.0		39.0	39.0	39.0	39.0	39.0	39.0
Total Split (%)	12.3%	57.7%	57.7%	12.3%	57.7%		30.0%	30.0%	30.0%	30.0%	30.0%	30.0%
Maximum Green (s)	9.9	68.7	68.7	9.9	68.7		32.3	32.3	32.3	32.3	32.3	32.3
Yellow Time (s)	3.7	3.7	3.7	3.7	3.7		3.0	3.0	3.0	3.0	3.0	3.0
All-Red Time (s)	2.4	2.6	2.6	2.4	2.6		3.7	3.7	3.7	3.7	3.7	3.7
Lost Time Adjust (s)	0.0	0.0	0.0	0.0	0.0		0.0	0.0	0.0	0.0	0.0	0.0
Total Lost Time (s)	6.1	6.3	6.3	6.1	6.3		6.7	6.7	6.7	6.7	6.7	6.7
Lead/Lag	Lead	Lag	Lag	Lead	Lag							
Lead-Lag Optimize?	Yes	Yes	Yes	Yes	Yes							
Vehicle Extension (s)	3.0	3.0	3.0	3.0	3.0		3.0	3.0	3.0	3.0	3.0	3.0
Recall Mode	None	C-Max	C-Max	None	C-Max		None	None	None	None	None	None
Walk Time (s)		7.0	7.0		7.0		12.0	12.0	12.0	12.0	12.0	12.0
Flash Dont Walk (s)		18.0	18.0		18.0		19.0	19.0	19.0	19.0	19.0	19.0
Pedestrian Calls (#/hr)		4	4		5		4	4	4	4	4	4
Act Effct Green (s)	8.9	97.0	97.0	6.8	90.0		14.3	14.3	14.3	14.3	14.3	14.3
Actuated g/C Ratio	0.07	0.75	0.75	0.05	0.69		0.11	0.11	0.11	0.11	0.11	0.11
v/c Ratio	0.44	0.82	0.03	0.18	0.36		0.25	0.06	0.42	0.25	0.02	0.25
Control Delay	79.3	10.6	0.1	71.5	7.8		54.1	47.7	12.8	54.2	46.0	6.7
Queue Delay	0.0	0.0	0.0	0.0	0.0		0.0	0.0	0.0	0.0	0.0	0.0
Total Delay	79.3	10.6	0.1	71.5	7.8		54.1	47.7	12.8	54.2	46.0	6.7
LOS	E	B	A	E	A		D	D	B	D	D	A
Approach Delay		12.0			9.0			24.9			25.1	
Approach LOS		B			A			C			C	
Queue Length 50th (m)	11.2	15.1	0.0	3.8	28.4		8.4	2.7	0.0	7.8	0.9	0.0
Queue Length 95th (m)	m13.3	#331.8	m0.0	m11.7	34.7		15.6	7.0	13.7	14.6	3.5	6.1
Internal Link Dist (m)		286.7			42.2			57.0			83.6	
Turn Bay Length (m)	85.0		40.0						30.0	45.0		75.0
Base Capacity (vph)	124	2505	1128	130	2267		329	447	458	306	447	415
Starvation Cap Reductn	0	0	0	0	0		0	0	0	0	0	0
Spillback Cap Reductn	0	0	0	0	0		0	0	0	0	0	0
Storage Cap Reductn	0	0	0	0	0		0	0	0	0	0	0
Reduced v/c Ratio	0.38	0.82	0.03	0.12	0.36		0.11	0.03	0.24	0.11	0.01	0.14

Intersection Summary

Area Type: Other  
 Cycle Length: 130  
 Actuated Cycle Length: 130  
 Offset: 36 (28%), Referenced to phase 2:EBT and 6:WBT, Start of Green  
 Natural Cycle: 145  
 Control Type: Actuated-Coordinated  
 Maximum v/c Ratio: 0.82  
 Intersection Signal Delay: 12.3  
 Intersection LOS: B  
 Intersection Capacity Utilization 89.5%  
 ICU Level of Service E  
 Analysis Period (min) 15  
 # 95th percentile volume exceeds capacity, queue may be longer.  
 Queue shown is maximum after two cycles.  
 m Volume for 95th percentile queue is metered by upstream signal.

Splits and Phases: 2: Lynhar Road/Stafford Road & Robertson Road

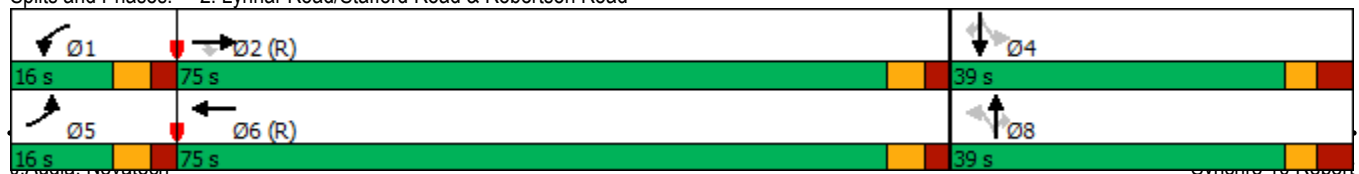

3: Northside Road East & Robertson Road  
AM Peak Hour

1826 Robertson Road  
Existing Traffic (RTOR restrictions)

Lane Group	EBL	EBT	EBR	WBL	WBT	WBR	NBL	NBT	NBR	SBL	SBT	SBR
Lane Configurations												
Traffic Volume (vph)	23	1752	12	40	612	67	95	24	38	34	8	9
Future Volume (vph)	23	1752	12	40	612	67	95	24	38	34	8	9
Ideal Flow (vphpl)	1800	1800	1800	1800	1800	1800	1800	1800	1800	1800	1800	1800
Storage Length (m)	55.0		0.0	75.0		80.0	0.0		0.0	0.0		0.0
Storage Lanes	1		0	1		1	1		0	1		1
Taper Length (m)	30.0			15.0			10.0			10.0		
Lane Util. Factor	1.00	0.95	0.95	1.00	0.95	1.00	1.00	1.00	1.00	1.00	1.00	1.00
Ped Bike Factor	1.00	1.00				0.96	0.99	0.99		0.99		0.98
Frt		0.999				0.850		0.909				0.850
Flt Protected	0.950			0.950			0.950			0.950		
Satd. Flow (prot)	1712	3354	0	1647	3325	1532	1679	1519	0	1679	1802	1532
Flt Permitted	0.355			0.081			0.752			0.712		
Satd. Flow (perm)	637	3354	0	140	3325	1475	1322	1519	0	1250	1802	1506
Right Turn on Red			No			Yes			No			Yes
Satd. Flow (RTOR)						99						93
Link Speed (k/h)		60			60			40				40
Link Distance (m)		105.4			310.9			87.0				90.9
Travel Time (s)		6.3			18.7			7.8				8.2
Confl. Peds. (#/hr)	5		3	3		5	3		4	4		3
Confl. Bikes (#/hr)			5			6			3			
Peak Hour Factor	0.90	0.90	0.90	0.90	0.90	0.90	0.90	0.90	0.90	0.90	0.90	0.90
Heavy Vehicles (%)	1%	3%	1%	5%	4%	1%	3%	5%	9%	3%	1%	1%
Adj. Flow (vph)	26	1947	13	44	680	74	106	27	42	38	9	10
Shared Lane Traffic (%)												
Lane Group Flow (vph)	26	1960	0	44	680	74	106	69	0	38	9	10
Enter Blocked Intersection	No	No	No	No	No	No	No	No	No	No	No	No
Lane Alignment	L NA	Left	R NA	L NA	Left	R NA	L NA	Left	R NA	L NA	Left	R NA
Median Width(m)		5.5			5.5			3.7				3.7
Link Offset(m)		0.0			0.0			0.0				0.0
Crosswalk Width(m)		5.0			5.0			5.0				5.0
Two way Left Turn Lane												
Headway Factor	1.06	1.06	1.06	1.06	1.06	1.06	1.06	1.06	1.06	1.06	1.06	1.06
Turning Speed (k/h)	24		14	24		14	24		14	24		14
Number of Detectors	1	2		1	2		1	1	2		1	2
Detector Template	Left	Thru		Left	Thru	Right	Left	Thru		Left	Thru	Right
Leading Detector (m)	6.1	30.5		6.1	30.5	6.1	6.1	30.5		6.1	30.5	6.1
Trailing Detector (m)	0.0	0.0		0.0	0.0	0.0	0.0	0.0		0.0	0.0	0.0
Detector 1 Position(m)	0.0	0.0		0.0	0.0	0.0	0.0	0.0		0.0	0.0	0.0
Detector 1 Size(m)	6.1	1.8		6.1	1.8	6.1	6.1	1.8		6.1	1.8	6.1
Detector 1 Type	Cl+Ex	Cl+Ex		Cl+Ex	Cl+Ex	Cl+Ex	Cl+Ex	Cl+Ex		Cl+Ex	Cl+Ex	Cl+Ex
Detector 1 Channel												
Detector 1 Extend (s)	0.0	0.0		0.0	0.0	0.0	0.0	0.0		0.0	0.0	0.0
Detector 1 Queue (s)	0.0	0.0		0.0	0.0	0.0	0.0	0.0		0.0	0.0	0.0
Detector 1 Delay (s)	0.0	0.0		0.0	0.0	0.0	0.0	0.0		0.0	0.0	0.0
Detector 2 Position(m)		28.7			28.7			28.7				28.7
Detector 2 Size(m)		1.8			1.8			1.8				1.8
Detector 2 Type		Cl+Ex			Cl+Ex			Cl+Ex				Cl+Ex
Detector 2 Channel												
Detector 2 Extend (s)		0.0			0.0			0.0				0.0
Turn Type	pm+pt	NA		Perm	NA	Perm	Perm	NA		Perm	NA	Perm
Protected Phases	5	2			6			8				4
Permitted Phases	2			6		6	8			4		4
Detector Phase	5	2		6	6	6	8	8		4	4	4

Lane Group	Ø3	Ø7
Lane Configurations		
Traffic Volume (vph)		
Future Volume (vph)		
Ideal Flow (vphpl)		
Storage Length (m)		
Storage Lanes		
Taper Length (m)		
Lane Util. Factor		
Ped Bike Factor		
Frt		
Flt Protected		
Satd. Flow (prot)		
Flt Permitted		
Satd. Flow (perm)		
Right Turn on Red		
Satd. Flow (RTOR)		
Link Speed (k/h)		
Link Distance (m)		
Travel Time (s)		
Confl. Peds. (#/hr)		
Confl. Bikes (#/hr)		
Peak Hour Factor		
Heavy Vehicles (%)		
Adj. Flow (vph)		
Shared Lane Traffic (%)		
Lane Group Flow (vph)		
Enter Blocked Intersection		
Lane Alignment		
Median Width(m)		
Link Offset(m)		
Crosswalk Width(m)		
Two way Left Turn Lane		
Headway Factor		
Turning Speed (k/h)		
Number of Detectors		
Detector Template		
Leading Detector (m)		
Trailing Detector (m)		
Detector 1 Position(m)		
Detector 1 Size(m)		
Detector 1 Type		
Detector 1 Channel		
Detector 1 Extend (s)		
Detector 1 Queue (s)		
Detector 1 Delay (s)		
Detector 2 Position(m)		
Detector 2 Size(m)		
Detector 2 Type		
Detector 2 Channel		
Detector 2 Extend (s)		
Turn Type		
Protected Phases	3	7
Permitted Phases		
Detector Phase		

3: Northside Road East & Robertson Road  
AM Peak Hour

1826 Robertson Road  
Existing Traffic (RTOR restrictions)



Lane Group	EBL	EBT	EBR	WBL	WBT	WBR	NBL	NBT	NBR	SBL	SBT	SBR
Switch Phase												
Minimum Initial (s)	5.0	10.0		10.0	10.0	10.0	10.0	10.0		10.0	10.0	10.0
Minimum Split (s)	11.7	30.7		30.7	30.7	30.7	29.8	29.8		29.8	29.8	29.8
Total Split (s)	16.0	94.0		78.0	78.0	78.0	30.0	30.0		30.0	30.0	30.0
Total Split (%)	12.3%	72.3%		60.0%	60.0%	60.0%	23.1%	23.1%		23.1%	23.1%	23.1%
Maximum Green (s)	10.0	87.9		71.9	71.9	71.9	23.2	23.2		23.2	23.2	23.2
Yellow Time (s)	3.7	3.7		3.7	3.7	3.7	3.0	3.0		3.0	3.0	3.0
All-Red Time (s)	2.3	2.4		2.4	2.4	2.4	3.8	3.8		3.8	3.8	3.8
Lost Time Adjust (s)	0.0	0.0		0.0	0.0	0.0	0.0	0.0		0.0	0.0	0.0
Total Lost Time (s)	6.0	6.1		6.1	6.1	6.1	6.8	6.8		6.8	6.8	6.8
Lead/Lag	Lead			Lag	Lag	Lag	Lag	Lag		Lag	Lag	Lag
Lead-Lag Optimize?	Yes			Yes	Yes	Yes	Yes	Yes		Yes	Yes	Yes
Vehicle Extension (s)	3.0	3.0		3.0	3.0	3.0	3.0	3.0		3.0	3.0	3.0
Recall Mode	None	C-Max		C-Max	C-Max	C-Max	None	None		None	None	None
Walk Time (s)		7.0		7.0	7.0	7.0	1.0	1.0		1.0	1.0	1.0
Flash Dont Walk (s)		17.0		17.0	17.0	17.0	22.0	22.0		22.0	22.0	22.0
Pedestrian Calls (#/hr)		3		5	5	5	4	4		3	3	3
Act Effct Green (s)	101.2	101.1		93.7	93.7	93.7	16.0	16.0		16.0	16.0	16.0
Actuated g/C Ratio	0.78	0.78		0.72	0.72	0.72	0.12	0.12		0.12	0.12	0.12
v/c Ratio	0.05	0.75		0.44	0.28	0.07	0.65	0.37		0.25	0.04	0.04
Control Delay	3.5	6.9		29.1	8.0	1.0	72.0	56.4		53.4	47.2	0.2
Queue Delay	0.0	0.1		0.0	0.0	0.0	0.0	0.0		0.0	0.0	0.0
Total Delay	3.5	7.0		29.1	8.0	1.0	72.0	56.4		53.4	47.2	0.2
LOS	A	A		C	A	A	E	E		D	D	A
Approach Delay		6.9			8.5			65.8			43.1	
Approach LOS		A			A			E			D	
Queue Length 50th (m)	0.6	26.2		4.3	30.2	0.0	24.3	15.2		8.3	1.9	0.0
Queue Length 95th (m)	m1.5	70.5		#23.2	47.2	2.9	39.9	27.2		17.2	6.4	0.0
Internal Link Dist (m)		81.4			286.9			63.0			66.9	
Turn Bay Length (m)	55.0			75.0		80.0						
Base Capacity (vph)	578	2607		101	2396	1090	235	271		223	321	345
Starvation Cap Reductn	0	73		0	0	0	0	0		0	0	0
Spillback Cap Reductn	0	0		0	0	0	0	0		0	0	0
Storage Cap Reductn	0	0		0	0	0	0	0		0	0	0
Reduced v/c Ratio	0.04	0.77		0.44	0.28	0.07	0.45	0.25		0.17	0.03	0.03

Intersection Summary

Area Type: Other  
 Cycle Length: 130  
 Actuated Cycle Length: 130  
 Offset: 37 (28%), Referenced to phase 2:EBTL and 6:WBTL, Start of Green  
 Natural Cycle: 100  
 Control Type: Actuated-Coordinated  
 Maximum v/c Ratio: 0.75  
 Intersection Signal Delay: 11.5 Intersection LOS: B  
 Intersection Capacity Utilization 75.4% ICU Level of Service D  
 Analysis Period (min) 15  
 # 95th percentile volume exceeds capacity, queue may be longer.  
 Queue shown is maximum after two cycles.  
 m Volume for 95th percentile queue is metered by upstream signal.

Splits and Phases: 3: Northside Road East & Robertson Road

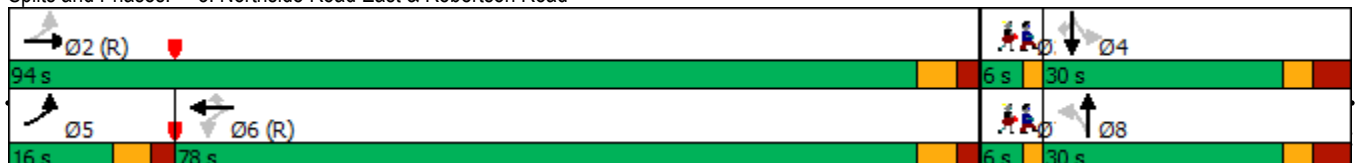

Lane Group	Ø3	Ø7
Switch Phase		
Minimum Initial (s)	4.0	4.0
Minimum Split (s)	6.0	6.0
Total Split (s)	6.0	6.0
Total Split (%)	5%	5%
Maximum Green (s)	4.0	4.0
Yellow Time (s)	2.0	2.0
All-Red Time (s)	0.0	0.0
Lost Time Adjust (s)		
Total Lost Time (s)		
Lead/Lag	Lead	Lead
Lead-Lag Optimize?	Yes	Yes
Vehicle Extension (s)	3.0	3.0
Recall Mode	None	None
Walk Time (s)		
Flash Dont Walk (s)		
Pedestrian Calls (#/hr)		
Act Effct Green (s)		
Actuated g/C Ratio		
v/c Ratio		
Control Delay		
Queue Delay		
Total Delay		
LOS		
Approach Delay		
Approach LOS		
Queue Length 50th (m)		
Queue Length 95th (m)		
Internal Link Dist (m)		
Turn Bay Length (m)		
Base Capacity (vph)		
Starvation Cap Reductn		
Spillback Cap Reductn		
Storage Cap Reductn		
Reduced v/c Ratio		
Intersection Summary		

4: Northside Road West & Robertson Road  
AM Peak Hour

1826 Robertson Road  
Existing Traffic (RTOR restrictions)

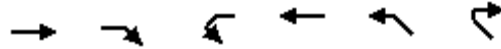

Lane Group	EBT	EBR	WBL	WBT	NWL	NWR
Lane Configurations	↑↑			↑↑↑		
Traffic Volume (vph)	1883	108	0	745	0	0
Future Volume (vph)	1883	108	0	745	0	0
Ideal Flow (vphpl)	1800	1800	1800	1800	1800	1800
Storage Length (m)		0.0	25.0		0.0	0.0
Storage Lanes		0	1		0	0
Taper Length (m)			25.0		10.0	
Lane Util. Factor	0.95	0.95	1.00	0.91	1.00	1.00
Fr <sub>t</sub>	0.992					
Flt Protected						
Satd. Flow (prot)	3356	0	0	4871	0	0
Flt Permitted						
Satd. Flow (perm)	3356	0	0	4871	0	0
Link Speed (k/h)	60			60	50	
Link Distance (m)	66.2			72.0	100.3	
Travel Time (s)	4.0			4.3	7.2	
Peak Hour Factor	0.90	0.90	0.90	0.90	0.90	0.90
Heavy Vehicles (%)	2%	6%	1%	2%	1%	1%
Adj. Flow (vph)	2092	120	0	828	0	0
Shared Lane Traffic (%)						
Lane Group Flow (vph)	2212	0	0	828	0	0
Enter Blocked Intersection	Yes	Yes	Yes	Yes	No	No
Lane Alignment	Left	Right	Left	Left	Left	Right
Median Width(m)	3.7			3.7	0.0	
Link Offset(m)	0.0			0.0	0.0	
Crosswalk Width(m)	0.0			0.0	0.0	
Two way Left Turn Lane						
Headway Factor	1.06	1.06	1.06	1.06	1.06	1.06
Turning Speed (k/h)		50	24		24	14
Sign Control	Free			Free	Free	

Intersection Summary

Area Type: Other

Control Type: Unsignalized

Intersection Capacity Utilization 61.9% ICU Level of Service B

Analysis Period (min) 15

5: Larkspur Drive & Northside Road West  
AM Peak Hour

1826 Robertson Road  
Existing Traffic (RTOR restrictions)

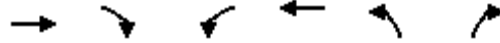

Lane Group	EBT	EBR	WBL	WBT	NBL	NBR
Lane Configurations						
Traffic Volume (vph)	100	8	51	0	0	26
Future Volume (vph)	100	8	51	0	0	26
Ideal Flow (vphpl)	1800	1800	1800	1800	1800	1800
Lane Util. Factor	1.00	1.00	1.00	1.00	1.00	1.00
Ped Bike Factor						
Frt	0.990					0.865
Flt Protected			0.950			
Satd. Flow (prot)	1706	0	1572	0	0	1458
Flt Permitted			0.950			
Satd. Flow (perm)	1706	0	1572	0	0	1458
Link Speed (k/h)	50			40	40	
Link Distance (m)	100.3			62.0	54.2	
Travel Time (s)	7.2			5.6	4.9	
Confl. Peds. (#/hr)		17	17			
Peak Hour Factor	0.90	0.90	0.90	0.90	0.90	0.90
Heavy Vehicles (%)	6%	1%	10%	1%	1%	8%
Adj. Flow (vph)	111	9	57	0	0	29
Shared Lane Traffic (%)						
Lane Group Flow (vph)	120	0	57	0	0	29
Enter Blocked Intersection	No	No	No	No	No	No
Lane Alignment	L NA	R NA	L NA	R NA	Left	R NA
Median Width(m)	3.7			3.7	0.0	
Link Offset(m)	3.0			3.0	0.0	
Crosswalk Width(m)	5.0			5.0	5.0	
Two way Left Turn Lane						
Headway Factor	1.06	1.06	1.06	1.06	1.06	1.06
Turning Speed (k/h)		14	24		24	14
Sign Control	Stop			Stop	Stop	

Intersection Summary











Area Type: Other

Control Type: Unsignalized









Intersection Capacity Utilization 19.3%

ICU Level of Service A

Analysis Period (min) 15

						
Lane Group	WBL	WBR	NBT	NBR	SBL	SBT
Lane Configurations						
Traffic Volume (vph)	1	11	134	1	17	28
Future Volume (vph)	1	11	134	1	17	28
Ideal Flow (vphpl)	1800	1800	1800	1800	1800	1800
Storage Length (m)	0.0	0.0		45.0	15.0	
Storage Lanes	1	0		0	1	
Taper Length (m)	10.0				20.0	
Lane Util. Factor	1.00	1.00	0.95	0.95	1.00	1.00
Frt	0.875		0.999			
Flt Protected	0.996				0.950	
Satd. Flow (prot)	1570	0	3387	0	1712	1784
Flt Permitted	0.996				0.950	
Satd. Flow (perm)	1570	0	3387	0	1712	1784
Link Speed (k/h)	40		40		40	
Link Distance (m)	173.4		68.2		81.0	
Travel Time (s)	15.6		6.1		7.3	
Peak Hour Factor	0.90	0.90	0.90	0.90	0.90	0.90
Heavy Vehicles (%)	1%	1%	2%	1%	1%	2%
Adj. Flow (vph)	1	12	149	1	19	31
Shared Lane Traffic (%)						
Lane Group Flow (vph)	13	0	150	0	19	31
Enter Blocked Intersection	No	No	No	No	No	No
Lane Alignment	Left	Right	Left	Right	Left	Left
Median Width(m)	3.7		3.7		3.7	
Link Offset(m)	0.0		0.0		0.0	
Crosswalk Width(m)	5.0		5.0		5.0	
Two way Left Turn Lane						
Headway Factor	1.06	1.06	1.06	1.06	1.06	1.06
Turning Speed (k/h)	24	14		14	24	
Sign Control	Stop		Free			Free
<b>Intersection Summary</b>						
Area Type:	Other					
Control Type:	Unsignalized					
Intersection Capacity Utilization	20.6%			ICU Level of Service A		
Analysis Period (min)	15					



						
Lane Group	WBL	WBR	NBT	NBR	SBL	SBT
Lane Configurations						
Traffic Volume (vph)	0	4	131	1	6	23
Future Volume (vph)	0	4	131	1	6	23
Ideal Flow (vphpl)	1800	1800	1800	1800	1800	1800
Lane Util. Factor	1.00	1.00	1.00	1.00	1.00	1.00
Fr <sub>t</sub>	0.865		0.999			
Flt Protected						0.990
Satd. Flow (prot)	1559	0	1783	0	0	1770
Flt Permitted						0.990
Satd. Flow (perm)	1559	0	1783	0	0	1770
Link Speed (k/h)	50		50			50
Link Distance (m)	178.0		82.4			68.2
Travel Time (s)	12.8		5.9			4.9
Peak Hour Factor	0.90	0.90	0.90	0.90	0.90	0.90
Heavy Vehicles (%)	1%	1%	2%	1%	1%	2%
Adj. Flow (vph)	0	4	146	1	7	26
Shared Lane Traffic (%)						
Lane Group Flow (vph)	4	0	147	0	0	33
Enter Blocked Intersection	No	No	No	No	No	No
Lane Alignment	L NA	R NA	Left	Right	Left	Left
Median Width(m)	3.7		0.0			0.0
Link Offset(m)	0.0		0.0			0.0
Crosswalk Width(m)	5.0		5.0			5.0
Two way Left Turn Lane						
Headway Factor	1.06	1.06	1.06	1.06	1.06	1.06
Turning Speed (k/h)	97	97		97	97	
Sign Control	Stop		Free			Free
<b>Intersection Summary</b>						
Area Type:	Other					
Control Type:	Unsignalized					
Intersection Capacity Utilization	17.3%			ICU Level of Service A		
Analysis Period (min)	15					

8: Larkspur Drive & North Site Access  
AM Peak Hour

1826 Robertson Road  
Existing Traffic (RTOR restrictions)



Lane Group	EBL	EBR	NBL	NBT	SBT	SBR
Lane Configurations						
Traffic Volume (vph)	10	0	0	16	43	16
Future Volume (vph)	10	0	0	16	43	16
Ideal Flow (vphpl)	1800	1800	1800	1800	1800	1800
Lane Util. Factor	1.00	1.00	1.00	1.00	1.00	1.00
Frt					0.963	
Frt Protected	0.950					
Satd. Flow (prot)	1712	0	0	1802	1735	0
Frt Permitted	0.950					
Satd. Flow (perm)	1712	0	0	1802	1735	0
Link Speed (k/h)	40			40	40	
Link Distance (m)	173.4			67.2	54.2	
Travel Time (s)	15.6			6.0	4.9	
Peak Hour Factor	0.90	0.90	0.90	0.90	0.90	0.90
Heavy Vehicles (%)	1%	1%	1%	1%	1%	1%
Adj. Flow (vph)	11	0	0	18	48	18
Shared Lane Traffic (%)						
Lane Group Flow (vph)	11	0	0	18	66	0
Enter Blocked Intersection	No	No	No	No	No	No
Lane Alignment	Left	Right	Left	Left	Left	Right
Median Width(m)	3.7			0.0	0.0	
Link Offset(m)	0.0			0.0	0.0	
Crosswalk Width(m)	5.0			5.0	5.0	
Two way Left Turn Lane						
Headway Factor	1.06	1.06	1.06	1.06	1.06	1.06
Turning Speed (k/h)	24	14	24			14
Sign Control	Stop			Free	Free	

Intersection Summary

Area Type:	Other
Control Type:	Unsignalized
Intersection Capacity Utilization	13.4%
Analysis Period (min)	15
	ICU Level of Service A



Lane Group	EBL	EBR	NBL	NBT	SBT	SBR
Lane Configurations						
Traffic Volume (vph)	3	0	0	13	38	5
Future Volume (vph)	3	0	0	13	38	5
Ideal Flow (vphpl)	1800	1800	1800	1800	1800	1800
Lane Util. Factor	1.00	1.00	1.00	1.00	1.00	1.00
Frt					0.983	
Frt Protected	0.950					
Satd. Flow (prot)	1712	0	0	1802	1771	0
Frt Permitted	0.950					
Satd. Flow (perm)	1712	0	0	1802	1771	0
Link Speed (k/h)	50			50	50	
Link Distance (m)	178.0			106.1	67.2	
Travel Time (s)	12.8			7.6	4.8	
Peak Hour Factor	0.90	0.90	0.90	0.90	0.90	0.90
Heavy Vehicles (%)	1%	1%	1%	1%	1%	1%
Adj. Flow (vph)	3	0	0	14	42	6
Shared Lane Traffic (%)						
Lane Group Flow (vph)	3	0	0	14	48	0
Enter Blocked Intersection	No	No	No	No	No	No
Lane Alignment	L NA	R NA	Left	Left	Left	Right
Median Width(m)	3.7			0.0	0.0	
Link Offset(m)	0.0			0.0	0.0	
Crosswalk Width(m)	5.0			5.0	5.0	
Two way Left Turn Lane						
Headway Factor	1.06	1.06	1.06	1.06	1.06	1.06
Turning Speed (k/h)	97	97	97			97
Sign Control	Stop			Free	Free	

**Intersection Summary**

Area Type:	Other
Control Type:	Unsignalized
Intersection Capacity Utilization	13.3%
Analysis Period (min)	15
	ICU Level of Service A

1: Stinson Avenue & Robertson Road  
PM Peak Hour

1826 Robertson Road  
Existing Traffic (RTOR restrictions)

Lane Group	EBL	EBT	EBR	WBL	WBT	WBR	NBL	NBT	NBR	SBL	SBT	SBR
Lane Configurations												
Traffic Volume (vph)	16	1050	25	41	1343	5	12	1	25	20	1	46
Future Volume (vph)	16	1050	25	41	1343	5	12	1	25	20	1	46
Ideal Flow (vphpl)	1800	1800	1800	1800	1800	1800	1800	1800	1800	1800	1800	1800
Storage Length (m)	75.0		0.0	45.0		0.0	0.0		0.0	0.0		0.0
Storage Lanes	1		0	1		0	0		0	0		0
Taper Length (m)	10.0			10.0			10.0			10.0		
Lane Util. Factor	1.00	0.95	0.95	1.00	0.95	0.95	1.00	1.00	1.00	1.00	1.00	1.00
Ped Bike Factor		1.00		1.00	1.00			0.98			0.98	
Frt		0.996			0.999			0.910			0.907	
Flt Protected	0.950			0.950				0.985			0.985	
Satd. Flow (prot)	1647	3341	0	1712	3353	0	0	1587	0	0	1547	0
Flt Permitted	0.150			0.218				0.901			0.885	
Satd. Flow (perm)	260	3341	0	391	3353	0	0	1449	0	0	1384	0
Right Turn on Red			Yes			Yes			No			No
Satd. Flow (RTOR)		4			1							
Link Speed (k/h)		60			60			40			40	
Link Distance (m)		198.0			310.7			254.0			246.4	
Travel Time (s)		11.9			18.6			22.9			22.2	
Confl. Peds. (#/hr)	17		14	14		17	5		10	10		5
Peak Hour Factor	0.90	0.90	0.90	0.90	0.90	0.90	0.90	0.90	0.90	0.90	0.90	0.90
Heavy Vehicles (%)	5%	3%	1%	1%	3%	1%	1%	1%	1%	1%	1%	5%
Adj. Flow (vph)	18	1167	28	46	1492	6	13	1	28	22	1	51
Shared Lane Traffic (%)												
Lane Group Flow (vph)	18	1195	0	46	1498	0	0	42	0	0	74	0
Enter Blocked Intersection	No	No	No	No	No	No	No	No	No	No	No	No
Lane Alignment	L NA	Left	R NA	L NA	Left	R NA	L NA	Left	R NA	L NA	Left	R NA
Median Width(m)		3.7			3.7			0.0			0.0	
Link Offset(m)		0.0			0.0			0.0			0.0	
Crosswalk Width(m)		5.0			5.0			5.0			5.0	
Two way Left Turn Lane		Yes			Yes							
Headway Factor	1.06	1.06	1.06	1.06	1.06	1.06	1.06	1.06	1.06	1.06	1.06	1.06
Turning Speed (k/h)	24		14	24		14	24		14	24		14
Number of Detectors	1	2		1	2		1	2		1	2	
Detector Template	Left	Thru		Left	Thru		Left	Thru		Left	Thru	
Leading Detector (m)	6.1	30.5		6.1	30.5		6.1	30.5		6.1	30.5	
Trailing Detector (m)	0.0	0.0		0.0	0.0		0.0	0.0		0.0	0.0	
Detector 1 Position(m)	0.0	0.0		0.0	0.0		0.0	0.0		0.0	0.0	
Detector 1 Size(m)	6.1	1.8		6.1	1.8		6.1	1.8		6.1	1.8	
Detector 1 Type	Cl+Ex	Cl+Ex		Cl+Ex	Cl+Ex		Cl+Ex	Cl+Ex		Cl+Ex	Cl+Ex	
Detector 1 Channel												
Detector 1 Extend (s)	0.0	0.0		0.0	0.0		0.0	0.0		0.0	0.0	
Detector 1 Queue (s)	0.0	0.0		0.0	0.0		0.0	0.0		0.0	0.0	
Detector 1 Delay (s)	0.0	0.0		0.0	0.0		0.0	0.0		0.0	0.0	
Detector 2 Position(m)		28.7			28.7			28.7			28.7	
Detector 2 Size(m)		1.8			1.8			1.8			1.8	
Detector 2 Type		Cl+Ex			Cl+Ex			Cl+Ex			Cl+Ex	
Detector 2 Channel												
Detector 2 Extend (s)		0.0			0.0			0.0			0.0	
Turn Type	Perm	NA		Perm	NA		Perm	NA		Perm	NA	
Protected Phases		2			6			8			4	
Permitted Phases	2			6			8			4		
Detector Phase	2	2		6	6		8	8		4	4	
Switch Phase												

1: Stinson Avenue & Robertson Road  
PM Peak Hour

1826 Robertson Road  
Existing Traffic (RTOR restrictions)



Lane Group	EBL	EBT	EBR	WBL	WBT	WBR	NBL	NBT	NBR	SBL	SBT	SBR
Minimum Initial (s)	10.0	10.0		10.0	10.0		10.0	10.0		10.0	10.0	
Minimum Split (s)	26.8	26.8		26.8	26.8		31.6	31.6		31.6	31.6	
Total Split (s)	88.0	88.0		88.0	88.0		32.0	32.0		32.0	32.0	
Total Split (%)	73.3%	73.3%		73.3%	73.3%		26.7%	26.7%		26.7%	26.7%	
Maximum Green (s)	82.2	82.2		82.2	82.2		25.4	25.4		25.4	25.4	
Yellow Time (s)	3.7	3.7		3.7	3.7		3.0	3.0		3.0	3.0	
All-Red Time (s)	2.1	2.1		2.1	2.1		3.6	3.6		3.6	3.6	
Lost Time Adjust (s)	0.0	0.0		0.0	0.0			0.0			0.0	
Total Lost Time (s)	5.8	5.8		5.8	5.8			6.6			6.6	
Lead/Lag												
Lead-Lag Optimize?												
Vehicle Extension (s)	3.0	3.0		3.0	3.0		3.0	3.0		3.0	3.0	
Recall Mode	C-Max	C-Max		C-Max	C-Max		None	None		None	None	
Walk Time (s)	7.0	7.0		7.0	7.0		7.0	7.0		7.0	7.0	
Flash Dont Walk (s)	14.0	14.0		14.0	14.0		18.0	18.0		18.0	18.0	
Pedestrian Calls (#/hr)	14	14		17	17		10	10		5	5	
Act Effct Green (s)	98.0	98.0		98.0	98.0			14.0			14.0	
Actuated g/C Ratio	0.82	0.82		0.82	0.82			0.12			0.12	
v/c Ratio	0.08	0.44		0.14	0.55			0.25			0.46	
Control Delay	5.7	5.3		1.6	3.5			49.4			56.9	
Queue Delay	0.0	0.0		0.0	0.0			0.0			0.0	
Total Delay	5.7	5.3		1.6	3.5			49.4			56.9	
LOS	A	A		A	A			D			E	
Approach Delay		5.3			3.5			49.4			56.9	
Approach LOS		A			A			D			E	
Queue Length 50th (m)	0.7	34.2		0.4	5.9			8.6			15.6	
Queue Length 95th (m)	3.8	73.0		m0.6	176.3			16.6			26.3	
Internal Link Dist (m)		174.0			286.7			230.0			222.4	
Turn Bay Length (m)	75.0			45.0								
Base Capacity (vph)	212	2730		319	2739			306			292	
Starvation Cap Reductn	0	0		0	0			0			0	
Spillback Cap Reductn	0	0		0	0			0			0	
Storage Cap Reductn	0	0		0	0			0			0	
Reduced v/c Ratio	0.08	0.44		0.14	0.55			0.14			0.25	

Intersection Summary

Area Type: Other  
 Cycle Length: 120  
 Actuated Cycle Length: 120  
 Offset: 31 (26%), Referenced to phase 2:EBTL and 6:WBTL, Start of Green  
 Natural Cycle: 75  
 Control Type: Actuated-Coordinated  
 Maximum v/c Ratio: 0.55  
 Intersection Signal Delay: 6.3  
 Intersection Capacity Utilization 61.6%  
 Analysis Period (min) 15  
 m Volume for 95th percentile queue is metered by upstream signal.

Splits and Phases: 1: Stinson Avenue & Robertson Road

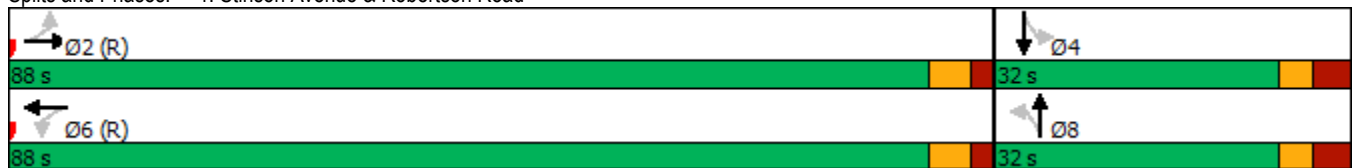

2: Lynhar Road/Stafford Road & Robertson Road  
PM Peak Hour

1826 Robertson Road  
Existing Traffic (RTOR restrictions)

Lane Group	EBL	EBT	EBR	WBL	WBT	WBR	NBL	NBT	NBR	SBL	SBT	SBR
Lane Configurations												
Traffic Volume (vph)	125	889	60	58	1069	77	92	41	80	201	36	173
Future Volume (vph)	125	889	60	58	1069	77	92	41	80	201	36	173
Ideal Flow (vphpl)	1800	1800	1800	1800	1800	1800	1800	1800	1800	1800	1800	1800
Storage Length (m)	85.0		40.0	0.0		0.0	0.0		30.0	45.0		75.0
Storage Lanes	1		1	1		0	1		1	1		1
Taper Length (m)	10.0			10.0			10.0			30.0		
Lane Util. Factor	1.00	0.95	1.00	1.00	0.95	0.95	1.00	1.00	1.00	1.00	1.00	1.00
Ped Bike Factor	0.99		0.94	0.99	1.00		0.98		0.95	0.97		0.97
Frt			0.850		0.990				0.850			0.850
Flt Protected	0.950			0.950			0.950			0.950		
Satd. Flow (prot)	1712	3357	1532	1712	3342	0	1631	1767	1502	1695	1802	1532
Flt Permitted	0.950			0.950			0.731			0.727		
Satd. Flow (perm)	1703	3357	1443	1695	3342	0	1236	1767	1434	1256	1802	1488
Right Turn on Red			Yes			No			Yes			Yes
Satd. Flow (RTOR)			145						142			192
Link Speed (k/h)		60			60			40			40	
Link Distance (m)		310.7			66.2			81.0			107.6	
Travel Time (s)		18.6			4.0			7.3			9.7	
Confl. Peds. (#/hr)	22		16	16		22	14		29	29		14
Confl. Bikes (#/hr)												1
Peak Hour Factor	0.90	0.90	0.90	0.90	0.90	0.90	0.90	0.90	0.90	0.90	0.90	0.90
Heavy Vehicles (%)	1%	3%	1%	1%	2%	4%	6%	3%	3%	2%	1%	1%
Adj. Flow (vph)	139	988	67	64	1188	86	102	46	89	223	40	192
Shared Lane Traffic (%)												
Lane Group Flow (vph)	139	988	67	64	1274	0	102	46	89	223	40	192
Enter Blocked Intersection	No	No	No	No	No	No	No	No	No	No	No	No
Lane Alignment	L NA	Left	R NA	L NA	Left	R NA	L NA	L NA	R NA	L NA	Left	R NA
Median Width(m)		3.7			7.4			7.4			7.4	
Link Offset(m)		0.0			0.0			0.0			0.0	
Crosswalk Width(m)		5.0			5.0			5.0			5.0	
Two way Left Turn Lane		Yes										
Headway Factor	1.06	1.06	1.06	1.06	1.06	1.06	1.06	1.06	1.06	1.06	1.06	1.06
Turning Speed (k/h)	24		14	24		14	24		14	24		14
Number of Detectors	1	2	1	1	2		1	2	1	1	2	1
Detector Template	Left	Thru	Right	Left	Thru		Left	Thru	Right	Left	Thru	Right
Leading Detector (m)	6.1	30.5	6.1	6.1	30.5		6.1	30.5	6.1	6.1	30.5	6.1
Trailing Detector (m)	0.0	0.0	0.0	0.0	0.0		0.0	0.0	0.0	0.0	0.0	0.0
Detector 1 Position(m)	0.0	0.0	0.0	0.0	0.0		0.0	0.0	0.0	0.0	0.0	0.0
Detector 1 Size(m)	6.1	1.8	6.1	6.1	1.8		6.1	1.8	6.1	6.1	1.8	6.1
Detector 1 Type	Cl+Ex	Cl+Ex	Cl+Ex	Cl+Ex	Cl+Ex		Cl+Ex	Cl+Ex	Cl+Ex	Cl+Ex	Cl+Ex	Cl+Ex
Detector 1 Channel												
Detector 1 Extend (s)	0.0	0.0	0.0	0.0	0.0		0.0	0.0	0.0	0.0	0.0	0.0
Detector 1 Queue (s)	0.0	0.0	0.0	0.0	0.0		0.0	0.0	0.0	0.0	0.0	0.0
Detector 1 Delay (s)	0.0	0.0	0.0	0.0	0.0		0.0	0.0	0.0	0.0	0.0	0.0
Detector 2 Position(m)		28.7			28.7			28.7			28.7	
Detector 2 Size(m)		1.8			1.8			1.8			1.8	
Detector 2 Type		Cl+Ex			Cl+Ex			Cl+Ex			Cl+Ex	
Detector 2 Channel												
Detector 2 Extend (s)		0.0			0.0			0.0			0.0	
Turn Type	Prot	NA	Perm	Prot	NA		pm+pt	NA	Perm	pm+pt	NA	Perm
Protected Phases	5	2		1	6		3	8		7	4	
Permitted Phases			2				8		8	4		4
Detector Phase	5	2	2	1	6		3	8	8	7	4	4



3: Northside Road East & Robertson Road  
PM Peak Hour

1826 Robertson Road  
Existing Traffic (RTOR restrictions)

Lane Group	EBL	EBT	EBR	WBL	WBT	WBR	NBL	NBT	NBR	SBL	SBT	SBR
Lane Configurations												
Traffic Volume (vph)	66	1033	16	79	1160	220	138	37	106	155	55	78
Future Volume (vph)	66	1033	16	79	1160	220	138	37	106	155	55	78
Ideal Flow (vphpl)	1800	1800	1800	1800	1800	1800	1800	1800	1800	1800	1800	1800
Storage Length (m)	55.0		0.0	75.0		80.0	0.0		0.0	0.0		0.0
Storage Lanes	1		0	1		1	1		0	1		1
Taper Length (m)	30.0			15.0			10.0			10.0		
Lane Util. Factor	1.00	0.95	0.95	1.00	0.95	1.00	1.00	1.00	1.00	1.00	1.00	1.00
Ped Bike Factor		1.00		1.00		0.97	0.98	0.99		0.99		0.96
Frt		0.998				0.850		0.889				0.850
Flt Protected	0.950			0.950			0.950			0.950		
Satd. Flow (prot)	1712	3383	0	1712	3390	1532	1695	1559	0	1712	1802	1532
Flt Permitted	0.129			0.238			0.717			0.594		
Satd. Flow (perm)	232	3383	0	428	3390	1488	1250	1559	0	1064	1802	1469
Right Turn on Red			No			Yes			No			Yes
Satd. Flow (RTOR)						244						101
Link Speed (k/h)		60			60			40			40	
Link Distance (m)		105.4			310.9			87.0			90.9	
Travel Time (s)		6.3			18.7			7.8			8.2	
Confl. Peds. (#/hr)	3		7	7		3	16		5	5		16
Confl. Bikes (#/hr)			1			2						4
Peak Hour Factor	0.90	0.90	0.90	0.90	0.90	0.90	0.90	0.90	0.90	0.90	0.90	0.90
Heavy Vehicles (%)	1%	2%	1%	1%	2%	1%	2%	3%	2%	1%	1%	1%
Adj. Flow (vph)	73	1148	18	88	1289	244	153	41	118	172	61	87
Shared Lane Traffic (%)												
Lane Group Flow (vph)	73	1166	0	88	1289	244	153	159	0	172	61	87
Enter Blocked Intersection	No	No	No	No	No	No	No	No	No	No	No	No
Lane Alignment	L NA	Left	R NA	L NA	Left	R NA	L NA	Left	R NA	L NA	Left	R NA
Median Width(m)		5.5			5.5			3.7			3.7	
Link Offset(m)		0.0			0.0			0.0			0.0	
Crosswalk Width(m)		5.0			5.0			5.0			5.0	
Two way Left Turn Lane												
Headway Factor	1.06	1.06	1.06	1.06	1.06	1.06	1.06	1.06	1.06	1.06	1.06	1.06
Turning Speed (k/h)	24		14	24		14	24		14	24		14
Number of Detectors	1	2		1	2		1	1	2		1	2
Detector Template	Left	Thru		Left	Thru	Right	Left	Thru		Left	Thru	Right
Leading Detector (m)	6.1	30.5		6.1	30.5	6.1	6.1	30.5		6.1	30.5	6.1
Trailing Detector (m)	0.0	0.0		0.0	0.0	0.0	0.0	0.0		0.0	0.0	0.0
Detector 1 Position(m)	0.0	0.0		0.0	0.0	0.0	0.0	0.0		0.0	0.0	0.0
Detector 1 Size(m)	6.1	1.8		6.1	1.8	6.1	6.1	1.8		6.1	1.8	6.1
Detector 1 Type	Cl+Ex	Cl+Ex		Cl+Ex	Cl+Ex	Cl+Ex	Cl+Ex	Cl+Ex		Cl+Ex	Cl+Ex	Cl+Ex
Detector 1 Channel												
Detector 1 Extend (s)	0.0	0.0		0.0	0.0	0.0	0.0	0.0		0.0	0.0	0.0
Detector 1 Queue (s)	0.0	0.0		0.0	0.0	0.0	0.0	0.0		0.0	0.0	0.0
Detector 1 Delay (s)	0.0	0.0		0.0	0.0	0.0	0.0	0.0		0.0	0.0	0.0
Detector 2 Position(m)		28.7			28.7			28.7			28.7	
Detector 2 Size(m)		1.8			1.8			1.8			1.8	
Detector 2 Type		Cl+Ex			Cl+Ex			Cl+Ex			Cl+Ex	
Detector 2 Channel												
Detector 2 Extend (s)		0.0			0.0			0.0			0.0	
Turn Type	pm+pt	NA		Perm	NA	Perm	Perm	NA		Perm	NA	Perm
Protected Phases	5	2			6			8			4	
Permitted Phases	2			6		6	8			4		4
Detector Phase	5	2		6	6	6	8	8		4	4	4



Lane Group	Ø3	Ø7
Lane Configurations		
Traffic Volume (vph)		
Future Volume (vph)		
Ideal Flow (vphpl)		
Storage Length (m)		
Storage Lanes		
Taper Length (m)		
Lane Util. Factor		
Ped Bike Factor		
Frt		
Flt Protected		
Satd. Flow (prot)		
Flt Permitted		
Satd. Flow (perm)		
Right Turn on Red		
Satd. Flow (RTOR)		
Link Speed (k/h)		
Link Distance (m)		
Travel Time (s)		
Confl. Peds. (#/hr)		
Confl. Bikes (#/hr)		
Peak Hour Factor		
Heavy Vehicles (%)		
Adj. Flow (vph)		
Shared Lane Traffic (%)		
Lane Group Flow (vph)		
Enter Blocked Intersection		
Lane Alignment		
Median Width(m)		
Link Offset(m)		
Crosswalk Width(m)		
Two way Left Turn Lane		
Headway Factor		
Turning Speed (k/h)		
Number of Detectors		
Detector Template		
Leading Detector (m)		
Trailing Detector (m)		
Detector 1 Position(m)		
Detector 1 Size(m)		
Detector 1 Type		
Detector 1 Channel		
Detector 1 Extend (s)		
Detector 1 Queue (s)		
Detector 1 Delay (s)		
Detector 2 Position(m)		
Detector 2 Size(m)		
Detector 2 Type		
Detector 2 Channel		
Detector 2 Extend (s)		
Turn Type		
Protected Phases	3	7
Permitted Phases		
Detector Phase		

3: Northside Road East & Robertson Road  
PM Peak Hour

1826 Robertson Road  
Existing Traffic (RTOR restrictions)



Lane Group	EBL	EBT	EBR	WBL	WBT	WBR	NBL	NBT	NBR	SBL	SBT	SBR
Switch Phase												
Minimum Initial (s)	5.0	10.0		10.0	10.0	10.0	10.0	10.0		10.0	10.0	10.0
Minimum Split (s)	11.7	30.7		30.7	30.7	30.7	29.8	29.8		29.8	29.8	29.8
Total Split (s)	15.0	83.0		68.0	68.0	68.0	31.0	31.0		31.0	31.0	31.0
Total Split (%)	12.5%	69.2%		56.7%	56.7%	56.7%	25.8%	25.8%		25.8%	25.8%	25.8%
Maximum Green (s)	9.0	76.9		61.9	61.9	61.9	24.2	24.2		24.2	24.2	24.2
Yellow Time (s)	3.7	3.7		3.7	3.7	3.7	3.0	3.0		3.0	3.0	3.0
All-Red Time (s)	2.3	2.4		2.4	2.4	2.4	3.8	3.8		3.8	3.8	3.8
Lost Time Adjust (s)	0.0	0.0		0.0	0.0	0.0	0.0	0.0		0.0	0.0	0.0
Total Lost Time (s)	6.0	6.1		6.1	6.1	6.1	6.8	6.8		6.8	6.8	6.8
Lead/Lag	Lead			Lag	Lag	Lag	Lag	Lag		Lag	Lag	Lag
Lead-Lag Optimize?	Yes			Yes	Yes	Yes	Yes	Yes		Yes	Yes	Yes
Vehicle Extension (s)	3.0	3.0		3.0	3.0	3.0	3.0	3.0		3.0	3.0	3.0
Recall Mode	None	C-Max		C-Max	C-Max	C-Max	None	None		None	None	None
Walk Time (s)		7.0		7.0	7.0	7.0	1.0	1.0		1.0	1.0	1.0
Flash Dont Walk (s)		17.0		17.0	17.0	17.0	22.0	22.0		22.0	22.0	22.0
Pedestrian Calls (#/hr)		7		3	3	3	5	5		16	16	16
Act Effct Green (s)	82.1	82.0		71.1	71.1	71.1	25.1	25.1		25.1	25.1	25.1
Actuated g/C Ratio	0.68	0.68		0.59	0.59	0.59	0.21	0.21		0.21	0.21	0.21
v/c Ratio	0.29	0.50		0.35	0.64	0.25	0.59	0.49		0.77	0.16	0.23
Control Delay	13.7	11.4		20.9	19.9	2.5	51.3	46.0		67.2	37.8	6.4
Queue Delay	0.0	0.0		0.0	0.0	0.0	0.0	0.0		0.0	0.0	0.0
Total Delay	13.7	11.4		20.9	19.9	2.5	51.3	46.0		67.2	37.8	6.4
LOS	B	B		C	B	A	D	D		E	D	A
Approach Delay		11.5			17.4			48.6			45.1	
Approach LOS		B			B			D			D	
Queue Length 50th (m)	5.1	56.5		10.0	98.7	0.0	29.7	30.2		35.0	10.8	0.0
Queue Length 95th (m)	m10.5	66.1		24.9	135.3	11.2	47.9	47.6		56.4	20.6	9.0
Internal Link Dist (m)		81.4			286.9			63.0			66.9	
Turn Bay Length (m)	55.0			75.0		80.0						
Base Capacity (vph)	269	2312		253	2008	980	281	351		239	405	408
Starvation Cap Reductn	0	0		0	0	0	0	0		0	0	0
Spillback Cap Reductn	0	0		0	0	0	0	0		0	0	0
Storage Cap Reductn	0	0		0	0	0	0	0		0	0	0
Reduced v/c Ratio	0.27	0.50		0.35	0.64	0.25	0.54	0.45		0.72	0.15	0.21

Intersection Summary

Area Type: Other  
 Cycle Length: 120  
 Actuated Cycle Length: 120  
 Offset: 111 (93%), Referenced to phase 2:EBTL and 6:WBTL, Start of Green  
 Natural Cycle: 90  
 Control Type: Actuated-Coordinated  
 Maximum v/c Ratio: 0.77  
 Intersection Signal Delay: 20.6      Intersection LOS: C  
 Intersection Capacity Utilization 81.7%      ICU Level of Service D  
 Analysis Period (min) 15  
 m Volume for 95th percentile queue is metered by upstream signal.

Splits and Phases: 3: Northside Road East & Robertson Road

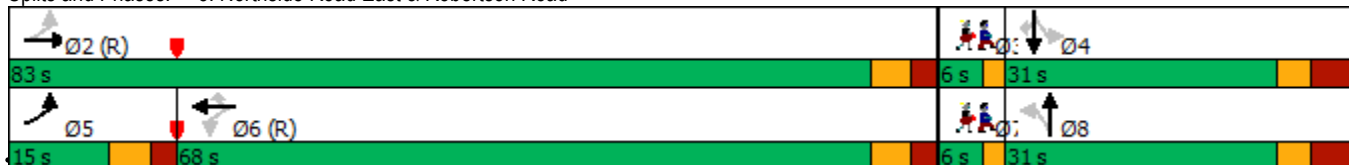

Lane Group	Ø3	Ø7
Switch Phase		
Minimum Initial (s)	4.0	4.0
Minimum Split (s)	6.0	6.0
Total Split (s)	6.0	6.0
Total Split (%)	5%	5%
Maximum Green (s)	4.0	4.0
Yellow Time (s)	2.0	2.0
All-Red Time (s)	0.0	0.0
Lost Time Adjust (s)		
Total Lost Time (s)		
Lead/Lag	Lead	Lead
Lead-Lag Optimize?	Yes	Yes
Vehicle Extension (s)	3.0	3.0
Recall Mode	None	None
Walk Time (s)		
Flash Dont Walk (s)		
Pedestrian Calls (#/hr)		
Act Effct Green (s)		
Actuated g/C Ratio		
v/c Ratio		
Control Delay		
Queue Delay		
Total Delay		
LOS		
Approach Delay		
Approach LOS		
Queue Length 50th (m)		
Queue Length 95th (m)		
Internal Link Dist (m)		
Turn Bay Length (m)		
Base Capacity (vph)		
Starvation Cap Reductn		
Spillback Cap Reductn		
Storage Cap Reductn		
Reduced v/c Ratio		
Intersection Summary		

4: Northside Road West & Robertson Road  
PM Peak Hour

1826 Robertson Road  
Existing Traffic (RTOR restrictions)

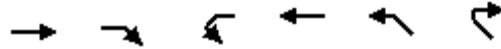

Lane Group	EBT	EBR	WBL	WBT	NWL	NWR
Lane Configurations	↑↑			↑↑↑		
Traffic Volume (vph)	1053	117	0	1204	0	0
Future Volume (vph)	1053	117	0	1204	0	0
Ideal Flow (vphpl)	1800	1800	1800	1800	1800	1800
Storage Length (m)		0.0	25.0		0.0	0.0
Storage Lanes		0	1		0	0
Taper Length (m)			25.0		10.0	
Lane Util. Factor	0.95	0.95	1.00	0.91	1.00	1.00
Fr <sub>t</sub>	0.985					
Flt Protected						
Satd. Flow (prot)	3326	0	0	4871	0	0
Flt Permitted						
Satd. Flow (perm)	3326	0	0	4871	0	0
Link Speed (k/h)	60			60	50	
Link Distance (m)	66.2			72.0	100.3	
Travel Time (s)	4.0			4.3	7.2	
Peak Hour Factor	0.90	0.90	0.90	0.90	0.90	0.90
Heavy Vehicles (%)	2%	6%	1%	2%	1%	1%
Adj. Flow (vph)	1170	130	0	1338	0	0
Shared Lane Traffic (%)						
Lane Group Flow (vph)	1300	0	0	1338	0	0
Enter Blocked Intersection	Yes	Yes	Yes	Yes	No	No
Lane Alignment	Left	Right	Left	Left	Left	Right
Median Width(m)	3.7			3.7	0.0	
Link Offset(m)	0.0			0.0	0.0	
Crosswalk Width(m)	0.0			0.0	0.0	
Two way Left Turn Lane						
Headway Factor	1.06	1.06	1.06	1.06	1.06	1.06
Turning Speed (k/h)		50	24		24	14
Sign Control	Free			Free	Free	

Intersection Summary

Area Type: Other

Control Type: Unsignalized

Intersection Capacity Utilization 38.0% ICU Level of Service A

Analysis Period (min) 15

5: Larkspur Drive & Northside Road West  
PM Peak Hour

1826 Robertson Road  
Existing Traffic (RTOR restrictions)



Lane Group	EBT	EBR	WBL	WBT	NBL	NBR
Lane Configurations						
Traffic Volume (vph)	107	10	98	0	0	79
Future Volume (vph)	107	10	98	0	0	79
Ideal Flow (vphpl)	1800	1800	1800	1800	1800	1800
Lane Util. Factor	1.00	1.00	1.00	1.00	1.00	1.00
Ped Bike Factor						
Frt	0.989					0.865
Flt Protected			0.950			
Satd. Flow (prot)	1690	0	1631	0	0	1514
Flt Permitted			0.950			
Satd. Flow (perm)	1690	0	1631	0	0	1514
Link Speed (k/h)	50			40	40	
Link Distance (m)	100.3			62.0	54.2	
Travel Time (s)	7.2			5.6	4.9	
Confl. Peds. (#/hr)		12	12			
Confl. Bikes (#/hr)		1				1
Peak Hour Factor	0.90	0.90	0.90	0.90	0.90	0.90
Heavy Vehicles (%)	7%	1%	6%	1%	1%	4%
Adj. Flow (vph)	119	11	109	0	0	88
Shared Lane Traffic (%)						
Lane Group Flow (vph)	130	0	109	0	0	88
Enter Blocked Intersection	No	No	No	No	No	No
Lane Alignment	L NA	R NA	L NA	R NA	Left	R NA
Median Width(m)	3.7			3.7	0.0	
Link Offset(m)	3.0			3.0	0.0	
Crosswalk Width(m)	5.0			5.0	5.0	
Two way Left Turn Lane						
Headway Factor	1.06	1.06	1.06	1.06	1.06	1.06
Turning Speed (k/h)		14	24		24	14
Sign Control	Stop			Stop	Stop	

Intersection Summary











Area Type: Other









Control Type: Unsignalized

Intersection Capacity Utilization 20.7%

ICU Level of Service A

Analysis Period (min) 15

						
Lane Group	WBL	WBR	NBT	NBR	SBL	SBT
Lane Configurations						
Traffic Volume (vph)	2	71	142	2	59	95
Future Volume (vph)	2	71	142	2	59	95
Ideal Flow (vphpl)	1800	1800	1800	1800	1800	1800
Storage Length (m)	0.0	0.0		45.0	15.0	
Storage Lanes	1	0		0	1	
Taper Length (m)	10.0				20.0	
Lane Util. Factor	1.00	1.00	0.95	0.95	1.00	1.00
Frt	0.868		0.998			
Flt Protected	0.999				0.950	
Satd. Flow (prot)	1563	0	3384	0	1712	1784
Flt Permitted	0.999				0.950	
Satd. Flow (perm)	1563	0	3384	0	1712	1784
Link Speed (k/h)	40		40			40
Link Distance (m)	173.4		68.2			81.0
Travel Time (s)	15.6		6.1			7.3
Peak Hour Factor	0.90	0.90	0.90	0.90	0.90	0.90
Heavy Vehicles (%)	1%	1%	2%	1%	1%	2%
Adj. Flow (vph)	2	79	158	2	66	106
Shared Lane Traffic (%)						
Lane Group Flow (vph)	81	0	160	0	66	106
Enter Blocked Intersection	No	No	No	No	No	No
Lane Alignment	Left	Right	Left	Right	Left	Left
Median Width(m)	3.7		3.7			3.7
Link Offset(m)	0.0		0.0			0.0
Crosswalk Width(m)	5.0		5.0			5.0
Two way Left Turn Lane						
Headway Factor	1.06	1.06	1.06	1.06	1.06	1.06
Turning Speed (k/h)	24	14		14	24	
Sign Control	Stop		Free			Free
<b>Intersection Summary</b>						
Area Type:	Other					
Control Type:	Unsignalized					
Intersection Capacity Utilization	22.4%			ICU Level of Service A		
Analysis Period (min)	15					

						
Lane Group	WBL	WBR	NBT	NBR	SBL	SBT
Lane Configurations						
Traffic Volume (vph)	1	9	135	1	9	88
Future Volume (vph)	1	9	135	1	9	88
Ideal Flow (vphpl)	1800	1800	1800	1800	1800	1800
Lane Util. Factor	1.00	1.00	1.00	1.00	1.00	1.00
Frt	0.877		0.999			
Flt Protected	0.995					0.995
Satd. Flow (prot)	1572	0	1783	0	0	1777
Flt Permitted	0.995					0.995
Satd. Flow (perm)	1572	0	1783	0	0	1777
Link Speed (k/h)	50		50			50
Link Distance (m)	178.0		82.4			68.2
Travel Time (s)	12.8		5.9			4.9
Peak Hour Factor	0.90	0.90	0.90	0.90	0.90	0.90
Heavy Vehicles (%)	1%	1%	2%	1%	1%	2%
Adj. Flow (vph)	1	10	150	1	10	98
Shared Lane Traffic (%)						
Lane Group Flow (vph)	11	0	151	0	0	108
Enter Blocked Intersection	No	No	No	No	No	No
Lane Alignment	L NA	R NA	Left	Right	Left	Left
Median Width(m)	3.7		0.0			0.0
Link Offset(m)	0.0		0.0			0.0
Crosswalk Width(m)	5.0		5.0			5.0
Two way Left Turn Lane						
Headway Factor	1.06	1.06	1.06	1.06	1.06	1.06
Turning Speed (k/h)	97	97		97	97	
Sign Control	Stop		Free			Free
<b>Intersection Summary</b>						
Area Type:	Other					
Control Type:	Unsignalized					
Intersection Capacity Utilization	22.8%			ICU Level of Service A		
Analysis Period (min)	15					

8: Larkspur Drive & North Site Access  
PM Peak Hour

1826 Robertson Road  
Existing Traffic (RTOR restrictions)



Lane Group	EBL	EBR	NBL	NBT	SBT	SBR
Lane Configurations						
Traffic Volume (vph)	23	0	0	56	75	33
Future Volume (vph)	23	0	0	56	75	33
Ideal Flow (vphpl)	1800	1800	1800	1800	1800	1800
Lane Util. Factor	1.00	1.00	1.00	1.00	1.00	1.00
Frt					0.958	
Frt Protected	0.950					
Satd. Flow (prot)	1712	0	0	1802	1721	0
Frt Permitted	0.950					
Satd. Flow (perm)	1712	0	0	1802	1721	0
Link Speed (k/h)	40			40	40	
Link Distance (m)	173.4			67.2	54.2	
Travel Time (s)	15.6			6.0	4.9	
Peak Hour Factor	0.90	0.90	0.90	0.90	0.90	0.90
Heavy Vehicles (%)	1%	1%	1%	1%	1%	2%
Adj. Flow (vph)	26	0	0	62	83	37
Shared Lane Traffic (%)						
Lane Group Flow (vph)	26	0	0	62	120	0
Enter Blocked Intersection	No	No	No	No	No	No
Lane Alignment	Left	Right	Left	Left	Left	Right
Median Width(m)	3.7			0.0	0.0	
Link Offset(m)	0.0			0.0	0.0	
Crosswalk Width(m)	5.0			5.0	5.0	
Two way Left Turn Lane						
Headway Factor	1.06	1.06	1.06	1.06	1.06	1.06
Turning Speed (k/h)	24	14	24			14
Sign Control	Stop			Free	Free	

Intersection Summary

Area Type:	Other
Control Type:	Unsignalized
Intersection Capacity Utilization	16.3%
Analysis Period (min)	15
	ICU Level of Service A



9: Larkspur Drive & South Site Access  
PM Peak Hour

1826 Robertson Road  
Existing Traffic (RTOR restrictions)



Lane Group	EBL	EBR	NBL	NBT	SBT	SBR
Lane Configurations						
Traffic Volume (vph)	8	0	0	48	68	7
Future Volume (vph)	8	0	0	48	68	7
Ideal Flow (vphpl)	1800	1800	1800	1800	1800	1800
Lane Util. Factor	1.00	1.00	1.00	1.00	1.00	1.00
Frt					0.987	
Flt Protected	0.950					
Satd. Flow (prot)	1712	0	0	1802	1779	0
Flt Permitted	0.950					
Satd. Flow (perm)	1712	0	0	1802	1779	0
Link Speed (k/h)	50			50	50	
Link Distance (m)	178.0			106.1	67.2	
Travel Time (s)	12.8			7.6	4.8	
Peak Hour Factor	0.90	0.90	0.90	0.90	0.90	0.90
Heavy Vehicles (%)	1%	1%	1%	1%	1%	1%
Adj. Flow (vph)	9	0	0	53	76	8
Shared Lane Traffic (%)						
Lane Group Flow (vph)	9	0	0	53	84	0
Enter Blocked Intersection	No	No	No	No	No	No
Lane Alignment	L NA	R NA	Left	Left	Left	Right
Median Width(m)	3.7			0.0	0.0	
Link Offset(m)	0.0			0.0	0.0	
Crosswalk Width(m)	5.0			5.0	5.0	
Two way Left Turn Lane						
Headway Factor	1.06	1.06	1.06	1.06	1.06	1.06
Turning Speed (k/h)	97	97	97			97
Sign Control	Stop			Free	Free	

Intersection Summary

Area Type:	Other
Control Type:	Unsignalized
Intersection Capacity Utilization	14.2%
Analysis Period (min)	15
	ICU Level of Service A

1: Stinson Avenue & Robertson Road  
SAT Peak Hour

1826 Robertson Road  
Existing Traffic (RTOR restrictions)



Lane Group	EBL	EBT	EBR	WBL	WBT	WBR	NBL	NBT	NBR	SBL	SBT	SBR
Lane Configurations												
Traffic Volume (vph)	15	1007	24	45	957	4	10	0	32	3	1	8
Future Volume (vph)	15	1007	24	45	957	4	10	0	32	3	1	8
Ideal Flow (vphpl)	1800	1800	1800	1800	1800	1800	1800	1800	1800	1800	1800	1800
Storage Length (m)	75.0		0.0	45.0		0.0	0.0		0.0	0.0		0.0
Storage Lanes	1		0	1		0	0		0	0		0
Taper Length (m)	10.0			10.0			10.0			10.0		
Lane Util. Factor	1.00	0.95	0.95	1.00	0.95	0.95	1.00	1.00	1.00	1.00	1.00	1.00
Ped Bike Factor	1.00	1.00		1.00	1.00			0.99			0.99	
Frt		0.996			0.999			0.897			0.907	
Flt Protected	0.950			0.950				0.988			0.989	
Satd. Flow (prot)	1712	3405	0	1712	3420	0	0	1575	0	0	1601	0
Flt Permitted	0.255			0.232				0.919			0.927	
Satd. Flow (perm)	457	3405	0	417	3420	0	0	1465	0	0	1499	0
Right Turn on Red			Yes			Yes			No			No
Satd. Flow (RTOR)		4			1							
Link Speed (k/h)		60			60			40			40	
Link Distance (m)		198.0			310.7			254.0			246.4	
Travel Time (s)		11.9			18.6			22.9			22.2	
Confl. Peds. (#/hr)	10		4	4		10	1		4	4		1
Confl. Bikes (#/hr)			4			2						
Peak Hour Factor	0.90	0.90	0.90	0.90	0.90	0.90	0.90	0.90	0.90	0.90	0.90	0.90
Heavy Vehicles (%)	1%	1%	4%	1%	1%	1%	1%	1%	1%	1%	1%	1%
Adj. Flow (vph)	17	1119	27	50	1063	4	11	0	36	3	1	9
Shared Lane Traffic (%)												
Lane Group Flow (vph)	17	1146	0	50	1067	0	0	47	0	0	13	0
Enter Blocked Intersection	No	No	No	No	No	No	No	No	No	No	No	No
Lane Alignment	L NA	Left	R NA	L NA	Left	R NA	L NA	Left	R NA	L NA	Left	R NA
Median Width(m)		3.7			3.7			0.0			0.0	
Link Offset(m)		0.0			0.0			0.0			0.0	
Crosswalk Width(m)		5.0			5.0			5.0			5.0	
Two way Left Turn Lane		Yes			Yes							
Headway Factor	1.06	1.06	1.06	1.06	1.06	1.06	1.06	1.06	1.06	1.06	1.06	1.06
Turning Speed (k/h)	24		14	24		14	24		14	24		14
Number of Detectors	1	2		1	2		1	2		1	2	
Detector Template	Left	Thru		Left	Thru		Left	Thru		Left	Thru	
Leading Detector (m)	6.1	30.5		6.1	30.5		6.1	30.5		6.1	30.5	
Trailing Detector (m)	0.0	0.0		0.0	0.0		0.0	0.0		0.0	0.0	
Detector 1 Position(m)	0.0	0.0		0.0	0.0		0.0	0.0		0.0	0.0	
Detector 1 Size(m)	6.1	1.8		6.1	1.8		6.1	1.8		6.1	1.8	
Detector 1 Type	Cl+Ex	Cl+Ex		Cl+Ex	Cl+Ex		Cl+Ex	Cl+Ex		Cl+Ex	Cl+Ex	
Detector 1 Channel												
Detector 1 Extend (s)	0.0	0.0		0.0	0.0		0.0	0.0		0.0	0.0	
Detector 1 Queue (s)	0.0	0.0		0.0	0.0		0.0	0.0		0.0	0.0	
Detector 1 Delay (s)	0.0	0.0		0.0	0.0		0.0	0.0		0.0	0.0	
Detector 2 Position(m)		28.7			28.7			28.7			28.7	
Detector 2 Size(m)		1.8			1.8			1.8			1.8	
Detector 2 Type		Cl+Ex			Cl+Ex			Cl+Ex			Cl+Ex	
Detector 2 Channel												
Detector 2 Extend (s)		0.0			0.0			0.0			0.0	
Turn Type	Perm	NA		Perm	NA		Perm	NA		Perm	NA	
Protected Phases		2			6			8			4	
Permitted Phases	2			6			8			4		
Detector Phase	2	2		6	6		8	8		4	4	

1: Stinson Avenue & Robertson Road  
SAT Peak Hour

1826 Robertson Road  
Existing Traffic (RTOR restrictions)



Lane Group	EBL	EBT	EBR	WBL	WBT	WBR	NBL	NBT	NBR	SBL	SBT	SBR
Switch Phase												
Minimum Initial (s)	10.0	10.0		10.0	10.0		10.0	10.0		10.0	10.0	
Minimum Split (s)	26.8	26.8		26.8	26.8		31.6	31.6		31.6	31.6	
Total Split (s)	88.0	88.0		88.0	88.0		32.0	32.0		32.0	32.0	
Total Split (%)	73.3%	73.3%		73.3%	73.3%		26.7%	26.7%		26.7%	26.7%	
Maximum Green (s)	82.2	82.2		82.2	82.2		25.4	25.4		25.4	25.4	
Yellow Time (s)	3.7	3.7		3.7	3.7		3.0	3.0		3.0	3.0	
All-Red Time (s)	2.1	2.1		2.1	2.1		3.6	3.6		3.6	3.6	
Lost Time Adjust (s)	0.0	0.0		0.0	0.0			0.0			0.0	
Total Lost Time (s)	5.8	5.8		5.8	5.8			6.6			6.6	
Lead/Lag												
Lead-Lag Optimize?												
Vehicle Extension (s)	3.0	3.0		3.0	3.0		3.0	3.0		3.0	3.0	
Recall Mode	C-Max	C-Max		C-Max	C-Max		None	None		None	None	
Walk Time (s)	7.0	7.0		7.0	7.0		7.0	7.0		7.0	7.0	
Flash Dont Walk (s)	14.0	14.0		14.0	14.0		18.0	18.0		18.0	18.0	
Pedestrian Calls (#/hr)	4	4		10	10		4	4		1	1	
Act Effct Green (s)	98.9	98.9		98.9	98.9			13.1			13.1	
Actuated g/C Ratio	0.82	0.82		0.82	0.82			0.11			0.11	
v/c Ratio	0.05	0.41		0.15	0.38			0.29			0.08	
Control Delay	4.5	4.7		1.8	1.8			51.8			45.7	
Queue Delay	0.0	0.0		0.0	0.0			0.0			0.0	
Total Delay	4.5	4.7		1.8	1.8			51.8			45.7	
LOS	A	A		A	A			D			D	
Approach Delay		4.7			1.8			51.8			45.7	
Approach LOS		A			A			D			D	
Queue Length 50th (m)	0.6	28.9		0.4	4.0			9.8			2.7	
Queue Length 95th (m)	3.4	67.7		m1.0	20.6			18.2			7.3	
Internal Link Dist (m)		174.0			286.7			230.0			222.4	
Turn Bay Length (m)	75.0			45.0								
Base Capacity (vph)	376	2808		344	2819			310			317	
Starvation Cap Reductn	0	0		0	0			0			0	
Spillback Cap Reductn	0	0		0	0			0			0	
Storage Cap Reductn	0	0		0	0			0			0	
Reduced v/c Ratio	0.05	0.41		0.15	0.38			0.15			0.04	

Intersection Summary

Area Type: Other  
 Cycle Length: 120  
 Actuated Cycle Length: 120  
 Offset: 31 (26%), Referenced to phase 2:EBTL and 6:WBTL, Start of Green  
 Natural Cycle: 60  
 Control Type: Actuated-Coordinated  
 Maximum v/c Ratio: 0.41  
 Intersection Signal Delay: 4.5  
 Intersection LOS: A  
 Intersection Capacity Utilization 59.7%  
 ICU Level of Service B  
 Analysis Period (min) 15  
 m Volume for 95th percentile queue is metered by upstream signal.

Splits and Phases: 1: Stinson Avenue & Robertson Road



2: Lynhar Road/Stafford Road & Robertson Road  
SAT Peak Hour

1826 Robertson Road  
Existing Traffic (RTOR restrictions)

Lane Group	EBL	EBT	EBR	WBL	WBT	WBR	NBL	NBT	NBR	SBL	SBT	SBR
Lane Configurations												
Traffic Volume (vph)	134	805	87	41	757	60	87	27	84	83	20	153
Future Volume (vph)	134	805	87	41	757	60	87	27	84	83	20	153
Ideal Flow (vphpl)	1800	1800	1800	1800	1800	1800	1800	1800	1800	1800	1800	1800
Storage Length (m)	85.0		40.0	0.0		0.0	0.0		30.0	45.0		75.0
Storage Lanes	1		1	1		0	1		1	1		1
Taper Length (m)	10.0			10.0			10.0			30.0		
Lane Util. Factor	1.00	0.95	1.00	1.00	0.95	0.95	1.00	1.00	1.00	1.00	1.00	1.00
Ped Bike Factor	1.00		0.94	0.99	1.00		0.98		0.96	0.98		0.97
Frt			0.850		0.989				0.850			0.850
Flt Protected	0.950			0.950			0.950			0.950		
Satd. Flow (prot)	1695	3424	1517	1712	3350	0	1712	1802	1532	1695	1802	1532
Flt Permitted	0.950			0.950			0.707			0.738		
Satd. Flow (perm)	1692	3424	1419	1692	3350	0	1251	1802	1474	1286	1802	1484
Right Turn on Red			Yes			No			Yes			Yes
Satd. Flow (RTOR)			145						142			170
Link Speed (k/h)		60			60			40			40	
Link Distance (m)		310.7			66.2			81.0			107.6	
Travel Time (s)		18.6			4.0			7.3			9.7	
Confl. Peds. (#/hr)	5		17	17		5	16		21	21		16
Confl. Bikes (#/hr)			5			4			2			1
Peak Hour Factor	0.90	0.90	0.90	0.90	0.90	0.90	0.90	0.90	0.90	0.90	0.90	0.90
Heavy Vehicles (%)	2%	1%	2%	1%	2%	1%	1%	1%	1%	2%	1%	1%
Adj. Flow (vph)	149	894	97	46	841	67	97	30	93	92	22	170
Shared Lane Traffic (%)												
Lane Group Flow (vph)	149	894	97	46	908	0	97	30	93	92	22	170
Enter Blocked Intersection	No	No	No	No	No	No	No	No	No	No	No	No
Lane Alignment	L NA	Left	R NA	L NA	Left	R NA	L NA	L NA	R NA	L NA	Left	R NA
Median Width(m)		3.7			7.4			7.4			7.4	
Link Offset(m)		0.0			0.0			0.0			0.0	
Crosswalk Width(m)		5.0			5.0			5.0			5.0	
Two way Left Turn Lane		Yes										
Headway Factor	1.06	1.06	1.06	1.06	1.06	1.06	1.06	1.06	1.06	1.06	1.06	1.06
Turning Speed (k/h)	24		14	24		14	24		14	24		14
Number of Detectors	1	2	1	1	2		1	2	1	1	2	1
Detector Template	Left	Thru	Right	Left	Thru		Left	Thru	Right	Left	Thru	Right
Leading Detector (m)	6.1	30.5	6.1	6.1	30.5		6.1	30.5	6.1	6.1	30.5	6.1
Trailing Detector (m)	0.0	0.0	0.0	0.0	0.0		0.0	0.0	0.0	0.0	0.0	0.0
Detector 1 Position(m)	0.0	0.0	0.0	0.0	0.0		0.0	0.0	0.0	0.0	0.0	0.0
Detector 1 Size(m)	6.1	1.8	6.1	6.1	1.8		6.1	1.8	6.1	6.1	1.8	6.1
Detector 1 Type	Cl+Ex	Cl+Ex	Cl+Ex	Cl+Ex	Cl+Ex		Cl+Ex	Cl+Ex	Cl+Ex	Cl+Ex	Cl+Ex	Cl+Ex
Detector 1 Channel												
Detector 1 Extend (s)	0.0	0.0	0.0	0.0	0.0		0.0	0.0	0.0	0.0	0.0	0.0
Detector 1 Queue (s)	0.0	0.0	0.0	0.0	0.0		0.0	0.0	0.0	0.0	0.0	0.0
Detector 1 Delay (s)	0.0	0.0	0.0	0.0	0.0		0.0	0.0	0.0	0.0	0.0	0.0
Detector 2 Position(m)		28.7			28.7			28.7			28.7	
Detector 2 Size(m)		1.8			1.8			1.8			1.8	
Detector 2 Type		Cl+Ex			Cl+Ex			Cl+Ex			Cl+Ex	
Detector 2 Channel												
Detector 2 Extend (s)		0.0			0.0			0.0			0.0	
Turn Type	Prot	NA	Perm	Prot	NA		pm+pt	NA	Perm	pm+pt	NA	Perm
Protected Phases	5	2		1	6		3	8		7	4	
Permitted Phases			2				8		8	4		4
Detector Phase	5	2	2	1	6		3	8	8	7	4	4



3: Northside Road East & Robertson Road  
SAT Peak Hour

1826 Robertson Road  
Existing Traffic (RTOR restrictions)

Lane Group	EBL	EBT	EBR	WBL	WBT	WBR	NBL	NBT	NBR	SBL	SBT	SBR
Lane Configurations												
Traffic Volume (vph)	78	799	15	84	655	167	86	44	70	141	30	103
Future Volume (vph)	78	799	15	84	655	167	86	44	70	141	30	103
Ideal Flow (vphpl)	1800	1800	1800	1800	1800	1800	1800	1800	1800	1800	1800	1800
Storage Length (m)	55.0		0.0	75.0		80.0	0.0		0.0	0.0		0.0
Storage Lanes	1		0	1		1	1		0	1		1
Taper Length (m)	30.0			15.0			10.0			10.0		
Lane Util. Factor	1.00	0.95	0.95	1.00	0.95	1.00	1.00	1.00	1.00	1.00	1.00	1.00
Ped Bike Factor	1.00	1.00		1.00		0.96	0.98	0.98		0.99		0.96
Frt		0.997				0.850		0.908				0.850
Flt Protected	0.950			0.950			0.950			0.950		
Satd. Flow (prot)	1712	3412	0	1695	3390	1532	1695	1610	0	1712	1802	1532
Flt Permitted	0.314			0.315			0.736			0.654		
Satd. Flow (perm)	564	3412	0	561	3390	1476	1282	1610	0	1166	1802	1474
Right Turn on Red			No			Yes			No			Yes
Satd. Flow (RTOR)						186						114
Link Speed (k/h)		60			60			40			40	
Link Distance (m)		105.4			310.9			87.0			90.9	
Travel Time (s)		6.3			18.7			7.8			8.2	
Confl. Peds. (#/hr)	6		4	4		6	16		8	8		16
Confl. Bikes (#/hr)			1			2			2			1
Peak Hour Factor	0.90	0.90	0.90	0.90	0.90	0.90	0.90	0.90	0.90	0.90	0.90	0.90
Heavy Vehicles (%)	1%	1%	1%	2%	2%	1%	2%	1%	1%	1%	1%	1%
Adj. Flow (vph)	87	888	17	93	728	186	96	49	78	157	33	114
Shared Lane Traffic (%)												
Lane Group Flow (vph)	87	905	0	93	728	186	96	127	0	157	33	114
Enter Blocked Intersection	No	No	No	No	No	No	No	No	No	No	No	No
Lane Alignment	L NA	Left	R NA	L NA	Left	R NA	L NA	Left	R NA	L NA	Left	R NA
Median Width(m)		5.5			5.5			3.7			3.7	
Link Offset(m)		0.0			0.0			0.0			0.0	
Crosswalk Width(m)		5.0			5.0			5.0			5.0	
Two way Left Turn Lane												
Headway Factor	1.06	1.06	1.06	1.06	1.06	1.06	1.06	1.06	1.06	1.06	1.06	1.06
Turning Speed (k/h)	24		14	24		14	24		14	24		14
Number of Detectors	1	2		1	2		1	1	2		1	2
Detector Template	Left	Thru		Left	Thru	Right	Left	Thru		Left	Thru	Right
Leading Detector (m)	6.1	30.5		6.1	30.5	6.1	6.1	30.5		6.1	30.5	6.1
Trailing Detector (m)	0.0	0.0		0.0	0.0	0.0	0.0	0.0		0.0	0.0	0.0
Detector 1 Position(m)	0.0	0.0		0.0	0.0	0.0	0.0	0.0		0.0	0.0	0.0
Detector 1 Size(m)	6.1	1.8		6.1	1.8	6.1	6.1	1.8		6.1	1.8	6.1
Detector 1 Type	Cl+Ex	Cl+Ex		Cl+Ex	Cl+Ex	Cl+Ex	Cl+Ex	Cl+Ex		Cl+Ex	Cl+Ex	Cl+Ex
Detector 1 Channel												
Detector 1 Extend (s)	0.0	0.0		0.0	0.0	0.0	0.0	0.0		0.0	0.0	0.0
Detector 1 Queue (s)	0.0	0.0		0.0	0.0	0.0	0.0	0.0		0.0	0.0	0.0
Detector 1 Delay (s)	0.0	0.0		0.0	0.0	0.0	0.0	0.0		0.0	0.0	0.0
Detector 2 Position(m)		28.7			28.7			28.7			28.7	
Detector 2 Size(m)		1.8			1.8			1.8			1.8	
Detector 2 Type		Cl+Ex			Cl+Ex			Cl+Ex			Cl+Ex	
Detector 2 Channel												
Detector 2 Extend (s)		0.0			0.0			0.0			0.0	
Turn Type	pm+pt	NA		Perm	NA	Perm	Perm	NA		Perm	NA	Perm
Protected Phases	5	2			6			8			4	
Permitted Phases	2			6		6	8			4		4
Detector Phase	5	2		6	6	6	8	8		4	4	4

Lane Group	Ø3	Ø7
Lane Configurations		
Traffic Volume (vph)		
Future Volume (vph)		
Ideal Flow (vphpl)		
Storage Length (m)		
Storage Lanes		
Taper Length (m)		
Lane Util. Factor		
Ped Bike Factor		
Frt		
Flt Protected		
Satd. Flow (prot)		
Flt Permitted		
Satd. Flow (perm)		
Right Turn on Red		
Satd. Flow (RTOR)		
Link Speed (k/h)		
Link Distance (m)		
Travel Time (s)		
Confl. Peds. (#/hr)		
Confl. Bikes (#/hr)		
Peak Hour Factor		
Heavy Vehicles (%)		
Adj. Flow (vph)		
Shared Lane Traffic (%)		
Lane Group Flow (vph)		
Enter Blocked Intersection		
Lane Alignment		
Median Width(m)		
Link Offset(m)		
Crosswalk Width(m)		
Two way Left Turn Lane		
Headway Factor		
Turning Speed (k/h)		
Number of Detectors		
Detector Template		
Leading Detector (m)		
Trailing Detector (m)		
Detector 1 Position(m)		
Detector 1 Size(m)		
Detector 1 Type		
Detector 1 Channel		
Detector 1 Extend (s)		
Detector 1 Queue (s)		
Detector 1 Delay (s)		
Detector 2 Position(m)		
Detector 2 Size(m)		
Detector 2 Type		
Detector 2 Channel		
Detector 2 Extend (s)		
Turn Type		
Protected Phases	3	7
Permitted Phases		
Detector Phase		

3: Northside Road East & Robertson Road  
SAT Peak Hour

1826 Robertson Road  
Existing Traffic (RTOR restrictions)



Lane Group	EBL	EBT	EBR	WBL	WBT	WBR	NBL	NBT	NBR	SBL	SBT	SBR
Switch Phase												
Minimum Initial (s)	5.0	10.0		10.0	10.0	10.0	10.0	10.0		10.0	10.0	10.0
Minimum Split (s)	11.7	30.7		30.7	30.7	30.7	29.8	29.8		29.8	29.8	29.8
Total Split (s)	15.0	83.0		68.0	68.0	68.0	31.0	31.0		31.0	31.0	31.0
Total Split (%)	12.5%	69.2%		56.7%	56.7%	56.7%	25.8%	25.8%		25.8%	25.8%	25.8%
Maximum Green (s)	9.0	76.9		61.9	61.9	61.9	24.2	24.2		24.2	24.2	24.2
Yellow Time (s)	3.7	3.7		3.7	3.7	3.7	3.0	3.0		3.0	3.0	3.0
All-Red Time (s)	2.3	2.4		2.4	2.4	2.4	3.8	3.8		3.8	3.8	3.8
Lost Time Adjust (s)	0.0	0.0		0.0	0.0	0.0	0.0	0.0		0.0	0.0	0.0
Total Lost Time (s)	6.0	6.1		6.1	6.1	6.1	6.8	6.8		6.8	6.8	6.8
Lead/Lag	Lead			Lag	Lag	Lag	Lag	Lag		Lag	Lag	Lag
Lead-Lag Optimize?	Yes			Yes	Yes	Yes	Yes	Yes		Yes	Yes	Yes
Vehicle Extension (s)	3.0	3.0		3.0	3.0	3.0	3.0	3.0		3.0	3.0	3.0
Recall Mode	None	C-Max		C-Max	C-Max	C-Max	None	None		None	None	None
Walk Time (s)		7.0		7.0	7.0	7.0	1.0	1.0		1.0	1.0	1.0
Flash Dont Walk (s)		17.0		17.0	17.0	17.0	22.0	22.0		22.0	22.0	22.0
Pedestrian Calls (#/hr)		4		6	6	6	8	8		16	16	16
Act Effct Green (s)	85.9	85.8		72.5	72.5	72.5	21.3	21.3		21.3	21.3	21.3
Actuated g/C Ratio	0.72	0.72		0.60	0.60	0.60	0.18	0.18		0.18	0.18	0.18
v/c Ratio	0.18	0.37		0.28	0.36	0.19	0.42	0.45		0.76	0.10	0.32
Control Delay	7.9	8.0		16.3	13.7	2.5	47.8	47.5		68.7	38.8	9.2
Queue Delay	0.0	0.0		0.0	0.0	0.0	0.0	0.0		0.0	0.0	0.0
Total Delay	7.9	8.0		16.3	13.7	2.5	47.8	47.5		68.7	38.8	9.2
LOS	A	A		B	B	A	D	D		E	D	A
Approach Delay		8.0			11.9			47.6			43.2	
Approach LOS		A			B			D			D	
Queue Length 50th (m)	5.7	32.8		9.0	39.3	0.0	18.7	24.9		32.7	6.1	0.0
Queue Length 95th (m)	9.2	34.8		23.1	62.7	10.0	31.1	38.5		50.0	13.1	12.9
Internal Link Dist (m)		81.4			286.9			63.0			66.9	
Turn Bay Length (m)	55.0			75.0		80.0						
Base Capacity (vph)	489	2439		338	2047	965	272	342		248	382	403
Starvation Cap Reductn	0	0		0	0	0	0	0		0	0	0
Spillback Cap Reductn	0	0		0	0	0	0	0		0	0	0
Storage Cap Reductn	0	0		0	0	0	0	0		0	0	0
Reduced v/c Ratio	0.18	0.37		0.28	0.36	0.19	0.35	0.37		0.63	0.09	0.28

Intersection Summary

Area Type: Other  
 Cycle Length: 120  
 Actuated Cycle Length: 120  
 Offset: 111 (93%), Referenced to phase 2:EBTL and 6:WBTL, Start of Green  
 Natural Cycle: 80  
 Control Type: Actuated-Coordinated  
 Maximum v/c Ratio: 0.76  
 Intersection Signal Delay: 17.3      Intersection LOS: B  
 Intersection Capacity Utilization 64.7%      ICU Level of Service C  
 Analysis Period (min) 15

Splits and Phases: 3: Northside Road East & Robertson Road





Lane Group	Ø3	Ø7
Switch Phase		
Minimum Initial (s)	4.0	4.0
Minimum Split (s)	6.0	6.0
Total Split (s)	6.0	6.0
Total Split (%)	5%	5%
Maximum Green (s)	4.0	4.0
Yellow Time (s)	2.0	2.0
All-Red Time (s)	0.0	0.0
Lost Time Adjust (s)		
Total Lost Time (s)		
Lead/Lag	Lead	Lead
Lead-Lag Optimize?	Yes	Yes
Vehicle Extension (s)	3.0	3.0
Recall Mode	None	None
Walk Time (s)		
Flash Dont Walk (s)		
Pedestrian Calls (#/hr)		
Act Effct Green (s)		
Actuated g/C Ratio		
v/c Ratio		
Control Delay		
Queue Delay		
Total Delay		
LOS		
Approach Delay		
Approach LOS		
Queue Length 50th (m)		
Queue Length 95th (m)		
Internal Link Dist (m)		
Turn Bay Length (m)		
Base Capacity (vph)		
Starvation Cap Reductn		
Spillback Cap Reductn		
Storage Cap Reductn		
Reduced v/c Ratio		
Intersection Summary		

4: Northside Road West & Robertson Road  
SAT Peak Hour

1826 Robertson Road  
Existing Traffic (RTOR restrictions)

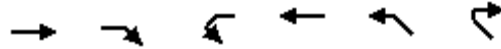

Lane Group	EBT	EBR	WBL	WBT	NWL	NWR
Lane Configurations	↑↑			↑↑↑		
Traffic Volume (vph)	889	83	0	858	0	0
Future Volume (vph)	889	83	0	858	0	0
Ideal Flow (vphpl)	1800	1800	1800	1800	1800	1800
Storage Length (m)		0.0	25.0		0.0	0.0
Storage Lanes		0	1		0	0
Taper Length (m)			25.0		10.0	
Lane Util. Factor	0.95	0.95	1.00	0.91	1.00	1.00
Frt	0.987					
Flt Protected						
Satd. Flow (prot)	3376	0	0	4919	0	0
Flt Permitted						
Satd. Flow (perm)	3376	0	0	4919	0	0
Link Speed (k/h)	60			60	50	
Link Distance (m)	66.2			72.0	100.3	
Travel Time (s)	4.0			4.3	7.2	
Peak Hour Factor	0.90	0.90	0.90	0.90	0.90	0.90
Heavy Vehicles (%)	1%	2%	1%	1%	1%	1%
Adj. Flow (vph)	988	92	0	953	0	0
Shared Lane Traffic (%)						
Lane Group Flow (vph)	1080	0	0	953	0	0
Enter Blocked Intersection	Yes	Yes	Yes	Yes	No	No
Lane Alignment	Left	Right	Left	Left	Left	Right
Median Width(m)	3.7			3.7	0.0	
Link Offset(m)	0.0			0.0	0.0	
Crosswalk Width(m)	0.0			0.0	0.0	
Two way Left Turn Lane						
Headway Factor	1.06	1.06	1.06	1.06	1.06	1.06
Turning Speed (k/h)		50	24		24	14
Sign Control	Free			Free	Free	

Intersection Summary

Area Type: Other

Control Type: Unsignalized

Intersection Capacity Utilization 32.1% ICU Level of Service A

Analysis Period (min) 15

5: Larkspur Drive & Northside Road West  
SAT Peak Hour

1826 Robertson Road  
Existing Traffic (RTOR restrictions)



Lane Group	EBT	EBR	WBL	WBT	NBL	NBR
Lane Configurations						
Traffic Volume (vph)	70	13	120	0	0	101
Future Volume (vph)	70	13	120	0	0	101
Ideal Flow (vphpl)	1800	1800	1800	1800	1800	1800
Lane Util. Factor	1.00	1.00	1.00	1.00	1.00	1.00
Ped Bike Factor						
Frt	0.979					0.865
Flt Protected			0.950			
Satd. Flow (prot)	1749	0	1712	0	0	1559
Flt Permitted			0.950			
Satd. Flow (perm)	1749	0	1712	0	0	1559
Link Speed (k/h)	50			40	40	
Link Distance (m)	100.3			62.0	54.2	
Travel Time (s)	7.2			5.6	4.9	
Confl. Peds. (#/hr)		27	27			
Confl. Bikes (#/hr)		1				2
Peak Hour Factor	0.90	0.90	0.90	0.90	0.90	0.90
Heavy Vehicles (%)	2%	1%	1%	1%	1%	1%
Adj. Flow (vph)	78	14	133	0	0	112
Shared Lane Traffic (%)						
Lane Group Flow (vph)	92	0	133	0	0	112
Enter Blocked Intersection	No	No	No	No	No	No
Lane Alignment	L NA	R NA	L NA	R NA	Left	R NA
Median Width(m)	3.7			3.7	0.0	
Link Offset(m)	3.0			3.0	0.0	
Crosswalk Width(m)	5.0			5.0	5.0	
Two way Left Turn Lane						
Headway Factor	1.06	1.06	1.06	1.06	1.06	1.06
Turning Speed (k/h)		14	24		24	14
Sign Control	Stop			Stop	Stop	











Intersection Summary

Area Type: Other

Control Type: Unsignalized

Intersection Capacity Utilization 23.3% ICU Level of Service A

Analysis Period (min) 15

						
Lane Group	WBL	WBR	NBT	NBR	SBL	SBT
Lane Configurations						
Traffic Volume (vph)	3	70	128	3	64	84
Future Volume (vph)	3	70	128	3	64	84
Ideal Flow (vphpl)	1800	1800	1800	1800	1800	1800
Storage Length (m)	0.0	0.0		45.0	15.0	
Storage Lanes	1	0		0	1	
Taper Length (m)	10.0				20.0	
Lane Util. Factor	1.00	1.00	0.95	0.95	1.00	1.00
Frt	0.870		0.997			
Flt Protected	0.998				0.950	
Satd. Flow (prot)	1565	0	3381	0	1712	1784
Flt Permitted	0.998				0.950	
Satd. Flow (perm)	1565	0	3381	0	1712	1784
Link Speed (k/h)	40		40		40	
Link Distance (m)	173.4		68.2		81.0	
Travel Time (s)	15.6		6.1		7.3	
Peak Hour Factor	0.90	0.90	0.90	0.90	0.90	0.90
Heavy Vehicles (%)	1%	1%	2%	1%	1%	2%
Adj. Flow (vph)	3	78	142	3	71	93
Shared Lane Traffic (%)						
Lane Group Flow (vph)	81	0	145	0	71	93
Enter Blocked Intersection	No	No	No	No	No	No
Lane Alignment	Left	Right	Left	Right	Left	Left
Median Width(m)	3.7		3.7		3.7	
Link Offset(m)	0.0		0.0		0.0	
Crosswalk Width(m)	5.0		5.0		5.0	
Two way Left Turn Lane						
Headway Factor	1.06	1.06	1.06	1.06	1.06	1.06
Turning Speed (k/h)	24	14		14	24	
Sign Control	Stop		Free			Free
<b>Intersection Summary</b>						
Area Type:	Other					
Control Type:	Unsignalized					
Intersection Capacity Utilization	22.3%			ICU Level of Service A		
Analysis Period (min)	15					



Lane Group	WBL	WBR	NBT	NBR	SBL	SBT
Lane Configurations						
Traffic Volume (vph)	1	10	121	1	12	75
Future Volume (vph)	1	10	121	1	12	75
Ideal Flow (vphpl)	1800	1800	1800	1800	1800	1800
Lane Util. Factor	1.00	1.00	1.00	1.00	1.00	1.00
Frt	0.876		0.999			
Flt Protected	0.996					0.993
Satd. Flow (prot)	1572	0	1783	0	0	1774
Flt Permitted	0.996					0.993
Satd. Flow (perm)	1572	0	1783	0	0	1774
Link Speed (k/h)	50		40			50
Link Distance (m)	178.0		82.4			68.2
Travel Time (s)	12.8		7.4			4.9
Peak Hour Factor	0.90	0.90	0.90	0.90	0.90	0.90
Heavy Vehicles (%)	1%	1%	2%	1%	1%	2%
Adj. Flow (vph)	1	11	134	1	13	83
Shared Lane Traffic (%)						
Lane Group Flow (vph)	12	0	135	0	0	96
Enter Blocked Intersection	No	No	No	No	No	No
Lane Alignment	L NA	R NA	Left	Right	Left	Left
Median Width(m)	3.7		0.0			0.0
Link Offset(m)	0.0		0.0			0.0
Crosswalk Width(m)	5.0		5.0			5.0
Two way Left Turn Lane						
Headway Factor	1.06	1.06	1.06	1.06	1.06	1.06
Turning Speed (k/h)	24	14		14	24	
Sign Control	Stop		Free			Free

**Intersection Summary**

Area Type:	Other
Control Type:	Unsignalized
Intersection Capacity Utilization	24.9%
ICU Level of Service	A
Analysis Period (min)	15

8: Larkspur Drive & North Site Access  
SAT Peak Hour

1826 Robertson Road  
Existing Traffic (RTOR restrictions)



Lane Group	EBL	EBR	NBL	NBT	SBT	SBR
Lane Configurations						
Traffic Volume (vph)	28	0	0	73	91	42
Future Volume (vph)	28	0	0	73	91	42
Ideal Flow (vphpl)	1800	1800	1800	1800	1800	1800
Lane Util. Factor	1.00	1.00	1.00	1.00	1.00	1.00
Frt					0.957	
Frt Protected	0.950					
Satd. Flow (prot)	1712	0	0	1802	1724	0
Frt Permitted	0.950					
Satd. Flow (perm)	1712	0	0	1802	1724	0
Link Speed (k/h)	40			40	40	
Link Distance (m)	173.4			67.2	54.2	
Travel Time (s)	15.6			6.0	4.9	
Peak Hour Factor	0.90	0.90	0.90	0.90	0.90	0.90
Heavy Vehicles (%)	1%	1%	1%	1%	1%	1%
Adj. Flow (vph)	31	0	0	81	101	47
Shared Lane Traffic (%)						
Lane Group Flow (vph)	31	0	0	81	148	0
Enter Blocked Intersection	No	No	No	No	No	No
Lane Alignment	Left	Right	Left	Left	Left	Right
Median Width(m)	3.7			0.0	0.0	
Link Offset(m)	0.0			0.0	0.0	
Crosswalk Width(m)	5.0			5.0	5.0	
Two way Left Turn Lane						
Headway Factor	1.06	1.06	1.06	1.06	1.06	1.06
Turning Speed (k/h)	24	14	24			14
Sign Control	Stop			Free	Free	

Intersection Summary

Area Type:	Other
Control Type:	Unsignalized
Intersection Capacity Utilization	17.8%
Analysis Period (min)	15
	ICU Level of Service A

9: Larkspur Drive & South Site Access  
SAT Peak Hour

1826 Robertson Road  
Existing Traffic (RTOR restrictions)



Lane Group	EBL	EBR	NBL	NBT	SBT	SBR
Lane Configurations						
Traffic Volume (vph)	9	0	0	64	81	10
Future Volume (vph)	9	0	0	64	81	10
Ideal Flow (vphpl)	1800	1800	1800	1800	1800	1800
Lane Util. Factor	1.00	1.00	1.00	1.00	1.00	1.00
Frt					0.985	
Flt Protected	0.950					
Satd. Flow (prot)	1712	0	0	1802	1775	0
Flt Permitted	0.950					
Satd. Flow (perm)	1712	0	0	1802	1775	0
Link Speed (k/h)	50			40	50	
Link Distance (m)	178.0			106.1	67.2	
Travel Time (s)	12.8			9.5	4.8	
Peak Hour Factor	0.90	0.90	0.90	0.90	0.90	0.90
Heavy Vehicles (%)	1%	1%	1%	1%	1%	1%
Adj. Flow (vph)	10	0	0	71	90	11
Shared Lane Traffic (%)						
Lane Group Flow (vph)	10	0	0	71	101	0
Enter Blocked Intersection	No	No	No	No	No	No
Lane Alignment	L NA	R NA	Left	Left	Left	Right
Median Width(m)	3.7			0.0	0.0	
Link Offset(m)	0.0			0.0	0.0	
Crosswalk Width(m)	5.0			5.0	5.0	
Two way Left Turn Lane						
Headway Factor	1.06	1.06	1.06	1.06	1.06	1.06
Turning Speed (k/h)	24	14	24			14
Sign Control	Stop			Free	Free	

Intersection Summary

Area Type:	Other
Control Type:	Unsignalized
Intersection Capacity Utilization	15.1%
Analysis Period (min)	15
	ICU Level of Service A

## **APPENDIX N**

---

Total Synchro Analysis



1: Stinson Avenue & Robertson Road  
AM Peak Hour

1826 Robertson Road  
2024 Total Traffic

Lane Group	EBL	EBT	EBR	WBL	WBT	WBR	NBL	NBT	NBR	SBL	SBT	SBR
Lane Configurations												
Traffic Volume (vph)	54	2020	6	20	639	22	9	2	32	2	0	11
Future Volume (vph)	54	2020	6	20	639	22	9	2	32	2	0	11
Ideal Flow (vphpl)	1800	1800	1800	1800	1800	1800	1800	1800	1800	1800	1800	1800
Storage Length (m)	75.0		0.0	45.0		0.0	0.0		0.0	0.0		0.0
Storage Lanes	1		0	1		0	0		0	0		0
Taper Length (m)	10.0			10.0			10.0			10.0		
Lane Util. Factor	1.00	0.95	0.95	1.00	0.95	0.95	1.00	1.00	1.00	1.00	1.00	1.00
Ped Bike Factor	0.99	1.00			1.00			1.00				0.98
Frt					0.995			0.900				0.886
Flt Protected	0.950			0.950				0.990				0.992
Satd. Flow (prot)	1662	3356	0	1572	3308	0	0	1554	0	0	1446	0
Flt Permitted	0.400			0.074				0.928			0.952	
Satd. Flow (perm)	691	3356	0	122	3308	0	0	1454	0	0	1388	0
Right Turn on Red			Yes			Yes			Yes			Yes
Satd. Flow (RTOR)		1			6			23			23	
Link Speed (k/h)		60			60			40			40	
Link Distance (m)		198.0			310.7			254.0			246.4	
Travel Time (s)		11.9			18.6			22.9			22.2	
Confl. Peds. (#/hr)	11		3	11		3	6					6
Peak Hour Factor	1.00	1.00	1.00	1.00	1.00	1.00	1.00	1.00	1.00	1.00	1.00	1.00
Heavy Vehicles (%)	4%	3%	10%	10%	4%	1%	10%	1%	3%	1%	1%	10%
Adj. Flow (vph)	54	2020	6	20	639	22	9	2	32	2	0	11
Shared Lane Traffic (%)												
Lane Group Flow (vph)	54	2026	0	20	661	0	0	43	0	0	13	0
Enter Blocked Intersection	No	No	No	No	No	No	No	No	No	No	No	No
Lane Alignment	L NA	Left	R NA	L NA	Left	R NA	L NA	Left	R NA	L NA	Left	R NA
Median Width(m)		3.7			3.7			0.0			0.0	
Link Offset(m)		0.0			0.0			0.0			0.0	
Crosswalk Width(m)		5.0			5.0			5.0			5.0	
Two way Left Turn Lane		Yes			Yes							
Headway Factor	1.06	1.06	1.06	1.06	1.06	1.06	1.06	1.06	1.06	1.06	1.06	1.06
Turning Speed (k/h)	24		14	24		14	24		14	24		14
Number of Detectors	1	2		1	2		1	2		1	2	
Detector Template	Left	Thru		Left	Thru		Left	Thru		Left	Thru	
Leading Detector (m)	6.1	30.5		6.1	30.5		6.1	30.5		6.1	30.5	
Trailing Detector (m)	0.0	0.0		0.0	0.0		0.0	0.0		0.0	0.0	
Detector 1 Position(m)	0.0	0.0		0.0	0.0		0.0	0.0		0.0	0.0	
Detector 1 Size(m)	6.1	1.8		6.1	1.8		6.1	1.8		6.1	1.8	
Detector 1 Type	Cl+Ex	Cl+Ex		Cl+Ex	Cl+Ex		Cl+Ex	Cl+Ex		Cl+Ex	Cl+Ex	
Detector 1 Channel												
Detector 1 Extend (s)	0.0	0.0		0.0	0.0		0.0	0.0		0.0	0.0	
Detector 1 Queue (s)	0.0	0.0		0.0	0.0		0.0	0.0		0.0	0.0	
Detector 1 Delay (s)	0.0	0.0		0.0	0.0		0.0	0.0		0.0	0.0	
Detector 2 Position(m)		28.7			28.7			28.7			28.7	
Detector 2 Size(m)		1.8			1.8			1.8			1.8	
Detector 2 Type		Cl+Ex			Cl+Ex			Cl+Ex			Cl+Ex	
Detector 2 Channel												
Detector 2 Extend (s)		0.0			0.0			0.0			0.0	
Turn Type	Perm	NA		Perm	NA		Perm	NA		Perm	NA	
Protected Phases		2			6			8			4	
Permitted Phases	2			6			8			4		
Detector Phase	2	2		6	6		8	8		4	4	
Switch Phase												



Lane Group	EBL	EBT	EBR	WBL	WBT	WBR	NBL	NBT	NBR	SBL	SBT	SBR
Minimum Initial (s)	10.0	10.0		10.0	10.0		10.0	10.0		10.0	10.0	
Minimum Split (s)	26.8	26.8		26.8	26.8		31.6	31.6		31.6	31.6	
Total Split (s)	98.0	98.0		98.0	98.0		32.0	32.0		32.0	32.0	
Total Split (%)	75.4%	75.4%		75.4%	75.4%		24.6%	24.6%		24.6%	24.6%	
Maximum Green (s)	92.2	92.2		92.2	92.2		25.4	25.4		25.4	25.4	
Yellow Time (s)	3.7	3.7		3.7	3.7		3.0	3.0		3.0	3.0	
All-Red Time (s)	2.1	2.1		2.1	2.1		3.6	3.6		3.6	3.6	
Lost Time Adjust (s)	0.0	0.0		0.0	0.0			0.0			0.0	
Total Lost Time (s)	5.8	5.8		5.8	5.8			6.6			6.6	
Lead/Lag												
Lead-Lag Optimize?												
Vehicle Extension (s)	3.0	3.0		3.0	3.0		3.0	3.0		3.0	3.0	
Recall Mode	C-Max	C-Max		C-Max	C-Max		None	None		None	None	
Walk Time (s)	7.0	7.0		7.0	7.0		7.0	7.0		7.0	7.0	
Flash Dont Walk (s)	14.0	14.0		14.0	14.0		18.0	18.0		18.0	18.0	
Pedestrian Calls (#/hr)	3	3		11	11		1	1		6	6	
Act Effct Green (s)	109.1	109.1		109.1	109.1			13.0			13.0	
Actuated g/C Ratio	0.84	0.84		0.84	0.84			0.10			0.10	
v/c Ratio	0.09	0.72		0.20	0.24			0.26			0.08	
Control Delay	4.0	8.6		9.3	2.6			32.6			8.8	
Queue Delay	0.0	0.0		0.0	0.0			0.0			0.0	
Total Delay	4.0	8.6		9.3	2.6			32.6			8.8	
LOS	A	A		A	A			C			A	
Approach Delay		8.5			2.8			32.6			8.8	
Approach LOS		A			A			C			A	
Queue Length 50th (m)	1.9	85.8		0.6	10.9			4.5			0.0	
Queue Length 95th (m)	7.6	198.3		4.2	21.4			13.5			3.3	
Internal Link Dist (m)		174.0			286.7			230.0			222.4	
Turn Bay Length (m)	75.0			45.0								
Base Capacity (vph)	579	2815		102	2777			302			289	
Starvation Cap Reductn	0	0		0	0			0			0	
Spillback Cap Reductn	0	0		0	0			0			0	
Storage Cap Reductn	0	0		0	0			0			0	
Reduced v/c Ratio	0.09	0.72		0.20	0.24			0.14			0.04	

Intersection Summary























Area Type: Other  
 Cycle Length: 130  
 Actuated Cycle Length: 130  
 Offset: 129 (99%), Referenced to phase 2:EBTL and 6:WBTL, Start of Green  
 Natural Cycle: 90  
 Control Type: Actuated-Coordinated  
 Maximum v/c Ratio: 0.72  
 Intersection Signal Delay: 7.5  
 Intersection Capacity Utilization 80.1%  
 Analysis Period (min) 15  
 Intersection LOS: A  
 ICU Level of Service D

Splits and Phases: 1: Stinson Avenue & Robertson Road



2: Lynhar Road/Stafford Road & Robertson Road  
AM Peak Hour

1826 Robertson Road  
2024 Total Traffic

												
Lane Group	EBL	EBT	EBR	WBL	WBT	WBR	NBL	NBT	NBR	SBL	SBT	SBR
Lane Configurations												
Traffic Volume (vph)	42	1875	50	17	651	83	46	12	115	31	5	52
Future Volume (vph)	42	1875	50	17	651	83	46	12	115	31	5	52
Ideal Flow (vphpl)	1800	1800	1800	1800	1800	1800	1800	1800	1800	1800	1800	1800
Storage Length (m)	85.0		40.0	0.0		0.0	0.0		30.0	45.0		75.0
Storage Lanes	1		1	1		0	1		1	1		1
Taper Length (m)	10.0			10.0			10.0			30.0		
Lane Util. Factor	1.00	0.95	1.00	1.00	0.95	0.95	1.00	1.00	1.00	1.00	1.00	1.00
Ped Bike Factor	1.00		0.97	1.00	1.00		1.00		0.98	1.00		0.98
Frt			0.850		0.983				0.850			0.850
Flt Protected	0.950			0.950			0.950			0.950		
Satd. Flow (prot)	1572	3357	1532	1712	3275	0	1679	1802	1532	1572	1802	1459
Flt Permitted	0.950			0.950			0.754			0.750		
Satd. Flow (perm)	1567	3357	1485	1711	3275	0	1326	1802	1506	1235	1802	1435
Right Turn on Red			Yes			Yes			Yes			Yes
Satd. Flow (RTOR)			82		16				115			79
Link Speed (k/h)		60			60			40			40	
Link Distance (m)		310.7			66.2			81.0			107.6	
Travel Time (s)		18.6			4.0			7.3			9.7	
Confl. Peds. (#/hr)	5		4	4		5	4		4	4		4
Peak Hour Factor	1.00	1.00	1.00	1.00	1.00	1.00	1.00	1.00	1.00	1.00	1.00	1.00
Heavy Vehicles (%)	10%	3%	1%	1%	3%	8%	3%	1%	1%	10%	1%	6%
Adj. Flow (vph)	42	1875	50	17	651	83	46	12	115	31	5	52
Shared Lane Traffic (%)												
Lane Group Flow (vph)	42	1875	50	17	734	0	46	12	115	31	5	52
Enter Blocked Intersection	No	No	No	No	No	No	No	No	No	No	No	No
Lane Alignment	L NA	Left	R NA	L NA	Left	R NA	L NA	L NA	R NA	L NA	Left	R NA
Median Width(m)		3.7			7.4			7.4			7.4	
Link Offset(m)		0.0			0.0			0.0			0.0	
Crosswalk Width(m)		5.0			5.0			5.0			5.0	
Two way Left Turn Lane		Yes										
Headway Factor	1.06	1.06	1.06	1.06	1.06	1.06	1.06	1.06	1.06	1.06	1.06	1.06
Turning Speed (k/h)	24		14	24		14	24		14	24		14
Number of Detectors	1	2	1	1	2		1	2	1	1	2	1
Detector Template	Left	Thru	Right	Left	Thru		Left	Thru	Right	Left	Thru	Right
Leading Detector (m)	6.1	30.5	6.1	6.1	30.5		6.1	30.5	6.1	6.1	30.5	6.1
Trailing Detector (m)	0.0	0.0	0.0	0.0	0.0		0.0	0.0	0.0	0.0	0.0	0.0
Detector 1 Position(m)	0.0	0.0	0.0	0.0	0.0		0.0	0.0	0.0	0.0	0.0	0.0
Detector 1 Size(m)	6.1	1.8	6.1	6.1	1.8		6.1	1.8	6.1	6.1	1.8	6.1
Detector 1 Type	CI+Ex	CI+Ex	CI+Ex	CI+Ex	CI+Ex		CI+Ex	CI+Ex	CI+Ex	CI+Ex	CI+Ex	CI+Ex
Detector 1 Channel												
Detector 1 Extend (s)	0.0	0.0	0.0	0.0	0.0		0.0	0.0	0.0	0.0	0.0	0.0
Detector 1 Queue (s)	0.0	0.0	0.0	0.0	0.0		0.0	0.0	0.0	0.0	0.0	0.0
Detector 1 Delay (s)	0.0	0.0	0.0	0.0	0.0		0.0	0.0	0.0	0.0	0.0	0.0
Detector 2 Position(m)		28.7			28.7			28.7			28.7	
Detector 2 Size(m)		1.8			1.8			1.8			1.8	
Detector 2 Type		CI+Ex			CI+Ex			CI+Ex			CI+Ex	
Detector 2 Channel												
Detector 2 Extend (s)		0.0			0.0			0.0			0.0	
Turn Type	Prot	NA	Perm	Prot	NA		Perm	NA	Perm	Perm	NA	Perm
Protected Phases	5	2		1	6			8			4	
Permitted Phases			2				8		8	4		4
Detector Phase	5	2	2	1	6		8	8	8	4	4	4
Switch Phase												



Lane Group	EBL	EBT	EBR	WBL	WBT	WBR	NBL	NBT	NBR	SBL	SBT	SBR
Minimum Initial (s)	5.0	10.0	10.0	5.0	10.0		10.0	10.0	10.0	10.0	10.0	10.0
Minimum Split (s)	11.1	31.3	31.3	11.1	31.3		37.7	37.7	37.7	37.7	37.7	37.7
Total Split (s)	16.0	75.0	75.0	16.0	75.0		39.0	39.0	39.0	39.0	39.0	39.0
Total Split (%)	12.3%	57.7%	57.7%	12.3%	57.7%		30.0%	30.0%	30.0%	30.0%	30.0%	30.0%
Maximum Green (s)	9.9	68.7	68.7	9.9	68.7		32.3	32.3	32.3	32.3	32.3	32.3
Yellow Time (s)	3.7	3.7	3.7	3.7	3.7		3.0	3.0	3.0	3.0	3.0	3.0
All-Red Time (s)	2.4	2.6	2.6	2.4	2.6		3.7	3.7	3.7	3.7	3.7	3.7
Lost Time Adjust (s)	0.0	0.0	0.0	0.0	0.0		0.0	0.0	0.0	0.0	0.0	0.0
Total Lost Time (s)	6.1	6.3	6.3	6.1	6.3		6.7	6.7	6.7	6.7	6.7	6.7
Lead/Lag	Lead	Lag	Lag	Lead	Lag							
Lead-Lag Optimize?	Yes	Yes	Yes	Yes	Yes							
Vehicle Extension (s)	3.0	3.0	3.0	3.0	3.0		3.0	3.0	3.0	3.0	3.0	3.0
Recall Mode	None	C-Max	C-Max	None	C-Max		None	None	None	None	None	None
Walk Time (s)		7.0	7.0		7.0		12.0	12.0	12.0	12.0	12.0	12.0
Flash Dont Walk (s)		18.0	18.0		18.0		19.0	19.0	19.0	19.0	19.0	19.0
Pedestrian Calls (#/hr)		4	4		5		4	4	4	4	4	4
Act Effct Green (s)	8.6	96.8	96.8	6.9	90.0		14.5	14.5	14.5	14.5	14.5	14.5
Actuated g/C Ratio	0.07	0.74	0.74	0.05	0.69		0.11	0.11	0.11	0.11	0.11	0.11
v/c Ratio	0.40	0.75	0.04	0.19	0.32		0.31	0.06	0.43	0.22	0.02	0.23
Control Delay	80.0	9.0	0.4	71.8	7.4		55.7	47.3	12.7	53.0	45.6	5.5
Queue Delay	0.0	0.0	0.0	0.0	0.0		0.0	0.0	0.0	0.0	0.0	0.0
Total Delay	80.0	9.0	0.4	71.8	7.4		55.7	47.3	12.7	53.0	45.6	5.5
LOS	F	A	A	E	A		E	D	B	D	D	A
Approach Delay		10.3			8.8			26.5			24.5	
Approach LOS		B			A			C			C	
Queue Length 50th (m)	9.9	11.8	0.0	4.0	24.9		10.6	2.7	0.0	7.1	1.1	0.0
Queue Length 95th (m)	m12.5	#285.4	m0.4	m12.0	30.4		18.5	7.0	13.7	13.6	4.0	4.4
Internal Link Dist (m)		286.7			42.2			57.0			83.6	
Turn Bay Length (m)	85.0		40.0						30.0	45.0		75.0
Base Capacity (vph)	123	2498	1126	130	2273		329	447	460	306	447	415
Starvation Cap Reductn	0	0	0	0	0		0	0	0	0	0	0
Spillback Cap Reductn	0	0	0	0	0		0	0	0	0	0	0
Storage Cap Reductn	0	0	0	0	0		0	0	0	0	0	0
Reduced v/c Ratio	0.34	0.75	0.04	0.13	0.32		0.14	0.03	0.25	0.10	0.01	0.13

Intersection Summary

Area Type: Other  
 Cycle Length: 130  
 Actuated Cycle Length: 130  
 Offset: 36 (28%), Referenced to phase 2:EBT and 6:WBT, Start of Green  
 Natural Cycle: 125  
 Control Type: Actuated-Coordinated  
 Maximum v/c Ratio: 0.75  
 Intersection Signal Delay: 11.3      Intersection LOS: B  
 Intersection Capacity Utilization 90.0%      ICU Level of Service E  
 Analysis Period (min) 15  
 # 95th percentile volume exceeds capacity, queue may be longer.  
 Queue shown is maximum after two cycles.  
 m Volume for 95th percentile queue is metered by upstream signal.

Splits and Phases: 2: Lynhar Road/Stafford Road & Robertson Road

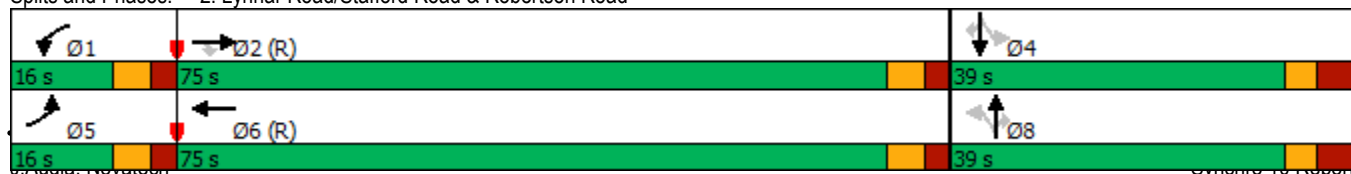

3: Northside Road East & Robertson Road  
AM Peak Hour

1826 Robertson Road  
2024 Total Traffic



Lane Group	EBL	EBT	EBR	WBL	WBT	WBR	NBL	NBT	NBR	SBL	SBT	SBR
Lane Configurations												
Traffic Volume (vph)	23	1781	12	52	618	67	95	24	45	34	8	9
Future Volume (vph)	23	1781	12	52	618	67	95	24	45	34	8	9
Ideal Flow (vphpl)	1800	1800	1800	1800	1800	1800	1800	1800	1800	1800	1800	1800
Storage Length (m)	55.0		0.0	75.0		80.0	0.0		0.0	0.0		0.0
Storage Lanes	1		0	1		1	1		0	1		1
Taper Length (m)	30.0			15.0			10.0			10.0		
Lane Util. Factor	1.00	0.95	0.95	1.00	0.95	1.00	1.00	1.00	1.00	1.00	1.00	1.00
Ped Bike Factor	1.00	1.00				0.96	0.99	0.99		0.99		0.98
Frt		0.999				0.850		0.902				0.850
Flt Protected	0.950			0.950			0.950			0.950		
Satd. Flow (prot)	1712	3354	0	1647	3325	1532	1679	1503	0	1679	1802	1532
Flt Permitted	0.382			0.107			0.752			0.712		
Satd. Flow (perm)	685	3354	0	185	3325	1475	1322	1503	0	1250	1802	1506
Right Turn on Red			Yes			Yes			Yes			Yes
Satd. Flow (RTOR)		1				99		45				93
Link Speed (k/h)		60			60			40				40
Link Distance (m)		105.4			310.9			87.0				90.9
Travel Time (s)		6.3			18.7			7.8				8.2
Confl. Peds. (#/hr)	5		3	3		5	3		4	4		3
Confl. Bikes (#/hr)			5			6			3			
Peak Hour Factor	1.00	1.00	1.00	1.00	1.00	1.00	1.00	1.00	1.00	1.00	1.00	1.00
Heavy Vehicles (%)	1%	3%	1%	5%	4%	1%	3%	5%	9%	3%	1%	1%
Adj. Flow (vph)	23	1781	12	52	618	67	95	24	45	34	8	9
Shared Lane Traffic (%)												
Lane Group Flow (vph)	23	1793	0	52	618	67	95	69	0	34	8	9
Enter Blocked Intersection	No	No	No	No	No	No	No	No	No	No	No	No
Lane Alignment	L NA	Left	R NA	L NA	Left	R NA	L NA	Left	R NA	L NA	Left	R NA
Median Width(m)		5.5			5.5			3.7				3.7
Link Offset(m)		0.0			0.0			0.0				0.0
Crosswalk Width(m)		5.0			5.0			5.0				5.0
Two way Left Turn Lane												
Headway Factor	1.06	1.06	1.06	1.06	1.06	1.06	1.06	1.06	1.06	1.06	1.06	1.06
Turning Speed (k/h)	24		14	24		14	24		14	24		14
Number of Detectors	1	2		1	2		1	1	2		1	2
Detector Template	Left	Thru		Left	Thru	Right	Left	Thru		Left	Thru	Right
Leading Detector (m)	6.1	30.5		6.1	30.5	6.1	6.1	30.5		6.1	30.5	6.1
Trailing Detector (m)	0.0	0.0		0.0	0.0	0.0	0.0	0.0		0.0	0.0	0.0
Detector 1 Position(m)	0.0	0.0		0.0	0.0	0.0	0.0	0.0		0.0	0.0	0.0
Detector 1 Size(m)	6.1	1.8		6.1	1.8	6.1	6.1	1.8		6.1	1.8	6.1
Detector 1 Type	Cl+Ex	Cl+Ex		Cl+Ex	Cl+Ex	Cl+Ex	Cl+Ex	Cl+Ex		Cl+Ex	Cl+Ex	Cl+Ex
Detector 1 Channel												
Detector 1 Extend (s)	0.0	0.0		0.0	0.0	0.0	0.0	0.0		0.0	0.0	0.0
Detector 1 Queue (s)	0.0	0.0		0.0	0.0	0.0	0.0	0.0		0.0	0.0	0.0
Detector 1 Delay (s)	0.0	0.0		0.0	0.0	0.0	0.0	0.0		0.0	0.0	0.0
Detector 2 Position(m)		28.7			28.7			28.7				28.7
Detector 2 Size(m)		1.8			1.8			1.8				1.8
Detector 2 Type		Cl+Ex			Cl+Ex			Cl+Ex				Cl+Ex
Detector 2 Channel												
Detector 2 Extend (s)		0.0			0.0			0.0				0.0
Turn Type	pm+pt	NA		Perm	NA	Perm	Perm	NA		Perm	NA	Perm
Protected Phases	5	2			6			8				4
Permitted Phases	2			6		6	8			4		4
Detector Phase	5	2		6	6	6	8	8		4	4	4

Lane Group	Ø3	Ø7
Lane Configurations		
Traffic Volume (vph)		
Future Volume (vph)		
Ideal Flow (vphpl)		
Storage Length (m)		
Storage Lanes		
Taper Length (m)		
Lane Util. Factor		
Ped Bike Factor		
Frt		
Flt Protected		
Satd. Flow (prot)		
Flt Permitted		
Satd. Flow (perm)		
Right Turn on Red		
Satd. Flow (RTOR)		
Link Speed (k/h)		
Link Distance (m)		
Travel Time (s)		
Confl. Peds. (#/hr)		
Confl. Bikes (#/hr)		
Peak Hour Factor		
Heavy Vehicles (%)		
Adj. Flow (vph)		
Shared Lane Traffic (%)		
Lane Group Flow (vph)		
Enter Blocked Intersection		
Lane Alignment		
Median Width(m)		
Link Offset(m)		
Crosswalk Width(m)		
Two way Left Turn Lane		
Headway Factor		
Turning Speed (k/h)		
Number of Detectors		
Detector Template		
Leading Detector (m)		
Trailing Detector (m)		
Detector 1 Position(m)		
Detector 1 Size(m)		
Detector 1 Type		
Detector 1 Channel		
Detector 1 Extend (s)		
Detector 1 Queue (s)		
Detector 1 Delay (s)		
Detector 2 Position(m)		
Detector 2 Size(m)		
Detector 2 Type		
Detector 2 Channel		
Detector 2 Extend (s)		
Turn Type		
Protected Phases	3	7
Permitted Phases		
Detector Phase		

3: Northside Road East & Robertson Road  
AM Peak Hour

1826 Robertson Road  
2024 Total Traffic



Lane Group	EBL	EBT	EBR	WBL	WBT	WBR	NBL	NBT	NBR	SBL	SBT	SBR
Switch Phase												
Minimum Initial (s)	5.0	10.0		10.0	10.0	10.0	10.0	10.0		10.0	10.0	10.0
Minimum Split (s)	11.0	30.1		30.1	30.1	30.1	29.8	29.8		29.8	29.8	29.8
Total Split (s)	16.0	94.0		78.0	78.0	78.0	30.0	30.0		30.0	30.0	30.0
Total Split (%)	12.3%	72.3%		60.0%	60.0%	60.0%	23.1%	23.1%		23.1%	23.1%	23.1%
Maximum Green (s)	10.0	87.9		71.9	71.9	71.9	23.2	23.2		23.2	23.2	23.2
Yellow Time (s)	3.7	3.7		3.7	3.7	3.7	3.0	3.0		3.0	3.0	3.0
All-Red Time (s)	2.3	2.4		2.4	2.4	2.4	3.8	3.8		3.8	3.8	3.8
Lost Time Adjust (s)	0.0	0.0		0.0	0.0	0.0	0.0	0.0		0.0	0.0	0.0
Total Lost Time (s)	6.0	6.1		6.1	6.1	6.1	6.8	6.8		6.8	6.8	6.8
Lead/Lag	Lead			Lag	Lag	Lag	Lag	Lag		Lag	Lag	Lag
Lead-Lag Optimize?	Yes			Yes	Yes	Yes	Yes	Yes		Yes	Yes	Yes
Vehicle Extension (s)	3.0	3.0		3.0	3.0	3.0	3.0	3.0		3.0	3.0	3.0
Recall Mode	None	C-Max		C-Max	C-Max	C-Max	None	None		None	None	None
Walk Time (s)		7.0		7.0	7.0	7.0	1.0	1.0		1.0	1.0	1.0
Flash Dont Walk (s)		17.0		17.0	17.0	17.0	22.0	22.0		22.0	22.0	22.0
Pedestrian Calls (#/hr)		3		5	5	5	4	4		3	3	3
Act Effct Green (s)	101.8	101.7		94.4	94.4	94.4	15.4	15.4		15.4	15.4	15.4
Actuated g/C Ratio	0.78	0.78		0.73	0.73	0.73	0.12	0.12		0.12	0.12	0.12
v/c Ratio	0.04	0.68		0.39	0.26	0.06	0.61	0.32		0.23	0.04	0.03
Control Delay	3.4	5.2		21.2	7.5	0.7	70.0	25.3		53.5	47.6	0.2
Queue Delay	0.0	0.1		0.0	0.0	0.0	0.0	0.0		0.0	0.0	0.0
Total Delay	3.4	5.3		21.2	7.5	0.7	70.0	25.3		53.5	47.6	0.2
LOS	A	A		C	A	A	E	C		D	D	A
Approach Delay		5.3			7.8			51.2			43.2	
Approach LOS		A			A			D			D	
Queue Length 50th (m)	0.6	24.2		4.7	25.8	0.0	21.8	5.2		7.4	1.7	0.0
Queue Length 95th (m)	m1.4	48.4		19.2	42.2	2.1	36.0	17.0		15.9	5.8	0.0
Internal Link Dist (m)		81.4			286.9			63.0			66.9	
Turn Bay Length (m)	55.0			75.0		80.0						
Base Capacity (vph)	615	2625		134	2415	1098	235	305		223	321	345
Starvation Cap Reductn	0	74		0	0	0	0	0		0	0	0
Spillback Cap Reductn	0	0		0	0	0	0	0		0	0	0
Storage Cap Reductn	0	0		0	0	0	0	0		0	0	0
Reduced v/c Ratio	0.04	0.70		0.39	0.26	0.06	0.40	0.23		0.15	0.02	0.03

Intersection Summary

Area Type: Other  
 Cycle Length: 130  
 Actuated Cycle Length: 130  
 Offset: 37 (28%), Referenced to phase 2:EBTL and 6:WBTL, Start of Green  
 Natural Cycle: 90  
 Control Type: Actuated-Coordinated  
 Maximum v/c Ratio: 0.68  
 Intersection Signal Delay: 9.4 Intersection LOS: A  
 Intersection Capacity Utilization 76.2% ICU Level of Service D  
 Analysis Period (min) 15  
 m Volume for 95th percentile queue is metered by upstream signal.

Splits and Phases: 3: Northside Road East & Robertson Road

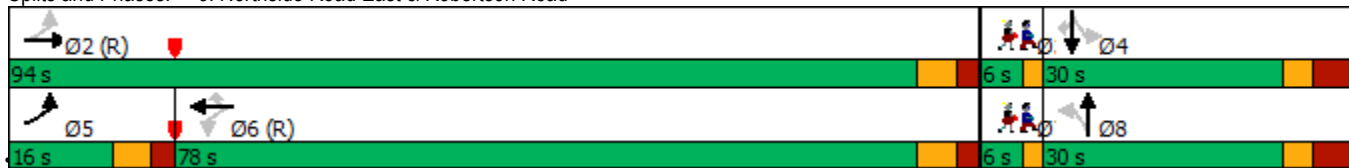

Lane Group	Ø3	Ø7
Switch Phase		
Minimum Initial (s)	4.0	4.0
Minimum Split (s)	6.0	6.0
Total Split (s)	6.0	6.0
Total Split (%)	5%	5%
Maximum Green (s)	4.0	4.0
Yellow Time (s)	2.0	2.0
All-Red Time (s)	0.0	0.0
Lost Time Adjust (s)		
Total Lost Time (s)		
Lead/Lag	Lead	Lead
Lead-Lag Optimize?	Yes	Yes
Vehicle Extension (s)	3.0	3.0
Recall Mode	None	None
Walk Time (s)		
Flash Dont Walk (s)		
Pedestrian Calls (#/hr)		
Act Effct Green (s)		
Actuated g/C Ratio		
v/c Ratio		
Control Delay		
Queue Delay		
Total Delay		
LOS		
Approach Delay		
Approach LOS		
Queue Length 50th (m)		
Queue Length 95th (m)		
Internal Link Dist (m)		
Turn Bay Length (m)		
Base Capacity (vph)		
Starvation Cap Reductn		
Spillback Cap Reductn		
Storage Cap Reductn		
Reduced v/c Ratio		
Intersection Summary		



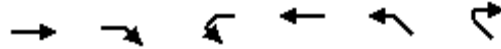

Lane Group	EBT	EBR	WBL	WBT	NWL	NWR
Lane Configurations	↑↑			↑↑↑		
Traffic Volume (vph)	1913	108	0	752	0	0
Future Volume (vph)	1913	108	0	752	0	0
Ideal Flow (vphpl)	1800	1800	1800	1800	1800	1800
Storage Length (m)		0.0	25.0		0.0	0.0
Storage Lanes		0	1		0	0
Taper Length (m)			25.0		10.0	
Lane Util. Factor	0.95	0.95	1.00	0.91	1.00	1.00
Fr <sub>t</sub>	0.992					
<b>Flt Protected</b>						
Satd. Flow (prot)	3356	0	0	4871	0	0
<b>Flt Permitted</b>						
Satd. Flow (perm)	3356	0	0	4871	0	0
Link Speed (k/h)	60			60	50	
Link Distance (m)	66.2			72.0	100.3	
Travel Time (s)	4.0			4.3	7.2	
Peak Hour Factor	1.00	1.00	1.00	1.00	1.00	1.00
Heavy Vehicles (%)	2%	6%	1%	2%	1%	1%
Adj. Flow (vph)	1913	108	0	752	0	0
<b>Shared Lane Traffic (%)</b>						
Lane Group Flow (vph)	2021	0	0	752	0	0
Enter Blocked Intersection	Yes	Yes	Yes	Yes	No	No
Lane Alignment	Left	Right	Left	Left	Left	Right
Median Width(m)	3.7			3.7	0.0	
Link Offset(m)	0.0			0.0	0.0	
Crosswalk Width(m)	0.0			0.0	0.0	
<b>Two way Left Turn Lane</b>						
Headway Factor	1.06	1.06	1.06	1.06	1.06	1.06
Turning Speed (k/h)		50	24		24	14
Sign Control	Free			Free	Free	

**Intersection Summary**

Area Type: Other

Control Type: Unsignalized

Intersection Capacity Utilization 62.8% ICU Level of Service B











Analysis Period (min) 15











Lane Group	EBT	EBR	WBL	WBT	NBL	NBR
Lane Configurations						
Traffic Volume (vph)	100	8	63	0	0	33
Future Volume (vph)	100	8	63	0	0	33
Ideal Flow (vphpl)	1800	1800	1800	1800	1800	1800
Lane Util. Factor	1.00	1.00	1.00	1.00	1.00	1.00
Ped Bike Factor						
Frt	0.990					0.865
Flt Protected			0.950			
Satd. Flow (prot)	1706	0	1572	0	0	1458
Flt Permitted			0.950			
Satd. Flow (perm)	1706	0	1572	0	0	1458
Link Speed (k/h)	50			40	40	
Link Distance (m)	100.3			62.0	54.2	
Travel Time (s)	7.2			5.6	4.9	
Confl. Peds. (#/hr)		17	17			
Peak Hour Factor	1.00	1.00	1.00	1.00	1.00	1.00
Heavy Vehicles (%)	6%	1%	10%	1%	1%	8%
Adj. Flow (vph)	100	8	63	0	0	33
Shared Lane Traffic (%)						
Lane Group Flow (vph)	108	0	63	0	0	33
Enter Blocked Intersection	No	No	No	No	No	No
Lane Alignment	L NA	R NA	L NA	R NA	Left	R NA
Median Width(m)	3.7			3.7	0.0	
Link Offset(m)	3.0			3.0	0.0	
Crosswalk Width(m)	5.0			5.0	5.0	
Two way Left Turn Lane						
Headway Factor	1.06	1.06	1.06	1.06	1.06	1.06
Turning Speed (k/h)		14	24		24	14
Sign Control	Stop			Stop	Stop	

**Intersection Summary**

Area Type:	Other
Control Type:	Unsignalized
Intersection Capacity Utilization 19.3%	ICU Level of Service A
Analysis Period (min)	15

						
Lane Group	WBL	WBR	NBT	NBR	SBL	SBT
Lane Configurations						
Traffic Volume (vph)	1	39	134	3	44	28
Future Volume (vph)	1	39	134	3	44	28
Ideal Flow (vphpl)	1800	1800	1800	1800	1800	1800
Storage Length (m)	0.0	0.0		45.0	15.0	
Storage Lanes	1	0		0	1	
Taper Length (m)	10.0				20.0	
Lane Util. Factor	1.00	1.00	0.95	0.95	1.00	1.00
Frt	0.868		0.997			
Flt Protected	0.999				0.950	
Satd. Flow (prot)	1563	0	3381	0	1712	1784
Flt Permitted	0.999				0.950	
Satd. Flow (perm)	1563	0	3381	0	1712	1784
Link Speed (k/h)	40		40			40
Link Distance (m)	173.4		68.2			81.0
Travel Time (s)	15.6		6.1			7.3
Peak Hour Factor	1.00	1.00	1.00	1.00	1.00	1.00
Heavy Vehicles (%)	1%	1%	2%	1%	1%	2%
Adj. Flow (vph)	1	39	134	3	44	28
Shared Lane Traffic (%)						
Lane Group Flow (vph)	40	0	137	0	44	28
Enter Blocked Intersection	No	No	No	No	No	No
Lane Alignment	Left	Right	Left	Right	Left	Left
Median Width(m)	3.7		3.7			3.7
Link Offset(m)	0.0		0.0			0.0
Crosswalk Width(m)	5.0		5.0			5.0
Two way Left Turn Lane						
Headway Factor	1.06	1.06	1.06	1.06	1.06	1.06
Turning Speed (k/h)	24	14		14	24	
Sign Control	Stop		Free			Free
<b>Intersection Summary</b>						
Area Type:	Other					
Control Type:	Unsignalized					
Intersection Capacity Utilization 20.7%	ICU Level of Service A					
Analysis Period (min) 15						

						
Lane Group	WBL	WBR	NBT	NBR	SBL	SBT
Lane Configurations						
Traffic Volume (vph)	1	3	134	1	6	23
Future Volume (vph)	1	3	134	1	6	23
Ideal Flow (vphpl)	1800	1800	1800	1800	1800	1800
Lane Util. Factor	1.00	1.00	1.00	1.00	1.00	1.00
Frt	0.899		0.999			
Flt Protected	0.988					0.990
Satd. Flow (prot)	1601	0	1783	0	0	1770
Flt Permitted	0.988					0.990
Satd. Flow (perm)	1601	0	1783	0	0	1770
Link Speed (k/h)	50		50			50
Link Distance (m)	178.0		82.4			68.2
Travel Time (s)	12.8		5.9			4.9
Peak Hour Factor	1.00	1.00	1.00	1.00	1.00	1.00
Heavy Vehicles (%)	1%	1%	2%	1%	1%	2%
Adj. Flow (vph)	1	3	134	1	6	23
Shared Lane Traffic (%)						
Lane Group Flow (vph)	4	0	135	0	0	29
Enter Blocked Intersection	No	No	No	No	No	No
Lane Alignment	L NA	R NA	Left	Right	Left	Left
Median Width(m)	3.7		0.0			0.0
Link Offset(m)	0.0		0.0			0.0
Crosswalk Width(m)	5.0		5.0			5.0
Two way Left Turn Lane						
Headway Factor	1.06	1.06	1.06	1.06	1.06	1.06
Turning Speed (k/h)	97	97		97	97	
Sign Control	Stop		Free			Free
<b>Intersection Summary</b>						
Area Type:	Other					
Control Type:	Unsignalized					
Intersection Capacity Utilization	17.5%			ICU Level of Service A		
Analysis Period (min)	15					



Lane Group	EBL	EBR	NBL	NBT	SBT	SBR
Lane Configurations						
Traffic Volume (vph)	17	0	0	16	43	28
Future Volume (vph)	17	0	0	16	43	28
Ideal Flow (vphpl)	1800	1800	1800	1800	1800	1800
Lane Util. Factor	1.00	1.00	1.00	1.00	1.00	1.00
Frnt					0.947	
Flt Protected	0.950					
Satd. Flow (prot)	1712	0	0	1802	1706	0
Flt Permitted	0.950					
Satd. Flow (perm)	1712	0	0	1802	1706	0
Link Speed (k/h)	40			40	40	
Link Distance (m)	173.4			67.2	54.2	
Travel Time (s)	15.6			6.0	4.9	
Peak Hour Factor	1.00	1.00	1.00	1.00	1.00	1.00
Heavy Vehicles (%)	1%	1%	1%	1%	1%	1%
Adj. Flow (vph)	17	0	0	16	43	28
Shared Lane Traffic (%)						
Lane Group Flow (vph)	17	0	0	16	71	0
Enter Blocked Intersection	No	No	No	No	No	No
Lane Alignment	Left	Right	Left	Left	Left	Right
Median Width(m)	3.7			0.0	0.0	
Link Offset(m)	0.0			0.0	0.0	
Crosswalk Width(m)	5.0			5.0	5.0	
Two way Left Turn Lane						
Headway Factor	1.06	1.06	1.06	1.06	1.06	1.06
Turning Speed (k/h)	24	14	24			14
Sign Control	Stop			Free	Free	

**Intersection Summary**

Area Type:	Other
Control Type:	Unsignalized
Intersection Capacity Utilization	14.2%
Analysis Period (min)	15
	ICU Level of Service A



Lane Group	EBL	EBR	NBL	NBT	SBT	SBR
Lane Configurations						
Traffic Volume (vph)	3	0	0	13	38	5
Future Volume (vph)	3	0	0	13	38	5
Ideal Flow (vphpl)	1800	1800	1800	1800	1800	1800
Lane Util. Factor	1.00	1.00	1.00	1.00	1.00	1.00
Frt					0.984	
Frt Protected	0.950					
Satd. Flow (prot)	1712	0	0	1802	1773	0
Frt Permitted	0.950					
Satd. Flow (perm)	1712	0	0	1802	1773	0
Link Speed (k/h)	50			50	50	
Link Distance (m)	178.0			106.1	67.2	
Travel Time (s)	12.8			7.6	4.8	
Peak Hour Factor	1.00	1.00	1.00	1.00	1.00	1.00
Heavy Vehicles (%)	1%	1%	1%	1%	1%	1%
Adj. Flow (vph)	3	0	0	13	38	5
Shared Lane Traffic (%)						
Lane Group Flow (vph)	3	0	0	13	43	0
Enter Blocked Intersection	No	No	No	No	No	No
Lane Alignment	L NA	R NA	Left	Left	Left	Right
Median Width(m)	3.7			0.0	0.0	
Link Offset(m)	0.0			0.0	0.0	
Crosswalk Width(m)	5.0			5.0	5.0	
Two way Left Turn Lane						
Headway Factor	1.06	1.06	1.06	1.06	1.06	1.06
Turning Speed (k/h)	97	97	97			97
Sign Control	Stop			Free	Free	

**Intersection Summary**

Area Type:	Other
Control Type:	Unsignalized
Intersection Capacity Utilization	13.3%
Analysis Period (min)	15
	ICU Level of Service A

1: Stinson Avenue & Robertson Road  
PM Peak Hour

1826 Robertson Road  
2024 Total Traffic

Lane Group	EBL	EBT	EBR	WBL	WBT	WBR	NBL	NBT	NBR	SBL	SBT	SBR
Lane Configurations												
Traffic Volume (vph)	16	1097	25	41	1362	5	12	1	25	20	1	46
Future Volume (vph)	16	1097	25	41	1362	5	12	1	25	20	1	46
Ideal Flow (vphpl)	1800	1800	1800	1800	1800	1800	1800	1800	1800	1800	1800	1800
Storage Length (m)	75.0		0.0	45.0		0.0	0.0		0.0	0.0		0.0
Storage Lanes	1		0	1		0	0		0	0		0
Taper Length (m)	10.0			10.0			10.0			10.0		
Lane Util. Factor	1.00	0.95	0.95	1.00	0.95	0.95	1.00	1.00	1.00	1.00	1.00	1.00
Ped Bike Factor	1.00	1.00		0.99	1.00			0.98			0.98	
Frt		0.997			0.999			0.911			0.907	
Flt Protected	0.950			0.950				0.984			0.985	
Satd. Flow (prot)	1647	3344	0	1712	3353	0	0	1588	0	0	1547	0
Flt Permitted	0.178			0.239				0.899			0.886	
Satd. Flow (perm)	307	3344	0	428	3353	0	0	1447	0	0	1386	0
Right Turn on Red			Yes			Yes			Yes			Yes
Satd. Flow (RTOR)		4			1			25			46	
Link Speed (k/h)		60			60			40			40	
Link Distance (m)		198.0			310.7			254.0			246.4	
Travel Time (s)		11.9			18.6			22.9			22.2	
Confl. Peds. (#/hr)	17		14	14		17	5		10	10		5
Peak Hour Factor	1.00	1.00	1.00	1.00	1.00	1.00	1.00	1.00	1.00	1.00	1.00	1.00
Heavy Vehicles (%)	5%	3%	1%	1%	3%	1%	1%	1%	1%	1%	1%	5%
Adj. Flow (vph)	16	1097	25	41	1362	5	12	1	25	20	1	46
Shared Lane Traffic (%)												
Lane Group Flow (vph)	16	1122	0	41	1367	0	0	38	0	0	67	0
Enter Blocked Intersection	No	No	No	No	No	No	No	No	No	No	No	No
Lane Alignment	L NA	Left	R NA	L NA	Left	R NA	L NA	Left	R NA	L NA	Left	R NA
Median Width(m)		3.7			3.7			0.0			0.0	
Link Offset(m)		0.0			0.0			0.0			0.0	
Crosswalk Width(m)		5.0			5.0			5.0			5.0	
Two way Left Turn Lane		Yes			Yes							
Headway Factor	1.06	1.06	1.06	1.06	1.06	1.06	1.06	1.06	1.06	1.06	1.06	1.06
Turning Speed (k/h)	24		14	24		14	24		14	24		14
Number of Detectors	1	2		1	2		1	2		1	2	
Detector Template	Left	Thru		Left	Thru		Left	Thru		Left	Thru	
Leading Detector (m)	6.1	30.5		6.1	30.5		6.1	30.5		6.1	30.5	
Trailing Detector (m)	0.0	0.0		0.0	0.0		0.0	0.0		0.0	0.0	
Detector 1 Position(m)	0.0	0.0		0.0	0.0		0.0	0.0		0.0	0.0	
Detector 1 Size(m)	6.1	1.8		6.1	1.8		6.1	1.8		6.1	1.8	
Detector 1 Type	Cl+Ex	Cl+Ex		Cl+Ex	Cl+Ex		Cl+Ex	Cl+Ex		Cl+Ex	Cl+Ex	
Detector 1 Channel												
Detector 1 Extend (s)	0.0	0.0		0.0	0.0		0.0	0.0		0.0	0.0	
Detector 1 Queue (s)	0.0	0.0		0.0	0.0		0.0	0.0		0.0	0.0	
Detector 1 Delay (s)	0.0	0.0		0.0	0.0		0.0	0.0		0.0	0.0	
Detector 2 Position(m)		28.7			28.7			28.7			28.7	
Detector 2 Size(m)		1.8			1.8			1.8			1.8	
Detector 2 Type		Cl+Ex			Cl+Ex			Cl+Ex			Cl+Ex	
Detector 2 Channel												
Detector 2 Extend (s)		0.0			0.0			0.0			0.0	
Turn Type	Perm	NA		Perm	NA		Perm	NA		Perm	NA	
Protected Phases		2			6			8			4	
Permitted Phases	2			6			8			4		
Detector Phase	2	2		6	6		8	8		4	4	
Switch Phase												



Lane Group	EBL	EBT	EBR	WBL	WBT	WBR	NBL	NBT	NBR	SBL	SBT	SBR
Minimum Initial (s)	10.0	10.0		10.0	10.0		10.0	10.0		10.0	10.0	
Minimum Split (s)	26.8	26.8		26.8	26.8		31.6	31.6		31.6	31.6	
Total Split (s)	88.0	88.0		88.0	88.0		32.0	32.0		32.0	32.0	
Total Split (%)	73.3%	73.3%		73.3%	73.3%		26.7%	26.7%		26.7%	26.7%	
Maximum Green (s)	82.2	82.2		82.2	82.2		25.4	25.4		25.4	25.4	
Yellow Time (s)	3.7	3.7		3.7	3.7		3.0	3.0		3.0	3.0	
All-Red Time (s)	2.1	2.1		2.1	2.1		3.6	3.6		3.6	3.6	
Lost Time Adjust (s)	0.0	0.0		0.0	0.0			0.0			0.0	
Total Lost Time (s)	5.8	5.8		5.8	5.8			6.6			6.6	
Lead/Lag												
Lead-Lag Optimize?												
Vehicle Extension (s)	3.0	3.0		3.0	3.0		3.0	3.0		3.0	3.0	
Recall Mode	C-Max	C-Max		C-Max	C-Max		None	None		None	None	
Walk Time (s)	7.0	7.0		7.0	7.0		7.0	7.0		7.0	7.0	
Flash Dont Walk (s)	14.0	14.0		14.0	14.0		18.0	18.0		18.0	18.0	
Pedestrian Calls (#/hr)	14	14		17	17		10	10		5	5	
Act Effct Green (s)	99.1	99.1		99.1	99.1			13.0			13.0	
Actuated g/C Ratio	0.83	0.83		0.83	0.83			0.11			0.11	
v/c Ratio	0.06	0.41		0.12	0.49			0.21			0.35	
Control Delay	4.9	4.7		1.4	3.1			25.5			24.5	
Queue Delay	0.0	0.0		0.0	0.0			0.0			0.0	
Total Delay	4.9	4.7		1.4	3.1			25.5			24.5	
LOS	A	A		A	A			C			C	
Approach Delay		4.7			3.1			25.5			24.5	
Approach LOS		A			A			C			C	
Queue Length 50th (m)	0.6	28.2		0.3	5.1			2.7			4.3	
Queue Length 95th (m)	3.4	66.5		m0.6	75.1			10.8			14.9	
Internal Link Dist (m)		174.0			286.7			230.0			222.4	
Turn Bay Length (m)	75.0			45.0								
Base Capacity (vph)	253	2761		353	2768			325			329	
Starvation Cap Reductn	0	0		0	0			0			0	
Spillback Cap Reductn	0	0		0	0			0			0	
Storage Cap Reductn	0	0		0	0			0			0	
Reduced v/c Ratio	0.06	0.41		0.12	0.49			0.12			0.20	

Intersection Summary

Area Type: Other  
 Cycle Length: 120  
 Actuated Cycle Length: 120  
 Offset: 31 (26%), Referenced to phase 2:EBTL and 6:WBTL, Start of Green  
 Natural Cycle: 70  
 Control Type: Actuated-Coordinated  
 Maximum v/c Ratio: 0.49  
 Intersection Signal Delay: 4.6  
 Intersection Capacity Utilization 62.1%  
 Analysis Period (min) 15  
 m Volume for 95th percentile queue is metered by upstream signal.

Splits and Phases: 1: Stinson Avenue & Robertson Road

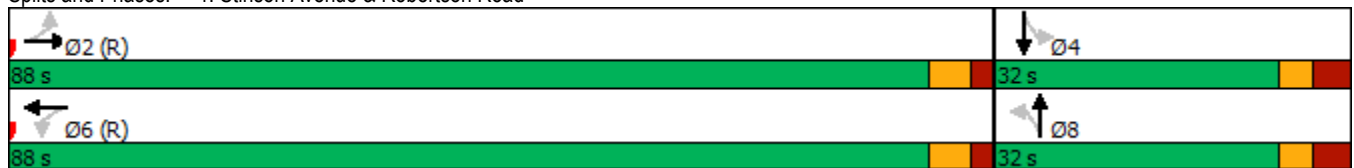



2: Lynhar Road/Stafford Road & Robertson Road  
PM Peak Hour

1826 Robertson Road  
2024 Total Traffic

Lane Group	EBL	EBT	EBR	WBL	WBT	WBR	NBL	NBT	NBR	SBL	SBT	SBR
Lane Configurations												
Traffic Volume (vph)	125	925	68	60	1079	77	99	42	85	201	37	173
Future Volume (vph)	125	925	68	60	1079	77	99	42	85	201	37	173
Ideal Flow (vphpl)	1800	1800	1800	1800	1800	1800	1800	1800	1800	1800	1800	1800
Storage Length (m)	85.0		40.0	0.0		0.0	0.0		30.0	45.0		75.0
Storage Lanes	1		1	1		0	1		1	1		1
Taper Length (m)	10.0			10.0			10.0			30.0		
Lane Util. Factor	1.00	0.95	1.00	1.00	0.95	0.95	1.00	1.00	1.00	1.00	1.00	1.00
Ped Bike Factor	0.99		0.94	0.99	1.00		0.98		0.95	0.97		0.97
Frt			0.850		0.990				0.850			0.850
Flt Protected	0.950			0.950			0.950			0.950		
Satd. Flow (prot)	1712	3357	1532	1712	3342	0	1631	1767	1502	1695	1802	1532
Flt Permitted	0.950			0.950			0.733			0.629		
Satd. Flow (perm)	1701	3357	1443	1694	3342	0	1239	1767	1434	1087	1802	1488
Right Turn on Red			Yes			Yes			Yes			Yes
Satd. Flow (RTOR)			145		7				142			173
Link Speed (k/h)		60			60			40			40	
Link Distance (m)		310.7			66.2			81.0			107.6	
Travel Time (s)		18.6			4.0			7.3			9.7	
Confl. Peds. (#/hr)	22		16	16		22	14		29	29		14
Confl. Bikes (#/hr)												1
Peak Hour Factor	1.00	1.00	1.00	1.00	1.00	1.00	1.00	1.00	1.00	1.00	1.00	1.00
Heavy Vehicles (%)	1%	3%	1%	1%	2%	4%	6%	3%	3%	2%	1%	1%
Adj. Flow (vph)	125	925	68	60	1079	77	99	42	85	201	37	173
Shared Lane Traffic (%)												
Lane Group Flow (vph)	125	925	68	60	1156	0	99	42	85	201	37	173
Enter Blocked Intersection	No	No	No	No	No	No	No	No	No	No	No	No
Lane Alignment	L NA	Left	R NA	L NA	Left	R NA	L NA	L NA	R NA	L NA	Left	R NA
Median Width(m)		3.7			7.4			7.4			7.4	
Link Offset(m)		0.0			0.0			0.0			0.0	
Crosswalk Width(m)		5.0			5.0			5.0			5.0	
Two way Left Turn Lane		Yes										
Headway Factor	1.06	1.06	1.06	1.06	1.06	1.06	1.06	1.06	1.06	1.06	1.06	1.06
Turning Speed (k/h)	24		14	24		14	24		14	24		14
Number of Detectors	1	2	1	1	2		1	2	1	1	2	1
Detector Template	Left	Thru	Right	Left	Thru		Left	Thru	Right	Left	Thru	Right
Leading Detector (m)	6.1	30.5	6.1	6.1	30.5		6.1	30.5	6.1	6.1	30.5	6.1
Trailing Detector (m)	0.0	0.0	0.0	0.0	0.0		0.0	0.0	0.0	0.0	0.0	0.0
Detector 1 Position(m)	0.0	0.0	0.0	0.0	0.0		0.0	0.0	0.0	0.0	0.0	0.0
Detector 1 Size(m)	6.1	1.8	6.1	6.1	1.8		6.1	1.8	6.1	6.1	1.8	6.1
Detector 1 Type	Cl+Ex	Cl+Ex	Cl+Ex	Cl+Ex	Cl+Ex		Cl+Ex	Cl+Ex	Cl+Ex	Cl+Ex	Cl+Ex	Cl+Ex
Detector 1 Channel												
Detector 1 Extend (s)	0.0	0.0	0.0	0.0	0.0		0.0	0.0	0.0	0.0	0.0	0.0
Detector 1 Queue (s)	0.0	0.0	0.0	0.0	0.0		0.0	0.0	0.0	0.0	0.0	0.0
Detector 1 Delay (s)	0.0	0.0	0.0	0.0	0.0		0.0	0.0	0.0	0.0	0.0	0.0
Detector 2 Position(m)		28.7			28.7			28.7			28.7	
Detector 2 Size(m)		1.8			1.8			1.8			1.8	
Detector 2 Type		Cl+Ex			Cl+Ex			Cl+Ex			Cl+Ex	
Detector 2 Channel												
Detector 2 Extend (s)		0.0			0.0			0.0			0.0	
Turn Type	Prot	NA	Perm	Prot	NA		pm+pt	NA	Perm	pm+pt	NA	Perm
Protected Phases	5	2		1	6		3	8		7	4	
Permitted Phases			2				8		8	4		4
Detector Phase	5	2	2	1	6		3	8	8	7	4	4



3: Northside Road East & Robertson Road  
PM Peak Hour

1826 Robertson Road  
2024 Total Traffic

Lane Group	EBL	EBT	EBR	WBL	WBT	WBR	NBL	NBT	NBR	SBL	SBT	SBR
Lane Configurations												
Traffic Volume (vph)	66	1075	16	84	1173	220	138	37	108	155	55	78
Future Volume (vph)	66	1075	16	84	1173	220	138	37	108	155	55	78
Ideal Flow (vphpl)	1800	1800	1800	1800	1800	1800	1800	1800	1800	1800	1800	1800
Storage Length (m)	55.0		0.0	75.0		80.0	0.0		0.0	0.0		0.0
Storage Lanes	1		0	1		1	1		0	1		1
Taper Length (m)	30.0			15.0			10.0			10.0		
Lane Util. Factor	1.00	0.95	0.95	1.00	0.95	1.00	1.00	1.00	1.00	1.00	1.00	1.00
Ped Bike Factor		1.00		1.00		0.97	0.98	0.99		0.99		0.96
Frt		0.998				0.850		0.888				0.850
Flt Protected	0.950			0.950			0.950			0.950		
Satd. Flow (prot)	1712	3383	0	1712	3390	1532	1695	1557	0	1712	1802	1532
Flt Permitted	0.167			0.262			0.721			0.611		
Satd. Flow (perm)	301	3383	0	471	3390	1488	1257	1557	0	1094	1802	1469
Right Turn on Red			Yes			Yes			Yes			Yes
Satd. Flow (RTOR)		2				220		108				101
Link Speed (k/h)		60			60			40				40
Link Distance (m)		105.4			310.9			87.0				90.9
Travel Time (s)		6.3			18.7			7.8				8.2
Confl. Peds. (#/hr)	3		7	7		3	16		5	5		16
Confl. Bikes (#/hr)			1			2						4
Peak Hour Factor	1.00	1.00	1.00	1.00	1.00	1.00	1.00	1.00	1.00	1.00	1.00	1.00
Heavy Vehicles (%)	1%	2%	1%	1%	2%	1%	2%	3%	2%	1%	1%	1%
Adj. Flow (vph)	66	1075	16	84	1173	220	138	37	108	155	55	78
Shared Lane Traffic (%)												
Lane Group Flow (vph)	66	1091	0	84	1173	220	138	145	0	155	55	78
Enter Blocked Intersection	No	No	No	No	No	No	No	No	No	No	No	No
Lane Alignment	L NA	Left	R NA	L NA	Left	R NA	L NA	Left	R NA	L NA	Left	R NA
Median Width(m)		5.5			5.5			3.7				3.7
Link Offset(m)		0.0			0.0			0.0				0.0
Crosswalk Width(m)		5.0			5.0			5.0				5.0
Two way Left Turn Lane												
Headway Factor	1.06	1.06	1.06	1.06	1.06	1.06	1.06	1.06	1.06	1.06	1.06	1.06
Turning Speed (k/h)	24		14	24		14	24		14	24		14
Number of Detectors	1	2		1	2	1	1	2		1	2	1
Detector Template	Left	Thru		Left	Thru	Right	Left	Thru		Left	Thru	Right
Leading Detector (m)	6.1	30.5		6.1	30.5	6.1	6.1	30.5		6.1	30.5	6.1
Trailing Detector (m)	0.0	0.0		0.0	0.0	0.0	0.0	0.0		0.0	0.0	0.0
Detector 1 Position(m)	0.0	0.0		0.0	0.0	0.0	0.0	0.0		0.0	0.0	0.0
Detector 1 Size(m)	6.1	1.8		6.1	1.8	6.1	6.1	1.8		6.1	1.8	6.1
Detector 1 Type	Cl+Ex	Cl+Ex		Cl+Ex	Cl+Ex	Cl+Ex	Cl+Ex	Cl+Ex		Cl+Ex	Cl+Ex	Cl+Ex
Detector 1 Channel												
Detector 1 Extend (s)	0.0	0.0		0.0	0.0	0.0	0.0	0.0		0.0	0.0	0.0
Detector 1 Queue (s)	0.0	0.0		0.0	0.0	0.0	0.0	0.0		0.0	0.0	0.0
Detector 1 Delay (s)	0.0	0.0		0.0	0.0	0.0	0.0	0.0		0.0	0.0	0.0
Detector 2 Position(m)		28.7			28.7			28.7				28.7
Detector 2 Size(m)		1.8			1.8			1.8				1.8
Detector 2 Type		Cl+Ex			Cl+Ex			Cl+Ex				Cl+Ex
Detector 2 Channel												
Detector 2 Extend (s)		0.0			0.0			0.0				0.0
Turn Type	pm+pt	NA		Perm	NA	Perm	Perm	NA		Perm	NA	Perm
Protected Phases	5	2			6			8				4
Permitted Phases	2			6		6	8			4		4
Detector Phase	5	2		6	6	6	8	8		4	4	4

Lane Group	Ø3	Ø7
Lane Configurations		
Traffic Volume (vph)		
Future Volume (vph)		
Ideal Flow (vphpl)		
Storage Length (m)		
Storage Lanes		
Taper Length (m)		
Lane Util. Factor		
Ped Bike Factor		
Frt		
Flt Protected		
Satd. Flow (prot)		
Flt Permitted		
Satd. Flow (perm)		
Right Turn on Red		
Satd. Flow (RTOR)		
Link Speed (k/h)		
Link Distance (m)		
Travel Time (s)		
Confl. Peds. (#/hr)		
Confl. Bikes (#/hr)		
Peak Hour Factor		
Heavy Vehicles (%)		
Adj. Flow (vph)		
Shared Lane Traffic (%)		
Lane Group Flow (vph)		
Enter Blocked Intersection		
Lane Alignment		
Median Width(m)		
Link Offset(m)		
Crosswalk Width(m)		
Two way Left Turn Lane		
Headway Factor		
Turning Speed (k/h)		
Number of Detectors		
Detector Template		
Leading Detector (m)		
Trailing Detector (m)		
Detector 1 Position(m)		
Detector 1 Size(m)		
Detector 1 Type		
Detector 1 Channel		
Detector 1 Extend (s)		
Detector 1 Queue (s)		
Detector 1 Delay (s)		
Detector 2 Position(m)		
Detector 2 Size(m)		
Detector 2 Type		
Detector 2 Channel		
Detector 2 Extend (s)		
Turn Type		
Protected Phases	3	7
Permitted Phases		
Detector Phase		

3: Northside Road East & Robertson Road  
PM Peak Hour

1826 Robertson Road  
2024 Total Traffic



Lane Group	EBL	EBT	EBR	WBL	WBT	WBR	NBL	NBT	NBR	SBL	SBT	SBR
Switch Phase												
Minimum Initial (s)	5.0	10.0		10.0	10.0	10.0	10.0	10.0		10.0	10.0	10.0
Minimum Split (s)	11.0	30.1		30.1	30.1	30.1	29.8	29.8		29.8	29.8	29.8
Total Split (s)	15.0	83.0		68.0	68.0	68.0	31.0	31.0		31.0	31.0	31.0
Total Split (%)	12.5%	69.2%		56.7%	56.7%	56.7%	25.8%	25.8%		25.8%	25.8%	25.8%
Maximum Green (s)	9.0	76.9		61.9	61.9	61.9	24.2	24.2		24.2	24.2	24.2
Yellow Time (s)	3.7	3.7		3.7	3.7	3.7	3.0	3.0		3.0	3.0	3.0
All-Red Time (s)	2.3	2.4		2.4	2.4	2.4	3.8	3.8		3.8	3.8	3.8
Lost Time Adjust (s)	0.0	0.0		0.0	0.0	0.0	0.0	0.0		0.0	0.0	0.0
Total Lost Time (s)	6.0	6.1		6.1	6.1	6.1	6.8	6.8		6.8	6.8	6.8
Lead/Lag	Lead			Lag	Lag	Lag	Lag	Lag		Lag	Lag	Lag
Lead-Lag Optimize?	Yes			Yes	Yes	Yes	Yes	Yes		Yes	Yes	Yes
Vehicle Extension (s)	3.0	3.0		3.0	3.0	3.0	3.0	3.0		3.0	3.0	3.0
Recall Mode	None	C-Max		C-Max	C-Max	C-Max	None	None		None	None	None
Walk Time (s)		7.0		7.0	7.0	7.0	1.0	1.0		1.0	1.0	1.0
Flash Dont Walk (s)		17.0		17.0	17.0	17.0	22.0	22.0		22.0	22.0	22.0
Pedestrian Calls (#/hr)		7		3	3	3	5	5		16	16	16
Act Effct Green (s)	85.2	85.1		74.4	74.4	74.4	22.0	22.0		22.0	22.0	22.0
Actuated g/C Ratio	0.71	0.71		0.62	0.62	0.62	0.18	0.18		0.18	0.18	0.18
v/c Ratio	0.22	0.45		0.29	0.56	0.22	0.60	0.39		0.78	0.17	0.22
Control Delay	8.7	8.8		17.3	16.5	2.4	54.7	15.2		70.3	39.7	5.1
Queue Delay	0.0	0.0		0.0	0.0	0.0	0.0	0.0		0.0	0.0	0.0
Total Delay	8.7	8.8		17.3	16.5	2.4	54.7	15.2		70.3	39.7	5.1
LOS	A	A		B	B	A	D	B		E	D	A
Approach Delay		8.8			14.5			34.5			46.8	
Approach LOS		A			B			C			D	
Queue Length 50th (m)	4.2	45.5		8.4	77.3	0.0	27.7	6.8		32.2	10.1	0.0
Queue Length 95th (m)	m7.3	53.3		22.2	116.9	10.7	43.5	21.5		50.1	19.1	6.9
Internal Link Dist (m)		81.4			286.9			63.0			66.9	
Turn Bay Length (m)	55.0			75.0		80.0						
Base Capacity (vph)	319	2399		291	2100	1005	269	419		234	386	394
Starvation Cap Reductn	0	0		0	0	0	0	0		0	0	0
Spillback Cap Reductn	0	0		0	0	0	0	0		0	0	0
Storage Cap Reductn	0	0		0	0	0	0	0		0	0	0
Reduced v/c Ratio	0.21	0.45		0.29	0.56	0.22	0.51	0.35		0.66	0.14	0.20

Intersection Summary

Area Type: Other  
 Cycle Length: 120  
 Actuated Cycle Length: 120  
 Offset: 111 (93%), Referenced to phase 2:EBTL and 6:WBTL, Start of Green  
 Natural Cycle: 80  
 Control Type: Actuated-Coordinated  
 Maximum v/c Ratio: 0.78  
 Intersection Signal Delay: 17.1 Intersection LOS: B  
 Intersection Capacity Utilization 82.9% ICU Level of Service E  
 Analysis Period (min) 15  
 m Volume for 95th percentile queue is metered by upstream signal.

Splits and Phases: 3: Northside Road East & Robertson Road

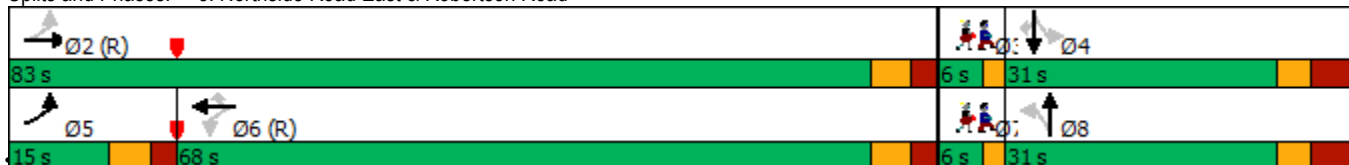

Lane Group	Ø3	Ø7
Switch Phase		
Minimum Initial (s)	4.0	4.0
Minimum Split (s)	6.0	6.0
Total Split (s)	6.0	6.0
Total Split (%)	5%	5%
Maximum Green (s)	4.0	4.0
Yellow Time (s)	2.0	2.0
All-Red Time (s)	0.0	0.0
Lost Time Adjust (s)		
Total Lost Time (s)		
Lead/Lag	Lead	Lead
Lead-Lag Optimize?	Yes	Yes
Vehicle Extension (s)	3.0	3.0
Recall Mode	None	None
Walk Time (s)		
Flash Dont Walk (s)		
Pedestrian Calls (#/hr)		
Act Effct Green (s)		
Actuated g/C Ratio		
v/c Ratio		
Control Delay		
Queue Delay		
Total Delay		
LOS		
Approach Delay		
Approach LOS		
Queue Length 50th (m)		
Queue Length 95th (m)		
Internal Link Dist (m)		
Turn Bay Length (m)		
Base Capacity (vph)		
Starvation Cap Reductn		
Spillback Cap Reductn		
Storage Cap Reductn		
Reduced v/c Ratio		
Intersection Summary		

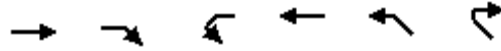

Lane Group	EBT	EBR	WBL	WBT	NWL	NWR
Lane Configurations	↑↑			↑↑↑		
Traffic Volume (vph)	1096	117	0	1217	0	0
Future Volume (vph)	1096	117	0	1217	0	0
Ideal Flow (vphpl)	1800	1800	1800	1800	1800	1800
Storage Length (m)		0.0	25.0		0.0	0.0
Storage Lanes		0	1		0	0
Taper Length (m)			25.0		10.0	
Lane Util. Factor	0.95	0.95	1.00	0.91	1.00	1.00
Fr <sub>t</sub>	0.986					
<b>Flt Protected</b>						
Satd. Flow (prot)	3330	0	0	4871	0	0
<b>Flt Permitted</b>						
Satd. Flow (perm)	3330	0	0	4871	0	0
Link Speed (k/h)	60			60	50	
Link Distance (m)	66.2			72.0	100.3	
Travel Time (s)	4.0			4.3	7.2	
Peak Hour Factor	1.00	1.00	1.00	1.00	1.00	1.00
Heavy Vehicles (%)	2%	6%	1%	2%	1%	1%
Adj. Flow (vph)	1096	117	0	1217	0	0
<b>Shared Lane Traffic (%)</b>						
Lane Group Flow (vph)	1213	0	0	1217	0	0
Enter Blocked Intersection	Yes	Yes	Yes	Yes	No	No
Lane Alignment	Left	Right	Left	Left	Left	Right
Median Width(m)	3.7			3.7	0.0	
Link Offset(m)	0.0			0.0	0.0	
Crosswalk Width(m)	0.0			0.0	0.0	
<b>Two way Left Turn Lane</b>						
Headway Factor	1.06	1.06	1.06	1.06	1.06	1.06
Turning Speed (k/h)		50	24		24	14
Sign Control	Free			Free	Free	

**Intersection Summary**

Area Type: Other

Control Type: Unsignalized

Intersection Capacity Utilization 39.2% ICU Level of Service A

Analysis Period (min) 15





















Lane Group	EBT	EBR	WBL	WBT	NBL	NBR
Lane Configurations						
Traffic Volume (vph)	107	10	103	0	0	81
Future Volume (vph)	107	10	103	0	0	81
Ideal Flow (vphpl)	1800	1800	1800	1800	1800	1800
Lane Util. Factor	1.00	1.00	1.00	1.00	1.00	1.00
Ped Bike Factor						
Frt	0.988					0.865
Flt Protected			0.950			
Satd. Flow (prot)	1689	0	1631	0	0	1514
Flt Permitted			0.950			
Satd. Flow (perm)	1689	0	1631	0	0	1514
Link Speed (k/h)	50			40	40	
Link Distance (m)	100.3			62.0	54.2	
Travel Time (s)	7.2			5.6	4.9	
Confl. Peds. (#/hr)		12	12			
Confl. Bikes (#/hr)		1				1
Peak Hour Factor	1.00	1.00	1.00	1.00	1.00	1.00
Heavy Vehicles (%)	7%	1%	6%	1%	1%	4%
Adj. Flow (vph)	107	10	103	0	0	81
Shared Lane Traffic (%)						
Lane Group Flow (vph)	117	0	103	0	0	81
Enter Blocked Intersection	No	No	No	No	No	No
Lane Alignment	L NA	R NA	L NA	R NA	Left	R NA
Median Width(m)	3.7			3.7	0.0	
Link Offset(m)	3.0			3.0	0.0	
Crosswalk Width(m)	5.0			5.0	5.0	
Two way Left Turn Lane						
Headway Factor	1.06	1.06	1.06	1.06	1.06	1.06
Turning Speed (k/h)		14	24		24	14
Sign Control	Stop			Stop	Stop	

**Intersection Summary**

Area Type:	Other
Control Type:	Unsignalized
Intersection Capacity Utilization 20.8%	ICU Level of Service A
Analysis Period (min)	15



						
Lane Group	WBL	WBR	NBT	NBR	SBL	SBT
Lane Configurations						
Traffic Volume (vph)	3	83	143	3	70	95
Future Volume (vph)	3	83	143	3	70	95
Ideal Flow (vphpl)	1800	1800	1800	1800	1800	1800
Storage Length (m)	0.0	0.0		45.0	15.0	
Storage Lanes	1	0		0	1	
Taper Length (m)	10.0				20.0	
Lane Util. Factor	1.00	1.00	0.95	0.95	1.00	1.00
Frt	0.870		0.997			
Flt Protected	0.998				0.950	
Satd. Flow (prot)	1565	0	3381	0	1712	1784
Flt Permitted	0.998				0.950	
Satd. Flow (perm)	1565	0	3381	0	1712	1784
Link Speed (k/h)	40		40			40
Link Distance (m)	173.4		68.2			81.0
Travel Time (s)	15.6		6.1			7.3
Peak Hour Factor	1.00	1.00	1.00	1.00	1.00	1.00
Heavy Vehicles (%)	1%	1%	2%	1%	1%	2%
Adj. Flow (vph)	3	83	143	3	70	95
Shared Lane Traffic (%)						
Lane Group Flow (vph)	86	0	146	0	70	95
Enter Blocked Intersection	No	No	No	No	No	No
Lane Alignment	Left	Right	Left	Right	Left	Left
Median Width(m)	3.7		3.7			3.7
Link Offset(m)	0.0		0.0			0.0
Crosswalk Width(m)	5.0		5.0			5.0
Two way Left Turn Lane						
Headway Factor	1.06	1.06	1.06	1.06	1.06	1.06
Turning Speed (k/h)	24	14		14	24	
Sign Control	Stop		Free			Free
<b>Intersection Summary</b>						
Area Type:	Other					
Control Type:	Unsignalized					
Intersection Capacity Utilization	24.0%			ICU Level of Service A		
Analysis Period (min)	15					

						
Lane Group	WBL	WBR	NBT	NBR	SBL	SBT
Lane Configurations						
Traffic Volume (vph)	1	9	137	1	8	90
Future Volume (vph)	1	9	137	1	8	90
Ideal Flow (vphpl)	1800	1800	1800	1800	1800	1800
Lane Util. Factor	1.00	1.00	1.00	1.00	1.00	1.00
Frt	0.878		0.999			
Flt Protected	0.995					0.996
Satd. Flow (prot)	1574	0	1783	0	0	1779
Flt Permitted	0.995					0.996
Satd. Flow (perm)	1574	0	1783	0	0	1779
Link Speed (k/h)	50		50			50
Link Distance (m)	178.0		82.4			68.2
Travel Time (s)	12.8		5.9			4.9
Peak Hour Factor	1.00	1.00	1.00	1.00	1.00	1.00
Heavy Vehicles (%)	1%	1%	2%	1%	1%	2%
Adj. Flow (vph)	1	9	137	1	8	90
Shared Lane Traffic (%)						
Lane Group Flow (vph)	10	0	138	0	0	98
Enter Blocked Intersection	No	No	No	No	No	No
Lane Alignment	L NA	R NA	Left	Right	Left	Left
Median Width(m)	3.7		0.0			0.0
Link Offset(m)	0.0		0.0			0.0
Crosswalk Width(m)	5.0		5.0			5.0
Two way Left Turn Lane						
Headway Factor	1.06	1.06	1.06	1.06	1.06	1.06
Turning Speed (k/h)	97	97		97	97	
Sign Control	Stop		Free			Free
<b>Intersection Summary</b>						
Area Type:	Other					
Control Type:	Unsignalized					
Intersection Capacity Utilization	22.0%			ICU Level of Service A		
Analysis Period (min)	15					



Lane Group	EBL	EBR	NBL	NBT	SBT	SBR
Lane Configurations						
Traffic Volume (vph)	25	0	0	56	74	39
Future Volume (vph)	25	0	0	56	74	39
Ideal Flow (vphpl)	1800	1800	1800	1800	1800	1800
Lane Util. Factor	1.00	1.00	1.00	1.00	1.00	1.00
Fr <sub>t</sub>						0.953
Flt Protected	0.950					
Satd. Flow (prot)	1712	0	0	1802	1711	0
Flt Permitted	0.950					
Satd. Flow (perm)	1712	0	0	1802	1711	0
Link Speed (k/h)	40			40	40	
Link Distance (m)	173.4			67.2	54.2	
Travel Time (s)	15.6			6.0	4.9	
Peak Hour Factor	1.00	1.00	1.00	1.00	1.00	1.00
Heavy Vehicles (%)	1%	1%	1%	1%	1%	2%
Adj. Flow (vph)	25	0	0	56	74	39
Shared Lane Traffic (%)						
Lane Group Flow (vph)	25	0	0	56	113	0
Enter Blocked Intersection	No	No	No	No	No	No
Lane Alignment	Left	Right	Left	Left	Left	Right
Median Width(m)	3.7			0.0	0.0	
Link Offset(m)	0.0			0.0	0.0	
Crosswalk Width(m)	5.0			5.0	5.0	
Two way Left Turn Lane						
Headway Factor	1.06	1.06	1.06	1.06	1.06	1.06
Turning Speed (k/h)	24	14	24			14
Sign Control	Stop			Free	Free	

**Intersection Summary**

Area Type:	Other
Control Type:	Unsignalized
Intersection Capacity Utilization	16.6%
Analysis Period (min)	15
	ICU Level of Service A



Lane Group	EBL	EBR	NBL	NBT	SBT	SBR
Lane Configurations						
Traffic Volume (vph)	8	0	0	48	67	7
Future Volume (vph)	8	0	0	48	67	7
Ideal Flow (vphpl)	1800	1800	1800	1800	1800	1800
Lane Util. Factor	1.00	1.00	1.00	1.00	1.00	1.00
Frt					0.987	
Flt Protected	0.950					
Satd. Flow (prot)	1712	0	0	1802	1779	0
Flt Permitted	0.950					
Satd. Flow (perm)	1712	0	0	1802	1779	0
Link Speed (k/h)	50			50	50	
Link Distance (m)	178.0			106.1	67.2	
Travel Time (s)	12.8			7.6	4.8	
Peak Hour Factor	1.00	1.00	1.00	1.00	1.00	1.00
Heavy Vehicles (%)	1%	1%	1%	1%	1%	1%
Adj. Flow (vph)	8	0	0	48	67	7
Shared Lane Traffic (%)						
Lane Group Flow (vph)	8	0	0	48	74	0
Enter Blocked Intersection	No	No	No	No	No	No
Lane Alignment	L NA	R NA	Left	Left	Left	Right
Median Width(m)	3.7			0.0	0.0	
Link Offset(m)	0.0			0.0	0.0	
Crosswalk Width(m)	5.0			5.0	5.0	
Two way Left Turn Lane						
Headway Factor	1.06	1.06	1.06	1.06	1.06	1.06
Turning Speed (k/h)	97	97	97			97
Sign Control	Stop			Free	Free	

**Intersection Summary**

Area Type:	Other
Control Type:	Unsignalized
Intersection Capacity Utilization	14.2%
Analysis Period (min)	15
	ICU Level of Service A

1: Stinson Avenue & Robertson Road  
SAT Peak Hour

1826 Robertson Road  
2024 Total Traffic

Lane Group	EBL	EBT	EBR	WBL	WBT	WBR	NBL	NBT	NBR	SBL	SBT	SBR
Lane Configurations												
Traffic Volume (vph)	15	1052	24	45	976	4	10	0	32	3	1	8
Future Volume (vph)	15	1052	24	45	976	4	10	0	32	3	1	8
Ideal Flow (vphpl)	1800	1800	1800	1800	1800	1800	1800	1800	1800	1800	1800	1800
Storage Length (m)	75.0		0.0	45.0		0.0	0.0		0.0	0.0		0.0
Storage Lanes	1		0	1		0	0		0	0		0
Taper Length (m)	10.0			10.0			10.0			10.0		
Lane Util. Factor	1.00	0.95	0.95	1.00	0.95	0.95	1.00	1.00	1.00	1.00	1.00	1.00
Ped Bike Factor	0.99	1.00		1.00	1.00			0.99			0.99	
Frt		0.997			0.999			0.897			0.910	
Flt Protected	0.950			0.950				0.988			0.988	
Satd. Flow (prot)	1712	3409	0	1712	3420	0	0	1576	0	0	1606	0
Flt Permitted	0.281			0.252				0.919			0.923	
Satd. Flow (perm)	503	3409	0	453	3420	0	0	1465	0	0	1498	0
Right Turn on Red			Yes			Yes			Yes			Yes
Satd. Flow (RTOR)		4			1			32			8	
Link Speed (k/h)		60			60			40			40	
Link Distance (m)		198.0			310.7			254.0			246.4	
Travel Time (s)		11.9			18.6			22.9			22.2	
Confl. Peds. (#/hr)	10		4	4		10	1		4	4		1
Confl. Bikes (#/hr)			4			2						
Peak Hour Factor	1.00	1.00	1.00	1.00	1.00	1.00	1.00	1.00	1.00	1.00	1.00	1.00
Heavy Vehicles (%)	1%	1%	4%	1%	1%	1%	1%	1%	1%	1%	1%	1%
Adj. Flow (vph)	15	1052	24	45	976	4	10	0	32	3	1	8
Shared Lane Traffic (%)												
Lane Group Flow (vph)	15	1076	0	45	980	0	0	42	0	0	12	0
Enter Blocked Intersection	No	No	No	No	No	No	No	No	No	No	No	No
Lane Alignment	L NA	Left	R NA	L NA	Left	R NA	L NA	Left	R NA	L NA	Left	R NA
Median Width(m)		3.7			3.7			0.0			0.0	
Link Offset(m)		0.0			0.0			0.0			0.0	
Crosswalk Width(m)		5.0			5.0			5.0			5.0	
Two way Left Turn Lane		Yes			Yes							
Headway Factor	1.06	1.06	1.06	1.06	1.06	1.06	1.06	1.06	1.06	1.06	1.06	1.06
Turning Speed (k/h)	24		14	24		14	24		14	24		14
Number of Detectors	1	2		1	2		1	2		1	2	
Detector Template	Left	Thru		Left	Thru		Left	Thru		Left	Thru	
Leading Detector (m)	6.1	30.5		6.1	30.5		6.1	30.5		6.1	30.5	
Trailing Detector (m)	0.0	0.0		0.0	0.0		0.0	0.0		0.0	0.0	
Detector 1 Position(m)	0.0	0.0		0.0	0.0		0.0	0.0		0.0	0.0	
Detector 1 Size(m)	6.1	1.8		6.1	1.8		6.1	1.8		6.1	1.8	
Detector 1 Type	Cl+Ex	Cl+Ex		Cl+Ex	Cl+Ex		Cl+Ex	Cl+Ex		Cl+Ex	Cl+Ex	
Detector 1 Channel												
Detector 1 Extend (s)	0.0	0.0		0.0	0.0		0.0	0.0		0.0	0.0	
Detector 1 Queue (s)	0.0	0.0		0.0	0.0		0.0	0.0		0.0	0.0	
Detector 1 Delay (s)	0.0	0.0		0.0	0.0		0.0	0.0		0.0	0.0	
Detector 2 Position(m)		28.7			28.7			28.7			28.7	
Detector 2 Size(m)		1.8			1.8			1.8			1.8	
Detector 2 Type		Cl+Ex			Cl+Ex			Cl+Ex			Cl+Ex	
Detector 2 Channel												
Detector 2 Extend (s)		0.0			0.0			0.0			0.0	
Turn Type	Perm	NA		Perm	NA		Perm	NA		Perm	NA	
Protected Phases		2			6			8			4	
Permitted Phases	2			6			8			4		
Detector Phase	2	2		6	6		8	8		4	4	



Lane Group	EBL	EBT	EBR	WBL	WBT	WBR	NBL	NBT	NBR	SBL	SBT	SBR
Switch Phase												
Minimum Initial (s)	10.0	10.0		10.0	10.0		10.0	10.0		10.0	10.0	
Minimum Split (s)	26.8	26.8		26.8	26.8		31.6	31.6		31.6	31.6	
Total Split (s)	88.0	88.0		88.0	88.0		32.0	32.0		32.0	32.0	
Total Split (%)	73.3%	73.3%		73.3%	73.3%		26.7%	26.7%		26.7%	26.7%	
Maximum Green (s)	82.2	82.2		82.2	82.2		25.4	25.4		25.4	25.4	
Yellow Time (s)	3.7	3.7		3.7	3.7		3.0	3.0		3.0	3.0	
All-Red Time (s)	2.1	2.1		2.1	2.1		3.6	3.6		3.6	3.6	
Lost Time Adjust (s)	0.0	0.0		0.0	0.0			0.0			0.0	
Total Lost Time (s)	5.8	5.8		5.8	5.8			6.6			6.6	
Lead/Lag												
Lead-Lag Optimize?												
Vehicle Extension (s)	3.0	3.0		3.0	3.0		3.0	3.0		3.0	3.0	
Recall Mode	C-Max	C-Max		C-Max	C-Max		None	None		None	None	
Walk Time (s)	7.0	7.0		7.0	7.0		7.0	7.0		7.0	7.0	
Flash Dont Walk (s)	14.0	14.0		14.0	14.0		18.0	18.0		18.0	18.0	
Pedestrian Calls (#/hr)	4	4		10	10		4	4		1	1	
Act Effct Green (s)	99.1	99.1		99.1	99.1			13.0			13.0	
Actuated g/C Ratio	0.83	0.83		0.83	0.83			0.11			0.11	
v/c Ratio	0.04	0.38		0.12	0.35			0.22			0.07	
Control Delay	4.3	4.5		1.7	2.1			22.3			28.4	
Queue Delay	0.0	0.0		0.0	0.0			0.0			0.0	
Total Delay	4.3	4.5		1.7	2.1			22.3			28.4	
LOS	A	A		A	A			C			C	
Approach Delay		4.5			2.1			22.3			28.4	
Approach LOS		A			A			C			C	
Queue Length 50th (m)	0.5	26.2		0.3	3.8			2.0			0.8	
Queue Length 95th (m)	3.0	61.9		m0.8	20.5			10.5			5.5	
Internal Link Dist (m)		174.0			286.7			230.0			222.4	
Turn Bay Length (m)	75.0			45.0								
Base Capacity (vph)	415	2815		374	2823			335			323	
Starvation Cap Reductn	0	0		0	0			0			0	
Spillback Cap Reductn	0	0		0	0			0			0	
Storage Cap Reductn	0	0		0	0			0			0	
Reduced v/c Ratio	0.04	0.38		0.12	0.35			0.13			0.04	

Intersection Summary

Area Type: Other  
 Cycle Length: 120  
 Actuated Cycle Length: 120  
 Offset: 31 (26%), Referenced to phase 2:EBTL and 6:WBTL, Start of Green  
 Natural Cycle: 60  
 Control Type: Actuated-Coordinated  
 Maximum v/c Ratio: 0.38  
 Intersection Signal Delay: 3.8 Intersection LOS: A  
 Intersection Capacity Utilization 59.7% ICU Level of Service B  
 Analysis Period (min) 15  
 m Volume for 95th percentile queue is metered by upstream signal.

Splits and Phases: 1: Stinson Avenue & Robertson Road



2: Lynhar Road/Stafford Road & Robertson Road  
SAT Peak Hour

1826 Robertson Road  
2024 Total Traffic

Lane Group	EBL	EBT	EBR	WBL	WBT	WBR	NBL	NBT	NBR	SBL	SBT	SBR
Lane Configurations												
Traffic Volume (vph)	134	834	100	45	762	60	99	28	91	83	20	153
Future Volume (vph)	134	834	100	45	762	60	99	28	91	83	20	153
Ideal Flow (vphpl)	1800	1800	1800	1800	1800	1800	1800	1800	1800	1800	1800	1800
Storage Length (m)	85.0		40.0	0.0		0.0	0.0		30.0	45.0		75.0
Storage Lanes	1		1	1		0	1		1	1		1
Taper Length (m)	10.0			10.0			10.0			30.0		
Lane Util. Factor	1.00	0.95	1.00	1.00	0.95	0.95	1.00	1.00	1.00	1.00	1.00	1.00
Ped Bike Factor	1.00		0.94	0.99	1.00		0.98		0.96	0.98		0.97
Frt			0.850		0.989				0.850			0.850
Flt Protected	0.950			0.950			0.950			0.950		
Satd. Flow (prot)	1695	3424	1517	1712	3350	0	1712	1802	1532	1695	1802	1532
Flt Permitted	0.950			0.950			0.709			0.739		
Satd. Flow (perm)	1691	3424	1419	1690	3350	0	1255	1802	1474	1288	1802	1484
Right Turn on Red			Yes			Yes			Yes			Yes
Satd. Flow (RTOR)			145		8				142			153
Link Speed (k/h)		60			60			40			40	
Link Distance (m)		310.7			66.2			81.0			107.6	
Travel Time (s)		18.6			4.0			7.3			9.7	
Confl. Peds. (#/hr)	5		17	17		5	16		21	21		16
Confl. Bikes (#/hr)			5			4			2			1
Peak Hour Factor	1.00	1.00	1.00	1.00	1.00	1.00	1.00	1.00	1.00	1.00	1.00	1.00
Heavy Vehicles (%)	2%	1%	2%	1%	2%	1%	1%	1%	1%	2%	1%	1%
Adj. Flow (vph)	134	834	100	45	762	60	99	28	91	83	20	153
Shared Lane Traffic (%)												
Lane Group Flow (vph)	134	834	100	45	822	0	99	28	91	83	20	153
Enter Blocked Intersection	No	No	No	No	No	No	No	No	No	No	No	No
Lane Alignment	L NA	Left	R NA	L NA	Left	R NA	L NA	L NA	R NA	L NA	Left	R NA
Median Width(m)		3.7			7.4			7.4			7.4	
Link Offset(m)		0.0			0.0			0.0			0.0	
Crosswalk Width(m)		5.0			5.0			5.0			5.0	
Two way Left Turn Lane		Yes										
Headway Factor	1.06	1.06	1.06	1.06	1.06	1.06	1.06	1.06	1.06	1.06	1.06	1.06
Turning Speed (k/h)	24		14	24		14	24		14	24		14
Number of Detectors	1	2	1	1	2		1	2	1	1	2	1
Detector Template	Left	Thru	Right	Left	Thru		Left	Thru	Right	Left	Thru	Right
Leading Detector (m)	6.1	30.5	6.1	6.1	30.5		6.1	30.5	6.1	6.1	30.5	6.1
Trailing Detector (m)	0.0	0.0	0.0	0.0	0.0		0.0	0.0	0.0	0.0	0.0	0.0
Detector 1 Position(m)	0.0	0.0	0.0	0.0	0.0		0.0	0.0	0.0	0.0	0.0	0.0
Detector 1 Size(m)	6.1	1.8	6.1	6.1	1.8		6.1	1.8	6.1	6.1	1.8	6.1
Detector 1 Type	Cl+Ex	Cl+Ex	Cl+Ex	Cl+Ex	Cl+Ex		Cl+Ex	Cl+Ex	Cl+Ex	Cl+Ex	Cl+Ex	Cl+Ex
Detector 1 Channel												
Detector 1 Extend (s)	0.0	0.0	0.0	0.0	0.0		0.0	0.0	0.0	0.0	0.0	0.0
Detector 1 Queue (s)	0.0	0.0	0.0	0.0	0.0		0.0	0.0	0.0	0.0	0.0	0.0
Detector 1 Delay (s)	0.0	0.0	0.0	0.0	0.0		0.0	0.0	0.0	0.0	0.0	0.0
Detector 2 Position(m)		28.7			28.7			28.7			28.7	
Detector 2 Size(m)		1.8			1.8			1.8			1.8	
Detector 2 Type		Cl+Ex			Cl+Ex			Cl+Ex			Cl+Ex	
Detector 2 Channel												
Detector 2 Extend (s)		0.0			0.0			0.0			0.0	
Turn Type	Prot	NA	Perm	Prot	NA		pm+pt	NA	Perm	pm+pt	NA	Perm
Protected Phases	5	2		1	6		3	8		7	4	
Permitted Phases			2				8		8	4		4
Detector Phase	5	2	2	1	6		3	8	8	7	4	4



Lane Group	EBL	EBT	EBR	WBL	WBT	WBR	NBL	NBT	NBR	SBL	SBT	SBR
Switch Phase												
Minimum Initial (s)	5.0	10.0	10.0	5.0	10.0		5.0	10.0	10.0	5.0	10.0	10.0
Minimum Split (s)	11.1	31.3	31.3	11.1	31.3		11.2	37.7	37.7	11.2	37.7	37.7
Total Split (s)	15.0	54.0	54.0	15.0	54.0		12.0	39.0	39.0	12.0	39.0	39.0
Total Split (%)	12.5%	45.0%	45.0%	12.5%	45.0%		10.0%	32.5%	32.5%	10.0%	32.5%	32.5%
Maximum Green (s)	8.9	47.7	47.7	8.9	47.7		5.8	32.3	32.3	5.8	32.3	32.3
Yellow Time (s)	3.7	3.7	3.7	3.7	3.7		3.0	3.0	3.0	3.0	3.0	3.0
All-Red Time (s)	2.4	2.6	2.6	2.4	2.6		3.2	3.7	3.7	3.2	3.7	3.7
Lost Time Adjust (s)	0.0	0.0	0.0	0.0	0.0		0.0	0.0	0.0	0.0	0.0	0.0
Total Lost Time (s)	6.1	6.3	6.3	6.1	6.3		6.2	6.7	6.7	6.2	6.7	6.7
Lead/Lag	Lead	Lag	Lag	Lead	Lag		Lead	Lag	Lag	Lead	Lag	Lag
Lead-Lag Optimize?	Yes	Yes	Yes	Yes	Yes		Yes	Yes	Yes	Yes	Yes	Yes
Vehicle Extension (s)	3.0	3.0	3.0	3.0	3.0		3.0	3.0	3.0	3.0	3.0	3.0
Recall Mode	None	C-Max	C-Max	None	C-Max		None	None	None	None	None	None
Walk Time (s)		7.0	7.0		7.0			12.0	12.0		12.0	12.0
Flash Dont Walk (s)		18.0	18.0		18.0			19.0	19.0		19.0	19.0
Pedestrian Calls (#/hr)		17	17		5			21	21		16	16
Act Effct Green (s)	13.1	60.4	60.4	8.2	53.2		30.1	25.0	25.0	28.9	22.6	22.6
Actuated g/C Ratio	0.11	0.50	0.50	0.07	0.44		0.25	0.21	0.21	0.24	0.19	0.19
v/c Ratio	0.73	0.48	0.13	0.38	0.55		0.29	0.07	0.22	0.25	0.06	0.38
Control Delay	71.2	27.9	6.5	79.7	22.5		32.4	35.8	2.4	31.2	35.1	8.3
Queue Delay	0.0	0.0	0.0	0.0	0.0		0.0	0.0	0.0	0.0	0.0	0.0
Total Delay	71.2	27.9	6.5	79.7	22.5		32.4	35.8	2.4	31.2	35.1	8.3
LOS	E	C	A	E	C		C	D	A	C	D	A
Approach Delay		31.3			25.5			20.3			17.8	
Approach LOS		C			C			C			B	
Queue Length 50th (m)	29.3	66.1	0.0	8.0	76.5		14.4	4.6	0.0	12.0	3.3	0.0
Queue Length 95th (m)	#64.7	106.4	12.1	21.9	97.3		25.9	11.4	2.8	22.4	9.0	14.6
Internal Link Dist (m)		286.7			42.2			57.0			83.6	
Turn Bay Length (m)	85.0		40.0						30.0	45.0		75.0
Base Capacity (vph)	184	1722	786	132	1490		337	485	500	330	485	511
Starvation Cap Reductn	0	0	0	0	0		0	0	0	0	0	0
Spillback Cap Reductn	0	0	0	0	0		0	0	0	0	0	0
Storage Cap Reductn	0	0	0	0	0		0	0	0	0	0	0
Reduced v/c Ratio	0.73	0.48	0.13	0.34	0.55		0.29	0.06	0.18	0.25	0.04	0.30

Intersection Summary

Area Type: Other  
 Cycle Length: 120  
 Actuated Cycle Length: 120  
 Offset: 7 (6%), Referenced to phase 2:EBT and 6:WBT, Start of Green  
 Natural Cycle: 95  
 Control Type: Actuated-Coordinated  
 Maximum v/c Ratio: 0.73  
 Intersection Signal Delay: 26.8 Intersection LOS: C  
 Intersection Capacity Utilization 67.2% ICU Level of Service C  
 Analysis Period (min) 15  
 # 95th percentile volume exceeds capacity, queue may be longer.  
 Queue shown is maximum after two cycles.

Splits and Phases: 2: Lynhar Road/Stafford Road & Robertson Road





3: Northside Road East & Robertson Road  
SAT Peak Hour

1826 Robertson Road  
2024 Total Traffic

Lane Group	EBL	EBT	EBR	WBL	WBT	WBR	NBL	NBT	NBR	SBL	SBT	SBR
Lane Configurations												
Traffic Volume (vph)	78	835	15	94	663	167	86	44	73	141	30	103
Future Volume (vph)	78	835	15	94	663	167	86	44	73	141	30	103
Ideal Flow (vphpl)	1800	1800	1800	1800	1800	1800	1800	1800	1800	1800	1800	1800
Storage Length (m)	55.0		0.0	75.0		80.0	0.0		0.0	0.0		0.0
Storage Lanes	1		0	1		1	1		0	1		1
Taper Length (m)	30.0			15.0			10.0			10.0		
Lane Util. Factor	1.00	0.95	0.95	1.00	0.95	1.00	1.00	1.00	1.00	1.00	1.00	1.00
Ped Bike Factor	1.00	1.00		1.00		0.96	0.98	0.98		0.99		0.96
Frt		0.997				0.850		0.906				0.850
Flt Protected	0.950			0.950			0.950			0.950		
Satd. Flow (prot)	1712	3412	0	1695	3390	1532	1695	1606	0	1712	1802	1532
Flt Permitted	0.348			0.333			0.738			0.675		
Satd. Flow (perm)	624	3412	0	593	3390	1476	1285	1606	0	1203	1802	1474
Right Turn on Red			Yes			Yes			Yes			Yes
Satd. Flow (RTOR)		3				167		62				103
Link Speed (k/h)		60			60			40			40	
Link Distance (m)		105.4			310.9			87.0			90.9	
Travel Time (s)		6.3			18.7			7.8			8.2	
Confl. Peds. (#/hr)	6		4	4		6	16		8	8		16
Confl. Bikes (#/hr)			1			2			2			1
Peak Hour Factor	1.00	1.00	1.00	1.00	1.00	1.00	1.00	1.00	1.00	1.00	1.00	1.00
Heavy Vehicles (%)	1%	1%	1%	2%	2%	1%	2%	1%	1%	1%	1%	1%
Adj. Flow (vph)	78	835	15	94	663	167	86	44	73	141	30	103
Shared Lane Traffic (%)												
Lane Group Flow (vph)	78	850	0	94	663	167	86	117	0	141	30	103
Enter Blocked Intersection	No	No	No	No	No	No	No	No	No	No	No	No
Lane Alignment	L NA	Left	R NA	L NA	Left	R NA	L NA	Left	R NA	L NA	Left	R NA
Median Width(m)		5.5			5.5			3.7			3.7	
Link Offset(m)		0.0			0.0			0.0			0.0	
Crosswalk Width(m)		5.0			5.0			5.0			5.0	
Two way Left Turn Lane												
Headway Factor	1.06	1.06	1.06	1.06	1.06	1.06	1.06	1.06	1.06	1.06	1.06	1.06
Turning Speed (k/h)	24		14	24		14	24		14	24		14
Number of Detectors	1	2		1	2		1	1	2		1	2
Detector Template	Left	Thru		Left	Thru	Right	Left	Thru		Left	Thru	Right
Leading Detector (m)	6.1	30.5		6.1	30.5	6.1	6.1	30.5		6.1	30.5	6.1
Trailing Detector (m)	0.0	0.0		0.0	0.0	0.0	0.0	0.0		0.0	0.0	0.0
Detector 1 Position(m)	0.0	0.0		0.0	0.0	0.0	0.0	0.0		0.0	0.0	0.0
Detector 1 Size(m)	6.1	1.8		6.1	1.8	6.1	6.1	1.8		6.1	1.8	6.1
Detector 1 Type	Cl+Ex	Cl+Ex		Cl+Ex	Cl+Ex	Cl+Ex	Cl+Ex	Cl+Ex		Cl+Ex	Cl+Ex	Cl+Ex
Detector 1 Channel												
Detector 1 Extend (s)	0.0	0.0		0.0	0.0	0.0	0.0	0.0		0.0	0.0	0.0
Detector 1 Queue (s)	0.0	0.0		0.0	0.0	0.0	0.0	0.0		0.0	0.0	0.0
Detector 1 Delay (s)	0.0	0.0		0.0	0.0	0.0	0.0	0.0		0.0	0.0	0.0
Detector 2 Position(m)		28.7			28.7			28.7			28.7	
Detector 2 Size(m)		1.8			1.8			1.8			1.8	
Detector 2 Type		Cl+Ex			Cl+Ex			Cl+Ex			Cl+Ex	
Detector 2 Channel												
Detector 2 Extend (s)		0.0			0.0			0.0			0.0	
Turn Type	pm+pt	NA		Perm	NA	Perm	Perm	NA		Perm	NA	Perm
Protected Phases	5	2			6			8			4	
Permitted Phases	2			6		6	8			4		4
Detector Phase	5	2		6	6	6	8	8		4	4	4

Lane Group	Ø3	Ø7
Lane Configurations		
Traffic Volume (vph)		
Future Volume (vph)		
Ideal Flow (vphpl)		
Storage Length (m)		
Storage Lanes		
Taper Length (m)		
Lane Util. Factor		
Ped Bike Factor		
Frt		
Flt Protected		
Satd. Flow (prot)		
Flt Permitted		
Satd. Flow (perm)		
Right Turn on Red		
Satd. Flow (RTOR)		
Link Speed (k/h)		
Link Distance (m)		
Travel Time (s)		
Confl. Peds. (#/hr)		
Confl. Bikes (#/hr)		
Peak Hour Factor		
Heavy Vehicles (%)		
Adj. Flow (vph)		
Shared Lane Traffic (%)		
Lane Group Flow (vph)		
Enter Blocked Intersection		
Lane Alignment		
Median Width(m)		
Link Offset(m)		
Crosswalk Width(m)		
Two way Left Turn Lane		
Headway Factor		
Turning Speed (k/h)		
Number of Detectors		
Detector Template		
Leading Detector (m)		
Trailing Detector (m)		
Detector 1 Position(m)		
Detector 1 Size(m)		
Detector 1 Type		
Detector 1 Channel		
Detector 1 Extend (s)		
Detector 1 Queue (s)		
Detector 1 Delay (s)		
Detector 2 Position(m)		
Detector 2 Size(m)		
Detector 2 Type		
Detector 2 Channel		
Detector 2 Extend (s)		
Turn Type		
Protected Phases	3	7
Permitted Phases		
Detector Phase		

3: Northside Road East & Robertson Road  
SAT Peak Hour

1826 Robertson Road  
2024 Total Traffic



Lane Group	EBL	EBT	EBR	WBL	WBT	WBR	NBL	NBT	NBR	SBL	SBT	SBR
Switch Phase												
Minimum Initial (s)	5.0	10.0		10.0	10.0	10.0	10.0	10.0		10.0	10.0	10.0
Minimum Split (s)	11.0	30.1		30.1	30.1	30.1	29.8	29.8		29.8	29.8	29.8
Total Split (s)	15.0	83.0		68.0	68.0	68.0	31.0	31.0		31.0	31.0	31.0
Total Split (%)	12.5%	69.2%		56.7%	56.7%	56.7%	25.8%	25.8%		25.8%	25.8%	25.8%
Maximum Green (s)	9.0	76.9		61.9	61.9	61.9	24.2	24.2		24.2	24.2	24.2
Yellow Time (s)	3.7	3.7		3.7	3.7	3.7	3.0	3.0		3.0	3.0	3.0
All-Red Time (s)	2.3	2.4		2.4	2.4	2.4	3.8	3.8		3.8	3.8	3.8
Lost Time Adjust (s)	0.0	0.0		0.0	0.0	0.0	0.0	0.0		0.0	0.0	0.0
Total Lost Time (s)	6.0	6.1		6.1	6.1	6.1	6.8	6.8		6.8	6.8	6.8
Lead/Lag	Lead			Lag	Lag	Lag	Lag	Lag		Lag	Lag	Lag
Lead-Lag Optimize?	Yes			Yes	Yes	Yes	Yes	Yes		Yes	Yes	Yes
Vehicle Extension (s)	3.0	3.0		3.0	3.0	3.0	3.0	3.0		3.0	3.0	3.0
Recall Mode	None	C-Max		C-Max	C-Max	C-Max	None	None		None	None	None
Walk Time (s)		7.0		7.0	7.0	7.0	1.0	1.0		1.0	1.0	1.0
Flash Dont Walk (s)		17.0		17.0	17.0	17.0	22.0	22.0		22.0	22.0	22.0
Pedestrian Calls (#/hr)		4		6	6	6	8	8		16	16	16
Act Effct Green (s)	87.9	87.8		76.9	76.9	76.9	19.3	19.3		19.3	19.3	19.3
Actuated g/C Ratio	0.73	0.73		0.64	0.64	0.64	0.16	0.16		0.16	0.16	0.16
v/c Ratio	0.15	0.34		0.25	0.31	0.17	0.42	0.38		0.73	0.10	0.32
Control Delay	6.3	6.6		14.3	11.7	2.3	49.5	24.3		68.0	40.5	10.0
Queue Delay	0.0	0.0		0.0	0.0	0.0	0.0	0.0		0.0	0.0	0.0
Total Delay	6.3	6.6		14.3	11.7	2.3	49.5	24.3		68.0	40.5	10.0
LOS	A	A		B	B	A	D	C		E	D	A
Approach Delay		6.6			10.2			35.0			43.2	
Approach LOS		A			B			C			D	
Queue Length 50th (m)	5.0	29.5		8.5	32.9	0.0	17.0	10.5		29.5	5.6	0.0
Queue Length 95th (m)	6.7	26.4		21.8	53.8	9.0	29.1	24.2		46.0	12.4	12.7
Internal Link Dist (m)		81.4			286.9			63.0			66.9	
Turn Bay Length (m)	55.0			75.0		80.0						
Base Capacity (vph)	538	2496		379	2172	1006	266	382		249	373	387
Starvation Cap Reductn	0	0		0	0	0	0	0		0	0	0
Spillback Cap Reductn	0	0		0	0	0	0	0		0	0	0
Storage Cap Reductn	0	0		0	0	0	0	0		0	0	0
Reduced v/c Ratio	0.14	0.34		0.25	0.31	0.17	0.32	0.31		0.57	0.08	0.27

Intersection Summary

Area Type: Other  
 Cycle Length: 120  
 Actuated Cycle Length: 120  
 Offset: 111 (93%), Referenced to phase 2:EBTL and 6:WBTL, Start of Green  
 Natural Cycle: 80  
 Control Type: Actuated-Coordinated  
 Maximum v/c Ratio: 0.73  
 Intersection Signal Delay: 14.8  
 Intersection LOS: B  
 Intersection Capacity Utilization 65.7%  
 ICU Level of Service C  
 Analysis Period (min) 15

Splits and Phases: 3: Northside Road East & Robertson Road

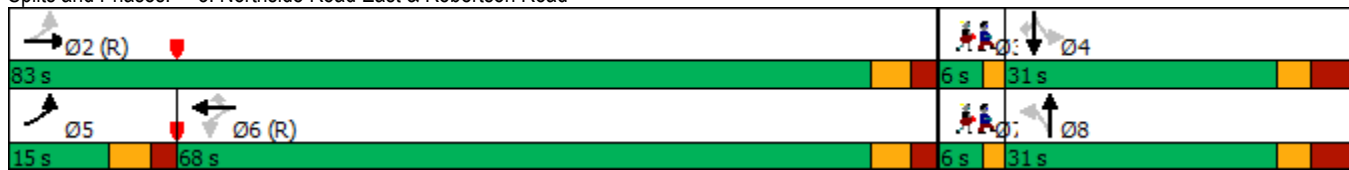

Lane Group	Ø3	Ø7
Switch Phase		
Minimum Initial (s)	4.0	4.0
Minimum Split (s)	6.0	6.0
Total Split (s)	6.0	6.0
Total Split (%)	5%	5%
Maximum Green (s)	4.0	4.0
Yellow Time (s)	2.0	2.0
All-Red Time (s)	0.0	0.0
Lost Time Adjust (s)		
Total Lost Time (s)		
Lead/Lag	Lead	Lead
Lead-Lag Optimize?	Yes	Yes
Vehicle Extension (s)	3.0	3.0
Recall Mode	None	None
Walk Time (s)		
Flash Dont Walk (s)		
Pedestrian Calls (#/hr)		
Act Effct Green (s)		
Actuated g/C Ratio		
v/c Ratio		
Control Delay		
Queue Delay		
Total Delay		
LOS		
Approach Delay		
Approach LOS		
Queue Length 50th (m)		
Queue Length 95th (m)		
Internal Link Dist (m)		
Turn Bay Length (m)		
Base Capacity (vph)		
Starvation Cap Reductn		
Spillback Cap Reductn		
Storage Cap Reductn		
Reduced v/c Ratio		
Intersection Summary		

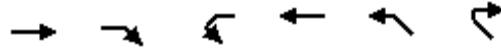

Lane Group	EBT	EBR	WBL	WBT	NWL	NWR
Lane Configurations	↑↑			↑↑↑		
Traffic Volume (vph)	926	83	0	869	0	0
Future Volume (vph)	926	83	0	869	0	0
Ideal Flow (vphpl)	1800	1800	1800	1800	1800	1800
Storage Length (m)		0.0	25.0		0.0	0.0
Storage Lanes		0	1		0	0
Taper Length (m)			25.0		10.0	
Lane Util. Factor	0.95	0.95	1.00	0.91	1.00	1.00
Frt	0.988					
Flt Protected						
Satd. Flow (prot)	3380	0	0	4919	0	0
Flt Permitted						
Satd. Flow (perm)	3380	0	0	4919	0	0
Link Speed (k/h)	60			60	50	
Link Distance (m)	66.2			72.0	100.3	
Travel Time (s)	4.0			4.3	7.2	
Peak Hour Factor	1.00	1.00	1.00	1.00	1.00	1.00
Heavy Vehicles (%)	1%	2%	1%	1%	1%	1%
Adj. Flow (vph)	926	83	0	869	0	0
Shared Lane Traffic (%)						
Lane Group Flow (vph)	1009	0	0	869	0	0
Enter Blocked Intersection	Yes	Yes	Yes	Yes	No	No
Lane Alignment	Left	Right	Left	Left	Left	Right
Median Width(m)	3.7			3.7	0.0	
Link Offset(m)	0.0			0.0	0.0	
Crosswalk Width(m)	0.0			0.0	0.0	
Two way Left Turn Lane						
Headway Factor	1.06	1.06	1.06	1.06	1.06	1.06
Turning Speed (k/h)		50	24		24	14
Sign Control	Free			Free	Free	

**Intersection Summary**

Area Type: Other

Control Type: Unsignalized

Intersection Capacity Utilization 33.1% ICU Level of Service A











Analysis Period (min) 15











Lane Group	EBT	EBR	WBL	WBT	NBL	NBR
Lane Configurations						
Traffic Volume (vph)	70	13	130	0	0	104
Future Volume (vph)	70	13	130	0	0	104
Ideal Flow (vphpl)	1800	1800	1800	1800	1800	1800
Lane Util. Factor	1.00	1.00	1.00	1.00	1.00	1.00
Ped Bike Factor						
Frt	0.979					0.865
Flt Protected			0.950			
Satd. Flow (prot)	1750	0	1712	0	0	1559
Flt Permitted			0.950			
Satd. Flow (perm)	1750	0	1712	0	0	1559
Link Speed (k/h)	50			40	40	
Link Distance (m)	100.3			62.0	54.2	
Travel Time (s)	7.2			5.6	4.9	
Confl. Peds. (#/hr)		27	27			
Confl. Bikes (#/hr)		1				2
Peak Hour Factor	1.00	1.00	1.00	1.00	1.00	1.00
Heavy Vehicles (%)	2%	1%	1%	1%	1%	1%
Adj. Flow (vph)	70	13	130	0	0	104
Shared Lane Traffic (%)						
Lane Group Flow (vph)	83	0	130	0	0	104
Enter Blocked Intersection	No	No	No	No	No	No
Lane Alignment	L NA	R NA	L NA	R NA	Left	R NA
Median Width(m)	3.7			3.7	0.0	
Link Offset(m)	3.0			3.0	0.0	
Crosswalk Width(m)	5.0			5.0	5.0	
Two way Left Turn Lane						
Headway Factor	1.06	1.06	1.06	1.06	1.06	1.06
Turning Speed (k/h)		14	24		24	14
Sign Control	Stop			Stop	Stop	

**Intersection Summary**

Area Type:	Other
Control Type:	Unsignalized
Intersection Capacity Utilization 23.5%	ICU Level of Service A
Analysis Period (min)	15

						
Lane Group	WBL	WBR	NBT	NBR	SBL	SBT
Lane Configurations						
Traffic Volume (vph)	3	90	128	3	83	82
Future Volume (vph)	3	90	128	3	83	82
Ideal Flow (vphpl)	1800	1800	1800	1800	1800	1800
Storage Length (m)	0.0	0.0		45.0	15.0	
Storage Lanes	1	0		0	1	
Taper Length (m)	10.0				20.0	
Lane Util. Factor	1.00	1.00	0.95	0.95	1.00	1.00
Frt	0.869		0.997			
Flt Protected	0.998				0.950	
Satd. Flow (prot)	1563	0	3381	0	1712	1784
Flt Permitted	0.998				0.950	
Satd. Flow (perm)	1563	0	3381	0	1712	1784
Link Speed (k/h)	40		40		40	
Link Distance (m)	173.4		68.2		81.0	
Travel Time (s)	15.6		6.1		7.3	
Peak Hour Factor	1.00	1.00	1.00	1.00	1.00	1.00
Heavy Vehicles (%)	1%	1%	2%	1%	1%	2%
Adj. Flow (vph)	3	90	128	3	83	82
Shared Lane Traffic (%)						
Lane Group Flow (vph)	93	0	131	0	83	82
Enter Blocked Intersection	No	No	No	No	No	No
Lane Alignment	Left	Right	Left	Right	Left	Left
Median Width(m)	3.7		3.7		3.7	
Link Offset(m)	0.0		0.0		0.0	
Crosswalk Width(m)	5.0		5.0		5.0	
Two way Left Turn Lane						
Headway Factor	1.06	1.06	1.06	1.06	1.06	1.06
Turning Speed (k/h)	24	14		14	24	
Sign Control	Stop		Free			Free
<b>Intersection Summary</b>						
Area Type:	Other					
Control Type:	Unsignalized					
Intersection Capacity Utilization 24.7%	ICU Level of Service A					
Analysis Period (min) 15						

						
Lane Group	WBL	WBR	NBT	NBR	SBL	SBT
Lane Configurations						
Traffic Volume (vph)	1	10	121	1	11	74
Future Volume (vph)	1	10	121	1	11	74
Ideal Flow (vphpl)	1800	1800	1800	1800	1800	1800
Lane Util. Factor	1.00	1.00	1.00	1.00	1.00	1.00
Frt	0.877		0.999			
Flt Protected	0.995					0.994
Satd. Flow (prot)	1572	0	1783	0	0	1776
Flt Permitted	0.995					0.994
Satd. Flow (perm)	1572	0	1783	0	0	1776
Link Speed (k/h)	50		40			50
Link Distance (m)	178.0		82.4			68.2
Travel Time (s)	12.8		7.4			4.9
Peak Hour Factor	1.00	1.00	1.00	1.00	1.00	1.00
Heavy Vehicles (%)	1%	1%	2%	1%	1%	2%
Adj. Flow (vph)	1	10	121	1	11	74
Shared Lane Traffic (%)						
Lane Group Flow (vph)	11	0	122	0	0	85
Enter Blocked Intersection	No	No	No	No	No	No
Lane Alignment	L NA	R NA	Left	Right	Left	Left
Median Width(m)	3.7		0.0			0.0
Link Offset(m)	0.0		0.0			0.0
Crosswalk Width(m)	5.0		5.0			5.0
Two way Left Turn Lane						
Headway Factor	1.06	1.06	1.06	1.06	1.06	1.06
Turning Speed (k/h)	24	14		14	24	
Sign Control	Stop		Free			Free
<b>Intersection Summary</b>						
Area Type:	Other					
Control Type:	Unsignalized					
Intersection Capacity Utilization	23.9%			ICU Level of Service A		
Analysis Period (min)	15					





Lane Group	EBL	EBR	NBL	NBT	SBT	SBR
Lane Configurations						
Traffic Volume (vph)	31	0	0	73	92	52
Future Volume (vph)	31	0	0	73	92	52
Ideal Flow (vphpl)	1800	1800	1800	1800	1800	1800
Lane Util. Factor	1.00	1.00	1.00	1.00	1.00	1.00
Frt					0.951	
Frt Protected	0.950					
Satd. Flow (prot)	1712	0	0	1802	1714	0
Frt Permitted	0.950					
Satd. Flow (perm)	1712	0	0	1802	1714	0
Link Speed (k/h)	40			40	40	
Link Distance (m)	173.4			67.2	54.2	
Travel Time (s)	15.6			6.0	4.9	
Peak Hour Factor	1.00	1.00	1.00	1.00	1.00	1.00
Heavy Vehicles (%)	1%	1%	1%	1%	1%	1%
Adj. Flow (vph)	31	0	0	73	92	52
Shared Lane Traffic (%)						
Lane Group Flow (vph)	31	0	0	73	144	0
Enter Blocked Intersection	No	No	No	No	No	No
Lane Alignment	Left	Right	Left	Left	Left	Right
Median Width(m)	3.7			0.0	0.0	
Link Offset(m)	0.0			0.0	0.0	
Crosswalk Width(m)	5.0			5.0	5.0	
Two way Left Turn Lane						
Headway Factor	1.06	1.06	1.06	1.06	1.06	1.06
Turning Speed (k/h)	24	14	24			14
Sign Control	Stop			Free	Free	

**Intersection Summary**

Area Type:	Other
Control Type:	Unsignalized
Intersection Capacity Utilization	18.5%
Analysis Period (min)	15
	ICU Level of Service A





















Lane Group	EBL	EBR	NBL	NBT	SBT	SBR
Lane Configurations						
Traffic Volume (vph)	9	0	0	64	82	10
Future Volume (vph)	9	0	0	64	82	10
Ideal Flow (vphpl)	1800	1800	1800	1800	1800	1800
Lane Util. Factor	1.00	1.00	1.00	1.00	1.00	1.00
Fr't					0.985	
Flt Protected	0.950					
Satd. Flow (prot)	1712	0	0	1802	1775	0
Flt Permitted	0.950					
Satd. Flow (perm)	1712	0	0	1802	1775	0
Link Speed (k/h)	50			40	50	
Link Distance (m)	178.0			106.1	67.2	
Travel Time (s)	12.8			9.5	4.8	
Peak Hour Factor	1.00	1.00	1.00	1.00	1.00	1.00
Heavy Vehicles (%)	1%	1%	1%	1%	1%	1%
Adj. Flow (vph)	9	0	0	64	82	10
Shared Lane Traffic (%)						
Lane Group Flow (vph)	9	0	0	64	92	0
Enter Blocked Intersection	No	No	No	No	No	No
Lane Alignment	L NA	R NA	Left	Left	Left	Right
Median Width(m)	3.7			0.0	0.0	
Link Offset(m)	0.0			0.0	0.0	
Crosswalk Width(m)	5.0			5.0	5.0	
Two way Left Turn Lane						
Headway Factor	1.06	1.06	1.06	1.06	1.06	1.06
Turning Speed (k/h)	24	14	24			14
Sign Control	Stop			Free	Free	

**Intersection Summary**

Area Type:	Other
Control Type:	Unsignalized
Intersection Capacity Utilization	15.2%
Analysis Period (min)	15
	ICU Level of Service A

1: Stinson Avenue & Robertson Road  
AM Peak Hour

1826 Robertson Road  
2029 Total Traffic

												
Lane Group	EBL	EBT	EBR	WBL	WBT	WBR	NBL	NBT	NBR	SBL	SBT	SBR
Lane Configurations												
Traffic Volume (vph)	54	2101	6	20	670	22	9	2	32	2	0	11
Future Volume (vph)	54	2101	6	20	670	22	9	2	32	2	0	11
Ideal Flow (vphpl)	1800	1800	1800	1800	1800	1800	1800	1800	1800	1800	1800	1800
Storage Length (m)	75.0		0.0	45.0		0.0	0.0		0.0	0.0		0.0
Storage Lanes	1		0	1		0	0		0	0		0
Taper Length (m)	10.0			10.0			10.0			10.0		
Lane Util. Factor	1.00	0.95	0.95	1.00	0.95	0.95	1.00	1.00	1.00	1.00	1.00	1.00
Ped Bike Factor	0.99	1.00			1.00			1.00				0.98
Frt					0.995			0.900				0.886
Flt Protected	0.950			0.950				0.990				0.992
Satd. Flow (prot)	1662	3356	0	1572	3308	0	0	1554	0	0	1446	0
Flt Permitted	0.388			0.065				0.928			0.952	
Satd. Flow (perm)	671	3356	0	108	3308	0	0	1454	0	0	1388	0
Right Turn on Red			Yes			Yes			Yes			Yes
Satd. Flow (RTOR)		1			6			19			23	
Link Speed (k/h)		60			60			40			40	
Link Distance (m)		198.0			310.7			254.0			246.4	
Travel Time (s)		11.9			18.6			22.9			22.2	
Confl. Peds. (#/hr)	11		3	11		3	6					6
Peak Hour Factor	1.00	1.00	1.00	1.00	1.00	1.00	1.00	1.00	1.00	1.00	1.00	1.00
Heavy Vehicles (%)	4%	3%	10%	10%	4%	1%	10%	1%	3%	1%	1%	10%
Adj. Flow (vph)	54	2101	6	20	670	22	9	2	32	2	0	11
Shared Lane Traffic (%)												
Lane Group Flow (vph)	54	2107	0	20	692	0	0	43	0	0	13	0
Enter Blocked Intersection	No	No	No	No	No	No	No	No	No	No	No	No
Lane Alignment	L NA	Left	R NA	L NA	Left	R NA	L NA	Left	R NA	L NA	Left	R NA
Median Width(m)		3.7			3.7			0.0			0.0	
Link Offset(m)		0.0			0.0			0.0			0.0	
Crosswalk Width(m)		5.0			5.0			5.0			5.0	
Two way Left Turn Lane		Yes			Yes							
Headway Factor	1.06	1.06	1.06	1.06	1.06	1.06	1.06	1.06	1.06	1.06	1.06	1.06
Turning Speed (k/h)	24		14	24		14	24		14	24		14
Number of Detectors	1	2		1	2		1	2		1	2	
Detector Template	Left	Thru		Left	Thru		Left	Thru		Left	Thru	
Leading Detector (m)	6.1	30.5		6.1	30.5		6.1	30.5		6.1	30.5	
Trailing Detector (m)	0.0	0.0		0.0	0.0		0.0	0.0		0.0	0.0	
Detector 1 Position(m)	0.0	0.0		0.0	0.0		0.0	0.0		0.0	0.0	
Detector 1 Size(m)	6.1	1.8		6.1	1.8		6.1	1.8		6.1	1.8	
Detector 1 Type	Cl+Ex	Cl+Ex		Cl+Ex	Cl+Ex		Cl+Ex	Cl+Ex		Cl+Ex	Cl+Ex	
Detector 1 Channel												
Detector 1 Extend (s)	0.0	0.0		0.0	0.0		0.0	0.0		0.0	0.0	
Detector 1 Queue (s)	0.0	0.0		0.0	0.0		0.0	0.0		0.0	0.0	
Detector 1 Delay (s)	0.0	0.0		0.0	0.0		0.0	0.0		0.0	0.0	
Detector 2 Position(m)		28.7			28.7			28.7			28.7	
Detector 2 Size(m)		1.8			1.8			1.8			1.8	
Detector 2 Type		Cl+Ex			Cl+Ex			Cl+Ex			Cl+Ex	
Detector 2 Channel												
Detector 2 Extend (s)		0.0			0.0			0.0			0.0	
Turn Type	Perm	NA		Perm	NA		Perm	NA		Perm	NA	
Protected Phases		2			6			8			4	
Permitted Phases	2			6			8			4		
Detector Phase	2	2		6	6		8	8		4	4	
Switch Phase												



Lane Group	EBL	EBT	EBR	WBL	WBT	WBR	NBL	NBT	NBR	SBL	SBT	SBR
Minimum Initial (s)	10.0	10.0		10.0	10.0		10.0	10.0		10.0	10.0	
Minimum Split (s)	26.8	26.8		26.8	26.8		31.6	31.6		31.6	31.6	
Total Split (s)	98.0	98.0		98.0	98.0		32.0	32.0		32.0	32.0	
Total Split (%)	75.4%	75.4%		75.4%	75.4%		24.6%	24.6%		24.6%	24.6%	
Maximum Green (s)	92.2	92.2		92.2	92.2		25.4	25.4		25.4	25.4	
Yellow Time (s)	3.7	3.7		3.7	3.7		3.0	3.0		3.0	3.0	
All-Red Time (s)	2.1	2.1		2.1	2.1		3.6	3.6		3.6	3.6	
Lost Time Adjust (s)	0.0	0.0		0.0	0.0			0.0			0.0	
Total Lost Time (s)	5.8	5.8		5.8	5.8			6.6			6.6	
Lead/Lag												
Lead-Lag Optimize?												
Vehicle Extension (s)	3.0	3.0		3.0	3.0		3.0	3.0		3.0	3.0	
Recall Mode	C-Max	C-Max		C-Max	C-Max		None	None		None	None	
Walk Time (s)	7.0	7.0		7.0	7.0		7.0	7.0		7.0	7.0	
Flash Dont Walk (s)	14.0	14.0		14.0	14.0		18.0	18.0		18.0	18.0	
Pedestrian Calls (#/hr)	3	3		11	11		1	1		6	6	
Act Effct Green (s)	109.1	109.1		109.1	109.1			13.0			13.0	
Actuated g/C Ratio	0.84	0.84		0.84	0.84			0.10			0.10	
v/c Ratio	0.10	0.75		0.22	0.25			0.27			0.08	
Control Delay	4.1	9.4		13.6	2.7			36.9			8.8	
Queue Delay	0.0	0.0		0.0	0.0			0.0			0.0	
Total Delay	4.1	9.4		13.6	2.7			36.9			8.8	
LOS	A	A		B	A			D			A	
Approach Delay		9.3			3.0			36.9			8.8	
Approach LOS		A			A			D			A	
Queue Length 50th (m)	1.9	95.4		0.6	11.6			5.4			0.0	
Queue Length 95th (m)	7.7	220.6		5.4	22.5			14.4			3.3	
Internal Link Dist (m)		174.0			286.7			230.0			222.4	
Turn Bay Length (m)	75.0			45.0								
Base Capacity (vph)	563	2815		90	2777			299			289	
Starvation Cap Reductn	0	0		0	0			0			0	
Spillback Cap Reductn	0	0		0	0			0			0	
Storage Cap Reductn	0	0		0	0			0			0	
Reduced v/c Ratio	0.10	0.75		0.22	0.25			0.14			0.04	

Intersection Summary























Area Type: Other  
 Cycle Length: 130  
 Actuated Cycle Length: 130  
 Offset: 129 (99%), Referenced to phase 2:EBTL and 6:WBTL, Start of Green  
 Natural Cycle: 100  
 Control Type: Actuated-Coordinated  
 Maximum v/c Ratio: 0.75  
 Intersection Signal Delay: 8.1  
 Intersection Capacity Utilization 82.4%  
 Analysis Period (min) 15  
 Intersection LOS: A  
 ICU Level of Service E

Splits and Phases: 1: Stinson Avenue & Robertson Road



2: Lynhar Road/Stafford Road & Robertson Road  
AM Peak Hour

1826 Robertson Road  
2029 Total Traffic

												
Lane Group	EBL	EBT	EBR	WBL	WBT	WBR	NBL	NBT	NBR	SBL	SBT	SBR
Lane Configurations												
Traffic Volume (vph)	42	1953	50	17	683	83	46	12	115	31	5	52
Future Volume (vph)	42	1953	50	17	683	83	46	12	115	31	5	52
Ideal Flow (vphpl)	1800	1800	1800	1800	1800	1800	1800	1800	1800	1800	1800	1800
Storage Length (m)	85.0		40.0	0.0		0.0	0.0		30.0	45.0		75.0
Storage Lanes	1		1	1		0	1		1	1		1
Taper Length (m)	10.0			10.0			10.0			30.0		
Lane Util. Factor	1.00	0.95	1.00	1.00	0.95	0.95	1.00	1.00	1.00	1.00	1.00	1.00
Ped Bike Factor	1.00		0.97	1.00	1.00		1.00		0.98	1.00		0.98
Frt			0.850		0.984				0.850			0.850
Flt Protected	0.950			0.950			0.950			0.950		
Satd. Flow (prot)	1572	3357	1532	1712	3279	0	1679	1802	1532	1572	1802	1459
Flt Permitted	0.950			0.950			0.754			0.750		
Satd. Flow (perm)	1568	3357	1485	1711	3279	0	1326	1802	1506	1235	1802	1435
Right Turn on Red			Yes			Yes			Yes			Yes
Satd. Flow (RTOR)			82		15				115			79
Link Speed (k/h)		60			60			40			40	
Link Distance (m)		310.7			66.2			81.0			107.6	
Travel Time (s)		18.6			4.0			7.3			9.7	
Confl. Peds. (#/hr)	5		4	4		5	4		4	4		4
Peak Hour Factor	1.00	1.00	1.00	1.00	1.00	1.00	1.00	1.00	1.00	1.00	1.00	1.00
Heavy Vehicles (%)	10%	3%	1%	1%	3%	8%	3%	1%	1%	10%	1%	6%
Adj. Flow (vph)	42	1953	50	17	683	83	46	12	115	31	5	52
Shared Lane Traffic (%)												
Lane Group Flow (vph)	42	1953	50	17	766	0	46	12	115	31	5	52
Enter Blocked Intersection	No	No	No	No	No	No	No	No	No	No	No	No
Lane Alignment	L NA	Left	R NA	L NA	Left	R NA	L NA	L NA	R NA	L NA	Left	R NA
Median Width(m)		3.7			7.4			7.4			7.4	
Link Offset(m)		0.0			0.0			0.0			0.0	
Crosswalk Width(m)		5.0			5.0			5.0			5.0	
Two way Left Turn Lane		Yes										
Headway Factor	1.06	1.06	1.06	1.06	1.06	1.06	1.06	1.06	1.06	1.06	1.06	1.06
Turning Speed (k/h)	24		14	24		14	24		14	24		14
Number of Detectors	1	2	1	1	2		1	2	1	1	2	1
Detector Template	Left	Thru	Right	Left	Thru		Left	Thru	Right	Left	Thru	Right
Leading Detector (m)	6.1	30.5	6.1	6.1	30.5		6.1	30.5	6.1	6.1	30.5	6.1
Trailing Detector (m)	0.0	0.0	0.0	0.0	0.0		0.0	0.0	0.0	0.0	0.0	0.0
Detector 1 Position(m)	0.0	0.0	0.0	0.0	0.0		0.0	0.0	0.0	0.0	0.0	0.0
Detector 1 Size(m)	6.1	1.8	6.1	6.1	1.8		6.1	1.8	6.1	6.1	1.8	6.1
Detector 1 Type	CI+Ex	CI+Ex	CI+Ex	CI+Ex	CI+Ex		CI+Ex	CI+Ex	CI+Ex	CI+Ex	CI+Ex	CI+Ex
Detector 1 Channel												
Detector 1 Extend (s)	0.0	0.0	0.0	0.0	0.0		0.0	0.0	0.0	0.0	0.0	0.0
Detector 1 Queue (s)	0.0	0.0	0.0	0.0	0.0		0.0	0.0	0.0	0.0	0.0	0.0
Detector 1 Delay (s)	0.0	0.0	0.0	0.0	0.0		0.0	0.0	0.0	0.0	0.0	0.0
Detector 2 Position(m)		28.7			28.7			28.7			28.7	
Detector 2 Size(m)		1.8			1.8			1.8			1.8	
Detector 2 Type		CI+Ex			CI+Ex			CI+Ex			CI+Ex	
Detector 2 Channel												
Detector 2 Extend (s)		0.0			0.0			0.0			0.0	
Turn Type	Prot	NA	Perm	Prot	NA		Perm	NA	Perm	Perm	NA	Perm
Protected Phases	5	2		1	6			8			4	
Permitted Phases			2				8		8	4		4
Detector Phase	5	2	2	1	6		8	8	8	4	4	4
Switch Phase												



Lane Group	EBL	EBT	EBR	WBL	WBT	WBR	NBL	NBT	NBR	SBL	SBT	SBR
Minimum Initial (s)	5.0	10.0	10.0	5.0	10.0		10.0	10.0	10.0	10.0	10.0	10.0
Minimum Split (s)	11.1	31.3	31.3	11.1	31.3		37.7	37.7	37.7	37.7	37.7	37.7
Total Split (s)	16.0	75.0	75.0	16.0	75.0		39.0	39.0	39.0	39.0	39.0	39.0
Total Split (%)	12.3%	57.7%	57.7%	12.3%	57.7%		30.0%	30.0%	30.0%	30.0%	30.0%	30.0%
Maximum Green (s)	9.9	68.7	68.7	9.9	68.7		32.3	32.3	32.3	32.3	32.3	32.3
Yellow Time (s)	3.7	3.7	3.7	3.7	3.7		3.0	3.0	3.0	3.0	3.0	3.0
All-Red Time (s)	2.4	2.6	2.6	2.4	2.6		3.7	3.7	3.7	3.7	3.7	3.7
Lost Time Adjust (s)	0.0	0.0	0.0	0.0	0.0		0.0	0.0	0.0	0.0	0.0	0.0
Total Lost Time (s)	6.1	6.3	6.3	6.1	6.3		6.7	6.7	6.7	6.7	6.7	6.7
Lead/Lag	Lead	Lag	Lag	Lead	Lag							
Lead-Lag Optimize?	Yes	Yes	Yes	Yes	Yes							
Vehicle Extension (s)	3.0	3.0	3.0	3.0	3.0		3.0	3.0	3.0	3.0	3.0	3.0
Recall Mode	None	C-Max	C-Max	None	C-Max		None	None	None	None	None	None
Walk Time (s)		7.0	7.0		7.0		12.0	12.0	12.0	12.0	12.0	12.0
Flash Dont Walk (s)		18.0	18.0		18.0		19.0	19.0	19.0	19.0	19.0	19.0
Pedestrian Calls (#/hr)		4	4		5		4	4	4	4	4	4
Act Effct Green (s)	8.6	96.8	96.8	6.9	90.0		14.5	14.5	14.5	14.5	14.5	14.5
Actuated g/c Ratio	0.07	0.74	0.74	0.05	0.69		0.11	0.11	0.11	0.11	0.11	0.11
v/c Ratio	0.40	0.78	0.04	0.19	0.34		0.31	0.06	0.43	0.22	0.02	0.23
Control Delay	79.5	9.9	0.4	71.5	7.4		55.7	47.3	12.7	53.0	45.6	5.5
Queue Delay	0.0	0.0	0.0	0.0	0.0		0.0	0.0	0.0	0.0	0.0	0.0
Total Delay	79.5	9.9	0.4	71.5	7.4		55.7	47.3	12.7	53.0	45.6	5.5
LOS	E	A	A	E	A		E	D	B	D	D	A
Approach Delay		11.1			8.8			26.5			24.5	
Approach LOS		B			A			C			C	
Queue Length 50th (m)	10.0	12.5	0.0	4.0	25.6		10.6	2.7	0.0	7.1	1.1	0.0
Queue Length 95th (m)	m12.2	#303.8	m0.3	m12.2	31.2		18.5	7.0	13.7	13.6	4.0	4.4
Internal Link Dist (m)		286.7			42.2			57.0			83.6	
Turn Bay Length (m)	85.0		40.0						30.0	45.0		75.0
Base Capacity (vph)	123	2498	1126	130	2275		329	447	460	306	447	415
Starvation Cap Reductn	0	0	0	0	0		0	0	0	0	0	0
Spillback Cap Reductn	0	0	0	0	0		0	0	0	0	0	0
Storage Cap Reductn	0	0	0	0	0		0	0	0	0	0	0
Reduced v/c Ratio	0.34	0.78	0.04	0.13	0.34		0.14	0.03	0.25	0.10	0.01	0.13

Intersection Summary

Area Type: Other  
 Cycle Length: 130  
 Actuated Cycle Length: 130  
 Offset: 36 (28%), Referenced to phase 2:EBT and 6:WBT, Start of Green  
 Natural Cycle: 125  
 Control Type: Actuated-Coordinated  
 Maximum v/c Ratio: 0.78  
 Intersection Signal Delay: 11.7  
 Intersection Capacity Utilization 92.3%  
 Analysis Period (min) 15  
 # 95th percentile volume exceeds capacity, queue may be longer.  
 Queue shown is maximum after two cycles.  
 m Volume for 95th percentile queue is metered by upstream signal.

Splits and Phases: 2: Lynhar Road/Stafford Road & Robertson Road

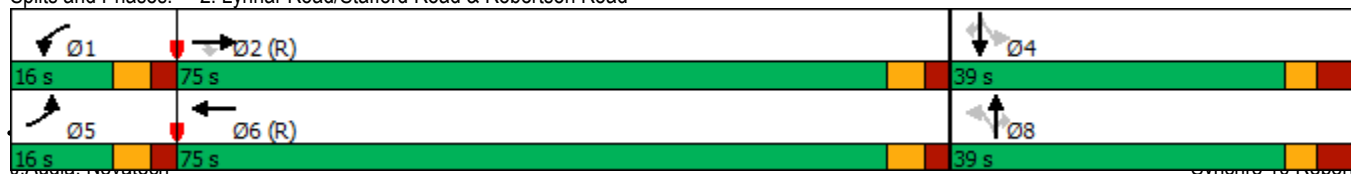

3: Northside Road East & Robertson Road  
AM Peak Hour

1826 Robertson Road  
2029 Total Traffic



Lane Group	EBL	EBT	EBR	WBL	WBT	WBR	NBL	NBT	NBR	SBL	SBT	SBR
Lane Configurations												
Traffic Volume (vph)	23	1856	12	52	648	67	95	24	45	34	8	9
Future Volume (vph)	23	1856	12	52	648	67	95	24	45	34	8	9
Ideal Flow (vphpl)	1800	1800	1800	1800	1800	1800	1800	1800	1800	1800	1800	1800
Storage Length (m)	55.0		0.0	75.0		80.0	0.0		0.0	0.0		0.0
Storage Lanes	1		0	1		1	1		0	1		1
Taper Length (m)	30.0			15.0			10.0			10.0		
Lane Util. Factor	1.00	0.95	0.95	1.00	0.95	1.00	1.00	1.00	1.00	1.00	1.00	1.00
Ped Bike Factor	1.00	1.00				0.96	0.99	0.99		0.99		0.98
Frt		0.999				0.850		0.902				0.850
Flt Protected	0.950			0.950			0.950			0.950		
Satd. Flow (prot)	1712	3354	0	1647	3325	1532	1679	1503	0	1679	1802	1532
Flt Permitted	0.369			0.095			0.752			0.712		
Satd. Flow (perm)	662	3354	0	165	3325	1475	1322	1503	0	1250	1802	1506
Right Turn on Red			Yes			Yes			Yes			Yes
Satd. Flow (RTOR)		1				99		45				93
Link Speed (k/h)		60			60			40				40
Link Distance (m)		105.4			310.9			87.0				90.9
Travel Time (s)		6.3			18.7			7.8				8.2
Confl. Peds. (#/hr)	5		3	3		5	3		4	4		3
Confl. Bikes (#/hr)			5			6			3			
Peak Hour Factor	1.00	1.00	1.00	1.00	1.00	1.00	1.00	1.00	1.00	1.00	1.00	1.00
Heavy Vehicles (%)	1%	3%	1%	5%	4%	1%	3%	5%	9%	3%	1%	1%
Adj. Flow (vph)	23	1856	12	52	648	67	95	24	45	34	8	9
Shared Lane Traffic (%)												
Lane Group Flow (vph)	23	1868	0	52	648	67	95	69	0	34	8	9
Enter Blocked Intersection	No	No	No	No	No	No	No	No	No	No	No	No
Lane Alignment	L NA	Left	R NA	L NA	Left	R NA	L NA	Left	R NA	L NA	Left	R NA
Median Width(m)		5.5			5.5			3.7				3.7
Link Offset(m)		0.0			0.0			0.0				0.0
Crosswalk Width(m)		5.0			5.0			5.0				5.0
Two way Left Turn Lane												
Headway Factor	1.06	1.06	1.06	1.06	1.06	1.06	1.06	1.06	1.06	1.06	1.06	1.06
Turning Speed (k/h)	24		14	24		14	24		14	24		14
Number of Detectors	1	2		1	2		1	1	2		1	2
Detector Template	Left	Thru		Left	Thru	Right	Left	Thru		Left	Thru	Right
Leading Detector (m)	6.1	30.5		6.1	30.5	6.1	6.1	30.5		6.1	30.5	6.1
Trailing Detector (m)	0.0	0.0		0.0	0.0	0.0	0.0	0.0		0.0	0.0	0.0
Detector 1 Position(m)	0.0	0.0		0.0	0.0	0.0	0.0	0.0		0.0	0.0	0.0
Detector 1 Size(m)	6.1	1.8		6.1	1.8	6.1	6.1	1.8		6.1	1.8	6.1
Detector 1 Type	Cl+Ex	Cl+Ex		Cl+Ex	Cl+Ex	Cl+Ex	Cl+Ex	Cl+Ex		Cl+Ex	Cl+Ex	Cl+Ex
Detector 1 Channel												
Detector 1 Extend (s)	0.0	0.0		0.0	0.0	0.0	0.0	0.0		0.0	0.0	0.0
Detector 1 Queue (s)	0.0	0.0		0.0	0.0	0.0	0.0	0.0		0.0	0.0	0.0
Detector 1 Delay (s)	0.0	0.0		0.0	0.0	0.0	0.0	0.0		0.0	0.0	0.0
Detector 2 Position(m)		28.7			28.7			28.7				28.7
Detector 2 Size(m)		1.8			1.8			1.8				1.8
Detector 2 Type		Cl+Ex			Cl+Ex			Cl+Ex				Cl+Ex
Detector 2 Channel												
Detector 2 Extend (s)		0.0			0.0			0.0				0.0
Turn Type	pm+pt	NA		Perm	NA	Perm	Perm	NA		Perm	NA	Perm
Protected Phases	5	2			6			8				4
Permitted Phases	2			6		6	8			4		4
Detector Phase	5	2		6	6	6	8	8		4	4	4

Lane Group	Ø3	Ø7
Lane Configurations		
Traffic Volume (vph)		
Future Volume (vph)		
Ideal Flow (vphpl)		
Storage Length (m)		
Storage Lanes		
Taper Length (m)		
Lane Util. Factor		
Ped Bike Factor		
Frt		
Flt Protected		
Satd. Flow (prot)		
Flt Permitted		
Satd. Flow (perm)		
Right Turn on Red		
Satd. Flow (RTOR)		
Link Speed (k/h)		
Link Distance (m)		
Travel Time (s)		
Confl. Peds. (#/hr)		
Confl. Bikes (#/hr)		
Peak Hour Factor		
Heavy Vehicles (%)		
Adj. Flow (vph)		
Shared Lane Traffic (%)		
Lane Group Flow (vph)		
Enter Blocked Intersection		
Lane Alignment		
Median Width(m)		
Link Offset(m)		
Crosswalk Width(m)		
Two way Left Turn Lane		
Headway Factor		
Turning Speed (k/h)		
Number of Detectors		
Detector Template		
Leading Detector (m)		
Trailing Detector (m)		
Detector 1 Position(m)		
Detector 1 Size(m)		
Detector 1 Type		
Detector 1 Channel		
Detector 1 Extend (s)		
Detector 1 Queue (s)		
Detector 1 Delay (s)		
Detector 2 Position(m)		
Detector 2 Size(m)		
Detector 2 Type		
Detector 2 Channel		
Detector 2 Extend (s)		
Turn Type		
Protected Phases	3	7
Permitted Phases		
Detector Phase		



3: Northside Road East & Robertson Road  
AM Peak Hour

1826 Robertson Road  
2029 Total Traffic



Lane Group	EBL	EBT	EBR	WBL	WBT	WBR	NBL	NBT	NBR	SBL	SBT	SBR
Switch Phase												
Minimum Initial (s)	5.0	10.0		10.0	10.0	10.0	10.0	10.0		10.0	10.0	10.0
Minimum Split (s)	11.0	30.1		30.1	30.1	30.1	29.8	29.8		29.8	29.8	29.8
Total Split (s)	16.0	94.0		78.0	78.0	78.0	30.0	30.0		30.0	30.0	30.0
Total Split (%)	12.3%	72.3%		60.0%	60.0%	60.0%	23.1%	23.1%		23.1%	23.1%	23.1%
Maximum Green (s)	10.0	87.9		71.9	71.9	71.9	23.2	23.2		23.2	23.2	23.2
Yellow Time (s)	3.7	3.7		3.7	3.7	3.7	3.0	3.0		3.0	3.0	3.0
All-Red Time (s)	2.3	2.4		2.4	2.4	2.4	3.8	3.8		3.8	3.8	3.8
Lost Time Adjust (s)	0.0	0.0		0.0	0.0	0.0	0.0	0.0		0.0	0.0	0.0
Total Lost Time (s)	6.0	6.1		6.1	6.1	6.1	6.8	6.8		6.8	6.8	6.8
Lead/Lag	Lead			Lag	Lag	Lag	Lag	Lag		Lag	Lag	Lag
Lead-Lag Optimize?	Yes			Yes	Yes	Yes	Yes	Yes		Yes	Yes	Yes
Vehicle Extension (s)	3.0	3.0		3.0	3.0	3.0	3.0	3.0		3.0	3.0	3.0
Recall Mode	None	C-Max		C-Max	C-Max	C-Max	None	None		None	None	None
Walk Time (s)		7.0		7.0	7.0	7.0	1.0	1.0		1.0	1.0	1.0
Flash Dont Walk (s)		17.0		17.0	17.0	17.0	22.0	22.0		22.0	22.0	22.0
Pedestrian Calls (#/hr)		3		5	5	5	4	4		3	3	3
Act Effct Green (s)	101.8	101.7		94.4	94.4	94.4	15.4	15.4		15.4	15.4	15.4
Actuated g/C Ratio	0.78	0.78		0.73	0.73	0.73	0.12	0.12		0.12	0.12	0.12
v/c Ratio	0.04	0.71		0.44	0.27	0.06	0.61	0.32		0.23	0.04	0.03
Control Delay	3.4	5.9		25.7	7.6	0.7	70.0	25.3		53.5	47.6	0.2
Queue Delay	0.0	0.1		0.0	0.0	0.0	0.0	0.0		0.0	0.0	0.0
Total Delay	3.4	6.0		25.7	7.6	0.7	70.0	25.3		53.5	47.6	0.2
LOS	A	A		C	A	A	E	C		D	D	A
Approach Delay		6.0			8.2			51.2			43.2	
Approach LOS		A			A			D			D	
Queue Length 50th (m)	0.6	25.1		4.9	27.4	0.0	21.8	5.2		7.4	1.7	0.0
Queue Length 95th (m)	m1.4	58.6		22.7	44.4	2.1	36.0	17.0		15.9	5.8	0.0
Internal Link Dist (m)		81.4			286.9			63.0			66.9	
Turn Bay Length (m)	55.0			75.0		80.0						
Base Capacity (vph)	599	2625		119	2415	1098	235	305		223	321	345
Starvation Cap Reductn	0	72		0	0	0	0	0		0	0	0
Spillback Cap Reductn	0	0		0	0	0	0	0		0	0	0
Storage Cap Reductn	0	0		0	0	0	0	0		0	0	0
Reduced v/c Ratio	0.04	0.73		0.44	0.27	0.06	0.40	0.23		0.15	0.02	0.03

Intersection Summary

Area Type: Other  
 Cycle Length: 130  
 Actuated Cycle Length: 130  
 Offset: 37 (28%), Referenced to phase 2:EBTL and 6:WBTL, Start of Green  
 Natural Cycle: 90  
 Control Type: Actuated-Coordinated  
 Maximum v/c Ratio: 0.71  
 Intersection Signal Delay: 9.8  
 Intersection LOS: A  
 Intersection Capacity Utilization 78.4%  
 ICU Level of Service D  
 Analysis Period (min) 15  
 m Volume for 95th percentile queue is metered by upstream signal.

Splits and Phases: 3: Northside Road East & Robertson Road

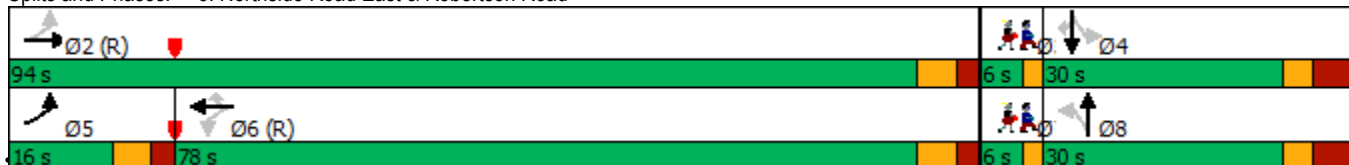

Lane Group	Ø3	Ø7
Switch Phase		
Minimum Initial (s)	4.0	4.0
Minimum Split (s)	6.0	6.0
Total Split (s)	6.0	6.0
Total Split (%)	5%	5%
Maximum Green (s)	4.0	4.0
Yellow Time (s)	2.0	2.0
All-Red Time (s)	0.0	0.0
Lost Time Adjust (s)		
Total Lost Time (s)		
Lead/Lag	Lead	Lead
Lead-Lag Optimize?	Yes	Yes
Vehicle Extension (s)	3.0	3.0
Recall Mode	None	None
Walk Time (s)		
Flash Dont Walk (s)		
Pedestrian Calls (#/hr)		
Act Effct Green (s)		
Actuated g/C Ratio		
v/c Ratio		
Control Delay		
Queue Delay		
Total Delay		
LOS		
Approach Delay		
Approach LOS		
Queue Length 50th (m)		
Queue Length 95th (m)		
Internal Link Dist (m)		
Turn Bay Length (m)		
Base Capacity (vph)		
Starvation Cap Reductn		
Spillback Cap Reductn		
Storage Cap Reductn		
Reduced v/c Ratio		
Intersection Summary		

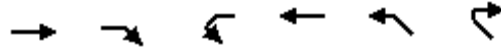

Lane Group	EBT	EBR	WBL	WBT	NWL	NWR
Lane Configurations	↑↑			↑↑↑		
Traffic Volume (vph)	1992	108	0	786	0	0
Future Volume (vph)	1992	108	0	786	0	0
Ideal Flow (vphpl)	1800	1800	1800	1800	1800	1800
Storage Length (m)		0.0	25.0		0.0	0.0
Storage Lanes		0	1		0	0
Taper Length (m)			25.0		10.0	
Lane Util. Factor	0.95	0.95	1.00	0.91	1.00	1.00
Fr <sub>t</sub>	0.992					
Flt Protected						
Satd. Flow (prot)	3356	0	0	4871	0	0
Flt Permitted						
Satd. Flow (perm)	3356	0	0	4871	0	0
Link Speed (k/h)	60			60	50	
Link Distance (m)	66.2			72.0	100.3	
Travel Time (s)	4.0			4.3	7.2	
Peak Hour Factor	1.00	1.00	1.00	1.00	1.00	1.00
Heavy Vehicles (%)	2%	6%	1%	2%	1%	1%
Adj. Flow (vph)	1992	108	0	786	0	0
Shared Lane Traffic (%)						
Lane Group Flow (vph)	2100	0	0	786	0	0
Enter Blocked Intersection	Yes	Yes	Yes	Yes	No	No
Lane Alignment	Left	Right	Left	Left	Left	Right
Median Width(m)	3.7			3.7	0.0	
Link Offset(m)	0.0			0.0	0.0	
Crosswalk Width(m)	0.0			0.0	0.0	
Two way Left Turn Lane						
Headway Factor	1.06	1.06	1.06	1.06	1.06	1.06
Turning Speed (k/h)		50	24		24	14
Sign Control	Free			Free	Free	

**Intersection Summary**

Area Type: Other

Control Type: Unsignalized

Intersection Capacity Utilization 65.1% ICU Level of Service C











Analysis Period (min) 15











Lane Group	EBT	EBR	WBL	WBT	NBL	NBR
Lane Configurations						
Traffic Volume (vph)	100	8	63	0	0	33
Future Volume (vph)	100	8	63	0	0	33
Ideal Flow (vphpl)	1800	1800	1800	1800	1800	1800
Lane Util. Factor	1.00	1.00	1.00	1.00	1.00	1.00
Ped Bike Factor						
Frt	0.990					0.865
Flt Protected			0.950			
Satd. Flow (prot)	1706	0	1572	0	0	1458
Flt Permitted			0.950			
Satd. Flow (perm)	1706	0	1572	0	0	1458
Link Speed (k/h)	50			40	40	
Link Distance (m)	100.3			62.0	54.2	
Travel Time (s)	7.2			5.6	4.9	
Confl. Peds. (#/hr)		17	17			
Peak Hour Factor	1.00	1.00	1.00	1.00	1.00	1.00
Heavy Vehicles (%)	6%	1%	10%	1%	1%	8%
Adj. Flow (vph)	100	8	63	0	0	33
Shared Lane Traffic (%)						
Lane Group Flow (vph)	108	0	63	0	0	33
Enter Blocked Intersection	No	No	No	No	No	No
Lane Alignment	L NA	R NA	L NA	R NA	Left	R NA
Median Width(m)	3.7			3.7	0.0	
Link Offset(m)	3.0			3.0	0.0	
Crosswalk Width(m)	5.0			5.0	5.0	
Two way Left Turn Lane						
Headway Factor	1.06	1.06	1.06	1.06	1.06	1.06
Turning Speed (k/h)		14	24		24	14
Sign Control	Stop			Stop	Stop	

**Intersection Summary**

Area Type:	Other
Control Type:	Unsignalized
Intersection Capacity Utilization 19.3%	ICU Level of Service A
Analysis Period (min)	15

						
Lane Group	WBL	WBR	NBT	NBR	SBL	SBT
Lane Configurations						
Traffic Volume (vph)	1	39	134	3	44	28
Future Volume (vph)	1	39	134	3	44	28
Ideal Flow (vphpl)	1800	1800	1800	1800	1800	1800
Storage Length (m)	0.0	0.0		45.0	15.0	
Storage Lanes	1	0		0	1	
Taper Length (m)	10.0				20.0	
Lane Util. Factor	1.00	1.00	0.95	0.95	1.00	1.00
Frt	0.868		0.997			
Flt Protected	0.999				0.950	
Satd. Flow (prot)	1563	0	3381	0	1712	1784
Flt Permitted	0.999				0.950	
Satd. Flow (perm)	1563	0	3381	0	1712	1784
Link Speed (k/h)	40		40		40	
Link Distance (m)	173.4		68.2		81.0	
Travel Time (s)	15.6		6.1		7.3	
Peak Hour Factor	1.00	1.00	1.00	1.00	1.00	1.00
Heavy Vehicles (%)	1%	1%	2%	1%	1%	2%
Adj. Flow (vph)	1	39	134	3	44	28
Shared Lane Traffic (%)						
Lane Group Flow (vph)	40	0	137	0	44	28
Enter Blocked Intersection	No	No	No	No	No	No
Lane Alignment	Left	Right	Left	Right	Left	Left
Median Width(m)	3.7		3.7		3.7	
Link Offset(m)	0.0		0.0		0.0	
Crosswalk Width(m)	5.0		5.0		5.0	
Two way Left Turn Lane						
Headway Factor	1.06	1.06	1.06	1.06	1.06	1.06
Turning Speed (k/h)	24	14		14	24	
Sign Control	Stop		Free			Free
<b>Intersection Summary</b>						
Area Type:	Other					
Control Type:	Unsignalized					
Intersection Capacity Utilization 20.7%	ICU Level of Service A					
Analysis Period (min) 15						

						
Lane Group	WBL	WBR	NBT	NBR	SBL	SBT
Lane Configurations						
Traffic Volume (vph)	1	3	134	1	6	23
Future Volume (vph)	1	3	134	1	6	23
Ideal Flow (vphpl)	1800	1800	1800	1800	1800	1800
Lane Util. Factor	1.00	1.00	1.00	1.00	1.00	1.00
Frt	0.899		0.999			
Flt Protected	0.988					0.990
Satd. Flow (prot)	1601	0	1783	0	0	1770
Flt Permitted	0.988					0.990
Satd. Flow (perm)	1601	0	1783	0	0	1770
Link Speed (k/h)	50		50			50
Link Distance (m)	178.0		82.4			68.2
Travel Time (s)	12.8		5.9			4.9
Peak Hour Factor	1.00	1.00	1.00	1.00	1.00	1.00
Heavy Vehicles (%)	1%	1%	2%	1%	1%	2%
Adj. Flow (vph)	1	3	134	1	6	23
Shared Lane Traffic (%)						
Lane Group Flow (vph)	4	0	135	0	0	29
Enter Blocked Intersection	No	No	No	No	No	No
Lane Alignment	L NA	R NA	Left	Right	Left	Left
Median Width(m)	3.7		0.0			0.0
Link Offset(m)	0.0		0.0			0.0
Crosswalk Width(m)	5.0		5.0			5.0
Two way Left Turn Lane						
Headway Factor	1.06	1.06	1.06	1.06	1.06	1.06
Turning Speed (k/h)	97	97		97	97	
Sign Control	Stop		Free			Free
<b>Intersection Summary</b>						
Area Type:	Other					
Control Type:	Unsignalized					
Intersection Capacity Utilization	17.5%			ICU Level of Service A		
Analysis Period (min)	15					



Lane Group	EBL	EBR	NBL	NBT	SBT	SBR
Lane Configurations						
Traffic Volume (vph)	17	0	0	16	43	28
Future Volume (vph)	17	0	0	16	43	28
Ideal Flow (vphpl)	1800	1800	1800	1800	1800	1800
Lane Util. Factor	1.00	1.00	1.00	1.00	1.00	1.00
Frt					0.947	
Flt Protected	0.950					
Satd. Flow (prot)	1712	0	0	1802	1706	0
Flt Permitted	0.950					
Satd. Flow (perm)	1712	0	0	1802	1706	0
Link Speed (k/h)	40			40	40	
Link Distance (m)	173.4			67.2	54.2	
Travel Time (s)	15.6			6.0	4.9	
Peak Hour Factor	1.00	1.00	1.00	1.00	1.00	1.00
Heavy Vehicles (%)	1%	1%	1%	1%	1%	1%
Adj. Flow (vph)	17	0	0	16	43	28
Shared Lane Traffic (%)						
Lane Group Flow (vph)	17	0	0	16	71	0
Enter Blocked Intersection	No	No	No	No	No	No
Lane Alignment	Left	Right	Left	Left	Left	Right
Median Width(m)	3.7			0.0	0.0	
Link Offset(m)	0.0			0.0	0.0	
Crosswalk Width(m)	5.0			5.0	5.0	
Two way Left Turn Lane						
Headway Factor	1.06	1.06	1.06	1.06	1.06	1.06
Turning Speed (k/h)	24	14	24			14
Sign Control	Stop			Free	Free	

**Intersection Summary**

Area Type:	Other
Control Type:	Unsignalized
Intersection Capacity Utilization	14.2%
Analysis Period (min)	15
	ICU Level of Service A



Lane Group	EBL	EBR	NBL	NBT	SBT	SBR
Lane Configurations						
Traffic Volume (vph)	3	0	0	13	38	5
Future Volume (vph)	3	0	0	13	38	5
Ideal Flow (vphpl)	1800	1800	1800	1800	1800	1800
Lane Util. Factor	1.00	1.00	1.00	1.00	1.00	1.00
Frt					0.984	
Frt Protected	0.950					
Satd. Flow (prot)	1712	0	0	1802	1773	0
Frt Permitted	0.950					
Satd. Flow (perm)	1712	0	0	1802	1773	0
Link Speed (k/h)	50			50	50	
Link Distance (m)	178.0			106.1	67.2	
Travel Time (s)	12.8			7.6	4.8	
Peak Hour Factor	1.00	1.00	1.00	1.00	1.00	1.00
Heavy Vehicles (%)	1%	1%	1%	1%	1%	1%
Adj. Flow (vph)	3	0	0	13	38	5
Shared Lane Traffic (%)						
Lane Group Flow (vph)	3	0	0	13	43	0
Enter Blocked Intersection	No	No	No	No	No	No
Lane Alignment	L NA	R NA	Left	Left	Left	Right
Median Width(m)	3.7			0.0	0.0	
Link Offset(m)	0.0			0.0	0.0	
Crosswalk Width(m)	5.0			5.0	5.0	
Two way Left Turn Lane						
Headway Factor	1.06	1.06	1.06	1.06	1.06	1.06
Turning Speed (k/h)	97	97	97			97
Sign Control	Stop			Free	Free	

**Intersection Summary**

Area Type:	Other
Control Type:	Unsignalized
Intersection Capacity Utilization	13.3%
ICU Level of Service	A
Analysis Period (min)	15



1: Stinson Avenue & Robertson Road  
PM Peak Hour

1826 Robertson Road  
2029 Total Traffic

Lane Group	EBL	EBT	EBR	WBL	WBT	WBR	NBL	NBT	NBR	SBL	SBT	SBR
Lane Configurations												
Traffic Volume (vph)	16	1147	25	41	1428	5	12	1	25	20	1	46
Future Volume (vph)	16	1147	25	41	1428	5	12	1	25	20	1	46
Ideal Flow (vphpl)	1800	1800	1800	1800	1800	1800	1800	1800	1800	1800	1800	1800
Storage Length (m)	75.0		0.0	45.0		0.0	0.0		0.0	0.0		0.0
Storage Lanes	1		0	1		0	0		0	0		0
Taper Length (m)	10.0			10.0			10.0			10.0		
Lane Util. Factor	1.00	0.95	0.95	1.00	0.95	0.95	1.00	1.00	1.00	1.00	1.00	1.00
Ped Bike Factor		1.00		0.99	1.00			0.98			0.98	
Frt		0.997		0.999				0.911			0.907	
Flt Protected	0.950			0.950				0.984			0.985	
Satd. Flow (prot)	1647	3344	0	1712	3353	0	0	1588	0	0	1547	0
Flt Permitted	0.164			0.225				0.899			0.886	
Satd. Flow (perm)	284	3344	0	403	3353	0	0	1447	0	0	1386	0
Right Turn on Red			Yes			Yes			Yes			Yes
Satd. Flow (RTOR)		4			1			25			46	
Link Speed (k/h)		60			60			40			40	
Link Distance (m)		198.0			310.7			254.0			246.4	
Travel Time (s)		11.9			18.6			22.9			22.2	
Confl. Peds. (#/hr)	17		14	14		17	5		10	10		5
Peak Hour Factor	1.00	1.00	1.00	1.00	1.00	1.00	1.00	1.00	1.00	1.00	1.00	1.00
Heavy Vehicles (%)	5%	3%	1%	1%	3%	1%	1%	1%	1%	1%	1%	5%
Adj. Flow (vph)	16	1147	25	41	1428	5	12	1	25	20	1	46
Shared Lane Traffic (%)												
Lane Group Flow (vph)	16	1172	0	41	1433	0	0	38	0	0	67	0
Enter Blocked Intersection	No	No	No	No	No	No	No	No	No	No	No	No
Lane Alignment	L NA	Left	R NA	L NA	Left	R NA	L NA	Left	R NA	L NA	Left	R NA
Median Width(m)		3.7			3.7			0.0			0.0	
Link Offset(m)		0.0			0.0			0.0			0.0	
Crosswalk Width(m)		5.0			5.0			5.0			5.0	
Two way Left Turn Lane		Yes			Yes							
Headway Factor	1.06	1.06	1.06	1.06	1.06	1.06	1.06	1.06	1.06	1.06	1.06	1.06
Turning Speed (k/h)	24		14	24		14	24		14	24		14
Number of Detectors	1	2		1	2		1	2		1	2	
Detector Template	Left	Thru		Left	Thru		Left	Thru		Left	Thru	
Leading Detector (m)	6.1	30.5		6.1	30.5		6.1	30.5		6.1	30.5	
Trailing Detector (m)	0.0	0.0		0.0	0.0		0.0	0.0		0.0	0.0	
Detector 1 Position(m)	0.0	0.0		0.0	0.0		0.0	0.0		0.0	0.0	
Detector 1 Size(m)	6.1	1.8		6.1	1.8		6.1	1.8		6.1	1.8	
Detector 1 Type	Cl+Ex	Cl+Ex		Cl+Ex	Cl+Ex		Cl+Ex	Cl+Ex		Cl+Ex	Cl+Ex	
Detector 1 Channel												
Detector 1 Extend (s)	0.0	0.0		0.0	0.0		0.0	0.0		0.0	0.0	
Detector 1 Queue (s)	0.0	0.0		0.0	0.0		0.0	0.0		0.0	0.0	
Detector 1 Delay (s)	0.0	0.0		0.0	0.0		0.0	0.0		0.0	0.0	
Detector 2 Position(m)		28.7			28.7			28.7			28.7	
Detector 2 Size(m)		1.8			1.8			1.8			1.8	
Detector 2 Type		Cl+Ex			Cl+Ex			Cl+Ex			Cl+Ex	
Detector 2 Channel												
Detector 2 Extend (s)		0.0			0.0			0.0			0.0	
Turn Type	Perm	NA		Perm	NA		Perm	NA		Perm	NA	
Protected Phases		2			6			8			4	
Permitted Phases	2			6			8		4			
Detector Phase	2	2		6	6		8	8		4	4	
Switch Phase												



Lane Group	EBL	EBT	EBR	WBL	WBT	WBR	NBL	NBT	NBR	SBL	SBT	SBR
Minimum Initial (s)	10.0	10.0		10.0	10.0		10.0	10.0		10.0	10.0	
Minimum Split (s)	26.8	26.8		26.8	26.8		31.6	31.6		31.6	31.6	
Total Split (s)	88.0	88.0		88.0	88.0		32.0	32.0		32.0	32.0	
Total Split (%)	73.3%	73.3%		73.3%	73.3%		26.7%	26.7%		26.7%	26.7%	
Maximum Green (s)	82.2	82.2		82.2	82.2		25.4	25.4		25.4	25.4	
Yellow Time (s)	3.7	3.7		3.7	3.7		3.0	3.0		3.0	3.0	
All-Red Time (s)	2.1	2.1		2.1	2.1		3.6	3.6		3.6	3.6	
Lost Time Adjust (s)	0.0	0.0		0.0	0.0			0.0			0.0	
Total Lost Time (s)	5.8	5.8		5.8	5.8			6.6			6.6	
Lead/Lag												
Lead-Lag Optimize?												
Vehicle Extension (s)	3.0	3.0		3.0	3.0		3.0	3.0		3.0	3.0	
Recall Mode	C-Max	C-Max		C-Max	C-Max		None	None		None	None	
Walk Time (s)	7.0	7.0		7.0	7.0		7.0	7.0		7.0	7.0	
Flash Dont Walk (s)	14.0	14.0		14.0	14.0		18.0	18.0		18.0	18.0	
Pedestrian Calls (#/hr)	14	14		17	17		10	10		5	5	
Act Effct Green (s)	99.1	99.1		99.1	99.1			13.0			13.0	
Actuated g/C Ratio	0.83	0.83		0.83	0.83			0.11			0.11	
v/c Ratio	0.07	0.42		0.12	0.52			0.21			0.35	
Control Delay	5.1	4.8		1.5	3.5			25.5			24.5	
Queue Delay	0.0	0.0		0.0	0.0			0.0			0.0	
Total Delay	5.1	4.8		1.5	3.5			25.5			24.5	
LOS	A	A		A	A			C			C	
Approach Delay		4.8			3.4			25.5			24.5	
Approach LOS		A			A			C			C	
Queue Length 50th (m)	0.6	30.2		0.3	5.3			2.7			4.3	
Queue Length 95th (m)	3.4	70.9		m0.6	168.5			10.8			14.9	
Internal Link Dist (m)		174.0			286.7			230.0			222.4	
Turn Bay Length (m)	75.0			45.0								
Base Capacity (vph)	234	2761		332	2768			325			329	
Starvation Cap Reductn	0	0		0	0			0			0	
Spillback Cap Reductn	0	0		0	0			0			0	
Storage Cap Reductn	0	0		0	0			0			0	
Reduced v/c Ratio	0.07	0.42		0.12	0.52			0.12			0.20	

Intersection Summary

Area Type: Other  
 Cycle Length: 120  
 Actuated Cycle Length: 120  
 Offset: 31 (26%), Referenced to phase 2:EBTL and 6:WBTL, Start of Green  
 Natural Cycle: 70  
 Control Type: Actuated-Coordinated  
 Maximum v/c Ratio: 0.52  
 Intersection Signal Delay: 4.8  
 Intersection Capacity Utilization 64.1%  
 Analysis Period (min) 15  
 m Volume for 95th percentile queue is metered by upstream signal.

Splits and Phases: 1: Stinson Avenue & Robertson Road

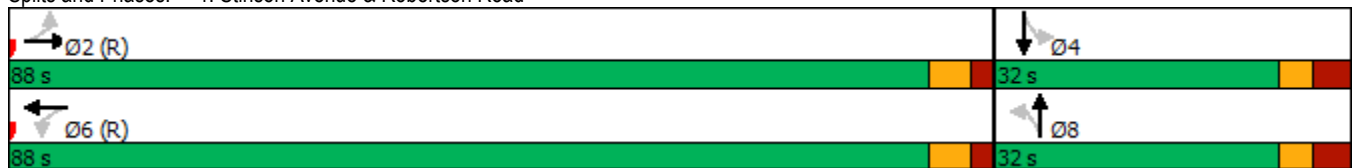

2: Lynhar Road/Stafford Road & Robertson Road  
PM Peak Hour

1826 Robertson Road  
2029 Total Traffic

Lane Group	EBL	EBT	EBR	WBL	WBT	WBR	NBL	NBT	NBR	SBL	SBT	SBR
Lane Configurations												
Traffic Volume (vph)	125	971	68	60	1137	77	99	42	85	201	37	173
Future Volume (vph)	125	971	68	60	1137	77	99	42	85	201	37	173
Ideal Flow (vphpl)	1800	1800	1800	1800	1800	1800	1800	1800	1800	1800	1800	1800
Storage Length (m)	85.0		40.0	0.0		0.0	0.0		30.0	45.0		75.0
Storage Lanes	1		1	1		0	1		1	1		1
Taper Length (m)	10.0			10.0			10.0			30.0		
Lane Util. Factor	1.00	0.95	1.00	1.00	0.95	0.95	1.00	1.00	1.00	1.00	1.00	1.00
Ped Bike Factor	0.99		0.94	0.99	1.00		0.98		0.95	0.97		0.97
Frt			0.850		0.990				0.850			0.850
Flt Protected	0.950			0.950			0.950			0.950		
Satd. Flow (prot)	1712	3357	1532	1712	3343	0	1631	1767	1502	1695	1802	1532
Flt Permitted	0.950			0.950			0.733			0.629		
Satd. Flow (perm)	1702	3357	1443	1695	3343	0	1239	1767	1434	1087	1802	1488
Right Turn on Red			Yes			Yes			Yes			Yes
Satd. Flow (RTOR)			145		7				142			173
Link Speed (k/h)		60			60			40			40	
Link Distance (m)		310.7			66.2			81.0			107.6	
Travel Time (s)		18.6			4.0			7.3			9.7	
Confl. Peds. (#/hr)	22		16	16		22	14		29	29		14
Confl. Bikes (#/hr)												1
Peak Hour Factor	1.00	1.00	1.00	1.00	1.00	1.00	1.00	1.00	1.00	1.00	1.00	1.00
Heavy Vehicles (%)	1%	3%	1%	1%	2%	4%	6%	3%	3%	2%	1%	1%
Adj. Flow (vph)	125	971	68	60	1137	77	99	42	85	201	37	173
Shared Lane Traffic (%)												
Lane Group Flow (vph)	125	971	68	60	1214	0	99	42	85	201	37	173
Enter Blocked Intersection	No	No	No	No	No	No	No	No	No	No	No	No
Lane Alignment	L NA	Left	R NA	L NA	Left	R NA	L NA	L NA	R NA	L NA	Left	R NA
Median Width(m)		3.7			7.4			7.4			7.4	
Link Offset(m)		0.0			0.0			0.0			0.0	
Crosswalk Width(m)		5.0			5.0			5.0			5.0	
Two way Left Turn Lane		Yes										
Headway Factor	1.06	1.06	1.06	1.06	1.06	1.06	1.06	1.06	1.06	1.06	1.06	1.06
Turning Speed (k/h)	24		14	24		14	24		14	24		14
Number of Detectors	1	2	1	1	2		1	2	1	1	2	1
Detector Template	Left	Thru	Right	Left	Thru		Left	Thru	Right	Left	Thru	Right
Leading Detector (m)	6.1	30.5	6.1	6.1	30.5		6.1	30.5	6.1	6.1	30.5	6.1
Trailing Detector (m)	0.0	0.0	0.0	0.0	0.0		0.0	0.0	0.0	0.0	0.0	0.0
Detector 1 Position(m)	0.0	0.0	0.0	0.0	0.0		0.0	0.0	0.0	0.0	0.0	0.0
Detector 1 Size(m)	6.1	1.8	6.1	6.1	1.8		6.1	1.8	6.1	6.1	1.8	6.1
Detector 1 Type	Cl+Ex	Cl+Ex	Cl+Ex	Cl+Ex	Cl+Ex		Cl+Ex	Cl+Ex	Cl+Ex	Cl+Ex	Cl+Ex	Cl+Ex
Detector 1 Channel												
Detector 1 Extend (s)	0.0	0.0	0.0	0.0	0.0		0.0	0.0	0.0	0.0	0.0	0.0
Detector 1 Queue (s)	0.0	0.0	0.0	0.0	0.0		0.0	0.0	0.0	0.0	0.0	0.0
Detector 1 Delay (s)	0.0	0.0	0.0	0.0	0.0		0.0	0.0	0.0	0.0	0.0	0.0
Detector 2 Position(m)		28.7			28.7			28.7			28.7	
Detector 2 Size(m)		1.8			1.8			1.8			1.8	
Detector 2 Type		Cl+Ex			Cl+Ex			Cl+Ex			Cl+Ex	
Detector 2 Channel												
Detector 2 Extend (s)		0.0			0.0			0.0			0.0	
Turn Type	Prot	NA	Perm	Prot	NA		pm+pt	NA	Perm	pm+pt	NA	Perm
Protected Phases	5	2		1	6		3	8		7	4	
Permitted Phases			2				8		8	4		4
Detector Phase	5	2	2	1	6		3	8	8	7	4	4



Lane Group	EBL	EBT	EBR	WBL	WBT	WBR	NBL	NBT	NBR	SBL	SBT	SBR
Switch Phase												
Minimum Initial (s)	5.0	10.0	10.0	5.0	10.0		5.0	10.0	10.0	5.0	10.0	10.0
Minimum Split (s)	11.1	31.3	31.3	11.1	31.3		11.2	37.7	37.7	11.2	37.7	37.7
Total Split (s)	15.0	54.0	54.0	15.0	54.0		12.0	39.0	39.0	12.0	39.0	39.0
Total Split (%)	12.5%	45.0%	45.0%	12.5%	45.0%		10.0%	32.5%	32.5%	10.0%	32.5%	32.5%
Maximum Green (s)	8.9	47.7	47.7	8.9	47.7		5.8	32.3	32.3	5.8	32.3	32.3
Yellow Time (s)	3.7	3.7	3.7	3.7	3.7		3.0	3.0	3.0	3.0	3.0	3.0
All-Red Time (s)	2.4	2.6	2.6	2.4	2.6		3.2	3.7	3.7	3.2	3.7	3.7
Lost Time Adjust (s)	0.0	0.0	0.0	0.0	0.0		0.0	0.0	0.0	0.0	0.0	0.0
Total Lost Time (s)	6.1	6.3	6.3	6.1	6.3		6.2	6.7	6.7	6.2	6.7	6.7
Lead/Lag	Lead	Lag	Lag	Lead	Lag		Lead	Lag	Lag	Lead	Lag	Lag
Lead-Lag Optimize?	Yes	Yes	Yes	Yes	Yes		Yes	Yes	Yes	Yes	Yes	Yes
Vehicle Extension (s)	3.0	3.0	3.0	3.0	3.0		3.0	3.0	3.0	3.0	3.0	3.0
Recall Mode	None	C-Max	C-Max	None	C-Max		None	None	None	None	None	None
Walk Time (s)		7.0	7.0		7.0			12.0	12.0		12.0	12.0
Flash Dont Walk (s)		18.0	18.0		18.0			19.0	19.0		19.0	19.0
Pedestrian Calls (#/hr)		16	16		22			29	29		14	14
Act Effct Green (s)	12.0	59.9	59.9	8.8	54.3		26.8	22.6	22.6	30.1	22.6	22.6
Actuated g/C Ratio	0.10	0.50	0.50	0.07	0.45		0.22	0.19	0.19	0.25	0.19	0.19
v/c Ratio	0.73	0.58	0.09	0.48	0.80		0.34	0.13	0.22	0.63	0.11	0.41
Control Delay	72.9	29.7	4.3	85.6	23.9		34.3	36.9	2.0	45.2	36.6	8.2
Queue Delay	0.0	0.0	0.0	0.0	0.0		0.0	0.0	0.0	0.0	0.0	0.0
Total Delay	72.9	29.7	4.3	85.6	23.9		34.3	36.9	2.0	45.2	36.6	8.2
LOS	E	C	A	F	C		C	D	A	D	D	A
Approach Delay		32.8			26.8			22.6			28.9	
Approach LOS		C			C			C			C	
Queue Length 50th (m)	27.1	77.5	0.0	12.6	131.4		14.5	7.0	0.0	31.3	6.1	0.0
Queue Length 95th (m)	#58.8	123.4	5.1	m24.3	#168.8		26.0	15.3	1.5	49.2	14.0	15.5
Internal Link Dist (m)		286.7			42.2			57.0			83.6	
Turn Bay Length (m)	85.0		40.0						30.0	45.0		75.0
Base Capacity (vph)	171	1676	792	136	1516		295	475	489	319	485	526
Starvation Cap Reductn	0	0	0	0	0		0	0	0	0	0	0
Spillback Cap Reductn	0	0	0	0	0		0	0	0	0	0	0
Storage Cap Reductn	0	0	0	0	0		0	0	0	0	0	0
Reduced v/c Ratio	0.73	0.58	0.09	0.44	0.80		0.34	0.09	0.17	0.63	0.08	0.33

Intersection Summary

Area Type: Other  
 Cycle Length: 120  
 Actuated Cycle Length: 120  
 Offset: 7 (6%), Referenced to phase 2:EBT and 6:WBT, Start of Green  
 Natural Cycle: 105  
 Control Type: Actuated-Coordinated  
 Maximum v/c Ratio: 0.80  
 Intersection Signal Delay: 29.1 Intersection LOS: C  
 Intersection Capacity Utilization 80.3% ICU Level of Service D  
 Analysis Period (min) 15  
 # 95th percentile volume exceeds capacity, queue may be longer.  
 Queue shown is maximum after two cycles.  
 m Volume for 95th percentile queue is metered by upstream signal.

Splits and Phases: 2: Lynhar Road/Stafford Road & Robertson Road

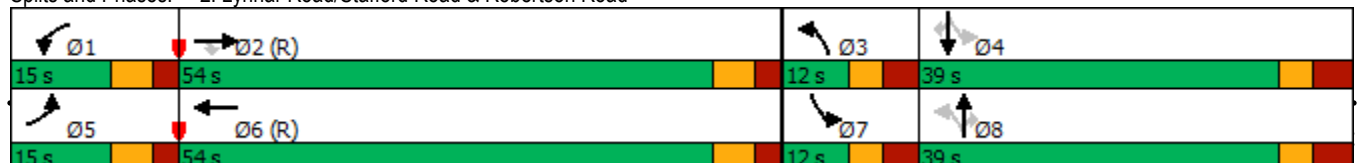

3: Northside Road East & Robertson Road  
PM Peak Hour

1826 Robertson Road  
2029 Total Traffic

Lane Group	EBL	EBT	EBR	WBL	WBT	WBR	NBL	NBT	NBR	SBL	SBT	SBR
Lane Configurations												
Traffic Volume (vph)	66	1125	16	84	1234	220	138	37	108	155	55	78
Future Volume (vph)	66	1125	16	84	1234	220	138	37	108	155	55	78
Ideal Flow (vphpl)	1800	1800	1800	1800	1800	1800	1800	1800	1800	1800	1800	1800
Storage Length (m)	55.0		0.0	75.0		80.0	0.0		0.0	0.0		0.0
Storage Lanes	1		0	1		1	1		0	1		1
Taper Length (m)	30.0			15.0			10.0			10.0		
Lane Util. Factor	1.00	0.95	0.95	1.00	0.95	1.00	1.00	1.00	1.00	1.00	1.00	1.00
Ped Bike Factor		1.00		1.00		0.97	0.98	0.99		0.99		0.96
Frt		0.998				0.850		0.888				0.850
Flt Protected	0.950			0.950			0.950			0.950		
Satd. Flow (prot)	1712	3383	0	1712	3390	1532	1695	1557	0	1712	1802	1532
Flt Permitted	0.151			0.249			0.721			0.611		
Satd. Flow (perm)	272	3383	0	448	3390	1488	1257	1557	0	1094	1802	1469
Right Turn on Red			Yes			Yes			Yes			Yes
Satd. Flow (RTOR)		2				220		108				101
Link Speed (k/h)		60			60			40				40
Link Distance (m)		105.4			310.9			87.0				90.9
Travel Time (s)		6.3			18.7			7.8				8.2
Confl. Peds. (#/hr)	3		7	7		3	16		5	5		16
Confl. Bikes (#/hr)			1			2						4
Peak Hour Factor	1.00	1.00	1.00	1.00	1.00	1.00	1.00	1.00	1.00	1.00	1.00	1.00
Heavy Vehicles (%)	1%	2%	1%	1%	2%	1%	2%	3%	2%	1%	1%	1%
Adj. Flow (vph)	66	1125	16	84	1234	220	138	37	108	155	55	78
Shared Lane Traffic (%)												
Lane Group Flow (vph)	66	1141	0	84	1234	220	138	145	0	155	55	78
Enter Blocked Intersection	No	No	No	No	No	No	No	No	No	No	No	No
Lane Alignment	L NA	Left	R NA	L NA	Left	R NA	L NA	Left	R NA	L NA	Left	R NA
Median Width(m)		5.5			5.5			3.7				3.7
Link Offset(m)		0.0			0.0			0.0				0.0
Crosswalk Width(m)		5.0			5.0			5.0				5.0
Two way Left Turn Lane												
Headway Factor	1.06	1.06	1.06	1.06	1.06	1.06	1.06	1.06	1.06	1.06	1.06	1.06
Turning Speed (k/h)	24		14	24		14	24		14	24		14
Number of Detectors	1	2		1	2	1	1	2		1	2	1
Detector Template	Left	Thru		Left	Thru	Right	Left	Thru		Left	Thru	Right
Leading Detector (m)	6.1	30.5		6.1	30.5	6.1	6.1	30.5		6.1	30.5	6.1
Trailing Detector (m)	0.0	0.0		0.0	0.0	0.0	0.0	0.0		0.0	0.0	0.0
Detector 1 Position(m)	0.0	0.0		0.0	0.0	0.0	0.0	0.0		0.0	0.0	0.0
Detector 1 Size(m)	6.1	1.8		6.1	1.8	6.1	6.1	1.8		6.1	1.8	6.1
Detector 1 Type	Cl+Ex	Cl+Ex		Cl+Ex	Cl+Ex	Cl+Ex	Cl+Ex	Cl+Ex		Cl+Ex	Cl+Ex	Cl+Ex
Detector 1 Channel												
Detector 1 Extend (s)	0.0	0.0		0.0	0.0	0.0	0.0	0.0		0.0	0.0	0.0
Detector 1 Queue (s)	0.0	0.0		0.0	0.0	0.0	0.0	0.0		0.0	0.0	0.0
Detector 1 Delay (s)	0.0	0.0		0.0	0.0	0.0	0.0	0.0		0.0	0.0	0.0
Detector 2 Position(m)		28.7			28.7			28.7				28.7
Detector 2 Size(m)		1.8			1.8			1.8				1.8
Detector 2 Type		Cl+Ex			Cl+Ex			Cl+Ex				Cl+Ex
Detector 2 Channel												
Detector 2 Extend (s)		0.0			0.0			0.0				0.0
Turn Type	pm+pt	NA		Perm	NA	Perm	Perm	NA		Perm	NA	Perm
Protected Phases	5	2			6			8				4
Permitted Phases	2			6		6	8			4		4
Detector Phase	5	2		6	6	6	8	8		4	4	4

Lane Group	Ø3	Ø7
Lane Configurations		
Traffic Volume (vph)		
Future Volume (vph)		
Ideal Flow (vphpl)		
Storage Length (m)		
Storage Lanes		
Taper Length (m)		
Lane Util. Factor		
Ped Bike Factor		
Frt		
Flt Protected		
Satd. Flow (prot)		
Flt Permitted		
Satd. Flow (perm)		
Right Turn on Red		
Satd. Flow (RTOR)		
Link Speed (k/h)		
Link Distance (m)		
Travel Time (s)		
Confl. Peds. (#/hr)		
Confl. Bikes (#/hr)		
Peak Hour Factor		
Heavy Vehicles (%)		
Adj. Flow (vph)		
Shared Lane Traffic (%)		
Lane Group Flow (vph)		
Enter Blocked Intersection		
Lane Alignment		
Median Width(m)		
Link Offset(m)		
Crosswalk Width(m)		
Two way Left Turn Lane		
Headway Factor		
Turning Speed (k/h)		
Number of Detectors		
Detector Template		
Leading Detector (m)		
Trailing Detector (m)		
Detector 1 Position(m)		
Detector 1 Size(m)		
Detector 1 Type		
Detector 1 Channel		
Detector 1 Extend (s)		
Detector 1 Queue (s)		
Detector 1 Delay (s)		
Detector 2 Position(m)		
Detector 2 Size(m)		
Detector 2 Type		
Detector 2 Channel		
Detector 2 Extend (s)		
Turn Type		
Protected Phases	3	7
Permitted Phases		
Detector Phase		

3: Northside Road East & Robertson Road  
PM Peak Hour

1826 Robertson Road  
2029 Total Traffic



Lane Group	EBL	EBT	EBR	WBL	WBT	WBR	NBL	NBT	NBR	SBL	SBT	SBR
Switch Phase												
Minimum Initial (s)	5.0	10.0		10.0	10.0	10.0	10.0	10.0		10.0	10.0	10.0
Minimum Split (s)	11.0	30.1		30.1	30.1	30.1	29.8	29.8		29.8	29.8	29.8
Total Split (s)	15.0	83.0		68.0	68.0	68.0	31.0	31.0		31.0	31.0	31.0
Total Split (%)	12.5%	69.2%		56.7%	56.7%	56.7%	25.8%	25.8%		25.8%	25.8%	25.8%
Maximum Green (s)	9.0	76.9		61.9	61.9	61.9	24.2	24.2		24.2	24.2	24.2
Yellow Time (s)	3.7	3.7		3.7	3.7	3.7	3.0	3.0		3.0	3.0	3.0
All-Red Time (s)	2.3	2.4		2.4	2.4	2.4	3.8	3.8		3.8	3.8	3.8
Lost Time Adjust (s)	0.0	0.0		0.0	0.0	0.0	0.0	0.0		0.0	0.0	0.0
Total Lost Time (s)	6.0	6.1		6.1	6.1	6.1	6.8	6.8		6.8	6.8	6.8
Lead/Lag	Lead			Lag	Lag	Lag	Lag	Lag		Lag	Lag	Lag
Lead-Lag Optimize?	Yes			Yes	Yes	Yes	Yes	Yes		Yes	Yes	Yes
Vehicle Extension (s)	3.0	3.0		3.0	3.0	3.0	3.0	3.0		3.0	3.0	3.0
Recall Mode	None	C-Max		C-Max	C-Max	C-Max	None	None		None	None	None
Walk Time (s)		7.0		7.0	7.0	7.0	1.0	1.0		1.0	1.0	1.0
Flash Dont Walk (s)		17.0		17.0	17.0	17.0	22.0	22.0		22.0	22.0	22.0
Pedestrian Calls (#/hr)		7		3	3	3	5	5		16	16	16
Act Effct Green (s)	85.2	85.1		74.4	74.4	74.4	22.0	22.0		22.0	22.0	22.0
Actuated g/C Ratio	0.71	0.71		0.62	0.62	0.62	0.18	0.18		0.18	0.18	0.18
v/c Ratio	0.24	0.48		0.30	0.59	0.22	0.60	0.39		0.78	0.17	0.22
Control Delay	9.3	9.3		17.9	17.1	2.4	54.7	15.2		70.3	39.7	5.1
Queue Delay	0.0	0.0		0.0	0.0	0.0	0.0	0.0		0.0	0.0	0.0
Total Delay	9.3	9.3		17.9	17.1	2.4	54.7	15.2		70.3	39.7	5.1
LOS	A	A		B	B	A	D	B		E	D	A
Approach Delay		9.3			15.1			34.5			46.8	
Approach LOS		A			B			C			D	
Queue Length 50th (m)	4.3	48.6		8.5	83.6	0.0	27.7	6.8		32.2	10.1	0.0
Queue Length 95th (m)	m7.8	60.7		22.8	126.2	10.7	43.5	21.5		50.1	19.1	6.9
Internal Link Dist (m)		81.4			286.9			63.0			66.9	
Turn Bay Length (m)	55.0			75.0		80.0						
Base Capacity (vph)	301	2399		277	2100	1005	269	419		234	386	394
Starvation Cap Reductn	0	0		0	0	0	0	0		0	0	0
Spillback Cap Reductn	0	0		0	0	0	0	0		0	0	0
Storage Cap Reductn	0	0		0	0	0	0	0		0	0	0
Reduced v/c Ratio	0.22	0.48		0.30	0.59	0.22	0.51	0.35		0.66	0.14	0.20

Intersection Summary

Area Type: Other  
 Cycle Length: 120  
 Actuated Cycle Length: 120  
 Offset: 111 (93%), Referenced to phase 2:EBTL and 6:WBTL, Start of Green  
 Natural Cycle: 90  
 Control Type: Actuated-Coordinated  
 Maximum v/c Ratio: 0.78  
 Intersection Signal Delay: 17.4 Intersection LOS: B  
 Intersection Capacity Utilization 84.4% ICU Level of Service E  
 Analysis Period (min) 15  
 m Volume for 95th percentile queue is metered by upstream signal.

Splits and Phases: 3: Northside Road East & Robertson Road

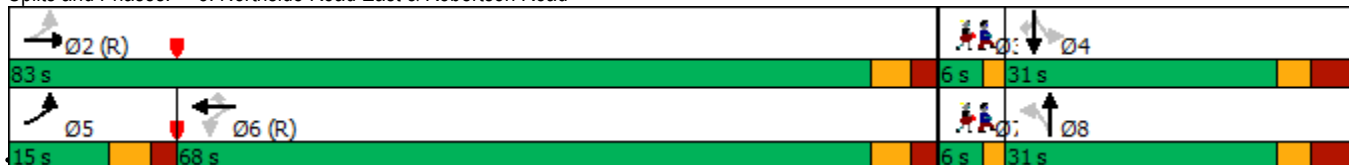

Lane Group	Ø3	Ø7
Switch Phase		
Minimum Initial (s)	4.0	4.0
Minimum Split (s)	6.0	6.0
Total Split (s)	6.0	6.0
Total Split (%)	5%	5%
Maximum Green (s)	4.0	4.0
Yellow Time (s)	2.0	2.0
All-Red Time (s)	0.0	0.0
Lost Time Adjust (s)		
Total Lost Time (s)		
Lead/Lag	Lead	Lead
Lead-Lag Optimize?	Yes	Yes
Vehicle Extension (s)	3.0	3.0
Recall Mode	None	None
Walk Time (s)		
Flash Dont Walk (s)		
Pedestrian Calls (#/hr)		
Act Effct Green (s)		
Actuated g/C Ratio		
v/c Ratio		
Control Delay		
Queue Delay		
Total Delay		
LOS		
Approach Delay		
Approach LOS		
Queue Length 50th (m)		
Queue Length 95th (m)		
Internal Link Dist (m)		
Turn Bay Length (m)		
Base Capacity (vph)		
Starvation Cap Reductn		
Spillback Cap Reductn		
Storage Cap Reductn		
Reduced v/c Ratio		
<b>Intersection Summary</b>		



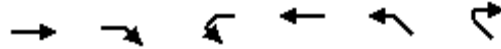

Lane Group	EBT	EBR	WBL	WBT	NWL	NWR
Lane Configurations	↑↑			↑↑↑		
Traffic Volume (vph)	1146	117	0	1279	0	0
Future Volume (vph)	1146	117	0	1279	0	0
Ideal Flow (vphpl)	1800	1800	1800	1800	1800	1800
Storage Length (m)		0.0	25.0		0.0	0.0
Storage Lanes		0	1		0	0
Taper Length (m)			25.0		10.0	
Lane Util. Factor	0.95	0.95	1.00	0.91	1.00	1.00
Frt	0.986					
Flt Protected						
Satd. Flow (prot)	3331	0	0	4871	0	0
Flt Permitted						
Satd. Flow (perm)	3331	0	0	4871	0	0
Link Speed (k/h)	60			60	50	
Link Distance (m)	66.2			72.0	100.3	
Travel Time (s)	4.0			4.3	7.2	
Peak Hour Factor	1.00	1.00	1.00	1.00	1.00	1.00
Heavy Vehicles (%)	2%	6%	1%	2%	1%	1%
Adj. Flow (vph)	1146	117	0	1279	0	0
Shared Lane Traffic (%)						
Lane Group Flow (vph)	1263	0	0	1279	0	0
Enter Blocked Intersection	Yes	Yes	Yes	Yes	No	No
Lane Alignment	Left	Right	Left	Left	Left	Right
Median Width(m)	3.7			3.7	0.0	
Link Offset(m)	0.0			0.0	0.0	
Crosswalk Width(m)	0.0			0.0	0.0	
Two way Left Turn Lane						
Headway Factor	1.06	1.06	1.06	1.06	1.06	1.06
Turning Speed (k/h)		50	24		24	14
Sign Control	Free			Free	Free	

**Intersection Summary**

Area Type: Other

Control Type: Unsignalized

Intersection Capacity Utilization 40.7% ICU Level of Service A











Analysis Period (min) 15











Lane Group	EBT	EBR	WBL	WBT	NBL	NBR
Lane Configurations						
Traffic Volume (vph)	107	10	103	0	0	81
Future Volume (vph)	107	10	103	0	0	81
Ideal Flow (vphpl)	1800	1800	1800	1800	1800	1800
Lane Util. Factor	1.00	1.00	1.00	1.00	1.00	1.00
Ped Bike Factor						
Frt	0.988					0.865
Flt Protected			0.950			
Satd. Flow (prot)	1689	0	1631	0	0	1514
Flt Permitted			0.950			
Satd. Flow (perm)	1689	0	1631	0	0	1514
Link Speed (k/h)	50			40	40	
Link Distance (m)	100.3			62.0	54.2	
Travel Time (s)	7.2			5.6	4.9	
Confl. Peds. (#/hr)		12	12			
Confl. Bikes (#/hr)		1				1
Peak Hour Factor	1.00	1.00	1.00	1.00	1.00	1.00
Heavy Vehicles (%)	7%	1%	6%	1%	1%	4%
Adj. Flow (vph)	107	10	103	0	0	81
Shared Lane Traffic (%)						
Lane Group Flow (vph)	117	0	103	0	0	81
Enter Blocked Intersection	No	No	No	No	No	No
Lane Alignment	L NA	R NA	L NA	R NA	Left	R NA
Median Width(m)	3.7			3.7	0.0	
Link Offset(m)	3.0			3.0	0.0	
Crosswalk Width(m)	5.0			5.0	5.0	
Two way Left Turn Lane						
Headway Factor	1.06	1.06	1.06	1.06	1.06	1.06
Turning Speed (k/h)		14	24		24	14
Sign Control	Stop			Stop	Stop	

**Intersection Summary**

Area Type:	Other
Control Type:	Unsignalized
Intersection Capacity Utilization 20.8%	ICU Level of Service A
Analysis Period (min)	15

						
Lane Group	WBL	WBR	NBT	NBR	SBL	SBT
Lane Configurations						
Traffic Volume (vph)	3	83	143	3	70	95
Future Volume (vph)	3	83	143	3	70	95
Ideal Flow (vphpl)	1800	1800	1800	1800	1800	1800
Storage Length (m)	0.0	0.0		45.0	15.0	
Storage Lanes	1	0		0	1	
Taper Length (m)	10.0				20.0	
Lane Util. Factor	1.00	1.00	0.95	0.95	1.00	1.00
Frt	0.870		0.997			
Flt Protected	0.998				0.950	
Satd. Flow (prot)	1565	0	3381	0	1712	1784
Flt Permitted	0.998				0.950	
Satd. Flow (perm)	1565	0	3381	0	1712	1784
Link Speed (k/h)	40		40			40
Link Distance (m)	173.4		68.2			81.0
Travel Time (s)	15.6		6.1			7.3
Peak Hour Factor	1.00	1.00	1.00	1.00	1.00	1.00
Heavy Vehicles (%)	1%	1%	2%	1%	1%	2%
Adj. Flow (vph)	3	83	143	3	70	95
Shared Lane Traffic (%)						
Lane Group Flow (vph)	86	0	146	0	70	95
Enter Blocked Intersection	No	No	No	No	No	No
Lane Alignment	Left	Right	Left	Right	Left	Left
Median Width(m)	3.7		3.7			3.7
Link Offset(m)	0.0		0.0			0.0
Crosswalk Width(m)	5.0		5.0			5.0
Two way Left Turn Lane						
Headway Factor	1.06	1.06	1.06	1.06	1.06	1.06
Turning Speed (k/h)	24	14		14	24	
Sign Control	Stop		Free			Free
<b>Intersection Summary</b>						
Area Type:	Other					
Control Type:	Unsignalized					
Intersection Capacity Utilization	24.0%			ICU Level of Service A		
Analysis Period (min)	15					

						
Lane Group	WBL	WBR	NBT	NBR	SBL	SBT
Lane Configurations						
Traffic Volume (vph)	1	9	137	1	8	90
Future Volume (vph)	1	9	137	1	8	90
Ideal Flow (vphpl)	1800	1800	1800	1800	1800	1800
Lane Util. Factor	1.00	1.00	1.00	1.00	1.00	1.00
Frt	0.878		0.999			
Flt Protected	0.995					0.996
Satd. Flow (prot)	1574	0	1783	0	0	1779
Flt Permitted	0.995					0.996
Satd. Flow (perm)	1574	0	1783	0	0	1779
Link Speed (k/h)	50		50			50
Link Distance (m)	178.0		82.4			68.2
Travel Time (s)	12.8		5.9			4.9
Peak Hour Factor	1.00	1.00	1.00	1.00	1.00	1.00
Heavy Vehicles (%)	1%	1%	2%	1%	1%	2%
Adj. Flow (vph)	1	9	137	1	8	90
Shared Lane Traffic (%)						
Lane Group Flow (vph)	10	0	138	0	0	98
Enter Blocked Intersection	No	No	No	No	No	No
Lane Alignment	L NA	R NA	Left	Right	Left	Left
Median Width(m)	3.7		0.0			0.0
Link Offset(m)	0.0		0.0			0.0
Crosswalk Width(m)	5.0		5.0			5.0
Two way Left Turn Lane						
Headway Factor	1.06	1.06	1.06	1.06	1.06	1.06
Turning Speed (k/h)	97	97		97	97	
Sign Control	Stop		Free			Free
<b>Intersection Summary</b>						
Area Type:	Other					
Control Type:	Unsignalized					
Intersection Capacity Utilization	22.0%			ICU Level of Service A		
Analysis Period (min)	15					



Lane Group	EBL	EBR	NBL	NBT	SBT	SBR
Lane Configurations						
Traffic Volume (vph)	25	0	0	56	74	39
Future Volume (vph)	25	0	0	56	74	39
Ideal Flow (vphpl)	1800	1800	1800	1800	1800	1800
Lane Util. Factor	1.00	1.00	1.00	1.00	1.00	1.00
Friction	0.953					
Flt Protected	0.950					
Satd. Flow (prot)	1712	0	0	1802	1711	0
Flt Permitted	0.950					
Satd. Flow (perm)	1712	0	0	1802	1711	0
Link Speed (k/h)	40			40	40	
Link Distance (m)	173.4			67.2	54.2	
Travel Time (s)	15.6			6.0	4.9	
Peak Hour Factor	1.00	1.00	1.00	1.00	1.00	1.00
Heavy Vehicles (%)	1%	1%	1%	1%	1%	2%
Adj. Flow (vph)	25	0	0	56	74	39
Shared Lane Traffic (%)						
Lane Group Flow (vph)	25	0	0	56	113	0
Enter Blocked Intersection	No	No	No	No	No	No
Lane Alignment	Left	Right	Left	Left	Left	Right
Median Width(m)	3.7			0.0	0.0	
Link Offset(m)	0.0			0.0	0.0	
Crosswalk Width(m)	5.0			5.0	5.0	
Two way Left Turn Lane						
Headway Factor	1.06	1.06	1.06	1.06	1.06	1.06
Turning Speed (k/h)	24	14	24			14
Sign Control	Stop			Free	Free	

**Intersection Summary**

Area Type:	Other
Control Type:	Unsignalized
Intersection Capacity Utilization	16.6%
Analysis Period (min)	15
	ICU Level of Service A



Lane Group	EBL	EBR	NBL	NBT	SBT	SBR
Lane Configurations						
Traffic Volume (vph)	8	0	0	48	67	7
Future Volume (vph)	8	0	0	48	67	7
Ideal Flow (vphpl)	1800	1800	1800	1800	1800	1800
Lane Util. Factor	1.00	1.00	1.00	1.00	1.00	1.00
Frt					0.987	
Frt Protected	0.950					
Satd. Flow (prot)	1712	0	0	1802	1779	0
Frt Permitted	0.950					
Satd. Flow (perm)	1712	0	0	1802	1779	0
Link Speed (k/h)	50			50	50	
Link Distance (m)	178.0			106.1	67.2	
Travel Time (s)	12.8			7.6	4.8	
Peak Hour Factor	1.00	1.00	1.00	1.00	1.00	1.00
Heavy Vehicles (%)	1%	1%	1%	1%	1%	1%
Adj. Flow (vph)	8	0	0	48	67	7
Shared Lane Traffic (%)						
Lane Group Flow (vph)	8	0	0	48	74	0
Enter Blocked Intersection	No	No	No	No	No	No
Lane Alignment	L NA	R NA	Left	Left	Left	Right
Median Width(m)	3.7			0.0	0.0	
Link Offset(m)	0.0			0.0	0.0	
Crosswalk Width(m)	5.0			5.0	5.0	
Two way Left Turn Lane						
Headway Factor	1.06	1.06	1.06	1.06	1.06	1.06
Turning Speed (k/h)	97	97	97			97
Sign Control	Stop			Free	Free	

**Intersection Summary**

Area Type:	Other
Control Type:	Unsignalized
Intersection Capacity Utilization	14.2%
ICU Level of Service	A
Analysis Period (min)	15

1: Stinson Avenue & Robertson Road  
SAT Peak Hour

1826 Robertson Road  
2029 Total Traffic

Lane Group	EBL	EBT	EBR	WBL	WBT	WBR	NBL	NBT	NBR	SBL	SBT	SBR
Lane Configurations												
Traffic Volume (vph)	15	1104	24	45	1035	4	10	0	32	3	1	8
Future Volume (vph)	15	1104	24	45	1035	4	10	0	32	3	1	8
Ideal Flow (vphpl)	1800	1800	1800	1800	1800	1800	1800	1800	1800	1800	1800	1800
Storage Length (m)	75.0		0.0	45.0		0.0	0.0		0.0	0.0		0.0
Storage Lanes	1		0	1		0	0		0	0		0
Taper Length (m)	10.0			10.0			10.0			10.0		
Lane Util. Factor	1.00	0.95	0.95	1.00	0.95	0.95	1.00	1.00	1.00	1.00	1.00	1.00
Ped Bike Factor	0.99	1.00		1.00	1.00			0.99			0.99	
Frt		0.997			0.999			0.897			0.910	
Flt Protected	0.950			0.950				0.988			0.988	
Satd. Flow (prot)	1712	3409	0	1712	3420	0	0	1576	0	0	1606	0
Flt Permitted	0.263			0.237				0.919			0.923	
Satd. Flow (perm)	472	3409	0	426	3420	0	0	1465	0	0	1498	0
Right Turn on Red			Yes			Yes			Yes			Yes
Satd. Flow (RTOR)		4			1			32			8	
Link Speed (k/h)		60			60			40			40	
Link Distance (m)		198.0			310.7			254.0			246.4	
Travel Time (s)		11.9			18.6			22.9			22.2	
Confl. Peds. (#/hr)	10		4	4		10	1		4	4		1
Confl. Bikes (#/hr)			4			2						
Peak Hour Factor	1.00	1.00	1.00	1.00	1.00	1.00	1.00	1.00	1.00	1.00	1.00	1.00
Heavy Vehicles (%)	1%	1%	4%	1%	1%	1%	1%	1%	1%	1%	1%	1%
Adj. Flow (vph)	15	1104	24	45	1035	4	10	0	32	3	1	8
Shared Lane Traffic (%)												
Lane Group Flow (vph)	15	1128	0	45	1039	0	0	42	0	0	12	0
Enter Blocked Intersection	No	No	No	No	No	No	No	No	No	No	No	No
Lane Alignment	L NA	Left	R NA	L NA	Left	R NA	L NA	Left	R NA	L NA	Left	R NA
Median Width(m)		3.7			3.7			0.0			0.0	
Link Offset(m)		0.0			0.0			0.0			0.0	
Crosswalk Width(m)		5.0			5.0			5.0			5.0	
Two way Left Turn Lane		Yes			Yes							
Headway Factor	1.06	1.06	1.06	1.06	1.06	1.06	1.06	1.06	1.06	1.06	1.06	1.06
Turning Speed (k/h)	24		14	24		14	24		14	24		14
Number of Detectors	1	2		1	2		1	2		1	2	
Detector Template	Left	Thru		Left	Thru		Left	Thru		Left	Thru	
Leading Detector (m)	6.1	30.5		6.1	30.5		6.1	30.5		6.1	30.5	
Trailing Detector (m)	0.0	0.0		0.0	0.0		0.0	0.0		0.0	0.0	
Detector 1 Position(m)	0.0	0.0		0.0	0.0		0.0	0.0		0.0	0.0	
Detector 1 Size(m)	6.1	1.8		6.1	1.8		6.1	1.8		6.1	1.8	
Detector 1 Type	Cl+Ex	Cl+Ex		Cl+Ex	Cl+Ex		Cl+Ex	Cl+Ex		Cl+Ex	Cl+Ex	
Detector 1 Channel												
Detector 1 Extend (s)	0.0	0.0		0.0	0.0		0.0	0.0		0.0	0.0	
Detector 1 Queue (s)	0.0	0.0		0.0	0.0		0.0	0.0		0.0	0.0	
Detector 1 Delay (s)	0.0	0.0		0.0	0.0		0.0	0.0		0.0	0.0	
Detector 2 Position(m)		28.7			28.7			28.7			28.7	
Detector 2 Size(m)		1.8			1.8			1.8			1.8	
Detector 2 Type		Cl+Ex			Cl+Ex			Cl+Ex			Cl+Ex	
Detector 2 Channel												
Detector 2 Extend (s)		0.0			0.0			0.0			0.0	
Turn Type	Perm	NA		Perm	NA		Perm	NA		Perm	NA	
Protected Phases		2			6			8			4	
Permitted Phases	2			6			8			4		
Detector Phase	2	2		6	6		8	8		4	4	



Lane Group	EBL	EBT	EBR	WBL	WBT	WBR	NBL	NBT	NBR	SBL	SBT	SBR
Switch Phase												
Minimum Initial (s)	10.0	10.0		10.0	10.0		10.0	10.0		10.0	10.0	
Minimum Split (s)	26.8	26.8		26.8	26.8		31.6	31.6		31.6	31.6	
Total Split (s)	88.0	88.0		88.0	88.0		32.0	32.0		32.0	32.0	
Total Split (%)	73.3%	73.3%		73.3%	73.3%		26.7%	26.7%		26.7%	26.7%	
Maximum Green (s)	82.2	82.2		82.2	82.2		25.4	25.4		25.4	25.4	
Yellow Time (s)	3.7	3.7		3.7	3.7		3.0	3.0		3.0	3.0	
All-Red Time (s)	2.1	2.1		2.1	2.1		3.6	3.6		3.6	3.6	
Lost Time Adjust (s)	0.0	0.0		0.0	0.0			0.0			0.0	
Total Lost Time (s)	5.8	5.8		5.8	5.8			6.6			6.6	
Lead/Lag												
Lead-Lag Optimize?												
Vehicle Extension (s)	3.0	3.0		3.0	3.0		3.0	3.0		3.0	3.0	
Recall Mode	C-Max	C-Max		C-Max	C-Max		None	None		None	None	
Walk Time (s)	7.0	7.0		7.0	7.0		7.0	7.0		7.0	7.0	
Flash Dont Walk (s)	14.0	14.0		14.0	14.0		18.0	18.0		18.0	18.0	
Pedestrian Calls (#/hr)	4	4		10	10		4	4		1	1	
Act Effct Green (s)	99.1	99.1		99.1	99.1			13.0			13.0	
Actuated g/C Ratio	0.83	0.83		0.83	0.83			0.11			0.11	
v/c Ratio	0.04	0.40		0.13	0.37			0.22			0.07	
Control Delay	4.4	4.6		1.6	2.1			22.3			28.4	
Queue Delay	0.0	0.0		0.0	0.0			0.0			0.0	
Total Delay	4.4	4.6		1.6	2.1			22.3			28.4	
LOS	A	A		A	A			C			C	
Approach Delay		4.6			2.1			22.3			28.4	
Approach LOS		A			A			C			C	
Queue Length 50th (m)	0.5	28.2		0.3	4.0			2.0			0.8	
Queue Length 95th (m)	3.0	66.3		m0.7	21.6			10.5			5.5	
Internal Link Dist (m)		174.0			286.7			230.0			222.4	
Turn Bay Length (m)	75.0			45.0								
Base Capacity (vph)	389	2815		351	2823			335			323	
Starvation Cap Reductn	0	0		0	0			0			0	
Spillback Cap Reductn	0	0		0	0			0			0	
Storage Cap Reductn	0	0		0	0			0			0	
Reduced v/c Ratio	0.04	0.40		0.13	0.37			0.13			0.04	

Intersection Summary

Area Type: Other  
 Cycle Length: 120  
 Actuated Cycle Length: 120  
 Offset: 31 (26%), Referenced to phase 2:EBTL and 6:WBTL, Start of Green  
 Natural Cycle: 60  
 Control Type: Actuated-Coordinated  
 Maximum v/c Ratio: 0.40  
 Intersection Signal Delay: 3.9 Intersection LOS: A  
 Intersection Capacity Utilization 59.7% ICU Level of Service B  
 Analysis Period (min) 15  
 m Volume for 95th percentile queue is metered by upstream signal.

Splits and Phases: 1: Stinson Avenue & Robertson Road

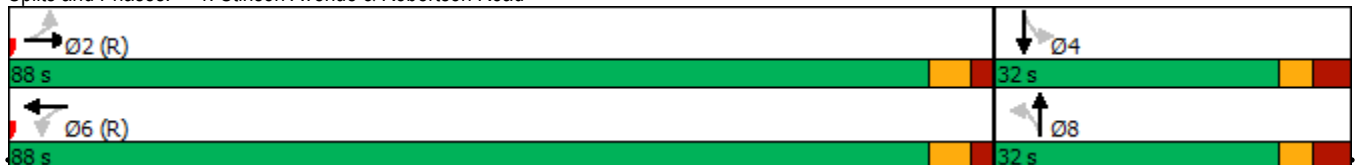



2: Lynhar Road/Stafford Road & Robertson Road  
SAT Peak Hour

1826 Robertson Road  
2029 Total Traffic

Lane Group	EBL	EBT	EBR	WBL	WBT	WBR	NBL	NBT	NBR	SBL	SBT	SBR
Lane Configurations												
Traffic Volume (vph)	134	881	100	45	816	60	99	28	91	83	20	153
Future Volume (vph)	134	881	100	45	816	60	99	28	91	83	20	153
Ideal Flow (vphpl)	1800	1800	1800	1800	1800	1800	1800	1800	1800	1800	1800	1800
Storage Length (m)	85.0		40.0	0.0		0.0	0.0		30.0	45.0		75.0
Storage Lanes	1		1	1		0	1		1	1		1
Taper Length (m)	10.0			10.0			10.0			30.0		
Lane Util. Factor	1.00	0.95	1.00	1.00	0.95	0.95	1.00	1.00	1.00	1.00	1.00	1.00
Ped Bike Factor	1.00		0.94	0.99	1.00		0.98		0.96	0.98		0.97
Frt			0.850		0.990				0.850			0.850
Flt Protected	0.950			0.950			0.950			0.950		
Satd. Flow (prot)	1695	3424	1517	1712	3354	0	1712	1802	1532	1695	1802	1532
Flt Permitted	0.950			0.950			0.709			0.739		
Satd. Flow (perm)	1691	3424	1419	1691	3354	0	1255	1802	1474	1288	1802	1484
Right Turn on Red			Yes			Yes			Yes			Yes
Satd. Flow (RTOR)			145		7				142			153
Link Speed (k/h)		60			60			40			40	
Link Distance (m)		310.7			66.2			81.0			107.6	
Travel Time (s)		18.6			4.0			7.3			9.7	
Confl. Peds. (#/hr)	5		17	17		5	16		21	21		16
Confl. Bikes (#/hr)			5			4			2			1
Peak Hour Factor	1.00	1.00	1.00	1.00	1.00	1.00	1.00	1.00	1.00	1.00	1.00	1.00
Heavy Vehicles (%)	2%	1%	2%	1%	2%	1%	1%	1%	1%	2%	1%	1%
Adj. Flow (vph)	134	881	100	45	816	60	99	28	91	83	20	153
Shared Lane Traffic (%)												
Lane Group Flow (vph)	134	881	100	45	876	0	99	28	91	83	20	153
Enter Blocked Intersection	No	No	No	No	No	No	No	No	No	No	No	No
Lane Alignment	L NA	Left	R NA	L NA	Left	R NA	L NA	L NA	R NA	L NA	Left	R NA
Median Width(m)		3.7			7.4			7.4			7.4	
Link Offset(m)		0.0			0.0			0.0			0.0	
Crosswalk Width(m)		5.0			5.0			5.0			5.0	
Two way Left Turn Lane		Yes										
Headway Factor	1.06	1.06	1.06	1.06	1.06	1.06	1.06	1.06	1.06	1.06	1.06	1.06
Turning Speed (k/h)	24		14	24		14	24		14	24		14
Number of Detectors	1	2	1	1	2		1	2	1	1	2	1
Detector Template	Left	Thru	Right	Left	Thru		Left	Thru	Right	Left	Thru	Right
Leading Detector (m)	6.1	30.5	6.1	6.1	30.5		6.1	30.5	6.1	6.1	30.5	6.1
Trailing Detector (m)	0.0	0.0	0.0	0.0	0.0		0.0	0.0	0.0	0.0	0.0	0.0
Detector 1 Position(m)	0.0	0.0	0.0	0.0	0.0		0.0	0.0	0.0	0.0	0.0	0.0
Detector 1 Size(m)	6.1	1.8	6.1	6.1	1.8		6.1	1.8	6.1	6.1	1.8	6.1
Detector 1 Type	Cl+Ex	Cl+Ex	Cl+Ex	Cl+Ex	Cl+Ex		Cl+Ex	Cl+Ex	Cl+Ex	Cl+Ex	Cl+Ex	Cl+Ex
Detector 1 Channel												
Detector 1 Extend (s)	0.0	0.0	0.0	0.0	0.0		0.0	0.0	0.0	0.0	0.0	0.0
Detector 1 Queue (s)	0.0	0.0	0.0	0.0	0.0		0.0	0.0	0.0	0.0	0.0	0.0
Detector 1 Delay (s)	0.0	0.0	0.0	0.0	0.0		0.0	0.0	0.0	0.0	0.0	0.0
Detector 2 Position(m)		28.7			28.7			28.7			28.7	
Detector 2 Size(m)		1.8			1.8			1.8			1.8	
Detector 2 Type		Cl+Ex			Cl+Ex			Cl+Ex			Cl+Ex	
Detector 2 Channel												
Detector 2 Extend (s)		0.0			0.0			0.0			0.0	
Turn Type	Prot	NA	Perm	Prot	NA		pm+pt	NA	Perm	pm+pt	NA	Perm
Protected Phases	5	2		1	6		3	8		7	4	
Permitted Phases			2				8		8	4		4
Detector Phase	5	2	2	1	6		3	8	8	7	4	4



Lane Group	EBL	EBT	EBR	WBL	WBT	WBR	NBL	NBT	NBR	SBL	SBT	SBR
Switch Phase												
Minimum Initial (s)	5.0	10.0	10.0	5.0	10.0		5.0	10.0	10.0	5.0	10.0	10.0
Minimum Split (s)	11.1	31.3	31.3	11.1	31.3		11.2	37.7	37.7	11.2	37.7	37.7
Total Split (s)	15.0	54.0	54.0	15.0	54.0		12.0	39.0	39.0	12.0	39.0	39.0
Total Split (%)	12.5%	45.0%	45.0%	12.5%	45.0%		10.0%	32.5%	32.5%	10.0%	32.5%	32.5%
Maximum Green (s)	8.9	47.7	47.7	8.9	47.7		5.8	32.3	32.3	5.8	32.3	32.3
Yellow Time (s)	3.7	3.7	3.7	3.7	3.7		3.0	3.0	3.0	3.0	3.0	3.0
All-Red Time (s)	2.4	2.6	2.6	2.4	2.6		3.2	3.7	3.7	3.2	3.7	3.7
Lost Time Adjust (s)	0.0	0.0	0.0	0.0	0.0		0.0	0.0	0.0	0.0	0.0	0.0
Total Lost Time (s)	6.1	6.3	6.3	6.1	6.3		6.2	6.7	6.7	6.2	6.7	6.7
Lead/Lag	Lead	Lag	Lag	Lead	Lag		Lead	Lag	Lag	Lead	Lag	Lag
Lead-Lag Optimize?	Yes	Yes	Yes	Yes	Yes		Yes	Yes	Yes	Yes	Yes	Yes
Vehicle Extension (s)	3.0	3.0	3.0	3.0	3.0		3.0	3.0	3.0	3.0	3.0	3.0
Recall Mode	None	C-Max	C-Max	None	C-Max		None	None	None	None	None	None
Walk Time (s)		7.0	7.0		7.0			12.0	12.0		12.0	12.0
Flash Dont Walk (s)		18.0	18.0		18.0			19.0	19.0		19.0	19.0
Pedestrian Calls (#/hr)		17	17		5			21	21		16	16
Act Effct Green (s)	13.1	60.4	60.4	8.2	53.2		30.1	25.0	25.0	28.9	22.6	22.6
Actuated g/C Ratio	0.11	0.50	0.50	0.07	0.44		0.25	0.21	0.21	0.24	0.19	0.19
v/c Ratio	0.73	0.51	0.13	0.38	0.59		0.29	0.07	0.22	0.25	0.06	0.38
Control Delay	71.1	28.4	6.6	80.1	22.9		32.4	35.8	2.4	31.2	35.1	8.3
Queue Delay	0.0	0.0	0.0	0.0	0.0		0.0	0.0	0.0	0.0	0.0	0.0
Total Delay	71.1	28.4	6.6	80.1	22.9		32.4	35.8	2.4	31.2	35.1	8.3
LOS	E	C	A	F	C		C	D	A	C	D	A
Approach Delay		31.5			25.6			20.3			17.8	
Approach LOS		C			C			C			B	
Queue Length 50th (m)	29.3	69.9	0.0	8.2	83.1		14.4	4.6	0.0	12.0	3.3	0.0
Queue Length 95th (m)	#64.9	112.3	12.5	21.9	104.7		25.9	11.4	2.8	22.4	9.0	14.6
Internal Link Dist (m)		286.7			42.2			57.0			83.6	
Turn Bay Length (m)	85.0		40.0						30.0	45.0		75.0
Base Capacity (vph)	184	1722	786	132	1491		337	485	500	330	485	511
Starvation Cap Reductn	0	0	0	0	0		0	0	0	0	0	0
Spillback Cap Reductn	0	0	0	0	0		0	0	0	0	0	0
Storage Cap Reductn	0	0	0	0	0		0	0	0	0	0	0
Reduced v/c Ratio	0.73	0.51	0.13	0.34	0.59		0.29	0.06	0.18	0.25	0.04	0.30

**Intersection Summary**

Area Type: Other  
 Cycle Length: 120  
 Actuated Cycle Length: 120  
 Offset: 7 (6%), Referenced to phase 2:EBT and 6:WBT, Start of Green  
 Natural Cycle: 95  
 Control Type: Actuated-Coordinated  
 Maximum v/c Ratio: 0.73  
 Intersection Signal Delay: 27.0 Intersection LOS: C  
 Intersection Capacity Utilization 68.8% ICU Level of Service C  
 Analysis Period (min) 15  
 # 95th percentile volume exceeds capacity, queue may be longer.  
 Queue shown is maximum after two cycles.

Splits and Phases: 2: Lynhar Road/Stafford Road & Robertson Road

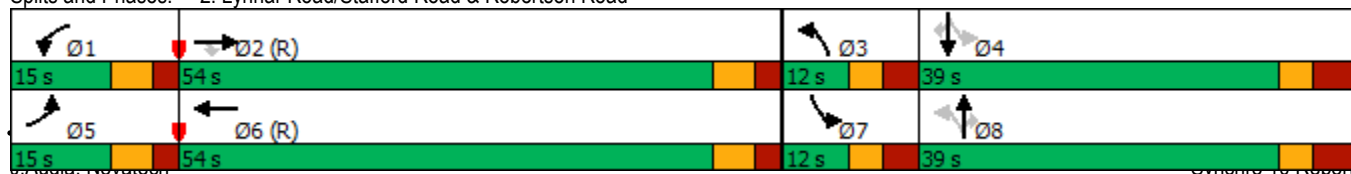

3: Northside Road East & Robertson Road  
SAT Peak Hour













1826 Robertson Road  
2029 Total Traffic

Lane Group	EBL	EBT	EBR	WBL	WBT	WBR	NBL	NBT	NBR	SBL	SBT	SBR
Lane Configurations												
Traffic Volume (vph)	78	882	15	94	715	167	86	44	73	141	30	103
Future Volume (vph)	78	882	15	94	715	167	86	44	73	141	30	103
Ideal Flow (vphpl)	1800	1800	1800	1800	1800	1800	1800	1800	1800	1800	1800	1800
Storage Length (m)	55.0		0.0	75.0		80.0	0.0		0.0	0.0		0.0
Storage Lanes	1		0	1		1	1		0	1		1
Taper Length (m)	30.0			15.0			10.0			10.0		
Lane Util. Factor	1.00	0.95	0.95	1.00	0.95	1.00	1.00	1.00	1.00	1.00	1.00	1.00
Ped Bike Factor	1.00	1.00		1.00		0.96	0.98	0.98		0.99		0.96
Frt		0.997				0.850		0.906				0.850
Flt Protected	0.950			0.950			0.950			0.950		
Satd. Flow (prot)	1712	3412	0	1695	3390	1532	1695	1606	0	1712	1802	1532
Flt Permitted	0.326			0.317			0.738			0.675		
Satd. Flow (perm)	585	3412	0	565	3390	1476	1285	1606	0	1203	1802	1474
Right Turn on Red			Yes			Yes			Yes			Yes
Satd. Flow (RTOR)		3				167		62				103
Link Speed (k/h)		60			60			40				40
Link Distance (m)		105.4			310.9			87.0				90.9
Travel Time (s)		6.3			18.7			7.8				8.2
Confl. Peds. (#/hr)	6		4	4		6	16		8	8		16
Confl. Bikes (#/hr)			1			2			2			1
Peak Hour Factor	1.00	1.00	1.00	1.00	1.00	1.00	1.00	1.00	1.00	1.00	1.00	1.00
Heavy Vehicles (%)	1%	1%	1%	2%	2%	1%	2%	1%	1%	1%	1%	1%
Adj. Flow (vph)	78	882	15	94	715	167	86	44	73	141	30	103
Shared Lane Traffic (%)												
Lane Group Flow (vph)	78	897	0	94	715	167	86	117	0	141	30	103
Enter Blocked Intersection	No	No	No	No	No	No	No	No	No	No	No	No
Lane Alignment	L NA	Left	R NA	L NA	Left	R NA	L NA	Left	R NA	L NA	Left	R NA
Median Width(m)		5.5			5.5			3.7				3.7
Link Offset(m)		0.0			0.0			0.0				0.0
Crosswalk Width(m)		5.0			5.0			5.0				5.0
Two way Left Turn Lane												
Headway Factor	1.06	1.06	1.06	1.06	1.06	1.06	1.06	1.06	1.06	1.06	1.06	1.06
Turning Speed (k/h)	24		14	24		14	24		14	24		14
Number of Detectors	1	2		1	2	1	1	2		1	2	1
Detector Template	Left	Thru		Left	Thru	Right	Left	Thru		Left	Thru	Right
Leading Detector (m)	6.1	30.5		6.1	30.5	6.1	6.1	30.5		6.1	30.5	6.1
Trailing Detector (m)	0.0	0.0		0.0	0.0	0.0	0.0	0.0		0.0	0.0	0.0
Detector 1 Position(m)	0.0	0.0		0.0	0.0	0.0	0.0	0.0		0.0	0.0	0.0
Detector 1 Size(m)	6.1	1.8		6.1	1.8	6.1	6.1	1.8		6.1	1.8	6.1
Detector 1 Type	Cl+Ex	Cl+Ex		Cl+Ex	Cl+Ex	Cl+Ex	Cl+Ex	Cl+Ex		Cl+Ex	Cl+Ex	Cl+Ex
Detector 1 Channel												
Detector 1 Extend (s)	0.0	0.0		0.0	0.0	0.0	0.0	0.0		0.0	0.0	0.0
Detector 1 Queue (s)	0.0	0.0		0.0	0.0	0.0	0.0	0.0		0.0	0.0	0.0
Detector 1 Delay (s)	0.0	0.0		0.0	0.0	0.0	0.0	0.0		0.0	0.0	0.0
Detector 2 Position(m)		28.7			28.7			28.7				28.7
Detector 2 Size(m)		1.8			1.8			1.8				1.8
Detector 2 Type		Cl+Ex			Cl+Ex			Cl+Ex				Cl+Ex
Detector 2 Channel												
Detector 2 Extend (s)		0.0			0.0			0.0				0.0
Turn Type	pm+pt	NA		Perm	NA	Perm	Perm	NA		Perm	NA	Perm
Protected Phases	5	2			6			8				4
Permitted Phases	2			6		6	8			4		4
Detector Phase	5	2		6	6	6	8	8		4	4	4

Lane Group	Ø3	Ø7
Lane Configurations		
Traffic Volume (vph)		
Future Volume (vph)		
Ideal Flow (vphpl)		
Storage Length (m)		
Storage Lanes		
Taper Length (m)		
Lane Util. Factor		
Ped Bike Factor		
Frt		
Flt Protected		
Satd. Flow (prot)		
Flt Permitted		
Satd. Flow (perm)		
Right Turn on Red		
Satd. Flow (RTOR)		
Link Speed (k/h)		
Link Distance (m)		
Travel Time (s)		
Confl. Peds. (#/hr)		
Confl. Bikes (#/hr)		
Peak Hour Factor		
Heavy Vehicles (%)		
Adj. Flow (vph)		
Shared Lane Traffic (%)		
Lane Group Flow (vph)		
Enter Blocked Intersection		
Lane Alignment		
Median Width(m)		
Link Offset(m)		
Crosswalk Width(m)		
Two way Left Turn Lane		
Headway Factor		
Turning Speed (k/h)		
Number of Detectors		
Detector Template		
Leading Detector (m)		
Trailing Detector (m)		
Detector 1 Position(m)		
Detector 1 Size(m)		
Detector 1 Type		
Detector 1 Channel		
Detector 1 Extend (s)		
Detector 1 Queue (s)		
Detector 1 Delay (s)		
Detector 2 Position(m)		
Detector 2 Size(m)		
Detector 2 Type		
Detector 2 Channel		
Detector 2 Extend (s)		
Turn Type		
Protected Phases	3	7
Permitted Phases		
Detector Phase		

3: Northside Road East & Robertson Road  
SAT Peak Hour

1826 Robertson Road  
2029 Total Traffic

												
Lane Group	EBL	EBT	EBR	WBL	WBT	WBR	NBL	NBT	NBR	SBL	SBT	SBR
Switch Phase												
Minimum Initial (s)	5.0	10.0		10.0	10.0	10.0	10.0	10.0		10.0	10.0	10.0
Minimum Split (s)	11.0	30.1		30.1	30.1	30.1	29.8	29.8		29.8	29.8	29.8
Total Split (s)	15.0	83.0		68.0	68.0	68.0	31.0	31.0		31.0	31.0	31.0
Total Split (%)	12.5%	69.2%		56.7%	56.7%	56.7%	25.8%	25.8%		25.8%	25.8%	25.8%
Maximum Green (s)	9.0	76.9		61.9	61.9	61.9	24.2	24.2		24.2	24.2	24.2
Yellow Time (s)	3.7	3.7		3.7	3.7	3.7	3.0	3.0		3.0	3.0	3.0
All-Red Time (s)	2.3	2.4		2.4	2.4	2.4	3.8	3.8		3.8	3.8	3.8
Lost Time Adjust (s)	0.0	0.0		0.0	0.0	0.0	0.0	0.0		0.0	0.0	0.0
Total Lost Time (s)	6.0	6.1		6.1	6.1	6.1	6.8	6.8		6.8	6.8	6.8
Lead/Lag	Lead			Lag	Lag	Lag	Lag	Lag		Lag	Lag	Lag
Lead-Lag Optimize?	Yes			Yes	Yes	Yes	Yes	Yes		Yes	Yes	Yes
Vehicle Extension (s)	3.0	3.0		3.0	3.0	3.0	3.0	3.0		3.0	3.0	3.0
Recall Mode	None	C-Max		C-Max	C-Max	C-Max	None	None		None	None	None
Walk Time (s)		7.0		7.0	7.0	7.0	1.0	1.0		1.0	1.0	1.0
Flash Dont Walk (s)		17.0		17.0	17.0	17.0	22.0	22.0		22.0	22.0	22.0
Pedestrian Calls (#/hr)		4		6	6	6	8	8		16	16	16
Act Effct Green (s)	87.9	87.8		76.9	76.9	76.9	19.3	19.3		19.3	19.3	19.3
Actuated g/C Ratio	0.73	0.73		0.64	0.64	0.64	0.16	0.16		0.16	0.16	0.16
v/c Ratio	0.16	0.36		0.26	0.33	0.17	0.42	0.38		0.73	0.10	0.32
Control Delay	6.9	7.2		14.6	11.9	2.3	49.5	24.3		68.0	40.5	10.0
Queue Delay	0.0	0.0		0.0	0.0	0.0	0.0	0.0		0.0	0.0	0.0
Total Delay	6.9	7.2		14.6	11.9	2.3	49.5	24.3		68.0	40.5	10.0
LOS	A	A		B	B	A	D	C		E	D	A
Approach Delay		7.1			10.5			35.0			43.2	
Approach LOS		A			B			C			D	
Queue Length 50th (m)	5.1	32.0		8.5	36.2	0.0	17.0	10.5		29.5	5.6	0.0
Queue Length 95th (m)	7.7	31.9		22.1	58.6	9.0	29.1	24.2		46.0	12.4	12.7
Internal Link Dist (m)		81.4			286.9			63.0			66.9	
Turn Bay Length (m)	55.0			75.0		80.0						
Base Capacity (vph)	513	2496		362	2172	1006	266	382		249	373	387
Starvation Cap Reductn	0	0		0	0	0	0	0		0	0	0
Spillback Cap Reductn	0	0		0	0	0	0	0		0	0	0
Storage Cap Reductn	0	0		0	0	0	0	0		0	0	0
Reduced v/c Ratio	0.15	0.36		0.26	0.33	0.17	0.32	0.31		0.57	0.08	0.27

Intersection Summary

Area Type: Other  
 Cycle Length: 120  
 Actuated Cycle Length: 120  
 Offset: 111 (93%), Referenced to phase 2:EBTL and 6:WBTL, Start of Green  
 Natural Cycle: 80  
 Control Type: Actuated-Coordinated  
 Maximum v/c Ratio: 0.73  
 Intersection Signal Delay: 14.9      Intersection LOS: B  
 Intersection Capacity Utilization 67.1%      ICU Level of Service C  
 Analysis Period (min) 15

Splits and Phases: 3: Northside Road East & Robertson Road



Lane Group	Ø3	Ø7
Switch Phase		
Minimum Initial (s)	4.0	4.0
Minimum Split (s)	6.0	6.0
Total Split (s)	6.0	6.0
Total Split (%)	5%	5%
Maximum Green (s)	4.0	4.0
Yellow Time (s)	2.0	2.0
All-Red Time (s)	0.0	0.0
Lost Time Adjust (s)		
Total Lost Time (s)		
Lead/Lag	Lead	Lead
Lead-Lag Optimize?	Yes	Yes
Vehicle Extension (s)	3.0	3.0
Recall Mode	None	None
Walk Time (s)		
Flash Dont Walk (s)		
Pedestrian Calls (#/hr)		
Act Effct Green (s)		
Actuated g/C Ratio		
v/c Ratio		
Control Delay		
Queue Delay		
Total Delay		
LOS		
Approach Delay		
Approach LOS		
Queue Length 50th (m)		
Queue Length 95th (m)		
Internal Link Dist (m)		
Turn Bay Length (m)		
Base Capacity (vph)		
Starvation Cap Reductn		
Spillback Cap Reductn		
Storage Cap Reductn		
Reduced v/c Ratio		
Intersection Summary		

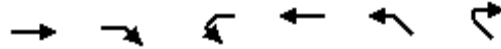

Lane Group	EBT	EBR	WBL	WBT	NWL	NWR
Lane Configurations	↑↑			↑↑↑		
Traffic Volume (vph)	975	83	0	926	0	0
Future Volume (vph)	975	83	0	926	0	0
Ideal Flow (vphpl)	1800	1800	1800	1800	1800	1800
Storage Length (m)		0.0	25.0		0.0	0.0
Storage Lanes		0	1		0	0
Taper Length (m)			25.0		10.0	
Lane Util. Factor	0.95	0.95	1.00	0.91	1.00	1.00
Fr <sub>t</sub>	0.988					
<b>Flt Protected</b>						
Satd. Flow (prot)	3380	0	0	4919	0	0
<b>Flt Permitted</b>						
Satd. Flow (perm)	3380	0	0	4919	0	0
Link Speed (k/h)	60			60	50	
Link Distance (m)	66.2			72.0	100.3	
Travel Time (s)	4.0			4.3	7.2	
Peak Hour Factor	1.00	1.00	1.00	1.00	1.00	1.00
Heavy Vehicles (%)	1%	2%	1%	1%	1%	1%
Adj. Flow (vph)	975	83	0	926	0	0
<b>Shared Lane Traffic (%)</b>						
Lane Group Flow (vph)	1058	0	0	926	0	0
Enter Blocked Intersection	Yes	Yes	Yes	Yes	No	No
Lane Alignment	Left	Right	Left	Left	Left	Right
Median Width(m)	3.7			3.7	0.0	
Link Offset(m)	0.0			0.0	0.0	
Crosswalk Width(m)	0.0			0.0	0.0	
<b>Two way Left Turn Lane</b>						
Headway Factor	1.06	1.06	1.06	1.06	1.06	1.06
Turning Speed (k/h)		50	24		24	14
Sign Control	Free			Free	Free	

**Intersection Summary**

Area Type: Other

Control Type: Unsignalized

Intersection Capacity Utilization 34.6% ICU Level of Service A

Analysis Period (min) 15



Lane Group	EBT	EBR	WBL	WBT	NBL	NBR
Lane Configurations						
Traffic Volume (vph)	70	13	130	0	0	104
Future Volume (vph)	70	13	130	0	0	104
Ideal Flow (vphpl)	1800	1800	1800	1800	1800	1800
Lane Util. Factor	1.00	1.00	1.00	1.00	1.00	1.00
Ped Bike Factor						
Frt	0.979				0.865	
Flt Protected			0.950			
Satd. Flow (prot)	1750	0	1712	0	0	1559
Flt Permitted	0.950					
Satd. Flow (perm)	1750	0	1712	0	0	1559
Link Speed (k/h)	50			40	40	
Link Distance (m)	100.3			62.0	54.2	
Travel Time (s)	7.2			5.6	4.9	
Confl. Peds. (#/hr)	27		27			
Confl. Bikes (#/hr)	1		2			
Peak Hour Factor	1.00	1.00	1.00	1.00	1.00	1.00
Heavy Vehicles (%)	2%	1%	1%	1%	1%	1%
Adj. Flow (vph)	70	13	130	0	0	104
Shared Lane Traffic (%)						
Lane Group Flow (vph)	83	0	130	0	0	104
Enter Blocked Intersection	No	No	No	No	No	No
Lane Alignment	L NA	R NA	L NA	R NA	Left	R NA
Median Width(m)	3.7			3.7	0.0	
Link Offset(m)	3.0			3.0	0.0	
Crosswalk Width(m)	5.0			5.0	5.0	
Two way Left Turn Lane						
Headway Factor	1.06	1.06	1.06	1.06	1.06	1.06
Turning Speed (k/h)	14		24		24	14
Sign Control	Stop			Stop	Stop	

**Intersection Summary**











Area Type: Other









Control Type: Unsignalized

Intersection Capacity Utilization 23.5% ICU Level of Service A

Analysis Period (min) 15



						
Lane Group	WBL	WBR	NBT	NBR	SBL	SBT
Lane Configurations						
Traffic Volume (vph)	3	90	128	3	83	82
Future Volume (vph)	3	90	128	3	83	82
Ideal Flow (vphpl)	1800	1800	1800	1800	1800	1800
Storage Length (m)	0.0	0.0		45.0	15.0	
Storage Lanes	1	0		0	1	
Taper Length (m)	10.0				20.0	
Lane Util. Factor	1.00	1.00	0.95	0.95	1.00	1.00
Frt	0.869		0.997			
Flt Protected	0.998				0.950	
Satd. Flow (prot)	1563	0	3381	0	1712	1784
Flt Permitted	0.998				0.950	
Satd. Flow (perm)	1563	0	3381	0	1712	1784
Link Speed (k/h)	40		40		40	
Link Distance (m)	173.4		68.2		81.0	
Travel Time (s)	15.6		6.1		7.3	
Peak Hour Factor	1.00	1.00	1.00	1.00	1.00	1.00
Heavy Vehicles (%)	1%	1%	2%	1%	1%	2%
Adj. Flow (vph)	3	90	128	3	83	82
Shared Lane Traffic (%)						
Lane Group Flow (vph)	93	0	131	0	83	82
Enter Blocked Intersection	No	No	No	No	No	No
Lane Alignment	Left	Right	Left	Right	Left	Left
Median Width(m)	3.7		3.7		3.7	
Link Offset(m)	0.0		0.0		0.0	
Crosswalk Width(m)	5.0		5.0		5.0	
Two way Left Turn Lane						
Headway Factor	1.06	1.06	1.06	1.06	1.06	1.06
Turning Speed (k/h)	24	14		14	24	
Sign Control	Stop		Free			Free
<b>Intersection Summary</b>						
Area Type:	Other					
Control Type:	Unsignalized					
Intersection Capacity Utilization 24.7%	ICU Level of Service A					
Analysis Period (min) 15						

						
Lane Group	WBL	WBR	NBT	NBR	SBL	SBT
Lane Configurations						
Traffic Volume (vph)	1	10	121	1	11	74
Future Volume (vph)	1	10	121	1	11	74
Ideal Flow (vphpl)	1800	1800	1800	1800	1800	1800
Lane Util. Factor	1.00	1.00	1.00	1.00	1.00	1.00
Frt	0.877		0.999			
Flt Protected	0.995					0.994
Satd. Flow (prot)	1572	0	1783	0	0	1776
Flt Permitted	0.995					0.994
Satd. Flow (perm)	1572	0	1783	0	0	1776
Link Speed (k/h)	50		40			50
Link Distance (m)	178.0		82.4			68.2
Travel Time (s)	12.8		7.4			4.9
Peak Hour Factor	1.00	1.00	1.00	1.00	1.00	1.00
Heavy Vehicles (%)	1%	1%	2%	1%	1%	2%
Adj. Flow (vph)	1	10	121	1	11	74
Shared Lane Traffic (%)						
Lane Group Flow (vph)	11	0	122	0	0	85
Enter Blocked Intersection	No	No	No	No	No	No
Lane Alignment	L NA	R NA	Left	Right	Left	Left
Median Width(m)	3.7		0.0			0.0
Link Offset(m)	0.0		0.0			0.0
Crosswalk Width(m)	5.0		5.0			5.0
Two way Left Turn Lane						
Headway Factor	1.06	1.06	1.06	1.06	1.06	1.06
Turning Speed (k/h)	24	14		14	24	
Sign Control	Stop		Free			Free
<b>Intersection Summary</b>						
Area Type:	Other					
Control Type:	Unsignalized					
Intersection Capacity Utilization	23.9%			ICU Level of Service A		
Analysis Period (min)	15					



Lane Group	EBL	EBR	NBL	NBT	SBT	SBR
Lane Configurations						
Traffic Volume (vph)	31	0	0	73	92	52
Future Volume (vph)	31	0	0	73	92	52
Ideal Flow (vphpl)	1800	1800	1800	1800	1800	1800
Lane Util. Factor	1.00	1.00	1.00	1.00	1.00	1.00
Frt					0.951	
Frt Protected	0.950					
Satd. Flow (prot)	1712	0	0	1802	1714	0
Frt Permitted	0.950					
Satd. Flow (perm)	1712	0	0	1802	1714	0
Link Speed (k/h)	40			40	40	
Link Distance (m)	173.4			67.2	54.2	
Travel Time (s)	15.6			6.0	4.9	
Peak Hour Factor	1.00	1.00	1.00	1.00	1.00	1.00
Heavy Vehicles (%)	1%	1%	1%	1%	1%	1%
Adj. Flow (vph)	31	0	0	73	92	52
Shared Lane Traffic (%)						
Lane Group Flow (vph)	31	0	0	73	144	0
Enter Blocked Intersection	No	No	No	No	No	No
Lane Alignment	Left	Right	Left	Left	Left	Right
Median Width(m)	3.7			0.0	0.0	
Link Offset(m)	0.0			0.0	0.0	
Crosswalk Width(m)	5.0			5.0	5.0	
Two way Left Turn Lane						
Headway Factor	1.06	1.06	1.06	1.06	1.06	1.06
Turning Speed (k/h)	24	14	24			14
Sign Control	Stop			Free	Free	

**Intersection Summary**

Area Type:	Other
Control Type:	Unsignalized
Intersection Capacity Utilization	18.5%
Analysis Period (min)	15
	ICU Level of Service A



Lane Group	EBL	EBR	NBL	NBT	SBT	SBR
Lane Configurations						
Traffic Volume (vph)	9	0	0	64	82	10
Future Volume (vph)	9	0	0	64	82	10
Ideal Flow (vphpl)	1800	1800	1800	1800	1800	1800
Lane Util. Factor	1.00	1.00	1.00	1.00	1.00	1.00
Fr <sub>t</sub>					0.985	
Flt Protected	0.950					
Satd. Flow (prot)	1712	0	0	1802	1775	0
Flt Permitted	0.950					
Satd. Flow (perm)	1712	0	0	1802	1775	0
Link Speed (k/h)	50			40	50	
Link Distance (m)	178.0			106.1	67.2	
Travel Time (s)	12.8			9.5	4.8	
Peak Hour Factor	1.00	1.00	1.00	1.00	1.00	1.00
Heavy Vehicles (%)	1%	1%	1%	1%	1%	1%
Adj. Flow (vph)	9	0	0	64	82	10
Shared Lane Traffic (%)						
Lane Group Flow (vph)	9	0	0	64	92	0
Enter Blocked Intersection	No	No	No	No	No	No
Lane Alignment	L NA	R NA	Left	Left	Left	Right
Median Width(m)	3.7			0.0	0.0	
Link Offset(m)	0.0			0.0	0.0	
Crosswalk Width(m)	5.0			5.0	5.0	
Two way Left Turn Lane						
Headway Factor	1.06	1.06	1.06	1.06	1.06	1.06
Turning Speed (k/h)	24	14	24			14
Sign Control	Stop			Free	Free	

**Intersection Summary**

Area Type:	Other
Control Type:	Unsignalized
Intersection Capacity Utilization	15.2%
Analysis Period (min)	15
	ICU Level of Service A