











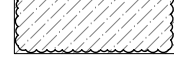
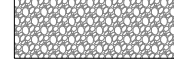
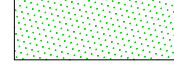

Drawing Remains the Property of Copyright Reserved by GJA INC. Do Not Use or Reproduce Without Approval of GJA INC. NOT To Be Used For Construction Unless Indicated by Revision: **FOR LANDSCAPE CONSTRUCTION**. Contractor is Responsible for Verification of Site Locations of all Utilities. Report any Discrepancies Between Site and Drawing Immediately to GJA INC. Do NOT Proceed Until Clarified.

TURF AREAS TO BE SOD CW 150MM DEPTH TOPSOIL ON APPROVED SUBGRADE | SOD TO BE #1 GRADE TURFGRASS NURSERY SOD per NSGA - Fine Fescue/Kentucky Bluegrass Sod | PLANTING MIX TO BE APPROVED BY LANDSCAPE ARCHITECT | PLANT MATERIAL TO MEET CNLA STANDARDS/BE APPROVED BY LANDSCAPE ARCHITECT PRIOR TO PLANTING | ALL MATERIALS & WORK TO BE MAINTAINED UNTIL FINAL ACCEPTANCE, (MOWING TURF, WEEDING BEDS, WATERING TURF & PLANTS) & INCLUDE 1 YEAR WARRANTY FROM DATE OF FINAL ACCEPTANCE | PROVIDE WATERING OF ALL PLANT MATERIAL AS REQUIRED FOR PROPER ESTABLISHMENT UNTIL END OF WARRANTY PERIOD | REFER TO CIVIL ENGINEER'S DRAWING FOR ELEVATIONS / GRADING | The Landscape Plan is to be read in conjunction with the grading, servicing, site and survey plan | Bare root material to be planted in season only | All plant material locations to be staked on site by the landscape contractor and checked by the landscape architect prior to planting | All trees to be preserved on or directly adjacent to the site will be protected | Plant material area to be installed a minimum of 3.0m away from any part of any hydro transformer, 3.0m corridor between a fire hydrant and the curb, a 2.5m radius beside or behind a fire hydrant, 2.0m from any servicing/utility line or structure |

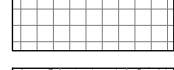
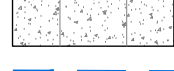
REFER TO TCR BY IFS

-  Existing Tree to Remain
-  Existing Tree to Remove
-  Protection for Existing Trees
- LANDSCAPE PLAN**
-  1.1m Ht. Decorative Steel Fence
-  2.1m Ht Solid Privacy Fence
-  Proposed Deciduous Tree
-  Shrub Planting Bed
-  Riverwash Stone
-  Turf
-  Soil Cell
-  Pedestrian Slabs / Pavers
-  Concrete
-  Parking Garage Below
- BELOW GRADE SERVICES REFER TO CIVIL**
-  WTR - WTR - WTR U/G Water Service
-  STM - STM - STM U/G Storm Service
-  SAN - SAN - SAN U/G Sanitary Service

1	FIRST SUBMISSION SPC	FEBRUARY 21 2023
0	COORDINATION / REVIEW	JANUARY 2023
#	REVISION	DATE

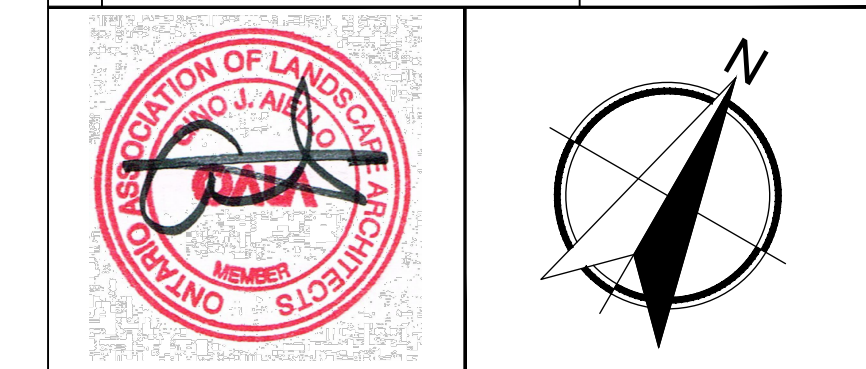

Property Owner **S.E.C.**
381 KENT LP
 301-69 rue Jean-Proulx Gatineau Quebec, J8Z 1W2

Gino J. Aiello | landscape architect GJALA.com
 GJA Inc. Gino@GJALA.com (613) 286 5130
 110 Desbary Road Unit # 8 | Ottawa Ontario K2T 0Z2

Project
9 STOREY MIXED USE
 381 KENT STREET @ JAMES / GILMORE

LANDSCAPE

Scale: 1:200 **L1** D07-xx-xx-xxxx

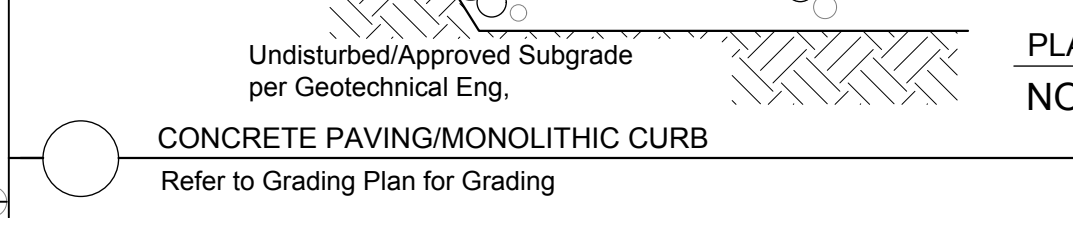
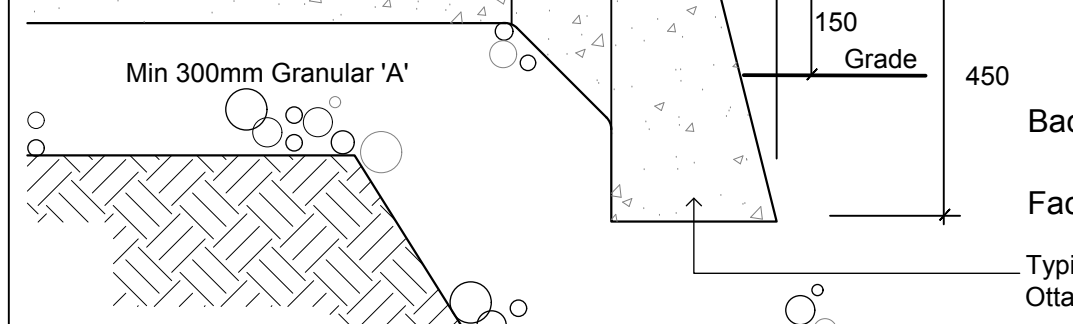
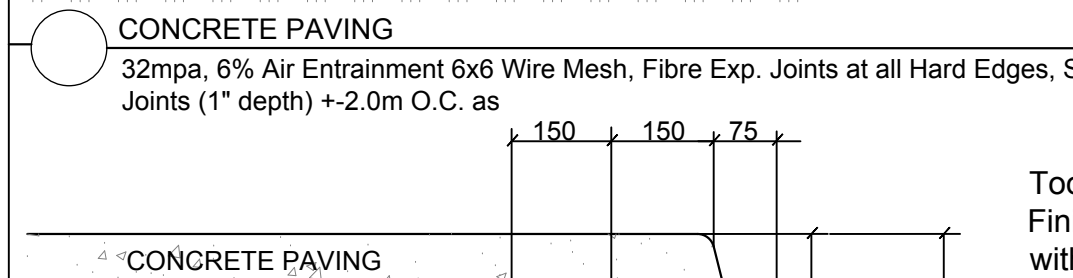
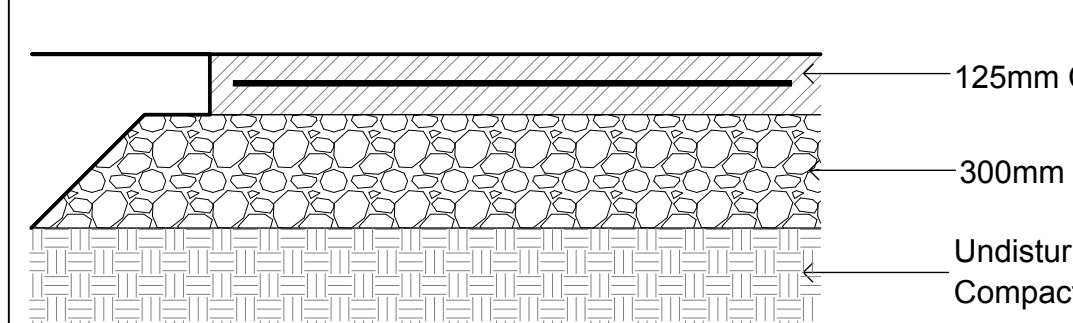
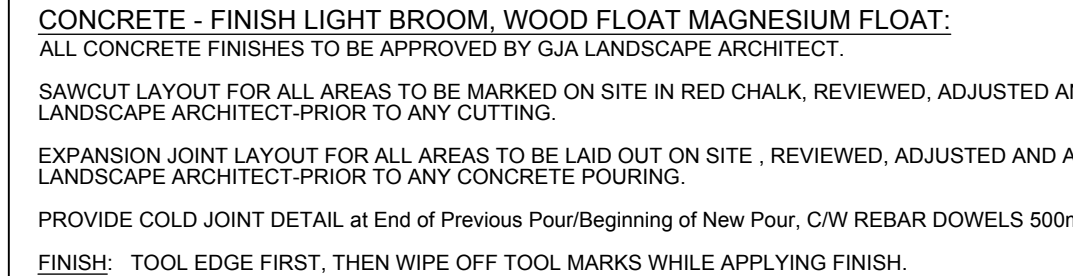
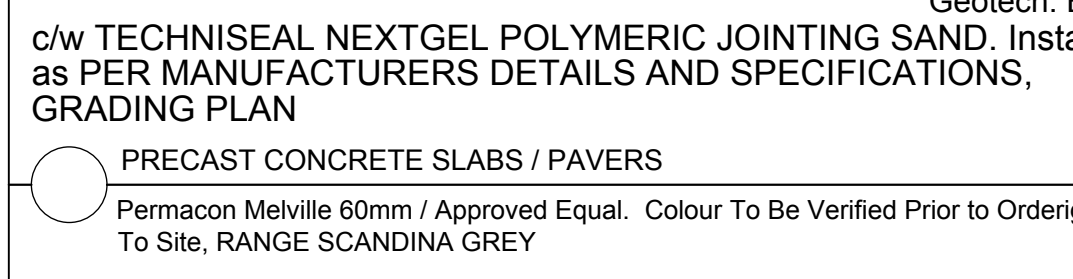
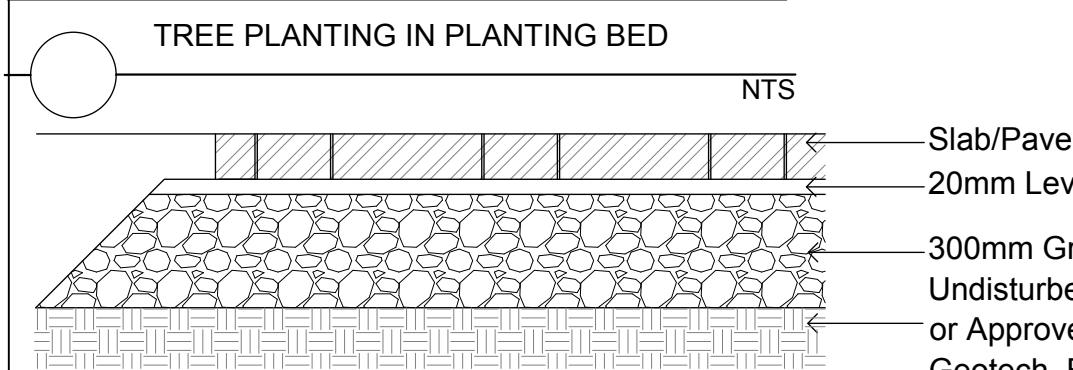
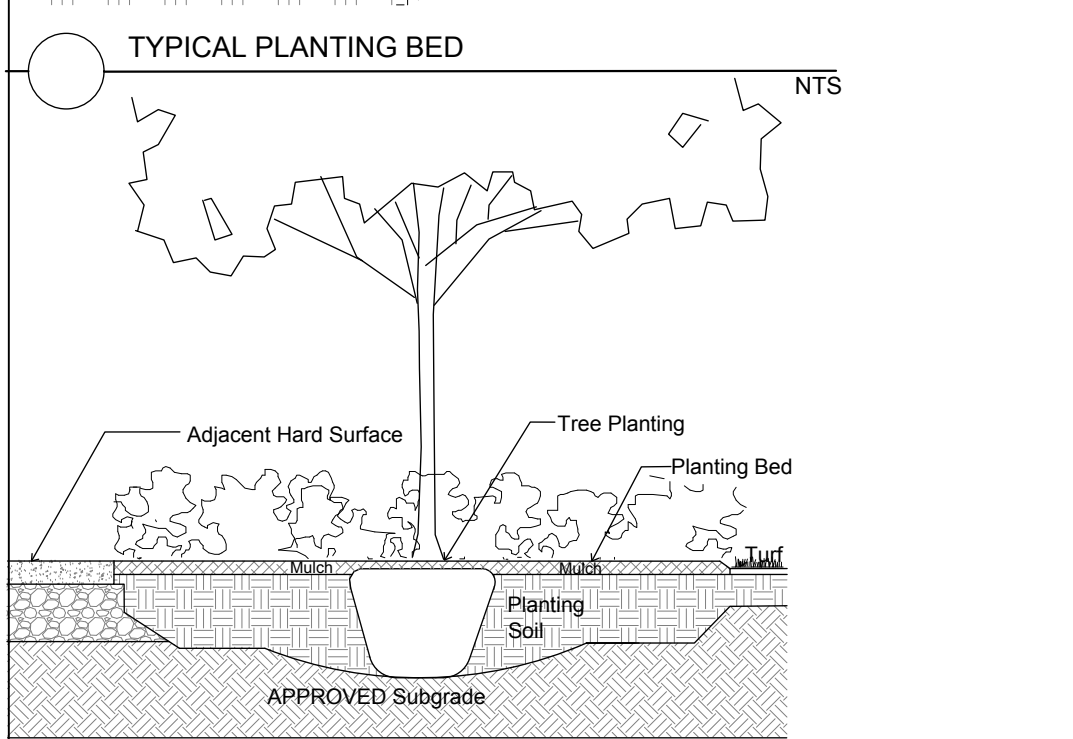
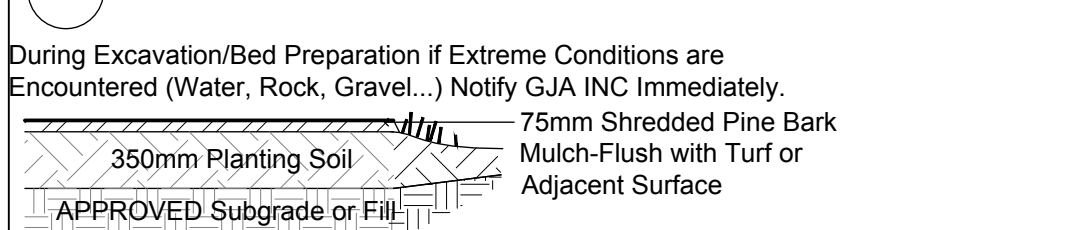
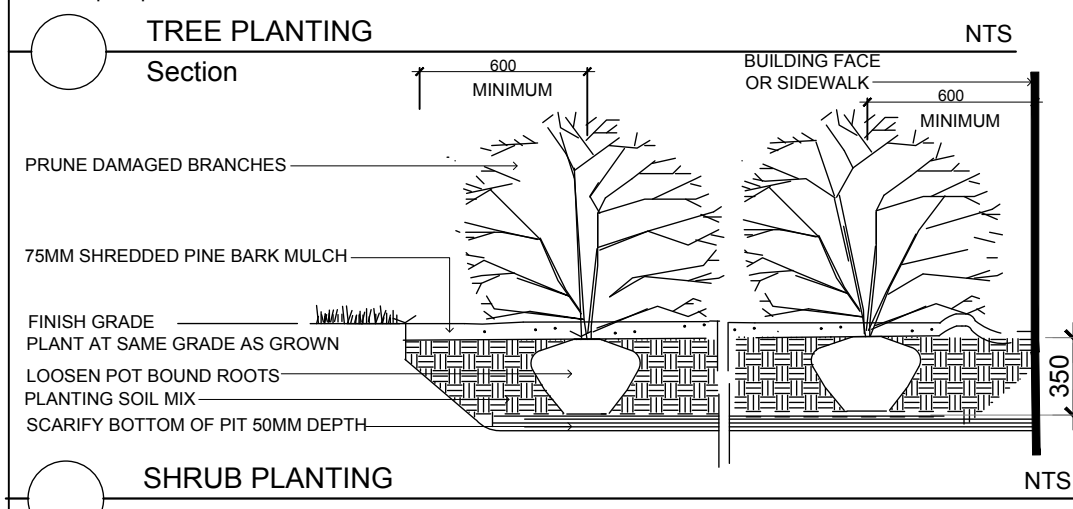
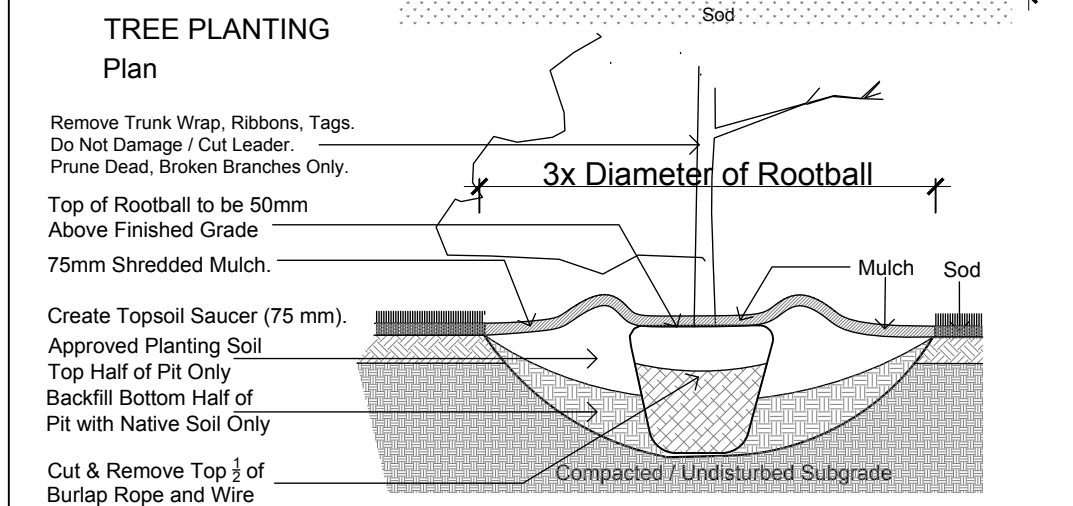
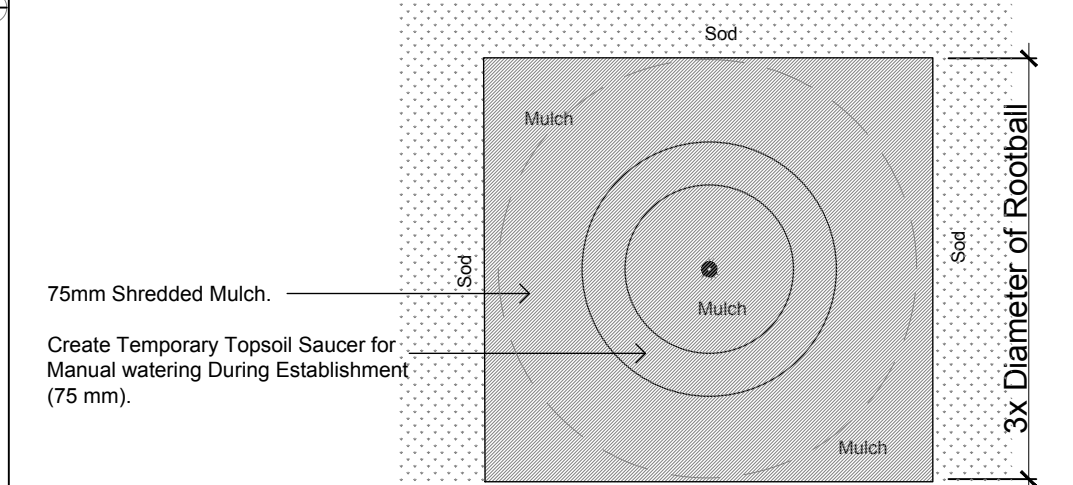

Code	Qty.	Botanical Name	Common Name	Size	Condition
AG	3	Aesculus glabra	Ohio Buckeye	60mm cal	B + B specimen
AR	1	Acer rubrum	Red Maple	70mm cal	B + B specimen
AS	1	Acer saccharum	Sugar Maple	60mm cal	B + B specimen
BP	1	Betula papyrifera	Paper Birch	60mm cal	B + B specimen
Cov	2	Carya ovata	Shagbark Hickory	60mm cal	B + B specimen
CO	3	Celtis occidentalis	Common Hackberry	60mm cal	B + B specimen
GB	8	Ginkgo biloba	Maidenhair Tree	70mm cal	B + B specimen
GD	3	Gymnocladus dioicus	Kentucky Coffee Tree	60mm cal	B + B specimen

Code	Qty.	Botanical Name	Common Name	Size	Condition
HK	250	Hypericum kalmianum	St. John's Wort	40cm Ht.	Pot
SA	250	Spiraea alba	Meadowsweet	60cm Ht.	Pot

Qty.	Botanical Name	Common Name	Condition
125	Geranium macrorrhizum	Bigroot Geranium	9cm Pot
125	Geranium psilostemon 'Gerwat'	Rozanne Geranium	9cm Pot
110	Panicum virgatum	Switch Grass	9cm Pot
55	Pinus mugo var. pumilio	Mugho Pine	30cm spr
60	Arctostaphylos Uva Ursi	Bearberry	30cm spr

