

# **Site Servicing & Stormwater Management Report**

**Commercial Development**

**5581 Doctor Leach Drive**

**Ottawa, Ontario**

# Table of Contents

1.0 INTRODUCTION .....	1
2.0 PURPOSE.....	1
3.0 EXISTING CONDITIONS .....	1
4.0 PROPOSED DEVELOPMENT .....	2
5.0 STORMWATER MANAGEMENT PLAN.....	2
5.1 Pre-Development Conditions.....	2
5.2 Post-Development Conditions .....	2
i. 5-year site storage requirements .....	3
ii. 100-year site storage requirements.....	3
6.0 STORM SEWERS AND SWM SYSTEM .....	3
6.1 Storm Sewers .....	3
6.2 SWM System.....	4
7.0 SANITARY SEWER .....	4
8.0 WATER SERVICING.....	4
9.0 EROSION AND SEDIMENT CONTROL DURING CONSTRUCTION .....	4
10.0 CONCLUSIONS .....	4

## List of Tables

Table 2: ICD Schedule .....	3
-----------------------------	---

## List of Appendices

- Appendix A: Stormwater Management Calculations
- Appendix B: Storm and Sanitary Sewer Computation Forms
- Appendix C: Sanitary Load
- Appendix D: Stormceptor Design and Specifications
- Appendix E: Stormwater Storage Chambers Specifications

## Drawings

- Drawing C101 | Erosion and Sediment Control & Removals Plan
- Drawing C102 | Site Servicing Plan
- Drawing C103 | Grading Plan
- Drawing C104 | Details
- Drawing C105 | Pre-Development Drainage Plan
- Drawing C106 | Post Development Drainage Plan

## 1.0 INTRODUCTION

Parsons Inc. was retained by the Rideau Non-Profit Housing Inc to provide engineering services for a new two-storey apartment building located at 5581 Doctor Leach in Ottawa, Ontario.

The site encompasses a total area of approximately 0.59 ha and is bordered by residential developments to the north and south, Doctor Leach on the west and a future developable site to the east.

The proposed development includes a new 2-storey apartment building containing 38 units intended for seniors housing. The site will include a 29-vehicle parking and the new on-site storm sewers, sanitary services, and new water services.



## 2.0 PURPOSE

This report summarizes the proposed site servicing, grading and drainage design, documents the proposed method of attenuating stormwater runoff from the subject site, and deals with erosion and sediment control measures to be undertaken during construction.

Stormwater management items addressed include the following:

- establishing the allowable post-development release rate from the site;
- calculating the post-development runoff from the site;
- determining the required on-site stormwater storage volume and storage areas; and,

## 3.0 EXISTING CONDITIONS

The subject site is currently vacant with an existing septic system servicing the seniors housing to the north of the proposed development. The site is not currently serviced by means of sanitary sewer. An existing 600mm concrete sanitary is located north of the subject development near Eastman Ave. A 150mm watermain runs across the site's frontage on Doctor Leach Ave. The site generally slopes from NW to SE of the subject site, where stormwater is captured and drains through a

1200mm storm sewer located at the residential properties' rear yards. The storm sewer ultimately discharges to the Rideau River through an outlet creek along Potter Dr.

## 4.0 PROPOSED DEVELOPMENT

As shown on the Architectural Site Plan, the proposed development will consist of a new senior housing building with a building footprint of 1302m<sup>2</sup>. The proposal will also include parking spaces, concrete sidewalks, concrete curbs, pedestrian pathways and new vehicle access from Doctor Leach Drive.

The site grading will match the existing conditions along the existing properties line on the north and west side of the subject site.

## 5.0 STORMWATER MANAGEMENT PLAN

**Drawing C105** and **C106**, appended to this report, depict the boundaries of the pre- and post-development drainage areas and should be read in conjunction with this report.

The design approach for the stormwater management is to ensure that the post-development peak flows do not exceed the existing release rate flow or negatively impact the property's existing storm sewer network.

For the pre-development 5-year storm event, the allowable release rate was calculated based on the following:

- Runoff Coefficient (C) = 0.2
- Drainage Area (A) = 0.59 ha
- Time of Concentration (Tc) = 15min

The Rational Method formula has been used to calculate stormwater runoff and rainfall data is based on the IDF curve equations from the *Ottawa Sewer Design Guidelines, Second Edition, October 2012*.

$$Q = 2.78 CIA, \text{ where:}$$

Q = Flow rate (L/s)  
C = Runoff coefficient  
I = Rainfall intensity (mm/hr)  
A = Area (ha)

$$\text{Rainfall intensity: } I_5 = 998.071 / (Tc + 6.053)^{0.814}$$

Using the Rational Method formula and the above parameters, the allowable post-development release rate for this site is **27.4 L/s**.

### 5.1 Pre-Development Conditions

As mentioned earlier, the subject site is currently vacant. Based on the topographical survey received, the site grading is generally sloping to the SW corner where the stormwater is captured by an existing storm sewer system.

### 5.2 Post-Development Conditions

Based on post-development boundary conditions, area WS-01, WS-03 and WS-06 will drain uncontrolled to the existing ditch similar to the pre-development conditions. Drainage areas WS-02, WS-04 and WS-05 will drain to the on-site SWM system.

For the purposes of calculating the average runoff coefficients for the post-development areas, the following guidelines were used:

- Landscaped surfaces (grass, trees, shrubs, etc.) C = 0.20
- Impervious surfaces (asphalt, concrete, pavers, rooftops, etc.) C = 0.90
- The runoff coefficient for 100-year event is increased by 25% based on the Ottawa Sewer Design Guidelines.

**Appendix A** “Stormwater Management Calculations” provides a summary of the post-development areas and average runoff coefficients.

Runoff from the site will be collected and controlled to drain to the on-site SWM system. As illustrated on **Drawing C102**, runoff from areas WS-02, WS-04 and WS-05 will be collected by the proposed storm sewer and managed by the SWM system. Area WS-01, WS-03 and WS-06 will direct drainage to the existing ditch and existing overland flow route. Runoff from areas outside the boundaries of the drainage areas will continue to drain as they had prior to this development and will undergo no changes.

An ICD is required to control the flows from the site to the allowable release rate of **27.4 L/s**. Based on this controlled release rate, the required storage to attenuate the 5-year and 100-year post-development flow has been calculated to be **79.3 m<sup>3</sup>** and **183.5 m<sup>3</sup>**, respectively. The calculations are shown in **Appendix A**.

Storage requirements to attenuate the post-development flow rates are given below:

**i. 5-year site storage requirements**

The 5-year post-development flow will be captured within the piped storm system and subsurface storage system. Below grade storage will be provided within the on-site storm piping and related storm structures. The design will utilize **79.3m<sup>3</sup>** of the subsurface storage.

**ii. 100-year site storage requirements**

The 100-year post-development flow will be captured within the SWM system with use of sub-surface storage. Below grade storage will be provided within the on-site storm piping and related storm structures. The design will require **183.5 m<sup>3</sup>** of the subsurface storage.

The proposed underground subsurface stormwater management system will be MC-7200 by StormTech or equivalent. The underground storage chamber will provide an equivalent storage capacity of **185.0 m<sup>3</sup>**. See design reference table in **Appendix A**.

To control the total discharge within the piped system to the identified flow rate of **9.3 L/s**, an ICD will be installed on the outlet pipe upstream of the monitoring maintenance hole. The design head was calculated as the delta in height between the center of the ICD and the top of the underground storage chambers which is equivalent to the 100-year storage elevation. See **Appendix A** for detailed pipe outlet calculations and **Drawing C102** for ICD detail.

The **Table 2** lists all the requirements for the manufacturer to design the appropriate ICD.

**Table 1: ICD Schedule**

ICD ID	LOCATION	OUTLET DIAMETER (mm)	FLOW (L/s)	HEAD (m)	EQUIVALENT DIAMETER (mm)	MODEL
1	MH-STM-02	300	9.3	1.93	55	VORTEX TYPE

## 6.0 STORM SEWERS AND SWM SYSTEM

### 6.1 Storm Sewers

Calculations showing the storm sewer capacities are appended to this report under **Appendix B** “Storm Sewer Computation Forms”. The storm sewer design spreadsheet is based on the Rational Method and Manning formula and was used to calculate the design flow and required pipe sizes. Capacity required for proposed storm sewers is based on the 5-year rainfall intensity obtained from the Ottawa Sewer Design Guidelines, where  $T_c$  is the time of concentration:

- $I_5$  (mm/hr) =  $998.071 / (T_c + 6.053)^{0.814}$

**Drawing C106** shows the proposed drainage areas. Details including pipe lengths, sizes, materials, inverts elevations and structure types are shown on **Drawing C102**.

## 6.2 SWM System

As mentioned above, the SWM system includes an ICD in MH-STM-02 that will control the flow to a maximum of **9.3 L/s**. Any additional flow will be store on-site using underground storage chambers. The site stormwater runoff ultimately discharges to the Rideau River. An oil/grit separator (ST-OGS-01), downstream of MH-STM-02, will provide the required **80% TSS removal**.

## 7.0 SANITARY SEWER

The new residential units and the existing residential building within the proposed development will be served with a new on-site sanitary system. Each building will have its own sanitary service. A new 250mm sanitary sewer at 0.5% will be constructed within a new register easement. The peak sanitary flow for the proposed development is calculated to be **1.7 L/s**, including infiltration. The sanitary load calculations can be found in **Appendix C**.

Details concerning pipe length, material, and elevation are shown on **Drawing C102**.

## 8.0 WATER SERVICING

The site is to be serviced by a new 150 mm diameter watermain that will connect to the existing 550 mm diameter watermain located on Doctor Leach Drive. As the building is not sprinklered, the existing fire hydrant that is located less the 90m from the building will be sufficient to provide fire flow to the building.

## 9.0 EROSION AND SEDIMENT CONTROL DURING CONSTRUCTION

To mitigate the impacts due to erosion and sedimentation during construction, erosion and sediment control measures shall be installed and maintained throughout the duration of construction.

Measures shall only be removed once the construction activities are complete, and the site has stabilized.

The measures will include:

- Siltsack® shall be installed between the frame and cover of existing and new catchbasins and maintenance holes, to minimize sediments entering the storm drainage system.
- All grassed areas must be completed prior to the removal of the Siltsack® in catch basins and maintenance holes.
- Light Duty Silt Fence Barriers placed around the perimeter of the site where necessary, installed and maintained according to OPSS 577 and OPSD 219.110.

## 10.0 CONCLUSIONS

Stormwater flows from the site will be over controlled to a flow of **5.9 L/s** for 5-year and **9.3 L/s** for 100-year events. Stormwater storage is provided up to and including the 100-year storm in an underground SWM chamber and in the storm pond prior to discharging to the municipal storm sewer system. Stormwater quality treatment will be provided onsite by an oil and grit separator.

The water servicing will be provided by a new 150mm water service to Doctor Leach Drive.

The sanitary servicing of the building including the existing building to the north will be provided by constructing a new sewer line north towards Eastman Ave. The peak sanitary flow for the proposed building, including infiltration, is calculated to be **1.7L/s**. The existing sanitary sewer is adequate to carry the additional sanitary load.

Grading and drainage measures will ensure proper drainage of the site, while erosion and sediment control measures will minimize downstream impacts due to construction activities.

We look forward to receiving approval of this report and the appended plans from the City to proceed with construction of the site.

Prepared by:



---

Mathew Theiner, P.Eng., ing.

**Appendix A:  
Stormwater Management Calculations**



**TABLE I - ALLOWABLE RUNOFF CALCULATIONS BASED ON EXISTING CONDITIONS**

Area Description	Area (ha)	Time of Conc, Tc (min)	Minor Storm			
			Storm = 5 yr	I <sub>5</sub> (mm/hr)	C <sub>AVG</sub>	Q <sub>ALLOW</sub> (L/s)
EWS-01	0.59	15	Storm = 5 yr	83.56	0.20	<b>27.4</b>
<b>TOTAL</b>	<b>0.59</b>					<b>27.4</b>

5-year Storm                      C<sub>ASPH/ROOF/CONC</sub> = 0.90                      C<sub>GRASS</sub> = 0.20  
 100-year Storm                  C<sub>ASPH/ROOF/CONC</sub> = 1.00                      C<sub>GRASS</sub> = 0.25

**TABLE II - POST-DEVELOPMENT AVERAGE RUNOFF COEFFICIENTS**

Watershed Area No.	Impervious Areas (m <sup>2</sup> )	A * C <sub>ASPH</sub>	Pervious Areas (m <sup>2</sup> )	A * C <sub>GRASS</sub>	Sum AC	Total Area (m <sup>2</sup> )	C <sub>AVG (5yr)</sub>	C <sub>AVG(100yr)</sub>
WS-01**	49.04	44	486.96	97	142	536	0.26	0.33
WS-02	870.25	783	417.75	84	867	1288	0.67	0.84
WS-03**	67.41	61	6.71	1	62	74	0.84	1.00
WS-04	660.30	594	1501.95	300	895	2162	0.41	0.52
WS-05	1203.57	1083	217.20	43	1127	1421	0.79	0.99
WS-06**	0.00	0	453.70	91	91	454	0.20	0.25
<b>Total</b>	<b>2851</b>		<b>3084</b>		<b>3182</b>	<b>5935</b>		

\* Roof top storage Areas

\*\*Uncontrolled Areas

**TABLE III - TOTAL RUNOFF COEFFICIENT FOR CONTROLLED AREAS (EXCLUDING ROOF TOP AREAS)**

$C_{AVG(5yr)} = \frac{\text{Sum AC}}{\text{Total Area}} = \frac{3,030}{5,407} = 0.56$	$C_{AVG(100yr)} = 0.70$
---	-------------------------

**TABLE IV - SUMMARY OF POST-DEVELOPMENT RUNOFF**

Area No	Area (ha)	Storm = 5 yr				Storm = 100 yr			
		I <sub>5</sub> (mm/hr)	C <sub>AVG(5yr)</sub>	Q <sub>GEN</sub> (L/s)	Q <sub>CONT</sub> (L/s)	I <sub>100</sub> (mm/hr)	C <sub>AVG(100yr)</sub>	Q <sub>GEN</sub> (L/s)	Q <sub>CONT</sub> (L/s)
WS-01**	0.054	104.19	0.26	4.1	6.1	178.56	0.33	8.8	8.8
WS-02	0.129	104.19	0.67	25.1		178.56	0.84	53.8	9.3
WS-03**	0.007	104.19	0.84	1.8	1.8	178.56	1.00	3.7	3.7
WS-04	0.216	104.19	0.41	25.9	6.1	178.56	0.52	55.5	9.3
WS-05	0.142	104.19	0.79	32.6		178.56	0.99	69.9	
WS-06**	0.045	104.19	0.20	2.6	2.6	178.56	0.25	5.6	5.6
<b>Total</b>	0.593			92.2	<b>10.47</b>			197.295	<b>18.6</b>

\* Roof top storage Areas

$$I_5 = 998.071 / (Tc+6.053)^{0.514}$$

$$I_{100} = 1735.688 / (Tc+6.014)^{0.620}$$

Time of concentration (min), Tc = 10 mins

**Table V - Storage Volumes (5-Year and 100-Year Storm Events)**

**Site Storage Requirement**

$C_{AVG} = 0.56$  (5-year)  
 $C_{AVG} = 0.70$  (100-year)  
 Time Interval = 5 (mins)  
 Drainage Area = 0.487 (hectares)

Duration (min)	Release Rate = <u>6.1</u> (L/sec) Return Period = <u>5</u> (years) IDF Parameters, A = <u>998.071</u> , B = <u>0.814</u> $I = A/(T_c+6.199)^B$						Release Rate = <u>9.3</u> (L/sec) Return Period = <u>100</u> (years) IDF Parameters, A = <u>1735.688</u> , B = <u>0.820</u> $I = A/(T_c+6.014)^B$					
	Rainfall Intensity, I (mm/hr)	Peak Flow (L/sec)	Peak Flow from Roof (L/sec)	Release Rate (L/sec)	Storage Rate (L/sec)	Storage (m <sup>3</sup> )	Rainfall Intensity, I (mm/hr)	Peak Flow (L/sec)	Peak Flow from Roof (L/sec)	Release Rate (L/sec)	Storage Rate (L/sec)	Storage (m <sup>3</sup> )
0	-	-	-	-	-	-	-	-	-	-	-	-
5	141.2	107.1		6.1	101.1	30.3	242.7	230.2	9.3	220.9	66.3	
10	104.2	79.1		6.1	73.0	43.8	178.6	169.4	9.3	160.0	96.0	
15	83.6	63.4		6.1	57.3	51.6	142.9	135.5	9.3	126.2	113.6	
20	70.3	53.3		6.1	47.3	56.7	120.0	113.8	9.3	104.4	125.3	
25	60.9	46.2		6.1	40.2	60.2	103.8	98.5	9.3	89.2	133.8	
30	53.9	40.9		6.1	34.9	62.8	91.9	87.1	9.3	77.8	140.1	
35	48.5	36.8		6.1	30.8	64.6	82.6	78.3	9.3	69.0	144.9	
40	44.2	33.5		6.1	27.5	65.9	75.1	71.3	9.3	62.0	148.7	
45	40.6	30.8		6.1	24.8	66.9	69.1	65.5	9.3	56.2	151.7	
50	37.7	28.6		6.1	22.5	67.6	64.0	60.7	9.3	51.3	154.0	
55	35.1	26.6		6.1	20.6	68.0	59.6	56.5	9.3	47.2	155.9	
60	32.9	25.0		6.1	18.9	68.2	55.9	53.0	9.3	43.7	157.3	
65	31.0	23.6		6.1	17.5	68.3	52.6	49.9	9.3	40.6	158.4	
70	29.4	22.3		6.1	16.2	68.2	49.8	47.2	9.3	37.9	159.2	
75	27.9	21.2		6.1	15.1	68.0	47.3	44.8	9.3	35.5	159.7	
80	26.6	20.2		6.1	14.1	67.7	45.0	42.7	9.3	33.4	160.1	
85	25.4	19.2		6.1	13.2	67.3	43.0	40.7	9.3	31.4	160.2	
90	24.3	18.4		6.1	12.4	66.8	41.1	39.0	9.3	29.7	160.2	
95	23.3	17.7		6.1	11.6	66.3	39.4	37.4	9.3	28.1	160.1	
100	22.4	17.0		6.1	11.0	65.7	37.9	35.9	9.3	26.6	159.8	
105	21.6	16.4		6.1	10.3	65.0	36.5	34.6	9.3	25.3	159.4	
110	20.8	15.8		6.1	9.7	64.3	35.2	33.4	9.3	24.1	158.9	
115	20.1	15.3		6.1	9.2	63.6	34.0	32.3	9.3	22.9	158.2	
120	19.5	14.8		6.1	8.7	62.8	32.9	31.2	9.3	21.9	157.5	
Max =						<b>68.3</b>						<b>160.2</b>

**Notes**

- 1 ) Peak flow is equal to the product of 2.78 x C x I x A
- 2) Rainfall Intensity,  $I_5 = A/(T_c+6.053)^B$  &  $I_{100} = A/(T_c+6.014)^B$
- 3) Release Rate = LESSER of Min (Release Rate, Peak Flow) - Minus 100 Year Flow Of Uncontrolled Areas OR Pipe Outlet Capacity
- 4 ) Storage Rate = Peak Flow - Release Rate
- 5) Storage = Duration x Storage Rate
- 6) Maximum Storage = Max Storage Over Duration

### ICD Design Table - VII

$Q = 0.62 \times A \times [2gh]^{0.5}$  where:

$g = 9.81$

Location	Pipe Outlet Diameter (mm)	Pipe Outlet Invert (m)	HGL (m)		Outlet flow (L/s)		Trial orifice size (mm)	Orifice size (mm)	Orifice Area (sqm)	Head (m)	
			100-year event	5-year event	100-year event	5-year event				100-year event	5-year event
<i>EX CBMH</i>	300	86.30	88.26	87.14	9.3	6.1	55	55.78	0.00244	1.93	0.81

**Appendix B:  
Storm and Sanitary Sewer Computation Forms**

## STORM SEWER COMPUTATION FORM

**Rational Method**

$Q = 2.78 \cdot A \cdot I \cdot R$

Q = Flow (L/sec)  
 A = Area (ha)  
 I = Rainfall Intensity (mm/h)  
 R = Ave. Runoff Coefficient

**City of Ottawa IDF Curve - 5-y**

$I_5 = 998.071 / (T_c + 6.053)^{0.814}$

 Minimum Time of Conc.  $T_c = 10 \text{ min}$ 

 Manning's  $n = 0.013$ 

Drainage Area	From	To	Area (ha)	Runoff Parameters					Roof Flow Q (L/sec)	Peak Flow Q (L/sec)	Pipe Dia.		Slope (%)	Length (m)	Capacity full (L/sec)	Velocity		Time of Flow (min)	Q(d) / Q(f)	REMARKS
				Runoff Coeff. R	Indiv. 2.78AR	Accum. 2.78AR	Time of Conc. (min)	Rainfall Intensity (mm/hr)			nom. (mm)	actual (mm)				full (m/sec)	actual (m/sec)			
WS-02	RY-CB-01	RY-CB-02	0.130	0.67	0.24	0.24	10.00	104.19	25.34	250	254	0.75	15.1	53.73	1.06	0.88	0.24	0.47		
	RY-CB-02	RY-CB-03				0.24	10.24	102.94	25.04	250	254	0.75	13.7	53.73	1.06	0.88	0.22	0.47		
	RY-CB-03	RY-CB-04				0.24	10.46	101.82	24.76	250	254	0.75	12.4	53.73	1.06	0.88	0.20	0.46		
	RY-CB-04	RY-CB-05				0.24	10.66	100.83	24.52	250	254	0.75	10.6	53.73	1.06	0.88	0.17	0.46		
	RY-CB-05	RY-CB-06				0.24	10.83	100.00	24.32	250	254	0.75	24.2	53.73	1.06	0.87	0.38	0.45		
	RY-CB-06	RY-CB-07				0.24	11.21	98.21	23.89	250	254	0.75	11.1	53.73	1.06	0.87	0.18	0.44		
	RY-CB-07	CB-MH-02				0.24	11.39	97.38	23.68	250	254	0.75	10.2	53.73	1.06	0.87	0.16	0.44		
WS-04	MST-05427	STM-MH-01	0.216	0.41	0.25	0.25	10.00	104.19	25.91	300	305	0.50	53.6	71.33	0.98	0.74	0.91	0.36		
	STM-MH-01	STM-MH-02				0.25	10.91	99.62	24.78	300	305	0.50	16.1	71.33	0.98	0.74	0.27	0.35		
WS-05	CB-MH-02	STM-MH-04	0.142	0.79	0.31	0.56	10.46	101.82	56.66	200	203	4.00	46.0	68.43	2.11	2.09	0.36	0.83		
	STM-MH-04	MH-STM-05				0.56	10.82	100.05	55.67	1500	1524	0.50	25.0	5214.56	2.86	0.91	0.15	0.01		
	MH-STM-05	CB-MH-01				0.56	10.97	99.33	55.27	300	305	2.00	2.8	142.67	1.96	1.53	0.02	0.39		
	CB-MH-01	STM-MH-02				0.56	10.99	99.24	55.22	300	305	0.50	6.5	71.33	0.98	0.95	0.11	0.77		
	STM-MH-02	OGS-01				0.81	11.10	98.72	79.48	375	381	0.50	2.4	129.34	1.13	1.02	0.04	0.61		
	OGS-01	MHST05423				0.81	11.14	98.53	79.33	375	381	0.50	18.6	129.34	1.13	1.12	0.27	0.61		
	MHST05423	MHST39981				0.81	11.41	97.29	78.33	1200	1067	0.25	18.6	1424.40	1.59	0.51	0.19	0.05		
	MHST39981	MHST39982				0.81	11.60	96.44	77.65	1200	1067	0.35	18.6	1685.37	1.89	0.60	0.16	0.05		
	MHST39982	MHST39983				0.81	11.76	95.73	77.08	1200	1067	0.35	18.6	1685.37	1.89	1.83	0.16	0.05		
	MHST39983	MHST39984				0.81	11.92	95.04	76.52	1200	1067	0.35	18.6	1685.37	1.89	1.70	0.16	0.05		
	MHST39984																			

Note:

**Design:** J. Birtwistle  
**Check:** M. Theiner  
**Date:** 3/29/2023

**Project:** Manotick Affordable Seniors Residences  
 5581 Doctor Leach Dr. Manotick Ontario  
**Client:** CLV Group

**Appendix C:  
Sanitary Load**

## SANITARY DESIGN FLOWS

Area	RESIDENTIAL POPULATION					TOTAL	INFILTRATION			Total	
	Pop.	Cumulative		Peak Factor (per Ottawa)	Peak Flow (L/s)	Peak Flow (L/s)	Site Area (ha)	Infiltration Allowance (L/s/ha)	Infil. Flow (L/s)	Total Peak Flow (L/s)	
		Area (ha)	Capita								
<b>Subject Site</b>											
<b>Existing Seinors Residence</b>											
<b>30 Units</b>	42	0.10	42	4.0	0.5444	0.54	0.71	0.33	0.23	0.23	
<b>Proposed Seinors Residence</b>											
<b>38 Units</b>							0.59	0.33	0.19	0.19	
<b>First Floor</b>											
<b>3 Bachelor Units</b>	4.2	0.01	4	4.0	0.0544						
<b>16 One Bedroom Units</b>	22.4	0.08	22	4.0	0.2904						
<b>Second Floor</b>											
<b>3 Bachelor Units</b>	4.2	0.01	4	4.0	0.0544						
<b>12 One Bedroom Units</b>	16.8	0.06	17	4.0	0.2178						
<b>4 Two Bedroom Units</b>	8.4	0.03	8	4.0	0.1089	0.7				0.73	
									<b>Total</b>	<b>1.70</b>	
<b>Average Daily Demands</b>											
<i>(Based on City of Ottawa Sewer Design Guidelines 2012 and MOE Water Design Guidelines)</i>											
Average Residential Daily Flow =	280 L/p/d										
Institutional Flow =	28,000 L/ha/d										
Commercial Flow =	28,000 L/ha/d										
Light Industrial Flow =	35,000 L/ha/d										
Heavy Industrial Flow =	55,000 L/ha/d										
Hotel Daily Flow =	225 L/bed/d										
Office/Warehouse Daily Flow =	75 L/empl/d										
Shopping Centres =	2,500 L/(1000m <sup>2</sup> /d)										
<b>Population Densities</b>											
Average suburban residential dev.	60 p/ha										
Single family	3.4 p./unit										
Semi-detached	2.7 p./unit										
Duplex	2.3 p./unit										
Townhouse	2.7 p./unit										
Appartment average	1.8 p./unit										
Bachelor	1.4 p./unit										
1 Bedroom	1.4 p./unit										
2 Bedrooms	2.1 p./unit										
3 Bedrooms	3.1 p./unit										
Hotel room, 18 m2	1 p./unit										
Restaurant, 1 m2	1 p./unit										
Office	1 p/25m <sup>2</sup>										
Warehouse	1 p/90m <sup>2</sup>										
Automotive Service Centre, per bay	1 p/bay (plus management)										
<b>Design:</b>							JB	<b>Project:</b> Manotick Seinors Residence CLV Group			
<b>Check :</b>							MT	<b>Location:</b> 5581 Doctor leach Dr. Manotick, Ontario			
<b>Dwg reference:</b>								<b>Project # :</b> 478221 <b>Date:</b> March 2023 <b>Sheet:</b> 1 of 1			



**Appendix D:  
Stormceptor Design and Specifications**

# Stormceptor<sup>®</sup> EF Sizing Report

## STORMCEPTOR<sup>®</sup> ESTIMATED NET ANNUAL SEDIMENT (TSS) LOAD REDUCTION

03/31/2023

Province:	Ontario
City:	Ottawa
Nearest Rainfall Station:	OTTAWA CDA RCS
Climate Station Id:	6105978
Years of Rainfall Data:	20

Project Name:	Hyfield Manotick
Project Number:	478221
Designer Name:	Mathew Theiner
Designer Company:	Parsons
Designer Email:	mathew.theiner@parsons.com
Designer Phone:	613-738-4160
EOR Name:	
EOR Company:	
EOR Email:	
EOR Phone:	

Site Name:	
------------	--

Drainage Area (ha):	0.59
% Imperviousness:	80.00

Runoff Coefficient 'c': 0.78

Particle Size Distribution:	Fine
Target TSS Removal (%):	80.0

Required Water Quality Runoff Volume Capture (%):	90.00
Estimated Water Quality Flow Rate (L/s):	14.85
Oil / Fuel Spill Risk Site?	Yes
Upstream Flow Control?	Yes
Upstream Orifice Control Flow Rate to Stormceptor (L/s):	10.00
Peak Conveyance (maximum) Flow Rate (L/s):	
Site Sediment Transport Rate (kg/ha/yr):	

Net Annual Sediment (TSS) Load Reduction Sizing Summary	
Stormceptor Model	TSS Removal Provided (%)
EFO4	86
EFO6	94
EFO8	98
EFO10	100
EFO12	100

**Recommended Stormceptor EFO Model: EFO4**  
**Estimated Net Annual Sediment (TSS) Load Reduction (%): 86**  
**Water Quality Runoff Volume Capture (%): > 90**

## Stormceptor® EF Sizing Report

### THIRD-PARTY TESTING AND VERIFICATION

► **Stormceptor® EF and Stormceptor® EFO** are the latest evolutions in the Stormceptor® oil-grit separator (OGS) technology series, and are designed to remove a wide variety of pollutants from stormwater and snowmelt runoff. These technologies have been third-party tested in accordance with the Canadian ETV **Procedure for Laboratory Testing of Oil-Grit Separators** and performance has been third-party verified in accordance with the **ISO 14034 Environmental Technology Verification (ETV)** protocol.

### PERFORMANCE

► **Stormceptor® EF and EFO** remove stormwater pollutants through gravity separation and floatation, and feature a patent-pending design that generates positive removal of total suspended solids (TSS) throughout each storm event, including high-intensity storms. Captured pollutants include sediment, free oils, and sediment-bound pollutants such as nutrients, heavy metals, and petroleum hydrocarbons. Stormceptor is sized to remove a high level of TSS from the frequent rainfall events that contribute the vast majority of annual runoff volume and pollutant load. The technology incorporates an internal bypass to convey excessive stormwater flows from high-intensity storms through the device without resuspension and washout (scour) of previously captured pollutants. Proper routine maintenance ensures high pollutant removal performance and protection of downstream waterways.

### PARTICLE SIZE DISTRIBUTION (PSD)

► The **Canadian ETV PSD** shown in the table below was used, or in part, for this sizing. This is the identical PSD that is referenced in the Canadian ETV **Procedure for Laboratory Testing of Oil-Grit Separators** for both sediment removal testing and scour testing. The Canadian ETV PSD contains a wide range of particle sizes in the sand and silt fractions, and is considered reasonably representative of the particle size fractions found in typical urban stormwater runoff.

Particle Size (µm)	Percent Less Than	Particle Size Fraction (µm)	Percent
1000	100	500-1000	5
500	95	250-500	5
250	90	150-250	15
150	75	100-150	15
100	60	75-100	10
75	50	50-75	5
50	45	20-50	10
20	35	8-20	15
8	20	5-8	10
5	10	2-5	5
2	5	<2	5

## Stormceptor<sup>®</sup> EF Sizing Report

### Upstream Flow Controlled Results

Rainfall Intensity (mm / hr)	Percent Rainfall Volume (%)	Cumulative Rainfall Volume (%)	Flow Rate (L/s)	Flow Rate (L/min)	Surface Loading Rate (L/min/m <sup>2</sup> )	Removal Efficiency (%)	Incremental Removal (%)	Cumulative Removal (%)
0.5	8.6	8.6	0.64	38.0	32.0	100	8.6	8.6
1	20.3	29.0	1.28	77.0	64.0	100	20.3	29.0
2	16.2	45.2	2.56	154.0	128.0	93	15.1	44.1
3	12.0	57.2	3.84	230.0	192.0	84	10.1	54.2
4	8.4	65.6	5.12	307.0	256.0	81	6.8	61.0
5	5.9	71.6	6.40	384.0	320.0	78	4.6	65.7
6	4.6	76.2	7.68	461.0	384.0	75	3.5	69.1
7	23.8	100.0	8.96	537.0	448.0	72	17.1	86.2
8	0.0	100.0	10.00	600.0	500.0	69	0.0	86.2
9	0.0	100.0	10.00	600.0	500.0	69	0.0	86.2
10	0.0	100.0	10.00	600.0	500.0	69	0.0	86.2
11	0.0	100.0	10.00	600.0	500.0	69	0.0	86.2
12	0.0	100.0	10.00	600.0	500.0	69	0.0	86.2
13	0.0	100.0	10.00	600.0	500.0	69	0.0	86.2
14	0.0	100.0	10.00	600.0	500.0	69	0.0	86.2
15	0.0	100.0	10.00	600.0	500.0	69	0.0	86.2
16	0.0	100.0	10.00	600.0	500.0	69	0.0	86.2
17	0.0	100.0	10.00	600.0	500.0	69	0.0	86.2
18	0.0	100.0	10.00	600.0	500.0	69	0.0	86.2
19	0.0	100.0	10.00	600.0	500.0	69	0.0	86.2
20	0.0	100.0	10.00	600.0	500.0	69	0.0	86.2
21	0.0	100.0	10.00	600.0	500.0	69	0.0	86.2
22	0.0	100.0	10.00	600.0	500.0	69	0.0	86.2
23	0.0	100.0	10.00	600.0	500.0	69	0.0	86.2
24	0.0	100.0	10.00	600.0	500.0	69	0.0	86.2
25	0.0	100.0	10.00	600.0	500.0	69	0.0	86.2
30	0.0	100.0	10.00	600.0	500.0	69	0.0	86.2
35	0.0	100.0	10.00	600.0	500.0	69	0.0	86.2
40	0.0	100.0	10.00	600.0	500.0	69	0.0	86.2
45	0.0	100.0	10.00	600.0	500.0	69	0.0	86.2
<b>Estimated Net Annual Sediment (TSS) Load Reduction =</b>								<b>86 %</b>

Climate Station ID: 6105978 Years of Rainfall Data: 20

# Stormceptor<sup>®</sup> EF Sizing Report

## RAINFALL DATA FROM OTTAWA CDA RCS RAINFALL STATION

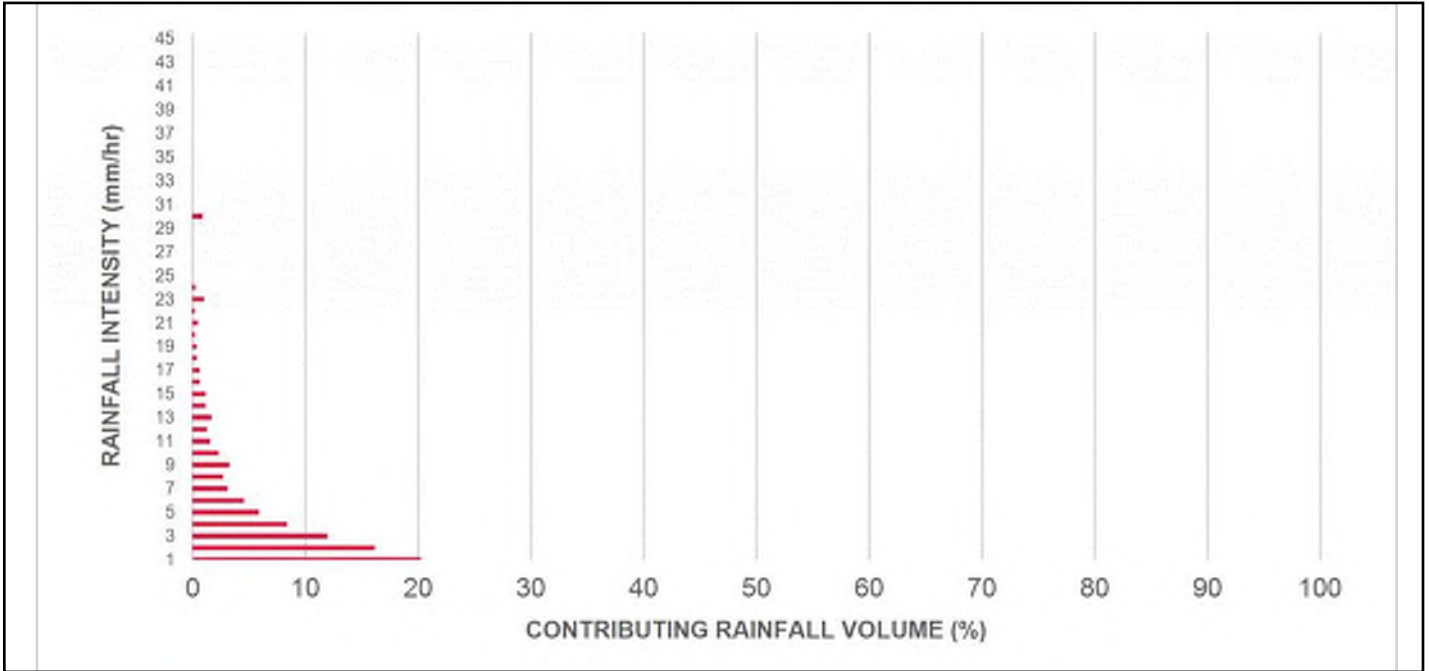

## INCREMENTAL AND CUMULATIVE TSS REMOVAL FOR THE RECOMMENDED STORMCEPTOR<sup>®</sup> MODEL

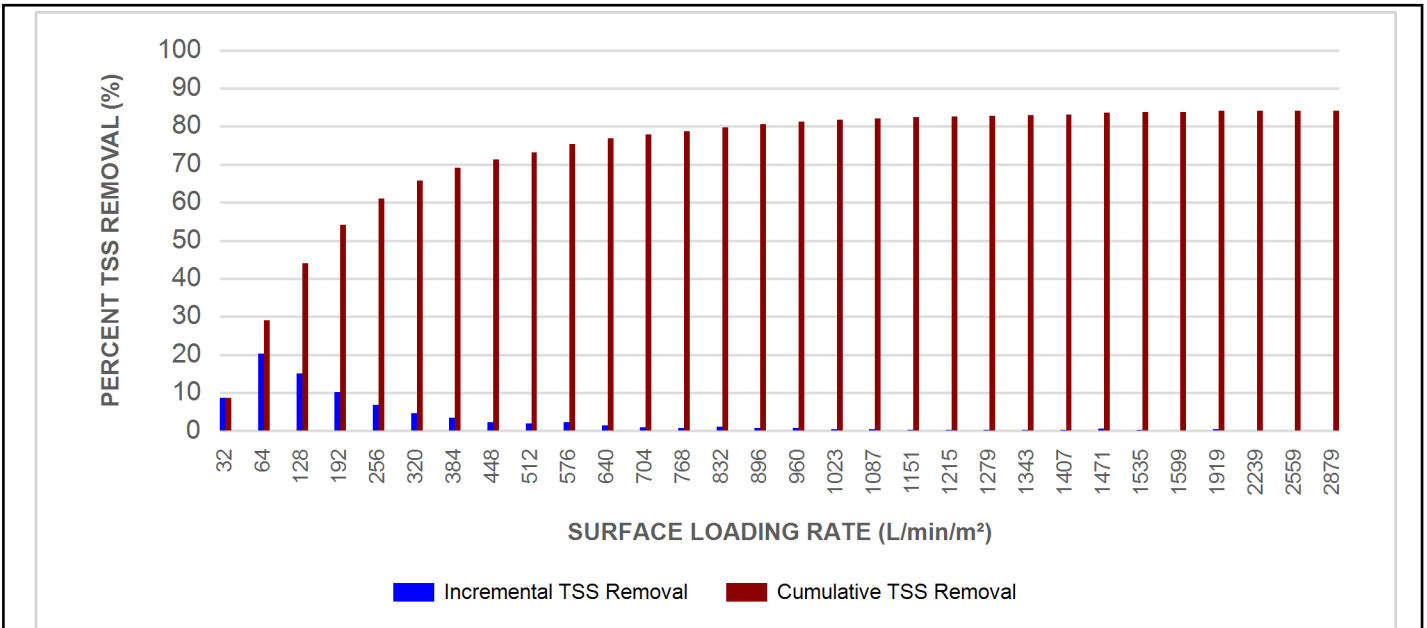

## Stormceptor® EF Sizing Report

### Maximum Pipe Diameter / Peak Conveyance

Stormceptor EF / EFO	Model Diameter		Min Angle Inlet / Outlet Pipes	Max Inlet Pipe Diameter		Max Outlet Pipe Diameter		Peak Conveyance Flow Rate	
	(m)	(ft)		(mm)	(in)	(mm)	(in)	(L/s)	(cfs)
EF4 / EFO4	1.2	4	90	609	24	609	24	425	15
EF6 / EFO6	1.8	6	90	914	36	914	36	990	35
EF8 / EFO8	2.4	8	90	1219	48	1219	48	1700	60
EF10 / EFO10	3.0	10	90	1828	72	1828	72	2830	100
EF12 / EFO12	3.6	12	90	1828	72	1828	72	2830	100

### SCOUR PREVENTION AND ONLINE CONFIGURATION

► **Stormceptor® EF and EFO** feature an internal bypass and superior scour prevention technology that have been demonstrated in third-party testing according to the scour testing provisions of the Canadian ETV **Procedure for Laboratory Testing of Oil-Grit Separators**, and the exceptional scour test performance has been third-party verified in accordance with the ISO 14034 ETV protocol. As a result, Stormceptor EF and EFO are approved for online installation, eliminating the need for costly additional bypass structures, piping, and installation expense.

### DESIGN FLEXIBILITY

► **Stormceptor® EF and EFO** offers design flexibility in one simplified platform, accepting stormwater flow from a single inlet pipe or multiple inlet pipes, and/or surface runoff through an inlet grate. The device can also serve as a junction structure, accommodate a 90-degree inlet-to-outlet bend angle, and can be modified to ensure performance in submerged conditions.

### OIL CAPTURE AND RETENTION

► While Stormceptor® EF will capture and retain oil from dry weather spills and low intensity runoff, **Stormceptor® EFO** has demonstrated superior oil capture and greater than 99% oil retention in third-party testing according to the light liquid re-entrainment testing provisions of the Canadian ETV **Procedure for Laboratory Testing of Oil-Grit Separators**. Stormceptor EFO is recommended for sites where oil capture and retention is a requirement.

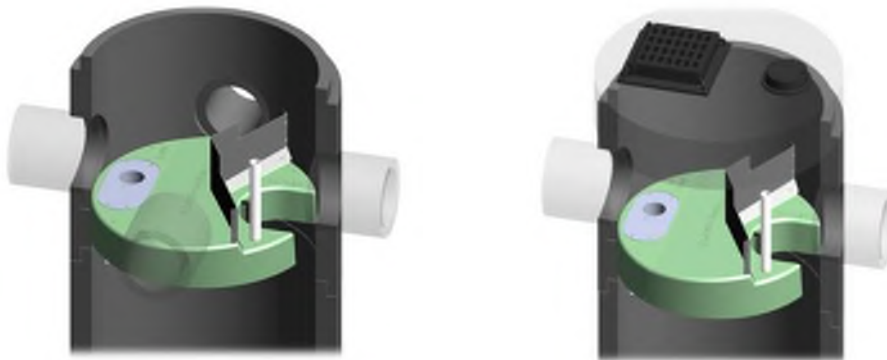

## Stormceptor® EF Sizing Report

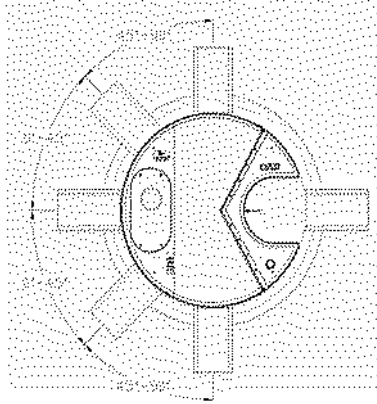

### INLET-TO-OUTLET DROP

Elevation differential between inlet and outlet pipe inverts is dictated by the angle at which the inlet pipe(s) enters the unit.

0° - 45° : The inlet pipe is 1-inch (25mm) higher than the outlet pipe.

45° - 90° : The inlet pipe is 2-inches (50mm) higher than the outlet pipe.

### HEAD LOSS

The head loss through Stormceptor EF is similar to that of a 60-degree bend structure. The applicable K value for calculating minor losses through the unit is 1.1.

For submerged conditions the applicable K value is 3.0.

### Pollutant Capacity

Stormceptor EF / EFO	Model Diameter		Depth (Outlet Pipe Invert to Sump Floor)		Oil Volume		Recommended Sediment Maintenance Depth *		Maximum Sediment Volume *		Maximum Sediment Mass **	
	(m)	(ft)	(m)	(ft)	(L)	(Gal)	(mm)	(in)	(L)	(ft³)	(kg)	(lb)
EF4 / EFO4	1.2	4	1.52	5.0	265	70	203	8	1190	42	1904	5250
EF6 / EFO6	1.8	6	1.93	6.3	610	160	305	12	3470	123	5552	15375
EF8 / EFO8	2.4	8	2.59	8.5	1070	280	610	24	8780	310	14048	38750
EF10 / EFO10	3.0	10	3.25	10.7	1670	440	610	24	17790	628	28464	78500
EF12 / EFO12	3.6	12	3.89	12.8	2475	655	610	24	31220	1103	49952	137875

\*Increased sump depth may be added to increase sediment storage capacity

\*\* Average density of wet packed sediment in sump = 1.6 kg/L (100 lb/ft³)

Feature	Benefit	Feature Appeals To
Patent-pending enhanced flow treatment and scour prevention technology	Superior, verified third-party performance	Regulator, Specifying & Design Engineer
Third-party verified light liquid capture and retention for EFO version	Proven performance for fuel/oil hotspot locations	Regulator, Specifying & Design Engineer, Site Owner
Functions as bend, junction or inlet structure	Design flexibility	Specifying & Design Engineer
Minimal drop between inlet and outlet	Site installation ease	Contractor
Large diameter outlet riser for inspection and maintenance	Easy maintenance access from grade	Maintenance Contractor & Site Owner

### STANDARD STORMCEPTOR EF/EFO DRAWINGS

For standard details, please visit <http://www.imbriumsystems.com/stormwater-treatment-solutions/stormceptor-ef>

### STANDARD STORMCEPTOR EF/EFO SPECIFICATION

For specifications, please visit <http://www.imbriumsystems.com/stormwater-treatment-solutions/stormceptor-ef>

## Stormceptor<sup>®</sup> EF Sizing Report

# STANDARD PERFORMANCE SPECIFICATION FOR “OIL GRIT SEPARATOR” (OGS) STORMWATER QUALITY TREATMENT DEVICE

## PART 1 – GENERAL

### 1.1 WORK INCLUDED

This section specifies requirements for selecting, sizing, and designing an underground Oil Grit Separator (OGS) device for stormwater quality treatment, with third-party testing results and a Statement of Verification in accordance with ISO 14034 Environmental Management – Environmental Technology Verification (ETV).

### 1.2 REFERENCE STANDARDS & PROCEDURES

ISO 14034:2016 Environmental management – Environmental technology verification (ETV)

Canadian Environmental Technology Verification (ETV) Program’s **Procedure for Laboratory Testing of Oil-Grit Separators**

### 1.3 SUBMITTALS

1.3.1 All submittals, including sizing reports & shop drawings, shall be submitted upon request with each order to the contractor then forwarded to the Engineer of Record for review and acceptance. Shop drawings shall detail all OGS components, elevations, and sequence of construction.

1.3.2 Alternative devices shall have features identical to or greater than the specified device, including: treatment chamber diameter, treatment chamber wet volume, sediment storage volume, and oil storage volume.

1.3.3 Unless directed otherwise by the Engineer of Record, OGS stormwater quality treatment product substitutions or alternatives submitted within ten days prior to project bid shall not be accepted. All alternatives or substitutions submitted shall be signed and sealed by a local registered Professional Engineer, based on the exact same criteria detailed in Section 3, in entirety, subject to review and approval by the Engineer of Record.

## PART 2 – PRODUCTS

### 2.1 OGS POLLUTANT STORAGE

The OGS device shall include a sump for sediment storage, and a protected volume for the capture and storage of petroleum hydrocarbons and buoyant gross pollutants. The minimum sediment & petroleum hydrocarbon storage capacity shall be as follows:

2.1.1	4 ft (1219 mm) Diameter OGS Units:	1.19 m <sup>3</sup> sediment / 265 L oil
	6 ft (1829 mm) Diameter OGS Units:	3.48 m <sup>3</sup> sediment / 609 L oil
	8 ft (2438 mm) Diameter OGS Units:	8.78 m <sup>3</sup> sediment / 1,071 L oil
	10 ft (3048 mm) Diameter OGS Units:	17.78 m <sup>3</sup> sediment / 1,673 L oil
	12 ft (3657 mm) Diameter OGS Units:	31.23 m <sup>3</sup> sediment / 2,476 L oil

## PART 3 – PERFORMANCE & DESIGN

### 3.1 GENERAL

The OGS stormwater quality treatment device shall be verified in accordance with ISO 14034:2016 Environmental management – Environmental technology verification (ETV). The OGS stormwater quality treatment device shall



## Stormceptor<sup>®</sup> EF Sizing Report

remove oil, sediment and gross pollutants from stormwater runoff during frequent wet weather events, and retain these pollutants during less frequent high flow wet weather events below the insert within the OGS for later removal during maintenance. The Manufacturer shall have at least ten (10) years of local experience, history and success in engineering design, manufacturing and production and supply of OGS stormwater quality treatment device systems, acceptable to the Engineer of Record.

### 3.2 SIZING METHODOLOGY

The OGS device shall be engineered, designed and sized to provide stormwater quality treatment based on treating a minimum of 90 percent of the average annual runoff volume and a minimum removal of an annual average 60% of the sediment (TSS) load based on the Particle Size Distribution (PSD) specified in the sizing report for the specified device. Sizing of the OGS shall be determined by use of a minimum ten (10) years of local historical rainfall data provided by Environment Canada. Sizing shall also be determined by use of the sediment removal performance data derived from the ISO 14034 ETV third-party verified laboratory testing data from testing conducted in accordance with the Canadian ETV protocol Procedure for Laboratory Testing of Oil-Grit Separators, as follows:

3.2.1 Sediment removal efficiency for a given surface loading rate and its associated flow rate shall be based on sediment removal efficiency demonstrated at the seven (7) tested surface loading rates specified in the protocol, ranging 40 L/min/m<sup>2</sup> to 1400 L/min/m<sup>2</sup>, and as stated in the ISO 14034 ETV Verification Statement for the OGS device.

3.2.2 Sediment removal efficiency for surface loading rates between 40 L/min/m<sup>2</sup> and 1400 L/min/m<sup>2</sup> shall be based on linear interpolation of data between consecutive tested surface loading rates.

3.2.3 Sediment removal efficiency for surface loading rates less than the lowest tested surface loading rate of 40 L/min/m<sup>2</sup> shall be assumed to be identical to the sediment removal efficiency at 40 L/min/m<sup>2</sup>. No extrapolation shall be allowed that results in a sediment removal efficiency that is greater than that demonstrated at 40 L/min/m<sup>2</sup>.

3.2.4 Sediment removal efficiency for surface loading rates greater than the highest tested surface loading rate of 1400 L/min/m<sup>2</sup> shall assume zero sediment removal for the portion of flow that exceeds 1400 L/min/m<sup>2</sup>, and shall be calculated using a simple proportioning formula, with 1400 L/min/m<sup>2</sup> in the numerator and the higher surface loading rate in the denominator, and multiplying the resulting fraction times the sediment removal efficiency at 1400 L/min/m<sup>2</sup>.

The OGS device shall also have sufficient annual sediment storage capacity as specified and calculated in Section 2.1.

### 3.3 CANADIAN ETV or ISO 14034 ETV VERIFICATION OF SCOUR TESTING

The OGS device shall have Canadian ETV or ISO 14034 ETV Verification of third-party scour testing conducted in accordance with the Canadian ETV Program's **Procedure for Laboratory Testing of Oil-Grit Separators**.

3.3.1 To be acceptable for on-line installation, the OGS device must demonstrate an average scour test effluent concentration less than 10 mg/L at each surface loading rate tested, up to and including 2600 L/min/m<sup>2</sup>.

### 3.4 LIGHT LIQUID RE-ENTRAINMENT SIMULATION TESTING

The OGS device shall have Canadian ETV or ISO 14034 ETV Verification of completed third-party Light Liquid Re-entrainment Simulation Testing in accordance with the Canadian ETV **Program's Procedure for Laboratory Testing of Oil-Grit Separators**, with results reported within the Canadian ETV or ISO 14034 ETV verification. This re-entrainment testing is conducted with the device pre-loaded with low density polyethylene (LDPE) plastic beads as a surrogate for light liquids such as oil and fuel. Testing is conducted on the same OGS unit tested for sediment removal to

## Stormceptor<sup>®</sup> EF Sizing Report

assess whether light liquids captured after a spill are effectively retained at high flow rates.

3.4.1 For an OGS device to be an acceptable stormwater treatment device on a site where vehicular traffic occurs and the potential for an oil or fuel spill exists, the OGS device must have reported verified performance results of greater than 99% cumulative retention of LDPE plastic beads for the five specified surface loading rates (ranging 200 L/min/m<sup>2</sup> to 2600 L/min/m<sup>2</sup>) in accordance with the Light Liquid Re-entrainment Simulation Testing within the Canadian ETV Program's **Procedure for Laboratory Testing of Oil-Grit Separators**. However, an OGS device shall not be allowed if the Light Liquid Re-entrainment Simulation Testing was performed with screening components within the OGS device that are effective at retaining the LDPE plastic beads, but would not be expected to retain light liquids such as oil and fuel.

**Appendix E:**  
**Stormwater Storage Chambers Specifications**

## User Inputs

<b>Chamber Model:</b>	MC-7200
<b>Outlet Control Structure:</b>	No
<b>Project Name:</b>	CLV Manotick
<b>Engineer:</b>	Mathew Theiner
<b>Project Location:</b>	Ontario
<b>Measurement Type:</b>	Metric
<b>Required Storage Volume:</b>	14.16 cubic meters.
<b>Stone Porosity:</b>	40%
<b>Stone Foundation Depth:</b>	229 mm.
<b>Stone Above Chambers:</b>	305 mm.
<b>Average Cover Over Chambers:</b>	610 mm.
<b>Design Constraint Dimensions:</b>	(6.10 m. x 6.10 m.)

## Results

### System Volume and Bed Size

<b>Installed Storage Volume:</b>	151.06 cubic meters.
<b>Storage Volume Per Chamber:</b>	4.99 cubic meters.
<b>Number Of Chambers Required:</b>	16
<b>Number Of End Caps Required:</b>	4
<b>Chamber Rows:</b>	2
<b>Maximum Length:</b>	20.65 m.
<b>Maximum Width:</b>	5.92 m.
<b>Approx. Bed Size Required:</b>	122.19 square meters.

### System Components

<b>Amount Of Stone Required:</b>	168 cubic meters
<b>Volume Of Excavation (Not Including Fill):</b>	252 cubic meters
<b>Total Non-woven Geotextile Required:</b>	425 square meters
<b>Woven Geotextile Required (excluding Isolator Row):</b>	36 square meters
<b>Woven Geotextile Required (Isolator Row):</b>	114 square meters
<b>Total Woven Geotextile Required:</b>	150 square meters
<b>Impervious Liner Required:</b>	0 square meters

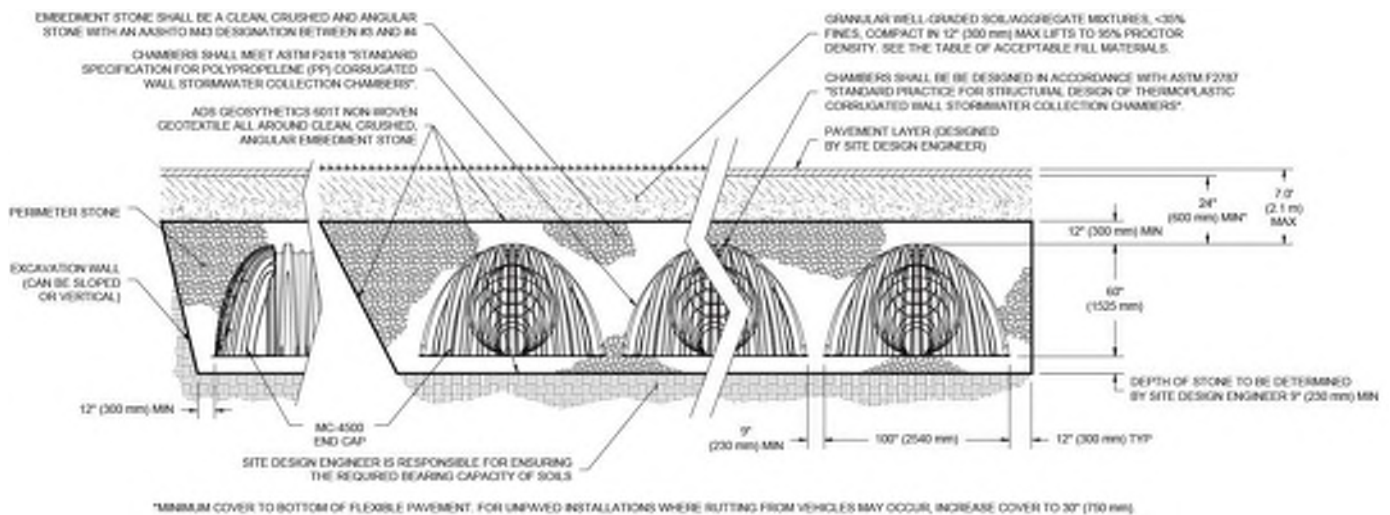

# MC-3500 & MC-7200 Design Manual

---

StormTech® Chamber Systems for Stormwater Management





# Table of Contents

- 1.0 Product Information ..... 2
- 2.0 Foundation for Chambers..... 8
- 3.0 Required Materials/Row Separation..... 11
- 4.0 Hydraulics..... 13
- 5.0 Cumulative Storage Volume ..... 15
- 6.0 System Sizing..... 20
- 7.0 Structural Cross Sections and Specifications ..... 22
- 8.0 General Notes ..... 24
- 9.0 Inspection and Maintenance ..... 25

\*For SC-160LP, SC-310, SC-740 & DC-780 designs, please refer to the SC-160LP/SC-310/SC-740/DC-780 Design Manual.

StormTech Engineering Services assists design professionals in specifying StormTech stormwater systems. This assistance includes the layout of chambers to meet the engineer’s volume requirements and the connections to and from the chambers. They can also assist converting and cost engineering projects currently specified with ponds, pipe, concrete vaults and other manufactured stormwater detention/retention products. Please note that it is the responsibility of the site design engineer to ensure that the chamber bed layout meets all design requirements and is in compliance with applicable laws and regulations governing a project.

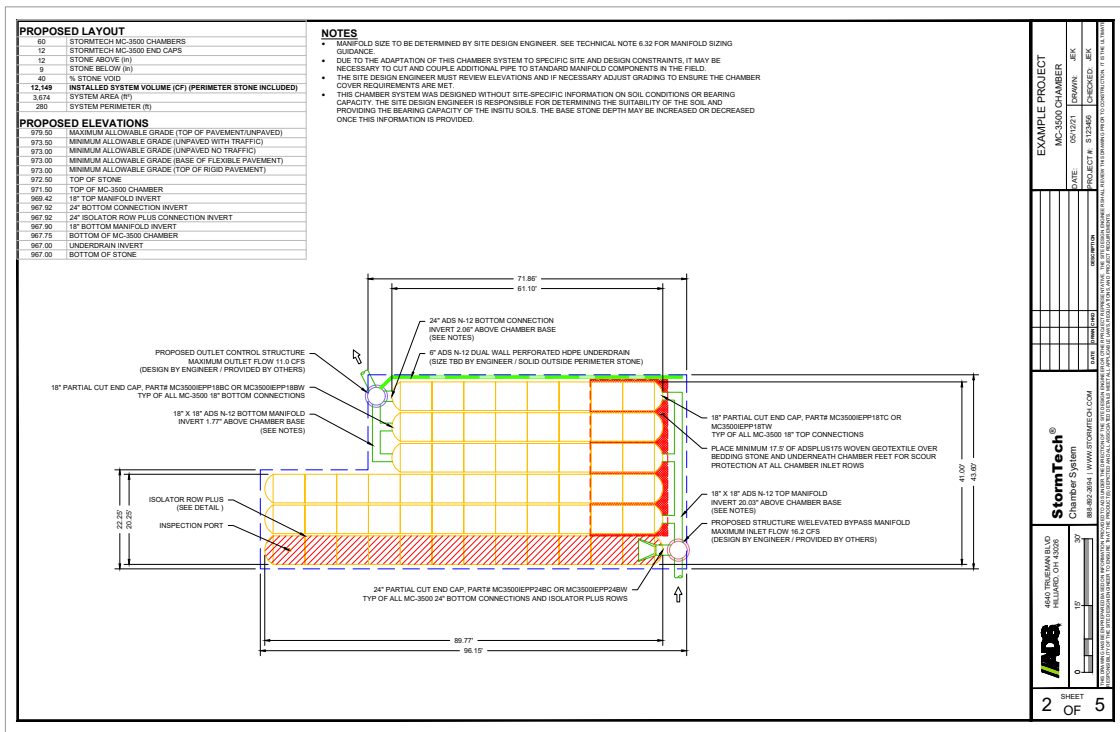

This manual is exclusively intended to assist engineers in the design of subsurface stormwater systems using StormTech chambers.

# StormTech MC-3500 Chamber

Designed to meet the most stringent industry performance standards for superior structural integrity while providing designers with a cost-effective method to save valuable land and protect water resources. The StormTech system is designed primarily to be used under parking lots, thus maximizing land usage for private (commercial) and public applications. StormTech chambers can also be used in conjunction with Green Infrastructure, thus enhancing the performance and extending the service life of these practices.

## MC-3500 Chamber (not to scale)

Nominal Specifications

Size (LxWxH)	90" x 77" x 45" (2286 x 1956 x 1143 mm)
Chamber Storage	109.9 ft <sup>3</sup> (3.11 m <sup>3</sup> )
Min. Installed Storage*	175.0 ft <sup>3</sup> (4.96 m <sup>3</sup> )
Weight	134 lbs (60.8 kg)

\*Assumes a minimum of 12" (300 mm) of stone above, 9" (230 mm) of stone below chambers, 6" (150 mm) of stone between chambers/end caps and 40% stone porosity.



## MC-3500 Chamber (not to scale)

Nominal Specifications

Size (LxWxH)	26.5" x 71" x 45.1" (673 x 1803 x 1145 mm)
End Cap Storage	14.9 ft <sup>3</sup> (0.42 m <sup>3</sup> )
Min. Installed Storage*	45.1 ft <sup>3</sup> (1.28 m <sup>3</sup> )
Weight	49 lbs (22.2 kg)

\*Assumes a minimum of 12" (300 mm) of stone above, 9" (230 mm) of stone below, 6" (150 mm) of stone perimeter, 6" (150 mm) of stone between chambers/end caps and 40% stone porosity.

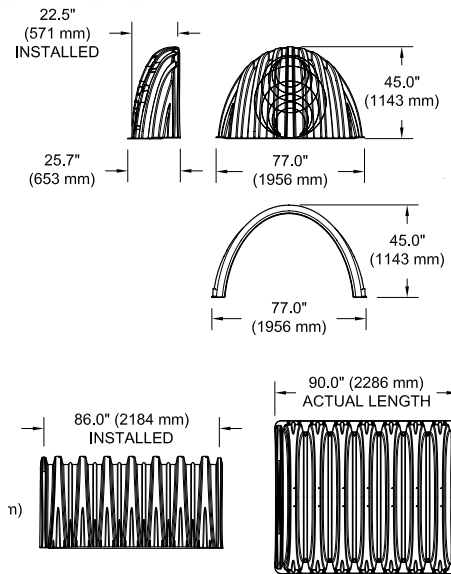

## Shipping

- 15 chambers/pallet
- 7 end caps/pallet
- 7 pallets/truck

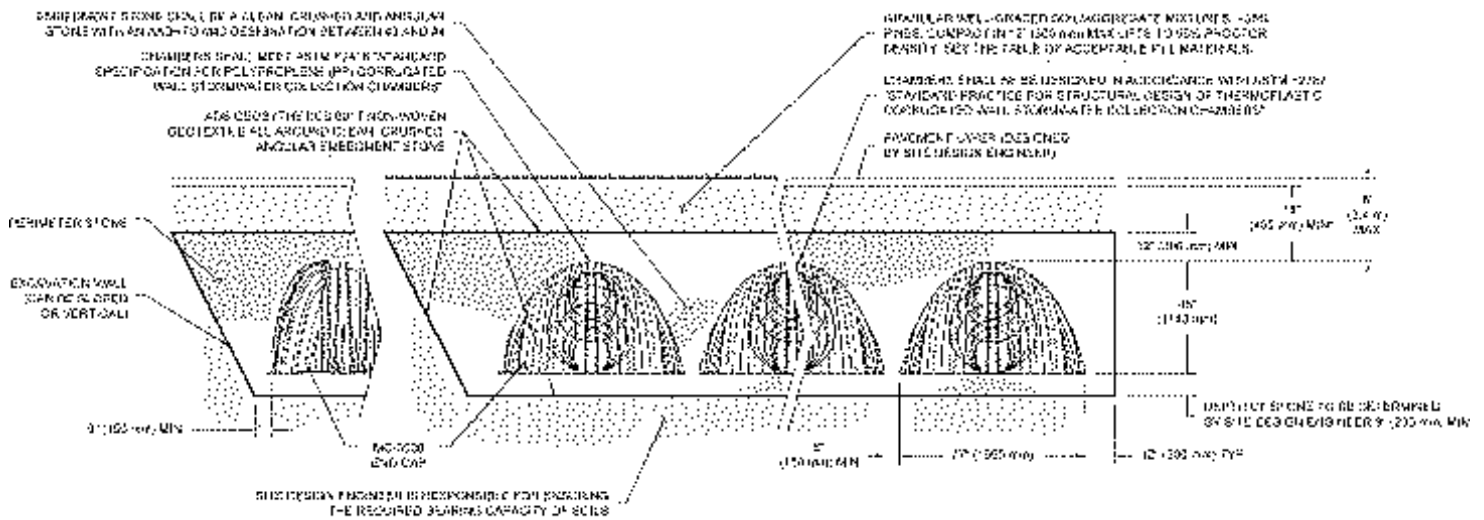

\*ENGINEER SHALL BE RESPONSIBLE FOR VERIFYING INSTALLATION WHERE RUTTING FROM TRUCKS MAY OCCUR. WORKING COVER TO 1800 mm



### Storage Volume Per Chamber/End Cap ft<sup>3</sup> (m<sup>3</sup>)

	Bare Unit Storage ft <sup>3</sup> (m <sup>3</sup> )	Chamber/End Cap and Stone Volume — Stone Foundation Depth in. (mm)			
		9 (230)	12 (300)	15 (375)	18 (450)
Chamber	109.9 (3.11)	175.0 (4.96)	179.9 (5.09)	184.9 (5.24)	189.9 (5.38)
End Cap	14.9 (0.42)	45.1 (1.28)	46.6 (1.32)	48.3 (1.37)	49.9 (1.41)

**Note:** Assumes 6" (150 mm) row spacing, 40% stone porosity, 12" (300 mm) stone above and includes the bare chamber/end cap volume.

### Amount of Stone Per Chamber

ENGLISH tons (yd <sup>3</sup> )	Stone Foundation Depth			
	9" 230 mm	12" 300 mm	15" 375 mm	18" 450 mm
Chamber	8.5 (6.0)	9.1 (6.5)	9.7 (6.9)	10.4 (7.4)
End Cap	3.9 (2.8)	4.1 (2.9)	4.3 (3.1)	4.5 (3.2)
METRIC kg (m <sup>3</sup> )	230 mm	300 mm	375 mm	450 mm
Chamber	7711 (4.6)	8255 (5.0)	8800 (5.3)	9435 (5.7)
End Cap	3538 (2.1)	3719 (2.2)	3901 (2.4)	4082 (2.5)

**Note:** Assumes 12" (300 mm) of stone above and 6" (150 mm) row spacing and 6" (150 mm) of perimeter stone in front of end caps.

### Volume of Excavation Per Chamber/End Cap yd<sup>3</sup> (m<sup>3</sup>)

	Stone Foundation Depth			
	9" (230 mm)	12" (300 mm)	15" (375 mm)	18" (450 mm)
Chamber	11.9 (9.1)	12.4 (9.5)	12.8 (9.8)	13.3 (10.2)
End Cap	4.0 (3.1)	4.1 (3.2)	4.3 (3.3)	4.4 (3.4)

**Note:** Assumes 6" (150 mm) of separation between chamber rows and 24" (600 mm) of cover. The volume of excavation will vary as depth of cover increases.



*Special applications will be considered on a project by project basis. Please contact our application department should you have a unique application for our team to evaluate.*



# StormTech MC-7200 Chamber

Designed to meet the most stringent industry performance standards for superior structural integrity while providing designers with a cost-effective method to save valuable land and protect water resources. The StormTech system is designed primarily to be used under parking lots, thus maximizing land usage for private (commercial) and public applications. StormTech chambers can also be used in conjunction with Green Infrastructure, thus enhancing the performance and extending the service life of these practices.

## MC-7200 Chamber (not to scale)

Nominal Specifications

Size (LxWxH)	83.4" x 100" x 60" (2120 x 2540 x 1524 mm)
Chamber Storage	175.9 ft <sup>3</sup> (4.98 m <sup>3</sup> )
Min. Installed Storage*	267.3 ft <sup>3</sup> (7.56 m <sup>3</sup> )
Weight	205 lbs (92.9 kg)

\*Assumes a minimum of 12" (300 mm) of stone above, 9" (230 mm) of stone below chambers, 9" (230 mm) of stone between chambers/end caps and 40% stone porosity.

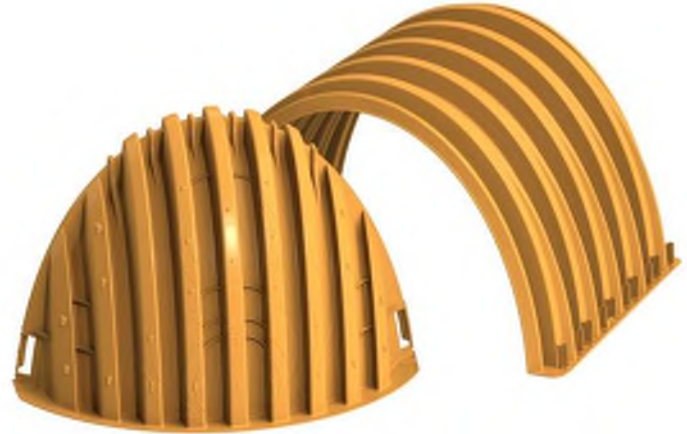

## MC-7200 Chamber (not to scale)

Nominal Specifications

Size (LxWxH)	38" x 90" x 61" (965 x 2286 x 1549 mm)
End Cap Storage	39.5 ft <sup>3</sup> (1.12 m <sup>3</sup> )
Min. Installed Storage*	115.3 ft <sup>3</sup> (3.26 m <sup>3</sup> )
Weight	90.0 lbs (40.8 kg)

\*Assumes a minimum of 12" (300 mm) of stone above, 9" (230 mm) of stone below, 12" (300 mm) of stone perimeter, 9" (230 mm) of stone between chambers/end caps and 40% stone porosity.

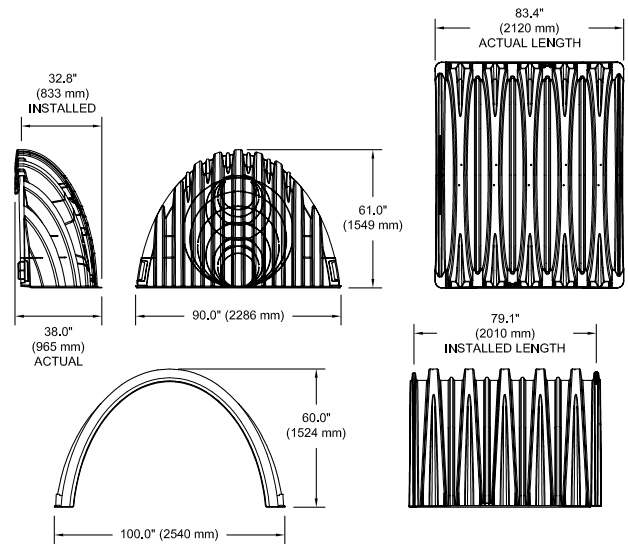

## Shipping

- 7 chambers/pallet
- 5 end caps/pallet
- 6 pallets/truck

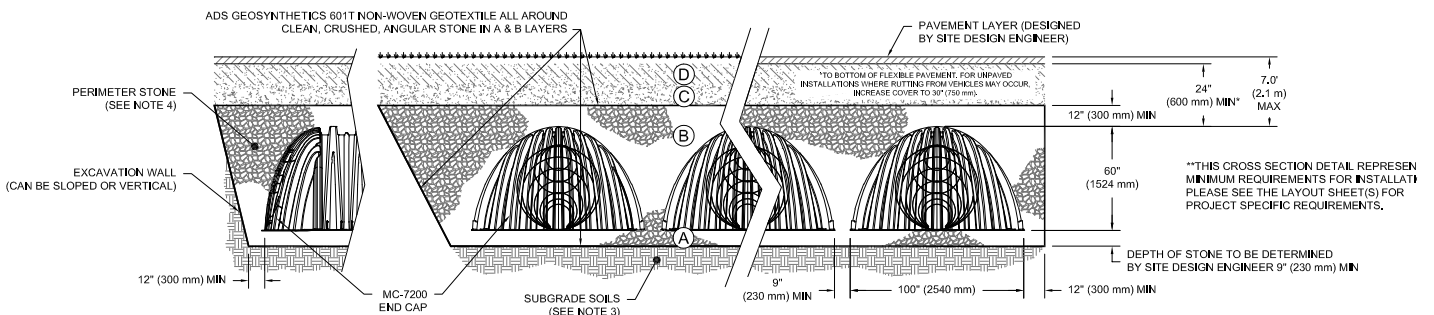

### Storage Volume Per Chamber/End Cap ft<sup>3</sup> (m<sup>3</sup>)

	Bare Unit Storage ft <sup>3</sup> (m <sup>3</sup> )	Chamber/End Cap and Stone Volume — Stone Foundation Depth in. (mm)			
		9 (230)	12 (300)	15 (375)	18 (450)
Chamber	175.9 (4.98)	267.3 (7.57)	273.3 (7.74)	279.3 (7.91)	285.2 (8.08)
End Cap	39.5 (1.12)	115.3 (3.26)	111.9 (3.17)	121.9 (3.45)	125.2 (3.54)

**Note:** Assumes 9" (230 mm) row spacing, 40% stone porosity, 12" (300 mm) stone above and includes the bare chamber/end cap volume. End cap volume assumes 12" (300 mm) stone perimeter in front of end cap.

### Amount of Stone Per Chamber

ENGLISH tons (yd <sup>3</sup> )	Stone Foundation Depth			
	9" (230 mm)	12" (300 mm)	15" (375 mm)	18" (450 mm)
Chamber	11.9 (8.5)	12.6 (9.0)	13.4 (9.6)	14.6 (10.1)
End Cap	9.8 (7.0)	10.2 (7.3)	10.6 (7.6)	11.1 (7.9)
METRIC kg (m <sup>3</sup> )	230 mm	300 mm	375 mm	450 mm
Chamber	10796 (6.5)	11431 (6.9)	12156 (7.3)	13245 (7.7)
End Cap	8890 (5.3)	9253 (5.5)	9616 (5.8)	10069 (6.0)

**Note:** Assumes 12" (300 mm) of stone above and 9" (230 mm) row spacing and 12" (300 mm) of perimeter stone in front of end caps.

### Volume of Excavation Per Chamber/End Cap yd<sup>3</sup> (m<sup>3</sup>)

	Stone Foundation Depth			
	9" (230 mm)	12" (300 mm)	15" (375 mm)	18" (450 mm)
Chamber	17.2 (13.2)	17.7 (13.5)	18.3 (14.0)	18.8 (14.4)
End Cap	9.7 (7.4)	10.0 (7.6)	10.3 (7.9)	10.6 (8.1)

**Note:** Assumes 9" (230 mm) of separation between chamber rows, 12" (300 mm) of perimeter in front of the end caps, and 24" (600 mm) of cover. The volume of excavation will vary as depth of cover increases.



*Special applications will be considered on a project by project basis. Please contact our application department should you have a unique application for our team to evaluate.*



# 1.0 Product Information

## 1.1 Product Design

StormTech's commitment to thorough product testing programs, materials evaluation and adherence to national standards has resulted in two more superior products. Like other StormTech chambers, the MC-3500 and MC-7200 are designed to meet the full scope of design requirements of the American Society of Testing Materials (ASTM) International specification F2787 "Standard Practice for Structural Design of Thermoplastic Corrugated Wall Stormwater Collection Chambers" and produced to the requirements of the ASTM F 2418 "Standard Specification for Polypropylene (PP) Corrugated Stormwater Collection Chambers".

The StormTech MC-3500 and MC-7200 chambers provide the full AASHTO safety factors for live loads and permanent earth loads. The ASTM F 2787 standard provides specific guidance on how to design thermoplastic chambers in accordance with AASHTO Section 12.12. of the AASHTO LRFD Bridge Design Specifications. ASTM F 2787 requires that the safety factors included in the AASHTO guidance are achieved as a prerequisite to meeting ASTM F 2418. The three standards provide both the assurance of product quality and safe structural design.

The design of larger chambers in the same tradition of our other chambers required the collaboration of experts in soil-structure interaction, plastics and manufacturing. Years of extensive research, including laboratory testing and field verification, were required to produce chambers that are ready to meet both the rigors of installation and the longevity expected by engineers and owners.

This Design Manual provides the details and specifications necessary for consulting engineers to design stormwater management systems using the MC-3500 and MC-7200 chambers. It provides specifications for storage capacities, layout dimensions as well as requirements for design to ensure a long service life. The basic design concepts for foundation and backfill materials, subgrade bearing capacities and row spacing remain equally as pertinent for the MC-3500 and MC-7200 as the SC-740, SC-310 and DC-780 chamber systems. However, since many design values and dimensional requirements are different for these larger chambers than the SC-740, SC-310 and DC-780 chambers, design manuals and installation instructions are not interchangeable.

This manual includes only those details, dimensions, cover limits, etc for the MC-3500 and MC-7200 and is intended to be a stand-alone design guide for the MC-3500 and MC-7200 chambers. A Construction Guide specifically for these two chamber models has also been published.

## 1.2 Technical Support

The StormTech Technical Services Department is available to assist the engineer with the layout of MC-3500 and MC-7200 chamber systems and answer questions regarding all the StormTech chamber models. Call the Technical Services Department, email us at [info@stormtech.com](mailto:info@stormtech.com) or contact your local StormTech representative.

## 1.3 MC-3500 and MC-7200 Chambers

All StormTech chambers are designed to the full scope of AASHTO requirements without repeating end walls or other structural reinforcing. StormTech's continuously curved, elliptical arch and the surrounding angular backfill are the key components of the structural system. With the addition of patent pending integral stiffening ribs (Figure 5), the MC-3500 and MC-7200 are assured to provide a long, safe service life. Like other StormTech chambers, the MC-3500 and MC-7200 are produced from high quality, impact modified resins which are tested for short-term and long-term mechanical properties.

With all StormTech chambers, one chamber type is used for the start, middle and end of rows. Rows are formed by overlapping the upper joint corrugation of the next chamber over the lower joint corrugation of the previous chamber (Figure 6).

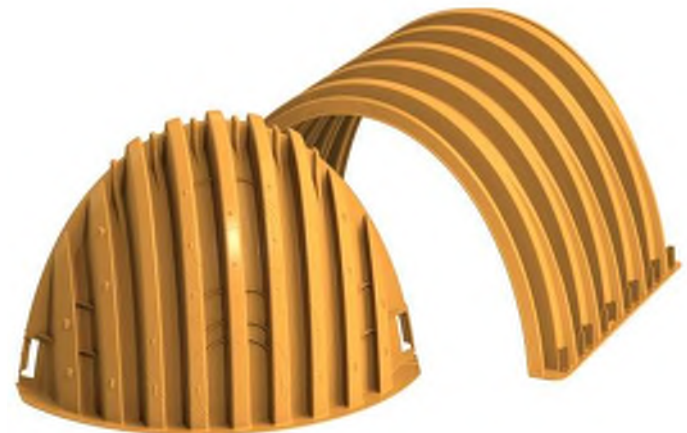

## 1.4 Chamber Joints

All StormTech chambers are designed with an optimized joining system. The height and width of the end corrugations have been designed to provide the required structural safety factors while providing an unobstructed flow path down each row.

# 1.0 Product Information

To assist the contractor, StormTech chambers are molded with simple assembly instructions and arrows that indicate the direction in which to build rows. The corrugation valley immediately adjacent to the lower joint corrugation is marked "Overlap Here - Lower Joint." The corrugation valley immediately adjacent to the upper joint corrugation is marked "Build This Direction - Upper Joint."

Two people can safely and efficiently carry and place chambers without cumbersome connectors, special tools or heavy equipment. Each row of chambers must begin and end with a joint corrugation. Since joint corrugations are of a different size than the corrugations along the body of the chamber, chambers cannot be field cut and installed. Only whole MC-3500 and MC-7200 chambers can be used. For system layout assistance contact StormTech.

## 1.5 MC-3500 and MC-7200 End Caps

The MC-3500 and MC-7200 end caps are easy to install. These end caps are designed with a corrugation joint that fits over the top of either end of the chamber. The end cap joint is simply set over the top of either of the upper or lower chamber joint corrugations (Figure 7).

The MC-3500 end cap has pipe cutting guides for 12"-24" (300 mm-600 mm) top inverts (Figure 9).

The MC-7200 end cap has pipe cutting guides for 12"-42" (300 mm-1050 mm) bottom inverts and 12"-24" (300 mm-600 mm) top inverts (Figure 8).

Standard and custom pre-cored end caps are available. MC-3500 pre-cored end caps, 18" in diameter and larger include a welded crown plate.

Figure 5 - Chamber and End Cap Components

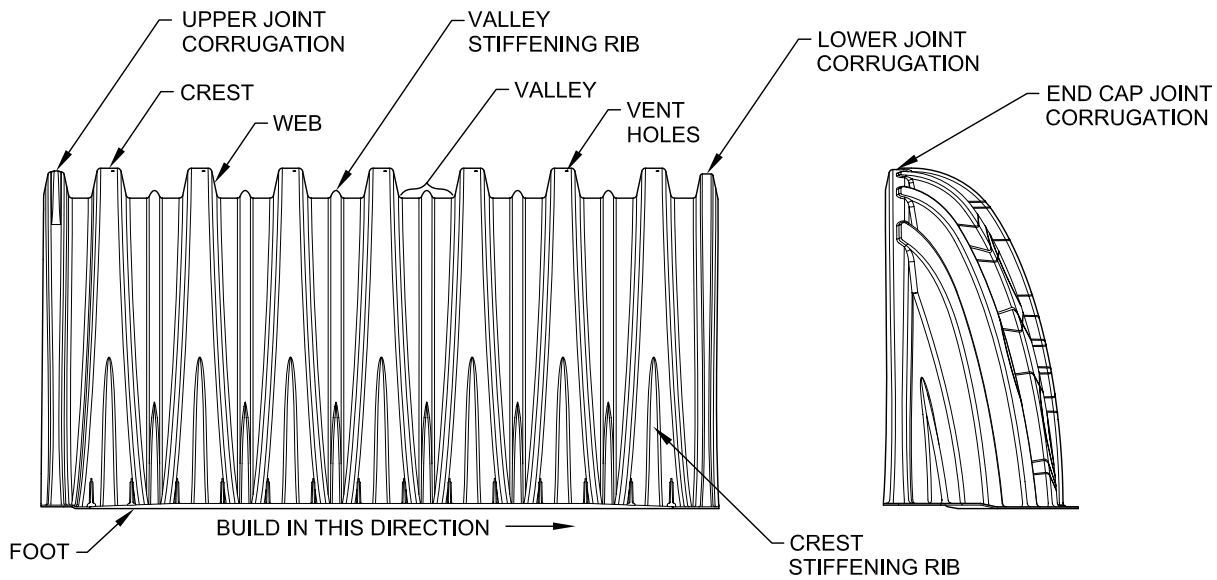

Figure 6 - Chamber Joint Overlap



Figure 7 - End Cap Joint Overlap



# 1.0 Product Information

Figure 8 - MC-7200 End Cap Inverts

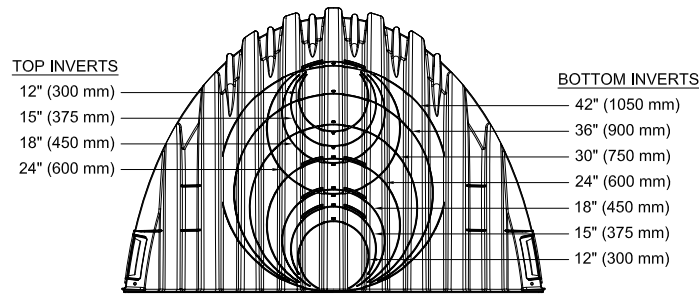
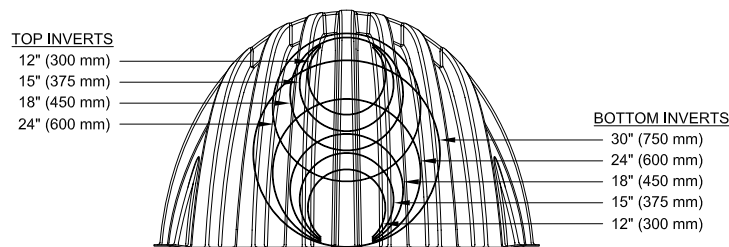

Figure 9 - MC-3500 End Cap Inverts



## 2.0 Foundations for Chambers

### 2.1 Foundation Requirements

StormTech chamber systems can be installed in various soil types. The subgrade bearing capacity and the cover height over the chambers determine the required depth of clean, crushed, angular foundation stone below the chambers. Foundation stone, also called bedding, is the stone between the subgrade soils and the feet of the chamber. Flexible structures are designed to transfer a significant portion of both live and dead loads through the surrounding soils. Chamber systems accomplish this by creating load paths through the columns of embedment stone between and around the rows of chambers. This creates load concentrations at the base of the columns between the rows. The foundation stone spreads out the concentrated loads to distributed loads that can be supported by the subgrade soils.

Since increasing the cover height (top of chamber to finished grade) causes increasing soil load, a greater depth of foundation stone is necessary to distribute the load to the subgrade soils. **Table 1** and **2** specify the minimum required foundation depths for varying cover heights and allowable subgrade bearing capacities. These tables are based on StormTech service loads. The minimum required foundation depth is 9" (230 mm) for both chambers.

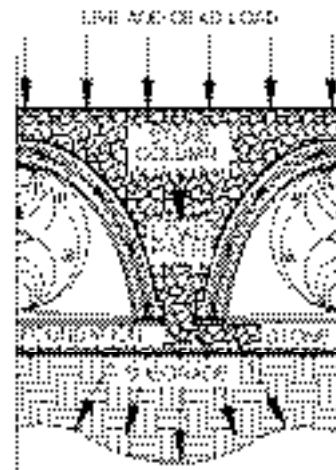

For additional guidance on foundation stone design please see our Technical Note 6.22 - StormTech Subgrade Performance

### 2.2 Weaker Soils

StormTech has not provided guidance for subgrade bearing capacities less than 2000 pounds per square foot [(2.0 ksf) (96 kPa)]. These soils are often highly variable, may contain organic materials and could be more sensitive to moisture. A geotechnical engineer must be consulted if soils with bearing capacities less than 2000 psf (96 kPa) are present.

# 2.0 Foundations for Chambers

**Table 1 - MC-3500 Minimum Required Foundation Depth in inches (millimeters)**  
Assumes 6" (150 mm) row spacing.

Cover Hgt. ft. (m)	Minimum Bearing Resistance for Service Loads ksf (kPa)																									
	4.4 (211)	4.3 (206)	4.2 (201)	4.1 (196)	4.0 (192)	3.9 (187)	3.8 (182)	3.7 (177)	3.6 (172)	3.5 (168)	3.4 (163)	3.3 (158)	3.2 (153)	3.1 (148)	3.0 (144)	2.9 (139)	2.8 (134)	2.7 (129)	2.6 (124)	2.5 (120)	2.4 (115)	2.3 (110)	2.2 (105)	2.1 (101)	2.0 (96)	
1.5 (0.46)	9 (230)	9 (230)	9 (230)	9 (230)	9 (230)	9 (230)	9 (230)	9 (230)	9 (230)	9 (230)	9 (230)	9 (230)	9 (230)	9 (230)	9 (230)	9 (230)	9 (230)	9 (230)	12 (300)	12 (300)	12 (300)	15 (375)	15 (375)	15 (375)	18 (450)	18 (450)
2.0 (0.61)	9 (230)	9 (230)	9 (230)	9 (230)	9 (230)	9 (230)	9 (230)	9 (230)	9 (230)	9 (230)	9 (230)	9 (230)	9 (230)	9 (230)	9 (230)	9 (230)	12 (300)	12 (300)	12 (300)	12 (300)	15 (375)	15 (375)	15 (375)	18 (450)	18 (450)	18 (450)
2.5 (0.76)	9 (230)	9 (230)	9 (230)	9 (230)	9 (230)	9 (230)	9 (230)	9 (230)	9 (230)	9 (230)	9 (230)	9 (230)	9 (230)	9 (230)	12 (300)	12 (300)	12 (300)	12 (300)	12 (300)	15 (375)	15 (375)	15 (375)	18 (450)	18 (450)	18 (450)	21 (525)
3.0 (0.91)	9 (230)	9 (230)	9 (230)	9 (230)	9 (230)	9 (230)	9 (230)	9 (230)	9 (230)	9 (230)	9 (230)	9 (230)	9 (230)	12 (300)	12 (300)	12 (300)	15 (375)	15 (375)	15 (375)	15 (375)	18 (450)	18 (450)	18 (450)	21 (525)	21 (525)	21 (525)
3.5 (1.07)	9 (230)	9 (230)	9 (230)	9 (230)	9 (230)	9 (230)	9 (230)	9 (230)	9 (230)	9 (230)	9 (230)	12 (300)	12 (300)	12 (300)	12 (300)	15 (375)	15 (375)	15 (375)	15 (375)	18 (450)	18 (450)	18 (450)	21 (525)	21 (525)	21 (525)	24 (600)
4.0 (1.22)	9 (230)	9 (230)	9 (230)	9 (230)	9 (230)	9 (230)	9 (230)	9 (230)	9 (230)	12 (300)	12 (300)	12 (300)	12 (300)	12 (300)	15 (375)	15 (375)	15 (375)	15 (375)	18 (450)	18 (450)	18 (450)	21 (525)	21 (525)	21 (525)	24 (600)	24 (600)
4.5 (1.37)	9 (230)	9 (230)	9 (230)	9 (230)	9 (230)	9 (230)	9 (230)	12 (300)	12 (300)	12 (300)	12 (300)	12 (300)	15 (375)	15 (375)	15 (375)	15 (375)	18 (450)	18 (450)	18 (450)	18 (450)	21 (525)	21 (525)	21 (525)	24 (600)	24 (600)	27 (675)
5.0 (1.52)	9 (230)	9 (230)	9 (230)	9 (230)	9 (230)	9 (230)	12 (300)	12 (300)	12 (300)	12 (300)	12 (300)	15 (375)	15 (375)	15 (375)	18 (450)	18 (450)	18 (450)	18 (450)	21 (525)	21 (525)	21 (525)	24 (600)	24 (600)	24 (600)	27 (675)	30 (750)
5.5 (1.68)	9 (230)	9 (230)	9 (230)	9 (230)	12 (300)	12 (300)	12 (300)	12 (300)	12 (300)	15 (375)	15 (375)	15 (375)	15 (375)	15 (375)	18 (450)	18 (450)	18 (450)	21 (525)	21 (525)	21 (525)	24 (600)	24 (600)	24 (600)	27 (675)	27 (675)	30 (750)
6.0 (1.83)	9 (230)	9 (230)	9 (230)	12 (300)	12 (300)	12 (300)	12 (300)	12 (300)	15 (375)	15 (375)	15 (375)	15 (375)	15 (375)	18 (450)	18 (450)	18 (450)	21 (525)	21 (525)	21 (525)	24 (600)	24 (600)	24 (600)	27 (675)	27 (675)	30 (750)	30 (750)
6.5 (1.98)	9 (230)	9 (230)	12 (300)	12 (300)	12 (300)	12 (300)	12 (300)	15 (375)	15 (375)	15 (375)	15 (375)	15 (375)	18 (450)	18 (450)	18 (450)	21 (525)	21 (525)	21 (525)	24 (600)	24 (600)	27 (675)	27 (675)	27 (675)	30 (750)	30 (750)	30 (750)
7.0 (2.13)	12 (300)	12 (300)	12 (300)	12 (300)	12 (300)	12 (300)	15 (375)	15 (375)	15 (375)	15 (375)	15 (375)	18 (450)	18 (450)	18 (450)	21 (525)	21 (525)	21 (525)	24 (600)	24 (600)	27 (675)	27 (675)	27 (675)	30 (750)	30 (750)	30 (750)	30 (750)
7.5 (2.30)	12 (300)	12 (300)	12 (300)	12 (300)	12 (300)	15 (375)	15 (375)	15 (375)	15 (375)	18 (450)	18 (450)	18 (450)	18 (450)	21 (525)	21 (525)	21 (525)	24 (600)	24 (600)	27 (675)	27 (675)	27 (675)	30 (750)	30 (750)	30 (750)	30 (750)	30 (750)
8.0 (2.44)	12 (300)	12 (300)	12 (300)	15 (375)	15 (375)	15 (375)	15 (375)	15 (375)	18 (450)	18 (450)	18 (450)	18 (450)	21 (525)	21 (525)	21 (525)	24 (600)	24 (600)	24 (600)	27 (675)	27 (675)	30 (750)	30 (750)	30 (750)	30 (750)	30 (750)	30 (750)

**NOTE:** The design engineer is solely responsible for assessing the bearing resistance (allowable bearing capacity) of the subgrade soils and determining the depth of foundation stone. Subgrade bearing resistance should be assessed with consideration for the range of soil moisture conditions expected under a stormwater system.

**Figure 10A - MC-3500 Structural Cross Section Detail (Not to Scale)**

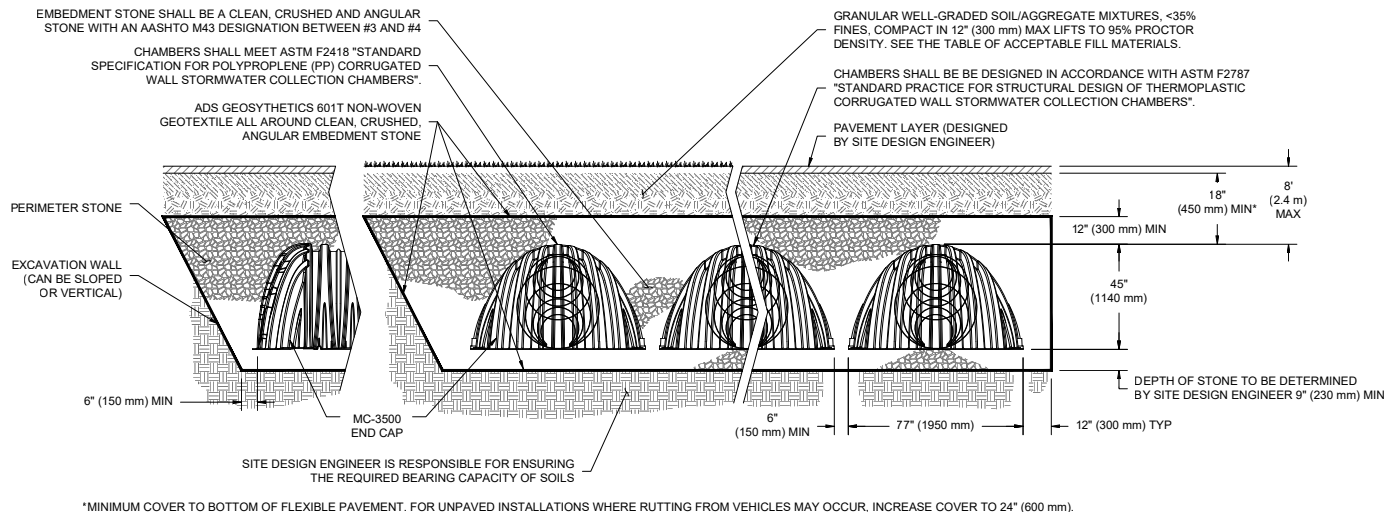

Special applications will be considered on a project by project basis. Please contact our applications department should you have a unique application for our team to evaluate.

## 2.0 Foundations for Chambers

**Table 2 - MC-7200 Minimum Required Foundation Depth in inches (millimeters)**

Assumes 9" (230 mm) row spacing.

Cover Hgt. ft. (m)	Minimum Bearing Resistance for Service Loads ksf (kPa)																								
	4.4 (211)	4.3 (206)	4.2 (201)	4.1 (196)	4.0 (192)	3.9 (187)	3.8 (182)	3.7 (177)	3.6 (172)	3.5 (168)	3.4 (163)	3.3 (158)	3.2 (153)	3.1 (148)	3.0 (144)	2.9 (139)	2.8 (134)	2.7 (129)	2.6 (124)	2.5 (120)	2.4 (115)	2.3 (110)	2.2 (105)	2.1 (101)	2.0 (96)
2.0 (0.61)	9 (230)	9 (230)	9 (230)	9 (230)	9 (230)	9 (230)	9 (230)	9 (230)	9 (230)	9 (230)	9 (230)	9 (230)	9 (230)	9 (230)	9 (230)	12 (300)	12 (300)	12 (300)	15 (375)	15 (375)	15 (375)	18 (450)	18 (450)	21 (525)	21 (525)
2.5 (0.76)	9 (230)	9 (230)	9 (230)	9 (230)	9 (230)	9 (230)	9 (230)	9 (230)	9 (230)	9 (230)	9 (230)	9 (230)	9 (230)	12 (300)	12 (300)	12 (300)	15 (375)	15 (375)	15 (375)	18 (450)	18 (450)	18 (450)	21 (525)	21 (525)	24 (600)
3.0 (0.91)	9 (230)	9 (230)	9 (230)	9 (230)	9 (230)	9 (230)	9 (230)	9 (230)	9 (230)	9 (230)	9 (230)	12 (300)	12 (300)	12 (300)	15 (375)	15 (375)	15 (375)	18 (450)	18 (450)	18 (450)	21 (525)	21 (525)	24 (600)	24 (600)	27 (675)
3.5 (1.07)	9 (230)	9 (230)	9 (230)	9 (230)	9 (230)	9 (230)	9 (230)	9 (230)	12 (300)	12 (300)	12 (300)	12 (300)	15 (375)	15 (375)	15 (375)	18 (450)	18 (450)	18 (450)	21 (525)	21 (525)	21 (525)	24 (600)	24 (600)	27 (675)	30 (750)
4.0 (1.22)	9 (230)	9 (230)	9 (230)	9 (230)	9 (230)	9 (230)	12 (300)	12 (300)	12 (300)	12 (300)	12 (300)	15 (375)	15 (375)	15 (375)	18 (450)	18 (450)	18 (450)	21 (525)	21 (525)	21 (525)	24 (600)	24 (600)	27 (675)	30 (750)	30 (750)
4.5 (1.37)	9 (230)	9 (230)	9 (230)	9 (230)	9 (230)	12 (300)	12 (300)	12 (300)	12 (300)	15 (375)	15 (375)	15 (375)	15 (375)	18 (450)	18 (450)	18 (450)	21 (525)	21 (525)	24 (600)	24 (600)	27 (675)	27 (675)	30 (750)	33 (825)	33 (825)
5.0 (1.52)	9 (230)	9 (230)	9 (230)	12 (300)	12 (300)	12 (300)	15 (375)	15 (375)	15 (375)	15 (375)	18 (450)	18 (450)	18 (450)	21 (525)	21 (525)	21 (525)	24 (600)	24 (600)	27 (675)	27 (675)	27 (675)	30 (750)	33 (825)	33 (825)	36 (900)
5.5 (1.68)	9 (230)	12 (300)	12 (300)	12 (300)	12 (300)	15 (375)	15 (375)	15 (375)	18 (450)	18 (450)	18 (450)	18 (450)	21 (525)	21 (525)	24 (600)	24 (600)	24 (600)	27 (675)	27 (675)	30 (750)	30 (750)	33 (825)	33 (825)	36 (900)	36 (900)
6.0 (1.83)	12 (300)	12 (300)	12 (300)	12 (300)	12 (300)	15 (375)	15 (375)	15 (375)	18 (450)	18 (450)	18 (450)	21 (525)	21 (525)	21 (525)	24 (600)	24 (600)	27 (675)	27 (675)	30 (750)	30 (750)	33 (825)	33 (825)	36 (900)	36 (900)	36 (900)
6.5 (1.98)	12 (300)	12 (300)	15 (375)	15 (375)	15 (375)	15 (375)	18 (450)	18 (450)	18 (450)	18 (450)	21 (525)	21 (525)	24 (600)	24 (600)	24 (600)	27 (675)	27 (675)	30 (750)	30 (750)	33 (825)	33 (825)	36 (900)	36 (900)	36 (900)	36 (900)
7.0 (2.13)	15 (375)	15 (375)	15 (375)	15 (375)	18 (450)	18 (450)	18 (450)	18 (450)	21 (525)	21 (525)	21 (525)	24 (600)	24 (600)	24 (600)	27 (675)	27 (675)	30 (750)	30 (750)	33 (825)	36 (900)	36 (900)	36 (900)	36 (900)	36 (900)	36 (900)

**NOTE:** The design engineer is solely responsible for assessing the bearing resistance (allowable bearing capacity) of the subgrade soils and determining the depth of foundation stone. Subgrade bearing resistance should be assessed with consideration for the range of soil moisture conditions expected under a stormwater system.

**Figure 10B - MC-7200 Structural Cross Section Detail (Not to Scale)**

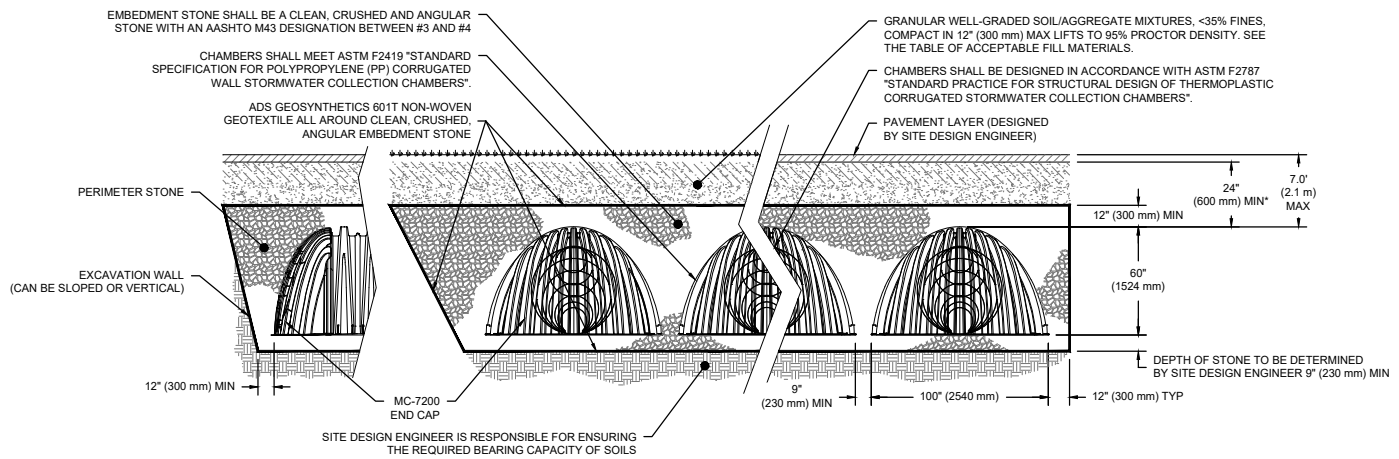

Special applications will be considered on a project by project basis. Please contact our applications department should you have a unique application for our team to evaluate.



# 3.0 Required Materials/Row Separation

## 3.1 Foundation and Embedment Stone

The stone surrounding the chambers consists of the foundation stone below the chambers and embedment stone surrounding the chambers. The foundation stone and embedment stone are important components of the structural system and also provide open void space for stormwater storage. Table 3 provides the stone specifications that achieve both structural requirements and a porosity of 40% for stormwater storage. Figure 11 specifies the extents of each backfill stone location.

**Table 3 - Acceptable Fill Materials**

Material Location	Description	AASHTO Material Classifications	Compaction / Density Requirement
<b>D Final Fill:</b> Fill Material for layer 'D' starts from the top of the 'C' layer to the bottom of flexible pavement or unpaved finished grade above. Note that pavement subbase may be part of the 'D' layer.	Any soil/rock materials, native soils, or per engineer's plans. check plans for pavement subgrade requirements.	N/A	Prepare per site design engineer's plans. Paved installations may have stringent material and preparation requirements.
<b>C Initial Fill:</b> Fill material for layer 'C' starts from the top of the embedment stone ('B' layer) to 24" (600 mm) above the top of the chamber. note that pavement subbase may be a part of the 'C' layer.	Granular well-graded soil/aggregate mixtures, <35% fines or processed aggregate. most pavement subbase materials can be used in lieu of this layer.	AASHTO M145 <sup>1</sup> a-1,a-2-4,a-3 or AASHTO M43 <sup>1</sup> 3, 357, 4, 467, 5, 56, 57, 6, 67, 68, 7, 78, 8, 89, 9, 10	Begin compactoins after 24" (600 mm) of material over the chambers is reached. compact additional layers in 12" (300 mm) max lifts to a min. 95% proctor density for well-graded material and 95% relative density for processed aggregate materials.
<b>B Embedment Stone:</b> Fill surrounding the chambers form the foudation stone ('A' layer) to the 'C' layer above.	Clean, crushed, angular stone	AASHTO M43 <sup>1</sup> 3, 4	No compaction required
<b>A Foundation Stone:</b> Fill below chambers from the subgrade up to the foot (bottom) of the chamber.	Clean, crushed, angular stone	AASHTO M43 <sup>1</sup> 3, 4	Plate compact or roll to achieve a flat surface. <sup>2 3</sup>

Please Note:

- The listed AASHTO designations are for gradations only. The stone must also be clean, crushed, angular. For example, a specification for #4 stone would state: "clean, crushed, angular NO. 4 (AASHTO m43) stone".
- Stormtech compaction requirements are met for 'A' location materials when placed and compacted in 9" (230 mm) (max) lifts using two full coverages with a vibratory compactor.
- Where infiltration surfaces may be compromised by compaction, for standard design load conditions, a flat surface may be achieved by raking or dragging without compaction equipment. For special load designs, contact stormtech for compaction requirements.

**Figure 11 - Fill Material Locations**

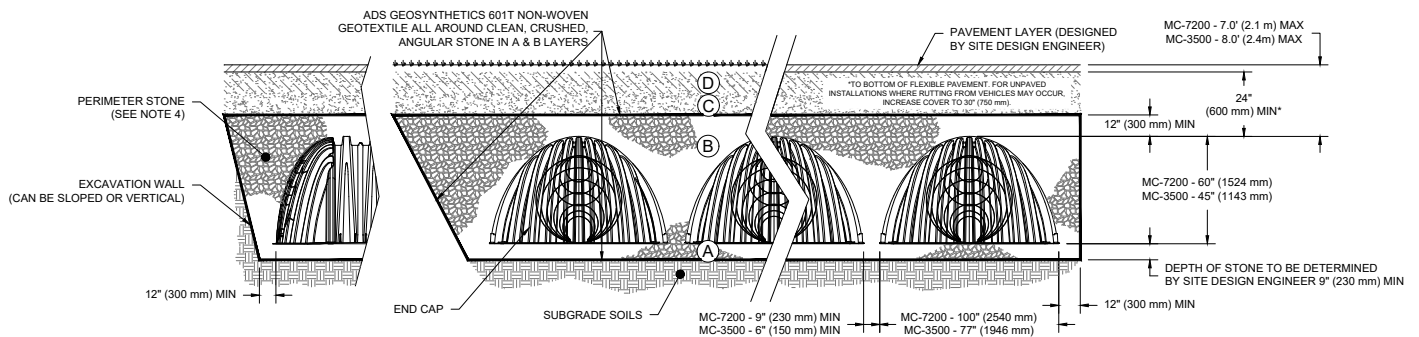

Once layer 'C' is placed, any soil/material can be placed in layer 'D' up to the finished grade. Most pavement subbase soils can be used to replace the materials of layer 'C' or 'D' at the design engineer's discretion.

## 3.0 Required Materials/Row Separation

### 3.2 Fill Above Chambers

Refer to Table 3 and Figure 11 for acceptable fill material above the clean, crushed, angular stone. StormTech requires a minimum of 24" (600 mm) from the top of the chamber to the bottom of flexible pavement. For non-paved installations where rutting from vehicles may occur StormTech requires a minimum of 30" (750 mm) from top of chamber to finished grade.

### 3.3 Geotextile Separation

A non-woven geotextile meeting AASHTO M288 Class 2 separation requirements must be installed to completely envelope the system and prevent soil intrusion into the crushed, angular stone. Overlap adjacent geotextile rolls per AASHTO M288 separation guidelines. Contact StormTech for a list of acceptable geotextiles.

### 3.4 Parallel Row Separation/ Perpendicular Bed Separation

#### Parallel Row Separation

The minimum installed spacing between parallel rows after backfilling is 9" (230 mm) for the MC-7200 chambers and 6" (150mm) for the MC-3500 (measurement taken between the outside edges of the feet). Spacers may be used for layout convenience. Row spacing wider than the minimum spacing above may be specified.

#### Perpendicular Bed Separation

When beds are laid perpendicular to each other, a minimum installed spacing of 36" (900 mm) between beds is required.

### 3.5 Special Structural Designs

StormTech engineers may provide special structural designs to enable deeper cover depths or increase the capacity to carry higher live loads. Special designs may utilize the additional strength that can be achieved by compaction of embedment stone or by increasing the spacing between rows.

Increasing the spacing between chamber rows may also facilitate the application of StormTech chambers with either less foundation stone or with weaker subgrade soils. This may be a good option where vertical restrictions on site prevent the use of a deeper foundation.

Contact ADS Engineering Services for more information on special structural designs.

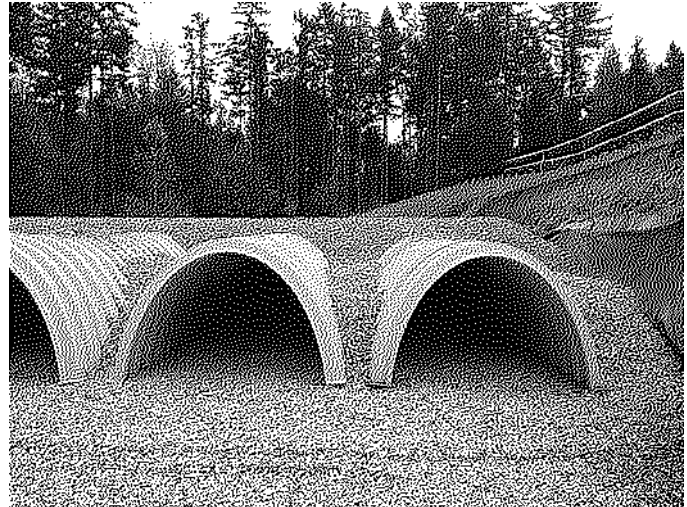

**System Cross Section**

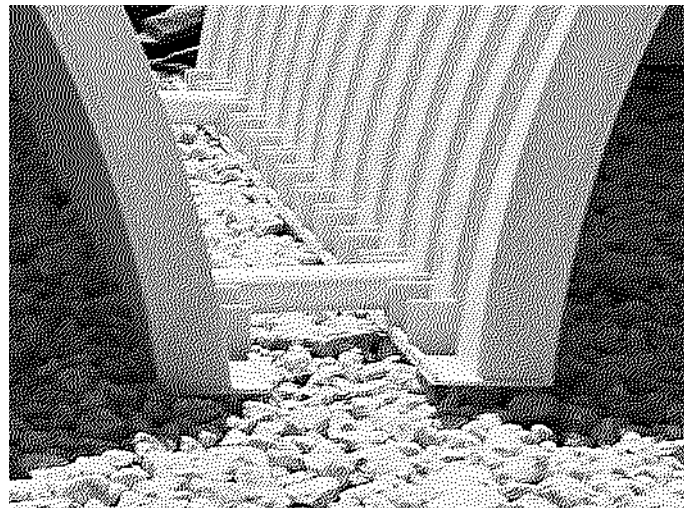

**Minimum Row Spacing**

## 4.0 Hydraulics

### 4.1 General

StormTech subsurface chamber systems offer the flexibility for a variety of inlet and outlet configurations. Contact the StormTech Technical Services Department or your local StormTech representative for assistance configuring inlet and outlet connections.

The open graded stone around and under the chambers provides a significant conveyance capacity ranging from approximately 0.8 cfs (23 l/s) to 13 cfs (368 l/s) per MC-3500 chamber and for the MC-7200 chamber. The actual conveyance capacity is dependent upon stone size, depth of foundation stone and head of water. Although the high conveyance capacity of the open graded stone is an important component of the flow network, StormTech recommends that a system of inlet and outlet manifolds be designed to distribute and convey the peak flow through the chamber system.

It is the responsibility of the design engineer to provide the design flow rates and storage volumes for the stormwater system and to ensure that the final design meets all conveyance and storage requirements. However, StormTech will work with the design engineer to assist with manifold and chamber layouts that meet the design objectives.

### 4.2 The Isolator® Row Plus

The Isolator Row Plus is a system that inexpensively captures total suspended solids (TSS) and debris and provides easy access for inspection and maintenance. In a typical configuration, a single layer of ADS Plus fabric is placed between the chambers and the stone foundations. This fabric traps and filters sediments as

well as protects the stone base during cleaning and maintenance. Each installed MC-3500 chamber and MC-3500 end cap provides 42.9 ft<sup>2</sup> (4.0 m<sup>2</sup>) and 7.5 ft<sup>2</sup> (0.7 m<sup>2</sup>) of bottom filter area respectively. Each installed MC-7200 chamber and MC-7200 end cap provides 57.9 ft<sup>2</sup> (5.4 m<sup>2</sup>) and 12.8 ft<sup>2</sup> (1.19 m<sup>2</sup>) of bottom filter area respectively.

The Isolator Row Plus can be configured for maintenance objectives or, in some regulatory jurisdictions, for water quality objectives. For water quality applications, the Isolator Row Plus can be sized based on water quality volume or flow rate.

All Isolator Plus Rows require: 1) a manhole for maintenance access, 2) a means of diversion of flows to the Isolator Row Plus 3) a high flow bypass and 4) FLAMP (Flared End Ramp). When used on an Isolator Row Plus, a 24" FLAMP (flared end ramp) is attached to the inside of the inlet pipe with a provided threaded rod and bolt. The FLAMP then lays on top of the ADS Plus fabric.. Flow diversion can be accomplished by either a weir in the upstream access manhole or simply by feeding the Isolator Row Plus at a lower elevation than the high flow bypass. Contact StormTech for assistance sizing Isolator Plus Rows.

When additional stormwater treatment is required, StormTech systems can be configured using a treatment train approach where other stormwater BMPs are located in series.

Figure 12 - StormTech Isolator Row Plus Detail

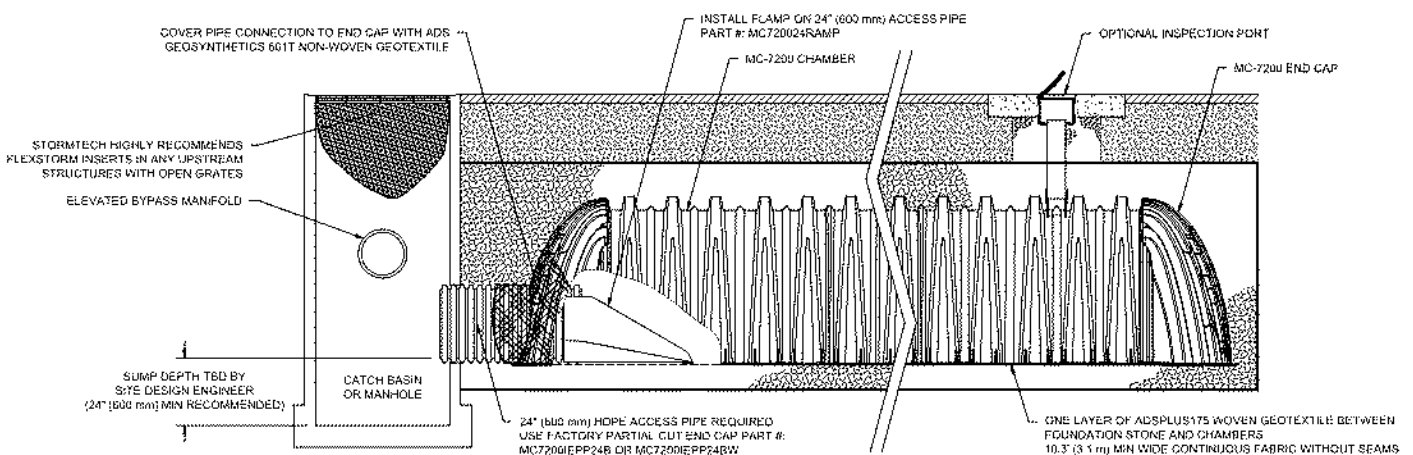

## 4.0 Hydraulics

**Figure 13 - Typical Inlet Configuration With Isolator Row Plus and Scour Protection**

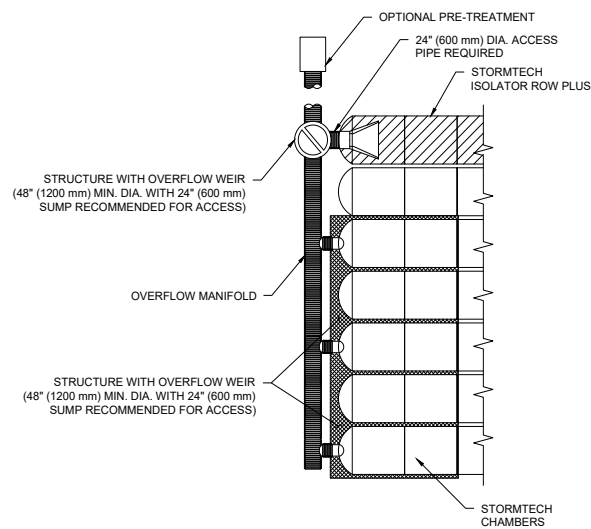

### 4.3 Inlet Manifolds

The primary function of the inlet manifold is to convey and distribute flows to a sufficient number of rows in the chamber bed such that there is ample conveyance capacity to pass the peak flows without creating an unacceptable backwater condition in upstream piping or scour the foundation stone under the chambers.

Manifolds are connected to the end caps either at the top or bottom of the end cap. Standard distances from the base of chamber to the invert of inlet and outlet manifolds connecting to StormTech end caps can be found in table 6. High inlet flow rates from either connection location produce a shear scour potential of the foundation stone. Inlet flows from top inlets also produce impingement scour potential. Scour potential is reduced when standing water is present over the foundation stone. However, for safe design across the wide range of applications, StormTech assumes minimal standing water at the time the design flow occurs.

To minimize scour potential, StormTech recommends the installation of woven scour protection fabric at each inlet row. This enables a protected transition zone from the concentrated flow coming out of the inlet pipe to a uniform flow across the entire width of the chamber for both top and bottom connections. Allowable flow rates for design are dependent upon: the elevation of inlet pipe, foundation stone size and scour protection. With an appropriate scour protection geotextile installed from the end cap to at least 14.5 ft (4.42 m) in front of the inlet pipe for the MC-3500 and for the MC-7200, for both top and bottom feeds, the flow rates listed in Table 4 can be used for all StormTech specified foundation stone gradations.

\*See StormTech's Tech Note 6.32 for manifold sizing guidance.

**Table 4 - Allowable Inlet Flows\***

Inlet Pipe Diameter Inches (mm)	Allowable Maximum Flow Rate cfs (l/s)
12 (300)	2.48 (70)
15 (375)	3.5 (99)
18 (450)	5.5 (156)
24 (600)	8.5 (241) [MC-3500]
24 (600)	9.5 (269) [MC-7200]

\*Assumes appropriate length of scour fabric per section 4.3

**Table 5 - Maximum Outlet Flow Rate Capacities From StormTech Outlet Manifolds**

Pipe Diameter	Flow (CFS)	Flow (L/S)
6" (150 mm)	0.4	11.3
8" (200 mm)	0.7	19.8
10" (250 mm)	1.0	28.3
12" (300 mm)	2.0	56.6
15" (375 mm)	2.7	76.5
18" (450 mm)	4.0	113.3
24" (600 mm)	7.0	198.2
30" (750 mm)	11.0	311.5
36" (900 mm)	16.0	453.1
42" (1050 mm)	22.0	623.0
48" (1200 mm)	28.0	792.9

**Table 6 - Standard Distances From Base of Chamber to Invert of Inlet and Outlet Manifolds on StormTech End Caps**

MC-3500 ENDCAPS			
	Pipe Diameter	Inv. (in)	Inv. (mm)
Top	6" (150 mm)	33.21	841
	8" (200 mm)	31.16	789
	10" (250 mm)	29.04	738
	12" (300 mm)	26.36	671
	15" (375 mm)	23.39	594
	18" (450 mm)	20.03	509
Bottom	24" (600 mm)	14.48	369
	12" (750 mm)	1.35	34
	15" (900 mm)	1.5	40
	18" (1050 mm)	1.77	46
24" (1200 mm)	2.06	52	

MC-7200 ENDCAPS			
	Pipe Diameter	Inv. (in)	Inv. (mm)
Top	12" (300 mm)	35.69	907
	15" (375 mm)	32.72	831
	18" (450 mm)	29.36	746
	24" (600 mm)	23.05	585
Bottom	12" (750 mm)	1.55	34
	15" (900 mm)	1.7	43
	18" (1050 mm)	1.97	50
	24" (1200 mm)	2.26	57

# 5.0 Cumulative Storage Volumes

## 4.4 Outlet Manifolds

The primary function of the outlet manifold is to convey peak flows from the chamber system to the outlet control structure. Outlet manifolds are often sized for attenuated flows. They may be smaller in diameter and have fewer row connections than inlet manifolds. In some applications however, the intent of the outlet piping is to convey an unattenuated bypass flow rate and manifolds may be sized similar to inlet manifolds.

Since chambers are generally flowing at or near full at the time of the peak outlet flow rate, scour is generally not governing and outlet manifold sizing is based on pipe flow equations. In most cases, StormTech recommends that outlet manifolds connect the same rows that are connected to an inlet manifold. This provides a continuous flow path through open conduits to pass the peak flow without dependence on passing peak flows through stone.

The primary function of the underdrains is to draw down water stored in the stone below the invert of the manifold. Underdrains are generally not sized for conveyance of the peak flow.

The maximum outlet flow rate capacities from StormTech outlet manifolds can be found in Table 5.

**Figure 14 - Typical Inlet, Outlet and Underdrain Configuration**

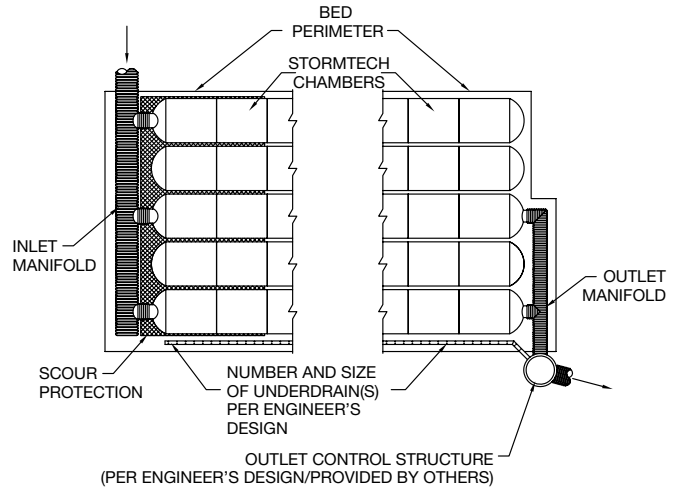

## 4.5 Inserta Tee® Inlet Connections

**Figure 15 - Inserta Tee Detail**

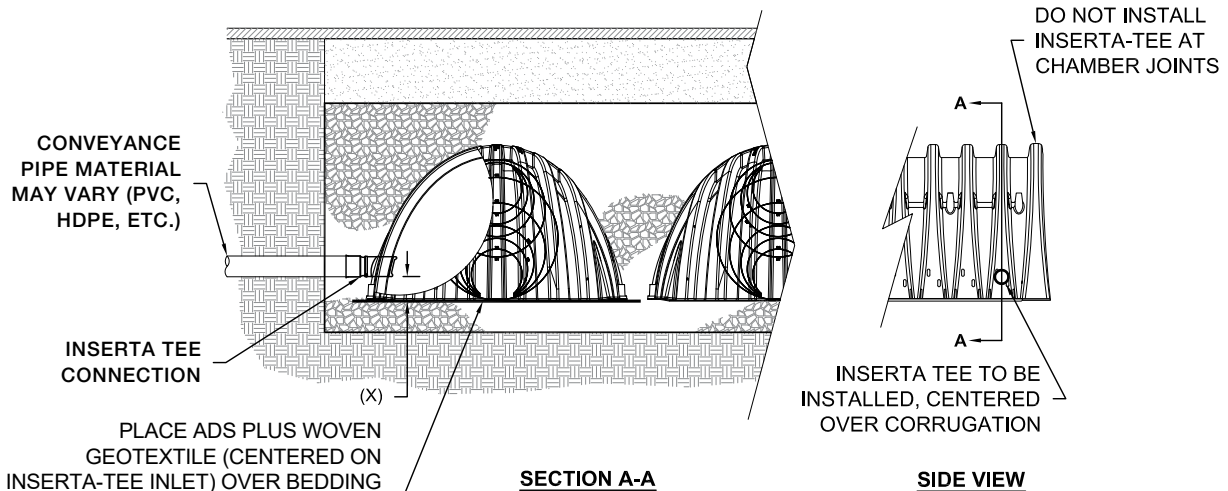

**NOTE:**  
PART NUMBERS WILL VARY BASED ON INLET PIPE MATERIALS. CONTACT STORMTECH FOR MORE INFORMATION.

CHAMBER	MAX DIAMETER OF INSERTA TEE	HEIGHT FROM BASE OF CHAMBER (X)
MC-3500	12" (250 mm)	6" (150 mm)
MC-7200	12" (250 mm)	8" (200 mm)
INSERTA TEE FITTINGS AVAILABLE FOR SDR 26, SDR 35, SCH 40 IPS GASKETED & SOLVENT WELD, N-12, HP STORM, C-900 OR DUCTILE IRON		

## 5.0 Cumulative Storage Volumes

Tables 7 and 8 provide cumulative storage volumes for the MC-3500 chamber and end cap. These tables can be used to calculate the stage-storage relationship for the retention or detention system. Digital spreadsheets in which the number of chambers and end caps can be input for quick cumulative storage calculations are available at [www.stormtech.com](http://www.stormtech.com). For assistance with site-specific calculations or input into routing software, contact the StormTech Technical Services Department.

**Table 7 – MC-3500 Incremental Storage Volume Per Chamber**

Assumes 40% stone porosity. Calculations are based upon a 9" (230 mm) stone base under the chambers, 12" (300 mm) of stone above chambers, and 6" (150 mm) of spacing between chambers.

Depth of Water in System Inches (mm)	Cumulative Chamber Storage ft <sup>3</sup> (m <sup>3</sup> )	Total System Cumulative Storage ft <sup>3</sup> (m <sup>3</sup> )	Depth of Water in System Inches (mm)	Cumulative Chamber Storage ft <sup>3</sup> (m <sup>3</sup> )	Total System Cumulative Storage ft <sup>3</sup> (m <sup>3</sup> )	
66 (1676)	↑ Stone Cover ↓	175.02 (4.956)	32 (813)	73.52 (2.082)	96.98 (2.746)	
65 (1651)		0.00	173.36 (4.909)	31 (787)	70.75 (2.003)	93.67 (2.652)
64 (1626)		0.00	171.71 (4.862)	30 (762)	67.92 (1.923)	90.32 (2.558)
63 (1600)		0.00	170.06 (4.816)	29 (737)	65.05 (1.842)	86.94 (2.462)
62 (1575)		0.00	168.41 (4.769)	28 (711)	62.12 (1.759)	83.54 (2.366)
61 (1549)		0.00	166.76 (4.722)	27 (686)	59.15 (1.675)	80.10 (2.268)
60 (1524)		0.00	165.10 (4.675)	26 (680)	56.14 (1.590)	76.64 (2.170)
59 (1499)		0.00	163.45 (4.628)	25 (635)	53.09 (1.503)	73.16 (2.072)
58 (1473)		0.00	161.80 (4.582)	24 (610)	49.99 (1.416)	69.65 (1.972)
57 (1448)		0.00	160.15 (4.535)	23 (584)	46.86 (1.327)	66.12 (1.872)
56 (1422)		0.00	158.49 (4.488)	22 (559)	43.70 (1.237)	62.57 (1.772)
55 (1397)		0.00	156.84 (4.441)	21 (533)	40.50 (1.147)	59.00 (1.671)
54 (1372)	109.95 (3.113)	155.19 (4.394)	20 (508)	37.27 (1.055)	55.41 (1.569)	
53 (1346)	109.89 (3.112)	153.50 (4.347)	19 (483)	34.01 (0.963)	51.80 (1.467)	
52 (1321)	109.69 (3.106)	151.73 (4.297)	18 (457)	30.72 (0.870)	48.17 (1.364)	
51 (1295)	109.40 (3.098)	149.91 (4.245)	17 (432)	27.40 (0.776)	44.53 (1.261)	
50 (1270)	109.00 (3.086)	148.01 (4.191)	16 (406)	24.05 (0.681)	40.87 (1.157)	
49 (1245)	108.31 (3.067)	145.95 (4.133)	15 (381)	20.69 (0.586)	37.20 (1.053)	
48 (1219)	107.28 (3.038)	143.68 (4.068)	14 (356)	17.29 (0.490)	33.51 (0.949)	
47 (1194)	106.03 (3.003)	141.28 (4.000)	13 (330)	13.88 (0.393)	29.81 (0.844)	
46 (1168)	104.61 (2.962)	138.77 (3.930)	12 (305)	10.44 (0.296)	26.09 (0.739)	
45 (1143)	103.04 (2.918)	136.17 (3.856)	11 (279)	6.98 (0.198)	22.37 (0.633)	
44 (1118)	101.33 (2.869)	133.50 (3.780)	10 (254)	3.51 (0.099)	18.63 (0.527)	
43 (1092)	99.50 (2.818)	130.75 (3.702)	9 (229)	0.00	14.87 (0.421)	
42 (1067)	97.56 (2.763)	127.93 (3.623)	8 (203)	0.00	13.22 (0.374)	
41 (1041)	95.52 (2.705)	125.06 (3.541)	7 (178)	0.00	11.57 (0.328)	
40 (1016)	93.39 (2.644)	122.12 (3.458)	6 (152)	0.00	9.91 (0.281)	
39 (991)	91.16 (2.581)	119.14 (3.374)	5 (127)	↑ Stone Cover ↓	8.26 (0.234)	
38 (965)	88.86 (2.516)	116.10 (3.288)	4 (102)		0.00	6.61 (0.187)
37 (948)	86.47 (2.449)	113.02 (3.200)	3 (76)		0.00	4.96 (0.140)
36 (914)	84.01 (2.379)	109.89 (3.112)	2 (51)		0.00	3.30 (0.094)
35 (889)	81.49 (2.307)	106.72 (3.022)	1 (25)		0.00	1.65 (0.047)
34 (864)	78.89 (2.234)	103.51 (2.931)				
33 (838)	76.24 (2.159)	100.27 (2.839)				

**NOTE:** Add 1.65 ft<sup>3</sup> (0.047 m<sup>3</sup>) of storage for each additional inch (25 mm) of stone foundation. Contact StormTech for cumulative volume spreadsheets in digital format.

## 5.0 Cumulative Storage Volume

**Table 8 – MC-3500 Incremental Storage Volume Per End Cap**

Assumes 40% stone porosity. Calculations are based upon a 9" (230 mm) stone base under the chambers, 12" (300 mm) of stone above end caps, and 6" (150 mm) of spacing between end caps and 6" (150 mm) of stone perimeter.

Depth of Water in System Inches (mm)	Cumulative End Cap Storage ft <sup>3</sup> (m <sup>3</sup> )	Total System Cumulative Storage ft <sup>3</sup> (m <sup>3</sup> )	Depth of Water in System Inches (mm)	Cumulative Chamber Storage ft <sup>3</sup> (m <sup>3</sup> )	Total System Cumulative Storage ft <sup>3</sup> (m <sup>3</sup> )	
66 (1676)	↑ Stone Cover ↓	45.10 (1.277)	33 (838)	12.53 (0.355)	24.82 (0.703)	
65 (1651)		0.00	44.55 (1.262)	32 (813)	12.18 (0.345)	24.06 (0.681)
64 (1626)		0.00	44.00 (1.246)	31 (787)	11.81 (0.335)	23.30 (0.660)
63 (1600)		0.00	43.46 (1.231)	30 (762)	11.42 (0.323)	22.53 (0.638)
62 (1575)		0.00	42.91 (1.215)	29 (737)	11.01 (0.312)	21.75 (0.616)
61 (1549)		0.00	42.36 (1.200)	28 (711)	10.58 (0.300)	20.96 (0.594)
60 (1524)		0.00	41.81 (1.184)	27 (686)	10.13 (0.287)	20.17 (0.571)
59 (1499)		0.00	41.27 (1.169)	26 (680)	9.67 (0.274)	19.37 (0.549)
58 (1473)		0.00	40.72 (1.153)	25 (635)	9.19 (0.260)	18.57 (0.526)
57 (1448)		0.00	40.17 (1.138)	24 (610)	8.70 (0.246)	17.76 (0.503)
56 (1422)		0.00	39.62 (1.122)	23 (584)	8.19 (0.232)	16.94 (0.480)
55 (1397)		0.00	39.08 (1.107)	22 (559)	7.67 (0.217)	16.12 (0.456)
54 (1372)		15.64 (0.443)	38.53 (1.091)	21 (533)	7.13 (0.202)	15.29 (0.433)
53 (1346)	15.64 (0.443)	37.98 (1.076)	20 (508)	6.59 (0.187)	14.45 (0.409)	
52 (1321)	15.63 (0.443)	37.42 (1.060)	19 (483)	6.03 (0.171)	13.61 (0.385)	
51 (1295)	15.62 (0.442)	36.85 (1.043)	18 (457)	5.46 (0.155)	12.76 (0.361)	
50 (1270)	15.60 (0.442)	36.27 (1.027)	17 (432)	4.88 (0.138)	11.91 (0.337)	
49 (1245)	15.56 (0.441)	35.68 (1.010)	16 (406)	4.30 (0.122)	11.06 (0.313)	
48 (1219)	15.51 (0.439)	35.08 (0.993)	15 (381)	3.70 (0.105)	10.20 (0.289)	
47 (1194)	15.44 (0.437)	34.47 (0.976)	14 (356)	3.10 (0.088)	9.33 (0.264)	
46 (1168)	15.35 (0.435)	33.85 (0.959)	13 (330)	2.49 (0.071)	8.46 (0.240)	
45 (1143)	15.25 (0.432)	33.22 (0.941)	12 (305)	1.88 (0.053)	7.59 (0.215)	
44 (1118)	15.13 (0.428)	32.57 (0.922)	11 (279)	1.26 (0.036)	6.71 (0.190)	
43 (1092)	14.99 (0.424)	31.91 (0.904)	10 (254)	0.63 (0.018)	5.83 (0.165)	
42 (1067)	14.83 (0.420)	31.25 (0.885)	9 (229)	↑ Stone Cover ↓	4.93 (0.139)	
41 (1041)	14.65 (0.415)	30.57 (0.866)	8 (203)		0.00	4.38 (0.124)
40 (1016)	14.45 (0.409)	29.88 (0.846)	7 (178)		0.00	3.83 (0.108)
39 (991)	14.24 (0.403)	29.18 (0.826)	6 (152)		0.00	3.28 (0.093)
38 (965)	14.00 (0.396)	28.48 (0.806)	5 (127)		0.00	2.74 (0.077)
37 (948)	13.74 (0.389)	27.76 (0.786)	4 (102)		0.00	2.19 (0.062)
36 (914)	13.47 (0.381)	27.04 (0.766)	3 (76)		0.00	1.64 (0.046)
35 (889)	13.18 (0.373)	26.30 (0.745)	2 (51)		0.00	1.09 (0.031)
34 (864)	12.86 (0.364)	25.56 (0.724)	1 (25)		0.00	0.55 (0.015)

**NOTE:** Add 0.56 ft<sup>3</sup> (0.016 m<sup>3</sup>) of storage for each additional inch (25 mm) of stone foundation. Contact StormTech for cumulative volume spreadsheets in digital format.

## 5.0 Cumulative Storage Volumes

**Tables 9 and 10** provide cumulative storage volumes for the MC-7200 chamber and end cap. These tables can be used to calculate the stage-storage relationship for the retention or detention system. Digital spreadsheets in which the number of chambers and end caps can be input for quick cumulative storage calculations are available at [www.stormtech.com](http://www.stormtech.com). For assistance with site-specific calculations or input into routing software, contact the StormTech Technical Services Department.

**Table 9 – MC-7200 Incremental Storage Volume Per Chamber**

Assumes 40% stone porosity. Calculations are based upon a 9" (230 mm) stone base under the chambers, 12" (300 mm) of stone above chambers, and 9" (230 mm) of spacing between chambers.

Depth of Water in System Inches (mm)	Cumulative Chamber Storage ft <sup>3</sup> (m <sup>3</sup> )	Total System Cumulative Storage ft <sup>3</sup> (m <sup>3</sup> )	Depth of Water in System Inches (mm)	Cumulative Chamber Storage ft <sup>3</sup> (m <sup>3</sup> )	Total System Cumulative Storage ft <sup>3</sup> (m <sup>3</sup> )	
81 (2057)	↑ Stone Cover ↓	0.00	267.30 (7.569)	40 (1016)	118.44 (3.354)	150.94 (4.274)
80 (2032)		0.00	265.30 (7.512)	39 (991)	115.14 (3.260)	146.97 (4.162)
79 (2007)		0.00	263.30 (7.456)	38 (965)	111.80 (3.166)	142.96 (4.048)
78 (1981)		0.00	261.31 (7.399)	37 (948)	108.40 (3.070)	138.93 (3.934)
77 (1956)		0.00	259.31 (7.343)	36 (914)	104.97 (2.972)	134.87 (3.819)
76 (1930)		0.00	257.31 (7.286)	35 (889)	101.48 (2.874)	130.78 (3.703)
75 (1905)		0.00	255.32 (7.230)	34 (864)	97.96 (2.774)	126.67 (3.587)
74 (1880)		0.00	253.32 (7.173)	33 (838)	94.39 (2.673)	122.54 (3.470)
73 (1854)		0.00	251.32 (7.117)	32 (813)	90.79 (2.571)	118.38 (3.352)
72 (1829)		0.00	249.33 (7.060)	31 (787)	87.14 (2.468)	114.19 (3.234)
71 (1803)		0.00	247.33 (7.004)	30 (762)	83.46 (2.363)	109.99 (3.114)
70 (1778)		0.00	245.33 (6.947)	29 (737)	79.75 (2.258)	105.76 (2.995)
69 (1753)	175.90 (4.981)	243.33 (6.890)	28 (711)	76.00 (2.152)	101.52 (2.875)	
68 (1727)	175.84 (4.979)	241.30 (6.833)	27 (686)	72.22 (2.045)	97.25 (2.754)	
67 (1702)	175.65 (4.974)	239.19 (6.773)	26 (680)	68.41 (1.937)	92.97 (2.632)	
66 (1676)	175.38 (4.966)	237.03 (6.712)	25 (610)	64.56 (1.828)	88.66 (2.511)	
65 (1651)	175.02 (4.956)	234.82 (6.649)	24 (609)	60.69 (1.719)	84.34 (2.388)	
64 (1626)	174.56 (4.943)	232.54 (6.585)	23 (584)	56.80 (1.608)	80.01 (2.266)	
63 (1600)	173.82 (4.922)	230.10 (6.516)	22 (559)	52.87 (1.497)	75.66 (2.142)	
62 (1575)	172.72 (4.891)	227.45 (6.441)	21 (533)	48.92 (1.385)	71.29 (2.019)	
61 (1549)	171.41 (4.854)	224.66 (6.362)	20 (508)	44.95 (1.273)	66.91 (1.895)	
60 (1524)	169.91 (4.811)	221.76 (6.280)	19 (483)	40.96 (1.160)	62.52 (1.770)	
59 (1499)	168.25 (4.764)	218.77 (6.195)	18 (457)	36.94 (1.046)	58.11 (1.646)	
58 (1473)	166.46 (4.714)	215.70 (6.108)	17 (432)	32.91 (0.932)	53.69 (1.520)	
57 (1448)	164.53 (4.659)	212.55 (6.019)	16 (406)	28.85 (0.817)	49.26 (1.395)	
56 (1422)	162.50 (4.602)	209.33 (5.928)	15 (381)	24.78 (0.702)	44.82 (1.269)	
55 (1397)	160.36 (4.541)	206.05 (5.835)	14 (356)	20.69 (0.586)	40.37 (1.143)	
54 (1372)	158.11 (4.477)	202.70 (5.740)	13 (330)	16.58 (0.469)	35.91 (1.017)	
53 (1346)	155.77 (4.411)	199.30 (5.644)	12 (305)	12.46 (0.353)	31.44 (0.890)	
52 (1321)	153.33 (4.342)	195.84 (5.546)	11 (279)	8.32 (0.236)	26.96 (0.763)	
51 (1295)	150.81 (4.271)	192.33 (5.446)	10 (254)	4.17 (0.118)	22.47 (0.636)	
50 (1270)	148.21 (4.197)	188.78 (5.346)	9 (229)	0.00	17.97 (0.509)	
49 (1245)	145.53 (4.121)	185.17 (5.244)	8 (203)	0.00	15.98 (0.452)	
48 (1219)	142.78 (4.043)	181.52 (5.140)	7 (178)	0.00	13.98 (0.396)	
47 (1194)	139.96 (3.963)	177.83 (5.036)	6 (152)	0.00	11.98 (0.339)	
46 (1168)	137.07 (3.881)	174.10 (4.930)	5 (127)	0.00	9.99 (0.283)	
45 (1143)	134.11 (3.798)	170.33 (4.823)	4 (102)	0.00	7.99 (0.226)	
44 (1118)	131.09 (3.712)	166.52 (4.715)	3 (76)	0.00	5.99 (0.170)	
43 (1092)	128.01 (3.625)	162.68 (4.607)	2 (51)	0.00	3.99 (0.113)	
42 (1067)	124.88 (3.536)	158.80 (4.497)	1 (25)	0.00	2.00 (0.057)	
41 (1041)	121.68 (3.446)	154.89 (4.386)				

**NOTE:** Add 2.00 ft<sup>3</sup> (0.057 m<sup>3</sup>) of storage for each additional inch (25 mm) of stone foundation. Contact StormTech for cumulative volume spreadsheets in digital format.



## 5.0 Cumulative Storage Volumes

**Table 10 – MC-7200 Incremental Storage Volume Per End Cap**

Assumes 40% stone porosity. Calculations are based upon a 9" (230 mm) stone base under the chambers, 12" (300 mm) of stone above end caps, and 9" (230 mm) of spacing between end caps and 6" (150 mm) of stone perimeter.

Depth of Water in System Inches (mm)	Cumulative End Cap Storage ft <sup>3</sup> (m <sup>3</sup> )	Total System Cumulative Storage ft <sup>3</sup> (m <sup>3</sup> )	Depth of Water in System Inches (mm)	Cumulative End Cap Storage ft <sup>3</sup> (m <sup>3</sup> )	Total System Cumulative Storage ft <sup>3</sup> (m <sup>3</sup> )	
81 (2057)	↑ Stone Cover ↓	115.28 (3.264)	40 (1016)	29.30 (0.830)	62.80 (1.778)	
80 (2032)		0.00	114.15 (3.232)	39 (991)	28.58 (0.809)	61.23 (1.734)
79 (2007)		0.00	113.02 (3.200)	38 (965)	27.84 (0.788)	59.65 (1.689)
78 (1981)		0.00	111.89 (3.168)	37 (948)	27.07 (0.767)	58.07 (1.644)
77 (1956)		0.00	110.76 (3.136)	36 (914)	26.29 (0.744)	56.46 (1.599)
76 (1930)		0.00	109.63 (3.104)	35 (889)	25.48 (0.722)	54.85 (1.553)
75 (1905)		0.00	108.50 (3.072)	34 (864)	24.66 (0.698)	53.23 (1.507)
74 (1880)		0.00	107.37 (3.040)	33 (838)	23.83 (0.675)	51.60 (1.461)
73 (1854)		0.00	106.24 (3.008)	32 (813)	22.98 (0.651)	49.96 (1.415)
72 (1829)		0.00	105.11 (2.976)	31 (787)	22.12 (0.626)	48.31 (1.368)
71 (1803)		0.00	103.98 (2.944)	30 (762)	21.23 (0.601)	46.65 (1.321)
70 (1778)		0.00	102.85 (2.912)	29 (737)	20.32 (0.575)	44.97 (1.273)
69 (1753)		39.54 (1.120)	101.72 (2.880)	28 (711)	19.40 (0.549)	43.29 (1.226)
68 (1727)		39.53 (1.119)	100.58 (2.848)	27 (686)	18.48 (0.523)	41.61 (1.178)
67 (1702)		39.50 (1.118)	99.43 (2.816)	26 (680)	17.54 (0.497)	39.91 (1.130)
66 (1676)		39.45 (1.117)	98.27 (2.783)	25 (610)	16.59 (0.470)	38.21 (1.082)
65 (1651)	39.38 (1.115)	97.10 (2.750)	24 (609)	15.62 (0.442)	36.50 (1.033)	
64 (1626)	39.30 (1.113)	95.92 (2.716)	23 (584)	14.64 (0.414)	34.78 (0.985)	
63 (1600)	39.19 (1.110)	94.73 (2.682)	22 (559)	13.66 (0.387)	33.07 (0.936)	
62 (1575)	39.06 (1.106)	93.52 (2.648)	21 (533)	12.66 (0.359)	31.33 (0.887)	
61 (1549)	38.90 (1.101)	92.29 (2.613)	20 (508)	11.65 (0.330)	29.60 (0.838)	
60 (1524)	38.71 (1.096)	91.04 (2.578)	19 (483)	10.63 (0.301)	27.85 (0.3789)	
59 (1499)	38.49 (1.090)	89.78 (2.542)	18 (457)	9.60 (0.272)	26.11 (0.739)	
58 (1473)	38.24 (1.083)	88.50 (2.506)	17 (432)	8.56 (0.242)	24.35 (0.690)	
57 (1448)	37.97 (1.075)	87.21 (2.469)	16 (406)	7.51 (0.213)	22.59 (0.640)	
56 (1422)	37.67 (1.067)	85.90 (2.432)	15 (381)	6.46 (0.183)	20.83 (0.590)	
55 (1397)	37.34 (1.057)	84.57 (2.395)	14 (356)	5.41 (0.153)	19.07 (0.540)	
54 (1372)	36.98 (1.047)	83.23 (2.357)	13 (330)	4.35 (0.123)	17.31 (0.490)	
53 (1346)	36.60 (1.036)	81.87 (2.318)	12 (305)	3.28 (0.093)	15.53 (0.440)	
52 (1321)	36.19 (1.025)	80.49 (2.279)	11 (279)	2.19 (0.062)	13.75 (0.389)	
51 (1295)	35.75 (1.012)	79.10 (2.240)	10 (254)	1.11 (0.031)	11.97 (0.339)	
50 (1270)	35.28 (0.999)	77.69 (2.200)	9 (229)	0.00	10.17 (0.288)	
49 (1245)	34.79 (0.985)	76.26 (2.159)	8 (203)	0.00	9.04 (0.256)	
48 (1219)	34.27 (0.970)	74.82 (2.119)	7 (178)	0.00	7.91 (0.224)	
47 (1194)	33.72 (0.955)	73.36 (2.077)	6 (152)	0.00	6.78 (0.192)	
46 (1168)	33.15 (0.939)	71.89 (2.036)	5 (127)	0.00	5.65 (0.160)	
45 (1143)	32.57 (0.922)	70.40 (1.994)	4 (102)	0.00	4.52 (0.128)	
44 (1118)	31.96 (0.905)	68.91 (1.951)	3 (76)	0.00	3.39 (0.096)	
43 (1092)	31.32 (0.887)	67.40 (1.909)	2 (51)	0.00	2.26 (0.064)	
42 (1067)	30.68 (0.869)	65.88 (1.866)	1 (25)	0.00	1.13 (0.032)	
41 (1041)	30.00 (0.850)	64.35 (1.822)				

**NOTE:** Add 1.08 ft<sup>3</sup> (0.031 m<sup>3</sup>) of storage for each additional inch (25 mm) of stone foundation. Contact StormTech for cumulative volume spreadsheets in digital format.

## 6.0 MC-3500 Chamber System Sizing

The following steps provide the calculations necessary for preliminary sizing of an MC-3500 chamber system. For custom bed configurations to fit specific sites, contact the StormTech Technical Services Department or your local StormTech representative.

**1) Determine the amount of storage volume (Vs) required.** It is the design engineer's sole responsibility to determine the storage volume required.

**Table 11 - Storage Volume Per Chamber/End Cap ft<sup>3</sup> (m<sup>3</sup>)**

	Bare Unit Storage ft <sup>3</sup> (m <sup>3</sup> )	Chamber/End Cap and Stone Volume — Stone Foundation Depth in. (mm)			
		9 (230)	12 (300)	15 (375)	18 (450)
MC-3500 Chamber	109.9 (3.11)	175.0 (4.96)	179.9 (5.09)	184.9 (5.24)	189.9 (5.38)
MC-3500 End Cap	14.9 (0.42)	45.1 (1.28)	46.6 (1.32)	48.3 (1.37)	49.9 (1.41)

NOTE: Assumes 6" (150 mm) row spacing, 40% stone porosity, 12" (300 mm) stone above and includes the bare chamber/end cap volume. End cap volume assumes 6" (150 mm) stone perimeter.

**2) Determine the number of chambers (C) required.** To calculate the number of chambers required for adequate storage, divide the storage volume (Vs) by the storage volume of the chamber (from **Table 11**), as follows: **C = Vs / Storage Volume per Chamber**

**3) Determine the number of end caps required.** The number of end caps (EC) required depends on the number of rows required by the project. Once the number of chamber rows is determined, multiply the number of chamber rows by 2 to determine the number of end caps required. **EC = No. of Chamber Rows x 2**

**NOTE:** Additional end caps may be required for systems having inlet locations within the chamber bed.

**4) Determine additional storage provided by end caps.**

End Caps will provide additional storage to the project. Multiply the number of end caps (EC) by the storage volume per end cap (ECS) to determine the additional storage (As) provided by the end caps. **As = EC x ECS**

**5) Adjust number of chambers (C) to account for additional end cap storage (As).** The original number of chambers (C) can now be reduced due to the additional storage in the end caps. Divide the additional storage (As) by the storage volume per chamber to determine the number of chambers that can be removed. **Number of chambers to remove = As/ volume per chamber**

**NOTE:** Additional storage exists in the stone perimeter as well as in the inlet and outlet manifold systems. Contact StormTech's Technical Services Department for assistance with determining the number of chambers and end caps required for your project.

**6) Determine the required bed size (S).**

The size of the bed will depend on the number of chambers and end caps required:

**MC-3500 area per chamber = 49.6 ft<sup>2</sup> (4.6 m<sup>2</sup>)**

**MC-3500 area per end cap = 16.4 ft<sup>2</sup> (1.5 m<sup>2</sup>)**

**S = (C x area per chamber) + (EC x area per end cap)**

**NOTE:** It is necessary to add 12" (300 mm) of stone perimeter parallel to the chamber rows and 6" (150 mm) of stone perimeter from the base of all end caps. The additional area due to perimeter stone is not included in the area numbers above.

**7) Determine the amount of stone (Vst) required.**

To calculate the total amount of clean, crushed, angular stone required, multiply the number of chambers (C) and the number of end caps (EC) by the selected weight of stone from **Table 12**.

**NOTE:** Clean, crushed, angular stone is also required around the perimeter of the system.

**Table 12 - Amount of Stone Per Chamber/End Cap**

ENGLISH tons (yd <sup>3</sup> )	Stone Foundation Depth			
	9"	12"	15"	18"
Chamber	8.5 (6.0)	9.1 (6.5)	9.7 (6.9)	10.4 (7.4)
End Cap	3.9 (2.8)	4.1 (2.9)	4.3 (3.1)	4.5 (3.2)
METRIC kg (m <sup>3</sup> )	230 mm	300 mm	375 mm	450 mm
Chamber	7711 (4.6)	8255 (5.0)	8800 (5.3)	9435 (5.7)
End Cap	3538 (2.1)	3719 (2.2)	3901 (2.4)	4082 (2.5)

NOTE: Assumes 12" (300 mm) of stone above, and 6" (150 mm) row spacing, and 6" (150 mm) of perimeter stone in front of end caps.

**8) Determine the volume of excavation (Ex) required.**

Each additional foot of cover will add a volume of excavation of 1.9 yd<sup>3</sup> (1.5 m<sup>3</sup>) per MC-3500 chamber and 0.6 yd<sup>3</sup> (0.5 m<sup>3</sup>) per MC-3500 end cap.

**Table 13—Volume of Excavation Per Chamber/End Cap yd<sup>3</sup> (m<sup>3</sup>)**

	Stone Foundation Depth			
	9" (230 mm)	12" (300 mm)	15" (375 mm)	18" (450 mm)
Chamber	11.9 (9.1)	12.4 (9.5)	12.8 (9.8)	13.3 (10.2)
End Cap	4.0 (3.1)	4.1 (3.2)	4.3 (3.3)	4.4 (3.4)

NOTE: Assumes 6" (150 mm) separation between chamber rows, 6" (150 mm) of perimeter in front of end caps, and 24" (600 mm) of cover. The volume of excavation will vary as the depth of cover increases.

**9) Determine the area of geotextile (F) required.**

The bottom, top and sides of the bed must be covered with a non-woven geotextile (filter fabric) that meets AASHTO M288 Class 2 requirements. The area of the sidewalls must be calculated and a 24" (600 mm) overlap must be included for all seams. Geotextiles typically come in 15 foot (4.57 m) wide rolls.

## 6.0 MC-7200 Chamber System Sizing

The following steps provide the calculations necessary for preliminary sizing of an MC-7200 chamber system. For custom bed configurations to fit specific sites, contact the StormTech Technical Services Department or your local StormTech representative.

**1) Determine the amount of storage volume (Vs) required.** It is the design engineer's sole responsibility to determine the storage volume required.

**Table 14 - Storage Volume Per Chamber/End Cap ft<sup>3</sup> (m<sup>3</sup>)**

	Bare Unit Storage ft <sup>3</sup> (m <sup>3</sup> )	Chamber/End Cap and Stone Volume — Stone Foundation Depth in. (mm)			
		9 (230)	12 (300)	15 (375)	18 (450)
MC-7200 Chamber	175.9 (4.98)	267.3 (7.57)	273.3 (7.74)	279.3 (7.91)	285.2 (8.08)
MC-7200 End Cap	39.5 (1.12)	115.3 (3.26)	118.6 (3.36)	121.9 (3.45)	125.29 (3.54)

NOTE: Assumes 9" (230 mm) row spacing, 40% stone porosity, 12" (300 mm) stone above and includes the bare chamber/end cap volume. End cap volume assumes 12" (300 mm) stone perimeter.

**2) Determine the number of chambers (C) required.**

To calculate the number of chambers required for adequate storage, divide the storage volume (Vs) by the storage volume of the chamber (from **Table 14**), as follows: **C = Vs / Storage Volume per Chamber**

**3) Determine the number of end caps required.**

The number of end caps (EC) required depends on the number of rows required by the project. Once the number of chamber rows is determined, multiply the number of chamber rows by 2 to determine the number of end caps required. **EC = No. of Chamber Rows x 2**

NOTE: Additional end caps may be required for systems having inlet locations within the chamber bed.

**4) Determine additional storage provided by end caps.**

End Caps will provide additional storage to the project. Multiply the number of end caps (EC) by the storage volume per end cap (ECS) to determine the additional storage (As) provided by the end caps. **As = EC x ECS**

**5) Adjust number of chambers (C) to account for additional end cap storage (As).** The original number of chambers (C) can now be reduced due to the additional storage in the end caps. Divide the additional storage (As) by the storage volume per chamber to determine the number of chambers that can be removed. **Number of chambers to remove = As/ volume per chamber**

NOTE: Additional storage exists in the stone perimeter as well as in the inlet and outlet manifold systems. Contact StormTech's Technical Services Department for assistance with determining the number of chambers and end caps required for your project.

**6) Determine the required bed size (S).**

The size of the bed will depend on the number of chambers and end caps required:

**MC-7200 area per chamber = 59.9 ft<sup>2</sup> (5.6 m<sup>2</sup>)**

**MC-7200 area per end cap = 33.9 ft<sup>2</sup> (3.1 m<sup>2</sup>)**

**S = (C x area per chamber) + (EC x area per end cap)**

NOTE: It is necessary to add 12" (300 mm) of stone perimeter parallel to the chamber rows and 6" (150 mm) of stone perimeter from the base of all end caps. The additional area due to perimeter stone is not included in the area numbers above.

**7) Determine the amount of stone (Vst) required.**

To calculate the total amount of clean, crushed, angular stone required, multiply the number of chambers (C) and the number of end caps (EC) by the selected weight of stone from **Table 15**.

NOTE: Clean, crushed, angular stone is also required around the perimeter of the system.

**Table 15 - Amount of Stone Per Chamber/End Cap**

ENGLISH tons (yd <sup>3</sup> )	Stone Foundation Depth			
	9"	12"	15"	18"
Chamber	11.9 (8.5)	12.6 (9.0)	13.4 (9.6)	14.6 (10.1)
End Cap	9.8 (7.0)	10.2 (7.3)	10.6 (7.6)	11.1 (7.9)
METRIC kg (m <sup>3</sup> )	230 mm	300 mm	375 mm	450 mm
Chamber	10796 (6.5)	11431 (6.9)	12156 (7.3)	13245 (7.7)
End Cap	8890 (5.3)	9253 (5.5)	9616 (5.8)	10069 (6.0)

NOTE: Assumes 12" (300 mm) of stone above, and 9" (230 mm) row spacing, and 12" (300 mm) of perimeter stone in front of end caps.

**8) Determine the volume of excavation (Ex) required.**

Each additional foot of cover will add a volume of excavation of 2.2 yd<sup>3</sup> (1.7 m<sup>3</sup>) per MC-7200 chamber and 1.4 yd<sup>3</sup> (0.8 m<sup>3</sup>) per MC-7200 end cap.

**Table 13- Volume of Excavation Per Chamber/End Cap yd<sup>3</sup> (m<sup>3</sup>)**

	Stone Foundation Depth			
	9" (230 mm)	12" (300 mm)	15" (375 mm)	18" (450 mm)
Chamber	17.2 (13.2)	17.7 (13.5)	18.3 (14.0)	18.8 (14.4)
End Cap	9.7 (7.4)	10.0 (7.6)	10.3 (7.9)	10.6 (8.1)

NOTE: Assumes 9" (230 mm) separation between chamber rows, 12" (300 mm) of perimeter in front of end caps, and 24" (600 mm) of cover. The volume of excavation will vary as the depth of cover increases.

**9) Determine the area of geotextile (F) required.**

The bottom, top and sides of the bed must be covered with a non-woven geotextile (filter fabric) that meets AASHTO M288 Class 2 requirements. The area of the sidewalls must be calculated and a 24" (600 mm) overlap must be included for all seams. Geotextiles typically come in 15 foot (4.57 m) wide rolls.

# 7.0 Structural Cross Sections and Specifications

**Figure 16A - MC-3500 Structural Cross Section Detail (Not to Scale)**

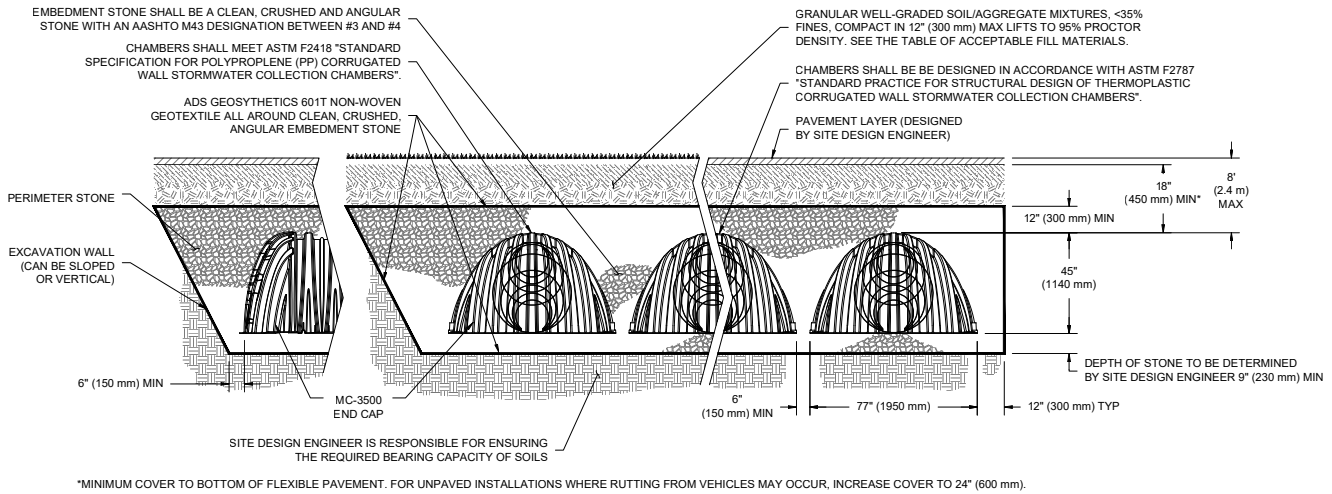

*Special applications will be considered on a project by project basis. Please contact our application department should you have a unique application for our team to evaluate.*

## MC-3500 Stormwater Chamber Specifications

1. Chambers shall be StormTech MC-3500 or approved equal.
2. Chambers shall be made from virgin, impact-modified polypropylene copolymers.
3. Chamber rows shall provide continuous, unobstructed internal space with no internal panels that would impede flow.
4. The structural design of the chambers, the structural backfill and the installation requirements shall ensure that the load factors specified in the AASHTO LRFD Bridge Design Specifications, Section 12.12 are met for: 1) long-duration dead loads and 2) short-duration live loads, based on the AASHTO Design Truck with consideration for impact and multiple vehicle presences.
5. Chambers shall meet the requirements of ASTM F 2418, "Standard Specification for Polypropylene (PP) Corrugated Wall Stormwater Collection Chambers."
6. Chambers shall conform to the requirements of ASTM F 2787, "Standard Practice for Structural Design of Thermoplastic Corrugated Wall Stormwater Collection Chambers."
7. Only chambers that are approved by the engineer will be allowed. The contractor shall submit (3 sets) of the following to the engineer for approval before delivering chambers to the project site:
  - A structural evaluation by a registered structural engineer that demonstrates that the load factors specified in the AASHTO LRFD Bridge Design Specifications, Section 12.12 are met. The 50-year creep modulus data specified in ASTM F 2418 must be used as part of the AASHTO structural evaluation to verify long-term performance.
  - Structural cross section detail on which the structural cross section is based.
8. The installation of chambers shall be in accordance with the manufacturer's latest Construction Guide.

Detail drawings available in Cad Rev. 2000 format at [www.stormtech.com](http://www.stormtech.com)

# 7.0 Structural Cross Sections and Specifications

**Figure 16B - MC-7200 Structural Cross Section Detail** (Not to Scale)

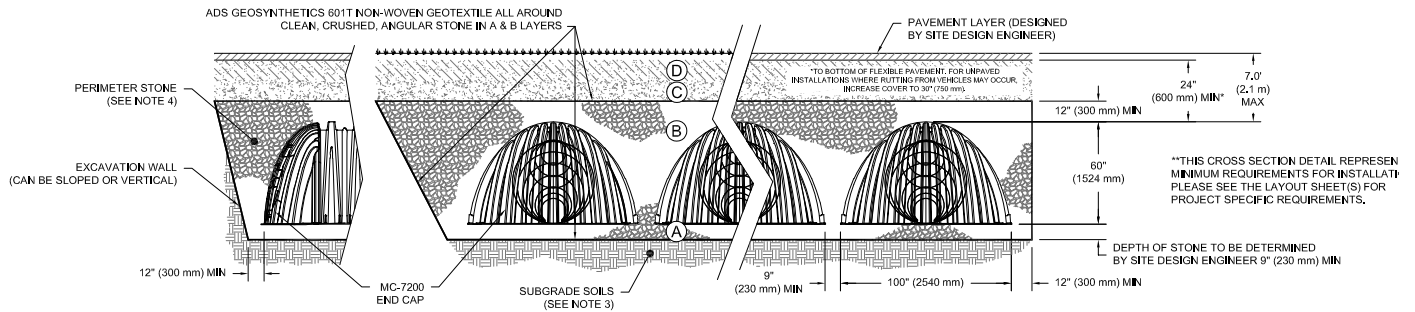

*Special applications will be considered on a project by project basis. Please contact our application department should you have a unique application for our team to evaluate.*

## MC-7200 Stormwater Chamber Specifications

1. Chambers shall be StormTech MC-7200 or approved equal.
2. Chambers shall be made from virgin, impact-modified polypropylene copolymers.
3. Chamber rows shall provide continuous, unobstructed internal space with no internal panels that would impede flow.
4. The structural design of the chambers, the structural backfill and the installation requirements shall ensure that the load factors specified in the AASHTO LRFD Bridge Design Specifications, Section 12.12 are met for: 1) long-duration dead loads and 2) short-duration live loads, based on the AASHTO Design Truck with consideration for impact and multiple vehicle presences.
5. Chambers shall meet the requirements of ASTM F 2418, "Standard Specification for Polypropylene (PP) Corrugated Wall Stormwater Collection Chambers."
6. Chambers shall conform to the requirements of ASTM F 2787, "Standard Practice for Structural Design of Thermoplastic Corrugated Wall Stormwater Collection Chambers."
7. Only chambers that are approved by the engineer will be allowed. The contractor shall submit (3 sets) of the following to the engineer for approval before delivering chambers to the project site:
  - A structural evaluation by a registered structural engineer that demonstrates that the load factors specified in the AASHTO LRFD Bridge Design Specifications, Section 12.12 are met. The 50-year creep modulus data specified in ASTM F 2418 must be used as part of the AASHTO structural evaluation to verify long-term performance.
  - Structural cross section detail on which the structural cross section is based.
8. The installation of chambers shall be in accordance with the manufacturer's latest Construction Guide.

Detail drawings available in Cad Rev. 2000 format at [www.stormtech.com](http://www.stormtech.com)

## 8.0 General Notes

1. StormTech requires installing contractors to use and understand the latest StormTech **MC-3500 and MC-7200 Construction Guides** prior to beginning system installation.
2. StormTech offers installation consultations to installing contractors. Contact our Technical Service Department or local StormTech representative at least 30 days prior to system installation to arrange a pre-installation consultation. Our representatives can then answer questions or address comments on the StormTech chamber system and inform the installing contractor of the minimum installation requirements before beginning the system's construction. Call 860-529-8188 to speak to a Technical Service Representative or visit [www.stormtech.com](http://www.stormtech.com) to receive a copy of our Construction Guide.
3. StormTech requirements for systems with pavement design (asphalt, concrete pavers, etc.): Minimum cover is 18" (450mm) for the MC-3500 and 24" (600mm) for the MC-7200 not including pavement; MC-3500 maximum cover is 8.0' (1.98 m) and MC-7200 maximum cover is 7.0' (2.43 m) both including pavement. For designs with cover depths deeper than these maximums, please contact Stormtech. For installations that do not include pavement, where rutting from vehicles may occur, minimum required cover is increased to 30" (762 mm).
4. The contractor must report any discrepancies with the bearing capacity of the subgrade materials to the design engineer.
5. AASHTO M288 Class 2 non-woven geotextile (ADS601 or equal) (filter fabric) must be used as indicated in the project plans.
6. Stone placement between chamber rows and around perimeter must follow instructions as indicated in the most current version of StormTech MC-3500 / MC-7200 Construction Guides.
7. Backfilling over the chambers must follow requirements as indicated in the most current version of StormTech MC-3500 / MC-7200 Construction Guides.
8. The contractor must refer to StormTech MC-3500 / MC-7200 Construction Guides for a Table of Acceptable Vehicle Loads at various depths of cover. This information is also available at the StormTech website: [www.stormtech.com](http://www.stormtech.com). The contractor is responsible for preventing vehicles that exceed StormTech requirements from traveling across or parking over the stormwater system. Temporary fencing, warning tape and appropriately located signs are commonly used to prevent unauthorized vehicles from entering sensitive construction areas.
9. The contractor must apply erosion and sediment control measures to protect the stormwater system during all phases of site construction per local codes and design engineer's specifications.
10. STORMTECH PRODUCT WARRANTY IS LIMITED. Contact StormTech for warranty information.

## 9.0 Inspection and Maintenance

### 9.1 Isolator Row Plus Inspection

Regular inspection and maintenance are essential to assure a properly functioning stormwater system. Inspection is easily accomplished through the manhole or optional inspection ports of an Isolator Row Plus. Please follow local and OSHA rules for a confined space entry.

Inspection ports can allow inspection to be accomplished completely from the surface without the need for a confined space entry. Inspection ports provide visual access to the system with the use of a flashlight. A stadia rod may be inserted to determine the depth of sediment. If upon visual inspection it is found that sediment has accumulated to an average depth exceeding 3" (76 mm), cleanout is required.

A StormTech Isolator Row Plus should initially be inspected immediately after completion of the site's construction. While every effort should be made to prevent sediment from entering the system during construction, it is during this time that excess amounts of sediments are most likely to enter any stormwater system. Inspection and maintenance, if necessary, should be performed prior to passing responsibility over to the site's owner. Once in normal service, a StormTech Isolator Row Plus should be inspected bi-annually until an understanding of the sites characteristics is developed. The site's maintenance manager can then revise the inspection schedule based on experience or local requirements.

### 9.2 Isolator Row Plus Maintenance

JetVac maintenance is recommended if sediment has been collected to an average depth of 3" (76 mm) inside the Isolator Row Plus. More frequent maintenance may be required to maintain minimum flow rates through the Isolator Row Plus. The JetVac process utilizes a high pressure water nozzle to propel itself down the Isolator Row Plus while scouring and suspending sediments. As the nozzle is retrieved, a wave of suspended sediments is flushed back into the manhole for vacuuming. Most sewer and pipe maintenance companies have vacuum/ JetVac combination vehicles. Fixed nozzles designed for culverts or large diameter pipe cleaning are preferable. Rear facing jets with an effective spread of at least 45" (1143 mm) are best. StormTech recommends a maximum nozzle pressure of 2000 psi be utilized during cleaning. The JetVac process shall only be performed on StormTech Rows that have ADS Plus fabric over the foundation stone.

A Flamp (flared end ramp) is attached to the inlet pipe on the inside of the chamber end cap to provide a smooth transition from pipe invert to fabric bottom. It is configured to improve chamber function performance over time by distributing sediment and debris that would otherwise collect at the inlet. It also serves to improve the fluid and solid flow back into the inlet pipe during maintenance and cleaning, and to guide cleaning and inspection equipment back into the inlet pipe when complete.



**Flamp (Flared End Ramp)**

**A typical JetVac truck (This is not a StormTech product.)**

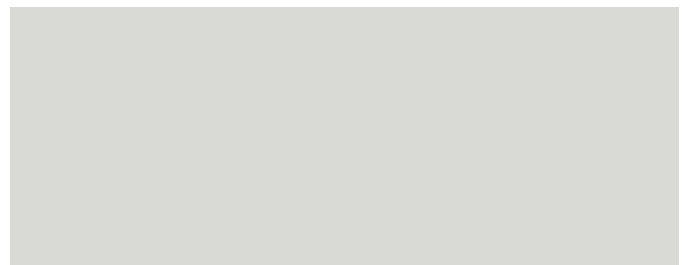

**Examples of culvert cleaning nozzles appropriate for Isolator Row Plus maintenance. (These are not StormTech products).**

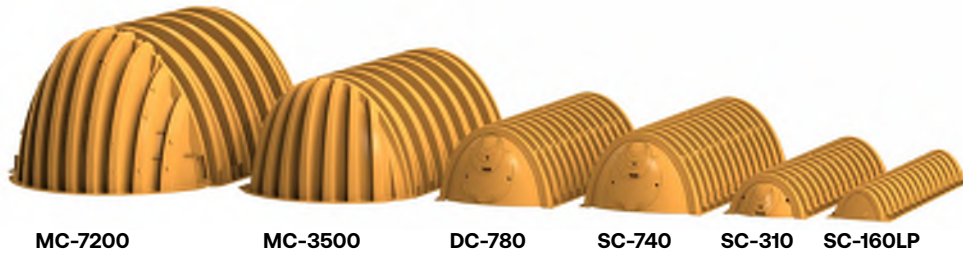

MC-7200

MC-3500

DC-780

SC-740

SC-310

SC-160LP

## A Family of Products and Services for the Stormwater Industry:

MC-3500 and MC-7200 Chambers and End Caps  
SC-160LP, SC-310 and SC-740 Chambers & End Caps  
DC-780 Chambers and End Caps  
Fabricated End Caps  
Fabricated Manifold Fittings  
Patented Isolator Row PLUS for Maintenance and  
Water Quality  
Chamber Separation Spacers  
In-House System Layout Assistance  
On-Site Educational Seminars  
Worldwide Technical Sales Group  
Centralized Product Applications Department  
Research and Development Team  
Technical Literature, O&M Manuals and Detailed CAD  
drawings all downloadable via our Website

**StormTech provides state-of-the-art products and services that meet or exceed industry performance standards and expectations. We offer designers, regulators, owners and contractors the highest quality products and services for stormwater management that Saves Valuable Land and Protects Water Resources.**

[adspipe.com](http://adspipe.com)

800-821-6710



# Isolator<sup>®</sup> Row Plus

## O&M Manual

---



# The Isolator<sup>®</sup> Row Plus

## Introduction

An important component of any Stormwater Pollution Prevention Plan is inspection and maintenance. The StormTech Isolator Row Plus is a technique to inexpensively enhance Total Suspended Solids (TSS) and Total Phosphorus (TP) removal with easy access for inspection and maintenance.

## The Isolator Row Plus

The Isolator Row Plus is a row of StormTech chambers, either SC-160, SC-310, SC-310-3, SC-740, DC-780, MC-3500 or MC-7200 models, that is surrounded with filter fabric and connected to a closely located manhole for easy access. The fabric-wrapped chambers provide for sediment settling and filtration as stormwater rises in the Isolator Row Plus and passes through the filter fabric. The open bottom chambers and perforated sidewalls (SC-310, SC-310-3 and SC-740 models) allow stormwater to flow both vertically and horizontally out of the chambers. Sediments are captured in the Isolator Row Plus protecting the adjacent stone and chambers storage areas from sediment accumulation.

ADS geotextile fabric is placed between the stone and the Isolator Row Plus chambers. The woven geotextile provides a media for stormwater filtration, a durable surface for maintenance, prevents scour of the underlying stone and remains intact during high pressure jetting. A non-woven fabric is placed over the chambers to provide a filter media for flows passing through the chamber's sidewall. The non-woven fabric is not required over the SC-160, DC-780, MC-3500 or MC-7200 models as these chambers do not have perforated side walls.

The Isolator Row Plus is designed to capture the "first flush" runoff and offers the versatility to be sized on a volume basis or a flow-rate basis. An upstream manhole provides access to the Isolator Row Plus and includes a high/low concept such that stormwater flow rates or volumes that exceed the capacity of the Isolator Row Plus bypass through a manifold to the other chambers. This is achieved with an elevated bypass manifold or a high-flow weir. This creates a differential between the Isolator Row Plus row of chambers and the manifold to the rest of the system, thus allowing for settlement time in the Isolator Row Plus. After Stormwater flows through the Isolator Row Plus and into the rest of the chamber system it is either exfiltrated into the soils below or passed at a controlled rate through an outlet manifold and outlet control structure.

The Isolator Row FLAMP<sup>™</sup> (patent pending) is a flared end ramp apparatus attached to the inlet pipe on the inside of the chamber end cap. The FLAMP provides a smooth transition from pipe invert to fabric bottom. It is configured to improve chamber function performance by enhancing outflow of solid debris that would otherwise collect at the chamber's end. It also serves to improve the fluid and solid flow into the access pipe during maintenance and cleaning and to guide cleaning and inspection equipment back into the inlet pipe when complete.

The Isolator Row Plus may be part of a treatment train system. The treatment train design and pretreatment device selection by the design engineer is often driven by regulatory requirements. Whether pretreatment is used or not, StormTech recommend using the Isolator Row Plus to minimize maintenance requirements and maintenance costs.

**Note:** See the StormTech Design Manual for detailed information on designing inlets for a StormTech system, including the Isolator Row Plus.



Looking down the Isolator Row PLUS from the manhole opening, ADS PLUS Fabric is shown between the chamber and stone base.



StormTech Isolator Row PLUS with Overflow Spillway (not to scale)

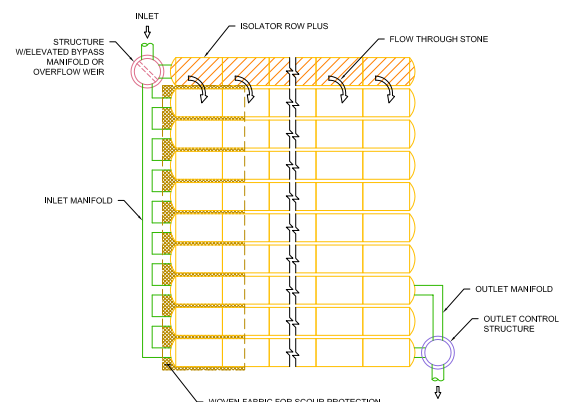

# Isolator Row Plus Inspection/Maintenance

## Inspection

The frequency of inspection and maintenance varies by location. A routine inspection schedule needs to be established for each individual location based upon site specific variables. The type of land use (i.e. industrial, commercial, residential), anticipated pollutant load, percent imperviousness, climate, etc. all play a critical role in determining the actual frequency of inspection and maintenance practices.

At a minimum, StormTech recommends annual inspections. Initially, the Isolator Row Plus should be inspected every 6 months for the first year of operation. For subsequent years, the inspection should be adjusted based upon previous observation of sediment deposition.

The Isolator Row Plus incorporates a combination of standard manhole(s) and strategically located inspection ports (as needed). The inspection ports allow for easy access to the system from the surface, eliminating the need to perform a confined space entry for inspection purposes.

If upon visual inspection it is found that sediment has accumulated, a stadia rod should be inserted to determine the depth of sediment. When the average depth of sediment exceeds 3 inches throughout the length of the Isolator Row Plus, clean-out should be performed.

## Maintenance

The Isolator Row Plus was designed to reduce the cost of periodic maintenance. By “isolating” sediments to just one row, costs are dramatically reduced by eliminating the need to clean out each row of the entire storage bed. If inspection indicates the potential need for maintenance, access is provided

via a manhole(s) located on the end(s) of the row for cleanout. If entry into the manhole is required, please follow local and OSHA rules for a confined space entries.

Maintenance is accomplished with the JetVac process. The JetVac process utilizes a high pressure water nozzle to propel itself down the Isolator Row Plus while scouring and suspending sediments. As the nozzle is retrieved, the captured pollutants are flushed back into the manhole for vacuuming. Most sewer and pipe maintenance companies have vacuum/JetVac combination vehicles. Selection of an appropriate JetVac nozzle will improve maintenance efficiency. Fixed nozzles designed for culverts or large diameter pipe cleaning are preferable. Rear facing jets with an effective spread of at least 45” are best. StormTech recommends a maximum nozzle pressure of 2000 psi be utilized during cleaning. JetVac reels can vary in length. For ease of maintenance, ADS recommends Isolator Row Plus lengths up to 200' (61 m). **The JetVac process shall only be performed on StormTech Isolator Row Plus that have ADS Plus Fabric (as specified by StormTech) over their angular base stone.**

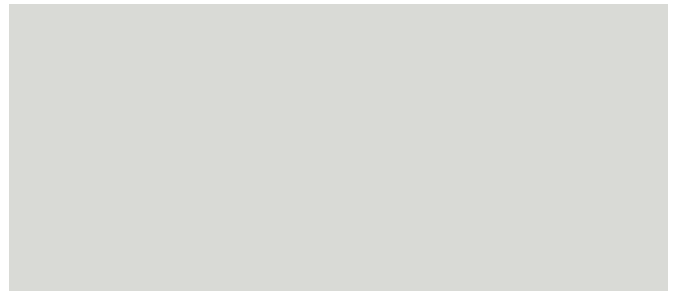

## StormTech Isolator Row PLUS (not to scale)

**Note:** Non-woven fabric is only required over the inlet pipe connection into the end cap for SC-160LP, DC-780, MC-3500 and MC-7200 chamber models and is not required over the entire Isolator Row PLUS.

# Isolator Row Plus Step By Step Maintenance Procedures

## Step 1

Inspect Isolator Row Plus for sediment.

- A) Inspection ports (if present)
  - i. Remove lid from floor box frame
  - ii. Remove cap from inspection riser
  - iii. Using a flashlight and stadia rod, measure depth of sediment and record results on maintenance log.
  - iv. If sediment is at or above 3 inch depth, proceed to Step 2. If not, proceed to Step 3.
- B) All Isolator Row Plus
  - i. Remove cover from manhole at upstream end of Isolator Row Plus
  - ii. Using a flashlight, inspect down Isolator Row Plus through outlet pipe
    - 1. Mirrors on poles or cameras may be used to avoid a confined space entry
    - 2. Follow OSHA regulations for confined space entry if entering manhole
  - iii. If sediment is at or above the lower row of sidewall holes (approximately 3 inches), proceed to Step 2. If not, proceed to Step 3.

## Step 2

Clean out Isolator Row Plus using the JetVac process.

- A) A fixed floor cleaning nozzle with rear facing nozzle spread of 45 inches or more is preferable
- B) Apply multiple passes of JetVac until backflush water is clean
- C) Vacuum manhole sump as required

## Step 3

Replace all caps, lids and covers, record observations and actions.

## Step 4

Inspect & clean catch basins and manholes upstream of the StormTech system.

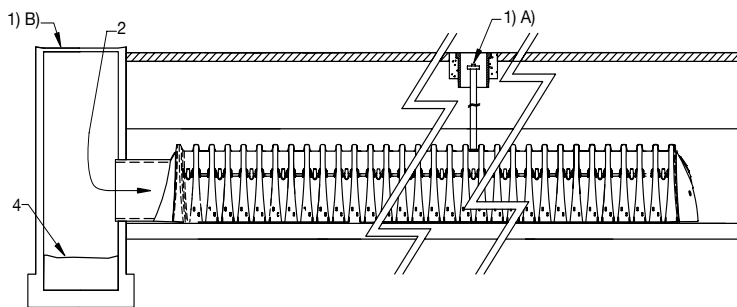

## Sample Maintenance Log

Date	Stadia Rod Readings		Sedi-ment Depth (1)-(2)	Observations/Actions	Inspector
	Fixed point to chamber bottom (1)	Fixed point to top of sediment (2)			
3/15/11	6.3 ft	none		New installation. Fixed point is CI frame at grade	DJM
9/24/11		6.2	0.1 ft	Some grit felt	SM
6/20/13		5.8	0.5 ft	Mucky feel, debris visible in manhole and in Isolator Row PLUS, maintenance due	NV
7/7/13	6.3 ft		0	System jetted and vacuumed	DJM

adspipe.com

800-821-6710

## DRAWINGS



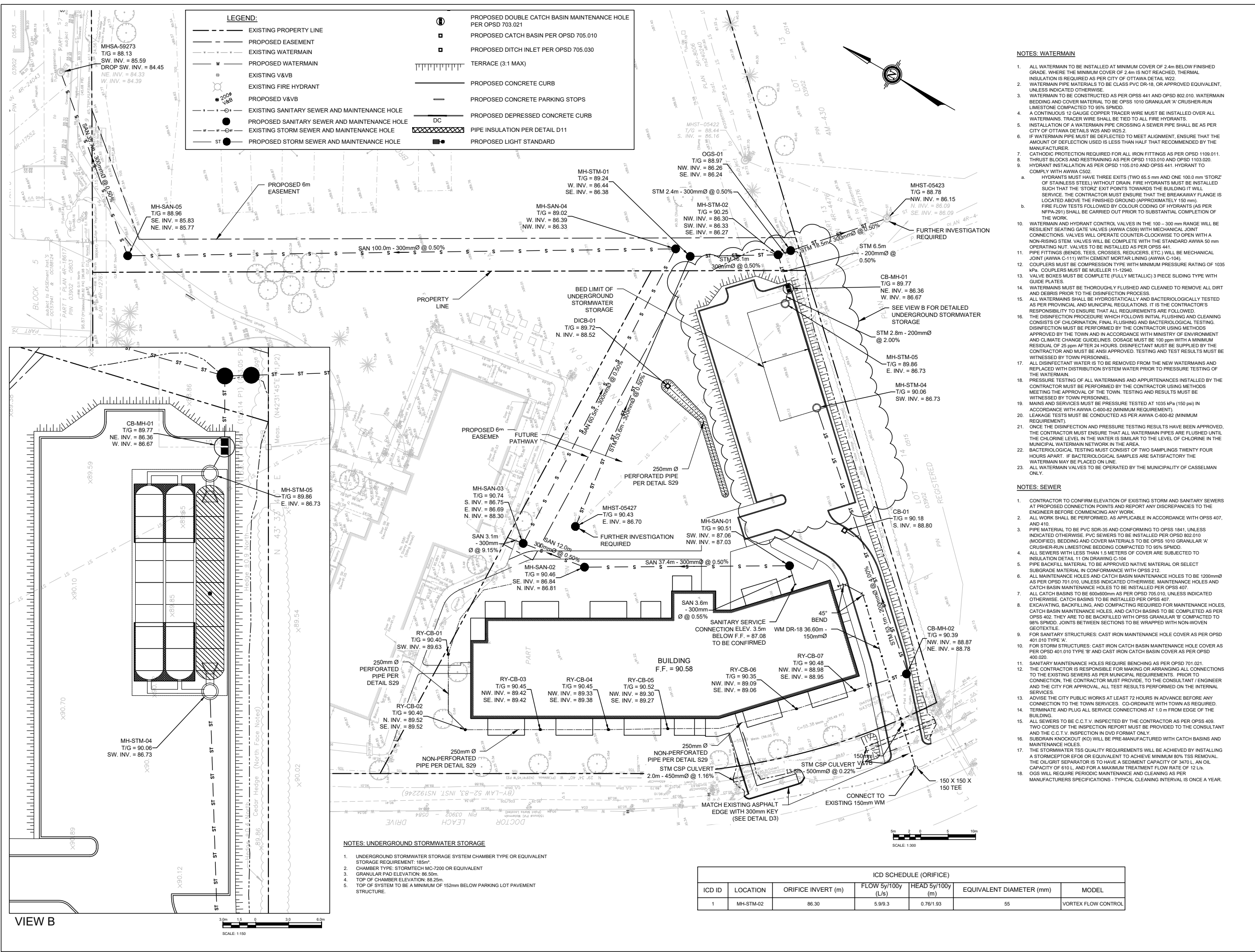

**LEGEND:**

---	EXISTING PROPERTY LINE	○	PROPOSED DOUBLE CATCH BASIN MAINTENANCE HOLE PER OPSD 703.021
---	PROPOSED EASEMENT	□	PROPOSED CATCH BASIN PER OPSD 705.010
---	EXISTING WATERMAIN	□	PROPOSED DITCH INLET PER OPSD 705.030
---	PROPOSED WATERMAIN	▬	TERRACE (3:1 MAX)
---	EXISTING V&VB	---	PROPOSED CONCRETE CURB
---	EXISTING FIRE HYDRANT	---	PROPOSED CONCRETE PARKING STOPS
---	PROPOSED V&VB	---	PROPOSED DEPRESSED CONCRETE CURB
---	EXISTING SANITARY SEWER AND MAINTENANCE HOLE	DC	PIPE INSULATION PER DETAIL D11
---	PROPOSED SANITARY SEWER AND MAINTENANCE HOLE	■	PROPOSED LIGHT STANDARD
---	EXISTING STORM SEWER AND MAINTENANCE HOLE		
---	PROPOSED STORM SEWER AND MAINTENANCE HOLE		

- NOTES: WATERMAIN**
- ALL WATERMAIN TO BE INSTALLED AT MINIMUM COVER OF 2.4m BELOW FINISHED GRADE. WHERE THE MINIMUM COVER OF 2.4m IS NOT REACHED, THERMAL INSULATION IS REQUIRED AS PER CITY OF OTTAWA DETAIL W22.
  - WATERMAIN PIPE MATERIALS TO BE CLASS PVC DR-18, OR APPROVED EQUIVALENT, UNLESS INDICATED OTHERWISE.
  - WATERMAIN TO BE CONSTRUCTED AS PER OPSD 441 AND OPSD 802.010. WATERMAIN BEDDING AND COVER MATERIAL, TO BE OPSD 1010 GRANULAR 'A' CRUSHER-RUN LIMESTONE COMPACTED TO 95% SPMD.
  - A CONTINUOUS 12 GAUGE COPPER TRACER WIRE MUST BE INSTALLED OVER ALL WATERMANS. TRACER WIRE SHALL BE TIED TO ALL FIRE HYDRANTS.
  - INSTALLATION OF A WATERMAIN PIPE CROSSING A SEWER PIPE SHALL BE AS PER CITY OF OTTAWA DETAILS W25 AND W22.
  - IF WATERMAIN PIPE MUST BE DEFLECTED TO MEET ALIGNMENT, ENSURE THAT THE AMOUNT OF DEFLECTION USED IS LESS THAN HALF THAT RECOMMENDED BY THE MANUFACTURER.
  - CATHODIC PROTECTION REQUIRED FOR ALL IRON FITTINGS AS PER OPSD 1109.011.
  - THRUST BLOCKS AND RESTRAINING AS PER OPSD 1103.010 AND OPSD 1103.020.
  - HYDRANT INSTALLATION AS PER OPSD 1105.010 AND OPSD 441. HYDRANT TO COMPLY WITH AWWA C502.
  - HYDRANTS MUST HAVE THREE EXITS (TWO 65.5 mm AND ONE 100.0 mm STORZ OF STAINLESS STEEL) WITHOUT DRAIN. FIRE HYDRANTS MUST BE INSTALLED SUCH THAT THE STORZ EXIT POINTS TOWARDS THE BUILDING IT WILL SERVICE. THE CONTRACTOR MUST ENSURE THAT THE BREAKAWAY FLANGE IS LOCATED ABOVE THE FINISHED GROUND (APPROXIMATELY 150 mm).
  - FIRE FLOW TESTS FOLLOWED BY COLOUR CODING OF HYDRANTS (AS PER NFPA-291) SHALL BE CARRIED OUT PRIOR TO SUBSTANTIAL COMPLETION OF THE WORK.
  - WATERMAIN AND HYDRANT CONTROL VALVES IN THE 100 - 300 mm RANGE WILL BE RESILIENT SEATING GATE VALVES (AWWA C509) WITH MECHANICAL JOINT CONNECTIONS. VALVES WILL OPERATE COUNTER-CLOCKWISE TO OPEN WITH A NON-RISING STEM. VALVES WILL BE COMPLETE WITH THE STANDARD AWWA 50 mm OPERATING NUT. VALVES TO BE INSTALLED AS PER OPSD 441.
  - PIPE FITTINGS (BENDS, TEES, CROSSES, REDUCERS, ETC.) WILL BE MECHANICAL JOINT (AWWA C-111) WITH CEMENT MORTAR LINING (AWWA C-104).
  - COUPLERS MUST BE COMPRESSION TYPE WITH MINIMUM PRESSURE RATING OF 1035 kPa. COUPLERS MUST BE MUELLER 11-12940.
  - VALVE BOXES MUST BE COMPLETE (FULLY METALLIC) 3 PIECE SLIDING TYPE WITH GUIDE PLATES.
  - WATERMANS MUST BE THOROUGHLY FLUSHED AND CLEANED TO REMOVE ALL DIRT AND DEBRIS PRIOR TO THE DISINFECTION PROCESS.
  - ALL WATERMANS SHALL BE HYDROSTATICALLY AND BACTERIOLOGICALLY TESTED AS PER PROVINCIAL AND MUNICIPAL REGULATIONS. IT IS THE CONTRACTOR'S RESPONSIBILITY TO ENSURE THAT ALL REQUIREMENTS ARE FOLLOWED.
  - THE DISINFECTION PROCEDURE WHICH FOLLOWS INITIAL FLUSHING AND CLEANING CONSISTS OF CHLORINATION, FINAL FLUSHING AND BACTERIOLOGICAL TESTING. DISINFECTION MUST BE PERFORMED BY THE CONTRACTOR USING METHODS APPROVED BY THE TOWN AND IN ACCORDANCE WITH MINISTRY OF ENVIRONMENT AND CLIMATE CHANGE GUIDELINES. DOSAGE MUST BE 100 ppm WITH A MINIMUM RESIDUAL OF 25 ppm AFTER 24 HOURS. DISINFECTANT MUST BE SUPPLIED BY THE CONTRACTOR AND MUST BE ANSI APPROVED. TESTING AND TEST RESULTS MUST BE WITNESSED BY TOWN PERSONNEL.
  - ALL DISINFECTANT WATER IS TO BE REMOVED FROM THE NEW WATERMANS AND REPLACED WITH DISTRIBUTION SYSTEM WATER PRIOR TO PRESSURE TESTING OF THE WATERMAIN.
  - PRESSURE TESTING OF ALL WATERMANS AND APPURTENANCES INSTALLED BY THE CONTRACTOR MUST BE PERFORMED BY THE CONTRACTOR USING METHODS MEETING THE APPROVAL OF THE TOWN. TESTING AND RESULTS MUST BE WITNESSED BY TOWN PERSONNEL.
  - MAINS AND SERVICES MUST BE PRESSURE TESTED AT 1035 kPa (150 psi) IN ACCORDANCE WITH AWWA C-600-82 (MINIMUM REQUIREMENT).
  - LEAKAGE TESTS MUST BE CONDUCTED AS PER AWWA C-600-82 (MINIMUM REQUIREMENT).
  - ONCE THE DISINFECTION AND PRESSURE TESTING RESULTS HAVE BEEN APPROVED, THE CONTRACTOR MUST ENSURE THAT ALL WATERMAIN PIPES ARE FLUSHED UNTIL THE CHLORINE LEVEL IN THE WATER IS SIMILAR TO THE LEVEL OF CHLORINE IN THE MUNICIPAL WATERMAIN NETWORK IN THE AREA.
  - BACTERIOLOGICAL TESTING MUST CONSIST OF TWO SAMPLINGS TWENTY FOUR HOURS APART. IF BACTERIOLOGICAL SAMPLES ARE SATISFACTORY THE WATERMAIN MAY BE PLACED ON LINE.
  - ALL WATERMAIN VALVES TO BE OPERATED BY THE MUNICIPALITY OF CASSELMAN ONLY.

- NOTES: SEWER**
- CONTRACTOR TO CONFIRM ELEVATION OF EXISTING STORM AND SANITARY SEWERS AT PROPOSED CONNECTION POINTS AND REPORT ANY DISCREPANCIES TO THE ENGINEER BEFORE COMMENCING ANY WORK.
  - ALL WORK SHALL BE PERFORMED, AS APPLICABLE IN ACCORDANCE WITH OPSD 407, AND 410.
  - PIPE MATERIAL TO BE PVC SDR-35 AND CONFORMING TO OPSD 1841, UNLESS INDICATED OTHERWISE. PVC SEWERS TO BE INSTALLED PER OPSD 802.010 (MODIFIED). BEDDING AND COVER MATERIALS TO BE OPSD 1010 GRANULAR 'A' CRUSHER-RUN LIMESTONE BEDDING COMPACTED TO 95% SPMD.
  - ALL SEWERS WITH LESS THAN 1.5 METERS OF COVER ARE SUBJECT TO INSULATION DETAIL 11 ON DRAWING C-104.
  - PIPE BACKFILL MATERIAL TO BE APPROVED NATIVE MATERIAL OR SELECT SUBGRADE MATERIAL IN CONFORMANCE WITH OPSD 212.
  - ALL MAINTENANCE HOLES AND CATCH BASIN MAINTENANCE HOLES TO BE 1200mmØ AS PER OPSD 701.010, UNLESS INDICATED OTHERWISE. MAINTENANCE HOLES AND CATCH BASIN MAINTENANCE HOLES TO BE INSTALLED PER OPSD 407.
  - ALL CATCH BASINS TO BE 600x900mm AS PER OPSD 105.010, UNLESS INDICATED OTHERWISE. CATCH BASINS TO BE INSTALLED PER OPSD 407.
  - EXCAVATING, BACKFILLING, AND COMPACTING REQUIRED FOR MAINTENANCE HOLES, CATCH BASIN MAINTENANCE HOLES, AND CATCH BASINS TO BE COMPLETED AS PER OPSD 402. THEY ARE TO BE BACKFILLED WITH OPSD GRANULAR 'B' COMPACTED TO 96% SPMD. JOINTS BETWEEN SECTIONS TO BE WRAPPED WITH NON-WOVEN GEOTEXTILE.
  - FOR SANITARY STRUCTURES: CAST IRON MAINTENANCE HOLE COVER AS PER OPSD 401.010 TYPE 'A'.
  - FOR STORM STRUCTURES: CAST IRON CATCH BASIN MAINTENANCE HOLE COVER AS PER OPSD 401.010 TYPE 'B' AND CAST IRON CATCH BASIN COVER AS PER OPSD 400.020.
  - SANITARY MAINTENANCE HOLES REQUIRE BENCHING AS PER OPSD 701.021.
  - THE CONTRACTOR IS RESPONSIBLE FOR MAKING OR ARRANGING ALL CONNECTIONS TO THE EXISTING SEWERS AS PER MUNICIPAL REQUIREMENTS. PRIOR TO CONNECTION, THE CONTRACTOR MUST PROVIDE, TO THE CONSULTANT / ENGINEER AND THE CITY FOR APPROVAL, ALL TEST RESULTS PERFORMED ON THE INTERNAL SERVICES.
  - ADVISE THE CITY PUBLIC WORKS AT LEAST 72 HOURS IN ADVANCE BEFORE ANY CONNECTION TO THE TOWN SERVICES. COORDINATE WITH TOWN AS REQUIRED. TERMINATE AND PLUG ALL SERVICE CONNECTIONS AT 1.0 m FROM EDGE OF THE BUILDING.
  - ALL SEWERS TO BE C.C.T.V. INSPECTED BY THE CONTRACTOR AS PER OPSD 409. TWO COPIES OF THE INSPECTION REPORT MUST BE PROVIDED TO THE CONSULTANT AND THE C.C.T.V. INSPECTION IN DVD FORMAT ONLY.
  - SUBDRAIN KNOCKOUT (KO) WILL BE PRE-MANUFACTURED WITH CATCH BASINS AND MAINTENANCE HOLES.
  - THE STORMWATER QUALITY REQUIREMENTS WILL BE ACHIEVED BY INSTALLING A STORMCEPTOR EF06 OR EQUIVALENT TO ACHIEVE MINIMUM 80% TSS REMOVAL. THE OILGRIT SEPARATOR IS TO HAVE A SEDIMENT CAPACITY OF 3470 L, AN OIL CAPACITY OF 810 L, AND FOR A MAXIMUM TREATMENT FLOW RATE OF 12 L/s.
  - ALL SEWERS WILL REQUIRE PERIODIC MAINTENANCE AND CLEANING AS PER MANUFACTURERS SPECIFICATIONS - TYPICAL CLEANING INTERVAL IS ONCE A YEAR.

- NOTES: UNDERGROUND STORMWATER STORAGE**
- UNDERGROUND STORMWATER STORAGE SYSTEM CHAMBER TYPE OR EQUIVALENT STORAGE REQUIREMENT: 185m³
  - CHAMBER TYPE: STORMTECH MC-7200 OR EQUIVALENT
  - GRANULAR PAD ELEVATION: 86.50m
  - TOP OF CHAMBER ELEVATION: 88.25m
  - TOP OF SYSTEM TO BE A MINIMUM OF 152mm BELOW PARKING LOT PAVEMENT STRUCTURE.

**ICD SCHEDULE (ORIFICE)**

ICD ID	LOCATION	ORIFICE INVERT (m)	FLOW 5y/100y (L/s)	HEAD 5y/100y (m)	EQUIVALENT DIAMETER (mm)	MODEL
1	MH-STM-02	86.30	5.9/3.3	0.76/1.93	55	VORTEX FLOW CONTROL

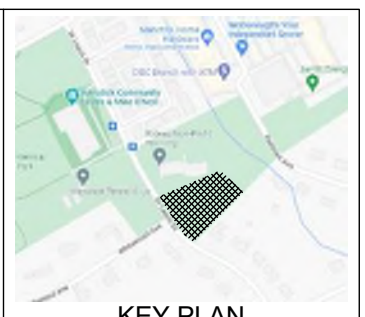

**REVISIONS**

No.	DATE	DESCRIPTION	BY

**PARSONS**  
1223 Michael Street, Suite 100, Ottawa, Ontario, Canada K1J 7T2  
Tel: (613) 738-4160 Fax: (613) 739-7105

CLIENT: CLV GROUP  
485 BANK STREET, SUITE 200  
OTTAWA, ON K2P 1Z2

PROJECT: MANOTICK AFFORDABLE SENIORS RESIDENCE

TITLE: SITE SERVICING PLAN

DESIGNED BY		PROJECT NO.	
DRAWN BY	J.B.		
CHECKED BY	M.T.	<b>C-102</b>	<b>SS</b>
DATE	JANUARY 2023	DRAWING NO.	
SCALE	1:300	DRAWING	

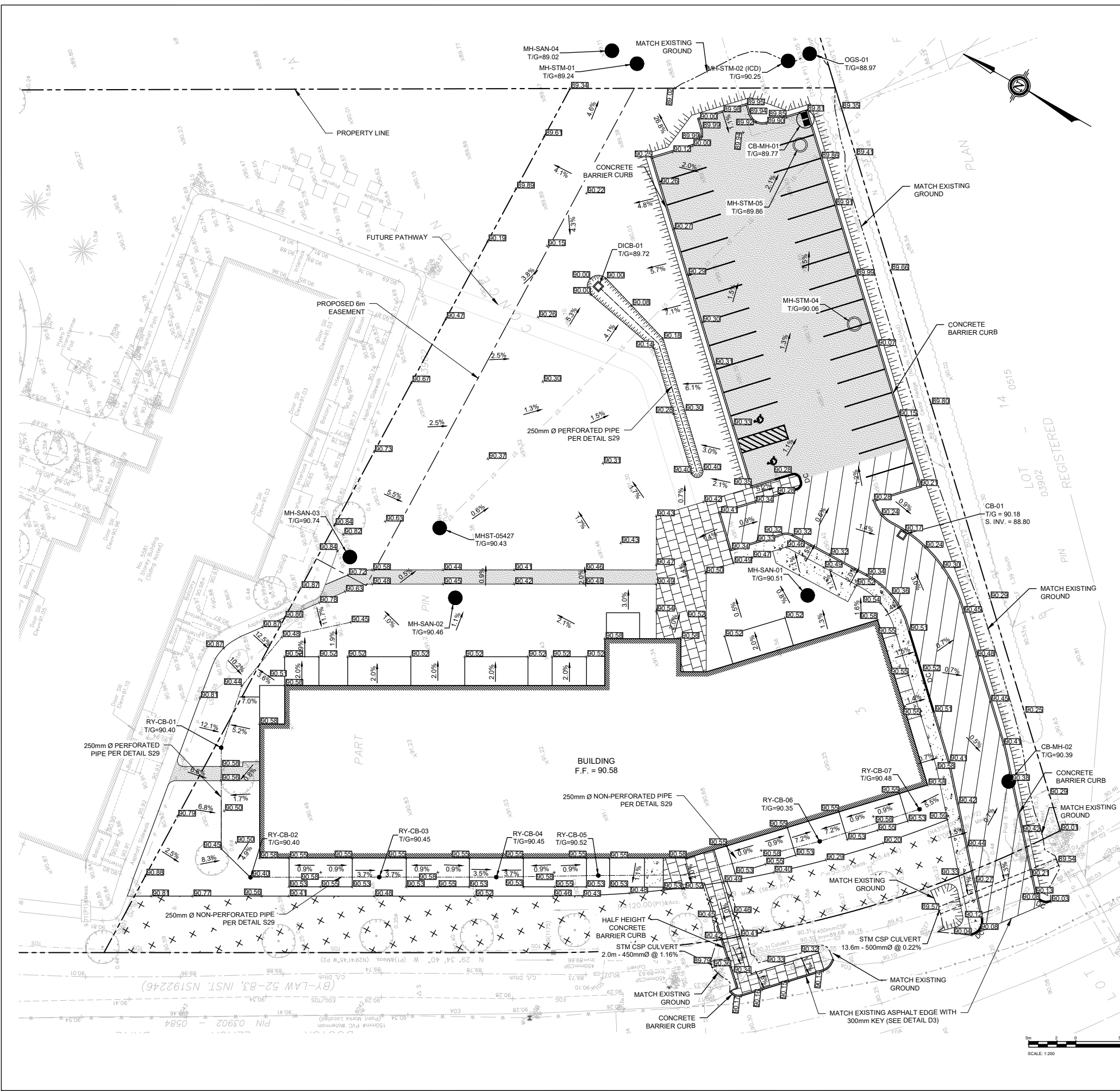

- LEGEND:**
- PROPOSED LIGHT DUTY PAVEMENT
  - PROPOSED HEAVY DUTY PAVEMENT
  - PROPOSED LANDSCAPE AREAS TO BE RE-GRADED
  - PROPOSED CONCRETE SIDEWALK
  - PROPOSED PAVERS
  - TREE ROOT ZONE - NO GRADING
  - NEW LANDSCAPING
  - EXISTING GRADE
  - PROPOSED GRADE
  - TOP OF WALL PROPOSED GRADE
  - PROPOSED DITCH CENTRELINE
  - LIMIT OF GRADING
  - PROPOSED MAINTENANCE HOLE
  - PROPOSED CATCH BASIN PER OPSD 705.010
  - PROPOSED DITCH INLET PER OPSD 705.030
  - EXISTING PROPERTY LINE
  - PROPOSED EASEMENT
  - TERRACE (3:1 MAX)
  - PROPOSED CONCRETE CURB
  - PROPOSED CONCRETE PARKING STOPS
  - PROPOSED DEPRESSED CONCRETE CURB
  - PROPOSED LIGHT STANDARD

PAVEMENT STRUCTURES		
MATERIAL	LIGHT DUTY	HEAVY DUTY
Asphaltic Concrete Surface Course: HL-3 (OPSS1150) (PG58-34)	35 mm	35 mm
Asphaltic Concrete Binder Course: HL-8 (OPSS 1150) (PG 58-34)	55 mm	85 mm
Granular Base: OPSS 1010 Granular A (crushed limestone)	150 mm	150 mm
Granular Sub-base: OPSS 1010 Granular B, Type II	300 mm	450 mm

FROM: GEOTECHNICAL INVESTIGATION, PROPOSED RESIDENTIAL DEVELOPMENT, 5581 DOCTOR LEACH DRIVE, OTTAWA, ONTARIO, BY PINCHIN LTD. DATED OCTOBER 12, 2022

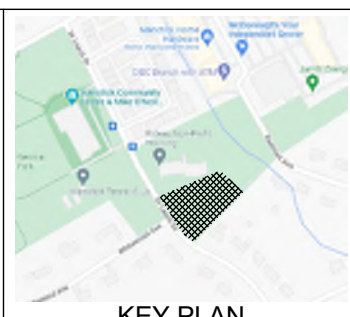

KEY PLAN

No.	DATE	DESCRIPTION	BY
REVISIONS			

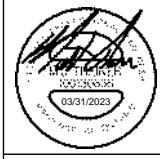

CLIENT  
**CLV GROUP**  
 485 BANK STREET, SUITE 200  
 OTTAWA, ON K2P 1Z2

PROJECT  
**MANOTICK AFFORDABLE  
 SENIORS RESIDENCE**

TITLE  
**GRADING PLAN**

DESIGNED BY	PROJECT NO.	C-103	GR
DRAWN BY	J.B.		
CHECKED BY	M.T.	JANUARY 2023	DRAWING NO.
DATE			
SCALE	1:200	DRAWING	





KEY PLAN

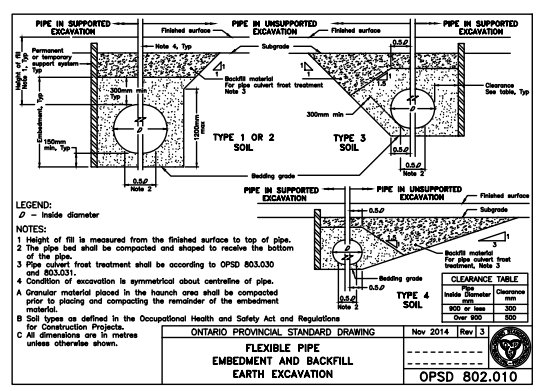
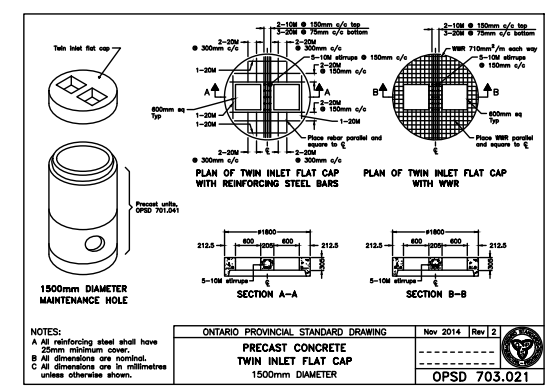
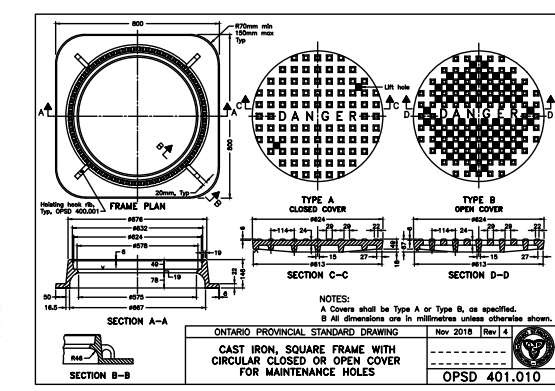
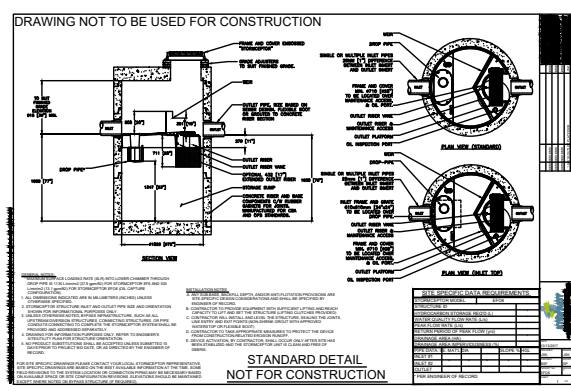
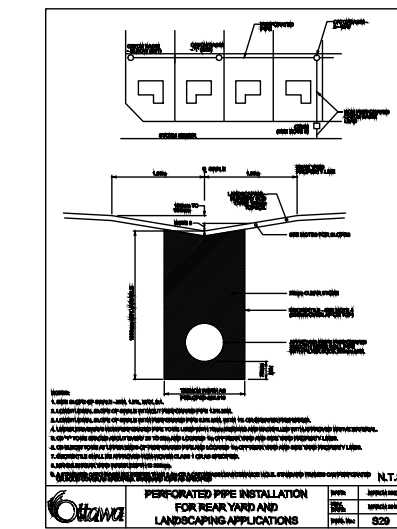
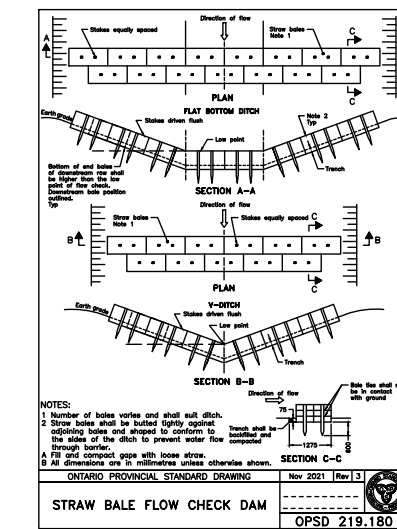
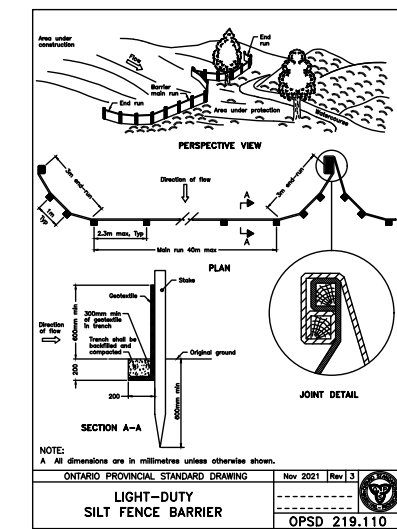
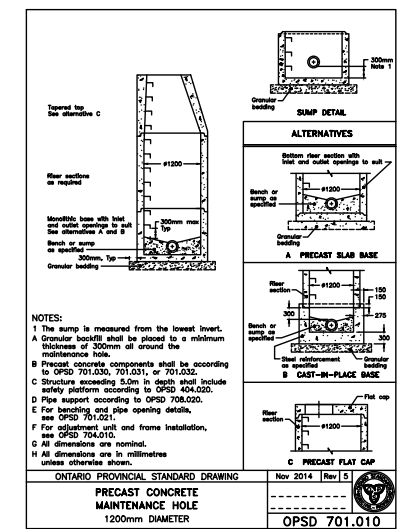
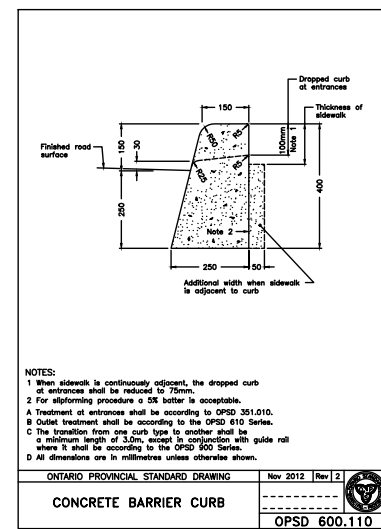
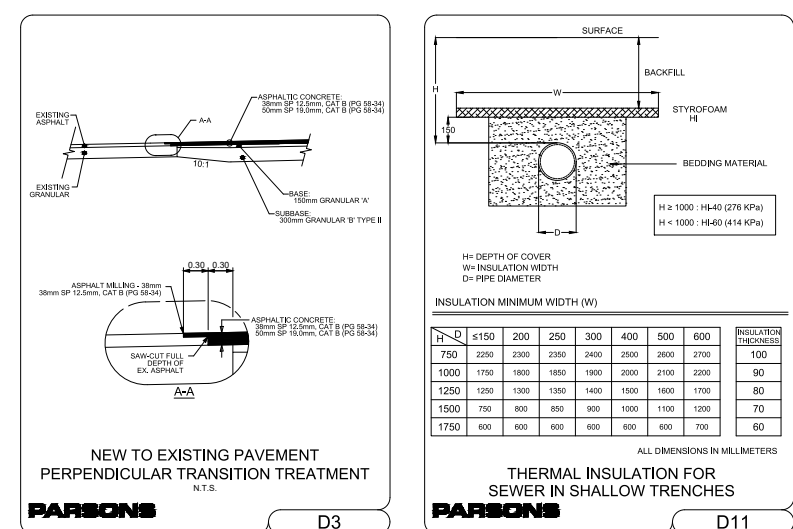

No.	DATE	DESCRIPTION	BY

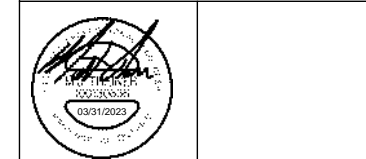

**PARSONS**  
1223 Michael Street, Suite 100, Ottawa, Ontario, Canada K1J 7J2  
Tel: (613) 738-4160 Fax: (613) 738-7105

CLIENT  
**CLV GROUP**  
485 BANK STREET, SUITE 200  
OTTAWA, ON K2P 1Z2

PROJECT  
**MANOTICK AFFORDABLE SENIORS RESIDENCE**

TITLE  
**DETAILS**

DESIGNED BY	PROJECT NO.	C-104	DET
DRAWN BY	J.B.		
CHECKED BY	M.T.	JANUARY 2023	
DATE			
SCALE	N.T.S.	DRAWING NO.	DRAWING

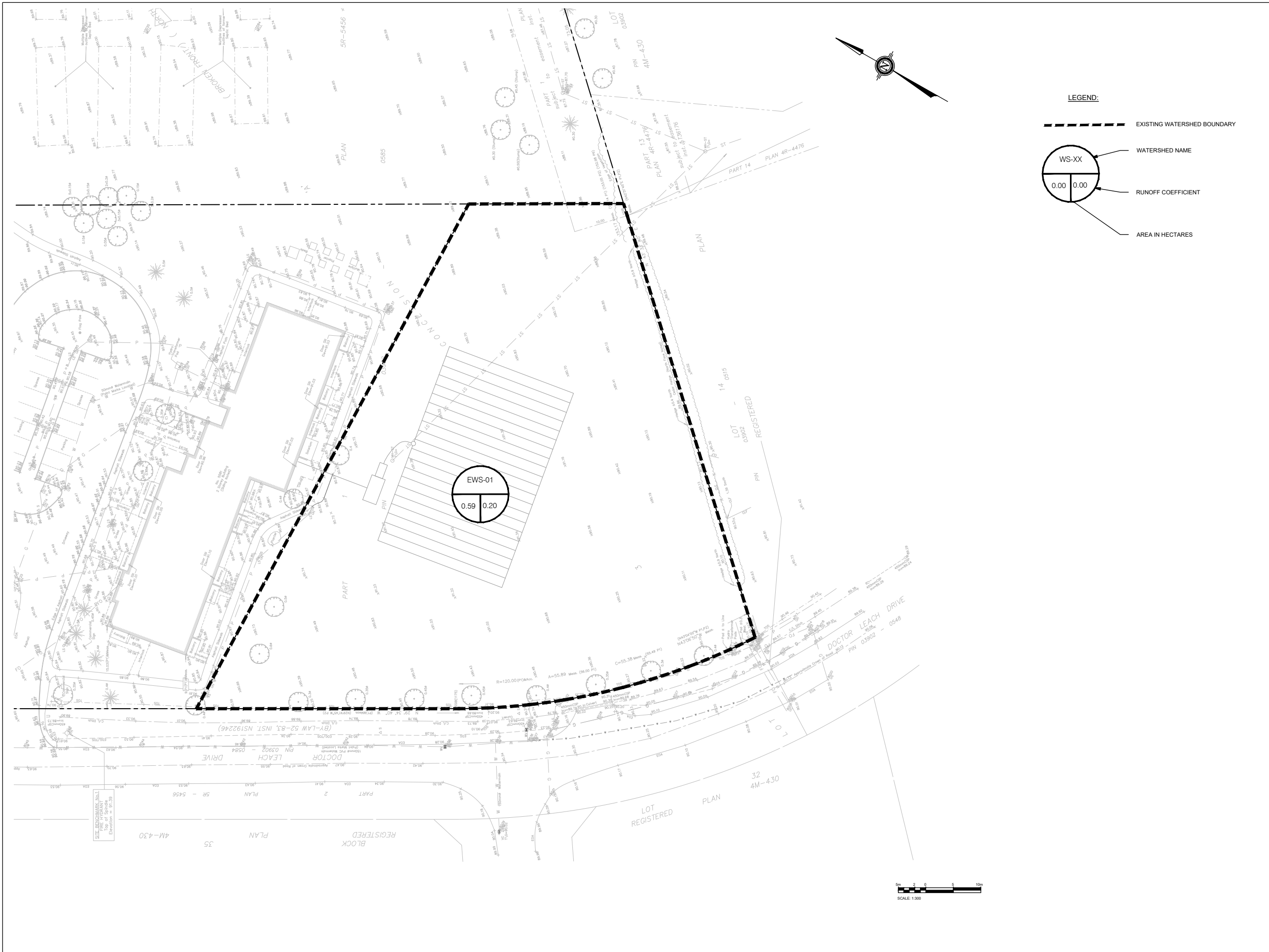

KEY PLAN

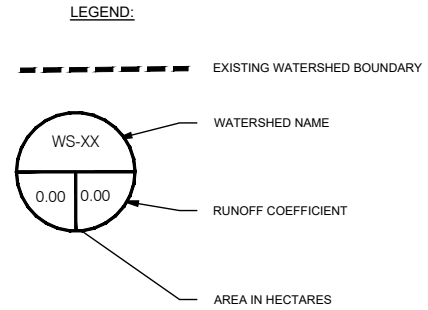

No.	DATE	DESCRIPTION	BY



CLIENT  
**CLV GROUP**  
 485 BANK STREET, SUITE 200  
 OTTAWA, ON K2P 1Z2

PROJECT  
**MANOTICK AFFORDABLE SENIORS RESIDENCE**

TITLE  
**PRE-DEVELOPMENT DRAINAGE PLAN**

DESIGNED BY -	PROJECT NO.
DRAWN BY J.B.	<b>C-105</b>
CHECKED BY M.T.	
DATE JANUARY 2023	<b>PRE</b>
SCALE 1:300	DRAWING NO. / DRAWING

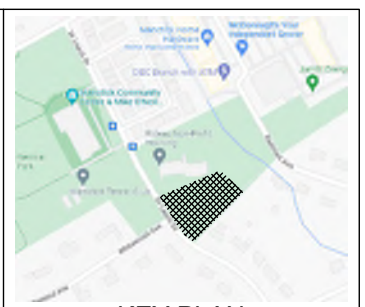
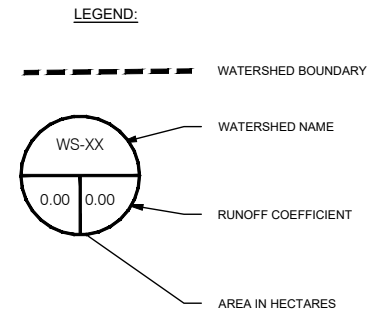
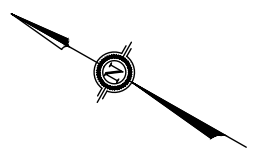
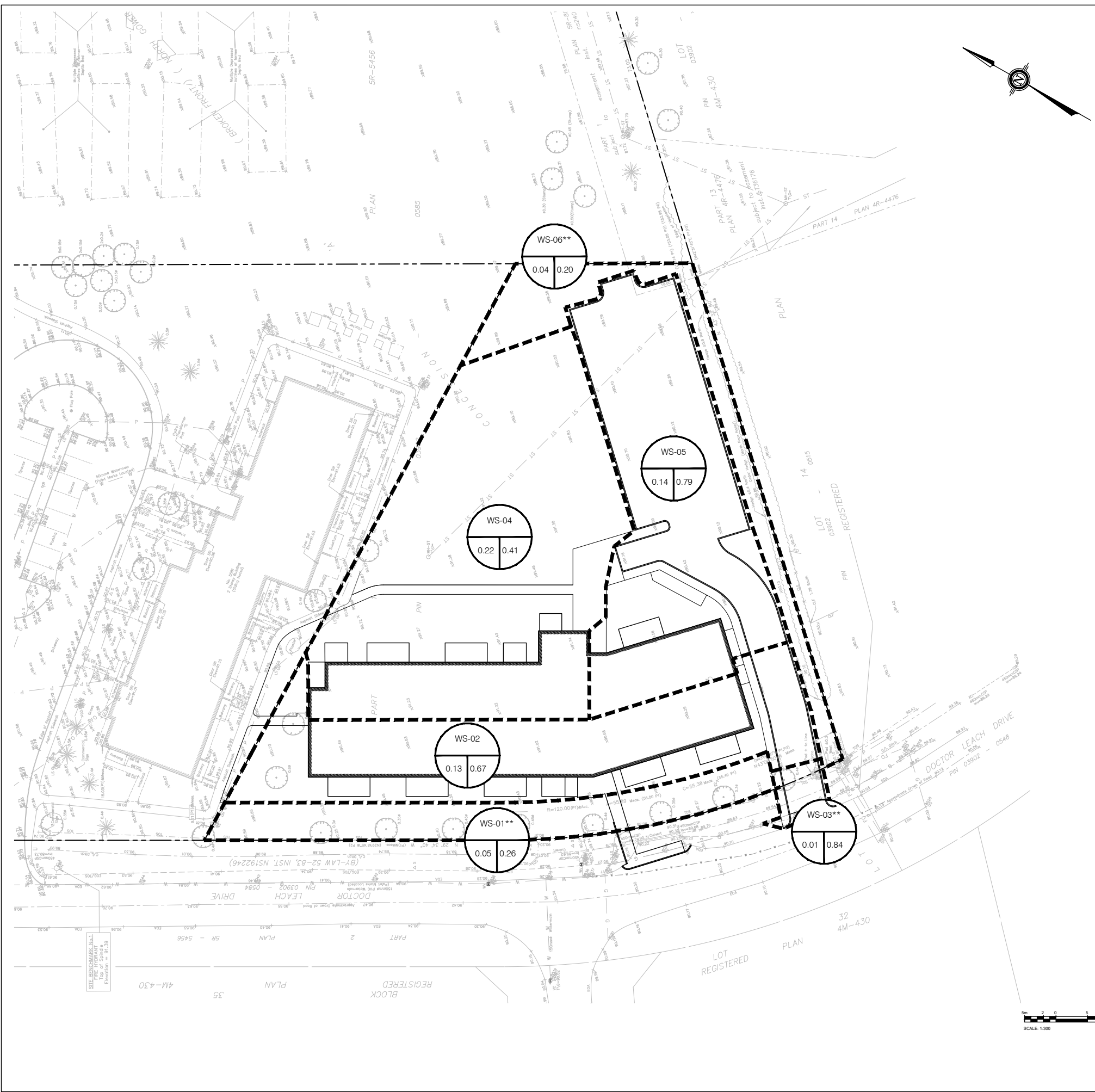

No.	DATE	DESCRIPTION	BY

No.	DATE	DESCRIPTION	BY

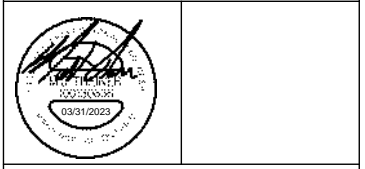

CLIENT  
**CLV GROUP**  
 485 BANK STREET, SUITE 200  
 OTTAWA, ON K2P 1Z2

PROJECT  
**MANOTICK AFFORDABLE SENIORS RESIDENCE**

TITLE  
**POST-DEVELOPMENT DRAINAGE PLAN**

DESIGNED BY	PROJECT NO.	<b>C-106</b>	<b>POST</b>
DRAWN BY	J.B.		
CHECKED BY	M.T.	<b>1:300</b>	DRAWING NO. DRAWING
DATE	JANUARY 2023		
SCALE	1:300		