

3850 Cambrian Road

Transportation Impact Assessment

Step 1 Screening Report

Step 2 Scoping Report

Step 3 Forecasting Report

Step 4 Strategy Report (Rev #1)

Prepared for:

Choice Properties Limited Partnership
700-22 St Clair Ave E
Toronto ON, M4T 2S5

Prepared by:



6 Plaza Court
Ottawa, ON K2H 7W1

October 2023

PN: 2022-066

Table of Contents

1	Screening.....	1
2	Existing and Planned Conditions.....	1
2.1	Proposed Development.....	1
2.2	Existing Conditions.....	3
2.2.1	Area Road Network.....	3
2.2.2	Existing Intersections.....	3
2.2.3	Existing Driveways.....	3
2.2.4	Cycling and Pedestrian Facilities.....	3
2.2.5	Existing Transit.....	5
2.2.6	Existing Area Traffic Management Measures.....	6
2.2.7	Existing Peak Hour Travel Demand.....	6
2.2.8	Collision Analysis.....	8
2.3	Planned Conditions.....	9
2.3.1	Changes to the Area Transportation Network.....	9
2.3.2	Other Study Area Developments.....	9
3	Study Area and Time Periods.....	11
3.1	Study Area.....	11
3.2	Time Periods.....	11
3.3	Horizon Years.....	11
4	Exemption Review.....	11
5	Development-Generated Travel Demand.....	12
5.1	Mode Shares.....	12
5.2	Trip Generation.....	12
5.3	Trip Distribution.....	14
5.4	Trip Assignment.....	14
6	Background Network Travel Demands.....	16
6.1	Transportation Network Plans.....	16
6.2	Background Growth.....	16
6.3	Other Developments.....	17
7	Demand Rationalization.....	18
7.1	2024 Future Background Operations.....	18
7.2	2029 Future Background Operations.....	19
7.3	2024 Future Total Operations.....	21
7.4	2029 Future Total Operations.....	22
7.5	Modal Share Sensitivity and Demand Rationalization Conclusions.....	24
7.5.1	Network Rationalization.....	24
7.5.2	Development Rationalization.....	24
8	Development Design.....	24
8.1	Design for Sustainable Modes.....	24
8.2	Circulation and Access.....	24
9	Parking.....	25
9.1	Parking Supply.....	25

10	Boundary Street Design.....	26
11	Access Intersections Design	26
11.1	Location and Design of Access.....	26
11.2	Intersection Control.....	27
11.3	Access Intersection Design	27
11.3.1	Future Access Intersection Operations	27
11.3.2	Access Intersection MMLOS	27
11.3.3	Recommended Design Elements.....	27
12	Transportation Demand Management	27
12.1	Context for TDM	27
12.2	Need and Opportunity.....	27
12.3	TDM Program	27
13	Transit.....	27
13.1	Route Capacity.....	27
13.2	Transit Priority	28
14	Network Intersection Design.....	28
14.1	Network Intersection Control.....	28
14.2	Network Intersection Design.....	28
14.2.1	2024 & 2029 Future Total Network Intersection Operations	28
14.2.2	Network Intersection MMLOS.....	28
14.2.3	Recommended Design Elements.....	28
15	Summary of Improvements Indicated and Modifications Options.....	29
16	Conclusion	32

List of Figures

Figure 1: Area Context Plan.....	1
Figure 2: Concept Plan.....	2
Figure 3: Study Area Pedestrian Facilities	4
Figure 4: Study Area Cycling Facilities	4
Figure 5: Existing Pedestrian Volumes	5
Figure 6: Existing Cyclist Volumes	5
Figure 7: Existing Study Area Transit Service.....	6
Figure 8: Existing Study Area Transit Stops - Within 400 metres.....	6
Figure 9: Existing Traffic Counts	7
Figure 10: Representation of Study Area Collision Records.....	8
Figure 11: New Site Generation Auto Volumes.....	15
Figure 12: Pass-by Volumes.....	15
Figure 13: New Site Generation, Pass-by, ana Diverted Trip – Beyond 2031 (informational only)	16
Figure 14: 2024 Total Background Development Volumes.....	17
Figure 15: 2029 Total Background Development Volumes.....	18
Figure 16: 2024 Future Background Volumes	18
Figure 17: 2029 Future Background Volumes	20
Figure 18: 2024 Future Total Volumes	21

Figure 19: 2029 Future Total Volumes 23

Table of Tables

Table 1: Intersection Count Date.....7
 Table 2: Existing Intersection Operations.....7
 Table 3: Study Area Collision Summary, 2016-20208
 Table 4: Summary of Collision Locations, 2016-2020.....8
 Table 5: Exemption Review 11
 Table 6: TRANS Trip Generation Manual Recommended Mode Shares – South Nepean 12
 Table 7: Trip Generation Person Trip Rates by Peak Hour 12
 Table 8: Total Person Trip Generation by Peak Hour 13
 Table 9: Trip Generation by Mode 13
 Table 10: Local Barrhaven South Distribution 14
 Table 11: Trip Assignment 14
 Table 12: 2024 Future Background Intersection Operations 19
 Table 13: 2029 Future Background Intersection Operations 20
 Table 14: 2024 Future Total Intersection Operations 21
 Table 15: 2029 Future Total Intersection Operations 23
 Table 16: Boundary Street MMLOS Analysis 26
 Table 17: Trip Generation by Transit Mode 27
 Table 18: Study Area Intersection MMLOS Analysis 28

List of Appendices

Appendix A – TIA Screening Form and Certification Form
 Appendix B – Turning Movement Count Data
 Appendix C – Synchro Intersection Worksheets – Existing Conditions
 Appendix D – Collision Data
 Appendix E – Greenbank Road and South West Transitway Extension Preliminary Design
 Appendix F – Background Development Volumes
 Appendix G – Synchro Intersection Worksheets – 2024 Future Background Conditions
 Appendix H – Signal Warrant Calculation Sheet
 Appendix I – Synchro Intersection Worksheets – 2029 Future Background Conditions
 Appendix J – Synchro Intersection Worksheets – 2024 Future Total Conditions
 Appendix K – Synchro Intersection Worksheets – 2029 Future Total Conditions
 Appendix L – Turning Templates
 Appendix M – TDM Checklist
 Appendix N – MMLOS Worksheets

1 Screening

This study has been prepared according to the City of Ottawa’s 2017 Transportation Impact Assessment (TIA) Guidelines, prior to the June 2023 updates. Accordingly, a Step 1 Screening Form has been prepared and is included as Appendix A, along with the Certification Form for the TIA Study PM. As shown in the Screening Form, a TIA is required including the Design Review component and the Network Impact Component. This study has been prepared to support a site plan application.

2 Existing and Planned Conditions

2.1 Proposed Development

The existing site, located at 3850 Cambrian Road, is zoned as General Mixed Use Zone (GM[1628]). The proposed development consists of a gross floor area of 17,000 sq.ft pharmacy and gross leasable area of 18,781 sq.ft retail buildings. A total of 121 surface vehicle parking spaces and 18 surface bicycle parking spaces are proposed. The concept plan includes one new full-movement access on Cambrian Road in the interim condition. In the ultimate condition, two right-in/right-out accesses are proposed on Re-Aligned Greenbank Road corridor, and the access on Cambrian Road will be right-in/right-out. The ultimate condition is beyond the study horizon year and are not included in this report. The anticipated full build-out and occupancy horizon is 2024 with construction occurring in a single phase. The site is located within the Barrhaven South Community Design Plan area and Barrhaven South Community Core design priority area. Figure 1 illustrates the study area context. Figure 2 illustrates the proposed concept plan.

Figure 1: Area Context Plan

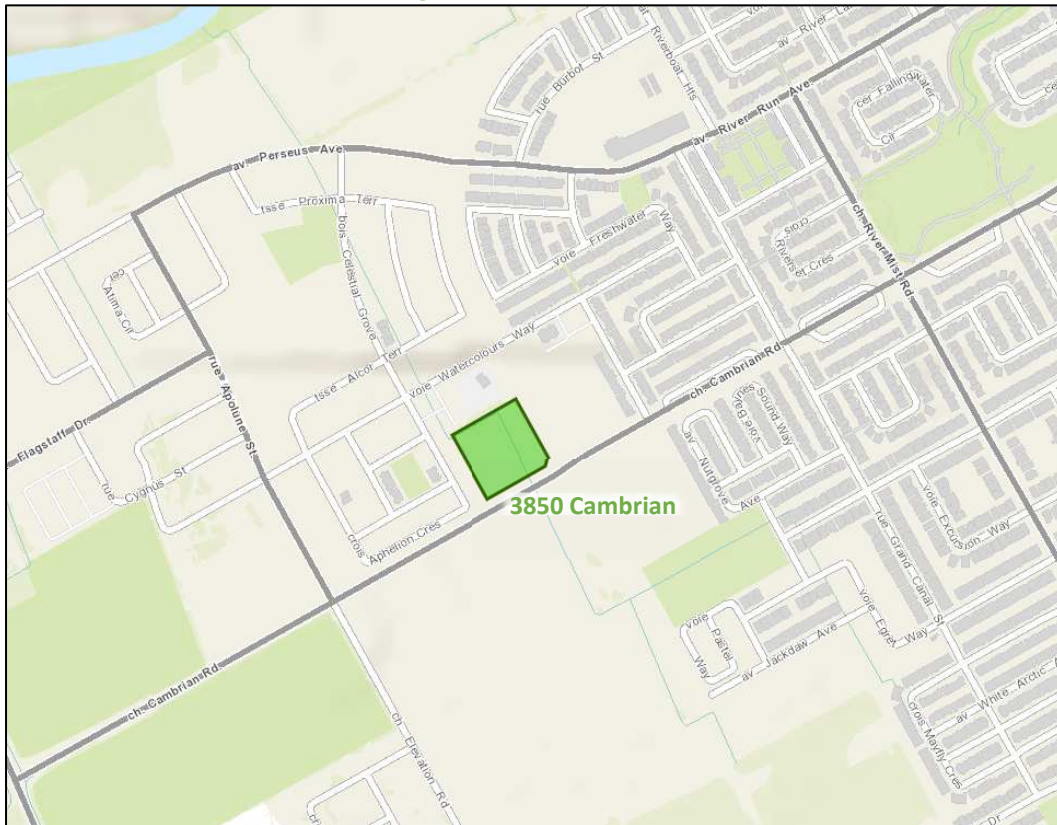

Source: <http://maps.ottawa.ca/geoOttawa/> Accessed: July 28, 2022

Figure 2: Concept Plan

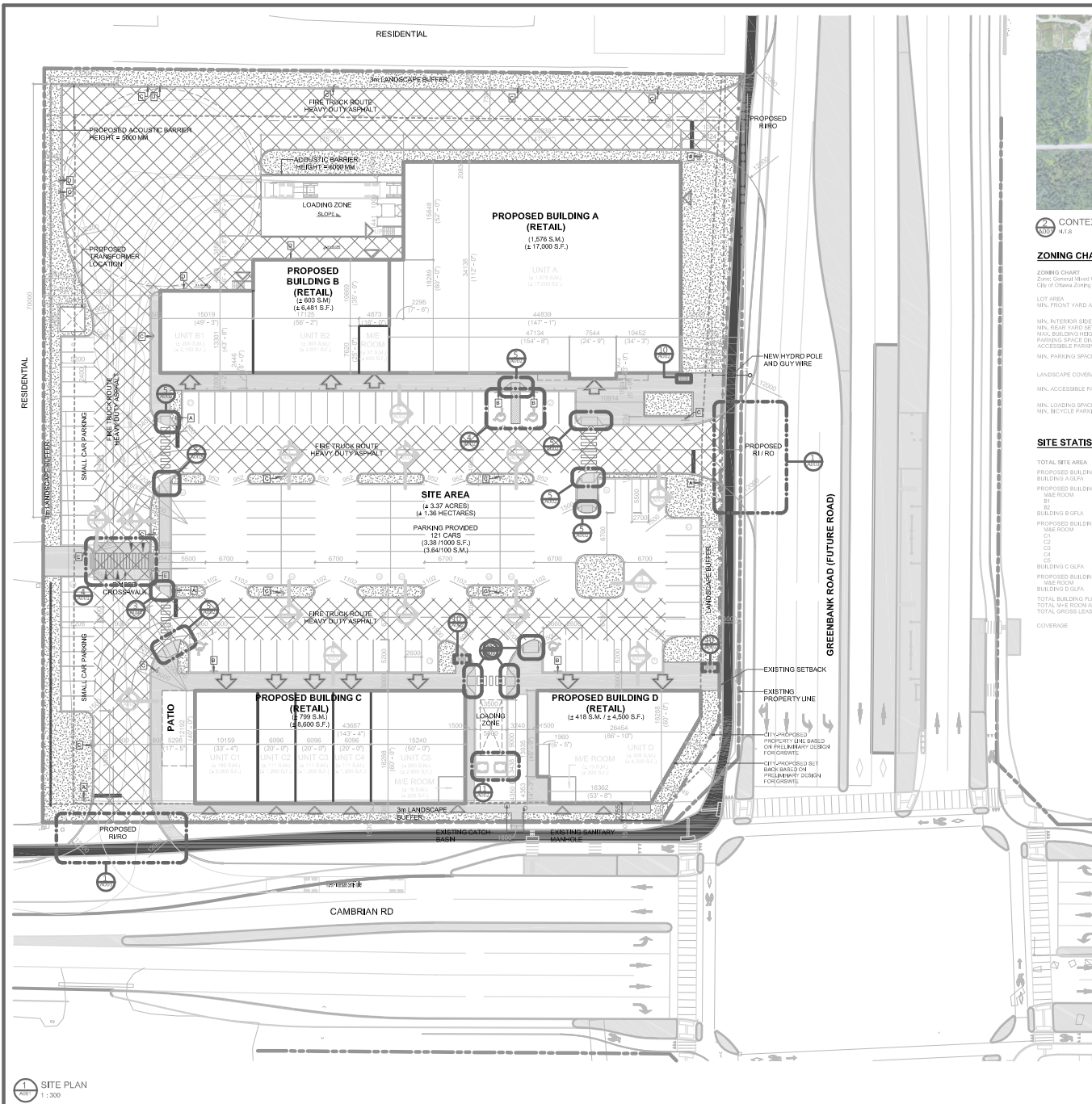

CONTEXT PLAN

ZONING CHART

ZONING CHART	REQUIRED	PROPOSED
Zone General Mixed Use (GM1650)		Indicates non-compliance
City of Ottawa Zoning By-Law No. 2006-20		
LOT AREA	NO MINIMUM	13,637 S.M.
MIN. FRONT YARD AND CORNER SIDE YARD SETBACK	3.0M	3.0M (ALONG CAMBRIAN ROAD) 3.20M (ALONG RELEASED GREENBANK ROAD)
MIN. INTERIOR SIDE YARD SETBACK	5.0M	14.0M (WEST SIDE) 14.0M (NORTH SIDE)
MIN. REAR YARD SETBACK	7.0M	2.7M x 5.5M
MAX. BUILDING HEIGHT	20.0M (MIN. 3.1M (MAX) WIDE x 0.2M LONG	
PARKING SPACE DIMENSIONS	3.00M	
ACCESSIBLE PARKING DIMENSIONS		
MIN. PARKING SPACES		121 CARS 3,361 S.Q.F. S.F. 3,641 S.Q. S.M.
LANDSCAPE COVERAGE		15.0%
MIN. ACCESSIBLE PARKING SPACE	4 SPACES	
AS PER THE TRAFFIC AND PARKING BY-LAW		
MIN. LOADING SPACES	1 (1.0M X 3.0M)	2
MIN. BICYCLE PARKING SPACES		
	8 SPACES	18 SPACES
		SHOPPING CENTRE: 1 SPACE PER 500 S.Q. G.L.E.A.

SITE STATISTICS

SYMBOL	SIGN	DESCRIPTION
A	STOP	STOP SIGN REPLACE EXISTING STOP SIGN WITH NEW LEGAL SIGN, RECYCLED MATERIAL, 600MM DIA.
B	YIELD	YIELD SIGN REPLACE EXISTING YIELD SIGN WITH NEW LEGAL SIGN, RECYCLED MATERIAL, 600MM DIA.
C	ONE WAY	ONE WAY SIGN REPLACE EXISTING ONE WAY SIGN WITH NEW LEGAL SIGN, RECYCLED MATERIAL, 600MM DIA.
D	NO LEFT TURN	NO LEFT TURN SIGN REPLACE EXISTING NO LEFT TURN SIGN WITH NEW LEGAL SIGN, RECYCLED MATERIAL, 600MM DIA.
E	TRUCK STOP	TRUCK STOP SIGN REPLACE EXISTING TRUCK STOP SIGN WITH NEW LEGAL SIGN, RECYCLED MATERIAL, 600MM DIA.

TOTAL SITE AREA	23.37 ACRES	31.36 HA.
PROPOSED BUILDING A AREA	417,000 S.F.	41,579 S.M.
BUILDING A G.L.F.A.	417,000 S.F.	41,579 S.M.
PROPOSED BUILDING B AREA	45,451 S.F.	4,202 S.M.
ME ROOM	4,400 S.F.	407 S.M.
BI	42,150 S.F.	4,005 S.M.
BUILDING B G.L.F.A.	45,451 S.F.	4,202 S.M.
PROPOSED BUILDING C AREA	45,000 S.F.	4,195 S.M.
LANDSCAPE	42,000 S.F.	4,195 S.M.
CI	41,200 S.F.	4,111 S.M.
CS	41,200 S.F.	4,111 S.M.
CD	41,200 S.F.	4,111 S.M.
BUILDING C G.L.F.A.	45,000 S.F.	4,195 S.M.
PROPOSED BUILDING D AREA	45,000 S.F.	4,195 S.M.
ME ROOM	42,000 S.F.	4,195 S.M.
BUILDING D G.L.F.A.	45,000 S.F.	4,195 S.M.
TOTAL BUILDING FLOOR AREA	436,581 S.F.	43,398 S.M.
TOTAL ME ROOM AREA	48,000 S.F.	4,474 S.M.
TOTAL GROSS LEASABLE FLOOR AREA	484,581 S.F.	47,872 S.M.
COVERAGE		24.0%

RAISED CROSSWALK - TYPICAL SECTION DETAIL

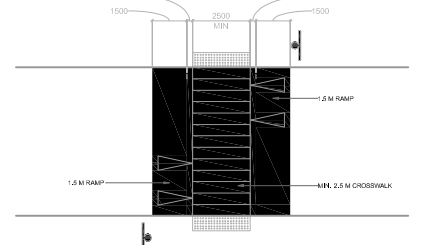

RAISED CROSSWALK - TYPICAL PLAN DETAIL



Turner Fleischer Architects Inc.
 87, 88th Street
 Toronto, Ontario M2N 6L1
 Tel: 416-442-2222
 Fax: 416-442-2223

SITE PLAN LEGEND

- PROPOSED ENTRANCE ARROW
- PROPOSED EXIT ARROW
- PROPOSED FIRE HYDRANT
- PROPOSED TRAILER CONNECTION
- PROPOSED BIKE
- PROPOSED FIRE & TRUCK ROUTE (HEAVY DUTY ASPHALT)
- PROPOSED CONCRETE SUBWALK
- PROPOSED LANDSCAPING
- PROPOSED PAINTED LINES
- PAINTED LINE FOR STOP SIGN



PROPOSED COMMERCIAL RETAIL PLAZA
 3850 CAMBRIAN ROAD,
 BARRHAVEN, ONTARIO

SITE PLAN

PROJECT NO.	21-327701
PROVISION	2023-07-27
DRAWN BY	BSH
CHECKED BY	DEM
SCALE	As Indicated
DATE	
PROJECT NO.	A001
REV.	2

1 SITE PLAN
 1:300

2.2 Existing Conditions

2.2.1 Area Road Network

Cambrian Road: Cambrian Road is a City of Ottawa arterial road. West of Seeley's Bay Street, it is two-lane rural cross-section with gravel shoulders present on both sides of the road. East of Seeley's Bay Street, it is two-lane urban cross-section with sidewalks on both sides of the road. The posted speed limit is 50 km/h within the study area, and the City-protected right-of-way is 37.5 metres.

River Mist Road: River Mist Road is a City of Ottawa collector road with a two-lane urban cross-section. Sidewalks are presented on both sides of the road. The unposted speed limit is assumed to be 50 km/hr, and the measured right-of-way is approximately 24.0 metres.

Apolune Street: Apolune Street is a City of Ottawa collector road with a two-lane urban cross-section including on-street parking and sidewalks on both sides of the road. The unposted speed limit is assumed to be 50 km/h and the measured right-of-way is 24.0 metres.

2.2.2 Existing Intersections

The key existing intersections within one kilometre of the site have been summarized below:

<i>Cambrian Road at River Mist Road</i>	The intersection of Cambrian Road at River Mist Road is an all-way stop-controlled intersection. Each approach consists of a shared all-movement lane. No turn restrictions were noted.
<i>Cambrian Road at Apolune Street</i>	The intersection of Cambrian Road at Apolune Street is a T intersection with stop-control on Apolune Street. The southbound approach consists of a shared left-turn/right-turn lane. The eastbound approach consists of an auxiliary left-turn lane and a through lane, and the westbound approach consists of a shared through/right-turn lane. No turn restrictions are noted.

2.2.3 Existing Driveways

Construction accesses are located within 200 metres of the future site access intersections. As these are temporary or minor in nature and are not expected to provide access to significant traffic generators, they are not anticipated to have an impact on this TIA.

2.2.4 Cycling and Pedestrian Facilities

Figure 3 illustrates the pedestrian facilities in the study area and Figure 4 illustrates the cycling facilities.

Sidewalks are provided on both sides of Cambrian Road east of Seeley's Bay Street, River Mist Road, and Apolune Street. An approximate 760-metre sidewalk is provided on the north side of Cambrian Road west of Seeley's Bay Street. Paved shoulders are provided on both sides along Cambrian Road between Borrisokane Road and Cambrian Road at Apolune Street/Elevation Road.

In the ultimate cycling network, the Re-Aligned Greenbank Road will be a spine cycling route, and Cambrian Road, Apolune Street, and River Mist Road are local routes. South of Cambrian Road, Apolune Street will continue as Elevation Road, is a local route, and is anticipated to include multi-use pathways. The Transportation Master Plan Part 1 identifies Re-Aligned Greenbank Road for designation as a cross-town bikeway.

Figure 3: Study Area Pedestrian Facilities

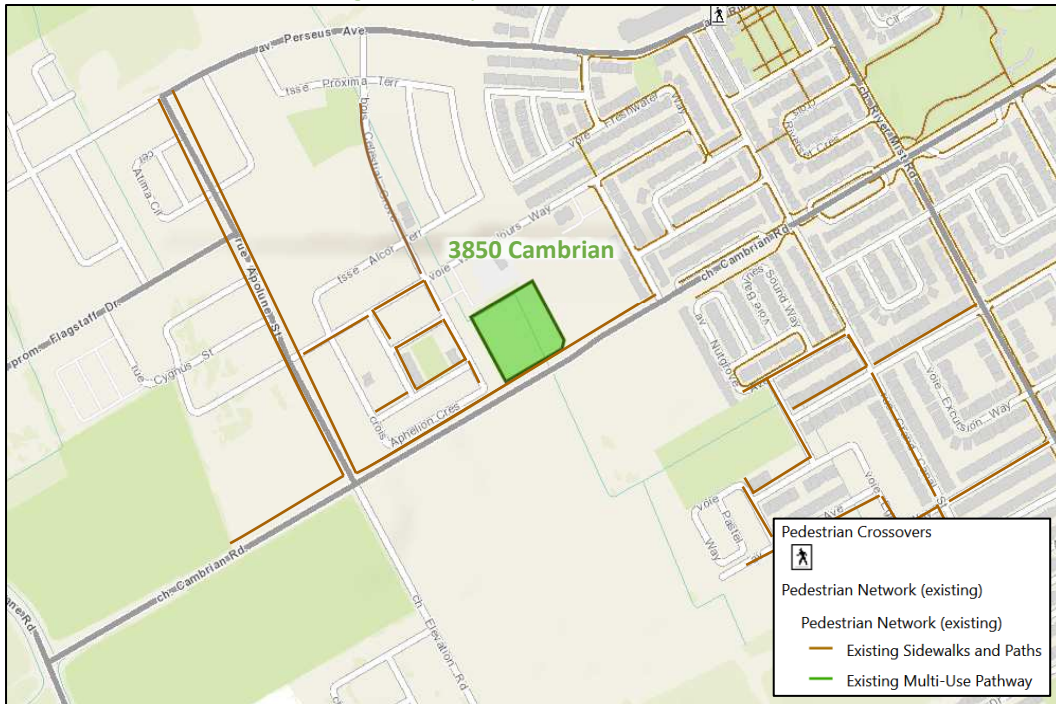

Source: <http://maps.ottawa.ca/geoOttawa/> Accessed: July 28, 2022

Figure 4: Study Area Cycling Facilities

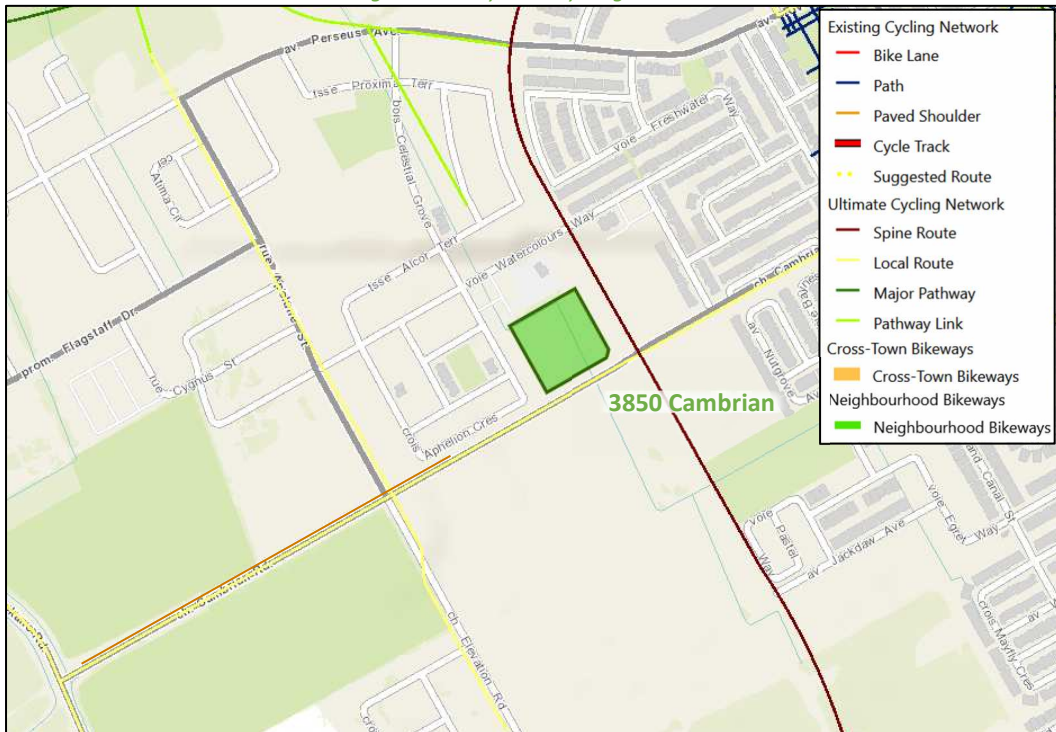

Source: <http://maps.ottawa.ca/geoOttawa/> Accessed: July 28, 2022

Pedestrian and cyclist volumes included in study area intersection counts, presented in Section 2.2.7, have been compiled and are illustrated in Figure 5 and Figure 6, respectively.

Figure 5: Existing Pedestrian Volumes

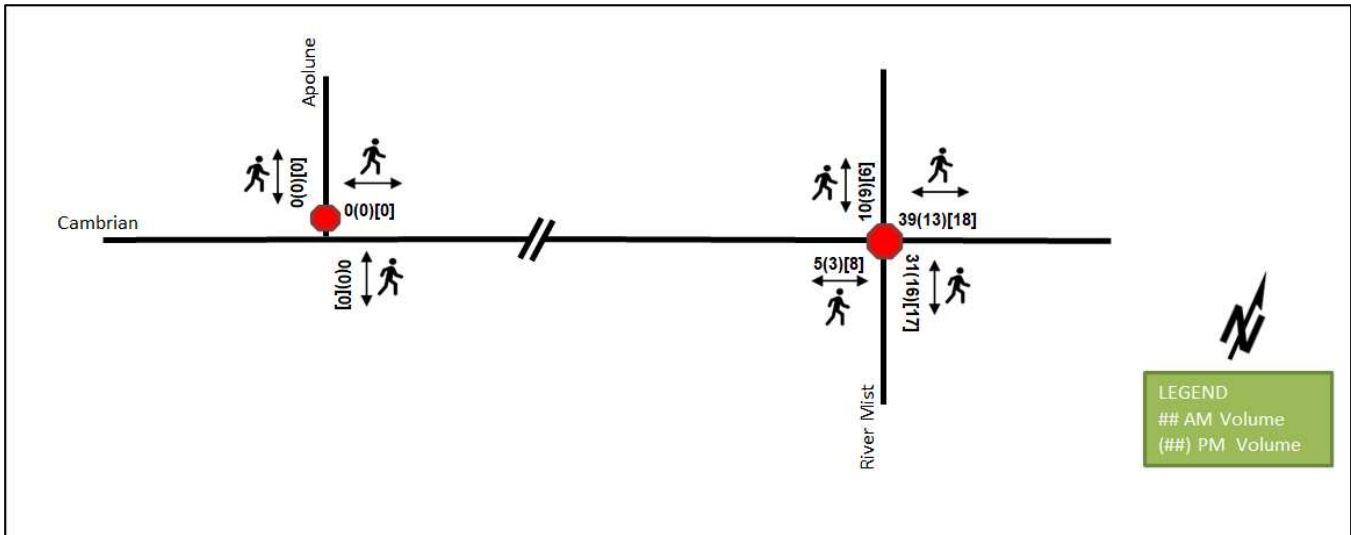
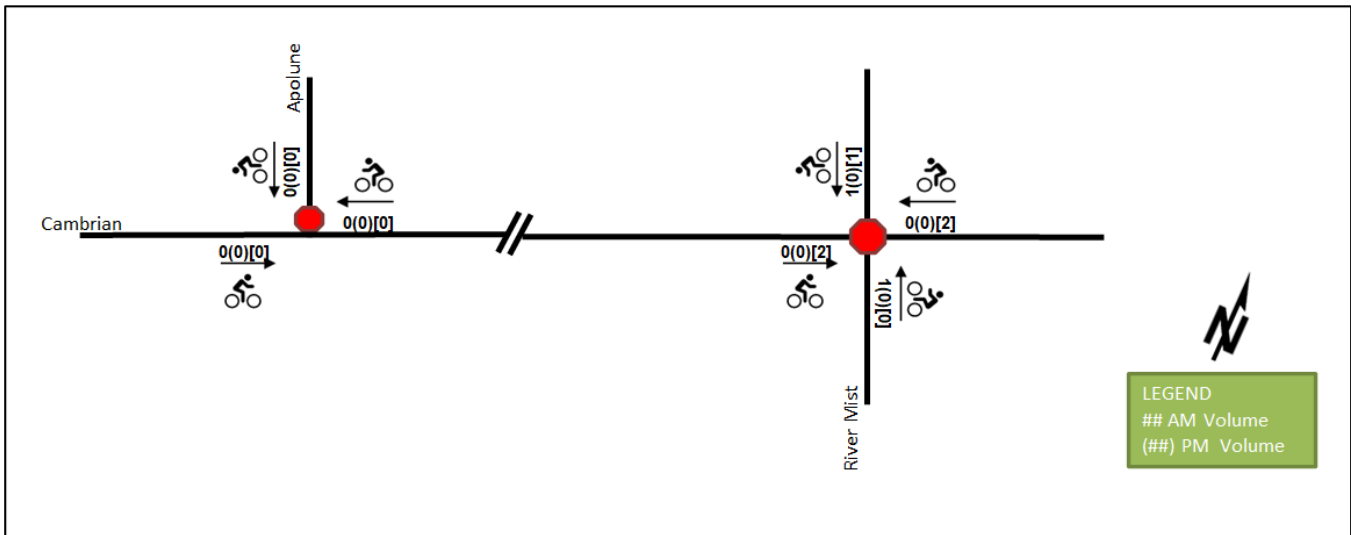

Figure 6: Existing Cyclist Volumes



2.2.5 Existing Transit

Figure 7 illustrates the transit system map in the study area and Figure 8 illustrates nearby transit stops. All transit information is from June 7, 2022 and is included for general information purposes and context to the surrounding area.

Within the study area, route #75 travels along Cambrian Road and River Mist Road. The frequency of these routes within proximity of the proposed site based on June 7, 2022 service levels are:

- Route # 75 – 10-minute service in the peak period/direction and 15-minute service all-day, 30-minute service after 8 PM

Figure 7: Existing Study Area Transit Service

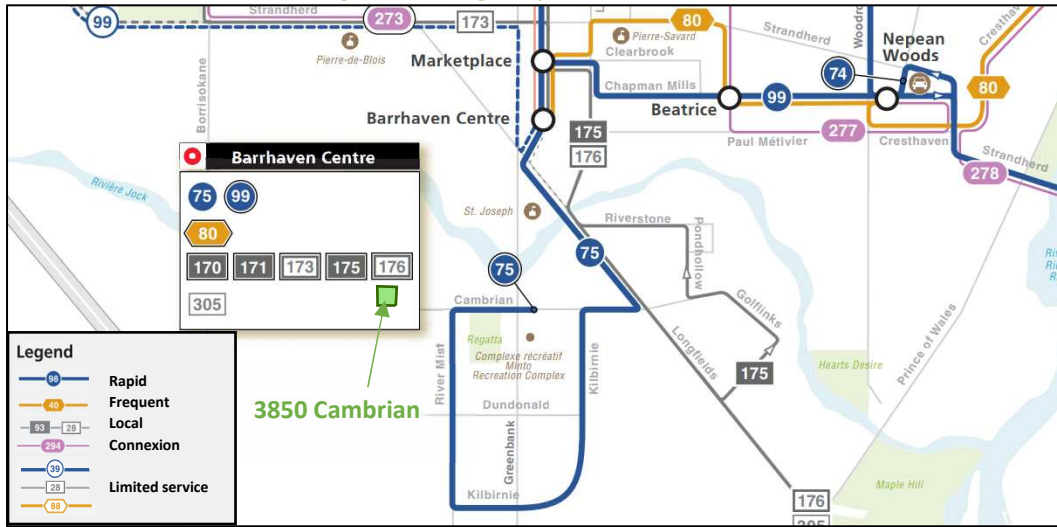

Source: <http://www.octranspo.com/> Accessed: June 7, 2022

Figure 8: Existing Study Area Transit Stops - Within 400 metres

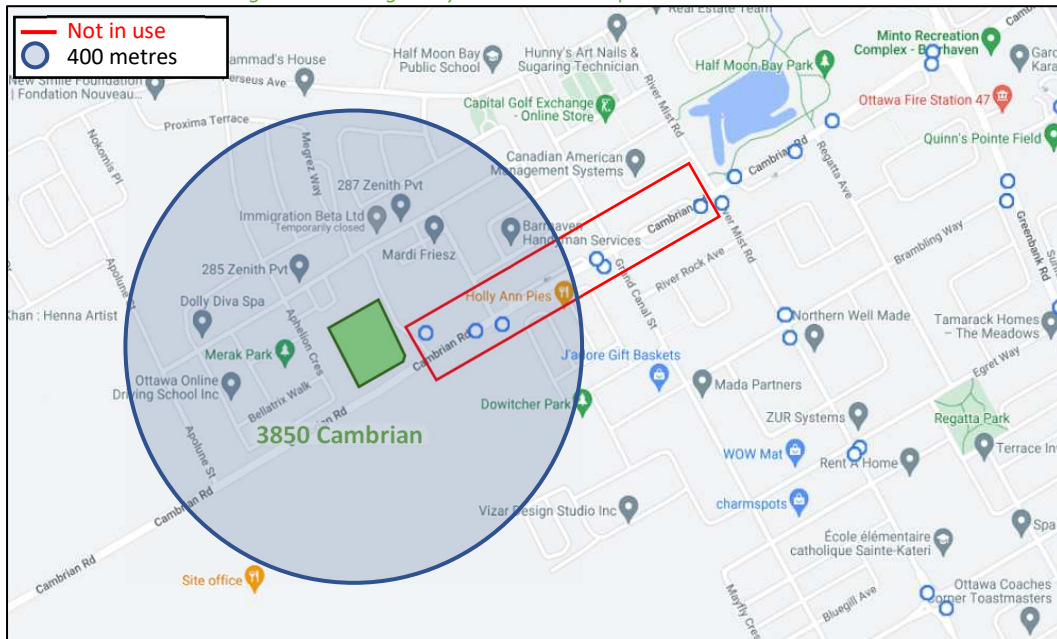

Source: <http://www.octranspo.com/> Accessed: June 7, 2022

2.2.6 Existing Area Traffic Management Measures

There are no existing area traffic management measures within the study area.

2.2.7 Existing Peak Hour Travel Demand

Existing turning movement count at Cambrian Road at River Mist Road was acquired from the City of Ottawa, and existing turning movement count at Cambrian Road at Grand Canal Street was acquired from the Traffic Specialist. The turning movements at the Cambrian Road at Apolune Street intersection were derived from the first phases of the Half Moon Bay West CTS (Stantec, 2016). Table 1 summarizes the intersection count dates.

Table 1: Intersection Count Date

Intersection	Count Date	Source
Cambrian Road at River Mist Road	Wednesday, October 23, 2019	City of Ottawa
	Saturday, October 15, 2022	The Traffic Specialist
Cambrian Road at Apolune Street	-	Half Moon Bay West CTS (Stantec, 2016)
	Saturday, October 15, 2022	The Traffic Specialist

Figure 9 illustrates the existing traffic counts and Table 2 summarizes the existing intersection operations. Synchro 11 has been used to model the unsignalized intersections and HCM 2010 methodology was used for unsignalized intersection operation. Detailed turning movement count data is included in Appendix B and the Synchro worksheets are provided in Appendix C.

Figure 9: Existing Traffic Counts

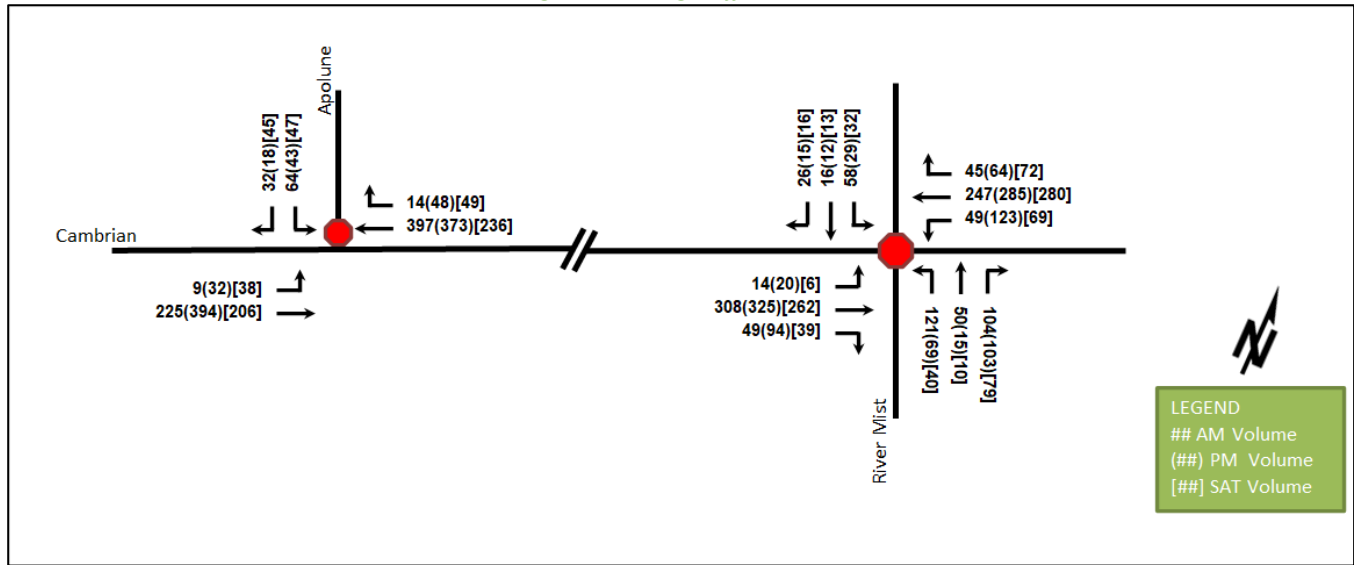

Table 2: Existing Intersection Operations

Intersection	Lane	AM Peak Hour				PM Peak Hour				SAT Peak Hour			
		LOS	V/C	Delay (s)	Q (95 th)	LOS	V/C	Delay (s)	Q (95 th)	LOS	V/C	Delay (s)	Q (95 th)
Cambrian Road at River Mist Road <i>Unsignalized</i>	EB	C	0.71	23.1	43.5	C	0.76	25.0	53.3	B	0.49	13.0	20.3
	WB	C	0.68	21.9	38.3	D	0.82	30.3	66.0	C	0.66	17.4	37.5
	NB	C	0.56	17.5	25.5	B	0.38	13.6	13.5	B	0.23	10.6	6.8
	SB	B	0.23	12.5	6.8	B	0.13	11.4	3.0	B	0.12	10.1	3.0
Overall	C	-	20.3	-	C	-	24.7	-	B	-	14.5	-	
Cambrian Road at Apolune Street <i>Unsignalized</i>	EBL	A	0.01	8.3	0.0	A	0.03	8.4	0.8	A	0.03	8.0	0.8
	EBT	-	-	-	-	-	-	-	-	-	-	-	-
	WBT/R	-	-	-	-	-	-	-	-	-	-	-	-
	SBL/R	C	0.25	15.9	6.8	C	0.21	19.0	6.0	B	0.19	13.1	5.3
Overall	A	-	2.2	-	A	-	1.6	-	A	-	2.5	-	

Notes: Saturation flow rate of 1800 veh/h/lane
 Peak Hour Factor = 0.90
 V/C = volume-to-capacity ratio
 Queue is measured in metres

Delay = average vehicle delay in seconds
 m = metered queue
 # = volume for the 95th %ile cycle exceeds capacity

During peak hours in the existing conditions, the study area intersections operate well. No capacity issues are noted.

2.2.8 Collision Analysis

Collision data have been acquired from the City of Ottawa open data website (data.ottawa.ca) for five years prior to the commencement of this TIA for the surrounding study area road network. Table 3 summarizes the collision types and conditions in the study area, Figure 10 illustrates the intersections and segments analyzed, and Table 4 summarizes the total collisions for each of these locations. Collision data are included in Appendix D.

Table 3: Study Area Collision Summary, 2016-2020

Total Collisions		Number	%
Total Collisions		2	100%
Classification	Fatality	0	0%
	Non-Fatal Injury	1	50%
	Property Damage Only	1	50%
Initial Impact Type	Angle	1	50%
	SMV Other	1	50%
Road Surface Condition	Dry	1	50%
	Loose Snow	1	50%
Pedestrian Involved		0	0%
Cyclists Involved		0	0%

Figure 10: Representation of Study Area Collision Records

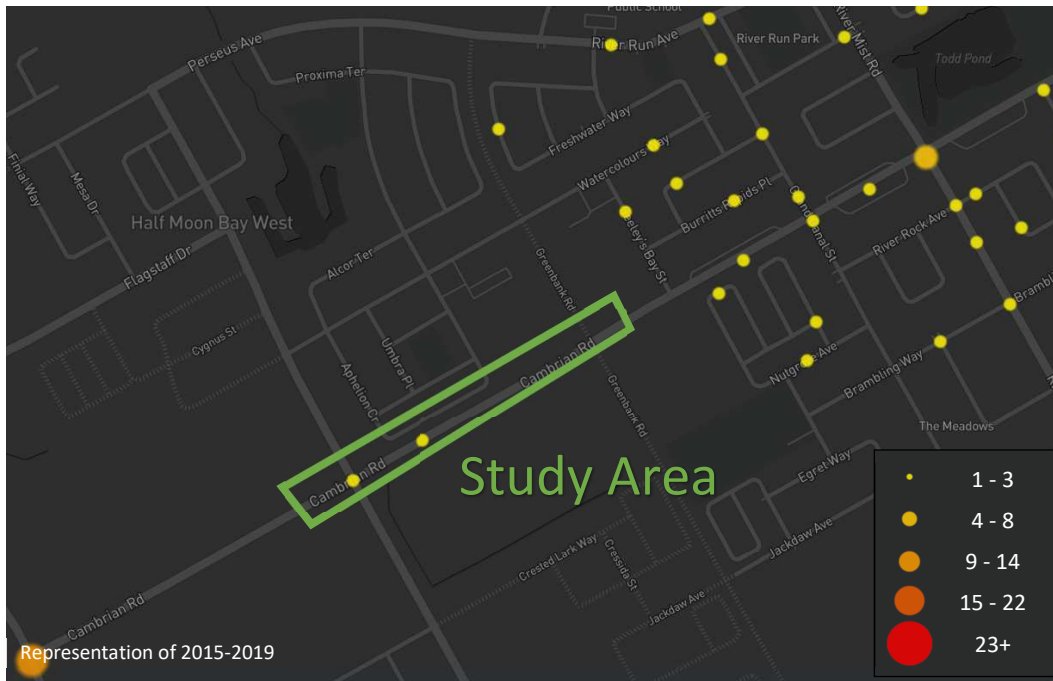

Table 4: Summary of Collision Locations, 2016-2020

Intersections / Segments	Number	%
Intersections / Segments	2	100%
Apolune St @ Cambrian Rd	1	50%
Cambrian Rd btwn Borrisokane Rd & Grand Canal St	1	50%

Within the study area, there are a total of two collisions during the 2016-2020 time period, with one involving property damage only and the remaining one having non-fatal injuries. No further collision review is required as part of this study.

2.3 Planned Conditions

2.3.1 Changes to the Area Transportation Network

The subject development is within the Barrhaven South Community Design Plan (CDP) Area. As such, it is subject to the planning policies outlined in the CDP. The CDP provides target population and employment densities in the four Sub-Planning Areas along with the plans for infrastructure to support the community growth. As part of this plan, the right-of-way along the following roads has been protected to accommodate an expansion to a four-lane arterial:

- Re-Aligned Greenbank Road rapid transit corridor north and south of Cambrian Road with a protected right-of-way of 41.5 metres
- Cambrian Road between Borrisokane Road and Longfields Road with a protected right-of-way of 37.5 metres

Realigned Greenbank Road will be located on the east side of the proposed development. The Re-Aligned Greenbank Road includes the design of a new 4-lane arterial roadway with 2-lane segregated median Bus Rapid Transit and facilities for pedestrians and cyclists between Marketplace Avenue/Chapman Mills Drive in the north and Barnsdale Road in the south. The preliminary design is included in Appendix E. The Re-Aligned Greenbank Road construction has not been scheduled and is assumed beyond 2031. Therefore, the Re-Aligned Greenbank Road is assumed to be after the study horizons and will not be modeled within the subject analyses.

Within the study horizons, a temporary road will be constructed on the south leg of the Cambrian Road at future Re-Aligned Greenbank Road intersection to serve as interim access for the future grocery site on the southeast quadrant of the intersection.

The westbound and southbound auxiliary left-turn lanes at the intersection of Cambrian Road at Apolune Street/Elevation Road have recently been painted. It is expected that an auxiliary left-turn lane will be on the northbound movement and the intersection is expected to be signalized within future horizons and will be included in the future horizons.

2.3.2 Other Study Area Developments

Mattamy's Half Moon Bay West Phase 3

The proposed subdivision is situated within the Mattamy Development of Half Moon Bay West, this phase of which is anticipated to be built-out during 2025. The development will include 38 detached single-family homes, 190 townhomes, and a 0.43-hectare commercial block. (CGH Transportation, 2021)

3555 Borrisokane Road

The proposed development includes a site plan application consisting of a car wash. It is anticipated to be built by 2023. This development forms a portion of the commercial block assessed within the Half Moon Bay West Phase 3 area. (D. J. Halpenny & Associates Ltd, 2022)

Glenview Homes (3387 Borrisokane Road)

The proposed development includes a plan of subdivision application consisting of 179 single family homes and 109 townhomes. It is anticipated to be built by 2023. (Stantec 2017)

OCSB Elementary School (135 Halyard Lane)

The proposed development application includes a site plan to have a single-storey elementary school with approximately 800 students and a 2,970 sq. ft of childcare centre. It is anticipated to be built by 2023. (Dillon Consulting, 2022)

Mattamy's Half Moon Bay West Phase 4

The proposed site is situated within the Mattamy Development of Half Moon Bay West, this phase of which is anticipated to be built-out during 2026. This phase of the development will include 59 detached single-family homes.

Minto's Kennedy (3432 Greenbank Road)

The proposed development includes a plan of subdivision application consisting of 523 units, including 103 single family homes, 274 executive townhomes, and 146 avenue townhomes, and is anticipated to be built by 2024. (CGH Transportation, 2022)

Loblaws Companies Ltd. (3845 Cambrian Road)

The proposed development includes a site plan application consisting of a 34,496 sq. ft. of grocery store and a 5,050 sq. ft. of retail store totaling 39,546 sq. ft. It is anticipated to be built by 2025. The file has been initiated and no TIA is available at this time.

Metro Ontario Inc. (3831 Cambrian Road)

The proposed development includes a site plan application consisting of a 4,024 sq. m supermarket, an attached 929 square metre retail store, an 830 square metre retail building, and a 1,060 sq. m mixed-use building. It is anticipated to be built by 2023. (CGH Transportation, 2021)

Meadow's Phase 7-8 (3640 Greenbank Road)

The proposed development, which was named Phase 5 in the TIA, includes a plan of subdivision application. The concept plan considers a total of 221 townhouses and 125 single family units. The full build-out and occupancy of Phase 7 is now assumed to be 2023 and Phase 8 by 2025. (IBI, 2018)

Mattamy's Half Moon Bay South Phase 5 (3718 Greenbank Road)

The proposed development application includes a plan of subdivision application consisting of 67 single detached home units and 97 townhouse units. This development is under construction and is assumed to be completed by the end of 2022. (CGH Transportation, 2019)

Mattamy's Half Moon Bay South Phase 7/8 (3718 Greenbank Road)

The proposed development, located on the west of the Re-Aligned Greenbank Road corridor and includes a mixture of 228 stacked townhouse units, and is anticipated to be built by 2024. (CGH Transportation, 2022)

Caivan's Ridge Phases 1-2 (3809 Borrisokane Road)

This development will include 279 townhouse units and 311 detached home units. This development is expected to be built-out during 2025. (CGH Transportation, 2019)

Caivan's The Ridge Phase 3-4 (3713 Borrisokane Road)

This development will include 589 townhouse units, 61 detached housing units. This development is expected to be built-out during 2024. (CGH Transportation, 2021)

Caivan's Conservancy East Stage (3285, 3288, 3305 Borrisokane Road)

This development will include 600 single family homes and 600 townhouses and 100 mid-rise dwelling units. This development is expected to be built-out during 2029. (CGH Transportation, 2021).

Minto's Quinn's Pointe Stages 4 (3882 Barnsdale Road and 3960 Greenbank Road)

The proposed development application includes a plan of subdivision application consists of 536 single-family dwelling units, 493 townhomes, 100 apartment units, and two elementary schools. Phases 2 and 3 have been completed, and Phase 4 is expected to be completed by 2025. (Stantec, 2018)

AIBC Manufacturing Site (3713 Borriskane Road)

The site includes approximately 3,250 square metres of general office space and 9,385 sq. m of industrial buildings. This development began operations in 2022, and the office component will be completed by 2023. (CGH Transportation, 2020)

3 Study Area and Time Periods

3.1 Study Area

The study area will include the intersections of:

- Cambrian Road at:
 - River Mist Road
 - Apolune Street
 - Site Access #1 (Future)

Future volumes at the ultimate access locations will be shown for the Re-Aligned Greenbank Road accesses and as they are outside the study horizons, will not be assessed from an operational perspective. This is informational only and are to be coordinated by the City through the Re-Aligned Greenbank design team.

The boundary road will be Cambrian Road and the preliminary design drawings will be used to assess the future Re-Aligned Greenbank Road. No screenlines are present within proximity to the site.

3.2 Time Periods

The weekday AM, PM and Saturday peak hours will be examined.

3.3 Horizon Years

The anticipated build-out year is 2024. As a result, the full build-out plus five years horizon year is 2029.

4 Exemption Review

Table 5 summarizes the exemptions for this TIA.

Table 5: Exemption Review

Module	Element	Explanation	Exempt/Required
Design Review Component			
4.1 Development Design	4.1.2 Circulation and Access	Only required for site plans	Required
	4.1.3 New Street Networks	Only required for plans of subdivision	Exempt
4.2 Parking	4.2.1 Parking Supply	Only required for site plans	Required
	4.2.2 Spillover Parking	Only required for site plans where parking supply is 15% below unconstrained demand	Exempt
Network Impact Component			
4.5 Transportation Demand Management	All Elements	Not required for site plans expected to have fewer than 60 employees and/or students on location at any given time	Required
4.6 Neighbourhood Traffic Management	4.6.1 Adjacent Neighbourhoods	Only required when the development relies on local or collector streets for access and	Exempt

Module	Element	Explanation	Exempt/Required
		total volumes exceed ATM capacity thresholds	
4.8 Network Concept		Only required when proposed development generates more than 200 person-trips during the peak hour in excess of equivalent volume permitted by established zoning	Exempt

5 Development-Generated Travel Demand

5.1 Mode Shares

Examining the mode shares recommended in the TRANS Trip Generation Manual (2020) for the subject district, derived from the most recent National Capital Region Origin-Destination survey (OD Survey), the existing average district mode shares by land use for South Nepean have been summarized in Table 6. The PM peak hour mode shares were used for the Saturday peak hour. Given the daytime peak for Saturday and sidewalks connecting to adjacent residential developments, the closest residents to may tend use non-auto trips to the grocery store during the Saturday peak hour. A 2% of auto driver mode has been shifted to each of the cycling and walking modes for the Saturday peak hour.

Table 6: TRANS Trip Generation Manual Recommended Mode Shares – South Nepean

Travel Mode	Commercial Generator		
	AM	PM	SAT
Auto Driver	74%	61%	57%
Auto Passenger	14%	27%	27%
Transit	1%	1%	1%
Cycling	0%	0%	2%
Walking	11%	11%	12%
Total	100%	100%	100%

5.2 Trip Generation

This TIA has been prepared using the vehicle trip rates and derived person trip rates for commercial component from the ITE Trip Generation Manual 11th Edition using the City-prescribed conversion factor of 1.28. Table 7 summarizes the person trip rates for the non-residential land uses by peak hour.

Table 7: Trip Generation Person Trip Rates by Peak Hour

Land Use	Land Use Code	Peak Hour	Vehicle Trip Rate	Person Trip Rates
Pharmacy/Drugstore without Drive-Through Window	880 (ITE)	AM	2.94	3.76
		PM	8.51	10.89
		SAT	10.68	13.67
Retail (<40k)	822 (ITE)	AM	2.36	3.02
		PM	6.59	8.44
		SAT	6.57	8.41

Using the above person trip rates, the total person trip generation has been estimated. Table 8 summarizes the total person trip generation for the non-residential land uses.

Table 8: Total Person Trip Generation by Peak Hour

Land Use	GFA/GLA	AM Peak Hour			PM Peak Hour			SAT Peak Hour		
		In	Out	Total	In	Out	Total	In	Out	Total
Pharmacy/Drugstore without Drive-Through Window	17,000 sq.ft	42	21	63	91	94	185	113	116	229
Retail (<40k)	18,781 sq.ft	34	23	57	80	80	160	81	77	158

It is noted that Internal capture rates from the ITE Trip Generation Handbook 3rd Edition only include development’s retail component for mixed-use developments. Therefore, the internal capture rates for Retail (<40k) to/from Supermarket were assumed to be 5% for the AM peak hour and 15% for the PM peak hour.

Pass-by reductions of 53% and 40%, have been applied to AM and PM peak hours for the land use of Pharmacy/Drugstore without Drive-Through Window and retail (<40k), respectively, and pass-by reductions of 31% and 45% have been assumed for Saturday peak hour for the land use of Pharmacy/Drugstore without Drive-Through Window and retail (<40k).

Using the above mode share targets for the internal capture and pass-by rates, and the person trip rates, the person trips by mode have been projected. Table 9 summarizes the residential trip generation and the non-residential trip generation by mode and peak hour.

Table 9: Trip Generation by Mode

Travel Mode		AM Peak Hour				PM Peak Hour				SAT Peak Hour			
		Mode Share	In	Out	Total	Mode Share	In	Out	Total	Mode Share	In	Out	Total
Pharmacy/Drugstore without Drive-Through Window	Auto Driver	74%	9	4	13	61%	8	7	15	57%	14	14	28
	Auto Passenger	14%	6	3	9	27%	25	25	50	27%	31	32	63
	Transit	1%	0	0	0	1%	1	1	2	1%	1	1	2
	Cycling	0%	0	0	0	0%	0	0	0	2%	2	2	4
	Walking	11%	5	2	7	11%	10	10	20	12%	14	14	28
	Pass-by	53%	-22	-12	-34	53%	-48	-50	-98	45%	-51	-53	-104
	Total	100%	20	9	29	100%	44	43	87	100%	62	63	125
Retail (<40k)	Auto Driver	74%	10	7	17	61%	12	12	24	57%	17	16	33
	Auto Passenger	14%	5	3	8	27%	20	20	40	27%	20	19	39
	Transit	1%	0	1	1	1%	1	1	2	1%	1	1	2
	Cycling	0%	0	0	0	0%	0	0	0	2%	1	1	2
	Walking	11%	4	2	6	11%	8	8	16	12%	9	8	17
	Pass-by	40%	-14	-9	-23	40%	-32	-32	-64	31%	-25	-24	-49
	Internal Capture	5%	-1	-1	-2	15%	-7	-7	-14	15%	-8	-8	-16
Total	100%	20	13	33	100%	41	41	82	100%	48	45	93	
Total	Auto Driver	74%	19	11	30	61%	20	19	39	57%	31	30	61
	Auto Passenger	14%	11	6	17	27%	45	45	90	27%	51	51	102
	Transit	1%	0	1	1	1%	2	2	4	1%	2	2	4
	Cycling	0%	0	0	0	0%	0	0	0	2%	3	3	6
	Walking	11%	9	4	13	11%	18	18	36	12%	23	22	45
	Pass-by	53%	-22	-12	-34	53%	-48	-50	-98	45%	-51	-53	-104
	Total	100%	39	22	61	100%	85	84	170	100%	110	108	218

As shown above, a total of 30 AM, 39 PM, and 61 Saturday new peak hour two-way vehicle trips are projected as a result of the proposed development.

5.3 Trip Distribution

Typically, the City’s TRANS O-D distribution would be used to approximate the distribution of development traffic for employment and residential developments. As the proposed site is located here to serve the local community, it was felt that a site-specific distribution would be required to factor in the adjacent residential developments. As such, the local Barrhaven South distribution is summarized in Table 10.

Table 10: Local Barrhaven South Distribution

To/From	% of Trips
North	10%
South	30%
East	50%
West	10%
Total	100%

5.4 Trip Assignment

Using the distribution outlined above, turning movement splits, and access to major transportation infrastructure, the trips generated by the site have been assigned to the study area road network. Re-Aligned Greenbank Road will extend south of Cambrian Road to Barnsdale Road beyond 2031 and not within the horizons of this study.

To assist in the City’s future planning, an assignment has been developed for this condition and has been supplied for informational purposes only. Any assessment of Re-Aligned Greenbank Road is a regional issue and unrelated to the planned right-in/right-out access arrangement.

Table 11 summarizes the proportional assignment to the study area roadways in the interim and ultimate conditions. Figure 11 and Figure 12 illustrate the new site generated volumes and pass-by volumes within the study horizons.

As noted above, Figure 13 illustrates the new site generated volumes once Re-Aligned Greenbank Road extends to the south, which will be beyond 2031. Since the ultimate condition is beyond the study horizon year, it will not be analysed in this TIA.

Table 11: Trip Assignment

To/From	Study Horizons	Beyond 2031 (informational only)
	Via	Via
North	8% River Mist (N) 2% Apolune (N)	5% River Mist (N) 5% Re-Aligned Greenbank (N)
South	25% Elevation (S) 5% River Mist (S)	20% Re-Aligned Greenbank (S) 5% River Mist (S) 5% Elevation (S)
East	30% Cambrian (E) 20% River Mist (S)	30% Cambrian Rd (E) 20% River Mist (S)
West	3% Cambrian (W) 7% Apolune (N)	3% Cambrian (W) 7% Apolune (N)
Total	100%	100%

Figure 11: New Site Generation Auto Volumes

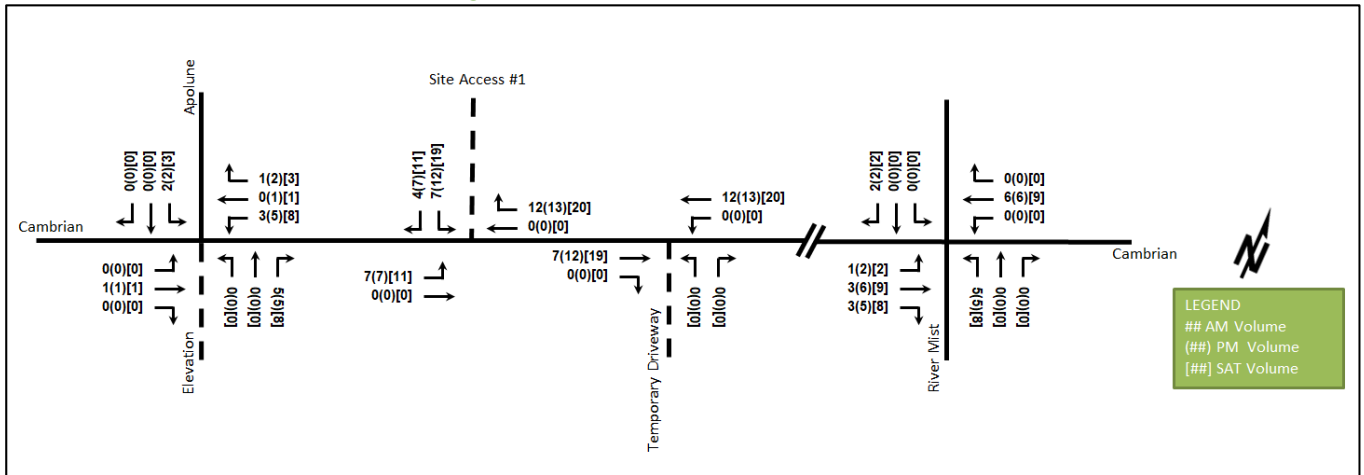

Figure 12: Pass-by Volumes

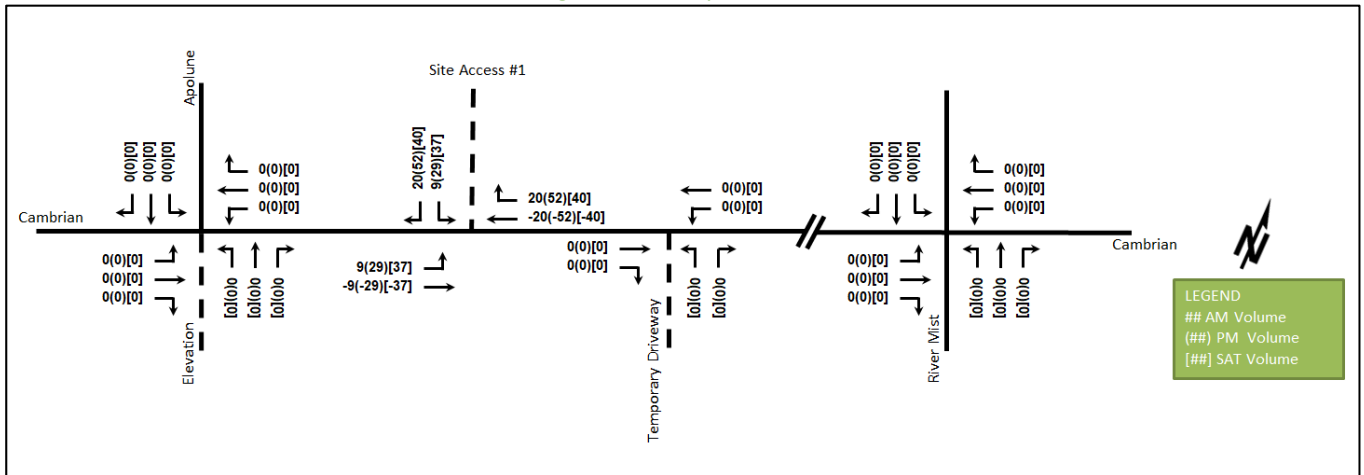
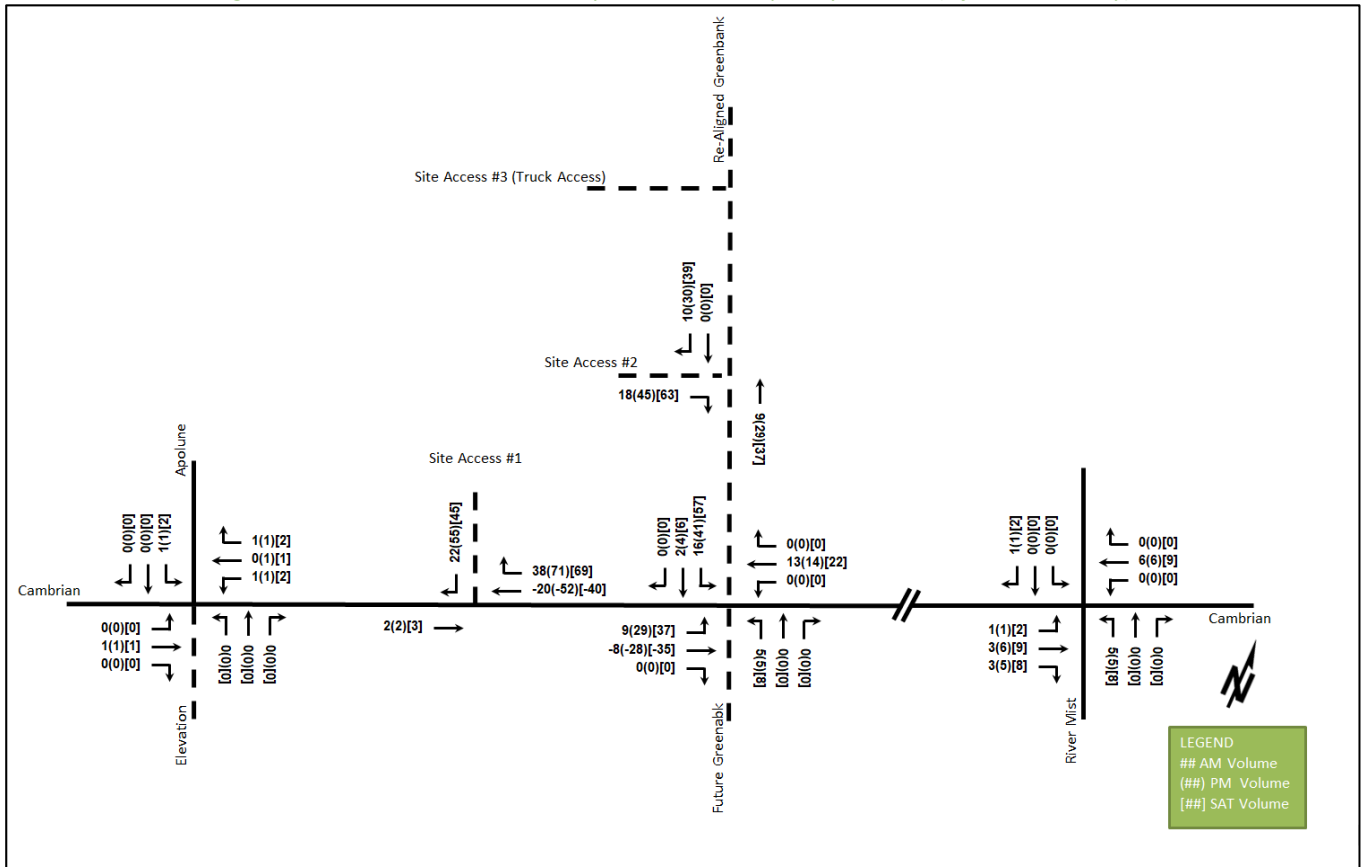

Figure 13: New Site Generation, Pass-by, and Diverted Trip – Beyond 2031 (informational only)



6 Background Network Travel Demands

6.1 Transportation Network Plans

The transportation network plans were discussed in Section 2.3. The signalized intersection of Cambrian Road at Apolune Street/Elevation Road, including the planned auxiliary lanes will be analyzed at all future horizons. Within the study horizons, a temporary road will be constructed on the south leg of the Cambrian Road at future Re-Aligned Greenbank Road intersection to serve as interim access for the future grocery site on the southeast quadrant of the intersection.

The Re-Aligned Greenbank Road was noted to be planned for implementation after the study horizons.

6.2 Background Growth

All background developments within Barrhaven South have been included in this TIA. All growth is assumed to be captured within the background development; therefore, no annual growth rate will be applied. Regional growth would be present on the north-south arterial network outside the study area intersections, such as Borrisokane Road, Greenbank Road and Longfields Drive.

6.3 Other Developments

The background developments explicitly considered in the background conditions (Section 6.2) include:

- Mattamy Half Moon Bay West Phases 3, 4
- 3555 Borrisokane Road
- Glenview Homes (3387 Borrisokane Road)
- OCSB Elementary School (135 Halyard Lane)
- Minto’s Kennedy (3432 Greenbank Road) (2024 new site generated auto volumes)
- Loblaws (3845 Cambrian Road)
- Metro Ontario Inc. (3831 Cambrian Road)
- Meadow’s Phase 7-8 (3640 Greenbank Road)
- Mattamy’s Half Moon Bay South Phase 5 (3718 Greenbank Road)
- Mattamy’s Half Moon Bay South Phase 7/8 (3718 Greenbank Road)
- Caivan’s Ridge Phases 1-2 (3809 Borrisokane Road)
- Caivan’s The Ridge Phase 3-4 (3713 Borrisokane Road)
- AIBC Manufacturing Site (3713 Borrisokane Road)
- Minto’s Quinn’s Pointe Stages 4 (3882 Barnsdale Road and 3960 Greenbank Road)
- Caivan’s Conservancy East Stage (3285, 3288, 3305 Borrisokane Road)

Figure 14 and Figure 15 illustrate the 2024 and 2029 total background development volumes. The background development volumes within the study area have been provided in Appendix F.

Figure 14: 2024 Total Background Development Volumes

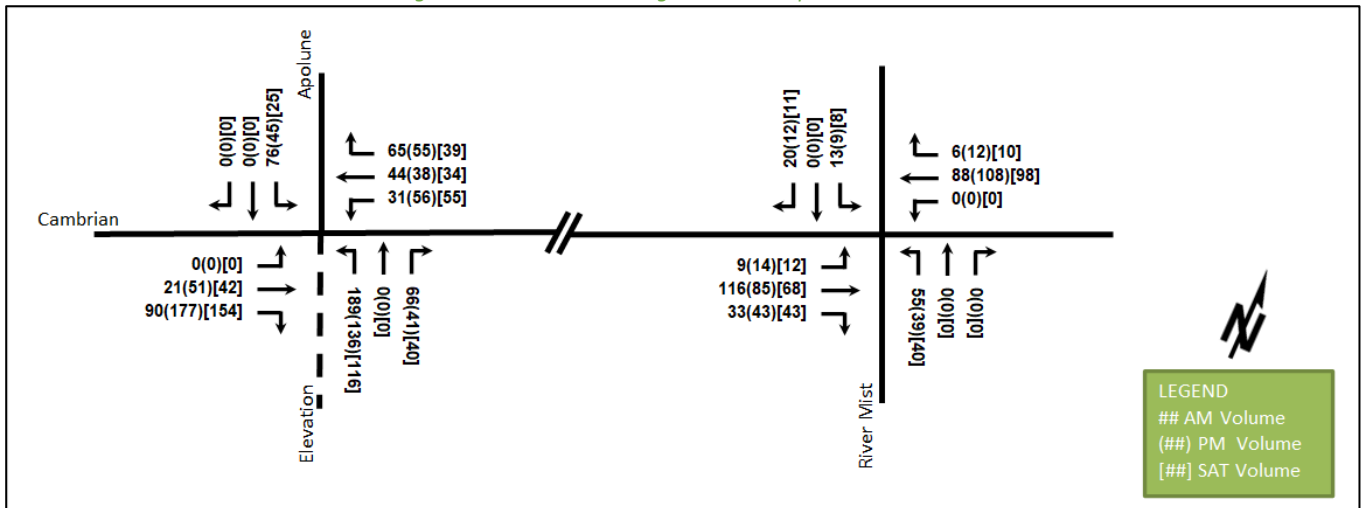
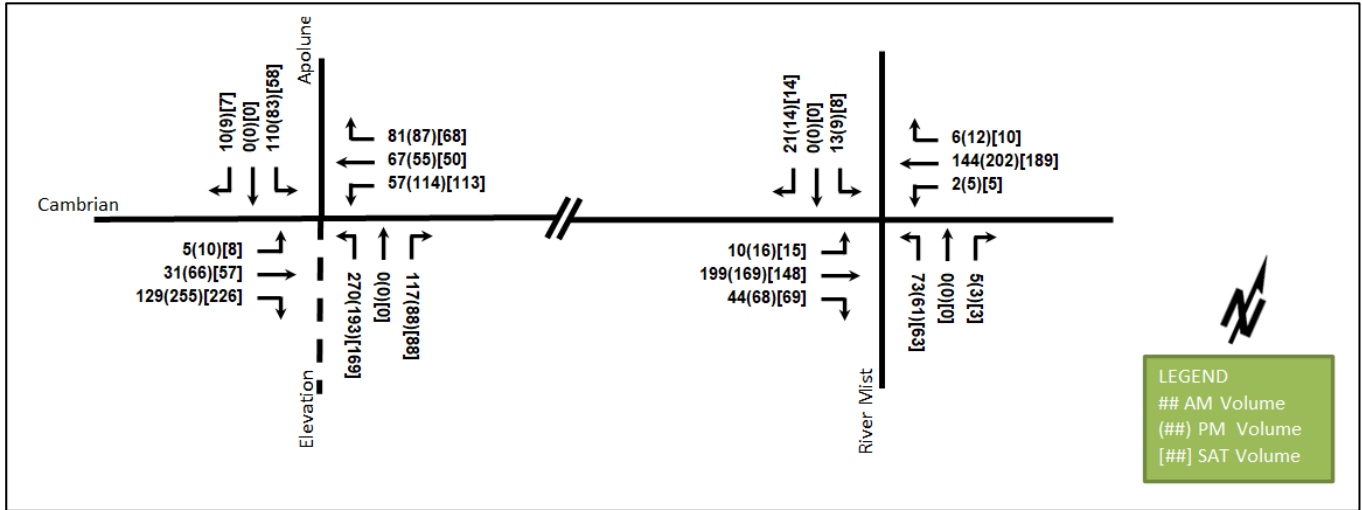

Figure 15: 2029 Total Background Development Volumes



7 Demand Rationalization

7.1 2024 Future Background Operations

The signalized intersection of Cambrian Road at Apolune Street/Elevation Road includes auxiliary left-turn lanes on all approaches. Figure 16 illustrates the 2024 background volumes and Table 12 summarizes the 2024 background intersection operations. Synchro 11 has been used to model the unsignalized intersections and HCM 2010 methodology was used for unsignalized intersection operation. The synchro worksheets for the 2024 future background horizon are provided in Appendix G.

Signal warrant analysis was performed for the intersection of Cambrian Road at River Mist Road and continues to not meet signal warrant. As the City does not have a planned improvement at this location, it is assumed to remain as an all-way stop-controlled intersection. Signal warrant calculation sheets are provided in Appendix H.

Figure 16: 2024 Future Background Volumes

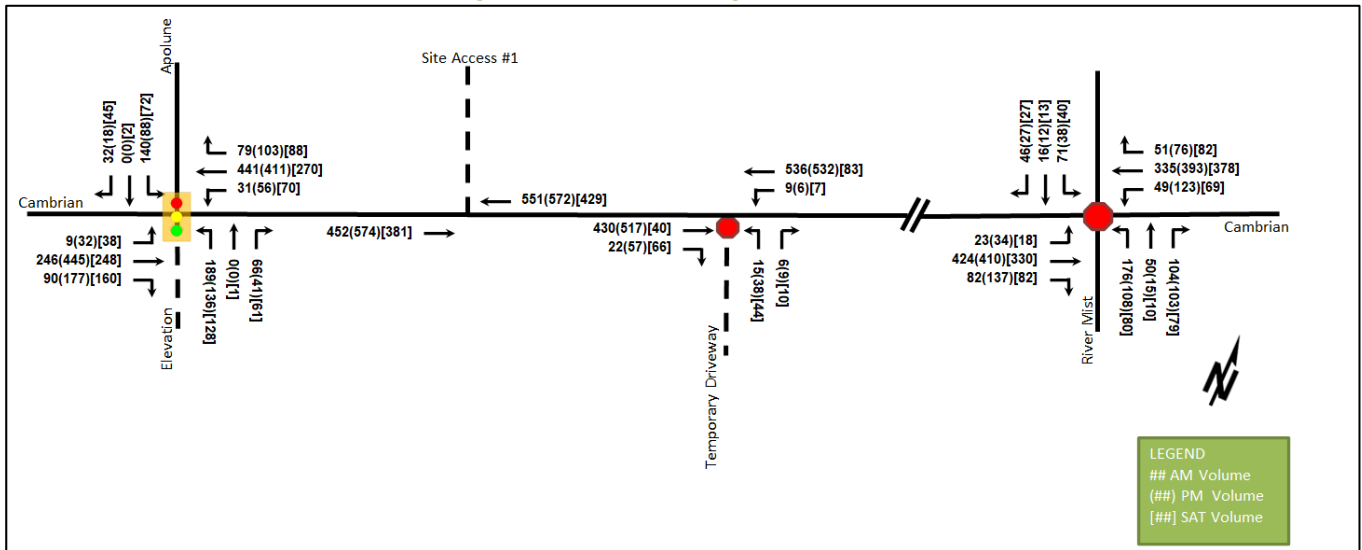

Table 12: 2024 Future Background Intersection Operations

Intersection	Lane	AM Peak Hour				PM Peak Hour				SAT Peak Hour			
		LOS	V/C	Delay (s)	Q (95 th)	LOS	V/C	Delay (s)	Q (95 th)	LOS	V/C	Delay (s)	Q (95 th)
Cambrian Road at River Mist Road <i>Unsignalized</i>	EB	F	1.02	76.4	114.8	F	0.99	59.1	106.5	C	0.66	18.6	36.0
	WB	E	0.89	44.1	71.3	F	1.01	66.8	115.5	D	0.80	26.8	60.0
	NB	D	0.70	26.5	39.0	C	0.47	16.7	18.0	B	0.31	12.4	9.8
	SB	C	0.32	15.6	9.8	B	0.18	13.0	4.5	B	0.15	11.2	3.8
	Overall	E	-	49.3	-	F	-	53.3	-	C	-	20.8	-
Cambrian Road at Apolune Street <i>Signalized</i>	EBL	A	0.02	8.3	2.7	A	0.06	5.2	5.4	A	0.06	5.0	6.0
	EBT/R	A	0.37	9.1	43.6	A	0.49	7.7	86.5	A	0.32	5.4	44.7
	WBL	A	0.05	8.2	6.1	A	0.11	5.6	8.7	A	0.14	5.6	10.4
	WBT/R	A	0.58	13.0	83.9	A	0.45	7.4	70.6	A	0.31	5.7	41.6
	NBL	B	0.63	32.9	35.0	B	0.70	67.0	48.8	B	0.70	67.4	46.7
	NBT/R	A	0.08	0.2	0.0	A	0.07	0.2	0.0	A	0.25	13.0	11.7
	SBL	A	0.54	30.0	27.1	A	0.52	56.8	33.9	A	0.46	55.0	28.7
	SBT/R	A	0.05	0.2	0.0	A	0.03	0.1	0.0	A	0.19	14.4	10.4
Overall	A	0.59	15.6	-	A	0.52	15.4	-	A	0.38	16.0	-	
Cambrian Road at Temporary Driveway <i>Unsignalized</i>	EB	-	-	-	-	-	-	-	-	-	-	-	-
	WB	A	0.01	8.3	0.0	A	0.01	8.6	0.0	A	0.01	7.4	0.0
	NB	C	0.07	17.0	1.5	C	0.18	21.6	4.5	A	0.06	9.6	1.5
	Overall	A	-	0.4	-	A	-	0.9	-	A	-	2.3	-

Notes: Saturation flow rate of 1800 veh/h/lane
 Peak Hour Factor = 1.00
 V/C = volume-to-capacity ratio
 Queue is measured in metres
 Delay = average vehicle delay in seconds
 m = metered queue
 # = volume for the 95th %ile cycle exceeds capacity

The intersections of Cambrian Road at River Mist Road on the eastbound during AM and PM peak hours and westbound movement during the PM peak hour may experience high delays and extended queues due to the background development. The capacity issues are due to the background developments and are considered the responsibility of the City to address through DC funding.

7.2 2029 Future Background Operations

Figure 17 illustrates the 2029 background volumes and Table 13 summarizes the 2029 background intersection operations. Synchro 11 has been used to model the unsignalized intersections and HCM 2010 methodology was used for unsignalized intersection operation. The synchro worksheets for the 2029 future background horizon are provided in Appendix I.

Signal warrant analysis was performed for the intersection of Cambrian Road at River Mist Road and continues to not meet signal warrant. As the City does not have a planned improvement at this location, it is assumed to remain as an all-way stop-controlled intersection. Signal warrant calculation sheets are provided in Appendix H.

Figure 17: 2029 Future Background Volumes

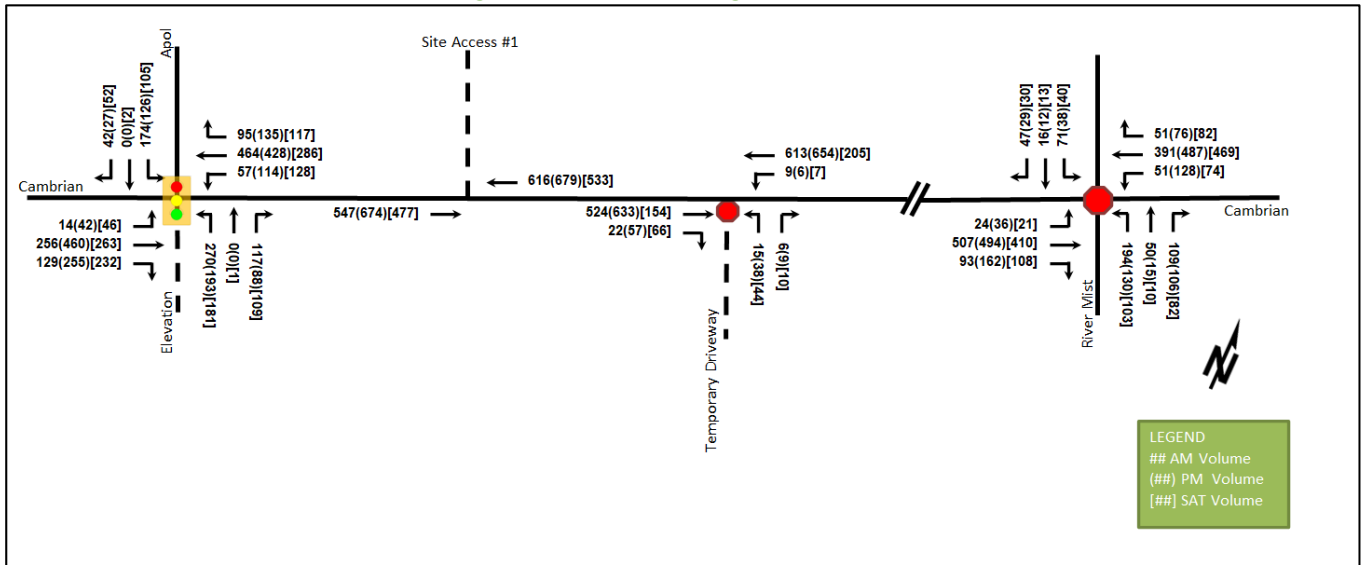

Table 13: 2029 Future Background Intersection Operations

Intersection	Lane	AM Peak Hour				PM Peak Hour				SAT Peak Hour			
		LOS	V/C	Delay (s)	Q (95 th)	LOS	V/C	Delay (s)	Q (95 th)	LOS	V/C	Delay (s)	Q (95 th)
Cambrian Road at River Mist Road <i>Unsignalized</i>	EB	F	1.28	164.9	193.5	F	1.23	126.5	177.0	E	0.90	38.7	78.0
	WB	F	1.09	77.3	102.8	F	1.25	133.4	182.3	F	1.03	74.3	129.0
	NB	D	0.82	34.1	48.0	C	0.56	19.1	21.0	B	0.40	15.0	13.5
	SB	C	0.36	17.6	10.5	B	0.20	14.2	5.3	B	0.18	12.7	4.5
	Overall	F	-	96.9	-	F	-	108.4	-	E	-	49.4	-
Cambrian Road at Apolune Street <i>Signalized</i>	EBL	A	0.04	9.5	3.6	A	0.09	7.5	8.2	A	0.08	7.2	8.5
	EBT/R	A	0.45	11.1	50.3	A	0.60	11.9	133.0	A	0.42	8.1	70.3
	WBL	A	0.12	9.9	9.8	A	0.29	10.2	22.8	A	0.30	9.9	24.9
	WBT/R	B	0.67	17.2	#107.4	A	0.52	10.8	98.9	A	0.38	8.3	59.6
	NBL	C	0.77	38.0	52.0	C	0.78	65.9	63.7	C	0.76	65.5	60.4
	NBT/R	A	0.14	0.4	0.0	A	0.14	0.5	0.0	A	0.32	9.5	13.9
	SBL	A	0.59	29.6	34.3	A	0.60	54.9	43.5	A	0.55	53.6	37.4
	SBT/R	A	0.07	0.2	0.0	A	0.04	0.1	0.0	A	0.18	11.5	10.2
Overall	B	0.70	18.6	-	A	0.64	19.1	-	A	0.48	18.4	-	
Cambrian Road at Temporary Driveway <i>Unsignalized</i>	EB	-	-	-	-	-	-	-	-	-	-	-	-
	WB	A	0.01	8.6	0.0	A	0.01	9.0	0.0	A	0.01	7.7	0.0
	NB	C	0.08	20.3	2.3	D	0.25	29.7	6.8	B	0.09	11.2	2.3
	Overall	A	-	0.4	-	A	-	1.0	-	A	-	1.4	-

Notes: Saturation flow rate of 1800 veh/h/lane
 Peak Hour Factor = 1.00
 V/C = volume-to-capacity ratio
 Queue is measured in metres

Delay = average vehicle delay in seconds
 m = metered queue
 # = volume for the 95th %ile cycle exceeds capacity

Capacity issues will remain at the intersection of Cambrian Road at River Mist Road, and on the westbound movement at the Cambrian Road at River Mist Road intersection may start to experience high delays and extended queues during the AM and Saturday peak hours due to the background developments. The capacity issues are due to the background developments and are considered the responsibility of the City to address through DC funding.

The westbound shared through/right-turn movement at the intersection of Cambrian Road at Apolune Street during the AM peak may be subject to extended queues at this horizon due to the background developments.

7.3 2024 Future Total Operations

Figure 18 illustrates the 2024 future total volumes and Table 14 summarizes the 2024 future total intersection operations. Synchro 11 has been used to model the unsignalized intersections and HCM 2010 methodology was used for unsignalized intersection operation. The synchro worksheets for the 2024 future total horizon are provided in Appendix J.

Signal warrant analysis was performed for the intersection of Cambrian Road at River Mist Road and continues to not meet signal warrant. As the City does not have a planned improvement at this location, it is assumed to remain as an all-way stop-controlled intersection. Signal warrant calculation sheets are provided in Appendix H.

Figure 18: 2024 Future Total Volumes

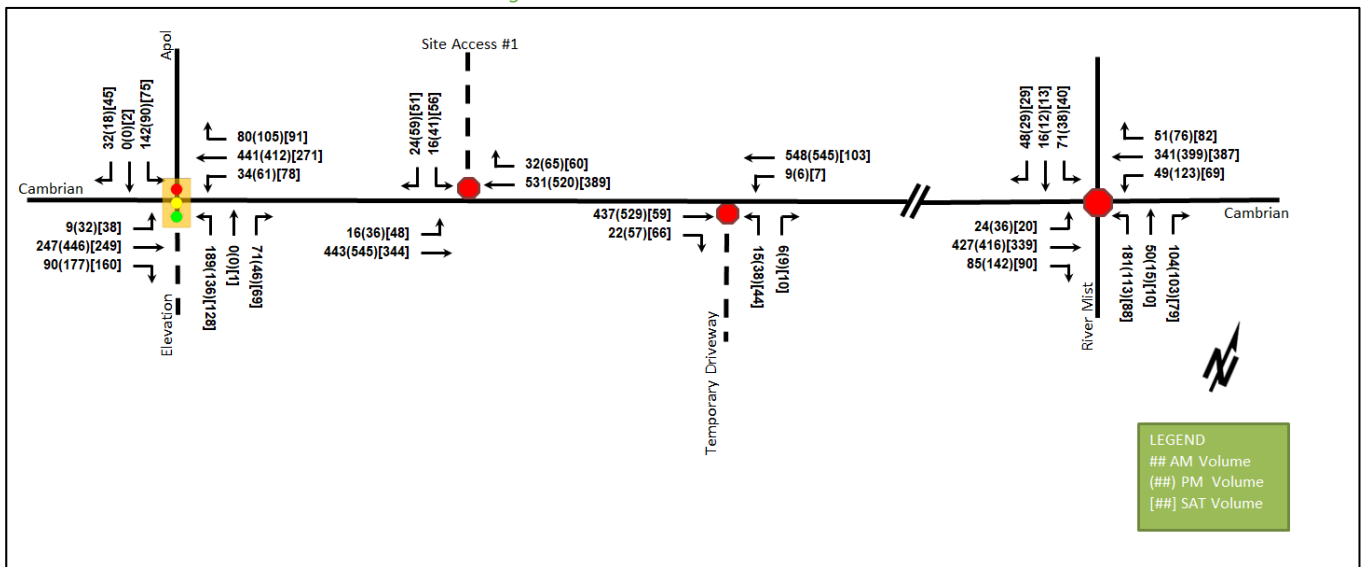

Table 14: 2024 Future Total Intersection Operations

Intersection	Lane	AM Peak Hour				PM Peak Hour				SAT Peak Hour			
		LOS	V/C	Delay (s)	Q (95 th)	LOS	V/C	Delay (s)	Q (95 th)	LOS	V/C	Delay (s)	Q (95 th)
Cambrian Road at River Mist Road <i>Unsignalized</i>	EB	F	1.05	85.5	123.0	F	1.01	60.5	108.0	C	0.70	21.1	43.5
	WB	E	0.92	48.5	75.8	F	1.03	74.1	124.5	D	0.83	31.4	69.0
	NB	D	0.73	28.1	41.3	C	0.48	16.9	18.0	B	0.33	13.0	10.5
	SB	C	0.33	16.0	10.5	B	0.18	13.1	4.5	B	0.16	11.5	4.5
	Overall	F	-	54.5	-	F	-	56.7	-	C	-	23.8	-
Cambrian Road at Apolune Street <i>Signalized</i>	EBL	A	0.02	8.3	2.7	A	0.06	5.2	5.4	A	0.06	5.0	6.0
	EBT/R	A	0.37	9.1	43.9	A	0.49	7.7	86.8	A	0.33	5.4	44.7
	WBL	A	0.06	8.2	6.6	A	0.12	5.7	9.3	A	0.15	5.7	11.5
	WBT/R	A	0.58	13.1	84.1	A	0.45	7.4	71.3	A	0.32	5.7	42.3
	NBL	B	0.63	32.9	35.0	B	0.70	67.0	48.8	B	0.70	67.4	46.7
	NBT/R	A	0.09	0.2	0.0	A	0.08	0.3	0.0	A	0.28	12.7	12.3
	SBL	A	0.55	30.4	27.6	A	0.54	57.6	34.4	A	0.48	56.1	29.9
	Overall	A	0.59	15.6	-	A	0.52	15.4	-	A	0.38	16.0	-

Intersection	Lane	AM Peak Hour				PM Peak Hour				SAT Peak Hour			
		LOS	V/C	Delay (s)	Q (95 th)	LOS	V/C	Delay (s)	Q (95 th)	LOS	V/C	Delay (s)	Q (95 th)
Cambrian Road at Temporary Driveway Unsignalized	EB	-	-	-	-	-	-	-	-	-	-	-	-
	WB	A	0.01	8.3	0.0	A	0.01	8.7	0.0	A	0.01	7.5	0.0
	NB	C	0.07	17.4	1.5	C	0.18	22.2	5.3	A	0.07	9.8	1.5
	Overall	A	-	0.4	-	A	-	0.9	-	A	-	2.0	-
Cambrian Road at Site Access #1 Unsignalized	EB	A	0.02	8.6	0.0	A	0.04	8.8	0.8	A	0.04	8.4	0.8
	WB	-	-	-	-	-	-	-	-	-	-	-	-
	SB	C	0.11	15.8	3.0	C	0.31	21.4	9.8	C	0.26	16.9	7.5
	Overall	A	-	0.7	-	A	-	1.9	-	A	-	2.3	-

Notes: Saturation flow rate of 1800 veh/h/lane
 Peak Hour Factor = 1.00
 V/C = volume-to-capacity ratio
 Queue is measured in metres

Delay = average vehicle delay in seconds
 m = metered queue
 # = volume for the 95th %ile cycle exceeds capacity

The study area intersections will operate similar to the 2024 future background condition. No additional capacity issues are noted.

The site is anticipated to generate less than a 2.3% increase in traffic during the weekday peak hours and less than a 4.5% increase during the Saturday peak at Cambrian Road at the River Mist Road intersection. These volume increases are not considered significant impacts on the intersections and remain the responsibility of the City to address through DC funding.

7.4 2029 Future Total Operations

Figure 19 illustrates the 2029 total volumes and Table 15 summarizes the 2029 total intersection operations. Synchro 11 has been used to model the unsignalized intersections and HCM 2010 methodology was used for unsignalized intersection operation. The synchro worksheets for the 2029 future total horizon are provided in Appendix K.

Signal warrant analysis was performed for the intersection of Cambrian Road at River Mist Road and continues to not meet signal warrant. As the City does not have a planned improvement at this location, it is assumed to remain as an all-way stop-controlled intersection. Signal warrant calculation sheets are provided in Appendix H.

Figure 19: 2029 Future Total Volumes

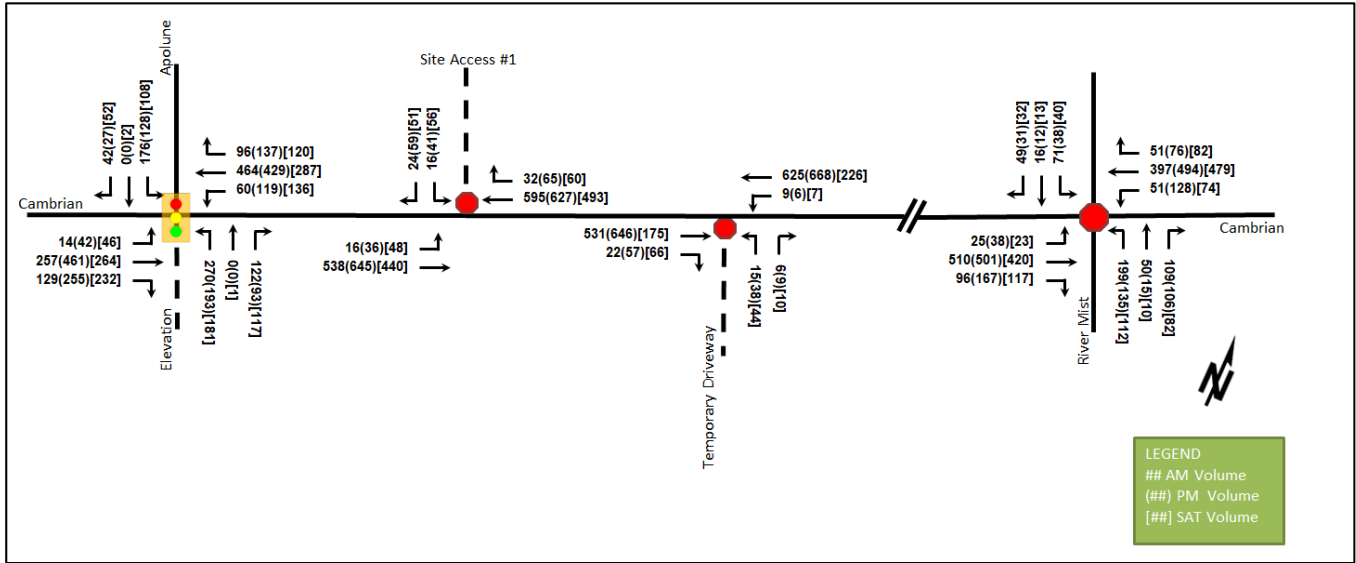

Table 15: 2029 Future Total Intersection Operations

Intersection	Lane	AM Peak Hour				PM Peak Hour				SAT Peak Hour			
		LOS	V/C	Delay (s)	Q (95 th)	LOS	V/C	Delay (s)	Q (95 th)	LOS	V/C	Delay (s)	Q (95 th)
Cambrian Road at River Mist Road <i>Unsignalized</i>	EB	F	1.30	166.5	193.5	F	1.28	140.0	189.0	E	0.94	45.0	87.0
	WB	F	1.11	83.5	108.0	F	1.28	142.7	189.8	F	1.06	85.3	140.3
	NB	E	0.84	35.6	50.3	C	0.58	19.8	22.5	C	0.42	15.6	14.3
	SB	C	0.37	17.9	11.3	B	0.21	14.4	5.3	B	0.19	12.9	5.3
Overall	F	-	99.7	-	F	-	117.6	-	F	-	56.4	-	
Cambrian Road at Apolune Street <i>Signalized</i>	EBL	A	0.04	9.5	3.6	A	0.09	7.5	8.2	A	0.08	7.2	8.5
	EBT/R	A	0.46	11.2	50.6	A	0.60	11.9	133.3	A	0.42	8.1	70.4
	WBL	A	0.12	9.9	10.3	A	0.31	10.4	23.9	A	0.32	10.3	26.9
	WBT/R	B	0.67	17.3	#107.6	A	0.53	10.9	99.8	A	0.38	8.3	60.2
	NBL	C	0.77	38.0	52.0	C	0.78	65.9	63.7	C	0.76	65.5	60.4
	NBT/R	A	0.15	0.4	0.0	A	0.15	0.5	0.0	A	0.34	9.3	14.2
	SBL	A	0.60	30.1	34.9	B	0.61	55.7	44.4	A	0.59	55.9	39.0
	NBT/R	A	0.07	0.2	0.0	A	0.04	0.1	0.0	A	0.18	11.5	10.2
Overall	B	0.70	18.6	-	B	0.64	19.2	-	A	0.48	18.6	-	
Cambrian Road at Temporary Driveway <i>Unsignalized</i>	EB	-	-	-	-	-	-	-	-	-	-	-	-
	WB	A	0.01	8.6	0.0	A	0.01	9.1	0.0	A	0.01	7.7	0.0
	NB	C	0.08	20.8	2.3	D	0.25	30.8	7.5	B	0.09	11.6	2.3
	Overall	A	-	0.4	-	A	-	1.1	-	A	-	1.3	-
Cambrian Road at Site Access #1 <i>Unsignalized</i>	EB	A	0.02	8.8	0.8	A	0.04	9.2	0.8	A	0.05	8.7	0.8
	WB	-	-	-	-	-	-	-	-	-	-	-	-
	SB	C	0.13	18.0	3.0	D	0.40	28.7	13.5	C	0.33	21.6	10.5
Overall	A	-	0.7	-	A	-	2.2	-	A	-	2.4	-	

Notes:
 Saturation flow rate of 1800 veh/h/lane
 Peak Hour Factor = 1.00
 V/C = volume-to-capacity ratio
 Queue is measured in metres

Delay = average vehicle delay in seconds
 m = metered queue
 # = volume for the 95th %ile cycle exceeds capacity

The Cambrian Road at River Mist Road intersection will operate similar to the 2029 future background condition. No additional capacity issues are noted. Compared to the 2024 future total condition, operational changes and increased queuing are similar to the changes between 2024 and 2029 future background conditions.

As outlined in the 2024 future total conditions, the site-generated volumes will have minimal impact the intersection of Cambrian Road at River Mist Road. The capacity issues are due to the background developments and are considered the responsibility of the City to address through DC funding.

7.5 Modal Share Sensitivity and Demand Rationalization Conclusions

7.5.1 Network Rationalization

The background conditions identify capacity constraints related to the intersection control at the Cambrian Road at River Mist Road intersection. Specifically, these are related to the eastbound movement during the AM and PM peak hours and westbound movement during the PM peak hour by 2024, and for the westbound movement during the AM and Saturday peak hours by 2029. These operational constraints are expected and have been reported previously in area TIAs that have assessed these intersections. The proposed site has minimal impact on the Cambrian Road volumes.

In the short term, motorist behavior may start to change to take alternative routes through the community to avoid these constraints. This has already been occurring with area diversions to Half Moon Bay at Greenbank Road where the City has addressed these diversions with a new mini-roundabout intersection.

Ultimately, the signalization of the intersection would be a local improvement for operations at this intersection, and more regional solution is the Re-Aligned Greenbank Road implementation south beyond Cambrian Road. The segment south of Cambrian Road would allow motorists to access the north-south arterial road network from east-west collections (e.g. Dundonald) rather than needing to use Cambrian Road for that connectivity.

Beyond the infrastructure noted, the subject site is a step towards mitigating the current vehicle trips headed to retail and grocery options north of the Jock River. It may not have a notable reduction on Cambrian Road at this time, but it likely has regional benefits that balance out the existence of the local constraints.

7.5.2 Development Rationalization

The proposed trip generation rates and modal shares are consistent with the surrounding area context and do not unduly impact the surrounding road network. No site specific demand rationalization is considered necessary as part of this TIA.

8 Development Design

8.1 Design for Sustainable Modes

The proposed development is a retail development with surface parking for both automobiles and bicycles. A total of 121 vehicle parking spaces and 18 bike parking spaces will be provided for the pharmacy and retails.

Future pedestrian and cycling facilities along Cambrian Road and future Greenbank Road are planned to be provided beyond the study horizon.

The infrastructure TDM checklist is provided in Appendix M.

8.2 Circulation and Access

Within the study horizon, Access #1 will accommodate vehicles accessing the site, and access will be all-movement access. The two-way access onto Cambrian Road is 9.0 metres wide, and the throat length is 13.0 metres, although

it is functionally longer with a total of 21.0 metres measured from the back of sidewalk to the first conflict point on-site. The internal drive aisles are 6.7 metres. The loading areas are provided at the back of Building A/B and between Buildings C and D. The delivery trucks and garbage collection vehicle turning templates were reviewed to confirm movements will be permitted on site, and the turning templates are provided in Appendix L.

Beyond 2031, Access #1 will become right-in/right-out with the new median as part of the Re-Aligned Greenbank Road and Cambrian Road signalized intersection when constructed by the City. Similarly, the right-in/right-out Accesses #2 and #3 will be opened with the Re-Aligned Greenbank Road construction. Access #2 width will be 7.6 metres and have an expected throat length of 14.5 metres, serving automobile movements, and Access #3 width will be 9.0 metres and have an expected throat length of 72.0 metres, serving as truck access for Building A/B. Actual throat lengths will be dependent on the City design for Cambrian Road and Re-Aligned Greenbank Road.

Access #1 is approximately 90 metres from the future Re-Aligned Greenbank Road and Cambrian Road intersection, which meets the minimum corner clearance of 70 metres from TAC (2017). On the south side of Cambrian Road, the 3845 Cambrian Road development has an access proposed approximately 30 metres to the east of Access #1. TAC notes that the relative location should be examined but provides no direct guidance on the desirable offset except in conditions with inter-development interaction is expected to be significant. The driveway volumes are not considered to be significant and low inter-development interaction is expected. As further examination, the left-turn movements were modeled with Auto-Turn to show possible conflicts and are provided in Appendix L. General automobile and larger truck (garbage truck) movements will have no overlap in travel sweeps and can be completed without concern should they proceed at the same time. Truck/trailer (WB-20) vehicles would overlap should they proceed to make opposing left-turn movements at the same time. This situation is considered to be an exceedingly rare occurrence and would not be a typical design consideration at access locations. Overall, this condition can be permitted during the interim condition prior to Cambrian Road becoming a divided road as part of the Re-Aligned Greenbank Road construction, where no interaction between the access would be permitted.

Beyond 2031, Access #2 would be located within 55 metres of the future Re-Aligned Greenbank Road and Cambrian Road intersection, which is 15 metres shorter than a typical 70 metre clearance requirement, and within the left-turn storage length plus bay taper for the southbound movement. The right-in/right-out restrictions on the future access conditions necessitate accesses be provided on both Cambrian Road and Re-Aligned Greenbank Road. While the Cambrian Road frontage and future signalization at Re-Aligned Greenbank limit the ability to separate the loading access from the shopper entrance, Re-Aligned Greenbank Road would allow these movements to be separated. Overall, the proposed Access #2 location has been located as far away from the future signalized intersection as possible, given lot size, site design and tenant requirements, and is a typical condition that is experienced throughout the City of Ottawa.

The current design activities for Re-Aligned Greenbank Road will need their design to consider and be supportive of the surrounding land-use, either approved, in application, or planned through the Barrhaven South Community Design Plan and Barrhaven South Community Core Concept Plan and Design Framework.

Access #3 is located beyond the corner clearance requirement of left-turn storage length plus bay taper.

9 Parking

9.1 Parking Supply

The site provides a total of 121 vehicle surface parking spaces and 18 bicycle parking spaces. The minimum parking provision is 3.6 vehicle parking spaces per 100 m² of gross floor area and 1 bicycle per 250 m² of gross floor area,

which is 120 vehicle parking spaces and eight bicycle parking spaces, and the minimum vehicle and bicycle parking requirements are satisfied.

Based on the City of Ottawa Traffic and Parking (By-law No. 2017-301), the total number of accessible spaces required is two spaces. The site provides a total of four accessible parking spaces, and it meets the requirements.

10 Boundary Street Design

Table 16 summarizes the MMLOS analysis for the boundary streets of Cambrian Road. The boundary street analysis is based on the land use of the “General Urban Area” and the policy area of “Within 300 metres of a school”. The MMLOS worksheets have been provided in Appendix N.

Table 16: Boundary Street MMLOS Analysis

Segment	Pedestrian LOS		Bicycle LOS		Transit LOS		Truck LOS	
	PLOS	Target	BLOS	Target	TLOS	Target	TrLOS	Target
Cambrian Road (Existing)	F	A	F	B	N/A	N/A	N/A	N/A
Cambrian Road (Future)	C	A	A	B	N/A	N/A	N/A	N/A
Re-Aligned Greenbank Road (Future)	D	A	A	A	A	A	A	D

Cambrian Road does not meet the pedestrian MMLOS targets, and the operating speed would need to be lower than 30 km/h. Cambrian Road does not meet the bicycle MMLOS targets in the existing condition but will be met in the future condition.

No mitigation for the boundary street design of Cambrian Road is required as part of this application and require higher level City adjustments to the road operations, such as speed limits.

Future Re-Aligned Greenbank Road will not meet the pedestrian MMLOS target and needs at least 2 metre-wide of sidewalk and boulevard. The City’s design team will need to rationalize the various elements and targets for the roadway.

11 Access Intersections Design

11.1 Location and Design of Access

The site is proposed to have a full-movement access (Access #1) within the study horizon years. Once the Re-Aligned Greenbank Road is built (Beyond 2031), right-in/right-out Access #2 and Access #3 will be provided along Re-Aligned Greenbank Road. The access along Cambrian Road is proposed to be 9.0 metres wide, while the future Access #2 is proposed to be 7.6 metres wide, and Access #3 is proposed to be 9.0 metres wide. All accesses widths meet the private approach by law.

The TAC Geometric Design Guidelines throat length requirements for a shopping if this size on an arterial road is 15.0 metres, as measured from the end of the corner radii. Access #1 will have a throat length of 13.0 metres once the future signalized intersection is constructed. This length is less than 15.0 metres primarily due to the larger radii required to support larger truck movements, and the actual space from the back of sidewalk to the first conflict point would be approximately 21.0 metres. This is similar to the future conditions at Access #2 where the length from the radii is 14.5 metres while the actual space is 20.6 metres. Access #3 does meet the 15.0 metre requirements.

Overall, no concerns are noted with the proposed configurations and are considered to meet the intentions of TAC in function and future operations.

11.2 Intersection Control

Based upon the projected volumes, the site access will have stop-control on the minor approach.

11.3 Access Intersection Design

11.3.1 Future Access Intersection Operations

The operations are noted in Section 7.4 and both 2024 and 2029 future total access intersections operate well with all movements and the overall intersection operating at LOS A.

11.3.2 Access Intersection MMLoS

Based upon the projected volumes, the site access will have stop-control on the minor approach.

11.3.3 Recommended Design Elements

No changes to the site access are proposed.

12 Transportation Demand Management

12.1 Context for TDM

The mode shares used within the TIA represent the unmodified district shares for the Barrhaven South. A shift from auto modes to transit modes, in both the subject and surrounding developments, may be anticipated once the BRT network is extended along the Re-Aligned Greenbank Road Corridor, but any such shifts are expected to occur outside of the analysis horizons of this report. Overall, the modal shares are likely to be achieved and supporting TDM measures should be provided.

The subject site is within the Barrhaven South Community Core design priority area.

12.2 Need and Opportunity

The subject site has been assumed to rely predominantly on auto travel and those assumptions have been carried through the analysis.

12.3 TDM Program

The “suite of post occupancy TDM measures” has been summarized in the TDM checklists for the non-residential land uses. The checklist is provided in Appendix M. The key TDM measures recommended include:

- Provide a multimodal travel option package to new/relocating employees

In addition to these measures, providing more than the minimum bicycle parking required, will help in achieving the mode shares for the proposed development and is recommended.

13 Transit

13.1 Route Capacity

In Section 5.1 the trip generation by mode was estimated, including an estimate of the number of transit trips that will be generated by the proposed development. Table 17 summarizes the transit trip generation.

Table 17: Trip Generation by Transit Mode

Travel Mode	Mode Share	AM Peak Hour			PM Peak Hour			SAT Peak Hour		
		In	Out	Total	In	Out	Total	In	Out	Total
Transit	1%	0	1	1	2	2	4	2	2	4

The proposed development is anticipated to generate an additional 1 AM, 4 PM, and 4 Saturday peak hour two-way transit trips. Overall, the existing transit service is expected to be accommodate these increased riders and be predominantly localized trips within Barrhaven South.

13.2 Transit Priority

Examining the study area intersection delays, negligible impacts are noted on the transit movements and no decrease in transit LOS at the study area intersections are noted as a result of forecasted site-generated traffic. It is expected that the local transit service may be reconfigured or improved by the City once the Re-Aligned Greenbank Road and Cambrian Road widening are completed, and it is outside of the study horizons.

14 Network Intersection Design

14.1 Network Intersection Control

No change to the existing signalized control is recommended for the network intersections.

14.2 Network Intersection Design

14.2.1 2024 & 2029 Future Total Network Intersection Operations

The operations are noted in Section 7.4 and no changes on the intersections within the study area are required.

14.2.2 Network Intersection MMLOS

Table 18 summarizes the MMLOS analysis for the intersection of Cambrian Road at Apolune Street/Elevation Road. The existing intersection is not signalized and therefore only the future conditions will be analyzed. The future intersection geometry is assumed to be the same as the functional design completed by Stantec without cycling infrastructure along the Cambrian Road within the study horizon years. The intersection analysis is based on the land use of “General Urban Area” and the policy area of “Within 300 metres of a school”. The MMLOS worksheets have been provided in Appendix N.

Table 18: Study Area Intersection MMLOS Analysis

Intersection	Pedestrian LOS		Bicycle LOS		Transit LOS		Truck LOS		Auto LOS	
	PLOS	Target	BLOS	Target	TLOS	Target	TrLOS	Target	ALOS	Target
Cambrian Rd at Apolune St / Elevation Rd	E	A	E	B	N/A	N/A	N/A	N/A	B	D

The MMLOS targets will not meet for the pedestrian and bicycle LOS in the future condition within the study horizon years at the intersection of Cambrian Road at Apolune Street/Elevation Road. The pedestrian level of service would require crossing distances of a maximum of two lane-widths per crossing and protected left-turn on each approach to meet a LOS A. The left-turn configurations would need to be two-stage or include turn boxes on each approach to meet the bicycle LOS target. The City will be responsible for exploring options to address the area PLOS and BLOS deficiencies for this intersection.

The MMLOS review for the Re-Aligned Greenbank Road is considered a responsibility of the City and their current design exercise. As they are currently working through this design, any review within this study would be premature.

14.2.3 Recommended Design Elements

No study area intersection design elements are proposed as part of this study.

15 Summary of Improvements Indicated and Modifications Options

The following summarizes the analysis and results presented in this TIA report:

Proposed Site and Screening

- The proposed site includes a gross floor area of 17,000 sq.ft pharmacy and gross leasable area of 18,781 sq.ft retail buildings
- A total of 121 surface vehicle parking spaces and 18 surface bicycle parking spaces are proposed
- The concept plan includes one new full-movement access on Cambrian Road in the interim condition
- In the ultimate condition, two right-in/right-out accesses are proposed on Re-Aligned Greenbank Road corridor, and the access on Cambrian Road will be right-in/right-out
- The ultimate condition is beyond the study horizon year, and would not be included in this report
- The development is proposed to be completed as a single phase by 2024
- The trip generation and location triggers were met for the TIA Screening

Existing Conditions

- Cambrian Road is an arterial road, and River Mist Road and Apolune Street are collector roads in the study area
- Sidewalks are provided on both sides of Cambrian Road east of Seeley's Bay Street, River Mist Road, and Apolune Street
- Paved shoulders are provided on both sides along Cambrian Road between Borrisokane Road and Cambrian Road at Apolune Street/Elevation Road
- Re-Aligned Greenbank Road will be a spine cycling route, and Cambrian Road, Apolune Street, and River Mist Road are local route
- The Transportation Master Plan Part 1 identifies Re-Aligned Greenbank Road for designation as a cross-town bikeway
- Within the study area, there are a total of two collisions during the 2016-2020 time period, and no further collision review is required as part of this study
- During peak hours in the existing conditions, the study area intersections operate well

Development Generated Travel Demand

- The proposed development is forecasted produce 61 AM, 170 PM, and 218 Saturday new peak hour people trips
- Of the forecasted people trips, a total of 30 AM, 39 PM, and 61 Saturday new peak hour two-way vehicle trips are projected as a result of the proposed development
- Of the forecasted trips, 10 % are anticipated to travel both the north and west, 30 % to the south, and 50 % to the east
- The proposed trip generation rates and modal shares are consistent with the surrounding area context and do not unduly impact the surrounding road network

Background Conditions

- The signalized intersection of Cambrian Road at Apolune Street/Elevation Road, including the planned auxiliary lanes will be analyzed at all future horizons
- All growth is assumed to be captured within the background development; therefore, no annual growth rate will be applied

- Within the study horizons, a temporary road will be constructed on the south leg of the Cambrian Road at future Re-Aligned Greenbank Road intersection to serve as interim access for the future grocery site on the southeast quadrant of the intersection
- The background conditions identify capacity constraints related to the intersection control at the Cambrian Road at River Mist Road intersection
- The capacity issues are due to the background developments and are considered the responsibility of the City to address through DC funding
- In the short term, motorist behavior may start to change to take alternative routes through the community to avoid these constraints
- Ultimately, the signalization of the intersections would be a local improvement for operations at these intersections, and more regional solution is the Re-Aligned Greenbank Road implementation south beyond Cambrian Road

Development Design

- The proposed development is a retail development with surface parking for both automobiles and bicycles
- Future pedestrian and cycling facilities along Cambrian Road and future Greenbank Road are planned to be provided beyond the study horizon
- Two loading zones are provided within the development
- The delivery trucks and garbage collection vehicle turning templates were reviewed to confirm movements will be permitted on site
- Access #1 is approximately 90 metres from the future Re-Aligned Greenbank Road and Cambrian Road intersection, which meets the minimum corner clearance of 70 metres from TAC (2017)
- Access #2 would be located within 55 metres of the future Re-Aligned Greenbank Road and Cambrian Road intersection, which is 15 metres shorter than a typical 70 metre clearance requirement, and within the left-turn storage length plus bay taper for the southbound movement
- The proposed Access #2 location has been located as far away from the future signalized intersection as possible, given lot size, site design and tenant requirements, and is a typical condition that is experienced throughout the City of Ottawa
- Access #3 is located beyond the corner clearance requirement of left-turn storage length plus bay taper
- On the south side of Cambrian Road, the 3845 Cambrian Road development has an access proposed approximately 30 metres to the east of Access #1, and general automobile and larger truck (garbage truck) movements will have no overlap in travel sweeps

Parking

- The site provides a total of 121 vehicle surface parking spaces and 18 bicycle parking spaces
- The minimum vehicle and bicycle parking requirements are satisfied
- The minimum accessible parking requirement is satisfied

Boundary Street Design

- Cambrian Road does not meet the pedestrian MMLOS targets and needs less than 30 km/h operating speed
- Cambrian Road does not meet the bicycle MMLOS targets in the existing condition but will be met in the future condition

- No mitigation for the boundary street design of Cambrian Road is required as part of this application and require higher level City adjustments to the road operations, such as speed limits
- Future Re-Aligned Greenbank Road will not meet the pedestrian MMLOS target and needs at least 2 metre-wide of sidewalk and boulevard, and should be rationalized through the City's design team

Access Intersections Design

- The site accesses are proposed to be 9.0-metres-wide and operate with minor approach stop-controlled
- Once the Re-Aligned Greenbank Road is constructed by the City, the Access #2 and Access # 3 can be opened and both accesses will operate as right-in/right-out
- Access #2 will be for automobile movements and access #3 will predominantly be the truck access for Building A/B
- The throat length requirement of 15.0 metres, per TAC, will not be strictly met at Access #1 and Access #2
- The curb radii required at the accesses overlap with the throat length area, where a total distance from the back of sidewalk is approximately 21.0 metres for Access #1 and 20.6 metres for Access #2
- Given the available distance between the roadway sidewalk and the first conflict point internal to the site are greater than 15.0 metres, are considered to meet the intentions of TAC in function and future operations
- No concerns are noted with the proposed configurations and are considered to meet the intentions of TAC in function and future operations
- The 2024 and 2029 future total access intersections operate well with all movements and the overall intersection operating at LOS A
- No additional design elements are proposed

TDM

- Supportive TDM measures to be included within the proposed development should include:
 - Provide a multimodal travel option package to new/relocating employees
- Providing more than the minimum bicycle parking required will help in achieving the mode shares for the proposed development and is recommended

Transit

- The proposed development is anticipated to generate an additional 1 AM, 4 PM and 4 Saturday peak hour two-way transit trips
- The existing transit service is expected to be accommodate these increased riders and be predominantly localized trips within Barrhaven South
- Negligible impacts are noted on the transit movements and no decrease in transit LOS at the study area intersections are noted as a result of forecasted site-generated traffic
- It is expected that the local transit service may be reconfigured or improved by the City once the Re-Aligned Greenbank Road and Cambrian Road widening are completed, and it is outside of the study horizons

Network Intersection Design

- The capacity issues are due to the background developments and are considered the responsibility of the City to address through DC funding
- No changes on the intersections within the study area are required
- No change to the existing signalized control is recommended for the network intersections

- The MMLOS targets will not be met the pedestrian and bicycle LOS at the intersections of Cambrian Road at Apolune Street/Elevation Road in the future conditions within the study horizon years
- Cambrian Road at Apolune Street/Elevation Road would require crossing distances of a maximum of two lane-widths per crossing and protected left-turn on each approach to meet the PLOS at this intersection
- Cambrian Road at Apolune Street/Elevation Road would require improved left-turn configurations on each approach to meet the BLOS at this intersection
- The City will be responsible for exploring options to address the area PLOS and BLOS deficiencies for Cambrian Road at Apolune Street/Elevation Road
- The MMLOS review for the Re-Aligned Greenbank Road is considered a responsibility of the City and their current design exercise. As they are currently working through this design, any review within this study would be premature

16 Conclusion

It is recommended that, from a transportation perspective, the proposed development applications proceed.

Prepared By:



Yu-Chu Chen, EIT
Transportation Engineering-Intern

Reviewed By:



Andrew Harte, P.Eng.
Senior Transportation Engineer

Appendix A

TIA Screening Form and PM Certification Form

City of Ottawa 2017 TIA Guidelines
Step 1 - Screening Form

Date: 06-Jul-22
Project Number: 2022-066
Project Reference: 3850 Cambrian

1.1 Description of Proposed Development	
Municipal Address	3850 Cambrian Road
Description of Location	Ward 3. 1.28 ha of rectangular parcel
Land Use Classification	General Mixed-Use Zone (GM[1628])
Development Size	Retail blocks totaling 36,748 sq ft
Accesses	An access onto Cambrian Road, future access to Re-Aligned Greenbank Road
Phase of Development	Single
Buildout Year	2025
TIA Requirement	Full TIA Required

1.2 Trip Generation Trigger		
Land Use Type	Destination retail	
Development Size	3,414	G.F.A.
Trip Generation Trigger	Yes	

1.3 Location Triggers		
Does the development propose a new driveway to a boundary street that is designated as part of the City's Transit Priority, Rapid Transit or Spine Bicycle Networks?	Yes	Future access
Is the development in a Design Priority Area (DPA) or Transit-oriented Development (TOD) zone?	Yes	Barrhaven South Community Core Design Priority Area
Location Trigger	Yes	

1.4. Safety Triggers		
Are posted speed limits on a boundary street 80 km/hr or greater?	No	
Are there any horizontal/vertical curvatures on a boundary street limits sight lines at a proposed driveway?	No	
Is the proposed driveway within the area of influence of an adjacent traffic signal or roundabout (i.e. within 300 m of intersection in rural conditions, or within 150 m of intersection in urban/ suburban conditions)?	No	Future Re-Aligned Greenbank Road and Cambrian Road will be within 150m
Is the proposed driveway within auxiliary lanes of an intersection?	No	Future Re-Aligned Greenbank Road and Cambrian Road will have medians.
Does the proposed driveway make use of an existing median break that serves an existing site?	No	
Is there is a documented history of traffic operations or safety concerns on the boundary streets within 500 m of the development?	No	
Does the development include a drive-thru facility?	No	
Safety Trigger	No	



TIA Plan Reports

On 14 June 2017, the Council of the City of Ottawa adopted new Transportation Impact Assessment (TIA) Guidelines. In adopting the guidelines, Council established a requirement for those preparing and delivering transportation impact assessments and reports to sign a letter of certification.

Individuals submitting TIA reports will be responsible for all aspects of development-related transportation assessment and reporting, and undertaking such work, in accordance and compliance with the City of Ottawa's Official Plan, the Transportation Master Plan and the Transportation Impact Assessment (2017) Guidelines.

By submitting the attached TIA report (and any associated documents) and signing this document, the individual acknowledges that s/he meets the four criteria listed below.

CERTIFICATION

1. I have reviewed and have a sound understanding of the objectives, needs and requirements of the City of Ottawa's Official Plan, Transportation Master Plan and the Transportation Impact Assessment (2017) Guidelines;
2. I have a sound knowledge of industry standard practice with respect to the preparation of transportation impact assessment reports, including multi modal level of service review;
3. I have substantial experience (more than 5 years) in undertaking and delivering transportation impact studies (analysis, reporting and geometric design) with strong background knowledge in transportation planning, engineering or traffic operations; and
4. I am either a licensed¹ or registered² professional in good standing, whose field of expertise [check appropriate field(s)] is either transportation engineering or transportation planning .

1,2 License of registration body that oversees the profession is required to have a code of conduct and ethics guidelines that will ensure appropriate conduct and representation for transportation planning and/or transportation engineering works.

City Of Ottawa
Infrastructure Services and Community
Sustainability
Planning and Growth Management
110 Laurier Avenue West, 4th fl.
Ottawa, ON K1P 1J1
Tel. : 613-580-2424
Fax: 613-560-6006

Ville d'Ottawa
Services d'infrastructure et Viabilité des
collectivités
Urbanisme et Gestion de la croissance
110, avenue Laurier Ouest
Ottawa (Ontario) K1P 1J1
Tél. : 613-580-2424
Télécopieur: 613-560-6006

Dated at Ottawa this 20 day of September, 2018.
(City)

Name: Andrew Harte
(Please Print)

Professional Title: Professional Engineer



Signature of Individual certifier that s/he meets the above four criteria

Office Contact Information (Please Print)
Address: 6 Plaza Court
City / Postal Code: Ottawa / K2H 7W1
Telephone / Extension: (613) 697-3797
E-Mail Address: Andrew.Harte@CGHTransportation.com



Appendix B

Turning Movement Counts



Transportation Services - Traffic Services

Turning Movement Count - Study Results

CAMBRIAN RD @ RIVER MIST RD

Survey Date: Wednesday, October 23, 2019
Start Time: 07:00

WO No: 38918
Device: Miovision

Full Study Diagram

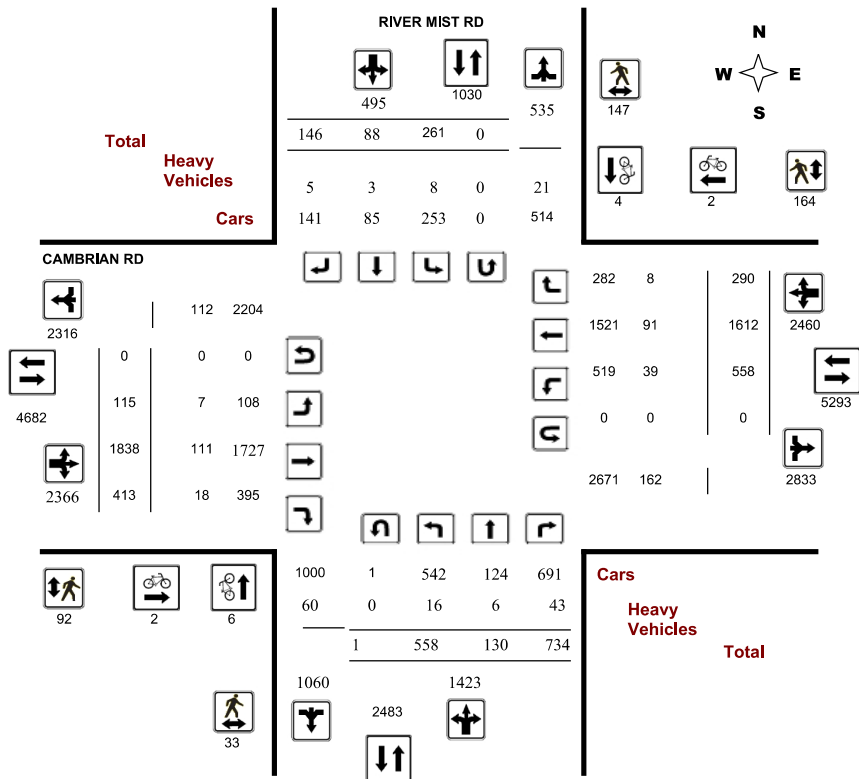

Transportation Services - Traffic Services

Turning Movement Count - Study Results

CAMBRIAN RD @ RIVER MIST RD

Survey Date: Wednesday, October 23, 2019
Start Time: 07:00

WO No: 38918
Device: Miovision

Full Study Peak Hour Diagram

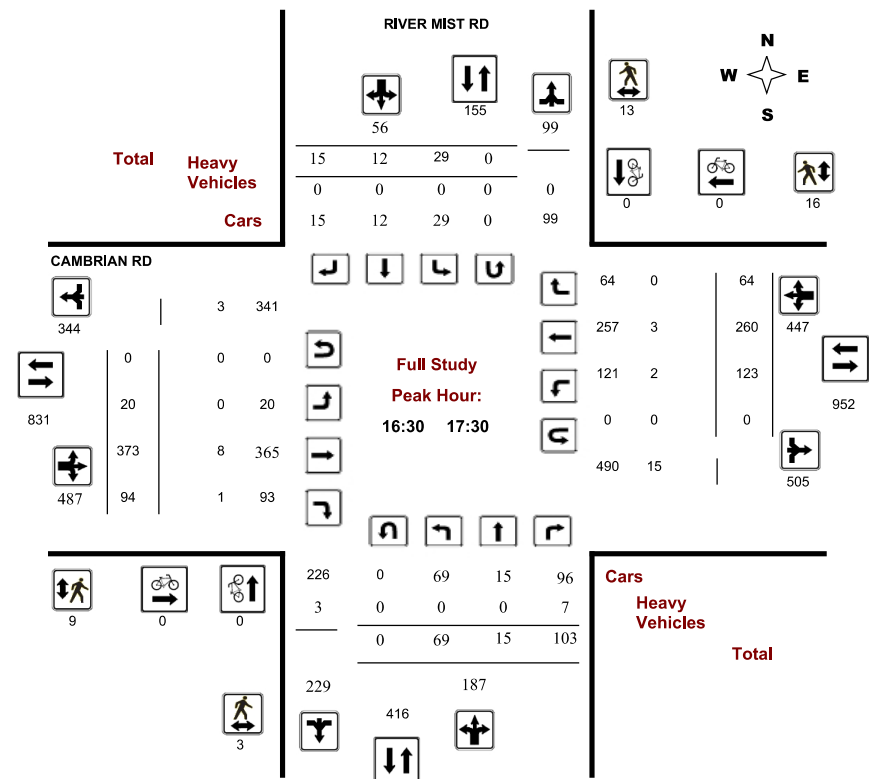



Transportation Services - Traffic Services

Turning Movement Count - Peak Hour Diagram

CAMBRIAN RD @ RIVER MIST RD

Survey Date: Wednesday, October 23, 2019
Start Time: 07:00

WO No: 38918
Device: Miovision

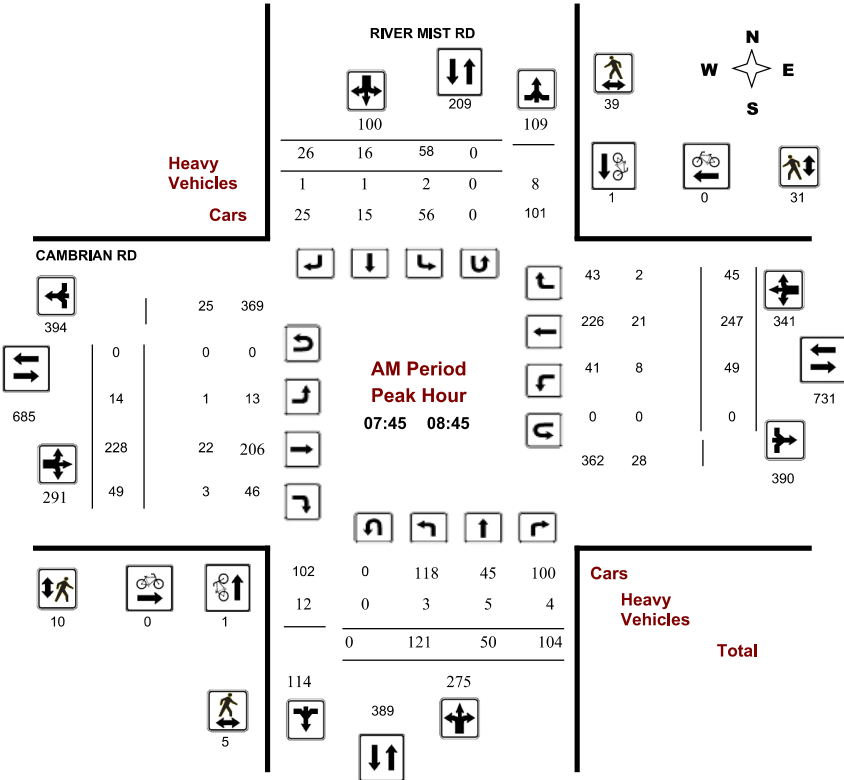

Comments



Transportation Services - Traffic Services

Turning Movement Count - Peak Hour Diagram

CAMBRIAN RD @ RIVER MIST RD

Survey Date: Wednesday, October 23, 2019
Start Time: 07:00

WO No: 38918
Device: Miovision

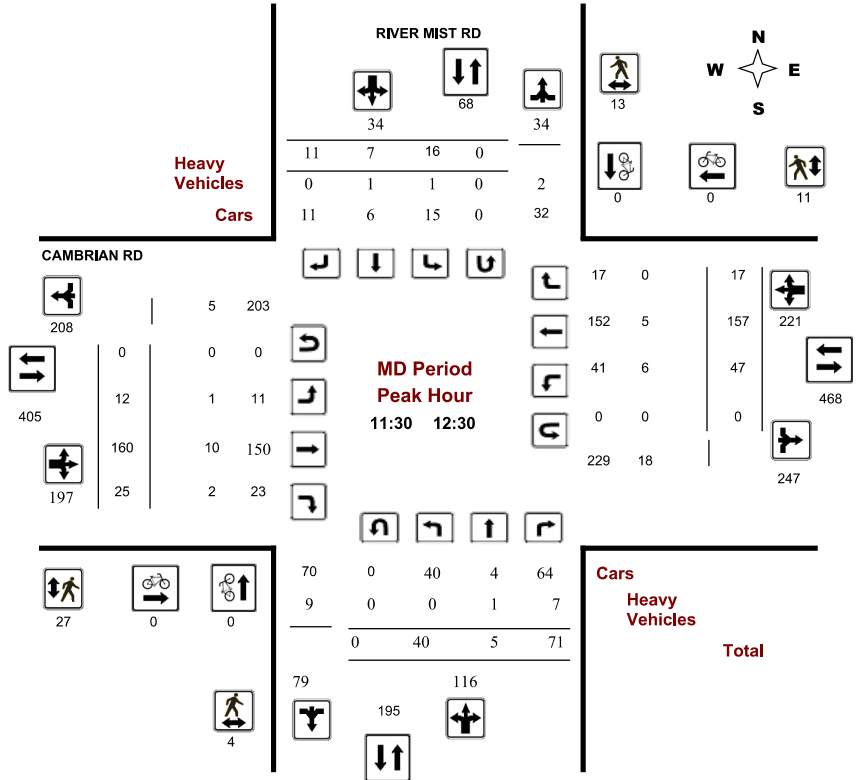

Comments



Transportation Services - Traffic Services

Turning Movement Count - Peak Hour Diagram

CAMBRIAN RD @ RIVER MIST RD

Survey Date: Wednesday, October 23, 2019
Start Time: 07:00

WO No: 38918
Device: Miovision

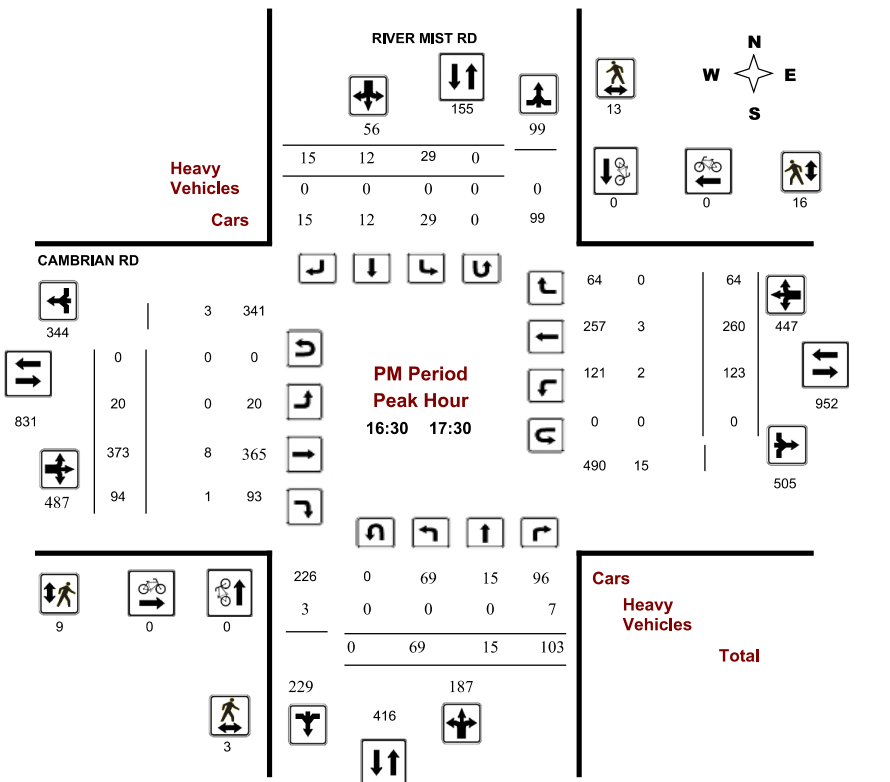

Comments



Transportation Services - Traffic Services

Turning Movement Count - Study Results

CAMBRIAN RD @ RIVER MIST RD

Survey Date: Wednesday, October 23, 2019
Start Time: 07:00

WO No: 38918
Device: Miovision

Full Study Summary (8 HR Standard)

Survey Date: Wednesday, October 23, 2019

Total Observed U-Turns **AADT Factor**

Northbound: 1	Southbound: 0	.90
Eastbound: 0	Westbound: 0	

Period	RIVER MIST RD								CAMBRIAN RD								Grand Total		
	Northbound				Southbound				Eastbound				Westbound						
	LT	ST	RT	NB TOT	LT	ST	RT	SB TOT	STR TOT	LT	ST	RT	EB TOT	LT	ST	RT		WB TOT	STR TOT
07:00 08:00	112	19	133	264	42	6	25	73	337	12	198	38	248	35	227	35	297	545	882
08:00 09:00	113	47	100	260	54	19	25	98	358	13	226	45	284	56	246	36	338	622	980
09:00 10:00	82	9	107	198	22	10	16	48	246	9	149	28	186	46	173	21	240	426	672
11:30 12:30	40	5	71	116	16	7	11	34	150	12	160	25	197	47	157	17	221	418	568
12:30 13:30	24	6	55	85	11	1	14	26	111	8	150	34	192	41	140	26	207	399	510
15:00 16:00	57	17	80	154	50	15	20	85	239	17	229	65	311	85	167	38	290	601	840
16:00 17:00	61	13	87	161	32	15	15	62	223	20	371	76	467	121	254	54	429	896	1119
17:00 18:00	69	14	101	184	34	15	20	69	253	24	355	102	481	127	248	63	438	919	1172
Sub Total	558	130	734	1422	261	88	146	495	1917	115	1838	413	2366	558	1612	290	2460	4826	6743
U Turns				1				0	1				0				0	0	1
Total	558	130	734	1423	261	88	146	495	1918	115	1838	413	2366	558	1612	290	2460	4826	6744
EQ 12Hr	776	181	1020	1978	363	122	203	688	2666	160	2555	574	3289	776	2241	403	3419	6708	9374
Note: These values are calculated by multiplying the totals by the appropriate expansion factor.													1.39						
AVG 12Hr	658	153	865	1678	308	104	172	584	2399	136	2167	487	2790	658	1901	342	2900	6037	8437
Note: These volumes are calculated by multiplying the Equivalent 12 hr. totals by the AADT factor.													0.9						
AVG 24Hr	862	201	1134	2198	403	136	225	765	2963	178	2839	638	3654	862	2490	448	3799	7453	10416
Note: These volumes are calculated by multiplying the Average Daily 12 hr. totals by 12 to 24 expansion factor.													1.31						
Note: U-Turns provided for approach totals. Refer to 'U-Turn' Report for specific breakdown.																			



Transportation Services - Traffic Services

Turning Movement Count - Study Results

CAMBRIAN RD @ RIVER MIST RD

Survey Date: Wednesday, October 23, 2019

WO No: 38918

Start Time: 07:00

Device: Miovision

Full Study 15 Minute Increments

RIVER MIST RD										CAMBRIAN RD										Grand Total
Northbound					Southbound					Eastbound					Westbound					
Time Period	LT	ST	RT	N TOT	LT	ST	RT	S TOT	STR TOT	LT	ST	RT	E TOT	LT	ST	RT	W TOT	STR TOT		
07:00	07:15	24	4	33	61	10	0	4	14	1	3	50	7	60	9	57	2	68	1	203
07:15	07:30	22	5	37	64	10	2	7	19	3	2	53	9	64	11	46	8	65	3	212
07:30	07:45	28	5	30	63	13	2	7	22	2	4	43	11	58	7	61	12	80	2	223
07:45	08:00	38	5	33	76	9	2	7	18	2	3	52	11	66	8	63	13	84	2	244
08:00	08:15	32	12	28	72	9	1	10	20	5	5	57	12	74	12	65	14	91	5	257
08:15	08:30	33	28	22	83	26	6	6	38	5	4	56	10	70	10	58	15	83	5	274
08:30	08:45	18	5	21	44	14	7	3	24	4	2	63	16	81	19	61	3	83	4	232
08:45	09:00	30	2	29	61	5	5	6	16	1	2	50	7	59	15	62	4	81	1	217
09:00	09:15	32	7	52	91	9	5	4	18	4	1	49	12	62	13	66	5	84	4	255
09:15	09:30	18	0	18	36	9	2	3	14	0	5	38	3	46	13	38	5	56	0	152
09:30	09:45	14	1	26	41	2	1	3	6	1	1	37	3	41	13	34	7	54	1	142
09:45	10:00	18	1	11	30	2	2	6	10	1	2	25	10	37	7	35	4	46	1	123
11:30	11:45	16	0	21	37	2	3	5	10	3	2	38	10	50	13	46	2	61	3	158
11:45	12:00	7	1	8	16	5	1	5	11	1	2	39	4	45	10	41	5	56	1	128
12:00	12:15	9	3	20	32	7	2	1	10	1	2	47	5	54	12	41	4	57	1	153
12:15	12:30	8	1	22	31	2	1	0	3	5	6	36	6	48	12	29	6	47	5	129
12:30	12:45	10	2	16	29	2	0	5	7	1	2	41	6	49	8	38	7	53	1	138
12:45	13:00	7	0	7	14	6	1	4	11	1	1	40	12	53	12	36	2	50	1	128
13:00	13:15	2	3	17	22	2	0	4	6	3	3	33	8	44	10	30	6	46	3	118
13:15	13:30	5	1	15	21	1	0	1	2	2	2	36	8	46	11	36	11	58	2	127
15:00	15:15	10	2	11	23	21	3	4	28	7	4	61	11	76	18	37	10	65	7	192
15:15	15:30	7	5	14	26	12	4	10	26	2	3	52	16	71	25	40	9	74	2	197
15:30	15:45	12	2	23	37	8	7	2	17	4	6	67	18	91	16	45	7	68	4	213
15:45	16:00	28	8	32	68	9	1	4	14	3	4	49	20	73	26	45	12	83	3	238
16:00	16:15	18	3	24	45	11	4	3	18	2	7	91	17	115	30	63	14	107	2	285
16:15	16:30	8	3	18	29	8	5	5	18	5	3	75	21	99	27	63	12	102	5	248
16:30	16:45	16	3	23	42	7	5	5	17	0	5	119	18	142	29	65	14	108	0	309
16:45	17:00	19	4	22	45	6	1	2	9	3	5	86	20	111	35	63	14	112	3	277
17:00	17:15	13	5	40	58	8	4	5	17	2	6	83	31	120	24	67	14	105	2	300
17:15	17:30	21	3	18	42	8	2	3	13	2	4	85	25	114	35	65	22	122	2	291
17:30	17:45	12	3	21	36	10	5	9	24	3	5	105	23	133	36	58	16	110	3	303
17:45	18:00	23	3	22	48	8	4	3	15	2	9	82	23	114	32	58	11	101	2	278
Total		558	130	734	1423	261	88	146	495	81	115	1838	413	2366	558	1612	290	2460	81	6,744

Note: U-Turns are included in Totals.



Transportation Services - Traffic Services

Turning Movement Count - Study Results

CAMBRIAN RD @ RIVER MIST RD

Survey Date: Wednesday, October 23, 2019

WO No: 38918

Start Time: 07:00

Device: Miovision

Full Study Cyclist Volume

Time Period	RIVER MIST RD			CAMBRIAN RD			Grand Total	
	Northbound	Southbound	Street Total	Eastbound	Westbound	Street Total		
07:00	07:15	0	0	0	0	1	1	
07:15	07:30	0	0	0	0	0	0	
07:30	07:45	1	0	1	1	1	2	
07:45	08:00	0	0	0	0	0	0	
08:00	08:15	0	1	1	0	0	1	
08:15	08:30	1	0	1	0	0	1	
08:30	08:45	0	0	0	0	0	0	
08:45	09:00	0	0	0	1	0	1	
09:00	09:15	0	0	0	0	0	0	
09:15	09:30	0	0	0	0	1	1	
09:30	09:45	1	0	1	0	0	1	
09:45	10:00	0	0	0	0	0	0	
11:30	11:45	0	0	0	0	0	0	
11:45	12:00	0	0	0	0	0	0	
12:00	12:15	0	0	0	0	0	0	
12:15	12:30	0	0	0	0	0	0	
12:30	12:45	0	0	0	0	0	0	
12:45	13:00	0	0	0	0	0	0	
13:00	13:15	0	0	0	0	0	0	
13:15	13:30	0	0	0	0	0	0	
15:00	15:15	0	2	2	0	0	2	
15:15	15:30	1	0	1	0	0	1	
15:30	15:45	0	0	0	0	0	0	
15:45	16:00	2	0	2	0	0	2	
16:00	16:15	0	1	1	0	0	1	
16:15	16:30	0	0	0	0	0	0	
16:30	16:45	0	0	0	0	0	0	
16:45	17:00	0	0	0	0	0	0	
17:00	17:15	0	0	0	0	0	0	
17:15	17:30	0	0	0	0	0	0	
17:30	17:45	0	0	0	0	0	0	
17:45	18:00	0	0	0	0	0	0	
Total		6	4	10	2	2	4	14



Transportation Services - Traffic Services

Turning Movement Count - Study Results

CAMBRIAN RD @ RIVER MIST RD

Survey Date: Wednesday, October 23, 2019

WO No: 38918

Start Time: 07:00

Device: Miovision

Full Study Pedestrian Volume

RIVER MIST RD

CAMBRIAN RD

Time Period	RIVER MIST RD		Total	CAMBRIAN RD		Total	Grand Total
	NB Approach (E or W Crossing)	SB Approach (E or W Crossing)		EB Approach (N or S Crossing)	WB Approach (N or S Crossing)		
07:00 07:15	1	2	3	1	4	5	8
07:15 07:30	0	3	3	7	1	8	11
07:30 07:45	0	5	5	1	4	5	10
07:45 08:00	0	6	6	0	0	0	6
08:00 08:15	1	19	20	3	11	14	34
08:15 08:30	0	8	8	0	13	13	21
08:30 08:45	4	6	10	7	7	14	24
08:45 09:00	4	8	12	2	8	10	22
09:00 09:15	0	0	0	0	1	1	1
09:15 09:30	0	1	1	0	3	3	4
09:30 09:45	0	1	1	0	2	2	3
09:45 10:00	1	1	2	0	3	3	5
11:30 11:45	2	2	4	23	4	27	31
11:45 12:00	0	2	2	0	0	0	2
12:00 12:15	2	5	7	2	4	6	13
12:15 12:30	0	4	4	2	3	5	9
12:30 12:45	1	1	2	0	1	1	3
12:45 13:00	2	2	4	1	3	4	8
13:00 13:15	0	4	4	4	3	7	11
13:15 13:30	0	1	1	0	0	0	1
15:00 15:15	3	9	12	6	30	36	48
15:15 15:30	0	3	3	8	5	13	16
15:30 15:45	2	8	10	0	8	8	18
15:45 16:00	1	12	13	8	3	11	24
16:00 16:15	3	6	9	3	6	9	18
16:15 16:30	2	7	9	1	4	5	14
16:30 16:45	1	2	3	4	0	4	7
16:45 17:00	1	9	10	4	4	8	18
17:00 17:15	1	2	3	1	6	7	10
17:15 17:30	0	0	0	0	6	6	6
17:30 17:45	1	6	7	3	10	13	20
17:45 18:00	0	2	2	1	7	8	10
Total	33	147	180	92	164	256	436



Transportation Services - Traffic Services

Turning Movement Count - Study Results

CAMBRIAN RD @ RIVER MIST RD

Survey Date: Wednesday, October 23, 2019

WO No: 38918

Start Time: 07:00

Device: Miovision

Full Study Heavy Vehicles

RIVER MIST RD

CAMBRIAN RD

Time Period	RIVER MIST RD						CAMBRIAN RD						Grand Total						
	Northbound			Southbound			Eastbound			Westbound									
	LT	ST	RT	N TOT	LT	ST	RT	S TOT	STR TOT	LT	ST	RT		E TOT	LT	ST	RT	W TOT	STR TOT
07:00 07:15	0	0	1	1	0	0	0	0	1	1	2	1	4	3	4	0	7	11	12
07:15 07:30	0	0	3	3	0	0	0	0	3	0	7	2	9	2	4	1	7	16	19
07:30 07:45	1	0	1	2	0	0	0	0	2	0	3	0	3	1	4	1	6	9	11
07:45 08:00	2	0	0	2	0	0	0	0	2	1	7	2	10	2	5	0	7	17	19
08:00 08:15	0	3	1	4	0	0	1	1	5	0	3	1	4	2	4	1	7	11	16
08:15 08:30	1	2	0	3	2	0	0	2	5	0	5	0	5	1	4	1	6	11	16
08:30 08:45	0	0	3	3	0	1	0	1	4	0	7	0	7	3	8	0	11	18	22
08:45 09:00	1	0	0	1	0	0	0	0	1	1	4	2	7	1	8	0	9	16	17
09:00 09:15	3	0	1	4	0	0	0	0	4	0	0	1	1	1	8	0	9	10	14
09:15 09:30	0	0	0	0	0	0	0	0	0	0	3	0	3	1	1	0	2	5	5
09:30 09:45	0	0	1	1	0	0	0	0	1	0	5	0	5	2	2	1	5	10	11
09:45 10:00	0	0	1	1	0	0	0	0	1	0	4	0	4	2	2	0	4	8	9
11:30 11:45	0	0	2	2	1	0	0	1	3	0	6	1	7	2	1	0	3	10	13
11:45 12:00	0	0	1	1	0	0	0	0	1	0	0	0	0	2	1	0	3	3	4
12:00 12:15	0	0	1	1	0	0	0	0	1	1	3	1	5	1	1	0	2	7	8
12:15 12:30	0	1	3	4	0	1	0	1	5	0	1	0	1	1	2	0	3	4	9
12:30 12:45	0	0	1	1	0	0	0	0	1	0	4	0	4	1	1	1	3	7	8
12:45 13:00	0	0	0	0	0	0	1	1	1	1	1	1	6	1	2	1	4	10	11
13:00 13:15	0	0	2	2	0	0	1	1	3	0	4	1	5	1	0	0	1	6	9
13:15 13:30	1	0	1	2	0	0	0	0	2	1	5	0	6	1	4	0	5	11	13
15:00 15:15	1	0	1	2	5	0	0	5	7	1	4	2	7	1	1	0	2	9	16
15:15 15:30	0	0	1	1	0	0	1	1	2	0	2	1	3	1	2	0	3	6	8
15:30 15:45	1	0	3	4	0	0	0	0	4	0	2	1	3	1	5	0	6	9	13
15:45 16:00	1	0	1	2	0	0	1	1	3	0	7	0	7	1	3	0	4	11	14
16:00 16:15	1	0	1	2	0	0	0	0	2	0	6	0	6	1	3	1	5	11	13
16:15 16:30	2	0	2	4	0	1	0	1	5	0	1	0	1	0	6	0	6	7	12
16:30 16:45	0	0	0	0	0	0	0	0	0	0	1	0	1	1	2	0	3	4	4
16:45 17:00	0	0	3	3	0	0	0	0	3	0	2	1	3	0	0	0	0	3	6
17:00 17:15	0	0	2	2	0	0	0	0	2	0	2	0	2	1	1	0	2	4	6
17:15 17:30	0	0	2	2	0	0	0	0	2	0	3	0	3	0	0	0	0	3	5
17:30 17:45	1	0	2	3	0	0	0	0	3	0	2	0	2	1	1	0	2	4	7
17:45 18:00	0	0	2	2	0	0	0	0	2	0	2	0	2	0	1	0	1	3	5
Total: None	16	6	43	65	8	3	5	16	81	7	111	18	136	39	91	8	138	274	355



Transportation Services - Traffic Services

Turning Movement Count - Study Results

CAMBRIAN RD @ RIVER MIST RD

Survey Date: Wednesday, October 23, 2019

WO No: 38918

Start Time: 07:00

Device: Miovision

Full Study 15 Minute U-Turn Total

RIVER MIST RD

CAMBRIAN RD

Time Period		Northbound U-Turn Total	Southbound U-Turn Total	Eastbound U-Turn Total	Westbound U-Turn Total	Total
07:00	07:15	0	0	0	0	0
07:15	07:30	0	0	0	0	0
07:30	07:45	0	0	0	0	0
07:45	08:00	0	0	0	0	0
08:00	08:15	0	0	0	0	0
08:15	08:30	0	0	0	0	0
08:30	08:45	0	0	0	0	0
08:45	09:00	0	0	0	0	0
09:00	09:15	0	0	0	0	0
09:15	09:30	0	0	0	0	0
09:30	09:45	0	0	0	0	0
09:45	10:00	0	0	0	0	0
11:30	11:45	0	0	0	0	0
11:45	12:00	0	0	0	0	0
12:00	12:15	0	0	0	0	0
12:15	12:30	0	0	0	0	0
12:30	12:45	1	0	0	0	1
12:45	13:00	0	0	0	0	0
13:00	13:15	0	0	0	0	0
13:15	13:30	0	0	0	0	0
15:00	15:15	0	0	0	0	0
15:15	15:30	0	0	0	0	0
15:30	15:45	0	0	0	0	0
15:45	16:00	0	0	0	0	0
16:00	16:15	0	0	0	0	0
16:15	16:30	0	0	0	0	0
16:30	16:45	0	0	0	0	0
16:45	17:00	0	0	0	0	0
17:00	17:15	0	0	0	0	0
17:15	17:30	0	0	0	0	0
17:30	17:45	0	0	0	0	0
17:45	18:00	0	0	0	0	0
Total		1	0	0	0	1

AM Peak Hour

PM Peak Hour

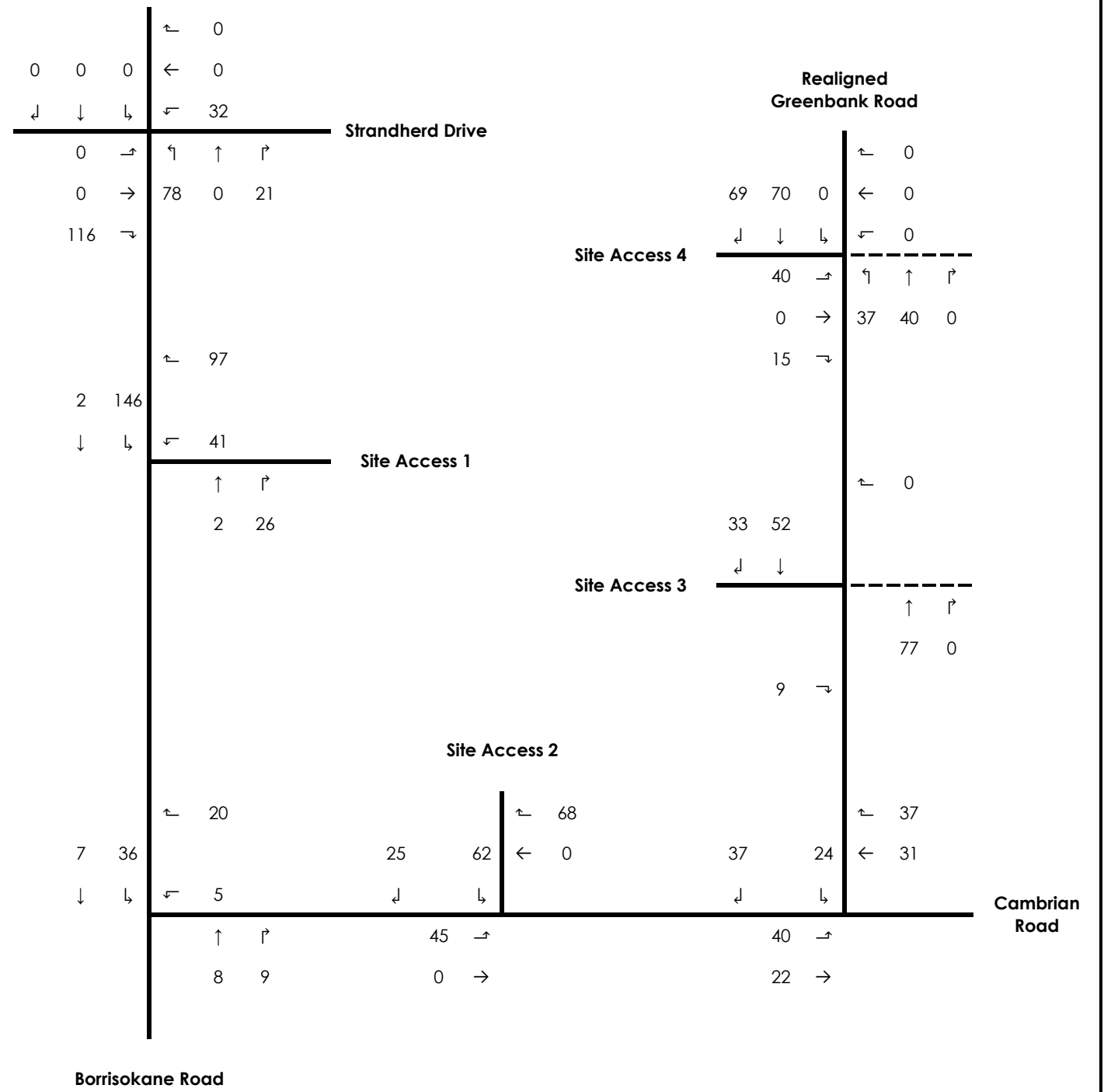
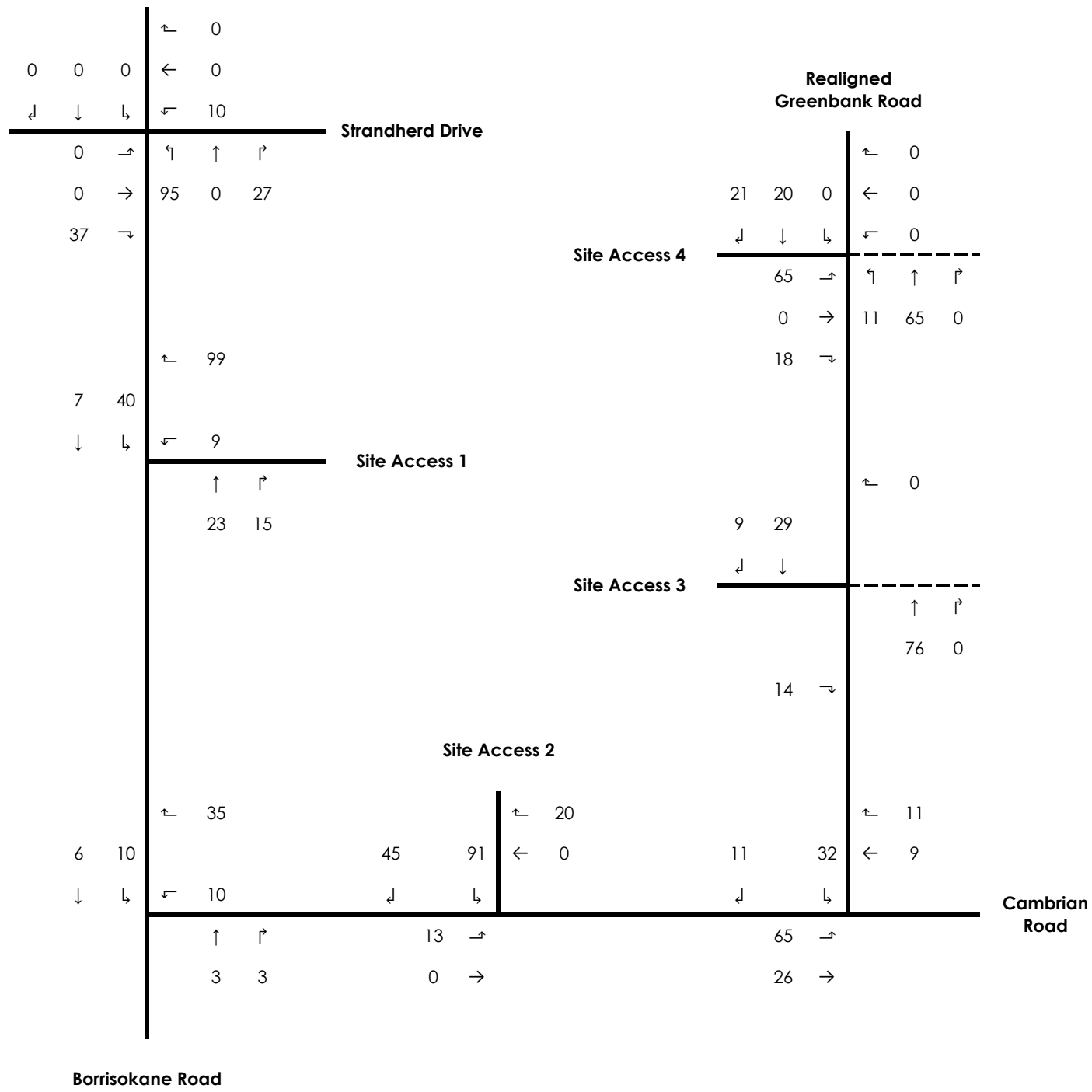

Mattamy Homes
 Half Moon Bay West
 Figure 9: Net New Site Traffic Volumes



Turning Movement Count Summary Report

Including OFF Peak, PM Peak and PHF
All Vehicles Except Bicycles



Cambrian Road & River Mist Road Barrhaven West, ON

Survey Date: Saturday, October 15, 2022 **Start Time:** 1100 **AADT Factor:** 1.1
Weather AM: Mainly Sunny 15° C **Survey Duration:** 5 Hrs. **Survey Hours:** 1100 - 1600
Weather PM: Overcast 12° C **Surveyor(s):** J. Mousseau

Time Period	Cambrian Rd. Eastbound				Cambrian Rd. Westbound				River Mist Rd. Northbound				River Mist Rd. Southbound				S/B Tot	Street Total	Grand Total				
	LT	ST	RT	UT	LT	ST	RT	UT	LT	ST	RT	UT	LT	ST	RT	UT							
1100-1200	3	233	21	0	257	63	232	39	0	334	591	45	5	85	0	135	32	9	9	0	50	185	776
1200-1300	6	262	39	0	307	69	280	72	0	421	728	40	10	79	0	129	32	13	16	0	61	190	918
1300-1400	16	243	27	0	286	61	253	33	0	347	633	52	8	90	0	150	42	8	14	0	64	214	847
1400-1500	7	264	49	0	320	75	261	40	0	376	696	32	6	68	0	106	26	4	11	0	41	147	843
1500-1600	14	237	40	0	291	77	272	48	0	397	688	48	10	72	0	130	24	4	14	0	42	172	860
Totals	46	1239	176	0	1461	345	1298	232	0	1875	3336	217	39	394	0	650	156	38	64	0	258	908	4244

Expansion factors are applied exclusively to standard weekday 8-hour turning movement counts conducted during the hours of 0700h - 1000h, 1130h - 1330h and 1500h - 1800h

OFF Peak Hour Factor → 0.98													Highest Hourly Vehicle Volume Between 1100h & 1500h												
OFF Peak Hr	LT	ST	RT	UT	Total	LT	ST	RT	UT	Total	Str. Tot.	LT	ST	RT	UT	Total	LT	ST	RT	UT	Total	Str. Tot.	Gr. Tot.		
1200-1300	6	262	39	0	307	69	280	72	0	421	728	40	10	79	0	129	32	13	16	0	61	190	918		

PM Peak Hour Factor → 0.92													Highest Hourly Vehicle Volume Between 1500h & 1900h												
PM Peak Hr	LT	ST	RT	UT	Total	LT	ST	RT	UT	Total	Str. Tot.	LT	ST	RT	UT	Total	LT	ST	RT	UT	Total	Str. Tot.	Gr. Tot.		
1500-1600	14	237	40	0	291	77	272	48	0	397	688	48	10	72	0	130	24	4	14	0	42	172	860		

Comments:
OC Transpo buses comprise 50.98% of the heavy vehicle traffic.

Notes:
1. Includes all vehicle types except bicycles and electric scooters.
2. When expansion and AADT factors are applied, the results will differ slightly due to rounding.



Turning Movement Count Summary, OFF and PM Peak Hour Flow Diagrams

All Vehicles Except Bicycles



Cambrian Road & River Mist Road Barrhaven West, ON

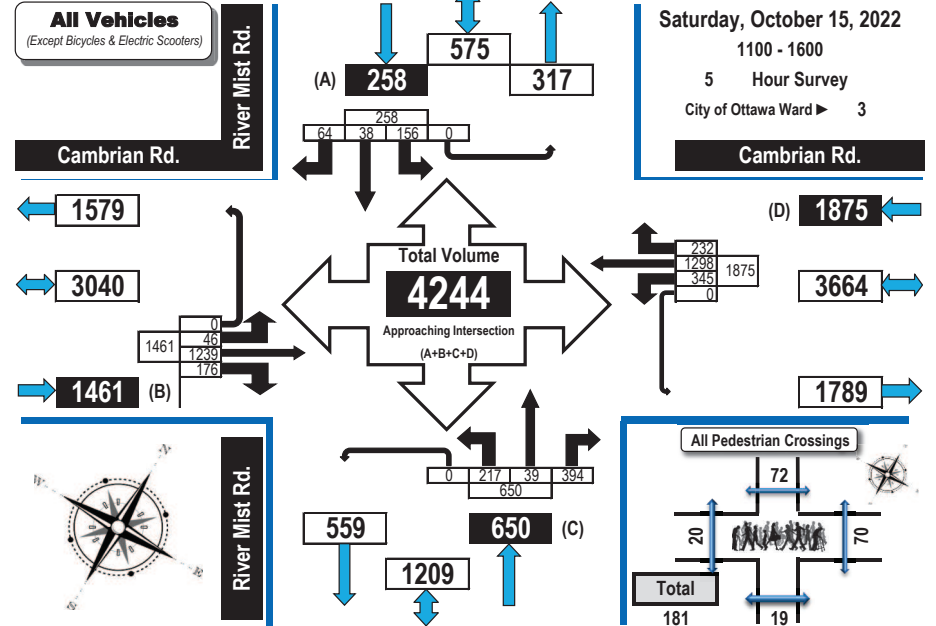

Off Peak Hour Flow Diagram PM Peak Hour Flow Diagram

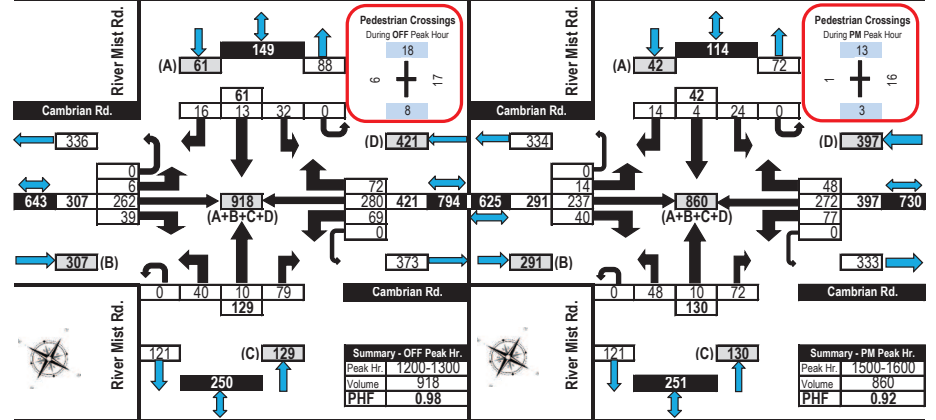



Turning Movement Count Heavy Vehicle Summary (FHWA Class 4-13) Flow Diagram

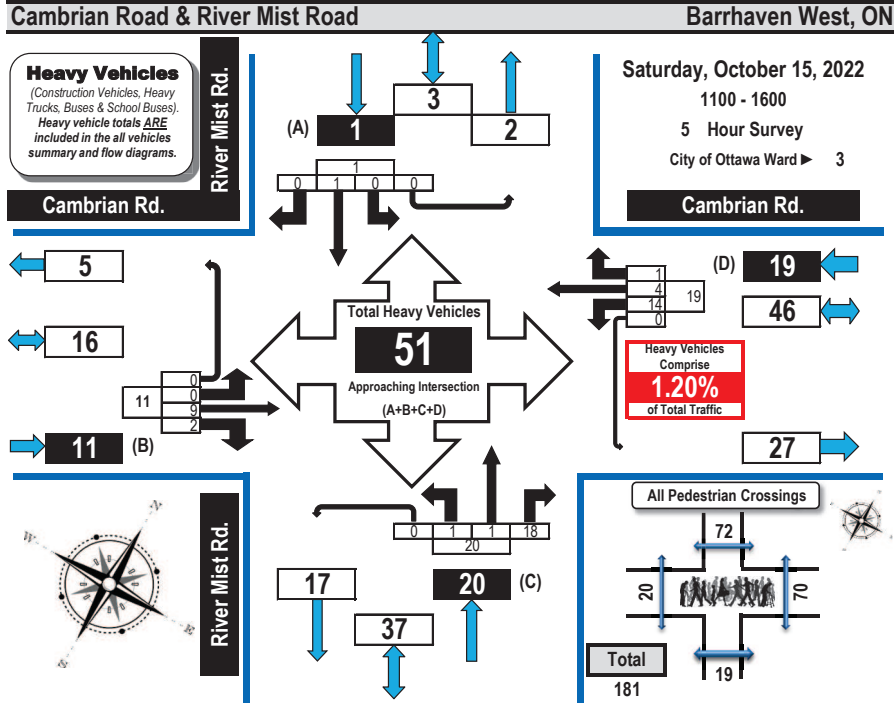

Time Period	Eastbound				Westbound				Northbound				Southbound				GR Tot			
	LT	ST	RT	UT	LT	ST	RT	UT	LT	ST	RT	UT	LT	ST	RT	UT				
1100-1200	0	4	1	0	5	2	0	0	2	0	1	3	0	4	0	0	0	0	0	11
1200-1300	0	1	0	0	1	5	0	0	5	0	0	3	0	3	0	1	0	0	0	10
1300-1400	0	1	0	0	1	2	2	0	4	0	0	5	0	5	0	0	0	0	0	10
1400-1500	0	2	1	0	3	2	1	0	3	0	0	1	0	1	0	0	0	0	0	7
1500-1600	0	1	0	0	1	3	1	1	5	1	0	6	0	7	0	0	0	0	0	13
Totals	0	9	2	0	11	14	4	1	19	1	1	18	0	20	0	1	0	1	0	51

Comments:

OC Transpo buses comprise 50.98% of the heavy vehicle traffic.



Turning Movement Count All Buses Summary (FHWA Class 4 ONLY) Flow Diagram

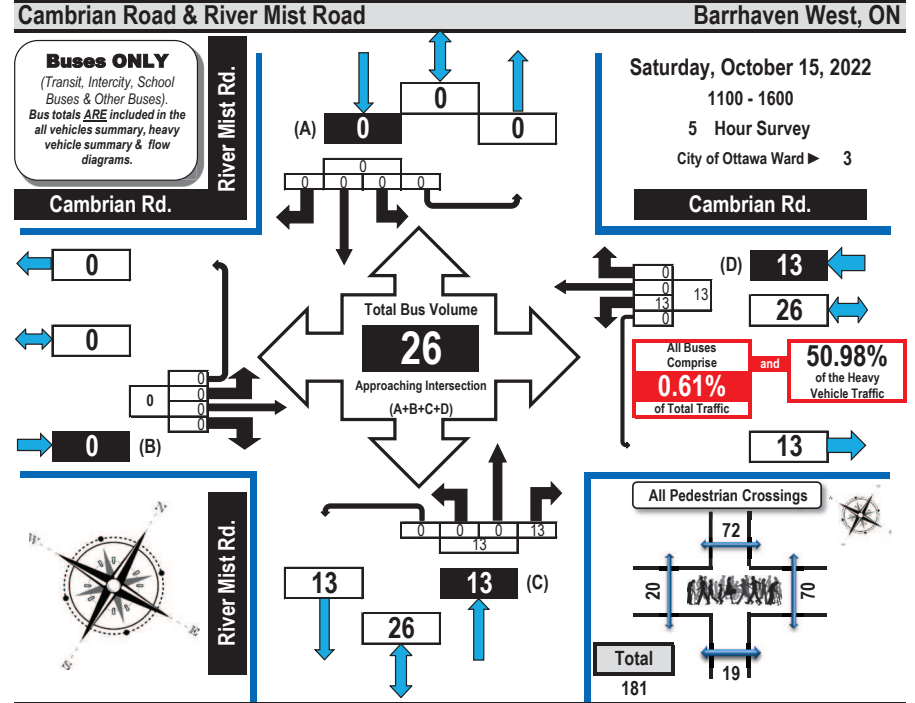

Time Period	Eastbound				Westbound				Northbound				Southbound				GR Tot			
	LT	ST	RT	UT	LT	ST	RT	UT	LT	ST	RT	UT	LT	ST	RT	UT				
1100-1200	0	0	0	0	2	0	0	0	2	0	0	2	0	2	0	0	0	0	0	4
1200-1300	0	0	0	0	4	0	0	0	4	0	0	2	0	2	0	0	0	0	0	6
1300-1400	0	0	0	0	2	0	0	0	2	0	0	4	0	4	0	0	0	0	0	6
1400-1500	0	0	0	0	2	0	0	0	2	0	0	1	0	1	0	0	0	0	0	3
1500-1600	0	0	0	0	3	0	0	0	3	0	0	4	0	4	0	0	0	0	0	7
Totals	0	0	0	0	13	0	0	0	13	0	0	13	0	13	0	0	0	0	0	26

Comments:

OC Transpo buses comprise 50.98% of the heavy vehicle traffic.



Turning Movement Count Bicycle Summary Flow Diagram



Cambrian Road & River Mist Road Barrhaven West, ON

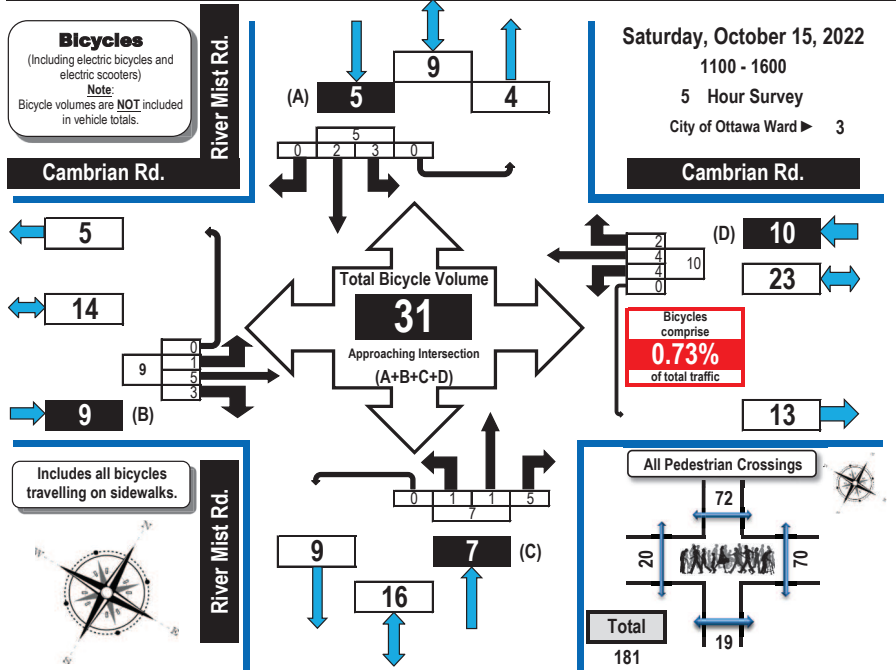

Time Period	Cambrian Rd. Eastbound				Cambrian Rd. Westbound				River Mist Rd. Northbound				River Mist Rd. Southbound				GR Tot		
	LT	ST	RT	UT	LT	ST	RT	UT	LT	ST	RT	UT	LT	ST	RT	UT			
	EB Tot				WB Tot				NB Tot				SB Tot						
1100-1200	0	2	0	0	2	2	1	0	3	0	0	0	0	0	2	0	2	0	7
1200-1300	0	0	2	0	2	0	0	2	0	0	0	0	0	1	0	0	0	1	5
1300-1400	1	1	0	0	2	0	1	0	1	0	1	1	2	0	0	0	0	0	5
1400-1500	0	2	0	0	2	1	2	0	3	1	0	1	2	2	0	0	2	0	9
1500-1600	0	0	1	0	1	1	0	0	1	0	0	3	0	0	0	0	0	0	5
Totals	1	5	3	0	9	4	4	2	10	1	1	5	7	3	2	0	5	31	

Comments:

OC Transpo buses comprise 50.98% of the heavy vehicle traffic.



Turning Movement Count Pedestrian Crossings Summary and Flow Diagram



Cambrian Road & River Mist Road Barrhaven West, ON

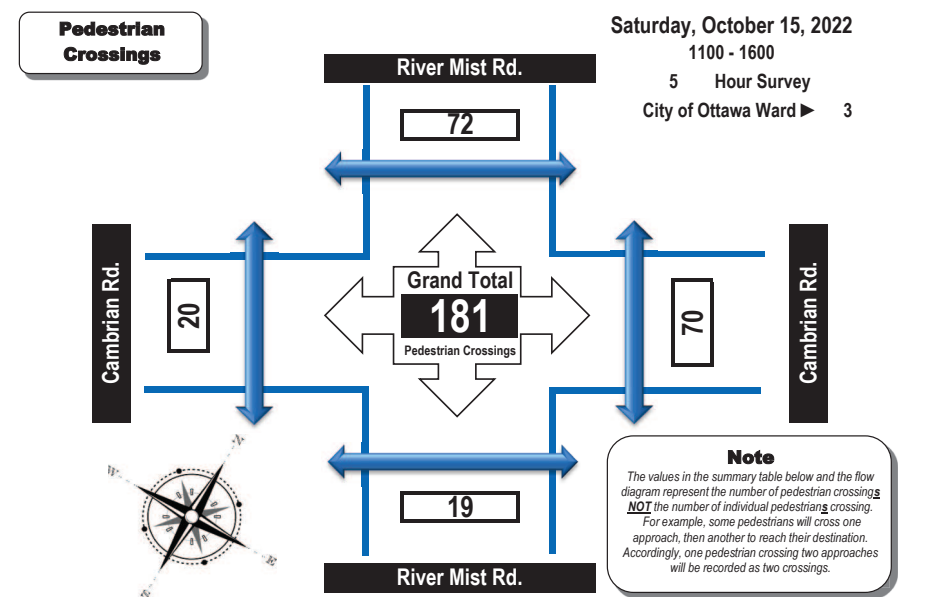

Time Period	West Side Crossing Cambrian Rd.	East Side Crossing Cambrian Rd.	Street Total	South Side Crossing River Mist Rd.	North Side Crossing River Mist Rd.	Street Total	Grand Total
1100-1200	7	23	30	3	30	33	63
1200-1300	6	17	23	8	18	26	49
1300-1400	5	8	13	4	8	12	25
1400-1500	1	6	7	1	3	4	11
1500-1600	1	16	17	3	13	16	33
Totals	20	70	90	19	72	91	181

Comments:

OC Transpo buses comprise 50.98% of the heavy vehicle traffic.



Turning Movement Count Summary Report

Including OFF Peak, PM Peak and PHF
All Vehicles Except Bicycles



Apolune Street/Elevation Road & Cambrian Road Barrhaven West, ON

Survey Date: Saturday, October 15, 2022 **Start Time:** 1100 **AADT Factor:** 1.1
Weather: AM: Mostly Sunny 15° C **Survey Duration:** 5 Hrs. **Survey Hours:** 1100 - 1600
Weather PM: Overcast 12° C **Surveyor(s):** M. Brazeau

Time Period	Cambrian Rd. Eastbound				Cambrian Rd. Westbound				Elevation Rd. Northbound				Apolune St. Southbound				S/B Tot	Street Total	Grand Total				
	LT	ST	RT	UT	LT	ST	RT	UT	LT	ST	RT	UT	LT	ST	RT	UT							
	W/B Tot				Street Total				N/B Tot				S/T Tot										
1100-1200	25	159	4	0	188	15	241	39	0	295	483	4	2	13	0	19	26	4	47	0	77	96	579
1200-1300	25	201	3	0	229	14	260	47	0	321	550	10	2	17	0	29	33	0	43	0	76	105	655
1300-1400	32	203	8	0	243	21	242	44	1	308	551	6	3	16	0	25	35	4	34	0	73	98	649
1400-1500	35	215	5	0	255	15	222	45	0	282	537	9	1	20	0	30	50	2	42	0	94	124	661
1500-1600	31	247	4	0	282	9	218	53	0	280	562	3	2	10	0	15	40	3	37	0	80	95	657
Totals	148	1025	24	0	1197	74	1183	228	1	1486	2683	32	10	76	0	118	184	13	203	0	400	518	3201

Expansion factors are applied exclusively to standard weekday 8-hour turning movement counts conducted during the hours of 0700h - 1000h, 1130h - 1330h and 1500h - 1800h

OFF Peak Hour Factor → 0.95		Highest Hourly Vehicle Volume Between 1100h & 1500h																					
OFF Peak Hr	LT	ST	RT	UT	Total	LT	ST	RT	UT	Total	LT	ST	RT	UT	Total	LT	ST	RT	UT	Total	Str. Tot.	Gr. Tot.	
1345-1445	38	206	6	0	250	15	236	49	0	300	550	12	1	21	0	34	47	2	45	0	94	128	678

PM Peak Hour Factor → 0.89		Highest Hourly Vehicle Volume Between 1500h & 1900h																					
PM Peak Hr	LT	ST	RT	UT	Total	LT	ST	RT	UT	Total	LT	ST	RT	UT	Total	LT	ST	RT	UT	Total	Str. Tot.	Gr. Tot.	
1500-1600	31	247	4	0	282	9	218	53	0	280	562	3	2	10	0	15	40	3	37	0	80	95	657

Comments:
New housing construction is underway in this area.

Notes:
1. Includes all vehicle types except bicycles and electric scooters.
2. When expansion and AADT factors are applied, the results will differ slightly due to rounding.



Turning Movement Count Summary, OFF and PM Peak Hour Flow Diagrams

All Vehicles Except Bicycles



Apolune Street/Elevation Road & Cambrian Road Barrhaven West, ON

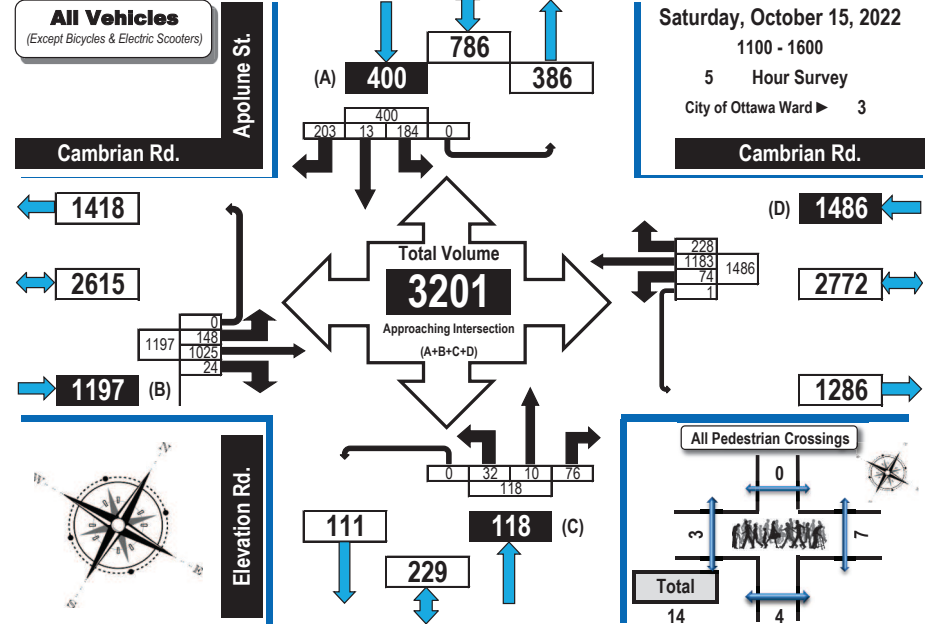

Off Peak Hour Flow Diagram PM Peak Hour Flow Diagram

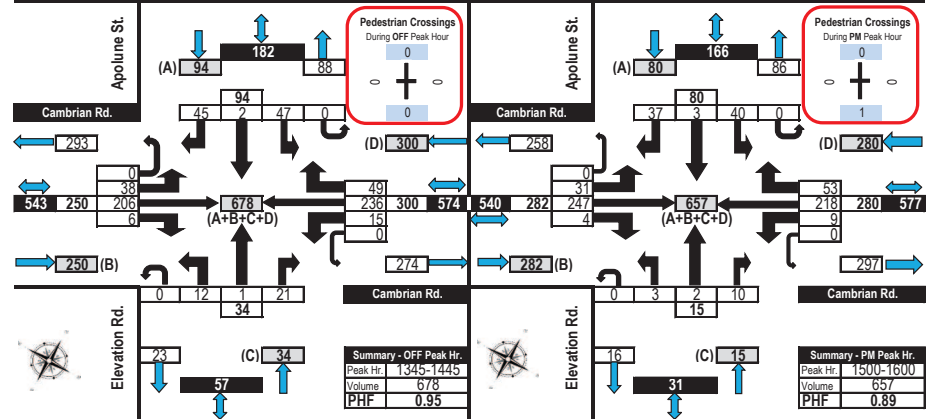



Turning Movement Count Heavy Vehicle Summary (FHWA Class 4-13) Flow Diagram

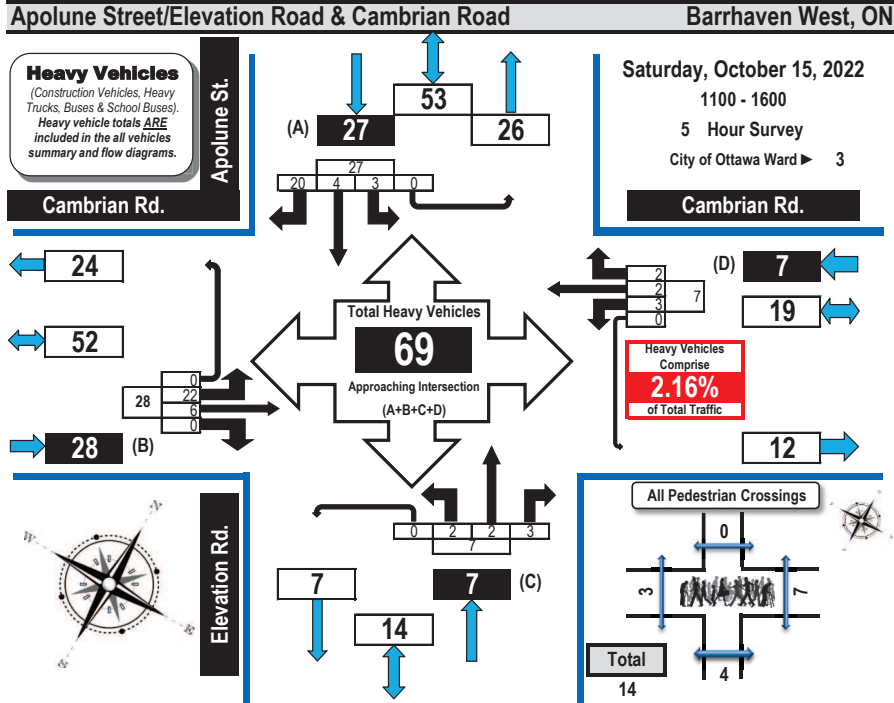

Time Period	Eastbound				Westbound				Northbound				Southbound				SB Tot	GR Tot		
	LT	ST	RT	UT	LT	ST	RT	UT	LT	ST	RT	UT	LT	ST	RT	UT				
1100-1200	5	2	0	0	7	1	0	0	1	1	0	1	0	2	0	1	5	0	6	16
1200-1300	7	0	0	0	7	1	0	0	1	1	0	1	0	2	0	0	4	0	4	14
1300-1400	5	2	0	0	7	1	1	0	2	0	1	0	0	1	0	1	3	0	4	14
1400-1500	3	1	0	0	4	0	0	1	1	0	0	0	0	0	3	0	4	0	7	12
1500-1600	2	1	0	0	3	0	1	1	2	0	1	1	0	2	2	4	0	6	13	
Totals	22	6	0	0	28	3	2	2	7	2	2	3	0	7	3	4	20	0	27	69

Comments:

New housing construction is underway in this area.



Turning Movement Count Bicycle Summary Flow Diagram

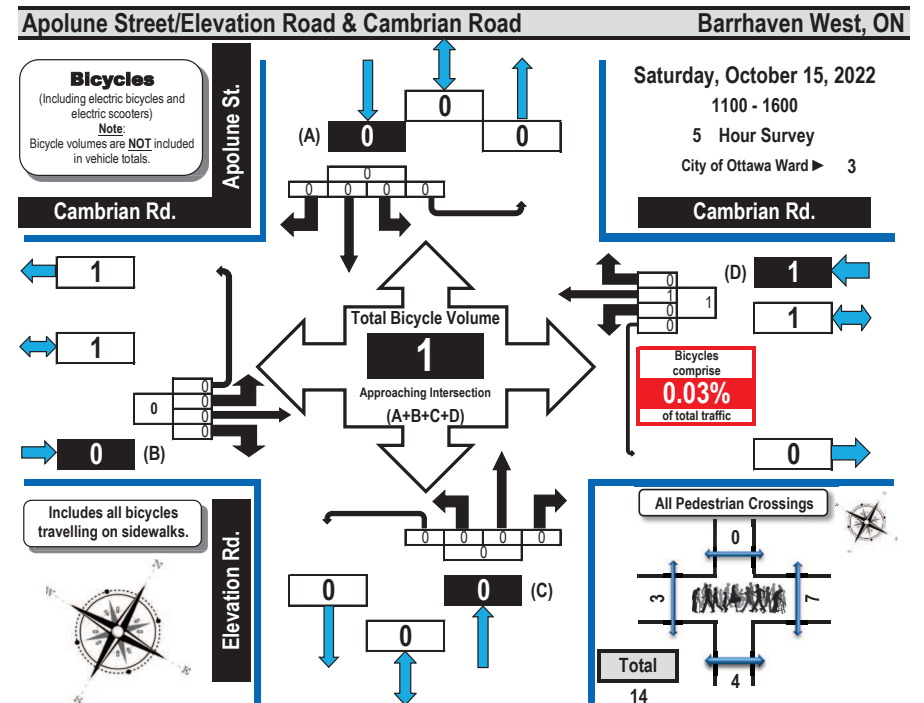

Time Period	Eastbound				Westbound				Northbound				Southbound				SB Tot	GR Tot		
	LT	ST	RT	UT	LT	ST	RT	UT	LT	ST	RT	UT	LT	ST	RT	UT				
1100-1200	0	0	0	0	0	0	1	0	1	0	0	0	0	0	0	0	0	0	0	1
1200-1300	0	0	0	0	0	0	0	0	0	0	0	0	0	0	0	0	0	0	0	0
1300-1400	0	0	0	0	0	0	0	0	0	0	0	0	0	0	0	0	0	0	0	0
1400-1500	0	0	0	0	0	0	0	0	0	0	0	0	0	0	0	0	0	0	0	0
1500-1600	0	0	0	0	0	0	0	0	0	0	0	0	0	0	0	0	0	0	0	0
Totals	0	0	0	0	0	0	1	0	1	0	0	0	0	0	0	0	0	0	0	1

Comments:

New housing construction is underway in this area.



Turning Movement Count Pedestrian Crossings Summary and Flow Diagram



Apolune Street/Elevation Road & Cambrian Road **Barrhaven West, ON**

Pedestrian Crossings

Saturday, October 15, 2022
1100 - 1600
5 Hour Survey
City of Ottawa Ward ► 3

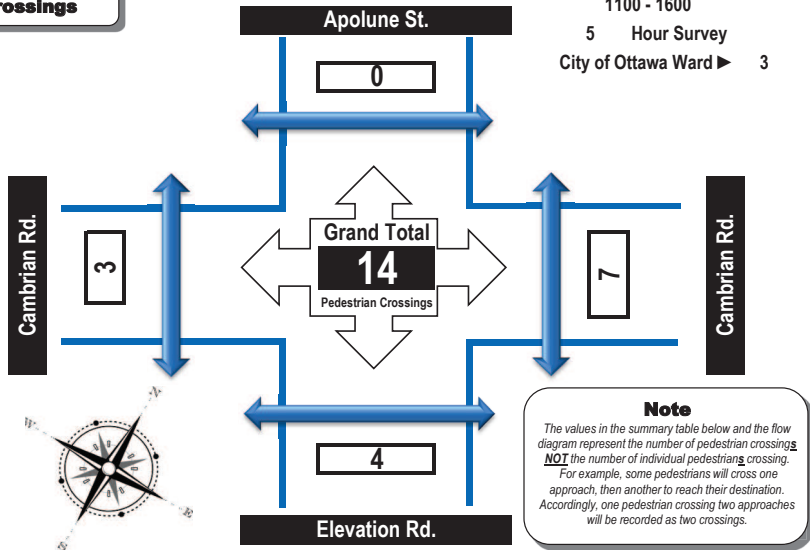

Time Period	West Side Crossing Cambrian Rd.	East Side Crossing Cambrian Rd.	Street Total	South Side Crossing Elevation Rd.	North Side Crossing Apolune St.	Street Total	Grand Total
1100-1200	3	2	5	2	0	2	7
1200-1300	0	5	5	0	0	0	5
1300-1400	0	0	0	1	0	1	1
1400-1500	0	0	0	0	0	0	0
1500-1600	0	0	0	1	0	1	1
Totals	3	7	10	4	0	4	14

Comments:

New housing construction is underway in this area.

Appendix C

Synchro Intersection Worksheets – Existing Conditions

HCM 2010 AWSC
1: River Mist Road & Cambrian Road

Existing
AM Peak Hour

Intersection												
Intersection Delay, s/veh	20.3											
Intersection LOS	C											
Movement	EBL	EBT	EBR	WBL	WBT	WBR	NBL	NBT	NBR	SBL	SBT	SBR
Lane Configurations		↔			↕			↕			↔	
Traffic Vol, veh/h	14	308	49	49	247	45	121	50	104	58	16	26
Future Vol, veh/h	14	308	49	49	247	45	121	50	104	58	16	26
Peak Hour Factor	0.90	0.90	0.90	0.90	0.90	0.90	0.90	0.90	0.90	0.90	0.90	0.90
Heavy Vehicles, %	7	10	6	16	9	4	2	10	4	3	6	4
Mvmt Flow	16	342	54	54	274	50	134	56	116	64	18	29
Number of Lanes	0	1	0	0	1	0	0	1	0	0	1	0
Approach	EB			WB			NB			SB		
Opposing Approach	WB			EB			SB			NB		
Opposing Lanes	1			1			1			1		
Conflicting Approach Left	SB			NB			EB			WB		
Conflicting Lanes Left	1			1			1			1		
Conflicting Approach Right	NB			SB			WB			EB		
Conflicting Lanes Right	1			1			1			1		
HCM Control Delay	23.1			21.9			17.5			12.5		
HCM LOS	C			C			C			B		
Lane	NBLn1	EBLn1	WBLn1	SBLn1								
Vol Left, %	44%	4%	14%	58%								
Vol Thru, %	18%	83%	72%	16%								
Vol Right, %	38%	13%	13%	26%								
Sign Control	Stop	Stop	Stop	Stop								
Traffic Vol by Lane	275	371	341	100								
LT Vol	121	14	49	58								
Through Vol	50	308	247	16								
RT Vol	104	49	45	26								
Lane Flow Rate	306	412	379	111								
Geometry Grp	1	1	1	1								
Degree of Util (X)	0.555	0.71	0.676	0.224								
Departure Headway (Hd)	6.538	6.201	6.421	7.26								
Convergence, Y/N	Yes	Yes	Yes	Yes								
Cap	550	581	561	491								
Service Time	4.603	4.263	4.485	5.349								
HCM Lane V/C Ratio	0.556	0.709	0.676	0.226								
HCM Control Delay	17.5	23.1	21.9	12.5								
HCM Lane LOS	C	C	C	B								
HCM 95th-tile Q	3.4	5.8	5.1	0.9								

HCM 2010 TWSC
2: Cambrian Road & Apolune Street

Existing
AM Peak Hour

Intersection						
Int Delay, s/veh	2.2					
Movement	EBL	EBT	WBT	WBR	SBL	SBR
Lane Configurations	↔	↑	↔		↔	
Traffic Vol, veh/h	9	225	397	14	64	32
Future Vol, veh/h	9	225	397	14	64	32
Conflicting Peds, #/hr	5	0	0	5	2	2
Sign Control	Free	Free	Free	Free	Stop	Stop
RT Channelized	-	None	-	None	-	None
Storage Length	75	-	-	-	0	-
Veh in Median Storage, #	-	0	0	-	0	-
Grade, %	-	0	0	-	0	-
Peak Hour Factor	90	90	90	90	90	90
Heavy Vehicles, %	2	21	6	2	2	2
Mvmt Flow	10	250	441	16	71	36
Major/Minor	Major1	Major2	Minor2			
Conflicting Flow All	462	0	0	726	456	
Stage 1	-	-	-	454	-	
Stage 2	-	-	-	272	-	
Critical Hdwy	4.12	-	-	6.42	6.22	
Critical Hdwy Stg 1	-	-	-	5.42	-	
Critical Hdwy Stg 2	-	-	-	5.42	-	
Follow-up Hdwy	2,218	-	-	3,518	3,318	
Pot Cap-1 Maneuver	1099	-	-	391	604	
Stage 1	-	-	-	640	-	
Stage 2	-	-	-	774	-	
Platoon blocked, %	-	-	-	-	-	
Mov Cap-1 Maneuver	1094	-	-	384	600	
Mov Cap-2 Maneuver	-	-	-	384	-	
Stage 1	-	-	-	631	-	
Stage 2	-	-	-	770	-	
Approach	EB	WB	SB			
HCM Control Delay, s	0.3	0	15.9			
HCM LOS			C			
Minor Lane/Major Mvmt	EBL	EBT	WBT	WBR	SBLn1	
Capacity (veh/h)	1094	-	-	-	436	
HCM Lane V/C Ratio	0.009	-	-	-	0.245	
HCM Control Delay (s)	8.3	-	-	-	15.9	
HCM Lane LOS	A	-	-	-	C	
HCM 95th-tile Q(veh)	0	-	-	-	0.9	

HCM 2010 AWSC
1: River Mist Road & Cambrian Road

Existing
PM Peak Hour

Intersection												
Intersection Delay, s/veh	24.7											
Intersection LOS	C											
Movement	EBL	EBT	EBR	WBL	WBT	WBR	NBL	NBT	NBR	SBL	SBT	SBR
Lane Configurations		↕			↕			↕			↕	
Traffic Vol, veh/h	20	325	94	123	285	64	69	15	103	29	12	15
Future Vol, veh/h	20	325	94	123	285	64	69	15	103	29	12	15
Peak Hour Factor	0.90	0.90	0.90	0.90	0.90	0.90	0.90	0.90	0.90	0.90	0.90	0.90
Heavy Vehicles, %	2	2	2	2	2	2	2	2	7	2	2	2
Mvmt Flow	22	361	104	137	317	71	77	17	114	32	13	17
Number of Lanes	0	1	0	0	1	0	0	1	0	0	1	0
Approach	EB			WB			NB			SB		
Opposing Approach	WB			EB			SB			NB		
Opposing Lanes	1			1			1			1		
Conflicting Approach Left	SB			NB			EB			WB		
Conflicting Lanes Left	1			1			1			1		
Conflicting Approach Right	NB			SB			WB			EB		
Conflicting Lanes Right	1			1			1			1		
HCM Control Delay	25			30.3			13.6			11.4		
HCM LOS	C			D			B			B		
Lane	NBLn1	EBLn1	WBLn1	SBLn1								
Vol Left, %	37%	5%	26%	52%								
Vol Thru, %	8%	74%	60%	21%								
Vol Right, %	55%	21%	14%	27%								
Sign Control	Stop	Stop	Stop	Stop								
Traffic Vol by Lane	187	439	472	56								
LT Vol	69	20	123	29								
Through Vol	15	325	285	12								
RT Vol	103	94	64	15								
Lane Flow Rate	208	488	524	62								
Geometry Grp	1	1	1	1								
Degree of Util (X)	0.38	0.768	0.829	0.126								
Departure Headway (Hd)	6.577	5.666	5.69	7.305								
Convergence, Y/N	Yes	Yes	Yes	Yes								
Cap	546	639	640	488								
Service Time	4.631	3.683	3.708	5.38								
HCM Lane V/C Ratio	0.381	0.764	0.819	0.127								
HCM Control Delay	13.6	25	30.3	11.4								
HCM Lane LOS	B	C	D	B								
HCM 95th-tile Q	1.8	7.1	8.8	0.4								

HCM 2010 TWSC
2: Cambrian Road & Apolune Street

Existing
PM Peak Hour

Intersection						
Int Delay, s/veh	1.6					
Movement	EBL	EBT	WBT	WBR	SBL	SBR
Lane Configurations	↕	↑	↕		↕	
Traffic Vol, veh/h	32	394	373	48	43	18
Future Vol, veh/h	32	394	373	48	43	18
Conflicting Peds, #/hr	6	0	0	6	3	0
Sign Control	Free	Free	Free	Free	Stop	Stop
RT Channelized	-	None	-	None	-	None
Storage Length	75	-	-	-	0	-
Veh in Median Storage, #	-	0	0	-	0	-
Grade, %	-	0	0	-	0	-
Peak Hour Factor	90	90	90	90	90	90
Heavy Vehicles, %	2	2	2	2	2	2
Mvmt Flow	36	438	414	53	48	20
Major/Minor	Major1	Major2	Minor2			
Conflicting Flow All	473	0	0	960	447	
Stage 1	-	-	-	447	-	
Stage 2	-	-	-	513	-	
Critical Hdwy	4.12	-	-	6.42	6.22	
Critical Hdwy Stg 1	-	-	-	5.42	-	
Critical Hdwy Stg 2	-	-	-	5.42	-	
Follow-up Hdwy	2,218	-	-	3,518	3,318	
Pot Cap-1 Maneuver	1089	-	-	285	612	
Stage 1	-	-	-	644	-	
Stage 2	-	-	-	601	-	
Platoon blocked, %	-	-	-	-	-	
Mov Cap-1 Maneuver	1083	-	-	272	609	
Mov Cap-2 Maneuver	-	-	-	272	-	
Stage 1	-	-	-	619	-	
Stage 2	-	-	-	597	-	
Approach	EB	WB	SB			
HCM Control Delay, s	0.6	0	19			
HCM LOS			C			
Minor Lane/Major Mvmt	EBL	EBT	WBT	WBR	SBLn1	
Capacity (veh/h)	1083	-	-	-	325	
HCM Lane V/C Ratio	0.033	-	-	-	0.209	
HCM Control Delay (s)	8.4	-	-	-	19	
HCM Lane LOS	A	-	-	-	C	
HCM 95th %tile Q(veh)	0.1	-	-	-	0.8	

HCM 2010 AWSC
1: River Mist Road & Cambrian Road

Existing
SAT Peak Hour

Intersection												
Intersection Delay, s/veh	14.5											
Intersection LOS	B											
Movement	EBL	EBT	EBR	WBL	WBT	WBR	NBL	NBT	NBR	SBL	SBT	SBR
Lane Configurations	↔			↕			↔			↕		
Traffic Vol, veh/h	6	262	39	69	280	72	40	10	79	32	13	16
Future Vol, veh/h	6	262	39	69	280	72	40	10	79	32	13	16
Peak Hour Factor	0.90	0.90	0.90	0.90	0.90	0.90	0.90	0.90	0.90	0.90	0.90	0.90
Heavy Vehicles, %	2	2	2	7	2	2	2	2	4	2	8	2
Mvmt Flow	7	291	43	77	311	80	44	11	88	36	14	18
Number of Lanes	0	1	0	0	1	0	0	1	0	0	1	0
Approach	EB			WB			NB			SB		
Opposing Approach	WB			EB			SB			NB		
Opposing Lanes	1			1			1			1		
Conflicting Approach Left	SB			NB			EB			WB		
Conflicting Lanes Left	1			1			1			1		
Conflicting Approach Right	NB			SB			WB			EB		
Conflicting Lanes Right	1			1			1			1		
HCM Control Delay	13			17.4			10.6			10.1		
HCM LOS	B			C			B			B		
Lane	NBLn1	EBLn1	WBLn1	SBLn1								
Vol Left, %	31%	2%	16%	52%								
Vol Thru, %	8%	85%	67%	21%								
Vol Right, %	61%	13%	17%	26%								
Sign Control	Stop	Stop	Stop	Stop								
Traffic Vol by Lane	129	307	421	61								
LT Vol	40	6	69	32								
Through Vol	10	262	280	13								
RT Vol	79	39	72	16								
Lane Flow Rate	143	341	468	68								
Geometry Grp	1	1	1	1								
Degree of Util (X)	0.231	0.488	0.659	0.117								
Departure Headway (Hd)	5.791	5.153	5.073	6.227								
Convergence, Y/N	Yes	Yes	Yes	Yes								
Cap	618	699	711	573								
Service Time	3.841	3.19	3.106	4.286								
HCM Lane V/C Ratio	0.231	0.488	0.658	0.119								
HCM Control Delay	10.6	13	17.4	10.1								
HCM Lane LOS	B	B	C	B								
HCM 95th-tile Q	0.9	2.7	5	0.4								

HCM 2010 TWSC
2: Cambrian Road & Apolune Street

Existing
SAT Peak Hour

Intersection						
Int Delay, s/veh	2.5					
Movement	EBL	EBT	WBT	WBR	SBL	SBR
Lane Configurations	↔	↑	↔		↔	↔
Traffic Vol, veh/h	38	206	236	49	47	45
Future Vol, veh/h	38	206	236	49	47	45
Conflicting Peds, #/hr	6	0	0	6	3	0
Sign Control	Free	Free	Free	Free	Stop	Stop
RT Channelized	-	None	-	None	-	None
Storage Length	75	-	-	-	0	-
Veh in Median Storage, #	-	0	0	-	0	-
Grade, %	-	0	0	-	0	-
Peak Hour Factor	90	90	90	90	90	90
Heavy Vehicles, %	2	2	2	2	2	2
Mvmt Flow	42	229	262	54	52	50
Major/Minor	Major1	Major2	Minor2			
Conflicting Flow All	322	0	0	611	295	
Stage 1	-	-	-	295	-	
Stage 2	-	-	-	316	-	
Critical Hdwy	4.12	-	-	6.42	6.22	
Critical Hdwy Stg 1	-	-	-	5.42	-	
Critical Hdwy Stg 2	-	-	-	5.42	-	
Follow-up Hdwy	2,218	-	-	3,518	3,318	
Pot Cap-1 Maneuver	1238	-	-	457	744	
Stage 1	-	-	-	755	-	
Stage 2	-	-	-	739	-	
Platoon blocked, %	-	-	-	-	-	
Mov Cap-1 Maneuver	1231	-	-	436	740	
Mov Cap-2 Maneuver	-	-	-	436	-	
Stage 1	-	-	-	725	-	
Stage 2	-	-	-	735	-	
Approach	EB	WB	SB			
HCM Control Delay, s	1.3	0	13.1			
HCM LOS			B			
Minor Lane/Major Mvmt	EBL	EBT	WBT	WBR	SBLn1	
Capacity (veh/h)	1231	-	-	-	546	
HCM Lane V/C Ratio	0.034	-	-	-	0.187	
HCM Control Delay (s)	8	-	-	-	13.1	
HCM Lane LOS	A	-	-	-	B	
HCM 95th %tile Q(veh)	0.1	-	-	-	0.7	

Appendix D

Collision Data

Accident Date	Accident Year	Accident Time	Location	Environment Condition	Light	Traffic Control	Traffic Control Condition	Classification Of Accident	Initial Impact Type	Road Surface Condition	# Vehicles	# Motorcycles	# Bicycles	# Pedestrians
2019-10-10	2019	15:43	APOLLINE ST @ CAMBRIAN RD (0018897)	01 - Clear	01 - Daylight	02 - Stop sign	01 - Functioning	03 - P.D. only	02 - Angle	01 - Dry	2	0	0	0
2016-01-30	2016	4:40	CAMBRIAN RD btwn BORRISOKANE RD & GRAND CANAL ST (___7N36UU)	03 - Snow	07 - Dark	10 - No control	0	02 - Non-fatal injury	07 - SMV other	03 - Loose snow	1	0	0	0

Appendix E

Greenbank Road and South West Transitway Extension Preliminary Design

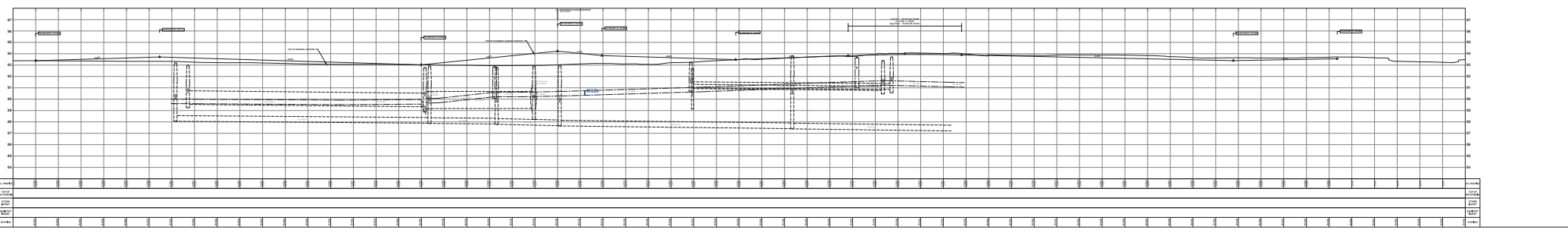
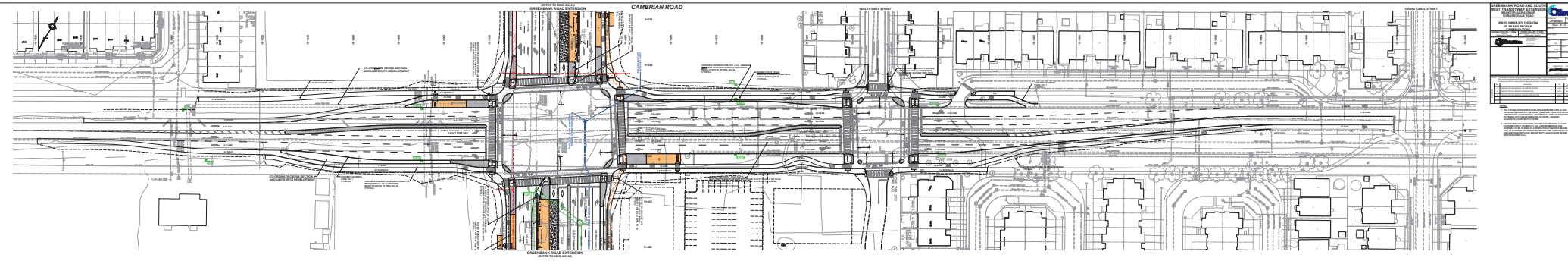

PROJEKTION: QUADRATEN-PROJEKTION
MÄSSSTAB: 1:200
VERMESSUNGSSTATION: 123456789
VERMESSUNGSNUMMER: 123456789
VERMESSUNGSJAHR: 2023
VERMESSUNGSART: 123456789
VERMESSUNGSZWECK: 123456789

NO.	BEZUGSWEISE	PROJEKTION
1	1:200	QUADRATEN-PROJEKTION
2	1:200	QUADRATEN-PROJEKTION
3	1:200	QUADRATEN-PROJEKTION
4	1:200	QUADRATEN-PROJEKTION
5	1:200	QUADRATEN-PROJEKTION
6	1:200	QUADRATEN-PROJEKTION
7	1:200	QUADRATEN-PROJEKTION
8	1:200	QUADRATEN-PROJEKTION
9	1:200	QUADRATEN-PROJEKTION
10	1:200	QUADRATEN-PROJEKTION

Appendix F

Background Development Volumes

Figure 9: New Site Generation Auto Volumes – Blended Rate Mode Shares

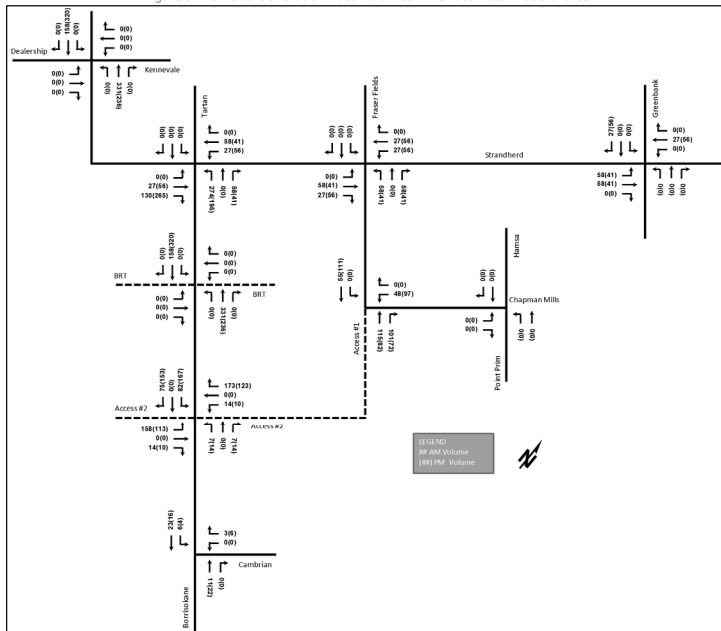

Figure 8: New Site Generation Auto Volumes

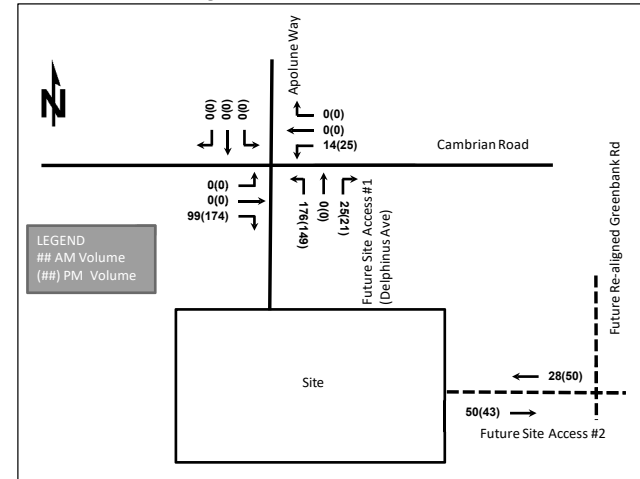

Figure 7: New 2022 Site Traffic Auto Volumes

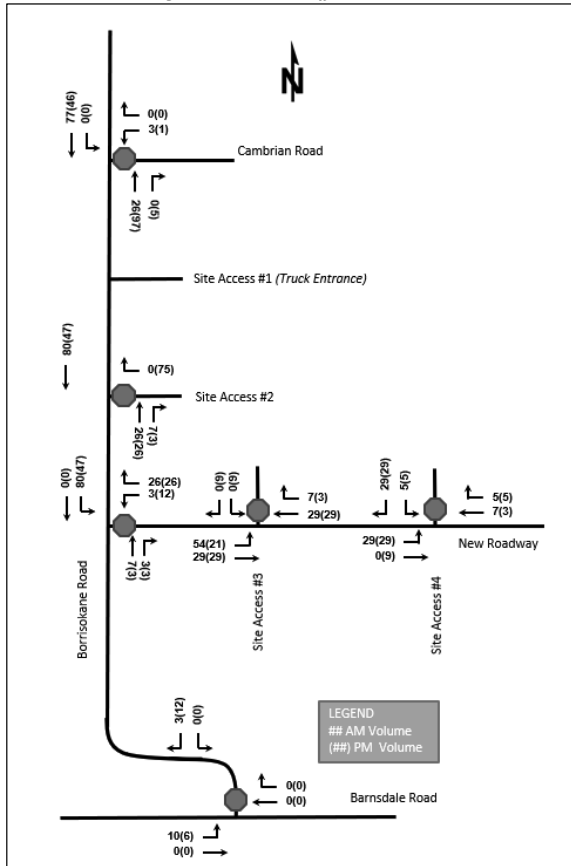

Figure 8: New 2027 Site Traffic Auto Volumes

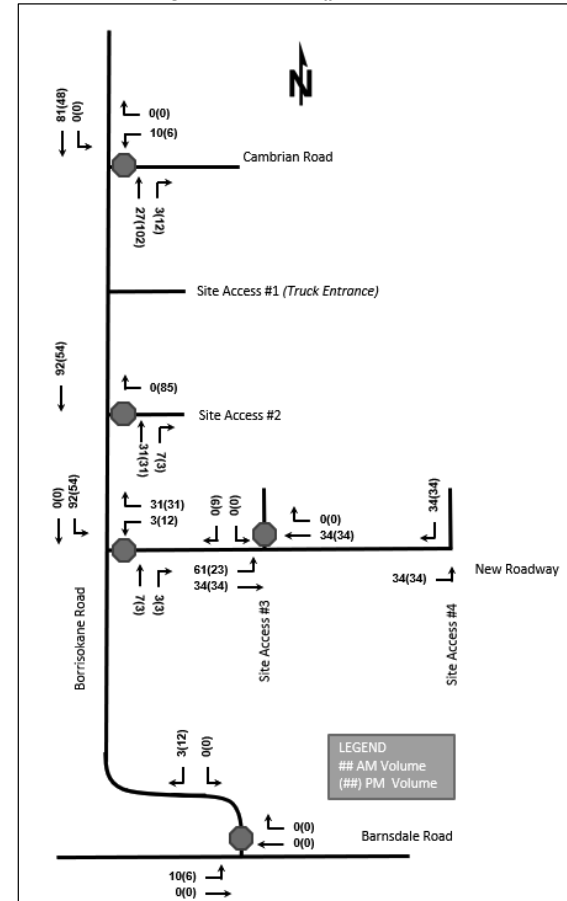

Figure 9: New Site Generation Auto Volumes

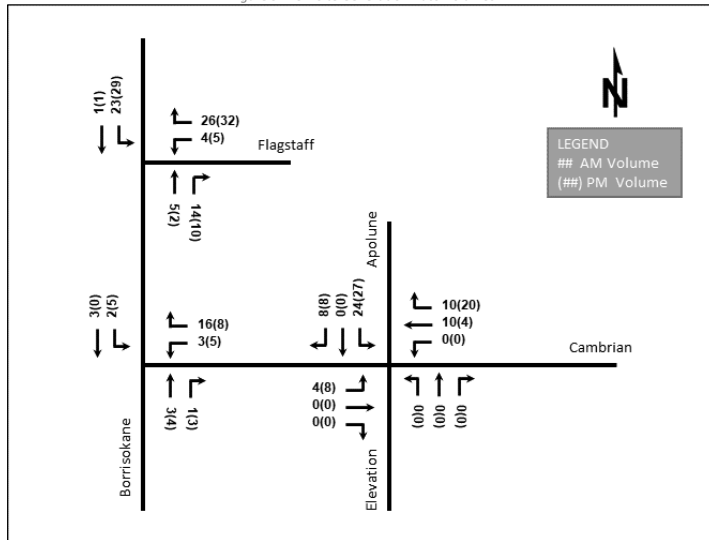
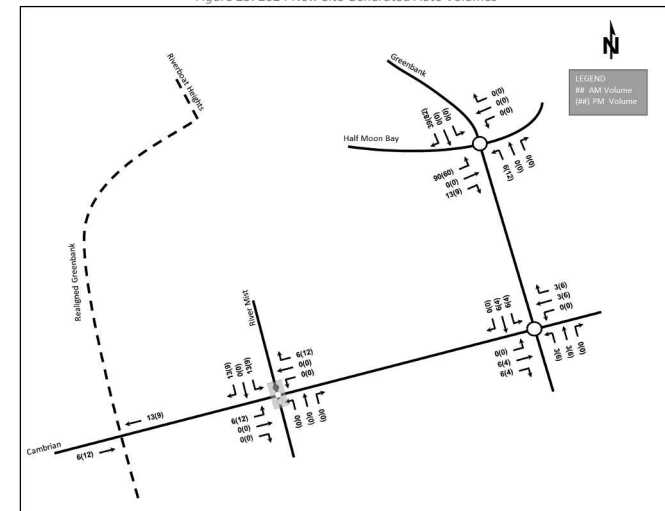
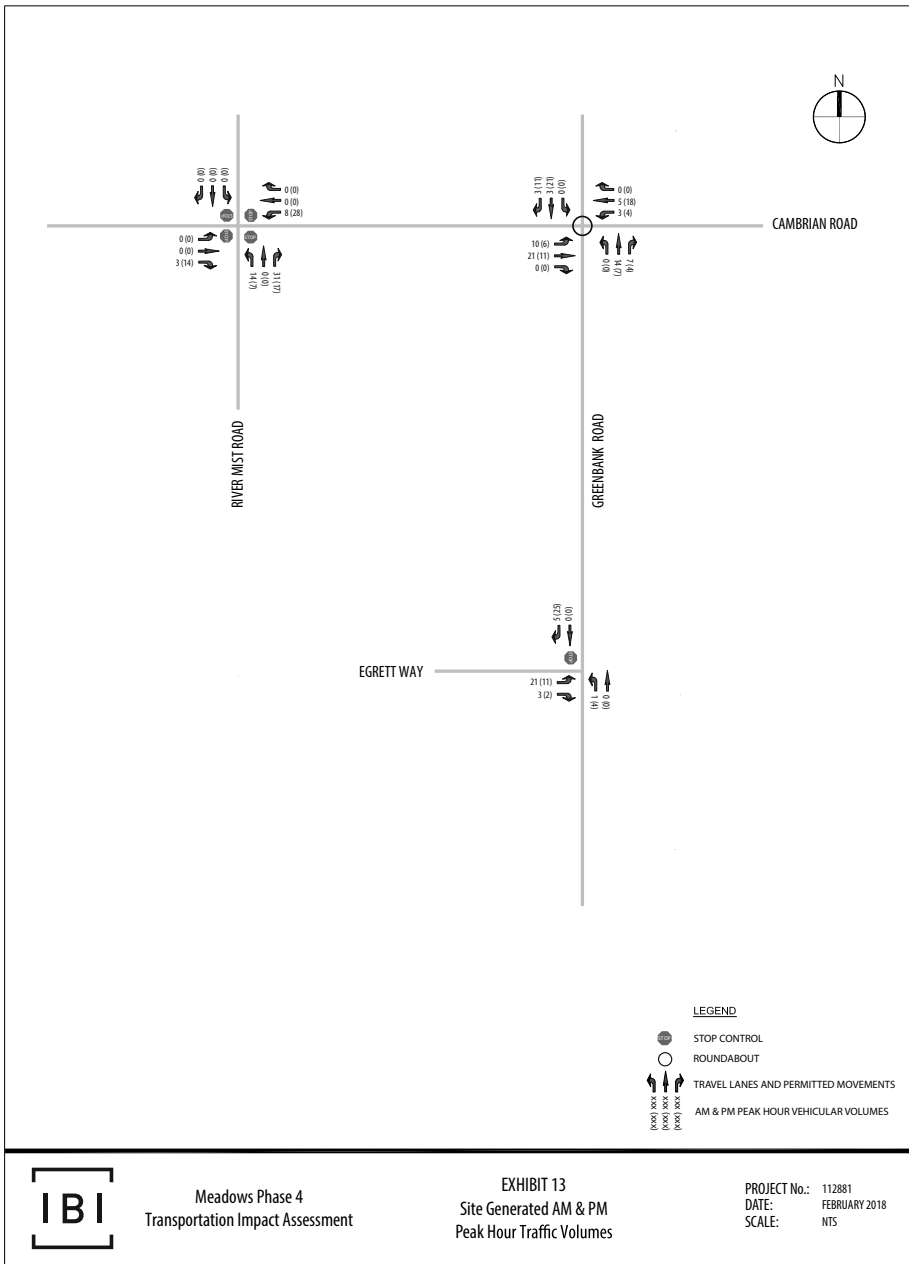

Figure 25: 2024 New Site Generated Auto Volumes





QUINN'S POINTE 2 TRANSPORTATION IMPACT ASSESSMENT

Forecasting
October 30, 2018

Figure 10 and Figure 11 summarize the trip assignment to the study area road network during the weekday AM and PM peak hours, respectively.

Figure 10 Trip Assignment – 2022 Interim – Weekday AM Peak Hour

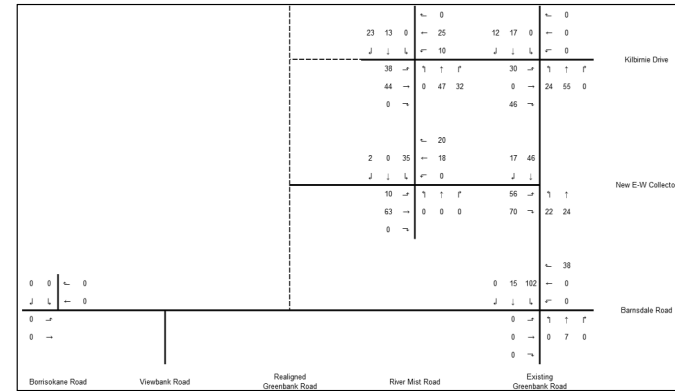

Figure 11 Trip Assignment – 2022 Interim – Weekday PM Peak Hour

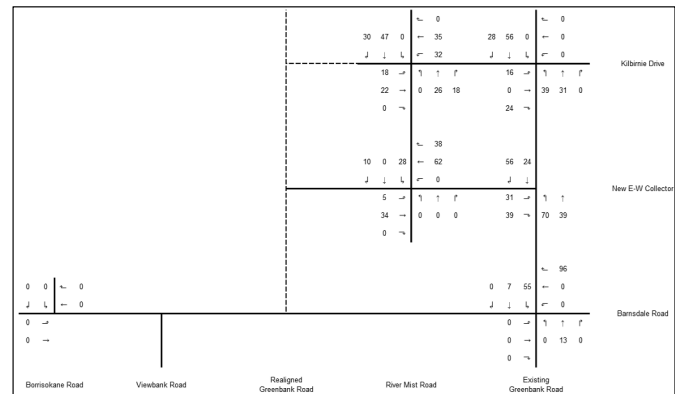

Figure 30: Net New Site Generation Auto Volumes

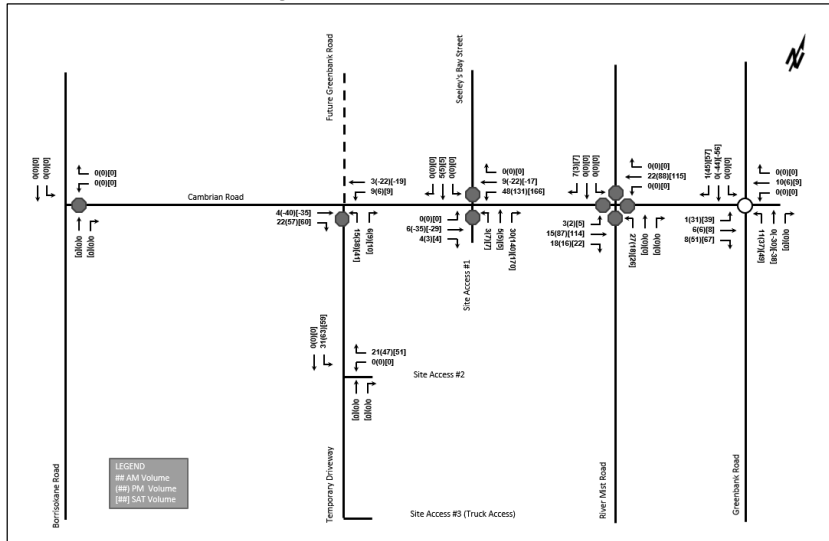
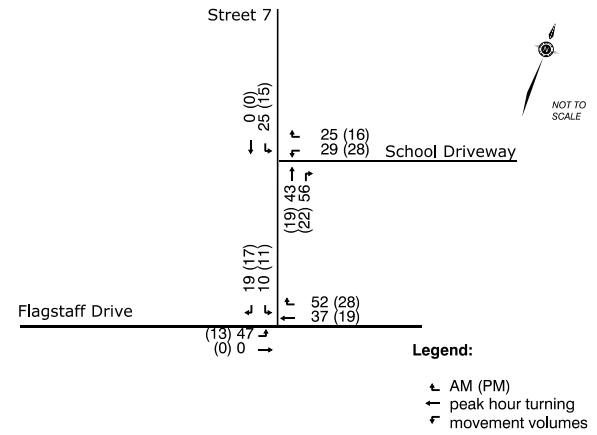

Figure 9: Site Generated Trips



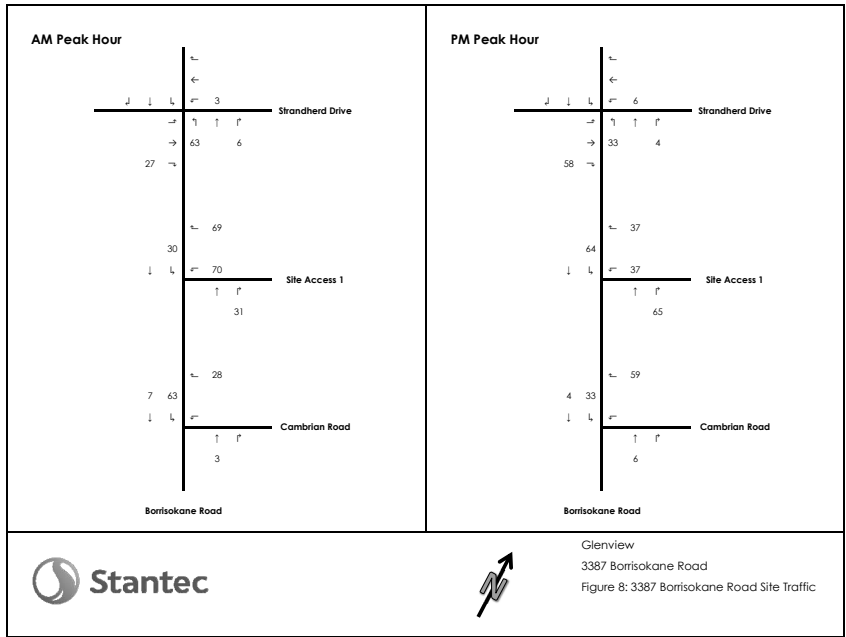

Figure 9: 2024 New Site Generation Auto Volumes

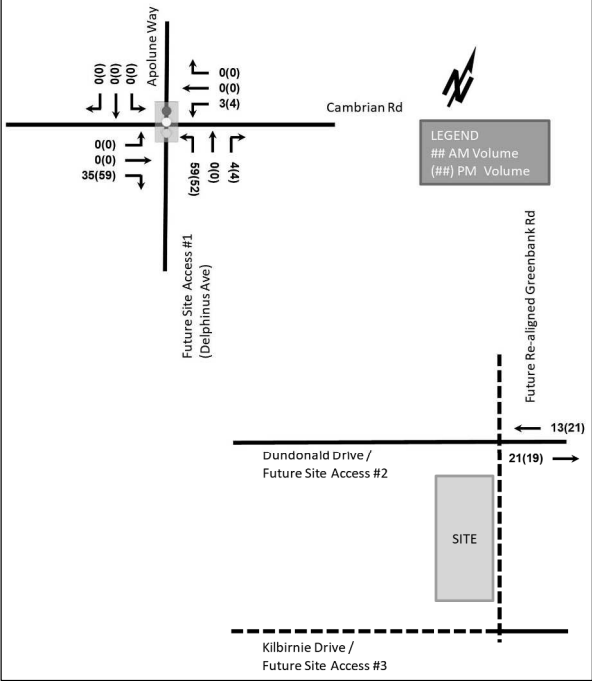
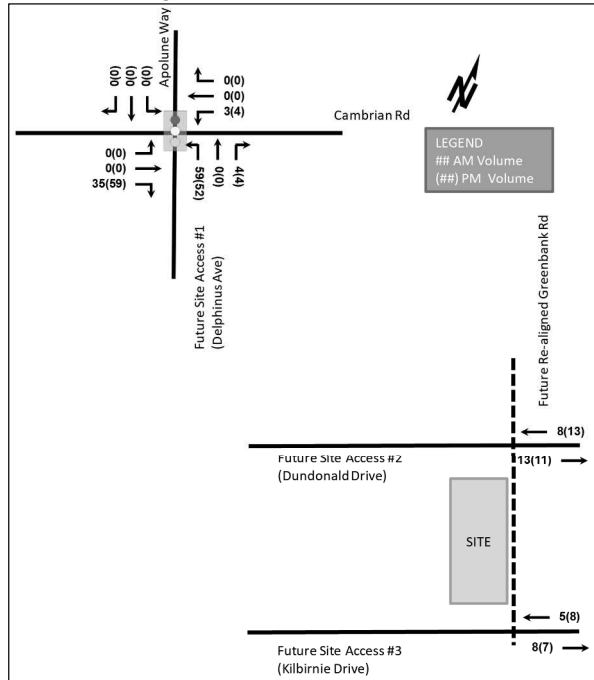

Figure 10: 2029 New Site Generated Auto Volumes



March 5, 2019
Rosanna Baggs, C.E.T.
Page 3 of 4

Reference: Mattamy Half Moon Bay West Community Transportation Study Update

Table 2 – Auto Trip Generation - Original Draft Plan (October 2017)

Land Use Code	Units	AM Peak Hour			PM Peak Hour		
		Inbound	Outbound	Rate	Inbound	Outbound	Rate
Step 1: ITE Trip Generation Rates							
210 - Single Detached Houses	518	25%	75%	0.72	63%	37%	0.89
230 - Residential Condo / Townhouse	427	17%	83%	0.39	67%	33%	0.46
220 - Apartments	92	20%	80%	0.53	65%	35%	0.74
Step 2: Auto Trips Generated							
210 - Single Detached Houses	518	93	280	373	290	171	461
230 - Residential Condo / Townhouse	427	28	139	167	131	65	196
220 - Apartments	92	10	39	49	44	24	68
Total Development		131	458	589	465	260	725

As can be seen in Table 2, the original draft plan was projected to generate 589 and 725 auto trips (two-way) during the AM and PM peak hours, respectively.

Table 3 – Auto Trip Generation - Revised Draft Plan (February 2019)

Land Use Code	Units	AM Peak Hour			PM Peak Hour		
		Inbound	Outbound	Rate	Inbound	Outbound	Rate
Step 1: ITE Trip Generation Rates							
210 - Single Detached Houses	446	25%	75%	0.72	63%	37%	0.89
230 - Residential Condo / Townhouse	455	17%	83%	0.39	67%	33%	0.46
220 - Apartments	72	20%	80%	0.53	65%	35%	0.74
Step 2: Auto Trips Generated							
210 - Single Detached Houses	446	80	241	321	250	147	397
230 - Residential Condo / Townhouse	455	30	147	177	140	69	209
220 - Apartments	72	8	30	38	34	19	53
Total Development		118	418	536	424	235	659

As can be seen in Table 3, the revised draft plan is expected to generate 536 and 659 auto trips (two-way) during the AM and PM peak hours, respectively.

CONCLUSION

A comparison of the original and revised plan shows that the proposed subdivision's collector road network and intersections with the existing boundary road network remain unchanged.

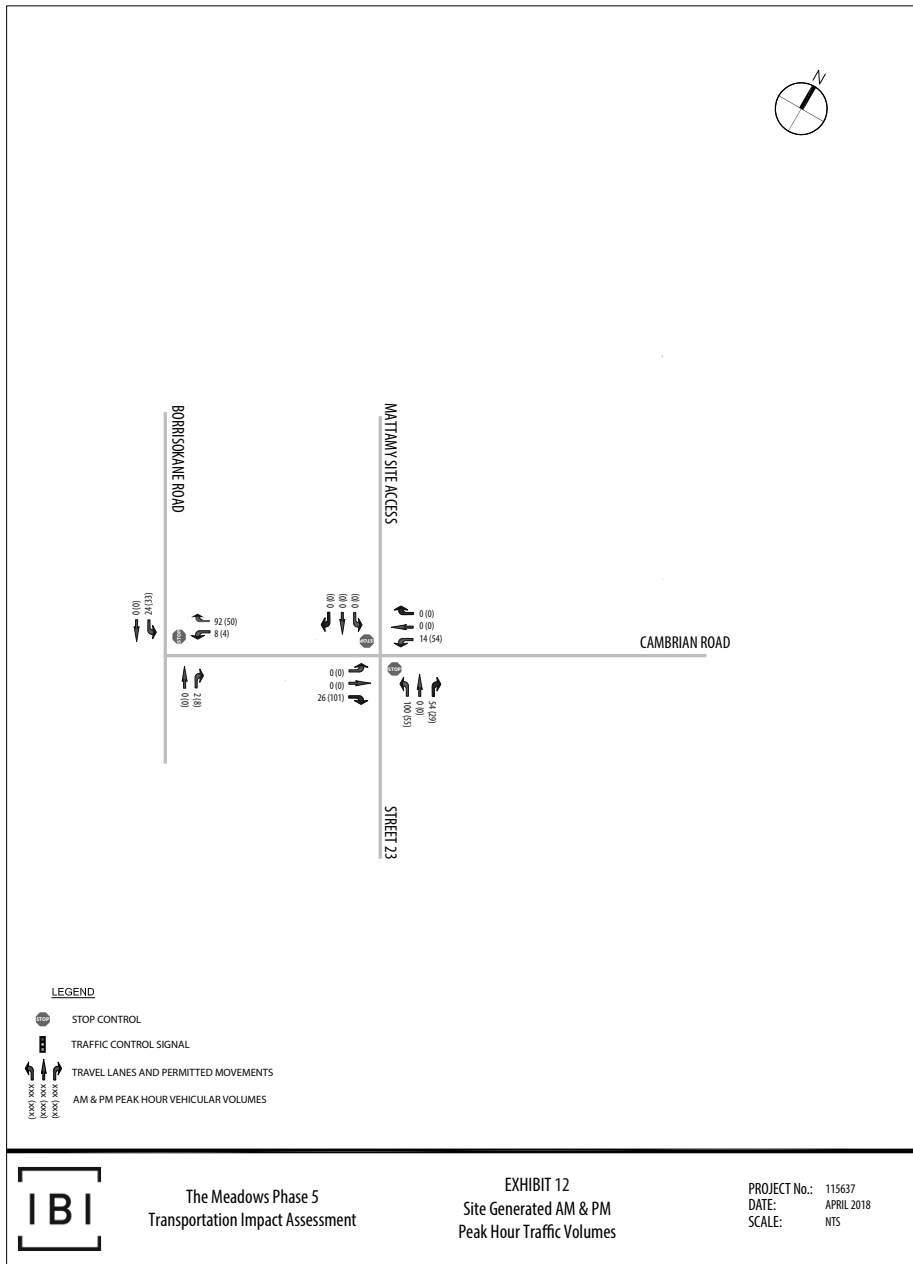
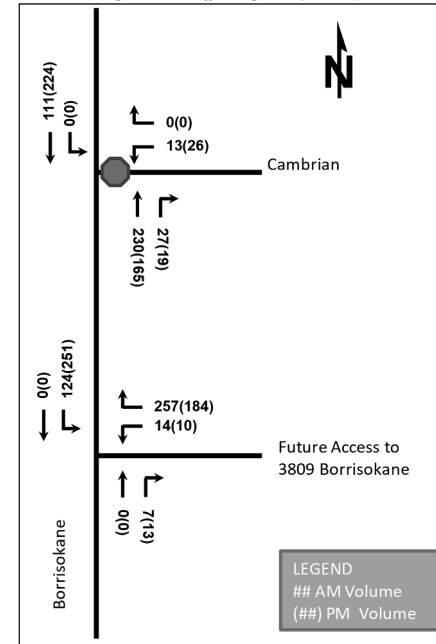

Figure 8: Site Traffic Assignment (Volumes)



3845 Cambrian Road Transportation Impact Assessment

Figure 11: New Site Generation Auto Volumes

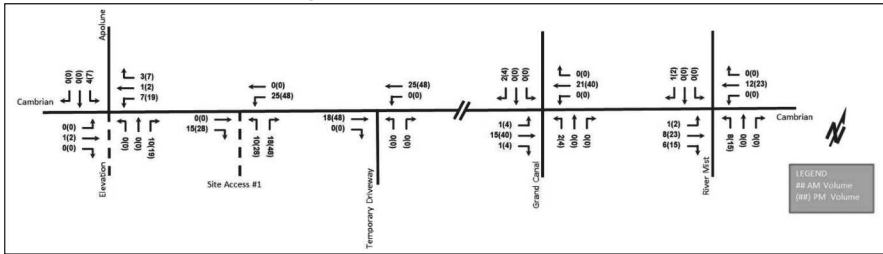
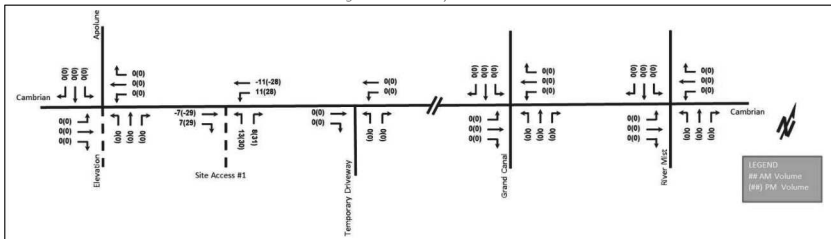

Figure 12: Pass-by Volumes



Appendix G

Synchro Intersection Worksheets – 2024 Future Background Conditions

HCM 2010 AWSC
1: River Mist & Cambrian

2024 Future Background
AM Peak Hour

Intersection												
Intersection Delay, s/veh	49.3											
Intersection LOS	E											
Movement												
	EBL	EBT	EBR	WBL	WBT	WBR	NBL	NBT	NBR	SBL	SBT	SBR
Lane Configurations		↔			↕			↕			↔	
Traffic Vol, veh/h	23	424	82	49	335	51	176	50	104	71	16	46
Future Vol, veh/h	23	424	82	49	335	51	176	50	104	71	16	46
Peak Hour Factor	1.00	1.00	1.00	1.00	1.00	1.00	1.00	1.00	1.00	1.00	1.00	1.00
Heavy Vehicles, %	7	10	6	16	9	4	2	10	4	3	6	4
Mvmt Flow	23	424	82	49	335	51	176	50	104	71	16	46
Number of Lanes	0	1	0	0	1	0	0	1	0	0	1	0
Approach												
	EB			WB			NB			SB		
Opposing Approach	WB			EB			SB			NB		
Opposing Lanes	1			1			1			1		
Conflicting Approach Left	SB			NB			EB			WB		
Conflicting Lanes Left	1			1			1			1		
Conflicting Approach Right	NB			SB			WB			EB		
Conflicting Lanes Right	1			1			1			1		
HCM Control Delay	76.4			44.1			26.5			15.6		
HCM LOS	F			E			D			C		

Lane	NBLn1	EBLn1	WBLn1	SBLn1
Vol Left, %	53%	4%	11%	53%
Vol Thru, %	15%	80%	77%	12%
Vol Right, %	32%	16%	12%	35%
Sign Control	Stop	Stop	Stop	Stop
Traffic Vol by Lane	330	529	435	133
LT Vol	176	23	49	71
Through Vol	50	424	335	16
RT Vol	104	82	51	46
Lane Flow Rate	330	529	435	133
Geometry Grp	1	1	1	1
Degree of Util (X)	0.693	1.037	0.879	0.312
Departure Headway (Hd)	7.769	7.056	7.485	8.735
Convergence, Y/N	Yes	Yes	Yes	Yes
Cap	469	518	487	414
Service Time	5.769	5.056	5.485	6.735
HCM Lane V/C Ratio	0.704	1.021	0.893	0.321
HCM Control Delay	26.5	76.4	44.1	15.6
HCM Lane LOS	D	F	E	C
HCM 95th-tile Q	5.2	15.3	9.5	1.3

Lanes, Volumes, Timings
2: Elevation/Polune & Cambrian

2024 Future Background
AM Peak Hour

Lane Group	EBL	EBT	EBR	WBL	WBT	WBR	NBL	NBT	NBR	SBL	SBT	SBR
Lane Configurations	↔	↔		↔	↔		↔	↔		↔	↔	
Traffic Volume (vph)	9	246	90	31	441	79	189	0	66	140	0	32
Future Volume (vph)	9	246	90	31	441	79	189	0	66	140	0	32
Satd. Flow (prot)	1658	1474	0	1658	1485	0	1658	1483	0	1492	1483	0
Fit Permitted	0.408			0.549			0.736			0.714		
Satd. Flow (perm)	712	1474	0	958	1485	0	1284	1483	0	1121	1483	0
Satd. Flow (RTOR)		36		18			568			335		
Lane Group Flow (vph)	9	336	0	31	520	0	189	66	0	140	32	0
Turn Type	Perm	NA		Perm	NA		Perm	NA		Perm	NA	
Protected Phases		2			6			4			8	
Permitted Phases	2			6			4			8		
Detector Phase	2	2		6	6		4	4		8	8	
Switch Phase												
Minimum Initial (s)	10.0	10.0		10.0	10.0		10.0	10.0		10.0	10.0	
Minimum Split (s)	23.7	23.7		23.7	23.7		30.4	30.4		30.4	30.4	
Total Split (s)	39.6	39.6		39.6	39.6		30.4	30.4		30.4	30.4	
Total Split (%)	56.6%	56.6%		56.6%	56.6%		43.4%	43.4%		43.4%	43.4%	
Yellow Time (s)	4.2	4.2		4.2	4.2		3.3	3.3		3.3	3.3	
All-Red Time (s)	1.5	1.5		1.5	1.5		2.6	2.6		2.6	2.6	
Lost Time Adjust (s)	0.0	0.0		0.0	0.0		0.0	0.0		0.0	0.0	
Total Lost Time (s)	5.7	5.7		5.7	5.7		5.9	5.9		5.9	5.9	
Lead/Lag												
Lead-Lag Optimize?												
Recall Mode	C-Min	C-Min		C-Min	C-Min		None	None		None	None	
Act Effct Green (s)	42.1	42.1		42.1	42.1		16.3	16.3		16.3	16.3	
Actuated g/C Ratio	0.60	0.60		0.60	0.60		0.23	0.23		0.23	0.23	
v/c Ratio	0.02	0.37		0.05	0.58		0.63	0.08		0.54	0.05	
Control Delay	8.3	9.1		8.2	13.0		32.9	0.2		30.0	0.2	
Queue Delay	0.0	0.0		0.0	0.0		0.0	0.0		0.0	0.0	
Total Delay	8.3	9.1		8.2	13.0		32.9	0.2		30.0	0.2	
LOS	A	A		A	B		C	A		C	A	
Approach Delay		9.1			12.8			24.5			24.5	
Approach LOS		A			B			C			C	
Queue Length 50th (m)	0.4	16.9		1.4	34.3		22.6	0.0		16.4	0.0	
Queue Length 95th (m)	2.7	43.6		6.1	83.9		35.0	0.0		27.1	0.0	
Internal Link Dist (m)		192.0			254.3			97.9			184.1	
Turn Bay Length (m)	37.5			37.5			30.0			30.0		
Base Capacity (vph)	428	901		576	901		449	888		392	736	
Starvation Cap Reductn	0	0		0	0		0	0		0	0	
Spillback Cap Reductn	0	0		0	0		0	0		0	0	
Storage Cap Reductn	0	0		0	0		0	0		0	0	
Reduced v/c Ratio	0.02	0.37		0.05	0.58		0.42	0.07		0.36	0.04	

Intersection Summary												
Cycle Length: 70												
Actuated Cycle Length: 70												
Offset: 0 (0%), Referenced to phase 2:EBTL and 6:WBTL, Start of Green												
Natural Cycle: 60												
Control Type: Actuated-Coordinated												

Lanes, Volumes, Timings
2: Elevation/Apolune & Cambrian

2024 Future Background
AM Peak Hour

Maximum v/c Ratio: 0.63	Intersection LOS: B
Intersection Signal Delay: 15.6	ICU Level of Service B
Intersection Capacity Utilization 56.9%	
Analysis Period (min) 15	

Splits and Phases: 2: Elevation/Apolune & Cambrian

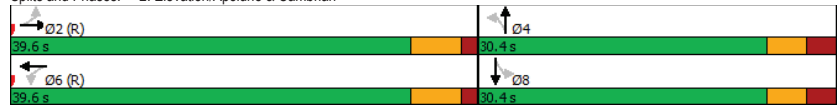

HCM 2010 TWSC
5: Temporary Driveway & Cambrian

2024 Future Background
AM Peak Hour

Intersection						
Int Delay, s/veh	0.4					
Movement	EBT	EBR	WBL	WBT	NBL	NBR
Lane Configurations	↔	↔	↔	↔	↔	↔
Traffic Vol, veh/h	430	22	9	536	15	6
Future Vol, veh/h	430	22	9	536	15	6
Conflicting Peds, #/hr	0	0	0	0	0	0
Sign Control	Free	Free	Free	Free	Stop	Stop
RT Channelized	-	None	-	None	-	None
Storage Length	-	-	-	-	0	-
Veh in Median Storage, #	0	-	-	0	0	-
Grade, %	0	-	-	0	0	-
Peak Hour Factor	100	100	100	100	100	100
Heavy Vehicles, %	2	2	2	2	2	2
Mvmt Flow	430	22	9	536	15	6
Major/Minor	Major1	Major2	Minor1			
Conflicting Flow All	0	0	452	0	995	441
Stage 1	-	-	-	-	441	-
Stage 2	-	-	-	-	554	-
Critical Hdwy	-	-	4.12	-	6.42	6.22
Critical Hdwy Stg 1	-	-	-	-	5.42	-
Critical Hdwy Stg 2	-	-	-	-	5.42	-
Follow-up Hdwy	-	-	2.218	-	3.518	3.318
Pot Cap-1 Maneuver	-	-	1109	-	271	616
Stage 1	-	-	-	-	648	-
Stage 2	-	-	-	-	575	-
Platoon blocked, %	-	-	-	-	-	-
Mov Cap-1 Maneuver	-	-	1109	-	268	616
Mov Cap-2 Maneuver	-	-	-	-	268	-
Stage 1	-	-	-	-	648	-
Stage 2	-	-	-	-	568	-
Approach	EB	WB	NB			
HCM Control Delay, s	0	0.1	17			
HCM LOS			C			
Minor Lane/Major Mvmt	NBLn1	EBT	EBR	WBL	WBT	
Capacity (veh/h)	320	-	-	1109	-	
HCM Lane V/C Ratio	0.066	-	-	0.008	-	
HCM Control Delay (s)	17	-	-	8.3	0	
HCM Lane LOS	C	-	-	A	A	
HCM 95th %tile Q(veh)	0.2	-	-	0	-	

HCM 2010 AWSC
1: River Mist & Cambrian

2024 Future Background
PM Peak Hour

Intersection	
Intersection Delay, s/veh	53.3
Intersection LOS	F

Movement	EBL	EBT	EBR	WBL	WBT	WBR	NBL	NBT	NBR	SBL	SBT	SBR
Lane Configurations		↔			↕			↕			↔	
Traffic Vol, veh/h	34	410	137	123	393	76	108	15	103	38	12	27
Future Vol, veh/h	34	410	137	123	393	76	108	15	103	38	12	27
Peak Hour Factor	1.00	1.00	1.00	1.00	1.00	1.00	1.00	1.00	1.00	1.00	1.00	1.00
Heavy Vehicles, %	2	2	2	2	2	2	2	2	7	2	2	2
Mvmt Flow	34	410	137	123	393	76	108	15	103	38	12	27
Number of Lanes	0	1	0	0	1	0	0	1	0	0	1	0

Approach	EB	WB	NB	SB
Opposing Approach	WB	EB	SB	NB
Opposing Lanes	1	1	1	1
Conflicting Approach Left	SB	NB	EB	WB
Conflicting Lanes Left	1	1	1	1
Conflicting Approach Right	NB	SB	WB	EB
Conflicting Lanes Right	1	1	1	1
HCM Control Delay	59.1	66.8	16.7	13
HCM LOS	F	F	C	B

Lane	NBLn1	EBLn1	WBLn1	SBLn1
Vol Left, %	48%	6%	21%	49%
Vol Thru, %	7%	71%	66%	16%
Vol Right, %	46%	24%	13%	35%
Sign Control	Stop	Stop	Stop	Stop
Traffic Vol by Lane	226	581	592	77
LT Vol	108	34	123	38
Through Vol	15	410	393	12
RT Vol	103	137	76	27
Lane Flow Rate	226	581	592	77
Geometry Grp	1	1	1	1
Degree of Util (X)	0.462	0.988	1.017	0.174
Departure Headway (Hd)	7.354	6.122	6.184	8.288
Convergence, Y/N	Yes	Yes	Yes	Yes
Cap	486	587	586	436
Service Time	5.452	4.201	4.263	6.288
HCM Lane V/C Ratio	0.465	0.99	1.01	0.177
HCM Control Delay	16.7	59.1	66.8	13
HCM Lane LOS	C	F	F	B
HCM 95th-tile Q	2.4	14.2	15.4	0.6

Lanes, Volumes, Timings
2: Elevation/Polune & Cambrian

2024 Future Background
PM Peak Hour



Lane Group	EBL	EBT	EBR	WBL	WBT	WBR	NBL	NBT	NBR	SBL	SBT	SBR
Lane Configurations	↔	↔		↔	↔		↔	↔		↔	↔	
Traffic Volume (vph)	32	445	177	56	411	103	136	0	41	88	0	18
Future Volume (vph)	32	445	177	56	411	103	136	0	41	88	0	18
Satd. Flow (prot)	1658	1670	0	1658	1511	0	1658	1483	0	1492	1483	0
Fit Permitted	0.442			0.382			0.746			0.730		
Satd. Flow (perm)	766	1670	0	667	1511	0	1302	1483	0	1139	1483	0
Satd. Flow (RTOR)		33			21			443				464
Lane Group Flow (vph)	32	622	0	56	514	0	136	41	0	88	18	0
Turn Type	Perm	NA		Perm	NA		Perm	NA		Perm	NA	
Protected Phases		2			6			4				8
Permitted Phases	2			6			4			8		
Detector Phase	2	2		6	6		4	4		8	8	
Switch Phase												
Minimum Initial (s)	10.0	10.0		10.0	10.0		10.0	10.0		10.0	10.0	
Minimum Split (s)	23.7	23.7		23.7	23.7		30.4	30.4		30.4	30.4	
Total Split (s)	82.0	82.0		82.0	82.0		38.0	38.0		38.0	38.0	
Total Split (%)	68.3%	68.3%		68.3%	68.3%		31.7%	31.7%		31.7%	31.7%	
Yellow Time (s)	4.2	4.2		4.2	4.2		3.3	3.3		3.3	3.3	
All-Red Time (s)	1.5	1.5		1.5	1.5		2.6	2.6		2.6	2.6	
Lost Time Adjust (s)	0.0	0.0		0.0	0.0		0.0	0.0		0.0	0.0	
Total Lost Time (s)	5.7	5.7		5.7	5.7		5.9	5.9		5.9	5.9	
Lead/Lag												
Lead-Lag Optimize?												
Recall Mode	C-Min	C-Min		C-Min	C-Min		None	None		None	None	
Act Effct Green (s)	90.6	90.6		90.6	90.6		17.8	17.8		17.8	17.8	
Actuated g/C Ratio	0.76	0.76		0.76	0.76		0.15	0.15		0.15	0.15	
v/c Ratio	0.06	0.49		0.11	0.45		0.70	0.07		0.52	0.03	
Control Delay	5.2	7.7		5.6	7.4		67.0	0.2		56.8	0.1	
Queue Delay	0.0	0.0		0.0	0.0		0.0	0.0		0.0	0.0	
Total Delay	5.2	7.7		5.6	7.4		67.0	0.2		56.8	0.1	
LOS	A	A		A	A		E	A		E	A	
Approach Delay		7.5			7.2			51.5				47.2
Approach LOS		A			A			D				D
Queue Length 50th (m)	1.7	46.0		3.0	36.6		30.8	0.0		19.4	0.0	
Queue Length 95th (m)	5.4	86.5		8.7	70.6		48.8	0.0		33.9	0.0	
Internal Link Dist (m)		122.9			259.5			171.4			184.1	
Turn Bay Length (m)	37.5			37.5			30.0			30.0		
Base Capacity (vph)	578	1268		503	1145		348	721		304	736	
Starvation Cap Reductn	0	0		0	0		0	0		0	0	
Spillback Cap Reductn	0	0		0	0		0	0		0	0	
Storage Cap Reductn	0	0		0	0		0	0		0	0	
Reduced v/c Ratio	0.06	0.49		0.11	0.45		0.39	0.06		0.29	0.02	

Intersection Summary	
Cycle Length:	120
Actuated Cycle Length:	120
Offset:	0 (0%), Referenced to phase 2:EBTL and 6:WBTL, Start of Green
Natural Cycle:	60
Control Type:	Actuated-Coordinated

Lanes, Volumes, Timings
2: Elevation/Apolune & Cambrian

2024 Future Background
PM Peak Hour

Maximum v/c Ratio: 0.70	Intersection LOS: B
Intersection Signal Delay: 15.4	ICU Level of Service D
Intersection Capacity Utilization 73.4%	
Analysis Period (min) 15	

Splits and Phases: 2: Elevation/Apolune & Cambrian

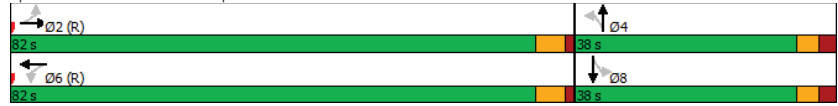

HCM 2010 TWSC
5: Temporary Driveway & Cambrian

2024 Future Background
PM Peak Hour

Intersection						
Int Delay, s/veh	0.9					
Movement	EBT	EBR	WBL	WBT	NBL	NBR
Lane Configurations	↔		↔		↔	
Traffic Vol, veh/h	517	57	6	532	38	9
Future Vol, veh/h	517	57	6	532	38	9
Conflicting Peds, #/hr	0	0	0	0	0	0
Sign Control	Free	Free	Free	Free	Stop	Stop
RT Channelized	-	None	-	None	-	None
Storage Length	-	-	-	-	0	-
Veh in Median Storage, #	0	-	-	0	0	-
Grade, %	0	-	-	0	0	-
Peak Hour Factor	100	100	100	100	100	100
Heavy Vehicles, %	2	2	2	2	2	2
Mvmt Flow	517	57	6	532	38	9

Major/Minor	Major1	Major2	Minor1
Conflicting Flow All	0	0	574
Stage 1	-	-	546
Stage 2	-	-	544
Critical Hdwy	-	4.12	6.42
Critical Hdwy Stg 1	-	-	5.42
Critical Hdwy Stg 2	-	-	5.42
Follow-up Hdwy	-	2.218	3.518
Pot Cap-1 Maneuver	-	999	238
Stage 1	-	-	580
Stage 2	-	-	582
Platoon blocked, %	-	-	-
Mov Cap-1 Maneuver	-	999	236
Mov Cap-2 Maneuver	-	-	236
Stage 1	-	-	580
Stage 2	-	-	577

Approach	EB	WB	NB
HCM Control Delay, s	0	0.1	21.6
HCM LOS			C

Minor Lane/Major Mvmt	NBLn1	EBT	EBR	WBL	WBT
Capacity (veh/h)	264	-	-	999	-
HCM Lane V/C Ratio	0.178	-	-	0.006	-
HCM Control Delay (s)	21.6	-	-	8.6	0
HCM Lane LOS	C	-	-	A	A
HCM 95th %tile Q(veh)	0.6	-	-	0	-

Intersection	
Intersection Delay, s/veh	20.8
Intersection LOS	C

Movement	EBL	EBT	EBR	WBL	WBT	WBR	NBL	NBT	NBR	SBL	SBT	SBR
Lane Configurations		↔			↕			↔			↕	
Traffic Vol, veh/h	18	330	82	69	378	82	80	10	79	40	13	27
Future Vol, veh/h	18	330	82	69	378	82	80	10	79	40	13	27
Peak Hour Factor	1.00	1.00	1.00	1.00	1.00	1.00	1.00	1.00	1.00	1.00	1.00	1.00
Heavy Vehicles, %	2	2	2	7	2	2	2	2	4	2	8	2
Mvmt Flow	18	330	82	69	378	82	80	10	79	40	13	27
Number of Lanes	0	1	0	0	1	0	0	1	0	0	1	0

Approach	EB	WB	NB	SB
Opposing Approach	WB	EB	SB	NB
Opposing Lanes	1	1	1	1
Conflicting Approach Left	SB	NB	EB	WB
Conflicting Lanes Left	1	1	1	1
Conflicting Approach Right	NB	SB	WB	EB
Conflicting Lanes Right	1	1	1	1
HCM Control Delay	18.4	26.8	12.4	11.2
HCM LOS	C	D	B	B

Lane	NBLn1	EBLn1	WBLn1	SBLn1
Vol Left, %	47%	4%	13%	50%
Vol Thru, %	6%	77%	71%	16%
Vol Right, %	47%	19%	16%	34%
Sign Control	Stop	Stop	Stop	Stop
Traffic Vol by Lane	169	430	529	80
LT Vol	80	18	69	40
Through Vol	10	330	378	13
RT Vol	79	82	82	27
Lane Flow Rate	169	430	529	80
Geometry Grp	1	1	1	1
Degree of Util (X)	0.306	0.653	0.799	0.154
Departure Headway (Hd)	6.527	5.465	5.439	6.909
Convergence, Y/N	Yes	Yes	Yes	Yes
Cap	554	654	661	522
Service Time	4.533	3.558	3.526	4.917
HCM Lane V/C Ratio	0.305	0.657	0.8	0.153
HCM Control Delay	12.4	18.4	26.8	11.2
HCM Lane LOS	B	C	D	B
HCM 95th-tile Q	1.3	4.8	8	0.5



Lane Group	EBL	EBT	EBR	WBL	WBT	WBR	NBL	NBT	NBR	SBL	SBT	SBR
Lane Configurations	↔	↔		↔	↔		↔	↔		↔	↔	
Traffic Volume (vph)	38	248	160	70	270	88	128	1	61	72	2	45
Future Volume (vph)	38	248	160	70	270	88	128	1	61	72	2	45
Satd. Flow (prot)	1566	1642	0	1271	1498	0	1658	1333	0	1436	1402	0
Fit Permitted	0.538			0.507			0.726			0.717		
Satd. Flow (perm)	878	1642	0	679	1498	0	1267	1333	0	1076	1402	0
Satd. Flow (RTOR)		48			24			61			45	
Lane Group Flow (vph)	38	408	0	70	358	0	128	62	0	72	47	0
Turn Type	Perm	NA		Perm	NA		Perm	NA		Perm	NA	
Protected Phases		2			6			4			8	
Permitted Phases	2			6			4			8		
Detector Phase	2	2		6	6		4	4		8	8	
Switch Phase												
Minimum Initial (s)	10.0	10.0		10.0	10.0		10.0	10.0		10.0	10.0	
Minimum Split (s)	23.7	23.7		23.7	23.7		30.4	30.4		30.4	30.4	
Total Split (s)	77.0	77.0		77.0	77.0		43.0	43.0		43.0	43.0	
Total Split (%)	64.2%	64.2%		64.2%	64.2%		35.8%	35.8%		35.8%	35.8%	
Yellow Time (s)	4.2	4.2		4.2	4.2		3.3	3.3		3.3	3.3	
All-Red Time (s)	1.5	1.5		1.5	1.5		2.6	2.6		2.6	2.6	
Lost Time Adjust (s)	0.0	0.0		0.0	0.0		0.0	0.0		0.0	0.0	
Total Lost Time (s)	5.7	5.7		5.7	5.7		5.9	5.9		5.9	5.9	
Lead/Lag												
Lead-Lag Optimize?												
Recall Mode	C-Min	C-Min		C-Min	C-Min		None	None		None	None	
Act Effct Green (s)	91.0	91.0		91.0	91.0		17.4	17.4		17.4	17.4	
Actuated g/C Ratio	0.76	0.76		0.76	0.76		0.14	0.14		0.14	0.14	
v/c Ratio	0.06	0.32		0.14	0.31		0.70	0.25		0.46	0.19	
Control Delay	5.0	5.4		5.6	5.7		67.4	13.0		55.0	14.4	
Queue Delay	0.0	0.0		0.0	0.0		0.0	0.0		0.0	0.0	
Total Delay	5.0	5.4		5.6	5.7		67.4	13.0		55.0	14.4	
LOS	A	A		A	A		E	B		D	B	
Approach Delay		5.4			5.7			49.7			38.9	
Approach LOS		A			A			D			D	
Queue Length 50th (m)	2.0	22.6		3.8	21.0		29.0	0.2		15.7	0.4	
Queue Length 95th (m)	6.0	44.7		10.4	41.6		46.7	11.7		28.7	10.4	
Internal Link Dist (m)		122.9			257.7			171.4			184.1	
Turn Bay Length (m)	37.5			37.5			30.0			30.0		
Base Capacity (vph)	665	1256		514	1141		391	454		332	464	
Starvation Cap Reductn	0	0		0	0		0	0		0	0	
Spillback Cap Reductn	0	0		0	0		0	0		0	0	
Storage Cap Reductn	0	0		0	0		0	0		0	0	
Reduced v/c Ratio	0.06	0.32		0.14	0.31		0.33	0.14		0.22	0.10	

Intersection Summary	
Cycle Length:	120
Actuated Cycle Length:	120
Offset:	0 (0%), Referenced to phase 2:EBTL and 6:WBTL, Start of Green
Natural Cycle:	60
Control Type:	Actuated-Coordinated

Lanes, Volumes, Timings
2: Elevation/Apolune & Cambrian

2024 Future Background
SAT Peak Hour

Maximum v/c Ratio: 0.70	Intersection LOS: B
Intersection Signal Delay: 16.0	ICU Level of Service B
Intersection Capacity Utilization 61.0%	
Analysis Period (min) 15	

Splits and Phases: 2: Elevation/Apolune & Cambrian

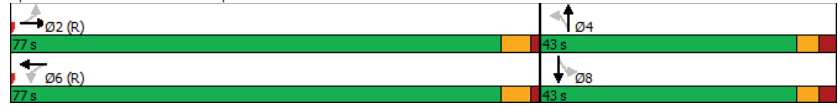

HCM 2010 TWSC
5: Temporary Driveway & Cambrian

2024 Future Background
SAT Peak Hour

Intersection						
Int Delay, s/veh	2.3					
Movement	EBT	EBR	WBL	WBT	NBL	NBR
Lane Configurations	↔	↔	↔	↔	↔	↔
Traffic Vol, veh/h	40	66	7	83	44	10
Future Vol, veh/h	40	66	7	83	44	10
Conflicting Peds, #/hr	0	0	0	0	0	0
Sign Control	Free	Free	Free	Free	Stop	Stop
RT Channelized	-	None	-	None	-	None
Storage Length	-	-	-	-	0	-
Veh in Median Storage, #	0	-	-	0	0	-
Grade, %	0	-	-	0	0	-
Peak Hour Factor	100	100	100	100	100	100
Heavy Vehicles, %	2	2	2	2	2	2
Mvmt Flow	40	66	7	83	44	10
Major/Minor	Major1	Major2	Minor1			
Conflicting Flow All	0	0	106	0	170	73
Stage 1	-	-	-	-	73	-
Stage 2	-	-	-	-	97	-
Critical Hdwy	-	-	4.12	-	6.42	6.22
Critical Hdwy Stg 1	-	-	-	-	5.42	-
Critical Hdwy Stg 2	-	-	-	-	5.42	-
Follow-up Hdwy	-	-	2.218	-	3.518	3.318
Pot Cap-1 Maneuver	-	-	1485	-	820	989
Stage 1	-	-	-	-	950	-
Stage 2	-	-	-	-	927	-
Platoon blocked, %	-	-	-	-	-	-
Mov Cap-1 Maneuver	-	-	1485	-	816	989
Mov Cap-2 Maneuver	-	-	-	-	816	-
Stage 1	-	-	-	-	950	-
Stage 2	-	-	-	-	922	-
Approach	EB	WB	NB			
HCM Control Delay, s	0	0.6	9.6			
HCM LOS			A			
Minor Lane/Major Mvmt	NBLn1	EBT	EBR	WBL	WBT	
Capacity (veh/h)	843	-	-	1485	-	
HCM Lane V/C Ratio	0.064	-	-	0.005	-	
HCM Control Delay (s)	9.6	-	-	7.4	0	
HCM Lane LOS	A	-	-	A	A	
HCM 95th %tile Q(veh)	0.2	-	-	0	-	

Appendix H

Signal Warrant Calculation Sheet

Cambrian Road @ River Mist Road
 FB 2024

Justification #7

Justification	Description	Minimum Requirement		Minimum Requirement		Compliance		Entire %	Signal
		1 Lane Highway		2 or More Lanes		Sectional			
		Free Flow	Restr. Flow	Free Flow	Restr. Flow	Numerical	%		
1. Minimum Vehicular Volume	A. Vehicle volume, all approaches (average hour)	480	720	600	900	726	101%	101%	No
	B. Vehicle volume, along minor streets (average hour)	120	170	120	170	192	113%		
2. Delay to Cross Traffic	A. Vehicle volumes, major street (average hour)	480	720	600	900	534	74%	74%	No
	B. Combined vehicle and pedestrian volume crossing artery from minor streets (average hour)	50	75	50	75	115	153%		

- Notes
1. Refer to OTM Book 12, pg 92, Mar 2012
 2. Lowest section percentage governs justification
 3. Average hourly volumes estimated from peak hour volumes, $AHV = PM/2$ or $(AM + PM) / 4$, including amplification factors
 4. T-intersection factor corrected, applies only to 1B

Cambrian Road @ River Mist Road
 FB 2029

Justification #7

Justification	Description	Minimum Requirement		Minimum Requirement		Compliance		Entire %	Signal
		1 Lane Highway		2 or More Lanes		Sectional			
		Free Flow	Restr. Flow	Free Flow	Restr. Flow	Numerical	%		
1. Minimum Vehicular Volume	A. Vehicle volume, all approaches (average hour)	480	720	600	900	830	115%	115%	No
	B. Vehicle volume, along minor streets (average hour)	120	170	120	170	204	120%		
2. Delay to Cross Traffic	A. Vehicle volumes, major street (average hour)	480	720	600	900	626	87%	87%	No
	B. Combined vehicle and pedestrian volume crossing artery from minor streets (average hour)	50	75	50	75	125	166%		

- Notes
1. Refer to OTM Book 12, pg 92, Mar 2012
 2. Lowest section percentage governs justification
 3. Average hourly volumes estimated from peak hour volumes, $AHV = PM/2$ or $(AM + PM) / 4$, including amplification factors
 4. T-intersection factor corrected, applies only to 1B

Cambrian Road @ River Mist Road
FT 2024

Justification #7

Justification	Description	Minimum Requirement		Minimum Requirement		Compliance		Entire %	Signal
		1 Lane Highway		2 or More Lanes		Sectional			
		Free Flow	Restr. Flow	Free Flow	Restr. Flow	Numerical	%		
1. Minimum Vehicular Volume	A. Vehicle volume, all approaches (average hour)	480	720	600	900	737	102%	102%	No
	B. Vehicle volume, along minor streets (average hour)	120	170	120	170	195	115%		
2. Delay to Cross Traffic	A. Vehicle volumes, major street (average hour)	480	720	600	900	542	75%	75%	No
	B. Combined vehicle and pedestrian volume crossing artery from minor streets (average hour)	50	75	50	75	117	156%		

- Notes
1. Refer to OTM Book 12, pg 92, Mar 2012
 2. Lowest section percentage governs justification
 3. Average hourly volumes estimated from peak hour volumes, $AHV = PM/2$ or $(AM + PM) / 4$, including amplification factors
 4. T-intersection factor corrected, applies only to 1B

Cambrian Road @ River Mist Road
FT 2029

Justification #7

Justification	Description	Minimum Requirement		Minimum Requirement		Compliance		Entire %	Signal
		1 Lane Highway		2 or More Lanes		Sectional			
		Free Flow	Restr. Flow	Free Flow	Restr. Flow	Numerical	%		
1. Minimum Vehicular Volume	A. Vehicle volume, all approaches (average hour)	480	720	600	900	841	117%	117%	No
	B. Vehicle volume, along minor streets (average hour)	120	170	120	170	208	122%		
2. Delay to Cross Traffic	A. Vehicle volumes, major street (average hour)	480	720	600	900	634	88%	88%	No
	B. Combined vehicle and pedestrian volume crossing artery from minor streets (average hour)	50	75	50	75	127	169%		

- Notes
1. Refer to OTM Book 12, pg 92, Mar 2012
 2. Lowest section percentage governs justification
 3. Average hourly volumes estimated from peak hour volumes, $AHV = PM/2$ or $(AM + PM) / 4$, including amplification factors
 4. T-intersection factor corrected, applies only to 1B

Appendix I

Synchro Intersection Worksheets – 2029 Future Background Conditions

Intersection	
Intersection Delay, s/veh	96.9
Intersection LOS	F

Movement	EBL	EBT	EBR	WBL	WBT	WBR	NBL	NBT	NBR	SBL	SBT	SBR
Lane Configurations		↔			↕			↕			↔	
Traffic Vol, veh/h	24	507	93	51	391	51	194	50	109	71	16	47
Future Vol, veh/h	24	507	93	51	391	51	194	50	109	71	16	47
Peak Hour Factor	1.00	1.00	1.00	1.00	1.00	1.00	1.00	1.00	1.00	1.00	1.00	1.00
Heavy Vehicles, %	7	10	6	16	9	4	2	10	4	3	6	4
Mvmt Flow	24	507	93	51	391	51	194	50	109	71	16	47
Number of Lanes	0	1	0	0	1	0	0	1	0	0	1	0

Approach	EB	WB	NB	SB
Opposing Approach	WB	EB	SB	NB
Opposing Lanes	1	1	1	1
Conflicting Approach Left	SB	NB	EB	WB
Conflicting Lanes Left	1	1	1	1
Conflicting Approach Right	NB	SB	WB	EB
Conflicting Lanes Right	1	1	1	1
HCM Control Delay	164.9	77.3	34.1	17.6
HCM LOS	F	F	D	C

Lane	NBLn1	EBLn1	WBLn1	SBLn1
Vol Left, %	55%	4%	10%	53%
Vol Thru, %	14%	81%	79%	12%
Vol Right, %	31%	15%	10%	35%
Sign Control	Stop	Stop	Stop	Stop
Traffic Vol by Lane	353	624	493	134
LT Vol	194	24	51	71
Through Vol	50	507	391	16
RT Vol	109	93	51	47
Lane Flow Rate	353	624	493	134
Geometry Grp	1	1	1	1
Degree of Util (X)	0.764	1.281	1.022	0.331
Departure Headway (Hd)	8.49	7.497	8.1	9.814
Convergence, Y/N	Yes	Yes	Yes	Yes
Cap	431	487	454	368
Service Time	6.49	5.497	6.1	7.814
HCM Lane V/C Ratio	0.819	1.281	1.086	0.364
HCM Control Delay	34.1	164.9	77.3	17.6
HCM Lane LOS	D	F	F	C
HCM 95th-tile Q	6.4	25.8	13.7	1.4



Lane Group	EBL	EBT	EBR	WBL	WBT	WBR	NBL	NBT	NBR	SBL	SBT	SBR
Lane Configurations	↔	↔		↔	↔		↔	↔		↔	↔	
Traffic Volume (vph)	14	256	129	57	464	95	270	0	117	174	0	42
Future Volume (vph)	14	256	129	57	464	95	270	0	117	174	0	42
Satd. Flow (prot)	1658	1475	0	1658	1483	0	1658	1483	0	1492	1483	0
Fit Permitted	0.360			0.497			0.730			0.682		
Satd. Flow (perm)	628	1475	0	867	1483	0	1274	1483	0	1071	1483	0
Satd. Flow (RTOR)		50			20			554				315
Lane Group Flow (vph)	14	385	0	57	559	0	270	117	0	174	42	0
Turn Type	Perm	NA		Perm	NA		Perm	NA		Perm	NA	
Protected Phases		2			6			4			8	
Permitted Phases	2			6			4			8		
Detector Phase	2	2		6	6		4	4		8	8	
Switch Phase												
Minimum Initial (s)	10.0	10.0		10.0	10.0		10.0	10.0		10.0	10.0	
Minimum Split (s)	23.7	23.7		23.7	23.7		30.4	30.4		30.4	30.4	
Total Split (s)	39.6	39.6		39.6	39.6		30.4	30.4		30.4	30.4	
Total Split (%)	56.6%	56.6%		56.6%	56.6%		43.4%	43.4%		43.4%	43.4%	
Yellow Time (s)	4.2	4.2		4.2	4.2		3.3	3.3		3.3	3.3	
All-Red Time (s)	1.5	1.5		1.5	1.5		2.6	2.6		2.6	2.6	
Lost Time Adjust (s)	0.0	0.0		0.0	0.0		0.0	0.0		0.0	0.0	
Total Lost Time (s)	5.7	5.7		5.7	5.7		5.9	5.9		5.9	5.9	
Lead/Lag												
Lead-Lag Optimize?												
Recall Mode	C-Min	C-Min		C-Min	C-Min		None	None		None	None	
Act Effct Green (s)	39.2	39.2		39.2	39.2		19.2	19.2		19.2	19.2	
Actuated g/C Ratio	0.56	0.56		0.56	0.56		0.27	0.27		0.27	0.27	
v/c Ratio	0.04	0.45		0.12	0.67		0.77	0.14		0.59	0.07	
Control Delay	9.5	11.1		9.9	17.2		38.0	0.4		29.6	0.2	
Queue Delay	0.0	0.0		0.0	0.0		0.0	0.0		0.0	0.0	
Total Delay	9.5	11.1		9.9	17.2		38.0	0.4		29.6	0.2	
LOS	A	B		A	B		D	A		C	A	
Approach Delay		11.1			16.6			26.6			23.9	
Approach LOS		B			B			C			C	
Queue Length 50th (m)	0.8	23.7		3.3	46.4		31.9	0.0		19.3	0.0	
Queue Length 95th (m)	3.6	50.3		9.8	#107.4		52.0	0.0		34.3	0.0	
Internal Link Dist (m)		192.0			268.9			97.9			184.1	
Turn Bay Length (m)	37.5			37.5			30.0			30.0		
Base Capacity (vph)	351	847		485	838		445	879		374	723	
Starvation Cap Reductn	0	0		0	0		0	0		0	0	
Spillback Cap Reductn	0	0		0	0		0	0		0	0	
Storage Cap Reductn	0	0		0	0		0	0		0	0	
Reduced v/c Ratio	0.04	0.45		0.12	0.67		0.61	0.13		0.47	0.06	

Intersection Summary	
Cycle Length:	70
Actuated Cycle Length:	70
Offset:	0 (0%), Referenced to phase 2:EBTL and 6:WBTL, Start of Green
Natural Cycle:	65
Control Type:	Actuated-Coordinated

Lanes, Volumes, Timings
2: Elevation/Apolune & Cambrian

2029 Future Background
AM Peak Hour

Maximum v/c Ratio: 0.77	Intersection LOS: B
Intersection Signal Delay: 18.6	ICU Level of Service D
Intersection Capacity Utilization 77.1%	
Analysis Period (min) 15	
# 95th percentile volume exceeds capacity, queue may be longer.	
Queue shown is maximum after two cycles.	

Splits and Phases: 2: Elevation/Apolune & Cambrian



HCM 2010 TWSC
5: Temporary Driveway & Cambrian

2029 Future Background
AM Peak Hour

Intersection						
Int Delay, s/veh	0.4					
Movement	EBT	EBR	WBL	WBT	NBL	NBR
Lane Configurations	↔		↔		↔	
Traffic Vol, veh/h	524	22	9	613	15	6
Future Vol, veh/h	524	22	9	613	15	6
Conflicting Peds, #/hr	0	0	0	0	0	0
Sign Control	Free	Free	Free	Free	Stop	Stop
RT Channelized	-	None	-	None	-	None
Storage Length	-	-	-	-	0	-
Veh in Median Storage, #	0	-	-	0	0	-
Grade, %	0	-	-	0	0	-
Peak Hour Factor	100	100	100	100	100	100
Heavy Vehicles, %	2	2	2	2	2	2
Mvmt Flow	524	22	9	613	15	6
Major/Minor	Major1	Major2	Minor1			
Conflicting Flow All	0	0	546	0	1166	535
Stage 1	-	-	-	-	535	-
Stage 2	-	-	-	-	631	-
Critical Hdwy	-	-	4.12	-	6.42	6.22
Critical Hdwy Stg 1	-	-	-	-	5.42	-
Critical Hdwy Stg 2	-	-	-	-	5.42	-
Follow-up Hdwy	-	-	2.218	-	3.518	3.318
Pot Cap-1 Maneuver	-	-	1023	-	214	545
Stage 1	-	-	-	-	587	-
Stage 2	-	-	-	-	530	-
Platoon blocked, %	-	-	-	-	-	-
Mov Cap-1 Maneuver	-	-	1023	-	211	545
Mov Cap-2 Maneuver	-	-	-	-	211	-
Stage 1	-	-	-	-	587	-
Stage 2	-	-	-	-	523	-
Approach	EB	WB	NB			
HCM Control Delay, s	0	0.1	20.3			
HCM LOS						C
Minor Lane/Major Mvmt	NBLn1	EBT	EBR	WBL	WBT	
Capacity (veh/h)	256	-	-	1023	-	
HCM Lane V/C Ratio	0.082	-	-	0.009	-	
HCM Control Delay (s)	20.3	-	-	8.6	0	
HCM Lane LOS	C	-	-	A	A	
HCM 95th %tile Q(veh)	0.3	-	-	0	-	

HCM 2010 AWSC
1: River Mist & Cambrian

2029 Future Background
PM Peak Hour

Intersection	
Intersection Delay, s/veh	108.4
Intersection LOS	F

Movement	EBL	EBT	EBR	WBL	WBT	WBR	NBL	NBT	NBR	SBL	SBT	SBR
Lane Configurations		↔			↕			↕			↔	
Traffic Vol, veh/h	36	494	162	128	487	76	130	15	106	38	12	29
Future Vol, veh/h	36	494	162	128	487	76	130	15	106	38	12	29
Peak Hour Factor	1.00	1.00	1.00	1.00	1.00	1.00	1.00	1.00	1.00	1.00	1.00	1.00
Heavy Vehicles, %	2	2	2	2	2	2	2	2	7	2	2	2
Mvmt Flow	36	494	162	128	487	76	130	15	106	38	12	29
Number of Lanes	0	1	0	0	1	0	0	1	0	0	1	0

Approach	EB	WB	NB	SB
Opposing Approach	WB	EB	SB	NB
Opposing Lanes	1	1	1	1
Conflicting Approach Left	SB	NB	EB	WB
Conflicting Lanes Left	1	1	1	1
Conflicting Approach Right	NB	SB	WB	EB
Conflicting Lanes Right	1	1	1	1
HCM Control Delay	126.5	133.4	19.1	14.2
HCM LOS	F	F	C	B

Lane	NBLn1	EBLn1	WBLn1	SBLn1
Vol Left, %	52%	5%	19%	48%
Vol Thru, %	6%	71%	70%	15%
Vol Right, %	42%	23%	11%	37%
Sign Control	Stop	Stop	Stop	Stop
Traffic Vol by Lane	251	692	691	79
LT Vol	130	36	128	38
Through Vol	15	494	487	12
RT Vol	106	162	76	29
Lane Flow Rate	251	692	691	79
Geometry Grp	1	1	1	1
Degree of Util (X)	0.507	1.193	1.21	0.181
Departure Headway (Hd)	8.084	6.564	6.647	9.173
Convergence, Y/N	Yes	Yes	Yes	Yes
Cap	449	561	553	393
Service Time	6.084	4.564	4.647	7.173
HCM Lane V/C Ratio	0.559	1.234	1.25	0.201
HCM Control Delay	19.1	126.5	133.4	14.2
HCM Lane LOS	C	F	F	B
HCM 95th-tile Q	2.8	23.6	24.3	0.7

Lanes, Volumes, Timings
2: Elevation/Polune & Cambrian

2029 Future Background
PM Peak Hour



Lane Group	EBL	EBT	EBR	WBL	WBT	WBR	NBL	NBT	NBR	SBL	SBT	SBR
Lane Configurations	↔	↔		↔	↔		↔	↔		↔	↔	
Traffic Volume (vph)	42	460	255	114	428	135	193	0	88	126	0	27
Future Volume (vph)	42	460	255	114	428	135	193	0	88	126	0	27
Satd. Flow (prot)	1658	1653	0	1658	1500	0	1658	1483	0	1492	1483	0
Fit Permitted	0.399			0.314			0.740			0.700		
Satd. Flow (perm)	692	1653	0	548	1500	0	1291	1483	0	1092	1483	0
Satd. Flow (RTOR)		46			26			430				447
Lane Group Flow (vph)	42	715	0	114	563	0	193	88	0	126	27	0
Turn Type	Perm	NA		Perm	NA		Perm	NA		Perm	NA	
Protected Phases		2			6			4				8
Permitted Phases	2			6			4			8		
Detector Phase	2	2		6	6		4	4		8	8	
Switch Phase												
Minimum Initial (s)	10.0	10.0		10.0	10.0		10.0	10.0		10.0	10.0	
Minimum Split (s)	23.7	23.7		23.7	23.7		30.4	30.4		30.4	30.4	
Total Split (s)	82.0	82.0		82.0	82.0		38.0	38.0		38.0	38.0	
Total Split (%)	68.3%	68.3%		68.3%	68.3%		31.7%	31.7%		31.7%	31.7%	
Yellow Time (s)	4.2	4.2		4.2	4.2		3.3	3.3		3.3	3.3	
All-Red Time (s)	1.5	1.5		1.5	1.5		2.6	2.6		2.6	2.6	
Lost Time Adjust (s)	0.0	0.0		0.0	0.0		0.0	0.0		0.0	0.0	
Total Lost Time (s)	5.7	5.7		5.7	5.7		5.9	5.9		5.9	5.9	
Lead/Lag												
Lead-Lag Optimize?												
Recall Mode	C-Min	C-Min		C-Min	C-Min		None	None		None	None	
Act Effct Green (s)	85.3	85.3		85.3	85.3		23.1	23.1		23.1	23.1	
Actuated g/C Ratio	0.71	0.71		0.71	0.71		0.19	0.19		0.19	0.19	
v/c Ratio	0.09	0.60		0.29	0.52		0.78	0.14		0.60	0.04	
Control Delay	7.5	11.9		10.2	10.8		65.9	0.5		54.9	0.1	
Queue Delay	0.0	0.0		0.0	0.0		0.0	0.0		0.0	0.0	
Total Delay	7.5	11.9		10.2	10.8		65.9	0.5		54.9	0.1	
LOS	A	B		B	B		E	A		D	A	
Approach Delay		11.6			10.7			45.4			45.3	
Approach LOS		B			B			D			D	
Queue Length 50th (m)	2.7	70.8		8.8	51.8		43.5	0.0		27.3	0.0	
Queue Length 95th (m)	8.2	133.0		22.8	98.9		63.7	0.0		43.5	0.0	
Internal Link Dist (m)		122.9			257.3			171.4			184.1	
Turn Bay Length (m)	37.5			37.5			30.0			30.0		
Base Capacity (vph)	491	1187		389	1073		345	711		292	724	
Starvation Cap Reductn	0	0		0	0		0	0		0	0	
Spillback Cap Reductn	0	0		0	0		0	0		0	0	
Storage Cap Reductn	0	0		0	0		0	0		0	0	
Reduced v/c Ratio	0.09	0.60		0.29	0.52		0.56	0.12		0.43	0.04	

Intersection Summary	
Cycle Length:	120
Actuated Cycle Length:	120
Offset:	0 (0%), Referenced to phase 2:EBTL and 6:WBTL, Start of Green
Natural Cycle:	70
Control Type:	Actuated-Coordinated

Lanes, Volumes, Timings
2: Elevation/Apolune & Cambrian

2029 Future Background
PM Peak Hour

Maximum v/c Ratio: 0.78	Intersection LOS: B
Intersection Signal Delay: 19.1	ICU Level of Service E
Intersection Capacity Utilization 82.7%	
Analysis Period (min) 15	

Splits and Phases: 2: Elevation/Apolune & Cambrian

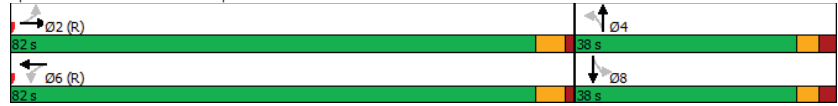

HCM 2010 TWSC
5: Temporary Driveway & Cambrian

2029 Future Background
PM Peak Hour

Intersection						
Int Delay, s/veh	1					
Movement	EBT	EBR	WBL	WBT	NBL	NBR
Lane Configurations	↔			↔	↔	↔
Traffic Vol, veh/h	633	57	6	654	38	9
Future Vol, veh/h	633	57	6	654	38	9
Conflicting Peds, #/hr	0	0	0	0	0	0
Sign Control	Free	Free	Free	Free	Stop	Stop
RT Channelized	-	None	-	None	-	None
Storage Length	-	-	-	-	0	-
Veh in Median Storage, #	0	-	-	0	0	-
Grade, %	0	-	-	0	0	-
Peak Hour Factor	100	100	100	100	100	100
Heavy Vehicles, %	2	2	2	2	2	2
Mvmt Flow	633	57	6	654	38	9
Major/Minor	Major1	Major2	Minor1			
Conflicting Flow All	0	0	690	0	1328	662
Stage 1	-	-	-	-	662	-
Stage 2	-	-	-	-	666	-
Critical Hdwy	-	-	4.12	-	6.42	6.22
Critical Hdwy Stg 1	-	-	-	-	5.42	-
Critical Hdwy Stg 2	-	-	-	-	5.42	-
Follow-up Hdwy	-	-	2.218	-	3.518	3.318
Pot Cap-1 Maneuver	-	-	905	-	171	462
Stage 1	-	-	-	-	513	-
Stage 2	-	-	-	-	511	-
Platoon blocked, %	-	-	-	-	-	-
Mov Cap-1 Maneuver	-	-	905	-	169	462
Mov Cap-2 Maneuver	-	-	-	-	169	-
Stage 1	-	-	-	-	513	-
Stage 2	-	-	-	-	506	-
Approach	EB	WB	NB			
HCM Control Delay, s	0	0.1	29.7			
HCM LOS			D			
Minor Lane/Major Mvmt	NBLn1	EBT	EBR	WBL	WBT	
Capacity (veh/h)	192	-	-	905	-	
HCM Lane V/C Ratio	0.245	-	-	0.007	-	
HCM Control Delay (s)	29.7	-	-	9	0	
HCM Lane LOS	D	-	-	A	A	
HCM 95th %tile Q(veh)	0.9	-	-	0	-	

Intersection	
Intersection Delay, s/veh	49.4
Intersection LOS	E

Movement	EBL	EBT	EBR	WBL	WBT	WBR	NBL	NBT	NBR	SBL	SBT	SBR
Lane Configurations		↔			↕			↔			↔	
Traffic Vol, veh/h	21	410	108	74	469	82	103	10	82	40	13	30
Future Vol, veh/h	21	410	108	74	469	82	103	10	82	40	13	30
Peak Hour Factor	1.00	1.00	1.00	1.00	1.00	1.00	1.00	1.00	1.00	1.00	1.00	1.00
Heavy Vehicles, %	2	2	2	7	2	2	2	2	4	2	8	2
Mvmt Flow	21	410	108	74	469	82	103	10	82	40	13	30
Number of Lanes	0	1	0	0	1	0	0	1	0	0	1	0

Approach	EB	WB	NB	SB
Opposing Approach	WB	EB	SB	NB
Opposing Lanes	1	1	1	1
Conflicting Approach Left	SB	NB	EB	WB
Conflicting Lanes Left	1	1	1	1
Conflicting Approach Right	NB	SB	WB	EB
Conflicting Lanes Right	1	1	1	1
HCM Control Delay	38.7	74.3	15	12.7
HCM LOS	E	F	B	B

Lane	NBLn1	EBLn1	WBLn1	SBLn1
Vol Left, %	53%	4%	12%	48%
Vol Thru, %	5%	76%	75%	16%
Vol Right, %	42%	20%	13%	36%
Sign Control	Stop	Stop	Stop	Stop
Traffic Vol by Lane	195	539	625	83
LT Vol	103	21	74	40
Through Vol	10	410	469	13
RT Vol	82	108	82	30
Lane Flow Rate	195	539	625	83
Geometry Grp	1	1	1	1
Degree of Util (X)	0.388	0.884	1.048	0.177
Departure Headway (Hd)	7.384	6.08	6.038	7.952
Convergence, Y/N	Yes	Yes	Yes	Yes
Cap	491	598	606	454
Service Time	5.384	4.08	4.038	5.952
HCM Lane V/C Ratio	0.397	0.901	1.031	0.183
HCM Control Delay	15	38.7	74.3	12.7
HCM Lane LOS	B	E	F	B
HCM 95th-tile Q	1.8	10.4	17.2	0.6



Lane Group	EBL	EBT	EBR	WBL	WBT	WBR	NBL	NBT	NBR	SBL	SBT	SBR
Lane Configurations	↔	↔		↔	↔		↔	↔		↔	↔	
Traffic Volume (vph)	46	263	232	128	286	117	181	1	109	105	2	52
Future Volume (vph)	46	263	232	128	286	117	181	1	109	105	2	52
Satd. Flow (prot)	1566	1623	0	1271	1484	0	1658	1330	0	1436	1401	0
Fit Permitted	0.500			0.442			0.722			0.673		
Satd. Flow (perm)	817	1623	0	592	1484	0	1260	1330	0	1011	1401	0
Satd. Flow (RTOR)		65			30			109				52
Lane Group Flow (vph)	46	495	0	128	403	0	181	110	0	105	54	0
Turn Type	Perm	NA		Perm	NA		Perm	NA		Perm	NA	
Protected Phases		2			6			4				8
Permitted Phases	2			6			4			8		
Detector Phase	2	2		6	6		4	4		8	8	
Switch Phase												
Minimum Initial (s)	10.0	10.0		10.0	10.0		10.0	10.0		10.0	10.0	
Minimum Split (s)	23.7	23.7		23.7	23.7		30.4	30.4		30.4	30.4	
Total Split (s)	77.0	77.0		77.0	77.0		43.0	43.0		43.0	43.0	
Total Split (%)	64.2%	64.2%		64.2%	64.2%		35.8%	35.8%		35.8%	35.8%	
Yellow Time (s)	4.2	4.2		4.2	4.2		3.3	3.3		3.3	3.3	
All-Red Time (s)	1.5	1.5		1.5	1.5		2.6	2.6		2.6	2.6	
Lost Time Adjust (s)	0.0	0.0		0.0	0.0		0.0	0.0		0.0	0.0	
Total Lost Time (s)	5.7	5.7		5.7	5.7		5.9	5.9		5.9	5.9	
Lead/Lag												
Lead-Lag Optimize?												
Recall Mode	C-Min	C-Min		C-Min	C-Min		None	None		None	None	
Act Effct Green (s)	85.8	85.8		85.8	85.8		22.6	22.6		22.6	22.6	
Actuated g/C Ratio	0.72	0.72		0.72	0.72		0.19	0.19		0.19	0.19	
v/c Ratio	0.08	0.42		0.30	0.38		0.76	0.32		0.55	0.18	
Control Delay	7.2	8.1		9.9	8.3		65.5	9.5		53.6	11.5	
Queue Delay	0.0	0.0		0.0	0.0		0.0	0.0		0.0	0.0	
Total Delay	7.2	8.1		9.9	8.3		65.5	9.5		53.6	11.5	
LOS	A	A		A	A		E	A		D	B	
Approach Delay		8.0			8.7			44.3			39.3	
Approach LOS		A			A			D			D	
Queue Length 50th (m)	2.9	35.8		9.8	30.1		40.8	0.2		22.6	0.4	
Queue Length 95th (m)	8.5	70.3		24.9	59.6		60.4	13.9		37.4	10.2	
Internal Link Dist (m)		122.9			257.3			171.4			184.1	
Turn Bay Length (m)	37.5			37.5			30.0			30.0		
Base Capacity (vph)	583	1178		423	1069		389	486		312	469	
Starvation Cap Reductn	0	0		0	0		0	0		0	0	
Spillback Cap Reductn	0	0		0	0		0	0		0	0	
Storage Cap Reductn	0	0		0	0		0	0		0	0	
Reduced v/c Ratio	0.08	0.42		0.30	0.38		0.47	0.23		0.34	0.12	

Intersection Summary	
Cycle Length:	120
Actuated Cycle Length:	120
Offset:	0 (0%), Referenced to phase 2:EBTL and 6:WBTL, Start of Green
Natural Cycle:	60
Control Type:	Actuated-Coordinated

Lanes, Volumes, Timings
2: Elevation/Apolune & Cambrian

2029 Future Background
SAT Peak Hour

Maximum v/c Ratio: 0.76	Intersection LOS: B
Intersection Signal Delay: 18.4	ICU Level of Service C
Intersection Capacity Utilization 69.6%	
Analysis Period (min) 15	

Splits and Phases: 2: Elevation/Apolune & Cambrian

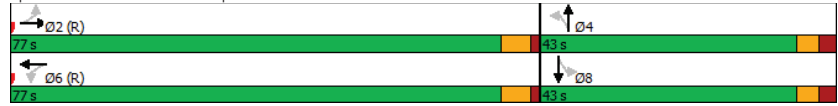

HCM 2010 TWSC
5: Temporary Driveway & Cambrian

2029 Future Background
SAT Peak Hour

Intersection						
Int Delay, s/veh	1.4					
Movement	EBT	EBR	WBL	WBT	NBL	NBR
Lane Configurations	↔ ↗ ↘ ↖ ↙ ↚					
Traffic Vol, veh/h	154	66	7	205	44	10
Future Vol, veh/h	154	66	7	205	44	10
Conflicting Peds, #/hr	0	0	0	0	0	0
Sign Control	Free	Free	Free	Free	Stop	Stop
RT Channelized	-	None	-	None	-	None
Storage Length	-	-	-	-	0	-
Veh in Median Storage, #	0	-	-	0	0	-
Grade, %	0	-	-	0	0	-
Peak Hour Factor	100	100	100	100	100	100
Heavy Vehicles, %	2	2	2	2	2	2
Mvmt Flow	154	66	7	205	44	10
Major/Minor	Major1	Major2	Minor1	Minor2	Minor3	Minor4
Conflicting Flow All	0	0	220	0	406	187
Stage 1	-	-	-	-	187	-
Stage 2	-	-	-	-	219	-
Critical Hdwy	-	-	4.12	-	6.42	6.22
Critical Hdwy Stg 1	-	-	-	-	5.42	-
Critical Hdwy Stg 2	-	-	-	-	5.42	-
Follow-up Hdwy	-	-	2.218	-	3.518	3.318
Pot Cap-1 Maneuver	-	-	1349	-	601	855
Stage 1	-	-	-	-	845	-
Stage 2	-	-	-	-	817	-
Platoon blocked, %	-	-	-	-	-	-
Mov Cap-1 Maneuver	-	-	1349	-	597	855
Mov Cap-2 Maneuver	-	-	-	-	597	-
Stage 1	-	-	-	-	845	-
Stage 2	-	-	-	-	812	-
Approach	EB	WB	NB	SB	WB	NB
HCM Control Delay, s	0	0.3	11.2	-	-	-
HCM LOS	-	-	B	-	-	-
Minor Lane/Major Mvmt	NBLn1	EBT	EBR	WBL	WBT	NBR
Capacity (veh/h)	632	-	-	1349	-	-
HCM Lane V/C Ratio	0.085	-	-	0.005	-	-
HCM Control Delay (s)	11.2	-	-	7.7	0	-
HCM Lane LOS	B	-	-	A	A	-
HCM 95th %tile Q(veh)	0.3	-	-	0	-	-

Appendix J

Synchro Intersection Worksheets – 2024 Future Total Conditions

HCM 2010 AWSC
1: River Mist & Cambrian

2024 Future Total
AM Peak Hour

Intersection												
Intersection Delay, s/veh	54.5											
Intersection LOS	F											
Movement												
	EBL	EBT	EBR	WBL	WBT	WBR	NBL	NBT	NBR	SBL	SBT	SBR
Lane Configurations		↔			↕			↕			↔	
Traffic Vol, veh/h	24	427	85	49	341	51	181	50	104	71	16	48
Future Vol, veh/h	24	427	85	49	341	51	181	50	104	71	16	48
Peak Hour Factor	1.00	1.00	1.00	1.00	1.00	1.00	1.00	1.00	1.00	1.00	1.00	1.00
Heavy Vehicles, %	7	10	6	16	9	4	2	10	4	3	6	4
Mvmt Flow	24	427	85	49	341	51	181	50	104	71	16	48
Number of Lanes	0	1	0	0	1	0	0	1	0	0	1	0
Approach												
	EB	WB			NB			SB				
Opposing Approach	WB	EB			SB			NB				
Opposing Lanes	1	1			1			1				
Conflicting Approach Left	SB	NB			EB			WB				
Conflicting Lanes Left	1	1			1			1				
Conflicting Approach Right	NB	SB			WB			EB				
Conflicting Lanes Right	1	1			1			1				
HCM Control Delay	85.5	48.5			28.1			16				
HCM LOS	F	E			D			C				

Lane	NBLn1	EBLn1	WBLn1	SBLn1
Vol Left, %	54%	4%	11%	53%
Vol Thru, %	15%	80%	77%	12%
Vol Right, %	31%	16%	12%	36%
Sign Control	Stop	Stop	Stop	Stop
Traffic Vol by Lane	335	536	441	135
LT Vol	181	24	49	71
Through Vol	50	427	341	16
RT Vol	104	85	51	48
Lane Flow Rate	335	536	441	135
Geometry Grp	1	1	1	1
Degree of Util (X)	0.712	1.066	0.903	0.321
Departure Headway (Hd)	7.888	7.158	7.601	8.895
Convergence, Y/N	Yes	Yes	Yes	Yes
Cap	462	509	481	406
Service Time	5.888	5.158	5.601	6.895
HCM Lane V/C Ratio	0.725	1.053	0.917	0.333
HCM Control Delay	28.1	85.5	48.5	16
HCM Lane LOS	D	F	E	C
HCM 95th-tile Q	5.5	16.4	10.1	1.4

Lanes, Volumes, Timings
2: Elevation/Polune & Cambrian

2024 Future Total
AM Peak Hour

Lane Group	EBL	EBT	EBR	WBL	WBT	WBR	NBL	NBT	NBR	SBL	SBT	SBR
Lane Configurations	↔	↔		↔	↔		↔	↔		↔	↔	
Traffic Volume (vph)	9	247	90	34	441	80	189	0	71	142	0	32
Future Volume (vph)	9	247	90	34	441	80	189	0	71	142	0	32
Satd. Flow (prot)	1658	1474	0	1658	1485	0	1658	1483	0	1492	1483	0
Fit Permitted	0.408			0.548			0.736			0.711		
Satd. Flow (perm)	712	1474	0	956	1485	0	1284	1483	0	1117	1483	0
Satd. Flow (RTOR)		36		18			567			335		
Lane Group Flow (vph)	9	337	0	34	521	0	189	71	0	142	32	0
Turn Type	Perm	NA		Perm	NA		Perm	NA		Perm	NA	
Protected Phases		2			6			4				8
Permitted Phases	2			6			4			8		
Detector Phase	2	2		6	6		4	4		8	8	
Switch Phase												
Minimum Initial (s)	10.0	10.0		10.0	10.0		10.0	10.0		10.0	10.0	
Minimum Split (s)	23.7	23.7		23.7	23.7		30.4	30.4		30.4	30.4	
Total Split (s)	39.6	39.6		39.6	39.6		30.4	30.4		30.4	30.4	
Total Split (%)	56.6%	56.6%		56.6%	56.6%		43.4%	43.4%		43.4%	43.4%	
Yellow Time (s)	4.2	4.2		4.2	4.2		3.3	3.3		3.3	3.3	
All-Red Time (s)	1.5	1.5		1.5	1.5		2.6	2.6		2.6	2.6	
Lost Time Adjust (s)	0.0	0.0		0.0	0.0		0.0	0.0		0.0	0.0	
Total Lost Time (s)	5.7	5.7		5.7	5.7		5.9	5.9		5.9	5.9	
Lead/Lag												
Lead-Lag Optimize?												
Recall Mode	C-Min	C-Min		C-Min	C-Min		None	None		None	None	
Act Effct Green (s)	42.1	42.1		42.1	42.1		16.3	16.3		16.3	16.3	
Actuated g/C Ratio	0.60	0.60		0.60	0.60		0.23	0.23		0.23	0.23	
v/c Ratio	0.02	0.37		0.06	0.58		0.63	0.09		0.55	0.05	
Control Delay	8.3	9.1		8.2	13.1		32.9	0.2		30.4	0.2	
Queue Delay	0.0	0.0		0.0	0.0		0.0	0.0		0.0	0.0	
Total Delay	8.3	9.1		8.2	13.1		32.9	0.2		30.4	0.2	
LOS	A	A		A	B		C	A		C	A	
Approach Delay		9.1			12.8		24.0				24.9	
Approach LOS		A			B		C				C	
Queue Length 50th (m)	0.4	17.0		1.6	34.3		22.6	0.0		16.6	0.0	
Queue Length 95th (m)	2.7	43.9		6.6	84.1		35.0	0.0		27.6	0.0	
Internal Link Dist (m)		192.0			170.7		97.9				184.1	
Turn Bay Length (m)	37.5			37.5			30.0			30.0		
Base Capacity (vph)	428	901		575	901		449	887		390	736	
Starvation Cap Reductn	0	0		0	0		0	0		0	0	
Spillback Cap Reductn	0	0		0	0		0	0		0	0	
Storage Cap Reductn	0	0		0	0		0	0		0	0	
Reduced v/c Ratio	0.02	0.37		0.06	0.58		0.42	0.08		0.36	0.04	

Intersection Summary												
Cycle Length: 70												
Actuated Cycle Length: 70												
Offset: 0 (0%), Referenced to phase 2:EBTL and 6:WBTL, Start of Green												
Natural Cycle: 60												
Control Type: Actuated-Coordinated												

Lanes, Volumes, Timings
2: Elevation/Apolune & Cambrian

2024 Future Total
AM Peak Hour

Maximum v/c Ratio: 0.63	Intersection LOS: B
Intersection Signal Delay: 15.6	ICU Level of Service B
Intersection Capacity Utilization 57.2%	
Analysis Period (min) 15	

Splits and Phases: 2: Elevation/Apolune & Cambrian

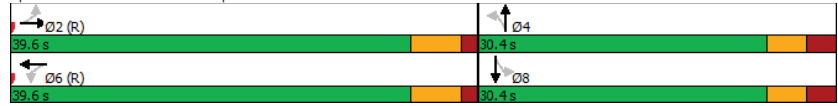

HCM 2010 TWSC
5: Temporary Driveway & Cambrian

2024 Future Total
AM Peak Hour

Intersection						
Int Delay, s/veh	0.4					
Movement	EBT	EBR	WBL	WBT	NBL	NBR
Lane Configurations	↔		↔		↔	
Traffic Vol, veh/h	437	22	9	548	15	6
Future Vol, veh/h	437	22	9	548	15	6
Conflicting Peds, #/hr	0	0	0	0	0	0
Sign Control	Free	Free	Free	Free	Stop	Stop
RT Channelized	-	None	-	None	-	None
Storage Length	-	-	-	-	0	-
Veh in Median Storage, #	0	-	-	0	0	-
Grade, %	0	-	-	0	0	-
Peak Hour Factor	100	100	100	100	100	100
Heavy Vehicles, %	2	2	2	2	2	2
Mvmt Flow	437	22	9	548	15	6
Major/Minor	Major1	Major2	Minor1			
Conflicting Flow All	0	0	459	0	1014	448
Stage 1	-	-	-	-	448	-
Stage 2	-	-	-	-	566	-
Critical Hdwy	-	-	4.12	-	6.42	6.22
Critical Hdwy Stg 1	-	-	-	-	5.42	-
Critical Hdwy Stg 2	-	-	-	-	5.42	-
Follow-up Hdwy	-	-	2.218	-	3.518	3.318
Pot Cap-1 Maneuver	-	-	1102	-	264	611
Stage 1	-	-	-	-	644	-
Stage 2	-	-	-	-	568	-
Platoon blocked, %	-	-	-	-	-	-
Mov Cap-1 Maneuver	-	-	1102	-	261	611
Mov Cap-2 Maneuver	-	-	-	-	261	-
Stage 1	-	-	-	-	644	-
Stage 2	-	-	-	-	561	-
Approach	EB	WB	NB			
HCM Control Delay, s	0	0.1	17.4			
HCM LOS			C			
Minor Lane/Major Mvmt	NBLn1	EBT	EBR	WBL	WBT	
Capacity (veh/h)	312	-	-	1102	-	
HCM Lane V/C Ratio	0.067	-	-	0.008	-	
HCM Control Delay (s)	17.4	-	-	8.3	0	
HCM Lane LOS	C	-	-	A	A	
HCM 95th %tile Q(veh)	0.2	-	-	0	-	

HCM 2010 TWSC
7: Cambrian & Access #1

2024 Future Total
AM Peak Hour

Intersection						
Int Delay, s/veh	0.7					
Movement	EBL	EBT	WBT	WBR	SBL	SBR
Lane Configurations		↕	↕		↕	↕
Traffic Vol, veh/h	16	443	531	32	16	24
Future Vol, veh/h	16	443	531	32	16	24
Conflicting Peds, #/hr	0	0	0	0	0	0
Sign Control	Free	Free	Free	Free	Stop	Stop
RT Channelized	-	None	-	None	-	None
Storage Length	-	-	-	-	0	-
Veh in Median Storage, #	-	0	0	-	0	-
Grade, %	-	0	0	-	0	-
Peak Hour Factor	100	100	100	100	100	100
Heavy Vehicles, %	2	2	2	2	2	2
Mvmt Flow	16	443	531	32	16	24
Major/Minor	Major1	Major2	Minor2			
Conflicting Flow All	563	0	0	1022	547	
Stage 1	-	-	-	547	-	
Stage 2	-	-	-	475	-	
Critical Hdwy	4.12	-	-	6.42	6.22	
Critical Hdwy Stg 1	-	-	-	5.42	-	
Critical Hdwy Stg 2	-	-	-	5.42	-	
Follow-up Hdwy	2.218	-	-	3.518	3.318	
Pot Cap-1 Maneuver	1008	-	-	261	537	
Stage 1	-	-	-	580	-	
Stage 2	-	-	-	626	-	
Platoon blocked, %	-	-	-	-	-	
Mov Cap-1 Maneuver	1008	-	-	256	537	
Mov Cap-2 Maneuver	-	-	-	256	-	
Stage 1	-	-	-	568	-	
Stage 2	-	-	-	626	-	
Approach	EB	WB	SB			
HCM Control Delay, s	0.3	0	15.8			
HCM LOS			C			
Minor Lane/Major Mvmt	EBL	EBT	WBT	WBR	SBLn1	
Capacity (veh/h)	1008	-	-	-	373	
HCM Lane V/C Ratio	0.016	-	-	-	0.107	
HCM Control Delay (s)	8.6	0	-	-	15.8	
HCM Lane LOS	A	A	-	-	C	
HCM 95th %tile Q(veh)	0	-	-	-	0.4	

HCM 2010 AWSC
1: River Mist & Cambrian

2024 Future Total
PM Peak Hour

Intersection												
Intersection Delay, s/veh	56.7											
Intersection LOS	F											
Movement	EBL	EBT	EBR	WBL	WBT	WBR	NBL	NBT	NBR	SBL	SBT	SBR
Lane Configurations		↕			↕			↕			↕	
Traffic Vol, veh/h	36	416	142	123	399	76	113	15	103	38	12	29
Future Vol, veh/h	36	416	142	123	399	76	113	15	103	38	12	29
Peak Hour Factor	1.00	1.00	1.00	1.00	1.00	1.00	1.00	1.00	1.00	1.00	1.00	1.00
Heavy Vehicles, %	2	2	2	2	2	2	2	2	7	2	2	2
Mvmt Flow	36	416	142	123	399	76	113	15	103	38	12	29
Number of Lanes	0	1	0	0	1	0	0	1	0	0	1	0
Approach	EB	WB	NB	SB								
Opposing Approach	WB	EB	SB	NB								
Opposing Lanes	1	1	1	1								
Conflicting Approach Left	SB	NB	EB	WB								
Conflicting Lanes Left	1	1	1	1								
Conflicting Approach Right	NB	SB	WB	EB								
Conflicting Lanes Right	1	1	1	1								
HCM Control Delay	60.5	74.1	16.9	13.1								
HCM LOS	F	F	C	B								
Lane	NBLn1	EBLn1	WBLn1	SBLn1								
Vol Left, %	49%	6%	21%	48%								
Vol Thru, %	6%	70%	67%	15%								
Vol Right, %	45%	24%	13%	37%								
Sign Control	Stop	Stop	Stop	Stop								
Traffic Vol by Lane	231	594	598	79								
LT Vol	113	36	123	38								
Through Vol	15	416	399	12								
RT Vol	103	142	76	29								
Lane Flow Rate	231	594	598	79								
Geometry Grp	1	1	1	1								
Degree of Util (X)	0.465	0.993	1.043	0.178								
Departure Headway (Hd)	7.518	6.248	6.279	8.343								
Convergence, Y/N	Yes	Yes	Yes	Yes								
Cap	483	588	580	433								
Service Time	5.518	4.248	4.286	6.343								
HCM Lane V/C Ratio	0.478	1.01	1.031	0.182								
HCM Control Delay	16.9	60.5	74.1	13.1								
HCM Lane LOS	C	F	F	B								
HCM 95th-tile Q	2.4	14.4	16.6	0.6								

Lanes, Volumes, Timings
2: Elevation/Apolune & Cambrian

2024 Future Total
PM Peak Hour

Lane Group	EBL	EBT	EBR	WBL	WBT	WBR	NBL	NBT	NBR	SBL	SBT	SBR
Lane Configurations	↔	↔	↔	↔	↔	↔	↔	↔	↔	↔	↔	↔
Traffic Volume (vph)	32	446	177	61	412	105	136	0	46	90	0	18
Future Volume (vph)	32	446	177	61	412	105	136	0	46	90	0	18
Satd. Flow (prot)	1658	1670	0	1658	1511	0	1658	1483	0	1492	1483	0
Fit Permitted	0.441			0.382			0.746			0.727		
Satd. Flow (perm)	765	1670	0	667	1511	0	1302	1483	0	1134	1483	0
Satd. Flow (RTOR)		33			21			442				463
Lane Group Flow (vph)	32	623	0	61	517	0	136	46	0	90	18	0
Turn Type	Perm	NA		Perm	NA		Perm	NA		Perm	NA	
Protected Phases		2			6			4			8	
Permitted Phases	2			6			4			8		
Detector Phase	2	2		6	6		4	4		8	8	
Switch Phase												
Minimum Initial (s)	10.0	10.0		10.0	10.0		10.0	10.0		10.0	10.0	
Minimum Split (s)	23.7	23.7		23.7	23.7		30.4	30.4		30.4	30.4	
Total Split (s)	82.0	82.0		82.0	82.0		38.0	38.0		38.0	38.0	
Total Split (%)	68.3%	68.3%		68.3%	68.3%		31.7%	31.7%		31.7%	31.7%	
Yellow Time (s)	4.2	4.2		4.2	4.2		3.3	3.3		3.3	3.3	
All-Red Time (s)	1.5	1.5		1.5	1.5		2.6	2.6		2.6	2.6	
Lost Time Adjust (s)	0.0	0.0		0.0	0.0		0.0	0.0		0.0	0.0	
Total Lost Time (s)	5.7	5.7		5.7	5.7		5.9	5.9		5.9	5.9	
Lead/Lag												
Lead-Lag Optimize?												
Recall Mode	C-Min	C-Min		C-Min	C-Min		None	None		None	None	
Act Effct Green (s)	90.6	90.6		90.6	90.6		17.8	17.8		17.8	17.8	
Actuated g/C Ratio	0.76	0.76		0.76	0.76		0.15	0.15		0.15	0.15	
v/c Ratio	0.06	0.49		0.12	0.45		0.70	0.08		0.54	0.03	
Control Delay	5.2	7.7		5.7	7.4		67.0	0.3		57.6	0.1	
Queue Delay	0.0	0.0		0.0	0.0		0.0	0.0		0.0	0.0	
Total Delay	5.2	7.7		5.7	7.4		67.0	0.3		57.6	0.1	
LOS	A	A		A	A		E	A		E	A	
Approach Delay		7.5			7.3			50.1			48.0	
Approach LOS		A			A			D			D	
Queue Length 50th (m)	1.7	46.2		3.3	37.1		30.8	0.0		19.8	0.0	
Queue Length 95th (m)	5.4	86.8		9.3	71.3		48.8	0.0		34.4	0.0	
Internal Link Dist (m)		122.9			169.1			171.4			184.1	
Turn Bay Length (m)	37.5			37.5			30.0			30.0		
Base Capacity (vph)	577	1268		503	1145		348	720		303	735	
Starvation Cap Reductn	0	0		0	0		0	0		0	0	
Spillback Cap Reductn	0	0		0	0		0	0		0	0	
Storage Cap Reductn	0	0		0	0		0	0		0	0	
Reduced v/c Ratio	0.06	0.49		0.12	0.45		0.39	0.06		0.30	0.02	

Intersection Summary	
Cycle Length:	120
Actuated Cycle Length:	120
Offset:	0 (0%), Referenced to phase 2:EBTL and 6:WBTL, Start of Green
Natural Cycle:	60
Control Type:	Actuated-Coordinated

Lanes, Volumes, Timings
2: Elevation/Apolune & Cambrian

2024 Future Total
PM Peak Hour

Maximum v/c Ratio: 0.70	Intersection LOS: B
Intersection Signal Delay: 15.4	ICU Level of Service D
Intersection Capacity Utilization 73.5%	
Analysis Period (min) 15	

Splits and Phases: 2: Elevation/Apolune & Cambrian

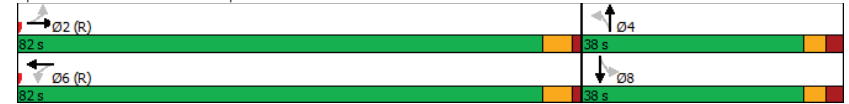

HCM 2010 TWSC
5: Temporary Driveway & Cambrian

2024 Future Total
PM Peak Hour

Intersection						
Int Delay, s/veh	0.9					
Movement	EBT	EBR	WBL	WBT	NBL	NBR
Lane Configurations	↶			↷	↶	↷
Traffic Vol, veh/h	529	57	6	545	38	9
Future Vol, veh/h	529	57	6	545	38	9
Conflicting Peds, #/hr	0	0	0	0	0	0
Sign Control	Free	Free	Free	Free	Stop	Stop
RT Channelized	-	None	-	None	-	None
Storage Length	-	-	-	-	0	-
Veh in Median Storage, #	0	-	-	0	0	-
Grade, %	0	-	-	0	0	-
Peak Hour Factor	100	100	100	100	100	100
Heavy Vehicles, %	2	2	2	2	2	2
Mvmt Flow	529	57	6	545	38	9

Major/Minor	Major1	Major2	Minor1
Conflicting Flow All	0	0	586
Stage 1	-	-	558
Stage 2	-	-	557
Critical Hdwy	-	4.12	6.42
Critical Hdwy Stg 1	-	-	5.42
Critical Hdwy Stg 2	-	-	5.42
Follow-up Hdwy	-	2.218	3.518
Pot Cap-1 Maneuver	-	989	230
Stage 1	-	-	573
Stage 2	-	-	574
Platoon blocked, %	-	-	-
Mov Cap-1 Maneuver	-	989	228
Mov Cap-2 Maneuver	-	-	228
Stage 1	-	-	573
Stage 2	-	-	569

Approach	EB	WB	NB
HCM Control Delay, s	0	0.1	22.2
HCM LOS			C

Minor Lane/Major Mvmt	NBLn1	EBT	EBR	WBL	WBT
Capacity (veh/h)	256	-	-	989	-
HCM Lane V/C Ratio	0.184	-	-	0.006	-
HCM Control Delay (s)	22.2	-	-	8.7	0
HCM Lane LOS	C	-	-	A	A
HCM 95th %tile Q(veh)	0.7	-	-	0	-

HCM 2010 TWSC
7: Cambrian & Access #1

2024 Future Total
PM Peak Hour

Intersection						
Int Delay, s/veh	1.9					
Movement	EBL	EBT	WBT	WBR	SBL	SBR
Lane Configurations		↶	↷		↶	↷
Traffic Vol, veh/h	36	545	520	65	41	59
Future Vol, veh/h	36	545	520	65	41	59
Conflicting Peds, #/hr	0	0	0	0	0	0
Sign Control	Free	Free	Free	Free	Stop	Stop
RT Channelized	-	None	-	None	-	None
Storage Length	-	-	-	-	0	-
Veh in Median Storage, #	-	0	0	-	0	-
Grade, %	-	0	0	-	0	-
Peak Hour Factor	100	100	100	100	100	100
Heavy Vehicles, %	2	2	2	2	2	2
Mvmt Flow	36	545	520	65	41	59

Major/Minor	Major1	Major2	Minor2
Conflicting Flow All	585	0	1170
Stage 1	-	-	553
Stage 2	-	-	617
Critical Hdwy	4.12	-	6.42
Critical Hdwy Stg 1	-	-	5.42
Critical Hdwy Stg 2	-	-	5.42
Follow-up Hdwy	2.218	-	3.518
Pot Cap-1 Maneuver	990	-	213
Stage 1	-	-	576
Stage 2	-	-	538
Platoon blocked, %	-	-	-
Mov Cap-1 Maneuver	990	-	202
Mov Cap-2 Maneuver	-	-	202
Stage 1	-	-	546
Stage 2	-	-	538

Approach	EB	WB	SB
HCM Control Delay, s	0.5	0	21.4
HCM LOS			C

Minor Lane/Major Mvmt	EBL	EBT	WBT	WBR	SBLn1
Capacity (veh/h)	990	-	-	-	319
HCM Lane V/C Ratio	0.036	-	-	-	0.313
HCM Control Delay (s)	8.8	0	-	-	21.4
HCM Lane LOS	A	A	-	-	C
HCM 95th %tile Q(veh)	0.1	-	-	-	1.3

HCM 2010 AWSC
1: River Mist & Cambrian

2024 Future Future
SAT Peak Hour

Intersection												
Intersection Delay, s/veh	23.8											
Intersection LOS	C											

Movement	EBL	EBT	EBR	WBL	WBT	WBR	NBL	NBT	NBR	SBL	SBT	SBR
Lane Configurations		↔			↕			↕			↔	
Traffic Vol, veh/h	20	339	90	69	387	82	88	10	79	40	13	29
Future Vol, veh/h	20	339	90	69	387	82	88	10	79	40	13	29
Peak Hour Factor	1.00	1.00	1.00	1.00	1.00	1.00	1.00	1.00	1.00	1.00	1.00	1.00
Heavy Vehicles, %	2	2	2	7	2	2	2	2	4	2	8	2
Mvmt Flow	20	339	90	69	387	82	88	10	79	40	13	29
Number of Lanes	0	1	0	0	1	0	0	1	0	0	1	0

Approach	EB	WB	NB	SB
Opposing Approach	WB	EB	SB	NB
Opposing Lanes	1	1	1	1
Conflicting Approach Left	SB	NB	EB	WB
Conflicting Lanes Left	1	1	1	1
Conflicting Approach Right	NB	SB	WB	EB
Conflicting Lanes Right	1	1	1	1
HCM Control Delay	21.1	31.4	13	11.5
HCM LOS	C	D	B	B

Lane	NBLn1	EBLn1	WBLn1	SBLn1
Vol Left, %	50%	4%	13%	49%
Vol Thru, %	6%	76%	72%	16%
Vol Right, %	45%	20%	15%	35%
Sign Control	Stop	Stop	Stop	Stop
Traffic Vol by Lane	177	449	538	82
LT Vol	88	20	69	40
Through Vol	10	339	387	13
RT Vol	79	90	82	29
Lane Flow Rate	177	449	538	82
Geometry Grp	1	1	1	1
Degree of Util (X)	0.328	0.705	0.842	0.161
Departure Headway (Hd)	6.664	5.649	5.634	7.054
Convergence, Y/N	Yes	Yes	Yes	Yes
Cap	538	642	646	507
Service Time	4.719	3.667	3.649	5.12
HCM Lane V/C Ratio	0.329	0.699	0.833	0.162
HCM Control Delay	13	21.1	31.4	11.5
HCM Lane LOS	B	C	D	B
HCM 95th-tile Q	1.4	5.8	9.2	0.6

Lanes, Volumes, Timings
2: Elevation/Polune & Cambrian

2024 Future Future
SAT Peak Hour



Lane Group	EBL	EBT	EBR	WBL	WBT	WBR	NBL	NBT	NBR	SBL	SBT	SBR
Lane Configurations	↔	↔		↔	↔		↔	↔		↔	↔	
Traffic Volume (vph)	38	249	160	78	271	91	128	1	69	75	2	45
Future Volume (vph)	38	249	160	78	271	91	128	1	69	75	2	45
Satd. Flow (prot)	1566	1642	0	1271	1496	0	1658	1332	0	1436	1402	0
Fit Permitted	0.536			0.506			0.726			0.711		
Satd. Flow (perm)	875	1642	0	677	1496	0	1267	1332	0	1067	1402	0
Satd. Flow (RTOR)		48			25			69			45	
Lane Group Flow (vph)	38	409	0	78	362	0	128	70	0	75	47	0
Turn Type	Perm	NA		Perm	NA		Perm	NA		Perm	NA	
Protected Phases		2			6			4			8	
Permitted Phases	2			6			4			8		
Detector Phase	2	2		6	6		4	4		8	8	
Switch Phase												
Minimum Initial (s)	10.0	10.0		10.0	10.0		10.0	10.0		10.0	10.0	
Minimum Split (s)	23.7	23.7		23.7	23.7		30.4	30.4		30.4	30.4	
Total Split (s)	77.0	77.0		77.0	77.0		43.0	43.0		43.0	43.0	
Total Split (%)	64.2%	64.2%		64.2%	64.2%		35.8%	35.8%		35.8%	35.8%	
Yellow Time (s)	4.2	4.2		4.2	4.2		3.3	3.3		3.3	3.3	
All-Red Time (s)	1.5	1.5		1.5	1.5		2.6	2.6		2.6	2.6	
Lost Time Adjust (s)	0.0	0.0		0.0	0.0		0.0	0.0		0.0	0.0	
Total Lost Time (s)	5.7	5.7		5.7	5.7		5.9	5.9		5.9	5.9	
Lead/Lag												
Lead-Lag Optimize?												
Recall Mode	C-Min	C-Min		C-Min	C-Min		None	None		None	None	
Act Effct Green (s)	91.0	91.0		91.0	91.0		17.4	17.4		17.4	17.4	
Actuated g/C Ratio	0.76	0.76		0.76	0.76		0.14	0.14		0.14	0.14	
v/c Ratio	0.06	0.33		0.15	0.32		0.70	0.28		0.48	0.19	
Control Delay	5.0	5.4		5.7	5.7		67.4	12.7		56.1	14.4	
Queue Delay	0.0	0.0		0.0	0.0		0.0	0.0		0.0	0.0	
Total Delay	5.0	5.4		5.7	5.7		67.4	12.7		56.1	14.4	
LOS	A	A		A	A		E	B		E	B	
Approach Delay		5.4			5.7			48.1			40.1	
Approach LOS		A			A			D			D	
Queue Length 50th (m)	2.0	22.7		4.3	21.3		29.0	0.2		16.5	0.4	
Queue Length 95th (m)	6.0	44.7		11.5	42.3		46.7	12.3		29.9	10.4	
Internal Link Dist (m)		122.9			166.9			171.4			184.1	
Turn Bay Length (m)	37.5			37.5			30.0			30.0		
Base Capacity (vph)	663	1256		513	1140		391	459		329	464	
Starvation Cap Reductn	0	0		0	0		0	0		0	0	
Spillback Cap Reductn	0	0		0	0		0	0		0	0	
Storage Cap Reductn	0	0		0	0		0	0		0	0	
Reduced v/c Ratio	0.06	0.33		0.15	0.32		0.33	0.15		0.23	0.10	

Intersection Summary												
Cycle Length: 120												
Actuated Cycle Length: 120												
Offset: 0 (0%), Referenced to phase 2:EBTL and 6:WBTL, Start of Green												
Natural Cycle: 60												
Control Type: Actuated-Coordinated												

Lanes, Volumes, Timings
2: Elevation/Apolune & Cambrian

2024 Future Future
SAT Peak Hour

Maximum v/c Ratio: 0.70	
Intersection Signal Delay: 16.0	Intersection LOS: B
Intersection Capacity Utilization 61.0%	ICU Level of Service B
Analysis Period (min) 15	

Splits and Phases: 2: Elevation/Apolune & Cambrian

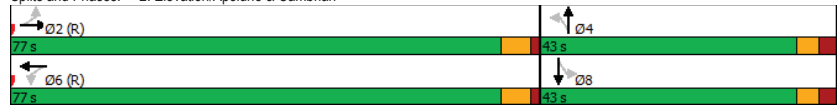

HCM 2010 TWSC
5: Temporary Driveway & Cambrian

2024 Future Future
SAT Peak Hour

Intersection						
Int Delay, s/veh	2					
Movement	EBT	EBR	WBL	WBT	NBL	NBR
Lane Configurations	↔			↔	↔	↔
Traffic Vol, veh/h	59	66	7	103	44	10
Future Vol, veh/h	59	66	7	103	44	10
Conflicting Peds, #/hr	0	0	0	0	0	0
Sign Control	Free	Free	Free	Free	Stop	Stop
RT Channelized	-	None	-	None	-	None
Storage Length	-	-	-	-	0	-
Veh in Median Storage, #	0	-	-	0	0	-
Grade, %	0	-	-	0	0	-
Peak Hour Factor	100	100	100	100	100	100
Heavy Vehicles, %	2	2	2	2	2	2
Mvmt Flow	59	66	7	103	44	10
Major/Minor	Major1	Major2	Minor1			
Conflicting Flow All	0	0	125	0	209	92
Stage 1	-	-	-	-	92	-
Stage 2	-	-	-	-	117	-
Critical Hdwy	-	-	4.12	-	6.42	6.22
Critical Hdwy Stg 1	-	-	-	-	5.42	-
Critical Hdwy Stg 2	-	-	-	-	5.42	-
Follow-up Hdwy	-	-	2.218	-	3.518	3.318
Pot Cap-1 Maneuver	-	-	1462	-	779	965
Stage 1	-	-	-	-	932	-
Stage 2	-	-	-	-	908	-
Platoon blocked, %	-	-	-	-	-	-
Mov Cap-1 Maneuver	-	-	1462	-	775	965
Mov Cap-2 Maneuver	-	-	-	-	775	-
Stage 1	-	-	-	-	932	-
Stage 2	-	-	-	-	903	-
Approach	EB	WB	NB			
HCM Control Delay, s	0	0.5	9.8			
HCM LOS			A			
Minor Lane/Major Mvmt	NBLn1	EBT	EBR	WBL	WBT	
Capacity (veh/h)	804	-	-	1462	-	
HCM Lane V/C Ratio	0.067	-	-	0.005	-	
HCM Control Delay (s)	9.8	-	-	7.5	0	
HCM Lane LOS	A	-	-	A	A	
HCM 95th %tile Q(veh)	0.2	-	-	0	-	

Intersection						
Int Delay, s/veh	2.3					
Movement	EBL	EBT	WBT	WBR	SBL	SBR
Lane Configurations		↕	↕		↕	↕
Traffic Vol, veh/h	48	344	389	60	56	51
Future Vol, veh/h	48	344	389	60	56	51
Conflicting Peds, #/hr	0	0	0	0	0	0
Sign Control	Free	Free	Free	Free	Stop	Stop
RT Channelized	-	None	-	None	-	None
Storage Length	-	-	-	-	0	-
Veh in Median Storage, #	-	0	0	-	0	-
Grade, %	-	0	0	-	0	-
Peak Hour Factor	100	100	100	100	100	100
Heavy Vehicles, %	2	2	2	2	2	2
Mvmt Flow	48	344	389	60	56	51
Major/Minor	Major1	Major2	Minor2			
Conflicting Flow All	449	0	-	0	859	419
Stage 1	-	-	-	-	419	-
Stage 2	-	-	-	-	440	-
Critical Hdwy	4.12	-	-	-	6.42	6.22
Critical Hdwy Stg 1	-	-	-	-	5.42	-
Critical Hdwy Stg 2	-	-	-	-	5.42	-
Follow-up Hdwy	2,218	-	-	-	3,518	3,318
Pot Cap-1 Maneuver	1111	-	-	-	327	634
Stage 1	-	-	-	-	664	-
Stage 2	-	-	-	-	649	-
Platoon blocked, %	-	-	-	-	-	-
Mov Cap-1 Maneuver	1111	-	-	-	310	634
Mov Cap-2 Maneuver	-	-	-	-	310	-
Stage 1	-	-	-	-	629	-
Stage 2	-	-	-	-	649	-
Approach	EB	WB	SB			
HCM Control Delay, s	1	0	16.9			
HCM LOS	C					
Minor Lane/Major Mvmt	EBL	EBT	WBT	WBR	SBLn1	
Capacity (veh/h)	1111	-	-	-	-	410
HCM Lane V/C Ratio	0.043	-	-	-	-	0.261
HCM Control Delay (s)	8.4	0	-	-	-	16.9
HCM Lane LOS	A	A	-	-	-	C
HCM 95th %tile Q(veh)	0.1	-	-	-	-	1

Appendix K

Synchro Intersection Worksheets – 2029 Future Total Conditions

HCM 2010 AWSC
1: River Mist & Cambrian

2029 Future Total
AM Peak Hour

Intersection	
Intersection Delay, s/veh	99.7
Intersection LOS	F

Movement	EBL	EBT	EBR	WBL	WBT	WBR	NBL	NBT	NBR	SBL	SBT	SBR
Lane Configurations		↔			↕			↕			↔	
Traffic Vol, veh/h	25	510	96	51	397	51	199	50	109	71	16	49
Future Vol, veh/h	25	510	96	51	397	51	199	50	109	71	16	49
Peak Hour Factor	1.00	1.00	1.00	1.00	1.00	1.00	1.00	1.00	1.00	1.00	1.00	1.00
Heavy Vehicles, %	7	10	6	16	9	4	2	10	4	3	6	4
Mvmt Flow	25	510	96	51	397	51	199	50	109	71	16	49
Number of Lanes	0	1	0	0	1	0	0	1	0	0	1	0

Approach	EB	WB	NB	SB
Opposing Approach	WB	EB	SB	NB
Opposing Lanes	1	1	1	1
Conflicting Approach Left	SB	NB	EB	WB
Conflicting Lanes Left	1	1	1	1
Conflicting Approach Right	NB	SB	WB	EB
Conflicting Lanes Right	1	1	1	1
HCM Control Delay	166.5	83.5	35.6	17.9
HCM LOS	F	F	E	C

Lane	NBLn1	EBLn1	WBLn1	SBLn1
Vol Left, %	56%	4%	10%	52%
Vol Thru, %	14%	81%	80%	12%
Vol Right, %	30%	15%	10%	36%
Sign Control	Stop	Stop	Stop	Stop
Traffic Vol by Lane	358	631	499	136
LT Vol	199	25	51	71
Through Vol	50	510	397	16
RT Vol	109	96	51	49
Lane Flow Rate	358	631	499	136
Geometry Grp	1	1	1	1
Degree of Util (X)	0.777	1.284	1.043	0.337
Departure Headway (Hd)	8.552	7.577	8.158	9.904
Convergence, Y/N	Yes	Yes	Yes	Yes
Cap	426	486	449	366
Service Time	6.552	5.577	6.158	7.904
HCM Lane V/C Ratio	0.84	1.298	1.111	0.372
HCM Control Delay	35.6	166.5	83.5	17.9
HCM Lane LOS	E	F	F	C
HCM 95th-tile Q	6.7	25.8	14.4	1.5

Lanes, Volumes, Timings
2: Elevation/Polune & Cambrian

2029 Future Total
AM Peak Hour



Lane Group	EBL	EBT	EBR	WBL	WBT	WBR	NBL	NBT	NBR	SBL	SBT	SBR
Lane Configurations	↔	↔		↔	↔		↔	↔		↔	↔	
Traffic Volume (vph)	14	257	129	60	464	96	270	0	122	176	0	42
Future Volume (vph)	14	257	129	60	464	96	270	0	122	176	0	42
Satd. Flow (prot)	1658	1475	0	1658	1482	0	1658	1483	0	1492	1483	0
Fit Permitted	0.359			0.496			0.730			0.679		
Satd. Flow (perm)	626	1475	0	866	1482	0	1274	1483	0	1066	1483	0
Satd. Flow (RTOR)		50			21			552				314
Lane Group Flow (vph)	14	386	0	60	560	0	270	122	0	176	42	0
Turn Type	Perm	NA		Perm	NA		Perm	NA		Perm	NA	
Protected Phases		2			6			4				8
Permitted Phases	2			6			4			8		
Detector Phase	2	2		6	6		4	4		8	8	
Switch Phase												
Minimum Initial (s)	10.0	10.0		10.0	10.0		10.0	10.0		10.0	10.0	
Minimum Split (s)	23.7	23.7		23.7	23.7		30.4	30.4		30.4	30.4	
Total Split (s)	39.6	39.6		39.6	39.6		30.4	30.4		30.4	30.4	
Total Split (%)	56.6%	56.6%		56.6%	56.6%		43.4%	43.4%		43.4%	43.4%	
Yellow Time (s)	4.2	4.2		4.2	4.2		3.3	3.3		3.3	3.3	
All-Red Time (s)	1.5	1.5		1.5	1.5		2.6	2.6		2.6	2.6	
Lost Time Adjust (s)	0.0	0.0		0.0	0.0		0.0	0.0		0.0	0.0	
Total Lost Time (s)	5.7	5.7		5.7	5.7		5.9	5.9		5.9	5.9	
Lead/Lag												
Lead-Lag Optimize?												
Recall Mode	C-Min	C-Min		C-Min	C-Min		None	None		None	None	
Act Effct Green (s)	39.2	39.2		39.2	39.2		19.2	19.2		19.2	19.2	
Actuated g/C Ratio	0.56	0.56		0.56	0.56		0.27	0.27		0.27	0.27	
v/c Ratio	0.04	0.46		0.12	0.67		0.77	0.15		0.60	0.07	
Control Delay	9.5	11.2		9.9	17.3		38.0	0.4		30.1	0.2	
Queue Delay	0.0	0.0		0.0	0.0		0.0	0.0		0.0	0.0	
Total Delay	9.5	11.2		9.9	17.3		38.0	0.4		30.1	0.2	
LOS	A	B		A	B		D	A		C	A	
Approach Delay		11.1			16.6			26.3			24.3	
Approach LOS		B			B			C			C	
Queue Length 50th (m)	0.8	23.8		3.5	46.4		31.9	0.0		19.6	0.0	
Queue Length 95th (m)	3.6	50.6		10.3	#107.6		52.0	0.0		34.9	0.0	
Internal Link Dist (m)		192.0			170.7			97.9			184.1	
Turn Bay Length (m)	37.5			37.5			30.0			30.0		
Base Capacity (vph)	350	847		484	838		445	877		373	723	
Starvation Cap Reductn	0	0		0	0		0	0		0	0	
Spillback Cap Reductn	0	0		0	0		0	0		0	0	
Storage Cap Reductn	0	0		0	0		0	0		0	0	
Reduced v/c Ratio	0.04	0.46		0.12	0.67		0.61	0.14		0.47	0.06	

Intersection Summary	
Cycle Length: 70	
Actuated Cycle Length: 70	
Offset: 0 (0%), Referenced to phase 2:EBTL and 6:WBTL, Start of Green	
Natural Cycle: 65	
Control Type: Actuated-Coordinated	

Lanes, Volumes, Timings
2: Elevation/Apolune & Cambrian

2029 Future Total
AM Peak Hour

Maximum v/c Ratio: 0.77	Intersection LOS: B
Intersection Signal Delay: 18.6	ICU Level of Service E
Intersection Capacity Utilization 83.7%	
Analysis Period (min) 15	
# 95th percentile volume exceeds capacity, queue may be longer.	
Queue shown is maximum after two cycles.	

Splits and Phases: 2: Elevation/Apolune & Cambrian



HCM 2010 TWSC
5: Temporary Driveway & Cambrian

2029 Future Total
AM Peak Hour

Intersection							
Int Delay, s/veh	0.4						
Movement	EBT	EBR	WBL	WBT	NBL	NBR	
Lane Configurations	↔		↔		↔		
Traffic Vol, veh/h	531	22	9	625	15	6	
Future Vol, veh/h	531	22	9	625	15	6	
Conflicting Peds, #/hr	0	0	0	0	0	0	
Sign Control	Free	Free	Free	Free	Stop	Stop	
RT Channelized	-	None	-	None	-	None	
Storage Length	-	-	-	-	0	-	
Veh in Median Storage, #	0	-	-	0	0	-	
Grade, %	0	-	-	0	0	-	
Peak Hour Factor	100	100	100	100	100	100	
Heavy Vehicles, %	2	2	2	2	2	2	
Mvmt Flow	531	22	9	625	15	6	
Major/Minor	Major1	Major2	Minor1				
Conflicting Flow All	0	0	553	0	1185	542	
Stage 1	-	-	-	-	542	-	
Stage 2	-	-	-	-	643	-	
Critical Hdwy	-	-	4.12	-	6.42	6.22	
Critical Hdwy Stg 1	-	-	-	-	5.42	-	
Critical Hdwy Stg 2	-	-	-	-	5.42	-	
Follow-up Hdwy	-	-	2.218	-	3.518	3.318	
Pot Cap-1 Maneuver	-	-	1017	-	209	540	
Stage 1	-	-	-	-	583	-	
Stage 2	-	-	-	-	523	-	
Platoon blocked, %	-	-	-	-	-	-	
Mov Cap-1 Maneuver	-	-	1017	-	206	540	
Mov Cap-2 Maneuver	-	-	-	-	206	-	
Stage 1	-	-	-	-	583	-	
Stage 2	-	-	-	-	516	-	
Approach	EB	WB	NB				
HCM Control Delay, s	0	0.1	20.7				
HCM LOS				C			
Minor Lane/Major Mvmt	NBLn1	EBT	EBR	WBL	WBT		
Capacity (veh/h)	250	-	-	1017	-		
HCM Lane V/C Ratio	0.084	-	-	0.009	-		
HCM Control Delay (s)	20.7	-	-	8.6	0		
HCM Lane LOS	C	-	-	A	A		
HCM 95th %tile Q(veh)	0.3	-	-	0	-		

HCM 2010 TWSC
7: Cambrian & Access #1

2029 Future Total
AM Peak Hour

Intersection						
Int Delay, s/veh	0.7					
Movement	EBL	EBT	WBT	WBR	SBL	SBR
Lane Configurations		↕	↕		↕	↕
Traffic Vol, veh/h	16	538	595	32	16	24
Future Vol, veh/h	16	538	595	32	16	24
Conflicting Peds, #/hr	0	0	0	0	0	0
Sign Control	Free	Free	Free	Free	Stop	Stop
RT Channelized	-	None	-	None	-	None
Storage Length	-	-	-	-	0	-
Veh in Median Storage, #	-	0	0	-	0	-
Grade, %	-	0	0	-	0	-
Peak Hour Factor	100	100	100	100	100	100
Heavy Vehicles, %	2	2	2	2	2	2
Mvmt Flow	16	538	595	32	16	24
Major/Minor	Major1	Major2	Minor2			
Conflicting Flow All	627	0	0	1181	611	
Stage 1	-	-	-	611	-	
Stage 2	-	-	-	570	-	
Critical Hdwy	4.12	-	-	6.42	6.22	
Critical Hdwy Stg 1	-	-	-	5.42	-	
Critical Hdwy Stg 2	-	-	-	5.42	-	
Follow-up Hdwy	2.218	-	-	3.518	3.318	
Pot Cap-1 Maneuver	955	-	-	210	494	
Stage 1	-	-	-	542	-	
Stage 2	-	-	-	566	-	
Platoon blocked, %	-	-	-	-	-	
Mov Cap-1 Maneuver	955	-	-	205	494	
Mov Cap-2 Maneuver	-	-	-	205	-	
Stage 1	-	-	-	529	-	
Stage 2	-	-	-	566	-	
Approach	EB	WB	SB			
HCM Control Delay, s	0.3	0	18			
HCM LOS			C			
Minor Lane/Major Mvmt	EBL	EBT	WBT	WBR	SBLn1	
Capacity (veh/h)	955	-	-	-	316	
HCM Lane V/C Ratio	0.017	-	-	-	0.127	
HCM Control Delay (s)	8.8	0	-	-	18	
HCM Lane LOS	A	A	-	-	C	
HCM 95th %tile Q(veh)	0.1	-	-	-	0.4	

HCM 2010 AWSC
1: River Mist & Cambrian

2029 Future Total
PM Peak Hour

Intersection												
Intersection Delay, s/veh	117.6											
Intersection LOS	F											
Movement	EBL	EBT	EBR	WBL	WBT	WBR	NBL	NBT	NBR	SBL	SBT	SBR
Lane Configurations		↕			↕			↕			↕	
Traffic Vol, veh/h	38	501	167	128	494	76	135	15	106	38	12	31
Future Vol, veh/h	38	501	167	128	494	76	135	15	106	38	12	31
Peak Hour Factor	1.00	1.00	1.00	1.00	1.00	1.00	1.00	1.00	1.00	1.00	1.00	1.00
Heavy Vehicles, %	2	2	2	2	2	2	2	2	7	2	2	2
Mvmt Flow	38	501	167	128	494	76	135	15	106	38	12	31
Number of Lanes	0	1	0	0	1	0	0	1	0	0	1	0
Approach	EB	WB	NB	SB								
Opposing Approach	WB	EB	SB	NB								
Opposing Lanes	1	1	1	1								
Conflicting Approach Left	SB	NB	EB	WB								
Conflicting Lanes Left	1	1	1	1								
Conflicting Approach Right	NB	SB	WB	EB								
Conflicting Lanes Right	1	1	1	1								
HCM Control Delay	140		142.7		19.8				14.4			
HCM LOS	F		F		C				B			
Lane	NBLn1	EBLn1	WBLn1	SBLn1								
Vol Left, %	53%	5%	18%	47%								
Vol Thru, %	6%	71%	71%	15%								
Vol Right, %	41%	24%	11%	38%								
Sign Control	Stop	Stop	Stop	Stop								
Traffic Vol by Lane	256	706	698	81								
LT Vol	135	38	128	38								
Through Vol	15	501	494	12								
RT Vol	106	167	76	31								
Lane Flow Rate	256	706	698	81								
Geometry Grp	1	1	1	1								
Degree of Util (X)	0.523	1.227	1.233	0.186								
Departure Headway (Hd)	8.188	6.646	6.744	9.324								
Convergence, Y/N	Yes	Yes	Yes	Yes								
Cap	443	551	544	387								
Service Time	6.188	4.646	4.744	7.324								
HCM Lane V/C Ratio	0.578	1.281	1.283	0.209								
HCM Control Delay	19.8	140	142.7	14.4								
HCM Lane LOS	C	F	F	B								
HCM 95th-tile Q	3	25.2	25.3	0.7								

Lanes, Volumes, Timings
2: Elevation/Apolune & Cambrian

2029 Future Total
PM Peak Hour

Lane Group	EBL	EBT	EBR	WBL	WBT	WBR	NBL	NBT	NBR	SBL	SBT	SBR
Lane Configurations	↔	↔	↔	↔	↔	↔	↔	↔	↔	↔	↔	↔
Traffic Volume (vph)	42	461	255	119	429	137	193	0	93	128	0	27
Future Volume (vph)	42	461	255	119	429	137	193	0	93	128	0	27
Satd. Flow (prot)	1658	1653	0	1658	1500	0	1658	1483	0	1492	1483	0
Fit Permitted	0.398			0.314			0.740			0.697		
Satd. Flow (perm)	691	1653	0	548	1500	0	1291	1483	0	1088	1483	0
Satd. Flow (RTOR)		46			26			428			447	
Lane Group Flow (vph)	42	716	0	119	566	0	193	93	0	128	27	0
Turn Type	Perm	NA		Perm	NA		Perm	NA		Perm	NA	
Protected Phases		2			6			4			8	
Permitted Phases	2			6			4			8		
Detector Phase	2	2		6	6		4	4		8	8	
Switch Phase												
Minimum Initial (s)	10.0	10.0		10.0	10.0		10.0	10.0		10.0	10.0	
Minimum Split (s)	23.7	23.7		23.7	23.7		30.4	30.4		30.4	30.4	
Total Split (s)	82.0	82.0		82.0	82.0		38.0	38.0		38.0	38.0	
Total Split (%)	68.3%	68.3%		68.3%	68.3%		31.7%	31.7%		31.7%	31.7%	
Yellow Time (s)	4.2	4.2		4.2	4.2		3.3	3.3		3.3	3.3	
All-Red Time (s)	1.5	1.5		1.5	1.5		2.6	2.6		2.6	2.6	
Lost Time Adjust (s)	0.0	0.0		0.0	0.0		0.0	0.0		0.0	0.0	
Total Lost Time (s)	5.7	5.7		5.7	5.7		5.9	5.9		5.9	5.9	
Lead/Lag												
Lead-Lag Optimize?												
Recall Mode	C-Min	C-Min		C-Min	C-Min		None	None		None	None	
Act Effct Green (s)	85.3	85.3		85.3	85.3		23.1	23.1		23.1	23.1	
Actuated g/C Ratio	0.71	0.71		0.71	0.71		0.19	0.19		0.19	0.19	
v/c Ratio	0.09	0.60		0.31	0.53		0.78	0.15		0.61	0.04	
Control Delay	7.5	11.9		10.4	10.9		65.9	0.5		55.7	0.1	
Queue Delay	0.0	0.0		0.0	0.0		0.0	0.0		0.0	0.0	
Total Delay	7.5	11.9		10.4	10.9		65.9	0.5		55.7	0.1	
LOS	A	B		B	B		E	A		E	A	
Approach Delay		11.7			10.8			44.6			46.0	
Approach LOS		B			B			D			D	
Queue Length 50th (m)	2.7	70.9		9.3	52.3		43.5	0.0		27.8	0.0	
Queue Length 95th (m)	8.2	133.3		23.9	99.8		63.7	0.0		44.4	0.0	
Internal Link Dist (m)		122.9			169.1			171.4			184.1	
Turn Bay Length (m)	37.5			37.5			30.0			30.0		
Base Capacity (vph)	491	1187		389	1073		345	710		291	724	
Starvation Cap Reductn	0	0		0	0		0	0		0	0	
Spillback Cap Reductn	0	0		0	0		0	0		0	0	
Storage Cap Reductn	0	0		0	0		0	0		0	0	
Reduced v/c Ratio	0.09	0.60		0.31	0.53		0.56	0.13		0.44	0.04	

Intersection Summary	
Cycle Length:	120
Actuated Cycle Length:	120
Offset:	0 (0%), Referenced to phase 2:EBTL and 6:WBTL, Start of Green
Natural Cycle:	70
Control Type:	Actuated-Coordinated

Lanes, Volumes, Timings
2: Elevation/Apolune & Cambrian

2029 Future Total
PM Peak Hour

Maximum v/c Ratio: 0.78	Intersection LOS: B
Intersection Signal Delay: 19.2	ICU Level of Service E
Intersection Capacity Utilization 82.7%	
Analysis Period (min) 15	

Splits and Phases: 2: Elevation/Apolune & Cambrian

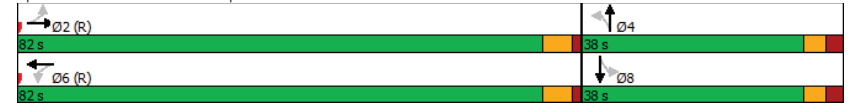

HCM 2010 TWSC
5: Temporary Driveway & Cambrian

2029 Future Total
PM Peak Hour

Intersection						
Int Delay, s/veh	1.1					
Movement	EBT	EBR	WBL	WBT	NBL	NBR
Lane Configurations	↔			↔	↔	↔
Traffic Vol, veh/h	646	57	6	668	38	9
Future Vol, veh/h	646	57	6	668	38	9
Conflicting Peds, #/hr	0	0	0	0	0	0
Sign Control	Free	Free	Free	Free	Stop	Stop
RT Channelized	-	None	-	None	-	None
Storage Length	-	-	-	-	0	-
Veh in Median Storage, #	0	-	-	0	0	-
Grade, %	0	-	-	0	0	-
Peak Hour Factor	100	100	100	100	100	100
Heavy Vehicles, %	2	2	2	2	2	2
Mvmt Flow	646	57	6	668	38	9

Major/Minor	Major1	Major2	Minor1
Conflicting Flow All	0	0	703
Stage 1	-	-	-
Stage 2	-	-	-
Critical Hdwy	-	-	4.12
Critical Hdwy Stg 1	-	-	-
Critical Hdwy Stg 2	-	-	-
Follow-up Hdwy	-	-	2.218
Pot Cap-1 Maneuver	-	-	895
Stage 1	-	-	-
Stage 2	-	-	-
Platoon blocked, %	-	-	-
Mov Cap-1 Maneuver	-	-	895
Mov Cap-2 Maneuver	-	-	-
Stage 1	-	-	-
Stage 2	-	-	-

Approach	EB	WB	NB
HCM Control Delay, s	0	0.1	30.8
HCM LOS			D

Minor Lane/Major Mvmt	NBLn1	EBT	EBR	WBL	WBT
Capacity (veh/h)	186	-	-	895	-
HCM Lane V/C Ratio	0.253	-	-	0.007	-
HCM Control Delay (s)	30.8	-	-	9	0
HCM Lane LOS	D	-	-	A	A
HCM 95th %tile Q(veh)	1	-	-	0	-

HCM 2010 TWSC
7: Cambrian & Access #1

2029 Future Total
PM Peak Hour

Intersection						
Int Delay, s/veh	2.2					
Movement	EBL	EBT	WBT	WBR	SBL	SBR
Lane Configurations		↔	↔		↔	↔
Traffic Vol, veh/h	36	645	627	65	41	59
Future Vol, veh/h	36	645	627	65	41	59
Conflicting Peds, #/hr	0	0	0	0	0	0
Sign Control	Free	Free	Free	Free	Stop	Stop
RT Channelized	-	None	-	None	-	None
Storage Length	-	-	-	-	0	-
Veh in Median Storage, #	-	0	0	-	0	-
Grade, %	-	0	0	-	0	-
Peak Hour Factor	100	100	100	100	100	100
Heavy Vehicles, %	2	2	2	2	2	2
Mvmt Flow	36	645	627	65	41	59

Major/Minor	Major1	Major2	Minor2
Conflicting Flow All	692	0	0
Stage 1	-	-	-
Stage 2	-	-	-
Critical Hdwy	4.12	-	-
Critical Hdwy Stg 1	-	-	-
Critical Hdwy Stg 2	-	-	-
Follow-up Hdwy	2.218	-	-
Pot Cap-1 Maneuver	903	-	-
Stage 1	-	-	-
Stage 2	-	-	-
Platoon blocked, %	-	-	-
Mov Cap-1 Maneuver	903	-	-
Mov Cap-2 Maneuver	-	-	-
Stage 1	-	-	-
Stage 2	-	-	-

Approach	EB	WB	SB
HCM Control Delay, s	0.5	0	28.7
HCM LOS			D

Minor Lane/Major Mvmt	EBL	EBT	WBT	WBR	SBLn1
Capacity (veh/h)	903	-	-	-	250
HCM Lane V/C Ratio	0.04	-	-	-	0.4
HCM Control Delay (s)	9.2	0	-	-	28.7
HCM Lane LOS	A	A	-	-	D
HCM 95th %tile Q(veh)	0.1	-	-	-	1.8

Intersection												
Intersection Delay, s/veh	56.4											
Intersection LOS	F											
Movement												
	EBL	EBT	EBR	WBL	WBT	WBR	NBL	NBT	NBR	SBL	SBT	SBR
Lane Configurations		↔			↕			↕			↔	
Traffic Vol, veh/h	23	420	117	74	479	82	112	10	82	40	13	32
Future Vol, veh/h	23	420	117	74	479	82	112	10	82	40	13	32
Peak Hour Factor	1.00	1.00	1.00	1.00	1.00	1.00	1.00	1.00	1.00	1.00	1.00	1.00
Heavy Vehicles, %	2	2	2	7	2	2	2	2	4	2	8	2
Mvmt Flow	23	420	117	74	479	82	112	10	82	40	13	32
Number of Lanes	0	1	0	0	1	0	0	1	0	0	1	0
Approach												
	EB			WB			NB			SB		
Opposing Approach	WB			EB			SB			NB		
Opposing Lanes	1			1			1			1		
Conflicting Approach Left	SB			NB			EB			WB		
Conflicting Lanes Left	1			1			1			1		
Conflicting Approach Right	NB			SB			WB			EB		
Conflicting Lanes Right	1			1			1			1		
HCM Control Delay	45			85.3			15.6			12.9		
HCM LOS	E			F			C			B		

Lane	NBLn1	EBLn1	WBLn1	SBLn1
Vol Left, %	55%	4%	12%	47%
Vol Thru, %	5%	75%	75%	15%
Vol Right, %	40%	21%	13%	38%
Sign Control	Stop	Stop	Stop	Stop
Traffic Vol by Lane	204	560	635	85
LT Vol	112	23	74	40
Through Vol	10	420	479	13
RT Vol	82	117	82	32
Lane Flow Rate	204	560	635	85
Geometry Grp	1	1	1	1
Degree of Util (X)	0.406	0.921	1.082	0.185
Departure Headway (Hd)	7.53	6.179	6.136	8.116
Convergence, Y/N	Yes	Yes	Yes	Yes
Cap	481	594	597	445
Service Time	5.53	4.179	4.144	6.116
HCM Lane V/C Ratio	0.424	0.943	1.064	0.191
HCM Control Delay	15.6	45	85.3	12.9
HCM Lane LOS	C	E	F	B
HCM 95th-tile Q	1.9	11.6	18.7	0.7

Lane Group	EBL	EBT	EBR	WBL	WBT	WBR	NBL	NBT	NBR	SBL	SBT	SBR
Lane Configurations	↔	↔		↔	↔		↔	↔		↔	↔	
Traffic Volume (vph)	46	264	232	136	287	120	181	1	117	108	2	52
Future Volume (vph)	46	264	232	136	287	120	181	1	117	108	2	52
Satd. Flow (prot)	1566	1623	0	1271	1484	0	1658	1330	0	1436	1401	0
Fit Permitted	0.497			0.441			0.722			0.653		
Satd. Flow (perm)	812	1623	0	590	1484	0	1260	1330	0	981	1401	0
Satd. Flow (RTOR)		65			31			117				52
Lane Group Flow (vph)	46	496	0	136	407	0	181	118	0	108	54	0
Turn Type	Perm	NA		Perm	NA		Perm	NA		Perm	NA	
Protected Phases		2			6			4			8	
Permitted Phases	2			6			4			8		
Detector Phase	2	2		6	6		4	4		8	8	
Switch Phase												
Minimum Initial (s)	10.0	10.0		10.0	10.0		10.0	10.0		10.0	10.0	
Minimum Split (s)	23.7	23.7		23.7	23.7		30.4	30.4		30.4	30.4	
Total Split (s)	77.0	77.0		77.0	77.0		43.0	43.0		43.0	43.0	
Total Split (%)	64.2%	64.2%		64.2%	64.2%		35.8%	35.8%		35.8%	35.8%	
Yellow Time (s)	4.2	4.2		4.2	4.2		3.3	3.3		3.3	3.3	
All-Red Time (s)	1.5	1.5		1.5	1.5		2.6	2.6		2.6	2.6	
Lost Time Adjust (s)	0.0	0.0		0.0	0.0		0.0	0.0		0.0	0.0	
Total Lost Time (s)	5.7	5.7		5.7	5.7		5.9	5.9		5.9	5.9	
Lead/Lag												
Lead-Lag Optimize?												
Recall Mode	C-Min	C-Min		C-Min	C-Min		None	None		None	None	
Act Effct Green (s)	85.8	85.8		85.8	85.8		22.6	22.6		22.6	22.6	
Actuated g/C Ratio	0.72	0.72		0.72	0.72		0.19	0.19		0.19	0.19	
v/c Ratio	0.08	0.42		0.32	0.38		0.76	0.34		0.59	0.18	
Control Delay	7.2	8.1		10.3	8.3		65.5	9.3		55.9	11.5	
Queue Delay	0.0	0.0		0.0	0.0		0.0	0.0		0.0	0.0	
Total Delay	7.2	8.1		10.3	8.3		65.5	9.3		55.9	11.5	
LOS	A	A		B	A		E	A		E	B	
Approach Delay		8.0			8.8			43.3			41.1	
Approach LOS		A			A			D			D	
Queue Length 50th (m)	2.9	36.0		10.6	30.5		40.8	0.2		23.4	0.4	
Queue Length 95th (m)	8.5	70.4		26.9	60.2		60.4	14.2		39.0	10.2	
Internal Link Dist (m)		122.9			166.9			171.4			184.1	
Turn Bay Length (m)	37.5			37.5			30.0			30.0		
Base Capacity (vph)	580	1178		421	1069		389	492		303	469	
Starvation Cap Reductn	0	0		0	0		0	0		0	0	
Spillback Cap Reductn	0	0		0	0		0	0		0	0	
Storage Cap Reductn	0	0		0	0		0	0		0	0	
Reduced v/c Ratio	0.08	0.42		0.32	0.38		0.47	0.24		0.36	0.12	

Intersection Summary												
Cycle Length: 120												
Actuated Cycle Length: 120												
Offset: 0 (0%), Referenced to phase 2:EBTL and 6:WBTL, Start of Green												
Natural Cycle: 60												
Control Type: Actuated-Coordinated												

Lanes, Volumes, Timings
2: Elevation/Apolune & Cambrian

2029 Future Future
SAT Peak Hour

Maximum v/c Ratio: 0.76	
Intersection Signal Delay: 18.6	Intersection LOS: B
Intersection Capacity Utilization 69.6%	ICU Level of Service C
Analysis Period (min) 15	

Splits and Phases: 2: Elevation/Apolune & Cambrian

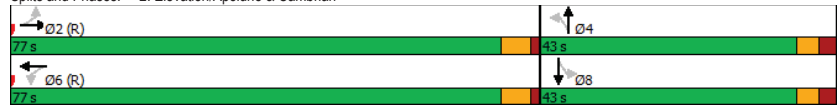

HCM 2010 TWSC
5: Cambrian

2029 Future Future
SAT Peak Hour

Intersection						
Int Delay, s/veh	1.3					
Movement	EBT	EBR	WBL	WBT	NBL	NBR
Lane Configurations	↔			↔	↔	↔
Traffic Vol, veh/h	175	66	7	226	44	10
Future Vol, veh/h	175	66	7	226	44	10
Conflicting Peds, #/hr	0	0	0	0	0	0
Sign Control	Free	Free	Free	Free	Stop	Stop
RT Channelized	-	None	-	None	-	None
Storage Length	-	-	-	-	0	-
Veh in Median Storage, #	0	-	-	0	0	-
Grade, %	0	-	-	0	0	-
Peak Hour Factor	100	100	100	100	100	100
Heavy Vehicles, %	2	2	2	2	2	2
Mvmt Flow	175	66	7	226	44	10
Major/Minor	Major1	Major2	Minor1			
Conflicting Flow All	0	0	241	0	448	208
Stage 1	-	-	-	-	208	-
Stage 2	-	-	-	-	240	-
Critical Hdwy	-	-	4.12	-	6.42	6.22
Critical Hdwy Stg 1	-	-	-	-	5.42	-
Critical Hdwy Stg 2	-	-	-	-	5.42	-
Follow-up Hdwy	-	-	2.218	-	3.518	3.318
Pot Cap-1 Maneuver	-	-	1326	-	568	832
Stage 1	-	-	-	-	827	-
Stage 2	-	-	-	-	800	-
Platoon blocked, %	-	-	-	-	-	-
Mov Cap-1 Maneuver	-	-	1326	-	565	832
Mov Cap-2 Maneuver	-	-	-	-	565	-
Stage 1	-	-	-	-	827	-
Stage 2	-	-	-	-	795	-
Approach	EB	WB	NB			
HCM Control Delay, s	0	0.2	11.6			
HCM LOS			B			
Minor Lane/Major Mvmt	NBLn1	EBT	EBR	WBL	WBT	
Capacity (veh/h)	601	-	-	1326	-	
HCM Lane V/C Ratio	0.09	-	-	0.005	-	
HCM Control Delay (s)	11.6	-	-	7.7	0	
HCM Lane LOS	B	-	-	A	A	
HCM 95th %tile Q(veh)	0.3	-	-	0	-	

Intersection						
Int Delay, s/veh	2.4					
Movement	EBL	EBT	WBT	WBR	SBL	SBR
Lane Configurations		↕	↕		↕	↕
Traffic Vol, veh/h	48	440	493	60	56	51
Future Vol, veh/h	48	440	493	60	56	51
Conflicting Peds, #/hr	0	0	0	0	0	0
Sign Control	Free	Free	Free	Free	Stop	Stop
RT Channelized	-	None	-	None	-	None
Storage Length	-	-	-	-	0	-
Veh in Median Storage, #	-	0	0	-	0	-
Grade, %	-	0	0	-	0	-
Peak Hour Factor	100	100	100	100	100	100
Heavy Vehicles, %	2	2	2	2	2	2
Mvmt Flow	48	440	493	60	56	51
Major/Minor	Major1	Major2	Minor2			
Conflicting Flow All	553	0	-	0	1059	523
Stage 1	-	-	-	-	523	-
Stage 2	-	-	-	-	536	-
Critical Hdwy	4.12	-	-	-	6.42	6.22
Critical Hdwy Stg 1	-	-	-	-	5.42	-
Critical Hdwy Stg 2	-	-	-	-	5.42	-
Follow-up Hdwy	2.218	-	-	-	3.518	3.318
Pot Cap-1 Maneuver	1017	-	-	-	249	554
Stage 1	-	-	-	-	595	-
Stage 2	-	-	-	-	587	-
Platoon blocked, %	-	-	-	-	-	-
Mov Cap-1 Maneuver	1017	-	-	-	234	554
Mov Cap-2 Maneuver	-	-	-	-	234	-
Stage 1	-	-	-	-	558	-
Stage 2	-	-	-	-	587	-
Approach	EB	WB	SB			
HCM Control Delay, s	0.9	0	21.6			
HCM LOS			C			
Minor Lane/Major Mvmt	EBL	EBT	WBT	WBR	SBLn1	
Capacity (veh/h)	1017	-	-	-	-	323
HCM Lane V/C Ratio	0.047	-	-	-	-	0.331
HCM Control Delay (s)	8.7	0	-	-	-	21.6
HCM Lane LOS	A	A	-	-	-	C
HCM 95th %tile Q(veh)	0.1	-	-	-	-	1.4

Appendix L

Turning Templates

HSU IN-BOUND MOVEMENTS

HSU OUT-BOUND MOVEMENTS

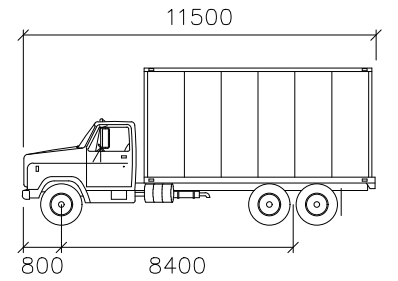
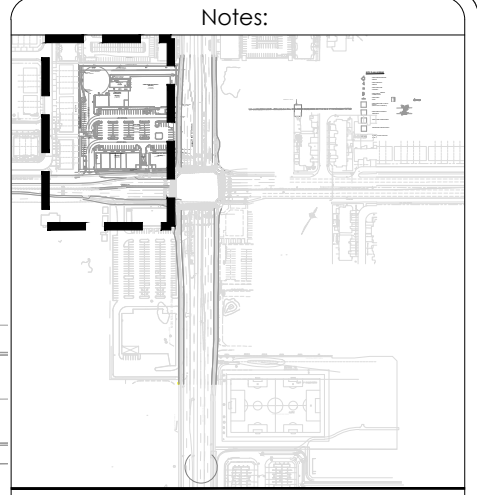
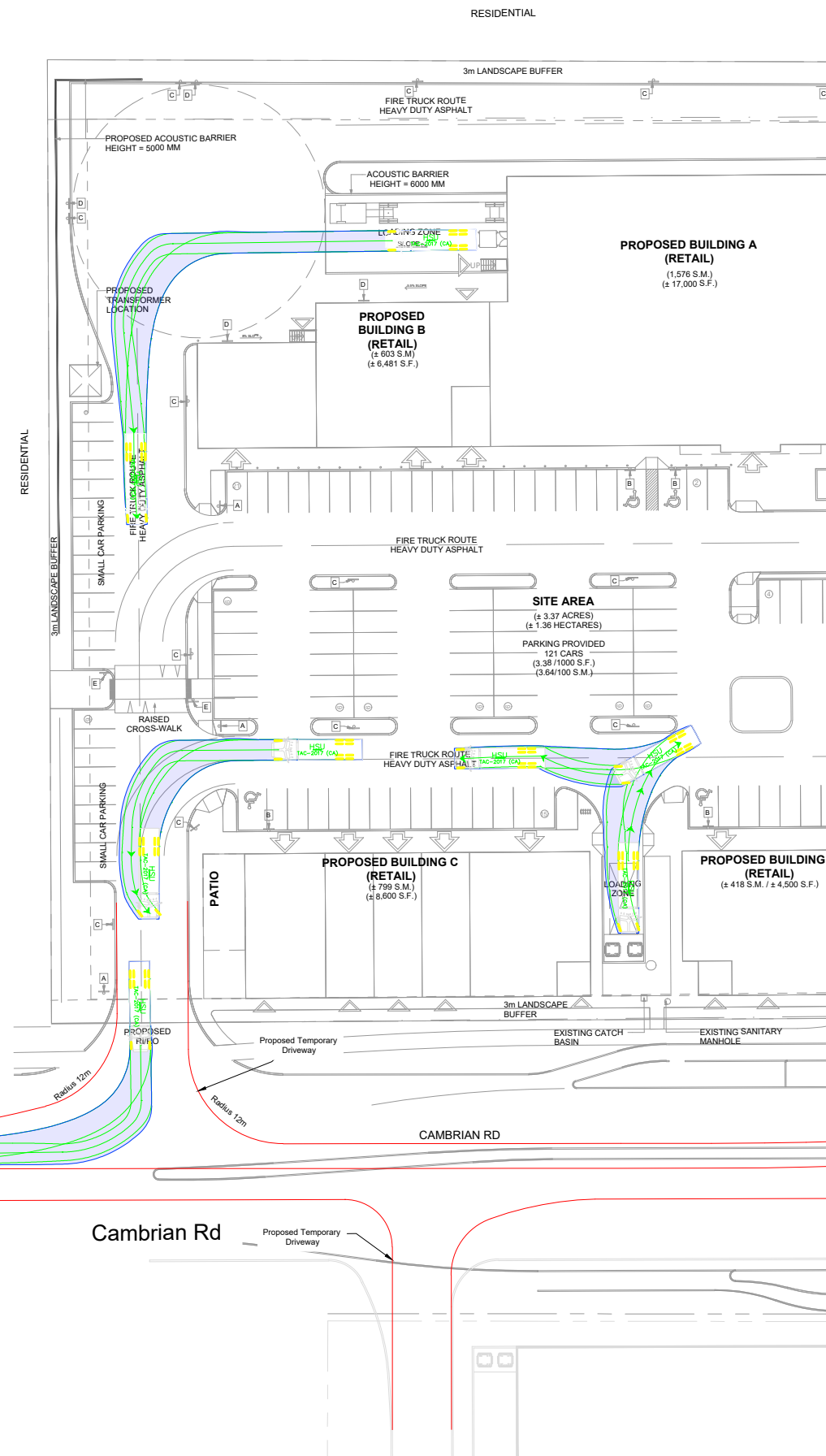
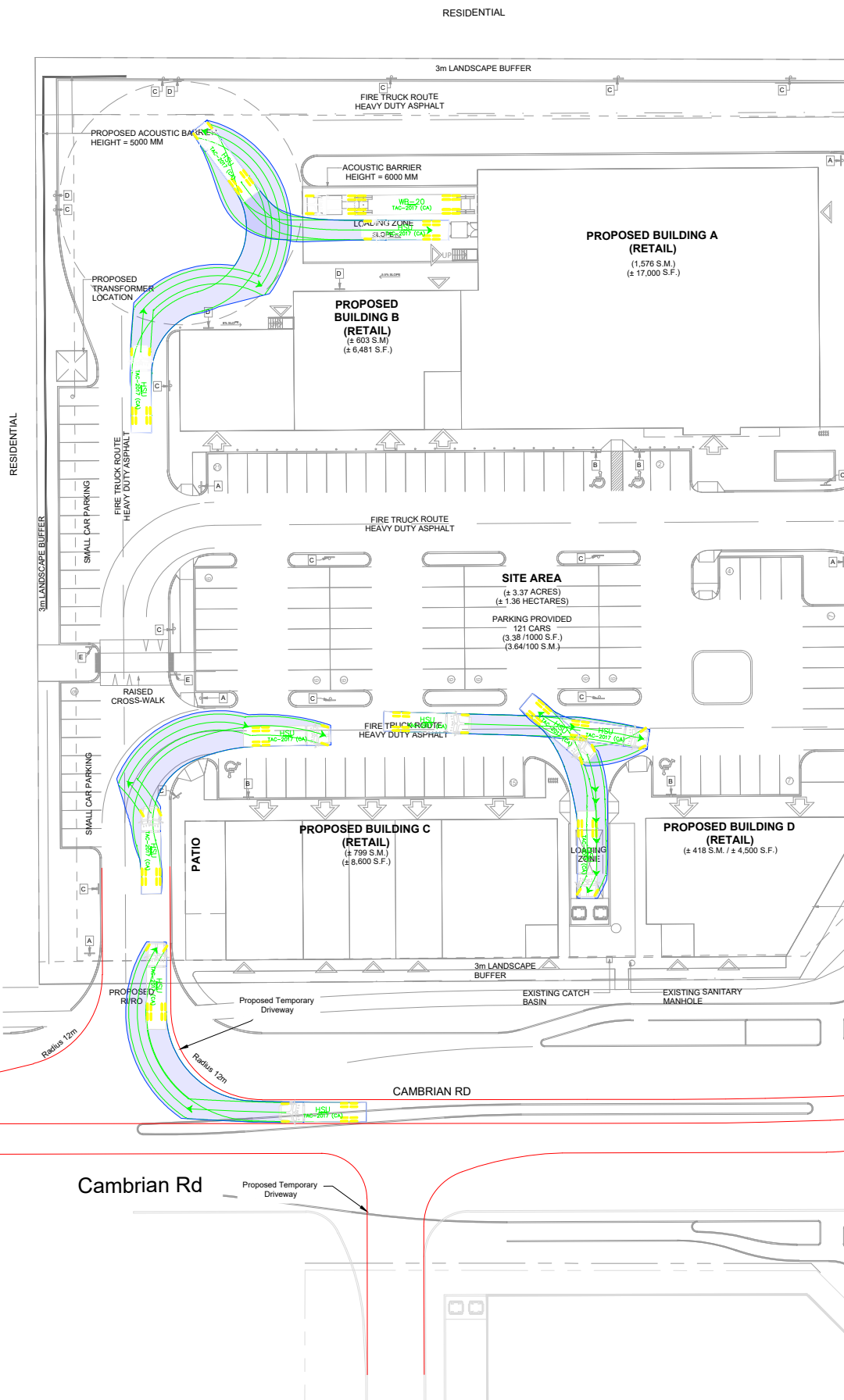

HSU

mm

Width : 2600
 Track : 2600
 Lock to Lock Time : 6.0
 Steering Angle : 40.0

06	Issued for Review	AN	2023-10-11
REV:	DESCRIPTION:	BY:	DATE:
STATUS:			

CGH Transportation
 6 Plaza Court
 Ottawa, ON
 K2H 7W1
 (343) 999-9117

CLIENT: Choice Properties Limited Partnership

ARCHITECT:

SITE: 3850 Cambrian Road			
TITLE: INTERIM - Existing Conditions HSU Turning Movements			
SCALE AT A3: NTS	DATE: 2023-10-11	DRAWN: AN	CHECKED: AH
PROJECT NO: 2022-066	DRAWING NO: 001	REVISION: 06	

WB-20 IN-BOUND MOVEMENTS

WB-20 OUT-BOUND MOVEMENTS

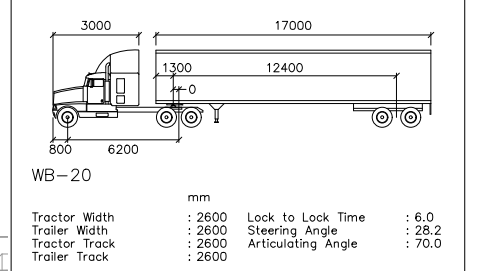
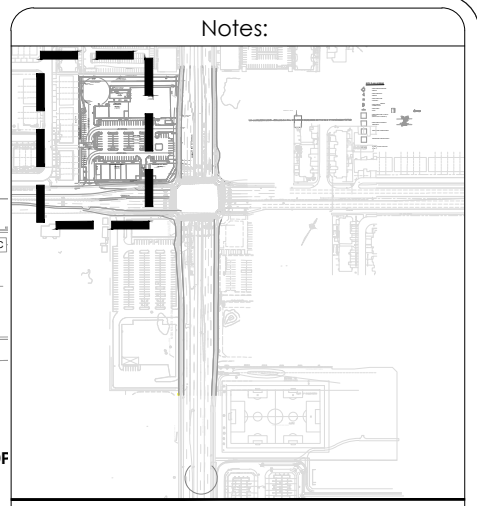
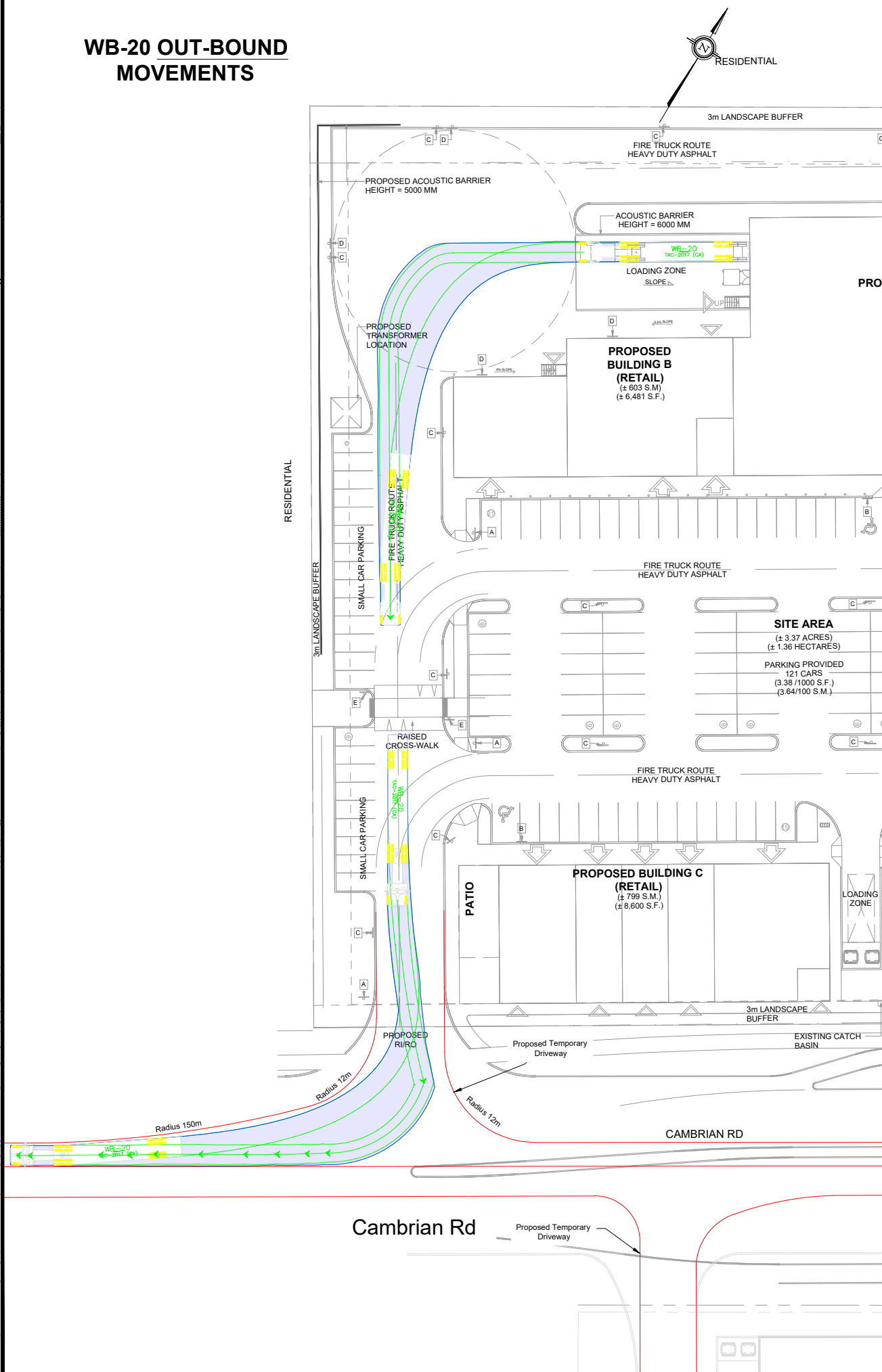
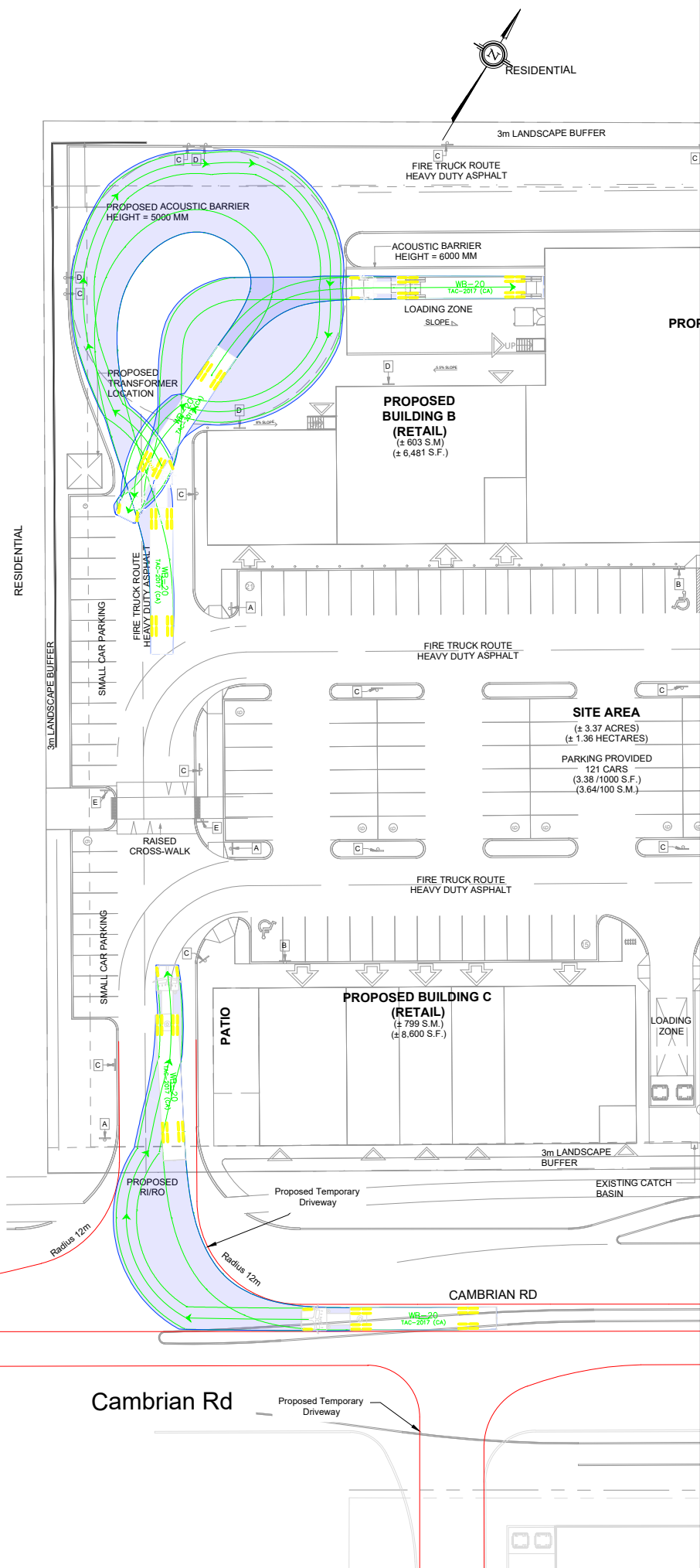

06	Issued for Review	AN	2023-10-11
REV:	DESCRIPTION:	BY:	DATE:
STATUS:			

CGH Transportation
6 Plaza Court
Ottawa, ON
K2H 7W1
(343) 999-9117

CLIENT: Choice Properties Limited Partnership

ARCHITECT:

SITE: 3850 Cambrian Road			
TITLE: INTERIM - Existing Conditions WB-20 Turning Movements			
SCALE AT A3:	DATE:	DRAWN:	CHECKED:
NTS	2023-10-11	AN	AH
PROJECT NO:	DRAWING NO:	REVISION:	
2022-066	002	06	

HSU IN-BOUND MOVEMENTS

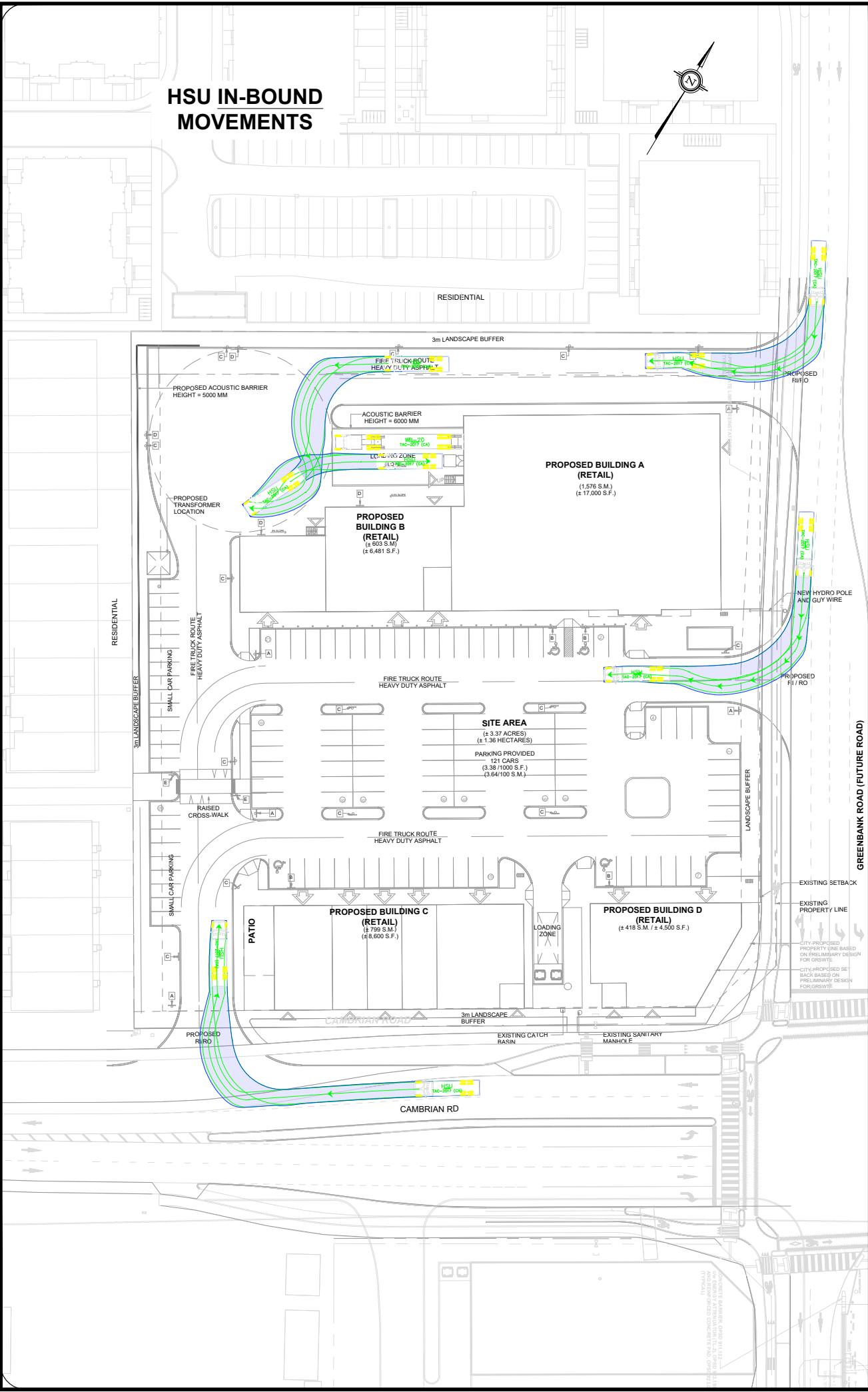

HSU OUT-BOUND MOVEMENTS

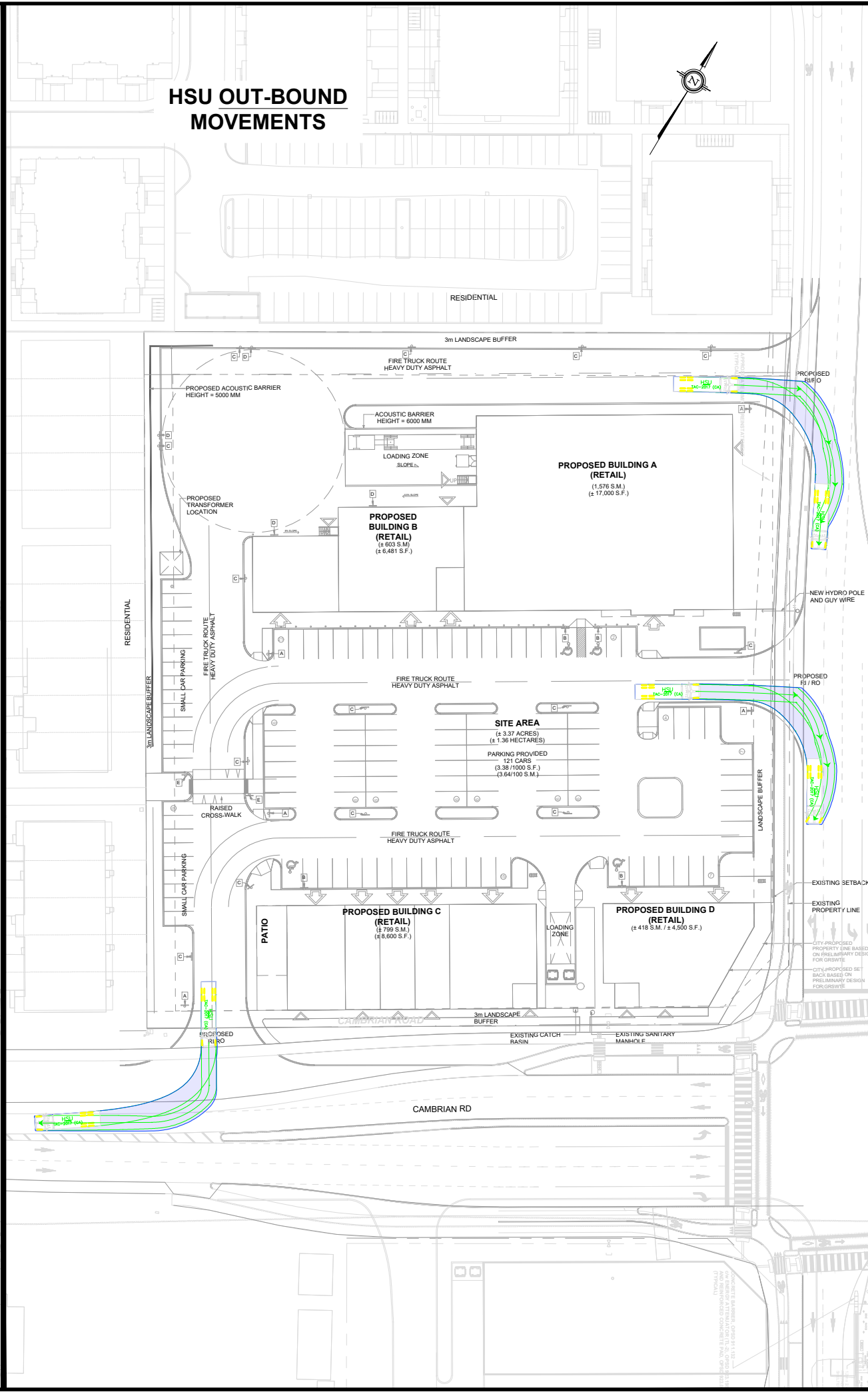

Notes:

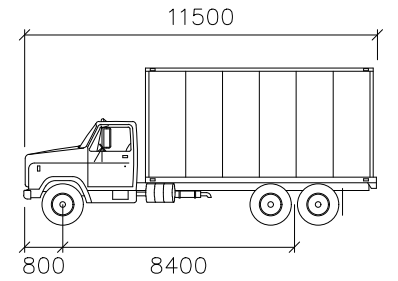
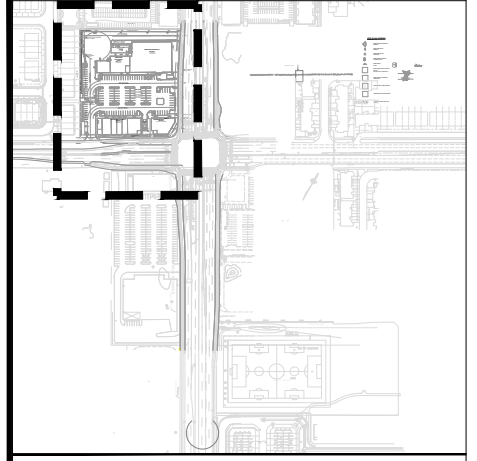

HSU

mm

Width : 2600
 Track : 2600
 Lock to Lock Time : 6.0
 Steering Angle : 40.0

06	Issued for Review	AN	2023-10-11
REV:	DESCRIPTION:	BY:	DATE:
STATUS:			



CGH Transportation
 6 Plaza Court
 Ottawa, ON
 K2H 7W1
 (343) 999-9117

CLIENT: Choice Properties Limited Partnership

ARCHITECT:

SITE: 3850 Cambrian Road

TITLE: ULTIMATE - Future Conditions
 HSU Turning Movements

SCALE AT A3:	DATE:	DRAWN:	CHECKED:
NTS	2023-10-11	AN	AH
PROJECT NO:	DRAWING NO:	REVISION:	
2022-066	001	06	

WB-20 IN-BOUND MOVEMENTS

WB-20 OUT-BOUND MOVEMENTS

Notes:

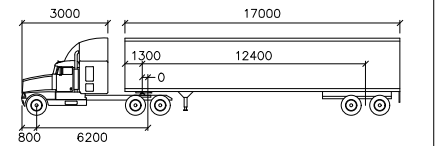
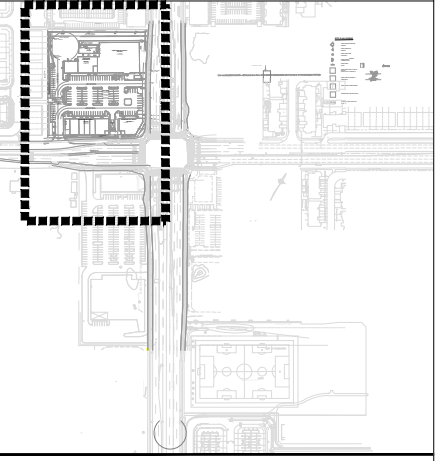

WB-20

Tractor Width	: 2600	Lock to Lock Time	: 6.0
Trailer Width	: 2600	Steering Angle	: 28.2
Tractor Track	: 2600	Articulating Angle	: 70.0
Trailer Track	: 2600		

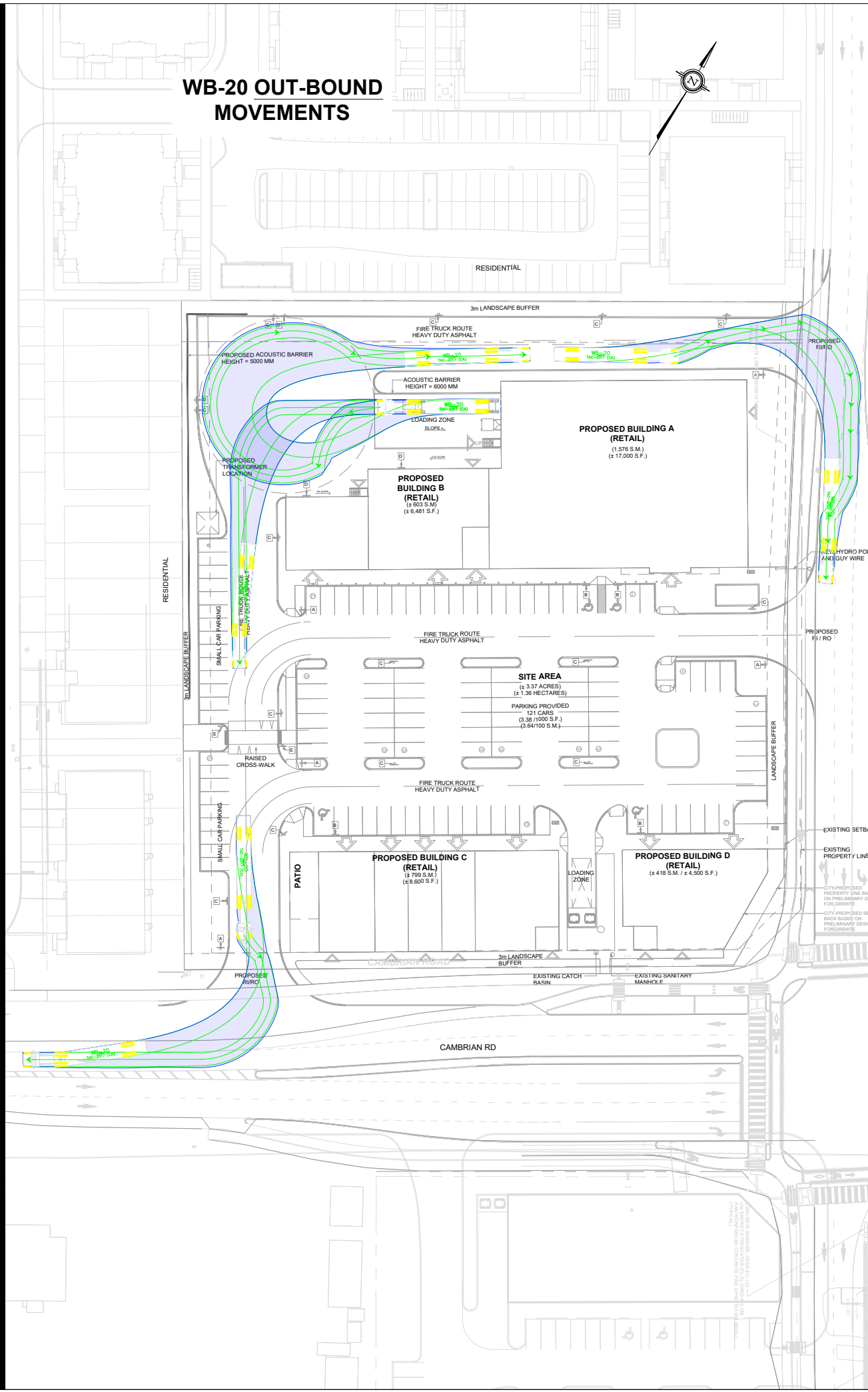
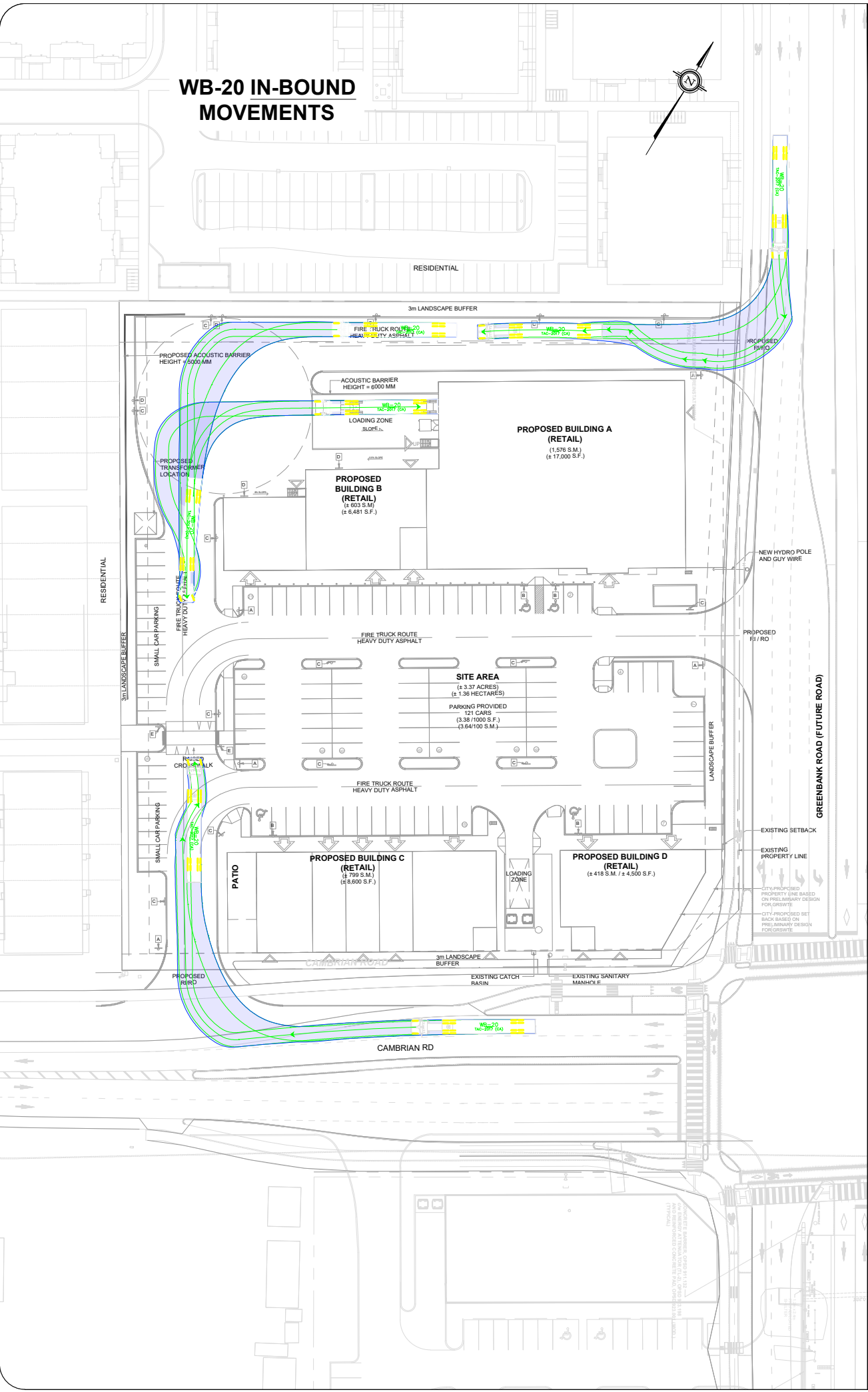

06	Issued for Review	AN	2023-10-11
REV:	DESCRIPTION:	BY:	DATE:
STATUS:			

CGH Transportation
6 Plaza Court
Ottawa, ON
K2H 7W1
(343) 999-9117

CLIENT: Choice Properties Limited Partnership

ARCHITECT:

SITE: 3850 Cambrian Road			
TITLE: ULTIMATE - Future Conditions WB-20 Turning Movements			
SCALE AT A3:	DATE:	DRAWN:	CHECKED:
NTS	2023-10-11	AN	AH
PROJECT NO:	DRAWING NO:	REVISION:	
2022-066	002	06	

Appendix M

TDM Checklist

TDM Measures Checklist:
Non-Residential Developments (office, institutional, retail or industrial)

Legend	
BASIC	The measure is generally feasible and effective, and in most cases would benefit the development and its users
BETTER	The measure could maximize support for users of sustainable modes, and optimize development performance
★	The measure is one of the most dependably effective tools to encourage the use of sustainable modes

TDM measures: <i>Non-residential developments</i>		Check if proposed & add descriptions
1. TDM PROGRAM MANAGEMENT		
1.1 Program coordinator		
BASIC	★	1.1.1 Designate an internal coordinator, or contract with an external coordinator <input type="checkbox"/>
1.2 Travel surveys		
BETTER		1.2.1 Conduct periodic surveys to identify travel-related behaviours, attitudes, challenges and solutions, and to track progress <input type="checkbox"/>
2. WALKING AND CYCLING		
2.1 Information on walking/cycling routes & destinations		
BASIC		2.1.1 Display local area maps with walking/cycling access routes and key destinations at major entrances <input type="checkbox"/>
2.2 Bicycle skills training		
<i>Commuter travel</i>		
BETTER	★	2.2.1 Offer on-site cycling courses for commuters, or subsidize off-site courses <input type="checkbox"/>
2.3 Valet bike parking		
<i>Visitor travel</i>		
BETTER		2.3.1 Offer secure valet bike parking during public events when demand exceeds fixed supply (e.g. for festivals, concerts, games) <input type="checkbox"/>

TDM measures: <i>Non-residential developments</i>		Check if proposed & add descriptions
3. TRANSIT		
3.1 Transit information		
BASIC		3.1.1 Display relevant transit schedules and route maps at entrances <input type="checkbox"/>
BASIC		3.1.2 Provide online links to OC Transpo and STO information <input type="checkbox"/>
BETTER		3.1.3 Provide real-time arrival information display at entrances <input type="checkbox"/>
3.2 Transit fare incentives		
<i>Commuter travel</i>		
BETTER		3.2.1 Offer preloaded PRESTO cards to encourage commuters to use transit <input type="checkbox"/>
BETTER	★	3.2.2 Subsidize or reimburse monthly transit pass purchases by employees <input type="checkbox"/>
<i>Visitor travel</i>		
BETTER		3.2.3 Arrange inclusion of same-day transit fare in price of tickets (e.g. for festivals, concerts, games) <input type="checkbox"/>
3.3 Enhanced public transit service		
<i>Commuter travel</i>		
BETTER		3.3.1 Contract with OC Transpo to provide enhanced transit services (e.g. for shift changes, weekends) <input type="checkbox"/>
<i>Visitor travel</i>		
BETTER		3.3.2 Contract with OC Transpo to provide enhanced transit services (e.g. for festivals, concerts, games) <input type="checkbox"/>
3.4 Private transit service		
<i>Commuter travel</i>		
BETTER		3.4.1 Provide shuttle service when OC Transpo cannot offer sufficient quality or capacity to serve demand (e.g. for shift changes, weekends) <input type="checkbox"/>
<i>Visitor travel</i>		
BETTER		3.4.2 Provide shuttle service when OC Transpo cannot offer sufficient quality or capacity to serve demand (e.g. for festivals, concerts, games) <input type="checkbox"/>

TDM measures: <i>Non-residential developments</i>		Check if proposed & add descriptions
4. RIDESHARING		
4.1 Ridematching service		
<i>Commuter travel</i>		
BASIC ★	4.1.1 Provide a dedicated ridematching portal at OttawaRideMatch.com	<input type="checkbox"/>
4.2 Carpool parking price incentives		
<i>Commuter travel</i>		
BETTER	4.2.1 Provide discounts on parking costs for registered carpools	<input type="checkbox"/>
4.3 Vanpool service		
<i>Commuter travel</i>		
BETTER	4.3.1 Provide a vanpooling service for long-distance commuters	<input type="checkbox"/>
5. CARSHARING & BIKESHARING		
5.1 Bikeshare stations & memberships		
BETTER	5.1.1 Contract with provider to install on-site bikeshare station for use by commuters and visitors	<input type="checkbox"/>
<i>Commuter travel</i>		
BETTER	5.1.2 Provide employees with bikeshare memberships for local business travel	<input type="checkbox"/>
5.2 Carshare vehicles & memberships		
<i>Commuter travel</i>		
BETTER	5.2.1 Contract with provider to install on-site carshare vehicles and promote their use by tenants	<input type="checkbox"/>
BETTER	5.2.2 Provide employees with carshare memberships for local business travel	<input type="checkbox"/>
6. PARKING		
6.1 Priced parking		
<i>Commuter travel</i>		
BASIC ★	6.1.1 Charge for long-term parking (daily, weekly, monthly)	<input type="checkbox"/>
BASIC	6.1.2 Unbundle parking cost from lease rates at multi-tenant sites	<input type="checkbox"/>
<i>Visitor travel</i>		
BETTER	6.1.3 Charge for short-term parking (hourly)	<input type="checkbox"/>

TDM measures: <i>Non-residential developments</i>		Check if proposed & add descriptions
7. TDM MARKETING & COMMUNICATIONS		
7.1 Multimodal travel information		
<i>Commuter travel</i>		
BASIC ★	7.1.1 Provide a multimodal travel option information package to new/relocating employees and students	<input checked="" type="checkbox"/>
<i>Visitor travel</i>		
BETTER ★	7.1.2 Include multimodal travel option information in invitations or advertising that attract visitors or customers (e.g. for festivals, concerts, games)	<input type="checkbox"/>
7.2 Personalized trip planning		
<i>Commuter travel</i>		
BETTER ★	7.2.1 Offer personalized trip planning to new/relocating employees	<input type="checkbox"/>
7.3 Promotions		
<i>Commuter travel</i>		
BETTER	7.3.1 Deliver promotions and incentives to maintain awareness, build understanding, and encourage trial of sustainable modes	<input type="checkbox"/>
8. OTHER INCENTIVES & AMENITIES		
8.1 Emergency ride home		
<i>Commuter travel</i>		
BETTER ★	8.1.1 Provide emergency ride home service to non-driving commuters	<input type="checkbox"/>
8.2 Alternative work arrangements		
<i>Commuter travel</i>		
BASIC ★	8.2.1 Encourage flexible work hours	<input type="checkbox"/>
BETTER	8.2.2 Encourage compressed workweeks	<input type="checkbox"/>
BETTER ★	8.2.3 Encourage telework	<input type="checkbox"/>
8.3 Local business travel options		
<i>Commuter travel</i>		
BASIC ★	8.3.1 Provide local business travel options that minimize the need for employees to bring a personal car to work	<input type="checkbox"/>
8.4 Commuter incentives		
<i>Commuter travel</i>		
BETTER	8.4.1 Offer employees a taxable, mode-neutral commuting allowance	<input type="checkbox"/>
8.5 On-site amenities		
<i>Commuter travel</i>		
BETTER	8.5.1 Provide on-site amenities/services to minimize mid-day or mid-commute errands	<input type="checkbox"/>

TDM-Supportive Development Design and Infrastructure Checklist:
Non-Residential Developments (office, institutional, retail or industrial)

Legend	
REQUIRED	The Official Plan or Zoning By-law provides related guidance that must be followed
BASIC	The measure is generally feasible and effective, and in most cases would benefit the development and its users
BETTER	The measure could maximize support for users of sustainable modes, and optimize development performance

TDM-supportive design & infrastructure measures: <i>Non-residential developments</i>		Check if completed & add descriptions, explanations or plan/drawing references
1. WALKING & CYCLING: ROUTES		
1.1 Building location & access points		
BASIC	1.1.1 Locate building close to the street, and do not locate parking areas between the street and building entrances	<input type="checkbox"/>
BASIC	1.1.2 Locate building entrances in order to minimize walking distances to sidewalks and transit stops/stations	<input checked="" type="checkbox"/>
BASIC	1.1.3 Locate building doors and windows to ensure visibility of pedestrians from the building, for their security and comfort	<input checked="" type="checkbox"/>
1.2 Facilities for walking & cycling		
REQUIRED	1.2.1 Provide convenient, direct access to stations or major stops along rapid transit routes within 600 metres; minimize walking distances from buildings to rapid transit; provide pedestrian-friendly, weather-protected (where possible) environment between rapid transit accesses and building entrances; ensure quality linkages from sidewalks through building entrances to integrated stops/stations (see <i>Official Plan policy 4.3.3</i>)	<input type="checkbox"/>
REQUIRED	1.2.2 Provide safe, direct and attractive pedestrian access from public sidewalks to building entrances through such measures as: reducing distances between public sidewalks and major building entrances; providing walkways from public streets to major building entrances; within a site, providing walkways along the front of adjoining buildings, between adjacent buildings, and connecting areas where people may congregate, such as courtyards and transit stops; and providing weather protection through canopies, colonnades, and other design elements wherever possible (see <i>Official Plan policy 4.3.12</i>)	<input checked="" type="checkbox"/>

TDM-supportive design & infrastructure measures: <i>Non-residential developments</i>		Check if completed & add descriptions, explanations or plan/drawing references
REQUIRED	1.2.3 Provide sidewalks of smooth, well-drained walking surfaces of contrasting materials or treatments to differentiate pedestrian areas from vehicle areas, and provide marked pedestrian crosswalks at intersection sidewalks (see <i>Official Plan policy 4.3.10</i>)	<input checked="" type="checkbox"/>
REQUIRED	1.2.4 Make sidewalks and open space areas easily accessible through features such as gradual grade transition, depressed curbs at street corners and convenient access to extra-wide parking spaces and ramps (see <i>Official Plan policy 4.3.10</i>)	<input checked="" type="checkbox"/>
REQUIRED	1.2.5 Include adequately spaced inter-block/street cycling and pedestrian connections to facilitate travel by active transportation. Provide links to the existing or planned network of public sidewalks, multi-use pathways and on-road cycle routes. Where public sidewalks and multi-use pathways intersect with roads, consider providing traffic control devices to give priority to cyclists and pedestrians (see <i>Official Plan policy 4.3.11</i>)	<input checked="" type="checkbox"/>
BASIC	1.2.6 Provide safe, direct and attractive walking routes from building entrances to nearby transit stops	<input type="checkbox"/>
BASIC	1.2.7 Ensure that walking routes to transit stops are secure, visible, lighted, shaded and wind-protected wherever possible	<input type="checkbox"/>
BASIC	1.2.8 Design roads used for access or circulation by cyclists using a target operating speed of no more than 30 km/h, or provide a separated cycling facility	<input type="checkbox"/>
1.3 Amenities for walking & cycling		
BASIC	1.3.1 Provide lighting, landscaping and benches along walking and cycling routes between building entrances and streets, sidewalks and trails	<input type="checkbox"/>
BASIC	1.3.2 Provide wayfinding signage for site access (where required, e.g. when multiple buildings or entrances exist) and egress (where warranted, such as when directions to reach transit stops/stations, trails or other common destinations are not obvious)	<input type="checkbox"/>

TDM-supportive design & infrastructure measures: <i>Non-residential developments</i>		Check if completed & add descriptions, explanations or plan/drawing references
2. WALKING & CYCLING: END-OF-TRIP FACILITIES		
2.1 Bicycle parking		
REQUIRED	2.1.1 Provide bicycle parking in highly visible and lighted areas, sheltered from the weather wherever possible (see <i>Official Plan policy 4.3.6</i>)	<input checked="" type="checkbox"/>
REQUIRED	2.1.2 Provide the number of bicycle parking spaces specified for various land uses in different parts of Ottawa; provide convenient access to main entrances or well-used areas (see <i>Zoning By-law Section 111</i>)	<input checked="" type="checkbox"/>
REQUIRED	2.1.3 Ensure that bicycle parking spaces and access aisles meet minimum dimensions; that no more than 50% of spaces are vertical spaces; and that parking racks are securely anchored (see <i>Zoning By-law Section 111</i>)	<input checked="" type="checkbox"/>
BASIC	2.1.4 Provide bicycle parking spaces equivalent to the expected number of commuter cyclists (assuming the cycling mode share target is met), plus the expected peak number of customer/visitor cyclists	<input type="checkbox"/>
BETTER	2.1.5 Provide bicycle parking spaces equivalent to the expected number of commuter and customer/visitor cyclists, plus an additional buffer (e.g. 25 percent extra) to encourage other cyclists and ensure adequate capacity in peak cycling season	<input type="checkbox"/>
2.2 Secure bicycle parking		
REQUIRED	2.2.1 Where more than 50 bicycle parking spaces are provided for a single office building, locate at least 25% of spaces within a building/structure, a secure area (e.g. supervised parking lot or enclosure) or bicycle lockers (see <i>Zoning By-law Section 111</i>)	<input type="checkbox"/>
BETTER	2.2.2 Provide secure bicycle parking spaces equivalent to the expected number of commuter cyclists (assuming the cycling mode share target is met)	<input type="checkbox"/>
2.3 Shower & change facilities		
BASIC	2.3.1 Provide shower and change facilities for the use of active commuters	<input type="checkbox"/>
BETTER	2.3.2 In addition to shower and change facilities, provide dedicated lockers, grooming stations, drying racks and laundry facilities for the use of active commuters	<input type="checkbox"/>
2.4 Bicycle repair station		
BETTER	2.4.1 Provide a permanent bike repair station, with commonly used tools and an air pump, adjacent to the main bicycle parking area (or secure bicycle parking area, if provided)	<input type="checkbox"/>

TDM-supportive design & infrastructure measures: <i>Non-residential developments</i>		Check if completed & add descriptions, explanations or plan/drawing references
3. TRANSIT		
3.1 Customer amenities		
BASIC	3.1.1 Provide shelters, lighting and benches at any on-site transit stops	<input type="checkbox"/>
BASIC	3.1.2 Where the site abuts an off-site transit stop and insufficient space exists for a transit shelter in the public right-of-way, protect land for a shelter and/or install a shelter	<input type="checkbox"/>
BETTER	3.1.3 Provide a secure and comfortable interior waiting area by integrating any on-site transit stops into the building	<input type="checkbox"/>
4. RIDESHARING		
4.1 Pick-up & drop-off facilities		
BASIC	4.1.1 Provide a designated area for carpool drivers (plus taxis and ride-hailing services) to drop off or pick up passengers without using fire lanes or other no-stopping zones	<input type="checkbox"/>
4.2 Carpool parking		
BASIC	4.2.1 Provide signed parking spaces for carpools in a priority location close to a major building entrance, sufficient in number to accommodate the mode share target for carpools	<input type="checkbox"/>
BETTER	4.2.2 At large developments, provide spaces for carpools in a separate, access-controlled parking area to simplify enforcement	<input type="checkbox"/>
5. CARSHARING & BIKESHARING		
5.1 Carshare parking spaces		
BETTER	5.1.1 Provide carshare parking spaces in permitted non-residential zones, occupying either required or provided parking spaces (see <i>Zoning By-law Section 94</i>)	<input type="checkbox"/>
5.2 Bikeshare station location		
BETTER	5.2.1 Provide a designated bikeshare station area near a major building entrance, preferably lighted and sheltered with a direct walkway connection	<input type="checkbox"/>

TDM-supportive design & infrastructure measures: <i>Non-residential developments</i>		Check if completed & add descriptions, explanations or plan/drawing references
6. PARKING		
6.1 Number of parking spaces		
REQUIRED	6.1.1 Do not provide more parking than permitted by zoning, nor less than required by zoning, unless a variance is being applied for	<input checked="" type="checkbox"/>
BASIC	6.1.2 Provide parking for long-term and short-term users that is consistent with mode share targets, considering the potential for visitors to use off-site public parking	<input type="checkbox"/>
BASIC	6.1.3 Where a site features more than one use, provide shared parking and reduce the cumulative number of parking spaces accordingly (see <i>Zoning By-law Section 104</i>)	<input type="checkbox"/>
BETTER	6.1.4 Reduce the minimum number of parking spaces required by zoning by one space for each 13 square metres of gross floor area provided as shower rooms, change rooms, locker rooms and other facilities for cyclists in conjunction with bicycle parking (see <i>Zoning By-law Section 111</i>)	<input type="checkbox"/>
6.2 Separate long-term & short-term parking areas		
BETTER	6.2.1 Separate short-term and long-term parking areas using signage or physical barriers, to permit access controls and simplify enforcement (i.e. to discourage employees from parking in visitor spaces, and vice versa)	<input type="checkbox"/>
7. OTHER		
7.1 On-site amenities to minimize off-site trips		
BETTER	7.1.1 Provide on-site amenities to minimize mid-day or mid-commute errands	<input type="checkbox"/>

Appendix N

MMLOS Worksheets

Multi-Modal Level of Service - Intersections Form

Consultant
Scenario
Comments

CGH Transportation Inc
Future

Project
Date

2022-066
8/21/2023

INTERSECTIONS		Cambrian Rd at ApoluneSt / Elevation Rd			
Crossing Side		NORTH	SOUTH	EAST	WEST
Pedestrian	Lanes	4	4	5	5
	Median	No Median - 2.4 m	No Median - 2.4 m	No Median - 2.4 m	No Median - 2.4 m
	Conflicting Left Turns	Permissive	Permissive	Permissive	Permissive
	Conflicting Right Turns	Permissive or yield control	Permissive or yield control	Permissive or yield control	Permissive or yield control
	Right Turns on Red (RTor) ?	RTOR allowed	RTOR allowed	RTOR allowed	RTOR allowed
	Ped Signal Leading Interval?	No	No	No	No
	Right Turn Channel	No Channel	No Channel	No Channel	No Channel
	Corner Radius	10-15m	10-15m	10-15m	10-15m
	Crosswalk Type	Std transverse markings	Std transverse markings	Std transverse markings	Std transverse markings
	PETSI Score	53	53	37	37
	Ped. Exposure to Traffic LoS	D	D	E	E
	Cycle Length				
	Effective Walk Time				
	Average Pedestrian Delay				
Pedestrian Delay LoS	-	-	-	-	
Level of Service	D	D	E	E	
	E				
Approach From		NORTH	SOUTH	EAST	WEST
Bicycle	Bicycle Lane Arrangement on Approach	Mixed Traffic	Mixed Traffic	Mixed Traffic	Mixed Traffic
	Right Turn Lane Configuration				
	Right Turning Speed				
	Cyclist relative to RT motorists	#N/A	#N/A	#N/A	#N/A
	Separated or Mixed Traffic	Mixed Traffic	Mixed Traffic	Mixed Traffic	Mixed Traffic
	Left Turn Approach	No lane crossed	No lane crossed	No lane crossed	No lane crossed
	Operating Speed	> 40 to ≤ 50 km/h	> 40 to ≤ 50 km/h	> 50 to < 60 km/h	> 50 to < 60 km/h
	Left Turning Cyclist	B	B	C	C
Level of Service	B	B	C	C	
	C				
Transit	Average Signal Delay				
	Level of Service	-	-	-	-
Truck	Effective Corner Radius				
	Number of Receiving Lanes on Departure from Intersection				
	Level of Service	-	-	-	-
Auto	Volume to Capacity Ratio	0.61 - 0.70			
	Level of Service	B			

Multi-Modal Level of Service - Segments Form

Consultant	CGH Transportation Inc
Scenario	Existing/Future
Comments	

Project	2022-066
Date	8/21/2023

SEGMENTS			Cambrian Rd	Cambrian Rd	Re-Aligned Greenbank Rd	Section
			Existing	Future	Future	4
Pedestrian	Sidewalk Width	F	no sidewalk	≥ 2 m	1.8 m	
	Boulevard Width		n/a	> 2 m	> 2 m	
	Avg Daily Curb Lane Traffic Volume		> 3000	> 3000	> 3000	
	Operating Speed		> 50 to 60 km/h	> 50 to 60 km/h	> 50 to 60 km/h	
	On-Street Parking		no	no	no	
	Exposure to Traffic PLoS		F	C	D	-
	Effective Sidewalk Width					
Pedestrian Volume						
Crowding PLoS	A	A	A	-		
Level of Service	F	C	D	-		
Bicycle	Type of Cycling Facility	D	Mixed Traffic	Physically Separated	Physically Separated	
	Number of Travel Lanes		≤ 2 (no centreline)			
	Operating Speed		≥ 50 to 60 km/h			
	# of Lanes & Operating Speed LoS		D	-	-	-
	Bike Lane (+ Parking Lane) Width					
	Bike Lane Width LoS		-	-	-	-
	Bike Lane Blockages					
	Blockage LoS		-	-	-	-
	Median Refuge Width (no median = < 1.8 m)		< 1.8 m refuge			
	No. of Lanes at Unsignalized Crossing		≤ 3 lanes			
Sidestreet Operating Speed	≤ 40 km/h					
Unsignalized Crossing - Lowest LoS	A	A		-		
Level of Service	D	A	A	-		
Transit	Facility Type	A			Segregated ROW	
	Friction or Ratio Transit:Posted Speed					
Level of Service	-	-	A	-		
Truck	Truck Lane Width	A			≤ 3.5 m	
	Travel Lanes per Direction				> 1	
Level of Service	-	-	A	-		