

3845 Cambrian Road

Transportation Impact Assessment

Step 1 Screening Report

Step 2 Scoping Report

Step 3 Forecasting Report

Step 4 Strategy Report (Rev #1)

Prepared for:

Loblaw Properties Limited
1 President's Choice Circle
Brampton, Ontario L6Y 5S5

Prepared by:



6 Plaza Court
Ottawa, ON K2H 7W1

October 2023

PN: 2022-024

Table of Contents

1	Screening.....	1
2	Existing and Planned Conditions.....	1
2.1	Proposed Development.....	1
2.2	Existing Conditions.....	3
2.2.1	Area Road Network.....	3
2.2.2	Existing Intersections.....	3
2.2.3	Existing Driveways.....	3
2.2.4	Cycling and Pedestrian Facilities.....	3
2.2.5	Existing Transit.....	5
2.2.6	Existing Area Traffic Management Measures.....	6
2.2.7	Existing Peak Hour Travel Demand.....	6
2.2.8	Collision Analysis.....	8
2.3	Planned Conditions.....	9
2.3.1	Changes to the Area Transportation Network.....	9
2.3.2	Other Study Area Developments.....	9
3	Study Area and Time Periods.....	11
3.1	Study Area.....	11
3.2	Time Periods.....	11
3.3	Horizon Years.....	11
4	Exemption Review.....	11
5	Development-Generated Travel Demand.....	12
5.1	Mode Shares.....	12
5.2	Trip Generation.....	12
5.3	Trip Distribution.....	13
5.4	Trip Assignment.....	14
6	Background Network Travel Demands.....	15
6.1	Transportation Network Plans.....	15
6.2	Background Growth.....	15
6.3	Other Developments.....	16
7	Demand Rationalization.....	17
7.1	2025 Future Background Operations.....	17
7.2	2030 Future Background Operations.....	18
7.3	2025 Future Total Operations.....	20
7.4	2030 Future Total Operations.....	21
7.5	Modal Share Sensitivity and Demand Rationalization Conclusions.....	22
7.5.1	Network Rationalization.....	22
7.5.2	Development Rationalization.....	23
8	Development Design.....	23
8.1	Design for Sustainable Modes.....	23
8.2	Circulation and Access.....	23
9	Parking.....	24
9.1	Parking Supply.....	24

10	Boundary Street Design.....	24
11	Access Intersections Design	25
11.1	Location and Design of Access.....	25
11.2	Intersection Control.....	25
11.3	Access Intersection Design	25
11.3.1	Future Access Intersection Operations	25
11.3.2	Access Intersection MMLOS	25
11.3.3	Recommended Design Elements.....	25
12	Transportation Demand Management	26
12.1	Context for TDM	26
12.2	Need and Opportunity.....	26
12.3	TDM Program	26
13	Transit.....	26
13.1	Route Capacity.....	26
13.2	Transit Priority	26
14	Network Intersection Design.....	26
14.1	Network Intersection Control.....	26
14.2	Network Intersection Design.....	27
14.2.1	2025 & 2030 Future Total Network Intersection Operations	27
14.2.2	Network Intersection MMLOS.....	27
14.2.3	Recommended Design Elements.....	27
15	Summary of Improvements Indicated and Modifications Options.....	27
16	Conclusion	31

List of Figures

Figure 1: Area Context Plan.....	1
Figure 2: Concept Plan.....	2
Figure 3: Study Area Pedestrian Facilities	4
Figure 4: Study Area Cycling Facilities	4
Figure 5: Existing Pedestrian Volumes	5
Figure 6: Existing Cyclist Volumes	5
Figure 7: Existing Study Area Transit Service.....	6
Figure 8: Existing Study Area Transit Stops – Within 400 metres	6
Figure 9: Existing Traffic Counts	7
Figure 10: Representation of Study Area Collision Records.....	8
Figure 11: New Site Generation Auto Volumes.....	14
Figure 12: Pass-by Volumes.....	15
Figure 13: New Site Generation and Pass-by Auto Volumes – Beyond 2031 (informational only)	15
Figure 14: 2025 Total Background Development Volumes.....	16
Figure 15: 2030 Total Background Development Volumes.....	17
Figure 16: 2025 Future Background Volumes	17
Figure 17: 2030 Future Background Volumes	19
Figure 18: 2025 Future Total Volumes	20

Figure 19: 2030 Future Total Volumes 21

Table of Tables

Table 1: Intersection Count Date.....7
 Table 2: Existing Intersection Operations.....7
 Table 3: Study Area Collision Summary, 2016-20208
 Table 4: Summary of Collision Locations, 2016-2020.....8
 Table 5: Exemption Review 11
 Table 6: TRANS Trip Generation Manual Recommended Mode Shares – South Nepean 12
 Table 7: Trip Generation Person Trip Rates by Peak Hour 12
 Table 8: Total Person Trip Generation by Peak Hour 12
 Table 9: Trip Generation by Mode 13
 Table 10: Local Barrhaven South Distribution 14
 Table 11: Trip Assignment 14
 Table 12: 2025 Future Background Intersection Operations 18
 Table 13: 2030 Future Background Intersection Operations 19
 Table 14: 2025 Future Total Intersection Operations 20
 Table 15: 2030 Future Total Intersection Operations 22
 Table 16: Boundary Street MMLOS Analysis 25
 Table 17: Trip Generation by Transit Mode 26
 Table 18: Study Area Intersection MMLOS Analysis 27

List of Appendices

Appendix A – TIA Screening Form and Certification Form
 Appendix B – Turning Movement Count Data
 Appendix C – Synchro Intersection Worksheets – Existing Conditions
 Appendix D – Collision Data
 Appendix E – Greenbank Road and Southwest Transitway Extension Preliminary Design
 Appendix F – Background Development Volumes
 Appendix G – Synchro Intersection Worksheets – 2025 Future Background Conditions
 Appendix H – Signal Warrant Calculation Sheet
 Appendix I – Synchro Intersection Worksheets – 2030 Future Background Conditions
 Appendix J – Synchro Intersection Worksheets – 2025 Future Total Conditions
 Appendix K – Synchro Intersection Worksheets – 2030 Future Total Conditions
 Appendix L – Turning Templates
 Appendix M – MMLOS Worksheets
 Appendix N – TDM Checklist

1 Screening

This study has been prepared according to the City of Ottawa’s 2017 Transportation Impact Assessment (TIA) Guidelines, prior to the June 2023 updates. Accordingly, a Step 1 Screening Form has been prepared and is included as Appendix A, along with the Certification Form for the TIA Study PM. As shown in the Screening Form, a TIA is required including the Design Review component and the Network Impact Component. This study has been prepared to support a site plan application.

2 Existing and Planned Conditions

2.1 Proposed Development

The existing site, located at 3845 Cambrian Road, is zoned as General Mixed-Use Zone (GM[1628]). The proposed development consists of a gross floor area of 34,496 sq. ft. grocery store and a gross floor area of 4,794 sq. ft. retail store totaling 39,290 sq. ft. A total of 180 surface parking spaces are proposed. The concept plan includes one new full-movement access on Cambrian Road in the interim condition. In the ultimate condition, a right-in/right-out access is proposed on Re-Aligned Greenbank Road corridor, and the access on Cambrian Road will be a right-in/right-out access. The ultimate condition is beyond the study horizon year and are not included in this report. The anticipated full build-out and occupancy horizon is 2025 with construction occurring in a single phase. The site is located within the Barrhaven South Community Design Plan area and Barrhaven South Community Core design priority area. Figure 1 illustrates the study area context. Figure 2 illustrates the proposed concept plan.

Figure 1: Area Context Plan

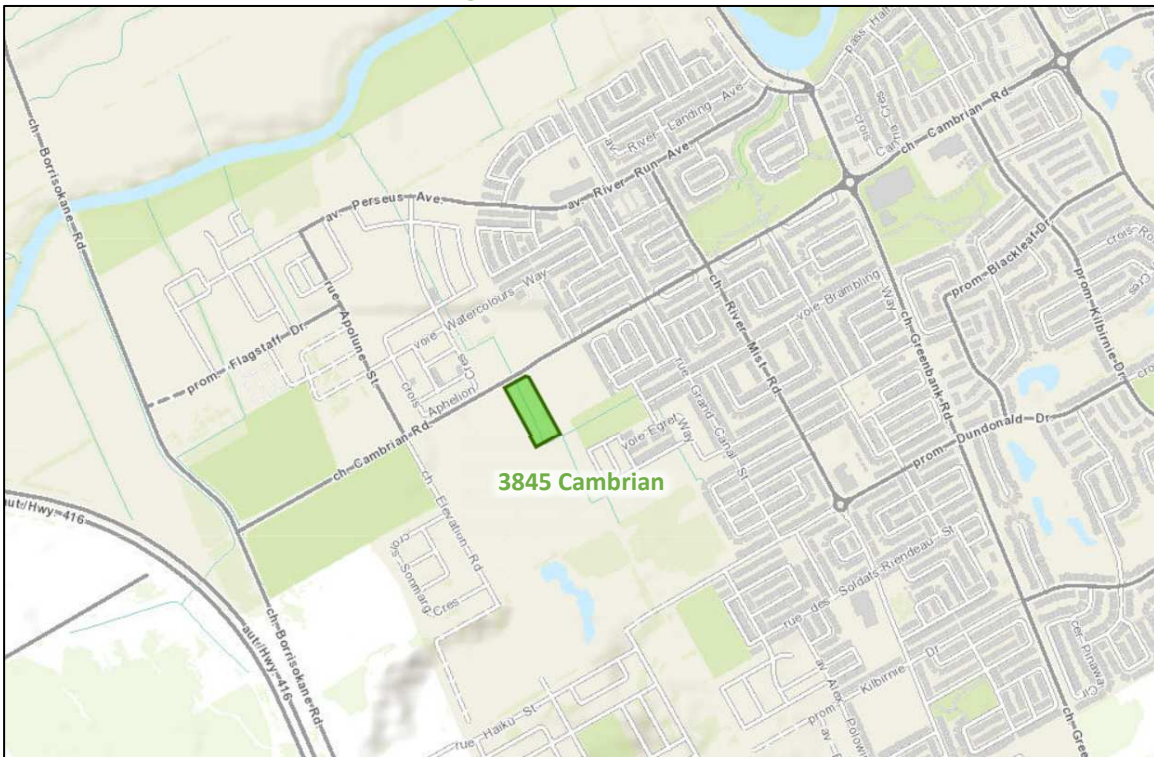

Source: <http://maps.ottawa.ca/geoOttawa/> Accessed: June 7, 2022

Figure 2: Concept Plan



2 CONTEXT PLAN
A001 N.T.S.

ZONING COMPLIANCE CHART - ZONING: GM[1628]		
	REQUIRED	PROPOSED
Minimum Lot Width (m)	N/A	76.98 m
Minimum Lot Area (acres)	N/A	3.66 acres
Minimum Front Yard Setback (Cambrian Rd) (m)	3 m	3 m
Minimum Rear Yard Setback (m)	7.5 m (from any portion of a rear lot line abutting a residential zone)	21.76 m
Minimum Interior Side Yard Setback (m)	5 m (for a non-residential or mixed-use building, from any portion of lot line abutting a residential zone)	9.38 m West 1.10 m East
Maximum Height (m)	18 m	7.48 m / 1 storey
Maximum Floor Space Index	N/A	0.24
Minimum Parking Dimensions (m)	2.6m x 5.2m	2.7m x 5.5m
Minimum Parking required (3.6 per 100 s.m. of total GFA)	132 spaces	180 spaces
Minimum Bicycle Parking required (1 per 500 s.m. of GFA)	8 spaces	8 spaces
Loading spaces (for up to 4999 s.m. of GFA)	1 standard space (3.5x9x4.2 m) 1 oversized space (4.3x13x4.2 m)	3 standard spaces 1 oversized space
Minimum Drive Aisle Width (parking angle at 90 degrees) (m)	6.7 m	6.7 m

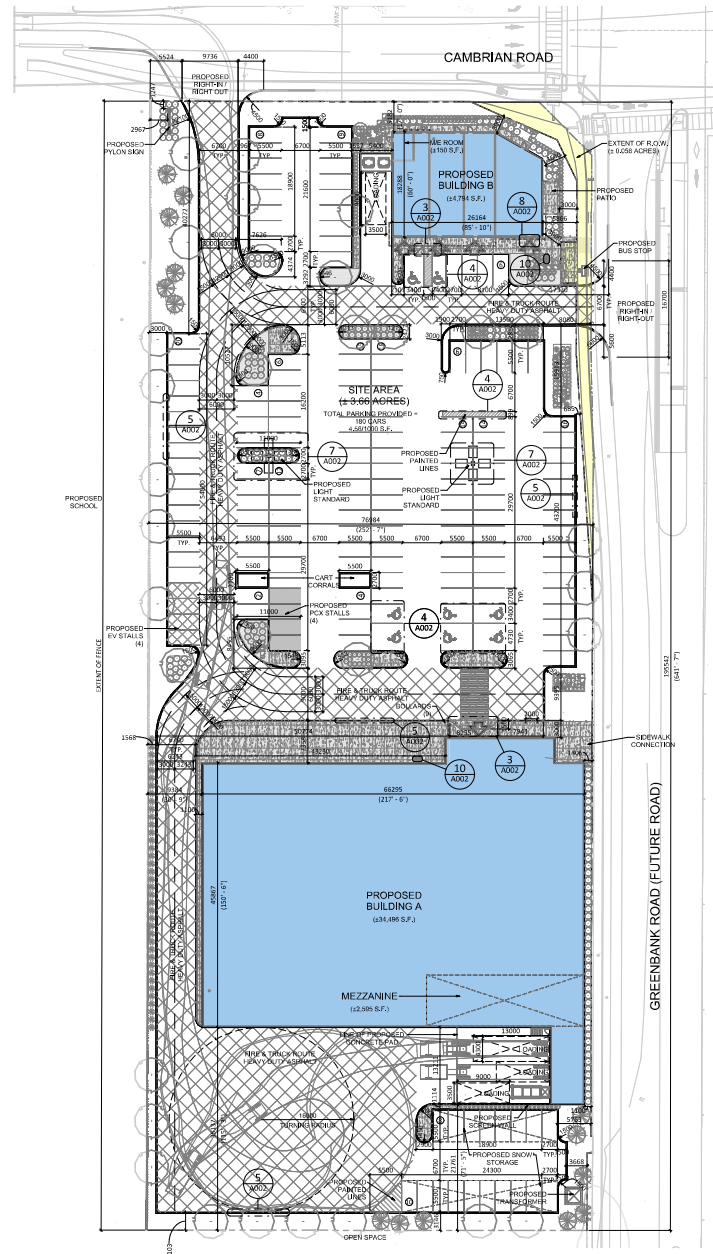

1 SITE PLAN
A001 1:400

TURNER FLEISCHER

Turner Fleischer Architects Inc.
177 Lakeshore Blvd.
Toronto, ON M5S 2E1
T 416 423 2222
turnerfleischer.com

The drawing is an instrument of service, licensed by the City of Toronto. It is the property of Turner Fleischer Architects Inc. and shall remain the property of the City of Toronto. It is not to be used for any other purpose without the written consent of Turner Fleischer Architects Inc. The drawing is not to be used for any other purpose without the written consent of Turner Fleischer Architects Inc. The drawing is not to be used for any other purpose without the written consent of Turner Fleischer Architects Inc.

LEGAL DESCRIPTION

TOPOGRAPHIC PLAN OF PART OF LOT 10
(CONCESSION 3 (SHEPPARD RD))
GEOGRAPHIC TOWNSHIP OF NEPEAN
CITY OF OTTAWA

STATISTICS

SITE AREA	0.585 ACRES	11.48 HA.
PROPOSED BUILDING A AREA	0.344 ACRES	13.265 S.M.
MEZZANINE AREA	0.285 S.F.	0.241 S.M.
TOTAL BUILDING A AREA	0.379 ACRES	13.446 S.M.
PROPOSED BUILDING B AREA	0.174 ACRES	14.8 S.M.
MEZZANINE AREA	0.150 S.F.	0.131 S.M.
TOTAL BUILDING B AREA	0.189 ACRES	16.9 S.M.
TOTAL GROSS FLOOR AREA	0.394 ACRES	17.346 S.M.
TOTAL BUILDING AREA	0.568 ACRES	20.346 S.M.
TOTAL PARKING PROVIDED	180 SPACES	180 S.M.
COVERAGE	24.74 %	

LEGEND

- PROPOSED BUILDING
- PROPOSED ENTRANCE ARROYO
- PROPOSED CONCRETE SIDEWALK
- PROPOSED FIRE & TRUCK ROUTE (HEAVY DUTY ASPHALT)
- PROPOSED PCX PARKING
- PROPOSED EV PARKING
- PROPOSED TRANSFORMER
- EXTENT OF RIGHT OF WAY (R.O.W.)

2	2024-02-15	ISSUED FOR BSA	PH
1	2024-01-15	ISSUED FOR COOPERATIVE	PH
0	2024-01-15	ISSUED FOR COOPERATIVE	PH
0	2024-01-15	ISSUED FOR COOPERATIVE	PH
0	2024-01-15	ISSUED FOR COOPERATIVE	PH
0	2024-01-15	ISSUED FOR COOPERATIVE	PH
0	2024-01-15	ISSUED FOR COOPERATIVE	PH
0	2024-01-15	ISSUED FOR COOPERATIVE	PH
0	2024-01-15	ISSUED FOR COOPERATIVE	PH
0	2024-01-15	ISSUED FOR COOPERATIVE	PH

Loblaw Companies Limited

PROJECT
CAMBRIAN RD (S. PARCEL)

BARRHAVEN, ONTARIO

DRAWING

SITE PLAN & FLOOR PLAN

PROJECT NO.	213MSD
PROJECT DATE	2024-02-15
DRAWN BY	PH
CHECKED BY	RCH
SCALE	1:400
DRAWING NO.	A001

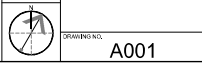

A001

2.2 Existing Conditions

2.2.1 Area Road Network

Cambrian Road: Cambrian Road is a City of Ottawa arterial road. West of Seeley's Bay Street, it is two-lane rural cross-section with gravel shoulders present on both sides of the road. East of Seeley's Bay Street, it is two-lane urban cross-section with sidewalks on both sides of the road. The posted speed limit is 50 km/h within the study area, and the City-protected right-of-way is 37.5 metres.

River Mist Road: River Mist Road is a City of Ottawa collector road with a two-lane urban cross-section. Sidewalks are presented on both sides of the road. The unposted speed limit is assumed to be 50 km/hr, and the measured right-of-way is approximately 24.0 metres.

Apolune Street: Apolune Street is a City of Ottawa collector road with a two-lane urban cross-section including on-street parking and sidewalks on both sides of the road. The unposted speed limit is assumed to be 50 km/h and the measured right-of-way is 24.0 metres.

Grand Canal Street: Grand Canal Street is a City of Ottawa local road with a two-lane urban cross-section including on-street parking on both sides of the road and sidewalk on the west side of the road. The unposted speed limit is assumed to be 50 km/h and the measured right-of-way is 16.5 metres.

2.2.2 Existing Intersections

The key existing intersections within one kilometre of the site have been summarized below:

<i>Cambrian Road at River Mist Road</i>	The intersection of Cambrian Road at River Mist Road is an all-way stop-controlled intersection. Each approach consists of a shared all-movement lane. No turn restrictions were noted.
<i>Cambrian Road at Apolune Street</i>	The intersection of Cambrian Road at Apolune Street is a T intersection with stop-control on Apolune Street. The southbound approach consists of a shared left-turn/right-turn lane. The eastbound approach consists of an auxiliary left-turn lane and a through lane, and the westbound approach consists of a shared through/right-turn lane. No turn restrictions are noted.
<i>Cambrian Road at Grand Canal Street</i>	The intersection of Cambrian Road at Grand Canal Street is an all-way stop-controlled intersection. Each approach consists of a shared all-movement lane. No turn restrictions were noted.

2.2.3 Existing Driveways

Construction accesses are located within 200 metres of the future site access intersections. As these are temporary or minor in nature and are not expected to provide access to significant traffic generators, they are not anticipated to have an impact on this TIA.

2.2.4 Cycling and Pedestrian Facilities

Figure 3 illustrates the pedestrian facilities in the study area and Figure 4 illustrates the cycling facilities.

Sidewalks are provided on both sides of Cambrian Road east of Seeley's Bay Street, River Mist Road, and Apolune Street and on the west side of Grand Canal Street. An approximate 760-metre sidewalk is provided on the north side of Cambrian Road west of Seeley's Bay Street. Paved shoulders are provided on both sides along Cambrian Road between Borrisokane Road and Cambrian Road at Apolune Street/Elevation Road.

In the ultimate cycling network, the Re-Aligned Greenbank Road will be a spine cycling route, and Cambrian Road, Apolune Street, and River Mist Road are local routes. South of Cambrian Road, Apolune Street will continue as Elevation Road, is a local route, and is anticipated to include multi-use pathways. The Transportation Master Plan Part 1 identifies Re-Aligned Greenbank Road for designation as a cross-town bikeway.

Figure 3: Study Area Pedestrian Facilities

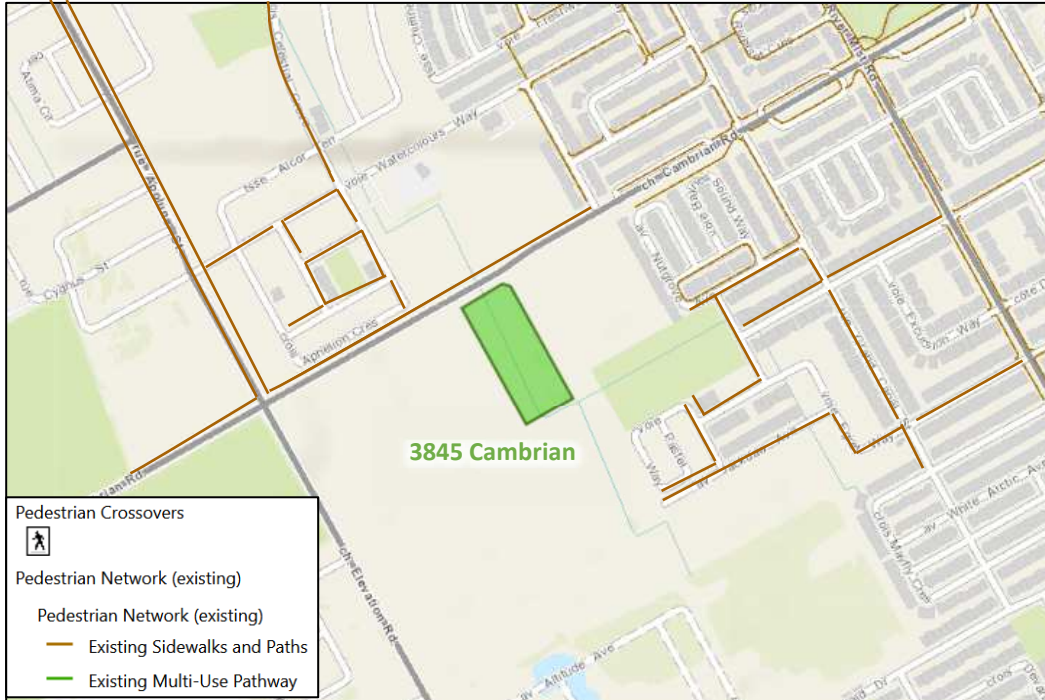

Source: <http://maps.ottawa.ca/geoOttawa/> Accessed: April 20, 2023

Figure 4: Study Area Cycling Facilities

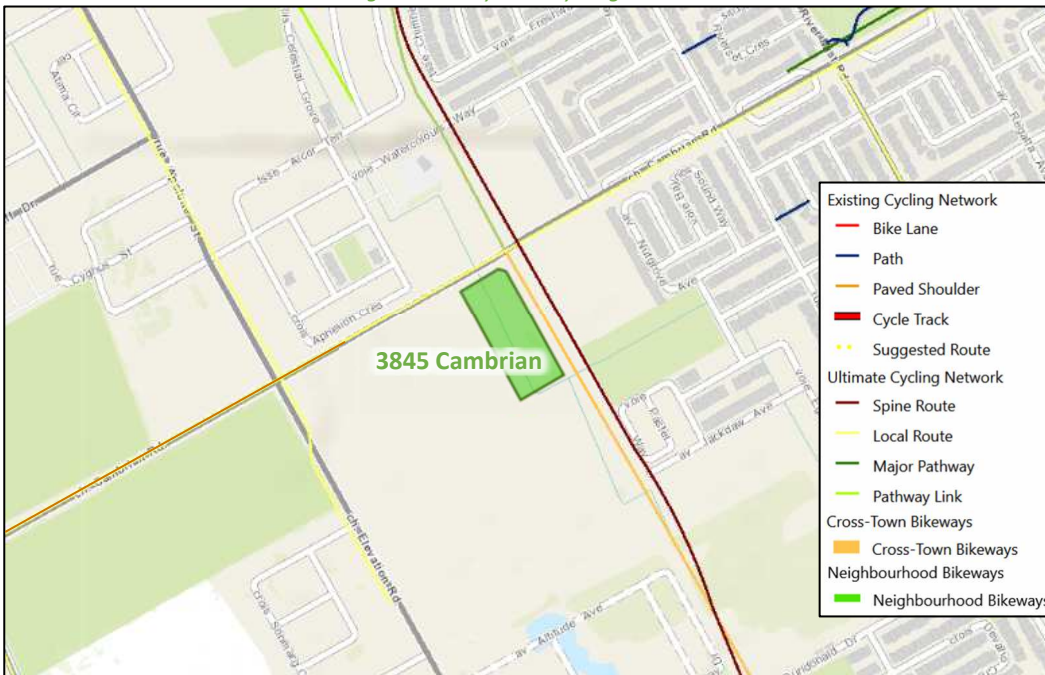

Source: <http://maps.ottawa.ca/geoOttawa/> Accessed: April 20, 2023

Pedestrian and cyclist volumes included in study area intersection counts, presented in Section 2.2.7, have been compiled and are illustrated in Figure 5 and Figure 6, respectively.

Figure 5: Existing Pedestrian Volumes

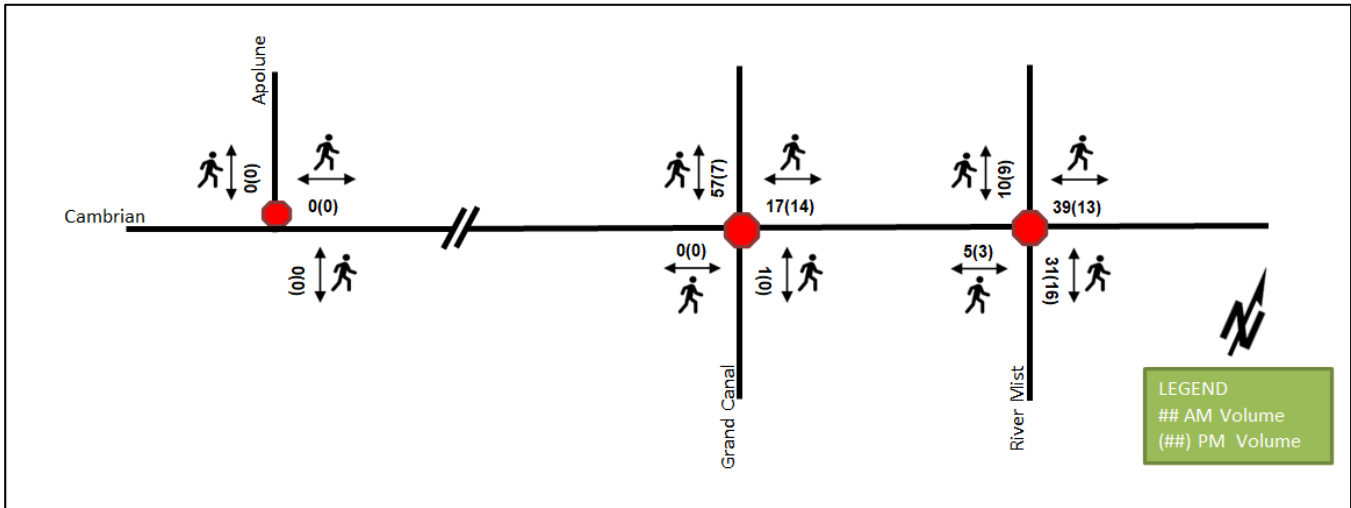
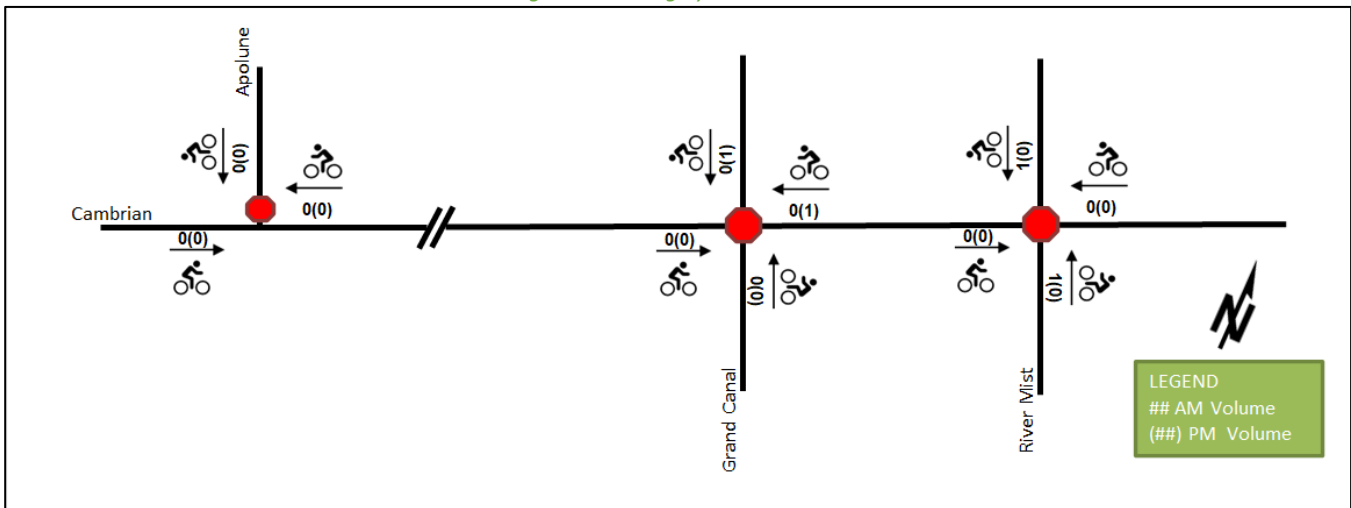

Figure 6: Existing Cyclist Volumes



2.2.5 Existing Transit

Figure 7 illustrates the transit system map in the study area and Figure 8 illustrates nearby transit stops. All transit information is from June 7, 2022, and is included for general information purposes and context to the surrounding area.

Within the study area, route #75 travels along Cambrian Road and River Mist Road. The frequency of these routes within proximity of the proposed site based on June 7, 2022, service levels are:

- Route # 75 – 10-minute service in the peak period/direction and 15-20-minute service all-day, 30-minute service after 8 PM

Figure 7: Existing Study Area Transit Service

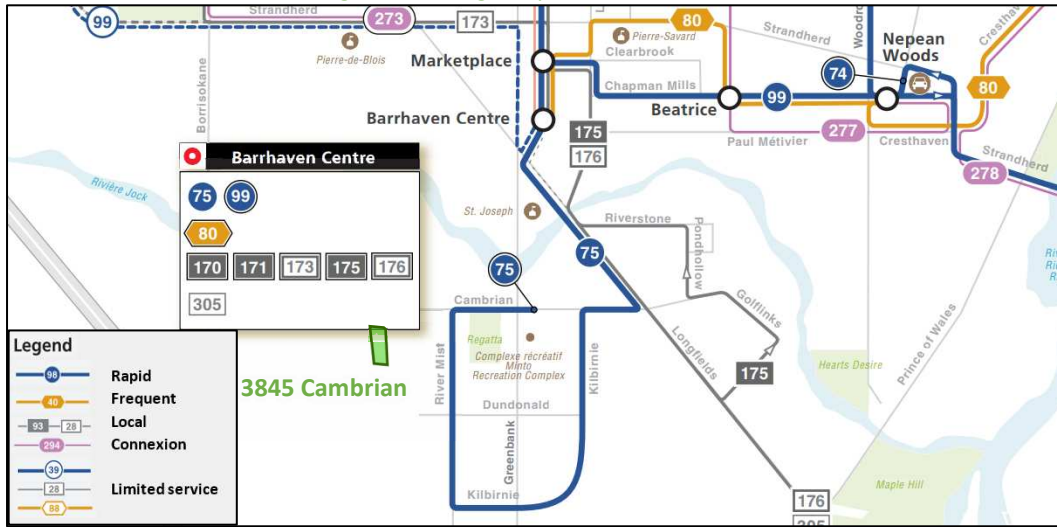

Source: <http://www.octranspo.com/> Accessed: June 7, 2022

Figure 8: Existing Study Area Transit Stops – Within 400 metres

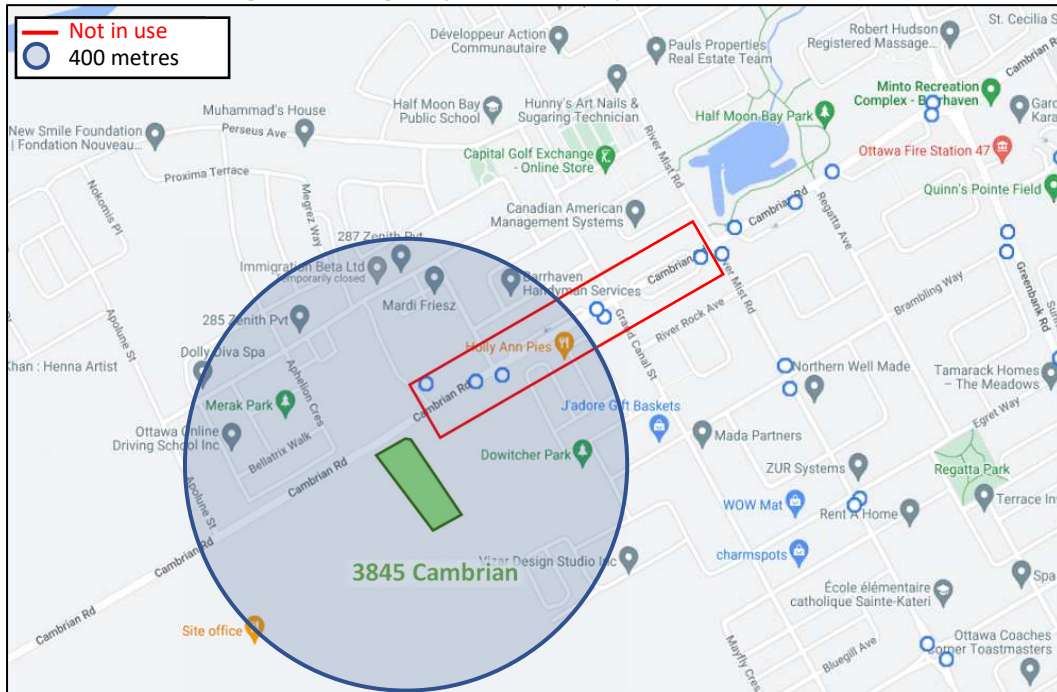

Source: <http://www.octranspo.com/> Accessed: June 7, 2022

2.2.6 Existing Area Traffic Management Measures

There are no existing area traffic management measures within the study area.

2.2.7 Existing Peak Hour Travel Demand

Existing turning movement counts at Cambrian Road and River Mist Road was acquired from the City of Ottawa, and existing turning movement counts at Cambrian Road and Grand Canal Street was acquired from the Traffic Specialist. The turning movements at Cambrian Road at Apolune Street intersection were derived from the first phases of the Half Moon Bay West CTS (Stantec, 2016). Table 1 summarizes the intersection count dates.

Table 1: Intersection Count Date

Intersection	Count Date	Source
Cambrian Road at River Mist Road	Wednesday, October 23, 2019	City of Ottawa
Cambrian Road at Apolune Street	-	Half Moon Bay West CTS (Stantec, 2016)
Cambrian Road at Grand Canal Street	Wednesday, October 19, 2022	The Traffic Specialist

Figure 9 illustrates the 2022 existing traffic counts and Table 2 summarizes the existing intersection operations. Synchro 11 has been used to model the unsignalized intersections and HCM 2010 methodology was used for unsignalized intersection operation. Detailed turning movement count data is included in Appendix B and the Synchro worksheets are provided in Appendix C.

Figure 9: Existing Traffic Counts

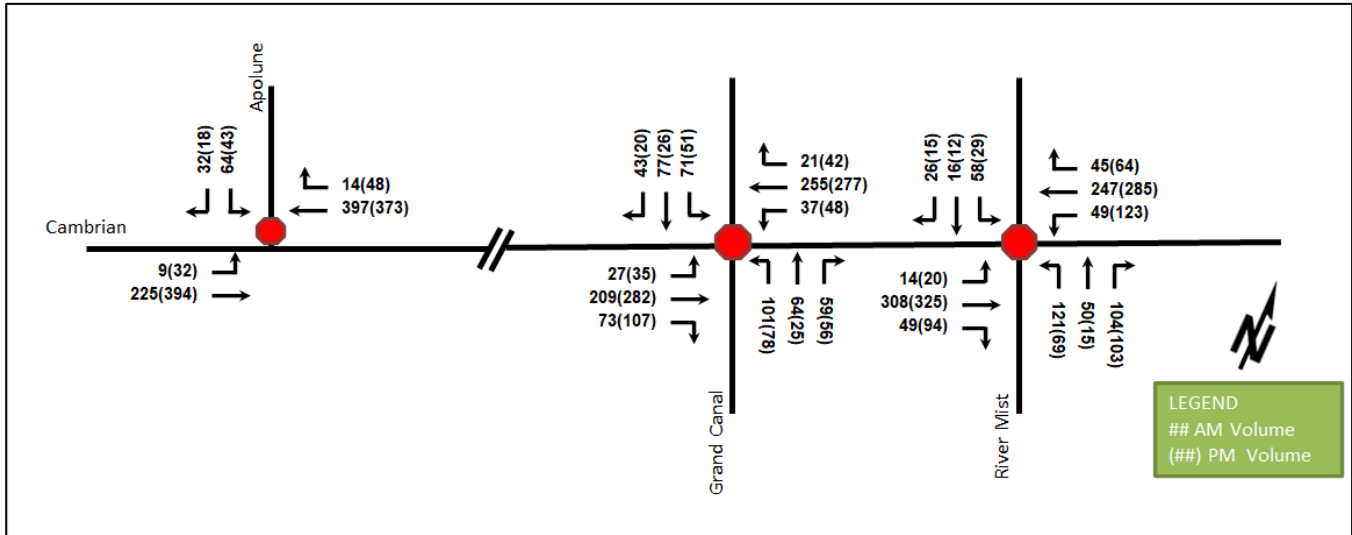

Table 2: Existing Intersection Operations

Intersection	Lane	AM Peak Hour				PM Peak Hour			
		LOS	V/C	Delay (s)	Q (95 th)	LOS	V/C	Delay (s)	Q (95 th)
Cambrian Road at River Mist Road <i>Unsignalized</i>	EB	C	0.71	23.1	43.5	C	0.76	25.0	53.3
	WB	C	0.68	21.9	38.3	D	0.82	30.3	66.0
	NB	C	0.56	17.5	25.5	B	0.38	13.6	13.5
	SB	B	0.23	12.5	6.8	B	0.13	11.4	3.0
	Overall	C	-	20.3	-	C	-	24.7	-
Cambrian Road at Apolune Street <i>Unsignalized</i>	EBL	A	0.01	8.3	0.0	A	0.03	8.4	0.8
	EBT	-	-	-	-	-	-	-	-
	WBT/R	-	-	-	-	-	-	-	-
	SBL/R	C	0.25	15.9	6.8	C	0.21	19.0	6.0
	Overall	A	-	2.2	-	A	-	1.6	-
Cambrian Road at Grand Canal Street <i>Unsignalized</i>	EB	C	0.59	17.7	28.5	C	0.71	20.8	43.5
	WB	C	0.60	18.2	30.0	C	0.64	18.3	34.5
	NB	C	0.46	15.1	18.0	B	0.32	12.6	10.5
	SB	B	0.40	14.1	14.3	B	0.21	11.6	6.0
	Overall	C	-	16.6	-	C	-	17.8	-

Notes:
 Saturation flow rate of 1800 veh/h/lane
 Queue is measured in metres
 Peak Hour Factor = 0.90
 V/C = volume-to-capacity ratio

Delay = average vehicle delay in seconds
 m = metered queue
 # = volume for the 95th %ile cycle exceeds capacity

During both peak hours in the existing conditions, the study area intersections operate well. No capacity issues are noted.

2.2.8 Collision Analysis

Collision data have been acquired from the City of Ottawa open data website (data.ottawa.ca) for five years prior to the commencement of this TIA for the surrounding study area road network. Table 3 summarizes the collision types and conditions in the study area, Figure 10 illustrates the intersections and segments analyzed, and Table 4 summarizes the total collisions for each of these locations. Collision data are included in Appendix D.

Table 3: Study Area Collision Summary, 2016-2020

Total Collisions		Number	%
		2	100%
Classification	Fatality	0	0%
	Non-Fatal Injury	1	50%
	Property Damage Only	1	50%
Initial Impact Type	Angle	1	50%
	SMV Other	1	50%
Road Surface Condition	Dry	1	50%
	Loose Snow	1	50%
Pedestrian Involved		0	0%
Cyclists Involved		0	0%

Figure 10: Representation of Study Area Collision Records

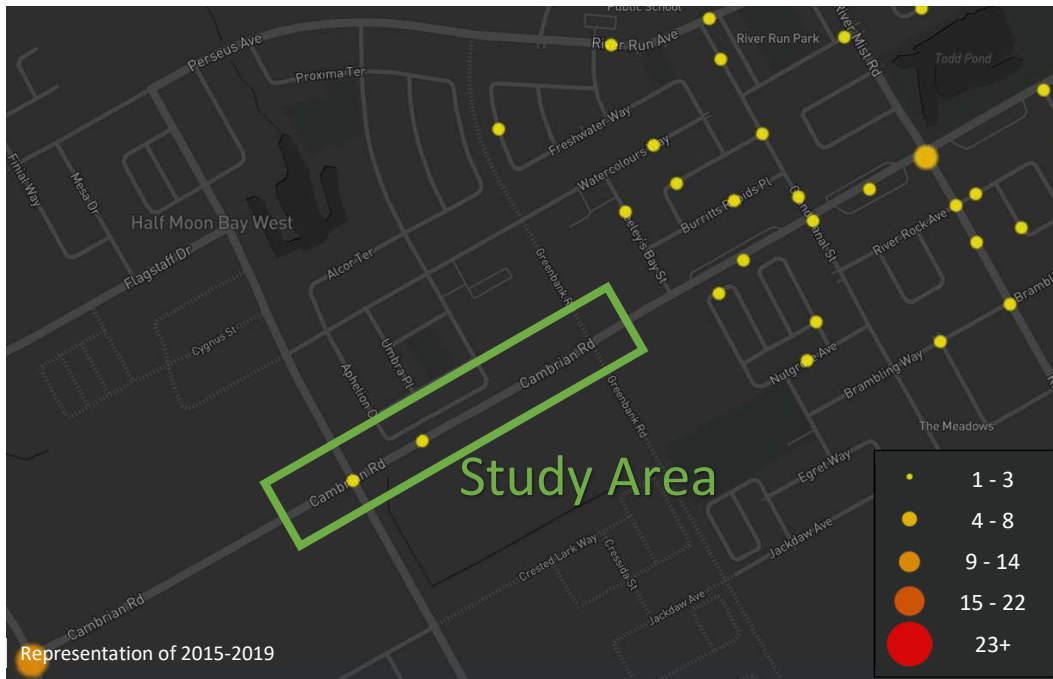

Table 4: Summary of Collision Locations, 2016-2020

Intersections / Segments	Number	%
	2	100%
Apolune St @ Cambrian Rd	1	50%
Cambrian Rd btwn Borrisokane Rd & Grand Canal St	1	50%

Within the study area, there are a total of two collisions during the 2016-2020 time period, with one involving property damage only and the remaining one having non-fatal injuries. No further collision review is required as part of this study.

2.3 Planned Conditions

2.3.1 Changes to the Area Transportation Network

The subject development is within the Barrhaven South Community Design Plan (CDP) Area. As such, it is subject to the planning policies outlined in the CDP. The CDP provides target population and employment densities in the four Sub-Planning Areas along with the plans for infrastructure to support the community growth. As part of this plan, the right-of-way along the following roads has been protected to accommodate an expansion to a four-lane arterial:

- Re-Aligned Greenbank Road rapid transit corridor north and south of Cambrian Road with a protected right-of-way of 41.5 metres
- Cambrian Road between Borrisokane Road and Longfields Road with a protected right-of-way of 37.5 metres

Realigned Greenbank Road will be located on the east side of the proposed development. The Re-Aligned Greenbank Road includes the design of a new 4-lane arterial roadway with 2-lane segregated median Bus Rapid Transit and facilities for pedestrians and cyclists between Marketplace Avenue/Chapman Mills Drive in the north and Barnsdale Road in the south. The preliminary design is included in Appendix E. The Re-Aligned Greenbank Road construction has not been scheduled and is assumed beyond 2031. Therefore, the Re-Aligned Greenbank Road is assumed to be after the study horizons and will not be modeled within the subject analyses.

Within the study horizons, a temporary road will be constructed on the south leg of the Cambrian Road at future Re-Aligned Greenbank Road intersection to serve as interim access for the future grocery site on the southeast quadrant of the intersection.

The westbound and southbound auxiliary left-turn lanes at the intersection of Cambrian Road at Apolune Street/Elevation Road have recently been painted. It is expected that an auxiliary left-turn lane will be on the northbound movement and the intersection is expected to be signalized within future horizons and will be included in the future horizons.

2.3.2 Other Study Area Developments

Mattamy's Half Moon Bay West Phase 3

The proposed subdivision is situated within the Mattamy Development of Half Moon Bay West, this phase of which is anticipated to be built-out during 2025. The development will include 38 detached single-family homes, 190 townhomes, and a 0.43-hectare commercial block. (CGH Transportation, 2021)

3555 Borrisokane Road

The proposed development includes a site plan application consisting of a car wash. It is anticipated to be built by 2023. This development forms a portion of the commercial block assessed within the Half Moon Bay West Phase 3 area. (D. J. Halpenny & Associates Ltd, 2022)

Glenview Homes (3387 Borrisokane Road)

The proposed development includes a plan of subdivision application consisting of 179 single family homes and 109 townhomes. It is anticipated to be built by 2023. (Stantec 2017)

OCSB Elementary School (135 Halyard Lane)

The proposed development application includes a site plan to have a single storey elementary school with approximately 800 students and a 2,970 sq. ft of childcare centre. It is anticipated to be built by 2023. (Dillon Consulting, 2022)

Mattamy's Half Moon Bay West Phase 4

The proposed site is situated within the Mattamy Development of Half Moon Bay West, this phase of which is anticipated to be built-out during 2026. This phase of the development will include 59 detached single-family homes.

Minto's Kennedy (3432 Greenbank Road)

The proposed development includes a plan of subdivision application consisting of 523 units, including 103 single family homes, 274 executive townhomes, and 146 avenue townhomes, and is anticipated to be built by 2024. (CGH Transportation, 2022)

Choice Properties (3850 Cambrian Road)

The proposed development includes a site plan application consisting of gross floor area of 17,000 sq. ft pharmacy and gross leasable area of 18,905 sq. Ft retail buildings. It is anticipated to be built by 2024. The file has been initiated and no TIA is available at this time.

Metro Ontario Inc. (3831 Cambrian Road)

The proposed development includes a site plan application consisting of a 4,024 square metre supermarket, an attached 929 square metre retail store, an 830 square metre retail building, and a 1,060 square metre mixed-use building. It is anticipated to be built by 2023. (CGH Transportation, 2021)

Meadow's Phase 7-8 (3640 Greenbank Road)

The proposed development, which was named Phase 5 in the TIA, includes a plan of subdivision application. The concept plan considers a total of 221 townhouses and 125 single family units. The full build-out and occupancy of Phase 7 is now assumed to be 2023 and Phase 8 by 2025. (IBI, 2018)

Mattamy's Half Moon Bay South Phase 5 (3718 Greenbank Road)

The proposed development application includes a plan of subdivision application consisting of 67 single detached home units and 97 townhouse units. This development is under construction and is assumed to be completed by the end of 2022. (CGH Transportation, 2019)

Mattamy's Half Moon Bay South Phase 7/8 (3718 Greenbank Road)

The proposed development, located on the west of the Re-Aligned Greenbank Road corridor and includes a mixture of 228 stacked townhouse units, and is anticipated to be built by 2024. (CGH Transportation, 2022)

Caivan's Ridge Phases 1-2 (3809 Borrisokane Road)

This development will include 279 townhouse units and 311 detached home units. This development is expected to be built-out during 2025. (CGH Transportation, 2019)

Caivan's The Ridge Phase 3-4 (3713 Borrisokane Road)

This development will include 589 townhouse units and 61 detached housing units. This development is expected to be built-out during 2024. (CGH Transportation, 2021)

Caivan's Conservancy East Stage (3285, 3288, 3305 Borrisokane Road)

This development will include 600 single family homes and 600 townhouses and 100 mid-rise dwelling units. This development is expected to be built-out during 2029. (CGH Transportation, 2021).

Minto’s Quinn’s Pointe Stages 4 (3882 Barnsdale Road and 3960 Greenbank Road)

The proposed development application includes a plan of subdivision application consisting of 536 single-family dwelling units, 493 townhomes, 100 apartment units, and two elementary schools. Phases 2 and 3 have been completed, and Phase 4 is expected to be completed by 2025. (Stantec, 2018)

AIBC Manufacturing Site (3713 Borrisokane Road)

The site includes approximately 3,250 square metres of general office space and 9,385 square metres of industrial buildings. This development began operations in 2022, and the office component will be completed by 2023. (CGH Transportation, 2020)

3 Study Area and Time Periods

3.1 Study Area

The study area will include the intersections of:

- Cambrian Road at:
 - River Mist Road
 - Apolune Street
 - Grand Canal Street
 - Site Access #1 (Future)

Future volumes at the ultimate access locations will be shown for the Re-Aligned Greenbank Road access and as they are outside the study horizons, will not be assessed from an operational perspective. This is informational only and are to be coordinated by the City through the Re-Aligned Greenbank design team.

The boundary roads will be Cambrian Road and the preliminary design drawings will be used to assess the future Re-Aligned Greenbank Road. No screenlines are present within proximity to the site.

3.2 Time Periods

The weekday AM and PM peak hours will be examined.

3.3 Horizon Years

The anticipated build-out year is 2025. As a result, the full build-out plus five years horizon year is 2030.

4 Exemption Review

Table 5 summarizes the exemptions for this TIA.

Table 5: Exemption Review

Module	Element	Explanation	Exempt/Required
Design Review Component			
4.1 Development Design	4.1.2 Circulation and Access	Only required for site plans	Required
	4.1.3 New Street Networks	Only required for plans of subdivision	Exempt
4.2 Parking	4.2.1 Parking Supply	Only required for site plans	Required
	4.2.2 Spillover Parking	Only required for site plans where parking supply is 15% below unconstrained demand	Exempt
Network Impact Component			

Module	Element	Explanation	Exempt/Required
4.5 Transportation Demand Management	All Elements	Not required for site plans expected to have fewer than 60 employees and/or students on location at any given time	Required
4.6 Neighbourhood Traffic Management	4.6.1 Adjacent Neighbourhoods	Only required when the development relies on local or collector streets for access and total volumes exceed ATM capacity thresholds	Exempt
4.8 Network Concept		Only required when proposed development generates more than 200 person-trips during the peak hour in excess of equivalent volume permitted by established zoning	Exempt

5 Development-Generated Travel Demand

5.1 Mode Shares

Examining the mode shares recommended in the TRANS Trip Generation Manual (2020) for the subject district, derived from the most recent National Capital Region Origin-Destination survey (OD Survey), the existing average district mode shares by land use for South Nepean have been summarized in Table 6.

Table 6: TRANS Trip Generation Manual Recommended Mode Shares – South Nepean

Travel Mode	Commercial Generator	
	AM	PM
Auto Driver	74%	61%
Auto Passenger	14%	27%
Transit	1%	1%
Cycling	0%	0%
Walking	11%	11%
Total	100%	100%

5.2 Trip Generation

This TIA has been prepared using the vehicle trip rates and derived person trip rates for commercial components from the ITE Trip Generation Manual 11th Edition using the City-prescribed conversion factor of 1.28. Table 7 summarizes the person trip rates for the non-residential land uses by peak hour.

Table 7: Trip Generation Person Trip Rates by Peak Hour

Land Use	Land Use Code	Peak Hour	Vehicle Trip Rate	Person Trip Rates
Supermarket	850 (ITE)	AM	2.86	3.66
		PM	8.95	11.46
Retail (<40k)	822 (ITE)	AM	2.36	3.02
		PM	6.59	8.44

Using the above person trip rates, the total person trip generation has been estimated. Table 8 summarizes the total person trip generation for the non-residential land uses.

Table 8: Total Person Trip Generation by Peak Hour

Land Use	GFA	AM Peak Hour			PM Peak Hour		
		In	Out	Total	In	Out	Total
Supermarket	34,496 sq.ft	74	52	126	198	198	396
Retail (<40k)	4,794 sq.ft	8	6	14	20	20	40

It is noted that Internal capture rates from the ITE Trip Generation Handbook 3rd Edition only include development’s retail component for mixed-use developments. Therefore, the internal capture rates for Retail (<40k) to/from Supermarket were assumed to be 5% for the AM peak hour and 20% for the PM peak hour.

Pass-by reduction of 24% have been taken from the rates presented in the ITE Trip Generation Manual 11th Edition for the land use of supermarket. Since ITE Trip Generation Manual 11th Edition does not have pass-by reduction for the land use of retail (<40k), a pass-by reduction of 40% for the land use of Shopping Plaza (40 - 150k) was applied to the land use of retail (<40k) peak hours.

Using the above mode share targets for the internal capture and pass-by rates, and the person trip rates, the person trips by mode have been projected. Table 9 summarizes the non-residential trip generation by mode and peak hour.

Table 9: Trip Generation by Mode

Travel Mode		AM Peak Hour				PM Peak Hour			
		Mode Share	In	Out	Total	Mode Share	In	Out	Total
Supermarket	Auto Driver	74%	37	26	63	61%	73	73	146
	Auto Passenger	14%	10	7	17	27%	53	53	106
	Transit	1%	1	1	2	1%	2	2	4
	Cycling	0%	0	0	0	0%	0	0	0
	Walking	11%	8	6	14	11%	22	22	44
	Pass-by	24%	-18	-12	-30	24%	-48	-48	-96
	Total	100%	56	40	96	100%	150	150	300
Retail (<40k)	Auto Driver	74%	3	2	5	61%	3	3	6
	Auto Passenger	14%	1	1	2	27%	5	5	10
	Transit	1%	0	0	0	1%	0	0	0
	Cycling	0%	0	0	0	0%	0	0	0
	Walking	11%	1	1	2	11%	2	2	4
	Pass-by	40%	-4	-2	-6	40%	-8	-8	-16
	Internal Capture	5%	0	0	0	20%	-2	-2	-4
	Total	100%	5	4	9	100%	10	10	20
Total	Auto Driver	74%	40	28	68	61%	76	76	152
	Auto Passenger	14%	11	8	19	27%	58	58	116
	Transit	1%	1	1	2	1%	2	2	4
	Cycling	0%	0	0	0	0%	0	0	0
	Walking	11%	9	7	16	11%	24	24	48
	Pass-by	varies	-22	-14	-36	varies	-56	-56	-112
	Internal Capture	varies	0	0	0	varies	-2	-2	-4
	Total	100%	61	44	105	100%	160	160	320

As shown above, a total of 68 AM and 152 PM new peak hour two-way vehicle trips are projected as a result of the proposed development.

5.3 Trip Distribution

Typically, the City’s TRANS O-D distribution would be used to approximate the distribution of development traffic for employment and residential developments. As the proposed site is located to serve the local community, it was felt that a site-specific distribution would be required, factoring in the adjacent residential developments. As such, the local Barrhaven South distribution is summarized in Table 10.

Table 10: Local Barrhaven South Distribution

To/From	% of Trips
North	10%
South	30%
East	50%
West	10%
Total	100%

5.4 Trip Assignment

Using the distribution outlined above, turning movement splits, and access to major transportation infrastructure, the trips generated by the site have been assigned to the study area road network. Re-Aligned Greenbank Road will extend south of Cambrian Road to Barnsdale Road beyond 2031 and not within the horizons of this study.

To assist in the City’s future planning, an assignment has been developed for this condition and has been supplied for informational purposes only. Any assessment of Re-Aligned Greenbank Road is a regional issue and unrelated to the planned right-in/right-out access arrangement.

Table 11 summarizes the proportional assignment to the study area roadways in the interim and ultimate conditions. Figure 11 and Figure 12 illustrate the new site generated volumes and pass-by volumes within the study horizons.

As noted above, Figure 13 illustrates the new site generated volumes once Re-Aligned Greenbank Road extends to the south, which will be beyond 2031. Since the ultimate condition is beyond the study horizon year, it will not be analysed in this TIA.

Table 11: Trip Assignment

To/From	Study Horizons	Beyond 2031 (informational only)	
	Via	Inbound Via	Outbound Via
North	5% Grand Canal (N)	3% Grand Canal (N)	3% Grand Canal (N)
	3% River Mist (N)	2% River Mist (N)	2% River Mist (N)
	2% Apolune (N)	5% Re-Aligned Greenbank (N)	5% Re-Aligned Greenbank (N)
South	25% Elevation (S)	25% Elevation (S)	25% Re-Aligned Greenbank (S)
	5% River Mist (S)	5% River Mist (S)	5% River Mist (S)
East	30% Cambrian (E)	30% Cambrian (E)	30% Cambrian (E)
	5% Grand Canal (S)	5% Grand Canal (S)	5% Grand Canal (S)
	15% River Mist (S)	15% River Mist (S)	15% River Mist (S)
West	3% Cambrian (W)	3% Cambrian (W)	3% Cambrian (W)
	7% Apolune (N)	7% Apolune (N)	7% Apolune (N)
Total	100%	100%	100%

Figure 11: New Site Generation Auto Volumes

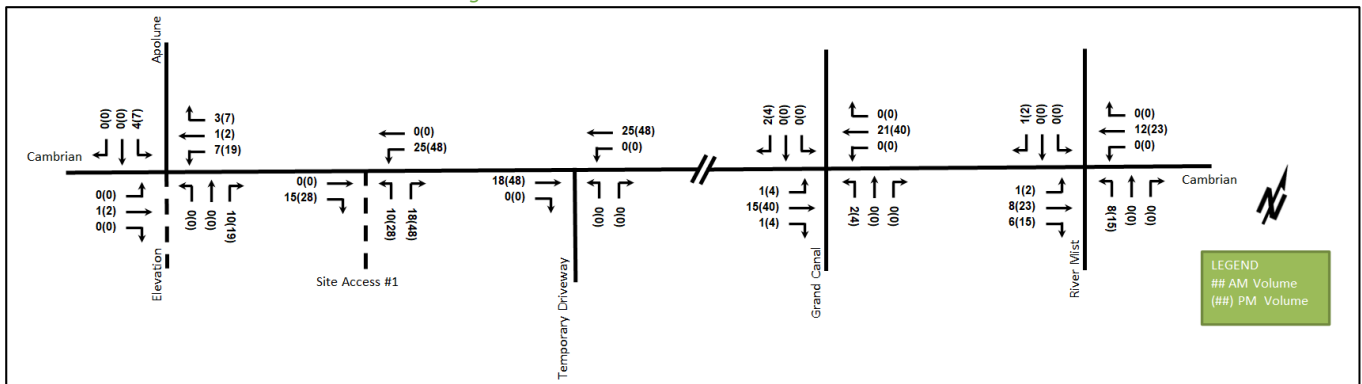

Figure 12: Pass-by Volumes

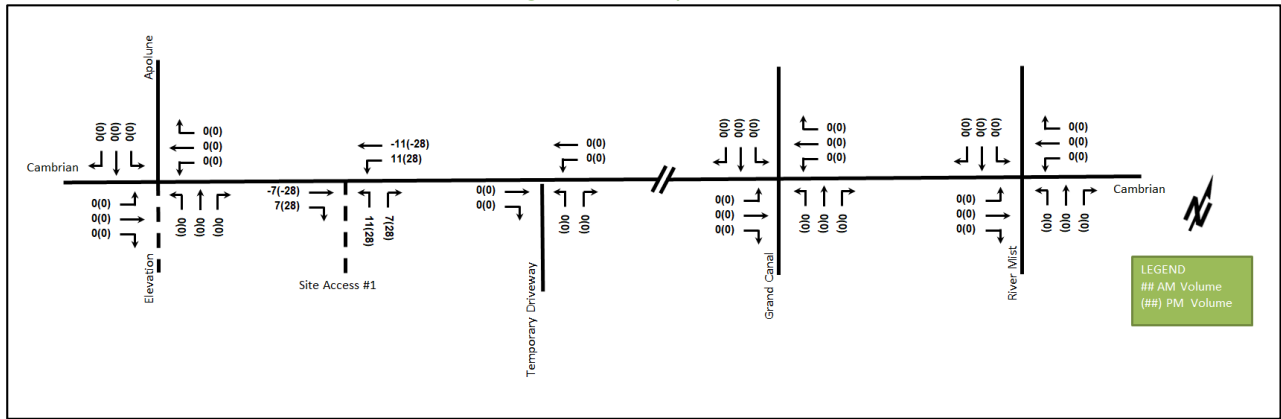
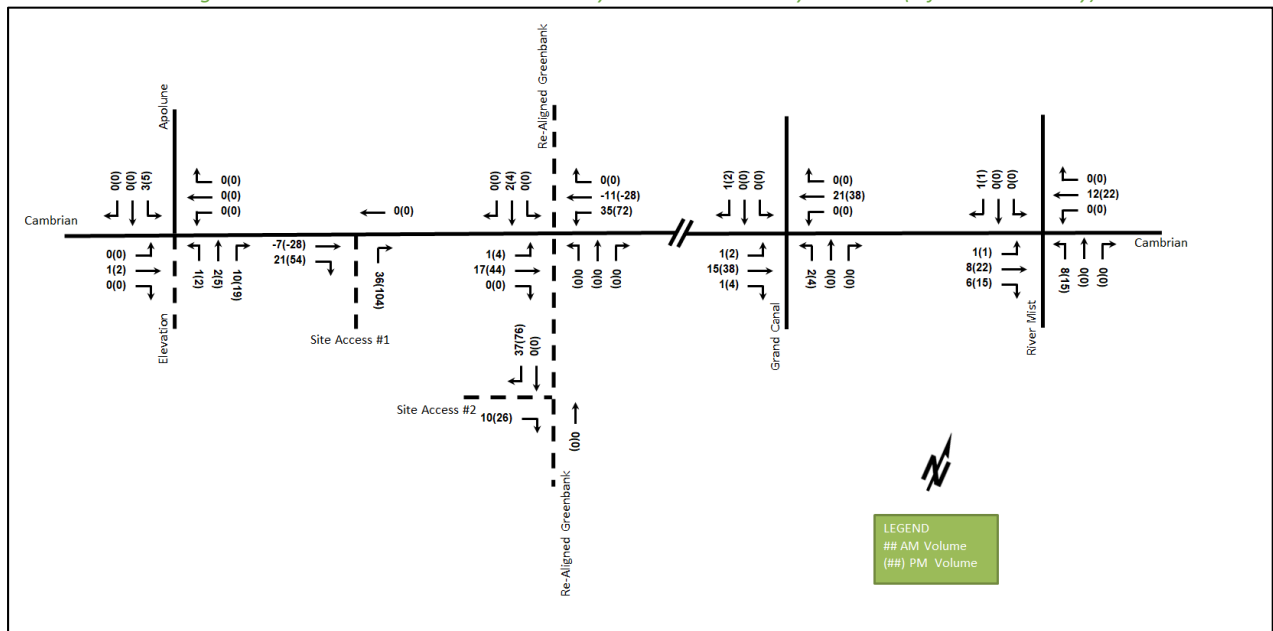

Figure 13: New Site Generation and Pass-by Auto Volumes – Beyond 2031 (informational only)



6 Background Network Travel Demands

6.1 Transportation Network Plans

The transportation network plans were discussed in Section 2.3. The signalized intersection of Cambrian Road at Apolune Street/Elevation Road, including the planned auxiliary lanes will be analyzed at all future horizons. Within the study horizons, a temporary road will be constructed on the south leg of the Cambrian Road at future Re-Aligned Greenbank Road intersection to serve as interim access for the future grocery site on the southeast quadrant of the intersection.

The Re-Aligned Greenbank Road was noted to be planned for implementation after the study horizons.

6.2 Background Growth

All background developments within Barrhaven South have been included in this TIA. All growth is assumed to be captured within the background development; therefore, no annual growth rate will be applied. Regional growth

would be present on the north-south arterial network outside the study area intersections, such as Borrisokane Road, Greenbank Road and Longfields Drive.

6.3 Other Developments

The background developments explicitly considered in the background conditions (Section 6.2) include:

- Mattamy Half Moon Bay West Phases 3, 4
- 3555 Borrisokane Road
- Glenview Homes (3387 Borrisokane Road)
- OCSB Elementary School (135 Halyard Lane)
- Minto’s Kennedy (3432 Greenbank Road) (2024 new site generated auto volumes)
- Choice Properties (3850 Cambrian Road)
- Metro Ontario Inc. (3831 Cambrian Road)
- Meadow’s Phase 7-8 (3640 Greenbank Road)
- Mattamy’s Half Moon Bay South Phase 5 (3718 Greenbank Road)
- Mattamy’s Half Moon Bay South Phase 7/8 (3718 Greenbank Road)
- Caivan’s Ridge Phases 1-2 (3809 Borrisokane Road)
- Caivan’s The Ridge Phase 3-4 (3713 Borrisokane Road)
- Caivan’s Conservancy East Stage (3285, 3288, 3305 Borrisokane Road)
- Minto’s Quinn’s Pointe Stages 4 (3882 Barnsdale Road and 3960 Greenbank Road)
- AIBC Manufacturing Site (3713 Borrisokane Road)

Figure 14 and Figure 15 illustrate the 2025 and 2030 total background development volumes. The background development volumes within the study area have been provided in Appendix F.

Figure 14: 2025 Total Background Development Volumes

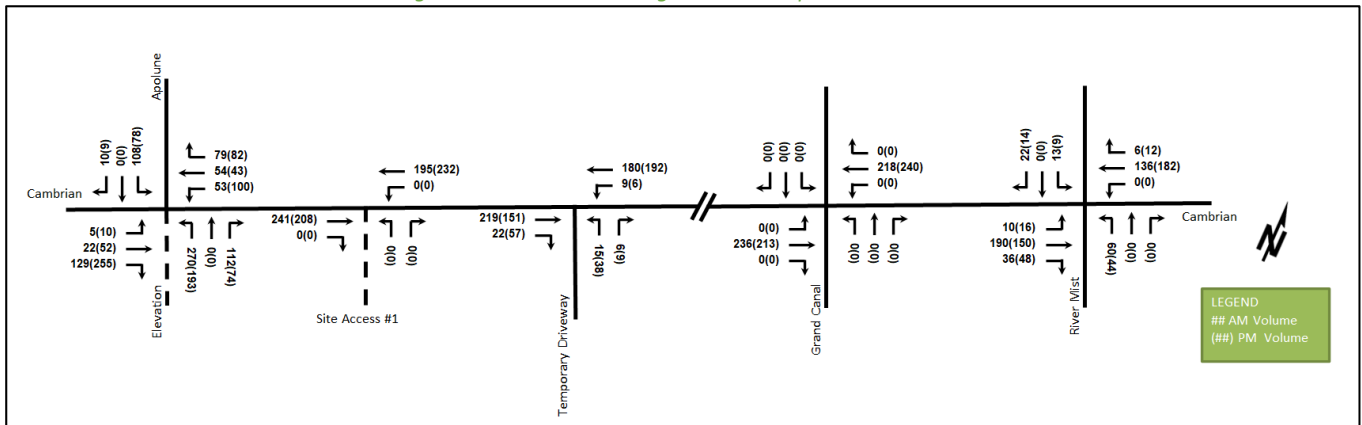
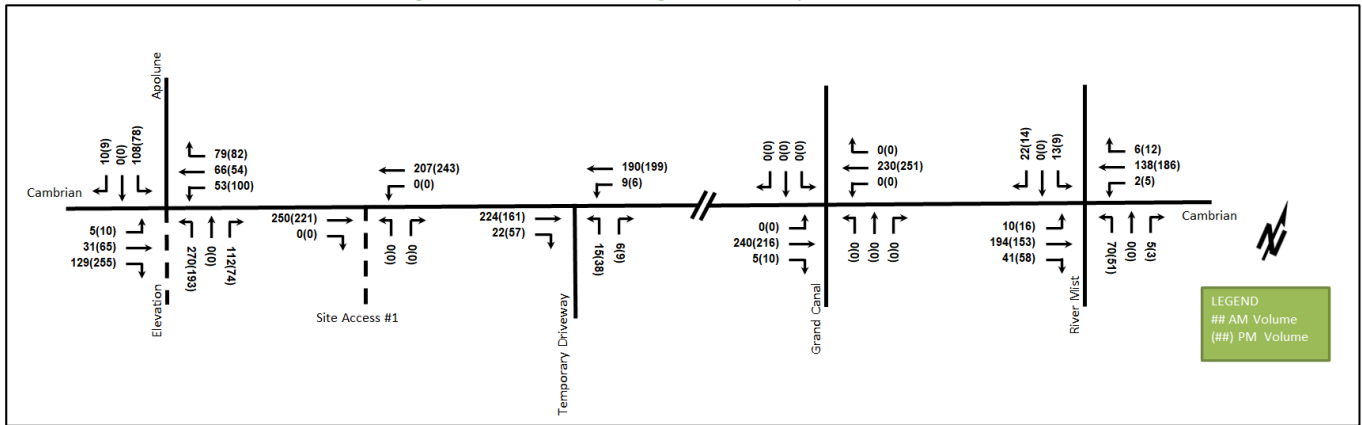

Figure 15: 2030 Total Background Development Volumes



7 Demand Rationalization

7.1 2025 Future Background Operations

The signalized intersection of Cambrian Road at Apolune Street/Elevation Road includes auxiliary left-turn lanes on all approaches. Figure 16 illustrates the 2025 background volumes and Table 12 summarizes the 2025 background intersection operations. Synchro 11 has been used to model the unsignalized intersections and HCM 2010 methodology was used for unsignalized intersection operation. The synchro worksheets for the 2025 future background horizon are provided in Appendix G.

Signal warrant analysis was performed for the intersections of Cambrian Road at River Mist Road and Cambrian Road at Grand Canal Street and continues to not meet signal warrants. As the City does not have a planned improvement at this location, it is assumed to remain as an all-way stop-controlled intersection. Signal warrant calculation sheets are provided in Appendix H.

Figure 16: 2025 Future Background Volumes

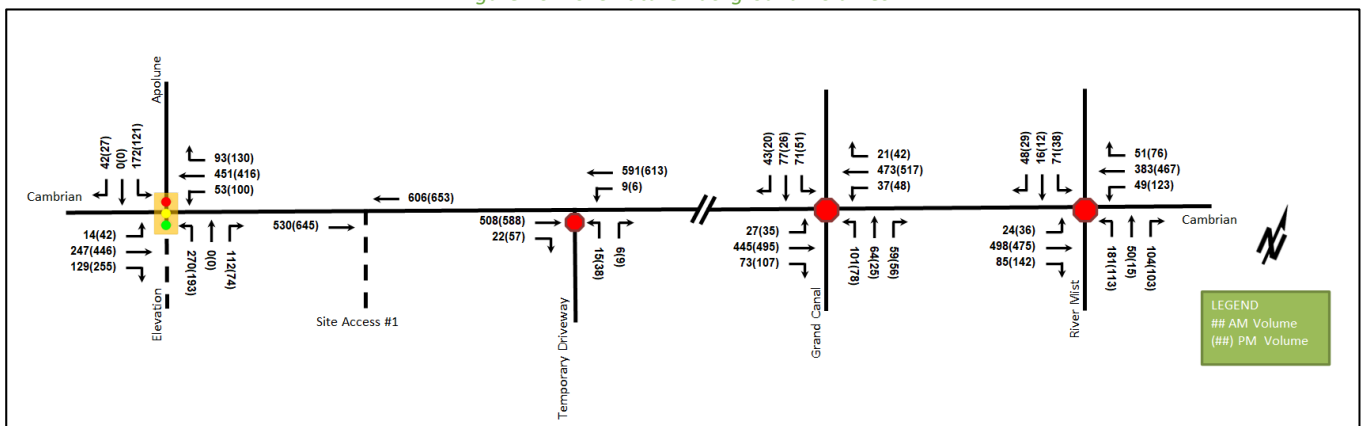

Table 12: 2025 Future Background Intersection Operations

Intersection	Lane	AM Peak Hour				PM Peak Hour			
		LOS	V/C	Delay (s)	Q (95 th)	LOS	V/C	Delay (s)	Q (95 th)
Cambrian Road at River Mist Road <i>Unsignalized</i>	EB	F	1.20	145.7	179.3	F	1.14	92.7	144.0
	WB	F	1.04	66.7	94.5	F	1.16	106.4	158.3
	NB	D	0.76	29.8	42.0	C	0.50	17.5	18.0
	SB	C	0.35	17.0	10.5	B	0.19	13.6	4.5
	Overall	F	-	85.2	-	F	-	83.8	-
Cambrian Road at Apolune Street <i>Signalized</i>	EBL	A	0.04	9.6	3.6	A	0.08	7.4	8.2
	EBT/R	A	0.44	11.0	49.2	A	0.59	11.6	128.5
	WBL	A	0.11	9.8	9.4	A	0.25	9.4	19.4
	WBT/R	B	0.65	16.7	#95.7	A	0.51	10.5	94.3
	NBL	C	0.77	37.7	51.5	C	0.78	65.9	63.7
	NBT/R	A	0.14	0.3	0.0	A	0.12	0.4	0.0
	SBL	A	0.58	29.0	33.5	A	0.57	53.1	41.9
	SBT/R	A	0.07	0.2	0.0	A	0.04	0.1	0.0
Overall	B	0.69	18.4	-	B	0.63	19.0	-	
Cambrian Road at Grand Canal Street <i>Unsignalized</i>	EB	F	1.05	81.1	120.0	F	1.05	71.3	126.0
	WB	F	1.04	71.3	108.0	F	1.01	62.3	112.5
	NB	C	0.52	19.7	21.0	B	0.34	14.4	10.5
	SB	C	0.46	18.2	16.5	B	0.22	13.3	6.0
	Overall	F	-	60.3	-	F	-	57.9	-
Cambrian Road at Temporary Driveway <i>Unsignalized</i>	EB	-	-	-	-	-	-	-	-
	WB	A	0.01	8.5	0.0	A	0.01	8.9	0.0
	NB	C	0.08	19.5	2.3	D	0.22	26.2	6.0
	Overall	A	-	0.4	-	A	-	1.0	-

Notes: Saturation flow rate of 1800 veh/h/lane
Peak Hour Factor = 1.00
V/C = volume-to-capacity ratio

Delay = average vehicle delay in seconds
m = metered queue
= volume for the 95th %ile cycle exceeds capacity

The intersections of Cambrian Road at River Mist Road and at Grand Canal Street may experience high delays and extended queues during peak hours on the eastbound and westbound movements due to the background development.

The westbound share through/right-turn movement at the intersection of Cambrian Road at Apolune Street during the AM peak may be subject to extended queues.

The capacity issues are due to the background developments and are considered the responsibility of the City to address through DC funding.

7.2 2030 Future Background Operations

Figure 17 illustrates the 2030 background volumes and Table 13 summarizes the 2030 background intersection operations. Synchro 11 has been used to model the unsignalized intersections and HCM 2010 methodology was used for unsignalized intersection operation. The synchro worksheets for the 2030 future background horizon are provided in Appendix I.

Signal warrant analysis was performed for the intersections of Cambrian Road at River Mist Road and Cambrian Road at Grand Canal Street and continues to not meet signal warrants. As the City does not have a planned improvement at this location, it is assumed to remain as an all-way stop-controlled intersection. Signal warrant calculation sheets are provided in Appendix H.

Figure 17: 2030 Future Background Volumes

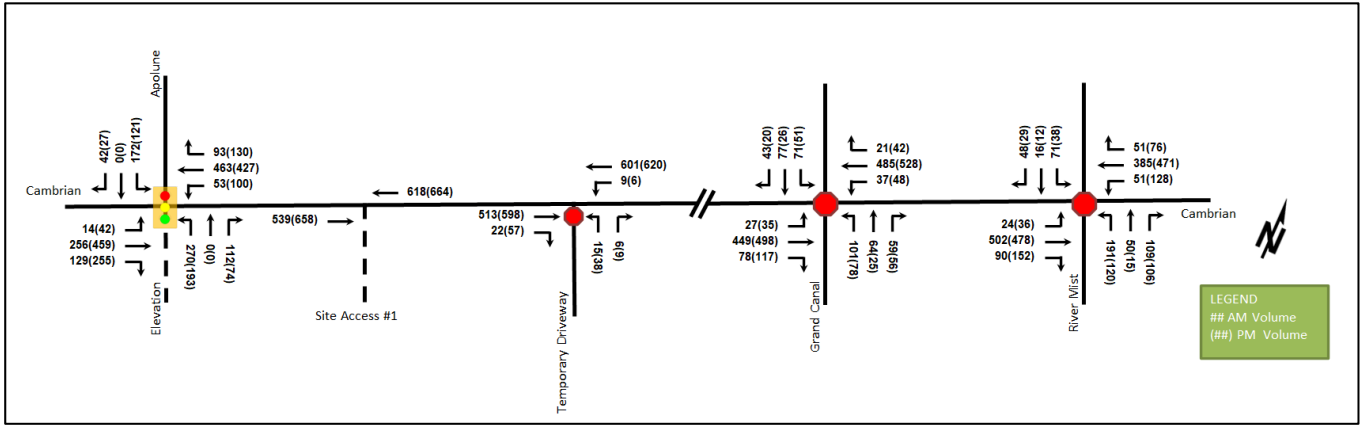

Table 13: 2030 Future Background Intersection Operations

Intersection	Lane	AM Peak Hour				PM Peak Hour			
		LOS	V/C	Delay (s)	Q (95 th)	LOS	V/C	Delay (s)	Q (95 th)
Cambrian Road at River Mist Road <i>Unsignalized</i>	EB	F	1.25	155.2	185.3	F	1.18	104.5	155.3
	WB	F	1.08	73.0	99.0	F	1.21	116.7	167.3
	NB	D	0.81	33.1	47.3	C	0.53	18.3	19.5
	SB	C	0.36	17.4	10.5	B	0.20	13.9	4.5
	Overall	F	-	91.4	-	F	-	92.6	-
Cambrian Road at Apolune Street <i>Signalized</i>	EBL	A	0.04	9.6	3.6	A	0.08	7.4	8.2
	EBT/R	A	0.46	11.2	50.8	A	0.60	11.9	133.1
	WBL	A	0.11	9.9	9.4	A	0.26	9.6	19.6
	WBT/R	B	0.66	17.3	#107.4	A	0.52	10.7	97.4
	NBL	C	0.77	37.7	51.5	C	0.78	65.9	63.7
	NBT/R	A	0.14	0.4	0.0	A	0.12	0.4	0.0
	SBL	A	0.58	29.0	33.5	A	0.57	53.1	41.9
	SBT/R	A	0.07	0.2	0.0	A	0.04	0.1	0.0
Overall	B	0.70	18.6	-	B	0.64	19.1	-	
Cambrian Road at Grand Canal Street <i>Unsignalized</i>	EB	F	1.08	83.4	121.5	F	1.06	78.9	135.0
	WB	F	1.07	78.7	115.5	F	1.03	64.9	115.5
	NB	C	0.53	19.9	21.0	B	0.34	14.5	10.5
	SB	C	0.46	18.3	16.5	B	0.22	13.3	6.0
	Overall	F	-	64.1	-	F	-	62.3	-
Cambrian Road at Temporary Driveway <i>Unsignalized</i>	EB	-	-	-	-	-	-	-	-
	WB	A	0.01	8.5	0.0	A	0.01	8.9	0.0
	NB	C	0.08	19.8	2.3	D	0.22	26.9	6.0
	Overall	A	-	0.4	-	A	-	1.0	-

Notes: Saturation flow rate of 1800 veh/h/lane
Queue is measured in metres
Peak Hour Factor = 1.00

Delay = average vehicle delay in seconds
m = metered queue
= volume for the 95th %ile cycle exceeds capacity

Intersections within the study area will operate similar to the 2025 future background condition, with decreasing operations due to the background developments.

Capacity issues will remain at the intersections of Cambrian Road at River Mist Road and Cambrian Road at Grand Canal Street. Similar to the 2025 future background horizon, the capacity issues at Cambrian Road at River Mist Road and at Grand Canal Street are due to the background developments and are considered the responsibility of the City.

7.3 2025 Future Total Operations

Figure 18 illustrates the 2025 future total volumes and Table 14 summarizes the 2025 future total intersection operations. Synchro 11 has been used to model the unsignalized intersections and HCM 2010 methodology was used for unsignalized intersection operation. The synchro worksheets for the 2025 future total horizon are provided in Appendix J.

Signal warrant analysis was performed for the intersections of Cambrian Road at River Mist Road and Cambrian Road at Grand Canal Street and continues to not meet signal warrants. As the City does not have a planned improvement at this location, it is assumed to remain as an all-way stop-controlled intersection. Signal warrant calculation sheets are provided in Appendix H.

Figure 18: 2025 Future Total Volumes

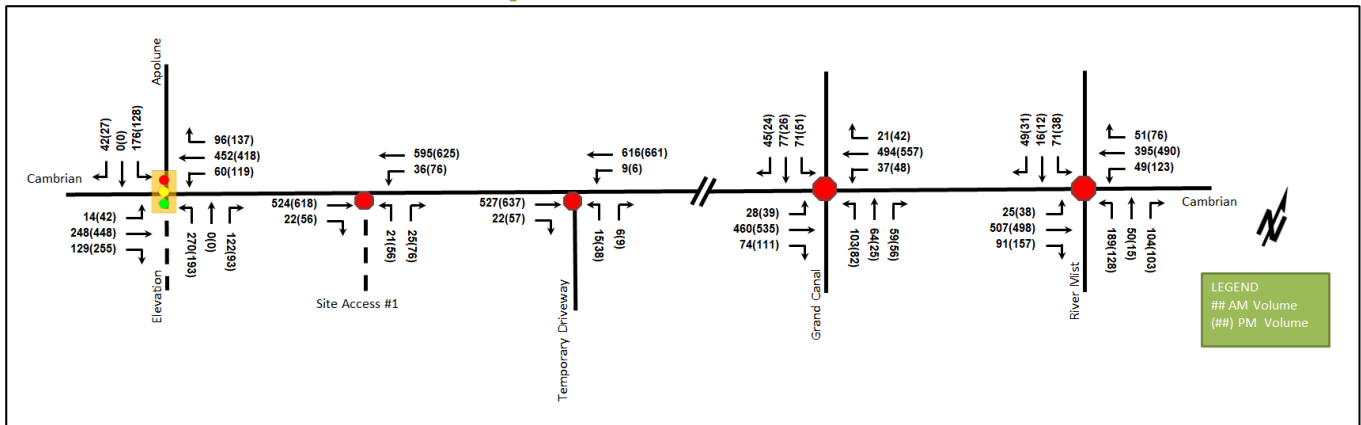

Table 14: 2025 Future Total Intersection Operations

Intersection	Lane	AM Peak Hour				PM Peak Hour			
		LOS	V/C	Delay (s)	Q (95 th)	LOS	V/C	Delay (s)	Q (95 th)
Cambrian Road at River Mist Road <i>Unsignalized</i>	EB	F	1.27	160.0	189.8	F	1.24	126.4	177.8
	WB	F	1.09	76.4	102.8	F	1.25	131.0	180.0
	NB	D	0.80	32.2	45.0	C	0.55	18.8	20.3
	SB	C	0.37	17.5	10.5	B	0.21	14.2	5.3
	Overall	F	-	94.5	-	F	-	107.4	-
Cambrian Road at Apolune Street <i>Signalized</i>	EBL	A	0.04	9.6	3.6	A	0.08	7.4	8.2
	EBT/R	A	0.45	11.0	49.3	A	0.59	11.7	128.8
	WBL	A	0.12	10.0	10.3	A	0.30	10.2	23.6
	WBT/R	B	0.65	16.9	#98.2	A	0.52	10.7	96.5
	NBL	C	0.77	37.7	51.5	C	0.78	65.9	63.7
	NBT/R	A	0.15	0.4	0.0	A	0.15	0.5	0.0
	SBL	A	0.60	29.9	34.6	B	0.61	55.7	44.4
	SBT/R	A	0.07	0.2	0.0	A	0.04	0.1	0.0
Overall	B	0.69	18.4	-	B	0.63	19.1	-	
Cambrian Road at Grand Canal Street <i>Unsignalized</i>	EB	F	1.10	91.2	128.3	F	1.15	101.1	159.0
	WB	F	1.09	86.5	123.0	F	1.10	83.3	135.8
	NB	C	0.54	20.3	21.0	B	0.36	15.0	11.3
	SB	C	0.47	18.7	16.5	B	0.24	13.8	6.0
	Overall	F	-	69.9	-	F	-	79.6	-

Intersection	Lane	AM Peak Hour				PM Peak Hour			
		LOS	V/C	Delay (s)	Q (95 th)	LOS	V/C	Delay (s)	Q (95 th)
Cambrian Road at Temporary Driveway Unsignalized	EB	-	-	-	-	-	-	-	-
	WB	A	0.01	8.6	0.0	A	0.01	9.0	0.0
	NB	C	0.08	20.4	2.3	D	0.25	30.1	6.8
	Overall	A	-	0.4	-	A	-	1.1	-
Cambrian Road at Site Access #1 Unsignalized	EB	-	-	-	-	-	-	-	-
	WB	A	0.04	8.6	0.8	A	0.08	9.3	2.3
	NB	B	0.05	11.9	0.8	B	0.16	14.1	4.5
	Overall	A	-	0.7	-	A	-	1.7	-

Notes: Saturation flow rate of 1800 veh/h/lane
 Queue is measured in metres
 Peak Hour Factor = 1.00
 Delay = average vehicle delay in seconds
 m = metered queue
 # = volume for the 95th %ile cycle exceeds capacity

The study area intersections will operate similar to the 2025 future background condition. No additional capacity issues are noted.

The site is anticipated to generate less than a 3.0% increase in traffic during the AM peak and less than a 5.8% increase during the PM peak on Cambrian Road at the River Mist Road intersection and generate less than a 4.3% increase in traffic during the AM peak and less than a 7.2% increase during the PM peak on Cambrian Road at Grand Canal Street intersection. These volume increases are not considered significant impacts on the intersections and remain the responsibility of the City to address through DC funding.

7.4 2030 Future Total Operations

Figure 19 illustrates the 2030 future total volumes and Table 15 summarizes the 2030 future total intersection operations. Synchro 11 has been used to model the unsignalized intersections and HCM 2010 methodology was used for unsignalized intersection operation. The synchro worksheets for the 2030 future total horizon are provided in Appendix K.

Signal warrant analysis was performed for the intersections of Cambrian Road at River Mist Road and Cambrian Road at Grand Canal Street and continues to not meet signal warrants. As the City does not have a planned improvement at this location, it is assumed to remain as an all-way stop-controlled intersection. Signal warrant calculation sheets are provided in Appendix H.

Figure 19: 2030 Future Total Volumes

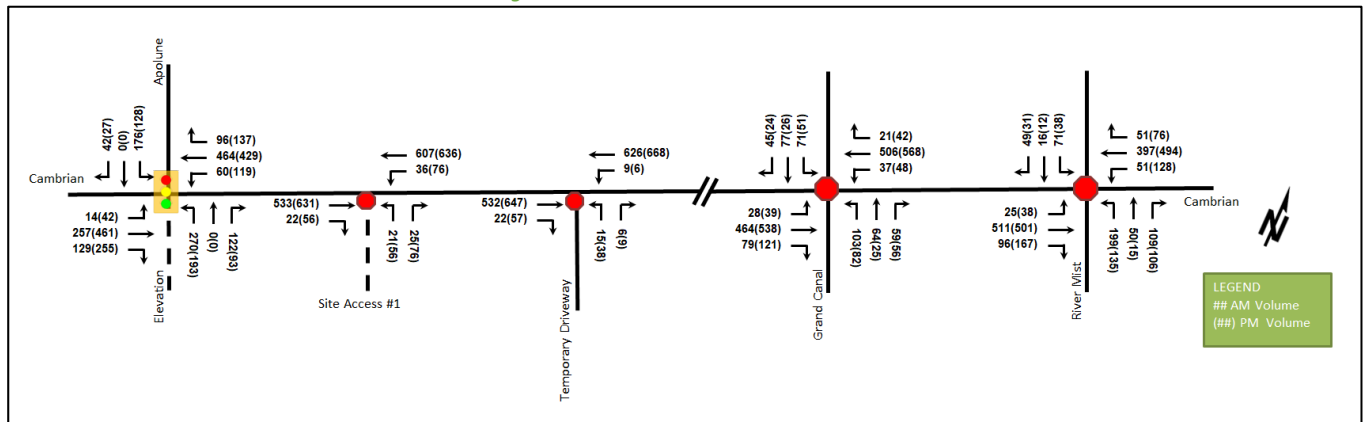

Table 15: 2030 Future Total Intersection Operations

Intersection	Lane	AM Peak Hour				PM Peak Hour			
		LOS	V/C	Delay (s)	Q (95 th)	LOS	V/C	Delay (s)	Q (95 th)
Cambrian Road at River Mist Road <i>Unsignalized</i>	EB	F	1.30	166.5	193.5	F	1.28	140.0	189.0
	WB	F	1.11	83.5	108.0	F	1.28	142.7	189.8
	NB	E	0.84	35.6	50.3	C	0.58	19.8	22.5
	SB	C	0.37	17.9	11.3	B	0.21	14.4	5.3
	Overall	F	-	99.7	-	F	-	117.6	-
Cambrian Road at Apolune Street <i>Unsignalized</i>	EBL	A	0.04	9.6	3.7	A	0.09	7.5	8.2
	EBT/R	A	0.46	11.2	51.2	A	0.60	11.9	133.3
	WBL	A	0.12	10.0	10.4	A	0.31	10.4	23.9
	WBT/R	B	0.67	17.5	#108.7	A	0.53	10.9	99.8
	NBL	C	0.77	37.7	51.5	C	0.78	65.9	63.7
	NBT/R	A	0.15	0.4	0.0	A	0.15	0.5	0.0
	SBL	A	0.60	29.9	34.6	B	0.61	55.7	44.4
	Overall	B	0.70	18.6	-	B	0.64	19.2	-
Cambrian Road at Grand Canal Street <i>Unsignalized</i>	EB	F	1.12	98.2	135.0	F	1.18	109.1	167.3
	WB	F	1.12	95.5	132.0	F	1.12	89.9	143.3
	NB	C	0.54	20.5	21.0	C	0.36	15.1	11.3
	SB	C	0.47	18.8	16.5	B	0.24	13.9	6.0
	Overall	F	-	76.1	-	F	-	85.9	-
Cambrian Road at Temporary Driveway <i>Unsignalized</i>	EB	-	-	-	-	-	-	-	-
	WB	A	0.01	8.6	0.0	A	0.01	9.0	0.0
	NB	C	0.08	20.8	2.3	D	0.25	30.8	7.5
	Overall	A	-	0.4	-	A	-	1.1	-
Cambrian Road at Site Access #1 <i>Unsignalized</i>	EB	-	-	-	-	-	-	-	-
	WB	A	0.04	8.7	0.8	A	0.08	9.3	2.3
	NB	B	0.05	12.0	1.5	B	0.17	14.3	4.5
	Overall	A	-	0.7	-	A	-	1.7	-

Notes: Saturation flow rate of 1800 veh/h/lane
Queue is measured in metres
Peak Hour Factor = 1.00

Delay = average vehicle delay in seconds
m = metered queue
= volume for the 95th %ile cycle exceeds capacity

The Cambrian Road at River Mist Road intersection will operate similar to the 2030 future background condition. No additional capacity issues are noted.

As outlined in the 2025 future total conditions, the site-generated volumes will have minimal impact on the intersections of Cambrian Road at River Mist Road and Cambrian Road at Grand Canal Street. The capacity issues are due to the background developments and are considered the responsibility of the City to address through DC funding.

7.5 Modal Share Sensitivity and Demand Rationalization Conclusions

7.5.1 Network Rationalization

The background conditions identify capacity constraints at the intersection control at the Cambrian Road at River Mist Road and Cambrian Road at Grand Canal Street intersections. Specifically, these are related to the eastbound and westbound movement during the AM and PM peak hours. These operational constraints are expected and have been reported previously in area TIAs that have assessed these intersections. The proposed site has minimal impact on the Cambrian Road volumes.

In the short term, motorist behavior may start to change to take alternative routes through the community to avoid these constraints. This has already been occurring with area diversions to Half Moon Bay at Greenbank Road where the City has addressed these diversions with a new mini-roundabout intersection.

Ultimately, the signalization of the intersections would be a local improvement for operations at these intersections, and more regional solution is the Re-Aligned Greenbank Road implementation south beyond Cambrian Road. The segment south of Cambrian Road would allow motorists to access the north-south arterial road network from east-west collections (e.g. Dundonald) rather than needing to use Cambrian Road for that connectivity.

Beyond the infrastructure noted, the subject site is a step towards mitigating the current vehicle trips headed to retail and grocery options north of the Jock River. It may not have a notable reduction on Cambrian Road at this time, but it likely has regional benefits that balance out the existence of the local constraints.

7.5.2 Development Rationalization

The proposed trip generation rates and modal shares are consistent with the surrounding area context and do not unduly impact the surrounding road network. No site-specific demand rationalization is considered necessary as part of this TIA.

8 Development Design

8.1 Design for Sustainable Modes

The proposed development is a retail development with surface parking for both automobiles and bicycles. A total of 180 vehicle parking spaces will be provided for the grocery store and retail.

A bus stop is proposed to locate on the boundary road of the future Re-Aligned Greenbank Road approximately 34.0 metres from the future Re-Aligned Greenbank Road at Cambrian Road intersection and approximately 2.7 metres from Access #2.

Future pedestrian and cycling facilities along Cambrian Road and Re-Aligned Greenbank Road are planned to be provided beyond the study horizon.

Concrete sidewalks are proposed along the frontage of the grocery store and retail to connect to the Re-Aligned Greenbank Road and proposed bus stop.

8.2 Circulation and Access

Within the study horizon, Access #1 will accommodate vehicles accessing the site, and access will be all-movement access. The two-way access onto Cambrian Road is 6.7 metres wide and the throat length is 29.5 metres, although it is functionally longer with a total of 48.5 metres measured from Cambrian Road to the first conflict point on-site. The internal drive aisles are 6.5 to 6.7 metres. The loading areas are provided at the back of the grocery store (Retail A) and on the west side of the retail store (Retail B). The delivery trucks and garbage collection vehicle turning templates during the interim condition were reviewed to confirm movements will be permitted on site, and the turning templates are provided in Appendix L.

Beyond 2031, Access #1 will become right-in/right-out with the new median as part of the Re-Aligned Greenbank Road and Cambrian Road signalized intersection when constructed by the City. Similarly, the right-in/right-out Accesses #2 will be opened with the Re-Aligned Greenbank Road construction. Access #2 width will be 6.7 metres and have an expected throat length of 10.5 metres, and it is functionally longer with a total of 15.0 metres

measured from Re-Aligned Greenbank Road to the first conflict point on-site. Actual throat lengths will be dependent on the City design for Cambrian Road and Re-Aligned Greenbank Road.

Access #1 is approximately 64 metres from the future Re-Aligned Greenbank Road and Cambrian Road intersection, which meets the minimum corner clearance of 25 metres from TAC (2017). On the north side of Cambrian Road, the 3850 Cambrian Road development has an access proposed approximately 30 metres to the west of Access #1. TAC notes that the relative location should be examined but provides no direct guidance on the desirable offset except in conditions with inter-development interaction is expected to be significant. The drive-way volumes are not considered to be significant and low inter-development interaction is expected. As further examination, the left-turn movements were modeled with Auto-Turn to show possible conflicts and are provided in Appendix L. General automobile and larger truck (garbage truck) movements will have no overlap in travel sweeps and can be completed without concern should they proceed at the same time. Truck/trailer (WB-20) vehicles would overlap should they proceed to make opposing left-turn movements at the same time. This situation is considered to be an exceedingly rare occurrence and would not be a typical design consideration at access locations. Overall, this condition can be permitted during the interim condition prior to Cambrian Road becoming a divided road as part of the Re-Aligned Greenbank Road construction, where no interaction between the access would be permitted.

Beyond 2031, Access #1 a right-in/right-out access, and it will meet the minimum corner clearance of left-turn storage length metres from TAC (2017). Access #2 would be located approximately 37 metres from the future Re-Aligned Greenbank Road and Cambrian Road intersection. The right-in/right-out restrictions on the future access conditions necessitate accesses be provided on both Cambrian Road and Re-Aligned Greenbank Road. The interaction between the bus stop and access was considered and it was preferred to limit the interaction of vehicles weaving around a stopped bus to enter the driveway. If further south, space would be available for vehicles to bypass the bus, creating conflict points as the bus pulls out, or attempts to transition towards the centre median lanes.

The current design activities for Re-Aligned Greenbank Road will need to consider and be supportive of the surrounding land-use, either approved, in application, or planned through the Barrhaven South Community Design Plan and Barrhaven South Community Core Concept Plan and Design Framework.

9 Parking

9.1 Parking Supply

The site provides a total of 180 vehicle surface parking spaces and eight bicycle parking spaces. The minimum parking provision is 3.6 vehicle parking spaces per 100 m² of gross floor area and 1 bike space per 500 m² of gross floor area, which is 132 vehicle parking spaces and eight bicycle parking spaces, and the minimum vehicle and bicycle parking requirements are satisfied.

Based on the City of Ottawa Traffic and Parking (By-law No. 2017-301), a total of two accessible parking spaces are required. The site provides a total of eight accessible parking spaces, and it meets the requirements.

10 Boundary Street Design

Table 16 summarizes the MMLoS analysis for the boundary streets of Cambrian Road. The boundary street analysis is based on the land use of “General Urban Area” and the policy area of “Within 300 metres of a school”. The MMLoS worksheets have been provided in Appendix M.

Table 16: Boundary Street MMLOS Analysis

Segment	Pedestrian LOS		Bicycle LOS		Transit LOS		Truck LOS	
	PLOS	Target	BLOS	Target	TLOS	Target	TrLOS	Target
Cambrian Road (Existing)	F	C	F	B	N/A	N/A	N/A	N/A
Cambrian Road (Future)	C	A	A	B	N/A	N/A	N/A	N/A
Re-Aligned Greenbank Road (Future)	D	A	A	A	A	A	A	D

Cambrian Road does not meet the pedestrian MMLOS targets and the operating speed would need to be lower than 30 km/h. Cambrian Road does not meet the bicycle MMLOS targets in the existing condition but will be met in the future condition.

No mitigation for the boundary street design of Cambrian Road is required as part of this application and require higher level City adjustments to the road operations, such as speed limits.

Future Re-Aligned Greenbank Road will not meet the pedestrian MMLOS target and needs at least 2 metre-wide of sidewalk and boulevard. The City's design team will need to rationalize the various elements and targets for the roadway.

11 Access Intersections Design

11.1 Location and Design of Access

The site is proposed to have a full-movement access (Access #1) within the study horizon years. Once the Re-Aligned Greenbank Road is built (Beyond 2031), right-in/right-out Access #2 will be provided along Re-Aligned Greenbank Road. Both accesses are proposed to be 6.7 metres wide and meet the private approach by law.

The TAC Geometric Design Guidelines throat length requirements for a grocery store of this size on an arterial road is 25.0 metres, as measured from the end of the corner radii. Access #1 will have a throat length of 29.5 metres, which is functionally longer with a total of 48.5 metres measured from Cambrian Road to the first conflict point on-site, and it meets the throat length requirement. Access #2 throat length is expected to have a throat length of 10.5 metres. This length is less than 15.0 metres primarily due to the larger radii required to support larger truck movements, and the actual space from Greenbank Road to the first conflict point on-site would be approximately 15.0 metres, depending on the City design for Cambrian Road and Re-Aligned Greenbank Road.

Overall, no concerns are noted with the proposed configurations and are considered to meet the intentions of TAC in function and future operations.

11.2 Intersection Control

Based upon the projected volumes, the site access will have stop-control on the minor approach.

11.3 Access Intersection Design

11.3.1 Future Access Intersection Operations

The operations are noted in Section 7.4 and both 2025 and 2030 future total access intersections operate well with all movements and the overall intersection operating at LOS A.

11.3.2 Access Intersection MMLOS

Based upon the projected volumes, the site access will have stop-control on the minor approach.

11.3.3 Recommended Design Elements

No changes to the site accesses are proposed.

12 Transportation Demand Management

12.1 Context for TDM

The mode shares used within the TIA represent the unmodified district shares for the Barrhaven South. A shift from auto modes to transit modes, in both the subject and surrounding developments, may be anticipated once the BRT network is extended along the Re-Aligned Greenbank Road Corridor, but any such shifts are expected to occur outside of the analysis horizons of this report. Overall, the modal shares are likely to be achieved and supporting TDM measures should be provided.

The subject site is within the Barrhaven South Community Core design priority area.

12.2 Need and Opportunity

The subject site has been assumed to rely predominantly on auto travel and those assumptions have been carried through the analysis.

12.3 TDM Program

The “suite of post occupancy TDM measures” has been summarized in the TDM checklists for the non-residential land uses. The checklist is provided in Appendix N. The key TDM measures recommended include:

- Provide a multimodal travel option package to new/relocating employees

13 Transit

13.1 Route Capacity

In Section 5.1 the trip generation by mode was estimated, including an estimate of the number of transit trips that will be generated by the proposed development. Table 17 summarizes the transit trip generation.

Table 17: Trip Generation by Transit Mode

Travel Mode	Mode Share	AM Peak Hour			PM Peak Hour		
		In	Out	Total	In	Out	Total
Transit	1%	1	0	1	2	2	4

The proposed development is anticipated to generate an additional 1 AM and 4 PM peak hour two-way transit trips. Overall, the existing transit service is expected to be accommodate these increased riders and be predominantly localized trips within Barrhaven South.

13.2 Transit Priority

Examining the study area intersection delays, negligible impacts are noted on the transit movements and no decrease in transit LOS at the study area intersections is noted as a result of forecasted site-generated traffic. It is expected that the local transit service may be reconfigured or improved by the City once the Re-Aligned Greenbank Road and Cambrian Road widening are completed, and it is outside of the study horizons.

14 Network Intersection Design

14.1 Network Intersection Control

No change to the existing signalized control is recommended for the network intersections.

14.2 Network Intersection Design

14.2.1 2025 & 2030 Future Total Network Intersection Operations

The operations are noted in Section 7.4 and no changes on the intersections within the study area are required.

14.2.2 Network Intersection MMLOS

Table 18 summarizes the MMLOS analysis for the intersection of Cambrian Road at Apolune Street/Elevation Road. The existing intersection is not signalized and therefore only the future conditions will be analyzed. The future intersection geometry is assumed to be the same as the functional design completed by Stantec without cycling infrastructure along the Cambrian Road within the study horizon years. The intersection analysis is based on the land use of “General Urban Area” and the policy area of “Within 300 metres of a school”. The MMLOS worksheets have been provided in Appendix M.

Table 18: Study Area Intersection MMLOS Analysis

Intersection	Pedestrian LOS		Bicycle LOS		Transit LOS		Truck LOS		Auto LOS	
	PLOS	Target	BLOS	Target	TLOS	Target	TrLOS	Target	ALOS	Target
Cambrian Rd at Apolune St / Elevation Rd	E	A	E	B	N/A	N/A	N/A	N/A	B	D

The MMLOS targets will not be met for the pedestrian and bicycle LOS in the future condition within the study horizon years at the intersection of Cambrian Road at Apolune Street/Elevation Road. The pedestrian level of service would require crossing distances of a maximum of two lane-widths per crossing and protected left-turn on each approach to meet a LOS A. The left-turn configurations would need to be two-stage or include turn boxes on each approach to meet the bicycle LOS target. The City will be responsible for exploring options to address the area PLOS and BLOS deficiencies for this intersection.

The MMLOS review for the Re-Aligned Greenbank Road is considered a responsibility of the City and their current design exercise. As they are currently working through this design, any review within this study would be premature.

14.2.3 Recommended Design Elements

No study area intersection design elements are proposed as part of this study.

15 Summary of Improvements Indicated and Modifications Options

The following summarizes the analysis and results presented in this TIA report:

Proposed Site and Screening

- The proposed site includes a 34,496 sq. ft. of grocery store and a 4,794 sq. ft. of retail store totaling 39,290 sq. ft
- The concept plan includes one new full-movement access on Cambrian Road in the interim condition
- In the ultimate condition, a right-in/right-out access is proposed on Re-Aligned Greenbank Road corridor, and the access on Cambrian Road will be a right-in/right-out access
- The development is proposed to be completed as a single phase by 2025
- The trip generation and location triggers were met for the TIA Screening

Existing Conditions

- Cambrian Road is an arterial road, and River Mist Road and Apolune Street are collector roads in the study area
- Sidewalks are provided on both sides of Cambrian Road east of Seeley's Bay Street, River Mist Road, and Apolune Street and on the west side of Grand Canal Street
- Paved shoulders are provided on both sides along Cambrian Road between Borrisokane Road and Cambrian Road at Apolune Street/Elevation Road
- Re-Aligned Greenbank Road will be a spine cycling route, and Cambrian Road, Apolune Street, and River Mist Road are local route
- The Transportation Master Plan Part 1 identifies Re-Aligned Greenbank Road for designation as a cross-town bikeway
- Within the study area, there are a total of two collisions during the 2016-2020 time period, and no further collision review is required as part of this study
- During peak hours in the existing conditions, the study area intersections operate well

Development Generated Travel Demand

- The proposed development is forecasted to produce 105 two-way people trips during the AM peak hour and 320 two-way people trips during the PM peak hour
- Of the forecasted people trips, 68 two-way trips will be vehicle trips during the AM peak hour and 152 two-way trips will be vehicle trips during the PM peak hour based on a 74% (61%) modal share target
- Of the forecasted trips, 10% are anticipated to travel north and the west, 50% to the east, and 30% to both the south
- The proposed trip generation rates and modal shares are consistent with the surrounding area context and do not unduly impact the surrounding road network

Background Conditions

- The signalized intersection of Cambrian Road at Apolune Street/Elevation Road, including the planned auxiliary lanes will be analyzed at all future horizons
- All growth is assumed to be captured within the background development; therefore, no annual growth rate will be applied
- Within the study horizons, a temporary road will be constructed on the south leg of the Cambrian Road at future Re-Aligned Greenbank Road intersection to serve as interim access for the future grocery site on the southeast quadrant of the intersection
- The background conditions identify capacity constraints related to the intersection control at the Cambrian Road at River Mist Road intersection
- The capacity issues at Cambrian Road at River Mist Road and at Grand Canal Street are due to the background developments and are considered the responsibility of the City
- In the short term, motorist behavior may start to change to take alternative routes through the community to avoid these constraints
- Ultimately, the signalization of the intersections would be a local improvement for operations at these intersections, and more regional solution is the Re-Aligned Greenbank Road implementation south beyond Cambrian Road

Development Design

- The proposed development is a retail development with surface parking for both automobiles and bicycles
- Future pedestrian and cycling facilities along Cambrian Road and future Greenbank Road are planned to be provided beyond the study horizon
- Two loading zones are provided within the development
- The delivery trucks and garbage collection vehicle turning templates during the interim condition were reviewed to confirm movements will be permitted on site
- Access #1 is approximately 64 metres from the future Re-Aligned Greenbank Road and Cambrian Road intersection, and it meets the minimum corner clearance from TAC (2017)
- Access #2 would be approximately 37 metres from the future Re-Aligned Greenbank Road and Cambrian Road intersection
- The right-in/right-out restrictions on the future access conditions necessitate accesses be provided on both Cambrian Road and Re-Aligned Greenbank Road
- The interaction between the bus stop and access was considered and it was preferred to limit the interaction of vehicles weaving around a stopped bus to enter the driveway
- On the north side of Cambrian Road, the 3850 Cambrian Road development has an access proposed approximately 30 metres to the west of Access #1, and general automobile and larger truck (garbage truck) movements will have no overlap in travel sweeps

Parking

- The site provides a total of 180 vehicle surface parking spaces and eight bicycle parking spaces
- The minimum parking requirements are satisfied

Boundary Street Design

- Cambrian Road does not meet the pedestrian MMLOS targets and needs less than 30 km/h operating speed
- Cambrian Road does not meet the bicycle MMLOS targets in the existing condition but will be met in the future condition
- No mitigation for the boundary street design of Cambrian Road is required as part of this application and require higher level City adjustments to the road operations, such as speed limits
- Future Re-Aligned Greenbank Road will not meet the pedestrian MMLOS target and needs at least 2 metre-wide of sidewalk and boulevard, and should be rationalized through the City's design team

Access Intersections Design

- The site accesses are proposed to be 6.7-metres-wide and operate with minor approach stop-controlled
- Once the Re-Aligned Greenbank Road is constructed by the City, the Access #2 can be opened and both accesses will operate as right-in/right-out
- The throat length requirement of 25.0 metres, per TAC, will be met at Access #1
- The throat length of Access #2 will depend on the final design for Re-Aligned Greenbank Road and is expected to be between 10 and 15 metres.
- No concerns are noted with the proposed configurations and are considered to meet the intentions of TAC in function and future operations
- Access #1 operates well and no issues are noted

TDM

- Supportive TDM measures to be included within the proposed development should include:
 - Provide a multimodal travel option package to new/relocating employees

Transit

- The proposed development is anticipated to generate an additional 1 AM and 4 PM peak hour two-way transit trips
- The existing transit service is expected to be accommodate these increased riders and be predominantly localized trips within Barrhaven South
- Negligible impacts are noted on the transit movements and no decrease in transit LOS at the study area intersections are noted as a result of forecasted site-generated traffic
- It is expected that the local transit service may be reconfigured or improved by the City once the Re-Aligned Greenbank Road and Cambrian Road widening are completed, and it is outside of the study horizons

Network Intersection Design

- The capacity issues are due to the background developments and are considered the responsibility of the City to address through DC funding
- No changes on the intersections within the study area are required
- No change to the existing signalized control is recommended for the network intersections
- The MMLOS targets will not be met the pedestrian and bicycle LOS at the intersections of Cambrian Road at Apolune Street/Elevation Road in the future conditions within the study horizon years
- Cambrian Road at Apolune Street/Elevation Road would require crossing distances of a maximum of two lane-widths per crossing and protected left-turn on each approach to meet the PLOS at this intersection
- Cambrian Road at Apolune Street/Elevation Road would require improved left-turn configurations on each approach to meet the BLOS at this intersection
- The City will be responsible for exploring options to address the area PLOS and BLOS deficiencies for Cambrian Road at Apolune Street/Elevation Road
- The MMLOS review for the Re-Aligned Greenbank Road is considered a responsibility of the City and their current design exercise. As they are currently working through this design, any review within this study would be premature

16 Conclusion

It is recommended that, from a transportation perspective, the proposed development applications proceed.

Prepared By:



Yu-Chu Chen, EIT
Transportation Engineering-Intern

Reviewed By:



Andrew Harte, P.Eng.
Senior Transportation Engineer

Appendix A

TIA Screening Form and PM Certification Form

City of Ottawa 2017 TIA Guidelines
Step 1 - Screening Form

Date: 24-Jun-22
Project Number: 2022-024
Project Reference: 3845 Cambrian

1.1 Description of Proposed Development	
Municipal Address	3845 Cambrian Road
Description of Location	Ward 3. 1.5 ha rectangular parcel on Cambrian Road between River Mist Road and Elevation Road
Land Use Classification	General Mixed Use Zone (GM[1628])
Development Size	A total of 49,100 sq ft (4561.54 sq m) retail
Accesses	One on Cambrian Road, three on the re-aligned Greenbank Road
Phase of Development	Single
Buildout Year	2025
TIA Requirement	Full TIA Required

1.2 Trip Generation Trigger		
Land Use Type	Destination retail	
Development Size	4,562	G.F.A.
Trip Generation Trigger	Yes	

1.3 Location Triggers		
Does the development propose a new driveway to a boundary street that is designated as part of the City's Transit Priority, Rapid Transit or Spine Bicycle Networks?	No	
Is the development in a Design Priority Area (DPA) or Transit-oriented Development (TOD) zone?	Yes	Barrhaven South Community Core design priority area
Location Trigger	Yes	

1.4. Safety Triggers	
Are posted speed limits on a boundary street 80 km/hr or greater?	No
Are there any horizontal/vertical curvatures on a boundary street limits sight lines at a proposed driveway?	No
Is the proposed driveway within the area of influence of an adjacent traffic signal or roundabout (i.e. within 300 m of intersection in rural conditions, or within 150 m of intersection in urban/ suburban conditions)?	No
Is the proposed driveway within auxiliary lanes of an intersection?	No
Does the proposed driveway make use of an existing median break that serves an existing site?	No
Is there is a documented history of traffic operations or safety concerns on the boundary streets within 500 m of the development?	No
Does the development include a drive-thru facility?	No
Safety Trigger	No



TIA Plan Reports

On 14 June 2017, the Council of the City of Ottawa adopted new Transportation Impact Assessment (TIA) Guidelines. In adopting the guidelines, Council established a requirement for those preparing and delivering transportation impact assessments and reports to sign a letter of certification.

Individuals submitting TIA reports will be responsible for all aspects of development-related transportation assessment and reporting, and undertaking such work, in accordance and compliance with the City of Ottawa's Official Plan, the Transportation Master Plan and the Transportation Impact Assessment (2017) Guidelines.

By submitting the attached TIA report (and any associated documents) and signing this document, the individual acknowledges that s/he meets the four criteria listed below.

CERTIFICATION

1. I have reviewed and have a sound understanding of the objectives, needs and requirements of the City of Ottawa's Official Plan, Transportation Master Plan and the Transportation Impact Assessment (2017) Guidelines;
2. I have a sound knowledge of industry standard practice with respect to the preparation of transportation impact assessment reports, including multi modal level of service review;
3. I have substantial experience (more than 5 years) in undertaking and delivering transportation impact studies (analysis, reporting and geometric design) with strong background knowledge in transportation planning, engineering or traffic operations; and
4. I am either a licensed¹ or registered² professional in good standing, whose field of expertise [check appropriate field(s)] is either transportation engineering or transportation planning .

1,2 License of registration body that oversees the profession is required to have a code of conduct and ethics guidelines that will ensure appropriate conduct and representation for transportation planning and/or transportation engineering works.

City Of Ottawa
Infrastructure Services and Community
Sustainability
Planning and Growth Management
110 Laurier Avenue West, 4th fl.
Ottawa, ON K1P 1J1
Tel. : 613-580-2424
Fax: 613-560-6006

Ville d'Ottawa
Services d'infrastructure et Viabilité des
collectivités
Urbanisme et Gestion de la croissance
110, avenue Laurier Ouest
Ottawa (Ontario) K1P 1J1
Tél. : 613-580-2424
Télécopieur: 613-560-6006

Dated at Ottawa this 20 day of September, 2018.
(City)

Name: Andrew Harte
(Please Print)

Professional Title: Professional Engineer



Signature of Individual certifier that s/he meets the above four criteria

Office Contact Information (Please Print)
Address: 6 Plaza Court
City / Postal Code: Ottawa / K2H 7W1
Telephone / Extension: (613) 697-3797
E-Mail Address: Andrew.Harte@CGHTransportation.com



Appendix B

Turning Movement Counts



Transportation Services - Traffic Services

Turning Movement Count - Study Results

CAMBRIAN RD @ RIVER MIST RD

Survey Date: Wednesday, October 23, 2019

WO No: 38918

Start Time: 07:00

Device: Miovision

Full Study Diagram

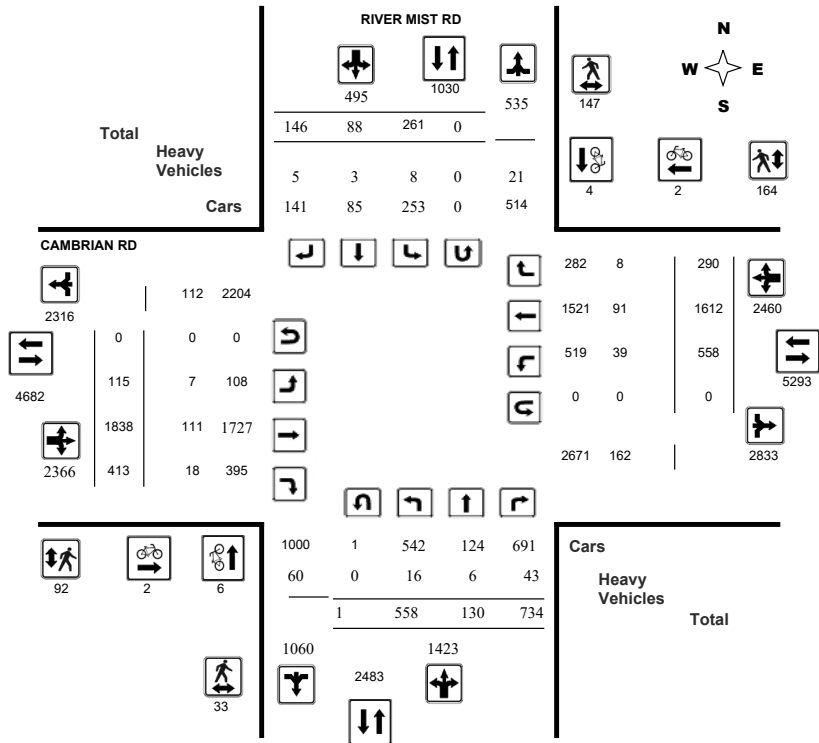

Transportation Services - Traffic Services

Turning Movement Count - Study Results

CAMBRIAN RD @ RIVER MIST RD

Survey Date: Wednesday, October 23, 2019

WO No: 38918

Start Time: 07:00

Device: Miovision

Full Study Peak Hour Diagram

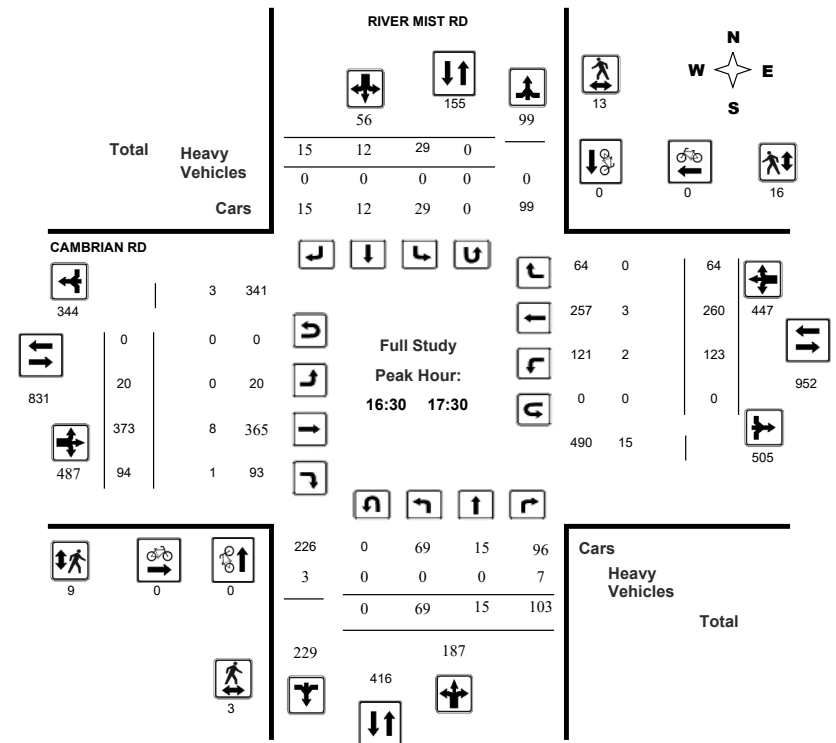



Transportation Services - Traffic Services

Turning Movement Count - Peak Hour Diagram

CAMBRIAN RD @ RIVER MIST RD

Survey Date: Wednesday, October 23, 2019
Start Time: 07:00

WO No: 38918
Device: Miovision

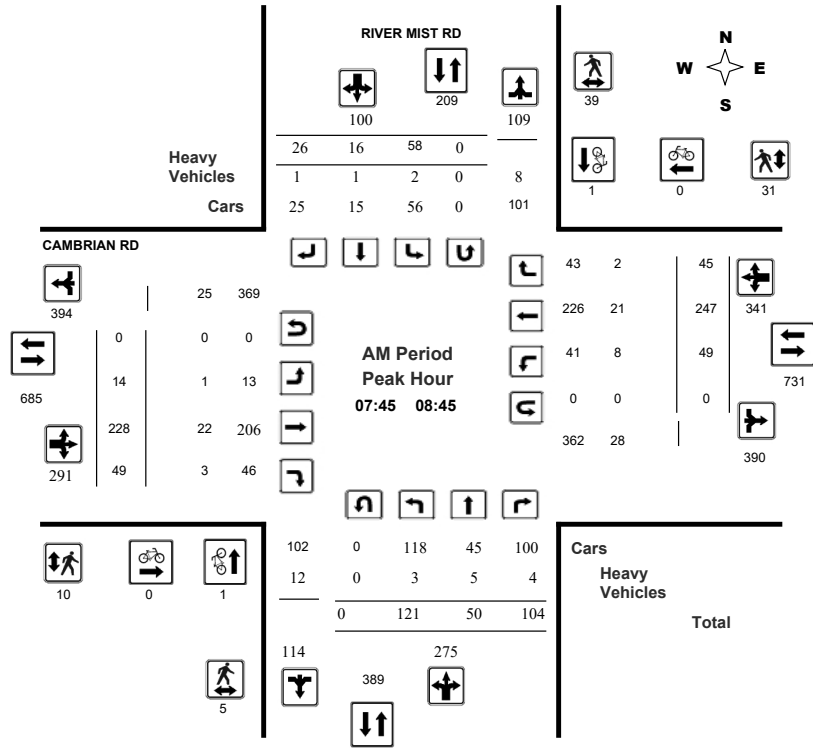

Comments



Transportation Services - Traffic Services

Turning Movement Count - Peak Hour Diagram

CAMBRIAN RD @ RIVER MIST RD

Survey Date: Wednesday, October 23, 2019
Start Time: 07:00

WO No: 38918
Device: Miovision

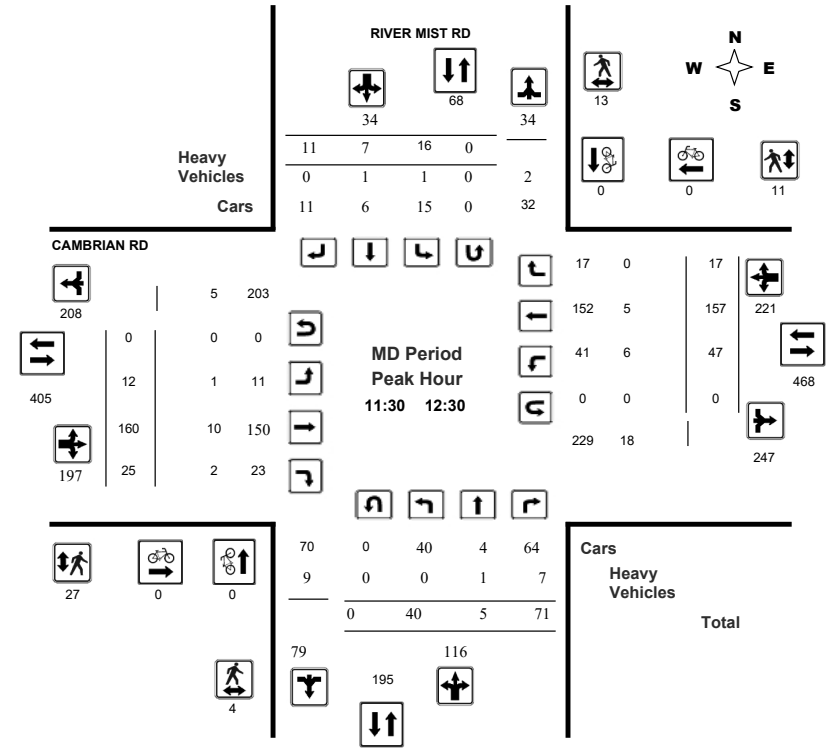

Comments



Transportation Services - Traffic Services
Turning Movement Count - Peak Hour Diagram
CAMBRIAN RD @ RIVER MIST RD

Survey Date: Wednesday, October 23, 2019
 Start Time: 07:00

WO No: 38918
 Device: Miovision

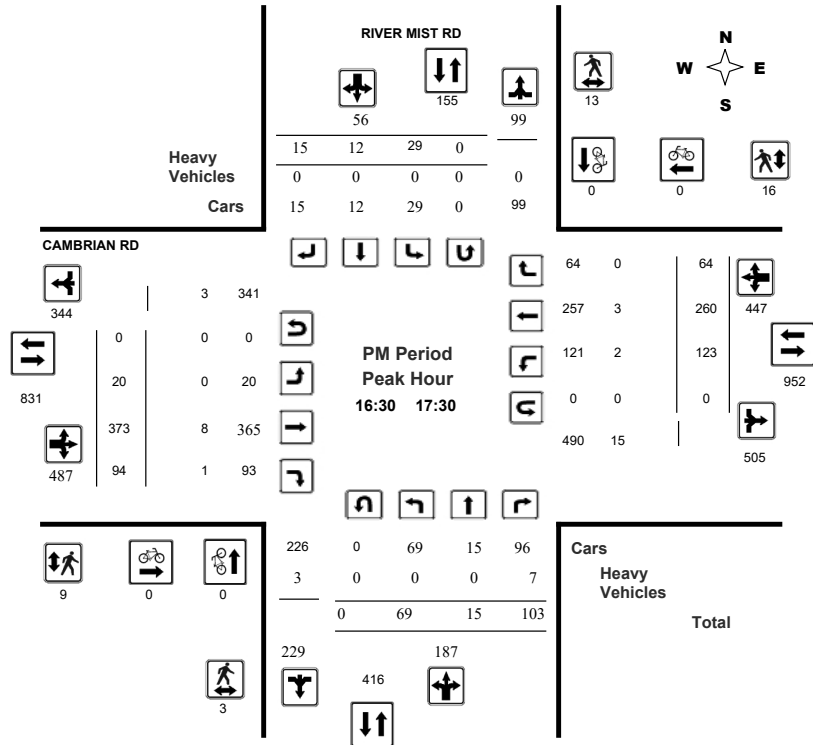

Comments



Transportation Services - Traffic Services
Turning Movement Count - Study Results
CAMBRIAN RD @ RIVER MIST RD

Survey Date: Wednesday, October 23, 2019
 Start Time: 07:00

WO No: 38918
 Device: Miovision

Full Study Summary (8 HR Standard)

Survey Date: Wednesday, October 23, 2019
 Total Observed U-Turns: Northbound: 1, Southbound: 0, Eastbound: 0, Westbound: 0
 AADT Factor: .90

Period	RIVER MIST RD										CAMBRIAN RD										Grand Total	
	Northbound					Southbound					Eastbound					Westbound						
	LT	ST	RT	NB TOT	STR TOT	LT	ST	RT	SB TOT	STR TOT	LT	ST	RT	EB TOT	STR TOT	LT	ST	RT	WB TOT	STR TOT		
07:00-08:00	112	19	133	264	337	42	6	25	73	337	12	198	38	248	248	35	227	35	297	297	545	882
08:00-09:00	113	47	100	260	358	54	19	25	98	358	13	226	45	284	284	56	246	36	338	338	622	980
09:00-10:00	82	9	107	198	246	22	10	16	48	246	9	149	28	186	186	46	173	21	240	240	426	672
11:30-12:30	40	5	71	116	150	16	7	11	34	150	12	160	25	197	197	47	157	17	221	221	418	568
12:30-13:30	24	6	55	85	111	11	1	14	26	111	8	150	34	192	192	41	140	26	207	207	399	510
15:00-16:00	57	17	80	154	239	50	15	20	85	239	17	229	65	311	311	85	167	38	290	290	601	840
16:00-17:00	61	13	87	161	223	32	15	15	62	223	20	371	76	467	467	121	254	54	429	429	896	1119
17:00-18:00	69	14	101	184	253	34	15	20	69	253	24	355	102	481	481	127	248	63	438	438	919	1172
Sub Total	558	130	734	1422	1917	261	88	146	495	1917	115	1838	413	2366	2366	558	1612	290	2460	2460	4826	6743
U Turns	1										0										1	
Total	558	130	734	1423	1918	261	88	146	495	1918	115	1838	413	2366	2366	558	1612	290	2460	2460	4826	6744
EQ 12Hr	776	181	1020	1978	2666	363	122	203	688	2666	160	2555	574	3289	3289	776	2241	403	3419	3419	6708	9374
Note: These values are calculated by multiplying the totals by the appropriate expansion factor.															1.39							
AVG 12Hr	658	153	865	1678	2399	308	104	172	584	2399	136	2167	487	2790	2790	658	1901	342	2900	2900	6037	8437
Note: These volumes are calculated by multiplying the Equivalent 12 hr. totals by the AADT factor.															0.9							
AVG 24Hr	862	201	1134	2198	2963	403	136	225	765	2963	178	2839	638	3654	3654	862	2490	448	3799	3799	7453	10416
Note: These volumes are calculated by multiplying the Average Daily 12 hr. totals by 12 to 24 expansion factor.															1.31							
Note: U-Turns provided for approach totals. Refer to 'U-Turn' Report for specific breakdown.																						



Transportation Services - Traffic Services

Turning Movement Count - Study Results

CAMBRIAN RD @ RIVER MIST RD

Survey Date: Wednesday, October 23, 2019

WO No: 38918

Start Time: 07:00

Device: Miovision

Full Study 15 Minute Increments

Table with columns for Time Period, Northbound (LT, ST, RT, N TOT, STR TOT), Southbound (LT, ST, RT, S TOT, STR TOT), Eastbound (LT, ST, RT, E TOT, STR TOT), Westbound (LT, ST, RT, W TOT, STR TOT), and Grand Total. Rows represent 15-minute intervals from 07:00 to 18:00.

Note: U-Turns are included in Totals.



Transportation Services - Traffic Services

Turning Movement Count - Study Results

CAMBRIAN RD @ RIVER MIST RD

Survey Date: Wednesday, October 23, 2019

WO No: 38918

Start Time: 07:00

Device: Miovision

Full Study Cyclist Volume

Table with columns for Time Period, RIVER MIST RD (Northbound, Southbound, Street Total), CAMBRIAN RD (Eastbound, Westbound, Street Total), and Grand Total. Rows represent 15-minute intervals from 07:00 to 18:00.



Transportation Services - Traffic Services

Turning Movement Count - Study Results

CAMBRIAN RD @ RIVER MIST RD

Survey Date: Wednesday, October 23, 2019

WO No: 38918

Start Time: 07:00

Device: Miovision

Full Study Pedestrian Volume

RIVER MIST RD

CAMBRIAN RD

Table with 8 columns: Time Period, NB Approach, SB Approach, Total, EB Approach, WB Approach, Total, Grand Total. Rows show pedestrian counts for various time intervals from 07:00 to 18:00.



Transportation Services - Traffic Services

Turning Movement Count - Study Results

CAMBRIAN RD @ RIVER MIST RD

Survey Date: Wednesday, October 23, 2019

WO No: 38918

Start Time: 07:00

Device: Miovision

Full Study Heavy Vehicles

RIVER MIST RD

CAMBRIAN RD

Table with 20 columns: Time Period, Northbound (LT, ST, RT, N TOT), Southbound (LT, ST, RT, S TOT, STR TOT), Eastbound (LT, ST, RT, E TOT), Westbound (LT, ST, RT, W TOT, STR TOT), Grand Total. Rows show heavy vehicle counts for various time intervals from 07:00 to 18:00.



Transportation Services - Traffic Services

Turning Movement Count - Study Results

CAMBRIAN RD @ RIVER MIST RD

Survey Date: Wednesday, October 23, 2019

WO No: 38918

Start Time: 07:00

Device: Miovision

Full Study 15 Minute U-Turn Total
RIVER MIST RD CAMBRIAN RD

Time Period	Northbound U-Turn Total	Southbound U-Turn Total	Eastbound U-Turn Total	Westbound U-Turn Total	Total
07:00-07:15	0	0	0	0	0
07:15-07:30	0	0	0	0	0
07:30-07:45	0	0	0	0	0
07:45-08:00	0	0	0	0	0
08:00-08:15	0	0	0	0	0
08:15-08:30	0	0	0	0	0
08:30-08:45	0	0	0	0	0
08:45-09:00	0	0	0	0	0
09:00-09:15	0	0	0	0	0
09:15-09:30	0	0	0	0	0
09:30-09:45	0	0	0	0	0
09:45-10:00	0	0	0	0	0
11:30-11:45	0	0	0	0	0
11:45-12:00	0	0	0	0	0
12:00-12:15	0	0	0	0	0
12:15-12:30	0	0	0	0	0
12:30-12:45	1	0	0	0	1
12:45-13:00	0	0	0	0	0
13:00-13:15	0	0	0	0	0
13:15-13:30	0	0	0	0	0
15:00-15:15	0	0	0	0	0
15:15-15:30	0	0	0	0	0
15:30-15:45	0	0	0	0	0
15:45-16:00	0	0	0	0	0
16:00-16:15	0	0	0	0	0
16:15-16:30	0	0	0	0	0
16:30-16:45	0	0	0	0	0
16:45-17:00	0	0	0	0	0
17:00-17:15	0	0	0	0	0
17:15-17:30	0	0	0	0	0
17:30-17:45	0	0	0	0	0
17:45-18:00	0	0	0	0	0
Total	1	0	0	0	1



Turning Movement Count
Summary Report Including Peak Hours,
AADT and Expansion Factors
All Vehicles Except Bicycles



Cambrian Road & Grand Canal Street **Barrhaven West, ON**

Survey Date: Wednesday, October 19, 2022

Start Time: 0700 AADT Factor: 0.9

Weather AM: Clear +2° C

Survey Duration: 8 Hrs.

Survey Hours: 0700-1000, 1130-1330 & 1500-1800

Weather PM: Overcast 6° C

Surveyor(s): T. Carmody

Time Period	Cambrian Rd.					Cambrian Rd.					Grand Canal St.					Grand Canal St.							
	Eastbound					Westbound					Northbound					Southbound							
	LT	ST	RT	UT	E/B Tot	LT	ST	RT	UT	W/B Tot	Street Total	LT	ST	RT	UT	N/B Tot	Street Total	LT	ST	RT	UT	S/B Tot	Street Total
0700-0800	16	175	30	0	221	17	244	15	0	276	497	98	8	60	0	166	46	4	28	0	78	244	741
0800-0900	32	193	71	0	296	30	246	21	0	297	593	95	64	53	0	212	65	74	45	0	184	396	989
0900-1000	13	174	41	0	228	36	235	17	0	288	516	68	8	47	0	123	37	9	16	0	62	185	701
1130-1230	10	180	40	0	230	28	193	15	0	236	466	39	6	47	0	92	16	7	18	0	41	133	599
1230-1330	19	182	58	0	259	42	213	15	0	270	529	46	1	36	0	83	19	9	17	0	45	128	657
1500-1600	28	245	93	0	366	36	202	29	0	267	633	74	34	49	0	157	46	80	22	0	148	305	938
1600-1700	37	302	105	0	444	62	271	46	0	379	823	56	14	52	0	122	51	17	26	0	94	216	1039
1700-1800	30	308	67	0	405	63	293	43	0	399	804	50	10	51	0	111	34	13	18	0	65	176	980
Totals	185	1759	505	0	2449	314	1897	201	0	2412	4861	526	145	395	0	1066	314	213	190	0	717	1783	6644

Equivalent 12 & 24-hour Vehicle Volumes Including the Annual Average Daily Traffic (AADT) Factor
Applicable to the Day and Month of the Turning Movement Count
Expansion factors are applied exclusively to standard weekday 8-hour turning movement counts
conducted during the hours of 0700h - 1000h, 1130h - 1330h and 1500h - 1800h

Equivalent 12-hour vehicle volumes. These volumes are calculated by multiplying the 8-hour totals by the 8 → 12 expansion factor of 1.39

Equ. 12 Hr	257	2445	702	0	3404	436	2637	279	0	3353	6757	731	202	549	0	1482	436	296	264	0	997	2478	9235
------------	-----	------	-----	---	------	-----	------	-----	---	------	------	-----	-----	-----	---	------	-----	-----	-----	---	-----	------	------

Average daily 12-hour vehicle volumes. These volumes are calculated by multiplying the equivalent 12-hour totals by the AADT factor of: 0.9

AADT 12-hr	231	2201	632	0	3064	393	2373	251	0	3017	6081	658	181	494	0	1334	393	266	238	0	897	2231	8312
------------	-----	------	-----	---	------	-----	------	-----	---	------	------	-----	-----	-----	---	------	-----	-----	-----	---	-----	------	------

24-Hour AADT. These volumes are calculated by multiplying the average daily 12-hour vehicle volumes by the 12 → 24 expansion factor of 1.31

AADT 24 Hr	303	2883	828	0	4013	515	3109	329	0	3953	7966	862	238	647	0	1747	515	349	311	0	1175	2922	10888
------------	-----	------	-----	---	------	-----	------	-----	---	------	------	-----	-----	-----	---	------	-----	-----	-----	---	------	------	-------

AADT and expansion factors provided by the City of Ottawa

AM Peak Hour Factor	0.92					Highest Hourly Vehicle Volume Between 0700h & 1000h																				
AM Peak Hr	LT	ST	RT	UT	Total	LT	ST	RT	UT	Total	LT	ST	RT	UT	Total	LT	ST	RT	UT	Total	LT	ST	RT	UT	Total	Gr. Tot
0815-0915	27	209	73	0	309	37	255	21	0	313	622	101	64	59	0	224	71	77	43	0	191	415	1037			
OFF Peak Hour Factor	0.94					Highest Hourly Vehicle Volume Between 1130h & 1330h																				
1230-1330	19	182	58	0	259	42	213	15	0	270	529	46	1	36	0	83	19	9	17	0	45	128	657			
PM Peak Hour Factor	0.98					Highest Hourly Vehicle Volume Between 1500h & 1800h																				
1545-1645	35	282	107	0	424	48	277	42	0	367	791	78	25	56	0	159	51	26	20	0	97	256	1047			

Comments:

OC Transpo and Para Transpo buses, private buses and school buses comprise 28.37% of the heavy vehicle traffic. Some drivers, from each direction, ignored the stop signs and when busy, assessing right-of-way was more difficult. There were 2 vehicle/vehicle conflicts and 1 vehicle/pedestrian conflict during this traffic count. A school crossing guard was present before and after school - primarily assisting pedestrians in the north and west side crossings.

Notes:

1. Includes all vehicle types except bicycles, electric bicycles, and electric scooters.
2. When expansion and AADT factors are applied, the results will differ slightly due to rounding.



Turning Movement Count Summary, AM and PM Peak Hour Flow Diagrams All Vehicles Except Bicycles

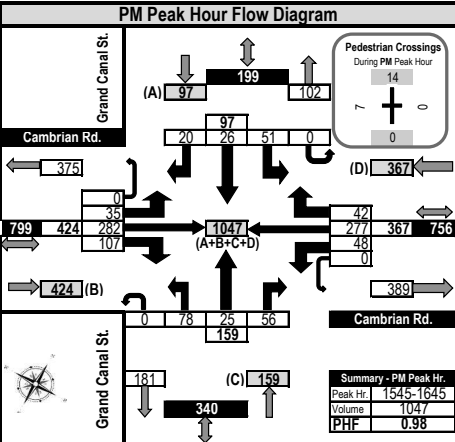
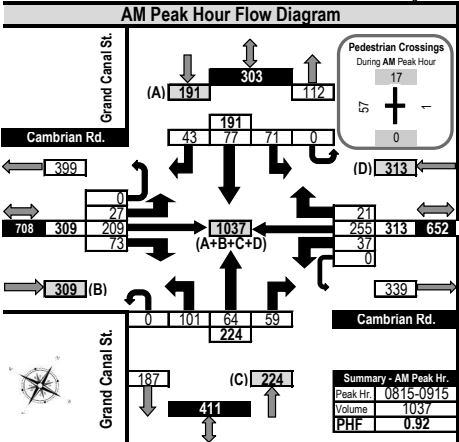
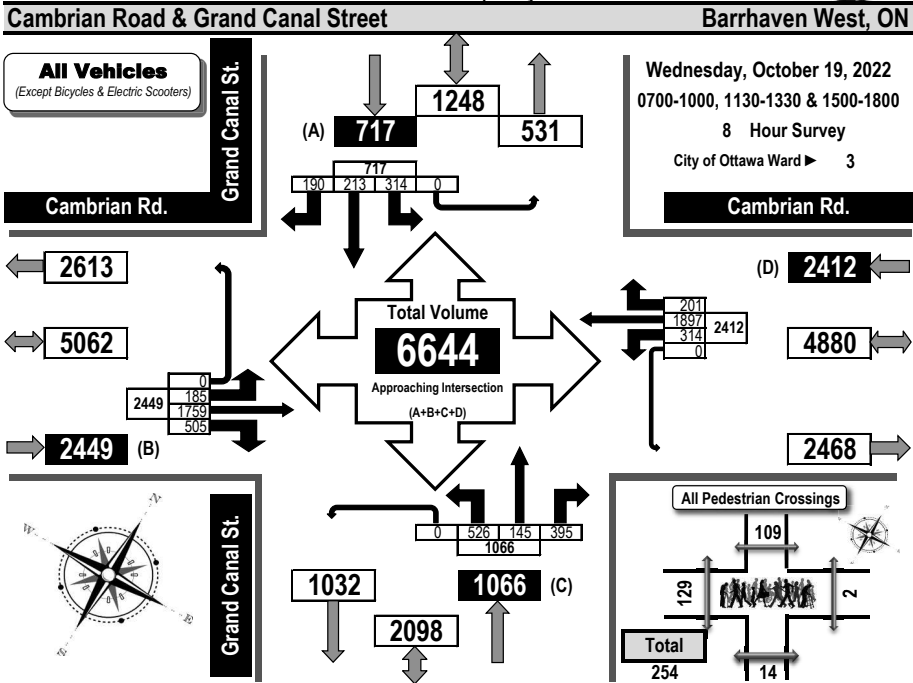

Turning Movement Count Summary, OFF and EVENING Peak Hour Flow Diagrams All Vehicles Except Bicycles

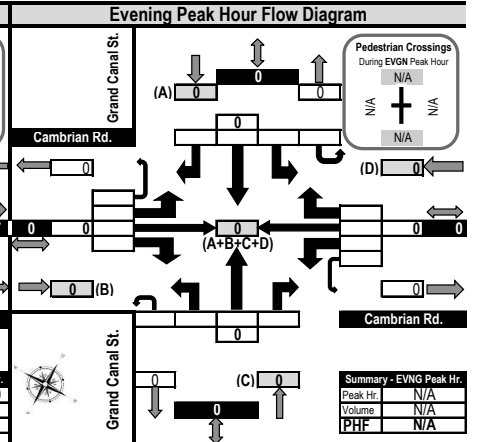
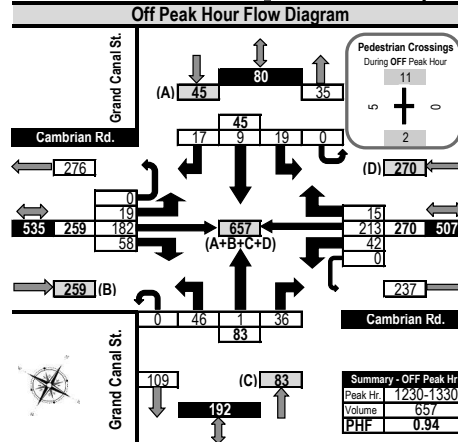
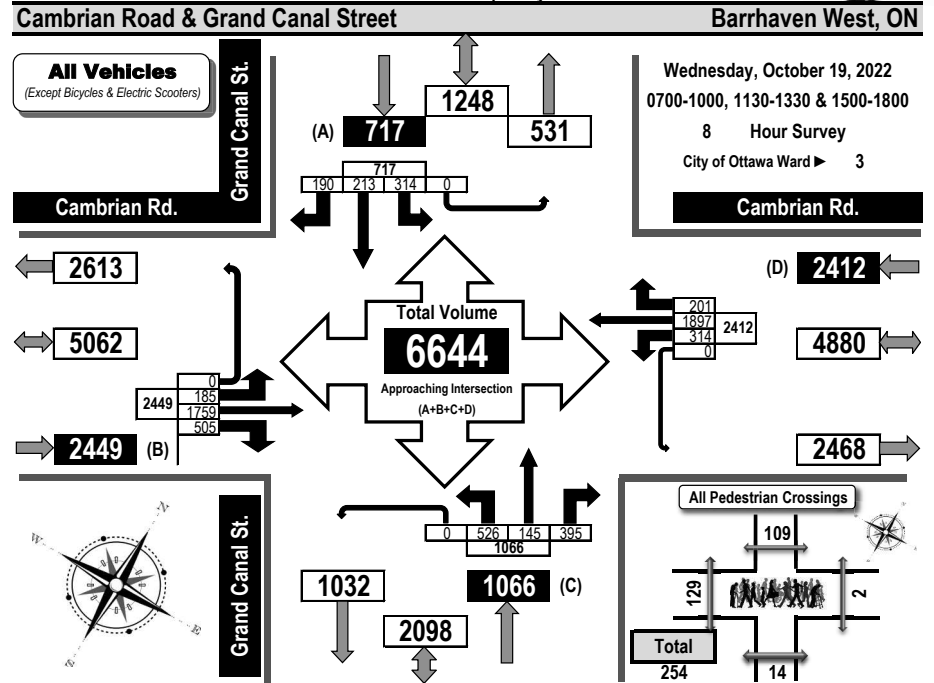



Turning Movement Count Heavy Vehicle Summary (FHWA Class 4-13) Flow Diagram

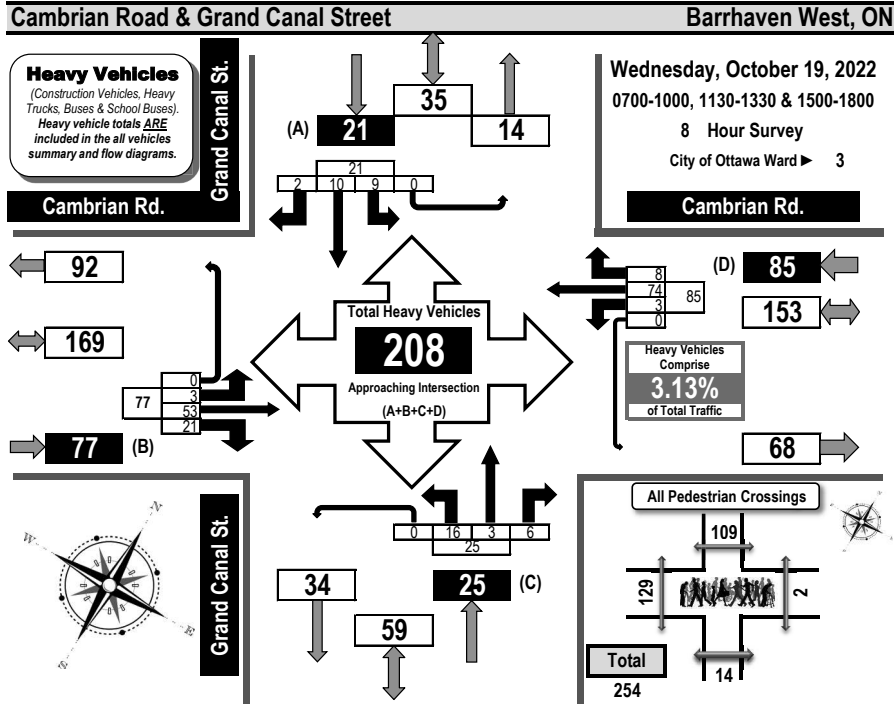

Time Period	Cambrian Rd. Eastbound				Cambrian Rd. Westbound				Grand Canal St. Northbound				Grand Canal St. Southbound				SB Tot	GR Tot			
	LT	ST	RT	UT	LT	ST	RT	UT	LT	ST	RT	UT	LT	ST	RT	UT					
0700-0800	1	7	5	0	13	1	10	1	0	12	1	0	1	0	2	1	0	0	0	1	28
0800-0900	1	5	1	0	7	0	10	2	0	12	5	1	1	0	7	3	2	2	0	7	33
0900-1000	0	8	4	0	12	0	7	1	0	8	0	0	0	0	0	2	1	0	0	3	23
1130-1230	0	7	0	0	7	1	10	1	0	12	1	1	2	0	4	1	1	0	0	2	25
1230-1330	0	4	6	0	10	0	12	0	0	12	1	0	1	0	2	0	2	0	0	2	26
1500-1600	0	8	1	0	9	1	8	2	0	11	6	0	0	0	6	0	3	0	0	3	29
1600-1700	1	10	4	0	15	0	13	1	0	14	2	0	1	0	3	2	1	0	0	3	35
1700-1800	0	4	0	0	4	0	4	0	0	4	0	1	0	0	1	0	0	0	0	0	9
Totals	3	53	21	0	77	3	74	8	0	85	16	3	6	0	25	9	10	2	0	21	208

Comments:
OC Transpo and Para Transpo buses, private buses and school buses comprise 28.37% of the heavy vehicle traffic. Some drivers, from each direction, ignored the stop signs and when busy, assessing right-of-way was more difficult. There were 2 vehicle/vehicle conflicts and 1 vehicle/pedestrian conflict during this traffic count. A school crossing guard was present before and after school - primarily assisting pedestrians in the north and west side crossings.



Turning Movement Count All Buses Summary (FHWA Class 4 ONLY) Flow Diagram

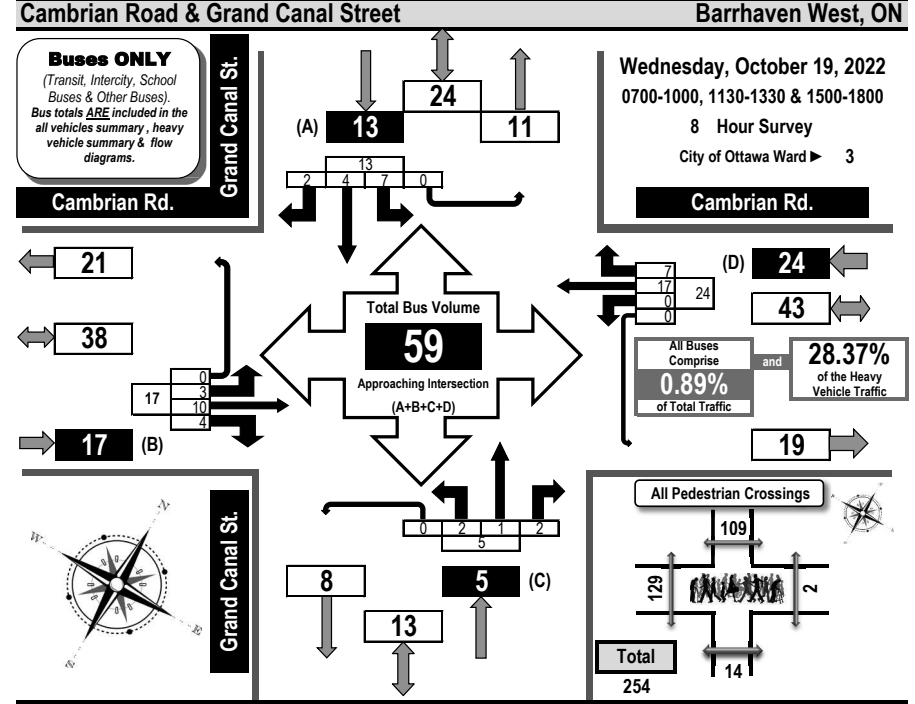

Time Period	Cambrian Rd. Eastbound				Cambrian Rd. Westbound				Grand Canal St. Northbound				Grand Canal St. Southbound				SB Tot	GR Tot			
	LT	ST	RT	UT	LT	ST	RT	UT	LT	ST	RT	UT	LT	ST	RT	UT					
0700-0800	1	3	3	0	7	0	3	1	0	4	0	0	1	0	1	1	0	0	0	1	13
0800-0900	1	0	0	0	1	0	4	2	0	6	2	1	1	0	4	2	1	2	0	5	16
0900-1000	0	1	0	0	1	0	2	0	0	2	0	0	0	0	0	2	0	0	0	2	5
1130-1230	0	1	0	0	1	0	0	1	0	1	0	0	0	0	0	0	0	0	0	0	2
1230-1330	0	0	0	0	0	0	0	0	0	0	0	0	0	0	0	0	0	0	0	0	0
1500-1600	0	1	0	0	1	0	2	2	0	4	0	0	0	0	0	0	2	0	0	2	7
1600-1700	1	4	1	0	6	0	5	1	0	6	0	0	0	0	0	2	1	0	0	3	15
1700-1800	0	0	0	0	0	0	1	0	0	1	0	0	0	0	0	0	0	0	0	0	1
Totals	3	10	4	0	17	0	17	7	0	24	2	1	2	0	5	7	4	2	0	13	59

Comments:
OC Transpo and Para Transpo buses, private buses and school buses comprise 28.37% of the heavy vehicle traffic. Some drivers, from each direction, ignored the stop signs and when busy, assessing right-of-way was more difficult. There were 2 vehicle/vehicle conflicts and 1 vehicle/pedestrian conflict during this traffic count. A school crossing guard was present before and after school - primarily assisting pedestrians in the north and west side crossings.

AM Peak Hour

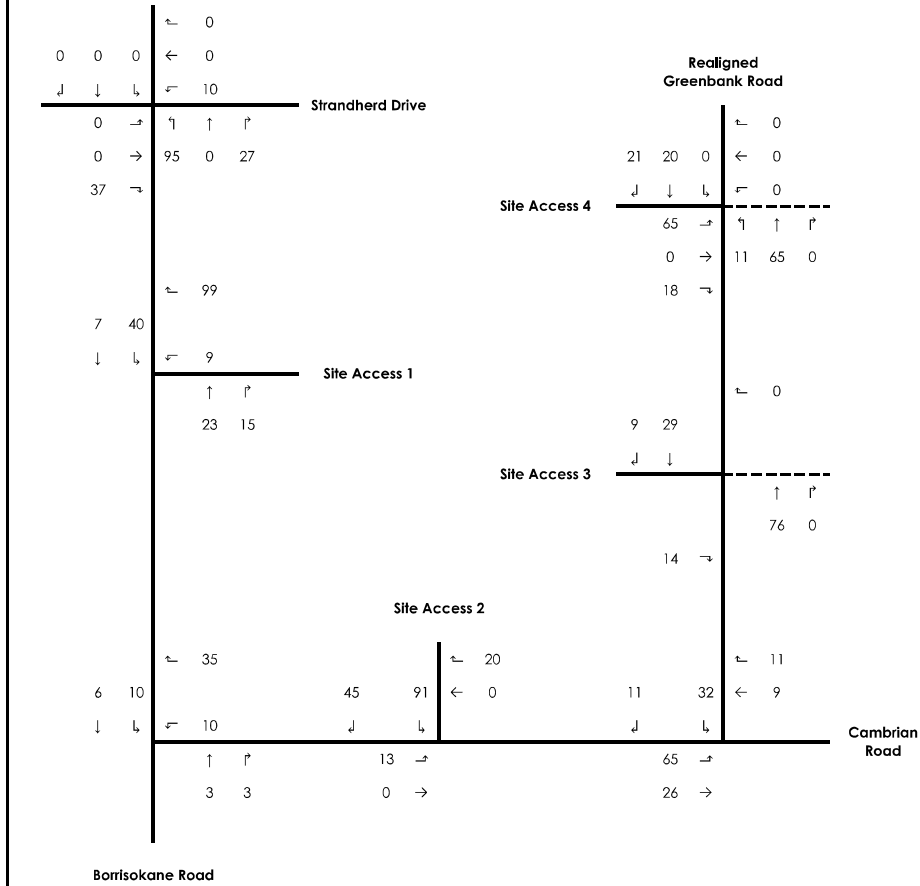

PM Peak Hour

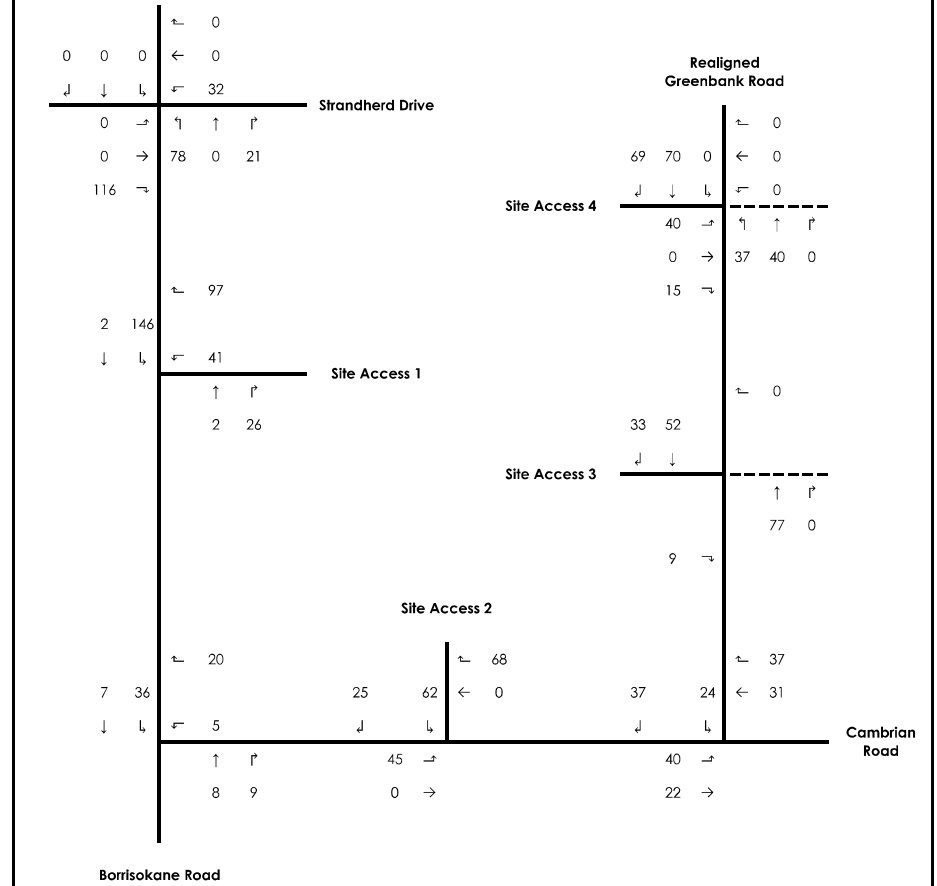

Mattamy Homes
Half Moon Bay West
Figure 9: Net New Site Traffic Volumes

Appendix C

Synchro Intersection Worksheets – Existing Conditions

HCM 2010 AWSC
1: River Mist Road & Cambrian Road

Existing
AM Peak Hour

Intersection												
Intersection Delay, s/veh	20.3											
Intersection LOS	C											
Movement	EBL	EBT	EBR	WBL	WBT	WBR	NBL	NBT	NBR	SBL	SBT	SBR
Lane Configurations		↕			↕			↕			↕	
Traffic Vol, veh/h	14	308	49	49	247	45	121	50	104	58	16	26
Future Vol, veh/h	14	308	49	49	247	45	121	50	104	58	16	26
Peak Hour Factor	0.90	0.90	0.90	0.90	0.90	0.90	0.90	0.90	0.90	0.90	0.90	0.90
Heavy Vehicles, %	7	10	6	16	9	4	2	10	4	3	6	4
Mvmt Flow	16	342	54	54	274	50	134	56	116	64	18	29
Number of Lanes	0	1	0	0	1	0	0	1	0	0	1	0
Approach	EB			WB			NB			SB		
Opposing Approach	WB			EB			SB			NB		
Opposing Lanes	1			1			1			1		
Conflicting Approach Left	SB			NB			EB			WB		
Conflicting Lanes Left	1			1			1			1		
Conflicting Approach Right	NB			SB			WB			EB		
Conflicting Lanes Right	1			1			1			1		
HCM Control Delay	23.1			21.9			17.5			12.5		
HCM LOS	C			C			C			B		
Lane	NBLn1	EBLn1	WBLn1	SBLn1								
Vol Left, %	44%	4%	14%	58%								
Vol Thru, %	18%	83%	72%	16%								
Vol Right, %	38%	13%	13%	26%								
Sign Control	Stop	Stop	Stop	Stop								
Traffic Vol by Lane	275	371	341	100								
LT Vol	121	14	49	58								
Through Vol	50	308	247	16								
RT Vol	104	49	45	26								
Lane Flow Rate	306	412	379	111								
Geometry Grp	1	1	1	1								
Degree of Util (X)	0.555	0.71	0.676	0.224								
Departure Headway (Hd)	6.538	6.201	6.421	7.26								
Convergence, Y/N	Yes	Yes	Yes	Yes								
Cap	550	581	561	491								
Service Time	4.603	4.263	4.485	5.349								
HCM Lane V/C Ratio	0.556	0.709	0.676	0.226								
HCM Control Delay	17.5	23.1	21.9	12.5								
HCM Lane LOS	C	C	C	B								
HCM 95th-tile Q	3.4	5.8	5.1	0.9								

HCM 2010 TWSC
2: Cambrian Road & Apolune Street

Existing
AM Peak Hour

Intersection						
Int Delay, s/veh	2.2					
Movement	EBL	EBT	WBT	WBR	SBL	SBR
Lane Configurations	↕	↑	↕		↕	
Traffic Vol, veh/h	9	225	397	14	64	32
Future Vol, veh/h	9	225	397	14	64	32
Conflicting Peds, #/hr	5	0	0	5	2	2
Sign Control	Free	Free	Free	Free	Stop	Stop
RT Channelized	-	None	-	None	-	None
Storage Length	75	-	-	-	0	-
Veh in Median Storage, #	-	0	0	-	0	-
Grade, %	-	0	0	-	0	-
Peak Hour Factor	90	90	90	90	90	90
Heavy Vehicles, %	2	21	6	2	2	2
Mvmt Flow	10	250	441	16	71	36
Major/Minor	Major1	Major2	Minor2			
Conflicting Flow All	462	0	0	726	456	
Stage 1	-	-	-	454	-	
Stage 2	-	-	-	272	-	
Critical Hdwy	4.12	-	-	6.42	6.22	
Critical Hdwy Stg 1	-	-	-	5.42	-	
Critical Hdwy Stg 2	-	-	-	5.42	-	
Follow-up Hdwy	2,218	-	-	3,518	3,318	
Pot Cap-1 Maneuver	1099	-	-	391	604	
Stage 1	-	-	-	640	-	
Stage 2	-	-	-	774	-	
Platoon blocked, %	-	-	-	-	-	
Mov Cap-1 Maneuver	1094	-	-	384	600	
Mov Cap-2 Maneuver	-	-	-	384	-	
Stage 1	-	-	-	631	-	
Stage 2	-	-	-	770	-	
Approach	EB	WB	SB			
HCM Control Delay, s	0.3	0	15.9			
HCM LOS			C			
Minor Lane/Major Mvmt	EBL	EBT	WBT	WBR	SBLn1	
Capacity (veh/h)	1094	-	-	-	436	
HCM Lane V/C Ratio	0.009	-	-	-	0.245	
HCM Control Delay (s)	8.3	-	-	-	15.9	
HCM Lane LOS	A	-	-	-	C	
HCM 95th %tile Q(veh)	0	-	-	-	0.9	

HCM 2010 AWSC
11: Grand Canal & Cambrian Road

Existing
AM Peak Hour

Intersection	
Intersection Delay, s/veh	16.6
Intersection LOS	C

Movement	EBL	EBT	EBR	WBL	WBT	WBR	NBL	NBT	NBR	SBL	SBT	SBR
Lane Configurations		↔			↕			↕			↔	
Traffic Vol, veh/h	27	209	73	37	255	21	101	64	59	71	77	43
Future Vol, veh/h	27	209	73	37	255	21	101	64	59	71	77	43
Peak Hour Factor	0.90	0.90	0.90	0.90	0.90	0.90	0.90	0.90	0.90	0.90	0.90	0.90
Heavy Vehicles, %	4	2	2	2	4	10	5	2	2	4	3	5
Mvmt Flow	30	232	81	41	283	23	112	71	66	79	86	48
Number of Lanes	0	1	0	0	1	0	0	1	0	0	1	0

Approach	EB	WB	NB	SB
Opposing Approach	WB	EB	SB	NB
Opposing Lanes	1	1	1	1
Conflicting Approach Left	SB	NB	EB	WB
Conflicting Lanes Left	1	1	1	1
Conflicting Approach Right	NB	SB	WB	EB
Conflicting Lanes Right	1	1	1	1
HCM Control Delay	17.7	18.2	15.1	14.1
HCM LOS	C	C	C	B

Lane	NBLn1	EBLn1	WBLn1	SBLn1
Vol Left, %	45%	9%	12%	37%
Vol Thru, %	29%	68%	81%	40%
Vol Right, %	26%	24%	7%	23%
Sign Control	Stop	Stop	Stop	Stop
Traffic Vol by Lane	224	309	313	191
LT Vol	101	27	37	71
Through Vol	64	209	255	77
RT Vol	59	73	21	43
Lane Flow Rate	249	343	348	212
Geometry Grp	1	1	1	1
Degree of Util (X)	0.456	0.587	0.6	0.394
Departure Headway (Hd)	6.597	6.15	6.207	6.688
Convergence, Y/N	Yes	Yes	Yes	Yes
Cap	543	584	581	535
Service Time	4.666	4.21	4.267	4.761
HCM Lane V/C Ratio	0.459	0.587	0.599	0.396
HCM Control Delay	15.1	17.7	18.2	14.1
HCM Lane LOS	C	C	C	B
HCM 95th-tile Q	2.4	3.8	4	1.9

HCM 2010 AWSC
1: River Mist Road & Cambrian Road

Existing
PM Peak Hour

Intersection	
Intersection Delay, s/veh	24.7
Intersection LOS	C

Movement	EBL	EBT	EBR	WBL	WBT	WBR	NBL	NBT	NBR	SBL	SBT	SBR
Lane Configurations		↔			↕			↕			↔	
Traffic Vol, veh/h	20	325	94	123	285	64	69	15	103	29	12	15
Future Vol, veh/h	20	325	94	123	285	64	69	15	103	29	12	15
Peak Hour Factor	0.90	0.90	0.90	0.90	0.90	0.90	0.90	0.90	0.90	0.90	0.90	0.90
Heavy Vehicles, %	2	2	2	2	2	2	2	2	7	2	2	2
Mvmt Flow	22	361	104	137	317	71	77	17	114	32	13	17
Number of Lanes	0	1	0	0	1	0	0	1	0	0	1	0

Approach	EB	WB	NB	SB
Opposing Approach	WB	EB	SB	NB
Opposing Lanes	1	1	1	1
Conflicting Approach Left	SB	NB	EB	WB
Conflicting Lanes Left	1	1	1	1
Conflicting Approach Right	NB	SB	WB	EB
Conflicting Lanes Right	1	1	1	1
HCM Control Delay	25	30.3	13.6	11.4
HCM LOS	C	D	B	B

Lane	NBLn1	EBLn1	WBLn1	SBLn1
Vol Left, %	37%	5%	26%	52%
Vol Thru, %	8%	74%	60%	21%
Vol Right, %	55%	21%	14%	27%
Sign Control	Stop	Stop	Stop	Stop
Traffic Vol by Lane	187	439	472	56
LT Vol	69	20	123	29
Through Vol	15	325	285	12
RT Vol	103	94	64	15
Lane Flow Rate	208	488	524	62
Geometry Grp	1	1	1	1
Degree of Util (X)	0.38	0.768	0.829	0.126
Departure Headway (Hd)	6.577	5.666	5.69	7.305
Convergence, Y/N	Yes	Yes	Yes	Yes
Cap	546	639	640	488
Service Time	4.631	3.683	3.708	5.38
HCM Lane V/C Ratio	0.381	0.764	0.819	0.127
HCM Control Delay	13.6	25	30.3	11.4
HCM Lane LOS	B	C	D	B
HCM 95th-tile Q	1.8	7.1	8.8	0.4

HCM 2010 TWSC
2: Cambrian Road & Apolune Street

Existing
PM Peak Hour

Intersection						
Int Delay, s/veh	1.6					
Movement	EBL	EBT	WBT	WBR	SBL	SBR
Lane Configurations	↖	↑	↗		↖	↗
Traffic Vol, veh/h	32	394	373	48	43	18
Future Vol, veh/h	32	394	373	48	43	18
Conflicting Peds, #/hr	6	0	0	6	3	0
Sign Control	Free	Free	Free	Free	Stop	Stop
RT Channelized	-	None	-	None	-	None
Storage Length	75	-	-	-	0	-
Veh in Median Storage, #	-	0	0	-	0	-
Grade, %	-	0	0	-	0	-
Peak Hour Factor	90	90	90	90	90	90
Heavy Vehicles, %	2	2	2	2	2	2
Mvmt Flow	36	438	414	53	48	20
Major/Minor	Major1	Major2	Minor2			
Conflicting Flow All	473	0	0	960	447	
Stage 1	-	-	-	447	-	
Stage 2	-	-	-	513	-	
Critical Hdwy	4.12	-	-	6.42	6.22	
Critical Hdwy Stg 1	-	-	-	5.42	-	
Critical Hdwy Stg 2	-	-	-	5.42	-	
Follow-up Hdwy	2.218	-	-	3.518	3.318	
Pot Cap-1 Maneuver	1089	-	-	285	612	
Stage 1	-	-	-	644	-	
Stage 2	-	-	-	601	-	
Platoon blocked, %	-	-	-	-	-	
Mov Cap-1 Maneuver	1083	-	-	272	609	
Mov Cap-2 Maneuver	-	-	-	272	-	
Stage 1	-	-	-	619	-	
Stage 2	-	-	-	597	-	
Approach	EB	WB	SB			
HCM Control Delay, s	0.6	0	19			
HCM LOS				C		
Minor Lane/Major Mvmt	EBL	EBT	WBT	WBR	SBLn1	
Capacity (veh/h)	1083	-	-	-	325	
HCM Lane V/C Ratio	0.033	-	-	-	0.209	
HCM Control Delay (s)	8.4	-	-	-	19	
HCM Lane LOS	A	-	-	-	C	
HCM 95th %tile Q(veh)	0.1	-	-	-	0.8	

HCM 2010 AWSC
11: Grand Canal & Cambrian Road

Existing
PM Peak Hour

Intersection												
Intersection Delay, s/veh	17.8											
Intersection LOS	C											
Movement	EBL	EBT	EBR	WBL	WBT	WBR	NBL	NBT	NBR	SBL	SBT	SBR
Lane Configurations		↕			↕			↕			↕	
Traffic Vol, veh/h	35	282	107	48	277	42	78	25	56	51	26	20
Future Vol, veh/h	35	282	107	48	277	42	78	25	56	51	26	20
Peak Hour Factor	0.90	0.90	0.90	0.90	0.90	0.90	0.90	0.90	0.90	0.90	0.90	0.90
Heavy Vehicles, %	3	4	4	2	5	2	3	2	2	4	4	2
Mvmt Flow	39	313	119	53	308	47	87	28	62	57	29	22
Number of Lanes	0	1	0	0	1	0	0	1	0	0	1	0
Approach	EB	WB	NB	SB								
Opposing Approach	WB	EB	SB	NB								
Opposing Lanes	1	1	1	1								
Conflicting Approach Left	SB	NB	EB	WB								
Conflicting Lanes Left	1	1	1	1								
Conflicting Approach Right	NB	SB	WB	EB								
Conflicting Lanes Right	1	1	1	1								
HCM Control Delay	20.8	18.3	12.6	11.6								
HCM LOS	C	C	B	B								
Lane	NBLn1	EBLn1	WBLn1	SBLn1								
Vol Left, %	49%	8%	13%	53%								
Vol Thru, %	16%	67%	75%	27%								
Vol Right, %	35%	25%	11%	21%								
Sign Control	Stop	Stop	Stop	Stop								
Traffic Vol by Lane	159	424	367	97								
LT Vol	78	35	48	51								
Through Vol	25	282	277	26								
RT Vol	56	107	42	20								
Lane Flow Rate	177	471	408	108								
Geometry Grp	1	1	1	1								
Degree of Util (X)	0.32	0.708	0.642	0.205								
Departure Headway (Hd)	6.523	5.52	5.671	6.848								
Convergence, Y/N	Yes	Yes	Yes	Yes								
Cap	553	660	640	525								
Service Time	4.549	3.52	3.671	4.877								
HCM Lane V/C Ratio	0.32	0.714	0.637	0.206								
HCM Control Delay	12.6	20.8	18.3	11.6								
HCM Lane LOS	B	C	C	B								
HCM 95th-tile Q	1.4	5.8	4.6	0.8								

Appendix D

Collision Data

Accident Date	Accident Year	Accident Time	Location	Environment Condition	Light	Traffic Control	Traffic Control Condition	Classification Of Accident	Initial Impact Type	Road Surface Condition	# Vehicles	# Motorcycles	# Bicycles	# Pedestrians
2019-10-10	2019	15:43	APOLLINE ST @ CAMBRIAN RD (0018897)	01 - Clear	01 - Daylight	02 - Stop sign	01 - Functioning	03 - P.D. only	02 - Angle	01 - Dry	2	0	0	0
2016-01-30	2016	4:40	CAMBRIAN RD btwn BORRISOKANE RD & GRAND CANAL ST (___7N36UU)	03 - Snow	07 - Dark	10 - No control	0	02 - Non-fatal injury	07 - SMV other	03 - Loose snow	1	0	0	0

Appendix E

Greenbank Road and Southwest Transitway Extension Preliminary Design

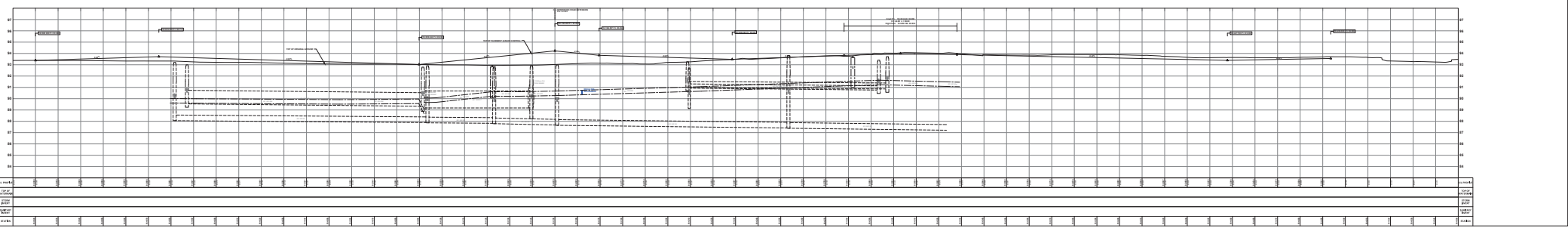
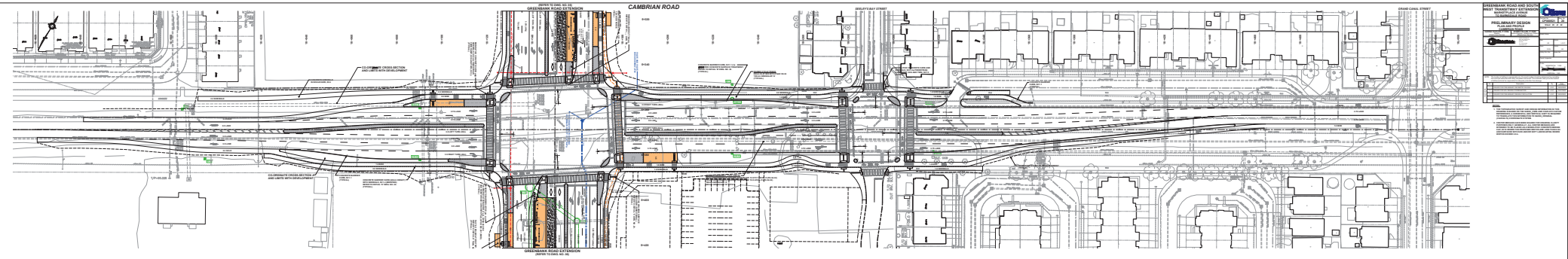

PROYECTO DE OBRAS DE RECONSTRUCCIÓN DEL SECTOR DE LA CALLE CAMBRIAN	
PLAN DE OBRAS DE RECONSTRUCCIÓN DEL SECTOR DE LA CALLE CAMBRIAN	
Escala: 1:500	
FECHA:	15/05/2023
PROYECTANTE:	ING. JUAN CARLOS GONZALEZ
PROYECTO:	RECONSTRUCCIÓN DEL SECTOR DE LA CALLE CAMBRIAN
UBICACIÓN:	SECTOR DE LA CALLE CAMBRIAN, CIUDAD DE QUITO
PROYECTO:	RECONSTRUCCIÓN DEL SECTOR DE LA CALLE CAMBRIAN
UBICACIÓN:	SECTOR DE LA CALLE CAMBRIAN, CIUDAD DE QUITO
PROYECTO:	RECONSTRUCCIÓN DEL SECTOR DE LA CALLE CAMBRIAN
UBICACIÓN:	SECTOR DE LA CALLE CAMBRIAN, CIUDAD DE QUITO

Appendix F

Background Development Volumes

Figure 7: New 2022 Site Traffic Auto Volumes

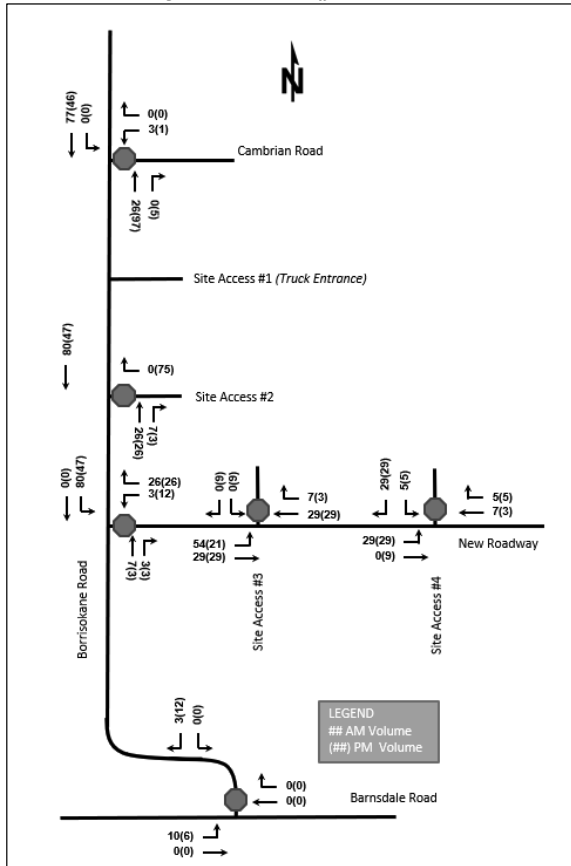

Figure 8: New 2027 Site Traffic Auto Volumes

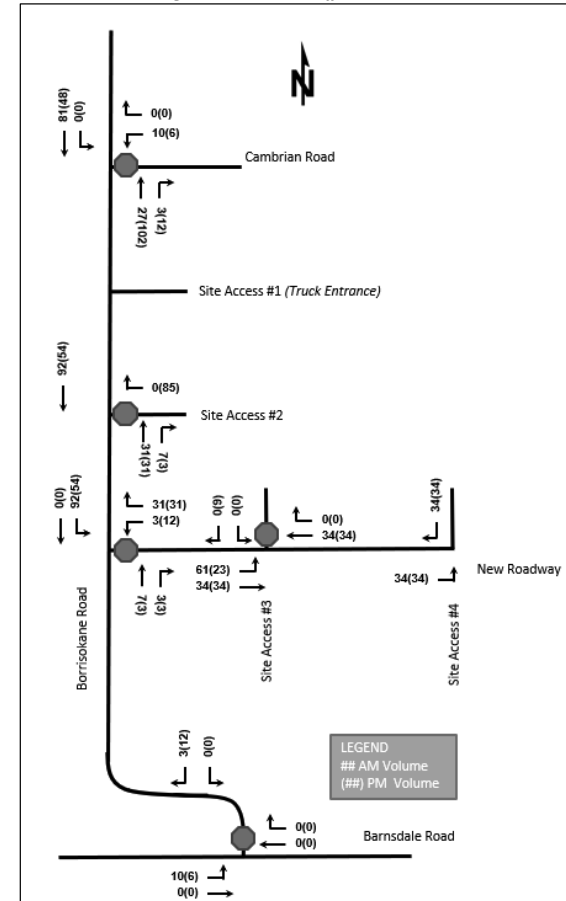

Figure 9: New Site Generation Auto Volumes

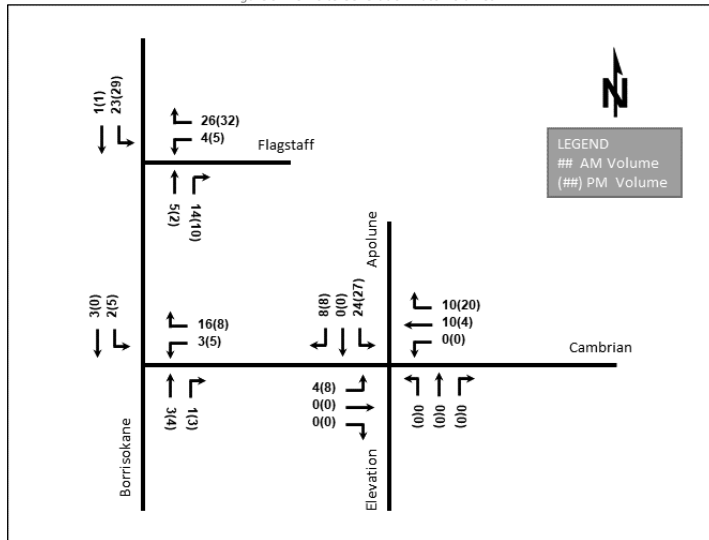
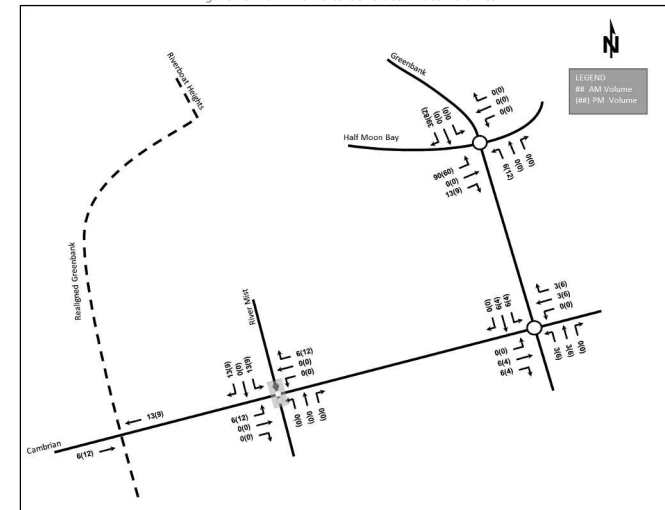
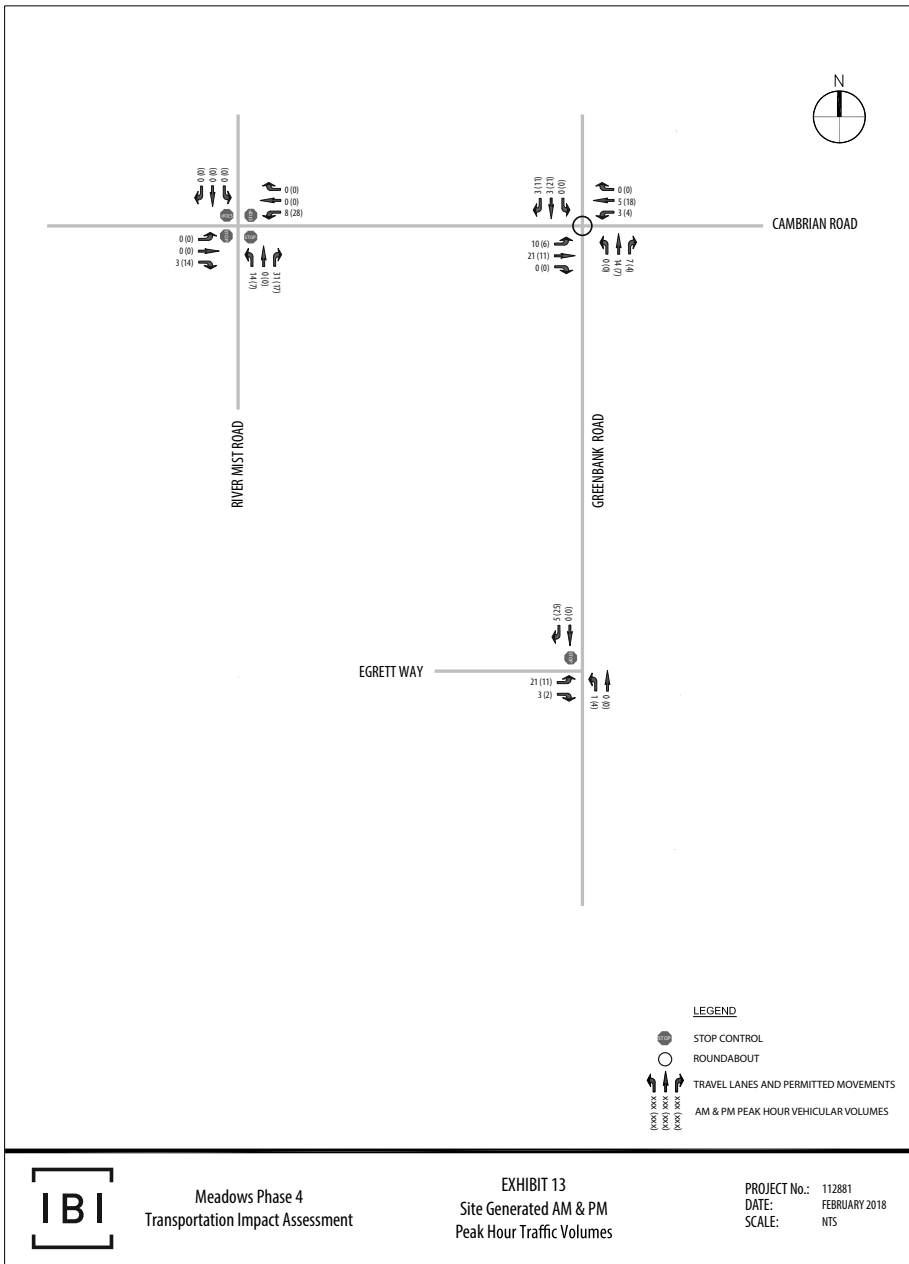

Figure 25: 2024 New Site Generated Auto Volumes





QUINN'S POINTE 2 TRANSPORTATION IMPACT ASSESSMENT

Forecasting
October 30, 2018

Figure 10 and Figure 11 summarize the trip assignment to the study area road network during the weekday AM and PM peak hours, respectively.

Figure 10 Trip Assignment – 2022 Interim – Weekday AM Peak Hour

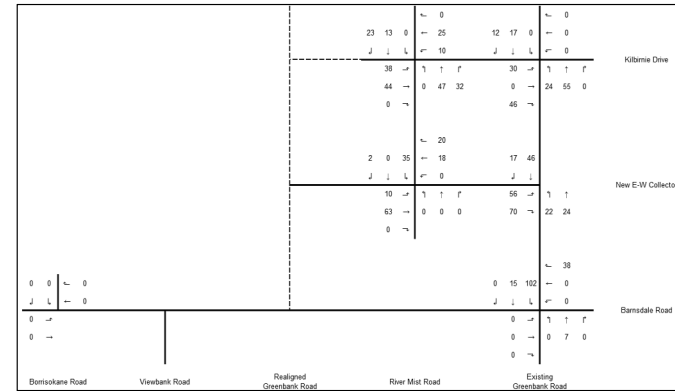
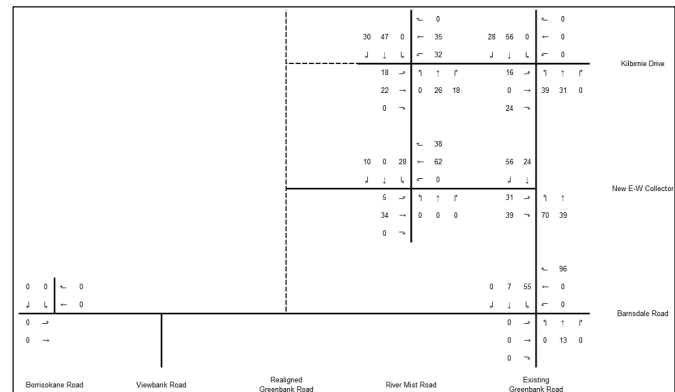

Figure 11 Trip Assignment – 2022 Interim – Weekday PM Peak Hour



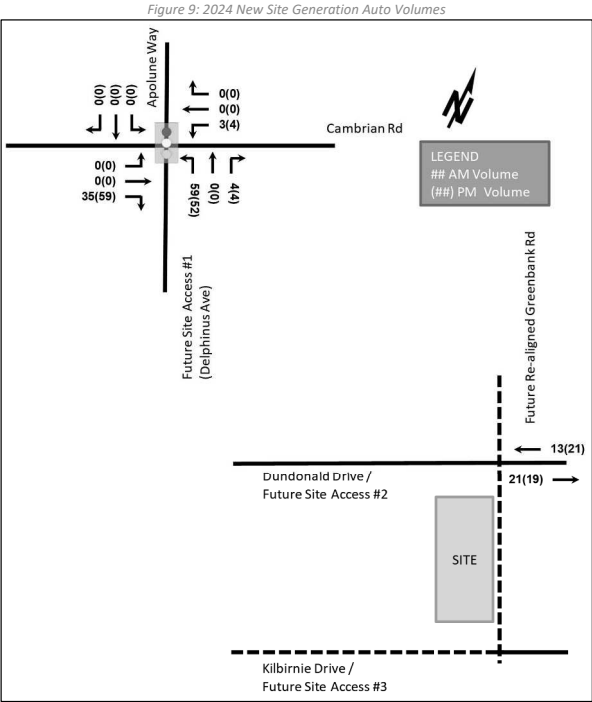
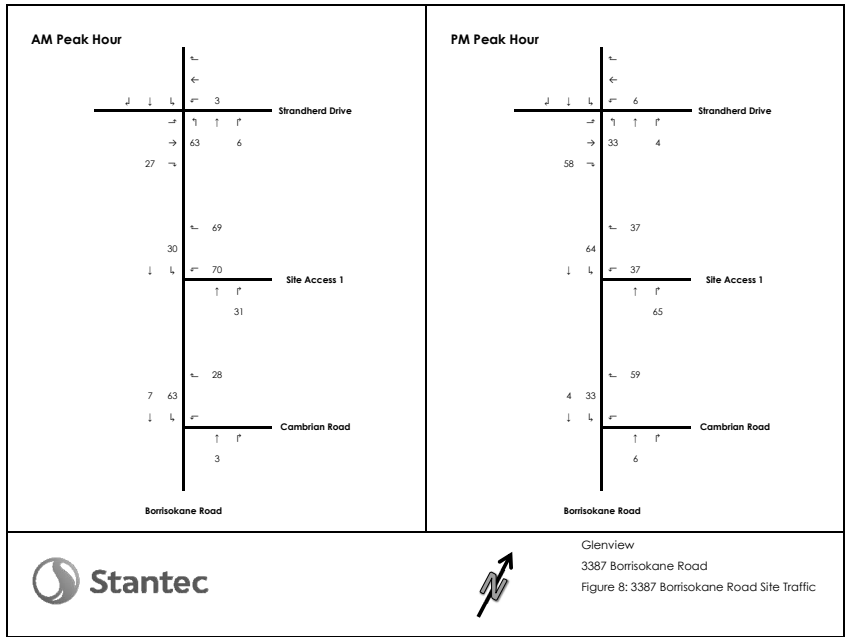
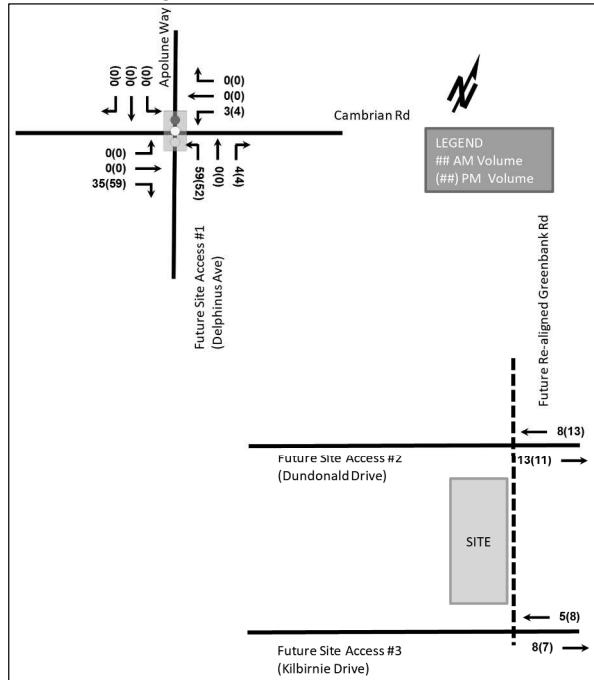

Figure 10: 2029 New Site Generated Auto Volumes



March 5, 2019
 Rosanna Baggs, C.E.T.
 Page 3 of 4

Reference: Mattamy Half Moon Bay West Community Transportation Study Update

Table 2 – Auto Trip Generation - Original Draft Plan (October 2017)

Land Use Code	Units	AM Peak Hour			PM Peak Hour		
		Inbound	Outbound	Rate	Inbound	Outbound	Rate
Step 1: ITE Trip Generation Rates							
210 - Single Detached Houses	518	25%	75%	0.72	63%	37%	0.89
230 - Residential Condo / Townhouse	427	17%	83%	0.39	67%	33%	0.46
220 - Apartments	92	20%	80%	0.53	65%	35%	0.74
Step 2: Auto Trips Generated							
210 - Single Detached Houses	518	93	280	373	290	171	461
230 - Residential Condo / Townhouse	427	28	139	167	131	65	196
220 - Apartments	92	10	39	49	44	24	68
Total Development		131	458	589	465	260	725

As can be seen in Table 2, the original draft plan was projected to generate 589 and 725 auto trips (two-way) during the AM and PM peak hours, respectively.

Table 3 – Auto Trip Generation - Revised Draft Plan (February 2019)

Land Use Code	Units	AM Peak Hour			PM Peak Hour		
		Inbound	Outbound	Rate	Inbound	Outbound	Rate
Step 1: ITE Trip Generation Rates							
210 - Single Detached Houses	446	25%	75%	0.72	63%	37%	0.89
230 - Residential Condo / Townhouse	455	17%	83%	0.39	67%	33%	0.46
220 - Apartments	72	20%	80%	0.53	65%	35%	0.74
Step 2: Auto Trips Generated							
210 - Single Detached Houses	446	80	241	321	250	147	397
230 - Residential Condo / Townhouse	455	30	147	177	140	69	209
220 - Apartments	72	8	30	38	34	19	53
Total Development		118	418	536	424	235	659

As can be seen in Table 3, the revised draft plan is expected to generate 536 and 659 auto trips (two-way) during the AM and PM peak hours, respectively.

CONCLUSION

A comparison of the original and revised plan shows that the proposed subdivision's collector road network and intersections with the existing boundary road network remain unchanged.

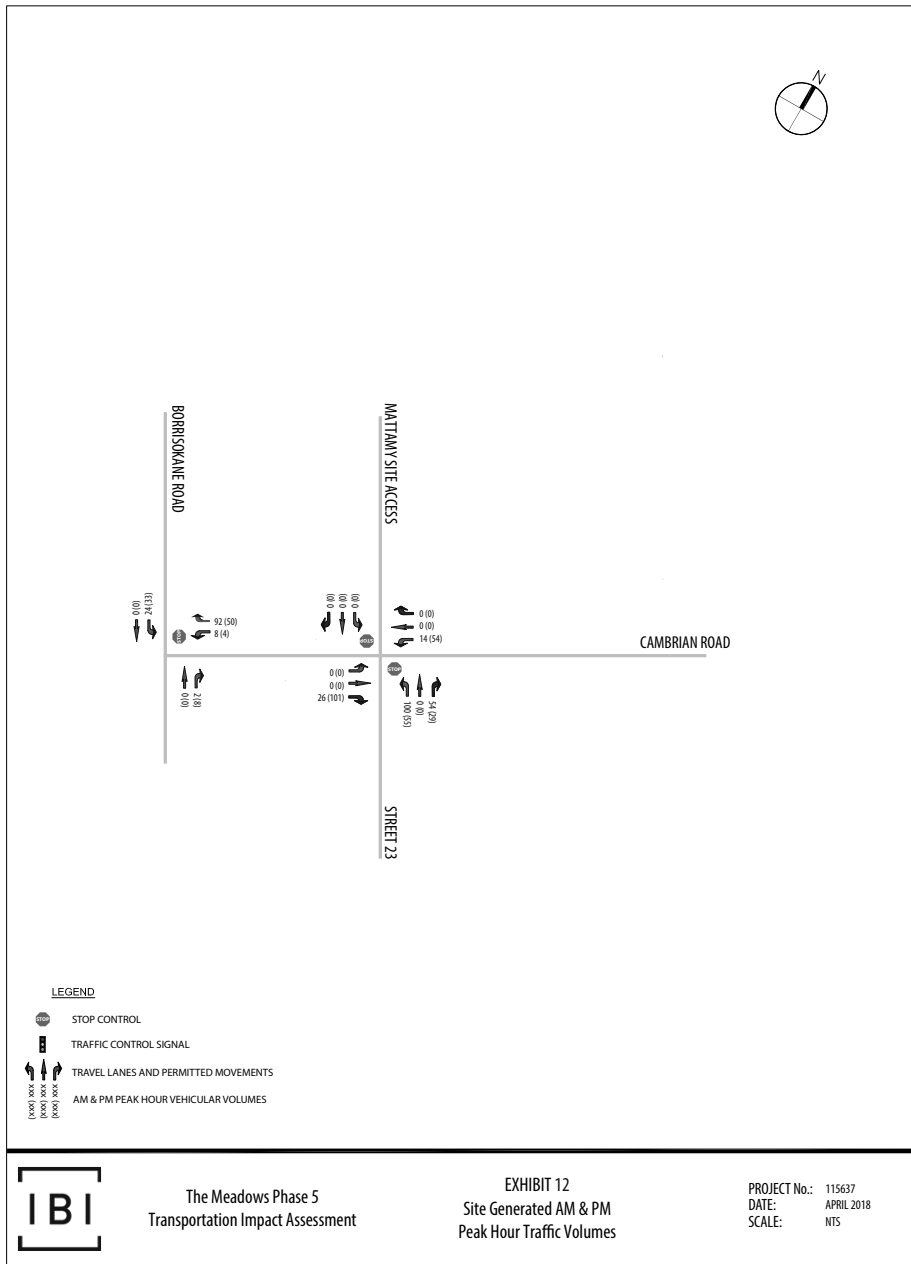
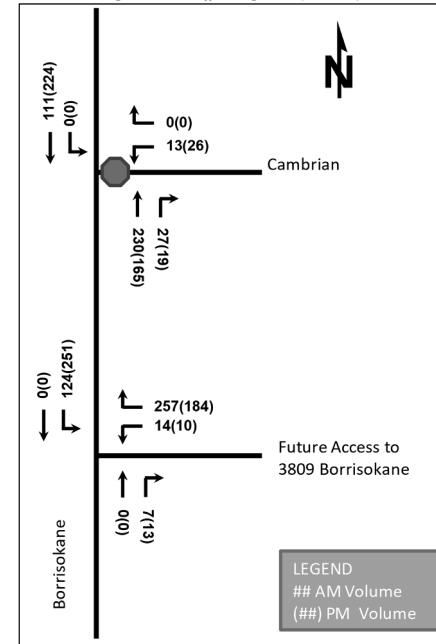

Figure 8: Site Traffic Assignment (Volumes)



3850 Cambrian Road Transportation Impact Assessment

Table 11: Trip Assignment

To/From	Interim	Beyond 2031 (informational only)
	Via	Via
North	8% River Mist (N) 2% Apolune (N)	5% River Mist (N) 5% Re-Aligned Greenbank (N)
South	25% Elevation (S) 5% River Mist (S)	20% Re-Aligned Greenbank (S) 5% River Mist (S) 5% Elevation (S)
East	30% Cambrian (E) 20% River Mist (S)	30% Cambrian Rd (E) 20% River Mist (S)
West	3% Cambrian (W) 7% Apolune (N)	3% Cambrian (W) 7% Apolune (N)
Total	100%	100%

Figure 11: New Site Generation Auto Volumes

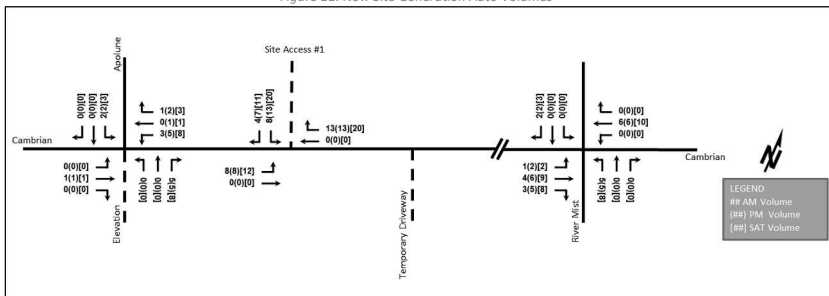
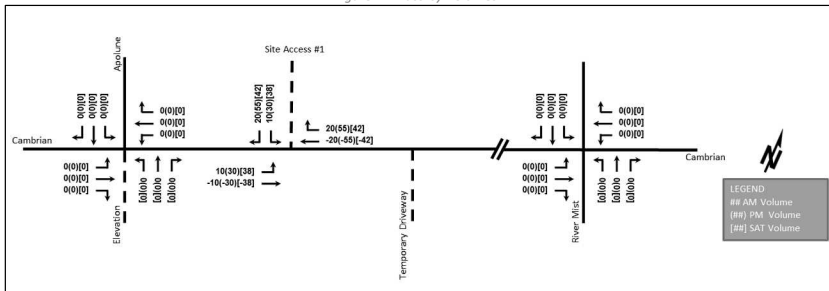

Figure 12: Pass-by Volumes



Appendix G

Synchro Intersection Worksheets – 2025 Future Background Conditions

HCM 2010 AWSC
1: River Mist & Cambrian

2025 Future Background
AM Peak Hour

Intersection	
Intersection Delay, s/veh	85.2
Intersection LOS	F

Movement	EBL	EBT	EBR	WBL	WBT	WBR	NBL	NBT	NBR	SBL	SBT	SBR
Lane Configurations		↔			↕			↕			↔	
Traffic Vol, veh/h	24	498	85	49	383	51	181	50	104	71	16	48
Future Vol, veh/h	24	498	85	49	383	51	181	50	104	71	16	48
Peak Hour Factor	1.00	1.00	1.00	1.00	1.00	1.00	1.00	1.00	1.00	1.00	1.00	1.00
Heavy Vehicles, %	7	10	6	16	9	4	2	10	4	3	6	4
Mvmt Flow	24	498	85	49	383	51	181	50	104	71	16	48
Number of Lanes	0	1	0	0	1	0	0	1	0	0	1	0

Approach	EB	WB	NB	SB
Opposing Approach	WB	EB	SB	NB
Opposing Lanes	1	1	1	1
Conflicting Approach Left	SB	NB	EB	WB
Conflicting Lanes Left	1	1	1	1
Conflicting Approach Right	NB	SB	WB	EB
Conflicting Lanes Right	1	1	1	1
HCM Control Delay	145.7	66.7	29.8	17
HCM LOS	F	F	D	C

Lane	NBLn1	EBLn1	WBLn1	SBLn1
Vol Left, %	54%	4%	10%	53%
Vol Thru, %	15%	82%	79%	12%
Vol Right, %	31%	14%	11%	36%
Sign Control	Stop	Stop	Stop	Stop
Traffic Vol by Lane	335	607	483	135
LT Vol	181	24	49	71
Through Vol	50	498	383	16
RT Vol	104	85	51	48
Lane Flow Rate	335	607	483	135
Geometry Grp	1	1	1	1
Degree of Util (X)	0.718	1.234	0.985	0.326
Departure Headway (Hd)	8.33	7.319	7.888	9.478
Convergence, Y/N	Yes	Yes	Yes	Yes
Cap	439	504	464	382
Service Time	6.33	5.319	5.888	7.478
HCM Lane V/C Ratio	0.763	1.204	1.041	0.353
HCM Control Delay	29.8	145.7	66.7	17
HCM Lane LOS	D	F	F	C
HCM 95th-tile Q	5.6	23.9	12.6	1.4

Lanes, Volumes, Timings
2: Elevation/Polune & Cambrian

2025 Future Background
AM Peak Hour

Lane Group	EBL	EBT	EBR	WBL	WBT	WBR	NBL	NBT	NBR	SBL	SBT	SBR
Lane Configurations	↔	↔		↔	↔		↔	↔		↔	↔	
Traffic Volume (vph)	14	247	129	53	451	93	270	0	112	172	0	42
Future Volume (vph)	14	247	129	53	451	93	270	0	112	172	0	42
Satd. Flow (prot)	1658	1476	0	1658	1482	0	1658	1483	0	1492	1483	0
Fit Permitted	0.370			0.504			0.730			0.685		
Satd. Flow (perm)	646	1476	0	880	1482	0	1274	1483	0	1076	1483	0
Satd. Flow (RTOR)		52			20			564				322
Lane Group Flow (vph)	14	376	0	53	544	0	270	112	0	172	42	0
Turn Type	Perm	NA		Perm	NA		Perm	NA		Perm	NA	
Protected Phases		2			6			4				8
Permitted Phases	2			6			4			8		
Detector Phase	2	2		6	6		4	4		8	8	
Switch Phase												
Minimum Initial (s)	10.0	10.0		10.0	10.0		10.0	10.0		10.0	10.0	
Minimum Split (s)	23.7	23.7		23.7	23.7		30.4	30.4		30.4	30.4	
Total Split (s)	39.3	39.3		39.3	39.3		30.7	30.7		30.7	30.7	
Total Split (%)	56.1%	56.1%		56.1%	56.1%		43.9%	43.9%		43.9%	43.9%	
Yellow Time (s)	4.2	4.2		4.2	4.2		3.3	3.3		3.3	3.3	
All-Red Time (s)	1.5	1.5		1.5	1.5		2.6	2.6		2.6	2.6	
Lost Time Adjust (s)	0.0	0.0		0.0	0.0		0.0	0.0		0.0	0.0	
Total Lost Time (s)	5.7	5.7		5.7	5.7		5.9	5.9		5.9	5.9	
Lead/Lag												
Lead-Lag Optimize?												
Recall Mode	C-Min	C-Min		C-Min	C-Min		None	None		None	None	
Act Effct Green (s)	39.1	39.1		39.1	39.1		19.3	19.3		19.3	19.3	
Actuated g/C Ratio	0.56	0.56		0.56	0.56		0.28	0.28		0.28	0.28	
v/c Ratio	0.04	0.44		0.11	0.65		0.77	0.14		0.58	0.07	
Control Delay	9.6	11.0		9.8	16.7		37.7	0.3		29.0	0.2	
Queue Delay	0.0	0.0		0.0	0.0		0.0	0.0		0.0	0.0	
Total Delay	9.6	11.0		9.8	16.7		37.7	0.3		29.0	0.2	
LOS	A	B		A	B		D	A		C	A	
Approach Delay		10.9			16.1			26.7			23.4	
Approach LOS		B			B			C			C	
Queue Length 50th (m)	0.8	22.7		3.1	44.4		31.9	0.0		19.1	0.0	
Queue Length 95th (m)	3.6	49.2		9.4	#95.7		51.5	0.0		33.5	0.0	
Internal Link Dist (m)		192.0			258.6			97.9			184.1	
Turn Bay Length (m)	37.5			37.5			30.0			30.0		
Base Capacity (vph)	361	847		491	837		451	889		381	733	
Starvation Cap Reductn	0	0		0	0		0	0		0	0	
Spillback Cap Reductn	0	0		0	0		0	0		0	0	
Storage Cap Reductn	0	0		0	0		0	0		0	0	
Reduced v/c Ratio	0.04	0.44		0.11	0.65		0.60	0.13		0.45	0.06	

Intersection Summary	
Cycle Length: 70	
Actuated Cycle Length: 70	
Offset: 0 (0%), Referenced to phase 2:EBTL and 6:WBTL, Start of Green	
Natural Cycle: 65	
Control Type: Actuated-Coordinated	

Lanes, Volumes, Timings
2: Elevation/Apolune & Cambrian

2025 Future Background
AM Peak Hour

Maximum v/c Ratio: 0.77	Intersection LOS: B
Intersection Signal Delay: 18.4	ICU Level of Service D
Intersection Capacity Utilization 76.2%	
Analysis Period (min) 15	
# 95th percentile volume exceeds capacity, queue may be longer.	
Queue shown is maximum after two cycles.	

Splits and Phases: 2: Elevation/Apolune & Cambrian



HCM 2010 TWSC
5: Temporary Driveway & Cambrian

2025 Future Background
AM Peak Hour

Intersection						
Int Delay, s/veh	0.4					
Movement	EBT	EBR	WBL	WBT	NBL	NBR
Lane Configurations	↔ ↗ ↘ ↙ ↘ ↗					
Traffic Vol, veh/h	508	22	9	591	15	6
Future Vol, veh/h	508	22	9	591	15	6
Conflicting Peds, #/hr	0	0	0	0	0	0
Sign Control	Free	Free	Free	Free	Stop	Stop
RT Channelized	-	None	-	None	-	None
Storage Length	-	-	-	-	0	-
Veh in Median Storage, #	0	-	-	0	0	-
Grade, %	0	-	-	0	0	-
Peak Hour Factor	100	100	100	100	100	100
Heavy Vehicles, %	2	2	2	2	2	2
Mvmt Flow	508	22	9	591	15	6
Major/Minor	Major1	Major2	Minor1			
Conflicting Flow All	0	0	530	0	1128	519
Stage 1	-	-	-	-	519	-
Stage 2	-	-	-	-	609	-
Critical Hdwy	-	-	4.12	-	6.42	6.22
Critical Hdwy Stg 1	-	-	-	-	5.42	-
Critical Hdwy Stg 2	-	-	-	-	5.42	-
Follow-up Hdwy	-	-	2.218	-	3.518	3.318
Pot Cap-1 Maneuver	-	-	1037	-	226	557
Stage 1	-	-	-	-	597	-
Stage 2	-	-	-	-	543	-
Platoon blocked, %	-	-	-	-	-	-
Mov Cap-1 Maneuver	-	-	1037	-	223	557
Mov Cap-2 Maneuver	-	-	-	-	223	-
Stage 1	-	-	-	-	597	-
Stage 2	-	-	-	-	536	-
Approach	EB	WB	NB			
HCM Control Delay, s	0	0.1	19.5			
HCM LOS						C
Minor Lane/Major Mvmt	NBLn1	EBT	EBR	WBL	WBT	
Capacity (veh/h)	269	-	-	1037	-	
HCM Lane V/C Ratio	0.078	-	-	0.009	-	
HCM Control Delay (s)	19.5	-	-	8.5	0	
HCM Lane LOS	C	-	-	A	A	
HCM 95th %tile Q(veh)	0.3	-	-	0	-	

HCM 2010 AWSC
11: Grand Canal & Cambrian

2025 Future Background
AM Peak Hour

Intersection	
Intersection Delay, s/veh	60.3
Intersection LOS	F

Movement	EBL	EBT	EBR	WBL	WBT	WBR	NBL	NBT	NBR	SBL	SBT	SBR
Lane Configurations		↕			↕			↕			↕	
Traffic Vol, veh/h	27	445	73	37	473	21	101	64	59	71	77	43
Future Vol, veh/h	27	445	73	37	473	21	101	64	59	71	77	43
Peak Hour Factor	1.00	1.00	1.00	1.00	1.00	1.00	1.00	1.00	1.00	1.00	1.00	1.00
Heavy Vehicles, %	4	2	2	2	4	10	5	2	2	4	3	5
Mvmt Flow	27	445	73	37	473	21	101	64	59	71	77	43
Number of Lanes	0	1	0	0	1	0	0	1	0	0	1	0

Approach	EB	WB	NB	SB
Opposing Approach	WB	EB	SB	NB
Opposing Lanes	1	1	1	1
Conflicting Approach Left	SB	NB	EB	WB
Conflicting Lanes Left	1	1	1	1
Conflicting Approach Right	NB	SB	WB	EB
Conflicting Lanes Right	1	1	1	1
HCM Control Delay	81.1	71.3	19.7	18.2
HCM LOS	F	F	C	C

Lane	NBLn1	EBLn1	WBLn1	SBLn1
Vol Left, %	45%	5%	7%	37%
Vol Thru, %	29%	82%	89%	40%
Vol Right, %	26%	13%	4%	23%
Sign Control	Stop	Stop	Stop	Stop
Traffic Vol by Lane	224	545	531	191
LT Vol	101	27	37	71
Through Vol	64	445	473	77
RT Vol	59	73	21	43
Lane Flow Rate	224	545	531	191
Geometry Grp	1	1	1	1
Degree of Util (X)	0.504	1.053	1.017	0.438
Departure Headway (Hd)	8.445	7.071	7.151	8.617
Convergence, Y/N	Yes	Yes	Yes	Yes
Cap	430	518	510	420
Service Time	6.445	5.071	5.151	6.617
HCM Lane V/C Ratio	0.521	1.052	1.041	0.455
HCM Control Delay	19.7	81.1	71.3	18.2
HCM Lane LOS	C	F	F	C
HCM 95th-tile Q	2.8	16	14.4	2.2

HCM 2010 AWSC
1: River Mist & Cambrian

2025 Future Background
PM Peak Hour

Intersection	
Intersection Delay, s/veh	83.8
Intersection LOS	F

Movement	EBL	EBT	EBR	WBL	WBT	WBR	NBL	NBT	NBR	SBL	SBT	SBR
Lane Configurations		↕			↕			↕			↕	
Traffic Vol, veh/h	36	475	142	123	467	76	113	15	103	38	12	29
Future Vol, veh/h	36	475	142	123	467	76	113	15	103	38	12	29
Peak Hour Factor	1.00	1.00	1.00	1.00	1.00	1.00	1.00	1.00	1.00	1.00	1.00	1.00
Heavy Vehicles, %	2	2	2	2	2	2	2	2	7	2	2	2
Mvmt Flow	36	475	142	123	467	76	113	15	103	38	12	29
Number of Lanes	0	1	0	0	1	0	0	1	0	0	1	0

Approach	EB	WB	NB	SB
Opposing Approach	WB	EB	SB	NB
Opposing Lanes	1	1	1	1
Conflicting Approach Left	SB	NB	EB	WB
Conflicting Lanes Left	1	1	1	1
Conflicting Approach Right	NB	SB	WB	EB
Conflicting Lanes Right	1	1	1	1
HCM Control Delay	92.7	106.4	17.5	13.6
HCM LOS	F	F	C	B

Lane	NBLn1	EBLn1	WBLn1	SBLn1
Vol Left, %	49%	6%	18%	48%
Vol Thru, %	6%	73%	70%	15%
Vol Right, %	45%	22%	11%	37%
Sign Control	Stop	Stop	Stop	Stop
Traffic Vol by Lane	231	653	666	79
LT Vol	113	36	123	38
Through Vol	15	475	467	12
RT Vol	103	142	76	29
Lane Flow Rate	231	653	666	79
Geometry Grp	1	1	1	1
Degree of Util (X)	0.468	1.101	1.14	0.177
Departure Headway (Hd)	7.818	6.38	6.424	8.741
Convergence, Y/N	Yes	Yes	Yes	Yes
Cap	464	575	573	413
Service Time	5.818	4.38	4.424	6.741
HCM Lane V/C Ratio	0.498	1.136	1.162	0.191
HCM Control Delay	17.5	92.7	106.4	13.6
HCM Lane LOS	C	F	F	B
HCM 95th-tile Q	2.4	19.2	21.1	0.6

Lanes, Volumes, Timings
2: Elevation/Apolune & Cambrian

2025 Future Background
PM Peak Hour

Lane Group	EBL	EBT	EBR	WBL	WBT	WBR	NBL	NBT	NBR	SBL	SBT	SBR
Lane Configurations	↔	↔	↔	↔	↔	↔	↔	↔	↔	↔	↔	↔
Traffic Volume (vph)	42	446	255	100	416	130	193	0	74	121	0	27
Future Volume (vph)	42	446	255	100	416	130	193	0	74	121	0	27
Satd. Flow (prot)	1658	1649	0	1658	1500	0	1658	1483	0	1492	1483	0
Fit Permitted	0.409			0.322			0.740			0.709		
Satd. Flow (perm)	710	1649	0	562	1500	0	1291	1483	0	1106	1483	0
Satd. Flow (RTOR)		47			26			442				459
Lane Group Flow (vph)	42	701	0	100	546	0	193	74	0	121	27	0
Turn Type	Perm	NA		Perm	NA		Perm	NA		Perm	NA	
Protected Phases		2			6			4			8	
Permitted Phases	2			6			4			8		
Detector Phase	2	2		6	6		4	4		8	8	
Switch Phase												
Minimum Initial (s)	10.0	10.0		10.0	10.0		10.0	10.0		10.0	10.0	
Minimum Split (s)	23.7	23.7		23.7	23.7		30.4	30.4		30.4	30.4	
Total Split (s)	82.0	82.0		82.0	82.0		38.0	38.0		38.0	38.0	
Total Split (%)	68.3%	68.3%		68.3%	68.3%		31.7%	31.7%		31.7%	31.7%	
Yellow Time (s)	4.2	4.2		4.2	4.2		3.3	3.3		3.3	3.3	
All-Red Time (s)	1.5	1.5		1.5	1.5		2.6	2.6		2.6	2.6	
Lost Time Adjust (s)	0.0	0.0		0.0	0.0		0.0	0.0		0.0	0.0	
Total Lost Time (s)	5.7	5.7		5.7	5.7		5.9	5.9		5.9	5.9	
Lead/Lag												
Lead-Lag Optimize?												
Recall Mode	C-Min	C-Min		C-Min	C-Min		None	None		None	None	
Act Effct Green (s)	85.3	85.3		85.3	85.3		23.1	23.1		23.1	23.1	
Actuated g/C Ratio	0.71	0.71		0.71	0.71		0.19	0.19		0.19	0.19	
v/c Ratio	0.08	0.59		0.25	0.51		0.78	0.12		0.57	0.04	
Control Delay	7.4	11.6		9.4	10.5		65.9	0.4		53.1	0.1	
Queue Delay	0.0	0.0		0.0	0.0		0.0	0.0		0.0	0.0	
Total Delay	7.4	11.6		9.4	10.5		65.9	0.4		53.1	0.1	
LOS	A	B		A	B		E	A		D	A	
Approach Delay		11.4			10.3			47.8			43.5	
Approach LOS		B			B			D			D	
Queue Length 50th (m)	2.7	68.3		7.4	49.2		43.5	0.0		26.0	0.0	
Queue Length 95th (m)	8.2	128.5		19.4	94.3		63.7	0.0		41.9	0.0	
Internal Link Dist (m)		122.9			258.0			171.4			184.1	
Turn Bay Length (m)	37.5			37.5			30.0			30.0		
Base Capacity (vph)	504	1185		399	1073		345	720		295	732	
Starvation Cap Reductn	0	0		0	0		0	0		0	0	
Spillback Cap Reductn	0	0		0	0		0	0		0	0	
Storage Cap Reductn	0	0		0	0		0	0		0	0	
Reduced v/c Ratio	0.08	0.59		0.25	0.51		0.56	0.10		0.41	0.04	

Intersection Summary												
Cycle Length: 120												
Actuated Cycle Length: 120												
Offset: 0 (0%), Referenced to phase 2:EBTL and 6:WBTL, Start of Green												
Natural Cycle: 70												
Control Type: Actuated-Coordinated												

Lanes, Volumes, Timings
2: Elevation/Apolune & Cambrian

2025 Future Background
PM Peak Hour

Maximum v/c Ratio: 0.78	Intersection LOS: B
Intersection Signal Delay: 19.0	ICU Level of Service D
Intersection Capacity Utilization 81.9%	
Analysis Period (min) 15	

Splits and Phases: 2: Elevation/Apolune & Cambrian

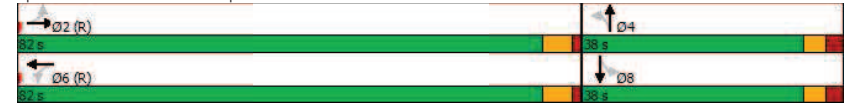

HCM 2010 TWSC
5: Temporary Driveway & Cambrian

2025 Future Background
PM Peak Hour

Intersection						
Int Delay, s/veh	1					
Movement	EBT	EBR	WBL	WBT	NBL	NBR
Lane Configurations	↔		↕		↕	
Traffic Vol, veh/h	588	57	6	613	38	9
Future Vol, veh/h	588	57	6	613	38	9
Conflicting Peds, #/hr	0	0	0	0	0	0
Sign Control	Free	Free	Free	Free	Stop	Stop
RT Channelized	- None		- None		- None	
Storage Length	-	-	-	-	0	-
Veh in Median Storage, #	0	-	-	0	0	-
Grade, %	0	-	-	0	0	-
Peak Hour Factor	100	100	100	100	100	100
Heavy Vehicles, %	2	2	2	2	2	2
Mvmt Flow	588	57	6	613	38	9
Major/Minor	Major1	Major2	Minor1			
Conflicting Flow All	0	0	645	0	1242	617
Stage 1	-	-	-	-	617	-
Stage 2	-	-	-	-	625	-
Critical Hdwy	-	-	4.12	-	6.42	6.22
Critical Hdwy Stg 1	-	-	-	-	5.42	-
Critical Hdwy Stg 2	-	-	-	-	5.42	-
Follow-up Hdwy	-	-	2.218	-	3.518	3.318
Pot Cap-1 Maneuver	-	-	940	-	193	490
Stage 1	-	-	-	-	538	-
Stage 2	-	-	-	-	534	-
Platoon blocked, %	-	-	-	-	-	-
Mov Cap-1 Maneuver	-	-	940	-	191	490
Mov Cap-2 Maneuver	-	-	-	-	191	-
Stage 1	-	-	-	-	538	-
Stage 2	-	-	-	-	529	-
Approach	EB	WB	NB			
HCM Control Delay, s	0	0.1	26.2			
HCM LOS				D		
Minor Lane/Major Mvmt	NBLn1	EBT	EBR	WBL	WBT	
Capacity (veh/h)	216	-	-	940	-	
HCM Lane V/C Ratio	0.218	-	-	0.006	-	
HCM Control Delay (s)	26.2	-	-	8.9	0	
HCM Lane LOS	D	-	-	A	A	
HCM 95th %tile Q(veh)	0.8	-	-	0	-	

HCM 2010 AWSC
11: Grand Canal & Cambrian

2025 Future Background
PM Peak Hour

Intersection												
Intersection Delay, s/veh	57.9											
Intersection LOS	F											
Movement	EBL	EBT	EBR	WBL	WBT	WBR	NBL	NBT	NBR	SBL	SBT	SBR
Lane Configurations	↔		↕		↕		↕		↕		↕	
Traffic Vol, veh/h	35	495	107	48	517	42	78	25	56	51	26	20
Future Vol, veh/h	35	495	107	48	517	42	78	25	56	51	26	20
Peak Hour Factor	1.00	1.00	1.00	1.00	1.00	1.00	1.00	1.00	1.00	1.00	1.00	1.00
Heavy Vehicles, %	3	4	4	2	5	2	3	2	2	4	4	2
Mvmt Flow	35	495	107	48	517	42	78	25	56	51	26	20
Number of Lanes	0	1	0	0	1	0	0	1	0	0	1	0
Approach	EB	WB	NB	SB								
Opposing Approach	WB	EB	SB	NB								
Opposing Lanes	1	1	1	1								
Conflicting Approach Left	SB	NB	EB	WB								
Conflicting Lanes Left	1	1	1	1								
Conflicting Approach Right	NB	SB	WB	EB								
Conflicting Lanes Right	1	1	1	1								
HCM Control Delay	71.3	62.3	14.4	13.3								
HCM LOS	F	F	B	B								
Lane	NBLn1	EBLn1	WBLn1	SBLn1								
Vol Left, %	49%	5%	8%	53%								
Vol Thru, %	16%	78%	85%	27%								
Vol Right, %	35%	17%	7%	21%								
Sign Control	Stop	Stop	Stop	Stop								
Traffic Vol by Lane	159	637	607	97								
LT Vol	78	35	48	51								
Through Vol	25	495	517	26								
RT Vol	56	107	42	20								
Lane Flow Rate	159	637	607	97								
Geometry Grp	1	1	1	1								
Degree of Util (X)	0.33	1.038	1.003	0.212								
Departure Headway (Hd)	7.694	6.014	6.102	8.131								
Convergence, Y/N	Yes	Yes	Yes	Yes								
Cap	471	605	601	444								
Service Time	5.694	4.014	4.102	6.131								
HCM Lane V/C Ratio	0.338	1.053	1.01	0.218								
HCM Control Delay	14.4	71.3	62.3	13.3								
HCM Lane LOS	B	F	F	B								
HCM 95th-tile Q	1.4	16.8	15	0.8								

Appendix H

Signal Warrant Calculation Sheet

Cambrian Road @ River Mist Road
 FB 2025

Justification #7

Justification	Description	Minimum Requirement		Minimum Requirement		Compliance		Entire %	Signal
		1 Lane Highway		2 or More Lanes		Sectional			
		Free Flow	Restr. Flow	Free Flow	Restr. Flow	Numerical	%		
1. Minimum Vehicular Volume	A. Vehicle volume, all approaches (average hour)	480	720	600	900	795	110%	110%	No
	B. Vehicle volume, along minor streets (average hour)	120	170	120	170	194	114%		
2. Delay to Cross Traffic	A. Vehicle volumes, major street (average hour)	480	720	600	900	601	83%	83%	No
	B. Combined vehicle and pedestrian volume crossing artery from minor streets (average hour)	50	75	50	75	117	155%		

- Notes
1. Refer to OTM Book 12, pg 92, Mar 2012
 2. Lowest section percentage governs justification
 3. Average hourly volumes estimated from peak hour volumes, $AHV = PM/2$ or $(AM + PM) / 4$, including amplification factors
 4. T-intersection factor corrected, applies only to 1B

Cambrian Road @ River Mist Road
 FB 2030

Justification #7

Justification	Description	Minimum Requirement		Minimum Requirement		Compliance		Entire %	Signal
		1 Lane Highway		2 or More Lanes		Sectional			
		Free Flow	Restr. Flow	Free Flow	Restr. Flow	Numerical	%		
1. Minimum Vehicular Volume	A. Vehicle volume, all approaches (average hour)	480	720	600	900	810	113%	113%	No
	B. Vehicle volume, along minor streets (average hour)	120	170	120	170	200	118%		
2. Delay to Cross Traffic	A. Vehicle volumes, major street (average hour)	480	720	600	900	610	85%	85%	No
	B. Combined vehicle and pedestrian volume crossing artery from minor streets (average hour)	50	75	50	75	121	161%		

- Notes
1. Refer to OTM Book 12, pg 92, Mar 2012
 2. Lowest section percentage governs justification
 3. Average hourly volumes estimated from peak hour volumes, $AHV = PM/2$ or $(AM + PM) / 4$, including amplification factors
 4. T-intersection factor corrected, applies only to 1B

Cambrian Road @ River Mist Road
FT 2025

Justification #7

Justification	Description	Minimum Requirement		Minimum Requirement		Compliance		Entire %	Signal
		1 Lane Highway		2 or More Lanes		Sectional			
		Free Flow	Restr. Flow	Free Flow	Restr. Flow	Numerical	%		
1. Minimum Vehicular Volume	A. Vehicle volume, all approaches (average hour)	480	720	600	900	824	114%	114%	No
	B. Vehicle volume, along minor streets (average hour)	120	170	120	170	201	118%		
2. Delay to Cross Traffic	A. Vehicle volumes, major street (average hour)	480	720	600	900	623	87%	87%	No
	B. Combined vehicle and pedestrian volume crossing artery from minor streets (average hour)	50	75	50	75	122	163%		

- Notes
1. Refer to OTM Book 12, pg 92, Mar 2012
 2. Lowest section percentage governs justification
 3. Average hourly volumes estimated from peak hour volumes, $AHV = PM/2$ or $(AM + PM) / 4$, including amplification factors
 4. T-intersection factor corrected, applies only to 1B

Cambrian Road @ River Mist Road
FT 2030

Justification #7

Justification	Description	Minimum Requirement		Minimum Requirement		Compliance		Entire %	Signal
		1 Lane Highway		2 or More Lanes		Sectional			
		Free Flow	Restr. Flow	Free Flow	Restr. Flow	Numerical	%		
1. Minimum Vehicular Volume	A. Vehicle volume, all approaches (average hour)	480	720	600	900	839	116%	116%	No
	B. Vehicle volume, along minor streets (average hour)	120	170	120	170	207	122%		
2. Delay to Cross Traffic	A. Vehicle volumes, major street (average hour)	480	720	600	900	632	88%	88%	No
	B. Combined vehicle and pedestrian volume crossing artery from minor streets (average hour)	50	75	50	75	127	169%		

- Notes
1. Refer to OTM Book 12, pg 92, Mar 2012
 2. Lowest section percentage governs justification
 3. Average hourly volumes estimated from peak hour volumes, $AHV = PM/2$ or $(AM + PM) / 4$, including amplification factors
 4. T-intersection factor corrected, applies only to 1B

Cambrian Road @ Grand Canal Street
 FB 2025

Justification #7

Justification	Description	Minimum Requirement		Minimum Requirement		Compliance		Entire %	Signal
		1 Lane Highway		2 or More Lanes		Sectional			
		Free Flow	Restr. Flow	Free Flow	Restr. Flow	Numerical	%		
1. Minimum Vehicular Volume	A. Vehicle volume, all approaches (average hour)	480	720	600	900	748	104%	99%	No
	B. Vehicle volume, along minor streets (average hour)	120	170	120	170	169	99%		
2. Delay to Cross Traffic	A. Vehicle volumes, major street (average hour)	480	720	600	900	579	80%	80%	No
	B. Combined vehicle and pedestrian volume crossing artery from minor streets (average hour)	50	75	50	75	102	135%		

- Notes
1. Refer to OTM Book 12, pg 92, Mar 2012
 2. Lowest section percentage governs justification
 3. Average hourly volumes estimated from peak hour volumes, $AHV = PM/2$ or $(AM + PM) / 4$, including amplification factors
 4. T-intersection factor corrected, applies only to 1B

Cambrian Road @ Grand Canal Street
 FB 2030

Justification #7

Justification	Description	Minimum Requirement		Minimum Requirement		Compliance		Entire %	Signal
		1 Lane Highway		2 or More Lanes		Sectional			
		Free Flow	Restr. Flow	Free Flow	Restr. Flow	Numerical	%		
1. Minimum Vehicular Volume	A. Vehicle volume, all approaches (average hour)	480	720	600	900	759	105%	99%	No
	B. Vehicle volume, along minor streets (average hour)	120	170	120	170	169	99%		
2. Delay to Cross Traffic	A. Vehicle volumes, major street (average hour)	480	720	600	900	590	82%	82%	No
	B. Combined vehicle and pedestrian volume crossing artery from minor streets (average hour)	50	75	50	75	102	135%		

- Notes
1. Refer to OTM Book 12, pg 92, Mar 2012
 2. Lowest section percentage governs justification
 3. Average hourly volumes estimated from peak hour volumes, $AHV = PM/2$ or $(AM + PM) / 4$, including amplification factors
 4. T-intersection factor corrected, applies only to 1B

Cambrian Road @ Grand Canal Street
FT 2025

Justification #7

Justification	Description	Minimum Requirement		Minimum Requirement		Compliance		Entire %	Signal
		1 Lane Highway		2 or More Lanes		Sectional			
		Free Flow	Restr. Flow	Free Flow	Restr. Flow	Numerical	%		
1. Minimum Vehicular Volume	A. Vehicle volume, all approaches (average hour)	480	720	600	900	782	109%	101%	No
	B. Vehicle volume, along minor streets (average hour)	120	170	120	170	172	101%		
2. Delay to Cross Traffic	A. Vehicle volumes, major street (average hour)	480	720	600	900	610	85%	85%	No
	B. Combined vehicle and pedestrian volume crossing artery from minor streets (average hour)	50	75	50	75	103	137%		

- Notes
1. Refer to OTM Book 12, pg 92, Mar 2012
 2. Lowest section percentage governs justification
 3. Average hourly volumes estimated from peak hour volumes, $AHV = PM/2$ or $(AM + PM) / 4$, including amplification factors
 4. T-intersection factor corrected, applies only to 1B

Cambrian Road @ Grand Canal Street
FT 2030

Justification #7

Justification	Description	Minimum Requirement		Minimum Requirement		Compliance		Entire %	Signal
		1 Lane Highway		2 or More Lanes		Sectional			
		Free Flow	Restr. Flow	Free Flow	Restr. Flow	Numerical	%		
1. Minimum Vehicular Volume	A. Vehicle volume, all approaches (average hour)	480	720	600	900	793	110%	101%	No
	B. Vehicle volume, along minor streets (average hour)	120	170	120	170	172	101%		
2. Delay to Cross Traffic	A. Vehicle volumes, major street (average hour)	480	720	600	900	621	86%	86%	No
	B. Combined vehicle and pedestrian volume crossing artery from minor streets (average hour)	50	75	50	75	103	137%		

- Notes
1. Refer to OTM Book 12, pg 92, Mar 2012
 2. Lowest section percentage governs justification
 3. Average hourly volumes estimated from peak hour volumes, $AHV = PM/2$ or $(AM + PM) / 4$, including amplification factors
 4. T-intersection factor corrected, applies only to 1B

Appendix I

Synchro Intersection Worksheets – 2030 Future Background Conditions

HCM 2010 AWSC
1: River Mist & Cambrian

2030 Future Background
AM Peak Hour

Intersection	
Intersection Delay, s/veh	91.4
Intersection LOS	F

Movement	EBL	EBT	EBR	WBL	WBT	WBR	NBL	NBT	NBR	SBL	SBT	SBR
Lane Configurations		↔			↕			↕			↔	
Traffic Vol, veh/h	24	502	90	51	385	51	191	50	109	71	16	48
Future Vol, veh/h	24	502	90	51	385	51	191	50	109	71	16	48
Peak Hour Factor	1.00	1.00	1.00	1.00	1.00	1.00	1.00	1.00	1.00	1.00	1.00	1.00
Heavy Vehicles, %	7	10	6	16	9	4	2	10	4	3	6	4
Mvmt Flow	24	502	90	51	385	51	191	50	109	71	16	48
Number of Lanes	0	1	0	0	1	0	0	1	0	0	1	0

Approach	EB	WB	NB	SB
Opposing Approach	WB	EB	SB	NB
Opposing Lanes	1	1	1	1
Conflicting Approach Left	SB	NB	EB	WB
Conflicting Lanes Left	1	1	1	1
Conflicting Approach Right	NB	SB	WB	EB
Conflicting Lanes Right	1	1	1	1
HCM Control Delay	155.2	73	33.1	17.4
HCM LOS	F	F	D	C

Lane	NBLn1	EBLn1	WBLn1	SBLn1
Vol Left, %	55%	4%	10%	53%
Vol Thru, %	14%	81%	79%	12%
Vol Right, %	31%	15%	10%	36%
Sign Control	Stop	Stop	Stop	Stop
Traffic Vol by Lane	350	616	487	135
LT Vol	191	24	51	71
Through Vol	50	502	385	16
RT Vol	109	90	51	48
Lane Flow Rate	350	616	487	135
Geometry Grp	1	1	1	1
Degree of Util (X)	0.755	1.257	1.007	0.331
Departure Headway (Hd)	8.422	7.453	8.038	9.692
Convergence, Y/N	Yes	Yes	Yes	Yes
Cap	434	493	453	374
Service Time	6.422	5.453	6.038	7.692
HCM Lane V/C Ratio	0.806	1.249	1.075	0.361
HCM Control Delay	33.1	155.2	73	17.4
HCM Lane LOS	D	F	F	C
HCM 95th-tile Q	6.3	24.7	13.2	1.4

Lanes, Volumes, Timings
2: Elevation/Polune & Cambrian

2030 Future Background
AM Peak Hour



Lane Group	EBL	EBT	EBR	WBL	WBT	WBR	NBL	NBT	NBR	SBL	SBT	SBR
Lane Configurations	↔	↔		↔	↔		↔	↔		↔	↔	
Traffic Volume (vph)	14	256	129	53	463	93	270	0	112	172	0	42
Future Volume (vph)	14	256	129	53	463	93	270	0	112	172	0	42
Satd. Flow (prot)	1658	1475	0	1658	1483	0	1658	1483	0	1492	1483	0
Fit Permitted	0.361			0.497			0.730			0.685		
Satd. Flow (perm)	630	1475	0	867	1483	0	1274	1483	0	1076	1483	0
Satd. Flow (RTOR)		50			20			551				311
Lane Group Flow (vph)	14	385	0	53	556	0	270	112	0	172	42	0
Turn Type	Perm	NA		Perm	NA		Perm	NA		Perm	NA	
Protected Phases		2			6			4			8	
Permitted Phases	2			6			4			8		
Detector Phase	2	2		6	6		4	4		8	8	
Switch Phase												
Minimum Initial (s)	10.0	10.0		10.0	10.0		10.0	10.0		10.0	10.0	
Minimum Split (s)	23.7	23.7		23.7	23.7		30.4	30.4		30.4	30.4	
Total Split (s)	39.3	39.3		39.3	39.3		30.7	30.7		30.7	30.7	
Total Split (%)	56.1%	56.1%		56.1%	56.1%		43.9%	43.9%		43.9%	43.9%	
Yellow Time (s)	4.2	4.2		4.2	4.2		3.3	3.3		3.3	3.3	
All-Red Time (s)	1.5	1.5		1.5	1.5		2.6	2.6		2.6	2.6	
Lost Time Adjust (s)	0.0	0.0		0.0	0.0		0.0	0.0		0.0	0.0	
Total Lost Time (s)	5.7	5.7		5.7	5.7		5.9	5.9		5.9	5.9	
Lead/Lag												
Lead-Lag Optimize?												
Recall Mode	C-Min	C-Min		C-Min	C-Min		None	None		None	None	
Act Effct Green (s)	39.1	39.1		39.1	39.1		19.3	19.3		19.3	19.3	
Actuated g/C Ratio	0.56	0.56		0.56	0.56		0.28	0.28		0.28	0.28	
v/c Ratio	0.04	0.46		0.11	0.66		0.77	0.14		0.58	0.07	
Control Delay	9.6	11.2		9.9	17.3		37.7	0.4		29.0	0.2	
Queue Delay	0.0	0.0		0.0	0.0		0.0	0.0		0.0	0.0	
Total Delay	9.6	11.2		9.9	17.3		37.7	0.4		29.0	0.2	
LOS	A	B		A	B		D	A		C	A	
Approach Delay		11.2			16.6			26.7			23.4	
Approach LOS		B			B			C			C	
Queue Length 50th (m)	0.8	23.7		3.1	45.9		31.9	0.0		19.1	0.0	
Queue Length 95th (m)	3.6	50.8		9.4	#107.4		51.5	0.0		33.5	0.0	
Internal Link Dist (m)		192.0			258.6			97.9			184.1	
Turn Bay Length (m)	37.5			37.5			30.0			30.0		
Base Capacity (vph)	352	846		484	837		451	881		381	726	
Starvation Cap Reductn	0	0		0	0		0	0		0	0	
Spillback Cap Reductn	0	0		0	0		0	0		0	0	
Storage Cap Reductn	0	0		0	0		0	0		0	0	
Reduced v/c Ratio	0.04	0.46		0.11	0.66		0.60	0.13		0.45	0.06	

Intersection Summary	
Cycle Length:	70
Actuated Cycle Length:	70
Offset:	0 (0%), Referenced to phase 2:EBTL and 6:WBTL, Start of Green
Natural Cycle:	65
Control Type:	Actuated-Coordinated

Lanes, Volumes, Timings
2: Elevation/Apolune & Cambrian

2030 Future Background
AM Peak Hour

Maximum v/c Ratio: 0.77	Intersection LOS: B
Intersection Signal Delay: 18.6	ICU Level of Service D
Intersection Capacity Utilization 76.9%	
Analysis Period (min) 15	
# 95th percentile volume exceeds capacity, queue may be longer.	
Queue shown is maximum after two cycles.	

Splits and Phases: 2: Elevation/Apolune & Cambrian

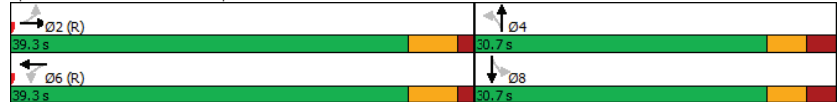

HCM 2010 TWSC
5: Temporary Driveway & Cambrian

2030 Future Background
AM Peak Hour

Intersection						
Int Delay, s/veh	0.4					
Movement	EBT	EBR	WBL	WBT	NBL	NBR
Lane Configurations	↔		↔		↔	
Traffic Vol, veh/h	513	22	9	601	15	6
Future Vol, veh/h	513	22	9	601	15	6
Conflicting Peds, #/hr	0	0	0	0	0	0
Sign Control	Free	Free	Free	Free	Stop	Stop
RT Channelized	-	None	-	None	-	None
Storage Length	-	-	-	-	0	-
Veh in Median Storage, #	0	-	-	0	0	-
Grade, %	0	-	-	0	0	-
Peak Hour Factor	100	100	100	100	100	100
Heavy Vehicles, %	2	2	2	2	2	2
Mvmt Flow	513	22	9	601	15	6

Major/Minor	Major1	Major2	Minor1
Conflicting Flow All	0	0	535
Stage 1	-	-	524
Stage 2	-	-	619
Critical Hdwy	-	4.12	6.42
Critical Hdwy Stg 1	-	-	5.42
Critical Hdwy Stg 2	-	-	5.42
Follow-up Hdwy	-	2.218	3.518
Pot Cap-1 Maneuver	-	1033	221
Stage 1	-	-	594
Stage 2	-	-	537
Platoon blocked, %	-	-	-
Mov Cap-1 Maneuver	-	1033	218
Mov Cap-2 Maneuver	-	-	218
Stage 1	-	-	594
Stage 2	-	-	530

Approach	EB	WB	NB
HCM Control Delay, s	0	0.1	19.8
HCM LOS			C

Minor Lane/Major Mvmt	NBLn1	EBT	EBR	WBL	WBT
Capacity (veh/h)	264	-	-	1033	-
HCM Lane V/C Ratio	0.08	-	-	0.009	-
HCM Control Delay (s)	19.8	-	-	8.5	0
HCM Lane LOS	C	-	-	A	A
HCM 95th %tile Q(veh)	0.3	-	-	0	-

HCM 2010 AWSC
11: Grand Canal & Cambrian

2030 Future Background
AM Peak Hour

Intersection	
Intersection Delay, s/veh	64.1
Intersection LOS	F

Movement	EBL	EBT	EBR	WBL	WBT	WBR	NBL	NBT	NBR	SBL	SBT	SBR
Lane Configurations		↔			↕			↕			↔	
Traffic Vol, veh/h	27	449	78	37	485	21	101	64	59	71	77	43
Future Vol, veh/h	27	449	78	37	485	21	101	64	59	71	77	43
Peak Hour Factor	1.00	1.00	1.00	1.00	1.00	1.00	1.00	1.00	1.00	1.00	1.00	1.00
Heavy Vehicles, %	4	2	2	2	4	10	5	2	2	4	3	5
Mvmt Flow	27	449	78	37	485	21	101	64	59	71	77	43
Number of Lanes	0	1	0	0	1	0	0	1	0	0	1	0

Approach	EB	WB	NB	SB
Opposing Approach	WB	EB	SB	NB
Opposing Lanes	1	1	1	1
Conflicting Approach Left	SB	NB	EB	WB
Conflicting Lanes Left	1	1	1	1
Conflicting Approach Right	NB	SB	WB	EB
Conflicting Lanes Right	1	1	1	1
HCM Control Delay	83.4	78.7	19.9	18.3
HCM LOS	F	F	C	C

Lane	NBLn1	EBLn1	WBLn1	SBLn1
Vol Left, %	45%	5%	7%	37%
Vol Thru, %	29%	81%	89%	40%
Vol Right, %	26%	14%	4%	23%
Sign Control	Stop	Stop	Stop	Stop
Traffic Vol by Lane	224	554	543	191
LT Vol	101	27	37	71
Through Vol	64	449	485	77
RT Vol	59	78	21	43
Lane Flow Rate	224	554	543	191
Geometry Grp	1	1	1	1
Degree of Util (X)	0.506	1.06	1.043	0.44
Departure Headway (Hd)	8.512	7.115	7.172	8.687
Convergence, Y/N	Yes	Yes	Yes	Yes
Cap	426	515	510	416
Service Time	6.512	5.115	5.172	6.687
HCM Lane V/C Ratio	0.526	1.076	1.065	0.459
HCM Control Delay	19.9	83.4	78.7	18.3
HCM Lane LOS	C	F	F	C
HCM 95th-tile Q	2.8	16.2	15.4	2.2

HCM 2010 AWSC
1: River Mist & Cambrian

2030 Future Background
PM Peak Hour

Intersection	
Intersection Delay, s/veh	92.6
Intersection LOS	F

Movement	EBL	EBT	EBR	WBL	WBT	WBR	NBL	NBT	NBR	SBL	SBT	SBR
Lane Configurations		↔			↕			↕			↔	
Traffic Vol, veh/h	36	478	152	128	471	76	120	15	106	38	12	29
Future Vol, veh/h	36	478	152	128	471	76	120	15	106	38	12	29
Peak Hour Factor	1.00	1.00	1.00	1.00	1.00	1.00	1.00	1.00	1.00	1.00	1.00	1.00
Heavy Vehicles, %	2	2	2	2	2	2	2	2	7	2	2	2
Mvmt Flow	36	478	152	128	471	76	120	15	106	38	12	29
Number of Lanes	0	1	0	0	1	0	0	1	0	0	1	0

Approach	EB	WB	NB	SB
Opposing Approach	WB	EB	SB	NB
Opposing Lanes	1	1	1	1
Conflicting Approach Left	SB	NB	EB	WB
Conflicting Lanes Left	1	1	1	1
Conflicting Approach Right	NB	SB	WB	EB
Conflicting Lanes Right	1	1	1	1
HCM Control Delay	104.5	116.7	18.3	13.9
HCM LOS	F	F	C	B

Lane	NBLn1	EBLn1	WBLn1	SBLn1
Vol Left, %	50%	5%	19%	48%
Vol Thru, %	6%	72%	70%	15%
Vol Right, %	44%	23%	11%	37%
Sign Control	Stop	Stop	Stop	Stop
Traffic Vol by Lane	241	666	675	79
LT Vol	120	36	128	38
Through Vol	15	478	471	12
RT Vol	106	152	76	29
Lane Flow Rate	241	666	675	79
Geometry Grp	1	1	1	1
Degree of Util (X)	0.49	1.134	1.167	0.179
Departure Headway (Hd)	7.917	6.467	6.526	8.923
Convergence, Y/N	Yes	Yes	Yes	Yes
Cap	458	566	560	404
Service Time	5.917	4.467	4.526	6.923
HCM Lane V/C Ratio	0.526	1.177	1.205	0.196
HCM Control Delay	18.3	104.5	116.7	13.9
HCM Lane LOS	C	F	F	B
HCM 95th-tile Q	2.6	20.7	22.3	0.6

Lanes, Volumes, Timings
2: Elevation/Apolune & Cambrian

2030 Future Background
PM Peak Hour

Lane Group	EBL	EBT	EBR	WBL	WBT	WBR	NBL	NBT	NBR	SBL	SBT	SBR
Lane Configurations	↔	↔	↔	↔	↔	↔	↔	↔	↔	↔	↔	↔
Traffic Volume (vph)	42	459	255	100	427	130	193	0	74	121	0	27
Future Volume (vph)	42	459	255	100	427	130	193	0	74	121	0	27
Satd. Flow (prot)	1658	1651	0	1658	1502	0	1658	1483	0	1492	1483	0
Fit Permitted	0.403			0.315			0.740			0.709		
Satd. Flow (perm)	699	1651	0	550	1502	0	1291	1483	0	1106	1483	0
Satd. Flow (RTOR)		46			25			430				449
Lane Group Flow (vph)	42	714	0	100	557	0	193	74	0	121	27	0
Turn Type	Perm	NA		Perm	NA		Perm	NA		Perm	NA	
Protected Phases		2			6			4			8	
Permitted Phases	2			6			4			8		
Detector Phase	2	2		6	6		4	4		8	8	
Switch Phase												
Minimum Initial (s)	10.0	10.0		10.0	10.0		10.0	10.0		10.0	10.0	
Minimum Split (s)	23.7	23.7		23.7	23.7		30.4	30.4		30.4	30.4	
Total Split (s)	82.0	82.0		82.0	82.0		38.0	38.0		38.0	38.0	
Total Split (%)	68.3%	68.3%		68.3%	68.3%		31.7%	31.7%		31.7%	31.7%	
Yellow Time (s)	4.2	4.2		4.2	4.2		3.3	3.3		3.3	3.3	
All-Red Time (s)	1.5	1.5		1.5	1.5		2.6	2.6		2.6	2.6	
Lost Time Adjust (s)	0.0	0.0		0.0	0.0		0.0	0.0		0.0	0.0	
Total Lost Time (s)	5.7	5.7		5.7	5.7		5.9	5.9		5.9	5.9	
Lead/Lag												
Lead-Lag Optimize?												
Recall Mode	C-Min	C-Min		C-Min	C-Min		None	None		None	None	
Act Effct Green (s)	85.3	85.3		85.3	85.3		23.1	23.1		23.1	23.1	
Actuated g/C Ratio	0.71	0.71		0.71	0.71		0.19	0.19		0.19	0.19	
v/c Ratio	0.08	0.60		0.26	0.52		0.78	0.12		0.57	0.04	
Control Delay	7.4	11.9		9.6	10.7		65.9	0.4		53.1	0.1	
Queue Delay	0.0	0.0		0.0	0.0		0.0	0.0		0.0	0.0	
Total Delay	7.4	11.9		9.6	10.7		65.9	0.4		53.1	0.1	
LOS	A	B		A	B		E	A		D	A	
Approach Delay		11.7			10.5			47.8			43.5	
Approach LOS		B			B			D			D	
Queue Length 50th (m)	2.7	70.7		7.5	50.9		43.5	0.0		26.0	0.0	
Queue Length 95th (m)	8.2	133.1		19.6	97.4		63.7	0.0		41.9	0.0	
Internal Link Dist (m)		122.9			258.0			171.4			184.1	
Turn Bay Length (m)	37.5			37.5			30.0			30.0		
Base Capacity (vph)	496	1186		391	1074		345	711		295	725	
Starvation Cap Reductn	0	0		0	0		0	0		0	0	
Spillback Cap Reductn	0	0		0	0		0	0		0	0	
Storage Cap Reductn	0	0		0	0		0	0		0	0	
Reduced v/c Ratio	0.08	0.60		0.26	0.52		0.56	0.10		0.41	0.04	

Intersection Summary												
Cycle Length: 120												
Actuated Cycle Length: 120												
Offset: 0 (0%), Referenced to phase 2:EBTL and 6:WBTL, Start of Green												
Natural Cycle: 70												
Control Type: Actuated-Coordinated												

Lanes, Volumes, Timings
2: Elevation/Apolune & Cambrian

2030 Future Background
PM Peak Hour

Maximum v/c Ratio: 0.78	Intersection LOS: B
Intersection Signal Delay: 19.1	ICU Level of Service E
Intersection Capacity Utilization 82.6%	
Analysis Period (min) 15	

Splits and Phases: 2: Elevation/Apolune & Cambrian

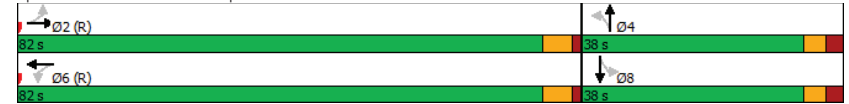

HCM 2010 TWSC
5: Temporary Driveway & Cambrian

2030 Future Background
PM Peak Hour

Intersection						
Int Delay, s/veh	1					
Movement	EBT	EBR	WBL	WBT	NBL	NBR
Lane Configurations	↔		↔		↔	
Traffic Vol, veh/h	598	57	6	620	38	9
Future Vol, veh/h	598	57	6	620	38	9
Conflicting Peds, #/hr	0	0	0	0	0	0
Sign Control	Free	Free	Free	Free	Stop	Stop
RT Channelized	- None		- None		- None	
Storage Length	-	-	-	-	0	-
Veh in Median Storage, #	0	-	-	0	0	-
Grade, %	0	-	-	0	0	-
Peak Hour Factor	100	100	100	100	100	100
Heavy Vehicles, %	2	2	2	2	2	2
Mvmt Flow	598	57	6	620	38	9
Major/Minor	Major1	Major2	Minor1			
Conflicting Flow All	0	0	655	0	1259	627
Stage 1	-	-	-	-	627	-
Stage 2	-	-	-	-	632	-
Critical Hdwy	-	-	4.12	-	6.42	6.22
Critical Hdwy Stg 1	-	-	-	-	5.42	-
Critical Hdwy Stg 2	-	-	-	-	5.42	-
Follow-up Hdwy	-	-	2.218	-	3.518	3.318
Pot Cap-1 Maneuver	-	-	932	-	188	484
Stage 1	-	-	-	-	532	-
Stage 2	-	-	-	-	530	-
Platoon blocked, %	-	-	-	-	-	-
Mov Cap-1 Maneuver	-	-	932	-	186	484
Mov Cap-2 Maneuver	-	-	-	-	186	-
Stage 1	-	-	-	-	532	-
Stage 2	-	-	-	-	525	-
Approach	EB	WB	NB			
HCM Control Delay, s	0	0.1	26.9			
HCM LOS				D		
Minor Lane/Major Mvmt	NBLn1	EBT	EBR	WBL	WBT	
Capacity (veh/h)	211	-	-	932	-	
HCM Lane V/C Ratio	0.223	-	-	0.006	-	
HCM Control Delay (s)	26.9	-	-	8.9	0	
HCM Lane LOS	D	-	-	A	A	
HCM 95th %tile Q(veh)	0.8	-	-	0	-	

HCM 2010 AWSC
11: Grand Canal & Cambrian

2030 Future Background
PM Peak Hour

Intersection												
Intersection Delay, s/veh	62.3											
Intersection LOS	F											
Movement	EBL	EBT	EBR	WBL	WBT	WBR	NBL	NBT	NBR	SBL	SBT	SBR
Lane Configurations	↔		↔		↔		↔		↔		↔	
Traffic Vol, veh/h	35	498	117	48	528	42	78	25	56	51	26	20
Future Vol, veh/h	35	498	117	48	528	42	78	25	56	51	26	20
Peak Hour Factor	1.00	1.00	1.00	1.00	1.00	1.00	1.00	1.00	1.00	1.00	1.00	1.00
Heavy Vehicles, %	3	4	4	2	5	2	3	2	2	4	4	2
Mvmt Flow	35	498	117	48	528	42	78	25	56	51	26	20
Number of Lanes	0	1	0	0	1	0	0	1	0	0	1	0
Approach	EB	WB	NB	SB								
Opposing Approach	WB	EB	SB	NB								
Opposing Lanes	1	1	1	1								
Conflicting Approach Left	SB	NB	EB	WB								
Conflicting Lanes Left	1	1	1	1								
Conflicting Approach Right	NB	SB	WB	EB								
Conflicting Lanes Right	1	1	1	1								
HCM Control Delay	78.9	64.9	14.5	13.3								
HCM LOS	F	F	B	B								
Lane	NBLn1	EBLn1	WBLn1	SBLn1								
Vol Left, %	49%	5%	8%	53%								
Vol Thru, %	16%	77%	85%	27%								
Vol Right, %	35%	18%	7%	21%								
Sign Control	Stop	Stop	Stop	Stop								
Traffic Vol by Lane	159	650	618	97								
LT Vol	78	35	48	51								
Through Vol	25	498	528	26								
RT Vol	56	117	42	20								
Lane Flow Rate	159	650	618	97								
Geometry Grp	1	1	1	1								
Degree of Util (X)	0.327	1.064	1.013	0.21								
Departure Headway (Hd)	7.744	6.006	6.119	8.184								
Convergence, Y/N	Yes	Yes	Yes	Yes								
Cap	467	611	599	441								
Service Time	5.744	4.006	4.119	6.184								
HCM Lane V/C Ratio	0.34	1.064	1.032	0.22								
HCM Control Delay	14.5	78.9	64.9	13.3								
HCM Lane LOS	B	F	F	B								
HCM 95th-tile Q	1.4	18	15.4	0.8								

Appendix J

Synchro Intersection Worksheets – 2025 Future Total Conditions

HCM 2010 AWSC
1: River Mist & Cambrian

2025 Future Total
AM Peak Hour

Intersection	
Intersection Delay, s/veh	94.8
Intersection LOS	F

Movement	EBL	EBT	EBR	WBL	WBT	WBR	NBL	NBT	NBR	SBL	SBT	SBR
Lane Configurations		↔			↕			↕			↔	
Traffic Vol, veh/h	25	507	91	49	395	51	189	50	104	71	16	49
Future Vol, veh/h	25	507	91	49	395	51	189	50	104	71	16	49
Peak Hour Factor	1.00	1.00	1.00	1.00	1.00	1.00	1.00	1.00	1.00	1.00	1.00	1.00
Heavy Vehicles, %	7	10	6	16	9	4	2	10	4	3	6	4
Mvmt Flow	25	507	91	49	395	51	189	50	104	71	16	49
Number of Lanes	0	1	0	0	1	0	0	1	0	0	1	0

Approach	EB	WB	NB	SB
Opposing Approach	WB	EB	SB	NB
Opposing Lanes	1	1	1	1
Conflicting Approach Left	SB	NB	EB	WB
Conflicting Lanes Left	1	1	1	1
Conflicting Approach Right	NB	SB	WB	EB
Conflicting Lanes Right	1	1	1	1
HCM Control Delay	160.7	76.4	32.3	17.5
HCM LOS	F	F	D	C

Lane	NBLn1	EBLn1	WBLn1	SBLn1
Vol Left, %	55%	4%	10%	52%
Vol Thru, %	15%	81%	80%	12%
Vol Right, %	30%	15%	10%	36%
Sign Control	Stop	Stop	Stop	Stop
Traffic Vol by Lane	343	623	495	136
LT Vol	189	25	49	71
Through Vol	50	507	395	16
RT Vol	104	91	51	49
Lane Flow Rate	343	623	495	136
Geometry Grp	1	1	1	1
Degree of Util (X)	0.743	1.271	1.02	0.333
Departure Headway (Hd)	8.479	7.449	8.033	9.714
Convergence, Y/N	Yes	Yes	Yes	Yes
Cap	429	492	455	373
Service Time	6.479	5.449	6.033	7.714
HCM Lane V/C Ratio	0.8	1.266	1.088	0.365
HCM Control Delay	32.3	160.7	76.4	17.5
HCM Lane LOS	D	F	F	C
HCM 95th-tile Q	6	25.4	13.7	1.4

Lanes, Volumes, Timings
2: Elevation/Polune & Cambrian

2025 Future Total
AM Peak Hour

Lane Group	EBL	EBT	EBR	WBL	WBT	WBR	NBL	NBT	NBR	SBL	SBT	SBR
Lane Configurations	↔	↔		↔	↔		↔	↔		↔	↔	
Traffic Volume (vph)	14	248	129	60	452	96	270	0	122	176	0	42
Future Volume (vph)	14	248	129	60	452	96	270	0	122	176	0	42
Satd. Flow (prot)	1658	1475	0	1658	1482	0	1658	1483	0	1492	1483	0
Fit Permitted	0.367			0.504			0.730			0.679		
Satd. Flow (perm)	640	1475	0	880	1482	0	1274	1483	0	1066	1483	0
Satd. Flow (RTOR)		51			21			562				322
Lane Group Flow (vph)	14	377	0	60	548	0	270	122	0	176	42	0
Turn Type	Perm	NA		Perm	NA		Perm	NA		Perm	NA	
Protected Phases		2			6			4				8
Permitted Phases	2			6			4			8		
Detector Phase	2	2		6	6		4	4		8	8	
Switch Phase												
Minimum Initial (s)	10.0	10.0		10.0	10.0		10.0	10.0		10.0	10.0	
Minimum Split (s)	23.7	23.7		23.7	23.7		30.4	30.4		30.4	30.4	
Total Split (s)	39.3	39.3		39.3	39.3		30.7	30.7		30.7	30.7	
Total Split (%)	56.1%	56.1%		56.1%	56.1%		43.9%	43.9%		43.9%	43.9%	
Yellow Time (s)	4.2	4.2		4.2	4.2		3.3	3.3		3.3	3.3	
All-Red Time (s)	1.5	1.5		1.5	1.5		2.6	2.6		2.6	2.6	
Lost Time Adjust (s)	0.0	0.0		0.0	0.0		0.0	0.0		0.0	0.0	
Total Lost Time (s)	5.7	5.7		5.7	5.7		5.9	5.9		5.9	5.9	
Lead/Lag												
Lead-Lag Optimize?												
Recall Mode	C-Min	C-Min		C-Min	C-Min		None	None		None	None	
Act Effct Green (s)	39.1	39.1		39.1	39.1		19.3	19.3		19.3	19.3	
Actuated g/C Ratio	0.56	0.56		0.56	0.56		0.28	0.28		0.28	0.28	
v/c Ratio	0.04	0.45		0.12	0.65		0.77	0.15		0.60	0.07	
Control Delay	9.6	11.0		10.0	16.9		37.7	0.4		29.9	0.2	
Queue Delay	0.0	0.0		0.0	0.0		0.0	0.0		0.0	0.0	
Total Delay	9.6	11.0		10.0	16.9		37.7	0.4		29.9	0.2	
LOS	A	B		A	B		D	A		C	A	
Approach Delay		11.0			16.2			26.1			24.2	
Approach LOS		B			B			C			C	
Queue Length 50th (m)	0.8	22.8		3.5	44.8		31.9	0.0		19.6	0.0	
Queue Length 95th (m)	3.6	49.3		10.3	#98.2		51.5	0.0		34.6	0.0	
Internal Link Dist (m)		192.0			194.3			97.9			184.1	
Turn Bay Length (m)	37.5			37.5			30.0			30.0		
Base Capacity (vph)	357	846		491	837		451	888		377	733	
Starvation Cap Reductn	0	0		0	0		0	0		0	0	
Spillback Cap Reductn	0	0		0	0		0	0		0	0	
Storage Cap Reductn	0	0		0	0		0	0		0	0	
Reduced v/c Ratio	0.04	0.45		0.12	0.65		0.60	0.14		0.47	0.06	

Intersection Summary	
Cycle Length: 70	
Actuated Cycle Length: 70	
Offset: 0 (0%), Referenced to phase 2:EBTL and 6:WBTL, Start of Green	
Natural Cycle: 65	
Control Type: Actuated-Coordinated	

Lanes, Volumes, Timings
2: Elevation/Apolune & Cambrian

2025 Future Total
AM Peak Hour

Maximum v/c Ratio: 0.77	Intersection LOS: B
Intersection Signal Delay: 18.4	ICU Level of Service E
Intersection Capacity Utilization 83.1%	
Analysis Period (min) 15	
# 95th percentile volume exceeds capacity, queue may be longer.	
Queue shown is maximum after two cycles.	

Splits and Phases: 2: Elevation/Apolune & Cambrian



HCM 2010 TWSC
5: Temporary Driveway & Cambrian

2025 Future Total
AM Peak Hour

Intersection						
Int Delay, s/veh	0.4					
Movement	EBT	EBR	WBL	WBT	NBL	NBR
Lane Configurations	↔		↔		↔	
Traffic Vol, veh/h	527	22	9	616	15	6
Future Vol, veh/h	527	22	9	616	15	6
Conflicting Peds, #/hr	0	0	0	0	0	0
Sign Control	Free	Free	Free	Free	Stop	Stop
RT Channelized	-	None	-	None	-	None
Storage Length	-	-	-	-	0	-
Veh in Median Storage, #	0	-	-	0	0	-
Grade, %	0	-	-	0	0	-
Peak Hour Factor	100	100	100	100	100	100
Heavy Vehicles, %	2	2	2	2	2	2
Mvmt Flow	527	22	9	616	15	6
Major/Minor	Major1	Major2	Minor1			
Conflicting Flow All	0	0	549	0	1172	538
Stage 1	-	-	-	-	538	-
Stage 2	-	-	-	-	634	-
Critical Hdwy	-	-	4.12	-	6.42	6.22
Critical Hdwy Stg 1	-	-	-	-	5.42	-
Critical Hdwy Stg 2	-	-	-	-	5.42	-
Follow-up Hdwy	-	-	2.218	-	3.518	3.318
Pot Cap-1 Maneuver	-	-	1021	-	213	543
Stage 1	-	-	-	-	585	-
Stage 2	-	-	-	-	529	-
Platoon blocked, %	-	-	-	-	-	-
Mov Cap-1 Maneuver	-	-	1021	-	210	543
Mov Cap-2 Maneuver	-	-	-	-	210	-
Stage 1	-	-	-	-	585	-
Stage 2	-	-	-	-	522	-
Approach	EB	WB	NB			
HCM Control Delay, s	0	0.1	20.4			
HCM LOS			C			
Minor Lane/Major Mvmt	NBLn1	EBT	EBR	WBL	WBT	
Capacity (veh/h)	255	-	-	1021	-	
HCM Lane V/C Ratio	0.082	-	-	0.009	-	
HCM Control Delay (s)	20.4	-	-	8.6	0	
HCM Lane LOS	C	-	-	A	A	
HCM 95th %tile Q(veh)	0.3	-	-	0	-	

HCM 2010 TWSC
7: Access#1 & Cambrian

2025 Future Total
AM Peak Hour

Intersection						
Int Delay, s/veh	0.7					
Movement	EBT	EBR	WBL	WBT	NBL	NBR
Lane Configurations	↗			↖		↗
Traffic Vol, veh/h	524	22	36	595	21	25
Future Vol, veh/h	524	22	36	595	21	25
Conflicting Peds, #/hr	0	0	0	0	0	0
Sign Control	Free	Free	Free	Free	Stop	Stop
RT Channelized	-	None	-	None	-	None
Storage Length	-	-	-	-	-	0
Veh in Median Storage, #	0	-	-	0	0	-
Grade, %	0	-	-	0	0	-
Peak Hour Factor	100	100	100	100	100	100
Heavy Vehicles, %	2	2	2	2	2	2
Mvmt Flow	524	22	36	595	21	25
Major/Minor	Major1	Major2	Minor1			
Conflicting Flow All	0	0	546	0	1202	535
Stage 1	-	-	-	-	535	-
Stage 2	-	-	-	-	667	-
Critical Hdwy	-	-	4.12	-	6.42	6.22
Critical Hdwy Stg 1	-	-	-	-	5.42	-
Critical Hdwy Stg 2	-	-	-	-	5.42	-
Follow-up Hdwy	-	-	2.218	-	3.518	3.318
Pot Cap-1 Maneuver	-	-	1023	-	204	545
Stage 1	-	-	-	-	587	-
Stage 2	-	-	-	-	510	-
Platoon blocked, %	-	-	-	-	-	-
Mov Cap-1 Maneuver	-	-	1023	-	193	545
Mov Cap-2 Maneuver	-	-	-	-	193	-
Stage 1	-	-	-	-	587	-
Stage 2	-	-	-	-	483	-
Approach	EB	WB	NB			
HCM Control Delay, s	0	0.5	11.9			
HCM LOS			B			
Minor Lane/Major Mvmt	NBLn1	EBT	EBR	WBL	WBT	
Capacity (veh/h)	545	-	-	1023	-	
HCM Lane V/C Ratio	0.046	-	-	0.035	-	
HCM Control Delay (s)	11.9	-	-	8.6	-	
HCM Lane LOS	B	-	-	A	-	
HCM 95th %tile Q(veh)	0.1	-	-	0.1	-	

HCM 2010 AWSC
11: Grand Canal & Cambrian

2025 Future Total
AM Peak Hour

Intersection												
Intersection Delay, s/veh	69.9											
Intersection LOS	F											
Movement	EBL	EBT	EBR	WBL	WBT	WBR	NBL	NBT	NBR	SBL	SBT	SBR
Lane Configurations		↔			↔			↔			↔	
Traffic Vol, veh/h	28	460	74	37	494	21	103	64	59	71	77	45
Future Vol, veh/h	28	460	74	37	494	21	103	64	59	71	77	45
Peak Hour Factor	1.00	1.00	1.00	1.00	1.00	1.00	1.00	1.00	1.00	1.00	1.00	1.00
Heavy Vehicles, %	4	2	2	2	4	10	5	2	2	4	3	5
Mvmt Flow	28	460	74	37	494	21	103	64	59	71	77	45
Number of Lanes	0	1	0	0	1	0	0	1	0	0	1	0
Approach	EB	WB	NB	SB								
Opposing Approach	WB	EB	SB	NB								
Opposing Lanes	1	1	1	1								
Conflicting Approach Left	SB	NB	EB	WB								
Conflicting Lanes Left	1	1	1	1								
Conflicting Approach Right	NB	SB	WB	EB								
Conflicting Lanes Right	1	1	1	1								
HCM Control Delay	91.2	86.5	20.3	18.7								
HCM LOS	F	F	C	C								
Lane	NBLn1	EBLn1	WBLn1	SBLn1								
Vol Left, %	46%	5%	7%	37%								
Vol Thru, %	28%	82%	89%	40%								
Vol Right, %	26%	13%	4%	23%								
Sign Control	Stop	Stop	Stop	Stop								
Traffic Vol by Lane	226	562	552	193								
LT Vol	103	28	37	71								
Through Vol	64	460	494	77								
RT Vol	59	74	21	45								
Lane Flow Rate	226	562	552	193								
Geometry Grp	1	1	1	1								
Degree of Util (X)	0.512	1.084	1.068	0.446								
Departure Headway (Hd)	8.623	7.188	7.238	8.795								
Convergence, Y/N	Yes	Yes	Yes	Yes								
Cap	420	511	508	413								
Service Time	6.623	5.188	5.238	6.795								
HCM Lane V/C Ratio	0.538	1.1	1.087	0.467								
HCM Control Delay	20.3	91.2	86.5	18.7								
HCM Lane LOS	C	F	F	C								
HCM 95th-tile Q	2.8	17.1	16.4	2.2								

HCM 2010 AWSC
1: River Mist & Cambrian

2025 Future Total
PM Peak Hour

Intersection												
Intersection Delay, s/veh	107.4											
Intersection LOS	F											
Movement	EBL	EBT	EBR	WBL	WBT	WBR	NBL	NBT	NBR	SBL	SBT	SBR
Lane Configurations		↔			↕			↕			↔	
Traffic Vol, veh/h	38	498	157	123	490	76	128	15	103	38	12	31
Future Vol, veh/h	38	498	157	123	490	76	128	15	103	38	12	31
Peak Hour Factor	1.00	1.00	1.00	1.00	1.00	1.00	1.00	1.00	1.00	1.00	1.00	1.00
Heavy Vehicles, %	2	2	2	2	2	2	2	2	7	2	2	2
Mvmt Flow	38	498	157	123	490	76	128	15	103	38	12	31
Number of Lanes	0	1	0	0	1	0	0	1	0	0	1	0
Approach	EB			WB			NB			SB		
Opposing Approach	WB			EB			SB			NB		
Opposing Lanes	1			1			1			1		
Conflicting Approach Left	SB			NB			EB			WB		
Conflicting Lanes Left	1			1			1			1		
Conflicting Approach Right	NB			SB			WB			EB		
Conflicting Lanes Right	1			1			1			1		
HCM Control Delay	126.4			131			18.8			14.2		
HCM LOS	F			F			C			B		

Lane	NBLn1	EBLn1	WBLn1	SBLn1
Vol Left, %	52%	5%	18%	47%
Vol Thru, %	6%	72%	71%	15%
Vol Right, %	42%	23%	11%	38%
Sign Control	Stop	Stop	Stop	Stop
Traffic Vol by Lane	246	693	689	81
LT Vol	128	38	123	38
Through Vol	15	498	490	12
RT Vol	103	157	76	31
Lane Flow Rate	246	693	689	81
Geometry Grp	1	1	1	1
Degree of Util (X)	0.497	1.193	1.204	0.184
Departure Headway (Hd)	8.088	6.544	6.628	9.117
Convergence, Y/N	Yes	Yes	Yes	Yes
Cap	448	561	551	396
Service Time	6.088	4.544	4.628	7.117
HCM Lane V/C Ratio	0.549	1.235	1.25	0.205
HCM Control Delay	18.8	126.4	131	14.2
HCM Lane LOS	C	F	F	B
HCM 95th-tile Q	2.7	23.7	24	0.7

Lanes, Volumes, Timings
2: Elevation/Polune & Cambrian

2025 Future Total
PM Peak Hour

Lane Group	EBL	EBT	EBR	WBL	WBT	WBR	NBL	NBT	NBR	SBL	SBT	SBR
Lane Configurations	↔	↔		↔	↔		↔	↔		↔	↔	
Traffic Volume (vph)	42	448	255	119	418	137	193	0	93	128	0	27
Future Volume (vph)	42	448	255	119	418	137	193	0	93	128	0	27
Satd. Flow (prot)	1658	1651	0	1658	1498	0	1658	1483	0	1492	1483	0
Fit Permitted	0.404			0.321			0.740			0.697		
Satd. Flow (perm)	701	1651	0	560	1498	0	1291	1483	0	1088	1483	0
Satd. Flow (RTOR)		47			27			440				457
Lane Group Flow (vph)	42	703	0	119	555	0	193	93	0	128	27	0
Turn Type	Perm	NA		Perm	NA		Perm	NA		Perm	NA	
Protected Phases		2			6			4				8
Permitted Phases	2			6			4			8		
Detector Phase	2	2		6	6		4	4		8	8	
Switch Phase												
Minimum Initial (s)	10.0	10.0		10.0	10.0		10.0	10.0		10.0	10.0	
Minimum Split (s)	23.7	23.7		23.7	23.7		30.4	30.4		30.4	30.4	
Total Split (s)	82.0	82.0		82.0	82.0		38.0	38.0		38.0	38.0	
Total Split (%)	68.3%	68.3%		68.3%	68.3%		31.7%	31.7%		31.7%	31.7%	
Yellow Time (s)	4.2	4.2		4.2	4.2		3.3	3.3		3.3	3.3	
All-Red Time (s)	1.5	1.5		1.5	1.5		2.6	2.6		2.6	2.6	
Lost Time Adjust (s)	0.0	0.0		0.0	0.0		0.0	0.0		0.0	0.0	
Total Lost Time (s)	5.7	5.7		5.7	5.7		5.9	5.9		5.9	5.9	
Lead/Lag												
Lead-Lag Optimize?												
Recall Mode	C-Min	C-Min		C-Min	C-Min		None	None		None	None	
Act Effct Green (s)	85.3	85.3		85.3	85.3		23.1	23.1		23.1	23.1	
Actuated g/C Ratio	0.71	0.71		0.71	0.71		0.19	0.19		0.19	0.19	
v/c Ratio	0.08	0.59		0.30	0.52		0.78	0.15		0.61	0.04	
Control Delay	7.4	11.7		10.2	10.7		65.9	0.5		55.7	0.1	
Queue Delay	0.0	0.0		0.0	0.0		0.0	0.0		0.0	0.0	
Total Delay	7.4	11.7		10.2	10.7		65.9	0.5		55.7	0.1	
LOS	A	B		B	B		E	A		E	A	
Approach Delay		11.4			10.6			44.6			46.0	
Approach LOS		B			B			D			D	
Queue Length 50th (m)	2.7	68.5		9.2	50.5		43.5	0.0		27.8	0.0	
Queue Length 95th (m)	8.2	128.8		23.6	96.5		63.7	0.0		44.4	0.0	
Internal Link Dist (m)		186.8			199.2			171.4			184.1	
Turn Bay Length (m)	37.5			37.5			30.0			30.0		
Base Capacity (vph)	498	1186		397	1072		345	719		291	731	
Starvation Cap Reductn	0	0		0	0		0	0		0	0	
Spillback Cap Reductn	0	0		0	0		0	0		0	0	
Storage Cap Reductn	0	0		0	0		0	0		0	0	
Reduced v/c Ratio	0.08	0.59		0.30	0.52		0.56	0.13		0.44	0.04	

Intersection Summary												
Cycle Length: 120												
Actuated Cycle Length: 120												
Offset: 0 (0%), Referenced to phase 2:EBTL and 6:WBTL, Start of Green												
Natural Cycle: 70												
Control Type: Actuated-Coordinated												

Lanes, Volumes, Timings
2: Elevation/Apolune & Cambrian

2025 Future Total
PM Peak Hour

Maximum v/c Ratio: 0.78	Intersection LOS: B
Intersection Signal Delay: 19.1	ICU Level of Service E
Intersection Capacity Utilization 82.0%	
Analysis Period (min) 15	

Splits and Phases: 2: Elevation/Apolune & Cambrian

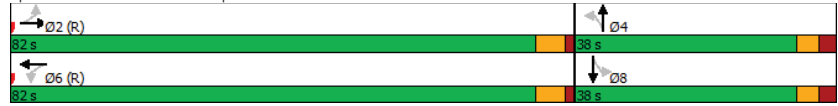

HCM 2010 TWSC
5: Temporary Driveway & Cambrian

2025 Future Total
PM Peak Hour

Intersection						
Int Delay, s/veh	1.1					
Movement	EBT	EBR	WBL	WBT	NBL	NBR
Lane Configurations	↔ ↗ ↘ ↖ ↗ ↘					
Traffic Vol, veh/h	637	57	6	661	38	9
Future Vol, veh/h	637	57	6	661	38	9
Conflicting Peds, #/hr	0	0	0	0	0	0
Sign Control	Free	Free	Free	Free	Stop	Stop
RT Channelized	-	None	-	None	-	None
Storage Length	-	-	-	-	0	-
Veh in Median Storage, #	0	-	-	0	0	-
Grade, %	0	-	-	0	0	-
Peak Hour Factor	100	100	100	100	100	100
Heavy Vehicles, %	2	2	2	2	2	2
Mvmt Flow	637	57	6	661	38	9
Major/Minor	Major1	Major2	Minor1			
Conflicting Flow All	0	0	694	0	1339	666
Stage 1	-	-	-	-	666	-
Stage 2	-	-	-	-	673	-
Critical Hdwy	-	-	4.12	-	6.42	6.22
Critical Hdwy Stg 1	-	-	-	-	5.42	-
Critical Hdwy Stg 2	-	-	-	-	5.42	-
Follow-up Hdwy	-	-	2.218	-	3.518	3.318
Pot Cap-1 Maneuver	-	-	901	-	168	459
Stage 1	-	-	-	-	511	-
Stage 2	-	-	-	-	507	-
Platoon blocked, %	-	-	-	-	-	-
Mov Cap-1 Maneuver	-	-	901	-	166	459
Mov Cap-2 Maneuver	-	-	-	-	166	-
Stage 1	-	-	-	-	511	-
Stage 2	-	-	-	-	501	-
Approach	EB	WB	NB			
HCM Control Delay, s	0	0.1	30.2			
HCM LOS			D			
Minor Lane/Major Mvmt	NBLn1	EBT	EBR	WBL	WBT	
Capacity (veh/h)	189	-	-	901	-	
HCM Lane V/C Ratio	0.249	-	-	0.007	-	
HCM Control Delay (s)	30.2	-	-	9	0	
HCM Lane LOS	D	-	-	A	A	
HCM 95th %tile Q(veh)	0.9	-	-	0	-	

HCM 2010 TWSC
7: Access #1 & Cambrian

2025 Future Total
PM Peak Hour

Intersection						
Int Delay, s/veh	1.7					
Movement	EBT	EBR	WBL	WBT	NBL	NBR
Lane Configurations	↔			↑		↗
Traffic Vol, veh/h	617	57	76	625	56	77
Future Vol, veh/h	617	57	76	625	56	77
Conflicting Peds, #/hr	0	0	0	0	0	0
Sign Control	Free	Free	Free	Free	Stop	Stop
RT Channelized	-	None	-	None	-	None
Storage Length	-	-	-	-	-	0
Veh in Median Storage, #	0	-	-	0	0	-
Grade, %	0	-	-	0	0	-
Peak Hour Factor	100	100	100	100	100	100
Heavy Vehicles, %	2	2	2	2	2	2
Mvmt Flow	617	57	76	625	56	77
Major/Minor	Major1	Major2	Minor1			
Conflicting Flow All	0	0	674	0	1423	646
Stage 1	-	-	-	-	646	-
Stage 2	-	-	-	-	777	-
Critical Hdwy	-	-	4.12	-	6.42	6.22
Critical Hdwy Stg 1	-	-	-	-	5.42	-
Critical Hdwy Stg 2	-	-	-	-	5.42	-
Follow-up Hdwy	-	-	2.218	-	3.518	3.318
Pot Cap-1 Maneuver	-	-	917	-	150	472
Stage 1	-	-	-	-	522	-
Stage 2	-	-	-	-	453	-
Platoon blocked, %	-	-	-	-	-	-
Mov Cap-1 Maneuver	-	-	917	-	131	472
Mov Cap-2 Maneuver	-	-	-	-	131	-
Stage 1	-	-	-	-	522	-
Stage 2	-	-	-	-	395	-
Approach	EB	WB	NB			
HCM Control Delay, s	0	1	14.1			
HCM LOS			B			
Minor Lane/Major Mvmt	NBLn1	EBT	EBR	WBL	WBT	
Capacity (veh/h)	472	-	-	917	-	
HCM Lane V/C Ratio	0.163	-	-	0.083	-	
HCM Control Delay (s)	14.1	-	-	9.3	-	
HCM Lane LOS	B	-	-	A	-	
HCM 95th %tile Q(veh)	0.6	-	-	0.3	-	

HCM 2010 AWSC
11: Grand Canal & Cambrian

2025 Future Total
PM Peak Hour

Intersection												
Intersection Delay, s/veh	79.6											
Intersection LOS	F											
Movement	EBL	EBT	EBR	WBL	WBT	WBR	NBL	NBT	NBR	SBL	SBT	SBR
Lane Configurations		↔			↕			↕			↔	
Traffic Vol, veh/h	39	535	111	48	557	42	82	25	56	51	26	24
Future Vol, veh/h	39	535	111	48	557	42	82	25	56	51	26	24
Peak Hour Factor	1.00	1.00	1.00	1.00	1.00	1.00	1.00	1.00	1.00	1.00	1.00	1.00
Heavy Vehicles, %	3	4	4	2	5	2	3	2	2	4	4	2
Mvmt Flow	39	535	111	48	557	42	82	25	56	51	26	24
Number of Lanes	0	1	0	0	1	0	0	1	0	0	1	0
Approach	EB	WB	NB	SB								
Opposing Approach	WB	EB	SB	NB								
Opposing Lanes	1	1	1	1								
Conflicting Approach Left	SB	NB	EB	WB								
Conflicting Lanes Left	1	1	1	1								
Conflicting Approach Right	NB	SB	WB	EB								
Conflicting Lanes Right	1	1	1	1								
HCM Control Delay	101.1		83.3		15				13.8			
HCM LOS	F		F		B				B			
Lane	NBLn1	EBLn1	WBLn1	SBLn1								
Vol Left, %	50%	6%	7%	50%								
Vol Thru, %	15%	78%	86%	26%								
Vol Right, %	34%	16%	6%	24%								
Sign Control	Stop	Stop	Stop	Stop								
Traffic Vol by Lane	163	685	647	101								
LT Vol	82	39	48	51								
Through Vol	25	535	557	26								
RT Vol	56	111	42	24								
Lane Flow Rate	163	685	647	101								
Geometry Grp	1	1	1	1								
Degree of Util (X)	0.339	1.129	1.074	0.221								
Departure Headway (Hd)	7.977	6.144	6.253	8.41								
Convergence, Y/N	Yes	Yes	Yes	Yes								
Cap	453	596	582	429								
Service Time	5.977	4.144	4.253	6.41								
HCM Lane V/C Ratio	0.36	1.149	1.112	0.235								
HCM Control Delay	15	101.1	83.3	13.8								
HCM Lane LOS	B	F	F	B								
HCM 95th-tile Q	1.5	21.2	18.1	0.8								

Appendix K

Synchro Intersection Worksheets – 2030 Future Total Conditions

HCM 2010 AWSC
1: River Mist & Cambrian

2030 Future Total
AM Peak Hour

Intersection												
Intersection Delay, s/veh	100											
Intersection LOS	F											
Movement												
	EBL	EBT	EBR	WBL	WBT	WBR	NBL	NBT	NBR	SBL	SBT	SBR
Lane Configurations		↔			↕			↕			↔	
Traffic Vol, veh/h	25	511	96	51	397	51	199	50	109	71	16	49
Future Vol, veh/h	25	511	96	51	397	51	199	50	109	71	16	49
Peak Hour Factor	1.00	1.00	1.00	1.00	1.00	1.00	1.00	1.00	1.00	1.00	1.00	1.00
Heavy Vehicles, %	7	10	6	16	9	4	2	10	4	3	6	4
Mvmt Flow	25	511	96	51	397	51	199	50	109	71	16	49
Number of Lanes	0	1	0	0	1	0	0	1	0	0	1	0
Approach												
	EB	WB		NB		SB						
Opposing Approach	WB	EB		SB		NB						
Opposing Lanes	1	1		1		1						
Conflicting Approach Left	SB	NB		EB		WB						
Conflicting Lanes Left	1	1		1		1						
Conflicting Approach Right	NB	SB		WB		EB						
Conflicting Lanes Right	1	1		1		1						
HCM Control Delay	167.3	83.5		35.6		17.9						
HCM LOS	F	F		E		C						

Lane	NBLn1	EBLn1	WBLn1	SBLn1
Vol Left, %	56%	4%	10%	52%
Vol Thru, %	14%	81%	80%	12%
Vol Right, %	30%	15%	10%	36%
Sign Control	Stop	Stop	Stop	Stop
Traffic Vol by Lane	358	632	499	136
LT Vol	199	25	51	71
Through Vol	50	511	397	16
RT Vol	109	96	51	49
Lane Flow Rate	358	632	499	136
Geometry Grp	1	1	1	1
Degree of Util (X)	0.777	1.286	1.043	0.337
Departure Headway (Hd)	8.555	7.577	8.161	9.908
Convergence, Y/N	Yes	Yes	Yes	Yes
Cap	426	487	449	366
Service Time	6.555	5.577	6.161	7.908
HCM Lane V/C Ratio	0.84	1.298	1.111	0.372
HCM Control Delay	35.6	167.3	83.5	17.9
HCM Lane LOS	E	F	F	C
HCM 95th-tile Q	6.7	25.8	14.4	1.5

Lanes, Volumes, Timings
2: Elevation/Polune & Cambrian

2030 Future Total
AM Peak Hour

Lane Group	EBL	EBT	EBR	WBL	WBT	WBR	NBL	NBT	NBR	SBL	SBT	SBR
Lane Configurations	↔	↔		↔	↔		↔	↔		↔	↔	
Traffic Volume (vph)	14	257	129	60	464	96	270	0	122	176	0	42
Future Volume (vph)	14	257	129	60	464	96	270	0	122	176	0	42
Satd. Flow (prot)	1658	1475	0	1658	1482	0	1658	1483	0	1492	1483	0
Fit Permitted	0.358			0.496			0.730			0.679		
Satd. Flow (perm)	625	1475	0	866	1482	0	1274	1483	0	1066	1483	0
Satd. Flow (RTOR)		50			20			549				311
Lane Group Flow (vph)	14	386	0	60	560	0	270	122	0	176	42	0
Turn Type	Perm	NA		Perm	NA		Perm	NA		Perm	NA	
Protected Phases		2			6			4				8
Permitted Phases	2			6			4			8		
Detector Phase	2	2		6	6		4	4		8	8	
Switch Phase												
Minimum Initial (s)	10.0	10.0		10.0	10.0		10.0	10.0		10.0	10.0	
Minimum Split (s)	23.7	23.7		23.7	23.7		30.4	30.4		30.4	30.4	
Total Split (s)	39.3	39.3		39.3	39.3		30.7	30.7		30.7	30.7	
Total Split (%)	56.1%	56.1%		56.1%	56.1%		43.9%	43.9%		43.9%	43.9%	
Yellow Time (s)	4.2	4.2		4.2	4.2		3.3	3.3		3.3	3.3	
All-Red Time (s)	1.5	1.5		1.5	1.5		2.6	2.6		2.6	2.6	
Lost Time Adjust (s)	0.0	0.0		0.0	0.0		0.0	0.0		0.0	0.0	
Total Lost Time (s)	5.7	5.7		5.7	5.7		5.9	5.9		5.9	5.9	
Lead/Lag												
Lead-Lag Optimize?												
Recall Mode	C-Min	C-Min		C-Min	C-Min		None	None		None	None	
Act Effct Green (s)	39.1	39.1		39.1	39.1		19.3	19.3		19.3	19.3	
Actuated g/C Ratio	0.56	0.56		0.56	0.56		0.28	0.28		0.28	0.28	
v/c Ratio	0.04	0.46		0.12	0.67		0.77	0.15		0.60	0.07	
Control Delay	9.6	11.2		10.0	17.5		37.7	0.4		29.9	0.2	
Queue Delay	0.0	0.0		0.0	0.0		0.0	0.0		0.0	0.0	
Total Delay	9.6	11.2		10.0	17.5		37.7	0.4		29.9	0.2	
LOS	A	B		B	B		D	A		C	A	
Approach Delay		11.2			16.8			26.1			24.2	
Approach LOS		B			B			C			C	
Queue Length 50th (m)	0.8	23.8		3.5	46.6		31.9	0.0		19.6	0.0	
Queue Length 95th (m)	3.7	51.2		10.4	#108.7		51.5	0.0		34.6	0.0	
Internal Link Dist (m)		192.0			196.7			97.9			184.1	
Turn Bay Length (m)	37.5			37.5			30.0			30.0		
Base Capacity (vph)	349	846		483	837		451	879		377	726	
Starvation Cap Reductn	0	0		0	0		0	0		0	0	
Spillback Cap Reductn	0	0		0	0		0	0		0	0	
Storage Cap Reductn	0	0		0	0		0	0		0	0	
Reduced v/c Ratio	0.04	0.46		0.12	0.67		0.60	0.14		0.47	0.06	

Intersection Summary												
Cycle Length: 70												
Actuated Cycle Length: 70												
Offset: 0 (0%), Referenced to phase 2:EBTL and 6:WBTL, Start of Green												
Natural Cycle: 65												
Control Type: Actuated-Coordinated												

Lanes, Volumes, Timings
2: Elevation/Apolune & Cambrian

2030 Future Total
AM Peak Hour

Maximum v/c Ratio: 0.77	Intersection LOS: B
Intersection Signal Delay: 18.6	ICU Level of Service E
Intersection Capacity Utilization 83.7%	
Analysis Period (min) 15	
# 95th percentile volume exceeds capacity, queue may be longer.	
Queue shown is maximum after two cycles.	

Splits and Phases: 2: Elevation/Apolune & Cambrian



HCM 2010 TWSC
5: Temporary Driveway & Cambrian

2030 Future Total
AM Peak Hour

Intersection						
Int Delay, s/veh	0.4					
Movement	EBT	EBR	WBL	WBT	NBL	NBR
Lane Configurations	↔		↔		↔	
Traffic Vol, veh/h	532	22	9	626	15	6
Future Vol, veh/h	532	22	9	626	15	6
Conflicting Peds, #/hr	0	0	0	0	0	0
Sign Control	Free	Free	Free	Free	Stop	Stop
RT Channelized	-	None	-	None	-	None
Storage Length	-	-	-	-	0	-
Veh in Median Storage, #	0	-	-	0	0	-
Grade, %	0	-	-	0	0	-
Peak Hour Factor	100	100	100	100	100	100
Heavy Vehicles, %	2	2	2	2	2	2
Mvmt Flow	532	22	9	626	15	6

Major/Minor	Major1	Major2	Minor1
Conflicting Flow All	0	0	554
Stage 1	-	-	543
Stage 2	-	-	644
Critical Hdwy	-	4.12	6.42
Critical Hdwy Stg 1	-	-	5.42
Critical Hdwy Stg 2	-	-	5.42
Follow-up Hdwy	-	2.218	3.518
Pot Cap-1 Maneuver	-	1016	208
Stage 1	-	-	582
Stage 2	-	-	523
Platoon blocked, %	-	-	-
Mov Cap-1 Maneuver	-	1016	205
Mov Cap-2 Maneuver	-	-	205
Stage 1	-	-	582
Stage 2	-	-	516

Approach	EB	WB	NB
HCM Control Delay, s	0	0.1	20.8
HCM LOS			C

Minor Lane/Major Mvmt	NBLn1	EBT	EBR	WBL	WBT
Capacity (veh/h)	249	-	-	1016	-
HCM Lane V/C Ratio	0.084	-	-	0.009	-
HCM Control Delay (s)	20.8	-	-	8.6	0
HCM Lane LOS	C	-	-	A	A
HCM 95th %tile Q(veh)	0.3	-	-	0	-

HCM 2010 TWSC
7: Access#1 & Cambrian

2030 Future Total
AM Peak Hour

Intersection						
Int Delay, s/veh	0.7					
Movement	EBT	EBR	WBL	WBT	NBL	NBR
Lane Configurations	↔			↑		↗
Traffic Vol, veh/h	533	22	36	607	21	25
Future Vol, veh/h	533	22	36	607	21	25
Conflicting Peds, #/hr	0	0	0	0	0	0
Sign Control	Free	Free	Free	Free	Stop	Stop
RT Channelized	-	None	-	None	-	None
Storage Length	-	-	-	-	-	0
Veh in Median Storage, #	0	-	-	0	0	-
Grade, %	0	-	-	0	0	-
Peak Hour Factor	100	100	100	100	100	100
Heavy Vehicles, %	2	2	2	2	2	2
Mvmt Flow	533	22	36	607	21	25
Major/Minor	Major1	Major2	Minor1			
Conflicting Flow All	0	0	555	0	1223	544
Stage 1	-	-	-	-	544	-
Stage 2	-	-	-	-	679	-
Critical Hdwy	-	-	4.12	-	6.42	6.22
Critical Hdwy Stg 1	-	-	-	-	5.42	-
Critical Hdwy Stg 2	-	-	-	-	5.42	-
Follow-up Hdwy	-	-	2.218	-	3.518	3.318
Pot Cap-1 Maneuver	-	-	1015	-	198	539
Stage 1	-	-	-	-	582	-
Stage 2	-	-	-	-	504	-
Platoon blocked, %	-	-	-	-	-	-
Mov Cap-1 Maneuver	-	-	1015	-	187	539
Mov Cap-2 Maneuver	-	-	-	-	187	-
Stage 1	-	-	-	-	582	-
Stage 2	-	-	-	-	477	-
Approach	EB	WB	NB			
HCM Control Delay, s	0	0.5	12			
HCM LOS			B			
Minor Lane/Major Mvmt	NBLn1	EBT	EBR	WBL	WBT	
Capacity (veh/h)	539	-	-	1015	-	
HCM Lane V/C Ratio	0.046	-	-	0.035	-	
HCM Control Delay (s)	12	-	-	8.7	-	
HCM Lane LOS	B	-	-	A	-	
HCM 95th %tile Q(veh)	0.1	-	-	0.1	-	

HCM 2010 AWSC
11: Grand Canal & Cambrian

2030 Future Total
AM Peak Hour

Intersection												
Intersection Delay, s/veh	76.1											
Intersection LOS	F											
Movement	EBL	EBT	EBR	WBL	WBT	WBR	NBL	NBT	NBR	SBL	SBT	SBR
Lane Configurations		↔			↕			↕			↕	
Traffic Vol, veh/h	28	464	79	37	506	21	103	64	59	71	77	45
Future Vol, veh/h	28	464	79	37	506	21	103	64	59	71	77	45
Peak Hour Factor	1.00	1.00	1.00	1.00	1.00	1.00	1.00	1.00	1.00	1.00	1.00	1.00
Heavy Vehicles, %	4	2	2	2	4	10	5	2	2	4	3	5
Mvmt Flow	28	464	79	37	506	21	103	64	59	71	77	45
Number of Lanes	0	1	0	0	1	0	0	1	0	0	1	0
Approach	EB	WB	NB	SB								
Opposing Approach	WB	EB	SB	NB								
Opposing Lanes	1	1	1	1								
Conflicting Approach Left	SB	NB	EB	WB								
Conflicting Lanes Left	1	1	1	1								
Conflicting Approach Right	NB	SB	WB	EB								
Conflicting Lanes Right	1	1	1	1								
HCM Control Delay	98.2		95.5		20.5		18.8					
HCM LOS	F		F		C		C					
Lane	NBLn1	EBLn1	WBLn1	SBLn1								
Vol Left, %	46%	5%	7%	37%								
Vol Thru, %	28%	81%	90%	40%								
Vol Right, %	26%	14%	4%	23%								
Sign Control	Stop	Stop	Stop	Stop								
Traffic Vol by Lane	226	571	564	193								
LT Vol	103	28	37	71								
Through Vol	64	464	506	77								
RT Vol	59	79	21	45								
Lane Flow Rate	226	571	564	193								
Geometry Grp	1	1	1	1								
Degree of Util (X)	0.511	1.105	1.096	0.444								
Departure Headway (Hd)	8.709	7.217	7.262	8.888								
Convergence, Y/N	Yes	Yes	Yes	Yes								
Cap	416	508	502	407								
Service Time	6.709	5.217	5.262	6.888								
HCM Lane V/C Ratio	0.543	1.124	1.124	0.474								
HCM Control Delay	20.5	98.2	95.5	18.8								
HCM Lane LOS	C	F	F	C								
HCM 95th-tile Q	2.8	18	17.6	2.2								

HCM 2010 AWSC
1: River Mist & Cambrian

2030 Future Total
PM Peak Hour

Intersection												
Intersection Delay, s/veh	117.6											
Intersection LOS	F											
Movement	EBL	EBT	EBR	WBL	WBT	WBR	NBL	NBT	NBR	SBL	SBT	SBR
Lane Configurations		↔			↕			↕			↔	
Traffic Vol, veh/h	38	501	167	128	494	76	135	15	106	38	12	31
Future Vol, veh/h	38	501	167	128	494	76	135	15	106	38	12	31
Peak Hour Factor	1.00	1.00	1.00	1.00	1.00	1.00	1.00	1.00	1.00	1.00	1.00	1.00
Heavy Vehicles, %	2	2	2	2	2	2	2	2	7	2	2	2
Mvmt Flow	38	501	167	128	494	76	135	15	106	38	12	31
Number of Lanes	0	1	0	0	1	0	0	1	0	0	1	0
Approach	EB			WB			NB			SB		
Opposing Approach	WB			EB			SB			NB		
Opposing Lanes	1			1			1			1		
Conflicting Approach Left	SB			NB			EB			WB		
Conflicting Lanes Left	1			1			1			1		
Conflicting Approach Right	NB			SB			WB			EB		
Conflicting Lanes Right	1			1			1			1		
HCM Control Delay	140			142.7			19.8			14.4		
HCM LOS	F			F			C			B		

Lane	NBLn1	EBLn1	WBLn1	SBLn1
Vol Left, %	53%	5%	18%	47%
Vol Thru, %	6%	71%	71%	15%
Vol Right, %	41%	24%	11%	38%
Sign Control	Stop	Stop	Stop	Stop
Traffic Vol by Lane	256	706	698	81
LT Vol	135	38	128	38
Through Vol	15	501	494	12
RT Vol	106	167	76	31
Lane Flow Rate	256	706	698	81
Geometry Grp	1	1	1	1
Degree of Util (X)	0.523	1.227	1.233	0.186
Departure Headway (Hd)	8.188	6.646	6.744	9.324
Convergence, Y/N	Yes	Yes	Yes	Yes
Cap	443	551	544	387
Service Time	6.188	4.646	4.744	7.324
HCM Lane V/C Ratio	0.578	1.281	1.283	0.209
HCM Control Delay	19.8	140	142.7	14.4
HCM Lane LOS	C	F	F	B
HCM 95th-tile Q	3	25.2	25.3	0.7

Lanes, Volumes, Timings
2: Elevation/Polune & Cambrian

2030 Future Total
PM Peak Hour

Lane Group	EBL	EBT	EBR	WBL	WBT	WBR	NBL	NBT	NBR	SBL	SBT	SBR
Lane Configurations	↔	↔		↔	↔		↔	↔		↔	↔	
Traffic Volume (vph)	42	461	255	119	429	137	193	0	93	128	0	27
Future Volume (vph)	42	461	255	119	429	137	193	0	93	128	0	27
Satd. Flow (prot)	1658	1653	0	1658	1500	0	1658	1483	0	1492	1483	0
Fit Permitted	0.398			0.314			0.740			0.697		
Satd. Flow (perm)	691	1653	0	548	1500	0	1291	1483	0	1088	1483	0
Satd. Flow (RTOR)		46			26			428				447
Lane Group Flow (vph)	42	716	0	119	566	0	193	93	0	128	27	0
Turn Type	Perm	NA		Perm	NA		Perm	NA		Perm	NA	
Protected Phases		2			6			4				8
Permitted Phases	2			6			4			8		
Detector Phase	2	2		6	6		4	4		8	8	
Switch Phase												
Minimum Initial (s)	10.0	10.0		10.0	10.0		10.0	10.0		10.0	10.0	
Minimum Split (s)	23.7	23.7		23.7	23.7		30.4	30.4		30.4	30.4	
Total Split (s)	82.0	82.0		82.0	82.0		38.0	38.0		38.0	38.0	
Total Split (%)	68.3%	68.3%		68.3%	68.3%		31.7%	31.7%		31.7%	31.7%	
Yellow Time (s)	4.2	4.2		4.2	4.2		3.3	3.3		3.3	3.3	
All-Red Time (s)	1.5	1.5		1.5	1.5		2.6	2.6		2.6	2.6	
Lost Time Adjust (s)	0.0	0.0		0.0	0.0		0.0	0.0		0.0	0.0	
Total Lost Time (s)	5.7	5.7		5.7	5.7		5.9	5.9		5.9	5.9	
Lead/Lag												
Lead-Lag Optimize?												
Recall Mode	C-Min	C-Min		C-Min	C-Min		None	None		None	None	
Act Effct Green (s)	85.3	85.3		85.3	85.3		23.1	23.1		23.1	23.1	
Actuated g/C Ratio	0.71	0.71		0.71	0.71		0.19	0.19		0.19	0.19	
v/c Ratio	0.09	0.60		0.31	0.53		0.78	0.15		0.61	0.04	
Control Delay	7.5	11.9		10.4	10.9		65.9	0.5		55.7	0.1	
Queue Delay	0.0	0.0		0.0	0.0		0.0	0.0		0.0	0.0	
Total Delay	7.5	11.9		10.4	10.9		65.9	0.5		55.7	0.1	
LOS	A	B		B	B		E	A		E	A	
Approach Delay	11.7			10.8			44.6			46.0		
Approach LOS	B			B			D			D		
Queue Length 50th (m)	2.7	70.9		9.3	52.3		43.5	0.0		27.8	0.0	
Queue Length 95th (m)	8.2	133.3		23.9	99.8		63.7	0.0		44.4	0.0	
Internal Link Dist (m)	186.8			199.1			171.4			184.1		
Turn Bay Length (m)	37.5			37.5			30.0			30.0		
Base Capacity (vph)	491	1187		389	1073		345	710		291	724	
Starvation Cap Reductn	0	0		0	0		0	0		0	0	
Spillback Cap Reductn	0	0		0	0		0	0		0	0	
Storage Cap Reductn	0	0		0	0		0	0		0	0	
Reduced v/c Ratio	0.09	0.60		0.31	0.53		0.56	0.13		0.44	0.04	

Intersection Summary												
Cycle Length: 120												
Actuated Cycle Length: 120												
Offset: 0 (0%), Referenced to phase 2:EBTL and 6:WBTL, Start of Green												
Natural Cycle: 70												
Control Type: Actuated-Coordinated												

Lanes, Volumes, Timings
2: Elevation/Apolune & Cambrian

2030 Future Total
PM Peak Hour

Maximum v/c Ratio: 0.78	
Intersection Signal Delay: 19.2	Intersection LOS: B
Intersection Capacity Utilization 82.7%	ICU Level of Service E
Analysis Period (min) 15	

Splits and Phases: 2: Elevation/Apolune & Cambrian

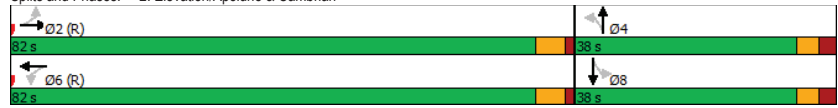

HCM 2010 TWSC
5: Temporary Driveway & Cambrian

2030 Future Total
PM Peak Hour

Intersection						
Int Delay, s/veh	1.1					
Movement	EBT	EBR	WBL	WBT	NBL	NBR
Lane Configurations	↔ ↗ ↘ ↖ ↗ ↘					
Traffic Vol, veh/h	647	57	6	668	38	9
Future Vol, veh/h	647	57	6	668	38	9
Conflicting Peds, #/hr	0	0	0	0	0	0
Sign Control	Free	Free	Free	Free	Stop	Stop
RT Channelized	-	None	-	None	-	None
Storage Length	-	-	-	-	0	-
Veh in Median Storage, #	0	-	-	0	0	-
Grade, %	0	-	-	0	0	-
Peak Hour Factor	100	100	100	100	100	100
Heavy Vehicles, %	2	2	2	2	2	2
Mvmt Flow	647	57	6	668	38	9

Major/Minor	Major1	Major2	Minor1
Conflicting Flow All	0	0	704
Stage 1	-	-	676
Stage 2	-	-	680
Critical Hdwy	-	4.12	6.42
Critical Hdwy Stg 1	-	-	5.42
Critical Hdwy Stg 2	-	-	5.42
Follow-up Hdwy	-	2.218	3.518
Pot Cap-1 Maneuver	-	894	165
Stage 1	-	-	505
Stage 2	-	-	503
Platoon blocked, %	-	-	-
Mov Cap-1 Maneuver	-	894	163
Mov Cap-2 Maneuver	-	-	163
Stage 1	-	-	505
Stage 2	-	-	497

Approach	EB	WB	NB
HCM Control Delay, s	0	0.1	30.8
HCM LOS			D

Minor Lane/Major Mvmt	NBLn1	EBT	EBR	WBL	WBT
Capacity (veh/h)	186	-	-	894	-
HCM Lane V/C Ratio	0.253	-	-	0.007	-
HCM Control Delay (s)	30.8	-	-	9.1	0
HCM Lane LOS	D	-	-	A	A
HCM 95th %tile Q(veh)	1	-	-	0	-

HCM 2010 TWSC
7: Access #1 & Cambrian

2030 Future Total
PM Peak Hour

Intersection						
Int Delay, s/veh	1.7					
Movement	EBT	EBR	WBL	WBT	NBL	NBR
Lane Configurations	↔		↑		↗	
Traffic Vol, veh/h	630	57	76	636	56	77
Future Vol, veh/h	630	57	76	636	56	77
Conflicting Peds, #/hr	0	0	0	0	0	0
Sign Control	Free	Free	Free	Free	Stop	Stop
RT Channelized	- None		- None		- None	
Storage Length	-					
Veh in Median Storage, #	0					
Grade, %	0					
Peak Hour Factor	100	100	100	100	100	100
Heavy Vehicles, %	2	2	2	2	2	2
Mvmt Flow	630	57	76	636	56	77
Major/Minor	Major1	Major2	Minor1			
Conflicting Flow All	0	0	687	0	1447	659
Stage 1	-	-	-	-	659	-
Stage 2	-	-	-	-	788	-
Critical Hdwy	-	-	4.12	-	6.42	6.22
Critical Hdwy Stg 1	-	-	-	-	5.42	-
Critical Hdwy Stg 2	-	-	-	-	5.42	-
Follow-up Hdwy	-	-	2.218	-	3.518	3.318
Pot Cap-1 Maneuver	-	-	907	-	145	464
Stage 1	-	-	-	-	515	-
Stage 2	-	-	-	-	448	-
Platoon blocked, %	-					
Mov Cap-1 Maneuver	-	-	907	-	126	464
Mov Cap-2 Maneuver	-	-	-	-	126	-
Stage 1	-	-	-	-	515	-
Stage 2	-	-	-	-	390	-
Approach	EB	WB	NB			
HCM Control Delay, s	0	1	14.3			
HCM LOS	B					
Minor Lane/Major Mvmt	NBLn1	EBT	EBR	WBL	WBT	
Capacity (veh/h)	464	-	-	907	-	
HCM Lane V/C Ratio	0.166	-	-	0.084	-	
HCM Control Delay (s)	14.3	-	-	9.3	-	
HCM Lane LOS	B	-	-	A	-	
HCM 95th %tile Q(veh)	0.6	-	-	0.3	-	

HCM 2010 AWSC
11: Grand Canal & Cambrian

2030 Future Total
PM Peak Hour

Intersection												
Intersection Delay, s/veh	85.9											
Intersection LOS	F											
Movement	EBL	EBT	EBR	WBL	WBT	WBR	NBL	NBT	NBR	SBL	SBT	SBR
Lane Configurations	↔		↕		↕		↕		↕		↕	
Traffic Vol, veh/h	39	538	121	48	568	42	82	25	56	51	26	24
Future Vol, veh/h	39	538	121	48	568	42	82	25	56	51	26	24
Peak Hour Factor	1.00	1.00	1.00	1.00	1.00	1.00	1.00	1.00	1.00	1.00	1.00	1.00
Heavy Vehicles, %	3	4	4	2	5	2	3	2	2	4	4	2
Mvmt Flow	39	538	121	48	568	42	82	25	56	51	26	24
Number of Lanes	0	1	0	0	1	0	0	1	0	0	1	0
Approach	EB			WB			NB			SB		
Opposing Approach	WB			EB			SB			NB		
Opposing Lanes	1			1			1			1		
Conflicting Approach Left	SB			NB			EB			WB		
Conflicting Lanes Left	1			1			1			1		
Conflicting Approach Right	NB			SB			WB			EB		
Conflicting Lanes Right	1			1			1			1		
HCM Control Delay	109.1			89.9			15.1			13.9		
HCM LOS	F			F			C			B		
Lane	NBLn1	EBLn1	WBLn1	SBLn1								
Vol Left, %	50%	6%	7%	50%								
Vol Thru, %	15%	77%	86%	26%								
Vol Right, %	34%	17%	6%	24%								
Sign Control	Stop	Stop	Stop	Stop								
Traffic Vol by Lane	163	698	658	101								
LT Vol	82	39	48	51								
Through Vol	25	538	568	26								
RT Vol	56	121	42	24								
Lane Flow Rate	163	698	658	101								
Geometry Grp	1	1	1	1								
Degree of Util (X)	0.34	1.151	1.094	0.221								
Departure Headway (Hd)	8.041	6.163	6.281	8.484								
Convergence, Y/N	Yes	Yes	Yes	Yes								
Cap	450	593	586	426								
Service Time	6.041	4.163	4.281	6.484								
HCM Lane V/C Ratio	0.362	1.177	1.123	0.237								
HCM Control Delay	15.1	109.1	89.9	13.9								
HCM Lane LOS	C	F	F	B								
HCM 95th-tile Q	1.5	22.3	19.1	0.8								

Appendix L

Turning Templates

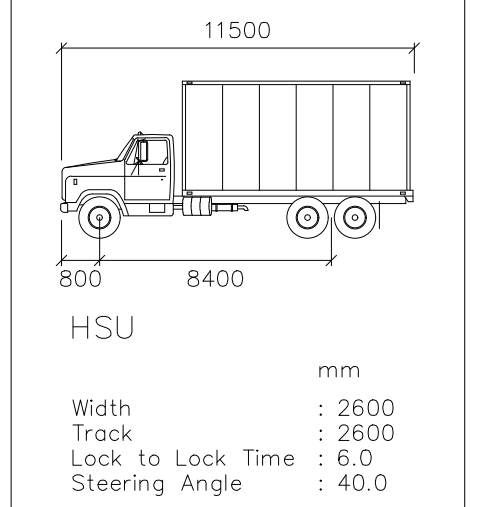
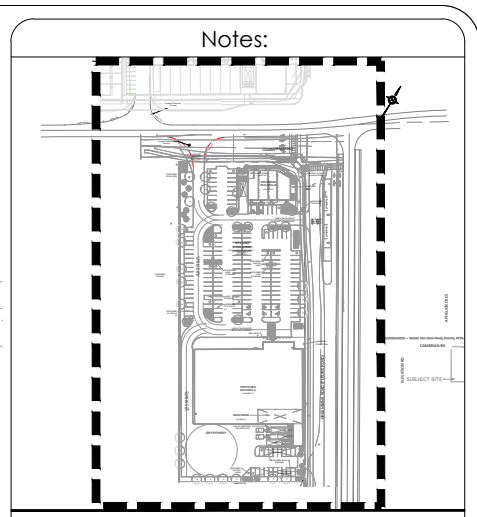
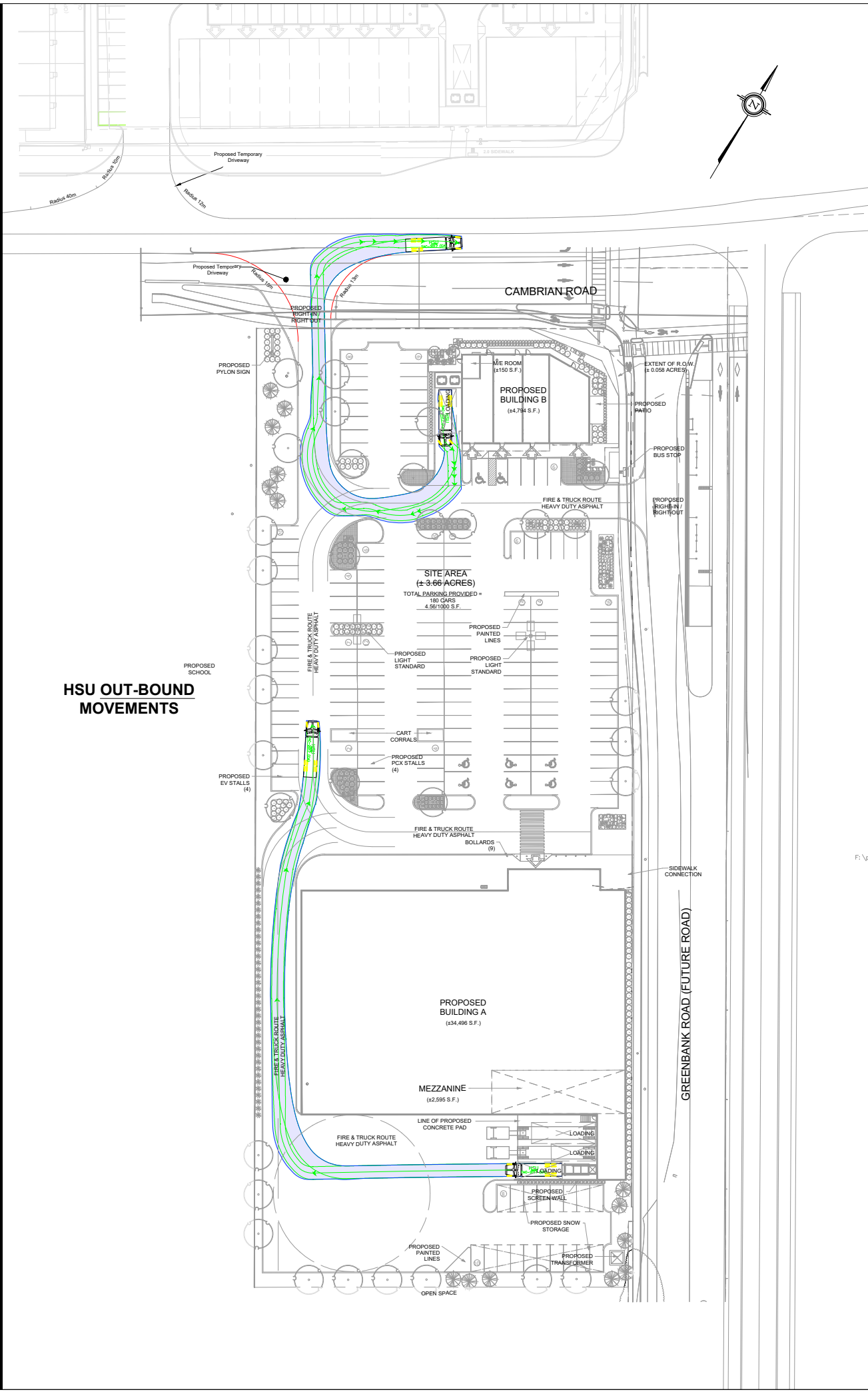
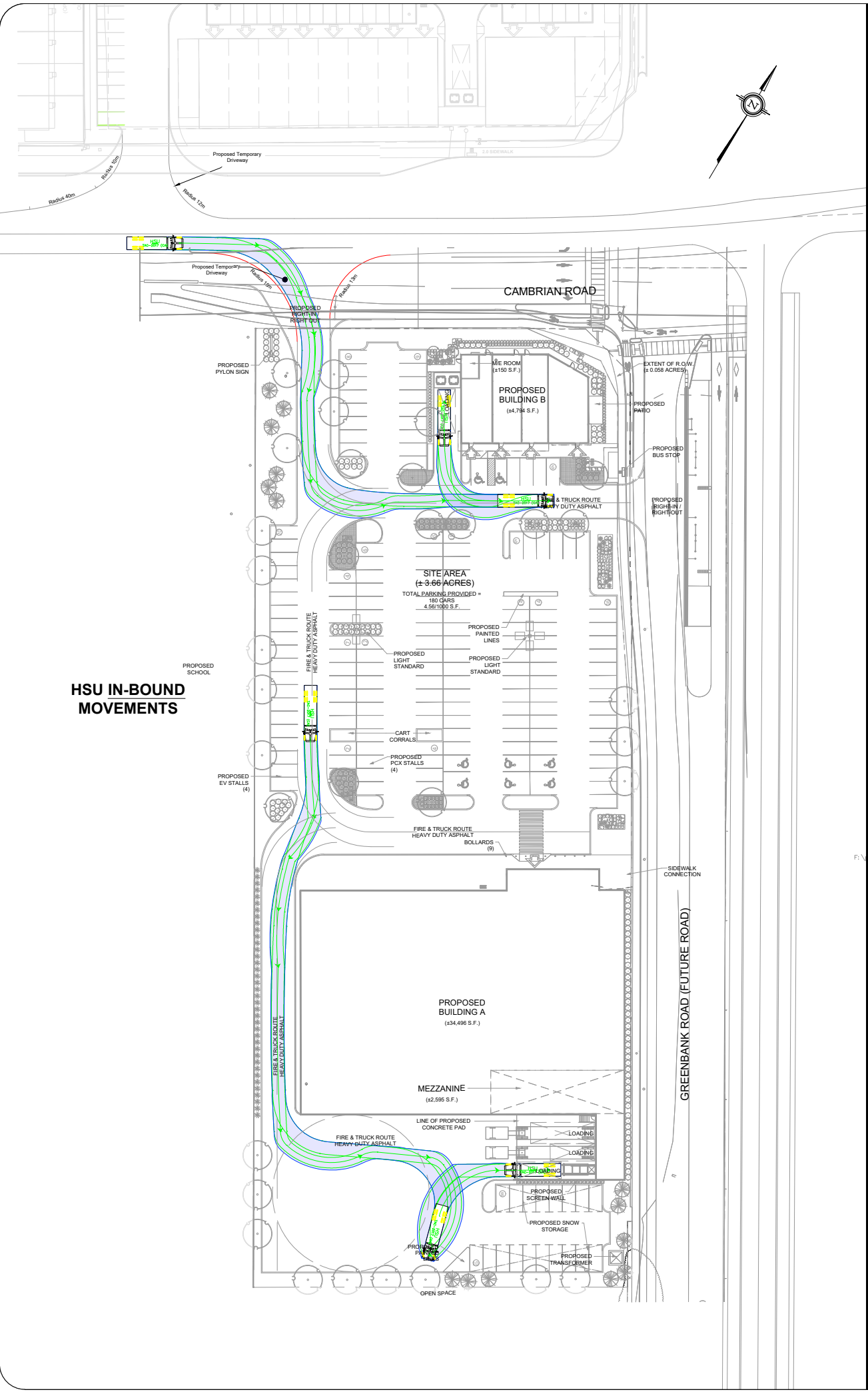

HSU IN-BOUND MOVEMENTS

HSU OUT-BOUND MOVEMENTS

06	Issued for Review	AN	2023-10-26
REV:	DESCRIPTION:	BY:	DATE:
STATUS:			



CGH Transportation
6 Plaza Court
Ottawa, ON
K2H 7W1
(343) 999-9117

CLIENT: Loblaws

ARCHITECT:

SITE: 3845 Cambrian Road			
TITLE: Turning Movement Analysis HSU Turning Movements			
SCALE AT A3: NTS	DATE: 2023-10-26	DRAWN: AN	CHECKED: AH
PROJECT NO: 2022-024	DRAWING NO: 001	REVISION: 06	

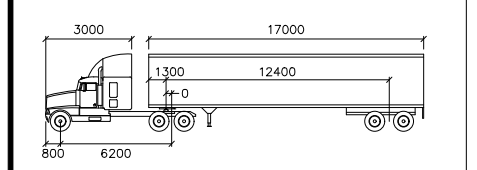
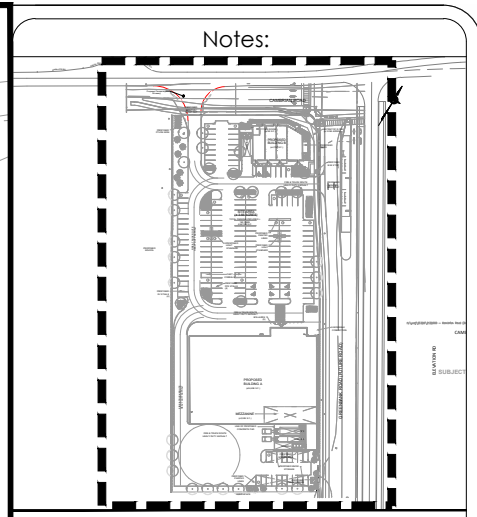
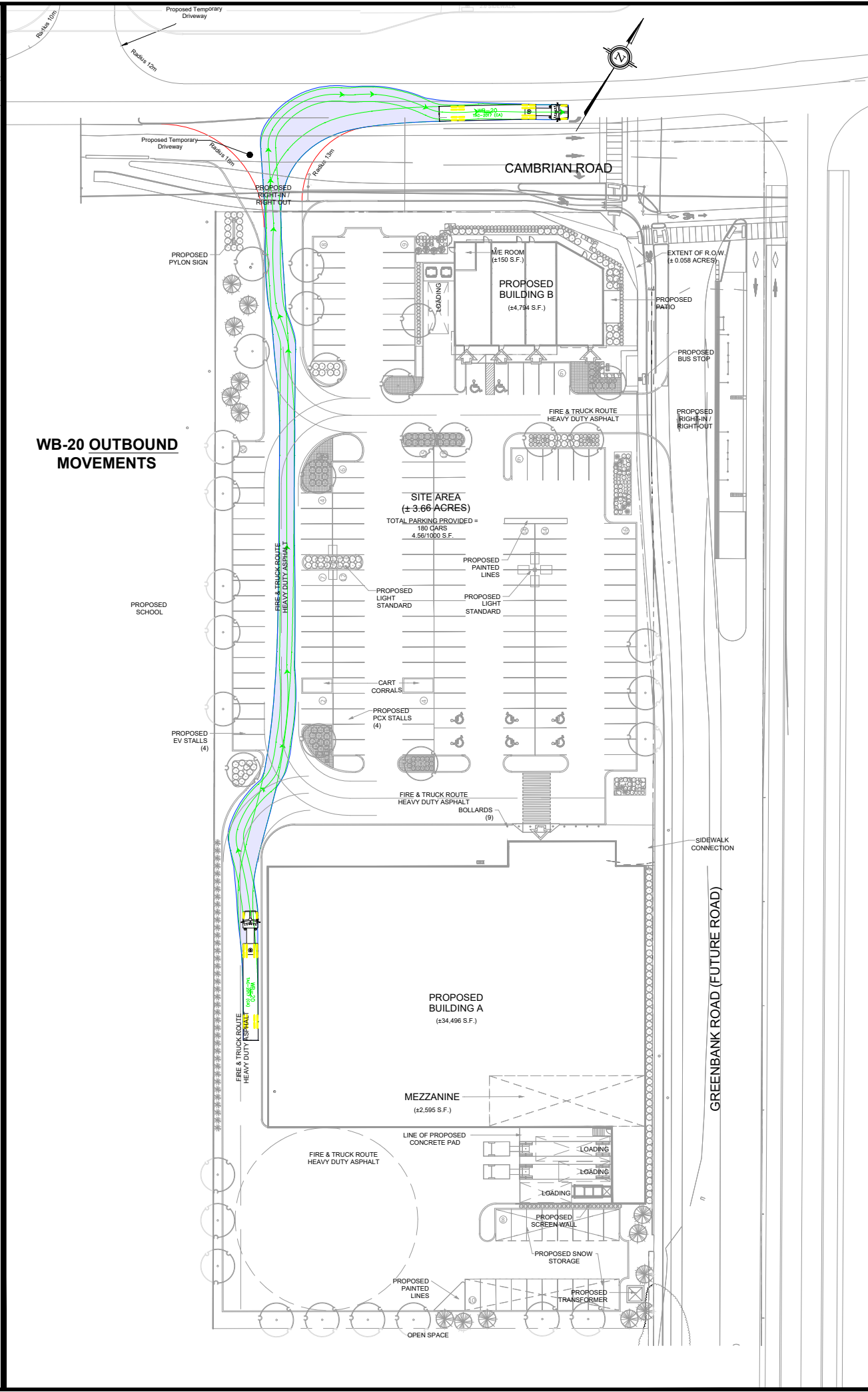
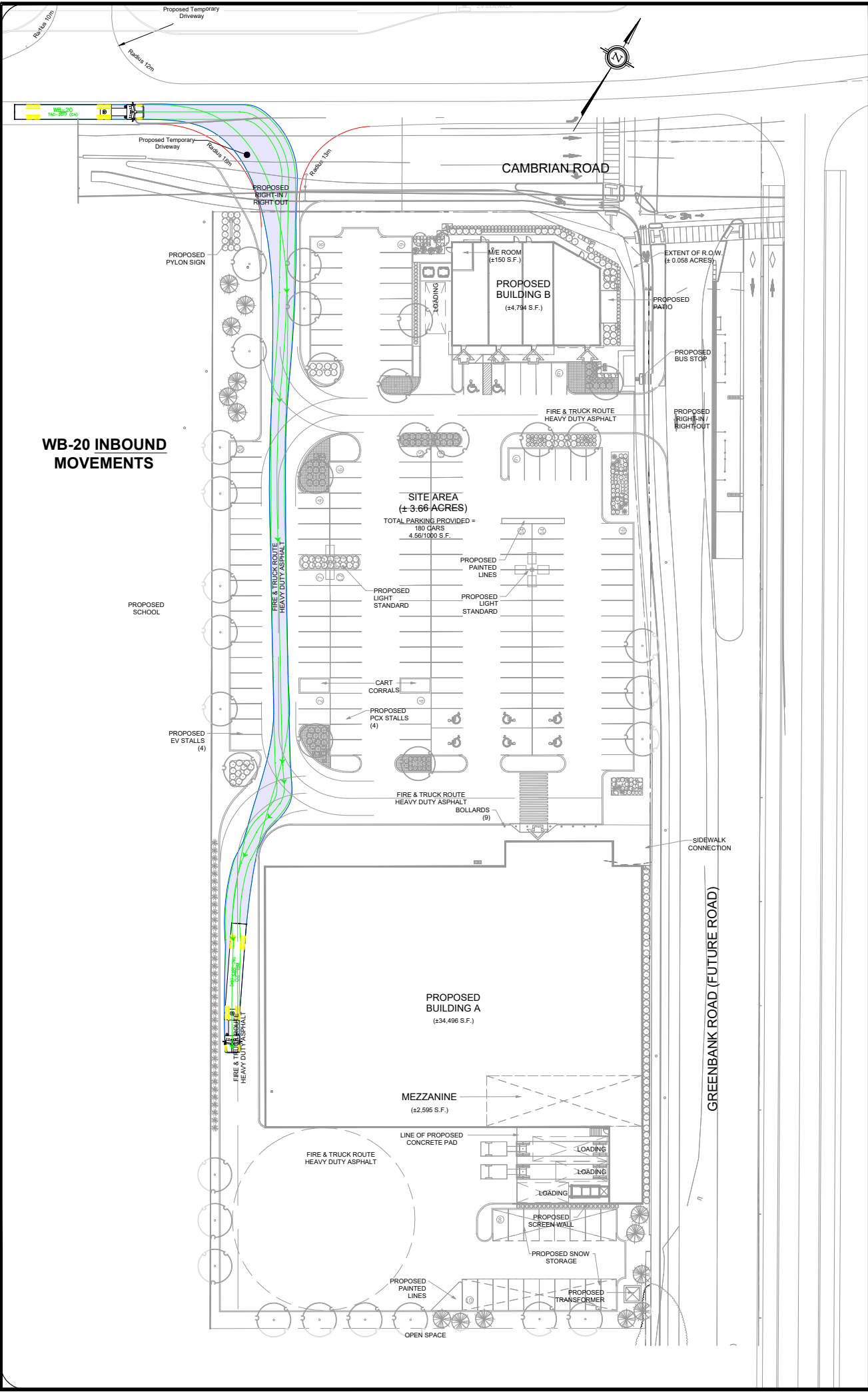

Tractor Width	: 2600	Lock to Lock Time	: 6.0
Trailer Width	: 2600	Steering Angle	: 28.2
Tractor Track	: 2600	Articulating Angle	: 70.0
Trailer Track	: 2600		

06	Issued for Review	AN	2023-10-26
REV:	DESCRIPTION:	BY:	DATE:
STATUS:			

CGH Transportation
6 Plaza Court
Ottawa, ON
K2H 7W1
(343) 999-9117

CLIENT: Loblaws

ARCHITECT:

SITE: 3845 Cambrian Road			
TITLE: Turning Movement Analysis WB-20 Access Turning Movements			
SCALE AT A3: NTS	DATE: 2023-10-26	DRAWN: AN	CHECKED: AH
PROJECT NO: 2022-024	DRAWING NO: 002	REVISION: 06	

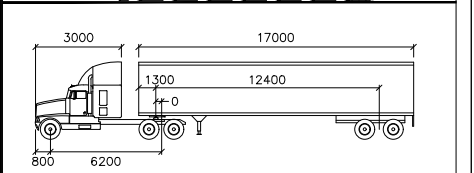
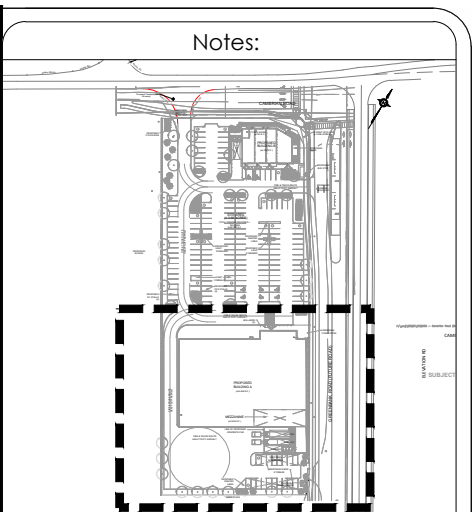
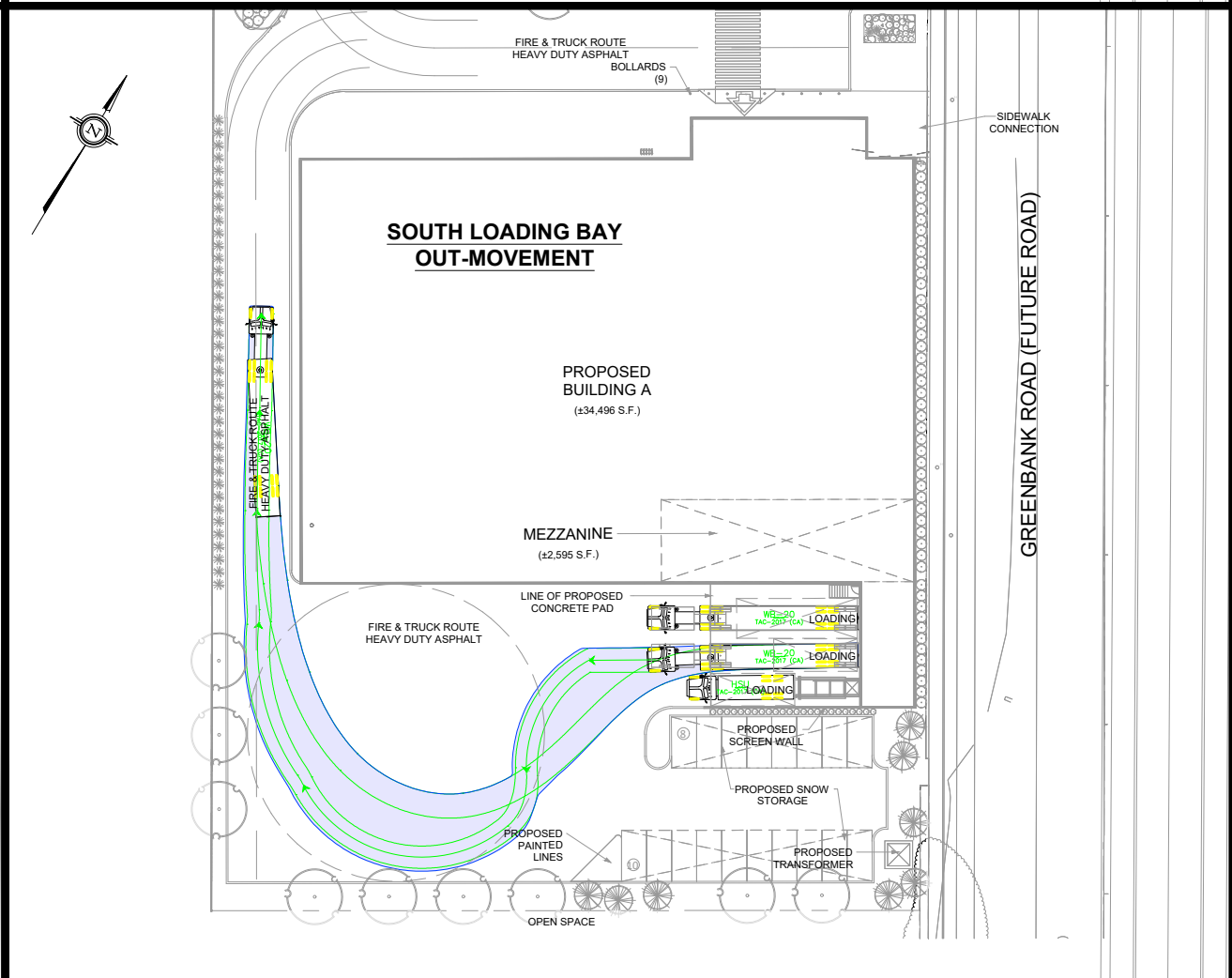
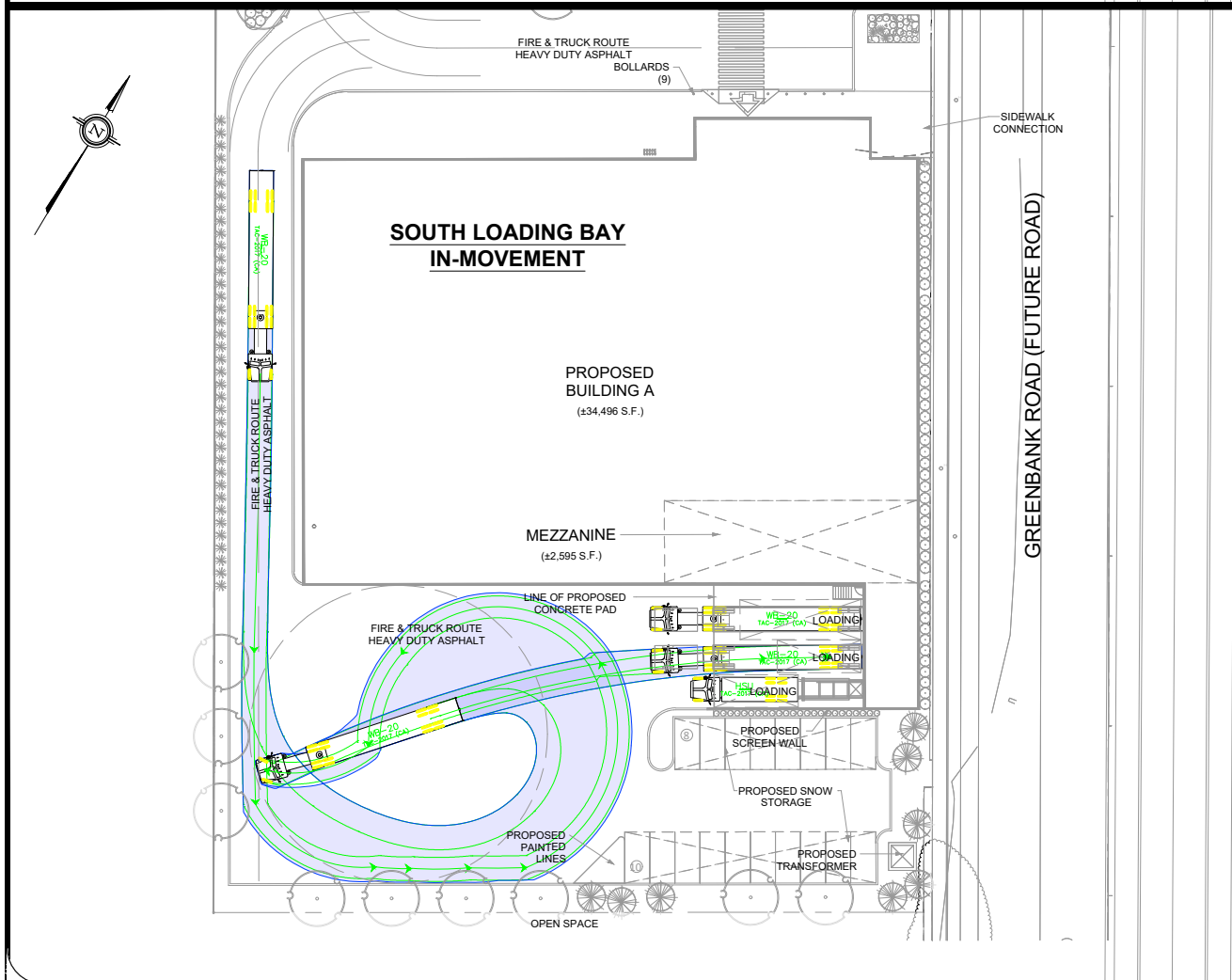
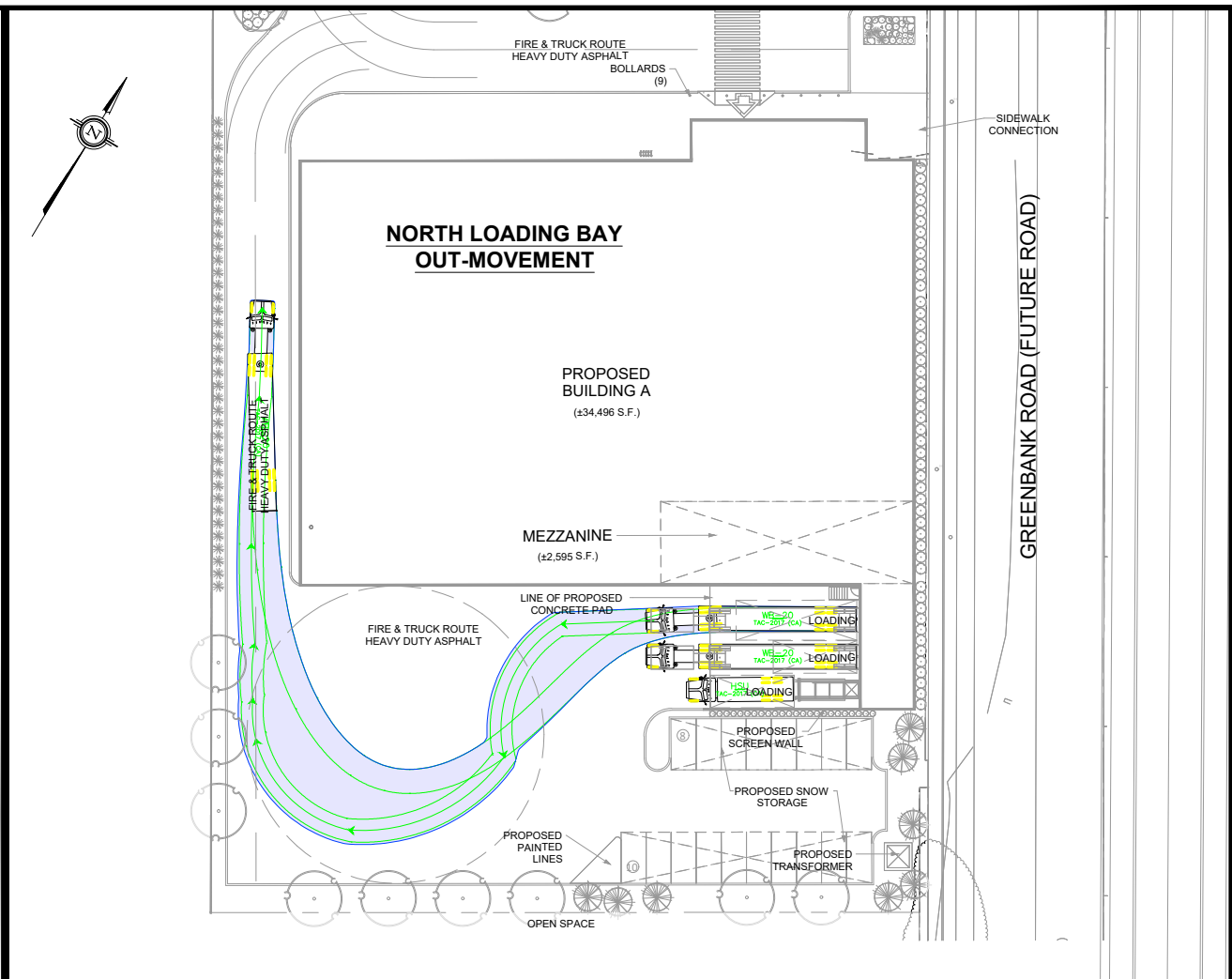
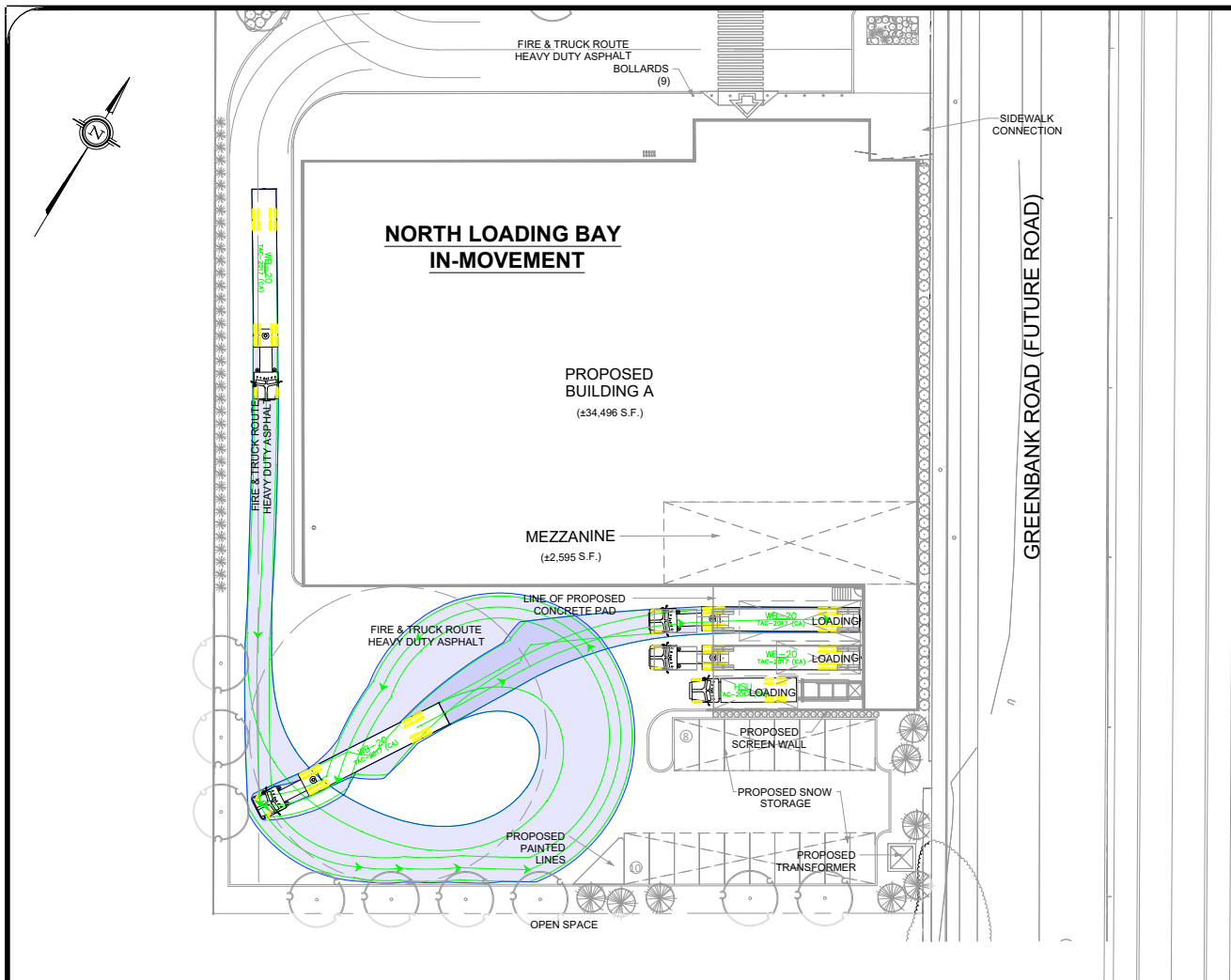

WB-20

Tractor Width	: 2600	Lock to Lock Time	: 6.0
Trailer Width	: 2600	Steering Angle	: 28.2
Tractor Track	: 2600	Articulating Angle	: 70.0
Trailer Track	: 2600		

06	Issued for Review	AN	2023-10-26
REV:	DESCRIPTION:	BY:	DATE:
STATUS:			

CGH Transportation
 6 Plaza Court
 Ottawa, ON
 K2H 7W1
 (343) 999-9117

CLIENT: Loblaws

ARCHITECT:

SITE: 3845 Cambrian Road

TITLE: Turning Movement Analysis
 WB-20 Loading Turning Movements

SCALE AT A3:	DATE:	DRAWN:	CHECKED:
NTS	2023-10-26	AN	AH
PROJECT NO:	DRAWING NO:	REVISION:	
2022-024	003	06	

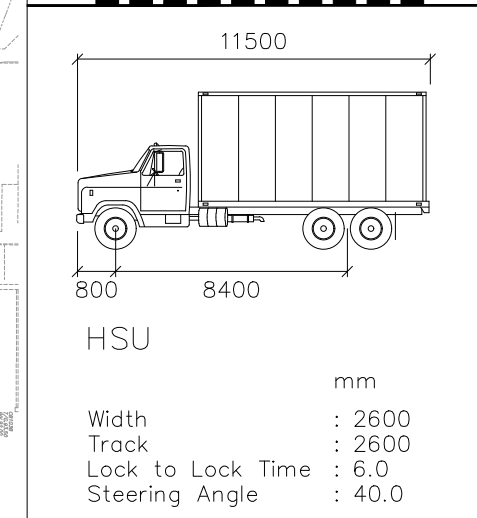
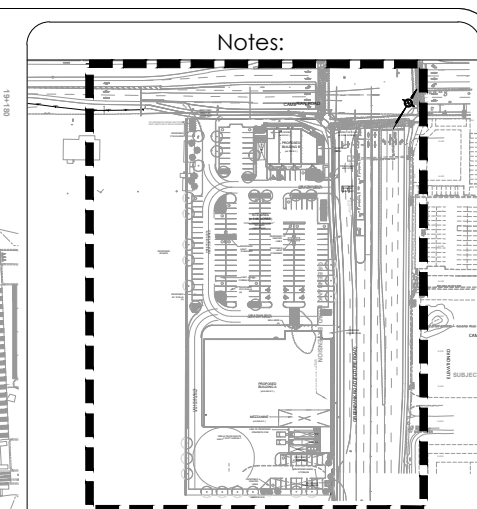
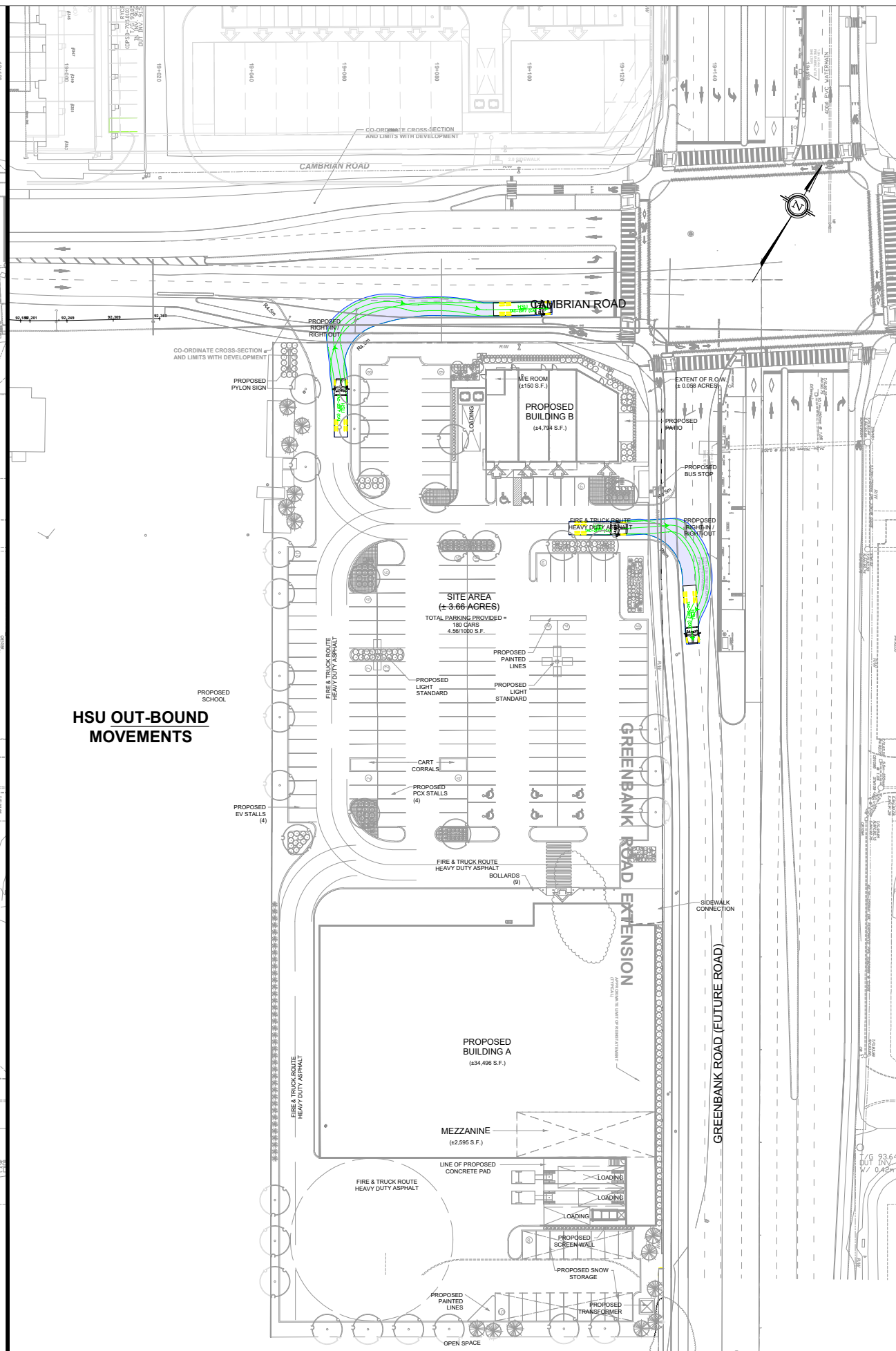
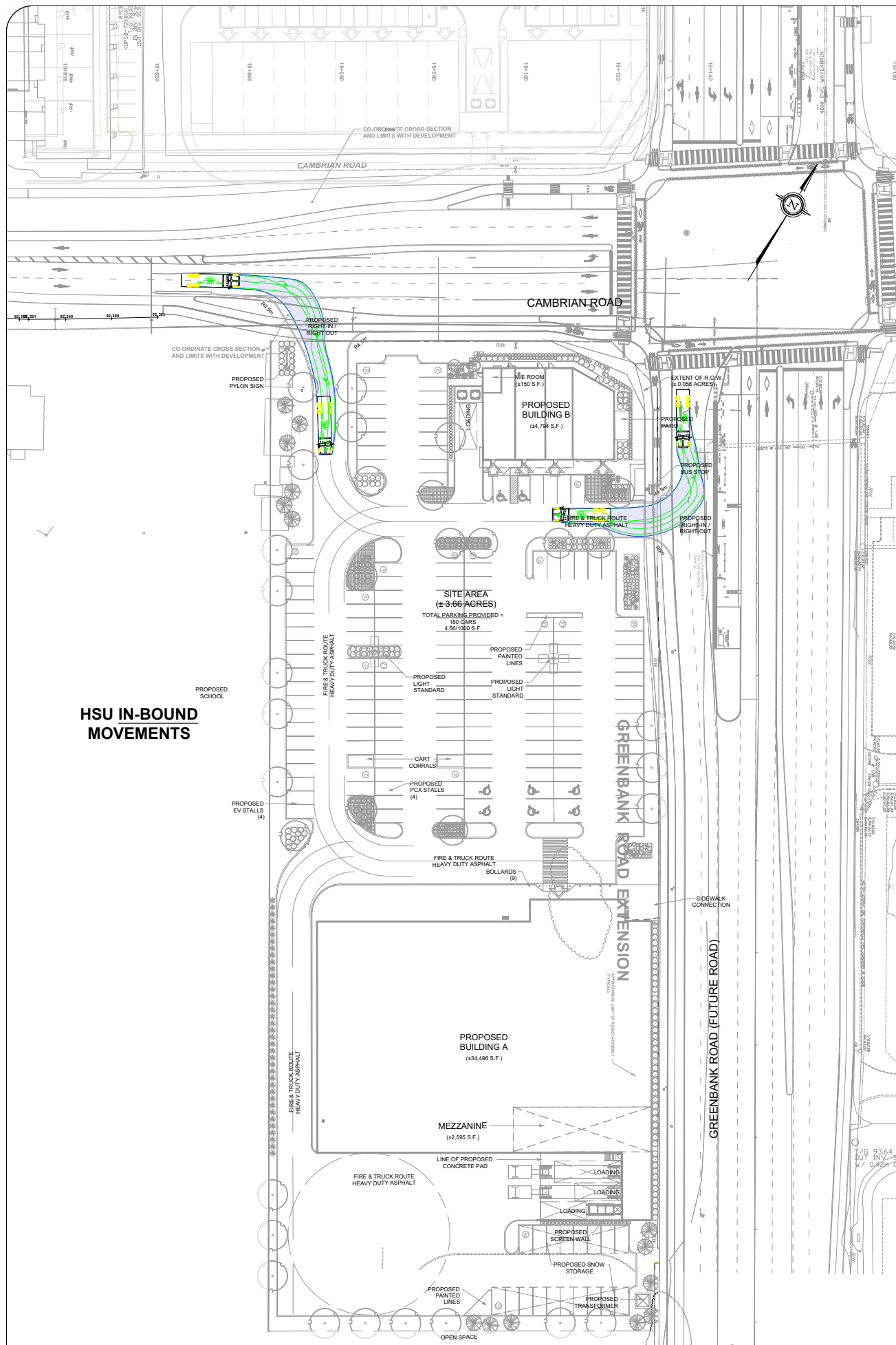

06	Issued for Review	AN	2023-10-26
REV:	DESCRIPTION:	BY:	DATE:
STATUS:			

CGH Transportation
 6 Plaza Court
 Ottawa, ON
 K2H 7W1
 (343) 999-9117

CLIENT: Loblaw's Companies Ltd.
 Loblaw's

ARCHITECT:

SITE: 3845 Cambrian Road			
TITLE: Future Re-Aligned Greenbank HSU Turning Movements			
SCALE AT A3:	DATE:	DRAWN:	CHECKED:
NTS	2023-10-26	AN	AH
PROJECT NO:	DRAWING NO:	REVISION:	
2022-024	004	06	

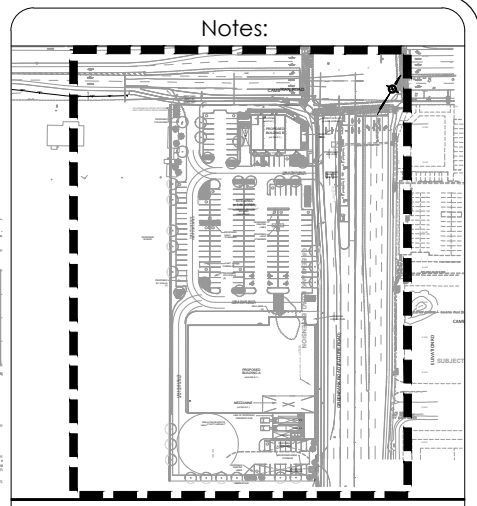
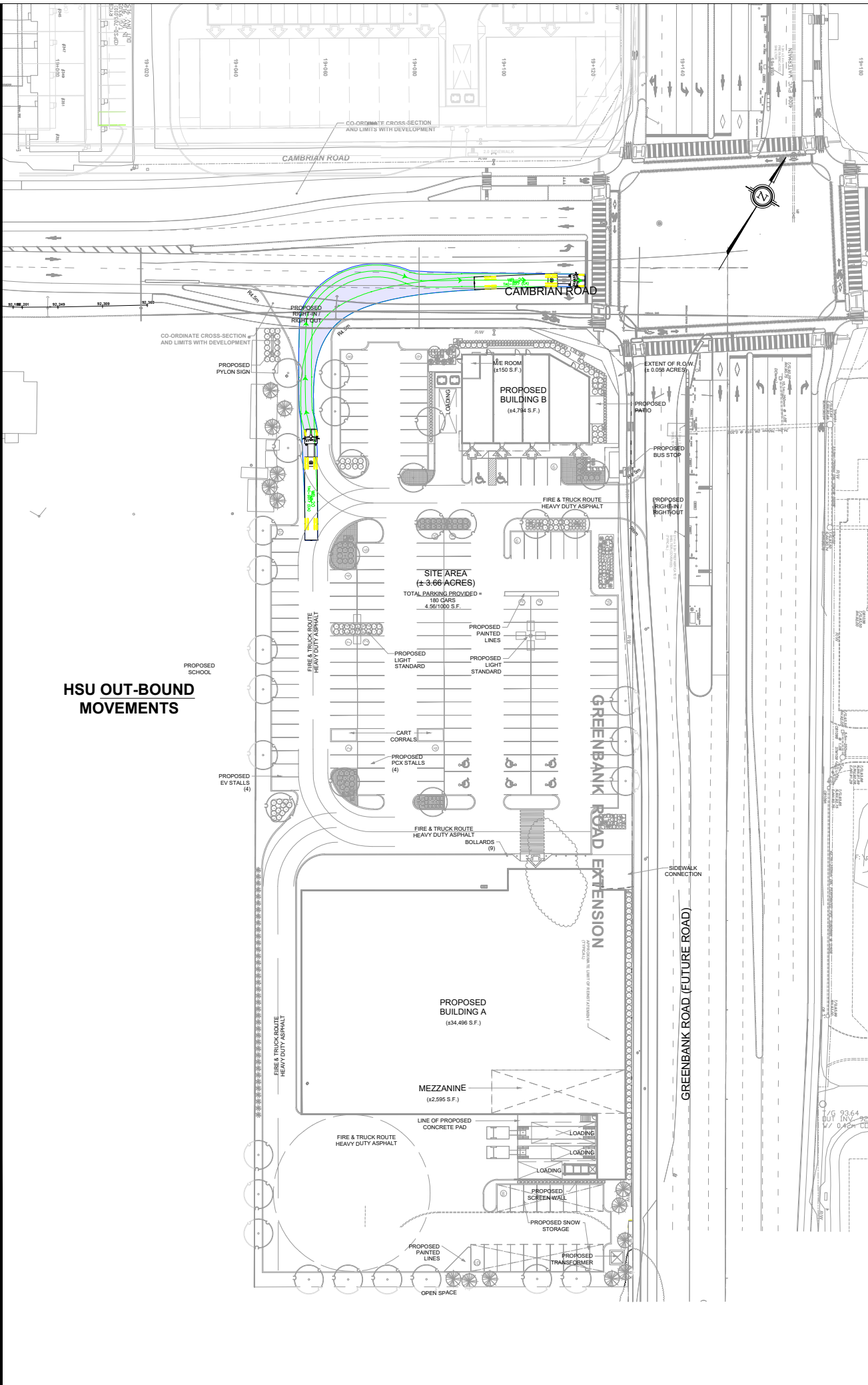
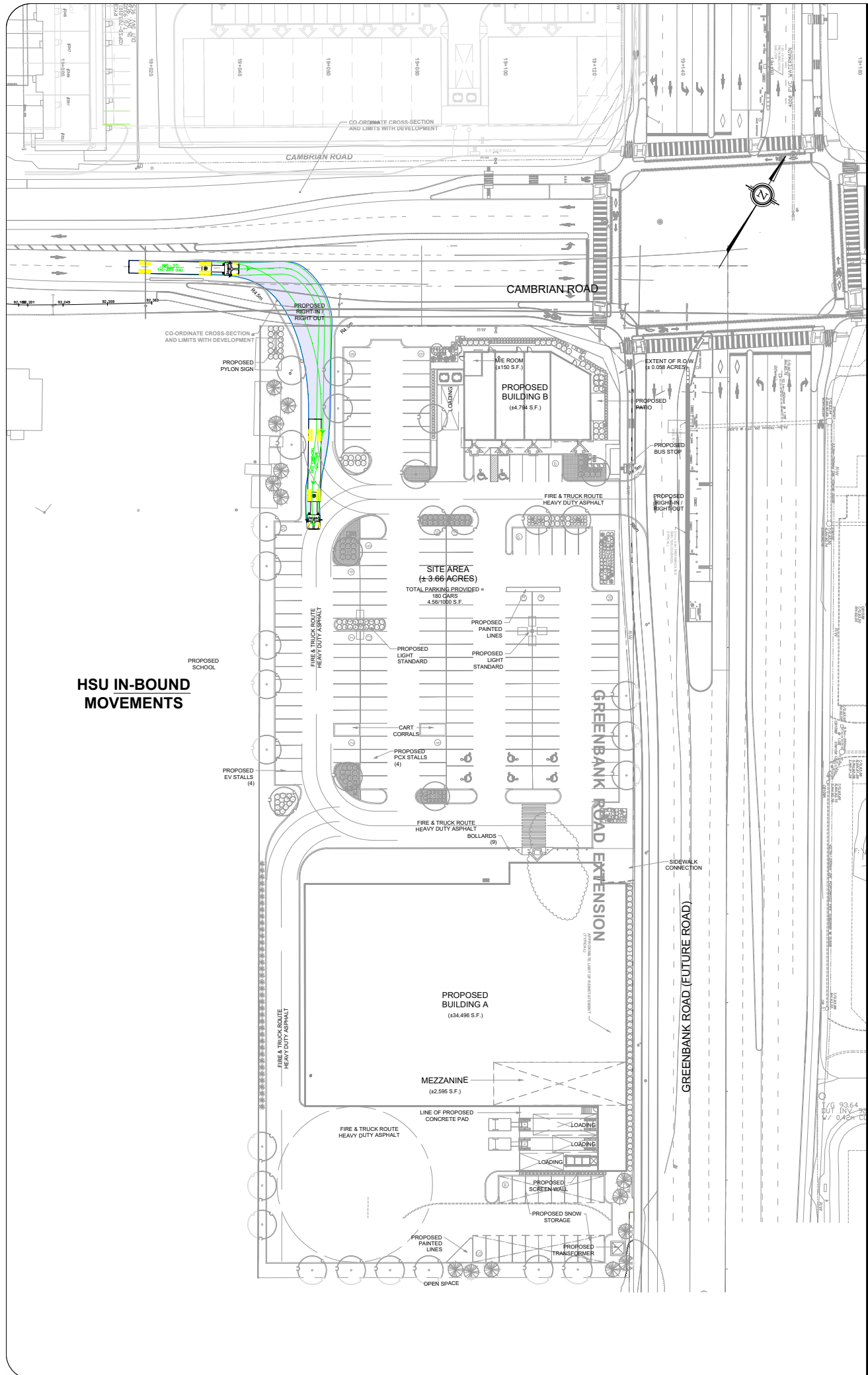

WB-20

Tractor Width	: 2600	Lock to Lock Time	: 6.0
Trailer Width	: 2600	Steering Angle	: 28.2
Tractor Track	: 2600	Articulating Angle	: 70.0
Trailer Track	: 2600		

06	Issued for Review	AN	2023-10-26
REV:	DESCRIPTION:	BY:	DATE:
STATUS:			

CGH Transportation
6 Plaza Court
Ottawa, ON
K2H 7W1
(343) 999-9117

CLIENT: Loblaw's Companies Ltd.
Loblaw's

ARCHITECT:

SITE: 3845 Cambrian Road

TITLE: Future Re-Aligned Greenbank WB-20 Turning Movements

SCALE AT A3:	DATE:	DRAWN:	CHECKED:
NTS	2023-10-26	AN	AH
PROJECT NO:	DRAWING NO:	REVISION:	
2022-024	005	06	

Appendix M

MMLOS Worksheets

Multi-Modal Level of Service - Intersections Form

Consultant
Scenario
Comments

CGH Transportation Inc
Future

Project
Date

2022-024
8/21/2023

INTERSECTIONS		Cambrian Rd at ApoluneSt / Elevation Rd			
Crossing Side		NORTH	SOUTH	EAST	WEST
Pedestrian	Lanes	4	4	5	5
	Median	No Median - 2.4 m	No Median - 2.4 m	No Median - 2.4 m	No Median - 2.4 m
	Conflicting Left Turns	Permissive	Permissive	Permissive	Permissive
	Conflicting Right Turns	Permissive or yield control	Permissive or yield control	Permissive or yield control	Permissive or yield control
	Right Turns on Red (RTor) ?	RTOR allowed	RTOR allowed	RTOR allowed	RTOR allowed
	Ped Signal Leading Interval?	No	No	No	No
	Right Turn Channel	No Channel	No Channel	No Channel	No Channel
	Corner Radius	10-15m	10-15m	10-15m	10-15m
	Crosswalk Type	Std transverse markings	Std transverse markings	Std transverse markings	Std transverse markings
	PETSI Score	53	53	37	37
	Ped. Exposure to Traffic LoS	D	D	E	E
	Cycle Length				
	Effective Walk Time				
	Average Pedestrian Delay				
	Pedestrian Delay LoS	-	-	-	-
Level of Service	D	D	E	E	
	E				
Approach From		NORTH	SOUTH	EAST	WEST
Bicycle	Bicycle Lane Arrangement on Approach	Mixed Traffic	Mixed Traffic	Mixed Traffic	Mixed Traffic
	Right Turn Lane Configuration				
	Right Turning Speed				
	Cyclist relative to RT motorists	#N/A	#N/A	#N/A	#N/A
	Separated or Mixed Traffic	Mixed Traffic	Mixed Traffic	Mixed Traffic	Mixed Traffic
	Left Turn Approach	No lane crossed	No lane crossed	No lane crossed	No lane crossed
	Operating Speed	> 40 to ≤ 50 km/h	> 40 to ≤ 50 km/h	> 50 to < 60 km/h	> 50 to < 60 km/h
	Left Turning Cyclist	B	B	C	C
Level of Service	B	B	C	C	
	C				
Transit	Average Signal Delay				
	Level of Service	-	-	-	-
Truck	Effective Corner Radius				
	Number of Receiving Lanes on Departure from Intersection				
	Level of Service	-	-	-	-
		-			
Auto	Volume to Capacity Ratio	0.61 - 0.70			
	Level of Service	B			

Multi-Modal Level of Service - Segments Form

Consultant	CGH Transportation Inc	Project	2022-024
Scenario	Existing/Future	Date	8/21/2023
Comments			

SEGMENTS			Cambrian Rd	Cambrian Rd	Re-Aligned Greenbank Rd
			Existing	Future	Future
Pedestrian	Sidewalk Width	F	no sidewalk	≥ 2 m	1.8 m
	Boulevard Width		n/a	> 2 m	> 2 m
	Avg Daily Curb Lane Traffic Volume		> 3000	> 3000	> 3000
	Operating Speed		> 50 to 60 km/h	> 50 to 60 km/h	> 50 to 60 km/h
	On-Street Parking		no	no	no
	Exposure to Traffic PLoS		F	C	D
	Effective Sidewalk Width				
Pedestrian Volume					
Crowding PLoS	A	A	A		
Level of Service	F	C	D		
Bicycle	Type of Cycling Facility	D	Mixed Traffic	Physically Separated	Physically Separated
	Number of Travel Lanes		≤ 2 (no centreline)		
	Operating Speed		≥ 50 to 60 km/h		
	# of Lanes & Operating Speed LoS		D	-	-
	Bike Lane (+ Parking Lane) Width				
	Bike Lane Width LoS		-	-	-
	Bike Lane Blockages				
	Blockage LoS		-	-	-
	Median Refuge Width (no median = < 1.8 m)		< 1.8 m refuge		
	No. of Lanes at Unsignalized Crossing		≤ 3 lanes		
Sidestreet Operating Speed	≤ 40 km/h				
Unsignalized Crossing - Lowest LoS	A	A			
Level of Service	D	A	A		
Transit	Facility Type	A			Segregated ROW
	Friction or Ratio Transit:Posted Speed				
Level of Service	-	-	A		
Truck	Truck Lane Width	A			≤ 3.5 m
	Travel Lanes per Direction				> 1
	Level of Service		-	-	A

Appendix N

TDM Checklist

TDM Measures Checklist:
Non-Residential Developments (office, institutional, retail or industrial)

Legend	
	BASIC The measure is generally feasible and effective, and in most cases would benefit the development and its users
	BETTER The measure could maximize support for users of sustainable modes, and optimize development performance
★	The measure is one of the most dependably effective tools to encourage the use of sustainable modes

TDM measures: <i>Non-residential developments</i>		Check if proposed & add descriptions
1. TDM PROGRAM MANAGEMENT		
1.1 Program coordinator		
BASIC	★ 1.1.1 Designate an internal coordinator, or contract with an external coordinator	<input type="checkbox"/>
1.2 Travel surveys		
BETTER	1.2.1 Conduct periodic surveys to identify travel-related behaviours, attitudes, challenges and solutions, and to track progress	<input type="checkbox"/>
2. WALKING AND CYCLING		
2.1 Information on walking/cycling routes & destinations		
BASIC	2.1.1 Display local area maps with walking/cycling access routes and key destinations at major entrances	<input type="checkbox"/>
2.2 Bicycle skills training		
<i>Commuter travel</i>		
BETTER	★ 2.2.1 Offer on-site cycling courses for commuters, or subsidize off-site courses	<input type="checkbox"/>
2.3 Valet bike parking		
<i>Visitor travel</i>		
BETTER	2.3.1 Offer secure valet bike parking during public events when demand exceeds fixed supply (e.g. for festivals, concerts, games)	<input type="checkbox"/>

TDM measures: <i>Non-residential developments</i>		Check if proposed & add descriptions
3. TRANSIT		
3.1 Transit information		
BASIC	3.1.1 Display relevant transit schedules and route maps at entrances	<input type="checkbox"/>
BASIC	3.1.2 Provide online links to OC Transpo and STO information	<input type="checkbox"/>
BETTER	3.1.3 Provide real-time arrival information display at entrances	<input type="checkbox"/>
3.2 Transit fare incentives		
<i>Commuter travel</i>		
BETTER	3.2.1 Offer preloaded PRESTO cards to encourage commuters to use transit	<input type="checkbox"/>
BETTER	★ 3.2.2 Subsidize or reimburse monthly transit pass purchases by employees	<input type="checkbox"/>
<i>Visitor travel</i>		
BETTER	3.2.3 Arrange inclusion of same-day transit fare in price of tickets (e.g. for festivals, concerts, games)	<input type="checkbox"/>
3.3 Enhanced public transit service		
<i>Commuter travel</i>		
BETTER	3.3.1 Contract with OC Transpo to provide enhanced transit services (e.g. for shift changes, weekends)	<input type="checkbox"/>
<i>Visitor travel</i>		
BETTER	3.3.2 Contract with OC Transpo to provide enhanced transit services (e.g. for festivals, concerts, games)	<input type="checkbox"/>
3.4 Private transit service		
<i>Commuter travel</i>		
BETTER	3.4.1 Provide shuttle service when OC Transpo cannot offer sufficient quality or capacity to serve demand (e.g. for shift changes, weekends)	<input type="checkbox"/>
<i>Visitor travel</i>		
BETTER	3.4.2 Provide shuttle service when OC Transpo cannot offer sufficient quality or capacity to serve demand (e.g. for festivals, concerts, games)	<input type="checkbox"/>

TDM measures: <i>Non-residential developments</i>		Check if proposed & add descriptions
4. RIDESHARING		
4.1 Ridematching service		
<i>Commuter travel</i>		
BASIC ★	4.1.1 Provide a dedicated ridematching portal at OttawaRideMatch.com	<input type="checkbox"/>
4.2 Carpool parking price incentives		
<i>Commuter travel</i>		
BETTER	4.2.1 Provide discounts on parking costs for registered carpools	<input type="checkbox"/>
4.3 Vanpool service		
<i>Commuter travel</i>		
BETTER	4.3.1 Provide a vanpooling service for long-distance commuters	<input type="checkbox"/>
5. CARSHARING & BIKESHARING		
5.1 Bikeshare stations & memberships		
BETTER	5.1.1 Contract with provider to install on-site bikeshare station for use by commuters and visitors	<input type="checkbox"/>
<i>Commuter travel</i>		
BETTER	5.1.2 Provide employees with bikeshare memberships for local business travel	<input type="checkbox"/>
5.2 Carshare vehicles & memberships		
<i>Commuter travel</i>		
BETTER	5.2.1 Contract with provider to install on-site carshare vehicles and promote their use by tenants	<input type="checkbox"/>
BETTER	5.2.2 Provide employees with carshare memberships for local business travel	<input type="checkbox"/>
6. PARKING		
6.1 Priced parking		
<i>Commuter travel</i>		
BASIC ★	6.1.1 Charge for long-term parking (daily, weekly, monthly)	<input type="checkbox"/>
BASIC	6.1.2 Unbundle parking cost from lease rates at multi-tenant sites	<input type="checkbox"/>
<i>Visitor travel</i>		
BETTER	6.1.3 Charge for short-term parking (hourly)	<input type="checkbox"/>

TDM measures: <i>Non-residential developments</i>		Check if proposed & add descriptions
7. TDM MARKETING & COMMUNICATIONS		
7.1 Multimodal travel information		
<i>Commuter travel</i>		
BASIC ★	7.1.1 Provide a multimodal travel option information package to new/relocating employees and students	<input checked="" type="checkbox"/>
<i>Visitor travel</i>		
BETTER ★	7.1.2 Include multimodal travel option information in invitations or advertising that attract visitors or customers (e.g. for festivals, concerts, games)	<input type="checkbox"/>
7.2 Personalized trip planning		
<i>Commuter travel</i>		
BETTER ★	7.2.1 Offer personalized trip planning to new/relocating employees	<input type="checkbox"/>
7.3 Promotions		
<i>Commuter travel</i>		
BETTER	7.3.1 Deliver promotions and incentives to maintain awareness, build understanding, and encourage trial of sustainable modes	<input type="checkbox"/>
8. OTHER INCENTIVES & AMENITIES		
8.1 Emergency ride home		
<i>Commuter travel</i>		
BETTER ★	8.1.1 Provide emergency ride home service to non-driving commuters	<input type="checkbox"/>
8.2 Alternative work arrangements		
<i>Commuter travel</i>		
BASIC ★	8.2.1 Encourage flexible work hours	<input type="checkbox"/>
BETTER	8.2.2 Encourage compressed workweeks	<input type="checkbox"/>
BETTER ★	8.2.3 Encourage telework	<input type="checkbox"/>
8.3 Local business travel options		
<i>Commuter travel</i>		
BASIC ★	8.3.1 Provide local business travel options that minimize the need for employees to bring a personal car to work	<input type="checkbox"/>
8.4 Commuter incentives		
<i>Commuter travel</i>		
BETTER	8.4.1 Offer employees a taxable, mode-neutral commuting allowance	<input type="checkbox"/>
8.5 On-site amenities		
<i>Commuter travel</i>		
BETTER	8.5.1 Provide on-site amenities/services to minimize mid-day or mid-commute errands	<input type="checkbox"/>

TDM-Supportive Development Design and Infrastructure Checklist:
Non-Residential Developments (office, institutional, retail or industrial)

Legend	
REQUIRED	The Official Plan or Zoning By-law provides related guidance that must be followed
BASIC	The measure is generally feasible and effective, and in most cases would benefit the development and its users
BETTER	The measure could maximize support for users of sustainable modes, and optimize development performance

TDM-supportive design & infrastructure measures: <i>Non-residential developments</i>		Check if completed & add descriptions, explanations or plan/drawing references
1. WALKING & CYCLING: ROUTES		
1.1 Building location & access points		
BASIC	1.1.1 Locate building close to the street, and do not locate parking areas between the street and building entrances	<input type="checkbox"/>
BASIC	1.1.2 Locate building entrances in order to minimize walking distances to sidewalks and transit stops/stations	<input checked="" type="checkbox"/>
BASIC	1.1.3 Locate building doors and windows to ensure visibility of pedestrians from the building, for their security and comfort	<input checked="" type="checkbox"/>
1.2 Facilities for walking & cycling		
REQUIRED	1.2.1 Provide convenient, direct access to stations or major stops along rapid transit routes within 600 metres; minimize walking distances from buildings to rapid transit; provide pedestrian-friendly, weather-protected (where possible) environment between rapid transit accesses and building entrances; ensure quality linkages from sidewalks through building entrances to integrated stops/stations (see <i>Official Plan policy 4.3.3</i>)	<input checked="" type="checkbox"/>
REQUIRED	1.2.2 Provide safe, direct and attractive pedestrian access from public sidewalks to building entrances through such measures as: reducing distances between public sidewalks and major building entrances; providing walkways from public streets to major building entrances; within a site, providing walkways along the front of adjoining buildings, between adjacent buildings, and connecting areas where people may congregate, such as courtyards and transit stops; and providing weather protection through canopies, colonnades, and other design elements wherever possible (see <i>Official Plan policy 4.3.12</i>)	<input checked="" type="checkbox"/>

TDM-supportive design & infrastructure measures: <i>Non-residential developments</i>		Check if completed & add descriptions, explanations or plan/drawing references
REQUIRED	1.2.3 Provide sidewalks of smooth, well-drained walking surfaces of contrasting materials or treatments to differentiate pedestrian areas from vehicle areas, and provide marked pedestrian crosswalks at intersection sidewalks (see <i>Official Plan policy 4.3.10</i>)	<input checked="" type="checkbox"/>
REQUIRED	1.2.4 Make sidewalks and open space areas easily accessible through features such as gradual grade transition, depressed curbs at street corners and convenient access to extra-wide parking spaces and ramps (see <i>Official Plan policy 4.3.10</i>)	<input checked="" type="checkbox"/>
REQUIRED	1.2.5 Include adequately spaced inter-block/street cycling and pedestrian connections to facilitate travel by active transportation. Provide links to the existing or planned network of public sidewalks, multi-use pathways and on-road cycle routes. Where public sidewalks and multi-use pathways intersect with roads, consider providing traffic control devices to give priority to cyclists and pedestrians (see <i>Official Plan policy 4.3.11</i>)	<input checked="" type="checkbox"/>
BASIC	1.2.6 Provide safe, direct and attractive walking routes from building entrances to nearby transit stops	<input type="checkbox"/>
BASIC	1.2.7 Ensure that walking routes to transit stops are secure, visible, lighted, shaded and wind-protected wherever possible	<input type="checkbox"/>
BASIC	1.2.8 Design roads used for access or circulation by cyclists using a target operating speed of no more than 30 km/h, or provide a separated cycling facility	<input type="checkbox"/>
1.3 Amenities for walking & cycling		
BASIC	1.3.1 Provide lighting, landscaping and benches along walking and cycling routes between building entrances and streets, sidewalks and trails	<input type="checkbox"/>
BASIC	1.3.2 Provide wayfinding signage for site access (where required, e.g. when multiple buildings or entrances exist) and egress (where warranted, such as when directions to reach transit stops/stations, trails or other common destinations are not obvious)	<input type="checkbox"/>

TDM-supportive design & infrastructure measures: <i>Non-residential developments</i>		Check if completed & add descriptions, explanations or plan/drawing references
2. WALKING & CYCLING: END-OF-TRIP FACILITIES		
2.1 Bicycle parking		
REQUIRED	2.1.1 Provide bicycle parking in highly visible and lighted areas, sheltered from the weather wherever possible (see <i>Official Plan policy 4.3.6</i>)	<input checked="" type="checkbox"/>
REQUIRED	2.1.2 Provide the number of bicycle parking spaces specified for various land uses in different parts of Ottawa; provide convenient access to main entrances or well-used areas (see <i>Zoning By-law Section 111</i>)	<input checked="" type="checkbox"/>
REQUIRED	2.1.3 Ensure that bicycle parking spaces and access aisles meet minimum dimensions; that no more than 50% of spaces are vertical spaces; and that parking racks are securely anchored (see <i>Zoning By-law Section 111</i>)	<input checked="" type="checkbox"/>
BASIC	2.1.4 Provide bicycle parking spaces equivalent to the expected number of commuter cyclists (assuming the cycling mode share target is met), plus the expected peak number of customer/visitor cyclists	<input type="checkbox"/>
BETTER	2.1.5 Provide bicycle parking spaces equivalent to the expected number of commuter and customer/visitor cyclists, plus an additional buffer (e.g. 25 percent extra) to encourage other cyclists and ensure adequate capacity in peak cycling season	<input type="checkbox"/>
2.2 Secure bicycle parking		
REQUIRED	2.2.1 Where more than 50 bicycle parking spaces are provided for a single office building, locate at least 25% of spaces within a building/structure, a secure area (e.g. supervised parking lot or enclosure) or bicycle lockers (see <i>Zoning By-law Section 111</i>)	<input type="checkbox"/>
BETTER	2.2.2 Provide secure bicycle parking spaces equivalent to the expected number of commuter cyclists (assuming the cycling mode share target is met)	<input type="checkbox"/>
2.3 Shower & change facilities		
BASIC	2.3.1 Provide shower and change facilities for the use of active commuters	<input type="checkbox"/>
BETTER	2.3.2 In addition to shower and change facilities, provide dedicated lockers, grooming stations, drying racks and laundry facilities for the use of active commuters	<input type="checkbox"/>
2.4 Bicycle repair station		
BETTER	2.4.1 Provide a permanent bike repair station, with commonly used tools and an air pump, adjacent to the main bicycle parking area (or secure bicycle parking area, if provided)	<input type="checkbox"/>

TDM-supportive design & infrastructure measures: <i>Non-residential developments</i>		Check if completed & add descriptions, explanations or plan/drawing references
3. TRANSIT		
3.1 Customer amenities		
BASIC	3.1.1 Provide shelters, lighting and benches at any on-site transit stops	<input type="checkbox"/>
BASIC	3.1.2 Where the site abuts an off-site transit stop and insufficient space exists for a transit shelter in the public right-of-way, protect land for a shelter and/or install a shelter	<input type="checkbox"/>
BETTER	3.1.3 Provide a secure and comfortable interior waiting area by integrating any on-site transit stops into the building	<input type="checkbox"/>
4. RIDESHARING		
4.1 Pick-up & drop-off facilities		
BASIC	4.1.1 Provide a designated area for carpool drivers (plus taxis and ride-hailing services) to drop off or pick up passengers without using fire lanes or other no-stopping zones	<input type="checkbox"/>
4.2 Carpool parking		
BASIC	4.2.1 Provide signed parking spaces for carpools in a priority location close to a major building entrance, sufficient in number to accommodate the mode share target for carpools	<input type="checkbox"/>
BETTER	4.2.2 At large developments, provide spaces for carpools in a separate, access-controlled parking area to simplify enforcement	<input type="checkbox"/>
5. CARSHARING & BIKESHARING		
5.1 Carshare parking spaces		
BETTER	5.1.1 Provide carshare parking spaces in permitted non-residential zones, occupying either required or provided parking spaces (see <i>Zoning By-law Section 94</i>)	<input type="checkbox"/>
5.2 Bikeshare station location		
BETTER	5.2.1 Provide a designated bikeshare station area near a major building entrance, preferably lighted and sheltered with a direct walkway connection	<input type="checkbox"/>

TDM-supportive design & infrastructure measures: <i>Non-residential developments</i>		Check if completed & add descriptions, explanations or plan/drawing references
6. PARKING		
6.1 Number of parking spaces		
REQUIRED	6.1.1 Do not provide more parking than permitted by zoning, nor less than required by zoning, unless a variance is being applied for	<input checked="" type="checkbox"/>
BASIC	6.1.2 Provide parking for long-term and short-term users that is consistent with mode share targets, considering the potential for visitors to use off-site public parking	<input type="checkbox"/>
BASIC	6.1.3 Where a site features more than one use, provide shared parking and reduce the cumulative number of parking spaces accordingly (<i>see Zoning By-law Section 104</i>)	<input type="checkbox"/>
BETTER	6.1.4 Reduce the minimum number of parking spaces required by zoning by one space for each 13 square metres of gross floor area provided as shower rooms, change rooms, locker rooms and other facilities for cyclists in conjunction with bicycle parking (<i>see Zoning By-law Section 111</i>)	<input type="checkbox"/>
6.2 Separate long-term & short-term parking areas		
BETTER	6.2.1 Separate short-term and long-term parking areas using signage or physical barriers, to permit access controls and simplify enforcement (i.e. to discourage employees from parking in visitor spaces, and vice versa)	<input type="checkbox"/>
7. OTHER		
7.1 On-site amenities to minimize off-site trips		
BETTER	7.1.1 Provide on-site amenities to minimize mid-day or mid-commute errands	<input type="checkbox"/>