

SERVICING AND STORMWATER MANAGEMENT REPORT MIXED USE DEVELOPMENT - PHASE 1 - 780 BASELINE ROAD



Project No.: CCO-22-0952

City File No.: D07-12-23-0076

Prepared for:

Theberge Homes
205-1600 Laperriere Ave
Ottawa, ON, K1Z 8P5

Prepared by:

McIntosh Perry Consulting Engineers Ltd.
115 Walgreen Road
Carp, ON K0A 1L0

September 25, 2023

McINTOSH PERRY

TABLE OF CONTENTS

1.0	PROJECT DESCRIPTION	1
1.1	Purpose.....	1
1.2	Site Description.....	1
1.3	Proposed Development and Statistics.....	1
1.4	Existing Conditions and Infrastructure.....	1
1.5	Approvals.....	2
2.0	BACKGROUND STUDIES, STANDARDS, AND REFERENCES.....	3
2.1	Background Reports / Reference Information	3
2.2	Applicable Guidelines and Standards.....	3
3.0	PRE-CONSULTATION SUMMARY.....	4
4.0	WATERMAIN.....	5
4.1	Existing Watermain	5
4.2	Proposed Watermain.....	5
5.0	SANITARY DESIGN	8
5.1	Existing Sanitary Sewer	8
5.2	Sanitary Sewer Realignment	8
5.2.1	Pipe Capacity.....	8
5.3	Proposed Sanitary Sewer.....	9
6.0	STORM SEWER DESIGN.....	10
6.1	Existing Storm Sewers.....	10
6.2	Proposed Storm Sewers.....	10
7.0	PROPOSED STORMWATER MANAGEMENT.....	11
7.1	Design Criteria and Methodology.....	11
7.2	Runoff Calculations.....	11
7.3	Pre-Development Drainage.....	12
7.4	Post-Development Drainage.....	12
7.5	Quality Control	13
8.0	EROSION AND SEDIMENT CONTROL.....	14
8.1	Temporary Measures.....	14
8.2	Permanent Measures.....	14
9.0	SUMMARY.....	16
10.0	RECOMMENDATION.....	17
11.0	STATEMENT OF LIMITATIONS.....	18

LIST OF TABLES

Table 1: Water Supply Design Criteria and Water Demands	6
Table 2: Boundary Condition Results.....	6
Table 3: Fire Protection Confirmation.....	7
Table 4: Sanitary Design Criteria.....	9
Table 5: Pre-Development Runoff Summary.....	12
Table 6: Post-Development Runoff Summary	12

APPENDICES

Appendix A: Site Location Plan

Appendix B: Background Documents

Appendix C: Watermain Calculations

Appendix D: Sanitary Calculations

Appendix G: Stormwater Management Calculations

1.0 PROJECT DESCRIPTION

1.1 Purpose

McIntosh Perry (MP) has been retained by Theberge Homes to prepare this Servicing and Stormwater Management Report in support of the Site Plan Control application for phase 1 of the proposed development located at 780 Baseline Road within the City of Ottawa.

The main purpose of this report is to present a servicing design for the development in accordance with the recommendations and guidelines provided by the City of Ottawa (City), the Rideau Valley Conservation Authority (RVCA), and the Ministry of the Environment, Conservation and Parks (MECP). This report will address the water, sanitary and storm sewer servicing for the development, ensuring that existing and available services will adequately service the proposed development.

This report should be read in conjunction with the following drawings:

- 000-22-0952, C101 – Site Grading and Drainage Plan, and
- 000-22-0952, C102 – Site Servicing Plan.
- 000-22-0952, PRE – Pre-Development Drainage Area Plan (Appendix E)
- 000-22-0952, POST – Post-Development Drainage Area Plan (Appendix F)

1.2 Site Description

The subject property, herein referred to as the site, is located at 780 Baseline Road within the Knoxdale-Merivale Ward. The site covers approximately 1.57 ha and is located at the intersection of Baseline Road and Fisher Avenue. The site is zoned for General Mixed use (GM). See Site Location Plan in Appendix 'A' for more details.

1.3 Proposed Development and Statistics

Phase 1 of the proposed development consists of a high-rise mixed-use building covering approximately 0.48 ha within the site which includes 0.04 Ha of parkland dedication. Building A contains 320 residential units and 711 m² of commercial space with access from Fisher Avenue. Underground parking and drive aisles will be provided throughout the site with access Fisher Avenue. Refer to Site Plan prepared by Roderick Lahey Architect Inc (RLA) and included in Appendix B for further details.

1.4 Existing Conditions and Infrastructure

The site is currently developed containing a 1-storey commercial strip mall and asphalt parking areas. The existing appears to be serviced by the 203 mm diameter watermain within Hillard Avenue. There is an existing 375 mm diameter municipal sanitary sewer that passes through the southern portion of the site, from Hillard Avenue to Fisher Avenue.

Sewer and watermain mapping collected from the City of Ottawa indicate that the following services exist across the property frontages within the adjacent municipal rights-of-way(s):

- ❖ Fisher Avenue
 - 406 mm diameter PVC watermain,
 - 375-450 mm diameter PVC sanitary sewer tributary to the Cave Creek collector,
 - 1200 mm diameter concrete storm sewer tributary to the Rideau Canal approximately 1 km downstream.

- ❖ Baseline Road
 - 406 mm diameter cast iron watermain,
 - 300 mm diameter concrete sanitary sewer tributary to the Cave Creek collector,
 - 1050 mm diameter concrete storm sewer tributary to the Rideau Canal approximately 1 km downstream.

- ❖ Hillard Avenue
 - 203 mm diameter PVC watermain,
 - 300 mm diameter PVC sanitary sewer tributary to the Cave Creek collector,
 - 450 mm diameter concrete storm sewer tributary to the Rideau Canal approximately 1.2 km downstream.

1.5 Approvals

The proposed development is subject to the City of Ottawa site plan control process. Site plan control requires the City to review, provide concurrence and approve the engineering design package. Permits to construct can be requested once the City has issued a site plan agreement.

An Environmental Compliance Approval (ECA) through the Ministry of Environment, Conservation and Parks (MECP) is not anticipated to be required for the development since the development is contained a single parcel of land, does not outlet to a combined sewershed, and does not propose industrial usage. As a result, the stormwater management system meets the exemption requirements under O.Reg 525/90.

2.0 BACKGROUND STUDIES, STANDARDS, AND REFERENCES

2.1 Background Reports/ Reference Information

As-built drawings of existing services, provided by the City of Ottawa Information centre, within the vicinity of the proposed site were reviewed in order to identify infrastructure available to service the contemplated development.

A topographic survey of the site was completed by Farley, Smith & Denis Surveying Ltd., dated April 27, 2022, Revised February 23, 2023 (File No.: 26-23).

An Assessment of Adequacy of Public Services Report was completed by McIntosh Perry, dated October 6th, 2022.

2.2 Applicable Guidelines and Standards

City of Ottawa:

- ◆ Ottawa Sewer Design Guidelines, City of Ottawa, SDG002, October 2012. (Ottawa Sewer Guidelines)
 - Technical Bulletin ISTB-2014-01 City of Ottawa, February 2014. (ISTB-2014-01)
 - Technical Bulletin PIEDTB-2016-01 City of Ottawa, September 2016. (PIEDTB-2016-01)
 - Technical Bulletin ISTB-2018-01 City of Ottawa, January 2018. (ISTB-2018-01)
 - Technical Bulletin ISTB-2018-03 City of Ottawa, March 2018. (ISTB-2018-03)
 - Technical Bulletin ISTB-2019-01 City of Ottawa, January 2019. (ISTB-2019-01)
 - Technical Bulletin ISTB-2019-02 City of Ottawa, February 2019. (ISTB-2019-02)
- ◆ Ottawa Design Guidelines – Water Distribution City of Ottawa, July 2010. (Ottawa Water Guidelines)
 - Technical Bulletin ISD-2010-2 City of Ottawa, December 15, 2010. (ISD-2010-2)
 - Technical Bulletin ISDTB-2014-02 City of Ottawa, May 2014. (ISDTB-2014-02)
 - Technical Bulletin ISTB-2018-02 City of Ottawa, March 2018. (ISTB-2018-02)

Ministry of Environment, Conservation and Parks:

- ◆ Stormwater Planning and Design Manual, Ministry of the Environment, March 2003. (MECP Stormwater Design Manual)
- ◆ Design Guidelines for Sewage Works, Ministry of the Environment, 2008. (MECP Sewer Design Guidelines)

Other:

- ◆ Water Supply for Public Fire Protection, Fire Underwriters Survey, 2020. (FUS Guidelines)

3.0 PRE-CONSULTATION SUMMARY

A pre-consultation email was provided by City staff on March 20, 2023, regarding the proposed site servicing. The notes from this meeting can be found in Appendix B. Specific design parameters to be incorporated within this design include the following:

- Control post-development flows to the 5-year pre-development storm with a maximum combined C value of 0.50, and calculated time of concentration.
- Flows to the storm sewer in excess of the 5-year storm release rate, up to and including the 100-year storm event, must be detained on site.
- Quality Control to an enhanced level (80% TSS removal).

4.0 WATERMAIN

4.1 Existing Watermain

The site is located within the 2W2C pressure zone, as per the Water Distribution System mapping included in Appendix C. There are three municipal fire hydrants along Fisher Avenue, one along Baseline Road, and one along Sunnycrest Drive available to service the development.

4.2 Proposed Watermain

Dual 150mm diameter PVC water services are proposed to service the development, extending from the existing 203mm PVC watermain within Hillard Avenue, complete with water valves located at the property line. In accordance with Section 4.3.1 of the Ottawa Water Guidelines, service areas with a basic day demand greater than 50 m³/day require a dual connection to the municipal system.

The Fire Underwriters Survey 2020 (FUS) method was utilized to determine the required fire flow for the site. The 'C' factor (type of construction) for the FUS calculation was determined to be 0.8 (non-combustible type). The occupancy type of the building was determined to be limited combustible per page 24 of the FUS guidelines. The total effective floor area ('A' value) for the FUS calculation was determined to be 6,913.8 m². The results of the calculations yielded a required fire flow of 9,000 L/min. The detailed calculations for the FUS can be found in Appendix C.

The water demands for the proposed building have been calculated to adhere to the Ottawa Design Guidelines – Water Distribution manual and can be found in Appendix C. The results have been summarized in Table 1, below. In accordance with Section 4.3.1 of the guidelines, service areas with a basic day demand greater than 50 m³/day require a dual connection to the municipal system. The basic day demand for the development is estimated to be 157 m³/day, therefore a dual connection is required.

Table 1: Water Supply Design Criteria and Water Demands

Phase 1 Site Area	0.48 ha
Bachelor/ 1 Bedroom	1.4 L/person/unit
2 Bedroom	2.1 L/person/unit
3 Bedroom	3.1 L/person/unit
Residential Daily Demand	280 L/person/day
Maximum Daily Peaking Factor	2.5 x avg day
Maximum Hour Peaking Factor	2.2 x max day
Commercial	28,000 L/ha/day
Average Day Demand (L/s)	1.82
Maximum Daily Demand (L/s)	4.51
Peak Hourly Demand (L/s)	8.09
FUS Fire Flow Requirement (L/s)	100.00 (6,000 L/min)

The City provided the estimated water pressures at both for the average day scenario, peak hour scenario and the max day plus fire flow scenario for the demands indicated by the correspondence in Appendix C. The resulting pressures for the boundary conditions results are shown in Table 2, below.

Table 2: Boundary Condition Results

Scenario	Proposed Demands (L/s)	Connection 1 HGL (m H ₂ O)* / kPa
Average Day Demand	1.80	48.7 / 477.4
Maximum Daily + Fire Flow Demand	154.52	34.8 / 341.0
Peak Hourly Demand	8.12	40.3 / 395.0

* Adjusted for an estimated ground elevation of 84.1 m above the connection point.

The normal operating pressure range is anticipated to be 395 kPa to 447 kPa and will not be less than 275 kPa (40 psi) or exceed 689 kPa (100 psi). The proposed watermains will meet the minimum required 20 psi (140 kPa) from the Ottawa Water Guidelines at the ground level under maximum day demand and fire flow conditions. A pressure reducing valve is not anticipated to be required since the pressures do not exceed 552 kPa (80 psi) in the average day scenario.

To confirm the adequacy of fire flow to protect the proposed development, public fire hydrants within 150 m of the proposed building were analysed per City of Ottawa ISTB 2018-02 Appendix I

Table 1. Based on City guidelines (ISTB-2018-02), the existing hydrants can provide adequate fire protection to the proposed development. The results are summarized in Table 3, below.

Table 3: Fire Protection Confirmation

Building	Fire Flow Demand (L/ min.)	Fire Hydrant(s) within 75m*	Fire Hydrant(s) within 150m*	Combined Fire Flow (L/ min.)
780 Baseline – Building A	9,000 (FUS)	3	2	24,700

* Fire hydrants within 75 metres contribute 5,700 L/min to fire flow and fire hydrants within 150 meters contribute 3,800 L/min to fire flow, respectively, per ISTB-2018-02.

5.0 SANITARY DESIGN

5.1 Existing Sanitary Sewer

There is an existing 300 mm diameter sanitary sewer within Baseline Road, an existing 450 mm diameter sanitary sewer within Fisher Avenue, and an existing 300 mm diameter sanitary sewer within Sunnycrest Drive/Hillard Avenue fronting the site. The subject site currently contributes wastewater to the Cave Creek trunk sewer.

In addition, there is an existing 375 mm diameter municipal sanitary sewer that crosses through site, from Hillard Avenue to Fisher Avenue.

5.2 Sanitary Sewer Realignment

The existing 375mm diameter AC sanitary crossing through the site and the two 300mm diameter PVC sanitary sewers directly upstream of the 375mm sewer need to be relocated to allow for the construction of the Phase I building.

5.2.1 Pipe Capacity

Based on as built drawings (Contract No. ISB05-2058, DWG No. 2058-03), the existing capacity of the existing 375mm crossing through the site with a 1.57-3.00% slope is 229 L/s. The capacity of the existing 300mm diameter sewer from MHSA 46203 to MHSA46205 at 0.52% is 73 L/s. The existing capacity of the 300mm sewer from MHSA46208 to MHSA46205 at 0.52%-0.57% is 76 L/s. The existing capacity of the 450mm sewer within Fisher Avenue from MHSA50442 to MHSA50433 is 126 L/s.

As shown in drawing C102 the existing 375mm sewer within the site is proposed to be realigned with a 375mm diameter sewer at 0.32%. The existing 300mm diameter sewer from MHSA46208 to MHSA46205 is proposed to be realigned with a 300mm diameter sewer at 0.57%. The existing 300mm diameter sewer from MHSA46203 to MHSA46205 is proposed to be realigned with a 300mm diameter sewer at 0.52%.

The realigned network will be conveyed through the site via a 6.00m utility easement in favor of the city of Ottawa. The alignment will be conveyed to proposed maintenance structure (MH1E) within the Fisher Avenue right-of-way. The existing 375mm diameter PVC sanitary sewer within Fisher Avenue is proposed to be replaced with a 450mm diameter concrete sewer from MH1E to existing maintenance structure MHSA50442.

As demonstrated in the Sanitary Sewer Design Sheet in Appendix D, the capacity of the existing legs of the realigned sanitary sewers within Hillard Avenue match or improve on the capacity of the respective existing sewers. The realigned 375mm sewer within the site has a capacity of 103 L/s. Due to the complexity of the downstream network, the City will need to advise of any downstream constraints.

5.3 Proposed Sanitary Sewer

A new 200 mm diameter gravity sanitary service is proposed to extend from a proposed sanitary maintenance structure (MH1D) which ties into the realigned 375mm diameter sanitary sewer. MH1D is proposed to provide monitoring for site sanitary flows per the Ottawa Sewer Design Guidelines and City of Ottawa Sewer-Use By-Law 2003-514 (14). Refer to plan C102.

The peak design flows for the proposed building were calculated using criteria from the Ottawa Sewer Guidelines and are summarized in Table 4, below. Based on the unit occupancy statistics provided by the architect, the proposed site development will generate a flow of 6.20 L/s. See Appendix D of this report for more details.

Table 4: Sanitary Design Criteria

Design Parameter	Value
Site Area	0.48 ha
Residential	280 L/person/day
Commercial/ Amenity	2,800 L/(m ² /day)
1 Bedroom Apartment	1.4 persons/unit
2 Bedroom Apartment	2.1 persons/unit
3 Bedroom Apartment	3.1 persons/unit
Bachelor Apartment	1.4 persons/unit
Residential Peaking Factor	3.36
Extraneous Flow Allowance	0.33 L/s/ha

The full flowing capacity of a 200 mm diameter service at a 1% slope is estimated to be 32.8 L/s. Therefore, a 200 mm diameter service would be sufficiently sized to accommodate the contemplated development.

A sanitary flow of 5.41 L/s for Building A was submitted to City staff for a review of the municipal system. It was indicated that there were no concerns with the additional flows. The estimated demand for Building A has increased to 6.20 L/s based on the latest site statistics provided by the architect. Due to the complexity of the downstream network, the City will need to advise of any downstream constraints. Refer to correspondence included in Appendix D for reference.

6.0 STORM SEWER DESIGN

6.1 Existing Storm Sewers

Stormwater runoff from the site is currently tributary to the Rideau River within the Ottawa River West sub-watershed. The site is currently serviced by series of existing catch basins.

There is an existing 450 mm diameter storm sewer within Hillard Avenue and an existing 1200 mm diameter storm sewer within Fisher Avenue available to service the site. The existing sewers are tributary to the Rideau River approximately 1.0-1.2 km downstream.

6.2 Proposed Storm Sewers

A new 250mm PVC storm service will be extended from the existing 450mm diameter storm sewer within Hillard Avenue. The sewer system will provide attenuation for the roof area and drive aisle/entrance area by an internal cistern complete with a Tempest LMF ICD or an approved equivalent. A cistern detail is to be provided by the Mechanical Engineer under separate cover.

Foundation drainage is proposed to be conveyed without flow attenuation via the 250mm diameter storm service downstream of any cistern controls.

0.13 ha of the site is proposed to be conveyed to the City as parkland. A new catchbasin is proposed to provide drainage for the parkland site via a 250mm storm lead extending to the existing 450mm diameter storm sewer within Hillard Avenue.

Two new catch basins are proposed to collect drainage north of the Phase I development. The existing drainage is currently collected by catch basins that are to be removed in order to construct Building A. The proposed catch basins will convey runoff to the existing site storm system.

See COO-22-0952 - POST include in Appendix F of this report for more details. The Stormwater Management design for the subject property will be outlined in Section 7.0 of this report.

7.0 PROPOSED STORMWATER MANAGEMENT

7.1 Design Criteria and Methodology

Stormwater management for the proposed site will be maintained using an internal cistern and will collect runoff from the at-grade areas within the site. The flow will be directed to the existing 450mm diameter storm sewer within Hillard Avenue.

In summary, the following design criteria have been employed in developing the stormwater management design for the site as directed by the RVCA and City:

Quality Control

- 80% TSS removal is required for the site.

Quantity Control

- Any storm events greater than 5-year, up to 100-year, and including 100-year storm event must be detained on site.
- Post-development to be restricted to the 5-year storm event, based on a calculated time of concentration greater than 10 minutes and a rational method coefficient of 0.50. Refer to Section 7.2 for further details.

7.2 Runoff Calculations

Runoff calculations presented in this report are derived using the Rational Method, given as:

$$Q = 2.78CIA \text{ (L/s)}$$

Where: C = Runoff coefficient
I = Rainfall intensity in mm/hr (City of Ottawa IDF curves)
A = Drainage area in hectares

It is recognized that the Rational Method tends to overestimate runoff rates. As a result, the conservative calculation of runoff ensures that any SWM facility sized using this method is expected to function as intended. The following coefficients were used to develop an average C for each area:

Roofs/ Concrete/ Asphalt	0.90
Undeveloped and Grass	0.20

As per the City of Ottawa - Sewer Design Guidelines, the 5-year balanced 'C' value must be increased by 25% for a 100-year storm event to a maximum of 1.0.

7.3 Pre-Development Drainage

The site currently contains a catch basin system within the parking lot. It has been assumed that the existing development contained no stormwater management controls for flow attenuation. The estimated pre-development peak flows for the 5- and 100-year events are summarized below in Table 5. See COO-22-0952 - PRE in Appendix G for calculations.

Table 5: Pre-Development Runoff Summary

Drainage Area	Area (ha)	Q (L/s)	
		5-Year	100-Year
A1	*0.34	83.88	160.04

* Phase I Site Area Less Parkland Dedication

7.4 Post-Development Drainage

The proposed site drainage limits are demonstrated on the Post-Development Drainage Area Plan. See COO-22-0952 - POST in Appendix F of this report for more details. Based on the quantity control criteria discussed in Section 7.1 and a site area of 0.34 ha, post development drainage from the site is to be limited to a maximum release rate of 49.17 L/S. A summary of the Post-Development Runoff Calculations can be found below.

Table 6: Post-Development Runoff Summary

Drainage Area	Area (ha)	5-year Peak Flow (L/s)	100-year Peak Flow (L/s)	100-year Storage Required (m ³)	100-year Storage Available (m ³)
B1	0.30	15.52	29.67	73.90	73.90
B2	0.04	9.41	17.93	-	-
Total	0.34	24.93	47.60	73.90	73.90

Runoff for area B1 will be collected by roof drains (uncontrolled) and surface drains and conveyed to the internal cistern. The 74 m³ internal cistern is anticipated to convey stormwater to the outlet at a maximum flow rate of 15.52 L/s and 29.67 L/s for the 5 and 100-year storms, respectively. Flows in excess of the 100-year storm event will need to be directed to Hillard Avenue via a cistern overflow. The cistern details are to be provided by the Mechanical Engineer; however, it is anticipated that the cistern will be equipped with Tempest HMFICD for attenuation.

Foundation drainage is proposed to be conveyed without flow attenuation via the 250 mm storm service, downstream of cistern controls.

7.5 Quality Control

Quality control for Area B1 will be provided via a Stormceptor EFO4 OGS Unit (or approved equivalent) within the building upstream of the cistern. A detailed internal design is to be confirmed with the Mechanical Engineer and the Architect. The OGS will provide 80% TSS removal for surface runoff collected from area B1 before discharging it to the cistern. Refer to Appendix G.

8.0 EROSION AND SEDIMENT CONTROL

8.1 Temporary Measures

Before construction begins, temporary silt fence, straw bale or rock flow check dams will be installed at all natural runoff outlets from the property. It is crucial that these controls be maintained throughout construction and inspection of sediment and erosion control will be facilitated by the Contractor or Contract Administration staff throughout the construction period.

Silt fences will be installed where shown on the final engineering plans, specifically along the downstream property limits. The Contractor, at their discretion or at the instruction of the City, Conservation Authority or the Contract Administrator shall increase the quantity of sediment and erosion controls on-site to ensure that the site is operating as intended and no additional sediment finds its way off site. The rock flow, straw bale & silt fence check dams and barriers shall be inspected weekly and after rainfall events. Care shall be taken to properly remove sediment from the fences and check dams as required. Fibre roll barriers are to be installed at all existing curb inlet catchbasins and filter fabric is to be placed under the grates of all existing catchbasins and manholes along the frontage of the site and any new structures immediately upon installation. The measures for the existing/proposed structures is to be removed only after all areas have been paved. Care shall be taken at the removal stage to ensure that any silt that has accumulated is properly handled and disposed of. Removal of silt fences without prior removal of the sediments shall not be permitted.

Although not anticipated, work through winter months shall be closely monitored for erosion along sloped areas. Should erosion be noted, the Contractor shall be alerted and shall take all necessary steps to rectify the situation. Should the Contractor's efforts fail at remediating the eroded areas, the Contractor shall contact the City and/or Conservation Authority to review the site conditions and determine the appropriate course of action. As the ground begins to thaw, the Contractor shall place silt fencing at all required locations as soon as ground conditions warrant. Please see the Site Grading, Drainage and Sediment & Erosion Control Plan for additional details regarding the temporary measures to be installed and their appropriate OPSD references.

8.2 Permanent Measures

Rip-rap will be placed at all locations that have the potential for concentrated flow. It is crucial that the Contractor ensure that the geotextile is keyed in properly to ensure runoff does not undermine the rip rapped area. Additional rip rap is to be placed at erosion prone locations as identified by the Contractor / Contract Administrator / City or Conservation Authority.

It is expected that the Contractor will promptly ensure that all disturbed areas receive topsoil and seed/sod and that grass be established as soon as possible. Any areas of excess fill shall be removed or levelled as soon as possible and must be located a sufficient distance from any watercourse to ensure that no sediment is washed out into the watercourse. As the vegetation growth within the

site provides a key component to the control of sediment for the site, it must be properly maintained once established. Once the construction is complete, it will be up to the landowner to maintain the vegetation and ensure that the vegetation is not overgrown or impeded by foreign objects.

9.0 SUMMARY

- Phase 1 proposed development consists of a high-rise mixed-use building at 780 Baseline Road.
- Two 150mm diameter water services are proposed to be connected to the existing 203mm diameter within Hillard Avenue.
- The existing sanitary sewer passing through the site is proposed to be re-aligned.
- A new 200 mm diameter sanitary service is proposed, complete with an internal monitoring, to service the development via the realigned sanitary sewer within the site.
- A new 250mm storm service for rooftop, surface, and foundation drainage is proposed to service the development. The storm service will connect to the 450mm diameter storm sewer within Hillard Avenue, tributary to the Rideau River approximately 1.0-1.2 km downstream.
- Storage for the 5- through 100-year storm events will be provided through internal cistern attenuation.
- Quality control will be provided for the development via an internal Stormceptor EFO4 or approved equivalent.

10.0 RECOMMENDATION

Based on the information presented in this report, we recommend that City of Ottawa approve this Assessment of Adequacy of Public Services report in support of the Ste Plan Control application for the proposed development at 780 Baseline Road.

This report is respectfully being submitted for approval.

Regards,

McIntosh Perry Consulting Engineers Ltd.



Andrew MacLeod, P.Eng.
Senior Engineer
T: 365.527.2696
E: a.macleod@mcintoshperry.com

Ryan Robineau, E.I.T.
Civil Engineering Technologist
T: 613.714.6611
E: r.robineau@mcintoshperry.com

11.0 STATEMENT OF LIMITATIONS

This report was produced for the exclusive use of Theberge Homes. The purpose of the report is to assess the existing stormwater management system and provide recommendations and designs for the post-construction scenario that are in compliance with the guidelines and standards from the Ministry of the Environment, Parks and Climate Change, City of Ottawa and local approval agencies. McIntosh Perry reviewed the site information and background documents listed in Section 2.0 of this report. While the previous data was reviewed by McIntosh Perry and site visits were performed, no field verification/ measures of any information were conducted.







Any use of this review by a third party, or any reliance on decisions made based on it, without a reliance report is the responsibility of such third parties. McIntosh Perry accepts no responsibility for damages, if any, suffered by any third party as a result of decisions or actions made based on this review.

The findings, conclusions and/or recommendations of this report are only valid as of the date of this report. No assurance is made regarding any changes in conditions subsequent to this date. If additional information is discovered or becomes available at a future date, McIntosh Perry should be requested to re-evaluate the conclusions presented in this report, and provide amendments, if required.

**APPENDIX A
KEY PLAN**



LEGEND

-  Site Location
-  Local Road
-  Major Road
-  Railroad
-  Watercourse
-  Waterbody
-  Wooded Area

REFERENCE

GIS data provided by the Ontario Ministry of Northern Development, Mines, Natural Resources and Forestry, 2022.

CLIENT:		THEBERGE HOMES	
PROJECT:		780 BASELINE ROAD, OTTAWA	
TITLE:		SITE LOCATION	
PROJECT NO: CCO-22-0952		FIGURE:	
Date	Apr., 10, 2022	1	
GIS	SK		
Checked By	AG		

McINTOSH PERRY
 115 Walgreen Road, RR3, Carp, ON K0A1L0
 Tel: 613-836-2184 Fax: 613-836-3742
 www.mcintoshperry.com

C:\Users\stas.Hansen\McIntosh_Perry\GIS - Documents\Projects\2022\CCO-22-0952 - Theberge Homes\Key Maps\LandDevelopment\CCO-22-0952_KeyPlan.aprx

**APPENDIX B
BACKGROUND DOCUMENTS**

From: Livingstone, Kelly <kelly.livingstone@ottawa.ca>
Sent: Monday, March 20, 2023 9:11 AM
To: Scott Alain <alain@fotenn.com>
Cc: Joey Theberge <joeytheberge@thebergehomes.com>; Miguel Tremblay <tremblay@fotenn.com>; Jeremy Silburt <jeremy@thebergehomes.com>; Hamlin, Allison <Allison.Hamlin@ottawa.ca>; Candow, Julie <julie.candow@ottawa.ca>; Paudel, Neeti <neeti.paudel@ottawa.ca>; Hassan, Selma <Selma.Hassan@ottawa.ca>; Cervený, Louise <Louise.Cervený@ottawa.ca>; Juarez, Luis <luis.juarez@ottawa.ca>
Subject: 780 Baseline - Site Plan Control - Submission Requirements

Hello all,

Please see attached for Site Plan submission requirements for the 780 Baseline Avenue - Tower A proposal along Fisher, with retention of the existing commercial Plaza. No formal pre-consultation meeting was held due to the significant conversation we've already been having on the related Zoning By-law Amendment.

In addition to the Required Plans, two comments expressed by staff are provided herein:

- A public sanitary sewer and easement is located on the property; the continued functioning of the sanitary sewer must be demonstrated at the Site Plan Control stage if it is proposed to be re-located.
- Please also see attached the Terms of Reference for the Design Brief submission. A new Design Brief is required for the Site Plan submission. Please note a Planning Rationale is not required, and so all the information must be contained in the design brief.

Thank you,

Ryan Robineau

From: Candow, Julie <julie.candow@ottawa.ca>
Sent: May 15, 2023 11:58 AM
To: Ryan Robineau
Cc: Curtis Melanson; Livingstone, Kelly
Subject: Pre-consultation Notes for SPA - 780 Baseline Road

Hi Ryan,

Please see below, let me know if you have any questions. I have included the standard water boundary condition request comment below but acknowledge that you have already submitted your request.

1. Watermain Infrastructure:

a) Individual residential facilities with a basic day demand greater than 50 m³/day shall be connected with a minimum of two water services, separated by an isolation valve, to avoid the creation of a vulnerable service area (as per Tech Bulletin 2021-03).

b) Please submit a boundary condition request for this application:

Water Boundary condition requests must include the location of the services and the expected loads required by the proposed development. Please provide an email to Julie Candow (Julie.candow@ottawa.ca) with the following information:

i. Location of services

ii. Type of development and the amount of fire flow required (as per OBC Section 7.2.11 or FUS for fire flows 9,000 L/min or above – See technical bulletin ISTB 2021-03).

iii. Average daily demand: ___ l/s.

iv. Maximum daily demand: ___ l/s.

v. Maximum hourly daily demand: ___ l/s.

2. Sanitary / Storm Infrastructure:

a) A public sanitary sewer and easement is located on the property; the continued functioning of the sanitary sewer must be demonstrated at the Site Plan Control stage if it is proposed to be re-located.

b) Municipal storm and sanitary infrastructure is available on Fisher Avenue. Asset Management has no preliminary concerns with the sanitary release rate anticipated from this site (Tower A).

c) New services must be grouped in a common trench to minimize the number of road cuts.

3. The Stormwater Management Criteria, for the subject site, is to be based on the following:

a) Meet an allowable release rate based on the pre-development Rational Method Coefficient or a maximum of 0.50, employing the City of Ottawa IDF parameters for a 5-year storm with a calculated time of concentration equal to or greater than 10 minutes;

b) Attenuate all storms up to and including the City of Ottawa 100-year storm event on site.

- c) Quality control to be provided to “Enhanced” level of treatment (80% TSS removal).
- 4. An MECP Environmental Compliance Approval is not anticipated to be required for this application assuming the proposed development meets the following criteria:
 - a) Is designed to service one lot or parcel of land;
 - b) Discharges into a storm sewer that is not a combined sewer;
 - c) Does not service industrial land or a structure located on industrial land; and
 - d) Is not located on industrial land. O.Reg. 525/98, s. 3; O.Reg. 40/15, s. 4.
- 5. Phase 1 ESAs and Phase 2 ESAs must conform to Ontario Regulation 153/04.

Julie Candow, P.Eng
Project Manager
Planning, Real Estate and Economic Development Department - West Branch
City of Ottawa
110 Laurier Avenue West Ottawa, ON
613.580.2424 ext. 13850

Please take note that due to the current COVID situation, I am working remotely and phone communication may not be reliable at this time. The best way to reach me is by email.

From: Ryan Robineau <r.robineau@mcintoshperry.com>
Sent: May 12, 2023 2:15 PM
To: Candow, Julie <julie.candow@ottawa.ca>
Cc: Curtis Melanson <c.melanson@mcintoshperry.com>
Subject: RE: 780 Baseline Boundary Condition Request

CAUTION: This email originated from an External Sender. Please do not click links or open attachments unless you recognize the source.

ATTENTION : Ce courriel provient d'un expéditeur externe. Ne cliquez sur aucun lien et n'ouvrez pas de pièce jointe, excepté si vous connaissez l'expéditeur.

Thank you for the update Julie!

As noted in the attached pdf, no formal pre-consultation meeting was held for the 780 Baseline Tower A - Site Plan Control submission. Would you be able to provide a list of engineering requirements for the Tower A proposal?

Regards,

Ryan Robineau, EIT
Civil Engineering Technologist
T. 613.714.6611
r.robineau@mcintoshperry.com | www.mcintoshperry.com

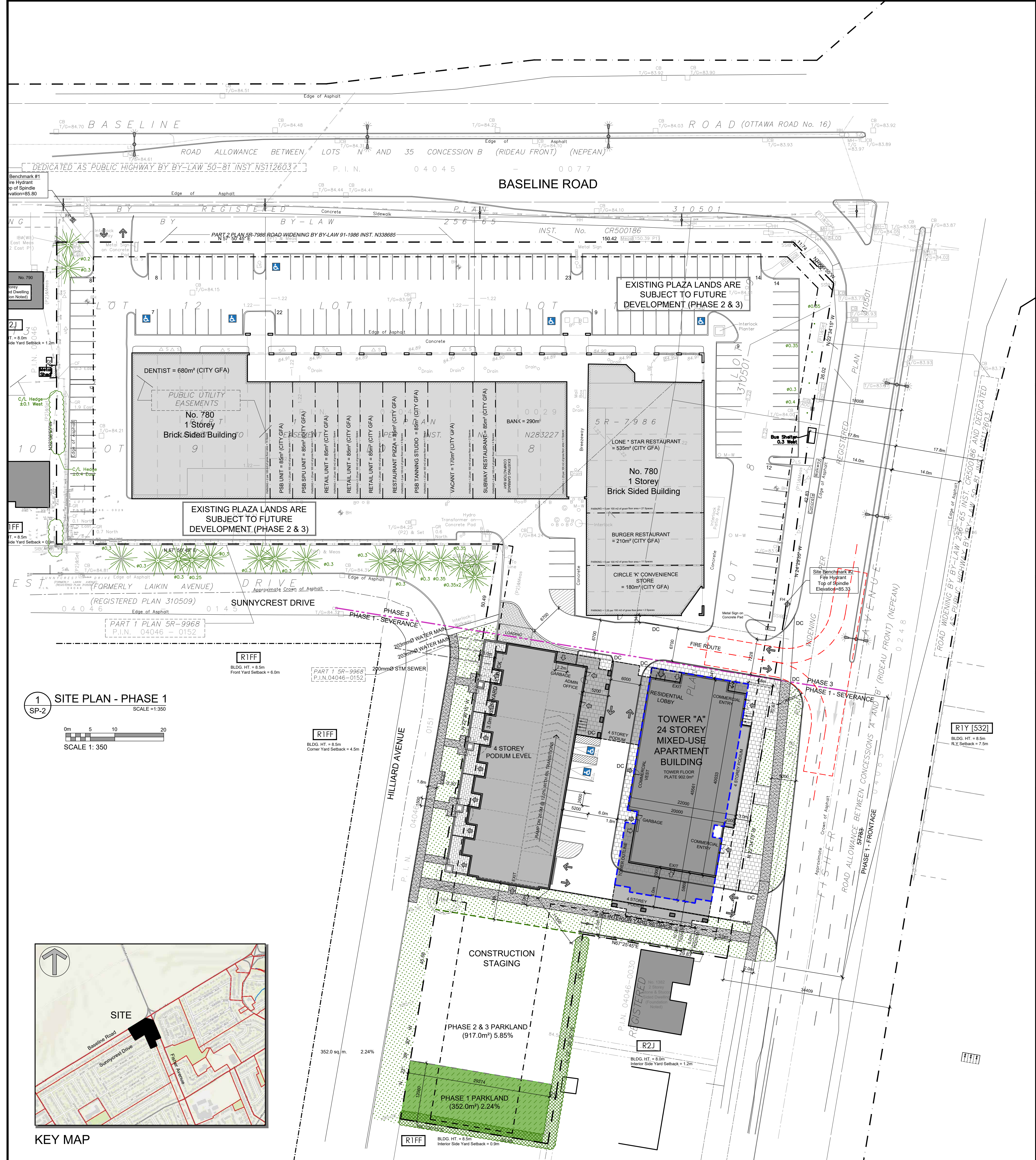

PROJECT DEVELOPER
Theberge Developments Ltd.
 1600 Laperriere Ave Suite 205
 Ottawa, ON K1Z 1B7
 Tel: (613) 421-1515
 Cell: (613) 880-5491
 Email: joeytheberge@thebergehomes.com
 Email: Jeremy@thebergehomes.com

URBAN PLANNER
Fotenn Consultants Inc.
 396 Cooper Street, Suite 300
 Ottawa, ON Canada, K2P 2H7
 Tel: (613) 730-5709
 Fax: (613) 730-1136
 E-Mail: alain@fotenn.com

TRANSPORTATION ENGINEER
CHG Transportation Inc.
 13 Markham Avenue
 Ottawa, ON K2G 3Z1
 Tel: (343) 999-9117
 Cell: (613) 697-3797
 Email: Christopher.Gordon@CHGTransportation.com
 Email: john.kingsley@chgtransportation.com

WIND / NOISE ENGINEER
Gradient Wind Engineering
 127 Walgreen Road,
 Ottawa, ON, Canada K0A 1L0
 Tel: (613) 836-0934
 Cell: (613) 226-5273
 Email: joshua.foster@gradientwind.com

CIVIL ENGINEER
McIntosh Perry
 115 Walgreen Road
 Ottawa, ON K0A 1L0
 Tel: (613) 836-2184
 Fax: (613) 836-3742
 Email: r.robinson@mcintoshperry.com

SURVEYOR
Farley, Smith & Denis Surveying Ltd.
 30 Colonnade Road North, unit 275
 Ottawa, Ontario K2E 7J6
 Tel: (613) 727-8226
 Fax: (613) 727-1823
 Email: jleslie@bellnet.ca

LANDSCAPE ARCHITECT
James B. Lennox & Associates Inc.
 Landscape Architects
 3332 Carling Ave.
 Ottawa, Ontario K2H 5A8
 Tel: 613-722-5168
 Fax: 1-866-343-3942
 Email: ml@jbla.ca

LEGAL DESCRIPTION
 TOPOGRAPHIC PLAN OF SURVEY OF
 LOT 6 AND
 PART OF LOTS 5, 7, 8, 9, 10, 11 & 12
 REGISTERED PLAN 310501
 & PART OF LOTS 5, 6, 7, 8 & 9
 REGISTERED PLAN 310509
 CITY OF OTTAWA
 FARLEY, SMITH & DENIS SURVEYING LTD. 2023

SITE PLAN LEGEND

- UNIT PAVERS SURFACE
- PRIVATE TERRACE
- NEW CONCRETE SIDEWALK
- EXISTING CONCRETE SIDEWALK
- SOFT LANDSCAPING
- PARKLAND DEDICATION
- BIKE RACK
- TWO WAY VEHICLE CIRCULATION
- RESIDENTIAL / COMMERCIAL DOOR
- PROPERTY LINE
- EXISTING TREE TO REMAIN
- EXISTING TREE TO BE REMOVED

PROJECT INFORMATION

Zoning	REQUIRED	PROVIDED
Zoning By-law 2008-250 Consolidation	GM R1FF	SITE AREA 1.57 ha, 15,688.6 sq. m, 188,870 sq. ft.
BUILDING HEIGHT	18.0m	24 STOREYS / 78.0m
ALLOWABLE PROJECTION - AMENITY LEVEL	0.0m	0.0m
DENSITY - MAXIMUM FLOOR SPACE INDEX (FULL SITE)	2.0 = 28,588.8 sq. m	4.6 = 64,056.5 sq. m
TOWER SEPARATION	23.0m	60.0m
TOWER FOOTPRINT	750 sq. m	930 sq. m
FRONT YARD SETBACK	3.0m	3.0m
INTERIOR SIDE YARD SETBACK	5.0m	6.5m
REAR YARD SETBACK	3.0m	3.0m
MINIMUM WIDTH OF LANDSCAPE AREA (ABUTTING A STREET OR RESIDENTIAL ZONE)	3.0m	6.5m
MINIMUM WIDTH OF LANDSCAPE BUFFER @ PARKING LOT	3.0m	6.5m
TOTAL RESIDENTIAL UNIT COUNT	-	328
PARKING - RESIDENTIAL (AFTER 12 UNITS PER BLDG.) - 0.5 PER UNIT	154	320
PARKING - VISITOR ONLY (AFTER 12 UNITS PER BLDG.) - 0.1 PER UNIT	30	30
PARKING - COMM. MEDICAL (UNDER 500m² GFA NOT REQUIRED) - 2 PER 100m² GFA	9	9
PARKING - COMM. OFFICE - 1 PER 100m² GFA	2	3
BICYCLE PARKING - RESIDENTIAL - 0.5 PER UNIT	160	320
BICYCLE PARKING - COMMERCIAL - 1 PER 250m² GFA	3	8
AMENITY AREA - TOTAL PER UNIT - 6.0m²	1,920.0m²	2,770.0m²
AMENITY AREA - 50% COMMUNAL PER UNIT - 3.0m²	960.0m²	1,320.0m²

SITE STATISTICS

GROSS BUILDING - AREA	EXISTING PLAZA - BASELINE	EXISTING PLAZA - FISHER	PROPOSED TOWER 'A'	TOTAL AREA
1,807.9 sq. m, 19,460 sq. ft.	925.5 sq. m, 9,960 sq. ft.	20,136.9 sq. m, 216,752 sq. ft.	22,870.0 sq. m, 246,172 sq. ft.	22,870.0 sq. m, 246,172 sq. ft.

BUILDING STATISTICS - PHASE 1

GROSS BUILDING - AREA	PARKING LEVEL	GROUND FLOOR	2nd FLOOR	3rd FLOOR	4th FLOOR	5th FLOOR	6th - 20th FLOOR - TOWER	21st & 22nd FLOOR	23rd & 24th FLOOR	TOTAL (EXISTING PLAZA)	PROPOSED TOWER 'A'	TOTAL AREA	TOWER FOOTPRINT AREA	UNIT STATISTICS
0.0 sq. m, 0.00 sq. ft.	0.00 sq. m, 0.00 sq. ft.	474.6 + 458.8 sq. m, 5,109 + 4,908 sq. ft.	1,691.2 sq. m, 18,204 sq. ft.	1,692.0 sq. m, 18,212 sq. ft.	1,687.7 sq. m, 18,166 sq. ft.	393.1 sq. m, 4,231 sq. ft.	15 x 745.2 sq. m, 160.4 sq. m, 15 x 6,000 sq. ft.	2 x 697.8 sq. m, 2 x 7,488 sq. ft.	2 x 639.3 sq. m, 2 x 6,973 sq. ft.	138	370	2,770.0 sq. m, 29,672 sq. ft.	9,989 sq. ft.	5.3% 17 1 BEDROOM UNIT 50.9% 163 2 BEDROOM UNIT 41.6% 133 3 BEDROOM 2.2% 7 TOTAL 330

LOT COVERAGE

EXISTING PLAZA - BASELINE	EXISTING PLAZA - FISHER	PROPOSED TOWER 'A'	PAVED SURFACE	LANDSCAPE OPEN SPACE	TOTAL
2,260.3m² 14.4%	1,156.7m² 7.4%	1,723.7m² 11.0%	5,634.1m² 35.9%	4,915.8m² 31.3%	15,688.6m² 100.0%

DRAWING NOTES

- PROPERTY LINE
- PHASE LINE
- BUILDING SETBACK LINES
- INTERNAL RAMP TO U/G GARAGE WITH TRENCH DRAIN
- EXISTING FIRE HYDRANT
- OUTLINE OF TOWER ABOVE
- OUTLINE OF PHASE 1 PARKING GARAGE
- SURFACE PARKING SPACE 2.6 X 5.2 M
- 2.0m WIDE CITY SIDEWALK
- EXISTING TREE TO REMAIN, PROTECT AS REQUIRED
- EXISTING STREET CURB AND SIDEWALK
- SOFT LANDSCAPING, SEE LANDSCAPE PLAN
- BELOW GRADE CISTERN IN PARKING GARAGE
- 1.2 X 1.8 CONCRETE PAD FOR GAS EQUIPMENT (GAS BLOW OFF)
- HYDRO VAULT LOCATION IN PARKING GARAGE
- SIAMSESE CONNECTION
- PROPOSED UTILITIES, SEE CIVIL
- EXISTING COMMERCIAL PLAZA / PARKING TO REMAIN
- EXISTING PEDESTRIAN WALKWAY
- INTERIOR LOADING BAY
- EXISTING UTILITY EQUIPMENT / KIOSK
- BICYCLE RACK, SEE LANDSCAPING
- PRIVACY SCREEN
- 2.1m HT. SOLID WOOD PRIVACY FENCE
- METAL GRATE - AIR SHAFT
- TEMPORARY SNOW STORAGE
- PARKLAND AREA / INTERIM CONSTRUCTION STAGING AREA WITH CONSTRUCTION FENCING
- PHASE 1 PARKLAND DEDICATION
- DEPRESSED CURB WITH 2.0m WIDE CONTINUOUS SIDEWALK TO CITY STANDARDS, SEE CIVIL
- 150mm HT CONCRETE BARRIER CURB
- 1.5m WIDE PRIVATE WALK
- EXISTING CEDAR HEDGE TO REMAIN
- ACCESSIBLE PARKING SPACES
- DEPRESSED CURB WITH 1.5m WIDE ACCESSIBLE AISLE
- 2.0m WIDE CONCRETE WALK
- EXISTING ISLAND TO BE REMOVED
- DEPRESSED CURB
- STRUCTURAL SUPPORT FOR BUILDING ABOVE
- PRIVATE TERRACES FOR TOWNHOUSE STYLE UNITS
- RE-ALINE EXISTING CURB AND DRIVEWAY
- PAINTED ISLAND
- PROPOSED CITY BOULEVARD - CURB / LANDSCAPE STRIP / SIDEWALK
- EXISTING RESIDENTIAL HOUSE / LOT TO BE CLEARED

IT IS THE RESPONSIBILITY OF THE APPROPRIATE CONTRACTOR TO CHECK AND VERIFY ALL DIMENSIONS ON SITE AND TO REPORT ALL ERRORS AND/OR OMISSIONS TO THE ARCHITECT.

ALL CONTRACTORS MUST COMPLY WITH ALL PERTINENT CODES AND BY-LAWS.

THIS DRAWING MAY NOT BE USED FOR CONSTRUCTION UNTIL SIGNED BY THE ARCHITECT.

DO NOT SCALE DRAWINGS.

COPYRIGHT RESERVED.

NOTATION SYMBOLS:

- INDICATES DRAWING NOTES, LISTED ON EACH SHEET.
- INDICATES ASSEMBLY TYPE; REFER TO TYPICAL ASSEMBLIES SCHEDULE.
- INDICATES WINDOW TYPE; REFER TO WINDOW ELEVATIONS AND DETAILS ON A800 SERIES.
- INDICATES DOOR TYPE; REFER TO DOOR SCHEDULES AND DETAILS ON A800 SERIES.
- DETAIL NUMBER
- DETAIL REFERENCE PAGE
- DETAIL CROSS REFERENCE PAGE

REVISIONS:

No.	DESCRIPTION	DATE
1	REVISED AS PER ROUND 1 SPC COMMENTS DRAFT	Sept 13, 23
2	ISSUED FOR SPC APPLICATION	June 09, 23
3	ISSUED FOR OWNER / CONSULTANT REVIEW	Apr. 13, 23

CLIENT: THEBERGE HOMES

ARCHITECT: RODERICK LAHEY ARCHITECT INC
 56 Beech Street, Ottawa, Ontario K1S 3J6
 1.613.724.9932 1.613.724.1209 www.rodericklahey.ca

PROJECT TITLE: 780 Baseline Road PHASE 1

OTTAWA ONTARIO

SHEET TITLE: SITE PLAN PHASE 1

DRAWN: RV **CHECKED:** T.Z. **SHEET No.:** SP-2

PROJECT No.: 2131

SCALE: 1:350

DATE: Thursday, September 21, 2023

PLOT SCALE: 1:1

PEN STYLE: 0-RLA-MASTER-100%.ctb

F:\2021\1231 - Baseline & Fisher\01 Design Development\01 Site Plan\2131 - Baseline SP-1 Site Plan 2023 0921 - 10m Tower Setback.dwg

Project No.: #

APPENDIX C
WATERMAIN CALCULATIONS

City of Ottawa - Water Distribution Systems Facilities & Feeder mains

PLANT & P.S. & RES.

**ENERGY MINES &
SOURCES P.S.**

CARLINGTON HEIGHTS P.S. & RES.

SUBJECT SITE

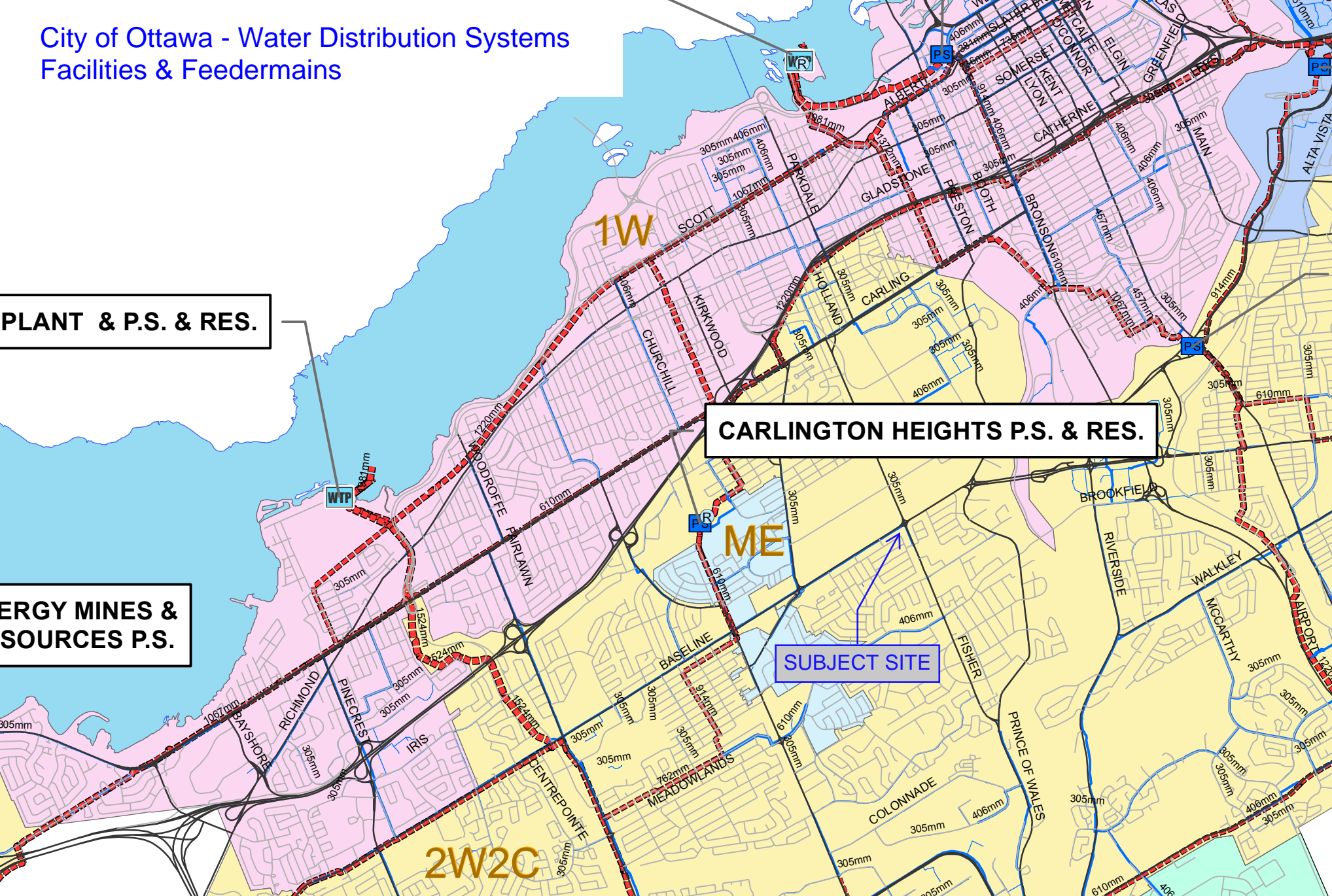

McINTOSH PERRY

000-22-0952 - 780 Baseline Road - Building A - Water Demands

Project:	780 Baseline Road - Building A	
Project No.:	000-22-0952	
Designed By:	RRR	
Checked By:	RRR	
Date:	September 14, 2023	
Site Area:	0.48 gross ha	Phase I Area

<u>Residential</u>	NUMBER OF UNITS	UNIT RATE	
Single Family	homes	3.4	persons/ unit
Semi-detached	homes	2.7	persons/ unit
Townhouse	homes	2.7	persons/ unit
Bachelor Apartment	17 units	1.4	persons/ unit
1 Bedroom Apartment	163 units	1.4	persons/ unit
2 Bedroom Apartment	133 units	2.1	persons/ unit
3 Bedroom Apartment	7 units	3.1	persons/ unit
Average Apartment	units	1.8	persons/ unit
Total Population	553 persons		
<u>Commercial</u>	711 m2		
<u>Industrial - Light</u>	m2		
<u>Industrial - Heavy</u>	m2		

AVERAGE DAILY DEMAND

DEMAND TYPE	AMOUNT	UNITS	
Residential	280	L/c/d	
Industrial - Light	35,000	L/gross ha/d	
Industrial - Heavy	55,000	L/gross ha/d	
Shopping Centres	2,500	L/(1000m ² /d)	
Hospital	900	L/(bed/day)	
Schools	70	L/(Student/d)	
Trailer Park with no Hook-Ups	340	L/(space/d)	
Trailer Park with Hook-Ups	800	L/(space/d)	
Campgrounds	225	L/(campsite/d)	
Mobile Home Parks	1,000	L/(Space/d)	
Motels	150	L/(bed-space/d)	
Hotels	225	L/(bed-space/d)	
Tourist Commercial	28,000	L/gross ha/d	
Other Commercial	28,000	L/gross ha/d	
AVERAGE DAILY DEMAND	Residential	1.79	L/s
	Commerical/ Industrial/ Institutional	0.02	L/s

McINTOSH PERRY

MAXIMUM DAILY DEMAND

DEMAND TYPE	AMOUNT		UNITS
Residential	2.5	x avg. day	L/ c/ d
Industrial	1.5	x avg. day	L/ gross ha/ d
Commercial	1.5	x avg. day	L/ gross ha/ d
Institutional	1.5	x avg. day	L/ gross ha/ d
MAXIMUM DAILY DEMAND	Residential	4.48	L/ s
	Commerical/ Industrial/ Institutional	0.03	L/ s

MAXIMUM HOUR DEMAND

DEMAND TYPE	AMOUNT		UNITS
Residential	2.2	x max. day	L/ c/ d
Industrial	1.8	x max. day	L/ gross ha/ d
Commercial	1.8	x max. day	L/ gross ha/ d
Institutional	1.8	x max. day	L/ gross ha/ d
MAXIMUM HOUR DEMAND	Residential	8.03	L/ s
	Commerical/ Industrial/ Institutional	0.06	L/ s

WATER DEMAND DESIGN FLOWS PER UNIT COUNT

CITY OF OTTAWA - WATER DISTRIBUTION GUIDELINES, JULY 2010

AVERAGE DAILY DEMAND	1.82	L/s
MAXIMUM DAILY DEMAND	4.51	L/s
MAXIMUM HOUR DEMAND	8.09	L/s

McINTOSH PERRY

OOO-22-0952 - 780 Baseline Road - Building A - Fire Underwriters Survey

Project: 780 Baseline Road - Building A
 Project No.: OOO-22-0952
 Designed By: FFR
 Checked By: C/M
 Date: September 14, 2023

From the Fire Underwriters Survey (2020)

From Part II – Guide for Determination of Required Fire Flow Copyright I.S.O.:
 City of Ottawa Technical Bulletin ISTB-2018-02 Applied Where Applicable

A. BASE REQUIREMENT (Rounded to the nearest 1000 L/min)

F = 220 x C x vA Where:

F = Required fire flow in liters per minute

C = Coefficient related to the type of construction.

A = The total effective floor area in square meters. Only the single largest floor plus 25% of the two immediately adjoining floors considered per the 2020 FUS Page 20 section 2B.

Construction Type Non-Combustible Construction

C

0.8

Protected Vertical Openings Per Architectural Plan

Floor Level	Area (m ²)	Area Applied (m ²)
L2	1692.0	1692.0
L3	1692.0	423.0
L4	1687.0	421.8

A - Total Floor Area (per the 2020 FUS Page 20 - Total Effective Area) 2,536.8 m²

Calculated Fire Flow

8,864.4 L/min
 9,000.0 L/min

B. REDUCTION FOR OCCUPANCY TYPE (No Rounding)

From Page 24 of the Fire Underwriters Survey:

Limited Combustible

-15%

Fire Flow

7,650.0 L/min

C. REDUCTION FOR SPRINKLER TYPE (No Rounding)

Fully Supervised Sprinklered

-50%

Reduction

-3,825.0 L/min

D. INCREASE FOR EXPOSURE (No Rounding)

Exposure	Separation Distance (m)	Cons. of Exposed Wall	Length Exposed Adjacent Wall (m)	Height (Stories)	Length-Height Factor	% Increase*
Exposure 1	3.1 to 10	Fire Resistive - Non Combustible (Unprotected Openings)	21.3	1	26.0	7%
Exposure 2	Over 30 m	Wood frame	7	2	14.0	0%
Exposure 3	3.1 to 10	Wood frame	12.5	1	12.5	15%
Exposure 4	20.1 to 30	Wood frame	15	1	15.0	0%
						% Increase*
						22%

Increase*

1,683.0 L/min

E. Total Fire Flow (Rounded to the Nearest 1000 L/min)

Fire Flow

5,508.0 L/min

Fire Flow Required**

6,000.0 L/min

* In accordance with Part II, Section 4, the Increase for separation distance is not to exceed 75%

** In accordance with Section 4 the Fire flow is not to exceed 45,000 L/min or be less than 2,000 L/min

McINTOSH PERRY

000-22-0952 - 780 Baseline Road - Boundary Condition Unit Conversion

Project: 780 Baseline Road

Project No.: 000-22-0952

Designed By: AJG

Checked By: AJG

Date: September 14, 2023

Boundary Conditions Unit Conversion

HILLIARD AVE - BUILDING A

Scenario	Height (m)	Elevation (m)	m H ₂ O PSI		kPa
Avg. DD	132.8	84.1	48.7	69.2	477.4
Fire Flow (100 L/s or 6,000 L/min)	118.9	84.1	34.8	49.5	341.0
Peak Hour	124.4	84.1	40.3	57.3	395.0

Boundary Conditions for 780 Baseline Road



Ryan Robineau

From: Armstrong, Justin <justin.armstrong@ottawa.ca>
Sent: August 28, 2023 9:14 AM
To: Ryan Robineau
Cc: Pasool, Rubina
Subject: RE: 780 Baseline Boundary Condition Request
Attachments: 780 Baseline Road August 2023.pdf

Hi Ryan,

Here are the boundary conditions:

The following are boundary conditions, HGL, for hydraulic analysis at 780 Baseline Road (zone 2W2C) assumed to be a dual connection to either the 203 mm watermain on Hilliard Avenue OR the 406 mm watermain on Fisher Avenue (see attached PDF for location).

Both Connections:

Minimum HGL = 124.4 m

Maximum HGL = 132.8 m

MaxDay + FireFlow (150 L/s) = 118.9 m (Hilliard Connection), 126.4 m (Fisher Connection)

These are for current conditions and are based on computer model simulation.

Disclaimer: The boundary condition information is based on current operation of the city water distribution system. The computer model simulation is based on the best information available at the time. The operation of the water distribution system can change on a regular basis, resulting in a variation in boundary conditions. The physical properties of watermains deteriorate over time, as such must be assumed in the absence of actual field test data. The variation in physical watermain properties can therefore alter the results of the computer model simulation.

Thanks,
Justin

Justin Armstrong, P.Eng.

Project Manager

Planning, Real Estate and Economic Development Department – Direction générale de la planification, des biens immobiliers et du développement économique

Development Review - West Branch

City of Ottawa | Ville d'Ottawa

110 Laurier Avenue West Ottawa, ON | 110, avenue. Laurier Ouest. Ottawa (Ontario) K1P 1J1

613.580.2424 ext./poste 21746, justin.armstrong@ottawa.ca

From: Pasool, Rubina <Rubina.Pasool@ottawa.ca>

Sent: August 25, 2023 12:59 PM

- 2) For a building classified with a Construction Coefficient below 1.0:
- a) if any vertical openings in the building (ex. interconnected floor spaces, atria, elevators, escalators, etc.) are unprotected, consider the two largest adjoining floor areas plus 50% of all floors immediately above them up to a maximum of eight; or
 - b) if all vertical openings and exterior vertical communications are properly protected in accordance with the National Building Code, consider only the single largest Floor Area plus 25% of each of the two immediately adjoining floors.

Protection requirements:

The protection requirements for vertical openings are only applicable in buildings with a Construction Coefficient below 1.0. The type of protection for vertical openings shall be based on the construction of the enclosure walls and the type of opening or other device used for the protection of openings in the enclosure. See also NBC Division B, Section 3.5. Vertical Transportation.

Protected openings:

- i. Enclosures shall have walls of masonry or other limited or noncombustible construction with a fire resistance rating of not less than one hour.
- ii. Openings including doors shall be provided with automatic closing devices
- iii. Elevator doors shall be of metal or metal-covered construction, so arranged that the doors must normally be closed for operation of the elevator.

Unprotected openings:

- i. Any opening through horizontal separations that are unprotected or otherwise have closures that do not meet the minimum requirements for protected openings, above.

Julie Candow, P.Eng
Project Manager
Planning, Real Estate and Economic Development Department - West Branch
City of Ottawa
110 Laurier Avenue West Ottawa, ON
613.580.2424 ext. 13850

Please take note that due to the current COVID situation, I am working remotely and phone communication may not be reliable at this time. The best way to reach me is by email.

From: Ryan Robineau <r.robineau@mcintoshperry.com>
Sent: May 11, 2023 4:40 PM
To: Candow, Julie <julie.candow@ottawa.ca>
Cc: Curtis Melanson <c.melanson@mcintoshperry.com>
Subject: 780 Baseline Boundary Condition Request

CAUTION: This email originated from an External Sender. Please do not click links or open attachments unless you recognize the source.

ATTENTION : Ce courriel provient d'un expéditeur externe. Ne cliquez sur aucun lien et n'ouvrez pas de pièce jointe, excepté si vous connaissez l'expéditeur.

Good afternoon Julie,

We would like to request boundary conditions for a proposed development at 780 Baseline Road. The proposed development consists of a mixed use residential building. Could you please provide boundary conditions for a potential dual connection to the existing 203mm pvc watermain within Hillard Avenue and a potential dual connection to the 406mm diameter PVC watermain within Fisher Avenue.

- The estimated fire flow is 9,000 L/min based on the 2020 FUS
- Average daily demand: 1.82L/s
- Maximum daily demand 4.52 L/s
- Maximum hourly daily demand 8.12 L/s

Attached is a map showing the proposed connection location along with the calculations prepared for the demands listed above.

Please let me know if you have any questions.

Ryan Robineau, EIT

Civil Engineering Technologist

T. 613.714.6611

r.robineau@mcintoshperry.com | www.mcintoshperry.com

McINTOSH PERRY

Turning Possibilities Into Reality

Confidentiality Notice – If this email wasn't intended for you, please return or delete it. Click [here](#) to read all of the legal language around this concept.



Platinum member

This e-mail originates from the City of Ottawa e-mail system. Any distribution, use or copying of this e-mail or the information it contains by other than the intended recipient(s) is unauthorized. Thank you.

Le présent courriel a été expédié par le système de courriels de la Ville d'Ottawa. Toute distribution, utilisation ou reproduction du courriel ou des renseignements qui s'y trouvent par une personne autre que son destinataire prévu est interdite. Je vous remercie de votre collaboration.

This e-mail originates from the City of Ottawa e-mail system. Any distribution, use or copying of this e-mail or the information it contains by other than the intended recipient(s) is unauthorized. Thank you.

Le présent courriel a été expédié par le système de courriels de la Ville d'Ottawa. Toute distribution, utilisation ou reproduction du courriel ou des renseignements qui s'y trouvent par une personne autre que son destinataire prévu est interdite. Je vous remercie de votre collaboration.

This e-mail originates from the City of Ottawa e-mail system. Any distribution, use or copying of this e-mail or the information it contains by other than the intended recipient(s) is unauthorized. Thank you.

APPENDIX D
SANITARY CALCULATIONS

McINTOSH PERRY

000-22-0952 - 780 Baseline Road - Phase I Building A - Sanitary Demands

Project:	780 Baseline Road - Phase I Building A		
Project No.:	000-22-0952		
Designed By:	A.J.G		
Checked By:	A.J.G		
Date:	September 18, 2023		
Ste Area	0.48	Gross ha	Phase I Area
Bachelor	17		1.40 Persons per unit
1 Bedroom	163		1.40 Persons per unit
2 Bedroom	133		2.10 Persons per unit
3 Bedroom	7		3.10 Persons per unit
Total Population	553	Persons	
Commercial Area	554	m ²	

DESIGN PARAMETERS

Institutional/Commercial Peaking Factor	1	
Residential Peaking Factor	3.36	* Using Harmon Formula = $1+(14/(4+P^{0.5}))^{0.8}$ where P = population in thousands, Harmon's Correction Factor = 0.8
Mannings coefficient (n)	0.013	
Demand (per capita)	280	L/ day
Infiltration allowance	0.33	L/s/ Ha

EXTRANEIOUS FLOW ALLOWANCES

Infiltration / Inflow	Flow (L/s)
Dry	0.02
Wet	0.13
Total	0.16

AVERAGE DAILY DEMAND

DEMAND TYPE	AMOUNT	UNITS	POPULATION / AREA	Flow (L/s)
Residential	280	L/ c/ d	553	1.79
Industrial - Light**	35,000	L/gross ha/d		0
Industrial - Heavy**	55,000	L/gross ha/d		0
Commercial / Amenity	2,800	L/(1000m ² /d)	554	0.02
Hospital	900	L/(bed/ day)		0
Schools	70	L/(Student/ d)		0
Trailer Parks no Hook-Ups	340	L/(space/ d)		0
Trailer Park with Hook-Ups	800	L/(space/ d)		0
Campgrounds	225	L/(campsite/ d)		0
Mobile Home Parks	1,000	L/(Space/ d)		0
Motels	150	L/(bed-space/ d)		0
Hotels	225	L/(bed-space/ d)		0
Office	75	L/7.0m ² /d		0
Tourist Commercial	28,000	L/gross ha/d		0
Other Commercial	28,000	L/gross ha/d		0

McINTOSH PERRY

AVERAGE RESIDENTIAL FLOW	1.79	L/s
PEAK RESIDENTIAL FLOW	6.02	L/s
AVERAGE ICI FLOW	0.02	L/s
PEAK INSTITUTIONAL/ COMMERCIAL FLOW	0.02	L/s
PEAK INDUSTRIAL FLOW	0.00	L/s
TOTAL PEAK ICI FLOW	0.02	L/s

TOTAL SANITARY DEMAND

TOTAL ESTIMATED AVERAGE DRY WEATHER FLOW	1.83	L/s
TOTAL ESTIMATED PEAK DRY WEATHER FLOW	6.07	L/s
TOTAL ESTIMATED PEAK WET WEATHER FLOW	6.20	L/s

SANITARY SEWER DESIGN SHEET

PROJECT: OCO-22-0952
 LOCATION: 780 Baseline



LOCATION				RESIDENTIAL								IQ AREAS						INFILTRATION ALLOWANCE			FLOW		SEWER DATA								
1	2	3	4	5	6	7	8	9	10	11	12	13	14	15	16	17	18	19	20	21	22	23	24	25	26	27	28	29	30	31	
STREET	AREA ID	FROM	TO	UNIT TYPES				AREA (ha)	POPULATION		PEAK FACTOR	PEAK FLOW (L/s)	AREA (ha)						PEAK FLOW (L/s)	AREA (ha)		FLOW (L/s)	DESIGN FLOW (L/s)	CAPACITY (L/s)	LENGTH (m)	DIA (mm)	SLOPE (%)	VELOCITY (full) (m/s)	AVAILABLE CAPACITY		
				Bac/ 1-Bed	2-Bed	3-Bed	APT		IND	CUM			INSTITUTIONAL	COMMERCIAL	INDUSTRIAL		IND	CUM		IND	CUM								IND	CUM	L/s
		BLDG	MH1D	180	133	7		0.48	553.0	553.0	3.36	6.03	0.00	0.00	554.00	554.00			0.00	0.02	0.48	0.48	0.16	6.21	34.22	3.71	200	1.00	1.055	28.01	81.86
Design Parameters:				Notes:								Designed: RP						No.		Revision						Date					
Residential				1. Mannings coefficient (n) = 0.013								Checked: RFR																			
				2. Demand (per capita): 280 L/day								Project No.: OCO-22-0952																			
				3. Infiltration allowance: 0.33 L/s/ Ha																											
				4. Residential Peaking Factor: Harmon Formula = 1+(14/(4+P^0.5)* 0.8) where P = population in thousands																											
1-BED 1.4 p/p/u 2-Bed 2.1 p/p/u 3-Bed 3.1 p/p/u Other 60 p/p/Ha				INST 28,000 L/ Ha/ day COM 28,000 L/ Ha/ day IND 35,000 L/ Ha/ day								Peak Factor 1.5 1.5 MOE Chart																			
Sheet No: 1 of 1																															

SANITARY SEWER DESIGN SHEET

PROJECT: COO-22-0952
 LOCATION: 780 Baseline



LOCATION				RESIDENTIAL								ICI AREAS								INFILTRATION ALLOWANCE			FLOW		SEWER DATA								
1	2	3	4	5	6	7	8	9	10	11	12	13	14	15	16	17	18	19	20	21	22	23	24	25	26	27	28	29	30	31			
STREET	AREA ID	FROM MH	TO MH	UNIT TYPES				AREA (ha)	POPULATION		PEAK FACTOR	PEAK FLOW (L/s)	AREA (ha)						PEAK FLOW (L/s)		AREA (ha)		FLOW (L/s)	DESIGN FLOW (L/s)	CAPACITY (L/s)	LENGTH (m)	DIA (mm)	SLOPE (%)	VELOCITY (full) (m/s)	AVAILABLE CAPACITY			
				SF	SD	TH	APT		IND	CUM			INSTITUTIONAL		COMMERCIAL		INDUSTRIAL		IND	CUM	IND	CUM								IND	CUM	L/s	(%)
													IND	CUM	IND	CUM	IND	CUM															
Hillard Ave to Fisher Ave	Existing Sewer Capacity	MHSA46208	MHSA46206																		0.00	0.00	0.00	0.00	65.38	40.73	300	0.42	0.896	65.38			
		MHSA46206	MHSA46205																			0.00	0.00	0.00	0.00	76.16	12.90	300	0.57	1.044	76.16		
		MHSA46203	MHSA46204																			0.00	0.00	0.00	0.00	72.75	7.10	300	0.52	0.997	72.75		
		MHSA46204	MHSA46205																			0.00	0.00	0.00	0.00	72.75	32.50	300	0.52	0.997	72.75		
		MHSA46205	MHSA19079																			0.00	0.00	0.00	0.00	316.81	61.87	375	3.00	2.779	316.81		
		MHSA19079	MHSA50442																			0.00	0.00	0.00	0.00	229.19	21.00	375	1.57	2.010	229.19		
		MHSA50442	MHSA50443																			0.00	0.00	0.00	0.00	126.19	109.30	450	0.18	0.769	126.19		
	Proposed Sewer Capacity	MHSA46208	MH1C																		0.00	0.00	0.00	0.00	65.38	21.37	300	0.42	0.896	65.38			
		MHSA46203	MH1B																			0.00	0.00	0.00	0.00	72.75	40.15	300	0.52	0.997	72.75		
		MH1B	MH1C																			0.00	0.00	0.00	0.00	76.16	19.15	300	0.57	1.044	76.16		
		MH1C	MH1D																			0.00	0.00	0.00	0.00	103.47	11.56	375	0.32	0.908	103.47		
		MH1D	MH1E																			0.00	0.00	0.00	0.00	103.47	76.25	375	0.32	0.908	103.47		
		MH1E	MHSA50442																			0.00	0.00	0.00	0.00	126.19	39.30	450	0.18	0.769	126.19		
Design Parameters:				Notes:								Designed: FFR								No.		Revision						Date					
Residential				1. Mannings coefficient (n) = 0.013								Checked: AM																					
ICI Areas				2. Demand (per capita): 280 L/day								Project No.: COO-22-0952																					
SF 3.4 p/p/u				3. Infiltration allowance: 0.33 L/s/Ha																													
TH/SD 2.7 p/p/u				4. Residential Peaking Factor:																													
APT 2.3 p/p/u				Harmon Formula = 1+(14/(4+P*0.5)*0.8)																													
Other 60 p/p/Ha				where P = population in thousands																													
																												Sheet No: 1 of 1					

Alison Gosling

From: Candow, Julie <julie.candow@ottawa.ca>
Sent: October 6, 2022 11:41 AM
To: Alison Gosling
Subject: RE: 22-4516 - 780 Baseline - Sanitary Capacity

Follow Up Flag: Follow up
Flag Status: Flagged

Hi Alison,

Asset Management has no concerns with the extra flow.

Thanks,

Julie Candow, P.Eng
Project Manager
Planning, Real Estate and Economic Development Department - West Branch
City of Ottawa
110 Laurier Avenue West Ottawa, ON
613.580.2424 ext. 13850

Please take note that due to the current COVID situation, I am working remotely and phone communication may not be reliable at this time. The best way to reach me is by email.

From: Candow, Julie
Sent: September 29, 2022 10:18 AM
To: Alison Gosling <a.gosling@mcintoshperry.com>
Subject: RE: 22-4516 - 780 Baseline - Sanitary Capacity

Hi Alison, I have passed on your request to Asset Management Branch for their confirmation.

I will follow up once I hear from them.

Thank you,

Julie Candow, P.Eng
Project Manager
Planning, Real Estate and Economic Development Department - West Branch
City of Ottawa
110 Laurier Avenue West Ottawa, ON
613.580.2424 ext. 13850

Please take note that due to the current COVID situation, I am working remotely and phone communication may not be reliable at this time. The best way to reach me is by email.

From: Alison Gosling <a.gosling@mcintoshperry.com>
Sent: September 29, 2022 9:17 AM

To: Candow, Julie <julie.candow@ottawa.ca>
Subject: FW: 22-4516 - 780 Baseline - Sanitary Capacity

CAUTION: This email originated from an External Sender. Please do not click links or open attachments unless you recognize the source.

ATTENTION : Ce courriel provient d'un expéditeur externe. Ne cliquez sur aucun lien et n'ouvrez pas de pièce jointe, excepté si vous connaissez l'expéditeur.

Good morning Julie,

There have been some site statistic changes to the contemplated design for 780 Baseline. The changes will be reflected in a revised Assessment of Adequacy of Public Services report for the ZBLA application. Can the City please review the sanitary flows below and advise us of any concerns?

- Building A is anticipated to be serviced via the municipal sanitary sewer that crosses through the site, tributary to the 450mm sanitary sewer within Fisher Ave.
- Building B is anticipated to be serviced via the 300mm sanitary sewer within Baseline Rd.
- Building C is anticipated to be serviced via either the municipal sanitary sewer that crosses through the site or the 300mm sanitary sewer within Baseline Rd.

	Building A	Building B	Building C	Total
Average Dry Weather Flow	1.81	2.06	2.11	5.98
Peak Dry Weather Flow	6.01	6.74	6.93	18.21
Peak Wet Weather Flow	6.14	6.87	7.06	18.61

Please let me know if you have any questions.

Thank you,

Alison Gosling, P.Eng.

Project Engineer, Land Development

T. 613.714.4629

a.gosling@mcintoshperry.com | www.mcintoshperry.com

McINTOSH PERRY

Turning Possibilities Into Reality

Confidentiality Notice – If this email wasn't intended for you, please return or delete it. Click [here](#) to read all of the legal language around this concept.



Platinum
member

From: Alison Gosling <a.gosling@mcintoshperry.com>

Sent: April 4, 2022 2:14 PM

To: Valic, Jessica <jessica.valic@ottawa.ca>

Subject: RE: 22-4516 - 780 Baseline - Sanitary Capacity

Thanks Jessica.

Alison Gosling, P.Eng.

Project Engineer, Land Development

T. 613.714.4629

a.gosling@mcintoshperry.com | www.mcintoshperry.com

McINTOSH PERRY

Turning Possibilities Into Reality

From: Valic, Jessica <jessica.valic@ottawa.ca>

Sent: April 4, 2022 10:05 AM

To: Alison Gosling <a.gosling@mcintoshperry.com>

Subject: RE: 22-4516 - 780 Baseline - Sanitary Capacity

Hi Alison,

There is no issue with the additional flow.

Regards,

Jessica

From: Alison Gosling <a.gosling@mcintoshperry.com>

Sent: March 31, 2022 11:19 AM

To: Valic, Jessica <jessica.valic@ottawa.ca>

Subject: RE: 22-4516 - 780 Baseline - Sanitary Capacity

CAUTION: This email originated from an External Sender. Please do not click links or open attachments unless you recognize the source.

ATTENTION : Ce courriel provient d'un expéditeur externe. Ne cliquez sur aucun lien et n'ouvrez pas de pièce jointe, excepté si vous connaissez l'expéditeur.

Hi Jessica,

Did you get a response on this?

Thanks in advance,

Alison Gosling, P.Eng.

Project Engineer, Land Development

T. 613.714.4629

a.gosling@mcintoshperry.com | www.mcintoshperry.com

McINTOSH PERRY

Turning Possibilities Into Reality

From: Alison Gosling <a.gosling@mcintoshperry.com>

Sent: March 18, 2022 8:14 AM

To: Valic, Jessica <jessica.valic@ottawa.ca>

Subject: 22-4516 - 780 Baseline - Sanitary Capacity

Hi Jessica,

As discussed, can the City please assess the capacity of the local sanitary sewers for the contemplated development at 780 Baseline Road?

- Building A is anticipated to be serviced via the municipal sanitary sewer that crosses through the site, tributary to the 450mm sanitary sewer within Fisher Ave.
- Building B is anticipated to be serviced via either the municipal sanitary sewer that crosses through the site or the 300mm sanitary sewer within Baseline Rd.
- Building C is anticipated to be serviced via the 300mm sanitary sewer within Baseline Rd.

	Building A	Building B	Building C	Total
Average Dry Weather Flow	1.57	1.91	1.77	5.24
Peak Dry Weather Flow	5.28	6.28	5.79	16.12
Peak Wet Weather Flow	5.41	6.40	5.92	16.50

Please let me know if you have any questions.

Thank you,

Alison Gosling, P.Eng.

Project Engineer, Land Development

T. 613.714.4629

a.gosling@mcintoshperry.com | www.mcintoshperry.com

McINTOSH PERRY

Turning Possibilities Into Reality



Platinum member

Confidentiality Notice – If this email wasn't intended for you, please return or delete it. Click [here](#) to read all of the legal language around this concept.

This e-mail originates from the City of Ottawa e-mail system. Any distribution, use or copying of this e-mail or the information it contains by other than the intended recipient(s) is unauthorized. Thank you.

**APPENDIX E
PRE-DEVELOPMENT DRAINAGE PLAN**

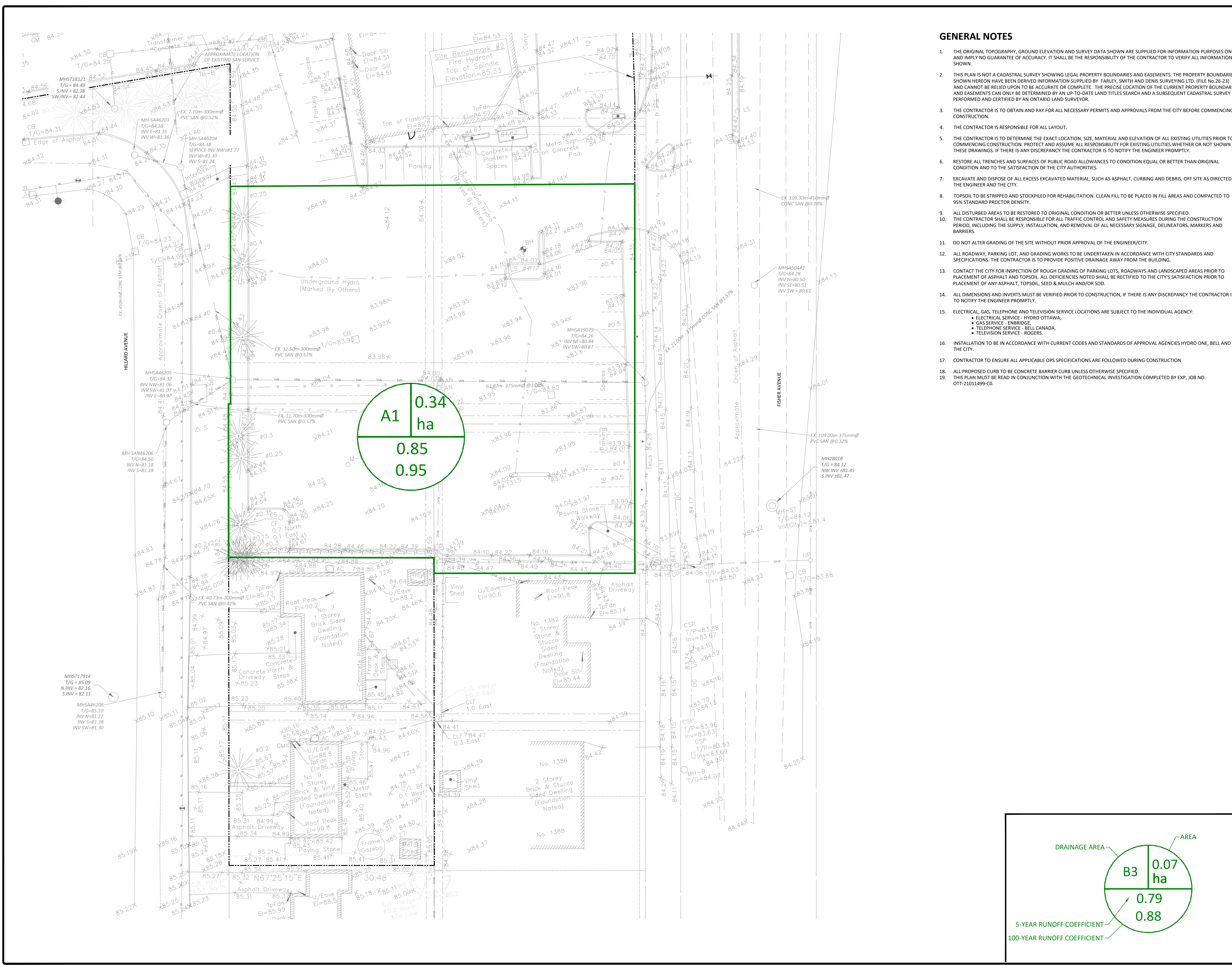

- ### GENERAL NOTES
- THE ORIGINAL TOPOGRAPHY, GROUND ELEVATION AND SURVEY DATA SHOWN ARE SUPPLIED FOR INFORMATION PURPOSES ONLY, AND IMPLY NO GUARANTEE OF ACCURACY. IT SHALL BE THE RESPONSIBILITY OF THE CONTRACTOR TO VERIFY ALL INFORMATION SHOWN.
 - THIS PLAN IS NOT A CADASTRAL SURVEY SHOWING LEGAL PROPERTY BOUNDARIES AND EASEMENTS. THE PROPERTY BOUNDARIES SHOWN HEREON HAVE BEEN DERIVED FROM INFORMATION SUPPLIED BY FARLEY, SMITH AND DENIS SURVEYING LTD. (FILE NO. 26-23) AND CANNOT BE RELIED UPON TO BE ACCURATE OR COMPLETE. THE PRECISE LOCATION OF THE CURRENT PROPERTY BOUNDARIES AND EASEMENTS CAN ONLY BE DETERMINED BY AN UP-TO-DATE LAND TITLE SEARCH AND A SUBSEQUENT CADASTRAL SURVEY PERFORMED AND CERTIFIED BY AN ONTARIO LAND SURVEYOR.
 - THE CONTRACTOR IS TO OBTAIN AND PAY FOR ALL NECESSARY PERMITS AND APPROVALS FROM THE CITY BEFORE COMMENCING CONSTRUCTION.
 - THE CONTRACTOR IS RESPONSIBLE FOR ALL LAYOUT.
 - THE CONTRACTOR IS TO DETERMINE THE EXACT LOCATION, SIZE, MATERIAL AND ELEVATION OF ALL EXISTING UTILITIES PRIOR TO COMMENCING CONSTRUCTION. PROTECT AND ASSUME ALL RESPONSIBILITY FOR EXISTING UTILITIES WHETHER OR NOT SHOWN ON THESE DRAWINGS. IF THERE IS ANY DISCREPANCY THE CONTRACTOR IS TO NOTIFY THE ENGINEER PROMPTLY.
 - RESTORE ALL TRENCHES AND SURFACES OF PUBLIC ROAD ALLOWANCES TO CONDITION EQUAL OR BETTER THAN ORIGINAL CONDITION AND TO THE SATISFACTION OF THE CITY AUTHORITIES.
 - EXCAVATE AND DISPOSE OF ALL EXCESS EXCAVATED MATERIAL, SUCH AS ASPHALT, CURBING AND DEBRIS, OFF SITE AS DIRECTED BY THE ENGINEER AND THE CITY.
 - TOPSOIL TO BE STRIPPED AND STOCKPILED FOR REHABILITATION. CLEAN FILL TO BE PLACED IN FILL AREAS AND COMPACTED TO 95% STANDARD PROCTOR DENSITY.
 - ALL DISTURBED AREAS TO BE RESTORED TO ORIGINAL CONDITION OR BETTER UNLESS OTHERWISE SPECIFIED. THE CONTRACTOR SHALL BE RESPONSIBLE FOR ALL TRAFFIC CONTROL AND SAFETY MEASURES DURING THE CONSTRUCTION PERIOD, INCLUDING THE SUPPLY, INSTALLATION, AND REMOVAL OF ALL NECESSARY SIGNAGE, DELINEATORS, MARKERS AND BARRIERS.
 - DO NOT ALTER GRADING OF THE SITE WITHOUT PRIOR APPROVAL OF THE ENGINEER/CITY.
 - ALL ROADWAY, PARKING LOT, AND GRADING WORKS TO BE UNDERTAKEN IN ACCORDANCE WITH CITY STANDARDS AND SPECIFICATIONS. THE CONTRACTOR IS TO PROVIDE POSITIVE DRAINAGE AWAY FROM THE BUILDING.
 - CONTACT THE CITY FOR INSPECTION OF ROUGH GRADING OF PARKING LOTS, ROADWAYS AND LANDSCAPED AREAS PRIOR TO PLACEMENT OF ASPHALT AND TOPSOIL. ALL DEFICIENCIES NOTED SHALL BE RECTIFIED TO THE CITY'S SATISFACTION PRIOR TO PLACEMENT OF ANY ASPHALT, TOPSOIL, SEED & MULCH AND/OR SOD.
 - ALL DIMENSIONS AND INVERTS MUST BE VERIFIED PRIOR TO CONSTRUCTION, IF THERE IS ANY DISCREPANCY THE CONTRACTOR IS TO NOTIFY THE ENGINEER PROMPTLY.
 - ELECTRICAL, GAS, TELEPHONE AND TELEVISION SERVICE LOCATIONS ARE SUBJECT TO THE INDIVIDUAL AGENCY:
 - ELECTRICAL SERVICE - HYDRO OTTAWA,
 - GAS SERVICE - ENBRIDGE,
 - TELEPHONE SERVICE - BELL CANADA,
 - TELEVISION SERVICE - ROGERS.
 - INSTALLATION TO BE IN ACCORDANCE WITH CURRENT CODES AND STANDARDS OF APPROVAL AGENCIES HYDRO ONE, BELL AND THE CITY.
 - CONTRACTOR TO ENSURE ALL APPLICABLE OPS SPECIFICATIONS ARE FOLLOWED DURING CONSTRUCTION
 - ALL PROPOSED CURB TO BE CONCRETE BARRIER CURB UNLESS OTHERWISE SPECIFIED. THIS PLAN MUST BE READ IN CONJUNCTION WITH THE GEOTECHNICAL INVESTIGATION COMPLETED BY EXP. JOB NO. OTT-21011499-CO.



LEGEND

DC	BARRIER CURB & CURB DEPRESSION	PROPOSED CONCRETE SIDEWALK/WALKWAY	PROPOSED ELEVATION EXISTING ELEVATION
MH#	STORM MANHOLE	CATCHBASIN, CURB INLET OR DITCH INLET	SWALE ELEVATION
MH#A	SANITARY MANHOLE	PROPERTY LINE	TOP/BOTTOM WALL FACE ELEVATIONS
WV	WATER VALVE/CHAMBER	FIRE HYDRANT	PROPOSED EMERGENCY OVERLAND FLOW ROUTE
FW	PROPOSED WALL	PROPOSED FIRE DEPARTMENT CONNECTION	EXISTING DRAINAGE PATTERN
M	PROPOSED WATER METER AND REMOTE METER	SEDMIMENT CONTROL DEVICE PER DETAIL	HEAVY DUTY SILT FENCE BARRIER PER OPSD 219.130
ST	EXISTING STORM SEWER	ST	EXISTING HYDRO LINE
SAN	EXISTING SAN SEWER	OW	EXISTING OHW
W	EXISTING WATERMAIN	G	EXISTING GAS LINE
		B	EXISTING BELL SERVICE

SUBJECT TO APPROVAL

No.	Revisions	Date
2	ISSUED FOR SITE PLAN CONTROL	SEPT 25, 2023
1	ISSUED FOR SITE PLAN CONTROL	JUNE 09, 2023

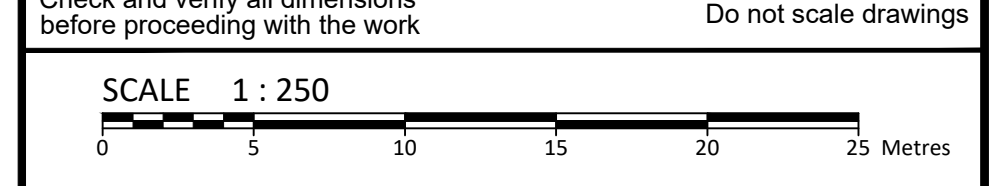

McINTOSH PERRY
 115 Walgreen Road, RR3, Carp, ON K0A 1L0
 Tel: 613-836-2184 Fax: 613-836-3742
 www.mcintoshperry.com

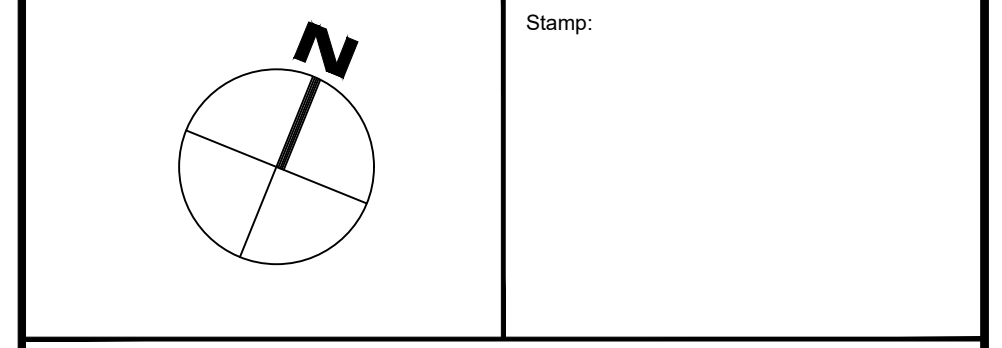

Client: **THEBERGE DEVELOPMENTS LTD.**
 1600 LAPPERRIERE AVE
 OTTAWA, ON K1Z 8P5

Project: **780 BASELINE - PHASE 1**

OTTAWA ON

Drawing Title: **PRE-DEVELOPMENT DRAINAGE PLAN**

Scale: 1:250	Project Number: CCO-22-0952
Drawn By: R.R.R.	Checked By: A.M.
Designed By: R.R.R.	Drawing Number: PRE

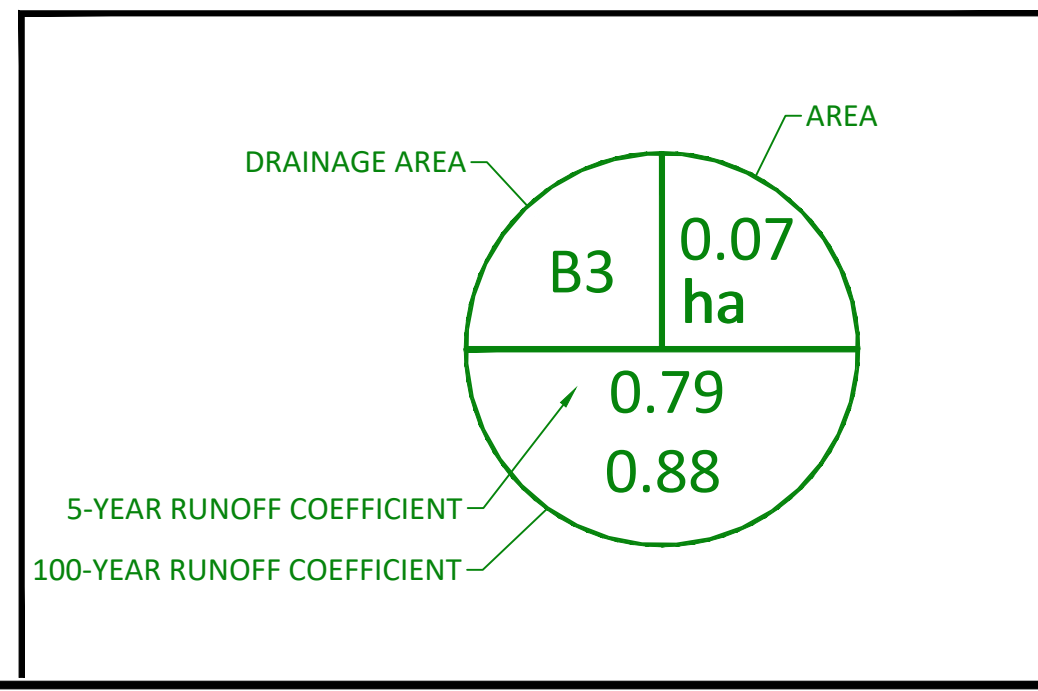

FILENAME: U:\Ottawa\01 Project - Precipitation\2023\09\23\0923_0923_0923_0923_Presentation.dwg
 DATE PLOTTED: Monday, September 25, 2023 10:51:52 AM
 PLOTTED BY: R.R.R.

D07-12-23-0076

APPENDIX F
POST-DEVELOPMENT DRAINAGE PLAN

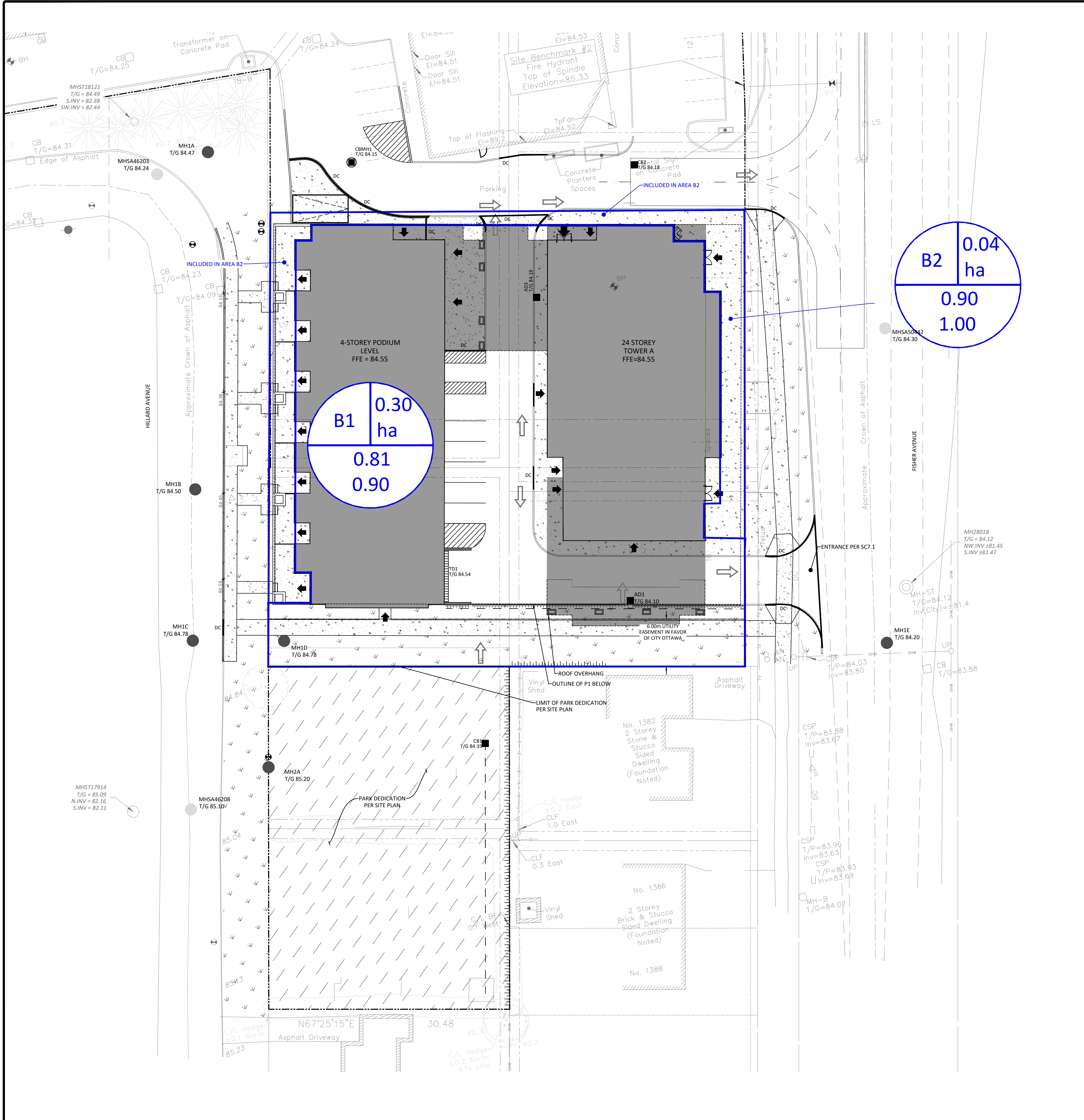

GENERAL NOTES

1. THE ORIGINAL TOPOGRAPHY, GROUND ELEVATION AND SURVEY DATA SHOWN ARE SUPPLIED FOR INFORMATION PURPOSES ONLY, AND IMPLY NO GUARANTEE OF ACCURACY. IT SHALL BE THE RESPONSIBILITY OF THE CONTRACTOR TO VERIFY ALL INFORMATION SHOWN.
2. THIS PLAN IS NOT A CADASTRAL SURVEY SHOWING LEGAL PROPERTY BOUNDARIES AND EASEMENTS. THE PROPERTY BOUNDARIES SHOWN HEREON HAVE BEEN DERIVED FROM INFORMATION SUPPLIED BY FARLEY, SMITH AND DENIS SURVEYING LTD. (FILE NO. 26-23) AND CANNOT BE RELIED UPON TO BE ACCURATE OR COMPLETE. THE PRECISE LOCATION OF THE CURRENT PROPERTY BOUNDARIES AND EASEMENTS CAN ONLY BE DETERMINED BY AN UP-TO-DATE LAND TITLES SEARCH AND A SUBSEQUENT CADASTRAL SURVEY PERFORMED AND CERTIFIED BY AN ONTARIO LAND SURVEYOR.
3. THE CONTRACTOR IS TO OBTAIN AND PAY FOR ALL NECESSARY PERMITS AND APPROVALS FROM THE CITY BEFORE COMMENCING CONSTRUCTION.
4. THE CONTRACTOR IS RESPONSIBLE FOR ALL LAYOUT.
5. THE CONTRACTOR IS TO DETERMINE THE EXACT LOCATION, SIZE, MATERIAL AND ELEVATION OF ALL EXISTING UTILITIES PRIOR TO COMMENCING CONSTRUCTION. PROTECT AND ASSUME ALL RESPONSIBILITY FOR EXISTING UTILITIES WHETHER OR NOT SHOWN ON THESE DRAWINGS. IF THERE IS ANY DISCREPANCY THE CONTRACTOR IS TO NOTIFY THE ENGINEER PROMPTLY.
6. RESTORE ALL TRENCHES AND SURFACES OF PUBLIC ROAD ALLOWANCES TO CONDITION EQUAL OR BETTER THAN ORIGINAL CONDITION AND TO THE SATISFACTION OF THE CITY AUTHORITIES.
7. EXCAVATE AND DISPOSE OF ALL EXCESS EXCAVATED MATERIAL, SUCH AS ASPHALT, CURBING AND DEBRIS, OFF SITE AS DIRECTED BY THE ENGINEER AND THE CITY.
8. TOPSOIL TO BE STRIPPED AND STOCKPILED FOR REHABILITATION. CLEAN FILL TO BE PLACED IN FILL AREAS AND COMPACTED TO 95% STANDARD PROCTOR DENSITY.
9. ALL DISTURBED AREAS TO BE RESTORED TO ORIGINAL CONDITION OR BETTER UNLESS OTHERWISE SPECIFIED. THE CONTRACTOR SHALL BE RESPONSIBLE FOR ALL TRAFFIC CONTROL AND SAFETY MEASURES DURING THE CONSTRUCTION PERIOD, INCLUDING THE SUPPLY, INSTALLATION, AND REMOVAL OF ALL NECESSARY SIGNAGE, DELINEATORS, MARKERS AND BARRIERS.
10. DO NOT ALTER GRADING OF THE SITE WITHOUT PRIOR APPROVAL OF THE ENGINEER/CITY.
11. ALL ROADWAY, PARKING LOT, AND GRADING WORKS TO BE UNDERTAKEN IN ACCORDANCE WITH CITY STANDARDS AND SPECIFICATIONS. THE CONTRACTOR IS TO PROVIDE POSITIVE DRAINAGE AWAY FROM THE BUILDING.
12. CONTACT THE CITY FOR INSPECTION OF ROUGH GRADING OF PARKING LOTS, ROADWAYS AND LANDSCAPED AREAS PRIOR TO PLACEMENT OF ANY ASPHALT AND TOPSOIL. ALL DEFICIENCIES NOTED SHALL BE RECTIFIED TO THE CITY'S SATISFACTION PRIOR TO PLACEMENT OF ANY ASPHALT, TOPSOIL, SEED & MULCH AND/OR SOD.
13. ALL DIMENSIONS AND INVERTS MUST BE VERIFIED PRIOR TO CONSTRUCTION, IF THERE IS ANY DISCREPANCY THE CONTRACTOR IS TO NOTIFY THE ENGINEER PROMPTLY.
14. ELECTRICAL, GAS, TELEPHONE AND TELEVISION SERVICE LOCATIONS ARE SUBJECT TO THE INDIVIDUAL AGENCY:
 - ELECTRICAL SERVICE - HYDRO OTTAWA,
 - GAS SERVICE - ENBRIDGE,
 - TELEPHONE SERVICE - BELL CANADA,
 - TELEVISION SERVICE - ROGERS.
15. INSTALLATION TO BE IN ACCORDANCE WITH CURRENT CODES AND STANDARDS OF APPROVAL AGENCIES HYDRO ONE, BELL AND THE CITY.
16. CONTRACTOR TO ENSURE ALL APPLICABLE OPS SPECIFICATIONS ARE FOLLOWED DURING CONSTRUCTION
17. ALL PROPOSED CURB TO BE CONCRETE BARRIER CURB UNLESS OTHERWISE SPECIFIED.
18. THIS PLAN MUST BE READ IN CONJUNCTION WITH THE GEOTECHNICAL INVESTIGATION COMPLETED BY EXP. JOB NO. OTT-21011499-C0.



LEGEND

DC	Barrier Curb & Curb Depression	95.94 93.20	PROPOSED ELEVATION EXISTING ELEVATION	
CB	PROPOSED CONCRETE SIDEWALK/WALKWAY	95.94 93	SWALE ELEVATION	
MH#	STORM MANHOLE	7x100.50 8x90.50	TOP/BOTTOM WALL FACE ELEVATIONS	
CB	CATCHBASIN, CURB INLET OR DITCH INLET		PROPOSED EMERGENCY OVERLAND FLOW ROUTE	
MH#A	SANITARY MANHOLE		EXISTING DRAINAGE PATTERN	
- - -	PROPERTY LINE		HEAVY DUTY SILT FENCE BARRIER PER OPSD 219.130	
WV	WATER VALVE/CHAMBER		BUILDING ENTRANCE	
FH	FIRE HYDRANT		PROPOSED GRASS	
W	PROPOSED WALL		PROPOSED ROAD CUT AND REINSTATEMENT PER CITY RID	
FC	PROPOSED FIRE DEPARTMENT CONNECTION		TEMPORARY CONSTRUCTION MUD MAT PER DETAIL	
WM	PROPOSED WATER METER AND REMOTE METER		CENTRELINE OF SWALE	
SCD	SEDIMENT CONTROL DEVICE PER DETAIL		EXISTING HYDRO LINE	
OP	OUTLINE OF PARK DEDICATION AREA REFER TO SITE PLAN		EXISTING OHW	
ST	EXISTING STORM SEWER		G	EXISTING GAS LINE
SAN	EXISTING SAN SEWER		B	EXISTING BELL SERVICE
W	EXISTING WATERMAIN			

SUBJECT TO APPROVAL

2	ISSUED FOR SITE PLAN CONTROL	SEPT 25, 2023
1	ISSUED FOR SITE PLAN CONTROL	JUNE 09, 2023
No.	Revisions	Date

Check and verify all dimensions before proceeding with the work. Do not scale drawings.

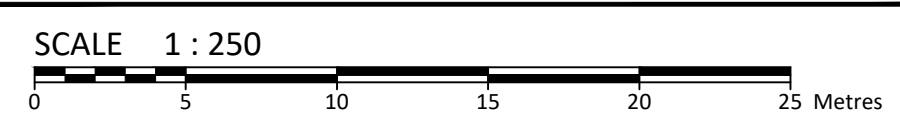

McINTOSH PERRY
 115 Walgreen Road, RR3, Carp, ON K0A 1L0
 Tel: 613-836-2184 Fax: 613-836-3742
 www.mcintoshperry.com

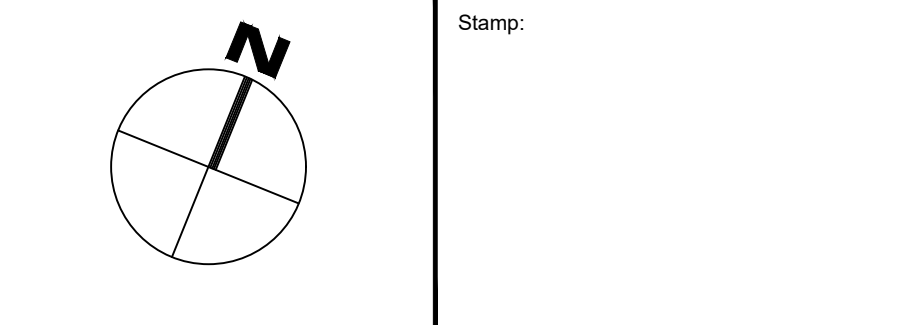

Client: **THEBERGE DEVELOPMENTS LTD.**
 1600 LAPPERRIERE AVE
 OTTAWA, ON K1Z 8P5

Project: **780 BASELINE - PHASE 1**

OTTAWA ON

Drawing Title: **POST-DEVELOPMENT DRAINAGE PLAN**

Scale: 1:250	Project Number: CCO-22-0952
Drawn By: R.R.R.	Checked By: A.M.
Designed By: R.R.R.	Drawing Number: POST

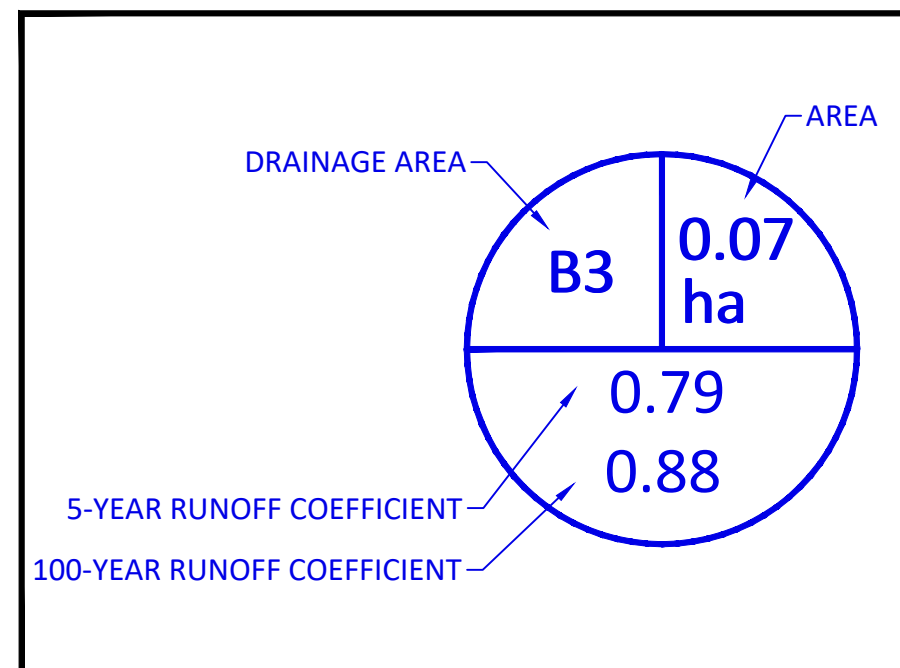
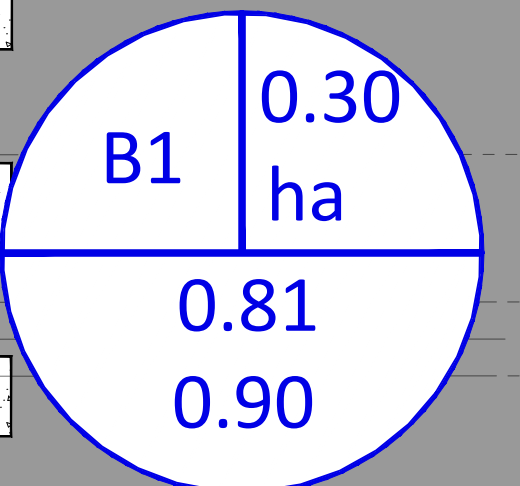
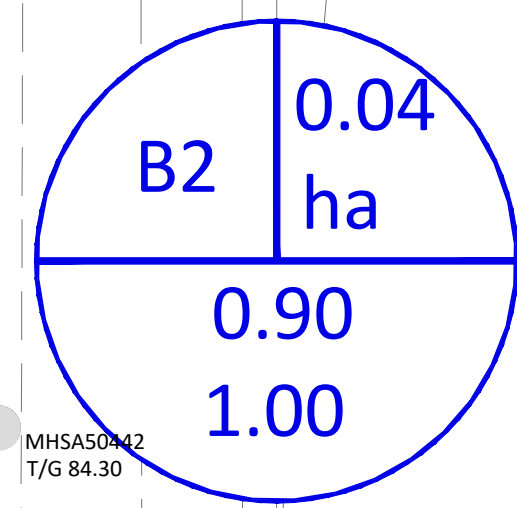

FILENAME: (U:\Ottawa\01 Project - Proposed\2023\hki\CCO-22-0952 - 780 Baseline Road\12 - Drawing\CCO-22-0952_PRESENTATION.dwg
 DATE SAVED: Saturday, September 23, 2023 10:51:51 AM
 LAST PLOTTED: Monday, September 25, 2023 10:51:51 AM

D07-12-23-0076

APPENDIX G
STORMWATER MANAGEMENT CALCULATIONS

McINTOSH PERRY

CO-22-0952 - 780 Baseline Phase 1 - SWM Calculations

1 of 3

Tc (min)	Intensity (mm/hr)		
	5-Year	100-Year	
10	104.2	178.6	PRE-DEVELOPMENT
10	104.2	178.6	POST-DEVELOPMENT

C-Values	
Impervious	0.90
Gravel	0.60
Pervious	0.20

Pre-Development Runoff Coefficient

Drainage Area	Impervious Area (m ²)	Gravel (m ²)	Pervious Area (m ²)	Average C (5-year)	Average C (100-year)
A1	3,167	0	228	0.85	0.95

Pre-Development Runoff Calculations

Drainage Area	Area (ha)	C 5-Year	C 100-Year	Tc (min)	Q (L/s)	
					5-Year	100-Year
A1	0.34	0.85	0.95	10	83.88	160.04
Total	0.34				83.88	160.04

Post-Development Runoff Coefficient

Drainage Area	Impervious Area (m ²)	Gravel (m ²)	Pervious Area (m ²)	Average C (5-year)	Average C (100-year)
B1	2,636	0	398	0.81	0.90
B2	361	0	0	0.90	1.00

Post-Development Runoff Calculations

Drainage Area	Area (ha)	C 5-Year	C 100-Year	Tc (min)	Q (L/s)		
					5-Year	100-Year	
B1	0.30	0.81	0.90	10	71.03	135.80	Restricted
B2	0.04	0.90	1.00	10	9.41	17.93	Unrestricted
Total	0.34				80.45	153.73	

Required Restricted Flow

Drainage Area	Area (ha)	C 5-Year	Tc (min)	Q (L/s)
				5-Year
A1	0.34	0.50	10	49.17

Post-Development Restricted Runoff Calculations

Drainage Area	Unrestricted Flow (L/S)		Restricted Flow (L/S)		Storage Required (m ³)		Storage Provided (m ³)	
	5-year	100-Year	5-Year	100-Year	5-Year	100-Year	5-Year	100-Year
B1	71.03	135.80	15.52	29.67	38.9	73.9	73.9	73.9
B2	9.41	17.93	9.41	17.93				
Total	80.45	153.73	24.93	47.60				

McINTOSH PERRY

CO-22-0952 - 780 Baseline Phase 1 - SWM Calculations

2 of 3

Storage Requirements for Area B1

5-Year Storm Event

Tc (min)	I (mm/hr)	Runoff (L/s) B1	Allowable Outflow (L/s)	Runoff to be Stored (L/s)	Storage Required (m ³)
10	104.2	71.04	15.52	55.52	33.31
20	70.3	47.93	15.52	32.41	38.89
30	53.9	36.74	15.52	21.22	38.20
40	44.2	30.13	15.52	14.61	35.07
50	37.7	25.70	15.52	10.18	30.54
60	32.9	22.43	15.52	6.91	24.87
70	29.4	20.04	15.52	4.52	19.00
80	26.6	18.13	15.52	2.61	12.55
90	24.3	16.57	15.52	1.05	5.65

Maximum Storage Required 5-year = 39 m³

100-Year Storm Event

Tc (min)	I (mm/hr)	Runoff (L/s) B1	Allowable Outflow (L/s)	Runoff to be Stored (L/s)	Storage Required (m ³)
10	178.6	135.83	29.67	106.16	63.70
20	120.0	91.27	29.67	61.60	73.91
30	91.9	69.89	29.67	40.22	72.40
40	75.1	57.12	29.67	27.45	65.87
50	64.0	48.67	29.67	19.00	57.01
60	55.9	42.51	29.67	12.84	46.24
70	49.8	37.87	29.67	8.20	34.46
80	45.0	34.22	29.67	4.55	21.86
90	41.1	31.26	29.67	1.59	8.58

Maximum Storage Required 100-year = 74 m³

5-Year Storm Event Storage Summary

Storage Available (m ³) = 73.9 *
Storage Required (m ³) = 38.9

100-Year Storm Event Storage Summary

Storage Available (m ³) = 73.9 *
Storage Required (m ³) = 73.9

* Available Storage calculated from Cstern

McINTOSH PERRY

Time of Concentration Pre-Development

Drainage Area ID	Sheet Flow Distance (m)	Slope of Land (%)	Tc (min) (5-Year)	Tc (min) (100-Year)
A1	67	2.30	5	3

Therefore, a Tc of 10 can be used

$$T_c = (3.26(1.1 - c)L^{0.5}/S^{0.33})$$

c = Balanced Runoff Coefficient

L = Length of drainage area

S = Average slope of watershed

STORM SEWER DESIGN SHEET

PROJECT: 780 Baseline - Phase 1
 LOCATION: 780 Baseline
 CLIENT: Theberg Developments Ltd.



LOCATION				CONTRIBUTING AREA (ha)				RATIONAL DESIGN FLOW											SEWER DATA									
1	2	3	4	5	6	7	8	9	10	11	12	13	14	15	16	17	18	19	20	21	22	23	24	25	26	27	28	
STREET	AREA ID	FROM	TO	C-VALUE	AREA	INDIV AC	CUMUL AC	INLET (min)	TIME IN PIPE	TOTAL (min)	i (5) (mm/hr)	i (10) (mm/hr)	i (100) (mm/hr)	5yr PEAK FLOW (L/s)	10yr PEAK FLOW (L/s)	100yr PEAK FLOW (L/s)	FIXED FLOW (L/s)	DESIGN FLOW (L/s)	CAPACITY (L/s)	LENGTH (m)	PIPE SIZE (mm)			SLOPE (%)	VELOCITY (m/s)	AVAIL CAP (5yr)		
																					DIA	W	H					
Hillard Ave	B1	BLDG	EX. 450mm CONC STM	0.81	0.30	0.25	0.25	10.00	0.23	10.23	104.19	122.14	178.56	71.03					29.67	62.04	16.53	250			1.00	1.224	32.37	52.18%
Definitions: Q = 2.78QA, where: Q = Peak Flow in Litres per Second (L/s) A = Area in Hectares (ha) i = Rainfall intensity in millimeters per hour (mm/hr) [i = 998.071 / (TC+6.053)^0.814] 5 YEAR [i = 1174.184 / (TC+6.014)^0.816] 10 YEAR [i = 1735.688 / (TC+6.014)^0.820] 100 YEAR				Notes: 1. Mannings coefficient (n) = 0.013				Designed: FP				Checked: PFR				Project No.: COO-22-0952				No. Revision Date								
Sheet No: 1 of 1																												

Stormceptor® EF Sizing Report

Imbrium® Systems

ESTIMATED NET ANNUAL SEDIMENT (TSS) LOAD REDUCTION

09/18/2023

Province:	Ontario
City:	Ottawa
Nearest Rainfall Station:	OTTAWA CDA RCS
Climate Station Id:	6105978
Years of Rainfall Data:	20

Project Name:	780 Baseline Phase I
Project Number:	CCO-22-0952
Designer Name:	Ryan Robineau
Designer Company:	McIntosh Perry
Designer Email:	r.robineau@mcintoshperry.com
Designer Phone:	613-714-6611
EOR Name:	
EOR Company:	
EOR Email:	
EOR Phone:	

Site Name:

Drainage Area (ha): 0.30

Runoff Coefficient 'c': 0.90

Particle Size Distribution: Fine

Target TSS Removal (%): 80.0

Required Water Quality Runoff Volume Capture (%):	90.00
Estimated Water Quality Flow Rate (L/s):	8.71
Oil / Fuel Spill Risk Site?	Yes
Upstream Flow Control?	No
Peak Conveyance (maximum) Flow Rate (L/s):	135.80
Influent TSS Concentration (mg/L):	100
Estimated Average Annual Sediment Load (kg/yr):	169
Estimated Average Annual Sediment Volume (L/yr):	138

Net Annual Sediment (TSS) Load Reduction Sizing Summary	
Stormceptor Model	TSS Removal Provided (%)
EFO4	90
EFO6	96
EFO8	99
EFO10	100
EFO12	100

Recommended Stormceptor EFO Model:	EFO4
Estimated Net Annual Sediment (TSS) Load Reduction (%):	90
Water Quality Runoff Volume Capture (%):	> 90

THIRD-PARTY TESTING AND VERIFICATION

► **Stormceptor® EF and Stormceptor® EFO** are the latest evolutions in the Stormceptor® oil-grit separator (OGS) technology series, and are designed to remove a wide variety of pollutants from stormwater and snowmelt runoff. These technologies have been third-party tested in accordance with the Canadian ETV **Procedure for Laboratory Testing of Oil-Grit Separators** and performance has been third-party verified in accordance with the **ISO 14034 Environmental Technology Verification (ETV)** protocol.

PERFORMANCE

► **Stormceptor® EF and EFO** remove stormwater pollutants through gravity separation and floatation, and feature a patent-pending design that generates positive removal of total suspended solids (TSS) throughout each storm event, including high-intensity storms. Captured pollutants include sediment, free oils, and sediment-bound pollutants such as nutrients, heavy metals, and petroleum hydrocarbons. Stormceptor is sized to remove a high level of TSS from the frequent rainfall events that contribute the vast majority of annual runoff volume and pollutant load. The technology incorporates an internal bypass to convey excessive stormwater flows from high-intensity storms through the device without resuspension and washout (scour) of previously captured pollutants. Proper routine maintenance ensures high pollutant removal performance and protection of downstream waterways.

PARTICLE SIZE DISTRIBUTION (PSD)

► The **Canadian ETV PSD** shown in the table below was used, or in part, for this sizing. This is the identical PSD that is referenced in the Canadian ETV **Procedure for Laboratory Testing of Oil-Grit Separators** for both sediment removal testing and scour testing. The Canadian ETV PSD contains a wide range of particle sizes in the sand and silt fractions, and is considered reasonably representative of the particle size fractions found in typical urban stormwater runoff.

Particle Size (µm)	Percent Less Than	Particle Size Fraction (µm)	Percent
1000	100	500-1000	5
500	95	250-500	5
250	90	150-250	15
150	75	100-150	15
100	60	75-100	10
75	50	50-75	5
50	45	20-50	10
20	35	8-20	15
8	20	5-8	10
5	10	2-5	5
2	5	<2	5

Stormceptor® EF Sizing Report

Rainfall Intensity (mm / hr)	Percent Rainfall Volume (%)	Cumulative Rainfall Volume (%)	Flow Rate (L/s)	Flow Rate (L/min)	Surface Loading Rate (L/min/m ²)	Removal Efficiency (%)	Incremental Removal (%)	Cumulative Removal (%)
0.50	8.6	8.6	0.38	23.0	19.0	100	8.6	8.6
1.00	20.3	29.0	0.75	45.0	38.0	100	20.3	29.0
2.00	16.2	45.2	1.50	90.0	75.0	100	16.2	45.2
3.00	12.0	57.2	2.25	135.0	113.0	95	11.4	56.5
4.00	8.4	65.6	3.00	180.0	150.0	89	7.6	64.1
5.00	5.9	71.6	3.75	225.0	188.0	86	5.1	69.2
6.00	4.6	76.2	4.50	270.0	225.0	82	3.8	73.0
7.00	3.1	79.3	5.25	315.0	263.0	80	2.5	75.4
8.00	2.7	82.0	6.00	360.0	300.0	78	2.2	77.6
9.00	3.3	85.3	6.76	405.0	338.0	77	2.6	80.2
10.00	2.3	87.6	7.51	450.0	375.0	75	1.7	81.9
11.00	1.6	89.2	8.26	495.0	413.0	73	1.1	83.0
12.00	1.3	90.5	9.01	540.0	450.0	72	0.9	84.0
13.00	1.7	92.2	9.76	585.0	488.0	70	1.2	85.2
14.00	1.2	93.5	10.51	631.0	525.0	68	0.8	86.0
15.00	1.2	94.6	11.26	676.0	563.0	66	0.8	86.8
16.00	0.7	95.3	12.01	721.0	600.0	65	0.5	87.2
17.00	0.7	96.1	12.76	766.0	638.0	64	0.5	87.7
18.00	0.4	96.5	13.51	811.0	676.0	64	0.3	88.0
19.00	0.4	96.9	14.26	856.0	713.0	64	0.3	88.2
20.00	0.2	97.1	15.01	901.0	751.0	63	0.1	88.4
21.00	0.5	97.5	15.76	946.0	788.0	63	0.3	88.7
22.00	0.2	97.8	16.51	991.0	826.0	63	0.2	88.8
23.00	1.0	98.8	17.26	1036.0	863.0	63	0.6	89.5
24.00	0.3	99.1	18.01	1081.0	901.0	62	0.2	89.6
25.00	0.0	99.1	18.77	1126.0	938.0	62	0.0	89.6
30.00	0.9	100.0	22.52	1351.0	1126.0	59	0.6	90.2
35.00	0.0	100.0	26.27	1576.0	1314.0	54	0.0	90.2
40.00	0.0	100.0	30.02	1801.0	1501.0	49	0.0	90.2
45.00	0.0	100.0	33.78	2027.0	1689.0	44	0.0	90.2
Estimated Net Annual Sediment (TSS) Load Reduction =								90 %

Climate Station ID: 6105978 Years of Rainfall Data: 20

Stormceptor® EF Sizing Report

RAINFALL DATA FROM OTTAWA CDA RCS RAINFALL STATION

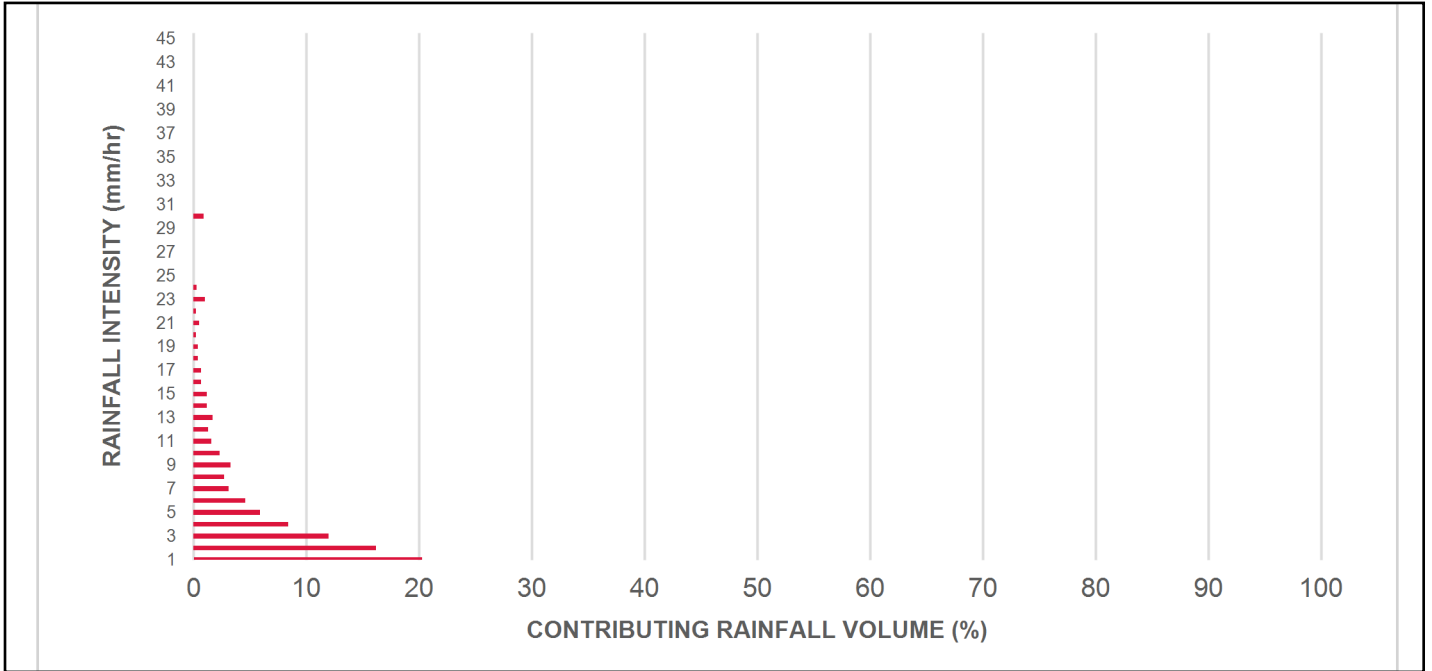

INCREMENTAL AND CUMULATIVE TSS REMOVAL FOR THE RECOMMENDED STORMCEPTOR® MODEL

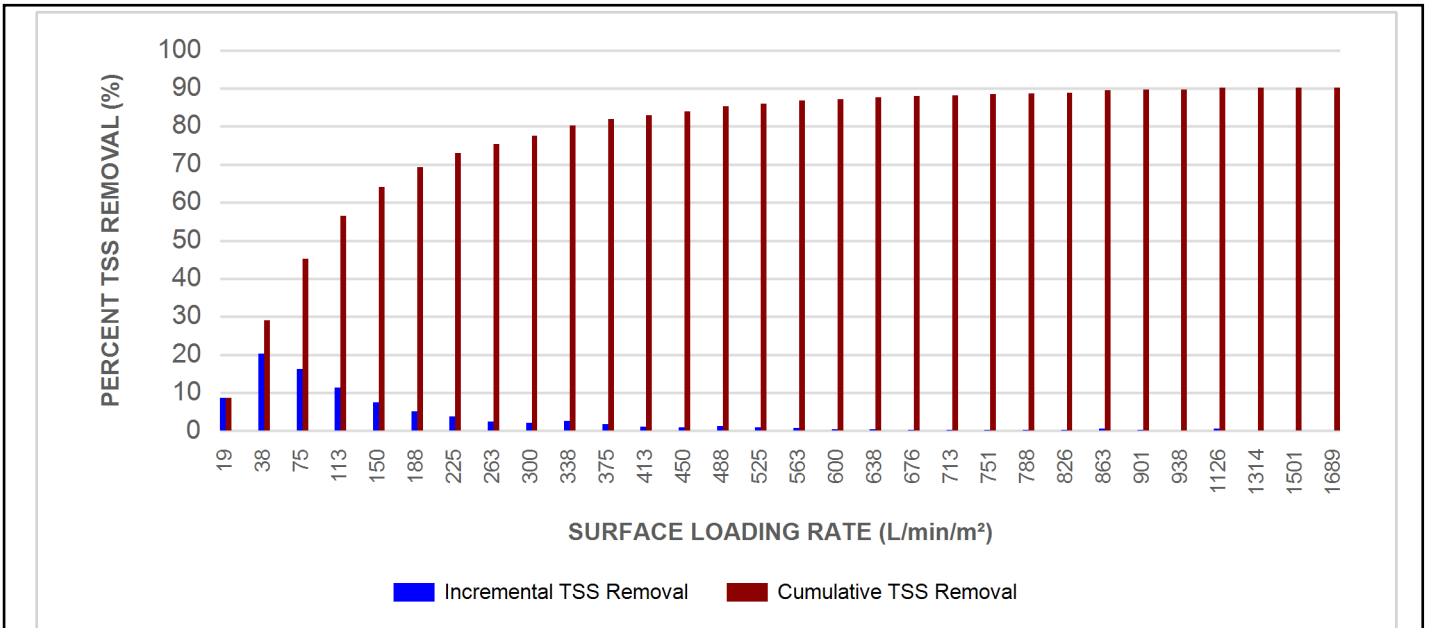

Stormceptor® EF Sizing Report

Maximum Pipe Diameter / Peak Conveyance

Stormceptor EF / EFO	Model Diameter		Min Angle Inlet / Outlet Pipes	Max Inlet Pipe Diameter		Max Outlet Pipe Diameter		Peak Conveyance Flow Rate	
	(m)	(ft)		(mm)	(in)	(mm)	(in)	(L/s)	(cfs)
EF4 / EFO4	1.2	4	90	609	24	609	24	425	15
EF6 / EFO6	1.8	6	90	914	36	914	36	990	35
EF8 / EFO8	2.4	8	90	1219	48	1219	48	1700	60
EF10 / EFO10	3.0	10	90	1828	72	1828	72	2830	100
EF12 / EFO12	3.6	12	90	1828	72	1828	72	2830	100

SCOUR PREVENTION AND ONLINE CONFIGURATION

► Stormceptor® EF and EFO feature an internal bypass and superior scour prevention technology that have been demonstrated in third-party testing according to the scour testing provisions of the Canadian ETV **Procedure for Laboratory Testing of Oil-Grit Separators**, and the exceptional scour test performance has been third-party verified in accordance with the ISO 14034 ETV protocol. As a result, Stormceptor EF and EFO are approved for online installation, eliminating the need for costly additional bypass structures, piping, and installation expense.

DESIGN FLEXIBILITY

► Stormceptor® EF and EFO offers design flexibility in one simplified platform, accepting stormwater flow from a single inlet pipe or multiple inlet pipes, and/or surface runoff through an inlet grate. The device can also serve as a junction structure, accommodate a 90-degree inlet-to-outlet bend angle, and can be modified to ensure performance in submerged conditions.

OIL CAPTURE AND RETENTION

► While Stormceptor® EF will capture and retain oil from dry weather spills and low intensity runoff, Stormceptor® EFO has demonstrated superior oil capture and greater than 99% oil retention in third-party testing according to the light liquid re-entrainment testing provisions of the Canadian ETV **Procedure for Laboratory Testing of Oil-Grit Separators**. Stormceptor EFO is recommended for sites where oil capture and retention is a requirement.

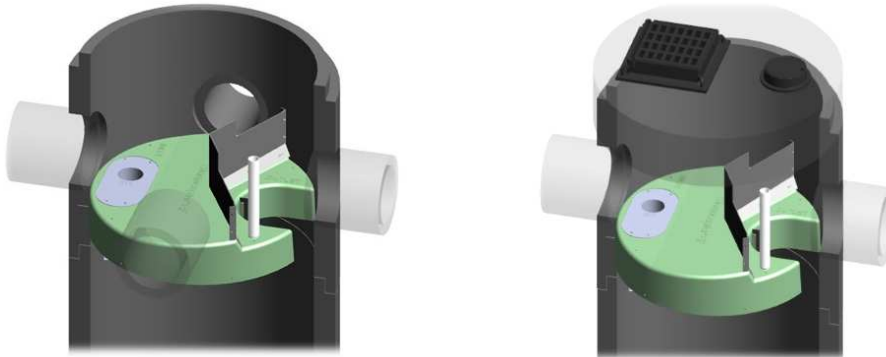

Stormceptor® EF Sizing Report

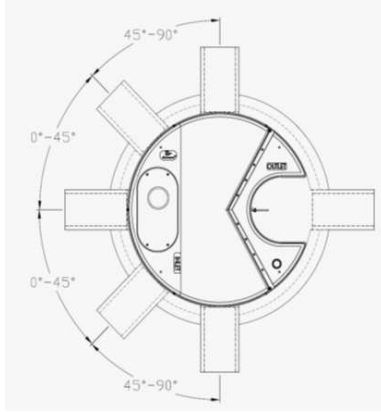

INLET-TO-OUTLET DROP

Elevation differential between inlet and outlet pipe inverts is dictated by the angle at which the inlet pipe(s) enters the unit.

0° - 45° : The inlet pipe is 1-inch (25mm) higher than the outlet pipe.

45° - 90° : The inlet pipe is 2-inches (50mm) higher than the outlet pipe.

HEAD LOSS

The head loss through Stormceptor EF is similar to that of a 60-degree bend structure. The applicable K value for calculating minor losses through the unit is 1.1. For submerged conditions the applicable K value is 3.0.

Pollutant Capacity

Stormceptor EF / EFO	Model Diameter		Depth (Outlet Pipe Invert to Sump Floor)		Oil Volume		Recommended Sediment Maintenance Depth *		Maximum Sediment Volume *		Maximum Sediment Mass **	
	(m)	(ft)	(m)	(ft)	(L)	(Gal)	(mm)	(in)	(L)	(ft³)	(kg)	(lb)
EF4 / EFO4	1.2	4	1.52	5.0	265	70	203	8	1190	42	1904	5250
EF6 / EFO6	1.8	6	1.93	6.3	610	160	305	12	3470	123	5552	15375
EF8 / EFO8	2.4	8	2.59	8.5	1070	280	610	24	8780	310	14048	38750
EF10 / EFO10	3.0	10	3.25	10.7	1670	440	610	24	17790	628	28464	78500
EF12 / EFO12	3.6	12	3.89	12.8	2475	655	610	24	31220	1103	49952	137875

*Increased sump depth may be added to increase sediment storage capacity

** Average density of wet packed sediment in sump = 1.6 kg/L (100 lb/ft³)

Feature	Benefit	Feature Appeals To
Patent-pending enhanced flow treatment and scour prevention technology	Superior, verified third-party performance	Regulator, Specifying & Design Engineer
Third-party verified light liquid capture and retention for EFO version	Proven performance for fuel/oil hotspot locations	Regulator, Specifying & Design Engineer, Site Owner
Functions as bend, junction or inlet structure	Design flexibility	Specifying & Design Engineer
Minimal drop between inlet and outlet	Site installation ease	Contractor
Large diameter outlet riser for inspection and maintenance	Easy maintenance access from grade	Maintenance Contractor & Site Owner

STANDARD STORMCEPTOR EF/EFO DRAWINGS

For standard details, please visit <http://www.imbriumsystems.com/stormwater-treatment-solutions/stormceptor-ef>

STANDARD STORMCEPTOR EF/EFO SPECIFICATION

For specifications, please visit <http://www.imbriumsystems.com/stormwater-treatment-solutions/stormceptor-ef>

STANDARD PERFORMANCE SPECIFICATION FOR “OIL GRIT SEPARATOR” (OGS) STORMWATER QUALITY TREATMENT DEVICE

PART 1 – GENERAL

1.1 WORK INCLUDED

This section specifies requirements for selecting, sizing, and designing an underground Oil Grit Separator (OGS) device for stormwater quality treatment, with third-party testing results and a Statement of Verification in accordance with ISO 14034 Environmental Management – Environmental Technology Verification (ETV).

1.2 REFERENCE STANDARDS & PROCEDURES

ISO 14034:2016 Environmental management – Environmental technology verification (ETV)

Canadian Environmental Technology Verification (ETV) Program’s **Procedure for Laboratory Testing of Oil-Grit Separators**

1.3 SUBMITTALS

1.3.1 All submittals, including sizing reports & shop drawings, shall be submitted upon request with each order to the contractor then forwarded to the Engineer of Record for review and acceptance. Shop drawings shall detail all OGS components, elevations, and sequence of construction.

1.3.2 Alternative devices shall have features identical to or greater than the specified device, including: treatment chamber diameter, treatment chamber wet volume, sediment storage volume, and oil storage volume.

1.3.3 Unless directed otherwise by the Engineer of Record, OGS stormwater quality treatment product substitutions or alternatives submitted within ten days prior to project bid shall not be accepted. All alternatives or substitutions submitted shall be signed and sealed by a local registered Professional Engineer, based on the exact same criteria detailed in Section 3, in entirety, subject to review and approval by the Engineer of Record.

PART 2 – PRODUCTS

2.1 OGS POLLUTANT STORAGE

The OGS device shall include a sump for sediment storage, and a protected volume for the capture and storage of petroleum hydrocarbons and buoyant gross pollutants. The minimum sediment & petroleum hydrocarbon storage capacity shall be as follows:

2.1.1	4 ft (1219 mm) Diameter OGS Units:	1.19 m ³ sediment / 265 L oil
	6 ft (1829 mm) Diameter OGS Units:	3.48 m ³ sediment / 609 L oil
	8 ft (2438 mm) Diameter OGS Units:	8.78 m ³ sediment / 1,071 L oil
	10 ft (3048 mm) Diameter OGS Units:	17.78 m ³ sediment / 1,673 L oil
	12 ft (3657 mm) Diameter OGS Units:	31.23 m ³ sediment / 2,476 L oil

PART 3 – PERFORMANCE & DESIGN

3.1 GENERAL

The OGS stormwater quality treatment device shall be verified in accordance with ISO 14034:2016 Environmental management – Environmental technology verification (ETV). The OGS stormwater quality treatment device shall

Stormceptor® EF Sizing Report

remove oil, sediment and gross pollutants from stormwater runoff during frequent wet weather events, and retain these pollutants during less frequent high flow wet weather events below the insert within the OGS for later removal during maintenance. The Manufacturer shall have at least ten (10) years of local experience, history and success in engineering design, manufacturing and production and supply of OGS stormwater quality treatment device systems, acceptable to the Engineer of Record.

3.2 SIZING METHODOLOGY

The OGS device shall be engineered, designed and sized to provide stormwater quality treatment based on treating a minimum of 90 percent of the average annual runoff volume and a minimum removal of an annual average 60% of the sediment (TSS) load based on the Particle Size Distribution (PSD) specified in the sizing report for the specified device. Sizing of the OGS shall be determined by use of a minimum ten (10) years of local historical rainfall data provided by Environment Canada. Sizing shall also be determined by use of the sediment removal performance data derived from the ISO 14034 ETV third-party verified laboratory testing data from testing conducted in accordance with the Canadian ETV protocol Procedure for Laboratory Testing of Oil-Grit Separators, as follows:

3.2.1 Sediment removal efficiency for a given surface loading rate and its associated flow rate shall be based on sediment removal efficiency demonstrated at the seven (7) tested surface loading rates specified in the protocol, ranging 40 L/min/m² to 1400 L/min/m², and as stated in the ISO 14034 ETV Verification Statement for the OGS device.

3.2.2 Sediment removal efficiency for surface loading rates between 40 L/min/m² and 1400 L/min/m² shall be based on linear interpolation of data between consecutive tested surface loading rates.

3.2.3 Sediment removal efficiency for surface loading rates less than the lowest tested surface loading rate of 40 L/min/m² shall be assumed to be identical to the sediment removal efficiency at 40 L/min/m². No extrapolation shall be allowed that results in a sediment removal efficiency that is greater than that demonstrated at 40 L/min/m².

3.2.4 Sediment removal efficiency for surface loading rates greater than the highest tested surface loading rate of 1400 L/min/m² shall assume zero sediment removal for the portion of flow that exceeds 1400 L/min/m², and shall be calculated using a simple proportioning formula, with 1400 L/min/m² in the numerator and the higher surface loading rate in the denominator, and multiplying the resulting fraction times the sediment removal efficiency at 1400 L/min/m².

The OGS device shall also have sufficient annual sediment storage capacity as specified and calculated in Section 2.1.

3.3 CANADIAN ETV or ISO 14034 ETV VERIFICATION OF SCOUR TESTING

The OGS device shall have Canadian ETV or ISO 14034 ETV Verification of third-party scour testing conducted in accordance with the Canadian ETV Program's **Procedure for Laboratory Testing of Oil-Grit Separators**.

3.3.1 To be acceptable for on-line installation, the OGS device must demonstrate an average scour test effluent concentration less than 10 mg/L at each surface loading rate tested, up to and including 2600 L/min/m².

3.4 LIGHT LIQUID RE-ENTRAINMENT SIMULATION TESTING

The OGS device shall have Canadian ETV or ISO 14034 ETV Verification of completed third-party Light Liquid Re-entrainment Simulation Testing in accordance with the Canadian ETV **Program's Procedure for Laboratory Testing of Oil-Grit Separators**, with results reported within the Canadian ETV or ISO 14034 ETV verification. This re-entrainment testing is conducted with the device pre-loaded with low density polyethylene (LDPE) plastic beads as a surrogate for light liquids such as oil and fuel. Testing is conducted on the same OGS unit tested for sediment removal to

Stormceptor® EF Sizing Report

assess whether light liquids captured after a spill are effectively retained at high flow rates.

3.4.1 For an OGS device to be an acceptable stormwater treatment device on a site where vehicular traffic occurs and the potential for an oil or fuel spill exists, the OGS device must have reported verified performance results of greater than 99% cumulative retention of LDPE plastic beads for the five specified surface loading rates (ranging 200 L/min/m² to 2600 L/min/m²) in accordance with the Light Liquid Re-entrainment Simulation Testing within the Canadian ETV Program's **Procedure for Laboratory Testing of Oil-Grit Separators**. However, an OGS device shall not be allowed if the Light Liquid Re-entrainment Simulation Testing was performed with screening components within the OGS device that are effective at retaining the LDPE plastic beads, but would not be expected to retain light liquids such as oil and fuel.

**APPENDIX H
CITY OF OTTAWA DESIGN CHECKLIST**

City of Ottawa

4. Development Servicing Study Checklist

The following section describes the checklist of the required content of servicing studies. It is expected that the proponent will address each one of the following items for the study to be deemed complete and ready for review by City of Ottawa Infrastructure Approvals staff.

The level of required detail in the Servicing Study will increase depending on the type of application. For example, for Official Plan amendments and re-zoning applications, the main issues will be to determine the capacity requirements for the proposed change in land use and confirm this against the existing capacity constraint, and to define the solutions, phasing of works and the financing of works to address the capacity constraint. For subdivisions and site plans, the above will be required with additional detailed information supporting the servicing within the development boundary.

4.1 General Content

Criteria	Location (if applicable)
<input type="checkbox"/> Executive Summary (for larger reports only).	N/A
<input type="checkbox"/> Date and revision number of the report.	On Cover
<input type="checkbox"/> Location map and plan showing municipal address, boundary, and layout of proposed development.	Appendix A
<input type="checkbox"/> Plan showing the site and location of all existing services.	N/A
<input type="checkbox"/> Development statistics, land use, density, adherence to zoning and official plan, and reference to applicable subwatershed and watershed plans that provide context to which individual developments must adhere.	1.1 Purpose 1.2 Site Description 6.0 Stormwater Management
<input type="checkbox"/> Summary of pre-consultation meetings with City and other approval agencies.	Appendix B
<input type="checkbox"/> Reference and confirm conformance to higher level studies and reports (Master Servicing Studies, Environmental Assessments, Community Design Plans), or in the case where it is not in conformance, the proponent must provide justification and develop a defensible design criteria.	1.1 Purpose 1.2 Site Description 6.0 Stormwater Management
<input type="checkbox"/> Statement of objectives and servicing criteria.	3.0 Pre-Consultation Summary

<input type="checkbox"/> Identification of existing and proposed infrastructure available in the immediate area.	N/A
<input type="checkbox"/> Identification of Environmentally Significant Areas, watercourses and Municipal Drains potentially impacted by the proposed development (Reference can be made to the Natural Heritage Studies, if available).	N/A
<input type="checkbox"/> Concept level master grading plan to confirm existing and proposed grades in the development. This is required to confirm the feasibility of proposed stormwater management and drainage, soil removal and fill constraints, and potential impacts to neighbouring properties. This is also required to confirm that the proposed grading will not impede existing major system flow paths.	N/A
<input type="checkbox"/> Identification of potential impacts of proposed piped services on private services (such as wells and septic fields on adjacent lands) and mitigation required to address potential impacts.	N/A
<input type="checkbox"/> Proposed phasing of the development, if applicable.	N/A
<input type="checkbox"/> Reference to geotechnical studies and recommendations concerning servicing.	Section 2.0 Background Studies, Standards and References
<input type="checkbox"/> All preliminary and formal site plan submissions should have the following information: <ul style="list-style-type: none"> ○ Metric scale ○ North arrow (including construction North) ○ Key plan ○ Name and contact information of applicant and property owner ○ Property limits including bearings and dimensions ○ Existing and proposed structures and parking areas ○ Easements, road widening and rights-of-way ○ Adjacent street names 	N/A

4.2 Development Servicing Report: Water

Criteria	Location (if applicable)
<input type="checkbox"/> Confirm consistency with Master Servicing Study, if available	N/A
<input type="checkbox"/> Availability of public infrastructure to service proposed development	N/A
<input type="checkbox"/> Identification of system constraints	N/A
<input type="checkbox"/> Identify boundary conditions	Appendix C
<input type="checkbox"/> Confirmation of adequate domestic supply and pressure	N/A
<input type="checkbox"/> Confirmation of adequate fire flow protection and confirmation that fire flow is calculated as per the Fire Underwriter’s Survey. Output should show available fire flow at locations throughout the development.	Appendix C
<input type="checkbox"/> Provide a check of high pressures. If pressure is found to be high, an assessment is required to confirm the application of pressure reducing valves.	N/A
<input type="checkbox"/> Definition of phasing constraints. Hydraulic modeling is required to confirm servicing for all defined phases of the project including the ultimate design	N/A
<input type="checkbox"/> Address reliability requirements such as appropriate location of shut-off valves	N/A
<input type="checkbox"/> Check on the necessity of a pressure zone boundary modification.	N/A
<input type="checkbox"/> Reference to water supply analysis to show that major infrastructure is capable of delivering sufficient water for the proposed land use. This includes data that shows that the expected demands under average day, peak hour and fire flow conditions provide water within the required pressure range	Appendix C, Section 4.2

<input type="checkbox"/> Description of the proposed water distribution network, including locations of proposed connections to the existing system, provisions for necessary looping, and appurtenances (valves, pressure reducing valves, valve chambers, and fire hydrants) including special metering provisions.	N/A
<input type="checkbox"/> Description of off-site required feeder mains, booster pumping stations, and other water infrastructure that will be ultimately required to service proposed development, including financing, interim facilities, and timing of implementation.	N/A
<input type="checkbox"/> Confirmation that water demands are calculated based on the City of Ottawa Design Guidelines.	Appendix C
<input type="checkbox"/> Provision of a model schematic showing the boundary conditions locations, streets, parcels, and building locations for reference.	N/A

4.3 Development Servicing Report: Wastewater

Criteria	Location (if applicable)
<input type="checkbox"/> Summary of proposed design criteria (Note: Wet-weather flow criteria should not deviate from the City of Ottawa Sewer Design Guidelines. Monitored flow data from relatively new infrastructure cannot be used to justify capacity requirements for proposed infrastructure).	N/A
<input type="checkbox"/> Confirm consistency with Master Servicing Study and/or justifications for deviations.	N/A
<input type="checkbox"/> Consideration of local conditions that may contribute to extraneous flows that are higher than the recommended flows in the guidelines. This includes groundwater and soil conditions, and age and condition of sewers.	N/A
<input type="checkbox"/> Description of existing sanitary sewer available for discharge of wastewater from proposed development.	Section 5.2 Proposed Sanitary Sewer

<input type="checkbox"/> Verify available capacity in downstream sanitary sewer and/or identification of upgrades necessary to service the proposed development. (Reference can be made to previously completed Master Servicing Study if applicable)	Section 5.3 Proposed Sanitary Design
<input type="checkbox"/> Calculations related to dry-weather and wet-weather flow rates from the development in standard MOE sanitary sewer design table (Appendix 'C') format.	N/A
<input type="checkbox"/> Description of proposed sewer network including sewers, pumping stations, and forcemains.	Section 5.2 Proposed Sanitary Sewer
<input type="checkbox"/> Discussion of previously identified environmental constraints and impact on servicing (environmental constraints are related to limitations imposed on the development in order to preserve the physical condition of watercourses, vegetation, soil cover, as well as protecting against water quantity and quality).	N/A
<input type="checkbox"/> Pumping stations: impacts of proposed development on existing pumping stations or requirements for new pumping station to service development.	N/A
<input type="checkbox"/> Forcemain capacity in terms of operational redundancy, surge pressure and maximum flow velocity.	N/A
<input type="checkbox"/> Identification and implementation of the emergency overflow from sanitary pumping stations in relation to the hydraulic grade line to protect against basement flooding.	N/A
<input type="checkbox"/> Special considerations such as contamination, corrosive environment etc.	N/A

4.4 Development Servicing Report: Stormwater Checklist

Criteria	Location (if applicable)
<input type="checkbox"/> Description of drainage outlets and downstream constraints including legality of outlets (i.e. municipal drain, right-of-way, watercourse, or private property)	Section 6.0 Stormwater Sewer Design & Section 7.0 Proposed Stormwater Management
<input type="checkbox"/> Analysis of available capacity in existing public infrastructure.	N/A
<input type="checkbox"/> A drawing showing the subject lands, its surroundings, the receiving watercourse, existing drainage patterns, and proposed drainage pattern.	N/A
<input type="checkbox"/> Water quantity control objective (e.g. controlling post-development peak flows to pre-development level for storm events ranging from the 2 or 5-year event (dependent on the receiving sewer design) to 100-year return period); if other objectives are being applied, a rationale must be included with reference to hydrologic analyses of the potentially affected subwatersheds, taking into account long-term cumulative effects.	Section 6.0 Stormwater Sewer Design & Section 7.0 Proposed Stormwater Management
<input type="checkbox"/> Water Quality control objective (basic, normal or enhanced level of protection based on the sensitivities of the receiving watercourse) and storage requirements.	Section 6.0 Stormwater Sewer Design & Section 7.0 Proposed Stormwater Management
<input type="checkbox"/> Description of the stormwater management concept with facility locations and descriptions with references and supporting information.	Section 6.0 Stormwater Sewer Design & Section 7.0 Proposed Stormwater Management
<input type="checkbox"/> Set-back from private sewage disposal systems.	N/A
<input type="checkbox"/> Watercourse and hazard lands setbacks.	N/A
<input type="checkbox"/> Record of pre-consultation with the Ontario Ministry of Environment and the Conservation Authority that has jurisdiction on the affected watershed.	N/A
<input type="checkbox"/> Confirm consistency with sub-watershed and Master Servicing Study, if applicable study exists.	N/A
<input type="checkbox"/> Storage requirements (complete with calculations) and conveyance capacity for minor events (1:5-year return period) and major events (1:100-year return period).	Appendix G

<input type="checkbox"/> Identification of watercourses within the proposed development and how watercourses will be protected, or, if necessary, altered by the proposed development with applicable approvals.	N/A
<input type="checkbox"/> Calculate pre-and post development peak flow rates including a description of existing site conditions and proposed impervious areas and drainage catchments in comparison to existing conditions.	Section 7.0 Proposed Stormwater Management Appendix G
<input type="checkbox"/> Any proposed diversion of drainage catchment areas from one outlet to another.	Section 6.0 Stormwater Sewer Design & Section 7.0 Proposed Stormwater Management
<input type="checkbox"/> Proposed minor and major systems including locations and sizes of stormwater trunk sewers, and stormwater management facilities.	Section 6.0 Stormwater Sewer Design & Section 7.0 Proposed Stormwater Management
<input type="checkbox"/> If quantity control is not proposed, demonstration that downstream system has adequate capacity for the post-development flows up to and including the 100-year return period storm event.	N/A
<input type="checkbox"/> Identification of potential impacts to receiving watercourses	N/A
<input type="checkbox"/> Identification of municipal drains and related approval requirements.	N/A
<input type="checkbox"/> Descriptions of how the conveyance and storage capacity will be achieved for the development.	Section 6.0 Stormwater Sewer Design & Section 7.0 Proposed Stormwater Management
<input type="checkbox"/> 100-year flood levels and major flow routing to protect proposed development from flooding for establishing minimum building elevations (MBE) and overall grading.	N/A
<input type="checkbox"/> Inclusion of hydraulic analysis including hydraulic grade line elevations.	N/A

<input type="checkbox"/> Description of approach to erosion and sediment control during construction for the protection of receiving watercourse or drainage corridors.	N/A
<input type="checkbox"/> Identification of floodplains – proponent to obtain relevant floodplain information from the appropriate Conservation Authority. The proponent may be required to delineate floodplain elevations to the satisfaction of the Conservation Authority if such information is not available or if information does not match current conditions.	N/A
<input type="checkbox"/> Identification of fill constraints related to floodplain and geotechnical investigation.	N/A

4.5 Approval and Permit Requirements: Checklist

The Servicing Study shall provide a list of applicable permits and regulatory approvals necessary for the proposed development as well as the relevant issues affecting each approval. The approval and permitting shall include but not be limited to the following:

Criteria	Location (if applicable)
<input type="checkbox"/> Conservation Authority as the designated approval agency for modification of floodplain, potential impact on fish habitat, proposed works in or adjacent to a watercourse, cut/fill permits and Approval under Lakes and Rivers Improvement Act. The Conservation Authority is not the approval authority for the Lakes and Rivers Improvement Act. Where there are Conservation Authority regulations in place, approval under the Lakes and Rivers Improvement Act is not required, except in cases of dams as defined in the Act.	N/A
<input type="checkbox"/> Application for Certificate of Approval (CofA) under the Ontario Water Resources Act.	N/A
<input type="checkbox"/> Changes to Municipal Drains.	N/A
<input type="checkbox"/> Other permits (National Capital Commission, Parks Canada, Public Works and Government Services Canada, Ministry of Transportation etc.)	N/A

4.6 Conclusion Checklist

Criteria	Location (if applicable)
<input type="checkbox"/> Clearly stated conclusions and recommendations	Section 8.0 Summary Section 9.0 Recommendations
<input type="checkbox"/> Comments received from review agencies including the City of Ottawa and information on how the comments were addressed. Final sign-off from the responsible reviewing agency.	All are stamped
<input type="checkbox"/> All draft and final reports shall be signed and stamped by a professional Engineer registered in Ontario	All are stamped