



**47 BEECHWOOD AVENUE SERVICING
AND STORMWATER MANAGEMENT
REPORT**

September 18, 2024

Prepared for:
2317916 Ontario Inc.

Prepared by:
Stantec Consulting Ltd.

Project Number:
160401786

47 Beechwood Avenue Servicing and Stormwater Management Report

Revision	Description	Author	Date	Quality Check	Date	Independent Review	Date
0	Issued for SPA	MW	2023-05-15	TM	2023-05-16	KK	2023-05-16
1	Revised as per city comments	WJ	2024-05-27	DT	2024-05-24	KK	2024-05-17
2	Revised as per city comments	WJ	2024-08-13	DT	2024-08-13	KK	2024-08-13
3	Revised Road Geometry	WJ	2024-09-18	DT	2024-09-18	KK	2024-09-18



47 Beechwood Avenue Servicing and Stormwater Management Report

The conclusions in the Report titled 47 Beechwood Avenue Servicing and Stormwater Management Report are Stantec's professional opinion, as of the time of the Report, and concerning the scope described in the Report. The opinions in the document are based on conditions and information existing at the time the scope of work was conducted and do not take into account any subsequent changes. The Report relates solely to the specific project for which Stantec was retained and the stated purpose for which the Report was prepared. The Report is not to be used or relied on for any variation or extension of the project, or for any other project or purpose, and any unauthorized use or reliance is at the recipient's own risk.

Stantec has assumed all information received from 2317916 Ontario Inc. (the "Client") and third parties in the preparation of the Report to be correct. While Stantec has exercised a customary level of judgment or due diligence in the use of such information, Stantec assumes no responsibility for the consequences of any error or omission contained therein.

This Report is intended solely for use by the Client in accordance with Stantec's contract with the Client. While the Report may be provided by the Client to applicable authorities having jurisdiction and to other third parties in connection with the project, Stantec disclaims any legal duty based upon warranty, reliance or any other theory to any third party, and will not be liable to such third party for any damages or losses of any kind that may result.

Prepared by: 

Signature

Warren Johnson, C.E.T.

Printed Name

Reviewed by: 

Signature

Dustin Thiffault, P.Eng

Printed Name

Approved by: 

Signature

Kris Kilborn

Table of Contents

1	INTRODUCTION	1.1
1.1	Objective.....	1.2
2	BACKGROUND.....	2.3
3	WATER SERVICING.....	3.4
3.1	Background	3.4
3.2	Water Demands.....	3.4
3.2.1	Potable (Domestic) Water Demands.....	3.4
3.2.2	Fire Flow Demands	3.5
3.3	Level of Servicing	3.5
3.3.1	Boundary Conditions	3.5
3.3.2	Allowable Domestic Pressures	3.5
3.3.3	Allowable Fire Flow Pressures	3.6
3.3.4	Fire Hydrant Coverage	3.6
3.4	Proposed Water Servicing.....	3.8
4	WASTEWATER SERVICING	4.9
4.1	Design Criteria.....	4.9
4.2	Wastewater Generation and Servicing Design	4.9
4.3	Proposed Sanitary Servicing	4.10
5	STORMWATER MANAGEMENT AND SERVICING	5.11
5.1	Objectives	5.11
5.2	Stormwater Management (SWM) Criteria	5.11
5.3	Existing Conditions	5.12
5.4	Stormwater Management Design.....	5.12
5.4.1	Allowable Release Rate	5.13
5.4.2	Quantity Control Storage Requirements	5.13
5.4.3	Quality Control.....	5.15
5.5	Proposed Stormwater Servicing.....	5.16
6	SITE GRADING.....	6.17
7	UTILITIES.....	7.18
8	APPROVALS	8.1
9	EROSION AND SEDIMENT CONTROL DURING CONSTRUCTION	2
10	GEOTECHNICAL INVESTIGATION	3
11	CONCLUSIONS	4
11.1	Water Servicing	4
11.2	Sanitary Servicing.....	4
11.3	Stormwater Servicing and Management	4
11.4	Grading	5
11.5	Erosion and Sediment Control During Construction	5
11.6	Geotechnical Investigation	5
11.7	Utilities	5
11.8	Approvals.....	5



LIST OF TABLES

Table 3-1: Estimated Water Demands 3.4
 Table 3-2: Boundary Conditions 3.5
 Table 4-1: Estimated Peak Wastewater Flow 4.9
 Table 5-1: Pre-Development Flow Rates 5.12
 Table 5-2: Summary of Subcatchment Areas 5.13
 Table 5-3: Roof Subcatchment (BLDG) Stormwater Management 5.14
 Table 5-4: Peak Post-Development Discharge Rates from Uncontrolled Areas 5.14
 Table 5-5: Subsurface Cistern Storage and Peak Release Rates 5.15
 Table 5-6: Summary of Total 2-Year and 100-Year Event Release Rates 5.15
 Table 10-1: Recommended Pavement Structure 3

LIST OF FIGURES

Figure 1-1: Key Plan of Site 1.1
 Figure 3-1: Fire Hydrant Coverage Sketch 3.7

LIST OF APPENDICES

APPENDIX A WATER DEMANDS 1
 A.1 Domestic Water Demands 1
 A.2 Fire Flow Demands (FUS 2020)..... 2
 A.3 Fire Flow Demands (OBC)..... 3
 A.4 Boundary Conditions 4
 A.5 Hydraulic Analysis 5
 A.6 Fire Hydrant Coverage Calculations 6
 A.7 Architectural Confirmations 7
APPENDIX B SITE PLAN BY PROJECT 1 STUDIOS INC. 8
APPENDIX C SANITARY 9
 C.1 Sanitary Calculation Sheet 9
 C.2 Correspondence with City on Sanitary Sewer Capacity 10
APPENDIX D STORMWATER SERVICING 11
 D.1 Modified Rational Method Sheet 11
 D.2 Watts Drainage Adjustable Accutrol Weir Detail (2016)..... 12
 D.3 Storm Sewer Design Sheet 13
 D.4 Correspondence on Douglas Avenue Storm Capacity 14
 D.5 Conceptual Roof Ponding Plan 15
APPENDIX E BACKGROUND STUDIES 16
 E.1 Geotechnical Investigation (Paterson Group, January 2023) 16
 E.2 Draft Phase One Environmental Site Assessment (Pinchin, March 2023) 17
 E.3 Topographic Survey Plan by Annis, O’Sullivan, Vollebakk Ltd. (September 9, 2021) 18
APPENDIX F PRE-CONSULTATION 19
APPENDIX G SERVICING STUDY CHECKLIST 20
APPENDIX H DRAWINGS 21



1 Introduction

Stantec Consulting Ltd. has been commissioned by 2317916 Ontario Inc. to prepare the following Servicing and Stormwater Management Report in support of a Site Plan Control – Complex and Zoning By-Law Amendment application for the proposed development located at 47 Beechwood Avenue in the City of Ottawa.

The 0.215 ha site is situated along the north side of Beechwood Avenue, between the intersections with Springfield Road and Douglas Avenue. The site is currently zoned TM8 and contains four existing two-storey mixed-use buildings with surface parking. The site is bounded by Beechwood Avenue and existing commercial developments to the south, Douglas Avenue to the east, Springfield Avenue to the west, and existing residential developments to the north, as shown in **Figure 1-1** below.

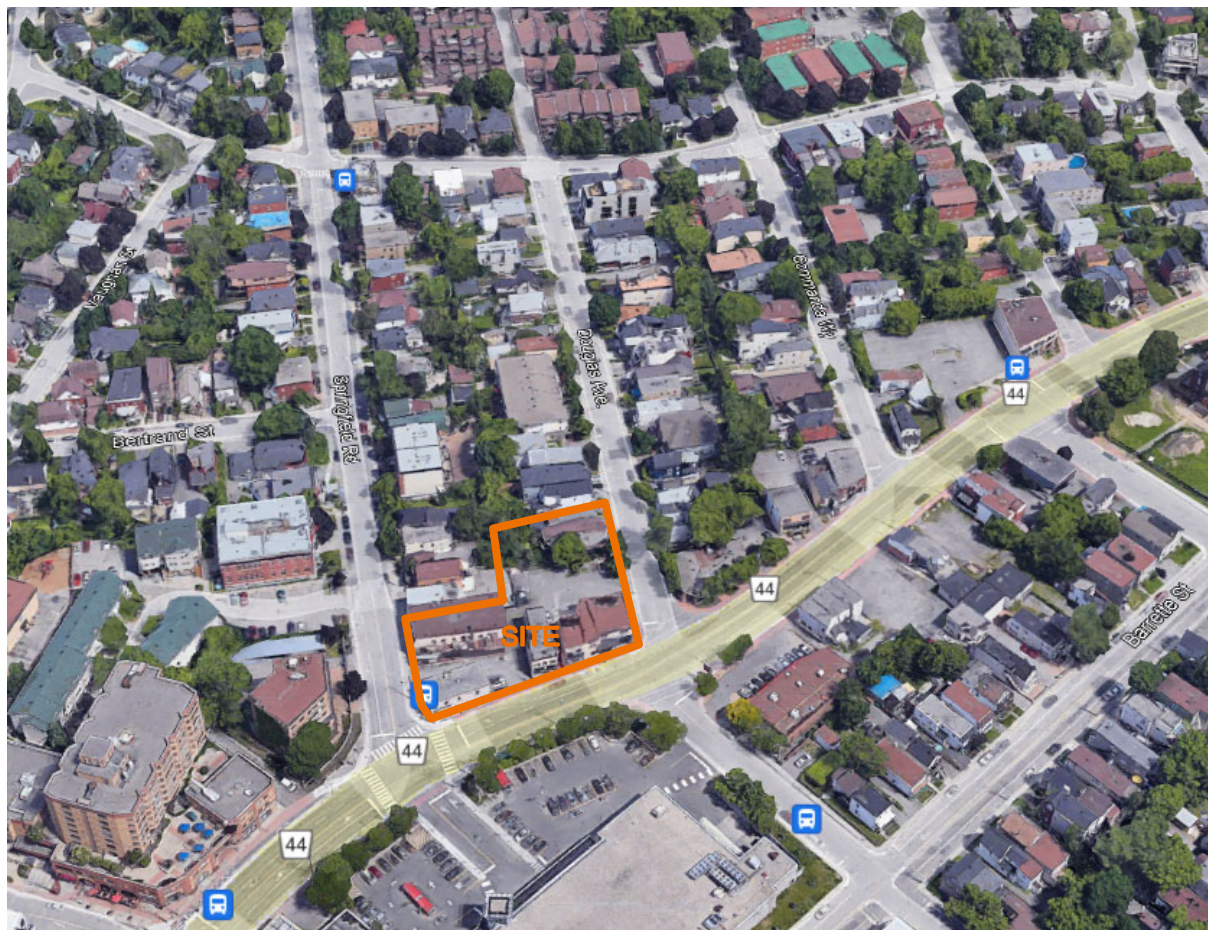

Figure 1-1: Key Plan of Site

The proposed development is an eight-storey mixed-use building, consisting of 123 residential units and 551 m² of commercial space. The proposed building will include thirty-one (31) studio apartments, twenty-



47 Beechwood Avenue Servicing and Stormwater Management Report

nine (29) one-bedroom units, twenty-one (21) one-bedroom units with dens, and forty-two (42) two-bedroom units. Project 1 Studios Inc. has prepared a site plan dated April 30, 2024, which defines the proposed development (see **Appendix B**).

1.1 Objective

This site servicing and stormwater management (SWM) report presents a servicing scheme that is free of conflicts, provides on-site servicing in accordance with City of Ottawa Design Guidelines, and uses the existing municipal infrastructure in accordance with any limitations communicated during consultation with City of Ottawa staff. Details of the existing infrastructure located within Beechwood Avenue, Douglas Avenue, and Springfield Road rights-of-way (ROW) were obtained from available as-built drawings and site topographic survey (see **Appendix E.2**).

Criteria and constraints provided by the City of Ottawa have been used as a basis for the detailed servicing design of the proposed development. Specific and potential development constraints to be addressed are as follows:

- Potable Water Servicing
 - Estimated water demands to characterize the proposed feed(s) for the proposed development which will be serviced from the 305 mm diameter watermain within the Springfield Road ROW.
 - Watermain servicing for the development is to be able to provide average day and maximum day (including peak hour) demands (i.e., non-emergency conditions) at pressures within the acceptable range of 345 to 552 kPa (50 to 80 psi)
 - Under fire flow (emergency) conditions, the water distribution system is to maintain a minimum pressure greater than 140 kPa (20 psi)
- Wastewater (Sanitary) Servicing
 - Define and size the sanitary service lateral which will be connected to the existing 250 mm diameter sanitary sewer within the Douglas Avenue ROW.
- Storm Sewer Servicing
 - Define major and minor conveyance systems in conjunction with the proposed grading plan.
 - Determine the stormwater management storage requirements to meet the allowable release rate for the site.
 - Define and size the proposed storm service lateral that will be connected to the existing 375 mm diameter municipal storm sewer within the Douglas Avenue ROW.
- Prepare a grading plan in accordance with the proposed site plan and existing grades.

The accompanying drawings included in **Appendix H** of this report illustrate the proposed internal servicing scheme for the site.



2 Background

Documents referenced in preparing of this stormwater and servicing report for the 47 Beechwood Avenue development include:

- *City of Ottawa Sewer Design Guidelines (SDG)*, City of Ottawa, October 2012, including all subsequent technical bulletins
- *City of Ottawa Design Guidelines – Water Distribution*, City of Ottawa, July 2010, including all subsequent technical bulletins
- *Design Guidelines for Drinking Water Systems*, Ministry of the Environment, Conservation, and Parks (MECP), 2008
- *Fire Protection Water Supply Guideline for Part 3 in the Ontario Building Code*, Office of the Fire Marshal (OFM), October 2020
- *Technical Bulletin ISTB-2021-03*, City of Ottawa, August 2021
- *Water Supply for Public Fire Protection*, Fire Underwriters Survey (FUS), 2020
- *Geotechnical Investigation*, Paterson Group, PG6484-1, January 13, 2023
- *Phase I – ESA*, Pinchin, Phase 1 ESA – 47 Beechwood Avenue, File 321299, March 15, 2023
- *Site Plan*, Project1 Studio, April 30, 2024



3 Water Servicing

3.1 Background

The proposed building is in Pressure Zone 1E of the City of Ottawa’s Water Distribution System. The existing watermain along the boundaries of the site consists of a 203 mm diameter watermain within Douglas Avenue, a 305 mm diameter watermain within Springfield Road, and a 203 mm diameter watermain within Beechwood Avenue. There are existing fire hydrants on Springfield Road, Douglas Avenue, and Beechwood Avenue. The four existing buildings are presently each serviced by a water service lateral, which would be decommissioned as shown in the Existing Conditions and Removals Plan (see **Drawing EX-1** in **Appendix H**).

3.2 Water Demands

3.2.1 POTABLE (DOMESTIC) WATER DEMANDS

The proposed building will include thirty-one (31) studio apartments, twenty-nine (29) one-bedroom units, twenty-one (21) one-bedroom units with dens, and forty-two (42) two-bedroom units, and 551 m² of commercial space. The City of Ottawa Water Distribution Guidelines (July 2010) and ISTB 2021-03 Technical Bulletin were used to determine water demands based on projected population densities for residential areas and peaking factors. The population was estimated using an occupancy of 1.4 persons per unit for studio and one-bedroom apartments, 2.1 persons per unit for one-bedroom with den and two-bedroom apartments, and 3.1 persons per unit for three-bedroom apartments. The proposed building was estimated to have a total projected population of 216 residents.

A daily rate of 280 L/cap/day has been used to estimate average daily (AVDY) potable water demand for the residential units, and 28,000 L/gross ha/day for the commercial spaces. Maximum day (MXDY) demands were determined by multiplying the AVDY demands by a factor of 2.5 for residential areas and 1.5 for commercial areas. Peak hourly (PKHR) demands were determined by multiplying the MXDY by a factor of 2.2 for residential areas and 1.8 for commercial areas. The estimated demands for each commercial and residential plot are summarized in **Table 3-1** below.

Table 3-1: Estimated Water Demands

	Comm. Area (m²)	Total Apartment Units	Population	AVDY (L/s)	MXDY (L/s)	PKHR (L/s)
Building	551	123	216	0.72	1.78	3.90



3.2.2 FIRE FLOW DEMANDS

Fire flow requirements were estimated using Fire Underwriters Survey (FUS) methodology, as the estimated fire flow for the site exceeds 9,000 L/min (150.0 L/s) when determined through the Office of the Fire Marshal (OFM) fire protection water supply guidelines under the Ontario Building Code. The FUS estimate is based on a building of non-combustible construction type with two-hour fire rated structural members and full protections of vertical openings (one hour fire rating).

As a result, the ‘gross construction area’ of the single largest floor area (floor with the largest footprint 1423 m²) + 25% of the gross construction area of the two immediately adjoining floors was used for the purpose of the FUS calculation, as per page 22 of the *Fire Underwriters Survey’s Water Supply for Public Fire Protection*, 2020. Additionally, the building will be equipped with an automatic sprinkler system that is fully supervised and conforms to the NFPA 13 standard. The residential area of the building will have a limited combustible occupancy charge while the commercial area will have limited combustible to combustible occupancy charges. The two occupancies will be separated by a two-hour fire separation, so the residential area was used for the calculation as it is significantly larger than the commercial occupancy and therefore the worst-case scenario. Required fire flows were determined to be 7,000 L/min (116.7 L/s). Since the fire flow determined in the FUS calculations was less than the 9,000 L/min (150 L/s) from the OBC calculations, the OBC fire flow was used for conservatism.

Refer to **Appendix A.7** for confirmations from the architect regarding the assumptions used in the FUS calculations. Detailed fire flow calculations per the FUS and OBC methodology are provided in **Appendix A.2 and A.3** respectively.

3.3 Level of Servicing

3.3.1 BOUNDARY CONDITIONS

The estimated domestic water and fire flow demands were used to define the level of servicing required for the proposed development from the municipal watermain and hydrants within the Beechwood Avenue, Douglas Avenue and Springfield Road ROWs. **Table 3-2** outlines the boundary conditions provided by the City of Ottawa on March 27, 2023 (See **Appendix A.4** for correspondence).

Table 3-2: Boundary Conditions

	Connection at Springfield Road	Connection at Beechwood Avenue	Connection at Douglas Avenue
Min. HGL (m)	109.4		
Max. HGL (m)	118.4		
Max. Day + Fire Flow (150 L/s) HGL (m)	110.6	110.2	107.9

3.3.2 ALLOWABLE DOMESTIC PRESSURES

The desired normal operating pressure range in occupied areas as per the City of Ottawa 2010 Water Distribution Design Guidelines is 345 kPa to 552 kPa (50 psi to 80 psi) under a condition of maximum



47 Beechwood Avenue Servicing and Stormwater Management Report

daily flow and no less than 276 kPa (40 psi) under a condition of maximum hourly demand. Furthermore, the maximum pressure at any point in the water distribution should not exceed 689 kPa (100 psi) as per the Ontario Building/Plumbing Code; pressure reducing measures are required to service occupied areas where pressures greater than 552 kPa (80 psi) are anticipated.

The proposed finished floor elevation of the first floor, 56.6 m, will serve as the ground floor elevation for the calculation of residual pressures at ground level. As per the boundary conditions, the onsite pressures are expected to range from 517.7 kPa to 605.9 kPa (75.1 psi to 87.9 psi) under normal operating conditions. A minimum head loss of about 29.7 kPa (4.3 psi) is estimated for each storey due to the average grade differential between floors. This value does not consider additional pressure losses due to piping frictional losses and appurtenances, etc. It is expected that the upper storey (the eighth floor) will experience maximum pressures in the range of 308.3 kPa to 396.6 kPa (44.7 psi to 57.5 psi).

Calculations of the residual pressures under normal operating conditions have been provided in **Appendix A.5**. On the first floor, these values are above the normal operating pressure objectives as defined by City of Ottawa design guidelines which requires 345 kPa to 552 kPa (50 psi to 80 psi) in occupied areas. Therefore, pressure reducing valves (PRV's) are to be installed for the proposed building.

The minimum residual pressures at the upper stories fall below the minimum of 345 kPa (50 psi). Consequently, we anticipate booster pumps may be required to provide adequate water pressure to the top floors of the proposed development. The requirement for booster pumps is to be confirmed by the mechanical consultant.

3.3.3 ALLOWABLE FIRE FLOW PRESSURES

The boundary conditions provided by the City of Ottawa indicate that the three watermains on Douglas Avenue, Beechwood Avenue, and Springfield Road are expected to maintain a residual pressure range of 51.3m to 54.0 m, equivalent to a range of 503.0 kPa to 529.4 kPa (72.9 psi to 76.8 psi) under the required fire flow condition. Each of the existing municipal watermains can provide the required fire flow while maintaining a residual pressure of 138 kPa (20 psi), demonstrating adequacy to support fire suppression for the proposed development.

3.3.4 FIRE HYDRANT COVERAGE

The building will be sprinklered and a Siamese (fire department) connection is to be provided at the ramp leading to the underground parking. There are four hydrants in proximity to the proposed development site, as shown in **Figure 3-1**. The distance of each hydrant from the proposed building is less than 130 m.

According to the NFPA 1 Table 18.5.4.3, a hydrant situated less than 76 m away from a building can supply a maximum capacity of 5,678 L/min, while a hydrant situated between 76 m and 152 m away from a building can supply a maximum capacity of 3,785 L/min. Hence, the required fire flow from the site can be achieved with a combination of HYD-01, HYD-02 and HYD-03. See **Appendix A.6** for fire hydrant coverage table calculations and NFPA Table 18.5.4.3.





Figure 3-1: Fire Hydrant Coverage Sketch

Both HYD-01 and HYD-02 are located within 45 m of the Siamese connection as per the OBC.



3.4 Proposed Water Servicing

The development will be serviced via two 150 mm diameter building service connections to the existing 305 mm diameter watermain on Springfield Road. The sizing of the service connections will be confirmed by the mechanical consultant. The proposed water servicing is shown on **Drawing SSP-1** in **Appendix H**. Based on City of Ottawa Design Guidelines, the existing 305 mm diameter watermain on Springfield Road can provide adequate fire and domestic flows for the subject site. The mechanical consultant or plumbing contractor will ultimately be responsible to confirm building pressures are adequate to meet building code requirements.



4 Wastewater Servicing

The site will be serviced from the existing 250 mm diameter PVC sanitary sewer within the Douglas Avenue ROW. The existing buildings on site are presently each serviced by a sanitary service lateral connected to the existing adjacent sanitary sewers, which will be decommissioned and abandoned by City Staff, as shown in Existing Conditions and Removals Plan (see **Drawing EX-1** in **Appendix H**).

4.1 Design Criteria

As outlined in the City of Ottawa Sewer Design Guidelines and the MECP Design Guidelines for Sewage Works, the following criteria were used to calculate the estimated wastewater flow rates and to determine the size and location of the sanitary service lateral:

- Minimum velocity = 0.6 m/s (0.8 m/s for upstream sections)
- Maximum velocity = 3.0 m/s
- Manning roughness coefficient for all smooth wall pipes = 0.013
- Minimum size of sanitary sewer service = 135 mm
- Minimum grade of sanitary sewer service = 1.0 % (2.0 % preferred)
- Average wastewater generation = 280 L/person/day (per City Design Guidelines)
- Peak Factor = based on Harmon Equation; maximum of 4.0 (residential)
- Harmon correction factor = 0.8
- Infiltration allowance = 0.33 L/s/ha (per City Design Guidelines)
- Minimum cover for sewer service connections – 2.0 m
- Population density for one-bedroom and bachelor apartments – 1.4 persons/apartment
- Population density for one-bedroom with den and two-bedroom apartments – 2.1 persons/apartment
- Population density for three-bedroom apartments – 3.1 persons/apartment

4.2 Wastewater Generation and Servicing Design

The proposed 0.215 ha development will consist of an 8-storey mixed-use building consisting of thirty-one (31) studio apartments, twenty-nine (29) one-bedroom units, twenty-one (21) one-bedroom units with dens, and forty-two (42) two-bedroom units, and 551 m² of commercial space. The anticipated peak wastewater flow generated from the proposed development is summarized in **Table 4-1** below.

Table 4-1: Estimated Peak Wastewater Flow

Peak Residential Wastewater Flow			Commercial Wastewater Flow	Infiltration Flow (L/s)	Total Peak Flow (L/s)
Population	Peak Factor	Peak Flow (L/s)			
216	3.31	2.26	0.03	0.07	2.42



47 Beechwood Avenue Servicing and Stormwater Management Report

Detailed sanitary sewage calculations are included in **Appendix C.1**. A full port backwater valve will be required for the proposed building in accordance with the Sewer Design Guidelines and will be coordinated with the building mechanical engineers.

The anticipated peak wastewater flows for the proposed development were provided to the City of Ottawa staff to evaluate the adequacy of the receiving municipal sanitary sewer system in the vicinity of the site and downstream network. Confirmation was obtained that there are no concerns with respect to adding the proposed peak flows to the existing sanitary sewers in Douglas Street and Springfield Road (see correspondence in **Appendix C.2**).

4.3 Proposed Sanitary Servicing

A 150 mm diameter sanitary building service, complete with full port backwater valve as per City standard S14.1, is recommended to service the proposed development. Final sizing of the lateral is to be confirmed by the mechanical consultant. The sanitary lateral is to be equipped with a sanitary wastewater sampling / inspection chamber. The proposed sanitary servicing is shown on **Drawing SSP-1** in **Appendix H**.



5 Stormwater Management and Servicing

5.1 Objectives

The goal of this stormwater servicing and stormwater management (SWM) plan is to determine the measures necessary to control the quantity and quality of stormwater released from the proposed development to meet the criteria established during the consultation process with City of Ottawa and Rideau Valley Conservation Authority (RVCA) staff, and to provide sufficient details required for approval.

5.2 Stormwater Management (SWM) Criteria

The Stormwater Management (SWM) criteria were established by combining current design practices outlined by the City of Ottawa Sewer Design Guidelines (SDG) (October 2012), review of project pre-consultation notes with the City of Ottawa, and through consultation with City of Ottawa staff. The following summarizes the criteria, with the source of each criterion indicated in brackets:

General

- Use of the dual drainage principle (City of Ottawa SDG)
- Wherever feasible and practical, site-level measures should be used to reduce and control the volume and rate of runoff (City of Ottawa SDG)
- Assess impact of 100-year event outlined in the City of Ottawa Sewer Design Guidelines on the major and minor drainage systems (City of Ottawa SDG)
- The proposed site is not subject to quality control criteria (City of Ottawa pre-consultation, **Appendix F**)

Storm Sewer & Inlet Controls

- Size storm sewers to convey 2-year flow.
- Discharge for each storm event to be restricted to a 2-year storm event pre-development rate with a maximum pre-development C coefficient of 0.5 (City of Ottawa pre-consultation, **Appendix F**)
- Peak flows generated from events greater than the 2-year and including the 100-year storm must be detained on site (City of Ottawa pre-consultation, **Appendix F**)
- The preferred stormwater system outlet for this site is the 375 mm diameter storm sewer within the Douglas Avenue ROW to limit road disturbance on Beechwood Avenue. (City of Ottawa pre-consultation follow up email confirming 5-year capacity in Douglas Avenue main, **Appendix D.4**)
- The foundation drainage system is to be independently connected to sewer main unless being pumped with appropriate back up power, sufficient sized pump, and backflow prevention. (City of Ottawa pre-consultation, **Appendix F**)
- T_c should be not less than 10 minutes since IDF curves become unrealistic at less than 10 min (City of Ottawa SDG).

Surface Storage & Overland Flow



47 Beechwood Avenue Servicing and Stormwater Management Report

- Building openings to be a minimum of 0.30 m above the 100-year water level (City of Ottawa SDG)
- Maximum depth of flow under either static or dynamic conditions shall be less than 0.35 m (City of Ottawa SDG)
- Provide adequate emergency overflow conveyance off-site with a minimum vertical clearance of 15 cm between the spill elevation and the ground elevation at the building envelope in the proximity of the flow route or ponding area (City of Ottawa SDG)

The proposed stormwater system outlet for this site is the 375 mm diameter storm sewer within the Douglas Avenue ROW.

5.3 Existing Conditions

The existing site (0.215 ha) is dominated by roofs and asphalt pavement with approximately 77 m² being soft landscape, as such the overall site pre-development runoff coefficient was established to be C=0.88, in which the hard surface areas use a coefficient of 0.90 while soft surface areas have a coefficient of 0.20. This exceeds the maximum permissible pre-development runoff coefficient of C=0.5 identified in the City of Ottawa pre-consultation for this site. Therefore, the pre-development runoff coefficient of 0.5 was used for the site analysis.

The pre-development release rates for the site have been determined using the rational method and the drainage characteristics identified above. A time of concentration for the pre-development area (10 minutes) was assigned based on the small site size and its proximity to the existing drainage outlet. The peak pre-development flow rates shown in **Table 5-1** have been calculated using the rational method as follows:

$$Q = 2.78 (C)(I)(A)$$

Where:

Q = peak flow rate, L/s

C = site runoff coefficient

I = rainfall intensity, mm/hr (per City of Ottawa IDF curves)

A = drainage area, ha

Table 5-1: Pre-Development Flow Rates

Design Storm	Pre-Development Flow Rate (L/s) for C=0.5, A=0.215 ha, t _c = 10 min
2-year	23.0
100-year	53.4

5.4 Stormwater Management Design

The Modified Rational Method was employed to assess the rate and volume of runoff anticipated during post-development rainfall runoff events. The site was subdivided into subcatchments (subareas) as



defined by the proposed grades and the location, nature, or presence/absence of inlet control devices (ICDs). Each subcatchment was assigned a runoff coefficient based on the proposed finished surface. A summary of subcatchment areas and runoff coefficients is provided in **Table 5-2** below. Further details can be found in **Appendix D.1**, while **Drawing SD-1** in **Appendix H** illustrates the proposed subcatchments.

Table 5-2: Summary of Subcatchment Areas

Catchment Areas	C	A (ha)	Flow Type	Outlet
BLDG-1 (Roof Drains)	0.90	0.123	Controlled	Storm Service Lateral (downstream of cistern)
BLDG-2, BLDG-3 (Terrace Drains)	0.90	0.036	Uncontrolled	Cistern
CB 1-4	0.71	0.020	Uncontrolled	Cistern
CB 5	0.90	0.002	Uncontrolled	Cistern
UNC-1	0.86	0.034	Uncontrolled	Public Road ROW
Total Site	0.88	0.215	-	-

5.4.1 ALLOWABLE RELEASE RATE

The pre-development 2-year release rate for the site was determined using the rational method to be 23.0 L/s. Runoff coefficient values have been increased by 25% for the post-development 100-year storm event based on the City of Ottawa SDG.

5.4.2 QUANTITY CONTROL STORAGE REQUIREMENTS

The site requires quantity control measures to meet the restrictive stormwater release criteria. It is proposed that rooftop storage via restricted roof release and an internal cistern with controlled pump flow discharge be used to reduce the site peak outflow. A spreadsheet using the Modified Rational Method (MRM) was used to size the roof storage and cistern, as shown in **Appendix D.1**.

5.4.2.1 Rooftop Storage

It is proposed to retain stormwater on the building rooftop by installing restricted flow roof drains. The MRM calculations assume the roof will be equipped with twelve standard Watts model roof drains complete with Adjustable Accutrol Weirs. Discharge from the twelve controlled roof drains will be routed by the mechanical consultant through the building’s internal plumbing to the proposed building storm service lateral on the downstream side of the cistern and backwater prevention valve.

Watts Drainage Adjustable Accutrol roof drain weir data (see **Appendix D.2**) and the roof plan (see **Appendix B**) has been used to calculate a practical roof release rate and detention storage volume for the rooftop areas, with 80% of the roof area assumed to be available for storage. It should be noted that



the Accutrol weir has been used as an example only, and that other products may be specified for use, provided that:

- the peak roof drain release rate is restricted to match the pre-development 2-year release of 23.0 L/s indicated in **Table 5-1**,
- sufficient roof storage is provided to meet (or exceed) the required volume of detained stormwater indicated in **Table 5-3**, and
- the maximum ponding depth of 150 mm is not exceeded during a design storm event.

The proposed drain release rates and storage volumes have been calculated based on all roof drain weirs at 25% opened setting. Rooftop storage volumes and controlled release rates are summarized in **Table 5-3**. Restricted roof release is to discharge to the storm sewer lateral downstream of controlled outflow from the proposed cistern described in sections below. Refer to **Appendix D.5** for the Conceptual Roof Ponding Plan.

Table 5-3: Roof Subcatchment (BLDG) Stormwater Management

Design Storm	Storage Depth (mm)	Peak Discharge (L/s)	Volume Stored (m ³)	Volume Available (m ³)
2-Year (Roof)	83	8.8	8.9	49.2
100-Year (Roof)	135	10.8	37.1	49.2

5.4.2.2 Uncontrolled Areas

Given the nature of the existing site and the proposed pedestrian friendly development, it is extremely difficult to capture the perimeter run-off within the internal storm system. Providing a maximum grade of 2%, extending from the existing right of way and up to the proposed building results in an uncontrolled run-off rate that greatly limits the allowable discharge to the public storm sewer. As the site under existing conditions is paved almost entirely, and primarily discharges to adjacent Rights-of-way overland uncontrolled, it is proposed that the small site outer perimeter continue to drain overland to their respective Rights-of-way irrespective of the required 2-year controlled discharge rate to the sewer. It should also be noted that the maximum existing C value of 0.5 used in the pre-development calculations compared to the actual 0.86 value based on existing conditions is very conservative, and 2-year allowable release rates from the site are met under the 2-year storm condition even with inclusion of the uncontrolled release rates noted below.

Table 5-4: Peak Post-Development Discharge Rates from Uncontrolled Areas

Design Storm	UNC-1 Discharge (L/s)
2-year	6.2
100-Year	16.9



5.4.2.3 Subsurface Cistern

It is proposed that remaining areas of the site be directed to a network of area drains located above the building foundation extent. Captured flows are to be directed internally to a 10m³ subsurface cistern for controlled release to the existing downstream storm sewer via pumped discharge. The pump discharge rate has been set to conform to peak allowable discharge rates from the site as described in sections above less release rates from controlled flow roof drains that discharge to the storm sewer downstream of the proposed cistern. Proposed cistern sizing and expected release rates are noted in the table below.

Table 5-5: Subsurface Cistern Storage and Peak Release Rates

Design Storm	Peak Discharge (L/s)	Volume Stored (m ³)
2-Year	10.3	0
100-Year	12.2	9.3

5.4.2.4 Pre-development Flow Comparison

Under existing conditions an approximately 0.08 ha with a runoff coefficient of 0.82 (area 4 - refer to **Drawing EXSD-1 in Appendix G**) is directed uncontrolled through the minor system to the existing 375mm storm sewer in Douglas Avenue where the proposed development is anticipated to outlet. With runoff coefficient values increased by 25% (to a maximum of 1.00) for the 100-year storm event based on the City of Ottawa SDG, the resulting existing flow rate to the minor system is 39.7 L/s. Given that the proposed 100-year post-development minor system peak flow is 23 L/s there are not anticipated to be capacity issues in the existing storm sewer.

5.4.2.5 Results

The proposed stormwater management plan meets the requirements identified during pre-consultation. **Table 5-6** provides a summary of the peak design discharge rates calculated from the MRM analysis, shown in **Appendix D.1**.

Table 5-6: Summary of Total 2-Year and 100-Year Event Release Rates

Drainage areas	2-year Peak Discharge (L/s)	100-Year Peak Discharge (L/s)
Uncontrolled Areas	6.2	16.9
Controlled Areas	19.2	23.0
Target (L/s)	23.0	23.0
Total (L/s)	25.4	39.8

5.4.3 QUALITY CONTROL

During the pre-consultation meeting, the Rideau Valley Conservation Authority (RVCA) has confirmed that no quality control measures are required for the site based on the Site Plan provided. Best management practices are encouraged where possible.



5.5 Proposed Stormwater Servicing

One 250 mm diameter stormwater building service, complete with full port backwater valve as per City standard S14.1 is proposed for the foundation drain and the roof drain, as per **Drawing SSP-1** in **Appendix G**. A stormwater sump and pump are required for the proposed foundation drain, and cistern and is to be connected to the service lateral downstream of the sump pump and full port backwater valve. Thermal insulation will be provided for the full length of the stormwater sewer lateral to protect from freezing, as the covering provided is less than the 2.0 m minimum required cover. The laterals are to connect to the main in Douglas Avenue with a PVC tee branch. The mechanical consultant is to confirm the final sizing of the lateral and provide the design for the sump pump/pit.



6 Site Grading

The proposed re-development site measures approximately 0.215 ha in area and consists of four existing mixed-use buildings with surface parking. The topographic survey plan provided by Annis, O'Sullivan, Vollebekk Ltd. (see **Appendix E.2**) indicates that the existing site is relatively flat with the west parking space draining towards the Springfield Road ROW, the south yard and parking space draining towards the Beechwood Avenue ROW, and the east parking space draining towards the Douglas Avenue ROW.

A detailed grading plan (see **Appendix H, Drawing GP-1**) has been prepared to satisfy the stormwater management requirements described in **Section 5**, provide for minimum cover requirements for storm and sanitary sewers where possible, and to allow for positive drainage away from the face of the building. Site grading has been established to provide emergency overland flow routes required for stormwater management.

The proposed grading plan respects the existing grades at the property line everywhere except where the project site plan is coordinated with existing curb, sidewalks, and asphalt as indicated in **Drawing GP-1**. The existing building in the northwest section of the site and proposed for demolition, shares an exterior wall with the adjacent property and will require coordination with the landowner. Revised survey will be required following demolition to confirm the north boundary line grading conditions.

The proposed grading plan provides minimum cover over USF (1.5m), provides an adequate overland flow route, and maintains the existing drainage conditions for the perimeter locations adjacent to the public right of way. The maximum slope extending into the private lot has been restricted to maximum of 2% where possible. No retaining walls are required for the proposed development. As identified on the grading plan, various depressed curbs and associated sidewalks will be removed and replaced with full height barrier curbs and sidewalks in accordance with Ottawa standards.



7 Utilities

Overhead (OH) hydro-wires run parallel to the east and west property lines with branches servicing the existing buildings from the south and via the wires crossing through the middle of the site. All utilities within the work area will require relocation during construction. The existing utility poles are to be protected during construction.

Hydro Ottawa, Bell, Rogers, and Enbridge have existing utility plants in the area, which will be used to service this site. The exact size, location, and routing of utilities will be finalized after design circulation. Existing overhead wires and utility plants may need to be temporarily moved/reconfigured to allow sufficient clearance for the movement of heavy machinery required for construction. The relocation of existing utilities will be coordinated with the individual utility providers upon design circulation.



8 Approvals

The proposed development lies on a private site under singular ownership; drains to an approved separated sewer outlet; and is not intended to service industrial land or land uses. Therefore, the site is exempt from the Ministry of the Environment, Conservation and Parks (MECP) Environmental Compliance Application (ECA) process under O.Reg. 525/98.

For ground or surface water volumes being pumped during the construction phase, typically between 50,000 to 400,000 L/day, it is required to register on the Environmental Activity and Sector Registry (EASR). It is possible that groundwater may be encountered during the foundation excavation on this site. A minimum of two to four weeks should be allotted for completion of the EASR registration and the preparation of the Water Taking and Discharge Plan by a Qualified Person as stipulated under O.Reg. 63/16. An MECP Permit to Take Water (PTTW), which is required for dewatering volumes exceeding 400,000L/day, is not anticipated for the site.



9 Erosion and Sediment Control During Construction

To protect downstream water quality and prevent sediment build-up in catch basins and storm sewers, erosion and sediment control measures must be implemented during construction. The following recommendations will be included in the contract documents and communicated to the Contractor.

1. Implement best management practices to provide appropriate protection of the existing and proposed drainage system and the receiving water course(s).
2. Limit the extent of the exposed soils at any given time.
3. Re-vegetate exposed areas as soon as possible.
4. Minimize the area to be cleared and grubbed.
5. Protect exposed slopes with geotextiles, geogrid, or synthetic mulches.
6. Install silt barriers/fencing around the perimeter of the site as indicated in **Drawing ECDS-1 in Appendix H** to prevent the migration of sediment offsite.
7. Install trackout control mats (mud mats) at the entrance/egress to prevent migration of sediment into the public ROW.
8. Provide sediment traps and basins during dewatering works.
9. Install sediment traps (such as SiltSack® by Terrafix) between catch basins and frames.
10. Schedule the construction works at times which avoid flooding due to seasonal rains.

The Contractor will also be required to complete inspections and guarantee the proper performance of their erosion and sediment control measures at least after every rainfall. The inspections are to include:

- Verification that water is not flowing under silt barriers.
- Cleaning and changing the sediment traps placed on catch basins.

Refer to **Drawing ECDS-1 in Appendix H** for the proposed location of silt fences, sediment traps, and other erosion control measures.



10 Geotechnical Investigation

A geotechnical investigation report was prepared by Paterson Group on January 13, 2023, to provide an assessment of the subsurface conditions found at the site. Five (5) boreholes were advanced to a maximum depth of 4.0 metres below the existing ground surface (BGS) in the investigation carried out on November 29, 2022. The information obtained from the field investigation will guide the detailed design of the site and identify development constraints.

The subsurface profile encountered at the borehole locations are characterized primarily by a layer of asphaltic concrete overlying a fill layer, which is found to generally consist of brown silty sand with crushed stone and, at times, topsoil, ash, brick, coal, rock fragments and organics. The fill layer is underlain by dense to very dense brown silty sand deposit, and glacial till deposit encountered at BH 5-22 at 1.9 m BGS was observed to consist of compact brown silty sand with gravel, cobbles, and boulders.

Based on available geological mapping, the bedrock consists of Paleozoic shale of the Billings formation. Groundwater was only encountered at BH 5-22 at 3.05 m BGS, though as groundwater levels are subject to seasonal fluctuations, they could vary at the time of construction.

Based on Paterson’s recommendations, the site is suitable for the proposed development. It is recommended that the building be founded on conventional spread footings bearing on the undisturbed dense silty sand, compact glacial till or clean bedrock surface. Sub-excavation will be required for installation of the proposed footings.

The recommended rigid pavement structure is further presented in

Table 10-1 below.

Table 10-1: Recommended Pavement Structure

Material	Car Only Parking	Access Lanes and Heavy Truck Parking
Wear Course – HL-3 or Superpave 12.5- Asphaltic Concrete	50 mm	40 mm
Binder Course – HL-8 or Superpave 19.0 Asphaltic Concrete	-	50 mm
BASE – OPSS Granular A Crushed Stone	150 mm	
SUBBASE – OPSS Granular B Type II	300 mm	450 mm

Refer to the full geotechnical report attached in **Appendix E** for further details.



11 Conclusions

11.1 Water Servicing

Based on the supplied boundary conditions for existing watermains and calculated domestic and fire flow demands for the subject site, the adjacent watermain on Springfield Road has sufficient capacity to sustain the required domestic demands for the development. The existing fire hydrants in the area each has sufficient capacity to provide fire flow demands for the site. The proposed development requires two 150 mm diameter water service laterals which will be connected to the existing 305 mm watermain on Springfield Road. Sizing of the water service(s) are to be confirmed by the mechanical consultant.

11.2 Sanitary Servicing

The proposed sanitary sewer service will consist of a 150 mm diameter sanitary service lateral, a sanitary sump pit, a sampling/inspection chamber, and sump pump directing wastewater to the existing 250 mm diameter sanitary sewer on Douglas Avenue. Existing connections are to be abandoned and full port backwater valves installed on the proposed sanitary service within the site to prevent any surcharge from the downstream sewer main from impacting the proposed property. A sump pump will be required for sewage discharge from the mechanical room. Sizing of the service lateral, sump pit, and sump pump are to be confirmed by the mechanical consultant.

11.3 Stormwater Servicing and Management

A single 250 mm diameter storm service lateral is proposed for the building's foundation drain and roof drain, the full-port backwater valve will prevent flooding if the storm sewer on Douglas Avenue surcharges. The proposed stormwater lateral for the building will be connected to the sump pump(s) in the mechanical room to provide storm discharge for drains. The mechanical consultant is to confirm the sizing of the stormwater service lateral and provide the design of the sump pump/pit. Insulation is proposed for the stormwater service lateral, which has less than 2.0 m of cover.

Rooftop storage and subsurface cistern storage has been proposed to limit the stormwater discharge rate to the downstream sewer for all rainfall events up to and including the 100-year event to a peak 2-year predevelopment release rate. The controlled/restricted roof drainage are to discharge through the service lateral downstream of the proposed cistern and drain to the existing storm sewer within the Douglas Avenue ROW. Due to site grading and servicing restrictions, the remainder of the site will drain uncontrolled as per existing conditions. We would like to request a relaxation to the required 2-year pre-development restricted release rate in consideration of site existing conditions where substantial overland runoff exists from paved surface areas. This requirement leads to a very low building release rate and large cistern volume due to the offsite flow based on the extents of perimeter sidewalks draining offsite while respecting the required 2% grade extension up from the public road right of way for the required 6-9m. The building perimeter is proposed to continue to be graded overland with uncontrolled discharge to surrounding ROWs per existing conditions.



11.4 Grading

Site grading has been designed to provide adequate emergency overland flow routes, provide for minimum cover requirements for storm and sanitary sewers where possible, and to allow for positive drainage away from the face of the building.

11.5 Erosion and Sediment Control During Construction

Erosion and sediment control measures and best management practices outlined in this report and included in the drawing set, will be implemented during construction to reduce the impact on adjacent properties, the public ROW, and existing facilities.

11.6 Geotechnical Investigation

Based on the geotechnical investigation, the site is considered suitable for the proposed building, and it is recommended that it be founded using conventional spread footings placed on undisturbed to very dense silty sand, compact glacial till or clean, surface sounded bedrock. Sub-excavation will be required for installation of the proposed footings. Seasonal variations in the groundwater table should be expected.

11.7 Utilities

The site is situated within an established neighbourhood, hence existing utility infrastructure is readily available to service the proposed development. Overhead wires along all boundaries of the site will need to be accommodated during construction. It is anticipated that existing infrastructure will be sufficient to provide a means of distribution for the proposed site. Exact size, location and routing of utilities will be finalized after design circulation.

11.8 Approvals

This site will not be subjected to the Ministry of the Environment, Conservation and Parks (MECP) Environmental Compliance Approval (ECA) process under O.Reg. 525/98. For the expected dewatering needs of 50,000 to 400,000 L/day, the proponent may need to register on the MECP's Environmental Activity and Sector Registry (EASR) subject to geotechnical recommendations. A Permit to Take Water, for dewatering needs in excess of 400,000 L/day, is not anticipated for this site.



APPENDICES



Appendix A Water Demands

A.1 Domestic Water Demands



47 Beechwood Avenue - Domestic Water Demand Estimates

Site Plan provided by Project1 Studio (2024-04-30)

Project Number: 160401786

Population densities as per Table 4.1 of the Ottawa Water Design Guidelines:		
Bachelor	1.4	ppu
1 Bedroom	1.4	ppu
2 Bedroom	2.1	ppu
3 Bedroom	3.1	ppu

Demand conversion factors as per Table 4.2 of the Ottawa Water Design Guidelines - Water Distribution ⁵ :		
Residential	280	L/cap/day
Commercial	28000	L/gross ha/day



Building ID	Gross Parcel Area (ha)	Number of Apt Units ³	Estimated Population	Daily Rate of Demand ⁵	Avg. Day Demand		Max. Day Demand ^{1, 2}		Peak Hour Demand ^{1, 2}	
					(L/min)	(L/s)	(L/min)	(L/s)	(L/min)	(L/s)
Commercial	0.055	-	-	28,000	1.1	0.02	1.6	0.03	2.9	0.05
Studio	-	31	43	280	8.4	0.14	21.1	0.35	46.4	0.77
1-Bedroom	-	29	41	280	7.9	0.13	19.7	0.33	43.4	0.72
1-Bedroom+Den ⁴	-	21	44	280	8.6	0.14	21.4	0.36	47.2	0.79
2-Bedroom	-	42	88	280	17.2	0.29	42.9	0.71	94.3	1.57
3-Bedroom	-	0	0	280	0.0	0.00	0.0	0.00	0.0	0.00
						0.70		1.75		3.86
Total Site :	0.055	123	216		43.1	0.72	106.8	1.78	234.2	3.90

Notes:

1 Water demand criteria used to estimate peak demand rates for residential areas are as follows:

maximum day demand rate = 2.5 x average day demand rate

peak hour demand rate = 2.2 x maximum day demand rate (as per Technical Bulletin ISD-2010-02)

2 Water demand criteria used to estimate peak demand rates for commercial/amenity areas are as follows:

maximum day demand rate = 1.5 x average day demand rate

peak hour demand rate = 1.8 x maximum day demand rate (as per Technical Bulletin ISD-2010-02)

3 Number of apartment units as per drawing SP-02 prepared by **Project1 Studios Suite Plan** dated April 30, 2024.

4 Assumption that "1 bedroom with den" has density of 2.1 ppu

5 As per Table 4-2 from the City of Ottawa Water Design Guidelines and Technical Bulletin ISTB-2021-03, the average daily rate of water demand for residential areas: 280 L/cap/day

A.2 Fire Flow Demands (FUS 2020)





FUS Fire Flow Calculation Sheet - 2020 FUS Guidelines

Stantec Project #: 160401786
 Project Name: 47 Beechwood Avenue
 Date: 3/9/2023

Fire Flow Calculation #: 1

Description: 7-storey mixed-use building with penthouse apartment at top. Two hour fire separation between commercial and residential occupancies.

Notes: Site Plan provided by Project 1 Studios on April 30, 2024. Confirmation of floor area, sprinklers, protected openings, construction type, occupancy charge, and fire separation between occupancies provided by Project 1 Studios on May 1, 2024.

Step	Task	Notes									Value Used	Req'd Fire Flow (L/min)
1	Determine Type of Construction	Type II - Noncombustible Construction / Type IV-A - Mass Timber Construction									0.8	-
2	Determine Effective Floor Area	Sum of Largest Floor + 25% of Two Additional Floors					Vertical Openings Protected?				YES	-
		1423	1409	1409	1260	1260	1260	1188	193		2128	-
3	Determine Required Fire Flow	(F = 220 x C x A ^{1/2}). Round to nearest 1000 L/min									-	8000
4	Determine Occupancy Charge	Limited Combustible									-15%	6800
5	Determine Sprinkler Reduction	Conforms to NFPA 13									-30%	-3400
		Standard Water Supply									-10%	
		Fully Supervised									-10%	
		% Coverage of Sprinkler System									100%	
6	Determine Increase for Exposures (Max. 75%)	Direction	Exposure Distance (m)	Exposed Length (m)	Exposed Height (Stories)	Length-Height Factor (m x stories)	Construction of Adjacent Wall	Firewall / Sprinklered ?		-	-	
		North	0 to 3	59	2	> 100	Type V	NO		25%	3536	
		East	10.1 to 20	29	2	41-60	Type V	NO		12%		
		South	> 30	0	0	0-20	Type V	NO		0%		
		West	10.1 to 20	29	5	> 100	Type V	NO		15%		
7	Determine Final Required Fire Flow	Total Required Fire Flow in L/min, Rounded to Nearest 1000L/min										7000
		Total Required Fire Flow in L/s										116.7
		Required Duration of Fire Flow (hrs)										2.00
		Required Volume of Fire Flow (m ³)										840

A.3 Fire Flow Demands (OBC)



Fire Flow Calculations as per Ontario Building Code 2006 (Appendix A)

Job# 160401786
Date 30-Apr-24

Designed by: WJ
Checked by:
Description: 7-storey mixed-use with penthouse

$$Q = KVS_{\text{tot}}$$

Q = Volume of water required (L)

V = Total building volume (m³)

K = Water supply coefficient from Table 1

S_{tot} = Total of spatial coefficient values from property line exposures on all sides as obtained from the formula

$$S_{\text{tot}} = 1.0 + [S_{\text{side1}} + S_{\text{side2}} + S_{\text{side3}} + S_{\text{side4}}]$$

1	Type of construction	Building Classification		Water Supply Coefficient
	Non-Combustible without Fire-Resistance Ratings	A-2, B-1, B-2, B-3, C, D		16
2	Area of one floor (m ²)	number of floors	height of ceiling (m)	Total Building Volume (m ³)
	1423	1	3.5	4,981
	1409	2	3	8,454
	1260	3	3	11,340
	1188	1	3	3,564
	193	1	2.7	521
				0
			0	
3	Side	Exposure Distance (m)	Spatial Coefficient	Total Spatial Coefficient
	North	1.5	0.5	2
	East	1	0.5	
	South	0	0.5	
	West	1	0.5	
4	Established Fire Safety Plan?	Reduction in Volume (%)		Total Volume Reduction
	no	0%		0%
5	Total Volume 'Q' (L)			
				923,520
				Minimum Required Fire Flow (L/min)
				9,000

A.4 Boundary Conditions



Johnson, Warren

From: Fawzi, Mohammed <mohammed.fawzi@ottawa.ca>
Sent: Friday, May 24, 2024 9:59 AM
To: Johnson, Warren
Cc: Kilborn, Kris; Thiffault, Dustin
Subject: RE: 47 Beechwood Avenue
Attachments: 47 Beechwood Avenue REVISED May 2024.pdf

Follow Up Flag: Follow up
Flag Status: Flagged

Hi Warren,

The following are boundary conditions, HGL, for hydraulic analysis at 47 Beechwood Avenue (zone 1E) assumed to be connected to the 305 mm watermain on Springfield Road OR the 203 mm watermain on Beechwood Avenue OR the 203 mm watermain on Douglas Avenue (see attached PDF for location).

All Connections:

Min HGL: 109.4 m

Max HGL: 118.4 m *The maximum pressure (all connections) is estimated to be more than 80 psi. A pressure check at completion of construction is recommended to determine if pressure control is required.*

Max Day + Fire Flow (150 L/s): 110.6 m (Springfield)

Max Day + Fire Flow (150 L/s): 110.2 m (Beechwood)

Max Day + Fire Flow (150 L/s): 107.9 m (Douglas)

These are for current conditions and are based on computer model simulation.

Disclaimer: The boundary condition information is based on current operation of the city water distribution system. The computer model simulation is based on the best information available at the time. The operation of the water distribution system can change on a regular basis, resulting in a variation in boundary conditions. The physical properties of watermains deteriorate over time, as such must be assumed in the absence of actual field test data. The variation in physical watermain properties can therefore alter the results of the computer model simulation.

Best Regards,

Mohammed Fawzi, P.Eng.

Project Manager, Infrastructure - Gestionnaire de projet, Projets d'infrastructure
Development Review All Wards (DRAW) | Direction de l'examen des projets d'aménagement - Tous les quartiers (EPATQ)
Planning, Development and Building Services Department (PDBS) | Direction générale des services de la planification, de l'aménagement et du bâtiment (DGSPAB)
City of Ottawa | Ville d'Ottawa
110 Laurier Avenue West | 110 Avenue Laurier Ouest
Ottawa, ON K1P 1J1
613.580.2424 ext./poste 20120, Mohammed.Fawzi@ottawa.ca

From: Fawzi, Mohammed
Sent: Friday, May 24, 2024 9:41 AM
To: Johnson, Warren <Warren.Johnson@stantec.com>
Cc: Kilborn, Kris <kris.kilborn@stantec.com>; Thiffault, Dustin <dustin.thiffault@stantec.com>
Subject: RE: 47 Beechwood Avenue

Hi Warren,

I just sent a follow up email. I hope to have something soon. Will keep you posted.

Best Regards,

Mohammed Fawzi, P.Eng.

Project Manager, Infrastructure - Gestionnaire de projet, Projets d'infrastructure
Development Review All Wards (DRAW) | Direction de l'examen des projets d'aménagement - Tous les
quartiers (EPATQ)
Planning, Development and Building Services Department (PDBS) | Direction générale des services de la
planification, de l'aménagement et du bâtiment (DGSPAB)
City of Ottawa | Ville d'Ottawa
110 Laurier Avenue West | 110 Avenue Laurier Ouest
Ottawa, ON K1P 1J1
613.580.2424 ext./poste 20120, Mohammed.Fawzi@ottawa.ca

From: Johnson, Warren <Warren.Johnson@stantec.com>
Sent: Thursday, May 23, 2024 3:54 PM
To: Fawzi, Mohammed <mohammed.fawzi@ottawa.ca>
Cc: Kilborn, Kris <kris.kilborn@stantec.com>; Thiffault, Dustin <dustin.thiffault@stantec.com>
Subject: RE: 47 Beechwood Avenue

CAUTION: This email originated from an External Sender. Please do not click links or open attachments unless you recognize the source.

ATTENTION : Ce courriel provient d'un expéditeur externe. Ne cliquez sur aucun lien et n'ouvrez pas de pièce jointe, excepté si vous connaissez l'expéditeur.

Hi Mohammed,

Just following up on the status of this boundary request. Our client is hoping to resubmit shortly so if you could provide an estimated timeline it would be greatly appreciated.

Thanks!

Warren Johnson C.E.T.
Civil Engineering Technologist
Direct: 613 784-2272
Warren.Johnson@stantec.com
Stantec

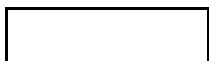



The content of this email is the confidential property of Stantec and should not be copied, modified, retransmitted, or used for any purpose except with Stantec's written authorization. If you are not the intended recipient, please delete all copies and notify us immediately.

Please consider the environment before printing this email.

From: Fawzi, Mohammed <mohammed.fawzi@ottawa.ca>
Sent: Monday, May 6, 2024 9:04 AM
To: Johnson, Warren <Warren.Johnson@stantec.com>
Cc: Kilborn, Kris <kris.kilborn@stantec.com>; Thiffault, Dustin <Dustin.Thiffault@stantec.com>
Subject: RE: 47 Beechwood Avenue

Hi Warren,

This is to confirm your request for boundary conditions has been received. I'll forward you the results as soon as they are available.

I expect this may take a couple weeks.

Thank you.

Best Regards,

Mohammed Fawzi, P.Eng.

Project Manager, Infrastructure - Gestionnaire de projet, Projets d'infrastructure
Development Review All Wards (DRAW) | Direction de l'examen des projets d'aménagement - Tous les quartiers (EPATQ)
Planning, Development and Building Services Department (PDBS) | Direction générale des services de la planification, de l'aménagement et du bâtiment (DGSPAB)
City of Ottawa | Ville d'Ottawa
110 Laurier Avenue West | 110 Avenue Laurier Ouest
Ottawa, ON K1P 1J1
613.580.2424 ext./poste 20120, Mohammed.Fawzi@ottawa.ca

From: Johnson, Warren <Warren.Johnson@stantec.com>
Sent: Wednesday, May 1, 2024 3:30 PM
To: Fawzi, Mohammed <mohammed.fawzi@ottawa.ca>
Cc: Kilborn, Kris <kris.kilborn@stantec.com>; Thiffault, Dustin <dustin.thiffault@stantec.com>
Subject: 47 Beechwood Avenue

CAUTION: This email originated from an External Sender. Please do not click links or open attachments unless you recognize the source.

ATTENTION : Ce courriel provient d'un expéditeur externe. Ne cliquez sur aucun lien et n'ouvrez pas de pièce jointe, excepté si vous connaissez l'expéditeur.

Hi Mohammed,

We would like to request updated boundary conditions for the development on 47 Beechwood Avenue as there have been changes to the proposed building which impact the water demands. The proposed development consists of a seven-storey plus penthouse mixed-use building comprising of 123 apartment units (31 studio units, 29 one-bedroom units, 21 one-bedroom with den units, and 42 two-bedroom units) projected to serve 216 residents with 551 m² of commercial spaces.

The proposed site is expected to be serviced via connections to the existing 305 mm diameter watermain in Springfield Road, although we would also like to request boundary conditions for the 305 mm and 203 mm diameter

watermain in Beechwood Avenue and the 203 mm diameter watermain in Douglas Avenue, all circled in green in the attached map.

Estimated domestic demands based on the City of Ottawa guidelines and fire flow requirements for the site are as follows:

- Domestic demands:
 - Average Day Demand: 0.72 L/s (43.1 L/min)
 - Maximum Day Demand: 1.78 L/s (106.8 L/min)
 - Peak Hour Demand: 3.90 L/s (234.2 L/min)
- Fire Flow Demand per FUS methodology: 116.7 L/s (7,000 L/min)
- Fire Flow Demand per OBC methodology: 150.0 L/s (9,000 L/min)

Given that the OBC methodology provides a higher fire flow we would like to **proceed with 9,000 L/min** for conservatism.

Attached are the boundary condition map, site plan, water demand, fire flow calculations, and architectural confirmations for your information.

Please let me know if you have any questions or need additional information.

Thanks,

Warren Johnson C.E.T.
Civil Engineering Technologist

Direct: 613 784-2272
Warren.Johnson@stantec.com

Stantec



The content of this email is the confidential property of Stantec and should not be copied, modified, retransmitted, or used for any purpose except with Stantec's written authorization. If you are not the intended recipient, please delete all copies and notify us immediately.

Please consider the environment before printing this email.

This e-mail originates from the City of Ottawa e-mail system. Any distribution, use or copying of this e-mail or the information it contains by other than the intended recipient(s) is unauthorized. Thank you.

Le présent courriel a été expédié par le système de courriels de la Ville d'Ottawa. Toute distribution, utilisation ou reproduction du courriel ou des renseignements qui s'y trouvent par une personne autre que son destinataire prévu est interdite. Je vous remercie de votre collaboration.

Caution: This email originated from outside of Stantec. Please take extra precaution.

Attention: Ce courriel provient de l'extérieur de Stantec. Veuillez prendre des précautions supplémentaires.

Atención: Este correo electrónico proviene de fuera de Stantec. Por favor, tome precauciones adicionales.

This e-mail originates from the City of Ottawa e-mail system. Any distribution, use or copying of this e-mail or the information it contains by other than the intended recipient(s) is unauthorized. Thank you.

Le présent courriel a été expédié par le système de courriels de la Ville d'Ottawa. Toute distribution, utilisation ou reproduction du courriel ou des renseignements qui s'y trouvent par une personne autre que son destinataire prévu est interdite. Je vous remercie de votre collaboration.

Caution: This email originated from outside of Stantec. Please take extra precaution.

Attention: Ce courriel provient de l'extérieur de Stantec. Veuillez prendre des précautions supplémentaires.

Atención: Este correo electrónico proviene de fuera de Stantec. Por favor, tome precauciones adicionales.

A.5 Hydraulic Analysis





Project:	47 Beechwood Avenue	No.	160401786
SITE PLAN HYDRAULIC ANALYSIS			
Revision:	02	Prepared By:	WJ
Revision Date:	27-May-2024	Checked By:	

BOUNDARY CONDITIONS (BC)	
Connection at Springfield Road	
Site Plan Revision Date	30-Apr-2024
Min. HGL (m)	109.4
Max. HGL (m)	118.4
Max. Day + Fire Flow (183.3 L/s)	110.6

Ground Floor Elevation (GFE) (Level 01) (m)	56.6
---	------

GROUND FLOOR (GF) PRESSURE RANGE				
	GF HGL (m)	GF Pressure (kPa)	GF Pressure (psi)	Outcome
	= BC HGL (m) - FFE (m)	= GF HGL (m) x 9.804 (kPa/m)	= GF Pressure (kPa) x 0.145 (psi/kPa)	If min <50 psi: booster pump If max >80 psi: pressure reducer
Minimum Normal	52.8	517.7	75.1	No Booster Pump Required
Maximum Normal	61.8	605.9	87.9	Pressure Reducer Required

Number of Floors Above Ground	8
Approximate Height of One Storey (m)	3.05
Pressure Drop Per Floor (kPa)	29.9
Pressure Drop Per Floor (psi)	4.3

RESIDUAL PRESSURE RANGE IN MULTI-LEVEL BUILDINGS			
	Residual Pressure (kPa)	Residual Pressure (psi)	Outcome
Top Floor Min	308.3	44.7	Booster Pump Required
Top Floor Max	396.6	57.5	
Maximum Number of Floors Above Ground at Minimum Pressure	8		

RESIDUAL PRESSURE UNDER FIRE FLOW CONDITIONS			
	Residual HGL (m)	Residual Pressure (kPa)	Residual Pressure (psi)
Ground Floor	54	529.4	76.8
Top Floor	32.65	320.1	46.4

PRESSURE CHECK		
	Pressure (kPa)	Pressure (psi)
UNDER NORMAL OPERATING CONDITIONS		
Pressure Below Minimum	<276	<40
Pressure Below Normal	276-345	40-50
Pressure Within Normal Range	345-552	50-80
Pressure Above Normal Range	552-690	80-100
Pressure Above Maximum	>690	>100
UNDER FIRE FLOW CONDITIONS		
Pressure Below Minimum	<140	<20
Acceptable Pressure	≥140	≥20

A.6 Fire Hydrant Coverage Calculations





Project: **47 Beechwood Avenue** 160401786

**TABLE 1:
FIRE HYDRANT COVERAGE TABLE**

Revision: 2 Prepared By: WJ

Revision Date: 4/30/2024 Checked By:

Description	Hydrants ¹				Total Available Fire Flow (L/min)	Total Required Fire Flow ² (L/min)
	HYD-01	HYD-02	HYD-03	HYD-04		
47 Beechwood Avenue						
Distance from building (m)	14.0	45.0	113.0	127.0	-	-
Maximum fire flow capacity ³ (L/min)	5,678	5,678	3,785	3,785	18,926	12,000

NFPA 1 Table 18.5.4.3	
Distance to Building (m)	Maximum Capacity (L/min)
≤ 76	5,678
> 76 and ≤ 152	3,785
> 152 and ≤ 305	2,839

Notes:

1. Hydrant locations as per GeoOttawa accessed May 1, 2024. Refer to fire hydrant coverage sketch (Figure 3-1).
2. See FUS Calculations, Appendix A.2 for fire flow requirements.
3. See NFPA 1 Table 18.5.4.3 and Appendix I of the City of Ottawa Technical Bulletin ISTB-2018-02 for maximum fire flow capacity of hydrants by distance to building.

A.7 Architectural Confirmations



Johnson, Warren

Subject: FW: 47 Beechwood Avenue Comment Response Letter and Resubmission 122186

From: Julien Hebert <hebert@project1studio.ca>

Sent: Wednesday, May 1, 2024 2:19 PM

To: Johnson, Warren <Warren.Johnson@stantec.com>; Kilborn, Kris <kris.kilborn@stantec.com>

Cc: Ryan Koolwine <koolwine@project1studio.ca>; Thiffault, Dustin <Dustin.Thiffault@stantec.com>

Subject: RE: 47 Beechwood Avenue Comment Response Letter and Resubmission 122186

Hi Warren,

Yes, there will be a 2HR separation between group C (residential) and group E (mercantile) occupancies.

Thanks for the clarification. I can confirm we satisfy the requirements for protected openings:

- Enclosures will have walls of non-combustible construction and will have FRRs of at least 1HR.
- Openings in all stair shafts will have closers – in service shafts, there will be fire dampers.
- Elevator doors will be metal and normally closed.

Thanks,

Julien Hébert

Architect, OAA / OAQ

project1studio | 613 884-3939 x6

From: Johnson, Warren <Warren.Johnson@stantec.com>

Sent: Wednesday, May 1, 2024 1:04 PM

To: Julien Hebert <hebert@project1studio.ca>; Kilborn, Kris <kris.kilborn@stantec.com>

Cc: Ryan Koolwine <koolwine@project1studio.ca>; Thiffault, Dustin <Dustin.Thiffault@stantec.com>

Subject: RE: 47 Beechwood Avenue Comment Response Letter and Resubmission 122186

Hi Julien,

Can you confirm whether there will be fire separations between the residential and commercial occupancies?

Also, you are noted that there will not be unprotected openings so then **all vertical openings will be protected?** See below screenshot of the requirements per the FUS guidelines. We have previously had issues with projects being able to meet the requirement for some openings to have automatic closing devices.

Protected openings:

- i. Enclosures shall have walls of masonry or other limited or noncombustible construction with a fire resistance rating of not less than one hour.
- ii. Openings including doors shall be provided with automatic closing devices
- iii. Elevator doors shall be of metal or metal-covered construction, so arranged that the doors must normally be closed for operation of the elevator.

Unprotected openings:

- i. Any opening through horizontal separations that are unprotected or otherwise have closures that do not meet the minimum requirements for protected openings, above.

Thanks,

Warren Johnson C.E.T.

Civil Engineering Technologist

Direct: 613 784-2272
Warren.Johnson@stantec.com

Stantec



The content of this email is the confidential property of Stantec and should not be copied, modified, retransmitted, or used for any purpose except with Stantec's written authorization. If you are not the intended recipient, please delete all copies and notify us immediately.

Please consider the environment before printing this email.

From: Julien Hebert <hebert@project1studio.ca>
Sent: Wednesday, May 1, 2024 12:18 PM
To: Kilborn, Kris <kris.kilborn@stantec.com>
Cc: Ryan Koolwine <koolwine@project1studio.ca>; Johnson, Warren <Warren.Johnson@stantec.com>; Thiffault, Dustin <Dustin.Thiffault@stantec.com>
Subject: RE: 47 Beechwood Avenue Comment Response Letter and Resubmission 122186

Some people who received this message don't often get email from hebert@project1studio.ca. [Learn why this is important](#)

Hi Kris,

Please see my notes in red below:

Items to be confirmed per the attached FUS calculations including:

- o Construction type – Type II Noncombustible **Correct**
- o Vertical Openings Protected – No **There will not be unprotected openings in the project.**
- o Floor Area – Gross floor areas from architectural drawing SP-02 used **See revised areas below:**

GROSS AREA (OBC)		
LEVEL	AREA	AREA (SF)
LEVEL P1	1759.94 m ²	18944 SF
LEVEL 1	1423.08 m ²	15318 SF
LEVEL 2	1409.13 m ²	15168 SF
LEVEL 3	1409.13 m ²	15168 SF
LEVEL 4	1259.64 m ²	13559 SF
LEVEL 5	1259.42 m ²	13556 SF
LEVEL 6	1259.44 m ²	13557 SF
LEVEL 7	1187.57 m ²	12783 SF
LEVEL 8	193.11 m ²	2079 SF
TOTAL	11160.46 m ²	120130 SF

- o Occupancy Charge – Limited combustible **Limited Combustible for residential occupancies. For the retail occupancies, it's Limited to Combustible**
- o Sprinklers – Conforms to NFPA 13, fully supervised **Correct**

Cheers,

Julien Hébert
Architect, OAA / OAQ

project1studio | 613 884-3939 x6

Appendix B Site Plan by Project 1 Studios Inc.



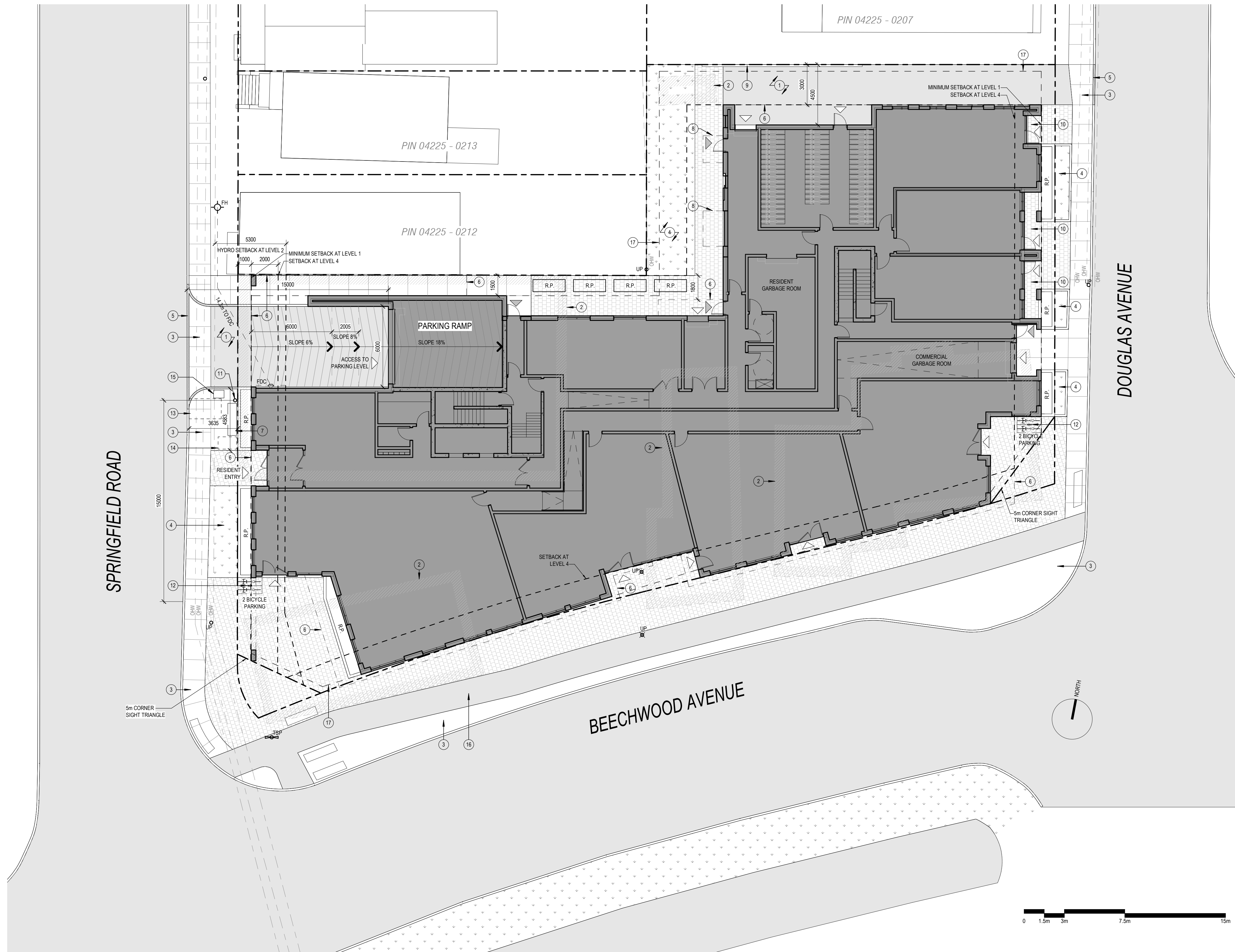

SITE PLAN SYMBOLS LEGEND

	BUILDING ENTRANCE		FIRE DEPARTMENT CONNECTION
	BUILDING EXIT		FIRE HYDRANT
	BICYCLE PARKING		NEW STREET LIGHT
	PROPERTY LINE		STREET LIGHT TO BE REMOVED
	SETBACK LINE		EXISTING STREET LIGHT TO REMAIN
	OVERHEAD WIRES		EXISTING UTILITY POLE TO REMAIN
	INTERLOCKING STONE PAVERS		UTILITY POLE TO BE REMOVED/RELOCATED
	EXISTING TRAFFIC SIGNAL POST		
	RAISED PLANTER		

- SITE PLAN NOTES**
- 1 ASPHALT
 - 2 EXISTING STRUCTURE TO BE DEMOLISHED
 - 3 CONCRETE SIDEWALK
 - 4 SOFT LANDSCAPING
 - 5 DEPRESSED CURB
 - 6 LINE OF CANOPY/BUILDING ABOVE
 - 7 BENCH
 - 8 BALCONY ABOVE
 - 9 CONCRETE CURB. SEE CIVIL
 - 10 RAISED TERRACE. SEE CIVIL
 - 11 BUS STOP FLAG POLE
 - 12 BIKE RACK. REFER TO LANDSCAPE
 - 13 BUS LOADING AREA (2400mm x 1500mm)
 - 14 ACCESSIBLE SEATING AREA (915mm x 1370mm)
 - 15 GARBAGE BIN
 - 16 CYCLE PATH
 - 17 LINE OF UNDERGROUND PARKING BELOW

GENERAL ARCHITECTURAL NOTES:

1. This drawing is the property of the Architect and may not be reproduced or used without the expressed consent of the Architect.
2. Drawings are not to be scaled. The Contractor is responsible for checking and verifying all levels and dimensions and shall report all discrepancies to the Architect and obtain clarification prior to commencing work.
3. Upon notice in writing, the Architect will provide written clarification or supplementary information regarding the intent of the Contract Documents.
4. The Architectural Drawings are to be read in conjunction with all other Contract Documents including Project Manuals and the Structural, Mechanical and Electrical Drawings.
5. Positions of exposed or finished Mechanical or Electrical devices, fittings and fixtures are indicated on the Architectural Drawings. Locations shown on the Architectural Drawings shall govern over Mechanical and Electrical Drawings. Mechanical and Electrical items not clearly located will be located as directed by the Architect.
6. These documents are not to be used for construction unless specifically noted for such purpose.

KEY PLAN

4	ISSUED FOR COORDINATION	2024-04-30
3	ISSUED FOR COORDINATION	2024-04-25
2	REISSUED FOR SPC	2024-04-10
1	ISSUED FOR SPC	2023-06-08

ISSUE RECORD

OWNER
 2317916 ONT INC.
 2081 MERIVALE ROAD
 OTTAWA, ON, K2G 1G9

ARCHITECT
 PROJECT1 STUDIO
 260 ST. PATRICK ST. SUITE 300
 OTTAWA, ON, K1N 5K5

PLANNER
 NOVATECH
 240 MICHAEL COWPLAND DRIVE, SUITE 200
 OTTAWA, ON, K2M 1P6

LANDSCAPE ARCHITECT
 NOVATECH
 240 MICHAEL COWPLAND DRIVE, SUITE 200
 OTTAWA, ON, K2M 1P6

CIVIL ENGINEER
 STANTEC
 300 - 1331 CLYDE AVENUE
 OTTAWA, ON, K2C 3G4

SURVEYOR
 ANNIS O'SULLIVAN VOLLEBEKK LTD.
 14 CONCOURSE GATE, SUITE 500
 OTTAWA, ON, K2E 7S6

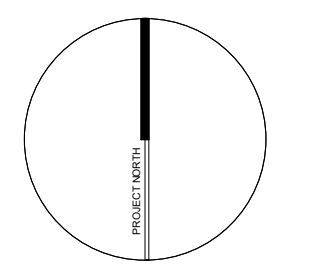

project1 studio

Project1 Studio Incorporated
 (613) 884-3939 | mail@project1studio.ca

PROJ	SCALE	DRAWN	REVIEWED
2218	NOTED	JH	RMK

SITE PLAN

SP-01

Appendix C Sanitary

C.1 Sanitary Calculation Sheet



	SITE: 47 Beechwood Avenue, Ottawa, ON		SANITARY SEWER DESIGN SHEET (City of Ottawa)										DESIGN PARAMETERS																								
	DATE: DESIGNED BY: CHECKED BY:	8/13/2024 WJ											FILE NUMBER: 160401786	MAX PEAK FACTOR (RES.): MIN PEAK FACTOR (RES.): PEAKING FACTOR (INDUSTRIAL): PEAKING FACTOR (CI >20%): PERSONS / 1 BEDROOM: PERSONS / 2 BEDROOM: PERSONS / 3 BEDROOM:	4.0 2.5 2.4 1.5 1.4 2.1 3.1	AVG. DAILY FLOW / PERSON: COMMERCIAL: INDUSTRIAL (HEAVY): INDUSTRIAL (LIGHT): INSTITUTIONAL: INFILTRATION:	280 lpd/day 28,000 l/day 55,000 l/day 35,000 l/day 28,000 l/day 0.33 l/s/ha	MINIMUM VELOCITY: MAXIMUM VELOCITY: MANNING'S n: BEDDING CLASS: MINIMUM COVER: HARMON CORRECTION FACTOR:	0.60 m/s 3.00 m/s 0.013 B 2.50 m 0.8																		
LOCATION		RESIDENTIAL AREA AND POPULATION										COMMERCIAL		INDUSTRIAL (I)		INDUSTRIAL (H)		INSTITUTIONAL		GREEN / UNUSED		C+H	INFILTRATION			TOTAL	PIPE										
AREA ID NUMBER	FROM M.H.	TO M.H.	AREA (ha)	1 BEDROOM	2 BEDROOM / 1 BEDROOM W DEN	3 BEDROOM	POP.	CUMULATIVE AREA (ha)	POP.	PEAK FACT.	PEAK FLOW (l/s)	AREA (ha)	ACCU. AREA (ha)	AREA (ha)	ACCU. AREA (ha)	AREA (ha)	ACCU. AREA (ha)	AREA (ha)	ACCU. AREA (ha)	AREA (ha)	ACCU. AREA (ha)	PEAK FLOW (l/s)	TOTAL AREA (ha)	ACCU. AREA (ha)	INFIL. FLOW (l/s)	LENGTH (m)	DIA (mm)	MATERIAL	CLASS	SLOPE (%)	CAP. (FULL) (l/s)	CAP. V. PEAK FLOW (%)	VEL. (FULL) (m/s)	VEL. (ACT.) (m/s)			
PROPOSED BLDG	BLDG	EX SAN	0.175	60	63	0	216	0.175	216	3.31	2.32	0.055	0.055	0.00	0.00	0.00	0.00	0.00	0.00	0.00	0.00	0.040	0.04	0.03	0.215	0.22	0.07	2.42	6.8	150	PVC	SDR 35	1.00	15.3	15.77%	0.86	0.52

Notes

1. Unit breakdown for proposed 8-storey mixed-use as per drawing SP-02 prepared by Project 1 Studios Inc. dated April 30, 2024.
2. Site to outlet to existing 250 mm dia. sanitary sewers on Douglas Avenue.
3. Entire site area considered as potential source of infiltration.
4. Assumption that "1 bedroom with den" has density of 2.1 ppu

C.2 Correspondence with City on Sanitary Sewer Capacity



Moir, Tyler

From: Fawzi, Mohammed <mohammed.fawzi@ottawa.ca>
Sent: Friday, March 24, 2023 11:04 AM
To: Wu, Michael
Cc: Moir, Tyler
Subject: RE: 47 Beechwood Avenue Confirmation of Sanitary Sewer Capacity

Hi Michael,

This email is to confirm that there is sufficient capacity.

Thank you and have a great weekend.

Best Regards,

Mohammed Fawzi, P.Eng.

Project Manager

Planning, Infrastructure and Economic Development Department - Services de la planification, de l'infrastructure et du développement économique

Development Review - Central Branch

City of Ottawa | Ville d'Ottawa

110 Laurier Avenue West Ottawa, ON | 110, avenue. Laurier Ouest. Ottawa (Ontario) K1P 1J1

613.580.2424 ext./poste 20120, Mohammed.Fawzi@ottawa.ca

****Please note that due to the current situation, I am working remotely. Email is currently the best way to contact me****

From: Wu, Michael <Michael.Wu@stantec.com>
Sent: March 21, 2023 3:56 PM
To: Fawzi, Mohammed <mohammed.fawzi@ottawa.ca>
Cc: Moir, Tyler <Tyler.Moir@stantec.com>
Subject: 47 Beechwood Avenue Confirmation of Sanitary Sewer Capacity

CAUTION: This email originated from an External Sender. Please do not click links or open attachments unless you recognize the source.

ATTENTION : Ce courriel provient d'un expéditeur externe. Ne cliquez sur aucun lien et n'ouvrez pas de pièce jointe, excepté si vous connaissez l'expéditeur.

Good afternoon, Mohammed:

In addition to the hydraulic boundary conditions, as part of the servicing for the proposed development on 47 Beechwood Avenue, we would like to confirm if there is sufficient capacity downstream of the existing 250 mm diameter sanitary sewers on Springfield Avenue or Douglas Street to receive an additional estimated peak flow of 2.2 L/s from the proposed development.

Please find out sanitary design sheet and location map, with the proposed sanitary service lateral connections labelled in **orange**, attached for your information.

Thank you,

Michael Wu, EIT

Civil Engineering Intern, Community Development

Work: (613) 738-6033

Mobile: (613) 858-0548

michael.wu@stantec.com

Stantec

300 - 1331 Clyde Avenue

Ottawa ON K2C 3G4



The content of this email is the confidential property of Stantec and should not be copied, modified, retransmitted, or used for any purpose except with Stantec's written authorization. If you are not the intended recipient, please delete all copies and notify us immediately.

This e-mail originates from the City of Ottawa e-mail system. Any distribution, use or copying of this e-mail or the information it contains by other than the intended recipient(s) is unauthorized. Thank you.

Le présent courriel a été expédié par le système de courriels de la Ville d'Ottawa. Toute distribution, utilisation ou reproduction du courriel ou des renseignements qui s'y trouvent par une personne autre que son destinataire prévu est interdite. Je vous remercie de votre collaboration.

Caution: This email originated from outside of Stantec. Please take extra precaution.

Attention: Ce courriel provient de l'extérieur de Stantec. Veuillez prendre des précautions supplémentaires.

Atención: Este correo electrónico proviene de fuera de Stantec. Por favor, tome precauciones adicionales.

Appendix D Stormwater Servicing

D.1 Modified Rational Method Sheet



Roof Drain Design Calculation Sheet

**Project #160401786, 47 Beechwood Avenue
Roof Drain Design Sheet, Area BLDG
Standard Watts Roof Drain with Adjustable Accutrol Weir**

Rating Curve				Volume Estimation				Water Depth (m)
Elevation (m)	Discharge Rate (cu.m/s)	Outlet Discharge (cu.m/s)	Storage (cu. m)	Elevation (m)	Area (sq. m)	Volume (cu. m)		
						Increment	Accumulated	
0.000	0.000000	0.0000	0.00	0.000	0	0.00	0.00	0.000
0.025	0.000315	0.0038	0.23	0.025	27.33	0.23	0.23	0.025
0.050	0.000631	0.0076	1.82	0.050	109.33	1.59	1.82	0.050
0.075	0.000710	0.0085	6.15	0.075	246.00	4.33	6.15	0.075
0.100	0.000789	0.0095	14.58	0.100	437.33	8.43	14.58	0.100
0.125	0.000867	0.0104	28.47	0.125	683.33	13.89	28.47	0.125
0.150	0.000946	0.0114	49.20	0.150	984.00	20.73	49.20	0.150

Drawdown Estimate			
Total Volume (cu.m)	Total Time (sec)	Total Vol (cu.m)	Total Detention Time (hr)
0.0	0.0	0.0	0
1.6	210.6	1.6	0.05851
5.9	508.2	4.3	0.19967
14.4	890.7	8.4	0.44707
28.2	1334.9	13.9	0.81787
49.0	1825.4	20.7	1.32494

Rooftop Storage Summary

Total Building Area (sq.m)	1230	
Assume Available Roof Area (sq.m)	80%	984
Roof Imperviousness		0.99
Roof Drain Requirement (sq.m/Notch)		232
Number of Roof Notches*		12
Max. Allowable Depth of Roof Ponding (m)	0.15	* As per Ontario Building Code section OBC 7.4.10.4.(2)(c).
Max. Allowable Storage (cu.m)		49
Estimated 100 Year Drawdown Time (h)		1.0

* Note: Number of drains can be reduced if multiple-notch drain used.

Adjustable Accutrol Weir Flow Rate Settings From Watts Drain Catalogue					
Head (m)	L/s				
	Open	75%	50%	25%	Closed
0.025	0.31542	0.31542	0.31542	0.31542	0.31542
0.05	0.63083	0.63083	0.63083	0.63083	0.31542
0.075	0.94625	0.8674	0.78854	0.70969	0.31542
0.1	1.26167	1.10396	0.94625	0.78854	0.31542
0.125	1.57708	1.34052	1.10396	0.8674	0.31542
0.15	1.8925	1.57708	1.26167	0.94625	0.31542

Calculation Results

	2yr	100yr	Available
Qresult (cu.m/s)	0.009	0.011	-
Depth (m)	0.083	0.135	0.150
Volume (cu.m)	8.9	37.1	49.2
Drain time (hrs)	0.3	1.0	

Stormwater Management Calculations

File No: **160401786**
 Project: **47 Beechwood Avenue**
 Date: **30-Apr-24**

SWM Approach:
 Post-development to Pre-development flows

Post-Development Site Conditions:

Overall Runoff Coefficient for Site and Sub-Catchment Areas

Runoff Coefficient Table									
Catchment Type	Sub-catchment Area		Area (ha) "A"	Runoff Coefficient "C"		"A x C"	Overall Runoff Coefficient		
	ID / Description								
Uncontrolled - Cistern	CB-5	Hard	0.002	0.9	0.002				
		Soft	0	0.2	0.000				
		Subtotal				0.002		0.002	0.900
Roof	BLDG	Hard	0.123	0.9	0.111				
		Soft	0.000	0.2	0.000				
		Subtotal				0.123		0.1107	0.900
Uncontrolled - Cistern	CB-1-4	Hard	0.015	0.9	0.013				
		Soft	0.005	0.2	0.001				
		Subtotal				0.02		0.0142	0.710
Roof Canopy	Bldg 2-3	Hard	0.036	0.9	0.032				
		Soft	0.000	0.2	0.000				
		Subtotal				0.036		0.0324	0.900
Uncontrolled - Non-Tributary	UNC-1	Hard	0.032	0.9	0.029				
		Soft	0.002	0.2	0.000				
		Subtotal				0.034		0.02924	0.860
Total						0.215		0.188	
Overall Runoff Coefficient= C:									0.88

Total Roof Area (Controlled)	0.123 ha
Roof Canopy/Terrace	0.036
Total Tributary Surface Areas (Controlled and Uncontrolled)	0.022 ha
Total Tributary Area to Outlet	0.181 ha
 Total Uncontrolled Areas (Non-Tributary)	 0.034 ha
 Total Site	 0.215 ha

Stormwater Management Calculations

Project #160401786, 47 Beechwood Avenue
Modified Rational Method Calculations for Storage

2 yr Intensity City of Ottawa	$I = a/(t + b)^c$	a = 732.951	t (min)	I (mm/hr)
		b = 6.199	10	76.81
		c = 0.81	20	52.03
			30	40.04
			40	32.86
			50	28.04
			60	24.56
			70	21.91
			80	19.83
			90	18.14
			100	16.75
			110	15.57
			120	14.56

2 YEAR Predevelopment Target Release from Portion of Site

Subdrainage Area: Predevelopment Tributary Area to Outlet
 Area (ha): 0.2150
 C: 0.50

Typical Time of Concentration

tc (min)	I (2 yr) (mm/hr)	Qtarget (L/s)
10	76.81	23.0

2 YEAR Modified Rational Method for Entire Site

Subdrainage Area: CB-5 Uncontrolled - Cistern
 Area (ha): 0.00
 C: 0.90

tc (min)	I (2 yr) (mm/hr)	Qactual (L/s)	Qrelease (L/s)	Qstored (L/s)	Vstored (m³)
10	76.81	0.4	0.4	0.0	0.0
20	52.03	0.3	0.3	0.0	0.0
30	40.04	0.2	0.2	0.0	0.0
40	32.86	0.2	0.2	0.0	0.0
50	28.04	0.1	0.1	0.0	0.0
60	24.56	0.1	0.1	0.0	0.0
70	21.91	0.1	0.1	0.0	0.0
80	19.83	0.1	0.1	0.0	0.0
90	18.14	0.1	0.1	0.0	0.0
100	16.75	0.1	0.1	0.0	0.0
110	15.57	0.1	0.1	0.0	0.0
120	14.56	0.1	0.1	0.0	0.0

Subdrainage Area: BLDG Roof
 Area (ha): 0.12 Maximum Storage Depth: 150 mm
 C: 0.90

tc (min)	I (2 yr) (mm/hr)	Qactual (L/s)	Qrelease (L/s)	Qstored (L/s)	Vstored (m³)	Depth (mm)
10	76.81	23.6	8.8	14.8	8.9	83.1
20	52.03	16.0	8.8	7.2	8.7	82.4
30	40.04	12.3	8.6	3.7	6.7	76.7
40	32.86	10.1	8.2	1.9	4.6	66.2
50	28.04	8.6	7.7	0.9	2.6	54.7
60	24.56	7.6	7.1	0.5	1.6	46.9
70	21.91	6.7	6.4	0.3	1.3	42.4
80	19.83	6.1	5.9	0.2	1.1	38.8
90	18.14	5.6	5.4	0.2	0.9	35.8
100	16.75	5.2	5.0	0.1	0.8	33.2
110	15.57	4.8	4.7	0.1	0.6	31.0
120	14.56	4.5	4.4	0.1	0.5	29.1

Storage: Roof Storage

Depth (mm)	Head (m)	Discharge (L/s)	Vreq (cu. m)	Vavail (cu. m)	Discharge Check
83.12	0.08	8.8	8.9	49.2	0.0

Subdrainage Area: CB-1-4 Uncontrolled - Cistern
 Area (ha): 0.02
 C: 0.71

tc (min)	I (2 yr) (mm/hr)	Qactual (L/s)	Qrelease (L/s)	Qstored (L/s)	Vstored (m³)
10	76.81	3.0	3.0	0.0	0.0
20	52.03	2.1	2.1	0.0	0.0
30	40.04	1.6	1.6	0.0	0.0
40	32.86	1.3	1.3	0.0	0.0
50	28.04	1.1	1.1	0.0	0.0
60	24.56	1.0	1.0	0.0	0.0
70	21.91	0.9	0.9	0.0	0.0
80	19.83	0.8	0.8	0.0	0.0
90	18.14	0.7	0.7	0.0	0.0
100	16.75	0.7	0.7	0.0	0.0
110	15.57	0.6	0.6	0.0	0.0
120	14.56	0.6	0.6	0.0	0.0

Subdrainage Area: Bldg 2-3 Roof Canopy
 Area (ha): 0.04
 C: 0.90

tc (min)	I (2 yr) (mm/hr)	Qactual (L/s)	Qrelease (L/s)	Qstored (L/s)	Vstored (m³)
10	76.81	6.9	6.9	0.0	0.0
20	52.03	4.7	4.7	0.0	0.0
30	40.04	3.6	3.6	0.0	0.0
40	32.86	3.0	3.0	0.0	0.0
50	28.04	2.5	2.5	0.0	0.0
60	24.56	2.2	2.2	0.0	0.0
70	21.91	2.0	2.0	0.0	0.0
80	19.83	1.8	1.8	0.0	0.0
90	18.14	1.6	1.6	0.0	0.0

Project #160401786, 47 Beechwood Avenue
Modified Rational Method Calculations for Storage

100 yr Intensity City of Ottawa	$I = a/(t + b)$	a = 1735.688	t (min)	I (mm/hr)
		b = 6.014	10	178.56
		c = 0.820	20	119.95
			30	91.87
			40	75.15
			50	63.95
			60	55.89
			70	49.79
			80	44.99
			90	41.11
			100	37.90
			110	35.20
			120	32.89

100 YEAR Predevelopment Target Release from Portion of Site

Subdrainage Area: Predevelopment Tributary Area to Outlet
 Area (ha): 0.2150
 C: 0.50

Typical Time of Concentration

tc (min)	I (100 yr) (mm/hr)	Qtarget (L/s)
10	178.56	54.0

100 YEAR Modified Rational Method for Entire Site

Subdrainage Area: CB-5 Uncontrolled - Cistern
 Area (ha): 0.00
 C: 1.00

tc (min)	I (100 yr) (mm/hr)	Qactual (L/s)	Qrelease (L/s)	Qstored (L/s)	Vstored (m³)
10	178.56	1.0	1.0	0.0	0.0
20	119.95	0.7	0.7	0.0	0.0
30	91.87	0.5	0.5	0.0	0.0
40	75.15	0.4	0.4	0.0	0.0
50	63.95	0.4	0.4	0.0	0.0
60	55.89	0.3	0.3	0.0	0.0
120	32.89	0.2	0.2	0.0	0.0
180	23.90	0.1	0.1	0.0	0.0
240	19.01	0.1	0.1	0.0	0.0
300	15.89	0.1	0.1	0.0	0.0
360	13.72	0.1	0.1	0.0	0.0
420	12.12	0.1	0.1	0.0	0.0

Subdrainage Area: BLDG Roof
 Area (ha): 0.12 Maximum Storage Depth: 150 mm
 C: 1.00

tc (min)	I (100 yr) (mm/hr)	Qactual (L/s)	Qrelease (L/s)	Qstored (L/s)	Vstored (m³)	Depth (mm)
10	178.56	61.1	10.5	50.6	30.3	127.2
20	119.95	41.0	10.8	30.2	36.3	134.4
30	91.87	31.4	10.8	20.6	37.1	135.4
40	75.15	25.7	10.7	14.9	35.9	133.9
50	63.95	21.9	10.6	11.2	33.7	131.3
60	55.89	19.1	10.5	8.6	30.9	128.0
120	32.89	11.2	9.4	1.9	13.6	97.2
180	23.90	8.2	7.9	0.3	3.2	58.1
240	19.01	6.5	6.4	0.1	1.3	42.3
300	15.89	5.4	5.4	0.1	0.9	35.6
360	13.72	4.7	4.7	0.0	0.6	30.8
420	12.12	4.1	4.1	0.0	0.4	27.3

Storage: Roof Storage

Depth (mm)	Head (m)	Discharge (L/s)	Vreq (cu. m)	Vavail (cu. m)	Discharge Check
135.41	0.14	10.8	37.1	49.2	0.0

Subdrainage Area: CB-1-4 Uncontrolled - Cistern
 Area (ha): 0.02
 C: 0.89

tc (min)	I (100 yr) (mm/hr)	Qactual (L/s)	Qrelease (L/s)	Qstored (L/s)	Vstored (m³)
10	178.56	8.8	8.8	0.0	0.0
20	119.95	5.9	5.9	0.0	0.0
30	91.87	4.5	4.5	0.0	0.0
40	75.15	3.7	3.7	0.0	0.0
50	63.95	3.2	3.2	0.0	0.0
60	55.89	2.8	2.8	0.0	0.0
120	32.89	1.6	1.6	0.0	0.0
180	23.90	1.2	1.2	0.0	0.0
240	19.01	0.9	0.9	0.0	0.0
300	15.89	0.8	0.8	0.0	0.0
360	13.72	0.7	0.7	0.0	0.0
420	12.12	0.6	0.6	0.0	0.0

Subdrainage Area: Bldg 2-3 Roof Canopy
 Area (ha): 0.04
 C: 1.00

tc (min)	I (100 yr) (mm/hr)	Qactual (L/s)	Qrelease (L/s)	Qstored (L/s)	Vstored (m³)
10	178.56	17.9	17.9	0.0	0.0
20	119.95	12.0	12.0	0.0	0.0
30	91.87	9.2	9.2	0.0	0.0
40	75.15	7.5	7.5	0.0	0.0
50	63.95	6.4	6.4	0.0	0.0
60	55.89	5.6	5.6	0.0	0.0
120	32.89	3.3	3.3	0.0	0.0
180	23.90	2.4	2.4	0.0	0.0
240	19.01	1.9	1.9	0.0	0.0

Stormwater Management Calculations

Project #160401786, 47 Beechwood Avenue
Modified Rational Method Calculations for Storage

100	16.75	1.5	1.5	0.0	0.0
110	15.57	1.4	1.4	0.0	0.0
120	14.56	1.3	1.3	0.0	0.0

Subdrainage Area: UNC-1 Uncontrolled - Non-Tributary
 Area (ha): 0.03
 C: 0.86

tc (min)	I (2 yr) (mm/hr)	Qactual (L/s)	Qrelease (L/s)	Qstored (L/s)	Vstored (m³)
10	76.81	6.2	6.2		
20	52.03	4.2	4.2		
30	40.04	3.3	3.3		
40	32.86	2.7	2.7		
50	28.04	2.3	2.3		
60	24.56	2.0	2.0		
70	21.91	1.8	1.8		
80	19.83	1.6	1.6		
90	18.14	1.5	1.5		
100	16.75	1.4	1.4		
110	15.57	1.3	1.3		
120	14.56	1.2	1.2		

Subdrainage Area: CISTERN 0.00
 Area (ha): 0.00
 C: 0.00

tc (min)	I (2 yr) (mm/hr)	Qactual (L/s)	Qrelease (L/s)	Qstored (L/s)	Vstored (m³)
10	76.81	10.3	10.3	0.0	0.0
20	52.03	7.0	7.0	0.0	0.0
30	40.04	5.4	5.4	0.0	0.0
40	32.86	4.4	4.4	0.0	0.0
50	28.04	3.8	3.8	0.0	0.0
60	24.56	3.3	3.3	0.0	0.0
70	21.91	2.9	2.9	0.0	0.0
80	19.83	2.7	2.7	0.0	0.0
90	18.14	2.4	2.4	0.0	0.0
100	16.75	2.3	2.3	0.0	0.0
110	15.57	2.1	2.1	0.0	0.0
120	14.56	2.0	2.0	0.0	0.0

Stage	Head (m)	Discharge (L/s)	Vreq (cu. m)	Vavail (cu. m)	Volume Check
Cistern	-	10.3	0.0	10.0	OK

SUMMARY TO OUTLET

	Controlled Area	0.181 ha	Vrequired	Vavailable*
Total 2yr Flow to Sewer		19.2 L/s	8.9	59.2 m³
Uncontrolled Area	0.034 ha			
Total 2yr Flow Uncontrolled	6.2 L/s			
Total Area	0.215 ha			
Total 2yr Flow	25.4 L/s			
Target	23.0 L/s			

Project #160401786, 47 Beechwood Avenue
Modified Rational Method Calculations for Storage

300	15.89	1.6	1.6	0.0	0.0
360	13.72	1.4	1.4	0.0	0.0
420	12.12	1.2	1.2	0.0	0.0

Subdrainage Area: UNC-1 Uncontrolled - Non-Tributary
 Area (ha): 0.03
 C: 1.00

tc (min)	I (100 yr) (mm/hr)	Qactual (L/s)	Qrelease (L/s)	Qstored (L/s)	Vstored (m³)
10	178.56	16.9	16.9		
20	119.95	11.3	11.3		
30	91.87	8.7	8.7		
40	75.15	7.1	7.1		
50	63.95	6.0	6.0		
60	55.89	5.3	5.3		
70	49.79	4.7	4.7		
80	44.99	4.3	4.3		
90	41.11	3.9	3.9		
100	37.90	3.6	3.6		
110	35.20	3.3	3.3		
120	32.89	3.1	3.1		

Subdrainage Area: CISTERN 0.00
 Area (ha): 0.00
 C: 0.00

tc (min)	I (100 yr) (mm/hr)	Qactual (L/s)	Qrelease (L/s)	Qstored (L/s)	Vstored (m³)
10	178.56	27.7	12.2	15.5	9.3
20	119.95	18.6	12.2	6.4	7.7
30	91.87	14.2	12.2	2.1	3.8
40	75.15	11.6	11.6	0.0	0.0
50	63.95	9.9	9.9	0.0	0.0
60	55.89	8.7	8.7	0.0	0.0
120	32.89	5.1	5.1	0.0	0.0
180	23.90	3.7	3.7	0.0	0.0
240	19.01	2.9	2.9	0.0	0.0
300	15.89	2.5	2.5	0.0	0.0
360	13.72	2.1	2.1	0.0	0.0
420	12.12	1.9	1.9	0.0	0.0

Stage	Head (m)	Discharge (L/s)	Vreq (cu. m)	Vavail (cu. m)	Volume Check
Cistern	-	12.2	9.3	10.0	OK

SUMMARY TO OUTLET

	Controlled Area	0.181 ha	Vrequired	Vavailable*
Total 100yr Flow to Sewer		23.0 L/s	46.4	59.2 m³
Uncontrolled Area	0.034 ha			
Total 100yr Flow Uncontrolled	16.9 L/s			
Total Area	0.215 ha			
Total 100yr Flow	39.8 L/s			
Target	23.0 L/s			

D.2 Watts Drainage Adjustable Accutrol Weir Detail (2016)





Adjustable Accutrol Weir

Tag: _____

Adjustable Flow Control for Roof Drains

ADJUSTABLE ACCUTROL (for Large Sump Roof Drains only)

For more flexibility in controlling flow with heads deeper than 2", Watts Drainage offers the Adjustable Accutrol. The Adjustable Accutrol Weir is designed with a single parabolic opening that can be covered to restrict flow above 2" of head to less than 5 gpm per inch, up to 6" of head. To adjust the flow rate for depths over 2" of head, set the slot in the adjustable upper cone according to the flow rate required. Refer to Table 1 below.
 Note: Flow rates are directly proportional to the amount of weir opening that is exposed.

EXAMPLE:

For example, if the adjustable upper cone is set to cover 1/2 of the weir opening, flow rates above 2" of head will be restricted to 2-1/2 gpm per inch of head.

Therefore, at 3" of head, the flow rate through the Accutrol Weir that has 1/2 the slot exposed will be:
 [5 gpm (per inch of head) x 2 inches of head] + 2-1/2 gpm (for the third inch of head) = 12-1/2 gpm.

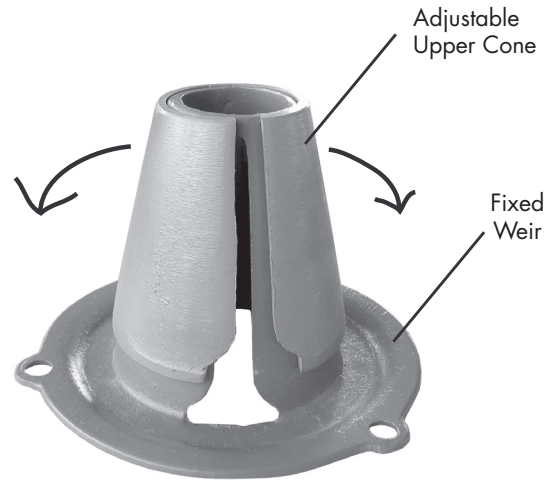
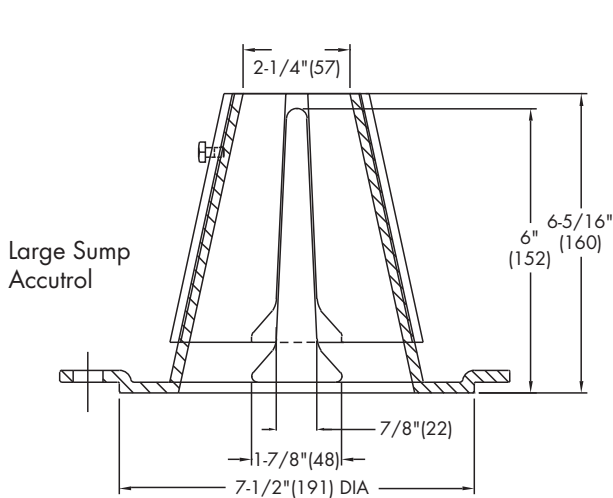

1/2 Weir Opening Exposed Shown Above

TABLE 1. Adjustable Accutrol Flow Rate Settings

Weir Opening Exposed	1"	2"	3"	4"	5"	6"
	Flow Rate (gallons per minute)					
Fully Exposed	5	10	15	20	25	30
3/4	5	10	13.75	17.5	21.25	25
1/2	5	10	12.5	15	17.5	20
1/4	5	10	11.25	12.5	13.75	15
Closed	5	5	5	5	5	5

Job Name _____
 Job Location _____
 Engineer _____

Contractor _____
 Contractor's P.O. No. _____
 Representative _____

Watts product specifications in U.S. customary units and metric are approximate and are provided for reference only. For precise measurements, please contact Watts Technical Service. Watts reserves the right to change or modify product design, construction, specifications, or materials without prior notice and without incurring any obligation to make such changes and modifications on Watts products previously or subsequently sold.

USA: Tel: (800) 338-2581 • Fax: (828) 248-3929 • Watts.com
 Canada: Tel: (905) 332-4090 • Fax: (905) 332-7068 • Watts.ca
 Latin America: Tel: (52) 81-1001-8600 • Fax: (52) 81-8000-7091 • Watts.com



A Watts Water Technologies Company

D.3 Storm Sewer Design Sheet





Beechwood Avenue

**STORM SEWER
DESIGN SHEET**
(City of Ottawa)

DESIGN PARAMETERS

$I = a / (t+b)^c$ (As per City of Ottawa Guidelines, 2012)

	1:2 yr	1:5 yr	1:10 yr	1:100 yr	
a =	732.951	998.071	1174.184	1735.688	MANNING'S n = 0.013
b =	6.199	6.053	6.014	6.014	BEDDING CLASS = B
c =	0.810	0.814	0.816	0.820	MINIMUM COVER: 2.00 m
					TIME OF ENTRY: 10 min

FILE NUMBER: 160401786

LOCATION			DRAINAGE AREA																PIPE SELECTION																				
AREA ID NUMBER	FROM M.H.	TO M.H.	AREA (2-YEAR)	AREA (5-YEAR)	AREA (10-YEAR)	AREA (100-YEAR)	AREA (ROOF)	C (2-YEAR)	C (5-YEAR)	C (10-YEAR)	C (100-YEAR)	A x C (2-YEAR)	ACCUM A x C (2YR)	A x C (5-YEAR)	ACCUM A x C (5YR)	A x C (10-YEAR)	ACCUM A x C (10YR)	A x C (100-YEAR)	ACCUM A x C (100YR)	T of C (min)	I ₂ -YEAR (mmh)	I ₅ -YEAR (mmh)	I ₁₀ -YEAR (mmh)	I ₁₀₀ -YEAR (mmh)	Q _{CONTROL} (L/s)	ACCUM. Q _{CONTROL} (L/s)	Q _{ACT} (CIA/360) (L/s)	LENGTH (m)	PIPE WIDTH OR DIAMETER (mm)	PIPE HEIGHT (mm)	PIPE SHAPE (-)	MATERIAL (-)	CLASS (-)	SLOPE (%)	Q _{cap} (FULL) (L/s)	% FULL (-)	VEL. (FULL) (m/s)	VEL. (ACT) (m/s)	TIME OF FLOW (min)
BLDG-1, BLDG-2, BLDG-3, CB1-4, CB-5	Building	STM2	0.000	0.058	0.000	0.000	0.123	0.00	0.83	0.00	0.00	0.000	0.000	0.048	0.048	0.000	0.000	0.000	0.000	10.00	76.81	104.19	122.14	178.56	10.8	10.8	24.8	8.9	250	250	CIRCULAR	PVC	-	1.00	60.4	41.07%	1.22	0.98	0.15

D.4 Correspondence on Douglas Avenue Storm Capacity



Moir, Tyler

From: Fawzi, Mohammed <mohammed.fawzi@ottawa.ca>
Sent: Thursday, March 16, 2023 11:49 AM
To: Moir, Tyler
Subject: RE: 47 Beechwood Avenue - Pre-Application PC2020-0250

Hi Tyler,

Douglas Avenue is an option. My apologies for not including that in the notes.

The storm sewer on Douglas has a 5-year level of service.

Happy to discuss further if needed. Thank you.

Best Regards,

Mohammed Fawzi, P.Eng.

Project Manager

Planning, Infrastructure and Economic Development Department - Services de la planification, de l'infrastructure et du développement économique

Development Review - Central Branch

City of Ottawa | Ville d'Ottawa

110 Laurier Avenue West Ottawa, ON | 110, avenue. Laurier Ouest. Ottawa (Ontario) K1P 1J1

613.580.2424 ext./poste 20120, Mohammed.Fawzi@ottawa.ca

****Please note that due to the current situation, I am working remotely. Email is currently the best way to contact me****

From: Moir, Tyler <Tyler.Moir@stantec.com>
Sent: March 15, 2023 1:42 PM
To: Fawzi, Mohammed <mohammed.fawzi@ottawa.ca>
Subject: 47 Beechwood Avenue - Pre-Application PC2020-0250

CAUTION: This email originated from an External Sender. Please do not click links or open attachments unless you recognize the source.

ATTENTION : Ce courriel provient d'un expéditeur externe. Ne cliquez sur aucun lien et n'ouvrez pas de pièce jointe, excepté si vous connaissez l'expéditeur.

Good afternoon,

I am reviewing the Pre-App meeting notes from October 4, 2022 on the above referenced project. Under engineering it was noted that infrastructure was available from Beechwood Avenue and Springfield Road. Is Douglas Street not an option due to capacity restraints? The main reason I'm looking at a servicing options to Douglas would be to limit disruption to Beechwood Avenue during construction. Just double checking that Douglas is not an option before we move forward with the detailed design.



Thanks
Tyler

Tyler Moir P.Eng.
Project Manager, Community Development

Direct: 902 620-0250
Mobile: 902 388-0100
Tyler.Moir@stantec.com

Stantec
165 Maple Hills Avenue
Charlottetown PE C1C 1N9

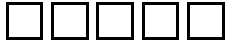

The content of this email is the confidential property of Stantec and should not be copied, modified, retransmitted, or used for any purpose except with Stantec's written authorization. If you are not the intended recipient, please delete all copies and notify us immediately.

Please consider the environment before printing this email.

This e-mail originates from the City of Ottawa e-mail system. Any distribution, use or copying of this e-mail or the information it contains by other than the intended recipient(s) is unauthorized. Thank you.

Le présent courriel a été expédié par le système de courriels de la Ville d'Ottawa. Toute distribution, utilisation ou reproduction du courriel ou des renseignements qui s'y trouvent par une personne autre que son destinataire prévu est interdite. Je vous remercie de votre collaboration.

Caution: This email originated from outside of Stantec. Please take extra precaution.

Attention: Ce courriel provient de l'extérieur de Stantec. Veuillez prendre des précautions supplémentaires.

Atención: Este correo electrónico proviene de fuera de Stantec. Por favor, tome precauciones adicionales.

D.5 Conceptual Roof Ponding Plan





SPRINGFIELD ROAD

DOUGLAS AVENUE

BEECHWOOD AVENUE

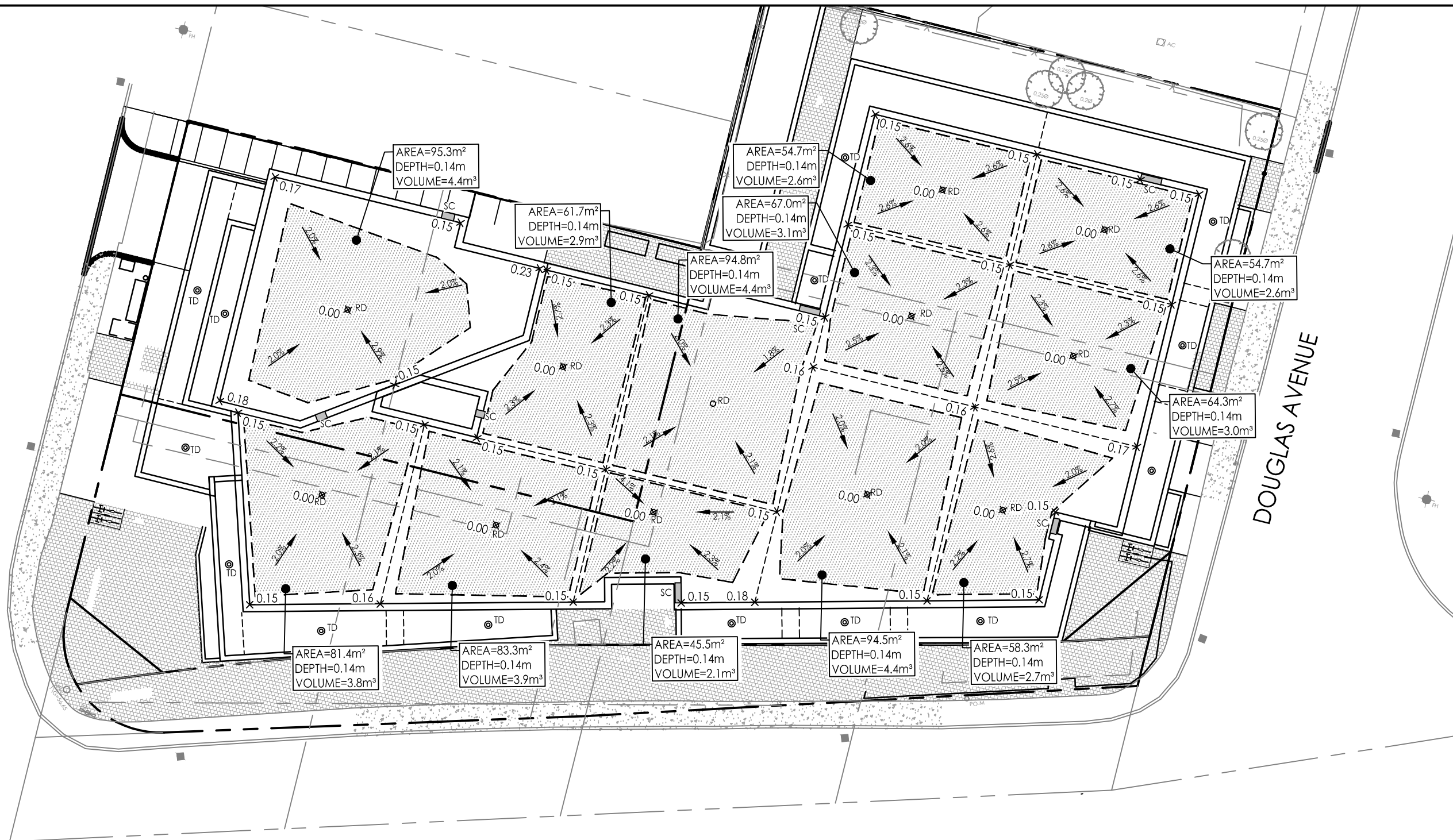

W:\active\160401786\design\drawing\160401786 ROOF.dwg
2024/08/13 2:35 PM By: Johnson, Warren

ORIGINAL SHEET - ANSI B



AUGUST 2024
160401786

Stantec
 Stantec Consulting Ltd.
 400 - 1331 Clyde Avenue
 Ottawa ON
 Tel. 613.722.4420
 www.stantec.com

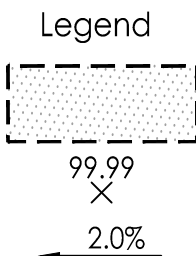

MAX 100-YEAR PONDING LIMITS

APPROXIMATE ELEVATION RELATIVE TO ROOF DRAIN.
REFER TO ARCHITECTURAL PLANS FOR DETAILS.

APPROXIMATE FLOW DIRECTION AND GRADE.
REFER TO ARCHITECTURAL PLANS FOR DETAILS.



APPROXIMATE LOCATION OF PROPOSED ROOF DRAIN.
REFER TO ARCHITECTURAL PLANS FOR DETAILS.

APPROXIMATE LOCATION OF PROPOSED TERRACE
DRAIN. REFER TO ARCHITECTURAL PLANS FOR DETAILS.

APPROXIMATE LOCATION OF PROPOSED SCUPPER.
REFER TO ARCHITECTURAL PLANS FOR DETAILS.

Client/Project
Project1 Studio
47 BEECHWOOD AVENUE

Figure No.

D.5

Title

CONCEPTUAL ROOF PONDING PLAN

Appendix E Background Studies

E.1 Geotechnical Investigation (Paterson Group, January 2023)



Geotechnical Investigation

Proposed Mixed-Use Mid-Rise Building

47 Beechwood Avenue, 5 Springfield Road
and 12 Douglas Avenue
Ottawa, Ontario

Prepared for Mr. Hussain Rahal

Report PG6484-1 dated January 13, 2023

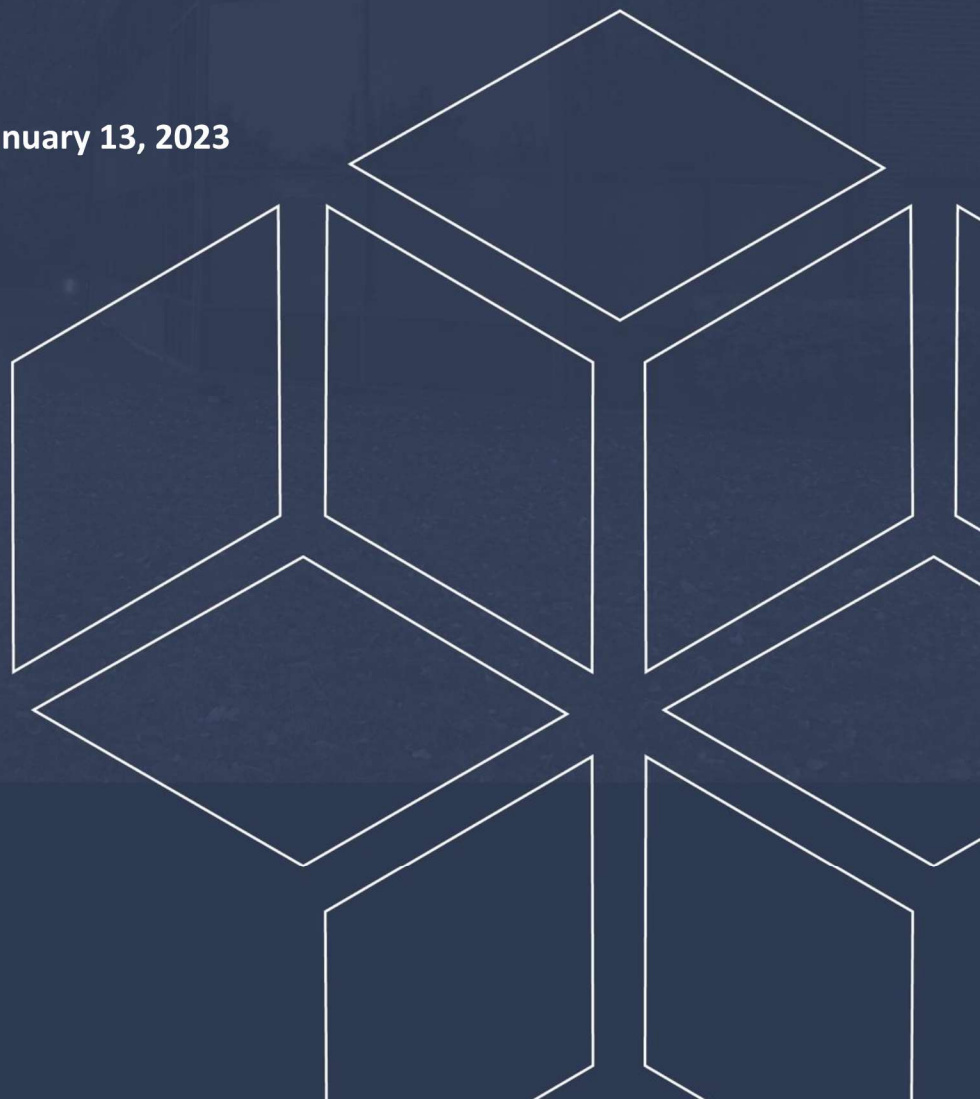

Table of Contents

1.0	Introduction	1
2.0	Proposed Development	1
3.0	Method of Investigation	2
3.1	Field Investigation	2
3.2	Field Survey	3
3.3	Laboratory Testing	3
3.4	Analytical Testing	3
4.0	Observations	4
4.1	Surface Conditions	4
4.2	Subsurface Profile	4
4.3	Groundwater	5
5.0	Discussion	6
5.1	Geotechnical Assessment	6
5.2	Site Grading and Preparation	6
5.3	Foundation Design	9
5.4	Design for Earthquakes	10
5.5	Basement Slab	11
5.6	Basement Wall	11
5.7	Pavement Structure	12
6.0	Design and Construction Precautions.....	14
6.1	Foundation Drainage and Backfill	14
6.2	Protection of Footings Against Frost Action	15
6.3	Excavation Side Slopes	15
6.4	Pipe Bedding and Backfill	17
6.5	Groundwater Control	18
6.6	Winter Construction.....	18
6.7	Corrosion Potential and Sulphate	19
7.0	Recommendations	20
8.0	Statement of Limitations.....	21

Appendices

- Appendix 1** Soil Profile and Test Data Sheets
 Symbols and Terms
 Analytical Testing Results
- Appendix 2** Figure 1 - Key Plan
 Drawing PG6484-1 - Test Hole Location Plan

1.0 Introduction

Paterson Group (Paterson) was commissioned by Mr. Hussain Rahal to conduct a Geotechnical Investigation for the proposed building to be located at 47 Beechwood Avenue, 5 Springfield Road and 12 Douglas Avenue, Ottawa, ON (refer to Figure 1 - Key Plan presented in Appendix 2).

The objectives of the geotechnical investigation were to:

- ❑ Determine the subsoil and groundwater conditions at this site by means of boreholes.
- ❑ Provide geotechnical recommendations for the design of the proposed development including construction considerations which may affect the design.

The following report has been prepared specifically and solely for the aforementioned project which is described herein. It contains our findings and includes geotechnical recommendations pertaining to the design and construction of the subject development as they are understood at the time of writing this report.

Investigating for the presence or potential presence of contamination on the subject property was not part of the scope of work of the present investigation. Therefore, the present report does not address environmental issues.

2.0 Proposed Development

It is expected that the development will consist of mixed-use mid-rise apartment building with one basement level. The subject site may have surface parking and it is expected that the site will be fully serviced by municipal infrastructure.

3.0 Method of Investigation

3.1 Field Investigation

Field Program

Paterson conducted a geotechnical investigation at the subject site on November 29, 2022. The current investigation consisted of drilling 5 boreholes extending to a maximum depth of 4.0 m below the existing ground surface.

The test hole locations were distributed in a manner to provide general coverage of the subject site. The locations of the test holes are shown on Drawing PG6484-1 - Test Hole Location Plan included in Appendix 2.

The test holes were advanced using a CME-55 Low Clearance Drill rig and operated by a two-person crew. The drilling procedure consisted of augering to the required depths at the selected locations, and sampling and testing the overburden. All fieldwork was conducted under the full-time supervision of Paterson personnel under the direction of a senior engineer.

Sampling and In Situ Testing

The soil samples were recovered from the auger flights and using a 50 mm diameter split-spoon sampler. The samples were initially classified on site, placed in sealed plastic bags and transported to our laboratory. The depths at which the auger and split-spoon samples were recovered from the boreholes are shown as AU and SS, respectively, on the Soil Profile and Test Data sheets in Appendix 1.

The Standard Penetration Test (SPT) was conducted in conjunction with the recovery of the split-spoon samples. The SPT results are recorded as “N” values on the Soil Profile and Test Data sheets. The “N” value is the number of blows required to drive the split-spoon sampler 300 mm into the soil after a 150 mm initial penetration using a 63.5 kg hammer falling from a height of 760 mm.

The subsurface conditions observed in the test holes were recorded in detail in the field. The soil profiles are logged on the Soil Profile and Test Data sheets in Appendix 1 of this report.

Groundwater

A piezometer was installed in all boreholes to permit monitoring of the groundwater levels subsequent to the completion of the sampling program.

The groundwater observations are discussed in Section 4.3 and presented on the Soil Profile and Test Data sheets in Appendix 1.

3.2 Field Survey

The test hole locations were selected by Paterson to provide general coverage of the proposed development taking into consideration the existing site features and underground utilities. The test hole locations and ground surface elevation at each test hole location were surveyed by Paterson with respect to a geodetic datum. The location of the test holes and ground surface elevation at each test hole location are presented on Drawing PG6484-1 - Test Hole Location Plan in Appendix 2.

3.3 Laboratory Testing

Soil samples were recovered from the subject site and visually examined in our laboratory to review the results of the field logging. Moisture content testing were completed on selected soil samples. All samples will be stored in the laboratory for a period of one (1) month after issuance of this report. They will then be discarded unless we are otherwise directed.

3.4 Analytical Testing

One (1) soil sample was submitted for analytical testing to assess the corrosion potential for exposed ferrous metals and the potential of sulphate attacks against subsurface concrete structures. The sample was analyzed to determine the concentration of sulphate and chloride, the resistivity, and the pH of the sample. The results are discussed in Section 6.7 and provided in Appendix 1.

4.0 Observations

4.1 Surface Conditions

Currently, the subject site was observed to be occupied by multiple residential and/or commercial buildings with the associated at grade asphalt paved parking lot. The ground surface across the subject site is relatively flat and approximately at grade with roadway.

The site is bordered by commercial buildings to the north, Douglas Avenue to the east, beechwood avenue to the south and Springfield Road to the west.

4.2 Subsurface Profile

Overburden

Generally, the soil profile at the borehole locations consists of asphaltic concrete overlying a fill layer followed by dense to very dense brown silty sand to sandy silt deposit or compact glacial till underlain by bedrock.

Fill

The fill material was found to generally consist of brown silty sand with crushed stone and, at times, topsoil, ash, brick, coal, rock fragments and organics. The fill layer thickness ranged approximately between 0.2 to 2.8 m.

Silty Sand

The silty sand deposit was generally encountered below the fill at depths ranging from 1.5 to 2.0 m. The silty sand deposit was generally observed to be dense to very dense brown in colour.

Glacial Till

The glacial till deposit was encountered at BH5-22 underlying the fill at depth 1.9 m from the ground surface. The glacial till deposit was generally observed to consist of compact brown silty sand with gravel, cobbles, boulders changing into gray colour at depth 2.2 m from ground surface.

Practical refusal to the augering was encountered at approximate depths ranging from 2.6 to 4.0 m.

Reference should be made to the Soil Profile and Test Data sheets in Appendix 1 for the details of the soil profiles encountered at each test hole location.

Bedrock

Based on available geological mapping, the bedrock in the subject area consists of Paleozoic shale of the Billings formation, with an overburden drift thickness of 2 to 5 m.

4.3 Groundwater

Groundwater levels measured in the piezometers are summarized in Table 1 below and are noted on the applicable Soil Profile and Test Data sheets presented in Appendix 1.

Table 1 - Summary of Groundwater Level Readings				
Test Hole Number	Ground Surface Elevation (m)	Groundwater Depth (m)	Groundwater Elevation (m)	Recording Date
BH 1-22	56.59	Dry	-	December 4, 2022
BH 2-22	56.63	Dry	-	December 4, 2022
BH 3-22	56.65	Dry	-	December 4, 2022
BH 4-22	57.04	Dry	-	December 4, 2022
BH 5-22	56.66	3.05	53.61	December 4, 2022
Note: The ground surface elevations from the current investigation are referenced to a geodetic datum.				

It should be noted that groundwater levels are subject to seasonal fluctuations. Therefore, the groundwater level could vary at the time of construction.

5.0 Discussion

5.1 Geotechnical Assessment

From a geotechnical perspective, the subject site is suitable for the proposed development. It is recommended that foundation support for the proposed building consist of conventional spread footings bearing on the undisturbed dense to very dense silty sand, compact glacial till or clean Bedrock surface.

Due to the presence of fill on site, it is expected that sub-excavation will be required for the installation of proposed footings.

Precautions should be taken during construction to reduce the risks associated with the potential for heaving of the expansive shale bedrock.

The above and other considerations are discussed in the following paragraphs.

5.2 Site Grading and Preparation

Stripping Depth

Due to the anticipated founding level for the proposed building, a significant portion of the existing overburden material will be excavated from within the proposed building footprint. Bedrock removal may be required for the construction of the parking garage levels within the east portion of the site.

Topsoil and fill, containing significant amounts of deleterious or organics materials, should be stripped from under any buildings, paved areas and other settlement sensitive structures.

If encountered, existing foundation walls and other construction debris should be entirely removed from within the building perimeter. Under paved areas, existing construction remnants, such as foundation walls, should be excavated to a minimum of 1 m below final grade.

Bedrock Removal

Bedrock removal can be accomplished by hoe ramming where the bedrock is weathered and/or where only small quantities of the bedrock need to be removed. Sound bedrock may be removed by line drilling in conjunction with controlled blasting and/or hoe ramming.

Prior to considering blasting operations, the blasting effects on the existing services, buildings, and other structures should be addressed. A pre-blast or pre-construction survey of the existing structures located in the proximity of the blasting operations should be carried out prior to commencing site activities.

The extent of the survey should be determined by the blasting consultant and should be sufficient to respond to any inquiries or claims related to the blasting operations.

As a general guideline, peak particle velocities (measured at the structures) should not exceed 25 mm/s during the blasting program to reduce the risks of damage to the existing surrounding structures. The blasting operations should be planned and conducted under the supervision of a licensed professional engineer who is also an experienced blasting consultant.

Vibration Considerations

Construction operations are also the cause of vibrations, and possibly, sources of nuisance to the community. Therefore, means to reduce the vibration levels should be incorporated in the construction operations to maintain, as much as possible, a cooperative environment with the residents.

The following construction equipment could be a source of vibrations: piling rig, hoe ram, compactor, dozer, crane, truck traffic, etc. Vibrations, whether it is caused by blasting operations or by construction operations, could be the cause of the source of detrimental vibrations on the nearby buildings and structures. Therefore, it is recommended that all vibrations be limited.

Two parameters are used to determine the permissible vibrations, namely, the maximum peak particle velocity and the frequency. For low frequency vibrations, the maximum allowable peak particle velocity is less than that for high frequency vibrations. As a guideline, the peak particle velocity should be less than 15 mm/s between frequencies of 4 to 12 Hz, and 50 mm/s above a frequency of 40 Hz (interpolate between 12 and 40 Hz).

It should be noted that these guidelines are for today's construction standards. Considering that these guidelines are above perceptible human level and, in some cases, could be very disturbing to some people, it is recommended that a pre-construction survey be completed to minimize the risks of claims during or following the construction of the proposed building.

Fill Placement

Fill used for grading beneath the proposed building should consist of clean imported granular fill, such as Ontario Provincial Standard Specifications (OPSS) Granular A or Granular B Type II or max. 100 mm diameter, well graded, site excavated blast rock approved by Paterson personnel at the time of placement. This material should be tested and approved prior to delivery to the site. The fill should be placed in lifts no greater than 300 mm thick and compacted using suitable compaction equipment for the lift thickness. Fill placed beneath the building should be compacted to at least 98% of the material's standard Proctor maximum dry density (SPMDD).

Non-specified existing fill, along with site-excavated soil, can be used as general landscaping fill where settlement of the ground surface is of minor concern. This material should be spread in thin lifts and at least compacted by the tracks of the spreading equipment to minimize voids.

If approved site excavated fill is to be used to build up the subgrade level for areas to be paved, it should be compacted in thin lifts to a minimum of 95% of the material's SPMDD.

Non-specified existing fill and site-excavated soils are not suitable for use as backfill against foundation walls unless used in conjunction with a composite drainage membrane as discussed under Section 6.1.

Protection of Potential Expansive Bedrock

It is anticipated that expansive shale will be encountered at the subject site. Although the effects of expansive shale will not affect the proposed building structure, it is possible that it will affect the proposed basement floor slab founded close to the shale bedrock.

A potential for heaving and rapid deterioration of the shale bedrock exists at this site. To reduce the long term deterioration of the shale, exposure of the bedrock surface to oxygen should be kept as low as possible. The bedrock surface within the proposed development footprint should be protected from excessive dewatering and exposure to ambient air. These requirements should be evaluated by Paterson during the excavation operations and should be discussed with Paterson during the design stage.

To accomplish this, a 50 mm thick concrete mud slab should be placed on the exposed bedrock surface within a 48 hour period of being exposed. A 17 MPa lean concrete is recommended for this purpose. As an alternative to the mud slab, keeping the shale surface covered with granular backfill is also acceptable.

Overbreak in Bedrock

Sedimentary bedrock formations contain bedding planes, joints and fractures, and mud seams which create natural planes of weakness within the rock mass. Although several factors of a blast may be controlled to reduce backbreak and overbreak, upon blasting, the rock mass will tend to break along natural planes of weakness that may be present beyond the designed blast profile. Due to this, estimating the exact amount of backbreak and overbreak that may occur is not possible with conventional construction drill and blast methods.

Backbreak should be expected to occur along the perimeter of building and site service excavation footprints with conventional drill and blast bedrock removal methods. Further, overbreak is expected to occur throughout the lowest lifts of blasting due to the variable bedding planes and planes of weakness in the in-situ bedrock. It is very difficult to mitigate significant over-blasting given the constraints posed by footing geometry and spacing with respect to the zone of influence of blasts and the bedrocks in-situ characteristics.

Depending on the methodology undertaken by the contractor, efforts taken to minimize backbreak and overbreak may add significant time and costs to the excavation operations and is not guaranteed to completely eliminate the potential for backbreak and overbreak. Overbreak below footings should be in-filled with lean-concrete and approved by Paterson prior to placing concrete.

As such, volume estimates of bedrock to be removed may not be reflective of the actual volume of bedrock that may be required to be removed at the time of construction. This may result in additional materials, such as imported fill and concrete, to make up for additional rock loss. It is recommended that the blasting operations be planned and conducted under the supervision of a licensed professional engineer who is an experienced blasting consultant.

5.3 Foundation Design

Footings for the proposed building placed over clean, surface sounded bedrock bearing surface can be designed using a factored bearing resistance value at Ultimate Limit States (ULS) of **1,000 kPa**.

A clean, surface-sounded bedrock bearing surface should be free of loose materials, and have no near surface seams, voids, fissures, or open joints which can be detected from surface sounding with a rock hammer.

Footings bearing on an acceptable bedrock bearing surface and designed for the bearing resistance values provided herein will be subjected to negligible potential post-construction total and differential settlements.

Lateral Support

The bearing medium under footing-supported structures is required to be provided with adequate lateral support with respect to excavations and different foundation levels.

Adequate lateral support is to be provided when a plane extending down and out from the bottom edges of the footing, at a minimum of 1.5H:1V, passes only through in situ soil of the same or higher capacity as that of the bearing medium. In unfractured bedrock, a plane with a slope of 1H:6V can be used.

Lean Concrete In-Filled Trenches

Where bedrock is expected near the design underside of footing elevation, consideration should be given to excavating zero entry, vertical trenches to expose the underlying bedrock surface and backfilling with lean concrete (15 MPa 28-day compressive strength). Typically, the excavation sidewalls will be used as the form to support the concrete. The additional width of the concrete poured against an undisturbed trench sidewall will suffice in providing a direct transfer of the footing load to the underlying bedrock.

The near vertical trench excavation should be at least 150 mm wider than all sides of the footing at the base of the excavation. The excavation bottom should be relatively clean using the hydraulic shovel only (workers will not be permitted in the excavation). Once approved by the Paterson field personnel, lean concrete can be poured up to the proposed founding elevation.

Footings placed on lean concrete filled trenches extending to a clean, bedrock surface can be designed using a factored bearing resistance value at ULS of **1,000 kPa**.

5.4 Design for Earthquakes

The site class for seismic site response can be taken as **Class C** for foundations constructed at the subject site. The soils underlying the subject site are not susceptible to liquefaction. Reference should be made to the latest revision of the 2012 Ontario Building Code for a full discussion of the earthquake design requirements. It is expected that a Class A or B will be applicable. However, a site specific seismic shear wave velocity test is required to confirm the higher seismic site class (Class A or B) in accordance with OBC standards.

5.5 Basement Slab

With the removal of all topsoil and deleterious fill from within the footprint of the proposed building, the native soil surface or approved engineered fill surface will be considered an acceptable subgrade on which to commence backfilling for floor slab construction.

Any soft areas should be removed and backfilled with appropriate backfill material prior to placing any fill. OPSS Granular B Type II, with a maximum particle size of 50 mm, is recommended for backfilling below the floor slab.

For structures with slab-on-grade construction, the upper 200 mm of sub-slab fill is recommended to consist of OPSS Granular A crushed stone. All backfill material within the footprint of the proposed buildings should be placed in maximum 300 mm thick loose layers and compacted to a minimum of 98% of the SPMDD.

For structures with basement slabs, it is recommended that the upper 200 mm of sub-floor fill consists of 19 mm clear crushed stone.

5.6 Basement Wall

There are several combinations of backfill materials and retained soils that could be applicable for the basement walls of the subject structure. However, the conditions can be well-represented by assuming the retained soil consists of a material with an angle of internal friction of 30 degrees and a bulk (drained) unit weight of 20 kN/m³. The applicable effective (undrained) unit weight of the retained soil can be taken as 13 kN/m³, where applicable. A hydrostatic pressure should be added to the total static earth pressure when using the effective unit weight.

Two distinct conditions, static and seismic, should be reviewed for design calculations. The corresponding parameters are presented below.

Lateral Earth Pressures

The static horizontal earth pressure (p_o) can be calculated using a triangular earth pressure distribution equal to $K_o \cdot \gamma \cdot H$ where:

- K_o = at-rest earth pressure coefficient of the applicable retained material (0.5)
- γ = unit weight of fill of the applicable retained soil (kN/m³)
- H = height of the wall (m)

An additional pressure having a magnitude equal to $K_o \cdot q$ and acting on the entire height of the wall should be added to the above diagram for any surcharge loading, q (kPa), that may be placed at ground surface adjacent to the wall. The surcharge pressure will only be applicable for static analyses and should not be used in conjunction with the seismic loading case.

Actual earth pressures could be higher than the “at-rest” case if care is not exercised during the compaction of the backfill materials to maintain a minimum separation of 0.3 m from the walls with the compaction equipment.

Seismic Earth Pressures

The total seismic force (P_{AE}) includes both the earth force component (P_o) and the seismic component (ΔP_{AE}).

The seismic earth force (ΔP_{AE}) can be calculated using $0.375 \cdot a_c \cdot \gamma \cdot H^2/g$ where:

$$a_c = (1.45 - a_{max}/g)a_{max}$$

γ = unit weight of fill of the applicable retained soil (kN/m³)

H = height of the wall (m)

g = gravity, 9.81 m/s²

The peak ground acceleration (a_{max}) for the Ottawa area is 0.32 g according to OBC 2012. Note that the vertical seismic coefficient is assumed to be zero.

The earth force component (P_o) under seismic conditions can be calculated using $P_o = 0.5 K_o \gamma H^2$, where $K_o = 0.5$ for the soil conditions noted above.

The total earth force (P_{AE}) is considered to act at a height, h (m), from the base of the wall, where:

$$h = \{P_o \cdot (H/3) + \Delta P_{AE} \cdot (0.6 \cdot H)\} / P_{AE}$$

The earth forces calculated are unfactored. For the ULS case, the earth loads should be factored as live loads, as per OBC 2020.

5.7 Pavement Structure

Driveways and local roads are anticipated at this site. The proposed pavement structures are presented in Tables 2 and 3.

Table 2 – Recommended Pavement Structure –Car Only Parking	
Thickness (mm)	Material Description
50	Wear Course – HL-3 or Superpave 12.5 Asphaltic Concrete
150	BASE – OPSS Granular A Crushed Stone
300	SUBBASE – OPSS Granular B Type II
SUBGRADE - Undisturbed native soil, or OPSS Granular B Type I or II material.	

Table 3 - Recommended Pavement Structure	
Access Lanes and Heavy Truck Parking Areas	
Thickness (mm)	Material Description
40	Wear Course - HL-3 or Superpave 12.5 Asphaltic Concrete
50	Binder Course - HL-8 or Superpave 19.0 Asphaltic Concrete
150	BASE - OPSS Granular A Crushed Stone
450	SUBBASE - OPSS Granular B Type II
SUBGRADE - Undisturbed native soil, or OPSS Granular B Type I or II material.	

The pavement granular base and subbase should be placed in maximum 300 mm thick lifts and compacted to a minimum of 100% of the material's SPMDD using suitable compaction equipment.

6.0 Design and Construction Precautions

6.1 Foundation Drainage and Backfill

Foundation Drainage

It's recommended that a perimeter foundation drainage system be provided for the proposed structure. It is expected that insufficient room will be available for exterior backfill and the foundation wall will be cast as a blind-sided pour against a shoring system. It is recommended that the drainage system consist of the following:

A composite drainage membrane (DeltaDrain 6000, MiraDrain G100N or equivalent) should be placed against the shoring system and bedrock excavation face from the finished ground surface to the top of the footing.

It is recommended that 150 mm diameter sleeves at 3 m centres be cast in the footing or at the foundation wall/footing interface to allow the infiltration of water to flow to the interior perimeter drainage pipe. The sleeves should be connected to openings in the HDPE face of the drainage board layer. The perimeter drainage pipe and underfloor drainage system should direct water to sump pit(s) within the lower basement area.

Water Infiltration Volumes

Based on the above-noted methodology, water carried by the foundation and underfloor drainage system will generally consist of surface water and will not consist of groundwater/long-term dewatering of the groundwater table. Water managed by this system will be directed to the appropriate building sump pit.

It is expected that the successful implementation of this system throughout the subject site will result in a long-term infiltration rate of less than 30,000 L/day of surface water. Peak periods of infiltration (i.e.- short-term conditions) should be anticipated during heavy rainfall and snow-melt events.

Underfloor Drainage

For design purposes, it is recommended the underfloor drainage system consist of 150 mm diameter perforate pipes surrounded by a geosock and a 150 mm thick layer of 19 mm clear crushed stone on all of its sides. Several north-south and east-west lines of pipes will be placed throughout the basement level, and as directed by the geotechnical consultant, to direct water from the foundation drainage and perimeter subdrain systems to the sump pump system. The final spacing of the underfloor drainage system should be confirmed at the time of completing the excavation when water infiltration can be better assessed.

Foundation Backfill

For areas where sufficient space is available for backfill against the exterior sides of the foundation walls, the backfill material should consist of free-draining non frost susceptible granular materials. The greater part of the site excavated materials will be frost susceptible and, as such, are not recommended for re-use as backfill against the foundation walls, unless used in conjunction with a drainage geocomposite, such as Miradrain G100N or Delta Drain 6000, connected to the perimeter foundation drainage system. Imported granular materials, such as clean sand or OPSS Granular B Type I granular material, should otherwise be used for this purpose.

6.2 Protection of Footings Against Frost Action

Perimeter footings of heated structures are required to be insulated against the deleterious effects of frost action. A minimum of 1.5 m of soil cover, or a minimum of 0.6 m of soil cover in conjunction with adequate foundation insulation, should be provided.

Exterior unheated footings, such as those for isolated exterior piers, are more prone to deleterious movement associated with frost action than the exterior walls of the heated structure and require additional protection, such as soil cover of 2.1 m or an equivalent combination of soil cover and foundation insulation.

6.3 Excavation Side Slopes

The side slopes of excavations in the overburden should be either cut back at acceptable slopes or should be retained by shoring systems from the start of the excavation until the structure is backfilled. It is expected that sufficient room will be available for the greater part of the excavation to be undertaken by open-cut methods (i.e. unsupported excavations).

The excavation side slopes above the groundwater level extending to a maximum depth of 3 m should be cut back at 1H:1V or flatter. The flatter slope is required for excavation below groundwater level. Excavations below the groundwater level should be cut back at a maximum slope of 1.5H:1V.

The subsoil at this site is considered to be mainly a Type 2 and 3 soil according to the Occupational Health and Safety Act and Regulations for Construction Projects.

Excavated soil should not be stockpiled directly at the top of excavations and heavy equipment should be kept away from the excavation sides.

Slopes in excess of 3 m in height should be periodically inspected by the geotechnical consultant in order to detect if the slopes are exhibiting signs of distress.

It is recommended that a trench box be used at all times to protect personnel working in trenches with steep or vertical sides. It is expected that services will be installed by “cut and cover” methods and excavations will not be left open for extended periods of time.

Temporary Shoring

Temporary shoring may be required for the overburden soil to complete the required excavations where insufficient room is available for open cut methods. The shoring requirements designed by a structural engineer specializing in those works will depend on the depth of the excavation, the proximity of the adjacent structures and the elevation of the adjacent building foundations and underground services. Geotechnical information provided below is to assist the designer in completing a suitable and safe shoring system. The designer should take into account the impact of a significant precipitation event and designate design measures to ensure that a precipitation will not negatively impact the shoring system or soils supported by the system.

Any changes to the approved shoring design system should be reported immediately to the owner’s structural design prior to implementation.

The temporary shoring system could consist of a soldier pile and lagging system. Any additional loading due to street traffic, construction equipment, adjacent structures and facilities, etc., should be included to the earth pressures described below. This system could be cantilevered, anchored or braced. The shoring system is recommended to be adequately supported to resist toe failure, if required, by means of extending the piles into the bedrock through pre-augered holes, if a soldier pile and lagging system is the preferred method.

The earth pressures acting on the temporary shoring system may be calculated with the following parameters.

Table 4 – Soils Parameter for Shoring System Design	
Parameters	Values
Active Earth Pressure Coefficient (K_a)	0.33
Passive Earth Pressure Coefficient (K_p)	3
At-Rest Earth Pressure Coefficient (K_o)	0.5
Unit Weight (γ), kN/m ³	20
Submerged Unit Weight (γ), kN/m ³	13

The active earth pressure should be calculated where wall movements are permissible while the at-rest pressure should be calculated if no movement is permissible. The dry unit weight should be calculated above the groundwater level while the effective unit weight should be calculated below the groundwater level.

The hydrostatic groundwater pressure should be included to the earth pressure distribution wherever the effective unit weights are calculated for earth pressures. If the groundwater level is lowered, the dry unit weight for the soil should be calculated full weight, with no hydrostatic groundwater pressure component.

For design purposes, the minimum factor of safety of 1.5 should be calculated.

6.4 Pipe Bedding and Backfill

Bedding and backfill materials should be in accordance with the most recent Material Specifications & Standard Detail Drawings of the OPSD.

A minimum of 150 mm of OPSS Granular A should be placed for bedding for sewer or water pipes when placed on a soil subgrade. If the bedding is placed on bedrock, the thickness of the bedding should be increased to 300 mm for sewer pipes. The bedding should extend to the spring line of the pipe.

Cover material, from the spring line to a minimum of 300 mm above the obvert of the pipe, should consist of OPSS Granular A (concrete or PSM PVC pipes) or sand (concrete pipe). The bedding and cover materials should be placed in maximum 225 mm thick lifts and compacted to 95% of the SPMDD.

It should generally be possible to re-use the site materials above the cover material if the operations are carried out in dry weather conditions.

Where hard surface areas are considered above the trench backfill, the trench backfill material within the frost zone (about 1.8 m below finished grade) and above the cover material should match the soils exposed at the trench walls to minimize differential frost heaving. The trench backfill should be placed in maximum 225 mm thick loose lifts and compacted to a minimum of 95% of the material standard Proctor maximum dry density.

6.5 Groundwater Control

It is anticipated that groundwater infiltration into the excavations should be minimal and controllable using open sumps. The contractor should be prepared to direct water away from all bearing surfaces and subgrades, regardless of the source, to prevent disturbance to the founding medium.

A temporary Ministry of Environment, Conservation and Parks (MECP) permit to take water (PTTW) may be required if more than 400,000 L/day of ground and/or surface water are to be pumped during the construction phase. At least 4 to 5 months should be allowed for completion of the application and issuance of the permit by the MECP.

For typical ground or surface water volumes being pumped during the construction phase, typically between 50,000 to 400,000 L/day, it is required to register on the Environmental Activity and Sector Registry (EASR). A minimum of two to four weeks should be allotted for completion of the EASR registration and the Water Taking and Discharge Plan to be prepared by a Qualified Person as stipulated under O.Reg. 63/16. If a project qualifies for a PTTW based upon anticipated conditions, an EASR will not be allowed as a temporary dewatering measure while awaiting the MECP review of the PTTW application.

6.6 Winter Construction

Precautions must be taken if winter construction is considered for this project.

The subsoil conditions at this site consist of frost susceptible materials. In the presence of water and freezing conditions, ice could form within the soil mass. Heaving and settlement upon thawing could occur.

In the event of construction during below zero temperatures, the founding stratum should be protected from freezing temperatures by the use of straw, propane heaters and tarpaulins or other suitable means. In this regard, the base of the excavations should be insulated from sub-zero temperatures immediately upon exposure and until such time as heat is adequately supplied to the building and the footings are protected with sufficient soil cover to prevent freezing at founding level.

Trench excavations and pavement construction are also difficult activities to complete during freezing conditions without introducing frost in the subgrade or in the excavation walls and bottoms. Precautions should be taken if such activities are to be carried out during freezing conditions. Additional information could be provided, if required.

6.7 Corrosion Potential and Sulphate

The results of the analytical testing of one (1) soil sample show that the sulphate content is less than 0.1%. This result is indicative that Type 10 Portland cement (General Use Cement) would be appropriate. The results of the chloride content and pH indicate that they are not significant factors in creating a corrosive environment for exposed ferrous metals at this site while the resistivity tests yielded results indicative of a aggressive to slightly aggressive corrosive environment.

7.0 Recommendations

It is a requirement for the foundation data provided herein to be applicable that the following material testing, and observation program be performed by the geotechnical consultant.

- Observation of all bearing surfaces prior to the placement of concrete.
- Review of the geotechnical aspects of the excavating program, prior to construction.
- Sampling and testing of the concrete and fill materials.
- Periodic observation of the condition of unsupported excavation side slopes in excess of 3 m in height, if applicable.
- Periodic inspection of the installation of the underfloor and perimeter drainage and waterproofing systems.
- Field density tests to determine the level of compaction achieved.
- Observation of all subgrades prior to backfilling.
- Sampling and testing of the bituminous concrete including mix design reviews.

All excess soils, with the exception of engineered crushed stone fill, generated by construction activities that will be transported on-site or off-site should be handled as per *Ontario Regulation 406/19: On-Site and Excess Soil Management*.

A report confirming that these works have been conducted in general accordance with our recommendations could be issued upon request, following the completion of a satisfactory material testing and observation program by Paterson.

8.0 Statement of Limitations

The recommendations provided are in accordance with the present understanding of the project. Paterson requests permission to review the recommendations when the drawings and specifications are completed.

A soils investigation is a limited sampling of a site. Should any conditions at the site be encountered which differ from those at the test locations, Paterson requests immediate notification to permit reassessment of our recommendations.

The recommendations provided herein should only be used by the design professionals associated with this project. They are not intended for contractors bidding on or undertaking the work. The latter should evaluate the factual information provided in this report and determine the suitability and completeness for their intended construction schedule and methods. Additional testing may be required for their purposes.

The present report applies only to the project described in this document. Use of this report for purposes other than those described herein or by person(s) other than Mr. Hussain Rahal, or their agents, is not authorized without review by Paterson for the applicability of our recommendations to the alternative use of the report.

Paterson Group Inc.



Balaji Nirmala, M.Eng.



David J. Gilbert, P.Eng

Report Distribution:

- Mr. Hussain Rahal
- Paterson Group

APPENDIX 1

SOIL PROFILE AND TEST DATA SHEETS

SYMBOLS AND TERMS

ANALYTICAL TESTING RESULTS

DATUM Geodetic

REMARKS

BORINGS BY CME-55 Low Clearance Drill

DATE November 29, 2022

FILE NO.
PG6484

HOLE NO.
BH 1-22

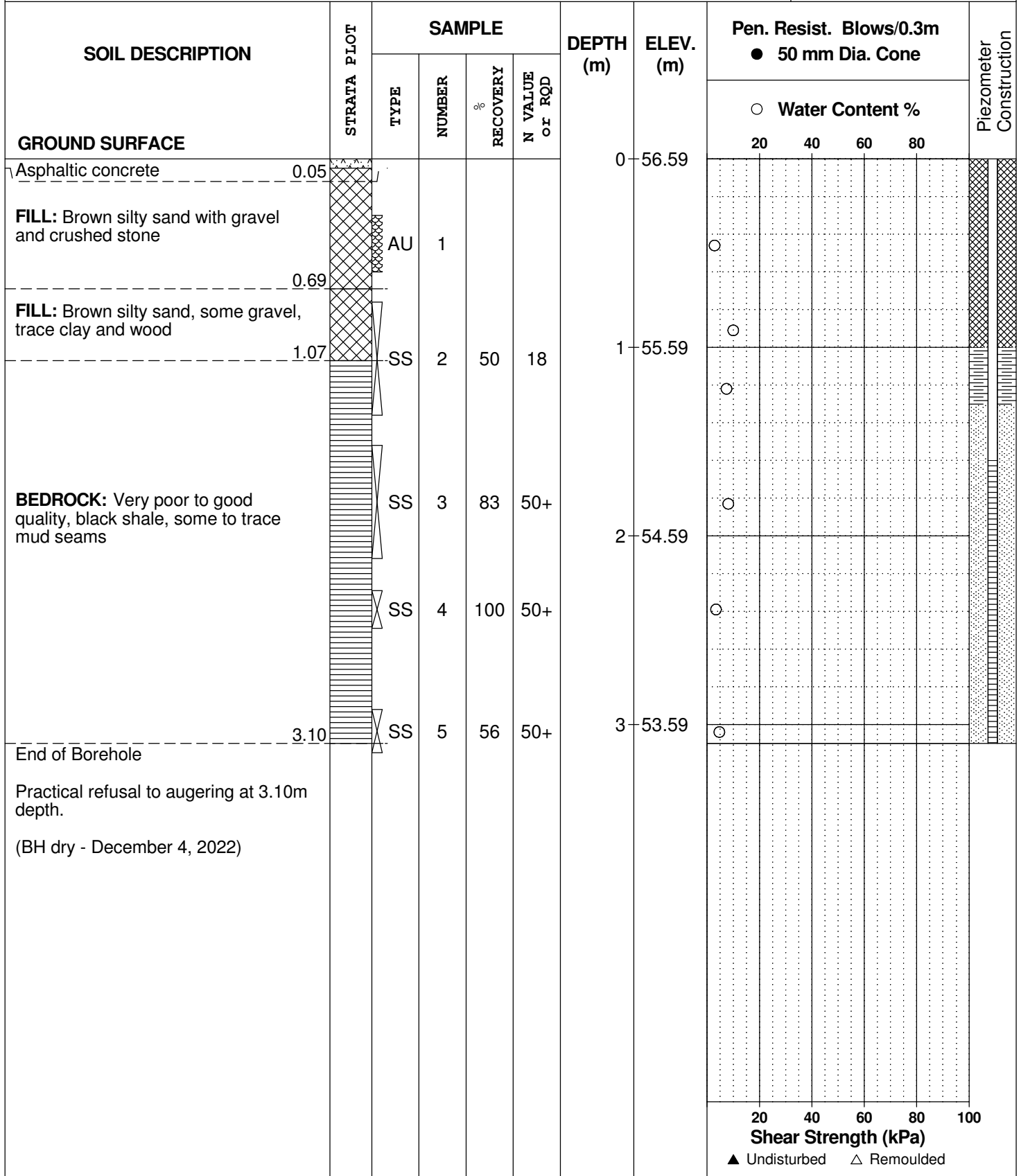

DATUM Geodetic

REMARKS

BORINGS BY CME-55 Low Clearance Drill

DATE November 29, 2022

FILE NO.
PG6484

HOLE NO.
BH 2-22

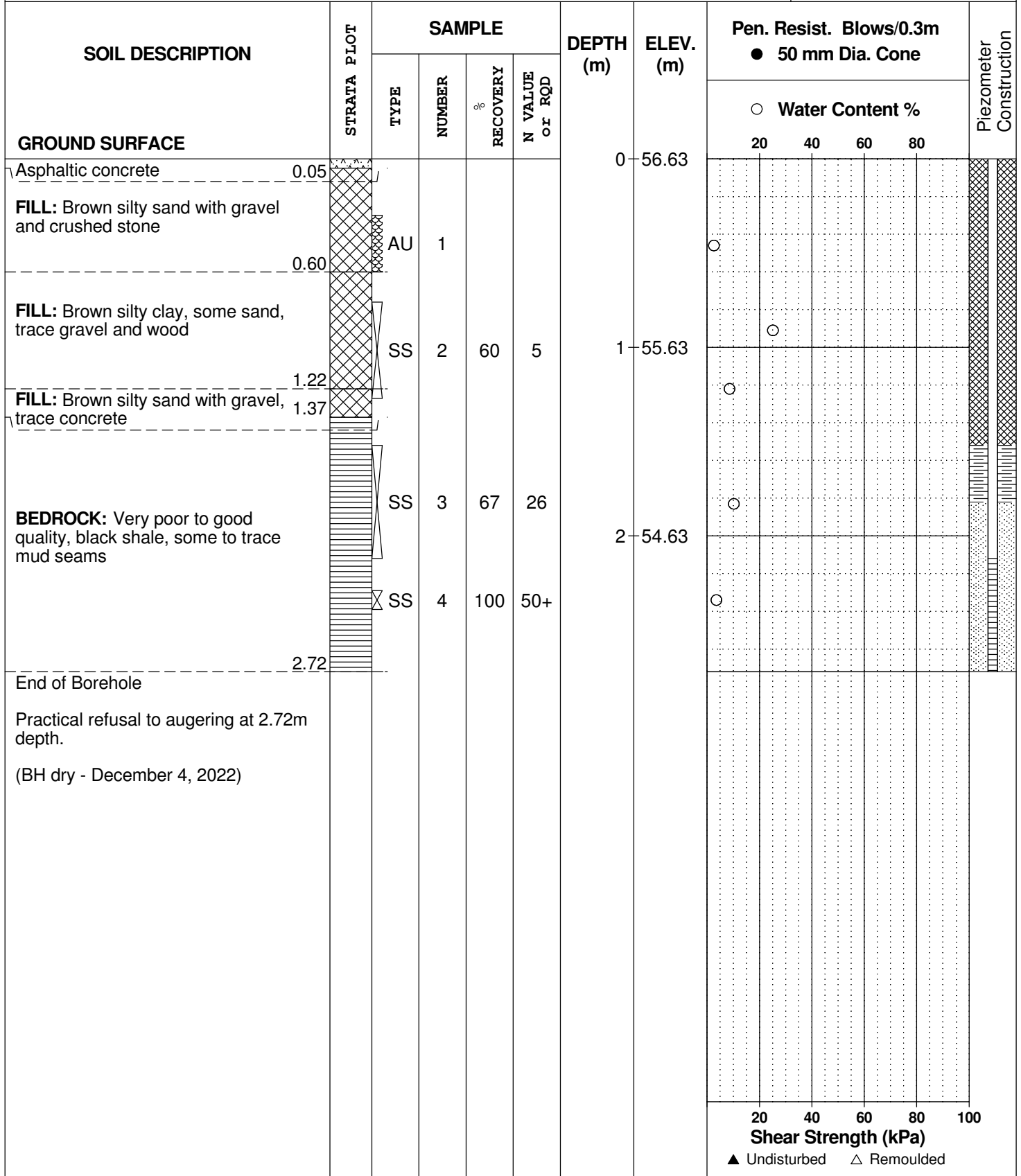

DATUM Geodetic

REMARKS

BORINGS BY CME-55 Low Clearance Drill

DATE November 29, 2022

FILE NO.
PG6484

HOLE NO.
BH 3-22

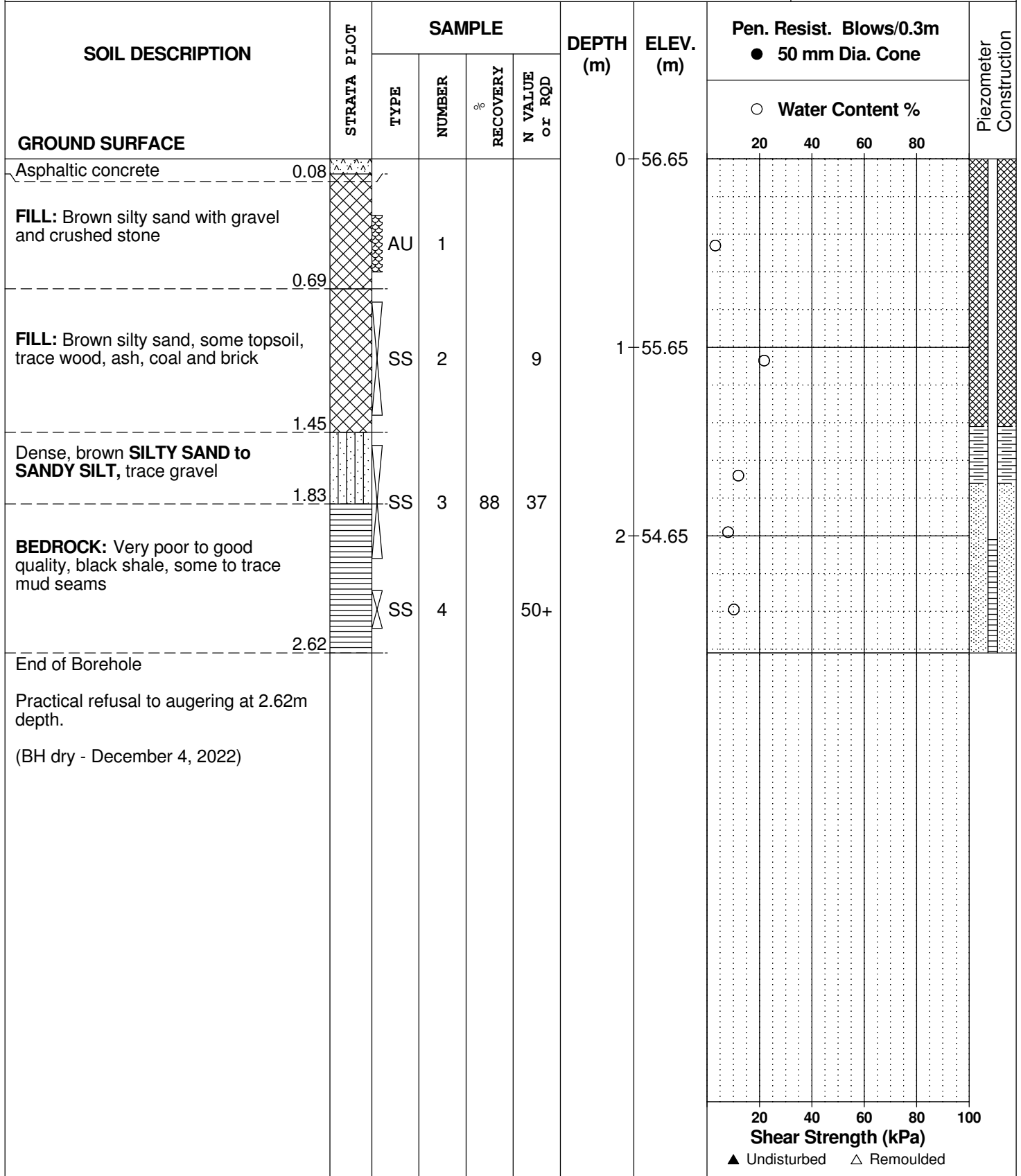

DATUM Geodetic

REMARKS

BORINGS BY CME-55 Low Clearance Drill

DATE November 29, 2022

FILE NO.
PG6484

HOLE NO.
BH 4-22

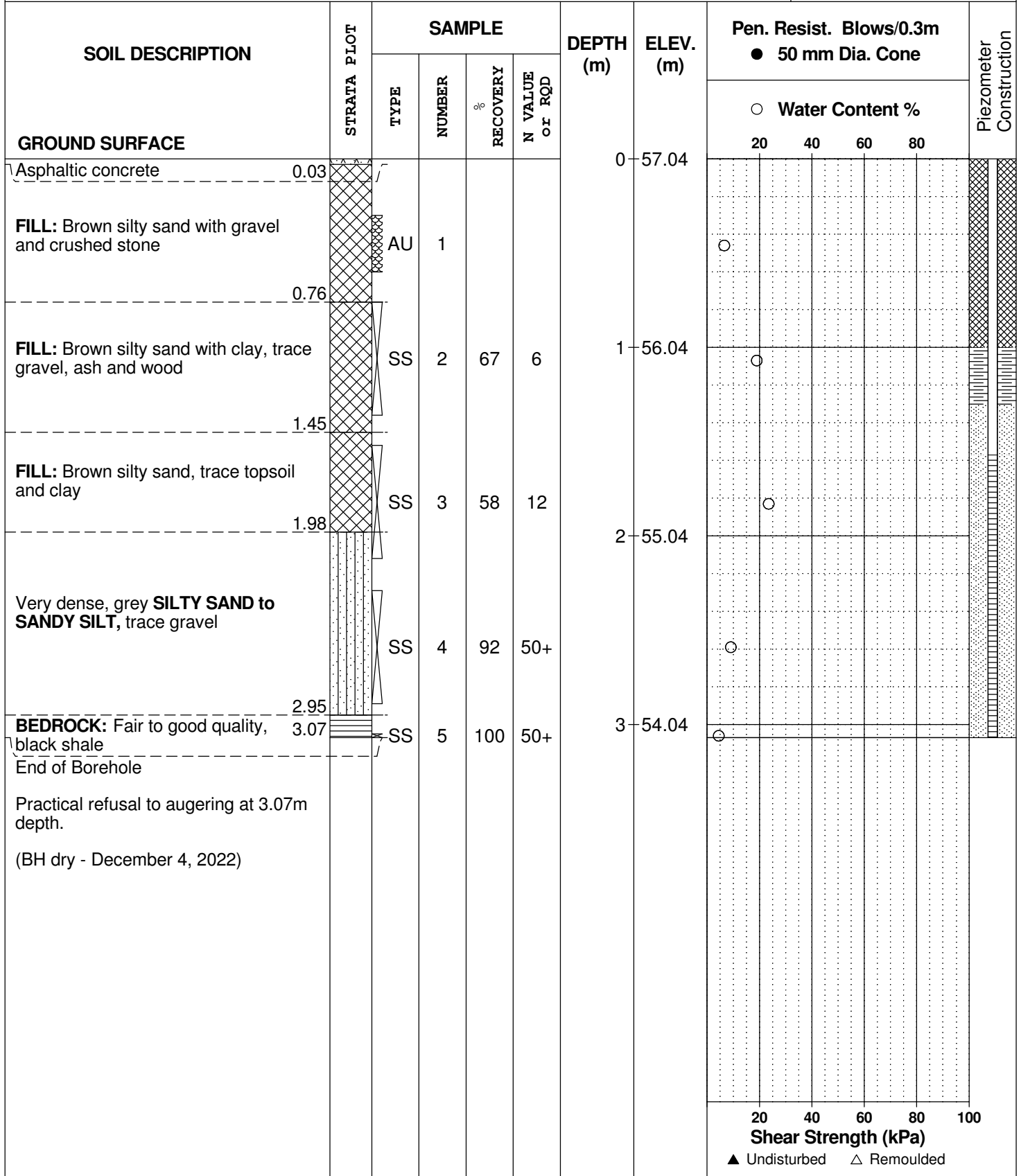

DATUM Geodetic

REMARKS

BORINGS BY CME-55 Low Clearance Drill

DATE November 29, 2022

FILE NO.
PG6484

HOLE NO.
BH 5-22

SOIL DESCRIPTION	STRATA PLOT	SAMPLE				DEPTH (m)	ELEV. (m)	Pen. Resist. Blows/0.3m ● 50 mm Dia. Cone				Piezometer Construction	
		TYPE	NUMBER	RECOVERY %	N VALUE or RQD			20	40	60	80		
GROUND SURFACE													
Asphaltic concrete	0.06					0	56.66						
FILL: Brown silty sand, some to trace clay and gravel		AU	1										
		SS	2		9	1	55.66						
		SS	3	75	22	2	54.66						
GLACIAL TILL: Compact, brown silty sand with gravel, cobbles and boulders - dark grey by 2.2m depth	1.88	SS	4	67	19								
		SS	5	75	29	3	53.66						
BEDROCK: Very poor to good quality, black shale, some to trace mud seams	3.15	SS	6	67	50+								
						4	52.66						
End of Borehole	4.01												
Practical refusal to augering at 4.01m depth. (GWL @ 3.05m - Dec. 4, 2022)													

20 40 60 80 100
Shear Strength (kPa)
▲ Undisturbed △ Remoulded

SYMBOLS AND TERMS

SOIL DESCRIPTION

Behavioural properties, such as structure and strength, take precedence over particle gradation in describing soils. Terminology describing soil structure are as follows:

Desiccated	-	having visible signs of weathering by oxidation of clay minerals, shrinkage cracks, etc.
Fissured	-	having cracks, and hence a blocky structure.
Varved	-	composed of regular alternating layers of silt and clay.
Stratified	-	composed of alternating layers of different soil types, e.g. silt and sand or silt and clay.
Well-Graded	-	Having wide range in grain sizes and substantial amounts of all intermediate particle sizes (see Grain Size Distribution).
Uniformly-Graded	-	Predominantly of one grain size (see Grain Size Distribution).

The standard terminology to describe the relative strength of cohesionless soils is the compactness condition, usually inferred from the results of the Standard Penetration Test (SPT) 'N' value. The SPT N value is the number of blows of a 63.5 kg hammer, falling 760 mm, required to drive a 51 mm O.D. split spoon sampler 300 mm into the soil after an initial penetration of 150 mm. An SPT N value of "P" denotes that the split-spoon sampler was pushed 300 mm into the soil without the use of a falling hammer.

Compactness Condition	'N' Value	Relative Density %
Very Loose	<4	<15
Loose	4-10	15-35
Compact	10-30	35-65
Dense	30-50	65-85
Very Dense	>50	>85

The standard terminology to describe the strength of cohesive soils is the consistency, which is based on the undisturbed undrained shear strength as measured by the in situ or laboratory shear vane tests, unconfined compression tests, or occasionally by the Standard Penetration Test (SPT). Note that the typical correlations of undrained shear strength to SPT N value (tabulated below) tend to underestimate the consistency for sensitive silty clays, so Paterson reviews the applicable split spoon samples in the laboratory to provide a more representative consistency value based on tactile examination.

Consistency	Undrained Shear Strength (kPa)	'N' Value
Very Soft	<12	<2
Soft	12-25	2-4
Firm	25-50	4-8
Stiff	50-100	8-15
Very Stiff	100-200	15-30
Hard	>200	>30

SYMBOLS AND TERMS (continued)

SOIL DESCRIPTION (continued)

Cohesive soils can also be classified according to their “sensitivity”. The sensitivity, S_t , is the ratio between the undisturbed undrained shear strength and the remoulded undrained shear strength of the soil. The classes of sensitivity may be defined as follows:

Low Sensitivity:	$S_t < 2$
Medium Sensitivity:	$2 < S_t < 4$
Sensitive:	$4 < S_t < 8$
Extra Sensitive:	$8 < S_t < 16$
Quick Clay:	$S_t > 16$

ROCK DESCRIPTION

The structural description of the bedrock mass is based on the Rock Quality Designation (RQD).

The RQD classification is based on a modified core recovery percentage in which all pieces of sound core over 100 mm long are counted as recovery. The smaller pieces are considered to be a result of closely-spaced discontinuities (resulting from shearing, jointing, faulting, or weathering) in the rock mass and are not counted. RQD is ideally determined from NQ or larger size core. However, it can be used on smaller core sizes, such as BQ, if the bulk of the fractures caused by drilling stresses (called “mechanical breaks”) are easily distinguishable from the normal in situ fractures.

RQD %	ROCK QUALITY
90-100	Excellent, intact, very sound
75-90	Good, massive, moderately jointed or sound
50-75	Fair, blocky and seamy, fractured
25-50	Poor, shattered and very seamy or blocky, severely fractured
0-25	Very poor, crushed, very severely fractured

SAMPLE TYPES

SS	-	Split spoon sample (obtained in conjunction with the performing of the Standard Penetration Test (SPT))
TW	-	Thin wall tube or Shelby tube, generally recovered using a piston sampler
G	-	"Grab" sample from test pit or surface materials
AU	-	Auger sample or bulk sample
WS	-	Wash sample
RC	-	Rock core sample (Core bit size BQ, NQ, HQ, etc.). Rock core samples are obtained with the use of standard diamond drilling bits.

SYMBOLS AND TERMS (continued)

PLASTICITY LIMITS AND GRAIN SIZE DISTRIBUTION

WC%	-	Natural water content or water content of sample, %
LL	-	Liquid Limit, % (water content above which soil behaves as a liquid)
PL	-	Plastic Limit, % (water content above which soil behaves plastically)
PI	-	Plasticity Index, % (difference between LL and PL)
D _{xx}	-	Grain size at which xx% of the soil, by weight, is of finer grain sizes These grain size descriptions are not used below 0.075 mm grain size
D ₁₀	-	Grain size at which 10% of the soil is finer (effective grain size)
D ₆₀	-	Grain size at which 60% of the soil is finer
C _c	-	Concavity coefficient = $(D_{30})^2 / (D_{10} \times D_{60})$
C _u	-	Uniformity coefficient = D_{60} / D_{10}

C_c and C_u are used to assess the grading of sands and gravels:

Well-graded gravels have: $1 < C_c < 3$ and $C_u > 4$

Well-graded sands have: $1 < C_c < 3$ and $C_u > 6$

Sands and gravels not meeting the above requirements are poorly-graded or uniformly-graded.

C_c and C_u are not applicable for the description of soils with more than 10% silt and clay (more than 10% finer than 0.075 mm or the #200 sieve)

CONSOLIDATION TEST

p' _o	-	Present effective overburden pressure at sample depth
p' _c	-	Preconsolidation pressure of (maximum past pressure on) sample
C _{cr}	-	Recompression index (in effect at pressures below p' _c)
C _c	-	Compression index (in effect at pressures above p' _c)
OC Ratio		Overconsolidation ratio = p'_c / p'_o
Void Ratio		Initial sample void ratio = volume of voids / volume of solids
W _o	-	Initial water content (at start of consolidation test)

PERMEABILITY TEST

k	-	Coefficient of permeability or hydraulic conductivity is a measure of the ability of water to flow through the sample. The value of k is measured at a specified unit weight for (remoulded) cohesionless soil samples, because its value will vary with the unit weight or density of the sample during the test.
---	---	--

SYMBOLS AND TERMS (continued)

STRATA PLOT



Topsoil



Asphalt

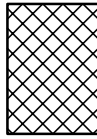

Fill



Peat

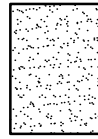

Sand

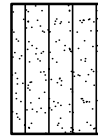

Silty Sand

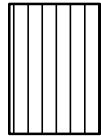

Silt



Sandy Silt



Clay

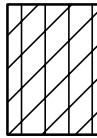

Silty Clay



Clayey Silty Sand

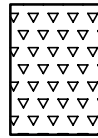

Glacial Till

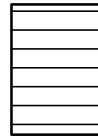

Shale

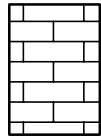

Bedrock

MONITORING WELL AND PIEZOMETER CONSTRUCTION

MONITORING WELL CONSTRUCTION

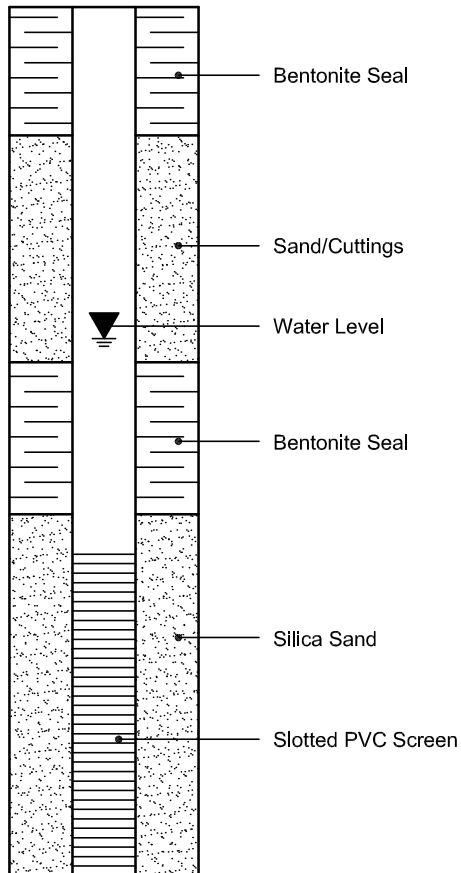

PIEZOMETER CONSTRUCTION

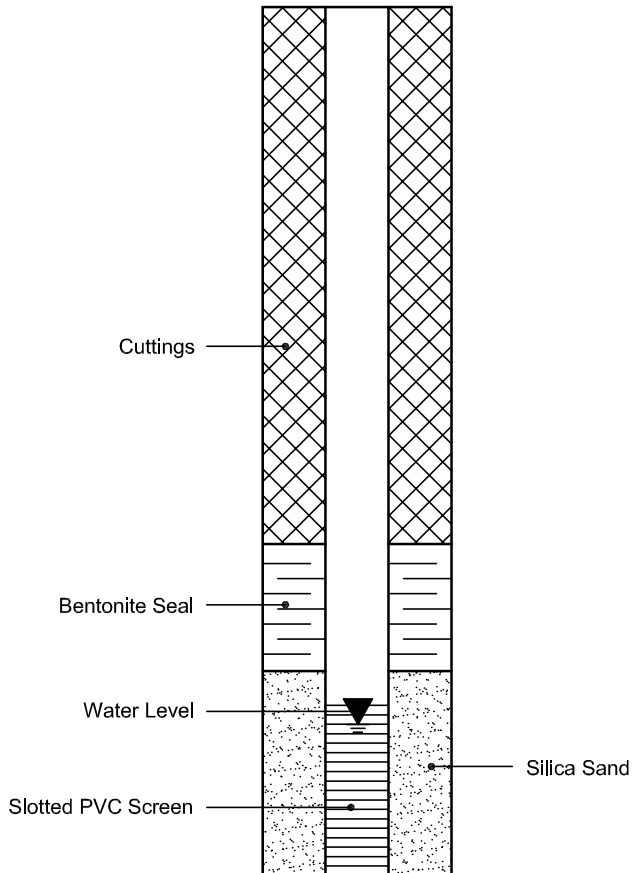

Certificate of Analysis

Report Date: 04-Dec-2022

Client: Paterson Group Consulting Engineers

Order Date: 29-Nov-2022

Client PO: 56346

Project Description: PG6484

Client ID:	BH4 - 22 SS4	-	-	-	-
Sample Date:	29-Nov-22 09:00	-	-	-	-
Sample ID:	2249239-01	-	-	-	-
Matrix:	Soil	-	-	-	-
MDL/Units					

Physical Characteristics

% Solids	0.1 % by Wt.	91.2	-	-	-	-
----------	--------------	------	---	---	---	---

General Inorganics

pH	0.05 pH Units	7.53	-	-	-	-
Resistivity	0.1 Ohm.m	18.3	-	-	-	-

Anions

Chloride	5 ug/g	89	-	-	-	-
Sulphate	5 ug/g	363	-	-	-	-

APPENDIX 2

FIGURE 1 – KEY PLAN
DRAWING PG6484-1 – TEST HOLE LOCATION PLAN

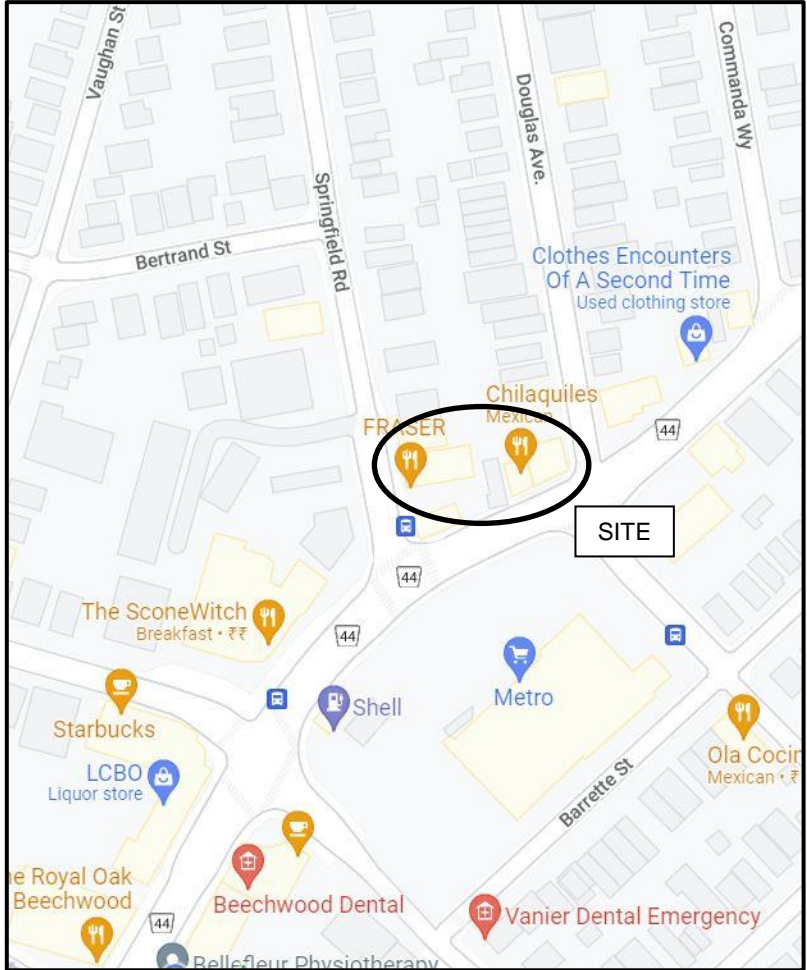
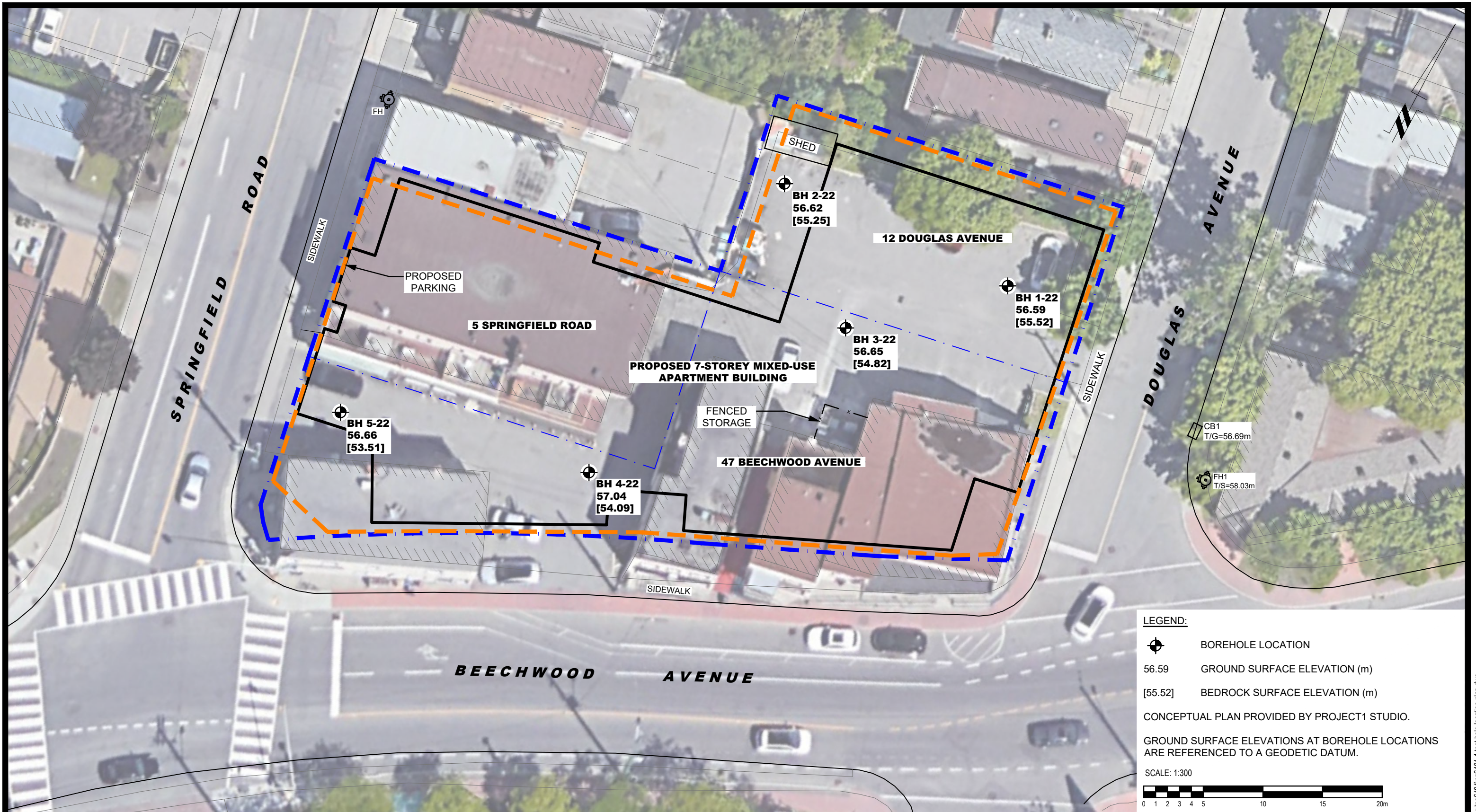

FIGURE 1

KEY PLAN



NO.	REVISIONS	DATE	INITIAL

MR. HUSSAIN RAHAL
 GEOTECHNICAL INVESTIGATION
 PROPOSED MID-RISE BUILDING
 47 BEECHWOOD AVENUE, 5 SPRINGFIELD ROAD
 AND 12 DOUGLAS AVENUE

OTTAWA, ONTARIO

Title: **TEST HOLE LOCATION PLAN**

Scale:	1:300	Date:	01/2023
Drawn by:	GK	Report No.:	PG6484-1
Checked by:	BN	Dwg. No.:	PG6484-1
Approved by:	DJG	Revision No.:	

**E.2 Draft Phase One Environmental Site Assessment (Pinchin,
March 2023)**



**E.3 Topographic Survey Plan by Annis, O'Sullivan, Vollebekk Ltd.
(September 9, 2021)**



PART 1 Plan of
PART OF LOTS 1, 2, 3 & 4
(NORTH BEECHWOOD AVENUE)
LOT 1 AND PART OF LOT 2
(WEST DOUGLAS AVENUE)
REGISTERED PLAN 74
CITY OF OTTAWA
 Surveyed by Annis, O'Sullivan, Vollebek Ltd.

Plan & Report Amended on July 21, 2022 to Include Lot 1 and Part of Lot 2 (West Douglas Avenue) Topographical Features.



Metric
 DISTANCES SHOWN ON THIS PLAN ARE IN METRES AND CAN BE CONVERTED TO FEET BY DIVIDING BY 0.3048

Surveyor's Certificate
 I CERTIFY THAT:
 1. This survey and plan are correct and in accordance with the Surveys Act and the Regulations made under them.
 2. The survey was completed on the 9th day of September, 2021.

Date _____
 E. H. Henweyer
 Ontario Land Surveyor

PART 2
 THIS PLAN MUST BE READ IN CONJUNCTION WITH SURVEY REPORT DATED: September 9, 2021

ANNIS, O'SULLIVAN, VOLLEBEK LTD. grants to _____ (The Client), their successors, mortgagees, and other related parties, permission to use original, signed, sealed copies of the Surveyor's Real Property Report in transactions involving The Client.

Notes & Legend

Denotes	
—□—	Survey Monument Planted
—■—	Survey Monument Found
SIB	Standard Iron Bar
SSIB	Short Standard Iron Bar
IB	Iron Bar
CP	Concrete Pin
(WIT)	Witness
Mess.	Measured
(AOG)	Annis, O'Sullivan, Vollebek Ltd.
(PI)	Registered Plan 74
(P2)	Plan 4R-328
(P3)	Plan SR-12071
(P4)	(1319) Plan December 6, 1990
(P5)	Plan SR-5953
(P6)	(90) Plan June 6, 2002
(P7)	(1287) Plan May 3, 2006
(P8)	(90) Plan December 11, 1992
(D)	Pin 04225-0208
⊙	Fire Hydrant
⊕	Water Valve
⊙	Water Stand Post
⊙	Maintenance Hole (Storm Sewer)
⊙	Maintenance Hole (Sanitary)
⊙	Maintenance Hole (Bell Telephone)
⊙	Maintenance Hole (Traffic)
⊙	Maintenance Hole (Hydro)
⊕	Gas Meter
⊕	Hydro Meter
⊕	Traffic Signal Post
⊕	Bollard
△	Sign
—ST—	Underground Storm Sewer
—S—	Underground Sanitary Sewer
—W—	Underground Water
—P—	Underground Power
—G—	Underground Gas
—FO—	Underground Fibre Optic
—OW—	Overhead Wires
□	Catch Basin
HT	Hydro Transformer
BF	Board Fence
⊕	Utility Pole
⊕	Anchor
⊕	Air Conditioner
⊕	Location of Elevations
⊕	Top of Concrete Curb Elevation
C/L	Centreline
Fdn.	Foundation
⊕	Deciduous Tree

Bearings are grid, derived from Westerly limit of Douglas Avenue shown to be N 10°35'00" W on Plan SR-12071 and are referred to the Central Meridian of MTM Zone 9 (76°30' West Longitude) NAD-83 (original).

ELEVATION NOTES

1. Elevations shown are geoidic and are referred to the CGVD28 geoidic datum, derived from City of Ottawa Benchmark No. C01, 107 having an elevation of 71.945 metres.
2. It is the responsibility of the user of this information to verify that the job benchmark has not been altered or disturbed and that it's relative elevation and description agrees with the information shown on this drawing.

UTILITY NOTES

1. This drawing cannot be accepted as acknowledging all of the utilities and it will be the responsibility of the user to contact the respective utility authorities for confirmation.
2. Only visible surface utilities were located.
3. Underground utility data derived from City of Ottawa utility sheets reference ISD18-3014 (Sheets 8 & 10) & 2692 (Sheet 7)
4. Sanitary and storm sewer grades and inverts were derived from City of Ottawa utility sheets reference ISD18-3014 (Sheets 8 & 10) & 2692 (Sheet 7)
5. A field location of underground plant by the pertinent utility authority is mandatory before any work involving breaking ground, probing, excavating etc.

ASSOCIATION OF ONTARIO LAND SURVEYORS
 PLAN SUBMISSION FORM
 V-16912

THIS PLAN IS NOT VALID UNLESS IT IS AN EMBOSSED ORIGINAL COPY ISSUED BY THE SURVEYOR in accordance with Regulation 1026, Section 29 (3).

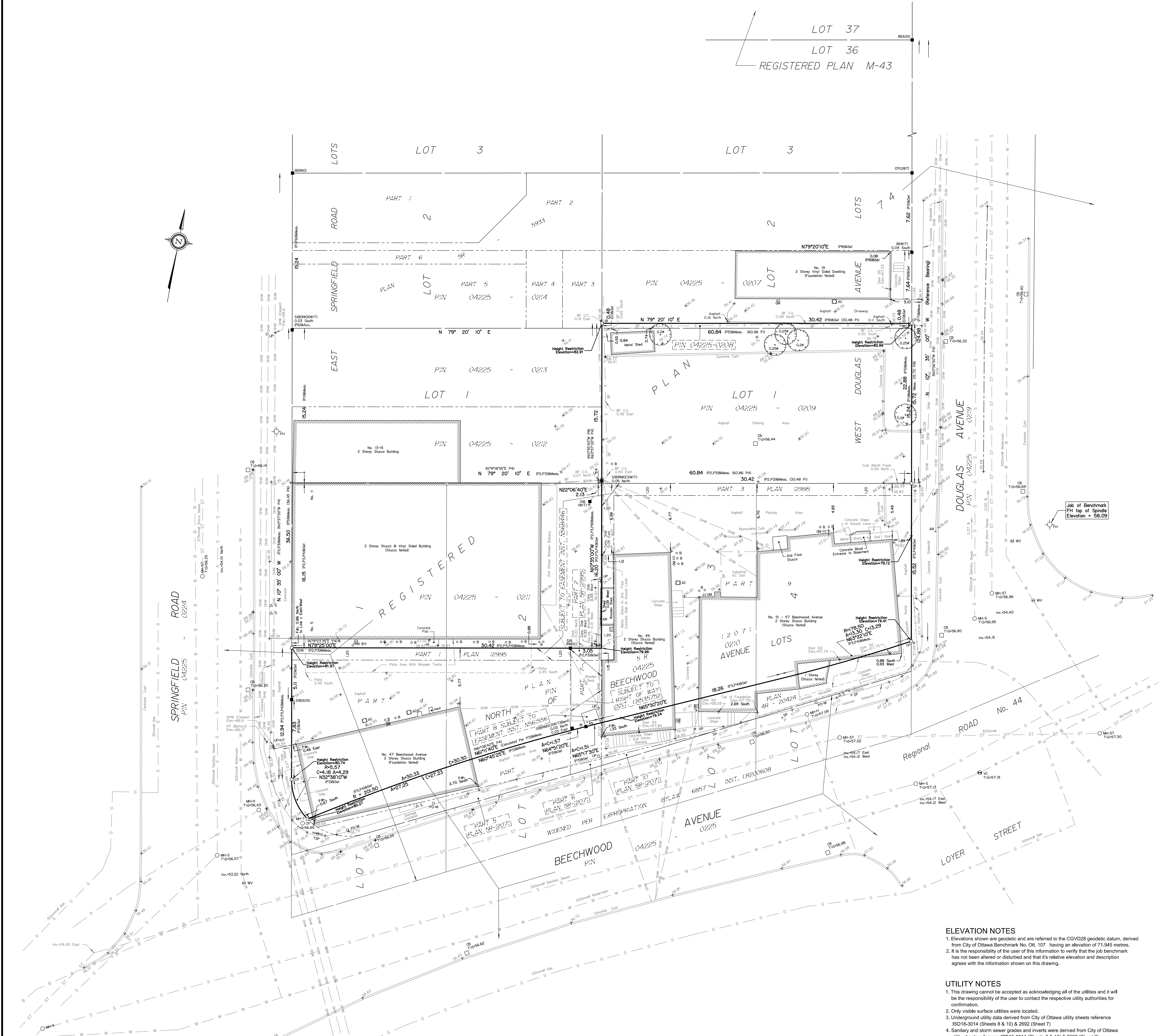

Appendix F Pre-consultation



Pre-Application Consultation Meeting Notes

Property Address: 47 Beechwood Avenue

PC2022-0250

October 4, 2022, 12:00 – 1:00 PM

Attendees: Colette Gorni, Planner (File Lead) – City of Ottawa
Mohammed Fawzi, Infrastructure Project Manager – City of Ottawa
Christopher Moise, Urban Design Planner – City of Ottawa
Amber Chen, Planning Co-op Student – City of Ottawa
Donna Kemp – Lindenlea Community Association
Hussain Rahal – Property Owner
Murray Chown, Planning Consultant – Novatech
Caleb Miller, Planning Consultant – Novatech
Ryan Koolwine, Architect – Project 1
Julien Hebert, Architect – Project 1

Regrets: Hayley Murray, Planning Forester – City of Ottawa
Wally Dubyk, Transportation Project Manager – City of Ottawa
Mary Ellen Wood, Parks Planner – City of Ottawa
Matthew Hayley, Environmental Planner – City of Ottawa
Eric Lalonde, RVCA Planner – Rideau Valley Conservation Authority

Subject: 47 Beechwood Avenue

Meeting notes:

Overview of the Proposal (Applicant)

1. The applicant is proposing a 7-storey mixed use building with a total of 110 residential units and 619m² of ground floor commercial space.
2. The subject site is composed of three parcels – 47 Beechwood Avenue, 5 Springfield Road, and 12 Douglas Avenue. The owner is also considering adding 18 Douglas Avenue to the site.
3. Relief required for min front yard setback, min corner side yard setback, min bicycle parking spaces (retail), min vehicle parking spaces (60 required, 45 provided). The corner side yard setback is not able to be met due to hydro wires along Springfield Road.
4. The building has been designed to be mindful of the character of the surrounding neighbourhood. Queues were taken from New Ediburough Square, as well as the relief spaces found throughout the area (restaurants using laneways, alleys, etc.). The building is intended to feel like the amalgamation of multiple buildings rather than one large mass.

5. The proposed building is not currently respecting the angular plane requirement where the site abuts 18 Douglas Avenue.
6. The site is located within the protected view plan of Beechwood Cemetery.

Planning (Colette Gorni)

1. Staff are generally supportive of the proposed development. However, there are some concerns about the interface between the subject site and the abutting residential along Douglas Avenue. Please consider ways to mitigate the impact of the lack of the required angular plane and/or provide the required angular plane.
2. Please note that Beechwood Avenue is considered the front lot line for the purposes of zoning, as per Section 197(5)(c) of the Zoning By-law.
3. Consider opportunities to provide additional bicycle parking in the proposed development.
4. Section 37 changes - In July 2022, Staff expect that the City's former Section 37 regime will be replaced with a "Community Benefits Charge" of 4% of the land value, following provincial *Planning Act* changes through Bill 108. This charge will be required for ALL buildings that are 5 or more storeys or 10 or more units and will be required at the time of building permit, unless the development is subject to an existing registered Section 37 agreement or has been issued a building permit. On August 31, 2022, Council passed a by-law, policy and prioritized list of projects regarding the CBC Charge. The by-law is in effect as of September 19, 2022. To review the components to the charge, you may review the staff report [here](#). Supporting documents are also published on the Engage Ottawa page and can be found [here](#).
5. Please note that Ottawa City Council passed the High Development Performance Development Standard (HPDS) on April 13, 2022. An overview of the purpose and objectives of HPDS has been provided for your reference.
6. The following applications are required to permit the proposed development:
 - a. A "Site Plan Control – Complex" application is required to permit the proposed development. More information on the Site Plan Control process can be found [here](#).
 - b. A "Zoning By-law Amendment (Minor)" is required to permit the proposed development. More information on the Zoning By-law Amendment process can be found [here](#).

Urban Design (Christopher Moise)

1. This proposal runs along one of the City's Design Priority Areas and must attend the City's UDRP.
2. We appreciate the design material submitted for the proposal and have the following comments/questions:

- a. **Stepping on Beechwood:** We recommend further elevational study with the streetscape along this length of Beechwood to determine the most appropriate datum lines to relate to and where the building should concentrate its step-back to support the streetscape scale;
 - b. **Property north on Springfield:** This property can redevelop to the same scale and relationship as the proposal. We recommend the property be analyzed through massing and step backs to better understand the relationship to the proposal and its facing sides;
 - c. **Public realm space (sidewalk):** We recommend further study of the sidewalk and public realm facing Beechwood once the ROW protection has been sorted out. Has sufficient space been allocated to support the future of the street?
 - d. **Angular plane towards residential zone:** This is an important tool we use to determine if the proposal is providing a sensitive relationship to the residential neighbourhood to the north. We recommend this plane be respected to allow for the potential seventh storey;
 - e. **Heritage:** Are there any heritage relationships intended for the site? Has this question been investigated?
 - f. **Parking reduction:** One of the main ways we recommend any parking reduction be favorable is when bike parking allocation is close to 1:1 for number of units or numbers increased to compensate for loss of vehicular parking.
3. A scoped Design Brief is a required submittal (and separate from any UDRP submission) for all Site Plan/Re-zoning applications and can be combined with the Planning Rationale. Please see the Design Brief Terms of Reference provided and consult the City's website for details regarding the UDRP schedule.

a. Note. The Design Brief submittal should have a section which addresses these pre-consultation comments.

This is an exciting project in an area full of potential. We look forward to helping you achieve its goals with the highest level of design resolution. We are happy to assist and answer any questions regarding the above. Good luck.

Engineering (Mohammed Fawzi)

1. Available Infrastructure
 - a. Beechwood Avenue:
 - i. Sanitary: 300mm PVC (Install 2019)
 - ii. Storm: 600mm Conc (Install 1973)
 - iii. Water: 203mm DI (Install 1987)

- b. Springfield Road:
 - i. Sanitary: 250mm PVC (Install 1989)
 - ii. Water: 305mm PVC (Install 2019)
- 2. Water Boundary Conditions – Will be provided at request of consultant. Requests must include the location of the service and the expected loads required by the proposed development. Please provide the following and submit Fire Flow Calculation Sheet per FUS method with the request:
 - a. Location of service
 - b. Type of development and amount of required fire flow (per FUS method – include FUS calculation sheet with request)
 - c. Average Daily Demand (l/s)
 - d. Maximum Hourly Demand (l/s)
 - e. Maximum Daily Demand (l/s)
 - f. Water Supply Redundancy – Fire Flow:
 - g. Applicant to ensure that a second service with an inline valve chamber be provided where the average daily demand exceeds 50 m³ / day (0.5787 l/s per day)

Water services larger than 19 mm require a Water Data Card. Please complete card and submit.

- 3. Stormwater Management (Quantity Control)
 - a. Coefficient (C) of runoff determined **as per existing conditions** but in no case more than 0.5.
 - b. TC = To be calculated, minimum 10 minutes
 - c. Any storm events greater than 2 year, up to 100 year, and including 100-year storm event must be detained on site.
 - d. Foundation drains are to be independently connected to sewer main unless being pumped with appropriate back up power, sufficient sized pump and back flow prevention.
 - e. Roof drains are to be connected downstream of any incorporated ICD within the SWM system.
- 4. Stormwater Management (Quality Control)
 - a. Rideau Valley Conservation Authority to provide Quality Controls.

5. Noise study required – due to proximity of an existing arterial road (Beechwood Avenue).
6. Phase I ESA is required; Phase II ESA may be required depending on the results of the Phase I ESA. Phase I ESA must include an EcoLog ERIS Report. Please note that the Phase I ESA and Phase II ESAs must conform to clause 4.8.4 of the Official Plan that requires that development applications conform to Ontario Regulation 153/04.
7. Required Studies:
 - Stormwater Management Report
 - Site Servicing Study
 - Geotechnical Study
 - Phase I ESA
 - Phase II ESA (depends on outcome of Phase I)
 - Noise Study
8. Required Plans:
 - Site Servicing Plan
 - Grade Control and Drainage Plan
 - Erosion and Sediment Control Plan (Can be combined with Grading Plan)
 - Existing Conditions and Removals Plan
 - Pre and Post Development Drainage Plans
 - Roof Drainage Plan
9. Any portion of the subject property which is intended to be used for permanent or temporary snow storage shall be as shown on the approved site plan and grading plan. Snow storage shall not interfere with approved grading and drainage patterns or servicing. Snow storage areas shall be setback from the property lines, foundations, fencing or landscaping a minimum of 1.5m. Snow storage areas shall not occupy driveways, aisles, required parking spaces or any portion of a road allowance. If snow is to be removed from the site please indicate this on the plan(s).
10. Any proposed light fixtures (both pole-mounted and wall mounted) must be part of the approved Site Plan. All external light fixtures must meet the criteria for Full Cut-off Classification as recognized by the Illuminating Engineering Society of North America (IESNA or IES), and must result in minimal light spillage onto adjacent properties (as a guideline, 0.5 fc is normally the maximum allowable spillage). In order to satisfy these criteria, the please provide the City with a Site Lighting Plan, and Certification

(Statement) Letter from an acceptable professional engineer stating that the design is compliant.

11. The Servicing Study Guidelines for Development Applications are available at the following address: <https://ottawa.ca/en/city-hall/planning-and-development/information-developers/development-application-review-process/development-application-submission/guide-preparing-studies-and-plans#servicing-study-guidelines-development-applications>
12. Servicing and site works shall be in accordance with the following documents:
 - Ottawa Sewer Design Guidelines (October 2012)
 - Ottawa Design Guidelines – Water Distribution (2010)
 - Geotechnical Investigation and Reporting Guidelines for Development Applications in the City of Ottawa (2007)
 - City of Ottawa Slope Stability Guidelines for Development Applications (revised 2012)
 - City of Ottawa Environmental Noise Control Guidelines (January 2016)
 - City of Ottawa Park and Pathway Development Manual (2012)
 - City of Ottawa Accessibility Design Standards (2012)
 - Ottawa Standard Tender Documents (latest version)
 - Ontario Provincial Standards for Roads & Public Works (2013)
13. Record drawings and utility plans are also available for purchase from the City (Contact the City's Information Centre by email at InformationCentre@ottawa.ca or by phone at (613) 580-2424 x.44455).
14. Any proposed work in utility easements requires written consent of easement owner.
15. Please note that these comments are considered preliminary based on the information available to date and therefore maybe amended as additional details become available and presented to the City. It is the responsibility of the applicant to verify the above information. The applicant may contact me for follow-up questions related to engineering/infrastructure prior to submission of an application if necessary.

Transportation (Wally Dubyk)

1. The Watermain Cathodic Protection work is targeted to start along Beechwood Avenue this season. (Contact Rene Monast. Project Manager, Forecast ID – LN56612).
2. The Roadway Resurfacing along Beechwood Avenue is targeted to start 3-5 years. (Forecast ID – LN50190, Contact info Not Available).
3. Beechwood Avenue is in the Design Priority Area.
4. The Screening Form has indicated that the TIA Triggers have been met. Please proceed with the TIA Step 2 – Forecasting report. During the Analysis, ensure that both TDM checklists are filled out and appropriate measures are taken to achieve the target modal shares. In the future, please contact Tim Wei (tim.wei@ottawa.ca) to obtain a local snapshot of the Long-Range Transportation model to help inform background growth rates.
5. Springfield Road is designated as a Collector Road. There are no additional protected ROW limits identified in the OP.
6. Douglas Avenue is designated as a Local Road. There are no additional protected ROW limits identified in the OP.
7. Beechwood Avenue is designated as an Arterial Road within the City's Official Plan. The ROW protection limit of (11.5 metres) are to be taken from the North Side of the road and dimensioned from the existing centerline of pavement and shown on the drawings. The Certified Ontario Land Surveyor is to confirm the ROW protected limits and any portion that may fall within the private property to be conveyed to the City.
8. ROW interpretation – Land for a road widening will be taken equally from both sides of a road, measured from the centreline in existence at the time of the widening if required by the City. The centreline is a line running down the middle of a road surface, equidistant from both edges of the pavement. In determining the centreline, paved shoulders, bus lay-bys, auxiliary lanes, turning lanes and other special circumstances are not included in the road surface.
9. A 5.0 metres x 5.0 metres sight triangle would be required at both intersections of Beechwood Avenue & Springfield Road and Beechwood Avenue & Douglas Avenue. The sight triangle area is to be conveyed to the City and is to be shown on all drawings. The sight triangle dimensions are to be measured from the new ROW protected limits.

10. All underground and above ground building footprints and permanent walls need to be shown on the plan to confirm that any permanent structure does not extend either above or below into the sight triangles and/or future road widening protection limits.
11. Permanent structures such as curbing, stairs, retaining walls, and underground parking foundation also bicycle parking racks are not to extend into the City's right-of-way limits.
12. The closure of an existing private approach shall reinstate the sidewalk, shoulder, curb and boulevard to City standards.
13. The Owner acknowledges and agrees that all private accesses to Roads shall comply with the City's Private Approach By-Law being By-Law No. 2003-447 as amended <https://ottawa.ca/en/living-ottawa/laws-licences-and-permits/laws/law-z/private-approach-law-no-2003-447> or as approved through the Site Plan control process.
14. The proponent is to provide an access grade that does not exceed 2% within the private property for a minimum distance of 6.0 metres from the **ROW limits**. This is a critical safe distance to allow a driver to stop at the top of the ramp and have a good sight angle of pedestrians.
15. The consultant should review the sight distance to the access and any obstructions that may hinder the view of the driver.
16. The concrete sidewalk is to meet City standards and be 2.0 metres in width and to be continuous and depressed through the proposed access (please refer to the City's sidewalk and curb standards)
17. The Tactile Walking Surface Indicator (TWSI) should be provided at pedestrian crossings. Under the Integrated Accessibility Standards of the Accessibility for Ontarians with Disabilities Act, 2005, and the City of Ottawa Accessibility Design Standards, TWSI's are required for new construction and the redevelopment of elements in public spaces, such as for exterior paths of travel (e.g. sidewalks and at the top of stairs).
18. The Owner shall be required to enter into maintenance and liability agreement for all pavers, plant and landscaping material placed in the City right-of-way and the Owner shall assume all maintenance and replacement responsibilities in perpetuity.
19. Bicycle parking spaces are required as per Section 111 of the Ottawa Comprehensive Zoning By-law. Bicycle parking spaces should be located in safe, secure places near main entrances and preferably protected from the weather.
20. A construction Traffic Management Plan is to be provided for approval by the Senior Engineer, Traffic Management, Transportation Services Dept.

Environment (Matthew Hayley)

1. No natural features on or adjacent (i.e., within 30 m) to the site that would trigger an EIS.
2. Bird-safe design: Please review and incorporate bird safe design elements. Some of the risk factors include glass and related design traps such as corner glass and fly-through conditions, ventilation grates and open pipes, landscaping, light pollution. More guidance and solutions are available in the guidelines which can be found here: https://documents.ottawa.ca/sites/documents/files/birdsafedesign_guidelines_en.pdf
3. Urban Heat Island: Please add features that reduce the urban heat island effect (see OP 10.3.3) produced by the parking lot and a building footprint. For example, this impact can be reduced by adding large canopy trees, green roofs, or vegetation walls, or constructing the parking lot or building differently.

Forestry (Hayley Murray)

TCR Requirements

1. A Tree Conservation Report (TCR) must be supplied for review along with the suite of other plans/reports required by the City.
 - a. An approved TCR is a requirement of Site Plan approval.
 - b. The TCR may be combined with the LP provided all information is supplied.
2. Any removal of privately-owned trees 10cm or larger in diameter, or city-owned trees of any diameter requires a tree permit issued under the Tree Protection Bylaw (Bylaw 2020 – 340); the permit will be based on an approved TCR and made available at or near plan approval.
3. The Planning Forester from Planning and Growth Management as well as foresters from Forestry Services will review the submitted TCR.
 - a. If tree removal is required, both municipal and privately-owned trees will be addressed in a single permit issued through the Planning Forester.
 - b. Compensation may be required for city owned trees – if so, it will need to be paid prior to the release of the tree permit.
4. The TCR must contain 2 separate plans:
 - a. Plan/Map 1 - show existing conditions with tree cover information.
 - b. Plan/Map 2 - show proposed development with tree cover information.
 - c. Please ensure retained trees are shown on the landscape plan.

5. The TCR must list all trees on site, as well as off-site trees if the CRZ extends into the developed area, by species, diameter and health condition.
 - a. Please identify trees by ownership – private onsite, private on adjoining site, city owned, boundary (trees on a property line).
6. If trees are to be removed, the TCR must clearly show where they are, and document the reason they cannot be retained.
7. All retained trees must be shown, and all retained trees within the area impacted by the development process must be protected as per City guidelines available at [Tree Protection Specification](#) or by searching Ottawa.ca.
 - a. The location of tree protection fencing must be shown on the plan.
8. The City encourages the retention of healthy trees; if possible, please seek opportunities for retention of trees that will contribute to the design/function of the site.
9. For more information on the process or help with tree retention options, contact Hayley Murray hayley.murray@ottawa.ca or on [City of Ottawa](#).

LP Tree Planting Requirements

(For additional information on the following please contact tracy.smith@Ottawa.ca)

10. Minimum Setbacks

- a. Maintain 1.5m from sidewalk or MUP/cycle track or water service laterals.
- b. Maintain 2.5m from curb
- c. Coniferous species require a minimum 4.5m setback from curb, sidewalk or MUP/cycle track/pathway.
- d. Maintain 7.5m between large growing trees, and 4m between small growing trees. Park or open space planting should consider 10m spacing, except where otherwise approved in naturalization / afforestation areas. Adhere to Ottawa Hydro's planting guidelines (species and setbacks) when planting around overhead primary conductors.

11. Tree Specifications

- a. Minimum stock size: 50mm tree caliper for deciduous, 200cm height for coniferous.
- b. Maximize the use of large deciduous species wherever possible to maximize future canopy coverage.
- c. Tree planting on city property shall be in accordance with the City of Ottawa's Tree Planting Specification; and include watering and warranty as described in the specification (can be provided by Forestry Services).

- d. Plant native trees whenever possible.
- e. No root barriers, dead-man anchor systems, or planters are permitted.
- f. No tree stakes unless necessary (and only 1 on the prevailing winds side of the tree).

12. Hard Surface Planting

- a. Curb style planter is highly recommended.
- b. No grates are to be used and if guards are required, City of Ottawa standard (which can be provided) shall be used.
- c. Trees are to be planted at grade.

13. Soil Volume

- a. Please document on the LP that adequate soil volumes can be met:

Tree Type/Size	Single Tree Soil Volume (m ³)	Multiple Tree Soil Volume (m ³ /tree)
Ornamental	15	9
Columnar	15	9
Small	20	12
Medium	25	15
Large	30	18
Conifer	25	15

- b. Please follow the City's 2017 Tree Planting in Sensitive Marine Clay guidelines.

14. Tree Canopy Cover

- a. The landscape plan shall show how the proposed tree planting will replace and increase canopy cover on the site over time, to support the City's 40% urban forest canopy cover target.
- b. At a site level, efforts shall be made to provide as much canopy cover as possible, through tree planting and tree retention, with an aim of 40% canopy cover at 40 years, as appropriate.
- c. Indicate on the plan the projected future canopy cover at 40 years for the site.

Parks (Mary Ellen Wood)

1. For the proposed 7-storey mid-rise mixed-use building with 104 residential units at 47 Beechwood Ave, the Owner shall pay cash-in-lieu of parkland in accordance with the Parkland Dedication By-law 2022-280 of the City of Ottawa.
2. Through a site plan application for a mid-rise mixed-use building the parkland dedication will be calculated at the following rate:

Section 4 – Conveyance Requirement

Table 1

Density	Type of Development or Use	Maximum Conveyance Requirement
All	Commercial and Industrial purposes	Cash-in-lieu of parkland: 2% of the gross land area
Residential density greater than 18 dwelling units/net hectare	Dwelling units within a mixed use building (as defined by the Zoning By-law) of five to nine storeys, inclusive	Cash-in-lieu parkland: 1 hectare per 500 dwelling units; or The required conveyance shall not exceed an amount equivalent to 15% of the gross land area

Section 4 (2b) For mixed-use development, the conveyance requirement shall be based on Table 1 herein and shall be calculated as follows:

- o Where land is developed for a mix of uses within a building, the required conveyance shall be the cumulative sum for each use, as calculated using the applicable rate prorated proportionally to the gross floor area allocated to each use.
3. The applicant will be required to provide parkland dedication calculation with their submitted material for site plan application.
 4. Please note, Section 10 – Valuation of cash-in-lieu. Where the payment of cash-in-lieu of parkland conveyance is required, the value of the land will be determined:
 - a. 1c) in accordance with Section 42(6) of the Planning Act, as the day before the day the building permit is issued in respect of the development or redevelopment or, where more than one building permit is required for the development or redevelopment, as of the day before the day the first permit issued.
 - b. 2) The value of the land shall be determined by market appraisal approved by the City, and appraisals submitted to or obtained by the City for the purposes of this by-law shall be considered valid for a maximum period of one year from the date the appraisal was completed, or such lesser time as may be specified in the appraisal.
 5. Please note, these park comments are preliminary and will be finalized (and subject to change) upon receipt of the development application. Additionally, if the proposed land use changes, then the parkland dedication requirement will be re-evaluated accordingly.

6. Please note that Parks and Facilities Planning has recently undertaken a legislated replacement of the Parkland Dedication By-law, with the new by-law approved by City Council on August 31, 2022. To ensure you are aware of parkland dedication requirements for your proposed development, we encourage you to familiarize yourself with the [staff report](#) and [recommended by-law](#) that were approved by Council on [August 31, 2022](#).

City Surveyor (Bill Harper)

1. The determination of property boundaries, minimum setbacks and other regulatory constraints are a critical component of development. An Ontario Land Surveyor (O.L.S.) needs to be consulted at the outset of a project to ensure properties are properly defined and can be used as the geospatial framework for the development.
2. Topographic details may also be required for a project and should be either carried out by the O.L.S. that has provided the Legal Survey or done in consultation with the O.L.S. to ensure that the project is integrated to the appropriate control network.

Questions regarding the above requirements can be directed to the City's Surveyor, Bill Harper, at Bill.Harper@ottawa.ca

Waste Services (Andre Laplante)

1. New multi-unit residential development, defined as containing six (6) or more units, intending to receive City waste collection services will be required, as of June 1, 2022, to participate in the City's Green Bin program in accordance with Council's approval of the [multi-residential waste diversion strategy](#). The development must include adequate facilities for the proper storage of allocated garbage, recycling, and green bin containers and such facilities built in accordance with the approved site design. Questions regarding this change and requirements can be directed to Andre.Laplante@ottawa.ca.

Rideau Valley Conservation Authority (Eric Lalonde)

1. The RVCA has no concerns with the proposal. Based on the Site Plan the RVCA does not have water quality control requirements for the project.

Lindenlea Community Association

1. Complimented the design of the proposed building.
2. What is the target demographic for the smaller residential units? There are many seniors in the area.
 - Applicant confirmed that the proposed development is intended to appeal to a wide demographic. The building will contain a mix of units.
3. What uses are anticipated to occupy the commercial units?
 - Applicant noted that there are no confirmed tenants at this time, but anticipates the commercial units will likely be occupied by cafes, retail stores, etc. There is a

requirement for active street frontage, so they would not be occupied by office uses.

4. Will the commercial units be live/work?
 - Applicant confirmed that the commercial units are not intended to be live/work currently, but it could be considered in the future.
5. What colour will the brick be?
 - Applicant confirmed that the palette has been taken from the character of the surrounding area – brick will be a orange/red colour.
6. The white portion of the building looks a bit heavy.
7. Has a shadowing study been completed?
 - Applicant noted that shadow study will be completed as part of the site plan control process. Study will be based on as-of right zoning permissions. Shadow concerns relate mainly to Douglas, as the residential homes abutting the site on Springfield are zoned TM.
8. What is the height of the 1st floor where the commercial units are located?
 - Applicant confirmed that the first floor will have a height of 4 metres.
9. Why has the number of units increased from 104 (initial drawings sent out with meeting request) to 110 (presented at the pre-consult meeting)?
 - A small unit was added to each floor.
10. Concerns about the reduced parking rate.
 - Applicant does not anticipate that the Ward Councillor will have concerns with the request for a reduced parking rate. Intention is to provide the required commercial and visitor parking and reduce the resident parking.

Submission requirements and fees

- Refer to attached list of submission requirements for plans and studies to be submitted at the time of a formal application.
- Additional information regarding fees related to planning applications can be found [here](#).
- Plans are to be standard A1 size (594 mm x 841 mm) or Arch D size (609.6 mm x 914.4 mm) sheets, dimensioned in metric and utilizing an appropriate Metric scale (1:200, 1:250, 1:300, 1:400 or 1:500).
- All PDF submitted documents are to be unlocked and flattened.

Next steps

- You are encouraged to reach out to the Ward Councillor, Councillor Rawlson King, at Rawlson.King@ottawa.ca to discuss the proposed development. You may also consider reaching out to community groups and neighbours surrounding the site.
- It is anticipated that, as a result of the *More Homes for Everyone Act, 2022*, for applications for site plan approval and zoning by-law amendments, new processes in respect of pre-application consultation will be in place as of January 1, 2023. The new processes are anticipated to require a multiple phase pre-application consultation approach before an application will be deemed complete. Applicants who have not filed a complete application by the effective date may be required to undertake further pre-application consultation(s) consistent with the provincial changes. The by-laws to be amended include By-law 2009-320, the Pre-Consultation By-law, By-law 2022-239, the planning fees by-law and By-law 2022-254, the Information and Materials for Planning Application By-law. The revisions are anticipated to be before Council in the period after the new Council takes office and the end of the year.

Appendix G Servicing Study Checklist



Servicing study guidelines for development applications

4. Development Servicing Study Checklist

The following section describes the checklist of the required content of servicing studies. It is expected that the proponent will address each one of the following items for the study to be deemed complete and ready for review by City of Ottawa Infrastructure Approvals staff.

The level of required detail in the Servicing Study will increase depending on the type of application. For example, for Official Plan amendments and re-zoning applications, the main issues will be to determine the capacity requirements for the proposed change in land use and confirm this against the existing capacity constraint, and to define the solutions, phasing of works and the financing of works to address the capacity constraint. For subdivisions and site plans, the above will be required with additional detailed information supporting the servicing within the development boundary.

4.1 General Content

- Executive Summary (for larger reports only).
- Date and revision number of the report.
- Location map and plan showing municipal address, boundary, and layout of proposed development.
- Plan showing the site and location of all existing services.
- Development statistics, land use, density, adherence to zoning and official plan, and reference to applicable subwatershed and watershed plans that provide context to which individual developments must adhere.
- Summary of Pre-consultation Meetings with City and other approval agencies.
- Reference and confirm conformance to higher level studies and reports (Master Servicing Studies, Environmental Assessments, Community Design Plans), or in the case where it is not in conformance, the proponent must provide justification and develop a defensible design criteria.
- Statement of objectives and servicing criteria.
- Identification of existing and proposed infrastructure available in the immediate area.
- Identification of Environmentally Significant Areas, watercourses and Municipal Drains potentially impacted by the proposed development (Reference can be made to the Natural Heritage Studies, if available).
- Concept level master grading plan to confirm existing and proposed grades in the development. This is required to confirm the feasibility of proposed stormwater management and drainage, soil removal and fill constraints, and potential impacts to neighbouring properties. This is also required to confirm that the proposed grading will not impede existing major system flow paths.
- Identification of potential impacts of proposed piped services on private services (such as wells and septic fields on adjacent lands) and mitigation required to address potential impacts.
- Proposed phasing of the development, if applicable.

- Reference to geotechnical studies and recommendations concerning servicing.

- All preliminary and formal site plan submissions should have the following information:
 - Metric scale

 - North arrow (including construction North)

 - Key plan

 - Name and contact information of applicant and property owner

 - Property limits including bearings and dimensions

 - Existing and proposed structures and parking areas

 - Easements, road widening and rights-of-way

 - Adjacent street names

4.2 Development Servicing Report: Water

- Confirm consistency with Master Servicing Study, if available
- Availability of public infrastructure to service proposed development
- Identification of system constraints
- Identify boundary conditions
- Confirmation of adequate domestic supply and pressure
- Confirmation of adequate fire flow protection and confirmation that fire flow is calculated as per the Fire Underwriter's Survey. Output should show available fire flow at locations throughout the development.
- Provide a check of high pressures. If pressure is found to be high, an assessment is required to confirm the application of pressure reducing valves.
- Definition of phasing constraints. Hydraulic modeling is required to confirm servicing for all defined phases of the project including the ultimate design
- Address reliability requirements such as appropriate location of shut-off valves
- Check on the necessity of a pressure zone boundary modification.
- Reference to water supply analysis to show that major infrastructure is capable of delivering sufficient water for the proposed land use. This includes data that shows that the expected demands under average day, peak hour and fire flow conditions provide water within the required pressure range

- Description of the proposed water distribution network, including locations of proposed connections to the existing system, provisions for necessary looping, and appurtenances (valves, pressure reducing valves, valve chambers, and fire hydrants) including special metering provisions.
- Description of off-site required feeder mains, booster pumping stations, and other water infrastructure that will be ultimately required to service proposed development, including financing, interim facilities, and timing of implementation.
- Confirmation that water demands are calculated based on the City of Ottawa Design Guidelines.
- Provision of a model schematic showing the boundary conditions locations, streets, parcels, and building locations for reference.

4.3 Development Servicing Report: Wastewater

- Summary of proposed design criteria (Note: Wet-weather flow criteria should not deviate from the City of Ottawa Sewer Design Guidelines. Monitored flow data from relatively new infrastructure cannot be used to justify capacity requirements for proposed infrastructure).
- Confirm consistency with Master Servicing Study and/or justifications for deviations.
- Consideration of local conditions that may contribute to extraneous flows that are higher than the recommended flows in the guidelines. This includes groundwater and soil conditions, and age and condition of sewers.
- Description of existing sanitary sewer available for discharge of wastewater from proposed development.
- Verify available capacity in downstream sanitary sewer and/or identification of upgrades necessary to service the proposed development. (Reference can be made to previously completed Master Servicing Study if applicable)
- Calculations related to dry-weather and wet-weather flow rates from the development in standard MOE sanitary sewer design table (Appendix 'C') format.
- Description of proposed sewer network including sewers, pumping stations, and forcemains.
- Discussion of previously identified environmental constraints and impact on servicing (environmental constraints are related to limitations imposed on the development in order to preserve the physical condition of watercourses, vegetation, soil cover, as well as protecting against water quantity and quality).
- Pumping stations: impacts of proposed development on existing pumping stations or requirements for new pumping station to service development.
- Forcemain capacity in terms of operational redundancy, surge pressure and maximum flow velocity.
- Identification and implementation of the emergency overflow from sanitary pumping stations in relation to the hydraulic grade line to protect against basement flooding.
- Special considerations such as contamination, corrosive environment etc.

4.4 Development Servicing Report: Stormwater Checklist

- Description of drainage outlets and downstream constraints including legality of outlets (i.e. municipal drain, right-of-way, watercourse, or private property)
- Analysis of available capacity in existing public infrastructure.
- A drawing showing the subject lands, its surroundings, the receiving watercourse, existing drainage patterns, and proposed drainage pattern.
- Water quantity control objective (e.g. controlling post-development peak flows to pre-development level for storm events ranging from the 2 or 5 year event (dependent on the receiving sewer design) to 100 year return period); if other objectives are being applied, a rationale must be included with reference to hydrologic analyses of the potentially affected subwatersheds, taking into account long-term cumulative effects.
- Water Quality control objective (basic, normal or enhanced level of protection based on the sensitivities of the receiving watercourse) and storage requirements.
- Description of the stormwater management concept with facility locations and descriptions with references and supporting information.
- Set-back from private sewage disposal systems.
- Watercourse and hazard lands setbacks.
- Record of pre-consultation with the Ontario Ministry of Environment and the Conservation Authority that has jurisdiction on the affected watershed.
- Confirm consistency with sub-watershed and Master Servicing Study, if applicable study exists.
- Storage requirements (complete with calculations) and conveyance capacity for minor events (1:5 year return period) and major events (1:100 year return period).
- Identification of watercourses within the proposed development and how watercourses will be protected, or, if necessary, altered by the proposed development with applicable approvals.
- Calculate pre and post development peak flow rates including a description of existing site conditions and proposed impervious areas and drainage catchments in comparison to existing conditions.
- Any proposed diversion of drainage catchment areas from one outlet to another.
- Proposed minor and major systems including locations and sizes of stormwater trunk sewers, and stormwater management facilities.
- If quantity control is not proposed, demonstration that downstream system has adequate capacity for the post-development flows up to and including the 100 year return period storm event.
- Identification of potential impacts to receiving watercourses
- Identification of municipal drains and related approval requirements.
- Descriptions of how the conveyance and storage capacity will be achieved for the development.
- 100 year flood levels and major flow routing to protect proposed development from flooding for establishing minimum building elevations (MBE) and overall grading.

- Inclusion of hydraulic analysis including hydraulic grade line elevations.
- Description of approach to erosion and sediment control during construction for the protection of receiving watercourse or drainage corridors.
- Identification of floodplains – proponent to obtain relevant floodplain information from the appropriate Conservation Authority. The proponent may be required to delineate floodplain elevations to the satisfaction of the Conservation Authority if such information is not available or if information does not match current conditions.
- Identification of fill constraints related to floodplain and geotechnical investigation.

4.5 Approval and Permit Requirements: Checklist

The Servicing Study shall provide a list of applicable permits and regulatory approvals necessary for the proposed development as well as the relevant issues affecting each approval. The approval and permitting shall include but not be limited to the following:

- Conservation Authority as the designated approval agency for modification of floodplain, potential impact on fish habitat, proposed works in or adjacent to a watercourse, cut/fill permits and Approval under Lakes and Rivers Improvement Act. The Conservation Authority is not the approval authority for the Lakes and Rivers Improvement Act. Where there are Conservation Authority regulations in place, approval under the Lakes and Rivers Improvement Act is not required, except in cases of dams as defined in the Act.
- Application for Certificate of Approval (CofA) under the Ontario Water Resources Act.
- Changes to Municipal Drains.
- Other permits (National Capital Commission, Parks Canada, Public Works and Government Services Canada, Ministry of Transportation etc.)

4.6 Conclusion Checklist

- Clearly stated conclusions and recommendations
- Comments received from review agencies including the City of Ottawa and information on how the comments were addressed. Final sign-off from the responsible reviewing agency.
- All draft and final reports shall be signed and stamped by a professional Engineer registered in Ontario

Appendix H Drawings





Copyright Reserved

The Contractor shall verify and be responsible for all dimensions. DO NOT scale the drawing - any errors or omissions shall be reported to Stantec without delay.
The Copyrights to all designs and drawings are the property of Stantec. Reproduction or use for any purpose other than that authorized by Stantec is forbidden.

Legend

	EXISTING WATERMAIN
	EXISTING VALVE CHAMBER
	EXISTING FIRE HYDRANT
	EXISTING SANITARY SEWER
	EXISTING STORM SEWER
	EXISTING CATCHBASIN
	EXISTING OVERHEAD WIRES
	EXISTING GAS
	EXISTING BELL
	EXISTING CURB
	EXISTING BUILDING EXTENTS

Notes

- EXISTING AS-RECORDED SEWER AND WATER INFORMATION HAS BEEN DERIVED FROM AS-BUILT INFORMATION PROVIDED BY THE CITY OF OTTAWA.
- CONTRACTOR TO VERIFY AS-RECORDED INFORMATION AND IMMEDIATELY REPORT ANY DISCREPANCIES OR CONFLICTS TO CIVIL ENGINEER PRIOR TO PROCEEDING WITH CONSTRUCTION.

Revision	By	Appd.	YY.MM.DD	
4	REVISED ROAD GEOMETRY	WJ	DT	24.09.18
3	REVISED PER CITY COMMENTS	WJ	DT	24.08.13
2	REVISED PER CITY COMMENTS	WJ	DT	24.05.27
1	ISSUED FOR REVIEW	TM	DT	23.06.07

Permit-Seal	TM	KK	TM	23.03.15
File Name: 160401786 DB.dwg	Dwn.	Chkd.	Dgn.	YY.MM.DD

Client/Project

Project1 Studio

47 BEECHWOOD AVENUE

OTTAWA, ONTARIO, CANADA

Title

EXISTING CONDITIONS AND REMOVALS PLAN

Project No.
1604001786

Scale
1:200

Drawing No.

Sheet

Revision

EX-1

1 of 6

4

PLAN # 19043

V:\Projects\160401786\Design\Drawings\160401786 DB.dwg
 2024/09/18 11:51 AM WJ-DT-230527-1.dwg

ORIGINAL SHEET - ARCH-D

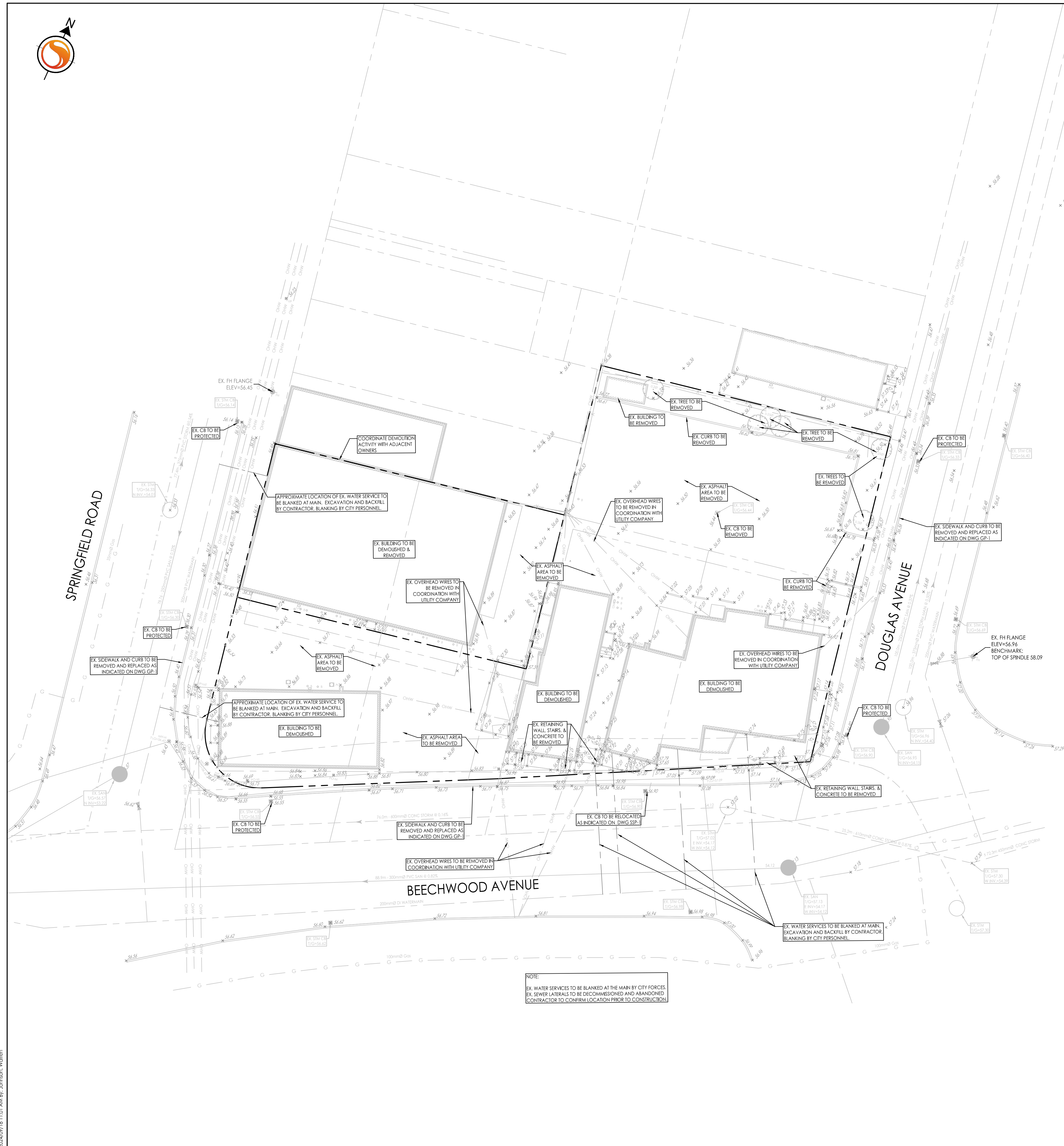

NOTE:
EX. WATER SERVICES TO BE BLANKED AT THE MAIN BY CITY FORCES.
EX. SEWER LATERALS TO BE DECOMMISSIONED AND ABANDONED.
CONTRACTOR TO CONFIRM LOCATION PRIOR TO CONSTRUCTION.

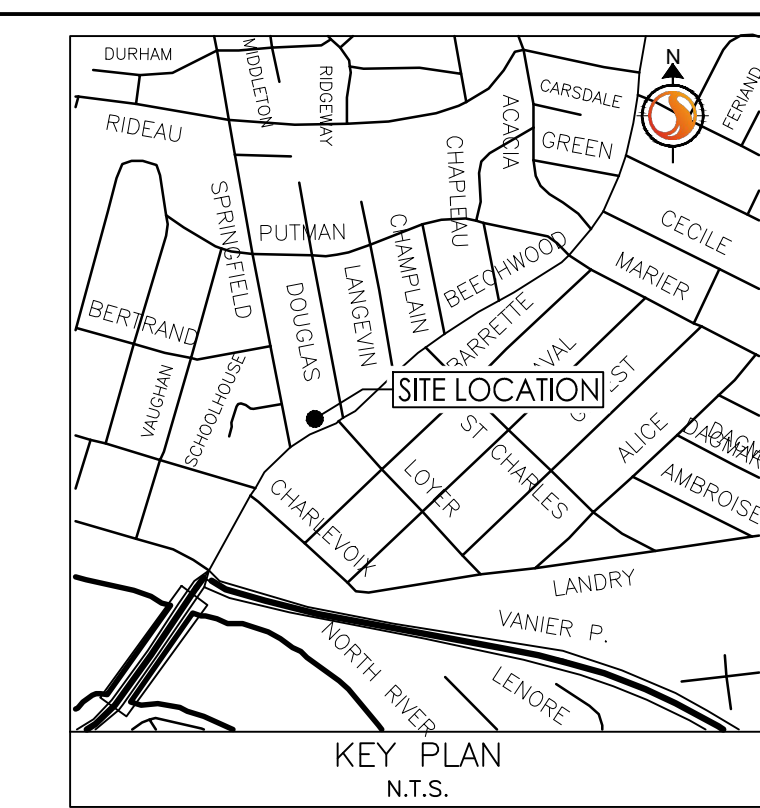

D07-12-23-0084



Copyright Reserved

The Contractor shall verify and be responsible for all dimensions. DO NOT scale the drawing - any errors or omissions shall be reported to Stantec without delay.
The Copyrights to all designs and drawings are the property of Stantec. Reproduction or use for any purpose other than that authorized by Stantec is forbidden.

Legend

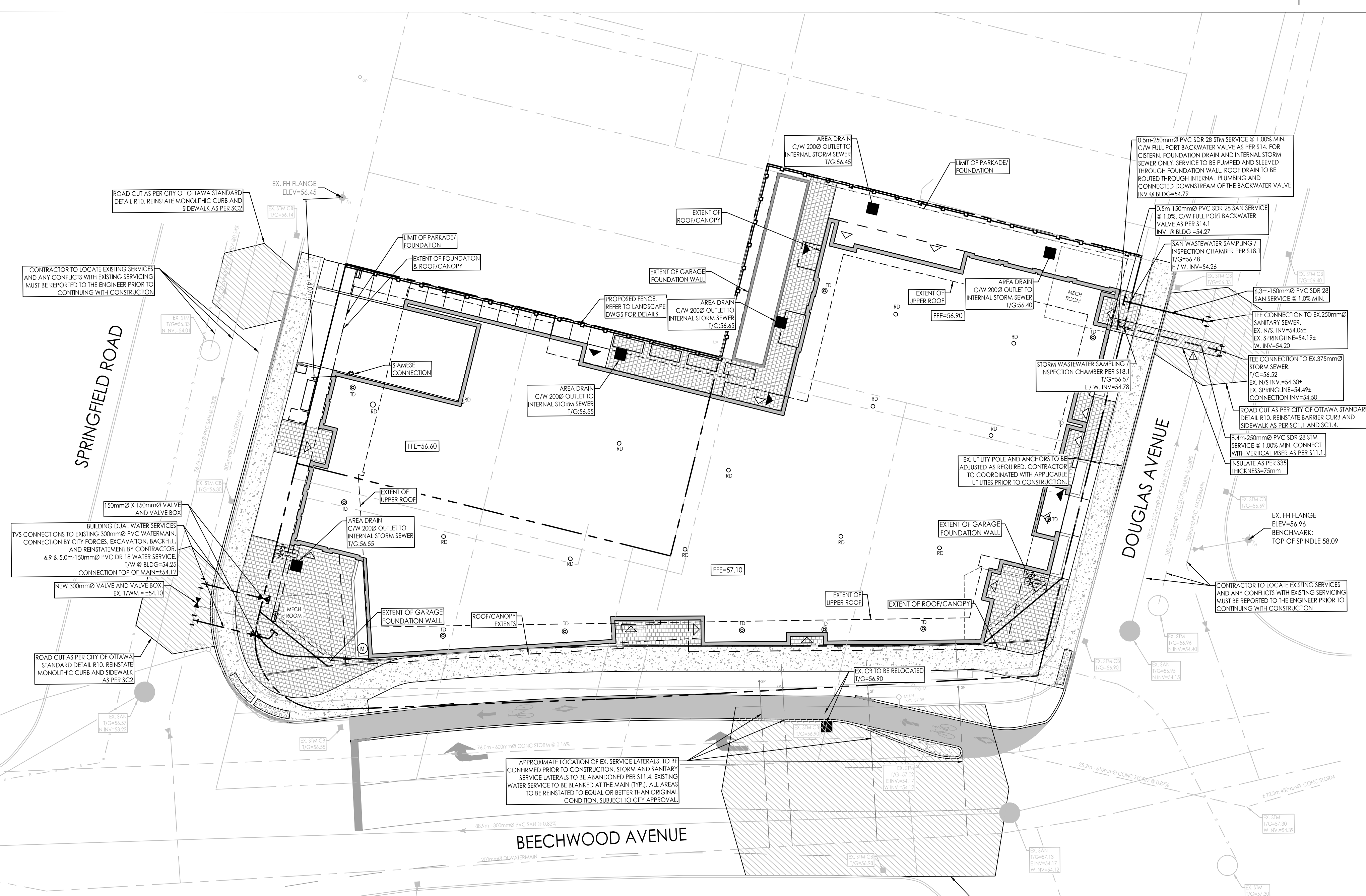
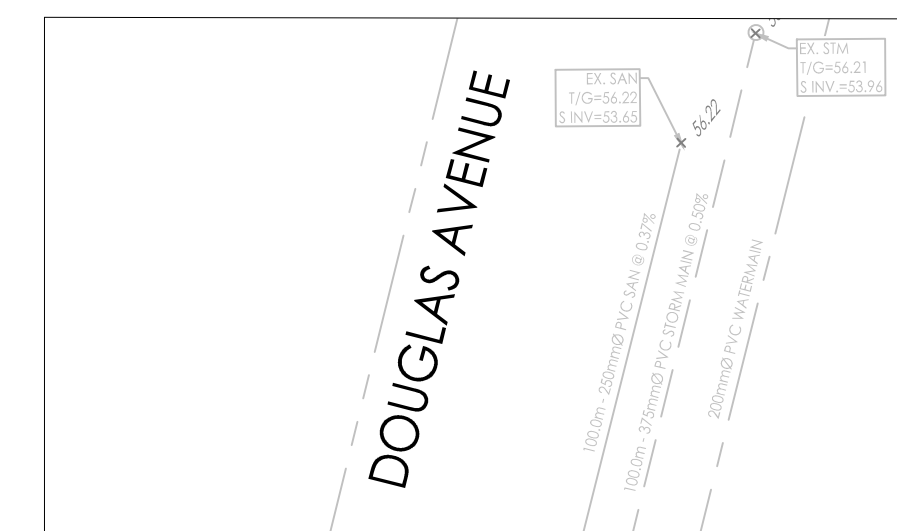
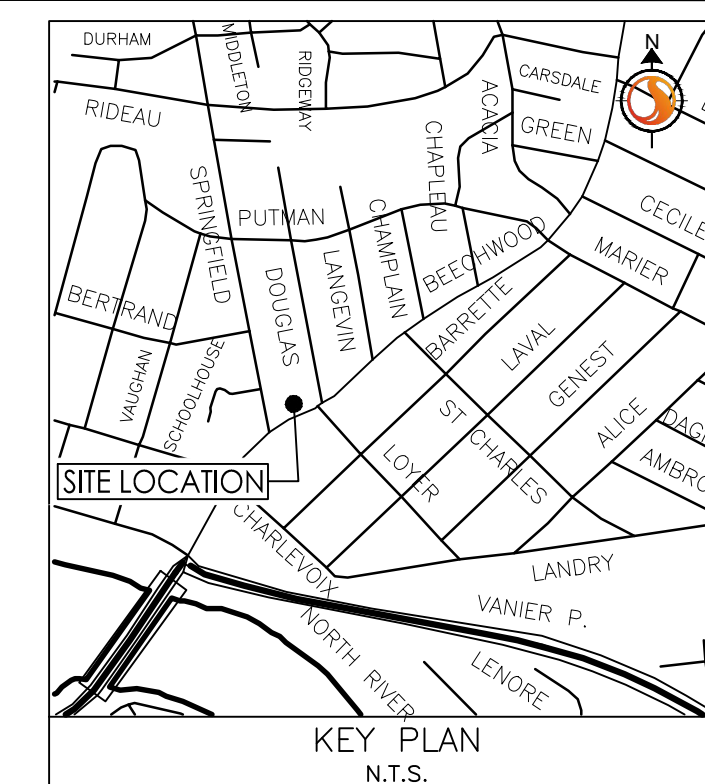
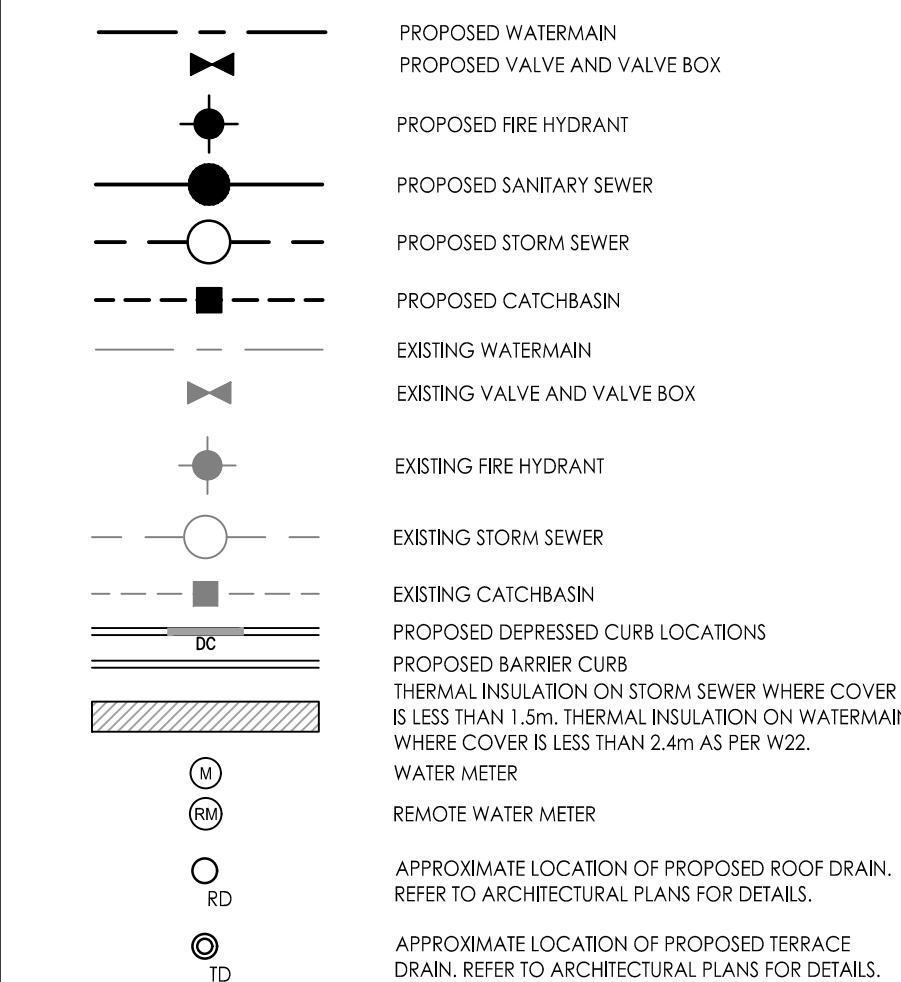

GENERAL NOTES

- ALL WORK SHALL BE CARRIED OUT IN COMPLIANCE WITH THE ONTARIO OCCUPATIONAL HEALTH AND SAFETY ACT AND REGULATIONS FOR CONSTRUCTION PROJECTS.
- ALL WORK AND MATERIALS TO CONFORM WITH CURRENT MINISTRY OF THE ENVIRONMENT & ENERGY OF ONTARIO, CITY OF OTTAWA AND ONTARIO PROVINCIAL STANDARDS AND SPECIFICATIONS. LOCAL UTILITY STANDARDS AND MINISTRY OF TRANSPORTATION STANDARDS WILL APPLY WHERE REQUIRED.
- THE CONTRACTOR IS ADVISED THAT WORKS BY OTHERS MAY BE ONGOING DURING THE PERIOD OF THIS CONTRACT. THE CONTRACTOR SHALL COORDINATE CONSTRUCTION ACTIVITIES AND COORDINATION WITH ALL OTHER CONTRACTORS AND PREVENT CONSTRUCTION CONFLICTS.
- THE INFORMATION SHOWN FOR EXISTING UTILITIES WAS PROVIDED BY OTHERS. THE CONTRACTOR IS RESPONSIBLE FOR LOCATING AND PROTECTING ALL UTILITIES DURING CONSTRUCTION. ALL EXISTING UTILITIES MUST BE LOCATED AND VERIFIED BY EACH UTILITY PRIOR TO COMMENCEMENT OF WORK. ANY VARIANCE IS TO BE IMMEDIATELY REPORTED TO THE ENGINEER. LOST TIME DUE TO FAILURE OF THE CONTRACTOR TO CONFIRM UTILITY LOCATIONS AND NOTIFY THE ENGINEER OF POSSIBLE CONFLICTS PRIOR TO CONSTRUCTION WILL BE AT THE CONTRACTORS EXPENSE.
- ALL CONSTRUCTION SHALL BE CARRIED OUT IN ACCORDANCE WITH THE RECOMMENDATIONS MADE IN THE GEOTECHNICAL REPORT.
- THE CONTRACTOR IS RESPONSIBLE FOR OBTAINING ALL PERMITS REQUIRED AND TO BEAR THE COST OF SAME INCLUDING WATER PERMIT AND ASSOCIATED COSTS.
- ALL DISTURBED AREAS SHALL BE RESTORED TO EQUAL OR BETTER CONDITION TO THE SATISFACTION THE ENGINEER AND THE CITY. PAVEMENT RESTATEMENT FOR SERVICE AND UTILITY CUTS SHALL BE IN ACCORDANCE WITH CITY STANDARD R10, OPSS 509.010 AND OPSS 310.
- BENCHMARKS: IT IS THE RESPONSIBILITY OF THE CONTRACTOR TO VERIFY THAT THE SITE BENCHMARK(S) HAS NOT BEEN ALTERED OR DISTURBED AND THAT ITS RELATIVE ELEVATION AND DESCRIPTION AGREES WITH THE INFORMATION SHOWN ON DRAWING GP-1.
- THE CONTRACTOR SHALL PROVIDE TO THE ENGINEER 1 (ONE) SET OF AS CONSTRUCTED SITE SERVICING, GRADING, AND SITE ELECTRICAL DWGS.
- EXISTING STORM AND SANITARY SERVICE LATERALS TO BE ABANDONED PER S11.4. EXISTING WATER SERVICE TO BE BLANKED AT THE MAIN (TYP.).
- TOPOGRAPHIC SURVEY SUPPLIED BY ANNS, O'SULLIVAN, VOLLEBEK LTD. DATED JULY 21, 2022 - FILE NO. 21968-21.
BENCHMARK: FIRE HYDRANT TOP OF SPINDLE EAST OF DOUGLAS AVENUE WITH AN ELEVATION OF 58.09m.
ELEVATIONS ARE GEODETIC AND REFERRED TO CGVD25 GEODETIC DATUM. DERIVED FROM CITY OF OTTAWA BENCHMARK NO. OH_107 WITH AN ELEVATION OF 71.945m.
- SITE PLAN PREPARED BY PROJECT1 STUDIO INC., PROVIDED MAY 15, 2024 DRAWING SP-01.
- GEOTECHNICAL INVESTIGATION PG6484-1 PREPARED BY PATERSON GROUP DATED JANUARY 13, 2023. GEOTECHNICAL INFORMATION PRESENTED ON THESE DRAWINGS MAY BE INTERPOLATED FROM THE ORIGINAL REPORT. REFER TO ORIGINAL GEOTECHNICAL REPORT FOR ADDITIONAL DETAILS AND TO VERIFY ASSUMPTIONS MADE HERE.

WATER SUPPLY SERVICING

- THE CONTRACTOR SHALL CONSTRUCT WATERMAIN, WATER SERVICES, CONNECTIONS & APPURTENANCES AS PER CITY OF OTTAWA SPECIFICATIONS & SHALL CO-ORDINATE AND PAY ALL RELATED COSTS INCLUDING THE COST OF CONNECTION, INSPECTION & IDENTIFICATION BY CITY PERSONNEL.
- WATER SERVICE TO BE INSTALLED 1.0m OFF BUILDING FACE. STAND POST TO BE INSTALLED AT PROPERTY LINE AS SHOWN ON DRAWING.
- WATERMAIN TRENCH AND BEDDING SHALL BE IN ACCORDANCE WITH CITY OF OTTAWA STD. W17 UNLESS OTHERWISE SPECIFIED. BEDDING AND COVER MATERIAL TO BE SPECIFIED BY PROJECT GEOTECHNICAL CONSULTANT.
- SERVICE CONNECTIONS SHALL BE INSTALLED A MINIMUM OF 2400mm FROM ANY CATCHBASIN, MANHOLE OR OBJECT THAT MAY CONTRIBUTE TO FREEZING. THERMAL INSULATION SHALL BE INSTALLED ON ALL PROPOSED CBS ON THE W/M STREET SIDE WHERE 2400mm SEPARATION CANNOT BE ACHIEVED (AS PER CITY OF OTTAWA W22 & W23).
- CATHODIC PROTECTION TO BE SUPPLIED ON METALLIC FITTINGS AS PER CITY OF OTTAWA W40 AND W42.
- ALL WATERMAIN BENDS, JOINTS, TEES AND PLUGS SHALL BE MECHANICALLY RESTRAINED IN ACCORDANCE WITH CITY OF OTTAWA STANDARDS.
- WATERMAIN TO HAVE MIN. 2.4m COVER. WHERE WATERMAIN COVER IS LESS THAN 2.4m, INSULATION TO BE SUPPLIED IN ACCORDANCE WITH CITY STANDARD W22.
- WATERMANS MUST COMPLY WITH MINIMUM HORIZONTAL AND VERTICAL CLEARANCES IN ACCORDANCE WITH LOCAL PROVINCIAL GUIDELINES AND THE APPLICABLE BUILDING AND PLUMBING CODE. WHERE HORIZONTAL SEPARATIONS CANNOT BE ACHIEVED, APPROVAL FROM THE ENGINEER MUST BE OBTAINED AND A MINIMUM 500mm VERTICAL SEPARATION MUST BE MAINTAINED.
- ALL WATERMANS SHALL BE BACTERIOLOGICALLY TESTED IN ACCORDANCE WITH THE CITY OF OTTAWA AND ONTARIO GUIDELINES. ALL CHLORINATED WATER TO BE DISCHARGED AND PRETREATED TO ACCEPTABLE LEVEL PRIOR TO DISCHARGE. ALL DISCHARGED WATER MUST BE CONTROLLED AND TREATED SO AS NOT TO ADVERSELY EFFECT THE ENVIRONMENT. IT IS THE RESPONSIBILITY OF THE CONTRACTOR TO ENSURE THAT ALL MUNICIPAL AND/OR PROVINCIAL REQUIREMENTS ARE FOLLOWED.

STORM AND SANITARY SEWERS

- SEWER TRENCH SHALL CONSIST OF CLASS 'B' BEDDING PER CITY OF OTTAWA STANDARDS S6 AND S7. COMPACTION SHALL BE A MINIMUM OF 95% STANDARD PROCTOR DENSITY.
- FOR CONSTRUCTION DETAILS NOT SHOWN ON PLANS, REFERENCE SHALL BE MADE TO THE ONTARIO PROVINCIAL STANDARDS DRAWINGS AND CITY OF OTTAWA STANDARDS.
- SERVICES TO BUILDINGS TO BE TERMINATED 1.0m FROM THE FACE OF BUILDING UNLESS OTHERWISE NOTED.
- THE CONTRACTOR IS TO PROVIDE CCTV CAMERA INSPECTIONS OF ALL SANITARY AND STORM SEWERS, INCLUDING PICTORIAL REPORT. ONE (1) CD COPY AND TWO (2) VIDEO TAPES IN A FORMAT SATISFACTORY TO THE ENGINEER. ALL SEWERS ARE TO BE FLUSHED PRIOR TO CAMERA INSPECTION. ASPHALT WEAR COURSE SHALL NOT BE PLACED UNTIL THE VIDEO INSPECTION OF SEWERS & NECESSARY REPAIRS HAVE BEEN CARRIED OUT TO THE SATISFACTION OF THE CONSULTANT.
- LASER ALIGNMENT CONTROL TO BE UTILIZED ON ALL SEWER INSTALLATIONS.
- FROST PROTECTION PER CITY OF OTTAWA STANDARD DRAWING W22 WHERE THERE IS LESS THAN 2.0m OF COVER ABOVE THE SEWER SERVICES.
- CONTRACTOR SHALL PERFORM LEAKAGE TESTING, IN THE PRESENCE OF THE CONSULTANT, FOR SANITARY SEWERS IN ACCORDANCE WITH OPSS 410 AND OPSS 407. A COPY OF THE INSPECTION REPORT SHALL BE SUBMITTED TO THE CONSULTANT FOR REVIEW.
- STORM SERVICE CONNECTION AS PER CITY STD DWG S11.1; SANITARY SERVICE CONNECTION AS PER CITY STD DWG S11.1. SERVICES TO CONNECT TO THE SPRINGLINE OF THE MAIN UNLESS OTHERWISE NOTED.
- CONTRACTOR TO VERIFY EXISTING SEWERS AND INVERTS, AND REPORT ANY DISCREPANCIES TO SITE ENGINEER BEFORE PROCEEDING WITH CONSTRUCTION.

CROSSING	STM INV	STM OBV	SAN INV	SAN OBV	WTR TOP	WTR BTM	NOTES
1	54.72	54.97	54.06	54.31			INSULATE STORM AS PER S35

DRAINAGE AREA ID	DRAIN TYPE	# DRAINS	2YR HEAD (m)	100 YEAR HEAD (m)	2YR RELEASE RATE (L/s)	100 YEAR RELEASE RATE (L/s)
BLDG	WATTS R1100 ACCUTROL (25% OPEN)	12	0.08	0.14	8.8	10.8

PROPOSED 3 STOREY APARTMENT BUILDING
FF=VARIES (REFER TO GRADING PLAN)
P1 PARKING=53.25
USF=152.48
REFER TO ARCHITECTURAL PLANS FOR TOP ELEVATIONS. TOP TO REMAIN MIN. 0.15m ABOVE FINISHED GRADE.
MAX 100-YR ROOF RELEASE RATE = 10.8 L/s
TOTAL PEAK FLOW TO CISTERN = 27.7 L/s
MAX 100-YR CISTERN RELEASE RATE = 12.2 L/s
CISTERN VOLUME REQUIRED = 10 m³
SLUMP PUMP REQUIRED TO DISCHARGE INTERNAL STORM SEWER AND FOUNDATION DRAIN. SLUMP PUMP REQUIRED FOR PARKADE LEVEL 1. REFER TO MECHANICAL DRAWINGS FOR DETAILS.
PROPOSED BUILDING TO BE EQUIPPED WITH PRESSURE REDUCING VALVES AS PER THE ONTARIO BUILDING CODE.

Revision	By	Appd.	YY.MM.DD	
4	REVISED ROAD GEOMETRY	WJ	DT	24.09.18
3	REVISED PER CITY COMMENTS	WJ	DT	24.08.13
2	REVISED PER CITY COMMENTS	WJ	DT	24.05.27
1	ISSUED FOR REVIEW	TM	DT	23.06.12

File Name:	TM	KK	TM	23.03.15
160401786 DB.dwg	Dwn.	Chkd.	Dgn.	YY.MM.DD

Permit-Seal

Client/Project

Project1 Studio

47 BEECHWOOD AVENUE

OTTAWA, ONTARIO, CANADA

Title

SITE SERVICING PLAN

Project No. 160401786	Scale 1:200	Sheet 0 2 6 10m	Revision 0
Drawing No. SSP-1	Sheet 2 of 6	Revision 4	Revision 4



Copyright Reserved

The Contractor shall verify and be responsible for all dimensions. DO NOT scale the drawing - any errors or omissions shall be reported to Stantec without delay.
The Copyrights to all designs and drawings are the property of Stantec. Reproduction or use for any purpose other than that authorized by Stantec is forbidden.

Legend

	ORIGINAL GROUND ELEVATION
	PROPOSED ELEVATION
	PROPOSED LOT CORNER ELEVATION
	EXISTING ELEVATION AT LOT CORNER
	FLOW DIRECTION AND GRADE
	FINISHED FIRST FLOOR ELEVATION
	UNDERSIDE OF FOOTING ELEVATION
	NUMBER OF RISERS
	TERRACING 3:1 SLOPE MAXIMUM (UNLESS OTHERWISE SHOWN)
	DIRECTION OF OVERLAND FLOW
	PROPOSED VALVE BOX
	PROPOSED VALVE CHAMBER
	PROPOSED FIRE HYDRANT
	PROPOSED SANITARY SEWER MANHOLE
	PROPOSED STORM SEWER MANHOLE
	PROPOSED CATCHBASIN MANHOLE
	PROPOSED CATCHBASIN
	PROPOSED DEPRESSED CURB LOCATION
	PROPOSED BARRIER CURB
	MAX EMERGENCY PONDING LIMITS
	OVERLAND SPILL LOCATION
	TWS LOCATION AS PER CITY STD

Notes

4	REVISED ROAD GEOMETRY	WJ	DT	24.09.18
3	REVISED PER CITY COMMENTS	WJ	DT	24.08.13
2	REVISED PER CITY COMMENTS	WJ	DT	24.05.27
1	ISSUED FOR REVIEW	TM	DT	23.06.12

Revision		By	Appd.	YY.MM.DD
----------	--	----	-------	----------

File Name:	160401784.D8.dwg	TM	KK	TM	23.03.15
		Dwn.	Chkd.	Dgn.	YY.MM.DD

Permit-Seal

Client/Project

Project1 Studio

47 BEECHWOOD AVENUE

OTTAWA, ONTARIO, CANADA

Title

GRADING PLAN

Project No.	Scale	0	2	6	10m
160401784	1:200				

Drawing No.	Sheet	Revision
GP-1	3 of 6	4

PLANNING # 19043

SITE GRADING

- ALL GRANULAR BASE & SUB-BASE COURSE MATERIALS SHALL BE COMPACTED TO 100% STANDARD PROCTOR MAX. DRY DENSITY.
- ALL DISTURBED GRASSED AREAS SHALL BE RESTORED TO ORIGINAL CONDITION OR BETTER, WITH SOD ON MIN. 100mm TOPSOIL. THE RELOCATION OF TREES AND SHRUBS SHALL BE SUBJECT TO APPROVAL BY THE PROJECT LANDSCAPE ARCHITECT OR ENGINEER.
- INSPECTIONS: ALL WORK ON THE MUNICIPAL RIGHT OF WAY AND EASEMENTS TO BE INSPECTED BY THE MUNICIPALITY PRIOR TO BACKFILLING. ALL WORK RELATING TO WATERMAINS AND SEWERS TO BE INSPECTED BY THE MUNICIPALITY WHEN REQUIRED.
- REFER TO ARCHITECTURAL SITE PLAN FOR DIMENSIONS AND SITE DETAILS.
- CONTRACTOR TO OBTAIN A ROAD OCCUPANCY PERMIT 48 HOURS PRIOR TO COMMENCING ANY WORK WITHIN THE MUNICIPAL ROAD ALLOWANCE IF REQUIRED BY THE MUNICIPALITY.
- EMBANKMENTS TO BE SLOPED AT MIN. 3:1, UNLESS OTHERWISE SPECIFIED.
- ALL TREES ON THE RIGHT-OF-WAY ARE TO BE MAINTAINED BEFORE AND AFTER CONSTRUCTION AND ALL TREES WITHIN THE PROPERTY SHALL BE PROTECTED AS PER THE MUNICIPAL TREES AND NATURAL AREAS PROTECTION BY-LAW AND THE URBAN TREES CONSERVATION BY-LAW AS AMENDED FROM TIME TO TIME.
- ALL NECESSARY CLEARING AND GRUBBING SHALL BE COMPLETED BY THE CONTRACTOR. REVIEW WITH ARCHITECT AND THE CITY OF OTTAWA PRIOR TO TREE CUTTING.
- EX-CAVATE SOFT AREAS & FILL WITH GRANULAR 'B' COMPACTED IN 0.15m LAYERS.
- NO ALTERATION TO EXISTING GRADES OR DRAINAGE PATTERN ON PROPERTY LINE MAY BE MADE WHERE NO PERMISSION TO ENTER ADJACENT PROPERTY EXISTS.
- NO EXCESS DRAINAGE, DURING AND AFTER CONSTRUCTION, IS TO BE DIRECTED TOWARDS NEIGHBOURING PROPERTIES.
- UNDERSIDE-OF-FOOTING TO HAVE MINIMUM COVER OF 1.5m, WHERE SUFFICIENT COVER IS NOT PROVIDED, FOOTINGS ARE TO BE INSULATED TO PROVIDED EQUIVALENT INSULATION.
- PAVEMENT REINSTATEMENT FOR SERVICE AND UTILITY CUTS SHALL BE IN ACCORDANCE WITH R10 AND OPSD 509.010 AND OPSD 310.
- ALL RETAINING WALLS GREATER THAN 1.0m IN HEIGHT ARE TO BE DESIGNED, APPROVED, AND STAMPED BY STRUCTURAL ENGINEER.
- FENCES OR RAILINGS ARE REQUIRED FOR RETAINING WALLS GREATER THAN 0.40m IN HEIGHT.
- TOPOGRAPHIC SURVEY SUPPLIED BY ANNE, OUSLIJAN, VOLLEBEK LTD. DATED JULY 21, 2022 - FILE NO. 21948-21.

BENCHMARK: FIRE HYDRANT TOP OF SPINDLE EAST OF DOUGLAS AVENUE WITH AN ELEVATION OF 38.02m. ELEVATIONS ARE GEODETIC AND REFERRED TO CADDIS GEODETIC DATUM, DERIVED FROM CITY OF OTTAWA BENCHMARK NO. CTT-107 WITH AN ELEVATION OF 71.9454.

AREAS SUBJECT TO CAR PARKING ONLY
50mm WEAR COURSE - HL-8 OR SUPERPAVE 12.5 ASPHALTIC CONCRETE
150mm BASE - OPS GRANULAR A CRUSHED STONE
300mm SUBBASE - OPS GRANULAR B TYPE II

ACCESS LANES AND HEAVY TRUCK PARKING AREAS
80mm WEAR COURSE - HL-8 OR SUPERPAVE 12.5 ASPHALTIC CONCRETE
50mm BINDER COURSE - HL-8 OR SUPERPAVE 19.0 ASPHALTIC CONCRETE
150mm BASE - OPS GRANULAR A CRUSHED STONE
450mm SUBBASE - OPS GRANULAR B TYPE II
SUBGRADE - UNDISTURBED NATIVE SOIL OR OPS GRANULAR B TYPE II OR III MATERIAL.



PROPOSED 3 STOREY APARTMENT BUILDING
FF=VARIES (REFER TO GRADING PLAN)
P1 PARKING=53.25
USF=152.48

REFER TO ARCHITECTURAL PLANS FOR TOP ELEVATIONS, TOP TO REMAIN MIN. 0.15m ABOVE FINISHED GRADE.

MAX 100-YR ROOF RELEASE RATE = 10.8 L/S
TOTAL PEAK FLOW TO CISTERN = 27.7 L/S
MAX 100-YR CISTERN RELEASE RATE = 12.2 L/S
CISTERN VOLUME REQUIRED = 10 m³

SUMP PUMP REQUIRED TO DISCHARGE INTERNAL STORM SEWER AND FOUNDATION DRAIN. SUMP PUMP REQUIRED FOR PARKADE LEVEL 1. REFER TO MECHANICAL DRAWINGS FOR DETAILS.

PROPOSED BUILDING TO BE EQUIPPED WITH PRESSURE REDUCING VALVES AS PER THE ONTARIO BUILDING CODE.



Copyright Reserved

The Contractor shall verify and be responsible for all dimensions. DO NOT scale the drawing - any errors or omissions shall be reported to Stantec without delay.
The Copyrights to all designs and drawings are the property of Stantec. Reproduction or use for any purpose other than that authorized by Stantec is forbidden.

Legend

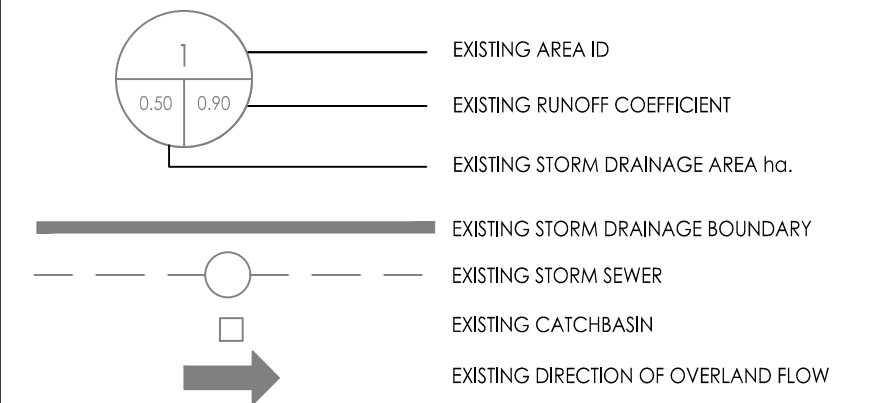

Revision	By	Appd.	YY.MM.DD
4	WJ	DT	24.09.18
3	WJ	DT	24.08.13
2	WJ	DT	24.05.27
1	TM	DT	23.06.07

File Name:	TM	KK	TM	23.03.15
160401786 DB.dwg	Dwn.	Chkd.	Dgn.	YY.MM.DD

Permit-Seal

Client/Project
Project1 Studio

47 BEECHWOOD AVENUE

OTTAWA, ONTARIO, CANADA

Title
EXISTING STORM DRAINAGE PLAN

Project No. 1604001786	Scale 1:200	Sheet 4 of 6	Revision 4
Drawing No. EXSD-1	PLAN # 19043		

X:\Projects\160401786\Design\Drawings\160401786 DB.dwg
 2024/09/18 11:50 AM WJ-240918-10.dgn

D07-12-23-0084



Copyright Reserved

The Contractor shall verify and be responsible for all dimensions. DO NOT scale the drawing - any errors or omissions shall be reported to Stantec without delay.
The Copyrights to all designs and drawings are the property of Stantec. Reproduction or use for any purpose other than that authorized by Stantec is forbidden.

Legend

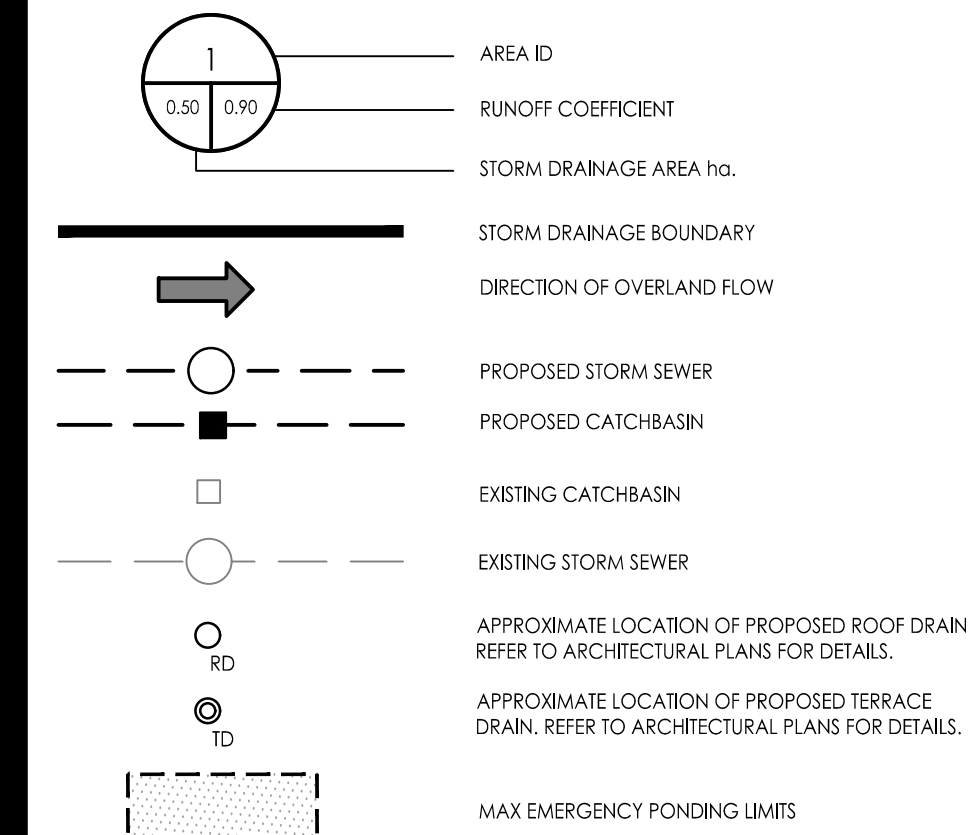

Notes

- REQUIRED CISTERN VOLUME 10m³

Revision	By	Appd.	YY.MM.DD
4	WJ	DT	24.09.18
3	WJ	DT	24.08.13
2	WJ	DT	24.05.27
1	TM	DT	23.06.12

File Name:	TM	KK	TM	23.03.15
160401784 DB.dwg	Dwn.	Chkd.	Dgn.	YY.MM.DD

Permit-Seal

Client/Project

Project1 Studio

47 BEECHWOOD AVENUE

OTTAWA, ONTARIO, CANADA

Title

STORM DRAINAGE PLAN

Project No.	Scale	Sheet	Revision
1604001786	1:200	5 of 6	4
Drawing No.	Sheet		Revision

SD-1 5 of 6 4 PLAN # 19043

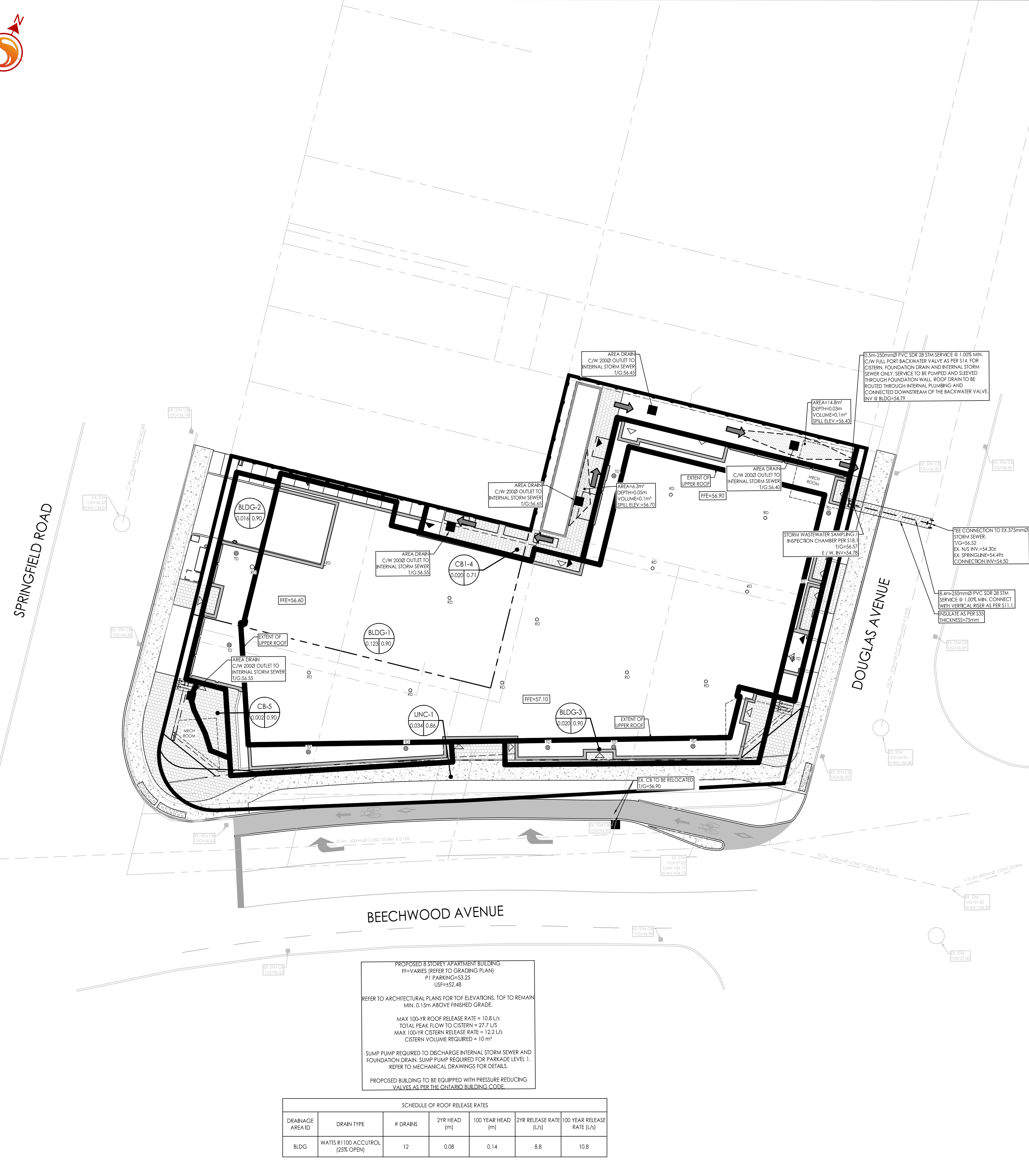
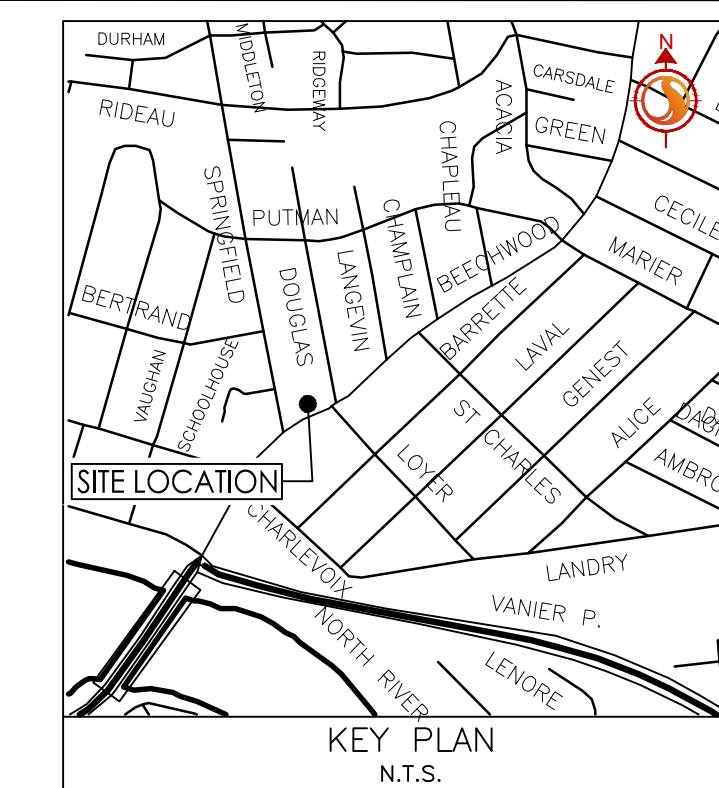

PROPOSED 3 STOREY APARTMENT BUILDING
FF=VARIES (REFER TO GRADING PLAN)
P1 PARKING=53.25
USF=152.48
REFER TO ARCHITECTURAL PLANS FOR TOF ELEVATIONS. TOF TO REMAIN MIN. 0.15m ABOVE FINISHED GRADE.
MAX 100-YR ROOF RELEASE RATE = 10.8 L/s
TOTAL PEAK FLOW TO CISTERN = 27.7 L/s
MAX 100-YR CISTERN RELEASE RATE = 12.2 L/s
CISTERN VOLUME REQUIRED = 10 m³
SLUMP PUMP REQUIRED TO DISCHARGE INTERNAL STORM SEWER AND FOUNDATION DRAIN. SLUMP PUMP REQUIRED FOR PARKADE LEVEL 1. REFER TO MECHANICAL DRAWINGS FOR DETAILS.
PROPOSED BUILDING TO BE EQUIPPED WITH PRESSURE REDUCING VALVES AS PER THE ONTARIO BUILDING CODE.

SCHEDULE OF ROOF RELEASE RATES						
DRAINAGE AREA ID	DRAIN TYPE	# DRAINS	2YR HEAD (m)	100 YEAR HEAD (m)	2YR RELEASE RATE (L/s)	100 YEAR RELEASE RATE (L/s)
BLDG	WATTS R1 00 ACCUTROL (23% OPEN)	12	0.08	0.14	8.8	10.8

Copyright Reserved

The Contractor shall verify and be responsible for all dimensions. DO NOT scale the drawings - any errors or omissions shall be reported to Stantec without delay.
The Copyrights to all designs and drawings are the property of Stantec. Reproduction or use for any purpose other than that authorized by Stantec is forbidden.

Legend

- PROPOSED SILT FENCE BOUNDARY AS PER OPSD 219.110
- PROPOSED MUD MAT LOCATION
- PROPOSED CATCH BASIN PROTECTION AS PER DETAIL
- EXISTING STORM MANHOLE
- PROPOSED SANITARY MANHOLE
- EXISTING SANITARY MANHOLE
- EXISTING CATCH BASIN

Notes

Best Management Practices

CONTRACTOR TO PROVIDE EROSION AND SEDIMENT CONTROLS (BEST MANAGEMENT PRACTICES) DURING CONSTRUCTION OF THIS PROJECT.

EROSION MUST BE MINIMIZED AND SEDIMENTS MUST BE REMOVED FROM CONSTRUCTION SITE RUN-OFF IN ORDER TO PROTECT DOWNSTREAM AREAS. DURING ALL CONSTRUCTION, EROSION AND SEDIMENTATION SHOULD BE CONTROLLED BY THE FOLLOWING TECHNIQUES.

1. LIMIT THE EXTENT OF EXPOSED SOILS AT ANY GIVEN TIME.
2. REVEGETATE EXPOSED AREAS AND SLOPES AS SOON AS POSSIBLE.
3. MINIMIZE AREA TO BE CLEARED AND GRUBBED.
4. PROTECT EXPOSED SLOPES WITH PLASTIC OR SYNTHETIC MULCHES.
5. INSTALL FILTER CLOTH BETWEEN FRAME AND COVER ON ALL PROPOSED CATCH BASINS AND CATCH BASIN MANHOLES AND ON ALL EXISTING CATCH BASINS THAT WILL RECEIVE RUN-OFF FROM THE SITE.
6. A SILT FENCE SHALL BE INSTALLED AROUND THE PERIMETER OF ALL AND ANY STOCKPILES OF MATERIAL TO BE USED OR REMOVED FROM SITE (LOCATION TO BE DETERMINED).
7. A VISUAL INSPECTION SHALL BE DONE DAILY ON SEDIMENT CONTROL MEASURES AND CLEANED OF ANY ACCUMULATED SILT AS REQUIRED. THE DEPOSITS WILL BE DISPOSED OFF SITE AS PER THE REQUIREMENTS OF THE CONTRACT.
8. SEDIMENT CONTROL BARRIERS MAY ONLY BE REMOVED TEMPORARILY WITH APPROVAL OF CONTRACT ADMINISTRATOR TO ACCOMMODATE CONSTRUCTION OPERATIONS. ALL AFFECTED BARRIERS MUST BE REINSTATED AT NIGHT WHEN CONSTRUCTION IS COMPLETED. NO REMOVAL WILL OCCUR IF THERE IS A SIGNIFICANT RAINFALL EVENT ANTICIPATED (>10mm) UNLESS A NEW DEVICE HAS BEEN INSTALLED TO PROTECT THE EXISTING STORM AND SANITARY SEWER SYSTEMS.
9. NO REFUELING OR CLEANING OF EQUIPMENT IS PERMITTED NEAR ANY EXISTING WATERWAY.
10. CONTRACTOR SHALL REMOVE SEDIMENT CONTROL MEASURES WHEN, IN THE OPINION OF THE CONTRACT ADMINISTRATOR, THE MEASURE(S) IS NO LONGER REQUIRED. NO CONTROL MEASURES SHALL BE PERMANENTLY REMOVED WITHOUT PRIOR WRITTEN AUTHORIZATION FROM THE CONTRACT ADMINISTRATOR.
11. THE CONTRACTOR SHALL PERIODICALLY, OR WHEN REQUESTED BY THE CONTRACT ADMINISTRATOR, CLEAN OUT ACCUMULATED SEDIMENTS AS REQUIRED.
12. THE CONTRACTOR SHALL IMMEDIATELY REPORT TO THE ENGINEER ANY ACCIDENTAL DISCHARGES OF SEDIMENT MATERIAL INTO THE WATERCOURSE. APPROPRIATE RESPONSE MEASURES, INCLUDING ANY REPAIRS TO EXISTING CONTROL MEASURES OR THE IMPLEMENTATION OF ADDITIONAL CONTROL MEASURES, SHALL BE CARRIED OUT BY THE CONTRACTOR WITHOUT DELAY.
13. CONTRACTOR SHALL INSTALL MUD MATS AT ALL ENTRANCES TO THE SITE.
14. CONTRACTOR IS RESPONSIBLE TO KEEP THE ROADS FREE AND CLEAR OF MUD AND DEBRIS.

Rev	By	Appd.	YY.MM.DD
4	WJ	DT	24.09.18
3	WJ	DT	24.08.13
2	WJ	DT	24.05.27
1	TM	DT	23.06.07

Revision

File Name:	TM	KK	TM	23.03.15
160401786 DB.dwg	Dwn.	Chkd.	Dgn.	YY.MM.DD

Permit-Seal

Client/Project
Project Studio
47 BEECHWOOD AVENUE
OTTAWA, ONTARIO, CANADA

Title
EROSION CONTROL
AND DETAILS SHEET

Project No.	Scale
160401786	

Drawing No.	Sheet	Revision
EC-1	6 of 6	4

