

Engineering

Land/Site
Development

Municipal
Infrastructure

Environmental/
Water Resources

Traffic/
Transportation

Recreational

Planning

Land/Site
Development

Planning Application
Management

Municipal Planning

Urban Design

Expert Witness
(LPAT)

Wireless Industry

Landscape Architecture

Streetscapes &
Public Amenities

Open Space, Parks &
Recreation

Community &
Residential

Commercial &
Institutional

Environmental
Restoration



PROPOSED RESIDENTIAL DEVELOPMENT 3317 NAVAN ROAD

Development Servicing Study and
Stormwater Management Report

**PROPOSED RESIDENTIAL DEVELOPMENT
3317 NAVAN ROAD**

**DEVELOPMENT SERVICING STUDY AND
STORMWATER MANAGEMENT REPORT**

Prepared by:

NOVATECH

Suite 200, 240 Michael Cowpland Drive
Kanata, Ontario
K2M 1P6

June 8, 2023

Revised: November 13, 2023

Revised: February 14, 2024

Ref: R-2023-024

Novatech File No. 118076

February 14, 2024

2628576 Ontario Inc.
231 Brittany Drive, Suite D
Ottawa, Ontario
K1K 0R8

Attention: Lalit Aggarwal

**Re: Development Servicing Study and Stormwater Management Report
Proposed Residential Development
3317 Navan Road, Ottawa, ON
Novatech File No.: 118076**

Enclosed is a copy of the revised 'Development Servicing Study and Stormwater Management Report' for the proposed residential development of 3317 Navan Road properties in the City of Ottawa. This report addresses the approach to site servicing and stormwater management, and it is being submitted in support of concurrent Zoning By-law Amendment and Site Plan Control Applications.

Please contact the undersigned, should you have any questions or require additional information.

Yours truly,

NOVATECH



François Thauvette, P. Eng.
Senior Project Manager | Land Development & Public-Sector Engineering

cc: John Sevigny/Derek Unrau (City of Ottawa)
David Renfroe (Renfroe Land Management)
Pierre Proulx (Rossman Architecture)

TABLE OF CONTENTS

1.0	INTRODUCTION	1
1.1	Location and Site Description	1
1.2	Pre-Consultation Information	1
1.3	Proposed Development.....	2
1.4	Reference Material.....	2
2.0	SITE SERVICING.....	2
2.1	Sanitary Sewage	2
2.2	Water for Domestic Use and Fire Protection	3
2.2.1	Water Demands and Watermain Analysis	3
2.3	Storm Drainage and Stormwater Management.....	6
2.3.1	Stormwater Management Criteria and Objectives	7
2.3.2	Pre-Development Conditions and Allowable Release Rate	7
2.3.3	Post-Development Conditions	7
2.3.3.1	Area A-1 – Uncontrolled Direct Runoff.....	8
2.3.3.2	Area R-1 – Controlled Flow from Building A Roof.....	8
2.3.3.3	Area R-2 – Controlled Flow from Building B Roof.....	8
2.3.3.4	Area R-3 – Controlled Flow from Building C Roof.....	9
2.3.3.5	Area A-2 – Controlled Flow from SWM Pond	10
2.3.3.6	Area A-3 – Uncontrolled Garage Ramp Flows	10
2.3.3.7	Summary of Post- Development Flows	11
2.3.3.8	Stormwater Quality Control.....	11
3.0	SITE GRADING	12
4.0	GEOTECHNICAL INVESTIGATIONS.....	12
5.0	EROSION AND SEDIMENT CONTROL	12
6.0	CONCLUSION	14

LIST OF FIGURES

Figure 1 Aerial Plan

LIST OF APPENDICES

Appendix A: Project Correspondence

Appendix B: Development Servicing Study Checklist

Appendix C: Sanitary Sewage Calculations

Appendix D: Water Demands, FUS Calculations, Hydrant Sketch, Watermain Boundary Conditions, Schematic of the Hydraulic Model and Modelling Results

Appendix E: IDF Curves, SWM Calculations

Appendix F: Control Flow Roof Drain Information

Appendix G: Stormwater Quality Treatment Unit Information

Appendix H: Engineering Drawings

LIST OF PLANS

General Plan of Services (118076-GP)

Grading and Erosion and Sediment Control Plan (118076-GR)

Pre-Development Storm Drainage Area Plan (118076-STM1)

Post-Development Storm Drainage Area Plan (118076-STM2)

1.0 INTRODUCTION

Novatech has been retained by 2628576 Ontario Inc. to complete the site servicing, grading, and stormwater management design for the proposed residential development. This report is being submitted in support of concurrent Zoning By-Law Amendment and Site Plan Control applications.

1.1 Location and Site Description

The subject site consists of the property at 3317 Navan Road. This property covers an approximate area of 1.482 hectares (accounting for the Navan Road widening). The existing site is undeveloped. The subject site is surrounded by an existing residential development to the north and east, existing residential property to the west and Navan Road to the south. An existing drainage ditch currently runs through the site, directing stormwater runoff towards the Navan Road ditch. The legal description of the subject site is designated as Part of Lot 4, Concession 4 (Ottawa Front), Geographic Township of Gloucester, City of Ottawa.

Figure 1: Aerial view of the site



1.2 Pre-Consultation Information

A pre-consultation meeting was held with the City of Ottawa on February 14, 2022, at which time the client was advised of the general submission requirements. The Rideau Valley Conservation Authority (RVCA) was also consulted regarding the proposed development and recommended an appropriate stormwater quality target for the Green's Creek Subwatershed. Based on a review of **O. Reg. 525/98: Approval Exemptions**, a Ministry of the Environment, Conservation and Parks (MECP) Environmental Compliance Approval (ECA) will be required as storm flows are being directed to a roadside ditch. Refer to **Appendix A** for a summary of the correspondence related to the proposed development.

1.3 Proposed Development

The proposed development will consist of three (3) four-storey residential apartment buildings, with shared surface and underground parking. The proposed residential development will be serviced by the municipal sanitary sewer in Navan Road and municipal watermains in Navan Road and Esselmont Street (currently under construction). Storm drainage will be directed towards the Navan Road roadside ditch as there is currently no storm sewer in Navan Road.

1.4 Reference Material

¹ Geotechnical Investigation Proposed Mid-Rise Apartment Buildings – 3317 Navan Road – (Report No.: PG6582-1, Revision 1), prepared by Paterson Group, dated January 29, 2024.

2.0 SITE SERVICING

The objective of the site servicing design is to provide proper sewage outlets, a suitable domestic water supply and to ensure that appropriate fire protection is provided for the proposed development. The servicing criteria, the expected sewage flows, and the water demands are to conform to the requirements of the City of Ottawa municipal design guidelines for sewer and water distribution systems. Refer to the General Plan of Services (118076-GP) and the subsequent sections of the report for further details.

The City of Ottawa Servicing Study Guidelines for Development Applications requires that a Development Servicing Study Checklist be included in the report to confirm that each applicable item is deemed complete and ready for review by City of Ottawa Infrastructure Approvals. Enclosed in **Appendix B** of the report is a completed checklist.

2.1 Sanitary Sewage

Under post-development conditions the proposed development will be serviced by the existing 600mm dia. concrete sanitary sewer on Navan Road. Based on a review of the Ashcroft Homes - East Urban Community - Sanitary Drainage Plan (SA-3), sanitary sewage flows from the subject site are tributary to sub-catchment area R605-1A. As a result, sanitary flows will be directed towards the existing 200mm dia. sanitary sewer stub that was installed as part of the Navan Road sewer works, immediately to the west of the property. It is anticipated that a drainage agreement will be required with the adjacent property owner.

The City of Ottawa design criteria were used to calculate the theoretical sanitary flows for the proposed development. The following design criteria were taken from the City of Ottawa Sewer Design Guidelines and subsequent Technical Bulletins:

Residential Uses

- Residential Units (1-Bedroom or Studio): 1.4 people per unit
- Residential Units (2-Bedroom): 2.1 people per unit
- Residential Unit (3-Bedroom): 3.1 people per unit
- Average Daily Residential Sewage Flow: 280 L/person/day (ISTB-2018-01)
- Residential Peaking Factor = 3.77 (Harmon Equation)
- Infiltration Allowance: $0.33 \text{ L/s/ha} \times 1.482 \text{ ha site} \times 1/3 = 0.16 \text{ L/s/building}$ (ISTB-2018-01)

Table 1 identifies the theoretical sanitary flows for the proposed commercial development based on the above design criteria.

Table 1: Theoretical Post-Development Sanitary Flows

Proposed Residential Apartment Development	Unit Count	Design Population	Peak Res. Flow (L/s)	Infiltration Allowance (L/s)	Peak Sanitary Flow (L/s)
Building A	55	101	1.23	0.16	1.40
Building B	55	101	1.23	0.16	1.40
Building C	54	99	1.21	0.16	1.37
Total	164	301*	3.67*	0.48*	4.17*

*Represents rounded values

The 200mm dia. PVC sanitary sewer stub, installed as part of the Navan Road sewer works, at a minimum slope of 0.35% has a full flow conveyance capacity of 20.2 L/s and should have enough capacity to convey the theoretical sanitary flows from the proposed development. Refer to **Appendix C** for detailed sanitary sewage calculations.

2.2 Water for Domestic Use and Fire Protection

Under post-development conditions, the proposed development will be serviced by the 305mm ductile iron municipal watermain in Navan Road and the 305mm PVC watermain in Esselmont Street (currently under construction). All three apartment buildings will be fully-sprinklered and constructed using wood frame materials. The respective building fire department (siamese) connections will each be located within 45m of one of the nearby private on-site fire hydrants. The water meters will be located within the water entry rooms of the respective buildings, with remote meters on the exterior face of the buildings. The subject site is located within the City of Ottawa 2E watermain pressure zone.

To determine if the existing 305mm dia. municipal watermains have adequate capacity to accommodate the proposed development a hydraulic analysis was completed based on boundary conditions provided by the City of Ottawa.

2.2.1 Water Demands and Watermain Analysis

The theoretical water demands for the proposed development are based on the design criteria from the City of Ottawa Water Distribution Guidelines. The Fire Underwriters Survey (FUS) method was used to calculate the fire flows based on general assumptions and information provided by the architect. The water demands are calculated based on the following criteria:

- Residential Units (1-Bedroom or Studio): 1.4 people per unit
- Residential Units (2-Bedroom): 2.1 people per unit
- Residential Units (3-Bedroom): 3.1 people per unit
- Average Daily Residential Water Demand: 280 L/person/day (ISTB-2021-03)
- Maximum Day Demand Peaking Factor = 2.5 x Avg. Day Demand (City Water Table 4.2)
- Peak Hour Demand Peaking Factor = 2.2 x Max. Day Demand (City Water Table 4.2)

Table 2 identifies the theoretical domestic water demands and fire flow requirements for the development based on the above design criteria.

Table 2: Theoretical Water Demand for Proposed Development

Residential Building	Unit Count	Design Population	Avg. Day Demand (L/s)	Max. Day Demand (L/s)	Peak Hour Demand (L/s)	Fire Flow (L/s)
Building A	55	101	0.33	0.82	1.80	283
Building B	55	101	0.33	0.82	1.80	250
Building C	54	99	0.32	0.80	1.76	217
Total for Site	164	301*	0.98*	2.44*	5.36*	283 Max

*Represents rounded values

The fire flow requirements were calculated using the Fire Underwriters Survey (FUS). Based on information provided by the architect, the fire flow requirements for the buildings are expected to be in the order of 217-283 L/s, including both sprinkler system and hose allowances in accordance with the OBC and NFPA 13. The sprinkler system will be designed by the fire protection (sprinkler) contractor as this process involves detailed hydraulic calculations based on building layout, pipe runs, head losses, fire pump requirements, etc. Refer to **Appendix D** for detailed calculations and correspondence from the City of Ottawa.

As discussed with the City of Ottawa, a multi-hydrant approach to firefighting is anticipated to be required to achieve the maximum fire flow requirements on-site. In addition to the nearby existing hydrants, three new private fire hydrants are being proposed on-site. Based on the City of Ottawa Technical Bulletin ISTB-2018-02, Class AA (blue bonnet) hydrants within 75m have a maximum capacity 95 L/s while hydrants between 75m and 150m have a maximum capacity 63 L/s (at a pressure of 20 PSI). The combined maximum flow from the various nearby fire hydrants should exceed the Max Day + Fire Flow requirement of the proposed development. This multi-hydrant approach to firefighting is in accordance with the City of Ottawa Technical Bulletin ISTB-2018-02. **Table 2.1** summarizes the total theoretical combined fire flow available from the nearby fire hydrants and compares it to the fire flow demands based on FUS calculations.

Table 2.1: Theoretical Fire Protection Summary Table

Building	Fire Flow Demand (L/s)	Fire Hydrant(s) within 75m (~ 95 L/s each)	Fire Hydrant(s) within 150m (~ 63 L/s each)	Theoretical Combined Available Fire Flow (L/s)
Building A	283	3	1	>283
Building B	250	3	2	
Building C	217	3	2	

Preliminary domestic water demands, and fire flow requirements were provided to the City of Ottawa. **Table 2.2** summarizes preliminary hydraulic analysis results based on municipal watermain boundary conditions provided by the City of Ottawa.

Table 2.2: Hydraulic Boundary Conditions Provided by the City

Municipal Watermain Boundary Condition	Boundary Condition	Normal Operating Pressure Range (psi)	Anticipated WM Pressure (psi)*
Connection #1 – 305mm dia. PVC WM in Esselmont Street			
Minimum HGL (Peak Hour Demand)	126.6 m	40 psi (min.)	~ 57.0 psi
Maximum HGL (Average Day Demand)	130.6 m	50 - 70 psi	~ 62.7 psi
HGL (Max Day + 166.67 L/s Fire Flow)	123.8 m	20 psi (min.)	~ 52.9 psi
HGL (Max Day + 350 L/s Fire Flow)	109.8 m	20 psi (min.)	~ 33.1 psi
Connection #2 – 305mm dia. DI WM in Navan Road			
Minimum HGL (Peak Hour Demand)	126.6 m	40 psi (min.)	~ 57.0 psi
Maximum HGL (Average Day Demand)	130.6 m	50 - 70 psi	~ 62.7 psi
HGL (Max Day + 166.67 L/s Fire Flow)	125.9 m	20 psi (min.)	~ 56.0 psi
HGL (Max Day + 350 L/s Fire Flow)	118.3 m	20 psi (min.)	~ 45.2 psi

*Based on an approximate roadway elevation of 86.6m in Esselmont Street and an elevation of approximately 86.5m in Navan Road at the connection points. Design pressure = (HGL – watermain elevation) x 1.42197 PSI/m.

The following design criteria were taken from Section 4.2.2 – ‘Watermain Pressure and Demand Objectives’ of the City of Ottawa Design Guidelines for Water Distribution:

- Normal operating pressures are to range between 345 kPa (50 psi) and 483 kPa (70 psi) under Average Day demands.
- Minimum system pressures are to be 276 kPa (40 psi) under Peak Hour demands.
- Minimum system pressures are to be 140 kPa (20 psi) under Max Day + Fire Flow demands.

The hydraulic model EPANET was used to analyzing the performance of the proposed watermain configuration for three (3) theoretical conditions:

- Peak Hour Demand
- Maximum HGL
- Maximum Day + Fire Flow Demand

A schematic representation of the hydraulic network depicts the node and pipe numbers used in the model. The model is based on hydraulic boundary conditions provided by the City of Ottawa. **Tables 2.3, 2.4, and 2.5** summarize the hydraulic model results. The values demonstrate that fire flow conditions for the buildings can be met. Refer to **Appendix D** for City of Ottawa boundary conditions, the hydraulic modeling schematic and modeling results.

Table 2.3: Peak Hour Demand

Operating Condition	Minimum System Pressure	Maximum System Pressure
Peak Hour demand of 1.8 L/s at J21 (Bldg A), 1.8 L/s at J23 (Bldg B) and 1.8 L/s at J20 (Bldg C).	Minimum system pressure of 412.0 kPa (59.8 psi) is available at Node J23 (Bldg B)	Maximum system pressure 418.9 kPa (60.7 psi) is available at Nodes J4 and J22 (on-site watermain near Esselmont Street connection)

Table 2.4: Maximum HGL

Operating Condition	Minimum System Pressure	Maximum System Pressure
Average Day demand of 0.3 L/s at J21 (Bldg A), 0.3 L/s at J23 (Bldg B) and 0.3 L/s at J20 (Bldg C).	Minimum system pressure of 451.3 kPa (65.4 psi) is available at Node J23 (Bldg B)	Maximum system pressure 458.1 kPa (66.4 psi) is available at Nodes J4 and J22 (on-site watermain near Esselmont Street connection)

Table 2.5: Maximum Day + Fire Flow Demand

Operating Condition	Minimum System Pressure	Maximum System Pressure
Max Day demand of 0.8 L/s at J21 (Bldg A), 0.8 L/s at J23 (Bldg B) and 0.8 L/s at J20 (Bldg C). Demand of 95 L/s at Nodes J11, J14, J19 (on-site hydrants)	Minimum system pressure of 266.2 kPa (38.6psi) is available at Node J14 (on-site Hydrant)	Maximum system pressure 330.9 kPa (48.0 psi) is available at Node J9 (on-site watermain)

*Based on worst case scenario at Building A (FUS fire flow of 283 L/s). Buildings B and C have fire flows less than 283 L/s and thus, should meet the minimum pressure requirements.

The hydraulic analysis indicates that the municipal watermain and private on-site watermain will provide adequate water and system pressures during 'Peak Hour' and 'Max Day + Fire Flow' conditions. Pressure reducing valves will not be required as system pressures are not expected to exceed 80 psi during any of the conditions shown in the tables above. Refer to **Appendix D** for detailed calculations and correspondence from the City of Ottawa.

2.3 Storm Drainage and Stormwater Management

Under post-development conditions, the proposed development will be serviced by an on-site storm sewer system and dry pond located in the southeast corner of the property. Site flows from the building roofs, paved parking area and a portion of the landscaped area will be treated prior to being directed to the roadside ditch on the North side of Navan Road, while runoff from the remainder of the landscaped areas will sheet drain uncontrolled towards the existing roadside ditch. The approach for the stormwater management design for the site is discussed in the subsequent sections of the report.

2.3.1 Stormwater Management Criteria and Objectives

The stormwater management (SWM) criteria have been provided during pre-consultation meetings with the City of Ottawa and the RVCA. The SWM criteria and objectives are as follows:

- Maintain existing drainage patterns and direct site flows to the roadside ditch along Navan Road.
- Provide a dual drainage system (i.e., minor system and emergency overland flow route for events exceeding the 100-year design storm).
- Control post-development storm flows to the lesser of 85 L/s/ha or pre-development storm flows, using a runoff coefficient equivalent to existing conditions.
- Ensure that no surface ponding will occur on the paved surfaces (parking stalls and drive aisles) during the 2-year storm event.
- Provide on-site water quality control equivalent to an 'Enhanced' Level of Protection (i.e., minimum 80% TSS removal) as recommended by the RVCA prior to releasing flows from the site's paved areas.
- Provide guidelines to ensure that site preparation and construction is in accordance with the current Best Management Practices for Erosion and Sediment Control.

Refer to **Appendix A** for correspondence from the City of Ottawa and RVCA.

2.3.2 Pre-Development Conditions and Allowable Release Rate

The uncontrolled pre-development flows from the 1.482 ha site have been calculated using the Rational Method and are summarized in **Table 3**.

Table 3: Pre-Development (Allowable) Release Rates Summary Table

Storm Event	Runoff Coefficient	Time of Concentration (min)	Area (ha)	Storm Intensity (mm/hr)	Pre-Dev. Flow Rates (L/s)
2-Year	0.20 - 0.25	10	1.482	76.8	63.3
5-Year				104.2	85.9
100-Year				178.6	184.0

Since the pre-development flows are less than the values calculated using 85 L/s/ha, the pre-development release rates are the allowable release rates. Refer to **Appendix E** for detailed calculations.

2.3.3 Post-Development Conditions

Stormwater runoff from the proposed site will be a combination of controlled flow and uncontrolled direct runoff from landscaped area. Flow from the building roofs will be attenuated using control flow roof drains, while stormwater runoff from the paved parking areas, drive aisles, patios and a portion of the landscaped areas will be directed to the on-site dry pond and attenuated by an inlet control device (ICD) installed within the downstream storm sewer system. Flows will be controlled for storms up to and including the 100-year design event and all site flows will be directed to the existing ditch along the North side of Navan Road. Refer to the enclosed Post-Development Storm Drainage Area Plan (118076-STM2) for sub-catchment areas.

2.3.3.1 Area A-1 – Uncontrolled Direct Runoff

The uncontrolled post-development flow from this sub-catchment area was calculated using the Rational Method to be approximately 26.5 L/s during the 2-year design event, 35.9 L/s during the 5-year design event and 71.9 L/s during the 100-year design event. Refer to **Appendix E** for detailed SWM calculations. Direct runoff from the landscaped areas, sidewalks and patios is considered clean and will therefore not require water quality treatment prior to draining into the Navan roadside ditch.

2.3.3.2 Area R-1 – Controlled Flow from Building A Roof

The post-development flow from this sub-catchment area will be attenuated using Watts adjustable ‘Accutrol’ control flow roof drains (model number RD-100-A-ADJ: all set to have 1/4 exposed weirs) prior to being directed to the surface on the north side of the building.

Table 3.1 summarizes the post-development design flows from this sub-catchment area as well as the type of roof drains, the maximum anticipated ponding depths, storage volumes required and storage volumes provided for the 2-year, 5-year and 100-year design events.

Table 3.1: Building A - Controlled Flow Roof Drains

Roof Drain ID & Drainage Area per Drain (ha)	Number of Roof Drains	Watts Roof Drain Model ID (Weir Opening)	Controlled Flow per Drain (L/s)			Approximate Ponding Depth Above Drains (m)			Storage Volume Required (m ³)			Max. Storage Available (m ³)
			2 Yr	5 Yr	100 Yr	2 Yr	5 Yr	100 Yr	2 Yr	5 Yr	100 Yr	
RD 1A, 4A (0.034 ha)	2	RD-100-A-ADJ (1/4 Exposed)	0.72	0.82	0.91	0.10	0.11	0.14	5.0	7.2	16.1	17.9
RD 2A, 3A (0.032 ha)	2	RD-100-A-ADJ (1/4 Exposed)	0.72	0.82	0.91	0.10	0.11	0.14	4.7	6.7	15.0	17.0
Total Roof (0.132ha)*	4	-	2.9*	3.3*	3.6*	-	-	-	19.4*	27.8*	62.2*	69.8*

*Table represents rounded values

Refer to **Appendix E** for detailed SWM calculations and **Appendix F** for the control flow roof drain information. As indicated in the table above, the building roof will provide sufficient storage for the 2-year, 5-year and 100-year design events.

2.3.3.3 Area R-2 – Controlled Flow from Building B Roof

The post-development flow from this sub-catchment area will be attenuated using Watts adjustable ‘Accutrol’ control flow roof drains (model number RD-100-A-ADJ: all set to have 1/4 exposed weirs) prior to being directed to the surface on the north side of the building.

Table 3.2 summarizes the post-development design flows from this sub-catchment area as well as the type of roof drains, the maximum anticipated ponding depths, storage volumes required and storage volumes provided for the 2-year, 5-year and 100-year design events.

Table 3.2: Building B - Controlled Flow Roof Drains

Roof Drain ID & Drainage Area per Drain (ha)	Number of Roof Drains	Watts Roof Drain Model ID (Weir Opening)	Controlled Flow per Drain (L/s)			Approximate Ponding Depth Above Drains (m)			Storage Volume Required (m ³)			Max. Storage Available (m ³)
			2 Yr	5 Yr	100 Yr	2 Yr	5 Yr	100 Yr	2 Yr	5 Yr	100 Yr	
RD 1B, 4B (0.034 ha)	2	RD-100-A-ADJ (1/4 Exposed)	0.72	0.82	0.91	0.10	0.11	0.14	5.0	7.2	16.1	17.9
RD 2B, 3B (0.032 ha)	2	RD-100-A-ADJ (1/4 Exposed)	0.72	0.82	0.91	0.10	0.11	0.14	4.7	6.7	15.0	17.0
Total Roof (0.132ha)*	4	-	2.9*	3.3*	3.6*	-	-	-	19.4*	27.8*	62.2*	69.8*

*Table represents rounded values

Refer to **Appendix E** for detailed SWM calculations and **Appendix F** for the control flow roof drain information. As indicated in the table above, the building roof will provide sufficient storage for the 2-year, 5-year and 100-year design events.

2.3.3.4 Area R-3 – Controlled Flow from Building C Roof

The post-development flow from this sub-catchment area will be attenuated using Watts adjustable 'Accutrol' control flow roof drains (model number RD-100-A-ADJ: all set to have 1/4 exposed weirs) prior to being directed to the surface on the north side of the building.

Table 3.3 summarizes the post-development design flows from this sub-catchment area as well as the type of roof drains, the maximum anticipated ponding depths, storage volumes required and storage volumes provided for the 2-year, 5-year and 100-year design events.

Table 3.3: Building C - Controlled Flow Roof Drains

Roof Drain ID & Drainage Area per Drain (ha)	Number of Roof Drains	Watts Roof Drain Model ID (Weir Opening)	Controlled Flow per Drain (L/s)			Approximate Ponding Depth Above Drains (m)			Storage Volume Required (m ³)			Max. Storage Available (m ³)
			2 Yr	5 Yr	100 Yr	2 Yr	5 Yr	100 Yr	2 Yr	5 Yr	100 Yr	
RD 1C, 4C (0.034 ha)	2	RD-100-A-ADJ (1/4 Exposed)	0.72	0.82	0.91	0.10	0.11	0.14	5.0	7.2	16.1	17.9
RD 2C, 3C (0.032 ha)	2	RD-100-A-ADJ (1/4 Exposed)	0.72	0.82	0.91	0.10	0.11	0.14	4.7	6.7	15.0	17.0
RD 5C (0.005 ha)	1	RD-100-A-ADJ (1/4 Exposed)	0.66	0.69	0.82	0.06	0.07	0.11	0.2	0.4	1.2	2.8
Total Roof (0.137ha)*	5	-	3.5*	4.0*	4.5*	-	-	-	19.6*	28.2*	63.4*	72.6*

*Table represents rounded values

Refer to **Appendix E** for detailed SWM calculations and **Appendix F** for the control flow roof drain information. As indicated in the table above, the building roof will provide sufficient storage for the 2-year, 5-year and 100-year design events.

2.3.3.5 Area A-2 – Controlled Flow from SWM Pond

The post-development flow from this sub-catchment area will be attenuated by an ICD installed in the outlet pipe of CBMH 104. Stormwater runoff from this sub-catchment area will be temporarily stored underground within the storm sewer system and in the proposed dry pond prior to being discharged into the downstream storm sewer system before being discharged into the roadside ditch.

Table 3.4 summarizes the post-development design flow from this sub-catchment area as well as the ICD specifications, the anticipated ponding elevations, storage volumes required and storage volume provided for the 2-year, 5-year and the 100-year design events.

Table 3.4: Stormwater Flows, ICD & Surface Storage

Design Event	Controlled Site Flows from Area A-2					
	ICD Type	Peak Flow	Ponding Depth/Elev.	~Average Flow (50% Qpeak)**	Storage Vol. Required*	Max Storage Provided
2-Year	118mm dia. Orifice Plug Type ICD	13.5 L/s	0.20 m (84.82 m)	6.8 L/s	84.8 m ³	591.7 m ³
5-Year		16.8 L/s	0.31 m (84.93 m)	8.4 L/s	116.4 m ³	
100-Year		24.3 L/s	0.65 m (85.27 m)	12.2 L/s	242.9 m ³	
100-Year (+20%)		26.7 L/s	0.79 m (85.41 m)	13.4 L/s	299.2 m ³	

*Storage volumes are based on the 50% Qpeak flow rates, which generally represents the average flow.

**Represents rounded values.

Refer to **Appendix E** for detailed SWM calculations.

As indicated in the table above, this sub-catchment area will provide sufficient storage for the 2-year, 5-year, 100-year, as well as the 100-year + 20% design events. Per City of Ottawa Design Guidelines, the site has been designed to ensure that no stormwater will pond on the paved drive aisles and/or parking stalls during the 2-year storm event. Furthermore, the site grading design will ensure that surface ponding depths will not touch the building envelope or lowest building openings during the 100-year+20% stress test. During a large storm, exceeding the 100-year design event, stormwater within the paved areas and the east portion of the site (i.e., grassed areas) could potentially overflow towards the existing roadside ditch along Navan Road.

2.3.3.6 Area A-3 – Uncontrolled Garage Ramp Flows

Stormwater runoff from the ramp providing access to the underground parking level will be directed to a trench drain. Since the trench drain is lower than the Navan roadside ditch, flow from the trench drain will need to be pumped up to the surface via the internal plumbing and building storm service outlet. The uncontrolled post-development flow from this sub-catchment area was calculated using the Rational Method to be approximately 3.7 L/s during the 2-year design event, 5.0 L/s during the 5-year design event and 9.4 L/s during the 100-year design event. Refer to **Appendix E** for detailed SWM calculations.

2.3.3.7 Summary of Post- Development Flows

Table 3.5 compares the post-development site flows from the proposed development to the uncontrolled pre-development flows (i.e., the maximum allowable release rates) during the 2-year, 5-year, and the 100-year design events.

Table 3.5: Stormwater Flow Comparison Table

Design Event	Pre-Dev. Conditions	Drainage Areas A-1 to A-3 & R-1 to R-3							
		Post-Development Conditions							
	Ex. Site Flows (L/s)	A-1 Flow (L/s)	A-2 Flow (L/s)	A-3 Flow (L/s)	R-1 Flow (L/s)	R-2 Flow (L/s)	R-3 Flow (L/s)	Total Flow (L/s)*	Reduction in Flow (L/s or %)**
2-Yr	63.3	26.5	13.5	3.7	2.9	2.9	3.5	52.9	10.4 or 16%
5-Yr	85.9	35.9	16.8	5.0	3.3	3.3	4.0	68.2	17.7 or 12%
100-Yr	184.0	71.9	24.3	9.4	3.6	3.6	4.5	117.3	66.7 or 36%

*Represents rounded values

**Reduced flow compared to pre-development uncontrolled conditions.

As indicated above, the 2-year, 5-year and 100-year post-development flows will be less than the uncontrolled pre-development flows for the site. Furthermore, this represents a reduction in total site flow rate when compared to the respective pre-development conditions, especially during the 100-year storm event. Refer to **Appendix E** for detailed SWM calculations. Should a storm sewer be constructed in Navan Road in the future, the outlet pipe from CBMH106, currently discharging into the roadside ditch, would be extended, and connected into the new storm sewer in Navan Road.

2.3.3.8 Stormwater Quality Control

The subject site is located within the jurisdiction of the Rideau Valley Conservation Authority (RVCA). Based on correspondence with the RVCA, it was recommended that surface parking lots and drive aisles meet an 'Enhanced' Level of Protection (i.e.: 80% TSS removal) as an appropriate water quality target for the Green's Creek sub-watershed. Landscaped areas and roof tops are considered clean for the purposes of water quality and aquatic habitat protection.

To achieve this level of quality control protection, a new oil-grit separator unit (CDS Model PMSU 2015-4-C) will be installed as part of the on-site storm sewer system (upstream of dry pond). Stormwater runoff collected by the on-site storm sewer system (0.572 ha tributary area) will be directed through the proposed treatment unit. The contributing area includes the proposed paved parking lots, drive aisle, patios, and a portion of the landscaped areas, excluding the dry pond.

As stated above, the proposed oil-grit separator has been sized to provide an 'Enhanced' Level of water quality treatment prior to discharging the stormwater into the existing roadside ditch. Echelon Environmental and Contech Engineering Solutions LLC. have modeled and analyzed the tributary area to provide a CDS unit capable of meeting the TSS removal requirements. The model parameters for the TSS removal were based on historical rainfall data for Ottawa from Canadian Station 6105976. It was determined that a CDS Model PMSU 2015-4-C will exceed the target removal rate, providing a net annual 82.4% TSS removal. The CDS unit has a treatment capacity of approximately 20 L/s, a sediment storage capacity of 0.838 m³; an oil storage capacity of 232 L and will treat a net annual volume of approximately 97.6% for the tributary area. The on-site catchbasins and storm manhole structures will be equipped with sumps to promote additional settling of sediment.

Maintenance and Monitoring of the Storm Sewer and Stormwater Management Systems

It is recommended that the client implement a maintenance and monitoring program for both the on-site storm sewers and the stormwater management systems: The storm drainage system should be inspected routinely (at least annually); the ICD should be inspected to ensure it is free of debris; and the oil-grit separator should be inspected at regular intervals and maintained when necessary to ensure optimum performance. Refer to **Appendix G** for the CDS unit design parameters, sizing analysis, operation, design, performance, and maintenance summary parameters as well as the annual TSS removal efficiency data.

3.0 SITE GRADING

The existing site generally slopes from east to west towards the existing ditches running across the site and along the west property line. The existing ditch running from the northeast corner of the site to the southwest corner of the site will be filled while the existing ditch running along the west property line will be maintained as it captures minimal flow from the adjacent property. The finished floor elevations of all three proposed buildings have been set at 87.20m to accommodate the proposed elevation of the site, provide minimum pipe cover, tie into existing grades along the site perimeter, including Esselmont Street (currently under construction). The site grading design will also provide an emergency overland flow route towards the roadside ditch. A retaining wall has been proposed along the east property line due to the existing grades on the neighboring property. In addition, the grades along the property line east and south of the dry pond have been raised to 86.60m to ensure the major overland flow route is directed towards the Navan roadside ditch as opposed to towards the neighboring private property. Refer to the enclosed Grading and ESC Plan (118076-GR) for details.

4.0 GEOTECHNICAL INVESTIGATIONS

Patterson Group prepared a Geotechnical Investigation Report for the proposed development. Refer to the Geotechnical Report¹ for subsurface conditions, construction recommendations and geotechnical inspection requirements, especially as it relates to the maximum grade raise restrictions and the need for lightweight fill (LWF) around the perimeter of the proposed buildings.

5.0 EROSION AND SEDIMENT CONTROL

To mitigate erosion and to prevent sediment from entering the storm sewer system and downstream ditches, temporary erosion and sediment control measures will be implemented on-site during construction in accordance with the Best Management Practices for Erosion and Sediment Control. This includes the following temporary measures:

- Filter bags will be placed under the grates of nearby catchbasins, manholes and will remain in place until vegetation has been established and construction is completed.
- Silt fencing will be placed per OPSS 577 and OPSD 219.110 along the surrounding construction limits.
- Mud mats will be installed at the site entrance.
- Street sweeping and cleaning will be performed, as required, to suppress dust and to provide safe and clean roadways adjacent to the construction site.
- On-site dewatering is to be directed to a sediment trap and/or gravel splash pad and discharged safely to an approved outlet as directed by the engineer.

The temporary erosion and sediment control measures will be implemented prior to construction and will remain in place during all phases of construction. Regular inspection and maintenance of the erosion control measures will be undertaken.

In addition, the following measures will provide permanent erosion and sediment control on the proposed site:

- A CDS Model PMSU 2015-4-C type Oil/Grit Separator will be installed to provide water quality control prior to releasing stormwater from sub-catchment area A-2.

6.0 CONCLUSION

This report has been prepared in support of concurrent Zoning By-Law Amendment and Site Plan Control applications for the proposed residential development at 3317 Navan Road. The conclusions are as follows:

- The proposed development will be serviced by the municipal watermain in Navan Road and Esselmont Street and the municipal sanitary sewer in Navan Road.
- The residential buildings will be sprinklered and supplied with fire department (siamese) connections. The fire department connections for each building will be located within 45m of at least one of the nearby on-site fire hydrants.

The proposed stormwater design, including both quantity and quality control measures, will ultimately reduce peak flows into the Navan roadside ditch.

- Post-development flow from sub-catchment area A-2 will be controlled by an inlet control device (ICD) installed within the on-site storm sewer system, while flows from the building roofs area R-1, R-2 and R-3 will be attenuated by control flow roof drains.
- The total post-development flow from the subject site will be approximately 52.9 L/s during the 2-year design event, 68.2 L/s during the 5-year event and 117.3 L/s during the 100-year event, all less than the respective uncontrolled pre-development (allowable) flows. The post-development conditions represent a reduction when compared to the respective pre-development conditions, especially during the 100-year storm event.
- Erosion and sediment controls will be provided both during construction and on a permanent basis. An oil / grit separator unit (CDS Model PMSU 2015-4-C) will provide an 'Enhanced' Level of water quality control for the controlled flows from the site discharging into the existing roadside ditch along Navan Road.
- Regular inspection and maintenance of the storm sewer system, including the inlet control devices, control flow roof drains and the water quality treatment unit is recommended to ensure that the storm drainage system is clean and operational.

It is recommended that the proposed site servicing and stormwater management design be approved for implementation.

NOVATECH

Prepared by:



Chris Visser
Project Coordinator - Land Development

Reviewed by:



François Thauvette, P. Eng.
Senior Project Manager - Land Development

APPENDIX A
Project Correspondence

Good afternoon Adam,

The following summary notes and attachments are provided as a follow-up to the pre-application consultation meeting held on February 14th, 2022.

They are regarding a future site plan control, plan of subdivision, and a zoning by-law amendment application for the development of back-to-back townhouse dwellings, condominium apartment building, underground and surface parking proposed by Novatech, located at 3317 Navan Road. The proposal includes a public street connection between the ends of Glenlivet Avenue (existing) and Esselmont Street (to be constructed). The built form fronting onto the new public street will primarily be 32 units of back-to-back townhouses, which will be partly built on private streets. Additionally, a proposed four storey condominium apartment building is proposed to be located with a total of approximately 62 one- and two-bedroom residential units between the new public street and Navan Road. The remaining lands will be dedicated to parkland to provide amenity space for the residences. There are no public or private vehicular connection to Navan Road.

Also attached is the list of required plans and studies in support of an application for site plan control and condominium approval should your client choose to formally submit one.

The following City staff preliminary comments are based upon the attached information that was made available at the time of the pre-application consultation.

Planning – Comments provided by Steve Belan, RPP, MCIP, Planner II

One additional issue that was not raised at the Pre-consultation meeting was the sites proximity with the landfill facility to the south and southeast. An Impact Assessment of Adjacent Waste Disposal/Former Landfill Site will be required with the ZBA and Draft Plan of Subdivision applications.

- Zoning By-law and Draft Plan of Subdivision applications can be made at the same time to take advantage of multi-application discounts.
- The property is zoned DR at present. A zoning application will be necessary prior to development;
 - The proposed zoning (possibility the R4Z [xxxx]) to permit low-rise development including Towns, Stacked-Towns, Back to back units and low-rise apartments;
 - An exception to this subzone would need to conform to the product that you are proposing.
- We would like the lots and street to be created through a draft plan of subdivision application;
 - There are remnant blocks and lands to the east and west sides of this site that need to be considered when planning this development. Blocks are to be created on the east side to be merged with the remnant blocks to create complete lots and the lands to the west should be incorporated into the development to include a street connection to the north. Let me know if you want me to reach out to Ashcroft. I will attempt to persuade them to talk about collaborating.
- Site Plan Applications can be made after the subdivision application has progress towards registration. The application level will depend on the size of each of the projects as per the Site Plan Control By-law.
 - The site plan agreements will not be able to be registered until the blocks are created through the subdivision with a unique legal description.

- Draft Plan of Condominium – If you are considering the creation of a Condominium on any of the development block(s). You may make an application(s) at the same time as the Site Plan Control application(s). The condo agreement will proceed after the site plan application has been approved.

Urban Design – Comments provided by Selma Hassan, Architect/Urban Designer

- A Design Brief will be required if the applicant submits a Site Plan Application, and / or ZBL application that proposes densities and built form greater than the ground-oriented residential shown in the CDP. A Design Brief Terms of Reference is attached.
- The CDP for the Phase 1 area of the EUC illustrates this land as suitable for low-density residential. This decision was made as, at the time the CDP was completed the available geotechnical information indicated that this land would not support higher densities. Does the current site geotechnical information support the proposed higher density development? The submission needs to discuss this deviation from the CDP.
- Parts of the CDP for the Phase 2 Area of the EUC apply to the entire EUC areas. Specifically:
 - Section 3.1.1.1 and Table 1 of the CDP identify specific requirements for higher density sites and PUDs. These include tree planting requirements and requirements for a communal amenity area that supports “play equipment, seating and trees”. The applicant should review the section and table and ensure that their application meets all of the requirements.
 - Section 3.4 and Table 2 identify tree planting requirements. The CDP requires 1 tree for every two townhomes and 1 tree for every four stacked townhomes. Back-to-back townhomes would have the same requirement as townhomes and apartments would have the same requirements as stacked townhomes. The CDP adds “these planting requirements are in addition to general subdivision and boulevard tree planting requirements. General subdivision and boulevard trees are required on both sides of the frontage of all public streets.” The applicant should ensure that their application meets these requirements.
- I would suggest that there are more efficient ways to lot the site. The applicant could look to the development to the north along Glenlivet Ave. and Galston Private. Two other possibilities are attached to this email. If three apartments are proposed, the applicant should examine removing the private streets and locating parking between the two buildings.
- The applicant should rotate the apartment building so that it is either parallel to the new east-west public street or parallel to Navan Road.
- All proposed plans need to address:
 - Requirements for visitor parking
 - Where snow storage will occur
 - How garbage will be dealt with
 - How vehicles will manoeuvre on private streets (hammerheads or turning circles are required)
 - The CDP requirements noted in #3 above
- The public street is to include sidewalks.
 - As noted by staff in Transportation, a pedestrian walkway should be provided to the existing bus stop on Navan Road.
 - I would suggest that a second pre-consult, when the plan is more fully developed, would ultimately save the applicant time in the overall development review process.

Engineering – Comments provided by William Curry, P. Eng., Senior Engineer

Subdivision Draft Plan

- Functional Servicing Report
- Geotech Report
- Topographical Plan of Survey Plan with a published Bench Mark
- 4 M plan

Detailed Subdivision Design

- Road Cross Sections Plan
- Site Plan
- Topographical Plan of Survey Plan with a published Bench Mark
- Grading & Drainage Plan
- General Plan of Services
- ROW Plan and Profile
- CUP
- Erosion & Sediment Control Plan
- Landscape Plans and TCR
- Design Brief and Stormwater Management Report
- Geotechnical Report
- Modeling

Site Plan Requirements

- Submission Requirements
 - Water Boundary condition requests must include the location of the service and the expected loads required by the proposed development. Please provide the following information:
 - Location of service connections (MAP)
 - Type of development and the amount of fire flow required (as per FUS).
 - Average daily demand: ___ l/s.
 - Maximum daily demand: ___ l/s.
 - Maximum hourly daily demand: ___ l/s.
- Submission Documents:
 - Site Plan
 - Topographical Plan of Survey Plan with a published Bench Mark
 - Grading & Drainage Plan
 - General Plan of Services
 - Erosion & Sediment Control Plan
 - Design Brief and Stormwater Management Report
 - Geotechnical Report
 - Lighting Plan

Design Criteria

- Subdivision Storm: RR is 85 L/s/ha. Store up to 100-year on site. No 2-year ponding in the ROW or on-Site Plans. Permissible ponding of 350mm up to 100-year

- Site Plans: Storm, Post to Pre-85 L/s/ha and at 100-year ponding elevation you must spill to City ROW
- 100-year Spill elevation must be 300mm lower than any building opening (includes ramps)

Minimum Drawing and File Requirements- All Plans

- Plans are to be submitted on standard A1 size (594mm x 841mm) sheets, utilizing an appropriate Metric scale (1:200, 1:250, 1:300, 1:400, or 1:500).
- With all submitted hard copies provide individual PDF of the DWGs and for reports please provide one PDF file of the reports. All PDF documents are to be unlocked and flattened.

Transportation – Comments provided by Neeti Paudel, Transportation Project Manager

- If there are changes to the number of units, please update the screening form and submit to the transportation project manager for review.
- ROW protection on Navan at this location is 37.5m. Ensure this is protected and shown on the draft plan.
- Geometric Road Design (GRD) drawings will be required with the first submission of underground infrastructure and grading drawings. These drawings should include such items as, but is not limited to:
 - Road Signage and Pavement Marking for the subdivision;
 - Intersection control measure at new internal intersections; and
 - Location of depressed curbs and TWSIs;
 - More details can be provided upon request
- Local roads should be designed to operate at 30km/h speed. Include traffic calming measures on roads within the limits of their subdivision to limit vehicular speed to 30 kph and improve pedestrian safety. These measures may include either vertical or horizontal features.
- Corner triangles as per OP Annex 1 - Road Classification and Rights-of-Way at the following locations on the final plan will be required:
 - Local Road to Local Road: 3 metre x 3 metres
- Noise Impact Studies required:
 - Feasibility before draft approval
 - Detailed before registration
 - Road
 - Stationary (if in proximity to neighbouring exposed mechanical equipment) or (if there will be any exposed mechanical equipment due to the proximity to neighbouring noise sensitive land uses)
- As the site proposed is residential, AODA legislation applies for all areas accessible to the public (i.e., outdoor pathways, parking, etc.). Consider using the City's Accessibility Design Standards.
- Turning templates will be required for largest vehicles turnaround on the private streets. Acceptable turning space must be provided.
- There is an existing bus stop on Navan. A pedestrian access/connection to Navan should be considered.
- Please contact Neeti Paudel for any questions respecting the above matters.

Forestry – Comments provided by Mark Richardson, R.P.F., Planning Forester

- A Tree Conservation Report (TCR) must be supplied for review along with the suite of other plans/reports required by the City
 - An approved TCR is a requirement of Site Plan approval.
 - The TCR may be combined with the Landscape Plan provided all information is supplied
- Any removal of privately-owned trees 10cm or larger in diameter, or city-owned trees of any diameter requires a tree permit issued under the Tree Protection Bylaw (Bylaw 2020 – 340); the permit will be based on an approved TCR and made available at or near plan approval.
- The Planning Forester from Planning and Growth Management as well as foresters from Forestry Services will review the submitted TCR
 - If tree removal is required, both municipal and privately-owned trees will be addressed in a single permit issued through the Planning Forester
 - Compensation may be required for city owned trees – if so, it will need to be paid prior to the release of the tree permit
- The TCR must list all trees on site, as well as off-site trees if the CRZ extends into the developed area, by species, diameter and health condition
- Please identify trees by ownership – private onsite, private on adjoining site, city owned, co-owned (trees on a property line)
- If trees are to be removed, the TCR must clearly show where they are, and document the reason they cannot be retained
- All retained trees must be shown and all retained trees within the area impacted by the development process must be protected as per City guidelines available at [Tree Protection Specification](#) or by searching Ottawa.ca
 - The location of tree protection fencing must be shown on a plan
 - Show the critical root zone of the retained trees
 - If excavation will occur within the critical root zone, please show the limits of excavation
- The City encourages the retention of healthy trees; if possible, please seek opportunities for retention of trees that will contribute to the design/function of the site.
- For more information on the process or help with tree retention options, contact Mark Richardson mark.richardson@ottawa.ca or on [City of Ottawa](#)

Landscape Plan tree planting requirements:

- Minimum Setbacks
 - Maintain 1.5m from sidewalk or MUP/cycle track.
 - Maintain 2.5m from curb.
 - Coniferous species require a minimum 4.5m setback from curb, sidewalk or MUP/cycle track/pathway.
 - Maintain 7.5m between large growing trees, and 4m between small growing trees. Park or open space planting should consider 10m spacing.
 - Adhere to Ottawa Hydro's planting guidelines (species and setbacks) when planting around overhead primary conductors.
- Tree Specifications
 - Minimum stock size: 50mm tree caliper for deciduous, 200cm height for coniferous.

- Maximize the use of large deciduous species wherever possible to maximize future canopy coverage.
- Tree planting on city property shall be in accordance with the City of Ottawa’s Tree Planting Specification; and include watering and warranty as described in the specification (can be provided by Forestry Services).
- Plant native trees whenever possible
- No root barriers, dead-man anchor systems, or planters are permitted.
- No tree stakes unless necessary (and only 1 on the prevailing winds side of the tree)
- Hard Surface Planting
 - Curb style planter is highly recommended
 - No grates are to be used and if guards are required, City of Ottawa standard (which can be provided) shall be used.
 - Trees are to be planted at grade
- Soil Volume
 - Please ensure adequate soil volumes are met:

● Tree Type/Size	● Single Tree Soil Volume (m3)	● Multiple Tree Soil Volume (m3/tree)
● Ornamental	● 15	● 9
● Columnar	● 15	● 9
● Small	● 20	● 12
● Medium	● 25	● 15
● Large	● 30	● 18
● Conifer	● 25	● 15

Please note that these soil volumes are not applicable in cases with Sensitive Marine Clay.

- Sensitive Marine Clay
- Please follow the City’s 2017 Tree Planting in Sensitive Marine Clay guidelines

Tree Canopy Cover

- The landscape plan shall show how the proposed tree planting will replace and increase canopy cover on the site over time, to support the City’s 40% urban forest canopy cover target.
- At a site level, efforts shall be made to provide as much canopy cover as possible, through tree planting and tree retention, with an aim of 40% canopy cover at 40 years, as appropriate.
- Indicate on the plan the projected future canopy cover at 40 years for the site.
- For additional information on the following please contact tracy.smith@Ottawa.ca

Parkland – Comments provided by Phil Castro, RPP, MCIP, Parks Planner

- Please refer to the attached “Pre-application consultation Parks and Facilities memo” summarizing parkland dedication considerations as per our discussion.
- For additional information on the following please contact phil.castro@Ottawa.ca

Application Type and Fees:

- The Application Fees (2022 Rates) for the applications are as follows:

Application Type	Planning/ Legal Fee	Initial Engineering Design Review & Inspection Fee (Value of Hard & Soft Servicing > \$300,000)	Conservation Authority Fee (Initial)	Total (**)
Zoning By-law Amendment - Major	\$22,472.80		\$400.00	\$22,872.80
Site Plan Control – New, Complex	\$49,964.88	\$10,000.00	\$1,065.00	\$61,029.88
Plan of Subdivision (251 or more dw. units)	\$98,605.83	\$10,000 (incl. HST) Applies to hard & soft services >\$300,000	\$3,920.00	\$112,525.83

** Normally, each planning application fee would be reduced by 10 per cent if two or more applications are submitted at the same time and for the same lands. This would not apply in this case, given the above-noted exemption. However, Committee of Adjustment applications, Private Road Naming applications, Conservation Authority, and Engineering Design Review and Inspection fees are not subject to this reduction.

- Link to Application for Site Plan Control Approval: <https://ottawa.ca/en/planning-development-and-construction/developing-property/development-application-review-process/development-application-submission/development-applications/site-plan-control>
- Link to Application for Draft Plan of Subdivision Approval: <https://ottawa.ca/en/planning-development-and-construction/developing-property/development-application-review-process/development-application-submission/development-applications/plan-subdivision>
- Link to Application for Zoning By-law Amendment: <https://ottawa.ca/en/planning-development-and-construction/developing-property/development-application-review-process/development-application-submission/development-applications/zoning-law-amendment>
- Links to Relevant Policy and Guidelines – As part of Planning staff’s review, we will evaluate your proposal against the relevant Official Plan policies and applicable guidelines. I have provided links to them on the City’s website. I don’t have a link yet to the New Official Plan (2021).

- City Official Plan (2003): <https://ottawa.ca/en/planning-development-and-construction/official-plan-and-master-plans/official-plan>
- City of Ottawa Suite of Design Guidelines: <https://ottawa.ca/en/planning-development-and-construction/developing-property/development-application-review-process/development-application-submission/development-applications/zoning-law-amendment>

Of relevance to the proposed development, please review the following design guidelines.

Environmental Noise Control Guidelines
Transportation Impact Assessment Guidelines
Tree Planting in Sensitive Marine Clay Soils – 2017 Guidelines
Local Residential Streets 30 km/h Design Toolbox

Other

- Please refer to the links to [Guide to preparing studies and plans](#) for further information. Additional information is available related to [building permits](#), [development charges](#), and the [Accessibility Design Standards](#). Be aware that other fees and permits may be required, outside of the development review process. You may obtain background drawings by contacting informationcentre@ottawa.ca.

Required Plans and Reports Submissions

- Attached for your information and action are lists of plans and studies required for both types of applications outlined above. The required plans and studies focus on the above and other matters necessary for staff and circulated agencies to provide informed review and comment on the proposed zoning amendment and site plan control approval applications. The list is also used to deem the applications complete.

The above pre-application consultation comments are valid for one year. If you submit a development application(s) after this time, you may be required to attend another pre-consultation meeting and/or the submission requirements may change. You are also encouraged to contact us for a follow-up meeting if the plan/concept is further refined.

Please do not hesitate to contact me if you have any questions.

Sincerely,

Steve Belan, RPP, MCIP

Senior Planner, Development Review - East
City of Ottawa
Planning, Real Estate and Economic Development Department
110 Laurier Avenue West, 4th Floor
Ottawa, ON K1P 1J1
steve.belan@ottawa.ca

Francois Thauvette

From: Belan, Steve <Steve.Belan@ottawa.ca>
Sent: Wednesday, September 28, 2022 10:50 AM
To: Lee Sheets
Cc: David Renfroe; Murray Chown; Wildman, Geraldine; Polyak, Alex
Subject: RE: Pre-Consultation Follow-up for 3317 Navan Road (PC2022-0020)

Follow Up Flag: Follow up
Flag Status: Flagged

Lee,

I apologize for missing this email and the delay. Alex Polyak is the Project Manager who would be able to best help you with your engineering questions.

Thank you
Steve

From: Lee Sheets <l.sheets@novatech-eng.com>
Sent: September 22, 2022 3:56 PM
To: Belan, Steve <Steve.Belan@ottawa.ca>
Cc: David Renfroe <davidrenfroe@outlook.com>; Murray Chown <m.chown@novatech-eng.com>
Subject: Pre-Consultation Follow-up for 3317 Navan Road (PC2022-0020)

CAUTION: This email originated from an External Sender. Please do not click links or open attachments unless you recognize the source.

ATTENTION : Ce courriel provient d'un expéditeur externe. Ne cliquez sur aucun lien et n'ouvrez pas de pièce jointe, excepté si vous connaissez l'expéditeur.

Hi Steve

Our client is getting quite anxious to file a Site Plan on the above mentioned project. I need to get some clarity around the eng comments below. Can you please advise who our new engineering contact is in light of Wil Curry's retirement?
Lee

J. Lee Sheets, C.E.T., Director | Land Development & Public Sector Infrastructure

NOVATECH Engineers, Planners & Landscape Architects

240 Michael Cowpland Drive, Suite 200, Ottawa, ON, K2M 1P6 | Tel: 613.254.9643 Ext: 209 | Cell: 613.262.3121 | Fax: 613.254.5867

The information contained in this email message is confidential and is for exclusive use of the addressee.

From: Lee Sheets
Sent: Monday, September 12, 2022 9:20 AM
To: Belan, Steve <Steve.Belan@ottawa.ca>
Subject: RE: Pre-Consultation Follow-up for 3317 Navan Road (PC2022-0020)

Hi Steve

I have been trying to connect with Wil Curry and I now understand he has retired, who will be my contact moving forward? I would like to discuss Wil's comments on our latest plan.

Lee

J. Lee Sheets, C.E.T., Director | Land Development & Public Sector Infrastructure

NOVATECH Engineers, Planners & Landscape Architects

240 Michael Cowpland Drive, Suite 200, Ottawa, ON, K2M 1P6 | Tel: 613.254.9643 Ext: 209 | Cell: 613.262.3121 | Fax: 613.254.5867

The information contained in this email message is confidential and is for exclusive use of the addressee.

From: Belan, Steve <Steve.Belan@ottawa.ca>

Sent: Friday, August 5, 2022 2:10 PM

To: David Renfroe <davidrenfroe@outlook.com>; Adam Thompson <a.thompson@novatech-eng.com>; Wildman, Geraldine <Geraldine.Wildman@ottawa.ca>

Cc: Lalit Aggarwal <lisa@manorparkcap.com>; Anand Aggarwal (asaggarwal@gmail.com) <asaggarwal@gmail.com>; Lee Sheets <l.sheets@novatech-eng.com>; Murray Chown <m.Chown@novatech-eng.com>; Wildman, Geraldine <Geraldine.Wildman@ottawa.ca>; Curry, William <William.Curry@ottawa.ca>; Paudel, Neeti <neeti.paudel@ottawa.ca>; Hassan, Selma <Selma.Hassan@ottawa.ca>

Subject: RE: Pre-Consultation Follow-up for 3317 Navan Road (PC2022-0020)

David/Adam,

Please find the design comments related to the most recent concept. However, in preparing to respond, Will Curry, the engineer, indicated that these plans do not conform with the approved MSS and that it will be very difficult to service this site, given the limited capacity. Further, I understand that Ashcroft is difficult to work with but, I have seen no effort in trying to integrate this site into the subdivisions around it. I think that you are going to need to provide me with a rationale as to why we need to divert from the demonstrated plan in the CDP. Is this good orderly development when we are creating a cul-de-sac, not making planned street connections and leaving orphaned remnant pieces of land that will be hard to develop in future?



Before you submit any applications, I would like you to provide me with some preliminary engineering, supporting that this site can be serviced. I will have Will do a quick review to confirm that the capacity is there. Since the number of units have changed, please return the completed TIA screening form so that I can forward it on to the Transportation Planner.

The comments on the design are:

1. The access ramps to underground parking along the north property line need to be set-back from the property line itself; the concept sketch suggests that they are centimeters from the property line. I would suggest a 4m setback depending on soil conditions and ability to not impact the properties to the north.
2. To setback the ramps from the property line will require the building footprints to be shortened on the north side. This would likely drop the total units in each building to 50 (from the 58 shown).

3. I am assuming that the footprint for underground parking is directly under the building walls and does not extend into the sideyard setbacks that are shown. This is important in order to achieve tree planting on the site, in particular given the marine clay soils; underground parking should not extend beyond the building.
4. Tree planting, despite the marine clay soils, will be important on this site; ample tree planting is expected.
5. Architectural design (including the location of entries, window placement / treatments, materials, façade detailing, interface with the street / parking areas / ramps / garbage area etc.) will be critical.
6. Is the proposed size of the garbage area adequate for the number of units? Any garbage area will need to be well screened from the units and from Navan.
7. Where would secure bike parking be located?
8. Do the drive aisles and parking areas provided sufficient space for truck turning movements?
9. How will private and communal amenity areas be provided?
10. There should be a pedestrian connection linking Navan Road to Birkhill Place.

Despite the progress on the design, I have serious concerns about supporting a rezoning of the property unless we are sure that the site can be serviced and that you can address my question regarding good planning.

Steve Belan

From: David Renfroe <davidrenfroe@outlook.com>

Sent: August 04, 2022 8:20 AM

To: Adam Thompson <a.thompson@novatech-eng.com>; Belan, Steve <Steve.Belan@ottawa.ca>; Wildman, Geraldine <Geraldine.Wildman@ottawa.ca>

Cc: Lalit Aggarwal <lisa@manorparkcap.com>; Anand Aggarwal (asaggarwal@gmail.com) <asaggarwal@gmail.com>; l.sheets@novatech-eng.com; Murray Chown <m.chown@novatech-eng.com>

Subject: RE: Pre-Consultation Follow-up for 3317 Navan Road (PC2022-0020)

CAUTION: This email originated from an External Sender. Please do not click links or open attachments unless you recognize the source.

ATTENTION : Ce courriel provient d'un expéditeur externe. Ne cliquez sur aucun lien et n'ouvrez pas de pièce jointe, excepté si vous connaissez l'expéditeur.

Good morning Steve,

We would like to proceed with the submission of the site plan for 3317 Navan Rd. Could you please schedule a quick informal follow-up meeting with our team next week or provide support for the current concept to allow us to take next steps. We need to move this project forward. Thank you.

Regards,



David S. Renfroe, B.S., M.B.A.
Renfroe Land Management
davidrenfroe@outlook.com
613.883.6124

From: Adam Thompson <a.thompson@novatech-eng.com>

Sent: July 12, 2022 4:10 PM

To: Belan, Steve <Steve.Belan@ottawa.ca>; Wildman, Geraldine <Geraldine.Wildman@ottawa.ca>

Cc: Lalit Aggarwal <lisa@manorparkcap.com>; David Renfroe <davidrenfroe@outlook.com>; Anand Aggarwal

(asaggarwal@gmail.com) <asaggarwal@gmail.com>; Lee Sheets <l.sheets@novatech-eng.com>; Murray Chown <m.Chown@novatech-eng.com>

Subject: RE: Pre-Consultation Follow-up for 3317 Navan Road (PC2022-0020)

Steve,

Further to your email below, we have gone back and revised the concept plan further to address your comments below. In particular we have increased the ground floor amenity areas for each building to ensure private amenity areas as well as a communal outdoor amenity space. Sidewalks have been added to the plan to demonstrate pedestrian connectivity.

The goal remains to proceed with a full design of the concept for the purposes of filing concurrent applications for a Zoning By-law Amendment and Site Plan Control. In order to finalize a work plan, we would appreciate an opportunity to discuss the Submission Requirements previously provided for only a ZBLA. Could you let me know your availability later this week or next week for a brief discussion?

Thank you,

Adam Thompson, BES, Senior Project Manager | Planning & Development

NOVATECH Engineers, Planners & Landscape Architects

240 Michael Cowpland Drive, Suite 200, Ottawa, ON, K2M 1P6 | Tel: 613.254.9643 x 270 | Fax: 613.254.5867

The information contained in this email message is confidential and is for exclusive use of the addressee.

From: Belan, Steve <Steve.Belan@ottawa.ca>

Sent: Thursday, June 2, 2022 5:17 PM

To: Adam Thompson <a.thompson@novatech-eng.com>; Wildman, Geraldine <Geraldine.Wildman@ottawa.ca>

Cc: Lalit Aggarwal <lisa@manorparkcap.com>; David Renfroe <davidrenfroe@outlook.com>; Anand Aggarwal (asaggarwal@gmail.com) <asaggarwal@gmail.com>; Lee Sheets <l.sheets@novatech-eng.com>; Murray Chown <m.Chown@novatech-eng.com>

Subject: RE: Pre-Consultation Follow-up for 3317 Navan Road (PC2022-0020)

Adam,

Thank you for the new concept plan. We reviewed it internally and have many of the same concerns as with the original concept. Servicing, the density/amenity space along with integration of this site with the Ashcroft subdivision still have not been addressed. The following are some of the additional comments.

- There is no private, at-grade communal amenity area as required by the CDP for PUDs
- With underground parking and the amount of hard surface area, the proposal is very unlikely to meet the requirements for tree planting set by the CDP and the new OP.
- As shown, there is no privacy for ground floor units. The CDP notes “Ensure that reduced setbacks achieve satisfactory privacy for residential units and permit adequate front yard landscaping” and “Ensure that the facing distance between buildings provides appropriate access light, views, and privacy”.
- The parking lot facing Navan is undesirable. It would be better for the building to run parallel to Navan and the parking lot to be internal. Regardless the CDP notes “Provide a minimum 3m landscape setback from the property line of any parking area facing the street, open spaces or residential buildings. Landscape the setback with shrubs and trees to create a continuous canopy. The screening must be effective all seasons and understorey planting should not exceed 1m in height”.

- There is really no pedestrian system shown and no space to put one; people will be forced to walk in the drive aisle to leave the site.
- Where snow storage will occur and how would garbage be dealt with?

At this time, I am not sure that a meeting would be constructive as the key issue is related to integrating this property into surround developments. I would be happy to review more concepts and will set up a meeting once the plan is more matured.

Steve Belan

From: Adam Thompson <a.thompson@novatech-eng.com>
Sent: May 25, 2022 3:48 PM
To: Belan, Steve <Steve.Belan@ottawa.ca>
Cc: Lalit Aggarwal <lisa@manorparkcap.com>; David Renfroe <davidrenfroe@outlook.com>; Anand Aggarwal (asaggarwal@gmail.com) <asaggarwal@gmail.com>; l.sheets@novatech-eng.com; Murray Chown <m.chown@novatech-eng.com>
Subject: RE: Pre-Consultation Follow-up for 3317 Navan Road (PC2022-0020)

CAUTION: This email originated from an External Sender. Please do not click links or open attachments unless you recognize the source.

ATTENTION : Ce courriel provient d'un expéditeur externe. Ne cliquez sur aucun lien et n'ouvrez pas de pièce jointe, excepté si vous connaissez l'expéditeur.

Steve,

Following up again as it has been another week... could we schedule a follow up meeting to discuss our latest concept for 3317 Navan Road?

Thanks,

Adam Thompson, BES, Senior Project Manager | Planning & Development
NOVATECH Engineers, Planners & Landscape Architects
240 Michael Cowpland Drive, Suite 200, Ottawa, ON, K2M 1P6 | Tel: 613.254.9643 x 270 | Fax: 613.254.5867
The information contained in this email message is confidential and is for exclusive use of the addressee.

From: Adam Thompson
Sent: Wednesday, May 18, 2022 4:58 PM
To: Belan, Steve <Steve.Belan@ottawa.ca>
Cc: Lalit Aggarwal <lisa@manorparkcap.com>; David Renfroe <davidrenfroe@outlook.com>; Anand Aggarwal (asaggarwal@gmail.com) <asaggarwal@gmail.com>; Lee Sheets <l.sheets@novatech-eng.com>; Murray Chown <m.Chown@novatech-eng.com>
Subject: RE: Pre-Consultation Follow-up for 3317 Navan Road (PC2022-0020)

Steve,

Following up on our email below, can you provide your availability for a follow up discussion on our revised concept?

Thanks,

Adam Thompson, BES, Senior Project Manager | Planning & Development
NOVATECH Engineers, Planners & Landscape Architects
240 Michael Cowpland Drive, Suite 200, Ottawa, ON, K2M 1P6 | Tel: 613.254.9643 x 270 | Fax: 613.254.5867
The information contained in this email message is confidential and is for exclusive use of the addressee.

From: Belan, Steve <Steve.Belan@ottawa.ca>
Sent: Tuesday, May 10, 2022 8:53 AM
To: Murray Chown <m.Chown@novatech-eng.com>
Cc: Lalit Aggarwal <lisa@manorparkcap.com>; David Renfroe <davidrenfroe@outlook.com>; Anand Aggarwal (asaggarwal@gmail.com) <asaggarwal@gmail.com>; Adam Thompson <a.thompson@novatech-eng.com>; Lee Sheets <l.sheets@novatech-eng.com>
Subject: RE: Pre-Consultation Follow-up for 3317 Navan Road (PC2022-0020)

Thank you, for this.

I have passed the plan on to the others and asked for their availability. I will get back to you soon.

Steve Belan

From: Murray Chown <m.Chown@novatech-eng.com>
Sent: May 10, 2022 8:41 AM
To: Belan, Steve <Steve.Belan@ottawa.ca>; Martinov, Amya <amya.martinov@ottawa.ca>
Cc: Lalit Aggarwal <lisa@manorparkcap.com>; David Renfroe <davidrenfroe@outlook.com>; Anand Aggarwal (asaggarwal@gmail.com) <asaggarwal@gmail.com>; Adam Thompson <a.thompson@novatech-eng.com>; l.sheets@novatech-eng.com
Subject: RE: Pre-Consultation Follow-up for 3317 Navan Road (PC2022-0020)

CAUTION: This email originated from an External Sender. Please do not click links or open attachments unless you recognize the source.

ATTENTION : Ce courriel provient d'un expéditeur externe. Ne cliquez sur aucun lien et n'ouvrez pas de pièce jointe, excepté si vous connaissez l'expéditeur.

Steve and Amya:

Further to Adam's email, please note that the revised concept is significantly different from our initial concept which proposed a public road through the site. The revised concept will be developed as a "planned unit development" entirely on private "roads/lanes". There will be no plan of subdivision. Development will be by way of site plan control.

Murray Chown, MCIP, RPP, Director | Planning & Development

NOVATECH Engineers, Planners & Landscape Architects

240 Michael Cowpland Drive, Suite 200, Ottawa, ON, K2M 1P6 | Tel: 613.254.9643 x 239 | Fax: 613.254.5867

The information contained in this email message is confidential and is for exclusive use of the addressee.

From: Adam Thompson <a.thompson@novatech-eng.com>
Sent: Monday, May 9, 2022 4:49 PM
To: Martinov, Amya <amya.martinov@ottawa.ca>; Belan, Steve <Steve.Belan@ottawa.ca>
Cc: Murray Chown <m.Chown@novatech-eng.com>; Lalit Aggarwal <lisa@manorparkcap.com>; David Renfroe (davidrenfroe@outlook.com) <davidrenfroe@outlook.com>; Anand Aggarwal (asaggarwal@gmail.com) <asaggarwal@gmail.com>
Subject: RE: Pre-Consultation Follow-up for 3317 Navan Road (PC2022-0020)

Steve / Amya,

Further to your email below and our pre-consultation meeting on February 14, 2022, the development concept has been updated to take into consideration the comments from City staff with respect to the initial concept plan. Please find attached a revised Concept Plan for a multi-family residential complex consisting of approximately 175 units.

We would like to have the opportunity to meet with the City again as a follow up to our February 14th meeting to have an opportunity to discuss the revised concept. Could you provide some options for when City staff would be available for a meeting in the next week or so?

Thank you,

Adam Thompson, BES, Senior Project Manager | Planning & Development

NOVATECH Engineers, Planners & Landscape Architects

240 Michael Cowpland Drive, Suite 200, Ottawa, ON, K2M 1P6 | Tel: 613.254.9643 x 270 | Fax: 613.254.5867

The information contained in this email message is confidential and is for exclusive use of the addressee.

From: Martinov, Amya <amya.martinov@ottawa.ca>

Sent: Friday, February 25, 2022 2:09 PM

To: Adam Thompson <a.thompson@novatech-eng.com>

Cc: Belan, Steve <Steve.Belan@ottawa.ca>; Castro, Phil <phil.castro@ottawa.ca>; Hassan, Selma <Selma.Hassan@ottawa.ca>; Richardson, Mark <Mark.Richardson@ottawa.ca>; Paudel, Neeti <neeti.paudel@ottawa.ca>; Curry, William <William.Curry@ottawa.ca>

Subject: Pre-Consultation Follow-up for 3317 Navan Road (PC2022-0020)

Good afternoon Adam,

In follow up to our pre-application consultation meeting held on 14 February 2022, please find attached the following documents for your information and action:

- Summary of preliminary comments as confirmed from all team members discussed at the meeting and all additional comments by each discipline;
- Applicant's study and plan identification list (Submission Requirements);
- Pre-consultation Parks and Facilities Memo; and
- Design Brief TOR + alternative design layouts

If you have any questions, please direct them to any of the City of Ottawa staff members according to their discipline.

Thank you for your patience,

Amya Martinov (She/Her)

Student Planner | Étudiante en Urbanism

Development Review East | Examen des projets d'aménagement Est

City of Ottawa | Ville d'Ottawa

613-580-2424 Ext. 23601

amya.martinov@ottawa.ca

This e-mail originates from the City of Ottawa e-mail system. Any distribution, use or copying of this e-mail or the information it contains by other than the intended recipient(s) is unauthorized. Thank you.

Le présent courriel a été expédié par le système de courriels de la Ville d'Ottawa. Toute distribution, utilisation ou reproduction du courriel ou des renseignements qui s'y trouvent par une personne autre que son destinataire prévu est interdite. Je vous remercie de votre collaboration.

'
'
This e-mail originates from the City of Ottawa e-mail system. Any distribution, use or copying of this e-mail or the information it contains by other than the intended recipient(s) is unauthorized. Thank you.

Le présent courriel a été expédié par le système de courriels de la Ville d'Ottawa. Toute distribution, utilisation ou reproduction du courriel ou des renseignements qui s'y trouvent par une personne autre que son destinataire prévu est interdite. Je vous remercie de votre collaboration.

'
'
This e-mail originates from the City of Ottawa e-mail system. Any distribution, use or copying of this e-mail or the information it contains by other than the intended recipient(s) is unauthorized. Thank you.

Le présent courriel a été expédié par le système de courriels de la Ville d'Ottawa. Toute distribution, utilisation ou reproduction du courriel ou des renseignements qui s'y trouvent par une personne autre que son destinataire prévu est interdite. Je vous remercie de votre collaboration.

'
'
This e-mail originates from the City of Ottawa e-mail system. Any distribution, use or copying of this e-mail or the information it contains by other than the intended recipient(s) is unauthorized. Thank you.

Le présent courriel a été expédié par le système de courriels de la Ville d'Ottawa. Toute distribution, utilisation ou reproduction du courriel ou des renseignements qui s'y trouvent par une personne autre que son destinataire prévu est interdite. Je vous remercie de votre collaboration.

'
'
This e-mail originates from the City of Ottawa e-mail system. Any distribution, use or copying of this e-mail or the information it contains by other than the intended recipient(s) is unauthorized. Thank you.

Le présent courriel a été expédié par le système de courriels de la Ville d'Ottawa. Toute distribution, utilisation ou reproduction du courriel ou des renseignements qui s'y trouvent par une personne autre que son destinataire prévu est interdite. Je vous remercie de votre collaboration.

Francois Thauvette

From: Polyak, Alex <alex.polyak@ottawa.ca>
Sent: Thursday, March 16, 2023 10:45 AM
To: Francois Thauvette
Subject: RE: Pre-Consultation Follow-up for 3317 Navan Road (PC2022-0020)

Hello François,

The post development flows should be control to the pre-development conditions or 85 L/s/ha whichever is more restrictive. Only 1 storm outlet is allowed.

We can discuss if you have any questions.

Regards,

Oleksandr (Alex) Polyak, B.Eng., P.Eng

Project Manager, Infrastructure Approvals, Development Review East Branch | Gestionnaire de projet, Direction de l'examen des projets d'aménagement – Est.
Planning, Real Estate and Economic Development Department | Direction générale de la planification, des biens immobiliers et du développement économique

City of Ottawa | Ville d'Ottawa
110 Laurier Ave., 4th Fl East, Ottawa ON K1P 1J1
Email: alex.polyak@ottawa.ca
www.Ottawa.ca



From: Francois Thauvette <f.thauvette@novatech-eng.com>
Sent: March 16, 2023 10:12 AM
To: Polyak, Alex <alex.polyak@ottawa.ca>
Subject: RE: Pre-Consultation Follow-up for 3317 Navan Road (PC2022-0020)

CAUTION: This email originated from an External Sender. Please do not click links or open attachments unless you recognize the source.

ATTENTION : Ce courriel provient d'un expéditeur externe. Ne cliquez sur aucun lien et n'ouvrez pas de pièce jointe, excepté si vous connaissez l'expéditeur.

Hi Alex,

I am working with Lee Sheets on this project and was wondering if you would have time for a brief Teams call to discuss the SWM approach and allowable release rate(s) to the existing Navan Road ditch (prior to the construction of the future storm sewer). If discharging to the roadside ditch, are we to control post-development flows to pre-development conditions or to 85 L/s/ha as described below? Also, will the City allow more than 1 outlet to the roadside ditch?

Please advise when you have time for a brief Teams call.

Regards,

François Thauvette, P. Eng., Sr. Project Manager | Land Development & Public-Sector Engineering

NOVATECH

Engineers, Planners & Landscape Architects

240 Michael Cowpland Drive, Suite 200, Ottawa, ON, K2M 1P6 | T: 613.254.9643 Ext: 219 | C: 613.276.0310

The information contained in this email message is confidential and is for exclusive use of the addressee.

From: Polyak, Alex <alex.polyak@ottawa.ca>

Sent: Thursday, October 13, 2022 1:07 PM

To: Lee Sheets <l.sheets@novatech-eng.com>

Cc: Belan, Steve <Steve.Belan@ottawa.ca>

Subject: RE: Pre-Consultation Follow-up for 3317 Navan Road (PC2022-0020)

Hello Lee,

Following an internal discussion based on the information you, Steve and I discussed on Wednesday October 12th, most of the servicing design criteria requirements provided by Will Curry are still applicable.

The intended storm outlet location as you've pointed out is the below highlighted future STM MH 517-1, ultimately discharging to EUC Pond 3. The storm release rate is therefore required to be Post to Pre 85L/s/ha and at 100-year ponding elevation you must spill to City ROW.

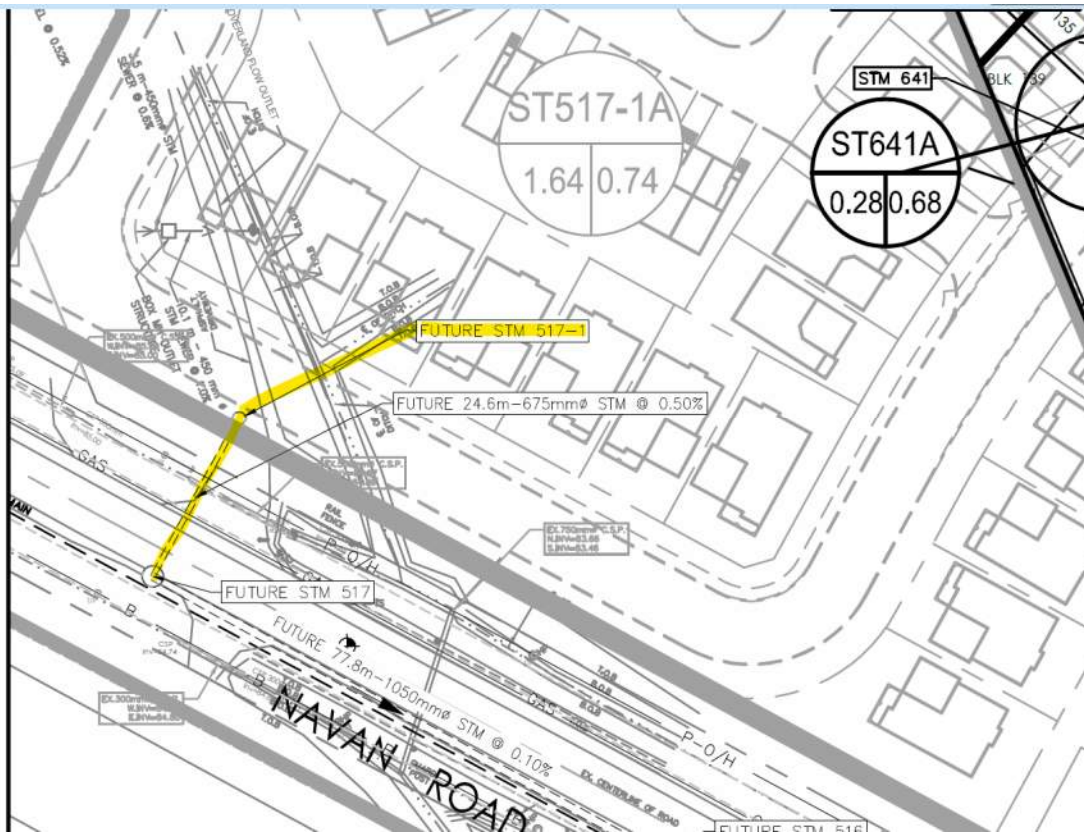

A sanitary connection to the below highlighted MH is preferred if you are restricted with draining to the adjacent subdivision east of the site. A connection to the sanitary sewer on Navan Road will likely require the use of trenchless technology in order to make the connection but this is certainly an option that can be explored.



Watermain servicing can be provided from Navan Road or from the adjacent properties east and north of the site.

I look forward to receiving your preliminary servicing calculations to confirm capacities in the existing services and whether this site can be developed.

Regards,

Oleksandr (Alex) Polyak., B.Eng., EIT

Prj Mgr, Infrastructure Approvals, Development Review East Branch | Gestionnaire de projet,
Direction de l'examen des projets d'aménagement – Est.
Planning, Real Estate and Economic Development Department | Direction générale de la
planification, des biens immobiliers et du développement économique
City of Ottawa | Ville d'Ottawa
110 Laurier Ave., 4th Fl East;
Ottawa ON K1P 1J1

Alex.Polyak@Ottawa.ca



From: Lee Sheets <l.sheets@novatech-eng.com>
Sent: October 06, 2022 6:54 AM
To: Polyak, Alex <alex.polyak@ottawa.ca>
Cc: Belan, Steve <Steve.Belan@ottawa.ca>
Subject: Re: Pre-Consultation Follow-up for 3317 Navan Road (PC2022-0020)

CAUTION: This email originated from an External Sender. Please do not click links or open attachments unless you recognize the source.

ATTENTION : Ce courriel provient d'un expéditeur externe. Ne cliquez sur aucun lien et n'ouvrez pas de pièce jointe, excepté si vous connaissez l'expéditeur.

11:30 or 3:30

Sent from my iPhone

On Oct 5, 2022, at 6:13 PM, Polyak, Alex <alex.polyak@ottawa.ca> wrote:

Good afternoon Lee,

I should have some available time for a meeting next Wednesday. What time would you like to meet?

Regards,

Oleksandr (Alex) Polyak., B.Eng., EIT

Prj Mgr, Infrastructure Approvals, Development Review East Branch | Gestionnaire de projet, Direction de l'examen des projets d'aménagement – Est.
Planning, Real Estate and Economic Development Department | Direction générale de la planification, des biens immobiliers et du développement économique
City of Ottawa | Ville d'Ottawa
110 Laurier Ave., 4th Fl East;
Ottawa ON K1P 1J1

Alex.Polyak@Ottawa.ca



From: Lee Sheets <l.sheets@novatech-eng.com>
Sent: October 03, 2022 1:11 PM
To: Polyak, Alex <alex.polyak@ottawa.ca>
Cc: Belan, Steve <Steve.Belan@ottawa.ca>
Subject: Pre-Consultation Follow-up for 3317 Navan Road (PC2022-0020)

CAUTION: This email originated from an External Sender. Please do not click links or open attachments unless you recognize the source.

ATTENTION : Ce courriel provient d'un expéditeur externe. Ne cliquez sur aucun lien et n'ouvrez pas de pièce jointe, excepté si vous connaissez l'expéditeur.

Hi Alex

I understand you will be taking over the file for 3317 Navan Road. Wil Curry had some comments (see below) related to our conceptual Site Plan. The comments relate to adherence to the MSS by our submission. Stantec has advised that they cannot service our site by gravity for sanitary and storm and recommend the Navan Road ROW as potential outlets. I have attached the drawings sent by Stantec to be included in a discussion. Please advise when we can meet to discuss.

Lee

J. Lee Sheets, C.E.T., Director | Land Development & Public Sector Infrastructure

NOVATECH Engineers, Planners & Landscape Architects

240 Michael Cowpland Drive, Suite 200, Ottawa, ON, K2M 1P6 | Tel: 613.254.9643 Ext: 209 | Cell: 613.262.3121 | Fax: 613.254.5867

The information contained in this email message is confidential and is for exclusive use of the addressee.

This e-mail originates from the City of Ottawa e-mail system. Any distribution, use or copying of this e-mail or the information it contains by other than the intended recipient(s) is unauthorized. Thank you.

Le présent courriel a été expédié par le système de courriels de la Ville d'Ottawa. Toute distribution, utilisation ou reproduction du courriel ou des renseignements qui s'y trouvent par une personne autre que son destinataire prévu est interdite. Je vous remercie de votre collaboration.

This e-mail originates from the City of Ottawa e-mail system. Any distribution, use or copying of this e-mail or the information it contains by other than the intended recipient(s) is unauthorized. Thank you.

Le présent courriel a été expédié par le système de courriels de la Ville d'Ottawa. Toute distribution, utilisation ou reproduction du courriel ou des renseignements qui s'y trouvent par une personne autre que son destinataire prévu est interdite. Je vous remercie de votre collaboration.

Francois Thauvette

From: Jamie Batchelor <jamie.batchelor@rvca.ca>
Sent: Friday, January 20, 2023 1:10 PM
To: Francois Thauvette
Subject: RE: 3317 Navan Road - RVCA Pre-Consultation

Good Afternoon Francois,

Thanks you for your inquiry. Due to changes enacted through Bill 23 and Ontario Regulation 596/22, the Conservation Authority can no longer provide comments on water quality requirements on site specific applications. Therefore, the decision whether on-site water quality treatment is required and what would trigger on-site water quality now rests with the City.

However, I can provide general information in relation to the Green's Creek subwatershed. The appropriate water quality target for the Green's Creek subwatershed is 'enhanced' (80% TSS Removal).

Jamie Batchelor, MCIP, RPP
Planner, ext. 1191
[Jamie.batchelor@rvca.ca](mailto:jamie.batchelor@rvca.ca)



3889 Rideau Valley Drive
PO Box 599, Manotick ON K4M 1A5
T 613-692-3571 | 1-800-267-3504 F 613-692-0831 | www.rvca.ca

This message may contain information that is privileged or confidential and is intended to be for the use of the individual(s) or entity named. If you are not the intended recipient of this e-mail, any use, review, revision, retransmission, distribution, dissemination, copying, printing or taking of any action in reliance upon this e-mail, is strictly prohibited. If you have received this e-mail in error, please contact the sender and any copy of the e-mail and any printout thereof, immediately. Your cooperation is appreciated.

From: Francois Thauvette <f.thauvette@novatech-eng.com>
Sent: Wednesday, January 18, 2023 3:48 PM
To: Jamie Batchelor <jamie.batchelor@rvca.ca>
Subject: 3317 Navan Road - RVCA Pre-Consultation

Hi Jamie,

We are working on a residential development at 3317 Navan Road. The current concept consists of three 4-storey residential buildings with approximately 58 units per building. The site will be accessible off the future Esselmont Street to the east and includes shared surface and underground parking. The southeastern corner of the property will likely be occupied by a stormwater management facility (dry pond) required for on-site stormwater management (quantity control) purposes, prior to releasing storm flows into the roadside along Navan Road. See attached concept plan for details. Someday, site storm flows may be directed to a 'future' storm sewer in Navan Road.

Please confirm the stormwater quality control requirements for this property, assuming site flows are ultimately tributary to Green's Creek.

Regards,

François Thauvette, P. Eng., Senior Project Manager | Land Development & Public Sector Engineering

NOVATECH Engineers, Planners & Landscape Architects

Please note that I am working from home. Email or MS Teams are the best ways to contact me.

240 Michael Cowpland Drive, Suite 200, Ottawa, ON, K2M 1P6 | Tel: 613.254.9643 Ext: 219 | Cell: 613.276.0310 | Fax: 613.254.5867

The information contained in this email message is confidential and is for exclusive use of the addressee.

APPENDIX B
Development Servicing Study Checklist

Servicing study guidelines for development applications

4. Development Servicing Study Checklist

The following section describes the checklist of the required content of servicing studies. It is expected that the proponent will address each one of the following items for the study to be deemed complete and ready for review by City of Ottawa Infrastructure Approvals staff.

The level of required detail in the Servicing Study will increase depending on the type of application. For example, for Official Plan amendments and re-zoning applications, the main issues will be to determine the capacity requirements for the proposed change in land use and confirm this against the existing capacity constraint, and to define the solutions, phasing of works and the financing of works to address the capacity constraint. For subdivisions and site plans, the above will be required with additional detailed information supporting the servicing within the development boundary.

4.1 General Content

- Executive Summary (for larger reports only).
- Date and revision number of the report.
- Location map and plan showing municipal address, boundary, and layout of proposed development.
- Plan showing the site and location of all existing services.
- Development statistics, land use, density, adherence to zoning and official plan, and reference to applicable subwatershed and watershed plans that provide context to which individual developments must adhere.
- Summary of Pre-consultation Meetings with City and other approval agencies.
- Reference and confirm conformance to higher level studies and reports (Master Servicing Studies, Environmental Assessments, Community Design Plans), or in the case where it is not in conformance, the proponent must provide justification and develop a defensible design criteria.
- Statement of objectives and servicing criteria.
- Identification of existing and proposed infrastructure available in the immediate area.
- Identification of Environmentally Significant Areas, watercourses and Municipal Drains potentially impacted by the proposed development (Reference can be made to the Natural Heritage Studies, if available).
- Concept level master grading plan to confirm existing and proposed grades in the development. This is required to confirm the feasibility of proposed stormwater management and drainage, soil removal and fill constraints, and potential impacts to neighbouring properties. This is also required to confirm that the proposed grading will not impede existing major system flow paths.
- Identification of potential impacts of proposed piped services on private services (such as wells and septic fields on adjacent lands) and mitigation required to address potential impacts.
- Proposed phasing of the development, if applicable.

- Reference to geotechnical studies and recommendations concerning servicing.

- All preliminary and formal site plan submissions should have the following information:
 - Metric scale

 - North arrow (including construction North)

 - Key plan

 - Name and contact information of applicant and property owner

 - Property limits including bearings and dimensions

 - Existing and proposed structures and parking areas

 - Easements, road widening and rights-of-way

 - Adjacent street names

4.2 Development Servicing Report: Water

- Confirm consistency with Master Servicing Study, if available
- Availability of public infrastructure to service proposed development
- Identification of system constraints
- Identify boundary conditions
- Confirmation of adequate domestic supply and pressure
- Confirmation of adequate fire flow protection and confirmation that fire flow is calculated as per the Fire Underwriter's Survey. Output should show available fire flow at locations throughout the development.
- Provide a check of high pressures. If pressure is found to be high, an assessment is required to confirm the application of pressure reducing valves.
- Definition of phasing constraints. Hydraulic modeling is required to confirm servicing for all defined phases of the project including the ultimate design
- Address reliability requirements such as appropriate location of shut-off valves
- Check on the necessity of a pressure zone boundary modification.
- Reference to water supply analysis to show that major infrastructure is capable of delivering sufficient water for the proposed land use. This includes data that shows that the expected demands under average day, peak hour and fire flow conditions provide water within the required pressure range

- Description of the proposed water distribution network, including locations of proposed connections to the existing system, provisions for necessary looping, and appurtenances (valves, pressure reducing valves, valve chambers, and fire hydrants) including special metering provisions.
- Description of off-site required feeder mains, booster pumping stations, and other water infrastructure that will be ultimately required to service proposed development, including financing, interim facilities, and timing of implementation.
- Confirmation that water demands are calculated based on the City of Ottawa Design Guidelines.
- Provision of a model schematic showing the boundary conditions locations, streets, parcels, and building locations for reference.

4.3 Development Servicing Report: Wastewater

- Summary of proposed design criteria (Note: Wet-weather flow criteria should not deviate from the City of Ottawa Sewer Design Guidelines. Monitored flow data from relatively new infrastructure cannot be used to justify capacity requirements for proposed infrastructure).
- Confirm consistency with Master Servicing Study and/or justifications for deviations.
- Consideration of local conditions that may contribute to extraneous flows that are higher than the recommended flows in the guidelines. This includes groundwater and soil conditions, and age and condition of sewers.
- Description of existing sanitary sewer available for discharge of wastewater from proposed development.
- Verify available capacity in downstream sanitary sewer and/or identification of upgrades necessary to service the proposed development. (Reference can be made to previously completed Master Servicing Study if applicable)
- Calculations related to dry-weather and wet-weather flow rates from the development in standard MOE sanitary sewer design table (Appendix 'C') format.
- Description of proposed sewer network including sewers, pumping stations, and forcemains.
- Discussion of previously identified environmental constraints and impact on servicing (environmental constraints are related to limitations imposed on the development in order to preserve the physical condition of watercourses, vegetation, soil cover, as well as protecting against water quantity and quality).
- Pumping stations: impacts of proposed development on existing pumping stations or requirements for new pumping station to service development.
- Forcemain capacity in terms of operational redundancy, surge pressure and maximum flow velocity.
- Identification and implementation of the emergency overflow from sanitary pumping stations in relation to the hydraulic grade line to protect against basement flooding.
- Special considerations such as contamination, corrosive environment etc.

4.4 Development Servicing Report: Stormwater Checklist

- Description of drainage outlets and downstream constraints including legality of outlets (i.e. municipal drain, right-of-way, watercourse, or private property)
- Analysis of available capacity in existing public infrastructure.
- A drawing showing the subject lands, its surroundings, the receiving watercourse, existing drainage patterns, and proposed drainage pattern.
- Water quantity control objective (e.g. controlling post-development peak flows to pre-development level for storm events ranging from the 2 or 5 year event (dependent on the receiving sewer design) to 100 year return period); if other objectives are being applied, a rationale must be included with reference to hydrologic analyses of the potentially affected subwatersheds, taking into account long-term cumulative effects.
- Water Quality control objective (basic, normal or enhanced level of protection based on the sensitivities of the receiving watercourse) and storage requirements.
- Description of the stormwater management concept with facility locations and descriptions with references and supporting information.
- Set-back from private sewage disposal systems.
- Watercourse and hazard lands setbacks.
- Record of pre-consultation with the Ontario Ministry of Environment and the Conservation Authority that has jurisdiction on the affected watershed.
- Confirm consistency with sub-watershed and Master Servicing Study, if applicable study exists.
- Storage requirements (complete with calculations) and conveyance capacity for minor events (1:5 year return period) and major events (1:100 year return period).
- Identification of watercourses within the proposed development and how watercourses will be protected, or, if necessary, altered by the proposed development with applicable approvals.
- Calculate pre and post development peak flow rates including a description of existing site conditions and proposed impervious areas and drainage catchments in comparison to existing conditions.
- Any proposed diversion of drainage catchment areas from one outlet to another.
- Proposed minor and major systems including locations and sizes of stormwater trunk sewers, and stormwater management facilities.
- If quantity control is not proposed, demonstration that downstream system has adequate capacity for the post-development flows up to and including the 100 year return period storm event.
- Identification of potential impacts to receiving watercourses
- Identification of municipal drains and related approval requirements.
- Descriptions of how the conveyance and storage capacity will be achieved for the development.
- 100 year flood levels and major flow routing to protect proposed development from flooding for establishing minimum building elevations (MBE) and overall grading.

- Inclusion of hydraulic analysis including hydraulic grade line elevations.
- Description of approach to erosion and sediment control during construction for the protection of receiving watercourse or drainage corridors.
- Identification of floodplains – proponent to obtain relevant floodplain information from the appropriate Conservation Authority. The proponent may be required to delineate floodplain elevations to the satisfaction of the Conservation Authority if such information is not available or if information does not match current conditions.
- Identification of fill constraints related to floodplain and geotechnical investigation.

4.5 Approval and Permit Requirements: Checklist

The Servicing Study shall provide a list of applicable permits and regulatory approvals necessary for the proposed development as well as the relevant issues affecting each approval. The approval and permitting shall include but not be limited to the following:

- Conservation Authority as the designated approval agency for modification of floodplain, potential impact on fish habitat, proposed works in or adjacent to a watercourse, cut/fill permits and Approval under Lakes and Rivers Improvement Act. The Conservation Authority is not the approval authority for the Lakes and Rivers Improvement Act. Where there are Conservation Authority regulations in place, approval under the Lakes and Rivers Improvement Act is not required, except in cases of dams as defined in the Act.
- Application for Certificate of Approval (CofA) under the Ontario Water Resources Act.
- Changes to Municipal Drains.
- Other permits (National Capital Commission, Parks Canada, Public Works and Government Services Canada, Ministry of Transportation etc.)

4.6 Conclusion Checklist

- Clearly stated conclusions and recommendations
- Comments received from review agencies including the City of Ottawa and information on how the comments were addressed. Final sign-off from the responsible reviewing agency.
- All draft and final reports shall be signed and stamped by a professional Engineer registered in Ontario

APPENDIX C
Sanitary Sewage Calculations

3317 Navan Road - Proposed Residential Building A

SANITARY SEWAGE ANALYSIS

Residential	Post-Development	
Number of 1-Bedroom Apartments	31	
Number of Persons per 1-Bdrm Apartment	1.4	
Number of 2-Bedroom Apartments	17	
Number of Persons per 2-Bdrm Apartment	2.1	
Number of 3-Bedroom Apartments	7	
Number of Persons per 3-Bdrm Apartment	3.1	
Design Population	101	
Average Daily Flow per resident	280	L/c/day
Peak Factor (Harmon Formula)	3.77	
Peak Residential Flow	1.23	L/s
Extraneous Flow		
Site Area	0.49	ha
Infiltration Allowance	0.33	L/s/ha
Peak Extraneous Flows	0.16	L/s
Total Peak Sanitary Flow	1.40	L/s

3317 Navan Road - Proposed Residential Building B

SANITARY SEWAGE ANALYSIS

Residential	Post-Development	
Number of 1-Bedroom Apartments	31	
Number of Persons per 1-Bdrm Apartment	1.4	
Number of 2-Bedroom Apartments	17	
Number of Persons per 2-Bdrm Apartment	2.1	
Number of 3-Bedroom Apartments	7	
Number of Persons per 3-Bdrm Apartment	3.1	
Design Population	101	
Average Daily Flow per resident	280	L/c/day
Peak Factor (Harmon Formula)	3.77	
Peak Residential Flow	1.23	L/s
Extraneous Flow		
Site Area	0.49	ha
Infiltration Allowance	0.33	L/s/ha
Peak Extraneous Flows	0.16	L/s
Total Peak Sanitary Flow	1.40	L/s

3317 Navan Road - Proposed Residential Building C

SANITARY SEWAGE ANALYSIS

Residential	Post-Development	
Number of 1-Bedroom Apartments	31	
Number of Persons per 1-Bdrm Apartment	1.4	
Number of 2-Bedroom Apartments	16	
Number of Persons per 2-Bdrm Apartment	2.1	
Number of 3-Bedroom Apartments	7	
Number of Persons per 3-Bdrm Apartment	3.1	
Design Population	99	
Average Daily Flow per resident	280	L/c/day
Peak Factor (Harmon Formula)	3.77	
Peak Residential Flow	1.21	L/s
Extraneous Flow		
Site Area	0.49	ha
Infiltration Allowance	0.33	L/s/ha
Peak Extraneous Flows	0.16	L/s
Total Peak Sanitary Flow	1.37	L/s

APPENDIX D

Water Demands, FUS Calculations, Hydrant Sketch, Watermain Boundary Conditions, Schematic of the Hydraulic Model and Modelling Results

3317 Navan Road - Proposed Residential Building A

WATER ANALYSIS

DOMESTIC WATER DEMANDS

Residential	Post-Development	
Number of 1-Bedroom Apartments	31	
Number of Persons per 1-Bdrm Apartment	1.4	
Number of 2-Bedroom Apartments	17	
Number of Persons per 2-Bdrm Apartment	2.1	
Number of 3-Bedroom Apartments	7	
Number of Persons per 3-Bdrm Apartment	3.1	
Design Population	101	
Average Daily Flow per resident	280	L/c/day
Average Day Demand	0.33	L/s
Maximum Day Demand (2.5 x avg. day)	0.82	L/s
Peak Hour Demand (2.2 x max. day)	1.80	L/s
TOTAL		
Average Day Demand	0.33	L/s
Maximum Day Demand	0.82	L/s
Peak Hour Demand	1.80	L/s

3317 Navan Road - Proposed Residential Building B

WATER ANALYSIS

DOMESTIC WATER DEMANDS

Residential	Post-Development	
Number of 1-Bedroom Apartments	31	
Number of Persons per 1-Bdrm Apartment	1.4	
Number of 2-Bedroom Apartments	17	
Number of Persons per 2-Bdrm Apartment	2.1	
Number of 3-Bedroom Apartments	7	
Number of Persons per 3-Bdrm Apartment	3.1	
Design Population	101	
Average Daily Flow per resident	280	L/c/day
Average Day Demand	0.33	L/s
Maximum Day Demand (2.5 x avg. day)	0.82	L/s
Peak Hour Demand (2.2 x max. day)	1.80	L/s
TOTAL		
Average Day Demand	0.33	L/s
Maximum Day Demand	0.82	L/s
Peak Hour Demand	1.80	L/s

3317 Navan Road - Proposed Residential Building C

WATER ANALYSIS

DOMESTIC WATER DEMANDS

Residential	Post-Development	
Number of 1-Bedroom Apartments	31	
Number of Persons per 1-Bdrm Apartment	1.4	
Number of 2-Bedroom Apartments	16	
Number of Persons per 2-Bdrm Apartment	2.1	
Number of 3-Bedroom Apartments	7	
Number of Persons per 3-Bdrm Apartment	3.1	
Design Population	99	
Average Daily Flow per resident	280	L/c/day
Average Day Demand	0.32	L/s
Maximum Day Demand (2.5 x avg. day)	0.80	L/s
Peak Hour Demand (2.2 x max. day)	1.76	L/s
TOTAL		
Average Day Demand	0.32	L/s
Maximum Day Demand	0.80	L/s
Peak Hour Demand	1.76	L/s

FUS - Fire Flow Calculations

As per 2020 Fire Underwriter's Survey Guidelines



Novatech Project #: 118076
 Project Name: 3317 Navan Road
 Date: 6/5/2023
 Input By: Zarak Ali
 Reviewed By: François Thauvette

Legend
 Input by User
 No Information or Input Required

Building Description: Bldg A: 4-Storey, 55-unit Residential Apt.
 Type V - Wood frame

Step	Input		Value Used	Total Fire Flow (L/min)	
Base Fire Flow					
1	Construction Material		Multiplier	1.5	
	Coefficient related to type of construction C	Type V - Wood frame	Yes		1.5
		Type IV - Mass Timber			Varies
		Type III - Ordinary construction			1
		Type II - Non-combustible construction			0.8
Type I - Fire resistive construction (2 hrs)			0.6		
2	Floor Area		5,304	24,000	
	A	Building Footprint (m ²)			1326
		Number of Floors/Storeys			4
		Area of structure considered (m ²)			
F	Base fire flow without reductions		$F = 220 C (A)^{0.5}$		
Reductions or Surcharges					
3	Occupancy hazard reduction or surcharge		FUS Table 3	Reduction/Surcharge	
	(1)	Non-combustible		-25%	
		Limited combustible	Yes	-15%	
		Combustible		0%	
		Free burning		15%	
Rapid burning			25%		
4	Sprinkler Reduction		FUS Table 4	Reduction	
	(2)	Adequately Designed System (NFPA 13)	Yes	-30%	
		Standard Water Supply	Yes	-10%	
		Fully Supervised System	No	-10%	
		Cumulative Sub-Total		-40%	
	Area of Sprinklered Coverage (m ²)	5,304	100%		
		Cumulative Total	-40%		
5	Exposure Surcharge		FUS Table 6	Surcharge	
	(3)	North Side	10.1 - 20 m	11%	
		East Side	10.1 - 20 m	11%	
		South Side	>30m	0%	
		West Side	>30m	0%	
		Cumulative Total	22%		
Results					
6	(1) + (2) + (3)	Total Required Fire Flow, rounded to nearest 1000L/min		L/min	
		(2,000 L/min < Fire Flow < 45,000 L/min)		17,000	
		or		L/s	
		or		283	
				4,491	

Novatech Project #: 118076
 Project Name: 3317 Navan Road
 Date: 6/5/2023
 Input By: Zarak Ali
 Reviewed By: François Thauvette

Building Description: Bldg A: 4-Storey, 55-unit Residential Apt.
Type V - Wood frame
 Automatic Sprinklers Yes

FUS - Table 6 worksheet

To be used only if adjacent *Exposed Building* construction is known



Exposed Building North	
Description/Address	616 Birkhill Place
Height (storeys*)	2
Construction Type	Type V - Wood frame
Protected Openings	No
Length-Height Factor	24.4
Automatic Sprinklers	No
Exposure Surcharge Adjustment	11%

Calculated Exposure Charges	
Table 6	
North Side	11%
East Side	11%
South Side	0%
West Side	0%
Total	22%

Exposed Building West	
Description/Address	3317 Navan Rd Bldg B
Height (storeys*)	4
Construction Type	Type V - Wood frame
Protected Openings	No
Length-Height Factor	272
Automatic Sprinklers	Yes
Exposure Surcharge Adjustment	0%

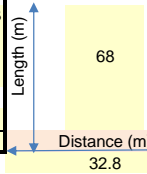

Exposed Building East	
Description/Address	Esselmont (ashcroft)
Height (storeys*)	2
Construction Type	Type V - Wood frame
Protected Openings	No
Length-Height Factor	30
Automatic Sprinklers	No
Exposure Surcharge Adjustment	11%

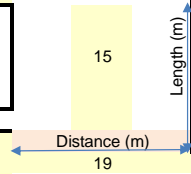

Exposed Building South	
Description/Address	3317 Navan Rd Bldg C
Height (storeys*)	4
Construction Type	Type V - Wood frame
Protected Openings	No
Length-Height Factor	272
Automatic Sprinklers	Yes
Exposure Surcharge Adjustment	0%

* Storey assumption is based on 4m or fraction thereof. Adjust number of storeys for non-standard storey heights (i.e. 10m single storey warehouse)

Source of Information	

Legend Input by User
 No Information or Input Required

FUS - Fire Flow Calculations

As per 2020 Fire Underwriter's Survey Guidelines



Novatech Project #: 118076
 Project Name: 3317 Navan Road
 Date: 6/5/2023
 Input By: Zarak Ali
 Reviewed By: François Thauvette

Legend
 Input by User
 No Information or Input Required

Building Description: Bldg B: 4-Storey, 55-unit Residential Apt.
 Type V - Wood frame

Step	Input		Value Used	Total Fire Flow (L/min)		
Base Fire Flow						
1	C Coefficient related to type of construction	Construction Material	Multiplier	1.5		
		Type V - Wood frame	Yes		1.5	
		Type IV - Mass Timber			Varies	
		Type III - Ordinary construction			1	
		Type II - Non-combustible construction			0.8	
Type I - Fire resistive construction (2 hrs)		0.6				
2	A	Floor Area		5,304		
		Building Footprint (m ²)	1326			
		Number of Floors/Storeys	4			
	F	Base fire flow without reductions		24,000		
Reductions or Surcharges						
3	(1)	Occupancy hazard reduction or surcharge	FUS Table 3	Reduction/Surcharge		
		Non-combustible		-25%		
		Limited combustible	Yes	-15%		
		Combustible		0%		
		Free burning		15%		
Rapid burning		25%				
4	(2)	Sprinkler Reduction	FUS Table 4	Reduction		
		Adequately Designed System (NFPA 13)	Yes	-30%		
		Standard Water Supply	Yes	-10%		
		Fully Supervised System	No	-10%		
		Cumulative Sub-Total		-40%		
Area of Sprinklered Coverage (m ²)	5,304	100%				
Cumulative Total		-40%				
5	(3)	Exposure Surcharge	FUS Table 6	Surcharge		
		North Side	10.1 - 20 m	11%		
		East Side	>30m	0%		
		South Side	10.1 - 20 m	0%		
		West Side	20.1 - 30 m	2%		
Cumulative Total		13%				
Results						
6	(1) + (2) + (3)	Total Required Fire Flow, rounded to nearest 1000L/min		L/min	15,000	
		(2,000 L/min < Fire Flow < 45,000 L/min)		or	L/s	250
				or	USGPM	3,963

Novatech Project #: 118076
 Project Name: 3317 Navan Road
 Date: 6/5/2023
 Input By: Zarak Ali
 Reviewed By: François Thauvette

Building Description: Bldg B: 4-Storey, 55-unit Residential Apt.
 Type V - Wood frame
 Automatic Sprinklers Yes

FUS - Table 6 worksheet

To be used only if adjacent *Exposed Building* construction is known



Exposed Building North	
Description/Address	600 Birkhill Place
Height (storeys*)	2
Construction Type	Type V - Wood frame
Protected Openings	No
Length-Height Factor	28
Automatic Sprinklers	No
Exposure Surcharge Adjustment	11%

Calculated Exposure Charges	
Table 6	
North Side	11%
East Side	0%
South Side	0%
West Side	2%
Total	13%

Exposed Building West	
Description/Address	3253 Navan Rd
Height (storeys*)	2
Construction Type	Type V - Wood frame
Protected Openings	No
Length-Height Factor	32
Automatic Sprinklers	No
Exposure Surcharge Adjustment	2%

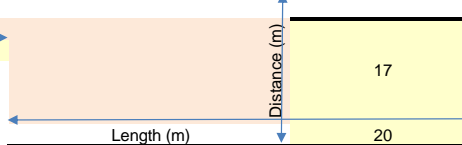
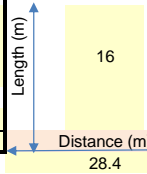

Exposed Building East	
Description/Address	3317 Navan Rd Bldg A
Height (storeys*)	4
Construction Type	Type V - Wood frame
Protected Openings	No
Length-Height Factor	272
Automatic Sprinklers	Yes
Exposure Surcharge Adjustment	0%

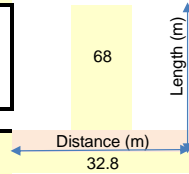

* Storey assumption is based on 4m or fraction thereof. Adjust number of storeys for non-standard storey heights (i.e. 10m single storey warehouse)

Source of Information	

Exposed Building South	
Description/Address	3317 Navan Rd Bldg C
Height (storeys*)	4
Construction Type	Type V - Wood frame
Protected Openings	No
Length-Height Factor	80
Automatic Sprinklers	Yes
Exposure Surcharge Adjustment	0%

(Both bldgs fully sprinklered)

Legend Input by User
 No Information or Input Required

FUS - Fire Flow Calculations

As per 2020 Fire Underwriter's Survey Guidelines



Novatech Project #: 118076
 Project Name: 3317 Navan Road
 Date: 6/5/2023
 Input By: Zarak Ali
 Reviewed By: François Thauvette

Legend
 Input by User
 No Information or Input Required

Building Description: Bldg C: 4-Storey, 54-unit Residential Apt.
 Type V - Wood frame

Step			Input	Value Used		Total Fire Flow (L/min)	
Base Fire Flow							
1	Construction Material			Multiplier			
	Coefficient related to type of construction C	Type V - Wood frame	Yes	1.5	1.5		
		Type IV - Mass Timber		Varies			
		Type III - Ordinary construction		1			
		Type II - Non-combustible construction		0.8			
Type I - Fire resistive construction (2 hrs)			0.6				
2	Floor Area						
	A	Building Footprint (m ²)	1379				
		Number of Floors/Storeys	4				
		Area of structure considered (m ²)			5,516		
F	Base fire flow without reductions			25,000			
	F = 220 C (A)^{0.5}						
Reductions or Surcharges							
3	Occupancy hazard reduction or surcharge			FUS Table 3	Reduction/Surcharge	21,250	
	(1)	Non-combustible		-25%	-15%		
		Limited combustible	Yes	-15%			
		Combustible		0%			
		Free burning		15%			
Rapid burning			25%				
4	Sprinkler Reduction			FUS Table 4	Reduction	-8,500	
	(2)	Adequately Designed System (NFPA 13)	Yes	-30%	-30%		
		Standard Water Supply	Yes	-10%	-10%		
		Fully Supervised System	No	-10%			
		Cumulative Sub-Total			-40%		
		Area of Sprinklered Coverage (m²)	5,516	100%			
Cumulative Total			-40%				
5	Exposure Surcharge			FUS Table 6	Surcharge	0	
	(3)	North Side	10.1 - 20 m		0%		
		East Side	>30m		0%		
		South Side	>30m		0%		
		West Side	>30m		0%		
Cumulative Total				0%			
Results							
6	(1) + (2) + (3)	Total Required Fire Flow, rounded to nearest 1000L/min			L/min	13,000	
		(2,000 L/min < Fire Flow < 45,000 L/min)			or	L/s	217
					or	USGPM	3,435

Novatech Project #: 118076
 Project Name: 3317 Navan Road
 Date: 6/5/2023
 Input By: Zarak Ali
 Reviewed By: François Thauvette

Building Description: Bldg C: 4-Storey, 54-unit Residential Apt.
Type V - Wood frame
 Automatic Sprinklers Yes

FUS - Table 6 worksheet

To be used only if adjacent *Exposed Building* construction is known



Exposed Building North	
Description/Address	3317 Navan Rd Bldg B
Height (storeys*)	4
Construction Type	Type V - Wood frame
Protected Openings	No
Length-Height Factor	80
Automatic Sprinklers	Yes
Exposure Surcharge Adjustment	0%

(Both bldgs fully sprinklered)

Calculated Exposure Charges	
Table 6	
North Side	0%
East Side	0%
South Side	0%
West Side	0%
Total	0%

Exposed Building West	
Description/Address	3270 Navan Rd
Height (storeys*)	1
Construction Type	Type V - Wood frame
Protected Openings	No
Length-Height Factor	13
Automatic Sprinklers	No
Exposure Surcharge Adjustment	0%

Length (m)

13

Distance (m)
>45

Subject Building (Bldg C)

Distance (m)

17

Distance (m)

>45

20

Distance (m)
31

Length (m)

20

Exposed Building South	
Description/Address	3323 Navan Rd
Height (storeys*)	2
Construction Type	Type V - Wood frame
Protected Openings	No
Length-Height Factor	28
Automatic Sprinklers	No
Exposure Surcharge Adjustment	0%

Length (m)

14

* Storey assumption is based on 4m or fraction thereof. Adjust number of stories for non-standard storey heights (i.e. 10m single storey warehouse)

Source of Information	

Legend Input by User
 No Information or Input Required

WATER BOUNDARY CONDITIONS SKETCH 3317 NAVAN ROAD



HYDRANT ID: 382032H106
APPROX. 130m FROM
BUILDING A

THE PROPOSED DEVELOPMENT WILL
INCLUDE PRIVATE HYDRANTS TO
MEET FUS FIREFLOW REQUIREMENTS.

PROPOSED CONNECTION #1
TO EXISTING 305mm WM ON
FUTURE ESSELMONT ST.

PROPOSED CONNECTION #2 TO
EXISTING 305mm WM ON NAVAN RD.

PROP.
HYDRANT

BIRK HILL PL.

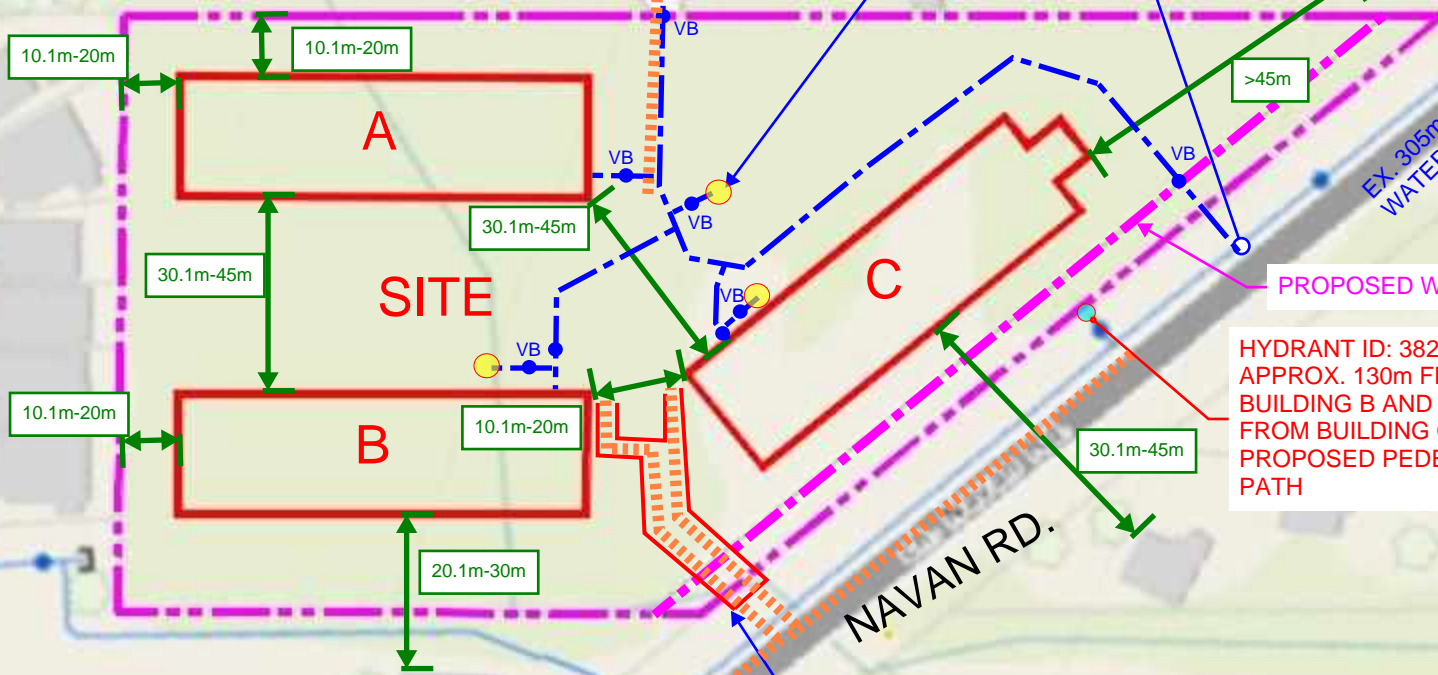

PROPOSED WIDENING

HYDRANT ID: 382032H009
APPROX. 130m FROM
BUILDING B AND 120m
FROM BUILDING C VIA
PROPOSED PEDESTRIAN
PATH

HYDRANT ID: 382032H008
APPROX. 120m FROM
BUILDING B AND 110m FROM
BUILDING C VIA PROPOSED
PEDESTRIAN PATH

PROPOSED PEDESTRIAN PATHWAY
CONNECTION TO NAVAN RD.

Boundary Conditions 3317 Navan Road

Provided Information

Scenario	Demand	
	L/min	L/s
Average Daily Demand	59	0.98
Maximum Daily Demand	146	2.44
Peak Hour	322	5.36
Fire Flow Demand #1	21,000	350.00
Fire Flow Demand #2	10,000	166.67

Location



Results

Connection 1 – Esselmont St.

Demand Scenario	Head (m)	Pressure ¹ (psi)
Maximum HGL	130.6	62.7
Peak Hour	126.6	57.0
Max Day plus Fire Flow #1	109.8	33.1
Max Day plus Fire Flow #2	123.8	52.9

¹ Ground Elevation = 86.6 m

Connection 2 – Navan Rd.

Demand Scenario	Head (m)	Pressure ¹ (psi)
Maximum HGL	130.6	62.7
Peak Hour	126.6	57.0
Max Day plus Fire Flow #1	118.3	45.2
Max Day plus Fire Flow #2	125.9	56.0

¹ Ground Elevation = 86.5 m

Disclaimer

The boundary condition information is based on current operation of the city water distribution system. The computer model simulation is based on the best information available at the time. The operation of the water distribution system can change on a regular basis, resulting in a variation in boundary conditions. The physical properties of watermains deteriorate over time, as such must be assumed in the absence of actual field test data. The variation in physical watermain properties can therefore alter the results of the computer model simulation. Fire Flow analysis is a reflection of available flow in the watermain; there may be additional restrictions that occur between the watermain and the hydrant that the model cannot take into account.

Zarak Ali

From: Polyak, Alex <alex.polyak@ottawa.ca>
Sent: Wednesday, May 24, 2023 9:21 AM
To: Francois Thauvette
Cc: Zarak Ali
Subject: 3317 Navan Road
Attachments: 3317 Navan Road_Boundary Condition(16May2023)_rev1.docx; Water Supply for Public Fire Protection in Canada 2020.pdf

Hello François,

Please see the attached.

The provided max day plus fire results can be interpolated for fires ranging from 10,000 l/min to 21000 l/min and would require several (4+) hydrants to combat the fire and from an asset management perspective. I was informed that this is an unusual request and we ask that you please confirm that the FUS calculations are in accordance with the 2020 FUS Guideline (attached). Also confirm if a construction material with fire resistance can be used to lower the construction coefficient and resultant required fire flow.

Regards,

Oleksandr (Alex) Polyak, B.Eng., P.Eng

Project Manager, Infrastructure Approvals, Development Review East Branch | Gestionnaire de projet, Direction de l'examen des projets d'aménagement – Est.
Planning, Real Estate and Economic Development Department | Direction générale de la planification, des biens immobiliers et du développement économique

City of Ottawa | Ville d'Ottawa
110 Laurier Ave., 4th Fl East, Ottawa ON K1P 1J1
Email: alex.polyak@ottawa.ca
www.Ottawa.ca



This e-mail originates from the City of Ottawa e-mail system. Any distribution, use or copying of this e-mail or the information it contains by other than the intended recipient(s) is unauthorized. Thank you.

Le présent courriel a été expédié par le système de courriels de la Ville d'Ottawa. Toute distribution, utilisation ou reproduction du courriel ou des renseignements qui s'y trouvent par une personne autre que son destinataire prévu est interdite. Je vous remercie de votre collaboration.

Zarak Ali

From: Francois Thauvette
Sent: Monday, May 1, 2023 12:37 PM
To: Polyak, Alex
Cc: Zarak Ali
Subject: FW: 3317 Navan Road - Municipal WM Boundary Conditions Request (118076)
Attachments: 118076-FUS.pdf; 118076-WaterDemands.pdf; WaterBoundaryConditionsSketch.pdf

Hi Alex,

We are sending this e-mail to request municipal watermain boundary conditions for the proposed residential development at 3317 Navan Road. Please see e-mail below and attachments for details.

Regards,

François Thauvette, P. Eng., Sr. Project Manager | Land Development & Public-Sector Engineering

NOVATECH

Engineers, Planners & Landscape Architects

240 Michael Cowpland Drive, Suite 200, Ottawa, ON, K2M 1P6 | T: 613.254.9643 Ext: 219 | C: 613.276.0310

The information contained in this email message is confidential and is for exclusive use of the addressee.

From: Zarak Ali <z.ali@novatech-eng.com>
Sent: Monday, May 1, 2023 11:49 AM
To: Francois Thauvette <f.thauvette@novatech-eng.com>
Subject: 3317 Navan Road - Municipal WM Boundary Conditions Request

Good morning,

We are looking for boundary conditions for the existing watermain infrastructure to complete a water servicing analysis for the 3317 Navan Road development. Please refer to the attached water boundary conditions sketch for the following:

- Existing water infrastructure and our proposed connection locations on Navan Road and the future Esselmont Street,
- Exposure separation distances to support the Fire Flow calculations (Fire flow calculations attached separately), and
- Hydrants that were identified as being considered to meet the required Fire Flow

Water Demands (detailed calculations attached separately) for the proposed development are provided below:

Building A

- Average Day Demand = 0.33 L/s
- Maximum Day Demand = 0.82 L/s
- Peak Hour Demand = 1.80 L/s
- Fire Flow Demand = 333 L/s

Building B

- Average Day Demand = 0.33 L/s

- Maximum Day Demand = 0.82 L/s
- Peak Hour Demand = 1.80 L/s
- Fire Flow Demand = 350 L/s

Building C

- Average Day Demand = 0.32 L/s
- Maximum Day Demand = 0.80 L/s
- Peak Hour Demand = 1.76 L/s
- Fire Flow Demand = 300 L/s

Please let us know if you require any additional information.

Regards,

Zarak Ali, E.I.T. | Land Development Engineering

NOVATECH

Engineers, Planners & Landscape Architects

240 Michael Cowpland Drive, Suite 200, Ottawa, ON, K2M 1P6 | Tel: 613.254.9643 Ext: 330

The information contained in this email message is confidential and is for exclusive use of the addressee.

3317 Navan Rd. - Proposed Residential Development Proposed Watermain Schematic

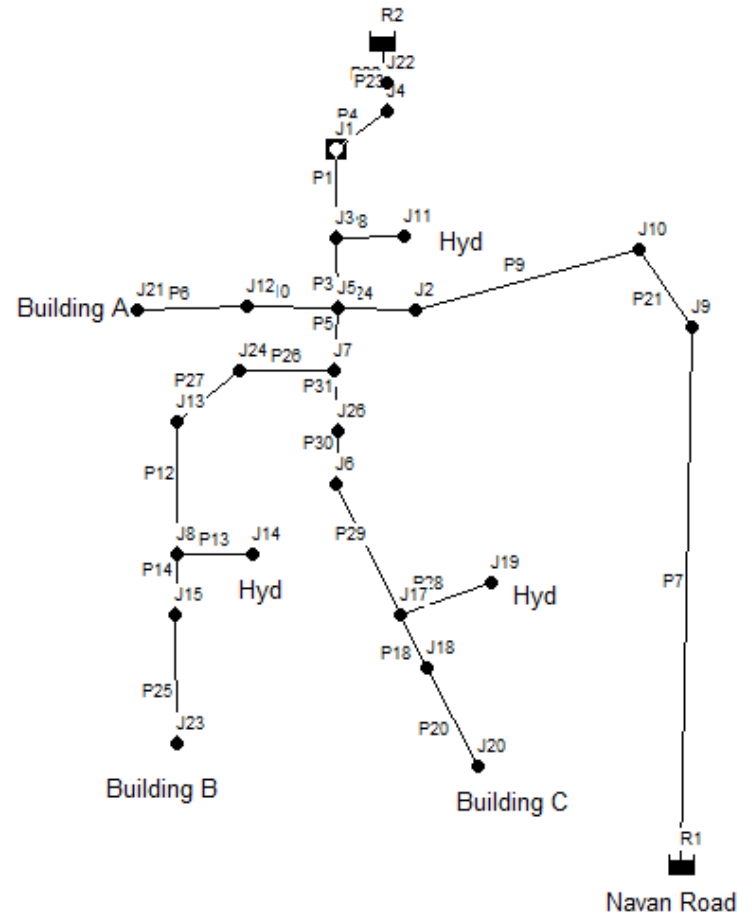

3317 Navan Rd. - Proposed Residential Development Water Model Results

Peak Hour Demand
 Network Table - Nodes

Node ID	Elevation m	Demand L/s	Head m	Pressure m	Pressure kPa	Pressure psi
Junc J1	84	0	126.6	42.6	417.91	60.61
Junc J4	83.9	0	126.6	42.7	418.89	60.75
Junc J3	84.2	0	126.6	42.4	415.94	60.33
Junc J5	84.2	0	126.6	42.4	415.94	60.33
Junc J6	84.3	0	126.6	42.3	414.96	60.19
Junc J7	84.2	0	126.6	42.4	415.94	60.33
Junc J8	84.4	0	126.6	42.2	413.98	60.04
Junc J9	84.2	0	126.6	42.4	415.94	60.33
Junc J2	84.2	0	126.6	42.4	415.94	60.33
Junc J10	84.2	0	126.6	42.4	415.94	60.33
Junc J11	84.2	0	126.6	42.4	415.94	60.33
Junc J12	84.3	0	126.6	42.3	414.96	60.19
Junc J13	84.3	0	126.6	42.3	414.96	60.19
Junc J14	84.4	0	126.6	42.2	413.98	60.04
Junc J15	84.4	0	126.6	42.2	413.98	60.04
Junc J17	84.5	0	126.6	42.1	413.00	59.90
Junc J18	84.5	0	126.6	42.1	413.00	59.90
Junc J19	84.5	0	126.6	42.1	413.00	59.90
Junc J20	84.5	1.8	126.6	42.1	413.00	59.90
Junc J21	84.3	1.8	126.6	42.3	414.96	60.19
Junc J22	83.9	0	126.6	42.7	418.89	60.75
Junc J23	84.6	1.8	126.6	42	412.02	59.76
Junc J24	84.3	0	126.6	42.3	414.96	60.19
Junc J26	84.3	0	126.6	42.3	414.96	60.19
Resvr R1	126.6	-1.86	126.6	0	0.00	0.00
Resvr R2	126.6	-3.54	126.6	0	0.00	0.00

Max= 60.75
 Min= 59.76

Peak Hour Demand
 Network Table - Links

Link ID	Length m	Diameter mm	Roughness	Flow L/s	Velocity m/s	Unit Headloss m/km
Pipe P4	9.2	250	120	-3.54	0.07	0.04
Pipe P1	21.2	250	120	3.54	0.07	0.04
Pipe P3	4.2	250	120	3.54	0.07	0.04
Pipe P5	7.1	250	120	3.6	0.07	0.04
Pipe P7	53.4	250	120	-1.86	0.04	0.01
Pipe P9	41	250	120	-1.86	0.04	0.01
Pipe P8	5.3	150	100	0	0	0
Pipe P10	1.2	150	100	1.8	0.1	0.18
Pipe P12	8.4	200	110	1.8	0.06	0.04
Pipe P13	3.3	150	100	0	0	0
Pipe P14	1	200	110	1.8	0.06	0.04
Pipe P18	1	200	110	1.8	0.06	0.04
Pipe P20	11	150	100	1.8	0.1	0.18
Pipe P21	9.6	250	120	-1.86	0.04	0.01
Pipe P6	6.5	150	100	1.8	0.1	0.18
Pipe P22	1	300	120	3.54	0.05	0.02
Pipe P23	1	250	120	3.54	0.07	0.04
Pipe P24	14.2	250	120	1.86	0.04	0.01
Pipe P25	12.2	150	100	1.8	0.1	0.18
Pipe P26	5.3	200	110	1.8	0.06	0.04
Pipe P27	9.3	200	110	1.8	0.06	0.04
Pipe P28	2.8	150	100	0	0	0
Pipe P29	6.5	200	110	-1.8	0.06	0.04
Pipe P30	6	200	110	-1.8	0.06	0.04
Pipe P31	1	250	120	-1.8	0.04	0.01

3317 Navan Rd. - Proposed Residential Development Water Model Results

Max HGL Demand
 Network Table - Nodes

Node ID	Elevation m	Demand L/s	Head m	Pressure m	Pressure kPa	Pressure psi
Junc J1	84	0	130.6	46.6	457.15	66.30
Junc J4	83.9	0	130.6	46.7	458.13	66.45
Junc J3	84.2	0	130.6	46.4	455.18	66.02
Junc J5	84.2	0	130.6	46.4	455.18	66.02
Junc J6	84.3	0	130.6	46.3	454.20	65.88
Junc J7	84.2	0	130.6	46.4	455.18	66.02
Junc J8	84.4	0	130.6	46.2	453.22	65.73
Junc J9	84.2	0	130.6	46.4	455.18	66.02
Junc J2	84.2	0	130.6	46.4	455.18	66.02
Junc J10	84.2	0	130.6	46.4	455.18	66.02
Junc J11	84.2	0	130.6	46.4	455.18	66.02
Junc J12	84.3	0	130.6	46.3	454.20	65.88
Junc J13	84.3	0	130.6	46.3	454.20	65.88
Junc J14	84.4	0	130.6	46.2	453.22	65.73
Junc J15	84.4	0	130.6	46.2	453.22	65.73
Junc J17	84.5	0	130.6	46.1	452.24	65.59
Junc J18	84.5	0	130.6	46.1	452.24	65.59
Junc J19	84.5	0	130.6	46.1	452.24	65.59
Junc J20	84.5	0.32	130.6	46.1	452.24	65.59
Junc J21	84.3	0.33	130.6	46.3	454.20	65.88
Junc J22	83.9	0	130.6	46.7	458.13	66.45
Junc J23	84.6	0.33	130.6	46	451.26	65.45
Junc J24	84.3	0	130.6	46.3	454.20	65.88
Junc J26	84.3	0	130.6	46.3	454.20	65.88
Resvr R1	130.6	-0.34	130.6	0	0.00	0.00
Resvr R2	130.6	-0.64	130.6	0	0.00	0.00

Max= 66.45
 Min= 65.45

Max HGL Demand
 Network Table - Links

Link ID	Length m	Diameter mm	Roughness	Flow L/s	Velocity m/s	Unit Headloss m/km
Pipe P4	9.2	250	120	-0.64	0.01	0
Pipe P1	21.2	250	120	0.64	0.01	0
Pipe P3	4.2	250	120	0.64	0.01	0
Pipe P5	7.1	250	120	0.65	0.01	0
Pipe P7	53.4	250	120	-0.34	0.01	0
Pipe P9	41	250	120	-0.34	0.01	0
Pipe P8	5.3	150	100	0	0	0
Pipe P10	1.2	150	100	0.33	0.02	0.01
Pipe P12	8.4	200	110	0.33	0.01	0
Pipe P13	3.3	150	100	0	0	0
Pipe P14	1	200	110	0.33	0.01	0.01
Pipe P18	1	200	110	0.32	0.01	0.01
Pipe P20	11	150	100	0.32	0.02	0.01
Pipe P21	9.6	250	120	-0.34	0.01	0
Pipe P6	6.5	150	100	0.33	0.02	0.01
Pipe P22	1	300	120	0.64	0.01	0
Pipe P23	1	250	120	0.64	0.01	0
Pipe P24	14.2	250	120	0.34	0.01	0
Pipe P25	12.2	150	100	0.33	0.02	0.01
Pipe P26	5.3	200	110	0.33	0.01	0
Pipe P27	9.3	200	110	0.33	0.01	0
Pipe P28	2.8	150	100	0	0	0
Pipe P29	6.5	200	110	-0.32	0.01	0
Pipe P30	6	200	110	-0.32	0.01	0
Pipe P31	1	250	120	-0.32	0.01	0

3317 Navan Rd. - Proposed Residential Development Water Model Results

Max Day + Fire Flow Demand
 Network Table - Nodes

Node ID	Elevation m	Demand L/s	Head m	Pressure m	Pressure kPa	Pressure psi
Junc J1	84	0	114.6	30.6	300.19	43.54
Junc J4	83.9	0	114.77	30.87	302.83	43.92
Junc J3	84.2	0	114.21	30.01	294.40	42.70
Junc J5	84.2	0	114.21	30.01	294.40	42.70
Junc J6	84.3	0	113.42	29.12	285.67	41.43
Junc J7	84.2	0	113.78	29.58	290.18	42.09
Junc J8	84.4	0	112.44	28.04	275.07	39.90
Junc J9	84.2	0	117.93	33.73	330.89	47.99
Junc J2	84.2	0	115.03	30.83	302.44	43.87
Junc J10	84.2	0	117.38	33.18	325.50	47.21
Junc J11	84.2	95	112.74	28.54	279.98	40.61
Junc J12	84.3	0	114.21	29.91	293.42	42.56
Junc J13	84.3	0	112.93	28.63	280.86	40.74
Junc J14	84.4	95	111.53	27.13	266.15	38.60
Junc J15	84.4	0	112.44	28.04	275.07	39.90
Junc J17	84.5	0	113.04	28.54	279.98	40.61
Junc J18	84.5	0	113.04	28.54	279.98	40.61
Junc J19	84.5	95	112.26	27.76	272.33	39.50
Junc J20	84.5	0.8	113.04	28.54	279.98	40.61
Junc J21	84.3	0.82	114.21	29.91	293.42	42.56
Junc J22	83.9	0	114.79	30.89	303.03	43.95
Junc J23	84.6	0.82	112.44	27.84	273.11	39.61
Junc J24	84.3	0	113.47	29.17	286.16	41.50
Junc J26	84.3	0	113.77	29.47	289.10	41.93
Resvr R1	121	-186.44	121	0	0.00	0.00
Resvr R2	114.8	-101	114.8	0	0.00	0.00

Max= 47.99
 Min= 38.60

Max Day + Fire Flow Demand
 Network Table - Links

Link ID	Length m	Diameter mm	Roughness	Flow L/s	Velocity m/s	Unit Headloss m/km
Pipe P4	9.2	250	120	-101	2.06	18.45
Pipe P1	21.2	250	120	101	2.06	18.45
Pipe P3	4.2	250	120	6	0.12	0.1
Pipe P5	7.1	250	120	191.62	3.9	60.41
Pipe P7	53.4	250	120	-186.44	3.8	57.42
Pipe P9	41	250	120	-186.44	3.8	57.42
Pipe P8	5.3	150	100	95	5.38	277.99
Pipe P10	1.2	150	100	0.82	0.05	0.04
Pipe P12	8.4	200	110	95.82	3.05	58.31
Pipe P13	3.3	150	100	95	5.38	278
Pipe P14	1	200	110	0.82	0.03	0.01
Pipe P18	1	200	110	0.8	0.03	0.01
Pipe P20	11	150	100	0.8	0.05	0.04
Pipe P21	9.6	250	120	-186.44	3.8	57.42
Pipe P6	6.5	150	100	0.82	0.05	0.04
Pipe P22	1	300	120	101	1.43	7.59
Pipe P23	1	250	120	101	2.06	18.45
Pipe P24	14.2	250	120	186.44	3.8	57.42
Pipe P25	12.2	150	100	0.82	0.05	0.04
Pipe P26	5.3	200	110	95.82	3.05	58.3
Pipe P27	9.3	200	110	95.82	3.05	58.31
Pipe P28	2.8	150	100	-95	5.38	277.99
Pipe P29	6.5	200	110	-95.8	3.05	58.28
Pipe P30	6	200	110	-95.8	3.05	58.28
Pipe P31	1	250	120	-95.8	1.95	16.72

APPENDIX E
IDF Curves, SWM Calculations

APPENDIX 5-A

OTTAWA INTENSITY DURATION FREQUENCY (IDF) CURVE

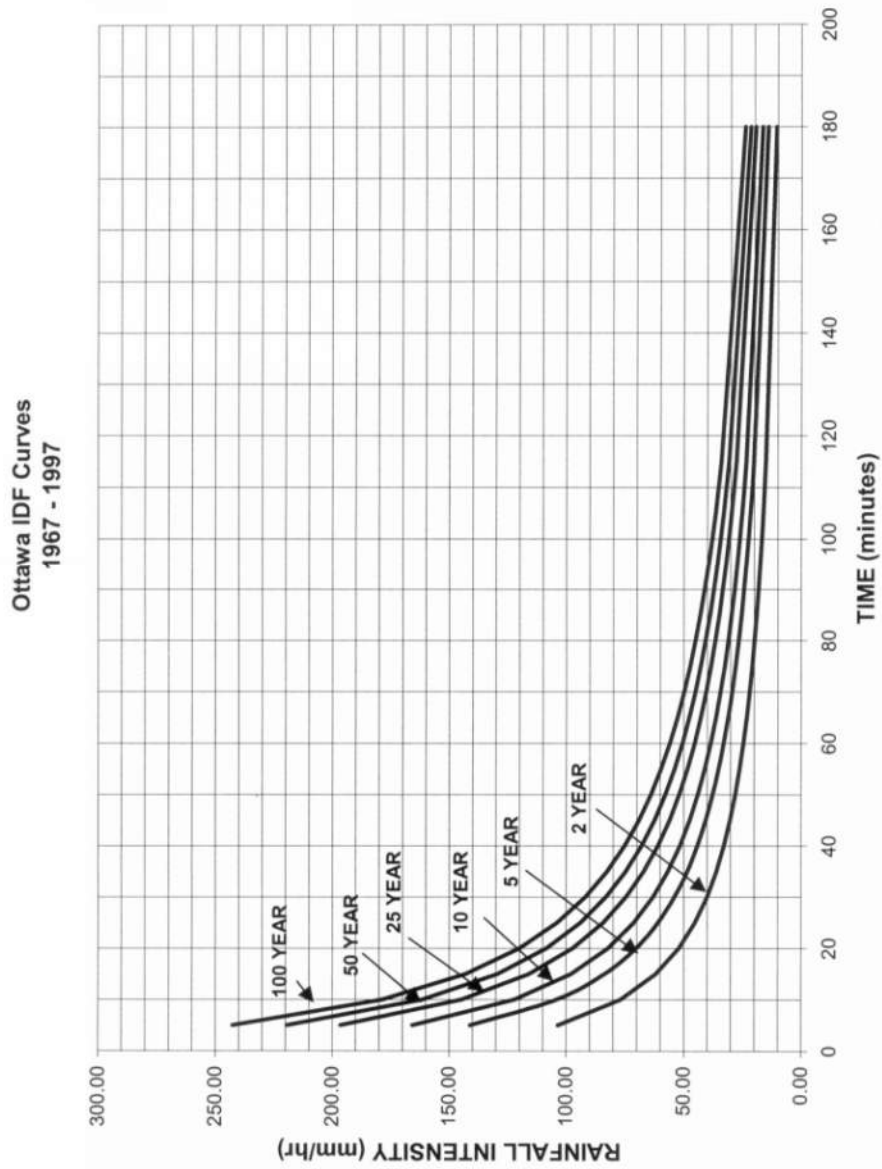

Proposed Residential Development 3317 Navan Road

Pre - Development Stormwater Flows										
Description	Area (ha)	A _{imperv} (ha) C=0.9	A _{gravel} (ha) C=0.7	A _{pervious} (ha) C=0.2	Weighted C _{w5}	Weighted C _{w100}	2-Year Flow (L/s)	5-Year Flow (L/s)	100-Year Flow (L/s)	85 L/s/ha
Subject Site to be Developed	1.482	0.000	0.000	1.482	0.20	0.25	63.3	85.9	184.0	126.0

Qallowable=Lesser of 85 L/s/ha or pre-development uncontrolled flows

T_c = 10mins

Post - Development Stormwater Flows																	
Area	Description	Area (ha)	A _{imp} (ha) C=0.9	A _{perv} (ha) C=0.2	C ₅	C ₁₀₀	Uncontrolled Flow (L/s)			Controlled Flow (L/s)			Storage Required (m ³)			Storage Provided (m ³)	
							2-year	5-year	100-year	2-year	5-year	100-year	2-year	5-year	100-year		
A-1	Direct Runoff to Roadside Ditches	0.330	0.083	0.247	0.38	0.44	26.5	35.9	71.9	-	-	-	-	-	-	-	
A-2	Controlled SWM Pond	0.730	0.423	0.307	0.61	0.68	-	-	-	13.5	16.8	24.3	84.8	116.4	242.9	591.7	
A-3	Uncontrolled Garage Ramp Flows	0.019	0.019	0.000	0.90	1.00	3.7	5.0	9.4	-	-	-	-	-	-	-	
R-1	Controlled Flow Roof Drains (Bldg A)	0.133	0.133	0.000	0.90	1.00	-	-	-	2.9	3.3	3.6	19.3	27.6	62.2	69.9	
R-2	Controlled Flow Roof Drains (Bldg B)	0.133	0.133	0.000	0.90	1.00	-	-	-	2.9	3.3	3.6	19.3	27.6	62.2	69.9	
R-3	Controlled Flow Roof Drains (Bldg C)	0.138	0.138	0.000	0.90	1.00	-	-	-	3.5	4.0	4.5	19.5	28.1	63.3	72.7	
Totals :		1.482	-	-	-	-	30.1	40.9	81.3	22.8	27.3	36.0	142.9	199.8	430.6	804.1	
							Total On-Site Stormwater Flows :			52.9	68.2	117.3					

T_c = 10mins

2.7 Weeping Tile Flow Allowance
 120.0

Proposed Residential Development Novatech Project No. 118076 Uncontrolled Runoff - 1:2 YEAR EVENT AREA A-1 Un-Controlled Runoff to Roadside Ditches				
OTTAWA IDF CURVE				
Area = 0.330 ha		Qallow = 26.5 L/s		
C = 0.38		Vol(max) = 0.0 m3		
Time (min)	Intensity (mm/hr)	Q (L/s)	Qnet (L/s)	Vol (m3)
5	103.57	35.73	9.23	2.77
10	76.81	26.50	0.00	0.00
15	61.77	21.31	-5.19	-4.67
20	52.03	17.95	-8.55	-10.26
25	45.17	15.58	-10.92	-16.37
30	40.04	13.81	-12.68	-22.83
35	36.06	12.44	-14.06	-29.52
40	32.86	11.34	-15.16	-36.38
45	30.24	10.43	-16.07	-43.38
50	28.04	9.67	-16.82	-50.47
55	26.17	9.03	-17.47	-57.65
60	24.56	8.47	-18.03	-64.89
65	23.15	7.99	-18.51	-72.19
70	21.91	7.56	-18.94	-79.54
75	20.81	7.18	-19.32	-86.93
90	18.14	6.26	-20.24	-109.29
105	16.13	5.57	-20.93	-131.87
120	14.56	5.02	-21.47	-154.61
135	13.30	4.59	-21.91	-177.48
150	12.25	4.23	-22.27	-200.44

Proposed Residential Development Novatech Project No. 118076 Uncontrolled Runoff - 1:5 YEAR EVENT AREA A-1 Un-Controlled Runoff to Roadside Ditches				
OTTAWA IDF CURVE				
Area = 0.330 ha		Qallow = 35.9 L/s		
C = 0.38		Vol(max) = 0.0 m3		
Time (min)	Intensity (mm/hr)	Q (L/s)	Qnet (L/s)	Vol (m3)
5	141.18	48.71	12.76	3.83
10	104.19	35.95	0.00	0.00
15	83.56	28.83	-7.12	-6.41
20	70.25	24.24	-11.71	-14.05
25	60.90	21.01	-14.94	-22.41
30	53.93	18.60	-17.34	-31.21
35	48.52	16.74	-19.21	-40.34
40	44.18	15.24	-20.70	-49.69
45	40.63	14.02	-21.93	-59.21
50	37.65	12.99	-22.96	-68.87
55	35.12	12.12	-23.83	-78.64
60	32.94	11.37	-24.58	-88.49
65	31.04	10.71	-25.24	-98.42
70	29.37	10.13	-25.81	-108.42
75	27.89	9.62	-26.32	-118.46
90	24.29	8.38	-27.57	-148.86
105	21.58	7.45	-28.50	-179.55
120	19.47	6.72	-29.23	-210.46
135	17.76	6.13	-29.82	-241.52
150	16.36	5.64	-30.30	-272.71

Proposed Residential Development Novatech Project No. 118076 Uncontrolled Runoff - 1:100 YEAR EVENT AREA A-1 Un-Controlled Runoff to Roadside Ditches				
OTTAWA IDF CURVE				
Area = 0.330 ha		Qallow = 71.9 L/s		
C = 0.44		Vol(max) = 0.0 m3		
Time (min)	Intensity (mm/hr)	Q (L/s)	Qnet (L/s)	Vol (m3)
5	242.70	97.67	25.81	7.74
10	178.56	71.85	0.00	0.00
15	142.89	57.50	-14.35	-12.92
20	119.95	48.27	-23.58	-28.30
25	103.85	41.79	-30.06	-45.10
30	91.87	36.97	-34.88	-62.79
35	82.58	33.23	-38.62	-81.11
40	75.15	30.24	-41.61	-99.87
45	69.05	27.79	-44.07	-118.98
50	63.95	25.74	-46.12	-138.35
55	59.62	23.99	-47.86	-157.94
60	55.89	22.49	-49.36	-177.70
65	52.65	21.19	-50.67	-197.60
70	49.79	20.04	-51.82	-217.63
75	47.26	19.02	-52.84	-237.77
90	41.11	16.54	-55.31	-298.67
105	36.50	14.69	-57.17	-360.15
120	32.89	13.24	-58.62	-422.04
135	30.00	12.07	-59.78	-484.24
150	27.61	11.11	-60.74	-546.68

Proposed Residential Development Novatech Project No. 118076 Uncontrolled Runoff - 1:100 YR + 20% IDF Increase AREA A-1 Un-Controlled Runoff to Roadside Ditches				
OTTAWA IDF CURVE				
Area = 0.330 ha		Qallow = 86.2 L/s		
C = 0.44		Vol(max) = 0.0 m3		
Time (min)	Intensity (mm/hr)	Q (L/s)	Qnet (L/s)	Vol (m3)
5	291.24	117.20	30.97	9.29
10	214.27	86.22	0.00	0.00
15	171.47	69.00	-17.22	-15.50
20	143.94	57.92	-28.30	-33.96
25	124.62	50.15	-36.08	-54.12
30	110.24	44.36	-41.86	-75.35
35	99.09	39.88	-46.35	-97.33
40	90.17	36.29	-49.94	-119.85
45	82.86	33.34	-52.88	-142.78
50	76.74	30.88	-55.34	-166.02
55	71.55	28.79	-57.43	-189.53
60	67.07	26.99	-59.23	-213.24
65	63.18	25.42	-60.80	-237.13
70	59.75	24.04	-62.18	-261.16
75	56.71	22.82	-63.40	-285.32
90	49.33	19.85	-66.37	-358.41
105	43.80	17.62	-68.60	-432.18
120	39.47	15.88	-70.34	-506.44
135	36.00	14.49	-71.74	-581.08
150	33.13	13.33	-72.89	-656.02

Proposed Residential Development Storage Calculations Using Average
 Novatech Project No. 118076 Release Rate Equal to 50% of the Qpeak
REQUIRED STORAGE - 1:2 YEAR EVENT

AREA A-2 Controlled Site Flows + Underground Storage & Pond

OTTAWA IDF CURVE
 Area = 0.730 ha Qpeak = 13.5 L/s
 C = 0.61 Qavg = 6.8 L/s
 Vol(max) = 84.8 m3
 (Vol calculated for Qallow-avg)

Time (min)	Intensity (mm/hr)	Q (L/s)	Qnet (L/s)	Vol (m3)
5	103.57	127.29	120.54	36.16
10	76.81	94.40	87.65	52.59
15	61.77	75.91	69.16	62.25
20	52.03	63.95	57.20	68.64
25	45.17	55.51	48.76	73.14
30	40.04	49.21	42.46	76.44
35	36.06	44.32	37.57	78.89
40	32.86	40.39	33.64	80.74
45	30.24	37.17	30.42	82.12
50	28.04	34.46	27.71	83.14
55	26.17	32.16	25.41	83.87
60	24.56	30.18	23.43	84.36
65	23.15	28.45	21.70	84.64
70	21.91	26.93	20.18	84.76
75	20.81	25.58	18.83	84.74
90	18.14	22.30	15.55	83.96
105	16.13	19.83	13.08	82.40
120	14.56	17.90	11.15	80.26
135	13.30	16.34	9.59	77.69
150	12.25	15.06	8.31	74.77

Proposed Residential Development Storage Calculations Using Average
 Novatech Project No. 118076 Release Rate Equal to 50% of the Qpeak
REQUIRED STORAGE - 1:5 YEAR EVENT

AREA A-2 Controlled Site Flows + Underground Storage & Pond

OTTAWA IDF CURVE
 Area = 0.730 ha Qpeak = 16.8 L/s
 C = 0.61 Qavg = 8.4 L/s
 Vol(max) = 116.4 m3
 (Vol calculated for Qallow-avg)

Time (min)	Intensity (mm/hr)	Q (L/s)	Qnet (L/s)	Vol (m3)
5	141.18	173.51	165.11	49.53
10	104.19	128.06	119.66	71.79
15	83.56	102.69	94.29	84.87
20	70.25	86.34	77.94	93.53
25	60.90	74.84	66.44	99.67
30	53.93	66.28	57.88	104.18
35	48.52	59.63	51.23	107.58
40	44.18	54.30	45.90	110.17
45	40.63	49.93	41.53	112.14
50	37.65	46.28	37.88	113.63
55	35.12	43.17	34.77	114.73
60	32.94	40.49	32.09	115.52
65	31.04	38.15	29.75	116.04
70	29.37	36.10	27.70	116.34
75	27.89	34.28	25.88	116.44
90	24.29	29.85	21.45	115.84
105	21.58	26.53	18.13	114.19
120	19.47	23.93	15.53	111.79
135	17.76	21.83	13.43	108.81
150	16.36	20.11	11.71	105.39

Proposed Residential Development Storage Calculations Using Average
 Novatech Project No. 118076 Release Rate Equal to 50% of the Qpeak
REQUIRED STORAGE - 1:100 YEAR EVENT

AREA A-2 Controlled Site Flows + Underground Storage & Pond

OTTAWA IDF CURVE
 Area = 0.730 ha Qpeak = 24.3 L/s
 C = 0.68 Qavg = 12.2 L/s
 Vol(max) = 242.9 m3
 (Vol calculated for Qallow-avg)

Time (min)	Intensity (mm/hr)	Q (L/s)	Qnet (L/s)	Vol (m3)
5	242.70	337.19	325.04	97.51
10	178.56	248.07	235.92	141.55
15	142.89	198.52	186.37	167.74
20	119.95	166.65	154.50	185.40
25	103.85	144.28	132.13	198.19
30	91.87	127.63	115.48	207.87
35	82.58	114.73	102.58	215.41
40	75.15	104.40	92.25	221.40
45	69.05	95.93	83.78	226.21
50	63.95	88.85	76.70	230.11
55	59.62	82.84	70.69	233.26
60	55.89	77.65	65.50	235.82
65	52.65	73.14	60.99	237.87
70	49.79	69.17	57.02	239.50
75	47.26	65.65	53.50	240.76
90	41.11	57.12	44.97	242.81
105	36.50	50.71	38.56	242.90
120	32.89	45.70	33.55	241.57
135	30.00	41.67	29.52	239.15
150	27.61	38.36	26.21	235.89

Proposed Residential Development Storage Calculations Using Average
 Novatech Project No. 118076 Release Rate Equal to 50% of the Qpeak
REQUIRED STORAGE - 1:100 YR + 20% IDF Increase

AREA A-2 Controlled Site Flows + Underground Storage & Pond

OTTAWA IDF CURVE
 Area = 0.730 ha Qpeak = 26.7 L/s
 C = 0.68 Qavg = 13.4 L/s
 Vol(max) = 299.2 m3
 (Vol calculated for Qallow-avg)

Time (min)	Intensity (mm/hr)	Q (L/s)	Qnet (L/s)	Vol (m3)
5	291.24	404.63	391.28	117.38
10	214.27	297.69	284.34	170.60
15	171.47	238.23	224.88	202.39
20	143.94	199.98	186.63	223.95
25	124.62	173.13	159.78	239.67
30	110.24	153.16	139.81	251.66
35	99.09	137.67	124.32	261.08
40	90.17	125.28	111.93	268.63
45	82.86	115.12	101.77	274.78
50	76.74	106.62	93.27	279.82
55	71.55	99.40	86.05	283.97
60	67.07	93.19	79.84	287.41
65	63.18	87.77	74.42	290.24
70	59.75	83.01	69.66	292.56
75	56.71	78.78	65.43	294.45
90	49.33	68.54	55.19	298.02
105	43.80	60.85	47.50	299.23
120	39.47	54.84	41.49	298.74
135	36.00	50.01	36.66	296.94
150	33.13	46.03	32.68	294.13

Structures	Size (mm)	Area (m²)	T/G	Inv IN	Inv OUT	Structures	Size (mm)	Area (m²)	T/G	Inv IN	Inv OUT
CBMH 104	1200	1.13	86.35	84.44	84.43	CBMH 100	1200	1.13	86.60	84.99	84.96
CBMH 102	1200	1.13	86.40	84.80	84.79						

Area A-2: Storage Table

Elevation (m)	System Depth (m)	CBMH 104 Volume (m³)	CBMH 102 Volume (m³)	CBMH 100 Volume (m³)	Total Volume (m³)	Pipe Volume (m³)	Pond Storage		Total Volume (m³)	Design Head
							Area (m²)	Volume (m³)		
84.43	0.00	-	0.00	0.00	0.00	0.00	0	0	0.00	-
84.50	0.07	0.08	0.00	0.00	0.08	1.00	220.3	0.0	1.08	-0.12
84.70	0.27	0.31	0.00	0.00	0.31	3.00	258.0	47.8	51.14	0.08
84.90	0.47	0.53	0.12	0.00	0.66	6.00	298.5	103.5	110.14	0.28
85.10	0.67	0.76	0.35	0.16	1.27	9.00	341.2	167.5	177.72	0.48
85.30	0.87	0.98	0.58	0.38	1.95	12.00	386.1	240.2	254.13	0.68
85.50	1.07	1.21	0.80	0.61	2.62	17.00	433.4	322.1	341.76	0.88
85.70	1.27	1.44	1.03	0.84	3.30	17.00	483.3	413.8	434.11	1.08
85.90	1.47	1.66	1.26	1.06	3.98	17.00	534.4	515.6	536.56	1.28
86.00	1.57	1.78	1.37	1.18	4.32	17.00	561.7	570.4	591.70	1.38

119mm Dia. Orifice Plug Type ICD

1:100 Yr
 Flow (L/s) = 24.3
 Head (m) = 0.65
 Elevation (m) = **85.27**
 Outlet Pipe Dia.(mm) = 375
 Volume (m3) = 242.9

1:5 Yr
 Flow (L/s) = 16.8
 Head (m) = 0.31
 Elevation (m) = **84.93**
 Outlet Pipe Dia.(mm) = 375
 Volume (m3) = 116.4

1:2 Yr
 Flow (L/s) = 13.5
 Head (m) = 0.20
 Elevation (m) = **84.82**
 Outlet Pipe Dia.(mm) = 375
 Volume (m3) = 84.8

Orifice Size - 1:100 yr Flow Check
 $Q=0.62xAx(2gh)^{0.5}$

Q (m³/s)	1:100 yr	Flow Check
Q (m³/s) =	0.0243	0.0243
g (m/s²) =	9.81	9.81
h (m) =	0.65	0.65

A (m²) =	0.010954053	0.01094
D (m) =	0.118097981	0.11800
D (mm) =	118	118.0

1:5 yr Flow Check

Q (m³/s)	1:5 yr
Q (m³/s) =	0.0168
g (m/s²) =	9.81
h (m) =	0.31

A (m²) =	0.01094
D (m) =	0.118
D (mm) =	118

1:2 yr Flow Check

Q (m³/s)	1:2 yr
Q (m³/s) =	0.0135
g (m/s²) =	9.81
h (m) =	0.20

A (m²) =	0.01094
D (m) =	0.118
D (mm) =	118

PI = 3.141592654
 PIPE I.D. = 380 (Concrete Pipe)
 U/G Storage Pipe Volume
 End Area 0.113 (m²)
 Total Length 149.5 (m)
 Pipe Volume 17.0 (m³)

*CBs, Landscape drains and pipes smaller than 375mm dia. were omitted in calculations as their storage volumes are negligible

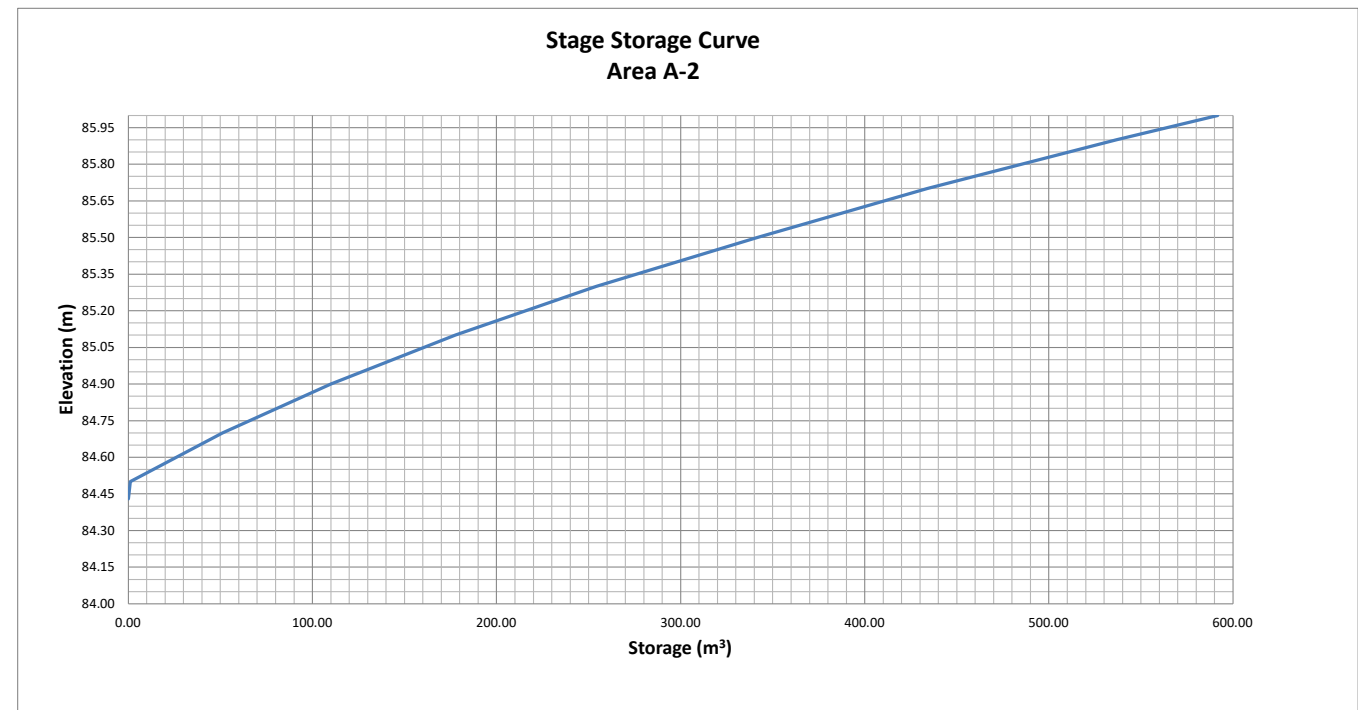

Proposed Residential Development Novatech Project No. 118076 Uncontrolled Runoff - 1:2 YEAR EVENT AREA A-3 Un-Controlled Garage Ramp Flows				
OTTAWA IDF CURVE				
Area = 0.019 ha		Qallow = 3.7 L/s		
C = 0.90		Vol(max) = 0.0 m3		
Time (min)	Intensity (mm/hr)	Q (L/s)	Qnet (L/s)	Vol (m3)
5	103.57	4.92	1.27	0.38
10	76.81	3.65	0.00	0.00
15	61.77	2.94	-0.71	-0.64
20	52.03	2.47	-1.18	-1.41
25	45.17	2.15	-1.50	-2.26
30	40.04	1.90	-1.75	-3.15
35	36.06	1.71	-1.94	-4.07
40	32.86	1.56	-2.09	-5.01
45	30.24	1.44	-2.21	-5.98
50	28.04	1.33	-2.32	-6.95
55	26.17	1.24	-2.41	-7.94
60	24.56	1.17	-2.48	-8.94
65	23.15	1.10	-2.55	-9.95
70	21.91	1.04	-2.61	-10.96
75	20.81	0.99	-2.66	-11.98
90	18.14	0.86	-2.79	-15.06
105	16.13	0.77	-2.88	-18.17
120	14.56	0.69	-2.96	-21.30
135	13.30	0.63	-3.02	-24.45
150	12.25	0.58	-3.07	-27.62

Proposed Residential Development Novatech Project No. 118076 Uncontrolled Runoff - 1:5 YEAR EVENT AREA A-3 Un-Controlled Garage Ramp Flows				
OTTAWA IDF CURVE				
Area = 0.019 ha		Qallow = 5.0 L/s		
C = 0.90		Vol(max) = 0.0 m3		
Time (min)	Intensity (mm/hr)	Q (L/s)	Qnet (L/s)	Vol (m3)
5	141.18	6.71	1.76	0.53
10	104.19	4.95	0.00	0.00
15	83.56	3.97	-0.98	-0.88
20	70.25	3.34	-1.61	-1.94
25	60.90	2.89	-2.06	-3.09
30	53.93	2.56	-2.39	-4.30
35	48.52	2.31	-2.65	-5.56
40	44.18	2.10	-2.85	-6.85
45	40.63	1.93	-3.02	-8.16
50	37.65	1.79	-3.16	-9.49
55	35.12	1.67	-3.28	-10.84
60	32.94	1.57	-3.39	-12.19
65	31.04	1.48	-3.48	-13.56
70	29.37	1.40	-3.56	-14.94
75	27.89	1.33	-3.63	-16.32
90	24.29	1.15	-3.80	-20.51
105	21.58	1.03	-3.93	-24.74
120	19.47	0.93	-4.03	-29.00
135	17.76	0.84	-4.11	-33.28
150	16.36	0.78	-4.18	-37.58

Proposed Residential Development Novatech Project No. 118076 Uncontrolled Runoff - 1:100 YEAR EVENT AREA A-3 Un-Controlled Garage Ramp Flows				
OTTAWA IDF CURVE				
Area = 0.019 ha		Qallow = 9.4 L/s		
C = 1.00		Vol(max) = 0.0 m3		
Time (min)	Intensity (mm/hr)	Q (L/s)	Qnet (L/s)	Vol (m3)
5	242.70	12.82	3.39	1.02
10	178.56	9.43	0.00	0.00
15	142.89	7.55	-1.88	-1.70
20	119.95	6.34	-3.10	-3.71
25	103.85	5.49	-3.95	-5.92
30	91.87	4.85	-4.58	-8.24
35	82.58	4.36	-5.07	-10.65
40	75.15	3.97	-5.46	-13.11
45	69.05	3.65	-5.78	-15.62
50	63.95	3.38	-6.05	-18.16
55	59.62	3.15	-6.28	-20.73
60	55.89	2.95	-6.48	-23.32
65	52.65	2.78	-6.65	-25.94
70	49.79	2.63	-6.80	-28.57
75	47.26	2.50	-6.94	-31.21
90	41.11	2.17	-7.26	-39.20
105	36.50	1.93	-7.50	-47.27
120	32.89	1.74	-7.69	-55.40
135	30.00	1.58	-7.85	-63.56
150	27.61	1.46	-7.97	-71.76

Proposed Residential Development Novatech Project No. 118076 Uncontrolled Runoff - 1:100 YR + 20% IDF Increase AREA A-3 Un-Controlled Garage Ramp Flows				
OTTAWA IDF CURVE				
Area = 0.019 ha		Qallow = 11.3 L/s		
C = 1.00		Vol(max) = 0.0 m3		
Time (min)	Intensity (mm/hr)	Q (L/s)	Qnet (L/s)	Vol (m3)
5	291.24	15.38	4.07	1.22
10	214.27	11.32	0.00	0.00
15	171.47	9.06	-2.26	-2.03
20	143.94	7.60	-3.71	-4.46
25	124.62	6.58	-4.74	-7.10
30	110.24	5.82	-5.49	-9.89
35	99.09	5.23	-6.08	-12.78
40	90.17	4.76	-6.55	-15.73
45	82.86	4.38	-6.94	-18.74
50	76.74	4.05	-7.26	-21.79
55	71.55	3.78	-7.54	-24.88
60	67.07	3.54	-7.77	-27.99
65	63.18	3.34	-7.98	-31.13
70	59.75	3.16	-8.16	-34.28
75	56.71	3.00	-8.32	-37.45
90	49.33	2.61	-8.71	-47.04
105	43.80	2.31	-9.00	-56.73
120	39.47	2.09	-9.23	-66.48
135	36.00	1.90	-9.42	-76.27
150	33.13	1.75	-9.57	-86.11

Proposed Residential Development					
Novatech Project No. 118076					
REQUIRED STORAGE - 1:2 YEAR EVENT					
AREA R-1,2,3 Controlled Roof Drain #1A,1B,1C,4A,4B,4C					
OTTAWA IDF CURVE					
Area =	0.034	ha	Qallow =	0.72	L/s
C =	0.90		Vol(max) =	5.0	m3
Time (min)	Intensity (mm/hr)	Q (L/s)	Qnet (L/s)	Vol (m3)	
5	103.57	8.81	8.09	2.43	
10	76.81	6.53	5.81	3.49	
15	61.77	5.25	4.53	4.08	
20	52.03	4.43	3.71	4.45	
25	45.17	3.84	3.12	4.68	
30	40.04	3.41	2.69	4.84	
35	36.06	3.07	2.35	4.93	
40	32.86	2.80	2.08	4.98	
45	30.24	2.57	1.85	5.00	
50	28.04	2.39	1.67	5.00	
55	26.17	2.23	1.51	4.97	
60	24.56	2.09	1.37	4.93	
65	23.15	1.97	1.25	4.87	
70	21.91	1.86	1.14	4.81	
75	20.81	1.77	1.05	4.73	
90	18.14	1.54	0.82	4.45	
105	16.13	1.37	0.65	4.11	
120	14.56	1.24	0.52	3.74	

Proposed Residential Development					
Novatech Project No. 118076					
REQUIRED STORAGE - 1:5 YEAR EVENT					
AREA R-1,2,3 Controlled Roof Drain #1A,1B,1C,4A,4B,4C					
OTTAWA IDF CURVE					
Area =	0.034	ha	Qallow =	0.82	L/s
C =	0.90		Vol(max) =	7.2	m3
Time (min)	Intensity (mm/hr)	Q (L/s)	Qnet (L/s)	Vol (m3)	
5	141.18	12.01	11.19	3.36	
10	104.19	8.86	8.04	4.83	
15	83.56	7.11	6.29	5.66	
20	70.25	5.98	5.16	6.19	
25	60.90	5.18	4.36	6.54	
30	53.93	4.59	3.77	6.78	
35	48.52	4.13	3.31	6.95	
40	44.18	3.76	2.94	7.05	
45	40.63	3.46	2.64	7.12	
50	37.65	3.20	2.38	7.15	
55	35.12	2.99	2.17	7.15	
60	32.94	2.80	1.98	7.14	
65	31.04	2.64	1.82	7.10	
70	29.37	2.50	1.68	7.05	
75	27.89	2.37	1.55	6.99	
90	24.29	2.07	1.25	6.73	
105	21.58	1.84	1.02	6.40	
120	19.47	1.66	0.84	6.02	

Watts Accutrol Flow Control Roof Drains: RD-100-A-ADJ set to 1/4 Exposed				
Design Event	Flow/Drain (L/s)	Total Flow (L/s)	Storage (m ³)	
			Ponding (cm)	Required / Provided
1:2 Year	0.72	0.72	10	5.0
1:5 Year	0.82	0.82	11	7.2
1:100 Year	0.91	0.91	14	16.1

Roof Drain Storage Table for Area RD 1A,1B,1C,4A,4B,4C		
Elevation	Area RD 1	Total Volume
m	m ²	m ³
0.00	0	0
0.05	37.78	0.9
0.10	151.12	5.7
0.15	340.02	17.9

Stage Storage Curve: Area R-1, R-2, R-3
 Controlled Roof Drain #1A,1B,1C,4A,4B,4C

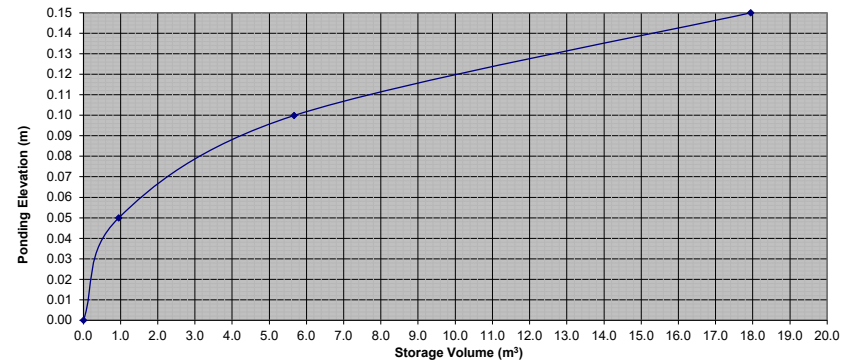

Proposed Residential Development					
Novatech Project No. 118076					
REQUIRED STORAGE - 1:100 YEAR EVENT					
AREA R-1,2,3 Controlled Roof Drain #1A,1B,1C,4A,4B,4C					
OTTAWA IDF CURVE					
Area =	0.034	ha	Qallow =	0.91	L/s
C =	1.00		Vol(max) =	16.1	m3
Time (min)	Intensity (mm/hr)	Q (L/s)	Qnet (L/s)	Vol (m3)	
5	242.70	22.94	22.03	6.61	
10	178.56	16.88	15.97	9.58	
15	142.89	13.51	12.60	11.34	
20	119.95	11.34	10.43	12.51	
25	103.85	9.82	8.91	13.36	
30	91.87	8.68	7.77	13.99	
35	82.58	7.81	6.90	14.48	
40	75.15	7.10	6.19	14.86	
45	69.05	6.53	5.62	15.16	
50	63.95	6.04	5.13	15.40	
55	59.62	5.64	4.73	15.59	
60	55.89	5.28	4.37	15.74	
65	52.65	4.98	4.07	15.86	
70	49.79	4.71	3.80	15.94	
75	47.26	4.47	3.56	16.00	
90	41.11	3.89	2.98	16.07	
105	36.50	3.45	2.54	16.00	
120	32.89	3.11	2.20	15.83	

Proposed Residential Development					
Novatech Project No. 118076					
REQUIRED STORAGE - 1:100 YEAR + 20%					
AREA R-1,2,3 Controlled Roof Drain #1A,1B,1C,4A,4B,4C					
OTTAWA IDF CURVE					
Area =	0.034	ha	Qallow =	0.91	L/s
C =	1.00		Vol(max) =	20.3	m3
Time (min)	Intensity (mm/hr)	Q (L/s)	Qnet (L/s)	Vol (m3)	
5	291.24	27.53	26.62	7.99	
10	214.27	20.25	19.34	11.61	
15	171.47	16.21	15.30	13.77	
20	143.94	13.61	12.70	15.23	
25	124.62	11.78	10.87	16.30	
30	110.24	10.42	9.51	17.12	
35	99.09	9.37	8.46	17.76	
40	90.17	8.52	7.61	18.27	
45	82.86	7.83	6.92	18.69	
50	76.74	7.25	6.34	19.03	
55	71.55	6.76	5.85	19.31	
60	67.07	6.34	5.43	19.55	
65	63.18	5.97	5.06	19.74	
70	59.75	5.65	4.74	19.90	
75	56.71	5.36	4.45	20.02	
90	49.33	4.66	3.75	20.27	
105	43.80	4.14	3.23	20.35	
120	39.47	3.73	2.82	20.31	

Proposed Residential Development					
Novatech Project No. 118076					
REQUIRED STORAGE - 1:2 YEAR EVENT					
AREA R-1,2,3 Controlled Roof Drain #2A,2B,2C,3A,3B,3C					
OTTAWA IDF CURVE					
Area =	0.032	ha	Qallow =	0.72	L/s
C =	0.90		Vol(max) =	4.7	m3
Time (min)	Intensity (mm/hr)	Q (L/s)	Qnet (L/s)	Vol (m3)	
5	103.57	8.37	7.65	2.30	
10	76.81	6.21	5.49	3.29	
15	61.77	4.99	4.27	3.84	
20	52.03	4.20	3.48	4.18	
25	45.17	3.65	2.93	4.40	
30	40.04	3.24	2.52	4.53	
35	36.06	2.91	2.19	4.61	
40	32.86	2.66	1.94	4.65	
45	30.24	2.44	1.72	4.65	
50	28.04	2.27	1.55	4.64	
55	26.17	2.11	1.39	4.60	
60	24.56	1.98	1.26	4.55	
65	23.15	1.87	1.15	4.49	
70	21.91	1.77	1.05	4.41	
75	20.81	1.68	0.96	4.33	
90	18.14	1.47	0.75	4.03	
105	16.13	1.30	0.58	3.68	
120	14.56	1.18	0.46	3.29	

Proposed Residential Development					
Novatech Project No. 118076					
REQUIRED STORAGE - 1:5 YEAR EVENT					
AREA R-1,2,3 Controlled Roof Drain #2A,2B,2C,3A,3B,3C					
OTTAWA IDF CURVE					
Area =	0.032	ha	Qallow =	0.82	L/s
C =	0.90		Vol(max) =	6.7	m3
Time (min)	Intensity (mm/hr)	Q (L/s)	Qnet (L/s)	Vol (m3)	
5	141.18	11.41	10.59	3.18	
10	104.19	8.42	7.60	4.56	
15	83.56	6.75	5.93	5.34	
20	70.25	5.68	4.86	5.83	
25	60.90	4.92	4.10	6.15	
30	53.93	4.36	3.54	6.37	
35	48.52	3.92	3.10	6.51	
40	44.18	3.57	2.75	6.60	
45	40.63	3.28	2.46	6.65	
50	37.65	3.04	2.22	6.67	
55	35.12	2.84	2.02	6.66	
60	32.94	2.66	1.84	6.63	
65	31.04	2.51	1.69	6.59	
70	29.37	2.37	1.55	6.53	
75	27.89	2.25	1.43	6.45	
90	24.29	1.96	1.14	6.17	
105	21.58	1.74	0.92	5.82	
120	19.47	1.57	0.75	5.42	

Watts Accutrol Flow Control Roof Drains:			RD-100-A-ADJ set to 1/4 Exposed		
Design Event	Flow/Drain (L/s)	Total Flow (L/s)	Storage (m ³)		
			Ponding (cm)	Required	Provided
1:2 Year	0.72	0.72	10	4.7	
1:5 Year	0.82	0.82	11	6.7	17.0
1:100 Year	0.91	0.91	14	15.0	

Roof Drain Storage Table for Area RD 2A,2B,2C,3A,3B,3C		
Elevation	Area RD 1	Total Volume
m	m ²	m ³
0.00	0	0
0.05	35.67	0.9
0.10	142.68	5.4
0.15	322.99	17.0

Stage Storage Curve: Area R-1, R-2, R-3
 Controlled Roof Drain #2A,2B,2C,3A,3B,3C

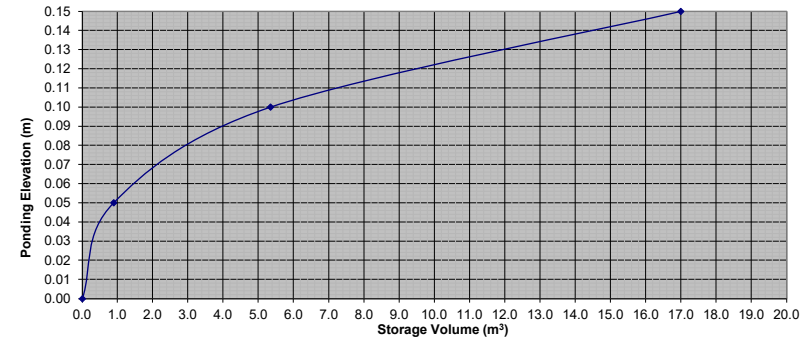

Proposed Residential Development					
Novatech Project No. 118076					
REQUIRED STORAGE - 1:100 YEAR EVENT					
AREA R-1,2,3 Controlled Roof Drain #2A,2B,2C,3A,3B,3C					
OTTAWA IDF CURVE					
Area =	0.032	ha	Qallow =	0.91	L/s
C =	1.00		Vol(max) =	15.0	m3
Time (min)	Intensity (mm/hr)	Q (L/s)	Qnet (L/s)	Vol (m3)	
5	242.70	21.79	20.88	6.27	
10	178.56	16.03	15.12	9.07	
15	142.89	12.83	11.92	10.73	
20	119.95	10.77	9.86	11.83	
25	103.85	9.32	8.41	12.62	
30	91.87	8.25	7.34	13.21	
35	82.58	7.42	6.51	13.66	
40	75.15	6.75	5.84	14.01	
45	69.05	6.20	5.29	14.28	
50	63.95	5.74	4.83	14.50	
55	59.62	5.35	4.44	14.66	
60	55.89	5.02	4.11	14.79	
65	52.65	4.73	3.82	14.89	
70	49.79	4.47	3.56	14.96	
75	47.26	4.24	3.33	15.00	
90	41.11	3.69	2.78	15.02	
105	36.50	3.28	2.37	14.91	
120	32.89	2.95	2.04	14.72	

Proposed Residential Development					
Novatech Project No. 118076					
REQUIRED STORAGE - 1:100 YEAR + 20%					
AREA R-1,2,3 Controlled Roof Drain #2A,2B,2C,3A,3B,3C					
OTTAWA IDF CURVE					
Area =	0.032	ha	Qallow =	0.91	L/s
C =	1.00		Vol(max) =	19.0	m3
Time (min)	Intensity (mm/hr)	Q (L/s)	Qnet (L/s)	Vol (m3)	
5	291.24	26.15	25.24	7.57	
10	214.27	19.24	18.33	11.00	
15	171.47	15.40	14.49	13.04	
20	143.94	12.92	12.01	14.42	
25	124.62	11.19	10.28	15.42	
30	110.24	9.90	8.99	16.18	
35	99.09	8.90	7.99	16.77	
40	90.17	8.10	7.19	17.25	
45	82.86	7.44	6.53	17.63	
50	76.74	6.89	5.98	17.94	
55	71.55	6.42	5.51	18.20	
60	67.07	6.02	5.11	18.41	
65	63.18	5.67	4.76	18.57	
70	59.75	5.36	4.45	18.71	
75	56.71	5.09	4.18	18.82	
90	49.33	4.43	3.52	19.01	
105	43.80	3.93	3.02	19.04	
120	39.47	3.54	2.63	18.97	

Proposed Residential Development					
Novatech Project No. 118076					
REQUIRED STORAGE - 1:2 YEAR EVENT					
AREA R-3 Controlled Roof Drain #5C					
OTTAWA IDF CURVE					
Area =	0.005	ha	Qallow =	0.66	L/s
C =	0.90		Vol(max) =	0.2	m3
Time (min)	Intensity (mm/hr)	Q (L/s)	Qnet (L/s)	Vol (m3)	
5	103.57	1.37	0.71	0.21	
10	76.81	1.02	0.36	0.22	
15	61.77	0.82	0.16	0.14	
20	52.03	0.69	0.03	0.04	
25	45.17	0.60	-0.06	-0.09	
30	40.04	0.53	-0.13	-0.23	
35	36.06	0.48	-0.18	-0.38	
40	32.86	0.44	-0.22	-0.54	
45	30.24	0.40	-0.26	-0.70	
50	28.04	0.37	-0.29	-0.86	
55	26.17	0.35	-0.31	-1.03	
60	24.56	0.33	-0.33	-1.20	
65	23.15	0.31	-0.35	-1.38	
70	21.91	0.29	-0.37	-1.55	
75	20.81	0.28	-0.38	-1.73	
90	18.14	0.24	-0.42	-2.26	
105	16.13	0.21	-0.45	-2.81	
120	14.56	0.19	-0.47	-3.36	

Proposed Residential Development					
Novatech Project No. 118076					
REQUIRED STORAGE - 1:5 YEAR EVENT					
AREA R-3 Controlled Roof Drain #5C					
OTTAWA IDF CURVE					
Area =	0.005	ha	Qallow =	0.69	L/s
C =	0.90		Vol(max) =	0.4	m3
Time (min)	Intensity (mm/hr)	Q (L/s)	Qnet (L/s)	Vol (m3)	
5	141.18	1.87	1.18	0.35	
10	104.19	1.38	0.69	0.41	
15	83.56	1.11	0.42	0.38	
20	70.25	0.93	0.24	0.29	
25	60.90	0.81	0.12	0.18	
30	53.93	0.72	0.03	0.05	
35	48.52	0.64	-0.05	-0.10	
40	44.18	0.59	-0.10	-0.25	
45	40.63	0.54	-0.15	-0.41	
50	37.65	0.50	-0.19	-0.57	
55	35.12	0.47	-0.22	-0.74	
60	32.94	0.44	-0.25	-0.91	
65	31.04	0.41	-0.28	-1.09	
70	29.37	0.39	-0.30	-1.26	
75	27.89	0.37	-0.32	-1.44	
90	24.29	0.32	-0.37	-1.99	
105	21.58	0.29	-0.40	-2.54	
120	19.47	0.26	-0.43	-3.11	

Watts Accutrol Flow Control Roof Drains: RD-100-A-ADJ set to 1/4 Exposed					
Design Event	Flow/Drain (L/s)	Total Flow (L/s)	Ponding (cm)	Storage (m ³)	
				Required	Provided
1:2 Year	0.66	0.66	6	0.2	
1:5 Year	0.69	0.69	7	0.4	2.8
1:100 Year	0.82	0.82	11	1.2	

Roof Drain Storage Table for Area RD 5C		
Elevation	Area RD 1	Total Volume
m	m ²	m ³
0.00	0	0
0.05	5.9	0.1
0.10	23.61	0.9
0.15	53.12	2.8

Stage Storage Curve: Area R-3
 Controlled Roof Drain #5C

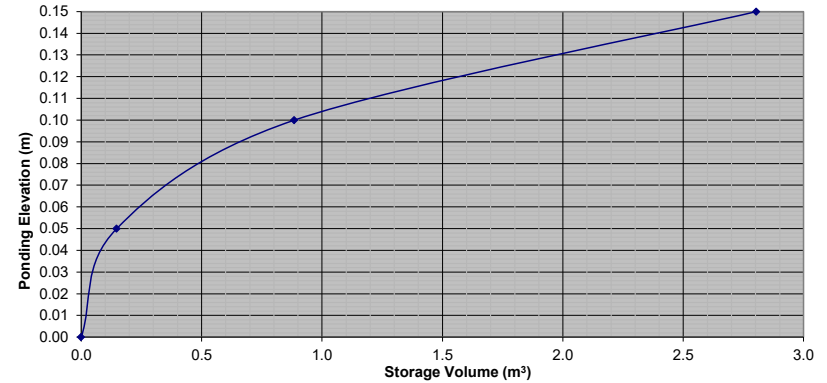

Proposed Residential Development					
Novatech Project No. 118076					
REQUIRED STORAGE - 1:100 YEAR EVENT					
AREA R-3 Controlled Roof Drain #5C					
OTTAWA IDF CURVE					
Area =	0.005	ha	Qallow =	0.82	L/s
C =	1.00		Vol(max) =	1.2	m3
Time (min)	Intensity (mm/hr)	Q (L/s)	Qnet (L/s)	Vol (m3)	
5	242.70	3.58	2.76	0.83	
10	178.56	2.63	1.81	1.09	
15	142.89	2.11	1.29	1.16	
20	119.95	1.77	0.95	1.14	
25	103.85	1.53	0.71	1.07	
30	91.87	1.35	0.53	0.96	
35	82.58	1.22	0.40	0.83	
40	75.15	1.11	0.29	0.69	
45	69.05	1.02	0.20	0.53	
50	63.95	0.94	0.12	0.37	
55	59.62	0.88	0.06	0.19	
60	55.89	0.82	0.00	0.01	
65	52.65	0.78	-0.04	-0.17	
70	49.79	0.73	-0.09	-0.36	
75	47.26	0.70	-0.12	-0.56	
90	41.11	0.61	-0.21	-1.16	
105	36.50	0.54	-0.28	-1.78	
120	32.89	0.48	-0.34	-2.41	

Proposed Residential Development					
Novatech Project No. 118076					
REQUIRED STORAGE - 1:100 YEAR + 20%					
AREA R-3 Controlled Roof Drain #5C					
OTTAWA IDF CURVE					
Area =	0.005	ha	Qallow =	0.82	L/s
C =	1.00		Vol(max) =	1.6	m3
Time (min)	Intensity (mm/hr)	Q (L/s)	Qnet (L/s)	Vol (m3)	
5	291.24	4.29	3.47	1.04	
10	214.27	3.16	2.34	1.40	
15	171.47	2.53	1.71	1.54	
20	143.94	2.12	1.30	1.56	
25	124.62	1.84	1.02	1.52	
30	110.24	1.62	0.80	1.45	
35	99.09	1.46	0.64	1.34	
40	90.17	1.33	0.51	1.22	
45	82.86	1.22	0.40	1.08	
50	76.74	1.13	0.31	0.93	
55	71.55	1.05	0.23	0.77	
60	67.07	0.99	0.17	0.61	
65	63.18	0.93	0.11	0.43	
70	59.75	0.88	0.06	0.25	
75	56.71	0.84	0.02	0.07	
90	49.33	0.73	-0.09	-0.50	
105	43.80	0.65	-0.17	-1.10	
120	39.47	0.58	-0.24	-1.72	

Proposed Residential Development Novatech Project No. 118076 Uncontrolled Runoff - 1:2 YEAR EVENT CDS TRIB AREA TO CDS				
OTTAWA IDF CURVE				
Area = 0.572 ha		Qallow = 87.9 L/s		
C = 0.72		Vol(max) = 0.0 m3		
Time (min)	Intensity (mm/hr)	Q (L/s)	Qnet (L/s)	Vol (m3)
5	103.57	118.58	30.65	9.19
10	76.81	87.94	0.00	0.00
15	61.77	70.72	-17.22	-15.50
20	52.03	59.57	-28.36	-34.04
25	45.17	51.71	-36.22	-54.33
30	40.04	45.85	-42.09	-75.76
35	36.06	41.28	-46.65	-97.97
40	32.86	37.63	-50.31	-120.74
45	30.24	34.62	-53.31	-143.95
50	28.04	32.10	-55.83	-167.49
55	26.17	29.96	-57.97	-191.31
60	24.56	28.12	-59.82	-215.35
65	23.15	26.51	-61.43	-239.57
70	21.91	25.09	-62.85	-263.96
75	20.81	23.83	-64.11	-288.48
90	18.14	20.77	-67.16	-362.68
105	16.13	18.47	-69.46	-437.62
120	14.56	16.67	-71.26	-513.09
135	13.30	15.22	-72.71	-588.97
150	12.25	14.03	-73.91	-665.17

Proposed Residential Development Novatech Project No. 118076 Uncontrolled Runoff - 1:5 YEAR EVENT CDS TRIB AREA TO CDS				
OTTAWA IDF CURVE				
Area = 0.572 ha		Qallow = 119.3 L/s		
C = 0.72		Vol(max) = 0.0 m3		
Time (min)	Intensity (mm/hr)	Q (L/s)	Qnet (L/s)	Vol (m3)
5	141.18	161.64	42.35	12.70
10	104.19	119.29	0.00	0.00
15	83.56	95.67	-23.63	-21.26
20	70.25	80.43	-38.86	-46.63
25	60.90	69.72	-49.57	-74.36
30	53.93	61.74	-57.55	-103.59
35	48.52	55.55	-63.74	-133.86
40	44.18	50.59	-68.70	-164.89
45	40.63	46.52	-72.78	-196.49
50	37.65	43.11	-76.18	-228.55
55	35.12	40.21	-79.08	-260.96
60	32.94	37.72	-81.57	-293.67
65	31.04	35.54	-83.75	-326.62
70	29.37	33.63	-85.66	-359.79
75	27.89	31.93	-87.36	-393.13
90	24.29	27.81	-91.48	-494.01
105	21.58	24.71	-94.58	-595.87
120	19.47	22.29	-97.00	-698.43
135	17.76	20.34	-98.95	-801.52
150	16.36	18.73	-100.56	-905.03

Proposed Residential Development Novatech Project No. 118076 Uncontrolled Runoff - 1:100 YEAR EVENT CDS TRIB AREA TO CDS				
OTTAWA IDF CURVE				
Area = 0.572 ha		Qallow = 230.0 L/s		
C = 0.81		Vol(max) = 0.0 m3		
Time (min)	Intensity (mm/hr)	Q (L/s)	Qnet (L/s)	Vol (m3)
5	242.70	312.61	82.62	24.79
10	178.56	229.99	0.00	0.00
15	142.89	184.05	-45.94	-41.34
20	119.95	154.50	-75.49	-90.59
25	103.85	133.76	-96.23	-144.35
30	91.87	118.33	-111.66	-200.99
35	82.58	106.36	-123.63	-259.61
40	75.15	96.79	-133.20	-319.68
45	69.05	88.94	-141.05	-380.84
50	63.95	82.37	-147.61	-442.84
55	59.62	76.80	-153.19	-505.53
60	55.89	71.99	-158.00	-568.78
65	52.65	67.81	-162.18	-632.50
70	49.79	64.13	-165.86	-696.61
75	47.26	60.87	-169.12	-761.05
90	41.11	52.95	-177.04	-956.00
105	36.50	47.01	-182.98	-1152.77
120	32.89	42.37	-187.62	-1350.86
135	30.00	38.64	-191.35	-1549.95
150	27.61	35.56	-194.43	-1749.83

Proposed Residential Development Novatech Project No. 118076 Uncontrolled Runoff - 1:100 YR + 20% IDF Increase CDS TRIB AREA TO CDS				
OTTAWA IDF CURVE				
Area = 0.572 ha		Qallow = 276.0 L/s		
C = 0.81		Vol(max) = 0.0 m3		
Time (min)	Intensity (mm/hr)	Q (L/s)	Qnet (L/s)	Vol (m3)
5	291.24	375.13	99.14	29.74
10	214.27	275.99	0.00	0.00
15	171.47	220.86	-55.12	-49.61
20	143.94	185.40	-90.59	-108.71
25	124.62	160.51	-115.48	-173.22
30	110.24	141.99	-133.99	-241.19
35	99.09	127.64	-148.35	-311.54
40	90.17	116.15	-159.84	-383.62
45	82.86	106.73	-169.26	-457.00
50	76.74	98.85	-177.14	-531.41
55	71.55	92.16	-183.83	-606.64
60	67.07	86.39	-189.59	-682.54
65	63.18	81.37	-194.61	-759.00
70	59.75	76.96	-199.03	-835.93
75	56.71	73.04	-202.95	-913.26
90	49.33	63.54	-212.44	-1147.20
105	43.80	56.41	-219.58	-1383.33
120	39.47	50.84	-225.14	-1621.03
135	36.00	46.36	-229.62	-1859.95
150	33.13	42.68	-233.31	-2099.80

APPENDIX F

Control Flow Roof Drain Information



Adjustable Accutrol Weir
 Tag: RD-100-A-ADJ

**Adjustable Flow Control
 for Roof Drains**

ADJUSTABLE ACCUTROL (for Large Sump Roof Drains only)

For more flexibility in controlling flow with heads deeper than 2", Watts Drainage offers the Adjustable Accutrol. The Adjustable Accutrol Weir is designed with a single parabolic opening that can be covered to restrict flow above 2" of head to less than 5 gpm per inch, up to 6" of head. To adjust the flow rate for depths over 2" of head, set the slot in the adjustable upper cone according to the flow rate required. Refer to Table 1 below.
 Note: Flow rates are directly proportional to the amount of weir opening that is exposed.

EXAMPLE:

For example, if the adjustable upper cone is set to cover 1/2 of the weir opening, flow rates above 2" of head will be restricted to 2-1/2 gpm per inch of head.

Therefore, at 3" of head, the flow rate through the Accutrol Weir that has 1/2 the slot exposed will be:
 [5 gpm (per inch of head) x 2 inches of head] + 2-1/2 gpm (for the third inch of head) = 12-1/2 gpm.

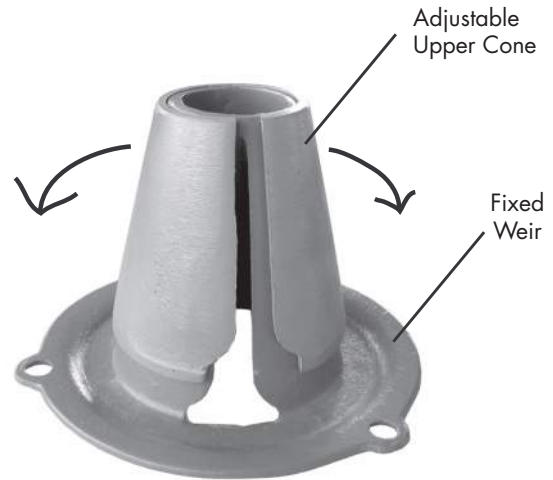
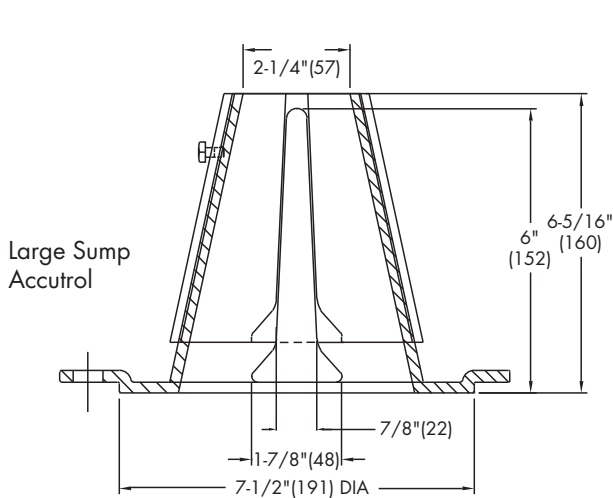

1/2 Weir Opening Exposed Shown Above

TABLE 1. Adjustable Accutrol Flow Rate Settings

Weir Opening Exposed	1"	2"	3"	4"	5"	6"
	Flow Rate (gallons per minute)					
Fully Exposed	5	10	15	20	25	30
3/4	5	10	13.75	17.5	21.25	25
1/2	5	10	12.5	15	17.5	20
1/4	5	10	11.25	12.5	13.75	15
Closed	5	5	5	5	5	5

Job Name _____
 Job Location _____
 Engineer _____

Contractor _____
 Contractor's P.O. No. _____
 Representative _____

Watts product specifications in U.S. customary units and metric are approximate and are provided for reference only. For precise measurements, please contact Watts Technical Service. Watts reserves the right to change or modify product design, construction, specifications, or materials without prior notice and without incurring any obligation to make such changes and modifications on Watts products previously or subsequently sold.

USA: Tel: (800) 338-2581 • Fax: (828) 248-3929 • Watts.com
 Canada: Tel: (905) 332-4090 • Fax: (905) 332-7068 • Watts.ca
 Latin America: Tel: (52) 81-1001-8600 • Fax: (52) 81-8000-7091 • Watts.com



APPENDIX G
Water Quality Treatment Unit
Information



**CDS ESTIMATED NET ANNUAL SOLIDS LOAD REDUCTION
BASED ON THE RATIONAL RAINFALL METHOD
BASED ON A FINE PARTICLE SIZE DISTRIBUTION**



Project Name: 3317 Navan Road
Location: Ottawa, On
OGS #: 1

Engineer: Novatech
Contact: Zarak Ali, E.I.T.
Report Date: 29-May-23

Area 0.572 ha
Weighted C 0.72
CDS Model 2015-4

Rainfall Station # 215
Particle Size Distribution FINE
CDS Treatment Capacity 20 l/s

<u>Rainfall Intensity¹</u> <u>(mm/hr)</u>	<u>Percent Rainfall Volume¹</u>	<u>Cumulative Rainfall Volume</u>	<u>Total Flowrate (l/s)</u>	<u>Treated Flowrate (l/s)</u>	<u>Operating Rate (%)</u>	<u>Removal Efficiency (%)</u>	<u>Incremental Removal (%)</u>
1.0	10.6%	19.8%	1.1	1.1	5.8	97.2	10.3
1.5	9.9%	29.7%	1.7	1.7	8.7	96.4	9.5
2.0	8.4%	38.1%	2.3	2.3	11.6	95.5	8.0
2.5	7.7%	45.8%	2.9	2.9	14.4	94.7	7.3
3.0	5.9%	51.7%	3.4	3.4	17.3	93.9	5.6
3.5	4.4%	56.1%	4.0	4.0	20.2	93.1	4.1
4.0	4.7%	60.7%	4.6	4.6	23.1	92.2	4.3
4.5	3.3%	64.0%	5.2	5.2	26.0	91.4	3.0
5.0	3.0%	67.1%	5.7	5.7	28.9	90.6	2.7
6.0	5.4%	72.4%	6.9	6.9	34.7	88.9	4.8
7.0	4.4%	76.8%	8.0	8.0	40.4	87.3	3.8
8.0	3.5%	80.3%	9.2	9.2	46.2	85.6	3.0
9.0	2.8%	83.2%	10.3	10.3	52.0	84.0	2.4
10.0	2.2%	85.3%	11.4	11.4	57.8	82.3	1.8
15.0	7.0%	92.3%	17.2	17.2	86.6	74.0	5.2
20.0	4.5%	96.9%	22.9	19.8	100.0	60.8	2.8
25.0	1.4%	98.3%	28.6	19.8	100.0	48.6	0.7
30.0	0.7%	99.0%	34.3	19.8	100.0	40.5	0.3
35.0	0.5%	99.5%	40.1	19.8	100.0	34.7	0.2
40.0	0.5%	100.0%	45.8	19.8	100.0	30.4	0.2
45.0	0.0%	100.0%	51.5	19.8	100.0	27.0	0.0
50.0	0.0%	100.0%	57.2	19.8	100.0	24.3	0.0

88.9

Removal Efficiency Adjustment² = 6.5%

Predicted Net Annual Load Removal Efficiency = 82.4%

Predicted Annual Rainfall Treated = 97.6%

1 - Based on 42 years of hourly rainfall data from Canadian Station 6105976, Ottawa ON

2 - Reduction due to use of 60-minute data for a site that has a time of concentration less than 30-minutes.

3 - CDS Efficiency based on testing conducted at the University of Central Florida

4 - CDS design flowrate and scaling based on standard manufacturer model & product specifications

CDS PMSU2015-4-C DESIGN NOTES

THE STANDARD CDS PMSU2015-4-C CONFIGURATION IS SHOWN. ALTERNATE CONFIGURATIONS ARE AVAILABLE AND ARE LISTED BELOW. SOME CONFIGURATIONS MAY BE COMBINED TO SUIT SITE REQUIREMENTS.

CONFIGURATION DESCRIPTION

- GRATED INLET ONLY (NO INLET PIPE)
- GRATED INLET WITH INLET PIPE OR PIPES
- CURB INLET ONLY (NO INLET PIPE)
- CURB INLET WITH INLET PIPE OR PIPES
- CUSTOMIZABLE SUMP DEPTH AVAILABLE
- ANTI-FLOTATION DESIGN AVAILABLE UPON REQUEST

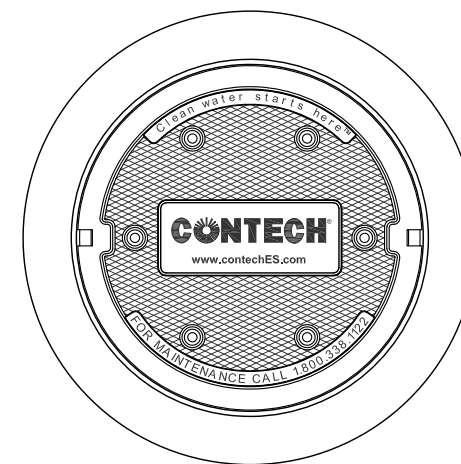
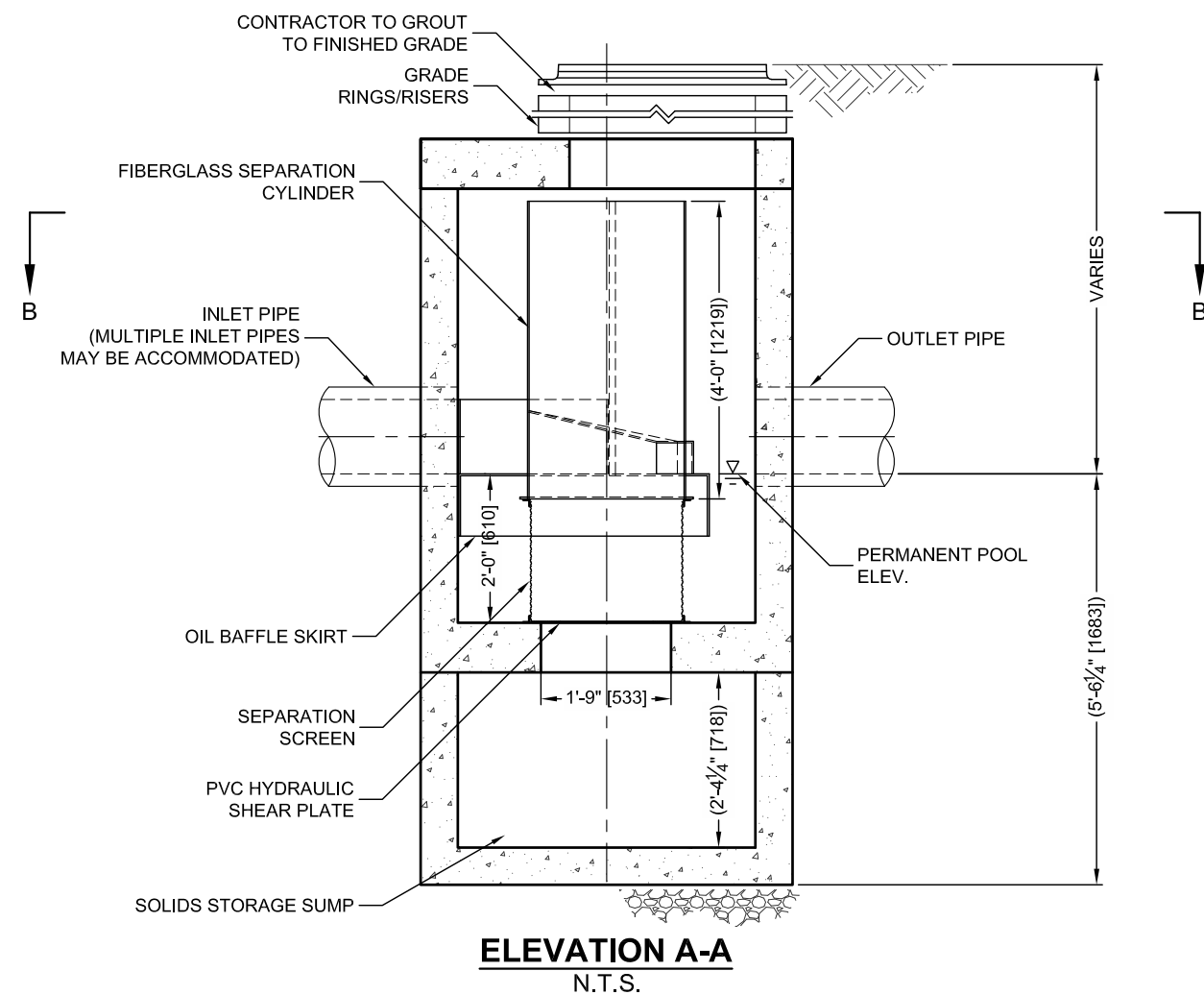
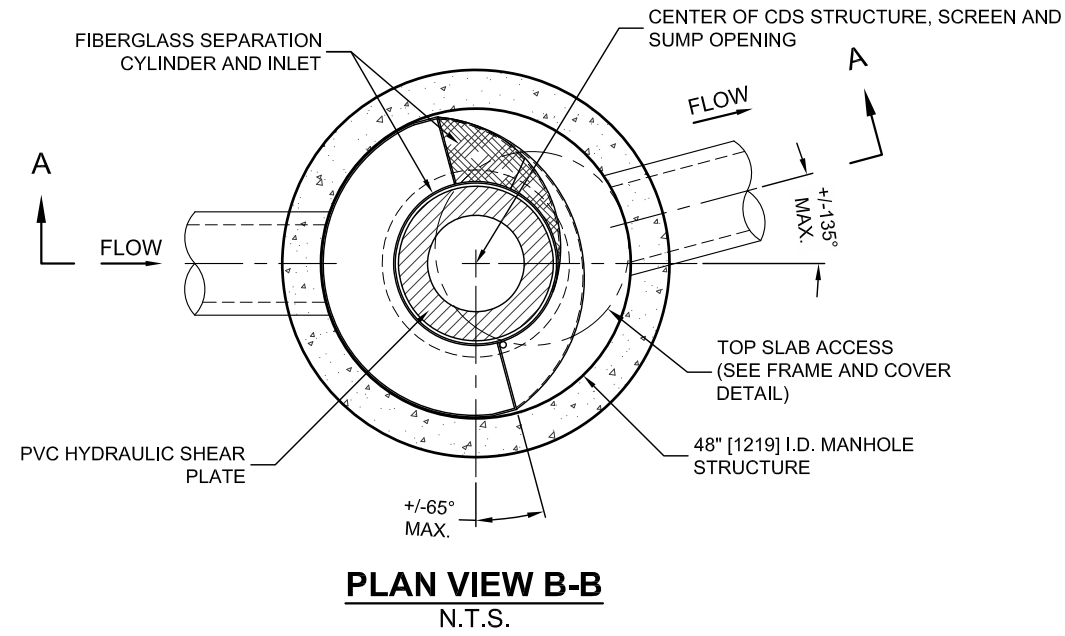

SITE SPECIFIC DATA REQUIREMENTS

STRUCTURE ID				
WATER QUALITY FLOW RATE (CFS OR L/s)				*
PEAK FLOW RATE (CFS OR L/s)				*
RETURN PERIOD OF PEAK FLOW (YRS)				*
SCREEN APERTURE (2400 OR 4700)				*
PIPE DATA:	I.E.	MATERIAL	DIAMETER	
INLET PIPE 1	*	*	*	
INLET PIPE 2	*	*	*	
OUTLET PIPE	*	*	*	
RIM ELEVATION				*
ANTI-FLOTATION BALLAST	*	*	*	*
NOTES/SPECIAL REQUIREMENTS:				
* PER ENGINEER OF RECORD				

GENERAL NOTES

1. CONTECH TO PROVIDE ALL MATERIALS UNLESS NOTED OTHERWISE.
2. DIMENSIONS MARKED WITH () ARE REFERENCE DIMENSIONS. ACTUAL DIMENSIONS MAY VARY.
3. FOR FABRICATION DRAWINGS WITH DETAILED STRUCTURE DIMENSIONS AND WEIGHTS, PLEASE CONTACT YOUR CONTECH ENGINEERED SOLUTIONS LLC REPRESENTATIVE. www.contechES.com
4. CDS WATER QUALITY STRUCTURE SHALL BE IN ACCORDANCE WITH ALL DESIGN DATA AND INFORMATION CONTAINED IN THIS DRAWING.
5. STRUCTURE SHALL MEET AASHTO HS20 AND CASTINGS SHALL MEET HS20 (AASHTO M 306) LOAD RATING, ASSUMING GROUNDWATER ELEVATION AT, OR BELOW, THE OUTLET PIPE INVERT ELEVATION. ENGINEER OF RECORD TO CONFIRM ACTUAL GROUNDWATER ELEVATION.
6. PVC HYDRAULIC SHEAR PLATE IS PLACED ON SHELF AT BOTTOM OF SCREEN CYLINDER. REMOVE AND REPLACE AS NECESSARY DURING MAINTENANCE CLEANING.

INSTALLATION NOTES

- A. ANY SUB-BASE, BACKFILL DEPTH, AND/OR ANTI-FLOTATION PROVISIONS ARE SITE-SPECIFIC DESIGN CONSIDERATIONS AND SHALL BE SPECIFIED BY ENGINEER OF RECORD.
- B. CONTRACTOR TO PROVIDE EQUIPMENT WITH SUFFICIENT LIFTING AND REACH CAPACITY TO LIFT AND SET THE CDS MANHOLE STRUCTURE (LIFTING CLUTCHES PROVIDED).
- C. CONTRACTOR TO ADD JOINT SEALANT BETWEEN ALL STRUCTURE SECTIONS, AND ASSEMBLE STRUCTURE.
- D. CONTRACTOR TO PROVIDE, INSTALL, AND GROUT PIPES. MATCH PIPE INVERTS WITH ELEVATIONS SHOWN.
- E. CONTRACTOR TO TAKE APPROPRIATE MEASURES TO ASSURE UNIT IS WATER TIGHT, HOLDING WATER TO FLOWLINE INVERT MINIMUM. IT IS SUGGESTED THAT ALL JOINTS BELOW PIPE INVERTS ARE GROUTED.

CONTECH
ENGINEERED SOLUTIONS LLC

www.contechES.com
9025 Centre Pointe Dr., Suite 400, West Chester, OH 45069
800-338-1122 513-645-7000 513-645-7993 FAX

CDS PMSU2015-4-C
INLINE CDS
STANDARD DETAIL



THIS PRODUCT MAY BE PROTECTED BY ONE OR MORE OF THE FOLLOWING U.S. PATENTS: 6,788,848; 6,841,722; 6,911,502; 6,981,783; RELATED FOREIGN PATENTS, OR OTHER PATENTS PENDING.

Zarak Ali

From: Patrick <patrick@echelonenvironmental.ca>
Sent: Monday, May 29, 2023 2:51 PM
To: Zarak Ali
Cc: Francois Thauvette
Subject: RE: CDS Sizing Request - 3317 Navan Road Residential Development in Ottawa (118076)
Attachments: CDS TSSR - 3317 Navan Road - PMSU 2015_4 .pdf

Good afternoon Zarak,

Thank you for reaching out to me for a CDS design. Attached you will find our CDS TSS calculation and sample drawing for your reference. Below is the relevant unit information for your files. For this project I recommend a CDS PMSU 2015_4 which has a treatment flow rate of 20 L/s and an approximate budget price of \$18,500. If you have any questions feel free to call me on my cell phone.

- % of net annual TSS removal – See report
- % of net annual treatment volume for the tributary area – See report
- The treatment capacity in L/s – 20 L/s
- The sediment storage capacity in m3 – 838 L
- The oil storage capacity in L - 232 L
- The total unit storage capacity in L – 1590 L

Best regards,

Patrick Graham
Project Manager



*****Please note our new addresses*****

Echelon Environmental Inc.
55 Albert Street
Suite 200
Markham, ON
L3P 2T4
Phone: 1-905-948-0000
Cell: 416-460-5819
Fax: 1-905-948-0577
email patrick@echelonenvironmental.ca

Mailing Address:

Echelon Environmental Inc.
5694 Hwy #7 East
Suite 354
Markham, ON
L3P 0E3

From: Zarak Ali <z.ali@novatech-eng.com>
Sent: Thursday, May 25, 2023 3:40 PM
To: Patrick <patrick@echelonenvironmental.ca>
Cc: Francois Thauvette <f.thauvette@novatech-eng.com>
Subject: CDS Sizing Request - 3317 Navan Road Residential Development in Ottawa (118076)

Hi Patrick,

We are currently working on a project that requires a stormwater quality control unit to treat water from the paved drive aisles on-site and landscaped areas. The project proposes to develop three (3) residential buildings and is located at 3317 Navan Road in the City of Ottawa.

The project details are as follows:

Tributary area = **0.572 ha**

Imperviousness = **74%** or $Cw_5=0.72$

2-year uncontrolled peak flow conveyed to unit: **87.9 L/s**

5-year uncontrolled peak flow conveyed to unit: **119.3 L/s**

100-year uncontrolled peak flow conveyed to unit: **230.0 L/s**

Time of concentration = 10min

IDF Curve = City of Ottawa (76.8mm/hr Intensity for 2yr) (104.2mm/hr Intensity for 5yr) (178.6mm/hr Intensity for 100yr)

We have a requirement to provide a level of quality control treatment to meet the MOE 'Enhanced' Level of Protection guidelines (i.e., 80% TSS removal and 90% of annual runoff treated). The proposed unit will be installed on a new 375mm dia. PVC outlet pipe with one 300mm dia. PVC and one 375mm dia. PVC inlet pipes (see attached STM and GP drawings for more information). A standard particle distribution (Fines) should be adequate for the design. Anticipated peak flows (controlled downstream of the OGS unit and on-site SWM pond) should be in the order of 12.3 L/s (2-year), 15.6 L/s (5-year) and 23.9 L/s (100-year) based on the City's requirement to control the site to predevelopment flows. See the attached mark-up of the proposed site servicing plan (118076-GP) and Storm Drainage Area Plan (118076-STM2) for a sketch of the area and proposed water quality treatment unit location (highlighted in yellow).

Can you please size a CDS unit for us and provide the design details as well as an approximate cost estimate? Please ensure the design includes the backwater effects of water stored in the SWM pond on the OGS unit (see attached SWM and servicing plans for details).

We will also need the following information on the unit for our SWM Report:

- % of net annual TSS removal
- % of net annual treatment volume for the tributary area
- The treatment capacity in L/s
- The sediment storage capacity in m³
- The oil storage capacity in L
- The total unit storage capacity in L

Thank you for your time and consideration in this matter. We are looking to submit to the city at the end the month, if you could get us something by then, it would be greatly appreciated. If there is any further information you require, please do not hesitate to reach out.

Regards,

Zarak Ali, E.I.T. | Land Development Engineering

NOVATECH

Engineers, Planners & Landscape Architects

240 Michael Cowpland Drive, Suite 200, Ottawa, ON, K2M 1P6 | Tel: 613.254.9643 Ext: 330

The information contained in this email message is confidential and is for exclusive use of the addressee.

APPENDIX H
Engineering Drawings

LEGEND

PROPERTY LINE	PROPOSED WATER METER AND REMOTE METER
SANMH 101	PROPOSED FINISHED FLOOR ELEVATION
CBMH 102	PROPOSED UNDERSIDE OF FOOTING ELEVATION
STMMH 108	PROPOSED BASEMENT FLOOR ELEVATION
CB 01	PROPOSED TOP OF FOUNDATION ELEVATION
HYD	EXISTING CONCRETE CURB
DC	EXISTING SANITARY MH & SEWER
WB	EXISTING STORM MH & SEWER
EX	EXISTING HYDRANT
LS	EXISTING UTILITY POLE
EX	EXISTING WATERMAIN
EX	EXISTING LIGHT STANDARD
EX	EXISTING FENCE
EX	EXISTING OVERHEAD UTILITY WIRES
ICD	PROPOSED INLET CONTROL DEVICE
PROPOSED TRENCH	
PROPOSED BUILDING ENTRANCE	
PROPOSED RETAINING WALL	

PROPOSED 150mmØ BLDG A WATER SERVICE TABLE

STATION	SURFACE ELEVATION	TWM ELEVATION	COMMENTS
1+000.0	86.62	84.22	250mmØ CROSS
1+001.3	86.65	84.25	250mmØ 150mm REDUCER(S)
1+003.8	86.65	84.25	150mmØ VALVE AND VALVE BOX
1+006.6	87.00	84.30	CAP 1.0m FROM BUILDING

PROPOSED 250mmØ WATERMAIN TABLE

STATION	SURFACE ELEVATION	TWM ELEVATION	COMMENTS
0+000.0	86.50	83.84	CONNECTION TO EX. 300mmØ WM STUB IN ESSELMONT ST
0+001.3	86.50	83.85	300mmØ 250mm REDUCER
0+001.3	86.58	83.90	45° HORIZONTAL BEND
0+007.1	86.57	83.92	VALVE AND VALVE BOX AT PROPERTY LINE
0+010.6	86.53	83.95	22.5° HORIZONTAL BEND
0+031.7	86.62	84.22	HYDRANT TEE
0+036.2	86.62	84.22	250mmØ CROSS
0+050.4	86.60	84.20	CROSS BELOW 375mmØ STM (±0.6m CLEARANCE)
0+091.2	86.72	84.20	45° HORIZONTAL BEND
0+110.0	86.69	84.20	45° HORIZONTAL BEND
0+107.0	86.60	84.10	CROSS BELOW 375mmØ STM (±0.54m CLEARANCE)
0+137.6	86.85	83.90	CROSS BELOW 375mmØ STM (±0.53m CLEARANCE)
0+141.5	86.69	83.99	VALVE AND VALVE BOX AT PROPERTY LINE
0+154.6	86.88	84.35	CONNECTION TO EX. 300mmØ WM IN NAVAN RD

PROPOSED 200mmØ-150mmØ BLDG C WATER SERVICE TABLE

STATION	SURFACE ELEVATION	TWM ELEVATION	COMMENTS
3+000.0	86.62	84.22	250mmØ CROSS
3+007.1	86.73	84.22	TEE (BUILDING B SERVICE)
3+008.1	86.72	84.25	250mmØ 200mm REDUCER
3+012.8	86.67	84.27	CROSS BELOW 375mmØ STM (±0.67m CLEARANCE)
3+014.3	86.65	84.25	45° HORIZONTAL BEND
3+020.5	86.85	84.45	HYDRANT TEE
3+022.1	87.03	84.45	200mmØ 150mm REDUCER
3+026.3	87.05	84.50	150mmØ VALVE AND VALVE BOX
3+031.6	87.19	84.50	CAP 1.0m FROM BUILDING

PROPOSED 200mmØ-150mmØ BLDG B WATER SERVICE TABLE

STATION	SURFACE ELEVATION	TWM ELEVATION	COMMENTS
2+000.0	86.73	84.22	TEE
2+005.3	86.95	84.30	45° HORIZONTAL BEND
2+014.6	86.70	84.30	45° HORIZONTAL BEND
2+014.6	86.67	84.27	CROSS BELOW 375mmØ STM (±0.70m CLEARANCE)
2+022.6	86.80	84.40	HYDRANT TEE
2+023.9	86.82	84.40	200mmØ 150mm REDUCER
2+032.8	87.10	84.60	150mmØ VALVE AND VALVE BOX
2+035.2	87.19	84.60	CAP 1.0m FROM BUILDING

AREA A-2: ICD TABLE - CBMH 104

DESIGN EVENT	TYPE OF ICD	DIAMETER OF OUTLET PIPE (mm)	DESIGN FLOW (L/s)	DESIGN HEAD (m)	WATER DEPTH (m)	VOLUME (m³)
1.2 YR	118mm DIA. ORIFICE	375	13.5	0.20	84.82	64.8
1.5 YR	PLUG TYPE ICD		16.8	0.31	84.93	116.4
1.100 YR			24.3	0.65	85.27	242.9

ROOF DRAIN TABLE

AREA ID	ROOF DRAIN NO. (WATTS MODEL)	ROOF DRAIN OPENING SETTING	2 YEAR RELEASE RATE	APPROX. 5-YR PONDING DEPTH	5-YEAR RELEASE RATE	100-YEAR PONDING DEPTH	100-YEAR RELEASE RATE	APPROX. 100-YR PONDING DEPTH
R-1	RD 1A (RD-100-A-ADJ)	1/4 EXPOSED	0.72 L/s	10 cm	0.82 L/s	11 cm	0.91 L/s	14 cm
	RD 2A (RD-100-A-ADJ)	1/4 EXPOSED	0.72 L/s	10 cm	0.82 L/s	11 cm	0.91 L/s	14 cm
	RD 3A (RD-100-A-ADJ)	1/4 EXPOSED	0.72 L/s	10 cm	0.82 L/s	11 cm	0.91 L/s	14 cm
	RD 4A (RD-100-A-ADJ)	1/4 EXPOSED	0.72 L/s	10 cm	0.82 L/s	11 cm	0.91 L/s	14 cm
R-2	RD 1B (RD-100-A-ADJ)	1/4 EXPOSED	0.72 L/s	10 cm	0.82 L/s	11 cm	0.91 L/s	14 cm
	RD 2B (RD-100-A-ADJ)	1/4 EXPOSED	0.72 L/s	10 cm	0.82 L/s	11 cm	0.91 L/s	14 cm
	RD 3B (RD-100-A-ADJ)	1/4 EXPOSED	0.72 L/s	10 cm	0.82 L/s	11 cm	0.91 L/s	14 cm
	RD 4B (RD-100-A-ADJ)	1/4 EXPOSED	0.72 L/s	10 cm	0.82 L/s	11 cm	0.91 L/s	14 cm
R-3	RD 1C (RD-100-A-ADJ)	1/4 EXPOSED	0.72 L/s	10 cm	0.82 L/s	11 cm	0.91 L/s	14 cm
	RD 2C (RD-100-A-ADJ)	1/4 EXPOSED	0.72 L/s	10 cm	0.82 L/s	11 cm	0.91 L/s	14 cm
	RD 3C (RD-100-A-ADJ)	1/4 EXPOSED	0.72 L/s	10 cm	0.82 L/s	11 cm	0.91 L/s	14 cm
	RD 4C (RD-100-A-ADJ)	1/4 EXPOSED	0.72 L/s	10 cm	0.82 L/s	11 cm	0.91 L/s	14 cm

CRITICAL SEWER PIPE CROSSING TABLE

CROSSING	LOWER PIPE	HIGHER PIPE	CLEARANCE SURFACE ELEVATION
1	250mmØ TWM-83.95	300mmØ STM INV-84.81 ± 1.0m	86.55 m
2	250mmØ TWM-84.20	375mmØ STM INV-84.81 ± 0.61m	86.60 m
3	250mmØ TWM-84.10	375mmØ STM INV-84.64 ± 0.54m	86.60 m
4	250mmØ TWM-83.90	375mmØ STM INV-84.43 ± 0.53m	86.85 m
5	200mmØ TWM-84.27	375mmØ STM INV-84.97 ± 0.70m	86.67 m
6	230mmØ TWM-84.27	375mmØ STM INV-84.94 ± 0.67m	86.67 m
7	200mmØ SAN OBV-84.27	375mmØ STM INV-85.03 ± 2.61m	86.77 m

SITE FLOWS & STORMWATER MANAGEMENT TABLE

DESIGN EVENT	PRE-DEVELOPMENT CONDITIONS		POST-DEVELOPMENT CONDITIONS						REDUCTION IN FLOW (L/s) %	
	UNCONTROLLED FLOW (L/s)	ALLOWABLE RELEASE RATE (L/s)*	A-1 DIRECT RUNOFF (L/s)	A-2 FLOW (L/s)	A-3 FLOW (L/s)	R-1 FLOW (L/s)	R-2 FLOW (L/s)	R-3 FLOW (L/s)		TOTAL FLOW (L/s)
1.2 YR	63.3	63.3	26.5	13.5	3.7	2.9	2.9	3.5	52.9	10.4 or 16%
1.5 YR	85.9	85.9	35.9	16.8	5.0	3.3	3.3	4.0	68.2	17.7 or 12%
1.100 YR	154.0	154.0	71.9	24.3	9.4	3.6	3.6	4.5	117.3	66.7 or 36%

* REDUCED FLOW COMPARED TO PRE-DEVELOPMENT UNCONTROLLED CONDITIONS
** LESSER OF UNCONTROLLED PRE-DEVELOPMENT FLOWS OR 85 L/s/m²

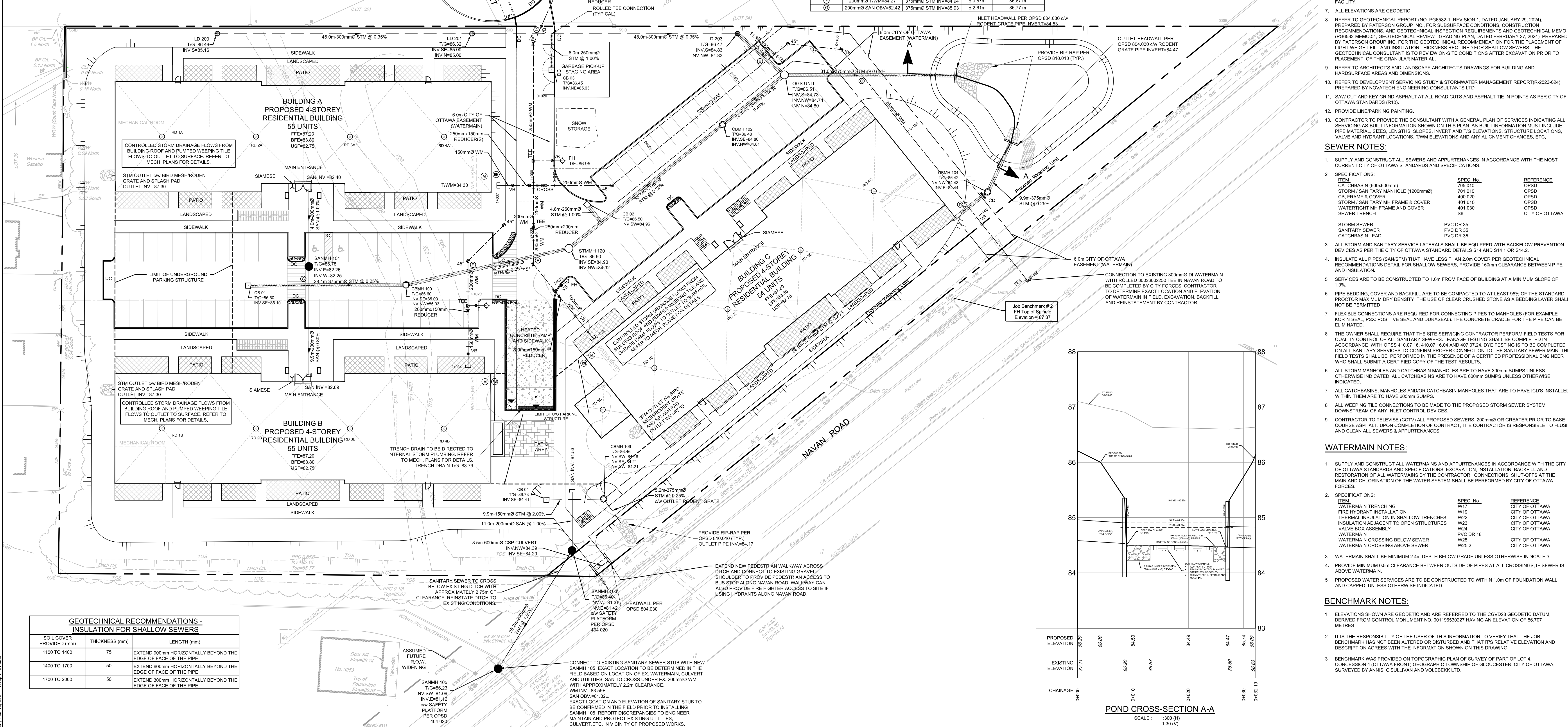
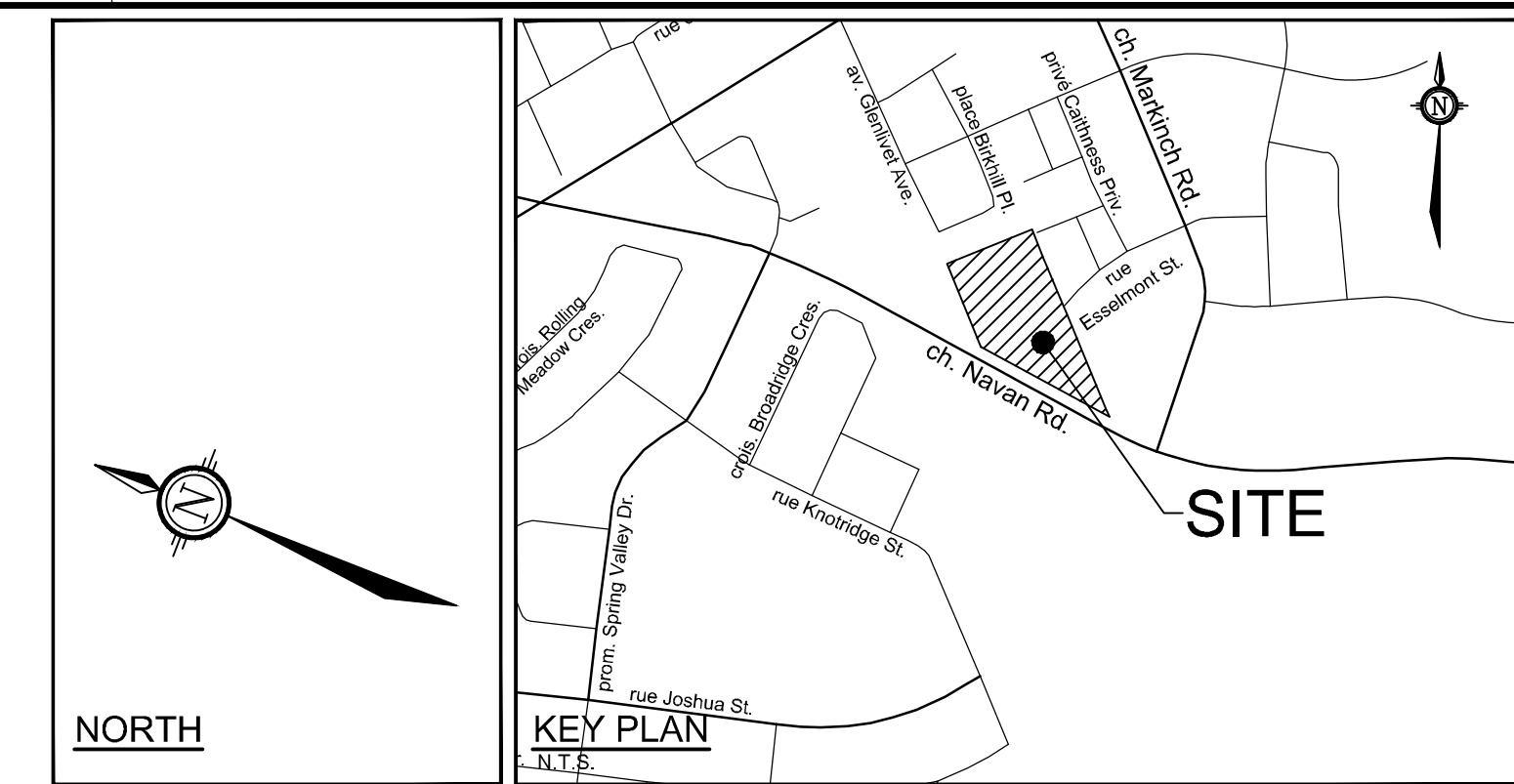

GEOTECHNICAL RECOMMENDATIONS - INSULATION FOR SHALLOW SEWERS

SOIL COVER PROVIDED (mm)	THICKNESS (mm)	LENGTH (mm)
1100 to 1400	75	EXTEND 900mm HORIZONTALLY BEYOND THE EDGE OF FACE OF THE PIPE
1400 to 1700	50	EXTEND 600mm HORIZONTALLY BEYOND THE EDGE OF FACE OF THE PIPE
1700 to 2000	50	EXTEND 300mm HORIZONTALLY BEYOND THE EDGE OF FACE OF THE PIPE

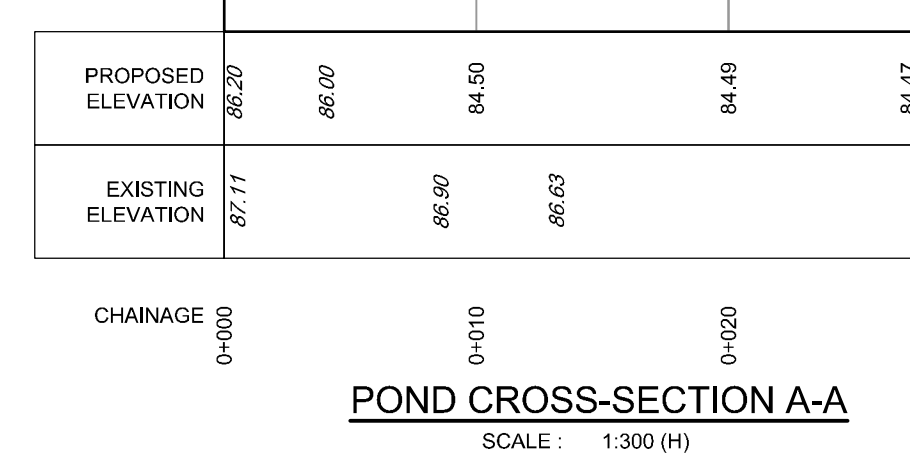

- GENERAL NOTES:**
- COORDINATE AND SCHEDULE ALL WORK WITH OTHER TRADES AND CONTRACTORS.
 - DETERMINE THE EXACT LOCATION, SIZE, MATERIAL AND ELEVATION OF ALL EXISTING UTILITIES PRIOR TO COMMENCING CONSTRUCTION. PROTECT AND ASSUME RESPONSIBILITY FOR ALL EXISTING UTILITIES WHETHER OR NOT SHOWN ON THIS DRAWING.
 - OBTAIN ALL NECESSARY PERMITS AND APPROVALS FROM THE CITY OF OTTAWA BEFORE COMMENCING CONSTRUCTION.
 - BEFORE COMMENCING CONSTRUCTION OBTAIN AND PROVIDE PROOF OF COMPREHENSIVE, ALL RISK AND OPERATIONAL LIABILITY INSURANCE FOR \$5,000,000.00. INSURANCE POLICY TO NAME OWNERS, ENGINEERS AND ARCHITECTS AS CO-INSURED.
 - RESTORE ALL DISTURBED AREAS ON-SITE AND OFF-SITE, INCLUDING TRENCHES AND SURFACES ON PUBLIC ROAD ALLOWANCES TO EXISTING CONDITIONS OR BETTER TO THE SATISFACTION OF THE CITY OF OTTAWA AND ENGINEER.
 - REMOVE FROM SITE ALL EXCESS EXCAVATED MATERIAL, ORGANIC MATERIAL AND DEBRIS UNLESS OTHERWISE INSTRUCTED BY ENGINEER. EXCAVATE AND REMOVE FROM SITE ANY CONTAMINATED MATERIAL. ALL CONTAMINATED MATERIAL SHALL BE DISPOSED OF AT A LICENSED LANDFILL FACILITY.
 - ALL ELEVATIONS ARE GEODETIC.
 - REFER TO GEOTECHNICAL REPORT (NO. PG658-1, REVISION 1, DATED JANUARY 20, 2024), PREPARED BY PATONER GROUP INC. FOR SUBSURFACE CONDITIONS, CONSTRUCTION RECOMMENDATIONS, AND GEOTECHNICAL INSPECTION REQUIREMENTS AND GEOTECHNICAL MEMO (PROVISIONAL) DATED FEBRUARY 2024, PREPARED BY PATONER GROUP INC. FOR THE GEOTECHNICAL RECOMMENDATION FOR THE PLACEMENT OF LIGHT WEIGHT FILL AND INSULATION THICKNESS REQUIRED FOR SHALLOW SEWERS. THE GEOTECHNICAL CONSULTANT IS TO REVIEW ON-SITE CONDITIONS AFTER EXCAVATION PRIOR TO THE PLACEMENT OF THE GRANULAR MATERIAL.
 - REFER TO ARCHITECT'S AND LANDSCAPE ARCHITECT'S DRAWINGS FOR BUILDING AND HARDSURFACE AREAS AND DIMENSIONS.
 - REFER TO DEVELOPMENT SERVICES STUDY & STORMWATER MANAGEMENT REPORT (R-2023-024) PREPARED BY NOVATECH ENGINEERING CONSULTANTS LTD.
 - SAW CUT AND KEY GRIND ASPHALT AT ALL ROAD CUTS AND ASPHALT TIE IN POINTS AS PER CITY OF OTTAWA STANDARDS (R10).
 - PROVIDE LINE/PARKING PAINTING.
 - CONTRACTOR TO PROVIDE THE CONSULTANT WITH A GENERAL PLAN OF SERVICES INDICATING ALL SERVICES, BUILT INFORMATION SHOWN ON THIS PLAN. AS-BUILT INFORMATION MUST INCLUDE PIPE MATERIAL, SIZES, LENGTHS, SLOPES, INVERT AND TO ELEVATIONS, STRUCTURE LOCATIONS, VALVE AND HYDRANT LOCATIONS, TWM ELEVATIONS AND ANY ALIGNMENT CHANGES, ETC.

- SEWER NOTES:**
- SURPLY AND CONSTRUCT ALL SEWERS AND APPURTENANCES IN ACCORDANCE WITH THE MOST CURRENT CITY OF OTTAWA STANDARDS AND SPECIFICATIONS.
 - SPECIFICATIONS:

ITEM	SPEC. NO.	REFERENCE
CATCHBASIN (600x800mm)	OPSD 804.030	CITY OF OTTAWA
STORM / SANITARY MANHOLE (1200mmØ)	701.010	OPSD
CB FRAME & COVER	400.020	OPSD
STORM / SANITARY MH FRAME & COVER	400.010	OPSD
WATER TIGHT MH FRAME AND COVER	401.030	OPSD
SEWER TRENCH	56	CITY OF OTTAWA
 - STORM SEWER:

ITEM	SPEC. NO.	REFERENCE
PVC DR 35	PVC DR 35	
PVC DR 35	PVC DR 35	
PVC DR 35	PVC DR 35	
 - ALL STORM AND SANITARY SERVICE LATERALS SHALL BE EQUIPPED WITH BACKFLOW PREVENTION DEVICES AS PER THE CITY OF OTTAWA STANDARD DETAILS S14 AND S14.1 OR S14.2.
 - INSULATE ALL PIPES (SANITARY) THAT HAVE LESS THAN 2.0m COVER PER GEOTECHNICAL RECOMMENDATIONS DETAIL FOR SHALLOW SEWERS. PROVIDE 150mm CLEARANCE BETWEEN PIPE AND INSULATION.
 - SERVICES ARE TO BE CONSTRUCTED TO 1.0m FROM FACE OF BUILDING AT A MINIMUM SLOPE OF 1/2%.
 - PIPE BEDDING, COVER AND BACKFILL ARE TO BE COMPACTED TO AT LEAST 95% OF THE STANDARD PROCTOR MAXIMUM DRY DENSITY. THE USE OF CLEAR CRUSHED STONE AS A BEDDING LAYER SHALL NOT BE PERMITTED.
 - FLEXIBLE CONNECTIONS ARE REQUIRED FOR CONNECTING PIPES TO MANHOLES (FOR EXAMPLE KORAN-SEAL, PEX, POSITIVE SEAL AND DURASEAL). THE CONCRETE GRADE FOR THE PIPE CAN BE ELIMINATED.
 - THE OWNER SHALL REQUIRE THAT THE SITE SERVING CONTRACTOR PERFORM FIELD TESTS FOR QUALITY CONTROL OF ALL SANITARY SEWERS. LEAKAGE TESTING SHALL BE COMPLETED IN ACCORDANCE WITH OPSD 410.07.16, 410.07.16.04 AND 407.07.2. DYE TESTING IS TO BE COMPLETED ON ALL SANITARY SERVICES TO CONFIRM PROPER CONNECTION TO THE SANITARY SEWER MAIN. THE FIELD TESTS SHALL BE PERFORMED IN THE PRESENCE OF A CERTIFIED PROFESSIONAL ENGINEER WHO SHALL SUBMIT A CERTIFIED COPY OF THE TEST RESULTS.
 - ALL STORM MANHOLES AND CATCHBASIN MANHOLES ARE TO HAVE 300mm SLUMPS UNLESS OTHERWISE INDICATED. ALL CATCHBASINS ARE TO HAVE 600mm SLUMPS UNLESS OTHERWISE INDICATED.
 - ALL CATCHBASINS, MANHOLES AND/OR CATCHBASIN MANHOLES THAT ARE TO HAVE ICD'S INSTALLED WITHIN THEM ARE TO HAVE 600mm SLUMPS.
 - ALL WEEPING TILE CONNECTIONS TO BE MADE TO THE PROPOSED STORM SEWER SYSTEM DOWNSTREAM OF ANY INLET CONTROL DEVICES.
 - CONTRACTOR TO TELEVISION (CCTV) ALL PROPOSED SEWERS, 200mmØ OR GREATER PRIOR TO BASE COURSE ASPHALT. UPON COMPLETION OF CONTRACT, THE CONTRACTOR IS RESPONSIBLE TO FLUSH AND CLEAN ALL SEWERS & APPURTENANCES.

- WATERMAIN NOTES:**
- SURPLY AND CONSTRUCT ALL WATERMANS AND APPURTENANCES IN ACCORDANCE WITH THE CITY OF OTTAWA STANDARDS AND SPECIFICATIONS. EXCAVATION, INSTALLATION, BACKFILL AND RESTORATION OF ALL WATERMANS BY THE CONTRACTOR. CONNECTIONS, SHUT-OFFS AT THE MAIN AND CHLORINATION OF THE WATER SYSTEM SHALL BE PERFORMED BY CITY OF OTTAWA FORCES.
 - SPECIFICATIONS:

ITEM	SPEC. NO.	REFERENCE
WATERMAIN TRENCHING	W19	CITY OF OTTAWA
FIRE HYDRANT INSTALLATION	W22	CITY OF OTTAWA
THERMAL INSULATION IN SHALLOW TRENCHES	W23	CITY OF OTTAWA
INSULATION ADJACENT TO OPEN STRUCTURES	W24	CITY OF OTTAWA
VALVE BOX ASSEMBLY	PL DR 18	CITY OF OTTAWA
WATERMAIN WATERMAIN CROSSING ABOVE SEWER	W25	CITY OF OTTAWA
WATERMAIN CROSSING ABOVE SEWER	W25.2	CITY OF OTTAWA
 - WATERMAIN SHALL BE MINIMUM 2.4m DEPTH BELOW GRADE UNLESS OTHERWISE INDICATED.
 - PROVIDE MINIMUM 0.5m CLEARANCE BETWEEN OUTSIDE OF PIPES AT ALL CROSSINGS, IF SEWER IS ABOVE WATERMAIN.
 - PROPOSED WATER SERVICES ARE TO BE CONSTRUCTED TO WITHIN 1.0m OF FOUNDATION WALL AND CAPPED, UNLESS OTHERWISE INDICATED.

- BENCHMARK NOTES:**
- ELEVATIONS SHOWN ARE GEODETIC AND ARE REFERRED TO THE COWD'S GEODETIC DATUM.
 - DERIVED FROM CONTROL MONUMENT NO. 00119653027 HAVING AN ELEVATION OF 86.707 METRES.
 - IT IS THE RESPONSIBILITY OF THE USER OF THIS INFORMATION TO VERIFY THAT THE JOB BENCHMARK HAS NOT BEEN ALTERED OR DISTURBED AND THAT ITS RELATIVE ELEVATION AND DESCRIPTION AGREES WITH THE INFORMATION SHOWN ON THIS DRAWING.
 - BENCHMARK HAS PROVIDED ON TOPOGRAPHIC PLAN OF SURVEY OF PART OF LOT 4, CONVESSION 4 (OTTAWA FRONT) GEOGRAPHIC TOWNSHIP OF GLOUCESTER, CITY OF OTTAWA, SURVEYED BY ANNIS, O'SULLIVAN AND VOLEBEK LTD.

NOTE:
THE POSITION OF ALL POLE LINES, CONDUITS, WATERMANS, SEWERS AND OTHER UNDERGROUND AND OVERGROUND UTILITIES AND STRUCTURES IS NOT NECESSARILY SHOWN ON THE CONTRACT DRAWINGS, AND WHERE SHOWN, THE ACCURACY OF THE POSITION OF SUCH UTILITIES AND STRUCTURES IS NOT GUARANTEED. BEFORE STARTING WORK, DETERMINE THE EXACT LOCATION OF ALL SUCH UTILITIES AND STRUCTURES AND ASSUME ALL LIABILITY FOR DAMAGE TO THEM.

OWNER INFORMATION
262676 ONTARIO INC.
231 BRITANNIA DRIVE, SUITE D
OTTAWA, ONTARIO, K1K 0R8
LALIT AGGARWAL
PHONE: (613)-746-1647
lsa@manorparkcap.com

No.	REVISION	DATE	BY
4.	REVISED PER GEOTECHNICAL COMMENTS	FEB 27/24	FST
3.	REVISED PER CITY COMMENTS	FEB 14/24	FST
2.	REVISED PER CITY COMMENTS	NOV 13/23	FST
1.	ISSUED FOR SITE PLAN CONTROL APPROVAL	JUNE 9/23	FST

FOR REVIEW ONLY

SCALE: 1:300

DATE: FEB 27, 2024

PROVINCE OF ONTARIO

NOVATECH
Engineers, Planners & Landscape Architects
Suite 200, 240 Michael Cowland Drive
Ottawa, Ontario, Canada K2M 1P6
Telephone: (613) 254-9643
Facsimile: (613) 254-5867
Website: www.novatech-eng.com

GENERAL PLAN OF SERVICES

LOCATION: CITY OF OTTAWA, 3317 NAVAN ROAD

DRAWING NAME: GENERAL PLAN OF SERVICES

PROJECT NO.: 118076

REV # 4

18076-GP

Plan #19008

D07-12-23-0085

LEGEND

PROPOSED ELEVATION
EXISTING ELEVATION
PROPOSED TERRACE ELEVATION
GRADE AND DIRECTION
MAXIMUM 3:1 SLOPE
EMERGENCY OVERLAND FLOW ROUTE
SAMMH 101
CBMH 102
STMMH 108
CB
HYD
DC
ICD
RD
RSD
FF
USF
BFE
TIF
ES YR
T.100 YR

PROPERTY LINE
PROPOSED RETAINING WALL
PROPOSED BUILDING ENTRANCE
PROPOSED SILT FENCING (OPSD 219.110)
PROPOSED MUD MAT / CONSTRUCTION ENTRANCE
EXISTING CONCRETE CURB
EXISTING SANITARY MANHOLE
EXISTING STORM MANHOLE
EXISTING HYDRANT
EXISTING TREES / VEGETATION
EXISTING UTILITY POLE
EXISTING FENCE
EXISTING ROOF DRAIN
EXISTING TWIS
EXISTING FINISHED FLOOR ELEVATION
EXISTING UNDERSIDE OF FOOTING ELEVATION
EXISTING BASEMENT FLOOR ELEVATION
EXISTING TOP OF FOUNDATION ELEVATION

APPROXIMATE PONDING LIMITS

Erosion and Sediment Control Responsibilities:

ESIC Measure	Symbol	Installation	Installation Responsibility	Maintenance Responsibility	Approved by	Inspected by	Accepted by
Silt Fence	---	Location as indicated on ESIC sheet	Developer's Contractor	Developer's Contractor	Consultant	Developer's Contractor	Developer's Contractor
Fiber Fabric	---	Location as indicated on ESIC sheet	Developer's Contractor	Developer's Contractor	Consultant	Developer's Contractor	Developer's Contractor
Mud Mat	---	Location as indicated on ESIC sheet	Developer's Contractor	Developer's Contractor	Consultant	Developer's Contractor	Developer's Contractor
Dust Control	---	Location as indicated on ESIC sheet	Developer's Contractor	Developer's Contractor	Consultant	Developer's Contractor	Developer's Contractor
Stabilized Natural Soils	---	Location as indicated on ESIC sheet	Developer's Contractor	Developer's Contractor	Consultant	Developer's Contractor	Developer's Contractor
Strawbed Silt (Or Road Silt) Control	---	Location as indicated on ESIC sheet	Developer's Contractor	Developer's Contractor	Consultant	Developer's Contractor	Developer's Contractor

PAVEMENT STRUCTURES:

Structure	Material	Notes
Light Duty (Car Only Parking Areas)	40mm HL.8 or SP 12.5 ASPHALTIC CONCRETE	4000mm GRAN "B" TYPE II *INSTALLED PER GEOTECHNICAL REPORT
Heavy Duty (Access Lanes)	50mm HL.8 or SP 19.0 ASPHALTIC CONCRETE	4000mm GRAN "B" TYPE II *INSTALLED PER GEOTECHNICAL REPORT

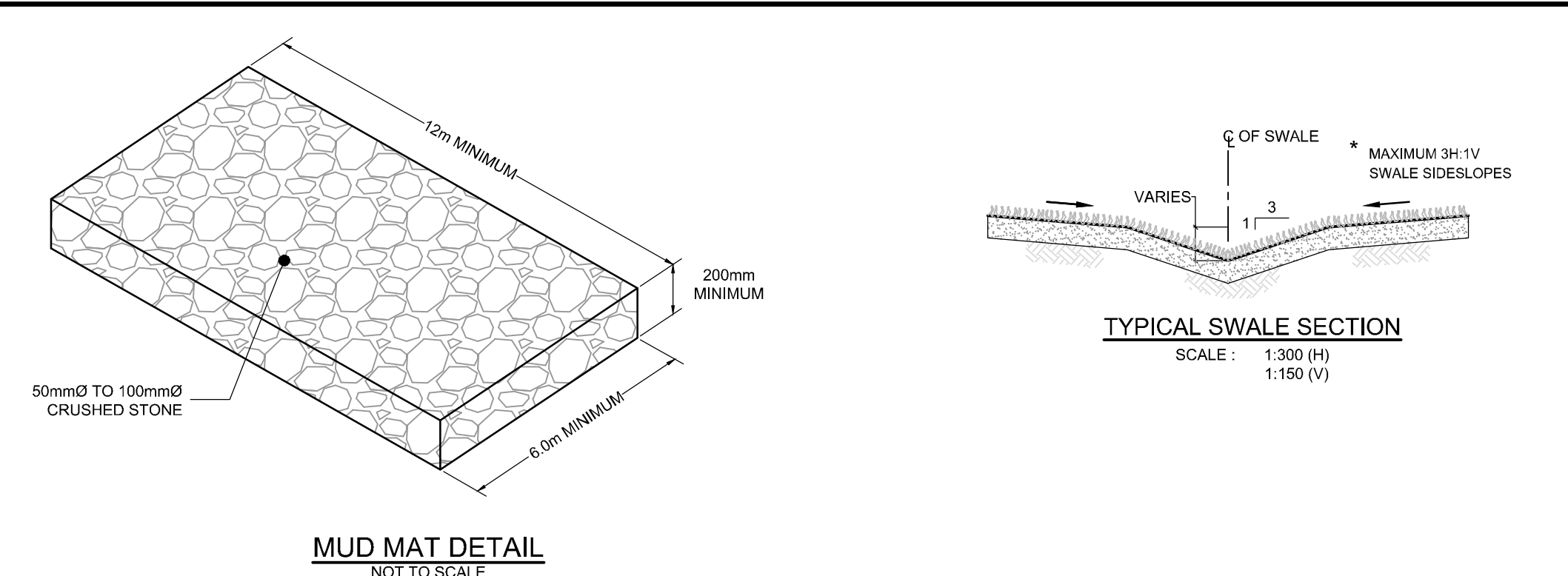

- GENERAL NOTES:**
- COORDINATE AND SCHEDULE ALL WORK WITH OTHER TRADES AND CONTRACTORS.
 - DETERMINE THE EXACT LOCATION, SIZE, MATERIAL AND ELEVATION OF ALL EXISTING UTILITIES PRIOR TO COMMENCING CONSTRUCTION. PROTECT AND ASSUME RESPONSIBILITY FOR ALL EXISTING UTILITIES WHETHER OR NOT SHOWN ON THIS DRAWING.
 - OBTAIN ALL NECESSARY PERMITS AND APPROVALS FROM THE CITY OF OTTAWA BEFORE COMMENCING CONSTRUCTION.
 - BEFORE COMMENCING CONSTRUCTION OBTAIN AND PROVIDE PROOF OF COMPREHENSIVE, ALL RISK AND OPERATIONAL LIABILITY INSURANCE FOR \$5,000,000.00. INSURANCE POLICY TO NAME OWNERS, ENGINEERS AND ARCHITECTS AS CO-INSURED.
 - RESTORE ALL DISTURBED AREAS ON-SITE AND OFF-SITE, INCLUDING TRENCHES AND SURFACES ON PUBLIC ROAD ALLOTTANCES TO EXISTING CONDITIONS OR BETTER TO THE SATISFACTION OF THE CITY OF OTTAWA AND ENGINEER.
 - REMOVE FROM SITE ALL EXCESS EXCAVATED MATERIAL, ORGANIC MATERIAL AND DEBRIS UNLESS OTHERWISE INSTRUCTED BY ENGINEER. EXCAVATE AND REMOVE FROM SITE ANY CONTAMINATED MATERIAL. ALL CONTAMINATED MATERIAL SHALL BE DISPOSED OF AT A LICENSED LANDFILL FACILITY.
 - ALL ELEVATIONS ARE GEODETIC.
 - REFER TO GEOTECHNICAL REPORT NO. P6582-1, REVISION 1, DATED JANUARY 28, 2024, PREPARED BY PATERSON GROUP INC. FOR SUBSURFACE CONDITIONS, CONSTRUCTION AND GEOTECHNICAL INSPECTION REQUIREMENTS AND GEOTECHNICAL MEMO P6582-MEMO-04, GEOTECHNICAL REVIEW - GRADING PLAN, DATED FEBRUARY 27, 2024, PREPARED BY PATERSON GROUP INC. FOR THE GEOTECHNICAL RECOMMENDATION FOR THE PLACEMENT OF LIGHT WEIGHT FILL AND INSULATION THICKNESS REQUIRED FOR SHALLOW SEWERS. THE GEOTECHNICAL CONSULTANT IS TO REVIEW ON-SITE CONDITIONS AFTER EXCAVATION PRIOR TO PLACEMENT OF THE GRANULAR MATERIAL.
 - REFER TO ARCHITECTS AND LANDSCAPE ARCHITECTS DRAWINGS FOR BUILDING AND HARD SURFACE AREAS AND DIMENSIONS.
 - REFER TO STORMWATER MANAGEMENT REPORT (R-2023-2024) PREPARED BY NOVATECH ENGINEERING CONSULTANTS LTD.
 - SAW CUT AND KEY GRIND ASPHALT AT ALL ROAD CUTS AND ASPHALT TIE IN POINTS AS PER CITY OF OTTAWA STANDARDS (SC1.1).
 - PROVIDE LINE PARKING PAINTING.

- GRADING NOTES:**
- ALL TOPSOIL, ORGANIC OR DELETERIOUS MATERIAL MUST BE ENTIRELY REMOVED FROM BENEATH THE PROPOSED PAVED AREAS AS DIRECTED BY THE SITE ENGINEER OR GEOTECHNICAL ENGINEER.
 - EXPOSED SUBGRADES IN PROPOSED PAVED AREAS SHOULD BE PROOF ROLLED WITH A LARGE STEEL DRUM ROLLER AND INSPECTED BY THE GEOTECHNICAL ENGINEER PRIOR TO THE PLACEMENT OF GRANULARS.
 - ANY SOFT AREAS EVIDENT FROM THE PROOF ROLLING SHOULD BE SUB-EXCAVATED AND REPLACED WITH SUITABLE MATERIAL THAT IS FROST COMPATIBLE WITH THE EXISTING SOILS AS RECOMMENDED BY THE GEOTECHNICAL ENGINEER.
 - THE GRANULAR BASE SHOULD BE COMPACTED TO AT LEAST 98% OF THE STANDARD PROCTOR MAXIMUM DRY DENSITY VALUE. ANY ADDITIONAL GRANULAR FILL BELOW THE PROPOSED PAVEMENT SHOULD BE COMPACTED TO AT LEAST 95% OF THE STANDARD PROCTOR MAXIMUM DRY DENSITY VALUE.
 - MINIMUM OF 2% GRADE FOR ALL GRASS AREAS UNLESS OTHERWISE NOTED.
 - MAXIMUM TERRACING GRADE TO BE 3:1 UNLESS OTHERWISE NOTED.
 - ALL CURBS SHALL BE BARRIER CURB (150mm) UNLESS OTHERWISE NOTED AND CONSTRUCTED AS PER CITY OF OTTAWA STANDARDS (SC1.1). MOUNTABLE CURBS ARE TO BE PER CITY OF OTTAWA STANDARD (SC1.3).
 - REFER TO LANDSCAPE PLAN FOR PLANTING AND OTHER LANDSCAPE FEATURE DETAILS.
 - CONTRACTOR TO PROVIDE THE CONSULTANT WITH A GRADING PLAN INDICATING AS-BUILT ELEVATIONS OF ALL DESIGN GRASSES SHOWN ON THIS PLAN.

- EROSION AND SEDIMENT CONTROL NOTES:**
- THE CONTRACTOR SHALL IMPLEMENT BEST MANAGEMENT PRACTICES, TO PROVIDE FOR PROTECTION OF THE AREA DRAINAGE SYSTEM AND THE RECEIVING WATERCOURSE. DURING CONSTRUCTION ACTIVITIES THE CONTRACTOR ACKNOWLEDGES THAT FAILURE TO IMPLEMENT APPROPRIATE EROSION AND SEDIMENT CONTROL MEASURES MAY BE SUBJECT TO PENALTIES IMPOSED BY ANY APPLICABLE REGULATORY AGENCY.
 - ALL EROSION AND SEDIMENT CONTROLS ARE TO BE INSTALLED TO THE SATISFACTION OF THE ENGINEER AND THE CITY OF OTTAWA. THEY ARE TO BE APPROPRIATE TO THE SITE CONDITIONS. PRIOR TO UNDERTAKING ANY SITE ALTERATIONS (FILLING, GRADING, REMOVAL OF VEGETATION, ETC.) AND DURING ALL PHASES OF SITE PREPARATION AND CONSTRUCTION, THESE PRACTICES ARE TO BE IMPLEMENTED IN ACCORDANCE WITH THE CURRENT BEST MANAGEMENT PRACTICES FOR EROSION AND SEDIMENT CONTROL. THIS SHOULD INCLUDE AS A MINIMUM THOSE MEASURES INDICATED ON THIS PLAN.
 - EROSION AND SEDIMENT CONTROL MEASURES WILL BE IMPLEMENTED DURING CONSTRUCTION IN ACCORDANCE WITH THE "GUIDELINES ON EROSION AND SEDIMENT CONTROL FOR URBAN CONSTRUCTION SITES" (GOVERNMENT OF ONTARIO, MAY 1987). THE CONTRACTOR SHALL BE SOLELY RESPONSIBLE FOR MEETING ALL REGULATORY AGENCY REQUIREMENTS.
 - TO PREVENT SURFACE EROSION FROM ENTERING ANY STORM SEWER SYSTEM DURING CONSTRUCTION, FILTER CLOTH WILL BE PLACED UNDER GRATES OF NEARBY CATCHBASINS AND STRUCTURES. A LIGHT DUTY SILT FENCE BARRIER WILL ALSO BE INSTALLED AROUND THE CONSTRUCTION AREA (WHERE APPLICABLE). THESE CONTROL MEASURES WILL REMAIN IN PLACE UNTIL CONSTRUCTION IS COMPLETE.
 - TO LIMIT EROSION, MINIMIZE THE AMOUNT OF EXPOSED SOILS AT ANY GIVEN TIME. RE-VEGETATE EXPOSED AREAS AND SLOPES AS SOON AS POSSIBLE AND PROTECT EXPOSED SLOPES WITH NATURAL OR SYNTHETIC MULCHES.
 - FOR MATERIAL STOCKPILES, MINIMIZE THE AMOUNT OF EXPOSED MATERIALS AT ANY GIVEN TIME. APPLY TEMPORARY SEEDING, TARPS, COMPACTION AND/OR SURFACE ROUGHENING AS REQUIRED TO STABILIZE STOCKPILED MATERIALS THAT WILL NOT BE USED WITHIN 14 DAYS.
 - THE SEDIMENT CONTROL MEASURES SHALL BE REMOVED WHEN IN THE OPINION OF THE ENGINEER, THE MEASURES ARE NO LONGER REQUIRED. NO CONTROL MEASURES MAY BE PERMANENTLY REMOVED WITHOUT PRIOR AUTHORIZATION FROM THE ENGINEER.
 - THE CONTRACTOR SHALL IMMEDIATELY REPORT TO THE ENGINEER ANY ACCIDENTAL DISCHARGES OF SEDIMENT MATERIAL INTO ANY STORM SEWER SYSTEM. APPROPRIATE RESPONSE MEASURES, INCLUDING ANY REPAIRS TO EXISTING CONTROL MEASURES OR THE IMPLEMENTATION OF ADDITIONAL CONTROL MEASURES, SHALL BE CARRIED OUT BY THE CONTRACTOR WITHOUT DELAY.
 - THE CONTRACTOR ACKNOWLEDGES THAT FAILURE TO IMPLEMENT EROSION AND SEDIMENT CONTROL MEASURES MAY BE SUBJECT TO PENALTIES IMPOSED BY ANY APPLICABLE REGULATORY AGENCY.
 - ROADWAYS ARE TO BE SWEEP AS REQUIRED OR AS DIRECTED BY THE ENGINEER AND/OR THE MUNICIPALITY.
 - THE CONTRACTOR SHALL ENSURE PROPER DUST CONTROL IS PROVIDED WITH THE APPLICATION OF WATER (AND IF REQUIRED, CALCIUM CHLORIDE) DURING DRY PERIODS. MONITOR DUST LEVELS DURING SITE PREPARATION, EXCAVATION AND CONSTRUCTION ACTIVITIES, AND WHEN DUST LEVELS BECOME VISUALLY APPARENT SPRAY WATER TO MINIMIZE THE RELEASE OF DUST FROM GRAVEL, PAVED AREAS AND EXPOSED SOILS. USE CHEMICAL DUST SUPPRESSANTS ONLY WHERE NECESSARY ON PROBLEM AREAS.

- BENCHMARK NOTES:**
- ELEVATIONS SHOWN ARE GEODETIC AND ARE REFERRED TO THE CGVD25 GEODETIC DATUM. DERIVED FROM CONTROL MONUMENT NO. 0011965027 HAVING AN ELEVATION OF 86.707 METRES.
 - IT IS THE RESPONSIBILITY OF THE USER OF THIS INFORMATION TO VERIFY THAT THE JOB BENCHMARK HAS NOT BEEN ALTERED OR DISTURBED AND THAT ITS RELATIVE ELEVATION AND DESCRIPTION ACCRUES WITH THE INFORMATION SHOWN ON THIS DRAWING.
 - BENCHMARK WAS PROVIDED ON TOPOGRAPHIC PLAN OF SURVEY OF PART OF LOT 4, CONCESSION 4 (OTTAWA FRONT) GEOGRAPHIC TOWNSHIP OF GLOUCESTER, CITY OF OTTAWA, SURVEYED BY ANNIS, O'SULLIVAN AND VOLBEK LTD.

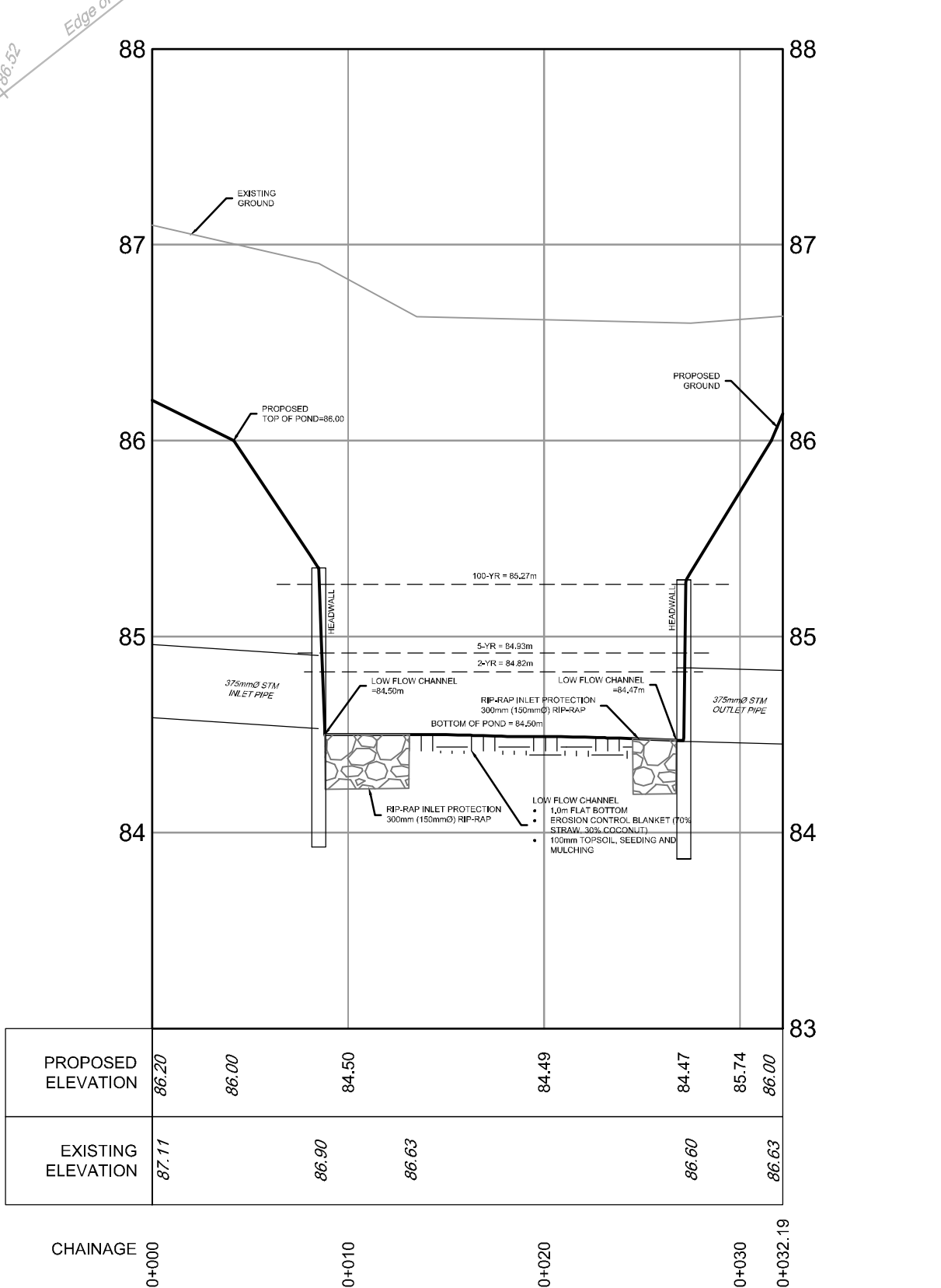
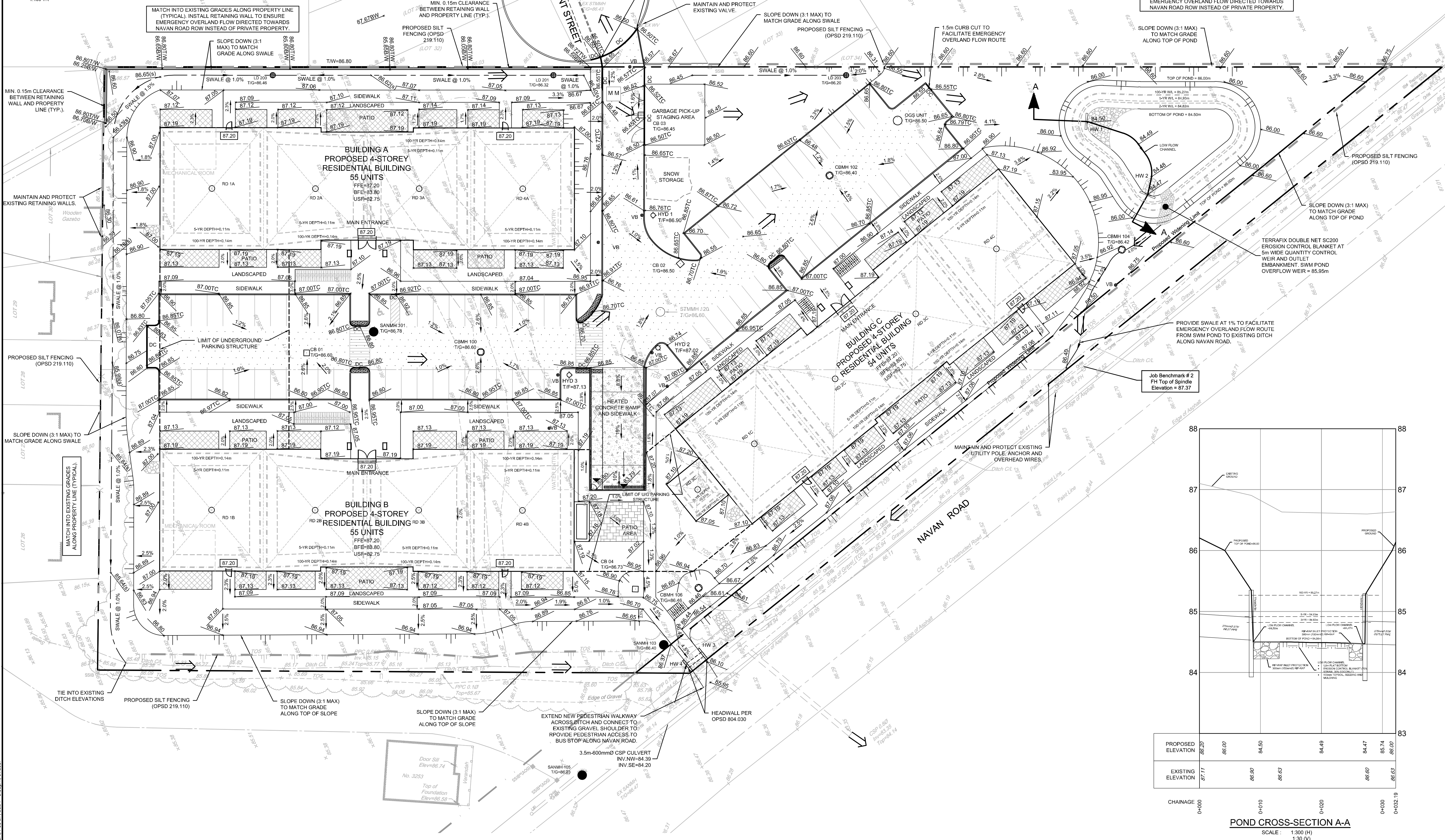

NOTE:
THE POSITION OF ALL POLE LINES, CONDUITS, WATERMANS, SEWERS AND OTHER UNDERGROUND AND OVERGROUND UTILITIES AND STRUCTURES IS NOT NECESSARILY SHOWN ON THE CONTRACT DRAWINGS, AND WHERE SHOWN, THE ACCURACY OF THE POSITION OF SUCH UTILITIES AND STRUCTURES IS NOT GUARANTEED. BEFORE STARTING WORK, DETERMINE THE EXACT LOCATION OF ALL SUCH UTILITIES AND STRUCTURES AND ASSUME ALL LIABILITY FOR DAMAGE TO THEM.

OWNER INFORMATION
262576 ONTARIO INC.
231 BRITANNY DRIVE, SUITE D
OTTAWA, ONTARIO, K1K 0R8
LALIT AGGARWAL
PHONE: (613)-746-1647
lsa@manorparkcap.com

No.	REVISION	DATE	BY
4.	REVISED PER GEOTECHNICAL COMMENTS	FEB 27/24	FST
3.	REVISED PER CITY COMMENTS	FEB 14/24	FST
2.	REVISED PER CITY COMMENTS	NOV 13/23	FST
1.	ISSUED FOR SITE PLAN CONTROL APPROVAL	JUNE 02/23	FST

SCALE
1:300

FOR REVIEW ONLY

DESIGN	DATE	BY
ZAC/V		
FST		
ZAC/V		
FST		
FST		

NOVATECH
Engineers, Planners & Landscape Architects
Suite 200, 240 Michael Cowpland Drive
Ottawa, Ontario, Canada K2M 1P6
Telephone: (613) 254-9643
Facsimile: (613) 254-5867
Website: www.novatech-ems.com

LOCATION
CITY OF OTTAWA
3317 NAVAN ROAD

DRAWING NAME
GRADING AND EROSION & SEDIMENT CONTROL PLAN

PROJECT NO.
118076

REV #
4

DRAWING NO.
118076-GR

Plan #19008

- LEGEND**
- PROPERTY LINE
 - DRAINAGE AREA LIMITS
 - PRE 0.129 0.20 PRE-DEVELOPMENT AREA ID
 - PRE-DEVELOPMENT DRAINAGE AREA (ha)
 - 1.5 YEAR WEIGHTED RUNOFF COEFFICIENT
 - ← DIRECTION OF MAJOR OVERLAND FLOW
 - 55.18 EXISTING ELEVATION
 - EX-STMMW EXISTING STORMWATER & SEWER
 - EXISTING CONCRETE CURB
 - EX-V&V EXISTING VALVE & VALVE BOX
 - EX-HYD EXISTING HYDRANT
 - EX-UP EXISTING UTILITY POLE C/W GUY WIRES

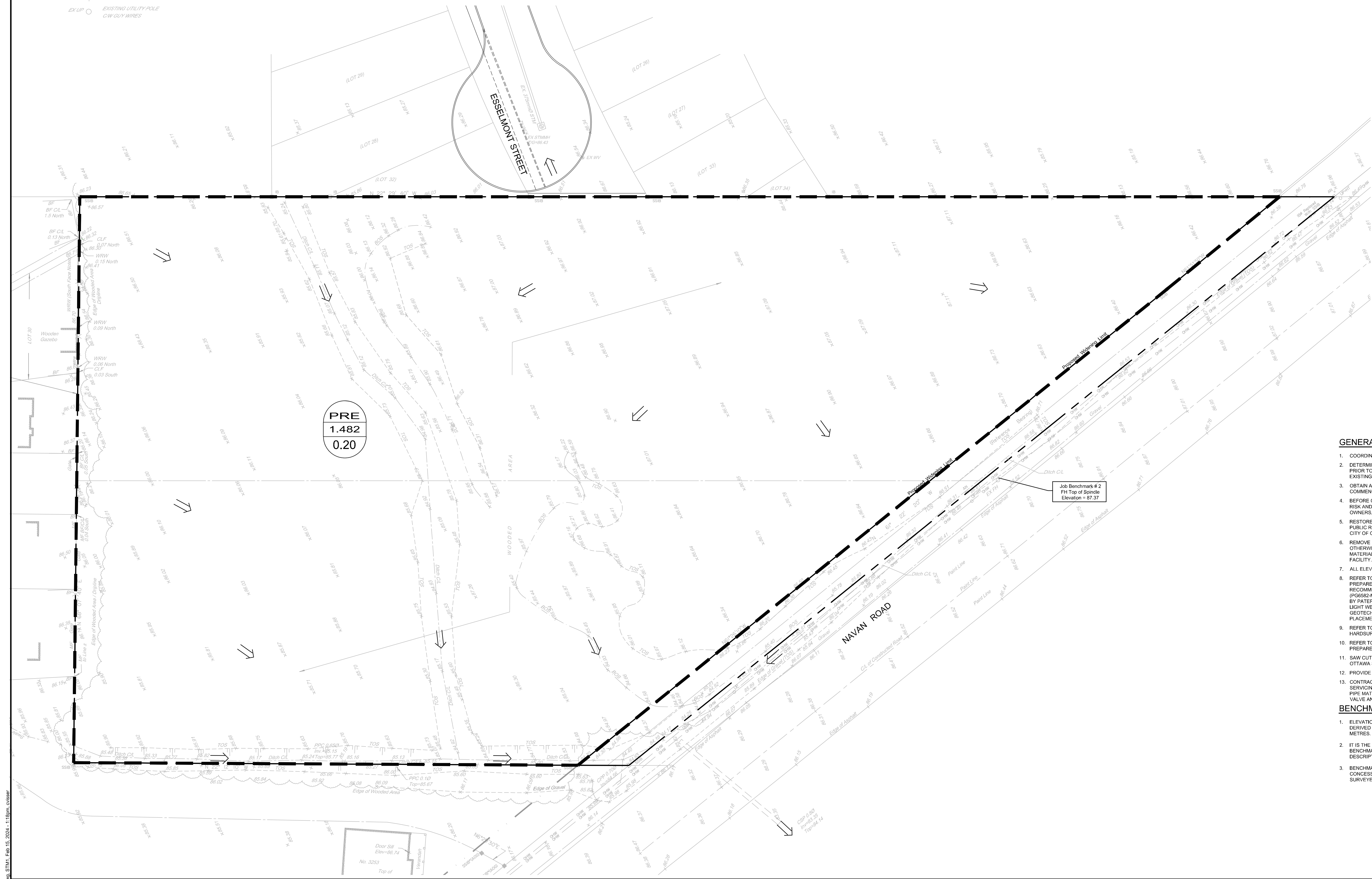
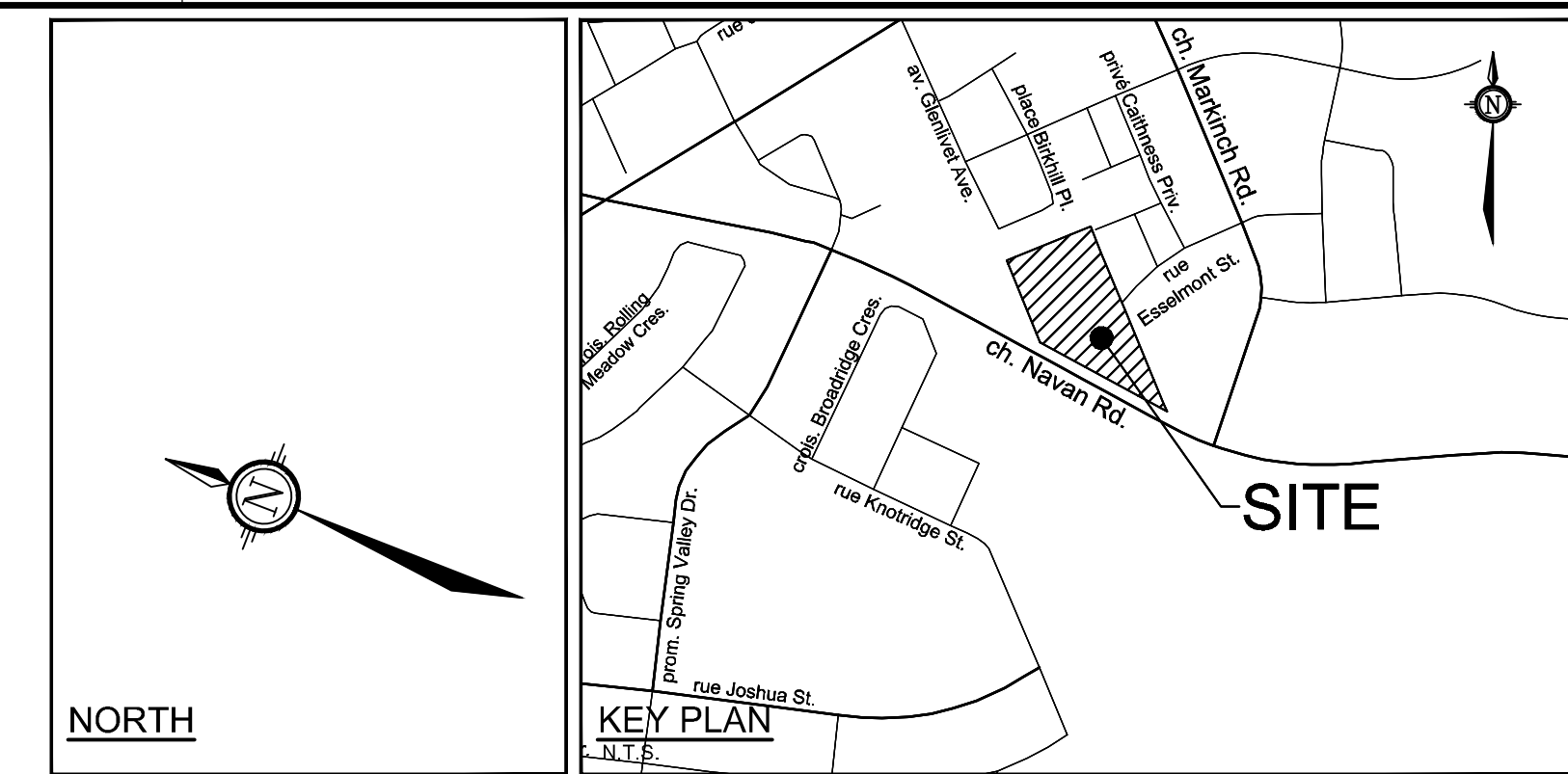

- GENERAL NOTES:**
- COORDINATE AND SCHEDULE ALL WORK WITH OTHER TRADES AND CONTRACTORS.
 - DETERMINE THE EXACT LOCATION, SIZE, MATERIAL AND ELEVATION OF ALL EXISTING UTILITIES PRIOR TO COMMENCING CONSTRUCTION. PROTECT AND ASSUME RESPONSIBILITY FOR ALL EXISTING UTILITIES WHETHER OR NOT SHOWN ON THIS DRAWING.
 - OBTAIN ALL NECESSARY PERMITS AND APPROVALS FROM THE CITY OF OTTAWA BEFORE COMMENCING CONSTRUCTION.
 - BEFORE COMMENCING CONSTRUCTION OBTAIN AND PROVIDE PROOF OF COMPREHENSIVE, ALL RISK AND OPERATIONAL LIABILITY INSURANCE FOR \$5,000,000.00. INSURANCE POLICY TO NAME OWNERS, ENGINEERS AND ARCHITECTS AS CO-INSURED.
 - RESTORE ALL DISTURBED AREAS ON-SITE AND OFF-SITE, INCLUDING TRENCHES AND SURFACES ON PUBLIC ROAD ALLOWANCES TO EXISTING CONDITIONS OR BETTER TO THE SATISFACTION OF THE CITY OF OTTAWA AND ENGINEER.
 - REMOVE FROM SITE ALL EXCESS EXCAVATED MATERIAL, ORGANIC MATERIAL AND DEBRIS UNLESS OTHERWISE INSTRUCTED BY ENGINEER. EXCAVATE AND REMOVE FROM SITE ANY CONTAMINATED MATERIAL. ALL CONTAMINATED MATERIAL SHALL BE DISPOSED OF AT A LICENSED LANDFILL FACILITY.
 - ALL ELEVATIONS ARE GEODETIC.
 - REFER TO GEOTECHNICAL REPORT (NO. PG6582-1, REVISION 1, DATED JANUARY 29, 2024), PREPARED BY PATERSON GROUP INC. FOR SUBSURFACE CONDITIONS, CONSTRUCTION RECOMMENDATIONS, AND GEOTECHNICAL INSPECTION REQUIREMENTS AND GEOTECHNICAL MEMO (PG6582-MEMO 04, GEOTECHNICAL REVIEW - GRADING PLAN, DATED FEBRUARY 27, 2024), PREPARED BY PATERSON GROUP INC. FOR THE GEOTECHNICAL RECOMMENDATION FOR THE PLACEMENT OF LIGHT WEIGHT FILL AND INSULATION THICKNESS REQUIRED FOR SHALLOW SEWERS. THE GEOTECHNICAL CONSULTANT IS TO REVIEW ON-SITE CONDITIONS AFTER EXCAVATION PRIOR TO PLACEMENT OF THE GRANULAR MATERIAL.
 - REFER TO ARCHITECTS AND LANDSCAPE ARCHITECT'S DRAWINGS FOR BUILDING AND HARDSURFACE AREAS AND DIMENSIONS.
 - REFER TO DEVELOPMENT SERVICING STUDY & STORMWATER MANAGEMENT REPORT (R-2023-024) PREPARED BY NOVATECH ENGINEERING CONSULTANTS LTD.
 - SAW CUT AND KEY GRIND ASPHALT AT ALL ROAD CUTS AND ASPHALT TIE IN POINTS AS PER CITY OF OTTAWA STANDARDS (R10).
 - PROVIDE LAMPING PAINTING.
 - CONTRACTOR TO PROVIDE THE CONSULTANT WITH A GENERAL PLAN OF SERVICES INDICATING ALL SERVICING AS-BUILT INFORMATION SHOWN ON THIS PLAN. AS-BUILT INFORMATION MUST INCLUDE: PIPE MATERIAL, SIZES, LENGTHS, SLOPES, INVERT AND T/O ELEVATIONS, STRUCTURE LOCATIONS, VALVE AND HYDRANT LOCATIONS, TWM ELEVATIONS AND ANY ALIGNMENT CHANGES, ETC.
- BENCHMARK NOTES:**
- ELEVATIONS SHOWN ARE GEODETIC AND ARE REFERRED TO THE CGVD28 GEODETIC DATUM, DERIVED FROM CONTROL MONUMENT NO. 001196550227 HAVING AN ELEVATION OF 86.707 METRES.
 - IT IS THE RESPONSIBILITY OF THE USER OF THIS INFORMATION TO VERIFY THAT THE JOB BENCHMARK HAS NOT BEEN ALTERED OR DISTURBED AND THAT ITS RELATIVE ELEVATION AND DESCRIPTION AGREES WITH THE INFORMATION SHOWN ON THIS DRAWING.
 - BENCHMARK WAS PROVIDED ON TOPOGRAPHIC PLAN OF SURVEY OF PART OF LOT 4, CONCESSION 4 (OTTAWA FRONT) GEOGRAPHIC TOWNSHIP OF GLOUCESTER, CITY OF OTTAWA, SURVEYED BY ANNS, O'SULLIVAN AND VOLEBEK LTD.

NOTE:
THE POSITION OF ALL POLE LINES, CONDUITS, WATERMANS, SEWERS AND OTHER UNDERGROUND AND OVERGROUND UTILITIES AND STRUCTURES IS NOT NECESSARILY SHOWN ON THE CONTRACT DRAWINGS, AND WHERE SHOWN, THE ACCURACY OF THE POSITION OF SUCH UTILITIES AND STRUCTURES IS NOT GUARANTEED. BEFORE STARTING WORK, DETERMINE THE EXACT LOCATION OF ALL SUCH UTILITIES AND STRUCTURES AND ASSUME ALL LIABILITY FOR DAMAGE TO THEM.

OWNER INFORMATION
262576 ONTARIO INC.
231 BRITTANY DRIVE, SUITE D
OTTAWA, ONTARIO, K1K 0R8
LALIT AGGARWAL
PHONE: (613)-746-1647
lsa@manorparkcap.com

No.	REVISION	DATE	BY
3	REVISED PER GEOTECHNICAL COMMENTS	FEB 27/24	FST
2	REVISED PER CITY COMMENTS	NOV 13/23	FST
1	ISSUED FOR SITE PLAN CONTROL APPROVAL	JUNE 02/23	FST

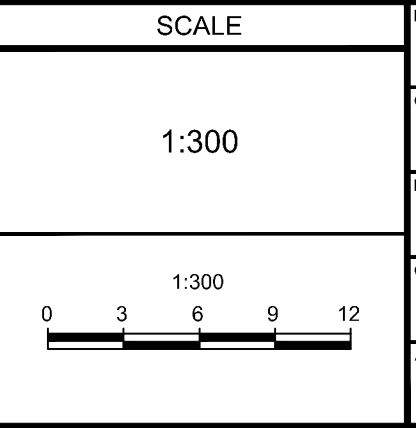

DESIGN	FOR REVIEW ONLY
Z/ACV	
FST	
Z/ACV	
FST	
FST	



NOVATECH
Engineers, Planners & Landscape Architects
Suite 200, 240 Michael Copland Drive
Ottawa, Ontario, Canada K2M 1P6
Telephone: (613) 254-9643
Facsimile: (613) 254-5867
Website: www.novatech-eng.com

LOCATION
CITY OF OTTAWA
3317 NAVAN ROAD

DRAWING NAME
PRE-DEVELOPMENT STORM DRAINAGE AREA PLAN

PROJECT NO.	118076
REV #	REV # 3
DRAWING NO.	118076-STM1

D07-12-23-0085

LEGEND

- PROPERTY LINE
- PROPOSED BARRIER CURB
- DC PROPOSED DEPRESSED CURB
- DRAINAGE AREA LIMITS
- A-2 POST-DEVELOPMENT AREA ID
- 0.729 POST-DEVELOPMENT DRAINAGE AREA (ha)
- 0.61 1.5 YEAR WEIGHTED RUNOFF COEFFICIENT
- STMH 108 PROPOSED STORM MANHOLE
- CBM 104 PROPOSED CATCHBASIN MANHOLE
- CB 01 PROPOSED CATCHBASIN
- RD ○ CONTROLLED FLOW ROOF DRAIN
- PROPOSED STORM SEWER AND FLOW DIRECTION
- ICD I PROPOSED INLET CONTROL DEVICE
- PROPOSED TVSI
- ← EMERGENCY OVERLAND FLOW ROUTE
- BFE PROPOSED BASEMENT FLOOR ELEVATION
- T/F PROPOSED TOP OF FOUNDATION ELEVATION
- FFE FINISHED FLOOR ELEVATION
- USF UNDERSIDE OF FOOTING ELEVATION
- PROPOSED RETAINING WALL

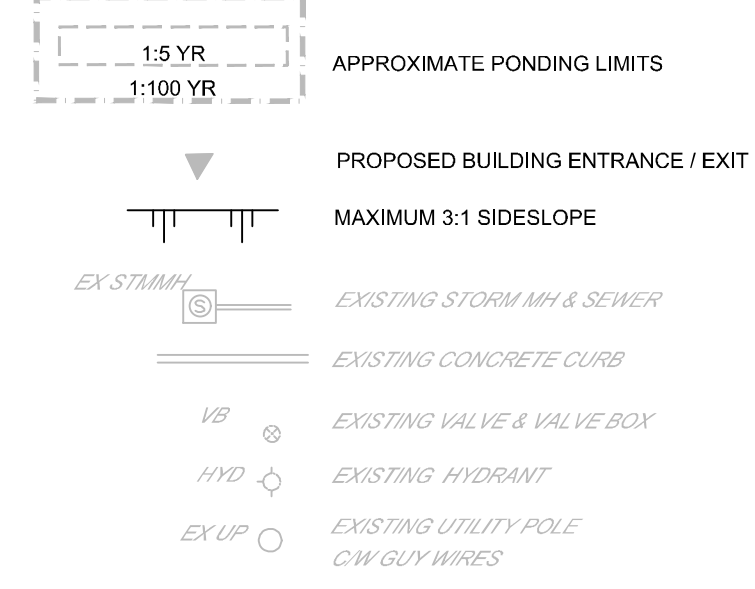

SITE FLOWS & STORMWATER MANAGEMENT TABLE

DESIGN EVENT	PRE-DEVELOPMENT CONDITIONS			POST-DEVELOPMENT CONDITIONS						REDUCTION IN FLOW (L/s or %)
	UNCONTROLLED FLOW (L/s)	ALLOWABLE RELEASE RATE (L/s)**	A-1 DIRECT RUNOFF (L/s)	A-2 FLOW (L/s)	A-3 FLOW (L/s)	R-1 FLOW (L/s)	R-2 FLOW (L/s)	R-3 FLOW (L/s)	TOTAL FLOW (L/s)	
1:2 YR	63.3	63.3	26.5	13.5	3.7	2.9	2.9	3.5	52.9	10.4 or 16%
1:5 YR	85.9	85.9	35.9	16.8	5.0	3.3	3.3	4.0	68.2	17.7 or 21%
1:100 YR	194.0	194.0	71.9	23.3	9.4	3.6	3.6	4.5	117.3	66.7 or 34%

AREA A-2: ICD TABLE - CBM 104

DESIGN EVENT	TYPE OF ICD	DIAMETER OF OUTLET PIPE (mm)	DESIGN FLOW (L/s)	DESIGN HEAD (m)	WATER DEPTH (m)	VOLUME (m³)
1:2 YR	118mm DIA. ORIFICE PLUG TYPE ICD	375	13.5	0.20	84.82	84.8
1:5 YR			16.8	0.31	84.93	116.4
1:100 YR			24.3	0.65	85.27	242.9

ROOF DRAIN TABLE

AREA ID	ROOF DRAIN No. (WATTS MODEL)	ROOF DRAIN OPENING SETTING	2 YEAR RELEASE RATE	APPROX. 2-YR PONDING DEPTH	5-YEAR RELEASE RATE	APPROX. 5-YEAR PONDING DEPTH	100-YEAR RELEASE RATE	APPROX. 100-YR PONDING DEPTH
R-1	RD 1A (RD-100-A-ADJ)	1/4 EXPOSED	0.72 L/s	10 cm	0.82 L/s	11 cm	0.91 L/s	14 cm
	RD 2A (RD-100-A-ADJ)	1/4 EXPOSED	0.72 L/s	10 cm	0.82 L/s	11 cm	0.91 L/s	14 cm
	RD 3A (RD-100-A-ADJ)	1/4 EXPOSED	0.72 L/s	10 cm	0.82 L/s	11 cm	0.91 L/s	14 cm
	RD 4A (RD-100-A-ADJ)	1/4 EXPOSED	0.72 L/s	10 cm	0.82 L/s	11 cm	0.91 L/s	14 cm
R-2	RD 1B (RD-100-A-ADJ)	1/4 EXPOSED	0.72 L/s	10 cm	0.82 L/s	11 cm	0.91 L/s	14 cm
	RD 2B (RD-100-A-ADJ)	1/4 EXPOSED	0.72 L/s	10 cm	0.82 L/s	11 cm	0.91 L/s	14 cm
	RD 3B (RD-100-A-ADJ)	1/4 EXPOSED	0.72 L/s	10 cm	0.82 L/s	11 cm	0.91 L/s	14 cm
	RD 4B (RD-100-A-ADJ)	1/4 EXPOSED	0.72 L/s	10 cm	0.82 L/s	11 cm	0.91 L/s	14 cm
R-3	RD 1C (RD-100-A-ADJ)	1/4 EXPOSED	0.72 L/s	10 cm	0.82 L/s	11 cm	0.91 L/s	14 cm
	RD 2C (RD-100-A-ADJ)	1/4 EXPOSED	0.72 L/s	10 cm	0.82 L/s	11 cm	0.91 L/s	14 cm
	RD 3C (RD-100-A-ADJ)	1/4 EXPOSED	0.72 L/s	10 cm	0.82 L/s	11 cm	0.91 L/s	14 cm
	RD 4C (RD-100-A-ADJ)	1/4 EXPOSED	0.72 L/s	10 cm	0.82 L/s	11 cm	0.91 L/s	14 cm

*REFER TO THE DEVELOPMENT SERVICING STUDY AND STORMWATER MANAGEMENT REPORT (R-2023-024) PREPARED BY NOVATECH FOR DRAINAGE AREA IDENTIFIERS AND STORMWATER MANAGEMENT DETAILS.
**ALL CONTROLLED FLOW ROOF DRAINS TO BE WATTS 'ADJUSTABLE ACCUTROL' ROOF DRAINS.

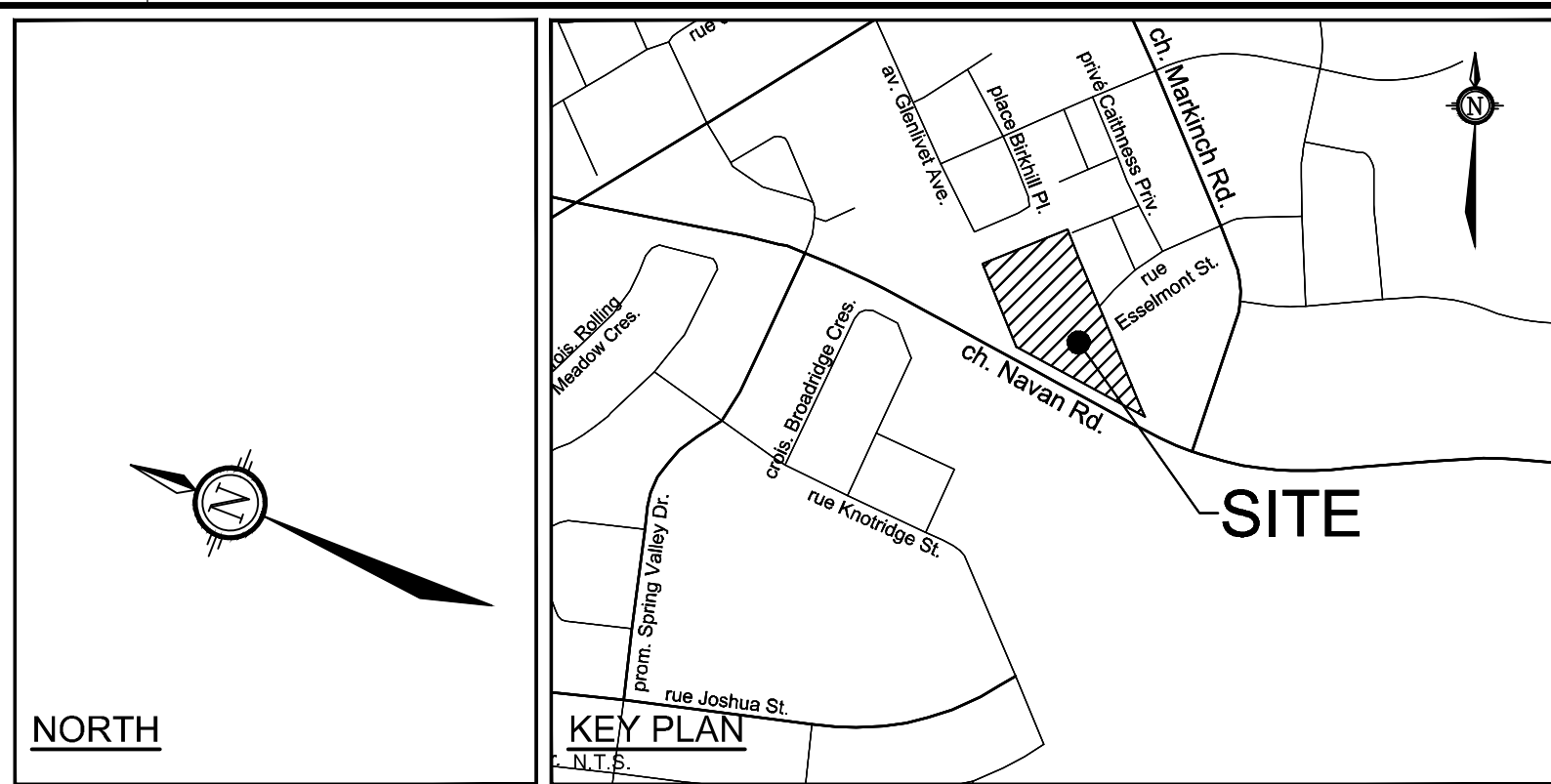

GENERAL NOTES:

- COORDINATE AND SCHEDULE ALL WORK WITH OTHER TRADES AND CONTRACTORS.
- DETERMINE THE EXACT LOCATION, SIZE, MATERIAL AND ELEVATION OF ALL EXISTING UTILITIES PRIOR TO COMMENCING CONSTRUCTION. PROTECT AND ASSUME RESPONSIBILITY FOR ALL EXISTING UTILITIES WHETHER OR NOT SHOWN ON THIS DRAWING.
- OBTAIN ALL NECESSARY PERMITS AND APPROVALS FROM THE CITY OF OTTAWA BEFORE COMMENCING CONSTRUCTION.
- BEFORE COMMENCING CONSTRUCTION OBTAIN AND PROVIDE PROOF OF COMPREHENSIVE, ALL RISK AND OPERATIONAL LIABILITY INSURANCE FOR \$5,000,000.00. INSURANCE POLICY TO NAME OWNERS, ENGINEERS AND ARCHITECTS AS COINSURED.
- RESTORE ALL DISTURBED AREAS ON-SITE AND OFF-SITE, INCLUDING TRENCHES AND SURFACES ON PUBLIC ROAD ALLOWANCES TO EXISTING CONDITIONS OR BETTER TO THE SATISFACTION OF THE CITY OF OTTAWA AND ENGINEER.
- REMOVE FROM SITE ALL EXCESS EXCAVATED MATERIAL, ORGANIC MATERIAL AND DEBRIS UNLESS OTHERWISE INSTRUCTED BY ENGINEER. EXCAVATE AND REMOVE FROM SITE ANY CONTAMINATED MATERIAL. ALL CONTAMINATED MATERIAL SHALL BE DISPOSED OF AT A LICENSED LANDFILL FACILITY.
- ALL ELEVATIONS ARE GEODETIC.
- REFER TO GEOTECHNICAL REPORT (NO. P06882-1, REVISION 1, DATED JANUARY 26, 2024), PREPARED BY PATERSON GROUP INC. FOR SUBSURFACE CONDITIONS, CONSTRUCTION RECOMMENDATIONS, AND GEOTECHNICAL INSPECTION REQUIREMENTS AND GEOTECHNICAL MEMO (FOR MEMO 04, GEOTECHNICAL REVIEW - GRADING PLAN, DATED FEBRUARY 27, 2024), PREPARED BY PATERSON GROUP INC. FOR THE GEOTECHNICAL RECOMMENDATION FOR THE PLACEMENT OF LIGHT WEIGHT FILL AND INSULATION THICKNESS REQUIRED FOR SHALLOW SEWERS. THE GEOTECHNICAL CONSULTANT IS TO REVIEW ON-SITE CONDITIONS AFTER EXCAVATION PRIOR TO WEIGHTING OF THE GRANULAR MATERIAL.
- REFER TO ARCHITECT'S AND LANDSCAPE ARCHITECT'S DRAWINGS FOR BUILDING AND HARDWARE SURFACE AREAS AND DIMENSIONS.
- REFER TO DEVELOPMENT SERVICING STUDY & STORMWATER MANAGEMENT REPORT (R-2023-024) PREPARED BY NOVATECH ENGINEERING CONSULTANTS LTD.
- SAW CUT AND KEY GRIND ASPHALT AT ALL ROAD CUTS AND ASPHALT TIE IN POINTS AS PER CITY OF OTTAWA STANDARDS (R10).
- PROVIDE LINE/PARKING PAINTING.
- CONTRACTOR TO PROVIDE THE CONSULTANT WITH A GENERAL PLAN OF SERVICES INDICATING ALL SERVICING AS-BUILT INFORMATION SHOWN ON THIS PLAN. AS-BUILT INFORMATION MUST INCLUDE: PIPE MATERIAL, SIZES, LENGTHS, SLOPES, INVERT AND TIG ELEVATIONS, STRUCTURE LOCATIONS, VALVE AND HYDRANT LOCATIONS, TWM ELEVATIONS AND ANY ALIGNMENT CHANGES, ETC.

BENCHMARK NOTES:

- ELEVATIONS SHOWN ARE GEODETIC AND ARE REFERRED TO THE CGVD28 GEODETIC DATUM, DERIVED FROM CONTROL MONUMENT NO. 00119653022 HAVING AN ELEVATION OF 66.707 METRES.
- IT IS THE RESPONSIBILITY OF THE USER OF THIS INFORMATION TO VERIFY THAT THE JOB BENCHMARK HAS NOT BEEN ALTERED OR DISTURBED AND THAT ITS RELATIVE ELEVATION AND DESCRIPTION AGREES WITH THE INFORMATION SHOWN ON THIS DRAWING.
- BENCHMARK WAS PROVIDED ON TOPOGRAPHIC PLAN OF SURVEY OF LOT 4, CONVECTION 4 (OTTAWA FRONT) GEOGRAPHIC TOWNSHIP OF GLOUCESTER, CITY OF OTTAWA, SURVEYED BY ANNIS, O'SULLIVAN AND VOLEBEK LTD.

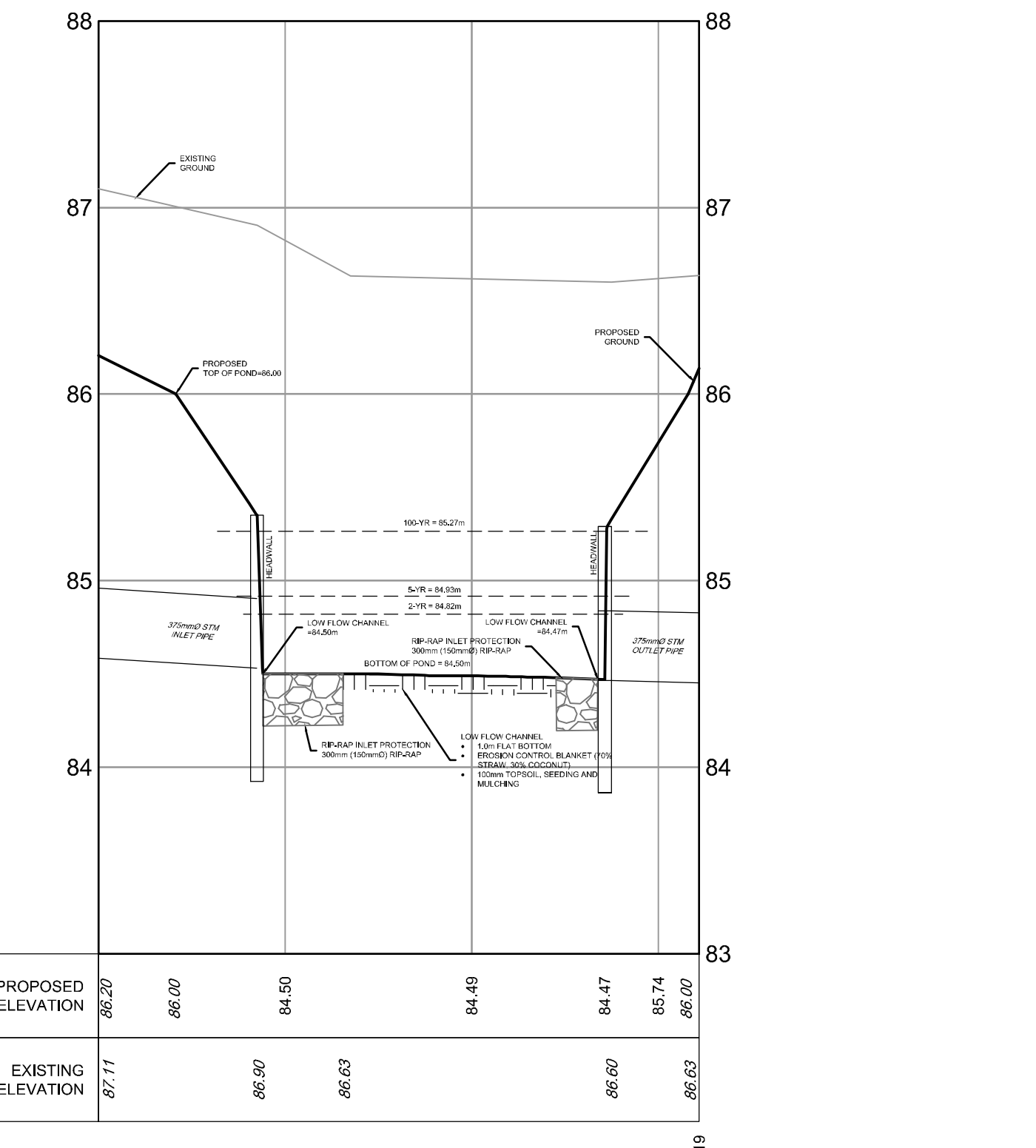
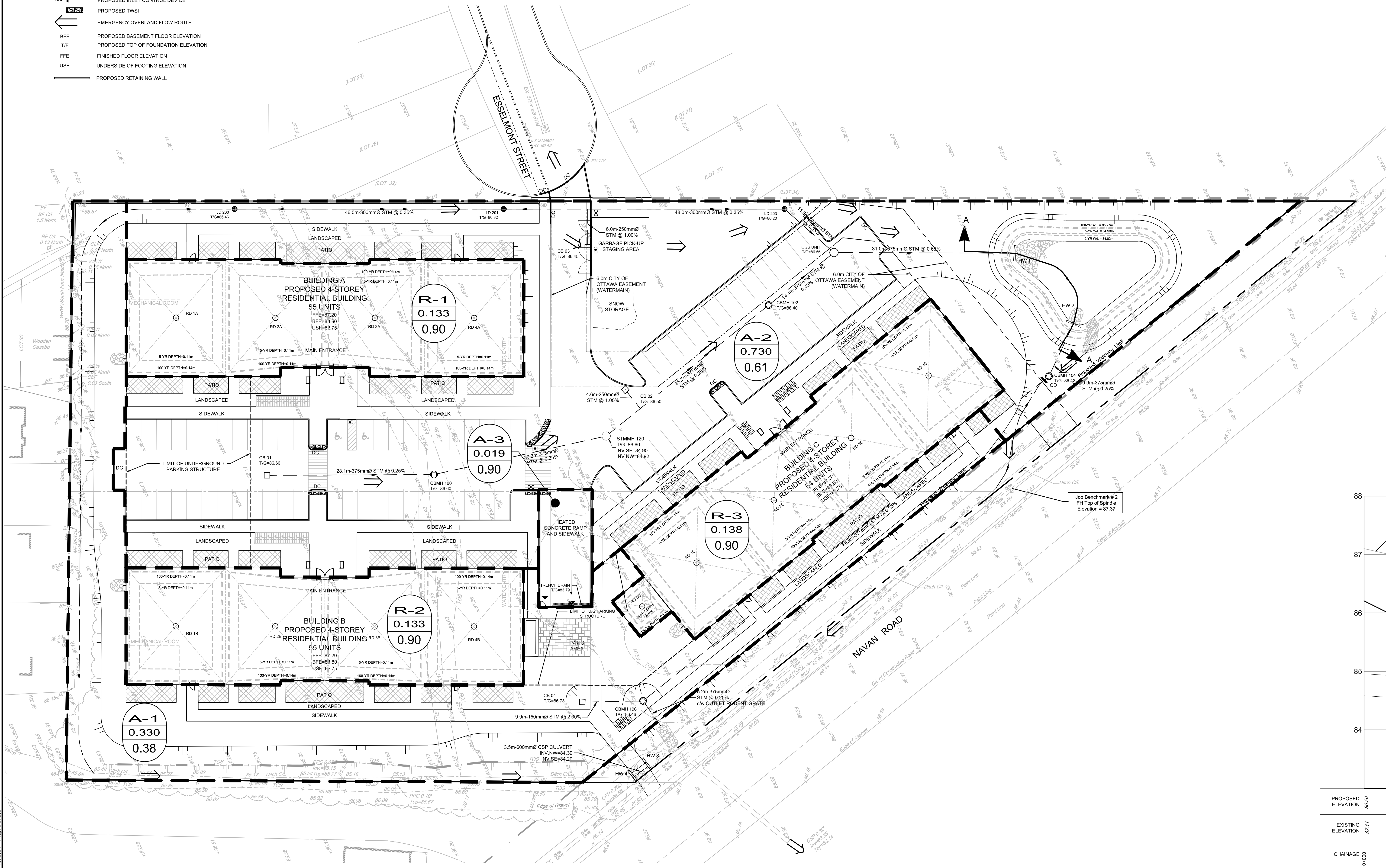

POND CROSS-SECTION A-A

NOTE:
THE POSITION OF ALL POLE LINES, CONDUITS, WATERMANS, SEWERS AND OTHER UNDERGROUND AND OVERGROUND UTILITIES AND STRUCTURES IS NOT NECESSARILY SHOWN ON THE CONTRACT DRAWINGS, AND WHERE SHOWN, THE ACCURACY OF THE POSITION OF SUCH UTILITIES AND STRUCTURES IS NOT GUARANTEED. BEFORE STARTING WORK, DETERMINE THE EXACT LOCATION OF ALL SUCH UTILITIES AND STRUCTURES AND ASSUME ALL LIABILITY FOR DAMAGE TO THEM.

OWNER INFORMATION
262576 ONTARIO INC.
231 BRITANNIA DRIVE, SUITE D
OTTAWA, ONTARIO, K1K 0R8
LALIT AGGARWAL
PHONE: (613) 746-1647
lsa@manorparkcap.com

No.	REVISION	DATE	BY
4.	REVISED PER GEOTECHNICAL COMMENTS	FEB 27/24	FST
3.	REVISED PER CITY COMMENTS	FEB 14/24	FST
2.	REVISED PER CITY COMMENTS	NOV 13/23	FST
1.	ISSUED FOR SITE PLAN CONTROL APPROVAL	JUNE 02/23	FST

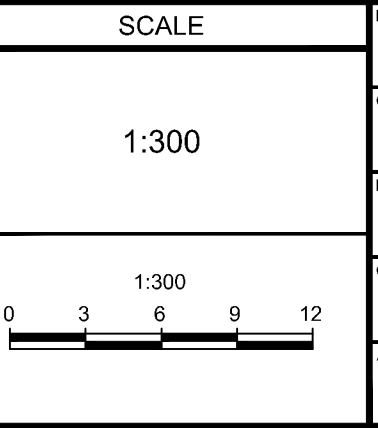

FOR REVIEW ONLY	
CHECKED	Z/ACV
DRAWN	FST
CHECKED	Z/ACV
APPROVED	FST



NOVATECH
Engineers, Planners & Landscape Architects
Suite 200, 240 Michael Cowpland Drive
Ottawa, Ontario, Canada K2M 1P6
Telephone: (613) 254-9543
Facsimile: (613) 254-5867
Website: www.novatech-eng.com

LOCATION
CITY OF OTTAWA
3317 NAVAN ROAD
DRAWING NAME
POST-DEVELOPMENT STORM DRAINAGE AREA PLAN

PROJECT NO.	118076
REV	REV # 4
DRAWING NO.	118076-STM2