

Engineering

Land/Site
Development

Municipal
Infrastructure

Environmental/
Water Resources

Traffic/
Transportation

Recreational

Planning

Land/Site
Development

Planning Application
Management

Municipal Planning

Urban Design

Expert Witness
(LPAT)

Wireless Industry

Landscape Architecture

Streetscapes &
Public Amenities

Open Space, Parks &
Recreation

Community &
Residential

Commercial &
Institutional

Environmental
Restoration

CHEO

1DOOR4CARE BUILDING

Transportation Impact Assessment

**Children's Hospital of Eastern Ontario (CHEO)
Proposed 1Door4Care Building
401 Smyth Road**

Transportation Impact Assessment

Prepared By:

NOVATECH

Suite 200, 240 Michael Cowpland Drive
Ottawa, Ontario
K2M 1P6

April 2024

Novatech File: 122210
Ref: R-2024-001

April 19, 2024

City of Ottawa
Planning, Real Estate, and Economic Development Department
110 Laurier Ave. W., 4th Floor
Ottawa, Ontario K1P 1J1

Attention: Mr. Mike Giampa
Sr. Transportation Engineer, Infrastructure Approvals

Dear Mr. Giampa:

Reference: Proposed 1Door4Care Building, 401 Smyth Road
Transportation Impact Assessment
Novatech File No. 122210

We are pleased to submit the following Transportation Impact Assessment (TIA), in support of a Site Plan Control application at 401 Smyth Road, for your review and signoff. The structure and format of this report is in accordance with the City of Ottawa's *Revised Transportation Impact Assessment Guidelines* (June 2023).

If you have any questions or comments regarding this report, please feel free to contact Jennifer Luong, or the undersigned.

Yours truly,

NOVATECH



Trevor Van Wiechen, M.Eng.
E.I.T. | Transportation



TIA Plan Reports

On 14 June 2017, the Council of the City of Ottawa adopted new Transportation Impact Assessment (TIA) Guidelines. In adopting the guidelines, Council established a requirement for those preparing and delivering transportation impact assessments and reports to sign a letter of certification.

Individuals submitting TIA reports will be responsible for all aspects of development-related transportation assessment and reporting, and undertaking such work, in accordance and compliance with the City of Ottawa's Official Plan, the Transportation Master Plan and the Transportation Impact Assessment (2017) Guidelines.

By submitting the attached TIA report (and any associated documents) and signing this document, the individual acknowledges that s/he meets the four criteria listed below.

CERTIFICATION

1. I have reviewed and have a sound understanding of the objectives, needs and requirements of the City of Ottawa's Official Plan, Transportation Master Plan and the Transportation Impact Assessment (2017) Guidelines;
2. I have a sound knowledge of industry standard practice with respect to the preparation of transportation impact assessment reports, including multi modal level of service review;
3. I have substantial experience (more than 5 years) in undertaking and delivering transportation impact studies (analysis, reporting and geometric design) with strong background knowledge in transportation planning, engineering or traffic operations; and
4. I am either a licensed¹ or registered² professional in good standing, whose field of expertise [check appropriate field(s)] is either transportation engineering or transportation planning .

1,2 License of registration body that oversees the profession is required to have a code of conduct and ethics guidelines that will ensure appropriate conduct and representation for transportation planning and/or transportation engineering works.

City Of Ottawa
Infrastructure Services and Community
Sustainability
Planning and Growth Management
110 Laurier Avenue West, 4th fl.
Ottawa, ON K1P 1J1
Tel. : 613-580-2424
Fax: 613-560-6006

Ville d'Ottawa
Services d'infrastructure et Viabilité des
collectivités
Urbanisme et Gestion de la croissance
110, avenue Laurier Ouest
Ottawa (Ontario) K1P 1J1
Tél. : 613-580-2424
Télécopieur: 613-560-6006

Dated at Ottawa this 19 day of April, 2024 .
(City)

Name: Jennifer Luong
(Please Print)

Professional Title: P. Eng. - Senior Project Manager

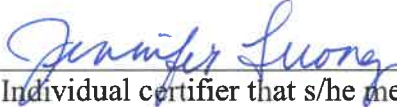
Signature of Individual certifier that s/he meets the above four criteria

Office Contact Information (Please Print)	
Address:	240 Michael Cowpland Drive
City / Postal Code:	Ottawa, ON K2M 1P6
Telephone / Extension:	613-254-9643 ext. 254
E-Mail Address:	j.luong@novaetch-eng.com

TABLE OF CONTENTS

1.0 SCREENING.....1

1.1 INTRODUCTION 1

1.2 PROPOSED DEVELOPMENT 1

1.3 SCREENING FORM 2

2.0 SCOPING.....4

2.1 EXISTING CONDITIONS 4

2.1.1 Roadways.....4

2.1.2 Intersections6

2.1.3 Driveways8

2.1.4 Pedestrian and Cycling Facilities9

2.1.5 Area Traffic Management11

2.1.6 Transit11

2.1.7 Existing Traffic Volumes12

2.1.8 Collision Records.....13

2.2 PLANNED CONDITIONS 16

2.2.1 Planned Transportation Projects.....16

2.2.2 Other Area Developments17

2.3 STUDY AREA AND TIME PERIODS 17

2.4 ACCESS DESIGN 18

2.5 DEVELOPMENT-GENERATED TRAVEL DEMAND..... 19

2.5.1 Trip Generation.....20

2.5.2 Trip Distribution and Assignment21

2.6 EXEMPTIONS REVIEW..... 21

3.0 BACKGROUND NETWORK TRAVEL DEMAND26

3.1 GENERAL BACKGROUND GROWTH RATE 26

3.2 OTHER AREA DEVELOPMENTS 26

3.3 RELOCATED TRAFFIC 27

3.3.1 Relocated Parking Traffic.....27

3.3.2 Relocated School Traffic.....28

3.3.3 Alterations to CHEO Non-Emergency Access.....29

3.3.4 Net Relocated Traffic29

3.4 FUTURE TRAFFIC CONDITIONS 32

3.5 DEMAND RATIONALIZATION..... 36

3.5.1 Existing Intersection Operations 37

3.5.2 2027 Background Intersection Operations38

3.5.3 2032 Background Intersection Operations39

4.0 ANALYSIS40

4.1 DEVELOPMENT DESIGN 40

4.1.1 Design for Sustainable Modes40

4.1.2 Circulation and Access41

4.2 PARKING 41

4.3 BOUNDARY STREETS 53

4.4 TRANSPORTATION DEMAND MANAGEMENT 54

4.4.1 Context for TDM 54

4.4.2 Need and Opportunity.....54

4.4.3 TDM Program54

4.5 TRANSIT 54

4.6 INTERSECTION DESIGN..... 55
 4.6.1 Intersection MMLOS55
 4.6.2 2027 Total Traffic Operations.....56
 4.6.3 2032 Total Traffic Operations.....58
5.0 CONCLUSIONS AND RECOMMENDATIONS59

Figures

Figure 1: View of the Subject Site 2
 Figure 2: CHEO Campus Parking Locations 3
 Figure 3: Roadway Network 5
 Figure 4: Existing Pedestrian Facilities..... 10
 Figure 5: Existing Cycling Facilities 10
 Figure 6: OC Transpo Bus Stop Locations 12
 Figure 7: Existing Auto Volumes 14
 Figure 8: Existing Pedestrian and Cyclist Volumes 15
 Figure 9: Trip Distribution and Assignment Percentages, Inbound Trips 22
 Figure 10: Trip Distribution and Assignment Percentages, Outbound Trips..... 23
 Figure 11: Site-Generated Traffic Volumes 24
 Figure 12: Relocated Traffic From Parking Lots B and E..... 28
 Figure 13: Relocated Traffic From the Existing School..... 30
 Figure 14: Remaining Displacement 31
 Figure 15: Net Relocated Traffic 32
 Figure 16: 2027 Background Traffic 33
 Figure 17: 2032 Background Traffic 34
 Figure 18: 2027 Total Traffic 35
 Figure 19: 2032 Total Traffic 36
 Figure 20: HSU Accessing Loading Area 42
 Figure 21: HSU Movements Within Loading Area 43
 Figure 22: Transit (B-12) and School Busses Entering CHEO Non-Emergency Access..... 44
 Figure 23: Transit (B-12) and School Busses Leaving CHEO Non-Emergency Access..... 45
 Figure 24: Transit (Articulated) and School Busses Entering CHEO Non-Emergency Access..... 46
 Figure 25: Transit (Articulated) and School Busses Leaving CHEO Non-Emergency Access 47
 Figure 26: Firetruck at 1Door4Care Access Loop Exiting Northbound..... 48
 Figure 27: Firetruck at 1Door4Care Access Loop Exiting Southbound..... 49
 Figure 28: Para-Transport at 1Door4Care Access Loop Exiting Northbound..... 50
 Figure 29: Para-Transport at 1Door4Care Access Loop Exiting Southbound 51
 Figure 30: Para-Transport at CHEO Drop-off Loop 52

Tables

Table 1: OC Transpo Transit Stops..... 11
 Table 2: OC Transpo Route Information 11
 Table 3: Reported Collisions 15
 Table 4: Proposed Development – Peak Hour Trip Generation..... 20
 Table 5: Proposed Development – Peak Hour Trips by Mode Share..... 20
 Table 6: TIA Exemptions..... 24
 Table 7: Composition of School Generated Vehicle Traffic 29
 Table 8: Existing Traffic Operations 37
 Table 9: 2027 Background Traffic Operations 38

Table 10: 2032 Background Traffic Operations 39
Table 11: Parking Review 41
Table 12: Segment MMLOS Summary..... 53
Table 13: Intersection MMLOS Summary..... 55
Table 14: 2027 Total Traffic Operations 56
Table 15: 2032 Total Traffic Operations 58

Appendices

- Appendix A: Preliminary Site Plan
- Appendix B: TIA Screening Form
- Appendix C: OC Transpo Route Maps
- Appendix D: Traffic Count Data
- Appendix E: Collision Records
- Appendix F: Strategic Long-Range Model Snapshots
- Appendix G: Other Area Developments
- Appendix H: Signal Timing Plans
- Appendix I: Detailed Analysis Reports
- Appendix J: Transportation Demand Management Checklists
- Appendix K: MMLOS Review

EXECUTIVE SUMMARY

This Transportation Impact Assessment (TIA) has been prepared in support of a Site Plan Control application for the property located at 401 Smyth Road. The subject development is a new '1Door4Care' building within the campus of the Children's Hospital of Eastern Ontario (CHEO). The site of the 1Door4Care Building is currently occupied by parking areas, which are being relocated to an approved on-campus parking garage, approximately 150m to the east.

The CHEO campus is bound by Ring Road to the north, south, and west, and is adjacent to The Ottawa Hospital (TOH) General Campus to the east. Outside of Ring Road, the hospital campuses are surrounded by the following:

- Parkland, followed by residential uses to the north,
- Smyth Road, followed by residential uses to the south,
- Roger Guindon Avenue, followed by institutional uses to the east, and
- Residential uses, industrial uses, or Department of National Defense offices to the west.

The proposed development consists of approximately 216,080ft² gross floor area (GFA) of hospital space and 17,500ft² of school space. The school will be on the north side of the new building and the clinical space will be on the south side. The proposed school will replace an existing school located on the northwest side of the CHEO campus, as shown in **Figure 1**. A new one-way access to Ring Road (N-S) is proposed to serve the clinical space of the new 1Door4Care Building, and a new loading access to Ring Road (E-W) is proposed. The existing looped two-way accesses to CHEO will be modified to a one-way access, and will also serve the school in the new building. The development of the 1Door4Care building will be constructed in a single phase, with a buildout year of 2027.

The new eight-storey parking garage located approximately 150m to the east is anticipated to be completed in 2025. The parking garage will have 1,050 parking spaces to accommodate the 1Door4Care parking demand and the displaced users of Lots B and E.

The subject site is designated as 'Evolving Neighbourhood' and 'Corridor – Mainstreet' (Smyth Road) on Schedule B3 of the City of Ottawa's Official Plan. The implemented zoning for the property is 'Major Institutional' (I2), which permits the existing and proposed hospital uses. The site is not within any Community Design Plan areas, and is located within the Alta Vista/Faircrest Heights/Riverview Park Secondary Plan area.

The conclusions and recommendations of this TIA can be summarized as follows:

Forecasting

- The proposed hospital clinic development is estimated to generate 401 person trips (including 241 vehicle trips) during the AM peak hour, and 387 person trips (including 233 vehicle trips) during the PM peak hour.
- Traffic from the existing school and Parking Lots B and E were redistributed within the subject site to account for the construction of the new parking garage and the 1Door4Care building. Traffic along the CHEO main access was redistributed due to the conversion of the road from two-way to one-way operations within the site.

Development Design

- A PXO Type D is proposed at the existing unmarked pedestrian crossing between the new 1Door4Care egress and the residential neighbourhood to the west. The PXO Type D is proposed as there is an existing pedestrian desire line. The PXO Type D is recommended based on the Ontario Traffic Manual (OTM) Book 15. Based on the 8-hour traffic volumes from the March 19, 2024, traffic count at the Ring Road (N-S)/Ring Road (E-W) intersection, the northern leg of the intersection has an 8-hour traffic volume of 2,847 vehicles. Given the posted speed limit of 40km/h, Table 7 of the OTM Book 15 was used to determine the required Type of PXO. Although the current roadway has a road platform of 9.5m and an effective 3 lane cross-section, it is recommended the roadway be narrowed on each side of Ring Road (N-S) by 1m for a total road platform width of 7.5m.
- Parking Lot B includes 286 parking spaces and Parking Lot E includes 270 parking spaces. The approved parking garage that is under construction in Parking Lot E will provide approximately 1,050 parking spaces and within the 1Door4Care site an additional 71 parking spaces are provided. The total number of parking spaces in the existing Parking Lots B and E plus the additional parking required by the ZBL for the 1Door4Care building totals 849 parking spaces. The approved parking garage therefore exceeds the parking requirements of the ZBL.
- Per Section 4.2.3 of the Stantec 2022 Transportation Study, the estimated parking generation rate for CHEO is approximately 3 spaces/100m². This is more than double the minimum zoning rate. Based on the observed rate, approximately 600 parking spaces are required to meet the demand for the new 1Door4Care clinic. With the 286 Lot B displaced spaces and the 270 Lot E displaced spaces, this amount to a total demand of 1,156 spaces. The 1,050 spaces in the approved Ph1A parking garage and the proposed 71 spaces for the Ph1B 1Door4Care site plan provide a total of 1,121 spaces, or 97% of the demand.
- The proposed development is considered to meet the required loading spaces as per Section 111 of the City's ZBL, due to the school bus lane to the north of the 1Door4Care building and the proposed loading area.
- For parking lots with over 1,000 parking spaces the City's Accessibility Design Standards require 11 +1% of the total parking spaces provided be a combination of Type A and Type B accessible parking spaces. Within the 1Door4Care site 14 Type A and 14 Type B parking spaces are provided. As 11 Type A and 11 Type B parking spaces are required for 1,121 total parking spaces this requirement is met.
- A total of 40 bicycle parking spaces will be provided near the 1Door4Care building.

Boundary Streets

- The proposed site plan includes 3.0m-wide multi-use pathways along the Ring Road (N-S) and Ring Road (E-W) frontages with boulevard widths of at least 0.5m.

Access Design

- The TAC *Geometric Design Guide* minimum corner clearance requirement of 20m is met by the proposed loop.
- The minimum clear throat requirement of 15m is met at the proposed access loop to Ring Road (N-S).

- The widths of the one-way ingress and egress of the proposed access loop exceed the requirements of the Private Approach By-law. However, Ring Road is not a municipal road and the accesses are not subject to the PABL.
- The proposed accesses to Ring Road (E-W) and Ring Road (N-S) are anticipated to operate with acceptable delays for the build-out year 2027 and horizon year 2032.

Transportation Demand Management (TDM)

- A review of the City's TDM Measures Checklist has been conducted. The proponent, is committed to providing the following TDM measures within this development:
 - Display local area maps with walking/cycling access routes and key destinations at major entrances;
 - Provide relevant transit schedules and route maps at main building entrances; and
 - Provide a multimodal travel option information package to new employees.

Transit

- Bus stop #1808 will need to be relocated to bus stop #7045 within the subject site due to the changes being proposed to the CHEO non-emergency access.

Intersection MMLOS

- The east approach of the Smyth Road/Ring Road (N-S)/South Haven Place intersection meets the City's vehicle/pedestrian conflict threshold for zebra-striped crosswalks (greater than 400,000 vehicle/pedestrian conflicts over an eight-hour period). This would improve the level of comfort for pedestrians crossing Smyth Road.
- Implementing bike boxes the Smyth Road/Ring Road (N-S)/South Haven Place intersection would require restricting right turns on red (RTOR) on the east and west approaches. This is identified for the City's consideration.
- A bike lane or higher order facility is identified on the north approach of the Smyth Road/Ring Road (N-S)/South Haven Place intersection for the City's consideration.
- The east and west approaches of the Smyth Road/General Hospital Access Road meet the City's vehicle/pedestrian conflict threshold for zebra-striped crosswalks. This would improve the level of comfort for pedestrians crossing Smyth Road.
- Two-stage left turn bike boxes are required to meet the target BLOS C at the north and west approaches of the Smyth Road/General Hospital Access Road intersection. For cyclists turning left from the north approach, this would involve a bike box in front of the eastbound stop bar. For cyclists turning left from the west approach, this would involve a jug handle facility and cyclist crossing signal. This is identified for the City's consideration.

Background Traffic Analysis

- All movements at study area intersections operate with acceptable LOS under 2027 and 2032 background traffic conditions.

Total Traffic Analysis

- All movements at study area intersections, except for the Ring Road (E-W)/General Hospital Access Road intersection, are expected to operate with acceptable LOS under total traffic conditions.
- Due to limitations in Synchro software the intersection was conservatively modeled as having free flow on the north and south approaches as opposed to only the south approach. It is assumed to operate with less delays and is recommended to be monitored in the future. Delays at the intersection are largely attributable to the existing conditions which includes a high volume of westbound left turning vehicles during the PM peak hour. A future additional westbound left turn lane may be required in addition to the existing westbound left turn lane and westbound through/right turn lane. Any additional travel lanes would likely impact the existing bus stop and retaining wall east of the Ring Road (E-W)/General Hospital Access Road intersection.

Based on the foregoing, the proposed development can be recommended from a transportation perspective.

1.0 SCREENING

1.1 Introduction

This Transportation Impact Assessment (TIA) has been prepared in support of a Site Plan Control application for the property located at 401 Smyth Road. The subject development is a new '1Door4Care' building within the campus of the Children's Hospital of Eastern Ontario (CHEO). The site of the 1Door4Care Building is currently occupied by parking areas, which are being relocated to an approved on-campus parking garage, approximately 150m to the east.

The CHEO campus is bound by Ring Road to the north, south, and west, and is adjacent to The Ottawa Hospital (TOH) General Campus to the east. Outside of Ring Road, the hospital campuses are surrounded by the following:

- Parkland, followed by residential uses to the north,
- Smyth Road, followed by residential uses to the south,
- Roger Guindon Avenue, followed by institutional uses to the east, and
- Residential uses, industrial uses, or Department of National Defense offices to the west.

An aerial of the vicinity around the subject site is provided in **Figure 1**, with the locations of the 1Door4Care site and approved parking garage shown. A separate figure outlining the existing parking lots within or adjacent to the CHEO campus is included as **Figure 2**.

For the purposes of this study, the north-south section of Ring Road that is immediately west of the proposed building and the east-west section of Ring Road that is immediately south of the proposed building are denoted in this study as Ring Road (N-S) and Ring Road (E-W), respectively.

1.2 Proposed Development

The proposed development consists of approximately 216,080ft² gross floor area (GFA) of hospital space and 17,500ft² of school space. The school will be on the north side of the new building and the clinical space will be on the south side. The proposed school will replace an existing school located on the northwest side of the CHEO campus, as shown in **Figure 1**. A new one-way access to Ring Road (N-S) is proposed to serve the clinical space of the new 1Door4Care Building, and a new loading access to Ring Road (E-W) is proposed. The existing looped two-way accesses to CHEO will be modified to a one-way access, and will also serve the school in the new building. The development of the 1Door4Care building will be constructed in a single phase, with a buildout year of 2027.

The new eight-storey parking garage located approximately 150m to the east is anticipated to be completed in 2025. The parking garage will have 1,050 parking spaces to accommodate the 1Door4Care parking demand and the displaced users of Lots B and E.

The subject site is designated as 'Evolving Neighbourhood' and 'Corridor – Mainstreet' (Smyth Road) on Schedule B3 of the City of Ottawa's Official Plan. The implemented zoning for the property is 'Major Institutional' (I2), which permits the existing and proposed hospital uses. The site is not within any Community Design Plan areas, and is located within the Alta Vista/Faircrest Heights/Riverview Park Secondary Plan area.

A copy of the preliminary site plan is included in **Appendix A**.

Figure 1: View of the Subject Site



1.3 Screening Form

The City’s 2023 Revised TIA Guidelines identify three triggers for completing a TIA report, including trip generation, location, and safety. The criteria for each trigger are outlined in the City’s TIA Screening Form, which is included in **Appendix B**. The trigger results are as follows:

- Trip Generation Trigger – The development is anticipated to generate over 60 peak hour person trips; further assessment is **required** based on this trigger.
- Location Triggers – The development does not propose a new connection to a designated Rapid Transit or Transit Priority (RTTP) corridor or a Crosstown Bikeway, and is not located within a Hub, Protected Major Transit Station Area (PMTSA), or Design Priority Area (DPA); further assessment is **not required** based on this trigger.

- Safety Triggers – The proposed driveway location to Ring Road (N-S) is within 150m of the adjacent signal at Smyth Road/Ring Road/South Haven Place; further assessment is **required** based on this trigger.

Figure 2: CHEO Campus Parking Locations



2.0 SCOPING

2.1 Existing Conditions

2.1.1 Roadways

The study area roadways Smyth Road and Hospital Link Road fall under the jurisdiction of the City of Ottawa. Ring Road, General Hospital Access Road, and all accesses within the CHEO campus are located outside of the City ROW.

Smyth Road is an arterial roadway that generally runs on an east-west alignment between Rideau River Drive and St. Laurent Boulevard/Russell Road. The roadway continues as Main Street west of Rideau River Drive, and as Lancaster Road east of St. Laurent Boulevard/Russell Road. Within the study area, Smyth Road has a four-lane undivided urban cross-section, asphalt sidewalks on both sides of the roadway, and a posted speed limit of 50 km/h. Smyth Road is classified as a truck route, allowing full loads. Street parking is prohibited on both sides of Smyth Road within the study area. The City's Official Plan identifies a 30m right-of-way (ROW) protection for Smyth Road. As the existing ROW of Smyth Road is approximately 26m at the subject site, a widening will be required.

Hospital Link Road is a local roadway that generally runs on a curvilinear alignment between Riverside Drive and Ring Road. At Riverside Drive, the roadway continues east as Hincks Lane. Hospital Link Road continues as Ring Road for the section that directly surrounds the CHEO campus. Within the study area, Hospital Link Road has a two-lane undivided urban cross-section, an asphalt multi-use pathway (MUP) on the south side of the roadway, and a posted speed limit of 50 km/h. Hospital Link Road is not classified as a truck route. Street parking is not prohibited along Hospital Link Road within the study area.

Ring Road is a local roadway that runs on a circuitous alignment around the CHEO campus, and is located within the sites at 401, 451, and 599 Smyth Road. Ring Road is connected to roadways within the City's jurisdiction via one connection to Roger Guindon Avenue, and two connections to Smyth Road. One connection is located in line with Ring Road (N-S), and the other is located in line with the General Hospital Access (approximately 400m to the east, measuring centre-to-centre). Ring Road has a two-lane undivided urban cross-section. On the inside of the roadway, asphalt or concrete sidewalks are provided in select areas, including the entire section of Ring Road (N-S). On the outside of the roadway, an asphalt MUP is provided between Hospital Link Road and the connection to Roger Guindon Avenue. Ring Road has a posted speed limit of 40 km/h, and is not classified as a truck route. Street parking is prohibited on both sides of the roadway, and the signage indicates that Ring Road is a fire route.

General Hospital Access Road is a local roadway that runs on a north-south alignment that intersects with Smyth Road and Ring Road (E-W), and extends to the north, providing access to parking for vehicles and ambulances, and drop-off zones for Para Transpo, taxis, and emergencies. General Hospital Access Road has a four-lane divided urban cross-section for the short section between Smyth Road and Ring Road (E-W), and a two-lane undivided urban cross-section north of Ring Road (E-W). Asphalt sidewalks are generally provided on both sides of General Hospital Access Road. As no posted speed limit signs are provided along General Hospital Access Road, the Highway Traffic Act stipulates a regulatory speed limit of 50 km/h. General Hospital Access Road is not classified as a truck route, and street parking is permitted in select perpendicular parking areas north of Ring Road (E-W).

The roadway of the greater area surrounding the subject site is illustrated in **Figure 3**.

Figure 3: Roadway Network

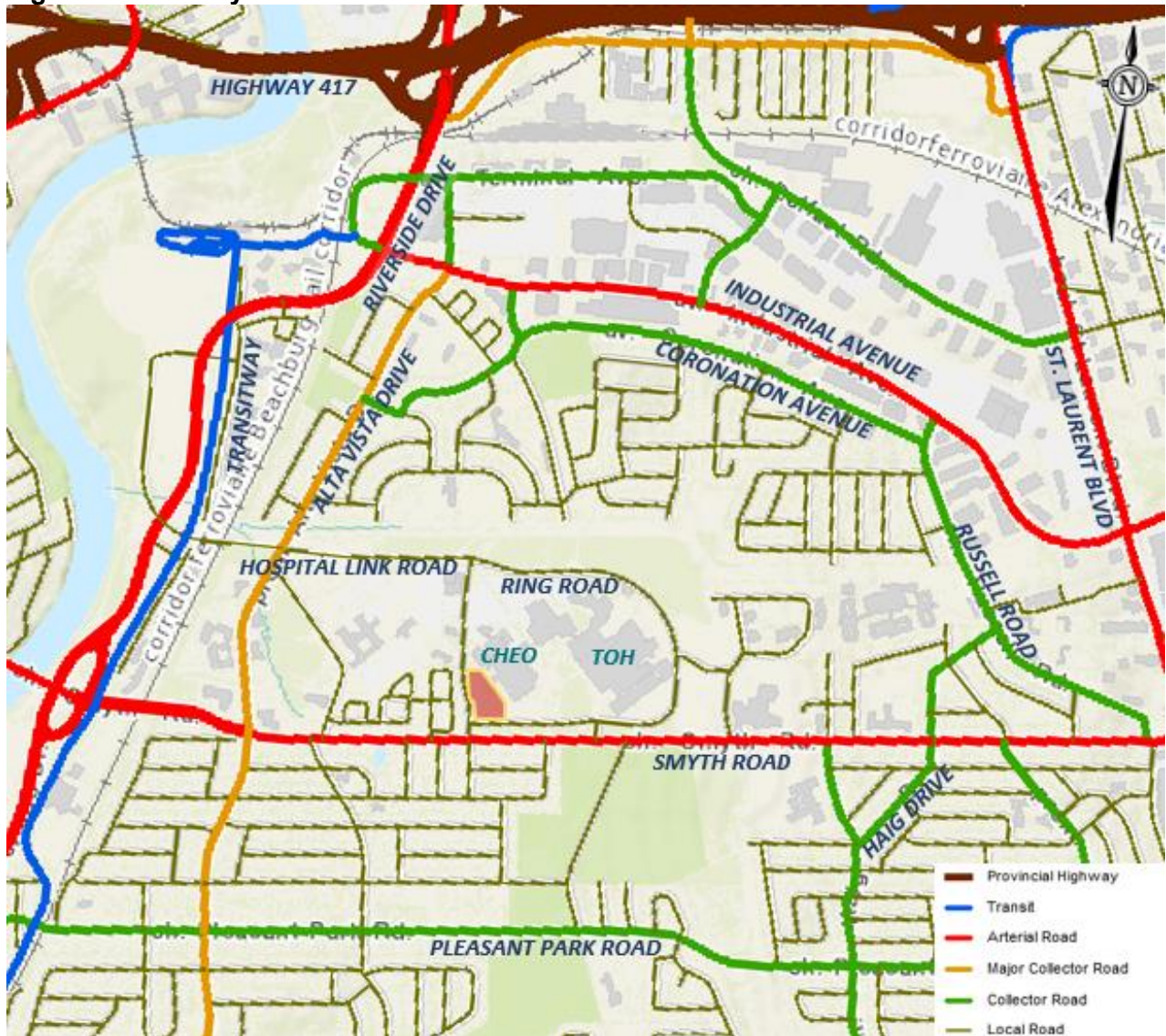

2.1.2 Intersections

Ring Road/Hospital Link Road

- Unsignalized three-legged intersection
- All-way stop control
- South Approach (Ring Road): one shared left turn/right turn lane
- East Approach (Ring Road): one shared left turn/through lane
- West Approach (Hospital Link Road): one shared through/right turn lane
- Standard crosswalks on all approaches
- Crossside provided at west approach



Ring Road (N-S)/CHEO Non-Emergency Access

- Unsignalized four-legged intersection
- All-way stop control
- East and west approaches offset
- North/South Approaches (Ring Road N-S): one shared left turn/through/right turn lane
- East Approach (CHEO Access): one shared left turn/through/right turn lane
- West Approach (access to 411 Smyth Road): one shared left turn/through/right turn lane
- Ladder crosswalks on north and east approaches



Ring Road (N-S)/Ring Road (E-W)

- Unsignalized three-legged intersection
- Stop control on east approach
- North Approach (Ring Road N-S): one shared left turn/through lane
- South Approach (Ring Road N-S): one shared through/right turn lane
- East Approach (Ring Road E-W): one shared left turn/right turn lane
- Ladder crosswalks on east approach

Smyth Road/Ring Road (N-S)/South Haven Place

- Signalized four-legged intersection
- North Approach (Ring Road N-S): one left turn lane and one right turn lane (through traffic is restricted, except for bicycles)
- South Approach (South Haven Place): one shared left turn/right turn lane (through traffic is restricted, except for bicycles)
- East Approach (Smyth Road): one shared left turn/through lane and one shared through/right turn lane
- West Approach (Smyth Road): one shared left turn/through lane and one shared through/right turn lane
- Standard crosswalks on all approaches



Ring Road (E-W)/CHEO Non-Emergency Access

- Unsignalized three-legged intersection
- Stop control on north approach
- North Approach (CHEO Non-Emergency Access): one shared left turn/right turn lane
- East Approach (Ring Road E-W): one shared through/right turn lane
- West Approach (Ring Road E-W): one shared left turn/through lane



Ring Road (E-W)/CHEO Emergency Access

- Unsignalized three-legged intersection
- Stop control on north approach
- North Approach (CHEO Emergency Access): one shared left turn/right turn lane
- East Approach (Ring Road E-W): one shared through/right turn lane
- West Approach (Ring Road E-W): one shared left turn/through lane
- Ladder crosswalk on east approach



Ring Road (E-W)/General Hospital Access Road

- Unsignalized four-legged intersection
- Three-way stop control on north, east, and west approaches
- North Approach (General Hospital Access Road): one shared left turn/through/right turn lane
- South Approach (General Hospital Access Road): one shared left turn/through lane and one right turn lane (channelized)
- East Approach (Ring Road E-W): one left turn lane and one shared left turn/through/right turn lane
- West Approach (Ring Road E-W): one shared left turn/through/right turn lane
- Ladder crosswalk on east and west approaches



Smyth Road/General Hospital Access Road

- Signalized three-legged intersection
- North Approach (General Hospital Access Road): dual left turn lanes and one right turn lane
- East Approach (Smyth Road): two through lanes and one right turn lane
- West Approach (Smyth Road): one left turn lane and two through lanes
- Standard crosswalks on all approaches

2.1.3 Driveways

In accordance with the *Revised TIA Guidelines*, a review of the existing adjacent driveways along the boundary roads are provided as follows. All driveways within 200m of the proposed loop accesses to Ring Road (N-S) and the proposed loading access to Ring Road (E-W) are listed as follows.

Ring Road (N-S), west side

- One driveway to the Ronald McDonald House at 401 Smyth Road;
- One driveway to a motel at 411 Smyth Road.

Ring Road (N-S), east side

- One internal intersection leading to the non-emergency entrance to the CHEO building at 401 Smyth Road;
- One internal intersection leading to the Roger Neilson House and Children’s Treatment Centre at 401 Smyth Road.

South Haven Place, west side

- Five driveways to residences at 1874, 1882, and 1890 South Haven Place.

South Haven Place, east side

- Three driveways to residences at 403 & 404 Simpson Road, and 404 Smyth Road.

Ring Road (E-W), north side

- One driveway to Parking Lot A adjacent to the CHEO building at 401 Smyth Road;
- Two internal intersections leading to the non-emergency and emergency entrances to the CHEO building at 401 Smyth Road.

Ring Road (E-W), south side

- No driveways

2.1.4 Pedestrian and Cycling Facilities

Sidewalks are provided on both sides of Smyth Road and General Hospital Access Road, on one side of Ring Road (N-S), and along the north side of Ring Road (E-W) next to Parking Lot E. There are also pathways within the CHEO and TOH campuses, which provide connectivity throughout the sites.

A MUP is provided on the south side of Hospital Link Road, which crosses to the north side at the Hospital Link Road/Ring Road intersection, and continues on the outside of Ring Road until the connection to Roger Guindon Avenue. The MUP then follows Roger Guindon Avenue and crosses Smyth Road, where it continues south of the study area through Lynda Lane Park. North of the CHEO campus, the MUP connects to another pathway that heads north to Station Boulevard.

In the City of Ottawa's 2013 Ottawa Cycling Plan (OCP), Smyth Road is designated as a Spine Route. Per the 2013 OCP, local routes in the area include South Haven Place, Roger Road, and Fairbanks Avenue to the south, Roger Guindon Avenue and Dauphin Road to the east. The section of pathway along the outside of Ring Road forms part of Crosstown Bikeway #4, which runs from Laurier Avenue East to Findlay Creek Boulevard.

A map of the existing pedestrian facilities is provided in **Figure 4** and a map of the existing cycling facilities is provided in **Figure 5**.

Figure 4: Existing Pedestrian Facilities



Figure 5: Existing Cycling Facilities



2.1.5 Area Traffic Management

Within the study area, there are no Area Traffic Management (ATM) studies that are in progress. As described in Section 2.1.2, northbound and southbound through restrictions are implemented at Smyth Road/Ring Road (N-S)/South Haven Place, which serves to keep traffic from travelling directly between the hospital campuses and the residences south of Smyth Road.

To the east of the study area, the Haig Drive Traffic Calming Study was completed by the City, with a final recommendation plan posted in August 2023. The recommended measures include painted bike lanes, traffic calming measures, and intersection modifications on Haig Drive between Smyth Road and Harding Road to the south.

On Smyth Road east of the study area, school zone signage and pavement markings are provided in vicinity of Vincent Massey School, along with a municipal speed camera to enforce speeds within the school zone.

2.1.6 Transit

The locations of OC Transpo bus stops that are relevant to the proposed development are described in **Table 1**, and shown in **Figure 6**. A summary of the various routes which serve the study area is included in **Table 2**. Detailed route information and an excerpt from the OC Transpo System Map are included in **Appendix C**.

Table 1: OC Transpo Transit Stops

Stop	Location	Routes Served
#1808	East side of CHEO Non-Emergency Access (between main entrance and access)	45, 55
#7045	West side of CHEO Non-Emergency Access (between main entrance and access)	55
#7072	North side of Ring Road (E-W), east of CHEO Non-Emergency Access	45, 55
#7231	East side of Ring Road (N-S), south of access to Roger Neilson House	45
#7236	North side of Smyth Road, across from Barnhart Place	55, 609, 645
#7237	South side of Smyth Road, east of Barnhart Place	55, 609
#7238	South side of Smyth Road, west of South Haven Place	609

Table 2: OC Transpo Route Information

Route	From ↔ To	Frequency
45	Hospital ~ Hôpital ↔ Hurdman & N Rideau	All day and limited overnight service, seven days a week; 15- to 60-minute headways
55	Elmvale ↔ Westgate	All day service, seven days a week; 15- to 30-minute headways
609	Elmvale ↔ De La Salle H.S.	Service at select times on school days only
645	Franco-Cité H.S. → Hurdman	Service in one direction after school, on school days only

Figure 6: OC Transpo Bus Stop Locations



2.1.7 Existing Traffic Volumes

Weekday traffic counts were coordinated by the City of Ottawa and Novatech. These counts were used to determine the existing traffic volumes at the study area intersections, and the data was collected during the following dates:

- Ring Road/Hospital Link Road March 19, 2024 (Novatech)
- Ring Road (N-S)/CHEO Non-Emergency Access March 19, 2024 (Novatech)
- Smyth Road/Ring Road (N-S)/South Haven Place October 4, 2022 (City)
- Ring Road (E-W)/CHEO Non-Emergency Access March 20, 2024 (Novatech)
- Ring Road (E-W)/CHEO Emergency Access February 20, 2020 (City)
- March 20, 2024 (Novatech)

- Ring Road (E-W)/General Hospital Access Road March 19,2024 (Novatech)
- Smyth Road/General Hospital Access Road December 11, 2019 (City)
- Ring Road (N-S)/Ring Road (E-W) March 19,2024 (Novatech)

Due to construction occurring in Parking Lot E at the time of the 2024 traffic counts the volumes of vehicles turning in and out of the CHEO emergency access were noticeably lower than previous traffic counts. To account for the construction eliminating parking in this area and lowering the turning volumes at this intersection the turning volumes from the 2020 traffic count were combined with the east-west through volumes from the 2024 traffic count.

It should be noted that all recent traffic counts completed within the study area occurred outside of the summer months and pedestrian and cyclist volumes may be higher during other times of the year.

The traffic count data is included in **Appendix D**. Peak hour vehicle volumes within the study area are shown in **Figure 7**, and peak hour pedestrian and cyclist volumes are shown in **Figure 8**.

2.1.8 Collision Records

Historical collision data from the last five years available was obtained from the City's Public Works and Service Department for the study area intersections and midblock segments. Copies of the collision summary reports are included in **Appendix E**. Department staff have advised that no reportable collisions were received for any location along Ring Road.

Private collision data was not available from Infrastructure Ontario for Ring Road.

The collision data has been evaluated to determine if there are any identifiable collision patterns, which are defined in the *Revised TIA Guidelines* as 'more than six collisions in five years' for any one movement. The number of collisions at each intersection from January 1, 2017 to December 31, 2021 is summarized in **Table 3**.

Figure 7: Existing Auto Volumes

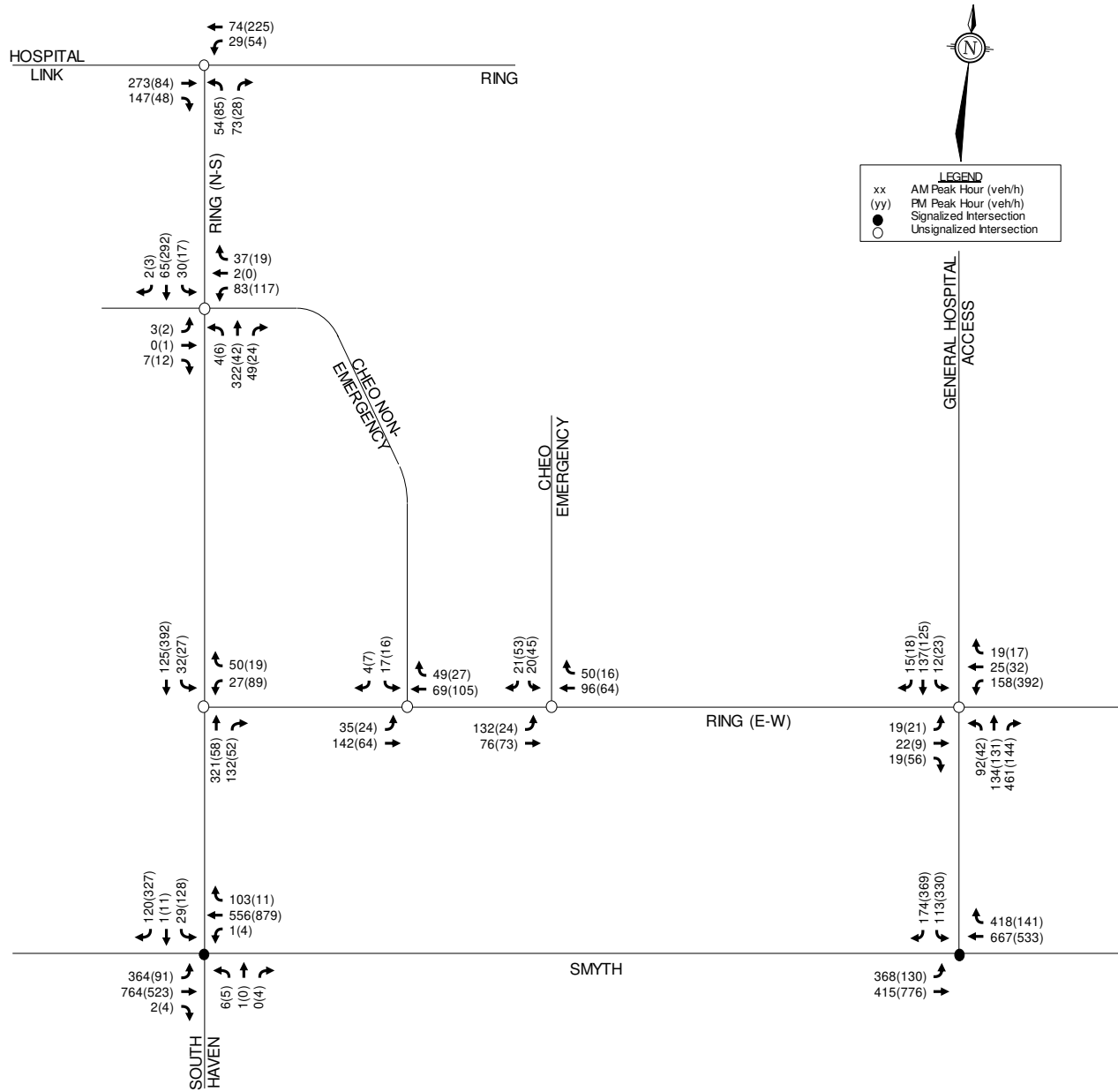

Figure 8: Existing Pedestrian and Cyclist Volumes

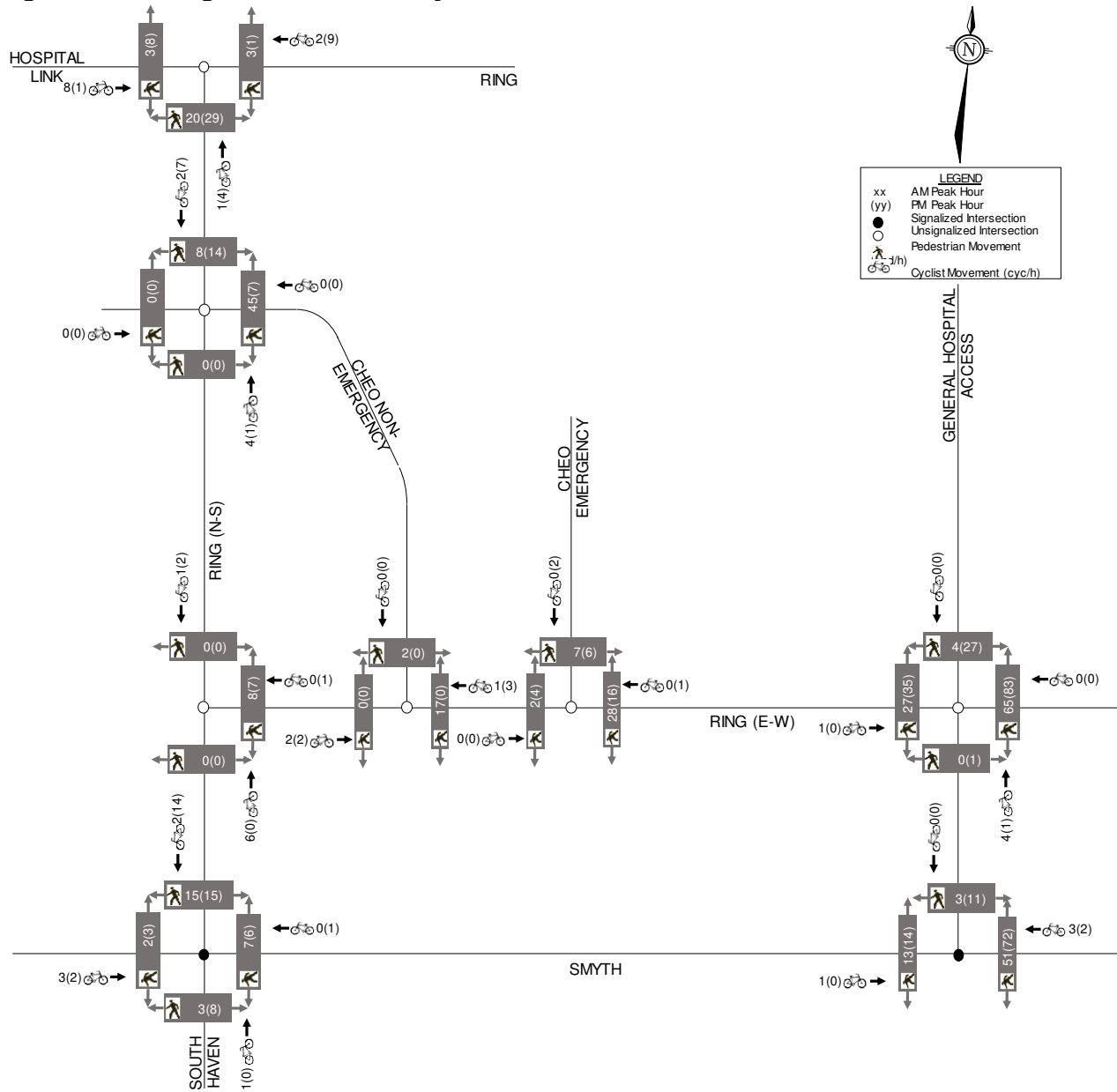

Table 3: Reported Collisions

Location	Impact Types						Total
	Approach	Angle	Rear End	Sideswipe	Turning Movement	SMV ⁽¹⁾ /Other	
Smyth Road/ Ring Road (N-S)/South Haven PI	-	1	4	3	5	-	13
Smyth Road/ General Hospital Access Road	-	-	7	5	4	1	17
Smyth Road btwn Ring Rd (N-S) & General Hospital Access Road	-	-	1	3	1	-	5

1. SMV = Single Motor Vehicle

Smyth Road/Ring Road (N-S)/South Haven Place

A total of 13 collisions were reported at this intersection over the last five years, consisting of one angle impact, four rear-end impacts, three sideswipe impacts, and five turning movement impacts. One collision resulted in non-fatal injuries, and none resulted in fatal injuries. Six of the 13 collisions (46%) occurred in poor driving conditions. No collisions involved pedestrians or cyclists.

Smyth Road/General Hospital Access Road

A total of 17 collisions were reported at this intersection over the last five years, consisting of seven rear-end impacts, five sideswipe impacts, four turning movement impacts, and one single vehicle/other impacts. One collision resulted in non-fatal injuries, and none resulted in fatal injuries. Nine of the 17 collisions (53%) occurred in poor driving conditions. No collisions involved pedestrians or cyclists.

Of the seven rear-end impacts, three occurred at the southbound approach, one occurred at the eastbound approach, and three occurred at the westbound approach. Therefore, no rear-end collision patterns are identified at any approach.

Segments of Smyth Road between Ring Road/South Haven Place & General Hospital Access Road

A total of five collisions were reported along this segment over the last five years, including two collisions at the intersection of Smyth Road/Highland Terrace. The five collisions consisted of one rear-end impact, three sideswipe impacts, and one turning movement impact. One collision occurred in non-fatal injuries, and none resulted in fatal injuries. Three of the five collisions (60%) occurred in poor driving conditions. No collisions involved pedestrians or cyclists.

2.2 Planned Conditions

2.2.1 Planned Transportation Projects

The City's 2013 *Transportation Master Plan (TMP)* identifies transit signal priority and queue jump lanes at select locations along Alta Vista Drive (from Smyth Road to Industrial Avenue) and Smyth Road (from Alta Vista Transportation Corridor and St. Laurent Boulevard), in the 2031 Rapid Transit and Transit Priority (RTTP) Network Concept.

The City's 2013 TMP also identifies the Alta Vista Transportation Corridor in its 2031 Road Network Concept and 2031 RTTP Network Concept. The corridor includes the now-constructed Hospital Link Road. In the 2031 Road Network Concept, this will include a new four-lane road between the Nicholas Street/Highway 417 interchange and Riverside Drive, and a new four-lane road between the Ottawa Health Sciences Centre and Walkley Road. In the 2031 RTTP Network Concept, bus and high-occupancy vehicle (HOV) lanes and transit signal priority is planned between Riverside Drive and the Ottawa Health Sciences Centre (i.e. Hospital Link Road and the adjacent northern section of Ring Road). Transit signal priority and queue jump lanes are identified between the Ottawa Health Sciences Centre and Walkley Road.

The 2013 Ottawa Cycling Plan and 2013 Ottawa Pedestrian Plan do not identify any upcoming pedestrian and cycling infrastructure projects within the study area. The City's *Draft TMP Update* (March 2023) includes a list of active transportation projects. West of the study area, the update identifies separated cycling facilities and/or bike lanes on Smyth Road from Alta Vista Drive to Riverside Drive, to provide connectivity to these streets and the Rideau River Eastern Pathway. East of the study area, a cycling infrastructure project is identified along the Botsford Street/Dauphin Street corridor, from Coronation Avenue to Kilborn Avenue.

2.2.2 Other Area Developments

Other developments that are in the approval process or have recently been completed, constructed, or approved and are summarized as follows.

355 and 374 Everest Private

A total of 293 dwellings are proposed to be added to an existing condominium complex at 355 and 374 Everest Private. The site plans at both addresses were approved by the City in February 2022.

401 Smyth Road (Parking Structure)

The new parking garage with 1,050 vehicle parking spaces will replace the gravel parking at Parking Lot E. A TIA was prepared by EXP in September 2023 with an addendum by Novatech in October, 2023. Buildout is expected in 2025.

451 Smyth Road

The University of Ottawa has proposed a six-storey medical research facility with a GFA of 267,270 ft². A TIA prepared by WSP in February 2024 had identified an estimated buildout year of 2026.

700 Coronation Avenue

A total of 35 dwellings are proposed to be added to an existing apartment development at 700 Coronation Avenue. The application is currently in the approval process. No traffic study was prepared for this development.

1740-1760 St. Laurent Boulevard

A total of 701 dwellings, 21,808 ft² of commercial space, and 9,383 ft² of restaurant space are proposed at the addresses above. A TIA prepared by Parsons in October 2023 had identified an estimated buildout year of 2024.

1967 Riverside Drive

TOH has entered into an agreement with the City of Ottawa to permit 256 long-term care units and 250 retirement units, adjacent to the Riverside Campus of TOH. A TIA prepared by CGH in January 2023 had identified an estimated buildout year of 2026.

1971 St. Laurent Boulevard

A total of 498 dwellings are proposed to be added to an existing apartment complex at 1971 St. Laurent Boulevard. A TIA prepared by CGH in March 2023 had identified an estimated buildout year of 2030.

2025 Othello Avenue

A total of 563 dwellings are proposed to be added to an existing apartment complex at 2025 Othello Avenue. A TIA prepared by Parsons in September 2021 had identified an estimated buildout year of 2023.

2.3 Study Area and Time Periods

The study area for this report includes Smyth Road, Ring Road (N-S), and Ring Road (E-W), as the boundary streets, and includes the following intersections.

- Ring Road/Hospital Link Road;
- Ring Road (N-S)/CHEO Non-Emergency Access;
- Ring Road (N-S)/Ring Road (E-W);

- Smyth Road/Ring Road (N-S)/South Haven Place;
- Ring Road (E-W)/CHEO Non-Emergency Access;
- Ring Road (E-W)/CHEO Emergency Access;
- Ring Road (E-W)/General Hospital Access Road;
- Smyth Road/General Hospital Access Road.

The peak hours of adjacent street traffic are generally 7:30-8:30am and 3:30-4:30PM. The PM peak of the intersections along Ring Road (E-W) is slightly earlier at 3:00-4:00PM. Existing and proposed school hours are 8:30AM-3:00PM with no before and after care programs. As outlined in this report, the school traffic is small compared to the proposed clinic traffic.

The selected time periods for the analysis are the weekday AM and PM peak hours, as they represent the 'worst case' combination of site generated traffic and adjacent street traffic. For this analysis the relocated school trips have been added to the AM and PM peak hour traffic. Analysis will be completed for the buildout year 2027 and horizon year 2032.

2.4 Access Design

This section summarizes the proposed new accesses to Ring Road (N-S) and Ring Road (E-W), and proposed changes to existing lane configurations for the CHEO Non-Emergency Accesses. Design vehicle turning templates and detailed intersection analysis has been completed within this TIA.

While the proposed development does not propose any new private approaches to City streets, certain relevant sections of the City's *Private Approach By-Law* (PABL) have been reviewed for each access.

New 1Door4Care Loop and Adjacent Surface Parking

The proposed 1Door4Care building will include a loop that accesses Ring Road (N-S), with access points approximately 40m and 85m north of Ring Road (E-W), measuring from the nearest edge of Ring Road (E-W) to the nearest edge of the access. The northerly end of the loop will operate as an egress, allowing both outbound left turns and outbound right turns. The southerly end of the loop will operate as an ingress, permitting inbound right turns. The Transportation Association of Canada (TAC)'s *Geometric Design Guide for Canadian Roads* includes minimum corner clearance requirements for accesses to different classes of roadways, that are in the vicinity of cross roads. Treating all sections of Ring Road as a collector, TAC's *Geometric Design Guide* identifies a minimum corner clearance requirement of 20m. This requirement is met by the proposed loop.

The loop will provide access to the main entrance to the clinical portion of the 1Door4Care building, as well as a surface parking lot with approximately 40 parking spaces. The nearest edge of the surface parking drive aisle is located approximately 15m from the nearest edge of Ring Road (N-S). TAC's *Geometric Design Guide* includes minimum clear throat requirements for collector and arterial accesses to certain land uses. The light industrial land use has been considered, as it is the land use closest to the proposed hospital use. A minimum clear throat requirement of 15m is identified for light industrial uses between 10,000 and 45,000 m² in area, and therefore the requirement is met.

Section 25(1)(d) of the City's PABL identifies a maximum permitted width of 7.5m for one-way private approaches. Measuring at the back of sidewalk on Ring Road (N-S), the one-way ingress of the loop is approximately 7.6m wide, which is marginally above the requirements of Section

25(1)(d). The one-way egress of the loop is approximately 8.3m wide, and therefore would not meet the requirements of Section 25(1)(d). Ring Road is not a municipal road and the accesses are not subject to the PABL. Required turning movements are reviewed in Section 4.1.2.

New 1Door4Care Loading Access

The proposed 1Door4Care building will also include a loading access to Ring Road (E-W), which will be designed to accommodate a Heavy Single Unit (HSU) design vehicle. The nearest edge of the loading access is located approximately 17m from the nearest edge of the non-emergency access.

Measuring from the back of sidewalk along Ring Road (E-W), the loading access is approximately 7.1m wide, meeting the requirements of Section 25(1)(c).

Proposed Reconfiguration of CHEO Non-Emergency Access

As part of the proposed development, the non-emergency access to Ring Road (N-S) will be converted from a two-way access to an ingress only, with separate entrances for the CHEO building and the 1Door4Care drop-off for school buses and parents. Vehicles will continue to the CHEO entrance or turn into the drop-off lane approximately 45m from Ring Road (N-S). This meets the minimum clear throat requirement of 15m.

Entering the ingress, the lane serving the bus loading area is approximately 3.6m in width, while the lane serving the CHEO entrance and fire route lane is approximately 6.0m in width. The two lanes are separated by an approximately 0.9m-wide buffer. The fire route/CHEO lane widens to approximately 6.3m after the split where school buses and parents can turn into the school drop-off lane. The school drop-off lane is approximately 6.0m in width. This allows for a 3.0m-wide drive aisle and 3.0m-wide lane for school bus or parent drop-offs.

Measuring from the back of sidewalk on Ring Road (N-S), the proposed ingress is approximately 17m wide. This does not meet the requirements of Section 25(1)(d) of the PABL. However, Section 25(1)(e) of the PABL identifies that private approaches in excess of 9m in width at the edge or roadway may be permitted for off-street bus loading areas, transport loading areas, and stations operated by the Ottawa Fire Department. As the ingress includes a lane to accommodate school bus queuing, this access would be permitted under the exceptions allowed by Section 25(1)(e).

The proposed configuration of the ingress will be able to accommodate a queue of 12 school buses from the front of the school bus drop-off zone to the edge of Ring Road (N-S), meeting the requirements of Infrastructure Ontario. The design bus vehicle considered is a Class A School Bus, which has a length of 8m, width of 2.4m, and height of 3m. The proposed parent drop-off area further downstream of the bus drop-off zone will be able to accommodate a queue of seven passenger vehicles.

The non-emergency access to Ring Road (E-W) will be converted from a two-way access to an egress only, with separate southbound left turn and right turn lanes. The drive aisle approaching the egress is approximately 7.9m in width. This marginally exceeds the requirements of Section 25(1)(d) of the PABL.

2.5 Development-Generated Travel Demand

The school that is proposed within the subject development currently exists and is operating to the north of the subject site within the CHEO campus. New trips will not be generated by the school as

it is expected to accommodate the same number of students and staff as the existing school. The relocated school traffic is shown in Section 3.3.2.

2.5.1 Trip Generation

The gross floor area of the proposed 1Door4Care building is approximately 21,700 m² (233,580 ft²). Within the proposed building the relocated school accounts for roughly 1,625 m² (17,500 ft²) of the total GFA. The number of peak hour person trips generated by the proposed hospital clinic has been estimated using the regression equations for the rates associated with the Hospital land use, as outlined in the *ITE Trip Generation Manual, 11th Edition*. As the *ITE Trip Generation Manual* produces trip generation rates in vehicle trips, a person trip conversion factor of 1.28 has been applied. The subsequent estimated number of person trips to be generated by the proposed development is shown in **Table 4**.

Table 4: Proposed Development – Peak Hour Trip Generation

Land Use	ITE Code	Units	AM Peak Hour (pph ⁽¹⁾)			PM Peak Hour (pph)		
			IN	OUT	TOT	IN	OUT	TOT
Hospital	610	216,080 ft ²	269	132	401	136	251	387

1. pph: Person Trips per Hour

The *TRANS O-D Survey Report* identifies the subject site as being located within the Alta Vista district. Considering all trips travelling to/within Alta Vista during the AM peak hour and all trips travelling from/within Alta Vista during the PM peak hour (i.e. trips associated with commuters travelling to work in the morning, and from work in the afternoon). Considering these trips, the observed mode shares for the Alta Vista district can be summarized as follows:

- Auto Driver: 61% in AM peak, 62% in PM peak;
- Auto Passenger: 15% in AM peak, 15% in PM peak;
- Transit: 16% in AM peak, 15% in PM peak;
- Cyclist: 2% in AM peak, 2% in PM peak;
- Pedestrian: 6% in AM peak, 6% in PM peak.

Site specific mode share data is not available from CHEO. The mode shares for the proposed 1Door4Care development are assumed to follow one set for both peak hours. The assumed shares generally follow the observed values above. This can be summarized as 60% driver, 15% passenger, 15% transit, 5% cyclist, and 5% pedestrian. A breakdown of the site-generated trips by mode share is included in **Table 5**.

Table 5: Proposed Development – Peak Hour Trips by Mode Share

Travel Mode	Mode Share	AM Peak Hour			PM Peak Hour		
		IN	OUT	TOT	IN	OUT	TOT
Hospital Person Trips		269	132	401	136	251	387
Auto Driver	60%	162	79	241	82	151	233
Auto Passenger	15%	40	20	60	20	38	58
Transit	15%	40	20	60	20	38	58
Cyclist	5%	14	6	20	7	12	19
Pedestrian	5%	13	7	20	7	12	19

From the previous tables, the proposed hospital clinic development is estimated to generate 401 person trips (including 241 vehicle trips) during the AM peak hour, and 387 person trips (including 233 vehicle trips) during the PM peak hour.

2.5.2 Trip Distribution and Assignment

The distribution of trips generated by the proposed development to the study area network has been derived, based on the peak hour volumes at Ring Road/Hospital Link Road, Smyth Road/Ring Road (N-S)/South Haven Place, and Smyth Road/General Hospital Access Road. For the purposes of this study, approximately 15% of peak hour trips have been assigned to the new 1Door4Care loop to Ring Road (N-S). The other 85% of peak hour trips have been assigned to the parking garage access to Ring Road (E-W).

The distribution and assignment percentages of inbound and outbound site-generated vehicle trips are shown in **Figure 9** and **Figure 10**, respectively. The site-generated peak hour traffic volumes to the study area intersections are shown in **Figure 11**.

2.6 Exemptions Review

This module reviews possible exemptions from the final TIA, as outlined in the *2017 TIA Guidelines* and *2023 Revisions to the TIA Guidelines*. The applicable exemptions for this site are shown in **Table 6**.

Figure 9: Trip Distribution and Assignment Percentages, Inbound Trips

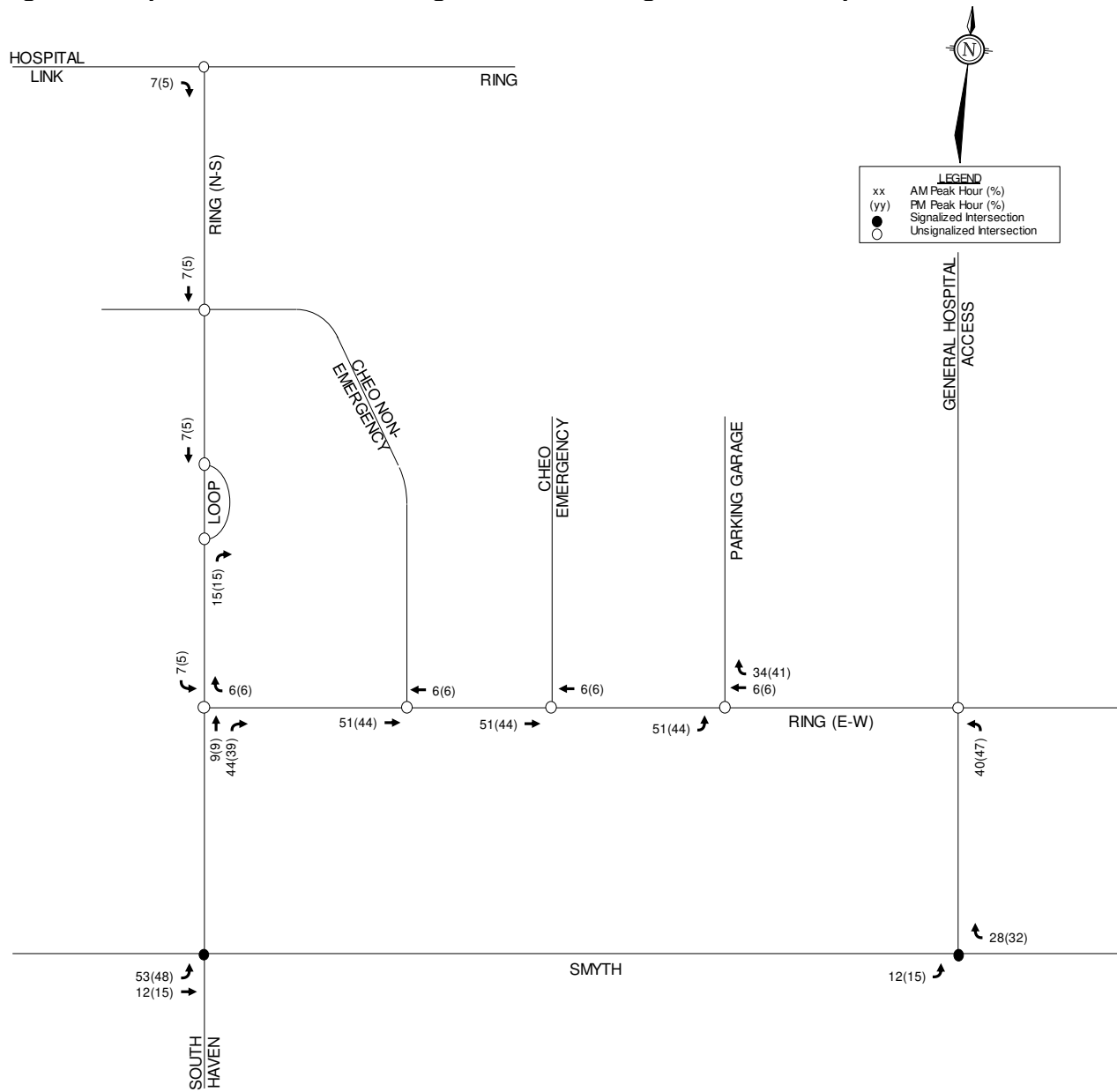

Figure 10: Trip Distribution and Assignment Percentages, Outbound Trips

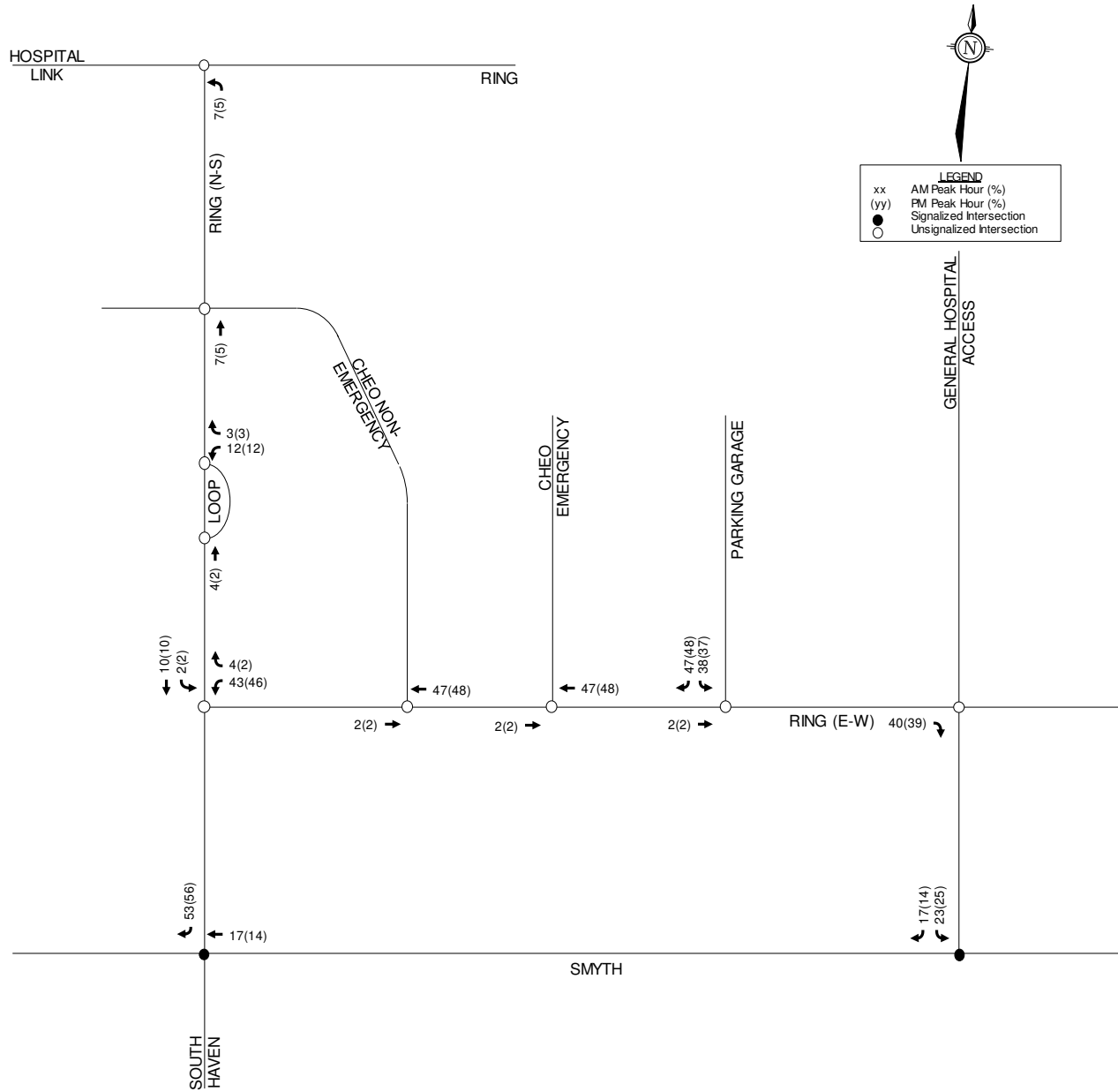

Figure 11: Site-Generated Traffic Volumes

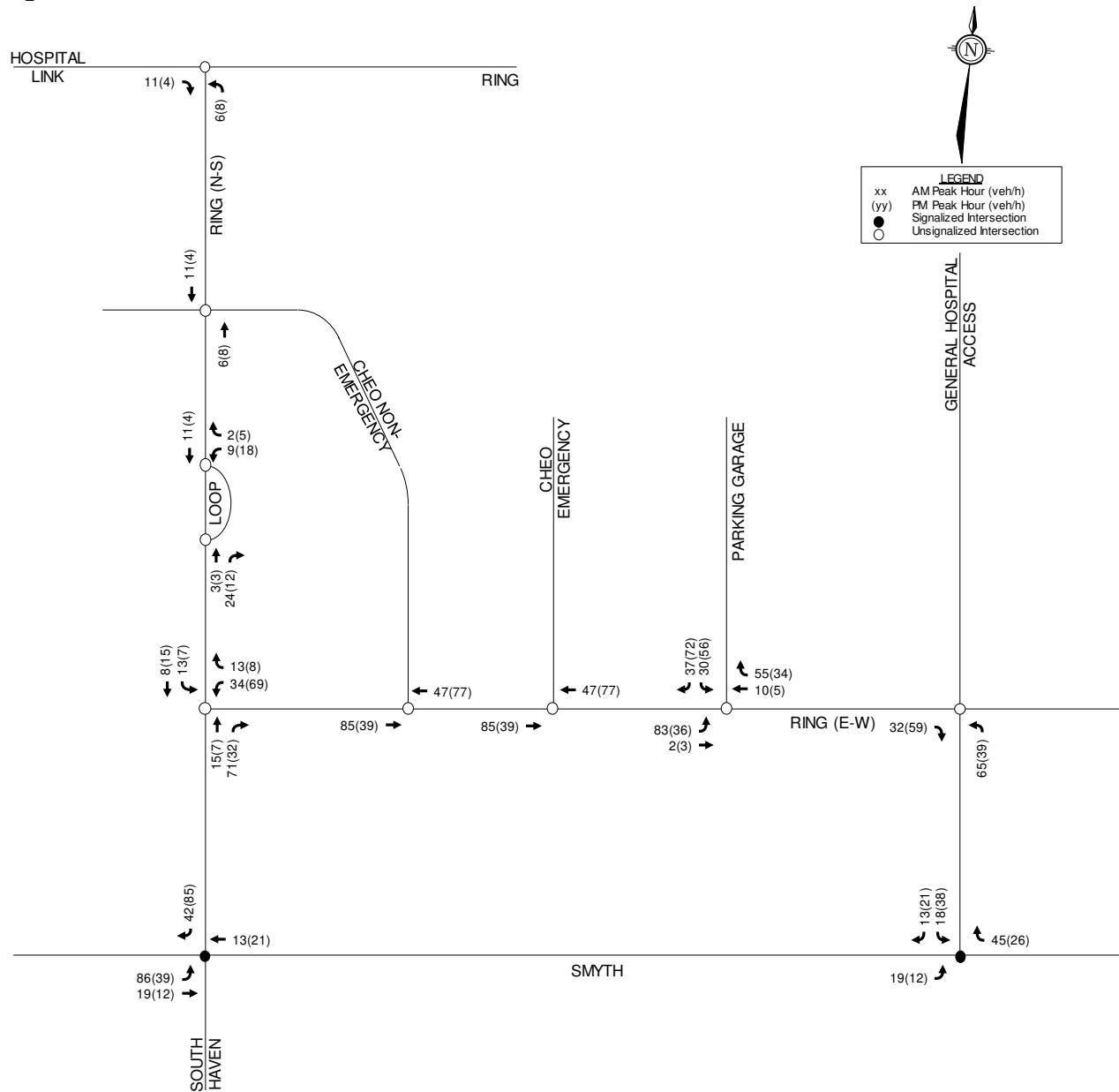

Table 6: TIA Exemptions

Module	Element	Exemption Criteria	Status
Design Review Component			
4.1 Development Design	4.1.2 Circulation and Access	<ul style="list-style-type: none"> Required for site plan control and zoning by-law amendment applications 	Not Exempt
	4.1.3 New Street Networks	<ul style="list-style-type: none"> Required for draft plan of subdivision applications 	Exempt
4.2 Parking	All elements	<ul style="list-style-type: none"> Required for site plan control and zoning by-law amendment applications 	Not Exempt

Module	Element	Exemption Criteria	Status
Network Impact Component			
4.5 Transportation Demand Management	<i>All elements</i>	<ul style="list-style-type: none"> Required when proposed development generates more than 60 person trips 	Not Exempt
4.6 Neighbourhood Traffic Calming	<i>All elements</i>	<ul style="list-style-type: none"> If all of the following criteria are met: <ol style="list-style-type: none"> Access is provided to a collector or local roadway Application is for zoning by-law amendment or draft plan of subdivision Proposed development generated more than 75 vehicle trips Site trip infiltration is expected, and site-generated traffic will increase peak hour volumes by 50% or more along the route between the site and an arterial roadway The subject street segment is adjacent to two or more of the following significant sensitive land uses: <ul style="list-style-type: none"> School (within 250m walking distance) Park Retirement/older adult facility Licensed child care centre Community centre 50+% of adjacent properties along the route(s) are occupied by residential lands and at least ten dwellings are occupied 	Exempt
4.7 Transit	4.7.1 Transit Route Capacity	<ul style="list-style-type: none"> Required when proposed development generates more than 75 transit trips 	Exempt
	4.7.2 Transit Priority Requirements	<ul style="list-style-type: none"> Required when proposed development generates more than 75 vehicle trips 	Not Exempt
4.8 Network Concept	<i>All elements</i>	<ul style="list-style-type: none"> Required when proposed development generates more than 200 person trips during the peak hour in excess of the equivalent volume permitted by the established zoning 	Exempt
4.9 Intersection Design	<i>All elements</i>	<ul style="list-style-type: none"> Required when proposed development generates more than 75 vehicle trips 	Not Exempt

Based on the foregoing, the following modules are included in the TIA report:

Design Review Component

- Module 4.1: Development Design
- Module 4.2: Parking
- Module 4.3: Boundary Streets
- Module 4.4: Access Design

Network Impact Component

- Module 4.5: Transportation Demand Management
- Module 4.7: Transit
- Module 4.9: Intersection Design

3.0 BACKGROUND NETWORK TRAVEL DEMAND

3.1 General Background Growth Rate

A review of snapshots of the City's *Strategic Long-Range Model* has been conducted which is included in **Appendix F**. Comparing snapshots of the 2011 and 2031 AM peak hour traffic volumes, the *Strategic Long-Range Model* showed a background growth rate of roughly 0.5% along Smyth Road. A background growth rate of 1% was selected to be conservative and to be consistent with other approved transportation studies in the study area that were completed in recent years.

3.2 Other Area Developments

A review of other area development traffic has been conducted, per the developments listed in Section 2.2.2. Traffic generated by these developments have been considered in this analysis and added to the future background traffic volumes, as they are currently under construction, approved, or in the approval process. Relevant excerpts of the traffic studies associated with the developments below are included in **Appendix G**.

355 and 374 Everest Private

The proposed residential development is expected to generate 85 and 92 vehicle trips during the AM and PM peak hours, respectively. The site was anticipated to be completed in 2020 and the site generated traffic have been added to the 2027 and 2032 background traffic.

401 Smyth Road (Parking Structure)

The new parking garage with 1,050 vehicle parking spaces is currently under construction. The parking garage is anticipated to accommodate new vehicle trips from the 1Door4Care building and displaced parking for Lots B and E. The flow of traffic to the parking garage is studied in this TIA.

451 Smyth Road

The planned medical research facility development is expected to generate 243 and 231 vehicle trips during the AM and PM peak hours, respectively. The site is anticipated to be completed in 2026 and the site generated traffic has been added to the 2027 and 2032 background traffic.

700 Coronation Avenue

No traffic study was prepared for this development, so it is assumed to generate an insignificant amount of vehicle traffic.

1740-1760 St. Laurent Boulevard

The proposed mixed-use development is expected to generate 150 and 149 vehicle trips during the AM and PM peak hours, respectively. The site is anticipated to be completed in 2024 and the site generated traffic has been added to the 2027 and 2032 background traffic.

1967 Riverside Drive

The proposed seniors living development is expected to generate 49 and 68 vehicle trips during the AM and PM peak hours, respectively. The site is anticipated to be completed in 2026 and the site generated traffic has been added to the 2027 and 2032 background traffic.

1971 St. Laurent Boulevard

The proposed residential development is expected to generate 72 and 88 vehicle trips during the AM and PM peak hours, respectively. The site is anticipated to be completed in 2030 and the site generated traffic has been added to the 2032 background traffic.

2025 Othello Avenue

The proposed residential development is expected to generate 93 and 105 vehicle trips during the AM and PM peak hours, respectively. The site was anticipated to be completed in 2023 and the site generated traffic has been added to the 2027 and 2032 background traffic.

3.3 Relocated Traffic

3.3.1 Relocated Parking Traffic

As an initial phase of the proposed development, a parking garage will be constructed on the land currently occupied by Parking Lot E and the clinic and school will be constructed on the land currently occupied by Parking Lot B. The parking currently provided by both of these existing parking lots will be accommodated in the parking garage. As shown in the October 25, 2022 Transportation Study completed by Stantec, Parking Lot B includes 286 parking spaces and Parking Lot E includes 270 parking spaces.

The redistribution of the vehicle traffic to and from Parking Lot E was estimated based on the traffic counts completed on February 20, 2020 and March 20, 2024 at the Ring Road (E-W)/CHEO Emergency Access intersection. The 2020 count included two-way traffic going to and from Parking Lot E while the 2024 count does not include this Parking Lot E related traffic as the parking lot was closed for construction at the time of count. By taking the difference of vehicles turning in and out of the CHEO Emergency Access from the two-counts it is possible to get a rough estimate of the traffic associated with the parking lot during the peak hours.

Given Parking Lots B and E provide a roughly equivalent number of parking spaces it is assumed that an equivalent number of vehicles will be displaced as part of the developments proposed in each of the parking lots.

The distribution of the trips displaced from Parking Lot B has been completed using the assumptions shown in Section 2.5.2.

The redistributed parking lot traffic is shown in **Figure 12**.

Figure 12: Relocated Traffic From Parking Lots B and E

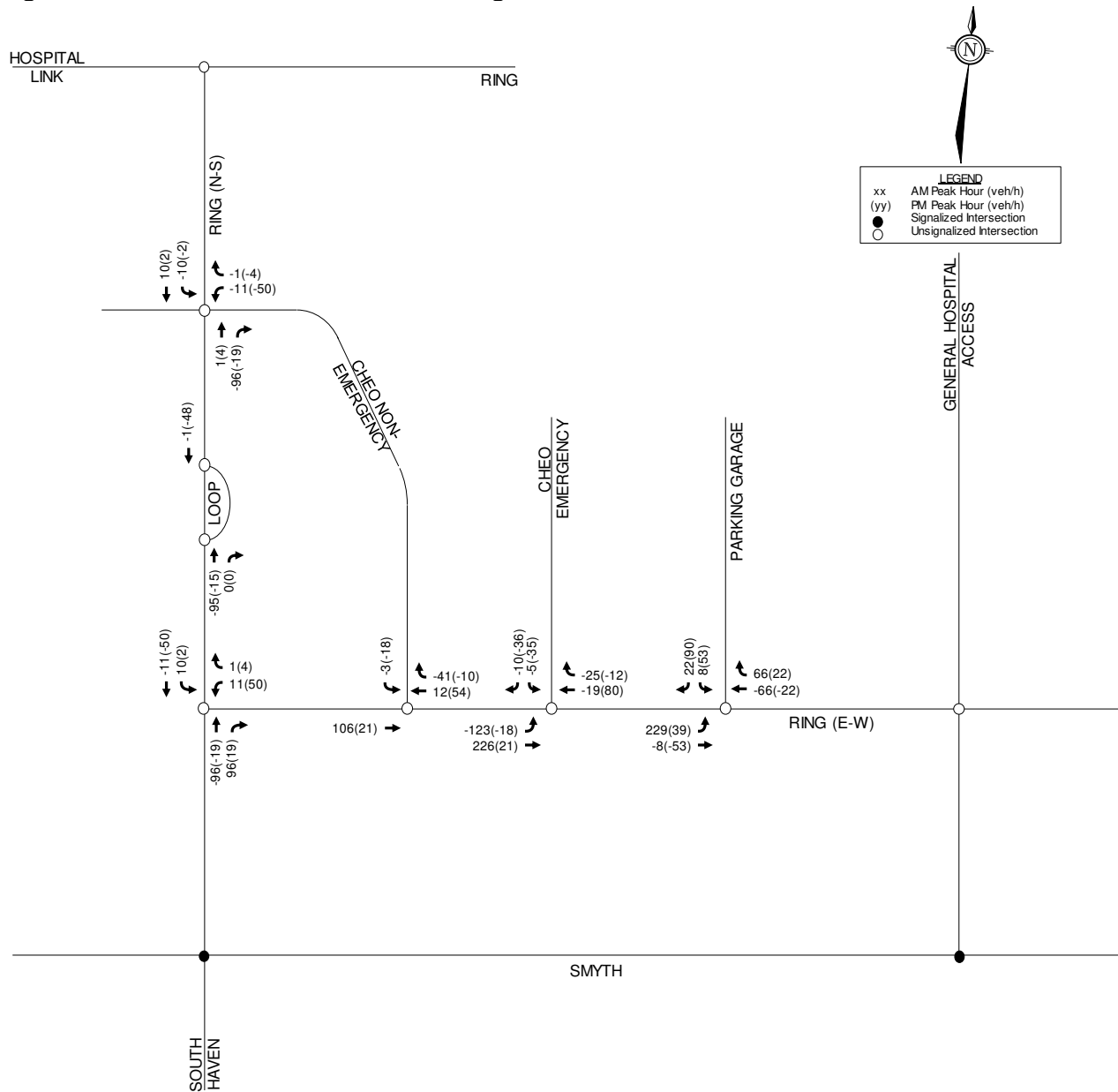

3.3.2 Relocated School Traffic

The school that is proposed within the subject development currently exists and is operating to the north of the subject site within the CHEO campus. The space dedicated to the school in the proposed building is roughly 1,625 m² (17,500 ft²) in size. The school is operational from 8:30 am and 3:00 pm. Staff are expected to arrive for work between 7:50 am and 8:15 am and will depart between 3:00 pm and 3:30 pm. No after school program is provided within the facility.

Based on discussions with the client, the existing school to be relocated has 31 students currently enrolled with a maximum capacity of 35 students. There are 5 classrooms that generally serve junior and senior kindergarten children. Grades 1 and 2 are offered, but enrollment is rare. The students are expected to arrive within 12 buses with one or two students being dropped off by

private vehicle. The 23 employees, including teachers and educational assistants, are expected to arrive and depart using the mode share identified in **Table 7** with roughly 60%, or 14 staff, arriving/departing the site as an auto driver.

Based on the foregoing assumptions, the estimated trips associated with the school is summarized in the following table.

Table 7: Composition of School Generated Vehicle Traffic

Traffic Generator	Time Period (vehicles)					
	AM Peak Hour			PM Peak Hour		
	IN	OUT	TOT	IN	OUT	TOT
Teachers/Staff	14	0	14	0	14	14
Student Drop-off/pick-up	2	2	4	2	2	4
Busses	12	12	24	12	12	24
TOTAL	28	14	42	14	28	42

The 42 AM and PM vehicle trips generated by the existing school will be redistributed to reflect the relocation of the school and the nearest parking lot for employees of the school. It is assumed that the staff currently park in Lots C or D as they are the closest parking lots to the existing school. It is assumed that staff will park at the new parking garage due to its proximity to the new school and the available walking paths connecting the school to the parking garage.

The redistributed school traffic is shown in **Figure 13**.

3.3.3 Alterations to CHEO Non-Emergency Access

As part of the proposed development the CHEO Non-Emergency Access will be changed from a two-way private road between Ring Road N/S and Ring Road E/W to a one-way road with ingress on Ring Road N/S and egress to Ring Road E/W. To account for traffic that was using the CHEO Non-Emergency Access from Ring Road E/W to drop-off patients, all remaining inbound turning vehicles at the CHEO Non-Emergency Access/Ring Road E/W intersection has been relocated to be inbound at the CHEO Non-Emergency Access/Ring Road N/S intersection and all westbound traffic coming out of the CHEO Non-Emergency Access/Ring Road (N-S) intersection will be relocated to being outbound at the CHEO Non-Emergency Access/Ring Road E/W intersection.

The redistributed traffic due to the conversion of the CHEO Non-Emergency Access is shown in **Figure 14**.

3.3.4 Net Relocated Traffic

A summary of all traffic relocated as part of the proposed development is shown in the following figure. Relocated traffic has been added to total traffic figures shown in Section 3.4.

Figure 13: Relocated Traffic From the Existing School

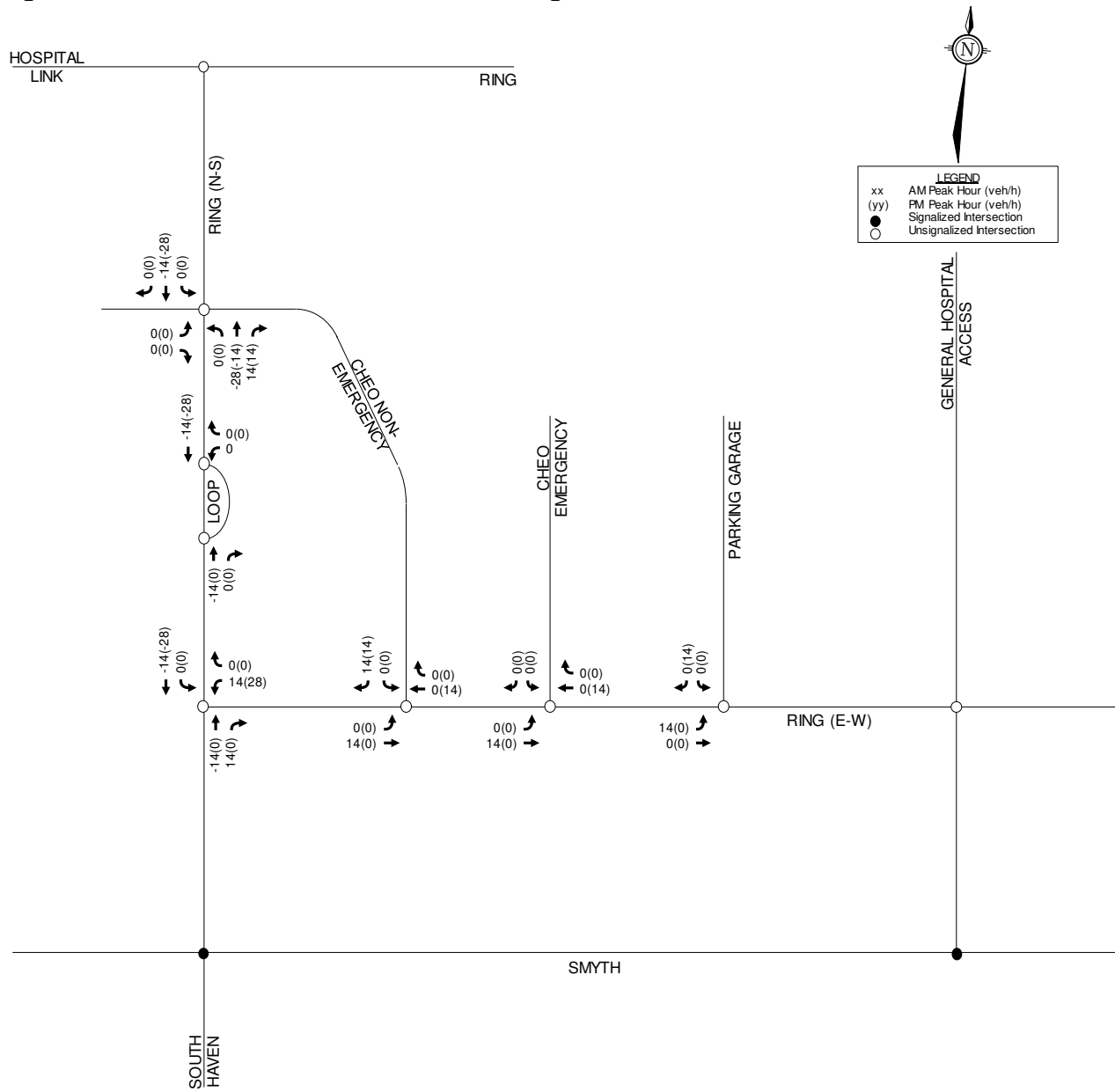

Figure 14: Remaining Displacement

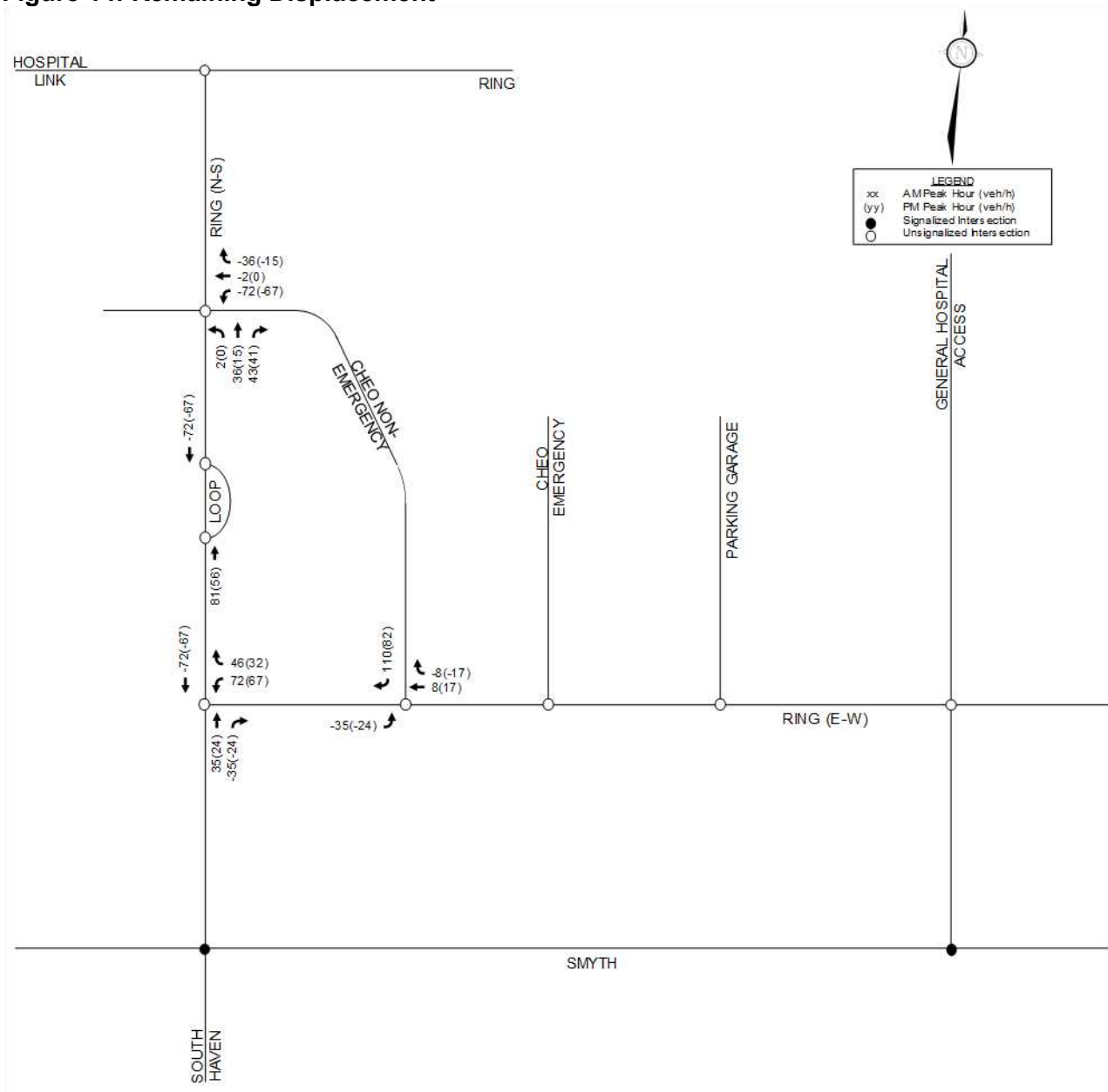
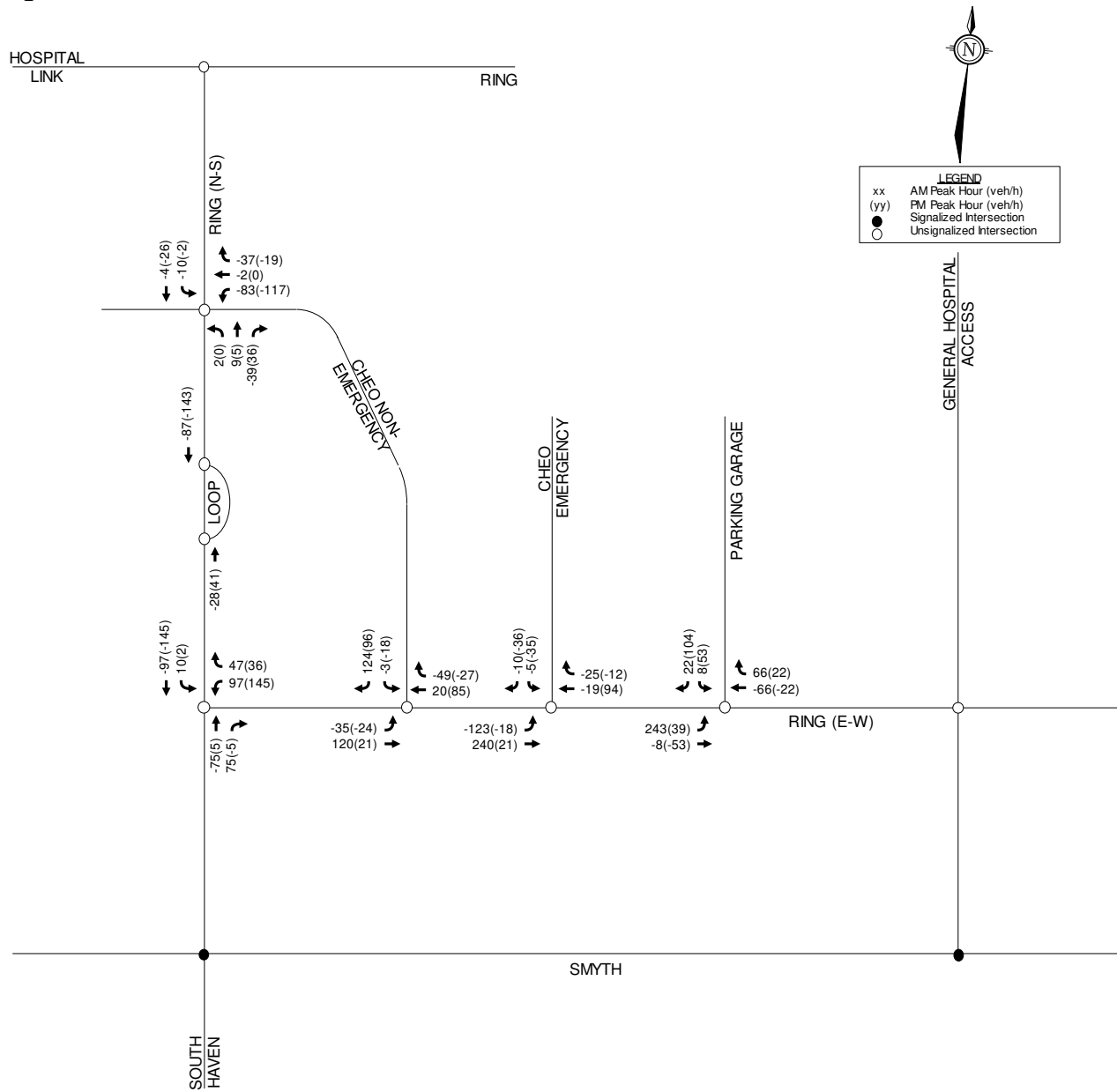

Figure 15: Net Relocated Traffic



3.4 Future Traffic Conditions

The figures listed below present the following future traffic conditions:

- Background traffic volumes in 2027 are shown in **Figure 16**;
- Background traffic volumes in 2032 are shown in **Figure 17**;
- Total traffic volumes in 2027 are shown in **Figure 18**;
- Total traffic volumes in 2032 are shown in **Figure 19**.

Figure 16: 2027 Background Traffic

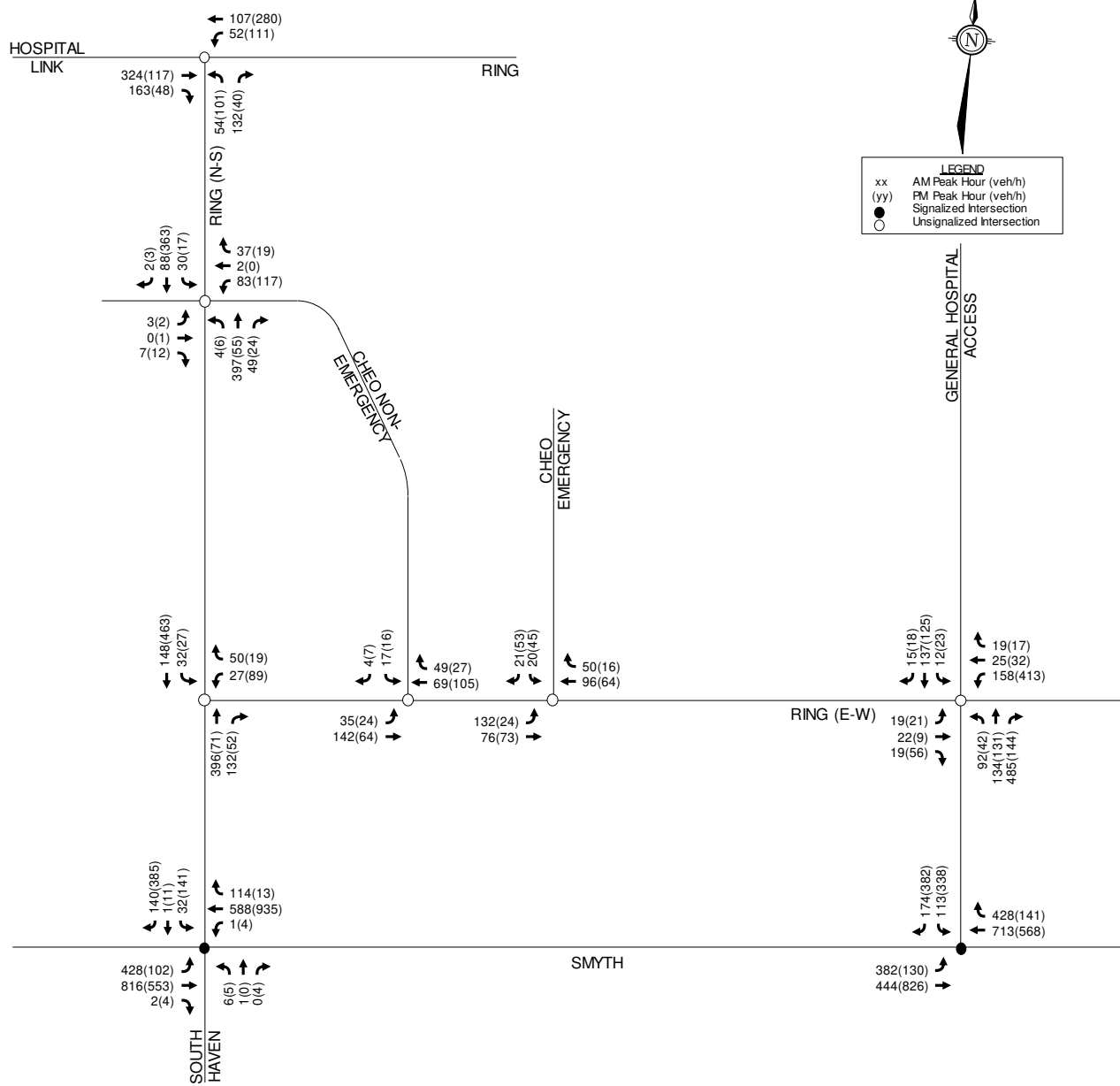

Figure 17: 2032 Background Traffic

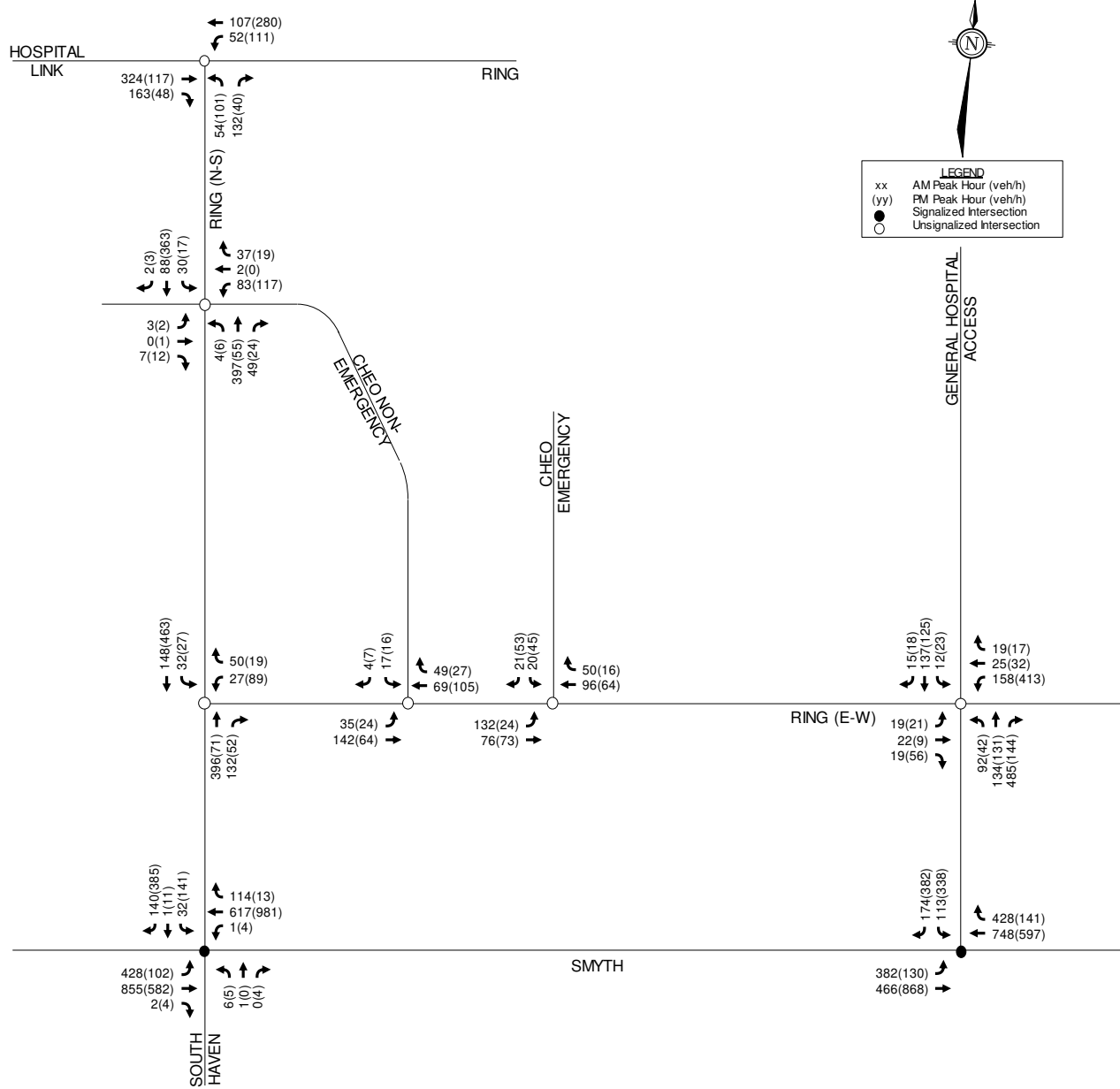

Figure 18: 2027 Total Traffic

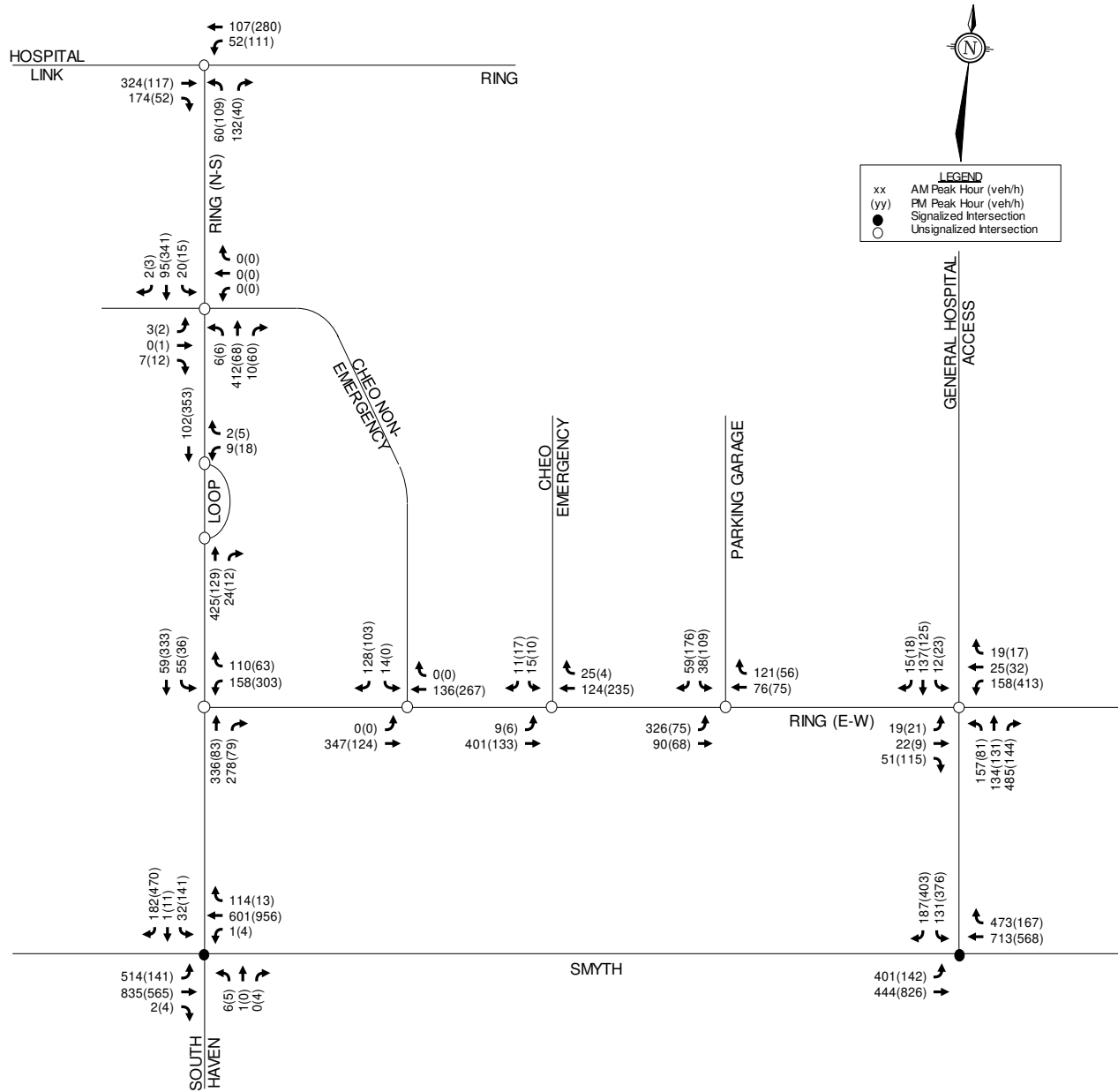
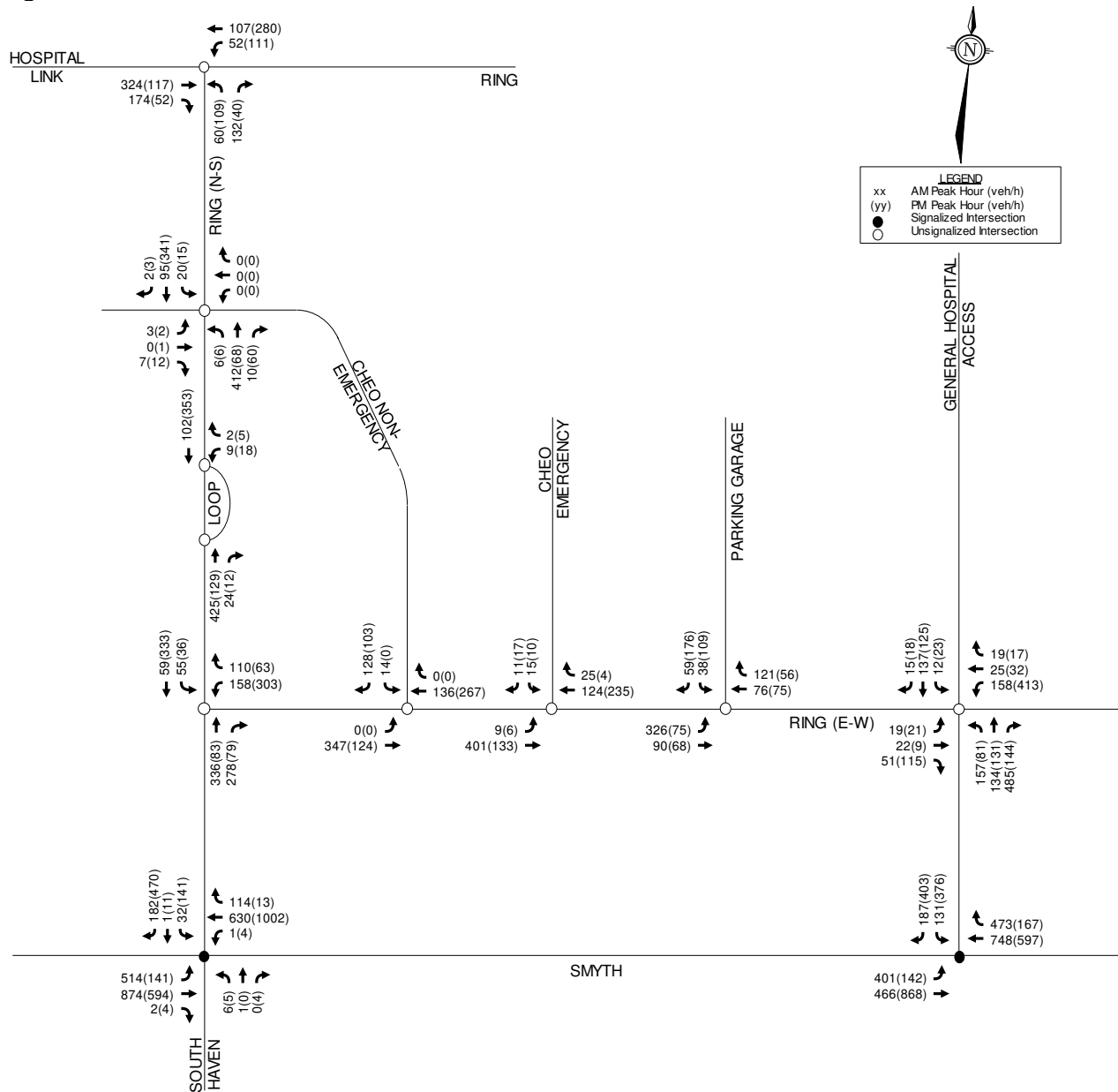

Figure 19: 2032 Total Traffic



3.5 Demand Rationalization

A review of the existing and background intersection operations has been conducted using Synchro 11, to determine if and when traffic volumes exceed capacity within the study area. The intersection parameters used in the analysis are consistent with the City's *TIA Guidelines* (Saturated Flow Rate: 1,800 vphpl, Peak Hour Factor: 0.9 in existing conditions and 1.0 in future conditions). Signal timing plans have been obtained from the City for the signalized intersections at Smyth Road/Ring Road (N-S)/South Haven Place and Smyth Road/General Hospital Access Road, and are included in **Appendix H**. Per Exhibit 22 of the *Multi-Modal Level of Service (MMLOS) Guidelines* (produced by IBI Group in October 2015), the target vehicular level of service (Auto LOS) is an Auto LOS E within 300m of a school, which equates to a maximum vehicle-to-capacity (v/c) ratio of 1.0 at signalized intersections, and a maximum approach delay of 50 seconds at unsignalized intersections.

3.5.1 Existing Intersection Operations

Intersection capacity analysis has been conducted for the existing traffic conditions. The results of the analysis are summarized in **Table 8** for the weekday AM and PM peak hours. Detailed reports are included in **Appendix I**.

Table 8: Existing Traffic Operations

Intersection	AM Peak Hour			PM Peak Hour		
	Max v/c or Delay	LOS	Mvmt	Max v/c or Delay	LOS	Mvmt
Ring Road/ Hospital Link Road ^(u)	14 sec.	B	EB	10 sec.	B	WB
Ring Road (N-S)/ CHEO Non-Emergency Access ^(u)	12 sec.	B	NB	11 sec.	B	SB
Ring Road (N-S)/ Ring Road (E-W) ^(u)	13 sec.	B	WB	15 sec.	B	WB
Smyth Road/Ring Road (N-S)/ South Haven Place ^(s)	0.72	C	WB	0.82	D	SBR
Ring Road (E-W)/ CHEO Non-Emergency Access ^(u)	11 sec.	B	SB	10 sec.	B	SB
Ring Road (E-W)/ CHEO Emergency Access ^(u)	12 sec.	B	SB	10 sec.	B	SB
Ring Road (E-W)/ General Hospital Access Road*	24 sec.	C	WBL	69 sec. 0.98	F	WBL
Smyth Road/ General Hospital Access Road ^(s)	0.62	B	EBL	0.83	D	SBR

(u): Unsignalized intersection

(s): Signalized intersection

*: Modeled as a two-way stop intersection on Ring Road (E-W) due to limitations in Synchro software

All movements at study area intersections, except for the Ring Road (E-W)/General Hospital Access Road intersection, are currently operating with acceptable LOS under existing traffic conditions.

The southbound approach at the Smyth Road/Ring Road (N-S)/South Haven Place intersection has roughly 30m of storage. During the PM peak hour the 95th percentile queues exceed the available storage for both the southbound right and left turn movements. The 95th percentile queue is 54m for the southbound right turn movement and 45m for the southbound left turn movement.

The southbound approach at the Smyth Road/General Hospital Access Road intersection has roughly 35m of storage. During the PM peak hour the 95th percentile queues exceed the available storage for both the southbound right and left turn movements. The 95th percentile queue is 75m for the southbound right turn movement and 50m for the southbound left turn movement.

The westbound left turn lane at the Ring Road (E-W)/General Hospital Access Road intersection operates with a LOS F during the PM peak hour. The westbound left turn lane has a 95th percentile queue length of 69m which exceeds the available storage of 40m. The westbound left turn lane has a v/c ratio of 0.98 during the PM peak hour.

3.5.2 2027 Background Intersection Operations

Intersection capacity analysis has been conducted for the 2027 background traffic conditions. The results of the analysis are summarized in **Table 9** for the weekday AM and PM peak hours. Detailed reports are included in **Appendix I**.

Table 9: 2027 Background Traffic Operations

Intersection	AM Peak Hour			PM Peak Hour		
	Max v/c or Delay	LOS	Mvmt	Max v/c or Delay	LOS	Mvmt
Ring Road/ Hospital Link Road ^(u)	13 sec.	B	EB	12 sec.	B	WB
Ring Road (N-S)/ CHEO Non-Emergency Access ^(u)	13 sec.	B	NB	12 sec.	B	SB
Ring Road (N-S)/ Ring Road (E-W) ^(u)	14 sec.	B	WB	15 sec.	B	WB
Smyth Road/Ring Road (N-S)/ South Haven Place ^(s)	0.69	B	WB	0.84	D	SBR
Ring Road (E-W)/ CHEO Non-Emergency Access ^(u)	11 sec.	B	SB	10 sec.	B	SB
Ring Road (E-W)/ CHEO Emergency Access ^(u)	11 sec.	B	SB	10 sec.	B	SB
Ring Road (E-W)/ General Hospital Access Road*	21 sec.	C	WBL	45 sec.	E	WBL
Smyth Road/ General Hospital Access Road ^(s)	0.59	A	EBL	0.83	D	SBR

(u): Unsignalized intersection

(s): Signalized intersection

*: Modeled as a two-way stop intersection on Ring Road (E-W) due to limitations in Synchro software

All movements at study area intersections operate with acceptable LOS under 2027 background traffic conditions.

The southbound approach at the Smyth Road/Ring Road (N-S)/South Haven Place intersection has roughly 30m of storage. During the PM peak hour the 95th percentile queues exceed the available storage for both the southbound right and left turn movements. The 95th percentile queue is 58m for the southbound right turn movement and 44m for the southbound left turn movement.

The southbound approach at the Smyth Road/General Hospital Access Road intersection has roughly 35m of storage. During the PM peak hour the 95th percentile queues exceed the available storage for both the southbound right and left turn movements. The 95th percentile queue is 71m for the southbound right turn movement and 46m for the southbound left turn movement.

The westbound left turn lane at the Ring Road (E-W)/General Hospital Access Road intersection improves to a LOS E during the PM peak hour due to the PHF of 1.0 being used for future conditions. The westbound left turn lane has a 95th percentile queue length of 52m which exceeds the available storage of 40m.

3.5.3 2032 Background Intersection Operations

Intersection capacity analysis has been conducted for the 2032 background traffic conditions. The results of the analysis are summarized in **Table 10** for the weekday AM and PM peak hours. Detailed reports are included in **Appendix I**.

Table 10: 2032 Background Traffic Operations

Intersection	AM Peak Hour			PM Peak Hour		
	Max v/c or Delay	LOS	Mvmt	Max v/c or Delay	LOS	Mvmt
Ring Road/ Hospital Link Road ^(u)	13 sec.	B	EB	12 sec.	B	WB
Ring Road (N-S)/ CHEO Non-Emergency Access ^(u)	13 sec.	B	NB	12 sec.	B	SB
Ring Road (N-S)/ Ring Road (E-W) ^(u)	14 sec.	B	WB	15 sec.	B	WB
Smyth Road/Ring Road (N-S)/ South Haven Place ^(s)	0.71	C	WB	0.84	D	SBR
Ring Road (E-W)/ CHEO Non-Emergency Access ^(u)	11 sec.	B	SB	10 sec.	B	SB
Ring Road (E-W)/ CHEO Emergency Access ^(u)	11 sec.	B	SB	10 sec.	B	SB
Ring Road (E-W)/ General Hospital Access Road*	21 sec.	C	WBL	45 sec.	E	WBL
Smyth Road/ General Hospital Access Road ^(s)	0.60	A	EBL	0.83	D	SBR

(u): Unsignalized intersection

(s): Signalized intersection

*: Modeled as a two-way stop intersection on Ring Road (E-W) due to limitations in Synchro software

All movements at study area intersections operate with acceptable LOS under 2032 background traffic conditions.

The southbound approach at the Smyth Road/Ring Road (N-S)/South Haven Place intersection has roughly 30m of storage. During the PM peak hour the 95th percentile queues exceed the available storage for both the southbound right and left turn movements. The 95th percentile queue is 60m for the southbound right turn movement and 44m for the southbound left turn movement.

The southbound approach at the Smyth Road/General Hospital Access Road intersection has roughly 35m of storage. During the PM peak hour the 95th percentile queues exceed the available storage for both the southbound right and left turn movements. The 95th percentile queue is 72m for the southbound right turn movement and 46m for the southbound left turn movement.

4.0 ANALYSIS

4.1 Development Design

4.1.1 Design for Sustainable Modes

Pedestrian connections will be provided between the building entrances and the proposed Multi-Use Pathways (MUP) along the north side of Ring Road (E-W) and the east side of Ring Road (N-S) along the site frontages. The proposed MUP along the site frontage on the north side of Ring Road (E-W) will connect to the approved MUP on the north side of Ring Road (E-W) to be constructed as part of the parking garage development. The 1Door4Care building will connect to the CHEO Hospital via above ground pedestrian facilities and an underground tunnel.

A PXO Type D is proposed at the existing unmarked pedestrian crossing between the new 1Door4Care egress and the residential neighbourhood to the west. The PXO Type D is proposed as there is an existing pedestrian desire line. The PXO Type D is recommended based on the Ontario Traffic Manual (OTM) Book 15. Based on the 8-hour traffic volumes from the March 19, 2024, traffic count at the Ring Road (N-S)/Ring Road (E-W) intersection, the northern leg of the intersection has an 8-hour traffic volume of 2,847 vehicles. Given the posted speed limit of 40km/h, Table 7 of the OTM Book 15 was used to determine the required Type of PXO. Although the current roadway has a road platform of 9.5m and an effective 3 lane cross-section, it is recommended the roadway be narrowed on each side of Ring Road (N-S) by 1m for a total road platform width of 7.5m.

A total of 40 bicycle parking spaces will be provided throughout the subject site. A further review of the parking provisions with respect to the City's *Zoning By-law* (ZBL) is provided in the subsequent section. Half of the spaces will be covered and near the south entrance to the clinic. The remaining bike parking is proposed near the northeast corner of the building and the southeast corner of the existing CHEO building.

The nearest bus stops to the subject site are discussed in Section 2.1.6 and shown in **Figure 4**. OC Transpo's service design guidelines for peak period service is to provide service within a five-minute (400m) walk of home, work, or school for 95% of urban residents. All of the transit stops outlined in Section 2.1.6 are within the 400m distance and provide service to transit routes #45, #55, #609, and #645.

As part of the proposed development transit stop #1808 will be removed and consolidated into bus stop #7045 with the one-way conversion of the main CHEO access mandated by Infrastructure Ontario. Routes 45 and 55 will have to be re-routed to circle the Ring Road (N-S)/Ring Road (E-W) intersection and access stop #7045 in the EB/SB direction. The new bus stop platform is 15m long and 3.7m wide, which can accommodate a 2.2m shelter and 1.5m sidewalk.

A review of the City's *Transportation Demand Management (TDM)-Supportive Development Design and Infrastructure Checklist* has been conducted. All required TDM-supportive design and infrastructure measures in the TDM checklist are met. A copy of this checklist is included in **Appendix J**. In addition to the required measures, the proposed development also meets the following 'basic' or 'better' measures as defined in the *TDM-Supportive Development Design and Infrastructure Checklist*.

- Locate building entrances in order to minimize walking distances to sidewalks and transit stops/stations;

- Locate building doors and windows to ensure visibility of pedestrians from the building, for their security and comfort;
- Provide safe, direct, and attractive walking routes from building entrances to nearby transit stops;
- Provide lighting, landscaping, and benches along walking and cycling routes between building entrances and streets, sidewalks, and trails.

4.1.2 Circulation and Access

Garbage bins will be wheeled from a garbage room on the ground floor to the loading area accessed from Ring Road (E-W). The fire route for the development is provided along the 1Door4Care new loop access to Ring Road (N-S) and along the CHEO Non-Emergency access.

The following turning movement scenarios were studied:

- A HSU design vehicle performing all necessary movements to enter the site and access the loading bay from Ring Road (E-W);
- A City Transit Bus turning at the CHEO Non-Emergency accesses;
- A small school bus at the CHEO Non-Emergency accesses;
- A fire truck and paratransport vehicle at the new loop access to Ring Road (N-S).

The studied turning movement scenarios are shown in **Figures 20 to 30**.

4.2 Parking

The subject site is located in Area B on both Schedule 1 and Schedule 1A of the City of Ottawa’s *Zoning By-Law (ZBL)*. Part 4 – Parking, Queueing, and Loading Provisions of the ZBL has been reviewed to confirm the parking and loading requirements for the proposed development, and Section 3 of the City’s *Accessibility Design Standards* has been reviewed to confirm the accessible parking requirements. The various parking/loading requirements versus the proposed parking and loading supply are summarized in **Table 11**.

Table 11: Parking Review

Land Use	Rate	Units	Required	Provided
<i>Minimum Vehicle Parking (Section 101 of ZBL)</i>				
Hospital	1.4 spaces per 100 m ² GFA	20,075 m ²	281	1,050 (Ph1A)
School, other	1.5 spaces per classroom (including portables)	5	8	71 (Ph1B)
Total			289	1,121
<i>Minimum Bicycle Parking (Section 111 of ZBL)</i>				
Hospital	1.0 spaces per 1,000 m ² GFA	20,075 m ²	20	40
School	1.0 spaces per 100 m ² GFA	1,625 m ²	16	
Total			36	40
<i>Minimum Loading (Section 113 of ZBL)</i>				
Hospital	2 spaces when GFA is between 10,000 and 24,999 m ²	20,075 m ²	2	2 12 bus queuing
School	1 space when GFA is between 1,000 and 9,999 m ²	1,625 m ²	1	
Total			3	2

C:\temp\AcPublish_325721122210-TM.dwg, Fig 20, Apr 18, 2024 - 4:01pm, millier

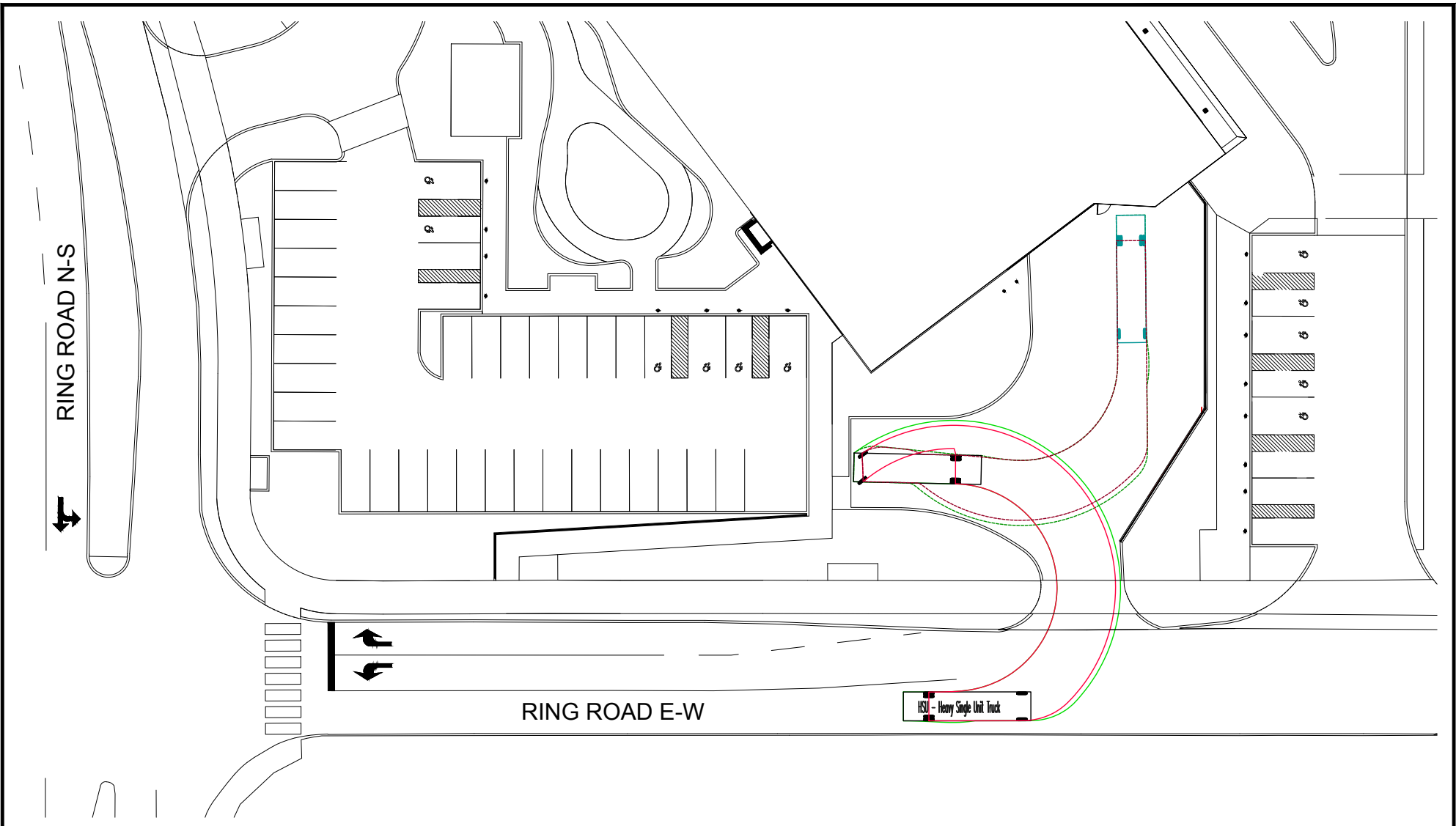

Engineers, Planners & Landscape Architects
 Suite 200, 240 Michael Cowpland Drive
 Ottawa, Ontario, Canada K2M 1P6

Telephone (613) 254-9643
 Facsimile (613) 254-5867
 Website www.novatech-eng.com

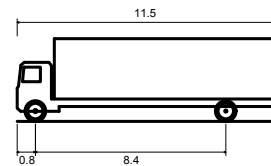

HSU - Heavy Single Unit Truck

Overall Length	11.500m
Overall Width	2.600m
Overall Body Height	3.650m
Min Body Ground Clearance	0.445m
Track Width	2.600m
Lock-to-lock time	4.00s
Curb to Curb Turning Radius	14.100m

CHEO

TURNING MOVEMENT
(HSU)

SCALE 1 : 500



DATE APR 2024

JOB 122210

FIGURE FIGURE 20

C:\temp\AcPublish_325721122210-TM.dwg, Fig 21, Apr 18, 2024 - 4:01pm, millier

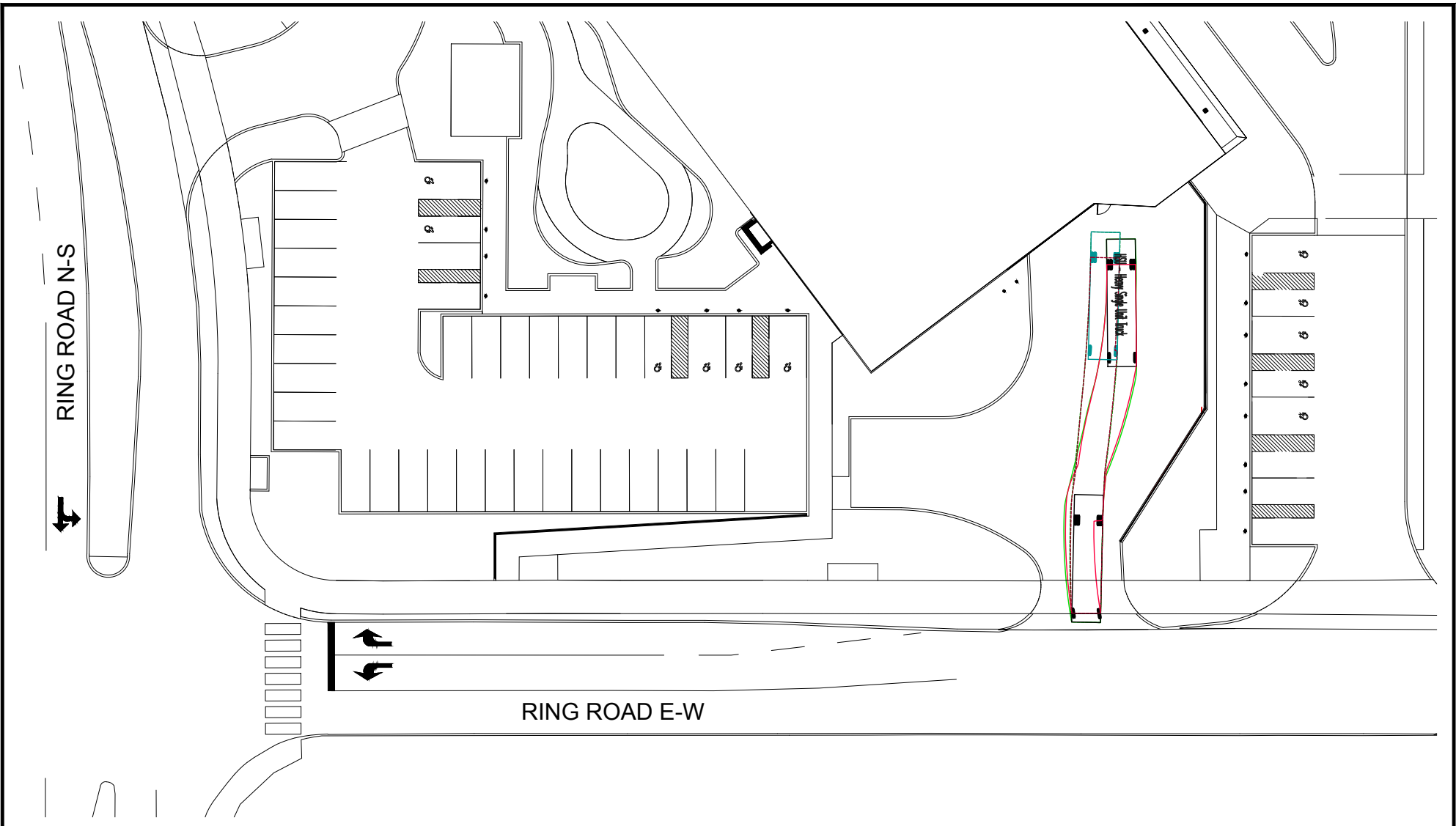

Engineers, Planners & Landscape Architects
 Suite 200, 240 Michael Cowpland Drive
 Ottawa, Ontario, Canada K2M 1P6

Telephone (613) 254-9643
 Facsimile (613) 254-5867
 Website www.novatech-eng.com

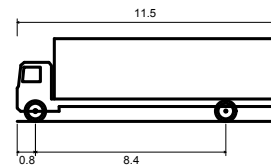

HSU - Heavy Single Unit Truck

Overall Length	11.500m
Overall Width	2.600m
Overall Body Height	3.650m
Min Body Ground Clearance	0.445m
Track Width	2.600m
Lock-to-lock time	4.00s
Curb to Curb Turning Radius	14.100m

CHEO

TURNING MOVEMENT
(HSU)

SCALE 1 : 500

DATE APR 2024

JOB 122210

FIGURE FIGURE 21

C:\temp\AcPublish_325721\22210-TM.dwg, Fig 22, Apr 18, 2024 - 4:01pm, millier

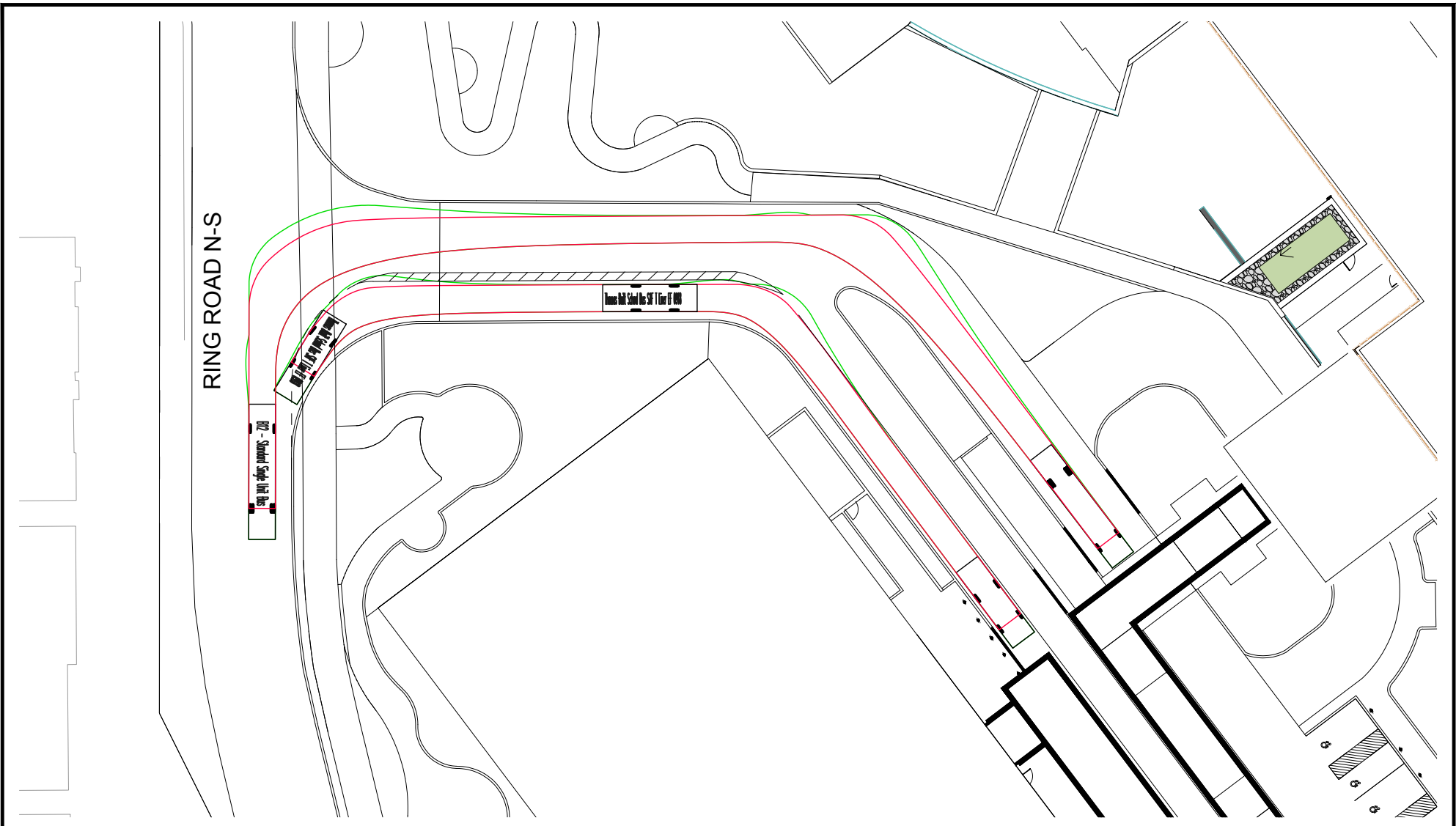

Engineers, Planners & Landscape Architects
 Suite 200, 240 Michael Cowpland Drive
 Ottawa, Ontario, Canada K2M 1P6

Telephone (613) 254-9643
 Facsimile (613) 254-5867
 Website www.novatech-eng.com

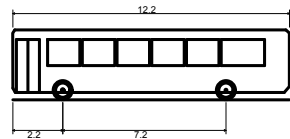

B12 - Standard Single Unit Bus

Overall Length	12.200m
Overall Width	2.400m
Overall Body Height	3.084m
Min Body Ground Clearance	0.319m
Track Width	2.400m
Lock-to-lock time	4.00s
Curb to Curb Turning Radius	12.900m

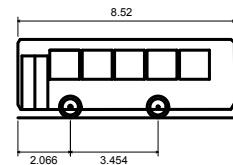

SAF T - Small School Bus (ASHTO)

Overall Length	8.520m
Overall Width	2.438m
Overall Body Height	3.084m
Min Body Ground Clearance	0.325m
Track Width	2.438m
Lock-to-lock time	6.00s
Wall to Wall Turning Radius	7.925m

CHEO

**TURNING MOVEMENTS
 (SCHOOL BUS / CITY BUS)**



DATE APR 2024	JOB 122210	FIGURE FIGURE 22
-------------------------	----------------------	----------------------------

C:\temp\AcPublish_325721122210-TM.dwg, Fig 23, Apr 18, 2024 - 4:01pm, millier

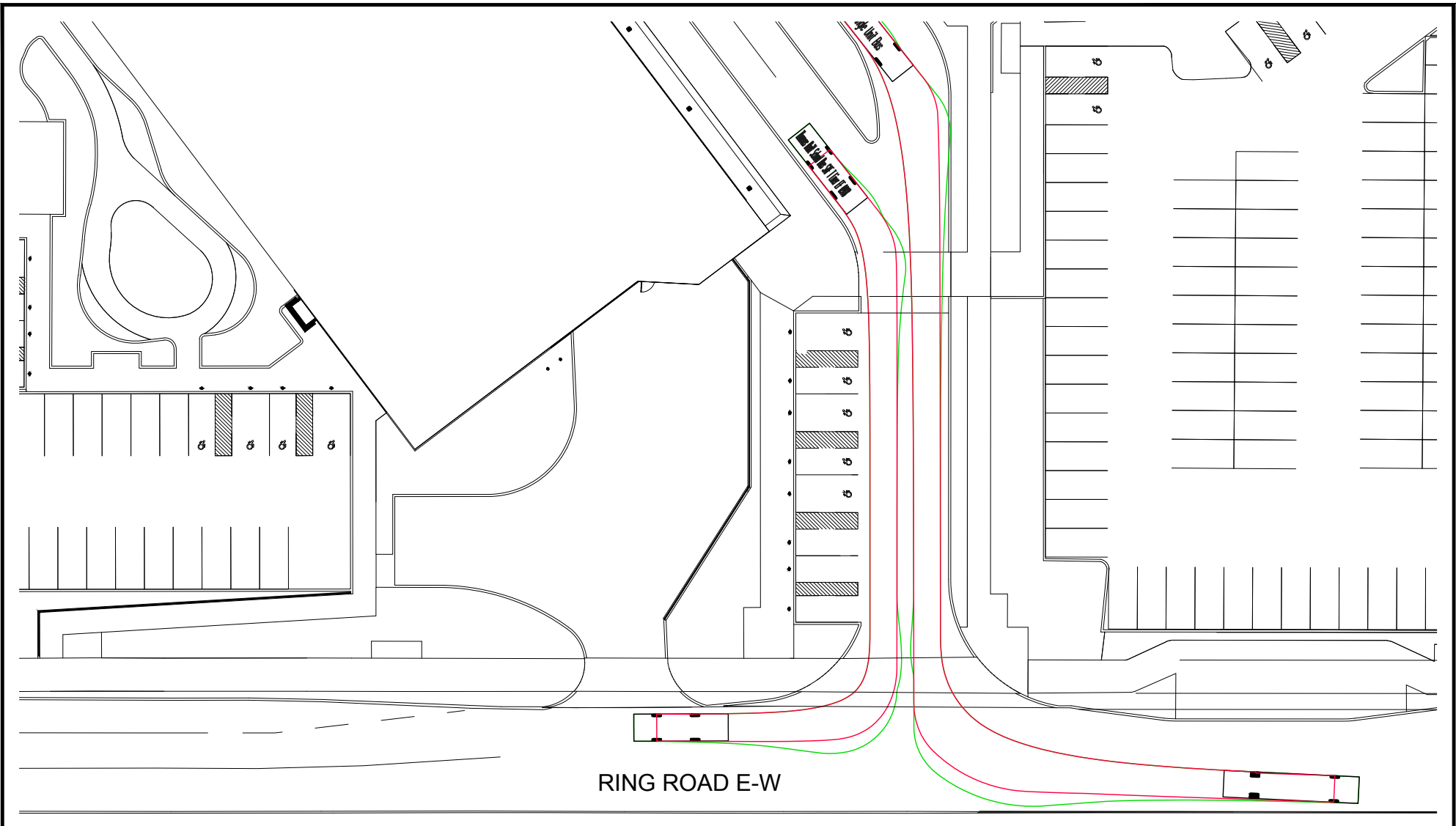

RING ROAD E-W



Engineers, Planners & Landscape Architects
 Suite 200, 240 Michael Cowpland Drive
 Ottawa, Ontario, Canada K2M 1P6

Telephone (613) 254-9643
 Facsimile (613) 254-5867
 Website www.novatech-eng.com

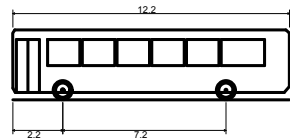

B12 - Standard Single Unit Bus

Overall Length	12.200m
Overall Width	2.400m
Overall Body Height	3.084m
Min Body Ground Clearance	0.319m
Track Width	2.400m
Lock-to-lock time	4.00s
Curb to Curb Turning Radius	12.900m

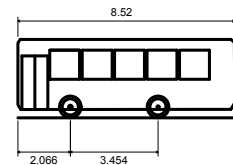

SAF T - Small School Bus (ASHTO)

Overall Length	8.520m
Overall Width	2.438m
Overall Body Height	3.084m
Min Body Ground Clearance	0.325m
Track Width	2.438m
Lock-to-lock time	6.00s
Wall to Wall Turning Radius	7.925m

CHEO

**TURNING MOVEMENTS
 (SCHOOL BUS / CITY BUS)**

SCALE 1 : 500

DATE APR 2024	JOB 122210	FIGURE FIGURE 23
------------------	---------------	---------------------

C:\temp\AcPublish_32572122210-TM.dwg, Fig 24, Apr 18, 2024 - 4:01pm, millier

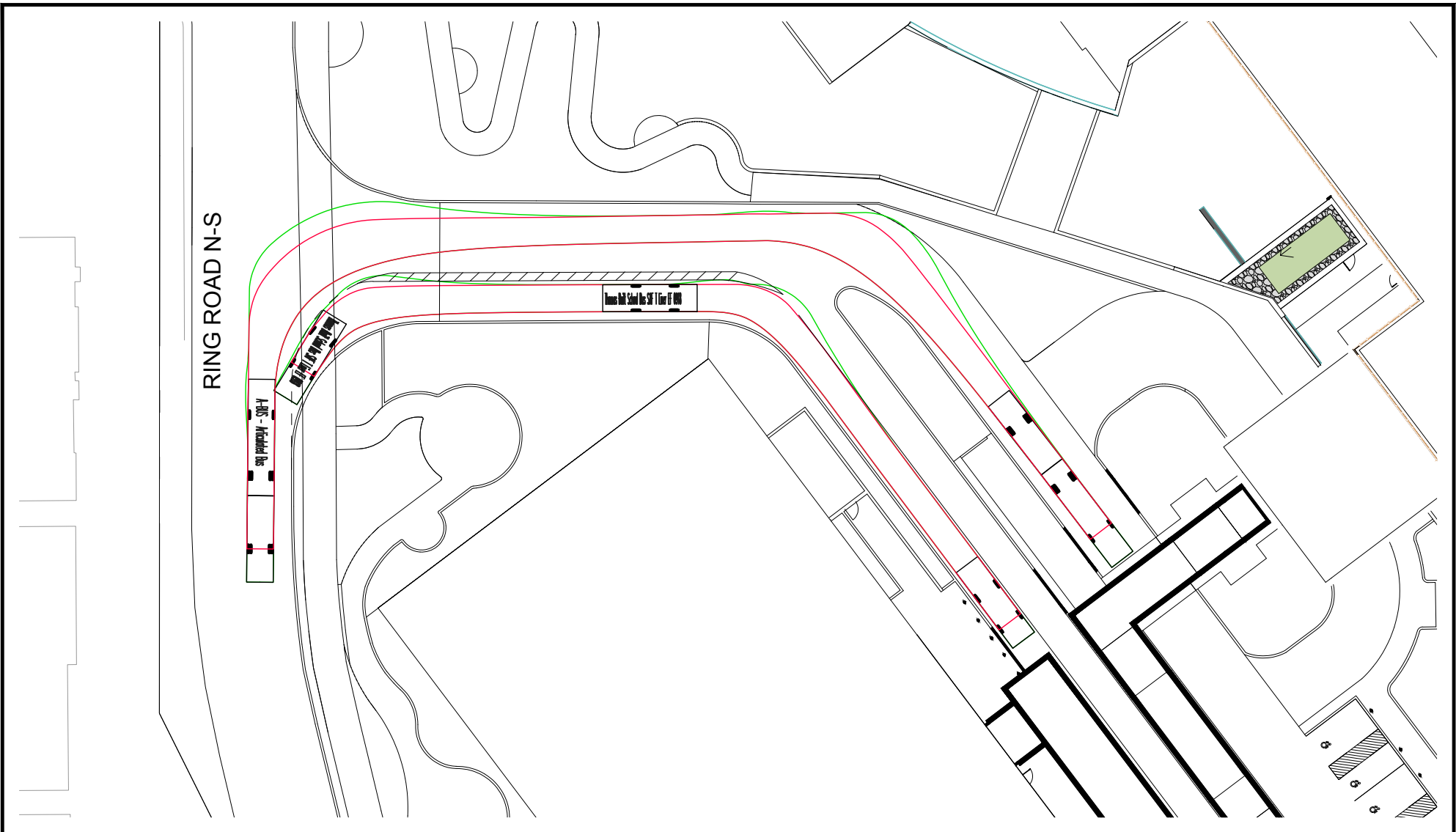

Engineers, Planners & Landscape Architects
 Suite 200, 240 Michael Cowpland Drive
 Ottawa, Ontario, Canada K2M 1P6

Telephone (613) 254-9643
 Facsimile (613) 254-5867
 Website www.novatech-eng.com

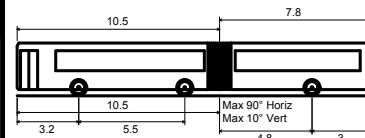

A-BUS - Articulated Bus

Overall Length	18.300m
Overall Width	2.400m
Overall Body Height	2.733m
Min Body Ground Clearance	0.320m
Track Width	2.400m
Lock-to-lock time	4.00s
Curb to Curb Turning Radius	13.100m

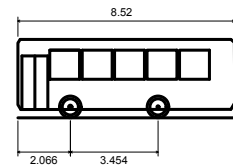

SAF T - Small School Bus (ASHTO)

Overall Length	8.520m
Overall Width	2.438m
Overall Body Height	3.084m
Min Body Ground Clearance	0.325m
Track Width	2.438m
Lock-to-lock time	6.00s
Wall to Wall Turning Radius	7.925m

CHEO

**TURNING MOVEMENTS
 (SCHOOL BUS / CITY BUS)**



DATE APR 2024	JOB 122210	FIGURE FIGURE 24
-------------------------	----------------------	----------------------------

C:\temp\AcPublish_325721122210-TM.dwg, Fig 25, Apr 18, 2024 - 4:01pm, millier

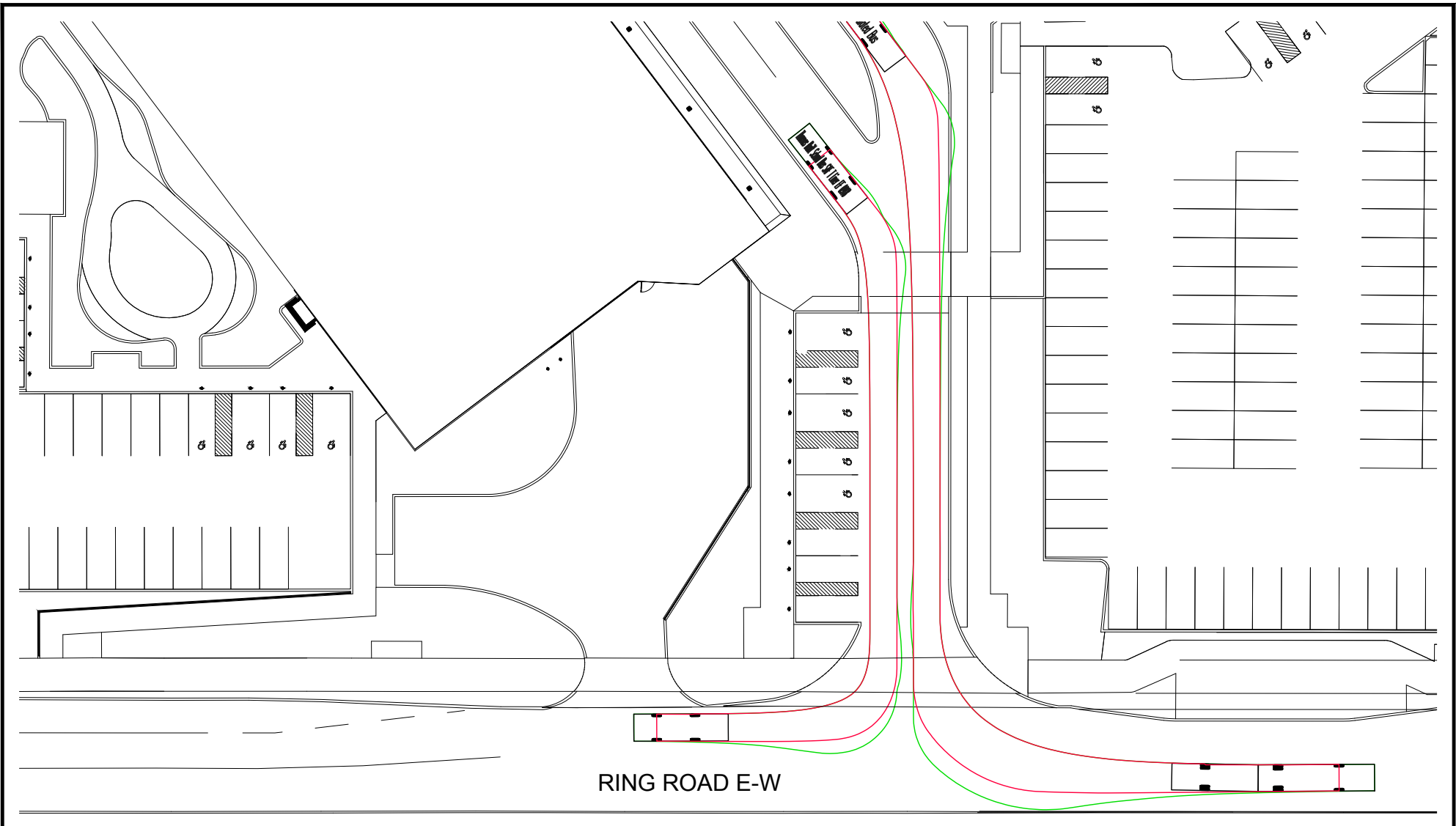

RING ROAD E-W



Engineers, Planners & Landscape Architects
 Suite 200, 240 Michael Cowpland Drive
 Ottawa, Ontario, Canada K2M 1P6

Telephone (613) 254-9643
 Facsimile (613) 254-5867
 Website www.novatech-eng.com

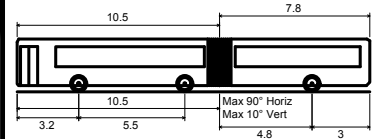

A-BUS - Articulated Bus

Overall Length	18.300m
Overall Width	2.400m
Overall Body Height	2.733m
Min Body Ground Clearance	0.320m
Track Width	2.400m
Lock-to-lock time	4.00s
Curb to Curb Turning Radius	13.100m

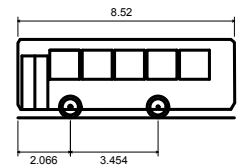

SAF T - Small School Bus (ASHTO)

Overall Length	8.520m
Overall Width	2.438m
Overall Body Height	3.084m
Min Body Ground Clearance	0.325m
Track Width	2.438m
Lock-to-lock time	6.00s
Wall to Wall Turning Radius	7.925m

CHEO

**TURNING MOVEMENTS
 (SCHOOL BUS / CITY BUS)**

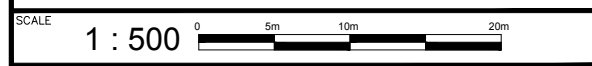

DATE APR 2024 JOB 122210 FIGURE FIGURE 25

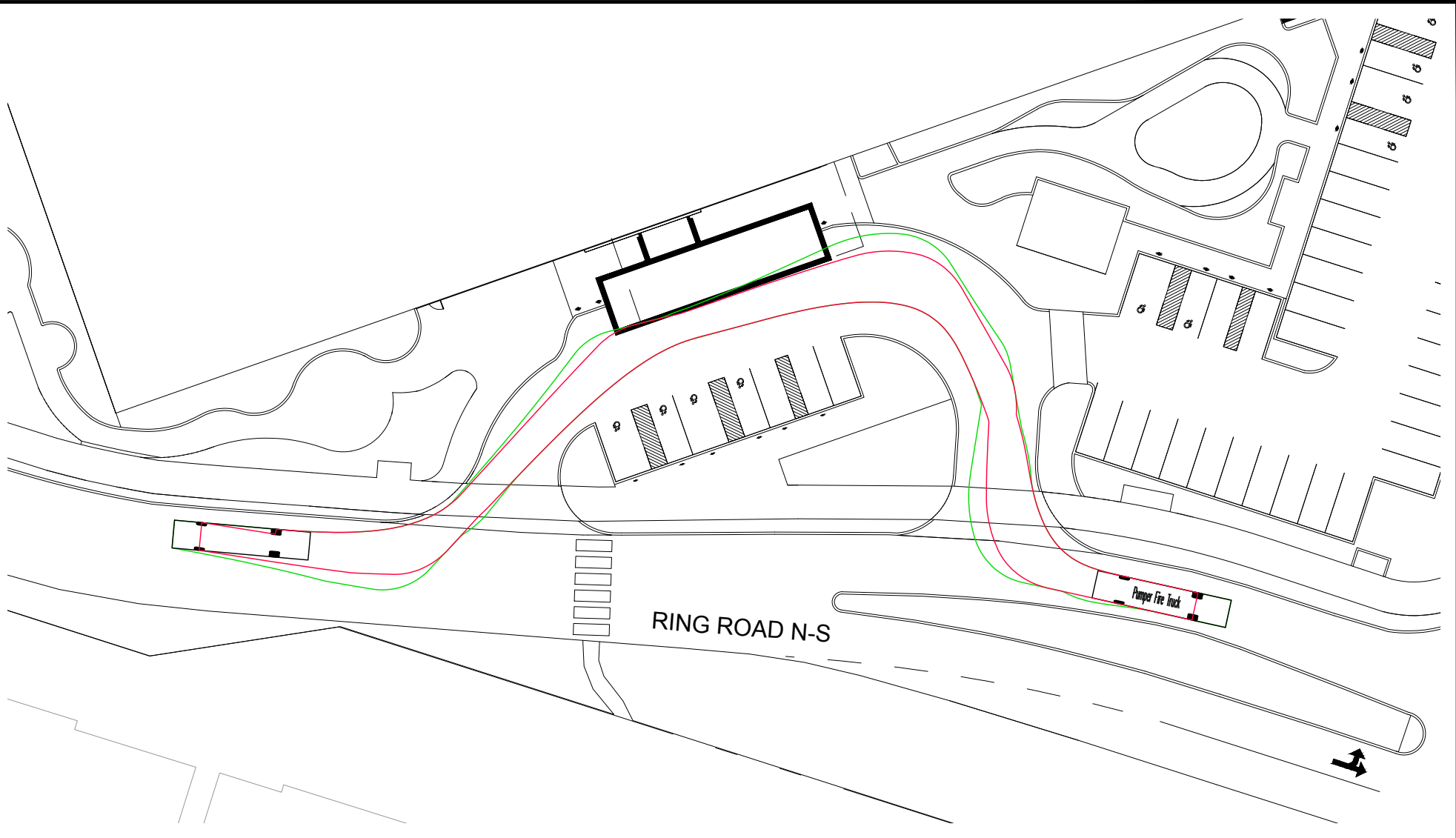

Engineers, Planners & Landscape Architects
 Suite 200, 240 Michael Cowpland Drive
 Ottawa, Ontario, Canada K2M 1P6

Telephone (613) 254-9643
 Facsimile (613) 254-5867
 Website www.novatech-eng.com

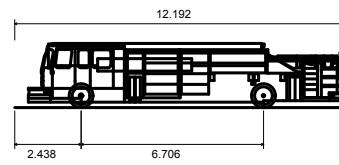

Pumper Fire Truck

Overall Length	12.192m
Overall Width	2.489m
Overall Body Height	2.361m
Min Body Ground Clearance	0.200m
Track Width	2.489m
Lock-to-lock time	5.00s
Max Wheel Angle	45.00°

CHEO

**TURNING MOVEMENT
(FIRE TRUCK)**

SCALE 1 : 500

DATE APR 2024

JOB 122210

FIGURE 26

C:\temp\AcPublish_325721\22210-TM.dwg, Fig 27, Apr 18, 2024 - 4:01pm, millier

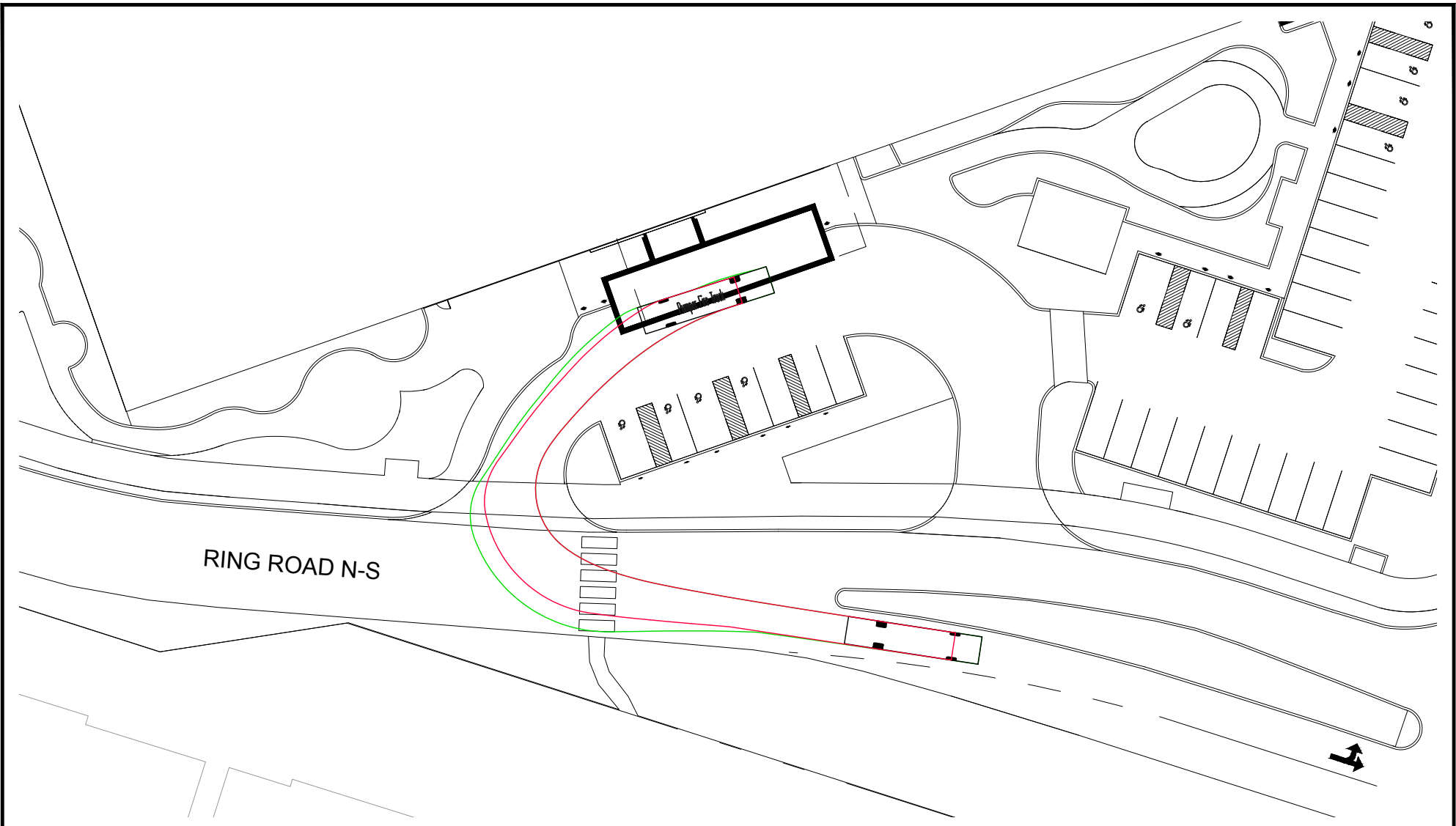

Engineers, Planners & Landscape Architects
 Suite 200, 240 Michael Cowpland Drive
 Ottawa, Ontario, Canada K2M 1P6

Telephone (613) 254-9643
 Facsimile (613) 254-5867
 Website www.novatech-eng.com

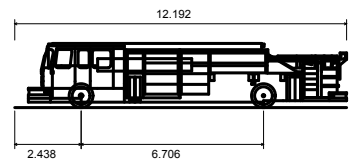

Pumper Fire Truck

Overall Length	12.192m
Overall Width	2.489m
Overall Body Height	2.361m
Min Body Ground Clearance	0.200m
Track Width	2.489m
Lock-to-lock time	5.00s
Max Wheel Angle	45.00°

CHEO

**TURNING MOVEMENT
(FIRE TRUCK)**

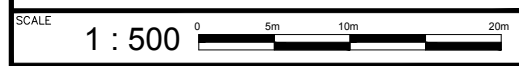

DATE APR 2024	JOB 122210	FIGURE FIGURE 27
------------------	---------------	---------------------

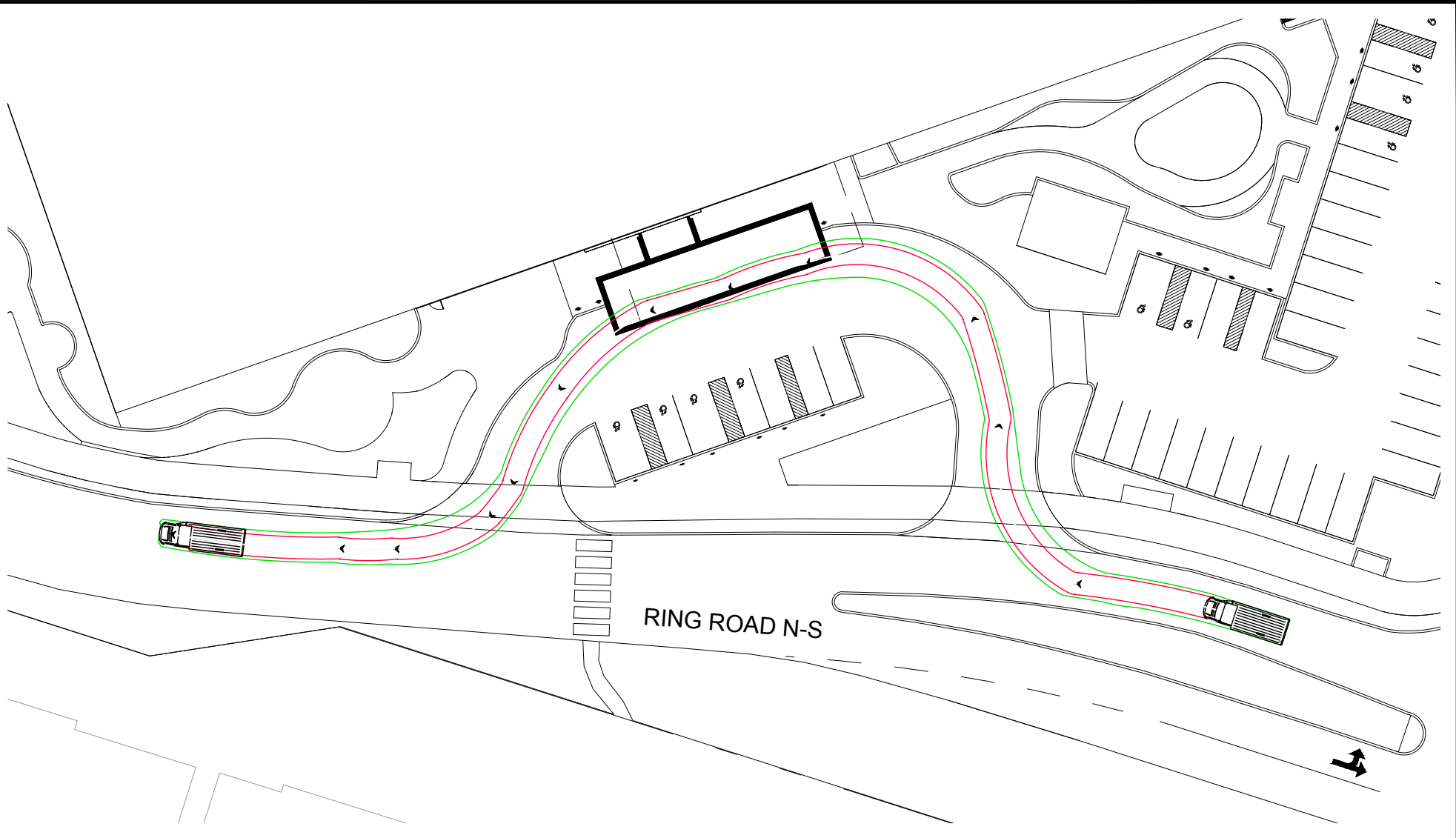

C:\temp\AcPublish_325721\22210-TM.dwg, Fig 28, Apr 18, 2024 - 4:01pm, millier



Engineers, Planners & Landscape Architects
 Suite 200, 240 Michael Cowpland Drive
 Ottawa, Ontario, Canada K2M 1P6

Telephone (613) 254-9643
 Facsimile (613) 254-5867
 Website www.novatech-eng.com

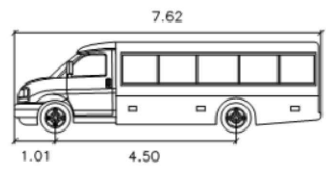

AllStar Chevrolet 4500
 meters
 Width : 2.44
 Track : 1.96
 Lock to Lock Time : 6.0
 Steering Angle : 34.2

CHEO

**TURNING MOVEMENT
(PARA-TRANSPO)**



DATE APR 2024	JOB 122210	FIGURE FIGURE 28
------------------	---------------	---------------------

C:\temp\AcPublish_325721122210-TM.dwg, Fig 29, Apr 18, 2024 - 4:01pm, millier

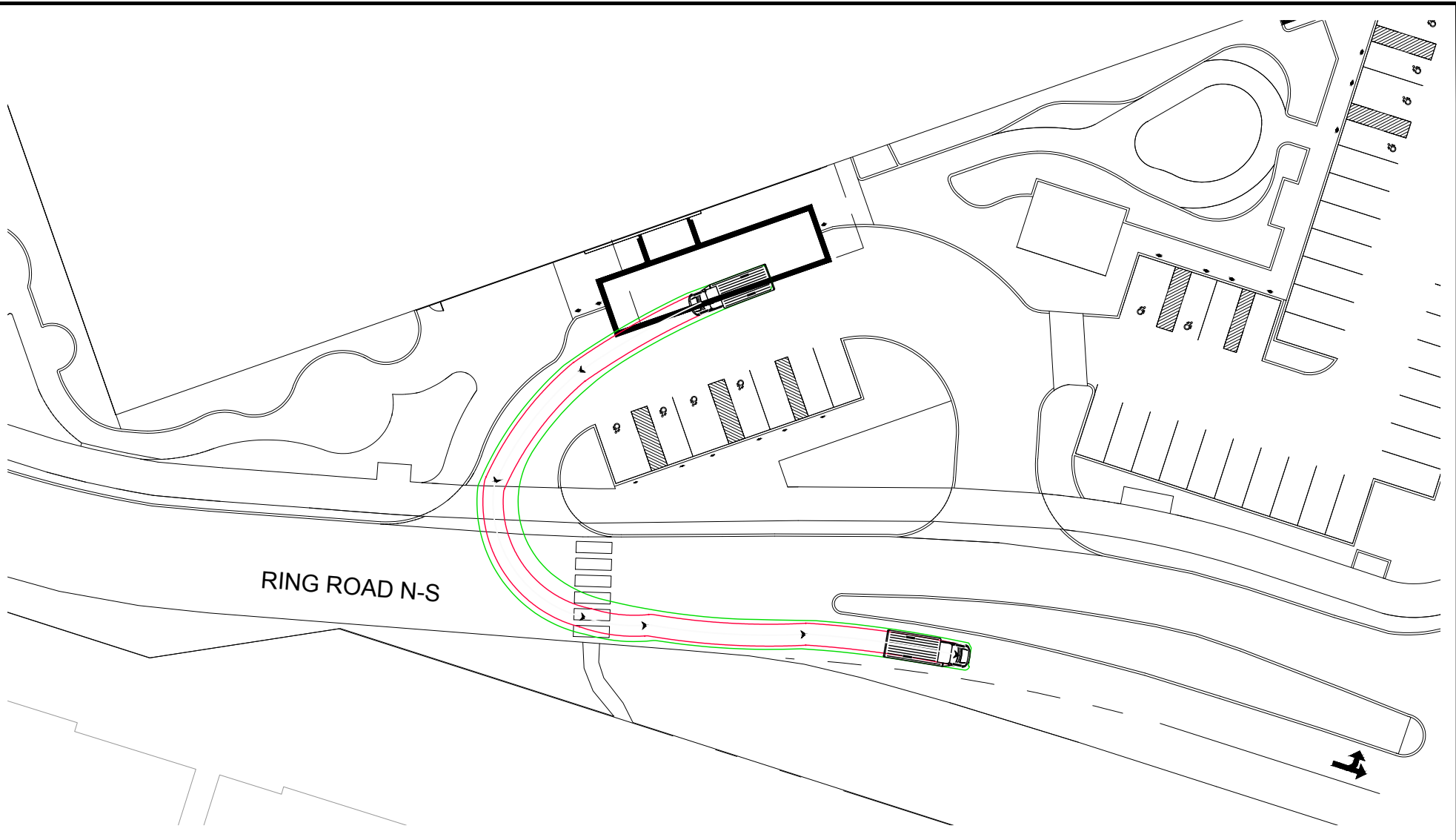

Engineers, Planners & Landscape Architects
 Suite 200, 240 Michael Cowpland Drive
 Ottawa, Ontario, Canada K2M 1P6

Telephone (613) 254-9643
 Facsimile (613) 254-5867
 Website www.novatech-eng.com

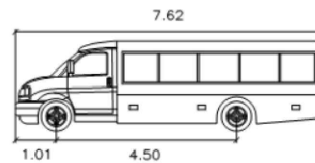

AllStar Chevrolet 4500
 meters
 Width : 2.44
 Track : 1.96
 Lock to Lock Time : 6.0
 Steering Angle : 34.2

CHEO

TURNING MOVEMENT
 (PARA-TRANSPO)

SCALE 1 : 500 0 5m 10m 20m

DATE APR 2024

JOB 122210

FIGURE FIGURE 29

C:\temp\Ap\Publish_32572\122210-TM.dwg, Fig 30, Apr 18, 2024 - 4:01pm, millier

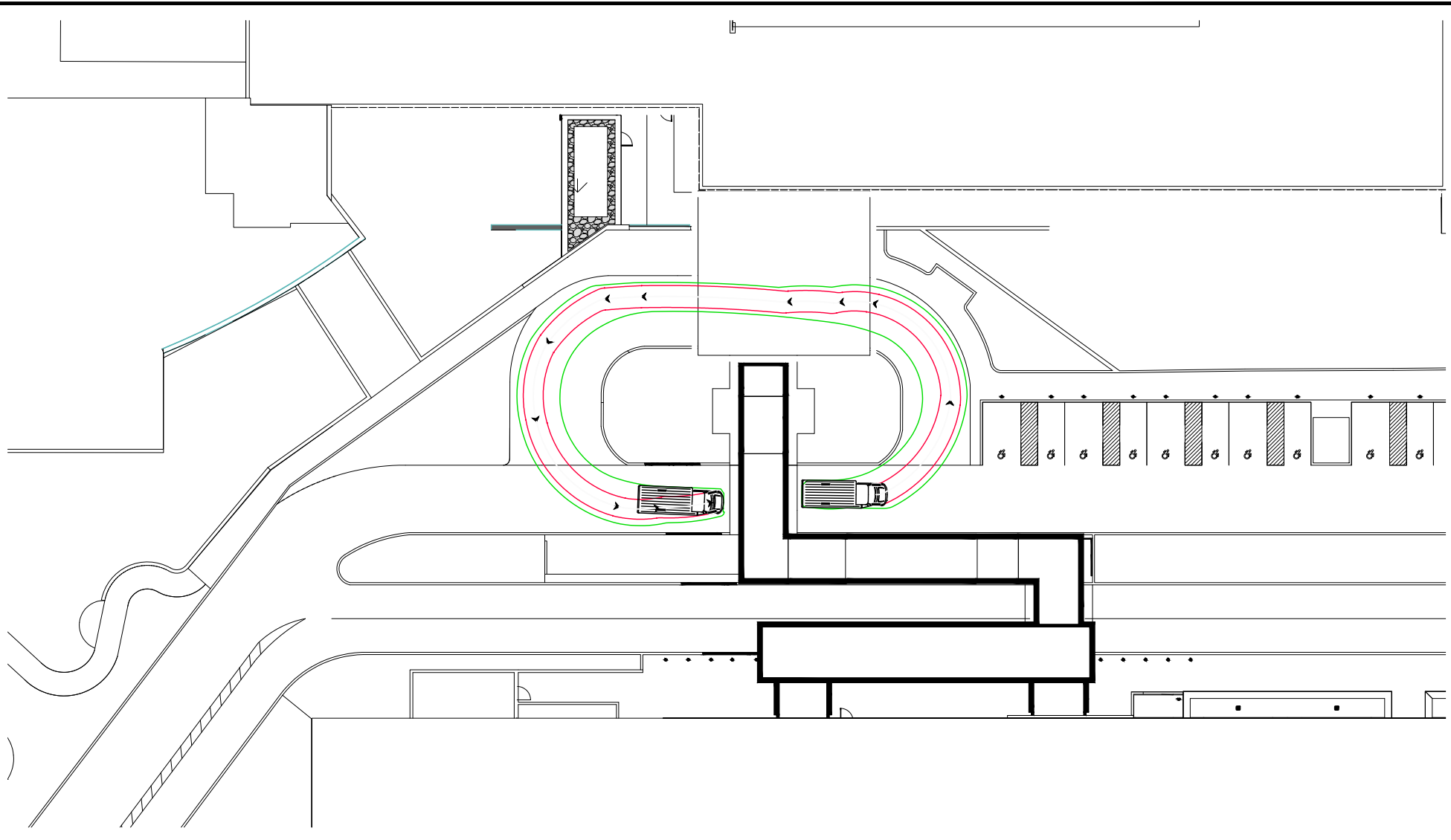

Engineers, Planners & Landscape Architects
 Suite 200, 240 Michael Cowpland Drive
 Ottawa, Ontario, Canada K2M 1P6

Telephone (613) 254-9643
 Facsimile (613) 254-5867
 Website www.novatech-eng.com

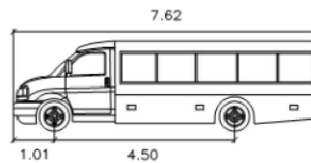

AllStar Chevrolet 4500
 meters
 Width : 2.44
 Track : 1.96
 Lock to Lock Time : 6.0
 Steering Angle : 34.2

CHEO

TURNING MOVEMENT
 (PARA-TRANSPO)

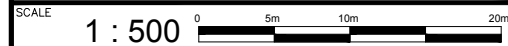

DATE APR 2024	JOB 122210	FIGURE FIGURE 30
------------------	---------------	---------------------

As shown in the October 25, 2022, Transportation Study completed by Stantec, Parking Lot B includes 286 parking spaces and Parking Lot E includes 270 parking spaces. The approved parking garage that is under construction in Parking Lot E will provide approximately 1,050 parking spaces and within the 1Door4Care site an additional 71 parking spaces are provided. The total number of parking spaces in the existing Parking Lots B and E plus the additional parking required by the ZBL for the 1Door4Care building totals 849 parking spaces. The approved parking garage therefore exceeds the parking requirements of the ZBL.

Based on the previous table, the minimum parking requirement will be met.

Per Section 4.2.3 of the Stantec 2022 Transportation Study, the estimated parking generation rate for CHEO is approximately 3 spaces/100m². This is more than double the minimum zoning rate. Based on the observed rate, approximately 600 parking spaces are required to meet the demand for the new 1Door4Care clinic. With the 286 Lot B displaced spaces and the 270 Lot E displaced spaces, this amount to a total demand of 1,156 spaces. The 1,050 spaces in the approved Ph1A parking garage and the proposed 71 spaces for the Ph1B 1Door4Care site plan provide a total of 1,121 spaces, or 97% of the demand.

The proposed development is considered to meet the required loading spaces as per Section 111 of the City’s ZBL, due to the school bus lane to the north of the 1Door4Care building and the proposed loading area.

For parking lots with over 1,000 parking spaces the City’s Accessibility Design Standards require 11 +1% of the total parking spaces provided be a combination of Type A and Type B accessible parking spaces. Within the 1Door4Care site 14 Type A and 14 Type B parking spaces are provided. As 11 Type A and 11 Type B parking spaces are required for 1,121 total parking spaces this requirement is met.

4.3 Boundary Streets

This section provides a review of the boundary streets Ring Road (N-S), and Ring Road (E-W), using complete streets principles. The *MMLOS Guidelines* were used to evaluate the levels of service for each alternative mode of transportation, based on existing conditions. Using Exhibit 22 of the *MMLOS Guidelines*, the boundary streets have been evaluated based on the targets for roadways within the General Urban Area.

A detailed segment MMLOS review of the boundary streets is included in **Appendix K**. A summary of the segment MMLOS analysis is provided below in **Table 12**.

Table 12: Segment MMLOS Summary

Segment	PLOS		BLOS		TLOS		TkLOS	
	Actual	Target	Actual	Target	Actual	Target	Actual	Target
Ring Road (N-S)	F	C	D	D	D	-	B	-
Ring Road (E-W)	F		D		D		B	

The results of the segment MMLOS review can be summarized as follows:

- No boundary streets meet the target pedestrian level of service (PLOS);
- Ring Road meets the target bicycle level of service (BLOS).

Further discussion of possible mitigations for the failing PLOS and BLOS scores are included below.

Pedestrian Level of Service

The east side of Ring Road (N-S) meets the target PLOS C, as an approximately 2.0m-wide sidewalk is provided on this side of the roadway. The west side of Ring Road (N-S) and both sides of Ring Road (E-W) do not meet the target PLOS, as sidewalks are either provided only in certain sections or not provided at all. It should be noted that the proposed site plan (shown in **Appendix A**) includes 3.0m-wide multi-use pathways, with boulevard widths of at least 0.5m. This will improve the east side of Ring Road (N-S) to a PLOS C and north side of Ring Road (E-W) to a PLOS A, per Exhibit 4 of the *MMLOS Guidelines*.

4.4 Transportation Demand Management

4.4.1 Context for TDM

The proposed development will consist of the 1Door4Care building which has a GFA of 21,700m² and includes medical clinic and school uses. The development includes 71 parking spaces within the subject site with an additional 1,050 parking spaces being provided within a parking garage that is being constructed as part of an initial phase.

4.4.2 Need and Opportunity

Smyth Road is designated as 'Evolving Neighbourhood' and 'Corridor – Mainstreet' on Schedule B3 of the City of Ottawa's Official Plan, and the site is located within the Alta Vista/ Faircrest Heights/Riverview Park Secondary Plan area. As discussed in Section 2.5.1, the peak hour driver share assumed for the proposed development (60%) is generally consistent with the observed peak hour drivers shares for the Alta Vista district (61% in AM peak hour and 62% in PM peak hour). If the proposed development achieved a 70% driver share rather than 60%, this would translate to an additional 40 vehicle trips to/from the development during each peak hour. It is anticipated that the 60% driver share is attainable.

4.4.3 TDM Program

A review of the City's *TDM Checklist* has been conducted by the proponent. A copy of the completed non-residential checklist is included in **Appendix K**. The list of measures to be considered are summarized as follows:

- Display local area maps with walking/cycling access routes and key destinations at major entrances;
- Provide relevant transit schedules and route maps at main building entrances; and
- Provide a multimodal travel option information package to new employees.

4.5 Transit

Based on the trip generation estimates presented in Section 2.5.1, the proposed development is anticipated to generate the following number of transit trips:

- AM Peak Hour: 60 transit trips, including 20 boarding and 40 alighting;
- PM Peak Hour: 58 transit trips, including 38 boarding and 20 alighting.

Transit trips generated by the proposed development are anticipated to board and alight via routes 45 and 55 at bus stops #7045, #7072, #7231, #7236, #7237 and #7238. Bus stops #1808 will need

to be relocated to bus stop #7045 within the subject site due to the changes being proposed to the CHEO non-emergency access. As both routes 45 and 55 operate on 15 to 30-minute headways during peak hours, it is expected that they can accommodate the additional transit trips generated by the proposed development.

4.6 Intersection Design

4.6.1 Intersection MMLOS

The following is a review of the MMLOS of the signalized intersections within the study area (Smyth Road/Ring Road (N-S)/South Haven Place and Smyth Road/General Hospital Access Road), using complete streets principles. These intersections have been evaluated based on existing conditions, using the MMLOS targets for intersections within the General Urban Area.

A detailed intersection MMLOS review of the two signalized intersections is included in **Appendix K**. A summary of the intersection MMLOS analysis is provided below in **Table 13**.

Table 13: Intersection MMLOS Summary

Segment	PLOS		BLOS		TLOS		TkLOS	
	Actual	Target	Actual	Target	Actual	Target	Actual	Target
Smyth Road/ Ring Road (N-S)/South Haven Place	F	A	F	B	E	-	F	D
Smyth Road/ General Hospital Access Road	F	C	F	C	F		B	

The results of the intersection MMLOS analysis can be summarized as follows:

- Neither study area intersection meets the target PLOS;
- Neither study area intersection meets the target BLOS;
- Smyth Road/General Hospital Access Road meets the target TkLOS, while Smyth Road/Ring Road (N-S)/South Haven Place does not.

Each intersection is discussed further below, relating to the modes where the target levels of service are not met.

Smyth Road/Ring Road (N-S)/South Haven Place

The intersection does not meet the target PLOS A, BLOS B, TLOS D, or TkLOS D.

Per the *MMLOS Guidelines*, every 3.5m in crossing distance is equivalent to one lane crossed. None of the approaches meet the target PLOS A, as all except the south approach have cross-sections with an equivalent of five to seven lanes crossed. The south approach (i.e. crossing South Haven Place) achieves PLOS C, with a cross-section equivalent to three lanes crossed. There is limited opportunity in improving the intersection PLOS without reducing the number of travel lanes at the north, east, and west approaches. The east approach meets the City’s vehicle/pedestrian conflict threshold for zebra-striped crosswalks (greater than 400,000 vehicle/pedestrian conflicts over an eight-hour period). This would improve the level of comfort for pedestrians crossing Smyth Road.

The north, east, and west approaches do not meet the target BLOS B based on left turn characteristics. Exhibit 12 of the *MMLOS Guidelines* identifies that these approaches require two-stage left turn bike boxes to meet the target BLOS B. Implementing bike boxes would require

restricting right turns on red (RTOR) on the east and west approaches. This is identified for the City’s consideration.

The north approach does not meet the target BLOS B based on right turn characteristics. Exhibit 12 of the *MMLOS Guidelines* identifies that a bike lane or higher order facility is required to meet the target BLOS. This is identified for the City’s consideration.

The west approach does not meet the target TkLOS D. This represents the movement of eastbound heavy vehicles on Smyth Road turning right onto South Haven Place, which is a residential street with traffic management measures already implemented (i.e. no through traffic). Therefore, increasing the curb radii to accommodate trucks is not recommended.

Smyth Road/General Hospital Access Road

The intersection does not meet the target PLOS C, BLOS C, or TLOS D.

No approaches meet the target PLOS C, as the approaches have cross-sections with an equivalent of six to eight lanes crossed. There is limited opportunity in improving the intersection PLOS without reducing the number of travel lanes at each approach. The east and west approaches meet the City’s vehicle/pedestrian conflict threshold for zebra-striped crosswalks. This would improve the level of comfort for pedestrians crossing Smyth Road.

The north and west approaches do not meet the target BLOS C based on left turn characteristics. Exhibit 12 of the *MMLOS Guidelines* identifies that two-stage left turn accommodations are required to meet the target BLOS C. For cyclists turning left from the north approach, this would involve a bike box in front of the eastbound stop bar. For cyclists turning left from the west approach, this would involve a jug handle facility and cyclist crossing signal. This is identified for the City’s consideration.

4.6.2 2027 Total Traffic Operations

Intersection capacity analysis has been conducted for the 2027 total traffic conditions. The results of the analysis are summarized in **Table 14** for the weekday AM and PM peak hours. Detailed reports are included in **Appendix I**.

Table 14: 2027 Total Traffic Operations

Intersection	AM Peak Hour			PM Peak Hour		
	Max v/c or Delay	LOS	Mvmt	Max v/c or Delay	LOS	Mvmt
Ring Road/ Hospital Link Road ^(u)	15 sec.	B	EB	12 sec.	B	WB
Ring Road (N-S)/ CHEO Non-Emergency Access ^(u)	11 sec.	B	NB	10 sec.	B	SB
Ring Road (N-S)/ Ring Road (E-W) ^(u)	23 sec.	C	WB	26 sec.	D	WB
Smyth Road/Ring Road (N-S)/ South Haven Place ^(s)	0.70	B	WB	0.91	E	SBR
Ring Road (E-W)/ CHEO Non-Emergency Access ^(u)	10 sec.	B	SB	10 sec.	B	SB
Ring Road (E-W)/ CHEO Emergency Access ^(u)	12 sec.	B	SB	11 sec.	B	SB

Intersection	AM Peak Hour			PM Peak Hour		
	Max v/c or Delay	LOS	Mvmt	Max v/c or Delay	LOS	Mvmt
Ring Road (E-W)/ General Hospital Access Road*	31 sec.	D	WBL	130 sec. 1.20	F	WBL
Smyth Road/ General Hospital Access Road ^(s)	0.61	B	EBL	0.83	D	SBR
Ring Road (N-C)/ 1Door4Care Loop Access ^(u)	12 sec.	B	WB	11 sec.	B	WB
Ring Road (E-W)/ Parking Garage Access ^(u)	16 sec.	C	SB	11 sec.	B	SB

(u): Unsignalized intersection

(s): Signalized intersection

*: Modeled as a two-way stop intersection on Ring Road (E-W) due to limitations in Synchro software

All movements at study area intersections, except for the Ring Road (E-W)/General Hospital Access Road intersection, are expected to operate with acceptable LOS under 2027 total traffic conditions.

The southbound approach at the Smyth Road/Ring Road (N-S)/South Haven Place intersection has roughly 30m of storage. During the PM peak hour the 95th percentile queues exceed the available storage for both the southbound right and left turn movements. The 95th percentile queue is 96m for the southbound right turn movement and 44m for the southbound left turn movement. This is not expected to block the egress of the proposed loop access.

The southbound approach at the Smyth Road/General Hospital Access Road intersection has roughly 35m of storage. During the PM peak hour the 95th percentile queues exceed the available storage for both the southbound right and left turn movements. The 95th percentile queue is 74m for the southbound right turn movement and 51m for the southbound left turn movement. This is a marginal increase of 5m or less compared to the 2027 background traffic condition.

It is recommended that the extra wide north and south approaches of the Ring Road (N-S)/Ring Road (E-W) intersection be formalized through line painting as having two lane approaches. A single through and right turn lane are recommended on the south approach and a shared through/left and through lane are recommended on the north approach. A 1.0m widening is recommended on the east approach to accommodate designated left and right turn lanes, based on the projected turning movement volumes. The existing road width is 9.5m and the proposed width of 10.5m as shown on the site plan will accommodate three 3.5m lanes. The City’s Roadway Modification Approval process is not required as Ring Road is not a City road. Detailed design drawings will be provided as part of Site Plan approval.

The westbound left turn lane at the Ring Road (E-W)/General Hospital Access Road intersection operates with a LOS F during the PM peak hour. The westbound left turn lane has a 95th percentile queue length of 95m which exceeds the available storage of 40m. The westbound left turn lane has a v/c ratio of 1.20 during the PM peak hour.

As noted in the footnotes below **Table 14**, the Synchro results are based on a two-way stop control intersection at the Ring Road (E-W)/General Hospital Access Road intersection with stop control along Ring Road (E-W). The analysis was completed using this assumption as Synchro is unable to analyze the existing intersection which is a three-way stop control intersection with the northbound leg of the General Hospital Access Road operating under free flow conditions. The analysis presented within this report is assumed to be conservative as the southbound leg of the Ring Road (E-W)/General Hospital Access Road intersection was not modelled as having stop

control and the free flow conditions modelled for the southbound leg limit the available capacity of the eastbound and westbound legs of the intersection and increase delays. Although the Ring Road (E-W)/General Hospital Access Road intersection is not under the jurisdiction of the City of Ottawa monitoring of this intersection is recommended. A future additional westbound left turn lane may be required in addition to the existing westbound left turn lane and westbound through/right turn lane based on the westbound left turning volume of 392 vehicles during the PM peak hour. There is roughly 90m of spacing between the Ring Road (E-W)/General Hospital Access Road intersection and the surface parking lot access to the east which provides sufficient distance for a 55m storage area with a 10:1 taper of 35m. Any additional travel lanes would likely impact the existing bus stop and retaining wall east of the Ring Road (E-W)/General Hospital Access Road intersection. During the PM peak hour the trips generated by the subject site send an additional 39 northbound left and 59 eastbound right turning vehicles through the Ring Road (E-W)/General Hospital Access Road intersection, as this traffic is relatively small compared to the current 392 westbound left turning vehicles the high delays at this intersection are primarily due to existing conditions.

4.6.3 2032 Total Traffic Operations

Intersection capacity analysis has been conducted for the 2032 total traffic conditions. The results of the analysis are summarized in **Table 15** for the weekday AM and PM peak hours. Detailed reports are included in **Appendix I**.

Table 15: 2032 Total Traffic Operations

Intersection	AM Peak Hour			PM Peak Hour		
	Max v/c or Delay	LOS	Mvmt	Max v/c or Delay	LOS	Mvmt
Ring Road/ Hospital Link Road ^(u)	15 sec.	B	EB	12 sec.	B	WB
Ring Road (N-S)/ CHEO Non-Emergency Access ^(u)	11 sec.	B	NB	10 sec.	B	SB
Ring Road (N-S)/ Ring Road (E-W) ^(u)	23 sec.	C	WB	26 sec.	D	WB
Smyth Road/Ring Road (N-S)/ South Haven Place ^(s)	0.73	B	WB	0.92	E	SBR
Ring Road (E-W)/ CHEO Non-Emergency Access ^(u)	10 sec.	B	SB	10 sec.	B	SB
Ring Road (E-W)/ CHEO Emergency Access ^(u)	12 sec.	B	SB	11 sec.	B	SB
Ring Road (E-W)/ General Hospital Access Road*	31 sec.	D	WBL	130 sec.	F	WBL
Smyth Road/ General Hospital Access Road ^(s)	0.61	B	EBL	0.83	D	SBR
Ring Road (N-C)/ 1Door4Care Loop Access ^(u)	12 sec.	B	WB	11 sec.	B	WB
Ring Road (E-W)/ Parking Garage Access ^(u)	16 sec.	C	SB	11 sec.	B	SB

(u): Unsignalized intersection

(s): Signalized intersection

*: Modeled as a two-way stop intersection on Ring Road (E-W) due to limitations in Synchro software

All movements at study area intersections, except for the Ring Road (E-W)/General Hospital Access Road intersection, are expected to operate with acceptable LOS under 2032 total traffic conditions.

The southbound approach at the Smyth Road/Ring Road (N-S)/South Haven Place intersection has roughly 30m of storage. During the PM peak hour the 95th percentile queues exceed the available storage for both the southbound right and left turn movements. The 95th percentile queue is 99m for the southbound right turn movement and 44m for the southbound left turn movement. Again, this is not expected to block the egress of the proposed loop access.

The southbound approach at the Smyth Road/General Hospital Access Road intersection has roughly 35m of storage. During the PM peak hour the 95th percentile queues exceed the available storage for both the southbound right and left turn movements. The 95th percentile queue is 75m for the southbound right turn movement and 51m for the southbound left turn movement.

The westbound left turn lane at the Ring Road (E-W)/General Hospital Access Road intersection operates with a LOS F during the PM peak hour. The westbound left turn lane has a 95th percentile queue length of 95m which exceeds the available storage of 40m. The westbound left turn lane has a v/c ratio of 1.20 during the PM peak hour.

5.0 CONCLUSIONS AND RECOMMENDATIONS

Forecasting

- The proposed hospital clinic development is estimated to generate 401 person trips (including 241 vehicle trips) during the AM peak hour, and 387 person trips (including 233 vehicle trips) during the PM peak hour.
- Traffic from the existing school and Parking Lots B and E were redistributed within the subject site to account for the construction of the new parking garage and the 1Door4Care building. Traffic along the CHEO main access was redistributed due to the conversion of the road from two-way to one-way operations within the site.

Development Design

- A PXO Type D is proposed at the existing unmarked pedestrian crossing between the new 1Door4Care egress and the residential neighbourhood to the west. The PXO Type D is proposed as there is an existing pedestrian desire line. The PXO Type D is recommended based on the Ontario Traffic Manual (OTM) Book 15. Based on the 8-hour traffic volumes from the March 19, 2024, traffic count at the Ring Road (N-S)/Ring Road (E-W) intersection, the northern leg of the intersection has an 8-hour traffic volume of 2,847 vehicles. Given the posted speed limit of 40km/h, Table 7 of the OTM Book 15 was used to determine the required Type of PXO. Although the current roadway has a road platform of 9.5m and an effective 3 lane cross-section, it is recommended the roadway be narrowed on each side of Ring Road (N-S) by 1m for a total road platform width of 7.5m.
- Parking Lot B includes 286 parking spaces and Parking Lot E includes 270 parking spaces. The approved parking garage that is under construction in Parking Lot E will provide approximately 1,050 parking spaces and within the 1Door4Care site an additional 71 parking spaces are provided. The total number of parking spaces in the existing Parking Lots B and E plus the additional parking required by the ZBL for the 1Door4Care building totals 849 parking spaces. The approved parking garage therefore exceeds the parking requirements of the ZBL.
- Per Section 4.2.3 of the Stantec 2022 Transportation Study, the estimated parking generation rate for CHEO is approximately 3 spaces/100m². This is more than double the

minimum zoning rate. Based on the observed rate, approximately 600 parking spaces are required to meet the demand for the new 1Door4Care clinic. With the 286 Lot B displaced spaces and the 270 Lot E displaced spaces, this amount to a total demand of 1,156 spaces. The 1,050 spaces in the approved Ph1A parking garage and the proposed 71 spaces for the Ph1B 1Door4Care site plan provide a total of 1,121 spaces, or 97% of the demand.

- The proposed development is considered to meet the required loading spaces as per Section 111 of the City's ZBL, due to the school bus lane to the north of the 1Door4Care building and the proposed loading area.
- For parking lots with over 1,000 parking spaces the City's Accessibility Design Standards require 11 +1% of the total parking spaces provided be a combination of Type A and Type B accessible parking spaces. Within the 1Door4Care site 14 Type A and 14 Type B parking spaces are provided. As 11 Type A and 11 Type B parking spaces are required for 1,121 total parking spaces this requirement is met.
- A total of 40 bicycle parking spaces will be provided near the 1Door4Care building.

Boundary Streets

- The proposed site plan includes 3.0m-wide multi-use pathways along the Ring Road (N-S) and Ring Road (E-W) frontages with boulevard widths of at least 0.5m.

Access Design

- The TAC *Geometric Design Guide* minimum corner clearance requirement of 20m is met by the proposed loop.
- The minimum clear throat requirement of 15m is met at the proposed access loop to Ring Road (N-S).
- The widths of the one-way ingress and egress of the proposed access loop exceed the requirements of the Private Approach By-law. However, Ring Road is not a municipal road and the accesses are not subject to the PABL.
- The proposed accesses to Ring Road (E-W) and Ring Road (N-S) are anticipated to operate with acceptable delays for the build-out year 2027 and horizon year 2032.

Transportation Demand Management (TDM)

- A review of the City's TDM Measures Checklist has been conducted. The proponent, is committed to providing the following TDM measures within this development:
 - Display local area maps with walking/cycling access routes and key destinations at major entrances;
 - Provide relevant transit schedules and route maps at main building entrances; and
 - Provide a multimodal travel option information package to new employees.

Transit

- Bus stop #1808 will need to be relocated to bus stop #7045 within the subject site due to the changes being proposed to the CHEO non-emergency access.

Intersection MMLOS

- The east approach of the Smyth Road/Ring Road (N-S)/South Haven Place intersection meets the City's vehicle/pedestrian conflict threshold for zebra-striped crosswalks (greater than 400,000 vehicle/pedestrian conflicts over an eight-hour period). This would improve the level of comfort for pedestrians crossing Smyth Road.
- Implementing bike boxes the Smyth Road/Ring Road (N-S)/South Haven Place intersection would require restricting right turns on red (RTOR) on the east and west approaches. This is identified for the City's consideration.
- A bike lane or higher order facility is identified on the north approach of the Smyth Road/Ring Road (N-S)/South Haven Place intersection for the City's consideration.
- The east and west approaches of the Smyth Road/General Hospital Access Road meet the City's vehicle/pedestrian conflict threshold for zebra-striped crosswalks. This would improve the level of comfort for pedestrians crossing Smyth Road.
- Two-stage left turn bike boxes are required to meet the target BLOS C at the north and west approaches of the Smyth Road/General Hospital Access Road intersection. For cyclists turning left from the north approach, this would involve a bike box in front of the eastbound stop bar. For cyclists turning left from the west approach, this would involve a jug handle facility and cyclist crossing signal. This is identified for the City's consideration.

Background Traffic Analysis

- All movements at study area intersections operate with acceptable LOS under 2027 and 2032 background traffic conditions.

Total Traffic Analysis

- All movements at study area intersections, except for the Ring Road (E-W)/General Hospital Access Road intersection, are expected to operate with acceptable LOS under total traffic conditions.
- Due to limitations in Synchro software the intersection was conservatively modeled as having free flow on the north and south approaches as opposed to only the south approach. It is assumed to operate with less delays and is recommended to be monitored in the future. Delays at the intersection are largely attributable to the existing conditions which includes a high volume of westbound left turning vehicles during the PM peak hour. A future additional westbound left turn lane may be required in addition to the existing westbound left turn lane and westbound through/right turn lane. Any additional travel lanes would likely impact the existing bus stop and retaining wall east of the Ring Road (E-W)/General Hospital Access Road intersection.

Based on the foregoing, the proposed development can be recommended from a transportation perspective.

NOVATECH

Prepared by:



Trevor Van Wiechen, M.Eng.
E.I.T. | Transportation

Reviewed by:



Jennifer Luong, P.Eng.
Senior Project Manager | Transportation

APPENDIX A

Preliminary Site Plan

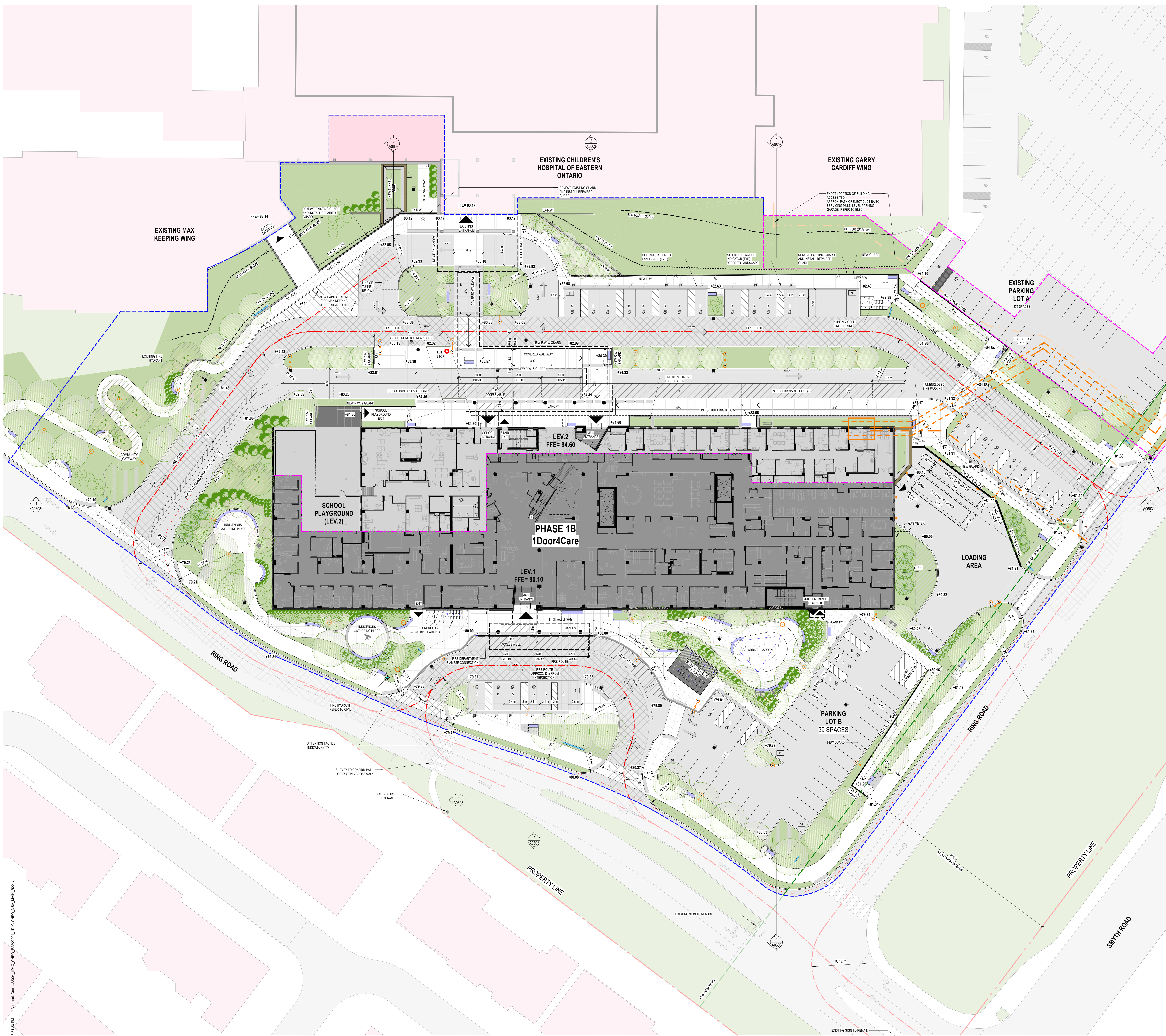

SYMBOL LEGEND

- F.F.E. FINISH FLOOR ELEVATION
- +120.45 GEODETIC ELEVATION (REFER TO CIVIL)
- CATCH BASIN (REFER TO CIVIL DWGS)
- AREA DRAIN (REFER TO CIVIL DWGS)
- MANHOLE (REFER TO CIVIL DWGS)
- CATCH BASIN/MANHOLE (REFER TO CIVIL DWGS)
- STREET LIGHTING (REFER TO ELECTRICAL DWGS)
- EXISTING SITE LIGHTING (REFER TO ELECTRICAL DWGS)
- SECURITY CAMERA (REFER TO ELECTRICAL DWGS)
- WALL MOUNTED LIGHT FIXTURE (REFER TO ELEC.)
- DURESS STATION (REFER TO ELEC. DWGS)
- ELECTRICAL OUTLETS (REFER TO ELEC. DWGS)
- FIRE DEPARTMENT CONNECTION
- FIRE HYDRANT (REFER TO CIVIL)
- PROPERTY LINE
- FIRE TRUCK ACCESS ROUTE
- FIRE TRUCK ACCESS ROUTE CLEARANCE
- SETBACK
- SCOPE OF WORK BOUNDARY - PHASE 1A
- SCOPE OF WORK BOUNDARY - PHASE 1B
- LEVEL SPILT (LEVEL 1 AND LEVEL 2 FFE AS NOTED)
- ELECTRICAL SITE SERVICES (REFER TO ELEC. DWGS)
- LANDSCAPED AREA (REFER TO LANDSCAPE DWGS)
- ROADS
- EXISTING CURB TO BE DEMOLISHED
- EXISTING BUILDING
- PROPOSED BUILDING
- GREEN ROOF
- CANOPY OR SHELTER (REFER TO LANDSCAPE DWGS)
- BUILDING ENTRANCE / EXIT
- EXISTING LOADING ENTRANCE
- LOADING DRIVE LEVEL ENTRANCE
- PARKING GARAGE ENTRANCE / EXIT
- BICYCLE PARKING
- INTAKE / EXHAUST VENT
- WAYFINDING LANDMARK
- EXISTING TREE (REFER TO LANDSCAPE DWGS)
- NEW TREE (REFER TO LANDSCAPE DWGS)
- BENCH (REFER TO LANDSCAPE DWGS)
- REST AREA (ACCOMMODATE TWO PEOPLE BY FIXED SEATING) W/ CLEAR FLOOR SPACE OF 300mm x 1200mm ADJACENT FOR MOBILITY DEVICE OR SERVICE ANIMAL TRAVEL DISTANCE SPACED MAXIMUM 30m APART)
- ATTENTION TACTILE INDICATOR (800mm DEPTH, ALIGN TO CURB)
- VEHICULAR DIRECTION OF TRAVEL
- PARKING SPACE
- BARRIER-FREE PARKING SPACE
- BF BARRIER-FREE PARKING SIGNAGE
- TYPE C PARKING SIGNAGE
- LINE PAINTING
- BUS STOP (LOC TRANSPO)
- STEEL BOLLARD
- SITE SIGNAGE
- WASTE RECEPTACLE (REFER TO LANDSCAPE DWGS)
- SLOPED WALKWAY (REFER TO CIVIL DWGS)
- R.W. RETAINING WALL

SITE DATA

ZONE	MIN. LOT WIDTH	NO. MINIMUM
NO. MINIMUM	NO MINIMUM	NO MINIMUM
MAX. BUILDING HEIGHT	15	NO MINIMUM
WITHIN 12m OF AN R1, R2, OR R3 ZONE	15	NO MINIMUM
MIN. FRONT YARD SETBACK	7.5m	49m (EXCEPT 37m)
MIN. REAR YARD SETBACK	7.5m	
MIN. CORNER SIDE YARD SETBACK	7.5m	
MIN. INTERIOR SIDE YARD SETBACK	7.5m	

COVERAGE TABLE	PHASE 1A	PHASE 1B	TOTAL
PARKING AREA	2,050m ²	1,800m ²	3,850m ²
BUILDING AREA	4,919m ²	4,919m ²	9,838m ²
SOFT LANDSCAPED AREA	15,955m ²		15,955m ²
HARD LANDSCAPED AREA	12,100m ²		12,100m ²
OVERALL SCOPE OF WORK EXTENT	16,331m ²	22,300m ²	38,631m ²

PARKING DATA

VEHICULAR PARKING REQUIRED	1,120 NEW SPACES
PARKING GARAGE (PHASE 1A)	270 DISPLACED SPACES
FORMER VISITOR PARKING (LOT E)	150 DISPLACED SPACES
PARKING 1DOOR4CARE (PHASE 1B)	42 NEW SPACES
FORMER STAFF PARKING (LOT B)	128 DISPLACED SPACES
ACCESSIBLE PARKING 1DOOR4CARE (PHASE 1B)	16 NEW SPACES
ACCESSIBLE PARKING (MAIN CHEO ENTRANCE)	12 NEW SPACES
TOTAL MINIMUM PARKING SPACES	1,120 NEW SPACES
VEHICULAR PARKING PROVIDED	1,050
PARKING GARAGE (PHASE 1A)	270
PARKING 1DOOR4CARE (PHASE 1B)	42
FORMER VISITOR PARKING (LOT E)	150
FORMER STAFF PARKING (LOT B)	128
ACCESSIBLE PARKING 1DOOR4CARE (PHASE 1B)	16
ACCESSIBLE PARKING (MAIN CHEO ENTRANCE)	12
TOTAL PHASE 1B PARKING SPACES	318
TOTAL NEW PARKING SPACES	1,121
BICYCLE PARKING REQUIRED	40 NEW SPACES
UNENCLOSED	REGULAR (0.9m x 1.8m) 10 LARGE (0.9m x 2.0m) 10
ENCLOSED	REGULAR (0.9m x 1.8m) 16 LARGE (0.9m x 2.0m) 4
TOTAL MINIMUM BICYCLE PARKING SPACES	40 NEW SPACES
BICYCLE PARKING PROVIDED	40 NEW SPACES
UNENCLOSED	REGULAR (0.9m x 1.8m) 10 LARGE (0.9m x 2.0m) 10
ENCLOSED	REGULAR (0.9m x 1.8m) 16 LARGE (0.9m x 2.0m) 4
TOTAL BICYCLE PARKING SPACES	40 NEW SPACES

CHEO
1Door4Care

Infrastructure Ontario

EllisDon
INFRASTRUCTURE Healthcare

Montgomery Sisam Architects Inc.
197 Spadina Avenue, Toronto, Ontario M5T 2C8 montgomerysisam.com
Tel 416.364.8079 Fax 416.364.7223

MontgomerySisam

PROJECT KEYPLAN
NORTH (0°N)

1: 23/12/15 ISSUED FOR SPIC DRAFT
2: 23/12/15 ISSUED FOR 90% DESIGN DEVELOPMENT

Scale: As indicated
drawn by: MSA
reviewed by: JS/D
job number: 20004
plot date: A3321
drawing number:

All drawing and specifications are the property of the architect. The contractor shall verify all dimensions and information on site and report any discrepancy to architect before proceeding.

1Door4Care CHEO Integrated Treatment Centre

401 Smyth Rd
Ottawa, ON K1H 1B1

1DOOR4CARE SITE PLAN - PHASE 1B

A0602

APPENDIX B

TIA Screening Form

City of Ottawa 2017 TIA Guidelines TIA Screening

1. Description of Proposed Development

Municipal Address	401 Smyth Road
Description of Location	NE of Ring Rd (N-S)/Ring Road (E-W)
Land Use Classification	hospital
Development Size (units)	
Development Size square metre (m ²)	21,700 sq.m.
Number of Accesses and Locations	1 one-way access to Ring Rd (N-S) plus ex. access to CHEO
Phase of Development	Phase 2 of 2 (parking garage is Phase 1)
Buildout Year	2027 (Parking Garage complete 2025)

If available, please attach a sketch of the development or site plan to this form.

2. Trip Generation Trigger

Considering the Development’s Land Use type and Size (as filled out in the previous section), please refer to the Trip Generation Trigger checks below.

Table notes:

1. Table 2, Table 3 & Table 4 TRANS Trip Generation Manual
2. Institute of Transportation Engineers (ITE) Trip Generation Manual 11.1 Ed.

Land Use Type	Minimum Development Size
Single-family homes	60 units
Multi-Use Family (Low-Rise) ¹	90 units
Multi-Use Family (High-Rise) ¹	150 units
Office ²	1,400 m ²
Industrial ²	7,000 m ²
Fast-food restaurant or coffee shop ²	110 m ²
Destination retail ²	1,800 m ²
Gas station or convenience market ²	90 m ²

If the proposed development size is equal to or greater than the sizes identified above, the Trip Generation Trigger is satisfied.

3. Location Triggers

	Yes	No
Does the development propose a new driveway to a boundary street that is designated as part of the Transit Priority Network, Rapid Transit network or Cross-Town Bikeways?	<input type="checkbox"/>	<input checked="" type="checkbox"/>
Is the development in a Hub, a Protected Major Transit Station Area (PMTSA), or a Design Priority Area (DPA)? ²	<input type="checkbox"/>	<input checked="" type="checkbox"/>

If any of the above questions were answered with ‘Yes,’ the Location Trigger is satisfied.

4. Safety Triggers

	Yes	No
Are posted speed limits on a boundary street are 80 kilometers per hour (km/h) or greater?	<input type="checkbox"/>	<input checked="" type="checkbox"/>
Are there any horizontal/vertical curvatures on a boundary street limits sight lines at a proposed driveway?	<input type="checkbox"/>	<input checked="" type="checkbox"/>
Is the proposed driveway within the area of influence of an adjacent traffic signal or roundabout (i.e. within 300 metre [m] of intersection in rural conditions, or within 150 m of intersection in urban/ suburban conditions)?	<input checked="" type="checkbox"/>	<input type="checkbox"/>
Is the proposed driveway within auxiliary lanes of an intersection?	<input type="checkbox"/>	<input checked="" type="checkbox"/>
Does the proposed driveway make use of an existing median break that serves an existing site?	<input type="checkbox"/>	<input checked="" type="checkbox"/>

² Hubs are identified in Schedules B1 to B8 of the City of Ottawa Official Plan. PMTSAs are identified in Schedule C1 of the Official Plan. DPAs are identified in Schedule C7A and C7B of the Official. See Chapter 4 for a list of City of Ottawa Planning and Engineering documents that support the completion of TIA.

Transportation Impact Assessment Guidelines

	Yes	No
Is there is a documented history of traffic operations or safety concerns on the boundary streets within 500 m of the development?	<input type="checkbox"/>	<input checked="" type="checkbox"/>
Does the development include a drive-thru facility?	<input type="checkbox"/>	<input checked="" type="checkbox"/>

If any of the above questions were answered with 'Yes,' the Safety Trigger is satisfied.

5. Summary

Results of Screening	Yes	No
Does the development satisfy the Trip Generation Trigger?	<input checked="" type="checkbox"/>	<input type="checkbox"/>
Does the development satisfy the Location Trigger?	<input type="checkbox"/>	<input checked="" type="checkbox"/>
Does the development satisfy the Safety Trigger?	<input checked="" type="checkbox"/>	<input type="checkbox"/>

If none of the triggers are satisfied, the TIA Study is complete. If one or more of the triggers is satisfied, the TIA Study must continue into the next stage (Screening and Scoping).

APPENDIX C

OC Transpo Route Maps

45



HOSPITAL HÔPITAL HURDMAN

Rapid^e

7 days a week / 7 jours par semaine

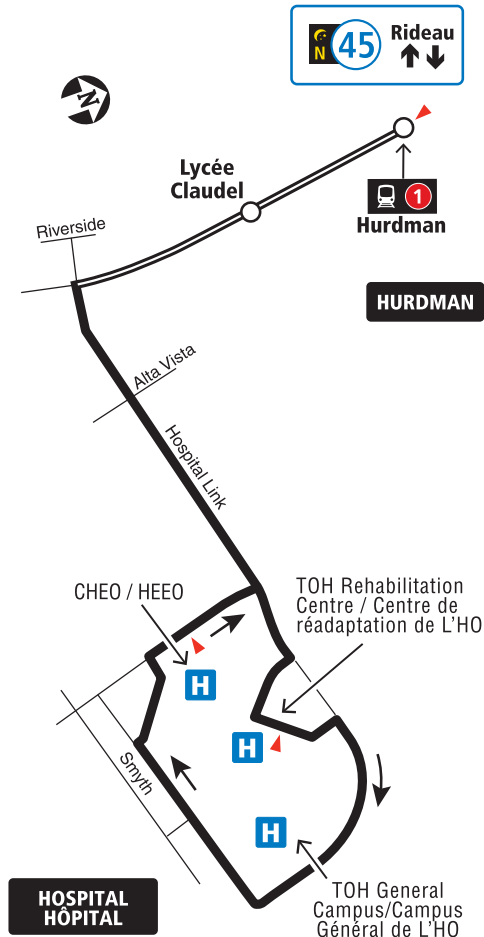
All day and limited overnight service
Service toute la journée et limité la nuit



 Transitway & Station
 Timepointe / Heures de passage

 When O-Train Line 1 is not running overnight, Route 45 will be extended downtown to Rideau Station. / Lorsque la ligne 1 de l'O-Train ne circule pas la nuit, le circuit 45 sera prolongée au centre-ville jusqu'à la station Rideau.

2019.07



Future route after O-Train Line 1 is open
Trajet du circuit après l'ouverture de la Ligne 1 de l'O-Train

Lost and Found / Objets perdus..... 613-563-4011
 Security / Sécurité..... 613-741-2478

 **INFO 613-741-4390**
 octranspo.com



55

ELMVALE WESTGATE

Local

7 days a week / 7 jours par semaine

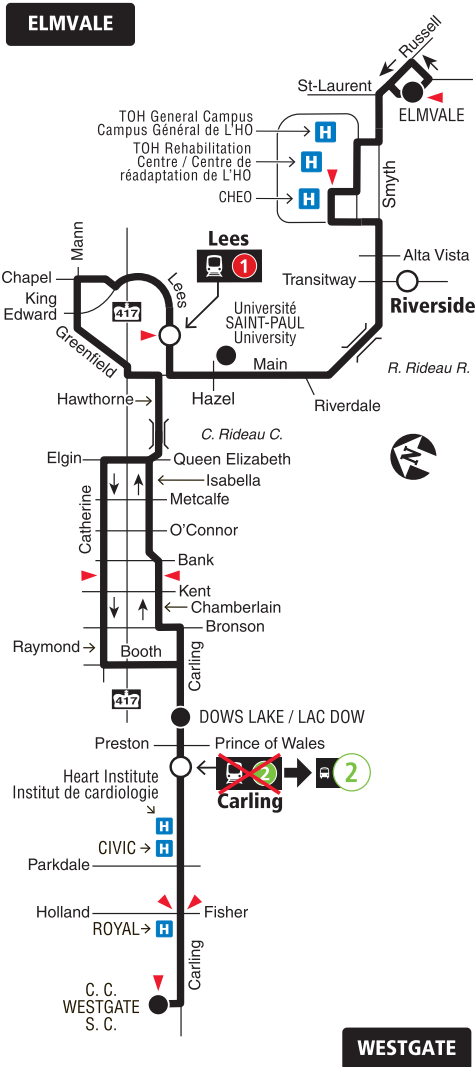

○ Stations
▲ Timepoint / Heures de passage

2021.06

Schedule / Horaire 613-560-1000
Text / Texto* 560560
plus your four digit bus stop number / plus votre numéro d'arrêt à quatre chiffres
*Standard message rates may apply / Les tarifs réguliers de messagerie texte peuvent s'appliquer

Customer Service
 Service à la clientèle **613-741-4390**
 Lost and Found / Objets perdus **613-563-4011**
 Security / Sécurité **613-741-2478**

Effective June 20, 2021
En vigueur 20 juin 2021

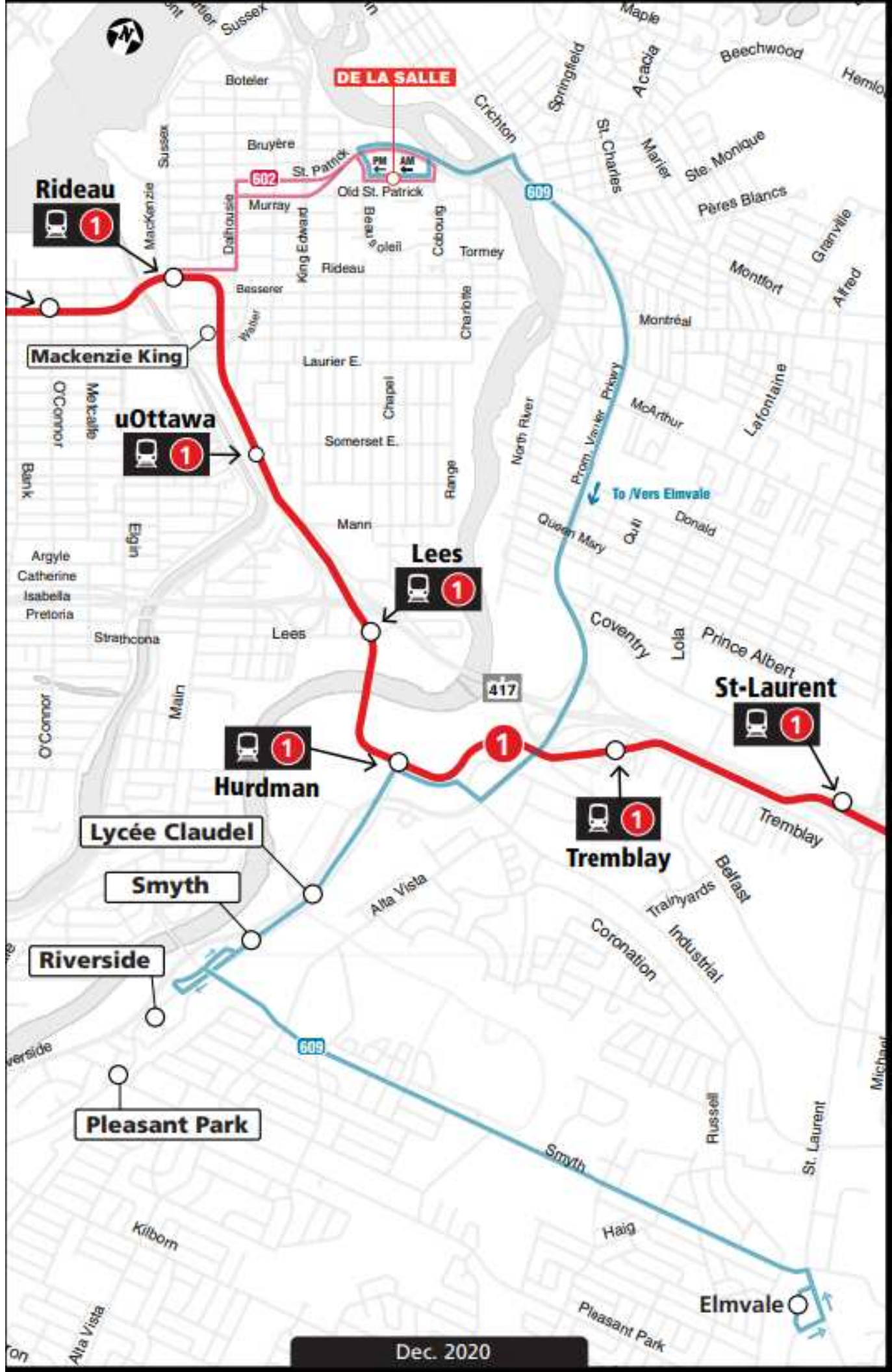

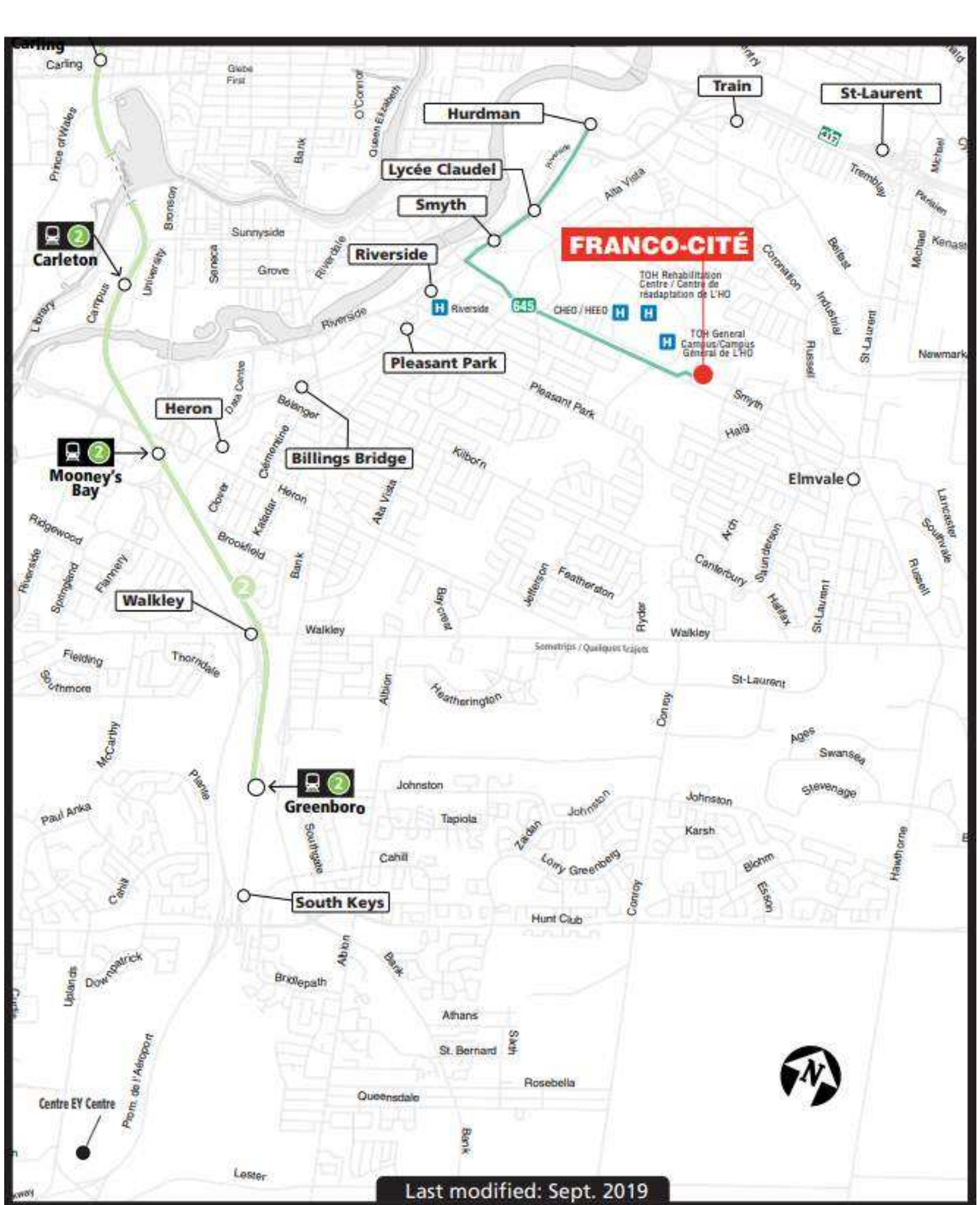

FRANCO-CITÉ

TOH Rehabilitation Centre / Centre de réadaptation de L'HO

TOH General Campus / Campus Général de L'HO



APPENDIX D

Traffic Count Data

5587528 - RING RD @ SMYTH RD/S HAVEN PL - SE... - TMC

Tue Oct 4, 2022

AM Peak (7:30 AM - 8:30 AM)

All Classes (Lights and Motorcycles, Heavy, Pedestrians, Bicycles on Road, Bicycles on Crosswalk)

All Movements

ID: 996505, Location: 45.399016, -75.652851, Site Code: 40590103



Leg Direction	South Northbound						North Southbound						West Eastbound						East Westbound						Int
	L	T	R	U	App	Ped*	L	T	R	U	App	Ped*	L	T	R	U	App	Ped*	L	T	R	U	App	Ped*	
2022-10-04 7:30AM	0	0	0	0	0	1	12	0	33	1	46	2	82	212	0	0	294	0	0	136	30	0	166	1	506
7:45AM	3	0	0	0	3	0	8	0	30	0	38	10	91	194	1	0	286	2	1	141	27	0	169	2	496
8:00AM	1	1	0	0	2	1	2	1	23	0	26	1	101	174	0	0	275	0	0	126	14	0	140	0	443
8:15AM	2	0	0	0	2	1	6	0	34	0	40	2	90	184	1	0	275	0	0	153	32	0	185	4	502
Total	6	1	0	0	7	3	28	1	120	1	150	15	364	764	2	0	1130	2	1	556	103	0	660	7	1947
% Approach	85.7%	14.3%	0%	0%	-	-	18.7%	0.7%	80.0%	0.7%	-	-	32.2%	67.6%	0.2%	0%	-	-	0.2%	84.2%	15.6%	0%	-	-	-
% Total	0.3%	0.1%	0%	0%	0.4%	-	1.4%	0.1%	6.2%	0.1%	7.7%	-	18.7%	39.2%	0.1%	0%	58.0%	-	0.1%	28.6%	5.3%	0%	33.9%	-	-
PHF	0.500	-	-	-	0.500	-	0.583	-	0.875	0.250	0.822	-	0.896	0.904	0.500	-	0.965	-	0.250	0.908	0.805	-	0.892	-	0.965
Lights and Motorcycles	6	0	0	0	6	-	27	0	111	1	139	-	355	748	2	0	1105	-	1	539	100	0	640	-	1890
% Lights and Motorcycles	100%	0%	0%	0%	85.7%	-	96.4%	0%	92.5%	100%	92.7%	-	97.5%	97.9%	100%	0%	97.8%	-	100%	96.9%	97.1%	0%	97.0%	-	97.1%
Heavy	0	0	0	0	0	-	1	0	8	0	9	-	7	15	0	0	22	-	0	17	3	0	20	-	51
% Heavy	0%	0%	0%	0%	0%	-	3.6%	0%	6.7%	0%	6.0%	-	1.9%	2.0%	0%	0%	1.9%	-	0%	3.1%	2.9%	0%	3.0%	-	2.6%
Bicycles on Road	0	1	0	0	1	-	0	1	1	0	2	-	2	1	0	0	3	-	0	0	0	0	0	-	6
% Bicycles on Road	0%	100%	0%	0%	14.3%	-	0%	100%	0.8%	0%	1.3%	-	0.5%	0.1%	0%	0%	0.3%	-	0%	0%	0%	0%	0%	-	0.3%
Pedestrians	-	-	-	-	-	2	-	-	-	-	-	11	-	-	-	-	-	0	-	-	-	-	-	6	6
% Pedestrians	-	-	-	-	-	66.7%	-	-	-	-	-	73.3%	-	-	-	-	-	0%	-	-	-	-	-	85.7%	-
Bicycles on Crosswalk	-	-	-	-	-	1	-	-	-	-	-	4	-	-	-	-	-	2	-	-	-	-	-	1	1
% Bicycles on Crosswalk	-	-	-	-	-	33.3%	-	-	-	-	-	26.7%	-	-	-	-	-	100%	-	-	-	-	-	14.3%	-

*Pedestrians and Bicycles on Crosswalk. L: Left, R: Right, T: Thru, U: U-Turn

5587528 - RING RD @ SMYTH RD/S HAVEN PL - SE... - TMC

Tue Oct 4, 2022

AM Peak (7:30 AM - 8:30 AM)

All Classes (Lights and Motorcycles, Heavy, Pedestrians, Bicycles on Road, Bicycles on Crosswalk)

All Movements

ID: 996505, Location: 45.399016, -75.652851, Site Code: 40590103

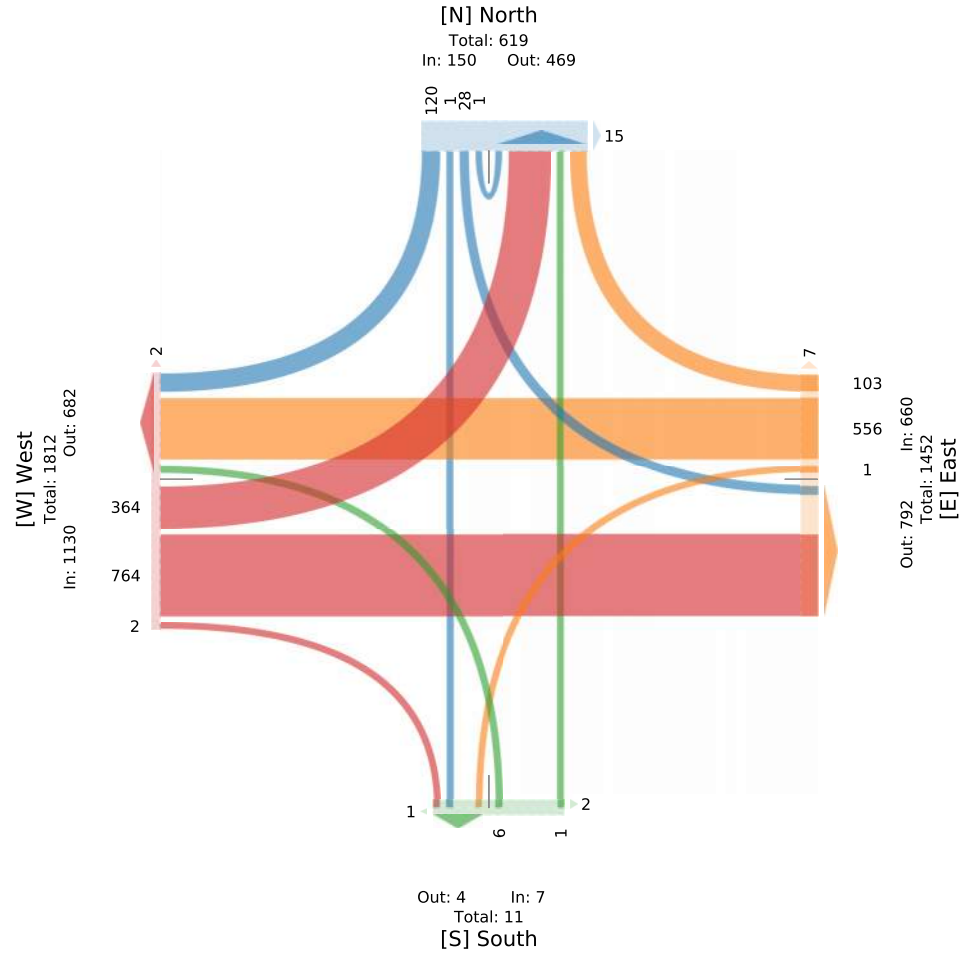

5587528 - RING RD @ SMYTH RD/S HAVEN PL - SE... - TMC

Tue Oct 4, 2022
 PM Peak (3:30 PM - 4:30 PM) - Overall Peak Hour
 All Classes (Lights and Motorcycles, Heavy, Pedestrians, Bicycles on Road, Bicycles on Crosswalk)
 All Movements
 ID: 996505, Location: 45.399016, -75.652851, Site Code: 40590103



Leg Direction	South Northbound						North Southbound						West Eastbound						East Westbound						Int
	L	T	R	U	App	Ped*	L	T	R	U	App	Ped*	L	T	R	U	App	Ped*	L	T	R	U	App	Ped*	
2022-10-04 3:30PM	1	0	0	0	1	0	39	2	92	0	133	1	23	141	0	0	164	0	2	252	6	0	260	0	558
3:45PM	2	0	4	0	6	4	23	0	77	0	100	6	34	149	2	0	185	1	0	219	4	0	223	4	514
4:00PM	0	0	0	0	0	2	36	2	92	0	130	3	16	117	2	0	135	2	1	213	0	0	214	2	479
4:15PM	2	0	0	0	2	2	30	7	66	0	103	5	18	116	0	0	134	0	1	195	1	0	197	0	436
Total	5	0	4	0	9	8	128	11	327	0	466	15	91	523	4	0	618	3	4	879	11	0	894	6	1987
% Approach	55.6%	0%	44.4%	0%	-	-	27.5%	2.4%	70.2%	0%	-	-	14.7%	84.6%	0.6%	0%	-	-	0.4%	98.3%	1.2%	0%	-	-	-
% Total	0.3%	0%	0.2%	0%	0.5%	-	6.4%	0.6%	16.5%	0%	23.5%	-	4.6%	26.3%	0.2%	0%	31.1%	-	0.2%	44.2%	0.6%	0%	45.0%	-	-
PHF	0.625	-	0.250	-	-0.375	-	0.814	0.250	0.880	-	0.863	-	0.669	0.874	0.500	-	0.832	-	0.500	0.875	0.458	-	0.862	-	0.887
Lights and Motorcycles	5	0	4	0	9	8	126	1	320	0	447	-	87	503	4	0	594	-	4	859	11	0	874	-	1924
% Lights and Motorcycles	100%	0%	100%	0%	100%	-	98.4%	9.1%	97.9%	0%	95.9%	-	95.6%	96.2%	100%	0%	96.1%	-	100%	97.7%	100%	0%	97.8%	-	96.8%
Heavy	0	0	0	0	0	-	1	0	4	0	5	-	4	18	0	0	22	-	0	19	0	0	19	-	46
% Heavy	0%	0%	0%	0%	0%	-	0.8%	0%	1.2%	0%	1.1%	-	4.4%	3.4%	0%	0%	3.6%	-	0%	2.2%	0%	0%	2.1%	-	2.3%
Bicycles on Road	0	0	0	0	0	-	1	10	3	0	14	-	0	2	0	0	2	-	0	1	0	0	1	-	17
% Bicycles on Road	0%	0%	0%	0%	0%	-	0.8%	90.9%	0.9%	0%	3.0%	-	0%	0.4%	0%	0%	0.3%	-	0%	0.1%	0%	0%	0.1%	-	0.9%
Pedestrians	-	-	-	-	-	6	-	-	-	-	14	-	-	-	-	-	3	-	-	-	-	-	6	-	6
% Pedestrians	-	-	-	-	-	75.0%	-	-	-	-	93.3%	-	-	-	-	-	100%	-	-	-	-	-	100%	-	-
Bicycles on Crosswalk	-	-	-	-	-	2	-	-	-	-	1	-	-	-	-	-	0	-	-	-	-	-	0	-	0
% Bicycles on Crosswalk	-	-	-	-	-	25.0%	-	-	-	-	6.7%	-	-	-	-	-	0%	-	-	-	-	-	0%	-	0%

*Pedestrians and Bicycles on Crosswalk. L: Left, R: Right, T: Thru, U: U-Turn

5587528 - RING RD @ SMYTH RD/S HAVEN PL - SE... - TMC

Tue Oct 4, 2022
 PM Peak (3:30 PM - 4:30 PM) - Overall Peak Hour
 All Classes (Lights and Motorcycles, Heavy, Pedestrians, Bicycles on Road, Bicycles on Crosswalk)
 All Movements
 ID: 996505, Location: 45.399016, -75.652851, Site Code: 40590103

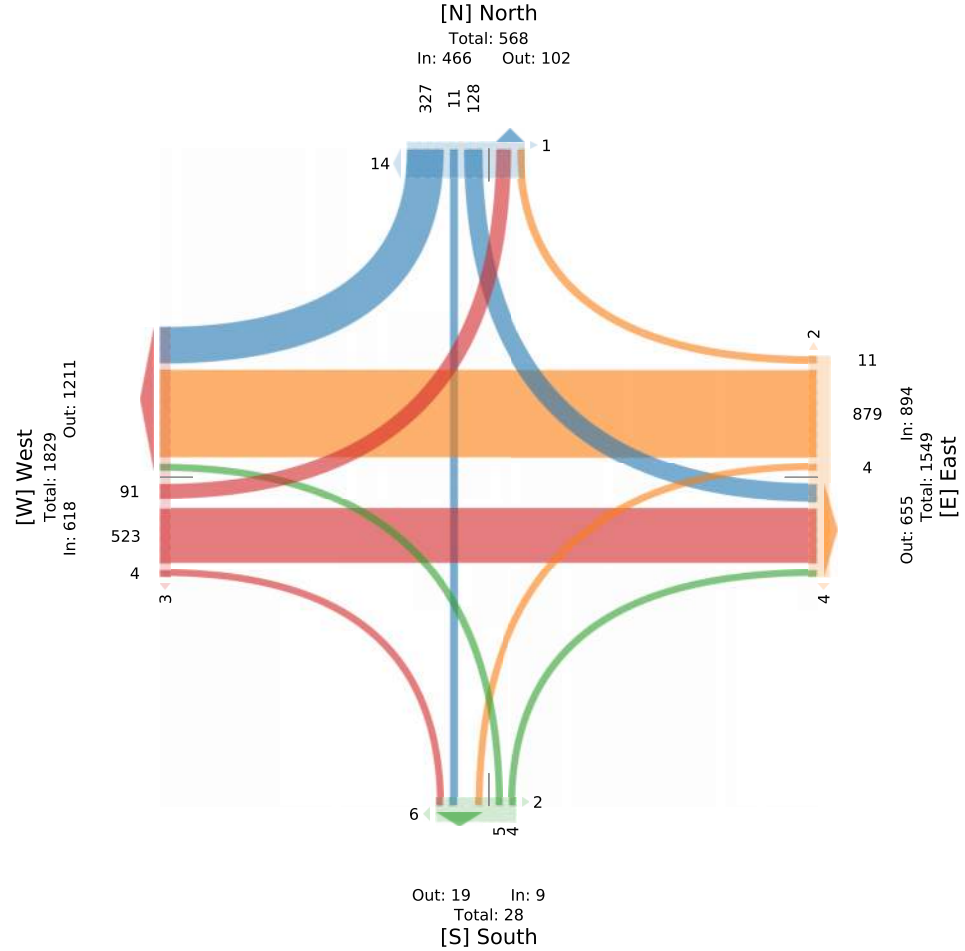

5473326 - RING RD @ CHEO EAST ENTRANCE - FEB... - TMC

Thu Feb 20, 2020
 AM Peak (9 AM - 10 AM) - Overall Peak Hour
 All Classes (Lights and Motorcycles, Heavy, Pedestrians, Bicycles on Road, Bicycles on Crosswalk)
 All Movements
 ID: 754891, Location: 45.399679, -75.649878



Leg Direction	North Southbound					West Eastbound					East Westbound					Int
	L	R	U	App	Ped*	L	T	U	App	Ped*	T	R	U	App	Ped*	
Time																
2020-02-20 9:00AM	4	4	0	8	0	23	16	0	39	0	18	12	0	30	2	77
9:15AM	4	2	0	6	1	28	9	1	38	0	21	13	0	34	1	78
9:30AM	5	9	0	14	0	39	14	0	53	0	11	13	0	24	4	91
9:45AM	7	6	0	13	0	42	14	2	58	0	19	13	1	33	6	104
Total	20	21	0	41	1	132	53	3	188	0	69	51	1	121	13	350
% Approach	48.8%	51.2%	0%	-	-	70.2%	28.2%	1.6%	-	-	57.0%	42.1%	0.8%	-	-	-
% Total	5.7%	6.0%	0%	11.7%	-	37.7%	15.1%	0.9%	53.7%	-	19.7%	14.6%	0.3%	34.6%	-	-
PHF	0.714	0.583	-	0.732	-	0.786	0.828	0.375	0.810	-	0.821	0.962	0.250	0.882	-	0.839
Lights and Motorcycles	19	21	0	40	-	132	48	3	183	-	58	50	1	109	-	332
% Lights and Motorcycles	95.0%	100%	0%	97.6%	-	100%	90.6%	100%	97.3%	-	84.1%	98.0%	100%	90.1%	-	94.9%
Heavy	1	0	0	1	-	0	5	0	5	-	11	0	0	11	-	17
% Heavy	5.0%	0%	0%	2.4%	-	0%	9.4%	0%	2.7%	-	15.9%	0%	0%	9.1%	-	4.9%
Bicycles on Road	0	0	0	0	-	0	0	0	0	-	0	1	0	1	-	1
% Bicycles on Road	0%	0%	0%	0%	-	0%	0%	0%	0%	-	0%	2.0%	0%	0.8%	-	0.3%
Pedestrians	-	-	-	-	1	-	-	-	-	0	-	-	-	-	13	-
% Pedestrians	-	-	-	-	100%	-	-	-	-	-	-	-	-	-	100%	-
Bicycles on Crosswalk	-	-	-	-	0	-	-	-	-	0	-	-	-	-	0	-
% Bicycles on Crosswalk	-	-	-	-	0%	-	-	-	-	-	-	-	-	-	0%	-

*Pedestrians and Bicycles on Crosswalk. L: Left, R: Right, T: Thru, U: U-Turn

5473326 - RING RD @ CHEO EAST ENTRANCE - FEB... - TMC

Thu Feb 20, 2020
 AM Peak (9 AM - 10 AM) - Overall Peak Hour
 All Classes (Lights and Motorcycles, Heavy, Pedestrians, Bicycles on Road, Bicycles on Crosswalk)
 All Movements
 ID: 754891, Location: 45.399679, -75.649878

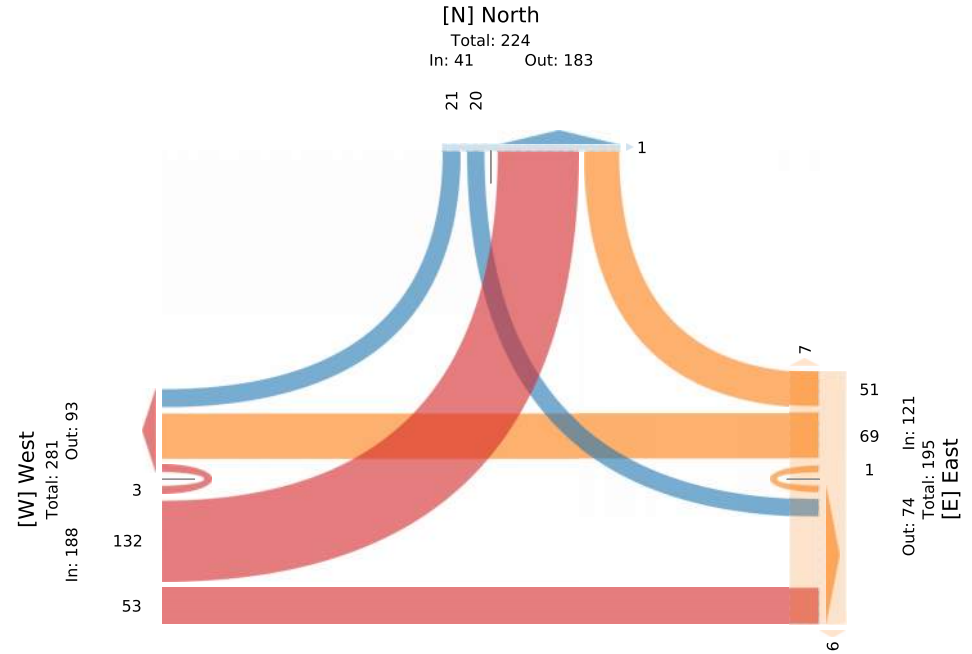

5473326 - RING RD @ CHEO EAST ENTRANCE - FEB... - TMC

Thu Feb 20, 2020
 PM Peak (3:15 PM - 4:15 PM)
 All Classes (Lights and Motorcycles, Heavy, Pedestrians, Bicycles on Road, Bicycles on Crosswalk)
 All Movements
 ID: 754891, Location: 45.399679, -75.649878



Leg Direction	North Southbound					West Eastbound					East Westbound					Int
	L	R	U	App	Ped*	L	T	U	App	Ped*	T	R	U	App	Ped*	
Time																
2020-02-20 3:15PM	10	14	0	24	1	10	15	0	25	0	12	6	0	18	3	67
3:30PM	11	15	0	26	2	7	14	0	21	0	24	3	0	27	1	74
3:45PM	11	14	0	25	2	3	18	0	21	0	20	4	0	24	1	70
4:00PM	13	10	0	23	0	4	23	0	27	0	19	3	0	22	2	72
Total	45	53	0	98	5	24	70	0	94	0	75	16	0	91	7	283
% Approach	45.9%	54.1%	0%	-	-	25.5%	74.5%	0%	-	-	82.4%	17.6%	0%	-	-	-
% Total	15.9%	18.7%	0%	34.6%	-	8.5%	24.7%	0%	33.2%	-	26.5%	5.7%	0%	32.2%	-	-
PHF	0.865	0.883	-	0.942	-	0.600	0.761	-	0.870	-	0.804	0.667	-	0.865	-	0.966
Lights and Motorcycles	44	53	0	97	-	23	67	0	90	-	66	16	0	82	-	269
% Lights and Motorcycles	97.8%	100%	0%	99.0%	-	95.8%	95.7%	0%	95.7%	-	88.0%	100%	0%	90.1%	-	95.1%
Heavy	1	0	0	1	-	1	3	0	4	-	8	0	0	8	-	13
% Heavy	2.2%	0%	0%	1.0%	-	4.2%	4.3%	0%	4.3%	-	10.7%	0%	0%	8.8%	-	4.6%
Bicycles on Road	0	0	0	0	-	0	0	0	0	-	1	0	0	1	-	1
% Bicycles on Road	0%	0%	0%	0%	-	0%	0%	0%	0%	-	1.3%	0%	0%	1.1%	-	0.4%
Pedestrians	-	-	-	-	5	-	-	-	-	0	-	-	-	-	7	-
% Pedestrians	-	-	-	-	100%	-	-	-	-	0	-	-	-	-	100%	-
Bicycles on Crosswalk	-	-	-	-	0	-	-	-	-	0	-	-	-	-	0	-
% Bicycles on Crosswalk	-	-	-	-	0%	-	-	-	-	0%	-	-	-	-	0%	-

*Pedestrians and Bicycles on Crosswalk. L: Left, R: Right, T: Thru, U: U-Turn

5473326 - RING RD @ CHEO EAST ENTRANCE - FEB... - TMC

Thu Feb 20, 2020
 PM Peak (3:15 PM - 4:15 PM)
 All Classes (Lights and Motorcycles, Heavy, Pedestrians, Bicycles on Road, Bicycles on Crosswalk)
 All Movements
 ID: 754891, Location: 45.399679, -75.649878

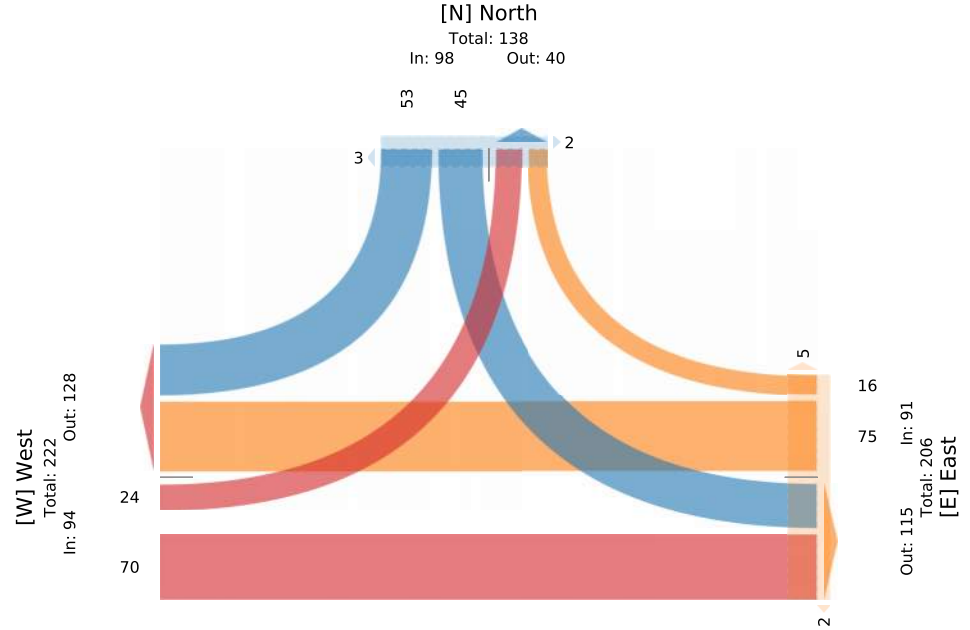

5467450 - Smyth and General Hospital E - Dec... - TMC

Wed Dec 11, 2019

AM Peak (7:30 AM - 8:30 AM)

All Classes (Lights and Motorcycles, Heavy, Pedestrians, Bicycles on Road, Bicycles on Crosswalk)

All Movements

ID: 735526, Location: 45.399388, -75.647834, Site Code: 39229103



Provided by: City of Ottawa
100 Constellation Dr,
Nepean, ON, K2G 5J9, CA

Leg Direction	North Southbound					West Eastbound					East Westbound					Int
	L	R	U	App	Ped*	L	T	U	App	Ped*	T	R	U	App	Ped*	
2019-12-11 7:30AM	36	58	0	94	2	92	108	0	200	3	165	98	0	263	5	557
7:45AM	32	41	0	73	1	102	114	0	216	4	146	128	0	274	8	563
8:00AM	24	38	0	62	0	87	91	0	178	4	167	116	0	283	18	523
8:15AM	21	37	0	58	0	88	102	0	190	2	189	79	0	268	20	516
Total	113	174	0	287	3	369	415	0	784	13	667	421	0	1088	51	2159
% Approach	39.4%	60.6%	0%	-	-	47.1%	52.9%	0%	-	-	61.3%	38.7%	0%	-	-	-
% Total	5.2%	8.1%	0%	13.3%	-	17.1%	19.2%	0%	36.3%	-	30.9%	19.5%	0%	50.4%	-	-
PHF	0.785	0.750	-	0.763	-	0.902	0.910	-	0.906	-	0.882	0.816	-	0.965	-	0.957
Lights and Motorcycles	110	172	0	282	-	364	406	0	770	-	644	410	0	1054	-	2106
% Lights and Motorcycles	97.3%	98.9%	0%	98.3%	-	98.6%	97.8%	0%	98.2%	-	96.6%	97.4%	0%	96.9%	-	97.5%
Heavy	3	2	0	5	-	4	9	0	13	-	23	8	0	31	-	49
% Heavy	2.7%	1.1%	0%	1.7%	-	1.1%	2.2%	0%	1.7%	-	3.4%	1.9%	0%	2.8%	-	2.3%
Bicycles on Road	0	0	0	0	-	1	0	0	1	-	0	3	0	3	-	4
% Bicycles on Road	0%	0%	0%	0%	-	0.3%	0%	0%	0.1%	-	0%	0.7%	0%	0.3%	-	0.2%
Pedestrians	-	-	-	-	3	-	-	-	-	13	-	-	-	-	50	-
% Pedestrians	-	-	-	-	100%	-	-	-	-	100%	-	-	-	-	98.0%	-
Bicycles on Crosswalk	-	-	-	-	0	-	-	-	-	0	-	-	-	-	1	-
% Bicycles on Crosswalk	-	-	-	-	0%	-	-	-	-	0%	-	-	-	-	2.0%	-

*Pedestrians and Bicycles on Crosswalk. L: Left, R: Right, T: Thru, U: U-Turn

5467450 - Smyth and General Hospital E - Dec... - TMC

Wed Dec 11, 2019

AM Peak (7:30 AM - 8:30 AM)

All Classes (Lights and Motorcycles, Heavy, Pedestrians, Bicycles on Road, Bicycles on Crosswalk)

All Movements

ID: 735526, Location: 45.399388, -75.647834, Site Code: 39229103



Provided by: City of Ottawa
100 Constellation Dr,
Nepean, ON, K2G 5J9, CA

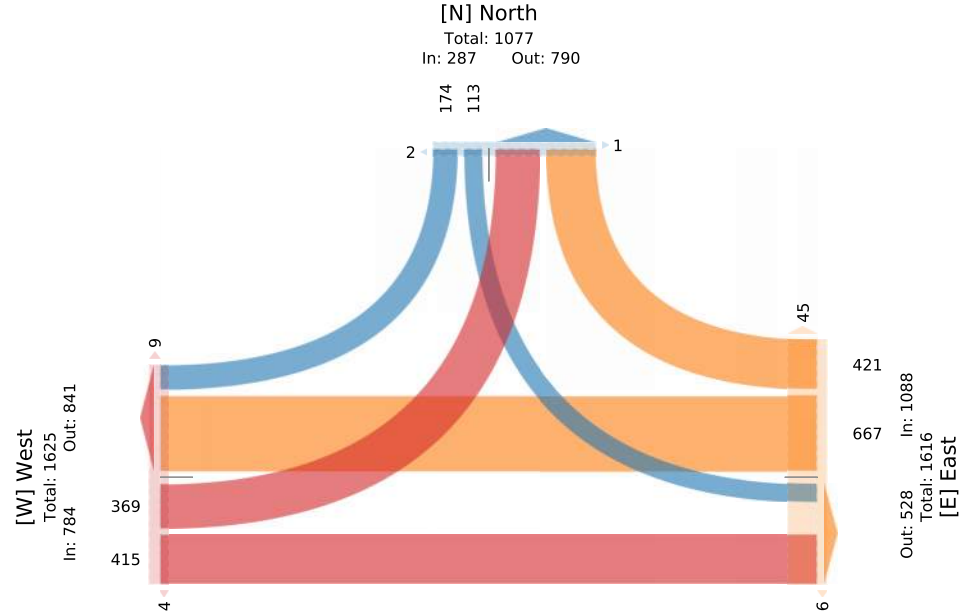

5467450 - Smyth and General Hospital E - Dec... - TMC

Wed Dec 11, 2019

PM Peak (3:30 PM - 4:30 PM) - Overall Peak Hour

All Classes (Lights and Motorcycles, Heavy, Pedestrians, Bicycles on Road, Bicycles on Crosswalk)

All Movements

ID: 735526, Location: 45.399388, -75.647834, Site Code: 39229103



Provided by: City of Ottawa
100 Constellation Dr,
Nepean, ON, K2G 5J9, CA

Leg Direction	North Southbound					West Eastbound					East Westbound					Int
	L	R	U	App	Ped*	L	T	U	App	Ped*	T	R	U	App	Ped*	
2019-12-11 3:30PM	70	93	0	163	3	39	198	0	237	5	127	33	0	160	14	560
3:45PM	81	100	0	181	6	34	164	0	198	2	156	39	0	195	21	574
4:00PM	83	98	0	181	1	21	192	0	213	3	143	40	0	183	14	577
4:15PM	96	78	0	174	1	36	222	0	258	4	109	29	0	138	23	570
Total	330	369	0	699	11	130	776	0	906	14	535	141	0	676	72	2281
% Approach	47.2%	52.8%	0%	-	-	14.3%	85.7%	0%	-	-	79.1%	20.9%	0%	-	-	-
% Total	14.5%	16.2%	0%	30.6%	-	5.7%	34.0%	0%	39.7%	-	23.5%	6.2%	0%	29.6%	-	-
PHF	0.859	0.923	-	0.965	-	0.833	0.874	-	0.878	-	0.854	0.881	-	0.864	-	0.989
Lights and Motorcycles	329	363	0	692	-	123	756	0	879	-	522	137	0	659	-	2230
% Lights and Motorcycles	99.7%	98.4%	0%	99.0%	-	94.6%	97.4%	0%	97.0%	-	97.6%	97.2%	0%	97.5%	-	97.8%
Heavy	1	6	0	7	-	7	20	0	27	-	11	4	0	15	-	49
% Heavy	0.3%	1.6%	0%	1.0%	-	5.4%	2.6%	0%	3.0%	-	2.1%	2.8%	0%	2.2%	-	2.1%
Bicycles on Road	0	0	0	0	-	0	0	0	0	-	2	0	0	2	-	2
% Bicycles on Road	0%	0%	0%	0%	-	0%	0%	0%	0%	-	0.4%	0%	0%	0.3%	-	0.1%
Pedestrians	-	-	-	-	11	-	-	-	-	14	-	-	-	-	-	70
% Pedestrians	-	-	-	-	100%	-	-	-	-	100%	-	-	-	-	-	97.2%
Bicycles on Crosswalk	-	-	-	-	0	-	-	-	-	0	-	-	-	-	-	2
% Bicycles on Crosswalk	-	-	-	-	0%	-	-	-	-	0%	-	-	-	-	-	2.8%

*Pedestrians and Bicycles on Crosswalk. L: Left, R: Right, T: Thru, U: U-Turn

5467450 - Smyth and General Hospital E - Dec... - TMC

Wed Dec 11, 2019

PM Peak (3:30 PM - 4:30 PM) - Overall Peak Hour

All Classes (Lights and Motorcycles, Heavy, Pedestrians, Bicycles on Road, Bicycles on Crosswalk)

All Movements

ID: 735526, Location: 45.399388, -75.647834, Site Code: 39229103



Provided by: City of Ottawa
100 Constellation Dr,
Nepean, ON, K2G 5J9, CA

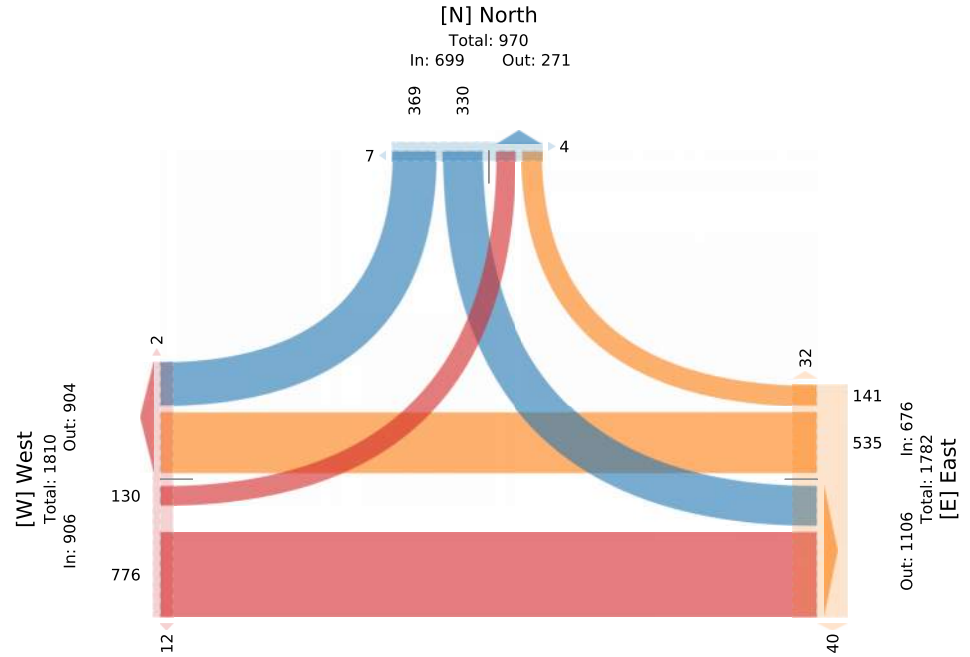



Diagrams, Maps and Photographs

Ring Road N-S & Hospital Link Road (Loc 01)

Tuesday, March 19, 2024

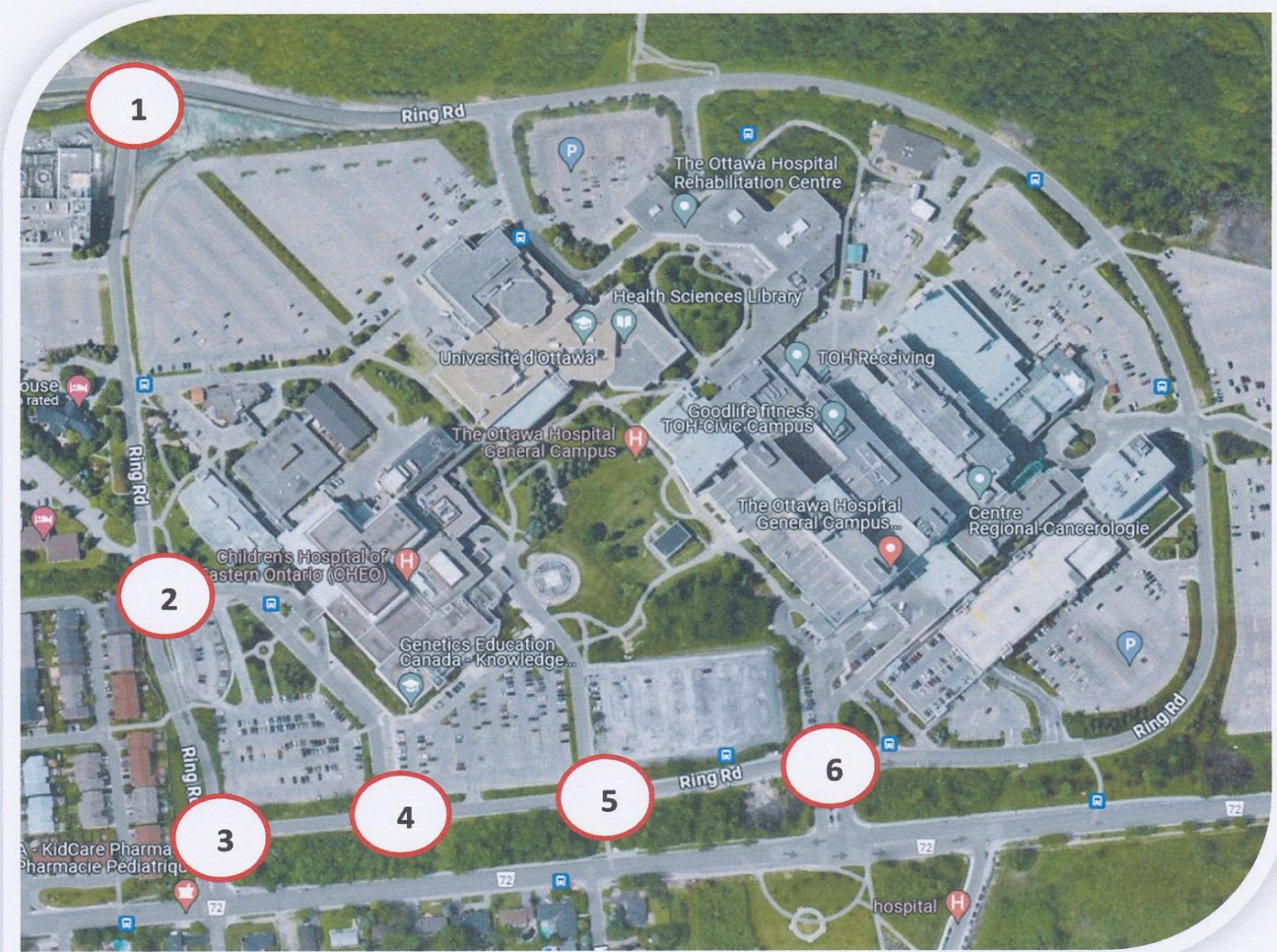

Intersection Names – CHEO & General Hospital Campus

1. Ring Road N-S & Hospital Link Road;
2. Ring Road N-S & CHEO Main Access (West);
3. Ring Road N-S & Ring Road E-W;
4. Ring Road E-W & CHEO Main Access (South);
5. Ring Road E-W & Parking Lots A/E; and
6. Ring Road E-W & General Hospital Access



Turning Movement Count

Summary, AM and PM Peak Hour

Flow Diagrams

All Vehicles Except Bicycles



Ring Road N-S & Hospital Link Road (Loc 01)

Ottawa, ON

All Vehicles
(Except Bicycles & Electric Scooters)

Total vehicle volume,
all approaches.
(B + C + D)

Tuesday, March 19, 2024
0700-1000, 1130-1330 & 1500-1800
8 Hour Survey
City of Ottawa Ward 18

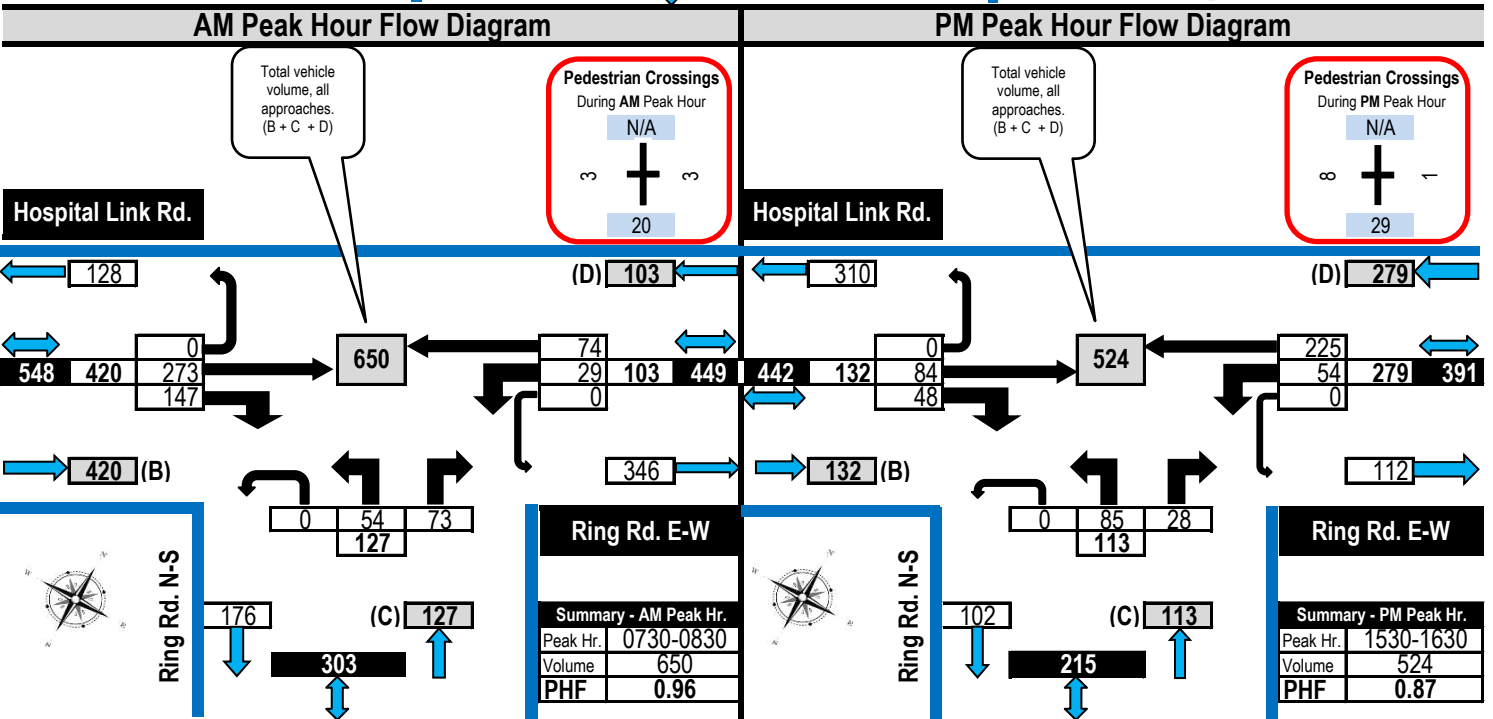
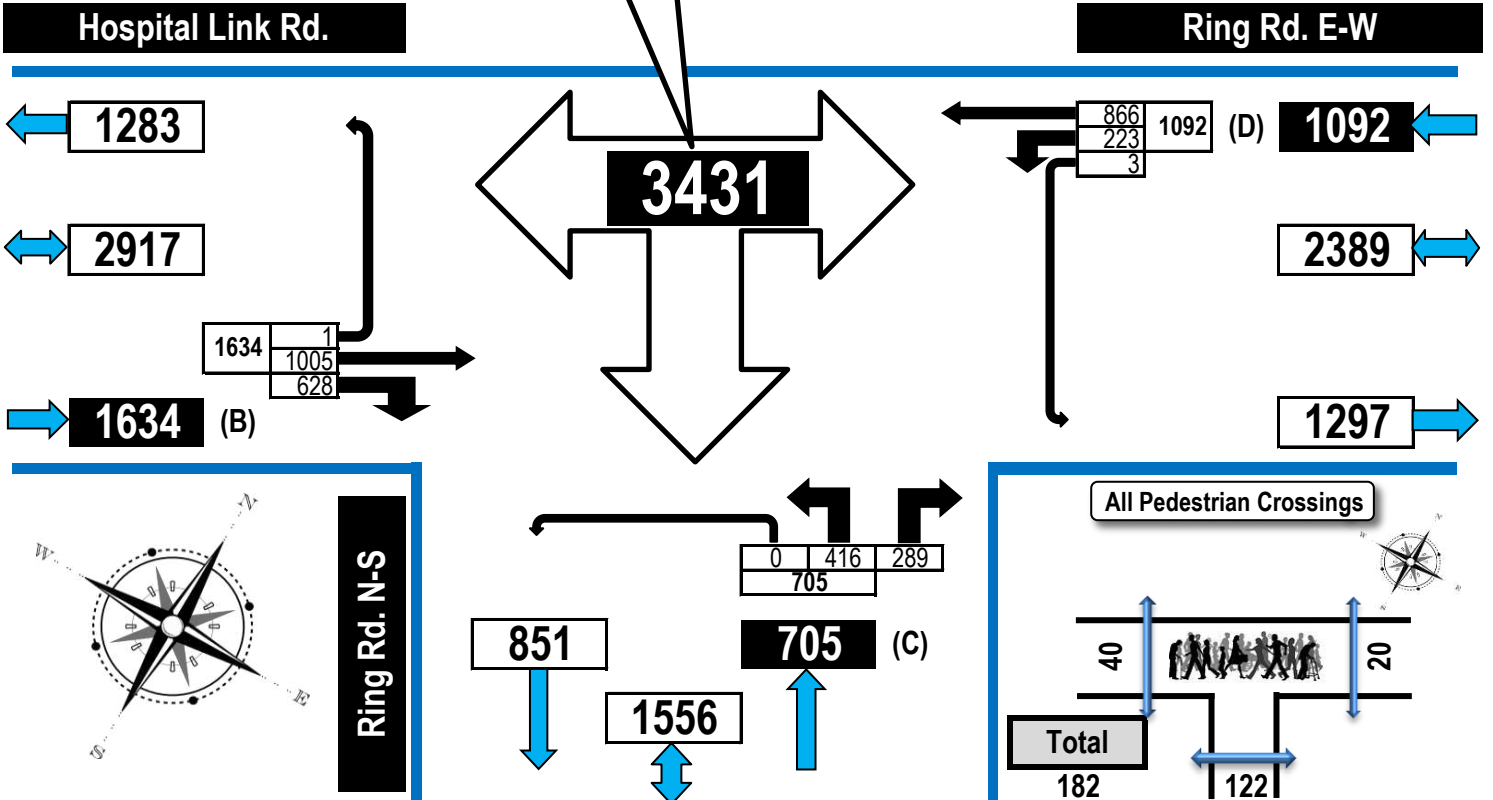



Turning Movement Count Summary, AM and PM Peak Hour Flow Diagrams

All Vehicles Except Bicycles



Ring Road N-S & CHEO Main Access West (Loc 02) Ottawa, ON

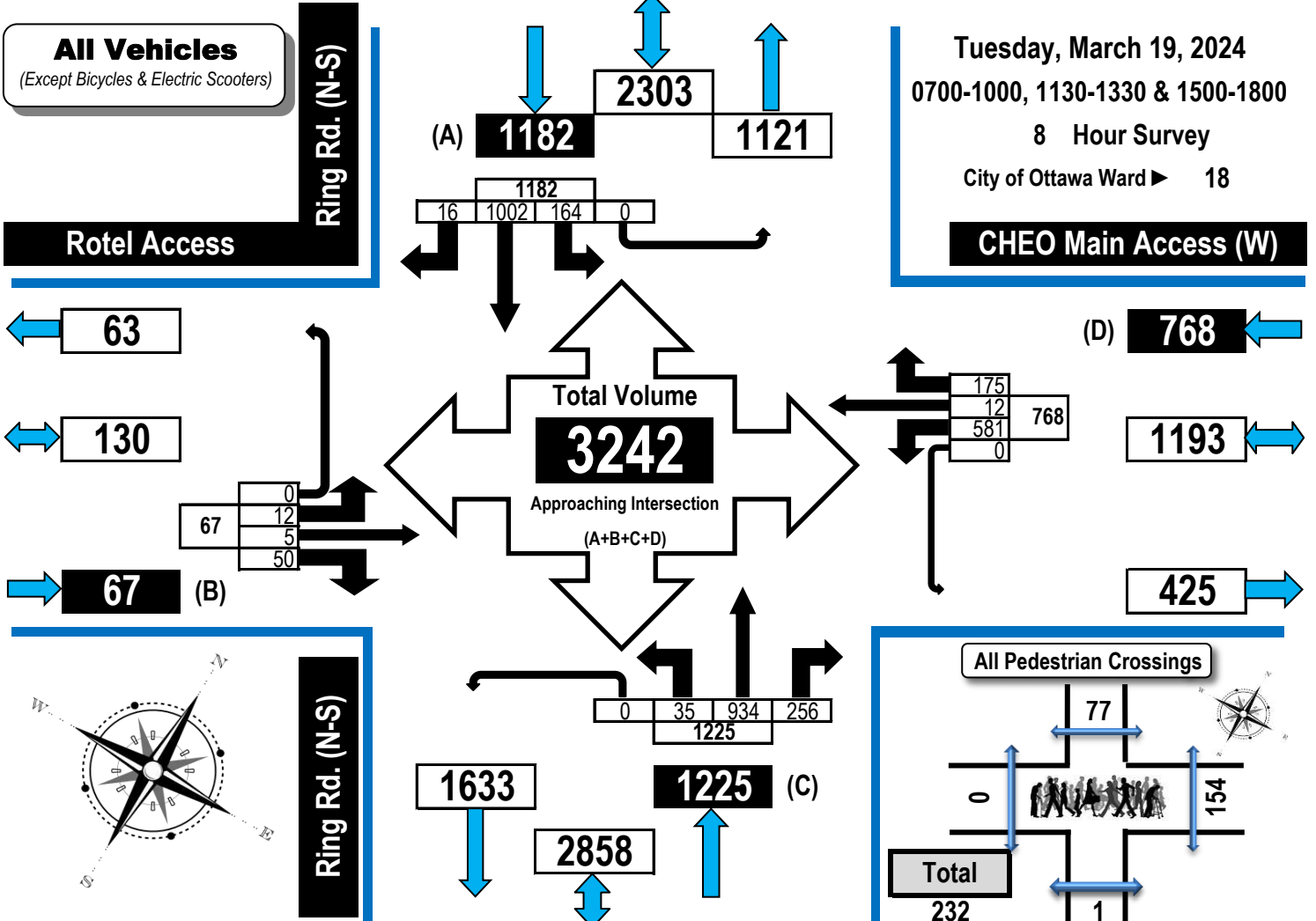

AM Peak Hour Flow Diagram PM Peak Hour Flow Diagram

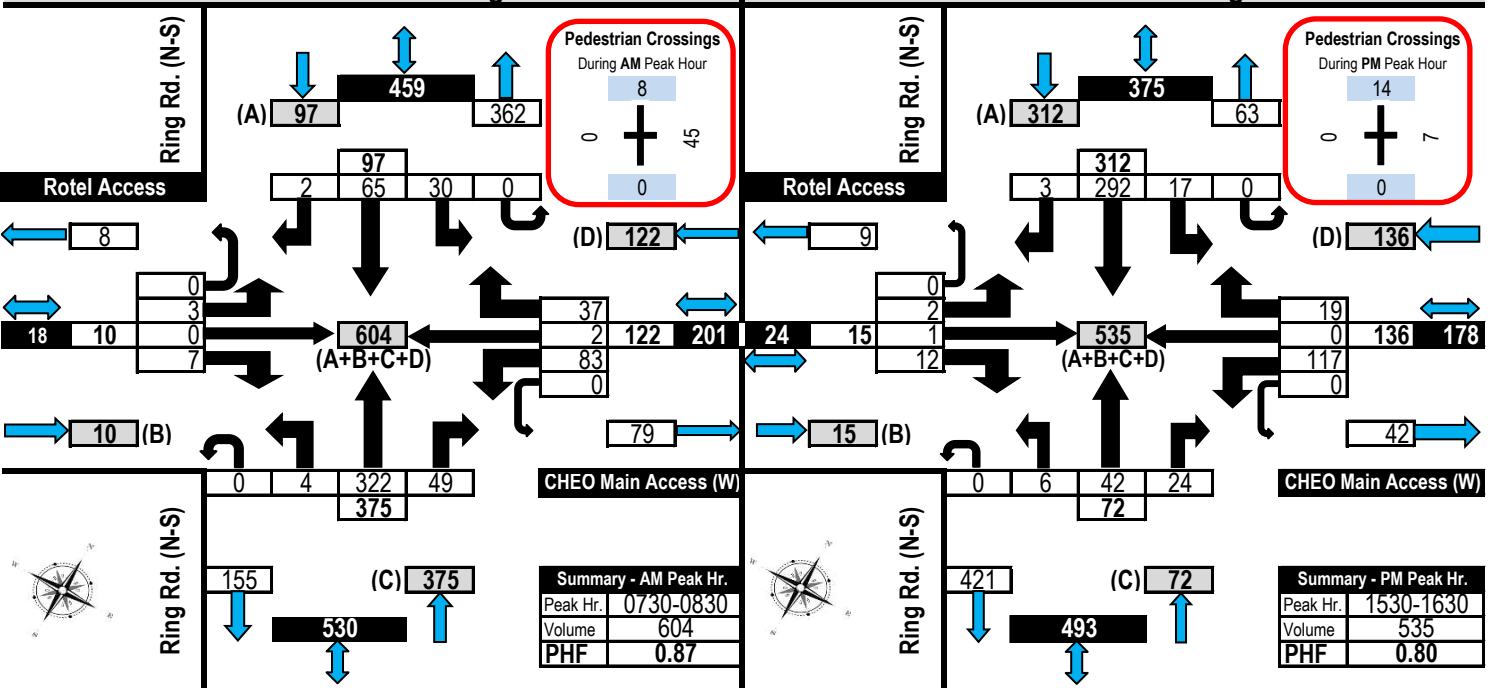



Turning Movement Count Summary, AM and PM Peak Hour Flow Diagrams All Vehicles Except Bicycles



Ring Road N-S & Ring Road E-W (Loc 03)

Ottawa, ON

All Vehicles
(Except Bicycles & Electric Scooters)

Tuesday, March 19, 2024
0700-1000, 1130-1330 & 1500-1800
8 Hour Survey
City of Ottawa Ward ► 18

Total vehicle volume,
all approaches.
(A + C + D)

Ring Rd. (E-W)

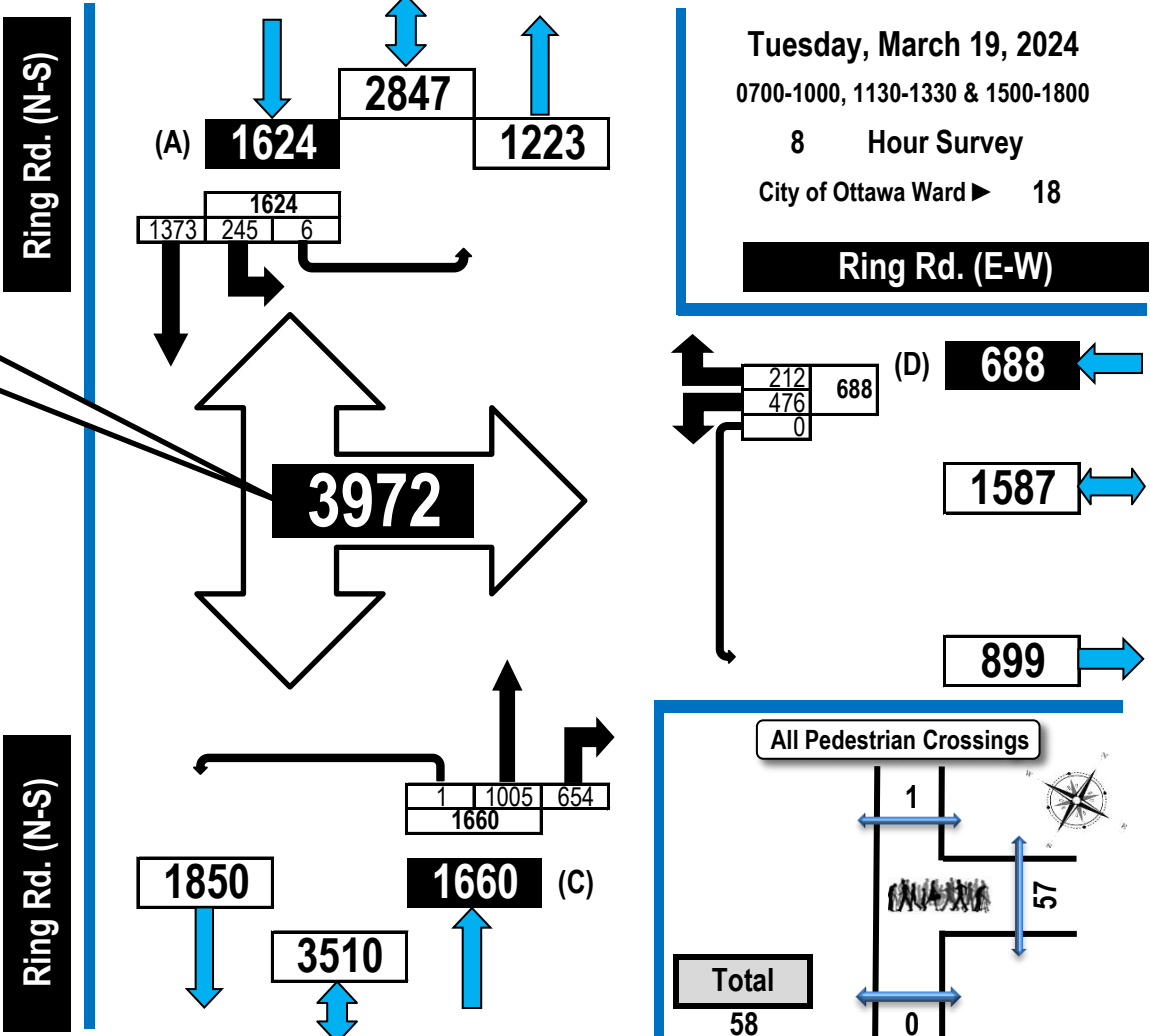
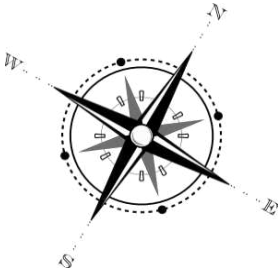

AM Peak Hour Flow Diagram

PM Peak Hour Flow Diagram

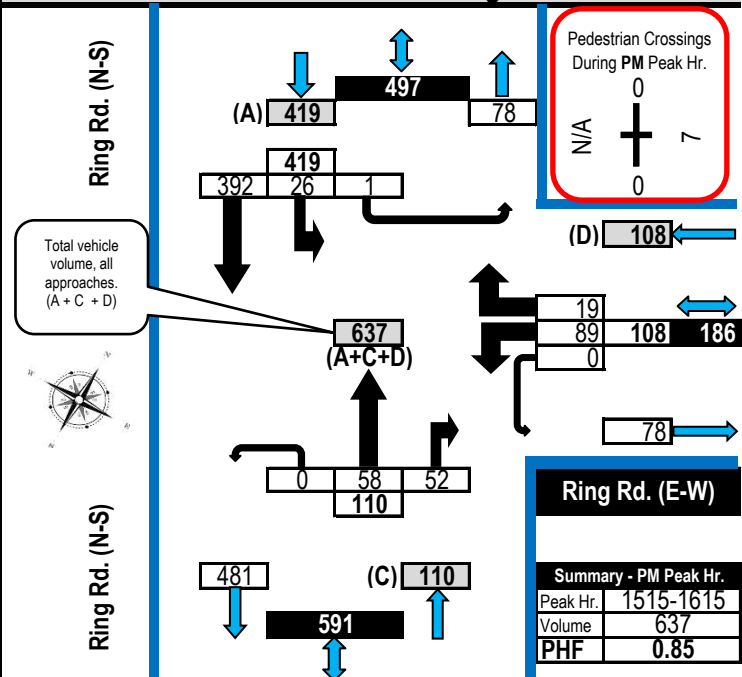
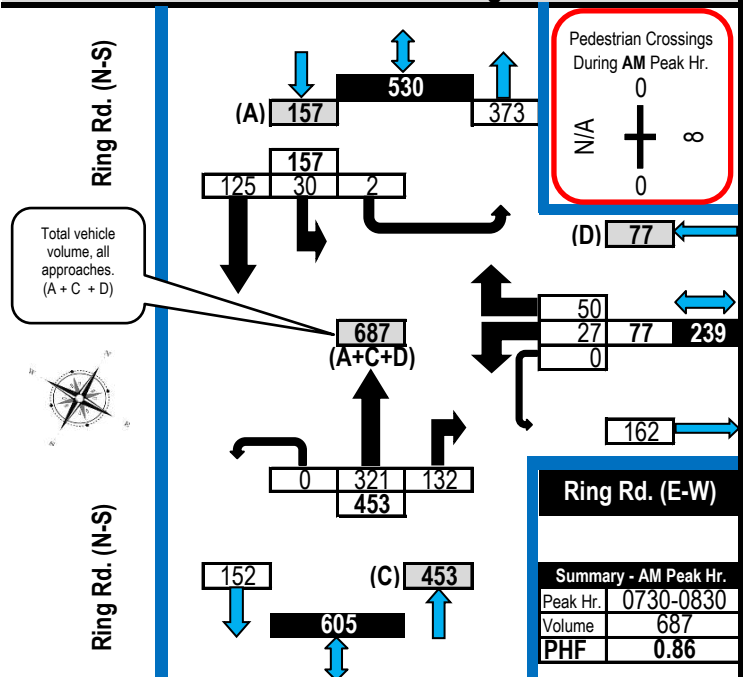



Turning Movement Count Summary, AM and PM Peak Hour Flow Diagrams All Vehicles Except Bicycles



Ring Road E-W & CHEO Main Access South (Loc 04)

Ottawa, ON

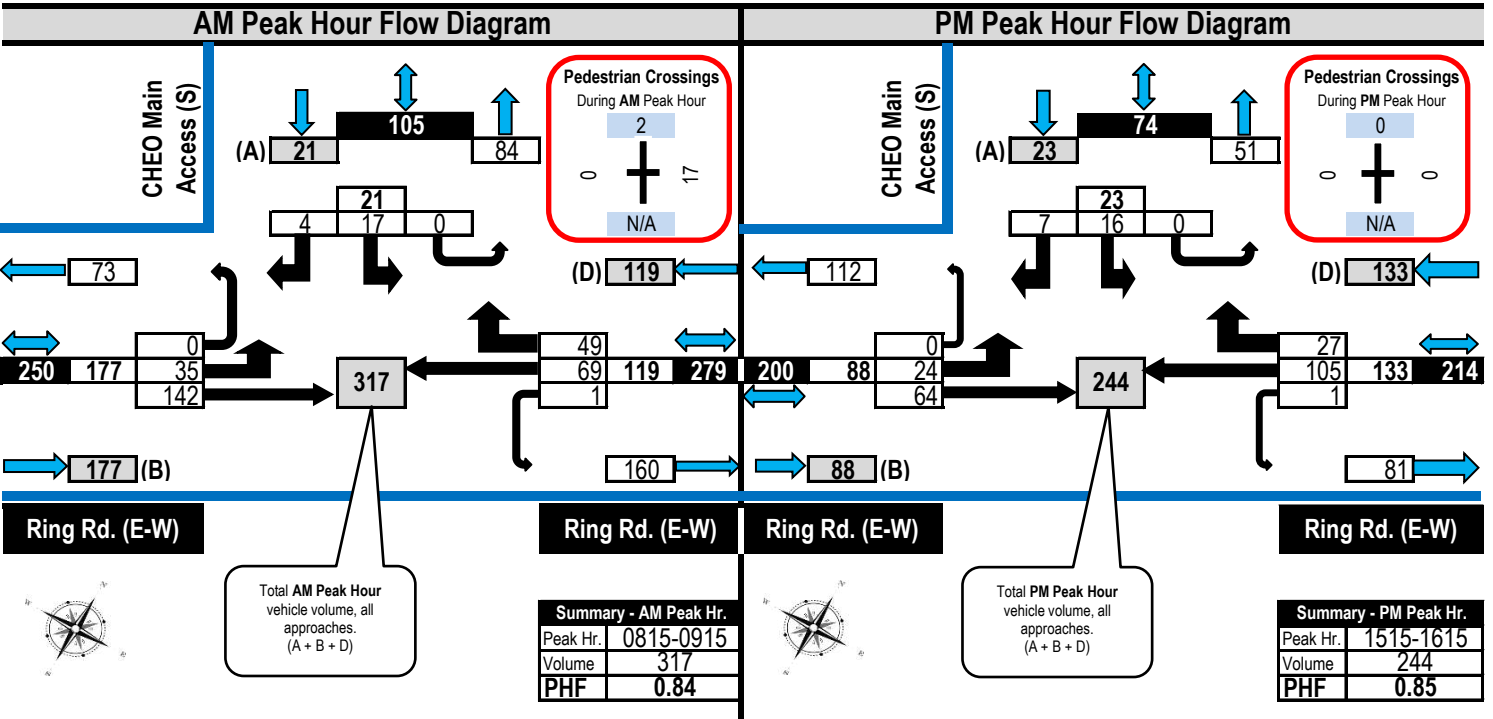
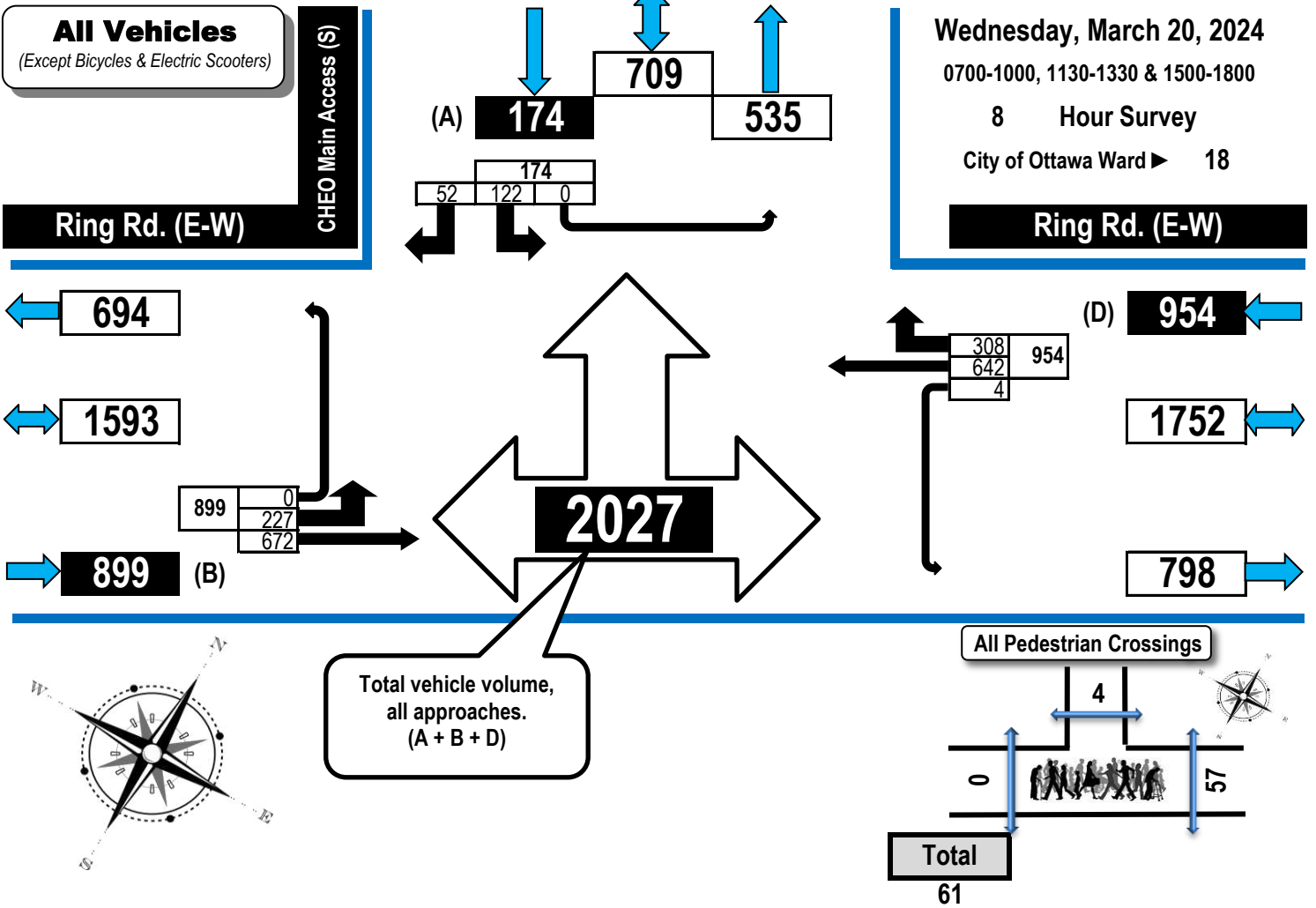



Turning Movement Count

Summary, AM and PM Peak Hour

Flow Diagrams

All Vehicles Except Bicycles



Ring Road E-W & Parking Lot A&E (Loc 05)

Ottawa, ON

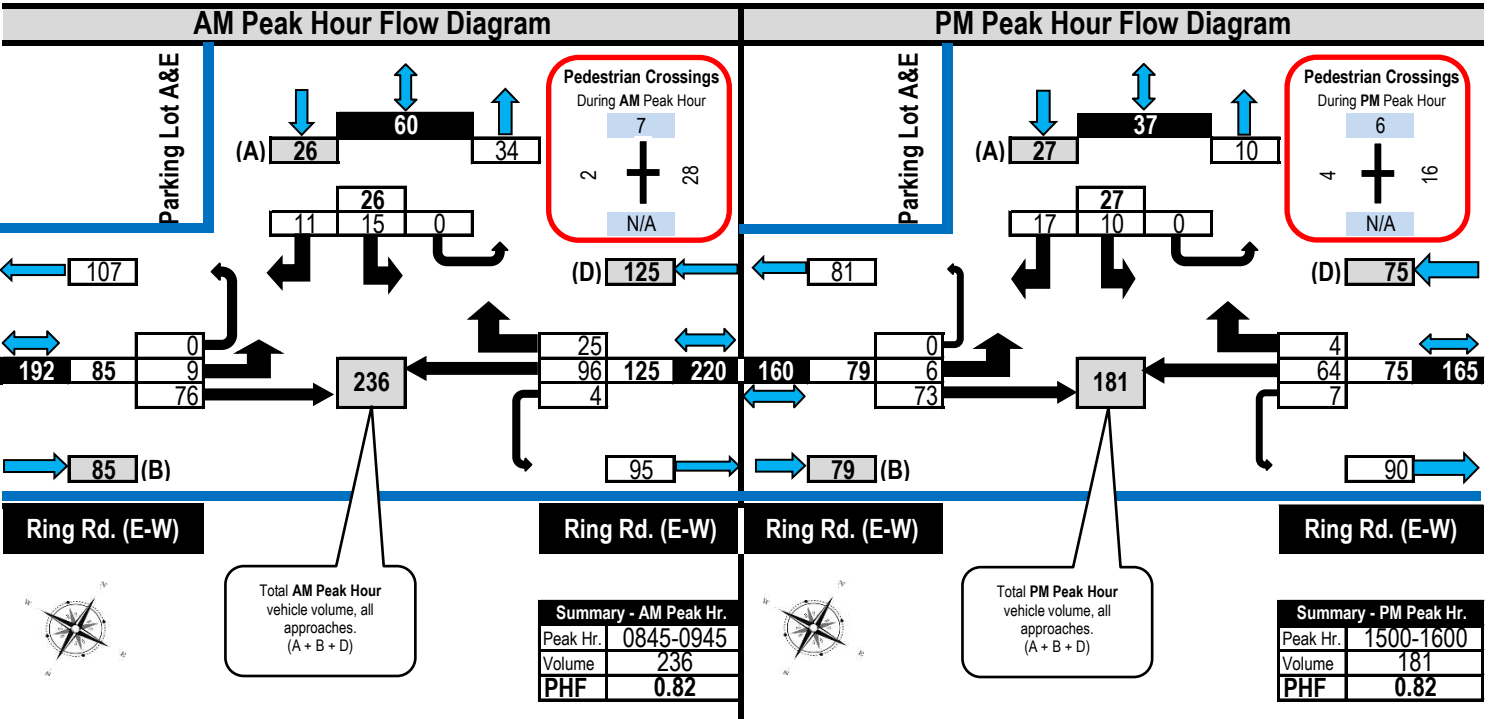
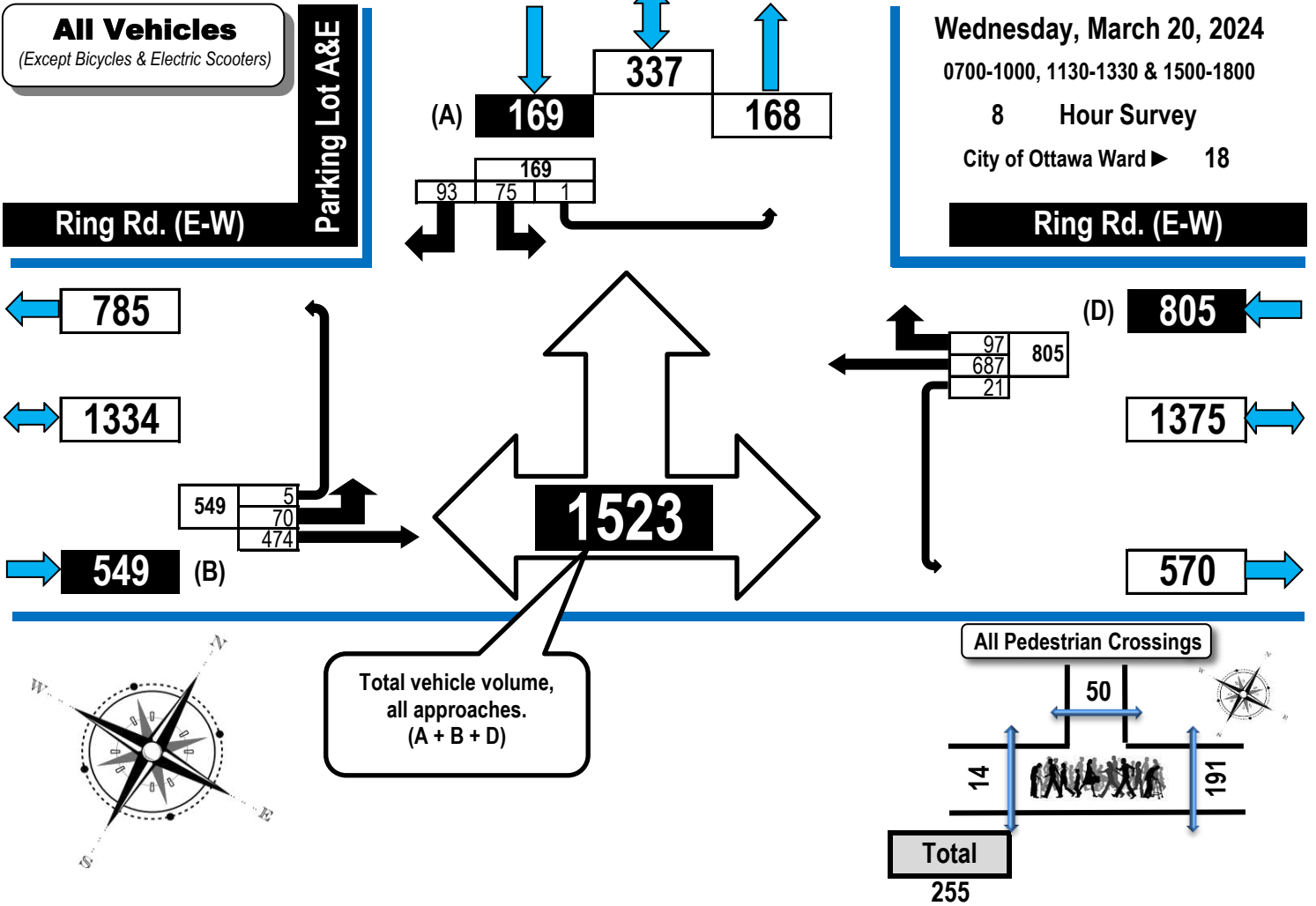



Turning Movement Count

Summary, AM and PM Peak Hour

Flow Diagrams

All Vehicles Except Bicycles



Ring Road E-W & General Hospital Access (Loc 06) Ottawa, ON

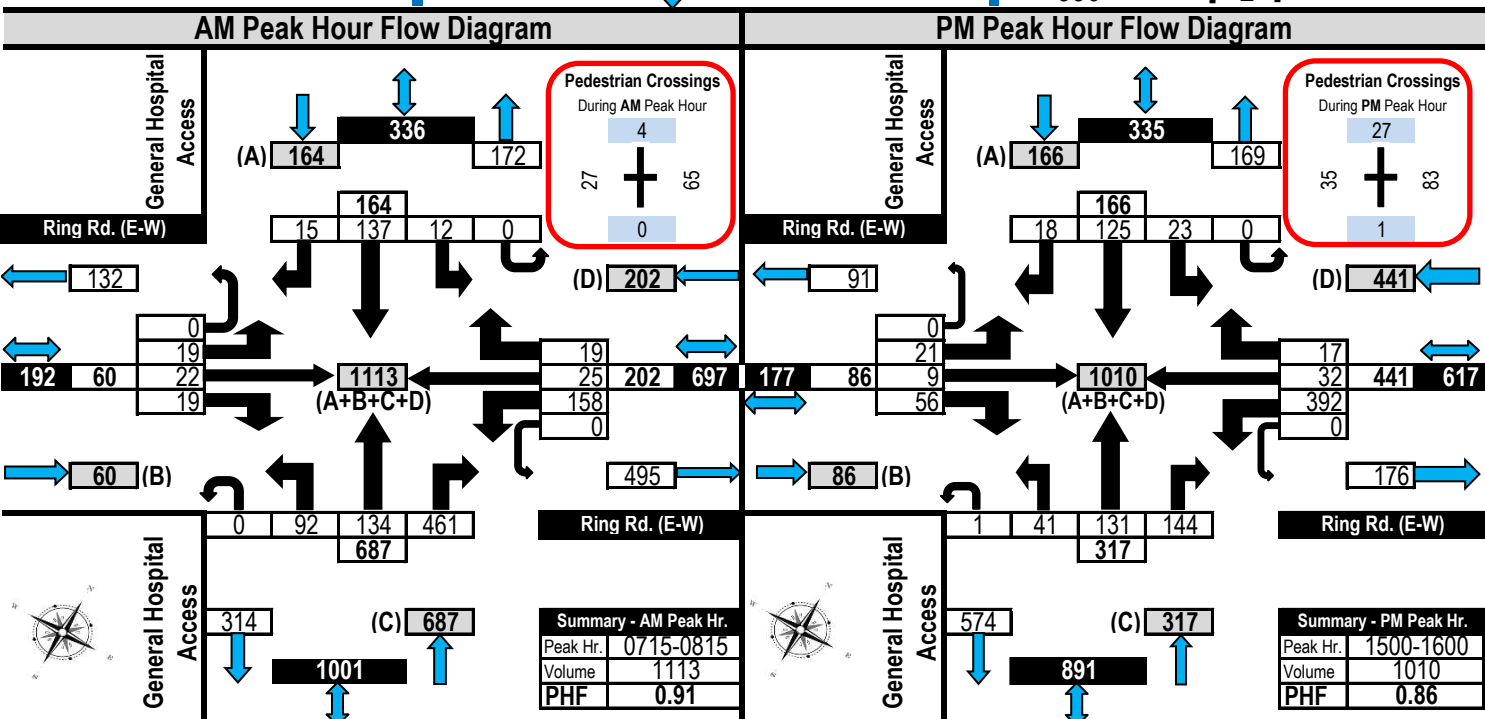
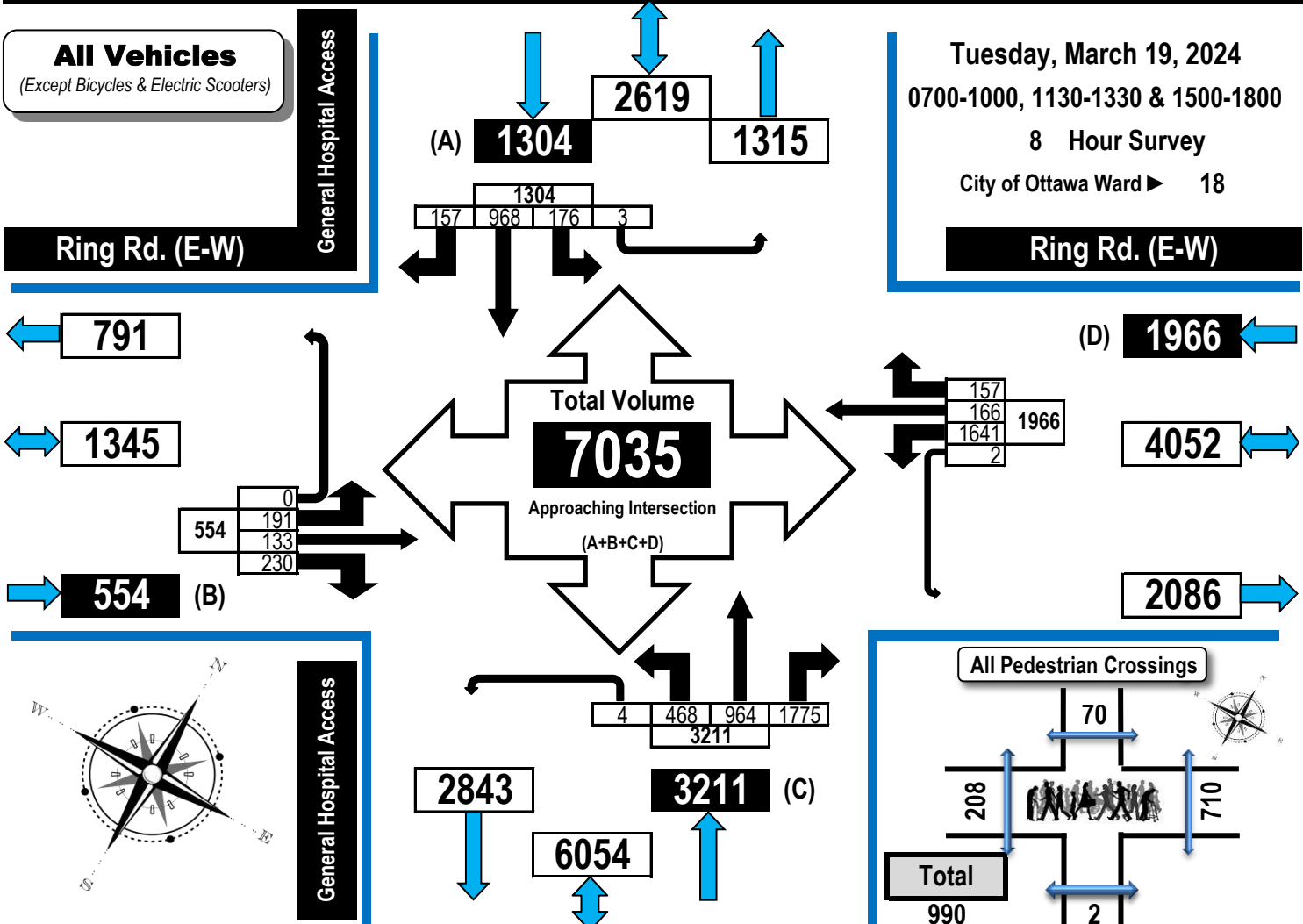

APPENDIX E

Collision Records



Transportation Services - Traffic Services

Collision Details Report - Public Version

From: January 1, 2017 To: December 31, 2021

Location: HIGHLAND TER @ SMYTH RD

Traffic Control: Stop sign

Total Collisions: 2

Date/Day/Time	Environment	Impact Type	Classification	Surface Cond'n	Veh. Dir	Vehicle Manoeuvre	Vehicle type	First Event	No. Ped
2017-May-17, Wed,16:06	Clear	Sideswipe	P.D. only	Dry	West	Changing lanes	Pick-up truck	Other motor vehicle	0
					West	Going ahead	Pick-up truck	Other motor vehicle	
					West	Stopped	Automobile, station wagon	Other motor vehicle	
2020-Nov-20, Fri,18:08	Clear	Turning movement	Non-fatal injury	Dry	West	Turning left	Pick-up truck	Other motor vehicle	0
					West	Overtaking	Police vehicle	Other motor vehicle	

Location: SMYTH RD @ GENERAL HOSPITAL E

Traffic Control: Traffic signal

Total Collisions: 17

Date/Day/Time	Environment	Impact Type	Classification	Surface Cond'n	Veh. Dir	Vehicle Manoeuvre	Vehicle type	First Event	No. Ped
2017-Dec-08, Fri,06:52	Clear	Rear end	P.D. only	Dry	West	Turning left	Automobile, station wagon	Other motor vehicle	0
					West	Turning left	Automobile, station wagon	Other motor vehicle	
					West	Turning left	Automobile, station wagon	Other motor vehicle	
					West	Turning left	Automobile, station wagon	Other motor vehicle	
2018-Jan-26, Fri,08:30	Clear	Rear end	P.D. only	Loose snow	East	Unknown	Unknown	Other motor vehicle	0
					East	Stopped	Automobile, station wagon	Other motor vehicle	
2018-Jun-27, Wed,07:32	Clear	Turning movement	P.D. only	Dry	East	Turning left	Automobile, station wagon	Other motor vehicle	0
					West	Going ahead	Automobile, station wagon	Other motor vehicle	
2018-Jul-06, Fri,07:29	Clear	Rear end	P.D. only	Dry	South	Going ahead	Automobile, station wagon	Other motor vehicle	0
					South	Stopped	Automobile, station wagon	Other motor vehicle	
2018-Oct-17, Wed,11:10	Clear	Sideswipe	P.D. only	Dry	South	Unknown	Unknown	Other motor vehicle	0
					South	Stopped	Automobile, station wagon	Other motor vehicle	
2018-Nov-30, Fri,15:32	Clear	Turning movement	Non-fatal injury	Dry	West	Going ahead	Automobile, station wagon	Other motor vehicle	0
					East	Turning left	Automobile, station wagon	Other motor vehicle	



Transportation Services - Traffic Services

Collision Details Report - Public Version

From: January 1, 2017 To: December 31, 2021

Location: SMYTH RD @ GENERAL HOSPITAL E

Traffic Control: Traffic signal

Total Collisions: 17

Date/Day/Time	Environment	Impact Type	Classification	Surface Cond'n	Veh. Dir	Vehicle Manoeuver	Vehicle type	First Event	No. Ped
2019-Jan-23, Wed,07:15	Snow	Sideswipe	Non-reportable	Packed snow	East	Changing lanes	Unknown	Other motor vehicle	0
					East	Going ahead	Automobile, station wagon	Other motor vehicle	
2019-Sep-05, Thu,07:57	Clear	Turning movement	P.D. only	Dry	East	Turning left	Automobile, station wagon	Other motor vehicle	0
					West	Going ahead	Automobile, station wagon	Other motor vehicle	
2019-Sep-10, Tue,09:00	Clear	Rear end	P.D. only	Dry	West	Going ahead	Truck - dump	Other motor vehicle	0
					West	Stopped	Automobile, station wagon	Other motor vehicle	
					West	Unknown	Unknown	Other motor vehicle	
2019-Dec-14, Sat,22:42	Snow	SMV other	P.D. only	Packed snow	East	Going ahead	Automobile, station wagon	Pole (utility, power)	0
2019-Dec-20, Fri,16:22	Clear	Sideswipe	P.D. only	Dry	South	Going ahead	Pick-up truck	Other motor vehicle	0
					South	Going ahead	Automobile, station wagon	Other motor vehicle	
2020-Jan-15, Wed,18:00	Clear	Rear end	P.D. only	Dry	South	Going ahead	Municipal transit bus	Other motor vehicle	0
					South	Stopped	Automobile, station wagon	Other motor vehicle	
2020-Jan-27, Mon,16:09	Clear	Rear end	P.D. only	Dry	South	Turning left	Automobile, station wagon	Other motor vehicle	0
					South	Turning left	Automobile, station wagon	Other motor vehicle	
2020-Mar-03, Tue,11:30	Clear	Rear end	P.D. only	Loose snow	West	Going ahead	School van	Other motor vehicle	0
					West	Slowing or stopping	Automobile, station wagon	Other motor vehicle	
2020-Mar-10, Tue,09:10	Rain	Sideswipe	P.D. only	Wet	East	Going ahead	Unknown	Other motor vehicle	0
					East	Turning left	Automobile, station wagon	Other motor vehicle	
2021-Feb-03, Wed,06:40	Snow	Sideswipe	P.D. only	Slush	South	Turning left	Pick-up truck	Other motor vehicle	0
					South	Turning left	Ambulance	Other motor vehicle	
2021-Nov-26, Fri,07:10	Rain	Turning movement	P.D. only	Wet	East	Turning left	Automobile, station wagon	Other motor vehicle	0
					West	Going ahead	Automobile, station wagon	Other motor vehicle	



Transportation Services - Traffic Services

Collision Details Report - Public Version

From: January 1, 2017 To: December 31, 2021

Location: SMYTH RD @ SOUTH HAVEN PL/GENERAL HOSPITAL ENTRANCE W

Traffic Control: Traffic signal

Total Collisions: 13

Date/Day/Time	Environment	Impact Type	Classification	Surface Cond'n	Veh. Dir	Vehicle Manoeuver	Vehicle type	First Event	No. Ped
2017-Jan-27, Fri,09:43	Clear	Rear end	P.D. only	Dry	South	Going ahead	Automobile, station wagon	Other motor vehicle	0
					South	Stopped	Automobile, station wagon	Other motor vehicle	
2017-Jun-27, Tue,12:44	Clear	Turning movement	P.D. only	Dry	West	Turning left	Automobile, station wagon	Other motor vehicle	0
					East	Going ahead	Pick-up truck	Other motor vehicle	
2017-Jun-27, Tue,13:43	Rain	Turning movement	P.D. only	Wet	West	Turning left	Automobile, station wagon	Other motor vehicle	0
					East	Going ahead	Pick-up truck	Other motor vehicle	
2017-Aug-06, Sun,19:50	Clear	Rear end	P.D. only	Dry	East	Going ahead	Automobile, station wagon	Other motor vehicle	0
					East	Stopped	Automobile, station wagon	Other motor vehicle	
2017-Nov-03, Fri,19:44	Clear	Turning movement	P.D. only	Dry	South	Going ahead	Automobile, station wagon	Other motor vehicle	0
					North	Turning left	Bus (other)	Other motor vehicle	
2018-Nov-07, Wed,18:00	Rain	Rear end	P.D. only	Wet	East	Going ahead	Automobile, station wagon	Other motor vehicle	0
					East	Stopped	Automobile, station wagon	Other motor vehicle	
2019-Jan-07, Mon,08:35	Clear	Turning movement	P.D. only	Ice	West	Turning left	Passenger van	Other motor vehicle	0
					East	Going ahead	Automobile, station wagon	Other motor vehicle	
2019-Jan-22, Tue,10:40	Clear	Angle	P.D. only	Packed snow	East	Going ahead	Unknown	Other motor vehicle	0
					North	Going ahead	Passenger van	Other motor vehicle	
2019-Aug-12, Mon,14:40	Clear	Sideswipe	P.D. only	Dry	East	Unknown	Unknown	Other motor vehicle	0
					East	Going ahead	Automobile, station wagon	Other motor vehicle	
2019-Nov-29, Fri,16:49	Clear	Sideswipe	P.D. only	Dry	East	Changing lanes	Automobile, station wagon	Other motor vehicle	0
					East	Going ahead	Automobile, station wagon	Other motor vehicle	
2019-Dec-04, Wed,09:50	Snow	Rear end	P.D. only	Wet	East	Changing lanes	Automobile, station wagon	Other motor vehicle	0
					East	Going ahead	Automobile, station wagon	Other motor vehicle	



Transportation Services - Traffic Services

Collision Details Report - Public Version

From: January 1, 2017 To: December 31, 2021

Location: SMYTH RD @ SOUTH HAVEN PL/GENERAL HOSPITAL ENTRANCE W

Traffic Control: Traffic signal

Total Collisions: 13

Date/Day/Time	Environment	Impact Type	Classification	Surface Cond'n	Veh. Dir	Vehicle Manoeuver	Vehicle type	First Event	No. Ped
2020-Sep-29, Tue,19:59	Clear	Turning movement	Non-fatal injury	Dry	East	Turning left	Automobile, station wagon	Other motor vehicle	0
					West	Going ahead	Automobile, station wagon	Other motor vehicle	
2021-Mar-23, Tue,09:36	Clear	Sideswipe	P.D. only	Dry	East	Changing lanes	Pick-up truck	Other motor vehicle	0
					East	Going ahead	Automobile, station wagon	Other motor vehicle	

Location: SMYTH RD btwn HIGHLAND TERR & RING RD/GENERAL HOSPITAL

Traffic Control: No control

Total Collisions: 3

Date/Day/Time	Environment	Impact Type	Classification	Surface Cond'n	Veh. Dir	Vehicle Manoeuver	Vehicle type	First Event	No. Ped
2017-Nov-15, Wed,17:00	Rain	Sideswipe	P.D. only	Wet	East	Unknown	Unknown	Other motor vehicle	0
					East	Going ahead	Pick-up truck	Other motor vehicle	
2018-Oct-03, Wed,23:50	Clear	Rear end	P.D. only	Dry	East	Pulling onto shoulder or toward curb	Automobile, station wagon	Other motor vehicle	0
					East	Overtaking	Police vehicle	Other motor vehicle	
2019-Apr-18, Thu,16:45	Clear	Sideswipe	P.D. only	Dry	East	Unknown	Unknown	Other motor vehicle	0
					East	Changing lanes	Automobile, station wagon	Other motor vehicle	

APPENDIX F

Strategic Long-Range Model Snapshots

TRANS Regional Model

Version 2.15 - Assigned June 16, 2020

AM Peak Hour Total Traffic Volume

Smyth Road

2011 Model - Basecase

N/A

User: Manav Singla

Plot Prepared: January 29, 2024

EMME Scenario: 21713



Legend

AM Peak Hour Total Traffic Volume

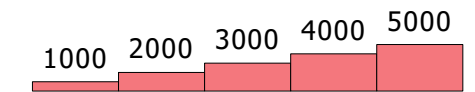

Distance (m)

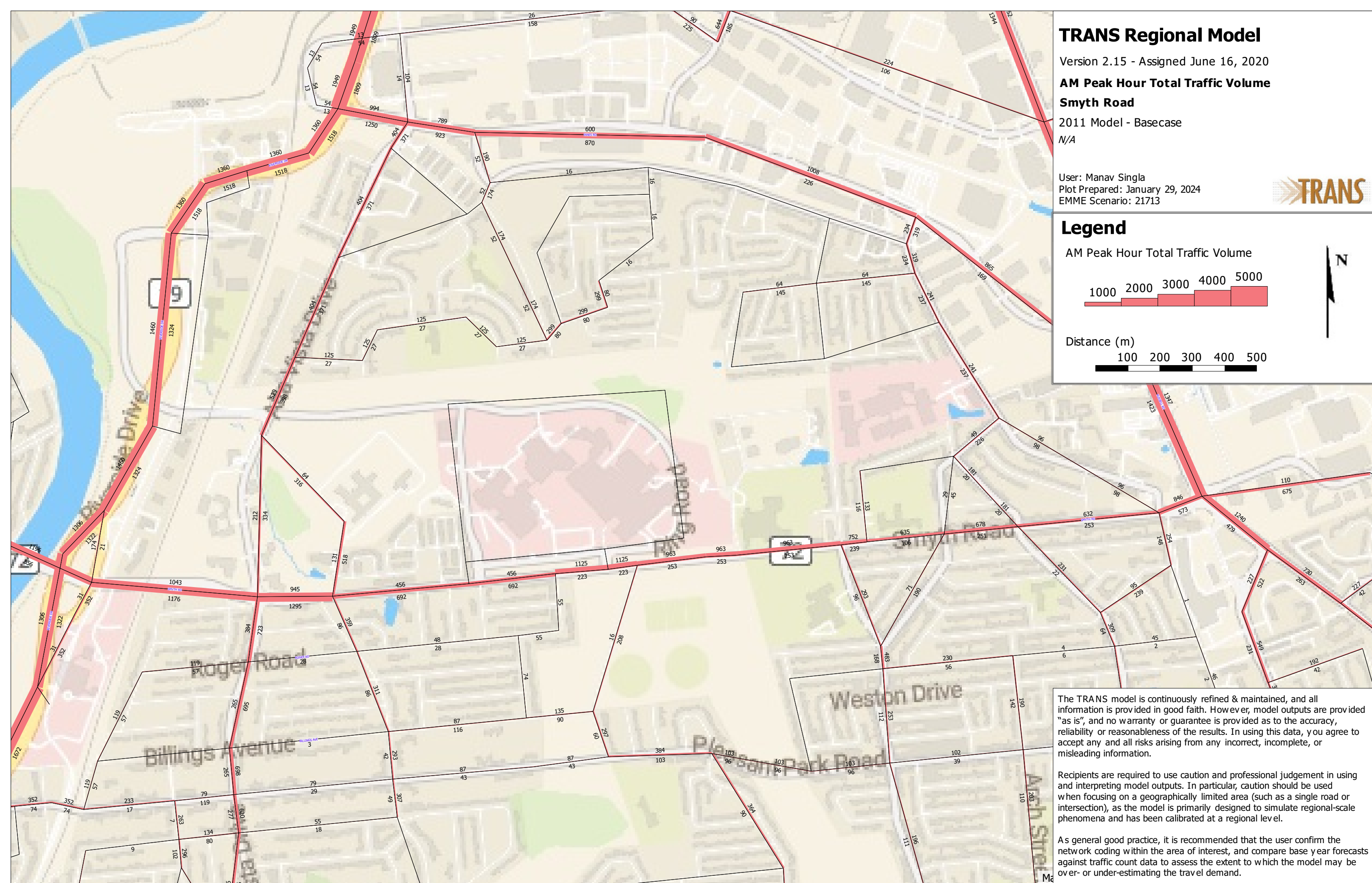

The TRANS model is continuously refined & maintained, and all information is provided in good faith. However, model outputs are provided "as is", and no warranty or guarantee is provided as to the accuracy, reliability or reasonableness of the results. In using this data, you agree to accept any and all risks arising from any incorrect, incomplete, or misleading information.

Recipients are required to use caution and professional judgement in using and interpreting model outputs. In particular, caution should be used when focusing on a geographically limited area (such as a single road or intersection), as the model is primarily designed to simulate regional-scale phenomena and has been calibrated at a regional level.

As general good practice, it is recommended that the user confirm the network coding within the area of interest, and compare base year forecasts against traffic count data to assess the extent to which the model may be over- or under-estimating the travel demand.

TRANS Regional Model

Version 2.15 - Assigned June 16, 2020

AM Peak Hour Total Traffic Volume

Smyth Road

2031 Model - Basecase

N/A

User: Manav Singla

Plot Prepared: January 29, 2024

EMME Scenario: 21717



Legend

AM Peak Hour Total Traffic Volume

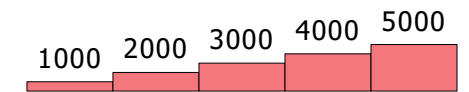

Distance (m)

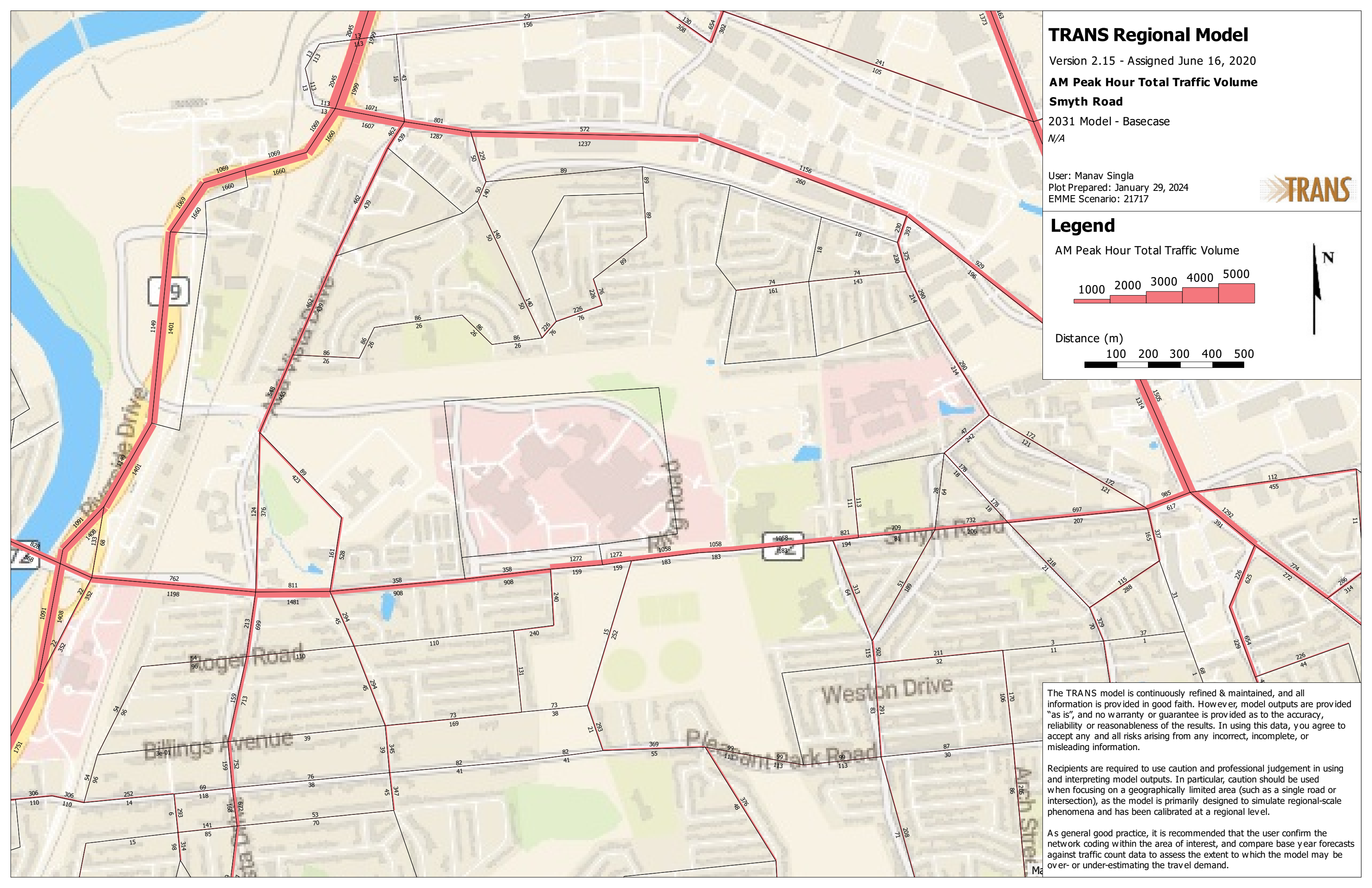

The TRANS model is continuously refined & maintained, and all information is provided in good faith. However, model outputs are provided "as is", and no warranty or guarantee is provided as to the accuracy, reliability or reasonableness of the results. In using this data, you agree to accept any and all risks arising from any incorrect, incomplete, or misleading information.

Recipients are required to use caution and professional judgement in using and interpreting model outputs. In particular, caution should be used when focusing on a geographically limited area (such as a single road or intersection), as the model is primarily designed to simulate regional-scale phenomena and has been calibrated at a regional level.

As general good practice, it is recommended that the user confirm the network coding within the area of interest, and compare base year forecasts against traffic count data to assess the extent to which the model may be over- or under-estimating the travel demand.

APPENDIX G

Other Area Developments

Figure 2: Proposed Site Plan

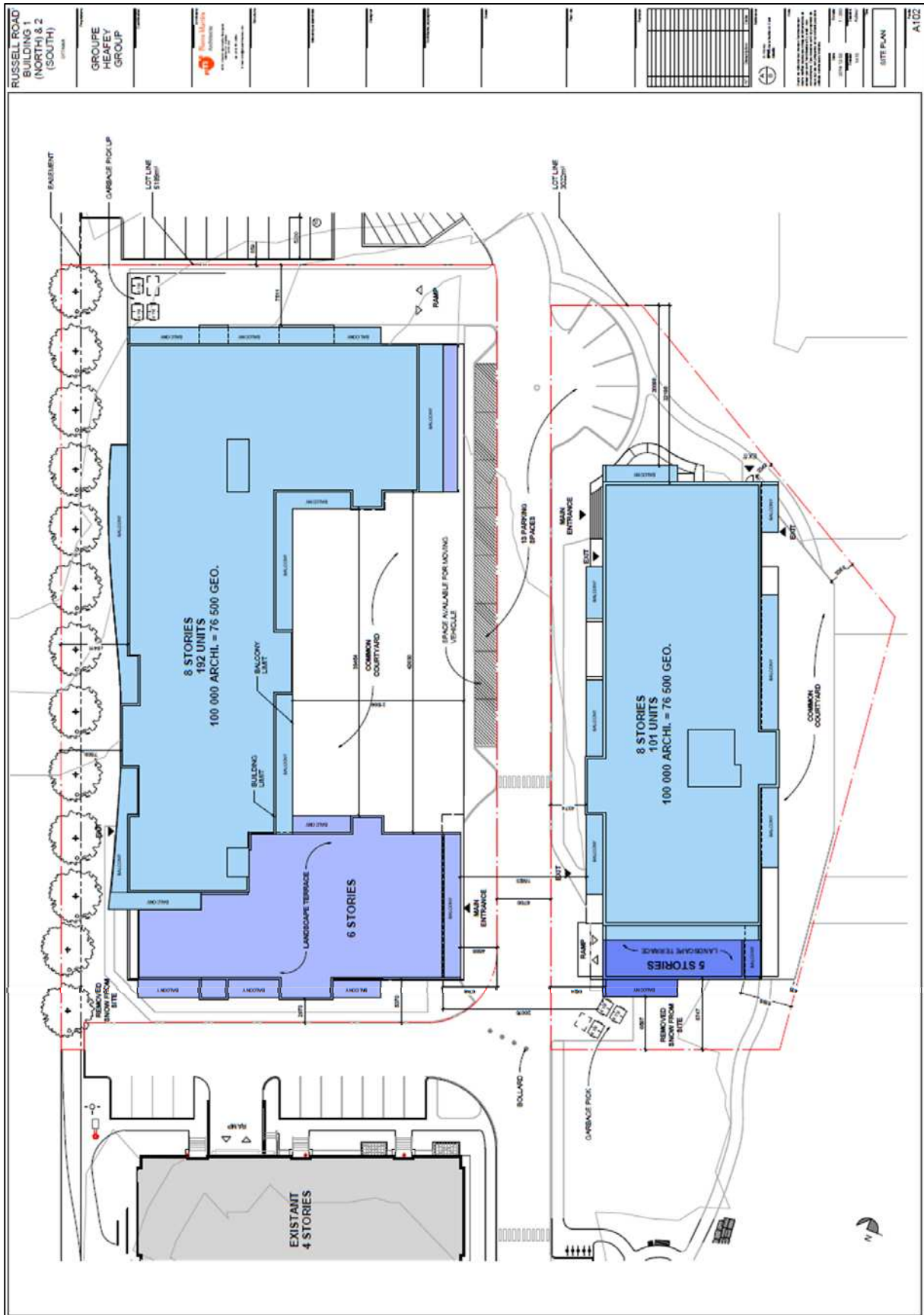

PARSONS

St Laurent/Smyth/Lancaster

The St Laurent/Smyth/Lancaster intersection is a signalized four-legged intersection. The north and south legs consist of two thru lanes, an auxiliary left-turn lane and a YIELD-controlled channelized right-turn lane. The west leg consists of two left-turn lanes, a single thru lane and a YIELD-controlled channelized right-turn lane. The east leg consists of two thru lanes, an auxiliary left-turn lane and a YIELD-controlled channelized right-turn lane. All left-turn movements at the intersection are fully protected. There are no restricted movements at the intersection.

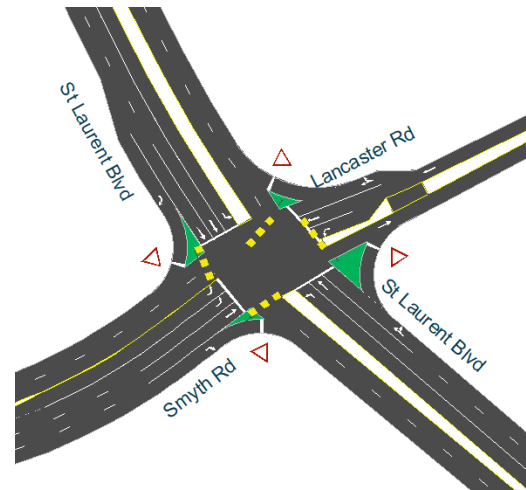

Existing Driveways to Adjacent Developments

In the interim, connectivity to the residential apartments to/from St Laurent Blvd will be limited to pedestrians, cyclists and emergency vehicles. As such, all traffic generated by both existing and planned future residential developments along Everest Priv will be directed to/from Russell Rd only¹. There are no existing driveways between the planned future development sites and Russell Rd (200 m radius).

Pedestrian/Cycling Network

With regards to pedestrians, sidewalk facilities and pathways are provided throughout Everest Priv and provide connectivity to Russell Rd and St Laurent Blvd. Along Russell Rd, sidewalks are provided on both the east and west sides of the roadway, between the Perley-Rideau access and Smyth Rd, and on the east side only of the roadway between the Perley-Rideau access and Industrial Ave. A pedestrian crossing signal (PXO) is provided at the south crosswalk of the Perley-Rideau driveway access. Along St Laurent Blvd, pedestrians have access to the sidewalk on the west side of the roadway.

With regards to cyclists, Russell Rd allows mixed traffic, while St Laurent Blvd is classified as a spine route and provides elevated cycling tracks on both sides of the roadway.

Transit Network and Bus Services

The following OC Transpo bus routes operate within the study area:

- **Route #40 (St Laurent <-> Greenboro, Hurdman):** identified by OC Transpo as a “Frequent Route”, this route operates at an average rate of every 15 minutes or less during weekday peak hours periods. The nearest bus stops to the site are available along St Laurent Blvd.
- **Route #42 (Blair <-> Hurdman):** identified by OC Transpo as a “Local Route”, this route operates at a rate of every 15-to-30 minutes during weekday morning and afternoon peak hour periods. The nearest bus stops to the future development site are available along Industrial Ave.
- **Route #46 (Hurdman <-> Billings Bridge):** identified by OC Transpo as a “Local Route”, this route operates at a rate of every 15 minutes during weekday morning and afternoon peak hour periods. The route runs along Russell Rd.
- **Route #55 (Elmvale <-> Bayshore):** identified by OC Transpo as a “Local Rote”, this route operates at a rate of every 15-to-30 minutes during weekday peak hour periods. The nearest bus stops to the development site are available along Smyth Rd.

¹ Until such time that traffic signal control is provided at St. Laurent Boulevard as part of future commercial development.

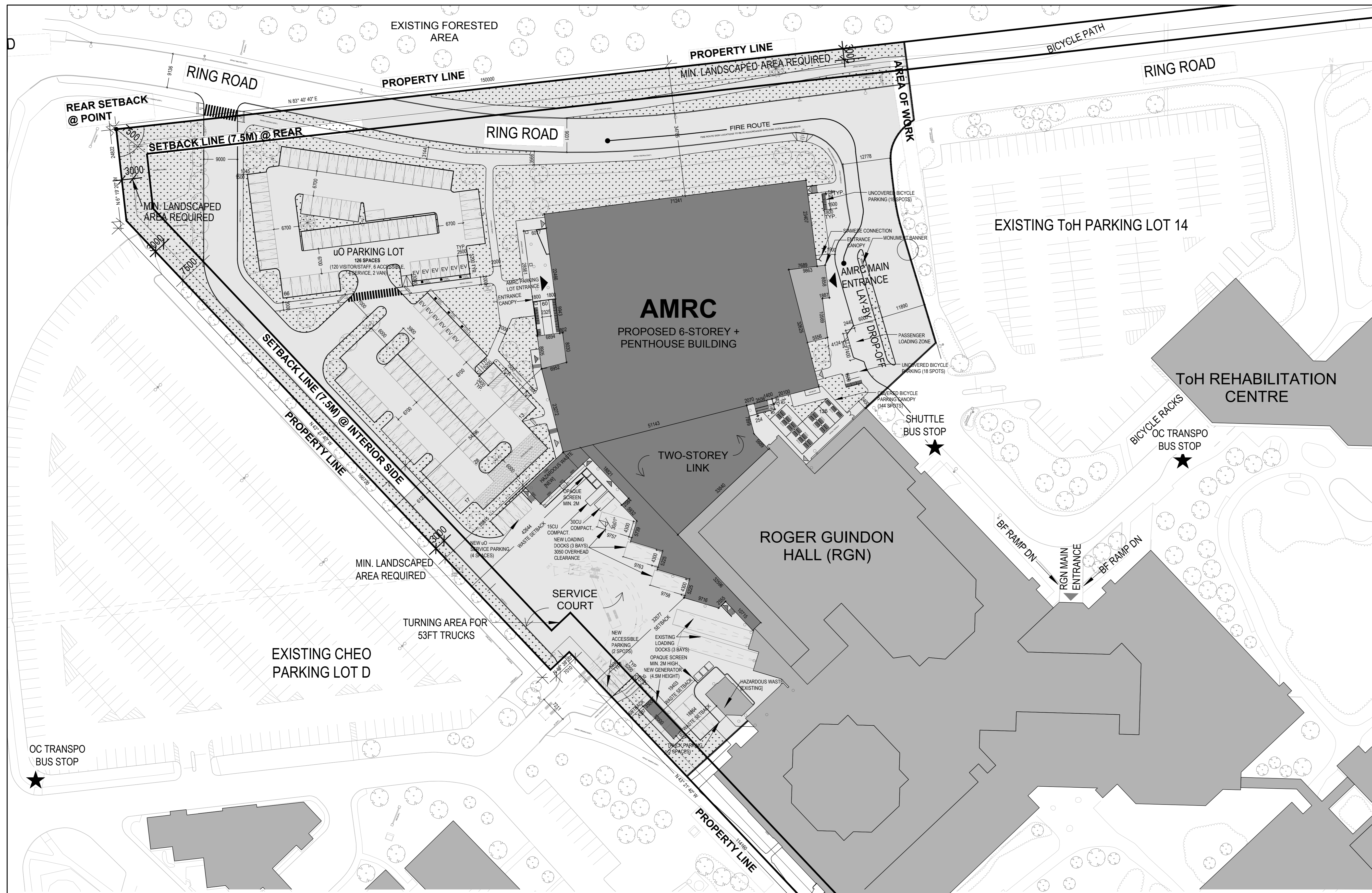

REFERENCE SURVEY: 1) 2023-11-25 REF. NO. 105 - 15 (JG) GR*
 2) 2022-11-22 FILE NO. 623-22*

MUNICIPAL ADDRESS: 451 SMYTH ROAD, OTTAWA ON
 K1H 8M5, CANADA

AREA OF WORK: 24,078.02 M²
 COMPLETE SITE AREA: 204,834.211 M²
 GFA (CITY OF OTTAWA DEF.) OF PROPOSED AMRC: 13,726.17 M²
 GFA (CITY OF OTTAWA DEF.) OF EXIST. BLDGS ON SITE: 128,023 M²
 GFA (CITY OF OTTAWA DEF.) OF PROPOSED + EXIST. BLDGS ON SITE: 141,749.17 M²
 BUILDING HEIGHT: 40.3M (6 STOREYS + MECHANICAL PENTHOUSE AND ATRIUM ROOF)

ZONE: I2 [402] F(1.5) S144
 SCHEDULE 1: N/A
 SCHEDULE 1A: N/A

ZONING PROVISION	REQUIRED	PROVIDED
MIN. LOT WIDTH	NO MINIMUM	257.4 M
MIN. LOT AREA	NO MINIMUM	204834.211 M ²
MIN. FRONT YARD SETBACK	45M	YES - 365M
MIN. CORNER YARD SETBACK	7.5M	YES - 103.7M
MIN. REAR YARD SETBACK	7.5M	YES - 26.1
MIN. INTERIOR YARD SETBACK	7.5M	YES - 28.9M
MAX. HEIGHT	NO MAXIMUM	39.1 M
LANDSCAPED AREA (AREA OF WORK)	15%	22.8% (5502.69 M ²)
LANDSCAPED AREA (SITE)	15%	29% (59721.75 M ²)

PARKING QUEING + LOADING	REQUIRED	PROVIDED
VISITOR SPACES (EXISTING)	N/A	879
STAFF SPACES (EXISTING)	N/A	1219
SPACES TO BE ELIMINATED (EXISTING)	N/A	361
VISITOR + STAFF SPACES (NEW)	N/A	120
SERVICE SPACES (NEW)	N/A	6
ACCESSIBLE PARKING (AMRC)	3	6
TOTAL PARKING (NEW AMRC)	103	126
TOTAL PARKING (SITE + AMRC)	1720	1863
BICYCLE PARKING (NEW AMRC)	55	222
BICYCLE PARKING (SITE + AMRC)	267	699

SITE PLAN GENERAL NOTES:

- ALL SITE INFORMATION GATHERED FROM SURVEYS 2022-11-22 FILE NO. 623-22 AND 2023-11-25 REF. NO. 101 - 15 (JG) GR
- NO EXISTING TREES ARE TO BE RETAINED - ALL TREES IN PLAN WILL BE PLANTED.
- SNOW STORAGE WILL OCCUR OFF SITE. AN INTERIM SNOW STORAGE LOCATION HAS BEEN OUTLINED AS PER THE RELEVANT HATCH (SEE LEGEND).

SITE PLAN - PROPOSED
 1:500

* 31 - A PORTION OF THE LANDS OWNED BY THE OTTAWA HEALTH SCIENCES CENTRE INC. AND CHILDREN'S HOSPITAL OF EASTERN ONTARIO CHILDREN'S TREATMENT CENTRE, CITY OF OTTAWA, FARLEY, SMITH & DENIS SURVEYING LTD. 2020; 2023-11-25
 * 32 - PART OF LOTS 20, 21 & 22, PART OF TERRACE ROAD (CLOSED BY JUDGE'S ORDER DIST. G43444) REGISTERED PLAN 405 PART OF LOT 15 JUNCTION CORNER, GEOGRAPHIC TOWNSHIP OF GLACEBAY BEING PART OF THE NORTHERLY AND WESTERLY LIMITS OF PLAN 5409-043 CITY OF OTTAWA, FARLEY, SMITH & DENIS SURVEYING LTD. 2020; 2022-11-22



No.	Description	Date
1	ISSUED FOR SPA PHASE 3 RESUBMISSION	02/26/24
1	ISSUED FOR REVISED SITE PLAN APPL.	01/22/24

All measurements are to be checked and verified on site by the contractor before proceeding with the work. Do not scale the drawings.

PARKIN

Owner: uOttawa
 UNIVERSITY OF OTTAWA
 451 SMYTH ROAD
 OTTAWA, ONTARIO, K1H 8M5
 TEL: 613-229-7104

Applicant: PCL
 PCL CONSTRUCTORS CANADA INC.
 49 AURICA DRIVE
 NEPEAN, ONTARIO, K2E 8A1
 TEL: 613-229-7104

Consultants: WSP
 WSP QUEENSWAY DRIVE, SUITE 300
 OTTAWA, ONTARIO, K2B 8K2
 TEL: 613-829-2800

Fairhall Moffatt & Woodland
 FAIRHALL MOFFATT & WOODLAND LTD.
 600 TERRY FOX DRIVE, SUITE 100
 OTTAWA, ONTARIO, K2L 4B6
 TEL: 613-591-1485

CLELAND JARDINE
 CLELAND JARDINE ENGINEERING LTD.
 580 TERRY FOX DRIVE
 KANATA, ONTARIO, K2L 4B9
 TEL: 613-591-1485

MERRICK CANADA
 MERRICK 580 TERRY FOX DRIVE
 KANATA, ONTARIO, K2L 4B9
 TEL: 613-592-5289

Project: **ADVANCED MEDICAL RESEARCH CENTRE**

Drawn By: [Signature] Date: 02/26/2024
 Checked By: [Signature] Scale: 1:500

Sheet Title: **SITE PLAN - PROPOSED**
 Sheet Number: **A100D**

LEGEND

	EXISTING ELEMENT		BUILDING ENTRANCE		PROPERTY LINE
	NEW ELEMENT		SERVICE ENTRANCE		AREA OF WORK LINE
	NEW ELEMENT - CANOPY		EMERGENCY EXIT		
	AREA OF WORK		TREE		
	SNOW STORAGE AREA		EV ELECTRIC VEHICLE PARKING SPOT		
	LANDSCAPED AREA		ACCESSIBLE PARKING SPOT		
			CR CURB RAMP		
			STANDARD EXT. LIGHT FIXTURE		
			STANDARD EXT. POST LIGHT		

SCALE BAR 1:500

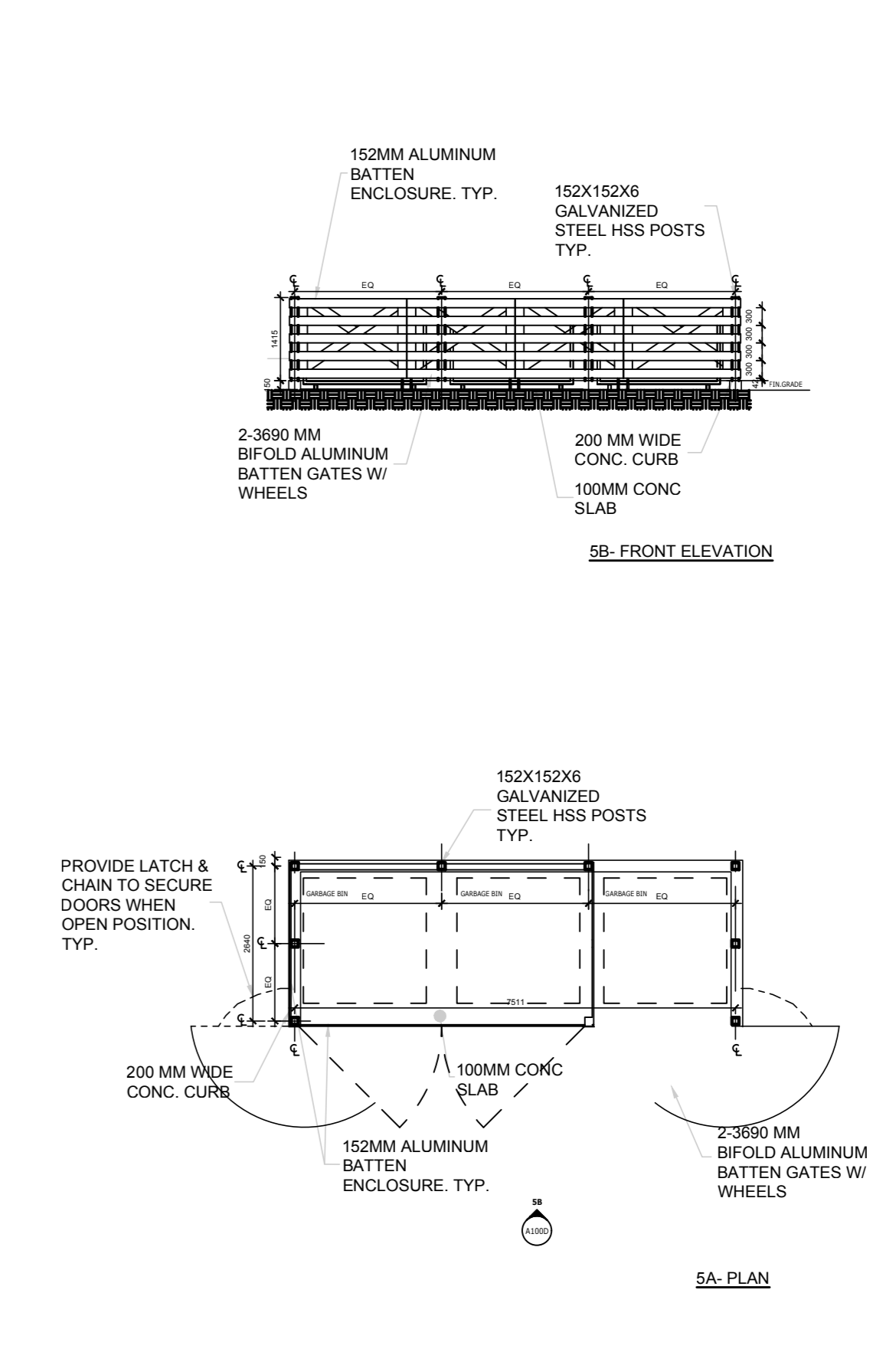
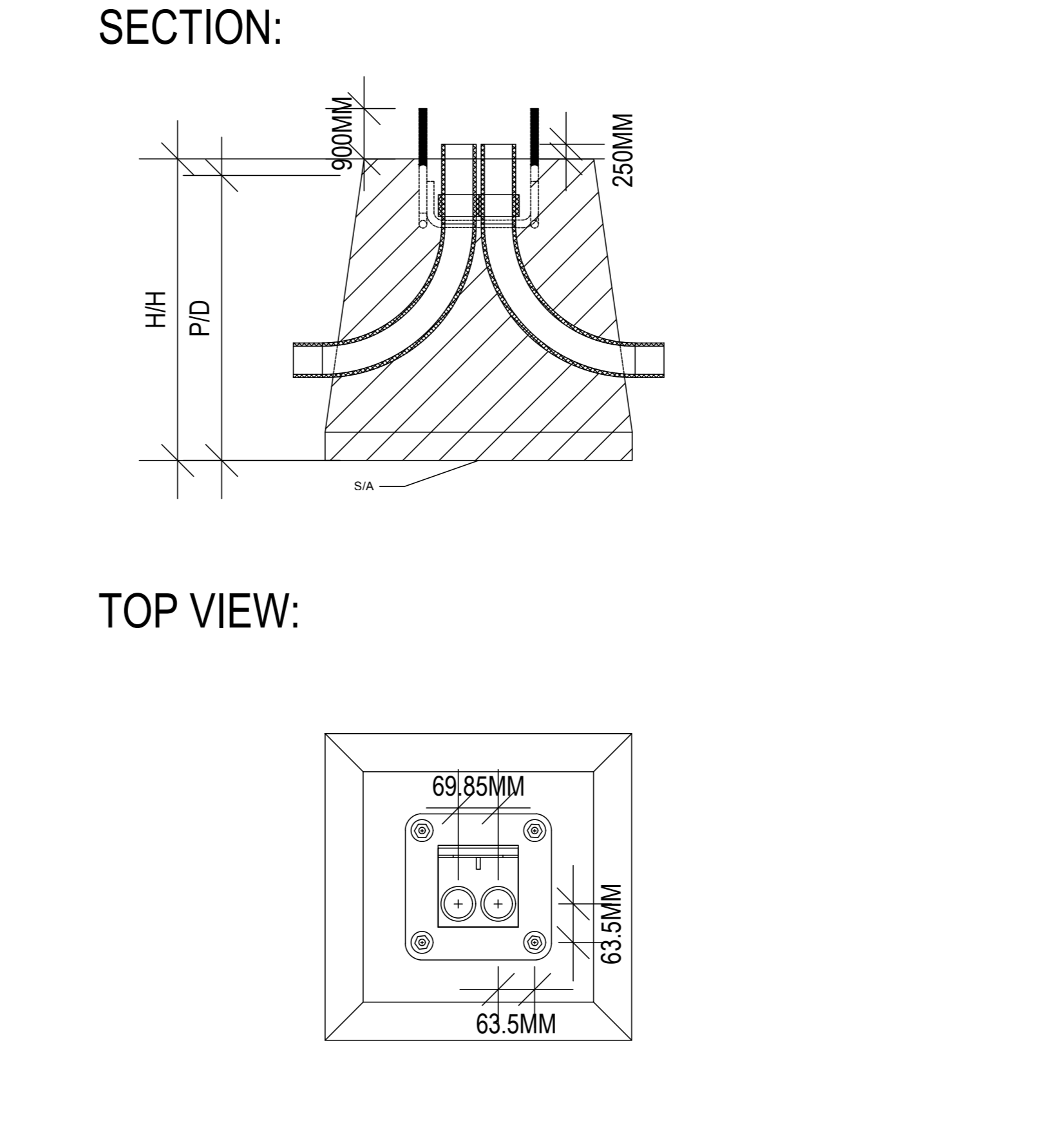
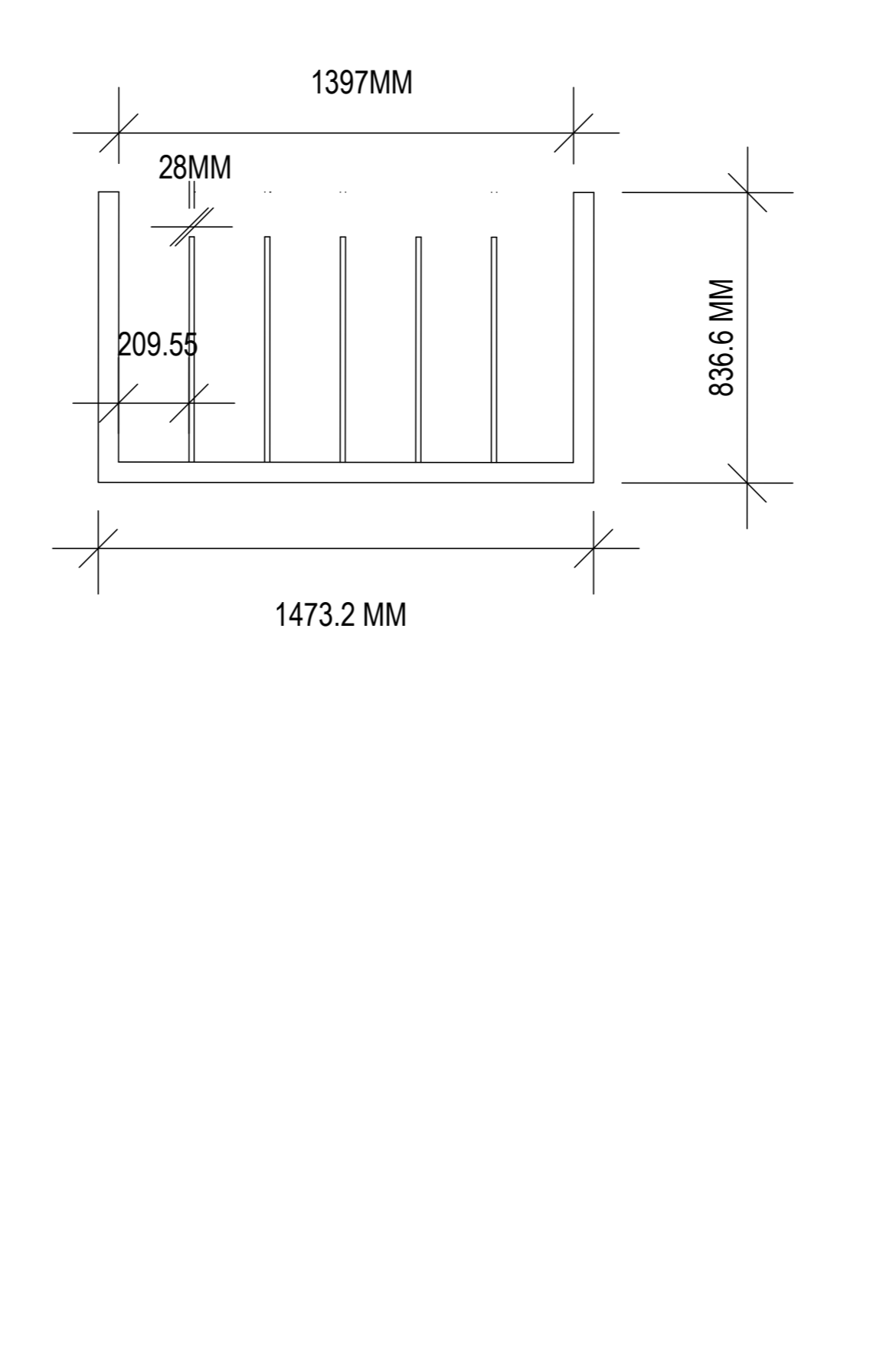
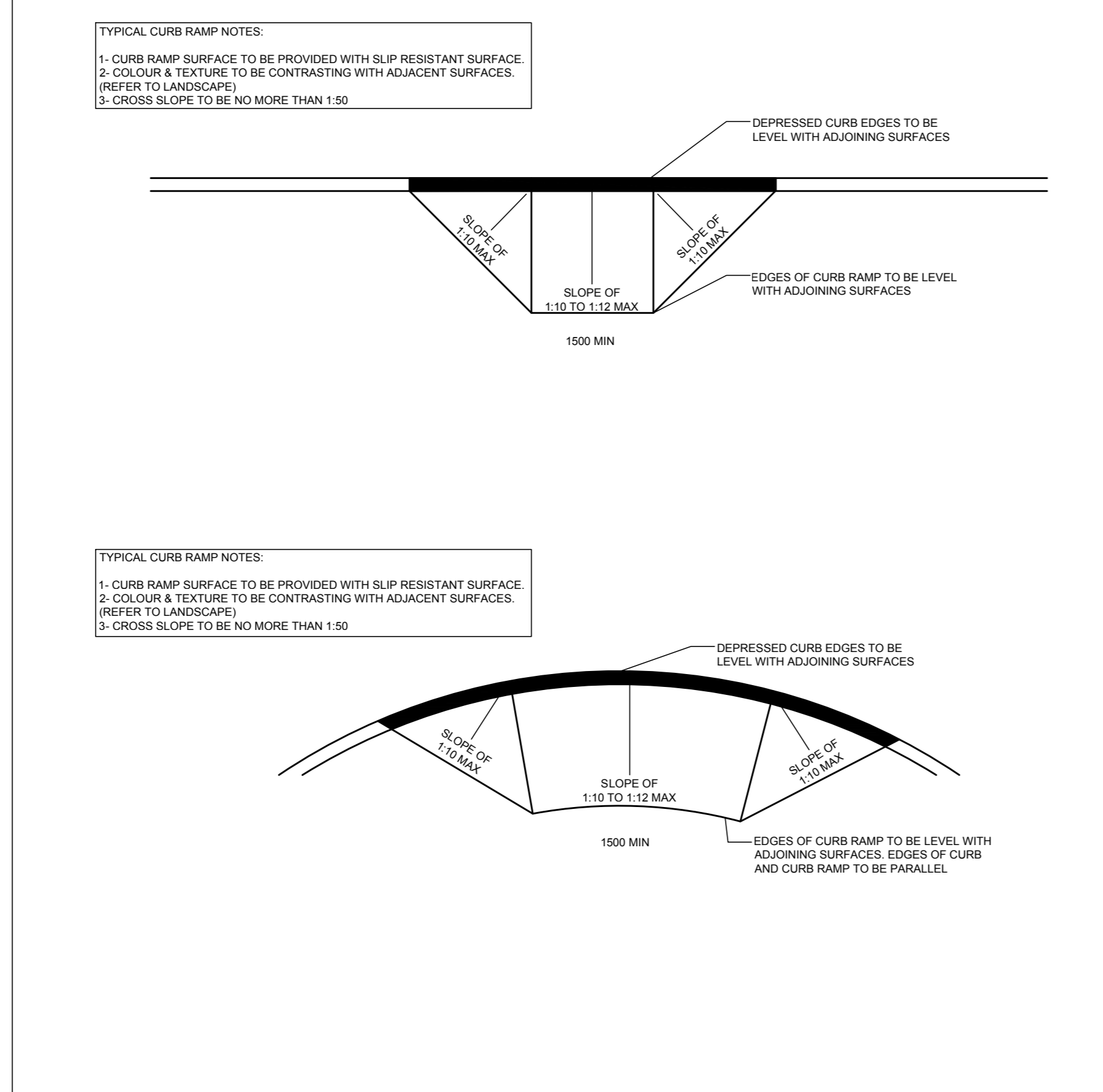

	AM	PM
Trips In	221	(57)
Trips Out	65	(214)
Total Trips	285	(272)

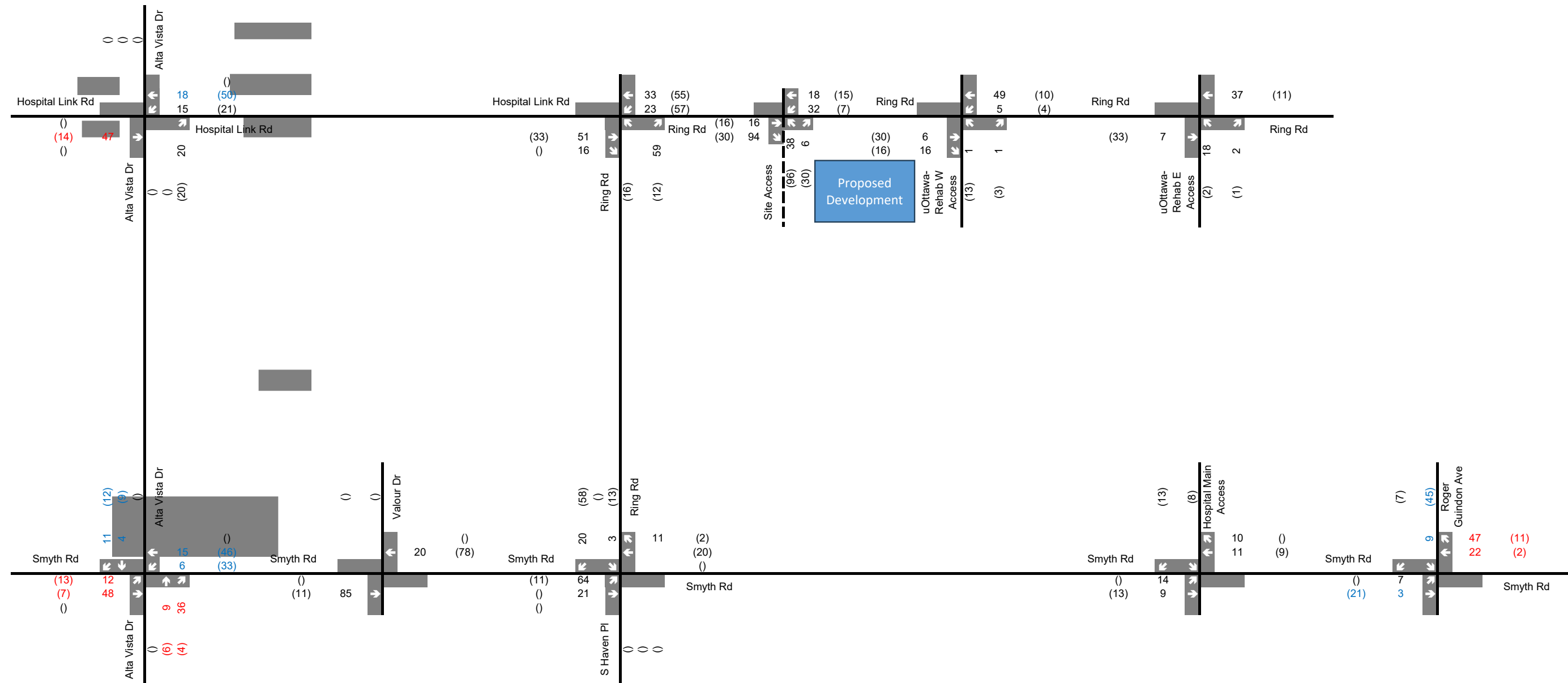

xx A.M. Peak Hour Traffic Volumes (xx) P.M. Peak Hour Traffic Volumes

Figure 2-8
Development-Generated Auto Trips

Figure 1: Local Context

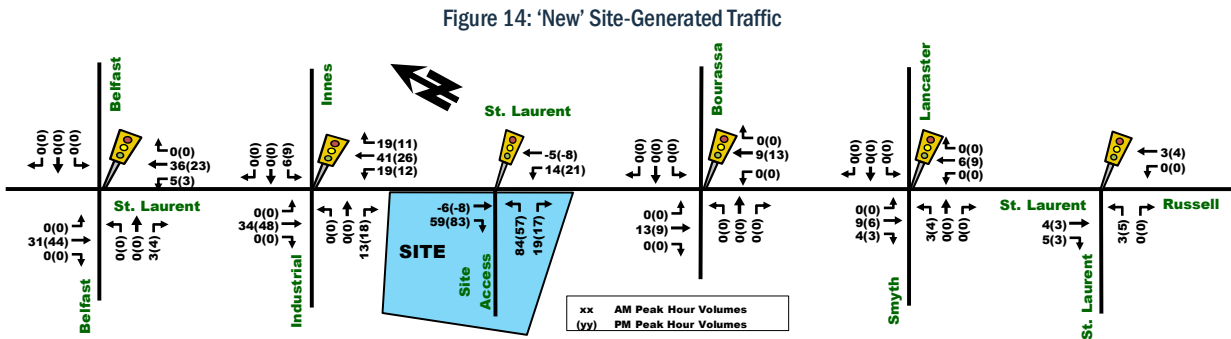

Figure 2: Proposed Site Plan



Site Plan received August 2023

signalized intersection will be located approximately 150m south of St. Laurent Boulevard. The ‘new’ site-generated vehicle trips provided in **Table 12**, were assigned to the study area network as shown in **Figure 14**. Note that negative numbers reflect pass-by trips.



3.2. Background Network Travel Demands

3.2.1. Transportation Network Plans

As mentioned in **Section 2.1.3** Planned Conditions, St. Laurent Boulevard is designated as a ‘transit priority corridor with isolated measures’ from Montreal Road to Elmvale Shopping Center within the 2031 Affordable Network and an at grade transitway within the New Official Plan.

The St. Laurent Transit Priority Corridor Planning and Environmental Assessment Study between Hemlock Road and Industrial Avenue is currently ongoing. Though the design is still in its early stages, the study aims at improving transit efficiency and connectivity to LRT while also improving the travel environment for all other modes of transportation such as pedestrians and cyclists. The EA study is anticipated to be complete by winter 2024.

For further detail, refer to **Section 2.1.3**.

3.2.2. Background Growth

The emphasis in the City’s recent Official Plan and Transportation Master Plan is to place priority on transit, encourage intensification around transit stations, encourage mixed-use developments and provide “complete streets” that better accommodate the active transportation needs of its residents and reduce the use of the private auto. Given the location of the site near frequent bus service within the St. Laurent transit priority corridor, close bus connectivity to the LRT Confederation Line and Elmvale Mall, the trips generated from this development as well as nearby developments will likely choose alternate modes of transportation over driving as transit infrastructure improves.

The following background traffic growth (summarized in **Table 13**) was calculated based on historical traffic count data (years 2001, 2009, 2014, 2016 and 2020) provided by the City of Ottawa at the Smyth/St. Laurent intersection near the site. Note that the year 2012 was omitted as counts were almost double any other year count and it was considered an anomaly year or miscount. Detailed background traffic growth analysis is included as **Appendix E**.

Table 13: Smyth/St. Laurent Historical Background Growth (2001-2020)

Time Period	Percent Annual Change				
	North Leg	South Leg	East Leg	West Leg	Overall
8 hrs	-0.17%	-0.13%	1.66%	0.47%	0.17%
AM Peak	-0.24%	0.00%	1.77%	0.52%	0.23%
PM Peak	-0.48%	-0.42%	1.53%	0.33%	-0.06%

As shown in **Table 13**, the Smyth/St. Laurent intersection, has experienced between 0.25% to 0% overall annual growth in traffic within recent years. A conservative growth rate of 1% annually will be added to background growth to account for future potential growth to the south and surrounding areas.

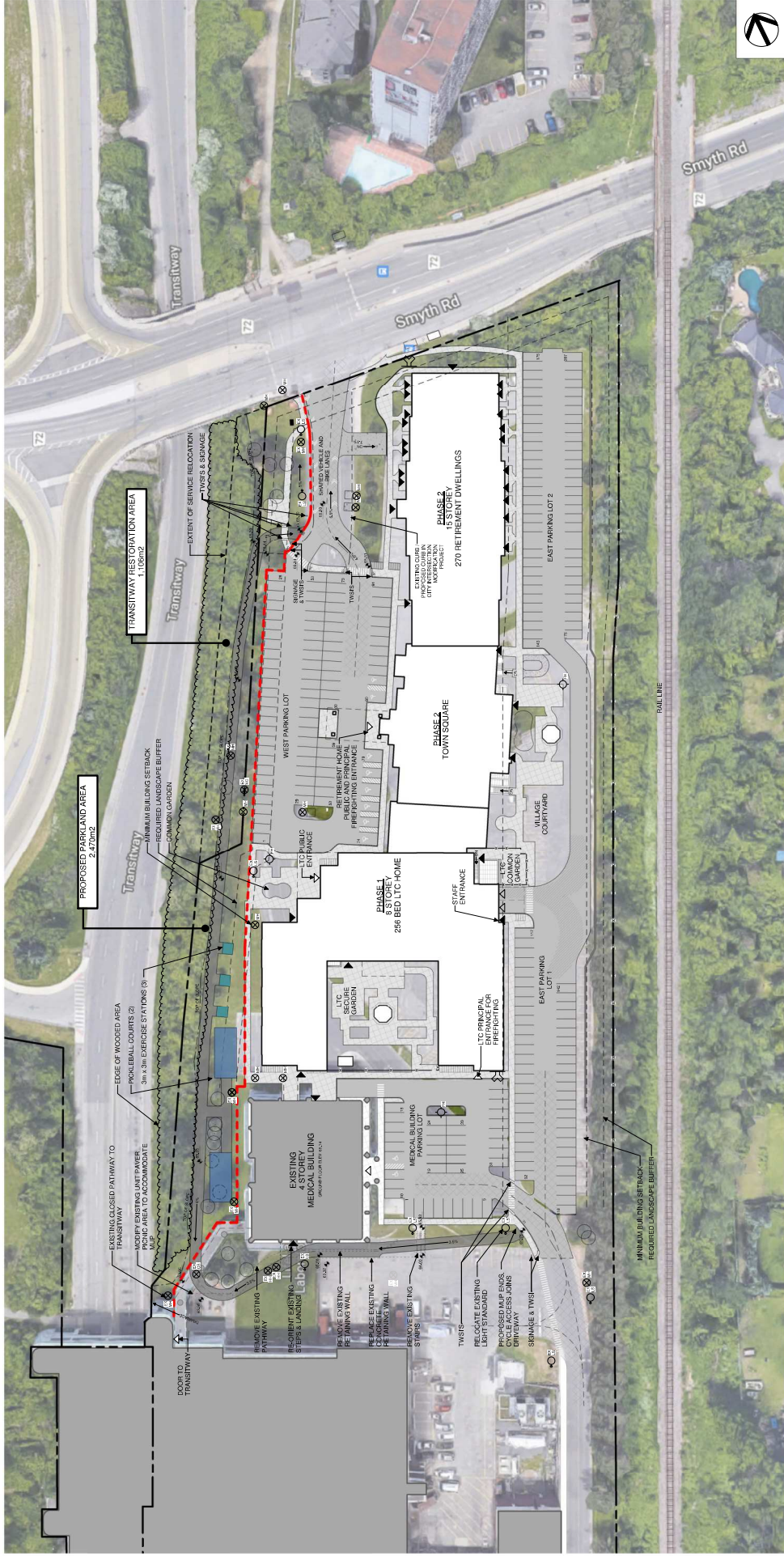

CSV ARCHITECTS
 sustainable design - conception écologique
SCHLEGEL VILLAGES
 OTTAWA
 SITE MASTER PLAN

1919, 1967 RIVERSIDE DRIVE, OTTAWA, ONTARIO
 2022-11-01

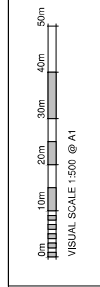

MASTER SITE PLAN SHOWING PROPOSED MULTIPURSE PATHWAY & LINEAR PARK



SCHLEGEL VILLAGES

CORNERSTONE
 ARCHITECTURE

Figure 12: New Site Generation Auto Volumes

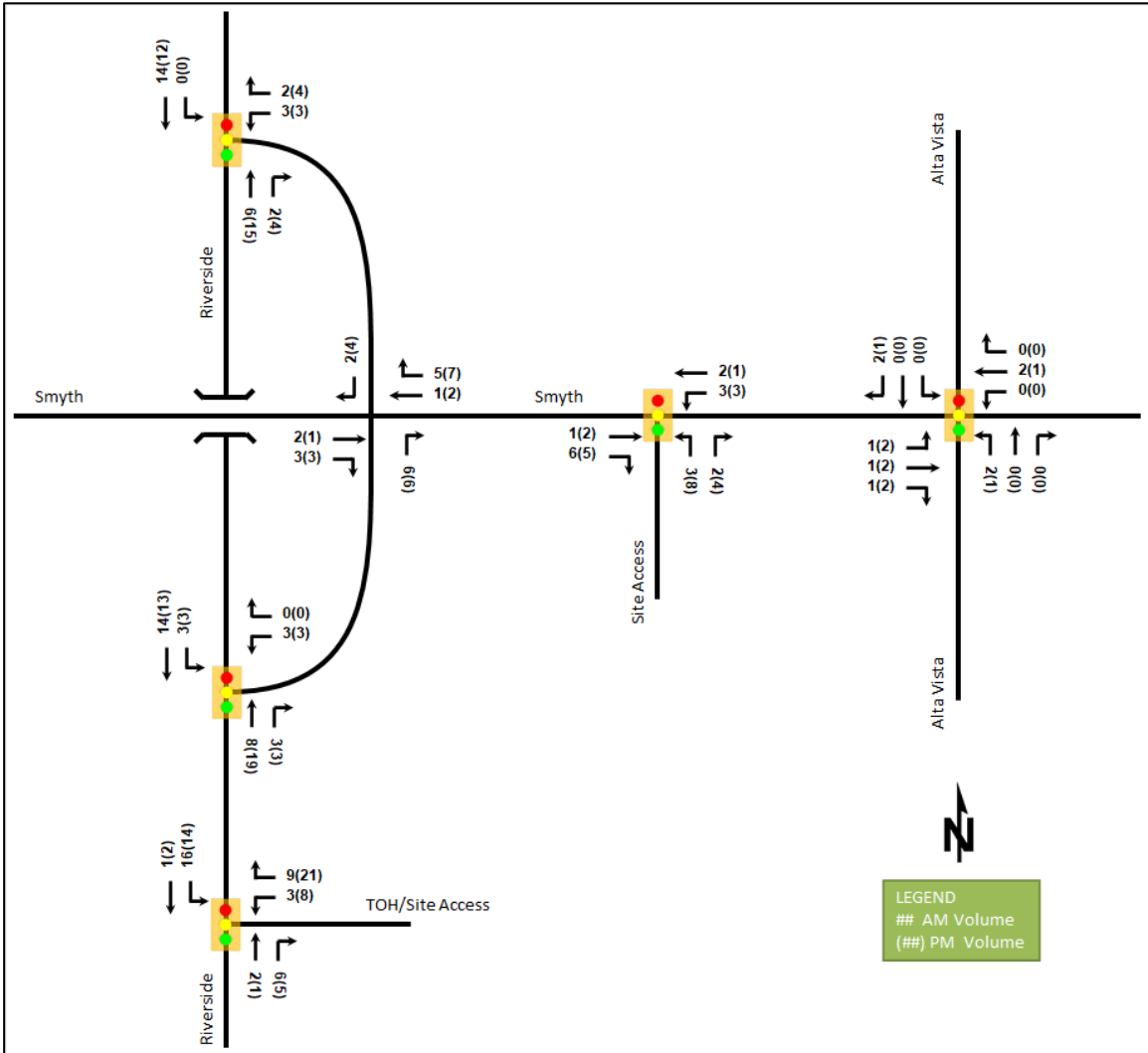

6 Background Network Travel Demands

6.1 Transportation Network Plans

The transportation network plans were discussed in Section 2.3. Changes from the Smyth Road Cycling Safety Improvements project will be included in the future conditions.

6.2 Background Growth

A review of the background projections from the City’s TRANS Regional Model for the 2011 and 2031 horizons was completed to determine the background growth for each of the study area roadways, and these horizons were compared to the existing roadway volumes. Table 16 summarizes the results of the model, and the projections are provided in Appendix E.

Figure 2: Concept Plan

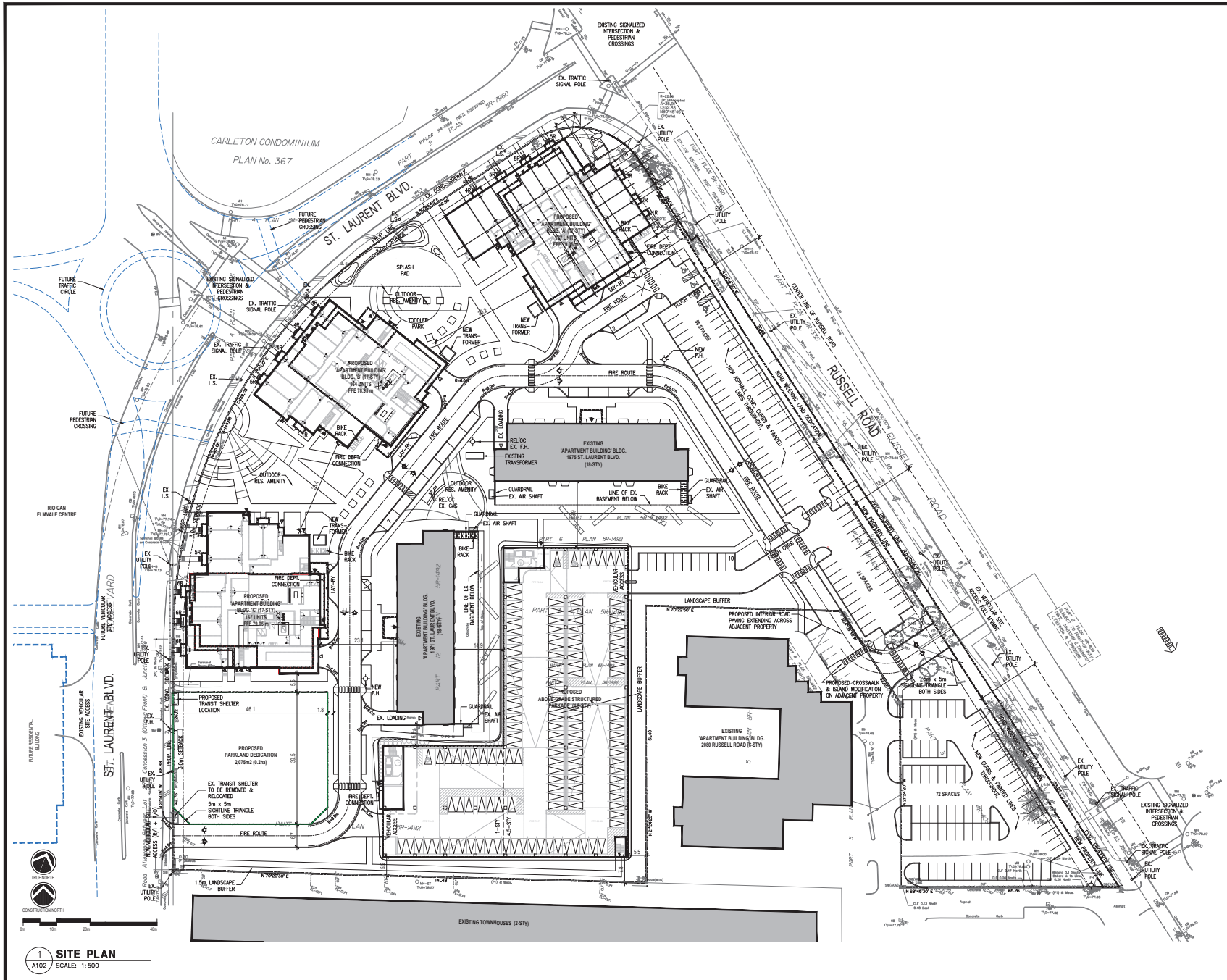

FILE NUMBER: D07-12-22-0044
 PLAN NUMBER #18715
 LEGAL DESCRIPTION:
 PART OF LOT 27,
 CONVESSION 3 (STAIRS FRONT),
 SOUTH OF DUNDAS STREET
 (GEOGRAPHICAL TOWNSHIP OF GLOUCESTER)
 CITY OF OTTAWA

KEY PLAN

SITE PLAN LEGEND

	PROPOSED FPN. GRADE
	TOPOGRAPHICAL GRADE
	TOP OF CATCH BASIN
	DOOR LOCATIONS
	DRIVE AISLE VEHICULAR TRAFFIC
	LOADING/GARAGE DOOR LOCATION
	CATCH BASINS
	SANITARY MANHOLE
	STORM SEWER MANHOLE
	FIRE HYDRANT
	ROOF DRAIN
	NEW LIGHT STANDARDS
	HEAVY DUTY ASPHALT PAVING
	BARRIER-FREE DEPRESSED CURB

SITE SERVICES & GRADING: BASED ON INFORMATION PREPARED BY COASTPOINT ENGINEERING INC. DATED 2022-JAN-31
 LANDSCAPE: BASED ON INFORMATION PREPARED BY MHC PLANNING, URBAN DESIGN & LANDSCAPE ARCHITECTURE, DATED 2022-FEB-03
 SURVEY & TOPOGRAPHICAL INFORMATION BASED ON DRAWING PREPARED BY ANNE TRULLIAN, VOLLEBERG LTD., ONTARIO LAND SURVEYORS, DRAWING DATED SEPTEMBER 27TH, 2021.

NO.	REVISIONS	DATE	BY
3	ISSUED FOR SITE PLAN APPROVAL #2	MAR.21.2023	OH
2	ISSUED FOR SITE PLAN APPROVAL #1	FEB.09.2021	OH
1	ISSUED FOR CLIENT REVIEW	FEB.04.2021	OH

SITE PLAN

PROPOSED MULTI-FAMILY RESIDENTIAL DEVELOPMENT
 1971 & 1975 ST. LAURENT BLVD.
 OTTAWA, ONTARIO
 FOR: STARLIGHT DEVELOPMENTS

PETROFF
 PETROFF PARTNERSHIP ARCHITECTS
 260 TOWN CENTRE BLVD. SUITE 300
 MARKHAM, ON L3R 9H8
 PH: 905-470-7000 www.petroff.com

CONVO ASSOCIATION
 CONVO ASSOCIATION OF ONTARIO
 1000 SHEPPARD AVENUE EAST
 SUITE 1000
 MARKHAM, ONTARIO L3R 9V7
 PH: 905-470-7000

DATE: 01	DESIGN: PETROFF	PROJECT NO: 21740
SCALE: 1:500	DATE: 01	DATE: 01
SCALE: 1:500	DATE: 01	DATE: 01

Figure 13: New Site Generation Auto Volumes

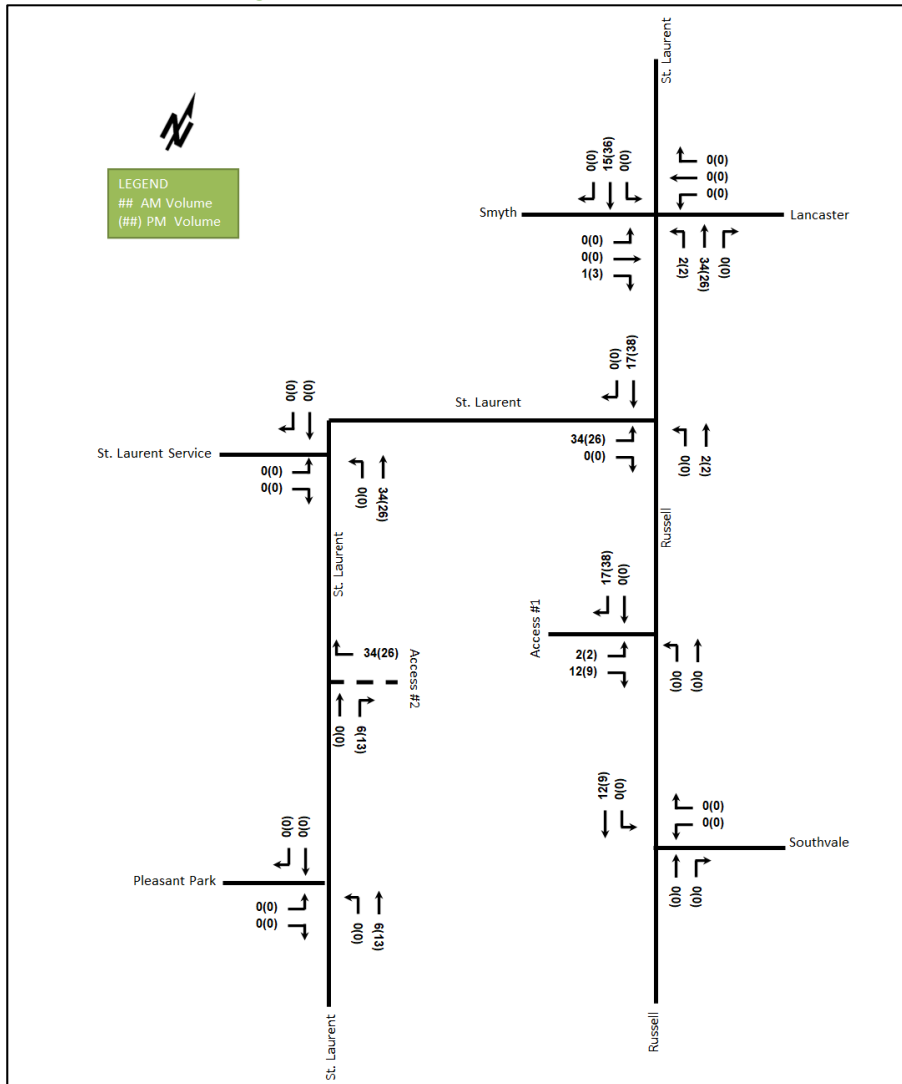

6 Background Network Travel Demands

6.1 Transportation Network Plans

The transportation network plans were discussed in Section 2.3. None of the proposed changes are considered to have any notable impact on the study area traffic volumes and travel patterns.

6.2 Background Growth

A review of the background projections from the City’s TRANS Regional Model for the 2011 and 2031 horizons was completed to determine the background growth for each of the study area roadways. The TRANS model plots and a summary of the results of the model interpolation are provided in Appendix E.

When comparing the existing volumes to 2031 horizons, the existing volumes northbound and southbound directions in the study area have exceeded the forecasted volumes. Resultantly, growth rates derived from the existing horizon to the 2031 model horizon rounded to the nearest 0.25% will be peak-directionally applied to the appropriate roadway’s mainline volumes and to the appropriate major turning movements at the intersections. Table 14 summarizes the growth rates applied within the study area.

Figure 7: AM and PM Peak Hour Site Generated Trips

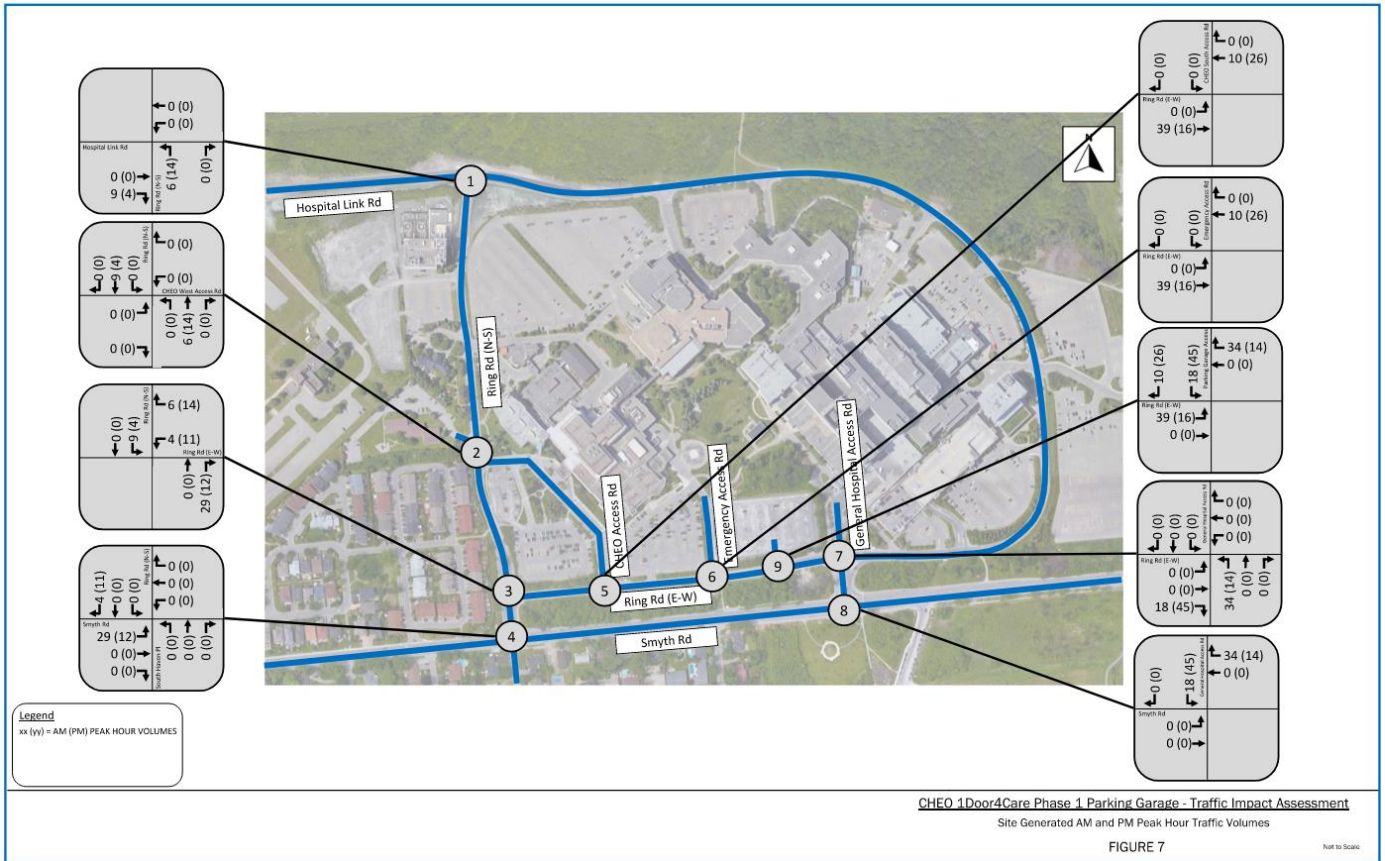

4. Analysis

4.1 Development Design

The proposed development and its transportation network elements were reviewed in order to ensure that a safe and efficient design has been proposed that will encourage walking, cycling, and transit use.

Pedestrian facilities will be provided between the proposed parking garage building entrance and the CHEO hospital facilities. A connection to the sidewalk along Ring Road (E-W) will be provided, as shown on the site plan. Sidewalks will be depressed and continuous across the study area road network, in accordance with City standards.

Bicycle parking will also be facilitated at the parking garage. It will be located at the south side of the garage and will be in accordance with the minimum requirement of the City’s Zoning By-Law. A copy of the proposed site plan is included in **Appendix E**.

OC Transpo’s service will not have its riders destined to the parking garage so the associated design features for transit do not come into play. However, if one feels they should be in play, the guidelines for peak period service to provide service within a five minute (400m) walk of the proposed development should be confirmed. Stops #1808, #7072, #1806, and #7234 are all located within 400m actual walking distance (measured using legal crosswalks) of the proposed development. As stated previously, the nearest bus stops to the subject site are described in **Section 2.1.2** and shown in **Figure 4**.

A review of the Transportation Demand Management (TDM) – Supportive Development Design and Infrastructure Checklist has been conducted. A copy of the TDM checklist is included in **Appendix F**. All required TDM-supportive design and infrastructure measures in the TDM checklist are met.

4.2 Parking

The parking garage itself does not generate a need for parking. It is the medical related buildings on campus that generate the parking needs. However, if one was to apply the by-law rates to identify parking requirements the following would come into play. The subject site is located in Area C on Schedule 1 and 1A of the City of Ottawa’s Zoning By-Law. Minimum vehicular and bicycle parking rates for the proposed uses are identified and are summarized in the following **Table 9**.

Table 9: Parking Requirement Per Zoning By-Law

Land Use	Rate	Units/GFA	Required
Minimum Vehicle Parking			
Hospital	0.7 per 100 m ² of gross floor area	33,500 m ²	234.5
Proposed Vehicle Parking			1,050 Total
Minimum Bicycle Parking			
Hospital	1 per 1000 m ² of gross floor area	33,500 m ²	33.5
Proposed Bicycle Parking			40 Total

The proposed development will include 1,050 parking spaces in a parking garage accessible via Ring Road (E-W), meeting the minimum Zoning By-law 2008-250 Consolidation parking requirements. As the proposed supply of on-site parking meets or exceeds the By-law requirement, no further review of vehicular parking is required.

As was the case for vehicle parking, bicycle parking would not apply for a parking garage. However, if bicycle parking was calculated for the garage the proposed development will include a total of 40 bicycle parking spaces, meeting the minimum Zoning By-law 2008-250 Consolidation parking requirements for all land uses in the Site Plan.

The TIA guidelines identify the need to review spillover parking when the parking supply is 15% below demand. As the 1,050 proposed parking spaces are exceeded the required demand, a review of spillover parking is not required for the TIA.

Figure 2: Proposed Site Plan



LOCATION PLAN

SITE INFO.	
SITE AREA	25283.0 sq. m.
EXISTING ZONING	AM10(2210)
GROSS FLOOR AREA (ZONING DEFINITION)	
2 EXISTING APARTMENTS (9 STOREY BUILDINGS)	~25,245.0 SQ.M.
EXISTING RESIDENTIAL UNITS	340

PROJECT INFO.	
NORTH BUILDING	
BUILDING HEIGHT	27 STOREY
GROSS FLOOR AREA (ZONING DEFINITION)	20111.5 SQ.M.
RESIDENTIAL UNITS	292
SOUTH BUILDING	
BUILDING HEIGHT	18 STOREY
GROSS FLOOR AREA (ZONING DEFINITION)	14911.7 SQ.M.
RESIDENTIAL UNITS	218
TOTAL RESIDENTIAL UNITS (PROPOSED)	498 (INCLUDING 199 TWO BEDROOM)
TOTAL GFA. (PROPOSED)	35023.2 SQ.M.
CAR PARKING (FOR EXISTING + PROPOSED)	
ZONING REQUIRED (0,6+0,1)	595
PROVIDED	715 (183 SURFACE +532 UNDERGROUND)
BICYCLE PARKING (FOR PROPOSED)	
ZONING REQUIRED (0,5)	255
PROVIDED	255
AMENITY SPACE (FOR PROPOSED)	
ZONING REQUIRED (6 SQ.M./PER UNITS)	3060 SQ.M.
MIN. COMMUNAL	1530 SQ.M.
PROVIDED COMMUNAL	2605 SQ.M. (890 INDOOR +1715 ROOFDECK)
LANDSCAPE AREA (INCLUDING 10% PARKLAND)	~ 40%
TOTAL RESIDENTIAL UNITS (EXISTING + PROPOSED)	838
TOTAL GFA. (EXISTING + PROPOSED)	60268.2 SQ.M.
FSI (EXISTING + PROPOSED)	~ 2.4

SITE PLAN

Figure 10: 'New' Site-Generated Traffic

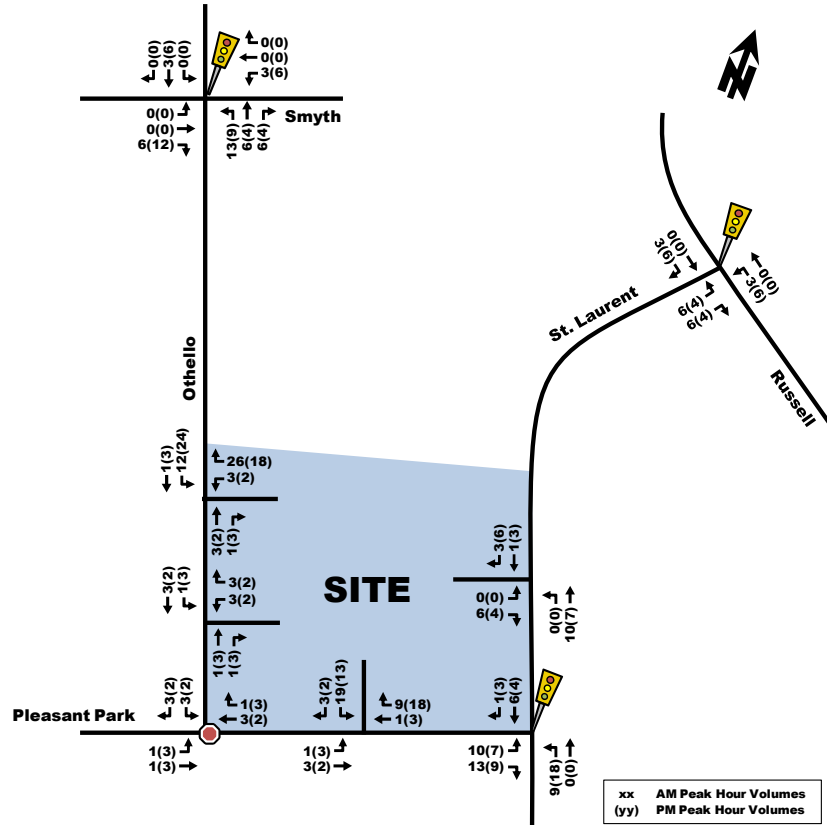
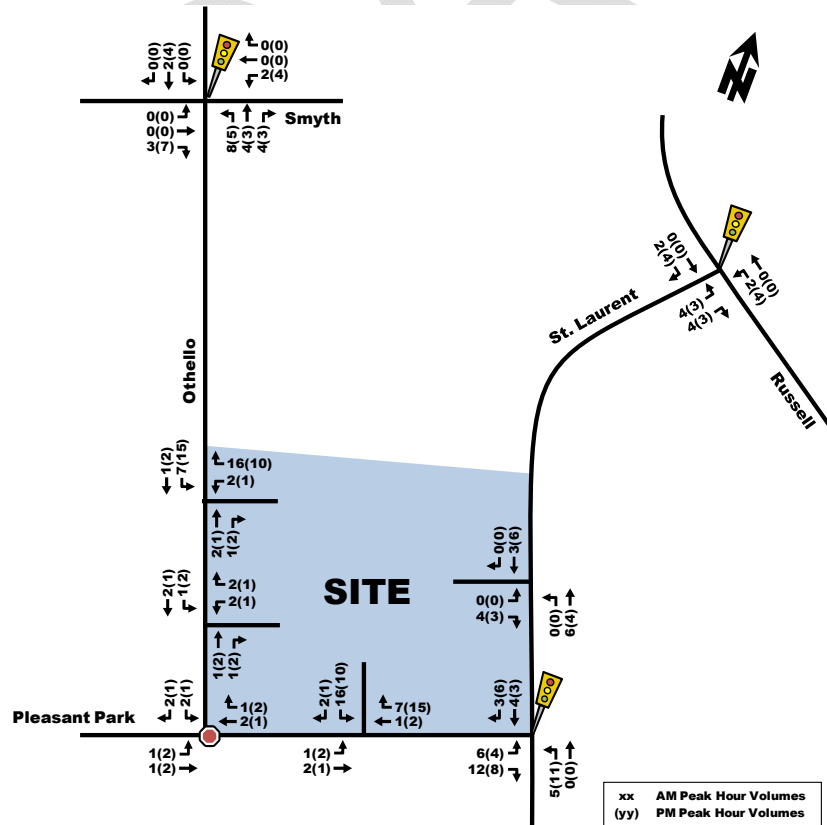

Figure 11: 'Existing' Site-Generated Traffic



3.1.3. Trip Assignment

Site-generated trips were then assigned to the road network based on the proportions developed in **Section 3.1.2**. The AM and PM peak hour site-generated traffic volumes are presented in **Figure 8**.

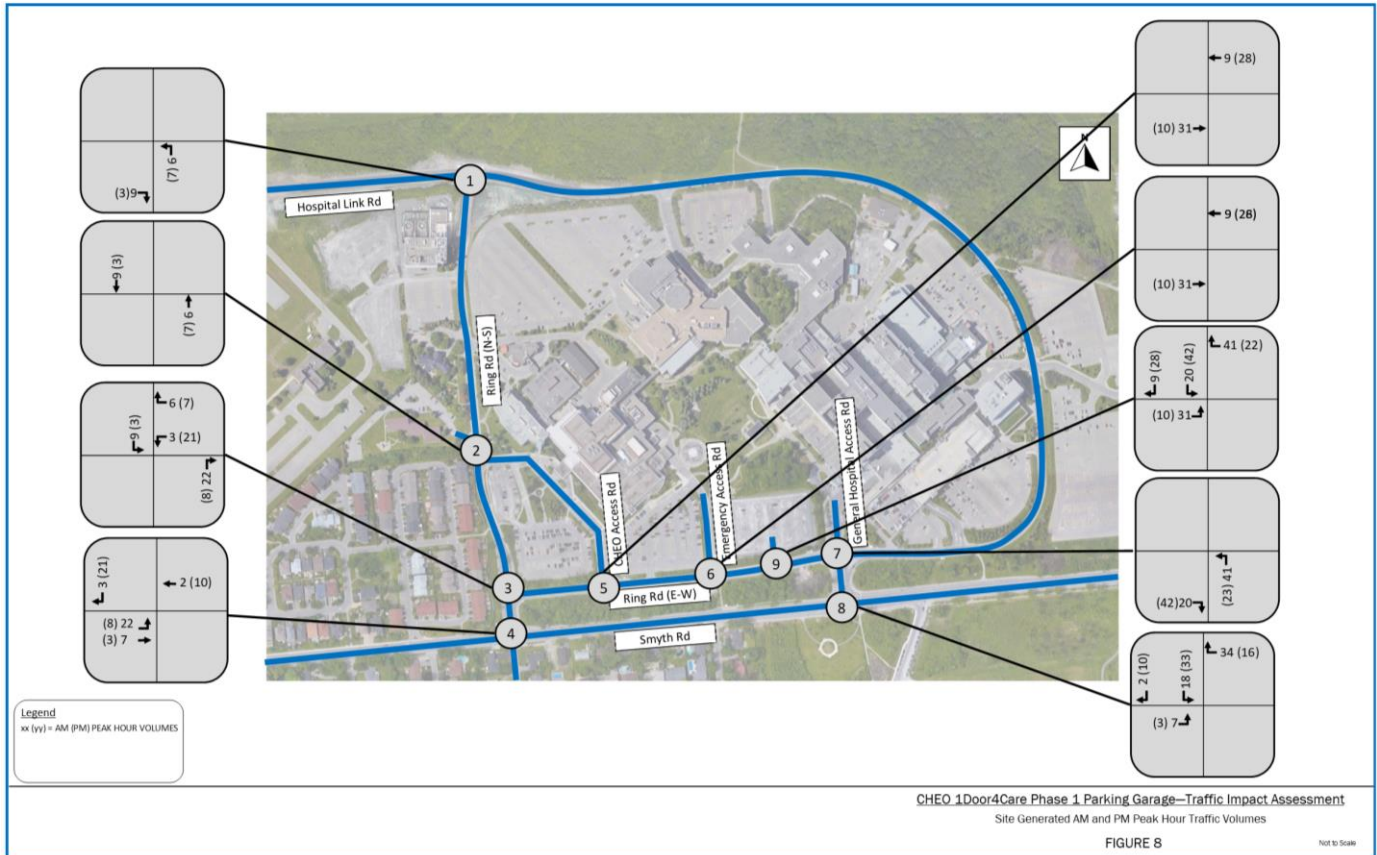

Figure 8: AM and PM Peak Hour Site Generated Trips

4.2 Parking

The parking garage itself does not generate a need for parking. It is the medical related buildings on campus that generate the parking needs. However, if one was to apply the by-law rates to identify parking requirements the following would come into play. The subject site is located in Area C on Schedule 1 and 1A of the City of Ottawa’s Zoning By-Law. Minimum vehicular and bicycle parking rates for the proposed uses are identified and are summarized in the following **Table 10**.

Table 10: Parking Requirement Per Zoning By-Law

Land Use	Rate	Units/GFA	Required
Minimum Vehicle Parking			
Hospital	0.7 per 100 m ² of gross floor area	33,500 m ²	234.5
Proposed Vehicle Parking			1,050 Total
Minimum Bicycle Parking			
Hospital	1 per 1,000 m ² of gross floor area	33,500 m ²	33.5
Proposed Bicycle Parking			40 Total

The proposed development will include 1,083 parking spaces in a parking garage accessible via Ring Road (E-W), meeting the minimum Zoning By-law 2008-250 Consolidation parking requirements. As the proposed supply of on-site parking meets or exceeds the By-law requirement, no further review of vehicular parking is required.

As was the case for vehicle parking, bicycle parking would not apply for a parking garage. However, if bicycle parking was calculated for the garage the proposed development will include a total of 40 bicycle parking spaces, meeting the minimum Zoning By-law 2008-250 Consolidation parking requirements for all land uses in the Site Plan.

The TIA guidelines identify the need to review spillover parking when the parking supply is 15% below demand. As the 1,083 proposed parking spaces exceeded the required demand, a review of spillover parking is not required for the TIA.

APPENDIX H

Signal Timing Plans

Traffic Signal Timing

City of Ottawa, Public Works Department

Traffic Signal Operations Unit

Intersection:	<i>Main:</i> Smyth	<i>Side:</i> South Haven/Ring
Controller:	<u>ATC 3</u>	TSD: 5545
Author:	<u>Ricardo Bettencourt-Da Silva</u>	Date: <u>09-Jan-2024</u>

Existing Timing Plans†

	Plan				Ped Minimum Time		
	AM Peak 1	Off Peak 2	PM Peak 3	Night 4	Walk	DW	A+R
Cycle	115	105	115	65			
Offset	66	41	62	X			
EB Thru	84	74	78	36	7	19	3.3+2.4
WB Thru	42	49	62	36	7	19	3.3+2.4
NB Thru	31	31	37	29	7	16	3.3+2.2
SB Thru	31	31	37	29	7	16	3.3+2.2
EB Left	42	25	16	-	-	-	3.3+2.3

Plan: 1,2,3

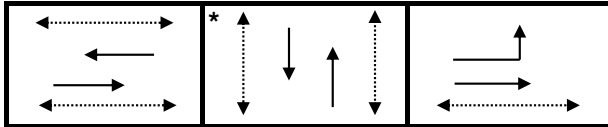

Plan: 4

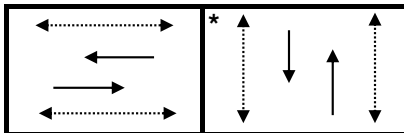

Notes: 1) The NB & SB thru movements are prohibited with bicycles excepted.

Schedule

Weekday

Time	Plan
0:15	4
6:15	1
9:30	2
15:00	3
18:30	2
22:30	4

Weekend

Time	Plan
0:15	4
8:00	2
22:30	4

Notes

†: Time for each direction includes amber and all red intervals
‡: Start of first phase should be used as reference point for offset
Asterisk (*) Indicates actuated phase

Traffic Signal Timing

City of Ottawa, Public Works Department

Traffic Signal Operations Unit

Intersection:	<i>Main:</i> Smyth	<i>Side:</i> General Hospital
Controller:	ATC 3	TSD: 5585
Author:	Ricardo Bettencourt-Da Silva	Date: 09-Jan-2024

Existing Timing Plans[†]

	Plan				Ped Minimum Time		
	AM Peak 1	Off Peak 2	PM Peak 3	Night 4	Walk	DW	A+R
Cycle	115	105	115	85			
Offset	43	35	59	X			
EB Thru	70	56	55	42	-	-	3.3+3.1
WB Thru	42	42	43	42	7	28	3.3+3.1
East Ped	32	32	32	32	7	21	3.0+1.0
SB Thru	45	49	60	32	7	17	3.3+2.2
SB Left (fp)	13	17	28	11	-	-	3.3+2.6
WB Right	13	17	28	11	-	-	3.3+2.6
EB Left	28	14	12	-	-	-	3.3+2.4
SB Right	28	14	12	-	-	-	3.3+2.4

Phasing Sequence[‡]

Plan: 1,2,3

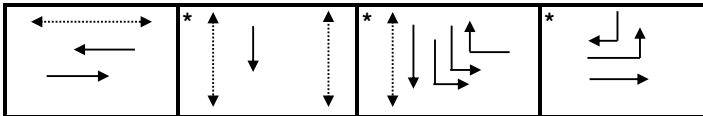

Plan: 4

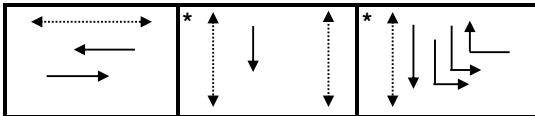

Schedule

Weekday

Time	Plan
0:15	4
6:15	1
9:30	2
15:00	3
18:30	2
22:30	4

Weekend

Time	Plan
0:15	4
8:00	2
22:30	4

Notes

[†]: Time for each direction includes amber and all red intervals

[‡]: Start of first phase should be used as reference point for offset

Asterisk (*) Indicates actuated phase

(fp): Fully Protected Left Turn

◄.....► Pedestrian signal

Cost is \$62.38 (\$55.20 + HST)

APPENDIX I

Detailed Analysis Reports



Lane Group	EBL	EBT	EBR	WBL	WBT	WBR	NBL	NBT	NBR	SBL	SBT	SBR
Lane Configurations		↕↕			↕↕			↕		↕		↕
Traffic Volume (vph)	364	764	2	1	556	103	6	1	0	30	0	120
Future Volume (vph)	364	764	2	1	556	103	6	1	0	30	0	120
Ideal Flow (vphpl)	1800	1800	1800	1800	1800	1800	1800	1800	1800	1800	1800	1800
Lane Util. Factor	0.95	0.95	0.95	0.95	0.95	0.95	1.00	1.00	1.00	1.00	1.00	1.00
Ped Bike Factor		1.00			0.99			1.00		0.99		0.98
Frt					0.977							0.850
Flt Protected		0.984						0.958		0.950		
Satd. Flow (prot)	0	3446	0	0	3361	0	0	1766	0	1717	0	1493
Flt Permitted		0.516			0.954			0.958		0.752		
Satd. Flow (perm)	0	1803	0	0	3206	0	0	1761	0	1345	0	1468
Right Turn on Red			Yes			Yes			Yes			Yes
Satd. Flow (RTOR)					19							133
Link Speed (k/h)		50			50			40				40
Link Distance (m)		218.8			394.7			154.1				51.9
Travel Time (s)		15.8			28.4			13.9				4.7
Confl. Peds. (#/hr)	15		3	3		15	2		7	7		2
Confl. Bikes (#/hr)			3						1			2
Peak Hour Factor	0.90	0.90	0.90	0.90	0.90	0.90	0.90	0.90	0.90	0.90	0.90	0.90
Heavy Vehicles (%)	2%	2%	2%	2%	3%	3%	2%	2%	2%	4%	2%	7%
Adj. Flow (vph)	404	849	2	1	618	114	7	1	0	33	0	133
Shared Lane Traffic (%)												
Lane Group Flow (vph)	0	1255	0	0	733	0	0	8	0	33	0	133
Enter Blocked Intersection	No	No	No	No	No	No	No	No	No	No	No	No
Lane Alignment	Left	Left	Right	Left	Left	Right	L NA	Left	R NA	L NA	Left	R NA
Median Width(m)		0.0			4.0			0.0				5.0
Link Offset(m)		0.0			0.0			0.0				0.0
Crosswalk Width(m)		5.0			5.0			5.0				5.0
Two way Left Turn Lane												
Headway Factor	1.01	1.01	1.01	1.01	1.01	1.01	1.01	1.01	1.01	1.01	1.01	1.01
Turning Speed (k/h)	24		14	24		14	24		14	24		14
Number of Detectors	1	2		1	2		1	2		1		1
Detector Template	Left	Thru		Left	Thru		Left	Thru		Left		Right
Leading Detector (m)	2.0	10.0		2.0	10.0		2.0	10.0		2.0		2.0
Trailing Detector (m)	0.0	0.0		0.0	0.0		0.0	0.0		0.0		0.0
Detector 1 Position(m)	0.0	0.0		0.0	0.0		0.0	0.0		0.0		0.0
Detector 1 Size(m)	2.0	0.6		2.0	0.6		2.0	0.6		2.0		2.0
Detector 1 Type	Cl+Ex	Cl+Ex		Cl+Ex	Cl+Ex		Cl+Ex	Cl+Ex		Cl+Ex		Cl+Ex
Detector 1 Channel												
Detector 1 Extend (s)	0.0	0.0		0.0	0.0		0.0	0.0		0.0		0.0
Detector 1 Queue (s)	0.0	0.0		0.0	0.0		0.0	0.0		0.0		0.0
Detector 1 Delay (s)	0.0	0.0		0.0	0.0		0.0	0.0		0.0		0.0
Detector 2 Position(m)		9.4			9.4			9.4				
Detector 2 Size(m)		0.6			0.6			0.6				
Detector 2 Type		Cl+Ex			Cl+Ex			Cl+Ex				
Detector 2 Channel												
Detector 2 Extend (s)		0.0			0.0			0.0				
Turn Type	pm+pt	NA		Perm	NA		Perm	NA		Perm		Perm
Protected Phases	5	2			6			8				



Lane Group	EBL	EBT	EBR	WBL	WBT	WBR	NBL	NBT	NBR	SBL	SBT	SBR
Permitted Phases	2			6			8			4		4
Detector Phase	5	2		6	6		8	8		4		4
Switch Phase												
Minimum Initial (s)	5.0	10.0		10.0	10.0		10.0	10.0		10.0		10.0
Minimum Split (s)	10.6	31.7		31.7	31.7		28.5	28.5		28.5		28.5
Total Split (s)	42.0	84.0		42.0	42.0		31.0	31.0		31.0		31.0
Total Split (%)	36.5%	73.0%		36.5%	36.5%		27.0%	27.0%		27.0%		27.0%
Maximum Green (s)	36.4	78.3		36.3	36.3		25.5	25.5		25.5		25.5
Yellow Time (s)	3.3	3.3		3.3	3.3		3.3	3.3		3.3		3.3
All-Red Time (s)	2.3	2.4		2.4	2.4		2.2	2.2		2.2		2.2
Lost Time Adjust (s)		0.0			0.0			0.0		0.0		0.0
Total Lost Time (s)		5.7			5.7			5.5		5.5		5.5
Lead/Lag	Lead			Lag			Lag			Lag		
Lead-Lag Optimize?												
Vehicle Extension (s)	3.0	3.0		3.0	3.0		3.0	3.0		3.0		3.0
Recall Mode	Max	C-Max		C-Max	C-Max		None	None		None		None
Walk Time (s)		7.0		7.0	7.0		7.0	7.0		7.0		7.0
Flash Dont Walk (s)		19.0		19.0	19.0		16.0	16.0		16.0		16.0
Pedestrian Calls (#/hr)		0		0	0		0	0		0		0
Act Effct Green (s)		93.3			36.3			10.5		10.5		10.5
Actuated g/C Ratio		0.81			0.32			0.09		0.09		0.09
v/c Ratio		0.57			0.72			0.05		0.27		0.52
Control Delay		4.4			32.9			47.9		54.3		16.0
Queue Delay		0.0			0.0			0.0		0.0		0.0
Total Delay		4.4			32.9			47.9		54.3		16.0
LOS		A			C			D		D		B
Approach Delay		4.4			32.9			47.9				23.6
Approach LOS		A			C			D				C

Intersection Summary

Area Type: Other
 Cycle Length: 115
 Actuated Cycle Length: 115
 Offset: 66 (57%), Referenced to phase 2:EBTL and 6:WBTL, Start of Green
 Natural Cycle: 90
 Control Type: Actuated-Coordinated
 Maximum v/c Ratio: 0.72
 Intersection Signal Delay: 15.7
 Intersection LOS: B
 Intersection Capacity Utilization 79.9%
 ICU Level of Service D
 Analysis Period (min) 15

Splits and Phases: 4: South Haven/Ring (N-S) & Smyth

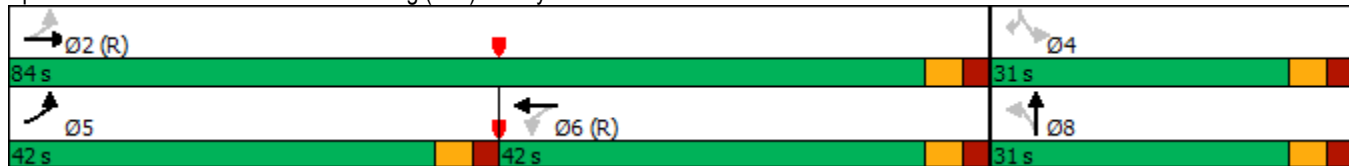



Lane Group	EBL	EBT	WBT	WBR	SBL	SBR	Ø4	Ø7
Lane Configurations	↗	↑↑	↑↑	↖	↖↗	↖		
Traffic Volume (vph)	368	415	667	418	113	174		
Future Volume (vph)	368	415	667	418	113	174		
Ideal Flow (vphpl)	1800	1800	1800	1800	1800	1800		
Storage Length (m)	55.0			175.0	0.0	0.0		
Storage Lanes	1			1	2	1		
Taper Length (m)	40.0				10.0			
Lane Util. Factor	1.00	0.95	0.95	1.00	0.97	1.00		
Ped Bike Factor	1.00			0.97	0.59	0.97		
Fr _t				0.850		0.850		
Fl _t Protected	0.950				0.950			
Satd. Flow (prot)	1751	3502	3468	1567	3364	1567		
Fl _t Permitted	0.308				0.950			
Satd. Flow (perm)	567	3502	3468	1523	1975	1519		
Right Turn on Red				Yes		Yes		
Satd. Flow (RTOR)				464		42		
Link Speed (k/h)		50	50		40			
Link Distance (m)		394.7	397.7		58.6			
Travel Time (s)		28.4	28.6		5.3			
Confl. Peds. (#/hr)	3			3	51	13		
Confl. Bikes (#/hr)				3				
Peak Hour Factor	0.90	0.90	0.90	0.90	0.90	0.90		
Heavy Vehicles (%)	2%	2%	3%	2%	3%	2%		
Adj. Flow (vph)	409	461	741	464	126	193		
Shared Lane Traffic (%)								
Lane Group Flow (vph)	409	461	741	464	126	193		
Enter Blocked Intersection	No	No	No	No	No	No		
Lane Alignment	Left	Left	Left	Right	Left	R NA		
Median Width(m)		4.0	4.0		8.0			
Link Offset(m)		0.0	0.0		0.0			
Crosswalk Width(m)		5.0	5.0		5.0			
Two way Left Turn Lane								
Headway Factor	1.01	1.01	1.01	1.01	1.01	1.01		
Turning Speed (k/h)	24			14	24	14		
Number of Detectors	1	2	2	1	1	1		
Detector Template	Left	Thru	Thru	Right	Left	Right		
Leading Detector (m)	2.0	10.0	10.0	2.0	2.0	2.0		
Trailing Detector (m)	0.0	0.0	0.0	0.0	0.0	0.0		
Detector 1 Position(m)	0.0	0.0	0.0	0.0	0.0	0.0		
Detector 1 Size(m)	2.0	0.6	0.6	2.0	2.0	2.0		
Detector 1 Type	Cl+Ex	Cl+Ex	Cl+Ex	Cl+Ex	Cl+Ex	Cl+Ex		
Detector 1 Channel								
Detector 1 Extend (s)	0.0	0.0	0.0	0.0	0.0	0.0		
Detector 1 Queue (s)	0.0	0.0	0.0	0.0	0.0	0.0		
Detector 1 Delay (s)	0.0	0.0	0.0	0.0	0.0	0.0		
Detector 2 Position(m)		9.4	9.4					
Detector 2 Size(m)		0.6	0.6					
Detector 2 Type		Cl+Ex	Cl+Ex					
Detector 2 Channel								

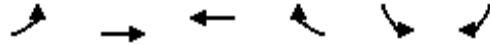

Lane Group	EBL	EBT	WBT	WBR	SBL	SBR	Ø4	Ø7
Detector 2 Extend (s)		0.0	0.0					
Turn Type	pm+pt	NA	NA	pm+ov	Prot	pm+ov		
Protected Phases	5	2	6	3	3	5	4	7
Permitted Phases	2			6		7		
Detector Phase	5	2	6	3	3	5		
Switch Phase								
Minimum Initial (s)	5.0	10.0	10.0	5.0	5.0	5.0	5.0	5.0
Minimum Split (s)	10.7	16.4	41.4	10.9	10.9	10.7	32.0	29.9
Total Split (s)	28.0	70.0	42.0	13.0	13.0	28.0	32.0	45.0
Total Split (%)	24.3%	60.9%	36.5%	11.3%	11.3%	24.3%	28%	39%
Maximum Green (s)	22.3	63.6	35.6	7.1	7.1	22.3	28.0	39.1
Yellow Time (s)	3.3	3.3	3.3	3.3	3.3	3.3	3.0	3.3
All-Red Time (s)	2.4	3.1	3.1	2.6	2.6	2.4	1.0	2.6
Lost Time Adjust (s)	0.0	0.0	0.0	0.0	0.0	0.0		
Total Lost Time (s)	5.7	6.4	6.4	5.9	5.9	5.7		
Lead/Lag	Lead		Lag	Lag	Lag	Lead	Lead	
Lead-Lag Optimize?								
Vehicle Extension (s)	3.0	3.0	3.0	3.0	3.0	3.0	3.0	3.0
Recall Mode	None	C-Max	C-Max	None	None	None	None	None
Walk Time (s)			7.0				7.0	7.0
Flash Dont Walk (s)			28.0				21.0	17.0
Pedestrian Calls (#/hr)			0				0	0
Act Effct Green (s)	93.6	92.9	67.8	78.1	9.8	29.4		
Actuated g/C Ratio	0.81	0.81	0.59	0.68	0.09	0.26		
v/c Ratio	0.62	0.16	0.36	0.39	0.44	0.45		
Control Delay	12.6	2.6	14.4	1.7	54.3	26.1		
Queue Delay	0.0	0.0	0.0	0.0	0.0	0.0		
Total Delay	12.6	2.6	14.4	1.7	54.3	26.1		
LOS	B	A	B	A	D	C		
Approach Delay		7.3	9.5		37.2			
Approach LOS		A	A		D			

Intersection Summary

Area Type:	Other
Cycle Length:	115
Actuated Cycle Length:	115
Offset:	43 (37%), Referenced to phase 2:EBTL and 6:WBT, Start of Green
Natural Cycle:	105
Control Type:	Actuated-Coordinated
Maximum v/c Ratio:	0.62
Intersection Signal Delay:	12.4
Intersection LOS:	B
Intersection Capacity Utilization:	69.9%
ICU Level of Service:	C
Analysis Period (min):	15

Splits and Phases: 8: Smyth & General Hospital

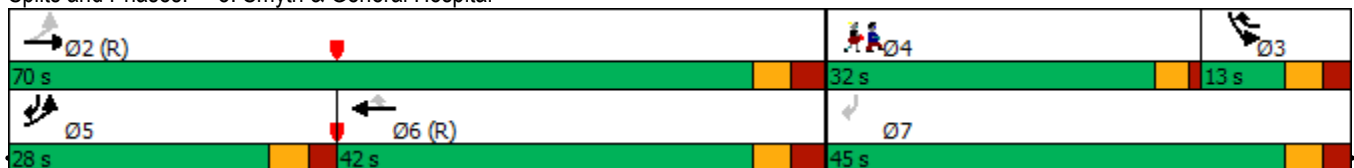



Movement	EBT	EBR	WBL	WBT	NBL	NBR
Lane Configurations						
Sign Control	Stop			Stop	Stop	
Traffic Volume (vph)	273	147	29	74	54	73
Future Volume (vph)	273	147	29	74	54	73
Peak Hour Factor	0.90	0.90	0.90	0.90	0.90	0.90
Hourly flow rate (vph)	303	163	32	82	60	81

Direction, Lane #	EB 1	WB 1	NB 1
Volume Total (vph)	466	114	141
Volume Left (vph)	0	32	60
Volume Right (vph)	163	0	81
Hadj (s)	-0.13	0.12	-0.12
Departure Headway (s)	4.3	4.9	5.1
Degree Utilization, x	0.56	0.16	0.20
Capacity (veh/h)	812	692	635
Control Delay (s)	12.5	8.8	9.3
Approach Delay (s)	12.5	8.8	9.3
Approach LOS	B	A	A

Intersection Summary		
Delay		11.3
Level of Service		B
Intersection Capacity Utilization	46.2%	ICU Level of Service
Analysis Period (min)		15

2024Ex AM
 2: Ring (N-S) & CHEO Non-Emergency

04/19/2024



Movement	EBL	EBT	EBR	WBL	WBT	WBR	NBL	NBT	NBR	SBL	SBT	SBR
Lane Configurations		↕			↕			↕			↕	
Sign Control		Stop			Stop			Stop			Stop	
Traffic Volume (vph)	3	0	7	83	2	37	4	322	49	30	65	2
Future Volume (vph)	3	0	7	83	2	37	4	322	49	30	65	2
Peak Hour Factor	0.90	0.90	0.90	0.90	0.90	0.90	0.90	0.90	0.90	0.90	0.90	0.90
Hourly flow rate (vph)	3	0	8	92	2	41	4	358	54	33	72	2

Direction, Lane #	EB 1	WB 1	NB 1	SB 1
Volume Total (vph)	11	135	416	107
Volume Left (vph)	3	92	4	33
Volume Right (vph)	8	41	54	2
Hadj (s)	-0.35	0.11	0.00	0.12
Departure Headway (s)	5.0	5.2	4.4	4.9
Degree Utilization, x	0.02	0.20	0.51	0.15
Capacity (veh/h)	628	625	790	694
Control Delay (s)	8.1	9.5	12.0	8.7
Approach Delay (s)	8.1	9.5	12.0	8.7
Approach LOS	A	A	B	A

Intersection Summary			
Delay		10.9	
Level of Service		B	
Intersection Capacity Utilization	47.2%		ICU Level of Service A
Analysis Period (min)		15	



Movement	WBL	WBR	NBT	NBR	SBL	SBT
Lane Configurations						
Traffic Volume (veh/h)	27	50	321	132	32	125
Future Volume (Veh/h)	27	50	321	132	32	125
Sign Control	Stop		Free		Free	
Grade	0%		0%		0%	
Peak Hour Factor	0.90	0.90	0.90	0.90	0.90	0.90
Hourly flow rate (vph)	30	56	357	147	36	139
Pedestrians	8					
Lane Width (m)	4.0					
Walking Speed (m/s)	1.0					
Percent Blockage	1					
Right turn flare (veh)						
Median type	None			None		
Median storage veh						
Upstream signal (m)	52					
pX, platoon unblocked						
vC, conflicting volume	650	438			512	
vC1, stage 1 conf vol						
vC2, stage 2 conf vol						
vCu, unblocked vol	650	438			512	
tC, single (s)	6.4	6.3			4.2	
tC, 2 stage (s)						
tF (s)	3.5	3.4			2.3	
p0 queue free %	93	91			96	
cM capacity (veh/h)	415	605			1019	
Direction, Lane #	WB 1	NB 1	SB 1			
Volume Total	86	504	175			
Volume Left	30	0	36			
Volume Right	56	147	0			
cSH	521	1700	1019			
Volume to Capacity	0.16	0.30	0.04			
Queue Length 95th (m)	4.1	0.0	0.8			
Control Delay (s)	13.3	0.0	2.0			
Lane LOS	B		A			
Approach Delay (s)	13.3	0.0	2.0			
Approach LOS	B					
Intersection Summary						
Average Delay			2.0			
Intersection Capacity Utilization			47.6%	ICU Level of Service		A
Analysis Period (min)			15			

2024Ex AM
5: Ring (E-W) & CHEO Non-Emergency

04/19/2024



Movement	EBL	EBT	WBT	WBR	SBL	SBR
Lane Configurations						
Traffic Volume (veh/h)	35	142	69	49	17	4
Future Volume (Veh/h)	35	142	69	49	17	4
Sign Control		Free	Free		Stop	
Grade		0%	0%		0%	
Peak Hour Factor	0.90	0.90	0.90	0.90	0.90	0.90
Hourly flow rate (vph)	39	158	77	54	19	4
Pedestrians			17		2	
Lane Width (m)			4.0		4.0	
Walking Speed (m/s)			1.0		1.0	
Percent Blockage			2		0	
Right turn flare (veh)						
Median type		None	None			
Median storage (veh)						
Upstream signal (m)						
pX, platoon unblocked						
vC, conflicting volume	133				359	106
vC1, stage 1 conf vol						
vC2, stage 2 conf vol						
vCu, unblocked vol	133				359	106
tC, single (s)	4.1				6.6	6.2
tC, 2 stage (s)						
tF (s)	2.2				3.7	3.3
p0 queue free %	97				97	100
cM capacity (veh/h)	1449				575	946
Direction, Lane #	EB 1	WB 1	SB 1			
Volume Total	197	131	23			
Volume Left	39	0	19			
Volume Right	0	54	4			
cSH	1449	1700	617			
Volume to Capacity	0.03	0.08	0.04			
Queue Length 95th (m)	0.6	0.0	0.8			
Control Delay (s)	1.7	0.0	11.1			
Lane LOS	A		B			
Approach Delay (s)	1.7	0.0	11.1			
Approach LOS			B			
Intersection Summary						
Average Delay			1.7			
Intersection Capacity Utilization		26.6%		ICU Level of Service		A
Analysis Period (min)			15			

2024Ex AM
6: Ring (E-W) & CHEO Emergency

04/19/2024



Movement	EBL	EBT	WBT	WBR	SBL	SBR
Lane Configurations		↕	↔		↙	↘
Traffic Volume (veh/h)	132	76	96	50	20	21
Future Volume (Veh/h)	132	76	96	50	20	21
Sign Control		Free	Free		Stop	
Grade		0%	0%		0%	
Peak Hour Factor	0.90	0.90	0.90	0.90	0.90	0.90
Hourly flow rate (vph)	147	84	107	56	22	23
Pedestrians		2	28		7	
Lane Width (m)		4.0	4.0		4.0	
Walking Speed (m/s)		1.0	1.0		1.0	
Percent Blockage		0	3		1	
Right turn flare (veh)						
Median type		None	None			
Median storage veh						
Upstream signal (m)						
pX, platoon unblocked						
vC, conflicting volume	170				548	144
vC1, stage 1 conf vol						
vC2, stage 2 conf vol						
vCu, unblocked vol	170				548	144
tC, single (s)	4.2				6.5	6.3
tC, 2 stage (s)						
tF (s)	2.3				3.6	3.4
p0 queue free %	89				95	97
cM capacity (veh/h)	1344				419	879
Direction, Lane #	EB 1	WB 1	SB 1			
Volume Total	231	163	45			
Volume Left	147	0	22			
Volume Right	0	56	23			
cSH	1344	1700	572			
Volume to Capacity	0.11	0.10	0.08			
Queue Length 95th (m)	2.6	0.0	1.8			
Control Delay (s)	5.4	0.0	11.8			
Lane LOS	A		B			
Approach Delay (s)	5.4	0.0	11.8			
Approach LOS			B			
Intersection Summary						
Average Delay			4.1			
Intersection Capacity Utilization		35.7%		ICU Level of Service		A
Analysis Period (min)			15			



Movement	EBL	EBT	EBR	WBL	WBT	WBR	NBL	NBT	NBR	SBL	SBT	SBR
Lane Configurations		↕		↖	↕			↗	↗		↕	
Traffic Volume (veh/h)	19	22	19	158	25	19	92	134	461	12	137	15
Future Volume (Veh/h)	19	22	19	158	25	19	92	134	461	12	137	15
Sign Control		Stop			Stop			Free			Free	
Grade		0%			0%			0%			0%	
Peak Hour Factor	0.90	0.90	0.90	0.90	0.90	0.90	0.90	0.90	0.90	0.90	0.90	0.90
Hourly flow rate (vph)	21	24	21	176	28	21	102	149	512	13	152	17
Pedestrians		27			65							4
Lane Width (m)		4.0			4.0						4.0	
Walking Speed (m/s)		1.0			1.0						1.0	
Percent Blockage		3			7						0	
Right turn flare (veh)												
Median type								None			None	
Median storage veh												
Upstream signal (m)								59				
pX, platoon unblocked												
vC, conflicting volume	606	632	188	638	640	218	196			214		
vC1, stage 1 conf vol												
vC2, stage 2 conf vol												
vCu, unblocked vol	606	632	188	638	640	218	196			214		
tC, single (s)	7.2	6.5	6.3	7.1	6.7	6.2	4.2			4.1		
tC, 2 stage (s)												
tF (s)	3.6	4.0	3.4	3.5	4.2	3.3	2.3			2.2		
p0 queue free %	93	93	97	39	91	97	92			99		
cM capacity (veh/h)	300	326	802	287	303	759	1307			1258		
Direction, Lane #	EB 1	WB 1	WB 2	NB 1	NB 2	SB 1						
Volume Total	66	117	108	251	512	182						
Volume Left	21	117	59	102	0	13						
Volume Right	21	0	21	0	512	17						
cSH	389	287	332	1307	1700	1258						
Volume to Capacity	0.17	0.41	0.32	0.08	0.30	0.01						
Queue Length 95th (m)	4.2	13.3	9.6	1.8	0.0	0.2						
Control Delay (s)	16.2	25.9	21.0	3.7	0.0	0.6						
Lane LOS	C	D	C	A		A						
Approach Delay (s)	16.2	23.6		1.2		0.6						
Approach LOS	C	C										
Intersection Summary												
Average Delay			6.0									
Intersection Capacity Utilization			60.2%		ICU Level of Service				B			
Analysis Period (min)			15									



Lane Group	EBL	EBT	EBR	WBL	WBT	WBR	NBL	NBT	NBR	SBL	SBT	SBR
Lane Configurations		↕↕			↕↕			↕		↕		↕
Traffic Volume (vph)	91	523	4	4	879	11	5	0	4	139	0	327
Future Volume (vph)	91	523	4	4	879	11	5	0	4	139	0	327
Ideal Flow (vphpl)	1800	1800	1800	1800	1800	1800	1800	1800	1800	1800	1800	1800
Lane Util. Factor	0.95	0.95	0.95	0.95	0.95	0.95	1.00	1.00	1.00	1.00	1.00	1.00
Ped Bike Factor		1.00			1.00			0.99		0.99		0.97
Frt		0.999			0.998			0.946				0.850
Flt Protected		0.993						0.971		0.950		
Satd. Flow (prot)	0	3435	0	0	3493	0	0	1679	0	1751	0	1567
Flt Permitted		0.607			0.953			0.971		0.751		
Satd. Flow (perm)	0	2098	0	0	3328	0	0	1674	0	1372	0	1523
Right Turn on Red			Yes			Yes			Yes			Yes
Satd. Flow (RTOR)		1			1			79				229
Link Speed (k/h)		50			50			40				40
Link Distance (m)		218.8			394.7			154.1				51.9
Travel Time (s)		15.8			28.4			13.9				4.7
Confl. Peds. (#/hr)	15		8	8		15	3		6	6		3
Confl. Bikes (#/hr)			2			1						14
Peak Hour Factor	0.90	0.90	0.90	0.90	0.90	0.90	0.90	0.90	0.90	0.90	0.90	0.90
Heavy Vehicles (%)	4%	3%	2%	2%	2%	2%	2%	2%	2%	2%	2%	2%
Adj. Flow (vph)	101	581	4	4	977	12	6	0	4	154	0	363
Shared Lane Traffic (%)												
Lane Group Flow (vph)	0	686	0	0	993	0	0	10	0	154	0	363
Enter Blocked Intersection	No	No	No	No	No	No	No	No	No	No	No	No
Lane Alignment	Left	Left	Right	Left	Left	Right	L NA	Left	R NA	L NA	Left	R NA
Median Width(m)		0.0			4.0			0.0				5.0
Link Offset(m)		0.0			0.0			0.0				0.0
Crosswalk Width(m)		5.0			5.0			5.0				5.0
Two way Left Turn Lane												
Headway Factor	1.01	1.01	1.01	1.01	1.01	1.01	1.01	1.01	1.01	1.01	1.01	1.01
Turning Speed (k/h)	24		14	24		14	24		14	24		14
Number of Detectors	1	2		1	2		1	2		1		1
Detector Template	Left	Thru		Left	Thru		Left	Thru		Left		Right
Leading Detector (m)	2.0	10.0		2.0	10.0		2.0	10.0		2.0		2.0
Trailing Detector (m)	0.0	0.0		0.0	0.0		0.0	0.0		0.0		0.0
Detector 1 Position(m)	0.0	0.0		0.0	0.0		0.0	0.0		0.0		0.0
Detector 1 Size(m)	2.0	0.6		2.0	0.6		2.0	0.6		2.0		2.0
Detector 1 Type	Cl+Ex	Cl+Ex		Cl+Ex	Cl+Ex		Cl+Ex	Cl+Ex		Cl+Ex		Cl+Ex
Detector 1 Channel												
Detector 1 Extend (s)	0.0	0.0		0.0	0.0		0.0	0.0		0.0		0.0
Detector 1 Queue (s)	0.0	0.0		0.0	0.0		0.0	0.0		0.0		0.0
Detector 1 Delay (s)	0.0	0.0		0.0	0.0		0.0	0.0		0.0		0.0
Detector 2 Position(m)		9.4			9.4			9.4				
Detector 2 Size(m)		0.6			0.6			0.6				
Detector 2 Type		Cl+Ex			Cl+Ex			Cl+Ex				
Detector 2 Channel												
Detector 2 Extend (s)		0.0			0.0			0.0				
Turn Type	pm+pt	NA		Perm	NA		Perm	NA		Perm		Perm
Protected Phases	5	2			6			8				



Lane Group	EBL	EBT	EBR	WBL	WBT	WBR	NBL	NBT	NBR	SBL	SBT	SBR
Permitted Phases	2			6			8			4		4
Detector Phase	5	2		6	6		8	8		4		4
Switch Phase												
Minimum Initial (s)	5.0	10.0		10.0	10.0		10.0	10.0		10.0		10.0
Minimum Split (s)	10.6	31.7		31.7	31.7		28.5	28.5		28.5		28.5
Total Split (s)	16.0	78.0		62.0	62.0		37.0	37.0		37.0		37.0
Total Split (%)	13.9%	67.8%		53.9%	53.9%		32.2%	32.2%		32.2%		32.2%
Maximum Green (s)	10.4	72.3		56.3	56.3		31.5	31.5		31.5		31.5
Yellow Time (s)	3.3	3.3		3.3	3.3		3.3	3.3		3.3		3.3
All-Red Time (s)	2.3	2.4		2.4	2.4		2.2	2.2		2.2		2.2
Lost Time Adjust (s)		0.0			0.0			0.0		0.0		0.0
Total Lost Time (s)		5.7			5.7			5.5		5.5		5.5
Lead/Lag	Lead			Lag			Lag			Lag		
Lead-Lag Optimize?												
Vehicle Extension (s)	3.0	3.0		3.0	3.0		3.0	3.0		3.0		3.0
Recall Mode	Max	C-Max		C-Max	C-Max		None	None		None		None
Walk Time (s)		7.0		7.0	7.0		7.0	7.0		7.0		7.0
Flash Dont Walk (s)		19.0		19.0	19.0		16.0	16.0		16.0		16.0
Pedestrian Calls (#/hr)		0		0	0		0	0		0		0
Act Effct Green (s)		84.6		56.3	56.3		19.2	19.2		19.2		19.2
Actuated g/C Ratio		0.74		0.49	0.49		0.17	0.17		0.17		0.17
v/c Ratio		0.38		0.61	0.61		0.03	0.03		0.68		0.82
Control Delay		6.4		22.8	22.8		0.1	0.1		58.3		31.2
Queue Delay		0.0		0.0	0.0		0.0	0.0		0.0		0.0
Total Delay		6.4		22.8	22.8		0.1	0.1		58.3		31.2
LOS		A		C	C		A	A		E		C
Approach Delay		6.4		22.8	22.8		0.1	0.1			39.3	
Approach LOS		A		C	C		A	A			D	

Intersection Summary

Area Type:	Other
Cycle Length:	115
Actuated Cycle Length:	115
Offset:	62 (54%), Referenced to phase 2:EBTL and 6:WBTL, Start of Green
Natural Cycle:	75
Control Type:	Actuated-Coordinated
Maximum v/c Ratio:	0.82
Intersection Signal Delay:	21.5
Intersection LOS:	C
Intersection Capacity Utilization:	73.7%
ICU Level of Service:	D
Analysis Period (min):	15

Splits and Phases: 4: South Haven/Ring (N-S) & Smyth



2024Ex PM
8: Smyth & General Hospital

04/19/2024



Lane Group	EBL	EBT	WBT	WBR	SBL	SBR	Ø4	Ø7
Lane Configurations								
Traffic Volume (vph)	130	776	533	141	330	369		
Future Volume (vph)	130	776	533	141	330	369		
Ideal Flow (vphpl)	1800	1800	1800	1800	1800	1800		
Storage Length (m)	55.0			175.0	0.0	0.0		
Storage Lanes	1			1	2	1		
Taper Length (m)	40.0				10.0			
Lane Util. Factor	1.00	0.95	0.95	1.00	0.97	1.00		
Ped Bike Factor	0.99			0.96	0.81	0.97		
Fr _t				0.850		0.850		
Fl _t Protected	0.950				0.950			
Satd. Flow (prot)	1701	3468	3502	1551	3397	1567		
Fl _t Permitted	0.369				0.950			
Satd. Flow (perm)	657	3468	3502	1491	2761	1517		
Right Turn on Red				Yes		Yes		
Satd. Flow (RTOR)				157		84		
Link Speed (k/h)		50	50		40			
Link Distance (m)		394.7	397.7		58.6			
Travel Time (s)		28.4	28.6		5.3			
Confl. Peds. (#/hr)	11			11	72	14		
Confl. Bikes (#/hr)				2				
Peak Hour Factor	0.90	0.90	0.90	0.90	0.90	0.90		
Heavy Vehicles (%)	5%	3%	2%	3%	2%	2%		
Adj. Flow (vph)	144	862	592	157	367	410		
Shared Lane Traffic (%)								
Lane Group Flow (vph)	144	862	592	157	367	410		
Enter Blocked Intersection	No	No	No	No	No	No		
Lane Alignment	Left	Left	Left	Right	Left	R NA		
Median Width(m)		4.0	4.0		8.0			
Link Offset(m)		0.0	0.0		0.0			
Crosswalk Width(m)		5.0	5.0		5.0			
Two way Left Turn Lane								
Headway Factor	1.01	1.01	1.01	1.01	1.01	1.01		
Turning Speed (k/h)	24			14	24	14		
Number of Detectors	1	2	2	1	1	1		
Detector Template	Left	Thru	Thru	Right	Left	Right		
Leading Detector (m)	2.0	10.0	10.0	2.0	2.0	2.0		
Trailing Detector (m)	0.0	0.0	0.0	0.0	0.0	0.0		
Detector 1 Position(m)	0.0	0.0	0.0	0.0	0.0	0.0		
Detector 1 Size(m)	2.0	0.6	0.6	2.0	2.0	2.0		
Detector 1 Type	Cl+Ex	Cl+Ex	Cl+Ex	Cl+Ex	Cl+Ex	Cl+Ex		
Detector 1 Channel								
Detector 1 Extend (s)	0.0	0.0	0.0	0.0	0.0	0.0		
Detector 1 Queue (s)	0.0	0.0	0.0	0.0	0.0	0.0		
Detector 1 Delay (s)	0.0	0.0	0.0	0.0	0.0	0.0		
Detector 2 Position(m)		9.4	9.4					
Detector 2 Size(m)		0.6	0.6					
Detector 2 Type		Cl+Ex	Cl+Ex					
Detector 2 Channel								



Lane Group	EBL	EBT	WBT	WBR	SBL	SBR	Ø4	Ø7
Detector 2 Extend (s)		0.0	0.0					
Turn Type	pm+pt	NA	NA	pm+ov	Prot	pm+ov		
Protected Phases	5	2	6	3	3	5	4	7
Permitted Phases	2			6		7		
Detector Phase	5	2	6	3	3	5		
Switch Phase								
Minimum Initial (s)	5.0	10.0	10.0	5.0	5.0	5.0	5.0	5.0
Minimum Split (s)	10.7	16.4	41.4	10.9	10.9	10.7	32.0	29.9
Total Split (s)	12.0	55.0	43.0	28.0	28.0	12.0	32.0	60.0
Total Split (%)	10.4%	47.8%	37.4%	24.3%	24.3%	10.4%	28%	52%
Maximum Green (s)	6.3	48.6	36.6	22.1	22.1	6.3	28.0	54.1
Yellow Time (s)	3.3	3.3	3.3	3.3	3.3	3.3	3.0	3.3
All-Red Time (s)	2.4	3.1	3.1	2.6	2.6	2.4	1.0	2.6
Lost Time Adjust (s)	0.0	0.0	0.0	0.0	0.0	0.0		
Total Lost Time (s)	5.7	6.4	6.4	5.9	5.9	5.7		
Lead/Lag	Lead		Lag	Lag	Lag	Lead	Lead	
Lead-Lag Optimize?								
Vehicle Extension (s)	3.0	3.0	3.0	3.0	3.0	3.0	3.0	3.0
Recall Mode	None	C-Max	C-Max	None	None	None	None	None
Walk Time (s)			7.0				7.0	7.0
Flash Dont Walk (s)			28.0				21.0	17.0
Pedestrian Calls (#/hr)			0				0	0
Act Effct Green (s)	85.8	85.1	64.7	82.9	17.6	32.5		
Actuated g/C Ratio	0.75	0.74	0.56	0.72	0.15	0.28		
v/c Ratio	0.23	0.34	0.30	0.14	0.71	0.83		
Control Delay	4.6	4.8	15.4	1.1	53.7	41.0		
Queue Delay	0.0	0.0	0.0	0.0	0.0	0.0		
Total Delay	4.6	4.8	15.4	1.1	53.7	41.0		
LOS	A	A	B	A	D	D		
Approach Delay		4.8	12.4		47.0			
Approach LOS		A	B		D			

Intersection Summary

Area Type: Other
 Cycle Length: 115
 Actuated Cycle Length: 115
 Offset: 59 (51%), Referenced to phase 2:EBTL and 6:WBT, Start of Green
 Natural Cycle: 95
 Control Type: Actuated-Coordinated
 Maximum v/c Ratio: 0.83
 Intersection Signal Delay: 20.0
 Intersection LOS: B
 Intersection Capacity Utilization 64.8%
 ICU Level of Service C
 Analysis Period (min) 15

Splits and Phases: 8: Smyth & General Hospital

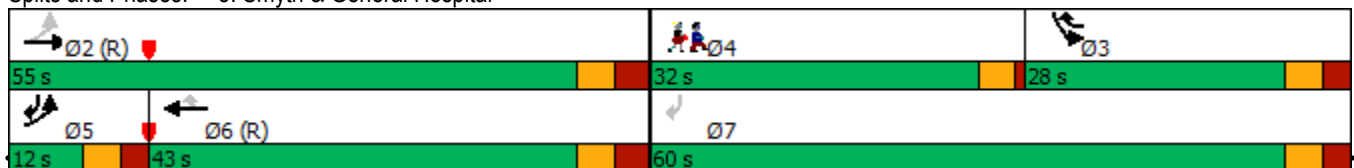



Movement	EBT	EBR	WBL	WBT	NBL	NBR
Lane Configurations	↻			↻	↻	
Sign Control	Stop			Stop	Stop	
Traffic Volume (vph)	84	48	54	225	85	28
Future Volume (vph)	84	48	54	225	85	28
Peak Hour Factor	0.90	0.90	0.90	0.90	0.90	0.90
Hourly flow rate (vph)	93	53	60	250	94	31

Direction, Lane #	EB 1	WB 1	NB 1
Volume Total (vph)	146	310	125
Volume Left (vph)	0	60	94
Volume Right (vph)	53	0	31
Hadj (s)	-0.14	0.10	0.17
Departure Headway (s)	4.5	4.5	5.1
Degree Utilization, x	0.18	0.39	0.18
Capacity (veh/h)	774	771	651
Control Delay (s)	8.4	10.3	9.2
Approach Delay (s)	8.4	10.3	9.2
Approach LOS	A	B	A

Intersection Summary			
Delay		9.6	
Level of Service		A	
Intersection Capacity Utilization	44.2%		ICU Level of Service A
Analysis Period (min)		15	

2024Ex PM
 2: Ring (N-S) & CHEO Non-Emergency

04/19/2024



Movement	EBL	EBT	EBR	WBL	WBT	WBR	NBL	NBT	NBR	SBL	SBT	SBR
Lane Configurations		↕			↕			↕			↕	
Sign Control		Stop			Stop			Stop			Stop	
Traffic Volume (vph)	2	1	12	117	0	19	6	42	24	17	292	3
Future Volume (vph)	2	1	12	117	0	19	6	42	24	17	292	3
Peak Hour Factor	0.90	0.90	0.90	0.90	0.90	0.90	0.90	0.90	0.90	0.90	0.90	0.90
Hourly flow rate (vph)	2	1	13	130	0	21	7	47	27	19	324	3

Direction, Lane #	EB 1	WB 1	NB 1	SB 1
Volume Total (vph)	16	151	81	346
Volume Left (vph)	2	130	7	19
Volume Right (vph)	13	21	27	3
Hadj (s)	-0.43	0.20	-0.08	0.09
Departure Headway (s)	4.7	5.1	4.7	4.5
Degree Utilization, x	0.02	0.22	0.11	0.44
Capacity (veh/h)	676	648	725	764
Control Delay (s)	7.8	9.5	8.2	11.0
Approach Delay (s)	7.8	9.5	8.2	11.0
Approach LOS	A	A	A	B

Intersection Summary			
Delay		10.2	
Level of Service		B	
Intersection Capacity Utilization	42.4%		ICU Level of Service A
Analysis Period (min)		15	

2024Ex PM
3: Ring (N-S) & Ring (E-W)

04/19/2024



Movement	WBL	WBR	NBT	NBR	SBL	SBT
Lane Configurations						
Traffic Volume (veh/h)	89	19	58	52	27	392
Future Volume (Veh/h)	89	19	58	52	27	392
Sign Control	Stop		Free		Free	
Grade	0%		0%		0%	
Peak Hour Factor	0.90	0.90	0.90	0.90	0.90	0.90
Hourly flow rate (vph)	99	21	64	58	30	436
Pedestrians	7					
Lane Width (m)	4.0					
Walking Speed (m/s)	1.0					
Percent Blockage	1					
Right turn flare (veh)						
Median type	None			None		
Median storage veh						
Upstream signal (m)	52					
pX, platoon unblocked						
vC, conflicting volume	596	100			129	
vC1, stage 1 conf vol						
vC2, stage 2 conf vol						
vCu, unblocked vol	596	100			129	
tC, single (s)	6.4	6.3			4.2	
tC, 2 stage (s)						
tF (s)	3.5	3.4			2.3	
p0 queue free %	78	98			98	
cM capacity (veh/h)	453	937			1415	
Direction, Lane #	WB 1	NB 1	SB 1			
Volume Total	120	122	466			
Volume Left	99	0	30			
Volume Right	21	58	0			
cSH	498	1700	1415			
Volume to Capacity	0.24	0.07	0.02			
Queue Length 95th (m)	6.5	0.0	0.5			
Control Delay (s)	14.5	0.0	0.7			
Lane LOS	B		A			
Approach Delay (s)	14.5	0.0	0.7			
Approach LOS	B					
Intersection Summary						
Average Delay	2.9					
Intersection Capacity Utilization	43.1%		ICU Level of Service		A	
Analysis Period (min)	15					

2024Ex PM
5: Ring (E-W) & CHEO Non-Emergency

04/19/2024



Movement	EBL	EBT	WBT	WBR	SBL	SBR
Lane Configurations						
Traffic Volume (veh/h)	24	64	105	27	16	7
Future Volume (Veh/h)	24	64	105	27	16	7
Sign Control		Free	Free		Stop	
Grade		0%	0%		0%	
Peak Hour Factor	0.90	0.90	0.90	0.90	0.90	0.90
Hourly flow rate (vph)	27	71	117	30	18	8
Pedestrians						
Lane Width (m)						
Walking Speed (m/s)						
Percent Blockage						
Right turn flare (veh)						
Median type		None	None			
Median storage (veh)						
Upstream signal (m)						
pX, platoon unblocked						
vC, conflicting volume	147				257	132
vC1, stage 1 conf vol						
vC2, stage 2 conf vol						
vCu, unblocked vol	147				257	132
tC, single (s)	4.1				6.6	6.2
tC, 2 stage (s)						
tF (s)	2.2				3.7	3.3
p0 queue free %	98				97	99
cM capacity (veh/h)	1435				679	917
Direction, Lane #	EB 1	WB 1	SB 1			
Volume Total	98	147	26			
Volume Left	27	0	18			
Volume Right	0	30	8			
cSH	1435	1700	738			
Volume to Capacity	0.02	0.09	0.04			
Queue Length 95th (m)	0.4	0.0	0.8			
Control Delay (s)	2.2	0.0	10.1			
Lane LOS	A		B			
Approach Delay (s)	2.2	0.0	10.1			
Approach LOS			B			
Intersection Summary						
Average Delay			1.8			
Intersection Capacity Utilization			25.9%	ICU Level of Service	A	
Analysis Period (min)			15			

2024Ex PM
6: Ring (E-W) & CHEO Emergency

04/19/2024



Movement	EBL	EBT	WBT	WBR	SBL	SBR
Lane Configurations						
Traffic Volume (veh/h)	24	73	64	16	45	53
Future Volume (Veh/h)	24	73	64	16	45	53
Sign Control		Free	Free		Stop	
Grade		0%	0%		0%	
Peak Hour Factor	0.90	0.90	0.90	0.90	0.90	0.90
Hourly flow rate (vph)	27	81	71	18	50	59
Pedestrians		4	16		6	
Lane Width (m)		4.0	4.0		4.0	
Walking Speed (m/s)		1.0	1.0		1.0	
Percent Blockage		0	2		1	
Right turn flare (veh)						
Median type		None	None			
Median storage (veh)						
Upstream signal (m)						
pX, platoon unblocked						
vC, conflicting volume	95				237	90
vC1, stage 1 conf vol						
vC2, stage 2 conf vol						
vCu, unblocked vol	95				237	90
tC, single (s)	4.2				6.5	6.3
tC, 2 stage (s)						
tF (s)	2.3				3.6	3.4
p0 queue free %	98				93	94
cM capacity (veh/h)	1435				709	941
Direction, Lane #	EB 1	WB 1	SB 1			
Volume Total	108	89	109			
Volume Left	27	0	50			
Volume Right	0	18	59			
cSH	1435	1700	818			
Volume to Capacity	0.02	0.05	0.13			
Queue Length 95th (m)	0.4	0.0	3.2			
Control Delay (s)	2.0	0.0	10.1			
Lane LOS	A		B			
Approach Delay (s)	2.0	0.0	10.1			
Approach LOS			B			
Intersection Summary						
Average Delay			4.3			
Intersection Capacity Utilization		26.0%		ICU Level of Service		A
Analysis Period (min)			15			



Movement	EBL	EBT	EBR	WBL	WBT	WBR	NBL	NBT	NBR	SBL	SBT	SBR
Lane Configurations		↕		↕	↕			↕	↕		↕	
Traffic Volume (veh/h)	21	9	56	392	32	17	42	131	144	23	125	18
Future Volume (Veh/h)	21	9	56	392	32	17	42	131	144	23	125	18
Sign Control		Stop			Stop			Free			Free	
Grade		0%			0%			0%			0%	
Peak Hour Factor	0.90	0.90	0.90	0.90	0.90	0.90	0.90	0.90	0.90	0.90	0.90	0.90
Hourly flow rate (vph)	23	10	62	436	36	19	47	146	160	26	139	20
Pedestrians		35			83			1			27	
Lane Width (m)		4.0			4.0			4.0			4.0	
Walking Speed (m/s)		1.0			1.0			1.0			1.0	
Percent Blockage		4			9			0			3	
Right turn flare (veh)												
Median type								None			None	
Median storage veh												
Upstream signal (m)								59				
pX, platoon unblocked												
vC, conflicting volume	540	559	185	592	569	256	194			229		
vC1, stage 1 conf vol												
vC2, stage 2 conf vol												
vCu, unblocked vol	540	559	185	592	569	256	194			229		
tC, single (s)	7.2	6.5	6.3	7.1	6.7	6.2	4.2			4.1		
tC, 2 stage (s)												
tF (s)	3.6	4.0	3.4	3.5	4.2	3.3	2.3			2.2		
p0 queue free %	93	97	92	0	89	97	96			98		
cM capacity (veh/h)	317	359	797	296	334	689	1297			1216		
Direction, Lane #	EB 1	WB 1	WB 2	NB 1	NB 2	SB 1						
Volume Total	95	291	200	193	160	185						
Volume Left	23	291	145	47	0	26						
Volume Right	62	0	19	0	160	20						
cSH	533	296	320	1297	1700	1216						
Volume to Capacity	0.18	0.98	0.63	0.04	0.09	0.02						
Queue Length 95th (m)	4.5	70.9	27.9	0.8	0.0	0.5						
Control Delay (s)	13.2	86.8	33.4	2.2	0.0	1.3						
Lane LOS	B	F	D	A		A						
Approach Delay (s)	13.2	65.1		1.2		1.3						
Approach LOS	B	F										
Intersection Summary												
Average Delay				30.1								
Intersection Capacity Utilization			55.0%		ICU Level of Service				A			
Analysis Period (min)			15									

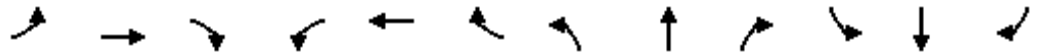

Lane Group	EBL	EBT	EBR	WBL	WBT	WBR	NBL	NBT	NBR	SBL	SBT	SBR
Lane Configurations												
Traffic Volume (vph)	428	816	2	1	588	114	6	1	0	33	0	140
Future Volume (vph)	428	816	2	1	588	114	6	1	0	33	0	140
Ideal Flow (vphpl)	1800	1800	1800	1800	1800	1800	1800	1800	1800	1800	1800	1800
Lane Util. Factor	0.95	0.95	0.95	0.95	0.95	0.95	1.00	1.00	1.00	1.00	1.00	1.00
Ped Bike Factor		1.00			0.99			1.00		0.99		0.98
Frt					0.976							0.850
Flt Protected		0.983						0.959		0.950		
Satd. Flow (prot)	0	3442	0	0	3356	0	0	1768	0	1717	0	1493
Flt Permitted		0.519			0.954			0.959		0.753		
Satd. Flow (perm)	0	1813	0	0	3202	0	0	1763	0	1347	0	1468
Right Turn on Red			Yes			Yes			Yes			Yes
Satd. Flow (RTOR)					20							140
Link Speed (k/h)		50			50			40				40
Link Distance (m)		218.8			394.7			154.1				51.9
Travel Time (s)		15.8			28.4			13.9				4.7
Confl. Peds. (#/hr)	15		3	3		15	2		7	7		2
Confl. Bikes (#/hr)			3						1			2
Peak Hour Factor	1.00	1.00	1.00	1.00	1.00	1.00	1.00	1.00	1.00	1.00	1.00	1.00
Heavy Vehicles (%)	2%	2%	2%	2%	3%	3%	2%	2%	2%	4%	2%	7%
Adj. Flow (vph)	428	816	2	1	588	114	6	1	0	33	0	140
Shared Lane Traffic (%)												
Lane Group Flow (vph)	0	1246	0	0	703	0	0	7	0	33	0	140
Enter Blocked Intersection	No	No	No	No	No	No	No	No	No	No	No	No
Lane Alignment	Left	Left	Right	Left	Left	Right	L NA	Left	R NA	L NA	Left	R NA
Median Width(m)		0.0			4.0			0.0				5.0
Link Offset(m)		0.0			0.0			0.0				0.0
Crosswalk Width(m)		5.0			5.0			5.0				5.0
Two way Left Turn Lane												
Headway Factor	1.01	1.01	1.01	1.01	1.01	1.01	1.01	1.01	1.01	1.01	1.01	1.01
Turning Speed (k/h)	24		14	24		14	24		14	24		14
Number of Detectors	1	2		1	2		1	2		1		1
Detector Template	Left	Thru		Left	Thru		Left	Thru		Left		Right
Leading Detector (m)	2.0	10.0		2.0	10.0		2.0	10.0		2.0		2.0
Trailing Detector (m)	0.0	0.0		0.0	0.0		0.0	0.0		0.0		0.0
Detector 1 Position(m)	0.0	0.0		0.0	0.0		0.0	0.0		0.0		0.0
Detector 1 Size(m)	2.0	0.6		2.0	0.6		2.0	0.6		2.0		2.0
Detector 1 Type	Cl+Ex	Cl+Ex		Cl+Ex	Cl+Ex		Cl+Ex	Cl+Ex		Cl+Ex		Cl+Ex
Detector 1 Channel												
Detector 1 Extend (s)	0.0	0.0		0.0	0.0		0.0	0.0		0.0		0.0
Detector 1 Queue (s)	0.0	0.0		0.0	0.0		0.0	0.0		0.0		0.0
Detector 1 Delay (s)	0.0	0.0		0.0	0.0		0.0	0.0		0.0		0.0
Detector 2 Position(m)		9.4			9.4			9.4				
Detector 2 Size(m)		0.6			0.6			0.6				
Detector 2 Type		Cl+Ex			Cl+Ex			Cl+Ex				
Detector 2 Channel												
Detector 2 Extend (s)		0.0			0.0			0.0				
Turn Type	pm+pt	NA		Perm	NA		Perm	NA		Perm		Perm
Protected Phases	5	2			6			8				



Lane Group	EBL	EBT	EBR	WBL	WBT	WBR	NBL	NBT	NBR	SBL	SBT	SBR
Permitted Phases	2			6			8			4		4
Detector Phase	5	2		6	6		8	8		4		4
Switch Phase												
Minimum Initial (s)	5.0	10.0		10.0	10.0		10.0	10.0		10.0		10.0
Minimum Split (s)	10.6	31.7		31.7	31.7		28.5	28.5		28.5		28.5
Total Split (s)	42.0	84.0		42.0	42.0		31.0	31.0		31.0		31.0
Total Split (%)	36.5%	73.0%		36.5%	36.5%		27.0%	27.0%		27.0%		27.0%
Maximum Green (s)	36.4	78.3		36.3	36.3		25.5	25.5		25.5		25.5
Yellow Time (s)	3.3	3.3		3.3	3.3		3.3	3.3		3.3		3.3
All-Red Time (s)	2.3	2.4		2.4	2.4		2.2	2.2		2.2		2.2
Lost Time Adjust (s)		0.0			0.0			0.0		0.0		0.0
Total Lost Time (s)		5.7			5.7			5.5		5.5		5.5
Lead/Lag	Lead			Lag	Lag							
Lead-Lag Optimize?												
Vehicle Extension (s)	3.0	3.0		3.0	3.0		3.0	3.0		3.0		3.0
Recall Mode	Max	C-Max		C-Max	C-Max		None	None		None		None
Walk Time (s)		7.0		7.0	7.0		7.0	7.0		7.0		7.0
Flash Dont Walk (s)		19.0		19.0	19.0		16.0	16.0		16.0		16.0
Pedestrian Calls (#/hr)		0		0	0		0	0		0		0
Act Effct Green (s)		93.3			36.3			10.5		10.5		10.5
Actuated g/C Ratio		0.81			0.32			0.09		0.09		0.09
v/c Ratio		0.57			0.69			0.04		0.27		0.54
Control Delay		4.4			33.4			47.6		54.1		16.0
Queue Delay		0.0			0.0			0.0		0.0		0.0
Total Delay		4.4			33.4			47.6		54.1		16.0
LOS		A			C			D		D		B
Approach Delay		4.4			33.4			47.6				23.3
Approach LOS		A			C			D				C

Intersection Summary

Area Type: Other
 Cycle Length: 115
 Actuated Cycle Length: 115
 Offset: 66 (57%), Referenced to phase 2:EBTL and 6:WBTL, Start of Green
 Natural Cycle: 90
 Control Type: Actuated-Coordinated
 Maximum v/c Ratio: 0.69
 Intersection Signal Delay: 15.7
 Intersection LOS: B
 Intersection Capacity Utilization 83.3%
 ICU Level of Service E
 Analysis Period (min) 15

Splits and Phases: 4: South Haven/Ring (N-S) & Smyth

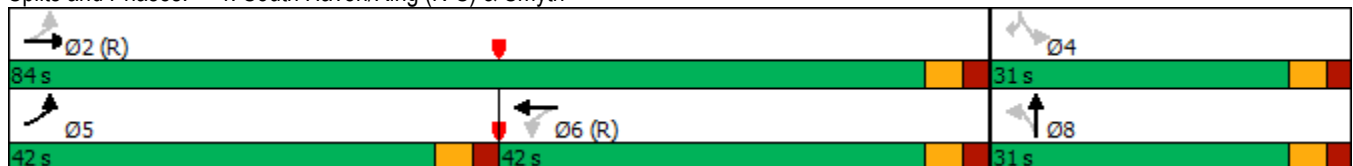

2027Bg AM
8: Smyth & General Hospital

04/19/2024

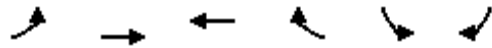

Lane Group	EBL	EBT	WBT	WBR	SBL	SBR	Ø4	Ø7
Lane Configurations								
Traffic Volume (vph)	382	444	713	428	113	174		
Future Volume (vph)	382	444	713	428	113	174		
Ideal Flow (vphpl)	1800	1800	1800	1800	1800	1800		
Storage Length (m)	55.0			175.0	0.0	0.0		
Storage Lanes	1			1	2	1		
Taper Length (m)	40.0				10.0			
Lane Util. Factor	1.00	0.95	0.95	1.00	0.97	1.00		
Ped Bike Factor	1.00			0.97	0.59	0.97		
Fr _t				0.850		0.850		
Fl _t Protected	0.950				0.950			
Satd. Flow (prot)	1751	3502	3468	1567	3364	1567		
Fl _t Permitted	0.329				0.950			
Satd. Flow (perm)	606	3502	3468	1523	1975	1519		
Right Turn on Red				Yes		Yes		
Satd. Flow (RTOR)				428		48		
Link Speed (k/h)		50	50		40			
Link Distance (m)		394.7	397.7		58.6			
Travel Time (s)		28.4	28.6		5.3			
Confl. Peds. (#/hr)	3			3	51	13		
Confl. Bikes (#/hr)				3				
Peak Hour Factor	1.00	1.00	1.00	1.00	1.00	1.00		
Heavy Vehicles (%)	2%	2%	3%	2%	3%	2%		
Adj. Flow (vph)	382	444	713	428	113	174		
Shared Lane Traffic (%)								
Lane Group Flow (vph)	382	444	713	428	113	174		
Enter Blocked Intersection	No	No	No	No	No	No		
Lane Alignment	Left	Left	Left	Right	Left	R NA		
Median Width(m)		4.0	4.0		8.0			
Link Offset(m)		0.0	0.0		0.0			
Crosswalk Width(m)		5.0	5.0		5.0			
Two way Left Turn Lane								
Headway Factor	1.01	1.01	1.01	1.01	1.01	1.01		
Turning Speed (k/h)	24			14	24	14		
Number of Detectors	1	2	2	1	1	1		
Detector Template	Left	Thru	Thru	Right	Left	Right		
Leading Detector (m)	2.0	10.0	10.0	2.0	2.0	2.0		
Trailing Detector (m)	0.0	0.0	0.0	0.0	0.0	0.0		
Detector 1 Position(m)	0.0	0.0	0.0	0.0	0.0	0.0		
Detector 1 Size(m)	2.0	0.6	0.6	2.0	2.0	2.0		
Detector 1 Type	Cl+Ex	Cl+Ex	Cl+Ex	Cl+Ex	Cl+Ex	Cl+Ex		
Detector 1 Channel								
Detector 1 Extend (s)	0.0	0.0	0.0	0.0	0.0	0.0		
Detector 1 Queue (s)	0.0	0.0	0.0	0.0	0.0	0.0		
Detector 1 Delay (s)	0.0	0.0	0.0	0.0	0.0	0.0		
Detector 2 Position(m)		9.4	9.4					
Detector 2 Size(m)		0.6	0.6					
Detector 2 Type		Cl+Ex	Cl+Ex					
Detector 2 Channel								

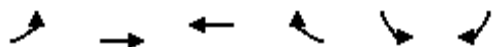

Lane Group	EBL	EBT	WBT	WBR	SBL	SBR	Ø4	Ø7
Detector 2 Extend (s)		0.0	0.0					
Turn Type	pm+pt	NA	NA	pm+ov	Prot	pm+ov		
Protected Phases	5	2	6	3	3	5	4	7
Permitted Phases	2			6		7		
Detector Phase	5	2	6	3	3	5		
Switch Phase								
Minimum Initial (s)	5.0	10.0	10.0	5.0	5.0	5.0	5.0	5.0
Minimum Split (s)	10.7	16.4	41.4	10.9	10.9	10.7	32.0	29.9
Total Split (s)	28.0	70.0	42.0	13.0	13.0	28.0	32.0	45.0
Total Split (%)	24.3%	60.9%	36.5%	11.3%	11.3%	24.3%	28%	39%
Maximum Green (s)	22.3	63.6	35.6	7.1	7.1	22.3	28.0	39.1
Yellow Time (s)	3.3	3.3	3.3	3.3	3.3	3.3	3.0	3.3
All-Red Time (s)	2.4	3.1	3.1	2.6	2.6	2.4	1.0	2.6
Lost Time Adjust (s)	0.0	0.0	0.0	0.0	0.0	0.0		
Total Lost Time (s)	5.7	6.4	6.4	5.9	5.9	5.7		
Lead/Lag	Lead		Lag	Lag	Lag	Lead	Lead	
Lead-Lag Optimize?								
Vehicle Extension (s)	3.0	3.0	3.0	3.0	3.0	3.0	3.0	3.0
Recall Mode	None	C-Max	C-Max	None	None	None	None	None
Walk Time (s)			7.0				7.0	7.0
Flash Dont Walk (s)			28.0				21.0	17.0
Pedestrian Calls (#/hr)			0				0	0
Act Effct Green (s)	94.2	93.5	72.2	81.9	9.2	25.0		
Actuated g/C Ratio	0.82	0.81	0.63	0.71	0.08	0.22		
v/c Ratio	0.59	0.16	0.33	0.35	0.42	0.47		
Control Delay	9.7	2.4	11.7	1.4	54.7	27.3		
Queue Delay	0.0	0.0	0.0	0.0	0.0	0.0		
Total Delay	9.7	2.4	11.7	1.4	54.7	27.3		
LOS	A	A	B	A	D	C		
Approach Delay		5.8	7.8		38.1			
Approach LOS		A	A		D			

Intersection Summary

Area Type:	Other
Cycle Length:	115
Actuated Cycle Length:	115
Offset:	43 (37%), Referenced to phase 2:EBTL and 6:WBT, Start of Green
Natural Cycle:	95
Control Type:	Actuated-Coordinated
Maximum v/c Ratio:	0.59
Intersection Signal Delay:	10.9
Intersection LOS:	B
Intersection Capacity Utilization:	70.7%
ICU Level of Service:	C
Analysis Period (min):	15

Splits and Phases: 8: Smyth & General Hospital

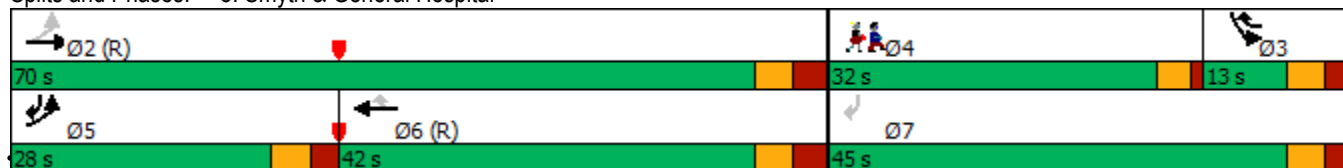



Movement	EBT	EBR	WBL	WBT	NBL	NBR
Lane Configurations						
Sign Control	Stop			Stop	Stop	
Traffic Volume (vph)	324	163	52	107	54	132
Future Volume (vph)	324	163	52	107	54	132
Peak Hour Factor	1.00	1.00	1.00	1.00	1.00	1.00
Hourly flow rate (vph)	324	163	52	107	54	132

Direction, Lane #	EB 1	WB 1	NB 1
Volume Total (vph)	487	159	186
Volume Left (vph)	0	52	54
Volume Right (vph)	163	0	132
Hadj (s)	-0.12	0.13	-0.24
Departure Headway (s)	4.5	5.1	5.2
Degree Utilization, x	0.61	0.23	0.27
Capacity (veh/h)	772	663	625
Control Delay (s)	14.3	9.6	10.0
Approach Delay (s)	14.3	9.6	10.0
Approach LOS	B	A	B

Intersection Summary			
Delay		12.4	
Level of Service		B	
Intersection Capacity Utilization	60.2%		ICU Level of Service B
Analysis Period (min)		15	

2027Bg AM
 2: Ring (N-S) & CHEO Non-Emergency

04/19/2024



Movement	EBL	EBT	EBR	WBL	WBT	WBR	NBL	NBT	NBR	SBL	SBT	SBR
Lane Configurations												
Sign Control		Stop			Stop			Stop			Stop	
Traffic Volume (vph)	3	0	7	83	2	37	4	397	49	30	88	2
Future Volume (vph)	3	0	7	83	2	37	4	397	49	30	88	2
Peak Hour Factor	1.00	1.00	1.00	1.00	1.00	1.00	1.00	1.00	1.00	1.00	1.00	1.00
Hourly flow rate (vph)	3	0	7	83	2	37	4	397	49	30	88	2

Direction, Lane #	EB 1	WB 1	NB 1	SB 1
Volume Total (vph)	10	122	450	120
Volume Left (vph)	3	83	4	30
Volume Right (vph)	7	37	49	2
Hadj (s)	-0.33	0.11	0.02	0.11
Departure Headway (s)	5.1	5.3	4.4	4.9
Degree Utilization, x	0.01	0.18	0.55	0.16
Capacity (veh/h)	610	609	793	696
Control Delay (s)	8.2	9.5	12.8	8.8
Approach Delay (s)	8.2	9.5	12.8	8.8
Approach LOS	A	A	B	A

Intersection Summary

Delay	11.5
Level of Service	B
Intersection Capacity Utilization	48.8%
ICU Level of Service	A
Analysis Period (min)	15



Movement	WBL	WBR	NBT	NBR	SBL	SBT
Lane Configurations						
Traffic Volume (veh/h)	27	50	396	132	32	148
Future Volume (Veh/h)	27	50	396	132	32	148
Sign Control	Stop		Free		Free	
Grade	0%		0%		0%	
Peak Hour Factor	1.00	1.00	1.00	1.00	1.00	1.00
Hourly flow rate (vph)	27	50	396	132	32	148
Pedestrians	8					
Lane Width (m)	4.0					
Walking Speed (m/s)	1.0					
Percent Blockage	1					
Right turn flare (veh)						
Median type	None			None		
Median storage veh						
Upstream signal (m)	52					
pX, platoon unblocked						
vC, conflicting volume	682	470			536	
vC1, stage 1 conf vol						
vC2, stage 2 conf vol						
vCu, unblocked vol	682	470			536	
tC, single (s)	6.4	6.3			4.2	
tC, 2 stage (s)						
tF (s)	3.5	3.4			2.3	
p0 queue free %	93	91			97	
cM capacity (veh/h)	399	580			998	
Direction, Lane #	WB 1	NB 1	SB 1			
Volume Total	77	528	180			
Volume Left	27	0	32			
Volume Right	50	132	0			
cSH	500	1700	998			
Volume to Capacity	0.15	0.31	0.03			
Queue Length 95th (m)	3.8	0.0	0.7			
Control Delay (s)	13.5	0.0	1.8			
Lane LOS	B		A			
Approach Delay (s)	13.5	0.0	1.8			
Approach LOS	B					
Intersection Summary						
Average Delay			1.7			
Intersection Capacity Utilization			48.7%	ICU Level of Service		A
Analysis Period (min)			15			

2027Bg AM
5: Ring (E-W) & CHEO Non-Emergency

04/19/2024



Movement	EBL	EBT	WBT	WBR	SBL	SBR
Lane Configurations						
Traffic Volume (veh/h)	35	142	69	49	17	4
Future Volume (Veh/h)	35	142	69	49	17	4
Sign Control		Free	Free		Stop	
Grade		0%	0%		0%	
Peak Hour Factor	1.00	1.00	1.00	1.00	1.00	1.00
Hourly flow rate (vph)	35	142	69	49	17	4
Pedestrians			17		2	
Lane Width (m)			4.0		4.0	
Walking Speed (m/s)			1.0		1.0	
Percent Blockage			2		0	
Right turn flare (veh)						
Median type		None	None			
Median storage (veh)						
Upstream signal (m)						
pX, platoon unblocked						
vC, conflicting volume	120				324	96
vC1, stage 1 conf vol						
vC2, stage 2 conf vol						
vCu, unblocked vol	120				324	96
tC, single (s)	4.1				6.6	6.2
tC, 2 stage (s)						
tF (s)	2.2				3.7	3.3
p0 queue free %	98				97	100
cM capacity (veh/h)	1464				604	959
Direction, Lane #	EB 1	WB 1	SB 1			
Volume Total	177	118	21			
Volume Left	35	0	17			
Volume Right	0	49	4			
cSH	1464	1700	650			
Volume to Capacity	0.02	0.07	0.03			
Queue Length 95th (m)	0.5	0.0	0.7			
Control Delay (s)	1.6	0.0	10.7			
Lane LOS	A		B			
Approach Delay (s)	1.6	0.0	10.7			
Approach LOS			B			
Intersection Summary						
Average Delay			1.6			
Intersection Capacity Utilization			26.6%		ICU Level of Service	A
Analysis Period (min)			15			

2027Bg AM
6: Ring (E-W) & CHEO Emergency

04/19/2024



Movement	EBL	EBT	WBT	WBR	SBL	SBR
Lane Configurations		↖	↗		↘	
Traffic Volume (veh/h)	132	76	96	50	20	21
Future Volume (Veh/h)	132	76	96	50	20	21
Sign Control		Free	Free		Stop	
Grade		0%	0%		0%	
Peak Hour Factor	1.00	1.00	1.00	1.00	1.00	1.00
Hourly flow rate (vph)	132	76	96	50	20	21
Pedestrians		2	28		7	
Lane Width (m)		4.0	4.0		4.0	
Walking Speed (m/s)		1.0	1.0		1.0	
Percent Blockage		0	3		1	
Right turn flare (veh)						
Median type		None	None			
Median storage (veh)						
Upstream signal (m)						
pX, platoon unblocked						
vC, conflicting volume	153				496	130
vC1, stage 1 conf vol						
vC2, stage 2 conf vol						
vCu, unblocked vol	153				496	130
tC, single (s)	4.2				6.5	6.3
tC, 2 stage (s)						
tF (s)	2.3				3.6	3.4
p0 queue free %	90				96	98
cM capacity (veh/h)	1364				455	895
Direction, Lane #	EB 1	WB 1	SB 1			
Volume Total	208	146	41			
Volume Left	132	0	20			
Volume Right	0	50	21			
cSH	1364	1700	608			
Volume to Capacity	0.10	0.09	0.07			
Queue Length 95th (m)	2.2	0.0	1.5			
Control Delay (s)	5.3	0.0	11.3			
Lane LOS	A		B			
Approach Delay (s)	5.3	0.0	11.3			
Approach LOS			B			
Intersection Summary						
Average Delay			4.0			
Intersection Capacity Utilization		35.7%		ICU Level of Service		A
Analysis Period (min)			15			

2027Bg AM
7: General Hospital & Ring (E-W)

04/19/2024



Movement	EBL	EBT	EBR	WBL	WBT	WBR	NBL	NBT	NBR	SBL	SBT	SBR
Lane Configurations		↕		↕	↕			↕	↕		↕	
Traffic Volume (veh/h)	19	22	19	158	25	19	92	134	485	12	137	15
Future Volume (Veh/h)	19	22	19	158	25	19	92	134	485	12	137	15
Sign Control		Stop			Stop			Free			Free	
Grade		0%			0%			0%			0%	
Peak Hour Factor	1.00	1.00	1.00	1.00	1.00	1.00	1.00	1.00	1.00	1.00	1.00	1.00
Hourly flow rate (vph)	19	22	19	158	25	19	92	134	485	12	137	15
Pedestrians		27			65							4
Lane Width (m)		4.0			4.0						4.0	
Walking Speed (m/s)		1.0			1.0						1.0	
Percent Blockage		3			7						0	
Right turn flare (veh)												
Median type								None			None	
Median storage veh												
Upstream signal (m)								59				
pX, platoon unblocked												
vC, conflicting volume	549	578	172	582	586	203	179			199		
vC1, stage 1 conf vol												
vC2, stage 2 conf vol												
vCu, unblocked vol	549	578	172	582	586	203	179			199		
tC, single (s)	7.2	6.5	6.3	7.1	6.7	6.2	4.2			4.1		
tC, 2 stage (s)												
tF (s)	3.6	4.0	3.4	3.5	4.2	3.3	2.3			2.2		
p0 queue free %	94	94	98	50	92	98	93			99		
cM capacity (veh/h)	336	353	819	319	329	774	1326			1274		
Direction, Lane #	EB 1	WB 1	WB 2	NB 1	NB 2	SB 1						
Volume Total	60	105	97	226	485	164						
Volume Left	19	105	53	92	0	12						
Volume Right	19	0	19	0	485	15						
cSH	422	319	364	1326	1700	1274						
Volume to Capacity	0.14	0.33	0.27	0.07	0.29	0.01						
Queue Length 95th (m)	3.4	9.8	7.4	1.6	0.0	0.2						
Control Delay (s)	14.9	21.7	18.4	3.6	0.0	0.6						
Lane LOS	B	C	C	A		A						
Approach Delay (s)	14.9	20.2		1.1		0.6						
Approach LOS	B	C										
Intersection Summary												
Average Delay			5.2									
Intersection Capacity Utilization			61.7%		ICU Level of Service				B			
Analysis Period (min)			15									

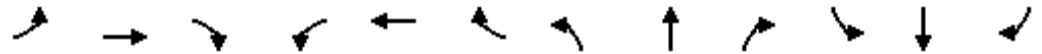

Lane Group	EBL	EBT	EBR	WBL	WBT	WBR	NBL	NBT	NBR	SBL	SBT	SBR
Lane Configurations		↕↕			↕↕			↕		↕		↕
Traffic Volume (vph)	102	553	4	4	935	13	5	0	4	152	0	385
Future Volume (vph)	102	553	4	4	935	13	5	0	4	152	0	385
Ideal Flow (vphpl)	1800	1800	1800	1800	1800	1800	1800	1800	1800	1800	1800	1800
Lane Util. Factor	0.95	0.95	0.95	0.95	0.95	0.95	1.00	1.00	1.00	1.00	1.00	1.00
Ped Bike Factor		1.00			1.00			0.99		0.99		0.97
Frt		0.999			0.998			0.940				0.850
Flt Protected		0.992						0.973		0.950		
Satd. Flow (prot)	0	3431	0	0	3492	0	0	1670	0	1751	0	1567
Flt Permitted		0.611			0.953			0.973		0.752		
Satd. Flow (perm)	0	2112	0	0	3328	0	0	1666	0	1374	0	1523
Right Turn on Red			Yes			Yes			Yes			Yes
Satd. Flow (RTOR)		1			2			79				237
Link Speed (k/h)		50			50			40				40
Link Distance (m)		218.8			394.7			154.1				51.9
Travel Time (s)		15.8			28.4			13.9				4.7
Confl. Peds. (#/hr)	15		8	8		15	3		6	6		3
Confl. Bikes (#/hr)			2			1						14
Peak Hour Factor	1.00	1.00	1.00	1.00	1.00	1.00	1.00	1.00	1.00	1.00	1.00	1.00
Heavy Vehicles (%)	4%	3%	2%	2%	2%	2%	2%	2%	2%	2%	2%	2%
Adj. Flow (vph)	102	553	4	4	935	13	5	0	4	152	0	385
Shared Lane Traffic (%)												
Lane Group Flow (vph)	0	659	0	0	952	0	0	9	0	152	0	385
Enter Blocked Intersection	No	No	No	No	No	No	No	No	No	No	No	No
Lane Alignment	Left	Left	Right	Left	Left	Right	L NA	Left	R NA	L NA	Left	R NA
Median Width(m)		0.0			4.0			0.0				5.0
Link Offset(m)		0.0			0.0			0.0				0.0
Crosswalk Width(m)		5.0			5.0			5.0				5.0
Two way Left Turn Lane												
Headway Factor	1.01	1.01	1.01	1.01	1.01	1.01	1.01	1.01	1.01	1.01	1.01	1.01
Turning Speed (k/h)	24		14	24		14	24		14	24		14
Number of Detectors	1	2		1	2		1	2		1		1
Detector Template	Left	Thru		Left	Thru		Left	Thru		Left		Right
Leading Detector (m)	2.0	10.0		2.0	10.0		2.0	10.0		2.0		2.0
Trailing Detector (m)	0.0	0.0		0.0	0.0		0.0	0.0		0.0		0.0
Detector 1 Position(m)	0.0	0.0		0.0	0.0		0.0	0.0		0.0		0.0
Detector 1 Size(m)	2.0	0.6		2.0	0.6		2.0	0.6		2.0		2.0
Detector 1 Type	Cl+Ex	Cl+Ex		Cl+Ex	Cl+Ex		Cl+Ex	Cl+Ex		Cl+Ex		Cl+Ex
Detector 1 Channel												
Detector 1 Extend (s)	0.0	0.0		0.0	0.0		0.0	0.0		0.0		0.0
Detector 1 Queue (s)	0.0	0.0		0.0	0.0		0.0	0.0		0.0		0.0
Detector 1 Delay (s)	0.0	0.0		0.0	0.0		0.0	0.0		0.0		0.0
Detector 2 Position(m)		9.4			9.4			9.4				
Detector 2 Size(m)		0.6			0.6			0.6				
Detector 2 Type		Cl+Ex			Cl+Ex			Cl+Ex				
Detector 2 Channel												
Detector 2 Extend (s)		0.0			0.0			0.0				
Turn Type	pm+pt	NA		Perm	NA		Perm	NA		Perm		Perm
Protected Phases	5	2			6			8				



Lane Group	EBL	EBT	EBR	WBL	WBT	WBR	NBL	NBT	NBR	SBL	SBT	SBR
Permitted Phases	2			6			8			4		4
Detector Phase	5	2		6	6		8	8		4		4
Switch Phase												
Minimum Initial (s)	5.0	10.0		10.0	10.0		10.0	10.0		10.0		10.0
Minimum Split (s)	10.6	31.7		31.7	31.7		28.5	28.5		28.5		28.5
Total Split (s)	16.0	78.0		62.0	62.0		37.0	37.0		37.0		37.0
Total Split (%)	13.9%	67.8%		53.9%	53.9%		32.2%	32.2%		32.2%		32.2%
Maximum Green (s)	10.4	72.3		56.3	56.3		31.5	31.5		31.5		31.5
Yellow Time (s)	3.3	3.3		3.3	3.3		3.3	3.3		3.3		3.3
All-Red Time (s)	2.3	2.4		2.4	2.4		2.2	2.2		2.2		2.2
Lost Time Adjust (s)		0.0			0.0			0.0		0.0		0.0
Total Lost Time (s)		5.7			5.7			5.5		5.5		5.5
Lead/Lag	Lead			Lag			Lag			Lag		
Lead-Lag Optimize?												
Vehicle Extension (s)	3.0	3.0		3.0	3.0		3.0	3.0		3.0		3.0
Recall Mode	Max	C-Max		C-Max	C-Max		None	None		None		None
Walk Time (s)		7.0		7.0	7.0		7.0	7.0		7.0		7.0
Flash Dont Walk (s)		19.0		19.0	19.0		16.0	16.0		16.0		16.0
Pedestrian Calls (#/hr)		0		0	0		0	0		0		0
Act Effct Green (s)		83.9			56.3			19.9		19.9		19.9
Actuated g/C Ratio		0.73			0.49			0.17		0.17		0.17
v/c Ratio		0.37			0.58			0.03		0.64		0.84
Control Delay		6.7			23.1			0.1		55.2		33.1
Queue Delay		0.0			0.0			0.0		0.0		0.0
Total Delay		6.7			23.1			0.1		55.2		33.1
LOS		A			C			A		E		C
Approach Delay		6.7			23.1			0.1				39.3
Approach LOS		A			C			A				D

Intersection Summary

Area Type: Other
 Cycle Length: 115
 Actuated Cycle Length: 115
 Offset: 62 (54%), Referenced to phase 2:EBTL and 6:WBTL, Start of Green
 Natural Cycle: 75
 Control Type: Actuated-Coordinated
 Maximum v/c Ratio: 0.84
 Intersection Signal Delay: 22.0 Intersection LOS: C
 Intersection Capacity Utilization 77.6% ICU Level of Service D
 Analysis Period (min) 15

Splits and Phases: 4: South Haven/Ring (N-S) & Smyth

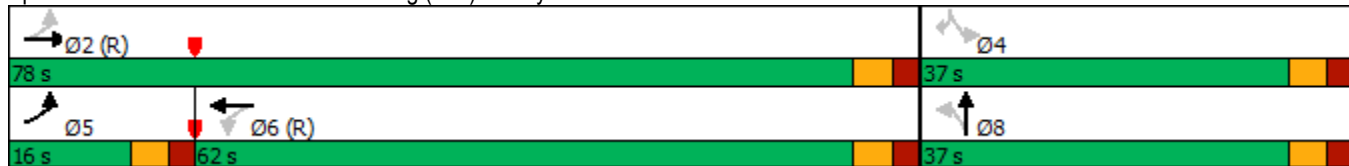

2027Bg PM
8: Smyth & General Hospital

04/19/2024



Lane Group	EBL	EBT	WBT	WBR	SBL	SBR	Ø4	Ø7
Lane Configurations								
Traffic Volume (vph)	130	826	568	141	338	382		
Future Volume (vph)	130	826	568	141	338	382		
Ideal Flow (vphpl)	1800	1800	1800	1800	1800	1800		
Storage Length (m)	55.0			175.0	0.0	0.0		
Storage Lanes	1			1	2	1		
Taper Length (m)	40.0				10.0			
Lane Util. Factor	1.00	0.95	0.95	1.00	0.97	1.00		
Ped Bike Factor	0.99			0.96	0.81	0.97		
Fr _t				0.850		0.850		
Fl _t Protected	0.950				0.950			
Satd. Flow (prot)	1701	3468	3502	1551	3397	1567		
Fl _t Permitted	0.386				0.950			
Satd. Flow (perm)	687	3468	3502	1491	2761	1517		
Right Turn on Red				Yes		Yes		
Satd. Flow (RTOR)				141		93		
Link Speed (k/h)		50	50		40			
Link Distance (m)		394.7	397.7		58.6			
Travel Time (s)		28.4	28.6		5.3			
Confl. Peds. (#/hr)	11			11	72	14		
Confl. Bikes (#/hr)				2				
Peak Hour Factor	1.00	1.00	1.00	1.00	1.00	1.00		
Heavy Vehicles (%)	5%	3%	2%	3%	2%	2%		
Adj. Flow (vph)	130	826	568	141	338	382		
Shared Lane Traffic (%)								
Lane Group Flow (vph)	130	826	568	141	338	382		
Enter Blocked Intersection	No	No	No	No	No	No		
Lane Alignment	Left	Left	Left	Right	Left	R NA		
Median Width(m)		4.0	4.0		8.0			
Link Offset(m)		0.0	0.0		0.0			
Crosswalk Width(m)		5.0	5.0		5.0			
Two way Left Turn Lane								
Headway Factor	1.01	1.01	1.01	1.01	1.01	1.01		
Turning Speed (k/h)	24			14	24	14		
Number of Detectors	1	2	2	1	1	1		
Detector Template	Left	Thru	Thru	Right	Left	Right		
Leading Detector (m)	2.0	10.0	10.0	2.0	2.0	2.0		
Trailing Detector (m)	0.0	0.0	0.0	0.0	0.0	0.0		
Detector 1 Position(m)	0.0	0.0	0.0	0.0	0.0	0.0		
Detector 1 Size(m)	2.0	0.6	0.6	2.0	2.0	2.0		
Detector 1 Type	Cl+Ex	Cl+Ex	Cl+Ex	Cl+Ex	Cl+Ex	Cl+Ex		
Detector 1 Channel								
Detector 1 Extend (s)	0.0	0.0	0.0	0.0	0.0	0.0		
Detector 1 Queue (s)	0.0	0.0	0.0	0.0	0.0	0.0		
Detector 1 Delay (s)	0.0	0.0	0.0	0.0	0.0	0.0		
Detector 2 Position(m)		9.4	9.4					
Detector 2 Size(m)		0.6	0.6					
Detector 2 Type		Cl+Ex	Cl+Ex					
Detector 2 Channel								



Lane Group	EBL	EBT	WBT	WBR	SBL	SBR	Ø4	Ø7
Detector 2 Extend (s)		0.0	0.0					
Turn Type	pm+pt	NA	NA	pm+ov	Prot	pm+ov		
Protected Phases	5	2	6	3	3	5	4	7
Permitted Phases	2			6		7		
Detector Phase	5	2	6	3	3	5		
Switch Phase								
Minimum Initial (s)	5.0	10.0	10.0	5.0	5.0	5.0	5.0	5.0
Minimum Split (s)	10.7	16.4	41.4	10.9	10.9	10.7	32.0	29.9
Total Split (s)	12.0	55.0	43.0	28.0	28.0	12.0	32.0	60.0
Total Split (%)	10.4%	47.8%	37.4%	24.3%	24.3%	10.4%	28%	52%
Maximum Green (s)	6.3	48.6	36.6	22.1	22.1	6.3	28.0	54.1
Yellow Time (s)	3.3	3.3	3.3	3.3	3.3	3.3	3.0	3.3
All-Red Time (s)	2.4	3.1	3.1	2.6	2.6	2.4	1.0	2.6
Lost Time Adjust (s)	0.0	0.0	0.0	0.0	0.0	0.0		
Total Lost Time (s)	5.7	6.4	6.4	5.9	5.9	5.7		
Lead/Lag	Lead		Lag	Lag	Lag	Lead	Lead	
Lead-Lag Optimize?								
Vehicle Extension (s)	3.0	3.0	3.0	3.0	3.0	3.0	3.0	3.0
Recall Mode	None	C-Max	C-Max	None	None	None	None	None
Walk Time (s)			7.0				7.0	7.0
Flash Dont Walk (s)			28.0				21.0	17.0
Pedestrian Calls (#/hr)			0				0	0
Act Effct Green (s)	86.7	86.0	67.8	84.9	16.7	29.4		
Actuated g/C Ratio	0.75	0.75	0.59	0.74	0.15	0.26		
v/c Ratio	0.21	0.32	0.28	0.12	0.69	0.83		
Control Delay	4.2	4.4	13.3	1.0	53.9	41.6		
Queue Delay	0.0	0.0	0.0	0.0	0.0	0.0		
Total Delay	4.2	4.4	13.3	1.0	53.9	41.6		
LOS	A	A	B	A	D	D		
Approach Delay		4.4	10.9		47.4			
Approach LOS		A	B		D			

Intersection Summary

Area Type: Other
 Cycle Length: 115
 Actuated Cycle Length: 115
 Offset: 59 (51%), Referenced to phase 2:EBTL and 6:WBT, Start of Green
 Natural Cycle: 95
 Control Type: Actuated-Coordinated
 Maximum v/c Ratio: 0.83
 Intersection Signal Delay: 19.3
 Intersection LOS: B
 Intersection Capacity Utilization 65.6%
 ICU Level of Service C
 Analysis Period (min) 15

Splits and Phases: 8: Smyth & General Hospital

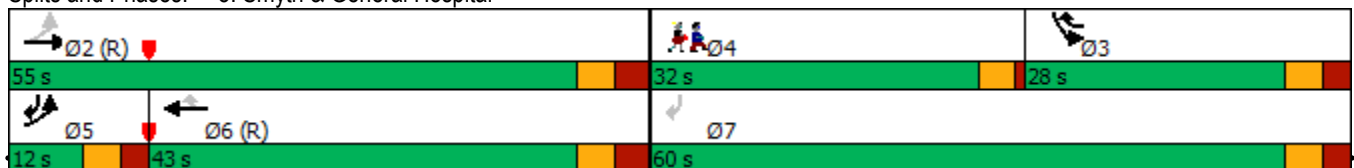



Movement	EBT	EBR	WBL	WBT	NBL	NBR
Lane Configurations	↻			↻	↻	
Sign Control	Stop			Stop	Stop	
Traffic Volume (vph)	117	48	111	280	101	40
Future Volume (vph)	117	48	111	280	101	40
Peak Hour Factor	1.00	1.00	1.00	1.00	1.00	1.00
Hourly flow rate (vph)	117	48	111	280	101	40

Direction, Lane #	EB 1	WB 1	NB 1
Volume Total (vph)	165	391	141
Volume Left (vph)	0	111	101
Volume Right (vph)	48	0	40
Hadj (s)	-0.09	0.12	0.14
Departure Headway (s)	4.7	4.6	5.3
Degree Utilization, x	0.21	0.50	0.21
Capacity (veh/h)	726	755	608
Control Delay (s)	8.9	12.2	9.7
Approach Delay (s)	8.9	12.2	9.7
Approach LOS	A	B	A

Intersection Summary			
Delay		10.9	
Level of Service		B	
Intersection Capacity Utilization	52.9%		ICU Level of Service A
Analysis Period (min)		15	

2027Bg PM
 2: Ring (N-S) & CHEO Non-Emergency

04/19/2024



Movement	EBL	EBT	EBR	WBL	WBT	WBR	NBL	NBT	NBR	SBL	SBT	SBR
Lane Configurations		↕			↕			↕			↕	
Sign Control		Stop			Stop			Stop			Stop	
Traffic Volume (vph)	2	1	12	117	0	19	6	55	24	17	363	3
Future Volume (vph)	2	1	12	117	0	19	6	55	24	17	363	3
Peak Hour Factor	1.00	1.00	1.00	1.00	1.00	1.00	1.00	1.00	1.00	1.00	1.00	1.00
Hourly flow rate (vph)	2	1	12	117	0	19	6	55	24	17	363	3

Direction, Lane #	EB 1	WB 1	NB 1	SB 1
Volume Total (vph)	15	136	85	383
Volume Left (vph)	2	117	6	17
Volume Right (vph)	12	19	24	3
Hadj (s)	-0.42	0.20	-0.06	0.09
Departure Headway (s)	4.8	5.2	4.7	4.5
Degree Utilization, x	0.02	0.20	0.11	0.48
Capacity (veh/h)	661	633	723	773
Control Delay (s)	7.9	9.5	8.3	11.6
Approach Delay (s)	7.9	9.5	8.3	11.6
Approach LOS	A	A	A	B

Intersection Summary			
Delay		10.6	
Level of Service		B	
Intersection Capacity Utilization	46.8%		ICU Level of Service A
Analysis Period (min)		15	

2027Bg PM
3: Ring (N-S) & Ring (E-W)

04/19/2024



Movement	WBL	WBR	NBT	NBR	SBL	SBT
Lane Configurations						
Traffic Volume (veh/h)	89	19	71	52	27	463
Future Volume (Veh/h)	89	19	71	52	27	463
Sign Control	Stop		Free		Free	
Grade	0%		0%		0%	
Peak Hour Factor	1.00	1.00	1.00	1.00	1.00	1.00
Hourly flow rate (vph)	89	19	71	52	27	463
Pedestrians	7					
Lane Width (m)	4.0					
Walking Speed (m/s)	1.0					
Percent Blockage	1					
Right turn flare (veh)						
Median type	None			None		
Median storage veh						
Upstream signal (m)	52					
pX, platoon unblocked						
vC, conflicting volume	621	104			130	
vC1, stage 1 conf vol						
vC2, stage 2 conf vol						
vCu, unblocked vol	621	104			130	
tC, single (s)	6.4	6.3			4.2	
tC, 2 stage (s)						
tF (s)	3.5	3.4			2.3	
p0 queue free %	80	98			98	
cM capacity (veh/h)	439	933			1414	
Direction, Lane #	WB 1	NB 1	SB 1			
Volume Total	108	123	490			
Volume Left	89	0	27			
Volume Right	19	52	0			
cSH	484	1700	1414			
Volume to Capacity	0.22	0.07	0.02			
Queue Length 95th (m)	5.9	0.0	0.4			
Control Delay (s)	14.6	0.0	0.6			
Lane LOS	B		A			
Approach Delay (s)	14.6	0.0	0.6			
Approach LOS	B					
Intersection Summary						
Average Delay			2.6			
Intersection Capacity Utilization			52.5%	ICU Level of Service		A
Analysis Period (min)			15			

2027Bg PM
5: Ring (E-W) & CHEO Non-Emergency

04/19/2024



Movement	EBL	EBT	WBT	WBR	SBL	SBR
Lane Configurations		↶	↷		↘	↘
Traffic Volume (veh/h)	24	64	105	27	16	7
Future Volume (Veh/h)	24	64	105	27	16	7
Sign Control		Free	Free		Stop	
Grade		0%	0%		0%	
Peak Hour Factor	1.00	1.00	1.00	1.00	1.00	1.00
Hourly flow rate (vph)	24	64	105	27	16	7
Pedestrians						
Lane Width (m)						
Walking Speed (m/s)						
Percent Blockage						
Right turn flare (veh)						
Median type		None	None			
Median storage (veh)						
Upstream signal (m)						
pX, platoon unblocked						
vC, conflicting volume	132				230	118
vC1, stage 1 conf vol						
vC2, stage 2 conf vol						
vCu, unblocked vol	132				230	118
tC, single (s)	4.1				6.6	6.2
tC, 2 stage (s)						
tF (s)	2.2				3.7	3.3
p0 queue free %	98				98	99
cM capacity (veh/h)	1453				706	933
Direction, Lane #	EB 1	WB 1	SB 1			
Volume Total	88	132	23			
Volume Left	24	0	16			
Volume Right	0	27	7			
cSH	1453	1700	762			
Volume to Capacity	0.02	0.08	0.03			
Queue Length 95th (m)	0.4	0.0	0.7			
Control Delay (s)	2.1	0.0	9.9			
Lane LOS	A		A			
Approach Delay (s)	2.1	0.0	9.9			
Approach LOS			A			
Intersection Summary						
Average Delay			1.7			
Intersection Capacity Utilization			25.9%	ICU Level of Service	A	
Analysis Period (min)			15			

2027Bg PM
6: Ring (E-W) & CHEO Emergency

04/19/2024



Movement	EBL	EBT	WBT	WBR	SBL	SBR
Lane Configurations						
Traffic Volume (veh/h)	24	73	64	16	45	53
Future Volume (Veh/h)	24	73	64	16	45	53
Sign Control		Free	Free		Stop	
Grade		0%	0%		0%	
Peak Hour Factor	1.00	1.00	1.00	1.00	1.00	1.00
Hourly flow rate (vph)	24	73	64	16	45	53
Pedestrians		4	16		6	
Lane Width (m)		4.0	4.0		4.0	
Walking Speed (m/s)		1.0	1.0		1.0	
Percent Blockage		0	2		1	
Right turn flare (veh)						
Median type		None	None			
Median storage (veh)						
Upstream signal (m)						
pX, platoon unblocked						
vC, conflicting volume	86				215	82
vC1, stage 1 conf vol						
vC2, stage 2 conf vol						
vCu, unblocked vol	86				215	82
tC, single (s)	4.2				6.5	6.3
tC, 2 stage (s)						
tF (s)	2.3				3.6	3.4
p0 queue free %	98				94	94
cM capacity (veh/h)	1446				731	951
Direction, Lane #	EB 1	WB 1	SB 1			
Volume Total	97	80	98			
Volume Left	24	0	45			
Volume Right	0	16	53			
cSH	1446	1700	836			
Volume to Capacity	0.02	0.05	0.12			
Queue Length 95th (m)	0.4	0.0	2.8			
Control Delay (s)	2.0	0.0	9.9			
Lane LOS	A		A			
Approach Delay (s)	2.0	0.0	9.9			
Approach LOS			A			
Intersection Summary						
Average Delay			4.2			
Intersection Capacity Utilization		26.0%		ICU Level of Service		A
Analysis Period (min)			15			

2027Bg PM
7: General Hospital & Ring (E-W)

04/19/2024



Movement	EBL	EBT	EBR	WBL	WBT	WBR	NBL	NBT	NBR	SBL	SBT	SBR
Lane Configurations		↕		↖	↕			↖	↖		↕	
Traffic Volume (veh/h)	21	9	56	413	32	17	42	131	144	23	125	18
Future Volume (Veh/h)	21	9	56	413	32	17	42	131	144	23	125	18
Sign Control		Stop			Stop			Free			Free	
Grade		0%			0%			0%			0%	
Peak Hour Factor	1.00	1.00	1.00	1.00	1.00	1.00	1.00	1.00	1.00	1.00	1.00	1.00
Hourly flow rate (vph)	21	9	56	413	32	17	42	131	144	23	125	18
Pedestrians		35			83			1			27	
Lane Width (m)		4.0			4.0			4.0			4.0	
Walking Speed (m/s)		1.0			1.0			1.0			1.0	
Percent Blockage		4			9			0			3	
Right turn flare (veh)												
Median type								None			None	
Median storage veh												
Upstream signal (m)								59				
pX, platoon unblocked												
vC, conflicting volume	490	513	170	540	522	241	178			214		
vC1, stage 1 conf vol												
vC2, stage 2 conf vol												
vCu, unblocked vol	490	513	170	540	522	241	178			214		
tC, single (s)	7.2	6.5	6.3	7.1	6.7	6.2	4.2			4.1		
tC, 2 stage (s)												
tF (s)	3.6	4.0	3.4	3.5	4.2	3.3	2.3			2.2		
p0 queue free %	94	98	93	0	91	98	97			98		
cM capacity (veh/h)	351	384	812	326	358	703	1315			1231		
Direction, Lane #	EB 1	WB 1	WB 2	NB 1	NB 2	SB 1						
Volume Total	86	275	187	173	144	166						
Volume Left	21	275	138	42	0	23						
Volume Right	56	0	17	0	144	18						
cSH	565	326	349	1315	1700	1231						
Volume to Capacity	0.15	0.84	0.54	0.03	0.08	0.02						
Queue Length 95th (m)	3.7	52.2	21.1	0.7	0.0	0.4						
Control Delay (s)	12.5	54.5	26.6	2.1	0.0	1.2						
Lane LOS	B	F	D	A		A						
Approach Delay (s)	12.5	43.2		1.1		1.2						
Approach LOS	B	E										
Intersection Summary												
Average Delay				21.0								
Intersection Capacity Utilization			55.6%		ICU Level of Service				B			
Analysis Period (min)			15									



Lane Group	EBL	EBT	EBR	WBL	WBT	WBR	NBL	NBT	NBR	SBL	SBT	SBR
Lane Configurations		↕↕			↕↕			↕		↕		↕
Traffic Volume (vph)	428	855	2	1	617	114	6	1	0	32	0	140
Future Volume (vph)	428	855	2	1	617	114	6	1	0	32	0	140
Ideal Flow (vphpl)	1800	1800	1800	1800	1800	1800	1800	1800	1800	1800	1800	1800
Lane Util. Factor	0.95	0.95	0.95	0.95	0.95	0.95	1.00	1.00	1.00	1.00	1.00	1.00
Ped Bike Factor		1.00			0.99			1.00		0.99		0.98
Frt					0.977							0.850
Flt Protected		0.984						0.959		0.950		
Satd. Flow (prot)	0	3446	0	0	3361	0	0	1768	0	1717	0	1493
Flt Permitted		0.517			0.954			0.959		0.753		
Satd. Flow (perm)	0	1806	0	0	3206	0	0	1763	0	1347	0	1468
Right Turn on Red			Yes			Yes			Yes			Yes
Satd. Flow (RTOR)					19							140
Link Speed (k/h)		50			50			40				40
Link Distance (m)		218.8			394.7			154.1				51.9
Travel Time (s)		15.8			28.4			13.9				4.7
Confl. Peds. (#/hr)	15		3	3		15	2		7	7		2
Confl. Bikes (#/hr)			3						1			2
Peak Hour Factor	1.00	1.00	1.00	1.00	1.00	1.00	1.00	1.00	1.00	1.00	1.00	1.00
Heavy Vehicles (%)	2%	2%	2%	2%	3%	3%	2%	2%	2%	4%	2%	7%
Adj. Flow (vph)	428	855	2	1	617	114	6	1	0	32	0	140
Shared Lane Traffic (%)												
Lane Group Flow (vph)	0	1285	0	0	732	0	0	7	0	32	0	140
Enter Blocked Intersection	No	No	No	No	No	No	No	No	No	No	No	No
Lane Alignment	Left	Left	Right	Left	Left	Right	L NA	Left	R NA	L NA	Left	R NA
Median Width(m)		0.0			4.0			0.0				5.0
Link Offset(m)		0.0			0.0			0.0				0.0
Crosswalk Width(m)		5.0			5.0			5.0				5.0
Two way Left Turn Lane												
Headway Factor	1.01	1.01	1.01	1.01	1.01	1.01	1.01	1.01	1.01	1.01	1.01	1.01
Turning Speed (k/h)	24		14	24		14	24		14	24		14
Number of Detectors	1	2		1	2		1	2		1		1
Detector Template	Left	Thru		Left	Thru		Left	Thru		Left		Right
Leading Detector (m)	2.0	10.0		2.0	10.0		2.0	10.0		2.0		2.0
Trailing Detector (m)	0.0	0.0		0.0	0.0		0.0	0.0		0.0		0.0
Detector 1 Position(m)	0.0	0.0		0.0	0.0		0.0	0.0		0.0		0.0
Detector 1 Size(m)	2.0	0.6		2.0	0.6		2.0	0.6		2.0		2.0
Detector 1 Type	Cl+Ex	Cl+Ex		Cl+Ex	Cl+Ex		Cl+Ex	Cl+Ex		Cl+Ex		Cl+Ex
Detector 1 Channel												
Detector 1 Extend (s)	0.0	0.0		0.0	0.0		0.0	0.0		0.0		0.0
Detector 1 Queue (s)	0.0	0.0		0.0	0.0		0.0	0.0		0.0		0.0
Detector 1 Delay (s)	0.0	0.0		0.0	0.0		0.0	0.0		0.0		0.0
Detector 2 Position(m)		9.4			9.4			9.4				
Detector 2 Size(m)		0.6			0.6			0.6				
Detector 2 Type		Cl+Ex			Cl+Ex			Cl+Ex				
Detector 2 Channel												
Detector 2 Extend (s)		0.0			0.0			0.0				
Turn Type	pm+pt	NA		Perm	NA		Perm	NA		Perm		Perm
Protected Phases	5	2			6			8				



Lane Group	EBL	EBT	EBR	WBL	WBT	WBR	NBL	NBT	NBR	SBL	SBT	SBR
Permitted Phases	2			6			8			4		4
Detector Phase	5	2		6	6		8	8		4		4
Switch Phase												
Minimum Initial (s)	5.0	10.0		10.0	10.0		10.0	10.0		10.0		10.0
Minimum Split (s)	10.6	31.7		31.7	31.7		28.5	28.5		28.5		28.5
Total Split (s)	42.0	84.0		42.0	42.0		31.0	31.0		31.0		31.0
Total Split (%)	36.5%	73.0%		36.5%	36.5%		27.0%	27.0%		27.0%		27.0%
Maximum Green (s)	36.4	78.3		36.3	36.3		25.5	25.5		25.5		25.5
Yellow Time (s)	3.3	3.3		3.3	3.3		3.3	3.3		3.3		3.3
All-Red Time (s)	2.3	2.4		2.4	2.4		2.2	2.2		2.2		2.2
Lost Time Adjust (s)		0.0			0.0			0.0		0.0		0.0
Total Lost Time (s)		5.7			5.7			5.5		5.5		5.5
Lead/Lag	Lead			Lag			Lag			Lag		
Lead-Lag Optimize?												
Vehicle Extension (s)	3.0	3.0		3.0	3.0		3.0	3.0		3.0		3.0
Recall Mode	Max	C-Max		C-Max	C-Max		None	None		None		None
Walk Time (s)		7.0		7.0	7.0		7.0	7.0		7.0		7.0
Flash Dont Walk (s)		19.0		19.0	19.0		16.0	16.0		16.0		16.0
Pedestrian Calls (#/hr)		0		0	0		0	0		0		0
Act Effct Green (s)		93.3			36.3			10.5		10.5		10.5
Actuated g/C Ratio		0.81			0.32			0.09		0.09		0.09
v/c Ratio		0.59			0.71			0.04		0.26		0.54
Control Delay		4.6			33.6			47.6		53.8		16.0
Queue Delay		0.0			0.0			0.0		0.0		0.0
Total Delay		4.6			33.6			47.6		53.8		16.0
LOS		A			C			D		D		B
Approach Delay		4.6			33.6			47.6				23.1
Approach LOS		A			C			D				C

Intersection Summary

Area Type: Other
 Cycle Length: 115
 Actuated Cycle Length: 115
 Offset: 66 (57%), Referenced to phase 2:EBTL and 6:WBTL, Start of Green
 Natural Cycle: 90
 Control Type: Actuated-Coordinated
 Maximum v/c Ratio: 0.71
 Intersection Signal Delay: 15.8
 Intersection Capacity Utilization 84.9%
 Analysis Period (min) 15
 Intersection LOS: B
 ICU Level of Service E

Splits and Phases: 4: South Haven/Ring (N-S) & Smyth

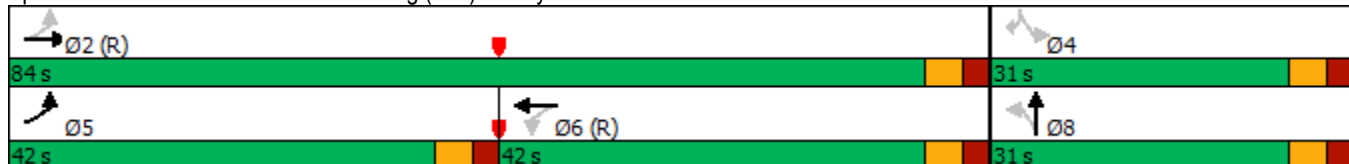

2032Bg AM
8: Smyth & General Hospital

04/19/2024



Lane Group	EBL	EBT	WBT	WBR	SBL	SBR	Ø4	Ø7
Lane Configurations	↖	↗↗	↖↖	↖	↖↖	↖		
Traffic Volume (vph)	382	466	748	428	113	174		
Future Volume (vph)	382	466	748	428	113	174		
Ideal Flow (vphpl)	1800	1800	1800	1800	1800	1800		
Storage Length (m)	55.0			175.0	0.0	0.0		
Storage Lanes	1			1	2	1		
Taper Length (m)	40.0				10.0			
Lane Util. Factor	1.00	0.95	0.95	1.00	0.97	1.00		
Ped Bike Factor	1.00			0.97	0.59	0.97		
Fr _t				0.850		0.850		
Fl _t Protected	0.950				0.950			
Satd. Flow (prot)	1751	3502	3468	1567	3364	1567		
Fl _t Permitted	0.312				0.950			
Satd. Flow (perm)	574	3502	3468	1523	1975	1519		
Right Turn on Red				Yes		Yes		
Satd. Flow (RTOR)				428		41		
Link Speed (k/h)		50	50		40			
Link Distance (m)		394.7	397.7		58.6			
Travel Time (s)		28.4	28.6		5.3			
Confl. Peds. (#/hr)	3			3	51	13		
Confl. Bikes (#/hr)				3				
Peak Hour Factor	1.00	1.00	1.00	1.00	1.00	1.00		
Heavy Vehicles (%)	2%	2%	3%	2%	3%	2%		
Adj. Flow (vph)	382	466	748	428	113	174		
Shared Lane Traffic (%)								
Lane Group Flow (vph)	382	466	748	428	113	174		
Enter Blocked Intersection	No	No	No	No	No	No		
Lane Alignment	Left	Left	Left	Right	Left	R NA		
Median Width(m)		4.0	4.0		8.0			
Link Offset(m)		0.0	0.0		0.0			
Crosswalk Width(m)		5.0	5.0		5.0			
Two way Left Turn Lane								
Headway Factor	1.01	1.01	1.01	1.01	1.01	1.01		
Turning Speed (k/h)	24			14	24	14		
Number of Detectors	1	2	2	1	1	1		
Detector Template	Left	Thru	Thru	Right	Left	Right		
Leading Detector (m)	2.0	10.0	10.0	2.0	2.0	2.0		
Trailing Detector (m)	0.0	0.0	0.0	0.0	0.0	0.0		
Detector 1 Position(m)	0.0	0.0	0.0	0.0	0.0	0.0		
Detector 1 Size(m)	2.0	0.6	0.6	2.0	2.0	2.0		
Detector 1 Type	Cl+Ex	Cl+Ex	Cl+Ex	Cl+Ex	Cl+Ex	Cl+Ex		
Detector 1 Channel								
Detector 1 Extend (s)	0.0	0.0	0.0	0.0	0.0	0.0		
Detector 1 Queue (s)	0.0	0.0	0.0	0.0	0.0	0.0		
Detector 1 Delay (s)	0.0	0.0	0.0	0.0	0.0	0.0		
Detector 2 Position(m)		9.4	9.4					
Detector 2 Size(m)		0.6	0.6					
Detector 2 Type		Cl+Ex	Cl+Ex					
Detector 2 Channel								



Lane Group	EBL	EBT	WBT	WBR	SBL	SBR	Ø4	Ø7
Detector 2 Extend (s)		0.0	0.0					
Turn Type	pm+pt	NA	NA	pm+ov	Prot	pm+ov		
Protected Phases	5	2	6	3	3	5	4	7
Permitted Phases	2			6		7		
Detector Phase	5	2	6	3	3	5		
Switch Phase								
Minimum Initial (s)	5.0	10.0	10.0	5.0	5.0	5.0	5.0	5.0
Minimum Split (s)	10.7	16.4	41.4	10.9	10.9	10.7	32.0	29.9
Total Split (s)	28.0	70.0	42.0	13.0	13.0	28.0	32.0	45.0
Total Split (%)	24.3%	60.9%	36.5%	11.3%	11.3%	24.3%	28%	39%
Maximum Green (s)	22.3	63.6	35.6	7.1	7.1	22.3	28.0	39.1
Yellow Time (s)	3.3	3.3	3.3	3.3	3.3	3.3	3.0	3.3
All-Red Time (s)	2.4	3.1	3.1	2.6	2.6	2.4	1.0	2.6
Lost Time Adjust (s)	0.0	0.0	0.0	0.0	0.0	0.0		
Total Lost Time (s)	5.7	6.4	6.4	5.9	5.9	5.7		
Lead/Lag	Lead		Lag	Lag	Lag	Lead	Lead	
Lead-Lag Optimize?								
Vehicle Extension (s)	3.0	3.0	3.0	3.0	3.0	3.0	3.0	3.0
Recall Mode	None	C-Max	C-Max	None	None	None	None	None
Walk Time (s)			7.0				7.0	7.0
Flash Dont Walk (s)			28.0				21.0	17.0
Pedestrian Calls (#/hr)			0				0	0
Act Effct Green (s)	94.2	93.5	71.0	80.7	9.2	26.2		
Actuated g/C Ratio	0.82	0.81	0.62	0.70	0.08	0.23		
v/c Ratio	0.60	0.16	0.35	0.36	0.42	0.45		
Control Delay	10.7	2.5	12.6	1.5	54.7	27.6		
Queue Delay	0.0	0.0	0.0	0.0	0.0	0.0		
Total Delay	10.7	2.5	12.6	1.5	54.7	27.6		
LOS	B	A	B	A	D	C		
Approach Delay		6.2	8.5		38.3			
Approach LOS		A	A		D			

Intersection Summary

Area Type: Other
 Cycle Length: 115
 Actuated Cycle Length: 115
 Offset: 43 (37%), Referenced to phase 2:EBTL and 6:WBT, Start of Green
 Natural Cycle: 95
 Control Type: Actuated-Coordinated
 Maximum v/c Ratio: 0.60
 Intersection Signal Delay: 11.4
 Intersection LOS: B
 Intersection Capacity Utilization 70.7%
 ICU Level of Service C
 Analysis Period (min) 15

Splits and Phases: 8: Smyth & General Hospital

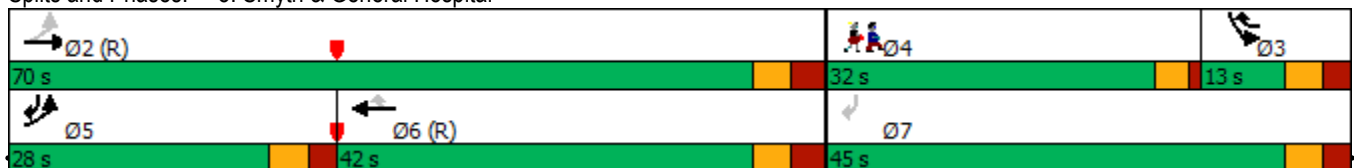



Movement	EBT	EBR	WBL	WBT	NBL	NBR
Lane Configurations	↻			↻	↻	
Sign Control	Stop			Stop	Stop	
Traffic Volume (vph)	324	163	52	107	54	132
Future Volume (vph)	324	163	52	107	54	132
Peak Hour Factor	1.00	1.00	1.00	1.00	1.00	1.00
Hourly flow rate (vph)	324	163	52	107	54	132

Direction, Lane #	EB 1	WB 1	NB 1
Volume Total (vph)	487	159	186
Volume Left (vph)	0	52	54
Volume Right (vph)	163	0	132
Hadj (s)	-0.12	0.13	-0.24
Departure Headway (s)	4.5	5.1	5.2
Degree Utilization, x	0.61	0.23	0.27
Capacity (veh/h)	772	663	625
Control Delay (s)	14.3	9.6	10.0
Approach Delay (s)	14.3	9.6	10.0
Approach LOS	B	A	B

Intersection Summary			
Delay		12.4	
Level of Service		B	
Intersection Capacity Utilization	60.2%		ICU Level of Service B
Analysis Period (min)		15	

2032Bg AM
 2: Ring (N-S) & CHEO Non-Emergency

04/19/2024



Movement	EBL	EBT	EBR	WBL	WBT	WBR	NBL	NBT	NBR	SBL	SBT	SBR
Lane Configurations		↕			↕			↕			↕	
Sign Control		Stop			Stop			Stop			Stop	
Traffic Volume (vph)	3	0	7	83	2	37	4	397	49	30	88	2
Future Volume (vph)	3	0	7	83	2	37	4	397	49	30	88	2
Peak Hour Factor	1.00	1.00	1.00	1.00	1.00	1.00	1.00	1.00	1.00	1.00	1.00	1.00
Hourly flow rate (vph)	3	0	7	83	2	37	4	397	49	30	88	2

Direction, Lane #	EB 1	WB 1	NB 1	SB 1
Volume Total (vph)	10	122	450	120
Volume Left (vph)	3	83	4	30
Volume Right (vph)	7	37	49	2
Hadj (s)	-0.33	0.11	0.02	0.11
Departure Headway (s)	5.1	5.3	4.4	4.9
Degree Utilization, x	0.01	0.18	0.55	0.16
Capacity (veh/h)	610	609	793	696
Control Delay (s)	8.2	9.5	12.8	8.8
Approach Delay (s)	8.2	9.5	12.8	8.8
Approach LOS	A	A	B	A

Intersection Summary

Delay	11.5
Level of Service	B
Intersection Capacity Utilization	48.8%
ICU Level of Service	A
Analysis Period (min)	15

2032Bg AM
3: Ring (N-S) & Ring (E-W)

04/19/2024



Movement	WBL	WBR	NBT	NBR	SBL	SBT
Lane Configurations						
Traffic Volume (veh/h)	27	50	396	132	32	148
Future Volume (Veh/h)	27	50	396	132	32	148
Sign Control	Stop		Free		Free	
Grade	0%		0%		0%	
Peak Hour Factor	1.00	1.00	1.00	1.00	1.00	1.00
Hourly flow rate (vph)	27	50	396	132	32	148
Pedestrians	8					
Lane Width (m)	4.0					
Walking Speed (m/s)	1.0					
Percent Blockage	1					
Right turn flare (veh)						
Median type	None			None		
Median storage veh						
Upstream signal (m)	52					
pX, platoon unblocked						
vC, conflicting volume	682	470			536	
vC1, stage 1 conf vol						
vC2, stage 2 conf vol						
vCu, unblocked vol	682	470			536	
tC, single (s)	6.4	6.3			4.2	
tC, 2 stage (s)						
tF (s)	3.5	3.4			2.3	
p0 queue free %	93	91			97	
cM capacity (veh/h)	399	580			998	
Direction, Lane #	WB 1	NB 1	SB 1			
Volume Total	77	528	180			
Volume Left	27	0	32			
Volume Right	50	132	0			
cSH	500	1700	998			
Volume to Capacity	0.15	0.31	0.03			
Queue Length 95th (m)	3.8	0.0	0.7			
Control Delay (s)	13.5	0.0	1.8			
Lane LOS	B		A			
Approach Delay (s)	13.5	0.0	1.8			
Approach LOS	B					
Intersection Summary						
Average Delay			1.7			
Intersection Capacity Utilization			48.7%	ICU Level of Service		A
Analysis Period (min)			15			

2032Bg AM
5: Ring (E-W) & CHEO Non-Emergency

04/19/2024



Movement	EBL	EBT	WBT	WBR	SBL	SBR
Lane Configurations						
Traffic Volume (veh/h)	35	142	69	49	17	4
Future Volume (Veh/h)	35	142	69	49	17	4
Sign Control		Free	Free		Stop	
Grade		0%	0%		0%	
Peak Hour Factor	1.00	1.00	1.00	1.00	1.00	1.00
Hourly flow rate (vph)	35	142	69	49	17	4
Pedestrians			17		2	
Lane Width (m)			4.0		4.0	
Walking Speed (m/s)			1.0		1.0	
Percent Blockage			2		0	
Right turn flare (veh)						
Median type		None	None			
Median storage veh						
Upstream signal (m)						
pX, platoon unblocked						
vC, conflicting volume	120				324	96
vC1, stage 1 conf vol						
vC2, stage 2 conf vol						
vCu, unblocked vol	120				324	96
tC, single (s)	4.1				6.6	6.2
tC, 2 stage (s)						
tF (s)	2.2				3.7	3.3
p0 queue free %	98				97	100
cM capacity (veh/h)	1464				604	959
Direction, Lane #	EB 1	WB 1	SB 1			
Volume Total	177	118	21			
Volume Left	35	0	17			
Volume Right	0	49	4			
cSH	1464	1700	650			
Volume to Capacity	0.02	0.07	0.03			
Queue Length 95th (m)	0.5	0.0	0.7			
Control Delay (s)	1.6	0.0	10.7			
Lane LOS	A		B			
Approach Delay (s)	1.6	0.0	10.7			
Approach LOS			B			
Intersection Summary						
Average Delay			1.6			
Intersection Capacity Utilization			26.6%		ICU Level of Service	A
Analysis Period (min)			15			

2032Bg AM
6: Ring (E-W) & CHEO Emergency

04/19/2024



Movement	EBL	EBT	WBT	WBR	SBL	SBR
Lane Configurations		↕	↔		↕	
Traffic Volume (veh/h)	132	76	96	50	20	21
Future Volume (Veh/h)	132	76	96	50	20	21
Sign Control		Free	Free		Stop	
Grade		0%	0%		0%	
Peak Hour Factor	1.00	1.00	1.00	1.00	1.00	1.00
Hourly flow rate (vph)	132	76	96	50	20	21
Pedestrians		2	28		7	
Lane Width (m)		4.0	4.0		4.0	
Walking Speed (m/s)		1.0	1.0		1.0	
Percent Blockage		0	3		1	
Right turn flare (veh)						
Median type		None	None			
Median storage (veh)						
Upstream signal (m)						
pX, platoon unblocked						
vC, conflicting volume	153				496	130
vC1, stage 1 conf vol						
vC2, stage 2 conf vol						
vCu, unblocked vol	153				496	130
tC, single (s)	4.2				6.5	6.3
tC, 2 stage (s)						
tF (s)	2.3				3.6	3.4
p0 queue free %	90				96	98
cM capacity (veh/h)	1364				455	895
Direction, Lane #	EB 1	WB 1	SB 1			
Volume Total	208	146	41			
Volume Left	132	0	20			
Volume Right	0	50	21			
cSH	1364	1700	608			
Volume to Capacity	0.10	0.09	0.07			
Queue Length 95th (m)	2.2	0.0	1.5			
Control Delay (s)	5.3	0.0	11.3			
Lane LOS	A		B			
Approach Delay (s)	5.3	0.0	11.3			
Approach LOS			B			
Intersection Summary						
Average Delay			4.0			
Intersection Capacity Utilization		35.7%		ICU Level of Service		A
Analysis Period (min)			15			

2032Bg AM
7: General Hospital & Ring (E-W)

04/19/2024



Movement	EBL	EBT	EBR	WBL	WBT	WBR	NBL	NBT	NBR	SBL	SBT	SBR
Lane Configurations		↕		↕	↕			↕	↕		↕	
Traffic Volume (veh/h)	19	22	19	158	25	19	92	134	485	12	137	15
Future Volume (Veh/h)	19	22	19	158	25	19	92	134	485	12	137	15
Sign Control		Stop			Stop			Free			Free	
Grade		0%			0%			0%			0%	
Peak Hour Factor	1.00	1.00	1.00	1.00	1.00	1.00	1.00	1.00	1.00	1.00	1.00	1.00
Hourly flow rate (vph)	19	22	19	158	25	19	92	134	485	12	137	15
Pedestrians		27			65							4
Lane Width (m)		4.0			4.0						4.0	
Walking Speed (m/s)		1.0			1.0						1.0	
Percent Blockage		3			7						0	
Right turn flare (veh)												
Median type								None			None	
Median storage veh												
Upstream signal (m)								59				
pX, platoon unblocked												
vC, conflicting volume	549	578	172	582	586	203	179			199		
vC1, stage 1 conf vol												
vC2, stage 2 conf vol												
vCu, unblocked vol	549	578	172	582	586	203	179			199		
tC, single (s)	7.2	6.5	6.3	7.1	6.7	6.2	4.2			4.1		
tC, 2 stage (s)												
tF (s)	3.6	4.0	3.4	3.5	4.2	3.3	2.3			2.2		
p0 queue free %	94	94	98	50	92	98	93			99		
cM capacity (veh/h)	336	353	819	319	329	774	1326			1274		
Direction, Lane #	EB 1	WB 1	WB 2	NB 1	NB 2	SB 1						
Volume Total	60	105	97	226	485	164						
Volume Left	19	105	53	92	0	12						
Volume Right	19	0	19	0	485	15						
cSH	422	319	364	1326	1700	1274						
Volume to Capacity	0.14	0.33	0.27	0.07	0.29	0.01						
Queue Length 95th (m)	3.4	9.8	7.4	1.6	0.0	0.2						
Control Delay (s)	14.9	21.7	18.4	3.6	0.0	0.6						
Lane LOS	B	C	C	A		A						
Approach Delay (s)	14.9	20.2		1.1		0.6						
Approach LOS	B	C										
Intersection Summary												
Average Delay			5.2									
Intersection Capacity Utilization			61.7%		ICU Level of Service				B			
Analysis Period (min)			15									



Lane Group	EBL	EBT	EBR	WBL	WBT	WBR	NBL	NBT	NBR	SBL	SBT	SBR
Lane Configurations		↕↕			↕↕			↕		↕		↕
Traffic Volume (vph)	102	582	4	4	981	13	5	0	4	152	0	385
Future Volume (vph)	102	582	4	4	981	13	5	0	4	152	0	385
Ideal Flow (vphpl)	1800	1800	1800	1800	1800	1800	1800	1800	1800	1800	1800	1800
Lane Util. Factor	0.95	0.95	0.95	0.95	0.95	0.95	1.00	1.00	1.00	1.00	1.00	1.00
Ped Bike Factor		1.00			1.00			0.99		0.99		0.97
Frt		0.999			0.998			0.940				0.850
Flt Protected		0.993						0.973		0.950		
Satd. Flow (prot)	0	3435	0	0	3493	0	0	1670	0	1751	0	1567
Flt Permitted		0.602			0.953			0.973		0.752		
Satd. Flow (perm)	0	2081	0	0	3328	0	0	1666	0	1374	0	1523
Right Turn on Red			Yes			Yes			Yes			Yes
Satd. Flow (RTOR)		1			2			79				229
Link Speed (k/h)		50			50			40				40
Link Distance (m)		218.8			394.7			154.1				51.9
Travel Time (s)		15.8			28.4			13.9				4.7
Confl. Peds. (#/hr)	15		8	8		15	3		6	6		3
Confl. Bikes (#/hr)			2			1						14
Peak Hour Factor	1.00	1.00	1.00	1.00	1.00	1.00	1.00	1.00	1.00	1.00	1.00	1.00
Heavy Vehicles (%)	4%	3%	2%	2%	2%	2%	2%	2%	2%	2%	2%	2%
Adj. Flow (vph)	102	582	4	4	981	13	5	0	4	152	0	385
Shared Lane Traffic (%)												
Lane Group Flow (vph)	0	688	0	0	998	0	0	9	0	152	0	385
Enter Blocked Intersection	No	No	No	No	No	No	No	No	No	No	No	No
Lane Alignment	Left	Left	Right	Left	Left	Right	L NA	Left	R NA	L NA	Left	R NA
Median Width(m)		0.0			4.0			0.0				5.0
Link Offset(m)		0.0			0.0			0.0				0.0
Crosswalk Width(m)		5.0			5.0			5.0				5.0
Two way Left Turn Lane												
Headway Factor	1.01	1.01	1.01	1.01	1.01	1.01	1.01	1.01	1.01	1.01	1.01	1.01
Turning Speed (k/h)	24		14	24		14	24		14	24		14
Number of Detectors	1	2		1	2		1	2		1		1
Detector Template	Left	Thru		Left	Thru		Left	Thru		Left		Right
Leading Detector (m)	2.0	10.0		2.0	10.0		2.0	10.0		2.0		2.0
Trailing Detector (m)	0.0	0.0		0.0	0.0		0.0	0.0		0.0		0.0
Detector 1 Position(m)	0.0	0.0		0.0	0.0		0.0	0.0		0.0		0.0
Detector 1 Size(m)	2.0	0.6		2.0	0.6		2.0	0.6		2.0		2.0
Detector 1 Type	Cl+Ex	Cl+Ex		Cl+Ex	Cl+Ex		Cl+Ex	Cl+Ex		Cl+Ex		Cl+Ex
Detector 1 Channel												
Detector 1 Extend (s)	0.0	0.0		0.0	0.0		0.0	0.0		0.0		0.0
Detector 1 Queue (s)	0.0	0.0		0.0	0.0		0.0	0.0		0.0		0.0
Detector 1 Delay (s)	0.0	0.0		0.0	0.0		0.0	0.0		0.0		0.0
Detector 2 Position(m)		9.4			9.4			9.4				
Detector 2 Size(m)		0.6			0.6			0.6				
Detector 2 Type		Cl+Ex			Cl+Ex			Cl+Ex				
Detector 2 Channel												
Detector 2 Extend (s)		0.0			0.0			0.0				
Turn Type	pm+pt	NA		Perm	NA		Perm	NA		Perm		Perm
Protected Phases	5	2			6			8				



Lane Group	EBL	EBT	EBR	WBL	WBT	WBR	NBL	NBT	NBR	SBL	SBT	SBR
Permitted Phases	2			6			8			4		4
Detector Phase	5	2		6	6		8	8		4		4
Switch Phase												
Minimum Initial (s)	5.0	10.0		10.0	10.0		10.0	10.0		10.0		10.0
Minimum Split (s)	10.6	31.7		31.7	31.7		28.5	28.5		28.5		28.5
Total Split (s)	16.0	78.0		62.0	62.0		37.0	37.0		37.0		37.0
Total Split (%)	13.9%	67.8%		53.9%	53.9%		32.2%	32.2%		32.2%		32.2%
Maximum Green (s)	10.4	72.3		56.3	56.3		31.5	31.5		31.5		31.5
Yellow Time (s)	3.3	3.3		3.3	3.3		3.3	3.3		3.3		3.3
All-Red Time (s)	2.3	2.4		2.4	2.4		2.2	2.2		2.2		2.2
Lost Time Adjust (s)		0.0			0.0			0.0		0.0		0.0
Total Lost Time (s)		5.7			5.7			5.5		5.5		5.5
Lead/Lag	Lead			Lag		Lag						
Lead-Lag Optimize?												
Vehicle Extension (s)	3.0	3.0		3.0	3.0		3.0	3.0		3.0		3.0
Recall Mode	Max	C-Max		C-Max	C-Max		None	None		None		None
Walk Time (s)		7.0		7.0	7.0		7.0	7.0		7.0		7.0
Flash Dont Walk (s)		19.0		19.0	19.0		16.0	16.0		16.0		16.0
Pedestrian Calls (#/hr)		0		0	0		0	0		0		0
Act Effct Green (s)		83.6			56.3			20.2		20.2		20.2
Actuated g/C Ratio		0.73			0.49			0.18		0.18		0.18
v/c Ratio		0.39			0.61			0.03		0.63		0.84
Control Delay		7.0			23.3			0.1		54.0		34.4
Queue Delay		0.0			0.0			0.0		0.0		0.0
Total Delay		7.0			23.3			0.1		54.0		34.4
LOS		A			C			A		D		C
Approach Delay		7.0			23.3			0.1				39.9
Approach LOS		A			C			A				D

Intersection Summary

Area Type: Other
 Cycle Length: 115
 Actuated Cycle Length: 115
 Offset: 62 (54%), Referenced to phase 2:EBTL and 6:WBTL, Start of Green
 Natural Cycle: 75
 Control Type: Actuated-Coordinated
 Maximum v/c Ratio: 0.84
 Intersection Signal Delay: 22.2
 Intersection LOS: C
 Intersection Capacity Utilization 78.9%
 ICU Level of Service D
 Analysis Period (min) 15

Splits and Phases: 4: South Haven/Ring (N-S) & Smyth



2032Bg PM
8: Smyth & General Hospital

04/19/2024



Lane Group	EBL	EBT	WBT	WBR	SBL	SBR	Ø4	Ø7
Lane Configurations	↖	↗↗	↖↖	↖	↗↗	↖		
Traffic Volume (vph)	130	868	597	141	338	382		
Future Volume (vph)	130	868	597	141	338	382		
Ideal Flow (vphpl)	1800	1800	1800	1800	1800	1800		
Storage Length (m)	55.0			175.0	0.0	0.0		
Storage Lanes	1			1	2	1		
Taper Length (m)	40.0				10.0			
Lane Util. Factor	1.00	0.95	0.95	1.00	0.97	1.00		
Ped Bike Factor	0.99			0.96	0.81	0.97		
Fr _t				0.850		0.850		
Fl _t Protected	0.950				0.950			
Satd. Flow (prot)	1701	3468	3502	1551	3397	1567		
Fl _t Permitted	0.371				0.950			
Satd. Flow (perm)	660	3468	3502	1491	2761	1517		
Right Turn on Red				Yes		Yes		
Satd. Flow (RTOR)				141		82		
Link Speed (k/h)		50	50		40			
Link Distance (m)		394.7	397.7		58.6			
Travel Time (s)		28.4	28.6		5.3			
Confl. Peds. (#/hr)	11			11	72	14		
Confl. Bikes (#/hr)				2				
Peak Hour Factor	1.00	1.00	1.00	1.00	1.00	1.00		
Heavy Vehicles (%)	5%	3%	2%	3%	2%	2%		
Adj. Flow (vph)	130	868	597	141	338	382		
Shared Lane Traffic (%)								
Lane Group Flow (vph)	130	868	597	141	338	382		
Enter Blocked Intersection	No	No	No	No	No	No		
Lane Alignment	Left	Left	Left	Right	Left	R NA		
Median Width(m)		4.0	4.0		8.0			
Link Offset(m)		0.0	0.0		0.0			
Crosswalk Width(m)		5.0	5.0		5.0			
Two way Left Turn Lane								
Headway Factor	1.01	1.01	1.01	1.01	1.01	1.01		
Turning Speed (k/h)	24			14	24	14		
Number of Detectors	1	2	2	1	1	1		
Detector Template	Left	Thru	Thru	Right	Left	Right		
Leading Detector (m)	2.0	10.0	10.0	2.0	2.0	2.0		
Trailing Detector (m)	0.0	0.0	0.0	0.0	0.0	0.0		
Detector 1 Position(m)	0.0	0.0	0.0	0.0	0.0	0.0		
Detector 1 Size(m)	2.0	0.6	0.6	2.0	2.0	2.0		
Detector 1 Type	Cl+Ex	Cl+Ex	Cl+Ex	Cl+Ex	Cl+Ex	Cl+Ex		
Detector 1 Channel								
Detector 1 Extend (s)	0.0	0.0	0.0	0.0	0.0	0.0		
Detector 1 Queue (s)	0.0	0.0	0.0	0.0	0.0	0.0		
Detector 1 Delay (s)	0.0	0.0	0.0	0.0	0.0	0.0		
Detector 2 Position(m)		9.4	9.4					
Detector 2 Size(m)		0.6	0.6					
Detector 2 Type		Cl+Ex	Cl+Ex					
Detector 2 Channel								



Lane Group	EBL	EBT	WBT	WBR	SBL	SBR	Ø4	Ø7
Detector 2 Extend (s)		0.0	0.0					
Turn Type	pm+pt	NA	NA	pm+ov	Prot	pm+ov		
Protected Phases	5	2	6	3	3	5	4	7
Permitted Phases	2			6		7		
Detector Phase	5	2	6	3	3	5		
Switch Phase								
Minimum Initial (s)	5.0	10.0	10.0	5.0	5.0	5.0	5.0	5.0
Minimum Split (s)	10.7	16.4	41.4	10.9	10.9	10.7	32.0	29.9
Total Split (s)	12.0	55.0	43.0	28.0	28.0	12.0	32.0	60.0
Total Split (%)	10.4%	47.8%	37.4%	24.3%	24.3%	10.4%	28%	52%
Maximum Green (s)	6.3	48.6	36.6	22.1	22.1	6.3	28.0	54.1
Yellow Time (s)	3.3	3.3	3.3	3.3	3.3	3.3	3.0	3.3
All-Red Time (s)	2.4	3.1	3.1	2.6	2.6	2.4	1.0	2.6
Lost Time Adjust (s)	0.0	0.0	0.0	0.0	0.0	0.0		
Total Lost Time (s)	5.7	6.4	6.4	5.9	5.9	5.7		
Lead/Lag	Lead		Lag	Lag	Lag	Lead	Lead	
Lead-Lag Optimize?								
Vehicle Extension (s)	3.0	3.0	3.0	3.0	3.0	3.0	3.0	3.0
Recall Mode	None	C-Max	C-Max	None	None	None	None	None
Walk Time (s)			7.0				7.0	7.0
Flash Dont Walk (s)			28.0				21.0	17.0
Pedestrian Calls (#/hr)			0				0	0
Act Effct Green (s)	86.7	86.0	67.1	84.2	16.7	30.1		
Actuated g/C Ratio	0.75	0.75	0.58	0.73	0.15	0.26		
v/c Ratio	0.21	0.33	0.29	0.12	0.69	0.83		
Control Delay	4.3	4.5	13.9	1.0	53.9	42.1		
Queue Delay	0.0	0.0	0.0	0.0	0.0	0.0		
Total Delay	4.3	4.5	13.9	1.0	53.9	42.1		
LOS	A	A	B	A	D	D		
Approach Delay		4.5	11.5		47.7			
Approach LOS		A	B		D			

Intersection Summary

Area Type:	Other
Cycle Length:	115
Actuated Cycle Length:	115
Offset:	59 (51%), Referenced to phase 2:EBTL and 6:WBT, Start of Green
Natural Cycle:	95
Control Type:	Actuated-Coordinated
Maximum v/c Ratio:	0.83
Intersection Signal Delay:	19.2
Intersection LOS:	B
Intersection Capacity Utilization:	65.6%
ICU Level of Service:	C
Analysis Period (min):	15

Splits and Phases: 8: Smyth & General Hospital

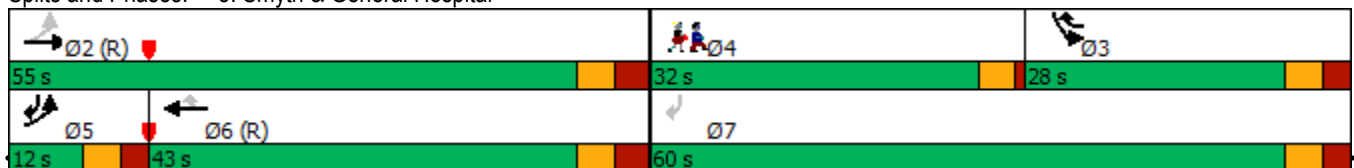



Movement	EBT	EBR	WBL	WBT	NBL	NBR
Lane Configurations	↻			↻	↻	
Sign Control	Stop			Stop	Stop	
Traffic Volume (vph)	117	48	111	280	101	40
Future Volume (vph)	117	48	111	280	101	40
Peak Hour Factor	1.00	1.00	1.00	1.00	1.00	1.00
Hourly flow rate (vph)	117	48	111	280	101	40

Direction, Lane #	EB 1	WB 1	NB 1
Volume Total (vph)	165	391	141
Volume Left (vph)	0	111	101
Volume Right (vph)	48	0	40
Hadj (s)	-0.09	0.12	0.14
Departure Headway (s)	4.7	4.6	5.3
Degree Utilization, x	0.21	0.50	0.21
Capacity (veh/h)	726	755	608
Control Delay (s)	8.9	12.2	9.7
Approach Delay (s)	8.9	12.2	9.7
Approach LOS	A	B	A

Intersection Summary			
Delay		10.9	
Level of Service		B	
Intersection Capacity Utilization	52.9%		ICU Level of Service A
Analysis Period (min)		15	

2032Bg PM
 2: Ring (N-S) & CHEO Non-Emergency

04/19/2024



Movement	EBL	EBT	EBR	WBL	WBT	WBR	NBL	NBT	NBR	SBL	SBT	SBR
Lane Configurations		↕			↕			↕			↕	
Sign Control		Stop			Stop			Stop			Stop	
Traffic Volume (vph)	2	1	12	117	0	19	6	55	24	17	363	3
Future Volume (vph)	2	1	12	117	0	19	6	55	24	17	363	3
Peak Hour Factor	1.00	1.00	1.00	1.00	1.00	1.00	1.00	1.00	1.00	1.00	1.00	1.00
Hourly flow rate (vph)	2	1	12	117	0	19	6	55	24	17	363	3

Direction, Lane #	EB 1	WB 1	NB 1	SB 1
Volume Total (vph)	15	136	85	383
Volume Left (vph)	2	117	6	17
Volume Right (vph)	12	19	24	3
Hadj (s)	-0.42	0.20	-0.06	0.09
Departure Headway (s)	4.8	5.2	4.7	4.5
Degree Utilization, x	0.02	0.20	0.11	0.48
Capacity (veh/h)	661	633	723	773
Control Delay (s)	7.9	9.5	8.3	11.6
Approach Delay (s)	7.9	9.5	8.3	11.6
Approach LOS	A	A	A	B

Intersection Summary			
Delay		10.6	
Level of Service		B	
Intersection Capacity Utilization	46.8%		ICU Level of Service A
Analysis Period (min)		15	

2032Bg PM
3: Ring (N-S) & Ring (E-W)

04/19/2024



Movement	WBL	WBR	NBT	NBR	SBL	SBT
Lane Configurations						
Traffic Volume (veh/h)	89	19	71	52	27	463
Future Volume (Veh/h)	89	19	71	52	27	463
Sign Control	Stop		Free		Free	
Grade	0%		0%		0%	
Peak Hour Factor	1.00	1.00	1.00	1.00	1.00	1.00
Hourly flow rate (vph)	89	19	71	52	27	463
Pedestrians	7					
Lane Width (m)	4.0					
Walking Speed (m/s)	1.0					
Percent Blockage	1					
Right turn flare (veh)						
Median type	None			None		
Median storage veh						
Upstream signal (m)	52					
pX, platoon unblocked						
vC, conflicting volume	621	104			130	
vC1, stage 1 conf vol						
vC2, stage 2 conf vol						
vCu, unblocked vol	621	104			130	
tC, single (s)	6.4	6.3			4.2	
tC, 2 stage (s)						
tF (s)	3.5	3.4			2.3	
p0 queue free %	80	98			98	
cM capacity (veh/h)	439	933			1414	
Direction, Lane #	WB 1	NB 1	SB 1			
Volume Total	108	123	490			
Volume Left	89	0	27			
Volume Right	19	52	0			
cSH	484	1700	1414			
Volume to Capacity	0.22	0.07	0.02			
Queue Length 95th (m)	5.9	0.0	0.4			
Control Delay (s)	14.6	0.0	0.6			
Lane LOS	B		A			
Approach Delay (s)	14.6	0.0	0.6			
Approach LOS	B					
Intersection Summary						
Average Delay			2.6			
Intersection Capacity Utilization			52.5%	ICU Level of Service	A	
Analysis Period (min)			15			

2032Bg PM
5: Ring (E-W) & CHEO Non-Emergency

04/19/2024



Movement	EBL	EBT	WBT	WBR	SBL	SBR
Lane Configurations						
Traffic Volume (veh/h)	24	64	105	27	16	7
Future Volume (Veh/h)	24	64	105	27	16	7
Sign Control		Free	Free		Stop	
Grade		0%	0%		0%	
Peak Hour Factor	1.00	1.00	1.00	1.00	1.00	1.00
Hourly flow rate (vph)	24	64	105	27	16	7
Pedestrians						
Lane Width (m)						
Walking Speed (m/s)						
Percent Blockage						
Right turn flare (veh)						
Median type		None	None			
Median storage veh						
Upstream signal (m)						
pX, platoon unblocked						
vC, conflicting volume	132				230	118
vC1, stage 1 conf vol						
vC2, stage 2 conf vol						
vCu, unblocked vol	132				230	118
tC, single (s)	4.1				6.6	6.2
tC, 2 stage (s)						
tF (s)	2.2				3.7	3.3
p0 queue free %	98				98	99
cM capacity (veh/h)	1453				706	933
Direction, Lane #	EB 1	WB 1	SB 1			
Volume Total	88	132	23			
Volume Left	24	0	16			
Volume Right	0	27	7			
cSH	1453	1700	762			
Volume to Capacity	0.02	0.08	0.03			
Queue Length 95th (m)	0.4	0.0	0.7			
Control Delay (s)	2.1	0.0	9.9			
Lane LOS	A		A			
Approach Delay (s)	2.1	0.0	9.9			
Approach LOS			A			
Intersection Summary						
Average Delay			1.7			
Intersection Capacity Utilization		25.9%		ICU Level of Service		A
Analysis Period (min)			15			

2032Bg PM
6: Ring (E-W) & CHEO Emergency



















04/19/2024



Movement	EBL	EBT	WBT	WBR	SBL	SBR
Lane Configurations						
Traffic Volume (veh/h)	24	73	64	16	45	53
Future Volume (Veh/h)	24	73	64	16	45	53
Sign Control		Free	Free		Stop	
Grade		0%	0%		0%	
Peak Hour Factor	1.00	1.00	1.00	1.00	1.00	1.00
Hourly flow rate (vph)	24	73	64	16	45	53
Pedestrians		4	16		6	
Lane Width (m)		4.0	4.0		4.0	
Walking Speed (m/s)		1.0	1.0		1.0	
Percent Blockage		0	2		1	
Right turn flare (veh)						
Median type		None	None			
Median storage (veh)						
Upstream signal (m)						
pX, platoon unblocked						
vC, conflicting volume	86				215	82
vC1, stage 1 conf vol						
vC2, stage 2 conf vol						
vCu, unblocked vol	86				215	82
tC, single (s)	4.2				6.5	6.3
tC, 2 stage (s)						
tF (s)	2.3				3.6	3.4
p0 queue free %	98				94	94
cM capacity (veh/h)	1446				731	951
Direction, Lane #	EB 1	WB 1	SB 1			
Volume Total	97	80	98			
Volume Left	24	0	45			
Volume Right	0	16	53			
cSH	1446	1700	836			
Volume to Capacity	0.02	0.05	0.12			
Queue Length 95th (m)	0.4	0.0	2.8			
Control Delay (s)	2.0	0.0	9.9			
Lane LOS	A		A			
Approach Delay (s)	2.0	0.0	9.9			
Approach LOS			A			
Intersection Summary						
Average Delay			4.2			
Intersection Capacity Utilization		26.0%		ICU Level of Service		A
Analysis Period (min)			15			

2032Bg PM
7: General Hospital & Ring (E-W)

04/19/2024

												
Movement	EBL	EBT	EBR	WBL	WBT	WBR	NBL	NBT	NBR	SBL	SBT	SBR
Lane Configurations												
Traffic Volume (veh/h)	21	9	56	413	32	17	42	131	144	23	125	18
Future Volume (Veh/h)	21	9	56	413	32	17	42	131	144	23	125	18
Sign Control		Stop			Stop			Free			Free	
Grade		0%			0%			0%			0%	
Peak Hour Factor	1.00	1.00	1.00	1.00	1.00	1.00	1.00	1.00	1.00	1.00	1.00	1.00
Hourly flow rate (vph)	21	9	56	413	32	17	42	131	144	23	125	18
Pedestrians		35			83			1			27	
Lane Width (m)		4.0			4.0			4.0			4.0	
Walking Speed (m/s)		1.0			1.0			1.0			1.0	
Percent Blockage		4			9			0			3	
Right turn flare (veh)												
Median type								None			None	
Median storage veh												
Upstream signal (m)								59				
pX, platoon unblocked												
vC, conflicting volume	490	513	170	540	522	241	178			214		
vC1, stage 1 conf vol												
vC2, stage 2 conf vol												
vCu, unblocked vol	490	513	170	540	522	241	178			214		
tC, single (s)	7.2	6.5	6.3	7.1	6.7	6.2	4.2			4.1		
tC, 2 stage (s)												
tF (s)	3.6	4.0	3.4	3.5	4.2	3.3	2.3			2.2		
p0 queue free %	94	98	93	0	91	98	97			98		
cM capacity (veh/h)	351	384	812	326	358	703	1315			1231		
Direction, Lane #	EB 1	WB 1	WB 2	NB 1	NB 2	SB 1						
Volume Total	86	275	187	173	144	166						
Volume Left	21	275	138	42	0	23						
Volume Right	56	0	17	0	144	18						
cSH	565	326	349	1315	1700	1231						
Volume to Capacity	0.15	0.84	0.54	0.03	0.08	0.02						
Queue Length 95th (m)	3.7	52.2	21.1	0.7	0.0	0.4						
Control Delay (s)	12.5	54.5	26.6	2.1	0.0	1.2						
Lane LOS	B	F	D	A		A						
Approach Delay (s)	12.5	43.2		1.1		1.2						
Approach LOS	B	E										
Intersection Summary												
Average Delay				21.0								
Intersection Capacity Utilization			55.6%		ICU Level of Service				B			
Analysis Period (min)			15									



Lane Group	EBL	EBT	EBR	WBL	WBT	WBR	NBL	NBT	NBR	SBL	SBT	SBR
Lane Configurations												
Traffic Volume (vph)	514	835	2	1	601	114	6	1	0	33	0	182
Future Volume (vph)	514	835	2	1	601	114	6	1	0	33	0	182
Ideal Flow (vphpl)	1800	1800	1800	1800	1800	1800	1800	1800	1800	1800	1800	1800
Lane Util. Factor	0.95	0.95	0.95	0.95	0.95	0.95	1.00	1.00	1.00	1.00	1.00	1.00
Ped Bike Factor		1.00			0.99			1.00		0.99		0.98
Frt					0.976							0.850
Flt Protected		0.981						0.959		0.950		
Satd. Flow (prot)	0	3435	0	0	3356	0	0	1768	0	1717	0	1493
Flt Permitted		0.521			0.954			0.959		0.753		
Satd. Flow (perm)	0	1819	0	0	3202	0	0	1763	0	1347	0	1468
Right Turn on Red			Yes			Yes			Yes			Yes
Satd. Flow (RTOR)					20							182
Link Speed (k/h)		50			50			40				40
Link Distance (m)		218.8			394.7			154.1			51.9	
Travel Time (s)		15.8			28.4			13.9			4.7	
Confl. Peds. (#/hr)	15		3	3		15	2		7	7		2
Confl. Bikes (#/hr)			3						1			2
Peak Hour Factor	1.00	1.00	1.00	1.00	1.00	1.00	1.00	1.00	1.00	1.00	1.00	1.00
Heavy Vehicles (%)	2%	2%	2%	2%	3%	3%	2%	2%	2%	4%	2%	7%
Adj. Flow (vph)	514	835	2	1	601	114	6	1	0	33	0	182
Shared Lane Traffic (%)												
Lane Group Flow (vph)	0	1351	0	0	716	0	0	7	0	33	0	182
Enter Blocked Intersection	No	No	No	No	No	No	No	No	No	No	No	No
Lane Alignment	Left	Left	Right	Left	Left	Right	L NA	Left	R NA	L NA	Left	R NA
Median Width(m)		0.0			4.0			0.0				5.0
Link Offset(m)		0.0			0.0			0.0				0.0
Crosswalk Width(m)		5.0			5.0			5.0				5.0
Two way Left Turn Lane												
Headway Factor	1.01	1.01	1.01	1.01	1.01	1.01	1.01	1.01	1.01	1.01	1.01	1.01
Turning Speed (k/h)	24		14	24		14	24		14	24		14
Number of Detectors	1	2		1	2		1	2		1		1
Detector Template	Left	Thru		Left	Thru		Left	Thru		Left		Right
Leading Detector (m)	2.0	10.0		2.0	10.0		2.0	10.0		2.0		2.0
Trailing Detector (m)	0.0	0.0		0.0	0.0		0.0	0.0		0.0		0.0
Detector 1 Position(m)	0.0	0.0		0.0	0.0		0.0	0.0		0.0		0.0
Detector 1 Size(m)	2.0	0.6		2.0	0.6		2.0	0.6		2.0		2.0
Detector 1 Type	Cl+Ex	Cl+Ex		Cl+Ex	Cl+Ex		Cl+Ex	Cl+Ex		Cl+Ex		Cl+Ex
Detector 1 Channel												
Detector 1 Extend (s)	0.0	0.0		0.0	0.0		0.0	0.0		0.0		0.0
Detector 1 Queue (s)	0.0	0.0		0.0	0.0		0.0	0.0		0.0		0.0
Detector 1 Delay (s)	0.0	0.0		0.0	0.0		0.0	0.0		0.0		0.0
Detector 2 Position(m)		9.4			9.4			9.4				
Detector 2 Size(m)		0.6			0.6			0.6				
Detector 2 Type		Cl+Ex			Cl+Ex			Cl+Ex				
Detector 2 Channel												
Detector 2 Extend (s)		0.0			0.0			0.0				
Turn Type	pm+pt	NA		Perm	NA		Perm	NA		Perm		Perm
Protected Phases	5	2			6			8				



Lane Group	EBL	EBT	EBR	WBL	WBT	WBR	NBL	NBT	NBR	SBL	SBT	SBR
Permitted Phases	2			6			8			4		4
Detector Phase	5	2		6	6		8	8		4		4
Switch Phase												
Minimum Initial (s)	5.0	10.0		10.0	10.0		10.0	10.0		10.0		10.0
Minimum Split (s)	10.6	31.7		31.7	31.7		28.5	28.5		28.5		28.5
Total Split (s)	42.0	84.0		42.0	42.0		31.0	31.0		31.0		31.0
Total Split (%)	36.5%	73.0%		36.5%	36.5%		27.0%	27.0%		27.0%		27.0%
Maximum Green (s)	36.4	78.3		36.3	36.3		25.5	25.5		25.5		25.5
Yellow Time (s)	3.3	3.3		3.3	3.3		3.3	3.3		3.3		3.3
All-Red Time (s)	2.3	2.4		2.4	2.4		2.2	2.2		2.2		2.2
Lost Time Adjust (s)		0.0			0.0			0.0		0.0		0.0
Total Lost Time (s)		5.7			5.7			5.5		5.5		5.5
Lead/Lag	Lead			Lag			Lag			Lag		
Lead-Lag Optimize?												
Vehicle Extension (s)	3.0	3.0		3.0	3.0		3.0	3.0		3.0		3.0
Recall Mode	Max	C-Max		C-Max	C-Max		None	None		None		None
Walk Time (s)		7.0		7.0	7.0		7.0	7.0		7.0		7.0
Flash Dont Walk (s)		19.0		19.0	19.0		16.0	16.0		16.0		16.0
Pedestrian Calls (#/hr)		0		0	0		0	0		0		0
Act Effct Green (s)		93.0			36.3			10.8		10.8		10.8
Actuated g/C Ratio		0.81			0.32			0.09		0.09		0.09
v/c Ratio		0.62			0.70			0.04		0.26		0.60
Control Delay		5.0			33.0			47.0		53.3		15.9
Queue Delay		0.0			0.0			0.0		0.0		0.0
Total Delay		5.0			33.0			47.0		53.3		15.9
LOS		A			C			D		D		B
Approach Delay		5.0			33.0			47.0				21.6
Approach LOS		A			C			D				C

Intersection Summary

Area Type: Other
 Cycle Length: 115
 Actuated Cycle Length: 115
 Offset: 66 (57%), Referenced to phase 2:EBTL and 6:WBTL, Start of Green
 Natural Cycle: 100
 Control Type: Actuated-Coordinated
 Maximum v/c Ratio: 0.70
 Intersection Signal Delay: 15.4
 Intersection Capacity Utilization 86.5%
 Analysis Period (min) 15
 Intersection LOS: B
 ICU Level of Service E

Splits and Phases: 4: South Haven/Ring (N-S) & Smyth

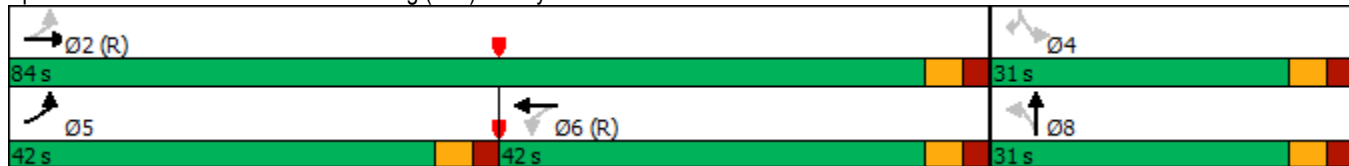

2027Tot AM
8: Smyth & General Hospital

04/19/2024



Lane Group	EBL	EBT	WBT	WBR	SBL	SBR	Ø4	Ø7
Lane Configurations	↖	↗↗	↖↖	↗	↖↖	↗		
Traffic Volume (vph)	401	444	713	473	131	187		
Future Volume (vph)	401	444	713	473	131	187		
Ideal Flow (vphpl)	1800	1800	1800	1800	1800	1800		
Storage Length (m)	55.0			175.0	0.0	0.0		
Storage Lanes	1			1	2	1		
Taper Length (m)	40.0				10.0			
Lane Util. Factor	1.00	0.95	0.95	1.00	0.97	1.00		
Ped Bike Factor	1.00			0.97	0.59	0.97		
Fr _t				0.850		0.850		
Fl _t Protected	0.950				0.950			
Satd. Flow (prot)	1751	3502	3468	1567	3364	1567		
Fl _t Permitted	0.323				0.950			
Satd. Flow (perm)	595	3502	3468	1523	1975	1519		
Right Turn on Red				Yes		Yes		
Satd. Flow (RTOR)				473		48		
Link Speed (k/h)		50	50		40			
Link Distance (m)		394.7	397.7		58.6			
Travel Time (s)		28.4	28.6		5.3			
Confl. Peds. (#/hr)	3			3	51	13		
Confl. Bikes (#/hr)				3				
Peak Hour Factor	1.00	1.00	1.00	1.00	1.00	1.00		
Heavy Vehicles (%)	2%	2%	3%	2%	3%	2%		
Adj. Flow (vph)	401	444	713	473	131	187		
Shared Lane Traffic (%)								
Lane Group Flow (vph)	401	444	713	473	131	187		
Enter Blocked Intersection	No	No	No	No	No	No		
Lane Alignment	Left	Left	Left	Right	Left	R NA		
Median Width(m)		4.0	4.0		8.0			
Link Offset(m)		0.0	0.0		0.0			
Crosswalk Width(m)		5.0	5.0		5.0			
Two way Left Turn Lane								
Headway Factor	1.01	1.01	1.01	1.01	1.01	1.01		
Turning Speed (k/h)	24			14	24	14		
Number of Detectors	1	2	2	1	1	1		
Detector Template	Left	Thru	Thru	Right	Left	Right		
Leading Detector (m)	2.0	10.0	10.0	2.0	2.0	2.0		
Trailing Detector (m)	0.0	0.0	0.0	0.0	0.0	0.0		
Detector 1 Position(m)	0.0	0.0	0.0	0.0	0.0	0.0		
Detector 1 Size(m)	2.0	0.6	0.6	2.0	2.0	2.0		
Detector 1 Type	Cl+Ex	Cl+Ex	Cl+Ex	Cl+Ex	Cl+Ex	Cl+Ex		
Detector 1 Channel								
Detector 1 Extend (s)	0.0	0.0	0.0	0.0	0.0	0.0		
Detector 1 Queue (s)	0.0	0.0	0.0	0.0	0.0	0.0		
Detector 1 Delay (s)	0.0	0.0	0.0	0.0	0.0	0.0		
Detector 2 Position(m)		9.4	9.4					
Detector 2 Size(m)		0.6	0.6					
Detector 2 Type		Cl+Ex	Cl+Ex					
Detector 2 Channel								



Lane Group	EBL	EBT	WBT	WBR	SBL	SBR	Ø4	Ø7
Detector 2 Extend (s)		0.0	0.0					
Turn Type	pm+pt	NA	NA	pm+ov	Prot	pm+ov		
Protected Phases	5	2	6	3	3	5	4	7
Permitted Phases	2			6		7		
Detector Phase	5	2	6	3	3	5		
Switch Phase								
Minimum Initial (s)	5.0	10.0	10.0	5.0	5.0	5.0	5.0	5.0
Minimum Split (s)	10.7	16.4	41.4	10.9	10.9	10.7	32.0	29.9
Total Split (s)	28.0	70.0	42.0	13.0	13.0	28.0	32.0	45.0
Total Split (%)	24.3%	60.9%	36.5%	11.3%	11.3%	24.3%	28%	39%
Maximum Green (s)	22.3	63.6	35.6	7.1	7.1	22.3	28.0	39.1
Yellow Time (s)	3.3	3.3	3.3	3.3	3.3	3.3	3.0	3.3
All-Red Time (s)	2.4	3.1	3.1	2.6	2.6	2.4	1.0	2.6
Lost Time Adjust (s)	0.0	0.0	0.0	0.0	0.0	0.0		
Total Lost Time (s)	5.7	6.4	6.4	5.9	5.9	5.7		
Lead/Lag	Lead		Lag	Lag	Lag	Lead	Lead	
Lead-Lag Optimize?								
Vehicle Extension (s)	3.0	3.0	3.0	3.0	3.0	3.0	3.0	3.0
Recall Mode	None	C-Max	C-Max	None	None	None	None	None
Walk Time (s)			7.0				7.0	7.0
Flash Dont Walk (s)			28.0				21.0	17.0
Pedestrian Calls (#/hr)			0				0	0
Act Effct Green (s)	93.4	92.7	69.5	80.0	10.0	27.7		
Actuated g/C Ratio	0.81	0.81	0.60	0.70	0.09	0.24		
v/c Ratio	0.61	0.16	0.34	0.39	0.45	0.46		
Control Delay	11.2	2.6	13.3	1.6	54.2	25.9		
Queue Delay	0.0	0.0	0.0	0.0	0.0	0.0		
Total Delay	11.2	2.6	13.3	1.6	54.2	25.9		
LOS	B	A	B	A	D	C		
Approach Delay		6.7	8.6		37.5			
Approach LOS		A	A		D			

Intersection Summary

Area Type:	Other
Cycle Length:	115
Actuated Cycle Length:	115
Offset:	43 (37%), Referenced to phase 2:EBTL and 6:WBT, Start of Green
Natural Cycle:	95
Control Type:	Actuated-Coordinated
Maximum v/c Ratio:	0.61
Intersection Signal Delay:	11.9
Intersection LOS:	B
Intersection Capacity Utilization:	71.8%
ICU Level of Service:	C
Analysis Period (min):	15

Splits and Phases: 8: Smyth & General Hospital

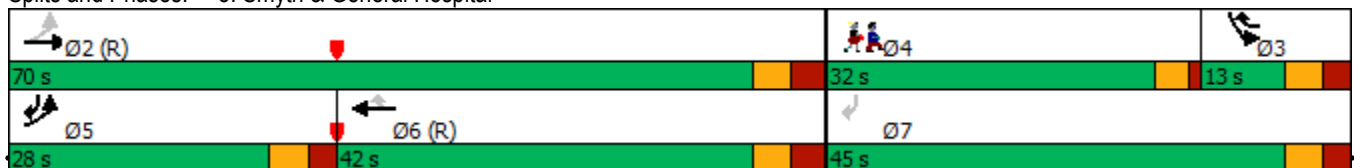



Movement	EBT	EBR	WBL	WBT	NBL	NBR
Lane Configurations	↶			↷	↷	
Sign Control	Stop			Stop	Stop	
Traffic Volume (vph)	324	174	52	107	60	132
Future Volume (vph)	324	174	52	107	60	132
Peak Hour Factor	1.00	1.00	1.00	1.00	1.00	1.00
Hourly flow rate (vph)	324	174	52	107	60	132

Direction, Lane #	EB 1	WB 1	NB 1
Volume Total (vph)	498	159	192
Volume Left (vph)	0	52	60
Volume Right (vph)	174	0	132
Hadj (s)	-0.13	0.13	-0.22
Departure Headway (s)	4.5	5.2	5.2
Degree Utilization, x	0.63	0.23	0.28
Capacity (veh/h)	770	657	620
Control Delay (s)	14.7	9.7	10.2
Approach Delay (s)	14.7	9.7	10.2
Approach LOS	B	A	B

Intersection Summary			
Delay		12.8	
Level of Service		B	
Intersection Capacity Utilization	61.3%		ICU Level of Service
Analysis Period (min)		15	B

2027Tot AM
 2: Ring (N-S) & CHEO Non-Emergency

04/19/2024



Movement	EBL	EBT	EBR	WBL	WBT	WBR	NBL	NBT	NBR	SBL	SBT	SBR
Lane Configurations												
Sign Control		Stop			Stop			Stop			Stop	
Traffic Volume (vph)	3	0	7	0	0	0	6	412	10	20	95	2
Future Volume (vph)	3	0	7	0	0	0	6	412	10	20	95	2
Peak Hour Factor	1.00	1.00	1.00	1.00	1.00	1.00	1.00	1.00	1.00	1.00	1.00	1.00
Hourly flow rate (vph)	3	0	7	0	0	0	6	412	10	20	95	2

Direction, Lane #	EB 1	WB 1	NB 1	SB 1
Volume Total (vph)	10	0	428	117
Volume Left (vph)	3	0	6	20
Volume Right (vph)	7	0	10	2
Hadj (s)	-0.33	0.00	0.06	0.10
Departure Headway (s)	4.7	5.1	4.1	4.4
Degree Utilization, x	0.01	0.00	0.49	0.14
Capacity (veh/h)	673	640	867	787
Control Delay (s)	7.8	8.1	10.9	8.2
Approach Delay (s)	7.8	0.0	10.9	8.2
Approach LOS	A	A	B	A

Intersection Summary			
Delay		10.3	
Level of Service		B	
Intersection Capacity Utilization	36.8%		ICU Level of Service A
Analysis Period (min)		15	

2027Tot AM
3: Ring (N-S) & Ring (E-W)

04/19/2024



Movement	WBL	WBR	NBT	NBR	SBL	SBT
Lane Configurations						
Traffic Volume (veh/h)	158	110	336	278	55	59
Future Volume (Veh/h)	158	110	336	278	55	59
Sign Control	Stop		Free		Free	
Grade	0%		0%		0%	
Peak Hour Factor	1.00	1.00	1.00	1.00	1.00	1.00
Hourly flow rate (vph)	158	110	336	278	55	59
Pedestrians	8					
Lane Width (m)	4.0					
Walking Speed (m/s)	1.0					
Percent Blockage	1					
Right turn flare (veh)						
Median type	None			None		
Median storage veh						
Upstream signal (m)	52					
pX, platoon unblocked						
vC, conflicting volume	652	483			622	
vC1, stage 1 conf vol						
vC2, stage 2 conf vol						
vCu, unblocked vol	652	483			622	
tC, single (s)	6.4	6.3			4.2	
tC, 2 stage (s)						
tF (s)	3.5	3.4			2.3	
p0 queue free %	61	81			94	
cM capacity (veh/h)	403	570			927	
Direction, Lane #	WB 1	NB 1	SB 1			
Volume Total	268	614	114			
Volume Left	158	0	55			
Volume Right	110	278	0			
cSH	458	1700	927			
Volume to Capacity	0.58	0.36	0.06			
Queue Length 95th (m)	25.6	0.0	1.3			
Control Delay (s)	23.3	0.0	4.7			
Lane LOS	C		A			
Approach Delay (s)	23.3	0.0	4.7			
Approach LOS	C					
Intersection Summary						
Average Delay			6.8			
Intersection Capacity Utilization			69.8%	ICU Level of Service		C
Analysis Period (min)	15					

2027Tot AM
5: Ring (E-W) & CHEO Non-Emergency

04/19/2024



Movement	EBL	EBT	WBT	WBR	SBL	SBR
Lane Configurations		↕	↔		↙	↘
Traffic Volume (veh/h)	0	347	136	0	14	128
Future Volume (Veh/h)	0	347	136	0	14	128
Sign Control		Free	Free		Stop	
Grade		0%	0%		0%	
Peak Hour Factor	1.00	1.00	1.00	1.00	1.00	1.00
Hourly flow rate (vph)	0	347	136	0	14	128
Pedestrians			17		2	
Lane Width (m)			4.0		4.0	
Walking Speed (m/s)			1.0		1.0	
Percent Blockage			2		0	
Right turn flare (veh)						
Median type		None	None			
Median storage veh						
Upstream signal (m)						
pX, platoon unblocked						
vC, conflicting volume	138				502	138
vC1, stage 1 conf vol						
vC2, stage 2 conf vol						
vCu, unblocked vol	138				502	138
tC, single (s)	4.1				6.6	6.2
tC, 2 stage (s)						
tF (s)	2.2				3.7	3.3
p0 queue free %	100				97	86
cM capacity (veh/h)	1443				486	908
Direction, Lane #	EB 1	WB 1	SB 1			
Volume Total	347	136	142			
Volume Left	0	0	14			
Volume Right	0	0	128			
cSH	1443	1700	837			
Volume to Capacity	0.00	0.08	0.17			
Queue Length 95th (m)	0.0	0.0	4.3			
Control Delay (s)	0.0	0.0	10.2			
Lane LOS			B			
Approach Delay (s)	0.0	0.0	10.2			
Approach LOS			B			
Intersection Summary						
Average Delay			2.3			
Intersection Capacity Utilization			35.1%	ICU Level of Service		A
Analysis Period (min)			15			

2027Tot AM
6: Ring (E-W) & CHEO Emergency

04/19/2024



Movement	EBL	EBT	WBT	WBR	SBL	SBR
Lane Configurations						
Traffic Volume (veh/h)	9	401	124	25	15	11
Future Volume (Veh/h)	9	401	124	25	15	11
Sign Control		Free	Free		Stop	
Grade		0%	0%		0%	
Peak Hour Factor	1.00	1.00	1.00	1.00	1.00	1.00
Hourly flow rate (vph)	9	401	124	25	15	11
Pedestrians		2	28		7	
Lane Width (m)		4.0	4.0		4.0	
Walking Speed (m/s)		1.0	1.0		1.0	
Percent Blockage		0	3		1	
Right turn flare (veh)						
Median type		None	None			
Median storage (veh)						
Upstream signal (m)						
pX, platoon unblocked						
vC, conflicting volume	156				590	146
vC1, stage 1 conf vol						
vC2, stage 2 conf vol						
vCu, unblocked vol	156				590	146
tC, single (s)	4.2				6.5	6.3
tC, 2 stage (s)						
tF (s)	2.3				3.6	3.4
p0 queue free %	99				97	99
cM capacity (veh/h)	1360				441	877
Direction, Lane #	EB 1	WB 1	SB 1			
Volume Total	410	149	26			
Volume Left	9	0	15			
Volume Right	0	25	11			
cSH	1360	1700	558			
Volume to Capacity	0.01	0.09	0.05			
Queue Length 95th (m)	0.1	0.0	1.0			
Control Delay (s)	0.2	0.0	11.8			
Lane LOS	A		B			
Approach Delay (s)	0.2	0.0	11.8			
Approach LOS			B			
Intersection Summary						
Average Delay			0.7			
Intersection Capacity Utilization			40.6%	ICU Level of Service		A
Analysis Period (min)			15			



Movement	EBL	EBT	EBR	WBL	WBT	WBR	NBL	NBT	NBR	SBL	SBT	SBR
Lane Configurations		↕		↖	↕			↖	↖		↕	
Traffic Volume (veh/h)	19	22	51	158	25	19	157	134	485	12	137	15
Future Volume (Veh/h)	19	22	51	158	25	19	157	134	485	12	137	15
Sign Control		Stop			Stop			Free			Free	
Grade		0%			0%			0%			0%	
Peak Hour Factor	1.00	1.00	1.00	1.00	1.00	1.00	1.00	1.00	1.00	1.00	1.00	1.00
Hourly flow rate (vph)	19	22	51	158	25	19	157	134	485	12	137	15
Pedestrians		27			65							4
Lane Width (m)		4.0			4.0						4.0	
Walking Speed (m/s)		1.0			1.0						1.0	
Percent Blockage		3			7						0	
Right turn flare (veh)												
Median type								None			None	
Median storage veh												
Upstream signal (m)								59				
pX, platoon unblocked												
vC, conflicting volume	679	708	172	744	716	203	179			199		
vC1, stage 1 conf vol												
vC2, stage 2 conf vol												
vCu, unblocked vol	679	708	172	744	716	203	179			199		
tC, single (s)	7.2	6.5	6.3	7.1	6.7	6.2	4.2			4.1		
tC, 2 stage (s)												
tF (s)	3.6	4.0	3.4	3.5	4.2	3.3	2.3			2.2		
p0 queue free %	93	92	94	30	90	98	88			99		
cM capacity (veh/h)	260	281	819	227	261	774	1326			1274		
Direction, Lane #	EB 1	WB 1	WB 2	NB 1	NB 2	SB 1						
Volume Total	92	105	97	291	485	164						
Volume Left	19	105	53	157	0	12						
Volume Right	51	0	19	0	485	15						
cSH	431	227	274	1326	1700	1274						
Volume to Capacity	0.21	0.46	0.35	0.12	0.29	0.01						
Queue Length 95th (m)	5.6	15.9	10.7	2.8	0.0	0.2						
Control Delay (s)	15.6	34.0	25.1	4.8	0.0	0.6						
Lane LOS	C	D	D	A		A						
Approach Delay (s)	15.6	29.7		1.8		0.6						
Approach LOS	C	D										
Intersection Summary												
Average Delay			7.3									
Intersection Capacity Utilization			63.8%		ICU Level of Service				B			
Analysis Period (min)			15									



Movement	WBL	WBR	NBT	NBR	SBL	SBT
Lane Configurations	↔		↑			↑
Traffic Volume (veh/h)	9	2	425	0	0	102
Future Volume (Veh/h)	9	2	425	0	0	102
Sign Control	Stop		Free			Free
Grade	0%		0%			0%
Peak Hour Factor	1.00	1.00	1.00	1.00	1.00	1.00
Hourly flow rate (vph)	9	2	425	0	0	102
Pedestrians						
Lane Width (m)						
Walking Speed (m/s)						
Percent Blockage						
Right turn flare (veh)						
Median type			None			None
Median storage veh						
Upstream signal (m)	144					
pX, platoon unblocked						
vC, conflicting volume	527	425			425	
vC1, stage 1 conf vol						
vC2, stage 2 conf vol						
vCu, unblocked vol	527	425			425	
tC, single (s)	6.4	6.2			4.1	
tC, 2 stage (s)						
tF (s)	3.5	3.3			2.2	
p0 queue free %	98	100			100	
cM capacity (veh/h)	512	629			1134	
Direction, Lane #	WB 1	NB 1	SB 1			
Volume Total	11	425	102			
Volume Left	9	0	0			
Volume Right	2	0	0			
cSH	530	1700	1700			
Volume to Capacity	0.02	0.25	0.06			
Queue Length 95th (m)	0.4	0.0	0.0			
Control Delay (s)	11.9	0.0	0.0			
Lane LOS	B					
Approach Delay (s)	11.9	0.0	0.0			
Approach LOS	B					
Intersection Summary						
Average Delay			0.2			
Intersection Capacity Utilization			44.3%	ICU Level of Service		A
Analysis Period (min)			15			

2027Tot AM
27: Ring (N-S) & Entry Clinic

04/19/2024



Movement	WBL	WBR	NBT	NBR	SBL	SBT
Lane Configurations			↔			↔
Traffic Volume (veh/h)	0	0	425	24	0	102
Future Volume (Veh/h)	0	0	425	24	0	102
Sign Control	Stop		Free		Free	
Grade	0%		0%		0%	
Peak Hour Factor	1.00	1.00	1.00	1.00	1.00	1.00
Hourly flow rate (vph)	0	0	425	24	0	102
Pedestrians						
Lane Width (m)						
Walking Speed (m/s)						
Percent Blockage						
Right turn flare (veh)						
Median type	None			None		
Median storage veh						
Upstream signal (m)	99					
pX, platoon unblocked						
vC, conflicting volume	539	437			449	
vC1, stage 1 conf vol						
vC2, stage 2 conf vol						
vCu, unblocked vol	539	437			449	
tC, single (s)	6.4	6.2			4.1	
tC, 2 stage (s)						
tF (s)	3.5	3.3			2.2	
p0 queue free %	100	100			100	
cM capacity (veh/h)	503	620			1111	
Direction, Lane #	NB 1	SB 1				
Volume Total	449	102				
Volume Left	0	0				
Volume Right	24	0				
cSH	1700	1700				
Volume to Capacity	0.26	0.06				
Queue Length 95th (m)	0.0	0.0				
Control Delay (s)	0.0	0.0				
Lane LOS						
Approach Delay (s)	0.0	0.0				
Approach LOS						
Intersection Summary						
Average Delay			0.0			
Intersection Capacity Utilization			44.3%	ICU Level of Service	A	
Analysis Period (min)			15			

2027Tot AM
 29: Ring (E-W) & Parking Garage Access

04/19/2024



Movement	EBL	EBT	WBT	WBR	SBL	SBR
Lane Configurations		↶	↶		↶	
Traffic Volume (veh/h)	326	90	76	121	38	59
Future Volume (Veh/h)	326	90	76	121	38	59
Sign Control		Free	Free		Stop	
Grade		0%	0%		0%	
Peak Hour Factor	1.00	1.00	1.00	1.00	1.00	1.00
Hourly flow rate (vph)	326	90	76	121	38	59
Pedestrians						
Lane Width (m)						
Walking Speed (m/s)						
Percent Blockage						
Right turn flare (veh)						
Median type		None	None			
Median storage (veh)						
Upstream signal (m)						
pX, platoon unblocked						
vC, conflicting volume	197				878	136
vC1, stage 1 conf vol						
vC2, stage 2 conf vol						
vCu, unblocked vol	197				878	136
tC, single (s)	4.1				6.4	6.2
tC, 2 stage (s)						
tF (s)	2.2				3.5	3.3
p0 queue free %	76				84	94
cM capacity (veh/h)	1376				243	912
Direction, Lane #	EB 1	WB 1	SB 1			
Volume Total	416	197	97			
Volume Left	326	0	38			
Volume Right	0	121	59			
cSH	1376	1700	439			
Volume to Capacity	0.24	0.12	0.22			
Queue Length 95th (m)	6.5	0.0	5.8			
Control Delay (s)	7.1	0.0	15.5			
Lane LOS	A		C			
Approach Delay (s)	7.1	0.0	15.5			
Approach LOS			C			
Intersection Summary						
Average Delay			6.3			
Intersection Capacity Utilization			52.2%	ICU Level of Service	A	
Analysis Period (min)			15			



Lane Group	EBL	EBT	EBR	WBL	WBT	WBR	NBL	NBT	NBR	SBL	SBT	SBR
Lane Configurations		↕↕			↕↕			↕		↕		↕
Traffic Volume (vph)	141	565	4	4	956	13	5	0	4	152	0	470
Future Volume (vph)	141	565	4	4	956	13	5	0	4	152	0	470
Ideal Flow (vphpl)	1800	1800	1800	1800	1800	1800	1800	1800	1800	1800	1800	1800
Lane Util. Factor	0.95	0.95	0.95	0.95	0.95	0.95	1.00	1.00	1.00	1.00	1.00	1.00
Ped Bike Factor		1.00			1.00			0.99		0.99		0.97
Frt		0.999			0.998			0.940				0.850
Flt Protected		0.990						0.973		0.950		
Satd. Flow (prot)	0	3423	0	0	3492	0	0	1670	0	1751	0	1567
Flt Permitted		0.535			0.953			0.973		0.752		
Satd. Flow (perm)	0	1848	0	0	3328	0	0	1666	0	1374	0	1523
Right Turn on Red			Yes			Yes			Yes			Yes
Satd. Flow (RTOR)		1			2			79				233
Link Speed (k/h)		50			50			40				40
Link Distance (m)		218.8			394.7			154.1				51.9
Travel Time (s)		15.8			28.4			13.9				4.7
Confl. Peds. (#/hr)	15		8	8		15	3		6	6		3
Confl. Bikes (#/hr)			2			1						14
Peak Hour Factor	1.00	1.00	1.00	1.00	1.00	1.00	1.00	1.00	1.00	1.00	1.00	1.00
Heavy Vehicles (%)	4%	3%	2%	2%	2%	2%	2%	2%	2%	2%	2%	2%
Adj. Flow (vph)	141	565	4	4	956	13	5	0	4	152	0	470
Shared Lane Traffic (%)												
Lane Group Flow (vph)	0	710	0	0	973	0	0	9	0	152	0	470
Enter Blocked Intersection	No	No	No	No	No	No	No	No	No	No	No	No
Lane Alignment	Left	Left	Right	Left	Left	Right	L NA	Left	R NA	L NA	Left	R NA
Median Width(m)		0.0			4.0			0.0				5.0
Link Offset(m)		0.0			0.0			0.0				0.0
Crosswalk Width(m)		5.0			5.0			5.0				5.0
Two way Left Turn Lane												
Headway Factor	1.01	1.01	1.01	1.01	1.01	1.01	1.01	1.01	1.01	1.01	1.01	1.01
Turning Speed (k/h)	24		14	24		14	24		14	24		14
Number of Detectors	1	2		1	2		1	2		1		1
Detector Template	Left	Thru		Left	Thru		Left	Thru		Left		Right
Leading Detector (m)	2.0	10.0		2.0	10.0		2.0	10.0		2.0		2.0
Trailing Detector (m)	0.0	0.0		0.0	0.0		0.0	0.0		0.0		0.0
Detector 1 Position(m)	0.0	0.0		0.0	0.0		0.0	0.0		0.0		0.0
Detector 1 Size(m)	2.0	0.6		2.0	0.6		2.0	0.6		2.0		2.0
Detector 1 Type	Cl+Ex	Cl+Ex		Cl+Ex	Cl+Ex		Cl+Ex	Cl+Ex		Cl+Ex		Cl+Ex
Detector 1 Channel												
Detector 1 Extend (s)	0.0	0.0		0.0	0.0		0.0	0.0		0.0		0.0
Detector 1 Queue (s)	0.0	0.0		0.0	0.0		0.0	0.0		0.0		0.0
Detector 1 Delay (s)	0.0	0.0		0.0	0.0		0.0	0.0		0.0		0.0
Detector 2 Position(m)		9.4			9.4			9.4				
Detector 2 Size(m)		0.6			0.6			0.6				
Detector 2 Type		Cl+Ex			Cl+Ex			Cl+Ex				
Detector 2 Channel												
Detector 2 Extend (s)		0.0			0.0			0.0				
Turn Type	pm+pt	NA		Perm	NA		Perm	NA		Perm		Perm
Protected Phases	5	2			6			8				



Lane Group	EBL	EBT	EBR	WBL	WBT	WBR	NBL	NBT	NBR	SBL	SBT	SBR
Permitted Phases	2			6			8			4		4
Detector Phase	5	2		6	6		8	8		4		4
Switch Phase												
Minimum Initial (s)	5.0	10.0		10.0	10.0		10.0	10.0		10.0		10.0
Minimum Split (s)	10.6	31.7		31.7	31.7		28.5	28.5		28.5		28.5
Total Split (s)	16.0	78.0		62.0	62.0		37.0	37.0		37.0		37.0
Total Split (%)	13.9%	67.8%		53.9%	53.9%		32.2%	32.2%		32.2%		32.2%
Maximum Green (s)	10.4	72.3		56.3	56.3		31.5	31.5		31.5		31.5
Yellow Time (s)	3.3	3.3		3.3	3.3		3.3	3.3		3.3		3.3
All-Red Time (s)	2.3	2.4		2.4	2.4		2.2	2.2		2.2		2.2
Lost Time Adjust (s)		0.0			0.0			0.0		0.0		0.0
Total Lost Time (s)		5.7			5.7			5.5		5.5		5.5
Lead/Lag	Lead			Lag		Lag						
Lead-Lag Optimize?												
Vehicle Extension (s)	3.0	3.0		3.0	3.0		3.0	3.0		3.0		3.0
Recall Mode	Max	C-Max		C-Max	C-Max		None	None		None		None
Walk Time (s)		7.0		7.0	7.0		7.0	7.0		7.0		7.0
Flash Dont Walk (s)		19.0		19.0	19.0		16.0	16.0		16.0		16.0
Pedestrian Calls (#/hr)		0		0	0		0	0		0		0
Act Effct Green (s)		78.5		56.3	56.3		25.3	25.3		25.3		25.3
Actuated g/C Ratio		0.68		0.49	0.49		0.22	0.22		0.22		0.22
v/c Ratio		0.48		0.60	0.60		0.02	0.50		0.50		0.91
Control Delay		9.4		23.2	23.2		0.1	43.8		43.8		44.0
Queue Delay		0.0		0.0	0.0		0.0	0.0		0.0		0.0
Total Delay		9.4		23.2	23.2		0.1	43.8		43.8		44.0
LOS		A		C	C		A	D		D		D
Approach Delay		9.4		23.2	23.2		0.1	44.0		44.0		44.0
Approach LOS		A		C	C		A	D		D		D

Intersection Summary

Area Type: Other
 Cycle Length: 115
 Actuated Cycle Length: 115
 Offset: 62 (54%), Referenced to phase 2:EBTL and 6:WBTL, Start of Green
 Natural Cycle: 75
 Control Type: Actuated-Coordinated
 Maximum v/c Ratio: 0.91
 Intersection Signal Delay: 24.5 Intersection LOS: C
 Intersection Capacity Utilization 83.7% ICU Level of Service E
 Analysis Period (min) 15

Splits and Phases: 4: South Haven/Ring (N-S) & Smyth

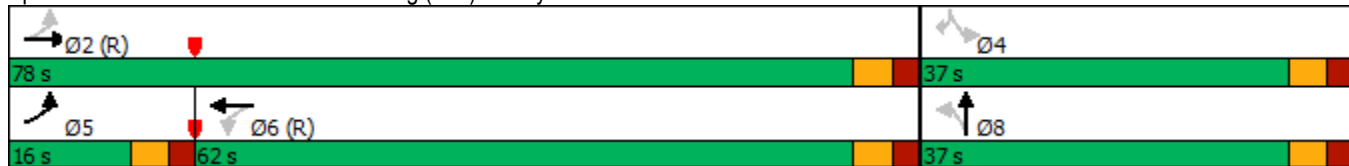

2027Tot PM
8: Smyth & General Hospital

04/19/2024



Lane Group	EBL	EBT	WBT	WBR	SBL	SBR	Ø4	Ø7
Lane Configurations	↖	↗↗	↖↖	↗	↖↖	↗		
Traffic Volume (vph)	142	826	568	167	376	403		
Future Volume (vph)	142	826	568	167	376	403		
Ideal Flow (vphpl)	1800	1800	1800	1800	1800	1800		
Storage Length (m)	55.0			175.0	0.0	0.0		
Storage Lanes	1			1	2	1		
Taper Length (m)	40.0				10.0			
Lane Util. Factor	1.00	0.95	0.95	1.00	0.97	1.00		
Ped Bike Factor	0.99			0.96	0.81	0.97		
Fr _t				0.850		0.850		
Fl _t Protected	0.950				0.950			
Satd. Flow (prot)	1701	3468	3502	1551	3397	1567		
Fl _t Permitted	0.383				0.950			
Satd. Flow (perm)	681	3468	3502	1491	2761	1517		
Right Turn on Red				Yes		Yes		
Satd. Flow (RTOR)				167		93		
Link Speed (k/h)		50	50		40			
Link Distance (m)		394.7	397.7		58.6			
Travel Time (s)		28.4	28.6		5.3			
Confl. Peds. (#/hr)	11			11	72	14		
Confl. Bikes (#/hr)				2				
Peak Hour Factor	1.00	1.00	1.00	1.00	1.00	1.00		
Heavy Vehicles (%)	5%	3%	2%	3%	2%	2%		
Adj. Flow (vph)	142	826	568	167	376	403		
Shared Lane Traffic (%)								
Lane Group Flow (vph)	142	826	568	167	376	403		
Enter Blocked Intersection	No	No	No	No	No	No		
Lane Alignment	Left	Left	Left	Right	Left	R NA		
Median Width(m)		4.0	4.0		8.0			
Link Offset(m)		0.0	0.0		0.0			
Crosswalk Width(m)		5.0	5.0		5.0			
Two way Left Turn Lane								
Headway Factor	1.01	1.01	1.01	1.01	1.01	1.01		
Turning Speed (k/h)	24			14	24	14		
Number of Detectors	1	2	2	1	1	1		
Detector Template	Left	Thru	Thru	Right	Left	Right		
Leading Detector (m)	2.0	10.0	10.0	2.0	2.0	2.0		
Trailing Detector (m)	0.0	0.0	0.0	0.0	0.0	0.0		
Detector 1 Position(m)	0.0	0.0	0.0	0.0	0.0	0.0		
Detector 1 Size(m)	2.0	0.6	0.6	2.0	2.0	2.0		
Detector 1 Type	Cl+Ex	Cl+Ex	Cl+Ex	Cl+Ex	Cl+Ex	Cl+Ex		
Detector 1 Channel								
Detector 1 Extend (s)	0.0	0.0	0.0	0.0	0.0	0.0		
Detector 1 Queue (s)	0.0	0.0	0.0	0.0	0.0	0.0		
Detector 1 Delay (s)	0.0	0.0	0.0	0.0	0.0	0.0		
Detector 2 Position(m)		9.4	9.4					
Detector 2 Size(m)		0.6	0.6					
Detector 2 Type		Cl+Ex	Cl+Ex					
Detector 2 Channel								



Lane Group	EBL	EBT	WBT	WBR	SBL	SBR	Ø4	Ø7
Detector 2 Extend (s)		0.0	0.0					
Turn Type	pm+pt	NA	NA	pm+ov	Prot	pm+ov		
Protected Phases	5	2	6	3	3	5	4	7
Permitted Phases	2			6		7		
Detector Phase	5	2	6	3	3	5		
Switch Phase								
Minimum Initial (s)	5.0	10.0	10.0	5.0	5.0	5.0	5.0	5.0
Minimum Split (s)	10.7	16.4	41.4	10.9	10.9	10.7	32.0	29.9
Total Split (s)	12.0	55.0	43.0	28.0	28.0	12.0	32.0	60.0
Total Split (%)	10.4%	47.8%	37.4%	24.3%	24.3%	10.4%	28%	52%
Maximum Green (s)	6.3	48.6	36.6	22.1	22.1	6.3	28.0	54.1
Yellow Time (s)	3.3	3.3	3.3	3.3	3.3	3.3	3.0	3.3
All-Red Time (s)	2.4	3.1	3.1	2.6	2.6	2.4	1.0	2.6
Lost Time Adjust (s)	0.0	0.0	0.0	0.0	0.0	0.0		
Total Lost Time (s)	5.7	6.4	6.4	5.9	5.9	5.7		
Lead/Lag	Lead		Lag	Lag	Lag	Lead	Lead	
Lead-Lag Optimize?								
Vehicle Extension (s)	3.0	3.0	3.0	3.0	3.0	3.0	3.0	3.0
Recall Mode	None	C-Max	C-Max	None	None	None	None	None
Walk Time (s)			7.0				7.0	7.0
Flash Dont Walk (s)			28.0				21.0	17.0
Pedestrian Calls (#/hr)			0				0	0
Act Effct Green (s)	85.5	84.8	66.1	84.5	17.9	31.1		
Actuated g/C Ratio	0.74	0.74	0.57	0.73	0.16	0.27		
v/c Ratio	0.23	0.32	0.28	0.15	0.71	0.83		
Control Delay	4.8	4.9	14.3	1.0	53.7	41.3		
Queue Delay	0.0	0.0	0.0	0.0	0.0	0.0		
Total Delay	4.8	4.9	14.3	1.0	53.7	41.3		
LOS	A	A	B	A	D	D		
Approach Delay		4.9	11.3		47.3			
Approach LOS		A	B		D			

Intersection Summary

Area Type: Other
 Cycle Length: 115
 Actuated Cycle Length: 115
 Offset: 59 (51%), Referenced to phase 2:EBTL and 6:WBT, Start of Green
 Natural Cycle: 95
 Control Type: Actuated-Coordinated
 Maximum v/c Ratio: 0.83
 Intersection Signal Delay: 20.1
 Intersection LOS: C
 Intersection Capacity Utilization 67.0%
 ICU Level of Service C
 Analysis Period (min) 15

Splits and Phases: 8: Smyth & General Hospital

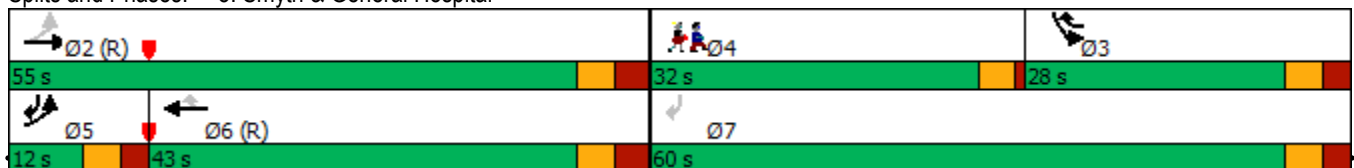



Movement	EBT	EBR	WBL	WBT	NBL	NBR
Lane Configurations						
Sign Control	Stop			Stop	Stop	
Traffic Volume (vph)	117	52	111	280	109	40
Future Volume (vph)	117	52	111	280	109	40
Peak Hour Factor	1.00	1.00	1.00	1.00	1.00	1.00
Hourly flow rate (vph)	117	52	111	280	109	40

Direction, Lane #	EB 1	WB 1	NB 1
Volume Total (vph)	169	391	149
Volume Left (vph)	0	111	109
Volume Right (vph)	52	0	40
Hadj (s)	-0.10	0.12	0.15
Departure Headway (s)	4.7	4.7	5.4
Degree Utilization, x	0.22	0.51	0.22
Capacity (veh/h)	722	749	606
Control Delay (s)	9.0	12.3	9.9
Approach Delay (s)	9.0	12.3	9.9
Approach LOS	A	B	A

Intersection Summary			
Delay		11.0	
Level of Service		B	
Intersection Capacity Utilization		53.5%	ICU Level of Service
Analysis Period (min)		15	A

2027Tot PM
 2: Ring (N-S) & CHEO Non-Emergency

04/19/2024



Movement	EBL	EBT	EBR	WBL	WBT	WBR	NBL	NBT	NBR	SBL	SBT	SBR
Lane Configurations		↕			↕			↕			↕	
Sign Control		Stop			Stop			Stop			Stop	
Traffic Volume (vph)	2	1	12	0	0	0	6	68	60	15	341	3
Future Volume (vph)	2	1	12	0	0	0	6	68	60	15	341	3
Peak Hour Factor	1.00	1.00	1.00	1.00	1.00	1.00	1.00	1.00	1.00	1.00	1.00	1.00
Hourly flow rate (vph)	2	1	12	0	0	0	6	68	60	15	341	3

Direction, Lane #	EB 1	WB 1	NB 1	SB 1
Volume Total (vph)	15	0	134	359
Volume Left (vph)	2	0	6	15
Volume Right (vph)	12	0	60	3
Hadj (s)	-0.42	0.00	-0.15	0.09
Departure Headway (s)	4.5	5.0	4.1	4.2
Degree Utilization, x	0.02	0.00	0.15	0.41
Capacity (veh/h)	709	658	847	850
Control Delay (s)	7.6	8.0	7.9	10.1
Approach Delay (s)	7.6	0.0	7.9	10.1
Approach LOS	A	A	A	B

Intersection Summary			
Delay		9.4	
Level of Service		A	
Intersection Capacity Utilization	38.5%		ICU Level of Service A
Analysis Period (min)		15	

2027Tot PM
3: Ring (N-S) & Ring (E-W)

04/19/2024



Movement	WBL	WBR	NBT	NBR	SBL	SBT
Lane Configurations						
Traffic Volume (veh/h)	303	63	83	79	36	333
Future Volume (Veh/h)	303	63	83	79	36	333
Sign Control	Stop		Free		Free	
Grade	0%		0%		0%	
Peak Hour Factor	1.00	1.00	1.00	1.00	1.00	1.00
Hourly flow rate (vph)	303	63	83	79	36	333
Pedestrians	7					
Lane Width (m)	4.0					
Walking Speed (m/s)	1.0					
Percent Blockage	1					
Right turn flare (veh)						
Median type	None			None		
Median storage veh						
Upstream signal (m)	52					
pX, platoon unblocked						
vC, conflicting volume	534	130			169	
vC1, stage 1 conf vol						
vC2, stage 2 conf vol						
vCu, unblocked vol	534	130			169	
tC, single (s)	6.4	6.3			4.2	
tC, 2 stage (s)						
tF (s)	3.5	3.4			2.3	
p0 queue free %	38	93			97	
cM capacity (veh/h)	489	903			1368	
Direction, Lane #	WB 1	NB 1	SB 1			
Volume Total	366	162	369			
Volume Left	303	0	36			
Volume Right	63	79	0			
cSH	531	1700	1368			
Volume to Capacity	0.69	0.10	0.03			
Queue Length 95th (m)	37.0	0.0	0.6			
Control Delay (s)	25.5	0.0	1.0			
Lane LOS	D		A			
Approach Delay (s)	25.5	0.0	1.0			
Approach LOS	D					
Intersection Summary						
Average Delay			10.8			
Intersection Capacity Utilization			63.1%	ICU Level of Service		B
Analysis Period (min)	15					

2027Tot PM
5: Ring (E-W) & CHEO Non-Emergency

04/19/2024



Movement	EBL	EBT	WBT	WBR	SBL	SBR
Lane Configurations						
Traffic Volume (veh/h)	0	124	267	0	0	103
Future Volume (Veh/h)	0	124	267	0	0	103
Sign Control		Free	Free		Stop	
Grade		0%	0%		0%	
Peak Hour Factor	1.00	1.00	1.00	1.00	1.00	1.00
Hourly flow rate (vph)	0	124	267	0	0	103
Pedestrians						
Lane Width (m)						
Walking Speed (m/s)						
Percent Blockage						
Right turn flare (veh)						
Median type		None	None			
Median storage (veh)						
Upstream signal (m)						
pX, platoon unblocked						
vC, conflicting volume	267				391	267
vC1, stage 1 conf vol						
vC2, stage 2 conf vol						
vCu, unblocked vol	267				391	267
tC, single (s)	4.1				6.6	6.2
tC, 2 stage (s)						
tF (s)	2.2				3.7	3.3
p0 queue free %	100				100	87
cM capacity (veh/h)	1297				578	772
Direction, Lane #	EB 1	WB 1	SB 1			
Volume Total	124	267	103			
Volume Left	0	0	0			
Volume Right	0	0	103			
cSH	1297	1700	772			
Volume to Capacity	0.00	0.16	0.13			
Queue Length 95th (m)	0.0	0.0	3.2			
Control Delay (s)	0.0	0.0	10.4			
Lane LOS			B			
Approach Delay (s)	0.0	0.0	10.4			
Approach LOS			B			
Intersection Summary						
Average Delay			2.2			
Intersection Capacity Utilization			28.2%	ICU Level of Service	A	
Analysis Period (min)			15			

2027Tot PM
6: Ring (E-W) & CHEO Emergency

04/19/2024



Movement	EBL	EBT	WBT	WBR	SBL	SBR
Lane Configurations						
Traffic Volume (veh/h)	6	133	235	4	10	17
Future Volume (Veh/h)	6	133	235	4	10	17
Sign Control		Free	Free		Stop	
Grade		0%	0%		0%	
Peak Hour Factor	1.00	1.00	1.00	1.00	1.00	1.00
Hourly flow rate (vph)	6	133	235	4	10	17
Pedestrians		4	16		6	
Lane Width (m)		4.0	4.0		4.0	
Walking Speed (m/s)		1.0	1.0		1.0	
Percent Blockage		0	2		1	
Right turn flare (veh)						
Median type		None	None			
Median storage (veh)						
Upstream signal (m)						
pX, platoon unblocked						
vC, conflicting volume	245				404	247
vC1, stage 1 conf vol						
vC2, stage 2 conf vol						
vCu, unblocked vol	245				404	247
tC, single (s)	4.2				6.5	6.3
tC, 2 stage (s)						
tF (s)	2.3				3.6	3.4
p0 queue free %	100				98	98
cM capacity (veh/h)	1262				576	769
Direction, Lane #	EB 1	WB 1	SB 1			
Volume Total	139	239	27			
Volume Left	6	0	10			
Volume Right	0	4	17			
cSH	1262	1700	684			
Volume to Capacity	0.00	0.14	0.04			
Queue Length 95th (m)	0.1	0.0	0.9			
Control Delay (s)	0.4	0.0	10.5			
Lane LOS	A		B			
Approach Delay (s)	0.4	0.0	10.5			
Approach LOS			B			
Intersection Summary						
Average Delay			0.8			
Intersection Capacity Utilization			24.6%	ICU Level of Service		A
Analysis Period (min)			15			



Movement	EBL	EBT	EBR	WBL	WBT	WBR	NBL	NBT	NBR	SBL	SBT	SBR
Lane Configurations		↕		↕	↕			↕	↕		↕	
Traffic Volume (veh/h)	21	9	115	413	32	17	81	131	144	23	146	18
Future Volume (Veh/h)	21	9	115	413	32	17	81	131	144	23	146	18
Sign Control		Stop			Stop			Free			Free	
Grade		0%			0%			0%			0%	
Peak Hour Factor	1.00	1.00	1.00	1.00	1.00	1.00	1.00	1.00	1.00	1.00	1.00	1.00
Hourly flow rate (vph)	21	9	115	413	32	17	81	131	144	23	146	18
Pedestrians		35			83			1			27	
Lane Width (m)		4.0			4.0			4.0			4.0	
Walking Speed (m/s)		1.0			1.0			1.0			1.0	
Percent Blockage		4			9			0			3	
Right turn flare (veh)												
Median type								None			None	
Median storage veh												
Upstream signal (m)								59				
pX, platoon unblocked												
vC, conflicting volume	589	612	191	698	621	241	199			214		
vC1, stage 1 conf vol												
vC2, stage 2 conf vol												
vCu, unblocked vol	589	612	191	698	621	241	199			214		
tC, single (s)	7.2	6.5	6.3	7.1	6.7	6.2	4.2			4.1		
tC, 2 stage (s)												
tF (s)	3.6	4.0	3.4	3.5	4.2	3.3	2.3			2.2		
p0 queue free %	93	97	85	0	89	98	94			98		
cM capacity (veh/h)	290	326	790	229	303	703	1292			1231		
Direction, Lane #	EB 1	WB 1	WB 2	NB 1	NB 2	SB 1						
Volume Total	145	275	187	212	144	187						
Volume Left	21	275	138	81	0	23						
Volume Right	115	0	17	0	144	18						
cSH	591	229	255	1292	1700	1231						
Volume to Capacity	0.25	1.20	0.73	0.06	0.08	0.02						
Queue Length 95th (m)	6.7	94.4	35.8	1.4	0.0	0.4						
Control Delay (s)	13.1	169.7	49.8	3.4	0.0	1.1						
Lane LOS	B	F	E	A		A						
Approach Delay (s)	13.1	121.3		2.0		1.1						
Approach LOS	B	F										
Intersection Summary												
Average Delay				51.2								
Intersection Capacity Utilization			62.2%		ICU Level of Service				B			
Analysis Period (min)			15									



Movement	WBL	WBR	NBT	NBR	SBL	SBT
Lane Configurations						
Traffic Volume (veh/h)	18	5	129	0	0	353
Future Volume (Veh/h)	18	5	129	0	0	353
Sign Control	Stop		Free		Free	
Grade	0%		0%		0%	
Peak Hour Factor	1.00	1.00	1.00	1.00	1.00	1.00
Hourly flow rate (vph)	18	5	129	0	0	353
Pedestrians						
Lane Width (m)						
Walking Speed (m/s)						
Percent Blockage						
Right turn flare (veh)						
Median type	None			None		
Median storage veh						
Upstream signal (m)	144					
pX, platoon unblocked						
vC, conflicting volume	482	129			129	
vC1, stage 1 conf vol						
vC2, stage 2 conf vol						
vCu, unblocked vol	482	129			129	
tC, single (s)	6.4	6.2			4.1	
tC, 2 stage (s)						
tF (s)	3.5	3.3			2.2	
p0 queue free %	97	99			100	
cM capacity (veh/h)	543	921			1457	
Direction, Lane #	WB 1	NB 1	SB 1			
Volume Total	23	129	353			
Volume Left	18	0	0			
Volume Right	5	0	0			
cSH	596	1700	1700			
Volume to Capacity	0.04	0.08	0.21			
Queue Length 95th (m)	0.8	0.0	0.0			
Control Delay (s)	11.3	0.0	0.0			
Lane LOS	B					
Approach Delay (s)	11.3	0.0	0.0			
Approach LOS	B					
Intersection Summary						
Average Delay			0.5			
Intersection Capacity Utilization			40.9%	ICU Level of Service		A
Analysis Period (min)			15			

2027Tot PM
27: Ring (N-S) & Entry Clinic

04/19/2024



Movement	WBL	WBR	NBT	NBR	SBL	SBT
Lane Configurations			↔			↔
Traffic Volume (veh/h)	0	0	129	12	0	353
Future Volume (Veh/h)	0	0	129	12	0	353
Sign Control	Stop		Free		Free	
Grade	0%		0%		0%	
Peak Hour Factor	1.00	1.00	1.00	1.00	1.00	1.00
Hourly flow rate (vph)	0	0	129	12	0	353
Pedestrians						
Lane Width (m)						
Walking Speed (m/s)						
Percent Blockage						
Right turn flare (veh)						
Median type	None			None		
Median storage veh						
Upstream signal (m)	99					
pX, platoon unblocked						
vC, conflicting volume	488	135			141	
vC1, stage 1 conf vol						
vC2, stage 2 conf vol						
vCu, unblocked vol	488	135			141	
tC, single (s)	6.4	6.2			4.1	
tC, 2 stage (s)						
tF (s)	3.5	3.3			2.2	
p0 queue free %	100	100			100	
cM capacity (veh/h)	539	914			1442	
Direction, Lane #	NB 1	SB 1				
Volume Total	141	353				
Volume Left	0	0				
Volume Right	12	0				
cSH	1700	1700				
Volume to Capacity	0.08	0.21				
Queue Length 95th (m)	0.0	0.0				
Control Delay (s)	0.0	0.0				
Lane LOS						
Approach Delay (s)	0.0	0.0				
Approach LOS						
Intersection Summary						
Average Delay			0.0			
Intersection Capacity Utilization			40.9%	ICU Level of Service	A	
Analysis Period (min)			15			

2027Tot PM
29: Ring (E-W) & Parking Garage Access

04/19/2024



Movement	EBL	EBT	WBT	WBR	SBL	SBR
Lane Configurations						
Traffic Volume (veh/h)	75	68	75	56	109	176
Future Volume (Veh/h)	75	68	75	56	109	176
Sign Control		Free	Free		Stop	
Grade		0%	0%		0%	
Peak Hour Factor	1.00	1.00	1.00	1.00	1.00	1.00
Hourly flow rate (vph)	75	68	75	56	109	176
Pedestrians						
Lane Width (m)						
Walking Speed (m/s)						
Percent Blockage						
Right turn flare (veh)						
Median type		None	None			
Median storage veh)						
Upstream signal (m)						
pX, platoon unblocked						
vC, conflicting volume	131				321	103
vC1, stage 1 conf vol						
vC2, stage 2 conf vol						
vCu, unblocked vol	131				321	103
tC, single (s)	4.1				6.4	6.2
tC, 2 stage (s)						
tF (s)	2.2				3.5	3.3
p0 queue free %	95				83	82
cM capacity (veh/h)	1454				638	952
Direction, Lane #	EB 1	WB 1	SB 1			
Volume Total	143	131	285			
Volume Left	75	0	109			
Volume Right	0	56	176			
cSH	1454	1700	801			
Volume to Capacity	0.05	0.08	0.36			
Queue Length 95th (m)	1.1	0.0	11.3			
Control Delay (s)	4.2	0.0	12.0			
Lane LOS	A		B			
Approach Delay (s)	4.2	0.0	12.0			
Approach LOS			B			
Intersection Summary						
Average Delay			7.2			
Intersection Capacity Utilization			43.7%		ICU Level of Service	A
Analysis Period (min)			15			



Lane Group	EBL	EBT	EBR	WBL	WBT	WBR	NBL	NBT	NBR	SBL	SBT	SBR
Lane Configurations		↕↕			↕↕			↕		↕		↕
Traffic Volume (vph)	514	874	2	1	630	114	6	1	0	33	0	182
Future Volume (vph)	514	874	2	1	630	114	6	1	0	33	0	182
Ideal Flow (vphpl)	1800	1800	1800	1800	1800	1800	1800	1800	1800	1800	1800	1800
Lane Util. Factor	0.95	0.95	0.95	0.95	0.95	0.95	1.00	1.00	1.00	1.00	1.00	1.00
Ped Bike Factor		1.00			0.99			1.00		0.99		0.98
Frt					0.977							0.850
Flt Protected		0.982						0.959		0.950		
Satd. Flow (prot)	0	3439	0	0	3361	0	0	1768	0	1717	0	1493
Flt Permitted		0.522			0.953			0.959		0.753		
Satd. Flow (perm)	0	1823	0	0	3203	0	0	1763	0	1347	0	1468
Right Turn on Red			Yes			Yes			Yes			Yes
Satd. Flow (RTOR)					19							182
Link Speed (k/h)		50			50			40				40
Link Distance (m)		218.8			394.7			154.1				51.9
Travel Time (s)		15.8			28.4			13.9				4.7
Confl. Peds. (#/hr)	15		3	3		15	2		7	7		2
Confl. Bikes (#/hr)			3						1			2
Peak Hour Factor	1.00	1.00	1.00	1.00	1.00	1.00	1.00	1.00	1.00	1.00	1.00	1.00
Heavy Vehicles (%)	2%	2%	2%	2%	3%	3%	2%	2%	2%	4%	2%	7%
Adj. Flow (vph)	514	874	2	1	630	114	6	1	0	33	0	182
Shared Lane Traffic (%)												
Lane Group Flow (vph)	0	1390	0	0	745	0	0	7	0	33	0	182
Enter Blocked Intersection	No	No	No	No	No	No	No	No	No	No	No	No
Lane Alignment	Left	Left	Right	Left	Left	Right	L NA	Left	R NA	L NA	Left	R NA
Median Width(m)		0.0			4.0			0.0				5.0
Link Offset(m)		0.0			0.0			0.0				0.0
Crosswalk Width(m)		5.0			5.0			5.0				5.0
Two way Left Turn Lane												
Headway Factor	1.01	1.01	1.01	1.01	1.01	1.01	1.01	1.01	1.01	1.01	1.01	1.01
Turning Speed (k/h)	24		14	24		14	24		14	24		14
Number of Detectors	1	2		1	2		1	2		1		1
Detector Template	Left	Thru		Left	Thru		Left	Thru		Left		Right
Leading Detector (m)	2.0	10.0		2.0	10.0		2.0	10.0		2.0		2.0
Trailing Detector (m)	0.0	0.0		0.0	0.0		0.0	0.0		0.0		0.0
Detector 1 Position(m)	0.0	0.0		0.0	0.0		0.0	0.0		0.0		0.0
Detector 1 Size(m)	2.0	0.6		2.0	0.6		2.0	0.6		2.0		2.0
Detector 1 Type	Cl+Ex	Cl+Ex		Cl+Ex	Cl+Ex		Cl+Ex	Cl+Ex		Cl+Ex		Cl+Ex
Detector 1 Channel												
Detector 1 Extend (s)	0.0	0.0		0.0	0.0		0.0	0.0		0.0		0.0
Detector 1 Queue (s)	0.0	0.0		0.0	0.0		0.0	0.0		0.0		0.0
Detector 1 Delay (s)	0.0	0.0		0.0	0.0		0.0	0.0		0.0		0.0
Detector 2 Position(m)		9.4			9.4			9.4				
Detector 2 Size(m)		0.6			0.6			0.6				
Detector 2 Type		Cl+Ex			Cl+Ex			Cl+Ex				
Detector 2 Channel												
Detector 2 Extend (s)		0.0			0.0			0.0				
Turn Type	pm+pt	NA		Perm	NA		Perm	NA		Perm		Perm
Protected Phases	5	2			6			8				



Lane Group	EBL	EBT	EBR	WBL	WBT	WBR	NBL	NBT	NBR	SBL	SBT	SBR
Permitted Phases	2			6			8			4		4
Detector Phase	5	2		6	6		8	8		4		4
Switch Phase												
Minimum Initial (s)	5.0	10.0		10.0	10.0		10.0	10.0		10.0		10.0
Minimum Split (s)	10.6	31.7		31.7	31.7		28.5	28.5		28.5		28.5
Total Split (s)	42.0	84.0		42.0	42.0		31.0	31.0		31.0		31.0
Total Split (%)	36.5%	73.0%		36.5%	36.5%		27.0%	27.0%		27.0%		27.0%
Maximum Green (s)	36.4	78.3		36.3	36.3		25.5	25.5		25.5		25.5
Yellow Time (s)	3.3	3.3		3.3	3.3		3.3	3.3		3.3		3.3
All-Red Time (s)	2.3	2.4		2.4	2.4		2.2	2.2		2.2		2.2
Lost Time Adjust (s)		0.0			0.0			0.0		0.0		0.0
Total Lost Time (s)		5.7			5.7			5.5		5.5		5.5
Lead/Lag	Lead			Lag			Lag			Lag		
Lead-Lag Optimize?												
Vehicle Extension (s)	3.0	3.0		3.0	3.0		3.0	3.0		3.0		3.0
Recall Mode	Max	C-Max		C-Max	C-Max		None	None		None		None
Walk Time (s)		7.0		7.0	7.0		7.0	7.0		7.0		7.0
Flash Dont Walk (s)		19.0		19.0	19.0		16.0	16.0		16.0		16.0
Pedestrian Calls (#/hr)		0		0	0		0	0		0		0
Act Effct Green (s)		93.0			36.3			10.8		10.8		10.8
Actuated g/C Ratio		0.81			0.32			0.09		0.09		0.09
v/c Ratio		0.63			0.73			0.04		0.26		0.60
Control Delay		5.1			33.1			47.0		53.3		15.9
Queue Delay		0.0			0.0			0.0		0.0		0.0
Total Delay		5.1			33.1			47.0		53.3		15.9
LOS		A			C			D		D		B
Approach Delay		5.1			33.1			47.0				21.6
Approach LOS		A			C			D				C

Intersection Summary

Area Type: Other
 Cycle Length: 115
 Actuated Cycle Length: 115
 Offset: 66 (57%), Referenced to phase 2:EBTL and 6:WBTL, Start of Green
 Natural Cycle: 100
 Control Type: Actuated-Coordinated
 Maximum v/c Ratio: 0.73
 Intersection Signal Delay: 15.6
 Intersection Capacity Utilization 88.5%
 Analysis Period (min) 15
 Intersection LOS: B
 ICU Level of Service E

Splits and Phases: 4: South Haven/Ring (N-S) & Smyth

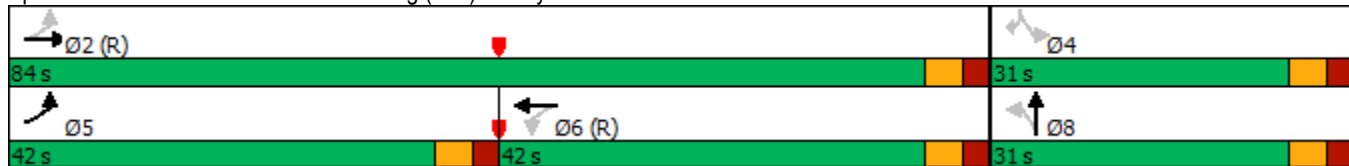

2032Tot AM
8: Smyth & General Hospital

04/19/2024



Lane Group	EBL	EBT	WBT	WBR	SBL	SBR	Ø4	Ø7
Lane Configurations	↖	↗↗	↖↖	↖	↗↗	↖		
Traffic Volume (vph)	401	466	748	473	131	187		
Future Volume (vph)	401	466	748	473	131	187		
Ideal Flow (vphpl)	1800	1800	1800	1800	1800	1800		
Storage Length (m)	55.0			175.0	0.0	0.0		
Storage Lanes	1			1	2	1		
Taper Length (m)	40.0				10.0			
Lane Util. Factor	1.00	0.95	0.95	1.00	0.97	1.00		
Ped Bike Factor	1.00			0.97	0.59	0.97		
Fr _t				0.850		0.850		
Fl _t Protected	0.950				0.950			
Satd. Flow (prot)	1751	3502	3468	1567	3364	1567		
Fl _t Permitted	0.306				0.950			
Satd. Flow (perm)	563	3502	3468	1523	1975	1519		
Right Turn on Red				Yes		Yes		
Satd. Flow (RTOR)				473		41		
Link Speed (k/h)		50	50		40			
Link Distance (m)		394.7	397.7		58.6			
Travel Time (s)		28.4	28.6		5.3			
Confl. Peds. (#/hr)	3			3	51	13		
Confl. Bikes (#/hr)				3				
Peak Hour Factor	1.00	1.00	1.00	1.00	1.00	1.00		
Heavy Vehicles (%)	2%	2%	3%	2%	3%	2%		
Adj. Flow (vph)	401	466	748	473	131	187		
Shared Lane Traffic (%)								
Lane Group Flow (vph)	401	466	748	473	131	187		
Enter Blocked Intersection	No	No	No	No	No	No		
Lane Alignment	Left	Left	Left	Right	Left	R NA		
Median Width(m)		4.0	4.0		8.0			
Link Offset(m)		0.0	0.0		0.0			
Crosswalk Width(m)		5.0	5.0		5.0			
Two way Left Turn Lane								
Headway Factor	1.01	1.01	1.01	1.01	1.01	1.01		
Turning Speed (k/h)	24			14	24	14		
Number of Detectors	1	2	2	1	1	1		
Detector Template	Left	Thru	Thru	Right	Left	Right		
Leading Detector (m)	2.0	10.0	10.0	2.0	2.0	2.0		
Trailing Detector (m)	0.0	0.0	0.0	0.0	0.0	0.0		
Detector 1 Position(m)	0.0	0.0	0.0	0.0	0.0	0.0		
Detector 1 Size(m)	2.0	0.6	0.6	2.0	2.0	2.0		
Detector 1 Type	Cl+Ex	Cl+Ex	Cl+Ex	Cl+Ex	Cl+Ex	Cl+Ex		
Detector 1 Channel								
Detector 1 Extend (s)	0.0	0.0	0.0	0.0	0.0	0.0		
Detector 1 Queue (s)	0.0	0.0	0.0	0.0	0.0	0.0		
Detector 1 Delay (s)	0.0	0.0	0.0	0.0	0.0	0.0		
Detector 2 Position(m)		9.4	9.4					
Detector 2 Size(m)		0.6	0.6					
Detector 2 Type		Cl+Ex	Cl+Ex					
Detector 2 Channel								

2032Tot AM
8: Smyth & General Hospital

04/19/2024

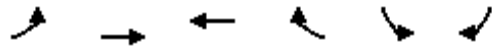

Lane Group	EBL	EBT	WBT	WBR	SBL	SBR	Ø4	Ø7
Detector 2 Extend (s)		0.0	0.0					
Turn Type	pm+pt	NA	NA	pm+ov	Prot	pm+ov		
Protected Phases	5	2	6	3	3	5	4	7
Permitted Phases	2			6		7		
Detector Phase	5	2	6	3	3	5		
Switch Phase								
Minimum Initial (s)	5.0	10.0	10.0	5.0	5.0	5.0	5.0	5.0
Minimum Split (s)	10.7	16.4	41.4	10.9	10.9	10.7	32.0	29.9
Total Split (s)	28.0	70.0	42.0	13.0	13.0	28.0	32.0	45.0
Total Split (%)	24.3%	60.9%	36.5%	11.3%	11.3%	24.3%	28%	39%
Maximum Green (s)	22.3	63.6	35.6	7.1	7.1	22.3	28.0	39.1
Yellow Time (s)	3.3	3.3	3.3	3.3	3.3	3.3	3.0	3.3
All-Red Time (s)	2.4	3.1	3.1	2.6	2.6	2.4	1.0	2.6
Lost Time Adjust (s)	0.0	0.0	0.0	0.0	0.0	0.0		
Total Lost Time (s)	5.7	6.4	6.4	5.9	5.9	5.7		
Lead/Lag	Lead		Lag	Lag	Lag	Lead	Lead	
Lead-Lag Optimize?								
Vehicle Extension (s)	3.0	3.0	3.0	3.0	3.0	3.0	3.0	3.0
Recall Mode	None	C-Max	C-Max	None	None	None	None	None
Walk Time (s)			7.0				7.0	7.0
Flash Dont Walk (s)			28.0				21.0	17.0
Pedestrian Calls (#/hr)			0				0	0
Act Effct Green (s)	93.4	92.7	67.9	78.5	10.0	29.3		
Actuated g/C Ratio	0.81	0.81	0.59	0.68	0.09	0.25		
v/c Ratio	0.61	0.17	0.37	0.40	0.45	0.44		
Control Delay	12.2	2.7	14.4	1.7	54.2	25.8		
Queue Delay	0.0	0.0	0.0	0.0	0.0	0.0		
Total Delay	12.2	2.7	14.4	1.7	54.2	25.8		
LOS	B	A	B	A	D	C		
Approach Delay		7.1	9.5		37.5			
Approach LOS		A	A		D			

Intersection Summary

Area Type:	Other
Cycle Length:	115
Actuated Cycle Length:	115
Offset:	43 (37%), Referenced to phase 2:EBTL and 6:WBT, Start of Green
Natural Cycle:	105
Control Type:	Actuated-Coordinated
Maximum v/c Ratio:	0.61
Intersection Signal Delay:	12.3
Intersection LOS:	B
Intersection Capacity Utilization:	71.8%
ICU Level of Service:	C
Analysis Period (min):	15

Splits and Phases: 8: Smyth & General Hospital

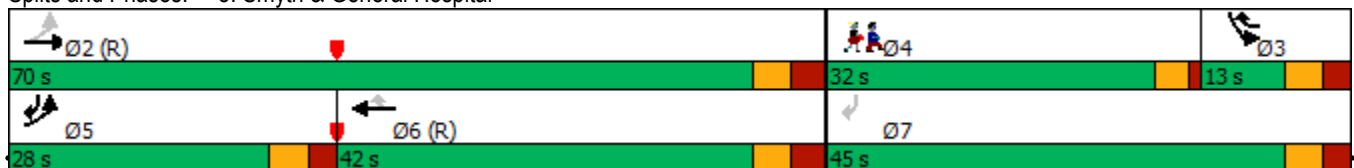



Movement	EBT	EBR	WBL	WBT	NBL	NBR
Lane Configurations	↶			↷	↷	
Sign Control	Stop			Stop	Stop	
Traffic Volume (vph)	324	174	52	107	60	132
Future Volume (vph)	324	174	52	107	60	132
Peak Hour Factor	1.00	1.00	1.00	1.00	1.00	1.00
Hourly flow rate (vph)	324	174	52	107	60	132

Direction, Lane #	EB 1	WB 1	NB 1
Volume Total (vph)	498	159	192
Volume Left (vph)	0	52	60
Volume Right (vph)	174	0	132
Hadj (s)	-0.13	0.13	-0.22
Departure Headway (s)	4.5	5.2	5.2
Degree Utilization, x	0.63	0.23	0.28
Capacity (veh/h)	770	657	620
Control Delay (s)	14.7	9.7	10.2
Approach Delay (s)	14.7	9.7	10.2
Approach LOS	B	A	B

Intersection Summary			
Delay		12.8	
Level of Service		B	
Intersection Capacity Utilization	61.3%		ICU Level of Service B
Analysis Period (min)		15	

2032Tot AM
2: Ring (N-S) & CHEO Non-Emergency

04/19/2024



Movement	EBL	EBT	EBR	WBL	WBT	WBR	NBL	NBT	NBR	SBL	SBT	SBR
Lane Configurations												
Sign Control		Stop			Stop			Stop			Stop	
Traffic Volume (vph)	3	0	7	0	0	0	6	412	10	20	95	2
Future Volume (vph)	3	0	7	0	0	0	6	412	10	20	95	2
Peak Hour Factor	1.00	1.00	1.00	1.00	1.00	1.00	1.00	1.00	1.00	1.00	1.00	1.00
Hourly flow rate (vph)	3	0	7	0	0	0	6	412	10	20	95	2

Direction, Lane #	EB 1	WB 1	NB 1	SB 1
Volume Total (vph)	10	0	428	117
Volume Left (vph)	3	0	6	20
Volume Right (vph)	7	0	10	2
Hadj (s)	-0.33	0.00	0.06	0.10
Departure Headway (s)	4.7	5.1	4.1	4.4
Degree Utilization, x	0.01	0.00	0.49	0.14
Capacity (veh/h)	673	640	867	787
Control Delay (s)	7.8	8.1	10.9	8.2
Approach Delay (s)	7.8	0.0	10.9	8.2
Approach LOS	A	A	B	A

Intersection Summary			
Delay		10.3	
Level of Service		B	
Intersection Capacity Utilization	36.8%		ICU Level of Service A
Analysis Period (min)		15	

2032Tot AM
3: Ring (N-S) & Ring (E-W)

04/19/2024



Movement	WBL	WBR	NBT	NBR	SBL	SBT
Lane Configurations						
Traffic Volume (veh/h)	158	110	336	278	55	59
Future Volume (Veh/h)	158	110	336	278	55	59
Sign Control	Stop		Free		Free	
Grade	0%		0%		0%	
Peak Hour Factor	1.00	1.00	1.00	1.00	1.00	1.00
Hourly flow rate (vph)	158	110	336	278	55	59
Pedestrians	8					
Lane Width (m)	4.0					
Walking Speed (m/s)	1.0					
Percent Blockage	1					
Right turn flare (veh)						
Median type	None			None		
Median storage veh						
Upstream signal (m)	52					
pX, platoon unblocked						
vC, conflicting volume	652	483			622	
vC1, stage 1 conf vol						
vC2, stage 2 conf vol						
vCu, unblocked vol	652	483			622	
tC, single (s)	6.4	6.3			4.2	
tC, 2 stage (s)						
tF (s)	3.5	3.4			2.3	
p0 queue free %	61	81			94	
cM capacity (veh/h)	403	570			927	
Direction, Lane #	WB 1	NB 1	SB 1			
Volume Total	268	614	114			
Volume Left	158	0	55			
Volume Right	110	278	0			
cSH	458	1700	927			
Volume to Capacity	0.58	0.36	0.06			
Queue Length 95th (m)	25.6	0.0	1.3			
Control Delay (s)	23.3	0.0	4.7			
Lane LOS	C		A			
Approach Delay (s)	23.3	0.0	4.7			
Approach LOS	C					
Intersection Summary						
Average Delay			6.8			
Intersection Capacity Utilization			69.8%	ICU Level of Service		C
Analysis Period (min)	15					

2032Tot AM
5: Ring (E-W) & CHEO Non-Emergency

04/19/2024



Movement	EBL	EBT	WBT	WBR	SBL	SBR
Lane Configurations						
Traffic Volume (veh/h)	0	347	136	0	14	128
Future Volume (Veh/h)	0	347	136	0	14	128
Sign Control		Free	Free		Stop	
Grade		0%	0%		0%	
Peak Hour Factor	1.00	1.00	1.00	1.00	1.00	1.00
Hourly flow rate (vph)	0	347	136	0	14	128
Pedestrians			17		2	
Lane Width (m)			4.0		4.0	
Walking Speed (m/s)			1.0		1.0	
Percent Blockage			2		0	
Right turn flare (veh)						
Median type		None	None			
Median storage veh						
Upstream signal (m)						
pX, platoon unblocked						
vC, conflicting volume	138				502	138
vC1, stage 1 conf vol						
vC2, stage 2 conf vol						
vCu, unblocked vol	138				502	138
tC, single (s)	4.1				6.6	6.2
tC, 2 stage (s)						
tF (s)	2.2				3.7	3.3
p0 queue free %	100				97	86
cM capacity (veh/h)	1443				486	908
Direction, Lane #	EB 1	WB 1	SB 1			
Volume Total	347	136	142			
Volume Left	0	0	14			
Volume Right	0	0	128			
cSH	1443	1700	837			
Volume to Capacity	0.00	0.08	0.17			
Queue Length 95th (m)	0.0	0.0	4.3			
Control Delay (s)	0.0	0.0	10.2			
Lane LOS			B			
Approach Delay (s)	0.0	0.0	10.2			
Approach LOS			B			
Intersection Summary						
Average Delay			2.3			
Intersection Capacity Utilization			35.1%	ICU Level of Service		A
Analysis Period (min)			15			

2032Tot AM
6: Ring (E-W) & CHEO Emergency









04/19/2024



Movement	EBL	EBT	WBT	WBR	SBL	SBR
Lane Configurations						
Traffic Volume (veh/h)	9	401	124	25	15	11
Future Volume (Veh/h)	9	401	124	25	15	11
Sign Control		Free	Free		Stop	
Grade		0%	0%		0%	
Peak Hour Factor	1.00	1.00	1.00	1.00	1.00	1.00
Hourly flow rate (vph)	9	401	124	25	15	11
Pedestrians		2	28		7	
Lane Width (m)		4.0	4.0		4.0	
Walking Speed (m/s)		1.0	1.0		1.0	
Percent Blockage		0	3		1	
Right turn flare (veh)						
Median type		None	None			
Median storage veh						
Upstream signal (m)						
pX, platoon unblocked						
vC, conflicting volume	156				590	146
vC1, stage 1 conf vol						
vC2, stage 2 conf vol						
vCu, unblocked vol	156				590	146
tC, single (s)	4.2				6.5	6.3
tC, 2 stage (s)						
tF (s)	2.3				3.6	3.4
p0 queue free %	99				97	99
cM capacity (veh/h)	1360				441	877
Direction, Lane #	EB 1	WB 1	SB 1			
Volume Total	410	149	26			
Volume Left	9	0	15			
Volume Right	0	25	11			
cSH	1360	1700	558			
Volume to Capacity	0.01	0.09	0.05			
Queue Length 95th (m)	0.1	0.0	1.0			
Control Delay (s)	0.2	0.0	11.8			
Lane LOS	A		B			
Approach Delay (s)	0.2	0.0	11.8			
Approach LOS			B			
Intersection Summary						
Average Delay			0.7			
Intersection Capacity Utilization			40.6%	ICU Level of Service		A
Analysis Period (min)			15			



Movement	EBL	EBT	EBR	WBL	WBT	WBR	NBL	NBT	NBR	SBL	SBT	SBR
Lane Configurations		↕		↖	↕			↗	↗		↕	
Traffic Volume (veh/h)	19	22	51	158	25	19	157	134	485	12	137	15
Future Volume (Veh/h)	19	22	51	158	25	19	157	134	485	12	137	15
Sign Control		Stop			Stop			Free			Free	
Grade		0%			0%			0%			0%	
Peak Hour Factor	1.00	1.00	1.00	1.00	1.00	1.00	1.00	1.00	1.00	1.00	1.00	1.00
Hourly flow rate (vph)	19	22	51	158	25	19	157	134	485	12	137	15
Pedestrians		27			65							4
Lane Width (m)		4.0			4.0						4.0	
Walking Speed (m/s)		1.0			1.0						1.0	
Percent Blockage		3			7						0	
Right turn flare (veh)												
Median type								None			None	
Median storage veh												
Upstream signal (m)								59				
pX, platoon unblocked												
vC, conflicting volume	679	708	172	744	716	203	179			199		
vC1, stage 1 conf vol												
vC2, stage 2 conf vol												
vCu, unblocked vol	679	708	172	744	716	203	179			199		
tC, single (s)	7.2	6.5	6.3	7.1	6.7	6.2	4.2			4.1		
tC, 2 stage (s)												
tF (s)	3.6	4.0	3.4	3.5	4.2	3.3	2.3			2.2		
p0 queue free %	93	92	94	30	90	98	88			99		
cM capacity (veh/h)	260	281	819	227	261	774	1326			1274		
Direction, Lane #	EB 1	WB 1	WB 2	NB 1	NB 2	SB 1						
Volume Total	92	105	97	291	485	164						
Volume Left	19	105	53	157	0	12						
Volume Right	51	0	19	0	485	15						
cSH	431	227	274	1326	1700	1274						
Volume to Capacity	0.21	0.46	0.35	0.12	0.29	0.01						
Queue Length 95th (m)	5.6	15.9	10.7	2.8	0.0	0.2						
Control Delay (s)	15.6	34.0	25.1	4.8	0.0	0.6						
Lane LOS	C	D	D	A		A						
Approach Delay (s)	15.6	29.7		1.8		0.6						
Approach LOS	C	D										
Intersection Summary												
Average Delay			7.3									
Intersection Capacity Utilization			63.8%		ICU Level of Service				B			
Analysis Period (min)			15									

						
Movement	WBL	WBR	NBT	NBR	SBL	SBT
Lane Configurations						
Traffic Volume (veh/h)	9	2	425	0	0	102
Future Volume (Veh/h)	9	2	425	0	0	102
Sign Control	Stop		Free			Free
Grade	0%		0%			0%
Peak Hour Factor	1.00	1.00	1.00	1.00	1.00	1.00
Hourly flow rate (vph)	9	2	425	0	0	102
Pedestrians						
Lane Width (m)						
Walking Speed (m/s)						
Percent Blockage						
Right turn flare (veh)						
Median type	None			None		
Median storage veh						
Upstream signal (m)	144					
pX, platoon unblocked						
vC, conflicting volume	527	425			425	
vC1, stage 1 conf vol						
vC2, stage 2 conf vol						
vCu, unblocked vol	527	425			425	
tC, single (s)	6.4	6.2			4.1	
tC, 2 stage (s)						
tF (s)	3.5	3.3			2.2	
p0 queue free %	98	100			100	
cM capacity (veh/h)	512	629			1134	
Direction, Lane #	WB 1	NB 1	SB 1			
Volume Total	11	425	102			
Volume Left	9	0	0			
Volume Right	2	0	0			
cSH	530	1700	1700			
Volume to Capacity	0.02	0.25	0.06			
Queue Length 95th (m)	0.4	0.0	0.0			
Control Delay (s)	11.9	0.0	0.0			
Lane LOS	B					
Approach Delay (s)	11.9	0.0	0.0			
Approach LOS	B					
Intersection Summary						
Average Delay			0.2			
Intersection Capacity Utilization			44.3%	ICU Level of Service	A	
Analysis Period (min)			15			

2032Tot AM
27: Ring (N-S) & Entry Clinic

04/19/2024



Movement	WBL	WBR	NBT	NBR	SBL	SBT
Lane Configurations			↔			↔
Traffic Volume (veh/h)	0	0	425	24	0	102
Future Volume (Veh/h)	0	0	425	24	0	102
Sign Control	Stop		Free		Free	
Grade	0%		0%		0%	
Peak Hour Factor	1.00	1.00	1.00	1.00	1.00	1.00
Hourly flow rate (vph)	0	0	425	24	0	102
Pedestrians						
Lane Width (m)						
Walking Speed (m/s)						
Percent Blockage						
Right turn flare (veh)						
Median type	None			None		
Median storage veh						
Upstream signal (m)	99					
pX, platoon unblocked						
vC, conflicting volume	539	437			449	
vC1, stage 1 conf vol						
vC2, stage 2 conf vol						
vCu, unblocked vol	539	437			449	
tC, single (s)	6.4	6.2			4.1	
tC, 2 stage (s)						
tF (s)	3.5	3.3			2.2	
p0 queue free %	100	100			100	
cM capacity (veh/h)	503	620			1111	
Direction, Lane #	NB 1	SB 1				
Volume Total	449	102				
Volume Left	0	0				
Volume Right	24	0				
cSH	1700	1700				
Volume to Capacity	0.26	0.06				
Queue Length 95th (m)	0.0	0.0				
Control Delay (s)	0.0	0.0				
Lane LOS						
Approach Delay (s)	0.0	0.0				
Approach LOS						
Intersection Summary						
Average Delay			0.0			
Intersection Capacity Utilization			44.3%	ICU Level of Service	A	
Analysis Period (min)			15			

2032Tot AM
29: Ring (E-W) & Parking Garage Access

04/19/2024



Movement	EBL	EBT	WBT	WBR	SBL	SBR
Lane Configurations		↶	↷		↘	↙
Traffic Volume (veh/h)	326	90	76	121	38	59
Future Volume (Veh/h)	326	90	76	121	38	59
Sign Control		Free	Free		Stop	
Grade		0%	0%		0%	
Peak Hour Factor	1.00	1.00	1.00	1.00	1.00	1.00
Hourly flow rate (vph)	326	90	76	121	38	59
Pedestrians						
Lane Width (m)						
Walking Speed (m/s)						
Percent Blockage						
Right turn flare (veh)						
Median type		None	None			
Median storage (veh)						
Upstream signal (m)						
pX, platoon unblocked						
vC, conflicting volume	197				878	136
vC1, stage 1 conf vol						
vC2, stage 2 conf vol						
vCu, unblocked vol	197				878	136
tC, single (s)	4.1				6.4	6.2
tC, 2 stage (s)						
tF (s)	2.2				3.5	3.3
p0 queue free %	76				84	94
cM capacity (veh/h)	1376				243	912
Direction, Lane #	EB 1	WB 1	SB 1			
Volume Total	416	197	97			
Volume Left	326	0	38			
Volume Right	0	121	59			
cSH	1376	1700	439			
Volume to Capacity	0.24	0.12	0.22			
Queue Length 95th (m)	6.5	0.0	5.8			
Control Delay (s)	7.1	0.0	15.5			
Lane LOS	A		C			
Approach Delay (s)	7.1	0.0	15.5			
Approach LOS			C			
Intersection Summary						
Average Delay			6.3			
Intersection Capacity Utilization			52.2%	ICU Level of Service	A	
Analysis Period (min)			15			



Lane Group	EBL	EBT	EBR	WBL	WBT	WBR	NBL	NBT	NBR	SBL	SBT	SBR
Lane Configurations		↕↕			↕↕			↕		↕		↕
Traffic Volume (vph)	141	594	4	4	1002	13	5	0	4	152	0	470
Future Volume (vph)	141	594	4	4	1002	13	5	0	4	152	0	470
Ideal Flow (vphpl)	1800	1800	1800	1800	1800	1800	1800	1800	1800	1800	1800	1800
Lane Util. Factor	0.95	0.95	0.95	0.95	0.95	0.95	1.00	1.00	1.00	1.00	1.00	1.00
Ped Bike Factor		1.00			1.00			0.99		0.99		0.97
Frt		0.999			0.998			0.940				0.850
Flt Protected		0.991						0.973		0.950		
Satd. Flow (prot)	0	3426	0	0	3493	0	0	1670	0	1751	0	1567
Flt Permitted		0.528			0.953			0.973		0.752		
Satd. Flow (perm)	0	1824	0	0	3328	0	0	1666	0	1374	0	1523
Right Turn on Red			Yes			Yes			Yes			Yes
Satd. Flow (RTOR)		1			2			79				225
Link Speed (k/h)		50			50			40				40
Link Distance (m)		218.8			394.7			154.1				51.9
Travel Time (s)		15.8			28.4			13.9				4.7
Confl. Peds. (#/hr)	15		8	8		15	3		6	6		3
Confl. Bikes (#/hr)			2			1						14
Peak Hour Factor	1.00	1.00	1.00	1.00	1.00	1.00	1.00	1.00	1.00	1.00	1.00	1.00
Heavy Vehicles (%)	4%	3%	2%	2%	2%	2%	2%	2%	2%	2%	2%	2%
Adj. Flow (vph)	141	594	4	4	1002	13	5	0	4	152	0	470
Shared Lane Traffic (%)												
Lane Group Flow (vph)	0	739	0	0	1019	0	0	9	0	152	0	470
Enter Blocked Intersection	No	No	No	No	No	No	No	No	No	No	No	No
Lane Alignment	Left	Left	Right	Left	Left	Right	L NA	Left	R NA	L NA	Left	R NA
Median Width(m)		0.0			4.0			0.0				5.0
Link Offset(m)		0.0			0.0			0.0				0.0
Crosswalk Width(m)		5.0			5.0			5.0				5.0
Two way Left Turn Lane												
Headway Factor	1.01	1.01	1.01	1.01	1.01	1.01	1.01	1.01	1.01	1.01	1.01	1.01
Turning Speed (k/h)	24		14	24		14	24		14	24		14
Number of Detectors	1	2		1	2		1	2		1		1
Detector Template	Left	Thru		Left	Thru		Left	Thru		Left		Right
Leading Detector (m)	2.0	10.0		2.0	10.0		2.0	10.0		2.0		2.0
Trailing Detector (m)	0.0	0.0		0.0	0.0		0.0	0.0		0.0		0.0
Detector 1 Position(m)	0.0	0.0		0.0	0.0		0.0	0.0		0.0		0.0
Detector 1 Size(m)	2.0	0.6		2.0	0.6		2.0	0.6		2.0		2.0
Detector 1 Type	Cl+Ex	Cl+Ex		Cl+Ex	Cl+Ex		Cl+Ex	Cl+Ex		Cl+Ex		Cl+Ex
Detector 1 Channel												
Detector 1 Extend (s)	0.0	0.0		0.0	0.0		0.0	0.0		0.0		0.0
Detector 1 Queue (s)	0.0	0.0		0.0	0.0		0.0	0.0		0.0		0.0
Detector 1 Delay (s)	0.0	0.0		0.0	0.0		0.0	0.0		0.0		0.0
Detector 2 Position(m)		9.4			9.4			9.4				
Detector 2 Size(m)		0.6			0.6			0.6				
Detector 2 Type		Cl+Ex			Cl+Ex			Cl+Ex				
Detector 2 Channel												
Detector 2 Extend (s)		0.0			0.0			0.0				
Turn Type	pm+pt	NA		Perm	NA		Perm	NA		Perm		Perm
Protected Phases	5	2			6			8				



Lane Group	EBL	EBT	EBR	WBL	WBT	WBR	NBL	NBT	NBR	SBL	SBT	SBR
Permitted Phases	2			6			8			4		4
Detector Phase	5	2		6	6		8	8		4		4
Switch Phase												
Minimum Initial (s)	5.0	10.0		10.0	10.0		10.0	10.0		10.0		10.0
Minimum Split (s)	10.6	31.7		31.7	31.7		28.5	28.5		28.5		28.5
Total Split (s)	16.0	78.0		62.0	62.0		37.0	37.0		37.0		37.0
Total Split (%)	13.9%	67.8%		53.9%	53.9%		32.2%	32.2%		32.2%		32.2%
Maximum Green (s)	10.4	72.3		56.3	56.3		31.5	31.5		31.5		31.5
Yellow Time (s)	3.3	3.3		3.3	3.3		3.3	3.3		3.3		3.3
All-Red Time (s)	2.3	2.4		2.4	2.4		2.2	2.2		2.2		2.2
Lost Time Adjust (s)		0.0			0.0			0.0		0.0		0.0
Total Lost Time (s)		5.7			5.7			5.5		5.5		5.5
Lead/Lag	Lead			Lag		Lag						
Lead-Lag Optimize?												
Vehicle Extension (s)	3.0	3.0		3.0	3.0		3.0	3.0		3.0		3.0
Recall Mode	Max	C-Max		C-Max	C-Max		None	None		None		None
Walk Time (s)		7.0		7.0	7.0		7.0	7.0		7.0		7.0
Flash Dont Walk (s)		19.0		19.0	19.0		16.0	16.0		16.0		16.0
Pedestrian Calls (#/hr)		0		0	0		0	0		0		0
Act Effct Green (s)		78.1			56.3			25.7		25.7		25.7
Actuated g/C Ratio		0.68			0.49			0.22		0.22		0.22
v/c Ratio		0.51			0.63			0.02		0.50		0.91
Control Delay		9.8			23.4			0.1		43.3		45.1
Queue Delay		0.0			0.0			0.0		0.0		0.0
Total Delay		9.8			23.4			0.1		43.3		45.1
LOS		A			C			A		D		D
Approach Delay		9.8			23.4			0.1				44.7
Approach LOS		A			C			A				D

Intersection Summary

Area Type: Other
 Cycle Length: 115
 Actuated Cycle Length: 115
 Offset: 62 (54%), Referenced to phase 2:EBTL and 6:WBTL, Start of Green
 Natural Cycle: 75
 Control Type: Actuated-Coordinated
 Maximum v/c Ratio: 0.91
 Intersection Signal Delay: 24.7
 Intersection LOS: C
 Intersection Capacity Utilization 85.1%
 ICU Level of Service E
 Analysis Period (min) 15

Splits and Phases: 4: South Haven/Ring (N-S) & Smyth



2032Tot PM
8: Smyth & General Hospital

04/19/2024



Lane Group	EBL	EBT	WBT	WBR	SBL	SBR	Ø4	Ø7
Lane Configurations	↖	↗↗	↖↖	↗	↘↘	↖		
Traffic Volume (vph)	142	868	597	167	376	403		
Future Volume (vph)	142	868	597	167	376	403		
Ideal Flow (vphpl)	1800	1800	1800	1800	1800	1800		
Storage Length (m)	55.0			175.0	0.0	0.0		
Storage Lanes	1			1	2	1		
Taper Length (m)	40.0				10.0			
Lane Util. Factor	1.00	0.95	0.95	1.00	0.97	1.00		
Ped Bike Factor	0.99			0.96	0.81	0.97		
Fr _t				0.850		0.850		
Fl _t Protected	0.950				0.950			
Satd. Flow (prot)	1701	3468	3502	1551	3397	1567		
Fl _t Permitted	0.368				0.950			
Satd. Flow (perm)	655	3468	3502	1491	2761	1517		
Right Turn on Red				Yes		Yes		
Satd. Flow (RTOR)				167		82		
Link Speed (k/h)		50	50		40			
Link Distance (m)		394.7	397.7		58.6			
Travel Time (s)		28.4	28.6		5.3			
Confl. Peds. (#/hr)	11			11	72	14		
Confl. Bikes (#/hr)				2				
Peak Hour Factor	1.00	1.00	1.00	1.00	1.00	1.00		
Heavy Vehicles (%)	5%	3%	2%	3%	2%	2%		
Adj. Flow (vph)	142	868	597	167	376	403		
Shared Lane Traffic (%)								
Lane Group Flow (vph)	142	868	597	167	376	403		
Enter Blocked Intersection	No	No	No	No	No	No		
Lane Alignment	Left	Left	Left	Right	Left	R NA		
Median Width(m)		4.0	4.0		8.0			
Link Offset(m)		0.0	0.0		0.0			
Crosswalk Width(m)		5.0	5.0		5.0			
Two way Left Turn Lane								
Headway Factor	1.01	1.01	1.01	1.01	1.01	1.01		
Turning Speed (k/h)	24			14	24	14		
Number of Detectors	1	2	2	1	1	1		
Detector Template	Left	Thru	Thru	Right	Left	Right		
Leading Detector (m)	2.0	10.0	10.0	2.0	2.0	2.0		
Trailing Detector (m)	0.0	0.0	0.0	0.0	0.0	0.0		
Detector 1 Position(m)	0.0	0.0	0.0	0.0	0.0	0.0		
Detector 1 Size(m)	2.0	0.6	0.6	2.0	2.0	2.0		
Detector 1 Type	Cl+Ex	Cl+Ex	Cl+Ex	Cl+Ex	Cl+Ex	Cl+Ex		
Detector 1 Channel								
Detector 1 Extend (s)	0.0	0.0	0.0	0.0	0.0	0.0		
Detector 1 Queue (s)	0.0	0.0	0.0	0.0	0.0	0.0		
Detector 1 Delay (s)	0.0	0.0	0.0	0.0	0.0	0.0		
Detector 2 Position(m)		9.4	9.4					
Detector 2 Size(m)		0.6	0.6					
Detector 2 Type		Cl+Ex	Cl+Ex					
Detector 2 Channel								



Lane Group	EBL	EBT	WBT	WBR	SBL	SBR	Ø4	Ø7
Detector 2 Extend (s)		0.0	0.0					
Turn Type	pm+pt	NA	NA	pm+ov	Prot	pm+ov		
Protected Phases	5	2	6	3	3	5	4	7
Permitted Phases	2			6		7		
Detector Phase	5	2	6	3	3	5		
Switch Phase								
Minimum Initial (s)	5.0	10.0	10.0	5.0	5.0	5.0	5.0	5.0
Minimum Split (s)	10.7	16.4	41.4	10.9	10.9	10.7	32.0	29.9
Total Split (s)	12.0	55.0	43.0	28.0	28.0	12.0	32.0	60.0
Total Split (%)	10.4%	47.8%	37.4%	24.3%	24.3%	10.4%	28%	52%
Maximum Green (s)	6.3	48.6	36.6	22.1	22.1	6.3	28.0	54.1
Yellow Time (s)	3.3	3.3	3.3	3.3	3.3	3.3	3.0	3.3
All-Red Time (s)	2.4	3.1	3.1	2.6	2.6	2.4	1.0	2.6
Lost Time Adjust (s)	0.0	0.0	0.0	0.0	0.0	0.0		
Total Lost Time (s)	5.7	6.4	6.4	5.9	5.9	5.7		
Lead/Lag	Lead		Lag	Lag	Lag	Lead	Lead	
Lead-Lag Optimize?								
Vehicle Extension (s)	3.0	3.0	3.0	3.0	3.0	3.0	3.0	3.0
Recall Mode	None	C-Max	C-Max	None	None	None	None	None
Walk Time (s)			7.0				7.0	7.0
Flash Dont Walk (s)			28.0				21.0	17.0
Pedestrian Calls (#/hr)			0				0	0
Act Effct Green (s)	85.5	84.8	65.4	83.8	17.9	31.8		
Actuated g/C Ratio	0.74	0.74	0.57	0.73	0.16	0.28		
v/c Ratio	0.23	0.34	0.30	0.15	0.71	0.83		
Control Delay	5.0	5.2	14.9	1.1	53.7	41.9		
Queue Delay	0.0	0.0	0.0	0.0	0.0	0.0		
Total Delay	5.0	5.2	14.9	1.1	53.7	41.9		
LOS	A	A	B	A	D	D		
Approach Delay		5.1	11.9		47.6			
Approach LOS		A	B		D			

Intersection Summary

Area Type: Other
 Cycle Length: 115
 Actuated Cycle Length: 115
 Offset: 59 (51%), Referenced to phase 2:EBTL and 6:WBT, Start of Green
 Natural Cycle: 95
 Control Type: Actuated-Coordinated
 Maximum v/c Ratio: 0.83
 Intersection Signal Delay: 20.1
 Intersection LOS: C
 Intersection Capacity Utilization 67.0%
 ICU Level of Service C
 Analysis Period (min) 15

Splits and Phases: 8: Smyth & General Hospital

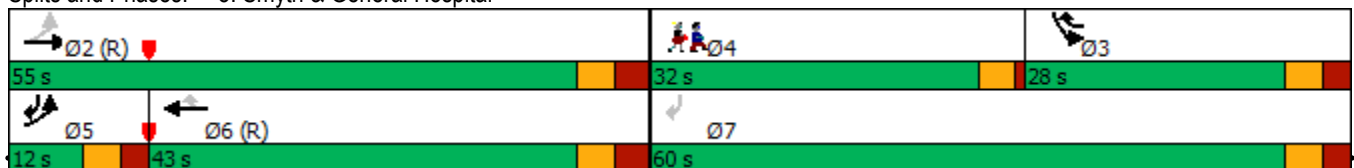



Movement	EBT	EBR	WBL	WBT	NBL	NBR
Lane Configurations						
Sign Control	Stop			Stop	Stop	
Traffic Volume (vph)	117	52	111	280	109	40
Future Volume (vph)	117	52	111	280	109	40
Peak Hour Factor	1.00	1.00	1.00	1.00	1.00	1.00
Hourly flow rate (vph)	117	52	111	280	109	40

Direction, Lane #	EB 1	WB 1	NB 1
Volume Total (vph)	169	391	149
Volume Left (vph)	0	111	109
Volume Right (vph)	52	0	40
Hadj (s)	-0.10	0.12	0.15
Departure Headway (s)	4.7	4.7	5.4
Degree Utilization, x	0.22	0.51	0.22
Capacity (veh/h)	722	749	606
Control Delay (s)	9.0	12.3	9.9
Approach Delay (s)	9.0	12.3	9.9
Approach LOS	A	B	A

Intersection Summary			
Delay		11.0	
Level of Service		B	
Intersection Capacity Utilization		53.5%	ICU Level of Service
Analysis Period (min)		15	A

2032Tot PM
 2: Ring (N-S) & CHEO Non-Emergency

04/19/2024



Movement	EBL	EBT	EBR	WBL	WBT	WBR	NBL	NBT	NBR	SBL	SBT	SBR
Lane Configurations		↕			↕			↕			↕	
Sign Control		Stop			Stop			Stop			Stop	
Traffic Volume (vph)	2	1	12	0	0	0	6	68	60	15	341	3
Future Volume (vph)	2	1	12	0	0	0	6	68	60	15	341	3
Peak Hour Factor	1.00	1.00	1.00	1.00	1.00	1.00	1.00	1.00	1.00	1.00	1.00	1.00
Hourly flow rate (vph)	2	1	12	0	0	0	6	68	60	15	341	3

Direction, Lane #	EB 1	WB 1	NB 1	SB 1
Volume Total (vph)	15	0	134	359
Volume Left (vph)	2	0	6	15
Volume Right (vph)	12	0	60	3
Hadj (s)	-0.42	0.00	-0.15	0.09
Departure Headway (s)	4.5	5.0	4.1	4.2
Degree Utilization, x	0.02	0.00	0.15	0.41
Capacity (veh/h)	709	658	847	850
Control Delay (s)	7.6	8.0	7.9	10.1
Approach Delay (s)	7.6	0.0	7.9	10.1
Approach LOS	A	A	A	B

Intersection Summary			
Delay		9.4	
Level of Service		A	
Intersection Capacity Utilization	38.5%		ICU Level of Service A
Analysis Period (min)		15	

2032Tot PM
3: Ring (N-S) & Ring (E-W)

04/19/2024



Movement	WBL	WBR	NBT	NBR	SBL	SBT
Lane Configurations						
Traffic Volume (veh/h)	303	63	83	79	36	333
Future Volume (Veh/h)	303	63	83	79	36	333
Sign Control	Stop		Free		Free	
Grade	0%		0%		0%	
Peak Hour Factor	1.00	1.00	1.00	1.00	1.00	1.00
Hourly flow rate (vph)	303	63	83	79	36	333
Pedestrians	7					
Lane Width (m)	4.0					
Walking Speed (m/s)	1.0					
Percent Blockage	1					
Right turn flare (veh)						
Median type	None			None		
Median storage veh						
Upstream signal (m)	52					
pX, platoon unblocked						
vC, conflicting volume	534	130			169	
vC1, stage 1 conf vol						
vC2, stage 2 conf vol						
vCu, unblocked vol	534	130			169	
tC, single (s)	6.4	6.3			4.2	
tC, 2 stage (s)						
tF (s)	3.5	3.4			2.3	
p0 queue free %	38	93			97	
cM capacity (veh/h)	489	903			1368	
Direction, Lane #	WB 1	NB 1	SB 1			
Volume Total	366	162	369			
Volume Left	303	0	36			
Volume Right	63	79	0			
cSH	531	1700	1368			
Volume to Capacity	0.69	0.10	0.03			
Queue Length 95th (m)	37.0	0.0	0.6			
Control Delay (s)	25.5	0.0	1.0			
Lane LOS	D		A			
Approach Delay (s)	25.5	0.0	1.0			
Approach LOS	D					
Intersection Summary						
Average Delay			10.8			
Intersection Capacity Utilization			63.1%	ICU Level of Service		B
Analysis Period (min)			15			

2032Tot PM
5: Ring (E-W) & CHEO Non-Emergency

04/19/2024



Movement	EBL	EBT	WBT	WBR	SBL	SBR
Lane Configurations						
Traffic Volume (veh/h)	0	124	267	0	0	103
Future Volume (Veh/h)	0	124	267	0	0	103
Sign Control		Free	Free		Stop	
Grade		0%	0%		0%	
Peak Hour Factor	1.00	1.00	1.00	1.00	1.00	1.00
Hourly flow rate (vph)	0	124	267	0	0	103
Pedestrians						
Lane Width (m)						
Walking Speed (m/s)						
Percent Blockage						
Right turn flare (veh)						
Median type		None	None			
Median storage veh)						
Upstream signal (m)						
pX, platoon unblocked						
vC, conflicting volume	267				391	267
vC1, stage 1 conf vol						
vC2, stage 2 conf vol						
vCu, unblocked vol	267				391	267
tC, single (s)	4.1				6.6	6.2
tC, 2 stage (s)						
tF (s)	2.2				3.7	3.3
p0 queue free %	100				100	87
cM capacity (veh/h)	1297				578	772
Direction, Lane #	EB 1	WB 1	SB 1			
Volume Total	124	267	103			
Volume Left	0	0	0			
Volume Right	0	0	103			
cSH	1297	1700	772			
Volume to Capacity	0.00	0.16	0.13			
Queue Length 95th (m)	0.0	0.0	3.2			
Control Delay (s)	0.0	0.0	10.4			
Lane LOS			B			
Approach Delay (s)	0.0	0.0	10.4			
Approach LOS			B			
Intersection Summary						
Average Delay			2.2			
Intersection Capacity Utilization		28.2%		ICU Level of Service		A
Analysis Period (min)			15			

2032Tot PM
6: Ring (E-W) & CHEO Emergency

04/19/2024



Movement	EBL	EBT	WBT	WBR	SBL	SBR
Lane Configurations						
Traffic Volume (veh/h)	6	133	235	4	10	17
Future Volume (Veh/h)	6	133	235	4	10	17
Sign Control		Free	Free		Stop	
Grade		0%	0%		0%	
Peak Hour Factor	1.00	1.00	1.00	1.00	1.00	1.00
Hourly flow rate (vph)	6	133	235	4	10	17
Pedestrians		4	16		6	
Lane Width (m)		4.0	4.0		4.0	
Walking Speed (m/s)		1.0	1.0		1.0	
Percent Blockage		0	2		1	
Right turn flare (veh)						
Median type		None	None			
Median storage (veh)						
Upstream signal (m)						
pX, platoon unblocked						
vC, conflicting volume	245				404	247
vC1, stage 1 conf vol						
vC2, stage 2 conf vol						
vCu, unblocked vol	245				404	247
tC, single (s)	4.2				6.5	6.3
tC, 2 stage (s)						
tF (s)	2.3				3.6	3.4
p0 queue free %	100				98	98
cM capacity (veh/h)	1262				576	769
Direction, Lane #	EB 1	WB 1	SB 1			
Volume Total	139	239	27			
Volume Left	6	0	10			
Volume Right	0	4	17			
cSH	1262	1700	684			
Volume to Capacity	0.00	0.14	0.04			
Queue Length 95th (m)	0.1	0.0	0.9			
Control Delay (s)	0.4	0.0	10.5			
Lane LOS	A		B			
Approach Delay (s)	0.4	0.0	10.5			
Approach LOS			B			
Intersection Summary						
Average Delay			0.8			
Intersection Capacity Utilization		24.6%		ICU Level of Service		A
Analysis Period (min)			15			



Movement	EBL	EBT	EBR	WBL	WBT	WBR	NBL	NBT	NBR	SBL	SBT	SBR
Lane Configurations		↕		↖	↕			↖	↖		↕	
Traffic Volume (veh/h)	21	9	115	413	32	17	81	131	144	23	125	18
Future Volume (Veh/h)	21	9	115	413	32	17	81	131	144	23	125	18
Sign Control		Stop			Stop			Free			Free	
Grade		0%			0%			0%			0%	
Peak Hour Factor	1.00	1.00	1.00	1.00	1.00	1.00	1.00	1.00	1.00	1.00	1.00	1.00
Hourly flow rate (vph)	21	9	115	413	32	17	81	131	144	23	125	18
Pedestrians		35			83			1			27	
Lane Width (m)		4.0			4.0			4.0			4.0	
Walking Speed (m/s)		1.0			1.0			1.0			1.0	
Percent Blockage		4			9			0			3	
Right turn flare (veh)												
Median type								None			None	
Median storage veh												
Upstream signal (m)								59				
pX, platoon unblocked												
vC, conflicting volume	568	591	170	676	600	241	178			214		
vC1, stage 1 conf vol												
vC2, stage 2 conf vol												
vCu, unblocked vol	568	591	170	676	600	241	178			214		
tC, single (s)	7.2	6.5	6.3	7.1	6.7	6.2	4.2			4.1		
tC, 2 stage (s)												
tF (s)	3.6	4.0	3.4	3.5	4.2	3.3	2.3			2.2		
p0 queue free %	93	97	86	0	90	98	94			98		
cM capacity (veh/h)	301	336	812	238	313	703	1315			1231		
Direction, Lane #	EB 1	WB 1	WB 2	NB 1	NB 2	SB 1						
Volume Total	145	275	187	212	144	166						
Volume Left	21	275	138	81	0	23						
Volume Right	115	0	17	0	144	18						
cSH	609	238	264	1315	1700	1231						
Volume to Capacity	0.24	1.16	0.71	0.06	0.08	0.02						
Queue Length 95th (m)	6.5	89.5	33.7	1.4	0.0	0.4						
Control Delay (s)	12.8	151.6	45.7	3.4	0.0	1.2						
Lane LOS	B	F	E	A		A						
Approach Delay (s)	12.8	108.8		2.0		1.2						
Approach LOS	B	F										
Intersection Summary												
Average Delay				47.0								
Intersection Capacity Utilization			61.8%		ICU Level of Service				B			
Analysis Period (min)			15									



Movement	WBL	WBR	NBT	NBR	SBL	SBT
Lane Configurations						
Traffic Volume (veh/h)	18	5	129	0	0	353
Future Volume (Veh/h)	18	5	129	0	0	353
Sign Control	Stop		Free		Free	
Grade	0%		0%		0%	
Peak Hour Factor	1.00	1.00	1.00	1.00	1.00	1.00
Hourly flow rate (vph)	18	5	129	0	0	353
Pedestrians						
Lane Width (m)						
Walking Speed (m/s)						
Percent Blockage						
Right turn flare (veh)						
Median type			None		None	
Median storage veh						
Upstream signal (m)			144			
pX, platoon unblocked						
vC, conflicting volume	482		129		129	
vC1, stage 1 conf vol						
vC2, stage 2 conf vol						
vCu, unblocked vol	482		129		129	
tC, single (s)	6.4		6.2		4.1	
tC, 2 stage (s)						
tF (s)	3.5		3.3		2.2	
p0 queue free %	97		99		100	
cM capacity (veh/h)	543		921		1457	
Direction, Lane #	WB 1	NB 1	SB 1			
Volume Total	23	129	353			
Volume Left	18	0	0			
Volume Right	5	0	0			
cSH	596	1700	1700			
Volume to Capacity	0.04	0.08	0.21			
Queue Length 95th (m)	0.8	0.0	0.0			
Control Delay (s)	11.3	0.0	0.0			
Lane LOS	B					
Approach Delay (s)	11.3	0.0	0.0			
Approach LOS	B					
Intersection Summary						
Average Delay			0.5			
Intersection Capacity Utilization			40.9%		ICU Level of Service	
Analysis Period (min)			15		A	

2032Tot PM
27: Ring (N-S) & Entry Clinic

04/19/2024



Movement	WBL	WBR	NBT	NBR	SBL	SBT
Lane Configurations			↔			↔
Traffic Volume (veh/h)	0	0	129	12	0	353
Future Volume (Veh/h)	0	0	129	12	0	353
Sign Control	Stop		Free		Free	
Grade	0%		0%		0%	
Peak Hour Factor	1.00	1.00	1.00	1.00	1.00	1.00
Hourly flow rate (vph)	0	0	129	12	0	353
Pedestrians						
Lane Width (m)						
Walking Speed (m/s)						
Percent Blockage						
Right turn flare (veh)						
Median type	None			None		
Median storage veh						
Upstream signal (m)	99					
pX, platoon unblocked						
vC, conflicting volume	488	135			141	
vC1, stage 1 conf vol						
vC2, stage 2 conf vol						
vCu, unblocked vol	488	135			141	
tC, single (s)	6.4	6.2			4.1	
tC, 2 stage (s)						
tF (s)	3.5	3.3			2.2	
p0 queue free %	100	100			100	
cM capacity (veh/h)	539	914			1442	
Direction, Lane #	NB 1	SB 1				
Volume Total	141	353				
Volume Left	0	0				
Volume Right	12	0				
cSH	1700	1700				
Volume to Capacity	0.08	0.21				
Queue Length 95th (m)	0.0	0.0				
Control Delay (s)	0.0	0.0				
Lane LOS						
Approach Delay (s)	0.0	0.0				
Approach LOS						
Intersection Summary						
Average Delay			0.0			
Intersection Capacity Utilization			40.9%	ICU Level of Service	A	
Analysis Period (min)			15			

2032Tot PM
29: Ring (E-W) & Parking Garage Access

04/19/2024



Movement	EBL	EBT	WBT	WBR	SBL	SBR
Lane Configurations						
Traffic Volume (veh/h)	75	68	75	56	109	176
Future Volume (Veh/h)	75	68	75	56	109	176
Sign Control		Free	Free		Stop	
Grade		0%	0%		0%	
Peak Hour Factor	1.00	1.00	1.00	1.00	1.00	1.00
Hourly flow rate (vph)	75	68	75	56	109	176
Pedestrians						
Lane Width (m)						
Walking Speed (m/s)						
Percent Blockage						
Right turn flare (veh)						
Median type		None	None			
Median storage veh						
Upstream signal (m)						
pX, platoon unblocked						
vC, conflicting volume	131				321	103
vC1, stage 1 conf vol						
vC2, stage 2 conf vol						
vCu, unblocked vol	131				321	103
tC, single (s)	4.1				6.4	6.2
tC, 2 stage (s)						
tF (s)	2.2				3.5	3.3
p0 queue free %	95				83	82
cM capacity (veh/h)	1454				638	952
Direction, Lane #	EB 1	WB 1	SB 1			
Volume Total	143	131	285			
Volume Left	75	0	109			
Volume Right	0	56	176			
cSH	1454	1700	801			
Volume to Capacity	0.05	0.08	0.36			
Queue Length 95th (m)	1.1	0.0	11.3			
Control Delay (s)	4.2	0.0	12.0			
Lane LOS	A		B			
Approach Delay (s)	4.2	0.0	12.0			
Approach LOS			B			
Intersection Summary						
Average Delay			7.2			
Intersection Capacity Utilization		43.7%		ICU Level of Service		A
Analysis Period (min)			15			

APPENDIX J

Transportation Demand Checklists

TDM Measures Checklist:
Non-Residential Developments (office, institutional, retail or industrial)

Legend	
BASIC	The measure is generally feasible and effective, and in most cases would benefit the development and its users
BETTER	The measure could maximize support for users of sustainable modes, and optimize development performance
★	The measure is one of the most dependably effective tools to encourage the use of sustainable modes

TDM measures: <i>Non-residential developments</i>		Check if proposed & add descriptions
1. TDM PROGRAM MANAGEMENT		
1.1 Program coordinator		
BASIC	★	1.1.1 Designate an internal coordinator, or contract with an external coordinator <input type="checkbox"/>
1.2 Travel surveys		
BETTER		1.2.1 Conduct periodic surveys to identify travel-related behaviours, attitudes, challenges and solutions, and to track progress <input type="checkbox"/>
2. WALKING AND CYCLING		
2.1 Information on walking/cycling routes & destinations		
BASIC		2.1.1 Display local area maps with walking/cycling access routes and key destinations at major entrances <input checked="" type="checkbox"/>
2.2 Bicycle skills training		
<i>Commuter travel</i>		
BETTER	★	2.2.1 Offer on-site cycling courses for commuters, or subsidize off-site courses <input type="checkbox"/>
2.3 Valet bike parking		
<i>Visitor travel</i>		
BETTER		2.3.1 Offer secure valet bike parking during public events when demand exceeds fixed supply (e.g. for festivals, concerts, games) <input type="checkbox"/>

TDM measures: <i>Non-residential developments</i>		Check if proposed & add descriptions
3. TRANSIT		
3.1 Transit information		
BASIC	3.1.1 Display relevant transit schedules and route maps at entrances	<input checked="" type="checkbox"/>
BASIC	3.1.2 Provide online links to OC Transpo and STO information	<input type="checkbox"/>
BETTER	3.1.3 Provide real-time arrival information display at entrances	<input type="checkbox"/>
3.2 Transit fare incentives		
<i>Commuter travel</i>		
BETTER	3.2.1 Offer preloaded PRESTO cards to encourage commuters to use transit	<input type="checkbox"/>
BETTER ★	3.2.2 Subsidize or reimburse monthly transit pass purchases by employees	<input type="checkbox"/>
<i>Visitor travel</i>		
BETTER	3.2.3 Arrange inclusion of same-day transit fare in price of tickets (e.g. for festivals, concerts, games)	<input type="checkbox"/>
3.3 Enhanced public transit service		
<i>Commuter travel</i>		
BETTER	3.3.1 Contract with OC Transpo to provide enhanced transit services (e.g. for shift changes, weekends)	<input type="checkbox"/>
<i>Visitor travel</i>		
BETTER	3.3.2 Contract with OC Transpo to provide enhanced transit services (e.g. for festivals, concerts, games)	<input type="checkbox"/>
3.4 Private transit service		
<i>Commuter travel</i>		
BETTER	3.4.1 Provide shuttle service when OC Transpo cannot offer sufficient quality or capacity to serve demand (e.g. for shift changes, weekends)	<input type="checkbox"/>
<i>Visitor travel</i>		
BETTER	3.4.2 Provide shuttle service when OC Transpo cannot offer sufficient quality or capacity to serve demand (e.g. for festivals, concerts, games)	<input type="checkbox"/>

TDM measures: <i>Non-residential developments</i>		Check if proposed & add descriptions
4. RIDESHARING		
4.1 Ridematching service		
<i>Commuter travel</i>		
BASIC	★ 4.1.1 Provide a dedicated ridematching portal at OttawaRideMatch.com	<input type="checkbox"/>
4.2 Carpool parking price incentives		
<i>Commuter travel</i>		
BETTER	4.2.1 Provide discounts on parking costs for registered carpools	<input type="checkbox"/>
4.3 Vanpool service		
<i>Commuter travel</i>		
BETTER	4.3.1 Provide a vanpooling service for long-distance commuters	<input type="checkbox"/>
5. CARSHARING & BIKESHARING		
5.1 Bikeshare stations & memberships		
BETTER	5.1.1 Contract with provider to install on-site bikeshare station for use by commuters and visitors	<input type="checkbox"/>
<i>Commuter travel</i>		
BETTER	5.1.2 Provide employees with bikeshare memberships for local business travel	<input type="checkbox"/>
5.2 Carshare vehicles & memberships		
<i>Commuter travel</i>		
BETTER	5.2.1 Contract with provider to install on-site carshare vehicles and promote their use by tenants	<input type="checkbox"/>
BETTER	5.2.2 Provide employees with carshare memberships for local business travel	<input type="checkbox"/>
6. PARKING		
6.1 Priced parking		
<i>Commuter travel</i>		
BASIC	★ 6.1.1 Charge for long-term parking (daily, weekly, monthly)	<input type="checkbox"/>
BASIC	6.1.2 Unbundle parking cost from lease rates at multi-tenant sites	<input type="checkbox"/>
<i>Visitor travel</i>		
BETTER	6.1.3 Charge for short-term parking (hourly)	<input type="checkbox"/>

TDM measures: <i>Non-residential developments</i>		Check if proposed & add descriptions
7. TDM MARKETING & COMMUNICATIONS		
7.1 Multimodal travel information		
<i>Commuter travel</i>		
BASIC ★	7.1.1 Provide a multimodal travel option information package to new/relocating employees and students	<input checked="" type="checkbox"/>
<i>Visitor travel</i>		
BETTER ★	7.1.2 Include multimodal travel option information in invitations or advertising that attract visitors or customers (e.g. for festivals, concerts, games)	<input type="checkbox"/>
7.2 Personalized trip planning		
<i>Commuter travel</i>		
BETTER ★	7.2.1 Offer personalized trip planning to new/relocating employees	<input type="checkbox"/>
7.3 Promotions		
<i>Commuter travel</i>		
BETTER	7.3.1 Deliver promotions and incentives to maintain awareness, build understanding, and encourage trial of sustainable modes	<input type="checkbox"/>
8. OTHER INCENTIVES & AMENITIES		
8.1 Emergency ride home		
<i>Commuter travel</i>		
BETTER ★	8.1.1 Provide emergency ride home service to non-driving commuters	<input type="checkbox"/>
8.2 Alternative work arrangements		
<i>Commuter travel</i>		
BASIC ★	8.2.1 Encourage flexible work hours	<input type="checkbox"/>
BETTER	8.2.2 Encourage compressed workweeks	<input type="checkbox"/>
BETTER ★	8.2.3 Encourage telework	<input type="checkbox"/>
8.3 Local business travel options		
<i>Commuter travel</i>		
BASIC ★	8.3.1 Provide local business travel options that minimize the need for employees to bring a personal car to work	<input type="checkbox"/>
8.4 Commuter incentives		
<i>Commuter travel</i>		
BETTER	8.4.1 Offer employees a taxable, mode-neutral commuting allowance	<input type="checkbox"/>
8.5 On-site amenities		
<i>Commuter travel</i>		
BETTER	8.5.1 Provide on-site amenities/services to minimize mid-day or mid-commute errands	<input type="checkbox"/>

TDM-Supportive Development Design and Infrastructure Checklist:
Non-Residential Developments (office, institutional, retail or industrial)

Legend	
REQUIRED	The Official Plan or Zoning By-law provides related guidance that must be followed
BASIC	The measure is generally feasible and effective, and in most cases would benefit the development and its users
BETTER	The measure could maximize support for users of sustainable modes, and optimize development performance

TDM-supportive design & infrastructure measures: <i>Non-residential developments</i>		Check if completed & add descriptions, explanations or plan/drawing references
1. WALKING & CYCLING: ROUTES		
1.1 Building location & access points		
BASIC	1.1.1 Locate building close to the street, and do not locate parking areas between the street and building entrances	<input type="checkbox"/>
BASIC	1.1.2 Locate building entrances in order to minimize walking distances to sidewalks and transit stops/stations	<input checked="" type="checkbox"/>
BASIC	1.1.3 Locate building doors and windows to ensure visibility of pedestrians from the building, for their security and comfort	<input checked="" type="checkbox"/>
1.2 Facilities for walking & cycling		
REQUIRED	1.2.1 Provide convenient, direct access to stations or major stops along rapid transit routes within 600 metres; minimize walking distances from buildings to rapid transit; provide pedestrian-friendly, weather-protected (where possible) environment between rapid transit accesses and building entrances; ensure quality linkages from sidewalks through building entrances to integrated stops/stations <i>(see Official Plan policy 4.3.3)</i>	<input checked="" type="checkbox"/>
REQUIRED	1.2.2 Provide safe, direct and attractive pedestrian access from public sidewalks to building entrances through such measures as: reducing distances between public sidewalks and major building entrances; providing walkways from public streets to major building entrances; within a site, providing walkways along the front of adjoining buildings, between adjacent buildings, and connecting areas where people may congregate, such as courtyards and transit stops; and providing weather protection through canopies, colonnades, and other design elements wherever possible <i>(see Official Plan policy 4.3.12)</i>	<input checked="" type="checkbox"/>

TDM-supportive design & infrastructure measures: <i>Non-residential developments</i>		Check if completed & add descriptions, explanations or plan/drawing references
REQUIRED	1.2.3 Provide sidewalks of smooth, well-drained walking surfaces of contrasting materials or treatments to differentiate pedestrian areas from vehicle areas, and provide marked pedestrian crosswalks at intersection sidewalks (<i>see Official Plan policy 4.3.10</i>)	<input checked="" type="checkbox"/>
REQUIRED	1.2.4 Make sidewalks and open space areas easily accessible through features such as gradual grade transition, depressed curbs at street corners and convenient access to extra-wide parking spaces and ramps (<i>see Official Plan policy 4.3.10</i>)	<input checked="" type="checkbox"/>
REQUIRED	1.2.5 Include adequately spaced inter-block/street cycling and pedestrian connections to facilitate travel by active transportation. Provide links to the existing or planned network of public sidewalks, multi-use pathways and on-road cycle routes. Where public sidewalks and multi-use pathways intersect with roads, consider providing traffic control devices to give priority to cyclists and pedestrians (<i>see Official Plan policy 4.3.11</i>)	<input checked="" type="checkbox"/>
BASIC	1.2.6 Provide safe, direct and attractive walking routes from building entrances to nearby transit stops	<input checked="" type="checkbox"/>
BASIC	1.2.7 Ensure that walking routes to transit stops are secure, visible, lighted, shaded and wind-protected wherever possible	<input type="checkbox"/>
BASIC	1.2.8 Design roads used for access or circulation by cyclists using a target operating speed of no more than 30 km/h, or provide a separated cycling facility	<input type="checkbox"/>
1.3 Amenities for walking & cycling		
BASIC	1.3.1 Provide lighting, landscaping and benches along walking and cycling routes between building entrances and streets, sidewalks and trails	<input checked="" type="checkbox"/>
BASIC	1.3.2 Provide wayfinding signage for site access (where required, e.g. when multiple buildings or entrances exist) and egress (where warranted, such as when directions to reach transit stops/stations, trails or other common destinations are not obvious)	<input type="checkbox"/>

TDM-supportive design & infrastructure measures: <i>Non-residential developments</i>		Check if completed & add descriptions, explanations or plan/drawing references
2. WALKING & CYCLING: END-OF-TRIP FACILITIES		
2.1 Bicycle parking		
REQUIRED	2.1.1 Provide bicycle parking in highly visible and lighted areas, sheltered from the weather wherever possible (see <i>Official Plan policy 4.3.6</i>)	<input checked="" type="checkbox"/>
REQUIRED	2.1.2 Provide the number of bicycle parking spaces specified for various land uses in different parts of Ottawa; provide convenient access to main entrances or well-used areas (see <i>Zoning By-law Section 111</i>)	<input checked="" type="checkbox"/>
REQUIRED	2.1.3 Ensure that bicycle parking spaces and access aisles meet minimum dimensions; that no more than 50% of spaces are vertical spaces; and that parking racks are securely anchored (see <i>Zoning By-law Section 111</i>)	<input checked="" type="checkbox"/>
BASIC	2.1.4 Provide bicycle parking spaces equivalent to the expected number of commuter cyclists (assuming the cycling mode share target is met), plus the expected peak number of customer/visitor cyclists	<input type="checkbox"/>
BETTER	2.1.5 Provide bicycle parking spaces equivalent to the expected number of commuter and customer/visitor cyclists, plus an additional buffer (e.g. 25 percent extra) to encourage other cyclists and ensure adequate capacity in peak cycling season	<input type="checkbox"/>
2.2 Secure bicycle parking		
REQUIRED	2.2.1 Where more than 50 bicycle parking spaces are provided for a single office building, locate at least 25% of spaces within a building/structure, a secure area (e.g. supervised parking lot or enclosure) or bicycle lockers (see <i>Zoning By-law Section 111</i>)	<input type="checkbox"/>
BETTER	2.2.2 Provide secure bicycle parking spaces equivalent to the expected number of commuter cyclists (assuming the cycling mode share target is met)	<input type="checkbox"/>
2.3 Shower & change facilities		
BASIC	2.3.1 Provide shower and change facilities for the use of active commuters	<input type="checkbox"/>
BETTER	2.3.2 In addition to shower and change facilities, provide dedicated lockers, grooming stations, drying racks and laundry facilities for the use of active commuters	<input type="checkbox"/>
2.4 Bicycle repair station		
BETTER	2.4.1 Provide a permanent bike repair station, with commonly used tools and an air pump, adjacent to the main bicycle parking area (or secure bicycle parking area, if provided)	<input type="checkbox"/>

TDM-supportive design & infrastructure measures: <i>Non-residential developments</i>		Check if completed & add descriptions, explanations or plan/drawing references
3. TRANSIT		
3.1 Customer amenities		
BASIC	3.1.1 Provide shelters, lighting and benches at any on-site transit stops	<input type="checkbox"/>
BASIC	3.1.2 Where the site abuts an off-site transit stop and insufficient space exists for a transit shelter in the public right-of-way, protect land for a shelter and/or install a shelter	<input type="checkbox"/>
BETTER	3.1.3 Provide a secure and comfortable interior waiting area by integrating any on-site transit stops into the building	<input type="checkbox"/>
4. RIDESHARING		
4.1 Pick-up & drop-off facilities		
BASIC	4.1.1 Provide a designated area for carpool drivers (plus taxis and ride-hailing services) to drop off or pick up passengers without using fire lanes or other no-stopping zones	<input type="checkbox"/>
4.2 Carpool parking		
BASIC	4.2.1 Provide signed parking spaces for carpools in a priority location close to a major building entrance, sufficient in number to accommodate the mode share target for carpools	<input type="checkbox"/>
BETTER	4.2.2 At large developments, provide spaces for carpools in a separate, access-controlled parking area to simplify enforcement	<input type="checkbox"/>
5. CARSHARING & BIKESHARING		
5.1 Carshare parking spaces		
BETTER	5.1.1 Provide carshare parking spaces in permitted non-residential zones, occupying either required or provided parking spaces (<i>see Zoning By-law Section 94</i>)	<input type="checkbox"/>
5.2 Bikeshare station location		
BETTER	5.2.1 Provide a designated bikeshare station area near a major building entrance, preferably lighted and sheltered with a direct walkway connection	<input type="checkbox"/>

TDM-supportive design & infrastructure measures: <i>Non-residential developments</i>		Check if completed & add descriptions, explanations or plan/drawing references
6. PARKING		
6.1 Number of parking spaces		
REQUIRED	6.1.1 Do not provide more parking than permitted by zoning, nor less than required by zoning, unless a variance is being applied for	<input checked="" type="checkbox"/>
BASIC	6.1.2 Provide parking for long-term and short-term users that is consistent with mode share targets, considering the potential for visitors to use off-site public parking	<input type="checkbox"/>
BASIC	6.1.3 Where a site features more than one use, provide shared parking and reduce the cumulative number of parking spaces accordingly (<i>see Zoning By-law Section 104</i>)	<input type="checkbox"/>
BETTER	6.1.4 Reduce the minimum number of parking spaces required by zoning by one space for each 13 square metres of gross floor area provided as shower rooms, change rooms, locker rooms and other facilities for cyclists in conjunction with bicycle parking (<i>see Zoning By-law Section 111</i>)	<input type="checkbox"/>
6.2 Separate long-term & short-term parking areas		
BETTER	6.2.1 Separate short-term and long-term parking areas using signage or physical barriers, to permit access controls and simplify enforcement (i.e. to discourage employees from parking in visitor spaces, and vice versa)	<input type="checkbox"/>
7. OTHER		
7.1 On-site amenities to minimize off-site trips		
BETTER	7.1.1 Provide on-site amenities to minimize mid-day or mid-commute errands	<input type="checkbox"/>

APPENDIX K

MMLOS Review

Segment MMLOS Analysis

This section provides a review of the boundary streets Ring Road (N-S) and Ring Road (E-W), using complete streets principles. The *Multi-Modal Level of Service (MMLOS) Guidelines*, produced by IBI Group in October 2015 and the 2017 Addendum, were used to evaluate the levels of service for each alternative mode of transportation on the boundary streets. Both boundary streets are located within the General Urban Area, as defined in the previous Official Plan.

Exhibit 4 of the *MMLOS Guidelines* has been used to evaluate the segment pedestrian level of service (PLOS) of the boundary streets. Exhibit 22 of the *MMLOS Guidelines* identifies a target PLOS C for all roadways in the General Urban Area. The results of the segment PLOS analysis are summarized in **Table 1**.

Exhibit 11 of the *MMLOS Guidelines* has been used to evaluate the segment bicycle level of service (BLOS) of the boundary streets. In the General Urban Area, Exhibit 22 of the *MMLOS Guidelines* identifies a target BLOS D for roadways with no cycling route designation (Ring Road). The results of the segment BLOS analysis are summarized in **Table 2**.

Exhibit 15 of the *MMLOS Guidelines* has been used to evaluate the segment transit level of service (TLOS) of the boundary streets. Exhibit 22 of the *MMLOS Guidelines* does not identify a target TLOS for roadways without a Rapid Transit or Transit Priority designation (Ring Road). Ring Road has still been evaluated for TLOS, as it is currently utilized by transit. The results of the segment TLOS analysis are summarized in **Table 3**.

Exhibit 20 of the *MMLOS Guidelines* has been used to evaluate the segment truck level of service (TkLOS) of the boundary streets. In the General Urban Area, Exhibit 22 of the *MMLOS Guidelines* does not identify a target TkLOS for local or collector roadways without a truck route designation (Ring Road). Ring Road has still been evaluated for TkLOS, due to the presence of heavy vehicles on Ring Road (including transit vehicles and ambulances). The results of the segment TkLOS analysis are summarized in **Table 4**.

Table 1: PLOS Segment Analysis

Sidewalk Width	Boulevard Width	Avg. Daily Curb Lane Traffic Volume	Presence of On-Street Parking	Operating Speed ⁽¹⁾	PLOS
Ring Road (N-S), east side					
≥ 2.0m	0m	> 3,000 vpd	N/A	50 km/h	C
Ring Road (N-S), west side					
No sidewalk		> 3,000 vpd	No	50 km/h	F
Ring Road (E-W), north side					
No sidewalk		≤ 3,000 vpd	No	50 km/h	F
Ring Road (E-W), south side					
No sidewalk		≤ 3,000 vpd	No	50 km/h	F

1. Operating speed taken as the speed limit plus 10 km/h.

Table 2: BLOS Segment Analysis

Road Class	Route Type	Bikeway Type	Travel Lanes	Operating Speed	BLOS
Ring Road (N-S), from Hospital Link Road to Ring Road (E-W)					
Local	No Class	Mixed Traffic	2	50 km/h	D
Ring Road (E-W), from General Hospital Access Road to Ring Road (N-S)					
Local	No Class	Mixed Traffic	2	50 km/h	D

Table 3: TLOS Segment Analysis

Facility Type	Exposure to Congestion Delay, Friction, and Incidents			TLOS
	Congestion	Friction	Incident Potential	
Ring Road (N-S), from Hospital Link Road to Ring Road (E-W)				
Mixed Traffic – Limited Parking/Driveway Friction	Yes	Low	Medium	D
Ring Road (E-W), from General Hospital Access Road to Ring Road (N-S)				
Mixed Traffic – Limited Parking/Driveway Friction	Yes	Low	Medium	D

Table 4: TkLOS Segment Analysis

Curb Lane Width	Number of Travel Lanes Per Direction	TkLOS
Ring Road (N-S), from Hospital Link Road to Ring Road (E-W)		
> 3.7m	1	B
Ring Road (E-W), from General Hospital Access Road to Ring Road (N-S)		
> 3.7m	1	B

Intersection MMLOS Analysis

The following is a review of the MMLOS of the signalized intersections within the study area (Smyth Road/Ring Road (N-S)/South Haven Place and Smyth Road/General Hospital Access Road), using complete streets principles. These intersections have been evaluated based on existing conditions, using the MMLOS targets for intersections within the General Urban Area (Smyth Road/General Hospital Access Road) and for intersections within 300m of a school (Smyth Road/Ring Road (N-S)/South Haven Place).

Exhibit 5 of the 2017 *Addendum to the MMLOS Guidelines* has been used to evaluate the existing PLOS at the intersections listed above. Exhibit 22 of the *MMLOS Guidelines* identifies a target PLOS C for all roadways in the General Urban Area and a target PLOS A for roadways within 300m of a school. The results of the intersection PLOS analysis are summarized in **Table 5** and **Table 6**.

Exhibit 12 of the *MMLOS Guidelines* has been used to evaluate the existing BLOS at the intersections listed above. In the General Urban Area, Exhibit 22 of the *MMLOS Guidelines* identifies a target BLOS B for Local Routes (South Haven Place), a target BLOS C for Spine Routes (Smyth Road), and a target BLOS D for roadways with no cycling route designation (Ring Road N-S and General Hospital Access Road). The results of the intersection BLOS analysis are summarized in **Table 7**.

Exhibit 16 of the *MMLOS Guidelines* has been used to evaluate the existing TLOS at the intersections listed above. In the General Urban Area and within 300m of a school, Exhibit 22 of the *MMLOS Guidelines* does not identify a target TLOS for areas that are not Transit Priority Corridors with Isolated Measures. The TLOS has been evaluated for the north, east, and west approaches at intersections listed above, as they are currently utilized by transit. The results of the intersection TLOS analysis are summarized in **Table 8**.

Exhibit 21 of the *MMLOS Guidelines* has been used to evaluate the existing TkLOS at the intersections listed above. In the General Urban Area and within 300m of a school, Exhibit 22 of the *MMLOS Guidelines* identifies a target TkLOS D for arterial truck routes (Smyth Road). The results of the intersection TkLOS analysis are summarized in **Table 9**.

Table 5: PLOS Intersection Analysis – Smyth Road/Ring Road (N-S)/South Haven Place

CRITERIA	North Approach		South Approach		East Approach		West Approach	
PETSI SCORE								
<i>CROSSING DISTANCE CONDITIONS</i>								
Median > 2.4m in Width	No	39	No	105	No	55	No	72
Lanes Crossed (3.5m Lane Width)	7		3		6		5	
<i>SIGNAL PHASING AND TIMING</i>								
Left Turn Conflict	Perm + Prot	-8	Permissive	-8	Permissive	-8	Permissive	-8
Right Turn Conflict	Permissive or Yield	-5	Permissive or Yield	-5	Permissive or Yield	-5	Permissive or Yield	-5
Right Turn on Red	RTOR Allowed	-3	RTOR Allowed	-3	RTOR Allowed	-3	RTOR Allowed	-3
Leading Pedestrian Interval	No	-2	No	-2	No	-2	No	-2
<i>CORNER RADIUS</i>								
Parallel Radius	> 10m to 15m	-6	> 5m to 10m	-5	> 5m to 10m	-5	> 5m to 10m	-5
Parallel Right Turn Channel	No Right Turn Channel	-4	No Right Turn Channel	-4	No Right Turn Channel	-4	No Right Turn Channel	-4
Perpendicular Radius	N/A	0	N/A	0	N/A	0	N/A	0
Perpendicular Right Turn Channel	N/A	0	N/A	0	N/A	0	N/A	0
<i>CROSSING TREATMENT</i>								
Treatment	Standard	-7	Standard	-7	Standard	-7	Standard	-7
	PETSI SCORE	4		71		21		38
	LOS	F		C		F		E
DELAY SCORE								
Cycle Length		115		115		115		115
Pedestrian Walk Time		17.3		53.3		9.5		9.5
	DELAY SCORE	41.5		16.6		48.4		48.4
	LOS	E		B		E		E
OVERALL		F		C		F		E

Table 6: PLOS Intersection Analysis – Smyth Road/General Hospital Access Road

CRITERIA	North Approach		East Approach		West Approach	
PETSI SCORE						
<i>CROSSING DISTANCE CONDITIONS</i>						
Median > 2.4m in Width	No	23	No	55	No	55
Lanes Crossed (3.5m Lane Width)	8		6		6	
<i>SIGNAL PHASING AND TIMING</i>						
Left Turn Conflict	Perm + Prot	-8	Protected	0	No Left Turn/Prohibited	0
Right Turn Conflict	Perm + Prot	-5	No Right Turn/Prohibited	0	Perm + Prot	-5
Right Turn on Red	RTOR Allowed	-3	RTOR Allowed	-3	N/A	0
Leading Pedestrian Interval	No	-2	Yes	0	Yes	0
<i>CORNER RADIUS</i>						
Parallel Radius	> 10m to 15m	-6	No Right Turn	0	> 10m to 15m	-6
Parallel Right Turn Channel	No Right Turn Channel	-4	No Right Turn	0	No Right Turn Channel	-4
Perpendicular Radius	N/A	0	N/A	0	N/A	0
Perpendicular Right Turn Channel	N/A	0	N/A	0	N/A	0
<i>CROSSING TREATMENT</i>						
Treatment	Standard	-7	Standard	-7	Standard	-7
	PETSI SCORE	-12		45		33
	LOS	F		D		E
DELAY SCORE						
Cycle Length		115		115		115
Pedestrian Walk Time		7.6		7.0		35.5
	DELAY SCORE	50.2		50.7		27.5
	LOS	E		E		C
OVERALL		F		E		E

Table 7: BLOS Intersection Analysis

Approach	Facility Type	Criteria	Travel Lanes and/or Speed	BLOS
Smyth Road/Ring Road (N-S)/South Haven Place				
North Approach	Mixed Traffic	Right Turn Lane Characteristics	Right turn lane < 50m; turning speed ≤ 25 km/h	D
		Left Turn Accommodation	One lane crossed; 50 km/h	D
South Approach	Mixed Traffic	Right Turn Lane Characteristics	Shared left turn/right turn lane	A
		Left Turn Accommodation	No lanes crossed; ≤ 50 km/h	B
East Approach	Mixed Traffic	Right Turn Lane Characteristics	Shared through/right turn lane	A
		Left Turn Accommodation	One lane crossed; ≥ 60 km/h	F
West Approach	Mixed Traffic	Right Turn Lane Characteristics	Shared through/right turn lane	A
		Left Turn Accommodation	One lane crossed; ≥ 60 km/h	F
Smyth Road/General Hospital Access Road				
North Approach	Mixed Traffic	Right Turn Lane Characteristics	Right turn lane < 50m; turning speed ≤ 25 km/h	D
		Left Turn Accommodation	Dual left turn lanes	F
East Approach	Mixed Traffic	Right Turn Lane Characteristics	Right turn lane > 50m	F
		Left Turn Accommodation	N/A	-
West Approach	Mixed Traffic	Right Turn Lane Characteristics	N/A	-
		Left Turn Accommodation	Two lanes crossed; ≥ 50 km/h	F

Table 8: TLOS Intersection Analysis

Approach	Delay ⁽¹⁾		TLOS
	AM Peak Hour	PM Peak Hour	
Smyth Road/Ring Road (N-S)/South Haven Place			
North Approach	24 sec	39 sec	E
East Approach	33 sec	23 sec	E
West Approach	4 sec	6 sec	B
Smyth Road/General Hospital Access Road			
North Approach	37 sec	47 sec	F
East Approach	10 sec	12 sec	C
West Approach	7 sec	5 sec	B

1. Delay based on outputs from Synchro analysis of existing conditions

Table 9: TkLOS Intersection Analysis

Approach	Effective Corner Radius	Number of Receiving Lanes Departing Intersection	TkLOS
Smyth Road/Ring Road (N-S)/South Haven Place			
North Approach	< 10m	2	D
South Approach	< 10m	2	D
East Approach	10m to 15m	2 ⁽¹⁾	B
West Approach	< 10m	1	F
Smyth Road/General Hospital Access Road			
North Approach	10m to 15m	2	B
East Approach	10m to 15m	2 ⁽¹⁾	B

1. Ring Road (N-S) and General Hospital Access Road have single receiving lanes. However, the widths of these lanes are greater than 7m and therefore more equivalent to the width of two standard lanes.