

1015 and 1045 Dairy Drive Transportation Impact Assessment



1015 and 1045 Dairy Drive Transportation Impact Assessment

Step 1 Screening Report

Step 2 Scoping Report

Step 3 Strategy Report

Prepared for:

The Effort Trust Company
50 King Street East
Hamilton, ON L8N 1A6

Prepared by:



6 Plaza Court
Ottawa, ON K2H 7W1

December 2024

PN: 2023-016

Table of Contents

1	Screening.....	1
2	Existing and Planned Conditions.....	1
2.1	Proposed Development.....	1
2.2	Existing Conditions.....	3
2.2.1	Area Road Network.....	3
2.2.2	Existing Intersections.....	3
2.2.3	Existing Driveways.....	3
2.2.4	Cycling and Pedestrian Facilities.....	4
2.2.5	Existing Transit.....	6
2.2.6	Existing Area Traffic Management Measures.....	8
2.2.7	Existing Peak Hour Travel Demand.....	8
2.2.8	Collision Analysis.....	9
2.3	Planned Conditions.....	11
2.3.1	Changes to the Area Transportation Network.....	11
3	Study Area and Time Periods.....	11
3.1	Study Area.....	11
3.2	Time Periods.....	11
3.3	Horizon Years.....	11
4	Development-Generated Travel Demand.....	11
4.1	Trip Generation.....	11
5	Exemption Review.....	12
6	Development Design.....	14
6.1	Design for Sustainable Modes.....	14
6.2	Development Access.....	14
6.2.1	Access Width.....	14
6.2.2	Access Spacing.....	14
6.2.3	Throat Length.....	15
6.2.4	Sightlines.....	15
6.3	Site Circulation.....	15
6.4	Construction Management Plan.....	16
6.5	Parking.....	16
6.5.1	Vehicular Parking Supply.....	16
6.5.2	Loading.....	19
6.5.3	Bicycle Parking.....	19
7	Boundary Street Design.....	20
8	Conclusions.....	21

List of Figures

Figure 1:	Area Context Plan.....	1
Figure 2:	Site Plan.....	2
Figure 3:	Area Driveways.....	3

Figure 4: Study Area Pedestrian Facilities4
 Figure 5: Study Area Cycling Facilities5
 Figure 6: Existing Pedestrian Volumes6
 Figure 7: Existing Cyclist Volumes6
 Figure 8: Existing Study Area Transit Service.....7
 Figure 9: Existing Study Area Transit Stops8
 Figure 10: Existing Traffic Counts9
 Figure 11: Study Area Collision Records..... 10

Table of Tables

Table 1: Intersection Count Date.....8
 Table 2: Existing Intersection Operations.....9
 Table 3: Study Area Collision Summary, 2018-2022 10
 Table 4: Summary of Collision Locations, 2018-2022..... 10
 Table 5: Trip Generation Vehicle Trip Rates by Peak Hour 11
 Table 6: Total Vehicle Trip Generation by Peak Hour 12
 Table 7: Exemption Review 12
 Table 8: Throat Length by Land Use 15
 Table 9: Vehicle Parking Requirement Zoning By-Law Approach 16
 Table 10: ITE Parking Demand..... 17
 Table 11: Proxy Site Parking Supply Rates..... 17
 Table 12: Parking Demand Rates at Comparable Sites 18
 Table 13: Parking Rates Comparison 18
 Table 14: Accessible Vehicle Parking Requirement - City of Ottawa 18
 Table 15: Loading Spaces Requirement - City of Ottawa Zoning Bylaw 19
 Table 16: Bicycle Parking Requirement - City of Ottawa Zoning Bylaw 19
 Table 17: Boundary Street MMLOS Analysis 20

List of Appendices

- Appendix A – TIA Screening Form and Certification Form
- Appendix B – Turning Movement Count Data
- Appendix C – Synchro Intersection Worksheets – Existing Conditions
- Appendix D – Collision Data
- Appendix E – Turning Template Analysis and Signage Plan
- Appendix F – Construction Management Plan and Scope Confirmation
- Appendix G – MMLOS Analysis

1 Screening

This study has been prepared according to the City of Ottawa's 2017 Transportation Impact Assessment (TIA) Guidelines, incorporating the 2023 Revision to Transportation Impact Assessment Guidelines. Accordingly, a Step 1 Screening Form has been prepared and is included as Appendix A, along with the Certification Form for the TIA Study PM. As shown in the Screening Form, a TIA is required.

2 Existing and Planned Conditions

2.1 Proposed Development

The proposed development, located at 1015 and 1045 Dairy Drive, is currently a greenfield property and is zoned as General Industrial (IG). The development will consist of a two storey self storage building with a total gross floor area (GFA) of 138,616 sq. ft., a four storey self storage building with a GFA of 155,388 sq. ft., and two one storey industrial condominiums with GFAs of 9,795 sq. ft and 6,070 sq. ft, respectively. Two site accesses are proposed, one right-in / right-out access on Old Montreal Road and one full-moves access on Dairy Drive. Both accesses are connected via the internal drive aisles. A total of 89 parking spaces are proposed. The anticipated full build-out and occupancy horizon is 2025 with construction occurring in one phase. Figure 1 illustrates the study area context. Figure 2 illustrates the proposed site plan.

Figure 1: Area Context Plan



Source: <http://maps.ottawa.ca/geoOttawa/> Accessed: July 11, 2023

Figure 2: Site Plan

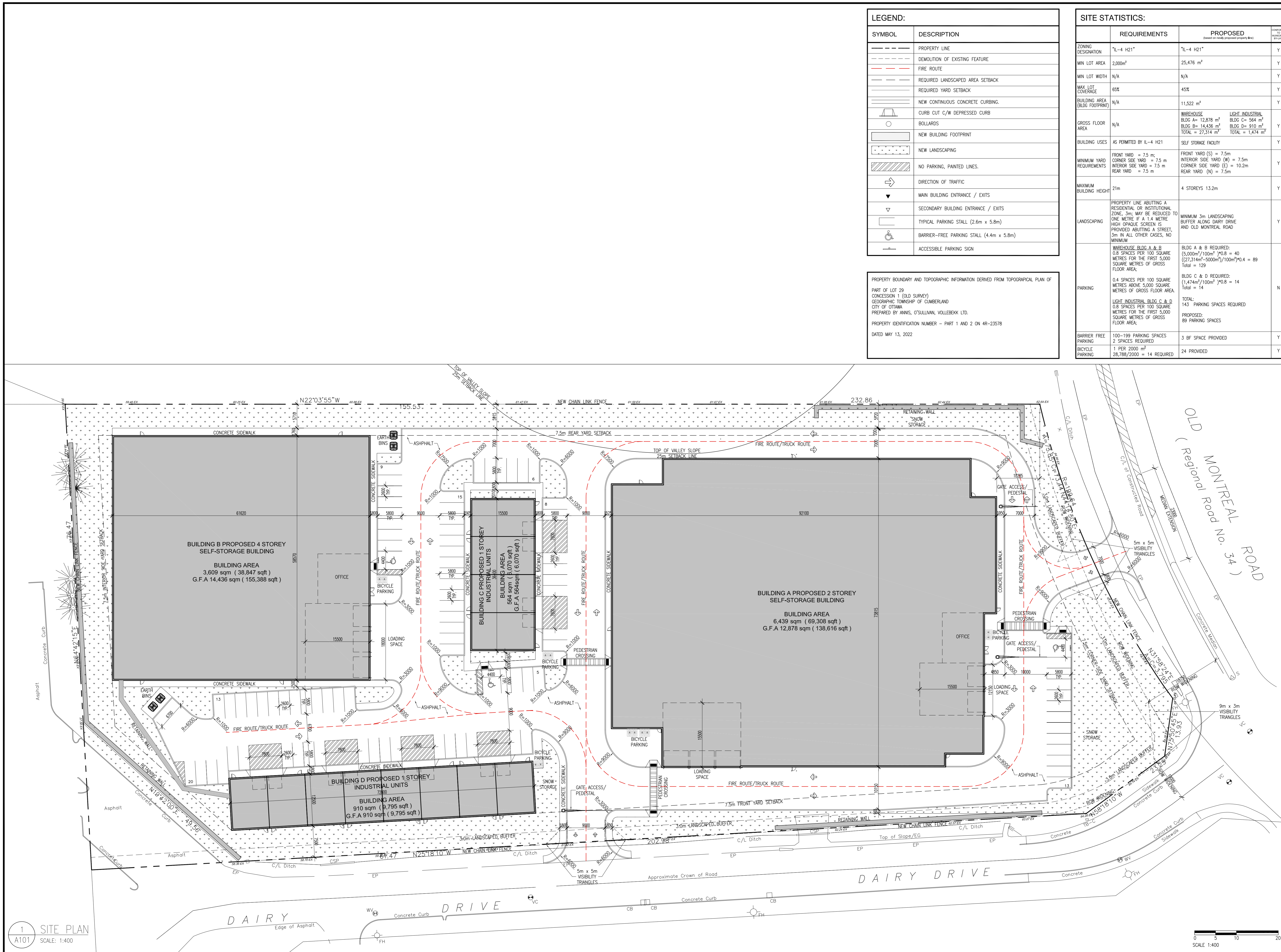

NO DRAWING DIVISION SHALL BE VIEWED INDEPENDENTLY. CONTRACTOR AND ALL SUB CONTRACTORS TO REVIEW AND BE FAMILIAR WITH ENTIRE DRAWING SET.

Revisions

No.	For:	Date:
4	SITE PLAN APPROVAL	11/27/2024
3	SITE PLAN APPROVAL	09/24/2024
2	PHASE 2 PRE-CON SUBMISSION	06/13/2024
1	REVISED FOR PHASE 3 PRE-CON SUBMISSION	02/15/2024

To: (Version) For: Date:

Issue Table

NOTE:
CONTRACTOR SHALL CHECK AND VERIFY ALL DIMENSIONS AND CONTRACTOR SHALL REPORT ANY DISCREPANCIES TO THE ARCHITECT BEFORE PROCEEDING WITH WORK. DO NOT SCALE DRAWINGS.
CONTRACTORS AND SUBCONTRACTORS SHALL USE THIS DRAWING IN CONJUNCTION WITH OTHER DISCIPLINARY ENGINEER DRAWINGS AND TENANT FIT-UP DRAWINGS.
THIS DRAWING SHALL NOT BE USED FOR CONSTRUCTION PURPOSE UNTIL ISSUED FOR CONSTRUCTION BY DESIGN PROFESSIONAL UNDER ISSUE COLUMN.

CONTRACT DOCUMENTS ARE THE COPYRIGHT OF THE CONSULTANTS AND SHALL NOT BE USED OR REPRODUCED WITHOUT AUTHORIZATION BY THE CONSULTANTS.

ALL DRAWINGS ARE TO BE REVIEWED AS A FULL PACKAGE SET.

Seal: **ONTARIO ASSOCIATION OF ARCHITECTS**
SAM M. ESPOSTO
LICENCE 5726

North Arrow: TRUE NORTH

Architect: **SAM ESPOSTO ARCHITECT INC.**
548 UPPER JAMES ST. HAMILTON, ON. L9C 2Y4
T. 905.383.7500 F. 905.383.5700

Applicant: **TSL - DAIRY LP**
50 KING STREET EAST,
HAMILTON, ONTARIO L8N 1A6

Project: **PROPOSED SELF-STORAGE BUILDINGS**
1015-1045 DAIRY DRIVE, OTTAWA, ON.

Drawing Title: **SITE PLAN**

Drawn By: **MG** Scale: **AS NOTED**
Checked By: **SE** Plot Date:
Project Date: **07.13.2023**
Project No: **23-104**

Drawing No: **A101** Sheet Version: **0**

2.2 Existing Conditions

2.2.1 Area Road Network

Old Montreal Road is a City of Ottawa arterial road with a two-lane cross-section east of Gerald Street, and a four-lane cross-section west of Gerald Street. A bike lane and sidewalk are provided on the north side of the road west of Dairy Drive, and a bike lane and asphalt pathway are provided on the south side of the road between Trim Road and Dairy Drive. Paved shoulders are provided on both sides of the road east of Dairy Drive. The posted speed limit is 60km/h, and the City-protected right of way is 37.5 metres within the study area.

Dairy Drive is a City of Ottawa local road with a two-lane cross-section including paved shoulders on both sides of the road. The unposted speed limit is 50km/h, and the City-protected right of way is 20 metres in the study area.

2.2.2 Existing Intersections

The key existing unsignalized intersection has been summarized below:

Old Montreal Road at Dairy Drive/Aveia Private

The intersection of Old Montreal Road at Dairy Drive/Aveia Private is a stop-controlled intersection on the minor approach of Dairy Drive/Aveia Private. The northbound approach consists of a shared all-movements lane. The southbound, eastbound, and westbound approaches each consist of an auxiliary left-turn lane and a shared through/right-turn lane. Bike lanes are provided on the west leg. No turn restrictions are noted.

2.2.3 Existing Driveways

Within 200 metres of the proposed site access, four existing driveways are present on Dairy Drive leading to two office buildings. A driveway on the north side of Old Montreal Road leads to an office building. Three driveways are present on the south side of Old Montreal Road to detached dwellings and a retirement home. Aveia Private is a private driveway to townhouses and attached dwellings. The existing driveway locations are illustrated in Figure 3. The proposed site driveways, noted in Section 2.1 have been noted in this figure for context.

Figure 3: Area Driveways

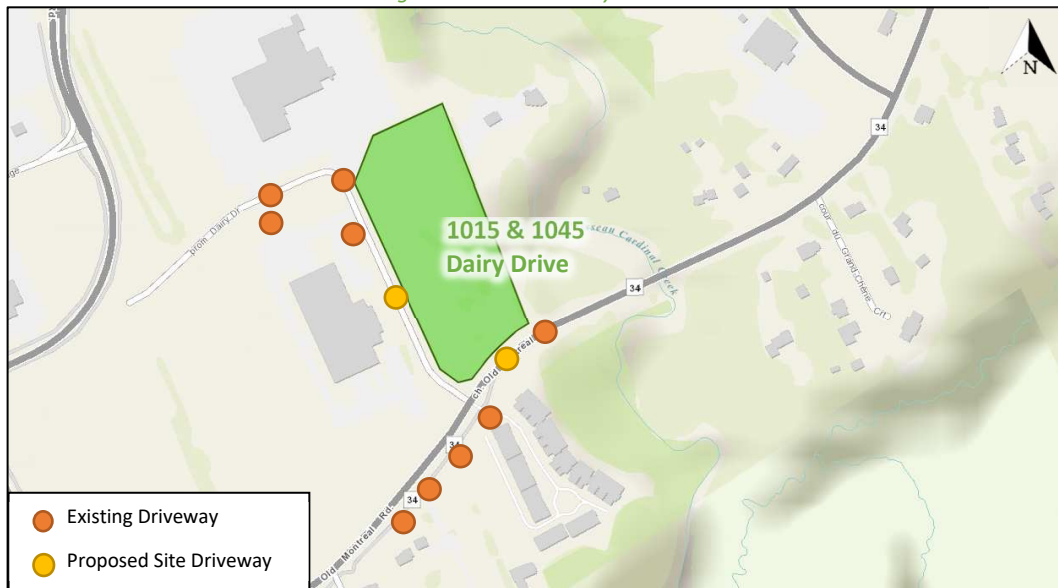

Source: <http://maps.ottawa.ca/geoOttawa/> Accessed: April 28, 2023

2.2.4 Cycling and Pedestrian Facilities

Figure 4 illustrates the pedestrian facilities in the study area and Figure 5 illustrates the cycling facilities.

Within the study area, sidewalks are provided along both sides of Old Montreal Road west of Dairy Drive. Cycling facilities include bike lanes along the north side of Old Montreal Road west of Dairy Drive and along the south side of Old Montreal Road between Trim Road and Dairy Drive. Paved shoulders are provided on both sides of Dairy Drive and on both sides of Old Montreal Road east of Dairy Drive.

A major pathway is noted aligned north-south through the east edge of the subject site. This pathway is 170 metres west of another major pathway corridor, running parallel to the pathway that passes through the subject site. No additional connectivity will be provided, and the subject pathway is redundant. Therefore, the pathway through the east edge of the subject site is not required and will not be shown or provided in the applicant's plans.

Figure 4: Study Area Pedestrian Facilities

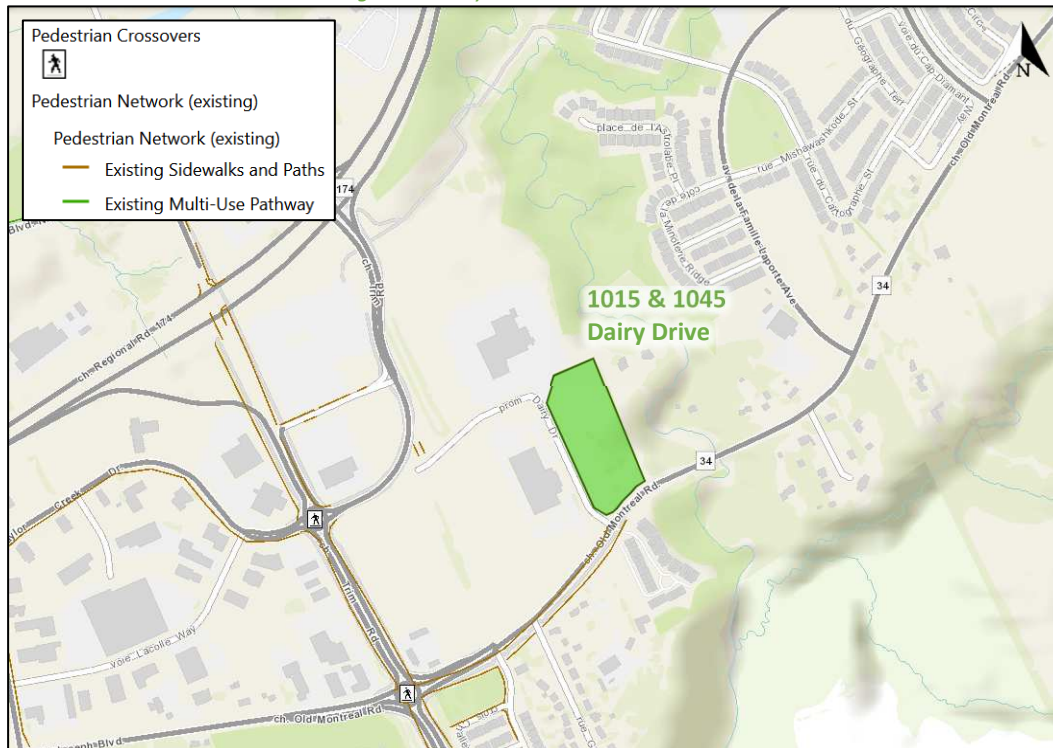

Source: <http://maps.ottawa.ca/geoOttawa/> Accessed: January 23, 2024

Figure 5: Study Area Cycling Facilities

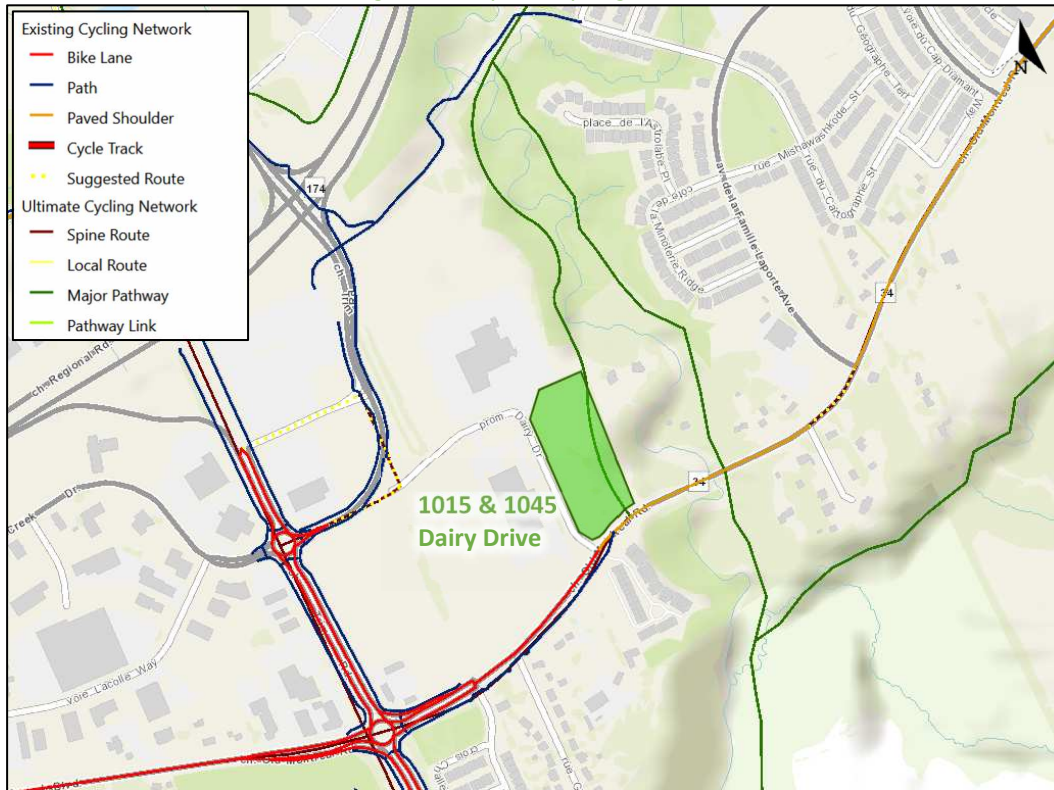

Source: <http://maps.ottawa.ca/geoOttawa/> Accessed: January 23, 2024

Pedestrian and cyclist volumes included in study area intersection counts, presented in Section 2.2.7, have been compiled and are illustrated in Figure 6 and Figure 7, respectively.

Figure 6: Existing Pedestrian Volumes

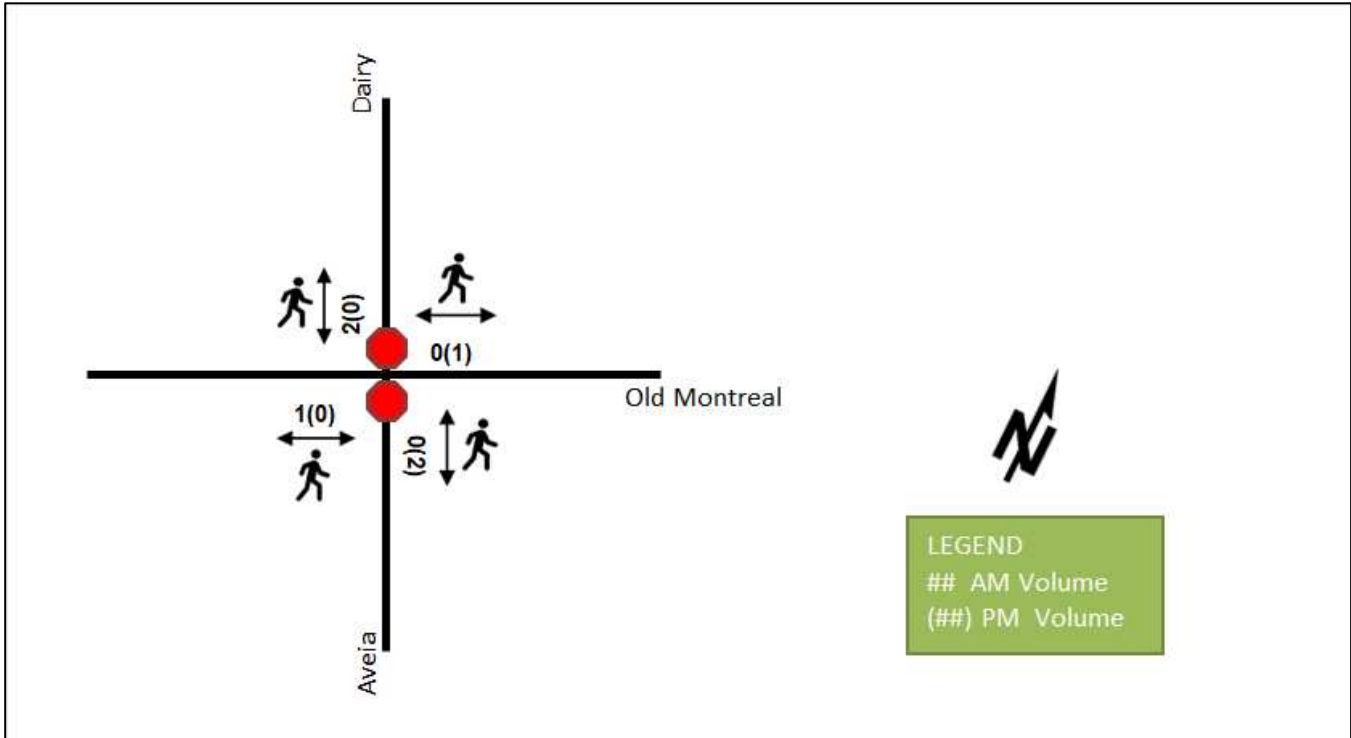
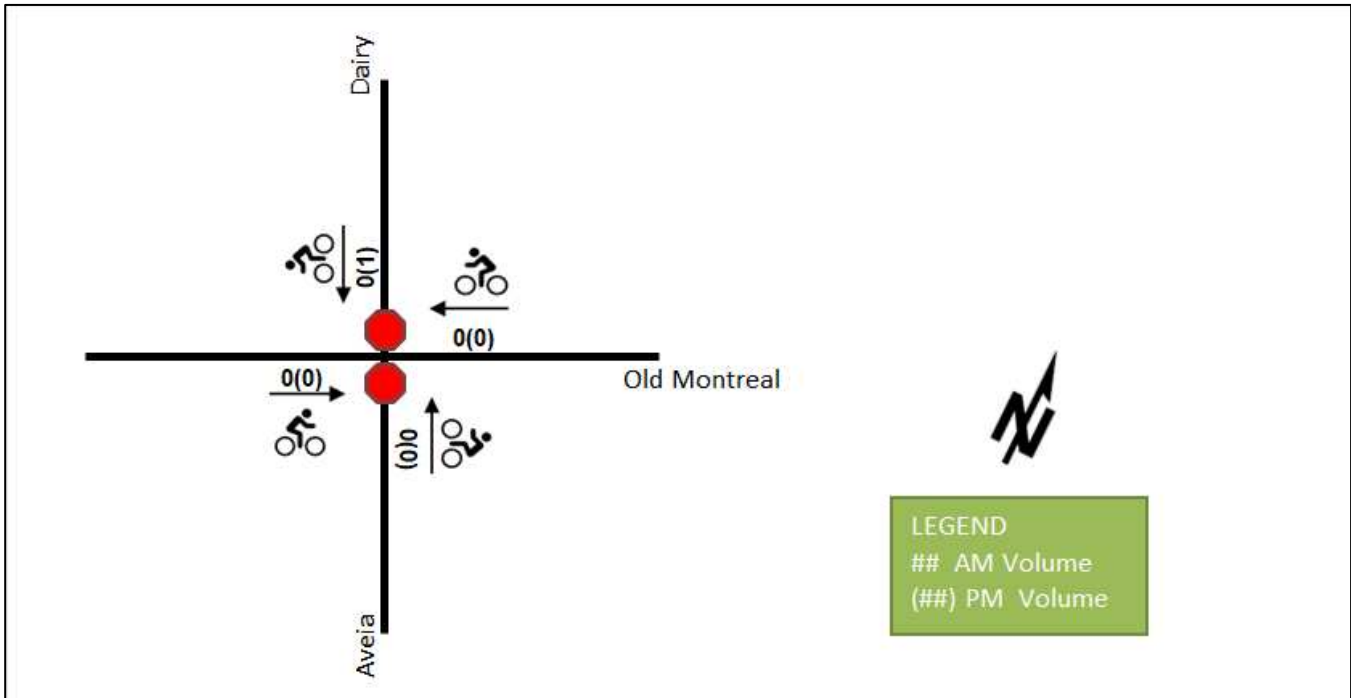

Figure 7: Existing Cyclist Volumes



2.2.5 Existing Transit

Figure 8 illustrates the transit system map in the study area and Figure 9 illustrates transit stops within 400 metres radius and transit stations within 800 metres radius of the site. All transit information is from July 11, 2023 and is included for general information purposes and context to the surrounding area.

Within the study area, the transit network includes routes #38, #39, and #221. The frequency of these routes within proximity of the proposed site based on July 11, 2023 service levels are:

- Route # 38 – 30-minute service all-day
- Route # 39 – 30-minute service all-day
- Route # 221 – 30-minute service between 6:30 AM to 8:30 AM

Additionally, the existing Trim Bus Rapid Transit (BRT) station and the future Trim Light Rail Transit (LRT) stations will be located within 800 metres radius of the site.

Figure 8: Existing Study Area Transit Service



Source: <http://www.octranspo.com/> Accessed: July 11, 2023

Figure 9: Existing Study Area Transit Stops

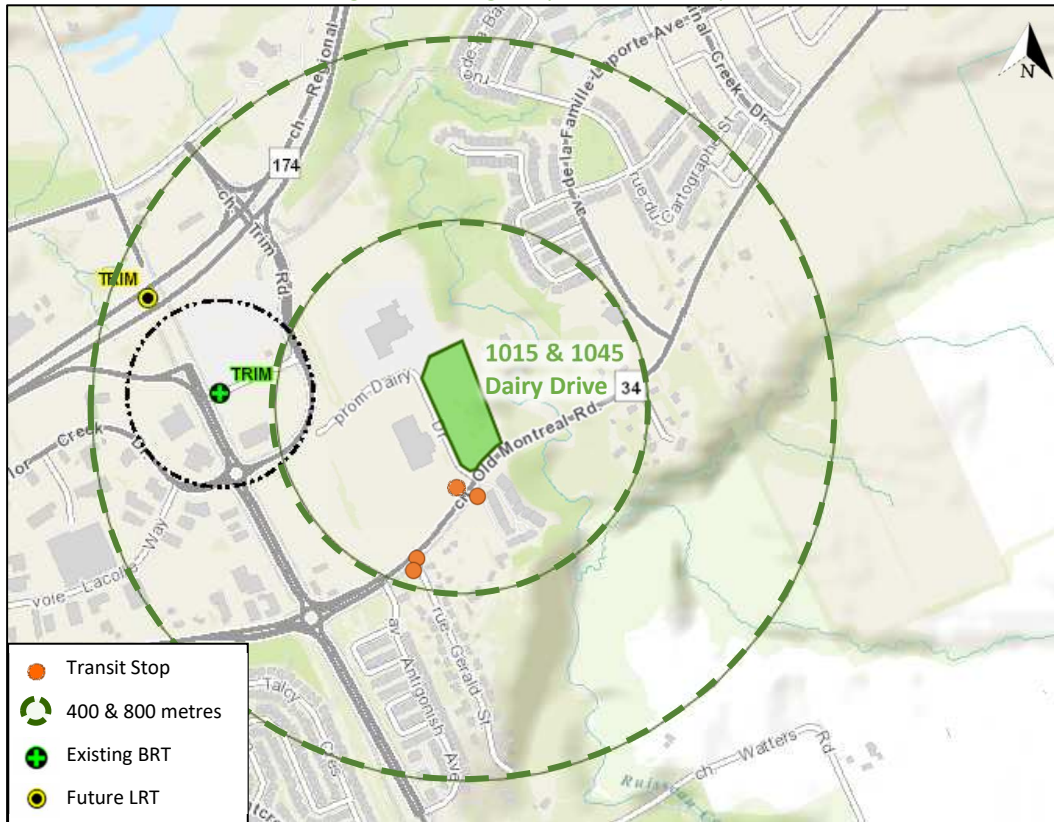

Source: <http://maps.ottawa.ca/geoOttawa/> Accessed: July 11, 2023

2.2.6 Existing Area Traffic Management Measures

There are no existing area traffic management measures on Old Montreal Road and Dairy Drive.

2.2.7 Existing Peak Hour Travel Demand

Existing turning movement counts were acquired from the City of Ottawa for the existing study area intersections. It is noted that at the time of the turning movement counts, Dairy Drive was connected to Trim Park & Ride and Trim Road at the Taylor Creek Drive. This is likely to result in higher volumes on the westbound right-turn and southbound left-turn turning volumes at the Dairy Drive and Old Montreal Road intersection. As the road network changes have resulted in Dairy Drive becoming a dead-end road, 2019 conditions are considered to be more conservative, and will be used for analysis. Table 1 summarizes the intersection count dates.

Table 1: Intersection Count Date

Intersection	Count Date
Old Montreal Road at Dairy Drive/Aveia Private	Wednesday, December 4, 2019

Table 1 illustrates the existing traffic counts and Table 2 summarizes the existing intersection operations. Synchro 11 has been used to model the unsignalized intersections and HCM 2010 methodology was used for unsignalized intersection operation. Detailed turning movement count data is included in Appendix B and the Synchro worksheets are provided in Appendix C.

Figure 10: Existing Traffic Counts

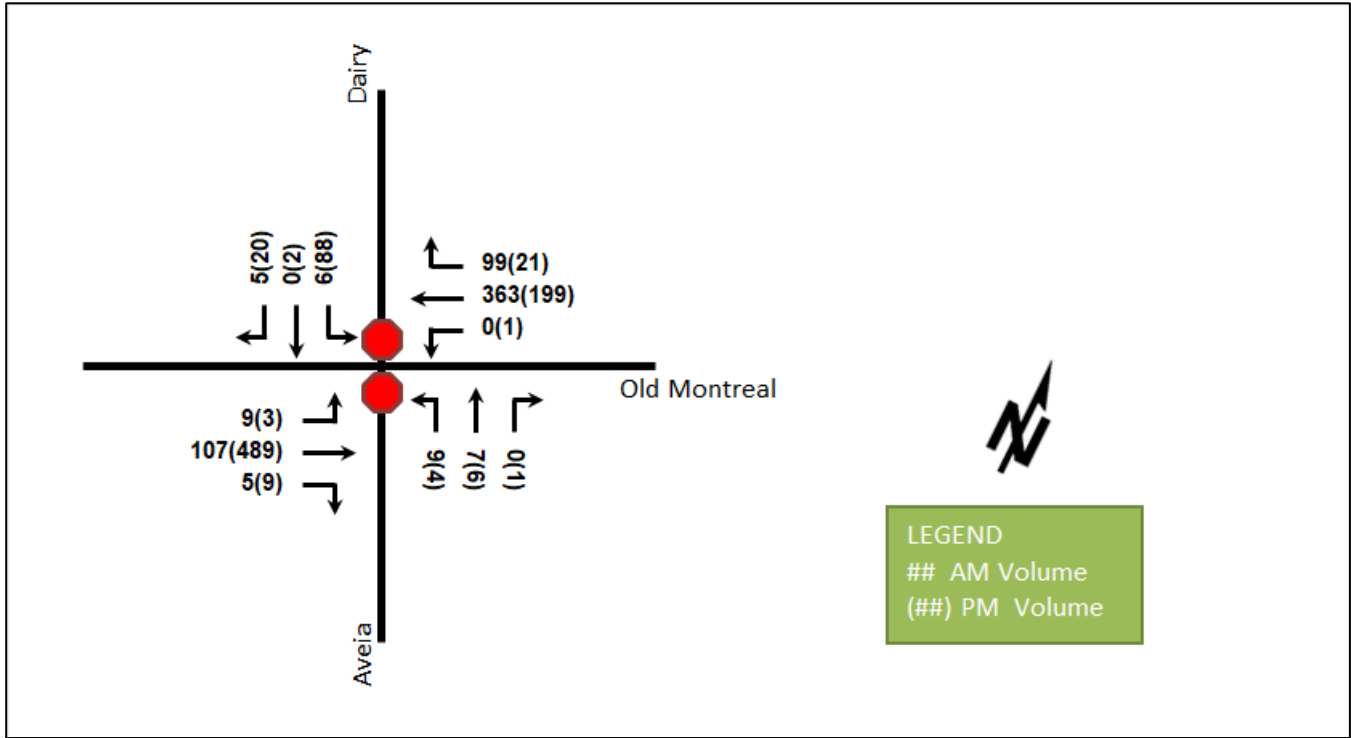

Table 2: Existing Intersection Operations

Intersection	Lane	AM Peak Hour				PM Peak Hour			
		LOS	V/C	Delay (s)	Q (95 th)	LOS	V/C	Delay (s)	Q (95 th)
Old Montreal Road at Dairy Drive / Aveia Private Unsignalized	EBL	A	0.01	8.5	0.0	A	0.00	8.1	0.0
	EBT/R	-	-	-	-	-	-	-	-
	WBL	A	-	0.0	0.0	A	0.00	8.5	0.0
	WBT/R	-	-	-	-	-	-	-	-
	NB	B	0.05	14.6	0.8	C	0.04	16.8	0.8
	SBL	B	0.02	14.6	0.8	C	0.33	22.9	10.5
	SBT/R	B	0.01	11.0	0.0	B	0.04	10.4	0.8
	Overall	A	-	0.7	-	A	-	2.9	-

Notes: Saturation flow rate of 1800 veh/h/lane
Queue is measured in metres
Peak Hour Factor = 0.90

Delay = average vehicle delay in seconds
m = metered queue
= volume for the 95th %ile cycle exceeds capacity

During both the AM and PM peak hours, the study area intersection operates well. No capacity issues are noted.

2.2.8 Collision Analysis

Collision data has been acquired from the City of Ottawa’s open data website (data.ottawa.ca) for five years prior to the commencement of this TIA for the surrounding study area road network. Table 3 summarizes the collision types and conditions in the study area, Figure 11 illustrates the intersections and segments analyzed, and Table 4 summarizes the total collisions for each of these locations. Collision data are included in Appendix D.

Table 3: Study Area Collision Summary, 2018-2022

		Number	%
Total Collisions		8	100%
Classification	Fatality	0	0%
	Non-Fatal Injury	1	12%
	Property Damage Only	7	88%
Initial Impact Type	Angle	4	50%
	SMV Unattended	1	13%
	SMV Other	3	32%
Road Surface Condition	Dry	7	88%
	Wet	1	12%
Pedestrian Involved		0	0%
Cyclists Involved		1	12%

Figure 11: Study Area Collision Records

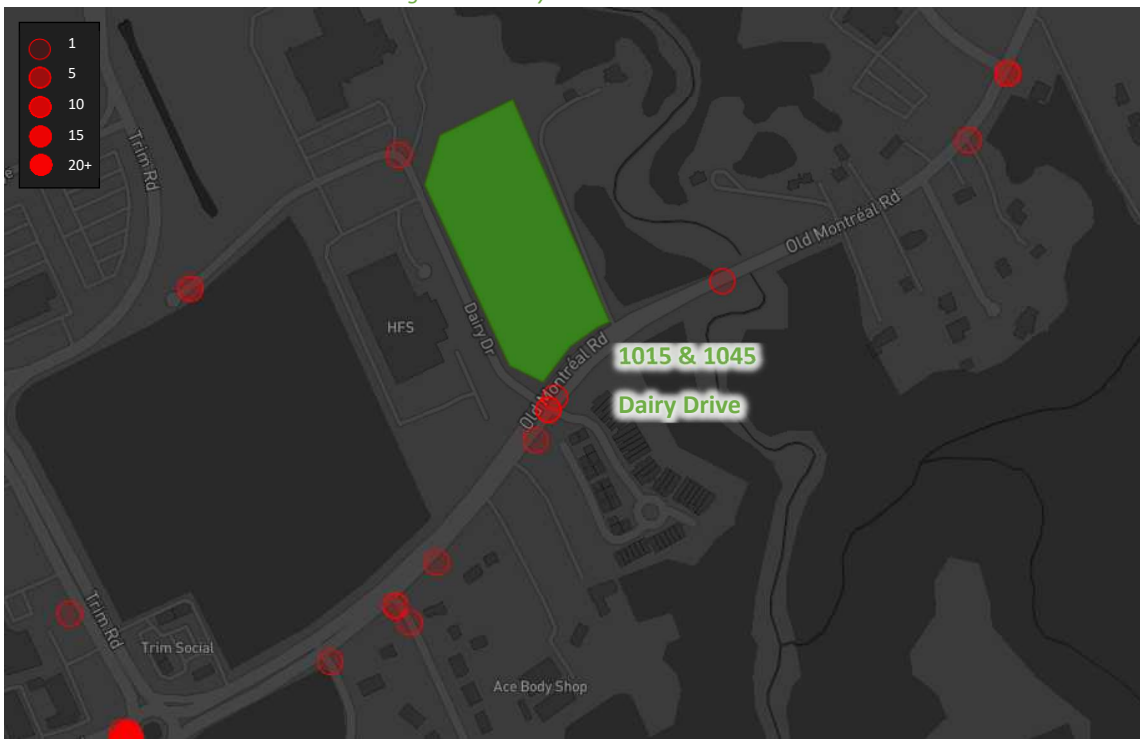

Table 4: Summary of Collision Locations, 2018-2022

Intersections / Segments	Number	%
Intersections / Segments	8	100%
Aveia Priv/Dairy Dr @ Old Montreal Rd	3	38%
Gerald St @ Old Montreal Rd	2	25%
Old Montreal Rd btwn Continuation of Old Montreal Rd & Grand-Ch-Ne, Co	2	25%
Old Montreal Rd btwn Gerald St & Continuation of Old Montreal Road	1	12%

Within the study area, there are a total of eight collisions during the 2018-2022 time period, with seven involving property damage only and the remaining one having non-fatal injuries. No collisions have been noted along Dairy Drive frontage. One turning movement cyclist collision is noted during wet weather condition at the intersection of Aveia Private/Dairy Drive at Old Montreal Road, and no specific pattern or cause is noted per the detailed collision report. No further collision review is required as part of this study.

2.3 Planned Conditions

2.3.1 Changes to the Area Transportation Network

Schedule C2 in the City Official Plan (2021) illustrates the Ultimate Transit Network. This diagram includes a conceptual future transit corridor along Old Montreal Road. As well, the eastern extension of the ongoing Stage 2 LRT project, continuing the O-Train line from Blair Road to Trim Road, is anticipated to open in early 2025.

3 Study Area and Time Periods

3.1 Study Area

The study area will include the intersections of:

- Old Montreal Road at Dairy Drive/Aveia Private

The boundary road will be Old Montreal Road and Dairy Drive and no screenlines are present within proximity to the site.

3.2 Time Periods

As the proposed development is composed of self-storage warehouse units and industrial condominiums with low anticipated trip generation throughout the entire day, the side street AM and PM peak hours will be examined as part of this TIA.

3.3 Horizon Years

The TIA will examine the existing 2024 study area intersection performance.

4 Development-Generated Travel Demand

4.1 Trip Generation

This TIA has been prepared using the vehicle trip rates from the ITE Trip Generation Manual 11th Edition (2021). No conversion to person trip rates has been applied as the trips to self-storage facilities and industrial condominiums are usually made by vehicles for the purposes of transporting goods. Table 5 summarizes the vehicle trip rates for the proposed development by peak hour.

Table 5: Trip Generation Vehicle Trip Rates by Peak Hour

Land Use	GFA (sq. ft)	Land Use Code	Peak Hour	Vehicle Trip Rate	Percent In	Percent Out
Mini-Warehouse #1	138,616	151 (ITE)	AM	0.09	59%	41%
			PM	0.15	47%	53%
Mini-Warehouse #2	155,388	151 (ITE)	AM	0.09	59%	41%
			PM	0.15	47%	53%
General Light Industrial #1	9,795	110 (ITE)	AM	1.07	88%	12%
			PM	0.77	14%	86%
General Light Industrial #2	6,070	110 (ITE)	AM	1.31	88%	12%
			PM	0.88	14%	86%

Using the above vehicle trip rates, the total vehicle trip generation has been estimated. Table 6 summarizes the trip generation for the proposed development.

Table 6: Total Vehicle Trip Generation by Peak Hour

Land Use	GFA (sq. ft)	AM Peak Hour			PM Peak Hour		
		In	Out	Total	In	Out	Total
Mini-Warehouse #1	138,616	7	5	12	10	11	21
Mini-Warehouse #2	155,388	8	6	14	11	12	23
General Light Industrial #1	9,795	9	1	10	1	7	8
General Light Industrial #2	6,070	7	1	8	1	4	5
TOTAL		31	13	44	23	34	57

As shown above, a total of 44 AM and 57 PM new peak hour two-way vehicle trips are projected as a result of the proposed development. Since the site trip generation is below 75 vehicle trips, no future background and future total horizon analyses are required.

5 Exemption Review

Table 7 summarizes the exemptions for this TIA.

Table 7: Exemption Review

Module	Element	Explanation	Exempt/Required
Site Design and TDM			
Development Design	4.1.2 Circulation and Access	Only required for site plan and zoning by-law applications	Required
	4.1.3 New Street Networks	Only required for plans of subdivision	Exempt
Parking	4.2.1 Parking Supply	Only required for site plan and zoning by-law applications	Required
Boundary Street Design		All applications	Required
Transportation Demand Management	All Elements	Only required when the development generates more than 60 person-trips	Exempt
Network Impact			
Background Network Travel Demand	All Elements	Only required when one or more other Network Impact Modules are triggered when the development generates more than 75 auto or transit trips	Exempt
Demand Rationalization		Only required when one or more other Network Impact Modules when the development generates more than 75 auto trips	Exempt

Module	Element	Explanation	Exempt/Required
Neighbourhood Traffic Calming	4.6.1 Adjacent Neighbourhoods	<p>If the development meets all of the following criteria along the route(s) site generated traffic is expected to utilize between an arterial road and the site's access:</p> <ol style="list-style-type: none"> 1. Access to Collector or Local; 2. "Significant sensitive land use presence" exists, where there is at least two of the following adjacent to the subject street segment: <ul style="list-style-type: none"> • School (within 250m walking distance); • Park; • Retirement / Older Adult Facility (i.e. long-term care and retirement homes); • Licenced Child Care Centre; • Community Centre; or • 50%, or greater, of adjacent property along the route(s) is occupied by residential lands and a minimum of 10 occupied residential units are present on the route. 3. Application is for Zoning By-Law Amendment or Draft Plan of Subdivision; 4. At least 75 site-generated auto trips; 5. Site Trip Infiltration is expected. Site traffic will increase peak hour vehicle volumes along the route by 50% or more. 	Exempt
Transit	4.7.1 Transit Route Capacity	Only required when the development generates more than 75 transit trips	Exempt
	4.7.2 Transit Priority Requirements	Only required when the development generates more than 75 auto trips	Exempt
Network Concept		Only required when proposed development generates more than 200 person-trips during the peak hour in excess of equivalent volume permitted by established zoning	Exempt
Intersection Design	4.4.1-2/4.9.1 Intersection Control	Only required when the development generates more than 75 auto trips	Exempt
	4.4.3/4.9.2 Intersection Design	Only required when the development generates more than 75 auto trips	Exempt

6 Development Design

6.1 Design for Sustainable Modes

The proposed development has two self storage buildings and two industrial condominiums with a total of 89 surface parking spaces. A total of 24 bicycle parking stalls will be provided externally. The self-storage building with a GFA of 138,616 sq. ft will have four stalls provided close to the office entrance and eight stalls near the loading spaces on the south side of the building. The self-storage building with a GFA of 155,388 sq. ft includes four proposed bicycle parking stalls near its office entrance. Each industrial condominium includes four stalls near entrances. Concrete sidewalks are proposed on both sides of the Dairy Drive access and on the west side of the Old Montreal Road access. The closest transit stops are located at the intersection of Dairy Drive at Old Montreal Road, within 50 metres from the site access to Old Montreal Road.

6.2 Development Access

The site is proposed to have one right-in / right-out only access along Old Montreal Road (Site Access #1) and one full-movement access along Dairy Drive (Site Access #2). Site Access #1 will be restricted to a right-in / right-out access via the extension of a centerline median along Old Montreal Road, which has been shown conceptually as part of the proposed site plan. Both site accesses will be internally connected via a fire route designed according to the Ontario Building Code fire route standards. Section 25 of the Private Approach By-Law (2023-447) provides the maximum number of private accesses permitted based on the frontage length of the subject property. There is approximately 80 metres of frontage on Old Montreal Road, and 240 metres on Dairy Road. As per the By-law, from 46 metres to 150 metres of frontage, a maximum of two two-way approaches are permitted. The subject site is within these parameters.

6.2.1 Access Width

The proposed right-in / right-out access on Old Montreal Road is seven meters in width, which is also in compliance with the By-law, which is less than the maximum access width as prescribed in Section 11 of the Private Approach By-law (maximum of 9.0 metres). The proposed access on Dairy Drive has a width of 9.0 metres which is equal to the maximum access width as prescribed in the Private Approach By-law. Both accesses were designed to have minimal widths while accommodating the design vehicle turning movements.

6.2.2 Access Spacing

Using Figure 8.8.2 in the 2017 TAC Geometric Guide for Canadian Roads, the spacing between the site access at Dairy Drive and the intersection of Dairy Road and Old Montreal Road has been checked for suggested minimum corner clearances. It was found that the suggested minimum clearance applicable to the Dairy Drive access is 15 metres. Site Access #2 is located approximately 140 meters north of Old Montreal Road, and thus this access meets the TAC minimum corner clearance requirements for a local road. The suggested minimum corner clearance requirement does not apply to the site access at Old Montreal Road as Old Montreal Road operates as free-flow at the intersection with Dairy Drive.

Using Section 25 of By-law 2023-447, and in consideration of the industrial classification of the site, the minimum clearance distance between the private approach and the nearest intersecting street line is 18 metres where 20 to 99 parking spaces are provided for the site. Both site accesses meet this requirement.

Additionally, using Section 25 of By-law 2023-447, the minimum distance between private approaches should be 9 metres. The distance between the proposed Old Montreal Road Access and the access to 1057 Old Montreal Road is approximately 25 metres, which meets the requirement.

6.2.3 Throat Length

According to the TAC Geometric Design Guide, Table 8.9.3, the suggested minimum clear throat length for major driveways for a development of this size is summarized in Table 8 below.

Table 8: Throat Length by Land Use

Land Use	Development Size Units / GFA (s.m.)	Required Clear Throat Length (m) for Arterial Roadway	Required Clear Throat Length (m) for Local Roadway
Light Industrial	28,788	30	N/A

The proposed site access on Old Montreal Road will have a throat length of 14.6 metres (or 20.2 metres including the curb radii), which is less than the minimum required 30 metres. Although the proposed throat length is below the TAC requirement, it is sufficient to accommodate the entirety of an HSU truck (the largest site design vehicle) or two TAC P vehicles waiting for conflicting movements on site to clear.

As specified in Section 4 of this report, there will be a maximum of 31 inbound peak hour trips, which results in vehicles entering the site approximately once every two minutes at both Site Accesses combined, or once every four minutes when considering one access. This is a conservative estimate for the Old Montreal Road access, as the restriction of the left-in and left-out movements at this access will lead to fewer trips accessing the site via the Old Montreal Road. Additionally, the alternative access at Dairy Drive provides a more direct connection to three out of four proposed buildings.

It is further unlikely that multiple vehicles will enter the site at the same time and encounter an internal conflicting movement along the drive aisle, requiring the inbound vehicles to wait within the available throat length. Therefore, based on the foregoing, the proposed clear throat length at Site Access #1 is sufficient to accommodate the needs of the proposed development without impacting the traffic flow along Old Montreal Road.

There is no suggested minimum throat length requirement for the site access along Dairy Drive, as Dairy Drive is a local road. However, this access was designed to accommodate an HSU design vehicle to stack within the access before the gate without impacting the flow of traffic on Dairy Drive.

6.2.4 Sightlines

It is acknowledged that there may be limited sightlines along Old Montreal Road due to the existing road geometry. This geometric roadway limitation cannot be mitigated without a complete reconstruction of the Old Montreal Road. Therefore, the sightlines along Old Montreal Road have been mitigated using Wa-13 and Wa-18t Ontario Traffic Manual signs shown in Appendix E. The proposed signage is also expected to provide an advanced warning for drivers approaching 1057 Old Montreal Road access and Dairy Drive.

6.3 Site Circulation

The proposed accesses, drive aisles, waste collection areas, and loading bays were tested using AutoTurn swept path analysis software. An HSU design vehicle was used to test waste collection movements and loading bays at self-storage buildings. An LSU design vehicle was used to test the loading bays at light industrial buildings. Internal drive aisles and site accesses were tested using both design vehicles. It was found that design vehicle swept paths can be accommodated within the proposed curbs, driveways, and loading spaces. Where waste collection vehicle crosses parking spaces to access the garbage bins, the parking spaces will be signed as “No Parking” during waste collection hours. It is important to note that the waste collection vehicle swept path affects only those parking

spaces that are in excess of the projected parking demand on site. The parking demand is discussed in detail in Section 7. The Turning Template Analysis and Signage Plan can be seen in Appendix E.

6.4 Construction Management Plan

A Construction Management Plan has been prepared to identify the construction-related mobility impacts. The Construction Management Plan and its scope confirmation can be seen in Appendix F. The plan shows three road cuts along Dairy Drive required to establish storm sewer, sanitary sewer, and water main connections to the site. Road closures are expected along Dairy Drive during the construction of these connections.

6.5 Parking

6.5.1 Vehicular Parking Supply

The proposed development will provide a total of 89 parking stalls, including three accessible parking spaces. The City of Ottawa Zoning By-law parking requirements for the proposed land uses are summarized in Table 9 below.

Table 9: Vehicle Parking Requirement Zoning By-Law Approach

Land Use	By-Law Land Use Category	GFA (m ²)	GFA (ft ²)	Parking Rate (Required)	Parking Spaces (Required)	Parking Spaces (Provided)	Difference
Self-storage	Warehouse	27,314	294,004	0.8 per 100 sq. m first 5000 sq. m, 0.4 per 100 sq. m above 5000 sq. m	129	77	-52
Industrial Condominium	Light Industrial Use	1,474	15,865	0.8 per 100 sq. m first 5000 sq. m, 0.4 per 100 sq. m above 5000 sq. m	12	12	0

As noted above, the parking requirement for the industrial condominiums is satisfied, while the proposed site does not meet the parking requirement prescribed in the zoning by-law for the self-storage sites. The proposed site will provide 77 parking spaces for the self-storage buildings, whereas the requirement is 129 parking spaces. However, a self-storage facility is not a typical industrial warehouse use, having minimal employees, as customers of the site unload and load their own storage lockers, requiring only one or two employees to manage the intake of new patrons. Additionally, some customers will not use parking stalls and instead stop their vehicles at the roll-up doors for their outdoor access locker, enabling additional customer parking beyond the delineated parking stalls.

To support the proposed parking variance for the self-storage warehouses, parking demand rates have been estimated using the ITE Parking Generation Manual (2019). The methodology used to determine whether to use the average rate or fitted curve relied on the availability of a fitted curve equation (i.e. where a fitted curve equation is not available, the average rate was used) as well as Figure 4.2: Process for Selecting Average Rate or Equation in Trip Generation Manual Data, in the ITE Trip Generation Handbook, 3rd edition. With this methodology, it was determined that the use of the average rate was most appropriate for the mini-warehouse land use. Table 10 summarizes the projected parking demand.

Table 10: ITE Parking Demand

Land Use	Land Use Code	GFA (m ²)	GFA (ft ²)	Parking Rate (Required)	Parking Spaces (Required)	Parking Spaces (Provided)	Difference
Mini Warehouse	151	27,314	294,004	0.1 per 1000 sq. ft (0.11 per 100 sq. m)	30	77	+47

As observed from Table 10, the parking demand observed through ITE surveys is less than the parking provisions on site. The ITE-based trip generation parking demand for a 27,314 square meter mini warehouse is 30 spaces, where the site parking provision is 77 spaces. Thus, based on the ITE parking generation, the proposed parking will satisfy the projected parking demand.

Additionally, to supplement the ITE data, parking supply data from comparable self-storage facilities in Ontario was reviewed. This data was obtained from self-storage facilities in Toronto, with most of the sites located outside of the City’s core areas, similar to 1015 Dairy Drive. The parking supply data is listed in Table 11.

Table 11: Proxy Site Parking Supply Rates

Site	Address	GFA (m ²)	Parking Supply	Parking Supply Rate
All City Storage*	145 Eastern Ave, Toronto	12,950	5	0.04 / 100 m ²
All Canadian Self Storage*	2256 Lakeshore Blvd. W, Etobicoke	8,208	18	0.22 / 100 m ²
Spaces Self-Storage*	356 Eastern Ave, Toronto	11,331	11	0.10 / 100 m ²
Storage Mart*	144 Norseman Street, Etobicoke	7,586	9	0.12 / 100 m ²
Storage Mart*	120 Wicksteed Ave, East York	13,710	8	0.06 / 100 m ²
Planet Storage*	1655 Dupont St, Toronto	17,596	10	0.06 / 100 m ²
Public Storage*	914 Dupont St, Toronto	11,817	7	0.06 / 100 m ²
SmartStop Self-Storage	69 Torbarrie Road, North York	11,116	42	0.38 / 100 m ²
SmartStop Self-Storage	145 Wicksteed Ave, East York	12,025	14	0.12 / 100 m ²
Harrisonjay Corp	19 Esandar Drive, East York	15,610	14	0.09 / 100 m ²
Talus (Dupont) Limited	1120 Dupont Street, Toronto	5,904	7	0.12 / 100 m ²
Instorage Inc	345 Danforth Road, Scarborough	8,215	13	0.16 / 100 m ²

*Source: BA, Vaughan NW Proposed SmartStop Self-Storage Facility Parking Study (2018)

As observed from Table 11, the parking supply at established, comparable self-storage sites is lower than the By-Law parking requirement, varying between 0.04 and 0.38 parking spaces per 100 square metres of GFA.

To ensure that the observed parking supply satisfies the demand, a parking survey has been undertaken at five established self-storage sites in the City of Toronto, including 356 Easter Avenue, 144 Norseman Street, 530 Adelaide Street West, 145 Wicksteed Avenue, and 69 Torbarrie Road. The peak observed parking demand for 356 Eastern Avenue and 144 Norseman Street self-storage facilities was determined using data from four survey dates, and the peak observed parking demand rate at 530 Adelaide Street was determined using two survey dates. Two self-storage sites were also surveyed on two different dates to consider the different peak hours on weekdays and weekends: 69 Torbarrie Road was surveyed on Friday, August 13, 2021, and Saturday, August 14, 2021; and 145 Wicksteed Avenue was surveyed on Friday, September 17, 2021, and Saturday, September 18, 2021. Table 12 contains the GFA and the maximum observed parking demand for each site and Attachment 2 contains proxy site parking generation counts.

Table 12: Parking Demand Rates at Comparable Sites

Site	Address	GFA (m ²)	Maximum Observed Parking Demand	Maximum Observed Parking Demand Rate
Spaces Self Storage*	356 Eastern Ave, Toronto	12,263	9	0.07 / 100 m ²
Storage Mart*	144 Norseman St, Etobicoke	8,076	7	0.09 / 100 m ²
Apple Storage*	530 Adelaide St W, Toronto	12,688	9	0.07 / 100 m ²
SmartStop Self-Storage	145 Wicksteed Ave, East York	12,025	7	0.06 / 100 m ²
SmartStop Self-Storage	69 Torbarrie Road, North York	11,116	12	0.11 / 100 m ²

*Source: BA, Vaughan NW Proposed SmartStop Self-Storage Facility Parking Study (2018)

As noted above, the maximum observed parking demand rate for the comparable sites ranges between 0.06 and 0.11 spaces per 100 square meters of the gross floor area. To remain conservative, the maximum observed parking demand rate of 0.11 spaces per 100 square meters was carried forward in the analysis.

The parking rates prescribed in the City of Ottawa Zoning By-law, the parking demand rates estimated using the ITE Parking Generation Manual (2019), and the maximum observed parking demand for comparable proxy sites in Ontario have been summarized in Table 13.

Table 13: Parking Rates Comparison

	Parking Rate / 100 m ²
City of Ottawa Zoning By-law	0.8 first 5000 sq. m, 0.4 above 5000 sq. m
ITE LUC 151 Parking Demand	0.11
Proxy Site Demand Survey	0.11

The results in Table 13 above indicate that the maximum demand observed as part of the proxy site surveys in the City of Toronto aligns with the ITE Mini-Warehouse parking survey data. Therefore, it can be concluded that parking provisions of 0.11 spaces per 100 square meters of gross floor area should be sufficient to meet the parking demands of a self-storage warehouse facility.

The self-storage component of the subject site includes a total of 77 parking spaces, which is equivalent to a rate of 0.28 per 100 square metres of gross floor area, and it is higher than the minimum parking demand rate of 0.11 per 100 square metres observed through ITE and proxy site surveys in the City of Toronto. Thus, the proposed vehicle parking for the 1015 Dairy Avenue self-storage facilities and industrial condominiums is expected to exceed the projected parking demand.

Due to the variance in the total parking spaces provided, the required accessible parking spaces shall be adjusted accordingly as well. The accessible parking spaces have been checked against the City of Ottawa Traffic and Parking (By-law No. 2017-301). Based on the total parking spaces proposed, the required and provided accessible parking spaces for the site are summarized in Table 14 below. It is shown that the three accessible parking stalls provided among the 89 stalls meets the City requirement.

Table 14: Accessible Vehicle Parking Requirement - City of Ottawa

Land Use	By-Law Land Use Category	Total Parking Spaces	Range	Accessible Parking Rate (Required)	Accessible Parking Spaces (Provided)	Difference
Self-storage and Industrial Condominium	Warehouse and Light Industrial Use	89	20-99	1	3	+2

6.5.2 Loading

The loading space provisions have been checked against the City of Ottawa Zoning By-law, and the required number of loading spaces for the site is summarized in Table 15 below.

Table 15: Loading Spaces Requirement - City of Ottawa Zoning Bylaw

Land Use	By-Law Land Use Category	GFA (m ²)	Range	Loading Spaces (Required)	Loading Spaces (Provided)	Difference
Self-storage Building A	Warehouse	12,878	10,000 – 14,999 m ²	2	5	+3
Self-storage Building B	Warehouse	14,436	10,000 – 14,999 m ²	2	3	+1
Industrial Condominium Building C	Light Industrial Use	564	350 – 999 m ²	0	4	+4
Industrial Condominium Building D	Light Industrial Use	910	350 – 999 m ²	0	8	+8

A total of twenty loading spaces are proposed, which exceeds the Zoning By-law requirement. The City of Ottawa By-Law requires two oversized loading spaces for self-storage building A and two oversized loading spaces for self-storage building B (both light industrial with GFA > 5000m²). The oversized space size is required to be 4.3 metres wide, 13 metres long, and have a 17-metre wide drive aisle accessing this space. The site plan shows building A loading spaces to range between 4.9 and 5.8 metres in width, have a length of 14.1 metres. Their drive aisles range from 10 to 14.8 metres. The site shows building B loading spaces to be 4.9 metres wide, 14.1 metres long, and the drive aisle to be 16.6 metres wide. Although the width of the drive aisles accessing the loading spaces is below the City's Zoning By-Law requirement of 17 metres, it meets the intended use of the site. Turning Template Analysis prepared to support this development shows that the drive aisle width can accommodate the movements of design trucks in and out of the proposed loading bays, as discussed in Section 6.3.

6.5.3 Bicycle Parking

Bicycle parking spaces are also provided and have been compared with the rates prescribed in the City of Ottawa Zoning By-law. The required and provided bicycle parking spaces are summarized in Table 16.

Table 16: Bicycle Parking Requirement - City of Ottawa Zoning Bylaw

Land Use	By-Law Land Use Category	GFA (m ²)	GFA (ft ²)	Bicycle Parking Rate (Required)	Bicycle Parking Spaces (Required)	Bicycle Parking Spaces (Provided)	Difference
Self-storage and Industrial Condominium	Warehouse	27,314	294,004	1.0 per 2000 sq. m	14	24	+10

As shown in Table 16 above, a total of 24 bicycle parking spaces are proposed, which exceeds the Zoning By-law requirement.

7 Boundary Street Design

Montreal Road and Dairy Drive are noted as boundary roads for the site. The existing and future conditions for both streets will be the same and will be considered in one row. The Segment Multi-Modal Level of Service (MMLOS) is broken down into the Pedestrian Level of Service (PLOS), Bicycle Level of Service (BLOS), Transit Level of Service (TLOS), and Truck Level of Service (TkLOS) and are all recorded in Table 17. The boundary street analysis is based on the land use of “Urban Employment Area”. The MMLOS worksheets have been provided in Appendix G.

Table 17: Boundary Street MMLOS Analysis

Segment	Pedestrian LOS		Bicycle LOS		Transit LOS		Truck LOS	
	PLOS	Target	BLOS	Target	TLOS	Target	TrLOS	Target
Old Montreal Road	F	C	F	C	N/A	N/A	B	D
Dairy Drive	F	C	E	No target	N/A	N/A	N/A	N/A

As shown in the table above, none of the boundary streets meet the PLOS targets and due to the lack of continuous sidewalks along the studied road segments. To meet the PLOS targets, at least a 2.0-metre sidewalk and a 0.5-metre boulevard would be required along Old Montreal Road, and at least a 1.8-metre sidewalk would be required along Dairy Drive. Additionally, the bicycle LOS will not be met along the segment of Old Montreal Road. Although a curbside bike lane is required along Old Montreal Road to meet the theoretical bicycle LOS targets, the paved shoulder along Old Montreal Road functions as a similar facility and provides additional space for the bicycle. No improvements are required for this mode.

8 Conclusions

The following summarizes the analysis and results presented in this TIA report:

Proposed Site and Screening

- The proposed site consists of two self-storage facilities with a total GFA of 294,004 sq. ft and two industrial condominiums with a total GFA of 15,865 sq. ft.
- The site is proposed to have one right-in / right-out only access along Old Montreal Road and one full-movement access along Dairy Drive
- The development is proposed to be completed as a single phase by 2025
- The location and safety triggers were met for the TIA Screening

Existing Conditions

- Old Montreal Road is an arterial road, and Dairy Drive is a local road in the study area
- Sidewalks are provided along both sides of Old Montreal Road west of Dairy Drive
- Bike lanes are provided along the north side of Old Montreal Road west of Dairy Drive and along the south side of Old Montreal Road between Trim Road and Dairy Drive
- There are a total of eight collisions during the 2018-2022 time period within the study area
- No collisions have been noted along Dairy Drive frontage
- One turning movement cyclist collision is noted during wet weather conditions at the intersection of Aveia Private/Dairy Drive at Old Montreal Road, and no specific pattern or cause is noted per the detailed collision report
- No further collision review is required as part of this study
- The study area intersections operate well in the existing condition during both peak hours

Development Generated Travel Demand

- The proposed development is forecasted to produce 44 two-way vehicle trips during the AM peak hour and 57 two-way vehicle trips during the PM peak hour
- Since the site trip generation is below 75 vehicle trips, no future background and future total horizon analyses are required

Development Design

- A total of 24 bicycle parking will be provided externally close to the office entrances to self storage buildings and industrial condominiums
- Concrete sidewalks are proposed at the access intersections on Dairy Drive and Old Montreal Road, and pedestrian crossings are proposed to connect the two-storey self storage building to the sidewalks
- The closest transit stops are located within 50 metres of the Old Montreal Road access
- The proposed accesses meet the City of Ottawa access frequency, width, and spacing requirements, as well as the TAC corner clearance requirements
- The proposed throat length was deemed adequate based on anticipated development volumes
- Signage was proposed to mitigate limited sightlines along Old Montreal Road and is also expected to provide an advanced warning for drivers approaching 1057 Old Montreal Road access and Dairy Drive
- HSU and LSU design paths can be accommodated by proposed curbs, drive aisles, and loading spaces

Parking and Loading

- The proposed development proposes a total of 89 parking stalls, three accessible parking, and 26 bicycle parking spaces
- The proposed vehicle parking for the 1015 Dairy Avenue self-storage facility is expected to exceed the projected parking demand
- The proposed accessible parking spaces exceed the zoning by-law requirement
- The proposed loading spaces exceed the zoning by-law requirement
- The loading space sizes and drive aisle widths meet the site's intended operations and were shown to accommodate design vehicle swept paths
- The proposed bicycle parking exceeds the zoning by-law requirement

Boundary Street Design

- Old Montreal Road and Dairy Drive do not meet the PLOS targets
- To meet the PLOS targets, at least a 2.0-metre sidewalk and a 0.5-metre boulevard would be needed along Old Montreal Road, and at least a 1.8-metre sidewalk would be needed along Dairy Drive
- The bicycle LOS will not be met along the segment of Old Montreal Road
- The paved shoulder along Old Montreal Road functions as a similar facility and provides additional space for the bicycle, and no improvements are required for this mode

It is recommended that, from a transportation perspective, the proposed development application proceeds.

Prepared by:



Viktoriya Zaytseva, B.A.Sc.
CGH Transportation Inc.
P: 416-567-3719
E: Viktoriya.Zaytseva@CGHTransportation.com

Reviewed by:



Christopher Gordon, P.Eng.
CGH Transportation Inc.
P: 343-999-9117
E: Christopher.Gordon@CGHTransportation.com

Appendix A

TIA Screening Form and PM Certification Form



Technical Memorandum

To: _____ Date: 2023-04-04

Cc: Christopher Gordon – CGH Transportation

From: Viktoriya Zaytseva – CGH Transportation Project Number: 2023-016

Re: 1015 Dairy Drive – Step 1, Screening Memo

Dear Alexander,

CGH Transportation has been retained by the Effort Trust Company to provide transportation services related to the 1015 Dairy Drive development in Ottawa. Based on our review of the proposed land uses, it is recommended that a scoped Step 2 and 3 as well as the Design Review Component of Step 4 of the Ottawa’s Transportation Impact Assessment (TIA) process should be conducted to support the proposed development from the transportation perspective.

The proposed development at 1015 Dairy Drive will include 139,000 square feet of ground floor self-storage warehousing. To understand the impact of the proposed development on the Study Area transportation network, a trip generation was determined using the 11th Edition of the ITE Trip Generation Manual. Based on the analysis (see attached), it was determined that the proposed development will result in 16 bi-directional vehicle trips during the AM peak hour and 27 bi-directional vehicle trips in the PM peak hour. Thus, it is recommended that a scoped Step 2 and Step 3 as well as the Design Review Component of Step 4 of the Ottawa’s TIA process should be conducted to support the proposed development, and a full Transportation Impact Assessment is not required.

City of Ottawa 2017 TIA Guidelines
Step 1 - Screening Form

Date: 04-Apr-23
Project Number: 2023-016
Project Reference: Dairy Drive

1.1 Description of Proposed Development	
Municipal Address	1015 Dairy Drive
Description of Location	Ward 1. North-East corner of Dairy Drive and Old Montreal Road intersection
Land Use Classification	Business Park Industrial, Subzone 4 (IP4)
Development Size	139,000 sq.ft (12,914 s.m.)
Accesses	2 full movement accesses, one via Dairy Drive, and one via Old Montreal Road
Phase of Development	Single
Buildout Year	2028
TIA Requirement	Design Review Component

1.2 Trip Generation Trigger	
Land Use Type	Industrial
Development Size	12914 G.F.A.
Trip Generation Trigger	No

The subject site is a self-storage warehouse development. The preliminary trip generation results in less than 60 peak hour person trips (see page 2 for details)

1.3 Location Triggers	
Does the development propose a new driveway to a boundary street that is designated as part of the City's Transit Priority, Rapid Transit or Spine Bicycle Networks?	Yes
Is the development in a Design Priority Area (DPA) or Transit-oriented Development (TOD) zone?	Yes
Location Trigger	Yes

1.4. Safety Triggers	
Are posted speed limits on a boundary street 80 km/hr or greater?	No
Are there any horizontal/vertical curvatures on a boundary street limits sight lines at a proposed driveway?	Yes
Is the proposed driveway within the area of influence of an adjacent traffic signal or roundabout (i.e. within 300 m of intersection in rural conditions, or within 150 m of intersection in urban/ suburban conditions)?	No
Is the proposed driveway within auxiliary lanes of an intersection?	Yes
Does the proposed driveway make use of an existing median break that serves an existing site?	No
Is there is a documented history of traffic operations or safety concerns on the boundary streets within 500 m of the development?	No
Does the development include a drive-thru facility?	No
Safety Trigger	Yes

The ITE Trip Generation Manual (11th Edition) was used to determine auto trip generation of proposed 139,000 square foot self-storage warehouse facility at 1015 Dairy Drive in Ottawa. Table 1 shows the applied trip rates and Table 2 shows the proposed trip generation at 1015 Dairy Drive.

Table 1: Trip Generation Vehicle Trip Rates by Peak Period

Land Use	ITE Land Use Code	Peak Period	Vehicle Trip Rate / 1000 s.f.
Mini-Warehouse	151	AM	0.09
		PM	0.15

Table 2: Total Vehicular Trip Generation by Peak Period

Land Use	GFA (s.f.)	AM Peak Period			PM Peak Period		
		In	Out	Total	In	Out	Total
Mini Warehouse LUC 151	139,000	9	5	16	13	14	27



TIA Plan Reports

On 14 June 2017, the Council of the City of Ottawa adopted new Transportation Impact Assessment (TIA) Guidelines. In adopting the guidelines, Council established a requirement for those preparing and delivering transportation impact assessments and reports to sign a letter of certification.

Individuals submitting TIA reports will be responsible for all aspects of development-related transportation assessment and reporting, and undertaking such work, in accordance and compliance with the City of Ottawa's Official Plan, the Transportation Master Plan and the Transportation Impact Assessment (2017) Guidelines.

By submitting the attached TIA report (and any associated documents) and signing this document, the individual acknowledges that s/he meets the four criteria listed below.

CERTIFICATION

1. I have reviewed and have a sound understanding of the objectives, needs and requirements of the City of Ottawa's Official Plan, Transportation Master Plan and the Transportation Impact Assessment (2017) Guidelines;
2. I have a sound knowledge of industry standard practice with respect to the preparation of transportation impact assessment reports, including multi modal level of service review;
3. I have substantial experience (more than 5 years) in undertaking and delivering transportation impact studies (analysis, reporting and geometric design) with strong background knowledge in transportation planning, engineering or traffic operations; and
4. I am either a licensed¹ or registered² professional in good standing, whose field of expertise [check appropriate field(s)] is either transportation engineering or transportation planning .

1,2 License of registration body that oversees the profession is required to have a code of conduct and ethics guidelines that will ensure appropriate conduct and representation for transportation planning and/or transportation engineering works.

City Of Ottawa
Infrastructure Services and Community
Sustainability
Planning and Growth Management
110 Laurier Avenue West, 4th fl.
Ottawa, ON K1P 1J1
Tel. : 613-580-2424
Fax: 613-560-6006

Ville d'Ottawa
Services d'infrastructure et Viabilité des
collectivités
Urbanisme et Gestion de la croissance
110, avenue Laurier Ouest
Ottawa (Ontario) K1P 1J1
Tél. : 613-580-2424
Télécopieur: 613-560-6006

Dated at Ottawa this 04 day of April, 2023.
(City)

Name: Christopher Gordon
(Please Print)

Professional Title: Professional Engineer



Signature of Individual certifier that s/he meets the above four criteria

Office Contact Information (Please Print)
Address: 6 Plaza Court
City / Postal Code: Ottawa / K2H 7W1
Telephone / Extension: (343) 999-9117
E-Mail Address: Christopher.Gordon@CGHTransportation.com



Appendix B

Turning Movement Count Data



Transportation Services - Traffic Services

Turning Movement Count - Peak Hour Diagram

AVEIA PRIV/DAIRY DR @ OLD MONTREAL RD

Survey Date: Wednesday, December 04, 2019

Start Time: 07:00

WO No: 39171

Device: Miovision

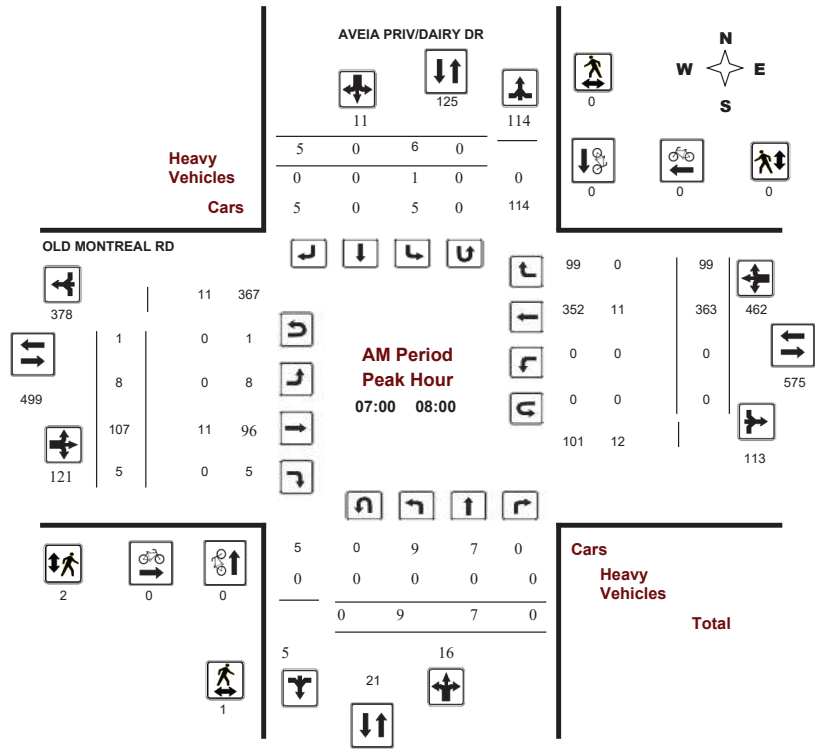

Comments



Transportation Services - Traffic Services

Turning Movement Count - Peak Hour Diagram

AVEIA PRIV/DAIRY DR @ OLD MONTREAL RD

Survey Date: Wednesday, December 04, 2019

Start Time: 07:00

WO No: 39171

Device: Miovision

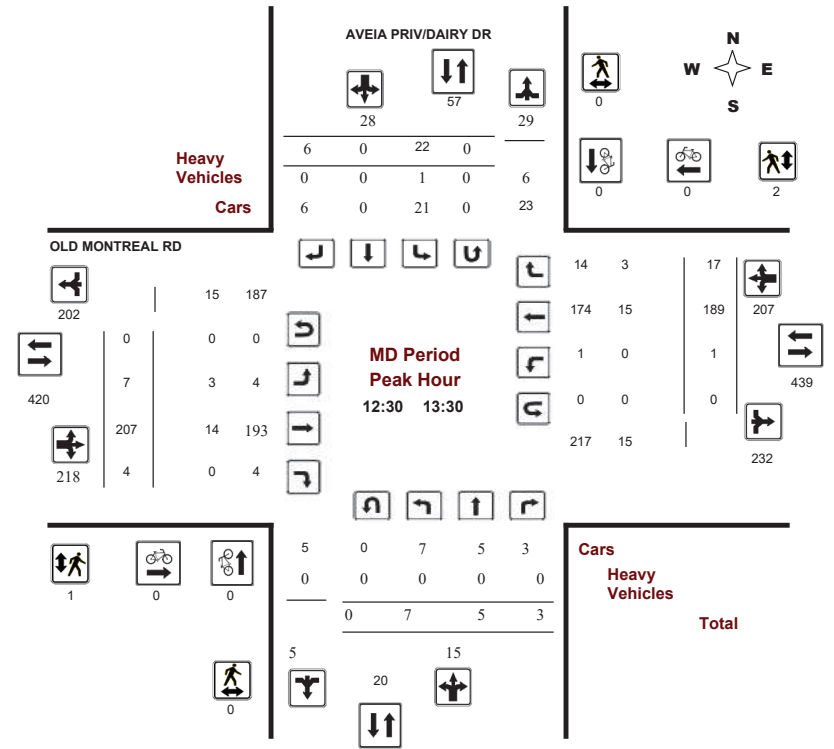

Comments



Transportation Services - Traffic Services

Turning Movement Count - Peak Hour Diagram

AVEIA PRIV/DAIRY DR @ OLD MONTREAL RD

Survey Date: Wednesday, December 04, 2019
Start Time: 07:00

WO No: 39171
Device: Miovision

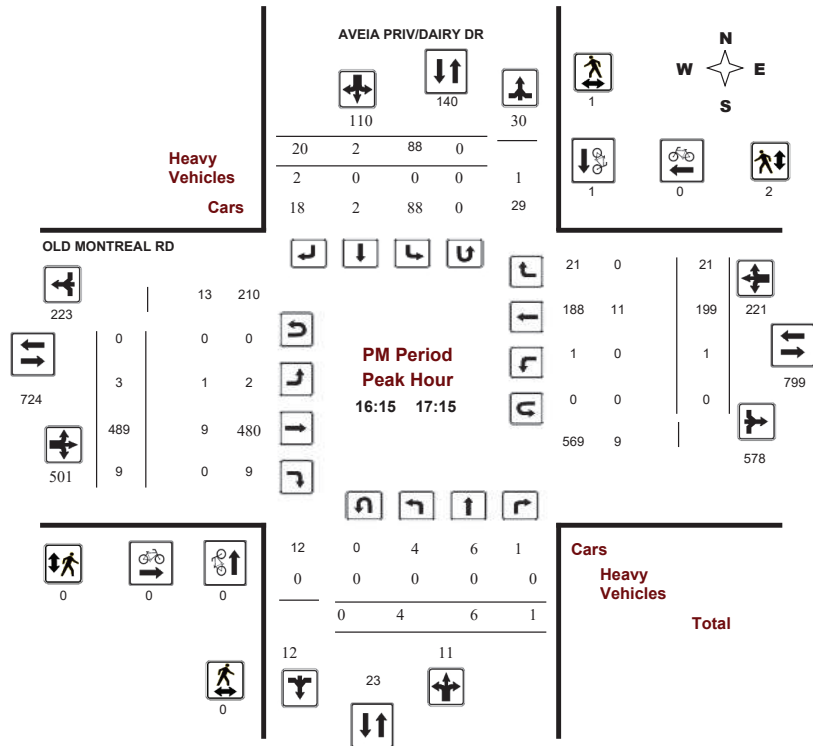

Comments



Transportation Services - Traffic Services

Turning Movement Count - Study Results

AVEIA PRIV/DAIRY DR @ OLD MONTREAL RD

Survey Date: Wednesday, December 04, 2019
Start Time: 07:00

WO No: 39171
Device: Miovision

Full Study Summary (8 HR Standard)

Survey Date: Wednesday, December 04, 2019

Total Observed U-Turns
Northbound: 0 Southbound: 0
Eastbound: 1 Westbound: 2

AADT Factor
1.00

Period	AVEIA PRIV/DAIRY DR										OLD MONTREAL RD										Grand Total
	Northbound					Southbound					Eastbound					Westbound					
	LT	ST	RT	NB TOT	STR TOT	LT	ST	RT	SB TOT	STR TOT	LT	ST	RT	EB TOT	STR TOT	LT	ST	RT	WB TOT	STR TOT	
07:00-08:00	9	7	0	16	27	6	0	5	11	27	8	107	5	120	32	0	363	99	462	582	609
08:00-09:00	8	6	1	15	27	9	0	3	12	27	7	147	0	154	32	0	284	53	337	491	518
09:00-10:00	4	2	0	6	11	3	0	2	5	11	3	130	1	134	32	1	257	20	278	412	423
11:30-12:30	2	0	2	4	32	18	1	9	28	32	4	186	5	195	32	1	191	15	207	402	434
12:30-13:30	7	5	3	15	43	22	0	6	28	43	7	207	4	218	43	1	189	17	207	425	468
15:00-16:00	9	0	2	11	62	42	1	8	51	62	4	380	12	396	62	0	192	10	202	598	660
16:00-17:00	1	6	0	7	112	84	0	21	105	112	3	501	12	516	112	1	192	20	213	729	841
17:00-18:00	10	1	2	13	92	64	5	10	79	92	4	380	18	402	92	0	188	14	202	604	696
Sub Total	50	27	10	87	406	248	7	64	319	406	40	2038	57	2135	406	4	1856	248	2108	4243	4649
U Turns	0	0	0	0	0	0	0	0	0	0	1	0	1	2	0	0	0	0	2	3	3
Total	50	27	10	87	406	248	7	64	319	406	41	2038	57	2136	406	6	1856	248	2110	4246	4652
EQ 12Hr	70	38	14	122	566	345	10	89	444	566	57	2833	79	2969	566	8	2580	345	2933	5902	6468
Note: These values are calculated by multiplying the totals by the appropriate expansion factor.																					
1.39																					
AVG 12Hr	70	38	14	122	566	345	10	89	444	566	57	2833	79	2969	566	8	2580	345	2933	5902	6468
Note: These volumes are calculated by multiplying the Equivalent 12 hr. totals by the AADT factor.																					
1.00																					
AVG 24Hr	92	50	18	160	742	452	13	117	582	742	75	3711	103	3889	742	10	3380	452	3842	7731	8473
Note: These volumes are calculated by multiplying the Average Daily 12 hr. totals by 12 to 24 expansion factor.																					
1.31																					
Note: U-Turns provided for approach totals. Refer to 'U-Turn' Report for specific breakdown.																					



Transportation Services - Traffic Services

Turning Movement Count - Study Results

AVEIA PRIV/DAIRY DR @ OLD MONTREAL RD

Survey Date: Wednesday, December 04, 2019

WO No: 39171

Start Time: 07:00

Device: Miovision

Full Study 15 Minute Increments

Table with columns for Time Period, Northbound (LT, ST, RT, N TOT, STR TOT), Southbound (LT, ST, RT, S TOT, STR TOT), Eastbound (LT, ST, RT, E TOT), Westbound (LT, ST, RT, W TOT, STR TOT), and Grand Total. Rows represent 15-minute intervals from 07:00 to 18:00.

Note: U-Turns are included in Totals.



Transportation Services - Traffic Services

Turning Movement Count - Study Results

AVEIA PRIV/DAIRY DR @ OLD MONTREAL RD

Survey Date: Wednesday, December 04, 2019

WO No: 39171

Start Time: 07:00

Device: Miovision

Full Study Cyclist Volume

Table with columns for Time Period, Northbound, Southbound, Street Total, Eastbound, Westbound, Street Total, and Grand Total. Rows represent 15-minute intervals from 07:00 to 18:00.



Transportation Services - Traffic Services

Turning Movement Count - Study Results

AVEIA PRIV/DAIRY DR @ OLD MONTREAL RD

Survey Date: Wednesday, December 04, 2019

WO No: 39171

Start Time: 07:00

Device: Miovision

Full Study Pedestrian Volume

AVEIA PRIV/DAIRY DR OLD MONTREAL RD

Table with columns: Time Period, NB Approach, SB Approach, Total, EB Approach, WB Approach, Grand Total. Rows show pedestrian counts for various time intervals from 07:00 to 18:00.



Transportation Services - Traffic Services

Turning Movement Count - Study Results

AVEIA PRIV/DAIRY DR @ OLD MONTREAL RD

Survey Date: Wednesday, December 04, 2019

WO No: 39171

Start Time: 07:00

Device: Miovision

Full Study Heavy Vehicles

AVEIA PRIV/DAIRY DR OLD MONTREAL RD

Table with columns: Time Period, Northbound (LT, ST, RT, N TOT), Southbound (LT, ST, RT, S TOT, STR TOT), Eastbound (LT, ST, RT, E TOT), Westbound (LT, ST, RT, W TOT, STR TOT), Grand Total. Rows show heavy vehicle counts for various time intervals from 07:00 to 18:00.



Transportation Services - Traffic Services

Turning Movement Count - Study Results

AVEIA PRIV/DAIRY DR @ OLD MONTREAL RD

Survey Date: Wednesday, December 04, 2019

WO No: 39171

Start Time: 07:00

Device: Miovision

Full Study 15 Minute U-Turn Total

AVEIA PRIV/DAIRY DR OLD MONTREAL RD

Time Period	Northbound U-Turn Total	Southbound U-Turn Total	Eastbound U-Turn Total	Westbound U-Turn Total	Total
07:00 07:15	0	0	0	0	0
07:15 07:30	0	0	0	0	0
07:30 07:45	0	0	0	0	0
07:45 08:00	0	0	1	0	1
08:00 08:15	0	0	0	0	0
08:15 08:30	0	0	0	0	0
08:30 08:45	0	0	0	1	1
08:45 09:00	0	0	0	0	0
09:00 09:15	0	0	0	1	1
09:15 09:30	0	0	0	0	0
09:30 09:45	0	0	0	0	0
09:45 10:00	0	0	0	0	0
11:30 11:45	0	0	0	0	0
11:45 12:00	0	0	0	0	0
12:00 12:15	0	0	0	0	0
12:15 12:30	0	0	0	0	0
12:30 12:45	0	0	0	0	0
12:45 13:00	0	0	0	0	0
13:00 13:15	0	0	0	0	0
13:15 13:30	0	0	0	0	0
15:00 15:15	0	0	0	0	0
15:15 15:30	0	0	0	0	0
15:30 15:45	0	0	0	0	0
15:45 16:00	0	0	0	0	0
16:00 16:15	0	0	0	0	0
16:15 16:30	0	0	0	0	0
16:30 16:45	0	0	0	0	0
16:45 17:00	0	0	0	0	0
17:00 17:15	0	0	0	0	0
17:15 17:30	0	0	0	0	0
17:30 17:45	0	0	0	0	0
17:45 18:00	0	0	0	0	0
Total	0	0	1	2	3

Appendix C

Synchro Intersection Worksheets – Existing Conditions

Intersection												
Int Delay, s/veh	0.7											
Movement	EBL	EBT	EBR	WBL	WBT	WBR	NBL	NBT	NBR	SBL	SBT	SBR
Lane Configurations	↶	↷		↶	↷			↷		↶	↷	
Traffic Vol, veh/h	9	107	5	0	363	99	9	7	0	6	0	5
Future Vol, veh/h	9	107	5	0	363	99	9	7	0	6	0	5
Conflicting Peds, #/hr	0	0	1	1	0	0	2	0	0	0	0	2
Sign Control	Free	Free	Free	Free	Free	Free	Stop	Stop	Stop	Stop	Stop	Stop
RT Channelized	-	-	None	-	-	None	-	-	None	-	-	None
Storage Length	40	-	-	55	-	-	-	-	-	15	-	-
Veh in Median Storage, #	-	0	-	-	0	-	-	0	-	-	0	-
Grade, %	-	0	-	-	0	-	-	0	-	-	0	-
Peak Hour Factor	90	90	90	90	90	90	90	90	90	90	90	90
Heavy Vehicles, %	2	10	2	2	3	2	2	2	2	17	2	2
Mvmt Flow	10	119	6	0	403	110	10	8	0	7	0	6

Major/Minor	Major1			Major2			Minor1			Minor2		
Conflicting Flow All	513	0	0	126	0	0	606	656	123	604	604	460
Stage 1	-	-	-	-	-	-	143	143	-	458	458	-
Stage 2	-	-	-	-	-	-	463	513	-	146	146	-
Critical Hdwy	4.12	-	-	4.12	-	-	7.12	6.52	6.22	7.27	6.52	6.22
Critical Hdwy Stg 1	-	-	-	-	-	-	6.12	5.52	-	6.27	5.52	-
Critical Hdwy Stg 2	-	-	-	-	-	-	6.12	5.52	-	6.27	5.52	-
Follow-up Hdwy	2.218	-	-	2.218	-	-	3.518	4.018	3.318	3.653	4.018	3.318
Pot Cap-1 Maneuver	1052	-	-	1460	-	-	409	385	928	389	412	601
Stage 1	-	-	-	-	-	-	860	779	-	555	567	-
Stage 2	-	-	-	-	-	-	579	536	-	822	776	-
Platoon blocked, %	-	-	-	-	-	-	-	-	-	-	-	-
Mov Cap-1 Maneuver	1052	-	-	1459	-	-	401	381	927	380	407	600
Mov Cap-2 Maneuver	-	-	-	-	-	-	401	381	-	380	407	-
Stage 1	-	-	-	-	-	-	851	770	-	549	567	-
Stage 2	-	-	-	-	-	-	573	536	-	806	767	-

Approach	EB	WB	NB	SB
HCM Control Delay, s	0.6	0	14.6	13
HCM LOS			B	B

Minor Lane/Major Mvmt	NBLn1	EBL	EBT	EBR	WBL	WBT	WBR	SBLn1	SBLn2
Capacity (veh/h)	392	1052	-	-	1459	-	-	380	600
HCM Lane V/C Ratio	0.045	0.01	-	-	-	-	-	0.018	0.009
HCM Control Delay (s)	14.6	8.5	-	-	0	-	-	14.6	11.1
HCM Lane LOS	B	A	-	-	A	-	-	B	B
HCM 95th %tile Q(veh)	0.1	0	-	-	0	-	-	0.1	0

Intersection												
Int Delay, s/veh	2.9											
Movement	EBL	EBT	EBR	WBL	WBT	WBR	NBL	NBT	NBR	SBL	SBT	SBR
Lane Configurations	↖	↗		↖	↗			↕		↖	↗	
Traffic Vol, veh/h	3	489	9	1	199	21	4	6	1	88	2	20
Future Vol, veh/h	3	489	9	1	199	21	4	6	1	88	2	20
Conflicting Peds, #/hr	1	0	0	0	0	1	0	0	2	2	0	0
Sign Control	Free	Free	Free	Free	Free	Free	Stop	Stop	Stop	Stop	Stop	Stop
RT Channelized	-	-	None	-	-	None	-	-	None	-	-	None
Storage Length	40	-	-	55	-	-	-	-	-	15	-	-
Veh in Median Storage, #	-	0	-	-	0	-	-	0	-	-	0	-
Grade, %	-	0	-	-	0	-	-	0	-	-	0	-
Peak Hour Factor	90	90	90	90	90	90	90	90	90	90	90	90
Heavy Vehicles, %	33	2	2	2	6	2	2	2	2	2	2	10
Mvmt Flow	3	543	10	1	221	23	4	7	1	98	2	22

Major/Minor	Major1			Major2			Minor1			Minor2		
Conflicting Flow All	245	0	0	553	0	0	801	801	550	796	795	234
Stage 1	-	-	-	-	-	-	554	554	-	236	236	-
Stage 2	-	-	-	-	-	-	247	247	-	560	559	-
Critical Hdwy	4.43	-	-	4.12	-	-	7.12	6.52	6.22	7.12	6.52	6.3
Critical Hdwy Stg 1	-	-	-	-	-	-	6.12	5.52	-	6.12	5.52	-
Critical Hdwy Stg 2	-	-	-	-	-	-	6.12	5.52	-	6.12	5.52	-
Follow-up Hdwy	2.497	-	-	2.218	-	-	3.518	4.018	3.318	3.518	4.018	3.39
Pot Cap-1 Maneuver	1160	-	-	1017	-	-	303	318	535	305	320	786
Stage 1	-	-	-	-	-	-	517	514	-	767	710	-
Stage 2	-	-	-	-	-	-	757	702	-	513	511	-
Platoon blocked, %	-	-	-	-	-	-	-	-	-	-	-	-
Mov Cap-1 Maneuver	1159	-	-	1017	-	-	292	316	534	298	318	785
Mov Cap-2 Maneuver	-	-	-	-	-	-	292	316	-	298	318	-
Stage 1	-	-	-	-	-	-	515	512	-	765	709	-
Stage 2	-	-	-	-	-	-	733	701	-	503	509	-

Approach	EB			WB			NB			SB		
HCM Control Delay, s	0			0			16.8			20.4		
HCM LOS							C			C		

Minor Lane/Major Mvmt	NBLn1	EBL	EBT	EBR	WBL	WBT	WBR	SBLn1	SBLn2
Capacity (veh/h)	318	1159	-	-	1017	-	-	298	693
HCM Lane V/C Ratio	0.038	0.003	-	-	0.001	-	-	0.328	0.035
HCM Control Delay (s)	16.8	8.1	-	-	8.5	-	-	22.9	10.4
HCM Lane LOS	C	A	-	-	A	-	-	C	B
HCM 95th %tile Q(veh)	0.1	0	-	-	0	-	-	1.4	0.1

Appendix D

Collision Data

Accident Date	Accident Year	Accident Time	Location	Environment Condition	Light	Traffic Control	Traffic Control Condition	Classification Of Accident	Initial Impact Type	Road Surface Condition	# Vehicles	# Motorcycles	# Bicycles	# Pedestrians
6/15/2018	2018	18:47	AVEIA PRIV/DAIRY DR @ OLD MONTREAL RD (0014909)	01 - Clear	01 - Daylight	02 - Stop sign	0	02 - Non-fatal injury	02 - Angle	01 - Dry	0	0	1	0
11/26/2019	2019	16:35	AVEIA PRIV/DAIRY DR @ OLD MONTREAL RD (0014909)	01 - Clear	05 - Dusk	01 - Traffic signal	0	03 - P.D. only	02 - Angle	01 - Dry	0	0	0	0
11/22/2019	2019	17:02	AVEIA PRIV/DAIRY DR @ OLD MONTREAL RD (0014909)	01 - Clear	07 - Dark	02 - Stop sign	0	03 - P.D. only	02 - Angle	01 - Dry	0	0	0	0
1/31/2020	2020	16:15	GERALD ST @ OLD MONTREAL RD (0004634)	01 - Clear	01 - Daylight	02 - Stop sign	0	03 - P.D. only	02 - Angle	01 - Dry	0	0	0	0
3/30/2021	2021	9:59	GERALD ST @ OLD MONTREAL RD (0004634)	01 - Clear	01 - Daylight	02 - Stop sign	0	03 - P.D. only	01 - Dry	01 - Dry	0	0	0	0
8/5/2020	2020	10:20	OLD MONTREAL RD (_32A24F)	01 - Clear	01 - Daylight	10 - No control	0	03 - P.D. only	06 - SMV unattended vehicle	01 - Dry	0	0	0	0
1/13/2020	2020	13:23	OLD MONTREAL RD btwn DU GRAND-CHENE CRT & FRANK KENNY RD (_32A2L8)	02 - Rain	01 - Daylight	10 - No control	0	03 - P.D. only	07 - SMV other	02 - Wet	0	0	0	0
6/29/2020	2020	18:30	OLD MONTREAL RD btwn DU GRAND-CHENE CRT & FRANK KENNY RD (_32A2L8)	01 - Clear	01 - Daylight	10 - No control	0	03 - P.D. only	07 - SMV other	01 - Dry	0	0	0	0



Transportation Services - Traffic Services

Collision Details Report - Public Version

From: January 1, 2017 To: December 31, 2021

Location: AVEIA PRIV/DAIRY DR @ OLD MONTREAL RD

Traffic Control: Stop sign

Total Collisions: 3

Date/Day/Time	Environment	Impact Type	Classification	Surface Cond'n	Veh. Dir	Vehicle Manoeuvre	Vehicle type	First Event	No. Ped
2018-Jun-15, Fri,18:47	Clear	Angle	Non-fatal injury	Dry	North	Going ahead	Automobile, station wagon	Cyclist	0
					East	Going ahead	Bicycle	Other motor vehicle	
2019-Nov-22, Fri,17:02	Clear	Angle	P.D. only	Dry	South	Turning left	Automobile, station wagon	Other motor vehicle	0
					West	Going ahead	Automobile, station wagon	Other motor vehicle	
2019-Nov-26, Tue,16:35	Clear	Angle	P.D. only	Dry	East	Turning left	Automobile, station wagon	Other motor vehicle	0
					South	Going ahead	Passenger van	Other motor vehicle	

Appendix E

Turning Template Analysis and Signage Plan

A)

HSU INBOUND MOVEMENTS

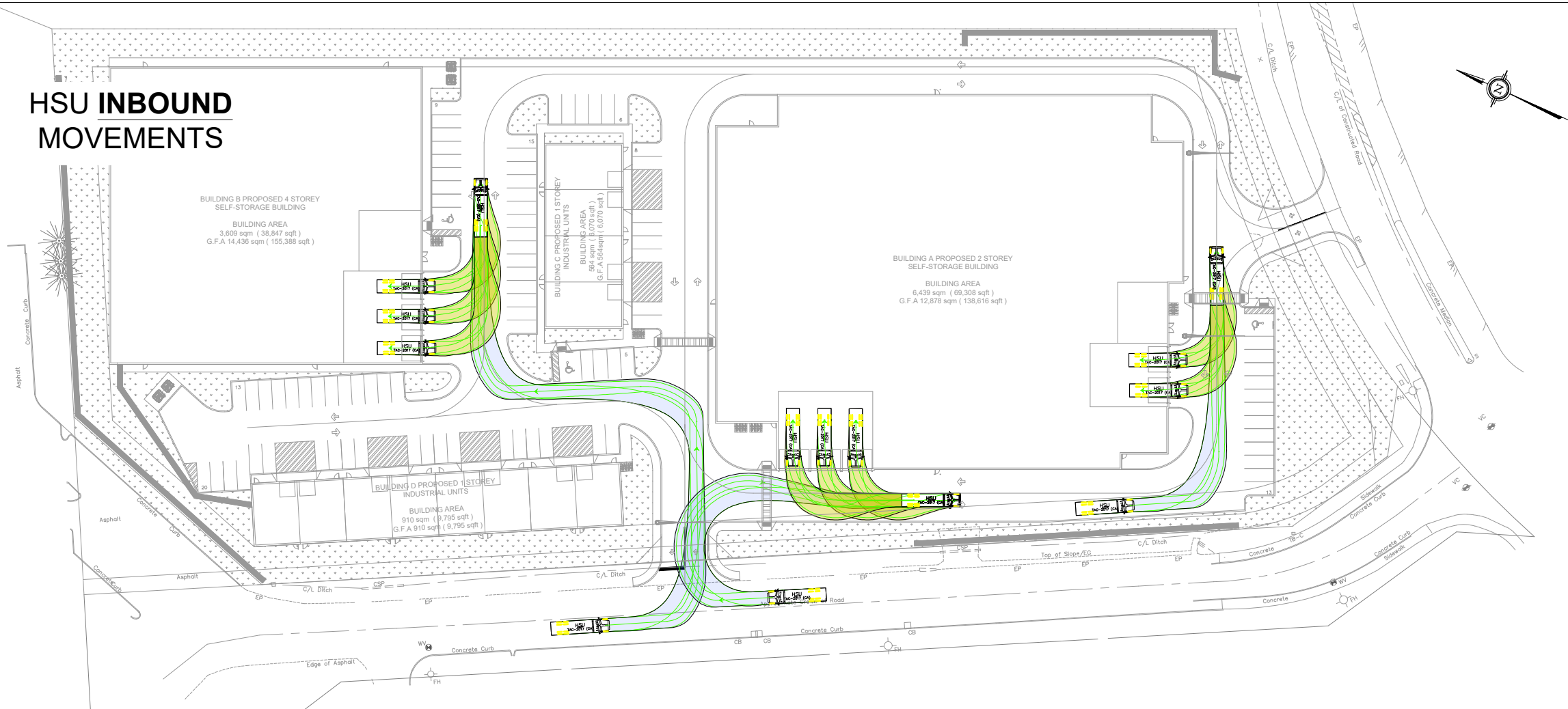

B)

HSU OUTBOUND MOVEMENTS

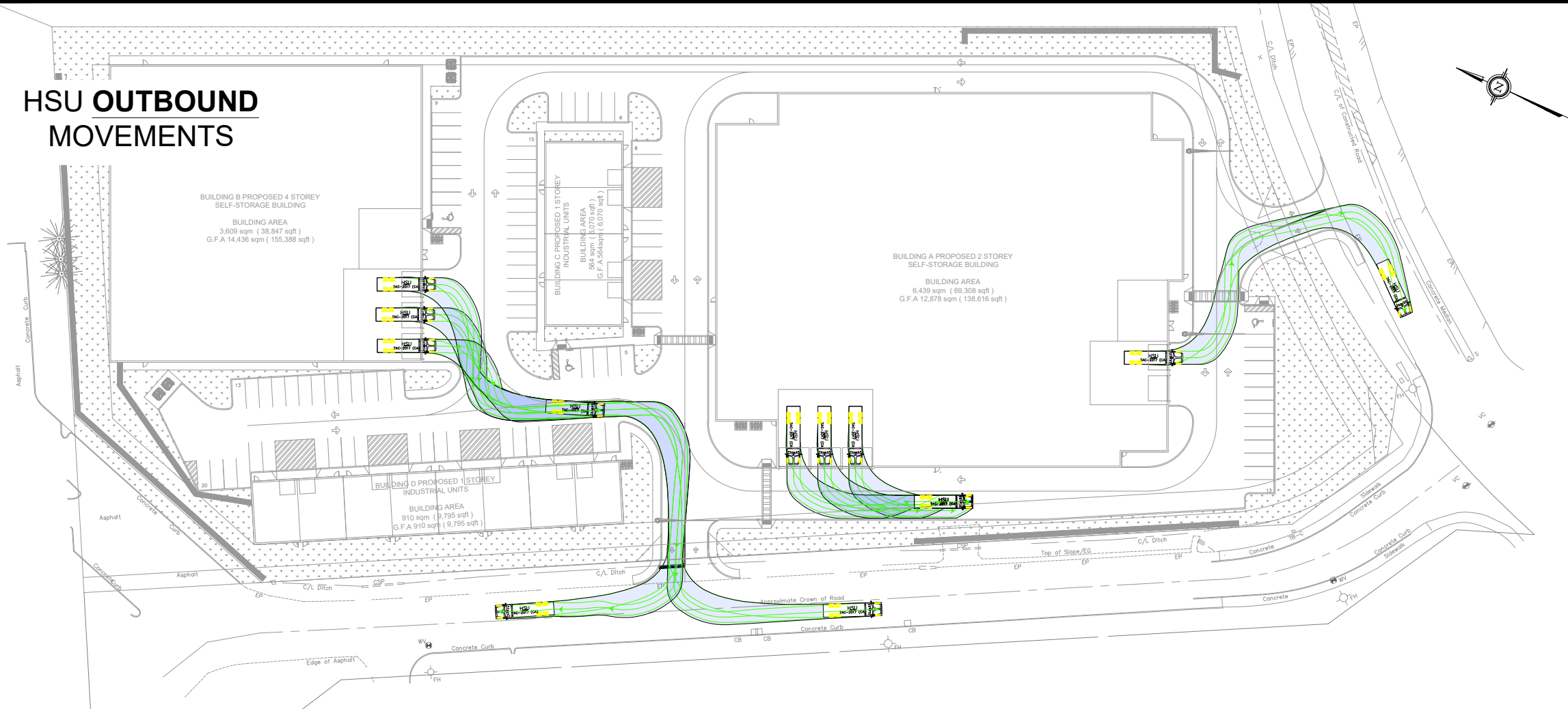

Notes:

Key Plan:

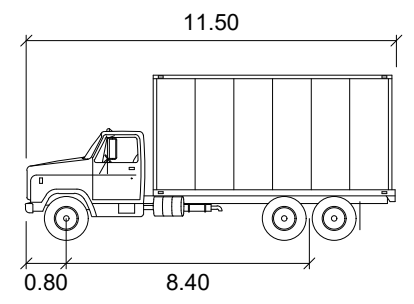
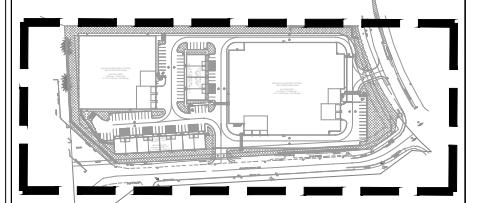

HSU

	units
Width	: 2.60 meters
Track	: 2.60
Lock to Lock Time	: 6.0
Steering Angle	: 40.0

05	Issued for Review:	EW	10/12/2024
REV:	DESCRIPTION:	BY:	DATE:
STATUS:			



CGH Transportation
 6 Plaza Court
 Ottawa, ON
 K2H 7W1
 (343) 999-9117

CLIENT: The Effort Trust Company

ARCHITECT:

SITE:
 1015 Dairy Drive

TITLE: Turning Movement Analysis
 HSU Turning Movements (1)

SCALE AT A3:	DATE:	DRAWN:	CHECKED:
NTS	10/12/2024	EW	VZ
PROJECT NO:	DRAWING NO:	REVISION:	
2023-016	001	05	

A)

HSU INBOUND MOVEMENTS

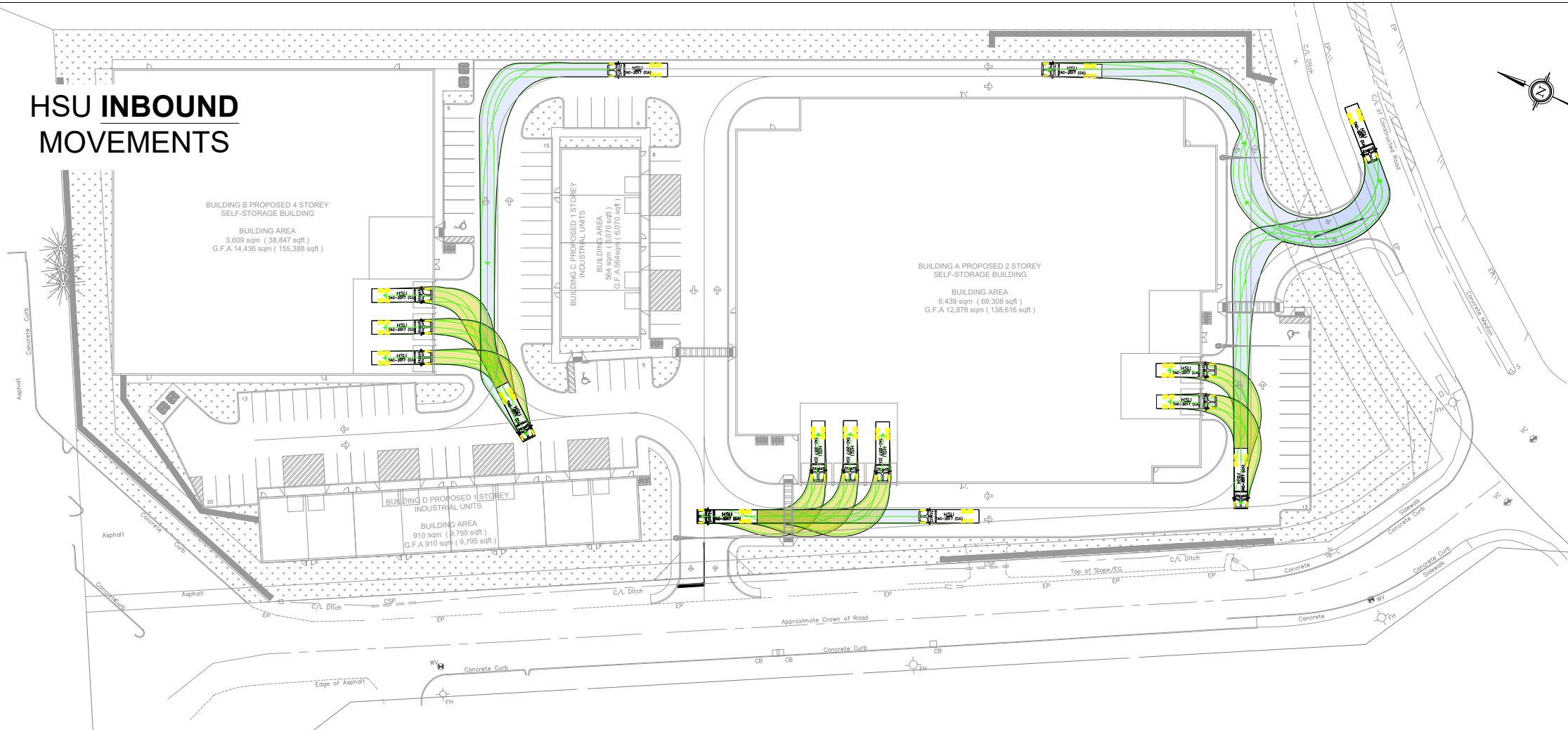

B)

HSU OUTBOUND MOVEMENTS

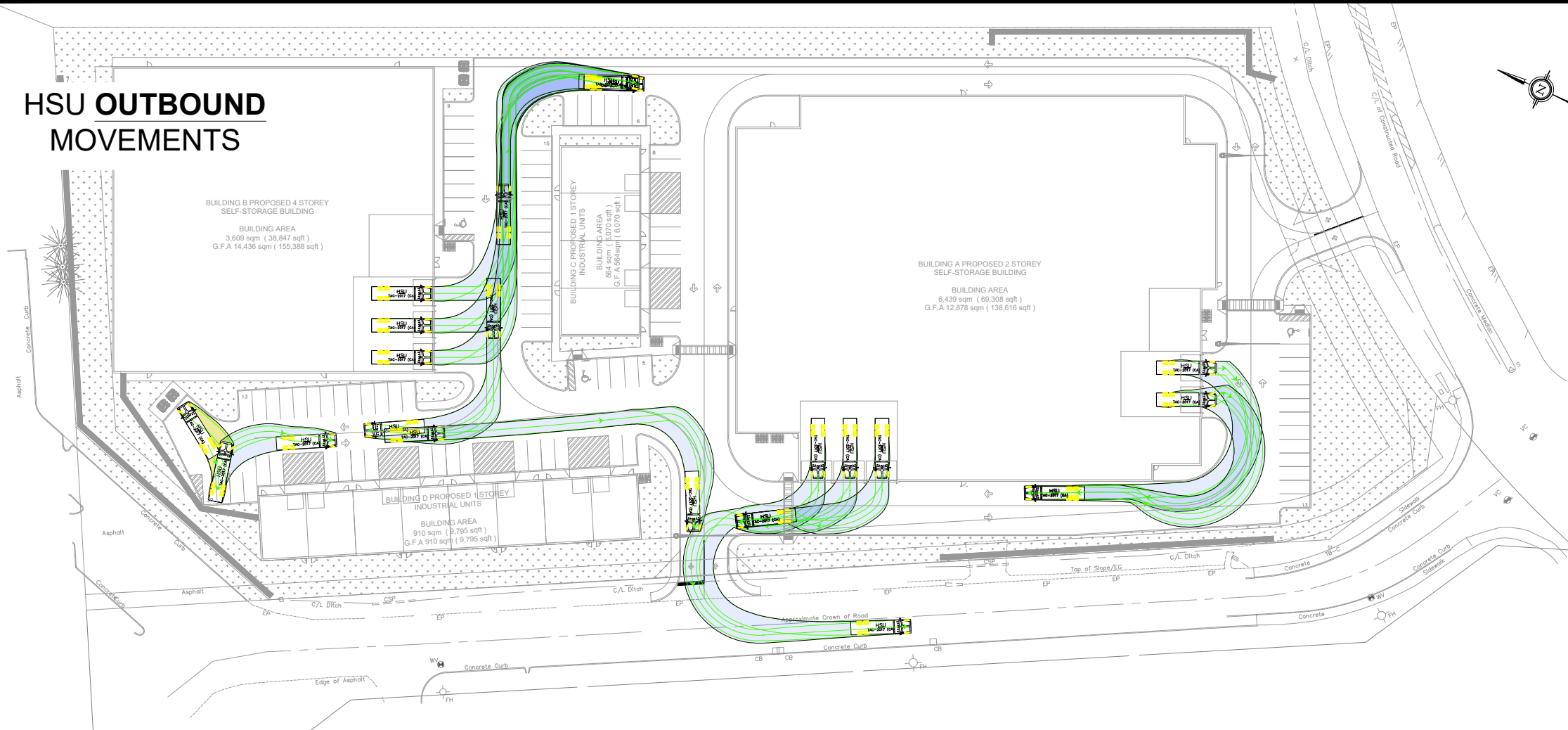

Notes:

Key Plan:

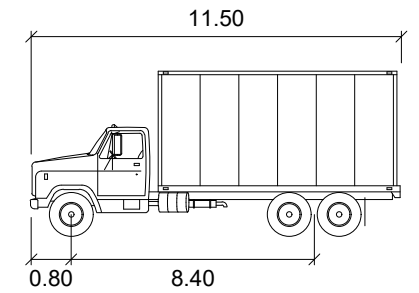
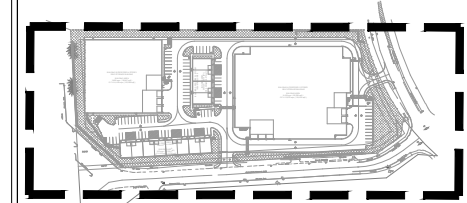

HSU

	units
Width	: 2.60
Track	: 2.60
Lock to Lock Time	: 6.0
Steering Angle	: 40.0

05	Issued for Review:	EW	10/12/2024
REV:	DESCRIPTION:	BY:	DATE:
STATUS:			

CGH Transportation
 6 Plaza Court
 Ottawa, ON
 K2H 7W1
 (343) 999-9117

CLIENT: The Effort Trust Company

ARCHITECT:

SITE:
 1015 Dairy Drive

TITLE: Turning Movement Analysis
 HSU Turning Movements (2)

SCALE AT A3: NTS	DATE: 10/12/2024	DRAWN: EW	CHECKED: VZ
PROJECT NO: 2023-016	DRAWING NO: 002	REVISION: 05	

A)

GARBAGE INBOUND MOVEMENTS

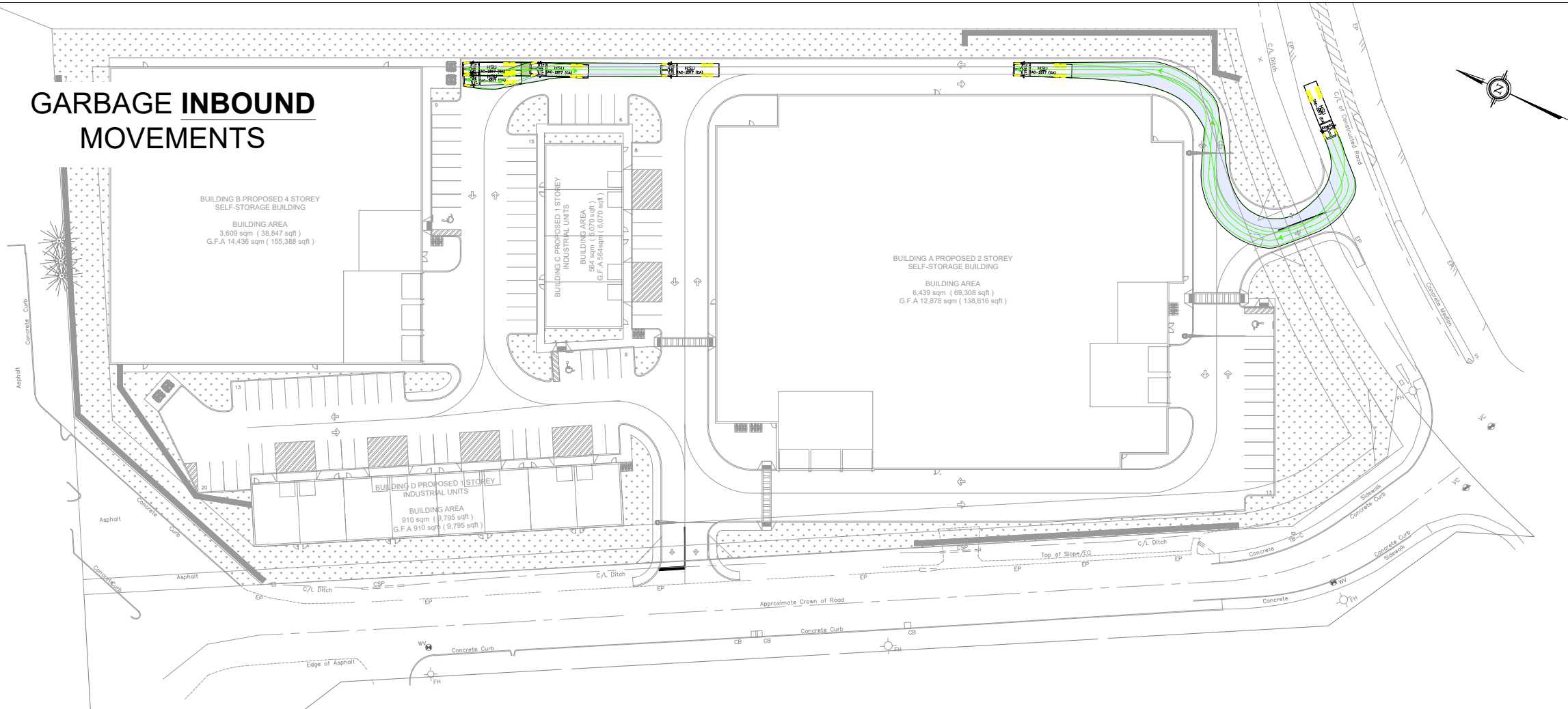

B)

GARBAGE OUTBOUND MOVEMENTS

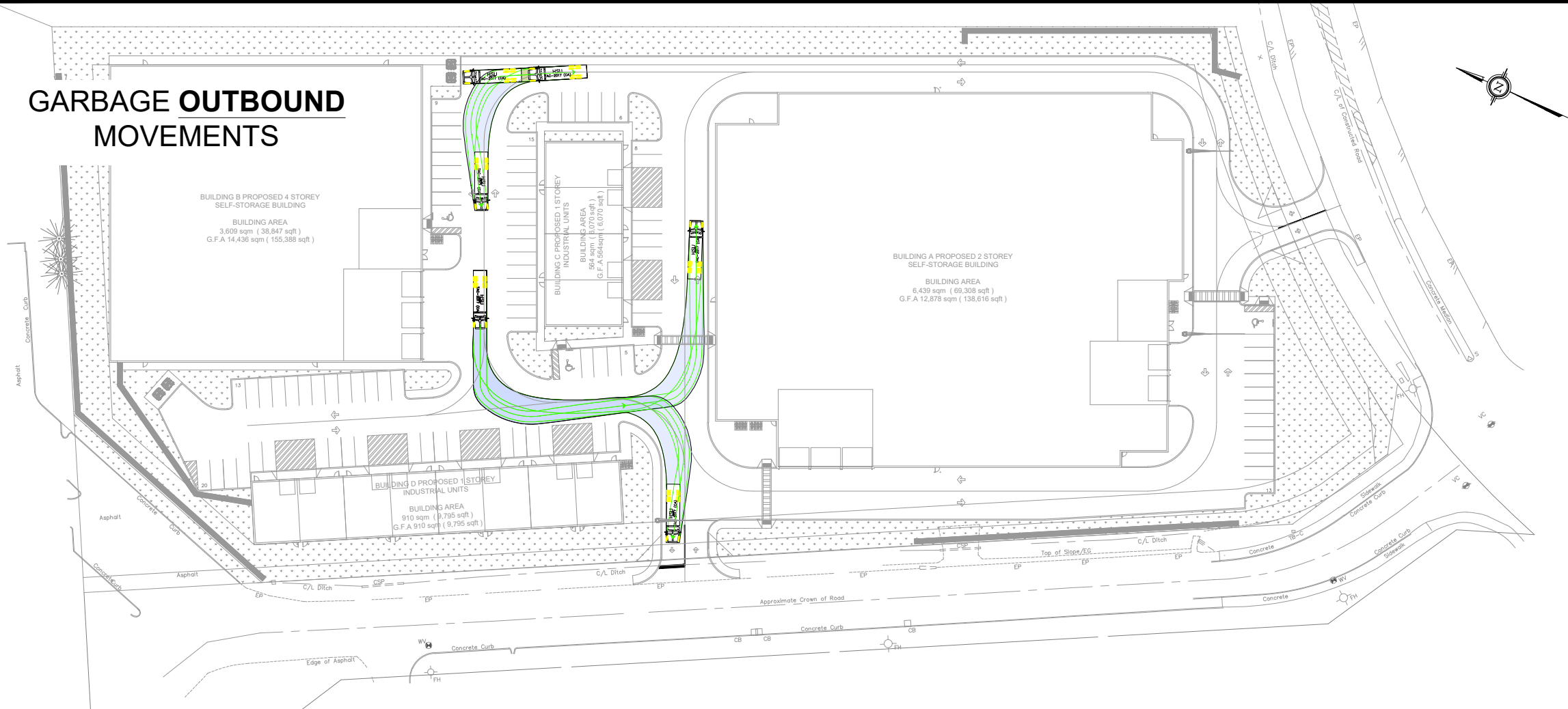

Notes:

Key Plan:

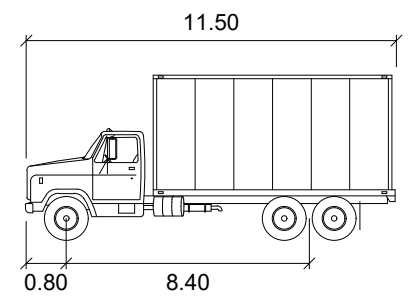
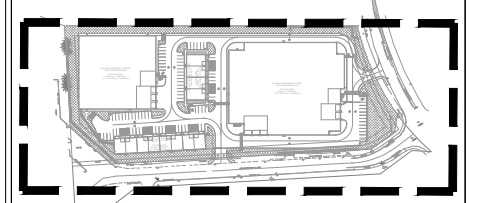

HSU

	meters
Width	: 2.60
Track	: 2.60
Lock to Lock Time	: 6.0
Steering Angle	: 40.0

05	Issued for Review:	EW	10/12/2024
REV:	DESCRIPTION:	BY:	DATE:
STATUS:			

CGH Transportation
 6 Plaza Court
 Ottawa, ON
 K2H 7W1
 (343) 999-9117

CLIENT: The Effort Trust Company

ARCHITECT:

SITE:
1015 Dairy Drive

TITLE: Turning Movement Analysis
Garbage Turning Movements (1)

SCALE AT A3: NTS	DATE: 10/12/2024	DRAWN: EW	CHECKED: VZ
PROJECT NO: 2023-016	DRAWING NO: 003	REVISION: 05	

A)

GARBAGE INBOUND MOVEMENTS

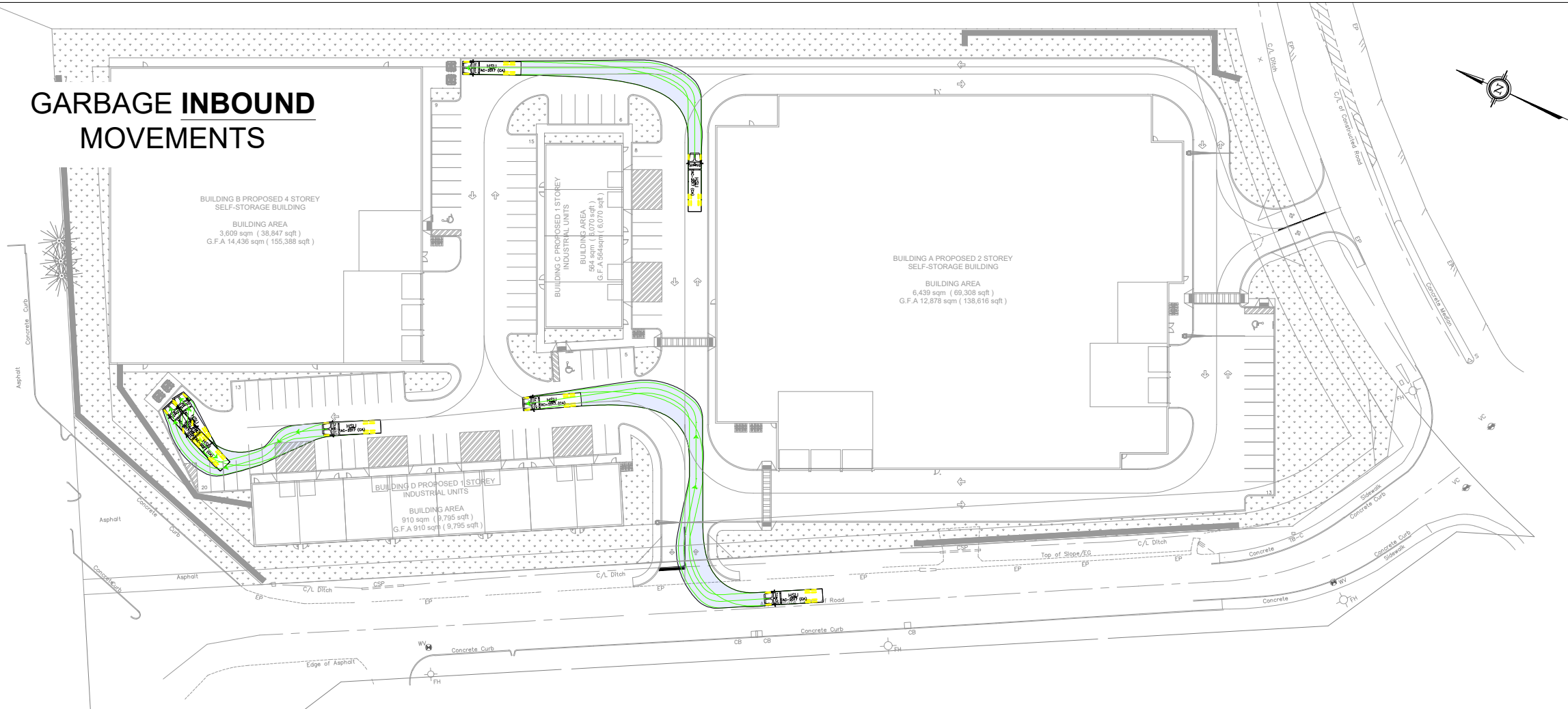

B)

GARBAGE OUTBOUND MOVEMENTS

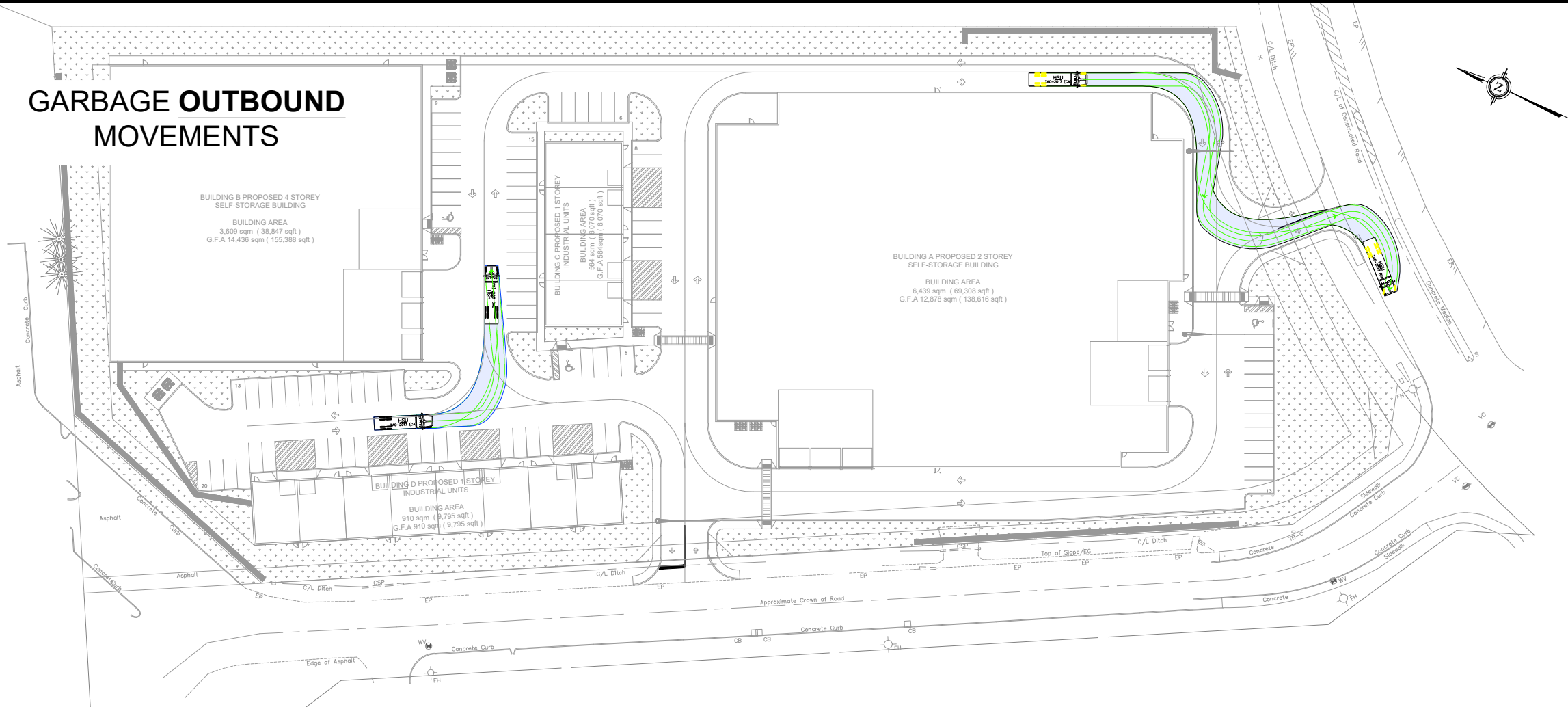

Notes:

Key Plan:

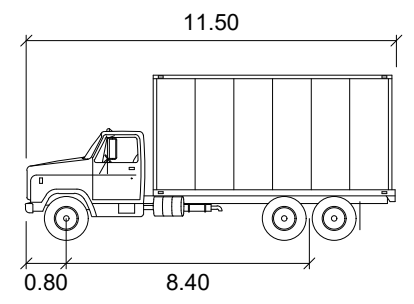
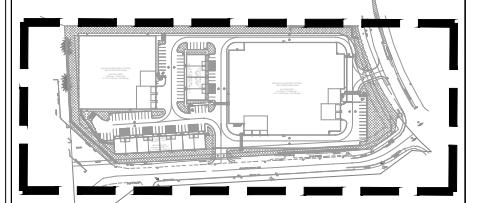

HSU

	units
Width	: 2.60 meters
Track	: 2.60 meters
Lock to Lock Time	: 6.0
Steering Angle	: 40.0

05	Issued for Review:	EW	10/12/2024
REV:	DESCRIPTION:	BY:	DATE:
STATUS:			

CGH Transportation
 6 Plaza Court
 Ottawa, ON
 K2H 7W1
 (343) 999-9117

CLIENT: The Effort Trust Company

ARCHITECT:

SITE:
1015 Dairy Drive

TITLE: Turning Movement Analysis
Garbage Turning Movements (2)

SCALE AT A3: NTS	DATE: 10/12/2024	DRAWN: EW	CHECKED: VZ
PROJECT NO: 2023-016	DRAWING NO: 004	REVISION: 05	

A)

LSU INBOUND MOVEMENTS

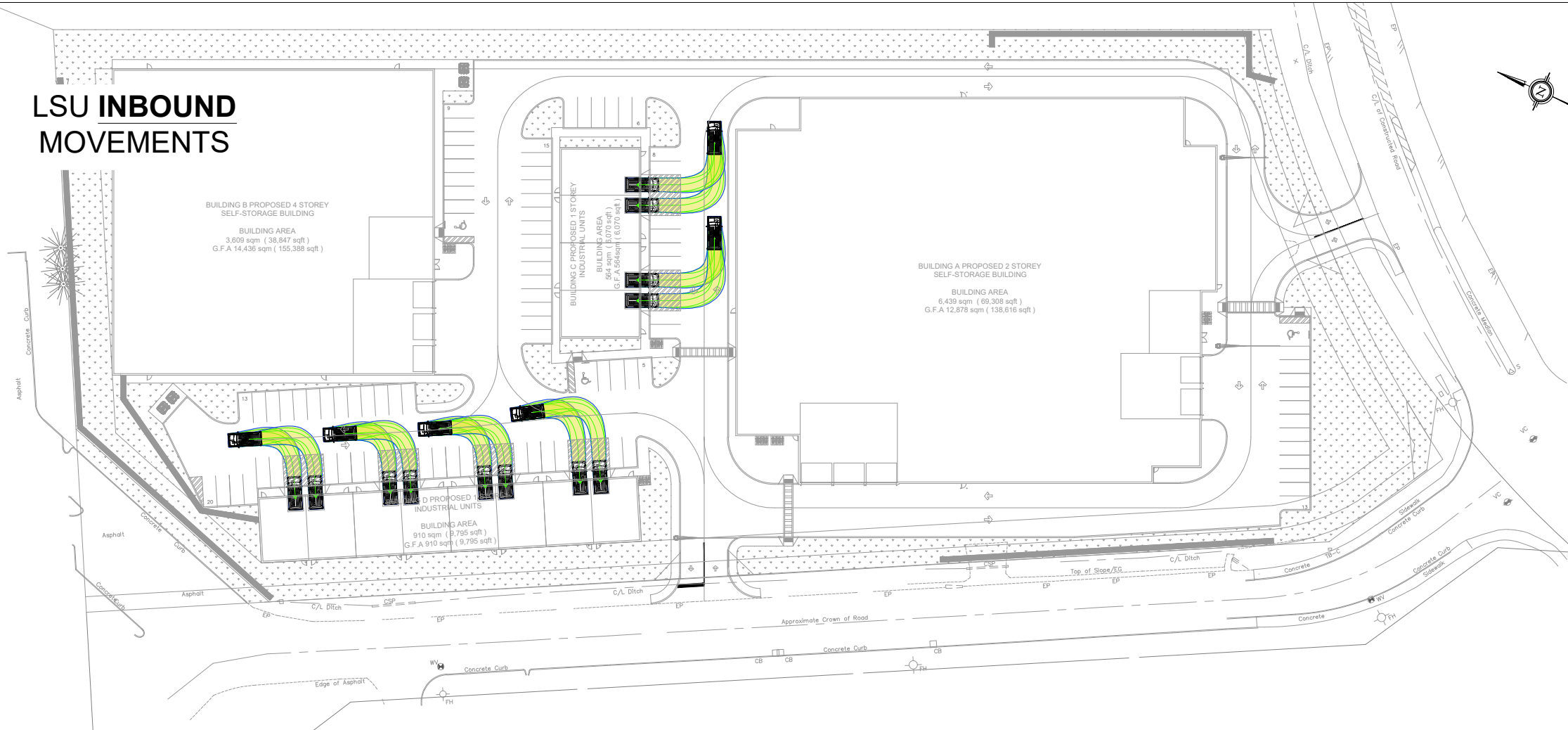

B)

LSU OUTBOUND MOVEMENTS

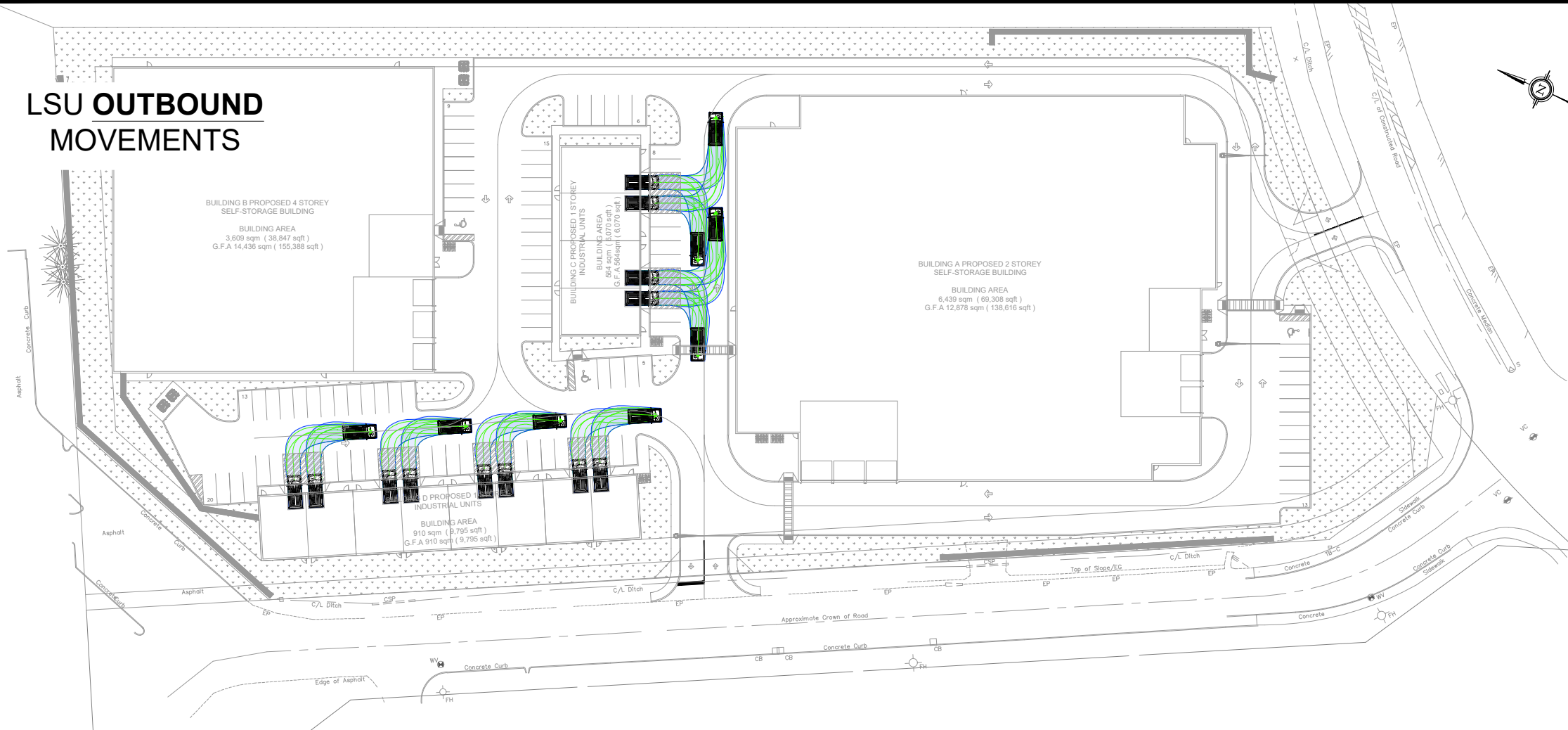

Notes:

Key Plan:

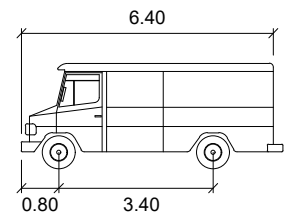
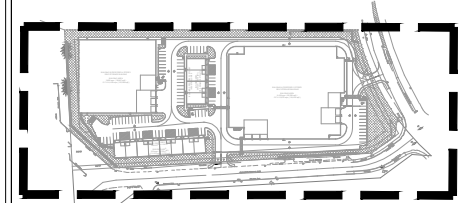

LSU

Width	: 2.60	Track	: 2.60
Lock to Lock Time	: 6.0	Steering Angle	: 40.3

05	Issued for Review:	EW	10/12/2024
REV:	DESCRIPTION:	BY:	DATE:
STATUS:			

CGH Transportation
 6 Plaza Court
 Ottawa, ON
 K2H 7W1
 (343) 999-9117

CLIENT: The Effort Trust Company

ARCHITECT:

SITE:
1015 Dairy Drive

TITLE: Turning Movement Analysis
LSU Turning Movements

SCALE AT A3:	DATE:	DRAWN:	CHECKED:
NTS	10/12/2024	EW	VZ
PROJECT NO:	DRAWING NO:	REVISION:	
2023-016	005	05	



Notes:

Key Plan:

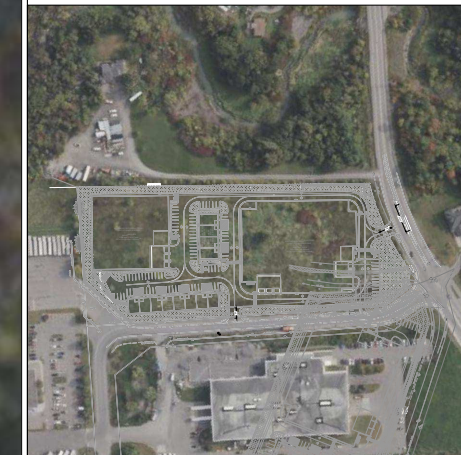

03	Issued for Review:	EW	10/12/2024
REV:	DESCRIPTION:	BY:	DATE:
STATUS:			

CGH Transportation
 6 Plaza Court
 Ottawa, ON
 K2H 7W1
 (343) 999-9117

CLIENT: The Effort Trust Company

ARCHITECT:

SITE:
 1015 Dairy Drive

TITLE:
 Pavement Marking &
 Signage Plan

SCALE AT A3: NTS	DATE: 10/12/2024	DRAWN: EW	CHECKED: VZ
PROJECT NO: 2023-016	DRAWING NO: 001	REVISION: 03	

Appendix F

Construction Management Plan and Scope Confirmation

City of Ottawa Preliminary Construction Management Plan:
 Will this construction require the temporary detour of a bus route? NO
 Will this work block a bike lane? NO
 Will this work block a sidewalk? NO
 Will this work require a lane of traffic to be closed? NO
 Will this work require a road closure? Yes, on Dairy Road for Municipal Service Connections.



Notes:

Key Plan:

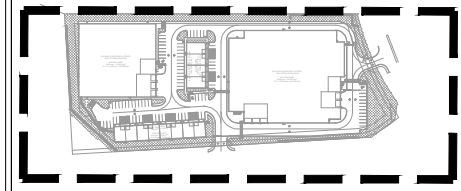

LEGEND

- ANTICIPATED CONSTRUCTION FENCE LINE
- MUNICIPAL SERVICE CONNECTION CONSTRUCTION AREA

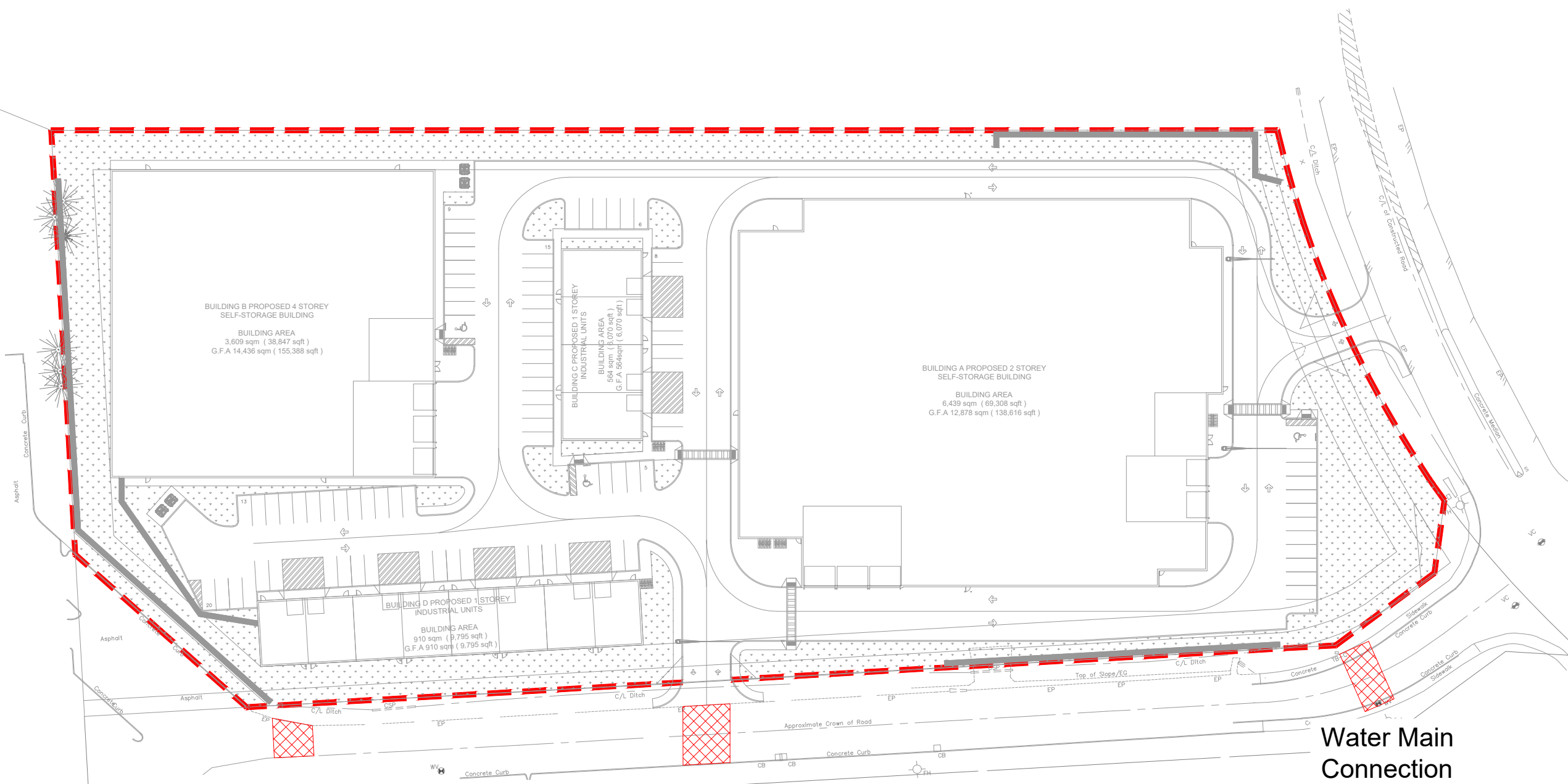

Storm Sewer Connection

Sanitary Sewer and
Water Main Connection

Water Main
Connection

03	Issued for Review:	EW	10/12/2024
REV:	DESCRIPTION:	BY:	DATE:
STATUS:			

CGH Transportation
 6 Plaza Court
 Ottawa, ON
 K2H 7W1
 (343) 999-9117

CLIENT: The Effort Trust Company

ARCHITECT:

SITE:
1015 Dairy Drive

TITLE:
Conceptual Construction
Management Plan

SCALE AT A3: NTS	DATE: 11/12/2024	DRAWN: EW	CHECKED: VZ
PROJECT NO: 2023-016	DRAWING NO: 001	REVISION: 03	

Viktoriya Zaytseva

From: Amade, Pagamo <pagamo.amade@ottawa.ca>
Sent: November 29, 2024 3:11 PM
To: Kaushal Desai
Cc: Viktoriya Zaytseva
Subject: RE: Construction Management Plan Questions - Site Plan Control Application 1015 and 1045 Dairy Drive; D07-12-24-0122 (PC2024-04200)

Good afternoon Kaushal,

Thank you for your email. The summary is accurate.

Please feel free to contact me if you have any questions or concerns. Thanks again.

Pagamo David Amade, PMP

Specialist, Traffic Management Construction
Public Works Dept. | City of Ottawa
Tel: 613-266-1100
Email: pagamo.amade@ottawa.ca

From: Kaushal Desai <kaushal.desai@cghtransportation.com>
Sent: November 28, 2024 4:19 PM
To: Amade, Pagamo <pagamo.amade@ottawa.ca>
Cc: Viktoriya Zaytseva <viktoriya.zaytseva@cghtransportation.com>
Subject: Construction Management Plan Questions - Site Plan Control Application 1015 and 1045 Dairy Drive; D07-12-24-0122 (PC2024-04200)

CAUTION: This email originated from an External Sender. Please do not click links or open attachments unless you recognize the source.

ATTENTION : Ce courriel provient d'un expéditeur externe. Ne cliquez sur aucun lien et n'ouvrez pas de pièce jointe, excepté si vous connaissez l'expéditeur.

Hi Pagamo,

Thank you for meeting with us yesterday. Please see below a summary of key takeaways from our conversation below:

- The Construction Management Plan consists of a written and a drawing component. The written component is called a checklist and includes answers to the four questions about site's construction impacts on the municipal ROW. Where impacts are anticipated, the location of impacts should be identified within the drawing component of the Construction Management Plan. These drawings are not the same as OTM book based TCP drawings, but rather schematic drawings showing location of impacts (i.e. location of scaffolding, a road cut for watermain, etc.). No TCP drawings are required to meet the Construction Management Plan requirements as these would be completed at later stages of the process.
- Additionally, construction impacts on roadway, bus routes, bike lanes, or sidewalks as a result of opening an access or modifying a road do not need to be covered within the Construction

Management Plan checklist, as these are dealt with through a Temporary Access Permit process, and a Road Modification Approval process, respectively.

Please let us know if you have any comments,
Thank you,



Kaushal Desai, BSc, BEng
CGH Transportation Inc.
P: 416-473-7297
E: Kaushal.Desai@CGHTransportation.com

This e-mail originates from the City of Ottawa e-mail system. Any distribution, use or copying of this e-mail or the information it contains by other than the intended recipient(s) is unauthorized. Thank you.

Le présent courriel a été expédié par le système de courriels de la Ville d'Ottawa. Toute distribution, utilisation ou reproduction du courriel ou des renseignements qui s'y trouvent par une personne autre que son destinataire prévu est interdite. Je vous remercie de votre collaboration.

Appendix G

MMLOS Analysis

Multi-Modal Level of Service - Segments Form

Consultant	CGH Transportation
Scenario	Existing/Future
Comments	

Project	2023-016
Date	17-Jan-24

SEGMENTS			Old Montreal Road	Dairy Drive	Section
			Existing/Future	Existing/Future	3
Pedestrian	Sidewalk Width	-	no sidewalk	no sidewalk	
	Boulevard Width		n/a	n/a	
	Avg Daily Curb Lane Traffic Volume		≤ 3000	≤ 3000	
	Operating Speed		> 60 km/h	> 50 to 60 km/h	
	On-Street Parking		no	yes	
	Exposure to Traffic PLoS		F	F	-
	Effective Sidewalk Width				
	Pedestrian Volume				
Crowding PLoS	-	-	-		
Level of Service	-	-	-		
Bicycle	Type of Cycling Facility	F	Mixed Traffic	Mixed Traffic	
	Number of Travel Lanes		2-3 lanes total	2-3 lanes total	
	Operating Speed		≥ 60 km/h	≥ 50 to 60 km/h	
	# of Lanes & Operating Speed LoS		F	E	-
	Bike Lane (+ Parking Lane) Width				
	Bike Lane Width LoS		-	-	-
	Bike Lane Blockages				
	Blockage LoS		-	-	-
	Median Refuge Width (no median = < 1.8 m)		< 1.8 m refuge	< 1.8 m refuge	
	No. of Lanes at Unsignalized Crossing		≤ 3 lanes	≤ 3 lanes	
	Sidestreet Operating Speed		>60 to <65 km/h	>50 to 60 km/h	
Unsignalized Crossing - Lowest LoS	D	B	-		
Level of Service	F	E	-		
Transit	Facility Type	-			
	Friction or Ratio Transit:Posted Speed				
	Level of Service		-	-	-
Truck	Truck Lane Width	B	> 3.7 m		
	Travel Lanes per Direction		1		
	Level of Service		B	-	-