

LEGEND:

	SITE PROPERTY LINE
	PROPOSED NEW PROPERTY LINE DUE TO RIGHT-OF-WAY WIDENING
	STRUCTURE TO BE REMOVED
	SEWER TO BE REMOVED
	LIGHT POST TO BE REMOVED
	SILT SACK PER DETAIL D1
	PROPOSED SILT FENCE AS PER OPSD 219.110
	EXISTING CURB REMOVAL
	EXISTING FENCE TO BE REMOVED
	ASPHALT REMOVAL
	LANDSCAPE REMOVAL
	CONCRETE REMOVAL
	BOREHOLE LOCATION & ELEVATION
	ID# & WATER LEVEL ELEVATION

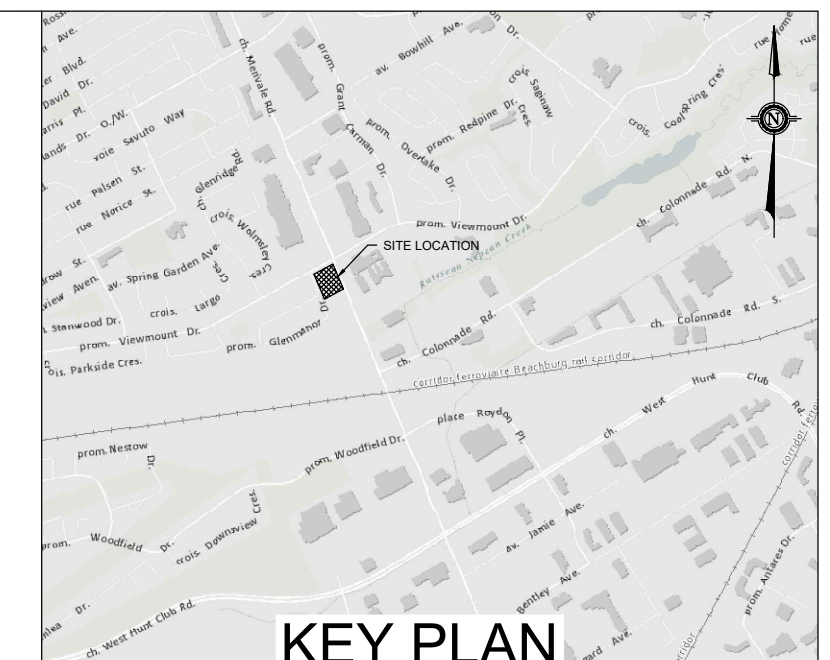

TOPOGRAPHIC INFORMATION & BENCHMARK
 TOPOGRAPHIC SURVEY COMPLETED BY VRSS ON MARCH 20th TO 22nd 2023. ELEVATIONS SHOWN ARE GEODETIC AND ARE REFERRED TO THE CGVD-28 GEODETIC DATUM.

SITE BENCHMARK No. 1 LOCATED ON NORTH WEST INTERSECTION OF MERIVALE ROAD AND VIEWMOUNT DRIVE. FIRE HYDRANT TOP OF NUT ELEVATION = 89.19

LEGAL PLAN
 LEGAL SURVEY COMPLETED BY FARLEY, SMITH & DENIS SURVEYING LTD. ON APRIL 21st, 2023. BEARINGS ARE ASTRONOMIC AND ARE REFERRED TO THE WESTERLY LIMIT OF MERIVALE ROAD HAVING A BEARING OF N 22° 18' 30" W AS SHOWN ON REGISTERED PLAN 401392.

No.	DATE	DESCRIPTION	BY
02	2025-02-19	ISSUED FOR SPA - REV01	M.T.
01	2024-03-21	ISSUED FOR SPA	M.T.

REVISIONS

02/20/2025

100139236

PROVINCE OF ONTARIO

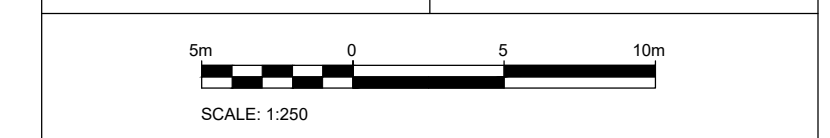

CLIENT
HARNOIS ÉNERGIES

PROJECT
**CONVENIENCE STORE/RESTO
 1660 MERIVALE
 NEPEAN, ONTARIO**

TITLE
**EROSION/ SEDIMENT CONTROL &
 REMOVALS PLAN**

DESIGNED BY	P.C.	PROJECT NO.	478684
DRAWN BY	P.C.		
CHECKED BY	M.T.	C-101	REM
DATE	JANUARY 2024		
SCALE	1:250	DRAWING NO.	DRAWING

EROSION AND SEDIMENT CONTROL MEASURES:

- CONTRACTOR IS RESPONSIBLE FOR ALL INSTALLATION, MONITORING, REPAIR AND REMOVAL OF ALL EROSION AND SEDIMENT CONTROL FEATURES. THE CONTRACTOR SHALL IMPLEMENT BEST MANAGEMENT PRACTICES, TO PROVIDE FOR PROTECTION OF THE AREA DRAINAGE SYSTEM AND THE RECEIVING WATERCOURSE, DURING CONSTRUCTION ACTIVITIES. THE CONTRACTOR ACKNOWLEDGES THAT FAILURE TO IMPLEMENT APPROPRIATE EROSION AND SEDIMENT CONTROL MEASURE MAY BE SUBJECT TO PENALTIES IMPOSED BY ANY APPLICABLE REGULATORY AGENCY.
 - SEDIMENT AND EROSION CONTROL PLAN OBJECTIVES:
 - PREVENT SOIL EROSION. THIS CAN RESULT FROM STREAMING RAIN WATER OR WIND EROSION DURING CONSTRUCTION.
 - PREVENT SEDIMENT DEPOSITS IN THE SEWER PIPES AND NEARBY COLLECTING STREAMS (AS APPLICABLE).
 - PREVENT AIR POLLUTION FROM PARTICULATE MATTER AND DUST.
- 1. PRIOR TO START OF CONSTRUCTION:**
- PRIOR TO THE REMOVAL OF ANY VEGETATIVE COVER, MOVING OF SOIL AND CONSTRUCTION:
 - INSTALL SILT FENCE (AS PER OPSD 219.110) ALONG DITCHES IMMEDIATELY DOWNSTREAM FROM AREAS TO BE DISTURBED (SEE PLAN FOR LOCATION).
 - INSTALL FILTER CLOTH ON DOWNSTREAM MANHOLE COVERS.
 - INSTALL SILT SACK FILTERS IN ALL CONCRETE CATCH BASINS STRUCTURES.
 - INSPECT MEASURES IMMEDIATELY AFTER INSTALLATION.
 - THE CONTRACTOR MUST SET UP THE MEASURES INDICATED ON THE PLAN, INSPECT THEM FREQUENTLY AND CLEAN AND REPAIR OR REPLACE THE DETERIORATED STRUCTURES. AT THE END OF THE CONSTRUCTION PERIOD, THE CONTRACTOR IS RESPONSIBLE FOR REMOVAL OF THE TEMPORARY STRUCTURES AND RECONDITIONING THE AFFECTED AREAS
- 2. DURING CONSTRUCTION:**
- SEDIMENT AND EROSION CONTROL MEASURES TO BE CONSTRUCTED AS PER OPSD 805.
 - WHEN SEDIMENT AND EROSION CONTROL MEASURES MUST BE REMOVED TO COMPLETE A PORTION OF THE WORK, THE SAME MEASURES MUST BE REINSTATED UPON THE WORK'S COMPLETION.
 - WORK TO BE DONE IN THE VICINITY OF MAJOR WATERWAYS TO BE CARRIED OUT FROM JULY AND SEPTEMBER ONLY.
 - MINIMIZE THE EXTENT OF DISTURBED AREAS AND THE DURATION OF EXPOSURE.
 - PROTECT DISTURBED AREAS FROM RUNOFF.
 - PROVIDE TEMPORARY COVER SUCH AS SEEDING OR MULCHING IF DISTURBED AREA WILL NOT BE REHABILITATED SHORTLY.

- INSPECT STRAW BALE FLOW CHECK DAMS, SILT FENCES, SILT SACKS, AND CATCH BASIN SUMPS REGULARLY AND AFTER EVERY MAJOR STORM EVENT. CLEAN AND REPAIR WHEN NECESSARY.
 - PLAN TO BE REVIEWED AND REVISED AS REQUIRED DURING CONSTRUCTION.
 - EROSION CONTROL FENCING TO BE ALSO INSTALLED AROUND THE BASE OF ALL STOCKPILES.
 - DO NOT LOCATE TOPSOIL PILES AND EXCAVATION MATERIAL CLOSER THAN 2.5m FROM ANY PAVED SURFACE, OR ONE WHICH IS TO BE PAVED BEFORE THE PILE IS REMOVED. ALL TOPSOIL PILES ARE TO BE SEEDED IF THEY ARE TO REMAIN ON SITE LONG ENOUGH FOR SEEDS TO GROW (LONGER THAN 30 DAYS). WHEN STORING SOIL ON SITE IN PILES THE CONTRACTOR MUST COVER EACH PILE WITH TARP, STRAW OR A GEOTEXTILE FABRIC TO AVOID FINE PARTICLE TRANSPORT BY WIND AND/OR STREAMING RAIN WATER.
 - CONTROL WIND-BLOWN DUST OFF SITE TO ACCEPTABLE LEVELS BY SEEDING TOPSOIL PILES AND OTHER AREAS TEMPORARILY (PROVIDE WATERING AS REQUIRED). FOR DUST CONTROL, CONTRACTOR TO APPLY CALCIUM CHLORIDE (TYPE I) - OPSD 2501 AND CANCGS8-15-1) AND WATER WITH EQUIPMENT APPROVED BY THE OWNER'S REPRESENTATIVE AT RATE IN ACCORDANCE TO OPSD 506 WHEN DIRECTED BY OWNER'S REPRESENTATIVE.
 - ALL EROSION CONTROL STRUCTURE TO REMAIN IN PLACE UNTIL ALL DISTURBED GROUND SURFACES HAVE BEEN STABILIZED EITHER BY PAVING OR RESTORATION OF VEGETATIVE GROUND COVER. SEDIMENT CAPTURE SILT SACKS MUST BE MAINTAINED AND CANNOT BE REMOVED UNTIL ALL LANDSCAPING AREAS ARE COMPLETED.
 - NO ALTERNATE METHODS OF EROSION PROTECTION SHALL BE PERMITTED UNLESS APPROVES BY THIS CONSULTING ENGINEER AND THE CITY OF OTTAWA DEPARTMENT OF PUBLIC WORKS.
 - CONTRACTOR RESPONSIBLE FOR MUNICIPAL ROADWAY AND SIDEWALK TO BE CLEANED OF ALL SEDIMENT FROM VEHICULAR TRACKING ETC. AT THE END OF EACH WORK DAY.
 - DURING WET CONDITIONS, TIRES OF ALL VEHICLES/EQUIPMENT LEAVING THE SITE ARE TO BE SCRAPPED.
 - ANY MUD/MATERIAL TRACKED ONTO THE ROAD SHALL BE REMOVED IMMEDIATELY BY HAND OR RUBBER TIRE LOADER.
 - TAKE ALL NECESSARY STEPS TO PREVENT BUILDING MATERIAL, CONSTRUCTION DEBRIS OR WASTE BEING SPILLED OR TRACKED ONTO ADJUTING PROPERTIES OR PUBLIC STREETS DURING CONSTRUCTION AND PROCEED IMMEDIATELY TO CLEAN UP ANY AREAS SO AFFECTED.
 - PROVIDE GRAVEL ENTRANCE WHEREVER EQUIPMENT LEAVES THE SITE TO PROVIDE MUD TRACKING ONTO PAVED SURFACES. GRAVEL BED SHALL BE A MINIMUM OF 10m LONG, 4m WIDE, AND 0.15m DEEP AND SHALL CONSIST OF COARSE MATERIAL. MAINTAIN GRAVEL ENTRANCE IN CLEAN CONDITION.
- 3. AFTER CONSTRUCTION:**
- PROVIDE PERMANENT COVER CONSISTING OF TOPSOIL AND SEED TO DISTURBED AREAS.
 - ALL SEDIMENT AND EROSION CONTROL MEASURES TO BE REMOVED BY THE CONTRACTOR FOLLOWING THE COMPLETION OF WORK AND AFTER DISTURBED AREAS HAVE BEEN REHABILITATED AND STABILIZED. THIS INCLUDES REMOVE STRAW BALE FLOW CHECK DAMS, SILT FENCES AND FILTER CLOTHS ON CATCH BASINS AND MANHOLE COVERS.
 - INSPECT AND CLEAN CATCH BASIN SUMPS AND STORM SEWERS.

NOTES: REMOVALS AND DEMOLITION

- PRE-REMOVAL, THE CONTRACTOR MUST VISIT THE PREMISES IN ORDER TO BE FULLY AWARE OF EXISTING CONDITIONS ON SITE, INCLUDING ALL ELEMENTS TO BE REMOVED AND DEMOLISHED. NO CLAIM WILL BE ACCEPTED DUE TO A POOR EVALUATION OF THE WORK TO BE COMPLETED.
- THE CONTRACTOR IS RESPONSIBLE FOR LOCATING AND THE REQUEST FOR INTERRUPTION OF PUBLIC UTILITY SERVICES, SUCH AS GAS, TELEPHONE, POWER, CABLE, SEWERS, WATERMAIN, ETC. BEFORE PROCEEDING WITH WORK. COORDINATE WITH ALL APPLICABLE UTILITY COMPANIES.
- FIRE HYDRANTS TO BE TAGGED AND BAGGED AND/OR PROTECTED AS INDICATED ON DRAWING.
- CURB, ASPHALT, SIDEWALK, AND GRANULAR BASE TO BE EXCAVATED WITHIN LIMITS OF DEMOLITION REMOVAL. THE CONTRACTOR MUST CARRY OUT NECESSARY SAW CUTS.
- SEWER / WATERMAIN PIPES TO BE ABANDONED MUST BE CUT, FILL WITH UNSHRINKABLE CONCRETE CONFORMING TO OPSD 1359, AND CAPPED.
- REMOVE AND DISPOSE SEWERS AS INDICATED. PLUG ANY SERVICE LATERALS TO BE ABANDONED.
- THE CONTRACTOR MUST ENTIRELY REMOVE THE DEMOLITION WRECKAGE FROM THE CONSTRUCTION SITE OFFSITE IN ACCORDANCE WITH THE REQUIREMENTS OF THE MINISTRY OF ENVIRONMENT CONSERVATION AND PARKS (MECP).
 - THE CONTRACTOR MUST DISCARD RECYCLABLE DEMOLITION MATERIALS IN COLLABORATION WITH A REGIONAL RECYCLING COMPANY.
 - ALL OTHER DEMOLITION MATERIALS MUST BE DISPOSED OFF-SITE AT AUTHORIZED LICENSED LANDFILLS AND IN CONFORMITY WITH THE APPLICABLE LAWS AND REGULATIONS. THE CONTRACTOR MUST BE ABLE TO PROVIDE, UPON REQUEST, COPIES OF THE DISPOSAL TICKETS TO THE OWNER'S REPRESENTATIVE.
- SURFACES AND WORKS LOCATED OUTSIDE OF THE CONSTRUCTION WORK LIMIT MUST BE REINSTATED AS THEY WERE BEFORE BEGINNING OF WORK. CONTRACTOR IS RESPONSIBLE TO MAKE GOOD ON ANY DAMAGES TO EXISTING CURB AND ASPHALT NOT SCHEDULED FOR REMOVAL.
- ALL MATERIALS, PRODUCTS AND OTHERS COMING FROM THE DEMOLITION BELONGS TO THE CONTRACTOR, UNLESS SPECIFIED OTHERWISE.
- THE CONTRACTOR MUST COMPLETE ALL REMOVALS AS SHOWN ON THE DRAWINGS AND AS REQUIRED TO MAKE THE WORK COMPLETE.
- THE CONTRACTOR MUST PROTECT AND MAINTAIN IN SERVICE THE EXISTING WORKS WHICH MUST REMAIN IN PLACE. IF THEY ARE DAMAGED, THE CONTRACTOR MUST IMMEDIATELY MAKE THE REPLACEMENTS AND NECESSARY REPAIRS TO THE SATISFACTION OF THE OWNER'S REPRESENTATIVE AND WITHOUT ADDITIONAL EXPENSE TO THE OWNER.
- THE CONTRACTOR MUST NOT PERFORM ANY TREE CUTTING DURING THE CORE MIGRATORY BIRDS NESTING PERIOD, WHICH IS APRIL 15 TO AUGUST 15.

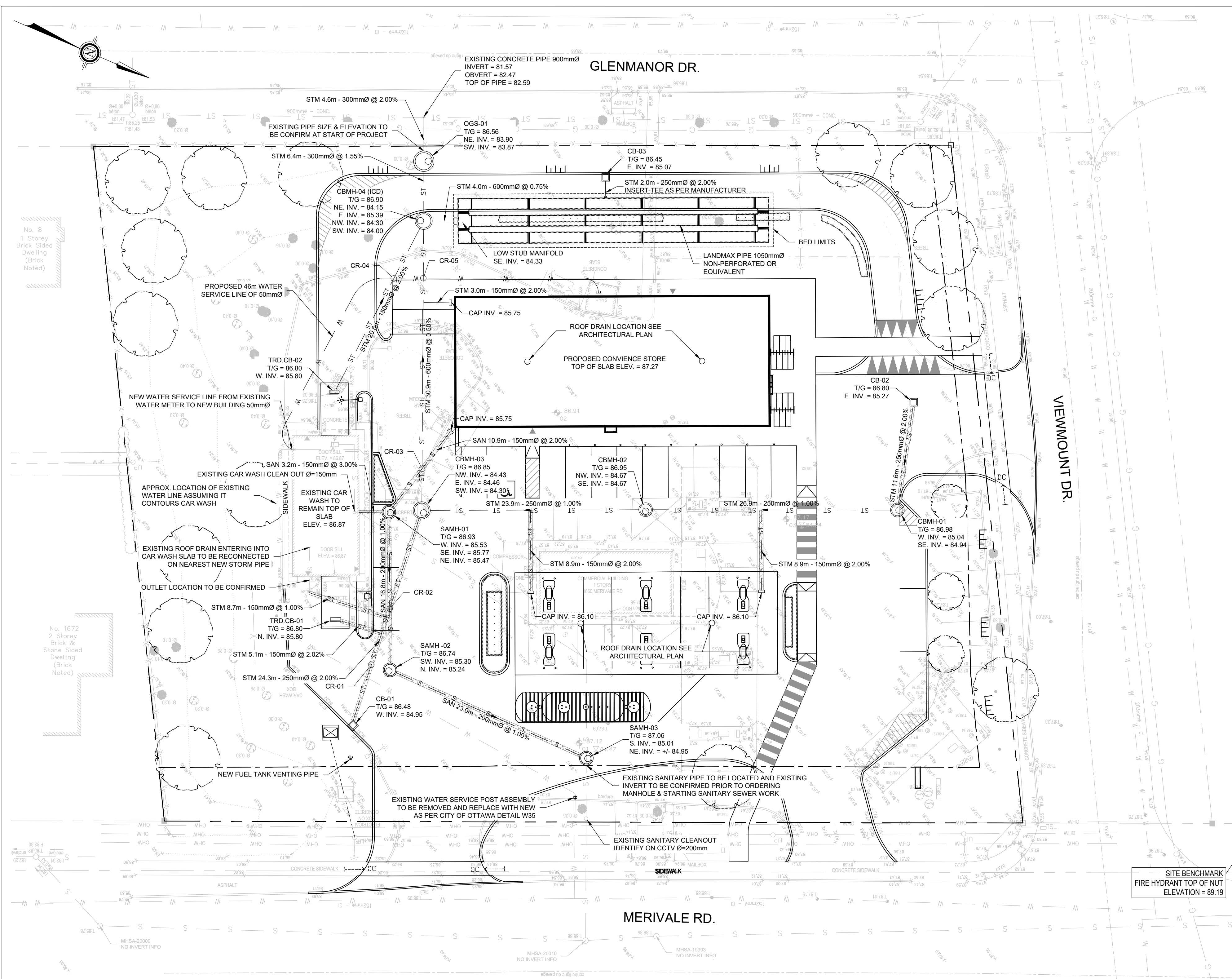

LEGEND:

- SITE PROPERTY LINE
- - - - PROPOSED NEW PROPERTY LINE DUE TO RIGHT-OF-WAY WIDENING
- EXISTING OVER HEAD HYDRO LINE
- EXISTING GAS LINE
- EXISTING WATERMAIN
- EXISTING FIRE HYDRANT
- EXISTING VALVE COVER
- PROPOSED WATERMAIN
- EXISTING SANITARY SEWER AND MAINTENANCE HOLE
- PROPOSED SANITARY SEWER AND MAINTENANCE HOLE
- EXISTING STORM SEWER AND MAINTENANCE HOLE
- EXISTING STORM CATCH BASIN
- PROPOSED STORM SEWER AND MAINTENANCE HOLE
- PROPOSED CATCH BASIN
- PROPOSED TRENCH DRAIN
- PIPE INSULATION REQUIRED AS PER CITY OF OTTAWA DETAIL S35

CROSSING TABLE

CROSSING NO.	TOP OF PIPE ELEV. AT CROSSING	PIPE INV. ELEV. AT CROSSING	CLEARANCE (m)
CR-01	WM. TOP 84.35	STM. INV. 84.82	0.47
CR-02	STM. TOP 84.95	SAN. INV. 85.37	0.41
CR-03	STM. TOP 84.88	SAN. INV. 85.65	0.77
CR-04	WM. TOP 84.66	STM. INV. 86.10	1.44
CR-05*	WM. TOP 83.88	STM. INV. 84.18	0.30

*50mmØ WATER SERVICE LINE TO BE DIVERTED AS PER CITY OF OTTAWA DETAIL W38

ICD SCHEDULE (ORIFICE)

ICD ID	LOCATION	ORIFICE INVERT (m)	FLOW 5y/100y (L/s)	HEAD 5y/100y (m)	EQUIVALENT DIAMETER (mm)	MODEL
01	CBMH-04	84.00	33.4/44.3	0.72/1.31	135	FRAME & PLATE CONTROL

*ICD SHOP DRAWING SHALL BE SUBMITTED TO PARSONS BEFORE COMMENCING ANY WORK

ROOF TOP DRAIN INFORMATION

BUILDING	ROOFTOP VOLUME (m³)	MAX DEPTH OF FLOW (mm)	LOCATION OF ROOF DRAIN AND SCUPPERS	NUMBER OF ROOF DRAINS	FLOW PER ROOF DRAIN (L/s)	TOTAL FLOW FROM ROOF (L/s)
A - PROPOSED CONVENIENCE STORE	6.2 / 5-yr 14.4 / 100-yr	96.7 / 5-yr 127.6 / 100-yr	SEE LOCATION ON PLAN	2	1.49 / 5-yr 1.96 / 100-yr	2.98 / 5-yr 3.92 / 100-yr
B - EXISTING CAR WASH	0.6 / 5-yr 1.4 / 100-yr	68.8 / 5-yr 97.0 / 100-yr	AS PER EXISTING CONDITIONS	2	1.03 / 5-yr 1.45 / 100-yr	2.06 / 5-yr 2.90 / 100-yr
C - PROPOSED GAS PUMP CANOPY	3.4 / 5-yr 8.0 / 100-yr	90.2 / 5-yr 120.4 / 100-yr	SEE LOCATION ON PLAN	2	1.35 / 5-yr 1.80 / 100-yr	2.70 / 5-yr 3.60 / 100-yr

- NOTES: SEWER**
- ALL CATCH BASIN, TRENCH DRAIN, MAINTENANCE HOLE COVERS AND OTHER STORM SEWER CONNECTION SHALL BE EQUIPPED WITH NITRILE RUBBER GASKET.
 - CONTRACTOR TO CONFIRM ELEVATION OF EXISTING STORM AND SANITARY SEWERS AT PROPOSED CONNECTION POINTS AND REPORT ANY DISCREPANCIES TO THE ENGINEER BEFORE COMMENCING ANY WORK.
 - ALL WORK SHALL BE PERFORMED, AS APPLICABLE IN ACCORDANCE WITH OPSS 407, AND 410.
 - PIPE MATERIAL TO BE PVC SDR-35 AND CONFORMING TO OPSS 1841, UNLESS INDICATED OTHERWISE. PVC SEWERS TO BE INSTALLED PER OPSS 802.010 (MODIFIED), BEDDING AND COVER MATERIALS TO BE OPSS 1010 GRANULAR 'A' CRUSHER-RUN LIMESTONE BEDDING COMPACTED TO 95% SPMD.
 - ALL SEWERS WITH LESS THAN 1.8 METERS OF COVER ARE SUBJECTED TO INSULATION DETAIL, S35 OF THE CITY OF OTTAWA ON DRAWING C-104
 - PIPE BACKFILL MATERIAL TO BE APPROVED NATIVE MATERIAL OR SELECT SUBGRADE MATERIAL IN CONFORMANCE WITH OPSS 212
 - ALL MAINTENANCE HOLES AND CATCH BASIN MAINTENANCE HOLES TO BE 1200mmØ AS PER OPSS 701.010, UNLESS INDICATED OTHERWISE. MAINTENANCE HOLES AND CATCH BASIN MAINTENANCE HOLES TO BE INSTALLED PER OPSS 407.
 - ALL CATCH BASINS TO BE 600x600mm AS PER OPSS 705.010, UNLESS INDICATED OTHERWISE. CATCH BASINS TO BE INSTALLED PER OPSS 407.
 - EXCAVATING, BACKFILLING, AND COMPACTING REQUIRED FOR MAINTENANCE HOLES, CATCH BASIN MAINTENANCE HOLES, AND CATCH BASINS TO BE COMPLETED AS PER OPSS 402. THEY ARE TO BE BACKFILLED WITH OPSS GRANULAR 'B' COMPACTED TO 95% SPMD. JOINTS BETWEEN SECTIONS TO BE WRAPPED WITH NON-WOVEN GEOTEXTILE. FOR SANITARY STRUCTURES: CAST IRON MAINTENANCE HOLE COVER AS PER OPSS 401.010 TYPE 'A'.
 - FOR STORM STRUCTURES: CAST IRON CATCH BASIN MAINTENANCE HOLE COVER AS PER OPSS 401.010 TYPE 'B' AND CAST IRON CATCH BASIN COVER AS PER OPSS 400.020.
 - SANITARY MAINTENANCE HOLES REQUIRE BENCHING AS PER OPSS 701.021.
 - THE CONTRACTOR IS RESPONSIBLE FOR MAKING OR ARRANGING ALL CONNECTIONS TO THE EXISTING SEWERS AS PER MUNICIPAL REQUIREMENTS. PRIOR TO CONNECTION, THE CONTRACTOR MUST PROVIDE, TO THE CONSULTANT / ENGINEER AND THE CITY FOR APPROVAL, ALL TEST RESULTS PERFORMED ON THE INTERNAL SERVICES.
 - ADVISE THE CITY PUBLIC WORKS AT LEAST 72 HOURS IN ADVANCE BEFORE ANY CONNECTION TO THE CITY SERVICES. CO-ORDINATE WITH CITY OF OTTAWA AS REQUIRED.
 - TERMINATE AND PLUG ALL SERVICE CONNECTIONS AT 1.0 m FROM EDGE OF THE BUILDING.
 - ALL SEWERS TO BE C.C.T.V. INSPECTED BY THE CONTRACTOR AS PER OPSS 409. TWO COPIES OF THE INSPECTION REPORT MUST BE PROVIDED TO THE CONSULTANT AND THE C.C.T.V. INSPECTION IN DVD FORMAT ONLY.
 - SUBDRAIN KNOCKOUT (KO) WILL BE PRE-MANUFACTURED WITH CATCH BASINS AND MAINTENANCE HOLES.
 - THE STORMWATER TSS QUALITY REQUIREMENTS WILL BE ACHIEVED BY INSTALLING AN EFO-04 OR EQUIVALENT TO ACHIEVE 80% TSS REMOVAL. THE OIL/GREASE SEPARATOR IS TO HAVE A SEDIMENT CAPACITY OF 1190L, AN OIL CAPACITY OF 265L, AND FOR A MAXIMUM TREATMENT FLOW RATE OF 12.9 L/s.
 - OGS WILL REQUIRE PERIODIC MAINTENANCE AND CLEANING AS PER MANUFACTURERS SPECIFICATIONS - TYPICAL CLEANING INTERVAL IS ONCE A YEAR. ANNUAL CLEANING AGREEMENT NEEDS TO BE WITNESSED BY THE CITY.
 - ALL BUILDINGS FOUNDATION DRAINS TO BE CONNECTED TO THE STORM SEWER DOWNSIDE OF THE ICD.

- NOTES: WATERMAIN**
- ALL WATERMAIN TO BE INSTALLED AT MINIMUM COVER OF 2.4m BELOW FINISHED GRADE, WHERE THE MINIMUM COVER OF 2.4m IS NOT REACHED, THERMAL INSULATION IS REQUIRED AS PER CITY OF OTTAWA DETAIL W22.
 - WATERMAIN PIPE MATERIALS TO BE CLASS PVC DR-18, OR APPROVED EQUIVALENT, UNLESS INDICATED OTHERWISE.
 - WATERMAIN TO BE CONSTRUCTED AS PER OPSS 441 AND OPSS 802.010. WATERMAIN BEDDING AND COVER MATERIAL TO BE OPSS 1010 GRANULAR 'A' CRUSHER-RUN LIMESTONE COMPACTED TO 95% SPMD.
 - A CONTINUOUS 12 GAUGE COPPER TRACER WIRE MUST BE INSTALLED OVER ALL WATERMANS. TRACER WIRE SHALL BE TIED TO ALL FIRE HYDRANTS.
 - INSTALLATION OF A WATERMAIN PIPE CROSSING A SEWER PIPE SHALL BE AS PER CITY OF OTTAWA DETAILS W25 AND W25.2.
 - IF WATERMAIN PIPE MUST BE DEFLECTED TO MEET ALIGNMENT, ENSURE THAT THE AMOUNT OF DEFLECTION USED IS LESS THAN HALF THAT RECOMMENDED BY THE MANUFACTURER.
 - CATHODIC PROTECTION REQUIRED FOR ALL IRON FITTINGS AS PER OPSS 1109.011.
 - THRUST BLOCKS AND RESTRAINING AS PER OPSS 1103.010 AND OPSS 1103.020.
 - HYDRANT INSTALLATION AS PER OPSS 1105.010 AND OPSS 441. HYDRANT TO COMPLY WITH AWWA C502.
 - HYDRANTS MUST HAVE THREE EXITS TWO 65.5 mm AND ONE 100 mm STORZ OF STAINLESS STEEL WITH DRAIN. FIRE HYDRANTS MUST BE INSTALLED SUCH THAT THE STORZ EXIT POINTS TOWARDS THE BUILDING IT WILL SERVICE. THE CONTRACTOR MUST ENSURE THAT THE BREAKAWAY FLANGE IS LOCATED ABOVE THE FINISHED GROUND (APPROXIMATELY 150 mm).
 - FIRE FLOW TESTS FOLLOWED BY COLOUR CODING OF HYDRANTS (AS PER NFPA-291) SHALL BE CARRIED OUT PRIOR TO SUBSTANTIAL COMPLETION OF THE WORK.
 - WATERMAIN AND HYDRANT CONTROL VALVES IN THE 100 - 300 mm RANGE WILL BE RESILIENT SEATING GATE VALVES (AWWA C509) WITH MECHANICAL JOINT CONNECTIONS. VALVES WILL OPERATE COUNTER-CLOCKWISE TO OPEN WITH A NON-RISING STEM. VALVES WILL BE COMPLETE WITH THE STANDARD AWWA 50 mm OPERATING NUT. VALVES TO BE INSTALLED AS PER OPSS 441.
 - PIPE FITTINGS (BENDS, TEES, CROSSES, REDUCERS, ETC.) WILL BE MECHANICAL JOINT (AWWA C-111) WITH CEMENT MORTAR LINING (AWWA C-104).
 - COUPLERS MUST BE COMPRESSION TYPE WITH MINIMUM PRESSURE RATING OF 1035 kPa. COUPLERS MUST BE MUELLER 11-12940.
 - VALVE BOXES MUST BE COMPLETE (FULLY METALLIC) 3 PIECE SLIDING TYPE WITH GUIDE PLATES.
 - WATERMANS MUST BE THOROUGHLY FLUSHED AND CLEANED TO REMOVE ALL DIRT AND DEBRIS PRIOR TO THE DISINFECTATION PROCESS.
 - ALL WATERMANS SHALL BE HYDROSTATICALLY AND BACTERIOLOGICALLY TESTED AS PER PROVINCIAL AND MUNICIPAL REGULATIONS. IT IS THE CONTRACTOR'S RESPONSIBILITY TO ENSURE THAT ALL REQUIREMENTS ARE FOLLOWED.
 - THE DISINFECTATION PROCEDURE WHICH FOLLOWS INITIAL FLUSHING AND CLEANING CONSISTS OF CHLORINATION, FINAL FLUSHING AND BACTERIOLOGICAL TESTING. DISINFECTATION MUST BE PERFORMED BY THE CONTRACTOR USING METHODS APPROVED BY THE CITY OF OTTAWA AND IN ACCORDANCE WITH MINISTRY OF ENVIRONMENT AND CLIMATE CHANGE GUIDELINES. DOSAGE MUST BE 100 ppm WITH A MINIMUM RESIDUAL OF 25 ppm AFTER 24 HOURS. DISINFECTANT MUST BE SUPPLIED BY THE CONTRACTOR AND MUST BE ANSI APPROVED. TESTING AND TEST RESULTS MUST BE WITNESSED BY CITY OF OTTAWA PERSONNEL.

- UNDERGROUND STORMWATER STORAGE**
- UNDERGROUND STORMWATER STORAGE SYSTEM PIPE TYPE OR EQUIVALENT STORAGE REQUIREMENT: 78m³
 - CHAMBER TYPE: LANDMAX 1500mmØ OR EQUIVALENT
 - BOTTOM OF GRANULAR PAD ELEVATION: 84.98m
 - PIPE INVERT ELEVATION: 84.33m
 - PIPE OBVERT ELEVATION: 85.38m
 - TOP OF PIPE ELEVATION: 85.47m
 - TOP OF SYSTEM TO BE A MINIMUM OF 750mm BELOW PARKING LOT PAVEMENT STRUCTURE.
- TRENCH DRAIN REQUIREMENTS:**
- MINIMUM GRATE WIDTH OF 300mm
 - MINIMUM GRATE LENGTH OF 1000mm
 - STEEL OR STAINLESS STEEL GRATE STRONG ENOUGH TO WITHSTAND CAR & TRUCK LOAD, AS PER MANUFACTURER
 - EXPANSION JOINT REQUIRED IN BETWEEN CAR WASH ENTERMENT CONCRETE SLAB AND TRENCH DRAIN
 - SHOP DRAWING BY MANUFACTURER TO BE PROVIDED PRIOR TO INSTALLATION.

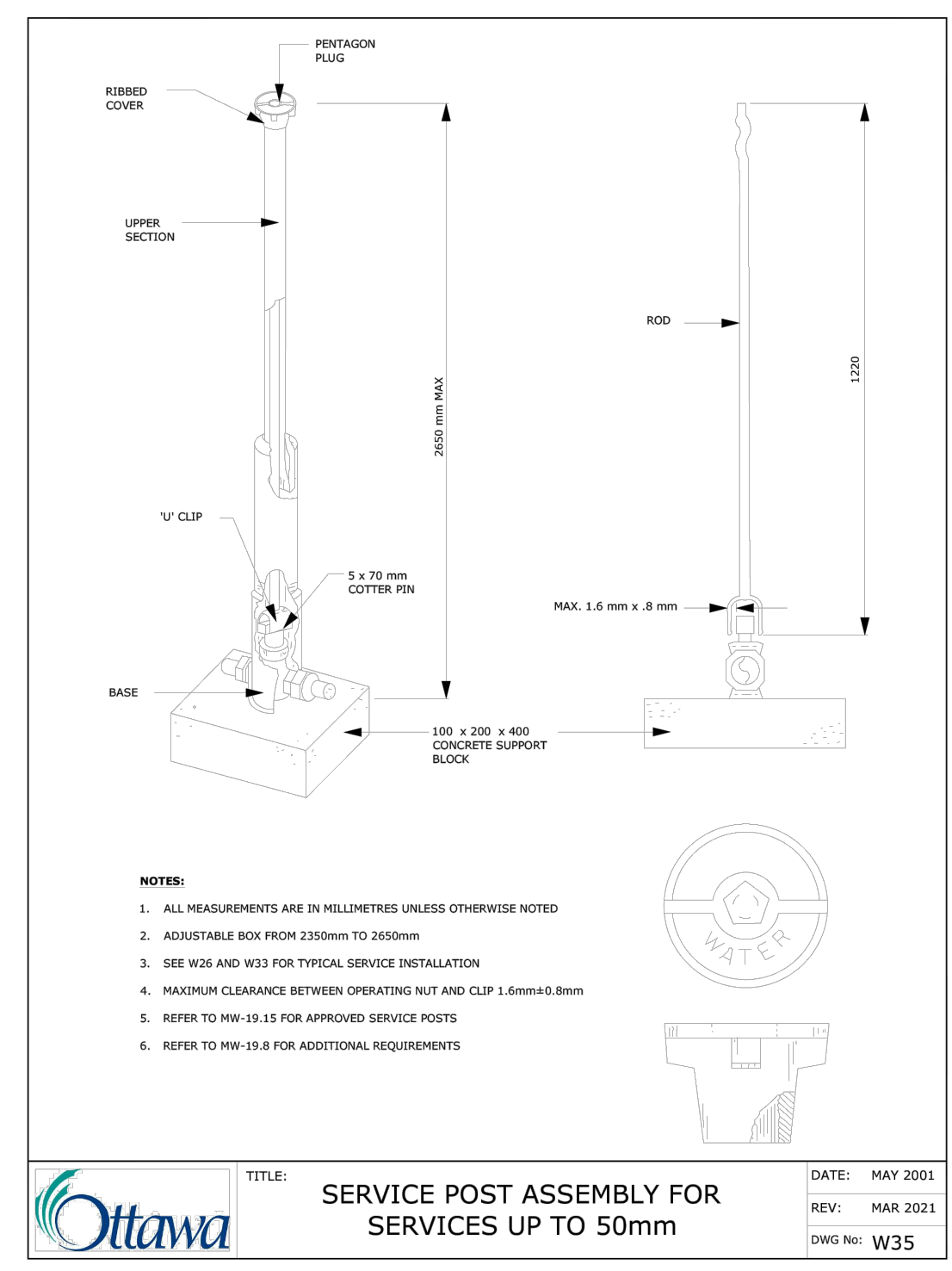

Service Post Assembly For Services Up to 50mm

DATE: MAY 2021
REV: MAR 2021
DWG No: W35

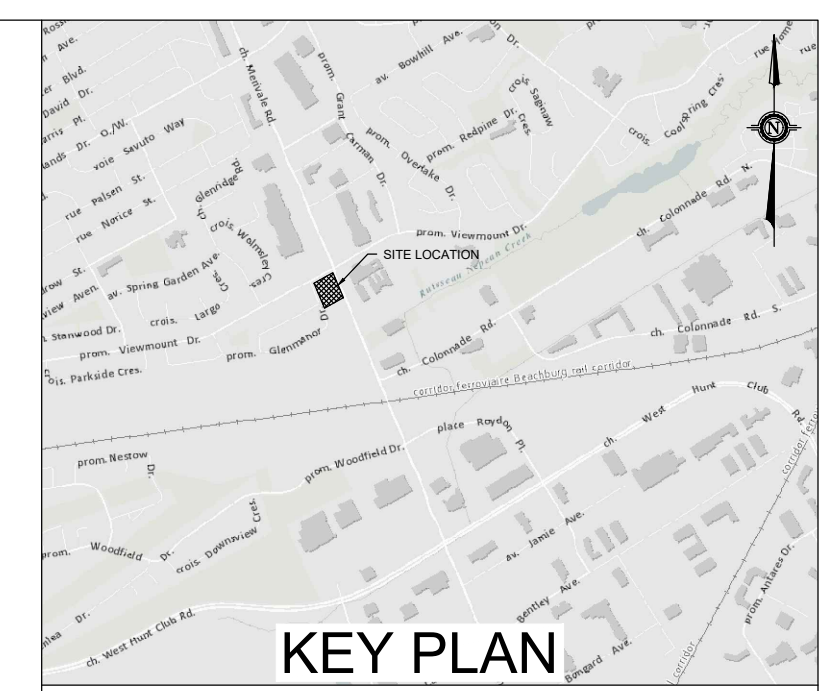

KEY PLAN

TOPOGRAPHIC INFORMATION & BENCHMARK
TOPOGRAPHIC SURVEY COMPLETED BY VRSS ON MARCH 20th TO 22nd, 2023. ELEVATIONS SHOWN ARE GEODETIC AND ARE REFERRED TO THE CGVD-28 GEODETIC DATUM.

LEGAL PLAN
LEGAL SURVEY COMPLETED BY FARLEY, SMITH & DENIS SURVEYING LTD. ON APRIL 21st, 2023. BEARINGS ARE ASTRONOMIC AND ARE REFERRED TO THE WESTERLY LIMIT OF MERIVALE ROAD HAVING A BEARING OF N 22° 18' 30" W AS SHOWN ON REGISTERED PLAN 401392.

No.	DATE	DESCRIPTION	BY
02	2025-02-19	ISSUED FOR SPA - REV01	M.T.
01	2024-03-21	ISSUED FOR SPA	M.T.

REVISIONS

100% PROPOSED
02/20/2025
PROVIDENCE OF DRAINAGE

SCALE: 1:250

PARSONS
1223 Michael Street, Suite 100, Ottawa, Ontario, Canada K1J 1T2
Tel: (613) 738-4160 Fax: (613) 739-7105

HARNOIS ÉNERGIES

PROJECT
CONVENIENCE STORE/RESTO
1660 MERIVALE
NEPEAN, ONTARIO

TITLE
SITE SERVICING PLAN

DESIGNED BY	P.C.	PROJECT NO.	478684
DRAWN BY	P.C.		
CHECKED BY	M.T.	C-102	SS
DATE	JANUARY 2024		
SCALE	1:250	DRAWING NO.	DRAWING

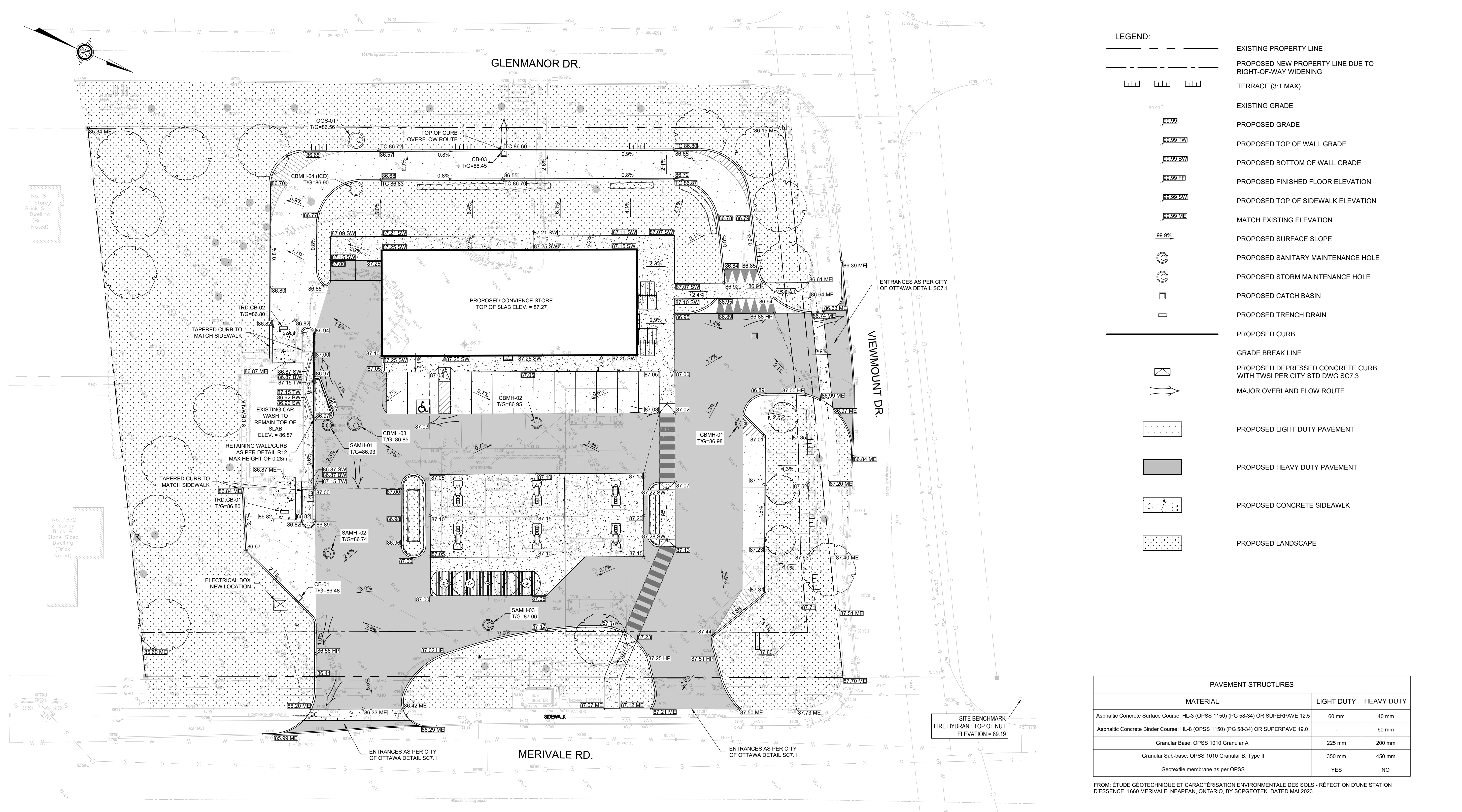

LEGEND:

	EXISTING PROPERTY LINE
	PROPOSED NEW PROPERTY LINE DUE TO RIGHT-OF-WAY WIDENING
	TERRACE (3:1 MAX)
	EXISTING GRADE
	PROPOSED GRADE
	PROPOSED TOP OF WALL GRADE
	PROPOSED BOTTOM OF WALL GRADE
	PROPOSED FINISHED FLOOR ELEVATION
	PROPOSED TOP OF SIDEWALK ELEVATION
	MATCH EXISTING ELEVATION
	PROPOSED SURFACE SLOPE
	PROPOSED SANITARY MAINTENANCE HOLE
	PROPOSED STORM MAINTENANCE HOLE
	PROPOSED CATCH BASIN
	PROPOSED TRENCH DRAIN
	PROPOSED CURB
	GRADE BREAK LINE
	PROPOSED DEPRESSED CONCRETE CURB WITH TWSI PER CITY STD DWG SC7.3
	MAJOR OVERLAND FLOW ROUTE
	PROPOSED LIGHT DUTY PAVEMENT
	PROPOSED HEAVY DUTY PAVEMENT
	PROPOSED CONCRETE SIDEWALK
	PROPOSED LANDSCAPE

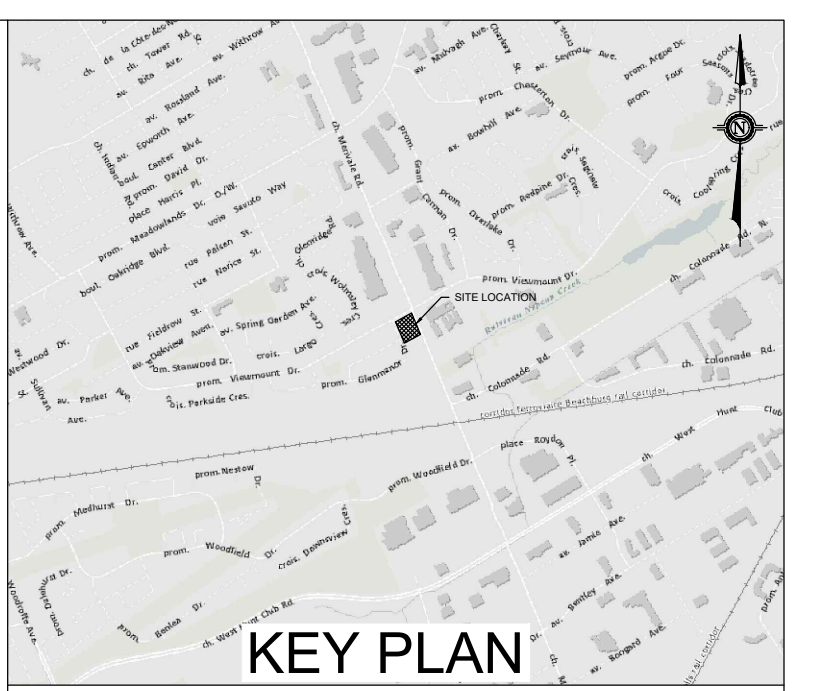

TOPOGRAPHIC INFORMATION & BENCHMARK
 TOPOGRAPHIC SURVEY COMPLETED BY VRSS ON MARCH 20TH TO 22ND 2023. ELEVATIONS SHOWN ARE GEODETIC AND ARE REFERRED TO THE CGVD-28 GEODETIC DATUM.
 SITE BENCHMARK No. 1 LOCATED ON NORTH WEST INTERSECTION OF MERIVALE ROAD AND VIEWMOUNT DRIVE. FIRE HYDRANT TOP OF NUT ELEVATION = 89.19

LEGAL PLAN
 LEGAL SURVEY COMPLETED BY FARLEY, SMITH & DENIS SURVEYING LTD. ON APRIL 21ST, 2023. BEARINGS ARE ASTRONOMIC AND ARE REFERRED TO THE WESTERLY LIMIT OF MERIVALE ROAD HAVING A BEARING OF N 22° 18' 30" W AS SHOWN ON REGISTERED PLAN 401392.

PAVEMENT STRUCTURES

MATERIAL	LIGHT DUTY	HEAVY DUTY
Asphaltic Concrete Surface Course: HL-3 (OPSS 1150) (PG 58-34) OR SUPERPAVE 12.5	60 mm	40 mm
Asphaltic Concrete Binder Course: HL-8 (OPSS 1150) (PG 58-34) OR SUPERPAVE 19.0	-	60 mm
Granular Base: OPSS 1010 Granular A	225 mm	200 mm
Granular Sub-base: OPSS 1010 Granular B, Type II	350 mm	450 mm
Geotextile membrane as per OPSS	YES	NO

FROM: ÉTUDE GÉOTECHNIQUE ET CARACTÉRISATION ENVIRONNEMENTALE DES SOLS - RÉFLECTION D'UNE STATION D'ESSENCE. 1660 MERIVALE, NEAPEAN, ONTARIO, BY SCGEOETC. DATED MAI 2023

No.	DATE	DESCRIPTION	BY
02	2025-02-19	ISSUED FOR SPA - REV01	M.T.
01	2024-03-21	ISSUED FOR SPA	M.T.

REVISIONS

[Signature]
 100%
 02/20/2025
 PROPOSED BY DESIGN

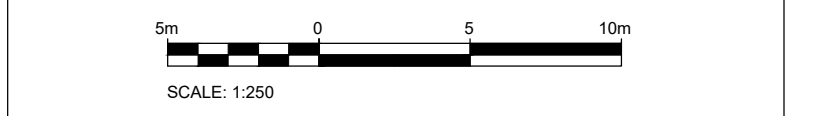

- NOTES: GENERAL**
- THE CONTRACTOR MUST CONFORM TO ALL LAWS, CODES, ORDINANCES, AND REGULATIONS ADOPTED BY FEDERAL, PROVINCIAL OR MUNICIPAL GOVERNMENT COUNCILS AND GOVERNMENT AGENCIES, APPLYING TO WORK TO BE CARRIED OUT. WHEREVER STANDARDS, LAWS AND/OR REGULATIONS ARE MENTIONED THEY REFER TO THEIR CURRENT VERSIONS, MODIFICATIONS INCLUDED.
 - ALL MATERIALS AND CONSTRUCTION METHODS SHALL BE IN ACCORDANCE WITH THE LATEST EDITION OF THE ONTARIO PROVINCIAL STANDARD SPECIFICATIONS AND DRAWINGS (OPSS AND OPSD), THE ONTARIO MINISTRY OF ENVIRONMENT AND CLIMATE CHANGE, THE ONTARIO MINISTRY OF NATURAL RESOURCES, APPLICABLE CONSERVATION AUTHORITIES, THE MUNICIPAL STANDARD SPECIFICATIONS AND DRAWINGS, AND ALL OTHER GOVERNING AUTHORITIES AS THEY APPLY, UNLESS OTHERWISE INDICATED.
 - ALL MATERIAL SUPPLIED AND PLACED FOR PARKING LOT AND ACCESS ROAD CONSTRUCTION SHALL BE TO OPSS STANDARDS AND SPECIFICATIONS UNLESS OTHERWISE NOTED. CONSTRUCTION TO OPSS 206, 310 & 314. MATERIALS TO OPSS 1001, 1003 & 1010.
 - THE LOCATION OF EXISTING UNDERGROUND MUNICIPAL SERVICES AND PUBLIC UTILITIES AS SHOWN ON THE PLANS ARE APPROXIMATE. THE CONTRACTOR MUST DETERMINE THE EXACT LOCATION, SIZE, MATERIAL AND ELEVATION OF ALL EXISTING UTILITIES (ON-SITE AND OFF-SITE) PRIOR TO ANY EXCAVATION WORK. DAMAGE TO ANY EXISTING SERVICES AND/OR EXISTING UTILITIES DURING CONSTRUCTION, WHETHER OR NOT SHOWN ON THE DRAWINGS MUST BE REPAIRED BY THE CONTRACTOR AT HIS OWN EXPENSE.
 - THE CONTRACTOR SHALL DETERMINE THE EXACT INVERT (GEODETIC ELEVATION), DIAMETER AND CONSTRUCTION MATERIAL OF THE EXISTING CONDUITS AT THE PROPOSED CONNECTIONS. THEY SHALL ALSO CARRY OUT, IF NECESSARY, EXPLORATORY DIGS IN ORDER TO DETERMINE THE EXACT LOCATION AND INVERTS OF EXISTING DUCK BANKS. THIS INFORMATION SHALL IMMEDIATELY BE PROVIDED TO THE CONSULTANT PRIOR TO START UNDERTAKING ANY MUNICIPAL SERVICES WORK AND A 48 HOUR PERIOD MUST BE ALLOCATED TO THE CONSULTANT FOR DESIGN REVIEW.
 - AT PROPOSED UTILITY CONNECTION POINTS AND CROSSINGS (I.E. STORM SEWER, SANITARY SEWER, WATER, ETC.) THE CONTRACTOR SHALL DETERMINE THE PRECISE LOCATION AND DEPTH OF EXISTING UTILITIES AND REPORT ANY DISCREPANCIES OR CONFLICTS TO THE ENGINEER BEFORE COMMENCING WORK.
 - CONTRACTOR IS RESPONSIBLE FOR ALL LAYOUT FOR CONSTRUCTION PURPOSES.
 - THE CONTRACTOR IS RESPONSIBLE FOR THE COORDINATION OF ALL WORK AND ACTIVITIES WITH OTHERS TRADES AND CONTRACTORS.
 - THE CONTRACTOR IS THE ONLY PERSON IN CHARGE OF SAFETY ON THE BUILDING SITE. THE CONTRACTOR IS RESPONSIBLE FOR PROVIDING ADEQUATE PROTECTION OF THE WORKERS, OTHER PERSONNEL AND THE GENERAL PUBLIC, PROTECTION OF MATERIALS, AS WELL AS MAINTAINING IN GOOD CONDITION THE COMPLETED WORKS AND WORKS TO BE COMPLETED. THE CONTRACTOR MUST PROVIDE AT ANY TIME.

- A SUFFICIENT NUMBER OF FENCES, BARRIERS, POSTERS, GUARDS AND OTHERS TO ENSURE SAFETY.
- NECESSARY CONVENIENCES FOR THE COMPLETION OF WORK SUCH AS HEATING, LIGHTING, VENTILATION ETC.
- CONTRACTOR IS RESPONSIBLE TO OBTAIN THE VARIOUS PERMITS/APPROVALS REQUIRED TO COMPLETE ALL THE WORKS AND ACTIVITIES AND BEAR COST OF THE SAME, SUCH AS BUT NOT LIMITED TO, ROAD CUT PERMITS, SEWER PERMITS, WATER PERMIT, ETC. AND THEIR ASSOCIATED COSTS.
- ALL ELEVATIONS ARE GEODETIC AND UTILIZE METRIC UNITS.
- JOB BENCH MARK - CONFORM WITH PARSONS PRIOR TO UTILIZATION. THE CONTRACTOR MUST MAINTAIN BENCHMARKS AND LANDMARK REFERENCES AS IS. OTHERWISE THESE REFERENCES WILL BE REPOSITIONED BY A CERTIFIED LAND SURVEYOR AT THE CONTRACTOR'S EXPENSE.
- ALL GROUND SURFACES SHALL BE EVENLY GRADED WITHOUT PONDING AREAS AND LOW POINTS EXCEPT WHERE APPROVED SWALE OR CATCH BASIN OUTLETS ARE PROVIDED.
- IF GROUNDWATER IS ENCOUNTERED DURING CONSTRUCTION, DEWATERING OF EXCAVATIONS COULD BE REQUIRED. IT IS ASSUMED THAT GROUNDWATER MAY BE CONTROLLED BY SUMP AND PUMPING METHODS. THE CONTRACTOR SHALL OBTAIN A PERMIT TO TAKE WATER IF SITE CONDITIONS REQUIRE TAKING MORE THAN A TOTAL OF 400 000 L/DAY.
- STRIP AND REMOVE ALL TOPSOIL FROM IMPROVED AREAS. SITE PREPARATION INCLUDES CLEARING, GRUBBING, STRIPPING OF TOPSOIL, DEMOLITION, REMOVAL OF UNSUITABLE MATERIALS, CUT, FILL AND ROUGH GRADING OF ALL AREAS TO RECEIVE FINISHED SURFACES.
- ABUTTING PROPERTY GRADE TO BE MATCHED.
- ALL EDGES OF DISTURBED PAVEMENT SHALL BE SAW CUT TO FORM A NEAT AND STRAIGHT LINE PRIOR TO PLACING NEW PAVEMENT. PAVEMENT REINSTATEMENT SHALL BE WITH STEP JOINTS OF 300mm WIDTH MINIMUM.
- CURBS TO BE BARRIER, CONSTRUCTED AS PER OPSS 600.110, EXCEPT WHERE INDICATED OTHERWISE. ELEVATION AT TOP OF CONCRETE CURBS TO BE 150 mm ABOVE THE ASPHALT, UNLESS OTHERWISE INDICATED ON THE DRAWINGS.
- DEPRESSED CURBS TO BE MOUNTABLE, CONSTRUCTED AS PER OPSS 600.100.
- LIGHT DUTY AND HEAVY DUTY ASPHALT PAVEMENTS TO BE CONSTRUCTED AS PER TABLE ON DRAWING C103.
- TRANSITION BETWEEN EXISTING AND PROPOSED PAVEMENT SHALL BE CONSTRUCTED AS PER DETAIL D3 ON DRAWING C104.
- RESTORE PAVEMENT STRUCTURE AND SURFACES ON EXISTING ROADS TO A CONDITION AT LEAST EQUAL TO ORIGINAL AND TO THE SATISFACTION OF THE CITY AUTHORITIES.
- CLEANLINESS ON THE SITE. INCLUDES THE CONTRACTOR SHALL CLEAN ROADWAYS AT HIS OWN COST AS DIRECTED BY THE OWNER'S REPRESENTATIVE. MATERIALS AND EQUIPMENT MUST BE LAID OUT IN AN ORGANIZED AND SAFE MANNER, AND ALL MATERIAL, EQUIPMENT AND TEMPORARY STRUCTURES WHICH ARE NO LONGER NECESSARY FOR THE EXECUTION OF THE CONTRACT MUST BE REMOVED FROM THE SITE.

- CONTRACTOR TO ENSURE MITIGATION MEASURES ARE IMPLEMENTED TO REDUCED THE RISK OF GROUND CONTAMINATION FROM PETROLEUM PRODUCTS.
- THE CONTRACTOR MUST ENSURE THE FOLLOWING MEASURES ARE IMPLEMENTED REGARDING THE HANDLING OF CONCRETE
 - CONCRETE SHOULD EITHER BE MIXED AWAY FROM THE SITE OR SHOULD BE PREPARED ON PAVED SURFACES IF ONLY SMALL QUANTITIES ARE REQUIRED (I.E. MINOR REPAIRS); EXCESS CONCRETE MUST BE DISPOSED OFF-SITE AT A LOCATION THAT MEETS ALL REGULATORY REQUIREMENTS.
 - THE WASHING OF CONCRETE TRUCKS AND OTHER EQUIPMENT USED FOR MIXING CONCRETE SHOULD NOT BE CARRIED OUT WITHIN 30 METERS OF A WATERCOURSE OR WETLAND AND SHOULD TAKE PLACE OUTSIDE OF THE WORK SITE.
 - ALL CONCRETE TRUCKS SHOULD COLLECT THEIR WASH WATER AND RECYCLE IT BACK INTO THEIR TRUCKS FOR DISPOSAL OFF-SITE AT A LOCATION MEETING ALL REGULATORY REQUIREMENTS.
- THE CONTRACTOR SHALL ENSURE THAT ALL EXCAVATED SURPLUS MATERIALS THAT WILL BE REQUIRED TO BE DISPOSED OFFSITE BE STOCKPILED TEMPORARILY FOR SAMPLING PRIOR BEING LOADED OFF SITE.
- MINIMIZE DISTURBANCE TO EXISTING VEGETATION DURING THE EXECUTION OF ALL WORKS.
- TRENCHING, BACKFILLS AND COMPACTING MUST CONFORM TO OPSS 401.
- DEWATERING OF PIPELINE, UTILITY AND ASSOCIATED STRUCTURE EXCAVATIONS TO BE COMPLETED AS PER OPSS 917.
- THE CONTRACTOR MUST CONTROL SURFACE RUNOFF FROM PRECIPITATION DURING CONSTRUCTION. FOR ALL GEOTECHNICAL WORK, CONTRACTOR TO REFER TO "GEOTECHNICAL INVESTIGATION, PROPOSED RESIDENTIAL DEVELOPMENT, 5581 DOCTOR LEACH DRIVE, OTTAWA, ONTARIO, BY PINCHIN LTD. DATED OCTOBER 12 2022
- REMOVE FROM SITE ALL EXCESS EXCAVATED MATERIAL UNLESS OTHERWISE DIRECTED FROM THE ENGINEER. EXCAVATE AND REMOVE ALL ORGANIC MATERIAL AND DEBRIS LOCATED WITHIN THE PROPOSED BUILDING, PARKING AND ROADWAY LOCATIONS.
- THE CONTRACTOR IS RESPONSIBLE FOR ALL EXCAVATION, BACKFILL AND REINSTATEMENT OFF ALL AREAS DISTURBED DURING CONSTRUCTION TO EXISTING CONDITIONS OR BETTER AND ALL ASSOCIATED WORKS TO THE SATISFACTION OF THE CONSULTANT AND MUNICIPAL AUTHORITIES. ASPHALT REINSTATEMENT MUST BE IN ACCORDANCE WITH OPSS 310. LANDSCAPE AREAS TO BE REINSTATED WITH 150 mm OF TOPSOIL AND SOD IN ACCORDANCE WITH OPSS 802 AND OPSS 803.
- DURING THE CONSTRUCTION PERIOD THE CONTRACTOR IS RESPONSIBLE FOR INSTALLING AND MAINTAINING TEMPORARY TRAFFIC SIGNAGE, INCLUDING TRAFFIC SIGNS, TRAFFIC MARKINGS AND TEMPORARY TRAFFIC LIGHTS, AND FLAGMEN, AS REQUIRED BY THE OWNER, THE CONSULTANT, THE MUNICIPALITY, THE MTO, AND OTHER GOVERNING AUTHORITIES.
- CONSTRUCT SIDEWALK EXPANSION JOINTS & CONTROL JOINTS AS PER OPSS 310.020.

- CONSTRUCT CONCRETE SIDEWALK AS PER OPSS 310.020 AND OPSS 351. TACTILE WALKING SURFACE INDICATORS PER OPSS 351.
- DISPOSE OF CONTAMINATED MATERIALS AT APPROPRIATE OFF-SITE FACILITY THAT MEETS ALL REGULATORY REQUIREMENTS.
- BE PREPARED TO INTERCEPT, CLEAN UP, AND DISPOSE OF SPILLS OR RELEASES THAT MAY OCCUR WHETHER ON LAND OR WATER. MAINTAIN MATERIALS AND EQUIPMENT REQUIRED FOR CLEANUP OF SPILLS OR RELEASES READILY ACCESSIBLE ON SITE.
- PROMPTLY REPORT SPILLS AND RELEASES POTENTIALLY CAUSING DAMAGE TO ENVIRONMENT TO: AUTHORITY HAVING JURISDICTION OR INTEREST IN SPILL OR RELEASE INCLUDING CONSERVATION AUTHORITY, WATER SUPPLY AUTHORITIES, DRAINAGE AUTHORITY, ROAD AUTHORITY, AND FIRE DEPARTMENT.
- DECONTAMINATE EQUIPMENT AFTER WORKING IN POTENTIALLY CONTAMINATED WORK AREAS AND PRIOR TO SUBSEQUENT WORK OR TRAVEL ON CLEAN AREAS.
- CONTRACTOR IS TO SUBMIT A TRAFFIC MANAGEMENT PLAN FOR APPROVAL ONE (1) WEEK PRIOR TO ANY WORK WITHIN THE ROW LIMITS TO MEET THE REQUIREMENTS OF MTO BOOK 7. THE CONTRACTOR WILL BE REQUIRED TO IMPLEMENT ALL REQUIREMENTS OF THE MTO BOOK 7.
- CITY PUBLIC WORKS DEPARTMENT TO BE CONTACTED MINIMUM 7 DAYS PRIOR TO PLANNED DATE FOR CONNECTION TO EXISTING STORM SEWERS, SANITARY SEWERS, AND WATERMAIN. CONNECTION TO EXISTING TO TAKE PLACE IN THE PRESENCE OF APPROPRIATE CITY OF OTTAWA STAFF.
- ALL THREE SITE ENTRANCES TO BE INSTALLED AS PER CITY OF OTTAWA STANDARD DETAIL SC7.1

PARSONS
 1223 Michael Street, Suite 100, Ottawa, Ontario, Canada K1J 1T2
 Tel: (613) 738-4160 Fax: (613) 739-7105

CLIENT
HARNOIS ÉNERGIES

PROJECT
**CONVENIENCE STORE/RESTO
 1660 MERIVALE
 NEPEAN, ONTARIO**

FILE
GRADING PLAN

DESIGNED BY	P.C.	PROJECT NO.	478684
DRAWN BY	P.C.		
CHECKED BY	M.T.	C-103	GR
DATE	JANUARY 2024		
SCALE	1:250	DRAWING NO.	DRAWING

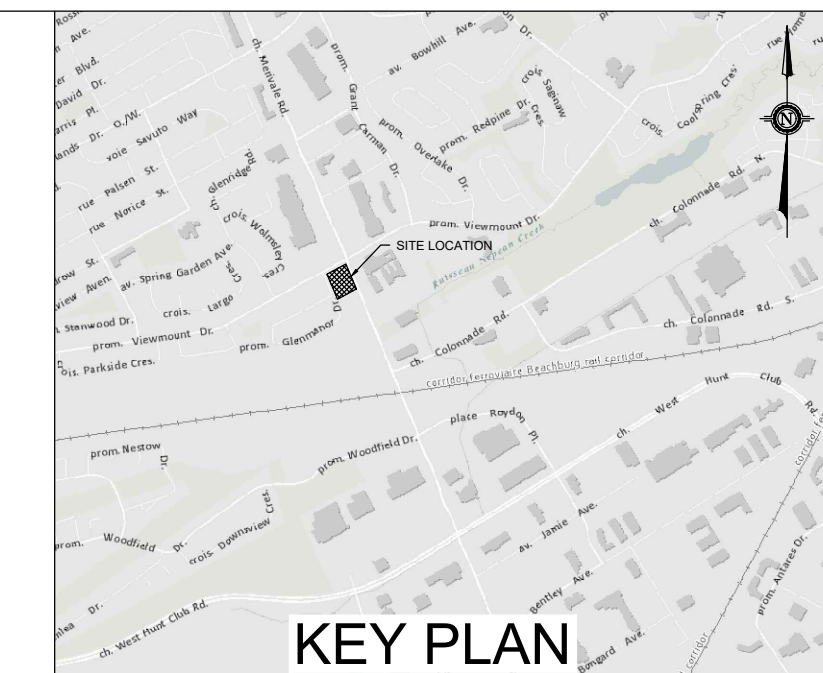
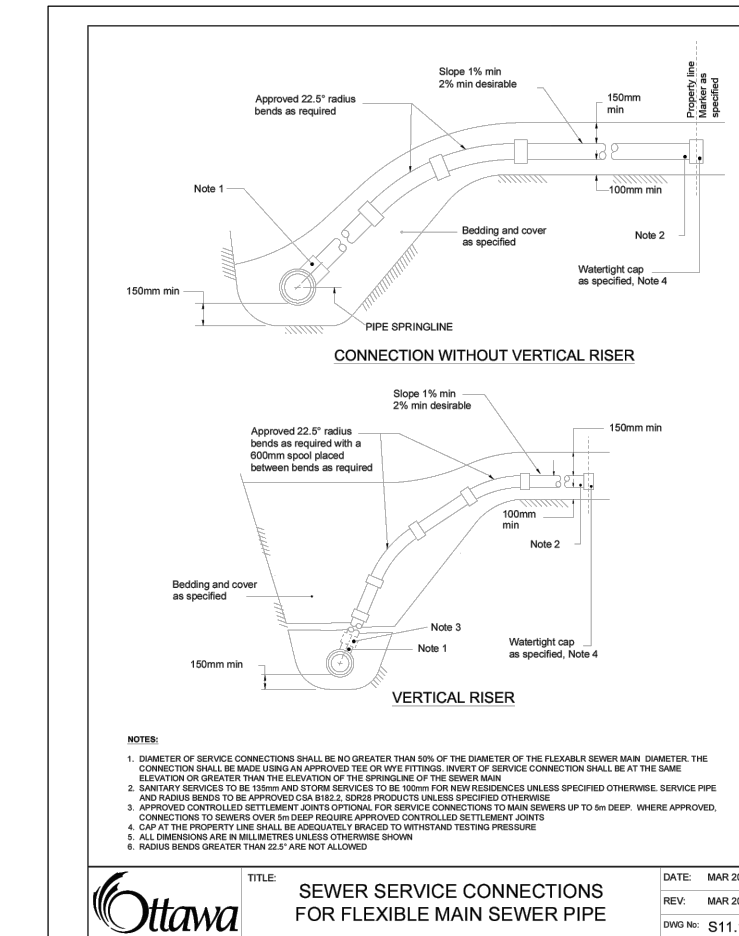
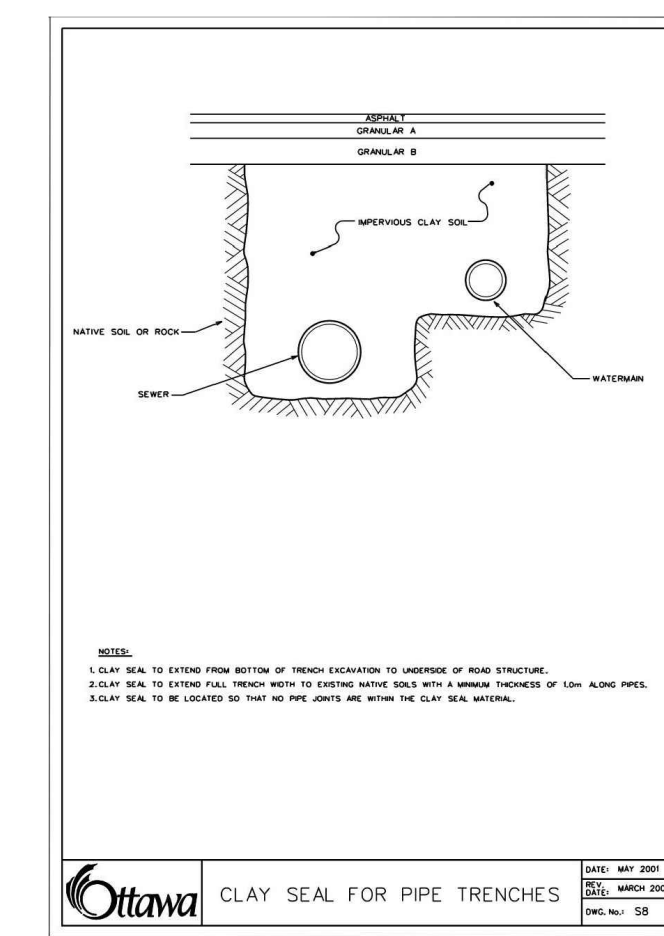
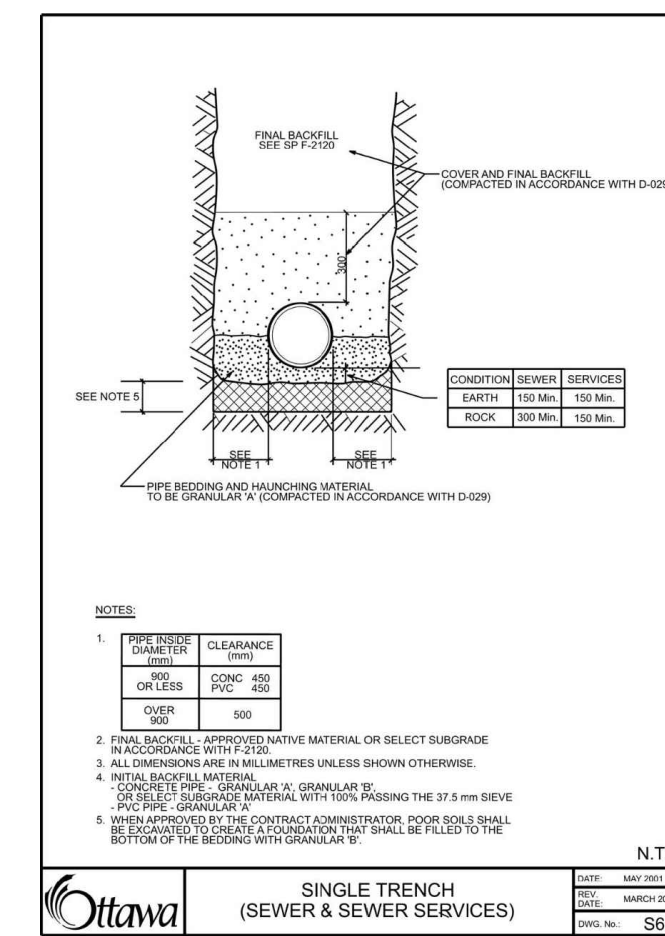
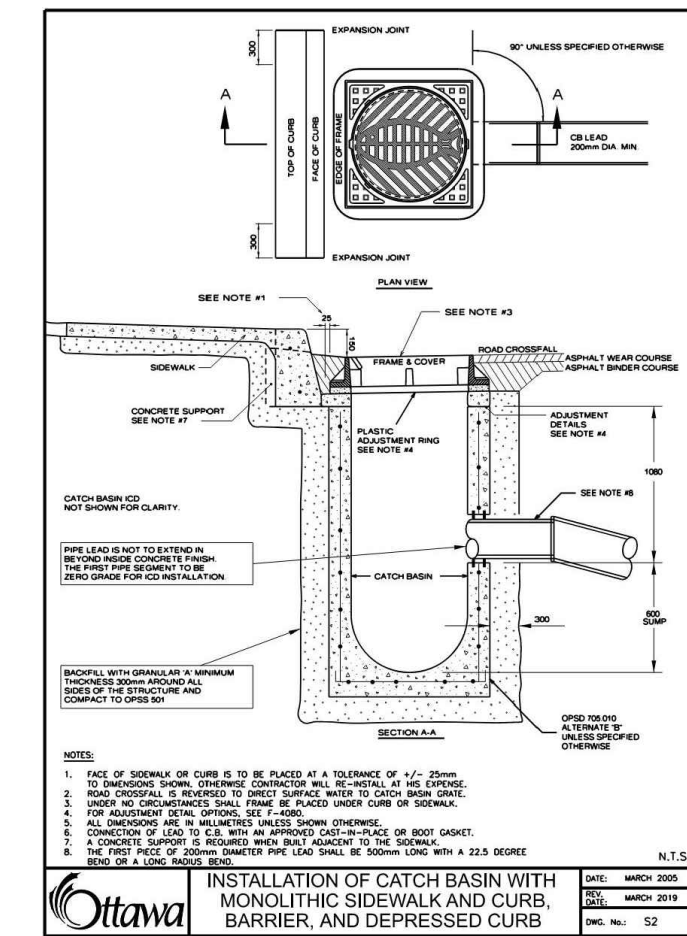
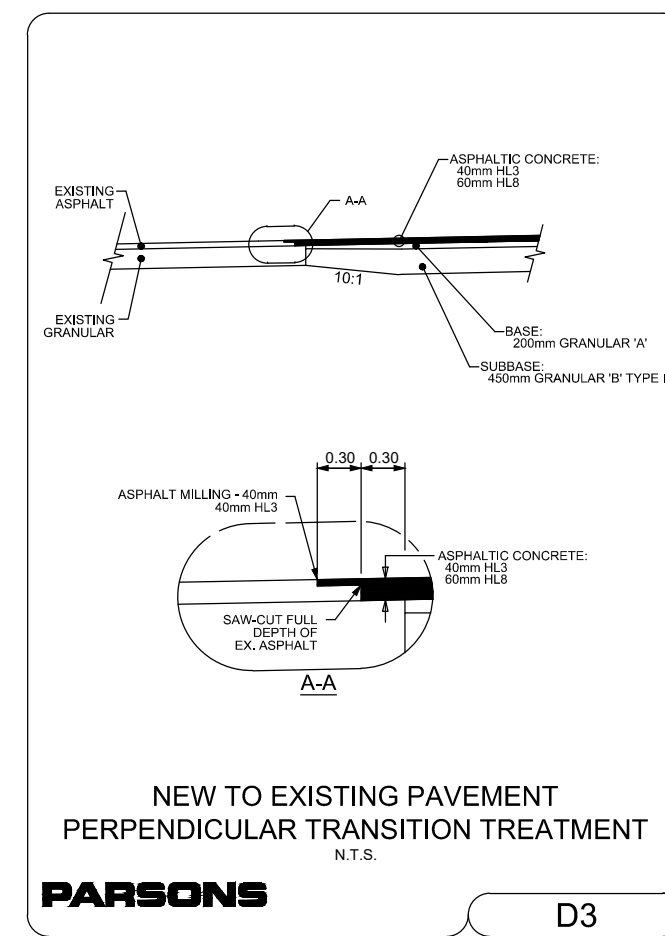
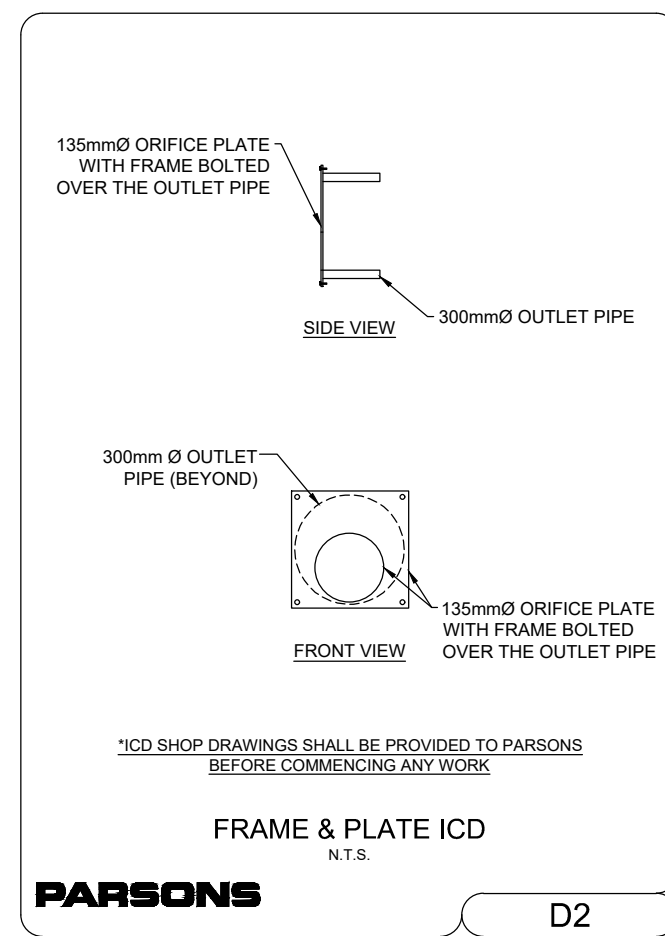
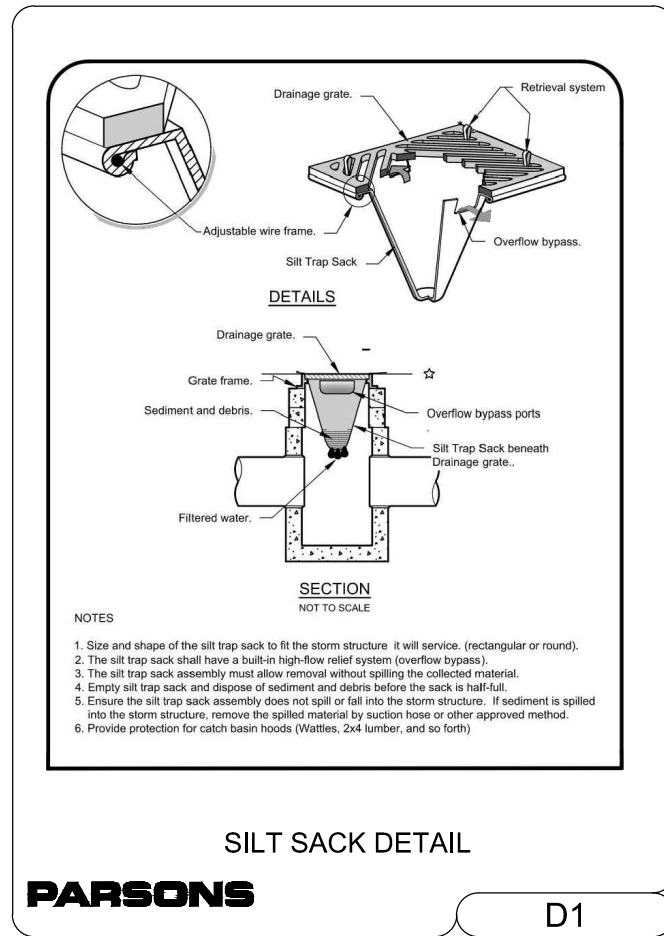

TOPOGRAPHIC INFORMATION & BENCHMARK

TOPOGRAPHIC SURVEY COMPLETED BY VRSS ON MARCH 20TH 2023. ELEVATIONS SHOWN ARE GEODETIC AND ARE REFERRED TO THE CGVD-28 GEODETIC DATUM.

SITE BENCHMARK No. 1 LOCATED ON NORTH WEST INTERSECTION OF MERVALE ROAD AND WESTLYN DRIVE. FIRE HYDRANT TOP OF NUVE ELEVATION = 89.19

LEGAL PLAN

LEGAL SURVEY COMPLETED BY FARLEY, SMITH & DENIS SURVEYING LTD. ON APRIL 21ST, 2023. BEARINGS ARE ASTRONOMIC AND ARE REFERRED TO THE WESTERLY LIMIT OF MERVALE ROAD HAVING A BEARING OF N 22° 18' 30" W AS SHOWN ON REGISTERED PLAN 401392.

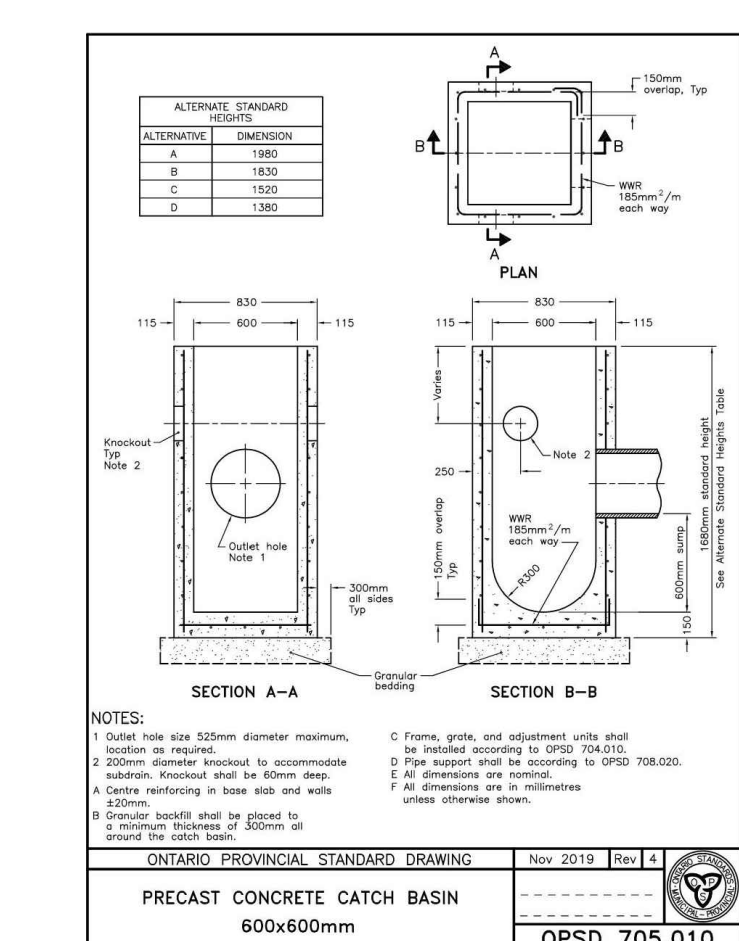
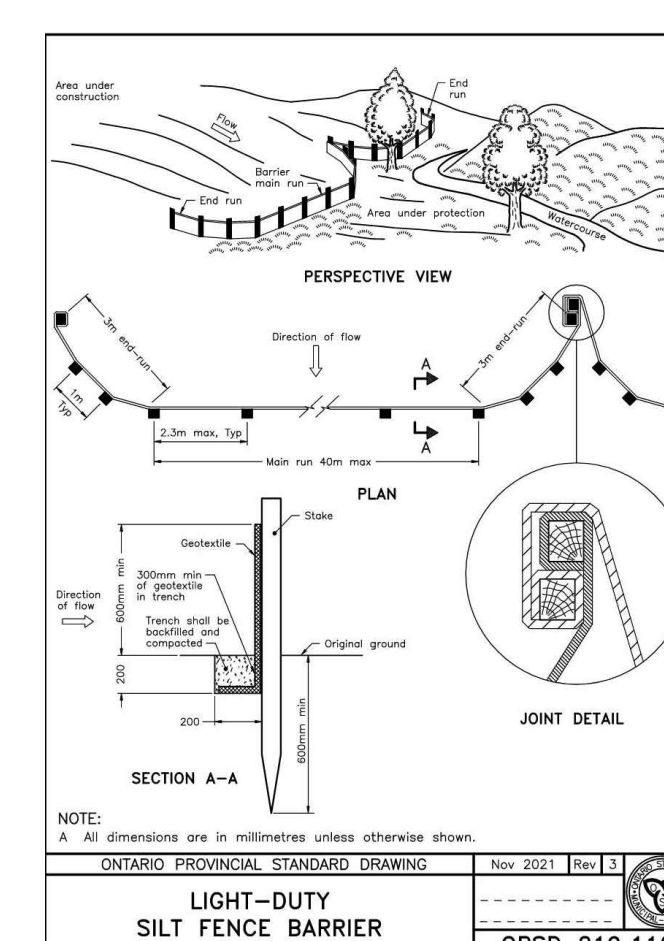
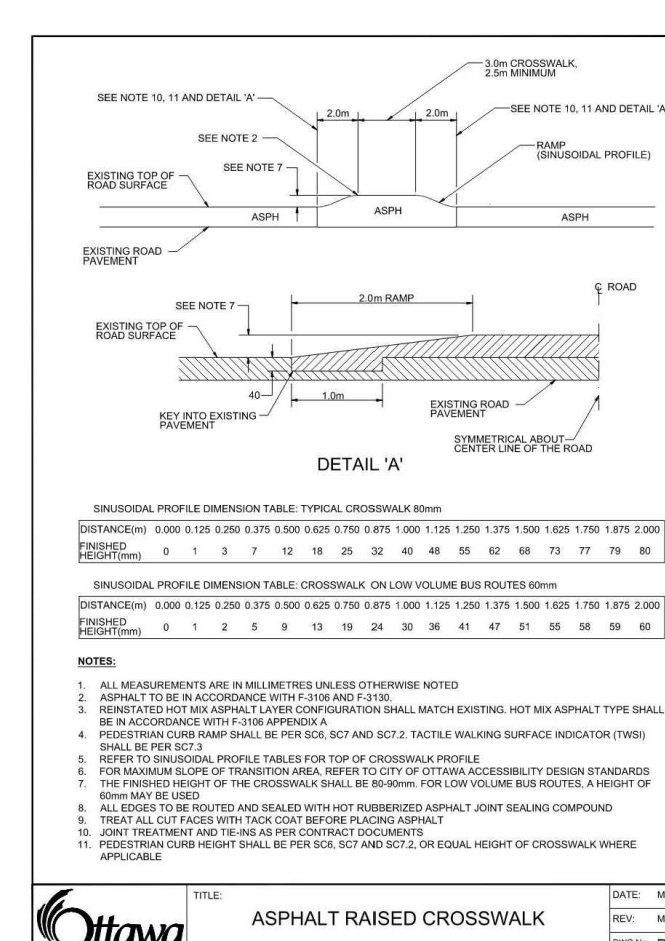
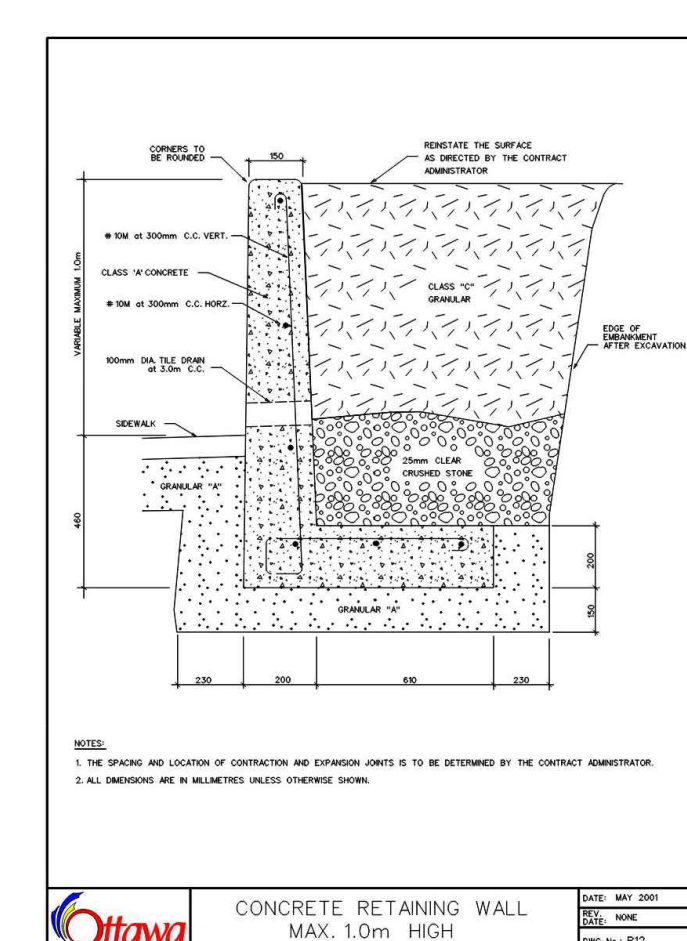
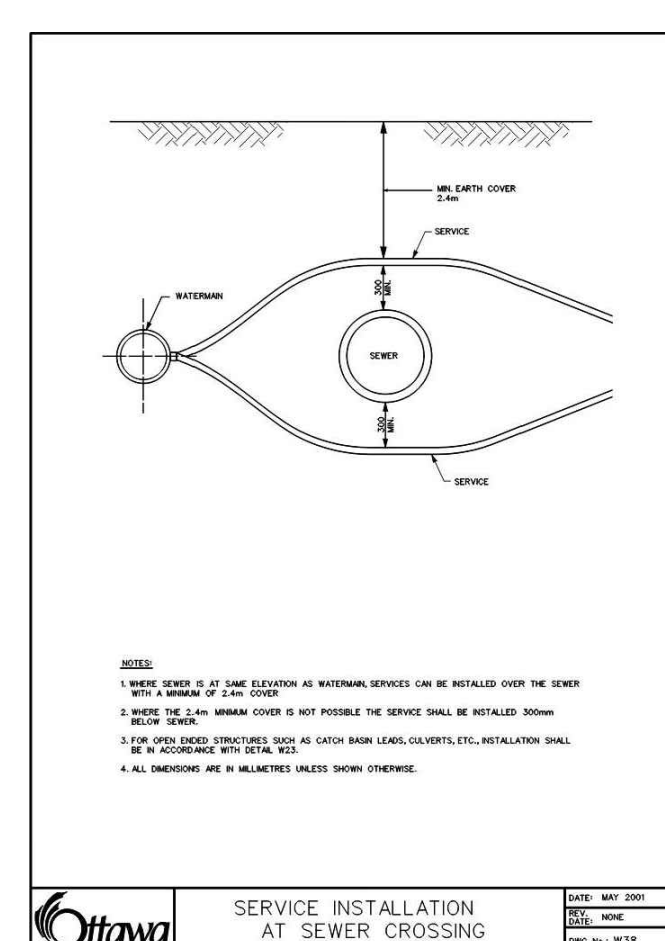
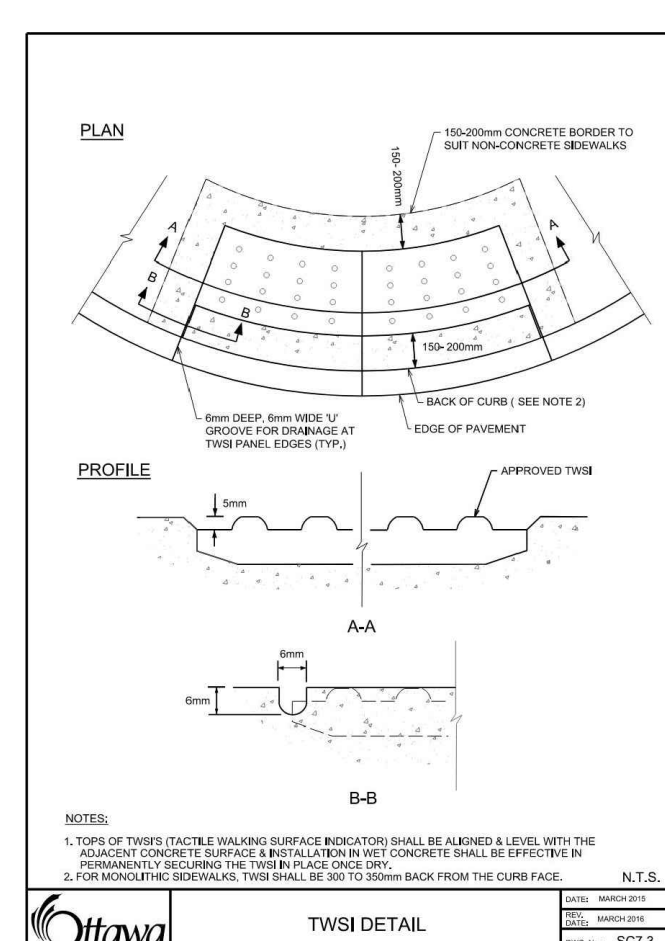
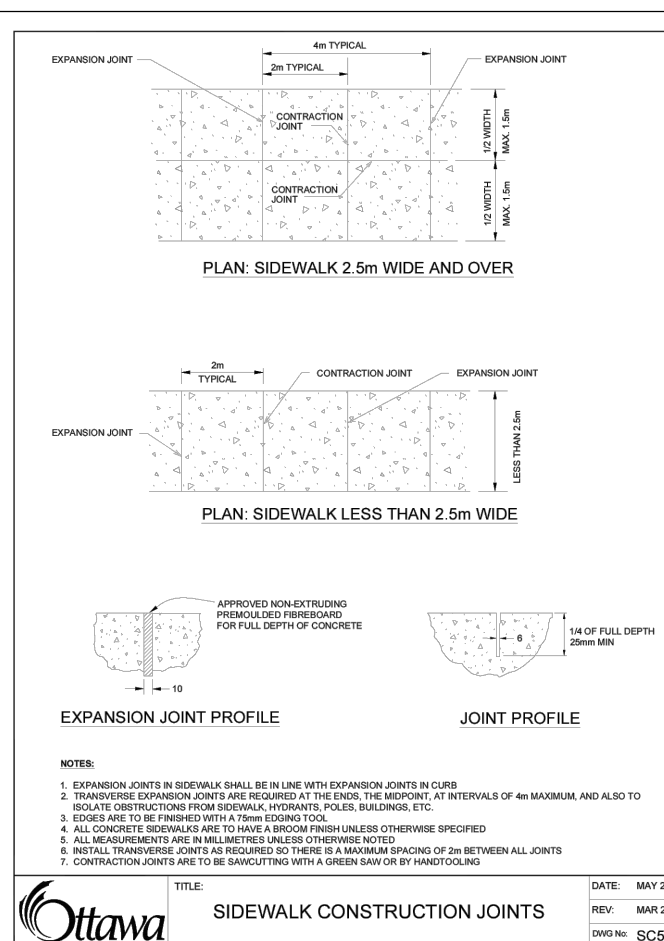
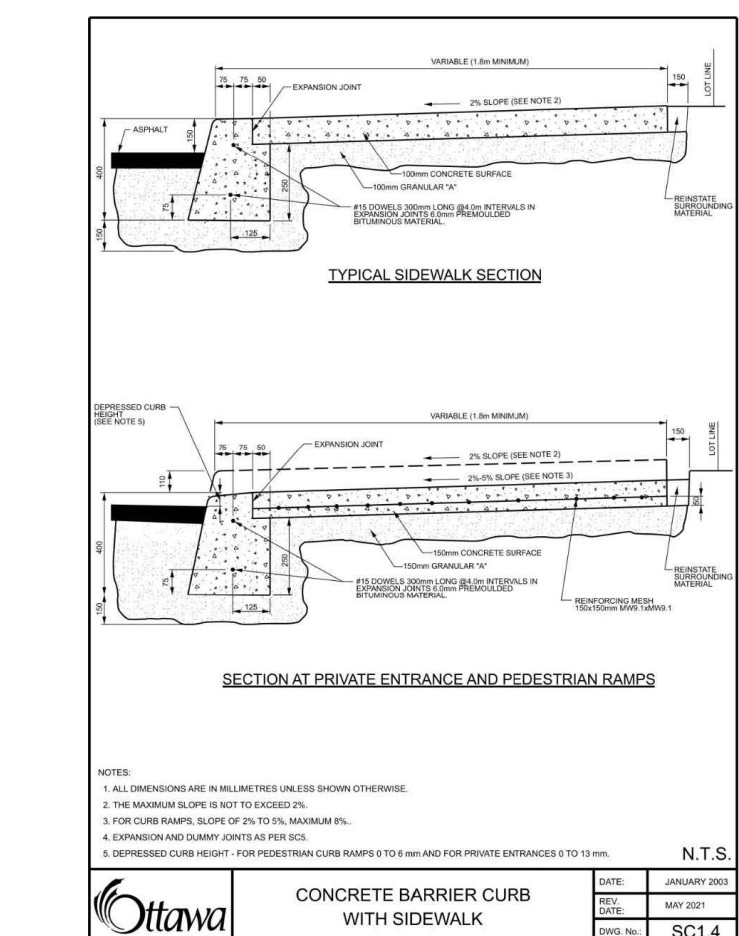
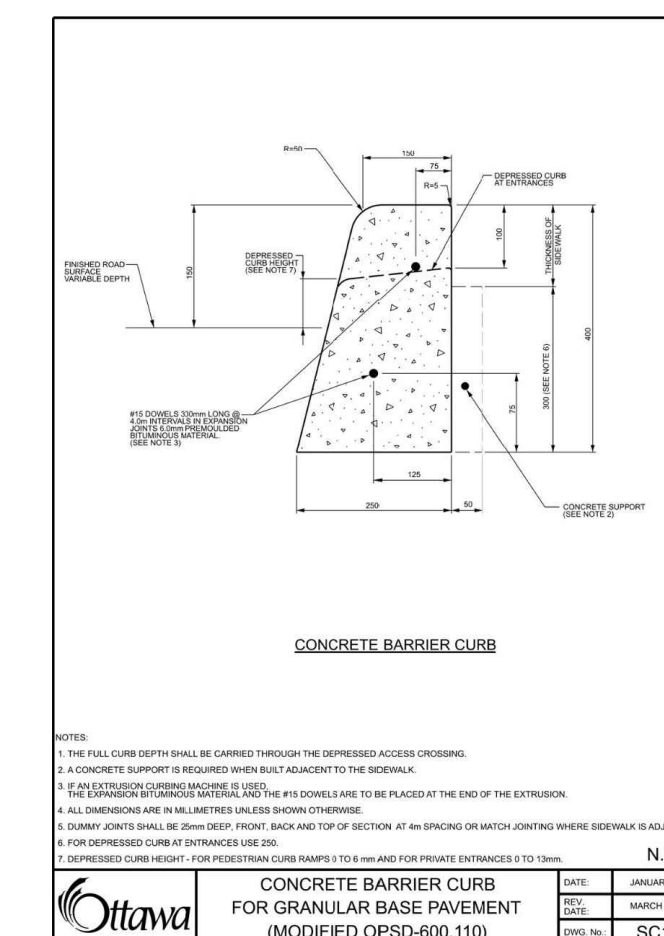
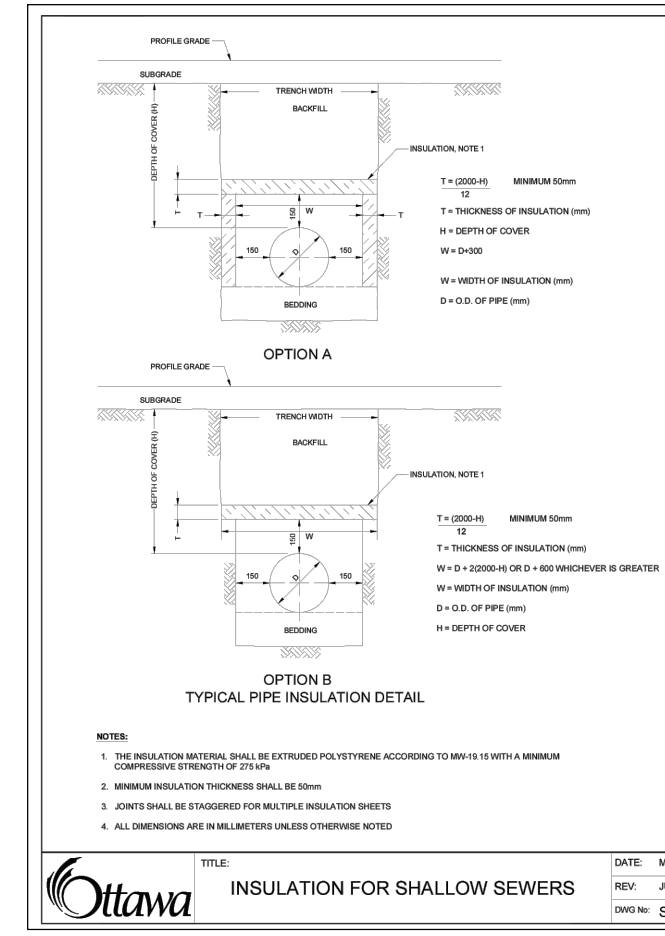
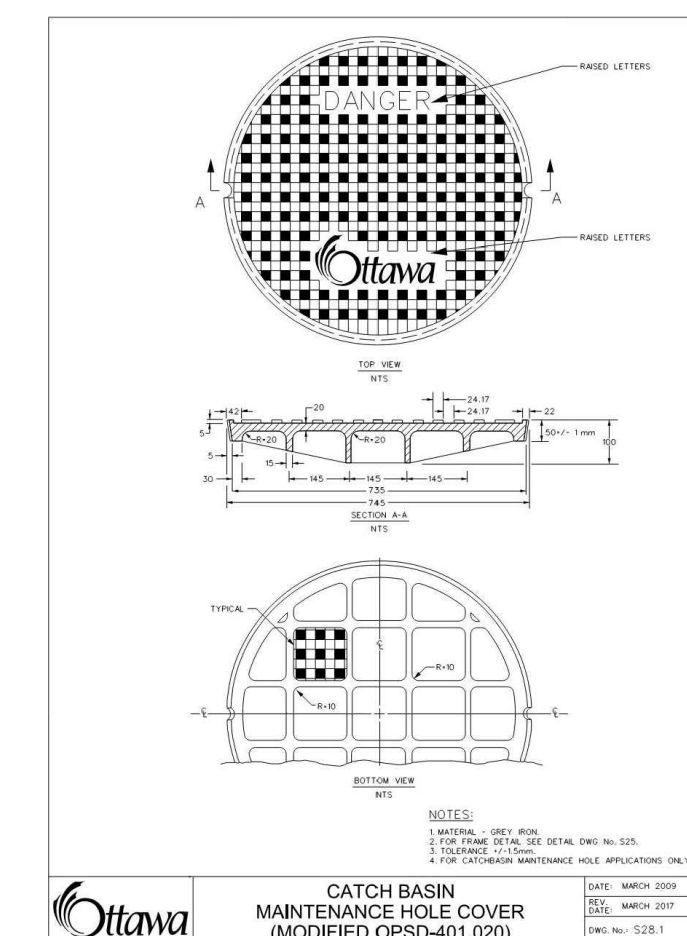
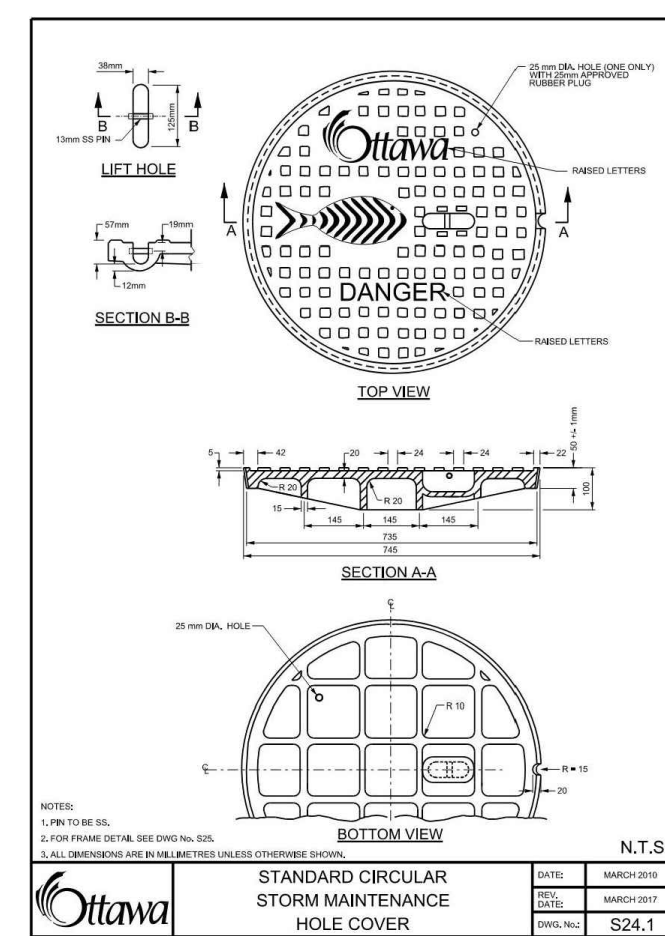
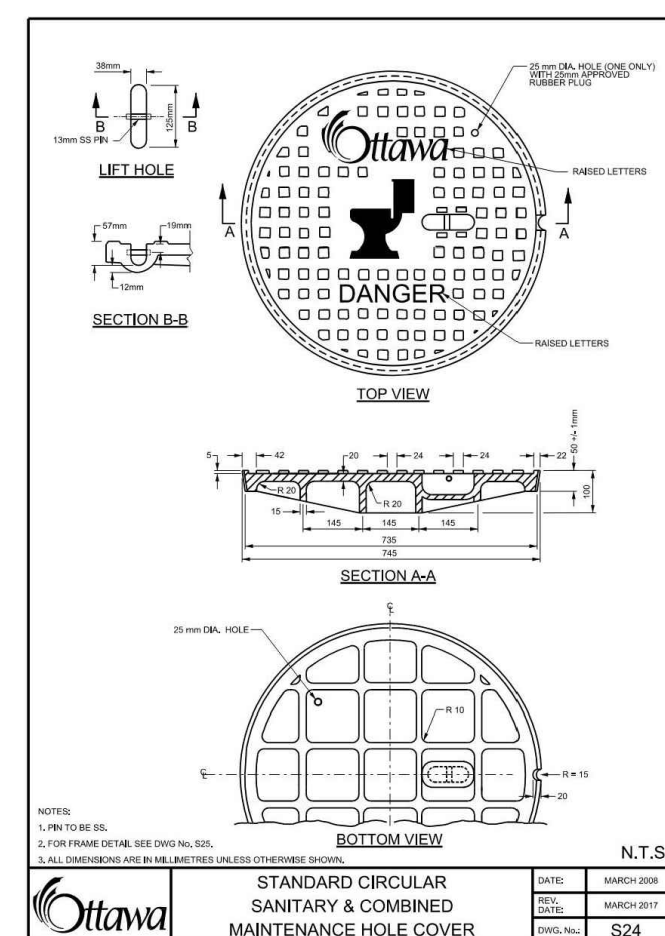
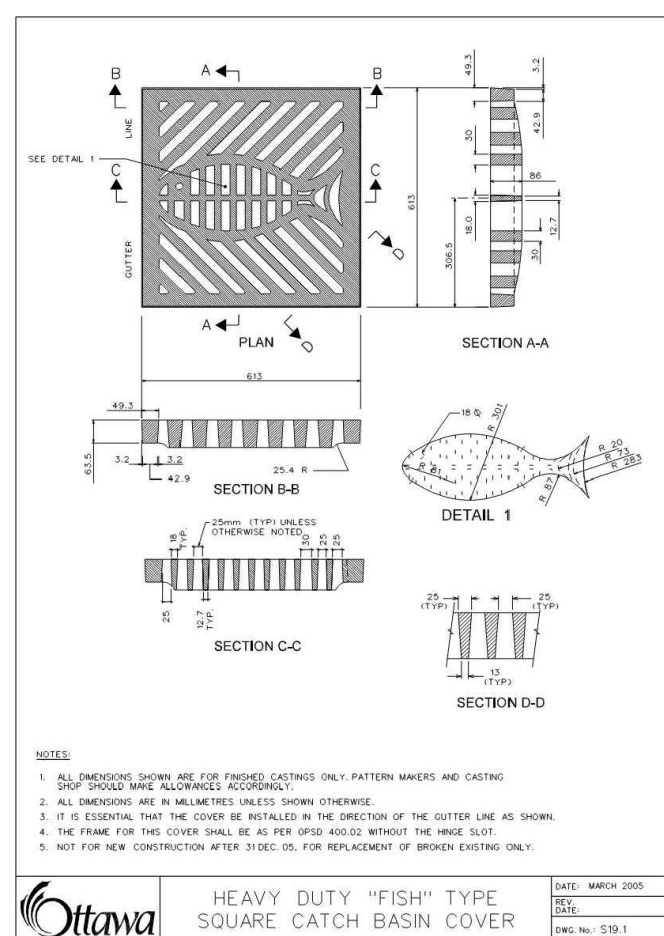

No.	DATE	DESCRIPTION	BY
02	2025-02-19	ISSUED FOR SPA - REV01	M.T.
01	2024-03-21	ISSUED FOR SPA	M.T.

REVISIONS

[Signature]
02/20/2025
PRODUCTION OF DRAWING

SCALE: 1:250

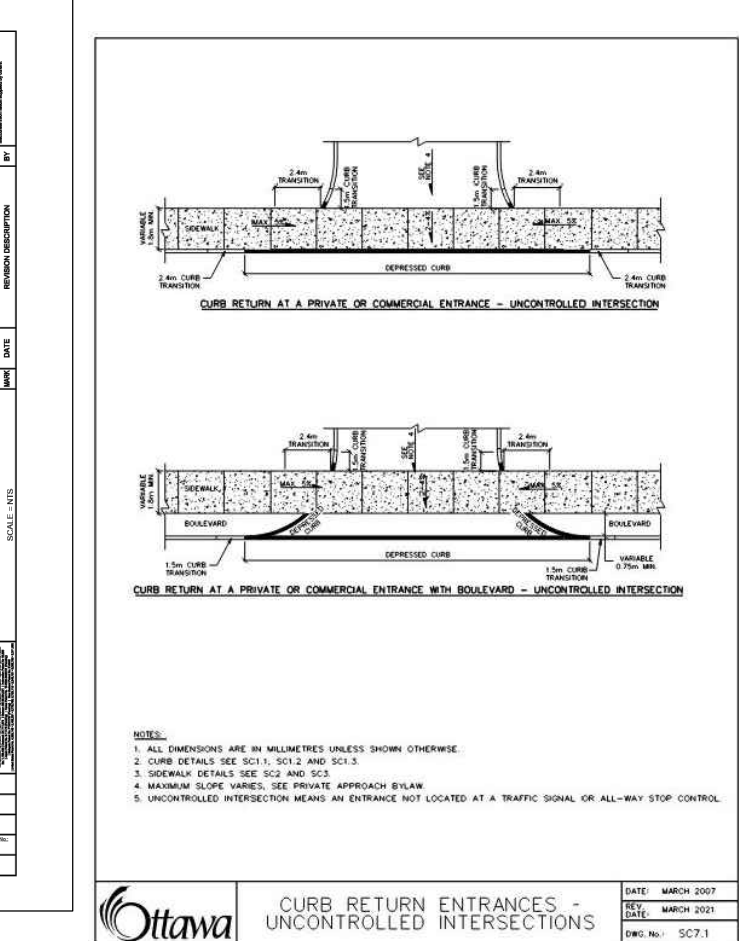
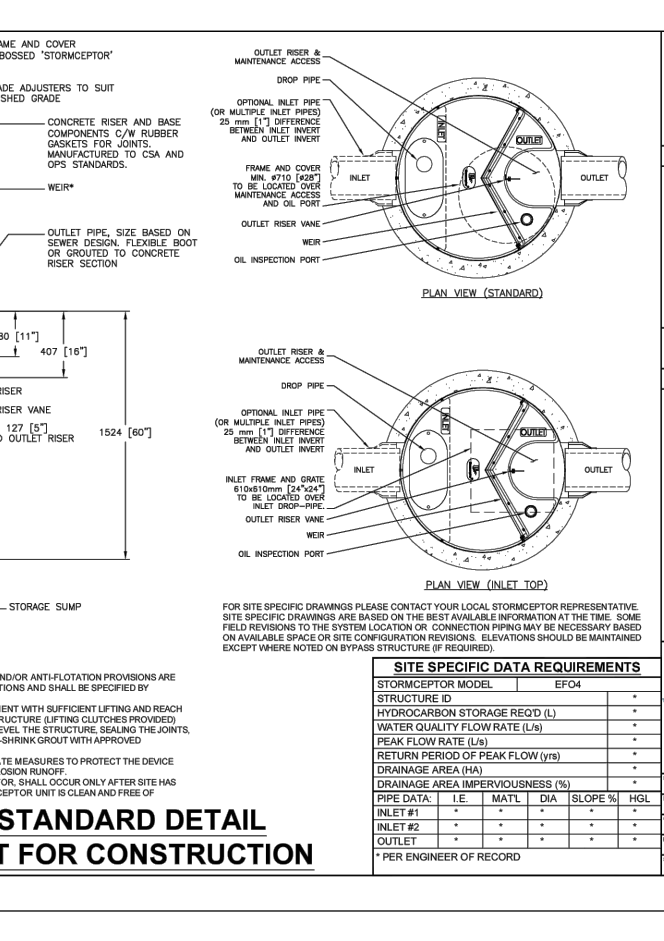
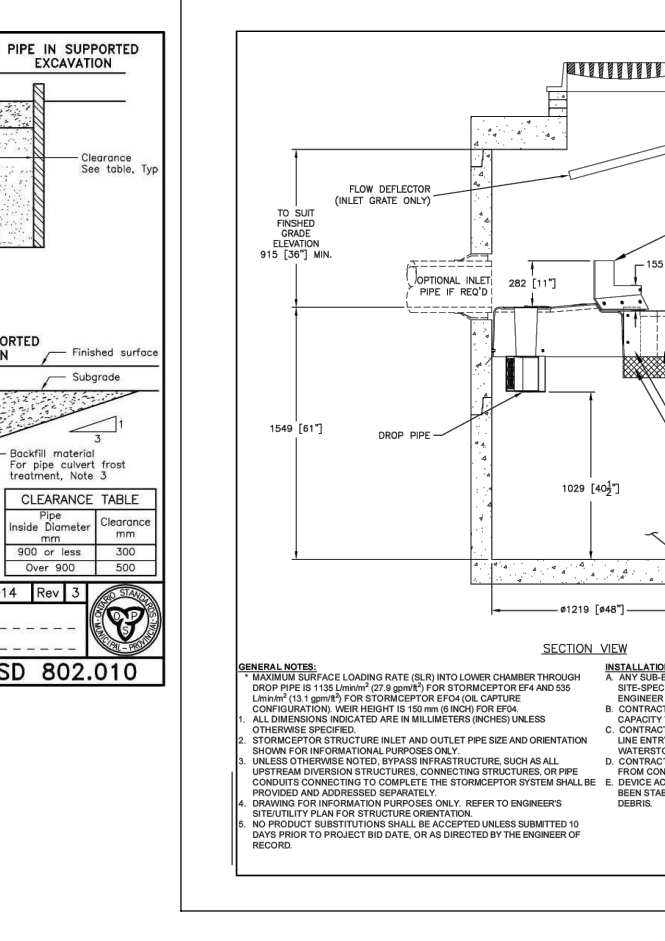
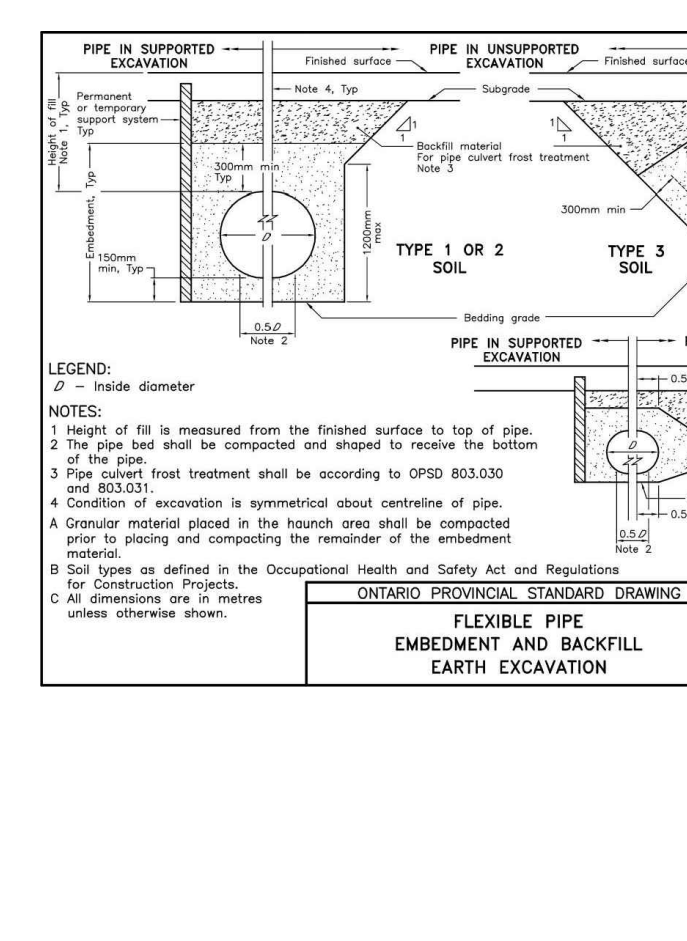
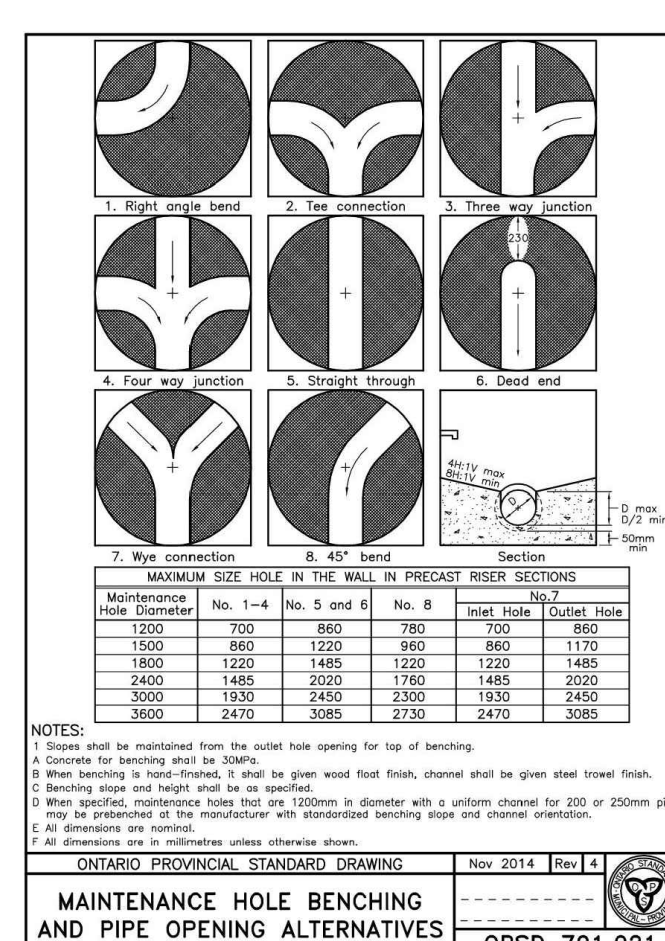
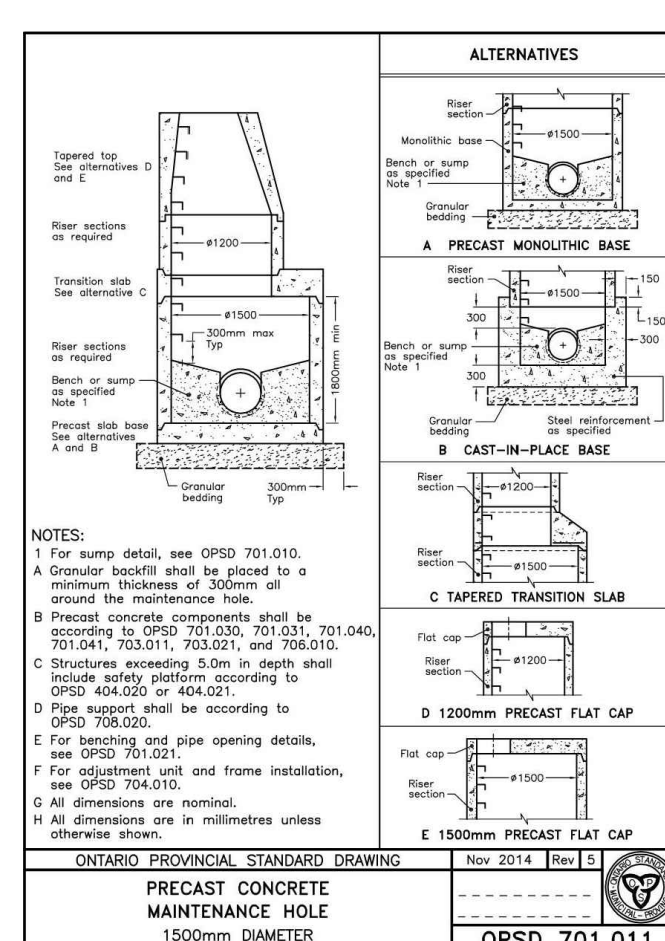
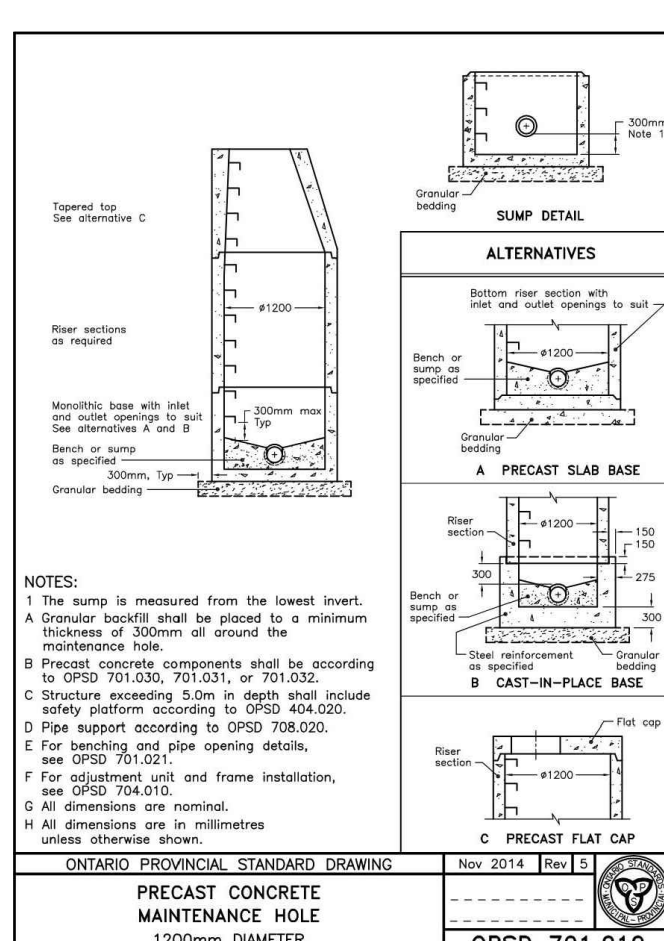

PARSONS
1223 Michael Street, Suite 100, Ottawa, Ontario, Canada K1J 7T2
Tel: (613) 738-4160 Fax: (613) 739-1105

CLIENT: HARNOS ÉNERGIES

PROJECT: CONVENIENCE STORE/RESTO 1660 MERVALE NEPEAN, ONTARIO

TITLE: DETAIL PAGE

DESIGNED BY	P.C.	PROJECT NO.	478684
DRAWN BY	P.C.		
CHECKED BY	M.T.	C104	DET
DATE	JANUARY 2024		
SCALE	N/A	DRAWING NO.	DRAWING

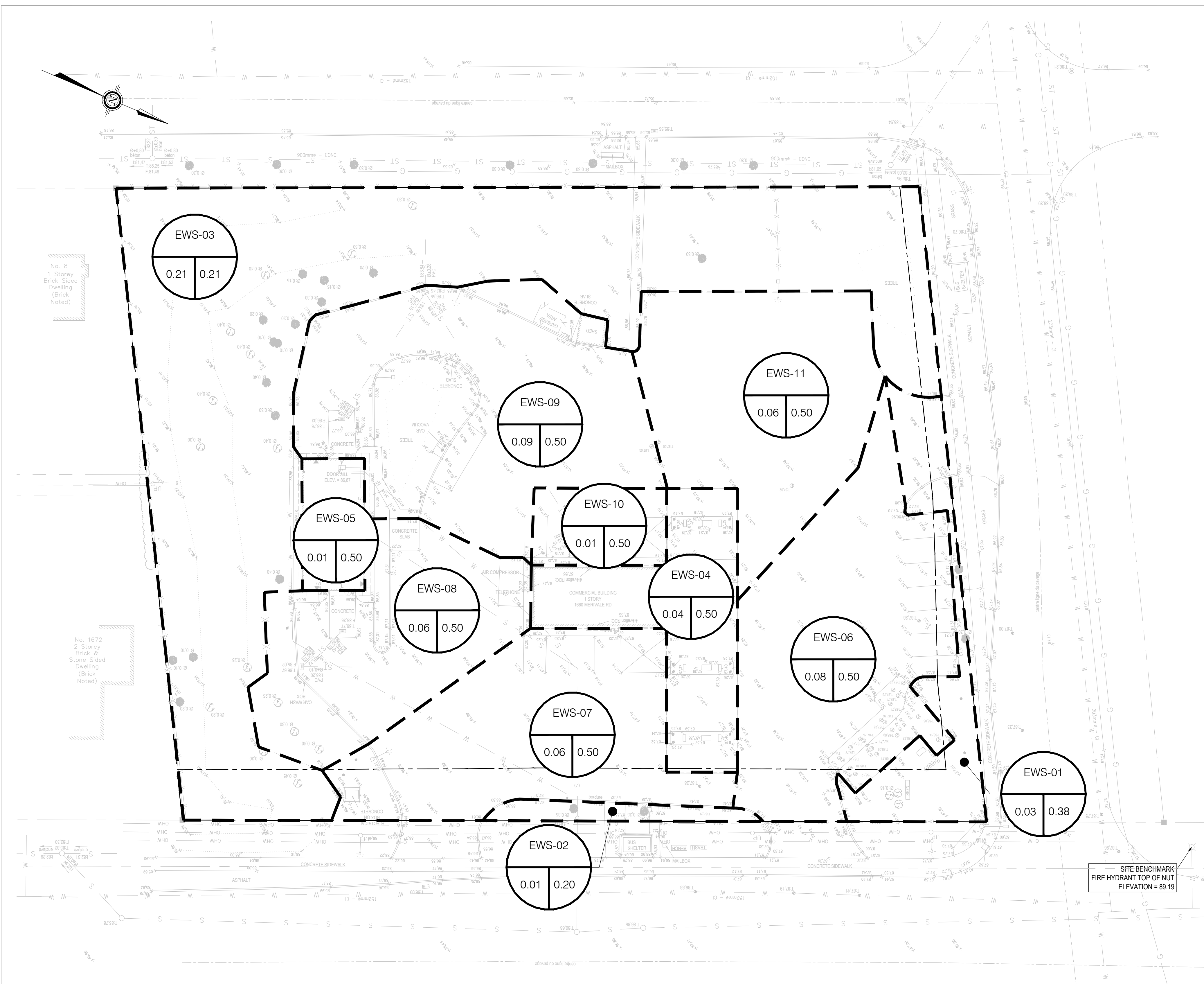

LEGEND:

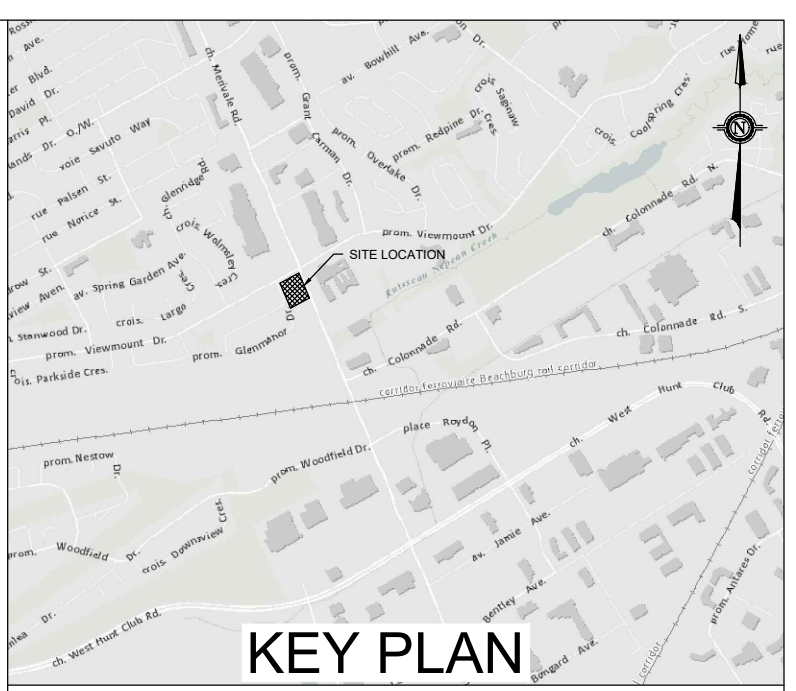
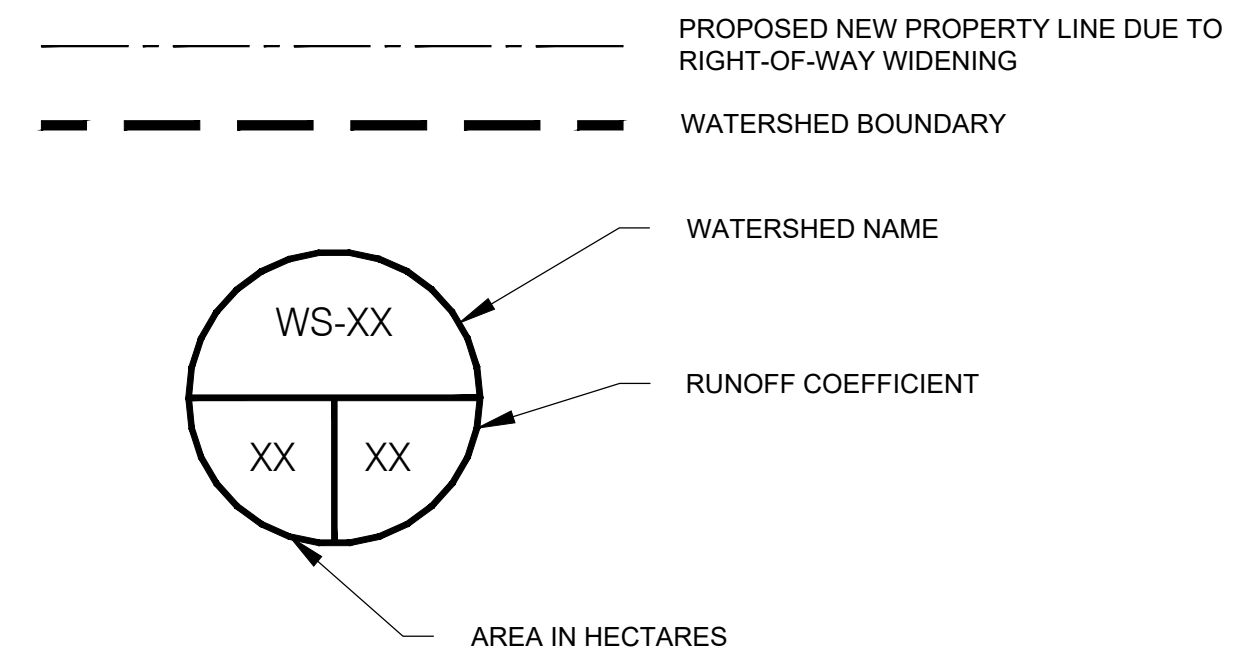

TOPOGRAPHIC INFORMATION & BENCHMARK

TOPOGRAPHIC SURVEY COMPLETED BY VRSSB ON MARCH 20th TO 22nd 2023. ELEVATIONS SHOWN ARE GEODETIC AND ARE REFERRED TO THE CGVD-28 GEODETIC DATUM.

LEGAL PLAN
LEGAL SURVEY COMPLETED BY FARLEY, SMITH & DENIS SURVEYING LTD. ON APRIL 21st, 2023. BEARINGS ARE ASTRONOMIC AND ARE REFERRED TO THE WESTERLY LIMIT OF MERIVALE ROAD HAVING A BEARING OF N 22° 18' 30" W AS SHOWN ON REGISTERED PLAN 401392.

No.	DATE	DESCRIPTION	BY
02	2025-02-19	ISSUED FOR SPA - REV01	M.T.
01	2024-03-21	ISSUED FOR SPA	M.T.

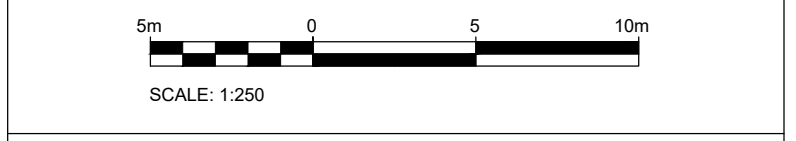
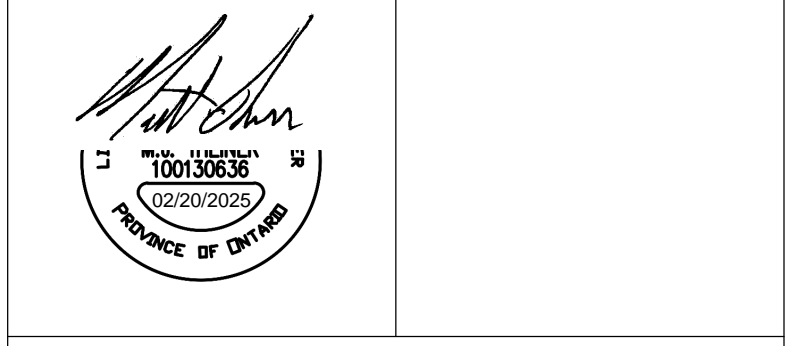

PARSONS
1223 Michael Street, Suite 100, Ottawa, Ontario, Canada K1J 7T2
Tel: (613) 738-4160 Fax: (613) 739-7105

CLIENT
HARNOIS ÉNERGIES

PROJECT
**CONVENIENCE STORE/RESTO
1660 MERIVALE
NEPEAN, ONTARIO**

TITLE
**PRE DEVELOPMENT
DRAINAGE AREAS**

DESIGNED BY	P.C.	PROJECT NO.	478684
DRAWN BY	P.C.	C105	PRE
CHECKED BY	M.T.		
DATE	JANUARY 2024		
SCALE	1:250	DRAWING NO.	DRAWING

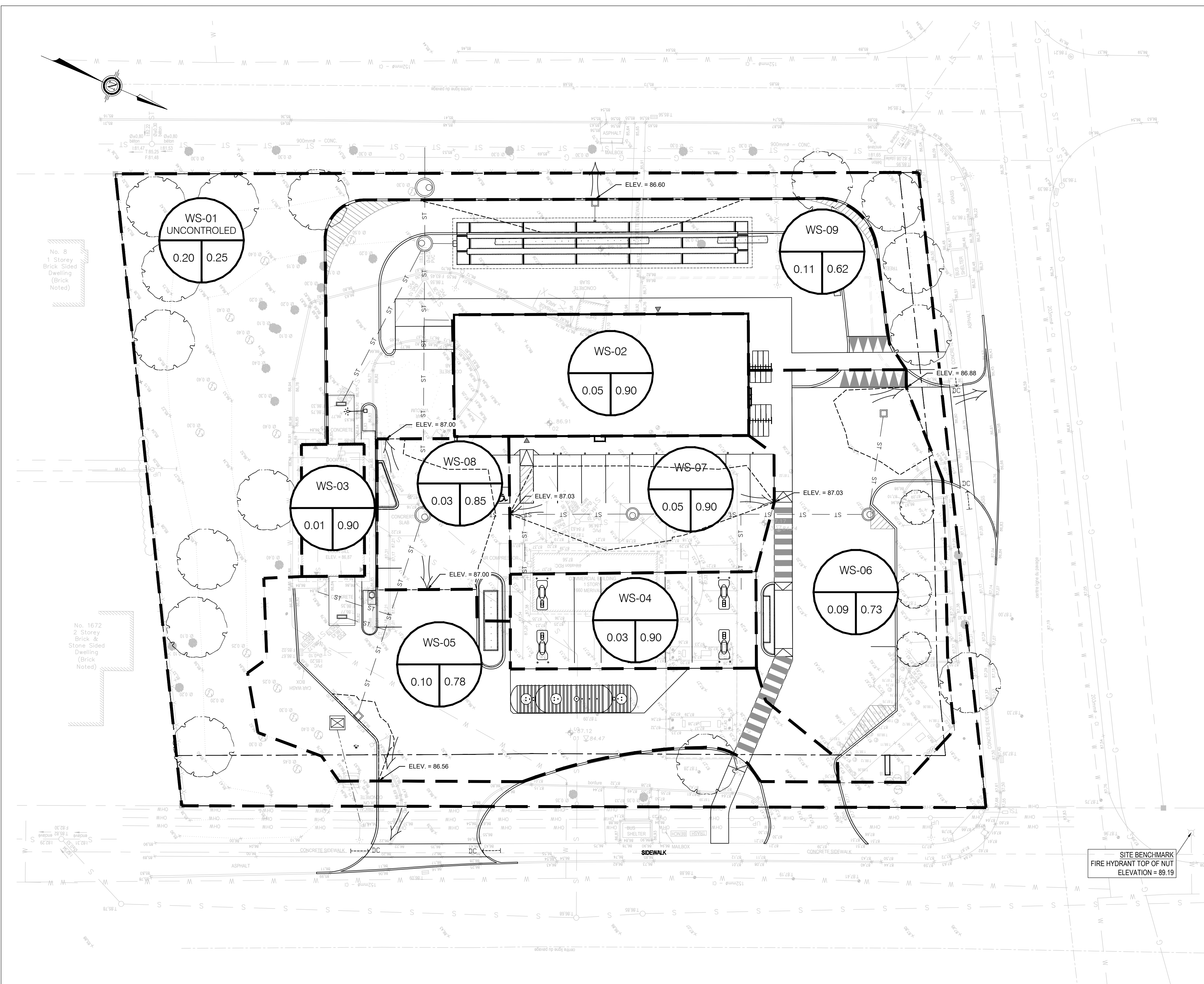

LEGEND:

- PROPOSED NEW PROPERTY LINE DUE TO RIGHT-OF-WAY WIDENING
- WATERSHED BOUNDARY
- WATERSHED NAME
- RUNOFF COEFFICIENT
- AREA IN HECTARES
- MAJOR OVERLAND FLOW ROUTE
- MAJOR OVERLAND PONDING AREA

NOTE: ALL STORM EVENTS UP TO 100YEARS ARE STORED IN UNDERGROUND STORAGE. NO SURFACE PONDING OCCURS.

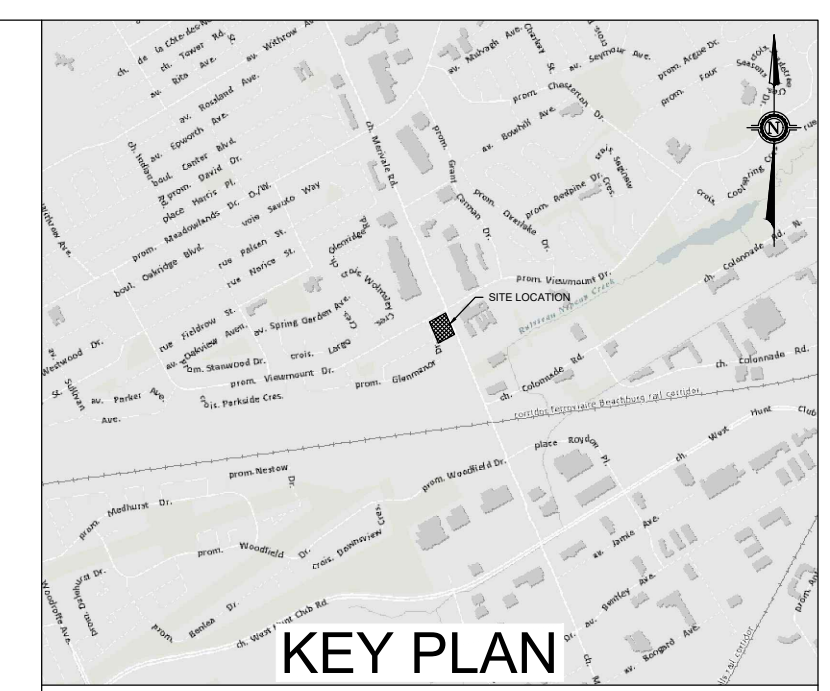

TOPOGRAPHIC INFORMATION & BENCHMARK
 TOPOGRAPHIC SURVEY COMPLETED BY VRSS ON MARCH 20th TO 22nd 2023. ELEVATIONS SHOWN ARE GEODETIC AND ARE REFERRED TO THE CGVD-28 GEODETIC DATUM.
 SITE BENCHMARK No. 1 LOCATED ON NORTH WEST INTERSECTION OF MERIVALE ROAD AND VIEWMOUNT DRIVE. FIRE HYDRANT TOP OF NUT ELEVATION = 89.19

LEGAL PLAN
 LEGAL SURVEY COMPLETED BY FARLEY, SMITH & DENIS SURVEYING LTD. ON APRIL 21st, 2023. BEARINGS ARE ASTRONOMIC AND ARE REFERRED TO THE WESTERLY LIMIT OF MERIVALE ROAD HAVING A BEARING OF N 22° 18' 30" W AS SHOWN ON REGISTERED PLAN 401392.

No.	DATE	DESCRIPTION	BY
02	2025-02-19	ISSUED FOR SPA - REV01	M.T.
01	2024-03-21	ISSUED FOR SPA	M.T.

REVISIONS

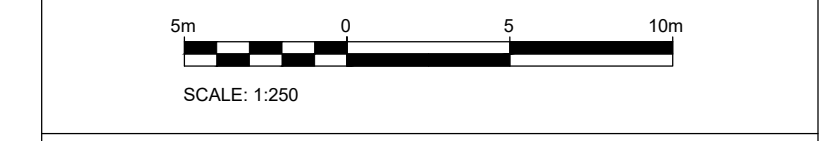

PARSONS
 1223 Michael Street, Suite 100, Ottawa, Ontario, Canada K1J 7T2
 Tel: (613) 738-4160 Fax: (613) 739-7105

CLIENT
HARNOIS ÉNERGIES

PROJECT
**CONVENIENCE STORE/RESTO
 1660 MERIVALE
 NEPEAN, ONTARIO**

TITLE
**POST DEVELOPMENT
 DRAINAGE AREAS**

DESIGNED BY	P.C.	PROJECT NO.	478684
DRAWN BY	P.C.	C106	POST
CHECKED BY	M.T.		
DATE	JANUARY 2024		
SCALE	1:250	DRAWING NO.	DRAWING