

The Meadows Phase 5

TRANSPORTATION IMPACT ASSESSMENT (TIA) REPORT



Prepared for Tamarack Homes
by IBI Group

April 2018



IBI GROUP
400-333 Preston Street
Ottawa ON K1S 5N4 Canada
tel 613 225 1311 fax 613 225 9868
ibigroup.com

April 11, 2018

Ms. Rosanna Baggs, CET
Project Manager
Infrastructure Approvals, Development Review
City of Ottawa
110 Laurier Avenue West
Ottawa, ON
K1P 1J1

Dear Ms. Baggs:

**RE: TAMARACK HOMES – THE MEADOWS PHASE 5
TIA STEP 4 SUBMISSION**

The enclosed submission for the Meadows Phase 5 in the City of Ottawa includes four (4) hardcopies of the Transportation Impact Assessment (TIA), as well as a USB stick containing an electronic copy of the TIA report, appendices and the Synchro files. The following TIA represents Steps 1 – 4, as defined in the City TIA Guidelines. The report has address/ incorporated the required technical comments received over the course of the submission process. We have also enclosed these comments with for your reference.

If you have any questions regarding the contents of this submission, please do not hesitate to contact the undersigned at 613-225-1311 ext. 564.

Sincerely,

Austin Shih, M.A.Sc, P.Eng.
Project Engineer

Ben Pascolo-Neveu

To: 'Baggs, Rosanna'
Cc: Austin Shih
Subject: RE: Meadows Ph 5 - TIA Study Area Requirements - Comments

From: Ben Pascolo-Neveu
Sent: Wednesday, April 11, 2018 10:49 AM
To: 'Baggs, Rosanna'
Cc: Austin Shih
Subject: RE: Meadows Ph 5 - TIA Study Area Requirements - Comments

Hi Rosanna,

Thank you for your comments. We are preparing to submit Step 4.

Regards,
Ben

Ben Pascolo-Neveu, EIT

IBI GROUP

Suite 400, 333 Preston Street
Ottawa ON K1S 5N4 Canada
tel +1 613 225 1311 ext 520 fax +1 613 225 9868



Defining the cities of tomorrow
ibigroup.com

NOTE: This email message/attachments may contain privileged and confidential information. If received in error, please notify the sender and delete this e-mail message.
NOTE: Ce courriel peut contenir de l'information privilégiée et confidentielle. Si vous avez reçu ce message par erreur, veuillez le mentionner immédiatement à l'expéditeur et effacer ce courriel.

From: Baggs, Rosanna [<mailto:Rosanna.Baggs@ottawa.ca>]
Sent: Monday, April 9, 2018 3:07 PM
To: Ben Pascolo-Neveu
Cc: Austin Shih
Subject: RE: Meadows Ph 5 - TIA Study Area Requirements - Comments

Hi Ben,

Please see the comments for the Traffic Impact Assessment Steps 1-3 submission:

Transportation Engineering Services

- 1) The City recommends using 2009 TRANS Trip Generation Study for residential rates. **Acknowledged.**

If the above can be incorporated into the next submission please proceed with Step 4. Otherwise please discuss responses prior to proceeding.

Regards,

Rosanna Baggs, C.E.T.

Project Manager, Infrastructure Approvals | GPRJ Approbation demandes infrastructure
Development Review West Branch | Dir Services d'exam des dem d'amgt
Tel | Tél. : 613-580- 2424 ext. | poste 26388

From: Ben Pascolo-Neveu <Ben.Pascolo-Neveu@ibigroup.com>

Sent: Friday, March 09, 2018 5:44 PM

To: Baggs, Rosanna <Rosanna.Baggs@ottawa.ca>

Cc: Austin Shih <austin.shih@IBIGroup.com>

Subject: RE: Meadows Ph 5 - TIA Study Area Requirments

Hi Rosanna,

Please find attached the Forecasting for The Meadows Phase 5.

Regards,

Ben

Ben Pascolo-Neveu, EIT

IBI GROUP

Suite 400, 333 Preston Street
Ottawa ON K1S 5N4 Canada
tel +1 613 225 1311 ext 520 fax +1 613 225 9868



Defining the cities of tomorrow
ibigroup.com

NOTE: This email message/attachments may contain privileged and confidential information. If received in error, please notify the sender and delete this e-mail message.

NOTE: Ce courriel peut contenir de l'information privilégiée et confidentielle. Si vous avez reçu ce message par erreur, veuillez le mentionner immédiatement à l'expéditeur et effacer ce courriel.

From: Austin Shih

Sent: Friday, March 9, 2018 2:47 PM

To: Baggs, Rosanna

Cc: Ben Pascolo-Neveu

Subject: RE: Meadows Ph 5 - TIA Study Area Requirments

Hey Rosanna,

Thanks for the comments to Phase 4 – I'll have a response to comments soon.

As for Phase 5 – the confirmation of access between Mattamy and Tamarack will come soon, so in the meantime we will send you the Forecasting report later this afternoon to send for review.

I wanted to clarify some points about the Grand Canal and Cambrian Road intersection. We do not expect it to be impacted by the Phase 5 development. Keep in mind that for Phase 4 – we directed all traffic to River Mist, with the majority of traffic to Greenbank to be conservative. Even still, it operated with City standards (0.81 v/c/ LOS D) at the

ultimate 2024 horizon as an all way stop. If you look at the numbers below; IBI got manual counts last year at the intersections of River Mist and Borriskoane/ Cambrian. As you can see, there is more peak traffic going to and from Borriskoane than Greenbank. So I don't believe there would be significant impacts to Grand Canal by Phase 5 traffic. It would take longer for them to navigate within the local road network of Phase 4 than to simply continue on west Cambrian and turn left directly into their development. We also have to consider that if we direct traffic between Phases 4 and 5 and vice versa, in the end, the numbers themselves will likely balance out and have little to no effect on the operations of the intersection.

Feel free to call if you wish to discuss.

Thanks,
Austin

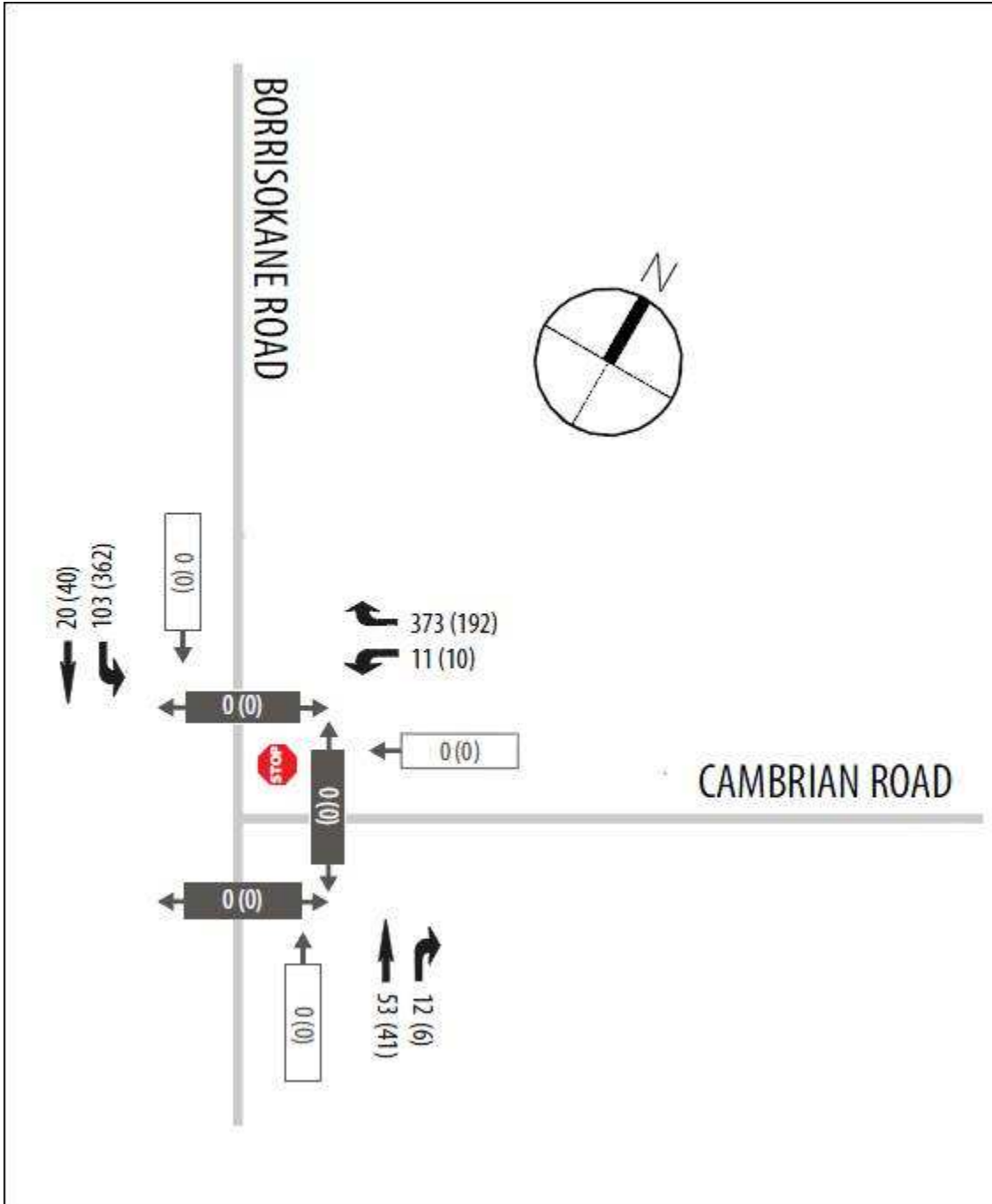

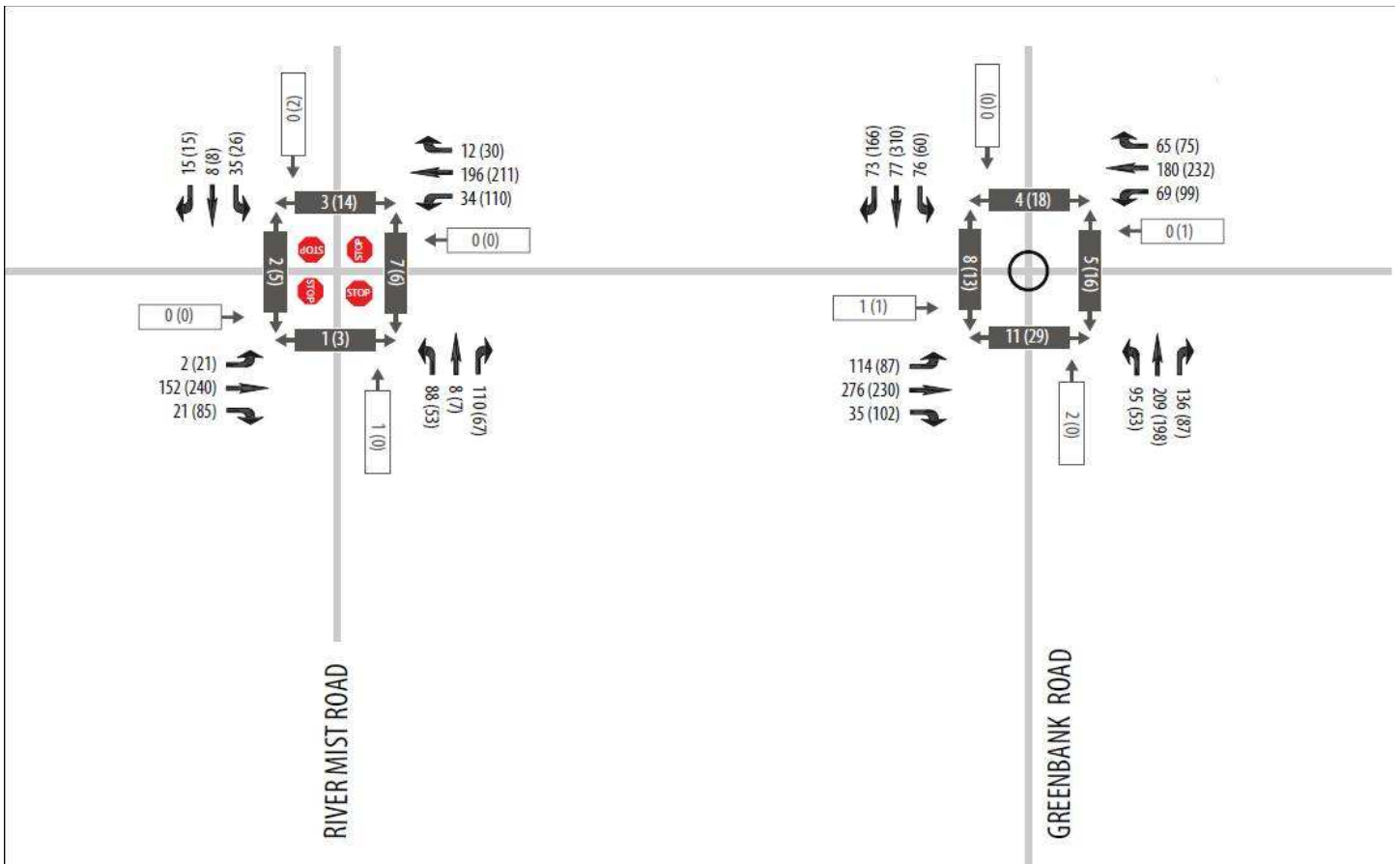

Austin Shih M.A.S.C., P.ENG.



From: Baggs, Rosanna [<mailto:Rosanna.Baggs@ottawa.ca>]

Sent: Friday, March 09, 2018 11:28 AM

To: Justin Date <jdate@IBIGroup.com>

Cc: Austin Shih <austin.shih@IBIGroup.com>; 'Taggart Michelle' (mtaggart@taggart.ca) <mtaggart@taggart.ca>; Ben Pascolo-Neveu <Ben.Pascolo-Neveu@ibigroup.com>; Moore, Sean <Sean.Moore@ottawa.ca>

Subject: RE: Meadows Ph 5 - TIA Study Area Requirments

Hi Justin,

As per our discussion last night, the content of your Traffic Impact Assessment needs to reflect how you plan on connecting the development with the rest of the network.

The options discussed were as follows:

- 1) The Traffic Impact Assessment can demonstrate how the development will operate with the Street 23 extension connecting to Cambrian. I do not have any documentation from Mattamy as to their plan or timing to construct this section of the road on their property. As such, it would be in your client's best interest to secure/confirm a plan to have this extension built; this confirmation should be included and discussed in your Traffic Impact Assessment. If this is the route taken, it will be a condition of draft approval that Street 23 and its extension through the Mattamy lands is constructed prior to the rest of the development proceeding.

- a. If this direction is taken, please include the analysis of the intersection of Street 23 and Cambrian, and the intersection of Grand Canal and Cambrian in addition to the intersection already reviewed in the report.
- 2) If the above cannot be accomplished then the Traffic Impact Assessment will have to analyze how the development will impact the network by providing access through Phase 4. This will require the same analysis as Ph4 with the addition of the volumes from Ph5.

Please let me know if you have any questions or concerns.

Regards,

Rosanna Baggs, C.E.T.

Project Manager, Infrastructure Approvals | GPRJ Approbation demandes infrastructure
Development Review West Branch | Dir Services d'exam des dem d'amgt
Tel | Tél. : 613-580- 2424 ext. | poste 26388

From: Justin Date [<mailto:jdate@IBIGroup.com>]

Sent: Thursday, March 08, 2018 5:54 PM

To: Baggs, Rosanna <Rosanna.Baggs@ottawa.ca>

Cc: Austin Shih <austin.shih@IBIGroup.com>; 'Taggart Michelle' (mtaggart@taggart.ca) <mtaggart@taggart.ca>; Ben Pascolo-Neveu <Ben.Pascolo-Neveu@ibigroup.com>

Subject: RE: Meadows Ph 5 - Screening & Scoping

Hi Rosanna,

I hope you are well.

Ben mentioned that you had some concerns with how access would be provided to The Meadows Phase 5 development in the interim period before the realigned Greenbank Road is constructed.

The intention is for primary access to be provided from Cambrian Road via the new north-south collector road in the adjacent Mattamy lands, as indicated on the attached. This connection is required for servicing as well as for providing access for vehicles.

It is our understanding that the Mattamy application is at a more advanced stage than The Meadows Phase 5 application and that construction of the new collector road connection to Cambrian Road will precede construction of Phase 5.

Michelle, could you please confirm the above?

Many thanks,

Justin

Justin Date P.ENG.

Associate | Manager, Transportation Engineering

IBI GROUP

400-333 Preston Street

Ottawa ON K1S 5N4 Canada

tel +1 613 225 1311 ext 508 fax +1 613 225 9868

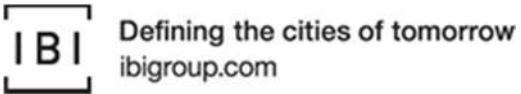

NOTE: This email message/attachments may contain privileged and confidential information. If received in error, please notify the sender and delete this e-mail message.
NOTE: Ce courriel peut contenir de l'information privilégiée et confidentielle. Si vous avez reçu ce message par erreur, veuillez le mentionner immédiatement à l'expéditeur et effacer ce courriel.

From: Baggs, Rosanna [<mailto:Rosanna.Baggs@ottawa.ca>]
Sent: Thursday, March 8, 2018 1:56 PM
To: Ben Pascolo-Neveu
Cc: Austin Shih
Subject: RE: Meadows Ph 5 - Screening & Scoping

Hi Ben,

My comments for you Step 1-2 submission is as follows:

- 1) Section 2.3 and 2.5 – you will have to include the same study area as the Meadows Ph 4 as this will be how the traffic will access the site until the Re-aligned Greenbank is constructed or Street 23 is connected to Cambrian. As such I don't think the intersection of Cambrian and Borrisokane is relevant unless Street 23 will connect in the very near future.

If the above can be incorporated into the next submission please proceed with Step 2. Otherwise please discuss responses prior to proceeding.

Regards,

Rosanna Baggs, C.E.T.

Project Manager, Infrastructure Approvals | GPRJ Approbation demandes infrastructure
Development Review West Branch | Dir Services d'examen des demandes
Tel | Tél. : 613-580- 2424 ext. | poste 26388

From: Ben Pascolo-Neveu [<mailto:Ben.Pascolo-Neveu@ibigroup.com>]
Sent: Friday, March 02, 2018 11:19 AM
To: Baggs, Rosanna <Rosanna.Baggs@ottawa.ca>
Cc: Austin Shih <austin.shih@IBIGroup.com>
Subject: Meadows Ph 5 - Screening & Scoping

Hi Rosanna,

Please find attached the Screening and Scoping for The Meadows Phase 5 (Tamarack) for your review.

Have a good weekend!

Regards,
Ben

Ben Pascolo-Neveu, EIT

IBI GROUP

Ben Pascolo-Neveu

From: Austin Shih
Sent: Friday, March 16, 2018 10:37 AM
To: Ben Pascolo-Neveu
Subject: FW: Meadows Ph 5 - TIA Study Area Requirments

FYI

Austin Shih M.A.SC., P.ENG.



From: Michelle Taggart [mailto:mtaggart@taggart.ca]
Sent: Friday, March 16, 2018 9:28 AM
To: Austin Shih <austin.shih@IBIGroup.com>; Terry Brule <tbrule@IBIGroup.com>; Stephanie Morris <morris@fotenn.com>
Subject: FW: Meadows Ph 5 - TIA Study Area Requirments

FYI

From: Baggs, Rosanna <Rosanna.Baggs@ottawa.ca>
Sent: March-16-18 9:22 AM
To: Michelle Taggart <mtaggart@taggart.ca>
Subject: Re: Meadows Ph 5 - TIA Study Area Requirments

That works, thanks.

Regards,

Rosanna Baggs, C.E.T.

On Mar 16, 2018, at 9:16 AM, Michelle Taggart <mtaggart@taggart.ca> wrote:

Rosanna,
Is this enough for you?

From: Melissa Pettem <Melissa.Pettem@mattamycorp.com>
Sent: March-16-18 9:08 AM
To: Michelle Taggart <mtaggart@taggart.ca>; Kevin Murphy <Kevin.Murphy@mattamycorp.com>
Subject: RE: Meadows Ph 5 - TIA Study Area Requirments

Hi Michelle,

We don't have any problems with you front ending the construction of the road.

<image001.jpg>

Melissa Pettem
Land Development Manager
T (613)831-3546 (direct). C (613)219-2065. F (613)831-9060.
melissa.pettem@mattamycorp.com
Ottawa Office: 50 Hines Road, Suite 100, Ottawa, ON K2K 2M5

Notice: This email is intended for use of the party to whom it is addressed and may contain confidential information. If you have received this email in error, please inform me and delete it. Thank you.

From: Michelle Taggart [<mailto:mtaggart@taggart.ca>]
Sent: Thursday, March 15, 2018 3:55 PM
To: Melissa Pettem; Kevin Murphy
Subject: RE: Meadows Ph 5 - TIA Study Area Requirments

Hi Melissa and Kevin,
It looks like we will need that road ahead of you. Are you ok if we front-end it and you pay us back later?

From: Melissa Pettem <Melissa.Pettem@mattamycorp.com>
Sent: March-12-18 2:31 PM
To: Michelle Taggart <mtaggart@taggart.ca>; Kevin Murphy <Kevin.Murphy@mattamycorp.com>
Subject: RE: Meadows Ph 5 - TIA Study Area Requirments

Hi Michelle,

The street will be registered as part of our Phase 1 of development, however the timing for construction of the road is tied to the school block purchase. We currently do not have a timeline from the school board as to when they are looking to purchase the block. They have 7 years to enter into an agreement, in which case the road may not be constructed in time for when you would need it. I can keep you posted if I hear anything from them in the meantime.

Let me know if you have any questions.

Thanks,

<image001.jpg>

Melissa Pettem
Land Development Manager
T (613)831-3546 (direct). C (613)219-2065. F (613)831-9060.
melissa.pettem@mattamycorp.com
Ottawa Office: 50 Hines Road, Suite 100, Ottawa, ON K2K 2M5

Notice: This email is intended for use of the party to whom it is addressed and may contain confidential information. If you have received this email in error, please inform me and delete it. Thank you.

This e-mail originates from the City of Ottawa e-mail system. Any distribution, use or copying of this e-mail or the information it contains by other than the intended recipient(s) is unauthorized. Thank you.

Le présent courriel a été expédié par le système de courriels de la Ville d'Ottawa. Toute distribution, utilisation ou reproduction du courriel ou des renseignements qui s'y trouvent par une personne autre que son destinataire prévu est interdite. Je vous remercie de votre collaboration.



TIA Plan Reports - Certification

On 14 June 2017, the Council of the City of Ottawa adopted new Transportation Impact Assessment (TIA) Guidelines. In adopting the guidelines, Council established a requirement for those preparing and delivering transportation impact assessments and reports to sign a letter of certification.

Individuals submitting TIA reports will be responsible for all aspects of development-related transportation assessment and reporting, and undertaking such work, in accordance and compliance with the City of Ottawa's Official Plan, the Transportation Master Plan and the Transportation Impact Assessment (2017) Guidelines.

By submitting the attached TIA report (and any associate documents) and signing this document, the individual acknowledges that s/he meets the four criteria listed below:

CERTIFICATION

1. I have reviewed and have a sound understanding of the objectives, needs and requirements of the City of Ottawa's Official Plan, Transportation Master Plan and the Transportation Impact Assessment (2017) Guidelines;
2. I have a sound knowledge of industry standard practice with respect to the preparation of transportation impact assessment reports, including multi modal level of service review;
3. I have substantial experience (more than 5 years) in undertaking and delivering transportation impact studies (analysis, reporting and geometric design) with strong background knowledge in transportation planning, engineering or traffic operations; and
4. I am either a licensed¹ or registered¹ professional in good standing, whose field of expertise [check appropriate field(s)] is either transportation engineering or transportation planning .

¹ License or registration body that oversees the profession is required to have a code of conduct and ethics guidelines that will ensure appropriate conduct and representation for transportation planning and/or transportation engineering works.

Dated at Ottawa this 11th day of April, 2018.
(City)

Name: Austin Shih, M.A.Sc., P.Eng.

Professional Title: Project Engineer

Signature of Individual certifier that she/he meets the above four criteria

| |
|--|
| Office Contact Information (Please Print) |
| Address: 400-333 Preston Street |
| City / Postal Code: K1S 5N4 |
| Telephone / Extension: 613-225-1311 ext. 564 |
| E-Mail Address: austin.shih@ibigroup.com |

Stamp





Document Control Page

| | |
|-------------------|--|
| CLIENT: | Tamarack Homes |
| PROJECT NAME: | The Meadows Phase 5 TIA |
| REPORT TITLE: | TIA Report |
| IBI REFERENCE: | 115637 |
| VERSION: | 3.0 |
| DIGITAL MASTER: | J:\115637_MeadowPh5TIA\5.2 Reports\5.2.4 Transportation\5.2.4.5 Traffic Impact_Submission |
| ORIGINATOR: | Ben Pascolo-Neveu, E.I.T. |
| REVIEWER: | Austin Shih, M.A.Sc, P.Eng. |
| AUTHORIZATION: | Justin Date, P.Eng. |
| CIRCULATION LIST: | Rosanna Baggs, C.E.T. |
| HISTORY: | 1.0. Screening and Scoping Report to City of Ottawa – March 2018 2.0. Screening, Scoping & Forecasting to City of Ottawa – March 2018 3.0. Screening, Scoping, Forecasting & Analysis to City of Ottawa – April 2018 |

DRAFT



Table of Contents

Executive Summary

| | | |
|----------|--|-----------|
| 1 | Introduction..... | 1 |
| 2 | Screening and Scoping | 1 |
| 2.1 | Screening Form | 1 |
| 2.2 | Description of Proposed Development | 3 |
| 2.2.1 | Site Location | 3 |
| 2.2.2 | Land Use | 3 |
| 2.2.3 | Site Layout..... | 6 |
| 2.2.4 | Transit, Pedestrian and Cycling Facilities..... | 6 |
| 2.3 | Existing Conditions | 6 |
| 2.3.1 | Existing Road Network | 6 |
| 2.3.1.1 | Roadways | 6 |
| 2.3.1.2 | Study Area Intersections..... | 6 |
| 2.3.1.3 | Traffic Management Measures | 6 |
| 2.3.1.4 | Existing Traffic Volumes | 6 |
| 2.3.2 | Existing Bicycle and Pedestrian Facilities | 7 |
| 2.3.3 | Existing Transit Facilities and Service | 7 |
| 2.3.4 | Collision Analysis..... | 8 |
| 2.4 | Planned Conditions..... | 9 |
| 2.4.1 | Changes to the Study Area Transportation Network | 9 |
| 2.4.1.1 | Future Road Network Projects (TMP)..... | 9 |
| 2.4.1.2 | Future Road Network Projects (Cambrian Road EA) | 10 |
| 2.4.1.3 | Future Transit Facilities and Services..... | 10 |
| 2.4.1.4 | Future Cycling and Pedestrian Facilities | 11 |
| 2.4.2 | Future Adjacent Developments | 12 |
| 2.4.3 | Network Concept Screenline | 14 |
| 2.5 | Study Area..... | 15 |
| 2.6 | Time Periods | 16 |
| 2.7 | Horizon Years..... | 16 |
| 2.8 | Exemptions Review | 16 |
| 3 | Forecasting..... | 18 |
| 3.1 | Development Generated Traffic..... | 18 |
| 3.1.1 | Trip Generation Methodology | 18 |
| 3.1.2 | Trip Generation Results..... | 18 |



Table of Contents

| | | |
|---------|--|----|
| 3.1.2.1 | ITE Vehicle Trip Generation | 18 |
| 3.1.2.2 | Person Trip Generation | 19 |
| 3.1.2.3 | Mode Share Proportions | 19 |
| 3.1.2.4 | Trip Generation by Mode | 20 |
| 3.1.3 | Trip Distribution and Assignment | 20 |
| 3.1 | Background Network Traffic | 21 |
| 3.1.1 | Changes to the Background Transportation Network | 21 |
| 3.1.2 | General Background Growth Rates | 21 |
| 3.1.3 | Other Area Development | 23 |
| 3.2 | Demand Rationalization | 23 |
| 3.2.1 | Description of Capacity Issues | 23 |
| 3.3 | Traffic Volume Summary | 24 |
| 3.3.1 | Future Background Traffic Volumes | 24 |
| 3.3.1 | Future Total Traffic Volumes | 25 |
| 4 | Analysis | 27 |
| 4.1 | Development Design | 27 |
| 4.1.1 | Design for Sustainable Modes | 27 |
| 4.1.2 | Circulation and Access | 27 |
| 4.1.3 | New Street Networks | 27 |
| 4.2 | Parking | 29 |
| 4.2.1 | Parking Supply | 29 |
| 4.2.2 | Spillover Parking | 29 |
| 4.3 | Boundary Streets | 29 |
| 4.4 | Access Intersections | 29 |
| 4.4.1 | Location and Design of Access Intersections | 29 |
| 4.4.2 | Intersection Control | 30 |
| 4.4.2.1 | Traffic Signal Warrants | 30 |
| 4.4.2.2 | Roundabout Analysis | 30 |
| 4.4.3 | Intersection Design (MMLOS) | 30 |
| 4.4.3.1 | Intersection Pedestrian Level of Service (PLOS) | 31 |
| 4.4.3.2 | Intersection Bicycle Level of Service (BLOS) | 31 |
| 4.4.3.3 | Intersection Transit Level of Service (TLOS) | 31 |
| 4.4.3.4 | Intersection Truck Level of Service (TKLOS) | 32 |
| 4.5 | Transportation Demand Management | 32 |



Table of Contents

| | | |
|----------|---|----|
| 4.6 | Neighbourhood Traffic Management | 32 |
| 4.6.1 | Adjacent Neighbourhoods | 32 |
| 4.6.2 | Local Intersection Requirements | 33 |
| 4.7 | Transit..... | 33 |
| 4.7.1 | Route Capacity | 33 |
| 4.8 | Review of Network Concept | 33 |
| 4.9 | Intersection Design | 34 |
| 4.9.1 | Base Road Network..... | 34 |
| 4.9.2 | Intersection Analysis Criteria | 35 |
| 4.9.2.1 | Signalized Intersections | 35 |
| 4.9.2.2 | Unsignalized Intersections | 35 |
| 4.9.2.3 | Roundabout Analysis..... | 36 |
| 4.9.3 | Intersection Control | 36 |
| 4.9.3.1 | Traffic Signal Warrant Methodology | 36 |
| 4.9.3.2 | Traffic Signal Warrants | 37 |
| 4.9.4 | Intersection Design (Operations)..... | 37 |
| 4.9.4.1 | Intersection Analysis Methodology | 37 |
| 4.9.4.2 | Existing (2018) Traffic Results | 37 |
| 4.9.4.3 | 2022 Background Traffic Results..... | 37 |
| 4.9.4.4 | 2027 Background Traffic Results..... | 38 |
| 4.9.4.5 | 2022 Total Traffic Results | 38 |
| 4.9.4.6 | 2027 Total Traffic Results | 39 |
| 4.9.5 | Intersection Design (MMLOS) | 39 |
| 4.10 | Geometric Review | 39 |
| 4.10.1 | Auxiliary Lane Analysis..... | 40 |
| 4.10.1.1 | Unsignalized Auxiliary Left-Turn Lane Requirements..... | 40 |
| 4.10.1.2 | Signalized Auxiliary Left-Turn Lane Requirements..... | 41 |
| 4.10.1.3 | Unsignalized Auxiliary Right-Turn Lane Requirements | 42 |
| 4.10.1.4 | Signalized Auxiliary Right-Turn Lane Requirements | 42 |
| 4.11 | Summary of Improvements Indicated and Modification Options..... | 43 |
| 4.11.1 | Cambrian Road and Borrisokane Road..... | 43 |
| 4.11.2 | Cambrian Road and Street 23/ Mattamy Site Access | 43 |
| 4.11.3 | Summary of Conclusions and Recommendations..... | 43 |



Table of Contents

LIST OF EXHIBITS

| | |
|---|----|
| EXHIBIT 1 – Site Location | 4 |
| EXHIBIT 2 – Proposed Development | 5 |
| EXHIBIT 3 – Existing (2018) Pedestrian, Cycling and Vehicular Volumes..... | 7 |
| EXHIBIT 4 – Existing Transit Stops | 8 |
| EXHIBIT 5 – Future Road Network Projects..... | 9 |
| EXHIBIT 6 – Barrhaven South Community Design Plan – Road Network | 10 |
| EXHIBIT 7 – Future ‘Affordable RTTP Network Projects’ | 11 |
| EXHIBIT 8 – Future Cycling Connections..... | 12 |
| EXHIBIT 9 – Riverside South Community Design Plan – Cycling and Pedestrian Network..... | 12 |
| EXHIBIT 10 – Future Adjacent Developments | 13 |
| EXHIBIT 11 – Nearest Screenlines | 15 |
| EXHIBIT 12 – Site Generated AM & PM Peak Hour Traffic Volumes | 22 |
| EXHIBIT 13 – Existing (2018) Auto, Cycling and Pedestrian AM & PM Peak Hour Traffic Volumes | 24 |
| EXHIBIT 14 – Future (2022) Background AM & PM Peak Hour Traffic Volumes..... | 25 |
| EXHIBIT 15 – Future (2027) Background AM & PM Peak Hour Traffic Volumes..... | 25 |
| EXHIBIT 16 – Future (2022) Total AM & PM Peak Hour Traffic Volumes..... | 26 |
| EXHIBIT 17 – Future (2027) Total AM & PM Peak Hour Traffic Volumes..... | 26 |
| EXHIBIT 18 – Proposed Transit Routes | 28 |
| EXHIBIT 19 – Nearest Screenlines | 34 |
| EXHIBIT 20 – Future (2027) Lane Configurations and Intersection Control..... | 45 |



Table of Contents

LIST OF TABLES

| | |
|---|----|
| TABLE 1 – Land Use Statistics..... | 3 |
| TABLE 2 – Reported Collisions within Study Area | 8 |
| TABLE 3 – Developments Adjacent to Subject Development | 14 |
| TABLE 4 – Exemptions Review..... | 17 |
| TABLE 5 – ITE Development Trip Generation Results..... | 19 |
| TABLE 6 – Development Person Trip Generation Results..... | 19 |
| TABLE 7 – Proposed Mode Shares for South Nepean (2011 OD Survey) | 20 |
| TABLE 8 – Development Generated Traffic by Mode | 20 |
| TABLE 9 – Trip Distribution by Direction | 21 |
| TABLE 10 – Future Adjacent Developments | 23 |
| TABLE 11 – Segment MMLOS – Future Background and Total Results | 29 |
| TABLE 12 – Intersection MMLOS – Future BG & Future BGSB Results..... | 31 |
| TABLE 13 – Road Classification Capacity..... | 32 |
| TABLE 14 – Development-Generated Transit Demand | 33 |
| TABLE 15 – 2031 Development Generated Transit Demand..... | 33 |
| TABLE 16 – LOS Criteria for Signalized Intersections | 35 |
| TABLE 17 – LOS Criteria for Unsignalized Intersections | 36 |
| TABLE 18 – Intersection Capacity Analysis: Existing (2018) Traffic | 37 |
| TABLE 19 – Intersection Capacity Analysis: Future (2022) Background Traffic | 37 |
| TABLE 20 – Intersection Capacity Analysis: Future (2027) Background Traffic | 38 |
| TABLE 21 – Intersection Capacity Analysis: Future (2022) Total Traffic..... | 38 |
| TABLE 22 – Intersection Capacity Analysis: Future (2027) Total Traffic..... | 39 |
| TABLE 23 – Auxiliary Left-Turn Lane Analysis at Unsignalized Intersections..... | 40 |
| TABLE 24 – Recommended Auxiliary Left-Turn Storage Lengths at Signalized Intersections | 41 |
| TABLE 25 – Recommended Auxiliary Right-Turn Storage Lengths at Signalized Intersections | 42 |
| TABLE 26 – Summary of Recommended Actions/ Modifications..... | 44 |



Table of Contents

LIST OF APPENDICES

- Appendix A – Traffic Data
- Appendix B – OC Transpo Maps
- Appendix C – Collision Data
- Appendix D – Cambrian Road Widening EA
- Appendix E – ITE Trip Generation Data
- Appendix F – 2011 OD Survey Data – South Nepean
- Appendix G – MMLOS Results
- Appendix H – Traffic Signal Warrants
- Appendix I – Roundabout Feasibility Screening Tool
- Appendix J – Synchro and SIDRA Results
- Appendix K – Technical Standards

DRAFT



1 Introduction

The Screening and Scoping has been prepared on behalf of Tamarack Homes in support of the Meadows Phase 5 (Meadows Ph5) draft plan of subdivision application. The format of the Screening and Scoping was based on the City of Ottawa’s 2017 Transportation Impact Assessment (TIA) Guidelines. The purpose of the Screening and Scoping is to identify “the range of analyses required to understand how well the development proposal aligns with City of Ottawa policies and objectives, and if the transportation network requires modification to offset development impacts.”¹

2 Screening and Scoping

Section 2 is the initial stage of the TIA. The Screening Form (Section 2.1) establishes the need to complete the study. The remainder of Section 2 focuses on the Scoping, which involves establishing the existing/ planned conditions of the study, key parameters and a review of possible exemptions.

2.1 Screening Form

STEP 1 - City of Ottawa 2017 TIA Guidelines Screening Form

1. Description of Proposed Development

| | |
|----------------------------------|--|
| Municipal Address | Tamarack Homes - The Meadows Phase 5 – TIA Screening Letter |
| Description of Location | Barrhaven South Subject site is located east of the future realigned Greenbank Road, south of Cambrian Road and is bounded by undeveloped lands to the north, south and west |
| Land Use Classification | Residential |
| Development Size (units) | 221 units (Townhomes/ Semi-detached Residential) 125 units (Single Family Homes) |
| Development Size (ha) | 19 ha |
| Number of Accesses and Locations | There are two (2) accesses/ egresses proposed for this development: (1) Street 23 – connects with residential development to the north (2) Street 17 – connects with residential development to the east and to the future realigned Greenbank Road. The future re-aligned Greenbank Road will eventually be a boundary street on the east side of the development; however, the realignment is not expected to be complete until after the study horizon years considered in this traffic study |
| Phase of Development | Single Phase |
| Buildout Year | 2022 (full buildout) 2027 (full buildout + 5 years) |

¹ Ottawa Transportation Impact Assessment Guidelines (2017), p.19



2. Trip Generation Trigger

Considering the Development's Land Use type and Size (as filled out in the previous section), please refer to the Trip Generation Trigger checks below.

| Land Use Type | Minimum Development Size |
|-------------------------------------|--------------------------|
| Single-family homes | 40 units ✓ |
| Townhomes or apartments | 90 units ✓ |
| Office | 3,500 m ² |
| Industrial | 5,000 m ² |
| Fast-food restaurant or coffee shop | 100 m ² |
| Destination retail | 1,000 m ² |
| Gas station or convenience market | 75 m ² |

* If the development has a land use type other than what is presented in the table above, estimates of person-trip generation may be made based on average trip generation characteristics represented in the current edition of the Institute of Transportation Engineers (ITE) Trip Generation Manual.

If the proposed development size is greater than the sizes identified above, therefore the Trip Generation Trigger is satisfied.

3. Location Triggers

| | Yes | No |
|--|-----|----|
| Does the development propose a new driveway to a boundary street that is designated as part of the City's Transit Priority, Rapid Transit or Spine Bicycle Networks? | | ✓ |
| Is the development in a Design Priority Area (DPA) or Transit-oriented Development (TOD) zone?* | | ✓ |

*DPA and TOD are identified in the City of Ottawa Official Plan (DPA in Section 2.5.1 and Schedules A and B; TOD in Annex 6). See Chapter 4 for a list of City of Ottawa Planning and Engineering documents that support the completion of TIA).

If any of the above questions were answered with 'Yes,' the Location Trigger is satisfied.

4. Safety Triggers

| | Yes | No |
|---|-----|----|
| Are posted speed limits on a boundary street are 80 km/h or greater? | | ✓ |
| Are there any horizontal/vertical curvatures on a boundary street limits sight lines at a proposed driveway? | | ✓ |
| Is the proposed driveway within the area of influence of an adjacent traffic signal or roundabout (i.e. within 300 m of intersection in rural conditions, or within 150 m of intersection in urban/ suburban conditions)? | | ✓ |
| Is the proposed driveway within auxiliary lanes of an intersection? | | ✓ |



| | | |
|--|--|---|
| Does the proposed driveway make use of an existing median break that serves an existing site? | | ✓ |
| Is there is a documented history of traffic operations or safety concerns on the boundary streets within 500 m of the development? | | ✓ |
| Does the development include a drive-thru facility? | | ✓ |

If any of the above questions were answered with ‘Yes,’ the Safety Trigger is satisfied.

5. Summary

| | Yes | No |
|---|-----|----|
| Does the development satisfy the Trip Generation Trigger? | ✓ | |
| Does the development satisfy the Location Trigger? | | ✓ |
| Does the development satisfy the Safety Trigger? | | ✓ |

Overall, the subject development has been found to satisfy one of the triggers for a Transportation Impact Assessment (TIA).

2.2 Description of Proposed Development

2.2.1 Site Location

The proposed Meadows Phase 5, part of the lands municipally known as 3640 Greenbank Road, is shown in Exhibit 1. The portion of these lands that is proposed to be developed is approximately 19 hectares in total. The land abuts the proposed future alignment of Greenbank Road to the east, and is bounded by undeveloped lands to the north, south and west. Cambrian Road is located approximately 200m north of the subject property.

2.2.2 Land Use

The proposed draft plan for the subject site is shown in Exhibit 2. The land is currently undeveloped, and is zoned mostly for development reserve zone, with a small section designated as mineral aggregate reserve zone. The proposed development will contain a mix of low and medium density residential land uses, as summarized in Table 1.

For the purposes of this study, full occupancy of the proposed development was assumed by the 2022 horizon year. However, the assumed buildout horizon year is highly dependent on market forces. It is possible full occupancy won't be achieved by the buildout horizon year.

TABLE 1 – Land Use Statistics

| LAND USE | SIZE (# OF UNITS) |
|-------------------------------------|-------------------|
| Townhome/ Semi-Detached Residential | 221 units |
| Single Family Homes | 125 units |



The Meadows Phase 5
Transportation Impact Assessment

Exhibit 1
Site Location

PROJECT No. 115637
DATE: APRIL 2018
SCALE:



JAN 24.18

park
1.5hec

PROPOSED SCHOOL LOCATION
2.8Hec

FUTURE REALIGNED GREENBANK ROAD
B 1 0 1 C K
3 6 3

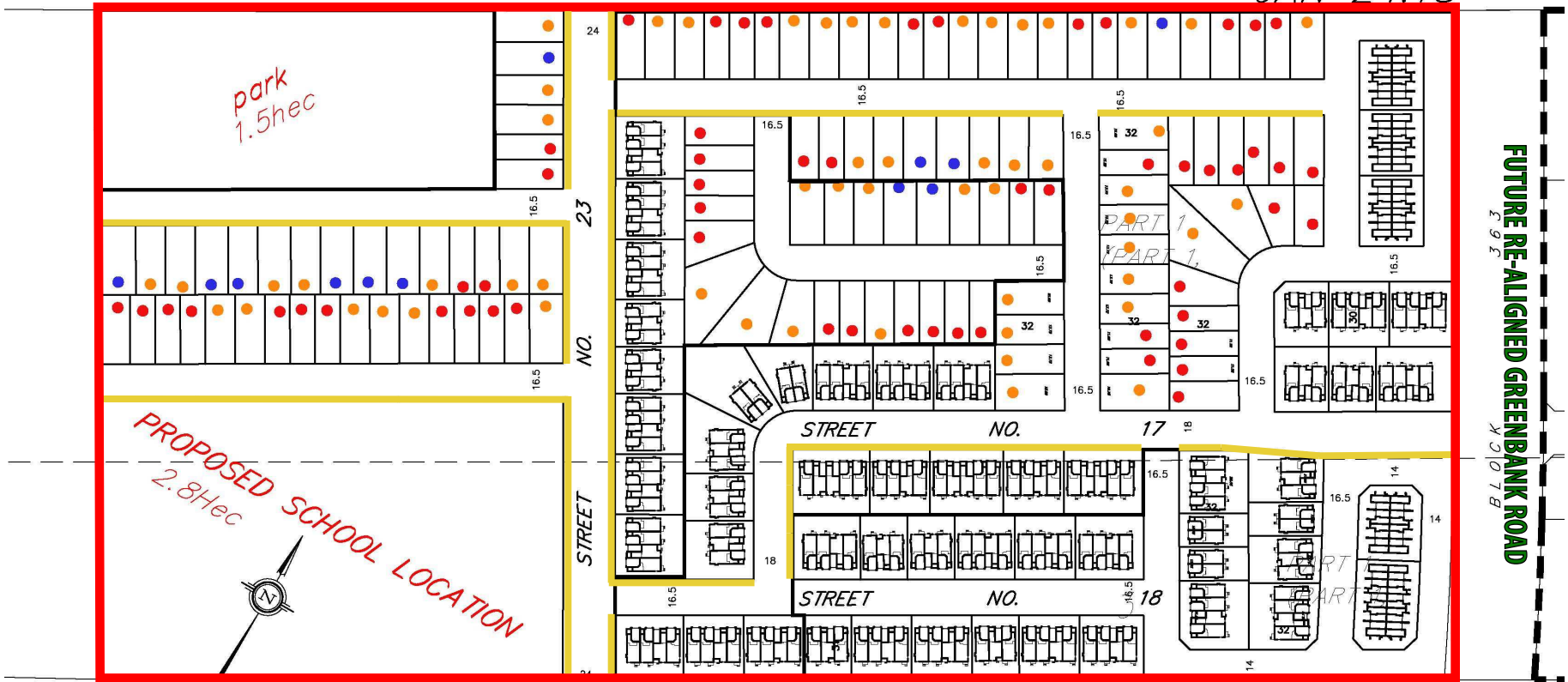

LEGEND

- Potential Sidewalk Location
- Proposed Development Limit





2.2.3 Site Layout

According to the plan of subdivision, the proposed development is expected to connect to the Meadows Phase 4 subdivision to the east via Street 17. Street 17 is proposed as an east-west local road with an 18m right-of-way, crossing the realigned Greenbank Road and terminating at Street 23 to the west. Street 23 is proposed as a north-south collector road with a 24m right-of-way (ROW) that will connect to Cambrian Road via the proposed Half Moon Bay West development access intersection to the north. Street 23 is approximately 300m in length, and will terminate at the southern edge of the development.

The remaining roads proposed within the development were proposed to have a 16.5m right-of-way (ROW) width for double-loaded streets, and 14m right-of-way (ROW) width for single-loaded streets.

2.2.4 Transit, Pedestrian and Cycling Facilities

The proposed development does not include any transit or cycling facilities. Sidewalks will be provided on select sections, as noted in Exhibit 2, to provide access to local amenities and adjacent developments.

2.3 Existing Conditions

2.3.1 Existing Road Network

2.3.1.1 Roadways

Cambrian Road is designated as an arterial road with a with a ROW width of 37.5 m that extends east-west from Longfields Drive (formerly Jockvale Road) to Borrisokane Road. Between Borrisokane Road and Seeley's Bay Street, Cambrian Road is a two-lane rural arterial road with a posted speed limit of 70km/h. East of Seeley's Bay Street, Cambrian Road transitions to a two-lane urban arterial road with a posted speed limit of 50km/h.

Borrisokane Road is a two-lane rural arterial road with a posted speed limit of 80km/h, and gravel shoulders along both sides of the roadway within the vicinity of the subject site.

2.3.1.2 Study Area Intersections

The following existing intersection will be evaluated in this report:

- Cambrian Road and Borrisokane Road

The Cambrian Road and Borrisokane Road intersection is stop-controlled on the westbound approach along Cambrian Road, and free-flow along Borrisokane Road in the northbound and southbound directions.

2.3.1.3 Traffic Management Measures

There are currently no existing traffic management or traffic calming measures on any of the boundary roads located within the study area.

2.3.1.4 Existing Traffic Volumes

Weekday morning and afternoon peak hour turning movement counts were conducted by IBI Group in February 2018 for the study area intersection of Cambrian Road and Borrisokane Road. The existing (2018) peak hour traffic volumes are shown in Exhibit 3. Traffic count data is provided in Appendix A.



EXHIBIT 3 – Existing (2018) Pedestrian, Cycling and Vehicular Volumes

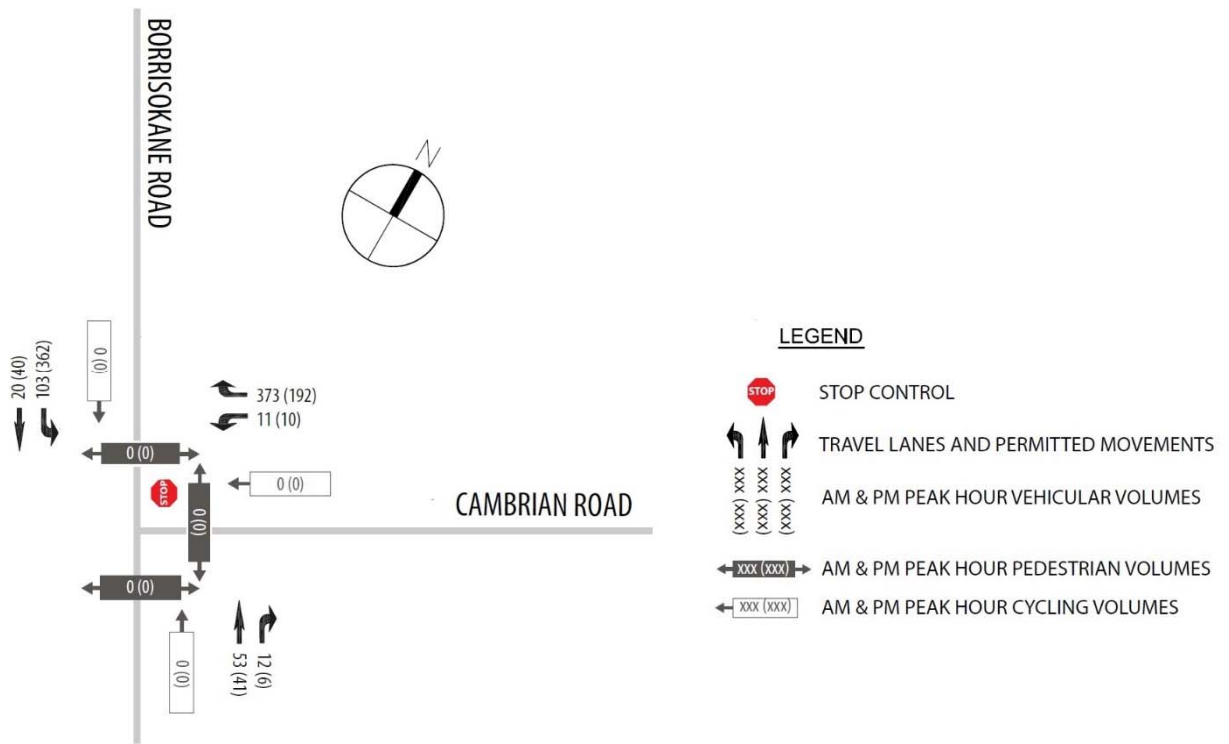

2.3.2 Existing Bicycle and Pedestrian Facilities

East of Seeley's Bay Street, formal urban sidewalks are located on both sides of Cambrian Road. West of Seeley's Bay Street, Cambrian Road transitions to a two-lane rural road with gravel shoulders, and no formal pedestrian facilities.

No dedicated cycling facilities exist within the vicinity of the subject site.

2.3.3 Existing Transit Facilities and Service

There is currently one OC Transpo service route that run through the study area.

- Route #177 is a regular/all-day service route with headways ranging from 15 to 30 minutes in the peak and off-peak hours. It operates between Barrhaven Centre and a loop just east of the study area on Cambrian Road. On weekends, transit service typically operates at 30-minute headways.

Exhibit 4 shows the existing transit stops in the study area. Transit data is provided in Appendix B.



EXHIBIT 4 – Existing Transit Stops

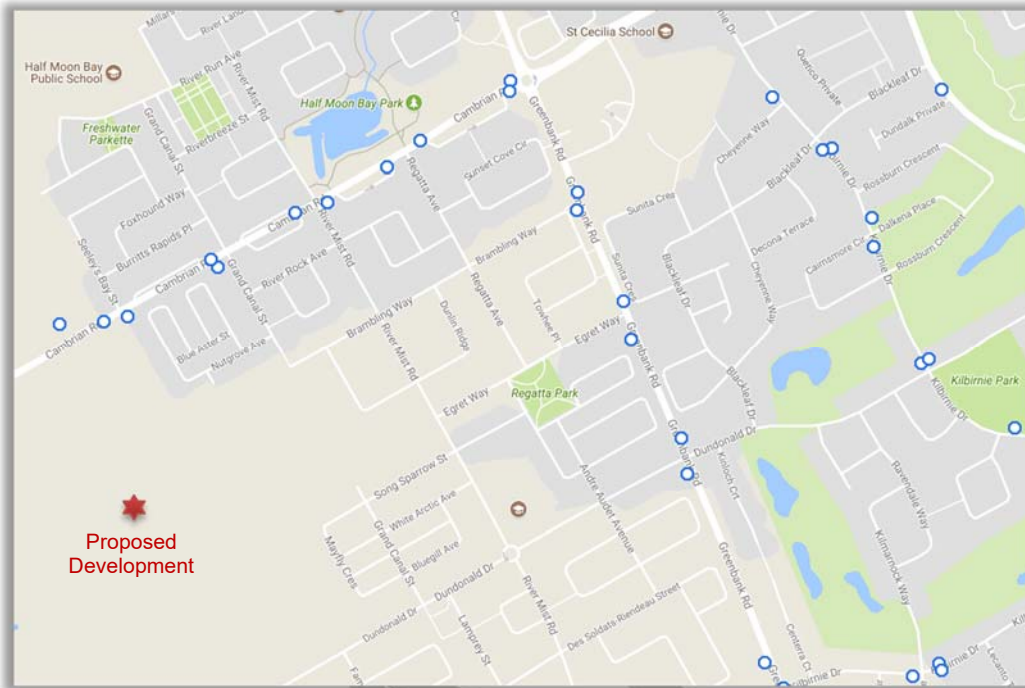

2.3.4 Collision Analysis

A review of historical collision data has been provided. The City requires a safety review if at least six collisions for any one movement or of a discernible pattern, over a five year period have occurred. Table 2 summarizes all reported collisions between January 1, 2011 and January 1, 2016.

TABLE 2 – Reported Collisions within Study Area

| LOCATION | # OF REPORTED COLLISIONS |
|---|--------------------------|
| Cambrian Road and River Mist Road | 1 |
| Cambrian Road and Grand Canal Street | 2 |
| Cambrian Road, between Greenbank Road and Borrisokane Road | 5 |
| Cambrian Road, between Grand Canal Street and Seeley's Bay Street | 1 |
| Cambrian Road, between Grand Canal Street and Borrisokane Road | 1 |

Upon review of all collision records, there were no discernible collision patterns noted. A copy of the City collision records is available in Appendix C.

2.4 Planned Conditions

2.4.1 Changes to the Study Area Transportation Network

2.4.1.1 Future Road Network Projects (TMP)

The 2013 Transportation Master Plan (TMP) outlines future road network modifications required in the 2031 'Affordable Road Network,' as shown in Exhibit 5. The following projects were noted that may have an impact on study area traffic:

- Greenbank Road realignment – New 4-lane road between Cambrian Road and Jockvale Road (Phase 1: 2014-2019). The anticipated completion date has been pushed to Phase 3 (2026-2031), as indicated by City staff.
- Jockvale Road (now Longfields Drive) widening – Widen from two to four lanes between Cambrian Road and Prince of Wales Drive (Phase 2: 2020-2025). At the time of this study, the project was not anticipated prior to Phase 3 (2026-2031).
- Chapman Mills Drive extension – New 4-lane road between Strandherd Drive and Longfields Drive (Phase 2: 2020-2025), currently projected by 2024.
- Strandherd Drive widening – Widen from two to four lanes between Fallowfield Drive and Maravista Drive (Phase 1: 2014-2019) and widen from two to four lanes between Maravista Drive and Jockvale Road (Phase 2: 2020-2025).

EXHIBIT 5 – Future Road Network Projects

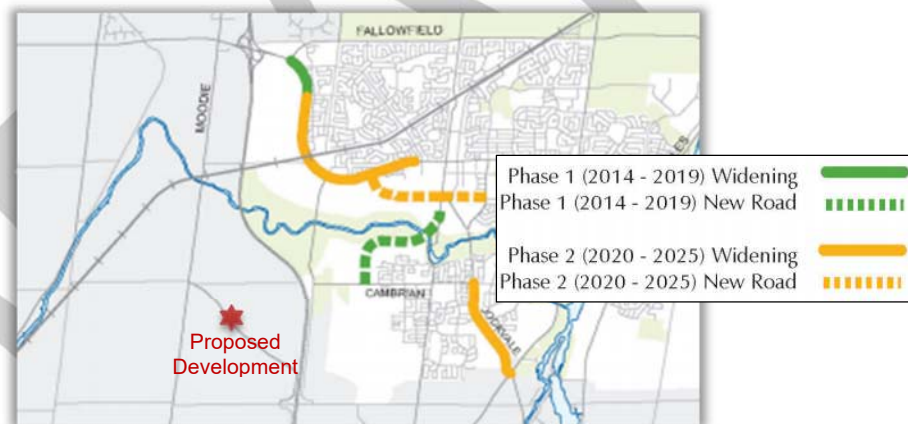

Phase 1 of the Strandherd Drive widening, between Fallowfield Drive and Maravista Drive has been completed. The Development Charges Amendment Background Study: Transit and Roads and Related Services (March 24, 2017) identified funds set aside for the Jockvale Road widening between 2024 and 2025, Strandherd Drive Phase 2 widening between 2020 and 2022, and Chapman Mills Drive extension between 2019 and 2020.

As noted above, the City indicated that the Greenbank Road re-alignment was postponed until Phase 3 (2026-2031) of the TMP. Addendum No. 1 of the Community Transportation Study (CTS) for Half Moon Bay West, completed in November 2017 (see Section 2.4.2), assumed that the re-alignment was not to be in place through to the ultimate planning horizon in 2029. This was meant to reflect the worst case scenario for traffic analysis purposes. At the time of this study, the Half Moon Bay West Addendum No. 1 CTS was pending approval, following resubmission to address minor comments. Similarly, for the Meadows Phase 5 Development, it was assumed that the Greenbank Road re-alignment would not be completed within the planning time horizons of this study. The planning horizons were further defined in Section 2.7.

2.4.1.2 Future Road Network Projects (Cambrian Road EA)

The Cambrian Road Widening Environmental Assessment (EA) was completed by Stantec in 2014, and proposes an ultimate four-lane cross-section along Cambrian Road from the future re-aligned Greenbank Road to Longfields Drive. Although this EA is not shown in the TMP's affordable network, it has been approved by Transportation Committee and City Council. Please refer to Appendix D for the Cambrian Road Widening EA Recommended 4-lane Functional Design.

The Barrhaven South Community Design Plan (CDP) outlined potential road widenings and rapid transit expansions in the study area. The CDP also highlighted a potential future interchange where Cambrian Road currently dead-ends at Highway 416. A map of the planned and potential transportation network and transit network changes as shown in the CDP are shown below in Exhibit 6.

EXHIBIT 6 – Barrhaven South Community Design Plan – Road Network

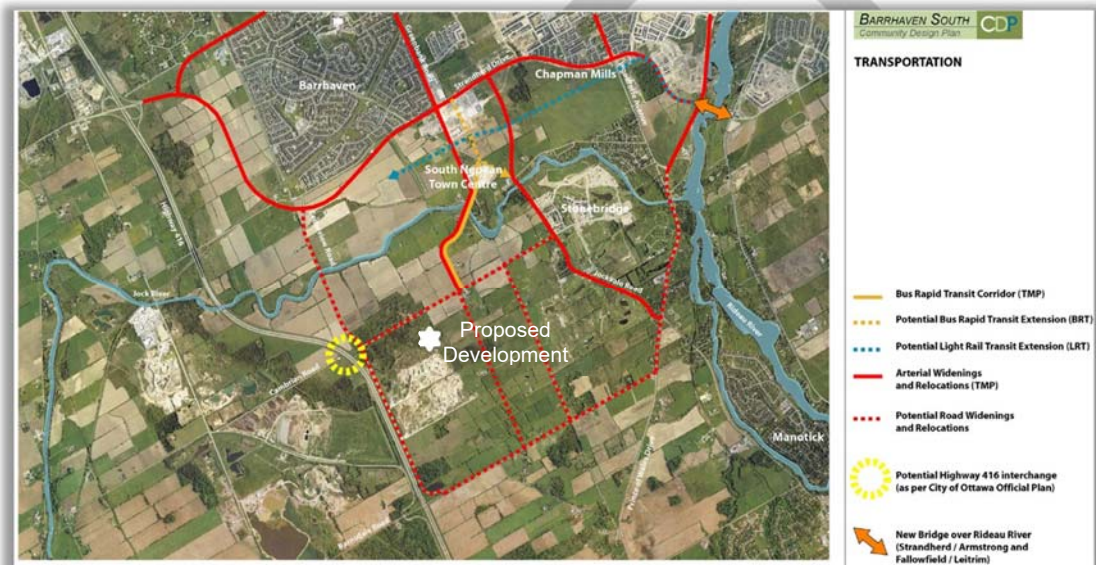

2.4.1.3 Future Transit Facilities and Services

The 2013 TMP outlines future rapid transit and transit priority (RTTP) network. The nearest project noted in the 'Affordable RTTP Network' was the Chapman Mills/ Strandherd / Earl Armstrong Transit Signal Priority and Queue Jump Lanes at select intersections between Barrhaven Centre Station to Bowesville Station. This project was not expected to impact study area traffic.

The following projects were noted in the '2031 Network Concept' that may have an impact on study area traffic:

- South Transitway Extension: At-Grade BRT corridor following the re-aligned Greenbank Road extension between Barrhaven Town Centre and Cambrian Road, with the possibility of a future extension to Barnsdale Road
- South Transitway: At-Grade BRT corridor between the Southwest Transitway and Riverside South Town Centre

Exhibit 7 shows the transit infrastructure projects in the vicinity of the study area that are part of the affordable plan.



In addition to the above-noted regional transit facilities outlined in the TMP, typical cross-sections presented in the Cambrian Road Environmental Assessment (EA) from 2014 demonstrates that this corridor will be able to accommodate mixed-use transit, as shown in Appendix D.

EXHIBIT 7 – Future ‘Affordable RTTP Network Projects’

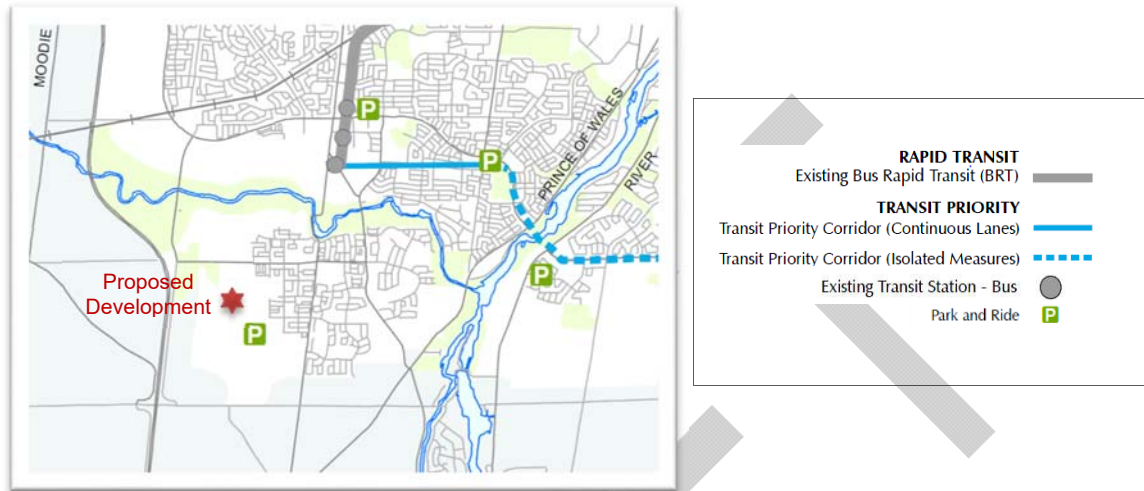

2.4.1.4 Future Cycling and Pedestrian Facilities

The Transportation Master Plan (TMP) designates Cambrian Road as “Local Route”.

The Ottawa Cycling Plan (2013), a long term strategic plan to strengthen and support cycling in the City, does not note any future modifications to the area cycling network based on the ‘Affordable Cycling Network Plan’ recommendations. Exhibit 8 below shows the future cycling network in the vicinity of the proposed development.

The Ottawa Pedestrian Plan (2013) does not propose any future modifications to the pedestrian network within the study area.

The Cambrian Road Environmental Assessment (EA) was completed in 2014, after the latest TMP update in 2013. This Environmental Assessment (EA) proposes a typical cross-section that features enhanced cycling and pedestrian facilities, as compared to the existing cross-section. Sharrows and dedicated cycling lanes will be utilized along the corridor to promote the use of active transportation methods, especially for inter-zonal commuting. In addition, 2.0m sidewalks separated by grassed boulevards and a multi-use pathway (MUP) is proposed on the south side of the roadway. Please refer to the Typical Cross-section in Appendix D.



EXHIBIT 8 – Future Cycling Connections

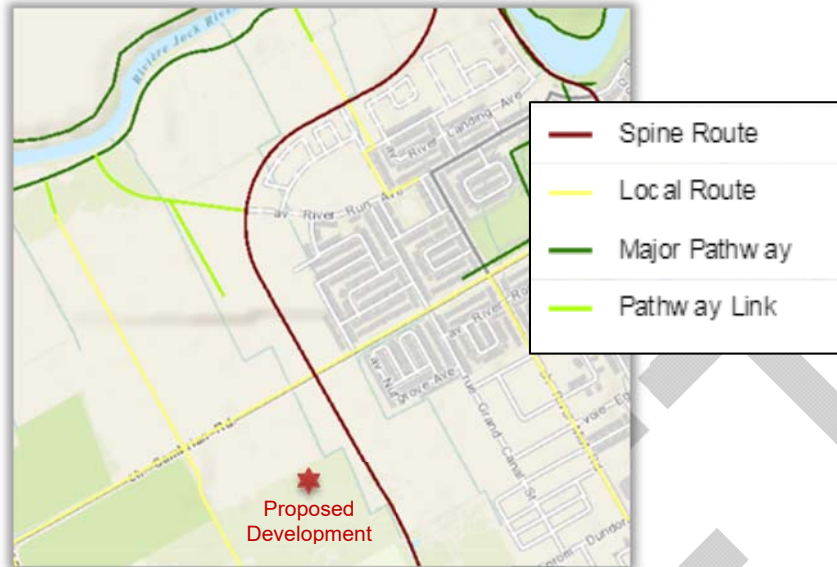

The Barrhaven South Community Design Plan (CDP) shows Cambrian Road immediately east and west of the proposed Greenbank Road re-alignment will provide “On-Road Linkages” for pedestrians and cyclists. The planned cycling and pedestrian network from the CDP are shown below in Exhibit 9.

EXHIBIT 9 – Riverside South Community Design Plan – Cycling and Pedestrian Network



2.4.2 Future Adjacent Developments

The City of Ottawa Transportation Impact Assessment (TIA) Guidelines specifies all significant developments within the study area which are likely to occur within the horizon year must be identified and recognized in all TIA reports. Since the traffic generated by these developments was not captured in the background traffic growth calculation, they must be added separately. Developments adjacent to the study area are shown in Exhibit 10.



The Meadows Phase 5
Transportation Impact Assessment

Exhibit 10
Future Adjacent Developments

PROJECT No. 115637
DATE: APRIL 2018
SCALE:





Table 3 outlines future adjacent developments to the study area. The development of Half Moon Bay West was proposed immediately to the north of the subject site, and The Meadows Phase 4 was proposed to the east of the subject site, according to TIA reports prepared for these developments. As confirmed via Google Maps aerial imagery at the time of writing this TIA, no portions of either site have been builtout.

TABLE 3 – Developments Adjacent to Subject Development

| DEVELOPMENT NAME | TIA PREPARED BY | SIZE/ NUMBER OF UNITS | EXPECTED BUILDOUT/ OCCUPANCY DATE | RECOMMENDED ROAD MODIFICATIONS |
|--------------------------------------|--------------------|------------------------------------|-----------------------------------|--|
| Half Moon Bay West (Mattamy Homes) | Stantec Consulting | 518 singles | 2024 (no occupancy in 2018) | Construction of auxiliary lanes and implementation of traffic signals at the following intersections: 1) Cambrian Road & Mattamy Site Access 2) Cambrian Road & Borrisokane Road |
| | | 427 townhome units | | |
| | | 5.3 acres of commercial land | | |
| | | 109 townhome units | | |
| | | 360 townhomes/back-to-back homes | | |
| The Meadows Phase 4 (Tamarack Homes) | IBI Group | 50 singles | 2019 (no occupancy in 2018) | No recommended modifications to intersections on roadways within study area. |
| | | 136 units townhomes/ Semi-detached | | |

2.4.3 Network Concept Screenline

A screenline is an imaginary line made up of a number of stations to count east/west or north/south travel within a particular area. Screenlines are typically located along geographical barriers such as rivers, rail lines or within the greenbelt. To be truly representative of the flow, there is a station at each intersecting road crossing the screenline.

As specified in Module 4.8 of the 2017 TIA Guidelines, the latest Network Concept will be reviewed with to ensure that the nearest strategic planning screenlines adjacent to the development are considered in the screenline analysis.

- SL42 – Rideau River (Manotick) – This is the closest north/south screenline to the subject site, and it is located along the Rideau River from just south of Mitch Owens Road to just north of Leirtrim Road. It has two (2) crossing points: the Vimy Memorial Bridge and the Manotick Bridge.
- SL49 – Jock River – This is the nearest east/west screenline to the subject site. It follows the Jock River from just west of Moodie Drive in the west to the Rideau River in the east. This screenline has six (6) crossing points over the Jock River, including: Moodie Drive, Highway 416, Cedarview Road (now called Borrisokane Road), Greenbank Road, Jockvale Road and Prince of Wales Drive.

SL42 and SL49 are shown in Exhibit 11, as determined from the City of Ottawa’s Road Network Development Report (2013), a supporting document to the 2013 Transportation Master Plan (TMP).



EXHIBIT 11 – Nearest Screenlines

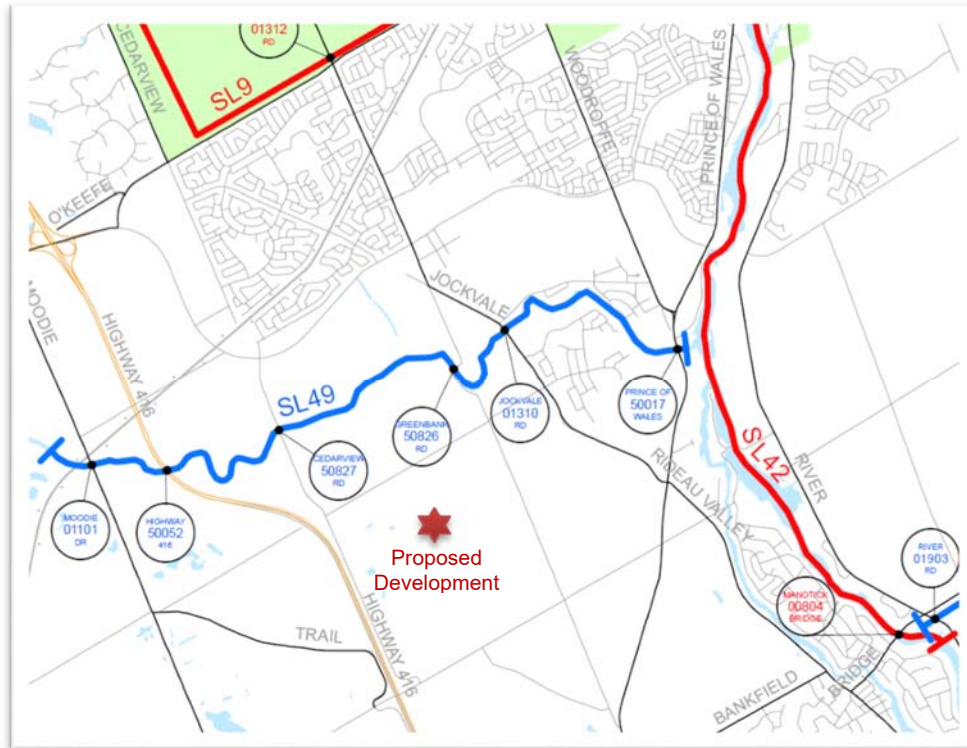

2.5 Study Area

Based on the review of the nearest screenlines, transit routes and active transportation facilities, the proposed study area will be defined by Cambrian Road to the north, Borrisokane Road to the west and undeveloped lands to the south and east.

The following existing intersection will be assessed as part of this TIA:

- Cambrian Road and Borrisokane Road

The following proposed intersection will be assessed as part of this TIA:

- Cambrian Road and Street 23/ Mattamy Site Access

Intersections along Cambrian Road east of Street 23 up to Greenbank Road were discussed and reviewed as part of the TIA prepared for the Meadows Phase 4, which is currently under review to address minor comments. As part of the Meadows Phase 4, the majority traffic was directed to River Mist Road and the existing Greenbank Road. Even with this conservative distribution, the River Mist Road and Cambrian Road intersection was shown to operate within City standards through to the ultimate 2024 planning horizon as stop-controlled intersection. Based on existing turning movement counts along Cambrian Road, the majority of traffic from the subject site is expected to utilize Street 23 and Borrisokane Road, as this a more direct route to Cambrian Road and the broader transportation network, rather than navigating through internal streets within the Meadows Phase 4 development. Since very little traffic is expected to bleed east through the development, existing intersections to the east of Street 23 along Cambrian Road were not considered as part of the study area.



As previously discussed in Section 2.4.1.1, this TIA will consider the worst case scenario, and rely on existing infrastructure to service the subject development. In this scenario, it was assumed that the Greenbank Road realignment to Cambrian Road would not be completed within the study horizons, and the existing Greenbank Road alignment remains through to the ultimate planning horizon. This approach provided a better evaluation of potential bottlenecks in the adjacent road network.

An agreement will be in place between the Mattamy Homes and Tamarack Homes as part of the conditions of approval, stating that the construction of Street 23 will be built from the subject lands and connect to Cambrian Road prior to the completion and occupancy of residential units within the subject development. Street 23 will be required for servicing, as well to provide vehicular access to the subject site.

2.6 Time Periods

Since this is a residential development, traffic generated during the morning and afternoon peak hour are expected to result in the most significant impact to traffic operations on the adjacent network in terms of development-generated and background traffic. These two (2) analysis periods will be used for operational analysis in the TIA.

2.7 Horizon Years

Two (2) future horizons are proposed for analysis in the Transportation Impact Analysis (TIA) Report:

- Year 2022 – Opening Day; Full occupancy
- Year 2027 – Opening Day plus 5 years

2.8 Exemptions Review

The TIA Guidelines provide exemption considerations for elements of the Design Review and Network Impact components. Table 4 identifies each element, and indicates whether or not it will be required in Step 4 – Analysis.



TABLE 4 – Exemptions Review

| TIA MODULE | ELEMENT | EXEMPTION CONSIDERATIONS | REQUIRED |
|--------------------------------------|-------------------------------|--|----------|
| Design Review Component | | | |
| 4.1 Development Design | 4.1.2 Circulation and Access | <ul style="list-style-type: none"> Only required for site plans | |
| | 4.1.3 New Street Networks | <ul style="list-style-type: none"> Only required for plans of subdivision | |
| 4.2 Parking | 4.2.1 Parking Supply | <ul style="list-style-type: none"> Only required for site plans | |
| | 4.2.2 Spillover Parking | <ul style="list-style-type: none"> Only required for site plans where parking supply is 15% below unconstrained demand | |
| Network Impact Component | | | |
| 4.5 Transportation Demand Management | All Elements | <ul style="list-style-type: none"> Not required for site plans expected to have fewer than 60 employees and/or students on location at any given time | |
| 4.6 Neighbourhood Traffic Management | 4.6.1 Adjacent Neighbourhoods | <ul style="list-style-type: none"> Only required when the development relies on local or collector streets for access and total volumes exceed ATM capacity thresholds | |
| 4.8 Network Concept | n/a | <ul style="list-style-type: none"> Only required when proposed development generates more than 200 person-trips during the peak hour in excess of the equivalent volume permitted by established zoning | |



3 Forecasting

The purpose of the Forecasting section is to “generate the future transportation demand number required to analyze pre and post-development network performance to determine if a network modification is required to offset development impacts.”²

3.1 Development Generated Traffic

3.1.1 Trip Generation Methodology

Peak hour development generated traffic volumes were developed using Institute of Transportation Engineers (ITE) Trip Generation Manual, 9th Edition, 2012. The Transportation Impact Assessment (TIA) Guidelines require ITE vehicle-trip rates to be adjusted to better reflect local travel patterns. The ITE trip generation rates are based on data collected from traffic surveys conducted across North America, but mostly in suburban areas of the United States where the level of transit use is traditionally very low (estimates show that ITE rates average approximately 96% auto mode split). This statistic is not representative of the City of Ottawa that has a well-established transit system and pedestrian/ cycling network.

The City recommends the ITE vehicle-trip rates be converted to person-trips split based on representative mode share proportions. This conversion factor was based on a recommended average vehicle occupancy of 1.15 and a 10% non-auto mode share. The person-trips were then split based on representative mode share percentages to determine the number of vehicle, transit, pedestrian, cycling and other trip types.

Local mode shares were based on the TRANS Committee: 2011 Origin-Destination (OD) Survey completed for the City of Ottawa. The OD Survey has mode share breakdowns for specific zones throughout the City; the South Nepean Zone contained the subject site and was applied in this analysis.

3.1.2 Trip Generation Results

3.1.2.1 ITE Vehicle Trip Generation

The peak hour vehicular traffic volumes from The Meadows Phase 5 development were determined using peak hour trip generation rates from the ITE Manual. A summary of the vehicular trip generation results for the proposed development has been summarized in Table 5.

The relevant extracts from the ITE Manual have been provided in Appendix E.

² Ottawa 2017 Transportation Impact Assessment Guidelines, p. 27



TABLE 5 – ITE Development Trip Generation Results

| LAND USE (ITE CODE) | SIZE (DU) | PERIOD | GENERATED TRIPS (VPH) | | |
|----------------------------------|--------------|--------|-----------------------|-----|-------|
| | | | IN | OUT | TOTAL |
| Single Detached Housing (210) | 125 | AM | 24 | 73 | 97 |
| | | PM | 81 | 48 | 56 |
| Townhouse (230) | 221 | AM | 17 | 81 | 98 |
| | | PM | 77 | 38 | 115 |

Notes: DU = Dwelling Units
 vph = vehicles per hour; DU = Dwelling Units vph = vehicles per hour; DU = Dwelling Units
 Formula Rate and Splits for Single Detached Homes Formula Rate and Splits for Townhomes
 AM T = 0.7(X) + 9.74 IN: 25%; OUT: 75% AM T = e^(0.80*ln(X) + 0.26) IN: 17%; OUT: 83%
 PM T = e^(0.9*ln(X)+0.51) IN: 63%; OUT: 37% PM T = e^(0.82*ln(X)+0.51) IN: 67%; OUT: 33%

3.1.2.2 Person Trip Generation

The ITE vehicle-trip to person-trip conversion factor of 1.28 based on an average vehicle occupancy of 1.15 and a default 10% non-auto mode share was applied to vehicle-trip results in Table 1. The results after applying this factor have been summarized in Table 6.

TABLE 6 – Development Person Trip Generation Results

| LAND USE (ITE CODE) | FACTOR | PERIOD | GENERATED TRIPS (PPH) | | |
|----------------------------------|--------|--------|-----------------------|-----|-------|
| | | | IN | OUT | TOTAL |
| Single Detached Housing (210) | 1.28 | AM | 24 | 73 | 97 |
| | | PM | 80 | 47 | 127 |
| Townhouse (230) | | AM | 16 | 81 | 97 |
| | | PM | 76 | 37 | 113 |
| Total | AM | 40 | 154 | 194 | |
| | PM | 156 | 84 | 240 | |

Notes:
 pph = persons per hour; DU = dwelling units

3.1.2.3 Mode Share Proportions

The total person trips generated by the proposed development were stratified by mode, based on mode share proportions in the 2011 Origin-Destination (OD) Survey for the South Nepean Traffic Assessment Zone (TAZ). The relevant extracts from the 2011 OD Survey has been provided in Appendix F.

No adjustments were made to active transportation modes such as walking or cycling for future planning horizons used for this traffic study. The existing and proposed mode share targets for the South Nepean TAZ for each of the analysis horizons are outlined in Table 7. Significant adjustments were made to the transit modal split to reduce it from 27% to 10% in the AM peak hour, and from 24% to 10% in the PM peak hour. The difference was shifted over to the auto-drive mode. This approach should be considered conservative.



TABLE 7 – Proposed Mode Shares for South Nepean (2011 OD Survey)

| TRAVEL MODE | 2011 OD SURVEY MODE SHARE | | ADJUSTED MODE SHARE | |
|----------------|---------------------------|------|---------------------|------|
| | AM | PM | AM | PM |
| Auto Driver | 61% | 63% | 78% | 77% |
| Transit | 27% | 24% | 10% | 10% |
| Auto Passenger | 8% | 11% | No Change | |
| Cycling | 0% | 0% | | |
| Walking | 0% | 0% | | |
| Other | 4% | 2% | | |
| Total | 100% | 100% | 100% | 100% |

3.1.2.4 Trip Generation by Mode

The mode share target in Table 7 were applied to person trips results from Table 6 to estimate the number of development generated trips by mode, as shown in Table 8.

TABLE 8 – Development Generated Traffic by Mode

| TRAVEL MODE | PEAK PERIOD TRIPS BY MODE | | | | | |
|----------------|---------------------------|-----|-------|-----|-----|-------|
| | AM | | | PM | | |
| | IN | OUT | TOTAL | IN | OUT | TOTAL |
| Auto Driver | 41 | 153 | 194 | 156 | 84 | 240 |
| Transit | 5 | 20 | 25 | 20 | 11 | 31 |
| Auto Passenger | 4 | 16 | 20 | 22 | 12 | 34 |
| Cycling | 0 | 0 | 0 | 0 | 0 | 0 |
| Walking | 0 | 0 | 0 | 0 | 0 | 0 |
| Other | 2 | 8 | 10 | 4 | 2 | 6 |

The proposed development is expected to generate approximately 194 morning and 240 afternoon peak hour vehicular trips at full buildout.

3.1.3 Trip Distribution and Assignment

A regional trip distribution was applied to the site generated traffic within the study area. The expected travel routes to and from the study area were as follows:

- East on Cambrian Road
- North and South on Borrisokane Road

It should be noted that since Cambrian Road terminates to the west at Borrisokane Road, any traffic heading west on Cambrian Road is captured in the north or south directions along Borrisokane Road. The estimated trip distributions were based on assumptions made in approved traffic studies completed within the study area.

A summary of trip distribution proportions applied to site generated trips is shown in Table 9.



TABLE 9 – Trip Distribution by Direction

| LOCATION | TRIP DISTRIBUTION | |
|------------------------------------|-------------------|-----|
| | IN | OUT |
| East on Cambrian Road | 35% | 35% |
| North on existing Borrisokane Road | 60% | 60% |
| South on existing Borrisokane Road | 5% | 5% |

The intersection level trip distribution was based on existing turning movement counts. The resulting development generated morning and afternoon peak hour traffic volumes has been provided in Exhibit 12.

3.1 Background Network Traffic

3.1.1 Changes to the Background Transportation Network

To properly assess future traffic conditions, the City requires that all anticipated changes to the transportation network over time, particularly road and transit route components, are accounted for in the traffic analysis. These changes would then be reflected in the future background demand volumes to develop an appropriate foundation for the TIA.

As noted in the Scoping, the impact of the Greenbank Road realignment was not accounted for in the following TIA. This approach was meant to represent the worst case scenario for the transportation network and provide a better evaluation of potential bottlenecks in the adjacent road network.

Recommended intersection modifications noted in the Half Moon Bay West Community Transportation Study (CTS): Addendum No. 1 dated November 2017, include adding traffic signals and auxiliary lanes at the intersections of Borrisokane Road and Cambrian Road, as well as at Street 23 and Cambrian Road. It is not anticipated that further modifications in addition to those recommended in the Half Moon Bay West CTS will be required to accommodate traffic generated from the subject development.

Existing transit service routes will need to be adjusted to increase transit coverage within the proposed development, however, as transit accessibility within 400m will be limited until the future Greenbank realignment south of Cambrian Road is completed.

3.1.2 General Background Growth Rates

The background growth rate is meant to represent regional growth, outside the study area, along the adjacent road network. Approved transportation impact assessments completed within the study area applied growth rates of 2% at the intersection of Borrisokane Road and Cambrian Road. For this study, a linear growth rate of 2% per annum to existing traffic volumes was applied to all movements at the Borrisokane Road and Cambrian Road intersection, as well as through movements along Cambrian Road.

The above assumptions were considered conservative since other area developments have been captured separately in the TIA, as discussed in the following section.

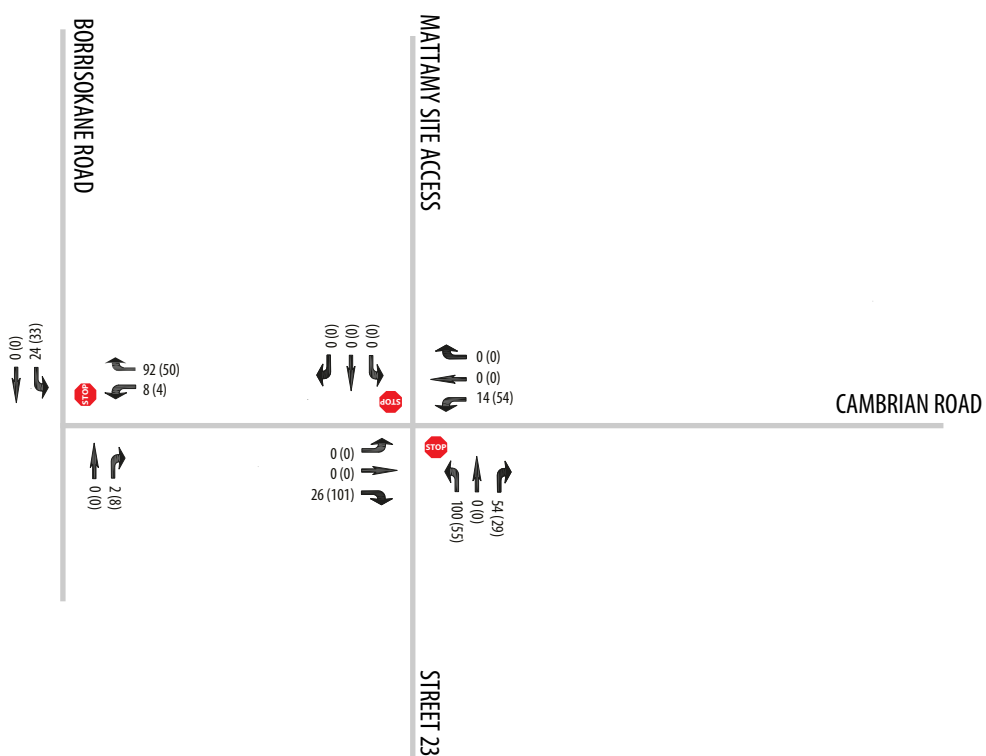

LEGEND

- STOP CONTROL
- TRAFFIC CONTROL SIGNAL
- TRAVEL LANES AND PERMITTED MOVEMENTS
- AM & PM PEAK HOUR VEHICULAR VOLUMES





3.1.3 Other Area Development

The City of Ottawa TIA Guidelines specifies all significant developments within the study area which are likely to occur within the horizon years must be identified and taken into consideration in all TIA reports. Since the traffic generated by these developments was not captured in the background traffic growth calculation, they must be added separately.

There are two (2) known developments expected to contribute traffic within the study area. These developments are currently in the development application approval process, and are both currently in the development review process. Construction has not begun on either development. Half Moon Bay West is located immediately to the north of the subject property, and the Meadows Phase 4 is located to the east of the subject property, on the other side of the future re-aligned Greenbank Road. The unit counts and characteristics for each development were based on traffic studies that supported the development application.

The adjacent developments have been summarized in Table 10, and their approximate locations in relation to subject site were shown in Exhibit 10.

TABLE 10 – Future Adjacent Developments

| DEVELOPMENT NAME | TIA PREPARED BY | SIZE/ NUMBER OF UNITS | EXPECTED BUILDOUT/ OCCUPANCY DATE | RECOMMENDED ROAD MODIFICATIONS |
|--------------------------------------|--------------------|------------------------------------|-----------------------------------|--|
| Half Moon Bay West (Mattamy Homes) | Stantec Consulting | 518 singles | 2024 (no occupancy in 2018) | Construction of auxiliary lanes and implementation of traffic signals at the following intersections: 1) Cambrian Road & Mattamy Site Access 2) Cambrian Road & Borrisokane Road |
| | | 427 townhome units | | |
| | | 5.3 acres of commercial land | | |
| | | 109 townhome units | | |
| | | 360 townhomes/back-to-back homes | | |
| The Meadows Phase 4 (Tamarack Homes) | IBI Group | 50 singles | 2019 (no occupancy in 2018) | No recommended modifications to intersections on roadways within study area. |
| | | 136 units townhomes/ Semi-detached | | |

3.2 Demand Rationalization

The following section summarizes any adjustments made to future travel demands in the study area to account for capacity limitations of the transportation network.

3.2.1 Description of Capacity Issues

A review of previous TIAs in the area reveal no major capacity issues within the study area. The development generated traffic volumes were not expected to create significant capacity issues in the local network.

According to the Needs and Opportunities Report (2013), both the SL42 – River Road (Manotick) and SL49 – Jock River have sufficient capacity to accommodate future traffic demand, in even the Inbound 2031 Base Scenario, which does not include modifications from the City 2031 Network Concept.

The City planned realignment of Greenbank Road and the future widening of Longfields Drive is expected to create additional capacity in the road network to accommodate any deficiencies that may be triggered by future background



or development generated traffic growth. As previously discussed, the realignment was assumed not to be completed in the future horizons, to represent the worst case scenario.

Therefore, there were no adjustments made to development generated or background network demand.

3.3 Traffic Volume Summary

3.3.1 Future Background Traffic Volumes

The existing (2018) peak hour traffic volumes from the Scoping Report has been provided in Exhibit 13. The future background traffic volumes developed in Section 3: Background Network Traffic for the 2022 and 2027 horizons have been provided in Exhibits 14 and 15, respectively.

EXHIBIT 13 – Existing (2018) Auto, Cycling and Pedestrian AM & PM Peak Hour Traffic Volumes

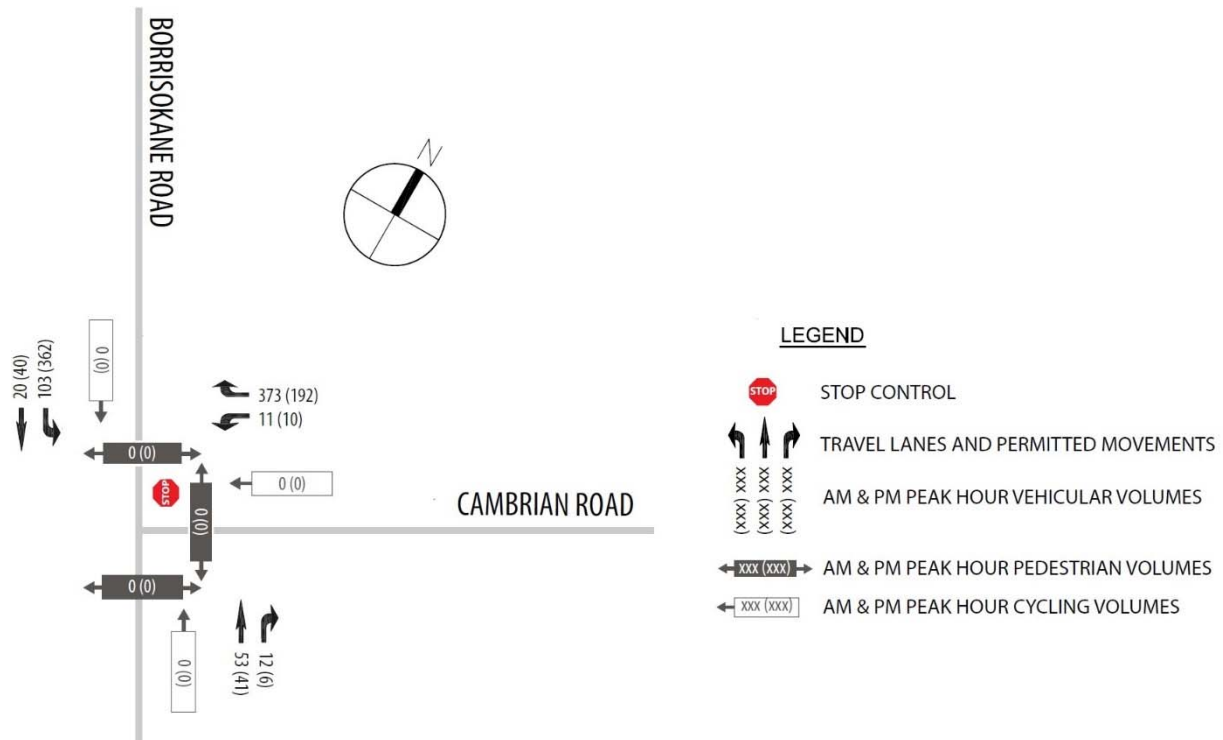



EXHIBIT 14 – Future (2022) Background AM & PM Peak Hour Traffic Volumes

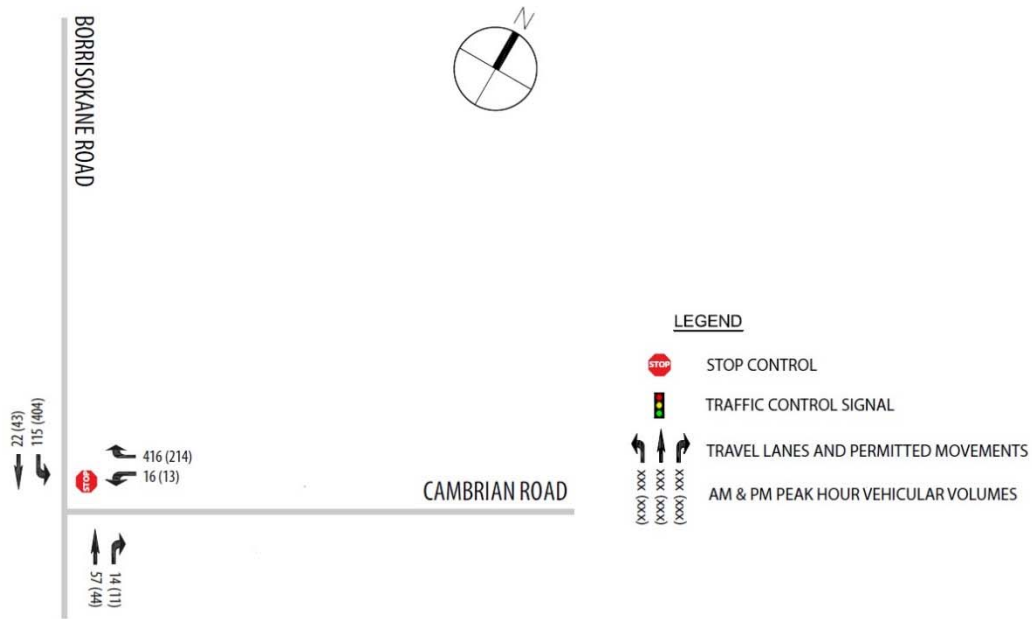
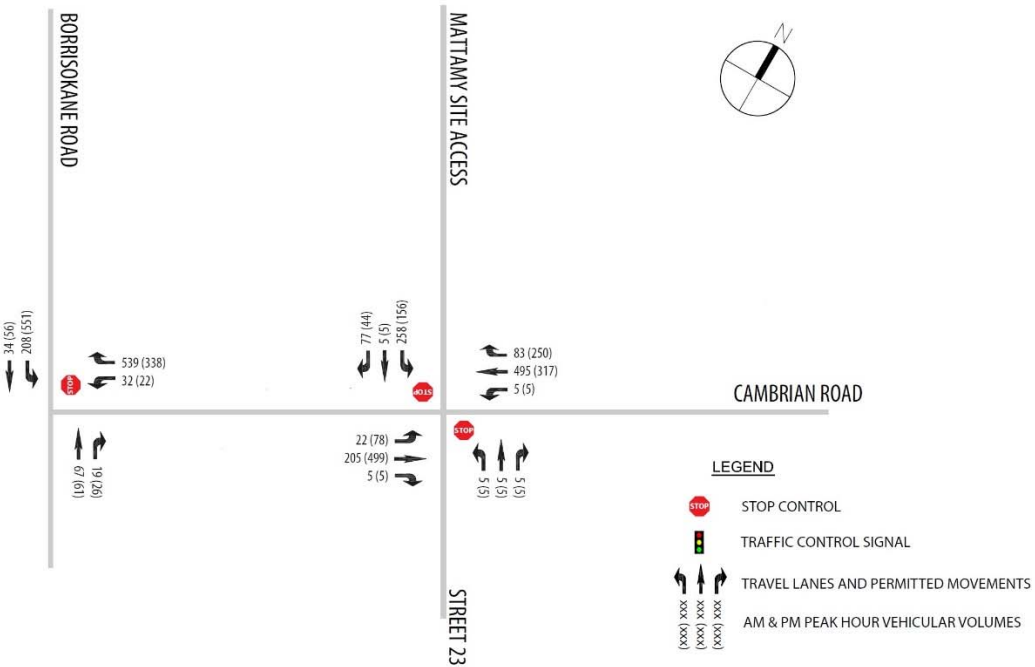

EXHIBIT 15 – Future (2027) Background AM & PM Peak Hour Traffic Volumes



3.3.1 Future Total Traffic Volumes

The site generated peak hour traffic volumes from Exhibit 12 were added to corresponding background traffic volumes to create background plus site generated or total peak hour traffic volumes for the 2022 and 2027 horizon years, as shown in Exhibits 16 and 17, respectively.



EXHIBIT 16 – Future (2022) Total AM & PM Peak Hour Traffic Volumes

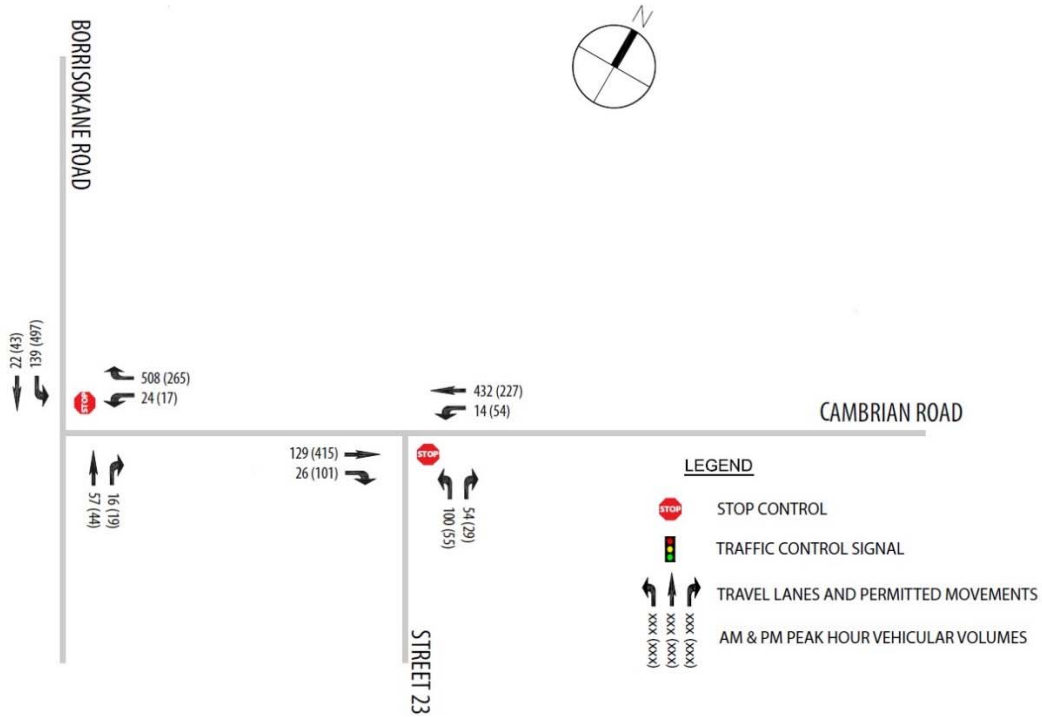
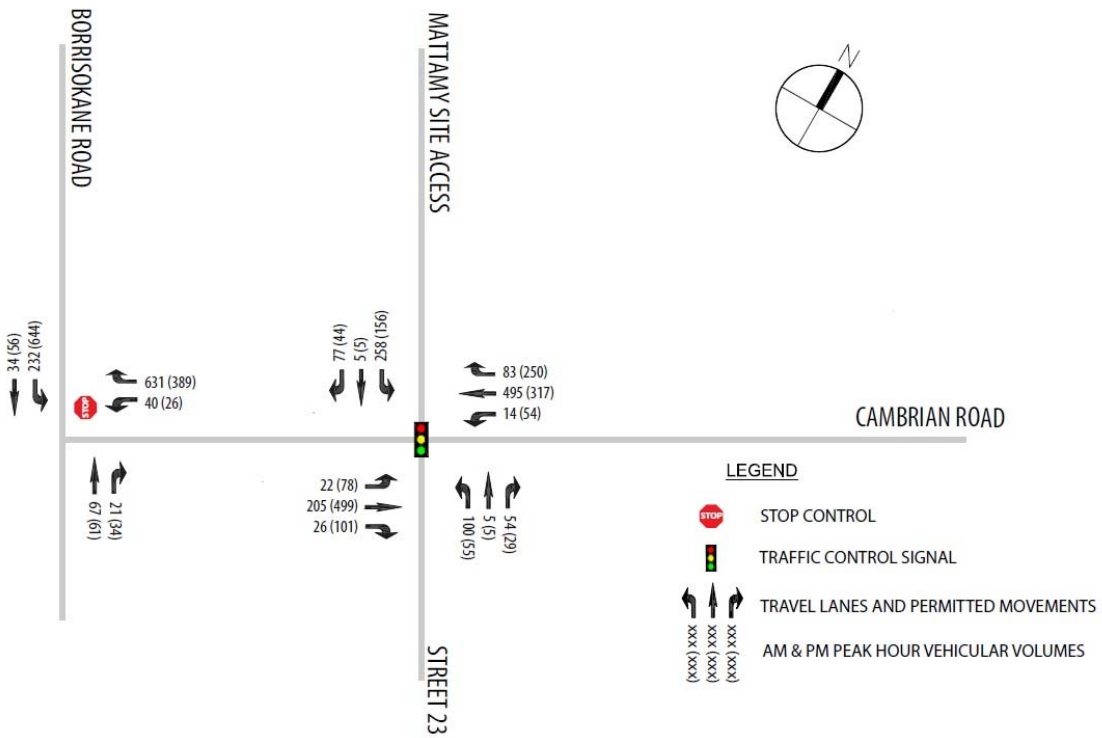

EXHIBIT 17 – Future (2027) Total AM & PM Peak Hour Traffic Volumes





4 Analysis

The purpose of the TIA Analysis is to “assess the alignment between the transportation elements of the proposed development and the City of Ottawa’s city-building objectives and identify any opportunities to improve alignment. It also evaluates the post-development performance of the planned transportation network based on the City’s established performance measures and targets and identifies potential mitigation measures to off-set development impacts.”³

4.1 Development Design

4.1.1 Design for Sustainable Modes

The nearest bus stop to the Meadows Phase 5 development is located northeast of the subject site at Seeley’s Bay Street and Cambrian Road, but it is beyond the 400m maximum walking distance to a transit stop as required by the City. Extending transit service west along Cambrian Road, south along the proposed Street 23 access and providing a turn-around area for buses at the southern edge of the subject site at Street 23, would put approximately 90% of residents within a 400m walking distance of a transit stop and approximately 100% of residents within a 500m walking distance of a transit stop. Proposed transit coverage is shown in Exhibit 18.

There are no cycling facilities planned within the proposed development. Sidewalks have been strategically placed to ensure adequate accessibility to the adjacent road network and local amenities, as shown in Exhibit 2.

4.1.2 Circulation and Access

This element is only required for site plans. Therefore, it has been exempt from this TIA.

4.1.3 New Street Networks

According to the plan of subdivision, the proposed development is expected to connect to the Meadows Phase 4 subdivision to the east via Street 17. Street 17 is proposed as an east-west local road with an 18m right-of-way, crossing the realigned Greenbank Road and terminating at Street 23 to the west. Street 23 is proposed as a north-south collector road with a 24m right-of-way (ROW) that will connect to Cambrian Road via the proposed Half Moon Bay West development access intersection to the north. Street 23 is approximately 500m in length, and was proposed to connect from Cambrian Road and terminate in a cul-de-sac at the southern edge of the subject development.

The remaining roads proposed within the development were proposed to have a 16.5m right-of-way (ROW) width for double-loaded streets, and 14m right-of-way (ROW) width for single-loaded streets.

³ Ottawa 2017 Transportation Impact Assessment (TIA) Guidelines, p. 35

JAN 24.18

park
1.5hec

PROPOSED SCHOOL LOCATION
2.8Hec

STREET 23

STREET 17

STREET 18

FUTURE RE-ALIGNED GREENBANK ROAD
B.C. 10793

LEGEND

- Potential Sidewalk Location
- Proposed Development Limit
- Future Potential Transit Stop Coverage (400m Walking Distance)
- Future Potential Transit Stop Coverage (500m Walking Distance)
- Potential Transit Stop Location





4.2 Parking

4.2.1 Parking Supply

The Parking Supply element is exempt from this TIA, as indicated in Section 2.8: Exemptions Review. This element is only required for site plan applications.

4.2.2 Spillover Parking

The Spillover Parking element is exempt from this TIA, as indicated in Section 2.8: Exemptions Review. This element is only required for site plan applications.

4.3 Boundary Streets

Cambrian Road is considered the only boundary street to the subject development, and it is classified as an arterial road, running east-west approximately 200m to the north of the subject development.

In the future, the re-aligned Greenbank Road will be extended south of Cambrian Road and run along the west property line. Future design elements along this frontage will be reviewed by the City during the Environmental Assessment of the future extension.

The results of the Segment Multi-Modal Level of Service (MMLOS) of Cambrian Road within the vicinity of the study area is provided in Table 11. Detailed results are provided in Appendix G. The Segment MMLOS is based on the geometry of the roadway and not traffic volumes.

TABLE 11 – Segment MMLOS – Future Background and Total Results

| INTERSECTION | SCENARIO | LEVEL OF SERVICE | | | |
|--|-----------------|------------------|----------------|------|-------|
| | | PLOS | BLOS | TLOS | TKLOS |
| Cambrian Road (300m east of Borrisokane Road to Existing Bus Turn-around) | Existing (2018) | F ¹ | F ² | D | B |
| | 2022 BG & BGSG | F ¹ | F ² | D | B |
| | 2027 BG & BGSG | B | F ² | D | B |

Notes: ¹ No formal sidewalks; rural cross-section on Cambrian Road with gravel shoulders

² The Segment BLOS of 'F' along Cambrian Road is attributed to the higher operating speed (>= 60 km/h) for vehicular traffic

The Community Transportation Study (CTS) for Half Moon Bay West: Addendum 1 (November 2017) indicated that there would be sidewalks provided along the approximately 500m section of Cambrian Road fronting the Half Moon Bay West development. Therefore, by 2027, it was assumed in this study that sidewalks would be provided along Cambrian Road from 300m east of Borrisokane Road to just west of the existing bus turn-around to coincide with the full buildout of the proposed Half Moon Bay West development.

4.4 Access Intersections

4.4.1 Location and Design of Access Intersections

The proposed primary vehicular access/ egress for the subject site was located to the north of the subject site via Street 23 and Cambrian Road. A secondary access/ egress was proposed via Street 17 to connect to the future Meadows Phase 4 development to the east.

Analysis is only shown for the Street 23 and Cambrian Road intersection, as the majority of traffic generated from the subject site is expected to access/ egress the site from the Street 23 access. This assumption, as a worst case scenario,



was based on the majority of traffic heading west on Cambrian Road to Borrisokane Road, as indicated by existing traffic counts conducted for intersections located to the east of the study area. Utilizing Street 23 provides a more direct route to access the Cambrian Road, compared with navigating through the local road network of Meadows Phase 4 and utilizing Grand Canal Street or River Mist Road to access Cambrian Road.

For the Meadows Phase 4 traffic study, the majority of traffic was directed to River Mist Road and was assumed to head towards the existing Greenbank Road, as a worst case scenario. The Cambrian Road and River Mist Road intersection was shown to operate with a v/c ratio of 0.81 and an LOS of 'D' in the 2024 total traffic condition with the existing four-way stop control, which could accommodate some traffic from the subject site, if it were to bleed through the proposed Meadows Phase 4 development. The Meadows Phase 4 and Meadows Phase 5 developments have similar unit counts, and it is expected that if some traffic from Meadows Phase 4 bleeds west through Meadows Phase 5 and vice versa, the traffic volumes will likely balance out and have little or no effect on the operations of the access intersections.

4.4.2 Intersection Control

4.4.2.1 Traffic Signal Warrants

The use of traffic signals was investigated at the intersections of Cambrian Road and Borrisokane Road, as well as Cambrian Road and Street 23/ Mattamy Site Access. Traffic signal warrants specified in the Ontario Traffic Manual (OTM) Book 12 were completed for both intersections. The results of the analysis indicated that signaling the intersection of Cambrian Road and Street 23/ Mattamy Site Access was warranted in the 2027 total traffic condition. Cambrian Road and Borrisokane Road did not trigger traffic signal warrants through to the 2027 total traffic condition.

The results of the traffic signal warrant analysis for the Street shown in Appendix H.

4.4.2.2 Roundabout Analysis

The Roundabout Screening Tool was used to determine the feasibility of a roundabout at the intersection of Cambrian Road and Street 23/ Mattamy Site Access, as this is proposed as a new City intersection, and traffic signals were warranted at this intersection in the 2027 traffic condition, as discussed in Section 4.4.2.1. There were no contradictions to suggest that a roundabout would be 'problematic', and the suitability factors suggested that roundabout is technically feasible at this intersection. The results of the Roundabout Feasibility Screening Tool are provided in Appendix I.

A detailed roundabout capacity analysis was completed using SIDRA analysis software for a single-lane roundabout at the proposed intersection of Cambrian Road and Street 23/ Mattamy Site Access. The analysis results showed that the roundabout operated within City operational standards in the 2027 total traffic condition. SIDRA is an industry accepted program that uses similar delay-based methodology as the HCM 2010. Any movement with a v/c ratio greater than 1.0 triggers an LOS F for that movement. If the v/c ratio for any movement is equal to or less than 1.0, the delay criteria for unsignalized intersections, shown in Table 16, should be used.

4.4.3 Intersection Design (MMLOS)

The Multi-Modal Level of Service (MMLOS) Guidelines provide guidance on how to assess various LOS for the different modes of transportation and specify target levels of service for each mode, given the location and context of the transportation project. This all-in-one evaluation tool allows for comparison using similar performance metrics for each non-auto mode.



The MMLOS procedure is only applied to signalized intersections and the worst-performing approach at the intersection for any mode represents the overall intersection MMLOS for that mode. As indicated in Section 4.4.2.1, the proposed Cambrian Road and Street 23/ Mattamy Site Access intersection is expected to require signals by the 2027 background and total traffic conditions; therefore, analysis was completed for 2027 background and total traffic condition scenarios only. MMLOS was only completed for the proposed Cambrian Road and Street 23/ Mattamy Site Access intersection in the 2027 background and total traffic conditions.

The detailed MMLOS results are provided in Appendix G, and Intersection MMLOS results are provided in Table 12.

TABLE 12 – Intersection MMLOS – Future BG & Future BGSG Results

| INTERSECTION | SCENARIO | LEVEL OF SERVICE | | | |
|--|-------------|------------------|---|---|----|
| | | 2027 | | | |
| | | P | B | T | TK |
| Cambrian Road and Street 23/ Mattamy Site Access | Future BG | C | F | D | F |
| | Future BGSG | C | F | D | F |

Notes:

LOS = Level of Service; P = Pedestrian LOS; B = Bicycle LOS; T = Transit LOS; TK = Truck LOS

Future BG = Future Background Traffic; Future BGSG = Future Background and Site-Generated Traffic

No Intersection MMLOS results were produced for Cambrian Road and Borrisokane Road, as this intersection did not require signals for the 2021 Background or 2021 Background plus Site-generated planning horizons. MMLOS warrants only apply to signalized intersections.

4.4.3.1 Intersection Pedestrian Level of Service (PLOS)

The PLOS at intersections is based on several factors including the number of traffic lanes that pedestrians must cross, corner radii, and whether the crossing allows for permissive or protective right or left turns, among others. The City of Ottawa target for PLOS is 'C'.

The proposed intersection of Cambrian Road and Street 23/ Mattamy Site Access was tested in the 2027 background and total traffic conditions. All of these scenarios met the City of Ottawa PLOS target of 'C'.

4.4.3.2 Intersection Bicycle Level of Service (BLOS)

The BLOS at intersections is dependent on the number of lanes that the cyclist is required to cross to make a left-turn or on the presence of a dedicated right-turn lane on the approach, as well as the operating speed of each approach. The City target for BLOS is 'C'.

The 2027 background and total traffic conditions were tested with traffic signals, and all resulted in a BLOS of 'F', due to the high operating speeds along the Cambrian Road (i.e. 60 km/h or greater), as well as the number of lanes that cyclists must cross to make a left-turn when left-turn lanes are added to an approach.

It should be noted that reducing the speed limit along Cambrian Road to 50km/h to match the urbanized section of the roadway to the east of Seeley's Bay Street will significantly improve the BLOS.

4.4.3.3 Intersection Transit Level of Service (TLOS)

Intersection TLOS is based on the average signal delay experienced by transit vehicles at each intersection. The City Target TLOS is 'C'.

The 2027 total traffic conditions result in a TLOS of 'D', which marginally exceeds the City's TLOS target of 'C'. The deterioration of the TLOS in the 2027 total traffic condition can be attributed to the approach delay experienced by



vehicles exiting the Mattamy Site Access to the north in the morning peak period. All other approaches at this intersection experienced delays resulting in a TLOS of 'C'.

4.4.3.4 Intersection Truck Level of Service (TKLOS)

The TKLOS is based on the right-turn radii, as well as the number of receiving lanes for vehicles making a right-turn from the traffic lane being analyzed. The City of Ottawa target for TKLOS is 'D'.

The intersection of Cambrian Road and Street 23/ Mattamy Site Access has a TKLOS of 'F', which is attributed to the tighter turning radii and single-receiving lanes. The main purpose of this intersection is to provide access for local, residential traffic to the Half Moon Bay West and Meadows Phase 5 developments.

4.5 Transportation Demand Management

The City of Ottawa is committed to implementing Transportation Demand Management (TDM) measures on a City-wide basis in an effort to reduce the automobile dependence of Ottawa residents, particularly during the weekday peak travel periods. TDM initiatives are aimed at encouraging individuals to use non-auto modes of travel during the peak periods.

Mode shares used to estimate future development traffic were based on the 2011 TRANS OD Survey for the Traffic Assessment Zone where the proposed development is located. The non-auto transportation mode shares were left constant in the future, which was a conservative assumption. There are no employment uses proposed onsite. However, the development will still conform to the City's TDM principles by providing direct connections to adjacent pedestrian, cycling and transit facilities where applicable.

4.6 Neighbourhood Traffic Management

4.6.1 Adjacent Neighbourhoods

The TIA Guidelines provide peak hour vehicular volume thresholds for local and collector roads that are located along significant access/ egress routes for the proposed development. For the subject site, Street 23 was proposed as the sole access for the subject development to connect directly with Cambrian Road to the north. To be conservative, it was assumed that 100% of development traffic utilized Street 23 to access/ egress the subject site. Street 17 provided a secondary site access/ egress location to the east; however, this is not a direct route to the arterial road network, and would force vehicles to navigate through the road network for the proposed Meadows Phase 4. As shown in Table 13, the proposed development is expected to generate less than 300 vehicles per hour per lane (vphpl) on Street 23, the threshold for a collector road.

The threshold of 120 vphpl for local roadways within the development is not expected to be exceeded, since traffic generated in the dominant direction by the entire development is expected to only marginally exceed the threshold for local roadways. Traffic utilizing the local roads to the east and west of Street 23, the collector road, will be further divided based on the resident's location within the subject development.

TABLE 13 – Road Classification Capacity

| STREET | SEGMENT | CAPACITY (VPHPL) | PEAK HOUR DEMAND IN PEAK DIRECTION (VPHPL) | |
|-----------|------------------------|------------------|--|-----|
| | | | AM | PM |
| Street 23 | South of Cambrian Road | 300 | 154 | 155 |

Notes: vphpl = vehicles per hour per lane



The results from Table 13 show that the local roadways in the vicinity of the proposed development are expected to accommodate future traffic. The overall impact of congestion is not expected to adversely impact the role or function of the roadway.

4.6.2 Local Intersection Requirements

Local road intersections within the subject development are expected to be signalized (stop-controlled) on the side street movement. These requirements will be reviewed and confirmed at detailed design. All pavement marking and signage requirements are expected to follow City standards.

4.7 Transit

4.7.1 Route Capacity

The estimated future 2027 total transit passenger demand within the study area was provided in Section 3.1.2.4: Trip Generation by Mode. The results have been summarized in Table 14.

TABLE 14 – Development-Generated Transit Demand

| PERIOD | PEAK PERIOD DEMAND | |
|--------|--------------------|-----|
| | IN | OUT |
| AM | 5 | 20 |
| PM | 20 | 11 |

The proposed development will generate a marginal amount of transit demand. Additional capacity and service improvements via transit priority measures were not deemed necessary.

When the realigned Greenbank Road is extended south of Cambrian Road, there will be opportunities for OC-Transpo to provide improved transit coverage for this development.

4.8 Review of Network Concept

Section 2.4.3 outlined nearby screenlines to the subject site, SL 42 – Rideau River (Manotick); and SL49 – Jock River, shown in Exhibit 19. A summary of 2031 Base and 2031 Network Concept demand and capacity scenarios have been provided in Table 15. The results of the 2031 Network Concept reflect the increase in roadway capacity associated with planned capital projects noted in the Transportation Master Plan (TMP), as compared with the 2031 Base scenario.

TABLE 15 – 2031 Development Generated Transit Demand

| SCREENLINE | AM 2031 INBOUND (BASE) | | | AM 2031 INBOUND (NETWORK CONCEPT) | | |
|------------------------------------|------------------------|----------|-----------|-----------------------------------|----------|-----------|
| | DEMAND | CAPACITY | V/C RATIO | DEMAND | CAPACITY | V/C RATIO |
| SL42 Rideau River (Manotick) | 2,928 | 3,800 | 0.77 | 2,596 | 3,800 | 0.68 |
| SL49 Jock River | 6,405 | 10,200 | 0.63 | 6,642 | 13,200 | 0.50 |

Notes:

Table results from TMP – Final Report: Road Network Development Report



Proposed development traffic does not trigger any capacity deficiencies along nearby screenlines in either the 2031 Base Scenario or 2031 Network Concept. However, future road projects such as the widening of Cambrian Road, the realignment of Greenbank Road and widening of Strandherd Drive should be completed on schedule to reduce or spread traffic demand along nearby screenlines and help mitigate local traffic bottlenecks.

EXHIBIT 19 – Nearest Screenlines

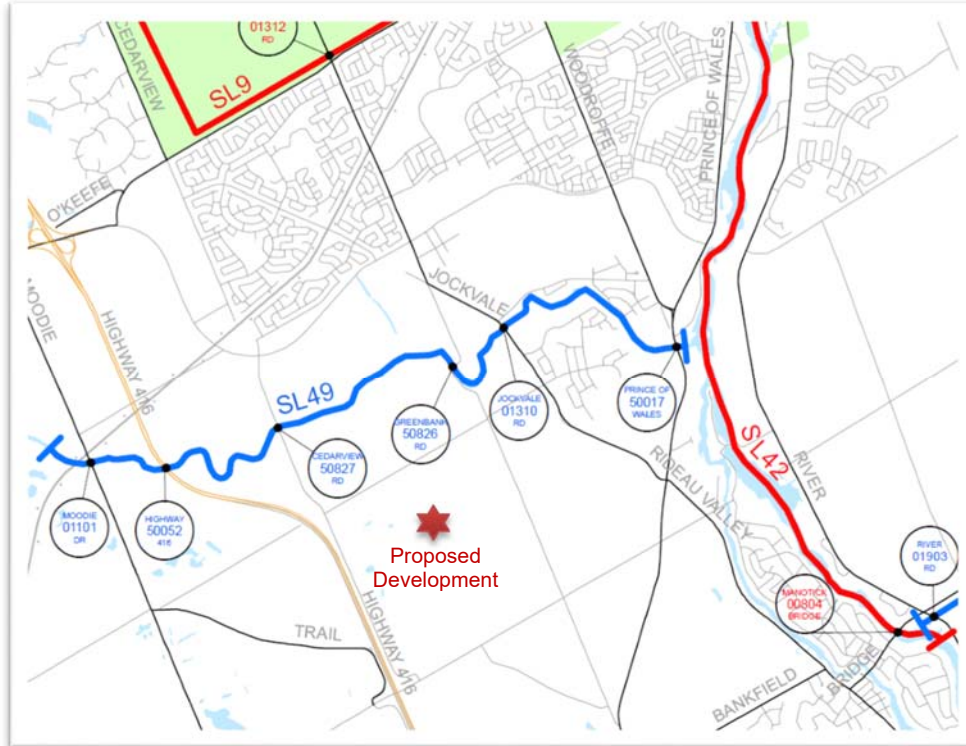

4.9 Intersection Design

The study area intersections were evaluated in the morning and afternoon peak hour traffic conditions at the following horizons:

- Existing Traffic (2018)
- Future (2022) Background Traffic
- Future (2027) Background Traffic
- Future (2022) Total Traffic
- Future (2027) Total Traffic

The following intersection was included in this analysis:

- Cambrian Road and Borrisokane Road

4.9.1 Base Road Network

There were no future roadway modifications noted in the Transportation Master Plan (TMP) "Affordable Network," DC Background Study or Capital Budget Forecasts within the study area.



Roundabouts were only considered at unsignalized intersections if shown to be operating below City standards. Further discussion on the geometric requirements for auxiliary turn lanes and storage lengths at proposed access intersections has been provided in Section 4.10.1: Auxiliary Lane Analysis.

4.9.2 Intersection Analysis Criteria

4.9.2.1 Signalized Intersections

In qualitative terms, the Level-of-Service (LOS) defines operational conditions within a traffic stream and their perception by motorists. A LOS definition generally describes these conditions in terms of such factors as delay, speed and travel time, freedom to manoeuvre, traffic interruptions, safety, comfort and convenience. LOS can also be related to the ratio of the volume to capacity (v/c) which is simply the relationship of the traffic volume (either measured or forecast) to the capability of the intersection or road section to accommodate a given traffic volume. This capability varies depending on the factors described above. LOS are given letter designations from A to F. LOS "A" represents the best operating conditions and LOS "E" represents the level at which the intersection or an approach to the intersection is carrying the maximum traffic volume that can, practicably, be accommodated. LOS F indicates that the intersection is operating beyond its theoretical capacity.

The City of Ottawa has developed criteria as part of the Transportation Impact Assessment Guidelines, which directly relate the volume to capacity (v/c) ratio of a signalized intersection to a LOS designation. These criteria are shown in Table 16.

TABLE 16 – LOS Criteria for Signalized Intersections

| LOS | VOLUME TO CAPACITY RATIO (v/c) |
|-----|-----------------------------------|
| A | 0 to 0.60 |
| B | 0.61 to 0.70 |
| C | 0.71 to 0.80 |
| D | 0.81 to 0.90 |
| E | 0.91 to 1.00 |
| F | > 1.00 |

The intersection capacity analysis technique provides an indication of the LOS for each movement at the intersection under consideration and for the intersection as a whole. The overall v/c ratio for an intersection is defined as the sum of equivalent volumes for all critical movements at the intersection divided by the sum of capacities for all critical movements.

4.9.2.2 Unsignalized Intersections

The capacity of an unsignalized intersection can also be expressed in terms of the LOS it provides. For an un-signalized intersection, the Level of Service is defined in terms of the average movement delays at the intersection. This is defined as the total elapsed time from when a vehicle stops at the end of the queue until the vehicle departs from the stop line; this includes the time required for a vehicle to travel from the last-in-queue position to the first-in-queue position. The average delay for any particular minor movement at the un-signalized intersection is a function of the capacity of the approach and the degree of saturation.

The Highway Capacity Manual 2010 (HCM), prepared by the Transportation Research Board, includes the following Levels of Service criteria for un-signalized intersections, related to average movement delays at the intersection, as indicated in Table 17.



TABLE 17 – LOS Criteria for Unsignalized Intersections

| LOS | DELAY (seconds) |
|-----|-----------------|
| A | <10 |
| B | >10 and <15 |
| C | >15 and <25 |
| D | >25 and <35 |
| E | >35 and <50 |
| F | >50 |

The unsignalized intersection capacity analysis technique included in the HCM and used in the current study provides an indication of the Level of Service for each movement of the intersection under consideration. By this technique, the performance of the unsignalized intersection can be compared under varying traffic conditions, using the Level of Service concept in a qualitative sense. One unsignalized intersection can be compared with another unsignalized intersection using this concept. Level of Service 'E' represents the capacity of the movement under consideration and generally, in large urban areas, Level of Service 'D' is considered to represent an acceptable operating condition (Level of Service 'E' is considered an acceptable operating condition for planning purposes for intersections located within Ottawa's Urban Core—the downtown and its vicinity). Level of Service 'F' indicates that the movement is operating beyond its design capacity.

4.9.2.3 Roundabout Analysis

The Roundabout Feasibility Screening Tool was not completed for the intersection of Cambrian Road and Borrisokane Road, as this intersection does not satisfy any of the following conditions that require a roundabout to be considered:

- (1) It is not a new City intersection
- (2) Traffic signals are not warranted at this intersection through to the 2027 total traffic condition
- (3) There were no capacity or safety problems are experienced through to the 2027 total traffic condition

The Roundabout Feasibility Screening Tool was completed for the proposed intersection of Cambrian Road and Street 23/ Mattamy Site Access, as discussed in Section 4.4.2.2.

4.9.3 Intersection Control

4.9.3.1 Traffic Signal Warrant Methodology

Traffic control signal warrants were completed for all unsignalized stop or yield controlled intersections. The warrant procedures for both existing and future conditions were based on the established methodology outlined in the Ontario Traffic Manual, Book 12, Ministry of Transportation Ontario (MTO), 2012.

Traffic signals are warranted at the intersection of

For future traffic conditions, an Average Hourly Volume (AHV) for each intersection approach is estimated using the following equation and applied to the warrant procedure:

$$\text{Average Hourly Volume} = \frac{(\text{AM Peak Hour Volume} + \text{PM Peak Hour Volume})}{2}$$



4.9.3.2 Traffic Signal Warrants

The traffic signal warrants were not triggered in the 2027 total traffic condition at the Cambrian Road and Borrisokane Road intersection. Details of the traffic signal warrants analyses described above are included in Appendix H.

4.9.4 Intersection Design (Operations)

4.9.4.1 Intersection Analysis Methodology

Using the established intersection capacity analysis criteria described above, the existing and future conditions were analyzed during the weekday peak hour traffic volumes derived in the previous sections of this report.

The worst/ critical observed LOS movement at each study area intersection was recorded; if the LOS was E or lower, it was compared to the intersection LOS. If the intersection LOS was also indicated to be below City standards, potential roadway modifications or measures were considered and the intersection was re-evaluated. Any recommended modifications would be carried forward to the following horizon.

The following section presents the results of the intersection capacity analysis and roundabout capacity analysis. All tables summarize study area intersection LOS results during the morning and afternoon peak hour periods. The Synchro and SIDRA analysis output files have been provided in Appendix J.

4.9.4.2 Existing (2018) Traffic Results

The existing (2018) intersection capacity analysis was based on morning and afternoon peak hour traffic volumes. A summary of the results has been provided in Table 18.

TABLE 18 – Intersection Capacity Analysis: Existing (2018) Traffic

| INTERSECTION | CONTROL | PEAK HOUR | V/C RATIO | | LEVEL OF SERVICE | |
|------------------------------------|---------|-----------|-------------------|--------------|-------------------|--------------|
| | | | CRITICAL MOVEMENT | INTERSECTION | CRITICAL MOVEMENT | INTERSECTION |
| Cambrian Road and Borrisokane Road | WB Stop | AM | 0.44 | - | B | - |
| | | PM | 0.26 | - | B | - |

Notes: EB = eastbound; WB = westbound; NB = northbound; SB = southbound

4.9.4.3 2022 Background Traffic Results

The 2022 background traffic condition intersection capacity analysis for total background traffic was completed using morning and afternoon peak hour traffic volumes. A summary of the results has been provided in Table 19.

TABLE 19 – Intersection Capacity Analysis: Future (2022) Background Traffic

| INTERSECTION | CONTROL | PEAK HOUR | V/C RATIO | | LEVEL OF SERVICE | |
|------------------------------------|---------|-----------|-------------------|--------------|-------------------|--------------|
| | | | CRITICAL MOVEMENT | INTERSECTION | CRITICAL MOVEMENT | INTERSECTION |
| Cambrian Road and Borrisokane Road | WB Stop | AM | 0.44 | - | B | - |
| | | PM | 0.27 | - | B | - |

Notes: EB = eastbound; WB = westbound; NB = northbound; SB = southbound



4.9.4.4 2027 Background Traffic Results

The 2027 background traffic condition intersection capacity for total background traffic analysis was completed using morning and afternoon peak hour traffic volumes. All recommended modifications from the 2022 background traffic condition have been carried forward to this horizon. A summary of the results has been provided in Table 20.

TABLE 20 – Intersection Capacity Analysis: Future (2027) Background Traffic

| INTERSECTION | CONTROL | PEAK HOUR | V/C RATIO | | LEVEL OF SERVICE | |
|--|------------------------------|-----------|-------------------|--------------|-------------------|--------------|
| | | | CRITICAL MOVEMENT | INTERSECTION | CRITICAL MOVEMENT | INTERSECTION |
| Cambrian Road & Borrisokane Road | WB Stop | AM | 0.62 | - | C | - |
| | | PM | 0.52 | - | C | - |
| Cambrian Road and Street 23/ Mattamy Site Access | NB/ SB Stop | AM | 0.99 | - | F | - |
| | | PM | 0.96 | - | F | - |
| | Traffic Signals ^a | AM | 0.78 | - | C | - |
| | | PM | 0.64 | - | B | - |
| | Roundabout ^b | AM | 0.55 | - | B | B |
| | | PM | 0.63 | - | B | B |

Notes: EB = eastbound; WB = westbound; NB = northbound; SB = southbound

Summary of Modifications:

- 1 - Cambrian Road and Street 23/ Mattamy Site Access intersection
 - a. Traffic Signals
 - i. Construct north leg (Mattamy Site Access) with 70m SBL storage lane
 - ii. Construct south leg (Street 23) with 20m NBL storage lane
 - iii. Construct 40m EBL storage lane
 - iv. Construct 15m WBL storage lane and 15m WBR storage lane
 - b. Single-lane roundabout
 - i. Construct north and south legs of intersection with shared-turning lanes on all approaches

4.9.4.5 2022 Total Traffic Results

The 2022 total traffic condition intersection capacity analysis was completed using morning and afternoon peak hour traffic volumes. A summary of the results has been provided in Table 21.

TABLE 21 – Intersection Capacity Analysis: Future (2022) Total Traffic

| INTERSECTION | CONTROL | PEAK HOUR | V/C RATIO | | LEVEL OF SERVICE | |
|----------------------------------|----------------------|-----------|-------------------|--------------|-------------------|--------------|
| | | | CRITICAL MOVEMENT | INTERSECTION | CRITICAL MOVEMENT | INTERSECTION |
| Cambrian Road & Borrisokane Road | WB Stop | AM | 0.69 | - | C | - |
| | | PM | 0.63 | - | C | - |
| Cambrian Road & Street 23 | NB Stop ¹ | AM | 0.31 | - | C | - |
| | | PM | 0.25 | - | C | - |

Notes: EB = eastbound; WB = westbound; NB = northbound; SB = southbound

Summary of Modifications:

- 1 - Cambrian Road and Street 23
 - a. Construct NB stop-controlled access with shared-through turning lane
 - b. Construct 15m WBL storage lane
 - c. Construct provisional EBL left-turn lane to ensure symmetry between eastbound and westbound through lanes



4.9.4.6 2027 Total Traffic Results

The 2027 total traffic condition intersection capacity analysis was completed using morning and afternoon peak hour traffic volumes. All recommended modifications from the 2022 total traffic condition have been carried forward to this horizon. A summary of the results has been provided in Table 22.

TABLE 22 – Intersection Capacity Analysis: Future (2027) Total Traffic

| INTERSECTION | CONTROL | PEAK HOUR | V/C RATIO | | LEVEL OF SERVICE | |
|--|------------------------------|-----------|-------------------|--------------|-------------------|--------------|
| | | | CRITICAL MOVEMENT | INTERSECTION | CRITICAL MOVEMENT | INTERSECTION |
| Cambrian Road & Borrisokane Road | WB Stop | AM | 0.74 | - | C | - |
| | | PM | 0.71 | - | C | - |
| Cambrian Road & Street 23/ Mattamy Site Access | NB/ SB Stop ^a | AM | 1.16 | - | F | - |
| | | PM | 1.41 | - | F | - |
| | Traffic Signals ^b | AM | 0.80 | - | C | - |
| | | PM | 0.77 | - | C | - |
| | Roundabout ^c | AM | 0.61 | - | C | B |
| | | PM | 0.77 | - | C | C |

Notes: EB = eastbound; WB = westbound; NB = northbound; SB = southbound
 Summary of Modifications:

- 1 - Cambrian Road and Street 23/ Mattamy Site Access intersection
 - a. NB/ SB stop-controlled intersection
 - i. Construct north leg (Mattamy Site Access) with shared through-turning lane
 - b. Traffic Signals
 - i. Construct north leg (Mattamy Site Access) with 70m SBL storage lane
 - ii. Construct 40m EBL storage lane, 20m NBL storage and 15m WBR storage lane
 - c. Single-lane roundabout
 - i. Construct north leg of intersection (Mattamy Site Access)
 - ii. Shared turning lanes on all approaches

4.9.5 Intersection Design (MMLOS)

The MMLOS Guidelines provide guidance on how to assess the various LOS for the different modes of transportation and what the specific target service levels for each mode should be given the location and context of the transportation project. This all-in-one evaluation tool will allow comparisons using similar performance metrics for each non-auto mode. The MMLOS procedure is only applied to signalized intersections and the worst performing approach at the intersection for any mode represents the overall intersection MMLOS for that mode, as per the MMLOS Guidelines.

MMLOS was only completed for the proposed Cambrian Road and Street 23/ Mattamy Site Access intersection in the 2027 background and total traffic conditions. No MMLOS results were produced for Cambrian Road and Borrisokane Road, as this intersection did not require signals through to the 2027 total traffic condition.

Refer to Section 4.4.3 for results of the MMLOS for Cambrian Road and Street 23/ Mattamy Site Access. The detailed MMLOS results are provided in Appendix G.

4.10 Geometric Review

The following section reviews all geometric requirements for the study area intersections. All relevant excerpts from referenced technical standards have been provided in Appendix K.



4.10.1 Auxiliary Lane Analysis

Auxiliary turning lane lengths for all study area intersections were evaluated for unsignalized intersections.

4.10.1.1 Unsignalized Auxiliary Left-Turn Lane Requirements

The MTO Geometric Design Standards for Ontario Highways left-turn warrant was applied to main-street approaches at all unsignalized intersections using the highest left-turn volume from either the morning or afternoon peak hour.

The results have been summarized below in Table 23.

TABLE 23 – Auxiliary Left-Turn Lane Analysis at Unsignalized Intersections

| INTERSECTION | MOVEMENT | POSTED SPEED (KM/H) | DESIGN SPEED (KM/H) | LEFT-TURN VOLUME (VPH) | APPROACH VOLUME (VPH) | OPPOSING VOLUME (VPH) | LEFT-TURN STORAGE (M) |
|------------------------------------|----------|---------------------|---------------------|------------------------|-----------------------|-----------------------|-----------------------|
| Cambrian Road & Street 23 | WBL | 70 | 80 | 54 | 282 | 516 | 15 ^{1,2,3} |
| Borrisokane Road and Cambrian Road | SBL | 80 | 90 | 644 | 700 | 96 | 120 ^{1,2} |

Notes: WBL = westbound left-turn; SBL = southbound left-turn

¹ Left-turn lanes requirements will be reviewed during detailed design stage

² Recommended storage lengths do not include deceleration lane and taper lengths. Units rounded to nearest 5m.

³ The City requires a minimum 35m storage length for left-turn lanes along arterial roads. Recommended left-turns storage lengths were based on the 95th percentile queue lengths from Synchro, and did not consider parallel deceleration or taper length requirements from TAC. Left-turn lane requirements will be reviewed and confirmed during detailed design.

Cambrian Road and Street 23

Auxiliary left-turn lane analysis was completed under 2022 total traffic conditions for the Cambrian Road and Street 23 intersection, triggering a 15m westbound left-turn storage lane. This intersection is expected to require traffic signals with the construction of the north leg for the Mattamy Site Access, as part of the Half Moon Bay West development in 2027. Signalized auxiliary left-turn lane analysis for this intersection will be verified in Section 4.10.1.2 under the 2027 total traffic condition.

In order to ensure symmetry of the eastbound and westbound through lanes at the Cambrian Road and Street 23 intersection, provisions for an eastbound left-turn lane are recommended to be constructed to oppose the proposed westbound left-turn in the 2022 total traffic condition. Street 23 should be constructed with an 11m pavement width to ensure that there is sufficient width to accommodate a left-turn lane, if one is required in the future.

Cambrian Road and Borrisokane Road

The storage length requirements for the southbound approach of the Cambrian Road and Borrisokane Road intersection could not be properly assessed using the MTO left-turn warrant, due to the high number of southbound left-turning vehicles in all planning horizons through to the 2027 total traffic condition. The proportion of southbound left-turning vehicles was approximately 90% of the overall southbound approach volumes. Graphs provided for left-turn warrant analysis only allow for the assessment of left-turns up to 40% of the total approach volume, which yielded a storage length of 30m. To determine the southbound left-turn storage length required in the worst-case scenario, the Cambrian Road and Borrisokane Road intersection was tested as an all-way stop in Synchro. This provided a very conservative 95th percentile queue length of 140m for the southbound left-turn. In the Half Moon Bay West Community Transportation Study (CTS), a 120m southbound left-turn storage length was shown to accommodate vehicular traffic through to the ultimate planning horizon with traffic signals at Cambrian Road and Borrisokane Road. Therefore, in this



TIA, it was reasonable to assume that a maximum southbound left-turn storage length of 120m would provide sufficient storage through to the ultimate planning horizon with the existing free-flow traffic condition along Borrisokane Road.

The recommended left-turn storage lanes for both intersections should be reviewed and confirmed during detailed design.

4.10.1.2 Signalized Auxiliary Left-Turn Lane Requirements

A review of auxiliary left-turn lane storage requirements was completed at the intersection of Cambrian Road and Street 23/ Mattamy Site Access, the only intersection within the study area expected to require signalization in the 2027 total traffic condition. The review compared the projected 95th percentile queue lengths from Synchro operational results, and the City of Ottawa queue length calculation based on the following equation:

$$\text{Storage Length, } S = \frac{NL}{C} \times 1.5$$

Where:

N = number of vehicles per hour

L = Length occupied by a vehicle in the queue = 7 m

C = number of traffic signal cycles per hour (3600 seconds per hour/cycle length)

The results of the auxiliary left-turn lane analysis storage lengths are summarized below in Table 24.

TABLE 24 – Recommended Auxiliary Left-Turn Storage Lengths at Signalized Intersections

| INTERSECTION | APPROACH | 95TH %ILE QUEUE LENGTH (M) | CITY QUEUE LENGTH (M) | EXISTING STORAGE LENGTH (M) | RECOMMENDED ADDITIONAL STORAGE LENGTH (M) |
|---|----------|----------------------------|-----------------------|-----------------------------|---|
| Cambrian Road and Street 23/ Mattamy Site Access | NB | <10 | 20 | - | 20 |
| | WB | 10 | 15 | - | 15 ¹ |

Recommended storage lengths do not include deceleration lane and taper lengths. Units rounded to nearest 5m.

- Synchro extrapolated queue lengths at congested intersections. From Synchro 9 User Guide, "In practice, 95th percentile queue lengths will rarely be exceeded and the queues shown with the # footnote are acceptable in the design of storage bays."

¹ The City requires a minimum 35m storage length for left-turn lanes along arterial roads. Recommended left-turns storage lengths were based on the 95th percentile queue lengths from Synchro, and did not consider parallel deceleration or taper length requirements from TAC. Left-turn lane requirements will be reviewed and confirmed during detailed design.

The following auxiliary storage lanes were recommended at the intersection of Cambrian Road and Street 23/ Mattamy Site Access in the Half Moon Bay West Community Transportation Study (CTS) – Addendum No. 1:

- A 40m eastbound left-turn storage lane
- A 70m southbound left-turn storage lane

As previously recommended in Section 4.10.1.1, Street 23 should be constructed with an 11m pavement width to meet the current standards width for a collector road. This will ensure that there is sufficient roadway width to accommodate a northbound left-turn lane at the Cambrian and Street 23/ Mattamy Site Access. The results of this traffic study indicated that a 20m northbound left-turn lane was required in the 2027 background and total traffic conditions, as per the City queue length calculation.

A 15m westbound left-turn storage lane was able to accommodate traffic in the 2027 total traffic condition, according to the 95th percentile Synchro results and the City of Ottawa queue length calculation.

The recommended left-turn storage lengths should be reviewed and confirmed during detailed design.



4.10.1.3 Unsignalized Auxiliary Right-Turn Lane Requirements

There is currently no formal City or MTO warrant procedure governing the application of auxiliary right-turn lanes at unsignalized intersections. Referring to TAC standards, Section 9.14.2 suggests an auxiliary right-turn lane be considered “when the volume of decelerating or accelerating vehicles compared with the through traffic volume causes undue hazard.” Field observations did not note any undue hazard; auxiliary right-turn lanes were not recommended at the Borrisokane Road and Cambrian Road intersection.

At the time of this study, there were no right-turn lanes provided at the intersection of Borrisokane Road and Cambrian Road. A westbound right-turn lane may be warranted under 2027 total traffic condition, due to the high number of right-turning vehicles anticipated in the morning peak period, which exceeded 600 vehicles per hour.

Right-turn lane requirements should be reviewed and confirmed during detailed design.

4.10.1.4 Signalized Auxiliary Right-Turn Lane Requirements

Signalized auxiliary right-turn lane requirements were verified using the worst AM or PM peak hour volumes in the 2027 total traffic condition. Section 9.14 of TAC recommends implementing a right-turn lane when more than 20% of vehicles on an approach are turning right, and generally when the peak hour demand exceeds 60 vehicles per hour. The results of the auxiliary right-turn lane analysis are summarized below in Table 25.

A westbound right-turn lane is warranted at the intersection of Cambrian Road and Street 23/ Mattamy Site Access. The requirements for a westbound right-turn lane are triggered in the 2027 background and total traffic conditions, and a westbound right-turn was recommended in the Half Moon Bay West Community Transportation Study (CTS) – Addendum No. 1 at this intersection.

Even though the peak hour volume requirement of 60 right-turning vehicles was met on the southbound and eastbound approaches of the Cambrian Road and Street 23/ Mattamy Site Access intersection under the 2027 total traffic conditions, Synchro results indicated that right-turn lanes on the eastbound and southbound approaches were not necessary for the intersection to operate within City standards. The southbound approach was anticipated to have very few vehicles travelling southbound through, so it was assumed that right-turn lane may be able to remain as a shared through-right turning lane, and the eastbound approach did not exceed the 20% threshold for right-turning vehicles.

Right-turn lane requirements should be reviewed and confirmed during detailed design.

TABLE 25 – Recommended Auxiliary Right-Turn Storage Lengths at Signalized Intersections

| INTERSECTION | APPROACH | RIGHT TURN VOLUME | APPROACH VEHICLES TURNING RIGHT (%) | 95TH PERCENTILE QUEUE LENGTH (M) | EXISTING STORAGE LENGTH (M) | RECOMMENDED ADDITIONAL STORAGE LENGTH (M) |
|--|----------|-------------------|-------------------------------------|----------------------------------|-----------------------------|---|
| Cambrian Road and Street 23/ Mattamy Site Access | EB | 101 | 15% | <10 | - | Not warranted at this time ¹ |
| | WB | 250 | 40% | 15 | - | 15 ^{1,2,3} |
| | NB | 54 | 35% | <10 | - | Not warranted at this time ¹ |
| | SB | 77 | 23% | <10 | - | Not warranted at this time ¹ |

¹ Right-turn lanes requirements will be reviewed during detailed design stage

² Recommended storage lengths do not include deceleration lane and taper lengths. Units rounded to nearest 5m.

³ The City requires a minimum 35m storage length for right-turn lanes along arterial roads. Recommended right-turns storage lengths were based on the 95th percentile queue lengths from Synchro, and did not consider parallel deceleration or taper length requirements from TAC. Right-turn lane requirements will be reviewed and confirmed during detailed design.



4.11 Summary of Improvements Indicated and Modification Options

4.11.1 Cambrian Road and Borrisokane Road

The Cambrian Road and Borrisokane Road intersection was shown to operate within City standards through to the 2027 total traffic condition with the existing lane configurations and stop-controlled westbound approach.

A westbound right-turn lane and a 120m westbound left-turn storage lane may be required to accommodate traffic from the Half Moon Bay West Development. Auxiliary lane requirements should be reviewed and confirmed during detailed design.

4.11.2 Cambrian Road and Street 23/ Mattamy Site Access

Under the 2022 total traffic condition, the proposed intersection of Cambrian Road and Street 23 was proposed as an unsignalized T-intersection with a northbound stop-controlled approach. The intersection was shown to operate within City standards in the 2022 planning horizon with shared-through lanes on all approaches.

MTO left-turn lane requirements triggered a 15m westbound left-turn storage lane with the 2022 total traffic demand. According to TAC Section 9.1.2.3, provisions should also be provided for the construction of an eastbound left-turn lane to ensure symmetry between eastbound and westbound approach and departure lanes, which will mitigate the risk of potential collisions between left-turns and opposing through traffic, once the north leg of the intersection is constructed.

By 2027, the Mattamy Site Access was assumed to be constructed to provide access to the Half Moon Bay West development to the north of Cambrian Road. The intersection did not conform to City operational standards with northbound and southbound stop-controlled approaches, and signal warrants were triggered under 2027 total traffic conditions. Based on the results of the OTM signal warrants and the Roundabout Feasibility Screening Tool, it was recommended to either implement traffic signals or a single-lane roundabout at this intersection. Both are considered acceptable solutions to accommodate the traffic demand in the 2027 total traffic condition.

Synchro results indicated that if the Cambrian Road and Street 23/ Mattamy Site Access intersection was signalized, a 15m westbound left-turn storage lane and 15m westbound right-turn storage lane would be sufficient to accommodate total traffic demand in 2027. According to the Community Transportation Study (CTS) for Half Moon Bay West – Addendum No. 1 (November 2017), a 70m southbound left-turn storage lane and a 40m eastbound left-turn storage lane were required at the intersection. In order to maintain the alignment of the northbound and southbound through lanes, a northbound left-turn with a storage length of 20m should be provided at the intersection to oppose the southbound left-turn lane.

4.11.3 Summary of Conclusions and Recommendations

The key conclusions from the TIA Analysis Report are as follows:

- The study area transportation network is expected to accommodate site-generated traffic volumes through to the 2027 horizon year. Tamarack Homes shall be responsible for constructing all required access intersections and internal transportation facilities as dictated by the proposed draft plan.
- There is a requirement for an RMA to construct Street 23 from the subject lands, crossing through Mattamy's lands, and connecting with Cambrian Road to the north. Street 23 is proposed as a north-south collector road, and is required to provide vehicular access to the subject site. Mattamy Homes shall be responsible for constructing further roadway modifications at the intersection of Cambrian Road and Street 23 to accommodate traffic generated from the future Half Moon Bay West Development.



- There is no requirement for a monitoring plan.



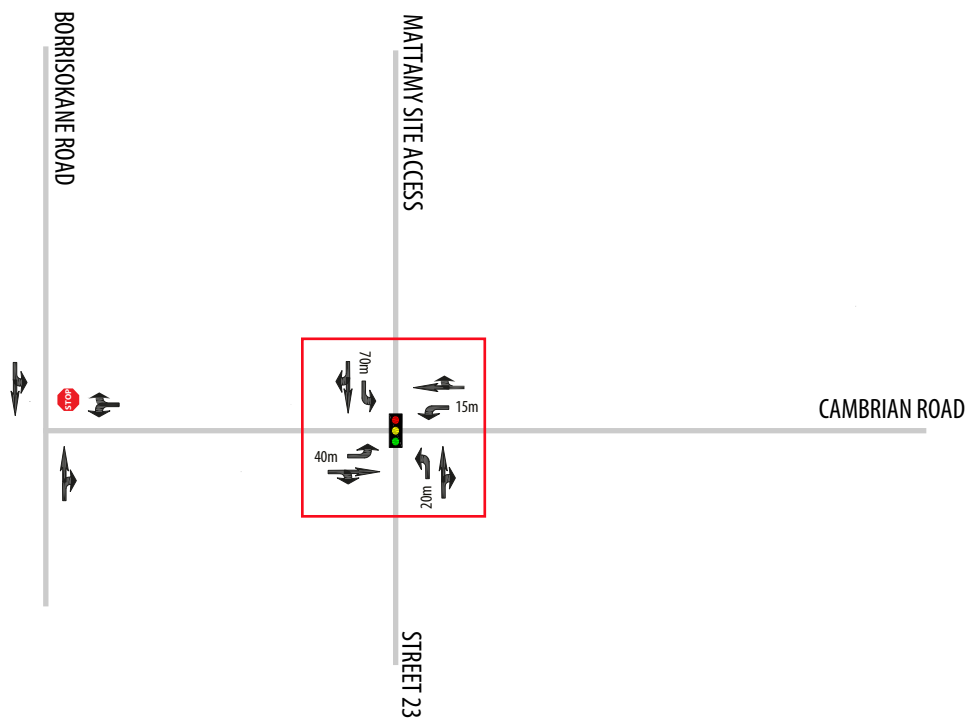

A summary of all recommendations has been provided in Table 26. The recommended design for all off-site roadway modifications in the 2027 total traffic condition has been provided in Exhibit 20.

TABLE 26 – Summary of Recommended Actions/ Modifications

| HORIZON | RECOMMENDED ACTIONS/ MODIFICATIONS |
|---|---|
| Existing (2018) | <p>Cambrian Road and Borrisokane Road</p> <ul style="list-style-type: none"> • Meets City operational guidelines |
| Future (2022) Background – No Meadows Phase 5 Traffic | <p>Assume all modifications from the Existing (2018) traffic conditions remain. No further recommendations.</p> <p>Cambrian Road and Borrisokane Road</p> <ul style="list-style-type: none"> • Meets City operational guidelines |
| Future (2022) Total – With Meadows Phase 5 Traffic | <p>Assume all modifications from the Existing (2018) traffic conditions remain. No further recommendations.</p> <p>Cambrian Road and Borrisokane Road</p> <ul style="list-style-type: none"> • Meets City operational guidelines <p>Cambrian Road and Street 23</p> <ul style="list-style-type: none"> • Unsignalized Intersection – Tamarack Homes <ul style="list-style-type: none"> ➢ Construct south leg (Street 23) with shared lane ➢ Northbound stop-controlled ➢ Construct 15m westbound left-turn storage lane and provision for an eastbound left-turn lane |
| Future (2027) Background – No Meadows Phase 5 Traffic | <p>Assume all modifications from the Future (2022) Background traffic conditions remain.</p> <p>Cambrian Road and Borrisokane Road</p> <ul style="list-style-type: none"> • Meets City operational guidelines • City of Ottawa – construct 120m southbound left-turn storage lane • City of Ottawa – construct westbound right-turn lane <p>Cambrian Road and Street 23/ Mattamy Site Access</p> <ul style="list-style-type: none"> • Traffic Signals – Mattamy Homes <ul style="list-style-type: none"> ➢ Construct north leg (Mattamy Site Access) with 70m southbound left-turn storage lane ➢ Construct south leg (Street 23) with 20m northbound left-turn storage lane ➢ Construct 40m eastbound left-turn storage lane ➢ Construct 15m westbound left-turn storage lane and 15m westbound right-turn storage lane OR • Single-lane roundabout – Mattamy Homes <ul style="list-style-type: none"> ➢ Construct south leg (Mattamy Site Access) with shared through-turning lane ➢ Construct south leg (Street 23) with shared through-turning lane |
| Future (2027) Total – With Meadows Phase 5 Traffic | <p>Assume all modifications from the Future (2022) Total traffic conditions remain. No further recommendations.</p> <p>Cambrian Road and Borrisokane Road</p> <ul style="list-style-type: none"> • Meets City operational guidelines • City of Ottawa – Construct 120m southbound left-turn storage lane • City of Ottawa – Construct westbound right-turn lane <p>Cambrian Road and Street 23/ Mattamy Site Access</p> <ul style="list-style-type: none"> • Traffic Signals – Mattamy Homes <ul style="list-style-type: none"> ➢ Construct north leg (Mattamy Site Access) with 70m southbound left-turn storage lane ➢ Construct 20m northbound left-turn storage lane ➢ Construct 40m eastbound left-turn storage lane ➢ Construct 15m westbound right-turn storage lane OR • Single-lane roundabout – Mattamy Homes <ul style="list-style-type: none"> ➢ Construct north leg (Mattamy Site Access) with shared through-turning lane ➢ Construct south leg (Street 23) with shared through-turning lane |



LEGEND

-  STOP CONTROL
-  TRAFFIC CONTROL SIGNAL
-  TRAVEL LANES AND PERMITTED MOVEMENTS
- XXm AUXILIARY STORAGE LENGTHS (METRES)
DOES NOT INCLUDE TAPER
-  RECOMMENDED MODIFICATION





The Meadows Phase 5

Transportation Impact Assessment Report

Appendix A: Traffic Data

April 2018



Survey Date: Tuesday February 15 2018
 Weather: Cloudy

TURNING MOVEMENT COUNT SUMMARY - ALL MODES



AM Peak Hour: 7:30 AM to 8:30 AM
 MD Peak Hour: 11:30 AM to 12:30 PM
 PM Peak Hour: 4:45 PM to 5:45 PM

AADT FACTOR: 1.0

Turning Movement Count - Full Study Summary Report (Vehicles)

| Time Period | Borrisokane Road | | | | | Borrisokane Road | | | | | N/S STREET TOTAL | 0 | | | | | Cambrian Road | | | | | E/W STREET TOTAL | Grand TOTAL |
|---|------------------|-----|-----|---------|----------|------------------|-----|----|---------|----------|------------------|-----------|----|----|---------|----------|---------------|----|-------|---------|----------|------------------|-------------|
| | Northbound | | | | | Southbound | | | | | | Eastbound | | | | | Westbound | | | | | | |
| | LT | ST | RT | U-Turns | NB TOTAL | LT | ST | RT | U-Turns | SB TOTAL | | LT | ST | RT | U-Turns | EB TOTAL | LT | ST | RT | U-Turns | WB TOTAL | | |
| 7:00 8:00 | 0 | 28 | 10 | 0 | 38 | 72 | 15 | 0 | 0 | 87 | 125 | 0 | 0 | 0 | 0 | 0 | 8 | 0 | 350 | 0 | 358 | 358 | 483 |
| 8:00 9:00 | 0 | 48 | 13 | 0 | 61 | 123 | 22 | 0 | 0 | 145 | 206 | 0 | 0 | 0 | 0 | 0 | 5 | 0 | 346 | 0 | 351 | 351 | 557 |
| 9:00 10:00 | 0 | 24 | 1 | 0 | 25 | 60 | 22 | 0 | 0 | 82 | 107 | 0 | 0 | 0 | 0 | 0 | 1 | 0 | 209 | 0 | 210 | 210 | 317 |
| AVG AM Pk HR | 0 | 33 | 8 | 0 | 41 | 85 | 20 | 0 | 0 | 105 | 146 | 0 | 0 | 0 | 0 | 0 | 5 | 0 | 302 | 0 | 306 | 306 | 452 |
| 11:30 12:30 | 0 | 54 | 9 | 0 | 63 | 105 | 26 | 0 | 0 | 131 | 194 | 0 | 0 | 0 | 0 | 0 | 4 | 0 | 139 | 0 | 143 | 143 | 337 |
| 12:30 13:30 | 0 | 48 | 6 | 0 | 54 | 87 | 23 | 0 | 0 | 110 | 164 | 0 | 0 | 0 | 0 | 0 | 2 | 0 | 117 | 0 | 119 | 119 | 283 |
| AVG MD Pk HR | 0 | 51 | 8 | 0 | 59 | 96 | 25 | 0 | 0 | 121 | 179 | 0 | 0 | 0 | 0 | 0 | 3 | 0 | 128 | 0 | 131 | 131 | 310 |
| 15:00 16:00 | 0 | 40 | 1 | 0 | 41 | 58 | 51 | 0 | 0 | 109 | 150 | 0 | 0 | 0 | 0 | 0 | 13 | 0 | 159 | 0 | 172 | 172 | 322 |
| 16:00 17:00 | 0 | 25 | 0 | 0 | 25 | 344 | 43 | 0 | 0 | 387 | 412 | 0 | 0 | 0 | 0 | 0 | 11 | 0 | 162 | 0 | 173 | 173 | 585 |
| 17:00 18:00 | 0 | 22 | 0 | 0 | 22 | 352 | 36 | 0 | 0 | 388 | 410 | 0 | 0 | 0 | 0 | 0 | 14 | 0 | 198 | 0 | 212 | 212 | 622 |
| AVG PM Pk HR | 0 | 29 | 0 | 0 | 29 | 251 | 43 | 0 | 0 | 295 | 324 | 0 | 0 | 0 | 0 | 0 | 13 | 0 | 173 | 0 | 186 | 186 | 510 |
| TOTAL | 0 | 373 | 56 | 0 | 429 | 1,382 | 282 | 0 | 0 | 1,664 | 2,093 | 0 | 0 | 0 | 0 | 0 | 66 | 0 | 2,110 | 0 | 2,175 | 2,175 | 4,268 |
| EQ 12Hr | 0 | 519 | 77 | 0 | 596 | 1921 | 392 | 0 | 0 | 2313 | 2909 | 0 | 0 | 0 | 0 | 0 | 91 | 0 | 2932 | 0 | 3024 | 3024 | 5933 |
| Note: These volumes are calculated by multiplying the totals by the appropriate expansion factor. | | | | | | | | | | | 1.39 | | | | | | | | | | | | |
| AVG 12Hr | 0 | 519 | 77 | 0 | 596 | 1921 | 392 | 0 | 0 | 2313 | 2909 | 0 | 0 | 0 | 0 | 0 | 91 | 0 | 2932 | 0 | 3024 | 3024 | 5933 |
| Note: These volumes are calculated by multiplying the Equivalent 12 hr. totals by the AADT factor. | | | | | | | | | | | 1.0 | | | | | | | | | | | | |
| AVG 24Hr | 0 | 680 | 101 | 0 | 781 | 2516 | 514 | 0 | 0 | 3030 | 3811 | 0 | 0 | 0 | 0 | 0 | 120 | 0 | 3841 | 0 | 3961 | 3961 | 7772 |
| Note: These volumes are calculated by multiplying the Average Daily 12hr. totals by the 12 to 24 expansion factor. | | | | | | | | | | | 1.31 | | | | | | | | | | | | |

Turning Movement Count - Full Study Summary Report (Pedestrians)

| Time Period | Borrisokane Road | | Borrisokane Road | | N/S STREET TOTAL | 0 | | Cambrian Road | | E/W STREET TOTAL | Grand TOTAL |
|---------------|-------------------------------------|--|-------------------------------------|--|------------------|---------------------------------------|--|---------------------------------------|--|------------------|-------------|
| | NB Approach (East or West Crossing) | | SB Approach (East or West Crossing) | | | EB Approach (North or South Crossing) | | WB Approach (North or South Crossing) | | | |
| 7:00 8:00 | 0 | | 0 | | 0 | 0 | | 0 | | 0 | 0 |
| 8:00 9:00 | 0 | | 0 | | 0 | 0 | | 0 | | 0 | 0 |
| 9:00 10:00 | 0 | | 0 | | 0 | 0 | | 1 | | 1 | 1 |
| 11:30 12:30 | 0 | | 0 | | 0 | 0 | | 0 | | 0 | 0 |
| 12:30 13:30 | 0 | | 0 | | 0 | 0 | | 0 | | 0 | 0 |
| 15:00 16:00 | 0 | | 0 | | 0 | 0 | | 0 | | 0 | 0 |
| 16:00 17:00 | 0 | | 228 | | 228 | 0 | | 0 | | 0 | 228 |
| 17:00 18:00 | 0 | | 0 | | 0 | 0 | | 0 | | 0 | 0 |
| TOTAL: | 0 | | 228 | | 228 | 0 | | 1 | | 1 | 229 |

Turning Movement Count - Full Study Summary Report (Cyclists)

| Time Period | Borrisokane Road | | N/S STREET TOTAL | 0 | | Cambrian Road | | E/W STREET TOTAL | Grand TOTAL |
|---------------|------------------|------------|------------------|-----------|-----------|---------------|---|------------------|-------------|
| | Northbound | Southbound | | Eastbound | Westbound | | | | |
| 7:00 8:00 | 0 | 0 | 0 | 0 | 0 | 0 | 0 | 0 | |
| 8:00 9:00 | 0 | 0 | 0 | 0 | 0 | 0 | 0 | 0 | |
| 9:00 10:00 | 0 | 0 | 0 | 0 | 0 | 0 | 0 | 0 | |
| 11:30 12:30 | 0 | 0 | 0 | 0 | 0 | 0 | 0 | 0 | |
| 12:30 13:30 | 0 | 0 | 0 | 0 | 0 | 0 | 0 | 0 | |
| 15:00 16:00 | 0 | 0 | 0 | 0 | 0 | 0 | 0 | 0 | |
| 16:00 17:00 | 0 | 0 | 0 | 0 | 0 | 0 | 0 | 0 | |
| 17:00 18:00 | 0 | 0 | 0 | 0 | 0 | 0 | 0 | 0 | |
| TOTAL: | 0 | 0 | 0 | 0 | 0 | 0 | 0 | 0 | |

Turning Movement Count - Full Study Summary Report (Heavy Vehicles)

| Time Period | Borrisokane Road | | | | | N/S STREET TOTAL | 0 | | | | | E/W STREET TOTAL | Grand TOTAL | | | | | | | | | | |
|---------------|------------------|----|----|---------|----------|------------------|------------|----|----|---------|----------|------------------|-------------|-----------|----|----|---------|----------|-----------|----|----|---------|----------|
| | Northbound | | | | | | Southbound | | | | | | | Eastbound | | | | | Westbound | | | | |
| | LT | ST | RT | U-Turns | NB TOTAL | | LT | ST | RT | U-Turns | SB TOTAL | | | LT | ST | RT | U-Turns | EB TOTAL | LT | ST | RT | U-Turns | WB TOTAL |
| 7:00 8:00 | 0 | 9 | 0 | 0 | 9 | 16 | 8 | 0 | 0 | 24 | 33 | 0 | 0 | 0 | 0 | 0 | 0 | 5 | 0 | 5 | 5 | 38 | |
| 8:00 9:00 | 0 | 10 | 2 | 0 | 12 | 4 | 10 | 0 | 0 | 14 | 26 | 0 | 0 | 0 | 0 | 0 | 2 | 0 | 16 | 0 | 18 | 18 | 44 |
| 9:00 10:00 | 0 | 12 | 0 | 0 | 12 | 7 | 13 | 0 | 0 | 20 | 32 | 0 | 0 | 0 | 0 | 0 | 0 | 0 | 10 | 0 | 10 | 10 | 42 |
| 11:30 12:30 | 0 | 11 | 1 | 0 | 12 | 2 | 11 | 0 | 0 | 13 | 25 | 0 | 0 | 0 | 0 | 0 | 1 | 0 | 5 | 0 | 6 | 6 | 31 |
| 12:30 13:30 | 0 | 10 | 3 | 0 | 13 | 2 | 11 | 0 | 0 | 13 | 26 | 0 | 0 | 0 | 0 | 0 | 0 | 0 | 5 | 0 | 5 | 5 | 31 |
| 15:00 16:00 | 0 | 2 | 0 | 0 | 2 | 10 | 2 | 0 | 0 | 12 | 14 | 0 | 0 | 0 | 0 | 0 | 1 | 0 | 11 | 0 | 12 | 12 | 26 |
| 16:00 17:00 | 0 | 1 | 5 | 0 | 6 | 6 | 2 | 0 | 0 | 8 | 14 | 0 | 0 | 0 | 0 | 0 | 4 | 0 | 17 | 0 | 21 | 21 | 35 |
| 17:00 18:00 | 0 | 2 | 1 | 0 | 3 | 1 | 1 | 0 | 0 | 2 | 5 | 0 | 0 | 0 | 0 | 0 | 2 | 0 | 5 | 0 | 7 | 7 | 12 |
| TOTAL: | 0 | 57 | 12 | 0 | 69 | 48 | 58 | 0 | 0 | 106 | 175 | 0 | 0 | 0 | 0 | 0 | 10 | 0 | 74 | 0 | 84 | 84 | 259 |



The Meadows Phase 5

Transportation Impact Assessment Report

Appendix B: OC Transpo Maps

April 2018





177

BARRHAVEN CENTRE CAMBRIAN

Local



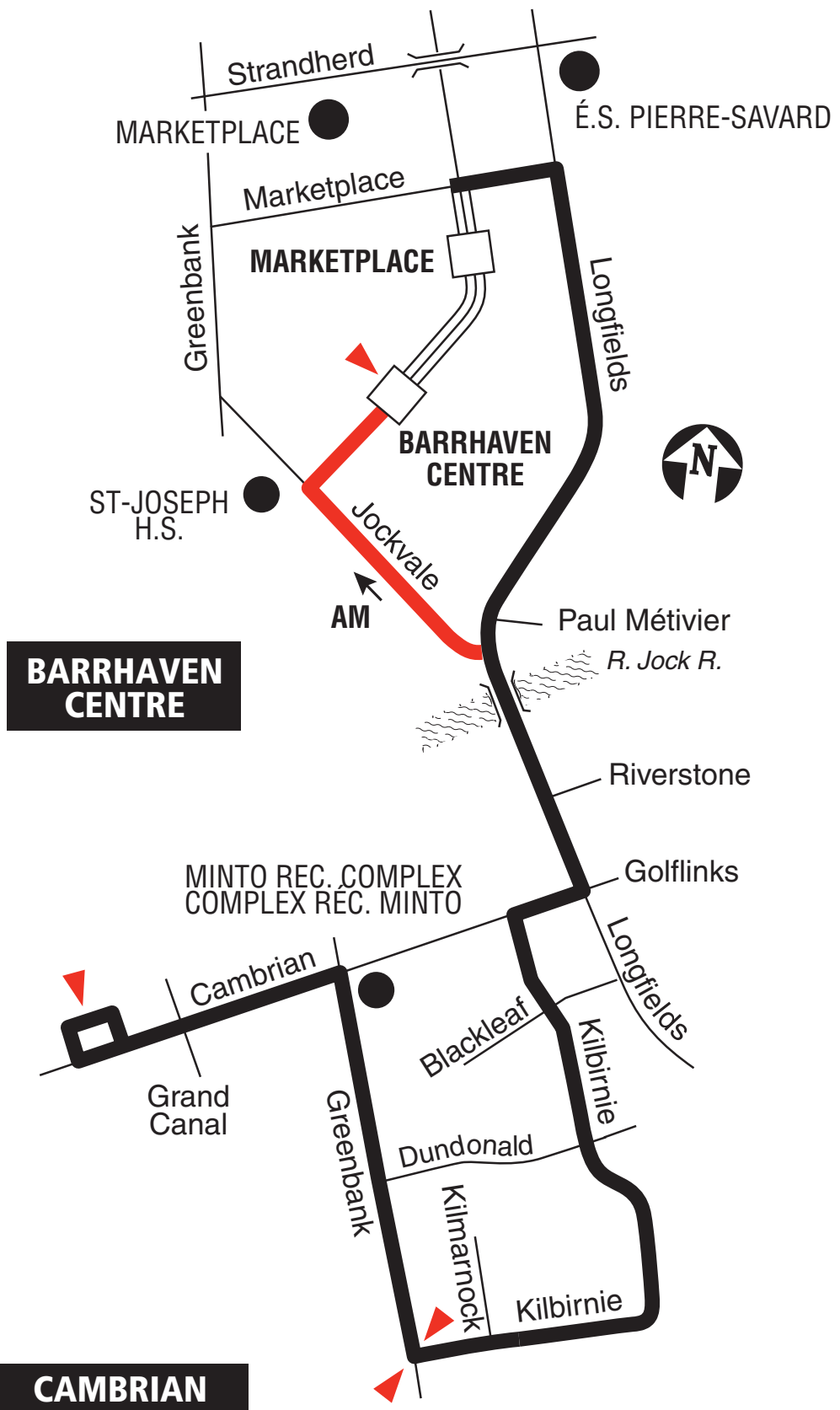

7 days a week / 7 jours par semaine

No Sunday evening service

Aucun service de soirée le dimanche

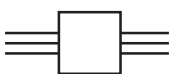

Legend • Légende

-  Transitway & Station / *Transitway & station*
-  Peak Periods only / *Périodes de pointe seulement*
-  Park & Ride / *Parc-o-bus*
-  Timepoint / *Heures de passage*

2017.01



Schedule / Horaire.....613-560-1000

Text / Texto560560

plus your four digit bus stop number / plus votre numéro d'arrêt à quatre chiffres

Customer Relations
Service à la clientèle **613-842-3600**

Lost and Found / Objets perdus..... **613-563-4011**

Security / Sécurité **613-741-2478**

Effective September 6, 2015

En vigueur 6 septembre 2015



INFO 613-741-4390
octranspo.com



The Meadows Phase 5

Transportation Impact Assessment Report

Appendix C: Collision Data

April 2018





City Operations - Transportation Services

Collision Details Report - Public Version

From: January 1, 2014 **To:** January 1, 2016

Location: CAMBRIAN RD @ GREENBANK RD

Traffic Control: Yield sign

Total Collisions: 2

| Date/Day/Time | Environment | Impact Type | Classification | Surface Cond'n | Veh. Dir | Vehicle Manoeuver | Vehicle type | First Event | No. Ped |
|------------------------|-------------|-------------|------------------|----------------|----------|---------------------|---------------------------|---------------------|---------|
| 2014-Jul-02, Wed,20:45 | Clear | Rear end | Non-fatal injury | Dry | West | Slowing or stopping | Automobile, station wagon | Other motor vehicle | |
| | | | | | West | Slowing or stopping | Passenger van | Other motor vehicle | |
| 2014-Aug-30, Sat,12:58 | Clear | Sideswipe | Non-fatal injury | Dry | East | Going ahead | Automobile, station wagon | Cyclist | |
| | | | | | East | Going ahead | Bicycle | Other motor vehicle | |

Location: CAMBRIAN RD @ REGATTA AVE

Traffic Control: Stop sign

Total Collisions: 2

| Date/Day/Time | Environment | Impact Type | Classification | Surface Cond'n | Veh. Dir | Vehicle Manoeuver | Vehicle type | First Event | No. Ped |
|------------------------|-------------|------------------|----------------|----------------|----------|-------------------|---------------------------|---------------------|---------|
| 2015-Jul-05, Sun,13:15 | Clear | Turning movement | P.D. only | Dry | West | Turning left | Passenger van | Other motor vehicle | |
| | | | | | West | Overtaking | Automobile, station wagon | Other motor vehicle | |
| 2015-Aug-11, Tue,22:06 | Clear | Angle | P.D. only | Dry | West | Turning left | Pick-up truck | Other motor vehicle | |
| | | | | | North | Stopped | Pick-up truck | Other motor vehicle | |

Location: CAMBRIAN RD @ RIVER MIST RD

Traffic Control: Stop sign

Total Collisions: 1

| Date/Day/Time | Environment | Impact Type | Classification | Surface Cond'n | Veh. Dir | Vehicle Manoeuver | Vehicle type | First Event | No. Ped |
|------------------------|-------------|-------------|----------------|----------------|----------|-------------------|---------------------------|---------------------|---------|
| 2015-Sep-04, Fri,07:15 | Clear | Angle | P.D. only | Dry | East | Going ahead | Automobile, station wagon | Other motor vehicle | |
| | | | | | North | Turning right | Automobile, station wagon | Other motor vehicle | |

Location: CAMBRIAN RD btwn BORRISOKANE RD & GRAND CANAL ST

Traffic Control: No control

Total Collisions: 1

| Date/Day/Time | Environment | Impact Type | Classification | Surface Cond'n | Veh. Dir | Vehicle Manoeuver | Vehicle type | First Event | No. Ped |
|------------------------|-------------|------------------------|----------------|----------------|----------|-------------------|--------------|--------------------|---------|
| 2015-Oct-09, Fri,00:00 | Clear | SMV unattended vehicle | P.D. only | Dry | West | Unknown | Unknown | Unattended vehicle | |



City Operations - Transportation Services

Collision Details Report - Public Version

From: January 1, 2014 **To:** January 1, 2016

Location: CAMBRIAN RD @ GREENBANK RD

Traffic Control: Yield sign

Total Collisions: 2

| Date/Day/Time | Environment | Impact Type | Classification | Surface Cond'n | Veh. Dir | Vehicle Manoeuver | Vehicle type | First Event | No. Ped |
|------------------------|-------------|-------------|------------------|----------------|----------|---------------------|---------------------------|---------------------|---------|
| 2014-Jul-02, Wed,20:45 | Clear | Rear end | Non-fatal injury | Dry | West | Slowing or stopping | Automobile, station wagon | Other motor vehicle | |
| | | | | | West | Slowing or stopping | Passenger van | Other motor vehicle | |
| 2014-Aug-30, Sat,12:58 | Clear | Sideswipe | Non-fatal injury | Dry | East | Going ahead | Automobile, station wagon | Cyclist | |
| | | | | | East | Going ahead | Bicycle | Other motor vehicle | |

Location: DUNDONALD DR @ GREENBANK RD

Traffic Control: Stop sign

Total Collisions: 6

| Date/Day/Time | Environment | Impact Type | Classification | Surface Cond'n | Veh. Dir | Vehicle Manoeuver | Vehicle type | First Event | No. Ped |
|------------------------|-------------|------------------|------------------|----------------|----------|-------------------|---------------------------|---------------------|---------|
| 2014-Jun-24, Tue,13:00 | Rain | Turning movement | P.D. only | Wet | South | Going ahead | Pick-up truck | Other motor vehicle | |
| | | | | | North | Turning left | Automobile, station wagon | Other motor vehicle | |
| 2014-Nov-05, Wed,18:20 | Clear | Angle | P.D. only | Dry | East | Turning left | Automobile, station wagon | Other motor vehicle | |
| | | | | | South | Going ahead | Automobile, station wagon | Other motor vehicle | |
| 2014-Sep-25, Thu,16:02 | Clear | SMV other | Non-fatal injury | Dry | North | Turning left | Automobile, station wagon | Pedestrian | 1 |

| | | | | | | | | |
|------------------------|-------|------------------|------------------|-----|-------|--------------|---------------------------|---------------------|
| 2014-Jul-24, Thu,16:07 | Clear | Turning movement | Non-fatal injury | Dry | North | Turning left | Automobile, station wagon | Other motor vehicle |
| | | | | | South | Going ahead | Pick-up truck | Other motor vehicle |

| | | | | | | | | |
|------------------------|-------|-------|-----------|-----|-------|-------------|---------------------------|---------------------|
| 2014-May-19, Mon,15:42 | Clear | Angle | P.D. only | Dry | West | Going ahead | Pick-up truck | Other motor vehicle |
| | | | | | South | Going ahead | Automobile, station wagon | Other motor vehicle |

| | | | | | | | | |
|------------------------|-------|-------|-----------|-----|-------|-------------|---------------------------|---------------------|
| 2015-Oct-09, Fri,14:10 | Clear | Angle | P.D. only | Dry | West | Going ahead | Automobile, station wagon | Other motor vehicle |
| | | | | | North | Going ahead | Automobile, station wagon | Other motor vehicle |

Location: EGRET WAY @ GREENBANK RD

Traffic Control: Stop sign

Total Collisions: 1

| Date/Day/Time | Environment | Impact Type | Classification | Surface Cond'n | Veh. Dir | Vehicle Manoeuver | Vehicle type | First Event | No. Ped |
|------------------------|-------------|-------------|----------------|----------------|----------|-------------------|---------------------------|---------------------|---------|
| 2015-Feb-27, Fri,07:32 | Clear | Angle | P.D. only | Dry | South | Turning right | Pick-up truck | Other motor vehicle | |
| | | | | | East | Stopped | Automobile, station wagon | Other motor vehicle | |

Location: GREENBANK RD btwn CAMBRIAN RD & DUNDONALD DR

Traffic Control: No control

Total Collisions: 2

| Date/Day/Time | Environment | Impact Type | Classification | Surface Cond'n | Veh. Dir | Vehicle Manoeuver | Vehicle type | First Event | No. Ped |
|------------------------|---------------|-------------|----------------|----------------|----------|-------------------|---------------|---------------------|---------|
| 2015-Jan-10, Sat,10:40 | Clear | Approaching | P.D. only | Wet | South | Going ahead | Unknown | Other motor vehicle | |
| | | | | | North | Going ahead | Pick-up truck | Other motor vehicle | |
| 2015-Jan-30, Fri,06:09 | Drifting Snow | SMV other | P.D. only | Ice | North | Going ahead | Pick-up truck | Ran off road | |



City Operations - Transportation Services

Collision Details Report - Public Version

From: January 1, 2014 **To:** January 1, 2016

Location: CAMBRIAN RD @ RIVER MIST RD

Traffic Control: Stop sign

Total Collisions: 1

| Date/Day/Time | Environment | Impact Type | Classification | Surface Cond'n | Veh. Dir | Vehicle Manoeuvre | Vehicle type | First Event | No. Ped |
|------------------------|-------------|-------------|----------------|----------------|----------|-------------------|---------------------------|---------------------|---------|
| 2015-Sep-04, Fri,07:15 | Clear | Angle | P.D. only | Dry | East | Going ahead | Automobile, station wagon | Other motor vehicle | |
| | | | | | North | Turning right | Automobile, station wagon | Other motor vehicle | |

Location: RIVER MIST RD btwn BRAMBLING WAY & RIVER ROCK AVE

Traffic Control: No control

Total Collisions: 1

| Date/Day/Time | Environment | Impact Type | Classification | Surface Cond'n | Veh. Dir | Vehicle Manoeuvre | Vehicle type | First Event | No. Ped |
|------------------------|-------------|------------------------|----------------|----------------|----------|-------------------|---------------------------|--------------------|---------|
| 2015-Jun-24, Wed,11:06 | Clear | SMV unattended vehicle | P.D. only | Dry | East | Reversing | Automobile, station wagon | Unattended vehicle | |

Collision Main Detail Summary

OnTRAC Reporting System

FROM: 2011-01-01 TO: 2014-01-01

CAMBRIAN RD, CEDARVIEW RD to GREENBANK RD

Former Municipality: Nepean

Traffic Control: No control

Number of Collisions: 5

| | DATE | DAY | TIME | ENV | LIGHT | IMPACT TYPE | CLASS | DIR | SURFACE COND'N | VEHICLE MANOEUVRE | VEHICLE TYPE | FIRST EVENT | No. PED |
|---|------------|-----|-------|--------|----------|----------------|-----------|--------------|----------------|------------------------|-----------------------------------|--|---------|
| 1 | 2011-05-16 | Mo | 16:00 | Rain | Daylight | Rear end | P.D. only | V1 E V2 E | Wet Wet | Going ahead Stopped | Automobile, station School bus | Other motor vehicle Other motor vehicle | 0 |
| 2 | 2012-03-05 | Mo | 21:00 | Clear | Dark | Single vehicle | P.D. only | V1 U | Dry | Unknown | Automobile, station | Unattended vehicle | 0 |
| 3 | 2012-10-20 | Sat | 04:35 | Clear | Dark | Single vehicle | P.D. only | V1 E | Wet | Going ahead | Automobile, station | Ran off road | 0 |
| 4 | 2013-02-22 | Fri | 07:00 | Unknow | Dawn | Single vehicle | P.D. only | V1 W | Slush | Going ahead | Unknown | Unattended vehicle | 0 |
| 5 | 2013-11-14 | Thu | 07:34 | Clear | Daylight | Single vehicle | P.D. only | V1 W | Dry | Going ahead | Automobile, station | Animal - wild | 0 |

CAMBRIAN RD & GREENBANK RD

Former Municipality: Nepean

Traffic Control: Stop sign

Number of Collisions: 4

| | DATE | DAY | TIME | ENV | LIGHT | IMPACT TYPE | CLASS | DIR | SURFACE COND'N | VEHICLE MANOEUVRE | VEHICLE TYPE | FIRST EVENT | No. PED |
|---|------------|-----|-------|-------|----------|----------------|-----------|--------------|----------------------------|-------------------------------|--|--|---------|
| 6 | 2012-03-01 | Thu | 12:07 | Snow | Daylight | Rear end | P.D. only | V1 S V2 S | Packed snow Packed snow | Going ahead Going ahead | Automobile, station Automobile, station | Skidding/Sliding Skidding/Sliding | 0 |
| 7 | 2013-02-14 | Thu | 16:20 | Clear | Daylight | Single vehicle | Non-fatal | V1 N | Mud | Going ahead | School bus | Skidding/Sliding | 0 |
| 8 | 2013-09-09 | Mo | 07:40 | Clear | Daylight | Sideswipe | P.D. only | V1 S V2 S | Dry Dry | Changing lanes Going ahead | Automobile, station Passenger van | Other motor vehicle Other motor vehicle | 0 |
| 9 | 2013-12-13 | Fri | 23:41 | Clear | Dark | Single vehicle | P.D. only | V1 N | Dry | Going ahead | Automobile, station | Pole (sign, parking) | 0 |

CAMBRIAN RD & GRAND CANAL ST

Former Municipality: Nepean

Traffic Control: Stop sign

Number of Collisions: 2

| | DATE | DAY | TIME | ENV | LIGHT | IMPACT TYPE | CLASS | DIR | SURFACE COND'N | VEHICLE MANOEUVRE | VEHICLE TYPE | FIRST EVENT | No. PED |
|----|------------|-----|-------|-------|----------|-------------|-----------|--------------|----------------|-----------------------------|--|--|---------|
| 10 | 2012-12-21 | Fri | 07:36 | Snow | Dawn | Angle | P.D. only | V1 W V2 S | Wet Wet | Slowing or Turning left | Automobile, station Automobile, station | Other motor vehicle Other motor vehicle | 0 |
| 11 | 2013-11-03 | Sun | 12:41 | Clear | Daylight | Turning | Non-fatal | V1 E V2 W | Dry Dry | Going ahead Turning left | Automobile, station Automobile, station | Other motor vehicle Other motor vehicle | 0 |

(Note: Time of Day = "00:00" represents unknown collision time)

Tuesday, August 22, 2017

Collision Main Detail Summary

OnTRAC Reporting System

FROM: 2011-01-01 TO: 2014-01-01

GREENBANK RD, BARNSDALE RD to CAMBRIAN RD

Former Municipality: Nepean

Traffic Control: **No control**

Number of Collisions: **3**

| | DATE | DAY | TIME | ENV | LIGHT | IMPACT TYPE | CLASS | DIR | SURFACE COND'N | VEHICLE MANOEUVRE | VEHICLE TYPE | FIRST EVENT | No. PED |
|----|------------|-----|-------|-------|----------|----------------|-----------|--------------|-------------------|----------------------------|--------------------------------------|--------------------------------------|------------|
| 12 | 2011-02-10 | Thu | 07:48 | Clear | Daylight | Other | P.D. only | V1 S V2 N | Wet Loose snow | Going ahead Going ahead | Pick-up truck Automobile, station | Other Moveable Debris falling off | 0 |
| 13 | 2011-09-25 | Sun | 20:50 | Clear | Dark | Single vehicle | P.D. only | V1 N | Loose sand or | Going ahead | Automobile, station | Debris on road | 0 |

CAMBRIAN RD, SEELEY'S BAY ST to GRAND CANAL ST

Former Municipality: Nepean

Traffic Control: **No control**

Number of Collisions: **7**

| | DATE | DAY | TIME | ENV | LIGHT | IMPACT TYPE | CLASS | DIR | SURFACE COND'N | VEHICLE MANOEUVRE | VEHICLE TYPE | FIRST EVENT | No. PED |
|----|------------|-----|-------|-------|----------|----------------|-----------|------|-------------------|----------------------|--------------|--------------------|------------|
| 14 | 2011-07-12 | Tue | 16:30 | Clear | Daylight | Single vehicle | P.D. only | V1 W | Dry | Reversing | Farm tractor | Unattended vehicle | 0 |

CAMBRIAN RD & REGATTA AVE

Former Municipality: Nepean

Traffic Control: **Stop sign**

Number of Collisions: **8**

| | DATE | DAY | TIME | ENV | LIGHT | IMPACT TYPE | CLASS | DIR | SURFACE COND'N | VEHICLE MANOEUVRE | VEHICLE TYPE | FIRST EVENT | No. PED |
|----|------------|-----|-------|------|-------|----------------|-----------|--------------|-------------------|-----------------------------|--------------------------------------|--|------------|
| 15 | 2011-11-17 | Thu | 17:09 | Rain | Dark | Turning | P.D. only | V1 W V2 E | Wet Wet | Turning left Going ahead | Automobile, station Pick-up truck | Other motor vehicle Other motor vehicle | 0 |

DUNDONALD DR & GREENBANK RD

Former Municipality: Nepean

Traffic Control: **Stop sign**

Number of Collisions: **2**

| | DATE | DAY | TIME | ENV | LIGHT | IMPACT TYPE | CLASS | DIR | SURFACE COND'N | VEHICLE MANOEUVRE | VEHICLE TYPE | FIRST EVENT | No. PED |
|----|------------|-----|-------|-------|----------|----------------|-----------|--------------|-------------------|----------------------------|--|--|------------|
| 16 | 2012-07-13 | Fri | 21:00 | Clear | Dusk | Rear end | P.D. only | V1 W V2 W | Dry Dry | Going ahead Stopped | Automobile, station Automobile, station | Other motor vehicle Other motor vehicle | 0 |
| 17 | 2012-12-13 | Thu | 09:42 | Clear | Daylight | Angle | P.D. only | V1 E V2 N | Wet Wet | Going ahead Going ahead | Pick-up truck Passenger van | Other motor vehicle Other motor vehicle | 0 |

(Note: Time of Day = "00:00" represents unknown collision time)

Tuesday, August 22, 2017

Page 2 of 2



The Meadows Phase 5

Transportation Impact Assessment Report

Appendix D: Cambrian Road Widening EA

April 2018



Document 3 - Illustrative Plan of the Recommended Ultimate Four-Lane Design

Cross-Section illustrations of the Ultimate Four-Lane Design and modifications in the vicinity of Half-Moon Bay Park

ULTIMATE TYPICAL CROSS SECTION

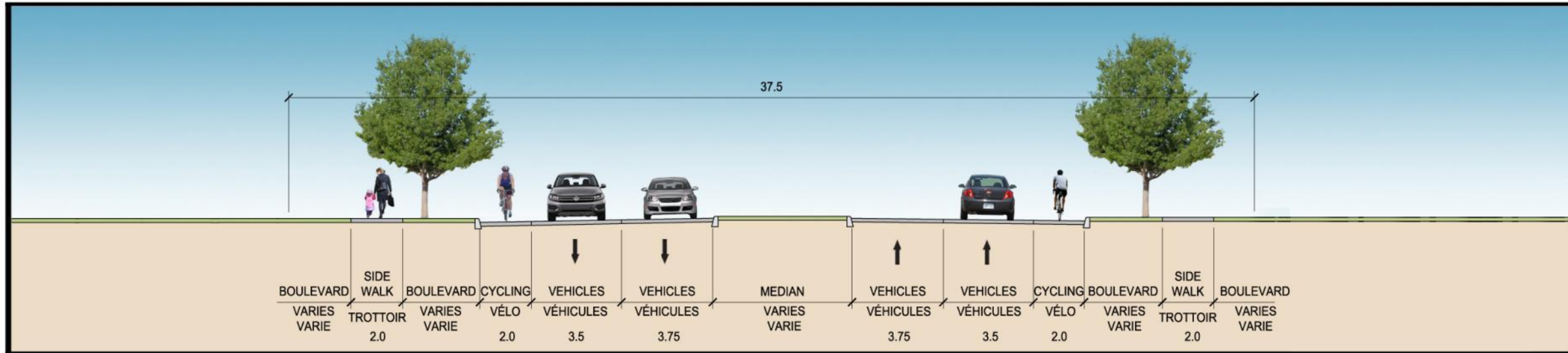

ULTIMATE CROSS SECTION IN VICINITY OF HALF MOON BAY PARK

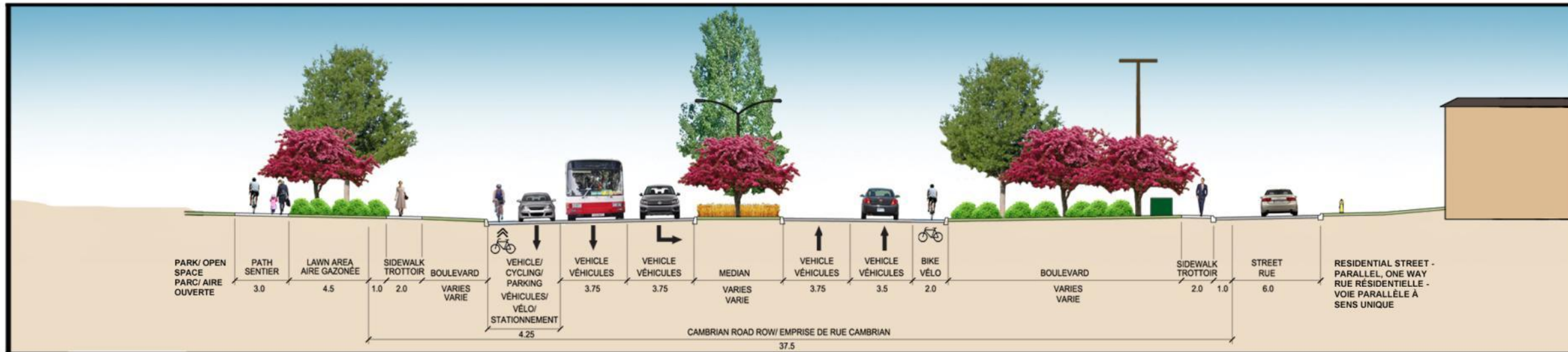

Recommended Ultimate Design for Four-Lane Design for Cambrian Road

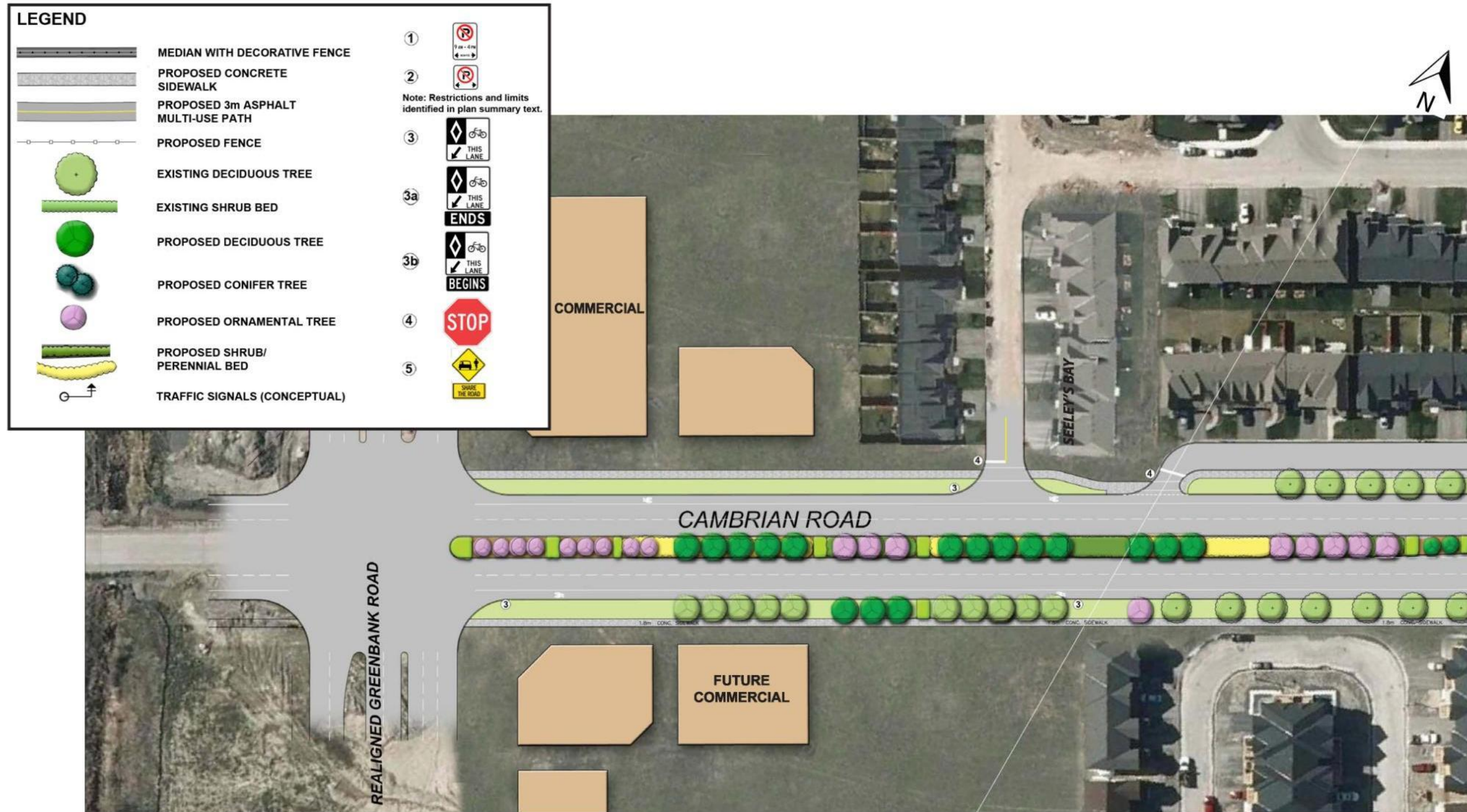

RECOMMENDED PLAN 4-LANE DESIGN
REALIGNED GREENBANK ROAD TO SEELEY'S BAY

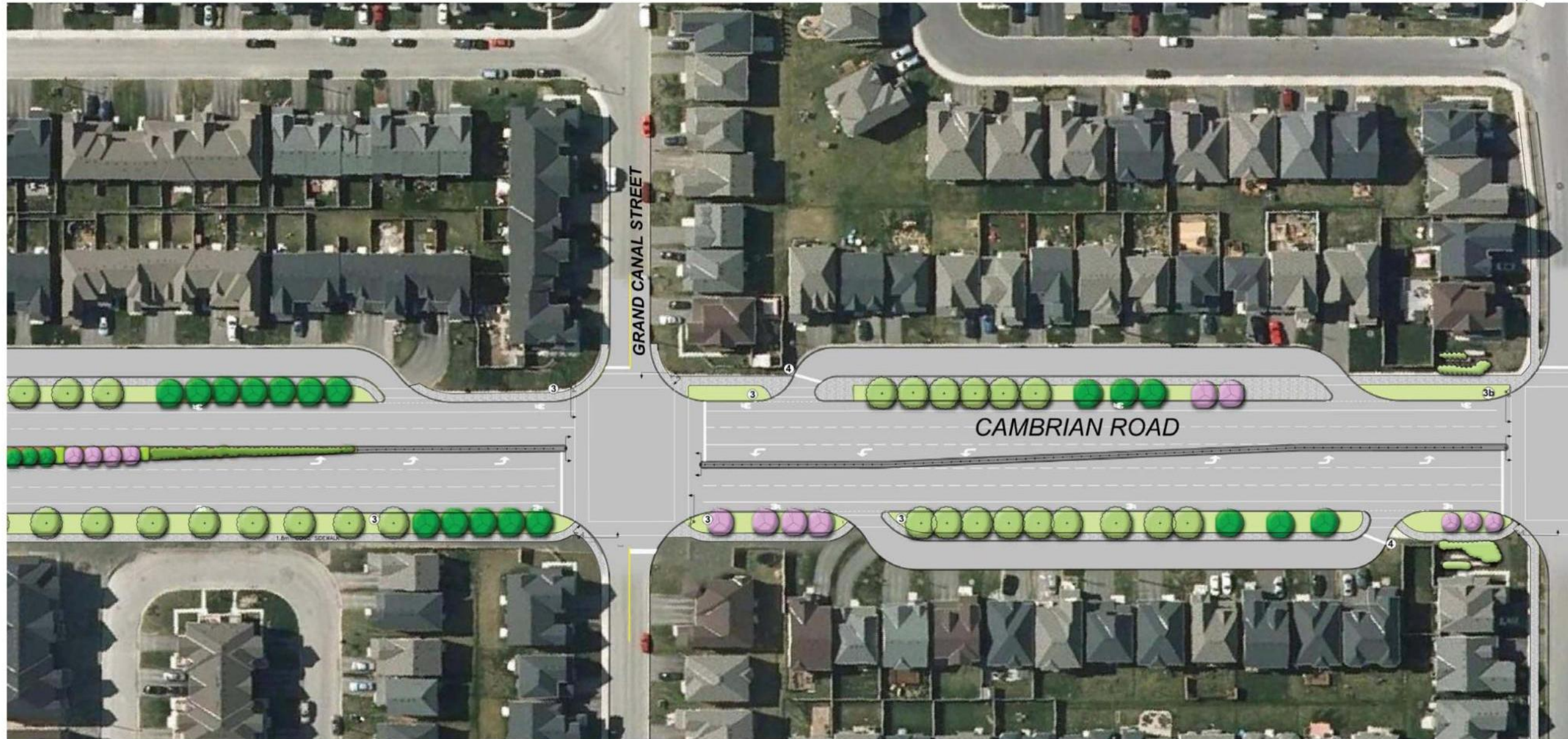

RECOMMENDED PLAN 4-LANE DESIGN
SEELEY'S BAY TO RIVER MIST ROAD



RECOMMENDED PLAN 4-LANE DESIGN
RIVER MIST ROAD TO REGATTA AVENUE



RECOMMENDED PLAN 4-LANE DESIGN
GREENBANK ROAD TO ST. CECILIA ELEMENTARY SCHOOL



RECOMMENDED PLAN 4-LANE DESIGN
ST. CECILIA ELEMENTARY SCHOOL TO TUSCANA WAY/KILBIRNIE DRIVE

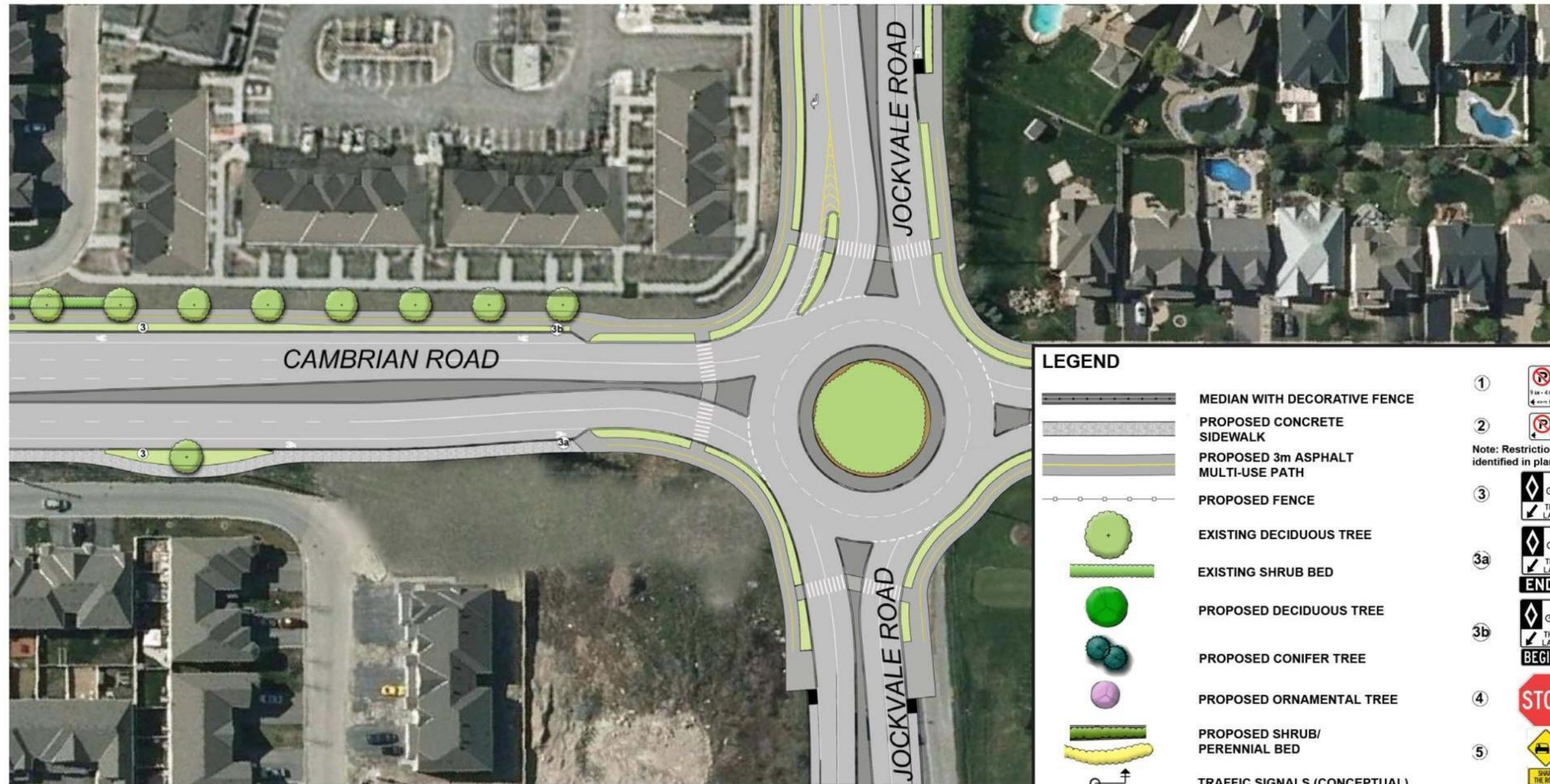

LEGEND

| | | | |
|--|------------------------------------|--|--|
| | MEDIAN WITH DECORATIVE FENCE | ① | |
| | PROPOSED CONCRETE SIDEWALK | ② | |
| | PROPOSED 3m ASPHALT MULTI-USE PATH | Note: Restrictions and limits identified in plan summary text. | |
| | PROPOSED FENCE | ③ | |
| | EXISTING DECIDUOUS TREE | 3a | |
| | EXISTING SHRUB BED | 3b | |
| | PROPOSED DECIDUOUS TREE | ④ | |
| | PROPOSED CONIFER TREE | ⑤ | |
| | PROPOSED ORNAMENTAL TREE | | |
| | PROPOSED SHRUB/ PERENNIAL BED | | |
| | TRAFFIC SIGNALS (CONCEPTUAL) | | |

RECOMMENDED PLAN 4-LANE DESIGN
TUSCANA WAY/KILBIRNIE DRIVE TO JOCKVALE ROAD



The Meadows Phase 5

Transportation Impact Assessment Report

Appendix E: ITE Trip Generation Data

April 2018



Single-Family Detached Housing (210)

Average Vehicle Trip Ends vs: Dwelling Units
On a: Weekday,
Peak Hour of Adjacent Street Traffic,
One Hour Between 7 and 9 a.m.

Number of Studies: 292
 Avg. Number of Dwelling Units: 194
 Directional Distribution: 25% entering, 75% exiting

Trip Generation per Dwelling Unit

| Average Rate | Range of Rates | Standard Deviation |
|--------------|----------------|--------------------|
| 0.75 | 0.33 - 2.27 | 0.90 |

Data Plot and Equation

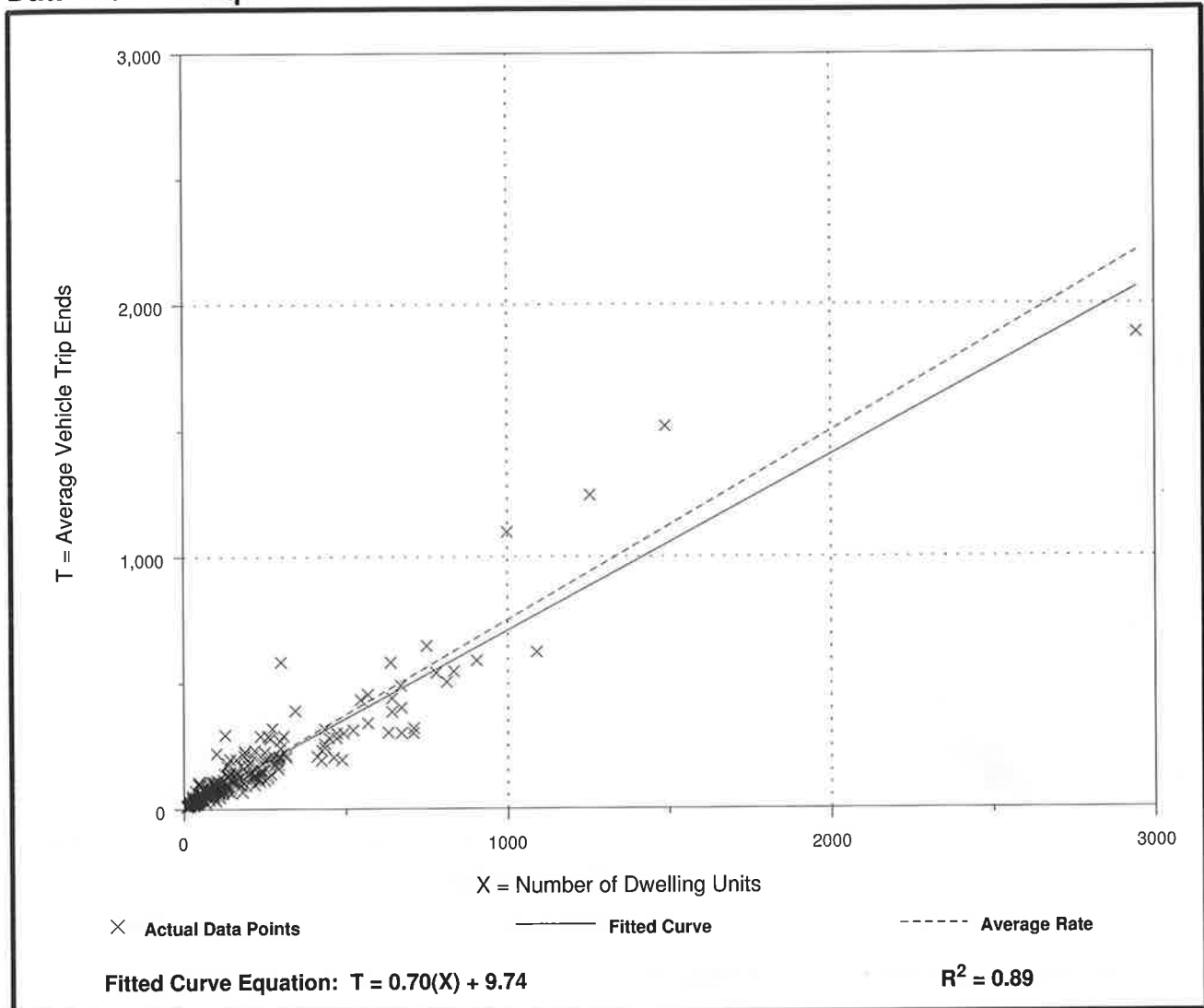

Single-Family Detached Housing (210)

Average Vehicle Trip Ends vs: Dwelling Units
On a: Weekday,
Peak Hour of Adjacent Street Traffic,
One Hour Between 4 and 6 p.m.

Number of Studies: 321
 Avg. Number of Dwelling Units: 207
 Directional Distribution: 63% entering, 37% exiting

Trip Generation per Dwelling Unit

| Average Rate | Range of Rates | Standard Deviation |
|--------------|----------------|--------------------|
| 1.00 | 0.42 - 2.98 | 1.05 |

Data Plot and Equation

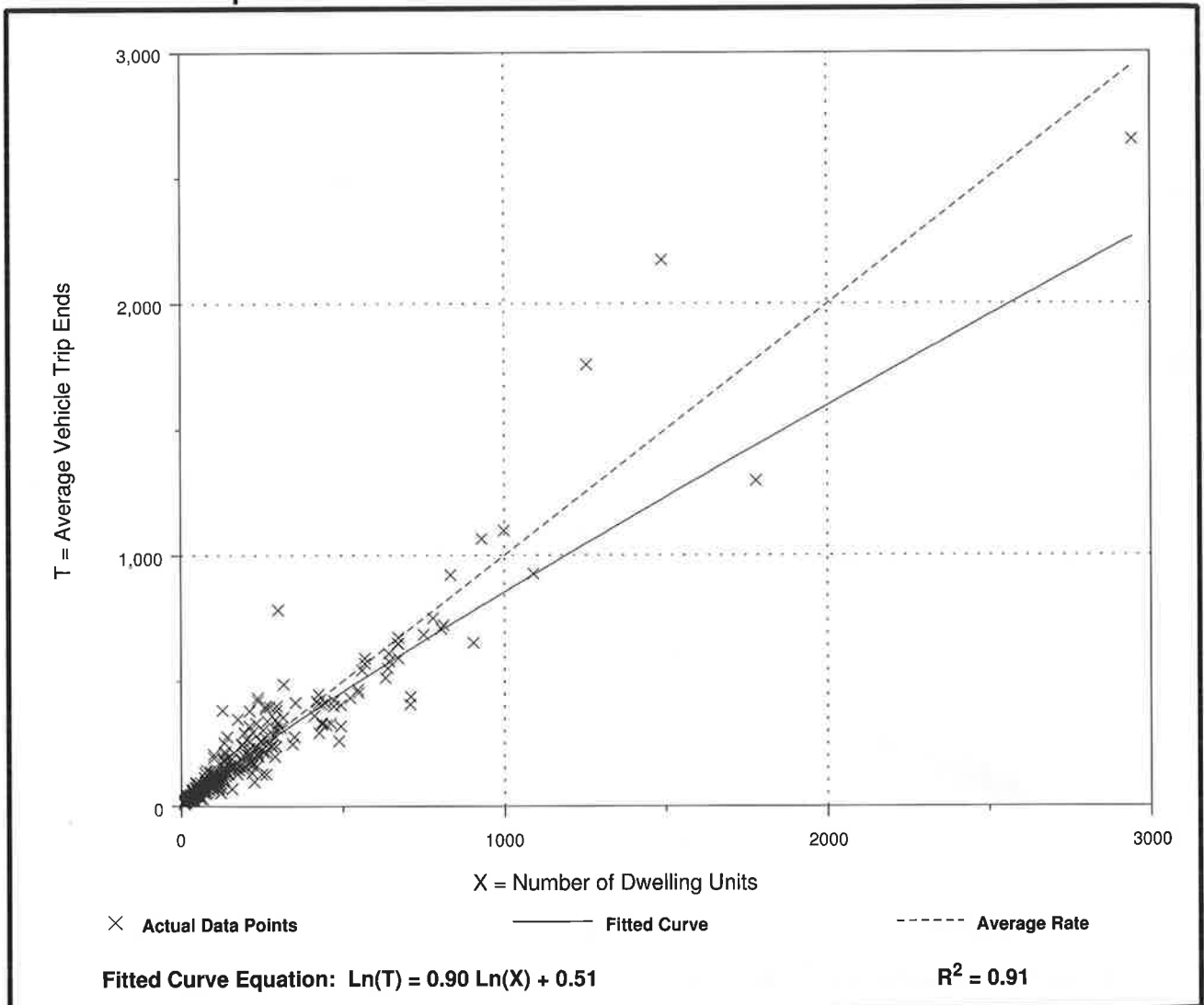

Residential Condominium/Townhouse (230)

Average Vehicle Trip Ends vs: Dwelling Units
On a: Weekday,
Peak Hour of Adjacent Street Traffic,
One Hour Between 7 and 9 a.m.

Number of Studies: 59
 Avg. Number of Dwelling Units: 213
 Directional Distribution: 17% entering, 83% exiting

Trip Generation per Dwelling Unit

| Average Rate | Range of Rates | Standard Deviation |
|--------------|----------------|--------------------|
| 0.44 | 0.15 - 1.61 | 0.69 |

Data Plot and Equation

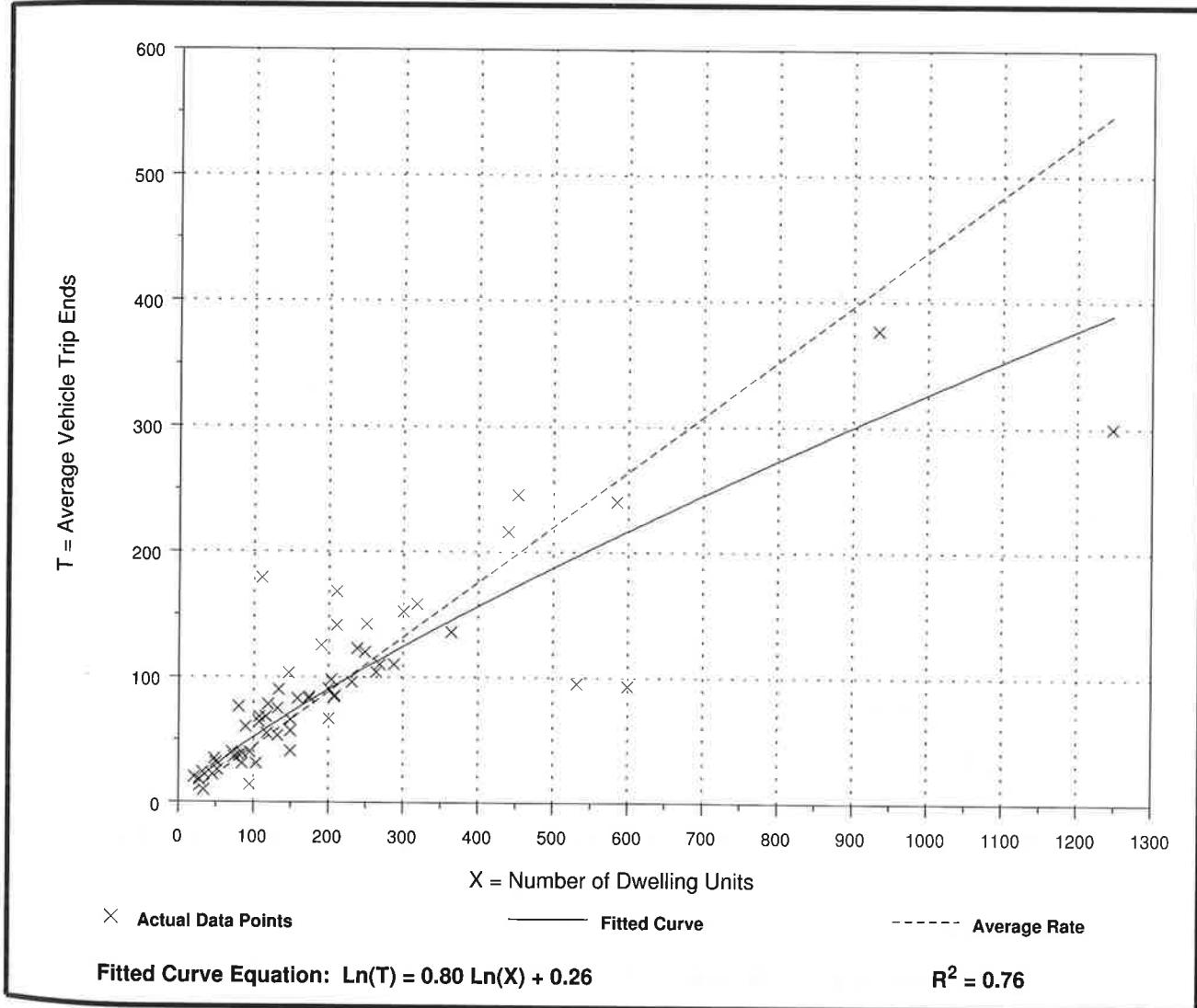

Residential Condominium/Townhouse (230)

Average Vehicle Trip Ends vs: Dwelling Units
On a: Weekday,
Peak Hour of Adjacent Street Traffic,
One Hour Between 4 and 6 p.m.

Number of Studies: 62
 Avg. Number of Dwelling Units: 205
 Directional Distribution: 67% entering, 33% exiting

Trip Generation per Dwelling Unit

| Average Rate | Range of Rates | Standard Deviation |
|--------------|----------------|--------------------|
| 0.52 | 0.18 - 1.24 | 0.75 |

Data Plot and Equation

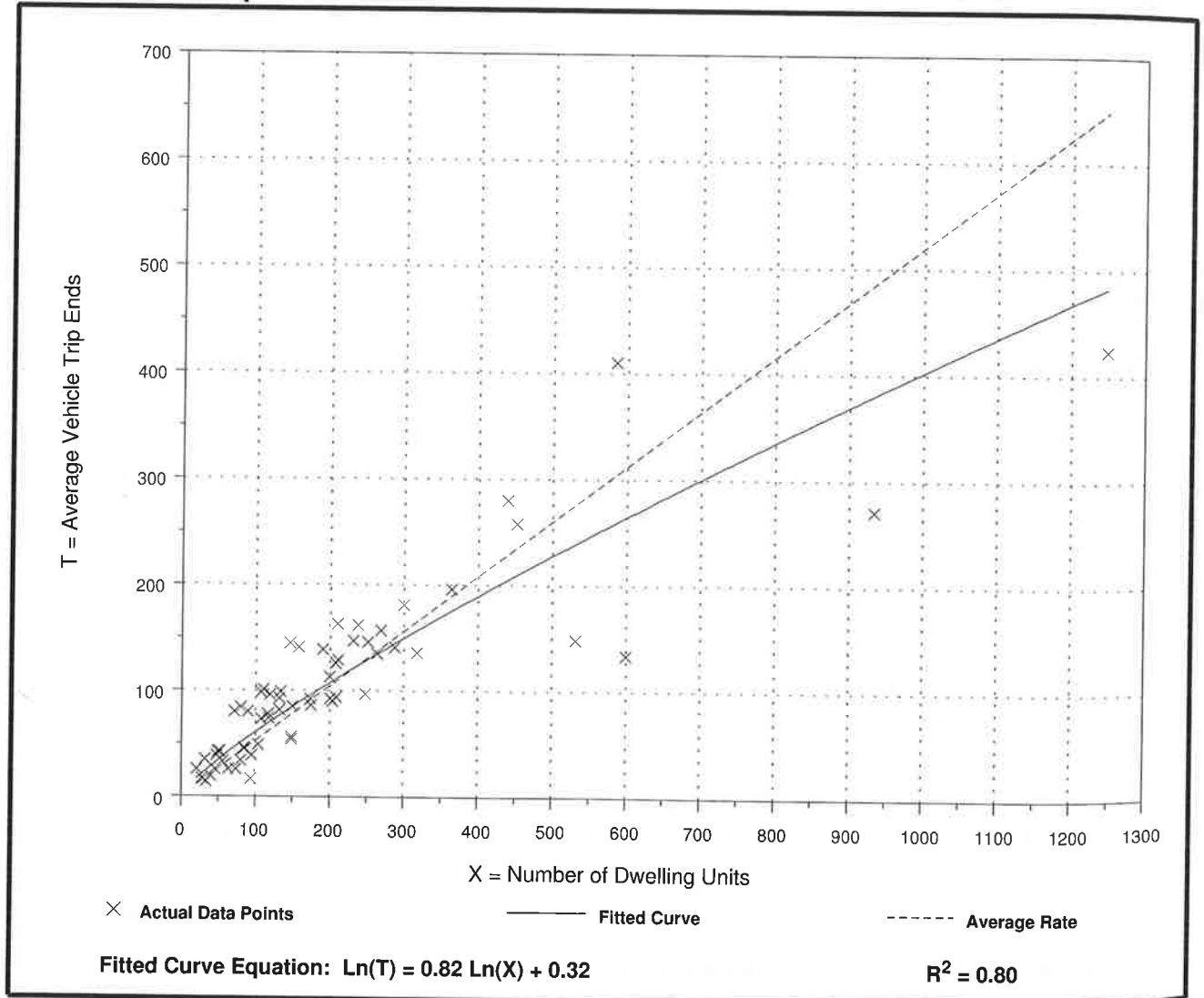



The Meadows Phase 5

Transportation Impact Assessment Report

Appendix F: 2011 OD Survey Data – South Nepean

April 2018



South Nepean

Demographic Characteristics

| | | | |
|---------------------|--------|-------------------------|--------|
| Population | 72,750 | Actively Travelled | 57,830 |
| Employed Population | 35,540 | Number of Vehicles | 44,130 |
| Households | 26,260 | Area (km ²) | 54.8 |

| Occupation | Male | Female | Total |
|--------------------|---------------|---------------|---------------|
| Status (age 5+) | | | |
| Full Time Employed | 17,630 | 14,730 | 32,350 |
| Part Time Employed | 620 | 2,570 | 3,190 |
| Student | 9,910 | 9,420 | 19,340 |
| Retiree | 3,420 | 4,200 | 7,620 |
| Unemployed | 720 | 500 | 1,220 |
| Homemaker | 180 | 2,390 | 2,570 |
| Other | 270 | 540 | 810 |
| Total: | 32,750 | 34,350 | 67,100 |

| Traveller Characteristics | Male | Female | Total |
|---------------------------|-------|--------|--------|
| Transit Pass Holders | 5,590 | 6,100 | 11,700 |

| | | | |
|------------------|--------|--------|--------|
| Licensed Drivers | 24,480 | 25,260 | 49,740 |
|------------------|--------|--------|--------|

| | | | |
|---------------|----|-----|-----|
| Telecommuters | 60 | 310 | 370 |
|---------------|----|-----|-----|

| | | | |
|-------------------------|--------|--------|---------|
| Trips made by residents | 88,180 | 97,380 | 185,550 |
|-------------------------|--------|--------|---------|

| Selected Indicators | |
|---|------|
| Daily Trips per Person (age 5+) | 2.77 |
| Vehicles per Person | 0.61 |
| Number of Persons per Household | 2.77 |
| Daily Trips per Household | 7.07 |
| Vehicles per Household | 1.68 |
| Workers per Household | 1.35 |
| Population Density (Pop/km ²) | 1330 |

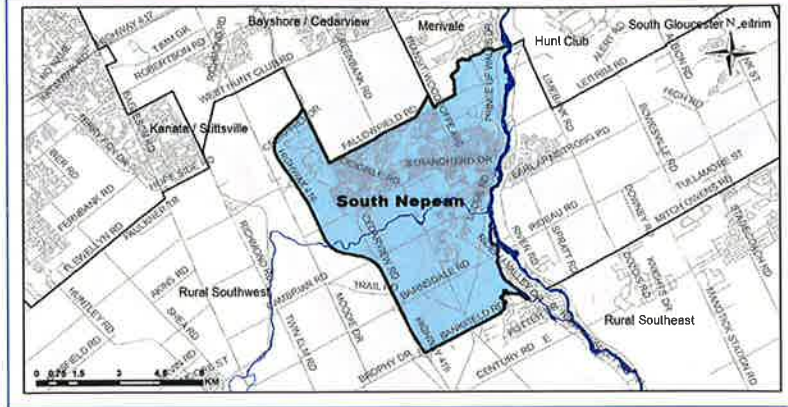

| Household Size | | |
|----------------|---------------|-------------|
| 1 person | 3,560 | 14% |
| 2 persons | 7,300 | 28% |
| 3 persons | 5,500 | 21% |
| 4 persons | 6,320 | 24% |
| 5+ persons | 3,590 | 14% |
| Total: | 26,260 | 100% |

| Households by Vehicle Availability | | |
|------------------------------------|---------------|-------------|
| 0 vehicles | 810 | 3% |
| 1 vehicle | 9,500 | 36% |
| 2 vehicles | 13,800 | 53% |
| 3 vehicles | 1,730 | 7% |
| 4+ vehicles | 410 | 2% |
| Total: | 26,260 | 100% |

| Households by Dwelling Type | | |
|-----------------------------|---------------|-------------|
| Single-detached | 14,530 | 55% |
| Semi-detached | 3,090 | 12% |
| Townhouse | 7,770 | 30% |
| Apartment/Condo | 870 | 3% |
| Total: | 26,260 | 100% |

Population

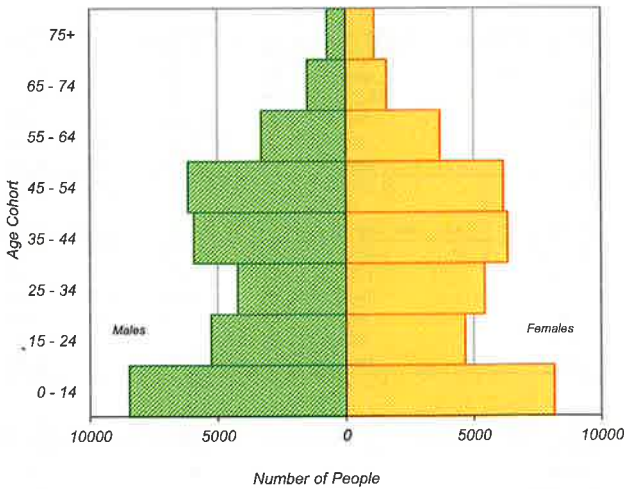

Employed Population

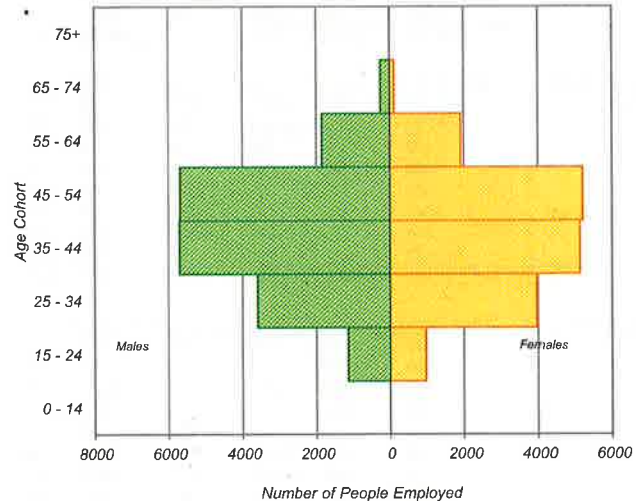

* In 2005 data was only collected for household members aged 11+ therefore these results cannot be compared to the 2011 data.

Travel Patterns

Top Five Destinations of Trips from South Nepean

AM Peak Period

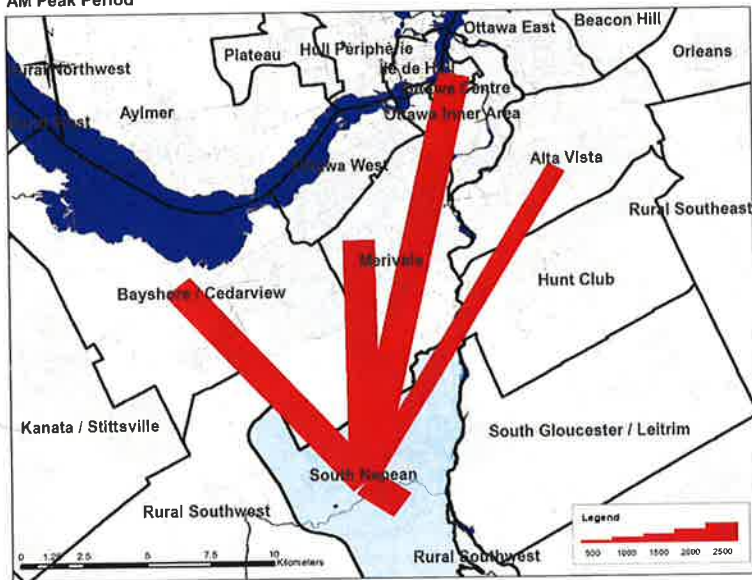

Summary of Trips to and from South Nepean

AM Peak Period (6:30 - 8:59)

| Districts | Destinations of Trips From | | Origins of Trips To | |
|----------------------------|----------------------------|-------------|---------------------|-------------|
| | District | % Total | District | % Total |
| Ottawa Centre | 3,820 | 9% | 30 | 0% |
| Ottawa Inner Area | 2,270 | 5% | 340 | 1% |
| Ottawa East | 630 | 2% | 50 | 0% |
| Beacon Hill | 370 | 1% | 50 | 0% |
| Alta Vista | 2,360 | 6% | 460 | 2% |
| Hunt Club | 920 | 2% | 440 | 2% |
| Merivale | 4,310 | 10% | 790 | 3% |
| Ottawa West | 1,830 | 4% | 160 | 1% |
| Bayshore / Cedarview | 3,230 | 8% | 700 | 3% |
| Orléans | 330 | 1% | 200 | 1% |
| Rural East | 20 | 0% | 60 | 0% |
| Rural Southeast | 250 | 1% | 580 | 2% |
| South Gloucester / Leitrim | 100 | 0% | 310 | 1% |
| South Nepean | 17,260 | 42% | 17,260 | 74% |
| Rural Southwest | 580 | 1% | 970 | 4% |
| Kanata / Stittsville | 1,800 | 4% | 690 | 3% |
| Rural West | 80 | 0% | 30 | 0% |
| Île de Hull | 840 | 2% | 50 | 0% |
| Hull Périphérie | 260 | 1% | 40 | 0% |
| Plateau | 0 | 0% | 40 | 0% |
| Aylmer | 60 | 0% | 40 | 0% |
| Rural Northwest | 40 | 0% | 40 | 0% |
| Pointe Gatineau | 0 | 0% | 0 | 0% |
| Gatineau Est | 0 | 0% | 20 | 0% |
| Rural Northeast | 10 | 0% | 20 | 0% |
| Buckingham / Masson-Angers | 20 | 0% | 0 | 0% |
| Ontario Sub-Total: | 40,160 | 97% | 23,120 | 99% |
| Québec Sub-Total: | 1,230 | 3% | 250 | 1% |
| Total: | 41,390 | 100% | 23,370 | 100% |

Trips by Trip Purpose

| 24 Hours | From District | | To District | | Within District | |
|---------------------------|---------------|-------------|---------------|-------------|-----------------|-------------|
| Work or related | 25,640 | 41% | 5,290 | 8% | 4,680 | 6% |
| School | 5,310 | 8% | 1,430 | 2% | 10,610 | 13% |
| Shopping | 4,940 | 8% | 4,220 | 7% | 12,840 | 16% |
| Leisure | 6,960 | 11% | 4,020 | 6% | 5,760 | 7% |
| Medical | 1,720 | 3% | 900 | 1% | 840 | 1% |
| Pick-up / drive passenger | 4,040 | 6% | 3,920 | 6% | 7,530 | 9% |
| Return Home | 11,460 | 18% | 40,960 | 65% | 34,630 | 43% |
| Other | 2,540 | 4% | 2,090 | 3% | 3,020 | 4% |
| Total: | 62,710 | 100% | 62,830 | 100% | 79,910 | 100% |

| AM Peak (06:30 - 08:59) | From District | | To District | | Within District | |
|---------------------------|---------------|-------------|--------------|-------------|-----------------|-------------|
| Work or related | 18,160 | 75% | 2,890 | 47% | 2,120 | 12% |
| School | 3,280 | 14% | 1,170 | 19% | 9,180 | 53% |
| Shopping | 180 | 1% | 70 | 1% | 720 | 4% |
| Leisure | 350 | 1% | 230 | 4% | 220 | 1% |
| Medical | 400 | 2% | 60 | 1% | 100 | 1% |
| Pick-up / drive passenger | 1,060 | 4% | 770 | 13% | 2,860 | 17% |
| Return Home | 210 | 1% | 640 | 10% | 1,070 | 6% |
| Other | 520 | 2% | 290 | 5% | 990 | 6% |
| Total: | 24,160 | 100% | 6,120 | 100% | 17,260 | 100% |

| PM Peak (15:30 - 17:59) | From District | | To District | | Within District | |
|---------------------------|---------------|-------------|---------------|-------------|-----------------|-------------|
| Work or related | 410 | 5% | 290 | 1% | 410 | 2% |
| School | 250 | 3% | 0 | 0% | 50 | 0% |
| Shopping | 900 | 11% | 1,090 | 5% | 2,090 | 11% |
| Leisure | 1,420 | 17% | 790 | 3% | 1,840 | 10% |
| Medical | 190 | 2% | 230 | 1% | 90 | 0% |
| Pick-up / drive passenger | 820 | 10% | 1,700 | 7% | 1,610 | 9% |
| Return Home | 3,800 | 47% | 18,990 | 81% | 11,810 | 64% |
| Other | 360 | 4% | 490 | 2% | 540 | 3% |
| Total: | 8,150 | 100% | 23,580 | 100% | 18,440 | 100% |

| Peak Period (%) | Total: | % of 24 Hours | Within District (%) |
|-----------------|---------|---------------|---------------------|
| 24 Hours | 205,450 | | 39% |
| AM Peak Period | 47,540 | 23% | 36% |
| PM Peak Period | 50,170 | 24% | 37% |

Trips by Primary Travel Mode

| 24 Hours | From District | | To District | | Within District | |
|----------------|---------------|-------------|---------------|-------------|-----------------|-------------|
| Auto Driver | 41,340 | 66% | 41,280 | 66% | 39,110 | 49% |
| Auto Passenger | 9,400 | 15% | 10,030 | 16% | 15,320 | 19% |
| Transit | 9,990 | 16% | 9,520 | 15% | 2,260 | 3% |
| Bicycle | 310 | 0% | 320 | 1% | 960 | 1% |
| Walk | 80 | 0% | 170 | 0% | 13,060 | 16% |
| Other | 1,600 | 3% | 1,520 | 2% | 9,210 | 12% |
| Total: | 62,720 | 100% | 62,840 | 100% | 79,920 | 100% |

| AM Peak (06:30 - 08:59) | From District | | To District | | Within District | |
|-------------------------|---------------|-------------|--------------|-------------|-----------------|-------------|
| Auto Driver | 14,570 | 60% | 4,360 | 71% | 5,800 | 34% |
| Auto Passenger | 1,930 | 8% | 780 | 13% | 3,210 | 19% |
| Transit | 6,610 | 27% | 330 | 5% | 730 | 4% |
| Bicycle | 80 | 0% | 50 | 1% | 320 | 2% |
| Walk | 20 | 0% | 10 | 0% | 3,000 | 17% |
| Other | 930 | 4% | 590 | 10% | 4,200 | 24% |
| Total: | 24,140 | 100% | 6,120 | 100% | 17,260 | 100% |

| PM Peak (15:30 - 17:59) | From District | | To District | | Within District | |
|-------------------------|---------------|-------------|---------------|-------------|-----------------|-------------|
| Auto Driver | 5,840 | 72% | 14,640 | 62% | 8,420 | 46% |
| Auto Passenger | 1,730 | 21% | 2,680 | 11% | 3,930 | 21% |
| Transit | 350 | 4% | 5,770 | 24% | 650 | 4% |
| Bicycle | 80 | 1% | 110 | 0% | 150 | 1% |
| Walk | 30 | 0% | 0 | 0% | 3,680 | 20% |
| Other | 100 | 1% | 380 | 2% | 1,590 | 9% |
| Total: | 8,130 | 100% | 23,580 | 100% | 18,420 | 100% |

| Avg Vehicle Occupancy | From District | | To District | | Within District | |
|-----------------------|---------------|--|-------------|--|-----------------|--|
| 24 Hours | 1.23 | | 1.24 | | 1.39 | |
| AM Peak Period | 1.13 | | 1.18 | | 1.55 | |
| PM Peak Period | 1.30 | | 1.18 | | 1.47 | |

| Transit Modal Split | From District | | To District | | Within District | |
|---------------------|---------------|--|-------------|--|-----------------|--|
| 24 Hours | 16% | | 16% | | 4% | |
| AM Peak Period | 29% | | 6% | | 7% | |
| PM Peak Period | 4% | | 25% | | 5% | |



The Meadows Phase 5

Transportation Impact Assessment Report

Appendix G: MMLOS Results

April 2018



Multi-Modal Level of Service

The Meadows Phase 5 - Transportation Impact Assessment (TIA)

Existing (2018) - Base

March 14, 2018



| INTERSECTIONS | | Cambrian Rd & Borrisokane Rd ¹ | | | | | | | | | | | |
|---|---|---|-----------|----------|----------|--|--|--|--|--|--|--|--|
| | | NORTH leg | SOUTH leg | EAST leg | WEST leg | | | | | | | | |
| Pedestrian | Lanes (do NOT include lanes protected by bulb-outs) | | | | | | | | | | | | |
| | Median | | | | | | | | | | | | |
| | Island Refuge | | | | | | | | | | | | |
| | Conflicting Left Turns (from street to right) | | | | | | | | | | | | |
| | Conflicting Right Turns (from street to left) | | | | | | | | | | | | |
| | RTOR? (from street to left) | | | | | | | | | | | | |
| | Ped Leading Interval? (on cross street) | | | | | | | | | | | | |
| Corner Radius | | | | | | | | | | | | | |
| Right Turn Channel | | | | | | | | | | | | | |
| Crosswalk Type | | | | | | | | | | | | | |
| LOS (PETS) | | | | | | | | | | | | | |
| Cycle Length (sec) | | | | | | | | | | | | | |
| Pedestrian Walk Time (solid white symbol) (sec) | | | | | | | | | | | | | |
| LOS (Delay,seconds) | | | | | | | | | | | | | |
| Overall Level of Service | | | | | | | | | | | | | |
| Cyclist | Type of Bikeway | | | | | | | | | | | | |
| | Turning Speed (based on corner radius & angle) | | | | | | | | | | | | |
| | Right Turn Storage Length | | | | | | | | | | | | |
| | Dual Right Turn? | | | | | | | | | | | | |
| | Shared Through-Right? | | | | | | | | | | | | |
| | Bike Box? | | | | | | | | | | | | |
| | Number of Lanes Crossed for Left Turns | | | | | | | | | | | | |
| | Operating Speed on Approach | | | | | | | | | | | | |
| Dual Left Turn Lanes? | | | | | | | | | | | | | |
| Level of Service | | | | | | | | | | | | | |
| Transit | Average Signal Delay | | | | | | | | | | | | |
| | Level of Service | | | | | | | | | | | | |
| Truck | Turning Radius (Right Turn) | | | | | | | | | | | | |
| | Number of Receiving Lanes | | | | | | | | | | | | |
| Auto | Level of Service | B (AM) / B (PM) | | | | | | | | | | | |

| SEGMENTS | | Borrisokane Road & Cambrian Road | Section | | | Cambrian Road & Seeley's Bay Street | | | | | | |
|----------------------------|--|----------------------------------|-----------------------------------|---------------|---------------|-------------------------------------|--|--|--|--|--|--|
| | | | 1 | 2 | 3 | | | | | | | |
| Pedestrian | Sidewalk Width | | No Sidewalk | No Sidewalk | No Sidewalk | | | | | | | |
| | Boulevard Width | | N/A | N/A | N/A | | | | | | | |
| | AADT | | > 3000 | > 3000 | > 3000 | | | | | | | |
| | On-Street Parking | | N/A | N/A | N/A | | | | | | | |
| | Operating Speed | | 51 to 60 km/h | 51 to 60 km/h | 51 to 60 km/h | | | | | | | |
| Level of Service | | | F | F | F | | | | | | | |
| Cyclist | Type of Bikeway | | Mixed Traffic | | | | | | | | | |
| | Number of Travel Lanes (per direction) | | 1 Travel Lane Per Direction | | | | | | | | | |
| | Raised Median? | | No | | | | | | | | | |
| | Bike Lane Width | | N/A | | | | | | | | | |
| | Operating Speed | | ≥ 70 km/h | | | | | | | | | |
| | Bike Lane Blockages (Commercial Areas) | | Rare | | | | | | | | | |
| | Median Refuge | | No Median Refuge | | | | | | | | | |
| | Number of Travel Lanes on Sidestreet | | 2 Lanes Crossed | | | | | | | | | |
| Sidestreet Operating Speed | | 50 km/h | | | | | | | | | | |
| Level of Service | | | F | | | | | | | | | |
| Transit | Facility Type | | Mixed Traffic | | | | | | | | | |
| | Friction | | Limited parking/driveway friction | | | | | | | | | |
| Level of Service | | | D | | | | | | | | | |
| Truck | Curb Lane Width | | >3.7 | >3.7 | >3.7 | | | | | | | |
| | Number of Travel Lanes | | 2 | 2 | 2 | | | | | | | |
| | Level of Service | | | B | B | B | | | | | | |
| | | | B | | | | | | | | | |

¹ Multi-Modal Level of Service does not apply to unsignalized intersections.

² Rural road with no formal sidewalk facilities



| INTERSECTIONS | | Cambrian Rd & Borrisokane Rd ¹ | | | | | | | | | | | |
|---|---|---|-----------|----------|----------|--|--|--|--|--|--|--|--|
| | | NORTH leg | SOUTH leg | EAST leg | WEST leg | | | | | | | | |
| Pedestrian | Lanes (do NOT include lanes protected by bulb-outs) | | | | | | | | | | | | |
| | Median | | | | | | | | | | | | |
| | Island Refuge | | | | | | | | | | | | |
| | Conflicting Left Turns (from street to right) | | | | | | | | | | | | |
| | Conflicting Right Turns (from street to left) | | | | | | | | | | | | |
| | RTOR? (from street to left) | | | | | | | | | | | | |
| | Ped Leading Interval? (on cross street) | | | | | | | | | | | | |
| Corner Radius | | | | | | | | | | | | | |
| Right Turn Channel | | | | | | | | | | | | | |
| Crosswalk Type | | | | | | | | | | | | | |
| LOS (PETS) | | | | | | | | | | | | | |
| Cycle Length (sec) | | | | | | | | | | | | | |
| Pedestrian Walk Time (solid white symbol) (sec) | | | | | | | | | | | | | |
| LOS (Delay,seconds) | | | | | | | | | | | | | |
| Overall Level of Service | | | | | | | | | | | | | |
| Cyclist | Type of Bikeway | | | | | | | | | | | | |
| | Turning Speed (based on corner radius & angle) | | | | | | | | | | | | |
| | Right Turn Storage Length | | | | | | | | | | | | |
| | Dual Right Turn? | | | | | | | | | | | | |
| | Shared Through-Right? | | | | | | | | | | | | |
| | Bike Box? | | | | | | | | | | | | |
| | Number of Lanes Crossed for Left Turns | | | | | | | | | | | | |
| | Operating Speed on Approach | | | | | | | | | | | | |
| Dual Left Turn Lanes? | | | | | | | | | | | | | |
| Level of Service | | | | | | | | | | | | | |
| Transit | Average Signal Delay | | | | | | | | | | | | |
| | Level of Service | | | | | | | | | | | | |
| Truck | Turning Radius (Right Turn) | | | | | | | | | | | | |
| | Number of Receiving Lanes | | | | | | | | | | | | |
| Auto | Level of Service | B (AM) / B (PM) | | | | | | | | | | | |

| SEGMENTS | | 300m East of Borrisokane & Cambrian | Section | | | Street 23 & Cambrian Road | Section | | | Cambrian Road & Existing Bus Turn-around | |
|----------------------------|--|-------------------------------------|-----------------------------------|---------------|---------------|---------------------------|-----------------------------------|---------------|---------------|--|--|
| | | | 1 | 2 | 3 | | 1 | 2 | 3 | | |
| Pedestrian | Sidewalk Width | | No Sidewalk | No Sidewalk | No Sidewalk | | No Sidewalk | No Sidewalk | No Sidewalk | | |
| | Boulevard Width | | N/A | N/A | N/A | | N/A | N/A | N/A | | |
| | AADT | | N/A | N/A | N/A | | N/A | N/A | N/A | | |
| | On-Street Parking | | N/A | N/A | N/A | | N/A | N/A | N/A | | |
| | Operating Speed | | 51 to 60 km/h | 51 to 60 km/h | 51 to 60 km/h | | 51 to 60 km/h | 51 to 60 km/h | 51 to 60 km/h | | |
| Level of Service | | | F | F | F | | F | F | F | | |
| Cyclist | Type of Bikeway | | Mixed Traffic | | | | Mixed Traffic | | | | |
| | Number of Travel Lanes (per direction) | | 1 Travel Lane Per Direction | | | | 1 Travel Lane Per Direction | | | | |
| | Raised Median? | | No | | | | No | | | | |
| | Bike Lane Width | | N/A | | | | N/A | | | | |
| | Operating Speed | | ≥ 70 km/h | | | | ≥ 70 km/h | | | | |
| | Bike Lane Blockages (Commercial Areas) | | Rare | | | | Rare | | | | |
| | Median Refuge | | No Median Refuge | | | | No Median Refuge | | | | |
| | Number of Travel Lanes on Sidestreet | | 2 Lanes Crossed | | | | 2 Lanes Crossed | | | | |
| Sidestreet Operating Speed | | 50 km/h | | | | 50 km/h | | | | | |
| Level of Service | | | F | | | | F | | | | |
| Transit | Facility Type | | Mixed Traffic | | | | Mixed Traffic | | | | |
| | Friction | | Limited parking/driveway friction | | | | Limited parking/driveway friction | | | | |
| Level of Service | | | D | | | | D | | | | |
| Truck | Curb Lane Width | | >3.7 | >3.7 | >3.7 | | >3.7 | >3.7 | >3.7 | | |
| | Number of Travel Lanes | | 2 | 2 | 2 | | 2 | 2 | 2 | | |
| | Level of Service | | | B | B | B | | B | B | B | |
| | | | B | | | | B | | | | |

¹ Multi-Modal Level of Service does not apply to unsignalized intersections.

² No formal pedestrian facilities provided along Cambrian Road.



| INTERSECTIONS | | Cambrian Rd & Borrisokane Rd ¹ | | | | Cambrian Rd & Street 23/ Mattamy Site Access | | | |
|---|---|---|-----------|----------|----------|--|------------------------------|------------------------------|------------------------------|
| | | NORTH leg | SOUTH leg | EAST leg | WEST leg | NORTH leg | SOUTH leg | EAST leg | WEST leg |
| Pedestrian | Lanes (do NOT include lanes protected by bulb-outs) | | | | | 2 | 2 | 2 | 2 |
| | Median | | | | | No Median | No Median | No Median | No Median |
| | Island Refuge | | | | | | | | |
| | Conflicting Left Turns (from street to right) | | | | | Permissive | Permissive | Permissive | Permissive |
| | Conflicting Right Turns (from street to left) | | | | | Permissive or yield control | Permissive or yield control | Permissive or yield control | Permissive or yield control |
| | RTOR? (from street to left) | | | | | RTOR allowed | RTOR allowed | RTOR allowed | RTOR allowed |
| | Ped Leading Interval? (on cross street) | | | | | No | No | No | No |
| | Corner Radius | | | | | > 5m to 10m | > 5m to 10m | > 5m to 10m | > 5m to 10m |
| | Right Turn Channel | | | | | No right turn channel | No right turn channel | No right turn channel | No right turn channel |
| | Crosswalk Type | | | | | Standard transverse markings | Standard transverse markings | Standard transverse markings | Standard transverse markings |
| LOS (PETS) | | | | | | 86 | 86 | 86 | 86 |
| | | | | | | B | B | B | B |
| Cycle Length (sec) | | | | | | 70 | 70 | 70 | 70 |
| Pedestrian Walk Time (solid white symbol) (sec) | | | | | | 7 | 7 | 7 | 7 |
| LOS (Delay,seconds) | | | | | | 28.4 | 28.4 | 28.4 | 28.4 |
| | | | | | | C | C | C | C |
| Overall Level of Service | | C | | | | | | | |
| Cyclist | Type of Bikeway | | | | | Mixed Traffic | Mixed Traffic | Mixed Traffic | Mixed Traffic |
| | Turning Speed (based on corner radius & angle) | | | | | Slow | Slow | Slow | Slow |
| | Right Turn Storage Length | | | | | | | | |
| | Dual Right Turn? | | | | | No | No | No | No |
| | Shared Through-Right? | | | | | Yes | Yes | Yes | Yes |
| | Bike Box? | | | | | No | No | No | No |
| | Number of Lanes Crossed for Left Turns | | | | | No Lanes Crossed | 1 Lane Crossed | No Lanes Crossed | No Lanes Crossed |
| | Operating Speed on Approach | | | | | 50km/h | 50km/h | 50km/h | 50km/h |
| Dual Left Turn Lanes? | | | | | No | No | No | No | |
| Level of Service | | | | | | D | F | D | D |
| | | F | | | | | | | |
| Transit | Average Signal Delay | | | | | ≤30 sec | ≤10 sec | ≤20 sec | ≤20 sec |
| | Level of Service | | | | | D | B | C | C |
| | | D | | | | | | | |
| Truck | Turning Radius (Right Turn) | | | | | < 10m | < 10m | < 10m | < 10m |
| | Number of Receiving Lanes | | | | | 1 | 1 | 1 | 1 |
| | Level of Service | | | | | | F | F | F |
| | | F | | | | | | | |
| Auto | Level of Service | C (AM) / C (PM) | | | | C (AM) / C (PM) | | | |

| SEGMENTS | | 300m East of Borrisokane & Cambrian | Section | | | Street 23 & Cambrian Road | Section | | | Cambrian Road & Existing Bus Turn-around |
|--------------------------------------|--|-------------------------------------|-----------------------------------|---------------|---------------|---------------------------|-----------------------------------|---------------|---------------|--|
| | | | 1 | 2 | 3 | | 1 | 2 | 3 | |
| Pedestrian | Sidewalk Width | | 2.0 or more | 2.0 or more | 2.0 or more | | 2.0 or more | 2.0 or more | 2.0 or more | |
| | Boulevard Width | | > 2 | > 2 | > 2 | | > 2 | > 2 | > 2 | |
| | AADT | | > 3000 | > 3000 | > 3000 | | > 3000 | > 3000 | > 3000 | |
| | On-Street Parking | | Yes | Yes | Yes | | Yes | Yes | Yes | |
| | Operating Speed | | 51 to 60 km/h | 51 to 60 km/h | 51 to 60 km/h | | 51 to 60 km/h | 51 to 60 km/h | 51 to 60 km/h | |
| Level of Service | | | B | B | B | | B | B | B | |
| | | | B | | | | B | | | |
| Cyclist | Type of Bikeway | | Mixed Traffic | | | | Mixed Traffic | | | |
| | Number of Travel Lanes (per direction) | | 1 Travel Lane Per Direction | | | | 1 Travel Lane Per Direction | | | |
| | Raised Median? | | No | | | | No | | | |
| | Bike Lane Width | | N/A | | | | N/A | | | |
| | Operating Speed | | ≥ 70 km/h | | | | ≥ 70 km/h | | | |
| | Bike Lane Blockages (Commercial Areas) | | Rare | | | | Rare | | | |
| | Median Refuge | | No Median Refuge | | | | No Median Refuge | | | |
| Number of Travel Lanes on Sidestreet | | 2 Lanes Crossed | | | | 2 Lanes Crossed | | | | |
| Sidestreet Operating Speed | | 50 km/h | | | | 50 km/h | | | | |
| Level of Service | | | F | | | | F | | | |
| Transit | Facility Type | | Mixed Traffic | | | | Mixed Traffic | | | |
| | Friction | | Limited parking/driveway friction | | | | Limited parking/driveway friction | | | |
| Level of Service | | | D | | | | D | | | |
| Truck | Curb Lane Width | | >3.7 | >3.7 | >3.7 | | >3.7 | >3.7 | >3.7 | |
| | Number of Travel Lanes | | 2 | 2 | 2 | | 2 | 2 | 2 | |
| | Level of Service | | | B | B | B | | B | B | B |
| | | | B | | | | B | | | |

¹ Multi-Modal Level of Service does not apply to unsignalized intersections.



| INTERSECTIONS | | Cambrian Rd & Borrisokane Rd ¹ | | | | Cambrian Rd & Street 23 ¹ | | | | | | | |
|---|---|---|-----------|----------|----------|--------------------------------------|-----------|----------|----------|--|--|--|--|
| | | NORTH leg | SOUTH leg | EAST leg | WEST leg | NORTH leg | SOUTH leg | EAST leg | WEST leg | | | | |
| Pedestrian | Lanes (do NOT include lanes protected by bulb-outs) | | | | | | | | | | | | |
| | Median | | | | | | | | | | | | |
| | Island Refuge | | | | | | | | | | | | |
| | Conflicting Left Turns (from street to right) | | | | | | | | | | | | |
| | Conflicting Right Turns (from street to left) | | | | | | | | | | | | |
| | RTOR? (from street to left) | | | | | | | | | | | | |
| Ped Leading Interval? (on cross street) | | | | | | | | | | | | | |
| Corner Radius | | | | | | | | | | | | | |
| Right Turn Channel | | | | | | | | | | | | | |
| Crosswalk Type | | | | | | | | | | | | | |
| LOS (PETS) | | | | | | | | | | | | | |
| Cycle Length (sec) | | | | | | | | | | | | | |
| Pedestrian Walk Time (solid white symbol) (sec) | | | | | | | | | | | | | |
| LOS (Delay,seconds) | | | | | | | | | | | | | |
| Overall Level of Service | | | | | | | | | | | | | |
| Cyclist | Type of Bikeway | | | | | | | | | | | | |
| | Turning Speed (based on corner radius & angle) | | | | | | | | | | | | |
| | Right Turn Storage Length | | | | | | | | | | | | |
| | Dual Right Turn? | | | | | | | | | | | | |
| | Shared Through-Right? | | | | | | | | | | | | |
| | Bike Box? | | | | | | | | | | | | |
| | Number of Lanes Crossed for Left Turns | | | | | | | | | | | | |
| | Operating Speed on Approach | | | | | | | | | | | | |
| Dual Left Turn Lanes? | | | | | | | | | | | | | |
| Level of Service | | | | | | | | | | | | | |
| Transit | Average Signal Delay | | | | | | | | | | | | |
| | Level of Service | | | | | | | | | | | | |
| Truck | Turning Radius (Right Turn) | | | | | | | | | | | | |
| | Number of Receiving Lanes | | | | | | | | | | | | |
| Auto | Level of Service | C (AM) / C (PM) | | | | C (AM) / C (PM) | | | | | | | |

| SEGMENTS | | 300m East of Borrisokane & Cambrian | Section | | | Street 23 & Cambrian Road | Section | | | Cambrian Road & Existing Bus Turn-around | | |
|----------------------------|--|-------------------------------------|-----------------------------------|---------------|---------------|---------------------------|-----------------------------------|---------------|---------------|--|--|--|
| | | | 1 | 2 | 3 | | 1 | 2 | 3 | | | |
| Pedestrian | Sidewalk Width | | No Sidewalk | No Sidewalk | No Sidewalk | | No Sidewalk | No Sidewalk | No Sidewalk | | | |
| | Boulevard Width | | N/A | N/A | N/A | | N/A | N/A | N/A | | | |
| | AADT | | N/A | N/A | N/A | | N/A | N/A | N/A | | | |
| | On-Street Parking | | N/A | N/A | N/A | | N/A | N/A | N/A | | | |
| Pedestrian | Operating Speed | | 51 to 60 km/h | 51 to 60 km/h | 51 to 60 km/h | | 51 to 60 km/h | 51 to 60 km/h | 51 to 60 km/h | | | |
| | Level of Service | | F | F | F | | F | F | F | | | |
| | | | F ² | | | F ² | | | | | | |
| Cyclist | Type of Bikeway | | Mixed Traffic | | | | Mixed Traffic | | | | | |
| | Number of Travel Lanes (per direction) | | 1 Travel Lane Per Direction | | | | 1 Travel Lane Per Direction | | | | | |
| | Raised Median? | | No | | | | No | | | | | |
| | Bike Lane Width | | N/A | | | | N/A | | | | | |
| | Operating Speed | | ≥ 70 km/h | | | | ≥ 70 km/h | | | | | |
| | Bike Lane Blockages (Commercial Areas) | | Rare | | | | Rare | | | | | |
| | Median Refuge | | No Median Refuge | | | | No Median Refuge | | | | | |
| | Number of Travel Lanes on Sidestreet | | 2 Lanes Crossed | | | | 2 Lanes Crossed | | | | | |
| Sidestreet Operating Speed | | 50 km/h | | | | 50 km/h | | | | | | |
| Level of Service | | | F | | | | F | | | | | |
| Transit | Facility Type | | Mixed Traffic | | | | Mixed Traffic | | | | | |
| | Friction | | Limited parking/driveway friction | | | | Limited parking/driveway friction | | | | | |
| Level of Service | | | D | | | | D | | | | | |
| Truck | Curb Lane Width | | >3.7 | >3.7 | >3.7 | | >3.7 | >3.7 | >3.7 | | | |
| | Number of Travel Lanes | | 2 | 2 | 2 | | 2 | 2 | 2 | | | |
| | Level of Service | | | B | B | B | | B | B | B | | |
| | | | B | | | | B | | | | | |

¹ Multi-Modal Level of Service does not apply to unsignalized intersections.

² No formal pedestrian facilities provided along Cambrian Road.



| INTERSECTIONS | | Cambrian Rd & Borrisokane Rd ¹ | | | | Cambrian Rd & Street 23/ Mattamy Site Access | | | | |
|---|---|---|-----------------|----------|----------|--|------------------------------|------------------------------|------------------------------|--|
| | | NORTH leg | SOUTH leg | EAST leg | WEST leg | NORTH leg | SOUTH leg | EAST leg | WEST leg | |
| Pedestrian | Lanes (do NOT include lanes protected by bulb-outs) | | | | | 2 | 2 | 3 | 3 | |
| | Median | | | | | No Median | No Median | No Median | No Median | |
| | Island Refuge | | | | | | | | | |
| | Conflicting Left Turns (from street to right) | | | | | Permissive | Permissive | Permissive | Permissive | |
| | Conflicting Right Turns (from street to left) | | | | | Permissive or yield control | Permissive or yield control | Permissive or yield control | Permissive or yield control | |
| | RTOR? (from street to left) | | | | | RTOR allowed | RTOR allowed | RTOR allowed | RTOR allowed | |
| | Ped Leading Interval? (on cross street) | | | | | No | No | No | No | |
| | Corner Radius | | | | | > 5m to 10m | > 5m to 10m | > 5m to 10m | > 5m to 10m | |
| | Right Turn Channel | | | | | No right turn channel | No right turn channel | No right turn channel | No right turn channel | |
| | Crosswalk Type | | | | | Standard transverse markings | Standard transverse markings | Standard transverse markings | Standard transverse markings | |
| LOS (PETS) | | | | | | 86 B | 86 B | 71 C | 71 C | |
| Cycle Length (sec) | | | | | | 70 | 70 | 70 | 70 | |
| Pedestrian Walk Time (solid white symbol) (sec) | | | | | | 7 | 7 | 7 | 7 | |
| LOS (Delay,seconds) | | | | | | 28.4 C | 28.4 C | 28.4 C | 28.4 C | |
| Overall Level of Service | | | | | | C | | | | |
| Cyclist | Type of Bikeway | | | | | Mixed Traffic | Mixed Traffic | Mixed Traffic | Mixed Traffic | |
| | Turning Speed (based on corner radius & angle) | | | | | Slow | Slow | Slow | Slow | |
| | Right Turn Storage Length | | | | | | | | | |
| | Dual Right Turn? | | | | | No | No | No | No | |
| | Shared Through-Right? | | | | | Yes | Yes | Yes | Yes | |
| | Bike Box? | | | | | No | No | No | No | |
| | Number of Lanes Crossed for Left Turns | | | | | No Lanes Crossed | 1 Lane Crossed | No Lanes Crossed | No Lanes Crossed | |
| | Operating Speed on Approach | | | | | 50km/h | 50km/h | 50km/h | 50km/h | |
| Dual Left Turn Lanes? | | | | | No | No | No | No | | |
| Level of Service | | | | | | D | F | D | D | |
| Overall Level of Service | | | | | | F | | | | |
| Transit | Average Signal Delay | | | | | ≤30 sec | ≤20 sec | ≤20 sec | ≤20 sec | |
| | Level of Service | | | | | D | C | C | C | |
| Overall Level of Service | | | | | | D | | | | |
| Truck | Turning Radius (Right Turn) | | | | | < 10m | < 10m | < 10m | < 10m | |
| | Number of Receiving Lanes | | | | | 1 | 1 | 1 | 1 | |
| | Level of Service | | | | | F | F | F | F | |
| Overall Level of Service | | | | | | F | | | | |
| Auto | Level of Service | | C (AM) / C (PM) | | | | C (AM) / C (PM) | | | |

| SEGMENTS | | 300m East of Borrisokane & Cambrian | Section | | | Street 23 & Cambrian Road | Section | | | Cambrian Road & Existing Bus Turn-around |
|--------------------------------------|--|-------------------------------------|-----------------------------------|---------------|---------------|---------------------------|-----------------------------------|---------------|---------------|--|
| | | | 1 | 2 | 3 | | 1 | 2 | 3 | |
| Pedestrian | Sidewalk Width | | 2.0 or more | 2.0 or more | 2.0 or more | | 2.0 or more | 2.0 or more | 2.0 or more | |
| | Boulevard Width | | > 2 | > 2 | > 2 | | > 2 | > 2 | > 2 | |
| | AADT | | > 3000 | > 3000 | > 3000 | | > 3000 | > 3000 | > 3000 | |
| | On-Street Parking | | Yes | Yes | Yes | | Yes | Yes | Yes | |
| | Operating Speed | | 51 to 60 km/h | 51 to 60 km/h | 51 to 60 km/h | | 51 to 60 km/h | 51 to 60 km/h | 51 to 60 km/h | |
| Level of Service | | | B | B | B | | B | B | B | |
| Overall Level of Service | | | B | | | | B | | | |
| Cyclist | Type of Bikeway | | Mixed Traffic | | | | Mixed Traffic | | | |
| | Number of Travel Lanes (per direction) | | 1 Travel Lane Per Direction | | | | 1 Travel Lane Per Direction | | | |
| | Raised Median? | | No | | | | No | | | |
| | Bike Lane Width | | N/A | | | | N/A | | | |
| | Operating Speed | | ≥ 70 km/h | | | | ≥ 70 km/h | | | |
| | Bike Lane Blockages (Commercial Areas) | | Rare | | | | Rare | | | |
| | Median Refuge | | No Median Refuge | | | | No Median Refuge | | | |
| Number of Travel Lanes on Sidestreet | | 2 Lanes Crossed | | | | 2 Lanes Crossed | | | | |
| Sidestreet Operating Speed | | 50 km/h | | | | 50 km/h | | | | |
| Level of Service | | | F | | | | F | | | |
| Overall Level of Service | | | F | | | | F | | | |
| Transit | Facility Type | | Mixed Traffic | | | | Mixed Traffic | | | |
| | Friction | | Limited parking/driveway friction | | | | Limited parking/driveway friction | | | |
| Level of Service | | | D | | | | D | | | |
| Overall Level of Service | | | D | | | | D | | | |
| Truck | Curb Lane Width | | >3.7 | >3.7 | >3.7 | | >3.7 | >3.7 | >3.7 | |
| | Number of Travel Lanes | | 2 | 2 | 2 | | 2 | 2 | 2 | |
| | Level of Service | | B | B | B | | B | B | B | |
| Overall Level of Service | | | B | | | | B | | | |

¹ Multi-Modal Level of Service does not apply to unsignalized intersections.



The Meadows Phase 5

Transportation Impact Assessment Report

Appendix H: Traffic Signal Warrants

April 2018



Input Data Sheet

Analysis Sheet

Results Sheet

Proposed Collision

GO TO Justification:

What are the intersecting roadways?

Borrisokane Road & Cambrian Road

What is the direction of the Main Road street?

North-South

When was the data collected?

Tuesday, February 15, 2018

Justification 1 - 4: Volume Warrants

a.- Number of lanes on the Main Road?

1

b.- Number of lanes on the Minor Road?

1

c.- How many approaches?

3

d.- What is the operating environment?

Rural

Population < 10,000

AND

Speed >= 70 km/hr

e.- What is the eight hour vehicle volume at the intersection? (Please fill in table below)

| Hour Ending | Main Northbound Approach | | | Minor Eastbound Approach | | | Main Southbound Approach | | | Minor Westbound Approach | | | Pedestrians Crossing Main Road |
|--------------|--------------------------|------------|-----------|--------------------------|----------|----------|--------------------------|----------|--------------|--------------------------|-----------|----------|--------------------------------|
| | LT | TH | RT | LT | TH | RT | LT | TH | RT | LT | TH | RT | |
| 8:00 | 0 | 28 | 10 | 0 | 0 | 0 | 8 | 0 | 350 | 72 | 15 | 0 | 0 |
| 9:00 | 0 | 48 | 6 | 0 | 0 | 0 | 5 | 0 | 346 | 123 | 22 | 0 | 0 |
| 10:00 | 0 | 8 | 1 | 0 | 0 | 0 | 1 | 0 | 209 | 60 | 22 | 0 | 0 |
| 12:30 | 0 | 30 | 1 | 0 | 0 | 0 | 4 | 0 | 139 | 30 | 1 | 0 | 0 |
| 13:30 | 0 | 33 | 5 | 0 | 0 | 0 | 2 | 0 | 117 | 33 | 5 | 0 | 0 |
| 16:00 | 0 | 27 | 4 | 0 | 0 | 0 | 13 | 0 | 159 | 27 | 4 | 0 | 0 |
| 17:00 | 0 | 29 | 9 | 0 | 0 | 0 | 11 | 0 | 162 | 29 | 9 | 0 | 0 |
| 18:00 | 0 | 37 | 4 | 0 | 0 | 0 | 14 | 0 | 198 | 37 | 4 | 0 | 0 |
| Total | 0 | 240 | 40 | 0 | 0 | 0 | 58 | 0 | 1,680 | 411 | 82 | 0 | 0 |

Justification 5: Collision Experience

| Preceding Months | Number of Collisions* |
|------------------|-----------------------|
| 1-12 | 0 |
| 13-24 | 0 |
| 25-36 | 0 |

* Include only collisions that are susceptible to correction through the installation of traffic signal control

Justification 6: Pedestrian Volume

a.- Please fill in table below summarizing total pedestrians crossing major roadway at the intersection or in proximity to the intersection (zones). Please reference Section 4.8 of the Manual for further explanation and graphical representation.

| | Zone 1 | | Zone 2 | | Zone 3 (if needed) | | Zone 4 (if needed) | | Total |
|---|----------|------------|----------|------------|--------------------|------------|--------------------|------------|-------|
| | Assisted | Unassisted | Assisted | Unassisted | Assisted | Unassisted | Assisted | Unassisted | |
| Total 8 hour pedestrian volume | 5 | 5 | 5 | 5 | 0 | 0 | 0 | 0 | |
| Factored 8 hour pedestrian volume | 15 | | 15 | | 0 | | 0 | | |
| % Assigned to crossing rate | 100% | | 50% | | 0% | | 0% | | |
| Net 8 Hour Pedestrian Volume at Crossing | | | | | | | | | 23 |
| Net 8 Hour Vehicular Volume on Street Being Crossed | | | | | | | | | 0 |

b.- Please fill in table below summarizing delay to pedestrians crossing major roadway at the intersection or in proximity to the intersection (zones). Please reference Section 4.8 of the Manual for further explanation and graphical representation.

| | Zone 1 | | Zone 2 | | Zone 3 (if needed) | | Zone 4 (if needed) | | Total |
|--|----------|------------|----------|------------|--------------------|------------|--------------------|------------|-------|
| | Assisted | Unassisted | Assisted | Unassisted | Assisted | Unassisted | Assisted | Unassisted | |
| Total 8 hour pedestrian volume | 5 | 5 | 5 | 5 | 0 | 0 | 0 | 0 | |
| Total 8 hour pedestrians delayed greater than 10 seconds | 0 | 0 | 0 | 0 | 0 | 0 | 0 | 0 | |
| Factored volume of total pedestrians | 15 | | 15 | | 0 | | 0 | | |
| Factored volume of delayed pedestrians | 0 | | 0 | | 0 | | 0 | | |
| % Assigned to Crossing Rate | 100% | | 50% | | 0% | | 0% | | |
| Net 8 Hour Volume of Total Pedestrians | | | | | | | | | 23 |
| Net 8 Hour Volume of Delayed Pedestrians | | | | | | | | | 0 |

Results Sheet

[Input Sheet](#)

[Analysis Sheet](#)

[Proposed Collision](#)

GO TO Justification:

Intersection: Borrisokane Road & Cambrian Road

Count Date: Tuesday, February 15, 2018

Summary Results

| | Justification | Compliance | Signal Justified? | |
|-----------------------------|-------------------|------------|--------------------------|-------------------------------------|
| | | | YES | NO |
| 1. Minimum Vehicular Volume | A Total Volume | 44 % | <input type="checkbox"/> | <input checked="" type="checkbox"/> |
| | B Crossing Volume | 24 % | <input type="checkbox"/> | <input checked="" type="checkbox"/> |
| 2. Delay to Cross Traffic | A Main Road | 53 % | <input type="checkbox"/> | <input checked="" type="checkbox"/> |
| | B Crossing Road | 82 % | <input type="checkbox"/> | <input checked="" type="checkbox"/> |
| 3. Combination | A Justificaton 1 | 24 % | <input type="checkbox"/> | <input checked="" type="checkbox"/> |
| | B Justification 2 | 53 % | <input type="checkbox"/> | <input checked="" type="checkbox"/> |
| 4. 4-Hr Volume | | 24 % | <input type="checkbox"/> | <input checked="" type="checkbox"/> |

| | | | | |
|-------------------------|--|-----|--------------------------|-------------------------------------|
| 5. Collision Experience | | 0 % | <input type="checkbox"/> | <input checked="" type="checkbox"/> |
|-------------------------|--|-----|--------------------------|-------------------------------------|

| | | | | |
|----------------|----------|-----------------------|--------------------------|-------------------------------------|
| 6. Pedestrians | A Volume | Justification not met | <input type="checkbox"/> | <input checked="" type="checkbox"/> |
| | B Delay | Justification not met | <input type="checkbox"/> | <input checked="" type="checkbox"/> |



MINIMUM WARRANTS FOR INSTALLATION OF TRAFFIC SIGNALS USING PROJECTED VOLUMES*

Project: Meadows Phase 5

Date: 2018-03-14

Project # 115637

Location Borrisokane Road
(Roadway)

at Cambrian Road
(Intersecting Roadway)

Municipality Barrhaven

Projected Volume Background and Site-Generated 2027

Peak Hour AM & PM

| WARRANT | DESCRIPTION | MINIMUM REQUIREMENT FOR 2 LANE HIGHWAYS | | | | COMPLIANCE | | |
|---------------------------|---|---|-----------------|--------------------|--------------------------|------------|------|----------|
| | | FREE FLOW | RESTRICTED FLOW | ADJUSTED FREE FLOW | ADJUSTED RESTRICTED FLOW | SECTIONAL | | ENTIRE % |
| | | | | | | Number | % | |
| 1. VEHICULAR VOLUME | A. Vehicle volumes, all approaches (Average Hour) | 480 | 720 | 576 | 864 | 559 | 97% | 97% |
| | B. Vehicle volume along minor roads (Average Hour) | 120 | 170 | 216 | 306 | 272 | 126% | |
| 2. DELAY TO CROSS TRAFFIC | A. Vehicle volumes, along artery (Average Hour) | 480 | 720 | 576 | 864 | 288 | 50% | 36% |
| | B. Combined vehicle and pedestrian volume crossing artery from minor roads (Average Hour) | 50 | 75 | 60 | 90 | 22 | 36% | |

Projected Traffic Volumes:

| Approach Volume Input (vph) | | | |
|-----------------------------|-----------|----------|----------|
| Artery V1 | Artery V2 | Minor V3 | Minor V4 |
| 241.75 | 46 | 271.5 | |

Average Hourly Volume (AHV) = PHV/2 or (amPHV + pmPHV)/4
PHV = Either AM or PM Peak Hour Volume

Notes and Adjustment Factors:

- 1. Vehicle volume warrants (1A) and (2A) for intersections of roadways having two or more moving lanes in one direction should be 25% higher than the values given above.
- 2. Warrant values for free flow apply when the 85th percentile speed of artery traffic equals or exceeds 70 km/h or when the intersection lies within the built-up area of an isolated community having a population of less than 10,000.
- 3. Warrant values for restricted flow apply to large urban communities when the 85th percentile speed of artery traffic does not exceed 70 km/h.
- 4. The lowest sectional percentage governs the entire warrant.
- 5. For "T" intersections the warrant values for the minor road should be increased by 50% (Warrant 1B only).
- 6. All flow values for Warrant 1 and Warrant 2 are to be increased by 20% for existing intersections and by 50% in the case of new intersections.
- 7. The crossing volumes are defined as:
 - (a) Left-turns from both minor road approaches.
 - (b) The heaviest through volume from the minor road.
 - © 50% of the heavier left turn movement from major road when both of the following are met:
 - (i) the left-turn volume >120 vph
 - (ii) the left-turn volume plus the opposing volume >720 vph
 - (d) Pedestrians crossing the main road.

| Adj. Factors |
|--------------|
| 1 |
| 1.5 |
| 1.2 |
| 0 |

CONCLUSION: The intersection does NOT meet the minimum warrants for traffic control signals.

* "Ontario Traffic Manual, Book 12", Ontario Ministry of Transportation.



MINIMUM WARRANTS FOR INSTALLATION OF TRAFFIC SIGNALS USING PROJECTED VOLUMES*

Project: Meadows Phase 5

Date: 2018-03-14

Project # 115637

Location Cambrian Road
(Roadway)

at Street 23/Half Moon Bay West Access 2
(Intersecting Roadway)

Municipality Barrhaven

Projected Volume Background and Site-Generated 2027

Peak Hour AM & PM

| WARRANT | DESCRIPTION | MINIMUM REQUIREMENT FOR 2 LANE HIGHWAYS | | | | COMPLIANCE | | |
|---------------------------|---|---|-----------------|--------------------|--------------------------|------------|------|----------|
| | | FREE FLOW | RESTRICTED FLOW | ADJUSTED FREE FLOW | ADJUSTED RESTRICTED FLOW | SECTIONAL | | ENTIRE % |
| | | | | | | Number | % | |
| 1. VEHICULAR VOLUME | A. Vehicle volumes, all approaches (Average Hour) | 480 | 720 | 576 | 864 | 730 | 127% | 127% |
| | B. Vehicle volume along minor roads (Average Hour) | 120 | 170 | 144 | 204 | 193 | 134% | |
| 2. DELAY TO CROSS TRAFFIC | A. Vehicle volumes, along artery (Average Hour) | 480 | 720 | 576 | 864 | 537 | 93% | 93% |
| | B. Combined vehicle and pedestrian volume crossing artery from minor roads (Average Hour) | 50 | 75 | 60 | 90 | 147 | 245% | |

Projected Traffic Volumes:

| Approach Volume Input (vph) | | | |
|-----------------------------|-----------|----------|----------|
| Artery V1 | Artery V2 | Minor V3 | Minor V4 |
| 303.5 | 233.25 | 59.5 | 133.75 |

Average Hourly Volume (AHV) = PHV/2 or (amPHV + pmPHV)/4
PHV = Either AM or PM Peak Hour Volume

Notes and Adjustment Factors:

- Vehicle volume warrants (1A) and (2A) for intersections of roadways having two or more moving lanes in one direction should be 25% higher than the values given above.
- Warrant values for free flow apply when the 85th percentile speed of artery traffic equals or exceeds 70 km/h or when the intersection lies within the built-up area of an isolated community having a population of less than 10,000.
- Warrant values for restricted flow apply to large urban communities when the 85th percentile speed of artery traffic does not exceed 70 km/h.
- The lowest sectional percentage governs the entire warrant.
- For "T" intersections the warrant values for the minor road should be increased by 50% (Warrant 1B only).
- All flow values for Warrant 1 and Warrant 2 are to be increased by 20% for existing intersections and by 50% in the case of new intersections.
- The crossing volumes are defined as:
 - Left-turns from both minor road approaches.
 - The heaviest through volume from the minor road.
 - © 50% of the heavier left turn movement from major road when both of the following are met:
 - the left-turn volume >120 vph
 - the left-turn volume plus the opposing volume >720 vph
 - Pedestrians crossing the main road.

| Adj. Factors |
|--------------|
| 1 |
| 1 |
| 1.2 |
| 0 |

CONCLUSION: The intersection meets the minimum warrants for traffic control signals.

* "Ontario Traffic Manual, Book 12", Ontario Ministry of Transportation.



The Meadows Phase 5

Transportation Impact Assessment Report

Appendix I: Roundabout Feasibility Screening Tool

April 2018



City of Ottawa Roundabout Initial Feasibility Screening Tool

The intent of this screening tool is to provide a relatively quick assessment of the feasibility of a roundabout at a particular intersection in comparison to other appropriate forms of traffic control or road modifications including all-way stop control, traffic signals, auxiliary lanes, etc. The intended outcome of this tool is to provide enough information to assist staff in deciding whether or not to proceed with an Intersection Control Study to investigate the feasibility of a roundabout in more detail.

| | | | | | | | | | | |
|-------------|--|--|-------------|-------------|-------------|-------------|-------------|-------------|-------------|-------------|
| 1 | Project Name: | Meadows Phase 5 | | | | | | | | |
| 2 | Intersection: | Street 23 + Cambrian Road | | | | | | | | |
| 3 | Location and Description of Intersection: <small>Lane configuration, total or approach AADT, distance to nearby intersection(s), etc. Attach or sketch a diagram and include existing and/or horizon-year turning movements. If an existing intersection then indicate type of control.</small> | <p>Proposed 4-legged intersection to be located approximately 590m east of Borrisokane Road.</p> <p>AADT (AM & PM)</p> <table style="margin-left: 20px;"> <tr><td>NB approach</td><td>- 1185 vehs</td></tr> <tr><td>SB approach</td><td>- 2675 vehs</td></tr> <tr><td>EB approach</td><td>- 4665 vehs</td></tr> <tr><td>WB approach</td><td>- 6670 vehs</td></tr> </table> | NB approach | - 1185 vehs | SB approach | - 2675 vehs | EB approach | - 4665 vehs | WB approach | - 6670 vehs |
| NB approach | - 1185 vehs | | | | | | | | | |
| SB approach | - 2675 vehs | | | | | | | | | |
| EB approach | - 4665 vehs | | | | | | | | | |
| WB approach | - 6670 vehs | | | | | | | | | |
| 4 | What traditional modifications are proposed? <small>All-way stop control, traffic signals, auxiliary lanes, etc. Attach or sketch a diagram if necessary.</small> | <ul style="list-style-type: none"> - SB and NB stop controls - Auxiliary southbound left turn lane along Cambria Road proposed (71m storage) | | | | | | | | |
| 5 | What size of roundabout is being considered? <small>Describe, and attach a Roundabout Traffic Flow Worksheet.</small> | Single-lane roundabout | | | | | | | | |
| 6 | Why is a roundabout being considered? | This is a "new city intersection" | | | | | | | | |

- 7 Are there contra-indications for a roundabout? If "Yes" is indicated for one or more of the contra-indications then a roundabout may be problematic at the subject intersection. That is not to say that a roundabout is not possible, just that there may be difficulties or high costs.

| No. | Contra-Indication | Outcome |
|-----|--|---|
| 1 | Is there insufficient property at the intersection (i.e. less than 44 metres diameter if considering a single-lane roundabout, and less than 60 metres if considering a two-lane roundabout) or property constraints that would require demolition of adjacent structures? | Yes <input type="checkbox"/> No <input checked="" type="checkbox"/> |
| 2 | Are there any instances where stopping sight distance (SSD) of a roundabout yield line may not be attainable (i.e. the intersection is on a crest vertical curve)? | Yes <input type="checkbox"/> No <input checked="" type="checkbox"/> |
| 3 | Is there an existing uncontrolled approach with a grade in excess of 4 percent? | Yes <input type="checkbox"/> No <input checked="" type="checkbox"/> |
| 4 | Is the intersection located within a coordinated signal system? | Yes <input type="checkbox"/> No <input checked="" type="checkbox"/> |
| 5 | Is there a closely-spaced traffic signal or railway crossing that could not be controlled with a nearby roundabout? | Yes <input type="checkbox"/> No <input checked="" type="checkbox"/> |
| 6 | Are significant differences in directional flows or any situations of sudden high demand expected? | Yes <input type="checkbox"/> No <input checked="" type="checkbox"/> |
| 7 | Are there known visually-impaired pedestrians that cross this intersection? | Yes <input type="checkbox"/> No <input checked="" type="checkbox"/> |

- 8 Are there suitability factors for a roundabout? If "Yes" is indicated for two or more of the suitability factors then a roundabout should be technically feasible at the subject intersection.

| No. | Suitability Factor | Outcome |
|-----|--|---|
| 1 | Does the intersection currently experience an average collision frequency of more than 1.5 injury crashes per year, or a collision rate in excess of 1 injury crash per 1 million vehicles entering (MVE)? | Yes <input type="checkbox"/> No <input checked="" type="checkbox"/> |
| 2 | Has there been a fatal crash at the intersection in the last 10 years? | Yes <input type="checkbox"/> No <input checked="" type="checkbox"/> |
| 3 | Are capacity problems currently being experienced, or expected in the future? | Yes <input type="checkbox"/> No <input checked="" type="checkbox"/> |
| 4 | Are traffic signals warranted, or expected to be warranted in the future? | Yes <input checked="" type="checkbox"/> No <input type="checkbox"/> |
| 5 | Does the intersection have more than 4 legs, or unusual geometry? | Yes <input type="checkbox"/> No <input checked="" type="checkbox"/> |
| 6 | Will planned modifications to the intersection require that nearby structures be widened (i.e. to accommodate left-turn lanes)? | Yes <input type="checkbox"/> No <input checked="" type="checkbox"/> |
| 7 | Is the intersection located at a transition between rural and urban environments (i.e. an urban boundary) such that a roundabout could act as a means of speed transition? | Yes <input checked="" type="checkbox"/> No <input type="checkbox"/> |

Intersection does not exist.

Intersection does not exist

- 9 Conclusions/recommendation whether to proceed with an Intersection Control Study:

The overall conclusion of the roundabout screening form for the proposed intersection of Cambrian Road and Street 23 is that a roundabout meets the requirements based on the suitability factors.

DRAFT

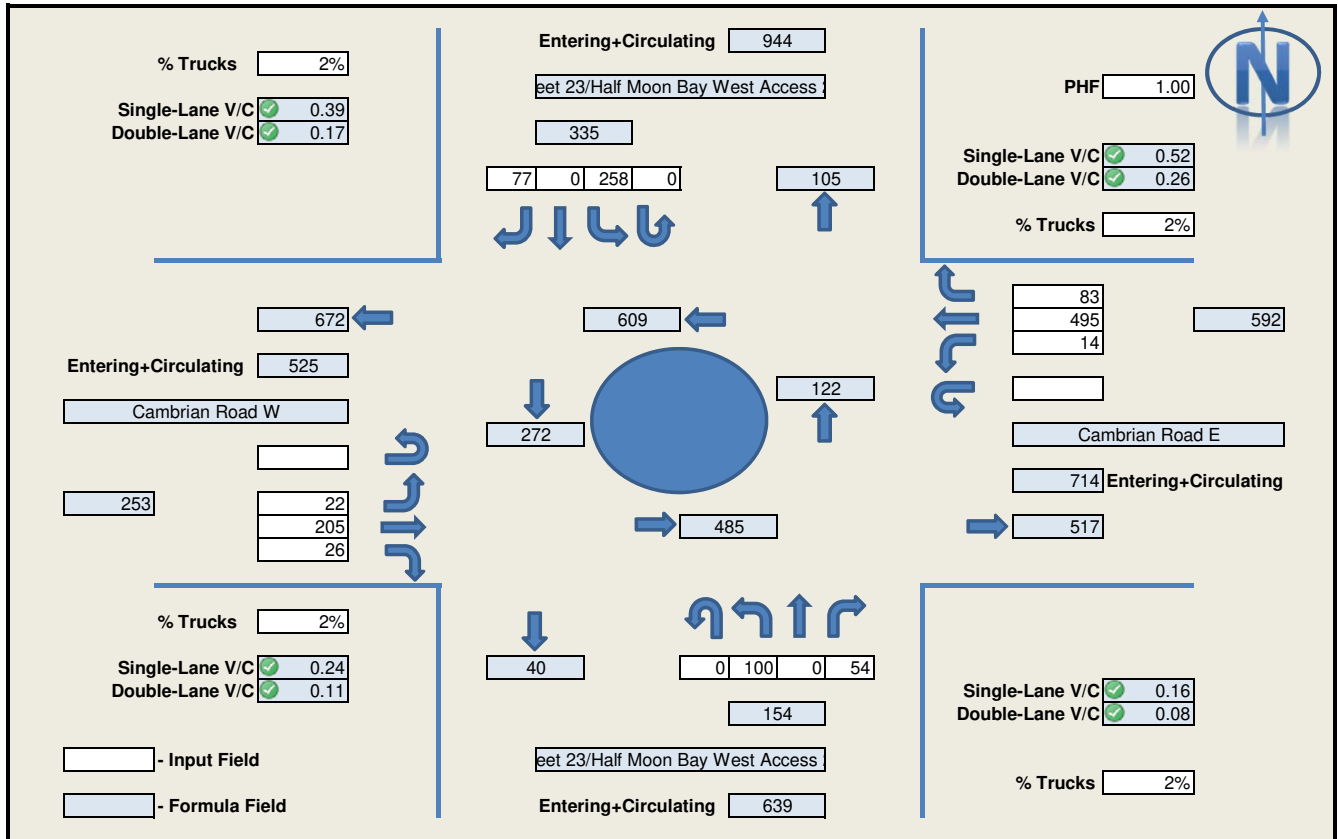

Capacity Guidelines for Single-Lane Roundabouts

1. Single-lane service volumes < 900 vph - 1200 vph
2. Exit flow < 900 vph - 1200 vph
3. Entry flow + circulating flow < 1400 vph - 1800 vph
4. Circulating flow downstream of any entry 1400 vph - 1800 vph
5. V/C > 0.85

| RODEL Inputs | | | | | |
|------------------------|------|----------|----------|----------|--------|
| Leg | PCU | 1st Exit | 2nd Exit | 3rd Exit | U-Turn |
| /Half Moon Bay West Ac | 1.02 | 77 | 0 | 258 | 0 |
| Cambrian Road W | 1.02 | 26 | 205 | 22 | 0 |
| /Half Moon Bay West Ac | 1.02 | 54 | 0 | 100 | 0 |
| Cambrian Road E | 1.02 | 83 | 495 | 14 | 0 |

Proposed Lane Arrangement

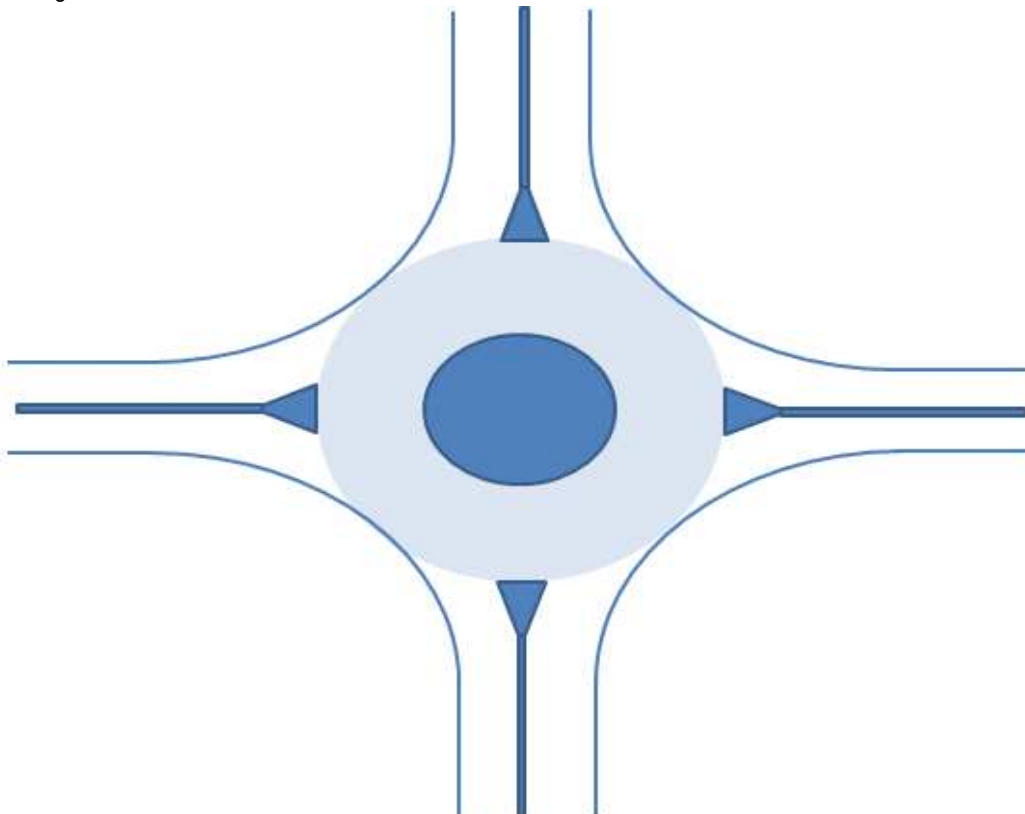

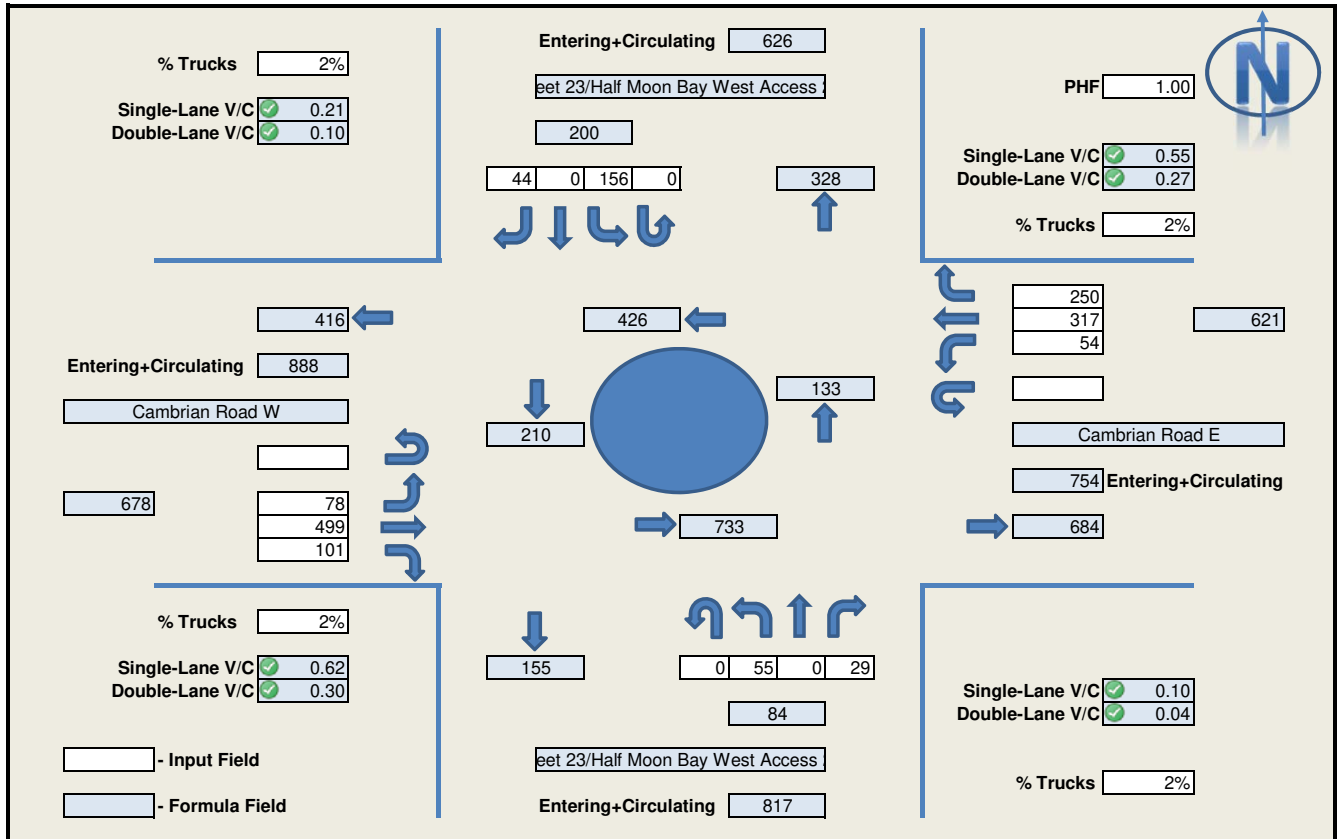

Capacity Guidelines for Single-Lane Roundabouts

1. Single-lane service volumes < 900 vph - 1200 vph
2. Exit flow < 900 vph - 1200 vph
3. Entry flow + circulating flow < 1400 vph - 1800 vph
4. Circulating flow downstream of any entry 1400 vph - 1800 vph
5. V/C > 0.85

| RODEL Inputs | | | | | |
|------------------------|------|----------|----------|----------|--------|
| Leg | PCU | 1st Exit | 2nd Exit | 3rd Exit | U-Turn |
| /Half Moon Bay West Ac | 1.02 | 44 | 0 | 156 | 0 |
| Cambrian Road W | 1.02 | 101 | 499 | 78 | 0 |
| /Half Moon Bay West Ac | 1.02 | 29 | 0 | 55 | 0 |
| Cambrian Road E | 1.02 | 250 | 317 | 54 | 0 |

Proposed Lane Arrangement

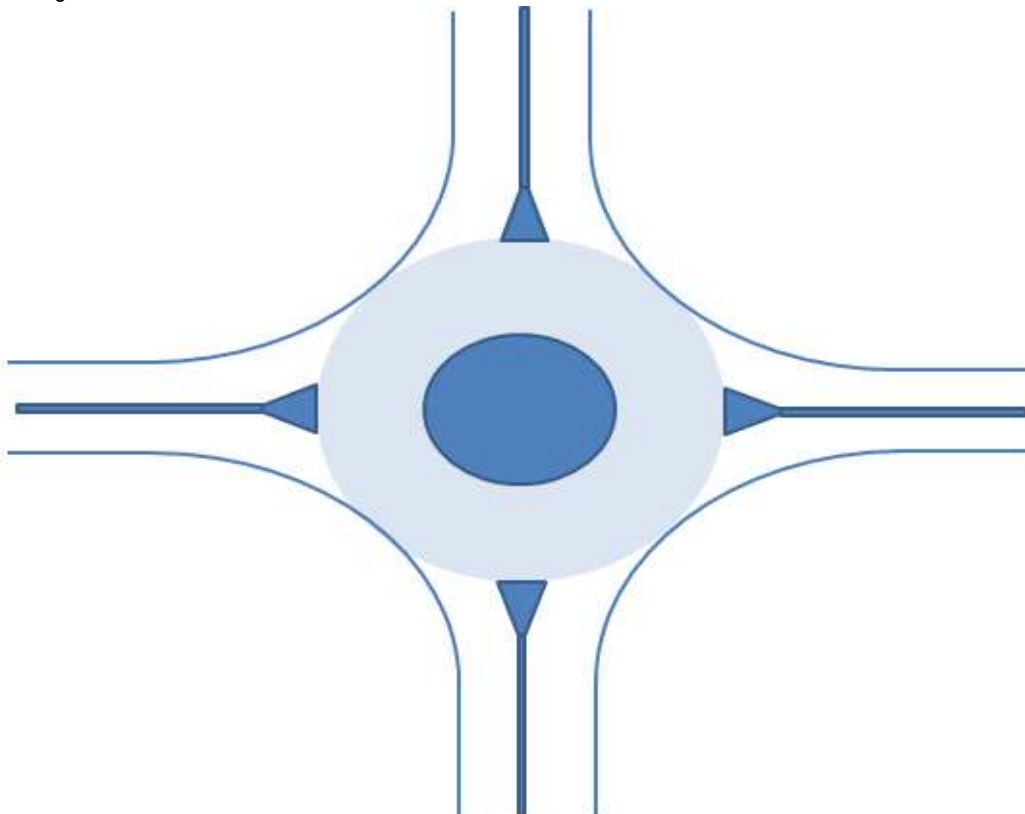



The Meadows Phase 5

Transportation Impact Assessment Report

Appendix J: Synchro and SIDRA Results

April 2018



Intersection

Int Delay, s/veh 9.1

| Movement | WBL | WBR | NBT | NBR | SBL | SBT |
|--------------------------|------|------|------|------|------|------|
| Lane Configurations | | | | | | |
| Traffic Vol, veh/h | 11 | 373 | 53 | 12 | 103 | 20 |
| Future Vol, veh/h | 11 | 373 | 53 | 12 | 103 | 20 |
| Conflicting Peds, #/hr | 0 | 0 | 0 | 0 | 0 | 0 |
| Sign Control | Stop | Stop | Free | Free | Free | Free |
| RT Channelized | - | None | - | None | - | None |
| Storage Length | 0 | - | - | - | - | - |
| Veh in Median Storage, # | 0 | - | 0 | - | - | 0 |
| Grade, % | 0 | - | 0 | - | - | 0 |
| Peak Hour Factor | 90 | 90 | 90 | 90 | 90 | 90 |
| Heavy Vehicles, % | 2 | 2 | 2 | 2 | 2 | 2 |
| Mvmt Flow | 12 | 414 | 59 | 13 | 114 | 22 |

| Major/Minor | Minor1 | Major1 | Major2 |
|----------------------|--------|--------|--------|
| Conflicting Flow All | 317 | 66 | 0 |
| Stage 1 | 66 | - | - |
| Stage 2 | 251 | - | - |
| Critical Hdwy | 6.42 | 6.22 | 4.12 |
| Critical Hdwy Stg 1 | 5.42 | - | - |
| Critical Hdwy Stg 2 | 5.42 | - | - |
| Follow-up Hdwy | 3.518 | 3.318 | 2.218 |
| Pot Cap-1 Maneuver | 676 | 998 | 1528 |
| Stage 1 | 957 | - | - |
| Stage 2 | 791 | - | - |
| Platoon blocked, % | | | |
| Mov Cap-1 Maneuver | 625 | 998 | 1528 |
| Mov Cap-2 Maneuver | 625 | - | - |
| Stage 1 | 957 | - | - |
| Stage 2 | 731 | - | - |

| Approach | WB | NB | SB |
|----------------------|------|----|-----|
| HCM Control Delay, s | 11.5 | 0 | 6.3 |
| HCM LOS | B | | |

| Minor Lane/Major Mvmt | NBT | NBRWBLn1 | SBL | SBT |
|-----------------------|-----|----------|-------|-----|
| Capacity (veh/h) | - | - 981 | 1528 | - |
| HCM Lane V/C Ratio | - | - 0.435 | 0.075 | - |
| HCM Control Delay (s) | - | - 11.5 | 7.5 | 0 |
| HCM Lane LOS | - | - B | A | A |
| HCM 95th %tile Q(veh) | - | - 2.2 | 0.2 | - |

Intersection

Int Delay, s/veh 7.8

| Movement | WBL | WBR | NBT | NBR | SBL | SBT |
|--------------------------|------|------|------|------|------|------|
| Lane Configurations | | | | | | |
| Traffic Vol, veh/h | 10 | 192 | 41 | 6 | 362 | 40 |
| Future Vol, veh/h | 10 | 192 | 41 | 6 | 362 | 40 |
| Conflicting Peds, #/hr | 0 | 0 | 0 | 0 | 0 | 0 |
| Sign Control | Stop | Stop | Free | Free | Free | Free |
| RT Channelized | - | None | - | None | - | None |
| Storage Length | 0 | - | - | - | - | - |
| Veh in Median Storage, # | 0 | - | 0 | - | - | 0 |
| Grade, % | 0 | - | 0 | - | - | 0 |
| Peak Hour Factor | 90 | 90 | 90 | 90 | 90 | 90 |
| Heavy Vehicles, % | 2 | 2 | 2 | 2 | 2 | 2 |
| Mvmt Flow | 11 | 213 | 46 | 7 | 402 | 44 |

| Major/Minor | Minor1 | Major1 | Major2 |
|----------------------|--------|--------|-------------|
| Conflicting Flow All | 898 | 49 | 0 0 52 0 |
| Stage 1 | 49 | - | - - - - |
| Stage 2 | 849 | - | - - - - |
| Critical Hdwy | 6.42 | 6.22 | - - 4.12 - |
| Critical Hdwy Stg 1 | 5.42 | - | - - - - |
| Critical Hdwy Stg 2 | 5.42 | - | - - - - |
| Follow-up Hdwy | 3.518 | 3.318 | - - 2.218 - |
| Pot Cap-1 Maneuver | 310 | 1020 | - - 1554 - |
| Stage 1 | 973 | - | - - - - |
| Stage 2 | 419 | - | - - - - |
| Platoon blocked, % | | | - - - - |
| Mov Cap-1 Maneuver | 228 | 1020 | - - 1554 - |
| Mov Cap-2 Maneuver | 228 | - | - - - - |
| Stage 1 | 973 | - | - - - - |
| Stage 2 | 308 | - | - - - - |

| Approach | WB | NB | SB |
|----------------------|------|----|-----|
| HCM Control Delay, s | 10.6 | 0 | 7.3 |
| HCM LOS | B | | |

| Minor Lane/Major Mvmt | NBT | NBRWBLn1 | SBL | SBT |
|-----------------------|-----|----------|-------|-----|
| Capacity (veh/h) | - | - 870 | 1554 | - |
| HCM Lane V/C Ratio | - | - 0.258 | 0.259 | - |
| HCM Control Delay (s) | - | - 10.6 | 8.1 | 0 |
| HCM Lane LOS | - | - B | A | A |
| HCM 95th %tile Q(veh) | - | - 1 | 1 | - |

Intersection

Int Delay, s/veh 9.2

| Movement | WBL | WBR | NBT | NBR | SBL | SBT |
|--------------------------|------|------|------|------|------|------|
| Lane Configurations | | | | | | |
| Traffic Vol, veh/h | 16 | 416 | 57 | 14 | 115 | 22 |
| Future Vol, veh/h | 16 | 416 | 57 | 14 | 115 | 22 |
| Conflicting Peds, #/hr | 0 | 0 | 0 | 0 | 0 | 0 |
| Sign Control | Stop | Stop | Free | Free | Free | Free |
| RT Channelized | - | None | - | None | - | None |
| Storage Length | 0 | - | - | - | - | - |
| Veh in Median Storage, # | 0 | - | 0 | - | - | 0 |
| Grade, % | 0 | - | 0 | - | - | 0 |
| Peak Hour Factor | 100 | 100 | 100 | 100 | 100 | 100 |
| Heavy Vehicles, % | 2 | 2 | 2 | 2 | 2 | 2 |
| Mvmt Flow | 16 | 416 | 57 | 14 | 115 | 22 |

| Major/Minor | Minor1 | | Major1 | | Major2 | |
|----------------------|--------|-------|--------|---|--------|---|
| Conflicting Flow All | 316 | 64 | 0 | 0 | 71 | 0 |
| Stage 1 | 64 | - | - | - | - | - |
| Stage 2 | 252 | - | - | - | - | - |
| Critical Hdwy | 6.42 | 6.22 | - | - | 4.12 | - |
| Critical Hdwy Stg 1 | 5.42 | - | - | - | - | - |
| Critical Hdwy Stg 2 | 5.42 | - | - | - | - | - |
| Follow-up Hdwy | 3.518 | 3.318 | - | - | 2.218 | - |
| Pot Cap-1 Maneuver | 677 | 1000 | - | - | 1529 | - |
| Stage 1 | 959 | - | - | - | - | - |
| Stage 2 | 790 | - | - | - | - | - |
| Platoon blocked, % | | | - | - | | - |
| Mov Cap-1 Maneuver | 626 | 1000 | - | - | 1529 | - |
| Mov Cap-2 Maneuver | 626 | - | - | - | - | - |
| Stage 1 | 959 | - | - | - | - | - |
| Stage 2 | 730 | - | - | - | - | - |

| Approach | WB | | NB | | SB |
|----------------------|------|--|----|--|-----|
| HCM Control Delay, s | 11.6 | | 0 | | 6.3 |
| HCM LOS | B | | | | |

| Minor Lane/Major Mvmt | NBT | NBRWBLn1 | SBL | SBT |
|-----------------------|-----|----------|-------|-----|
| Capacity (veh/h) | - | - 978 | 1529 | - |
| HCM Lane V/C Ratio | - | - 0.442 | 0.075 | - |
| HCM Control Delay (s) | - | - 11.6 | 7.5 | 0 |
| HCM Lane LOS | - | - B | A | A |
| HCM 95th %tile Q(veh) | - | - 2.3 | 0.2 | - |

Intersection

Int Delay, s/veh 7.9

| Movement | WBL | WBR | NBT | NBR | SBL | SBT |
|--------------------------|------|------|------|------|------|------|
| Lane Configurations | | | | | | |
| Traffic Vol, veh/h | 13 | 214 | 44 | 11 | 404 | 43 |
| Future Vol, veh/h | 13 | 214 | 44 | 11 | 404 | 43 |
| Conflicting Peds, #/hr | 0 | 0 | 0 | 0 | 0 | 0 |
| Sign Control | Stop | Stop | Free | Free | Free | Free |
| RT Channelized | - | None | - | None | - | None |
| Storage Length | 0 | - | - | - | - | - |
| Veh in Median Storage, # | 0 | - | 0 | - | - | 0 |
| Grade, % | 0 | - | 0 | - | - | 0 |
| Peak Hour Factor | 100 | 100 | 100 | 100 | 100 | 100 |
| Heavy Vehicles, % | 2 | 2 | 2 | 2 | 2 | 2 |
| Mvmt Flow | 13 | 214 | 44 | 11 | 404 | 43 |

| Major/Minor | Minor1 | | Major1 | | Major2 | |
|----------------------|--------|-------|--------|---|--------|---|
| Conflicting Flow All | 901 | 50 | 0 | 0 | 55 | 0 |
| Stage 1 | 50 | - | - | - | - | - |
| Stage 2 | 851 | - | - | - | - | - |
| Critical Hdwy | 6.42 | 6.22 | - | - | 4.12 | - |
| Critical Hdwy Stg 1 | 5.42 | - | - | - | - | - |
| Critical Hdwy Stg 2 | 5.42 | - | - | - | - | - |
| Follow-up Hdwy | 3.518 | 3.318 | - | - | 2.218 | - |
| Pot Cap-1 Maneuver | 309 | 1018 | - | - | 1550 | - |
| Stage 1 | 972 | - | - | - | - | - |
| Stage 2 | 419 | - | - | - | - | - |
| Platoon blocked, % | | | - | - | | |
| Mov Cap-1 Maneuver | 226 | 1018 | - | - | 1550 | - |
| Mov Cap-2 Maneuver | 226 | - | - | - | - | - |
| Stage 1 | 972 | - | - | - | - | - |
| Stage 2 | 307 | - | - | - | - | - |

| Approach | WB | NB | SB |
|----------------------|------|----|-----|
| HCM Control Delay, s | 10.8 | 0 | 7.4 |
| HCM LOS | B | | |

| Minor Lane/Major Mvmt | NBT | NBR | WBLn1 | SBL | SBT |
|-----------------------|-----|-----|-------|-------|-----|
| Capacity (veh/h) | - | - | 848 | 1550 | - |
| HCM Lane V/C Ratio | - | - | 0.268 | 0.261 | - |
| HCM Control Delay (s) | - | - | 10.8 | 8.1 | 0 |
| HCM Lane LOS | - | - | B | A | A |
| HCM 95th %tile Q(veh) | - | - | 1.1 | 1.1 | - |

Intersection

Int Delay, s/veh 13

| Movement | WBL | WBR | NBT | NBR | SBL | SBT |
|--------------------------|------|------|------|------|------|------|
| Lane Configurations | | | | | | |
| Traffic Vol, veh/h | 39 | 594 | 61 | 20 | 222 | 32 |
| Future Vol, veh/h | 39 | 594 | 61 | 20 | 222 | 32 |
| Conflicting Peds, #/hr | 0 | 0 | 0 | 0 | 0 | 0 |
| Sign Control | Stop | Stop | Free | Free | Free | Free |
| RT Channelized | - | None | - | None | - | None |
| Storage Length | 0 | - | - | - | - | - |
| Veh in Median Storage, # | 0 | - | 0 | - | - | 0 |
| Grade, % | 0 | - | 0 | - | - | 0 |
| Peak Hour Factor | 100 | 100 | 100 | 100 | 100 | 100 |
| Heavy Vehicles, % | 2 | 2 | 2 | 2 | 2 | 2 |
| Mvmt Flow | 39 | 594 | 61 | 20 | 222 | 32 |

| Major/Minor | Minor1 | Minor2 | Major1 | Major2 | Major3 | Major4 |
|----------------------|--------|--------|--------|--------|--------|--------|
| Conflicting Flow All | 547 | 71 | 0 | 0 | 81 | 0 |
| Stage 1 | 71 | - | - | - | - | - |
| Stage 2 | 476 | - | - | - | - | - |
| Critical Hdwy | 6.42 | 6.22 | - | - | 4.12 | - |
| Critical Hdwy Stg 1 | 5.42 | - | - | - | - | - |
| Critical Hdwy Stg 2 | 5.42 | - | - | - | - | - |
| Follow-up Hdwy | 3.518 | 3.318 | - | - | 2.218 | - |
| Pot Cap-1 Maneuver | 498 | 991 | - | - | 1517 | - |
| Stage 1 | 952 | - | - | - | - | - |
| Stage 2 | 625 | - | - | - | - | - |
| Platoon blocked, % | | | - | - | | |
| Mov Cap-1 Maneuver | 424 | 991 | - | - | 1517 | - |
| Mov Cap-2 Maneuver | 424 | - | - | - | - | - |
| Stage 1 | 952 | - | - | - | - | - |
| Stage 2 | 532 | - | - | - | - | - |

| Approach | WB | NB | SB |
|----------------------|------|----|-----|
| HCM Control Delay, s | 17.2 | 0 | 6.8 |
| HCM LOS | C | | |

| Minor Lane/Major Mvmt | NBT | NBR | WBLn1 | SBL | SBT |
|-----------------------|-----|-----|-------|-------|-----|
| Capacity (veh/h) | - | - | 916 | 1517 | - |
| HCM Lane V/C Ratio | - | - | 0.691 | 0.146 | - |
| HCM Control Delay (s) | - | - | 17.2 | 7.8 | 0 |
| HCM Lane LOS | - | - | C | A | A |
| HCM 95th %tile Q(veh) | - | - | 5.8 | 0.5 | - |

Intersection

Int Delay, s/veh 11.7

| Movement | WBL | WBR | NBT | NBR | SBL | SBT |
|--------------------------|------|------|------|------|------|------|
| Lane Configurations | | | | | | |
| Traffic Vol, veh/h | 25 | 370 | 57 | 34 | 608 | 52 |
| Future Vol, veh/h | 25 | 370 | 57 | 34 | 608 | 52 |
| Conflicting Peds, #/hr | 0 | 0 | 0 | 0 | 0 | 0 |
| Sign Control | Stop | Stop | Free | Free | Free | Free |
| RT Channelized | - | None | - | None | - | None |
| Storage Length | 0 | - | - | - | - | - |
| Veh in Median Storage, # | 0 | - | 0 | - | - | 0 |
| Grade, % | 0 | - | 0 | - | - | 0 |
| Peak Hour Factor | 100 | 100 | 100 | 100 | 100 | 100 |
| Heavy Vehicles, % | 2 | 2 | 2 | 2 | 2 | 2 |
| Mvmt Flow | 25 | 370 | 57 | 34 | 608 | 52 |

| Major/Minor | Minor1 | | Major1 | | Major2 | |
|----------------------|--------|-------|--------|---|--------|---|
| Conflicting Flow All | 1342 | 74 | 0 | 0 | 91 | 0 |
| Stage 1 | 74 | - | - | - | - | - |
| Stage 2 | 1268 | - | - | - | - | - |
| Critical Hdwy | 6.42 | 6.22 | - | - | 4.12 | - |
| Critical Hdwy Stg 1 | 5.42 | - | - | - | - | - |
| Critical Hdwy Stg 2 | 5.42 | - | - | - | - | - |
| Follow-up Hdwy | 3.518 | 3.318 | - | - | 2.218 | - |
| Pot Cap-1 Maneuver | 168 | 988 | - | - | 1504 | - |
| Stage 1 | 949 | - | - | - | - | - |
| Stage 2 | 265 | - | - | - | - | - |
| Platoon blocked, % | | | - | - | | - |
| Mov Cap-1 Maneuver | 98 | 988 | - | - | 1504 | - |
| Mov Cap-2 Maneuver | 98 | - | - | - | - | - |
| Stage 1 | 949 | - | - | - | - | - |
| Stage 2 | 155 | - | - | - | - | - |

| Approach | WB | | NB | | SB |
|----------------------|----|--|----|--|-----|
| HCM Control Delay, s | 20 | | 0 | | 8.3 |
| HCM LOS | C | | | | |

| Minor Lane/Major Mvmt | NBT | NBRWBLn1 | SBL | SBT |
|-----------------------|-----|----------|------|-------|
| Capacity (veh/h) | - | - | 627 | 1504 |
| HCM Lane V/C Ratio | - | - | 0.63 | 0.404 |
| HCM Control Delay (s) | - | - | 20 | 9 |
| HCM Lane LOS | - | - | C | A |
| HCM 95th %tile Q(veh) | - | - | 4.4 | 2 |

Intersection

Int Delay, s/veh 2.9

| Movement | EBT | EBR | WBL | WBT | NBL | NBR |
|--------------------------|------|------|------|------|------|------|
| Lane Configurations | ↑ | | ↓ | ↑ | ↓ | |
| Traffic Vol, veh/h | 194 | 26 | 14 | 456 | 100 | 54 |
| Future Vol, veh/h | 194 | 26 | 14 | 456 | 100 | 54 |
| Conflicting Peds, #/hr | 0 | 0 | 0 | 0 | 0 | 0 |
| Sign Control | Free | Free | Free | Free | Stop | Stop |
| RT Channelized | - | None | - | None | - | None |
| Storage Length | - | - | 150 | - | 0 | - |
| Veh in Median Storage, # | 0 | - | - | 0 | 0 | - |
| Grade, % | 0 | - | - | 0 | 0 | - |
| Peak Hour Factor | 100 | 100 | 100 | 100 | 100 | 100 |
| Heavy Vehicles, % | 2 | 2 | 2 | 2 | 2 | 2 |
| Mvmt Flow | 194 | 26 | 14 | 456 | 100 | 54 |

| Major/Minor | Major1 | Major2 | Minor1 |
|----------------------|--------|--------|--------|
| Conflicting Flow All | 0 | 0 | 220 |
| Stage 1 | - | - | - |
| Stage 2 | - | - | - |
| Critical Hdwy | - | - | 4.12 |
| Critical Hdwy Stg 1 | - | - | - |
| Critical Hdwy Stg 2 | - | - | - |
| Follow-up Hdwy | - | - | 2.218 |
| Pot Cap-1 Maneuver | - | - | 1349 |
| Stage 1 | - | - | - |
| Stage 2 | - | - | - |
| Platoon blocked, % | - | - | - |
| Mov Cap-1 Maneuver | - | - | 1349 |
| Mov Cap-2 Maneuver | - | - | - |
| Stage 1 | - | - | - |
| Stage 2 | - | - | - |

| Approach | EB | WB | NB |
|----------------------|----|-----|------|
| HCM Control Delay, s | 0 | 0.2 | 15.5 |
| HCM LOS | | | C |

| Minor Lane/Major Mvmt | NBLn1 | EBT | EBR | WBL | WBT |
|-----------------------|-------|-----|-----|------|-----|
| Capacity (veh/h) | 495 | - | - | 1349 | - |
| HCM Lane V/C Ratio | 0.311 | - | - | 0.01 | - |
| HCM Control Delay (s) | 15.5 | - | - | 7.7 | - |
| HCM Lane LOS | C | - | - | A | - |
| HCM 95th %tile Q(veh) | 1.3 | - | - | 0 | - |

Intersection

Int Delay, s/veh 2

| Movement | EBT | EBR | WBL | WBT | NBL | NBR |
|--------------------------|------|------|------|------|------|------|
| Lane Configurations | ↑ | | ↓ | ↑ | ↓ | |
| Traffic Vol, veh/h | 463 | 101 | 54 | 297 | 55 | 29 |
| Future Vol, veh/h | 463 | 101 | 54 | 297 | 55 | 29 |
| Conflicting Peds, #/hr | 0 | 0 | 0 | 0 | 0 | 0 |
| Sign Control | Free | Free | Free | Free | Stop | Stop |
| RT Channelized | - | None | - | None | - | None |
| Storage Length | - | - | 150 | - | 0 | - |
| Veh in Median Storage, # | 0 | - | - | 0 | 0 | - |
| Grade, % | 0 | - | - | 0 | 0 | - |
| Peak Hour Factor | 100 | 100 | 100 | 100 | 100 | 100 |
| Heavy Vehicles, % | 2 | 2 | 2 | 2 | 2 | 2 |
| Mvmt Flow | 463 | 101 | 54 | 297 | 55 | 29 |

| Major/Minor | Major1 | Major2 | Minor1 |
|----------------------|--------|--------|--------|
| Conflicting Flow All | 0 | 0 | 564 |
| Stage 1 | - | - | 514 |
| Stage 2 | - | - | 405 |
| Critical Hdwy | - | - | 4.12 |
| Critical Hdwy Stg 1 | - | - | 5.42 |
| Critical Hdwy Stg 2 | - | - | 5.42 |
| Follow-up Hdwy | - | - | 2.218 |
| Pot Cap-1 Maneuver | - | - | 1008 |
| Stage 1 | - | - | 600 |
| Stage 2 | - | - | 673 |
| Platoon blocked, % | - | - | - |
| Mov Cap-1 Maneuver | - | - | 1008 |
| Mov Cap-2 Maneuver | - | - | - |
| Stage 1 | - | - | 600 |
| Stage 2 | - | - | 637 |

| Approach | EB | WB | NB |
|----------------------|----|-----|------|
| HCM Control Delay, s | 0 | 1.3 | 18.9 |
| HCM LOS | | | C |

| Minor Lane/Major Mvmt | NBLn1 | EBT | EBR | WBL | WBT |
|-----------------------|-------|-----|-----|-------|-----|
| Capacity (veh/h) | 343 | - | - | 1008 | - |
| HCM Lane V/C Ratio | 0.245 | - | - | 0.054 | - |
| HCM Control Delay (s) | 18.9 | - | - | 8.8 | - |
| HCM Lane LOS | C | - | - | A | - |
| HCM 95th %tile Q(veh) | 0.9 | - | - | 0.2 | - |

Intersection

Int Delay, s/veh 11.4

| Movement | WBL | WBR | NBT | NBR | SBL | SBT |
|--------------------------|------|------|------|------|------|------|
| Lane Configurations | | | | | | |
| Traffic Vol, veh/h | 32 | 539 | 67 | 19 | 208 | 34 |
| Future Vol, veh/h | 32 | 539 | 67 | 19 | 208 | 34 |
| Conflicting Peds, #/hr | 0 | 0 | 0 | 0 | 0 | 0 |
| Sign Control | Stop | Stop | Free | Free | Free | Free |
| RT Channelized | - | None | - | None | - | None |
| Storage Length | 0 | - | - | - | - | - |
| Veh in Median Storage, # | 0 | - | 0 | - | - | 0 |
| Grade, % | 0 | - | 0 | - | - | 0 |
| Peak Hour Factor | 100 | 100 | 100 | 100 | 100 | 100 |
| Heavy Vehicles, % | 2 | 2 | 2 | 2 | 2 | 2 |
| Mvmt Flow | 32 | 539 | 67 | 19 | 208 | 34 |

| Major/Minor | Minor1 | | Major1 | | Major2 | |
|----------------------|--------|-------|--------|---|--------|---|
| Conflicting Flow All | 527 | 77 | 0 | 0 | 86 | 0 |
| Stage 1 | 77 | - | - | - | - | - |
| Stage 2 | 450 | - | - | - | - | - |
| Critical Hdwy | 6.42 | 6.22 | - | - | 4.12 | - |
| Critical Hdwy Stg 1 | 5.42 | - | - | - | - | - |
| Critical Hdwy Stg 2 | 5.42 | - | - | - | - | - |
| Follow-up Hdwy | 3.518 | 3.318 | - | - | 2.218 | - |
| Pot Cap-1 Maneuver | 512 | 984 | - | - | 1510 | - |
| Stage 1 | 946 | - | - | - | - | - |
| Stage 2 | 642 | - | - | - | - | - |
| Platoon blocked, % | | | - | - | | - |
| Mov Cap-1 Maneuver | 440 | 984 | - | - | 1510 | - |
| Mov Cap-2 Maneuver | 440 | - | - | - | - | - |
| Stage 1 | 946 | - | - | - | - | - |
| Stage 2 | 552 | - | - | - | - | - |

| Approach | WB | | NB | | SB |
|----------------------|------|--|----|--|-----|
| HCM Control Delay, s | 15.1 | | 0 | | 6.7 |
| HCM LOS | C | | | | |

| Minor Lane/Major Mvmt | NBT | NBRWBLn1 | SBL | SBT |
|-----------------------|-----|----------|-------|-----|
| Capacity (veh/h) | - | - 920 | 1510 | - |
| HCM Lane V/C Ratio | - | - 0.621 | 0.138 | - |
| HCM Control Delay (s) | - | - 15.1 | 7.8 | 0 |
| HCM Lane LOS | - | - C | A | A |
| HCM 95th %tile Q(veh) | - | - 4.5 | 0.5 | - |

Intersection

Int Delay, s/veh 9.9

| Movement | WBL | WBR | NBT | NBR | SBL | SBT |
|--------------------------|------|------|------|------|------|------|
| Lane Configurations | | | | | | |
| Traffic Vol, veh/h | 22 | 338 | 61 | 26 | 551 | 56 |
| Future Vol, veh/h | 22 | 338 | 61 | 26 | 551 | 56 |
| Conflicting Peds, #/hr | 0 | 0 | 0 | 0 | 0 | 0 |
| Sign Control | Stop | Stop | Free | Free | Free | Free |
| RT Channelized | - | None | - | None | - | None |
| Storage Length | 0 | - | - | - | - | - |
| Veh in Median Storage, # | 0 | - | 0 | - | - | 0 |
| Grade, % | 0 | - | 0 | - | - | 0 |
| Peak Hour Factor | 100 | 100 | 100 | 100 | 100 | 100 |
| Heavy Vehicles, % | 2 | 2 | 2 | 2 | 2 | 2 |
| Mvmt Flow | 22 | 338 | 61 | 26 | 551 | 56 |

| Major/Minor | Minor1 | | Major1 | | Major2 | |
|----------------------|--------|-------|--------|---|--------|---|
| Conflicting Flow All | 1232 | 74 | 0 | 0 | 87 | 0 |
| Stage 1 | 74 | - | - | - | - | - |
| Stage 2 | 1158 | - | - | - | - | - |
| Critical Hdwy | 6.42 | 6.22 | - | - | 4.12 | - |
| Critical Hdwy Stg 1 | 5.42 | - | - | - | - | - |
| Critical Hdwy Stg 2 | 5.42 | - | - | - | - | - |
| Follow-up Hdwy | 3.518 | 3.318 | - | - | 2.218 | - |
| Pot Cap-1 Maneuver | 196 | 988 | - | - | 1509 | - |
| Stage 1 | 949 | - | - | - | - | - |
| Stage 2 | 299 | - | - | - | - | - |
| Platoon blocked, % | | | - | - | | - |
| Mov Cap-1 Maneuver | 122 | 988 | - | - | 1509 | - |
| Mov Cap-2 Maneuver | 122 | - | - | - | - | - |
| Stage 1 | 949 | - | - | - | - | - |
| Stage 2 | 186 | - | - | - | - | - |

| Approach | WB | | NB | | SB |
|----------------------|------|--|----|--|-----|
| HCM Control Delay, s | 15.8 | | 0 | | 7.9 |
| HCM LOS | C | | | | |

| Minor Lane/Major Mvmt | NBT | NBRWBLn1 | SBL | SBT |
|-----------------------|-----|----------|-------|-------|
| Capacity (veh/h) | - | - | 689 | 1509 |
| HCM Lane V/C Ratio | - | - | 0.522 | 0.365 |
| HCM Control Delay (s) | - | - | 15.8 | 8.8 |
| HCM Lane LOS | - | - | C | A |
| HCM 95th %tile Q(veh) | - | - | 3.1 | 1.7 |

Intersection

Int Delay, s/veh 24.4

| Movement | EBL | EBT | EBR | WBL | WBT | WBR | NBL | NBT | NBR | SBL | SBT | SBR |
|--------------------------|------|------|------|------|------|------|------|------|------|------|------|------|
| Lane Configurations | | ↕ | | | ↕ | | | ↕ | | | ↕ | |
| Traffic Vol, veh/h | 22 | 205 | 0 | 0 | 495 | 83 | 0 | 0 | 0 | 258 | 0 | 77 |
| Future Vol, veh/h | 22 | 205 | 0 | 0 | 495 | 83 | 0 | 0 | 0 | 258 | 0 | 77 |
| Conflicting Peds, #/hr | 0 | 0 | 0 | 0 | 0 | 0 | 0 | 0 | 0 | 0 | 0 | 0 |
| Sign Control | Free | Free | Free | Free | Free | Free | Stop | Stop | Stop | Stop | Stop | Stop |
| RT Channelized | - | - | None | - | - | None | - | - | None | - | - | None |
| Storage Length | - | - | - | - | - | - | - | - | - | - | - | - |
| Veh in Median Storage, # | - | 0 | - | - | 0 | - | - | 0 | - | - | 0 | - |
| Grade, % | - | 0 | - | - | 0 | - | - | 0 | - | - | 0 | - |
| Peak Hour Factor | 100 | 100 | 100 | 100 | 100 | 100 | 100 | 100 | 100 | 100 | 100 | 100 |
| Heavy Vehicles, % | 2 | 2 | 2 | 2 | 2 | 2 | 2 | 2 | 2 | 2 | 2 | 2 |
| Mvmt Flow | 22 | 205 | 0 | 0 | 495 | 83 | 0 | 0 | 0 | 258 | 0 | 77 |

| Major/Minor | Major1 | Major2 | Minor1 | Minor2 | | | | | | | | |
|----------------------|--------|--------|--------|--------|---|---|-------|-------|-------|-------|-------|-------|
| Conflicting Flow All | 578 | 0 | 0 | 205 | 0 | 0 | 824 | 827 | 205 | 786 | 786 | 537 |
| Stage 1 | - | - | - | - | - | - | 249 | 249 | - | 537 | 537 | - |
| Stage 2 | - | - | - | - | - | - | 575 | 578 | - | 249 | 249 | - |
| Critical Hdwy | 4.12 | - | - | 4.12 | - | - | 7.12 | 6.52 | 6.22 | 7.12 | 6.52 | 6.22 |
| Critical Hdwy Stg 1 | - | - | - | - | - | - | 6.12 | 5.52 | - | 6.12 | 5.52 | - |
| Critical Hdwy Stg 2 | - | - | - | - | - | - | 6.12 | 5.52 | - | 6.12 | 5.52 | - |
| Follow-up Hdwy | 2.218 | - | - | 2.218 | - | - | 3.518 | 4.018 | 3.318 | 3.518 | 4.018 | 3.318 |
| Pot Cap-1 Maneuver | 996 | - | - | 1366 | - | - | 292 | 307 | 836 | 310 | 324 | 544 |
| Stage 1 | - | - | - | - | - | - | 755 | 701 | - | 528 | 523 | - |
| Stage 2 | - | - | - | - | - | - | 503 | 501 | - | 755 | 701 | - |
| Platoon blocked, % | | - | - | | - | - | | | | | | |
| Mov Cap-1 Maneuver | 996 | - | - | 1366 | - | - | 246 | 299 | 836 | 304 | 316 | 544 |
| Mov Cap-2 Maneuver | - | - | - | - | - | - | 246 | 299 | - | 304 | 316 | - |
| Stage 1 | - | - | - | - | - | - | 736 | 683 | - | 515 | 523 | - |
| Stage 2 | - | - | - | - | - | - | 432 | 501 | - | 736 | 683 | - |

| Approach | EB | WB | NB | SB |
|----------------------|-----|----|----|------|
| HCM Control Delay, s | 0.8 | 0 | 0 | 82.6 |
| HCM LOS | | | A | F |

| Minor Lane/Major Mvmt | NBLn1 | EBL | EBT | EBR | WBL | WBT | WBR | SBLn1 |
|-----------------------|-------|-------|-----|-----|------|-----|-----|-------|
| Capacity (veh/h) | - | 996 | - | - | 1366 | - | - | 338 |
| HCM Lane V/C Ratio | - | 0.022 | - | - | - | - | - | 0.991 |
| HCM Control Delay (s) | 0 | 8.7 | 0 | - | 0 | - | - | 82.6 |
| HCM Lane LOS | A | A | A | - | A | - | - | F |
| HCM 95th %tile Q(veh) | - | 0.1 | - | - | 0 | - | - | 11 |



| Lane Group | EBL | EBT | EBR | WBL | WBT | WBR | NBL | NBT | NBR | SBL | SBT | SBR |
|-------------------------|-------|-------|------|-------|-------|------|-------|-------|------|-------|-------|-------|
| Lane Configurations | | | | | | | | | | | | |
| Traffic Volume (vph) | 22 | 205 | 0 | 0 | 495 | 83 | 0 | 0 | 0 | 258 | 0 | 77 |
| Future Volume (vph) | 22 | 205 | 0 | 0 | 495 | 83 | 0 | 0 | 0 | 258 | 0 | 77 |
| Ideal Flow (vphpl) | 1800 | 1800 | 1800 | 1800 | 1800 | 1800 | 1800 | 1800 | 1800 | 1800 | 1800 | 1800 |
| Storage Length (m) | 15.0 | | 0.0 | 15.0 | | 0.0 | 0.0 | | 0.0 | 0.0 | | 0.0 |
| Storage Lanes | 1 | | 0 | 1 | | 0 | 0 | | 0 | 0 | | 0 |
| Taper Length (m) | 7.6 | | | 7.6 | | | 7.6 | | | 7.6 | | |
| Lane Util. Factor | 1.00 | 1.00 | 1.00 | 1.00 | 1.00 | 1.00 | 1.00 | 1.00 | 1.00 | 1.00 | 1.00 | 1.00 |
| Frt | | | | | 0.978 | | | | | | | 0.969 |
| Flt Protected | 0.950 | | | | | | | | | | | 0.963 |
| Satd. Flow (prot) | 1695 | 1784 | 0 | 1784 | 1745 | 0 | 0 | 1784 | 0 | 0 | 1665 | 0 |
| Flt Permitted | 0.282 | | | | | | | | | | | 0.775 |
| Satd. Flow (perm) | 503 | 1784 | 0 | 1784 | 1745 | 0 | 0 | 1784 | 0 | 0 | 1340 | 0 |
| Right Turn on Red | | | Yes | | | Yes | | | Yes | | | Yes |
| Satd. Flow (RTOR) | | | | | 15 | | | | | | | 42 |
| Link Speed (k/h) | | 70 | | | 70 | | | 50 | | | | 50 |
| Link Distance (m) | | 509.6 | | | 247.9 | | | 230.8 | | | | 283.1 |
| Travel Time (s) | | 26.2 | | | 12.7 | | | 16.6 | | | | 20.4 |
| Peak Hour Factor | 1.00 | 1.00 | 1.00 | 1.00 | 1.00 | 1.00 | 1.00 | 1.00 | 1.00 | 1.00 | 1.00 | 1.00 |
| Adj. Flow (vph) | 22 | 205 | 0 | 0 | 495 | 83 | 0 | 0 | 0 | 258 | 0 | 77 |
| Shared Lane Traffic (%) | | | | | | | | | | | | |
| Lane Group Flow (vph) | 22 | 205 | 0 | 0 | 578 | 0 | 0 | 0 | 0 | 0 | 335 | 0 |
| Turn Type | Perm | NA | | Perm | NA | | | | | Perm | NA | |
| Protected Phases | | 2 | | | 6 | | | 4 | | | | 8 |
| Permitted Phases | 2 | | | 6 | | | 4 | | | 8 | | |
| Detector Phase | 2 | 2 | | 6 | 6 | | 4 | 4 | | 8 | 8 | |
| Switch Phase | | | | | | | | | | | | |
| Minimum Initial (s) | 10.0 | 10.0 | | 10.0 | 10.0 | | 10.0 | 10.0 | | 10.0 | 10.0 | |
| Minimum Split (s) | 30.7 | 30.7 | | 30.7 | 30.7 | | 33.5 | 33.5 | | 33.5 | 33.5 | |
| Total Split (s) | 36.4 | 36.4 | | 36.4 | 36.4 | | 33.6 | 33.6 | | 33.6 | 33.6 | |
| Total Split (%) | 52.0% | 52.0% | | 52.0% | 52.0% | | 48.0% | 48.0% | | 48.0% | 48.0% | |
| Maximum Green (s) | 30.7 | 30.7 | | 30.7 | 30.7 | | 28.1 | 28.1 | | 28.1 | 28.1 | |
| Yellow Time (s) | 4.5 | 4.5 | | 4.5 | 4.5 | | 3.6 | 3.6 | | 3.6 | 3.6 | |
| All-Red Time (s) | 1.2 | 1.2 | | 1.2 | 1.2 | | 1.9 | 1.9 | | 1.9 | 1.9 | |
| Lost Time Adjust (s) | 0.0 | 0.0 | | 0.0 | 0.0 | | | 0.0 | | | 0.0 | |
| Total Lost Time (s) | 5.7 | 5.7 | | 5.7 | 5.7 | | | 5.5 | | | 5.5 | |
| Lead/Lag | | | | | | | | | | | | |
| Lead-Lag Optimize? | | | | | | | | | | | | |
| Vehicle Extension (s) | 3.0 | 3.0 | | 3.0 | 3.0 | | 3.0 | 3.0 | | 3.0 | 3.0 | |
| Recall Mode | Min | Min | | Min | Min | | None | None | | None | None | |
| Walk Time (s) | 7.0 | 7.0 | | 7.0 | 7.0 | | 7.0 | 7.0 | | 7.0 | 7.0 | |
| Flash Dont Walk (s) | 18.0 | 18.0 | | 18.0 | 18.0 | | 21.0 | 21.0 | | 21.0 | 21.0 | |
| Pedestrian Calls (#/hr) | 0 | 0 | | 0 | 0 | | 0 | 0 | | 0 | 0 | |
| Act Effct Green (s) | 21.6 | 21.6 | | | 21.6 | | | | | | | 17.7 |
| Actuated g/C Ratio | 0.42 | 0.42 | | | 0.42 | | | | | | | 0.34 |
| v/c Ratio | 0.10 | 0.27 | | | 0.78 | | | | | | | 0.69 |
| Control Delay | 12.0 | 11.7 | | | 22.0 | | | | | | | 21.7 |
| Queue Delay | 0.0 | 0.0 | | | 0.0 | | | | | | | 0.0 |
| Total Delay | 12.0 | 11.7 | | | 22.0 | | | | | | | 21.7 |

2: Street 23/Half Moon Bay West Access & Cambrian Road

AM Peak Hour



| Lane Group | EBL | EBT | EBR | WBL | WBT | WBR | NBL | NBT | NBR | SBL | SBT | SBR |
|------------------------|------|-------|-----|-----|-------|-----|-----|-------|-----|-----|-----|-------|
| LOS | B | B | | | | C | | | | | | C |
| Approach Delay | | 11.7 | | | 22.0 | | | | | | | 21.7 |
| Approach LOS | | B | | | C | | | | | | | C |
| Queue Length 50th (m) | 1.1 | 11.0 | | | 39.8 | | | | | | | 22.0 |
| Queue Length 95th (m) | 5.6 | 29.2 | | | #96.8 | | | | | | | 53.8 |
| Internal Link Dist (m) | | 485.6 | | | 223.9 | | | 206.8 | | | | 259.1 |
| Turn Bay Length (m) | 15.0 | | | | | | | | | | | |
| Base Capacity (vph) | 324 | 1150 | | | 1130 | | | | | | | 807 |
| Starvation Cap Reductn | 0 | 0 | | | 0 | | | | | | | 0 |
| Spillback Cap Reductn | 0 | 0 | | | 0 | | | | | | | 0 |
| Storage Cap Reductn | 0 | 0 | | | 0 | | | | | | | 0 |
| Reduced v/c Ratio | 0.07 | 0.18 | | | 0.51 | | | | | | | 0.42 |

Intersection Summary

Area Type: Other

Cycle Length: 70

Actuated Cycle Length: 51.4

Natural Cycle: 65

Control Type: Actuated-Uncoordinated

Maximum v/c Ratio: 0.78

Intersection Signal Delay: 19.8

Intersection LOS: B

Intersection Capacity Utilization 62.2%

ICU Level of Service B

Analysis Period (min) 15

95th percentile volume exceeds capacity, queue may be longer.

Queue shown is maximum after two cycles.

Splits and Phases: 2: Street 23/Half Moon Bay West Access & Cambrian Road

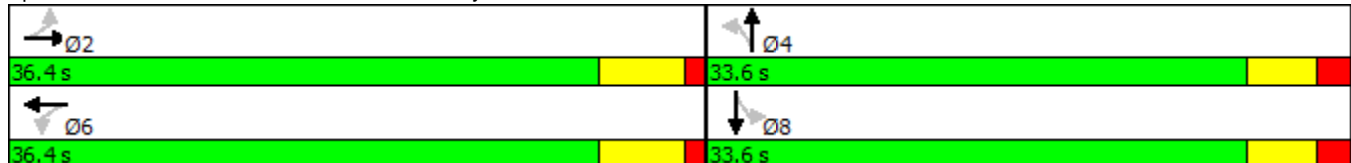

LANE SUMMARY

Site: Cambrian Rd & Street 23/ Mattamy Site Access - 2027 BG AM

AM Peak Hour
Roundabout

| Lane Use and Performance | | | | | | | | | | | | | |
|----------------------------|----------------|---------|---------------|---------------------|--------------------|-------------------------|---------------------|-------------------|-----------|----------------|---------------------|-------------------|----------------------|
| | Demand Flows | | Cap. veh/h | Deg. Satn v/c | Lane Util. % | Average Delay sec | Level of Service | 95% Back of Queue | | Lane Config | Lane Length m | Cap. Adj. % | Prob. Block. % |
| | Total veh/h | HV % | | | | | | Veh | Dist m | | | | |
| South: Street 23 | | | | | | | | | | | | | |
| Lane 1 ^d | 15 | 3.0 | 666 | 0.023 | 100 | 5.6 | LOS A | 0.1 | 0.6 | Full | 500 | 0.0 | 0.0 |
| Approach | 15 | 3.0 | | 0.023 | | 5.6 | LOS A | 0.1 | 0.6 | | | | |
| East: Cambrian Road | | | | | | | | | | | | | |
| Lane 1 ^d | 583 | 3.0 | 1062 | 0.549 | 100 | 10.2 | LOS B | 3.7 | 28.9 | Full | 500 | 0.0 | 0.0 |
| Approach | 583 | 3.0 | | 0.549 | | 10.2 | LOS B | 3.7 | 28.9 | | | | |
| North: Mattamy Site Access | | | | | | | | | | | | | |
| Lane 1 ^d | 340 | 3.0 | 652 | 0.521 | 100 | 14.0 | LOS B | 2.7 | 21.3 | Full | 500 | 0.0 | 0.0 |
| Approach | 340 | 3.0 | | 0.521 | | 14.0 | LOS B | 2.7 | 21.3 | | | | |
| West: Cambrian Road | | | | | | | | | | | | | |
| Lane 1 ^d | 232 | 3.0 | 832 | 0.279 | 100 | 7.4 | LOS A | 1.1 | 8.8 | Full | 500 | 0.0 | 0.0 |
| Approach | 232 | 3.0 | | 0.279 | | 7.4 | LOS A | 1.1 | 8.8 | | | | |
| Intersection | 1170 | 3.0 | | 0.549 | | 10.7 | LOS B | 3.7 | 28.9 | | | | |

Level of Service (LOS) Method: Delay & v/c (HCM 2010).

Roundabout LOS Method: Same as Sign Control.

Lane LOS values are based on average delay and v/c ratio (degree of saturation) per lane.

LOS F will result if v/c > irrespective of lane delay value (does not apply for approaches and intersection).

Intersection and Approach LOS values are based on average delay for all lanes (v/c not used as specified in HCM 2010).

Roundabout Capacity Model: US HCM 2010.

HCM Delay Formula option is used. Control Delay does not include Geometric Delay since Exclude Geometric Delay option applies.

Gap-Acceptance Capacity: Traditional M1.

HV (%) values are calculated for All Movement Classes of All Heavy Vehicle Model Designation.

^d Dominant lane on roundabout approach

SIDRA INTERSECTION 6.1 | Copyright © 2000-2015 Akcelik and Associates Pty Ltd | sidrasolutions.com

Organisation: IBI GROUP | Processed: Tuesday, April 10, 2018 4:46:57 PM

Project: J:\115637_MeadowPh5TIA\5.7 Calculations\5.7.6 Roads (Trans)\SIDRA\Cambrian & Street 23 & Mattamy Site Access.sip6

| Intersection | | | | | | | | | | | | |
|--------------------------|--------|-------|------|--------|------|------|--------|-------|-------|--------|-------|-------|
| Int Delay, s/veh | 15.5 | | | | | | | | | | | |
| Movement | EBL | EBT | EBR | WBL | WBT | WBR | NBL | NBT | NBR | SBL | SBT | SBR |
| Lane Configurations | | ↕ | | | ↕ | | | ↕ | | | ↕ | |
| Traffic Vol, veh/h | 78 | 499 | 0 | 0 | 317 | 250 | 0 | 0 | 0 | 156 | 0 | 44 |
| Future Vol, veh/h | 78 | 499 | 0 | 0 | 317 | 250 | 0 | 0 | 0 | 156 | 0 | 44 |
| Conflicting Peds, #/hr | 0 | 0 | 0 | 0 | 0 | 0 | 0 | 0 | 0 | 0 | 0 | 0 |
| Sign Control | Free | Free | Free | Free | Free | Free | Stop | Stop | Stop | Stop | Stop | Stop |
| RT Channelized | - | - | None | - | - | None | - | - | None | - | - | None |
| Storage Length | - | - | - | - | - | - | - | - | - | - | - | - |
| Veh in Median Storage, # | - | 0 | - | - | 0 | - | - | 0 | - | - | 0 | - |
| Grade, % | - | 0 | - | - | 0 | - | - | 0 | - | - | 0 | - |
| Peak Hour Factor | 100 | 100 | 100 | 100 | 100 | 100 | 100 | 100 | 100 | 100 | 100 | 100 |
| Heavy Vehicles, % | 2 | 2 | 2 | 2 | 2 | 2 | 2 | 2 | 2 | 2 | 2 | 2 |
| Mvmt Flow | 78 | 499 | 0 | 0 | 317 | 250 | 0 | 0 | 0 | 156 | 0 | 44 |
| Major/Minor | Major1 | | | Major2 | | | Minor1 | | | Minor2 | | |
| Conflicting Flow All | 567 | 0 | 0 | 499 | 0 | 0 | 1119 | 1222 | 499 | 1097 | 1097 | 442 |
| Stage 1 | - | - | - | - | - | - | 655 | 655 | - | 442 | 442 | - |
| Stage 2 | - | - | - | - | - | - | 464 | 567 | - | 655 | 655 | - |
| Critical Hdwy | 4.12 | - | - | 4.12 | - | - | 7.12 | 6.52 | 6.22 | 7.12 | 6.52 | 6.22 |
| Critical Hdwy Stg 1 | - | - | - | - | - | - | 6.12 | 5.52 | - | 6.12 | 5.52 | - |
| Critical Hdwy Stg 2 | - | - | - | - | - | - | 6.12 | 5.52 | - | 6.12 | 5.52 | - |
| Follow-up Hdwy | 2.218 | - | - | 2.218 | - | - | 3.518 | 4.018 | 3.318 | 3.518 | 4.018 | 3.318 |
| Pot Cap-1 Maneuver | 1005 | - | - | 1065 | - | - | 184 | 180 | 572 | 191 | 213 | 615 |
| Stage 1 | - | - | - | - | - | - | 455 | 463 | - | 594 | 576 | - |
| Stage 2 | - | - | - | - | - | - | 578 | 507 | - | 455 | 463 | - |
| Platoon blocked, % | | - | - | | - | - | | | | | | |
| Mov Cap-1 Maneuver | 1005 | - | - | 1065 | - | - | 157 | 161 | 572 | 175 | 190 | 615 |
| Mov Cap-2 Maneuver | - | - | - | - | - | - | 157 | 161 | - | 175 | 190 | - |
| Stage 1 | - | - | - | - | - | - | 406 | 413 | - | 530 | 576 | - |
| Stage 2 | - | - | - | - | - | - | 537 | 507 | - | 406 | 413 | - |
| Approach | EB | | | WB | | | NB | | | SB | | |
| HCM Control Delay, s | 1.2 | | | 0 | | | 0 | | | 100.6 | | |
| HCM LOS | | | | | | | A | | | F | | |
| Minor Lane/Major Mvmt | NBLn1 | EBL | EBT | EBR | WBL | WBT | WBR | SBLn1 | | | | |
| Capacity (veh/h) | - | 1005 | - | - | 1065 | - | - | 208 | | | | |
| HCM Lane V/C Ratio | - | 0.078 | - | - | - | - | - | 0.962 | | | | |
| HCM Control Delay (s) | 0 | 8.9 | 0 | - | 0 | - | - | 100.6 | | | | |
| HCM Lane LOS | A | A | A | - | A | - | - | F | | | | |
| HCM 95th %tile Q(veh) | - | 0.3 | - | - | 0 | - | - | 8.2 | | | | |

2: Street 23/Mattamy Site Access & Cambrian Road

PM Peak Hour



| Lane Group | EBL | EBT | EBR | WBL | WBT | WBR | NBL | NBT | NBR | SBL | SBT | SBR |
|-------------------------|-------|-------|------|-------|-------|------|-------|-------|------|-------|-------|-------|
| Lane Configurations | | | | | | | | | | | | |
| Traffic Volume (vph) | 78 | 499 | 0 | 0 | 317 | 250 | 0 | 0 | 0 | 156 | 0 | 44 |
| Future Volume (vph) | 78 | 499 | 0 | 0 | 317 | 250 | 0 | 0 | 0 | 156 | 0 | 44 |
| Ideal Flow (vphpl) | 1800 | 1800 | 1800 | 1800 | 1800 | 1800 | 1800 | 1800 | 1800 | 1800 | 1800 | 1800 |
| Storage Length (m) | 15.0 | | 0.0 | 15.0 | | 0.0 | 0.0 | | 0.0 | 0.0 | | 0.0 |
| Storage Lanes | 1 | | 0 | 1 | | 0 | 0 | | 0 | 0 | | 0 |
| Taper Length (m) | 7.6 | | | 7.6 | | | 7.6 | | | 7.6 | | |
| Lane Util. Factor | 1.00 | 1.00 | 1.00 | 1.00 | 1.00 | 1.00 | 1.00 | 1.00 | 1.00 | 1.00 | 1.00 | 1.00 |
| Frt | | | | | 0.934 | | | | | | | 0.970 |
| Flt Protected | 0.950 | | | | | | | | | | | 0.962 |
| Satd. Flow (prot) | 1695 | 1784 | 0 | 1784 | 1667 | 0 | 0 | 1784 | 0 | 0 | 1665 | 0 |
| Flt Permitted | 0.343 | | | | | | | | | | | 0.773 |
| Satd. Flow (perm) | 612 | 1784 | 0 | 1784 | 1667 | 0 | 0 | 1784 | 0 | 0 | 1338 | 0 |
| Right Turn on Red | | | Yes | | | Yes | | | Yes | | | Yes |
| Satd. Flow (RTOR) | | | | | 72 | | | | | | | 42 |
| Link Speed (k/h) | | 70 | | | 70 | | | 50 | | | | 50 |
| Link Distance (m) | | 509.6 | | | 247.9 | | | 230.8 | | | | 283.1 |
| Travel Time (s) | | 26.2 | | | 12.7 | | | 16.6 | | | | 20.4 |
| Peak Hour Factor | 1.00 | 1.00 | 1.00 | 1.00 | 1.00 | 1.00 | 1.00 | 1.00 | 1.00 | 1.00 | 1.00 | 1.00 |
| Adj. Flow (vph) | 78 | 499 | 0 | 0 | 317 | 250 | 0 | 0 | 0 | 156 | 0 | 44 |
| Shared Lane Traffic (%) | | | | | | | | | | | | |
| Lane Group Flow (vph) | 78 | 499 | 0 | 0 | 567 | 0 | 0 | 0 | 0 | 0 | 200 | 0 |
| Turn Type | Perm | NA | | Perm | NA | | | | | Perm | NA | |
| Protected Phases | | 2 | | | 6 | | | 4 | | | | 8 |
| Permitted Phases | 2 | | | 6 | | | 4 | | | 8 | | |
| Detector Phase | 2 | 2 | | 6 | 6 | | 4 | 4 | | 8 | 8 | |
| Switch Phase | | | | | | | | | | | | |
| Minimum Initial (s) | 10.0 | 10.0 | | 10.0 | 10.0 | | 10.0 | 10.0 | | 10.0 | 10.0 | |
| Minimum Split (s) | 30.7 | 30.7 | | 30.7 | 30.7 | | 33.5 | 33.5 | | 33.5 | 33.5 | |
| Total Split (s) | 36.5 | 36.5 | | 36.5 | 36.5 | | 33.5 | 33.5 | | 33.5 | 33.5 | |
| Total Split (%) | 52.1% | 52.1% | | 52.1% | 52.1% | | 47.9% | 47.9% | | 47.9% | 47.9% | |
| Maximum Green (s) | 30.8 | 30.8 | | 30.8 | 30.8 | | 28.0 | 28.0 | | 28.0 | 28.0 | |
| Yellow Time (s) | 4.5 | 4.5 | | 4.5 | 4.5 | | 3.6 | 3.6 | | 3.6 | 3.6 | |
| All-Red Time (s) | 1.2 | 1.2 | | 1.2 | 1.2 | | 1.9 | 1.9 | | 1.9 | 1.9 | |
| Lost Time Adjust (s) | 0.0 | 0.0 | | 0.0 | 0.0 | | | 0.0 | | | 0.0 | |
| Total Lost Time (s) | 5.7 | 5.7 | | 5.7 | 5.7 | | | 5.5 | | | 5.5 | |
| Lead/Lag | | | | | | | | | | | | |
| Lead-Lag Optimize? | | | | | | | | | | | | |
| Vehicle Extension (s) | 3.0 | 3.0 | | 3.0 | 3.0 | | 3.0 | 3.0 | | 3.0 | 3.0 | |
| Recall Mode | Min | Min | | Min | Min | | None | None | | None | None | |
| Walk Time (s) | 7.0 | 7.0 | | 7.0 | 7.0 | | 7.0 | 7.0 | | 7.0 | 7.0 | |
| Flash Dont Walk (s) | 18.0 | 18.0 | | 18.0 | 18.0 | | 21.0 | 21.0 | | 21.0 | 21.0 | |
| Pedestrian Calls (#/hr) | 0 | 0 | | 0 | 0 | | 0 | 0 | | 0 | 0 | |
| Act Effct Green (s) | 21.8 | 21.8 | | | 21.8 | | | | | | | 12.6 |
| Actuated g/C Ratio | 0.47 | 0.47 | | | 0.47 | | | | | | | 0.27 |
| v/c Ratio | 0.27 | 0.59 | | | 0.68 | | | | | | | 0.51 |
| Control Delay | 10.8 | 12.6 | | | 13.5 | | | | | | | 16.5 |
| Queue Delay | 0.0 | 0.0 | | | 0.0 | | | | | | | 0.0 |
| Total Delay | 10.8 | 12.6 | | | 13.5 | | | | | | | 16.5 |

2: Street 23/Mattamy Site Access & Cambrian Road

PM Peak Hour

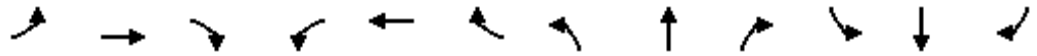

| Lane Group | EBL | EBT | EBR | WBL | WBT | WBR | NBL | NBT | NBR | SBL | SBT | SBR |
|------------------------|------|-------|-----|-----|-----|-------|-----|-------|-----|-----|-----|-------|
| LOS | B | B | | | | B | | | | | | B |
| Approach Delay | | 12.3 | | | | 13.5 | | | | | | 16.5 |
| Approach LOS | | B | | | | B | | | | | | B |
| Queue Length 50th (m) | 3.0 | 23.6 | | | | 24.1 | | | | | | 8.8 |
| Queue Length 95th (m) | 11.7 | 57.7 | | | | 64.6 | | | | | | 30.0 |
| Internal Link Dist (m) | | 485.6 | | | | 223.9 | | 206.8 | | | | 259.1 |
| Turn Bay Length (m) | 15.0 | | | | | | | | | | | |
| Base Capacity (vph) | 423 | 1234 | | | | 1176 | | | | | | 857 |
| Starvation Cap Reductn | 0 | 0 | | | | 0 | | | | | | 0 |
| Spillback Cap Reductn | 0 | 0 | | | | 0 | | | | | | 0 |
| Storage Cap Reductn | 0 | 0 | | | | 0 | | | | | | 0 |
| Reduced v/c Ratio | 0.18 | 0.40 | | | | 0.48 | | | | | | 0.23 |

Intersection Summary

| | |
|------------------------------------|------------------------|
| Area Type: | Other |
| Cycle Length: | 70 |
| Actuated Cycle Length: | 46 |
| Natural Cycle: | 65 |
| Control Type: | Actuated-Uncoordinated |
| Maximum v/c Ratio: | 0.68 |
| Intersection Signal Delay: | 13.4 |
| Intersection LOS: | B |
| Intersection Capacity Utilization: | 68.1% |
| ICU Level of Service: | C |
| Analysis Period (min): | 15 |

Splits and Phases: 2: Street 23/Mattamy Site Access & Cambrian Road

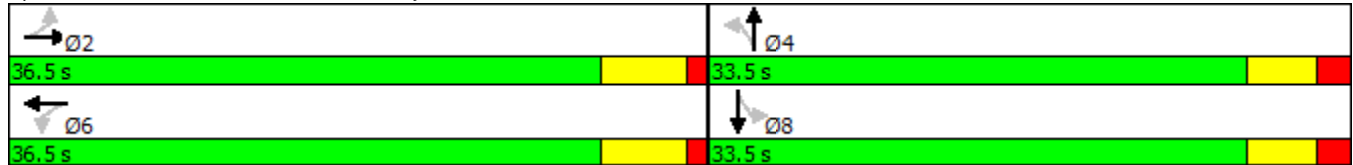

LANE SUMMARY

 **Site: Cambrian Rd & Street 23/ Mattamy Site Access - 2027 BG PM**

PM Peak Hour
Roundabout

| Lane Use and Performance | | | | | | | | | | | | | |
|----------------------------|----------------|---------|---------------|---------------------|--------------------|-------------------------|---------------------|-------------------|-----------|----------------|---------------------|-------------------|----------------------|
| | Demand Flows | | Cap. veh/h | Deg. Satn v/c | Lane Util. % | Average Delay sec | Level of Service | 95% Back of Queue | | Lane Config | Lane Length m | Cap. Adj. % | Prob. Block. % |
| | Total veh/h | HV % | | | | | | Veh | Dist m | | | | |
| South: Street 23 | | | | | | | | | | | | | |
| Lane 1 ^d | 15 | 3.0 | 516 | 0.029 | 100 | 7.3 | LOS A | 0.1 | 0.7 | Full | 500 | 0.0 | 0.0 |
| Approach | 15 | 3.0 | | 0.029 | | 7.3 | LOS A | 0.1 | 0.7 | | | | |
| East: Cambrian Road | | | | | | | | | | | | | |
| Lane 1 ^d | 572 | 3.0 | 1002 | 0.571 | 100 | 11.1 | LOS B | 3.8 | 29.3 | Full | 500 | 0.0 | 0.0 |
| Approach | 572 | 3.0 | | 0.571 | | 11.1 | LOS B | 3.8 | 29.3 | | | | |
| North: Mattamy Site Access | | | | | | | | | | | | | |
| Lane 1 ^d | 205 | 3.0 | 783 | 0.262 | 100 | 7.5 | LOS A | 1.0 | 8.0 | Full | 500 | 0.0 | 0.0 |
| Approach | 205 | 3.0 | | 0.262 | | 7.5 | LOS A | 1.0 | 8.0 | | | | |
| West: Cambrian Road | | | | | | | | | | | | | |
| Lane 1 ^d | 582 | 3.0 | 925 | 0.629 | 100 | 13.4 | LOS B | 4.4 | 34.5 | Full | 500 | 0.0 | 0.0 |
| Approach | 582 | 3.0 | | 0.629 | | 13.4 | LOS B | 4.4 | 34.5 | | | | |
| Intersection | 1374 | 3.0 | | 0.629 | | 11.5 | LOS B | 4.4 | 34.5 | | | | |

Level of Service (LOS) Method: Delay & v/c (HCM 2010).

Roundabout LOS Method: Same as Sign Control.

Lane LOS values are based on average delay and v/c ratio (degree of saturation) per lane.

LOS F will result if v/c > irrespective of lane delay value (does not apply for approaches and intersection).

Intersection and Approach LOS values are based on average delay for all lanes (v/c not used as specified in HCM 2010).

Roundabout Capacity Model: US HCM 2010.

HCM Delay Formula option is used. Control Delay does not include Geometric Delay since Exclude Geometric Delay option applies.

Gap-Acceptance Capacity: Traditional M1.

HV (%) values are calculated for All Movement Classes of All Heavy Vehicle Model Designation.

^d Dominant lane on roundabout approach

SIDRA INTERSECTION 6.1 | Copyright © 2000-2015 Akcelik and Associates Pty Ltd | sidrasolutions.com

Organisation: IBI GROUP | Processed: Tuesday, April 10, 2018 4:48:47 PM

Project: J:\115637_MeadowPh5TIA\5.7 Calculations\5.7.6 Roads (Trans)\SIDRA\Cambrian & Street 23 & Mattamy Site Access.sip6

Intersection

Int Delay, s/veh 14.5

| Movement | WBL | WBR | NBT | NBR | SBL | SBT |
|--------------------------|------|------|------|------|------|------|
| Lane Configurations | | | | | | |
| Traffic Vol, veh/h | 40 | 631 | 67 | 21 | 232 | 34 |
| Future Vol, veh/h | 40 | 631 | 67 | 21 | 232 | 34 |
| Conflicting Peds, #/hr | 0 | 0 | 0 | 0 | 0 | 0 |
| Sign Control | Stop | Stop | Free | Free | Free | Free |
| RT Channelized | - | None | - | None | - | None |
| Storage Length | 0 | - | - | - | - | - |
| Veh in Median Storage, # | 0 | - | 0 | - | - | 0 |
| Grade, % | 0 | - | 0 | - | - | 0 |
| Peak Hour Factor | 100 | 100 | 100 | 100 | 100 | 100 |
| Heavy Vehicles, % | 2 | 2 | 2 | 2 | 2 | 2 |
| Mvmt Flow | 40 | 631 | 67 | 21 | 232 | 34 |

| Major/Minor | Minor1 | | Major1 | | Major2 | |
|----------------------|--------|-------|--------|---|--------|---|
| Conflicting Flow All | 576 | 78 | 0 | 0 | 88 | 0 |
| Stage 1 | 78 | - | - | - | - | - |
| Stage 2 | 498 | - | - | - | - | - |
| Critical Hdwy | 6.42 | 6.22 | - | - | 4.12 | - |
| Critical Hdwy Stg 1 | 5.42 | - | - | - | - | - |
| Critical Hdwy Stg 2 | 5.42 | - | - | - | - | - |
| Follow-up Hdwy | 3.518 | 3.318 | - | - | 2.218 | - |
| Pot Cap-1 Maneuver | 479 | 983 | - | - | 1508 | - |
| Stage 1 | 945 | - | - | - | - | - |
| Stage 2 | 611 | - | - | - | - | - |
| Platoon blocked, % | | | - | - | | - |
| Mov Cap-1 Maneuver | 404 | 983 | - | - | 1508 | - |
| Mov Cap-2 Maneuver | 404 | - | - | - | - | - |
| Stage 1 | 945 | - | - | - | - | - |
| Stage 2 | 515 | - | - | - | - | - |

| Approach | WB | | NB | | SB |
|----------------------|------|--|----|--|-----|
| HCM Control Delay, s | 19.4 | | 0 | | 6.8 |
| HCM LOS | C | | | | |

| Minor Lane/Major Mvmt | NBT | NBRWBLn1 | SBL | SBT |
|-----------------------|-----|----------|-------|-----|
| Capacity (veh/h) | - | - 906 | 1508 | - |
| HCM Lane V/C Ratio | - | - 0.741 | 0.154 | - |
| HCM Control Delay (s) | - | - 19.4 | 7.8 | 0 |
| HCM Lane LOS | - | - C | A | A |
| HCM 95th %tile Q(veh) | - | - 6.9 | 0.5 | - |

Intersection

Int Delay, s/veh 13.3

| Movement | WBL | WBR | NBT | NBR | SBL | SBT |
|--------------------------|------|------|------|------|------|------|
| Lane Configurations | | | | | | |
| Traffic Vol, veh/h | 26 | 389 | 61 | 34 | 644 | 56 |
| Future Vol, veh/h | 26 | 389 | 61 | 34 | 644 | 56 |
| Conflicting Peds, #/hr | 0 | 0 | 0 | 0 | 0 | 0 |
| Sign Control | Stop | Stop | Free | Free | Free | Free |
| RT Channelized | - | None | - | None | - | None |
| Storage Length | 0 | - | - | - | - | - |
| Veh in Median Storage, # | 0 | - | 0 | - | - | 0 |
| Grade, % | 0 | - | 0 | - | - | 0 |
| Peak Hour Factor | 100 | 100 | 100 | 100 | 100 | 100 |
| Heavy Vehicles, % | 2 | 2 | 2 | 2 | 2 | 2 |
| Mvmt Flow | 26 | 389 | 61 | 34 | 644 | 56 |

| Major/Minor | Minor1 | | Major1 | | Major2 | |
|----------------------|--------|-------|--------|---|--------|---|
| Conflicting Flow All | 1422 | 78 | 0 | 0 | 95 | 0 |
| Stage 1 | 78 | - | - | - | - | - |
| Stage 2 | 1344 | - | - | - | - | - |
| Critical Hdwy | 6.42 | 6.22 | - | - | 4.12 | - |
| Critical Hdwy Stg 1 | 5.42 | - | - | - | - | - |
| Critical Hdwy Stg 2 | 5.42 | - | - | - | - | - |
| Follow-up Hdwy | 3.518 | 3.318 | - | - | 2.218 | - |
| Pot Cap-1 Maneuver | 150 | 983 | - | - | 1499 | - |
| Stage 1 | 945 | - | - | - | - | - |
| Stage 2 | 243 | - | - | - | - | - |
| Platoon blocked, % | | | - | - | | - |
| Mov Cap-1 Maneuver | 84 | 983 | - | - | 1499 | - |
| Mov Cap-2 Maneuver | 84 | - | - | - | - | - |
| Stage 1 | 945 | - | - | - | - | - |
| Stage 2 | 135 | - | - | - | - | - |

| Approach | WB | | NB | | SB |
|----------------------|------|--|----|--|-----|
| HCM Control Delay, s | 24.5 | | 0 | | 8.5 |
| HCM LOS | C | | | | |

| Minor Lane/Major Mvmt | NBT | NBRWBLn1 | SBL | SBT |
|-----------------------|-----|----------|------|-----|
| Capacity (veh/h) | - | - 588 | 1499 | - |
| HCM Lane V/C Ratio | - | - 0.706 | 0.43 | - |
| HCM Control Delay (s) | - | - 24.5 | 9.2 | 0 |
| HCM Lane LOS | - | - C | A | A |
| HCM 95th %tile Q(veh) | - | - 5.7 | 2.2 | - |

| Intersection | | | | | | | | | | | | |
|--|--------|-------|------|--------|------|------|--------|-------|-------|--------|-------|-------|
| Int Delay, s/veh | 39.4 | | | | | | | | | | | |
| Movement | EBL | EBT | EBR | WBL | WBT | WBR | NBL | NBT | NBR | SBL | SBT | SBR |
| Lane Configurations | | ↕ | | | ↕ | | | ↕ | | | ↕ | |
| Traffic Vol, veh/h | 22 | 205 | 26 | 14 | 495 | 83 | 100 | 0 | 54 | 258 | 0 | 77 |
| Future Vol, veh/h | 22 | 205 | 26 | 14 | 495 | 83 | 100 | 0 | 54 | 258 | 0 | 77 |
| Conflicting Peds, #/hr | 0 | 0 | 0 | 0 | 0 | 0 | 0 | 0 | 0 | 0 | 0 | 0 |
| Sign Control | Free | Free | Free | Free | Free | Free | Stop | Stop | Stop | Stop | Stop | Stop |
| RT Channelized | - | - | None | - | - | None | - | - | None | - | - | None |
| Storage Length | - | - | - | - | - | - | - | - | - | - | - | - |
| Veh in Median Storage, # | - | 0 | - | - | 0 | - | - | 0 | - | - | 0 | - |
| Grade, % | - | 0 | - | - | 0 | - | - | 0 | - | - | 0 | - |
| Peak Hour Factor | 100 | 100 | 100 | 100 | 100 | 100 | 100 | 100 | 100 | 100 | 100 | 100 |
| Heavy Vehicles, % | 2 | 2 | 2 | 2 | 2 | 2 | 2 | 2 | 2 | 2 | 2 | 2 |
| Mvmt Flow | 22 | 205 | 26 | 14 | 495 | 83 | 100 | 0 | 54 | 258 | 0 | 77 |
| Major/Minor | Major1 | | | Major2 | | | Minor1 | | | Minor2 | | |
| Conflicting Flow All | 578 | 0 | 0 | 231 | 0 | 0 | 865 | 868 | 218 | 854 | 840 | 537 |
| Stage 1 | - | - | - | - | - | - | 262 | 262 | - | 565 | 565 | - |
| Stage 2 | - | - | - | - | - | - | 603 | 606 | - | 289 | 275 | - |
| Critical Hdwy | 4.12 | - | - | 4.12 | - | - | 7.12 | 6.52 | 6.22 | 7.12 | 6.52 | 6.22 |
| Critical Hdwy Stg 1 | - | - | - | - | - | - | 6.12 | 5.52 | - | 6.12 | 5.52 | - |
| Critical Hdwy Stg 2 | - | - | - | - | - | - | 6.12 | 5.52 | - | 6.12 | 5.52 | - |
| Follow-up Hdwy | 2.218 | - | - | 2.218 | - | - | 3.518 | 4.018 | 3.318 | 3.518 | 4.018 | 3.318 |
| Pot Cap-1 Maneuver | 996 | - | - | 1337 | - | - | 274 | 290 | 822 | 279 | 302 | 544 |
| Stage 1 | - | - | - | - | - | - | 743 | 691 | - | 510 | 508 | - |
| Stage 2 | - | - | - | - | - | - | 486 | 487 | - | 719 | 683 | - |
| Platoon blocked, % | | - | - | | - | - | | | | | | |
| Mov Cap-1 Maneuver | 996 | - | - | 1337 | - | - | 228 | 278 | 822 | ~ 253 | 290 | 544 |
| Mov Cap-2 Maneuver | - | - | - | - | - | - | 228 | 278 | - | ~ 253 | 290 | - |
| Stage 1 | - | - | - | - | - | - | 724 | 674 | - | 497 | 500 | - |
| Stage 2 | - | - | - | - | - | - | 411 | 479 | - | 655 | 666 | - |
| Approach | EB | | | WB | | | NB | | | SB | | |
| HCM Control Delay, s | 0.8 | | | 0.2 | | | 28.3 | | | 143.1 | | |
| HCM LOS | | | | | | | D | | | F | | |
| Minor Lane/Major Mvmt | NBLn1 | EBL | EBT | EBR | WBL | WBT | WBR | SBLn1 | | | | |
| Capacity (veh/h) | 305 | 996 | - | - | 1337 | - | - | 288 | | | | |
| HCM Lane V/C Ratio | 0.505 | 0.022 | - | - | 0.01 | - | - | 1.163 | | | | |
| HCM Control Delay (s) | 28.3 | 8.7 | 0 | - | 7.7 | 0 | - | 143.1 | | | | |
| HCM Lane LOS | D | A | A | - | A | A | - | F | | | | |
| HCM 95th %tile Q(veh) | 2.7 | 0.1 | - | - | 0 | - | - | 14.5 | | | | |
| Notes | | | | | | | | | | | | |
| ~: Volume exceeds capacity \$: Delay exceeds 300s +: Computation Not Defined *: All major volume in platoon | | | | | | | | | | | | |

2: Street 23/Mattamy Site Access & Cambrian Road

AM Peak Hour



| Lane Group | EBL | EBT | EBR | WBL | WBT | WBR | NBL | NBT | NBR | SBL | SBT | SBR |
|---------------------------|-------|-------|------|-------|-------|------|-------|-------|------|-------|------|-------|
| Lane Configurations | | | | | | | | | | | | |
| Traffic Volume (vph) | 22 | 205 | 26 | 14 | 495 | 83 | 100 | 0 | 54 | 258 | 0 | 77 |
| Future Volume (vph) | 22 | 205 | 26 | 14 | 495 | 83 | 100 | 0 | 54 | 258 | 0 | 77 |
| Ideal Flow (vphpl) | 1800 | 1800 | 1800 | 1800 | 1800 | 1800 | 1800 | 1800 | 1800 | 1800 | 1800 | 1800 |
| Storage Length (m) | 15.0 | | 0.0 | 15.0 | | 0.0 | 0.0 | | 0.0 | 0.0 | | 0.0 |
| Storage Lanes | 1 | | 0 | 1 | | 0 | 0 | | 0 | 0 | | 0 |
| Taper Length (m) | 7.6 | | | 7.6 | | | 7.6 | | | 7.6 | | |
| Lane Util. Factor | 1.00 | 1.00 | 1.00 | 1.00 | 1.00 | 1.00 | 1.00 | 1.00 | 1.00 | 1.00 | 1.00 | 1.00 |
| Fr _t | | 0.983 | | | 0.978 | | | 0.953 | | | | 0.969 |
| Fl _t Protected | 0.950 | | | 0.950 | | | | 0.969 | | | | 0.963 |
| Satd. Flow (prot) | 1695 | 1754 | 0 | 1695 | 1745 | 0 | 0 | 1648 | 0 | 0 | 1665 | 0 |
| Fl _t Permitted | 0.275 | | | 0.615 | | | | 0.688 | | | | 0.698 |
| Satd. Flow (perm) | 491 | 1754 | 0 | 1097 | 1745 | 0 | 0 | 1170 | 0 | 0 | 1207 | 0 |
| Right Turn on Red | | | Yes | | | Yes | | | Yes | | | Yes |
| Satd. Flow (RTOR) | | 12 | | | 15 | | | 47 | | | | 42 |
| Link Speed (k/h) | | 70 | | | 70 | | | 50 | | | | 50 |
| Link Distance (m) | | 509.6 | | | 247.9 | | | 230.8 | | | | 283.1 |
| Travel Time (s) | | 26.2 | | | 12.7 | | | 16.6 | | | | 20.4 |
| Peak Hour Factor | 1.00 | 1.00 | 1.00 | 1.00 | 1.00 | 1.00 | 1.00 | 1.00 | 1.00 | 1.00 | 1.00 | 1.00 |
| Adj. Flow (vph) | 22 | 205 | 26 | 14 | 495 | 83 | 100 | 0 | 54 | 258 | 0 | 77 |
| Shared Lane Traffic (%) | | | | | | | | | | | | |
| Lane Group Flow (vph) | 22 | 231 | 0 | 14 | 578 | 0 | 0 | 154 | 0 | 0 | 335 | 0 |
| Turn Type | Perm | NA | | Perm | NA | | Perm | NA | | Perm | NA | |
| Protected Phases | | 2 | | | 6 | | | 4 | | | | 8 |
| Permitted Phases | 2 | | | 6 | | | 4 | | | 8 | | |
| Detector Phase | 2 | 2 | | 6 | 6 | | 4 | 4 | | 8 | | 8 |
| Switch Phase | | | | | | | | | | | | |
| Minimum Initial (s) | 10.0 | 10.0 | | 10.0 | 10.0 | | 10.0 | 10.0 | | 10.0 | | 10.0 |
| Minimum Split (s) | 30.7 | 30.7 | | 30.7 | 30.7 | | 33.5 | 33.5 | | 33.5 | | 33.5 |
| Total Split (s) | 36.0 | 36.0 | | 36.0 | 36.0 | | 34.0 | 34.0 | | 34.0 | | 34.0 |
| Total Split (%) | 51.4% | 51.4% | | 51.4% | 51.4% | | 48.6% | 48.6% | | 48.6% | | 48.6% |
| Maximum Green (s) | 30.3 | 30.3 | | 30.3 | 30.3 | | 28.5 | 28.5 | | 28.5 | | 28.5 |
| Yellow Time (s) | 4.5 | 4.5 | | 4.5 | 4.5 | | 3.6 | 3.6 | | 3.6 | | 3.6 |
| All-Red Time (s) | 1.2 | 1.2 | | 1.2 | 1.2 | | 1.9 | 1.9 | | 1.9 | | 1.9 |
| Lost Time Adjust (s) | 0.0 | 0.0 | | 0.0 | 0.0 | | | 0.0 | | | | 0.0 |
| Total Lost Time (s) | 5.7 | 5.7 | | 5.7 | 5.7 | | | 5.5 | | | | 5.5 |
| Lead/Lag | | | | | | | | | | | | |
| Lead-Lag Optimize? | | | | | | | | | | | | |
| Vehicle Extension (s) | 3.0 | 3.0 | | 3.0 | 3.0 | | 3.0 | 3.0 | | 3.0 | | 3.0 |
| Recall Mode | Min | Min | | Min | Min | | None | None | | None | | None |
| Walk Time (s) | 7.0 | 7.0 | | 7.0 | 7.0 | | 7.0 | 7.0 | | 7.0 | | 7.0 |
| Flash Dont Walk (s) | 18.0 | 18.0 | | 18.0 | 18.0 | | 21.0 | 21.0 | | 21.0 | | 21.0 |
| Pedestrian Calls (#/hr) | 0 | 0 | | 0 | 0 | | 0 | 0 | | 0 | | 0 |
| Act Effect Green (s) | 22.2 | 22.2 | | 22.2 | 22.2 | | | 18.8 | | | | 18.8 |
| Actuated g/C Ratio | 0.42 | 0.42 | | 0.42 | 0.42 | | | 0.35 | | | | 0.35 |
| v/c Ratio | 0.11 | 0.31 | | 0.03 | 0.78 | | | 0.35 | | | | 0.74 |
| Control Delay | 12.6 | 12.0 | | 10.9 | 23.0 | | | 12.5 | | | | 24.9 |
| Queue Delay | 0.0 | 0.0 | | 0.0 | 0.0 | | | 0.0 | | | | 0.0 |
| Total Delay | 12.6 | 12.0 | | 10.9 | 23.0 | | | 12.5 | | | | 24.9 |

2: Street 23/Mattamy Site Access & Cambrian Road

AM Peak Hour



| Lane Group | EBL | EBT | EBR | WBL | WBT | WBR | NBL | NBT | NBR | SBL | SBT | SBR |
|------------------------|------|-------|-----|------|--------|-----|-----|-------|-----|-----|-------|-----|
| LOS | B | B | | B | C | | | B | | | C | |
| Approach Delay | | 12.0 | | | 22.7 | | | 12.5 | | | 24.9 | |
| Approach LOS | | B | | | C | | | B | | | C | |
| Queue Length 50th (m) | 1.2 | 12.8 | | 0.7 | 43.0 | | | 7.1 | | | 23.6 | |
| Queue Length 95th (m) | 5.7 | 32.0 | | 3.9 | #100.6 | | | 20.9 | | | 56.9 | |
| Internal Link Dist (m) | | 485.6 | | | 223.9 | | | 206.8 | | | 259.1 | |
| Turn Bay Length (m) | 15.0 | | | 15.0 | | | | | | | | |
| Base Capacity (vph) | 303 | 1088 | | 678 | 1084 | | | 699 | | | 719 | |
| Starvation Cap Reductn | 0 | 0 | | 0 | 0 | | | 0 | | | 0 | |
| Spillback Cap Reductn | 0 | 0 | | 0 | 0 | | | 0 | | | 0 | |
| Storage Cap Reductn | 0 | 0 | | 0 | 0 | | | 0 | | | 0 | |
| Reduced v/c Ratio | 0.07 | 0.21 | | 0.02 | 0.53 | | | 0.22 | | | 0.47 | |

Intersection Summary

Area Type: Other
 Cycle Length: 70
 Actuated Cycle Length: 53.1
 Natural Cycle: 65
 Control Type: Actuated-Uncoordinated
 Maximum v/c Ratio: 0.78
 Intersection Signal Delay: 20.0
 Intersection LOS: C
 Intersection Capacity Utilization 67.2%
 ICU Level of Service C
 Analysis Period (min) 15
 # 95th percentile volume exceeds capacity, queue may be longer.
 Queue shown is maximum after two cycles.

Splits and Phases: 2: Street 23/Mattamy Site Access & Cambrian Road

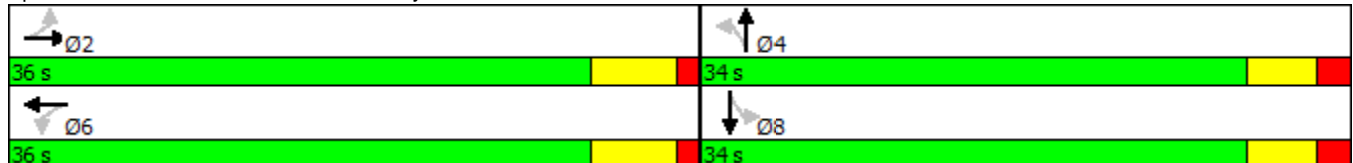

LANE SUMMARY

Site: Cambrian Rd & Street 23/ Mattamy Site Access - 2027 BSG AM

AM Peak Hour
Roundabout

| Lane Use and Performance | | | | | | | | | | | | | |
|----------------------------|----------------|---------|---------------|---------------------|--------------------|-------------------------|---------------------|-------------------|-----------|----------------|---------------------|-------------------|----------------------|
| | Demand Flows | | Cap. veh/h | Deg. Satn v/c | Lane Util. % | Average Delay sec | Level of Service | 95% Back of Queue | | Lane Config | Lane Length m | Cap. Adj. % | Prob. Block. % |
| | Total veh/h | HV % | | | | | | Veh | Dist m | | | | |
| South: Street 23 | | | | | | | | | | | | | |
| Lane 1 ^d | 155 | 3.0 | 666 | 0.233 | 100 | 8.2 | LOS A | 0.8 | 6.6 | Full | 500 | 0.0 | 0.0 |
| Approach | 155 | 3.0 | | 0.233 | | 8.2 | LOS A | 0.8 | 6.6 | | | | |
| East: Cambrian Road | | | | | | | | | | | | | |
| Lane 1 ^d | 592 | 3.0 | 967 | 0.612 | 100 | 12.5 | LOS B | 4.2 | 32.5 | Full | 500 | 0.0 | 0.0 |
| Approach | 592 | 3.0 | | 0.612 | | 12.5 | LOS B | 4.2 | 32.5 | | | | |
| North: Mattamy Site Access | | | | | | | | | | | | | |
| Lane 1 ^d | 336 | 3.0 | 586 | 0.573 | 100 | 16.9 | LOS C | 3.1 | 24.2 | Full | 500 | 0.0 | 0.0 |
| Approach | 336 | 3.0 | | 0.573 | | 16.9 | LOS C | 3.1 | 24.2 | | | | |
| West: Cambrian Road | | | | | | | | | | | | | |
| Lane 1 ^d | 253 | 3.0 | 828 | 0.305 | 100 | 7.8 | LOS A | 1.3 | 9.8 | Full | 500 | 0.0 | 0.0 |
| Approach | 253 | 3.0 | | 0.305 | | 7.8 | LOS A | 1.3 | 9.8 | | | | |
| Intersection | 1336 | 3.0 | | 0.612 | | 12.2 | LOS B | 4.2 | 32.5 | | | | |

Level of Service (LOS) Method: Delay & v/c (HCM 2010).

Roundabout LOS Method: Same as Sign Control.

Lane LOS values are based on average delay and v/c ratio (degree of saturation) per lane.

LOS F will result if v/c > irrespective of lane delay value (does not apply for approaches and intersection).

Intersection and Approach LOS values are based on average delay for all lanes (v/c not used as specified in HCM 2010).

Roundabout Capacity Model: US HCM 2010.

HCM Delay Formula option is used. Control Delay does not include Geometric Delay since Exclude Geometric Delay option applies.

Gap-Acceptance Capacity: Traditional M1.

HV (%) values are calculated for All Movement Classes of All Heavy Vehicle Model Designation.

^d Dominant lane on roundabout approach

SIDRA INTERSECTION 6.1 | Copyright © 2000-2015 Akcelik and Associates Pty Ltd | sidrasolutions.com

Organisation: IBI GROUP | Processed: Tuesday, April 10, 2018 4:43:10 PM

Project: J:\115637_MeadowPh5TIA\5.7 Calculations\5.7.6 Roads (Trans)\SIDRA\Cambrian & Street 23 & Mattamy Site Access.sip6

| Intersection | | | | | | | | | | | | |
|----------------------------|------------------------|-------|------|----------------------------|-------|------|--------------------------------|-------|-------|--------|-------|-------|
| Int Delay, s/veh | 38.8 | | | | | | | | | | | |
| Movement | EBL | EBT | EBR | WBL | WBT | WBR | NBL | NBT | NBR | SBL | SBT | SBR |
| Lane Configurations | | ↕ | | | ↕ | | | ↕ | | | ↕ | |
| Traffic Vol, veh/h | 78 | 499 | 101 | 54 | 317 | 250 | 55 | 0 | 29 | 156 | 0 | 44 |
| Future Vol, veh/h | 78 | 499 | 101 | 54 | 317 | 250 | 55 | 0 | 29 | 156 | 0 | 44 |
| Conflicting Peds, #/hr | 0 | 0 | 0 | 0 | 0 | 0 | 0 | 0 | 0 | 0 | 0 | 0 |
| Sign Control | Free | Free | Free | Free | Free | Free | Stop | Stop | Stop | Stop | Stop | Stop |
| RT Channelized | - | - | None | - | - | None | - | - | None | - | - | None |
| Storage Length | - | - | - | - | - | - | - | - | - | - | - | - |
| Veh in Median Storage, # | - | 0 | - | - | 0 | - | - | 0 | - | - | 0 | - |
| Grade, % | - | 0 | - | - | 0 | - | - | 0 | - | - | 0 | - |
| Peak Hour Factor | 100 | 100 | 100 | 100 | 100 | 100 | 100 | 100 | 100 | 100 | 100 | 100 |
| Heavy Vehicles, % | 2 | 2 | 2 | 2 | 2 | 2 | 2 | 2 | 2 | 2 | 2 | 2 |
| Mvmt Flow | 78 | 499 | 101 | 54 | 317 | 250 | 55 | 0 | 29 | 156 | 0 | 44 |
| Major/Minor | Major1 | | | Major2 | | | Minor1 | | | Minor2 | | |
| Conflicting Flow All | 567 | 0 | 0 | 600 | 0 | 0 | 1278 | 1381 | 550 | 1270 | 1306 | 442 |
| Stage 1 | - | - | - | - | - | - | 706 | 706 | - | 550 | 550 | - |
| Stage 2 | - | - | - | - | - | - | 572 | 675 | - | 720 | 756 | - |
| Critical Hdwy | 4.12 | - | - | 4.12 | - | - | 7.12 | 6.52 | 6.22 | 7.12 | 6.52 | 6.22 |
| Critical Hdwy Stg 1 | - | - | - | - | - | - | 6.12 | 5.52 | - | 6.12 | 5.52 | - |
| Critical Hdwy Stg 2 | - | - | - | - | - | - | 6.12 | 5.52 | - | 6.12 | 5.52 | - |
| Follow-up Hdwy | 2.218 | - | - | 2.218 | - | - | 3.518 | 4.018 | 3.318 | 3.518 | 4.018 | 3.318 |
| Pot Cap-1 Maneuver | 1005 | - | - | 977 | - | - | 143 | 144 | 535 | ~ 145 | 160 | 615 |
| Stage 1 | - | - | - | - | - | - | 427 | 439 | - | 519 | 516 | - |
| Stage 2 | - | - | - | - | - | - | 505 | 453 | - | 419 | 416 | - |
| Platoon blocked, % | | - | - | | - | - | | | | | | |
| Mov Cap-1 Maneuver | 1005 | - | - | 977 | - | - | 113 | 116 | 535 | ~ 117 | 129 | 615 |
| Mov Cap-2 Maneuver | - | - | - | - | - | - | 113 | 116 | - | ~ 117 | 129 | - |
| Stage 1 | - | - | - | - | - | - | 377 | 387 | - | 458 | 473 | - |
| Stage 2 | - | - | - | - | - | - | 429 | 415 | - | 350 | 367 | - |
| Approach | EB | | | WB | | | NB | | | SB | | |
| HCM Control Delay, s | 1 | | | 0.8 | | | 52.8 | | | 278.8 | | |
| HCM LOS | | | | | | | F | | | F | | |
| Minor Lane/Major Mvmt | NBLn1 | EBL | EBT | EBR | WBL | WBT | WBR | SBLn1 | | | | |
| Capacity (veh/h) | 155 | 1005 | - | - | 977 | - | - | 142 | | | | |
| HCM Lane V/C Ratio | 0.542 | 0.078 | - | - | 0.055 | - | - | 1.408 | | | | |
| HCM Control Delay (s) | 52.8 | 8.9 | 0 | - | 8.9 | 0 | - | 278.8 | | | | |
| HCM Lane LOS | F | A | A | - | A | A | - | F | | | | |
| HCM 95th %tile Q(veh) | 2.7 | 0.3 | - | - | 0.2 | - | - | 13 | | | | |
| Notes | | | | | | | | | | | | |
| ~: Volume exceeds capacity | \$: Delay exceeds 300s | | | +: Computation Not Defined | | | *: All major volume in platoon | | | | | |

2: Street 23/Mattamy Site Access & Cambrian Road

PM Peak Hour



| Lane Group | EBL | EBT | EBR | WBL | WBT | WBR | NBL | NBT | NBR | SBL | SBT | SBR |
|-------------------------|-------|-------|------|-------|-------|--------|-------|-------|------|-------|-------|-------|
| Lane Configurations | | | | | | | | | | | | |
| Traffic Volume (vph) | 78 | 499 | 101 | 54 | 317 | 250 | 55 | 0 | 29 | 156 | 0 | 44 |
| Future Volume (vph) | 78 | 499 | 101 | 54 | 317 | 250 | 55 | 0 | 29 | 156 | 0 | 44 |
| Ideal Flow (vphpl) | 1800 | 1800 | 1800 | 1800 | 1800 | 1800 | 1800 | 1800 | 1800 | 1800 | 1800 | 1800 |
| Storage Length (m) | 40.0 | | 0.0 | 15.0 | | 10.0 | 20.0 | | 0.0 | 70.0 | | 0.0 |
| Storage Lanes | 1 | | 0 | 1 | | 1 | 1 | | 0 | 1 | | 0 |
| Taper Length (m) | 7.6 | | | 7.6 | | | 7.6 | | | 7.6 | | |
| Lane Util. Factor | 1.00 | 1.00 | 1.00 | 1.00 | 1.00 | 1.00 | 1.00 | 1.00 | 1.00 | 1.00 | 1.00 | 1.00 |
| Frt | | 0.975 | | | | 0.850 | | 0.850 | | | | 0.850 |
| Flt Protected | 0.950 | | | 0.950 | | | 0.950 | | | 0.950 | | |
| Satd. Flow (prot) | 1695 | 1740 | 0 | 1695 | 1784 | 1517 | 1695 | 1517 | 0 | 1695 | 1517 | 0 |
| Flt Permitted | 0.568 | | | 0.300 | | | 0.728 | | | 0.738 | | |
| Satd. Flow (perm) | 1013 | 1740 | 0 | 535 | 1784 | 1517 | 1299 | 1517 | 0 | 1317 | 1517 | 0 |
| Right Turn on Red | | | Yes | | | Yes | | | Yes | | | Yes |
| Satd. Flow (RTOR) | | 20 | | | | 146 | | 283 | | | | 467 |
| Link Speed (k/h) | | 70 | | | 70 | | | 50 | | | | 50 |
| Link Distance (m) | | 509.6 | | | 247.9 | | | 230.8 | | | | 283.1 |
| Travel Time (s) | | 26.2 | | | 12.7 | | | 16.6 | | | | 20.4 |
| Peak Hour Factor | 1.00 | 1.00 | 1.00 | 1.00 | 1.00 | 1.00 | 1.00 | 1.00 | 1.00 | 1.00 | 1.00 | 1.00 |
| Adj. Flow (vph) | 78 | 499 | 101 | 54 | 317 | 250 | 55 | 0 | 29 | 156 | 0 | 44 |
| Shared Lane Traffic (%) | | | | | | | | | | | | |
| Lane Group Flow (vph) | 78 | 600 | 0 | 54 | 317 | 250 | 55 | 29 | 0 | 156 | 44 | 0 |
| Turn Type | Perm | NA | | Perm | NA | custom | Perm | NA | | Perm | NA | |
| Protected Phases | | 2 | | | 6 | | | 4 | | | | 8 |
| Permitted Phases | 2 | | | 6 | | 8 | 4 | | | 8 | | |
| Detector Phase | 2 | 2 | | 6 | 6 | 8 | 4 | 4 | | 8 | 8 | |
| Switch Phase | | | | | | | | | | | | |
| Minimum Initial (s) | 10.0 | 10.0 | | 10.0 | 10.0 | 10.0 | 10.0 | 10.0 | | 10.0 | 10.0 | |
| Minimum Split (s) | 33.5 | 33.5 | | 33.5 | 33.5 | 30.7 | 30.7 | 30.7 | | 30.7 | 30.7 | |
| Total Split (s) | 39.2 | 39.2 | | 39.2 | 39.2 | 30.8 | 30.8 | 30.8 | | 30.8 | 30.8 | |
| Total Split (%) | 56.0% | 56.0% | | 56.0% | 56.0% | 44.0% | 44.0% | 44.0% | | 44.0% | 44.0% | |
| Maximum Green (s) | 33.7 | 33.7 | | 33.7 | 33.7 | 25.1 | 25.1 | 25.1 | | 25.1 | 25.1 | |
| Yellow Time (s) | 3.6 | 3.6 | | 3.6 | 3.6 | 4.5 | 4.5 | 4.5 | | 4.5 | 4.5 | |
| All-Red Time (s) | 1.9 | 1.9 | | 1.9 | 1.9 | 1.2 | 1.2 | 1.2 | | 1.2 | 1.2 | |
| Lost Time Adjust (s) | 0.0 | 0.0 | | 0.0 | 0.0 | 0.0 | 0.0 | 0.0 | | 0.0 | 0.0 | |
| Total Lost Time (s) | 5.5 | 5.5 | | 5.5 | 5.5 | 5.7 | 5.7 | 5.7 | | 5.7 | 5.7 | |
| Lead/Lag | | | | | | | | | | | | |
| Lead-Lag Optimize? | | | | | | | | | | | | |
| Vehicle Extension (s) | 3.0 | 3.0 | | 3.0 | 3.0 | 3.0 | 3.0 | 3.0 | | 3.0 | 3.0 | |
| Recall Mode | Min | Min | | Min | Min | None | None | None | | None | None | |
| Walk Time (s) | 7.0 | 7.0 | | 7.0 | 7.0 | 7.0 | 7.0 | 7.0 | | 7.0 | 7.0 | |
| Flash Dont Walk (s) | 21.0 | 21.0 | | 21.0 | 21.0 | 18.0 | 18.0 | 18.0 | | 18.0 | 18.0 | |
| Pedestrian Calls (#/hr) | 0 | 0 | | 0 | 0 | 0 | 0 | 0 | | 0 | 0 | |
| Act Effect Green (s) | 20.9 | 20.9 | | 20.9 | 20.9 | 13.0 | 13.0 | 13.0 | | 13.0 | 13.0 | |
| Actuated g/C Ratio | 0.46 | 0.46 | | 0.46 | 0.46 | 0.28 | 0.28 | 0.28 | | 0.28 | 0.28 | |
| v/c Ratio | 0.17 | 0.74 | | 0.22 | 0.39 | 0.47 | 0.15 | 0.05 | | 0.42 | 0.06 | |
| Control Delay | 8.4 | 16.4 | | 10.3 | 9.8 | 10.5 | 15.7 | 0.1 | | 19.4 | 0.1 | |
| Queue Delay | 0.0 | 0.0 | | 0.0 | 0.0 | 0.0 | 0.0 | 0.0 | | 0.0 | 0.0 | |
| Total Delay | 8.4 | 16.4 | | 10.3 | 9.8 | 10.5 | 15.7 | 0.1 | | 19.4 | 0.1 | |

2: Street 23/Mattamy Site Access & Cambrian Road

PM Peak Hour



| Lane Group | EBL | EBT | EBR | WBL | WBT | WBR | NBL | NBT | NBR | SBL | SBT | SBR |
|------------------------|------|-------|-----|------|-------|------|------|-------|-----|------|------|-------|
| LOS | A | B | | B | A | B | B | A | | B | A | |
| Approach Delay | | 15.5 | | | 10.1 | | | 10.3 | | | | 15.1 |
| Approach LOS | | B | | | B | | | B | | | | B |
| Queue Length 50th (m) | 2.9 | 29.5 | | 2.0 | 13.0 | 5.8 | 3.0 | 0.0 | | 9.2 | 0.0 | |
| Queue Length 95th (m) | 10.5 | 77.5 | | 9.0 | 34.8 | 25.9 | 12.0 | 0.0 | | 29.0 | 0.0 | |
| Internal Link Dist (m) | | 485.6 | | | 223.9 | | | 206.8 | | | | 259.1 |
| Turn Bay Length (m) | 40.0 | | | 15.0 | | 10.0 | 20.0 | | | 70.0 | | |
| Base Capacity (vph) | 789 | 1360 | | 417 | 1390 | 941 | 753 | 999 | | 764 | 1076 | |
| Starvation Cap Reductn | 0 | 0 | | 0 | 0 | 0 | 0 | 0 | | 0 | 0 | |
| Spillback Cap Reductn | 0 | 0 | | 0 | 0 | 0 | 0 | 0 | | 0 | 0 | |
| Storage Cap Reductn | 0 | 0 | | 0 | 0 | 0 | 0 | 0 | | 0 | 0 | |
| Reduced v/c Ratio | 0.10 | 0.44 | | 0.13 | 0.23 | 0.27 | 0.07 | 0.03 | | 0.20 | 0.04 | |

Intersection Summary

| | |
|------------------------------------|------------------------|
| Area Type: | Other |
| Cycle Length: | 70 |
| Actuated Cycle Length: | 45.7 |
| Natural Cycle: | 65 |
| Control Type: | Actuated-Uncoordinated |
| Maximum v/c Ratio: | 0.74 |
| Intersection Signal Delay: | 13.1 |
| Intersection LOS: | B |
| Intersection Capacity Utilization: | 72.2% |
| ICU Level of Service: | C |
| Analysis Period (min): | 15 |

Splits and Phases: 2: Street 23/Mattamy Site Access & Cambrian Road



LANE SUMMARY

Site: Cambrian Rd & Street 23/ Mattamy Site Access - 2027 BSG PM

PM Peak Hour
Roundabout

| Lane Use and Performance | | | | | | | | | | | | | |
|----------------------------|----------------|---------|---------------|---------------------|--------------------|-------------------------|---------------------|-------------------|-----------|----------------|---------------------|-------------------|----------------------|
| | Demand Flows | | Cap. veh/h | Deg. Satn v/c | Lane Util. % | Average Delay sec | Level of Service | 95% Back of Queue | | Lane Config | Lane Length m | Cap. Adj. % | Prob. Block. % |
| | Total veh/h | HV % | | | | | | Veh | Dist m | | | | |
| South: Street 23 | | | | | | | | | | | | | |
| Lane 1 ^d | 85 | 3.0 | 516 | 0.165 | 100 | 9.2 | LOS A | 0.5 | 4.3 | Full | 500 | 0.0 | 0.0 |
| Approach | 85 | 3.0 | | 0.165 | | 9.2 | LOS A | 0.5 | 4.3 | | | | |
| East: Cambrian Road | | | | | | | | | | | | | |
| Lane 1 ^d | 621 | 3.0 | 956 | 0.650 | 100 | 13.7 | LOS B | 4.7 | 36.5 | Full | 500 | 0.0 | 0.0 |
| Approach | 621 | 3.0 | | 0.650 | | 13.7 | LOS B | 4.7 | 36.5 | | | | |
| North: Mattamy Site Access | | | | | | | | | | | | | |
| Lane 1 ^d | 201 | 3.0 | 707 | 0.284 | 100 | 8.5 | LOS A | 1.1 | 8.5 | Full | 500 | 0.0 | 0.0 |
| Approach | 201 | 3.0 | | 0.284 | | 8.5 | LOS A | 1.1 | 8.5 | | | | |
| West: Cambrian Road | | | | | | | | | | | | | |
| Lane 1 ^d | 678 | 3.0 | 883 | 0.768 | 100 | 20.0 | LOS C | 8.2 | 63.6 | Full | 500 | 0.0 | 0.0 |
| Approach | 678 | 3.0 | | 0.768 | | 20.0 | LOS C | 8.2 | 63.6 | | | | |
| Intersection | 1585 | 3.0 | | 0.768 | | 15.5 | LOS C | 8.2 | 63.6 | | | | |

Level of Service (LOS) Method: Delay & v/c (HCM 2010).

Roundabout LOS Method: Same as Sign Control.

Lane LOS values are based on average delay and v/c ratio (degree of saturation) per lane.

LOS F will result if v/c > irrespective of lane delay value (does not apply for approaches and intersection).

Intersection and Approach LOS values are based on average delay for all lanes (v/c not used as specified in HCM 2010).

Roundabout Capacity Model: US HCM 2010.

HCM Delay Formula option is used. Control Delay does not include Geometric Delay since Exclude Geometric Delay option applies.

Gap-Acceptance Capacity: Traditional M1.

HV (%) values are calculated for All Movement Classes of All Heavy Vehicle Model Designation.

^d Dominant lane on roundabout approach

SIDRA INTERSECTION 6.1 | Copyright © 2000-2015 Akcelik and Associates Pty Ltd | sidrasolutions.com

Organisation: IBI GROUP | Processed: Tuesday, April 10, 2018 4:46:34 PM

Project: J:\115637_MeadowPh5TIA\5.7 Calculations\5.7.6 Roads (Trans)\SIDRA\Cambrian & Street 23 & Mattamy Site Access.sip6



The Meadows Phase 5

Transportation Impact Assessment Report

Appendix K: Technical Standards

April 2018



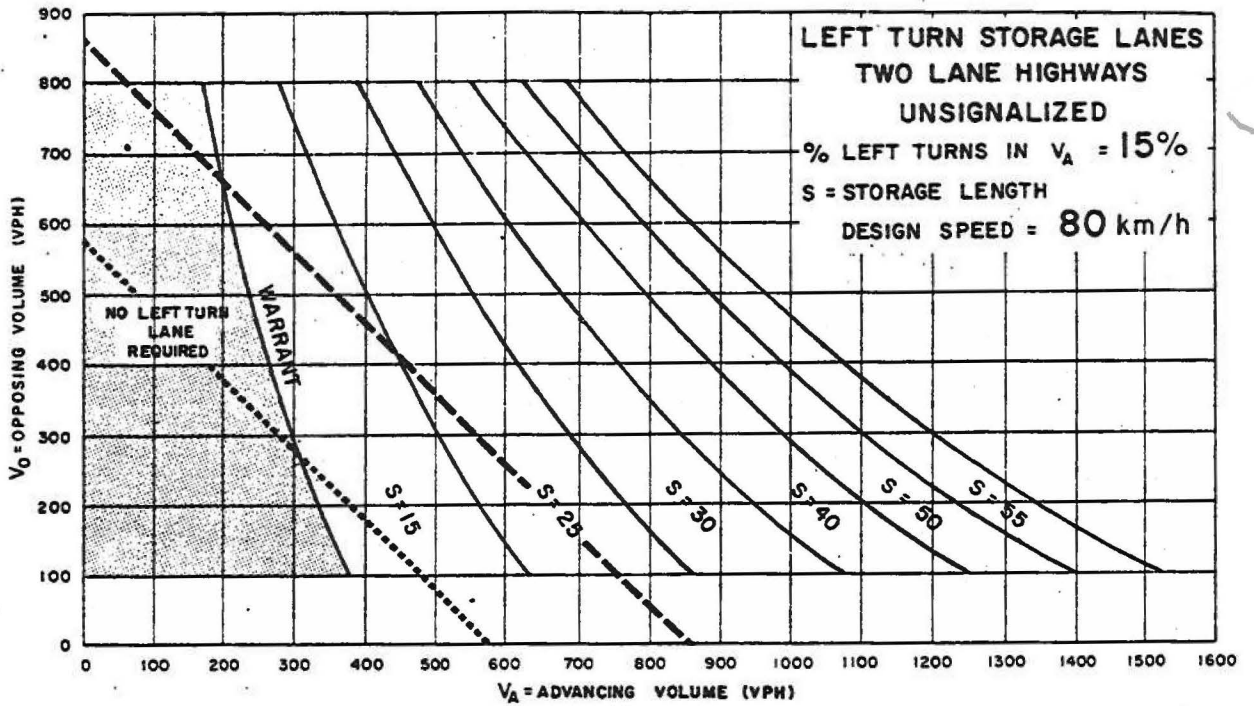

----- TRAFFIC SIGNALS MAY BE WARRANTED IN RURAL AREAS OR URBAN AREAS WITH RESTRICTED FLOW

..... TRAFFIC SIGNALS MAY BE WARRANTED IN "FREE FLOW" URBAN AREAS

Cambrian Rd & Street 23 - 2022 Total Traffic Condition
Westbound Left-turn

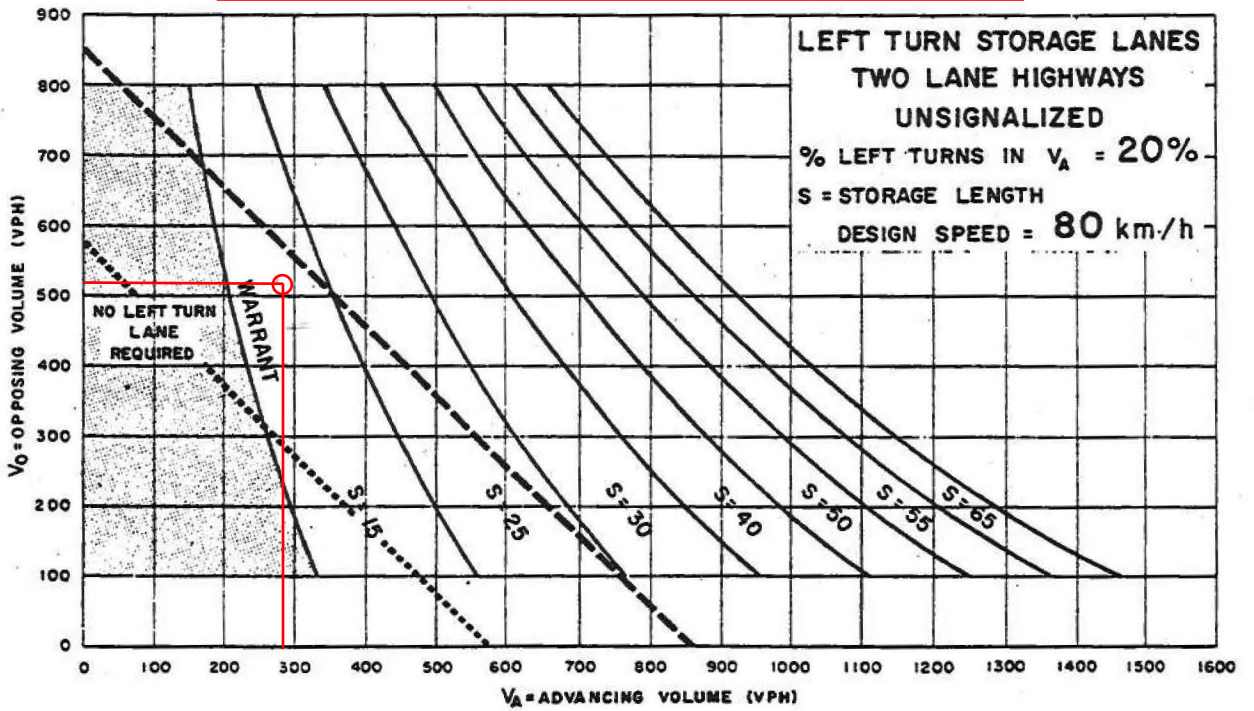
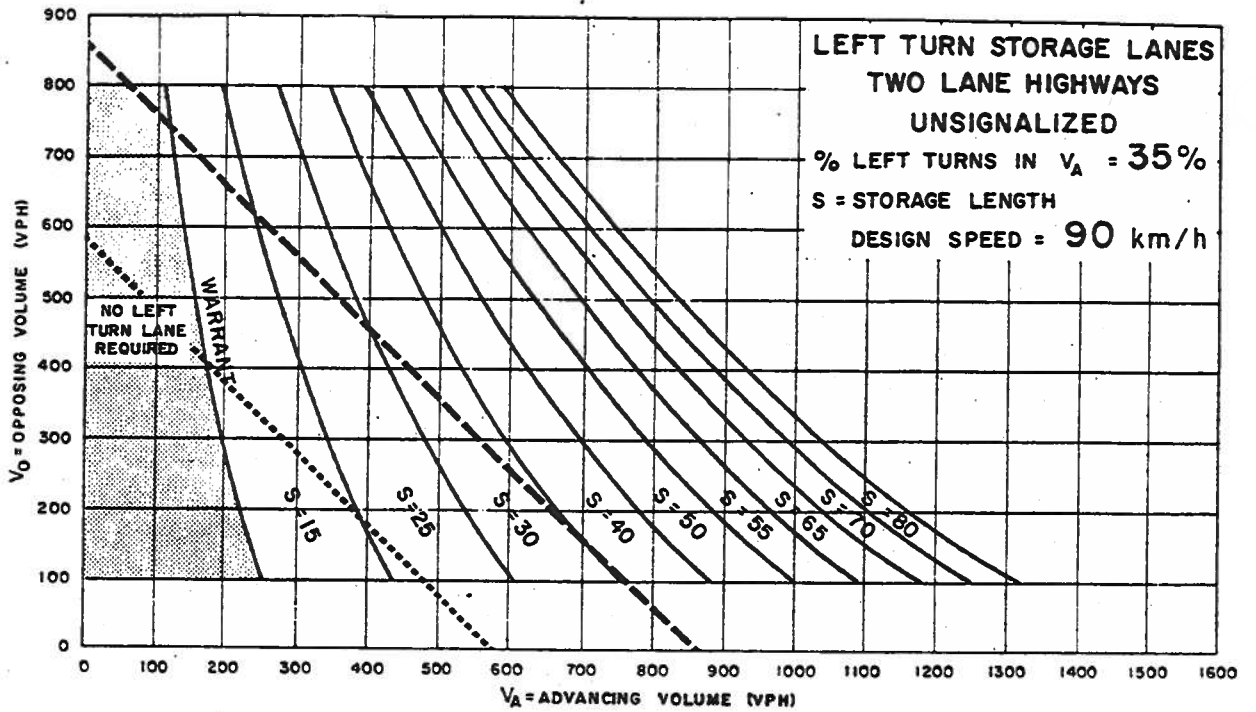

Figure EA-15



--- TRAFFIC SIGNALS MAY BE WARRANTED IN RURAL AREAS OR URBAN AREAS WITH RESTRICTED FLOW

..... TRAFFIC SIGNALS MAY BE WARRANTED IN "FREE FLOW" URBAN AREAS

Cambrian Road and Borrisokane Road SBL - 2027 Total Traffic Southbound Left-turn

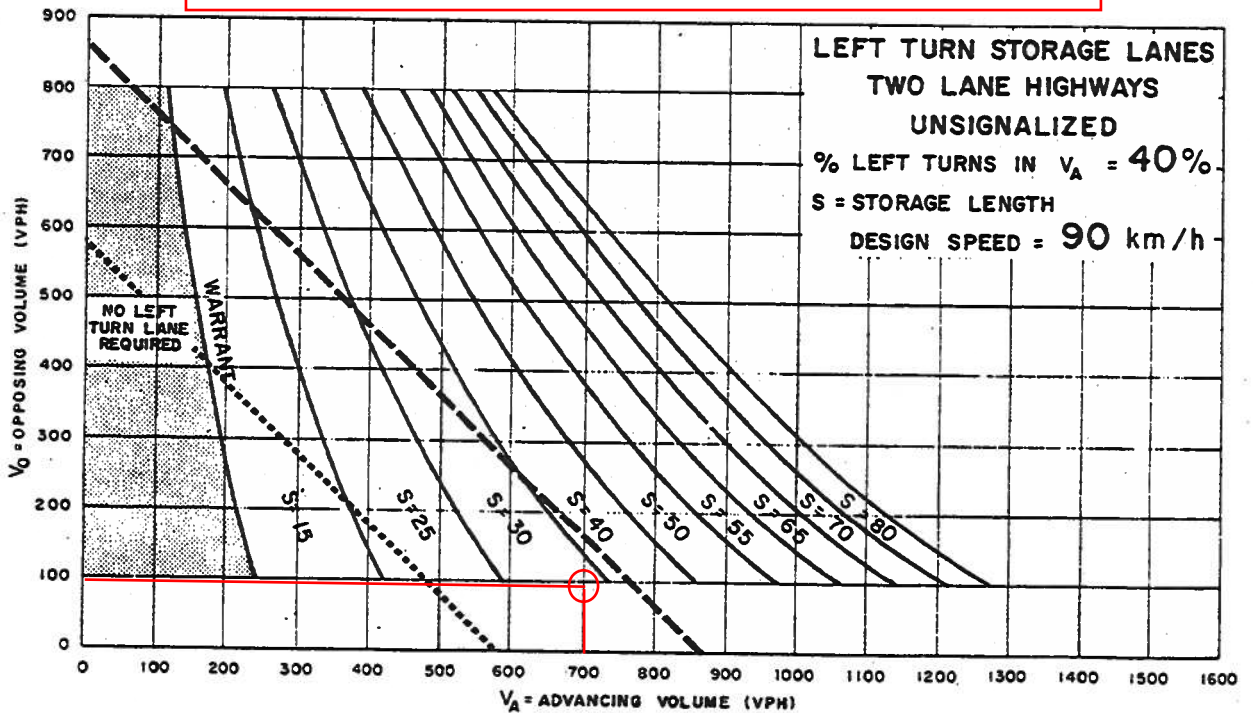

Figure EA-21