

Engineering

Land / Site
Development

Municipal
Infrastructure

Environmental /
Water Resources

Traffic /
Transportation

Structural

Recreational

Planning

Land / Site
Development

Planning Application
Management

Municipal Planning
Documents &
Studies

Expert Witness
(OMB)

Wireless Industry

Landscape Architecture

Urban Design &
Streetscapes

Open Space, Parks &
Recreation Planning

Community &
Residential
Developments

Commercial &
Institutional Sites

Environmental
Restoration



Provence Orléans Subdivision (Phase 6) 2065 Portobello Boulevard, Ottawa Transportation Impact Assessment

**Provence Orléans Subdivision (Phase 6)
2065 Portobello Boulevard**

Transportation Impact Assessment

Prepared By:

NOVATECH

Suite 200, 240 Michael Cowpland Drive
Ottawa, Ontario
K2M 1P6

Dated: October 2019
Revised: June 2020

Novatech File: 117155
Ref: R-2018-168

June 4, 2020

City of Ottawa
Planning and Growth Management Department
110 Laurier Ave. W., 4th Floor,
Ottawa, Ontario K1P 1J1

Attention: Mr. Mike Giampa
Senior Engineer, Infrastructure Applications

Dear Mr. Giampa:

Reference: Provence Orléans Subdivision (Phase 6)
Transportation Impact Assessment
Novatech File No. 117155

We are pleased to submit the following Transportation Impact Assessment (TIA) in support of a Draft Plan of Subdivision for Phase 6 of the Provence Orléans Subdivision (located at 2065 Portobello Boulevard), for your review and signoff. The structure and format of this report is in accordance with the City of Ottawa Transportation Impact Assessment Guidelines (June 2017).

A TIA was submitted to the City of Ottawa in November 2019 in support of a Draft Plan of Subdivision. This revised TIA has been prepared to reflect updates in the conceptual draft plan. The revised concept plan includes an increase of one residential townhouse. The previous Official Plan Amendment application to permit an increase in building height from four-storeys to six-storeys has been withdrawn by the proponent. As such, the proposal to develop four six-storey apartment buildings on the western vacant parcel of land is no longer being proposed. The parcel of land will be registered and zoned for future multi-unit residential development that will not exceed four storeys.

If you have any questions or comments regarding this report, please feel free to contact Jennifer Luong, or the undersigned.

Yours truly,

NOVATECH



Joshua Audia, B.Sc.
E.I.T. | Transportation/Traffic



TIA Plan Reports

On 14 June 2017, the Council of the City of Ottawa adopted new Transportation Impact Assessment (TIA) Guidelines. In adopting the guidelines, Council established a requirement for those preparing and delivering transportation impact assessments and reports to sign a letter of certification.

Individuals submitting TIA reports will be responsible for all aspects of development-related transportation assessment and reporting, and undertaking such work, in accordance and compliance with the City of Ottawa's Official Plan, the Transportation Master Plan and the Transportation Impact Assessment (2017) Guidelines.

By submitting the attached TIA report (and any associated documents) and signing this document, the individual acknowledges that s/he meets the four criteria listed below.

CERTIFICATION

1. I have reviewed and have a sound understanding of the objectives, needs and requirements of the City of Ottawa's Official Plan, Transportation Master Plan and the Transportation Impact Assessment (2017) Guidelines;
2. I have a sound knowledge of industry standard practice with respect to the preparation of transportation impact assessment reports, including multi modal level of service review;
3. I have substantial experience (more than 5 years) in undertaking and delivering transportation impact studies (analysis, reporting and geometric design) with strong background knowledge in transportation planning, engineering or traffic operations; and
4. I am either a licensed¹ or registered² professional in good standing, whose field of expertise [check appropriate field(s)] is either transportation engineering or transportation planning .

1,2 License of registration body that oversees the profession is required to have a code of conduct and ethics guidelines that will ensure appropriate conduct and representation for transportation planning and/or transportation engineering works.

City Of Ottawa
Infrastructure Services and Community
Sustainability
Planning and Growth Management
110 Laurier Avenue West, 4th fl.
Ottawa, ON K1P 1J1
Tel. : 613-580-2424
Fax: 613-560-6006

Ville d'Ottawa
Services d'infrastructure et Viabilité des
collectivités
Urbanisme et Gestion de la croissance
110, avenue Laurier Ouest
Ottawa (Ontario) K1P 1J1
Tél. : 613-580-2424
Télécopieur: 613-560-6006

Dated at Ottawa this 4th day of June, 2020.
(City)

Name: Jennifer Luong, P.Eng.
(Please Print)

Professional Title: Senior Project Manager, Transportation/Traffic



Signature of Individual certifier that s/he meets the above four criteria

| Office Contact Information (Please Print) | |
|--|---------------------------------------|
| Address: | 240 Michael Cowpland Drive, Suite 200 |
| City / Postal Code: | Ottawa, ON, K2M 1P6 |
| Telephone / Extension: | 613-254-9643 x 254 |
| E-Mail Address: | j.luong@novatech-eng.com |

TABLE OF CONTENTS

| | |
|--|-----------|
| EXECUTIVE SUMMARY | I |
| 1.0 INTRODUCTION..... | 1 |
| 2.0 PROPOSED DEVELOPMENT | 1 |
| 3.0 SCREENING..... | 3 |
| 3.1 SCREENING FORM | 3 |
| 4.0 SCOPING..... | 3 |
| 4.1 EXISTING CONDITIONS | 3 |
| 4.1.1 Roadways..... | 3 |
| 4.1.2 Intersections | 4 |
| 4.1.3 Driveways..... | 6 |
| 4.1.4 Pedestrian and Cycling Facilities | 6 |
| 4.1.5 Area Traffic Management | 6 |
| 4.1.6 Transit | 8 |
| 4.1.7 Existing Traffic Volumes | 9 |
| 4.1.8 Collision Records..... | 9 |
| 4.2 PLANNED CONDITIONS | 11 |
| 4.3 STUDY AREA AND TIME PERIODS | 11 |
| 4.4 EXEMPTIONS REVIEW..... | 11 |
| 5.0 FORECASTING | 13 |
| 5.1 DEVELOPMENT-GENERATED TRAVEL DEMAND..... | 13 |
| 5.1.1 Trip Generation..... | 13 |
| 5.1.2 Trip Distribution..... | 17 |
| 5.1.3 Trip Assignment..... | 17 |
| 5.2 BACKGROUND TRAFFIC | 17 |
| 5.2.1 General Background Growth Rate | 17 |
| 5.2.2 Other Area Developments | 18 |
| 6.0 ANALYSIS..... | 25 |
| 6.1 DEVELOPMENT DESIGN | 25 |
| 6.1.1 Road Network..... | 25 |
| 6.1.2 Roadway Cross-Sections..... | 25 |
| 6.1.3 Pedestrian Crossovers..... | 26 |
| 6.2 BOUNDARY STREETS | 27 |
| 6.2.1 Pedestrian Level of Service (PLOS)..... | 27 |
| 6.2.2 Bicycle Level of Service (BLOS) | 28 |
| 6.2.3 Transit Level of Service (TLOS)..... | 28 |
| 6.2.4 Truck Level of Service (TkLOS) | 29 |
| 6.2.5 Vehicular Level of Service (Auto LOS)..... | 29 |
| 6.2.6 Segment MMLOS Summary | 29 |
| 6.3 ACCESS INTERSECTIONS DESIGN..... | 32 |
| 6.4 TRANSPORTATION DEMAND MANAGEMENT | 33 |
| 6.5 NEIGHBOURHOOD TRAFFIC MANAGEMENT..... | 33 |
| 6.6 TRANSIT | 34 |
| 6.7 INTERSECTION DESIGN..... | 35 |

| | | |
|------------|---|-----------|
| 6.7.1 | Existing Intersection Operations | 35 |
| 6.7.2 | 2020 Background Intersection Operations | 35 |
| 6.7.3 | 2025 Background Intersection Operations | 36 |
| 6.7.4 | 2020 Total Intersection Operations | 36 |
| 6.7.5 | 2025 Total Intersection Operations | 37 |
| 7.0 | CONCLUSIONS AND RECOMMENDATIONS | 37 |

Figures

| | | |
|------------|---|----|
| Figure 1: | View of the Subject Site | 2 |
| Figure 2: | Trans-Orléans Pathway Functional Design | 7 |
| Figure 3: | OC Transpo Bus Stop Locations | 8 |
| Figure 4: | Existing Network Traffic Volumes | 10 |
| Figure 5: | Proposed Site-Generated Traffic, Phase 6 | 18 |
| Figure 6: | Site-Generated Traffic, Phase 1 | 19 |
| Figure 7: | Site-Generated Traffic, Phases 2-5 | 20 |
| Figure 8: | 2020 Background Traffic | 21 |
| Figure 9: | 2025 Background Traffic | 22 |
| Figure 10: | 2020 Total Traffic | 23 |
| Figure 11: | 2025 Total Traffic | 24 |
| Figure 12: | Pathways and Linkages Plan | 26 |
| Figure 13: | Desirable Cycling Facility Pre-Selection Nomograph..... | 32 |

Tables

| | | |
|-----------|---|----|
| Table 1: | AADT of Boundary Streets | 9 |
| Table 2: | Reported Collisions | 10 |
| Table 3: | TIA Exemptions | 12 |
| Table 4: | Proposed Residential Vehicle Trip Generation | 13 |
| Table 5: | Proposed Residential Person Trip Generation..... | 14 |
| Table 6: | Person Trips by Modal Share | 16 |
| Table 7: | PLOS Segment Analysis | 27 |
| Table 8: | BLOS Segment Analysis | 28 |
| Table 9: | TLOS Segment Analysis | 28 |
| Table 10: | TkLOS Segment Analysis..... | 29 |
| Table 11: | Auto LOS Segment Analysis | 29 |
| Table 12: | Segment MMLOS Summary..... | 30 |
| Table 13: | Existing Traffic – Intersection Operations | 35 |
| Table 14: | 2020 Background Traffic – Intersection Operations | 35 |
| Table 15: | 2025 Background Traffic – Intersection Operations | 36 |
| Table 16: | 2020 Total Traffic – Intersection Operations | 36 |
| Table 17: | 2025 Total Traffic – Intersection Operations | 37 |

Appendices

- Appendix A: Concept Plan
- Appendix B: TIA Screening Form
- Appendix C: Provence Avenue Area Traffic Management Options
- Appendix D: OC Transpo Route Maps
- Appendix E: Traffic Count Data
- Appendix F: Collision Records
- Appendix G: Notting Hill Subdivision Excerpts
- Appendix H: TDM Measures Checklist
- Appendix I: Synchro Analysis

EXECUTIVE SUMMARY

This Transportation Impact Assessment (TIA) has been prepared in support of a Draft Plan of Subdivision for the lands located at 2065 Portobello Boulevard. The approximately 11.1-hectare site is currently undeveloped. The proposed subdivision is considered the sixth phase of the 'Provence Orléans Subdivision' (formerly referred to as the 'Notting Hill Subdivision' or 'Legault Lands').

This TIA was originally submitted in November 2019, and considered a total of 48 single-detached homes, 61 townhomes, 312 apartment units, and a park. Following the initial application submission, and through ongoing consultation with local community members, the four six-storey apartment buildings proposed on the parcel of land fronting Portobello Boulevard have been removed from the current application. Future multi-unit residential development with a maximum of four storeys is intended for the vacant parcel of land, and will be subject to a future Site Plan application.

The analysis of this revised TIA has not been adjusted from the previous submission, as it represents the most conservative analysis. Compared to the previous submission, the proposed draft plan includes one additional townhome, as well as the previously described replacement of the mid-rise apartment block with a future multi-unit residential development.

The proposed subdivision is designated as General Urban Area and Urban Natural Features on Schedule B of the City of Ottawa's Official Plan. The implemented zoning for the property is Development Reserve (DR), Parks and Open Space (O1), and Environmental Protection (EP). The DR Zone acts as a placeholder to limit permitted uses to those which will not preclude future development options before studies have been completed and approved. There are no Secondary Plans or Community Design Plans applicable to the proposed subdivision.

Phase 6 of the proposed subdivision will include 421 dwellings at full buildout, with an anticipated buildout year of 2020. The entire six phases of the subdivision are anticipated to be fully built out by 2025. Connections from the subdivision to the existing road network are proposed at Grapefern Terrace/Plainridge Crescent West, Grapefern Terrace/Plainridge Crescent East, and Nantes Street/Brianna Way.

The study area for this report includes Portobello Boulevard, Provence Avenue, Aquaview Drive, Nantes Street, Brianna Way, Plainhill Drive, Plainridge Crescent, and Grapefern Terrace. The study area includes the intersections at Portobello Boulevard/Aquaview Drive/Nantes Street, Nantes Street/Brianna Way, Provence Avenue/Plainhill Drive, and Provence Avenue/Grapefern Terrace. The selected time periods for the analysis are the weekday AM and PM peak hours, as they represent the 'worst case' combination of site generated traffic and adjacent street traffic. The proposed development is expected to be completed in one phase, with full occupancy by the year 2020. The ultimate buildout of the entire Provence Orléans subdivision is anticipated in 2025. Therefore, this TIA will perform analysis for the weekday AM and PM peak hours in the buildout year 2020 and the horizon year 2025.

The conclusions and recommendations of this TIA can be summarized as follows:

Forecasting

- Phase 6 of the proposed subdivision is projected to generate approximately 327 person trips during the AM peak hour and 398 person trips during the PM peak hour, which includes 180 vehicle trips during the AM peak hour and 218 vehicle trips during the PM peak hour.

Development Design

- Street No. 11 and the remainder of Plainridge Crescent have a proposed ROW width of 18m and a proposed roadway width of 8.5m, which is sufficient for a travel lane in each direction and parking on one side. This is adequate given the context of the proposed development, a low-speed residential neighbourhood with limited opportunity for cut-through traffic.
- 1.8m concrete sidewalks are proposed on the east side of Street No. 11 between Nantes Street and the first residential lot, on the west side of Street No. 11 between Nantes Street and the future transitway, and on the inside of Street No. 11 and Plainridge Crescent between Grapefern Terrace and the northeast corner of the Lalande park.
- A PXO has recently been implemented at the north approach of Provence Avenue/Grapefern Terrace, as part of the Trans-Orléans Pathway project. There are no other candidate locations for a PXO within Phase 6 of the subdivision.

Boundary Streets

- The results of the segment MMLOS analysis can be summarized as follows:
 - Provence Avenue meets the target pedestrian level of service (PLOS), while Portobello Boulevard, Nantes Street, and Grapefern Terrace do not;
 - Portobello Boulevard, Nantes Street, and Grapefern Terrace meet the target bicycle level of service (BLOS), while Provence Avenue does not;
 - No roadways have targets for transit level of service (TLOS), however Portobello Boulevard and Provence Avenue achieve a TLOS D;
 - No roadways have targets for truck level of service (TkLOS), however Portobello Boulevard and Provence Avenue achieve a TkLOS B or better;
 - All roadways meet the target vehicular level of service (Auto LOS).
- The PLOS of Portobello Boulevard can be improved to the target PLOS A by implementing a 0.5m sidewalk boulevard while maintaining a 2.0m-wide sidewalk on the east side, and implementing a 1.8m-wide sidewalk while maintaining a 2.0m sidewalk boulevard. As it is still early in the life cycle of the sidewalk, and the existing cross-section of Portobello Boulevard met the City standard when it was widened approximately 10 years ago, widening this sidewalk to meet the target PLOS is not considered reasonable.
- The PLOS of Nantes Street can be improved to the target PLOS A by implementing sidewalks with a minimum width of 2.0m and a minimum boulevard width of 0.5m on the south side of the roadway. As the existing cross-section meets the current City standards, no modifications are recommended.

- The PLOS of Grapefern Terrace can be improved to the target PLOS A by implementing sidewalks with a minimum width of 2.0m and a minimum boulevard width of 0.5m on both sides of the roadway. A sidewalk was not deemed to be required as part of the Trans-Orléans Pathway project. As it is a short residential street and the existing cross-section meets the current City standards, no modifications are recommended.
- The *Ontario Traffic Manual – Book 18* identifies a shared roadway as suitable on Provence Avenue, given the low traffic volumes. As part of the Trans-Orléans Pathway, 1.5m-wide bike lanes have been proposed on Provence Avenue between Grapefern Terrace and Scala Avenue. This implementation would improve the BLOS of Provence Avenue to a BLOS C. Further improvement of the bicycle level of service requires a reduction in the operating speed.

Access Intersections

- Phase 6 of the proposed subdivision will be served by three accesses. The two sections of Plainridge Crescent will be connected in a loop as part of the Phase 6 development. A full-movement access on Street No. 11 will tie in to the intersection of Nantes Street/Brianna Way, making it a four-legged intersection.
- Among the two intersections at Grapefern Terrace/Plainridge Crescent West and Grapefern Terrace/Plainridge Crescent East, neither are anticipated to meet the OTM or City criteria for all-way stop control. Therefore, no changes to the stop control locations are recommended (Grapefern Terrace is stop-controlled at Grapefern Terrace/Plainridge Crescent West, and Plainridge Crescent is stop-controlled at Grapefern Terrace/Plainridge Crescent East).
- The intersection of Nantes Street/Brianna Way is currently all-way stop controlled. No changes are recommended upon construction of the Street No. 11 access.

Transportation Demand Management

- The following TDM measures will be implemented as Phase 6 of the subdivision is built:
 - Designate an internal TDM program coordinator;
 - Display local area maps with walking/cycling routes and key destinations (at sales centre);
 - Display relevant transit schedules and route maps (at sales centre);
 - Provide multimodal travel option information packages to new residents (at sales centre).
- Applicable measures for the multi-unit block are included in the list above.

Neighbourhood Traffic Management

- Provence Avenue, Plainhill Drive, and Grapefern Terrace are not anticipated to exceed their respective two-way peak hour volume thresholds for considering an NTM plan. While Portobello Boulevard and Nantes Street are anticipated to exceed their respective two-way peak hour volume thresholds for considering an NTM plan, the addition of development-generated traffic is not anticipated to change the function of those roadways.

Transit

- Phase 6 of the proposed subdivision is projected to generate 66 transit trips during the AM peak hour and 80 transit trips during the PM peak hour. Based on the projected passenger volumes and correspondence with OC Transpo confirming new bus routes on Provence Avenue as the proposed subdivision develops, no capacity problems are anticipated on the bus routes 33 and 233, which serve the stops adjacent to the proposed Phase 6 development.

Intersection Design

- Based on existing traffic conditions, all study area intersections operate at an Auto LOS A. Under the background and total traffic conditions, all intersections are anticipated to continue operating acceptably. Only the southbound left turn movement at Portobello Boulevard/Aquaview Drive/Nantes Street is projected to downgrade to an Auto LOS B, as a result of site-generated traffic.
- Based on the foregoing, Phase 6 of the proposed subdivision is recommended from a transportation perspective.

1.0 INTRODUCTION

This Transportation Impact Assessment (TIA) has been prepared in support of a Draft Plan of Subdivision for the lands located at 2065 Portobello Boulevard. The approximately 11.1-hectare site is currently undeveloped.

The proposed subdivision is considered the sixth phase of the 'Provence Orléans Subdivision' (formerly referred to as the 'Notting Hill Subdivision' or 'Legault Lands'). A TIA was submitted in July 2018 and revised in November 2018, in support of a Draft Plan of Subdivision for Phases 1-5, and will be referenced throughout this report (City File No. D07-16-18-0021). This TIA was originally submitted in November 2019, and considered a total of 48 single-detached homes, 61 townhomes, 312 apartment units, and a park. Following the initial application submission, and through ongoing consultation with local community members, the four six-storey apartment buildings proposed on the parcel of land fronting Portobello Boulevard have been removed from the current application. Future multi-unit residential development with a maximum of four storeys is intended for the vacant parcel of land, and will be subject to a future Site Plan application.

The analysis of this revised TIA has not been adjusted from the previous submission, as it represents the most conservative analysis. Compared to the previous submission, the proposed draft plan includes one additional townhome, as well as the previously described replacement of the mid-rise apartment block with a future multi-unit residential development.

The subject site is surrounded by the following:

- Residences and a future transitway to the north;
- Provence Avenue, residences, a future school, and parkland to the east;
- Nantes Street, Grapefern Terrace, residences, a school, and parkland to the south;
- Portobello Boulevard and future residences to the west.

A view of the subject site is provided in **Figure 1**.

2.0 PROPOSED DEVELOPMENT

The proposed subdivision is designated as General Urban Area and Urban Natural Features on Schedule B of the City of Ottawa's Official Plan. The implemented zoning for the property is Development Reserve (DR), Parks and Open Space (O1), and Environmental Protection (EP). The DR Zone acts as a placeholder to limit permitted uses to those which will not preclude future development options before studies have been completed and approved. There are no Secondary Plans or Community Design Plans applicable to the proposed subdivision.

For the purposes of analysis, Phase 6 of the proposed subdivision will include a park and 421 dwellings at full buildout, consisting of 48 single-detached homes, 61 townhomes, and 312 apartment units, with an anticipated buildout year of 2020. As stated in the previous section, the four six-storey apartment buildings proposed on the parcel of land fronting Portobello Boulevard have been removed from the current application. Future multi-unit residential development with a maximum of four storeys is intended for the vacant parcel of land, and will be subject to a future Site Plan application. The entire six phases of the subdivision are anticipated to be fully built out by 2025.

Connections from Phase 6 of the Provence Orléans subdivision to the existing road network are proposed at Grapefern Terrace/Plainridge Crescent West, Grapefern Terrace/Plainridge Crescent East, and Nantes Street/Brianna Way.

A copy of the conceptual draft plan is included in **Appendix A**.

Figure 1: View of the Subject Site



3.0 SCREENING

3.1 Screening Form

The City's 2017 TIA Guidelines identify three triggers for completing a TIA report, including trip generation, location, and safety. The criteria for each trigger are outlined in the City's TIA Screening Form, which is included in **Appendix B**. The trigger results are as follows:

- Trip Generation Trigger – The development is anticipated to generate over 60 person trips/peak hour; further assessment is required based on this trigger.
- Location Triggers – The development does not propose a driveway to a boundary street that is designated as part of the City's Transit Priority, Rapid Transit, or Spine Bicycle Networks (a future rapid transit corridor is adjacent); further assessment is not required based on this trigger.
- Safety Triggers – None of the safety trigger criteria have been met; further assessment is not required based on this trigger.

4.0 SCOPING

4.1 Existing Conditions

4.1.1 Roadways

All roadways within the study area fall under the jurisdiction of the City of Ottawa.

Portobello Boulevard is a major collector roadway that generally runs on a north-south alignment between Trim Road and Brian Coburn Boulevard. South of Brian Coburn Boulevard, Portobello Boulevard continues as a major collector roadway before terminating approximately 880m south of Brian Coburn Boulevard. Within the study area, Portobello Boulevard has a four-lane divided urban cross-section with bike lanes, and sidewalks on both sides of the roadway. The posted speed limit is 50 km/h, with a reduction to 40 km/h on school days (from 7:00am-9:30am and 2:00pm-5:00pm). Portobello Boulevard is not classified as a truck route. Street parking is not permitted.

Provence Avenue is a collector roadway that generally runs on a north-south alignment between Valin Street and Brian Coburn Boulevard. Within the study area, Provence Avenue has a two-lane undivided urban cross-section, sidewalks on both sides of the roadway, and a posted speed limit of 50 km/h. Provence Avenue is not classified as a truck route. Street parking is permitted. The ROW at the subject site is variable, ranging from approximately 26m at the northern and southern extents and approximately 56.5m at the future transitway.

Aquaview Drive is a collector roadway that runs east-west at the intersection with Portobello Boulevard, before curving into a north-south alignment and terminating at Brian Coburn Boulevard (approximately 370m east of Tenth Line Road). East of Portobello Boulevard, the roadway continues as Nantes Street. Within the study area, Aquaview Drive has a two-lane undivided urban cross-section, a multi-use pathway on the north side and sidewalk on the south side of the roadway, and a posted speed limit of 50 km/h. Aquaview Drive is not classified as a truck route. Street parking is permitted.

Nantes Street is a collector roadway that runs east-west at the intersection with Portobello Boulevard, before curving into a north-south alignment and terminating at Brian Coburn Boulevard (approximately 310m west of Provence Avenue). West of the intersection of Portobello Boulevard, the roadway continues as Aquaview Drive. Within the study area, Nantes Street has a two-lane undivided urban cross-section, a multi-use pathway on the north side of the roadway, and a posted speed limit of 40 km/h. As a temporary traffic calming device, flex posts have been installed on either side of the school zone on Nantes Street. Nantes Street is not classified as a truck route. Street parking is restricted on the south side of the roadway between Portobello Boulevard and Bérot Lane.

Brianna Way is a local roadway that runs on a north-south alignment between Nantes Street and Martello Drive. Within the study area, Brianna Way has a two-lane undivided urban cross-section, no sidewalks, and an unposted regulatory speed limit of 50 km/h under the Highway Traffic Act. Brianna Way is not classified as a truck route. Street parking is permitted.

Plainhill Drive is a local roadway that runs east-west at the intersections of Montmere Avenue and Provence Avenue, before curving into a north-south alignment and continuing as Comfrey Crescent at the intersection with Ivany Way. Within the study area, Plainhill Drive has a two-lane undivided urban cross-section, sidewalk on the north/west side of the roadway, and an unposted regulatory speed limit of 50 km/h. Plainhill Drive is not classified as a truck route. Street parking is permitted.

Plainridge Crescent is a local roadway that runs in two parallel north-south sections. The western section starts from Plainhill Drive and terminates approximately 30m north of Grapefern Terrace, while the eastern section starts approximately 60m east at Grapefern Terrace and terminates 170m north of Grapefern Terrace. Upon completion of the proposed subdivision, the two sections will connect at the northern end and form a loop. Within the study area, Plainridge Crescent has a two-lane undivided urban cross-section, no sidewalks, and an unposted regulatory speed limit of 50 km/h. Plainridge Crescent is not classified as a truck route. Street parking is permitted.

Grapefern Terrace is a local roadway that runs on an east-west alignment between Provence Avenue and Plainridge Crescent. Within the study area, Grapefern Terrace has a two-lane undivided urban cross-section, no sidewalks, and an unposted regulatory speed limit of 50 km/h. Grapefern Terrace is not classified as a truck route. Street parking is permitted.

4.1.2 Intersections

Portobello Boulevard/ Aquaview Drive/Nantes Street

- Unsignalized four-legged intersection
- All-way stop-controlled
- Northbound/Southbound: one shared left turn/through lane and one shared through/right turn lane
- Eastbound/Westbound: one shared left turn/through/right turn lane
- Bike lanes on northbound and southbound approaches



Nantes Street/Brianna Way

- Unsignalized three-legged intersection
- All-way stop-controlled
- Northbound: one shared left turn/right turn lane
- Eastbound: one shared through/right turn lane
- Westbound: one shared left turn/through lane



Provence Avenue/Grapefern Terrace

- Unsignalized four-legged intersection
- Minor street stop-controlled
- All approaches: one shared left turn/through/right turn lane
- Pedestrian crossover (PXO) at north approach

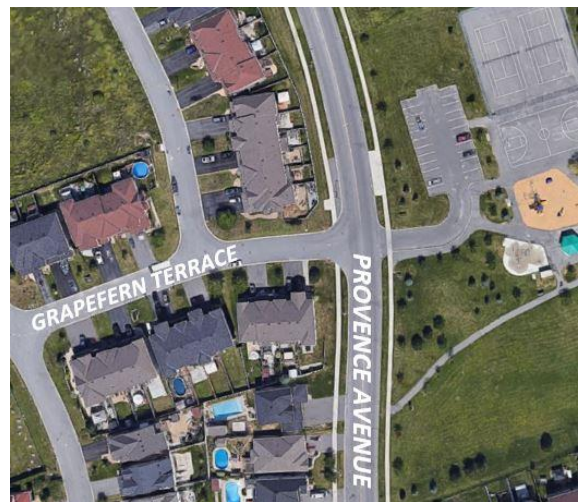

Provence Avenue/Plainhill Drive

- Unsignalized four-legged intersection
- All-way stop-controlled
- All approaches: one shared left turn/through/right turn lane



4.1.3 Driveways

Within 200m of the proposed accesses to the subdivision, there are accesses to multiple schools, which are identified as follows:

- Avalon Public School (accesses on Aquaview Drive and Portobello Boulevard);
- Des Sentiers Elementary School (access on Nantes Street).

In addition, an access to Provence Park is provided at the intersection of Provence Avenue/Grapefern Terrace. All existing residences are accessed via local roadways, Nantes Street, and Provence Avenue.

4.1.4 Pedestrian and Cycling Facilities

Concrete sidewalks are provided on both sides of Portobello Boulevard and Provence Avenue. Concrete sidewalks are provided on the north side of Plainhill Drive and the south side of Aquaview Drive. A PXO is provided at the north approach of Provence Avenue/Grapefern Terrace.

Multi-use pathways are provided on the north side of Aquaview Drive and Nantes Street, (adjacent to the Provence Orléans subdivision), and through Lalande Conservation Park, connecting Grapefern Terrace to Nantes Street and Des Sentiers Elementary School.

In the City of Ottawa's primary cycling network, Portobello Boulevard, Provence Avenue, Aquaview Drive, and Nantes Street are designated as Local Routes. Bike lanes are provided on Portobello Boulevard.

Construction of the Trans-Orléans Pathway, an asphalt multi-use pathway from Liska Street to Trim Road, has recently been completed. The pathway extends along the south limit of the Provence Orléans subdivision between Trim Road and Provence Avenue, connecting to Grapefern Terrace. It continues west along the north side of Aquaview Drive/Nantes Street to the transitway corridor, and connects to the RioCan Shopping Centre at Innes Road/Tenth Line Road, the Hydro corridor, and Liska Street. The pathway is designated as a Community Connectivity initiative project, which complements the Ottawa Cycling Plan. The relevant section of the Trans-Orléans Pathway Functional Design is shown in **Figure 2**.

4.1.5 Area Traffic Management

An Area Traffic Management (ATM) study for Provence Avenue between Valin Street and Brian Coburn Boulevard began in July 2018. The purpose of this study was to address community concerns regarding traffic on Provence Avenue, with speeding being the primary concern among local residents. The recommended plan, which was approved in November 2019 with construction forecasted to take place in 2021, includes curb-radii reductions, midblock and intersection narrowings, and pavement markings. Within the study area, this includes intersection narrowings at Provence Avenue/Plainhill Drive and edge line markings on Provence Avenue.

The recommended plan is included in **Appendix C**.

Figure 2: Trans-Orleans Pathway Functional Design

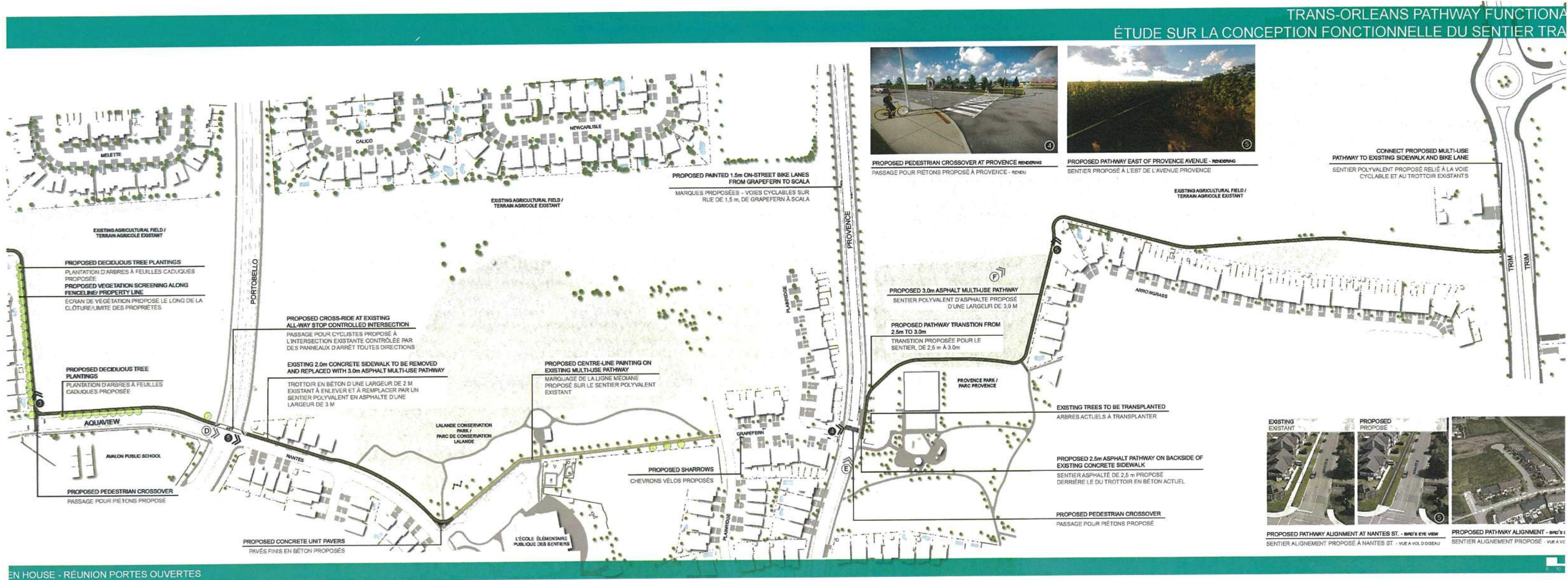

4.1.6 Transit

The nearest bus stops to the subject site are as follows:

Portobello Boulevard/Aquaview Drive/Nantes Street

- Stop #1367 – for routes 33 and 233 (located at the northwest corner)
- Stop #6314 – for routes 33 and 233 (located at the northeast corner)

Locations of these bus stops are shown in **Figure 3**.

Figure 3: OC Transpo Bus Stop Locations



OC Transpo Route 33 travels between the Blair O-Train Station and Portobello/Summer Sky. During the weekday peak periods, the route operates every 15 minutes from Portobello/Summer Sky toward Blair Station between 5:30am and 9:00am, and every 15 minutes from Blair Station to Portobello/Summer Sky between 4:00pm and 7:00pm. Additionally, the route operates every 30 minutes or longer between Blair Station and Portobello/Summer Sky from 7:00am to 11:00pm. The route does not operate on weekends.

OC Transpo Route 233 travels between either the Blair O-Train Station and Portobello/Summer Sky. During the weekday peak periods, the route operates every 30 minutes from Portobello/Summer Sky toward Blair Station between 6:30am and 7:30am, and every 30 minutes from Blair Station toward Portobello/Summer Sky between 4:30pm and 6:00pm. This route does not operate outside of these hours, and does not operate on weekends.

OC Transpo maps for the routes outlined above and a copy of the OC Transpo System Map are included in **Appendix D**.

4.1.7 Existing Traffic Volumes

Weekday traffic counts completed by the City of Ottawa and Novatech were used to determine the existing pedestrian, cyclist, and vehicular traffic volumes at the study area intersections. The traffic counts were completed on the following dates:

- Portobello Boulevard/Aquaview Drive/Nantes Street May 25, 2017
- Nantes Street/Brianna Way December 18, 2018
- Provence Avenue/Grapefern Terrace July 23, 2014
- Provence Avenue/Plainhill Drive January 22, 2014

The average annual daily traffic (AADT) of the boundary collector roadways are based on the most recent traffic counts, and shown in **Table 1**. Traffic count data is included in **Appendix E**.

Table 1: AADT of Boundary Streets

| Roadway | Road Class | AADT |
|----------------------|-----------------|-----------|
| Portobello Boulevard | Major Collector | 3,890 vpd |
| Provence Avenue | Collector | 850 vpd |
| Nantes Street | Collector | 2,280 vpd |

As the traffic count at Provence Avenue/Grapefern Terrace did not take place during the school year (July 2014), the northbound and southbound through movements at Provence Avenue/Grapefern Terrace have been adjusted to reflect the higher traffic volumes shown in the Provence Avenue/Plainhill Drive count (January 2014). Traffic volumes within the study area are shown in **Figure 4**.

4.1.8 Collision Records

Historical collision data from the last five years was obtained from the City's Public Works and Service Department for the study area intersections. Copies of the collision summary reports are included in **Appendix F**.

The collision data has been evaluated to determine if there are any identifiable collision patterns. The number of collisions at each intersection from January 1, 2013 to December 31, 2017 is summarized in **Table 2**.

Figure 4: Existing Network Traffic Volumes

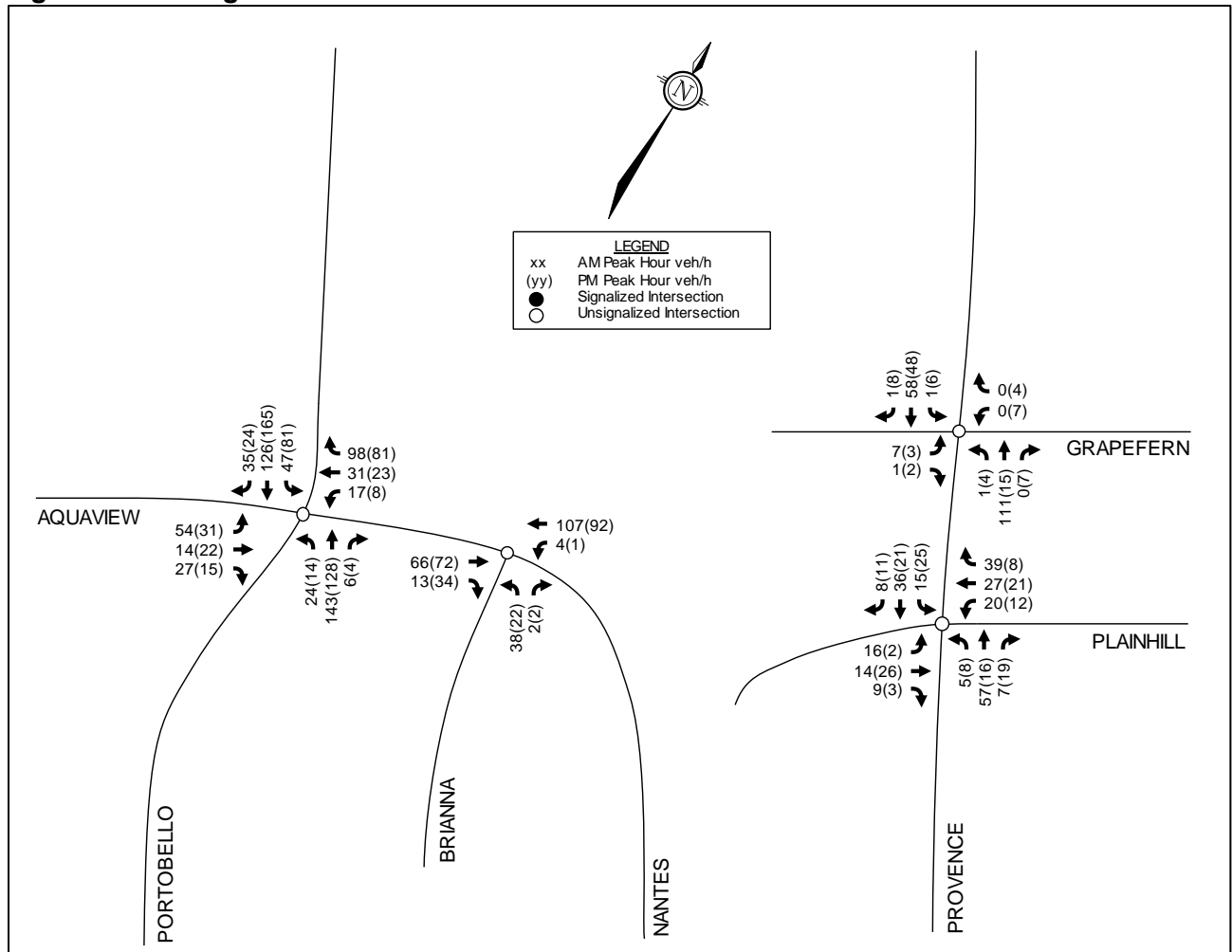

Table 2: Reported Collisions

| Intersection | Number of Reported Collisions |
|---|-------------------------------|
| Portobello Boulevard/Aquaview Drive/Nantes Street | 4 |
| Nantes Street/Brianna Way | 0 |
| Provençe Avenue/Grapefern Terrace | 0 |
| Provençe Avenue/Plainhill Drive | 0 |

Portobello Boulevard/Aquaview Drive/Nantes Street

A total of four collisions were reported at this intersection over the last five years, of which there was one rear-end impact, two angle impacts, and one single-vehicle/other impact involving a pedestrian. Two of the collisions caused injuries, but none caused fatalities.

4.2 Planned Conditions

The City of Ottawa's 2013 Transportation Master Plan (TMP) does not identify any upcoming roadway projects within the study area in its Affordable Road Network. The widening of Trim Road between North Service Road and Innes Road has been completed.

The Blackburn Hamlet Bypass Extension is identified as a Phase 2 project (2020-2025) under the Affordable Road Network, and includes a new four-lane road between Innes Road and Navan Road. The Brian Coburn Boulevard Extension is identified under the 2031 Network Concept, and includes a new two-lane roadway (ultimately four-lane) between Trim Road and Frank Kenny Road. Trim Road is also identified as a widened arterial roadway from Millennium Boulevard to Brian Coburn Boulevard under the Network Concept.

The Blackburn Hamlet Bypass and Brian Coburn Boulevard extensions will provide a major parallel arterial route south of Innes Road, and may provide some relief to the eastbound/westbound through traffic volumes on Innes Road.

The Affordable Rapid Transit and Transit Priority (RTTP) Network identifies Innes Road and Brian Coburn Boulevard west of Tenth Line Road as Transit Priority Corridors with Isolated Measures. Transit signal priority and queue jump lanes will be implemented at select intersections. Peak period bus lanes and transit signal priority are identified for the Blackburn Hamlet Bypass between Innes Road and Brian Coburn Boulevard, which may include the repurposing of general purpose lanes. The RTTP 2031 Network Concept identifies at-grade crossings throughout the study area for the Cumberland Transitway, with an underpass at Trim Road. A corridor for the proposed transitway has been reserved by the City of Ottawa. Grade separated crossings are identified between Blair Station and Tenth Line Road.

The 2013 Ottawa Cycling Plan does not identify any projects within the study area. Construction of the Trans-Orléans Pathway is designated as a Community Connectivity initiative, projects which complement the Ottawa Cycling Plan.

4.3 Study Area and Time Periods

The study area for this report includes Portobello Boulevard, Provence Avenue, Aquaview Drive, Nantes Street, Brianna Way, Plainhill Drive, Plainridge Crescent, and Grapefern Terrace. The study area includes the intersections at Portobello Boulevard/Aquaview Drive/Nantes Street, Nantes Street/Brianna Way, Provence Avenue/Plainhill Drive, and Provence Avenue/Grapefern Terrace.

The selected time periods for the analysis are the weekday AM and PM peak hours, as they represent the 'worst case' combination of site generated traffic and adjacent street traffic. The proposed development is expected to be completed in one phase, with full occupancy by the year 2020. The ultimate buildout of the entire Provence Orléans subdivision is anticipated in 2025. Therefore, this TIA will perform analysis for the weekday AM and PM peak hours in the buildout year 2020 and the horizon year 2025.

4.4 Exemptions Review

This module reviews possible exemptions from the final Transportation Impact Assessment, as outlined in the TIA guidelines. The applicable exemptions for this site are shown in **Table 3**.

Table 3: TIA Exemptions

| Module | Element | Exemption Criteria | Exemption Status |
|--|----------------------------------|--|------------------|
| Design Review Component | | | |
| 4.1 Development Design | 4.1.2 Circulation and Access | • Only required for site plans | Exempt |
| | 4.1.3 New Street Networks | • Only required for plans of subdivision | Not Exempt |
| 4.2 Parking | 4.2.1 Parking Supply | • Only required for site plans | Exempt |
| | 4.2.2 Spillover Parking | • Only required for site plans where parking supply is 15% below unconstrained demand | Exempt |
| Network Impact Component | | | |
| 4.5 Transportation Demand Management | <i>All elements</i> | • Not required for non-residential site plans expected to have fewer than 60 employees and/or students on location at any given time | Not Exempt |
| 4.6 Neighbourhood Traffic Management | 4.6.1 Adjacent Neighbourhoods | • Only required when the development relies on local or collector streets for access and total volumes exceed ATM capacity thresholds | Not Exempt |
| 4.8 Network Concept | <i>All elements</i> | • Only required when proposed development generates more than 200 person-trips during the peak hour in excess of the equivalent volume permitted by the established zoning | Exempt |

The Network Concept module has not been reviewed, as approximately 20 units are proposed in the O1 and EP Zones, which will not generate more than 200 person trips.

Based on the foregoing, the following modules are included in the TIA report:

- Module 4.1: Development Design
- Module 4.3: Boundary Streets
- Module 4.4: Access Design
- Module 4.5: Transportation Demand Management
- Module 4.6: Neighbourhood Traffic Management
- Module 4.7: Transit
- Module 4.9: Intersection Design

5.0 FORECASTING

5.1 Development-Generated Travel Demand

5.1.1 Trip Generation

The original application submission for Phase 6 of the proposed subdivision included 421 dwellings, consisting of 48 detached homes, 61 townhomes, and 312 apartment units. Compared to the original submission, the proposed draft plan now includes one additional townhome, but replaces the four six-storey apartment buildings with a 'future multi-unit residential development' block, which will consist of buildings with a maximum of four storeys. In the interest of maintaining a conservative analysis, the following forecasting and analysis still considers the number of units described in the original submission. Phases 1-5 of the proposed subdivision will include 535 dwellings, of which there will be 295 detached homes, 200 townhomes and 40 apartment units. This TIA report will account for these phases as background traffic.

Trips generated by these dwellings have been estimated using the relevant recommended rates outlined in the *TRANS Trip Generation Manual*. The vehicle trip generation rates, taken from Table 6.3 of the TRANS report, correspond to either Single-Detached Dwellings, Townhouses, Low-Rise (1-2 floors), or Mid-Rise Apartment (3-10 floors), all in the Suburban Area (outside the greenbelt). The directional split between inbound and outbound trips are based on the blended splits presented in Table 3.17 of the report.

The buildout years of each phase, along with estimates of the trips generated by all six phases of the proposed subdivision are summarized in **Table 4**. The corresponding number of person trips generated by each phase of the proposed subdivision are based on the modal shares presented in Table 3.13 of the TRANS report. The estimated number of person trips generated by each phase is shown in **Table 5**.

Table 4: Proposed Residential Vehicle Trip Generation

| Land Use | TRANS Rate | Units | AM Peak (VPH) | | | PM Peak (VPH) | | |
|--------------------------|----------------------|-----------|---------------|-----------|------------|---------------|-----------|------------|
| | | | IN | OUT | TOT | IN | OUT | TOT |
| Phase 1 (2019) | | | | | | | | |
| Single-Detached Dwelling | AM: 0.70 PM: 0.90 | 35 units | 8 | 17 | 25 | 20 | 12 | 32 |
| Townhouse | AM: 0.54 PM: 0.71 | 24 units | 5 | 8 | 13 | 9 | 8 | 17 |
| Phase 1 Total | | | 13 | 25 | 38 | 29 | 20 | 49 |
| Phase 2 (2021) | | | | | | | | |
| Single-Detached Dwelling | AM: 0.70 PM: 0.90 | 85 units | 17 | 43 | 60 | 48 | 29 | 77 |
| Townhouse | AM: 0.54 PM: 0.71 | 91 units | 18 | 31 | 49 | 34 | 30 | 64 |
| Phase 2 Total | | | 35 | 74 | 109 | 82 | 59 | 141 |
| Phase 3 (2022) | | | | | | | | |
| Single-Detached Dwelling | AM: 0.70 PM: 0.90 | 118 units | 24 | 59 | 83 | 66 | 41 | 107 |
| Townhouse | AM: 0.54 PM: 0.71 | 30 units | 6 | 10 | 16 | 11 | 10 | 21 |
| Phase 3 Total | | | 30 | 69 | 99 | 77 | 51 | 128 |

| Land Use | TRANS Rate | Units | AM Peak (VPH) | | | PM Peak (VPH) | | |
|--------------------------|----------------------|-----------|---------------|------------|------------|---------------|------------|------------|
| | | | IN | OUT | TOT | IN | OUT | TOT |
| Phase 4 (2023) | | | | | | | | |
| Single-Detached Dwelling | AM: 0.70 PM: 0.90 | 27 units | 6 | 13 | 19 | 15 | 9 | 24 |
| Townhouse | AM: 0.54 PM: 0.71 | 27 units | 6 | 9 | 15 | 10 | 9 | 19 |
| Low-Rise Apartment | AM: 0.37 PM: 0.46 | 40 units | 3 | 12 | 15 | 12 | 6 | 18 |
| Phase 4 Total | | | 15 | 34 | 49 | 37 | 24 | 61 |
| Phase 5 (2024) | | | | | | | | |
| Single-Detached Dwelling | AM: 0.70 PM: 0.90 | 30 units | 6 | 15 | 21 | 17 | 10 | 27 |
| Townhouse | AM: 0.54 PM: 0.71 | 28 units | 6 | 9 | 15 | 11 | 9 | 20 |
| Phase 5 Total | | | 12 | 24 | 36 | 28 | 19 | 47 |
| Phases 1-5 Total | | | 105 | 226 | 331 | 253 | 173 | 426 |
| Phase 6 (2020) | | | | | | | | |
| Single-Detached Dwelling | AM: 0.70 PM: 0.90 | 48 units | 9 | 25 | 34 | 31 | 19 | 50 |
| Townhouse | AM: 0.54 PM: 0.71 | 61 units | 11 | 22 | 33 | 23 | 20 | 43 |
| Mid-Rise Apartment | AM: 0.29 PM: 0.37 | 312 units | 22 | 68 | 90 | 71 | 44 | 115 |
| Phase 6 Total | | | 42 | 115 | 157 | 125 | 83 | 208 |

Table 5: Proposed Residential Person Trip Generation

| Land Use | TRANS Auto Share | AM Peak (PPH) | | | PM Peak (PPH) | | |
|--------------------------|--------------------|---------------|------------|------------|---------------|-----------|------------|
| | | IN | OUT | TOT | IN | OUT | TOT |
| Phase 1 (2019) | | | | | | | |
| Single-Detached Dwelling | AM: 55% PM: 64% | 13 | 32 | 45 | 31 | 19 | 50 |
| Townhouse | AM: 55% PM: 61% | 9 | 15 | 24 | 15 | 13 | 28 |
| Phase 1 Total | | 22 | 47 | 69 | 46 | 32 | 78 |
| Phase 2 (2021) | | | | | | | |
| Single-Detached Dwelling | AM: 55% PM: 64% | 31 | 77 | 108 | 74 | 46 | 120 |
| Townhouse | AM: 55% PM: 61% | 35 | 59 | 94 | 55 | 48 | 103 |
| Phase 2 Total | | 66 | 136 | 202 | 129 | 94 | 223 |
| Phase 3 (2022) | | | | | | | |
| Single-Detached Dwelling | AM: 55% PM: 64% | 44 | 107 | 151 | 104 | 63 | 167 |
| Townhouse | AM: 55% PM: 61% | 11 | 18 | 29 | 18 | 16 | 34 |
| Phase 3 Total | | 55 | 125 | 180 | 122 | 79 | 201 |

| Land Use | TRANS Auto Share | AM Peak (PPH) | | | PM Peak (PPH) | | |
|--------------------------|---------------------|---------------|------------|------------|---------------|------------|------------|
| | | IN | OUT | TOT | IN | OUT | TOT |
| Phase 4 (2023) | | | | | | | |
| Single-Detached Dwelling | AM: 55% PM: 64% | 10 | 25 | 35 | 24 | 14 | 38 |
| Townhouse | AM: 55% PM: 61% | 11 | 18 | 29 | 16 | 15 | 31 |
| Low-Rise Apartment | AM: 44% PM: 44% | 7 | 27 | 34 | 26 | 15 | 41 |
| Phase 4 Total | | 28 | 70 | 98 | 66 | 44 | 110 |
| Phase 5 (2024) | | | | | | | |
| Single-Detached Dwelling | AM: 55% PM: 64% | 11 | 27 | 38 | 26 | 16 | 42 |
| Townhouse | AM: 55% PM: 61% | 10 | 17 | 27 | 17 | 16 | 33 |
| Phase 5 Total | | 21 | 44 | 65 | 43 | 32 | 75 |
| Phases 1-5 Total | | 192 | 422 | 614 | 406 | 281 | 687 |
| Phase 6 (2020) | | | | | | | |
| Single-Detached Dwelling | AM: 55% PM: 64% | 18 | 44 | 62 | 42 | 25 | 67 |
| Townhouse | AM: 55% PM: 61% | 21 | 39 | 60 | 36 | 34 | 70 |
| Mid-Rise Apartment | AM: 44% PM: 44% | 50 | 155 | 205 | 161 | 100 | 261 |
| Phase 6 Total | | 89 | 238 | 327 | 239 | 159 | 398 |

From the previous table, Phase 6 of the proposed subdivision is projected to generate 327 person trips during the AM peak hour and 398 person trips during the PM peak hour. Phases 1-5 of the proposed subdivision are projected to generate 614 person trips during the AM peak hour and 687 person trips during the PM peak hour.

The modal shares for the proposed subdivision are assumed to be consistent with the modal shares outlined in the 2011 TRANS O-D Survey Report, specific to the Orléans region. The modal share values applied to the proposed dwellings are based on the typical commuter pattern, represented by all observed trips from/within Orléans in the AM peak hour, and all observed trips to/within Orléans in the PM peak hour. Consultation with City staff confirmed that the non-auto modal share should receive an increase due to the subdivision’s proximity to the multi-use pathways and bike lanes within the study area. This increase has been incorporated in the forecasting and analysis stages.

A full breakdown of the projected person trips generated by modal share is shown in **Table 6**.

Table 6: Person Trips by Modal Share

| Travel Mode | Modal Share | AM Peak | | | PM Peak | | |
|-------------------------------|-------------|------------|------------|------------|------------|------------|------------|
| | | IN | OUT | TOT | IN | OUT | TOT |
| Phase 1 (2019) | | | | | | | |
| <i>Person Trips</i> | | 22 | 47 | 69 | 46 | 32 | 78 |
| Auto Driver | 55% | 12 | 27 | 39 | 26 | 17 | 43 |
| Auto Passenger | 15% | 3 | 7 | 10 | 7 | 5 | 12 |
| Transit | 20% | 5 | 9 | 14 | 9 | 7 | 16 |
| Non-Auto | 10% | 2 | 4 | 6 | 4 | 3 | 7 |
| Phase 2 (2021) | | | | | | | |
| <i>Person Trips</i> | | 66 | 136 | 202 | 129 | 94 | 223 |
| Auto Driver | 55% | 36 | 75 | 111 | 71 | 52 | 123 |
| Auto Passenger | 15% | 10 | 20 | 30 | 19 | 14 | 33 |
| Transit | 20% | 13 | 27 | 40 | 26 | 19 | 45 |
| Non-Auto | 10% | 7 | 14 | 21 | 13 | 9 | 22 |
| Phase 3 (2022) | | | | | | | |
| <i>Person Trips</i> | | 55 | 125 | 180 | 122 | 79 | 201 |
| Auto Driver | 55% | 30 | 70 | 100 | 67 | 44 | 111 |
| Auto Passenger | 15% | 8 | 18 | 26 | 18 | 12 | 30 |
| Transit | 20% | 11 | 25 | 36 | 25 | 15 | 40 |
| Non-Auto | 10% | 6 | 12 | 18 | 12 | 8 | 20 |
| Phase 4 (2023) | | | | | | | |
| <i>Person Trips</i> | | 28 | 70 | 98 | 66 | 44 | 110 |
| Auto Driver | 55% | 16 | 38 | 54 | 36 | 25 | 61 |
| Auto Passenger | 15% | 4 | 10 | 14 | 10 | 6 | 16 |
| Transit | 20% | 6 | 14 | 20 | 13 | 9 | 22 |
| Non-Auto | 10% | 2 | 8 | 10 | 7 | 4 | 11 |
| Phase 5 (2024) | | | | | | | |
| <i>Person Trips</i> | | 21 | 44 | 65 | 43 | 32 | 75 |
| Auto Driver | 55% | 12 | 25 | 37 | 24 | 17 | 41 |
| Auto Passenger | 15% | 3 | 6 | 9 | 6 | 5 | 11 |
| Transit | 20% | 4 | 9 | 13 | 9 | 6 | 15 |
| Non-Auto | 10% | 2 | 4 | 6 | 4 | 4 | 8 |
| Auto Driver (Total) | | 106 | 235 | 341 | 224 | 155 | 379 |
| Auto Passenger (Total) | | 28 | 61 | 89 | 60 | 42 | 102 |
| Transit (Total) | | 39 | 84 | 123 | 82 | 56 | 138 |
| Non-Auto (Total) | | 19 | 42 | 61 | 40 | 28 | 68 |
| Phase 6 (2020) | | | | | | | |
| <i>Person Trips</i> | | 89 | 238 | 327 | 239 | 159 | 398 |
| Auto Driver | 55% | 49 | 131 | 180 | 131 | 87 | 218 |
| Auto Passenger | 15% | 13 | 35 | 48 | 36 | 24 | 60 |
| Transit | 20% | 18 | 48 | 66 | 48 | 32 | 80 |
| Non-Auto | 10% | 9 | 24 | 33 | 24 | 16 | 40 |
| Auto Driver (Total) | | 49 | 131 | 180 | 131 | 87 | 218 |
| Auto Passenger (Total) | | 13 | 35 | 48 | 36 | 24 | 60 |
| Transit (Total) | | 18 | 48 | 66 | 48 | 32 | 80 |
| Non-Auto (Total) | | 9 | 24 | 33 | 24 | 16 | 40 |

From the previous table, Phase 6 of the proposed subdivision is projected to generate 180 vehicle trips during the AM peak hour and 218 vehicle trips during the PM peak hour. Phases 1-5 of the

proposed subdivision are projected to generate 341 vehicle trips during the AM peak hour and 379 vehicle trips during the PM peak hour.

5.1.2 Trip Distribution

While a widening of Brian Coburn Boulevard (south of the study area) is identified in the TMP's ultimate road network, it is not identified in either the Affordable Network or the 2031 Network Concept. Therefore, the distribution of traffic generated by the proposed subdivision to the road network is assumed to be consistent with existing traffic patterns during the AM and PM peak hours. The trip distribution is as follows:

- 70% north toward Innes Road;
- 25% south toward Brian Coburn Boulevard;
- 5% east toward Millennium Boulevard.

5.1.3 Trip Assignment

Trips generated by Phase 6 of the proposed subdivision have been assigned to the accesses based on access proximity and logical trip routing. For example, a vehicle trip originating from a property closer to the access on Grapefern Terrace is anticipated to use Provence Avenue to travel north or south, while a vehicle trip originating from a property closer to the access on Nantes Street is anticipated to use Portobello Boulevard to travel north or south. All vehicles travelling east to the Millennium Park and Ride are anticipated to enter and exit the subdivision via Grapefern Terrace. The assignment of generated trips to the proposed accesses are listed by access below.

Nantes Street

- 80% of trips to/from the north via Portobello Boulevard;
- 40% of trips to/from the south via Portobello Boulevard;
- 40% of trips to/from the south via Brianna Way.

Grapefern Terrace

- 20% of trips to/from the north via Provence Avenue;
- 20% of trips to/from the south via Provence Avenue;
- 100% of trips to/from the east via Provence Avenue.

Trips generated by Phase 6 of the proposed subdivision are shown in **Figure 5**.

5.2 Background Traffic

5.2.1 General Background Growth Rate

A rate of background growth has been established through a review of the City of Ottawa's Strategic Long Range Model, comparing snapshots of 2011 and 2031 AM peak volumes, and the City's 2013 TMP. The snapshots indicate a growth rate of less than 1% on Portobello Boulevard, while growth rates on Provence Avenue were unrealistic. Section 2.3 of the TMP projects a 33% growth in the population of the Orléans area between 2011 and 2031, which translates to an annual growth rate of approximately 1.4% per annum. A 1% annual growth rate has been assumed for Portobello Boulevard, while a 0% growth rate has been applied to all other roadways within the study area.

Figure 5: Proposed Site-Generated Traffic, Phase 6

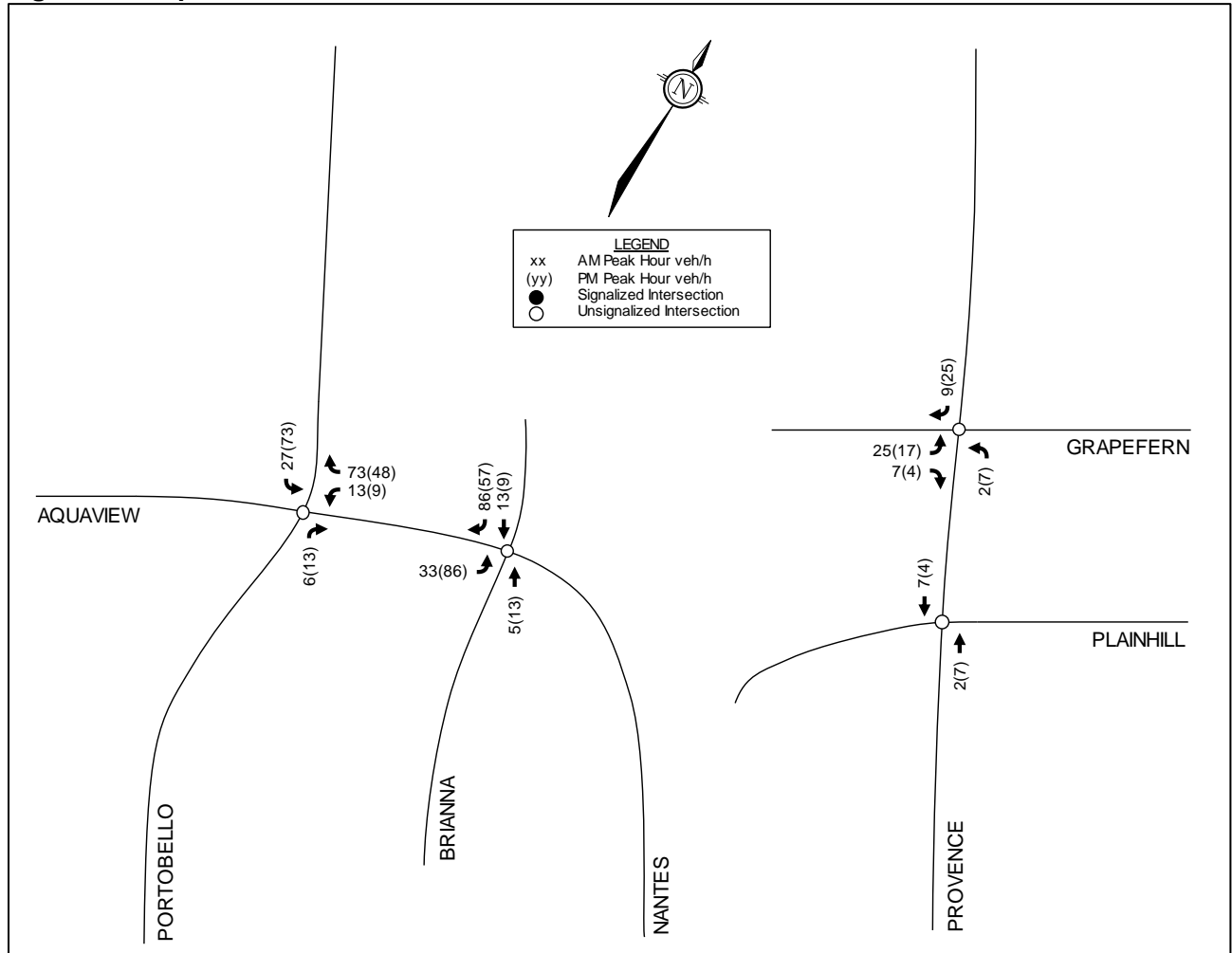

5.2.2 Other Area Developments

The projected traffic volumes generated by Phase 1 of the Provence Orléans subdivision have been added to the 2020 and 2025 background traffic conditions. Phases 2-5 of the subdivision have been added to the 2025 background traffic conditions only. Traffic generated by Phase 1 is shown in **Figure 6**. Traffic generated by Phases 2-5 is shown in **Figure 7**. Relevant excerpts of the TIA prepared in support of Phases 1-5 of the Provence Orléans subdivision (then referred to as the 'Notting Hill Subdivision') are included in **Appendix G**.

Background volumes for the 2020 buildout year and 2025 horizon year are shown in **Figure 8** and **Figure 9**, respectively. Total traffic volumes for the 2020 buildout year and 2025 horizon year are shown in **Figure 10** and **Figure 11**, respectively.

Figure 6: Site-Generated Traffic, Phase 1

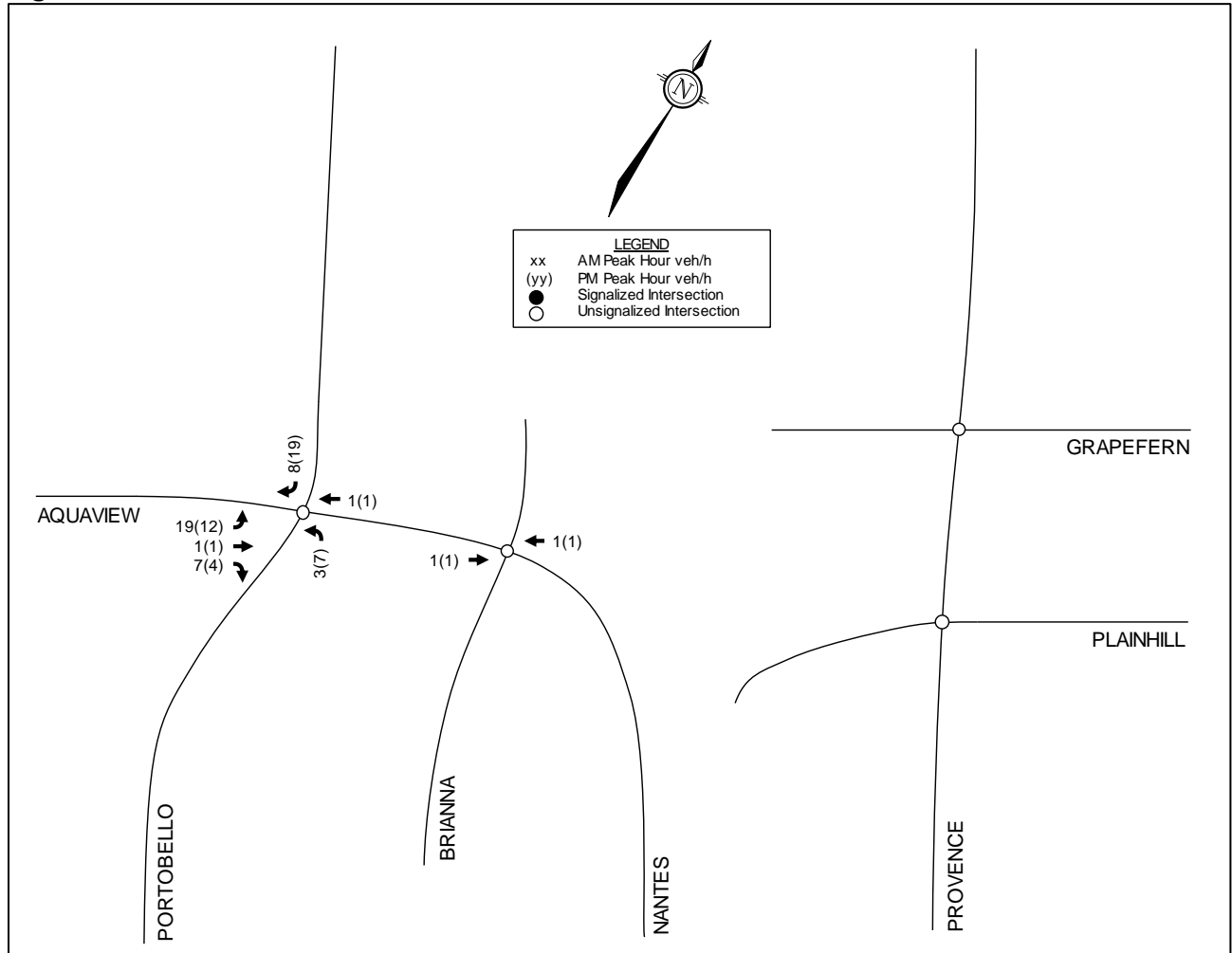

Figure 7: Site-Generated Traffic, Phases 2-5

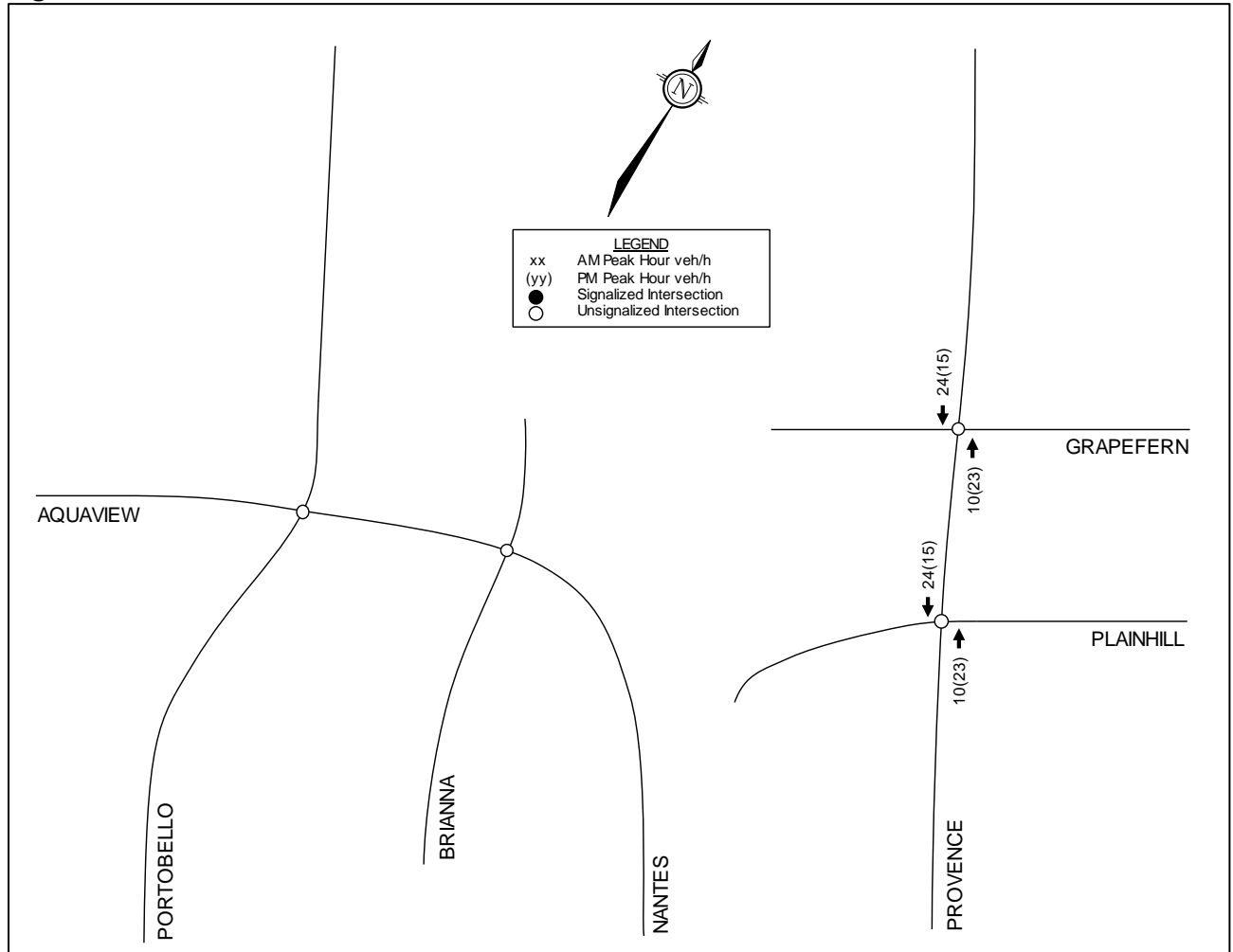

Figure 8: 2020 Background Traffic

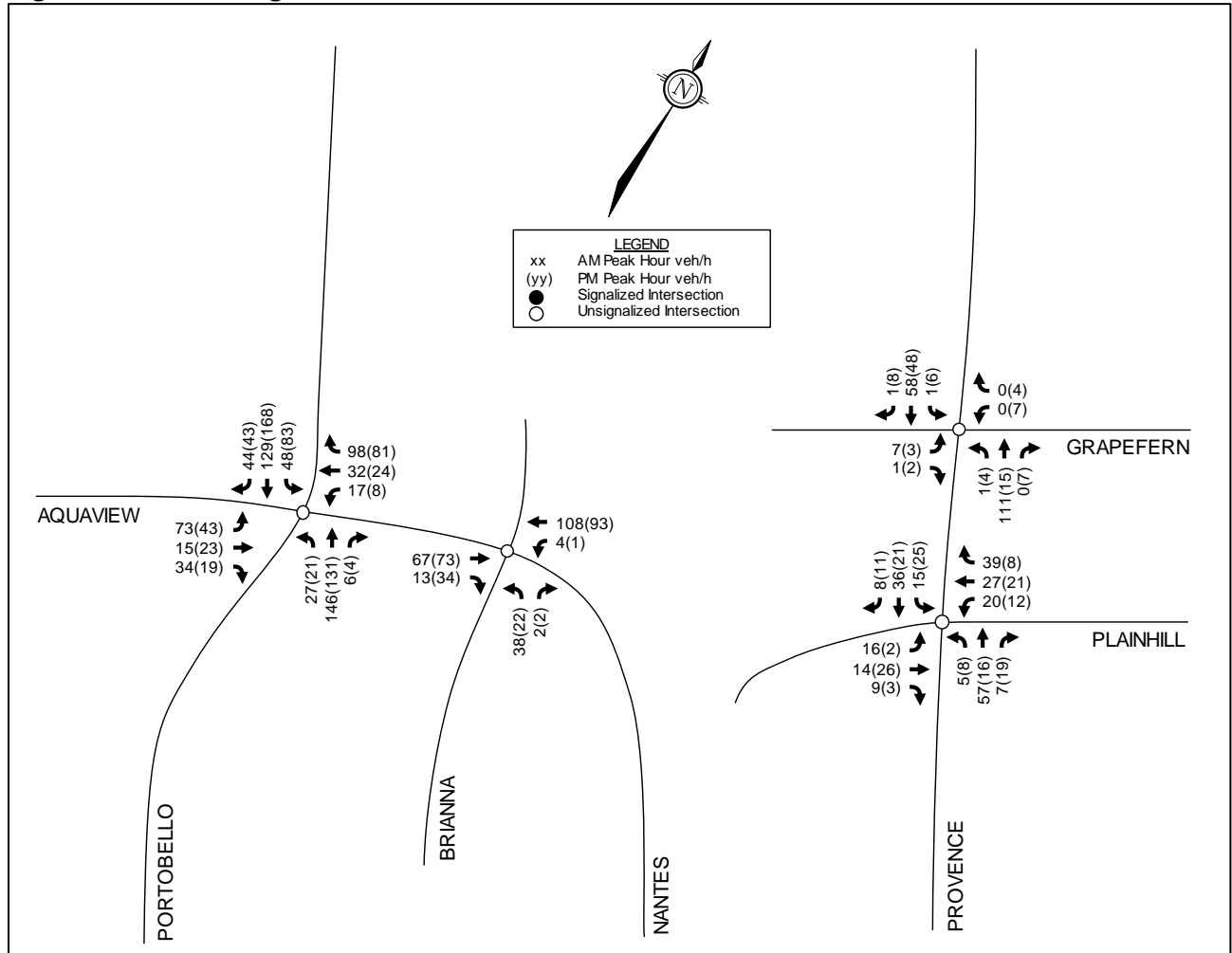

Figure 9: 2025 Background Traffic

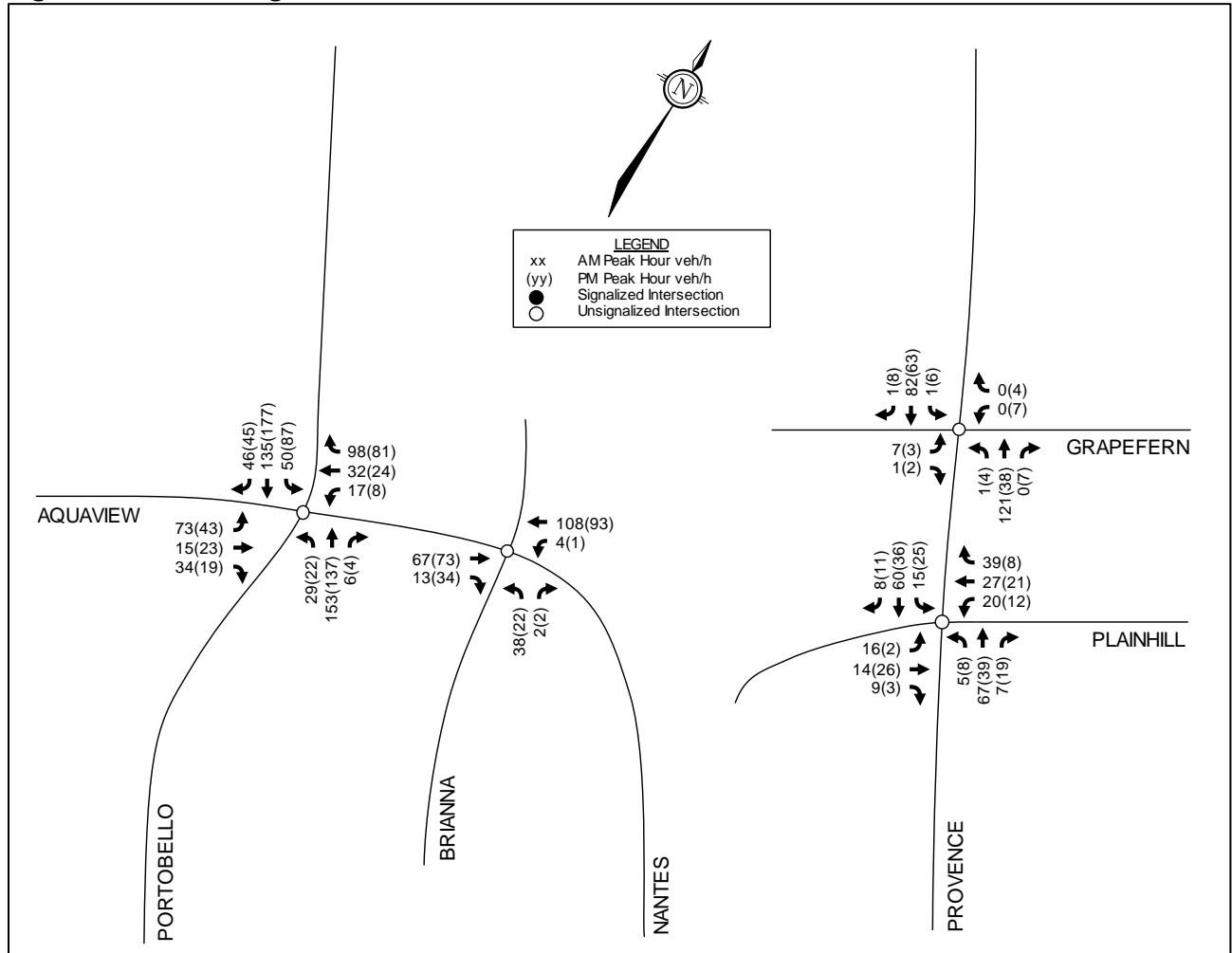

Figure 10: 2020 Total Traffic

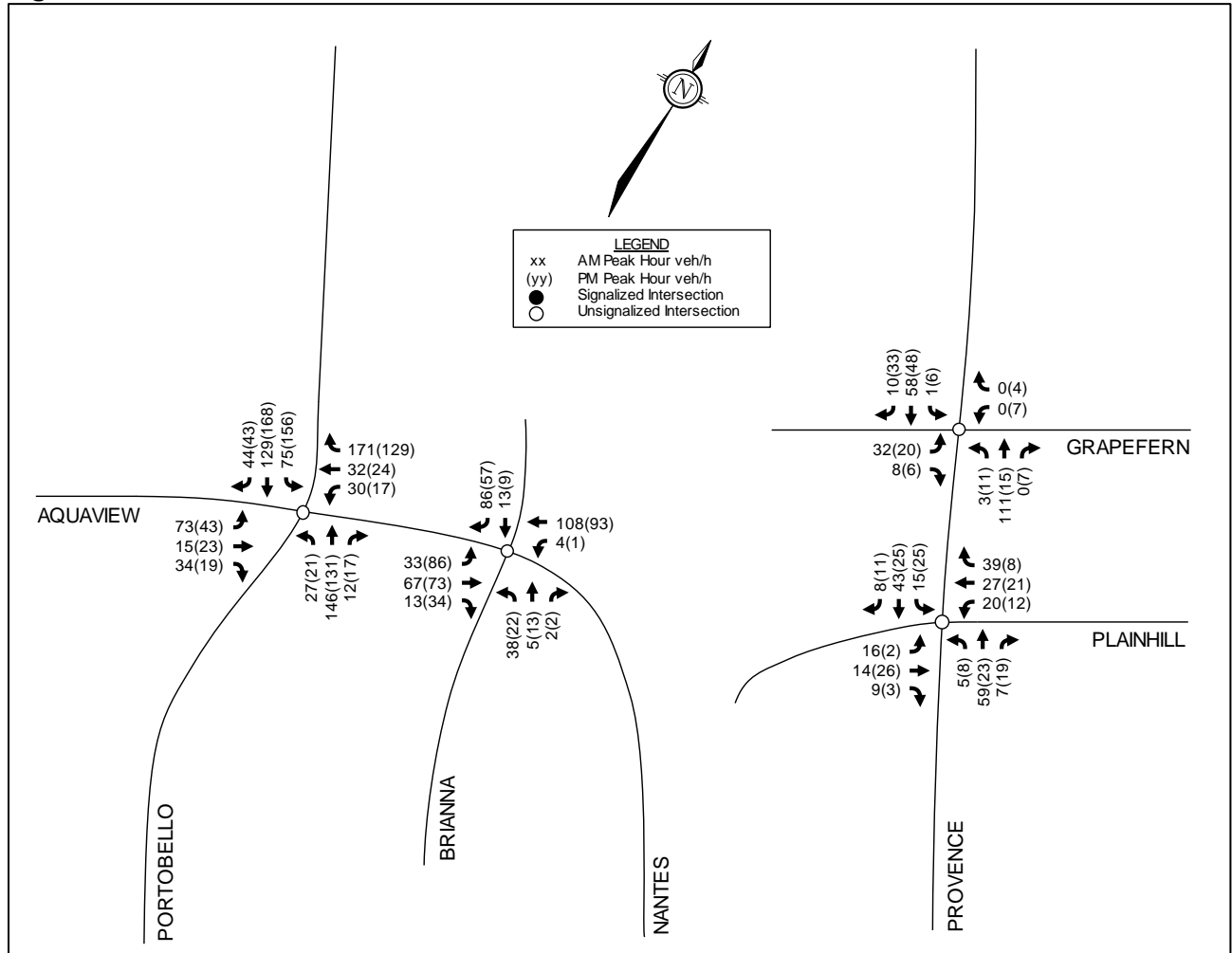
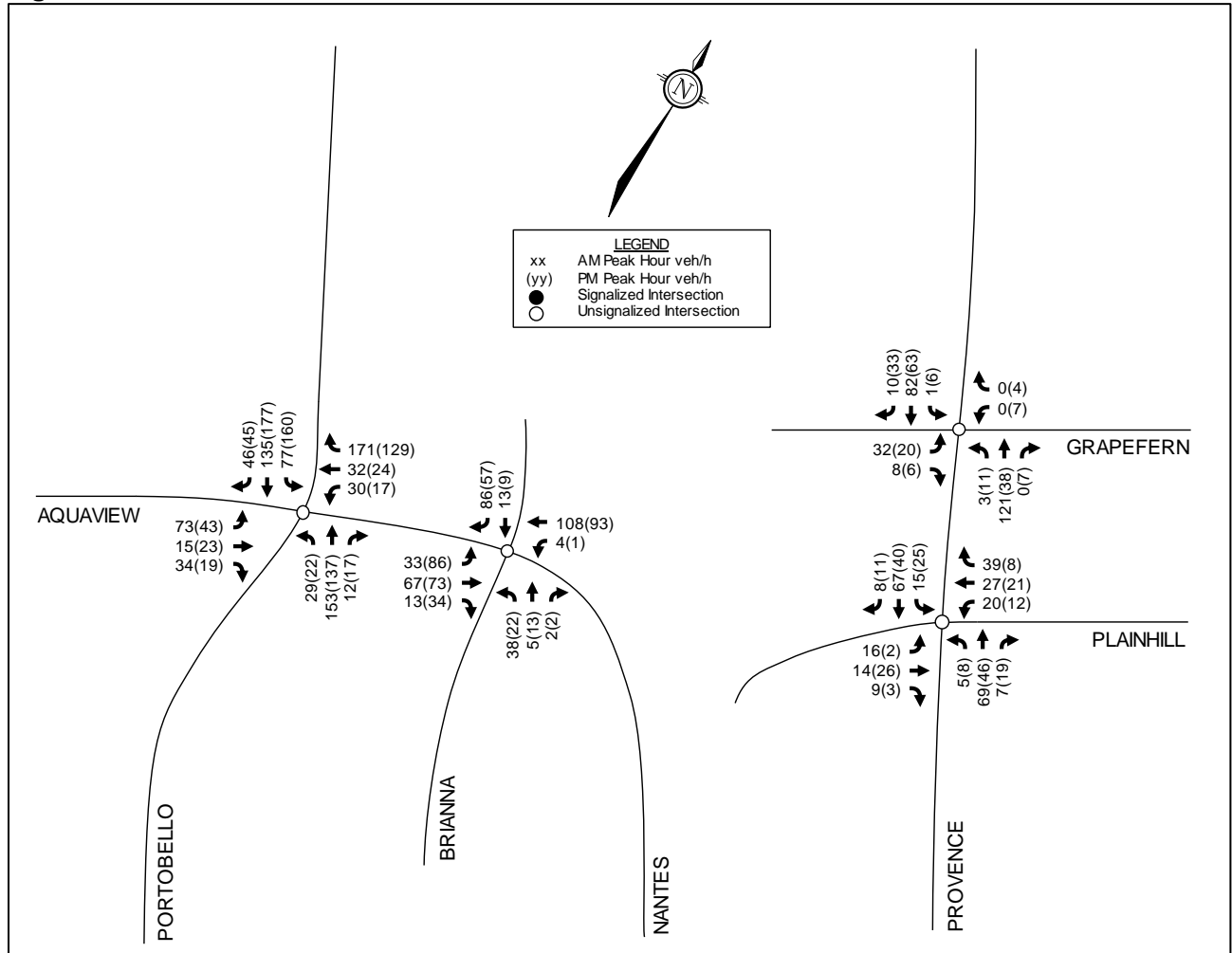

Figure 11: 2025 Total Traffic



6.0 ANALYSIS

6.1 Development Design

This section provides a review of the development design in terms of the road network, roadway cross-sections, and pedestrian crossing locations. A review of the City's Transportation Demand Management (TDM) – Supportive Development Design and Infrastructure Checklist is exempt from Draft Plan of Subdivision applications; however, this checklist will be reviewed for the future multi-unit residential block as part of a required future Site Plan application. A copy of the concept plan is provided in **Appendix A**.

6.1.1 Road Network

A review of the new road network with respect to the initiatives identified in the City's Building Better and Smarter Suburbs (BBSS) report was completed. The proposed road network is consistent with the following BBSS initiatives:

- Design the street network as an integral part and extension of the municipal grid, taking into consideration its future adjustments and evolution;
- Design the street network in conjunction with the land use and open space system to ensure direct pedestrian and cycling connectivity to key destinations in the community (schools, shops, bus stops and stations, etc.);
- Implement prescribed facilities from the 2013 Ottawa Pedestrian Plan and 2013 Ottawa Cycling Plan with development;
- Encourage representation from OC Transpo at pre-consultation meeting for plans of subdivision, in order to incorporate transit planning into initial subdivision design;
- Create street and lot patterns and building orientations that frame and enhance the presence of all parks, regardless of size.

The Transportation Association of Canada (TAC) *Geometric Design Guide for Canadian Roads* stipulates that the minimum desired distance between two T-intersections is 40m along a local roadway. Measuring centre-to-centre, there will be a distance of 80m between the proposed intersection of Street No. 11/Plainridge Crescent West and the existing intersection of Grapefern Terrace/Plainridge Crescent West. Therefore, these intersections can be considered appropriately spaced from one another.

6.1.2 Roadway Cross-Sections

ROW widths of 18m are proposed for Street No. 11 and the remainder of Plainridge Crescent. The proposed road width for these streets is 8.5m, which is consistent with the width of the existing Plainridge Crescent, and can accommodate a travel lane in each direction and parking on one side of the roadway. This road width is sufficient given the context of the proposed development, a low-speed residential neighbourhood with limited opportunity for cut-through traffic.

1.8m concrete sidewalks are proposed on the east side of Street No. 11 between Nantes Street and the first residential lot, on the west side of Street No. 11 between Nantes Street and the future transitway, and on the inside of Street No. 11 and Plainridge Crescent between Grapefern Terrace and the northeast corner of the Lalande park.

The proposed pathways and linkages plan is shown in **Figure 12**.

Figure 12: Pathways and Linkages Plan



6.1.3 Pedestrian Crossovers

The *Ontario Traffic Manual (OTM) – Book 15* identifies the following criteria for the consideration of a pedestrian crossover (PXO):

- If the total 8-hour pedestrian volume crossing the main road is greater than 100 and the total 8-hour vehicular volume is greater than 750 vehicles; or
- If the crossing location provides system connectivity or is on a pedestrian desire line.

A PXO has recently been implemented at the north approach of Provence Avenue/Grapefern Terrace, as part of the Trans-Orléans Pathway project. There are no other candidate locations for a PXO within Phase 6 of the subdivision.

6.2 Boundary Streets

This section provides a review of the boundary streets using complete streets principles. The *Multi-Modal Level of Service* (MMLOS) guidelines produced by IBI Group in October 2015 were used to evaluate the levels of service for the boundary roadways for each mode of transportation. Schedule B of the City of Ottawa's Official Plan identifies all boundary streets as being within the policy area 'Within 300m of a school.' As these targets are more stringent, they have been used to evaluate the MMLOS of all boundary roadways.

Targets for PLOS, BLOS, TLOS, TkLOS, and Auto LOS for the boundary streets adhere to those outlined in Exhibit 22 of the MMLOS guidelines. The boundary streets review evaluates the MMLOS for all boundary roadways based on existing conditions.

6.2.1 Pedestrian Level of Service (PLOS)

Exhibit 4 of the MMLOS guidelines has been used to evaluate the segment PLOS of the boundary roadways. Exhibit 22 of the MMLOS guidelines suggest a target PLOS A for all roadways within 300m of a school (Portobello Boulevard, Provence Avenue, Nantes Street, Grapefern Terrace).

The results of the segment PLOS analysis are summarized in **Table 7**.

Table 7: PLOS Segment Analysis

| Sidewalk Width | Boulevard Width | Avg. Daily Curb Lane Traffic Volume | Presence of On-Street Parking | Operating Speed ⁽¹⁾ | Segment PLOS |
|---|-----------------|-------------------------------------|-------------------------------|--------------------------------|--------------|
| Portobello Boulevard (east side) | | | | | |
| ≥ 2.0m | 0m | ≤ 3000 vpd | No | 50 km/h | B |
| Portobello Boulevard (west side) | | | | | |
| 1.5m | > 2.0m | ≤ 3000 vpd | No | 50 km/h | C |
| Provence Avenue (east side) | | | | | |
| ≥ 2.0m | > 2.0m | ≤ 3000 vpd | No | 60 km/h | A |
| Provence Avenue (west side) | | | | | |
| ≥ 2.0m | > 2.0m | ≤ 3000 vpd | No | 60 km/h | A |
| Nantes Street (north side) | | | | | |
| ≥ 2.0m | 0.5 to 2.0m | ≤ 3000 vpd | Yes | 50 km/h | A |
| Nantes Street (south side) | | | | | |
| No sidewalk | | ≤ 3000 vpd | No | 50 km/h | F |
| Grapefern Terrace (north side) | | | | | |
| No sidewalk | | ≤ 3000 vpd | Yes | 50 km/h | F |
| Grapefern Terrace (south side) | | | | | |
| No sidewalk | | ≤ 3000 vpd | Yes | 50 km/h | F |

1. Operating speed of Portobello Boulevard, Provence Avenue, and Nantes Street taken as the posted speed limit plus 10 km/h. The operating speed of Grapefern Terrace is taken as the unposted regulatory speed limit, as it is a short residential street, and vehicles are not anticipated to operate above the regulatory 50 km/h speed limit.

6.2.2 Bicycle Level of Service (BLOS)

Exhibit 11 of the MMLOS guidelines has been used to evaluate the segment BLOS of the boundary roadways. Within 300m of a school, Exhibit 22 of the MMLOS guidelines suggest a target BLOS B for Local Cycling Routes (Provence Avenue, Portobello Boulevard, and Nantes Street), and a target BLOS D for all roadways with no cycling designation (Grapefern Terrace).

The results of the segment BLOS analysis are summarized in **Table 8**.

Table 8: BLOS Segment Analysis

| Road Class | Bike Route | Type of Bikeway | Bike Lane Width | Bike Lane Blockage | Travel Lanes | Center-line Type | Operating Speed | Segment BLOS |
|--|-------------|-------------------|-----------------|--------------------|--------------|------------------|-----------------|--------------|
| Portobello Boulevard (Scala Avenue to Aquaview Drive/Nantes Street) | | | | | | | | |
| Major Collector | Local Route | Bike Lane | 1.5-1.8m | Rare | 4 | Raised Median | 50 km/h | B |
| Provence Avenue (Scala Avenue to Grapefern Terrace) | | | | | | | | |
| Collector | Local Route | Mixed Traffic | - | - | 2 | Line Markings | 60 km/h | F |
| Nantes Street (Portobello Boulevard to Brian Coburn Boulevard) | | | | | | | | |
| Collector | Local Route | Multi-Use Pathway | - | - | - | - | - | A |
| Grapefern Terrace (Plainridge Crescent to Provence Avenue) | | | | | | | | |
| Local | No Class | Mixed Traffic | - | - | 2 | No Markings | 50 km/h | B |

6.2.3 Transit Level of Service (TLOS)

Exhibit 15 of the MMLOS guidelines has been used to evaluate the segment TLOS of the boundary roadways. No boundary streets have TLOS targets, however Portobello Boulevard and Provence Avenue have been evaluated, as Portobello Boulevard currently serves transit, and Provence Avenue is anticipated to begin serving transit as the proposed subdivision develops. Nantes Street and Grapefern Terrace have not been evaluated for TLOS.

The results of the segment TLOS analysis are summarized in **Table 9**.

Table 9: TLOS Segment Analysis

| Facility Type | Level/Exposure to Congestion Delay, Friction and Incidents | | | Segment TLOS |
|--|--|----------|--------------------|--------------|
| | Congestion | Friction | Incident Potential | |
| Portobello Boulevard (Scala Avenue to Aquaview Drive/Nantes Street) | | | | |
| Mixed Traffic – Limited Parking/Driveway Friction | Yes | Low | Medium | D |
| Provence Avenue (Scala Avenue to Grapefern Terrace) | | | | |
| Mixed Traffic – Limited Parking/Driveway Friction | Yes | Low | Medium | D |

6.2.4 Truck Level of Service (TkLOS)

Exhibit 20 of the MMLOS guidelines has been used to evaluate the segment TkLOS of the boundary roadways. No boundary streets have TkLOS targets, however since Portobello Boulevard and Provence Avenue provide or will provide transit service, TkLOS has still been evaluated for these roadways.

The results of the segment TkLOS analysis are summarized in **Table 10**.

Table 10: TkLOS Segment Analysis

| Curb Lane Width | Number of Travel Lanes Per Direction | Segment TkLOS |
|--|--------------------------------------|---------------|
| Portobello Boulevard (Scala Avenue to Aquaview Drive/Nantes Street) | | |
| 3.3m to 3.5m | 2 | A |
| Provence Avenue (Scala Avenue to Grapefern Terrace) | | |
| > 3.7m | 1 | B |

6.2.5 Vehicular Level of Service (Auto LOS)

Exhibit 22 of the MMLOS guidelines suggest a target Auto LOS E for all roadways within 300m of a school. The typical lane capacity along the study area roadways are based on the City’s guidelines for the TRANS Long-Range Transportation Model. The lane capacity along the boundary streets has been estimated based on roadway classification and general characteristics (i.e. suburban with limited access, urban with on-street parking, etc.).

The results of the Auto LOS analysis are summarized in **Table 11**.

Table 11: Auto LOS Segment Analysis

| Direction | Directional Capacity | Traffic Volumes | | V/C Ratio and LOS | | | |
|--|----------------------|-----------------|---------|-------------------|-----|---------|-----|
| | | AM Peak | PM Peak | AM Peak | | PM Peak | |
| | | | | V/C | LOS | V/C | LOS |
| Portobello Boulevard (Scala Avenue to Aquaview Drive/Nantes Street) | | | | | | | |
| Northbound | 1,200 vph | 173 | 146 | 0.15 | A | 0.12 | A |
| Southbound | 1,200 vph | 208 | 270 | 0.17 | A | 0.23 | A |
| Provence Avenue (Scala Avenue to Grapefern Terrace) | | | | | | | |
| Northbound | 600 vph | 112 | 26 | 0.19 | A | 0.04 | A |
| Southbound | 600 vph | 60 | 62 | 0.10 | A | 0.10 | A |
| Nantes Street (Portobello Boulevard to Brian Coburn Boulevard) | | | | | | | |
| Eastbound | 600 vph | 67 | 112 | 0.11 | A | 0.19 | A |
| Westbound | 600 vph | 146 | 107 | 0.24 | A | 0.18 | A |
| Grapefern Terrace (Plainridge Crescent to Provence Avenue) | | | | | | | |
| Eastbound | 400 vph | 8 | 5 | 0.02 | A | 0.01 | A |
| Westbound | 400 vph | 2 | 12 | 0.01 | A | 0.03 | A |

6.2.6 Segment MMLOS Summary

A summary of the results of the segment MMLOS analysis for the boundary roadways are provided in **Table 12**.

Table 12: Segment MMLOS Summary

| | Segment | Portobello Boulevard | Provence Avenue | Nantes Street | Grapefern Terrace |
|-------------------|------------------------------------|----------------------|-----------------|-------------------|-------------------|
| Pedestrian | Sidewalk Width | 1.5m | ≥ 2.0m | No sidewalk | No sidewalk |
| | Boulevard Width | > 2.0m | > 2.0m | - | - |
| | Avg Daily Curb Lane Traffic Volume | ≤ 3000 vpd | ≤ 3000 vpd | ≤ 3000 vpd | ≤ 3000 vpd |
| | On-Street Parking | No | No | No | Yes |
| | Operating Speed | 50 km/h | 60 km/h | 50 km/h | 50 km/h |
| | Level of Service | C | A | F | F |
| Target | A | A | A | A | |
| Cyclist | Road Classification | Major Collector | Collector | Collector | Local |
| | Bike Route Classification | Local Route | Local Route | Local Route | No Class |
| | Type of Bikeway | Bike Lane | Mixed Traffic | Multi-Use Pathway | Mixed Traffic |
| | Bike Lane Width | 1.5 to 1.8m | - | - | - |
| | Bike Lane Blockage | Rare | - | - | - |
| | Travel Lanes | 4 | 2 | - | 2 |
| | Centerline Type | Raised Median | Line Markings | - | No Markings |
| | Operating Speed | 50 km/h | 60 km/h | 50 km/h | 50 km/h |
| | Level of Service | B | F | A | B |
| Target | B | B | B | D | |
| Transit | Facility Type | Mixed Traffic | Mixed Traffic | - | - |
| | Parking/Driving Friction | Limited | Limited | - | - |
| | Level of Service | D | D | - | - |
| | Target | - | - | - | - |
| Truck | Lane Width | 3.3m to 3.5m | > 3.7m | - | - |
| | Travel Lanes (per direction) | 2 | 1 | - | - |
| | Level of Service | A | B | - | - |
| | Target | - | - | - | - |
| Auto | Level of Service | A | A | A | A |
| | Target | E | E | E | E |

The results of the segment MMLOS analysis can be summarized as follows:

- Provence Avenue meets the target pedestrian level of service (PLOS), while Portobello Boulevard, Nantes Street, and Grapefern Terrace do not;
- Portobello Boulevard, Nantes Street, and Grapefern Terrace meet the target bicycle level of service (BLOS), while Provence Avenue does not;
- No roadways have targets for transit level of service (TLOS), however Portobello Boulevard and Provence Avenue achieve a TLOS D;
- No roadways have targets for truck level of service (TkLOS), however Portobello Boulevard and Provence Avenue achieve a TkLOS B or better;
- All roadways meet the target vehicular level of service (Auto LOS).

Pedestrian Level of Service

Portobello Boulevard currently achieves a PLOS B on the east side and a PLOS C on the west side. Per Exhibit 4 of the MMLOS guidelines, a PLOS A can be achieved by providing either:

- a) A minimum sidewalk width of 1.8m and a minimum sidewalk boulevard width of 2.0m, or;
- b) A minimum sidewalk width of 2.0m and a minimum sidewalk boulevard width of 0.5m.

As it is still early in the life cycle of the sidewalk, and the existing cross-section of Portobello Boulevard met the City standard when it was widened approximately 10 years ago, widening this sidewalk to meet the target PLOS is not considered reasonable. Therefore, no recommendations have been made.

Nantes Street currently achieves a PLOS A on the north side and a PLOS F on the south side. Per Exhibit 4 of the MMLOS guidelines, Nantes Street can achieve a PLOS A by implementing sidewalks with a minimum width of 2.0m and a minimum boulevard width of 0.5m. However, the existing cross-section meets the current City standards, and therefore no modifications are recommended.

Grapefern Terrace currently achieves a PLOS F on both sides of the roadway, as no sidewalks are provided. Per Exhibit 4 of the MMLOS guidelines, the target PLOS A can be achieved by implementing sidewalks with a minimum width of 2.0m and a minimum boulevard width of 0.5m. The Trans-Orléans Pathway connects to Grapefern Terrace east of Provence Avenue and west of Plainridge Crescent, and a sidewalk was not deemed to be required as part of that project. As it is a short residential street and the existing cross-section meets the current City standards, no modifications are recommended.

Bicycle Level of Service

Provence Avenue currently achieves a BLOS F. This is attributable to the operating speed of 60 km/h, and the requirement of cyclists to be in mixed traffic. For roadways with an AADT of approximately 1,000 vehicles/day and an operating speed of 60 km/h, the *Ontario Traffic Manual* states that a 'shared roadway' is appropriate. As part of the Trans-Orléans Pathway, 1.5m-wide bike lanes have been proposed on Provence Avenue between Grapefern Terrace and Scala Avenue. This implementation would improve the BLOS of Provence Avenue to a BLOS C. Further improvement of the bicycle level of service requires a reduction in the operating speed.

The selection tool used in OTM Book 18 to describe the desirable cycling facility is shown in **Figure 13**.

Figure 13: Desirable Cycling Facility Pre-Selection Nomograph

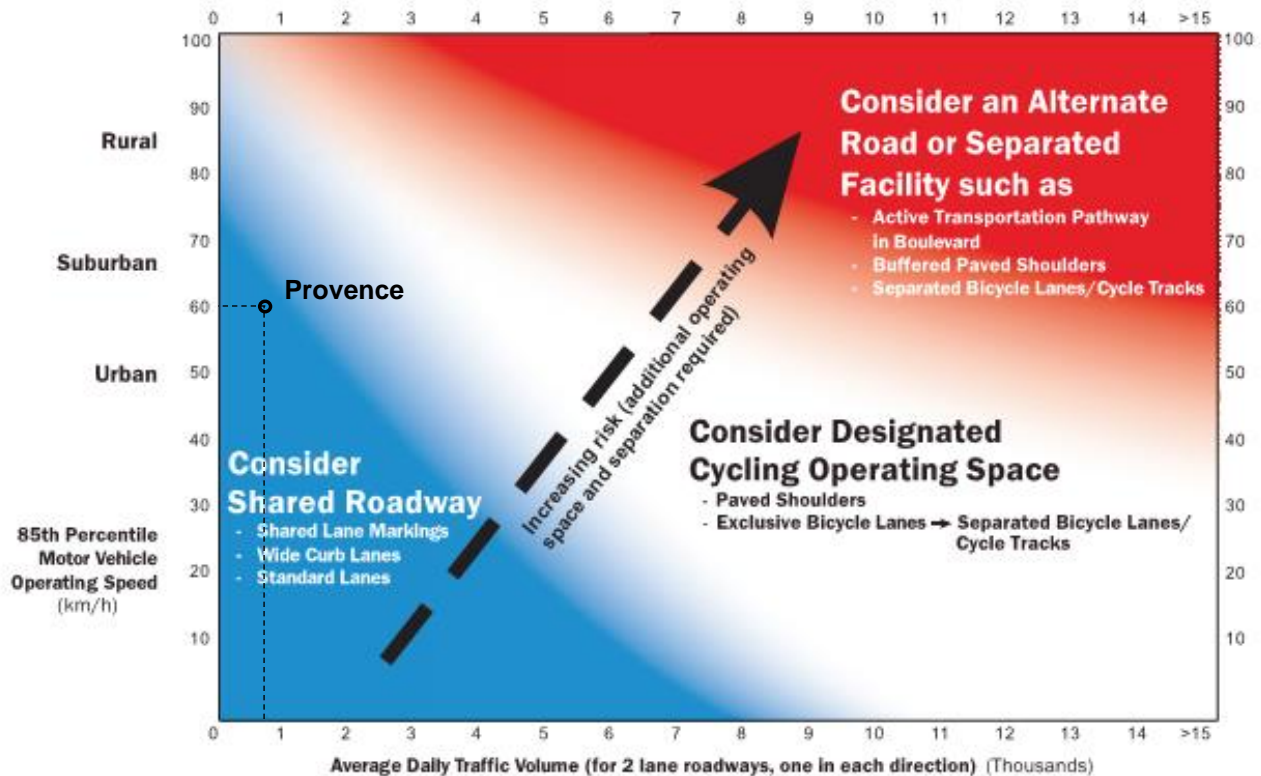

Footnotes: - This nomograph is the first of a three step bicycle facility selection process, and should not be used by itself as the justification for facility selection (see Steps 2 and 3). The nomograph simply helps practitioners pre-select a desirable cycling facility type, however the context of the situation governs the final decision.
 - The nomograph has been adapted for the North American context and is based on international examples and research for two lane roadways. It is, however, still applicable for multi-lane roadways. For those situations, designers should consider the operating speed, total combined traffic volume and traffic mix of the vehicles traveling in the lanes immediately adjacent to the cycling facilities.

- Consider a Separated Facility or an Alternate Road for roadways with an AADT greater than 15,000 vehicles and an operating speed of greater than 50 km/h. For rural and suburban locations this nomograph assumes good sightlines are provided for all road users. In urban areas, there are typically more frequent conflict points at driveways, midblock crossings and intersections (especially on multi-lane roads), as well as on road segments with on-street parking. This needs to be considered when assessing risk exposure in urban environments since it will influence the selection of a suitable facility type.

6.3 Access Intersections Design

Phase 6 of the proposed subdivision will be served by three accesses. The two sections of Plainridge Crescent will be connected in a loop as part of the Phase 6 development. A full-movement access on Street No. 11 will tie in to the intersection of Nantes Street/Brianna Way, making it a four-legged intersection.

The *Ontario Traffic Manual – Book 5* identifies criteria for the implementation of all-way stop control. Based on OTM Book 5, all-way stop control at a three-legged intersection should be implemented if the total vehicle volumes on all approaches to an intersection exceed 350 vehicles during the peak hour and if the split does not exceed 75%/25%.

The City of Ottawa identifies its own criteria for the implementation of all-way stop control. Based on the City’s criteria, all-way stop control for local or collector roadways is warranted if any of the following three criteria are met:

- **Volume:** Total vehicles on all approaches average more than 200 per hour over an 8-hour weekday period, and the total minor street volume (including pedestrians) average more than 80 per hour over the same 8-hour period;
- **Collision:** An average of three or more collisions have occurred over a three-year period (including only the collisions which are preventable by all-way stop control);
- **Visibility:** The sight distance from a point 2.7m from the edge of the major street is less than 55m to the left and 60m to the right.

Among the two intersections at Grapefern Terrace/Plainridge Crescent West and Grapefern Terrace/Plainridge Crescent East, neither are anticipated to meet the OTM or City criteria for all-way stop control. Therefore, no changes to the stop control locations are recommended (Grapefern Terrace is stop-controlled at Grapefern Terrace/Plainridge Crescent West, and Plainridge Crescent is stop-controlled at Grapefern Terrace/Plainridge Crescent East).

The intersection of Nantes Street/Brianna Way is currently all-way stop controlled. No changes are recommended upon construction of the Street No. 11 access.

6.4 Transportation Demand Management

A review of the TDM Measures Checklist was conducted, and can be found in **Appendix H**.

The following measures will be implemented as Phase 6 of the proposed subdivision is built:

- Designate an internal TDM program coordinator;
- Display local area maps with walking/cycling routes and key destinations (at sales centre);
- Display relevant transit schedules and route maps (at sales centre);
- Provide multimodal travel option information packages to new residents (at sales centre).

Applicable measures for the multi-unit block are included in the list above.

6.5 Neighbourhood Traffic Management

The 2017 TIA Guidelines identify two-way peak hour traffic volume thresholds for considering when a Neighbourhood Traffic Management (NTM) plan should be developed. The thresholds are 600 vehicles for major collector roadways, 300 vehicles for collector roadways, and 120 vehicles for local roadways. Based on the 2025 total traffic volumes shown in **Figure 11**, Portobello Boulevard (a major collector) and Nantes Street (a collector) are anticipated to exceed their respective thresholds in the AM and PM peak hours. Provence Avenue (a collector), Plainhill Drive (a local), and Grapefern Terrace (a local) are not anticipated to exceed their respective thresholds.

The typical lane capacities shown in the City's TRANS Long-Range Transportation Model have been used to estimate the directional capacity of these roadways, in vehicles per hour (vph). As shown in **Table 11**, the directional capacities of Portobello Boulevard and Nantes Street are 1,200 vph and 600 vph, respectively. The two-way ATM thresholds of 600 vph for Portobello Boulevard and 300 vph for Nantes Street, which equates to one-way thresholds of 300 vph and 150 vph, respectively. These thresholds represent only 25% of the capacity of these roadways. It should be noted that any roadway operating at 60% capacity or less (i.e. a v/c ratio of 0.60 or better) is considered to be operating at an Auto LOS A.

The directional capacity, 2025 total traffic volumes, and corresponding v/c ratios for Portobello Boulevard and Nantes Street is as follows:

- Portobello Boulevard
 - Capacity: 1,200 vph in each direction
 - Northbound Volumes:
 - 397 vph in AM peak (v/c: 0.33)
 - 309 vph in PM peak (v/c: 0.26)
 - Southbound Volumes:
 - 258 vph in AM peak (v/c: 0.22)
 - 382 vph in PM peak (v/c: 0.32)

- Nantes Street
 - Capacity: 600 vph in each direction
 - Eastbound Volumes:
 - 104 vph in AM peak (v/c: 0.17)
 - 200 vph in PM peak (v/c: 0.33)
 - Westbound Volumes:
 - 233 vph in AM peak (v/c: 0.39)
 - 170 vph in PM peak (v/c: 0.28)

From the above, Portobello Boulevard and Nantes Street are not anticipated to operate at or near capacity in the 2025 total traffic conditions. Detailed intersection analysis for the 2025 total traffic conditions is included in Section 6.7.5, and identifies no operational concerns. Therefore, the function of Portobello Boulevard as a major collector roadway and Nantes Street as a collector roadway is not anticipated to change as a result of the proposed development, and no neighbourhood traffic management measures are required.

6.6 Transit

Based on the trip generation presented in Section 5.1.1, Phase 6 of the proposed subdivision is projected to generate 66 transit trips in the AM peak hour and 80 transit trips in the PM peak hour. Discussions with City staff confirmed that as the subdivision develops, OC Transpo will provide transit service on Provence Avenue.

The transit trips are distributed as follows:

- 66 passengers (48 boarding, 18 alighting) at stop #1367, stop #6314, and new stops along Provence Avenue in the AM peak hour;
- 80 passengers (32 boarding, 48 alighting) at stop #1367, stop #6314, and new stops along Provence Avenue in the PM peak hour.

Based on the projected passenger volumes and correspondence with OC Transpo confirming new bus routes on Provence Avenue as the proposed subdivision develops, no capacity problems are anticipated on the bus routes 33 and 233, which serve the stops adjacent to the proposed Phase 6 development.

6.7 Intersection Design

6.7.1 Existing Intersection Operations

Intersection capacity analysis has been completed for the existing traffic conditions. The intersection parameters used in the analysis are consistent with the 2017 TIA Guidelines (Saturation Flow Rate: 1800 vphpl, Peak Hour Factor: 0.90). Exhibit 22 of the MMLOS Guidelines suggests a target Auto LOS E for all roadways within 300m of a school. The results of the Synchro analysis for the AM and PM peak hours are summarized in **Table 13**. Detailed reports are included in **Appendix I**.

Table 13: Existing Traffic – Intersection Operations

| Intersection | AM Peak | | | PM Peak | | |
|---|-----------|-----|-------------|-----------|-----|-------------|
| | Max Delay | LOS | Mvmt | Max Delay | LOS | Mvmt |
| Portobello Boulevard/ Aquaview Drive/Nantes Street | 9 sec | A | EBT/ WBT | 9 sec | A | SBL |
| Nantes Street/ Brianna Way | 8 sec | A | WBT | 8 sec | A | NBL/R |
| Provence Avenue/ Plainhill Drive | 8 sec | A | NBT/ SBT | 8 sec | A | SBT |
| Provence Avenue/ Grapefern Terrace | 10 sec | A | EBT | 9 sec | A | EBT/ WBT |

Based on the foregoing table, no operational concerns are anticipated, as all intersections perform at an Auto LOS A.

6.7.2 2020 Background Intersection Operations

Intersection capacity analysis has been completed for the 2020 background traffic conditions. The intersection parameters used in the analysis are consistent with the 2017 TIA Guidelines (Saturation Flow Rate: 1800 vphpl, Peak Hour Factor: 1.0). The results of the Synchro analysis for the AM and PM peak hours are summarized in **Table 14**. Detailed reports are included in **Appendix I**.

Table 14: 2020 Background Traffic – Intersection Operations

| Intersection | AM Peak | | | PM Peak | | |
|---|-----------|-----|-------------|-----------|-----|-------------|
| | Max Delay | LOS | Mvmt | Max Delay | LOS | Mvmt |
| Portobello Boulevard/ Aquaview Drive/Nantes Street | 9 sec | A | EBT | 9 sec | A | SBL |
| Nantes Street/ Brianna Way | 8 sec | A | WBT | 8 sec | A | NBT/ WBT |
| Provence Avenue/ Plainhill Drive | 8 sec | A | NBT/ SBT | 7 sec | A | SBT |
| Provence Avenue/ Grapefern Terrace | 10 sec | A | EBT | 9 sec | A | EBT |

Based on the foregoing table, no operational concerns are anticipated.

6.7.3 2025 Background Intersection Operations

Intersection capacity analysis has been completed for the 2025 background traffic conditions. The intersection parameters used in the analysis are consistent with the 2017 TIA Guidelines (Saturation Flow Rate: 1800 vphpl, Peak Hour Factor: 1.0). The results of the Synchro analysis for the AM and PM peak hours are summarized in **Table 15**. Detailed reports are included in **Appendix I**.

Table 15: 2025 Background Traffic – Intersection Operations

| Intersection | AM Peak | | | PM Peak | | |
|---|-----------|-----|-------------|-----------|-----|-------------|
| | Max Delay | LOS | Mvmt | Max Delay | LOS | Mvmt |
| Portobello Boulevard/ Aquaview Drive/Nantes Street | 9 sec | A | EBT | 9 sec | A | SBL |
| Nantes Street/ Brianna Way | 8 sec | A | WBT | 8 sec | A | NBT/ WBT |
| Provence Avenue/ Plainhill Drive | 8 sec | A | NBT/ SBT | 8 sec | A | SBT |
| Provence Avenue/ Grapefern Terrace | 10 sec | A | EBT | 9 sec | A | EBT |

Based on the foregoing table, no operational concerns are anticipated.

6.7.4 2020 Total Intersection Operations

Intersection capacity analysis has been completed for the 2020 total traffic conditions. The intersection parameters used in the analysis are consistent with the 2017 TIA Guidelines (Saturation Flow Rate: 1800 vphpl, Peak Hour Factor: 1.0). The results of the Synchro analysis for the AM and PM peak hours are summarized in **Table 16**. Detailed reports are included in **Appendix I**.

Table 16: 2020 Total Traffic – Intersection Operations

| Intersection | AM Peak | | | PM Peak | | |
|---|-----------|-----|------|-----------|-----|-------------|
| | Max Delay | LOS | Mvmt | Max Delay | LOS | Mvmt |
| Portobello Boulevard/ Aquaview Drive/Nantes Street | 10 sec | A | WBT | 11 sec | B | SBL |
| Nantes Street/ Brianna Way | 8 sec | A | WBT | 9 sec | A | EBT |
| Provence Avenue/ Plainhill Drive | 8 sec | A | NBT | 7 sec | A | SBT/ EBT |
| Provence Avenue/ Grapefern Terrace | 10 sec | A | EBT | 9 sec | A | EBT |

Based on the foregoing table, no operational concerns are anticipated. Marginal increases to delays are anticipated as a result of additional site traffic within the study area. Increased delays for the southbound left turn movement at Portobello Boulevard/Aquaview Drive/Nantes Street result in the level of service at that intersection downgrading to an Auto LOS B.

6.7.5 2025 Total Intersection Operations

Intersection capacity analysis has been completed for the 2025 total traffic conditions. The intersection parameters used in the analysis are consistent with the 2017 TIA Guidelines (Saturation Flow Rate: 1800 vphpl, Peak Hour Factor: 1.0). The results of the Synchro analysis for the AM and PM peak hours are summarized in **Table 17**. Detailed reports are included in **Appendix I**.

Table 17: 2025 Total Traffic – Intersection Operations

| Intersection | AM Peak | | | PM Peak | | |
|---|-----------|-----|-------------|-----------|-----|------|
| | Max Delay | LOS | Mvmt | Max Delay | LOS | Mvmt |
| Portobello Boulevard/ Aquaview Drive/Nantes Street | 10 sec | A | WBT | 11 sec | B | SBL |
| Nantes Street/ Brianna Way | 8 sec | A | WBT | 9 sec | A | EBT |
| Provence Avenue/ Plainhill Drive | 8 sec | A | NBT/ SBT | 8 sec | A | SBT |
| Provence Avenue/ Grapefern Terrace | 10 sec | A | EBT | 10 sec | A | EBT |

Based on the foregoing table, no operational concerns are anticipated.

7.0 CONCLUSIONS AND RECOMMENDATIONS

Based on the foregoing, the conclusions and recommendations of this TIA can be summarized as follows:

Forecasting

- Phase 6 of the proposed subdivision is projected to generate approximately 327 person trips during the AM peak hour and 398 person trips during the PM peak hour, which includes approximately 180 vehicle trips during the AM peak hour and 218 vehicle trips during the PM peak hour.

Development Design

- Street No. 11 and the remainder of Plainridge Crescent have a proposed ROW width of 18m and a proposed roadway width of 8.5m, which is sufficient for a travel lane in each direction and parking on one side of the roadway. This is adequate given the context of the proposed development, a low-speed residential neighbourhood with limited opportunity for cut-through traffic.
- 1.8m concrete sidewalks are proposed on the east side of Street No. 11 between Nantes Street and the first residential lot, on the west side of Street No. 11 between Nantes Street and the future transitway, and on the inside of Street No. 11 and Plainridge Crescent between Grapefern Terrace and the northeast corner of the Lalande park.
- A PXO has recently been implemented at the north approach of Provence Avenue/Grapefern Terrace, as part of the Trans-Orléans Pathway project. There are no other candidate locations for a PXO within Phase 6 of the subdivision.

Boundary Streets

- The results of the segment MMLOS analysis can be summarized as follows:
 - Provence Avenue meets the target pedestrian level of service (PLOS), while Portobello Boulevard, Nantes Street, and Grapefern Terrace do not;
 - Portobello Boulevard, Nantes Street, and Grapefern Terrace meet the target bicycle level of service (BLOS), while Provence Avenue does not;
 - No roadways have targets for transit level of service (TLOS), however Portobello Boulevard and Provence Avenue achieve a TLOS D;
 - No roadways have targets for truck level of service (TkLOS), however Portobello Boulevard and Provence Avenue achieve a TkLOS B or better;
 - All roadways meet the target vehicular level of service (Auto LOS).

- The PLOS of Portobello Boulevard can be improved to the target PLOS A by implementing a 0.5m sidewalk boulevard while maintaining a 2.0m-wide sidewalk on the east side, and implementing a 1.8m-wide sidewalk while maintaining a 2.0m sidewalk boulevard. As it is still early in the life cycle of the sidewalk, and the existing cross-section of Portobello Boulevard met the City standard when it was widened approximately 10 years ago, widening this sidewalk to meet the target PLOS is not considered reasonable.

- The PLOS of Nantes Street can be improved to the target PLOS A by implementing sidewalks with a minimum width of 2.0m and a minimum boulevard width of 0.5m on the south side of the roadway. As the existing cross-section meets the current City standards, no modifications are recommended.

- The PLOS of Grapefern Terrace can be improved to the target PLOS A by implementing sidewalks with a minimum width of 2.0m and a minimum boulevard width of 0.5m on both sides of the roadway. A sidewalk was not deemed to be required as part of the Trans-Orléans Pathway project. As it is a short residential street and the existing cross-section meets the current City standards, no modifications are recommended.

- The *Ontario Traffic Manual – Book 18* identifies a shared roadway as suitable on Provence Avenue, given the low traffic volumes. As part of the Trans-Orléans Pathway, 1.5m-wide bike lanes have been proposed on Provence Avenue between Grapefern Terrace and Scala Avenue. This implementation would improve the BLOS of Provence Avenue to a BLOS C. Further improvement of the bicycle level of service requires a reduction in the operating speed.

Access Intersections

- Phase 6 of the proposed subdivision will be served by three accesses. The two sections of Plainridge Crescent will be connected in a loop as part of the Phase 6 development. A full-movement access on Street No. 11 will tie in to the intersection of Nantes Street/Brianna Way, making it a four-legged intersection.

- Among the two intersections at Grapefern Terrace/Plainridge Crescent West and Grapefern Terrace/Plainridge Crescent East, neither are anticipated to meet the OTM or City criteria for all-way stop control. Therefore, no changes to the stop control locations are recommended (Grapefern Terrace is stop-controlled at Grapefern Terrace/Plainridge Crescent West, and Plainridge Crescent is stop-controlled at Grapefern Terrace/Plainridge Crescent East).

- The intersection of Nantes Street/Brianna Way is currently all-way stop controlled. No changes are recommended upon construction of the Street No. 11 access.

Transportation Demand Management

- The following TDM measures will be implemented as Phase 6 of the subdivision is built:
 - Designate an internal TDM program coordinator;
 - Display local area maps with walking/cycling routes and key destinations (at sales centre);
 - Display relevant transit schedules and route maps (at sales centre);
 - Provide multimodal travel option information packages to new residents (at sales centre).
- Applicable measures for the multi-unit block are included in the list above.

Neighbourhood Traffic Management

- Provence Avenue, Plainhill Drive, and Grapefern Terrace are not anticipated to exceed their respective two-way peak hour volume thresholds for considering an NTM plan. While Portobello Boulevard and Nantes Street are anticipated to exceed their respective two-way peak hour volume thresholds for considering an NTM plan, the addition of development-generated traffic is not anticipated to change the function of those roadways.

Transit

- Phase 6 of the proposed subdivision is projected to generate 66 transit trips during the AM peak hour and 80 transit trips during the PM peak hour.
- Based on the projected passenger volumes and correspondence with OC Transpo confirming new bus routes on Provence Avenue as the proposed subdivision develops, no capacity problems are anticipated on the bus routes 33 and 233, which serve the stops adjacent to the proposed Phase 6 development.

Intersection Design

- Based on existing traffic conditions, all study area intersections operate at an Auto LOS A. Under the background and total traffic conditions, all intersections are anticipated to continue operating acceptably. Only the southbound left turn movement at Portobello Boulevard/Aquaview Drive/Nantes Street is projected to downgrade to an Auto LOS B, as a result of site-generated traffic.
- Based on the foregoing, Phase 6 of the proposed subdivision is recommended from a transportation perspective.

NOVATECH

Prepared by:



Joshua Audia, B.Sc.
E.I.T.,
Transportation/Traffic

Reviewed by:



Jennifer Luong, P.Eng.
Senior Project Manager,
Transportation/Traffic

APPENDIX A

Concept Plan

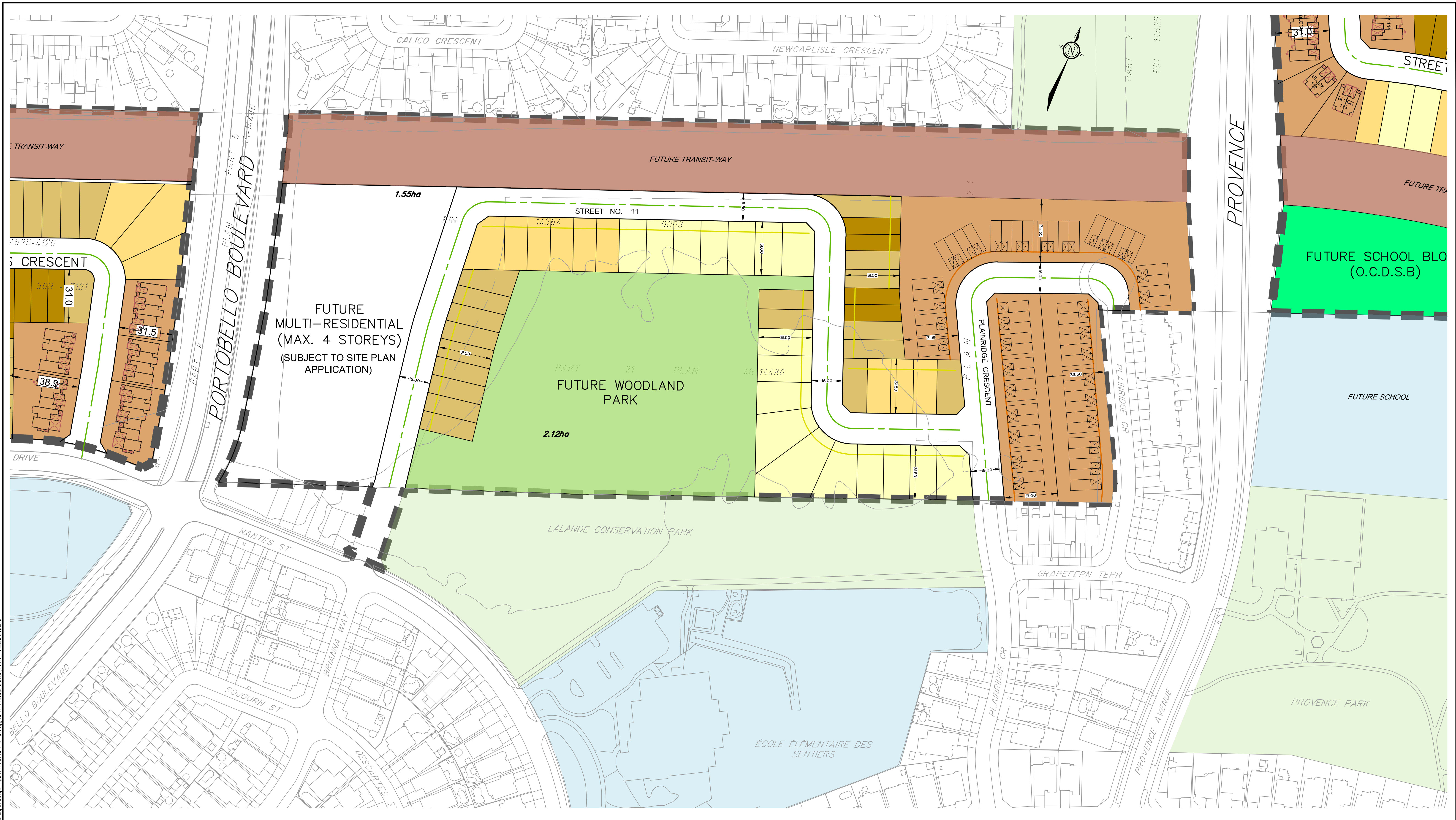

NOTE:
 THE POSITION OF ALL POLE LINES, CONDUITS,
 WATERMANS, SEWERS AND OTHER
 UNDERGROUND AND OVERGROUND UTILITIES AND
 STRUCTURES IS NOT NECESSARILY SHOWN ON
 THE CONTRACT DRAWINGS, AND WHERE SHOWN,
 THE ACCURACY OF THE POSITION OF SUCH
 UTILITIES AND STRUCTURES IS NOT GUARANTEED.
 BEFORE STARTING WORK, DETERMINE THE EXACT
 LOCATION OF ALL SUCH UTILITIES AND
 STRUCTURES AND ASSUME ALL LIABILITY FOR
 DAMAGE TO THEM.

LEGEND:

| | |
|-------------|----------------------|
| 31' | SINGLES |
| 35' | SINGLES |
| 42' | SINGLES |
| 50' | SINGLES |
| [Green Box] | PARK / WALKWAY BLOCK |

| No. | REVISION | DATE | BY |
|-----|---------------------------|------------|-----|
| 3. | ISSUED FOR REVIEW | APR 21/20 | MER |
| 2. | REVISED MULTI UNIT BLOCKS | SEPT 05/19 | MER |
| 1. | ISSUED FOR DISCUSSION | APR 17/19 | MER |

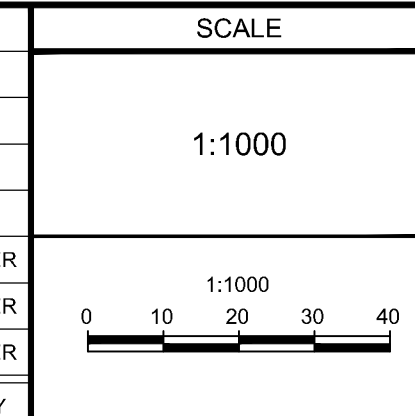

| DESIGN | FOR REVIEW ONLY |
|----------|-----------------|
| MER/WLS | |
| CHECKED | |
| MER | |
| DRAWN | |
| CAH | |
| CHECKED | |
| MER | |
| APPROVED | |
| MER | |

NOVATECH
 Engineers, Planners & Landscape Architects
 Suite 200, 240 Michael Cowpland Drive
 Ottawa, Ontario, Canada K2M 1P6
 Telephone: (613) 254-9643
 Facsimile: (613) 254-5867
 Website: www.novatech-eng.com

| | |
|---|-------------|
| LOCATION CITY OF OTTAWA PROVENCE ORLEANS SUBDIVISION (2128 TRIM ROAD) | |
| DRAWING NAME | PROJECT No. |
| CONCEPT PLAN 17 PHASE 6 | 117155-00 |
| | REV #3 |
| | DRAWING No. |
| | 117155-CP17 |

I:\projects\117155\CP17-Phase6\Concept Plans\117155-CP17-Phase6.dwg, CPTA-24236, Jun 02, 2020, 10:40am, weiss

APPENDIX B

TIA Screening Form

City of Ottawa 2017 TIA Guidelines Screening Form

1. Description of Proposed Development

| | |
|------------------------------------|--|
| Municipal Address | 2065 Portobello Boulevard (Provence Orléans) |
| Description of Location | The approximately 11-hectare property is located north of Nantes Street and Grapefern Terrace, between Portobello Boulevard and Provence Avenue |
| Land Use Classification | Single-family homes, townhomes and apartments |
| Development Size (units) | 421 units |
| Development Size (m ²) | - |
| Number of Accesses and Locations | <ul style="list-style-type: none"> • One access at Nantes Street/Brianna Way • Two accesses at Plainridge Crescent/Grapefern Terrace |
| Phase of Development | 1 |
| Buildout Year | Full buildout in 2020 |

If available, please attach a sketch of the development or site plan to this form.

2. Trip Generation Trigger

Considering the Development's Land Use type and Size (as filled out in the previous section), please refer to the Trip Generation Trigger checks below.

| Land Use Type | Minimum Development Size |
|-------------------------------------|--------------------------|
| Single-family homes | 40 units |
| Townhomes or apartments | 90 units |
| Office | 3,500 m ² |
| Industrial | 5,000 m ² |
| Fast-food restaurant or coffee shop | 100 m ² |
| Destination retail | 1,000 m ² |
| Gas station or convenience market | 75 m ² |

** If the development has a land use type other than what is presented in the table above, estimates of person-trip generation may be made based on average trip generation characteristics represented in the current edition of the Institute of Transportation Engineers (ITE) Trip Generation Manual.*

If the proposed development size is greater than the sizes identified above, the Trip Generation Trigger is satisfied.

3. Location Triggers

| | Yes | No |
|--|-----|----|
| Does the development propose a new driveway to a boundary street that is designated as part of the City's Transit Priority, Rapid Transit or Spine Bicycle Networks? | | ✓ |
| Is the development in a Design Priority Area (DPA) or Transit-oriented Development (TOD) zone?* | | ✓ |

**DPA and TOD are identified in the City of Ottawa Official Plan (DPA in Section 2.5.1 and Schedules A and B; TOD in Annex 6). See Chapter 4 for a list of City of Ottawa Planning and Engineering documents that support the completion of TIA).*

If any of the above questions were answered with 'Yes,' the Location Trigger is satisfied.

4. Safety Triggers

| | Yes | No |
|---|-----|----|
| Are posted speed limits on a boundary street are 80 km/hr or greater? | | ✓ |
| Are there any horizontal/vertical curvatures on a boundary street limits sight lines at a proposed driveway? | | ✓ |
| Is the proposed driveway within the area of influence of an adjacent traffic signal or roundabout (i.e. within 300 m of intersection in rural conditions, or within 150 m of intersection in urban/ suburban conditions)? | | ✓ |
| Is the proposed driveway within auxiliary lanes of an intersection? | | ✓ |
| Does the proposed driveway make use of an existing median break that serves an existing site? | | ✓ |
| Is there is a documented history of traffic operations or safety concerns on the boundary streets within 500 m of the development? | | ✓ |
| Does the development include a drive-thru facility? | | ✓ |

If any of the above questions were answered with 'Yes,' the Safety Trigger is satisfied.

5. Summary

| | Yes | No |
|---|-----|----|
| Does the development satisfy the Trip Generation Trigger? | ✓ | |
| Does the development satisfy the Location Trigger? | | ✓ |
| Does the development satisfy the Safety Trigger? | | ✓ |

If none of the triggers are satisfied, the TIA Study is complete. If one or more of the triggers is satisfied, the TIA Study must continue into the next stage (Screening and Scoping).

APPENDIX C

Provence Avenue Area Traffic Management Options

PROVENCE AVENUE AREA TRAFFIC MANAGEMENT STUDY (From Valin Street to Brian Coburn Boulevard) Recommended Plan

ÉTUDE DE GESTION DE LA CIRCULATION LOCALE SUR L'AVENUE PROVENCE (De la rue Valin à le boulevard Brian Coburn) Le plan recommandé

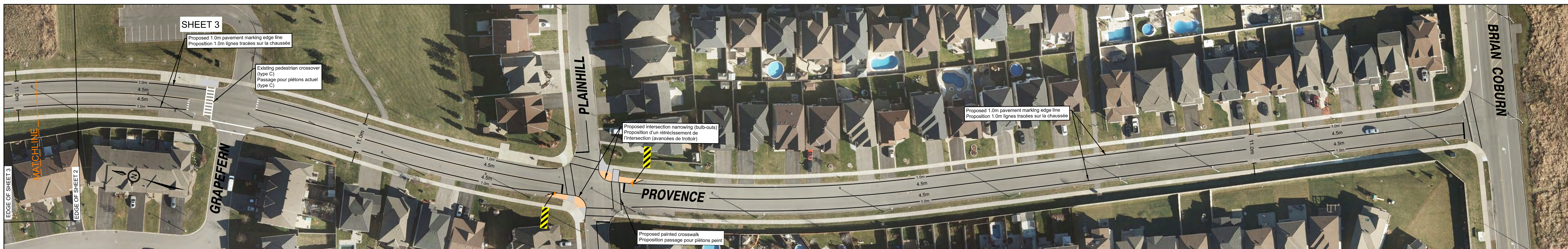
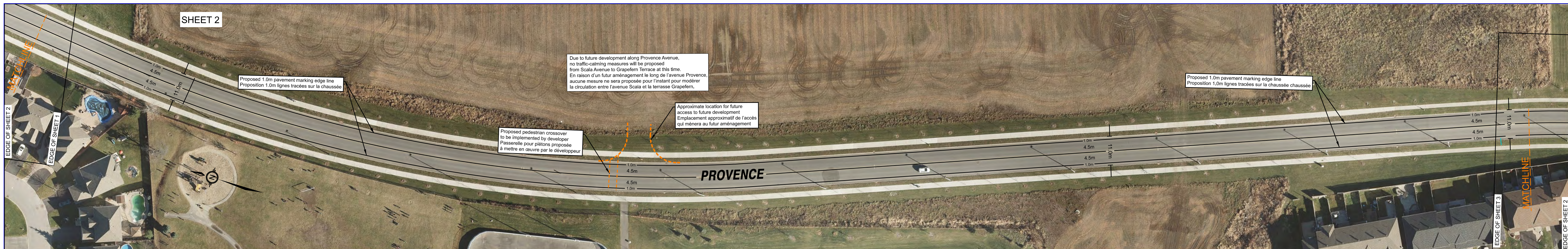
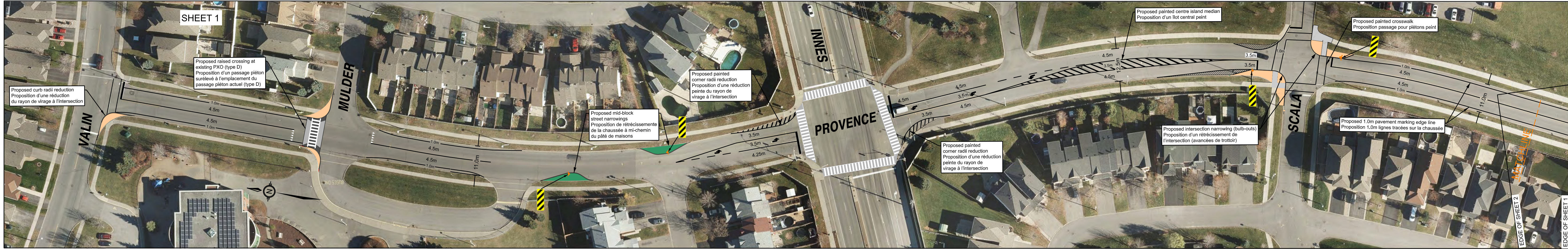

APPENDIX D

OC Transpo Route Maps



33

PORTOBELLO BLAIR

Local

Monday to Friday / Lundi au vendredi

Peak periods with selected trips midday and evening / Périodes de pointe et service limité en mi-journée et soirée

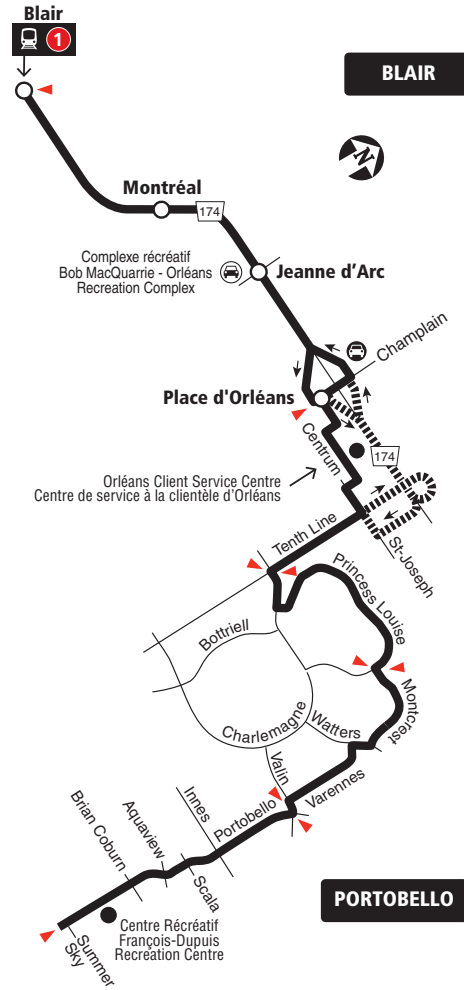

- Station
- Weekday Peak trips only / Trajets de semaine en périodes de pointe seulement
- Park & Ride / Parc-o-bus
- Timepoint / Heures de passage

2019.07

Future route after O-Train Line 1 is open
Trajet du circuit après l'ouverture de la Ligne 1 de l'O-Train

Lost and Found / Objets perdus..... 613-563-4011
 Security / Sécurité..... 613-741-2478

INFO 613-741-4390
 octranspo.com



233

PORTOBELLO BLAIR

Connexion

Monday to Friday / Lundi au vendredi

Peak periods only

Périodes de pointe seulement

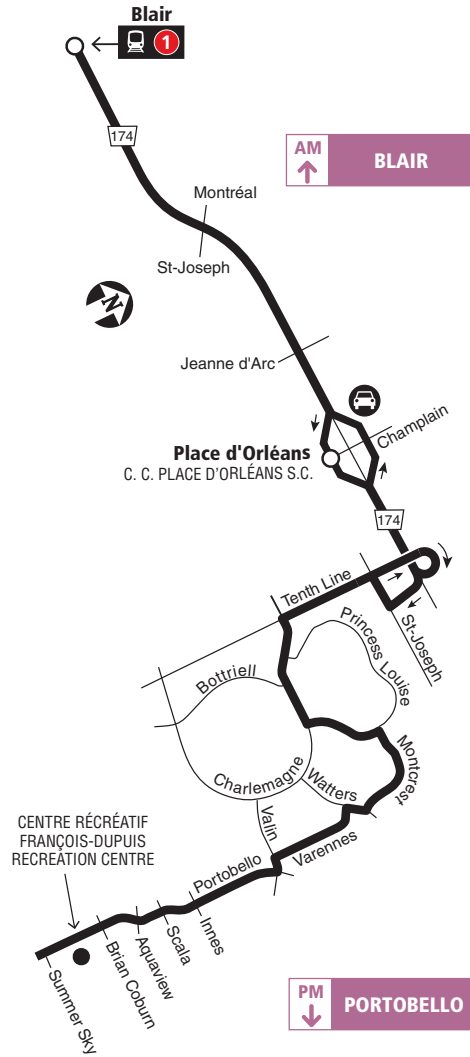

- Station
- 🚌 Park & Ride / Parc-o-bus

2019.07



Future route after O-Train Line 1 is open
Trajet du circuit après l'ouverture
de la Ligne 1 de l'O-Train

Lost and Found / Objets perdus..... 613-563-4011

Security / Sécurité..... 613-741-2478



INFO 613-741-4390
octranspo.com

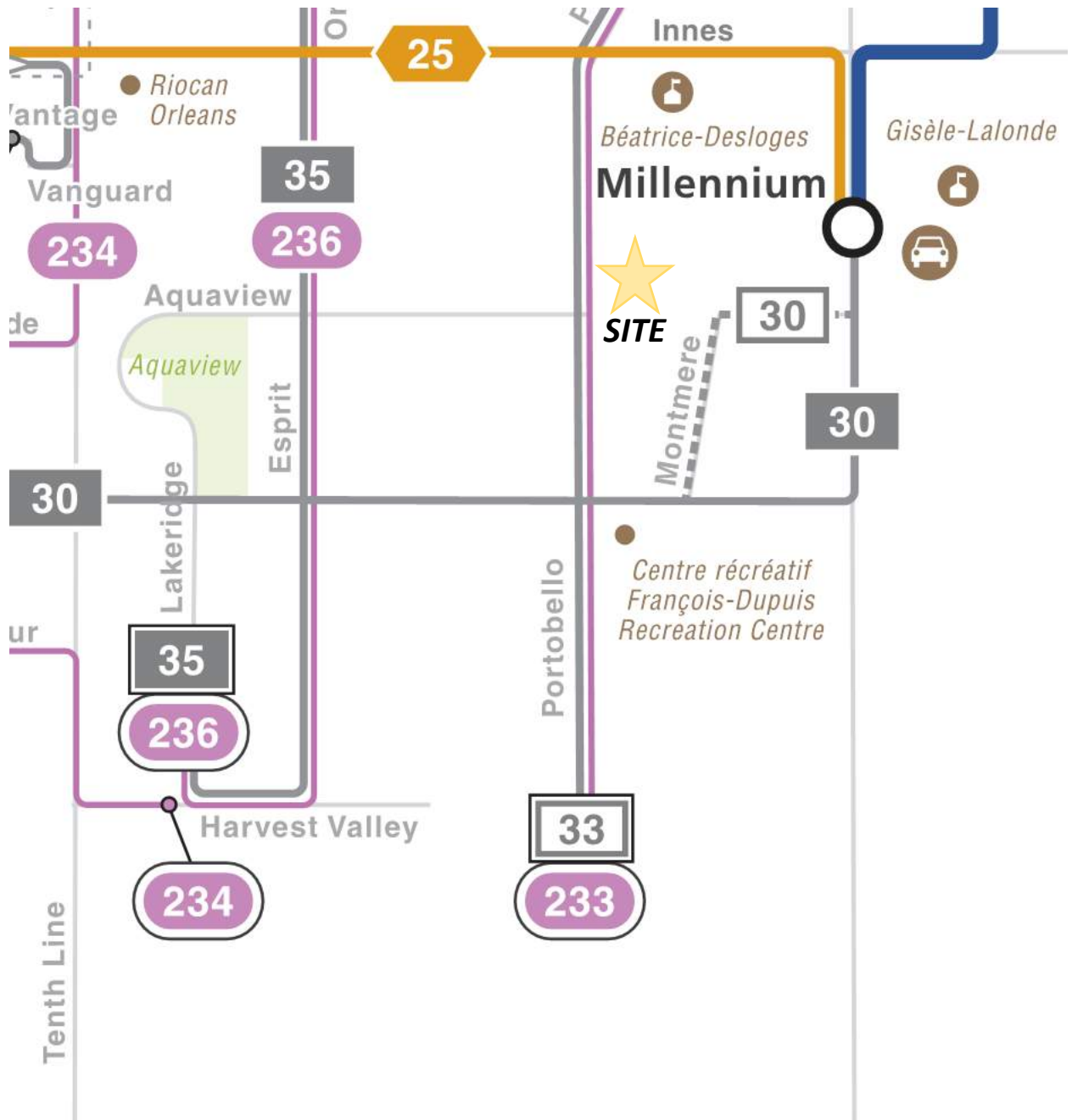

APPENDIX E

Traffic Count Data



Transportation Services - Traffic Services

Turning Movement Count - Full Study Peak Hour Diagram

PORTOBELLO BLVD @ AQUAVIEW DR/NANTES ST

Survey Date: Thursday, May 25, 2017

Start Time: 07:00

WO No: 37061

Device: Miovision

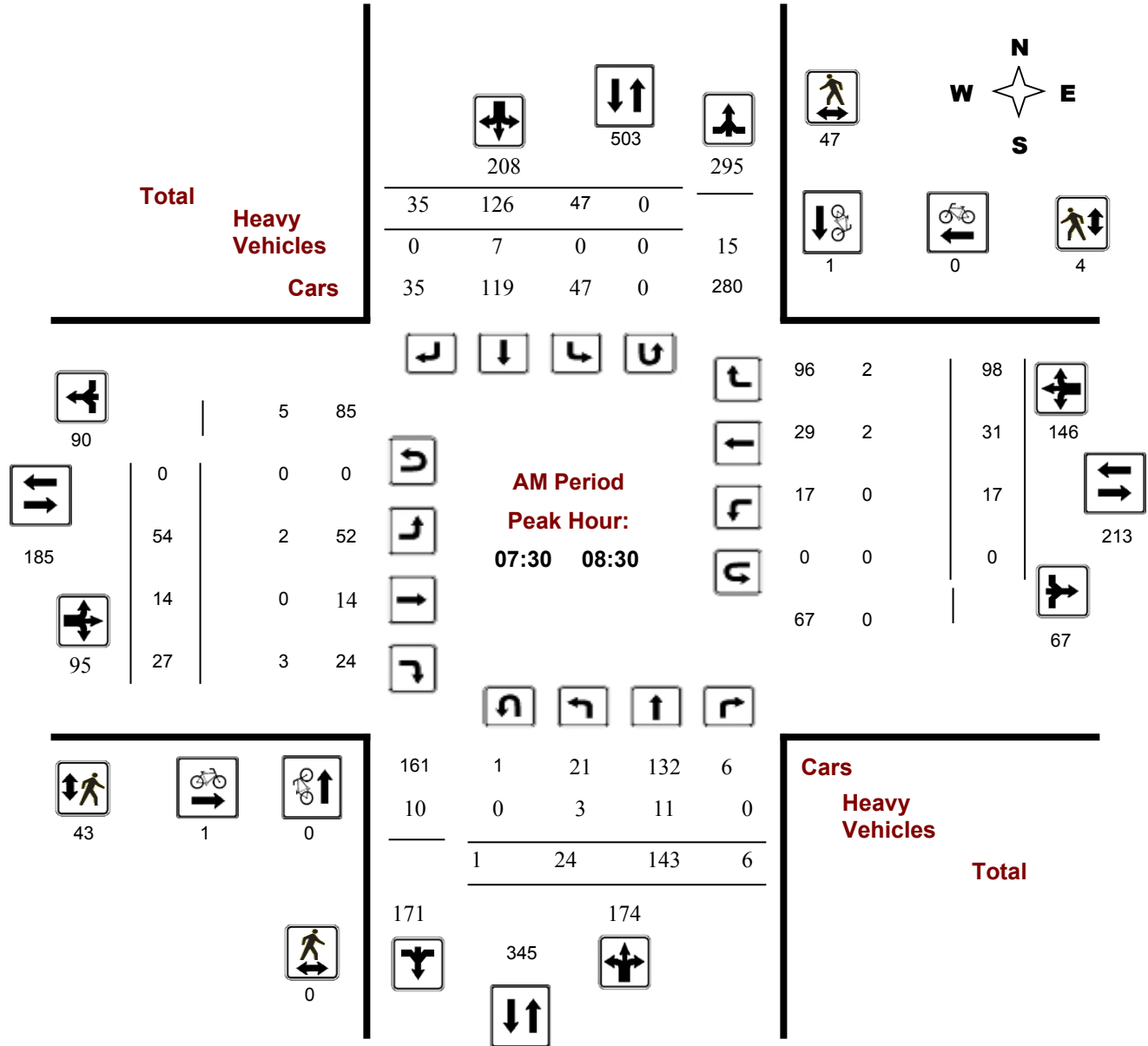

Comments



Transportation Services - Traffic Services

Turning Movement Count - Full Study Peak Hour Diagram

PORTOBELLO BLVD @ AQUAVIEW DR/NANTES ST

Survey Date: Thursday, May 25, 2017

Start Time: 07:00

WO No: 37061

Device: Miovision

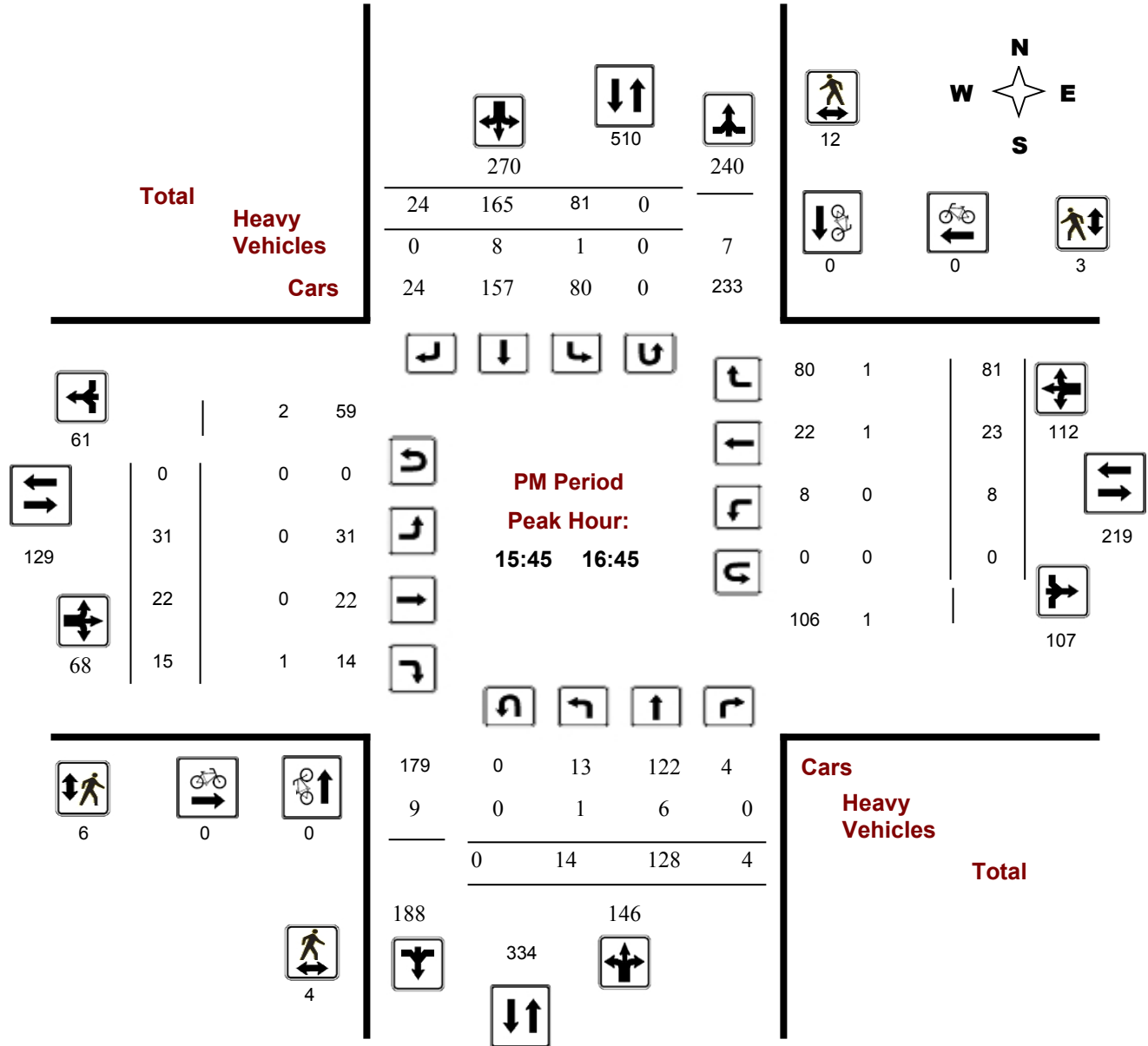

Comments

Turning Movement Count - Full Study Summary Report

PORTOBELLO BLVD @ AQUAVIEW DR/NANTES ST

Survey Date: Thursday, May 25, 2017

Total Observed U-Turns

| | |
|---------------|---------------|
| Northbound: 4 | Southbound: 2 |
| Eastbound: 1 | Westbound: 0 |

AADT Factor

.90

Full Study

| Period | Northbound | | | | Southbound | | | | Eastbound | | | | Westbound | | | | STR TOT | Grand Total | |
|---|------------|------|----|--------|------------|------|-----|--------|-----------|-----|-----|--------|-------------|----|-----|--------|---------|-------------|------|
| | LT | ST | RT | NB TOT | LT | ST | RT | SB TOT | LT | ST | RT | EB TOT | LT | ST | RT | WB TOT | | | |
| 07:00 08:00 | 19 | 134 | 4 | 157 | 31 | 129 | 33 | 193 | 350 | 47 | 11 | 19 | 77 | 12 | 33 | 99 | 144 | 221 | 571 |
| 08:00 09:00 | 16 | 126 | 7 | 149 | 51 | 97 | 15 | 163 | 312 | 34 | 13 | 15 | 62 | 8 | 16 | 91 | 115 | 177 | 489 |
| 09:00 10:00 | 2 | 72 | 4 | 78 | 29 | 66 | 8 | 103 | 181 | 14 | 11 | 2 | 27 | 3 | 23 | 55 | 81 | 108 | 289 |
| 11:30 12:30 | 4 | 56 | 0 | 60 | 31 | 62 | 13 | 106 | 166 | 14 | 10 | 2 | 26 | 4 | 5 | 34 | 43 | 69 | 235 |
| 12:30 13:30 | 2 | 47 | 2 | 51 | 23 | 52 | 9 | 84 | 135 | 18 | 5 | 3 | 26 | 2 | 7 | 24 | 33 | 59 | 194 |
| 15:00 16:00 | 13 | 106 | 1 | 120 | 76 | 154 | 20 | 250 | 370 | 27 | 19 | 8 | 54 | 7 | 17 | 46 | 70 | 124 | 494 |
| 16:00 17:00 | 12 | 129 | 5 | 146 | 84 | 162 | 23 | 269 | 415 | 29 | 23 | 18 | 70 | 6 | 13 | 79 | 98 | 168 | 583 |
| 17:00 18:00 | 15 | 161 | 4 | 180 | 80 | 150 | 29 | 259 | 439 | 19 | 27 | 9 | 55 | 4 | 17 | 52 | 73 | 128 | 567 |
| Sub Total | 83 | 831 | 27 | 941 | 405 | 872 | 150 | 1427 | 2368 | 202 | 119 | 76 | 397 | 46 | 131 | 480 | 657 | 1054 | 3422 |
| U Turns | | | | 4 | | | | 2 | 6 | | | | 1 | | | | 0 | 1 | 7 |
| Total | 83 | 831 | 27 | 945 | 405 | 872 | 150 | 1429 | 2374 | 202 | 119 | 76 | 398 | 46 | 131 | 480 | 657 | 1055 | 3429 |
| EQ 12Hr | 115 | 1155 | 38 | 1314 | 563 | 1212 | 208 | 1986 | 3300 | 281 | 165 | 106 | 553 | 64 | 182 | 667 | 913 | 1466 | 4766 |
| Note: These values are calculated by multiplying the totals by the appropriate expansion factor. | | | | | | | | | | | | | 1.39 | | | | | | |
| AVG 12Hr | 104 | 1040 | 34 | 1182 | 507 | 1091 | 188 | 1788 | 2970 | 253 | 149 | 95 | 498 | 58 | 164 | 600 | 822 | 1320 | 4290 |
| Note: These volumes are calculated by multiplying the Equivalent 12 hr. totals by the AADT factor. | | | | | | | | | | | | | .90 | | | | | | |
| AVG 24Hr | 136 | 1362 | 44 | 1549 | 664 | 1429 | 246 | 2342 | 3891 | 331 | 195 | 125 | 652 | 75 | 215 | 787 | 1077 | 1729 | 5620 |
| Note: These volumes are calculated by multiplying the Average Daily 12 hr. totals by 12 to 24 expansion factor. | | | | | | | | | | | | | 1.31 | | | | | | |

Comments:

Note: U-Turns provided for approach totals. Refer to 'U-Turn' Report for specific breakdown.



Turning Movement Count Summary, AM and PM Peak Hour Flow Diagrams

Automobiles, Taxis, Light Trucks, Vans, SUV's, Motorcycles, Heavy Trucks, Buses, and School Buses

Brianna Way & Nantes Street Orléans, ON

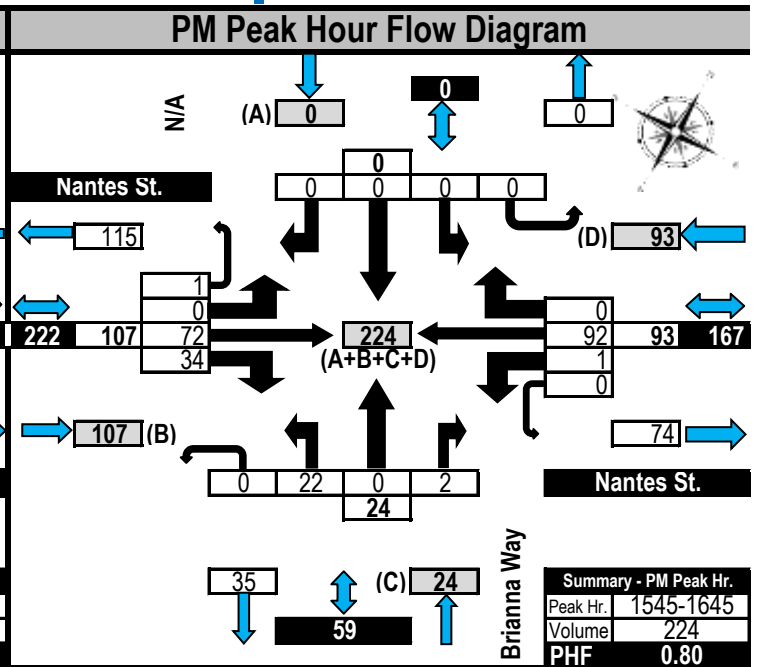
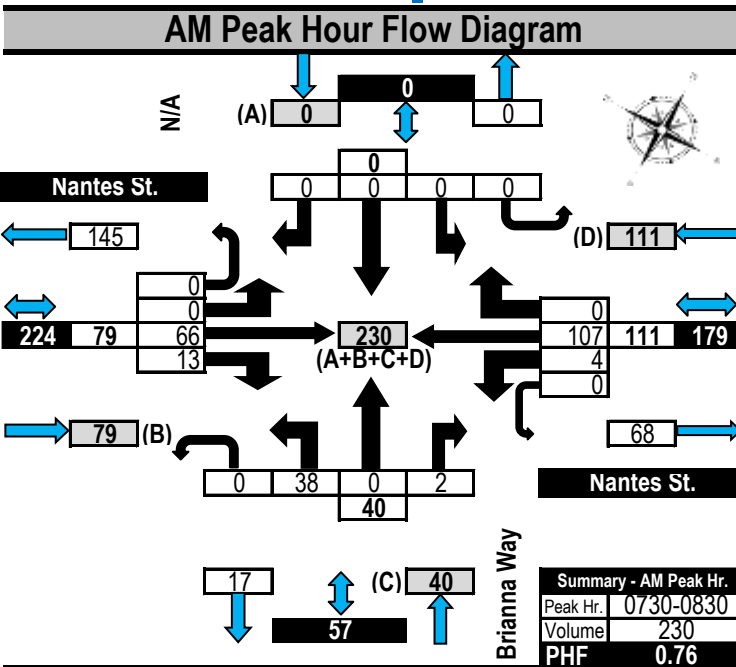
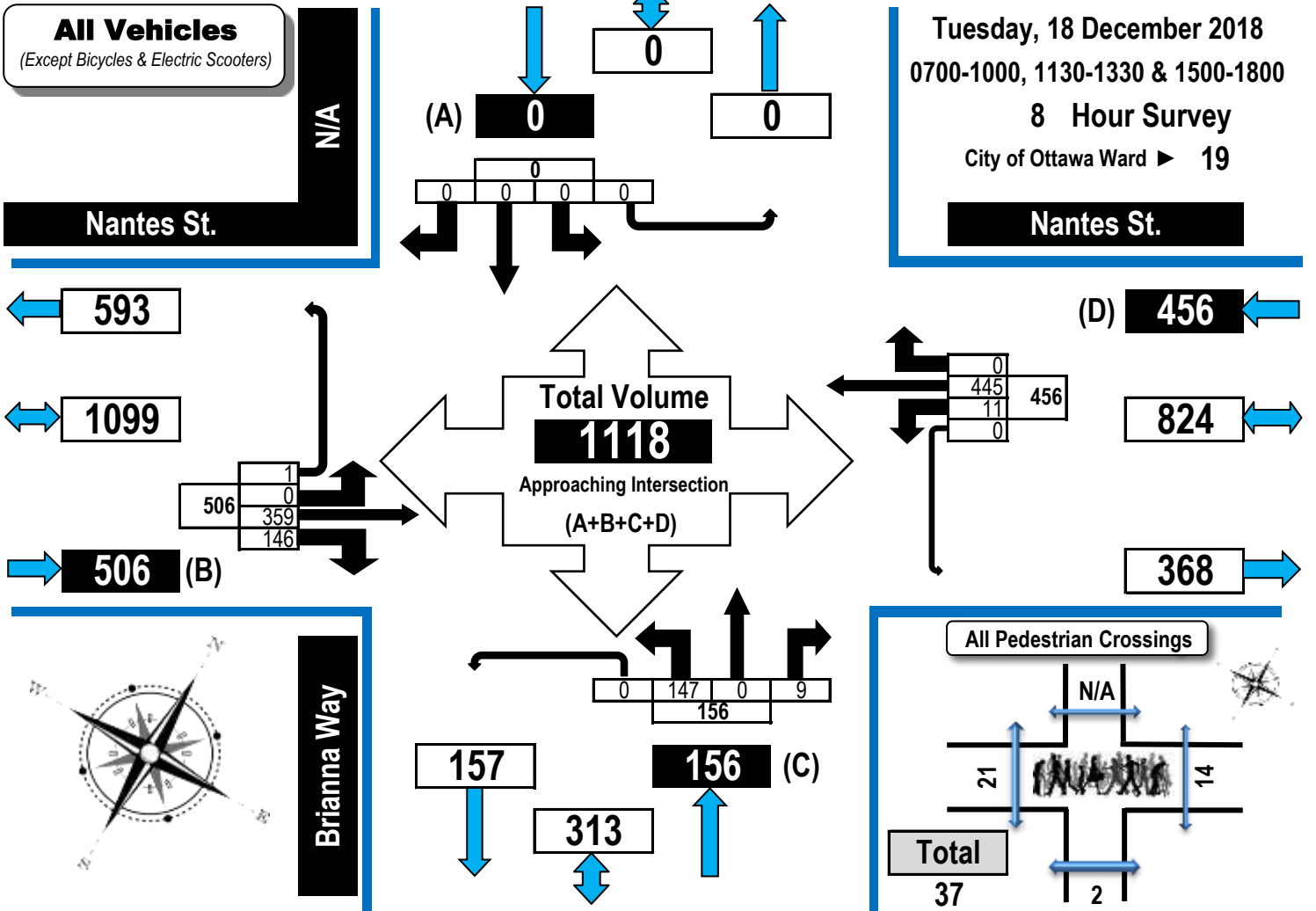



Turning Movement Count

Summary Report Including AM/PM Peak Hours, PHF, AADT and Expansion Factors

Automobiles, Taxis,
Light Trucks, Vans,
SUV's, Motorcycles,
Heavy Trucks, Buses,
and School Buses

Brianna Way & Nantes Street

Orléans, ON

Survey Date: Tuesday, 18 December 2018 **Start Time:** 0700 **AADT Factor:** 1.3
Weather-AM/PM Cloudy -8°C/Cloudy -5°C **Survey Duration:** 8 Hrs. **Survey Hours:** 0700-1000, 1130-1330 & 1500-1800

| Time Period | Nantes St. Eastbound | | | | | Nantes St. Westbound | | | | | Brianna Way Northbound | | | | | N/A Southbound | | | | | Street Total | Grand Total | |
|---------------|----------------------|------------|------------|----------|------------|----------------------|------------|----------|----------|------------|------------------------|------------|----------|----------|----------|----------------|----------|----------|----------|----------|--------------|-------------|-------------|
| | LT | ST | RT | UT | E/B Tot | LT | ST | RT | UT | W/B Tot | LT | ST | RT | UT | N/B Tot | LT | ST | RT | UT | S/B Tot | | | |
| | 0700-0800 | 0 | 43 | 11 | 0 | 54 | 0 | 101 | 0 | 0 | 101 | 155 | 44 | 0 | 3 | 0 | 47 | 0 | 0 | 0 | | | 0 |
| 0800-0900 | 0 | 73 | 11 | 0 | 84 | 4 | 73 | 0 | 0 | 77 | 161 | 18 | 0 | 0 | 0 | 18 | 0 | 0 | 0 | 0 | 0 | 18 | 179 |
| 0900-1000 | 0 | 38 | 12 | 0 | 50 | 2 | 63 | 0 | 0 | 65 | 115 | 12 | 0 | 0 | 0 | 12 | 0 | 0 | 0 | 0 | 0 | 12 | 127 |
| 1130-1230 | 0 | 13 | 14 | 0 | 27 | 1 | 24 | 0 | 0 | 25 | 52 | 7 | 0 | 1 | 0 | 8 | 0 | 0 | 0 | 0 | 0 | 8 | 60 |
| 1230-1330 | 0 | 18 | 11 | 0 | 29 | 0 | 22 | 0 | 0 | 22 | 51 | 10 | 0 | 0 | 0 | 10 | 0 | 0 | 0 | 0 | 0 | 10 | 61 |
| 1500-1600 | 0 | 52 | 16 | 1 | 69 | 2 | 43 | 0 | 0 | 45 | 114 | 17 | 0 | 2 | 0 | 19 | 0 | 0 | 0 | 0 | 0 | 19 | 133 |
| 1600-1700 | 0 | 69 | 41 | 0 | 110 | 1 | 77 | 0 | 0 | 78 | 188 | 17 | 0 | 2 | 0 | 19 | 0 | 0 | 0 | 0 | 0 | 19 | 207 |
| 1700-1800 | 0 | 53 | 30 | 0 | 83 | 1 | 42 | 0 | 0 | 43 | 126 | 22 | 0 | 1 | 0 | 23 | 0 | 0 | 0 | 0 | 0 | 23 | 149 |
| Totals | 0 | 359 | 146 | 1 | 506 | 11 | 445 | 0 | 0 | 456 | 962 | 147 | 0 | 9 | 0 | 156 | 0 | 0 | 0 | 0 | 0 | 156 | 1118 |

Equivalent 12 & 24-hour Vehicle Volumes Including the Annual Average Daily Traffic (AADT) Factor
Applicable to the Day and Month of the Turning Movement Count

➔ **Expansion factors are applied exclusively to standard weekday 8-hour turning movement counts** ←

| | | | | | | | | | | | | | | | | | | | | | | | |
|---|---|-----|-----|---|-----|----|-----|---|---|-----|------|-----|---|----|---|-----|---|---|---|---|---|-----|------|
| Equivalent 12-hour vehicle volumes. These volumes are calculated by multiplying the 8-hour totals by the 8 ➔12 expansion factor of 1.39 | | | | | | | | | | | | | | | | | | | | | | | |
| Equ. 12 Hr | 0 | 499 | 203 | 1 | 703 | 15 | 619 | 0 | 0 | 634 | 1337 | 204 | 0 | 13 | 0 | 217 | 0 | 0 | 0 | 0 | 0 | 217 | 1554 |

| | | | | | | | | | | | | | | | | | | | | | | | |
|---|---|-----|-----|---|-----|----|-----|---|---|-----|------|-----|---|----|---|-----|---|---|---|---|---|-----|------|
| Average daily 12-hour vehicle volumes. These volumes are calculated by multiplying the equivalent 12-hour totals by the AADT factor of: 1.3 | | | | | | | | | | | | | | | | | | | | | | | |
| AADT 12-hr | 0 | 649 | 264 | 2 | 914 | 20 | 804 | 0 | 0 | 824 | 1738 | 266 | 0 | 16 | 0 | 282 | 0 | 0 | 0 | 0 | 0 | 282 | 2020 |

| | | | | | | | | | | | | | | | | | | | | | | | |
|--|---|-----|-----|---|------|----|------|---|---|------|------|-----|---|----|---|-----|---|---|---|---|---|-----|------|
| 24-Hour AADT. These volumes are calculated by multiplying the average daily 12-hour vehicle volumes by the 12 ➔24 expansion factor of 1.31 | | | | | | | | | | | | | | | | | | | | | | | |
| AADT 24 Hr | 0 | 850 | 346 | 2 | 1198 | 26 | 1053 | 0 | 0 | 1079 | 2277 | 348 | 0 | 21 | 0 | 369 | 0 | 0 | 0 | 0 | 0 | 369 | 2646 |

| | | | | | | | | | | | | | | | | | | | | | | | |
|-----------------------------|----|----|----|----|-----|----|-----|----|----|-----------|---|----|----|----|-----|----|----|----|----|-----------|-------|----|-----|
| AM Peak Hour Factor ➔ 0.76 | | | | | | | | | | | Highest Hourly Vehicle Volume between 0700h & 1000h | | | | | | | | | | | | |
| AM Peak Hr | LT | ST | RT | UT | TOT | LT | ST | RT | UT | TOT S.TOT | LT | ST | RT | UT | TOT | LT | ST | RT | UT | TOT S.TOT | G.TOT | | |
| 0730-0830 | 0 | 66 | 13 | 0 | 79 | 4 | 107 | 0 | 0 | 111 | 190 | 38 | 0 | 2 | 0 | 40 | 0 | 0 | 0 | 0 | 0 | 40 | 230 |
| OFF Peak Hour Factor ➔ 0.79 | | | | | | | | | | | Highest Hourly Vehicle Volume between 1130h & 1330h | | | | | | | | | | | | |
| Off Peak Hr | LT | ST | RT | UT | TOT | LT | ST | RT | UT | TOT S.TOT | LT | ST | RT | UT | TOT | LT | ST | RT | UT | TOT S.TOT | G.TOT | | |
| 1200-1300 | 0 | 15 | 14 | 0 | 29 | 1 | 25 | 0 | 0 | 26 | 55 | 10 | 0 | 1 | 0 | 11 | 0 | 0 | 0 | 0 | 0 | 11 | 66 |
| PM Peak Hour Factor ➔ 0.80 | | | | | | | | | | | Highest Hourly Vehicle Volume between 1500h & 1800h | | | | | | | | | | | | |
| PM Peak Hr | LT | ST | RT | UT | TOT | LT | ST | RT | UT | TOT S.TOT | LT | ST | RT | UT | TOT | LT | ST | RT | UT | TOT S.TOT | G.TOT | | |
| 1545-1645 | 0 | 72 | 34 | 1 | 107 | 1 | 92 | 0 | 0 | 93 | 200 | 22 | 0 | 2 | 0 | 24 | 0 | 0 | 0 | 0 | 0 | 24 | 224 |

Comments

During this survey, 33 westbound drivers, 27 eastbound drivers and 1 northbound driver drove through the stop signs at speeds estimated to be in excess of 20 km/h. The majority of the heavy vehicle traffic consists of school buses.

Notes:

1. Includes all vehicle types except bicycles and electric scooters.
2. Expansion factors are not applied to turning movement counts if they are less than 8-hours in duration.
3. When expansion and AADT factors are applied, the results will differ slightly due to rounding.

Disclaimer:

The information contained in this data summary is for information purposes only, and may not apply to your situation. Every effort is made to ensure the traffic count information is accurate for the survey date provided on the summary and flow diagram forms. The author, publisher, and distributor provide no warranty about the content or accuracy of either the data summary or flow diagrams. Information provided is subjective. The author, publisher, and distributor shall not be liable for any loss of profit or any other commercial damages resulting from use of this data.

Turning Movement Count - Peak Hour Diagram

PROVENCE AVE @ GRAPEFERN TER

Survey Date: Wednesday, July 23, 2014

Start Time: 07:00

WO No: 29385

Device: Jamar Technologies, Inc

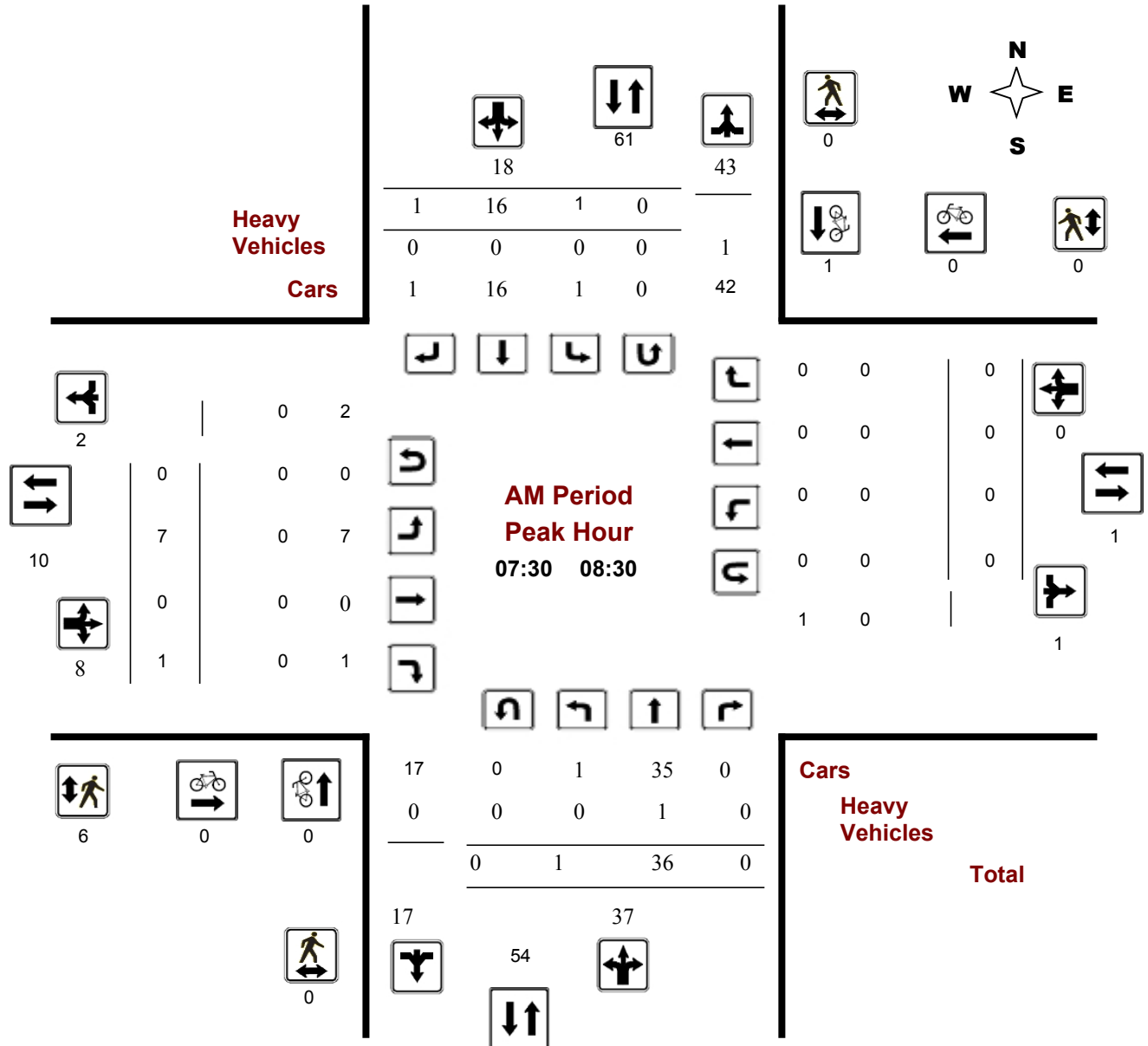

Comments

Turning Movement Count - Peak Hour Diagram

PROVENCE AVE @ GRAPEFERN TER

Survey Date: Wednesday, July 23, 2014

Start Time: 07:00

WO No: 29385

Device: Jamar Technologies, Inc

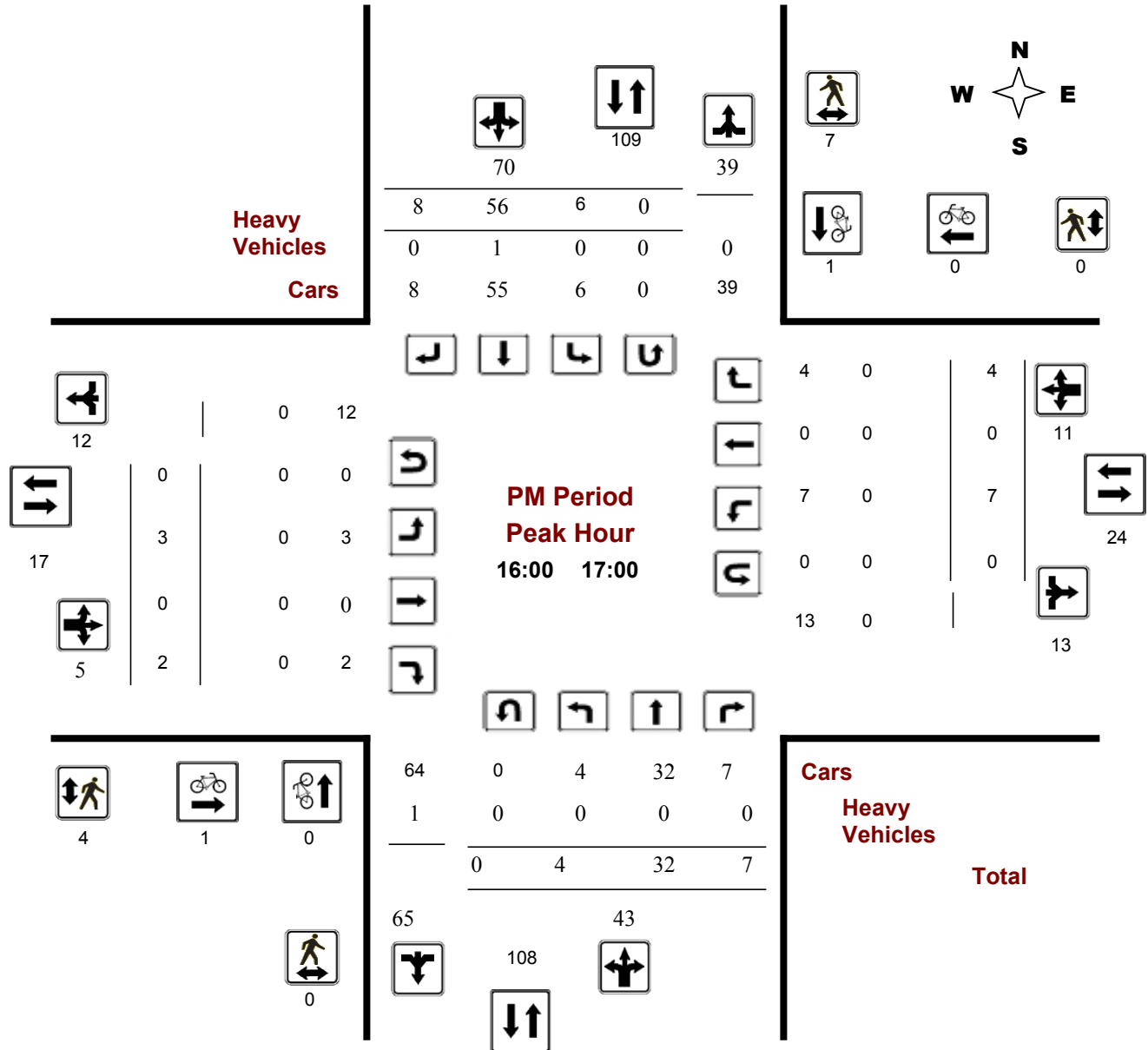

Comments



Transportation Services - Traffic Services

Turning Movement Count - Full Study Peak Hour Diagram

PLAINHILL DR @ PROVENCE AVE

Survey Date: Wednesday, January 22, 2014

Start Time: 07:00

WO No: 397

Device: Miovision

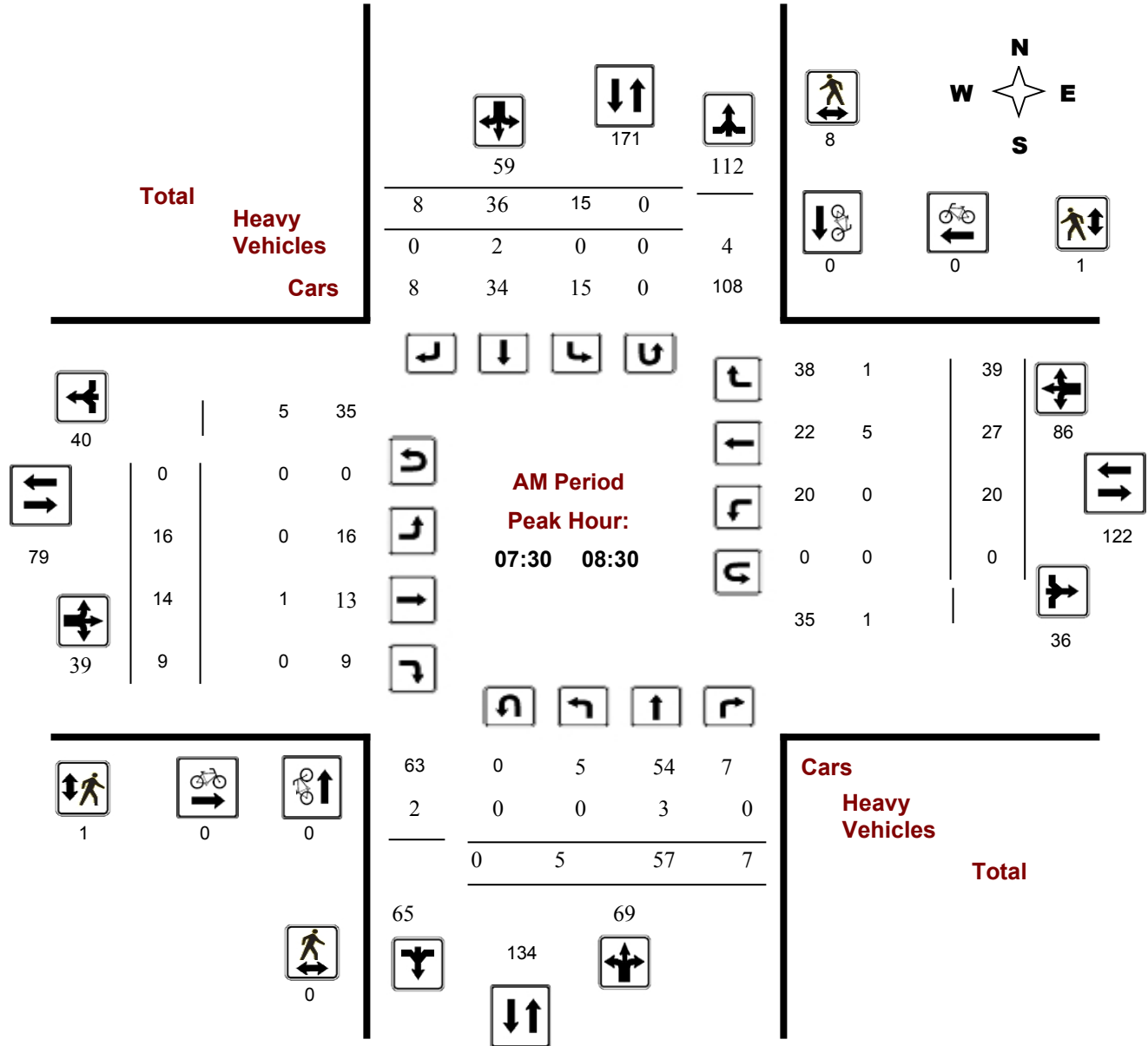

Comments



Transportation Services - Traffic Services

Turning Movement Count - Full Study Peak Hour Diagram

PLAINHILL DR @ PROVENCE AVE

Survey Date: Wednesday, January 22, 2014

Start Time: 07:00

WO No: 397

Device: Miovision

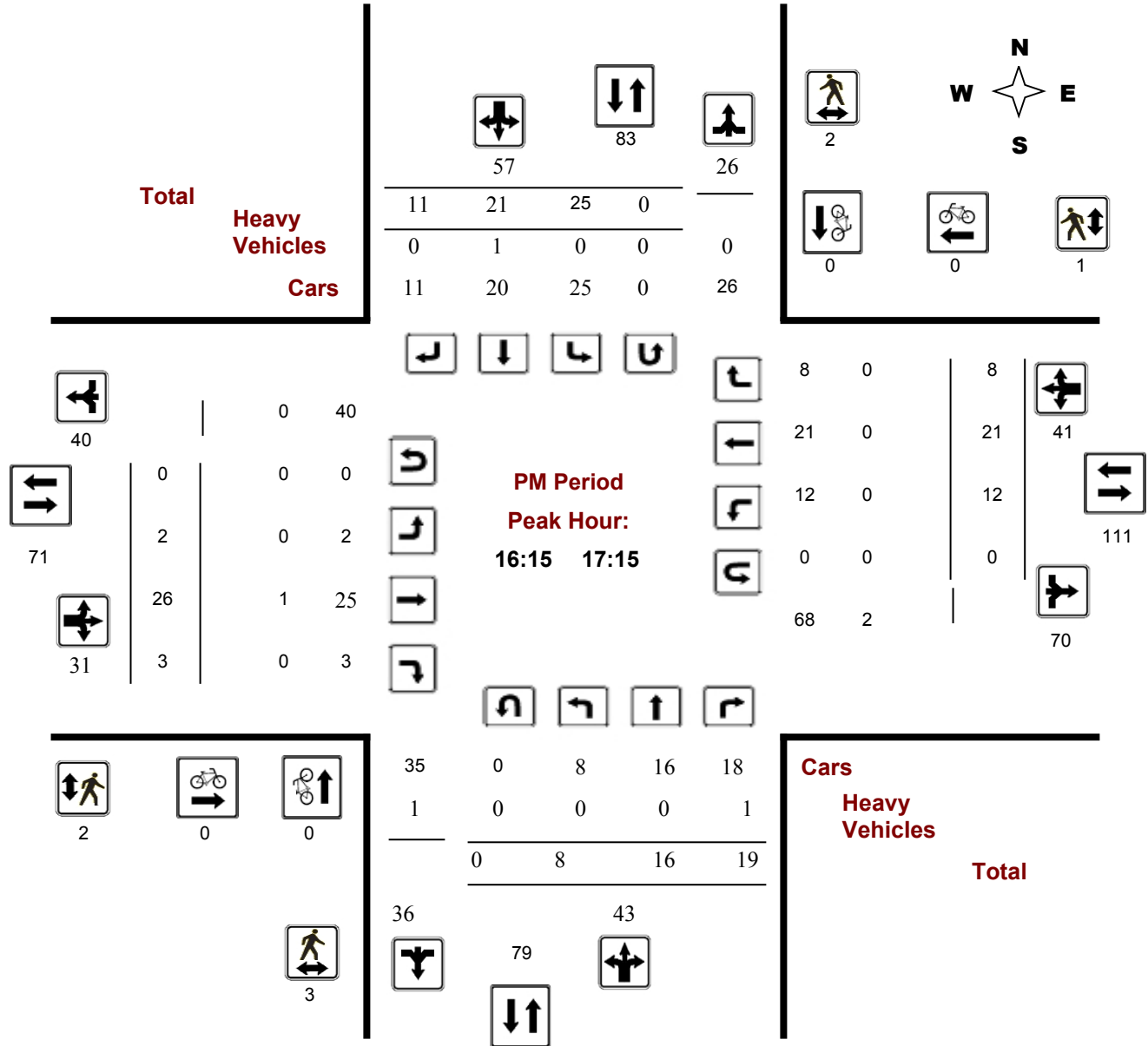

Comments

Turning Movement Count - Full Study Summary Report

PLAINHILL DR @ PROVENCE AVE

Survey Date: Wednesday, January 22, 2014

Total Observed U-Turns

AADT Factor

Northbound: 0 Southbound: 0
 Eastbound: 0 Westbound: 0

1.00

Full Study

| Period | Northbound | | | | Southbound | | | | STR TOT | Eastbound | | | Westbound | | | WB TOT | STR TOT | Grand Total | |
|---|------------|-----|-----|--------|------------|-----|----|--------|---------|-----------|-----|----|-------------|-----|-----|--------|---------|-------------|------|
| | LT | ST | RT | NB TOT | LT | ST | RT | SB TOT | | LT | ST | RT | EB TOT | LT | ST | | | | RT |
| 07:00 08:00 | 3 | 52 | 6 | 61 | 5 | 27 | 6 | 38 | 99 | 17 | 12 | 7 | 36 | 14 | 24 | 38 | 76 | 112 | 211 |
| 08:00 09:00 | 2 | 24 | 5 | 31 | 15 | 20 | 5 | 40 | 71 | 12 | 13 | 7 | 32 | 17 | 24 | 23 | 64 | 96 | 167 |
| 09:00 10:00 | 3 | 3 | 4 | 10 | 3 | 5 | 1 | 9 | 19 | 6 | 7 | 3 | 16 | 12 | 15 | 3 | 30 | 46 | 65 |
| 11:30 12:30 | 1 | 4 | 7 | 12 | 3 | 4 | 3 | 10 | 22 | 3 | 7 | 1 | 11 | 3 | 8 | 11 | 22 | 33 | 55 |
| 12:30 13:30 | 2 | 7 | 9 | 18 | 6 | 6 | 8 | 20 | 38 | 5 | 4 | 1 | 10 | 5 | 10 | 4 | 19 | 29 | 67 |
| 15:00 16:00 | 2 | 16 | 8 | 26 | 9 | 4 | 9 | 22 | 48 | 1 | 16 | 5 | 22 | 7 | 12 | 6 | 25 | 47 | 95 |
| 16:00 17:00 | 6 | 15 | 17 | 38 | 20 | 20 | 8 | 48 | 86 | 1 | 30 | 2 | 33 | 15 | 24 | 7 | 46 | 79 | 165 |
| 17:00 18:00 | 6 | 19 | 20 | 45 | 14 | 11 | 14 | 39 | 84 | 9 | 13 | 2 | 24 | 5 | 18 | 11 | 34 | 58 | 142 |
| Sub Total | 25 | 140 | 76 | 241 | 75 | 97 | 54 | 226 | 467 | 54 | 102 | 28 | 184 | 78 | 135 | 103 | 316 | 500 | 967 |
| U Turns | | | | 0 | | | | 0 | 0 | | | | 0 | | | | 0 | 0 | 0 |
| Total | 25 | 140 | 76 | 241 | 75 | 97 | 54 | 226 | 467 | 54 | 102 | 28 | 184 | 78 | 135 | 103 | 316 | 500 | 967 |
| EQ 12Hr | 35 | 195 | 106 | 335 | 104 | 135 | 75 | 314 | 649 | 75 | 142 | 39 | 256 | 108 | 188 | 143 | 439 | 695 | 1344 |
| Note: These values are calculated by multiplying the totals by the appropriate expansion factor. | | | | | | | | | | | | | 1.39 | | | | | | |
| AVG 12Hr | 35 | 195 | 106 | 335 | 104 | 135 | 75 | 314 | 649 | 75 | 142 | 39 | 256 | 108 | 188 | 143 | 439 | 695 | 1344 |
| Note: These volumes are calculated by multiplying the Equivalent 12 hr. totals by the AADT factor. | | | | | | | | | | | | | 1.00 | | | | | | |
| AVG 24Hr | 46 | 255 | 138 | 439 | 137 | 177 | 98 | 412 | 851 | 98 | 186 | 51 | 335 | 142 | 246 | 188 | 575 | 910 | 1761 |
| Note: These volumes are calculated by multiplying the Average Daily 12 hr. totals by 12 to 24 expansion factor. | | | | | | | | | | | | | 1.31 | | | | | | |

Comments:

Note: U-Turns provided for approach totals. Refer to 'U-Turn' Report for specific breakdown.

APPENDIX F

Collision Records

Location: PORTOBELLO BLVD @ AQUAVIEW DR/NANTES ST

Traffic Control: Stop sign

Total Collisions: 4

| Date/Day/Time | Environment | Impact Type | Classification | Surface Cond'n | Veh. Dir | Vehicle Manoeuver | Vehicle type | First Event | No. Ped |
|------------------------|-------------|-------------|------------------|----------------|----------|---------------------|---------------------------|---------------------|---------|
| 2014-Apr-10, Thu,20:50 | Rain | SMV other | Non-fatal injury | Wet | South | Turning left | Automobile, station wagon | Pedestrian | 1 |
| 2014-Jun-25, Wed,16:58 | Clear | Angle | Non-fatal injury | Dry | East | Going ahead | Bicycle | Other motor vehicle | |
| | | | | | South | Going ahead | Automobile, station wagon | Cyclist | |
| 2014-Dec-08, Mon,20:15 | Clear | Angle | P.D. only | Dry | South | Going ahead | Automobile, station wagon | Other motor vehicle | |
| | | | | | East | Going ahead | Automobile, station wagon | Other motor vehicle | |
| 2012-Apr-27, Fri,16:50 | Clear | Rear end | P.D. only | Dry | East | Slowing or stopping | Automobile, station wagon | Other motor vehicle | |

APPENDIX G

Notting Hill Subdivision Excerpts

Table 10: Person Trips by Modal Share

| Travel Mode | Modal Share | AM Peak | | | PM Peak | | |
|-------------------------------|-------------|------------|------------|------------|------------|------------|------------|
| | | IN | OUT | TOT | IN | OUT | TOT |
| Phase 1 | | | | | | | |
| <i>Person Trips</i> | | 22 | 47 | 69 | 46 | 32 | 78 |
| Auto Driver | 55% | 12 | 27 | 39 | 26 | 17 | 43 |
| Auto Passenger | 15% | 3 | 7 | 10 | 7 | 5 | 12 |
| Transit | 20% | 5 | 9 | 14 | 9 | 7 | 16 |
| Non-Auto | 10% | 2 | 4 | 6 | 4 | 3 | 7 |
| Phase 2 | | | | | | | |
| <i>Person Trips</i> | | 66 | 136 | 202 | 129 | 94 | 223 |
| Auto Driver | 55% | 36 | 75 | 111 | 71 | 52 | 123 |
| Auto Passenger | 15% | 10 | 20 | 30 | 19 | 14 | 33 |
| Transit | 20% | 13 | 27 | 40 | 26 | 19 | 45 |
| Non-Auto | 10% | 7 | 14 | 21 | 13 | 9 | 22 |
| Phase 3 | | | | | | | |
| <i>Person Trips</i> | | 55 | 125 | 180 | 122 | 79 | 201 |
| Auto Driver | 55% | 30 | 70 | 100 | 67 | 44 | 111 |
| Auto Passenger | 15% | 8 | 18 | 26 | 18 | 12 | 30 |
| Transit | 20% | 11 | 25 | 36 | 25 | 15 | 40 |
| Non-Auto | 10% | 6 | 12 | 18 | 12 | 8 | 20 |
| Phase 4 | | | | | | | |
| <i>Person Trips</i> | | 28 | 70 | 98 | 66 | 44 | 110 |
| Auto Driver | 55% | 16 | 38 | 54 | 36 | 25 | 61 |
| Auto Passenger | 15% | 4 | 10 | 14 | 10 | 6 | 16 |
| Transit | 20% | 6 | 14 | 20 | 13 | 9 | 22 |
| Non-Auto | 10% | 2 | 8 | 10 | 7 | 4 | 11 |
| Phase 5 | | | | | | | |
| <i>Person Trips</i> | | 21 | 44 | 65 | 43 | 32 | 75 |
| Auto Driver | 55% | 12 | 25 | 37 | 24 | 17 | 41 |
| Auto Passenger | 15% | 3 | 6 | 9 | 6 | 5 | 11 |
| Transit | 20% | 4 | 9 | 13 | 9 | 6 | 15 |
| Non-Auto | 10% | 2 | 4 | 6 | 4 | 4 | 8 |
| Auto Driver (Total) | | 106 | 235 | 341 | 224 | 155 | 379 |
| Auto Passenger (Total) | | 28 | 61 | 89 | 60 | 42 | 102 |
| Transit (Total) | | 39 | 84 | 123 | 82 | 56 | 138 |
| Non-Auto (Total) | | 19 | 42 | 61 | 40 | 28 | 68 |
| Phase 6 | | | | | | | |
| <i>Person Trips</i> | | 82 | 208 | 290 | 210 | 140 | 350 |
| Auto Driver | 55% | 46 | 116 | 162 | 116 | 76 | 192 |
| Auto Passenger | 15% | 12 | 30 | 42 | 31 | 22 | 53 |
| Transit | 20% | 16 | 42 | 58 | 42 | 28 | 70 |
| Non-Auto | 10% | 8 | 20 | 28 | 21 | 14 | 35 |
| Auto Driver (Total) | | 46 | 116 | 162 | 116 | 76 | 192 |
| Auto Passenger (Total) | | 12 | 30 | 42 | 31 | 22 | 53 |
| Transit (Total) | | 16 | 42 | 58 | 42 | 28 | 70 |
| Non-Auto (Total) | | 8 | 20 | 28 | 21 | 14 | 35 |

From the previous table, Phases 1-5 of the proposed subdivision are projected to generate 341 vehicle trips during the AM peak period and 379 vehicle trips during the PM peak period. Phase 6 of the proposed subdivision is projected to generate 162 vehicle trips during the AM peak period and 192 vehicle trips during the PM peak period.

5.1.2 Trip Distribution

While a widening of Brian Coburn Boulevard (south of the study area) is identified in the TMP's ultimate road network, it is not identified in either the Affordable Network or the 2031 Network Concept. Therefore, the distribution of traffic generated by the proposed subdivision to the road network is assumed to be consistent with existing traffic patterns during the AM and PM peak periods. The trip distribution is as follows:

- 70% north toward Innes Road, which is further distributed as follows:
 - 25% to/from the north on Trim Road;
 - 10% to/from the east on Innes Road;
 - 35% to/from the west on Innes Road;
- 25% south toward Brian Coburn Boulevard, of which all traffic is assumed to come to/from the west on Brian Coburn Boulevard;
- 5% east toward Millennium Boulevard.

5.1.3 Trip Assignment

Trips generated by the proposed subdivision have been assigned to the accesses based on access proximity and logical trip routing. For example, a vehicle trip originating from a property adjacent to the access on Provence Avenue is anticipated to use that access to travel north or south. However, that vehicle would use the access at Trim Road/Millennium Boulevard to travel east on Millennium Boulevard.

The assignment of generated trips to the proposed accesses are listed by phase below:

Phase 1

- Accesses at Aquaview Drive: 100% of all trips.

Phase 2

- Access at Provence Avenue: 25% of trips to/from the north;
- Access at Trim Road/Millennium Boulevard: 75% of trips to/from the north, 100% of trips to/from the south, 100% of trips to/from the east.

Phase 3

- Access at Provence Avenue: 75% of trips to/from the north, 100% of trips to/from the south;
- Access at Trim Road/Millennium Boulevard: 25% of trips to/from the north, 100% of trips to/from the east.

Phase 4

- Access at Trim Road/Millennium Boulevard: 100% of all trips.

Phase 5

- Access at Provence Avenue: 75% of trips to/from the north, 100% of trips to/from the south;
- Access at Trim Road/Millennium Boulevard: 25% of trips to/from the north, 100% of trips to/from the east.

Phase 6 (background traffic)

- Access at Nantes Street: 80% of trips to/from the north, 80% of trips to/from the south;
- Access at Grapefern Terrace: 20% of trips to/from the north, 20% of trips to/from the south, 100% of trips to/from the east.

Trips generated by Phases 1-5 of the proposed subdivision are shown in **Figure 5**. Trips generated by Phase 6 of the proposed subdivision are shown in **Figure 6**.

5.2 Background Traffic

5.2.1 General Background Growth Rate

A rate of background growth has been established through a review of the City of Ottawa's Strategic Long Range Model, comparing snapshots of 2011 and 2031 AM peak volumes, and the City's 2013 TMP. The snapshots indicate a growth rate of less than 1% on Innes Road and Portobello Boulevard, while growth rates on Trim Road and Provence Avenue were unrealistic. Section 2.3 of the TMP projects a 33% growth in the population of the Orléans area between 2011 and 2031, which translates to an annual growth rate of approximately 1.4% per annum. A 1% annual growth rate has been assumed for the arterial and major collector roadways (Innes Road, Trim Road, Portobello Boulevard), which is consistent with the 2014 Transportation Brief for the Trim Road Works Yard. A 0% growth rate has been applied to all other roadways within the study area.

5.2.2 Other Area Developments

The projected traffic volumes generated by the proposed retirement residence at 5157 Innes Road has been added to the background traffic at all relevant intersections within the study area. Relevant excerpts of IBI Group's study for 5157 Innes Road are included in **Appendix G**.

Background volumes for the 2025 buildout year are shown in **Figure 7**. Total traffic volumes for the 2025 buildout year are shown in **Figure 8**.

Figure 5: Proposed Site-Generated Traffic, Phases 1-5

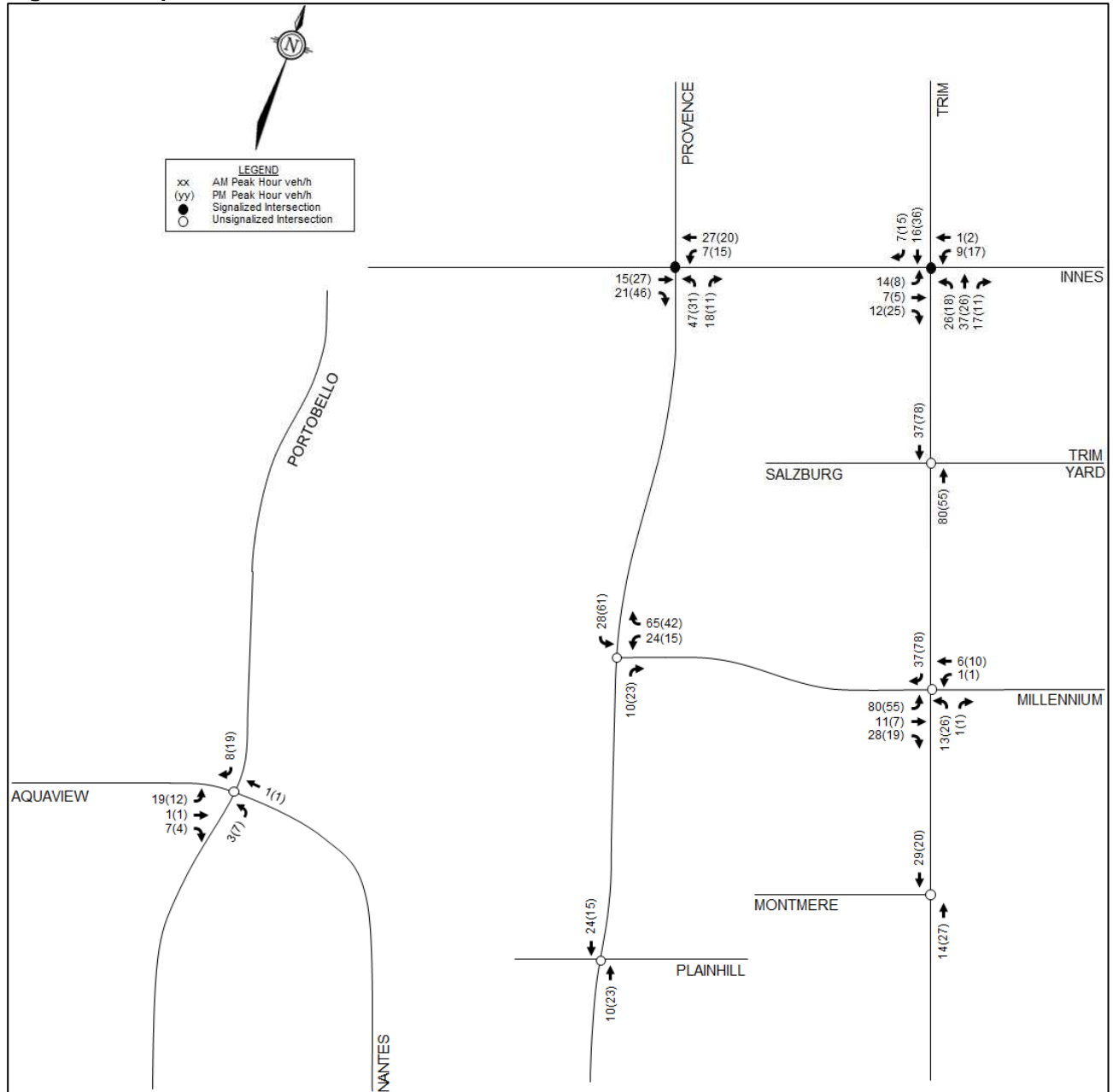

APPENDIX H

TDM Measures Checklist

TDM Measures Checklist:

Residential Developments (multi-family, condominium or subdivision)

| Legend | |
|---------------|--|
| BASIC | The measure is generally feasible and effective, and in most cases would benefit the development and its users |
| BETTER | The measure could maximize support for users of sustainable modes, and optimize development performance |
| ★ | The measure is one of the most dependably effective tools to encourage the use of sustainable modes |

| TDM measures: <i>Residential developments</i> | | Check if proposed & add descriptions |
|---|---|---|
| 1. TDM PROGRAM MANAGEMENT | | |
| 1.1 Program coordinator | | |
| BASIC | ★ | 1.1.1 Designate an internal coordinator, or contract with an external coordinator |
| | | <input checked="" type="checkbox"/> - member of EQ Homes marketing team |
| 1.2 Travel surveys | | |
| BETTER | | 1.2.1 Conduct periodic surveys to identify travel-related behaviours, attitudes, challenges and solutions, and to track progress |
| | | <input checked="" type="checkbox"/> |
| 2. WALKING AND CYCLING | | |
| 2.1 Information on walking/cycling routes & destinations | | |
| BASIC | | 2.1.1 Display local area maps with walking/cycling access routes and key destinations at major entrances (<i>multi-family, condominium</i>) |
| | | <input checked="" type="checkbox"/> - will be provided in sales centre |
| 2.2 Bicycle skills training | | |
| BETTER | | 2.2.1 Offer on-site cycling courses for residents, or subsidize off-site courses |
| | | <input checked="" type="checkbox"/> |

| TDM measures: <i>Residential developments</i> | | Check if proposed & add descriptions |
|---|--|---|
| 3. TRANSIT | | |
| 3.1 Transit information | | |
| BASIC | 3.1.1 Display relevant transit schedules and route maps at entrances (<i>multi-family, condominium</i>) | <input checked="" type="checkbox"/> - will be provided in sales centre |
| BETTER | 3.1.2 Provide real-time arrival information display at entrances (<i>multi-family, condominium</i>) | <input checked="" type="checkbox"/> |
| 3.2 Transit fare incentives | | |
| BASIC ★ | 3.2.1 Offer PRESTO cards preloaded with one monthly transit pass on residence purchase/move-in, to encourage residents to use transit | <input checked="" type="checkbox"/> |
| BETTER | 3.2.2 Offer at least one year of free monthly transit passes on residence purchase/move-in | <input checked="" type="checkbox"/> |
| 3.3 Enhanced public transit service | | |
| BETTER ★ | 3.3.1 Contract with OC Transpo to provide early transit services until regular services are warranted by occupancy levels (<i>subdivision</i>) | <input checked="" type="checkbox"/> |
| 3.4 Private transit service | | |
| BETTER | 3.4.1 Provide shuttle service for seniors homes or lifestyle communities (e.g. scheduled mall or supermarket runs) | <input checked="" type="checkbox"/> |
| 4. CARSHARING & BIKESHARING | | |
| 4.1 Bikeshare stations & memberships | | |
| BETTER | 4.1.1 Contract with provider to install on-site bikeshare station (<i>multi-family</i>) | <input checked="" type="checkbox"/> |
| BETTER | 4.1.2 Provide residents with bikeshare memberships, either free or subsidized (<i>multi-family</i>) | <input checked="" type="checkbox"/> |
| 4.2 Carshare vehicles & memberships | | |
| BETTER | 4.2.1 Contract with provider to install on-site carshare vehicles and promote their use by residents | <input checked="" type="checkbox"/> |
| BETTER | 4.2.2 Provide residents with carshare memberships, either free or subsidized | <input checked="" type="checkbox"/> |
| 5. PARKING | | |
| 5.1 Priced parking | | |
| BASIC ★ | 5.1.1 Unbundle parking cost from purchase price (<i>condominium</i>) | <input checked="" type="checkbox"/> - will be considered during Site Plan Control application |
| BASIC ★ | 5.1.2 Unbundle parking cost from monthly rent (<i>multi-family</i>) | <input checked="" type="checkbox"/> - will be considered during Site Plan Control application |

















| TDM measures: <i>Residential developments</i> | | Check if proposed & add descriptions |
|---|---|---|
| 6. TDM MARKETING & COMMUNICATIONS | | |
| 6.1 Multimodal travel information | | |
| BASIC ★ | 6.1.1 Provide a multimodal travel option information package to new residents | <input checked="" type="checkbox"/> - in sales centre |
| 6.2 Personalized trip planning | | |
| BETTER ★ | 6.2.1 Offer personalized trip planning to new residents | <input checked="" type="checkbox"/> |

APPENDIX I

Synchro Analysis

1: Portobello & Aquaview/Nantes
AM Peak Hour

Provence Orleans Subdivision (Phase 6)
Existing Traffic

| |  |  |  |  |  |  |  |  |  |  |  |  |
|---|---|---|---|---|---|---|--|---|---|---|---|---|
| Lane Group | EBL | EBT | EBR | WBL | WBT | WBR | NBL | NBT | NBR | SBL | SBT | SBR |
| Lane Configurations | |  | | |  | | |  | | |  | |
| Traffic Volume (vph) | 54 | 14 | 27 | 17 | 31 | 98 | 24 | 143 | 6 | 47 | 126 | 35 |
| Future Volume (vph) | 54 | 14 | 27 | 17 | 31 | 98 | 24 | 143 | 6 | 47 | 126 | 35 |
| Ideal Flow (vphpl) | 1800 | 1800 | 1800 | 1800 | 1800 | 1800 | 1800 | 1800 | 1800 | 1800 | 1800 | 1800 |
| Lane Util. Factor | 1.00 | 1.00 | 1.00 | 1.00 | 1.00 | 1.00 | 0.95 | 0.95 | 0.95 | 0.95 | 0.95 | 0.95 |
| Ped Bike Factor | | | | | | | | | | | | |
| Frt | | 0.962 | | | 0.909 | | | 0.995 | | | 0.975 | |
| Flt Protected | | 0.972 | | | 0.994 | | | 0.993 | | | 0.989 | |
| Satd. Flow (prot) | 0 | 1623 | 0 | 0 | 1602 | 0 | 0 | 3162 | 0 | 0 | 3175 | 0 |
| Flt Permitted | | 0.972 | | | 0.994 | | | 0.993 | | | 0.989 | |
| Satd. Flow (perm) | 0 | 1623 | 0 | 0 | 1602 | 0 | 0 | 3162 | 0 | 0 | 3175 | 0 |
| Link Speed (k/h) | | 50 | | | 50 | | | 50 | | | 50 | |
| Link Distance (m) | | 151.1 | | | 115.4 | | | 210.3 | | | 153.8 | |
| Travel Time (s) | | 10.9 | | | 8.3 | | | 15.1 | | | 11.1 | |
| Confl. Peds. (#/hr) | 47 | | | | | 47 | 43 | | 4 | 4 | | 43 |
| Confl. Bikes (#/hr) | | | 1 | | | | | | | | | 1 |
| Peak Hour Factor | 0.90 | 0.90 | 0.90 | 0.90 | 0.90 | 0.90 | 0.90 | 0.90 | 0.90 | 0.90 | 0.90 | 0.90 |
| Heavy Vehicles (%) | 4% | 2% | 8% | 2% | 5% | 2% | 10% | 8% | 2% | 2% | 7% | 2% |
| Adj. Flow (vph) | 60 | 16 | 30 | 19 | 34 | 109 | 27 | 159 | 7 | 52 | 140 | 39 |
| Shared Lane Traffic (%) | | | | | | | | | | | | |
| Lane Group Flow (vph) | 0 | 106 | 0 | 0 | 162 | 0 | 0 | 193 | 0 | 0 | 231 | 0 |
| Enter Blocked Intersection | No | No | No | No | No | No | No | No | No | No | No | No |
| Lane Alignment | Left | Left | Right | Left | Left | Right | Left | Left | Right | Left | Left | Right |
| Median Width(m) | | 0.0 | | | 0.0 | | | 2.0 | | | 2.0 | |
| Link Offset(m) | | 0.0 | | | 0.0 | | | 0.0 | | | 0.0 | |
| Crosswalk Width(m) | | 7.0 | | | 7.0 | | | 7.0 | | | 7.0 | |
| Two way Left Turn Lane | | | | | | | | | | | | |
| Headway Factor | 1.06 | 1.06 | 1.06 | 1.06 | 1.06 | 1.06 | 1.06 | 1.06 | 1.06 | 1.06 | 1.06 | 1.06 |
| Turning Speed (k/h) | 24 | | 14 | 24 | | 14 | 24 | | 14 | 24 | | 14 |
| Sign Control | | Stop | | | Stop | | | Stop | | | Stop | |
| Intersection Summary | | | | | | | | | | | | |
| Area Type: | Other | | | | | | | | | | | |
| Control Type: | Unsignalized | | | | | | | | | | | |
| Intersection Capacity Utilization 46.8% | ICU Level of Service A | | | | | | | | | | | |
| Analysis Period (min) 15 | | | | | | | | | | | | |

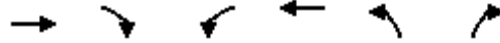

















| Lane Group | EBT | EBR | WBL | WBT | NBL | NBR |
|----------------------------|-------|-------|------|-------|-------|-------|
| Lane Configurations | | | | | | |
| Traffic Volume (vph) | 66 | 13 | 4 | 107 | 38 | 2 |
| Future Volume (vph) | 66 | 13 | 4 | 107 | 38 | 2 |
| Ideal Flow (vphpl) | 1800 | 1800 | 1800 | 1800 | 1800 | 1800 |
| Lane Util. Factor | 1.00 | 1.00 | 1.00 | 1.00 | 1.00 | 1.00 |
| Ped Bike Factor | | | | | | |
| Frt | 0.978 | | | | 0.994 | |
| Flt Protected | | | | 0.998 | 0.954 | |
| Satd. Flow (prot) | 1723 | 0 | 0 | 1691 | 1692 | 0 |
| Flt Permitted | | | | 0.998 | 0.954 | |
| Satd. Flow (perm) | 1723 | 0 | 0 | 1691 | 1692 | 0 |
| Link Speed (k/h) | 50 | | | 50 | 50 | |
| Link Distance (m) | 115.4 | | | 192.4 | 110.9 | |
| Travel Time (s) | 8.3 | | | 13.9 | 8.0 | |
| Confl. Peds. (#/hr) | | | | | 1 | 3 |
| Peak Hour Factor | 0.90 | 0.90 | 0.90 | 0.90 | 0.90 | 0.90 |
| Heavy Vehicles (%) | 2% | 10% | 50% | 6% | 2% | 2% |
| Adj. Flow (vph) | 73 | 14 | 4 | 119 | 42 | 2 |
| Shared Lane Traffic (%) | | | | | | |
| Lane Group Flow (vph) | 87 | 0 | 0 | 123 | 44 | 0 |
| Enter Blocked Intersection | No | No | No | No | No | No |
| Lane Alignment | Left | Right | Left | Left | Left | Right |
| Median Width(m) | 0.0 | | | 0.0 | 3.7 | |
| Link Offset(m) | 0.0 | | | 0.0 | 0.0 | |
| Crosswalk Width(m) | 6.0 | | | 6.0 | 6.0 | |
| Two way Left Turn Lane | | | | | | |
| Headway Factor | 1.06 | 1.06 | 1.06 | 1.06 | 1.06 | 1.06 |
| Turning Speed (k/h) | | 14 | 24 | | 24 | 14 |
| Sign Control | Stop | | | Stop | Stop | |

Intersection Summary

| | |
|---|------------------------|
| Area Type: | Other |
| Control Type: | Unsignalized |
| Intersection Capacity Utilization 20.3% | ICU Level of Service A |
| Analysis Period (min) | 15 |

















3: Provence & Plainhill
AM Peak Hour

Provence Orleans Subdivision (Phase 6)
Existing Traffic

| |  |  |  |  |  |  |  |  |  |  |  |  |
|---|---|---|---|---|---|---|--|---|---|---|---|---|
| Lane Group | EBL | EBT | EBR | WBL | WBT | WBR | NBL | NBT | NBR | SBL | SBT | SBR |
| Lane Configurations | |  | | |  | | |  | | |  | |
| Traffic Volume (vph) | 16 | 14 | 9 | 20 | 27 | 39 | 5 | 57 | 7 | 15 | 36 | 8 |
| Future Volume (vph) | 16 | 14 | 9 | 20 | 27 | 39 | 5 | 57 | 7 | 15 | 36 | 8 |
| Ideal Flow (vphpl) | 1800 | 1800 | 1800 | 1800 | 1800 | 1800 | 1800 | 1800 | 1800 | 1800 | 1800 | 1800 |
| Lane Util. Factor | 1.00 | 1.00 | 1.00 | 1.00 | 1.00 | 1.00 | 1.00 | 1.00 | 1.00 | 1.00 | 1.00 | 1.00 |
| Ped Bike Factor | | | | | | | | | | | | |
| Frt | | 0.969 | | | 0.939 | | | 0.986 | | | 0.982 | |
| Flt Protected | | 0.980 | | | 0.989 | | | 0.996 | | | 0.987 | |
| Satd. Flow (prot) | 0 | 1676 | 0 | 0 | 1610 | 0 | 0 | 1711 | 0 | 0 | 1699 | 0 |
| Flt Permitted | | 0.980 | | | 0.989 | | | 0.996 | | | 0.987 | |
| Satd. Flow (perm) | 0 | 1676 | 0 | 0 | 1610 | 0 | 0 | 1711 | 0 | 0 | 1699 | 0 |
| Link Speed (k/h) | | 50 | | | 50 | | | 50 | | | 50 | |
| Link Distance (m) | | 78.8 | | | 168.6 | | | 195.8 | | | 141.6 | |
| Travel Time (s) | | 5.7 | | | 12.1 | | | 14.1 | | | 10.2 | |
| Confl. Peds. (#/hr) | 8 | | | | | 8 | 1 | | 1 | 1 | | 1 |
| Peak Hour Factor | 0.90 | 0.90 | 0.90 | 0.90 | 0.90 | 0.90 | 0.90 | 0.90 | 0.90 | 0.90 | 0.90 | 0.90 |
| Heavy Vehicles (%) | 2% | 5% | 2% | 2% | 10% | 3% | 2% | 5% | 2% | 2% | 5% | 2% |
| Adj. Flow (vph) | 18 | 16 | 10 | 22 | 30 | 43 | 6 | 63 | 8 | 17 | 40 | 9 |
| Shared Lane Traffic (%) | | | | | | | | | | | | |
| Lane Group Flow (vph) | 0 | 44 | 0 | 0 | 95 | 0 | 0 | 77 | 0 | 0 | 66 | 0 |
| Enter Blocked Intersection | No | No | No | No | No | No | No | No | No | No | No | No |
| Lane Alignment | Left | Left | Right | Left | Left | Right | Left | Left | Right | Left | Left | Right |
| Median Width(m) | | 0.0 | | | 0.0 | | | 0.0 | | | 0.0 | |
| Link Offset(m) | | 0.0 | | | 0.0 | | | 0.0 | | | 0.0 | |
| Crosswalk Width(m) | | 7.0 | | | 7.0 | | | 7.0 | | | 7.0 | |
| Two way Left Turn Lane | | | | | | | | | | | | |
| Headway Factor | 1.06 | 1.06 | 1.06 | 1.06 | 1.06 | 1.06 | 1.06 | 1.06 | 1.06 | 1.06 | 1.06 | 1.06 |
| Turning Speed (k/h) | 24 | | 14 | 24 | | 14 | 24 | | 14 | 24 | | 14 |
| Sign Control | | Stop | | | Stop | | | Stop | | | Stop | |
| Intersection Summary | | | | | | | | | | | | |
| Area Type: | Other | | | | | | | | | | | |
| Control Type: | Unsignalized | | | | | | | | | | | |
| Intersection Capacity Utilization 22.4% | ICU Level of Service A | | | | | | | | | | | |
| Analysis Period (min) 15 | | | | | | | | | | | | |

















4: Provence & Grapefern
AM Peak Hour

Provence Orleans Subdivision (Phase 6)
Existing Traffic

| |  |  |  |  |  |  |  |  |  |  |  |  |  | |
|---|---|---|---|---|---|---|--|---|---|---|---|---|---|---|
| Lane Group | EBL | EBT | EBR | WBL | WBT | WBR | NBL | NBT | NBR | SBL | SBT | SBR | | |
| Lane Configurations | |  | | |  | | |  | | |  | | | |
| Traffic Volume (vph) | 7 | 0 | 1 | 0 | 0 | 0 | 1 | 111 | 0 | 1 | 58 | 1 | | |
| Future Volume (vph) | 7 | 0 | 1 | 0 | 0 | 0 | 1 | 111 | 0 | 1 | 58 | 1 | | |
| Ideal Flow (vphpl) | 1800 | 1800 | 1800 | 1800 | 1800 | 1800 | 1800 | 1800 | 1800 | 1800 | 1800 | 1800 | | |
| Lane Util. Factor | 1.00 | 1.00 | 1.00 | 1.00 | 1.00 | 1.00 | 1.00 | 1.00 | 1.00 | 1.00 | 1.00 | 1.00 | | |
| Ped Bike Factor | | | | | | | | | | | | | | |
| Frt | | | | | | | | | | | 0.985 | 0.998 | | |
| Flt Protected | | | | | | | | | | | 0.957 | 0.999 | | |
| Satd. Flow (prot) | 0 | 1682 | 0 | 0 | 1784 | 0 | 0 | 1767 | 0 | 0 | 1779 | 0 | | |
| Flt Permitted | | | | | | | | | | | 0.957 | 0.999 | | |
| Satd. Flow (perm) | 0 | 1682 | 0 | 0 | 1784 | 0 | 0 | 1767 | 0 | 0 | 1779 | 0 | | |
| Link Speed (k/h) | | | | | 50 | | | | | 50 | | | | |
| Link Distance (m) | | | | | 124.8 | | | | | 57.5 | | | | |
| Travel Time (s) | | | | | 9.0 | | | | | 4.1 | | | | |
| Confl. Peds. (#/hr) | | | | | | | | | | | | | 6 | 6 |
| Confl. Bikes (#/hr) | | | | | | | | | | | | | 1 | |
| Peak Hour Factor | 0.90 | 0.90 | 0.90 | 0.90 | 0.90 | 0.90 | 0.90 | 0.90 | 0.90 | 0.90 | 0.90 | 0.90 | | |
| Heavy Vehicles (%) | 2% | 2% | 2% | 2% | 2% | 2% | 2% | 3% | 2% | 2% | 2% | 2% | | |
| Adj. Flow (vph) | 8 | 0 | 1 | 0 | 0 | 0 | 1 | 123 | 0 | 1 | 64 | 1 | | |
| Shared Lane Traffic (%) | | | | | | | | | | | | | | |
| Lane Group Flow (vph) | 0 | 9 | 0 | 0 | 0 | 0 | 0 | 124 | 0 | 0 | 66 | 0 | | |
| Enter Blocked Intersection | No | No | No | No | No | No | No | No | No | No | No | No | | |
| Lane Alignment | Left | Left | Right | Left | Left | Right | Left | Left | Right | Left | Left | Right | | |
| Median Width(m) | | | 0.0 | | | 0.0 | | | 0.0 | | | 0.0 | | |
| Link Offset(m) | | | 0.0 | | | 0.0 | | | 0.0 | | | 0.0 | | |
| Crosswalk Width(m) | | | 3.0 | | | 3.0 | | | 3.0 | | | 3.0 | | |
| Two way Left Turn Lane | | | | | | | | | | | | | | |
| Headway Factor | 1.06 | 1.06 | 1.06 | 1.06 | 1.06 | 1.06 | 1.06 | 1.06 | 1.06 | 1.06 | 1.06 | 1.06 | | |
| Turning Speed (k/h) | 24 | | 14 | 24 | | 14 | 24 | | 14 | 24 | | 14 | | |
| Sign Control | Stop | | | | Stop | | Free | | | | Free | | | |
| Intersection Summary | | | | | | | | | | | | | | |
| Area Type: | Other | | | | | | | | | | | | | |
| Control Type: | Unsignalized | | | | | | | | | | | | | |
| Intersection Capacity Utilization 16.7% | ICU Level of Service A | | | | | | | | | | | | | |
| Analysis Period (min) 15 | | | | | | | | | | | | | | |

1: Portobello & Aquaview/Nantes
PM Peak Hour

Provence Orleans Subdivision (Phase 6)
Existing Traffic

| |  |  |  |  |  |  |  |  |  |  |  |  |
|---|---|---|---|---|---|---|--|---|---|---|---|---|
| Lane Group | EBL | EBT | EBR | WBL | WBT | WBR | NBL | NBT | NBR | SBL | SBT | SBR |
| Lane Configurations | |  | | |  | | |  | | |  | |
| Traffic Volume (vph) | 31 | 22 | 15 | 8 | 23 | 81 | 14 | 128 | 4 | 81 | 165 | 24 |
| Future Volume (vph) | 31 | 22 | 15 | 8 | 23 | 81 | 14 | 128 | 4 | 81 | 165 | 24 |
| Ideal Flow (vphpl) | 1800 | 1800 | 1800 | 1800 | 1800 | 1800 | 1800 | 1800 | 1800 | 1800 | 1800 | 1800 |
| Lane Util. Factor | 1.00 | 1.00 | 1.00 | 1.00 | 1.00 | 1.00 | 0.95 | 0.95 | 0.95 | 0.95 | 0.95 | 0.95 |
| Ped Bike Factor | | | | | | | | | | | | |
| Frt | | 0.969 | | | 0.903 | | | 0.996 | | | 0.986 | |
| Flt Protected | | 0.978 | | | 0.996 | | | 0.995 | | | 0.985 | |
| Satd. Flow (prot) | 0 | 1680 | 0 | 0 | 1595 | 0 | 0 | 3266 | 0 | 0 | 3235 | 0 |
| Flt Permitted | | 0.978 | | | 0.996 | | | 0.995 | | | 0.985 | |
| Satd. Flow (perm) | 0 | 1680 | 0 | 0 | 1595 | 0 | 0 | 3266 | 0 | 0 | 3235 | 0 |
| Link Speed (k/h) | | 50 | | | 50 | | | 50 | | | 50 | |
| Link Distance (m) | | 151.1 | | | 115.4 | | | 211.4 | | | 191.8 | |
| Travel Time (s) | | 10.9 | | | 8.3 | | | 15.2 | | | 13.8 | |
| Confl. Peds. (#/hr) | 12 | | 4 | 4 | | 12 | 6 | | 3 | 3 | | 6 |
| Peak Hour Factor | 0.90 | 0.90 | 0.90 | 0.90 | 0.90 | 0.90 | 0.90 | 0.90 | 0.90 | 0.90 | 0.90 | 0.90 |
| Heavy Vehicles (%) | 2% | 2% | 5% | 2% | 5% | 2% | 5% | 5% | 2% | 2% | 5% | 2% |
| Adj. Flow (vph) | 34 | 24 | 17 | 9 | 26 | 90 | 16 | 142 | 4 | 90 | 183 | 27 |
| Shared Lane Traffic (%) | | | | | | | | | | | | |
| Lane Group Flow (vph) | 0 | 75 | 0 | 0 | 125 | 0 | 0 | 162 | 0 | 0 | 300 | 0 |
| Enter Blocked Intersection | No | No | No | No | No | No | No | No | No | No | No | No |
| Lane Alignment | Left | Left | Right | Left | Left | Right | Left | Left | Right | Left | Left | Right |
| Median Width(m) | | 0.0 | | | 0.0 | | | 2.0 | | | 2.0 | |
| Link Offset(m) | | 0.0 | | | 0.0 | | | 0.0 | | | 0.0 | |
| Crosswalk Width(m) | | 7.0 | | | 7.0 | | | 7.0 | | | 7.0 | |
| Two way Left Turn Lane | | | | | | | | | | | | |
| Headway Factor | 1.06 | 1.06 | 1.06 | 1.06 | 1.06 | 1.06 | 1.06 | 1.06 | 1.06 | 1.06 | 1.06 | 1.06 |
| Turning Speed (k/h) | 24 | | 14 | 24 | | 14 | 24 | | 14 | 24 | | 14 |
| Sign Control | | Stop | | | Stop | | | Stop | | | Stop | |
| Intersection Summary | | | | | | | | | | | | |
| Area Type: | Other | | | | | | | | | | | |
| Control Type: | Unsignalized | | | | | | | | | | | |
| Intersection Capacity Utilization 35.3% | ICU Level of Service A | | | | | | | | | | | |
| Analysis Period (min) 15 | | | | | | | | | | | | |



















| Lane Group | EBT | EBR | WBL | WBT | NBL | NBR |
|----------------------------|-------|-------|------|-------|-------|-------|
| Lane Configurations | | | | | | |
| Traffic Volume (vph) | 72 | 34 | 1 | 92 | 22 | 2 |
| Future Volume (vph) | 72 | 34 | 1 | 92 | 22 | 2 |
| Ideal Flow (vphpl) | 1800 | 1800 | 1800 | 1800 | 1800 | 1800 |
| Lane Util. Factor | 1.00 | 1.00 | 1.00 | 1.00 | 1.00 | 1.00 |
| Ped Bike Factor | | | | | | |
| Frt | 0.957 | | | | 0.990 | |
| Flt Protected | | | | | 0.956 | |
| Satd. Flow (prot) | 1692 | 0 | 0 | 1734 | 1689 | 0 |
| Flt Permitted | | | | | 0.956 | |
| Satd. Flow (perm) | 1692 | 0 | 0 | 1734 | 1689 | 0 |
| Link Speed (k/h) | 50 | | | 50 | 50 | |
| Link Distance (m) | 115.4 | | | 192.4 | 110.9 | |
| Travel Time (s) | 8.3 | | | 13.9 | 8.0 | |
| Confl. Peds. (#/hr) | | 1 | 1 | | 4 | 2 |
| Peak Hour Factor | 0.90 | 0.90 | 0.90 | 0.90 | 0.90 | 0.90 |
| Heavy Vehicles (%) | 2% | 5% | 2% | 5% | 2% | 2% |
| Adj. Flow (vph) | 80 | 38 | 1 | 102 | 24 | 2 |
| Shared Lane Traffic (%) | | | | | | |
| Lane Group Flow (vph) | 118 | 0 | 0 | 103 | 26 | 0 |
| Enter Blocked Intersection | No | No | No | No | No | No |
| Lane Alignment | Left | Right | Left | Left | Left | Right |
| Median Width(m) | 0.0 | | | 0.0 | 3.7 | |
| Link Offset(m) | 0.0 | | | 0.0 | 0.0 | |
| Crosswalk Width(m) | 6.0 | | | 6.0 | 6.0 | |
| Two way Left Turn Lane | | | | | | |
| Headway Factor | 1.06 | 1.06 | 1.06 | 1.06 | 1.06 | 1.06 |
| Turning Speed (k/h) | | 14 | 24 | | 24 | 14 |
| Sign Control | Stop | | | Stop | Stop | |

Intersection Summary

| | |
|---|------------------------|
| Area Type: | Other |
| Control Type: | Unsignalized |
| Intersection Capacity Utilization 17.1% | ICU Level of Service A |
| Analysis Period (min) | 15 |

3: Provence & Plainhill
PM Peak Hour

Provence Orleans Subdivision (Phase 6)
Existing Traffic

| |  |  |  |  |  |  |  |  |  |  |  |  |
|---|---|---|---|---|---|---|--|---|---|---|---|---|
| Lane Group | EBL | EBT | EBR | WBL | WBT | WBR | NBL | NBT | NBR | SBL | SBT | SBR |
| Lane Configurations | |  | | |  | | |  | | |  | |
| Traffic Volume (vph) | 2 | 26 | 3 | 12 | 21 | 8 | 8 | 16 | 19 | 25 | 21 | 11 |
| Future Volume (vph) | 2 | 26 | 3 | 12 | 21 | 8 | 8 | 16 | 19 | 25 | 21 | 11 |
| Ideal Flow (vphpl) | 1800 | 1800 | 1800 | 1800 | 1800 | 1800 | 1800 | 1800 | 1800 | 1800 | 1800 | 1800 |
| Lane Util. Factor | 1.00 | 1.00 | 1.00 | 1.00 | 1.00 | 1.00 | 1.00 | 1.00 | 1.00 | 1.00 | 1.00 | 1.00 |
| Ped Bike Factor | | | | | | | | | | | | |
| Frt | | 0.988 | | | 0.973 | | | 0.941 | | | 0.974 | |
| Flt Protected | | 0.997 | | | 0.986 | | | 0.991 | | | 0.978 | |
| Satd. Flow (prot) | 0 | 1729 | 0 | 0 | 1712 | 0 | 0 | 1643 | 0 | 0 | 1682 | 0 |
| Flt Permitted | | 0.997 | | | 0.986 | | | 0.991 | | | 0.978 | |
| Satd. Flow (perm) | 0 | 1729 | 0 | 0 | 1712 | 0 | 0 | 1643 | 0 | 0 | 1682 | 0 |
| Link Speed (k/h) | | 50 | | | 50 | | | 50 | | | 50 | |
| Link Distance (m) | | 78.8 | | | 168.6 | | | 195.8 | | | 141.6 | |
| Travel Time (s) | | 5.7 | | | 12.1 | | | 14.1 | | | 10.2 | |
| Confl. Peds. (#/hr) | 2 | | 3 | 3 | | 2 | 2 | | 1 | 1 | | 2 |
| Peak Hour Factor | 0.90 | 0.90 | 0.90 | 0.90 | 0.90 | 0.90 | 0.90 | 0.90 | 0.90 | 0.90 | 0.90 | 0.90 |
| Heavy Vehicles (%) | 2% | 4% | 2% | 2% | 2% | 2% | 2% | 2% | 5% | 2% | 5% | 2% |
| Adj. Flow (vph) | 2 | 29 | 3 | 13 | 23 | 9 | 9 | 18 | 21 | 28 | 23 | 12 |
| Shared Lane Traffic (%) | | | | | | | | | | | | |
| Lane Group Flow (vph) | 0 | 34 | 0 | 0 | 45 | 0 | 0 | 48 | 0 | 0 | 63 | 0 |
| Enter Blocked Intersection | No | No | No | No | No | No | No | No | No | No | No | No |
| Lane Alignment | Left | Left | Right | Left | Left | Right | Left | Left | Right | Left | Left | Right |
| Median Width(m) | | 0.0 | | | 0.0 | | | 0.0 | | | 0.0 | |
| Link Offset(m) | | 0.0 | | | 0.0 | | | 0.0 | | | 0.0 | |
| Crosswalk Width(m) | | 7.0 | | | 7.0 | | | 7.0 | | | 7.0 | |
| Two way Left Turn Lane | | | | | | | | | | | | |
| Headway Factor | 1.06 | 1.06 | 1.06 | 1.06 | 1.06 | 1.06 | 1.06 | 1.06 | 1.06 | 1.06 | 1.06 | 1.06 |
| Turning Speed (k/h) | 24 | | 14 | 24 | | 14 | 24 | | 14 | 24 | | 14 |
| Sign Control | | Stop | | | Stop | | | Stop | | | Stop | |
| Intersection Summary | | | | | | | | | | | | |
| Area Type: | Other | | | | | | | | | | | |
| Control Type: | Unsignalized | | | | | | | | | | | |
| Intersection Capacity Utilization 20.7% | ICU Level of Service A | | | | | | | | | | | |
| Analysis Period (min) 15 | | | | | | | | | | | | |

















4: Provence & Grapefern
PM Peak Hour

Provence Orleans Subdivision (Phase 6)
Existing Traffic

| Lane Group | EBL | EBT | EBR | WBL | WBT | WBR | NBL | NBT | NBR | SBL | SBT | SBR |
|---|------------------------|-------|-------|------|-------|-------|------|-------|-------|------|-------|-------|
| Lane Configurations | | | | | | | | | | | | |
| Traffic Volume (vph) | 3 | 0 | 2 | 7 | 0 | 4 | 4 | 15 | 7 | 6 | 48 | 8 |
| Future Volume (vph) | 3 | 0 | 2 | 7 | 0 | 4 | 4 | 15 | 7 | 6 | 48 | 8 |
| Ideal Flow (vphpl) | 1800 | 1800 | 1800 | 1800 | 1800 | 1800 | 1800 | 1800 | 1800 | 1800 | 1800 | 1800 |
| Lane Util. Factor | 1.00 | 1.00 | 1.00 | 1.00 | 1.00 | 1.00 | 1.00 | 1.00 | 1.00 | 1.00 | 1.00 | 1.00 |
| Ped Bike Factor | | | | | | | | | | | | |
| Frt | | 0.946 | | | 0.955 | | | 0.963 | | | 0.982 | |
| Flt Protected | | 0.971 | | | 0.968 | | | 0.993 | | | 0.995 | |
| Satd. Flow (prot) | 0 | 1639 | 0 | 0 | 1649 | 0 | 0 | 1697 | 0 | 0 | 1743 | 0 |
| Flt Permitted | | 0.971 | | | 0.968 | | | 0.993 | | | 0.995 | |
| Satd. Flow (perm) | 0 | 1639 | 0 | 0 | 1649 | 0 | 0 | 1697 | 0 | 0 | 1743 | 0 |
| Link Speed (k/h) | | 50 | | | 50 | | | 50 | | | 50 | |
| Link Distance (m) | | 124.8 | | | 57.5 | | | 141.6 | | | 204.6 | |
| Travel Time (s) | | 9.0 | | | 4.1 | | | 10.2 | | | 14.7 | |
| Confl. Peds. (#/hr) | 7 | | | | | 7 | 4 | | | | | 4 |
| Confl. Bikes (#/hr) | | | 1 | | | | | | | | | 1 |
| Peak Hour Factor | 0.90 | 0.90 | 0.90 | 0.90 | 0.90 | 0.90 | 0.90 | 0.90 | 0.90 | 0.90 | 0.90 | 0.90 |
| Heavy Vehicles (%) | 2% | 2% | 2% | 2% | 2% | 2% | 2% | 3% | 2% | 2% | 2% | 2% |
| Adj. Flow (vph) | 3 | 0 | 2 | 8 | 0 | 4 | 4 | 17 | 8 | 7 | 53 | 9 |
| Shared Lane Traffic (%) | | | | | | | | | | | | |
| Lane Group Flow (vph) | 0 | 5 | 0 | 0 | 12 | 0 | 0 | 29 | 0 | 0 | 69 | 0 |
| Enter Blocked Intersection | No | No | No | No | No | No | No | No | No | No | No | No |
| Lane Alignment | Left | Left | Right | Left | Left | Right | Left | Left | Right | Left | Left | Right |
| Median Width(m) | | 0.0 | | | 0.0 | | | 0.0 | | | 0.0 | |
| Link Offset(m) | | 0.0 | | | 0.0 | | | 0.0 | | | 0.0 | |
| Crosswalk Width(m) | | 3.0 | | | 3.0 | | | 3.0 | | | 3.0 | |
| Two way Left Turn Lane | | | | | | | | | | | | |
| Headway Factor | 1.06 | 1.06 | 1.06 | 1.06 | 1.06 | 1.06 | 1.06 | 1.06 | 1.06 | 1.06 | 1.06 | 1.06 |
| Turning Speed (k/h) | 24 | | 14 | 24 | | 14 | 24 | | 14 | 24 | | 14 |
| Sign Control | | Stop | | | Stop | | | Free | | | Free | |
| Intersection Summary | | | | | | | | | | | | |
| Area Type: | Other | | | | | | | | | | | |
| Control Type: | Unsignalized | | | | | | | | | | | |
| Intersection Capacity Utilization 17.5% | ICU Level of Service A | | | | | | | | | | | |
| Analysis Period (min) 15 | | | | | | | | | | | | |

















1: Portobello & Aquaview/Nantes
AM Peak Hour

Provence Orleans Subdivision (Phase 6)
2020 Background Traffic

| |  |  |  |  |  |  |  |  |  |  |  |  |
|---|---|---|---|---|---|---|--|---|---|---|---|---|
| Lane Group | EBL | EBT | EBR | WBL | WBT | WBR | NBL | NBT | NBR | SBL | SBT | SBR |
| Lane Configurations | |  | | |  | | |  | | |  | |
| Traffic Volume (vph) | 73 | 15 | 34 | 17 | 32 | 98 | 27 | 146 | 6 | 48 | 129 | 44 |
| Future Volume (vph) | 73 | 15 | 34 | 17 | 32 | 98 | 27 | 146 | 6 | 48 | 129 | 44 |
| Ideal Flow (vphpl) | 1800 | 1800 | 1800 | 1800 | 1800 | 1800 | 1800 | 1800 | 1800 | 1800 | 1800 | 1800 |
| Lane Util. Factor | 1.00 | 1.00 | 1.00 | 1.00 | 1.00 | 1.00 | 0.95 | 0.95 | 0.95 | 0.95 | 0.95 | 0.95 |
| Ped Bike Factor | | | | | | | | | | | | |
| Frt | | 0.962 | | | 0.910 | | | 0.995 | | | 0.970 | |
| Flt Protected | | 0.971 | | | 0.994 | | | 0.993 | | | 0.989 | |
| Satd. Flow (prot) | 0 | 1621 | 0 | 0 | 1604 | 0 | 0 | 3161 | 0 | 0 | 3162 | 0 |
| Flt Permitted | | 0.971 | | | 0.994 | | | 0.993 | | | 0.989 | |
| Satd. Flow (perm) | 0 | 1621 | 0 | 0 | 1604 | 0 | 0 | 3161 | 0 | 0 | 3162 | 0 |
| Link Speed (k/h) | | 50 | | | 50 | | | 50 | | | 50 | |
| Link Distance (m) | | 151.1 | | | 115.4 | | | 210.3 | | | 153.8 | |
| Travel Time (s) | | 10.9 | | | 8.3 | | | 15.1 | | | 11.1 | |
| Confl. Peds. (#/hr) | 47 | | | | | 47 | 43 | | 4 | 4 | | 43 |
| Confl. Bikes (#/hr) | | | 1 | | | | | | | | | 1 |
| Peak Hour Factor | 1.00 | 1.00 | 1.00 | 1.00 | 1.00 | 1.00 | 1.00 | 1.00 | 1.00 | 1.00 | 1.00 | 1.00 |
| Heavy Vehicles (%) | 4% | 2% | 8% | 2% | 5% | 2% | 10% | 8% | 2% | 2% | 7% | 2% |
| Adj. Flow (vph) | 73 | 15 | 34 | 17 | 32 | 98 | 27 | 146 | 6 | 48 | 129 | 44 |
| Shared Lane Traffic (%) | | | | | | | | | | | | |
| Lane Group Flow (vph) | 0 | 122 | 0 | 0 | 147 | 0 | 0 | 179 | 0 | 0 | 221 | 0 |
| Enter Blocked Intersection | No | No | No | No | No | No | No | No | No | No | No | No |
| Lane Alignment | Left | Left | Right | Left | Left | Right | Left | Left | Right | Left | Left | Right |
| Median Width(m) | | 0.0 | | | 0.0 | | | 2.0 | | | 2.0 | |
| Link Offset(m) | | 0.0 | | | 0.0 | | | 0.0 | | | 0.0 | |
| Crosswalk Width(m) | | 7.0 | | | 7.0 | | | 7.0 | | | 7.0 | |
| Two way Left Turn Lane | | | | | | | | | | | | |
| Headway Factor | 1.06 | 1.06 | 1.06 | 1.06 | 1.06 | 1.06 | 1.06 | 1.06 | 1.06 | 1.06 | 1.06 | 1.06 |
| Turning Speed (k/h) | 24 | | 14 | 24 | | 14 | 24 | | 14 | 24 | | 14 |
| Sign Control | | Stop | | | Stop | | | Stop | | | Stop | |
| Intersection Summary | | | | | | | | | | | | |
| Area Type: | Other | | | | | | | | | | | |
| Control Type: | Unsignalized | | | | | | | | | | | |
| Intersection Capacity Utilization 51.8% | ICU Level of Service A | | | | | | | | | | | |
| Analysis Period (min) 15 | | | | | | | | | | | | |

















2: Brianna & Nantes
AM Peak Hour

Provence Orleans Subdivision (Phase 6)
2020 Background Traffic

| |  |  |  |  |  |  |  |  |  |  |  |  |
|---|---|---|---|---|---|---|--|---|---|---|---|---|
| Lane Group | EBL | EBT | EBR | WBL | WBT | WBR | NBL | NBT | NBR | SBL | SBT | SBR |
| Lane Configurations | |  | | |  | | |  | | |  | |
| Traffic Volume (vph) | 0 | 67 | 13 | 4 | 108 | 0 | 38 | 0 | 2 | 0 | 0 | 0 |
| Future Volume (vph) | 0 | 67 | 13 | 4 | 108 | 0 | 38 | 0 | 2 | 0 | 0 | 0 |
| Ideal Flow (vphpl) | 1800 | 1800 | 1800 | 1800 | 1800 | 1800 | 1800 | 1800 | 1800 | 1800 | 1800 | 1800 |
| Lane Util. Factor | 1.00 | 1.00 | 1.00 | 1.00 | 1.00 | 1.00 | 1.00 | 1.00 | 1.00 | 1.00 | 1.00 | 1.00 |
| Ped Bike Factor | | | | | | | | | | | | |
| Frt | 0.978 | | | | | | 0.993 | | | | | |
| Flt Protected | | | | | | | 0.998 | | | 0.955 | | |
| Satd. Flow (prot) | 0 | 1723 | 0 | 0 | 1689 | 0 | 0 | 1692 | 0 | 0 | 1784 | 0 |
| Flt Permitted | | | | | | | 0.998 | | | 0.955 | | |
| Satd. Flow (perm) | 0 | 1723 | 0 | 0 | 1689 | 0 | 0 | 1692 | 0 | 0 | 1784 | 0 |
| Link Speed (k/h) | | | | | 50 | | | | 50 | | | |
| Link Distance (m) | 115.4 | | | | 192.4 | | | | 110.9 | | | |
| Travel Time (s) | 8.3 | | | | 13.9 | | | | 8.0 | | | |
| Confl. Peds. (#/hr) | | | | | | | 1 | | | 3 | | |
| Peak Hour Factor | 1.00 | 1.00 | 1.00 | 1.00 | 1.00 | 1.00 | 1.00 | 1.00 | 1.00 | 1.00 | 1.00 | 1.00 |
| Heavy Vehicles (%) | 2% | 2% | 10% | 50% | 6% | 2% | 2% | 2% | 2% | 2% | 2% | 2% |
| Adj. Flow (vph) | 0 | 67 | 13 | 4 | 108 | 0 | 38 | 0 | 2 | 0 | 0 | 0 |
| Shared Lane Traffic (%) | | | | | | | | | | | | |
| Lane Group Flow (vph) | 0 | 80 | 0 | 0 | 112 | 0 | 0 | 40 | 0 | 0 | 0 | 0 |
| Enter Blocked Intersection | No | No | No | No | No | No | No | No | No | No | No | No |
| Lane Alignment | Left | Left | Right | Left | Left | Right | Left | Left | Right | Left | Left | Right |
| Median Width(m) | 0.0 | | | | 0.0 | | | | 0.0 | | | |
| Link Offset(m) | 0.0 | | | | 0.0 | | | | 0.0 | | | |
| Crosswalk Width(m) | 6.0 | | | | 6.0 | | | | 7.0 | | | |
| Two way Left Turn Lane | | | | | | | | | | | | |
| Headway Factor | 1.06 | 1.06 | 1.06 | 1.06 | 1.06 | 1.06 | 1.06 | 1.06 | 1.06 | 1.06 | 1.06 | 1.06 |
| Turning Speed (k/h) | 24 | | 14 | 24 | | 14 | 24 | | 14 | 24 | | 14 |
| Sign Control | Stop | | | Stop | | | Stop | | | Stop | | |
| Intersection Summary | | | | | | | | | | | | |
| Area Type: | Other | | | | | | | | | | | |
| Control Type: | Unsignalized | | | | | | | | | | | |
| Intersection Capacity Utilization 20.4% | ICU Level of Service A | | | | | | | | | | | |
| Analysis Period (min) 15 | | | | | | | | | | | | |

3: Provence & Plainhill
AM Peak Hour

Provence Orleans Subdivision (Phase 6)
2020 Background Traffic

| |  |  |  |  |  |  |  |  |  |  |  |  |
|---|---|---|---|---|---|---|--|---|---|---|---|---|
| Lane Group | EBL | EBT | EBR | WBL | WBT | WBR | NBL | NBT | NBR | SBL | SBT | SBR |
| Lane Configurations | |  | | |  | | |  | | |  | |
| Traffic Volume (vph) | 16 | 14 | 9 | 20 | 27 | 39 | 5 | 57 | 7 | 15 | 36 | 8 |
| Future Volume (vph) | 16 | 14 | 9 | 20 | 27 | 39 | 5 | 57 | 7 | 15 | 36 | 8 |
| Ideal Flow (vphpl) | 1800 | 1800 | 1800 | 1800 | 1800 | 1800 | 1800 | 1800 | 1800 | 1800 | 1800 | 1800 |
| Lane Util. Factor | 1.00 | 1.00 | 1.00 | 1.00 | 1.00 | 1.00 | 1.00 | 1.00 | 1.00 | 1.00 | 1.00 | 1.00 |
| Ped Bike Factor | | | | | | | | | | | | |
| Frt | | 0.969 | | | 0.939 | | | 0.986 | | | 0.982 | |
| Flt Protected | | 0.980 | | | 0.989 | | | 0.996 | | | 0.987 | |
| Satd. Flow (prot) | 0 | 1677 | 0 | 0 | 1610 | 0 | 0 | 1711 | 0 | 0 | 1699 | 0 |
| Flt Permitted | | 0.980 | | | 0.989 | | | 0.996 | | | 0.987 | |
| Satd. Flow (perm) | 0 | 1677 | 0 | 0 | 1610 | 0 | 0 | 1711 | 0 | 0 | 1699 | 0 |
| Link Speed (k/h) | | 50 | | | 50 | | | 50 | | | 50 | |
| Link Distance (m) | | 78.8 | | | 168.6 | | | 195.8 | | | 141.6 | |
| Travel Time (s) | | 5.7 | | | 12.1 | | | 14.1 | | | 10.2 | |
| Confl. Peds. (#/hr) | 8 | | | | | 8 | 1 | | 1 | 1 | | 1 |
| Peak Hour Factor | 1.00 | 1.00 | 1.00 | 1.00 | 1.00 | 1.00 | 1.00 | 1.00 | 1.00 | 1.00 | 1.00 | 1.00 |
| Heavy Vehicles (%) | 2% | 5% | 2% | 2% | 10% | 3% | 2% | 5% | 2% | 2% | 5% | 2% |
| Adj. Flow (vph) | 16 | 14 | 9 | 20 | 27 | 39 | 5 | 57 | 7 | 15 | 36 | 8 |
| Shared Lane Traffic (%) | | | | | | | | | | | | |
| Lane Group Flow (vph) | 0 | 39 | 0 | 0 | 86 | 0 | 0 | 69 | 0 | 0 | 59 | 0 |
| Enter Blocked Intersection | No | No | No | No | No | No | No | No | No | No | No | No |
| Lane Alignment | Left | Left | Right | Left | Left | Right | Left | Left | Right | Left | Left | Right |
| Median Width(m) | | 0.0 | | | 0.0 | | | 0.0 | | | 0.0 | |
| Link Offset(m) | | 0.0 | | | 0.0 | | | 0.0 | | | 0.0 | |
| Crosswalk Width(m) | | 7.0 | | | 7.0 | | | 7.0 | | | 7.0 | |
| Two way Left Turn Lane | | | | | | | | | | | | |
| Headway Factor | 1.06 | 1.06 | 1.06 | 1.06 | 1.06 | 1.06 | 1.06 | 1.06 | 1.06 | 1.06 | 1.06 | 1.06 |
| Turning Speed (k/h) | 24 | | 14 | 24 | | 14 | 24 | | 14 | 24 | | 14 |
| Sign Control | | Stop | | | Stop | | | Stop | | | Stop | |
| Intersection Summary | | | | | | | | | | | | |
| Area Type: | Other | | | | | | | | | | | |
| Control Type: | Unsignalized | | | | | | | | | | | |
| Intersection Capacity Utilization 22.4% | ICU Level of Service A | | | | | | | | | | | |
| Analysis Period (min) 15 | | | | | | | | | | | | |

















4: Provence & Grapefern
AM Peak Hour

Provence Orleans Subdivision (Phase 6)
2020 Background Traffic

| Lane Group | EBL | EBT | EBR | WBL | WBT | WBR | NBL | NBT | NBR | SBL | SBT | SBR | |
|-----------------------------------|--------------|-------|-------|------|------|-------|------------------------|-------|-------|------|-------|-------|--|
| Lane Configurations | | | | | | | | | | | | | |
| Traffic Volume (vph) | 7 | 0 | 1 | 0 | 0 | 0 | 1 | 111 | 0 | 1 | 58 | 1 | |
| Future Volume (vph) | 7 | 0 | 1 | 0 | 0 | 0 | 1 | 111 | 0 | 1 | 58 | 1 | |
| Ideal Flow (vphpl) | 1800 | 1800 | 1800 | 1800 | 1800 | 1800 | 1800 | 1800 | 1800 | 1800 | 1800 | 1800 | |
| Lane Util. Factor | 1.00 | 1.00 | 1.00 | 1.00 | 1.00 | 1.00 | 1.00 | 1.00 | 1.00 | 1.00 | 1.00 | 1.00 | |
| Ped Bike Factor | | | | | | | | | | | | | |
| Frt | | 0.983 | | | | | | | | | 0.998 | | |
| Flt Protected | | 0.958 | | | | | | | | | 0.999 | | |
| Satd. Flow (prot) | 0 | 1680 | 0 | 0 | 1784 | 0 | 0 | 1767 | 0 | 0 | 1779 | 0 | |
| Flt Permitted | | 0.958 | | | | | | | | | 0.999 | | |
| Satd. Flow (perm) | 0 | 1680 | 0 | 0 | 1784 | 0 | 0 | 1767 | 0 | 0 | 1779 | 0 | |
| Link Speed (k/h) | | 50 | | | 50 | | | 50 | | | 50 | | |
| Link Distance (m) | | 124.8 | | | 57.5 | | | 141.6 | | | 204.6 | | |
| Travel Time (s) | | 9.0 | | | 4.1 | | | 10.2 | | | 14.7 | | |
| Confl. Peds. (#/hr) | | | | | | | 6 | | | | | 6 | |
| Confl. Bikes (#/hr) | | | | | | | | | | | | 1 | |
| Peak Hour Factor | 1.00 | 1.00 | 1.00 | 1.00 | 1.00 | 1.00 | 1.00 | 1.00 | 1.00 | 1.00 | 1.00 | 1.00 | |
| Heavy Vehicles (%) | 2% | 2% | 2% | 2% | 2% | 2% | 2% | 3% | 2% | 2% | 2% | 2% | |
| Adj. Flow (vph) | 7 | 0 | 1 | 0 | 0 | 0 | 1 | 111 | 0 | 1 | 58 | 1 | |
| Shared Lane Traffic (%) | | | | | | | | | | | | | |
| Lane Group Flow (vph) | 0 | 8 | 0 | 0 | 0 | 0 | 0 | 112 | 0 | 0 | 60 | 0 | |
| Enter Blocked Intersection | No | No | No | No | No | No | No | No | No | No | No | No | |
| Lane Alignment | Left | Left | Right | Left | Left | Right | Left | Left | Right | Left | Left | Right | |
| Median Width(m) | | 0.0 | | | 0.0 | | | 0.0 | | | 0.0 | | |
| Link Offset(m) | | 0.0 | | | 0.0 | | | 0.0 | | | 0.0 | | |
| Crosswalk Width(m) | | 3.0 | | | 3.0 | | | 3.0 | | | 3.0 | | |
| Two way Left Turn Lane | | | | | | | | | | | | | |
| Headway Factor | 1.06 | 1.06 | 1.06 | 1.06 | 1.06 | 1.06 | 1.06 | 1.06 | 1.06 | 1.06 | 1.06 | 1.06 | |
| Turning Speed (k/h) | 24 | | 14 | 24 | | 14 | 24 | | 14 | 24 | | 14 | |
| Sign Control | | Stop | | | Stop | | | Free | | | Free | | |
| Intersection Summary | | | | | | | | | | | | | |
| Area Type: | Other | | | | | | | | | | | | |
| Control Type: | Unsignalized | | | | | | | | | | | | |
| Intersection Capacity Utilization | 16.7% | | | | | | ICU Level of Service A | | | | | | |
| Analysis Period (min) | 15 | | | | | | | | | | | | |

















1: Portobello & Aquaview/Nantes
PM Peak Hour

Provence Orleans Subdivision (Phase 6)
2020 Background Traffic

| |  |  |  |  |  |  |  |  |  |  |  |  |
|---|---|---|---|---|---|---|--|---|---|---|---|---|
| Lane Group | EBL | EBT | EBR | WBL | WBT | WBR | NBL | NBT | NBR | SBL | SBT | SBR |
| Lane Configurations | |  | | |  | | |  | | |  | |
| Traffic Volume (vph) | 43 | 23 | 19 | 8 | 24 | 81 | 21 | 131 | 4 | 83 | 168 | 43 |
| Future Volume (vph) | 43 | 23 | 19 | 8 | 24 | 81 | 21 | 131 | 4 | 83 | 168 | 43 |
| Ideal Flow (vphpl) | 1800 | 1800 | 1800 | 1800 | 1800 | 1800 | 1800 | 1800 | 1800 | 1800 | 1800 | 1800 |
| Lane Util. Factor | 1.00 | 1.00 | 1.00 | 1.00 | 1.00 | 1.00 | 0.95 | 0.95 | 0.95 | 0.95 | 0.95 | 0.95 |
| Ped Bike Factor | | | | | | | | | | | | |
| Frt | | 0.970 | | | 0.903 | | | 0.996 | | | 0.978 | |
| Flt Protected | | 0.975 | | | 0.996 | | | 0.993 | | | 0.986 | |
| Satd. Flow (prot) | 0 | 1676 | 0 | 0 | 1595 | 0 | 0 | 3260 | 0 | 0 | 3215 | 0 |
| Flt Permitted | | 0.975 | | | 0.996 | | | 0.993 | | | 0.986 | |
| Satd. Flow (perm) | 0 | 1676 | 0 | 0 | 1595 | 0 | 0 | 3260 | 0 | 0 | 3215 | 0 |
| Link Speed (k/h) | | 50 | | | 50 | | | 50 | | | 50 | |
| Link Distance (m) | | 151.1 | | | 115.4 | | | 211.4 | | | 191.8 | |
| Travel Time (s) | | 10.9 | | | 8.3 | | | 15.2 | | | 13.8 | |
| Confl. Peds. (#/hr) | 12 | | 4 | 4 | | 12 | 6 | | 3 | 3 | | 6 |
| Peak Hour Factor | 1.00 | 1.00 | 1.00 | 1.00 | 1.00 | 1.00 | 1.00 | 1.00 | 1.00 | 1.00 | 1.00 | 1.00 |
| Heavy Vehicles (%) | 2% | 2% | 5% | 2% | 5% | 2% | 5% | 5% | 2% | 2% | 5% | 2% |
| Adj. Flow (vph) | 43 | 23 | 19 | 8 | 24 | 81 | 21 | 131 | 4 | 83 | 168 | 43 |
| Shared Lane Traffic (%) | | | | | | | | | | | | |
| Lane Group Flow (vph) | 0 | 85 | 0 | 0 | 113 | 0 | 0 | 156 | 0 | 0 | 294 | 0 |
| Enter Blocked Intersection | No | No | No | No | No | No | No | No | No | No | No | No |
| Lane Alignment | Left | Left | Right | Left | Left | Right | Left | Left | Right | Left | Left | Right |
| Median Width(m) | | 0.0 | | | 0.0 | | | 2.0 | | | 2.0 | |
| Link Offset(m) | | 0.0 | | | 0.0 | | | 0.0 | | | 0.0 | |
| Crosswalk Width(m) | | 7.0 | | | 7.0 | | | 7.0 | | | 7.0 | |
| Two way Left Turn Lane | | | | | | | | | | | | |
| Headway Factor | 1.06 | 1.06 | 1.06 | 1.06 | 1.06 | 1.06 | 1.06 | 1.06 | 1.06 | 1.06 | 1.06 | 1.06 |
| Turning Speed (k/h) | 24 | | 14 | 24 | | 14 | 24 | | 14 | 24 | | 14 |
| Sign Control | | Stop | | | Stop | | | Stop | | | Stop | |
| Intersection Summary | | | | | | | | | | | | |
| Area Type: | Other | | | | | | | | | | | |
| Control Type: | Unsignalized | | | | | | | | | | | |
| Intersection Capacity Utilization 37.2% | ICU Level of Service A | | | | | | | | | | | |
| Analysis Period (min) 15 | | | | | | | | | | | | |

















2: Brianna & Nantes
PM Peak Hour

Provence Orleans Subdivision (Phase 6)
2020 Background Traffic

| |  |  |  |  |  |  |  |  |  |  |  |  |
|---|---|---|---|---|---|---|--|---|---|---|---|---|
| Lane Group | EBL | EBT | EBR | WBL | WBT | WBR | NBL | NBT | NBR | SBL | SBT | SBR |
| Lane Configurations | |  | | |  | | |  | | |  | |
| Traffic Volume (vph) | 0 | 73 | 34 | 1 | 93 | 0 | 22 | 0 | 2 | 0 | 0 | 0 |
| Future Volume (vph) | 0 | 73 | 34 | 1 | 93 | 0 | 22 | 0 | 2 | 0 | 0 | 0 |
| Ideal Flow (vphpl) | 1800 | 1800 | 1800 | 1800 | 1800 | 1800 | 1800 | 1800 | 1800 | 1800 | 1800 | 1800 |
| Lane Util. Factor | 1.00 | 1.00 | 1.00 | 1.00 | 1.00 | 1.00 | 1.00 | 1.00 | 1.00 | 1.00 | 1.00 | 1.00 |
| Ped Bike Factor | | | | | | | | | | | | |
| Frt | 0.957 | | | | | | 0.989 | | | | | |
| Flt Protected | | | | | | | 0.999 | | | | | |
| Satd. Flow (prot) | 0 | 1692 | 0 | 0 | 1732 | 0 | 0 | 1687 | 0 | 0 | 1784 | 0 |
| Flt Permitted | | | | | | | 0.999 | | | | | |
| Satd. Flow (perm) | 0 | 1692 | 0 | 0 | 1732 | 0 | 0 | 1687 | 0 | 0 | 1784 | 0 |
| Link Speed (k/h) | 50 | | | | 50 | | | | 50 | | | |
| Link Distance (m) | 115.4 | | | | 192.4 | | | | 110.9 | | | |
| Travel Time (s) | 8.3 | | | | 13.9 | | | | 8.0 | | | |
| Confl. Peds. (#/hr) | | | 1 | 1 | | | 4 | | | 2 | | |
| Peak Hour Factor | 1.00 | 1.00 | 1.00 | 1.00 | 1.00 | 1.00 | 1.00 | 1.00 | 1.00 | 1.00 | 1.00 | 1.00 |
| Heavy Vehicles (%) | 2% | 2% | 5% | 2% | 5% | 2% | 2% | 2% | 2% | 2% | 2% | 2% |
| Adj. Flow (vph) | 0 | 73 | 34 | 1 | 93 | 0 | 22 | 0 | 2 | 0 | 0 | 0 |
| Shared Lane Traffic (%) | | | | | | | | | | | | |
| Lane Group Flow (vph) | 0 | 107 | 0 | 0 | 94 | 0 | 0 | 24 | 0 | 0 | 0 | 0 |
| Enter Blocked Intersection | No | No | No | No | No | No | No | No | No | No | No | No |
| Lane Alignment | Left | Left | Right | Left | Left | Right | Left | Left | Right | Left | Left | Right |
| Median Width(m) | 0.0 | | | | 0.0 | | | | 0.0 | | | |
| Link Offset(m) | 0.0 | | | | 0.0 | | | | 0.0 | | | |
| Crosswalk Width(m) | 6.0 | | | | 6.0 | | | | 6.0 | | | |
| Two way Left Turn Lane | | | | | | | | | | | | |
| Headway Factor | 1.06 | 1.06 | 1.06 | 1.06 | 1.06 | 1.06 | 1.06 | 1.06 | 1.06 | 1.06 | 1.06 | 1.06 |
| Turning Speed (k/h) | 24 | | 14 | 24 | | 14 | 24 | | 14 | 24 | | 14 |
| Sign Control | Stop | | | Stop | | | Stop | | | Stop | | |
| Intersection Summary | | | | | | | | | | | | |
| Area Type: | Other | | | | | | | | | | | |
| Control Type: | Unsignalized | | | | | | | | | | | |
| Intersection Capacity Utilization 17.2% | ICU Level of Service A | | | | | | | | | | | |
| Analysis Period (min) 15 | | | | | | | | | | | | |

3: Provence & Plainhill
PM Peak Hour

Provence Orleans Subdivision (Phase 6)
2020 Background Traffic

| |  |  |  |  |  |  |  |  |  |  |  |  |
|---|---|---|---|---|---|---|--|---|---|---|---|---|
| Lane Group | EBL | EBT | EBR | WBL | WBT | WBR | NBL | NBT | NBR | SBL | SBT | SBR |
| Lane Configurations | |  | | |  | | |  | | |  | |
| Traffic Volume (vph) | 2 | 26 | 3 | 12 | 21 | 8 | 8 | 16 | 19 | 25 | 21 | 11 |
| Future Volume (vph) | 2 | 26 | 3 | 12 | 21 | 8 | 8 | 16 | 19 | 25 | 21 | 11 |
| Ideal Flow (vphpl) | 1800 | 1800 | 1800 | 1800 | 1800 | 1800 | 1800 | 1800 | 1800 | 1800 | 1800 | 1800 |
| Lane Util. Factor | 1.00 | 1.00 | 1.00 | 1.00 | 1.00 | 1.00 | 1.00 | 1.00 | 1.00 | 1.00 | 1.00 | 1.00 |
| Ped Bike Factor | | | | | | | | | | | | |
| Frt | | 0.987 | | | 0.974 | | | 0.940 | | | 0.974 | |
| Flt Protected | | 0.997 | | | 0.986 | | | 0.991 | | | 0.979 | |
| Satd. Flow (prot) | 0 | 1727 | 0 | 0 | 1714 | 0 | 0 | 1641 | 0 | 0 | 1683 | 0 |
| Flt Permitted | | 0.997 | | | 0.986 | | | 0.991 | | | 0.979 | |
| Satd. Flow (perm) | 0 | 1727 | 0 | 0 | 1714 | 0 | 0 | 1641 | 0 | 0 | 1683 | 0 |
| Link Speed (k/h) | | 50 | | | 50 | | | 50 | | | 50 | |
| Link Distance (m) | | 78.8 | | | 168.6 | | | 195.8 | | | 141.6 | |
| Travel Time (s) | | 5.7 | | | 12.1 | | | 14.1 | | | 10.2 | |
| Confl. Peds. (#/hr) | 2 | | 3 | 3 | | 2 | 2 | | 1 | 1 | | 2 |
| Peak Hour Factor | 1.00 | 1.00 | 1.00 | 1.00 | 1.00 | 1.00 | 1.00 | 1.00 | 1.00 | 1.00 | 1.00 | 1.00 |
| Heavy Vehicles (%) | 2% | 4% | 2% | 2% | 2% | 2% | 2% | 2% | 5% | 2% | 5% | 2% |
| Adj. Flow (vph) | 2 | 26 | 3 | 12 | 21 | 8 | 8 | 16 | 19 | 25 | 21 | 11 |
| Shared Lane Traffic (%) | | | | | | | | | | | | |
| Lane Group Flow (vph) | 0 | 31 | 0 | 0 | 41 | 0 | 0 | 43 | 0 | 0 | 57 | 0 |
| Enter Blocked Intersection | No | No | No | No | No | No | No | No | No | No | No | No |
| Lane Alignment | Left | Left | Right | Left | Left | Right | Left | Left | Right | Left | Left | Right |
| Median Width(m) | | 0.0 | | | 0.0 | | | 0.0 | | | 0.0 | |
| Link Offset(m) | | 0.0 | | | 0.0 | | | 0.0 | | | 0.0 | |
| Crosswalk Width(m) | | 7.0 | | | 7.0 | | | 7.0 | | | 7.0 | |
| Two way Left Turn Lane | | | | | | | | | | | | |
| Headway Factor | 1.06 | 1.06 | 1.06 | 1.06 | 1.06 | 1.06 | 1.06 | 1.06 | 1.06 | 1.06 | 1.06 | 1.06 |
| Turning Speed (k/h) | 24 | | 14 | 24 | | 14 | 24 | | 14 | 24 | | 14 |
| Sign Control | | Stop | | | Stop | | | Stop | | | Stop | |
| Intersection Summary | | | | | | | | | | | | |
| Area Type: | Other | | | | | | | | | | | |
| Control Type: | Unsignalized | | | | | | | | | | | |
| Intersection Capacity Utilization 20.7% | ICU Level of Service A | | | | | | | | | | | |
| Analysis Period (min) 15 | | | | | | | | | | | | |

















4: Provence & Grapefern
PM Peak Hour

Provence Orleans Subdivision (Phase 6)
2020 Background Traffic

| Lane Group | EBL | EBT | EBR | WBL | WBT | WBR | NBL | NBT | NBR | SBL | SBT | SBR |
|---|------------------------|-------|-------|------|-------|-------|------|-------|-------|------|-------|-------|
| Lane Configurations | | | | | | | | | | | | |
| Traffic Volume (vph) | 3 | 0 | 2 | 7 | 0 | 4 | 4 | 15 | 7 | 6 | 48 | 8 |
| Future Volume (vph) | 3 | 0 | 2 | 7 | 0 | 4 | 4 | 15 | 7 | 6 | 48 | 8 |
| Ideal Flow (vphpl) | 1800 | 1800 | 1800 | 1800 | 1800 | 1800 | 1800 | 1800 | 1800 | 1800 | 1800 | 1800 |
| Lane Util. Factor | 1.00 | 1.00 | 1.00 | 1.00 | 1.00 | 1.00 | 1.00 | 1.00 | 1.00 | 1.00 | 1.00 | 1.00 |
| Ped Bike Factor | | | | | | | | | | | | |
| Frt | | 0.946 | | | 0.951 | | | 0.964 | | | 0.983 | |
| Flt Protected | | 0.971 | | | 0.969 | | | 0.992 | | | 0.995 | |
| Satd. Flow (prot) | 0 | 1639 | 0 | 0 | 1644 | 0 | 0 | 1697 | 0 | 0 | 1745 | 0 |
| Flt Permitted | | 0.971 | | | 0.969 | | | 0.992 | | | 0.995 | |
| Satd. Flow (perm) | 0 | 1639 | 0 | 0 | 1644 | 0 | 0 | 1697 | 0 | 0 | 1745 | 0 |
| Link Speed (k/h) | | 50 | | | 50 | | | 50 | | | 50 | |
| Link Distance (m) | | 124.8 | | | 57.5 | | | 141.6 | | | 204.6 | |
| Travel Time (s) | | 9.0 | | | 4.1 | | | 10.2 | | | 14.7 | |
| Confl. Peds. (#/hr) | 7 | | | | | 7 | 4 | | | | | 4 |
| Confl. Bikes (#/hr) | | | 1 | | | | | | | | | 1 |
| Peak Hour Factor | 1.00 | 1.00 | 1.00 | 1.00 | 1.00 | 1.00 | 1.00 | 1.00 | 1.00 | 1.00 | 1.00 | 1.00 |
| Heavy Vehicles (%) | 2% | 2% | 2% | 2% | 2% | 2% | 2% | 3% | 2% | 2% | 2% | 2% |
| Adj. Flow (vph) | 3 | 0 | 2 | 7 | 0 | 4 | 4 | 15 | 7 | 6 | 48 | 8 |
| Shared Lane Traffic (%) | | | | | | | | | | | | |
| Lane Group Flow (vph) | 0 | 5 | 0 | 0 | 11 | 0 | 0 | 26 | 0 | 0 | 62 | 0 |
| Enter Blocked Intersection | No | No | No | No | No | No | No | No | No | No | No | No |
| Lane Alignment | Left | Left | Right | Left | Left | Right | Left | Left | Right | Left | Left | Right |
| Median Width(m) | | 0.0 | | | 0.0 | | | 0.0 | | | 0.0 | |
| Link Offset(m) | | 0.0 | | | 0.0 | | | 0.0 | | | 0.0 | |
| Crosswalk Width(m) | | 3.0 | | | 3.0 | | | 3.0 | | | 3.0 | |
| Two way Left Turn Lane | | | | | | | | | | | | |
| Headway Factor | 1.06 | 1.06 | 1.06 | 1.06 | 1.06 | 1.06 | 1.06 | 1.06 | 1.06 | 1.06 | 1.06 | 1.06 |
| Turning Speed (k/h) | 24 | | 14 | 24 | | 14 | 24 | | 14 | 24 | | 14 |
| Sign Control | | Stop | | | Stop | | | Free | | | Free | |
| Intersection Summary | | | | | | | | | | | | |
| Area Type: | Other | | | | | | | | | | | |
| Control Type: | Unsignalized | | | | | | | | | | | |
| Intersection Capacity Utilization 17.5% | ICU Level of Service A | | | | | | | | | | | |
| Analysis Period (min) 15 | | | | | | | | | | | | |

1: Portobello & Aquaview/Nantes
AM Peak Hour

Provence Orleans Subdivision (Phase 6)
2025 Background Traffic

| |  |  |  |  |  |  |  |  |  |  |  |  |
|---|---|---|---|---|---|---|--|---|---|---|---|---|
| Lane Group | EBL | EBT | EBR | WBL | WBT | WBR | NBL | NBT | NBR | SBL | SBT | SBR |
| Lane Configurations | |  | | |  | | |  | | |  | |
| Traffic Volume (vph) | 73 | 15 | 34 | 17 | 32 | 98 | 29 | 153 | 6 | 50 | 135 | 46 |
| Future Volume (vph) | 73 | 15 | 34 | 17 | 32 | 98 | 29 | 153 | 6 | 50 | 135 | 46 |
| Ideal Flow (vphpl) | 1800 | 1800 | 1800 | 1800 | 1800 | 1800 | 1800 | 1800 | 1800 | 1800 | 1800 | 1800 |
| Lane Util. Factor | 1.00 | 1.00 | 1.00 | 1.00 | 1.00 | 1.00 | 0.95 | 0.95 | 0.95 | 0.95 | 0.95 | 0.95 |
| Ped Bike Factor | | | | | | | | | | | | |
| Frt | | 0.962 | | | 0.910 | | | 0.995 | | | 0.970 | |
| Flt Protected | | 0.971 | | | 0.994 | | | 0.992 | | | 0.989 | |
| Satd. Flow (prot) | 0 | 1621 | 0 | 0 | 1604 | 0 | 0 | 3157 | 0 | 0 | 3162 | 0 |
| Flt Permitted | | 0.971 | | | 0.994 | | | 0.992 | | | 0.989 | |
| Satd. Flow (perm) | 0 | 1621 | 0 | 0 | 1604 | 0 | 0 | 3157 | 0 | 0 | 3162 | 0 |
| Link Speed (k/h) | | 50 | | | 50 | | | 50 | | | 50 | |
| Link Distance (m) | | 151.1 | | | 115.4 | | | 210.3 | | | 153.8 | |
| Travel Time (s) | | 10.9 | | | 8.3 | | | 15.1 | | | 11.1 | |
| Confl. Peds. (#/hr) | 47 | | | | | 47 | 43 | | 4 | 4 | | 43 |
| Confl. Bikes (#/hr) | | | 1 | | | | | | | | | 1 |
| Peak Hour Factor | 1.00 | 1.00 | 1.00 | 1.00 | 1.00 | 1.00 | 1.00 | 1.00 | 1.00 | 1.00 | 1.00 | 1.00 |
| Heavy Vehicles (%) | 4% | 2% | 8% | 2% | 5% | 2% | 10% | 8% | 2% | 2% | 7% | 2% |
| Adj. Flow (vph) | 73 | 15 | 34 | 17 | 32 | 98 | 29 | 153 | 6 | 50 | 135 | 46 |
| Shared Lane Traffic (%) | | | | | | | | | | | | |
| Lane Group Flow (vph) | 0 | 122 | 0 | 0 | 147 | 0 | 0 | 188 | 0 | 0 | 231 | 0 |
| Enter Blocked Intersection | No | No | No | No | No | No | No | No | No | No | No | No |
| Lane Alignment | Left | Left | Right | Left | Left | Right | Left | Left | Right | Left | Left | Right |
| Median Width(m) | | 0.0 | | | 0.0 | | | 2.0 | | | 2.0 | |
| Link Offset(m) | | 0.0 | | | 0.0 | | | 0.0 | | | 0.0 | |
| Crosswalk Width(m) | | 7.0 | | | 7.0 | | | 7.0 | | | 7.0 | |
| Two way Left Turn Lane | | | | | | | | | | | | |
| Headway Factor | 1.06 | 1.06 | 1.06 | 1.06 | 1.06 | 1.06 | 1.06 | 1.06 | 1.06 | 1.06 | 1.06 | 1.06 |
| Turning Speed (k/h) | 24 | | 14 | 24 | | 14 | 24 | | 14 | 24 | | 14 |
| Sign Control | | Stop | | | Stop | | | Stop | | | Stop | |
| Intersection Summary | | | | | | | | | | | | |
| Area Type: | Other | | | | | | | | | | | |
| Control Type: | Unsignalized | | | | | | | | | | | |
| Intersection Capacity Utilization 52.1% | ICU Level of Service A | | | | | | | | | | | |
| Analysis Period (min) 15 | | | | | | | | | | | | |

2: Brianna & Nantes
AM Peak Hour

Provence Orleans Subdivision (Phase 6)
2025 Background Traffic



| Lane Group | EBL | EBT | EBR | WBL | WBT | WBR | NBL | NBT | NBR | SBL | SBT | SBR |
|----------------------------|-------|------|-------|------|-------|-------|-------|------|-------|-------|------|-------|
| Lane Configurations | | ↕ | | | ↕ | | | ↕ | | | ↕ | |
| Traffic Volume (vph) | 0 | 67 | 13 | 4 | 108 | 0 | 38 | 0 | 2 | 0 | 0 | 0 |
| Future Volume (vph) | 0 | 67 | 13 | 4 | 108 | 0 | 38 | 0 | 2 | 0 | 0 | 0 |
| Ideal Flow (vphpl) | 1800 | 1800 | 1800 | 1800 | 1800 | 1800 | 1800 | 1800 | 1800 | 1800 | 1800 | 1800 |
| Lane Util. Factor | 1.00 | 1.00 | 1.00 | 1.00 | 1.00 | 1.00 | 1.00 | 1.00 | 1.00 | 1.00 | 1.00 | 1.00 |
| Ped Bike Factor | | | | | | | | | | | | |
| Frt | 0.978 | | | | | | 0.993 | | | | | |
| Flt Protected | | | | | | | 0.998 | | | 0.955 | | |
| Satd. Flow (prot) | 0 | 1723 | 0 | 0 | 1689 | 0 | 0 | 1692 | 0 | 0 | 1784 | 0 |
| Flt Permitted | | | | | | | 0.998 | | | 0.955 | | |
| Satd. Flow (perm) | 0 | 1723 | 0 | 0 | 1689 | 0 | 0 | 1692 | 0 | 0 | 1784 | 0 |
| Link Speed (k/h) | | | | | 50 | | | | 50 | | | |
| Link Distance (m) | 115.4 | | | | 192.4 | | | | 110.9 | | | |
| Travel Time (s) | 8.3 | | | | 13.9 | | | | 8.0 | | | |
| Confl. Peds. (#/hr) | | | | | | | 1 | | | 3 | | |
| Peak Hour Factor | 1.00 | 1.00 | 1.00 | 1.00 | 1.00 | 1.00 | 1.00 | 1.00 | 1.00 | 1.00 | 1.00 | 1.00 |
| Heavy Vehicles (%) | 2% | 2% | 10% | 50% | 6% | 2% | 2% | 2% | 2% | 2% | 2% | 2% |
| Adj. Flow (vph) | 0 | 67 | 13 | 4 | 108 | 0 | 38 | 0 | 2 | 0 | 0 | 0 |
| Shared Lane Traffic (%) | | | | | | | | | | | | |
| Lane Group Flow (vph) | 0 | 80 | 0 | 0 | 112 | 0 | 0 | 40 | 0 | 0 | 0 | 0 |
| Enter Blocked Intersection | No | No | No | No | No | No | No | No | No | No | No | No |
| Lane Alignment | Left | Left | Right | Left | Left | Right | Left | Left | Right | Left | Left | Right |
| Median Width(m) | 0.0 | | | | 0.0 | | | | 0.0 | | | |
| Link Offset(m) | 0.0 | | | | 0.0 | | | | 0.0 | | | |
| Crosswalk Width(m) | 6.0 | | | | 6.0 | | | | 7.0 | | | |
| Two way Left Turn Lane | | | | | | | | | | | | |
| Headway Factor | 1.06 | 1.06 | 1.06 | 1.06 | 1.06 | 1.06 | 1.06 | 1.06 | 1.06 | 1.06 | 1.06 | 1.06 |
| Turning Speed (k/h) | 24 | | 14 | 24 | | 14 | 24 | | 14 | 24 | | 14 |
| Sign Control | Stop | | | Stop | | | | Stop | | | Stop | |

Intersection Summary

| | |
|---|------------------------|
| Area Type: | Other |
| Control Type: | Unsignalized |
| Intersection Capacity Utilization 20.4% | ICU Level of Service A |
| Analysis Period (min) | 15 |

3: Provence & Plainhill
AM Peak Hour

Provence Orleans Subdivision (Phase 6)
2025 Background Traffic



| Lane Group | EBL | EBT | EBR | WBL | WBT | WBR | NBL | NBT | NBR | SBL | SBT | SBR |
|----------------------------|------|-------|-------|------|-------|-------|------|-------|-------|------|-------|-------|
| Lane Configurations | | | | | | | | | | | | |
| Traffic Volume (vph) | 16 | 14 | 9 | 20 | 27 | 39 | 5 | 67 | 7 | 15 | 60 | 8 |
| Future Volume (vph) | 16 | 14 | 9 | 20 | 27 | 39 | 5 | 67 | 7 | 15 | 60 | 8 |
| Ideal Flow (vphpl) | 1800 | 1800 | 1800 | 1800 | 1800 | 1800 | 1800 | 1800 | 1800 | 1800 | 1800 | 1800 |
| Lane Util. Factor | 1.00 | 1.00 | 1.00 | 1.00 | 1.00 | 1.00 | 1.00 | 1.00 | 1.00 | 1.00 | 1.00 | 1.00 |
| Ped Bike Factor | | | | | | | | | | | | |
| Frt | | 0.969 | | | 0.939 | | | 0.988 | | | 0.987 | |
| Flt Protected | | 0.980 | | | 0.989 | | | 0.997 | | | 0.991 | |
| Satd. Flow (prot) | 0 | 1677 | 0 | 0 | 1610 | 0 | 0 | 1715 | 0 | 0 | 1709 | 0 |
| Flt Permitted | | 0.980 | | | 0.989 | | | 0.997 | | | 0.991 | |
| Satd. Flow (perm) | 0 | 1677 | 0 | 0 | 1610 | 0 | 0 | 1715 | 0 | 0 | 1709 | 0 |
| Link Speed (k/h) | | 50 | | | 50 | | | 50 | | | 50 | |
| Link Distance (m) | | 78.8 | | | 168.6 | | | 195.8 | | | 141.6 | |
| Travel Time (s) | | 5.7 | | | 12.1 | | | 14.1 | | | 10.2 | |
| Confl. Peds. (#/hr) | 8 | | | | | 8 | 1 | | 1 | 1 | | 1 |
| Peak Hour Factor | 1.00 | 1.00 | 1.00 | 1.00 | 1.00 | 1.00 | 1.00 | 1.00 | 1.00 | 1.00 | 1.00 | 1.00 |
| Heavy Vehicles (%) | 2% | 5% | 2% | 2% | 10% | 3% | 2% | 5% | 2% | 2% | 5% | 2% |
| Adj. Flow (vph) | 16 | 14 | 9 | 20 | 27 | 39 | 5 | 67 | 7 | 15 | 60 | 8 |
| Shared Lane Traffic (%) | | | | | | | | | | | | |
| Lane Group Flow (vph) | 0 | 39 | 0 | 0 | 86 | 0 | 0 | 79 | 0 | 0 | 83 | 0 |
| Enter Blocked Intersection | No | No | No | No | No | No | No | No | No | No | No | No |
| Lane Alignment | Left | Left | Right | Left | Left | Right | Left | Left | Right | Left | Left | Right |
| Median Width(m) | | 0.0 | | | 0.0 | | | 0.0 | | | 0.0 | |
| Link Offset(m) | | 0.0 | | | 0.0 | | | 0.0 | | | 0.0 | |
| Crosswalk Width(m) | | 7.0 | | | 7.0 | | | 7.0 | | | 7.0 | |
| Two way Left Turn Lane | | | | | | | | | | | | |
| Headway Factor | 1.06 | 1.06 | 1.06 | 1.06 | 1.06 | 1.06 | 1.06 | 1.06 | 1.06 | 1.06 | 1.06 | 1.06 |
| Turning Speed (k/h) | 24 | | 14 | 24 | | 14 | 24 | | 14 | 24 | | 14 |
| Sign Control | | Stop | | | Stop | | | Stop | | | Stop | |

Intersection Summary

Area Type: Other

Control Type: Unsignalized

















Intersection Capacity Utilization 23.8%

ICU Level of Service A

Analysis Period (min) 15

















4: Provence & Grapefern
AM Peak Hour

Provence Orleans Subdivision (Phase 6)
2025 Background Traffic

| |  |  |  |  |  |  |  |  |  |  |  |  |
|---|---|---|---|---|---|---|--|---|---|---|---|---|
| Lane Group | EBL | EBT | EBR | WBL | WBT | WBR | NBL | NBT | NBR | SBL | SBT | SBR |
| Lane Configurations | |  | | |  | | |  | | |  | |
| Traffic Volume (vph) | 7 | 0 | 1 | 0 | 0 | 0 | 1 | 121 | 0 | 1 | 82 | 1 |
| Future Volume (vph) | 7 | 0 | 1 | 0 | 0 | 0 | 1 | 121 | 0 | 1 | 82 | 1 |
| Ideal Flow (vphpl) | 1800 | 1800 | 1800 | 1800 | 1800 | 1800 | 1800 | 1800 | 1800 | 1800 | 1800 | 1800 |
| Lane Util. Factor | 1.00 | 1.00 | 1.00 | 1.00 | 1.00 | 1.00 | 1.00 | 1.00 | 1.00 | 1.00 | 1.00 | 1.00 |
| Ped Bike Factor | | | | | | | | | | | | |
| Frt | | 0.983 | | | | | | | | | | 0.998 |
| Flt Protected | | 0.958 | | | | | | | | | | 0.999 |
| Satd. Flow (prot) | 0 | 1680 | 0 | 0 | 1784 | 0 | 0 | 1767 | 0 | 0 | 1779 | 0 |
| Flt Permitted | | 0.958 | | | | | | | | | | 0.999 |
| Satd. Flow (perm) | 0 | 1680 | 0 | 0 | 1784 | 0 | 0 | 1767 | 0 | 0 | 1779 | 0 |
| Link Speed (k/h) | | 50 | | | 50 | | | 50 | | | 50 | |
| Link Distance (m) | | 124.8 | | | 57.5 | | | 141.6 | | | 204.6 | |
| Travel Time (s) | | 9.0 | | | 4.1 | | | 10.2 | | | 14.7 | |
| Confl. Peds. (#/hr) | | | | | | | 6 | | | | | 6 |
| Confl. Bikes (#/hr) | | | | | | | | | | | | 1 |
| Peak Hour Factor | 1.00 | 1.00 | 1.00 | 1.00 | 1.00 | 1.00 | 1.00 | 1.00 | 1.00 | 1.00 | 1.00 | 1.00 |
| Heavy Vehicles (%) | 2% | 2% | 2% | 2% | 2% | 2% | 2% | 3% | 2% | 2% | 2% | 2% |
| Adj. Flow (vph) | 7 | 0 | 1 | 0 | 0 | 0 | 1 | 121 | 0 | 1 | 82 | 1 |
| Shared Lane Traffic (%) | | | | | | | | | | | | |
| Lane Group Flow (vph) | 0 | 8 | 0 | 0 | 0 | 0 | 0 | 122 | 0 | 0 | 84 | 0 |
| Enter Blocked Intersection | No | No | No | No | No | No | No | No | No | No | No | No |
| Lane Alignment | Left | Left | Right | Left | Left | Right | Left | Left | Right | Left | Left | Right |
| Median Width(m) | | 0.0 | | | 0.0 | | | 0.0 | | | 0.0 | |
| Link Offset(m) | | 0.0 | | | 0.0 | | | 0.0 | | | 0.0 | |
| Crosswalk Width(m) | | 3.0 | | | 3.0 | | | 3.0 | | | 3.0 | |
| Two way Left Turn Lane | | | | | | | | | | | | |
| Headway Factor | 1.06 | 1.06 | 1.06 | 1.06 | 1.06 | 1.06 | 1.06 | 1.06 | 1.06 | 1.06 | 1.06 | 1.06 |
| Turning Speed (k/h) | 24 | | 14 | 24 | | 14 | 24 | | 14 | 24 | | 14 |
| Sign Control | | Stop | | | Stop | | | Free | | | Free | |
| Intersection Summary | | | | | | | | | | | | |
| Area Type: | Other | | | | | | | | | | | |
| Control Type: | Unsignalized | | | | | | | | | | | |
| Intersection Capacity Utilization 17.3% | ICU Level of Service A | | | | | | | | | | | |
| Analysis Period (min) 15 | | | | | | | | | | | | |

















1: Portobello & Aquaview/Nantes
PM Peak Hour

Provence Orleans Subdivision (Phase 6)
2025 Background Traffic

| |  |  |  |  |  |  |  |  |  |  |  |  |
|---|---|---|---|---|---|---|--|---|---|---|---|---|
| Lane Group | EBL | EBT | EBR | WBL | WBT | WBR | NBL | NBT | NBR | SBL | SBT | SBR |
| Lane Configurations | |  | | |  | | |  | | |  | |
| Traffic Volume (vph) | 43 | 23 | 19 | 8 | 24 | 81 | 22 | 137 | 4 | 87 | 177 | 45 |
| Future Volume (vph) | 43 | 23 | 19 | 8 | 24 | 81 | 22 | 137 | 4 | 87 | 177 | 45 |
| Ideal Flow (vphpl) | 1800 | 1800 | 1800 | 1800 | 1800 | 1800 | 1800 | 1800 | 1800 | 1800 | 1800 | 1800 |
| Lane Util. Factor | 1.00 | 1.00 | 1.00 | 1.00 | 1.00 | 1.00 | 0.95 | 0.95 | 0.95 | 0.95 | 0.95 | 0.95 |
| Ped Bike Factor | | | | | | | | | | | | |
| Frt | | 0.970 | | | 0.903 | | | 0.996 | | | 0.978 | |
| Flt Protected | | 0.975 | | | 0.996 | | | 0.993 | | | 0.986 | |
| Satd. Flow (prot) | 0 | 1676 | 0 | 0 | 1595 | 0 | 0 | 3259 | 0 | 0 | 3215 | 0 |
| Flt Permitted | | 0.975 | | | 0.996 | | | 0.993 | | | 0.986 | |
| Satd. Flow (perm) | 0 | 1676 | 0 | 0 | 1595 | 0 | 0 | 3259 | 0 | 0 | 3215 | 0 |
| Link Speed (k/h) | | 50 | | | 50 | | | 50 | | | 50 | |
| Link Distance (m) | | 151.1 | | | 115.4 | | | 211.4 | | | 191.8 | |
| Travel Time (s) | | 10.9 | | | 8.3 | | | 15.2 | | | 13.8 | |
| Confl. Peds. (#/hr) | 12 | | 4 | 4 | | 12 | 6 | | 3 | 3 | | 6 |
| Peak Hour Factor | 1.00 | 1.00 | 1.00 | 1.00 | 1.00 | 1.00 | 1.00 | 1.00 | 1.00 | 1.00 | 1.00 | 1.00 |
| Heavy Vehicles (%) | 2% | 2% | 5% | 2% | 5% | 2% | 5% | 5% | 2% | 2% | 5% | 2% |
| Adj. Flow (vph) | 43 | 23 | 19 | 8 | 24 | 81 | 22 | 137 | 4 | 87 | 177 | 45 |
| Shared Lane Traffic (%) | | | | | | | | | | | | |
| Lane Group Flow (vph) | 0 | 85 | 0 | 0 | 113 | 0 | 0 | 163 | 0 | 0 | 309 | 0 |
| Enter Blocked Intersection | No | No | No | No | No | No | No | No | No | No | No | No |
| Lane Alignment | Left | Left | Right | Left | Left | Right | Left | Left | Right | Left | Left | Right |
| Median Width(m) | | 0.0 | | | 0.0 | | | 2.0 | | | 2.0 | |
| Link Offset(m) | | 0.0 | | | 0.0 | | | 0.0 | | | 0.0 | |
| Crosswalk Width(m) | | 7.0 | | | 7.0 | | | 7.0 | | | 7.0 | |
| Two way Left Turn Lane | | | | | | | | | | | | |
| Headway Factor | 1.06 | 1.06 | 1.06 | 1.06 | 1.06 | 1.06 | 1.06 | 1.06 | 1.06 | 1.06 | 1.06 | 1.06 |
| Turning Speed (k/h) | 24 | | 14 | 24 | | 14 | 24 | | 14 | 24 | | 14 |
| Sign Control | | Stop | | | Stop | | | Stop | | | Stop | |
| Intersection Summary | | | | | | | | | | | | |
| Area Type: | Other | | | | | | | | | | | |
| Control Type: | Unsignalized | | | | | | | | | | | |
| Intersection Capacity Utilization 37.7% | ICU Level of Service A | | | | | | | | | | | |
| Analysis Period (min) 15 | | | | | | | | | | | | |

















2: Brianna & Nantes
PM Peak Hour

Provence Orleans Subdivision (Phase 6)
2025 Background Traffic

| |  |  |  |  |  |  |  |  |  |  |  |  |
|---|---|---|---|---|---|---|--|---|---|---|---|---|
| Lane Group | EBL | EBT | EBR | WBL | WBT | WBR | NBL | NBT | NBR | SBL | SBT | SBR |
| Lane Configurations | |  | | |  | | |  | | |  | |
| Traffic Volume (vph) | 0 | 73 | 34 | 1 | 93 | 0 | 22 | 0 | 2 | 0 | 0 | 0 |
| Future Volume (vph) | 0 | 73 | 34 | 1 | 93 | 0 | 22 | 0 | 2 | 0 | 0 | 0 |
| Ideal Flow (vphpl) | 1800 | 1800 | 1800 | 1800 | 1800 | 1800 | 1800 | 1800 | 1800 | 1800 | 1800 | 1800 |
| Lane Util. Factor | 1.00 | 1.00 | 1.00 | 1.00 | 1.00 | 1.00 | 1.00 | 1.00 | 1.00 | 1.00 | 1.00 | 1.00 |
| Ped Bike Factor | | | | | | | | | | | | |
| Frt | 0.957 | | | | | | 0.989 | | | | | |
| Flt Protected | | | | | | | 0.999 | | | | | |
| Satd. Flow (prot) | 0 | 1692 | 0 | 0 | 1732 | 0 | 0 | 1687 | 0 | 0 | 1784 | 0 |
| Flt Permitted | | | | | | | 0.999 | | | | | |
| Satd. Flow (perm) | 0 | 1692 | 0 | 0 | 1732 | 0 | 0 | 1687 | 0 | 0 | 1784 | 0 |
| Link Speed (k/h) | | | | | 50 | | | | 50 | | | |
| Link Distance (m) | 115.4 | | | | 192.4 | | | | 110.9 | | | |
| Travel Time (s) | 8.3 | | | | 13.9 | | | | 8.0 | | | |
| Confl. Peds. (#/hr) | | | 1 | 1 | | | 4 | | | 2 | | |
| Peak Hour Factor | 1.00 | 1.00 | 1.00 | 1.00 | 1.00 | 1.00 | 1.00 | 1.00 | 1.00 | 1.00 | 1.00 | 1.00 |
| Heavy Vehicles (%) | 2% | 2% | 5% | 2% | 5% | 2% | 2% | 2% | 2% | 2% | 2% | 2% |
| Adj. Flow (vph) | 0 | 73 | 34 | 1 | 93 | 0 | 22 | 0 | 2 | 0 | 0 | 0 |
| Shared Lane Traffic (%) | | | | | | | | | | | | |
| Lane Group Flow (vph) | 0 | 107 | 0 | 0 | 94 | 0 | 0 | 24 | 0 | 0 | 0 | 0 |
| Enter Blocked Intersection | No | No | No | No | No | No | No | No | No | No | No | No |
| Lane Alignment | Left | Left | Right | Left | Left | Right | Left | Left | Right | Left | Left | Right |
| Median Width(m) | 0.0 | | | | 0.0 | | | | 0.0 | | | |
| Link Offset(m) | 0.0 | | | | 0.0 | | | | 0.0 | | | |
| Crosswalk Width(m) | 6.0 | | | | 6.0 | | | | 6.0 | | | |
| Two way Left Turn Lane | | | | | | | | | | | | |
| Headway Factor | 1.06 | 1.06 | 1.06 | 1.06 | 1.06 | 1.06 | 1.06 | 1.06 | 1.06 | 1.06 | 1.06 | 1.06 |
| Turning Speed (k/h) | 24 | | 14 | 24 | | 14 | 24 | | 14 | 24 | | 14 |
| Sign Control | Stop | | | Stop | | | Stop | | | Stop | | |
| Intersection Summary | | | | | | | | | | | | |
| Area Type: | Other | | | | | | | | | | | |
| Control Type: | Unsignalized | | | | | | | | | | | |
| Intersection Capacity Utilization 17.2% | ICU Level of Service A | | | | | | | | | | | |
| Analysis Period (min) 15 | | | | | | | | | | | | |

















3: Provence & Plainhill
PM Peak Hour

Provence Orleans Subdivision (Phase 6)
2025 Background Traffic

| |  |  |  |  |  |  |  |  |  |  |  |  |
|---|---|---|---|---|---|---|--|---|---|---|---|---|
| Lane Group | EBL | EBT | EBR | WBL | WBT | WBR | NBL | NBT | NBR | SBL | SBT | SBR |
| Lane Configurations | |  | | |  | | |  | | |  | |
| Traffic Volume (vph) | 2 | 26 | 3 | 12 | 21 | 8 | 8 | 39 | 19 | 25 | 36 | 11 |
| Future Volume (vph) | 2 | 26 | 3 | 12 | 21 | 8 | 8 | 39 | 19 | 25 | 36 | 11 |
| Ideal Flow (vphpl) | 1800 | 1800 | 1800 | 1800 | 1800 | 1800 | 1800 | 1800 | 1800 | 1800 | 1800 | 1800 |
| Lane Util. Factor | 1.00 | 1.00 | 1.00 | 1.00 | 1.00 | 1.00 | 1.00 | 1.00 | 1.00 | 1.00 | 1.00 | 1.00 |
| Ped Bike Factor | | | | | | | | | | | | |
| Frt | | 0.987 | | | 0.974 | | | 0.961 | | | 0.979 | |
| Flt Protected | | 0.997 | | | 0.986 | | | 0.994 | | | 0.983 | |
| Satd. Flow (prot) | 0 | 1727 | 0 | 0 | 1714 | 0 | 0 | 1690 | 0 | 0 | 1692 | 0 |
| Flt Permitted | | 0.997 | | | 0.986 | | | 0.994 | | | 0.983 | |
| Satd. Flow (perm) | 0 | 1727 | 0 | 0 | 1714 | 0 | 0 | 1690 | 0 | 0 | 1692 | 0 |
| Link Speed (k/h) | | 50 | | | 50 | | | 50 | | | 50 | |
| Link Distance (m) | | 78.8 | | | 168.6 | | | 195.8 | | | 141.6 | |
| Travel Time (s) | | 5.7 | | | 12.1 | | | 14.1 | | | 10.2 | |
| Confl. Peds. (#/hr) | 2 | | 3 | 3 | | 2 | 2 | | 1 | 1 | | 2 |
| Peak Hour Factor | 1.00 | 1.00 | 1.00 | 1.00 | 1.00 | 1.00 | 1.00 | 1.00 | 1.00 | 1.00 | 1.00 | 1.00 |
| Heavy Vehicles (%) | 2% | 4% | 2% | 2% | 2% | 2% | 2% | 2% | 5% | 2% | 5% | 2% |
| Adj. Flow (vph) | 2 | 26 | 3 | 12 | 21 | 8 | 8 | 39 | 19 | 25 | 36 | 11 |
| Shared Lane Traffic (%) | | | | | | | | | | | | |
| Lane Group Flow (vph) | 0 | 31 | 0 | 0 | 41 | 0 | 0 | 66 | 0 | 0 | 72 | 0 |
| Enter Blocked Intersection | No | No | No | No | No | No | No | No | No | No | No | No |
| Lane Alignment | Left | Left | Right | Left | Left | Right | Left | Left | Right | Left | Left | Right |
| Median Width(m) | | 0.0 | | | 0.0 | | | 0.0 | | | 0.0 | |
| Link Offset(m) | | 0.0 | | | 0.0 | | | 0.0 | | | 0.0 | |
| Crosswalk Width(m) | | 7.0 | | | 7.0 | | | 7.0 | | | 7.0 | |
| Two way Left Turn Lane | | | | | | | | | | | | |
| Headway Factor | 1.06 | 1.06 | 1.06 | 1.06 | 1.06 | 1.06 | 1.06 | 1.06 | 1.06 | 1.06 | 1.06 | 1.06 |
| Turning Speed (k/h) | 24 | | 14 | 24 | | 14 | 24 | | 14 | 24 | | 14 |
| Sign Control | | Stop | | | Stop | | | Stop | | | Stop | |
| Intersection Summary | | | | | | | | | | | | |
| Area Type: | Other | | | | | | | | | | | |
| Control Type: | Unsignalized | | | | | | | | | | | |
| Intersection Capacity Utilization 22.9% | ICU Level of Service A | | | | | | | | | | | |
| Analysis Period (min) 15 | | | | | | | | | | | | |

















4: Provence & Grapefern
PM Peak Hour

Provence Orleans Subdivision (Phase 6)
2025 Background Traffic

| |  |  |  |  |  |  |  |  |  |  |  |  |  |
|---|---|---|---|---|---|---|--|---|---|---|---|---|---|
| Lane Group | EBL | EBT | EBR | WBL | WBT | WBR | NBL | NBT | NBR | SBL | SBT | SBR | |
| Lane Configurations | |  | | |  | | |  | | |  | | |
| Traffic Volume (vph) | 3 | 0 | 2 | 7 | 0 | 4 | 4 | 38 | 7 | 6 | 63 | 8 | |
| Future Volume (vph) | 3 | 0 | 2 | 7 | 0 | 4 | 4 | 38 | 7 | 6 | 63 | 8 | |
| Ideal Flow (vphpl) | 1800 | 1800 | 1800 | 1800 | 1800 | 1800 | 1800 | 1800 | 1800 | 1800 | 1800 | 1800 | |
| Lane Util. Factor | 1.00 | 1.00 | 1.00 | 1.00 | 1.00 | 1.00 | 1.00 | 1.00 | 1.00 | 1.00 | 1.00 | 1.00 | |
| Ped Bike Factor | | | | | | | | | | | | | |
| Frt | | 0.946 | | | 0.951 | | | 0.981 | | | 0.986 | | |
| Flt Protected | | 0.971 | | | 0.969 | | | 0.996 | | | 0.996 | | |
| Satd. Flow (prot) | 0 | 1639 | 0 | 0 | 1644 | 0 | 0 | 1730 | 0 | 0 | 1752 | 0 | |
| Flt Permitted | | 0.971 | | | 0.969 | | | 0.996 | | | 0.996 | | |
| Satd. Flow (perm) | 0 | 1639 | 0 | 0 | 1644 | 0 | 0 | 1730 | 0 | 0 | 1752 | 0 | |
| Link Speed (k/h) | | 50 | | | 50 | | | 50 | | | 50 | | |
| Link Distance (m) | | 124.8 | | | 57.5 | | | 141.6 | | | 204.6 | | |
| Travel Time (s) | | 9.0 | | | 4.1 | | | 10.2 | | | 14.7 | | |
| Confl. Peds. (#/hr) | 7 | | | | | 7 | 4 | | | | | 4 | |
| Confl. Bikes (#/hr) | | | 1 | | | | | | | | | | 1 |
| Peak Hour Factor | 1.00 | 1.00 | 1.00 | 1.00 | 1.00 | 1.00 | 1.00 | 1.00 | 1.00 | 1.00 | 1.00 | 1.00 | |
| Heavy Vehicles (%) | 2% | 2% | 2% | 2% | 2% | 2% | 2% | 3% | 2% | 2% | 2% | 2% | |
| Adj. Flow (vph) | 3 | 0 | 2 | 7 | 0 | 4 | 4 | 38 | 7 | 6 | 63 | 8 | |
| Shared Lane Traffic (%) | | | | | | | | | | | | | |
| Lane Group Flow (vph) | 0 | 5 | 0 | 0 | 11 | 0 | 0 | 49 | 0 | 0 | 77 | 0 | |
| Enter Blocked Intersection | No | No | No | No | No | No | No | No | No | No | No | No | |
| Lane Alignment | Left | Left | Right | Left | Left | Right | Left | Left | Right | Left | Left | Right | |
| Median Width(m) | | 0.0 | | | 0.0 | | | 0.0 | | | 0.0 | | |
| Link Offset(m) | | 0.0 | | | 0.0 | | | 0.0 | | | 0.0 | | |
| Crosswalk Width(m) | | 3.0 | | | 3.0 | | | 3.0 | | | 3.0 | | |
| Two way Left Turn Lane | | | | | | | | | | | | | |
| Headway Factor | 1.06 | 1.06 | 1.06 | 1.06 | 1.06 | 1.06 | 1.06 | 1.06 | 1.06 | 1.06 | 1.06 | 1.06 | |
| Turning Speed (k/h) | 24 | | 14 | 24 | | 14 | 24 | | 14 | 24 | | 14 | |
| Sign Control | | Stop | | | Stop | | | Free | | | Free | | |
| Intersection Summary | | | | | | | | | | | | | |
| Area Type: | Other | | | | | | | | | | | | |
| Control Type: | Unsignalized | | | | | | | | | | | | |
| Intersection Capacity Utilization 18.7% | ICU Level of Service A | | | | | | | | | | | | |
| Analysis Period (min) 15 | | | | | | | | | | | | | |

















1: Portobello & Aquaview/Nantes
AM Peak Hour

Provence Orleans Subdivision (Phase 6)
2020 Total Traffic

| |  |  |  |  |  |  |  |  |  |  |  |  |
|---|---|---|---|---|---|---|--|---|---|---|---|---|
| Lane Group | EBL | EBT | EBR | WBL | WBT | WBR | NBL | NBT | NBR | SBL | SBT | SBR |
| Lane Configurations | |  | | |  | | |  | | |  | |
| Traffic Volume (vph) | 73 | 15 | 34 | 29 | 32 | 163 | 27 | 146 | 11 | 74 | 129 | 44 |
| Future Volume (vph) | 73 | 15 | 34 | 29 | 32 | 163 | 27 | 146 | 11 | 74 | 129 | 44 |
| Ideal Flow (vphpl) | 1800 | 1800 | 1800 | 1800 | 1800 | 1800 | 1800 | 1800 | 1800 | 1800 | 1800 | 1800 |
| Lane Util. Factor | 1.00 | 1.00 | 1.00 | 1.00 | 1.00 | 1.00 | 0.95 | 0.95 | 0.95 | 0.95 | 0.95 | 0.95 |
| Ped Bike Factor | | | | | | | | | | | | |
| Frt | | 0.962 | | | 0.902 | | | 0.991 | | | 0.973 | |
| Flt Protected | | 0.971 | | | 0.994 | | | 0.993 | | | 0.985 | |
| Satd. Flow (prot) | 0 | 1621 | 0 | 0 | 1593 | 0 | 0 | 3153 | 0 | 0 | 3168 | 0 |
| Flt Permitted | | 0.971 | | | 0.994 | | | 0.993 | | | 0.985 | |
| Satd. Flow (perm) | 0 | 1621 | 0 | 0 | 1593 | 0 | 0 | 3153 | 0 | 0 | 3168 | 0 |
| Link Speed (k/h) | | 50 | | | 50 | | | 50 | | | 50 | |
| Link Distance (m) | | 151.1 | | | 115.4 | | | 210.3 | | | 153.8 | |
| Travel Time (s) | | 10.9 | | | 8.3 | | | 15.1 | | | 11.1 | |
| Confl. Peds. (#/hr) | 47 | | | | | 47 | 43 | | 4 | 4 | | 43 |
| Confl. Bikes (#/hr) | | | 1 | | | | | | | | | 1 |
| Peak Hour Factor | 1.00 | 1.00 | 1.00 | 1.00 | 1.00 | 1.00 | 1.00 | 1.00 | 1.00 | 1.00 | 1.00 | 1.00 |
| Heavy Vehicles (%) | 4% | 2% | 8% | 2% | 5% | 2% | 10% | 8% | 2% | 2% | 7% | 2% |
| Adj. Flow (vph) | 73 | 15 | 34 | 29 | 32 | 163 | 27 | 146 | 11 | 74 | 129 | 44 |
| Shared Lane Traffic (%) | | | | | | | | | | | | |
| Lane Group Flow (vph) | 0 | 122 | 0 | 0 | 224 | 0 | 0 | 184 | 0 | 0 | 247 | 0 |
| Enter Blocked Intersection | No | No | No | No | No | No | No | No | No | No | No | No |
| Lane Alignment | Left | Left | Right | Left | Left | Right | Left | Left | Right | Left | Left | Right |
| Median Width(m) | | 0.0 | | | 0.0 | | | 2.0 | | | 2.0 | |
| Link Offset(m) | | 0.0 | | | 0.0 | | | 0.0 | | | 0.0 | |
| Crosswalk Width(m) | | 7.0 | | | 7.0 | | | 7.0 | | | 7.0 | |
| Two way Left Turn Lane | | | | | | | | | | | | |
| Headway Factor | 1.06 | 1.06 | 1.06 | 1.06 | 1.06 | 1.06 | 1.06 | 1.06 | 1.06 | 1.06 | 1.06 | 1.06 |
| Turning Speed (k/h) | 24 | | 14 | 24 | | 14 | 24 | | 14 | 24 | | 14 |
| Sign Control | | Stop | | | Stop | | | Stop | | | Stop | |
| Intersection Summary | | | | | | | | | | | | |
| Area Type: | Other | | | | | | | | | | | |
| Control Type: | Unsignalized | | | | | | | | | | | |
| Intersection Capacity Utilization 52.3% | ICU Level of Service A | | | | | | | | | | | |
| Analysis Period (min) 15 | | | | | | | | | | | | |

















2: Brianna & Nantes
AM Peak Hour

Provence Orleans Subdivision (Phase 6)
2020 Total Traffic

| |  |  |  |  |  |  |  |  |  |  |  |  |
|---|---|---|---|---|---|---|--|---|---|---|---|---|
| Lane Group | EBL | EBT | EBR | WBL | WBT | WBR | NBL | NBT | NBR | SBL | SBT | SBR |
| Lane Configurations | |  | | |  | | |  | | |  | |
| Traffic Volume (vph) | 31 | 67 | 13 | 4 | 108 | 0 | 38 | 5 | 2 | 0 | 12 | 77 |
| Future Volume (vph) | 31 | 67 | 13 | 4 | 108 | 0 | 38 | 5 | 2 | 0 | 12 | 77 |
| Ideal Flow (vphpl) | 1800 | 1800 | 1800 | 1800 | 1800 | 1800 | 1800 | 1800 | 1800 | 1800 | 1800 | 1800 |
| Lane Util. Factor | 1.00 | 1.00 | 1.00 | 1.00 | 1.00 | 1.00 | 1.00 | 1.00 | 1.00 | 1.00 | 1.00 | 1.00 |
| Ped Bike Factor | | | | | | | | | | | | |
| Frt | | 0.984 | | | | | | 0.994 | | | 0.883 | |
| Flt Protected | | 0.986 | | | 0.998 | | | 0.959 | | | | |
| Satd. Flow (prot) | 0 | 1715 | 0 | 0 | 1689 | 0 | 0 | 1701 | 0 | 0 | 1576 | 0 |
| Flt Permitted | | 0.986 | | | 0.998 | | | 0.959 | | | | |
| Satd. Flow (perm) | 0 | 1715 | 0 | 0 | 1689 | 0 | 0 | 1701 | 0 | 0 | 1576 | 0 |
| Link Speed (k/h) | | 50 | | | 50 | | | 50 | | | 50 | |
| Link Distance (m) | | 115.4 | | | 192.4 | | | 110.9 | | | 114.6 | |
| Travel Time (s) | | 8.3 | | | 13.9 | | | 8.0 | | | 8.3 | |
| Confl. Peds. (#/hr) | | | | | | | 1 | | 3 | | | |
| Peak Hour Factor | 1.00 | 1.00 | 1.00 | 1.00 | 1.00 | 1.00 | 1.00 | 1.00 | 1.00 | 1.00 | 1.00 | 1.00 |
| Heavy Vehicles (%) | 2% | 2% | 10% | 50% | 6% | 2% | 2% | 2% | 2% | 2% | 2% | 2% |
| Adj. Flow (vph) | 31 | 67 | 13 | 4 | 108 | 0 | 38 | 5 | 2 | 0 | 12 | 77 |
| Shared Lane Traffic (%) | | | | | | | | | | | | |
| Lane Group Flow (vph) | 0 | 111 | 0 | 0 | 112 | 0 | 0 | 45 | 0 | 0 | 89 | 0 |
| Enter Blocked Intersection | No | No | No | No | No | No | No | No | No | No | No | No |
| Lane Alignment | Left | Left | Right | Left | Left | Right | Left | Left | Right | Left | Left | Right |
| Median Width(m) | | 0.0 | | | 0.0 | | | 0.0 | | | 0.0 | |
| Link Offset(m) | | 0.0 | | | 0.0 | | | 0.0 | | | 0.0 | |
| Crosswalk Width(m) | | 6.0 | | | 6.0 | | | 6.0 | | | 7.0 | |
| Two way Left Turn Lane | | | | | | | | | | | | |
| Headway Factor | 1.06 | 1.06 | 1.06 | 1.06 | 1.06 | 1.06 | 1.06 | 1.06 | 1.06 | 1.06 | 1.06 | 1.06 |
| Turning Speed (k/h) | 24 | | 14 | 24 | | 14 | 24 | | 14 | 24 | | 14 |
| Sign Control | | Stop | | | Stop | | | Stop | | | Stop | |
| Intersection Summary | | | | | | | | | | | | |
| Area Type: | Other | | | | | | | | | | | |
| Control Type: | Unsignalized | | | | | | | | | | | |
| Intersection Capacity Utilization 29.4% | ICU Level of Service A | | | | | | | | | | | |
| Analysis Period (min) 15 | | | | | | | | | | | | |

















3: Provence & Plainhill
AM Peak Hour

Provence Orleans Subdivision (Phase 6)
2020 Total Traffic

| |  |  |  |  |  |  |  |  |  |  |  |  |
|---|---|---|---|---|---|---|--|---|---|---|---|---|
| Lane Group | EBL | EBT | EBR | WBL | WBT | WBR | NBL | NBT | NBR | SBL | SBT | SBR |
| Lane Configurations | |  | | |  | | |  | | |  | |
| Traffic Volume (vph) | 16 | 14 | 9 | 20 | 27 | 39 | 5 | 59 | 7 | 15 | 42 | 8 |
| Future Volume (vph) | 16 | 14 | 9 | 20 | 27 | 39 | 5 | 59 | 7 | 15 | 42 | 8 |
| Ideal Flow (vphpl) | 1800 | 1800 | 1800 | 1800 | 1800 | 1800 | 1800 | 1800 | 1800 | 1800 | 1800 | 1800 |
| Lane Util. Factor | 1.00 | 1.00 | 1.00 | 1.00 | 1.00 | 1.00 | 1.00 | 1.00 | 1.00 | 1.00 | 1.00 | 1.00 |
| Ped Bike Factor | | | | | | | | | | | | |
| Frt | | 0.969 | | | 0.939 | | | 0.987 | | | 0.983 | |
| Flt Protected | | 0.980 | | | 0.989 | | | 0.996 | | | 0.989 | |
| Satd. Flow (prot) | 0 | 1677 | 0 | 0 | 1610 | 0 | 0 | 1712 | 0 | 0 | 1702 | 0 |
| Flt Permitted | | 0.980 | | | 0.989 | | | 0.996 | | | 0.989 | |
| Satd. Flow (perm) | 0 | 1677 | 0 | 0 | 1610 | 0 | 0 | 1712 | 0 | 0 | 1702 | 0 |
| Link Speed (k/h) | | 50 | | | 50 | | | 50 | | | 50 | |
| Link Distance (m) | | 78.8 | | | 168.6 | | | 195.8 | | | 141.6 | |
| Travel Time (s) | | 5.7 | | | 12.1 | | | 14.1 | | | 10.2 | |
| Confl. Peds. (#/hr) | 8 | | | | | 8 | 1 | | 1 | 1 | | 1 |
| Peak Hour Factor | 1.00 | 1.00 | 1.00 | 1.00 | 1.00 | 1.00 | 1.00 | 1.00 | 1.00 | 1.00 | 1.00 | 1.00 |
| Heavy Vehicles (%) | 2% | 5% | 2% | 2% | 10% | 3% | 2% | 5% | 2% | 2% | 5% | 2% |
| Adj. Flow (vph) | 16 | 14 | 9 | 20 | 27 | 39 | 5 | 59 | 7 | 15 | 42 | 8 |
| Shared Lane Traffic (%) | | | | | | | | | | | | |
| Lane Group Flow (vph) | 0 | 39 | 0 | 0 | 86 | 0 | 0 | 71 | 0 | 0 | 65 | 0 |
| Enter Blocked Intersection | No | No | No | No | No | No | No | No | No | No | No | No |
| Lane Alignment | Left | Left | Right | Left | Left | Right | Left | Left | Right | Left | Left | Right |
| Median Width(m) | | 0.0 | | | 0.0 | | | 0.0 | | | 0.0 | |
| Link Offset(m) | | 0.0 | | | 0.0 | | | 0.0 | | | 0.0 | |
| Crosswalk Width(m) | | 7.0 | | | 7.0 | | | 7.0 | | | 7.0 | |
| Two way Left Turn Lane | | | | | | | | | | | | |
| Headway Factor | 1.06 | 1.06 | 1.06 | 1.06 | 1.06 | 1.06 | 1.06 | 1.06 | 1.06 | 1.06 | 1.06 | 1.06 |
| Turning Speed (k/h) | 24 | | 14 | 24 | | 14 | 24 | | 14 | 24 | | 14 |
| Sign Control | | Stop | | | Stop | | | Stop | | | Stop | |
| Intersection Summary | | | | | | | | | | | | |
| Area Type: | Other | | | | | | | | | | | |
| Control Type: | Unsignalized | | | | | | | | | | | |
| Intersection Capacity Utilization 22.7% | ICU Level of Service A | | | | | | | | | | | |
| Analysis Period (min) 15 | | | | | | | | | | | | |

















4: Provence & Grapefern
AM Peak Hour

Provence Orleans Subdivision (Phase 6)
2020 Total Traffic

| |  |  |  |  |  |  |  |  |  |  |  |  |
|---|---|---|---|---|---|---|--|---|---|---|---|---|
| Lane Group | EBL | EBT | EBR | WBL | WBT | WBR | NBL | NBT | NBR | SBL | SBT | SBR |
| Lane Configurations | |  | | |  | | |  | | |  | |
| Traffic Volume (vph) | 28 | 0 | 7 | 0 | 0 | 0 | 3 | 111 | 0 | 1 | 58 | 9 |
| Future Volume (vph) | 28 | 0 | 7 | 0 | 0 | 0 | 3 | 111 | 0 | 1 | 58 | 9 |
| Ideal Flow (vphpl) | 1800 | 1800 | 1800 | 1800 | 1800 | 1800 | 1800 | 1800 | 1800 | 1800 | 1800 | 1800 |
| Lane Util. Factor | 1.00 | 1.00 | 1.00 | 1.00 | 1.00 | 1.00 | 1.00 | 1.00 | 1.00 | 1.00 | 1.00 | 1.00 |
| Ped Bike Factor | | | | | | | | | | | | |
| Frt | | 0.973 | | | | | | | | | | 0.982 |
| Flt Protected | | 0.962 | | | | | | 0.999 | | | | 0.999 |
| Satd. Flow (prot) | 0 | 1670 | 0 | 0 | 1784 | 0 | 0 | 1766 | 0 | 0 | 1750 | 0 |
| Flt Permitted | | 0.962 | | | | | | 0.999 | | | | 0.999 |
| Satd. Flow (perm) | 0 | 1670 | 0 | 0 | 1784 | 0 | 0 | 1766 | 0 | 0 | 1750 | 0 |
| Link Speed (k/h) | | 50 | | | 50 | | | 50 | | | 50 | |
| Link Distance (m) | | 124.8 | | | 57.5 | | | 141.6 | | | 204.6 | |
| Travel Time (s) | | 9.0 | | | 4.1 | | | 10.2 | | | 14.7 | |
| Confl. Peds. (#/hr) | | | | | | | 6 | | | | | 6 |
| Confl. Bikes (#/hr) | | | | | | | | | | | | 1 |
| Peak Hour Factor | 1.00 | 1.00 | 1.00 | 1.00 | 1.00 | 1.00 | 1.00 | 1.00 | 1.00 | 1.00 | 1.00 | 1.00 |
| Heavy Vehicles (%) | 2% | 2% | 2% | 2% | 2% | 2% | 2% | 3% | 2% | 2% | 2% | 2% |
| Adj. Flow (vph) | 28 | 0 | 7 | 0 | 0 | 0 | 3 | 111 | 0 | 1 | 58 | 9 |
| Shared Lane Traffic (%) | | | | | | | | | | | | |
| Lane Group Flow (vph) | 0 | 35 | 0 | 0 | 0 | 0 | 0 | 114 | 0 | 0 | 68 | 0 |
| Enter Blocked Intersection | No | No | No | No | No | No | No | No | No | No | No | No |
| Lane Alignment | Left | Left | Right | Left | Left | Right | Left | Left | Right | Left | Left | Right |
| Median Width(m) | | 0.0 | | | 0.0 | | | 0.0 | | | 0.0 | |
| Link Offset(m) | | 0.0 | | | 0.0 | | | 0.0 | | | 0.0 | |
| Crosswalk Width(m) | | 3.0 | | | 3.0 | | | 3.0 | | | 3.0 | |
| Two way Left Turn Lane | | | | | | | | | | | | |
| Headway Factor | 1.06 | 1.06 | 1.06 | 1.06 | 1.06 | 1.06 | 1.06 | 1.06 | 1.06 | 1.06 | 1.06 | 1.06 |
| Turning Speed (k/h) | 24 | | 14 | 24 | | 14 | 24 | | 14 | 24 | | 14 |
| Sign Control | | Stop | | | Stop | | | Free | | | Free | |
| Intersection Summary | | | | | | | | | | | | |
| Area Type: | Other | | | | | | | | | | | |
| Control Type: | Unsignalized | | | | | | | | | | | |
| Intersection Capacity Utilization 18.0% | ICU Level of Service A | | | | | | | | | | | |
| Analysis Period (min) 15 | | | | | | | | | | | | |

















1: Portobello & Aquaview/Nantes
PM Peak Hour

Provence Orleans Subdivision (Phase 6)
2020 Total Traffic

| |  |  |  |  |  |  |  |  |  |  |  |  |
|---|---|---|---|---|---|---|--|---|---|---|---|---|
| Lane Group | EBL | EBT | EBR | WBL | WBT | WBR | NBL | NBT | NBR | SBL | SBT | SBR |
| Lane Configurations | |  | | |  | | |  | | |  | |
| Traffic Volume (vph) | 43 | 23 | 19 | 16 | 24 | 123 | 21 | 131 | 16 | 148 | 168 | 43 |
| Future Volume (vph) | 43 | 23 | 19 | 16 | 24 | 123 | 21 | 131 | 16 | 148 | 168 | 43 |
| Ideal Flow (vphpl) | 1800 | 1800 | 1800 | 1800 | 1800 | 1800 | 1800 | 1800 | 1800 | 1800 | 1800 | 1800 |
| Lane Util. Factor | 1.00 | 1.00 | 1.00 | 1.00 | 1.00 | 1.00 | 0.95 | 0.95 | 0.95 | 0.95 | 0.95 | 0.95 |
| Ped Bike Factor | | | | | | | | | | | | |
| Frt | | 0.970 | | | 0.898 | | | 0.986 | | | 0.982 | |
| Flt Protected | | 0.975 | | | 0.995 | | | 0.994 | | | 0.980 | |
| Satd. Flow (prot) | 0 | 1676 | 0 | 0 | 1587 | 0 | 0 | 3237 | 0 | 0 | 3218 | 0 |
| Flt Permitted | | 0.975 | | | 0.995 | | | 0.994 | | | 0.980 | |
| Satd. Flow (perm) | 0 | 1676 | 0 | 0 | 1587 | 0 | 0 | 3237 | 0 | 0 | 3218 | 0 |
| Link Speed (k/h) | | 50 | | | 50 | | | 50 | | | 50 | |
| Link Distance (m) | | 151.1 | | | 115.4 | | | 211.4 | | | 191.8 | |
| Travel Time (s) | | 10.9 | | | 8.3 | | | 15.2 | | | 13.8 | |
| Confl. Peds. (#/hr) | 12 | | 4 | 4 | | 12 | 6 | | 3 | 3 | | 6 |
| Peak Hour Factor | 1.00 | 1.00 | 1.00 | 1.00 | 1.00 | 1.00 | 1.00 | 1.00 | 1.00 | 1.00 | 1.00 | 1.00 |
| Heavy Vehicles (%) | 2% | 2% | 5% | 2% | 5% | 2% | 5% | 5% | 2% | 2% | 5% | 2% |
| Adj. Flow (vph) | 43 | 23 | 19 | 16 | 24 | 123 | 21 | 131 | 16 | 148 | 168 | 43 |
| Shared Lane Traffic (%) | | | | | | | | | | | | |
| Lane Group Flow (vph) | 0 | 85 | 0 | 0 | 163 | 0 | 0 | 168 | 0 | 0 | 359 | 0 |
| Enter Blocked Intersection | No | No | No | No | No | No | No | No | No | No | No | No |
| Lane Alignment | Left | Left | Right | Left | Left | Right | Left | Left | Right | Left | Left | Right |
| Median Width(m) | | 0.0 | | | 0.0 | | | 2.0 | | | 2.0 | |
| Link Offset(m) | | 0.0 | | | 0.0 | | | 0.0 | | | 0.0 | |
| Crosswalk Width(m) | | 7.0 | | | 7.0 | | | 7.0 | | | 7.0 | |
| Two way Left Turn Lane | | | | | | | | | | | | |
| Headway Factor | 1.06 | 1.06 | 1.06 | 1.06 | 1.06 | 1.06 | 1.06 | 1.06 | 1.06 | 1.06 | 1.06 | 1.06 |
| Turning Speed (k/h) | 24 | | 14 | 24 | | 14 | 24 | | 14 | 24 | | 14 |
| Sign Control | | Stop | | | Stop | | | Stop | | | Stop | |
| Intersection Summary | | | | | | | | | | | | |
| Area Type: | Other | | | | | | | | | | | |
| Control Type: | Unsignalized | | | | | | | | | | | |
| Intersection Capacity Utilization 43.9% | ICU Level of Service A | | | | | | | | | | | |
| Analysis Period (min) 15 | | | | | | | | | | | | |

















2: Brianna & Nantes
PM Peak Hour

Provence Orleans Subdivision (Phase 6)
2020 Total Traffic

| |  |  |  |  |  |  |  |  |  |  |  |  |
|---|---|---|---|---|---|---|--|---|---|---|---|---|
| Lane Group | EBL | EBT | EBR | WBL | WBT | WBR | NBL | NBT | NBR | SBL | SBT | SBR |
| Lane Configurations | |  | | |  | | |  | | |  | |
| Traffic Volume (vph) | 77 | 73 | 34 | 1 | 93 | 0 | 22 | 12 | 2 | 0 | 8 | 50 |
| Future Volume (vph) | 77 | 73 | 34 | 1 | 93 | 0 | 22 | 12 | 2 | 0 | 8 | 50 |
| Ideal Flow (vphpl) | 1800 | 1800 | 1800 | 1800 | 1800 | 1800 | 1800 | 1800 | 1800 | 1800 | 1800 | 1800 |
| Lane Util. Factor | 1.00 | 1.00 | 1.00 | 1.00 | 1.00 | 1.00 | 1.00 | 1.00 | 1.00 | 1.00 | 1.00 | 1.00 |
| Ped Bike Factor | | | | | | | | | | | | |
| Frt | | 0.975 | | | | | | 0.992 | | | 0.884 | |
| Flt Protected | | 0.980 | | | 0.999 | | | 0.970 | | | | |
| Satd. Flow (prot) | 0 | 1696 | 0 | 0 | 1732 | 0 | 0 | 1717 | 0 | 0 | 1577 | 0 |
| Flt Permitted | | 0.980 | | | 0.999 | | | 0.970 | | | | |
| Satd. Flow (perm) | 0 | 1696 | 0 | 0 | 1732 | 0 | 0 | 1717 | 0 | 0 | 1577 | 0 |
| Link Speed (k/h) | | 50 | | | 50 | | | 50 | | | 50 | |
| Link Distance (m) | | 115.4 | | | 192.4 | | | 110.9 | | | 131.9 | |
| Travel Time (s) | | 8.3 | | | 13.9 | | | 8.0 | | | 9.5 | |
| Confl. Peds. (#/hr) | | | 1 | 1 | | | 4 | | 2 | | | |
| Peak Hour Factor | 1.00 | 1.00 | 1.00 | 1.00 | 1.00 | 1.00 | 1.00 | 1.00 | 1.00 | 1.00 | 1.00 | 1.00 |
| Heavy Vehicles (%) | 2% | 2% | 5% | 2% | 5% | 2% | 2% | 2% | 2% | 2% | 2% | 2% |
| Adj. Flow (vph) | 77 | 73 | 34 | 1 | 93 | 0 | 22 | 12 | 2 | 0 | 8 | 50 |
| Shared Lane Traffic (%) | | | | | | | | | | | | |
| Lane Group Flow (vph) | 0 | 184 | 0 | 0 | 94 | 0 | 0 | 36 | 0 | 0 | 58 | 0 |
| Enter Blocked Intersection | No | No | No | No | No | No | No | No | No | No | No | No |
| Lane Alignment | Left | Left | Right | Left | Left | Right | Left | Left | Right | Left | Left | Right |
| Median Width(m) | | 0.0 | | | 0.0 | | | 0.0 | | | 0.0 | |
| Link Offset(m) | | 0.0 | | | 0.0 | | | 0.0 | | | 0.0 | |
| Crosswalk Width(m) | | 6.0 | | | 6.0 | | | 6.0 | | | 7.0 | |
| Two way Left Turn Lane | | | | | | | | | | | | |
| Headway Factor | 1.06 | 1.06 | 1.06 | 1.06 | 1.06 | 1.06 | 1.06 | 1.06 | 1.06 | 1.06 | 1.06 | 1.06 |
| Turning Speed (k/h) | 24 | | 14 | 24 | | 14 | 24 | | 14 | 24 | | 14 |
| Sign Control | | Stop | | | Stop | | | Stop | | | Stop | |
| Intersection Summary | | | | | | | | | | | | |
| Area Type: | Other | | | | | | | | | | | |
| Control Type: | Unsignalized | | | | | | | | | | | |
| Intersection Capacity Utilization 33.1% | ICU Level of Service A | | | | | | | | | | | |
| Analysis Period (min) 15 | | | | | | | | | | | | |

















3: Provence & Plainhill
PM Peak Hour

Provence Orleans Subdivision (Phase 6)
2020 Total Traffic

| |  |  |  |  |  |  |  |  |  |  |  |  |
|---|---|---|---|---|---|---|--|---|---|---|---|---|
| Lane Group | EBL | EBT | EBR | WBL | WBT | WBR | NBL | NBT | NBR | SBL | SBT | SBR |
| Lane Configurations | |  | | |  | | |  | | |  | |
| Traffic Volume (vph) | 2 | 26 | 3 | 12 | 21 | 8 | 8 | 22 | 19 | 25 | 25 | 11 |
| Future Volume (vph) | 2 | 26 | 3 | 12 | 21 | 8 | 8 | 22 | 19 | 25 | 25 | 11 |
| Ideal Flow (vphpl) | 1800 | 1800 | 1800 | 1800 | 1800 | 1800 | 1800 | 1800 | 1800 | 1800 | 1800 | 1800 |
| Lane Util. Factor | 1.00 | 1.00 | 1.00 | 1.00 | 1.00 | 1.00 | 1.00 | 1.00 | 1.00 | 1.00 | 1.00 | 1.00 |
| Ped Bike Factor | | | | | | | | | | | | |
| Frt | | 0.987 | | | 0.974 | | | 0.948 | | | 0.976 | |
| Flt Protected | | 0.997 | | | 0.986 | | | 0.992 | | | 0.980 | |
| Satd. Flow (prot) | 0 | 1727 | 0 | 0 | 1714 | 0 | 0 | 1659 | 0 | 0 | 1686 | 0 |
| Flt Permitted | | 0.997 | | | 0.986 | | | 0.992 | | | 0.980 | |
| Satd. Flow (perm) | 0 | 1727 | 0 | 0 | 1714 | 0 | 0 | 1659 | 0 | 0 | 1686 | 0 |
| Link Speed (k/h) | | 50 | | | 50 | | | 50 | | | 50 | |
| Link Distance (m) | | 78.8 | | | 168.6 | | | 195.8 | | | 141.6 | |
| Travel Time (s) | | 5.7 | | | 12.1 | | | 14.1 | | | 10.2 | |
| Confl. Peds. (#/hr) | 2 | | 3 | 3 | | 2 | 2 | | 1 | 1 | | 2 |
| Peak Hour Factor | 1.00 | 1.00 | 1.00 | 1.00 | 1.00 | 1.00 | 1.00 | 1.00 | 1.00 | 1.00 | 1.00 | 1.00 |
| Heavy Vehicles (%) | 2% | 4% | 2% | 2% | 2% | 2% | 2% | 2% | 5% | 2% | 5% | 2% |
| Adj. Flow (vph) | 2 | 26 | 3 | 12 | 21 | 8 | 8 | 22 | 19 | 25 | 25 | 11 |
| Shared Lane Traffic (%) | | | | | | | | | | | | |
| Lane Group Flow (vph) | 0 | 31 | 0 | 0 | 41 | 0 | 0 | 49 | 0 | 0 | 61 | 0 |
| Enter Blocked Intersection | No | No | No | No | No | No | No | No | No | No | No | No |
| Lane Alignment | Left | Left | Right | Left | Left | Right | Left | Left | Right | Left | Left | Right |
| Median Width(m) | | 0.0 | | | 0.0 | | | 0.0 | | | 0.0 | |
| Link Offset(m) | | 0.0 | | | 0.0 | | | 0.0 | | | 0.0 | |
| Crosswalk Width(m) | | 7.0 | | | 7.0 | | | 7.0 | | | 7.0 | |
| Two way Left Turn Lane | | | | | | | | | | | | |
| Headway Factor | 1.06 | 1.06 | 1.06 | 1.06 | 1.06 | 1.06 | 1.06 | 1.06 | 1.06 | 1.06 | 1.06 | 1.06 |
| Turning Speed (k/h) | 24 | | 14 | 24 | | 14 | 24 | | 14 | 24 | | 14 |
| Sign Control | | Stop | | | Stop | | | Stop | | | Stop | |
| Intersection Summary | | | | | | | | | | | | |
| Area Type: | Other | | | | | | | | | | | |
| Control Type: | Unsignalized | | | | | | | | | | | |
| Intersection Capacity Utilization 21.3% | ICU Level of Service A | | | | | | | | | | | |
| Analysis Period (min) 15 | | | | | | | | | | | | |

















4: Provence & Grapefern
PM Peak Hour

Provence Orleans Subdivision (Phase 6)
2020 Total Traffic

| |  |  |  |  |  |  |  |  |  |  |  |  |  |
|-----------------------------------|---|---|---|---|---|---|--|---|---|---|---|---|---|
| Lane Group | EBL | EBT | EBR | WBL | WBT | WBR | NBL | NBT | NBR | SBL | SBT | SBR | |
| Lane Configurations | |  | | |  | | |  | | |  | | |
| Traffic Volume (vph) | 17 | 0 | 6 | 7 | 0 | 4 | 10 | 15 | 7 | 6 | 48 | 29 | |
| Future Volume (vph) | 17 | 0 | 6 | 7 | 0 | 4 | 10 | 15 | 7 | 6 | 48 | 29 | |
| Ideal Flow (vphpl) | 1800 | 1800 | 1800 | 1800 | 1800 | 1800 | 1800 | 1800 | 1800 | 1800 | 1800 | 1800 | |
| Lane Util. Factor | 1.00 | 1.00 | 1.00 | 1.00 | 1.00 | 1.00 | 1.00 | 1.00 | 1.00 | 1.00 | 1.00 | 1.00 | |
| Ped Bike Factor | | | | | | | | | | | | | |
| Frt | | 0.965 | | | 0.951 | | | 0.970 | | | 0.953 | | |
| Flt Protected | | 0.964 | | | 0.969 | | | 0.985 | | | 0.996 | | |
| Satd. Flow (prot) | 0 | 1660 | 0 | 0 | 1644 | 0 | 0 | 1697 | 0 | 0 | 1694 | 0 | |
| Flt Permitted | | 0.964 | | | 0.969 | | | 0.985 | | | 0.996 | | |
| Satd. Flow (perm) | 0 | 1660 | 0 | 0 | 1644 | 0 | 0 | 1697 | 0 | 0 | 1694 | 0 | |
| Link Speed (k/h) | | 50 | | | 50 | | | 50 | | | 50 | | |
| Link Distance (m) | | 124.8 | | | 57.5 | | | 141.6 | | | 204.6 | | |
| Travel Time (s) | | 9.0 | | | 4.1 | | | 10.2 | | | 14.7 | | |
| Confl. Peds. (#/hr) | 7 | | | | | 7 | 4 | | | | | 4 | |
| Confl. Bikes (#/hr) | | | 1 | | | | | | | | | | 1 |
| Peak Hour Factor | 1.00 | 1.00 | 1.00 | 1.00 | 1.00 | 1.00 | 1.00 | 1.00 | 1.00 | 1.00 | 1.00 | 1.00 | |
| Heavy Vehicles (%) | 2% | 2% | 2% | 2% | 2% | 2% | 2% | 3% | 2% | 2% | 2% | 2% | |
| Adj. Flow (vph) | 17 | 0 | 6 | 7 | 0 | 4 | 10 | 15 | 7 | 6 | 48 | 29 | |
| Shared Lane Traffic (%) | | | | | | | | | | | | | |
| Lane Group Flow (vph) | 0 | 23 | 0 | 0 | 11 | 0 | 0 | 32 | 0 | 0 | 83 | 0 | |
| Enter Blocked Intersection | No | No | No | No | No | No | No | No | No | No | No | No | |
| Lane Alignment | Left | Left | Right | Left | Left | Right | Left | Left | Right | Left | Left | Right | |
| Median Width(m) | | 0.0 | | | 0.0 | | | 0.0 | | | 0.0 | | |
| Link Offset(m) | | 0.0 | | | 0.0 | | | 0.0 | | | 0.0 | | |
| Crosswalk Width(m) | | 3.0 | | | 3.0 | | | 3.0 | | | 3.0 | | |
| Two way Left Turn Lane | | | | | | | | | | | | | |
| Headway Factor | 1.06 | 1.06 | 1.06 | 1.06 | 1.06 | 1.06 | 1.06 | 1.06 | 1.06 | 1.06 | 1.06 | 1.06 | |
| Turning Speed (k/h) | 24 | | 14 | 24 | | 14 | 24 | | 14 | 24 | | 14 | |
| Sign Control | | Stop | | | Stop | | | Free | | | Free | | |
| Intersection Summary | | | | | | | | | | | | | |
| Area Type: | Other | | | | | | | | | | | | |
| Control Type: | Unsignalized | | | | | | | | | | | | |
| Intersection Capacity Utilization | 18.3% | | | | | | ICU Level of Service A | | | | | | |
| Analysis Period (min) | 15 | | | | | | | | | | | | |

















1: Portobello & Aquaview/Nantes
AM Peak Hour

Provence Orleans Subdivision (Phase 6)
2025 Total Traffic

| |  |  |  |  |  |  |  |  |  |  |  |  |
|---|---|---|---|---|---|---|--|---|---|---|---|---|
| Lane Group | EBL | EBT | EBR | WBL | WBT | WBR | NBL | NBT | NBR | SBL | SBT | SBR |
| Lane Configurations | |  | | |  | | |  | | |  | |
| Traffic Volume (vph) | 73 | 15 | 34 | 29 | 32 | 163 | 29 | 153 | 11 | 76 | 135 | 46 |
| Future Volume (vph) | 73 | 15 | 34 | 29 | 32 | 163 | 29 | 153 | 11 | 76 | 135 | 46 |
| Ideal Flow (vphpl) | 1800 | 1800 | 1800 | 1800 | 1800 | 1800 | 1800 | 1800 | 1800 | 1800 | 1800 | 1800 |
| Lane Util. Factor | 1.00 | 1.00 | 1.00 | 1.00 | 1.00 | 1.00 | 0.95 | 0.95 | 0.95 | 0.95 | 0.95 | 0.95 |
| Ped Bike Factor | | | | | | | | | | | | |
| Frt | | 0.962 | | | 0.902 | | | 0.991 | | | 0.973 | |
| Flt Protected | | 0.971 | | | 0.994 | | | 0.993 | | | 0.985 | |
| Satd. Flow (prot) | 0 | 1621 | 0 | 0 | 1593 | 0 | 0 | 3152 | 0 | 0 | 3168 | 0 |
| Flt Permitted | | 0.971 | | | 0.994 | | | 0.993 | | | 0.985 | |
| Satd. Flow (perm) | 0 | 1621 | 0 | 0 | 1593 | 0 | 0 | 3152 | 0 | 0 | 3168 | 0 |
| Link Speed (k/h) | | 50 | | | 50 | | | 50 | | | 50 | |
| Link Distance (m) | | 151.1 | | | 115.4 | | | 210.3 | | | 153.8 | |
| Travel Time (s) | | 10.9 | | | 8.3 | | | 15.1 | | | 11.1 | |
| Confl. Peds. (#/hr) | 47 | | | | | 47 | 43 | | 4 | 4 | | 43 |
| Confl. Bikes (#/hr) | | | 1 | | | | | | | | | 1 |
| Peak Hour Factor | 1.00 | 1.00 | 1.00 | 1.00 | 1.00 | 1.00 | 1.00 | 1.00 | 1.00 | 1.00 | 1.00 | 1.00 |
| Heavy Vehicles (%) | 4% | 2% | 8% | 2% | 5% | 2% | 10% | 8% | 2% | 2% | 7% | 2% |
| Adj. Flow (vph) | 73 | 15 | 34 | 29 | 32 | 163 | 29 | 153 | 11 | 76 | 135 | 46 |
| Shared Lane Traffic (%) | | | | | | | | | | | | |
| Lane Group Flow (vph) | 0 | 122 | 0 | 0 | 224 | 0 | 0 | 193 | 0 | 0 | 257 | 0 |
| Enter Blocked Intersection | No | No | No | No | No | No | No | No | No | No | No | No |
| Lane Alignment | Left | Left | Right | Left | Left | Right | Left | Left | Right | Left | Left | Right |
| Median Width(m) | | 0.0 | | | 0.0 | | | 2.0 | | | 2.0 | |
| Link Offset(m) | | 0.0 | | | 0.0 | | | 0.0 | | | 0.0 | |
| Crosswalk Width(m) | | 7.0 | | | 7.0 | | | 7.0 | | | 7.0 | |
| Two way Left Turn Lane | | | | | | | | | | | | |
| Headway Factor | 1.06 | 1.06 | 1.06 | 1.06 | 1.06 | 1.06 | 1.06 | 1.06 | 1.06 | 1.06 | 1.06 | 1.06 |
| Turning Speed (k/h) | 24 | | 14 | 24 | | 14 | 24 | | 14 | 24 | | 14 |
| Sign Control | | Stop | | | Stop | | | Stop | | | Stop | |
| Intersection Summary | | | | | | | | | | | | |
| Area Type: | Other | | | | | | | | | | | |
| Control Type: | Unsignalized | | | | | | | | | | | |
| Intersection Capacity Utilization 52.6% | ICU Level of Service A | | | | | | | | | | | |
| Analysis Period (min) 15 | | | | | | | | | | | | |

















2: Brianna & Nantes
AM Peak Hour

Provence Orleans Subdivision (Phase 6)
2025 Total Traffic

| |  |  |  |  |  |  |  |  |  |  |  |  |
|---|---|---|---|---|---|---|--|---|---|---|---|---|
| Lane Group | EBL | EBT | EBR | WBL | WBT | WBR | NBL | NBT | NBR | SBL | SBT | SBR |
| Lane Configurations | |  | | |  | | |  | | |  | |
| Traffic Volume (vph) | 31 | 67 | 13 | 4 | 108 | 0 | 38 | 5 | 2 | 0 | 12 | 77 |
| Future Volume (vph) | 31 | 67 | 13 | 4 | 108 | 0 | 38 | 5 | 2 | 0 | 12 | 77 |
| Ideal Flow (vphpl) | 1800 | 1800 | 1800 | 1800 | 1800 | 1800 | 1800 | 1800 | 1800 | 1800 | 1800 | 1800 |
| Lane Util. Factor | 1.00 | 1.00 | 1.00 | 1.00 | 1.00 | 1.00 | 1.00 | 1.00 | 1.00 | 1.00 | 1.00 | 1.00 |
| Ped Bike Factor | | | | | | | | | | | | |
| Frt | | 0.984 | | | | | | 0.994 | | | 0.883 | |
| Flt Protected | | 0.986 | | | 0.998 | | | 0.959 | | | | |
| Satd. Flow (prot) | 0 | 1715 | 0 | 0 | 1689 | 0 | 0 | 1701 | 0 | 0 | 1576 | 0 |
| Flt Permitted | | 0.986 | | | 0.998 | | | 0.959 | | | | |
| Satd. Flow (perm) | 0 | 1715 | 0 | 0 | 1689 | 0 | 0 | 1701 | 0 | 0 | 1576 | 0 |
| Link Speed (k/h) | | 50 | | | 50 | | | 50 | | | 50 | |
| Link Distance (m) | | 115.4 | | | 192.4 | | | 110.9 | | | 114.6 | |
| Travel Time (s) | | 8.3 | | | 13.9 | | | 8.0 | | | 8.3 | |
| Confl. Peds. (#/hr) | | | | | | | 1 | | 3 | | | |
| Peak Hour Factor | 1.00 | 1.00 | 1.00 | 1.00 | 1.00 | 1.00 | 1.00 | 1.00 | 1.00 | 1.00 | 1.00 | 1.00 |
| Heavy Vehicles (%) | 2% | 2% | 10% | 50% | 6% | 2% | 2% | 2% | 2% | 2% | 2% | 2% |
| Adj. Flow (vph) | 31 | 67 | 13 | 4 | 108 | 0 | 38 | 5 | 2 | 0 | 12 | 77 |
| Shared Lane Traffic (%) | | | | | | | | | | | | |
| Lane Group Flow (vph) | 0 | 111 | 0 | 0 | 112 | 0 | 0 | 45 | 0 | 0 | 89 | 0 |
| Enter Blocked Intersection | No | No | No | No | No | No | No | No | No | No | No | No |
| Lane Alignment | Left | Left | Right | Left | Left | Right | Left | Left | Right | Left | Left | Right |
| Median Width(m) | | 0.0 | | | 0.0 | | | 0.0 | | | 0.0 | |
| Link Offset(m) | | 0.0 | | | 0.0 | | | 0.0 | | | 0.0 | |
| Crosswalk Width(m) | | 6.0 | | | 6.0 | | | 6.0 | | | 7.0 | |
| Two way Left Turn Lane | | | | | | | | | | | | |
| Headway Factor | 1.06 | 1.06 | 1.06 | 1.06 | 1.06 | 1.06 | 1.06 | 1.06 | 1.06 | 1.06 | 1.06 | 1.06 |
| Turning Speed (k/h) | 24 | | 14 | 24 | | 14 | 24 | | 14 | 24 | | 14 |
| Sign Control | | Stop | | | Stop | | | Stop | | | Stop | |
| Intersection Summary | | | | | | | | | | | | |
| Area Type: | Other | | | | | | | | | | | |
| Control Type: | Unsignalized | | | | | | | | | | | |
| Intersection Capacity Utilization 29.4% | ICU Level of Service A | | | | | | | | | | | |
| Analysis Period (min) 15 | | | | | | | | | | | | |

















3: Provence & Plainhill
AM Peak Hour

Provence Orleans Subdivision (Phase 6)
2025 Total Traffic

| |  |  |  |  |  |  |  |  |  |  |  |  |
|---|---|---|---|---|---|---|--|---|---|---|---|---|
| Lane Group | EBL | EBT | EBR | WBL | WBT | WBR | NBL | NBT | NBR | SBL | SBT | SBR |
| Lane Configurations | |  | | |  | | |  | | |  | |
| Traffic Volume (vph) | 16 | 14 | 9 | 20 | 27 | 39 | 5 | 69 | 7 | 15 | 66 | 8 |
| Future Volume (vph) | 16 | 14 | 9 | 20 | 27 | 39 | 5 | 69 | 7 | 15 | 66 | 8 |
| Ideal Flow (vphpl) | 1800 | 1800 | 1800 | 1800 | 1800 | 1800 | 1800 | 1800 | 1800 | 1800 | 1800 | 1800 |
| Lane Util. Factor | 1.00 | 1.00 | 1.00 | 1.00 | 1.00 | 1.00 | 1.00 | 1.00 | 1.00 | 1.00 | 1.00 | 1.00 |
| Ped Bike Factor | | | | | | | | | | | | |
| Frt | | 0.969 | | | 0.939 | | | 0.988 | | | 0.988 | |
| Flt Protected | | 0.980 | | | 0.989 | | | 0.997 | | | 0.992 | |
| Satd. Flow (prot) | 0 | 1677 | 0 | 0 | 1610 | 0 | 0 | 1715 | 0 | 0 | 1711 | 0 |
| Flt Permitted | | 0.980 | | | 0.989 | | | 0.997 | | | 0.992 | |
| Satd. Flow (perm) | 0 | 1677 | 0 | 0 | 1610 | 0 | 0 | 1715 | 0 | 0 | 1711 | 0 |
| Link Speed (k/h) | | 50 | | | 50 | | | 50 | | | 50 | |
| Link Distance (m) | | 78.8 | | | 168.6 | | | 195.8 | | | 141.6 | |
| Travel Time (s) | | 5.7 | | | 12.1 | | | 14.1 | | | 10.2 | |
| Confl. Peds. (#/hr) | 8 | | | | | 8 | 1 | | 1 | 1 | | 1 |
| Peak Hour Factor | 1.00 | 1.00 | 1.00 | 1.00 | 1.00 | 1.00 | 1.00 | 1.00 | 1.00 | 1.00 | 1.00 | 1.00 |
| Heavy Vehicles (%) | 2% | 5% | 2% | 2% | 10% | 3% | 2% | 5% | 2% | 2% | 5% | 2% |
| Adj. Flow (vph) | 16 | 14 | 9 | 20 | 27 | 39 | 5 | 69 | 7 | 15 | 66 | 8 |
| Shared Lane Traffic (%) | | | | | | | | | | | | |
| Lane Group Flow (vph) | 0 | 39 | 0 | 0 | 86 | 0 | 0 | 81 | 0 | 0 | 89 | 0 |
| Enter Blocked Intersection | No | No | No | No | No | No | No | No | No | No | No | No |
| Lane Alignment | Left | Left | Right | Left | Left | Right | Left | Left | Right | Left | Left | Right |
| Median Width(m) | | 0.0 | | | 0.0 | | | 0.0 | | | 0.0 | |
| Link Offset(m) | | 0.0 | | | 0.0 | | | 0.0 | | | 0.0 | |
| Crosswalk Width(m) | | 7.0 | | | 7.0 | | | 7.0 | | | 7.0 | |
| Two way Left Turn Lane | | | | | | | | | | | | |
| Headway Factor | 1.06 | 1.06 | 1.06 | 1.06 | 1.06 | 1.06 | 1.06 | 1.06 | 1.06 | 1.06 | 1.06 | 1.06 |
| Turning Speed (k/h) | 24 | | 14 | 24 | | 14 | 24 | | 14 | 24 | | 14 |
| Sign Control | | Stop | | | Stop | | | Stop | | | Stop | |
| Intersection Summary | | | | | | | | | | | | |
| Area Type: | Other | | | | | | | | | | | |
| Control Type: | Unsignalized | | | | | | | | | | | |
| Intersection Capacity Utilization 24.1% | ICU Level of Service A | | | | | | | | | | | |
| Analysis Period (min) 15 | | | | | | | | | | | | |

















4: Provence & Grapefern
AM Peak Hour

Provence Orleans Subdivision (Phase 6)
2025 Total Traffic

| |  |  |  |  |  |  |  |  |  |  |  |  |
|---|---|---|---|---|---|---|--|---|---|---|---|---|
| Lane Group | EBL | EBT | EBR | WBL | WBT | WBR | NBL | NBT | NBR | SBL | SBT | SBR |
| Lane Configurations | |  | | |  | | |  | | |  | |
| Traffic Volume (vph) | 28 | 0 | 7 | 0 | 0 | 0 | 3 | 121 | 0 | 1 | 82 | 9 |
| Future Volume (vph) | 28 | 0 | 7 | 0 | 0 | 0 | 3 | 121 | 0 | 1 | 82 | 9 |
| Ideal Flow (vphpl) | 1800 | 1800 | 1800 | 1800 | 1800 | 1800 | 1800 | 1800 | 1800 | 1800 | 1800 | 1800 |
| Lane Util. Factor | 1.00 | 1.00 | 1.00 | 1.00 | 1.00 | 1.00 | 1.00 | 1.00 | 1.00 | 1.00 | 1.00 | 1.00 |
| Ped Bike Factor | | | | | | | | | | | | |
| Frt | | 0.973 | | | | | | | | | | 0.987 |
| Flt Protected | | 0.962 | | | | | | 0.999 | | | | 0.999 |
| Satd. Flow (prot) | 0 | 1670 | 0 | 0 | 1784 | 0 | 0 | 1766 | 0 | 0 | 1759 | 0 |
| Flt Permitted | | 0.962 | | | | | | 0.999 | | | | 0.999 |
| Satd. Flow (perm) | 0 | 1670 | 0 | 0 | 1784 | 0 | 0 | 1766 | 0 | 0 | 1759 | 0 |
| Link Speed (k/h) | | 50 | | | 50 | | | 50 | | | 50 | |
| Link Distance (m) | | 124.8 | | | 57.5 | | | 141.6 | | | 204.6 | |
| Travel Time (s) | | 9.0 | | | 4.1 | | | 10.2 | | | 14.7 | |
| Confl. Peds. (#/hr) | | | | | | | 6 | | | | | 6 |
| Confl. Bikes (#/hr) | | | | | | | | | | | | 1 |
| Peak Hour Factor | 1.00 | 1.00 | 1.00 | 1.00 | 1.00 | 1.00 | 1.00 | 1.00 | 1.00 | 1.00 | 1.00 | 1.00 |
| Heavy Vehicles (%) | 2% | 2% | 2% | 2% | 2% | 2% | 2% | 3% | 2% | 2% | 2% | 2% |
| Adj. Flow (vph) | 28 | 0 | 7 | 0 | 0 | 0 | 3 | 121 | 0 | 1 | 82 | 9 |
| Shared Lane Traffic (%) | | | | | | | | | | | | |
| Lane Group Flow (vph) | 0 | 35 | 0 | 0 | 0 | 0 | 0 | 124 | 0 | 0 | 92 | 0 |
| Enter Blocked Intersection | No | No | No | No | No | No | No | No | No | No | No | No |
| Lane Alignment | Left | Left | Right | Left | Left | Right | Left | Left | Right | Left | Left | Right |
| Median Width(m) | | 0.0 | | | 0.0 | | | 0.0 | | | 0.0 | |
| Link Offset(m) | | 0.0 | | | 0.0 | | | 0.0 | | | 0.0 | |
| Crosswalk Width(m) | | 3.0 | | | 3.0 | | | 3.0 | | | 3.0 | |
| Two way Left Turn Lane | | | | | | | | | | | | |
| Headway Factor | 1.06 | 1.06 | 1.06 | 1.06 | 1.06 | 1.06 | 1.06 | 1.06 | 1.06 | 1.06 | 1.06 | 1.06 |
| Turning Speed (k/h) | 24 | | 14 | 24 | | 14 | 24 | | 14 | 24 | | 14 |
| Sign Control | | Stop | | | Stop | | | Free | | | Free | |
| Intersection Summary | | | | | | | | | | | | |
| Area Type: | Other | | | | | | | | | | | |
| Control Type: | Unsignalized | | | | | | | | | | | |
| Intersection Capacity Utilization 18.7% | ICU Level of Service A | | | | | | | | | | | |
| Analysis Period (min) 15 | | | | | | | | | | | | |

1: Portobello & Aquaview/Nantes
PM Peak Hour

Provence Orleans Subdivision (Phase 6)
2025 Total Traffic

| |  |  |  |  |  |  |  |  |  |  |  |  |
|---|---|---|---|---|---|---|--|---|---|---|---|---|
| Lane Group | EBL | EBT | EBR | WBL | WBT | WBR | NBL | NBT | NBR | SBL | SBT | SBR |
| Lane Configurations | |  | | |  | | |  | | |  | |
| Traffic Volume (vph) | 43 | 23 | 19 | 16 | 24 | 123 | 22 | 137 | 16 | 152 | 177 | 45 |
| Future Volume (vph) | 43 | 23 | 19 | 16 | 24 | 123 | 22 | 137 | 16 | 152 | 177 | 45 |
| Ideal Flow (vphpl) | 1800 | 1800 | 1800 | 1800 | 1800 | 1800 | 1800 | 1800 | 1800 | 1800 | 1800 | 1800 |
| Lane Util. Factor | 1.00 | 1.00 | 1.00 | 1.00 | 1.00 | 1.00 | 0.95 | 0.95 | 0.95 | 0.95 | 0.95 | 0.95 |
| Ped Bike Factor | | | | | | | | | | | | |
| Frt | | 0.970 | | | 0.898 | | | 0.986 | | | 0.982 | |
| Flt Protected | | 0.975 | | | 0.995 | | | 0.994 | | | 0.980 | |
| Satd. Flow (prot) | 0 | 1676 | 0 | 0 | 1587 | 0 | 0 | 3236 | 0 | 0 | 3218 | 0 |
| Flt Permitted | | 0.975 | | | 0.995 | | | 0.994 | | | 0.980 | |
| Satd. Flow (perm) | 0 | 1676 | 0 | 0 | 1587 | 0 | 0 | 3236 | 0 | 0 | 3218 | 0 |
| Link Speed (k/h) | | 50 | | | 50 | | | 50 | | | 50 | |
| Link Distance (m) | | 151.1 | | | 115.4 | | | 211.4 | | | 191.8 | |
| Travel Time (s) | | 10.9 | | | 8.3 | | | 15.2 | | | 13.8 | |
| Confl. Peds. (#/hr) | 12 | | 4 | 4 | | 12 | 6 | | 3 | 3 | | 6 |
| Peak Hour Factor | 1.00 | 1.00 | 1.00 | 1.00 | 1.00 | 1.00 | 1.00 | 1.00 | 1.00 | 1.00 | 1.00 | 1.00 |
| Heavy Vehicles (%) | 2% | 2% | 5% | 2% | 5% | 2% | 5% | 5% | 2% | 2% | 5% | 2% |
| Adj. Flow (vph) | 43 | 23 | 19 | 16 | 24 | 123 | 22 | 137 | 16 | 152 | 177 | 45 |
| Shared Lane Traffic (%) | | | | | | | | | | | | |
| Lane Group Flow (vph) | 0 | 85 | 0 | 0 | 163 | 0 | 0 | 175 | 0 | 0 | 374 | 0 |
| Enter Blocked Intersection | No | No | No | No | No | No | No | No | No | No | No | No |
| Lane Alignment | Left | Left | Right | Left | Left | Right | Left | Left | Right | Left | Left | Right |
| Median Width(m) | | 0.0 | | | 0.0 | | | 2.0 | | | 2.0 | |
| Link Offset(m) | | 0.0 | | | 0.0 | | | 0.0 | | | 0.0 | |
| Crosswalk Width(m) | | 7.0 | | | 7.0 | | | 7.0 | | | 7.0 | |
| Two way Left Turn Lane | | | | | | | | | | | | |
| Headway Factor | 1.06 | 1.06 | 1.06 | 1.06 | 1.06 | 1.06 | 1.06 | 1.06 | 1.06 | 1.06 | 1.06 | 1.06 |
| Turning Speed (k/h) | 24 | | 14 | 24 | | 14 | 24 | | 14 | 24 | | 14 |
| Sign Control | | Stop | | | Stop | | | Stop | | | Stop | |
| Intersection Summary | | | | | | | | | | | | |
| Area Type: | Other | | | | | | | | | | | |
| Control Type: | Unsignalized | | | | | | | | | | | |
| Intersection Capacity Utilization 44.5% | ICU Level of Service A | | | | | | | | | | | |
| Analysis Period (min) 15 | | | | | | | | | | | | |

2: Brianna & Nantes
PM Peak Hour

Provence Orleans Subdivision (Phase 6)
2025 Total Traffic



| Lane Group | EBL | EBT | EBR | WBL | WBT | WBR | NBL | NBT | NBR | SBL | SBT | SBR |
|----------------------------|------|-------|-------|------|-------|-------|------|-------|-------|------|-------|-------|
| Lane Configurations | | ↕ | | | ↕ | | | ↕ | | | ↕ | |
| Traffic Volume (vph) | 77 | 73 | 34 | 1 | 93 | 0 | 22 | 12 | 2 | 0 | 8 | 50 |
| Future Volume (vph) | 77 | 73 | 34 | 1 | 93 | 0 | 22 | 12 | 2 | 0 | 8 | 50 |
| Ideal Flow (vphpl) | 1800 | 1800 | 1800 | 1800 | 1800 | 1800 | 1800 | 1800 | 1800 | 1800 | 1800 | 1800 |
| Lane Util. Factor | 1.00 | 1.00 | 1.00 | 1.00 | 1.00 | 1.00 | 1.00 | 1.00 | 1.00 | 1.00 | 1.00 | 1.00 |
| Ped Bike Factor | | | | | | | | | | | | |
| Frt | | 0.975 | | | | | | 0.992 | | | 0.884 | |
| Flt Protected | | 0.980 | | | 0.999 | | | 0.970 | | | | |
| Satd. Flow (prot) | 0 | 1696 | 0 | 0 | 1732 | 0 | 0 | 1717 | 0 | 0 | 1577 | 0 |
| Flt Permitted | | 0.980 | | | 0.999 | | | 0.970 | | | | |
| Satd. Flow (perm) | 0 | 1696 | 0 | 0 | 1732 | 0 | 0 | 1717 | 0 | 0 | 1577 | 0 |
| Link Speed (k/h) | | 50 | | | 50 | | | 50 | | | 50 | |
| Link Distance (m) | | 115.4 | | | 192.4 | | | 110.9 | | | 131.9 | |
| Travel Time (s) | | 8.3 | | | 13.9 | | | 8.0 | | | 9.5 | |
| Confl. Peds. (#/hr) | | | 1 | 1 | | | 4 | | 2 | | | |
| Peak Hour Factor | 1.00 | 1.00 | 1.00 | 1.00 | 1.00 | 1.00 | 1.00 | 1.00 | 1.00 | 1.00 | 1.00 | 1.00 |
| Heavy Vehicles (%) | 2% | 2% | 5% | 2% | 5% | 2% | 2% | 2% | 2% | 2% | 2% | 2% |
| Adj. Flow (vph) | 77 | 73 | 34 | 1 | 93 | 0 | 22 | 12 | 2 | 0 | 8 | 50 |
| Shared Lane Traffic (%) | | | | | | | | | | | | |
| Lane Group Flow (vph) | 0 | 184 | 0 | 0 | 94 | 0 | 0 | 36 | 0 | 0 | 58 | 0 |
| Enter Blocked Intersection | No | No | No | No | No | No | No | No | No | No | No | No |
| Lane Alignment | Left | Left | Right | Left | Left | Right | Left | Left | Right | Left | Left | Right |
| Median Width(m) | | 0.0 | | | 0.0 | | | 0.0 | | | 0.0 | |
| Link Offset(m) | | 0.0 | | | 0.0 | | | 0.0 | | | 0.0 | |
| Crosswalk Width(m) | | 6.0 | | | 6.0 | | | 6.0 | | | 7.0 | |
| Two way Left Turn Lane | | | | | | | | | | | | |
| Headway Factor | 1.06 | 1.06 | 1.06 | 1.06 | 1.06 | 1.06 | 1.06 | 1.06 | 1.06 | 1.06 | 1.06 | 1.06 |
| Turning Speed (k/h) | 24 | | 14 | 24 | | 14 | 24 | | 14 | 24 | | 14 |
| Sign Control | | Stop | | | Stop | | | Stop | | | Stop | |

Intersection Summary

Area Type: Other

Control Type: Unsignalized

















Intersection Capacity Utilization 33.1%

ICU Level of Service A

Analysis Period (min) 15

















3: Provence & Plainhill
PM Peak Hour

Provence Orleans Subdivision (Phase 6)
2025 Total Traffic

| |  |  |  |  |  |  |  |  |  |  |  |  |
|---|---|---|---|---|---|---|--|---|---|---|---|---|
| Lane Group | EBL | EBT | EBR | WBL | WBT | WBR | NBL | NBT | NBR | SBL | SBT | SBR |
| Lane Configurations | |  | | |  | | |  | | |  | |
| Traffic Volume (vph) | 2 | 26 | 3 | 12 | 21 | 8 | 8 | 45 | 19 | 25 | 40 | 11 |
| Future Volume (vph) | 2 | 26 | 3 | 12 | 21 | 8 | 8 | 45 | 19 | 25 | 40 | 11 |
| Ideal Flow (vphpl) | 1800 | 1800 | 1800 | 1800 | 1800 | 1800 | 1800 | 1800 | 1800 | 1800 | 1800 | 1800 |
| Lane Util. Factor | 1.00 | 1.00 | 1.00 | 1.00 | 1.00 | 1.00 | 1.00 | 1.00 | 1.00 | 1.00 | 1.00 | 1.00 |
| Ped Bike Factor | | | | | | | | | | | | |
| Frt | | 0.987 | | | 0.974 | | | 0.964 | | | 0.980 | |
| Flt Protected | | 0.997 | | | 0.986 | | | 0.994 | | | 0.984 | |
| Satd. Flow (prot) | 0 | 1727 | 0 | 0 | 1714 | 0 | 0 | 1697 | 0 | 0 | 1694 | 0 |
| Flt Permitted | | 0.997 | | | 0.986 | | | 0.994 | | | 0.984 | |
| Satd. Flow (perm) | 0 | 1727 | 0 | 0 | 1714 | 0 | 0 | 1697 | 0 | 0 | 1694 | 0 |
| Link Speed (k/h) | | 50 | | | 50 | | | 50 | | | 50 | |
| Link Distance (m) | | 78.8 | | | 168.6 | | | 195.8 | | | 141.6 | |
| Travel Time (s) | | 5.7 | | | 12.1 | | | 14.1 | | | 10.2 | |
| Confl. Peds. (#/hr) | 2 | | 3 | 3 | | 2 | 2 | | 1 | 1 | | 2 |
| Peak Hour Factor | 1.00 | 1.00 | 1.00 | 1.00 | 1.00 | 1.00 | 1.00 | 1.00 | 1.00 | 1.00 | 1.00 | 1.00 |
| Heavy Vehicles (%) | 2% | 4% | 2% | 2% | 2% | 2% | 2% | 2% | 5% | 2% | 5% | 2% |
| Adj. Flow (vph) | 2 | 26 | 3 | 12 | 21 | 8 | 8 | 45 | 19 | 25 | 40 | 11 |
| Shared Lane Traffic (%) | | | | | | | | | | | | |
| Lane Group Flow (vph) | 0 | 31 | 0 | 0 | 41 | 0 | 0 | 72 | 0 | 0 | 76 | 0 |
| Enter Blocked Intersection | No | No | No | No | No | No | No | No | No | No | No | No |
| Lane Alignment | Left | Left | Right | Left | Left | Right | Left | Left | Right | Left | Left | Right |
| Median Width(m) | | 0.0 | | | 0.0 | | | 0.0 | | | 0.0 | |
| Link Offset(m) | | 0.0 | | | 0.0 | | | 0.0 | | | 0.0 | |
| Crosswalk Width(m) | | 7.0 | | | 7.0 | | | 7.0 | | | 7.0 | |
| Two way Left Turn Lane | | | | | | | | | | | | |
| Headway Factor | 1.06 | 1.06 | 1.06 | 1.06 | 1.06 | 1.06 | 1.06 | 1.06 | 1.06 | 1.06 | 1.06 | 1.06 |
| Turning Speed (k/h) | 24 | | 14 | 24 | | 14 | 24 | | 14 | 24 | | 14 |
| Sign Control | | Stop | | | Stop | | | Stop | | | Stop | |
| Intersection Summary | | | | | | | | | | | | |
| Area Type: | Other | | | | | | | | | | | |
| Control Type: | Unsignalized | | | | | | | | | | | |
| Intersection Capacity Utilization 23.4% | ICU Level of Service A | | | | | | | | | | | |
| Analysis Period (min) 15 | | | | | | | | | | | | |

4: Provence & Grapefern
PM Peak Hour

Provence Orleans Subdivision (Phase 6)
2025 Total Traffic

| |  |  |  |  |  |  |  |  |  |  |  |  |
|---|---|---|---|---|---|---|--|---|---|---|---|---|
| Lane Group | EBL | EBT | EBR | WBL | WBT | WBR | NBL | NBT | NBR | SBL | SBT | SBR |
| Lane Configurations | |  | | |  | | |  | | |  | |
| Traffic Volume (vph) | 17 | 0 | 6 | 7 | 0 | 4 | 10 | 38 | 7 | 6 | 63 | 29 |
| Future Volume (vph) | 17 | 0 | 6 | 7 | 0 | 4 | 10 | 38 | 7 | 6 | 63 | 29 |
| Ideal Flow (vphpl) | 1800 | 1800 | 1800 | 1800 | 1800 | 1800 | 1800 | 1800 | 1800 | 1800 | 1800 | 1800 |
| Lane Util. Factor | 1.00 | 1.00 | 1.00 | 1.00 | 1.00 | 1.00 | 1.00 | 1.00 | 1.00 | 1.00 | 1.00 | 1.00 |
| Ped Bike Factor | | | | | | | | | | | | |
| Frt | | 0.965 | | | 0.951 | | | 0.983 | | | 0.960 | |
| Flt Protected | | 0.964 | | | 0.969 | | | 0.991 | | | 0.997 | |
| Satd. Flow (prot) | 0 | 1660 | 0 | 0 | 1644 | 0 | 0 | 1726 | 0 | 0 | 1708 | 0 |
| Flt Permitted | | 0.964 | | | 0.969 | | | 0.991 | | | 0.997 | |
| Satd. Flow (perm) | 0 | 1660 | 0 | 0 | 1644 | 0 | 0 | 1726 | 0 | 0 | 1708 | 0 |
| Link Speed (k/h) | | 50 | | | 50 | | | 50 | | | 50 | |
| Link Distance (m) | | 124.8 | | | 57.5 | | | 141.6 | | | 204.6 | |
| Travel Time (s) | | 9.0 | | | 4.1 | | | 10.2 | | | 14.7 | |
| Confl. Peds. (#/hr) | 7 | | | | | 7 | 4 | | | | | 4 |
| Confl. Bikes (#/hr) | | | 1 | | | | | | | | | 1 |
| Peak Hour Factor | 1.00 | 1.00 | 1.00 | 1.00 | 1.00 | 1.00 | 1.00 | 1.00 | 1.00 | 1.00 | 1.00 | 1.00 |
| Heavy Vehicles (%) | 2% | 2% | 2% | 2% | 2% | 2% | 2% | 3% | 2% | 2% | 2% | 2% |
| Adj. Flow (vph) | 17 | 0 | 6 | 7 | 0 | 4 | 10 | 38 | 7 | 6 | 63 | 29 |
| Shared Lane Traffic (%) | | | | | | | | | | | | |
| Lane Group Flow (vph) | 0 | 23 | 0 | 0 | 11 | 0 | 0 | 55 | 0 | 0 | 98 | 0 |
| Enter Blocked Intersection | No | No | No | No | No | No | No | No | No | No | No | No |
| Lane Alignment | Left | Left | Right | Left | Left | Right | Left | Left | Right | Left | Left | Right |
| Median Width(m) | | 0.0 | | | 0.0 | | | 0.0 | | | 0.0 | |
| Link Offset(m) | | 0.0 | | | 0.0 | | | 0.0 | | | 0.0 | |
| Crosswalk Width(m) | | 3.0 | | | 3.0 | | | 3.0 | | | 3.0 | |
| Two way Left Turn Lane | | | | | | | | | | | | |
| Headway Factor | 1.06 | 1.06 | 1.06 | 1.06 | 1.06 | 1.06 | 1.06 | 1.06 | 1.06 | 1.06 | 1.06 | 1.06 |
| Turning Speed (k/h) | 24 | | 14 | 24 | | 14 | 24 | | 14 | 24 | | 14 |
| Sign Control | | Stop | | | Stop | | | Free | | | Free | |
| Intersection Summary | | | | | | | | | | | | |
| Area Type: | Other | | | | | | | | | | | |
| Control Type: | Unsignalized | | | | | | | | | | | |
| Intersection Capacity Utilization 19.3% | ICU Level of Service A | | | | | | | | | | | |
| Analysis Period (min) 15 | | | | | | | | | | | | |