



DILLON
CONSULTING

URBANDALE CONSTRUCTION LTD.

130 Huntmar Drive

Transportation Impact Assessment (TIA)

Certification

I have reviewed and have a sound understanding of the objectives, needs, and requirements of the City of Ottawa's Official Plan and the Transportation Impact Assessment (2017) Guidelines;

I have a sound knowledge of industry standard practice with respect to the presentation of transportation impact assessment reports, including multimodal level of service review;

I have substantial experience (more than 5 years) in undertaking and delivering transportation impact studies (analysis, reporting and geometric design) with strong background knowledge in transportation planning, engineering, or traffic operations; and,

I am either a licensed or registered professional in good standing, whose field of expertise is either transportation engineering or transportation planning.

Signature of individual certifier that s/he meets the above four criteria.

Shawn Doyle, P.Eng., LEED AP
Senior Transportation Engineer
Project Manager
101-177 Colonnade Road
Nepean, ON K2E 7J4

Phone: (613) 745-2213 x3012
sdoyle@dillon.ca

Ian Borsuk, P.Eng.
Project Coordinator
101-177 Colonnade Road
Nepean, ON K2E 7J4

Phone: (613) 745-2213 x3013
iborsuk@dillon.ca

Table of Contents

1.0	Screening	1
1.1	Description of Proposed Development.....	1
1.2	Trip Generation Trigger.....	1
1.3	Location Triggers.....	2
1.4	Safety Triggers.....	2
1.5	Summary	2
2.0	Scoping	6
2.1	Existing and Planned Conditions.....	6
2.2	Study Parameters.....	28
2.3	Exemptions Review	31
3.0	Forecasting	33
3.1	Development-Generated Travel Demand.....	33
3.2	Background Network Travel Demand.....	41
3.3	Demand Rationalization.....	44
4.0	Analysis	47
4.1	Development Design.....	47
4.2	Parking	50
4.3	Boundary Street Design	50
4.4	Access Intersection Design.....	54
4.5	Transportation Demand Management	58
4.6	Neighbourhood Traffic Management	59
4.7	Transit	59
4.8	Review of Network Concept	60
4.9	Intersection Design	60
5.0	Conclusions	64

Figures

Figure 1: Site Location	3
Figure 2: Land Use Plan (Fotenn, September 2020).....	4
Figure 3: Site Plan (Urbandale, August 2020).....	5
Figure 4: Proposed Development.....	7
Figure 5: Urban Road Network.....	9
Figure 6: Existing Walking and Cycling Facilities	10
Figure 7: Existing Transit Service	12
Figure 8: Existing Traffic Volumes	14
Figure 9: Existing Lane Geometry and Traffic Control.....	15
Figure 10: Collision Map (2013 to 2018)	17
Figure 11: 2031 Affordable Road Network.....	19
Figure 12: 2024 Proposed Lane Configuration	20
Figure 13: 2029 Proposed Lane Configuration	21
Figure 14: 2031 Affordable Transit Network.....	23
Figure 15: Ultimate Transit Network (2013 TMP)	24
Figure 16: Ultimate Transit Network (2017 Kanata LRT EA)	25
Figure 17: Background Developments	27
Figure 18: Boundary Road Intersections	29
Figure 19: Network Intersections and Study Area	30
Figure 20: Trip Assignment.....	40
Figure 21: Background Traffic Volumes - 2024	42
Figure 22: Background Traffic Volumes – 2029.....	43
Figure 23: Total Traffic Volumes - 2024	45
Figure 24: Total Traffic Volumes - 2029	46
Figure 25: New Street Representative Cross-Section.....	49

Tables

Table 1: Existing Area Roads..... 8

Table 2: Existing Transit Routes..... 11

Table 3: Traffic Counts..... 13

Table 4: Collision Table..... 16

Table 5: Background Development Information..... 26

Table 6: Exemptions Review..... 32

Table 7: Person Trip Generation Rates – Residential and Commercial..... 34

Table 8: Person Trips – Residential and Commercial 35

Table 9: Elementary School Trip Generation..... 35

Table 10: Trip Generation by Mode – Retail and Residential..... 36

Table 11: Trip Generation by Mode After Internal Capture..... 37

Table 12: Pass-By and Diverted Traffic (Auto Driver Trips) 38

Table 13: Trip Distribution..... 39

Table 14: TRANS O-D Survey Annual Growth Prediction for Kanata / Stittsville 41

Table 15: Peak Period Ratios 44

Table 16: Roadway Design for Sustainable Modes 48

Table 17: Minimum Desirable MMLOS Targets..... 51

Table 18: MMLOS Conditions - Intersections 53

Table 19: Proximity to Adjacent Driveways..... 55

Table 20: Access Intersections – 2024 AM (PM) Peak Hour Operations..... 56

Table 21: Access Intersections – 2029 AM (PM) Peak Hour Operations..... 57

Table 22: Signal Warrant Analysis (Huntmar Drive and Street 1) 57

Table 23: AM (PM) Peak Hour Operations: Internal Intersections 58

Table 24: AM (PM) Peak Hour Operations – Existing (2019) Network Intersections..... 61

Table 25: AM (PM) Peak Hour Operations – 2024 Network Intersections 62

Table 26: AM (PM) Peak Hour Operations – 2029 Network Intersections 63

Appendices

Appendix A - Synchro Performance Worksheets

Appendix B - Signalized Intersection Traffic Operations Results

Appendix C - Signal Warrant Analysis

Appendix D - TDM Checklists

1.0

Screening

1.1 Description of Proposed Development

Municipal Address	130 Huntmar Drive, located in the North-East quadrant of the Huntmar Drive / Maple Grove Road intersection in Kanata West.
Description of Location	The proposed development will be a mixed-use concept, consistent with the Official Plan and the Kanata West Concept Plan. The site will include commercial lands adjacent to the planned Maple Grove Rapid Transit Station with low and medium density residential along the Rapid Transit corridor. There is a school planned at the corner of Huntmar Drive and Maple Grove Road.
Ward	Ward 6 - Stittsville
Land Use Classification	Residential (low and medium density) Commercial School
Development Size	235,568 m2 ~90 Single family homes ~226 Townhomes ~426 Stacked townhomes 30 000 ft2 of retail (2 790 m2) School - 2.409 Ha.
Number of accesses and locations	Huntmar Drive - 3 accesses Maple Grove Road - 3 accesses
Phases of development	One phase
Build-out year	2024

1.2 Trip Generation Trigger

Land Use Type	Minimum Development Size	Yes	No
Single-family homes	40 units	x	
Townhomes or apartments	90 units	x	
Office	3,500 sq.m.		x
Industrial	5,000 sq.m.		x
Fast-food restaurant or coffee shop	100 sq.m.		x
Destination retail	1,000 sq.m.		x
Gas station or convenience market	75 sq.m.		x
Other	60 person trips or more during weekday peak hours	x	

1.3 Location Triggers

	Yes	No
Does the development propose a new driveway to a boundary street that is designated as part of the City's Transit Priority, Rapid Transit or Spine Bicycle Networks?	x	
Is the development in a Design Priority Area (DPA) or Transit-oriented Development (TOD) zone?*	x	

1.4 Safety Triggers

	Yes	No
Are posted speed limits on a boundary street are 80 km/hr or greater?		x
Are there any horizontal/vertical curvatures on a boundary street limits sight lines at a proposed driveway?		x
Is the proposed driveway within the area of influence of an adjacent traffic signal or roundabout (i.e. within 300 m of intersection in rural conditions, or within 150 m of intersection in urban/ suburban conditions)?		x
Is the proposed driveway within auxiliary lanes of an intersection?		x
Does the proposed driveway make use of an existing median break that serves an existing site?		x
Is there is a documented history of traffic operations or safety concerns on the boundary streets within 500 m of the development?		x
Does the development include a drive-thru facility?		x

Note that it is unknown at this time where institutional land-use driveways will be located. The site is located in close proximity to the signalized intersection of Maple Grove Road and Huntmar Drive.

1.5 Summary

	Yes	No
Does the development satisfy the Trip Generation Trigger?	x	
Does the development satisfy the Location Trigger?	x	
Does the development satisfy the Safety Trigger?		x

Since the development satisfies the Trip Generation and Location Triggers, the network impact component will be addressed in the TIA. **Figure 1** illustrates the site location, **Figure 2** shows the various land uses, and **Figure 3** illustrates the site plan.

Figure 1: Site Location

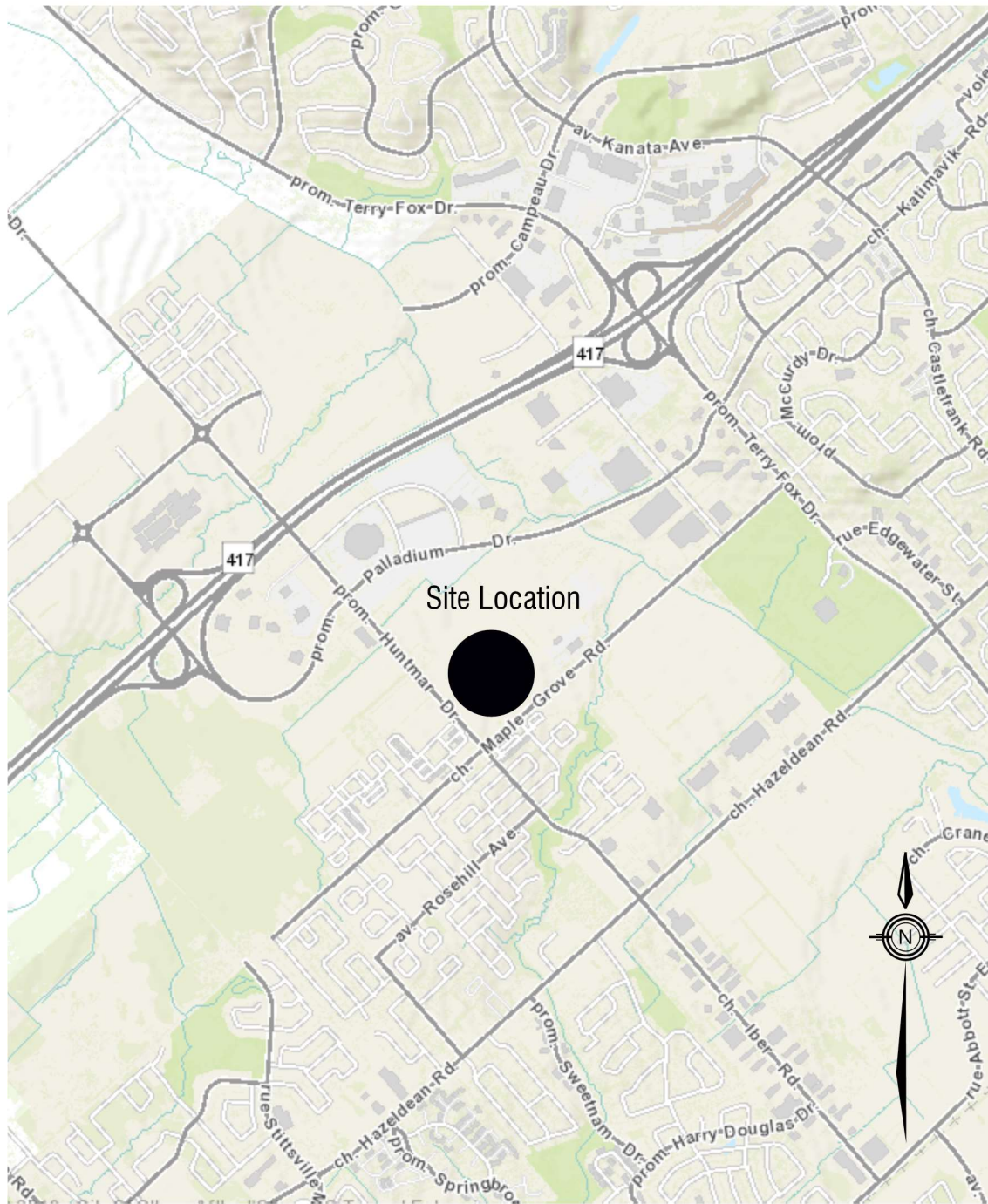

Background image source: geoOttawa, accessed October 25, 2019

Figure 2: Land Use Plan (Fotenn, September 2020)

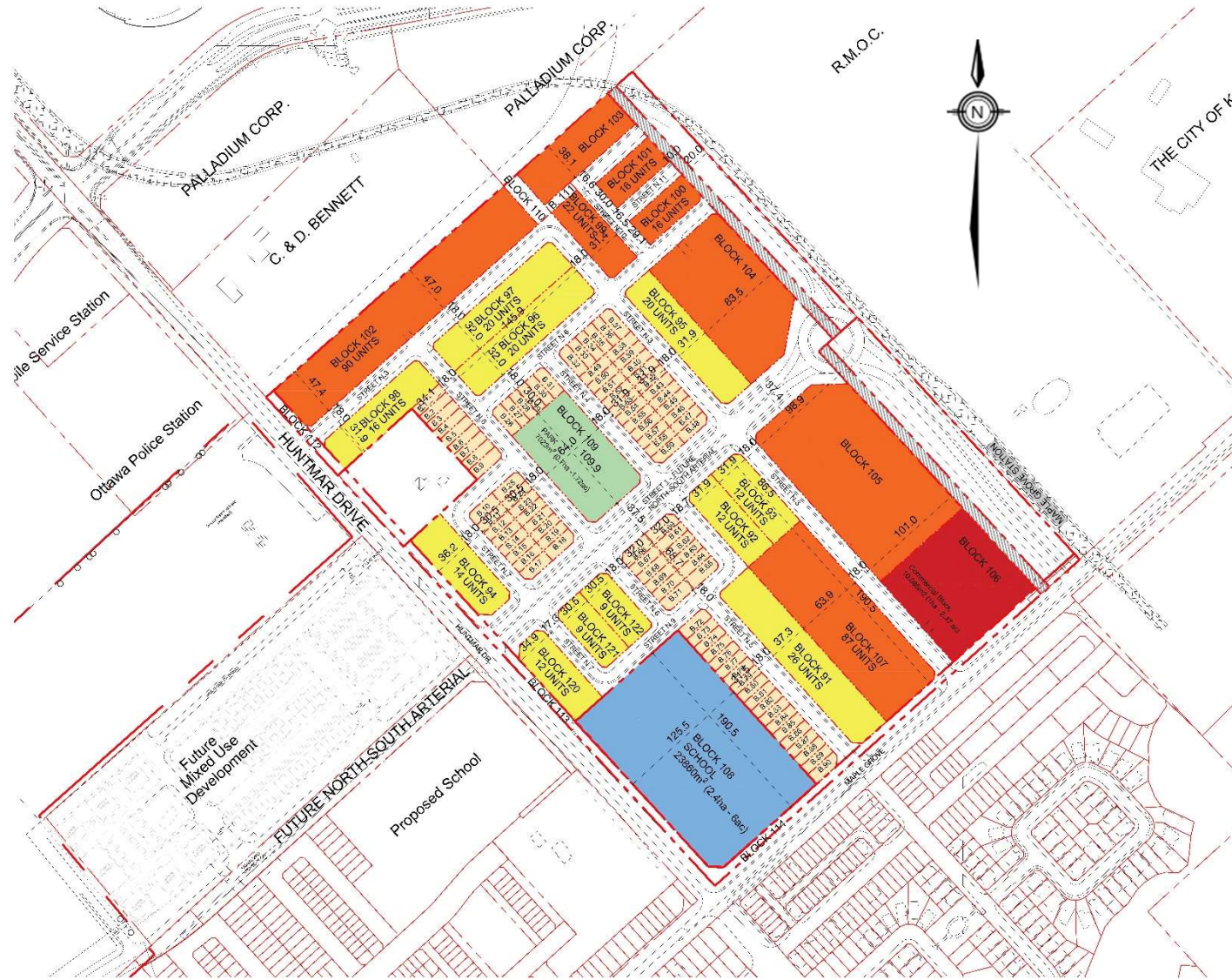

**130 HUNTMAR DR
OTTAWA
CONCEPT BLOCK
PLAN**



- LEGEND**
- RESIDENTIAL MID-DENSITY (6-34 UNITS)
 - RESIDENTIAL LOW DENSITY (FORMING URBES)
 - RESIDENTIAL LOW DENSITY SERVICE DETACHED
 - SCHOOL SITE (see)
 - COMMERCIAL
 - PARKLAND DEDICATION
 - CITYSHIPY BOUNDARY
 - STREET TRACKS

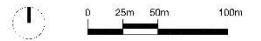

6	REVISE SIDEWALKS	2020.09.02	RP
5	FOR 1ST PRESUBMISSION	2020.08.24	RP
4	FOR OPA SUBMISSION	2020.02.19	RP
3	OPTION 4	2019.03.14	RP
2	FOR CLIENT REVIEW	2018.01.22	EL
1	DRAFT	2018.12.20	RP
No.	REVISION	DATE	BY

CLIENT
URBANDALE

FOTENN
Planning + Design

223 McLeod Street, Ottawa, ON K2P 6Z8
613.730.5709 www.fotenn.com

DESIGNED	RP
REVIEWED	MT
DATE	2018.12.20

P1

Figure 3: Site Plan (Urbandale, August 2020)

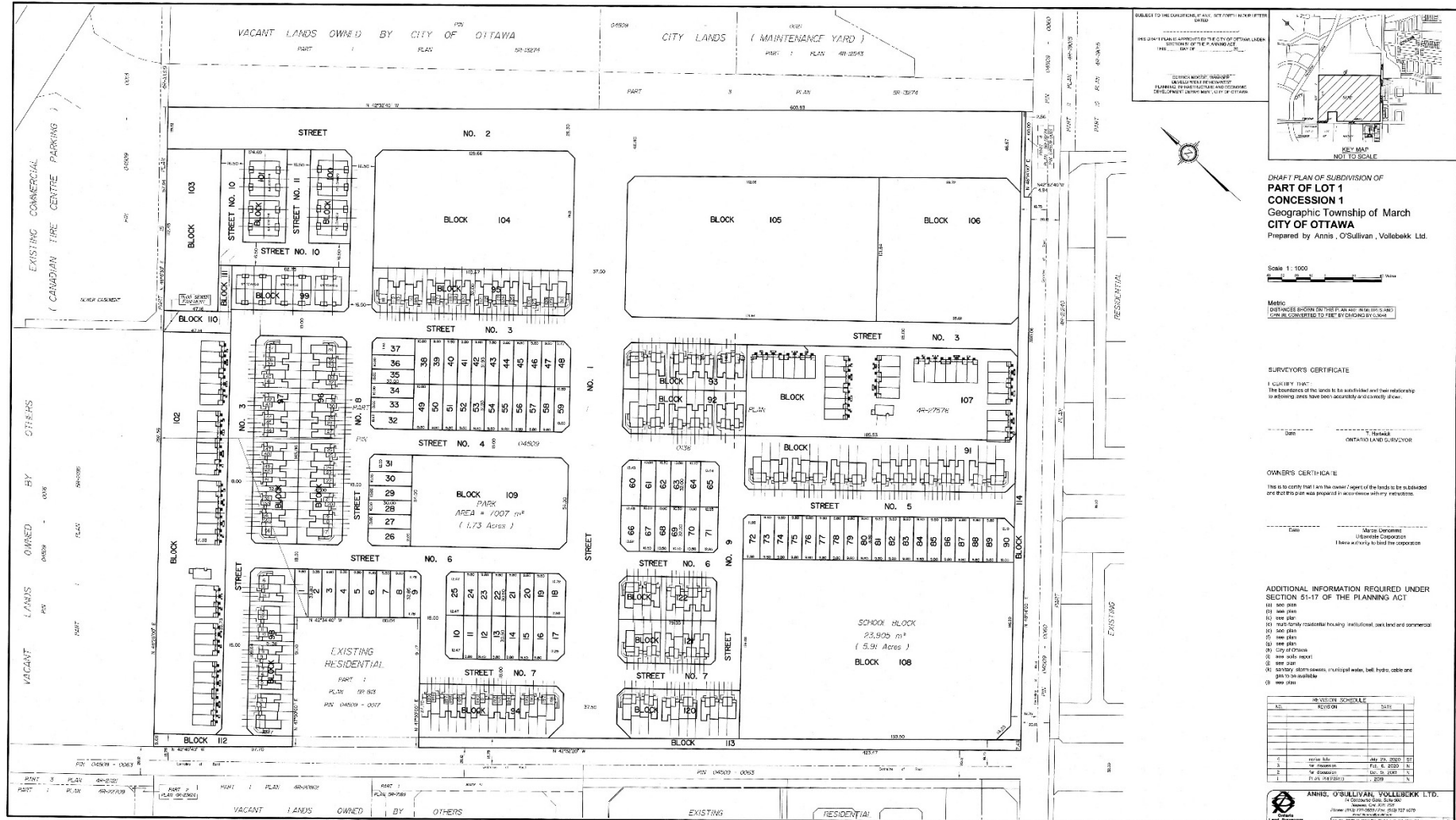

2.0 Scoping

2.1 Existing and Planned Conditions

2.1.1 Proposed Development

The proposed development is within the Kanata West Secondary Plan area. 130 Huntmar Drive, a Western suburb of Ottawa, is located approximately one kilometre South of Highway 417. The site is bound by Palladium Drive to the North, Terry Fox Drive to the East, Maple Grove Road to the South, and Huntmar Drive to the West.

The proposed development is to be constructed on vacant lands, and will include a mix of residential and commercial land uses as well as a school.

The right-of-way (ROW) protection for Huntmar Drive and Maple Grove Road is 37.5 metres. A future arterial roadway (called herein as the North-South Arterial) will travel through the site as Street 2 (north-south alignment from Maple Grove Road to a new roundabout) and Street 1 (east-west alignment from the new roundabout to Huntmar Drive). South of the roundabout, the North-South Arterial will have a ROW protection of approximately 47 metres in order to accommodate the future roundabout turning requirements. The east-west segment will include a ROW of 37.5 metres. All other internal roadways will consist of local roads mostly with a ROW protection of between 16.5 metres and 18 metres as per ROW protection requirements for the City of Ottawa.

Figure 4 illustrates the proposed development.

The ultimate plan is for a roundabout at the intersection of Street 1 and Street 2 once the N/S Arterial is connected beyond the development (south of Maple Grove Road, and west of Huntmar Drive). The intersection is expected to operate as an all-way-stop until such time as the N/S arterial is extended and will require capacity improvements. An all-way stop is recommended to facilitate pedestrian crossings of both Street 1 and Street 2. These streets have limited stop control as they are to be the primary vehicle roadway (future N/S Arterial) with local side streets being stop controlled.

Figure 4: Proposed Development

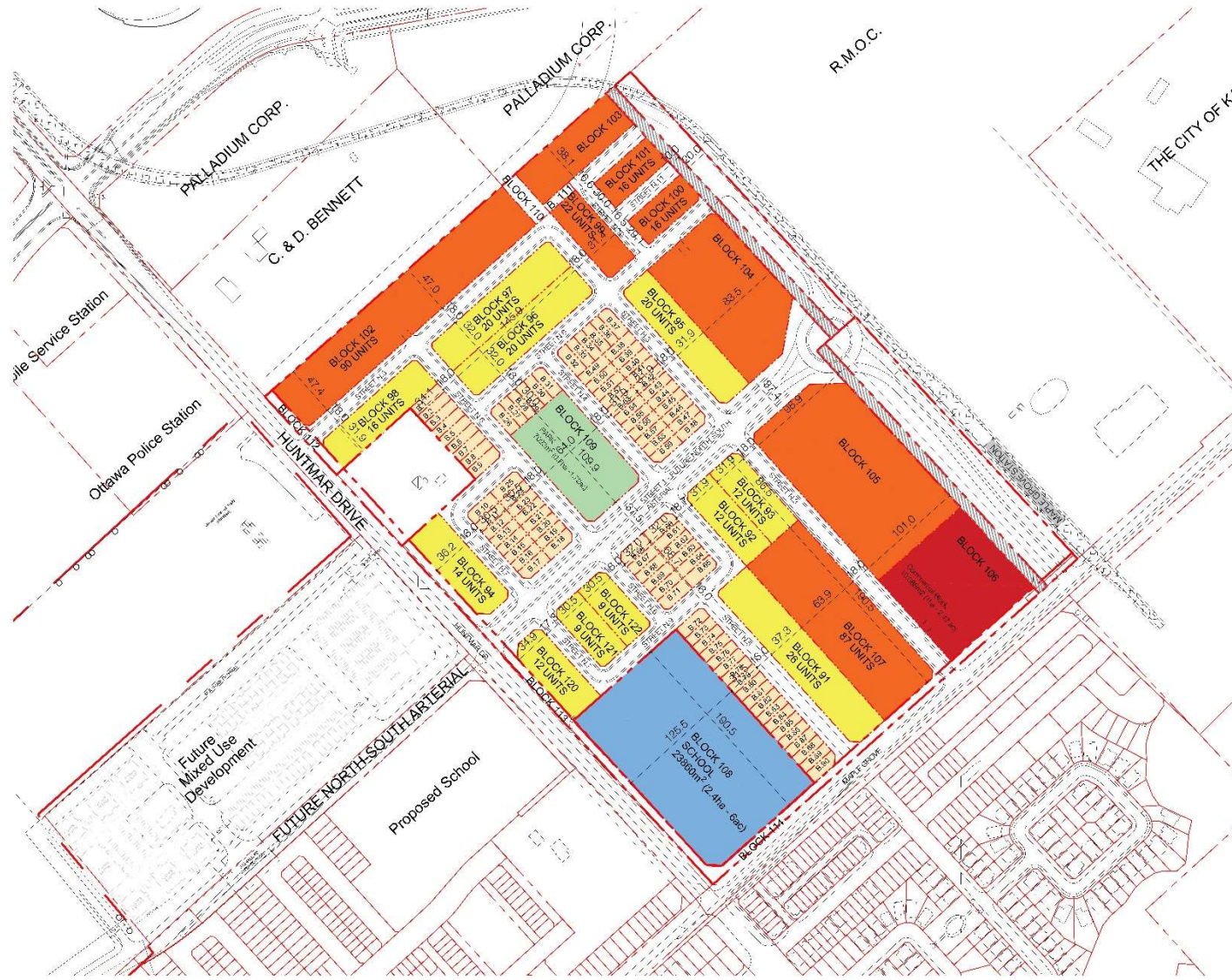

**130 HUNTMAR DR
OTTAWA**
CONCEPT BLOCK PLAN



- LEGEND**
- RESIDENTIAL MID DENSITY - 35-50 UPGRADES
 - RESIDENTIAL LOW DENSITY - 35-50 UPGRADES
 - RESIDENTIAL LOW DENSITY - 35-50 UPGRADES
 - SCHOOL 318 - 548
 - COMMERCIAL
 - PARK AND RECREATION
 - FUTURE MIXED USE
 - BOUNDARIES



6	FOR 1ST REGULATORY	2020.09.24	PP
4	FOR 1ST REGULATORY	2020.02.10	PP
3	CONCEPT	2019.03.14	PP
2	FOR CLIENT REVIEW	2019.01.22	PP
1	INITIAL	2018.12.22	PP
0	TELEVISION	19A	PP

CLIENT
URBANDALE

FOTENN
Planning + Design

223 McLeod Street, Ottawa, ON K2P 0Z2
613.730.6709 www.fotenn.com

DESIGNED	PP
REVIEWED	PP
DATE	2020.12.20

P1



2.1.2 Existing Conditions

2.1.2.1 Roads and Traffic Control

The roadways under consideration in the vicinity of the study area are described as follows:

Table 1: Existing Area Roads

Road	Description	Posted Speed
Huntmar Drive	Huntmar Drive Road is two-lane municipally-owned Arterial road running North-South, bordering the proposed development on the West side. Huntmar Drive connects to the Highway 417 via Palladium Drive.	50 km/h
Maple Grove Road	Maple Grove Road is a two-lane municipally-owned Major Collector running East-West from Alon Street in Stittsville to Young's Farm Way with connections to Huntmar Drive and Terry Fox Drive.	50 km/h
Terry Fox Drive	Terry Fox Drive is a four-lane, divided, municipally-owned road running North-South from Herzberg Road to Eagleson Road, where it becomes Hope Side Road. It is classified as a Major Collector East of March Road and as an Arterial West to Hope Side Road.	70 km/h
Palladium Drive	Palladium Drive is a four-lane, divided, municipally-owned Arterial road running East-West from Campeau Drive to Terry Fox Drive.	70 km/h
Hazeldean Road	Hazeldean Road is a four-lane, divided, municipally-owned Arterial road running West to East from Spruce Ridge Road (West of Highway 417) Market to Eagleson Road. It is located South of the proposed development.	60 km/h

Figure 5 shows the road classification in the study area.

2.1.2.2 Walking and Cycling

Figure 6 illustrates the pedestrian and cycling facilities in the study area. Sidewalks exist along both sides of Palladium Drive, Huntmar Drive (South of Maple Grove Road), and Hazeldean Road. There are sidewalks on the South side of Maple Grove Road from Huntmar Drive to 90 metres east of Rosehill Avenue.

The City's 2013 Transportation Master Plan (TMP) identifies Terry Fox Drive, Hazeldean Road and Huntmar Drive as part of the Cycling Network as Spine Routes. Existing cycling facilities include a bike lane along the East side of Huntmar Drive between Maple Grove Road and Palladium Drive. The west side of Huntmar Drive has a paved shoulder. Other major pathways exist in the area connecting various roadways.

Figure 5: Urban Road Network

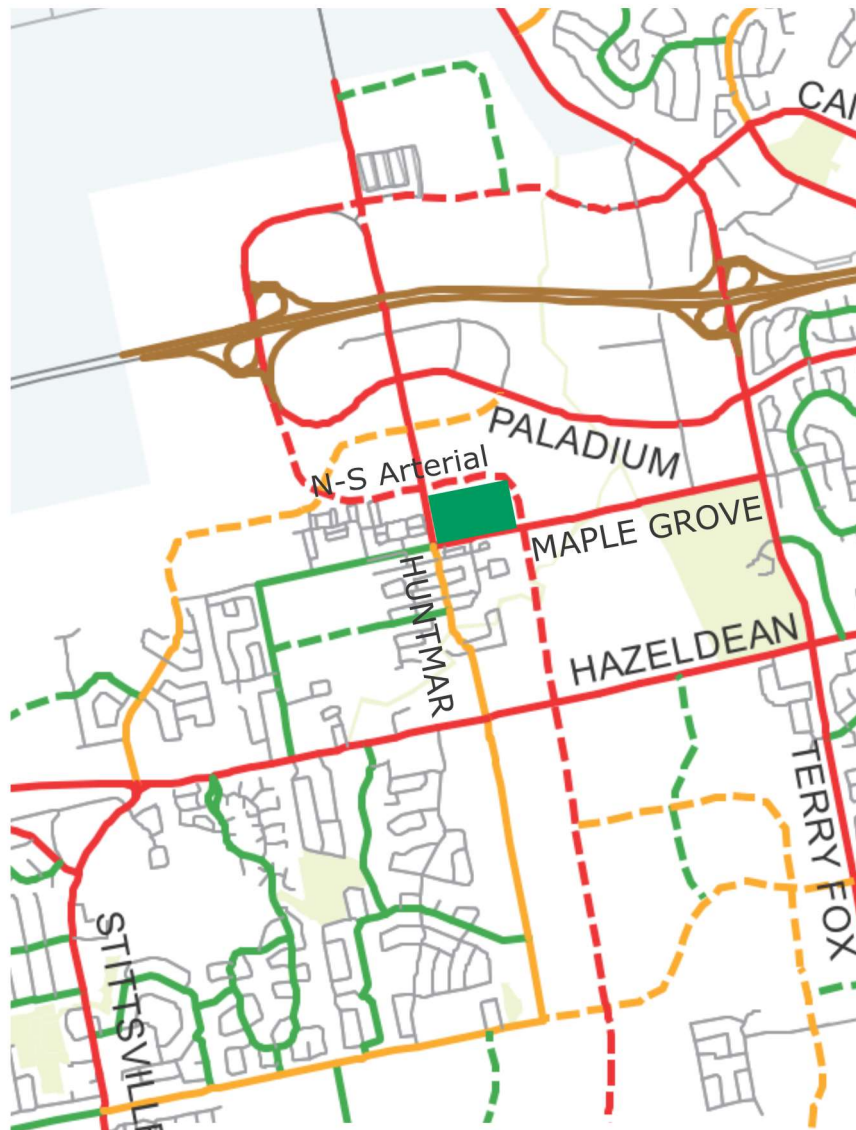

Background image source: geoOttawa, accessed October 25, 2019

Figure 6: Existing Walking and Cycling Facilities

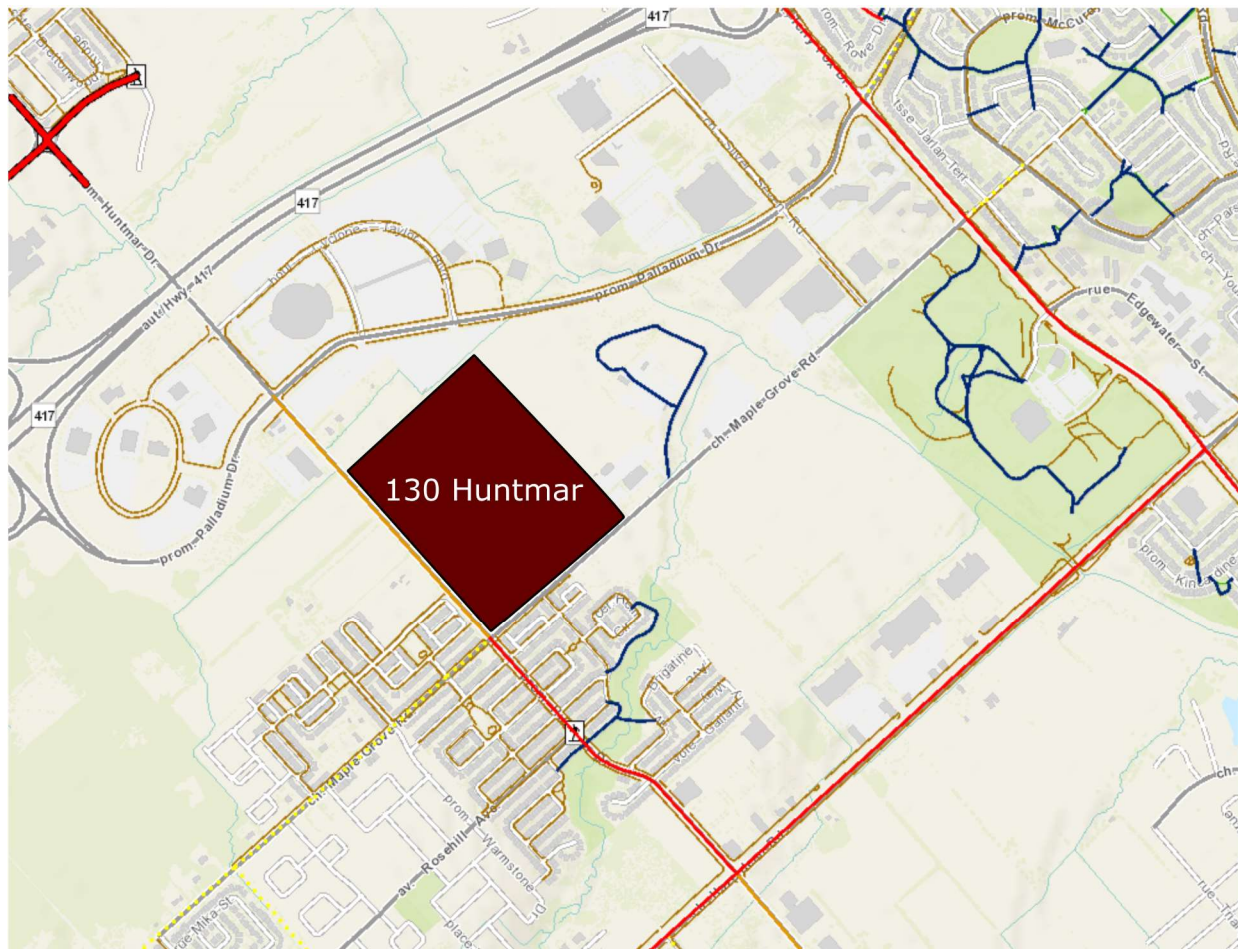



Legend:

Pedestrian Crossovers



Pedestrian Network (existing)

-  Existing Sidewalks and Paths
-  Existing Multi-Use Pathway

Existing Cycling Network

-  Bike Lane
-  Path
-  Paved Shoulder
-  Cycle Track
-  Suggested Route



NOT TO SCALE

Image source: geoOttawa, accessed November 27, 2019

2.1.2.3

Transit

Figure 7 shows the existing transit service near the proposed development. Existing transit services operate 7 days / week in all time periods along Huntmar Drive and Palladium Drive with convenient access to the O-Train. Transit services operate at headways between 15 minutes and 60 minutes near the site location. Route numbers along with respective transit operation information can be found in **Table 2**.

The TRANS Committee's 2011 *NCR Household Origin-Destination Survey* (O-D Survey) indicates that within the Kanata / Stittsville district, approximately 46% of residents make trips destined outside of the area during the AM peak period and 34% of trips originating elsewhere conclude within the Kanata / Stittsville district.

Furthermore, approximately 24% of residents originating from the Kanata / Stittsville district during the AM Peak Hour use transit as their primary mode of transportation, compared to 59% using a personal vehicle. Approximately 21% of residents destined to the Kanata / Stittsville district during the PM peak hour use transit, compared to 61% that use a personal vehicle. Roughly 4% of residents travelling within the Kanata / Stittsville district (internal trips) use transit as their primary travel mode during the AM peak period, compared to 2% during the PM peak period.

Table 2: Existing Transit Routes

Route	Stop Location	Destination	Service Hours	Headway (Minutes)
62	Huntmar / Maple Grove	Tunney's Pasture (O-Train Confederation Line)	07:00 - 23:59	30
261	Huntmar / Maple Grove	Tunney's Pasture (O-Train Confederation Line)	06:00 - 08:00	20
263	Huntmar / Maple Grove	Tunney's Pasture (O-Train Confederation Line)	06:00 - 08:00	20
162	Huntmar / Maple Grove	Tanger Outlets and Kanata Centrum	14:00 - 00:00	60
88	Terry Fox / Maple Grove	Hurdman Station	05:00 - 13:00	15

Figure 7: Existing Transit Service

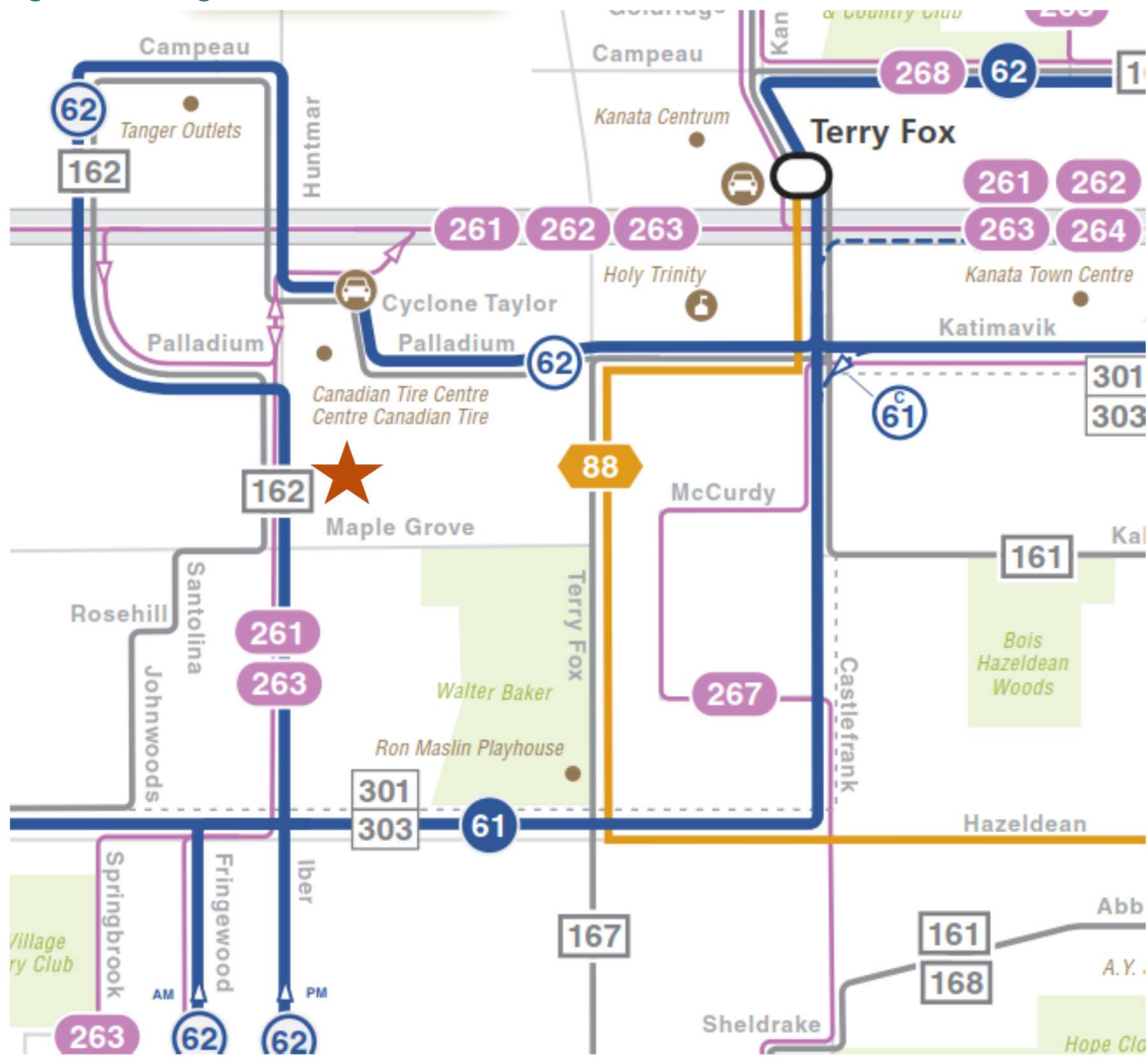

<p>O-Train Station-to-station train service Operating 7 days/week in all time periods Service de train de station à station Service offert en tout temps, tous les jours de la semaine</p> <p>Rapid • Rapide Station-to-station bus service Operating 7 days/week in all time periods Service d'autobus de station à station Service offert en tout temps, tous les jours de la semaine</p> <p>Frequent • Fréquent Service every 15 minutes or less on weekdays Operating 7 days/week in all time periods Service aux 15 minutes ou moins en semaine Service offert en tout temps, tous les jours de la semaine</p> <p>Local Custom routing to local destinations Réseau local adapté aux besoins des usagers</p> <p>Connexion Convenient connection to the O-Train Weekday peak-periods only Correspondance pratique à l'O-Train Service offert aux heures de pointe, les jours de semaine seulement</p>	<p>Limited service • Service limité Service does not operate in all time periods Service does not operate every day Service offert durant certaines périodes de la journée seulement. Service offert certains jours seulement</p> <p>Occasional trips only ★ Proposed Development Service occasionnel</p> <p>Terminus Beginning or end of route Début ou fin d'un circuit</p> <p>Legend • Légende</p> <ul style="list-style-type: none"> Transit station / Station de transport en commun Société de transport de l'Outaouais - sto.ca Park & Ride / Parc-o-bus School / École
---	--



Image source: Except from OC Transpo, accessed November 27, 2019

2.1.2.4 Traffic Management Measures

There are no traffic management measures in the study area.

2.1.2.5 Traffic Volumes

Table 3 summarizes the traffic counts used for this study.

Table 3: Traffic Counts

Intersection	Date	Source
Huntmar Drive & Hazeldean Road	July 2019	City of Ottawa
Huntmar Drive & Rosehill Avenue	December 2016	City of Ottawa
Palladium Drive & Huntmar Drive	April 2019	City of Ottawa
Palladium Drive & Terry Fox Drive	November 2017	City of Ottawa
Terry Fox Drive & Maple Grove Road	March 2016	City of Ottawa
Huntmar Drive & Maple Grove Road	November 2017	City of Ottawa
Maple Grove Road & Rosehill Avenue	August 2020	City of Ottawa

A separate field investigation was also undertaken by Dillon at the intersection of Maple Grove Road and Huntmar Drive in October 2019. This intersection was chosen due to new development in the area and in order to confirm the general distribution of traffic through the intersection. This location also allowed confirmation of annual growth rates between 2017 traffic count and the 2019 existing conditions. An additional traffic count was obtained during the preparation of this TIA at the intersection of Maple Gove Road and Rosehill Avenue as the proposed site plan includes a new road aligned with Rosehill Ave. While the count was undertaken during the COVID-19 pandemic, it still provided a good indication of the existing AM and PM peak trip generation via this local roadway, with traffic volumes as expected.

The 2016 and 2017 traffic volumes were grown by 3% per year to simulate existing 2019 conditions. This growth rate was derived from population growth in the surrounding area and by comparing 2016 and 2019 traffic volumes at Huntmar Drive and Rosehill Avenue. The analysis confirmed that a 3% annual growth rate is reasonable for this location. This growth rate was applied to all intersections in the area to obtain a baseline 2019 network.

Figure 8 illustrates the existing 2019 study area traffic volumes and **Figure 9** illustrates the existing lane geometry and traffic control.

Figure 8: Existing Traffic Volumes

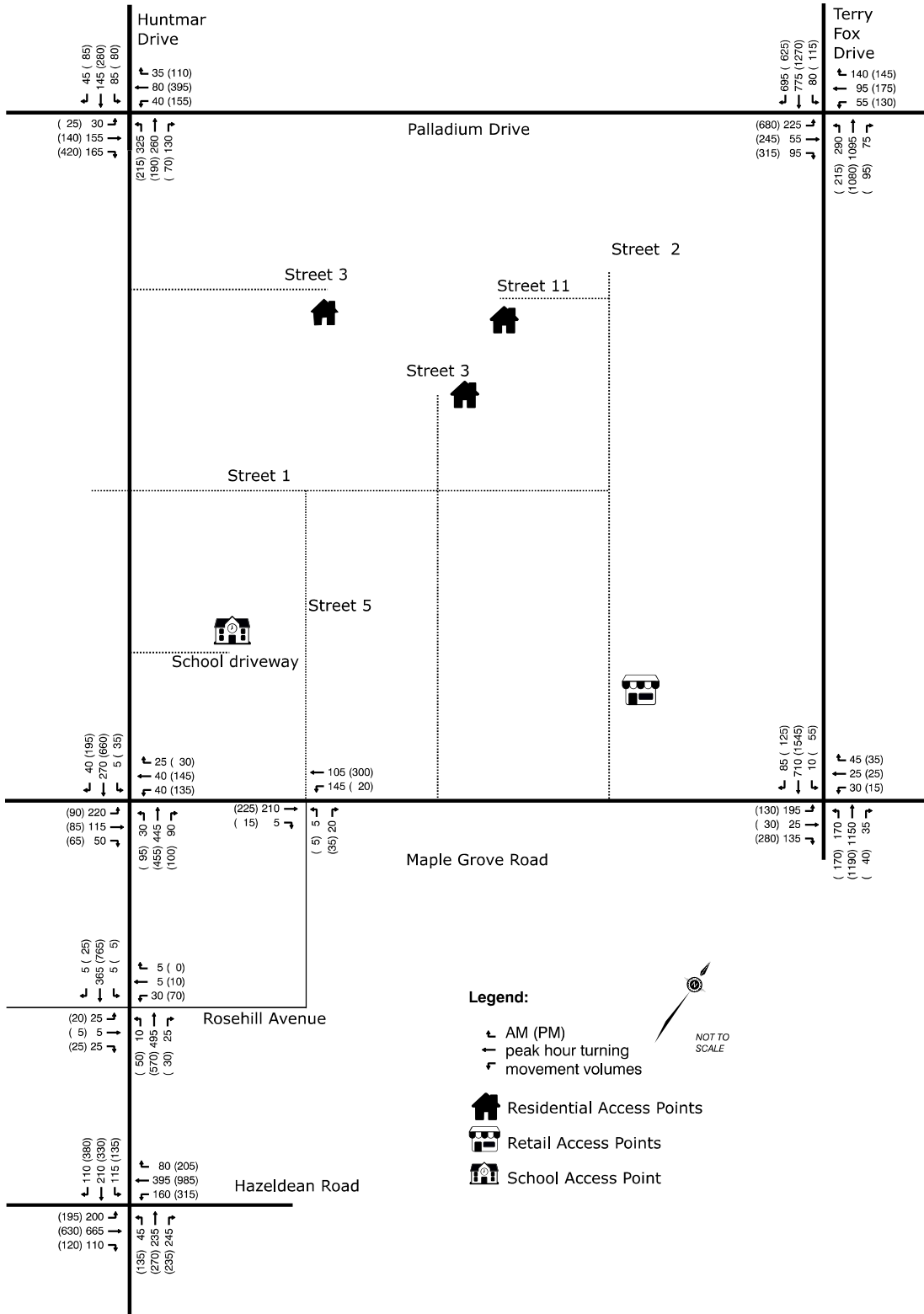
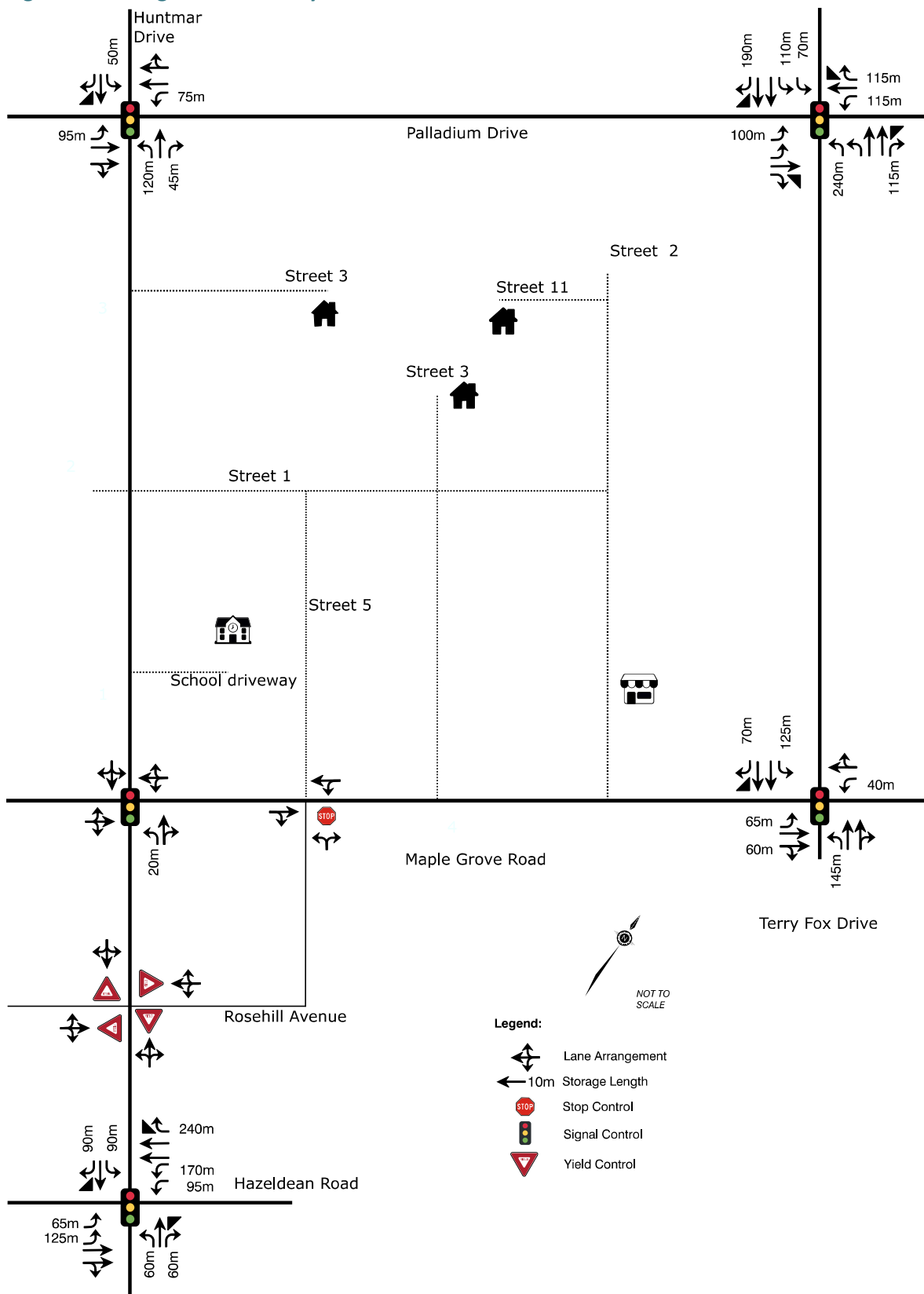

Figure 9: Existing Lane Geometry and Traffic Control



2.1.2.6

Collision History

Figure 10 illustrates the location and number of collisions in the study area between 2014 and 2018. The white number in the red circle indicates the number of total collisions at the location specified within this timeframe.

There are between five (5) and 30 collisions per year at major intersections. **Table 4** provides a breakdowns of collision types at three intersections from 2014 to 2018. The intersection of Huntmar Drive at Maple Grove Road was chosen based on its proximity to the proposed development, while Terry Fox Drive at Pallium Drive and Terry Fox Drive at Maple Grove Road were chosen based on having the highest collision rates of all the study intersections.

The majority of these collisions were rear-end and most resulted in property damage only. The accident rate for the intersection of Huntmar Drive and Maple Grove Road, including the North leg, is 2.9 accidents per million vehicle KMs, indicating low collision numbers in proximity to the development. None of the study area intersections are within the top 10 intersection collision areas within Ottawa based on the data from the 2016 City of Ottawa Road Safety Report.

Table 4: Collision Table

Intersection	Year	Rear End	Turning	Sideswipe	Angle	SMV	Approaching	Total
Huntmar Drive and Maple Grove Road	2014	1	-	-	1	1	-	3
	2015	7	-	-	2	2	-	11
	2016	5	2	1	-	3	-	11
	2017	-	-	1	-	-	1	2
	2018	5	-	-	-	2	-	7
	Total	18	2	2	3	8	1	34
Terry Fox Drive and Palladium Drive	2014	29	2	3	1	-	-	35
	2015	20	-	1	2	-	-	23
	2016	18	-	1	-	-	-	19
	2017	9	-	3	-	-	-	12
	2018	12	-	-	-	-	-	12
	Total	88	2	8	3	0	0	101
Terry Fox Drive and Maple Grove Road	2014	11	2	1	2	1	-	17
	2015	15	3	3	2	-	-	23
	2016	10	3	1	2	-	-	16
	2017	6	2	1	-	-	-	9
	2018	7	1	-	1	1	-	10
	Total	49	11	6	7	2	0	75

Figure 10: Collision Map (2013 to 2018)



Legend

Proposed Development



NOT TO SCALE

Image source: City of Ottawa Open Data Portal, accessed November 28, 2019

2.1.3 Planned Conditions

2.1.3.1 Road Network

The 2013 TMP identified several road network improvements in the study area:

1. Huntmar Drive to be widened between Maple Grove Road and Campeau Drive;
2. A new E/W Arterial road is to be constructed connecting with Street 1 (Robert Grant Expansion); and,
3. A new N/S Arterial road is to be constructed.

Figure 11 shows the 2031 Affordable Network from the TMP. We understand that discussions are underway regarding the alignment of the new N/S Arterial and it may shift further east as a result.

At the time of the 2013 TMP, these projects were all planned for completion prior to the 2031 horizon. However, as of late 2019, City staff indicated that these projects are unlikely to be completed prior to the 2031 horizon.

This analysis has not included the impacts of these road projects. The analysis within this report represents a “worst case” scenario (most constrained transportation scenario). The inclusion of the identified road projects would increase area roadway capacity, alleviating potential vehicle impacts.

Intersection modifications have been included at the intersection of Huntmar Drive and Maple Grove Road as a near term roadway improvement. The existing intersection is reaching capacity, and a widened intersection has been designed which includes the following:

- Auxiliary left-turns on all approaches
- Auxiliary southbound right-turn lane
- Two through lanes on the northbound approach
- Single through lanes on southbound, westbound, and eastbound approaches

Figure 12 illustrates the proposed lane configuration of the development in 2024, while **Figure 13** illustrates the proposed lane configuration of the development in 2029.

Figure 11: 2031 Affordable Road Network

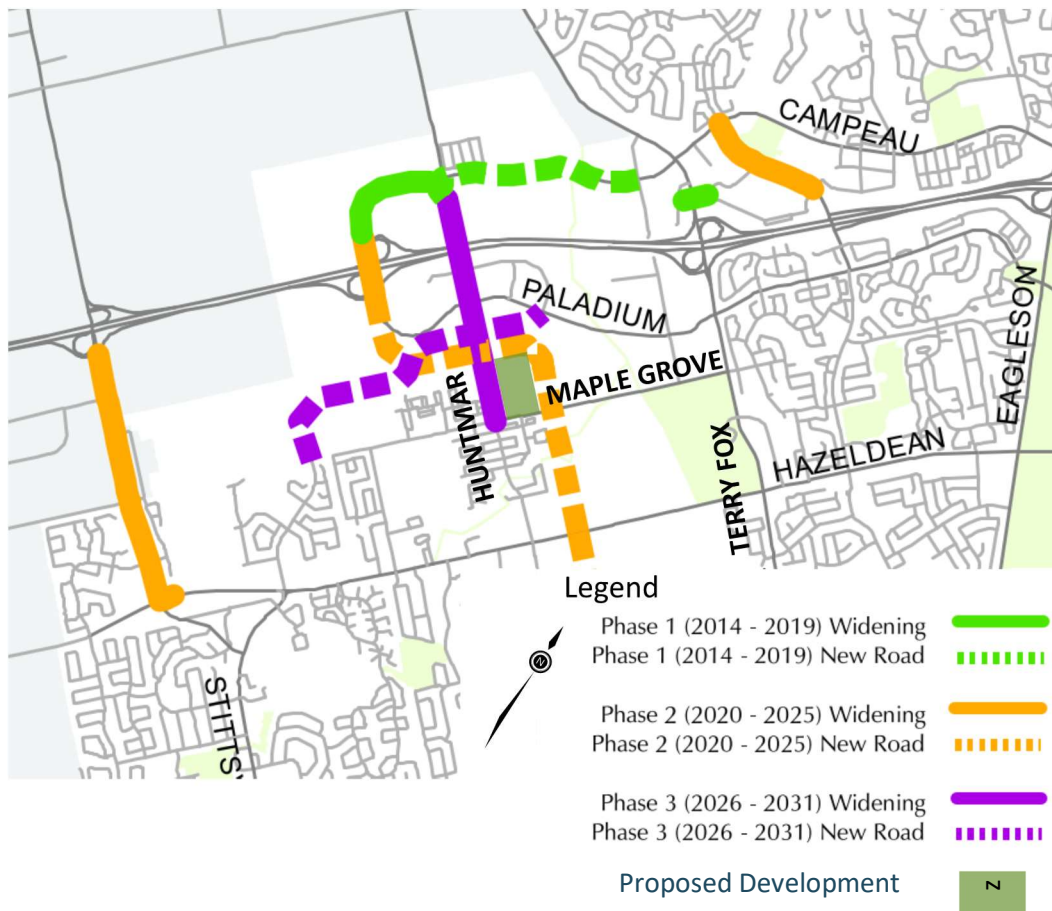

Image source: City of Ottawa 2013 TMP, 2031 Affordable Network, accessed November 28, 2019

Figure 12: 2024 Proposed Lane Configuration

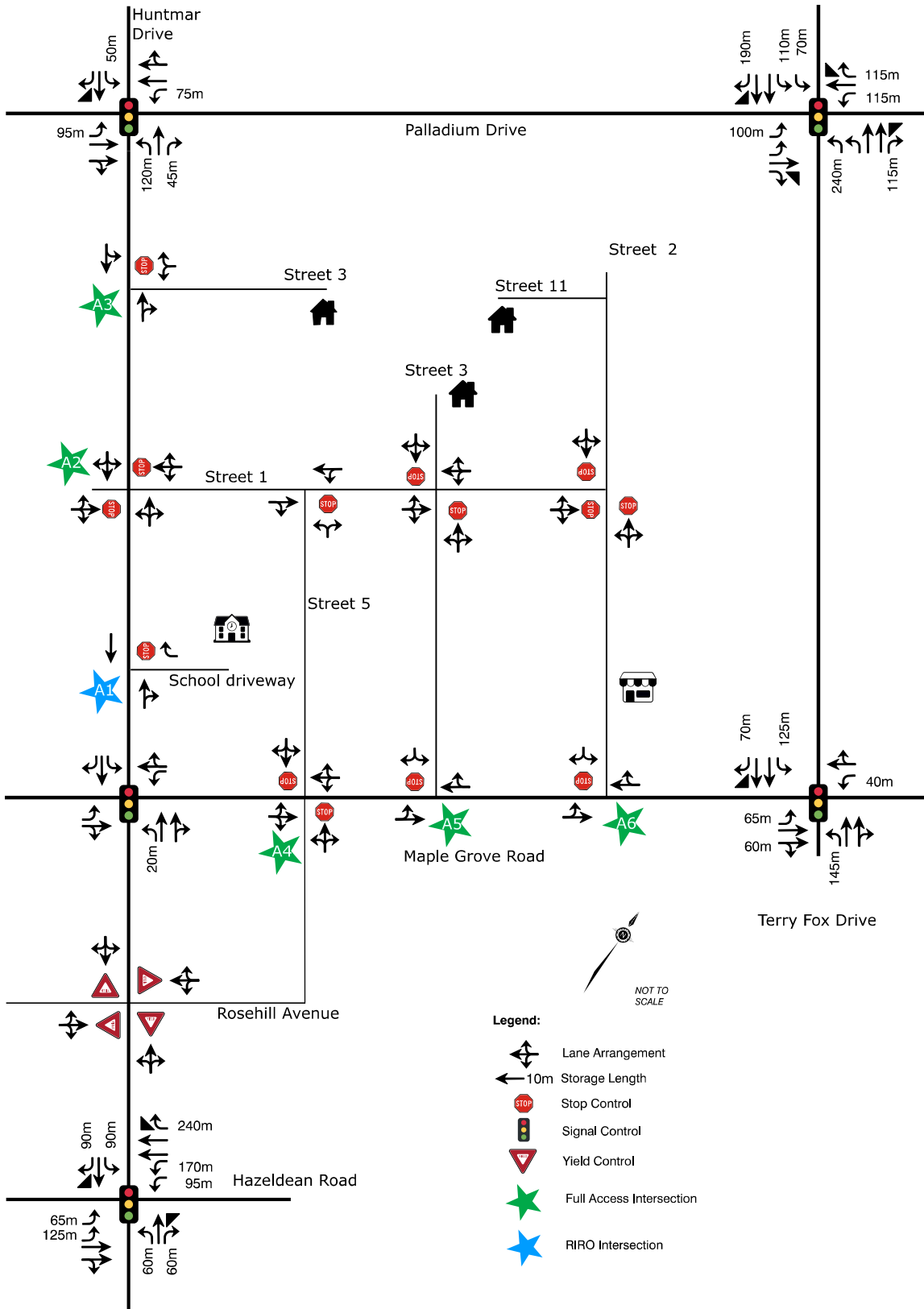
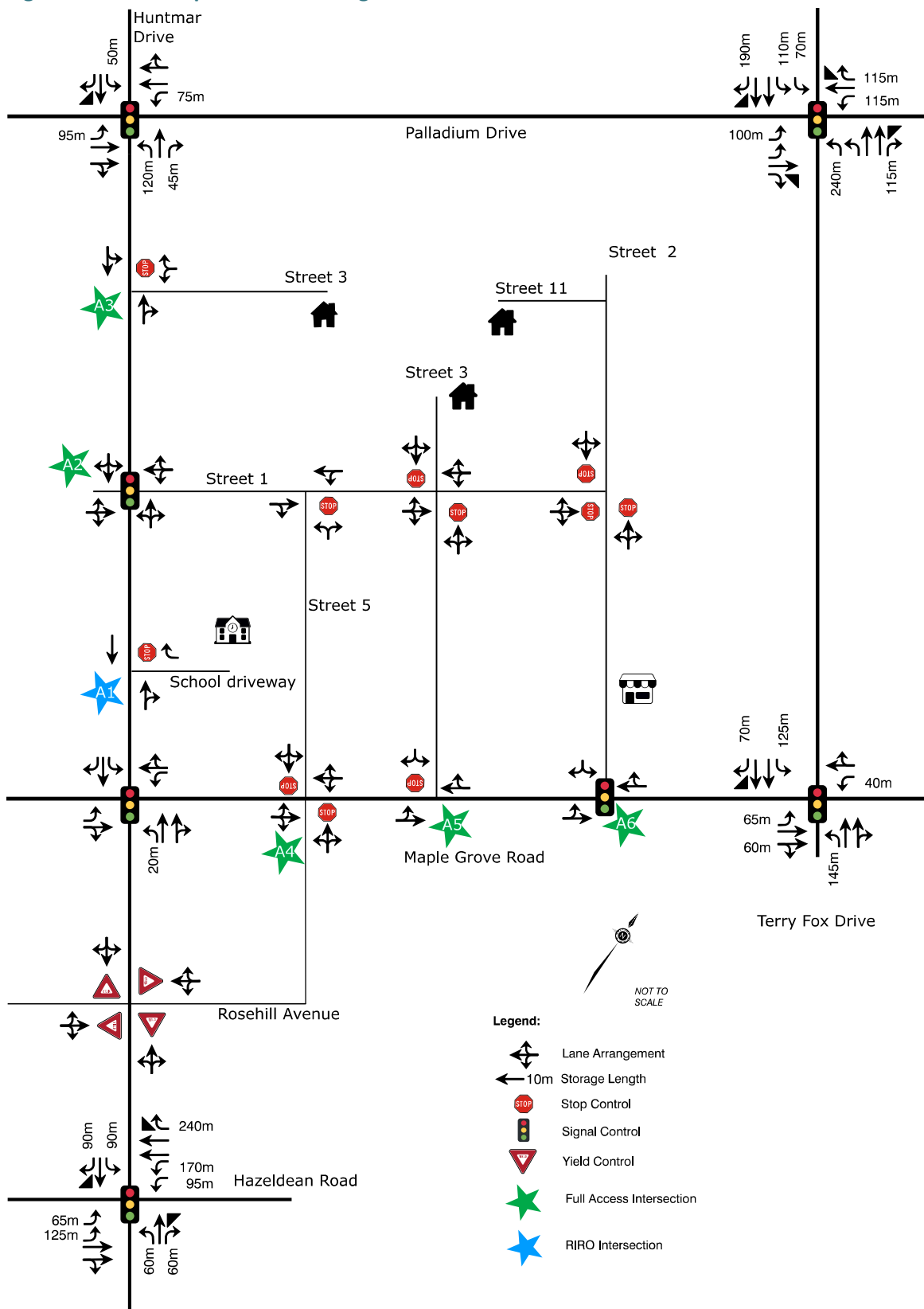

Figure 13: 2029 Proposed Lane Configuration



2.1.3.2 Walking and Cycling

The current plan in the 2031 Ottawa TMP includes a road expansion along Huntmar Drive between Maple Grove Road and Campeau Drive to increase the number of driving lanes from two to four by 2031, with sidewalks and facilities for pedestrians and cyclists. These lanes would be added following the completion of an EA, pending funding. In advance of this, a multi-use pathway will be implemented along Huntmar Drive.

Maple Grove Road will also see improvements by 2031 through infrastructure such as sidewalks and bike lanes.

2.1.3.3 Transit

Figure 14 shows the 2031 Affordable Transit Network in the study area. This included isolated transit measures on Hazeldean Road and isolated transit measures on the new NS Arterial roadway.

Figure 15 shows the Ultimate Transit Network in the study area. This included LRT service to the Canadian Tire Centre and then BRT with grade-separated crossings to Robertson Road and then LRT with at-grade crossings further south to Fernbank Road. The Ultimate Transit Network was amended following the *Kanata Light Rail Transit (LRT) Planning and Environmental Assessment Study (2017)*.

Figure 16 shows the amended Ultimate Transit Network. This included LRT service to the intersection of Hazeldean Road and the new N/S Arterial with a park and ride lot located at said intersection. LRT to Hazeldean Road is part of LRT Stage 3 and at this time is anticipated to occur until sometime after 2031, following completion of LRT Stage 2 in 2025.

City staff indicated that BRT, and LRT projects will **not** be completed by the 2024 or 2029 horizon years and therefore they will **not** be included in the analysis. The resulting analysis will be conservative since it assumes a constrained transportation scenario with higher vehicle mode shares.

The transit service will be greatly improved for the proposed development with the Ultimate transit network. With improved transit, the auto mode share will likely be reduced.

Figure 14: 2031 Affordable Transit Network

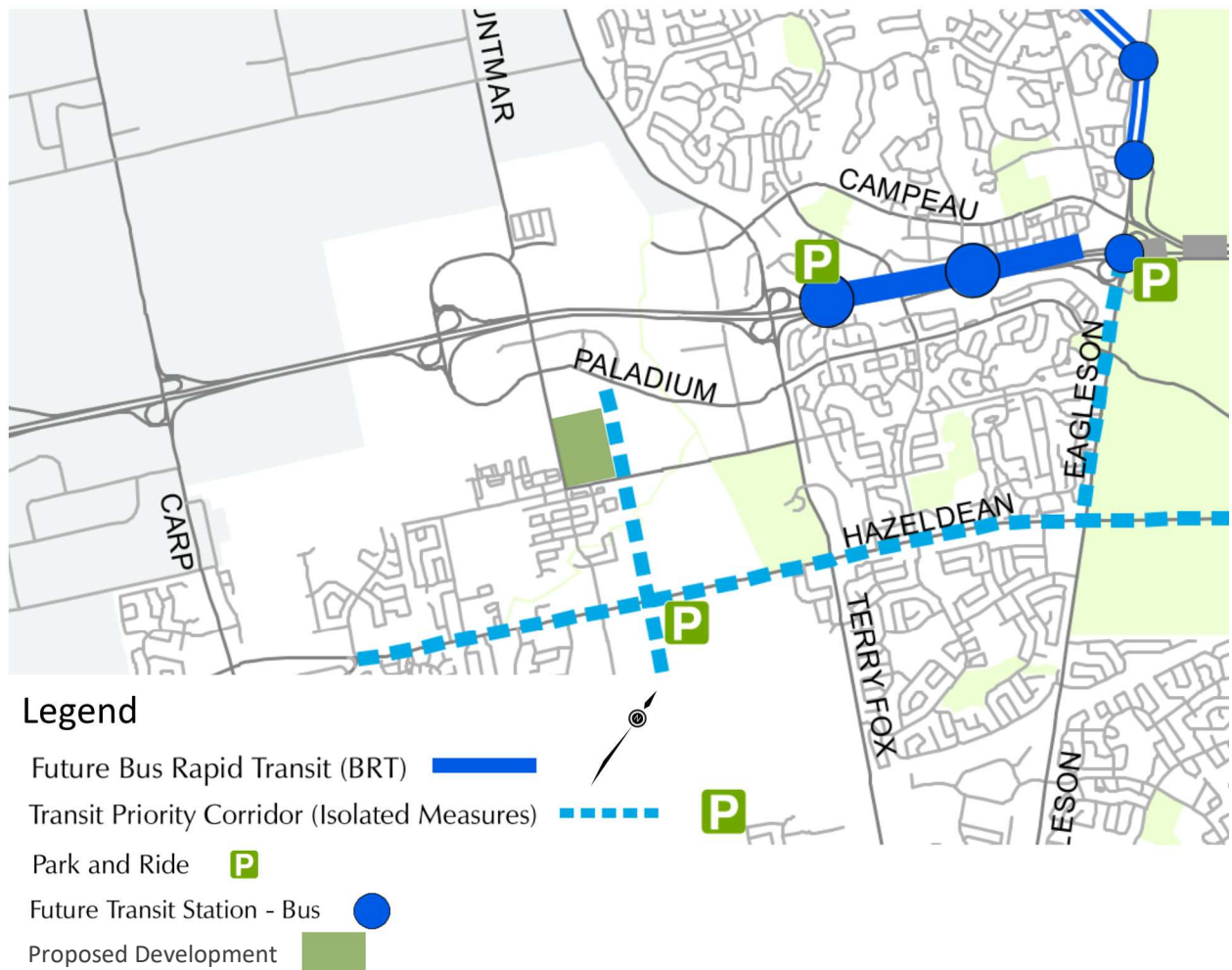

Image source: City of Ottawa 2013 TMP, 2031 Affordable Transit Network, accessed November 28, 2019

Figure 15: Ultimate Transit Network (2013 TMP)

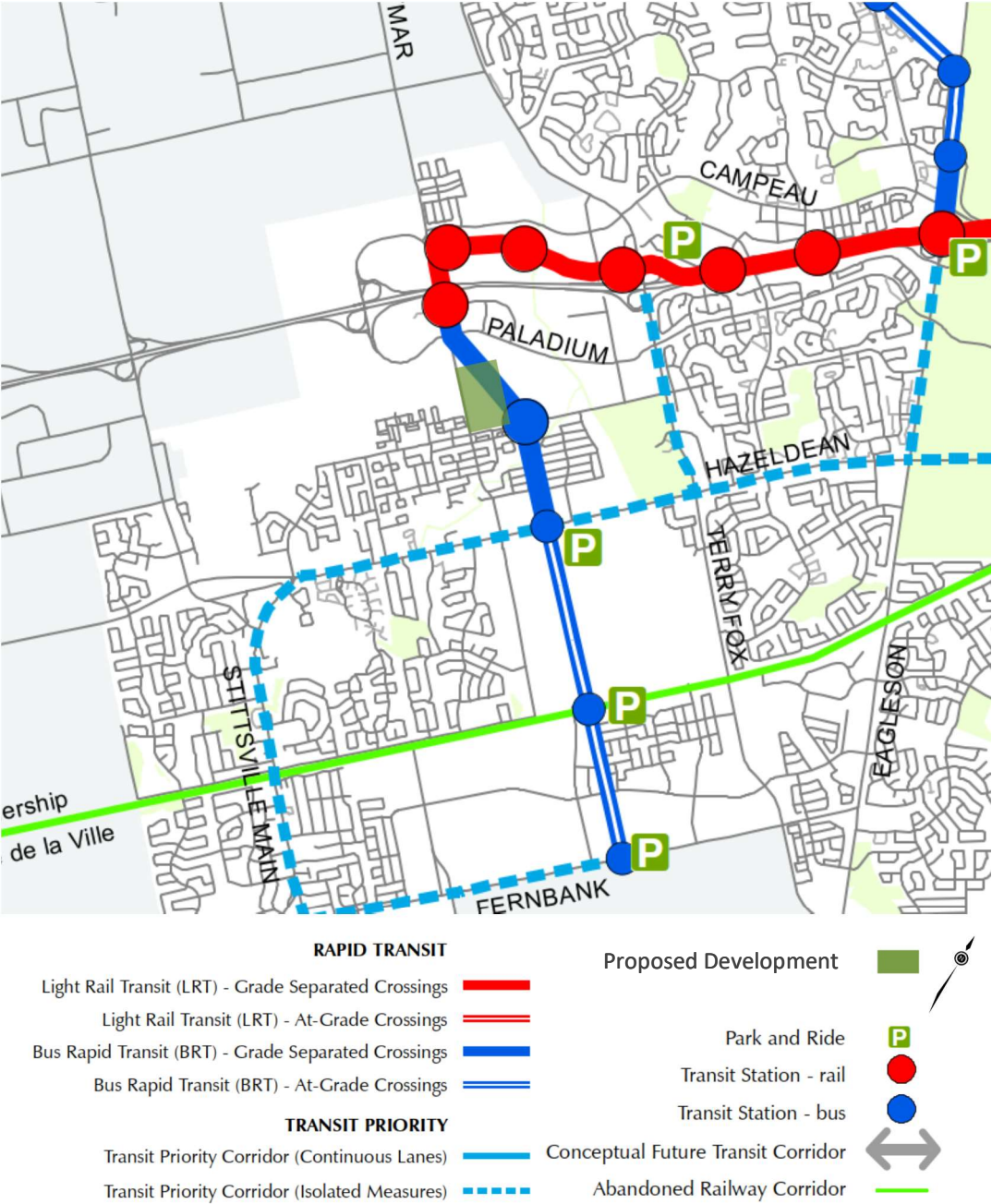

Image source: City of Ottawa 2013 TMP, Ultimate Network, accessed January 16, 2020

Figure 16: Ultimate Transit Network (2017 Kanata LRT EA)

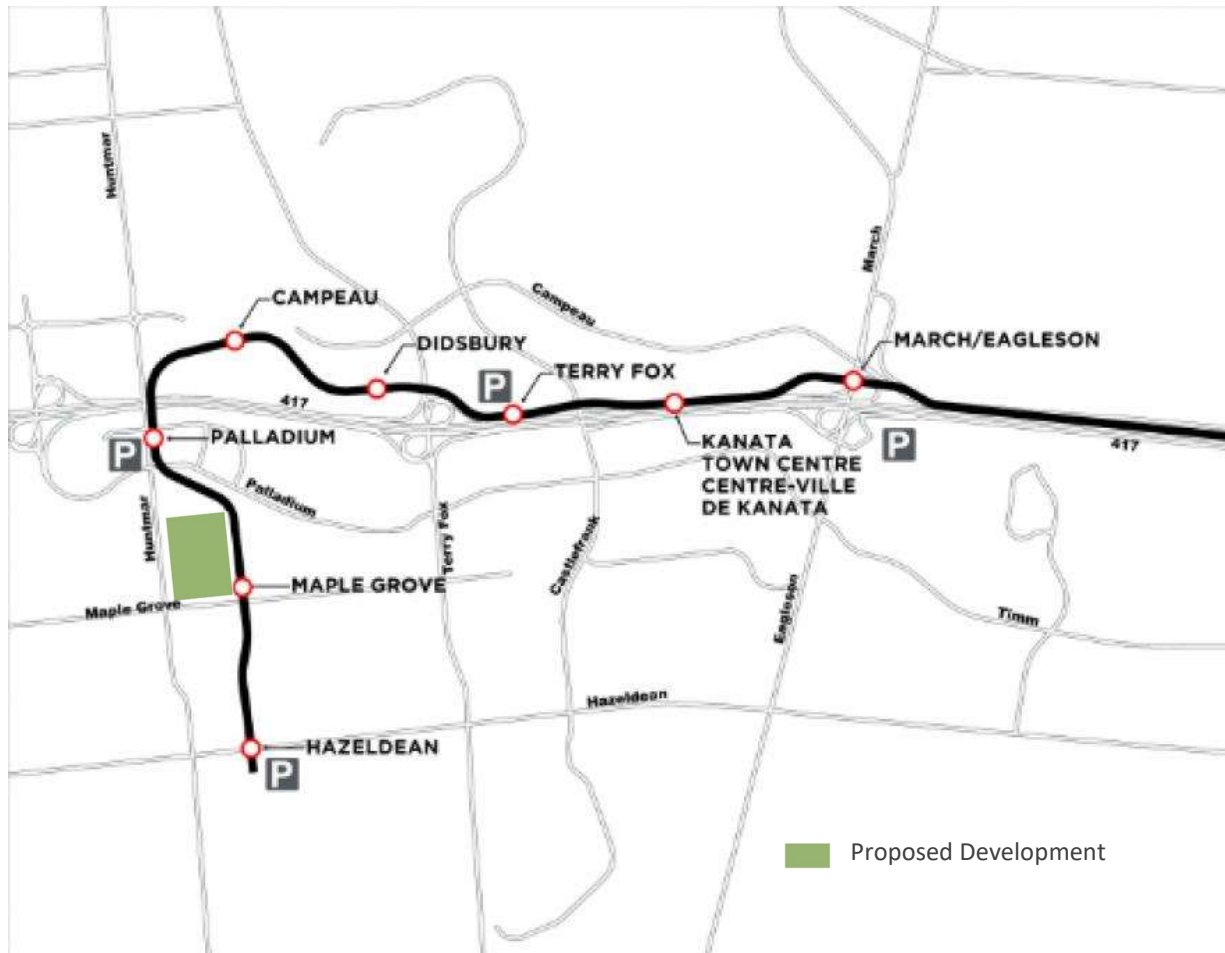

Image source: City of Ottawa Kanata Light Rail Transit Planning and Environmental Assessment Study website, accessed January 16, 2020

2.1.3.4

Future Background Developments

The City of Ottawa's development applications search tool was used to identify other developments within the study area that could impact study area intersections.

Table 5 contains further detail regarding these developments. The application type is mostly Plan of Subdivision and Site Plan Control. Additional developments are also underway along Palladium Drive to the West of Huntmar Drive. **Figure 17** illustrates the surrounding developments. It is noted that trips from the development located at 173 Huntmar Drive were not included since the build-out year was deemed to be beyond the scope of this TIA.

Table 5: Background Development Information

Development Number	Application Type	Land Use	Address	Size
D07-16-14-0016	Plan of Subdivision	Mixed-use Development	173 Huntmar Drive	206 residential units 65 000 ft ² of office / retail
D07-16-16-0011	Plan of Subdivision	Mixed-use Development	195 Huntmar Drive	691 residential units, a commercial block, and 5.98 ha district park
D07-16-18-0010	Plan of Subdivision	Residential Subdivision	1981 Maple Grove Road	196 residential units
D07-12-19-0168	Site Plan Control	Community Retail Development	5707 Hazeldean Road	47 710 ft ² GFA retail
D07-12-16-0032	Site Plan Control	Commercial Retail Development	5649/5705 Hazeldean Road	15 750 ft ² GFA retail
D07-12-19-0045	Site Plan Control	Mixed-use Development	800 Palladium Drive	11 000 ft ² GFA commercial 7 400 ft ² GFA office 5 000 ft ² GFA restaurant
D07-12-14-0147	Site Plan Control	Silver Seven Corporate Centre	777/737 Seven Silver Road	130 000 ft ² GFA commercial

Figure 17: Background Developments

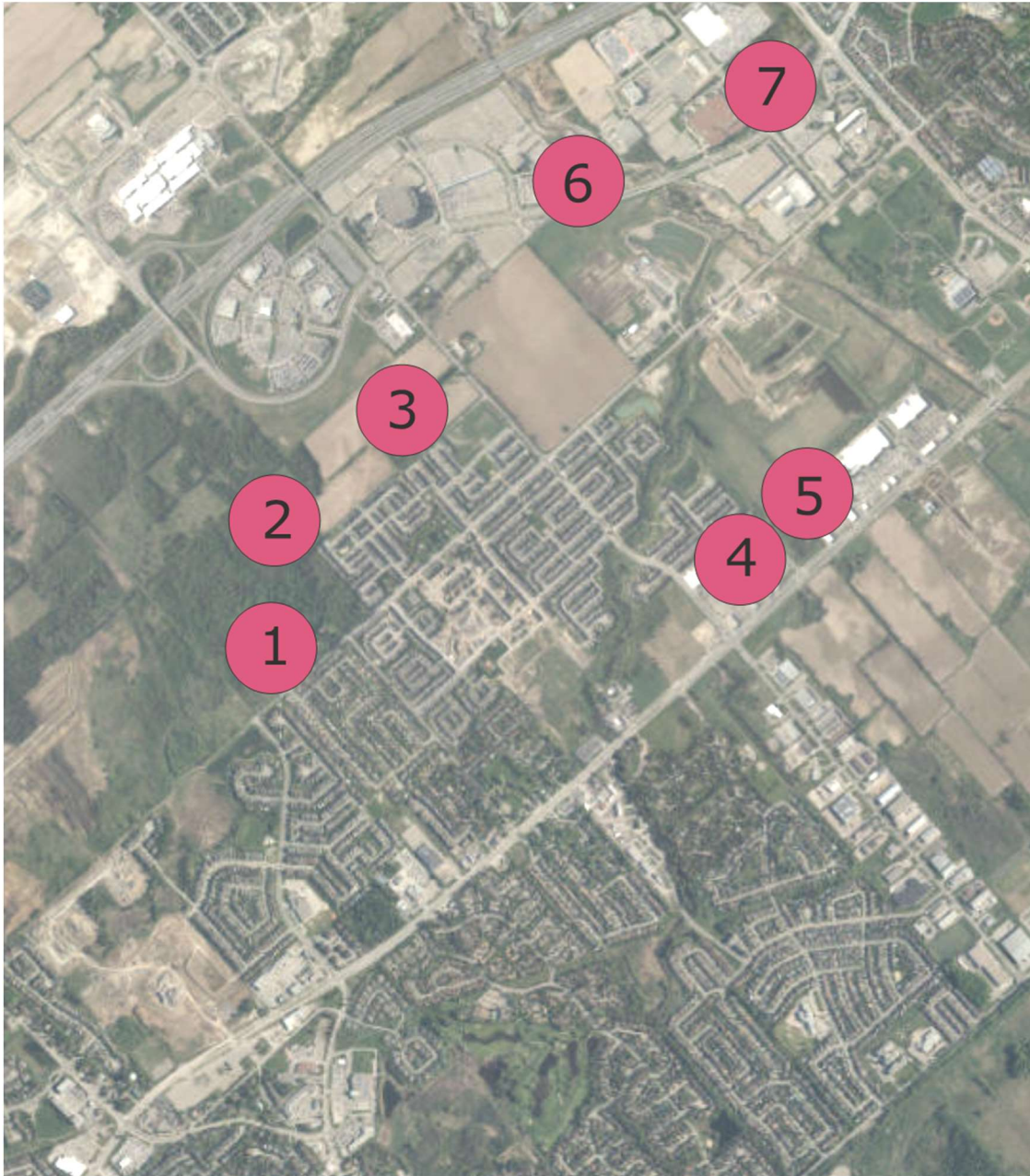

Legend

Development Area ●

- 1: D07-16-18-0010 - 1981 Maple Grove Road - Residential Subdivision
- 2: D07-16-14-0016 - 173 Huntmar Drive - Mixed Use Development
- 3: D07-16-16-0011 - 195 Huntmar Drive - Mixed Use Development
- 4: D07-12-19-0168 - 5707 Hazeldean Road - Community Retail Development
- 5: D07-12-16-0032 - 5649/5705 Hazeldean Road - Residential and Commercial
- 6: D07-12-19-0045 - 800 Palladium Drive - Mixed Use Development
- 7: D07-12-14-0147 - 777/737 Silver Seven Road - Silver Seven Corporate Centre

Background image source: *geoOttawa*, accessed December 4, 2019



2.2 Study Parameters

2.2.1 Study Area

Figure 18 illustrates the Boundary Road intersections that will be assessed as part of the transportation analysis:

- A1: Huntmar Drive and School Access
- A2: Huntmar Drive and Street 1
- A3: Huntmar Drive and Street 3
- A4: Maple Grove Road and Street 5
- A5: Maple Grove Road and Street 3
- A6: Maple Grove Road and Street 2

Figure 19 illustrates the Network intersections that will be assessed as part of the transportation analysis:

- N1: Huntmar Drive & Hazeldean Road
- N2: Huntmar Drive & Rosehill Avenue
- N3: Huntmar Drive & Maple Grove Road
- N4: Palladium Drive & Huntmar Drive
- N5: Palladium Drive & Terry Fox Drive
- N6: Terry Fox Drive & Maple Grove Road

Figure 18: Boundary Road Intersections

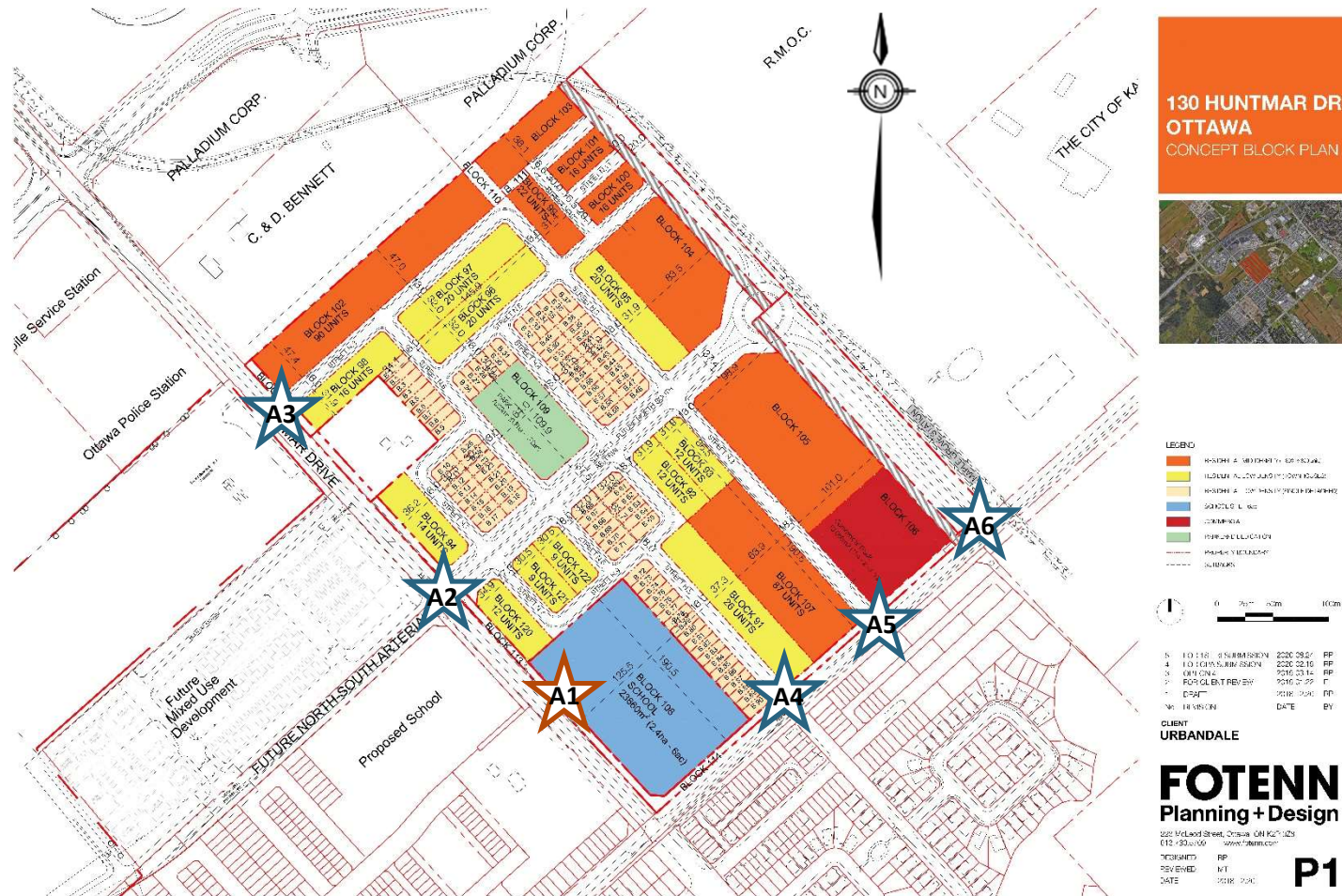

Proposed new full access intersections to be included in transportation assessment



Proposed new RIRO intersection to be included in transportation assessment

Figure 19: Network Intersections and Study Area

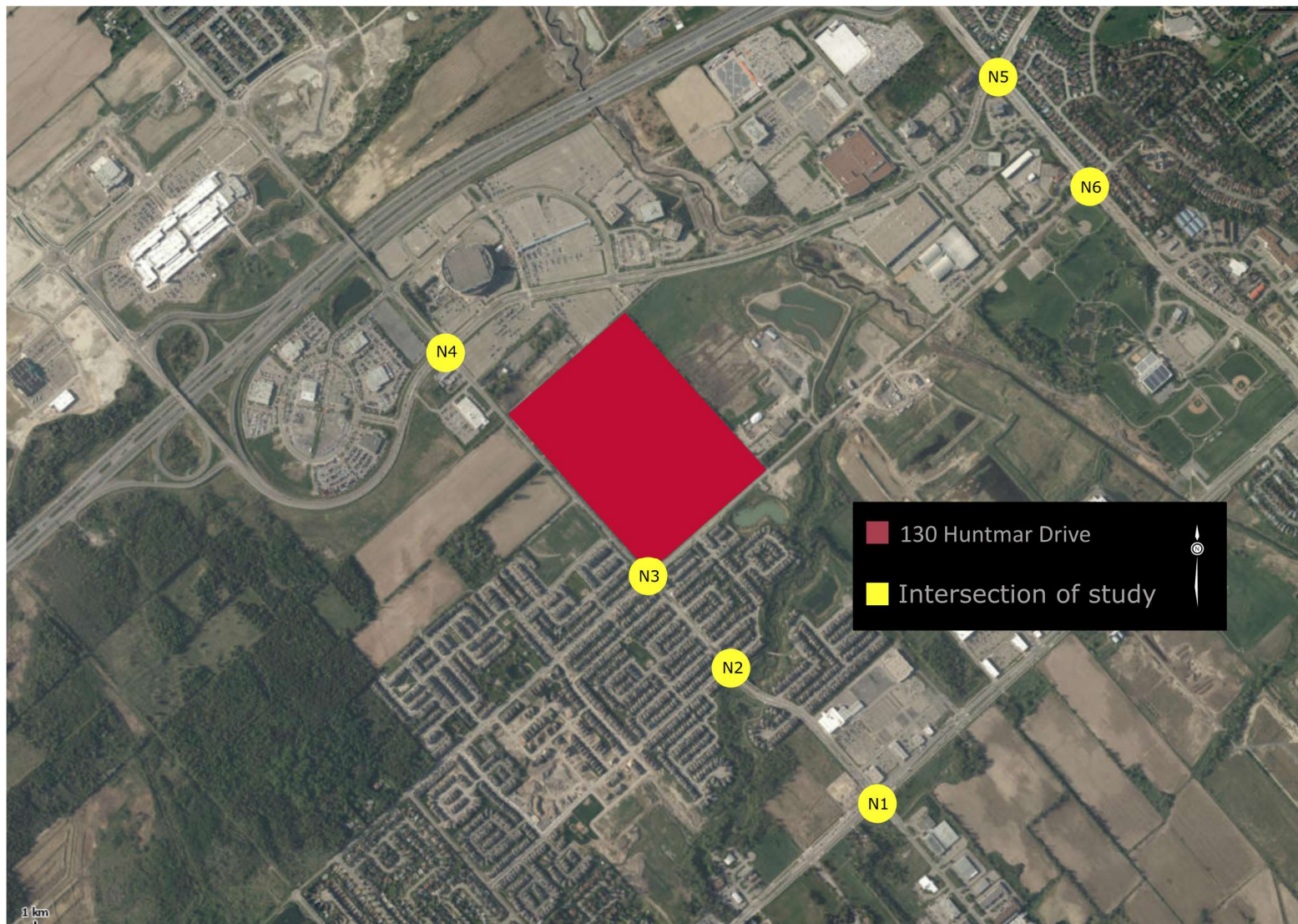

Background image source: geoOttawa, accessed October 25, 2019

2.2.2 Time Periods

The development is primarily residential and therefore the weekday AM and PM peak hours will govern the analysis.

2.2.3 Horizon Years

Construction will commence in 2022 and is planned to be completed in 2024. The analysis will assess transportation for the 2024 horizon year, and in 2029, five years after build-out.

2.3 Exemptions Review

Table 6 presents the exemptions review table from the City of Ottawa's 2017 *Transportation Impact Assessment Guidelines*. The exemptions were rationalized as follows:

1. the TIA is not being submitted for a site plan and therefore elements 4.1.2, 4.2.1, 4.2.2, and 4.5 are exempt; and,
2. the proposed development generates less than 200 person trips in excess of the equivalent volume permitted by established zoning.

Table 6: Exemptions Review

Module	Element	Exemption Consideration	Status
Design Review Component			
4.1 Development Design	4.1.2 Circulation and Access	Only required for site plans	Exempt
	4.1.3 New Street Networks	Only required for plans of subdivision	Included
4.2 Parking	4.2.1 Parking Supply	Only required for site plans	Exempt
	4.2.2 Spillover Parking	Only required for site plans where parking supply is 15% below unconstrained demand	Exempt
Network Impact Component			
4.5 Transportation Demand Management	All Elements	Not required for site plans expected to have fewer than 60 employees and/or students on location at any given time	Included
4.6 Neighbourhood Traffic Management	4.6.1 Adjacent Neighbourhoods	Only required when the development relies on Local or Collector streets for access <u>and</u> total volumes exceed ATM capacity thresholds	Exempt
4.8 Network Concept		Only required when proposed development generates more than 200 person trips during the peak hour in excess of the equivalent volume permitted by established zoning	Exempt
4.9 Intersection Design	All Elements	Not required if site generation trigger is not met	Included

3.0 Forecasting

3.1 Development-Generated Travel Demand

3.1.1 Trip Generation and Mode Shares

The proposed development includes residential, retail, recreation, and an elementary school. Several data sources were referenced to estimate the trip generation for the proposed development.

For residential and retail developments, the data sources are for vehicle trip generation. As per the TIA Guidelines, these vehicle trip rates were converted to person trip rates so that custom mode shares could be applied for the Kanata/Stittsville development context. The mode share for each land use was estimated using a combination of TRANS OD survey data, field observations, and professional judgement.

Residential Trips: The TRANS Trip Generation Study Report (2009) was used to estimate residential trip generation. The person trip rates were obtained by dividing the vehicle trip generation rates¹ by the auto vehicle mode share².

Retail Trips: The Institute of Transportation Engineers (ITE) Trip Generation Manual, 10th edition, was used to estimate the retail trip generation. ITE rates often correspond with data collected in the United States as far back as 1980; ITE rates typically represent a high auto driver mode share (assumed 90%). Average vehicle occupancy was assumed to be 1.15.

Recreation Trips: The planned park was not included in the trip generation calculation as it was assumed it will generate few trips during the peak hours and many of those trips would be local trips via walking or cycling and therefore there is minimal impact on the transportation network.

Elementary School Trips: The elementary school trip generation was estimated based on a trip generation study conducted in 2018 at the French catholic elementary school Bernard-Grandmaître, located in Riverside South. Bernard-Grandmaître has ~449 sq.m. of daycare, 765 students, 59 staff, and 11 school buses; this is more students, staff, and school buses than another French catholic elementary school in the area despite having a smaller footprint. The catchment areas of French catholic schools can be larger than English catholic or public schools, however, the vehicle trip generation is similar to the ITE rates (for the lower end of the spectrum). Overall, the trip generation for Bernard-Grandmaître is a reasonable proxy for estimating trip generation for the proposed school in Stittsville.

¹ TRANS Trip Generation Study Report (2009) Table 6.3

² TRANS Trip Generation Study Report (2009) Table 3.13

Table 7 and **Table 8** trip generation rates and total trips generated by the residential and retail land uses. **Table 9** summarizes the forecasted elementary school trip generation which is the same as the observed trip generation at Bernard-Grandmaître.

Table 7: Person Trip Generation Rates – Residential and Commercial

Land Use Code / Land Use	Source	Auto Trip Gen Rate				Auto Mode Share		Avg. Vehicle Occupancy	Units	Person Trip Generation Rate	
		AM		PM		AM	PM			AM	PM
		Rate	In %	Rate	In %						
210: Single-detached homes	TRANS	0.7	29%	0.9	62%	55%	64%	1.00	Dwellings	1.27	1.41
224: Semi-detached, townhomes	TRANS	0.54	37%	0.71	53%	52%	62%	1.00	Dwellings	1.04	1.15
223: Mid-rise apartment 3-10 floors	TRANS	0.29	24%	0.37	62%	44%	44%	1.00	Dwellings	0.66	0.84
816: Hardware/Paint Store	ITE	1.08	54%	2.68	47%	90%	90%	1.15	1000 sq. ft. GFA	1.38	3.42
851: Convenience Market	ITE	62.5	50%	49.1	51%	90%	90%	1.15	1000 sq. ft. GFA	79.91	62.75
890: Furniture Store	ITE	0.26	71%	0.52	47%	90%	90%	1.15	1000 sq. ft. GFA	0.33	0.66
912: Drive-In Bank	ITE	9.5	58%	20.5	50%	90%	90%	1.15	1000 sq. ft. GFA	28.80	33.73
933: Fast-Food Restaurant w/o Drive-Thru	ITE	25.1	60%	28.3	50%	90%	90%	1.15	1000 sq. ft. GFA	32.07	36.21
936: Coffee/Donut Shop w/o Drive-Thru	ITE	101.1	51%	36.3	50%	90%	90%	1.15	1000 sq. ft. GFA	129.23	46.40

Table 8: Person Trips – Residential and Commercial

Land Use	Size	AM Peak Hour			PM Peak Hour		
		Total	In	Out	Total	In	Out
210: Single-detached homes	90 D.U.	115	33	82	127	79	48
224: Semi-detached, townhomes	226 D.U.	235	87	148	259	137	122
223: Mid-rise apartment 3-10 floors	426 D.U.	281	67	214	358	222	136
816: Hardware/Paint Store	2.9 k sq.ft.	4	2	2	10	5	5
851: Convenience Market	1.4 k sq.ft.	111	56	55	87	44	43
890: Furniture Store	1.7 k sq.ft.	1	1	0	1	0	1
912: Drive-In Bank	1.0 k sq.ft.	29	15	14	34	17	17
933: Fast-Food Restaurant w/o drive-thru	1.2 k sq.ft.	37	22	15	42	21	21
936: Coffee/Donut Shop w/o drive-thru	1.0 k sq.ft.	126	64	62	45	23	22
Total		821	317	504	816	459	357

Table 9: Elementary School Trip Generation

Location	Weekday AM Peak Hour of Roadway			Weekday PM Peak Hour of Roadway ³		
	Total	In	Out	Total	In	Out
Staff parking lot vehicles	25	25	0	5	0	5
Student drop-offs / pick-up vehicles	94	47	47	0	0	0
Daycare drop-off / pick-up vehicles	74	37	37	30	15	15
School buses	22	11	11	0	0	0
Cycling (10% of students)	77	77	0	0	0	0
Walking (10% of students)	77	77	0	0	0	0
Total vehicle trips	193	109	84	35	15	20
Pass-by trips (student and daycare drop off)	94 + 74 / 193 = 87%			30 / 35 = 86%		
New trips (staff)	13%			14%		

For the retail and commercial land uses, the mode shares for the proposed development were determined using the TRANS O-D survey for the Kanata/Stittsville district:

- For residential mode shares, a blend of the 'from' and 'within' the district was used for the AM peak hour, and 'to' and 'within' the district was used for the PM peak hour.
- For retail mode shares, a blend of the 'to' and 'within' district was used for the AM peak hour and 'from' and 'within' the district was used for the PM peak hour.

³ The Weekday PM pk hr was not observed at the French catholic elementary school Bernard-Grandmaître. The total vehicle trips were assumed to be 1/7th the AM pk hr trip generation. This assumption was based on the difference between the AM and PM pk hr average vehicle trip generation rates for an elementary school (LUC 520), ITE Trip Generation Manual, 10th edition.

Table 10 summarizes the trip generation by mode for the proposed residential and retail land uses. This ‘other’ category includes walking, cycling, school bus, paratransit, motorcycle / scooter, taxi, ferry, VIA rail, intercity chartered bus, and airplane.

Table 10: Trip Generation by Mode – Retail and Residential

Land Use	Travel Mode	Mode Share		AM Peak Hour			PM Peak Hour		
		AM	PM	Total	In	Out	Total	In	Out
Residential	Auto Driver	52%	59%	328	97	231	439	258	181
	Auto Pass.	13%	19%	82	24	58	141	83	58
	Transit	14%	12%	88	26	62	86	50	35
	Other	21%	11%	133	39	93	78	46	32
	Total	100%	100%	631	187	444	744	438	306
Retail	Auto Driver	60%	65%	183	95	88	142	72	71
	Auto Pass.	12%	20%	37	19	18	44	22	22
	Transit	6%	5%	18	10	9	10	5	5
	Other	23%	11%	69	36	33	23	12	11
	Total	100%	100%	308	160	148	219	110	109

There are a total of 71 outbound and 55 inbound transit trips forecast for the AM and PM peak hours respectively. (Peak Direction)

3.1.1.1

Internal Capture

This analysis includes the assignment and evaluation of internal roadways for the proposed development and therefore it is not appropriate to apply the principle of internal capture reduction for trips **between** residential, retail, and school land uses. Instead, trips between these land uses will be assigned explicitly.

The retail is concentrated in one area and therefore the principle of internal capture can be applied for retail-retail trips; it may reduce the impact of the proposed development on the study area road network, since some trips may visit multiple retail properties.

The magnitude of internal capture depends on the land uses and the likelihood of users to visit multiple properties. For this proposed development, the major retail trip generators were assumed to be a convenience market, fast-food restaurant (without drive through), and coffee/donut shop (without drive through). These are relatively similar land uses and therefore the internal capture rate is anticipated to be low (assumed to be 5%).

Table 11 summarizes the trip generation by mode after internal capture reductions.

Table 11: Trip Generation by Mode After Internal Capture

Land Use	Travel Mode	Internal Capture Rate		AM Peak Hour			PM Peak Hour		
		AM	PM	Total	In	Out	Total	In	Out
Retail	Auto Driver	5%	5%	174	90	84	135	68	67
	Auto Pass.	5%	5%	35	18	17	42	21	21
	Transit	5%	5%	18	9	8	9	5	5
	Other	5%	5%	66	34	32	22	11	11
	Total	5%	5%	293	152	141	208	105	104

3.1.1.2

Pass-By and Diverted Traffic

Fast-food restaurants, convenience markets, and elementary schools are rarely the primary trip purpose; they are usually the mid-point of a trip, called a 'pass-by' or 'diverted' trip.

Table 12 summarizes the breakdown of new trips, pass-by trips, and diverted trips. The assumed rates are based professional judgement, since there is limited ITE data for these land uses or the ITE data was collected in the United States in 1987. Retail pass-by rates were calculated based on blended rates from individual land uses, provided in the ITE Trip Generation Handbook, 3rd Edition.

Overall it is anticipated that there will be 695 vehicle trips generated during the AM peak hour and 609 vehicle trips generated during the PM peak hour. Of these vehicle trips, there will be 435 new vehicle trips during the AM peak hour and 507 new vehicle trips during the PM peak hour. These values can be seen in **Table 12**. The remainder of the vehicle trips are anticipated to be pass-by or diverted trips.

Table 12: Pass-By and Diverted Traffic (Auto Driver Trips)

Land Use	Trip Type	Percent		Auto Driver Trips					
		AM	PM	AM			PM		
				Total	In	Out	Total	In	Out
School	Total trips	100%		193	109	84	35	15	20
	New staff trips	from Table 9		25	25	0	5	0	5
	Drop-off / Pick-up	remainder		168	84	84	30	15	15
	<i>from new residential</i>		33%	56	28	28	10	5	5
	<i>from existing residential</i>		67%	112	56	56	20	10	10
Retail	Total trips	100%		174	90	84	135	68	67
	Pass-by trips	56%	54%	92	46	46	72	36	36
	New trips	10%		82	44	38	63	32	31
Residential (new trips)	Total trips	100%		328	97	231	439	258	181
	Home-School-Work Trips	33% of drop-off/pick-up		56	28	28	10	5	5
	Home-Work Trips	Remainder		272	69	203	429	253	176
Total	Pass-by / diverted trips			260	130	130	102	51	51
	New trips			435	167	269	507	290	217
	Total			695	297	399	609	341	268

3.1.2 Trip Distribution

The trip distribution for new residential trips, pass-by school trips, and pass-by retail trips was specified separately than new retail trips and new school trips, since the former are likely home-work based and the latter are likely local only and therefore the distributions are different.

The TRANS O-D Survey indicated that 69% of all AM peak hour trips originating in the Kanata / Stittsville district are trips to work. Using this information it was determined that the majority of the origins (during PM peak period) and destinations (during AM peak period) are office and industry sectors located north and east of the study area. Traffic was assigned using three main points of destination to and from the area:

1. Ottawa Center (Destination for large majority of residents during peak hours);
2. Kanata North (Destination for residents during peak hours due to density of office spaces); and,
3. Nearby retail/schools (Destination within the district for smaller portion of residents during peak hours).

Table 13 summarizes the trip distribution used for this analysis.

Table 13: Trip Distribution

Cardinal Direction	New Residential New School (staff) Pass-by School Pass-by Retail	New Retail Trips New School (Home-School-Home drop-offs)
North	12%	25%
East	50%	25%
South	30%	25%
West	8%	25%
Total	100%	100%

3.1.3 Trip Assignment

Figure 20 illustrates the trip assignment to the study area road network. The trip assignment for new retail trips and new school trips was a simple assignment to the local road network surrounding the proposed development.

Figure 20: Trip Assignment

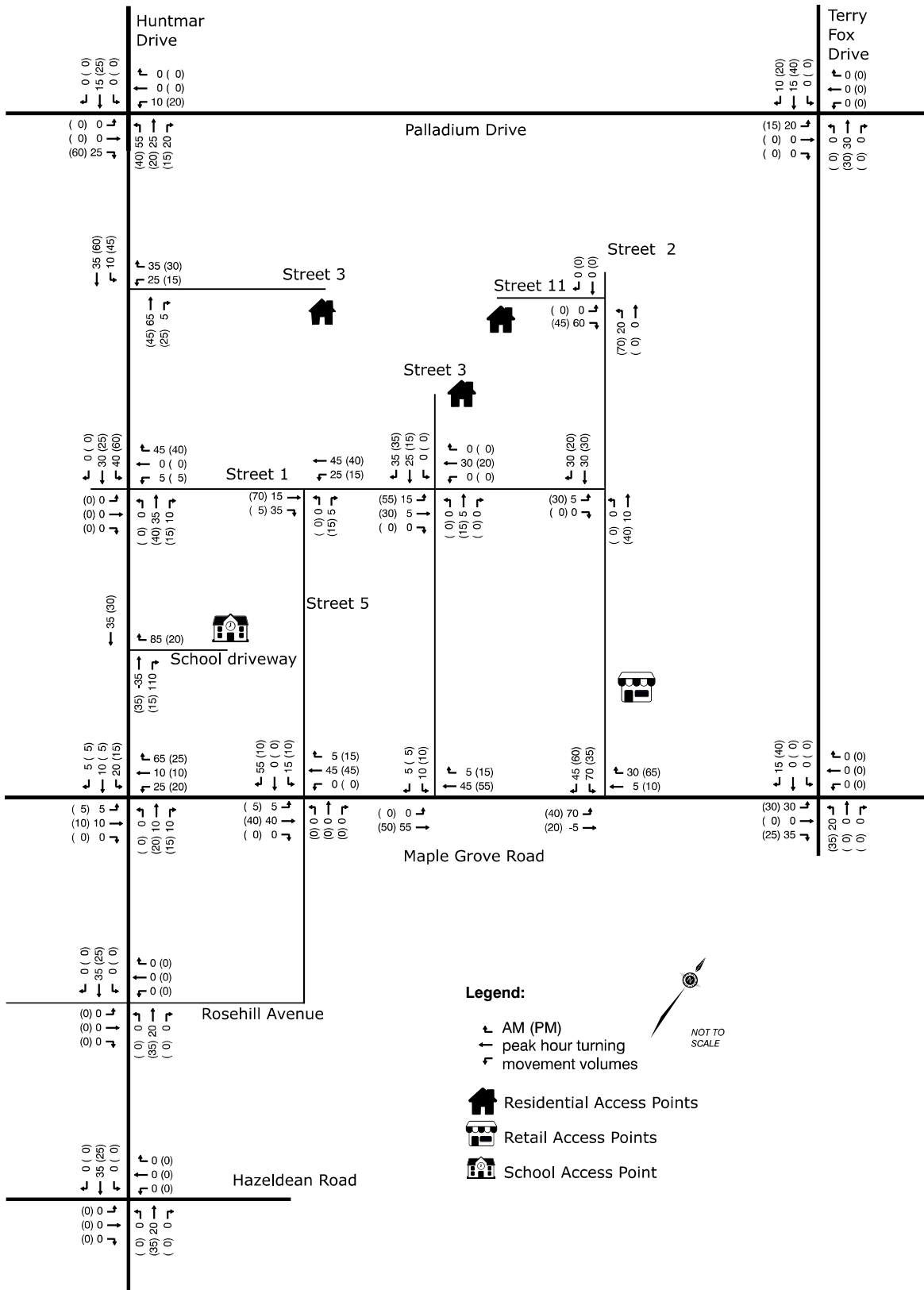

3.2 Background Network Travel Demand

3.2.1 Transportation Network Plans

There are several road network projects identified in the Transportation Master Plan, however, City staff indicated that these projects are unlikely to be completed prior to 2031 and therefore the impact of these road network projects has not been included in this analysis.

The Affordable and Ultimate networks will have additional road and transit capacity. The transit service will also be greatly improved, particularly for the proposed development for the Ultimate transit network. With improved transit, the auto mode share will likely be reduced and the new Arterial roadways will provide additional capacity for the remaining auto vehicles. In other words, issues identified as part of this analysis may be short-term and remedied by already-planned improvements.

3.2.2 Background Growth

Table 14 summarizes the predicted growth rate for the Kanata / Stittsville district based on data from the TRANS O-D Surveys. The 2019 traffic counts were grown at a rate of 2.43% annually, non-compounding, to represent 2024 and 2029 background traffic volumes.

Table 14: TRANS O-D Survey Annual Growth Prediction for Kanata / Stittsville

Measurement	2011 Actual	2031 Predicted	Annual Growth
Population	105,215	156,396	2.43%
Auto trips	157,040	233,431	2.43%

A review of historic intersection volumes (3%) confirms that this level of growth is appropriate for reflecting background growth.

3.2.3 Other Developments

There are seven planned developments near the proposed development which will impact study area intersections. Details for each planned development were listed on the City of Ottawa's development applications tool and were outlined in **Section 2.1.3.4**.

These development volumes have been included as part of the background traffic analysis and applied to the future road networks separately.

Figure 21 and **Figure 22** illustrate the forecasted 2024 and 2029 background traffic volumes, respectively.

Figure 21: Background Traffic Volumes - 2024

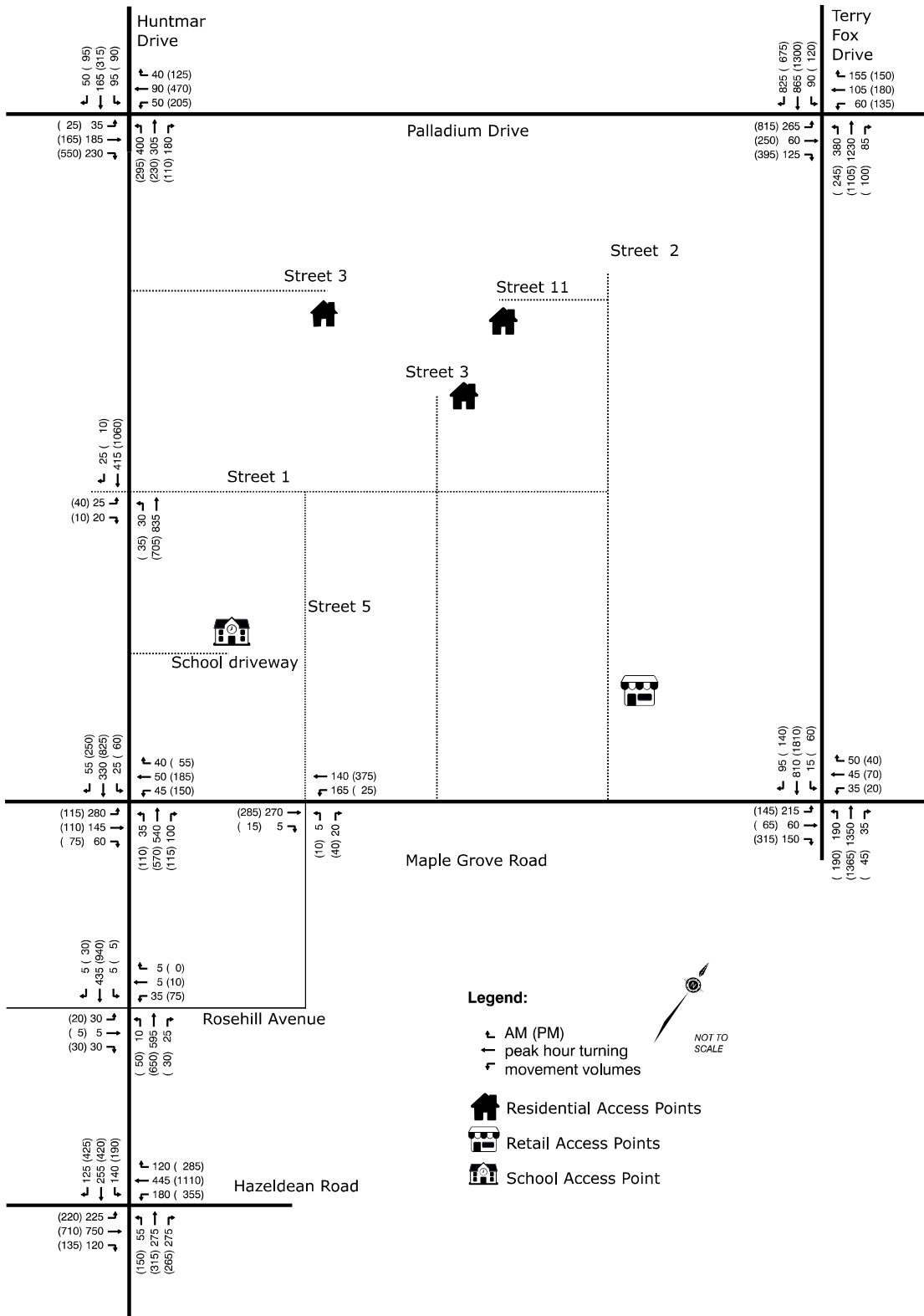
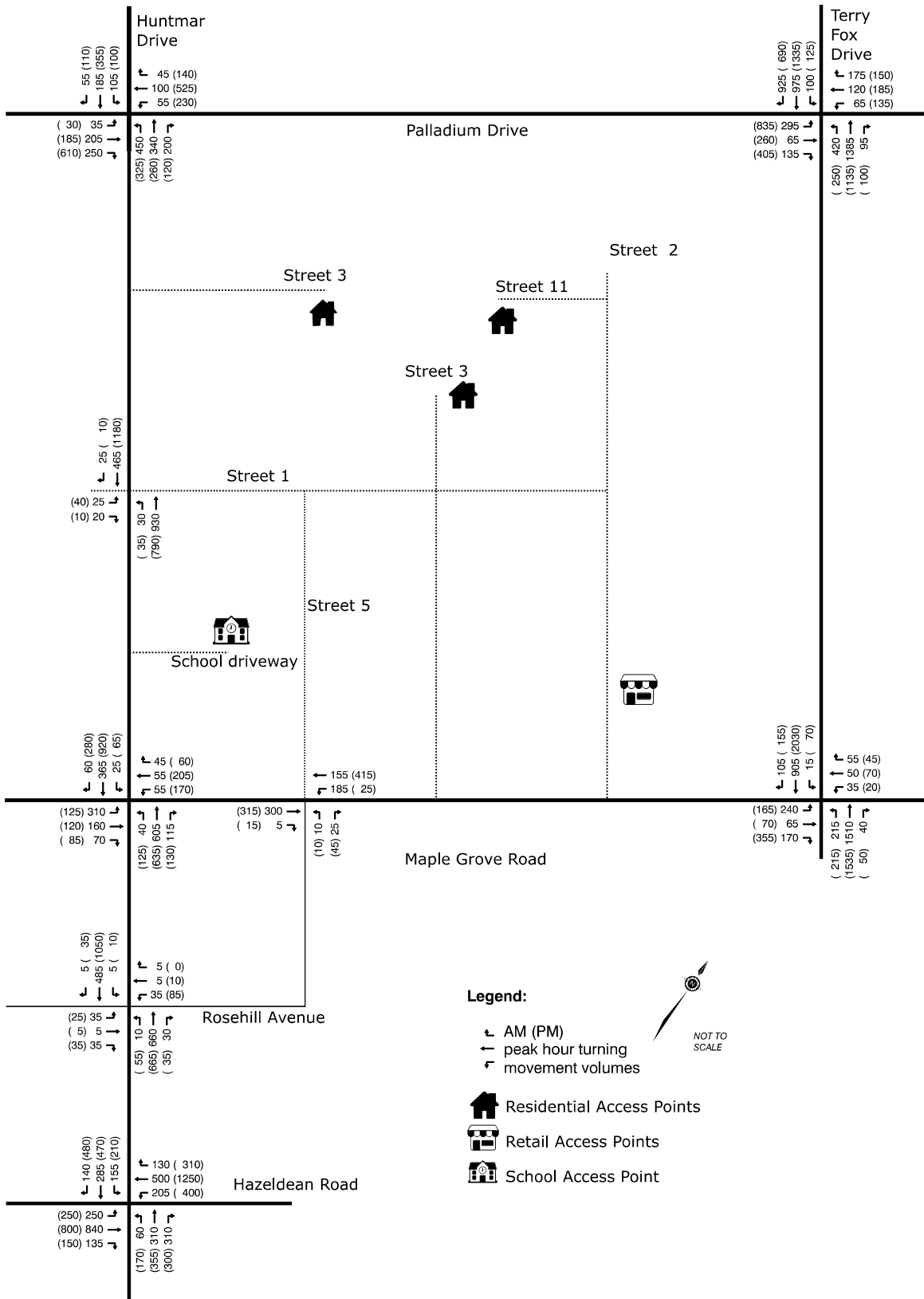

Figure 22: Background Traffic Volumes – 2029



3.3 Demand Rationalization

The proposed development is expected to generate additional vehicle trips that are to be accommodated by the roadway network. The analysis is based on application of transit mode shares representative of typical suburban areas. Future rapid transit would encourage increased shares of transit usage and would minimize the proposed vehicle network impacts. Without a full commitment that the widening of Huntmar Drive and/or construction of the new North-South Arterial would be complete by the 2029 planning horizon, the analysis is based on accommodating the forecast vehicle volumes via the existing road network with intersection improvements at the intersection of Maple Grove Road and Huntmar Drive. The analysis is therefore a conservative estimate of potential vehicle impacts. Future extension of the North-South Arterial will increase vehicle capacity and improve connectivity, but that is beyond the timeframe of this TIA.

3.3.1 Peak Period Ratio Analysis

Table 15 illustrates the distribution of vehicles across the peak period. A peak period ratio of 1.0 would indicate that peak hour volumes are maintained across the entire peak period. The table shows that with peak period ratios of between 0.81 and 0.91 in the AM and between 0.89 and 0.95 in the PM, there is the ability to accommodate further spreading of peak vehicles. This will likely be achieved in advance of widening Huntmar Drive or construction of the North-South Arterial.

Table 15: Peak Period Ratios

Intersection	Peak Period Volume* AM (PM)	Peak Hour Volume* AM (PM)	Peak Period Ratio
1. Huntmar & Hazeldean	444 (767)	542 (830)	0.82 (0.92)
2. Huntmar & Rosehill	161 (270)	186 (298)	0.86 (0.91)
3. Huntmar & Maple Grove	249 (374)	274 (416)	0.91 (0.9)
4. Huntmar & Palladium	260 (405)	315 (457)	0.83 (0.89)
5. Terry Fox & Palladium	589 (963)	728 (1012)	0.81 (0.95)
6. Terry Fox & Maple Grove	437 (649)	504 (704)	0.87 (0.92)

*Based of average of all movements

3.3.2 2024 and 2029 Vehicle Volumes

Figure 23 and **Figure 24** show the 2024 and 2029 AM and PM peak hour traffic volumes used in the analysis.

Figure 23: Total Traffic Volumes - 2024

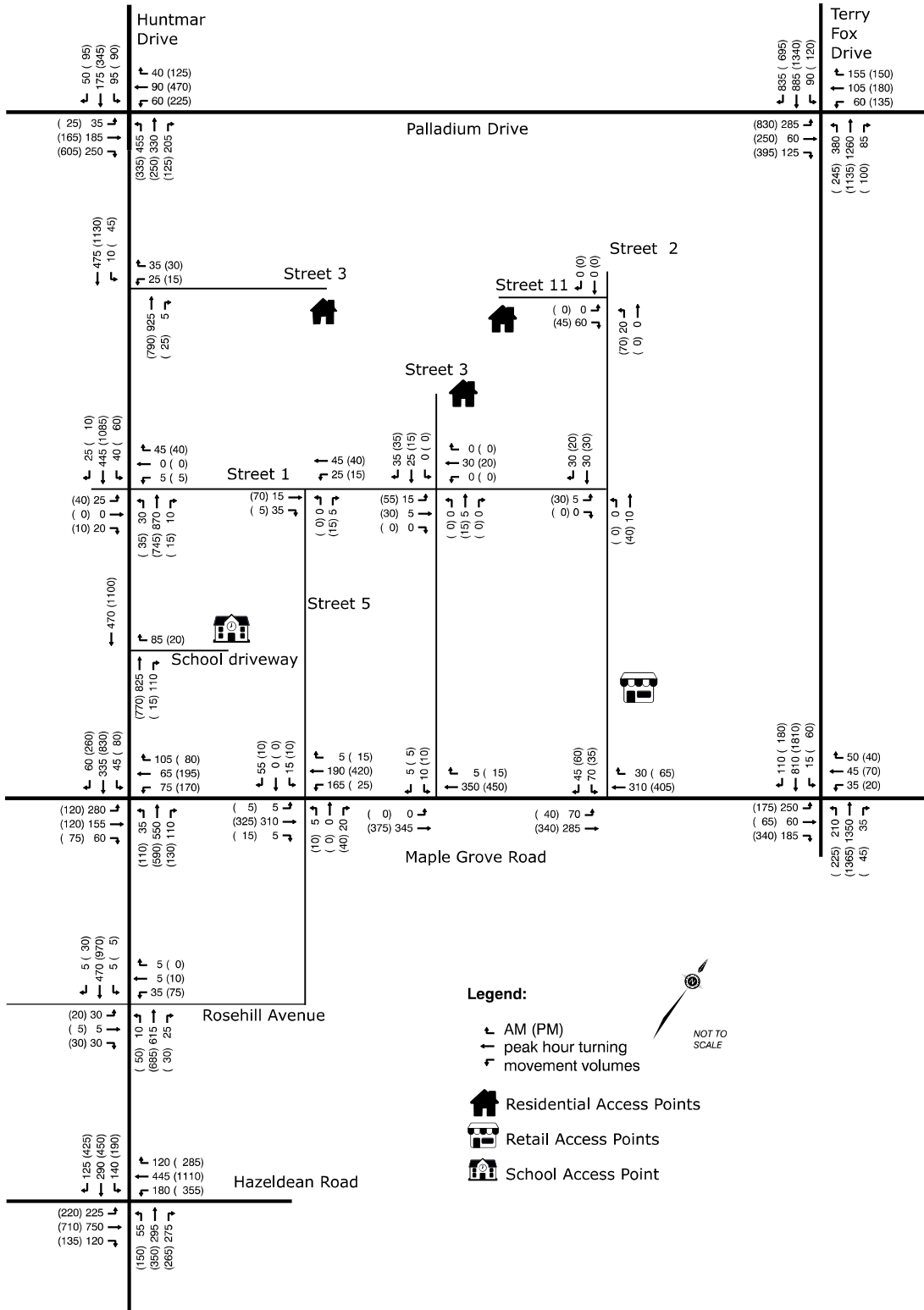
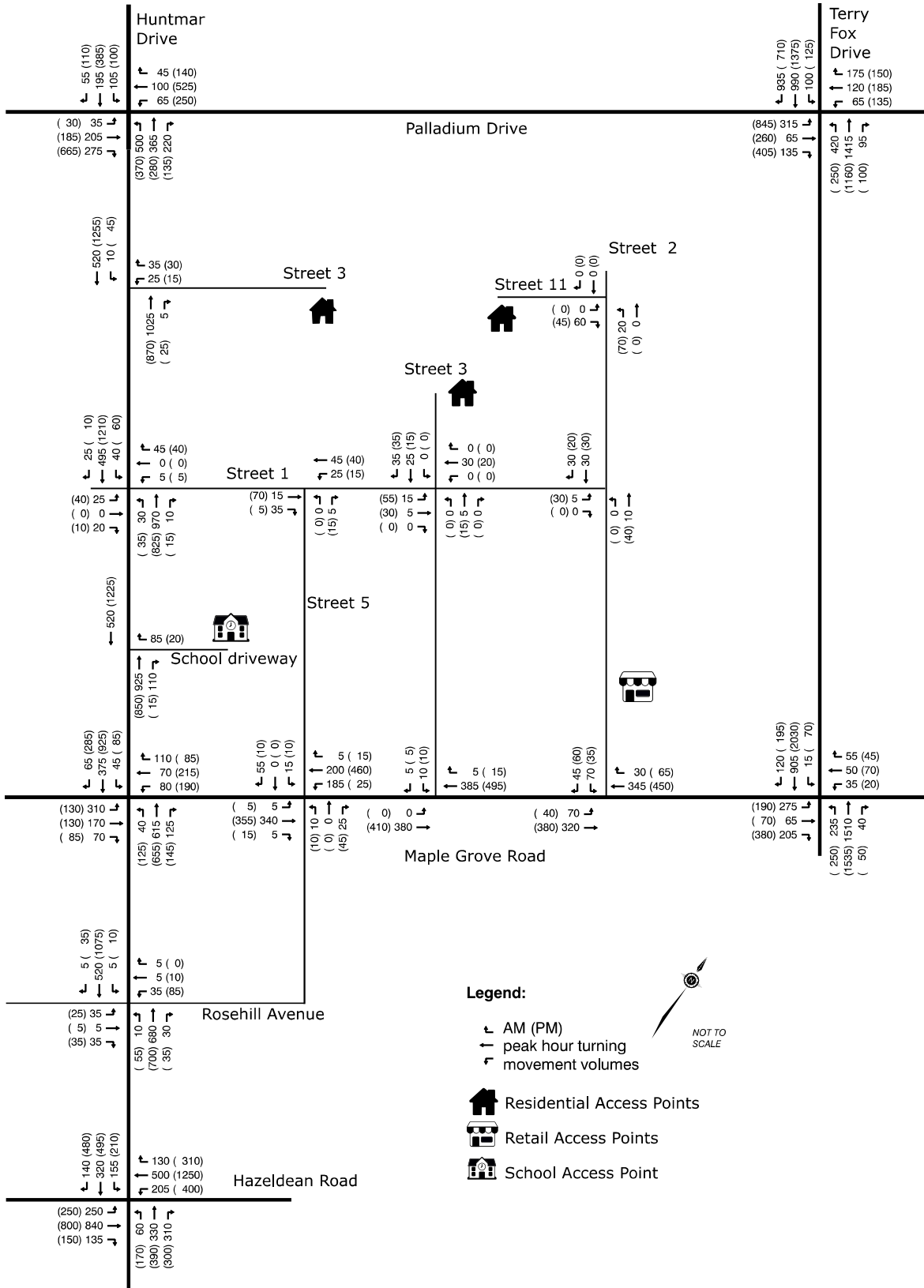

Figure 24: Total Traffic Volumes - 2029



4.0

Analysis

The transportation analysis that was undertaken was based on both Multi-Modal level of service as per the City of Ottawa MMLOS Guidelines, as well as Operational level of service (LOS) analysis using Trafficware's Synchro software version 10.0. This software package, which uses the methodologies of the Highway Capacity Manual (HCM), produces results in terms of level-of-service (LOS), volume to capacity ratio (V/C), vehicle delay, 50th percentile queues, and 95th percentile queues.

The volume-to-capacity ratio (V/C) is a measure of the utilization of the capacity of the intersection using the intersection's critical movements and approaches. **Appendix A** contains the Synchro performance worksheets.

4.1 Development Design

4.1.1 Design for Sustainable Modes

The community will be designed to match neighbourhood roadway designs. Facilities of the surrounding area and the local streets of the proposed development can be found in **Table 16**.

Internally within the development area, no signalized intersections are currently planned. Street 1 will be uncontrolled between Street 2 and Huntmar Drive, with side streets (Streets 3, 4, 6, and 7) being stop controlled. To facilitate pedestrian crossing of Street 1 between Street 2 and Huntmar Drive, a Pedestrian Crossing (PXO) could be provided

An internal connection is proposed to the elementary school, to increase internal walkability / cycling ability to/from the school. ROW is protected for future connections to the North.

On-street parking will be limited to collector and local roadways.

4.1.1.1 Pedestrian Connectivity

Pedestrians should be provided with a high degree of priority within 600m of a future rapid transit station and therefore a sidewalk should be provided without the need for people to share the road with motorized vehicles. Internal streets will have sidewalks on one side of the street, but the N/S Arterial (Street 1 and 2) will have sidewalks on both sides. Street 6 is a major desire line between the school and the park and as such a PXO should be included at the intersection of Street 1 and Street 6.

The extension of the N/S Arterial will require that the intersections of Street 1 at Huntmar Drive and Street 2 at Maple Grove Road be signalized in advance of their connection to the N/S arterial (signalization required for 2029). It is not required that the intersections be signalized for 2024. This will accommodate increasing traffic volumes and improve pedestrian connectivity.

4.1.1.2

Cycling Connectivity

A new MUP will be provided along Huntmar Drive in advance of planned Huntmar Drive widening. It is unknown at this time what cycling infrastructure will be included in a widened Huntmar Drive in addition to the planned MUP. (The Environmental Assessment for the widening of Huntmar Drive is currently being initiated by the City).

Maple Grove is designated as a “Local Route” in the ultimate cycling network. It is important to maintain continuity beyond the study area boundary and cycling should be provided in conjunction with a larger network plan.

The ROW dimensions for internal streets are provided in **Table 16**.

Table 16: Roadway Design for Sustainable Modes

Roadway	Cycling	Pedestrian	Parking	ROW (m)
Palladium Drive	Mixed Traffic	Sidewalk on both sides	None	-
Maple Grove Road	Mixed Traffic	Sidewalk on both sides	On-street parking on one side	-
Huntmar Drive	MUP	Sidewalk on both sides	None	-
Terry Fox Drive	Mixed Traffic	Sidewalk on both sides	None	-
Local Streets	Mixed Traffic	Sidewalk on one side	On-street parking on one side	16.5 - 18
Street 1	Cycle lane	Sidewalk on both sides	None	37.5
Street 2 (South of Street 1)	Cycle lane	Sidewalk on both sides	None	46.8
Street 2 (North of Street 1)	Cycle lane	Sidewalk on one side	On-street parking on both sides	29.3

4.1.1.3

Transit Connectivity

Transit service is currently provided along Huntmar Drive. As service expands in the area, additional stops will be situated along Huntmar Drive and Maple Grove Road to ensure residents are within 400m of a stop. There will be direct and convenient sidewalks and paved surfaces between the residential developments and the transit stops.

The future N/S Arterial (Street 2 and 1) will be designed to accommodate transit design vehicles, and sidewalks will be provided on Street 2 between Maple Grove Road and Street 1 to facilitate connections to the future Rapid Transit Station.

4.1.2 Circulation and Access

Not applicable; exempted during screening and scoping.

4.1.3 New Street Networks

The development plan includes several new roadways that will serve the development as well as future network connections. Arterials have been provided with a minimum 37.5 meter ROW while local roads include between 16.5 and 18 meters. **Figure 25** illustrates a representative cross-section lists for new roads within the study area. This figure was obtained from the City of Ottawa’s Road Corridor Planning and Design Guidelines document, released in 2008. While the figure shows a 20 metre ROW it also includes a 2 metre sidewalk and parking on both sides. The development will only have parking and a sidewalk on one side.

The proposed development will have a total of six (6) accesses: three on Huntmar Drive and three on Maple Grove Road. Internal roadways will be designed to accommodate transit vehicles, delivery trucks, and garbage trucks.

Figure 25: New Street Representative Cross-Section

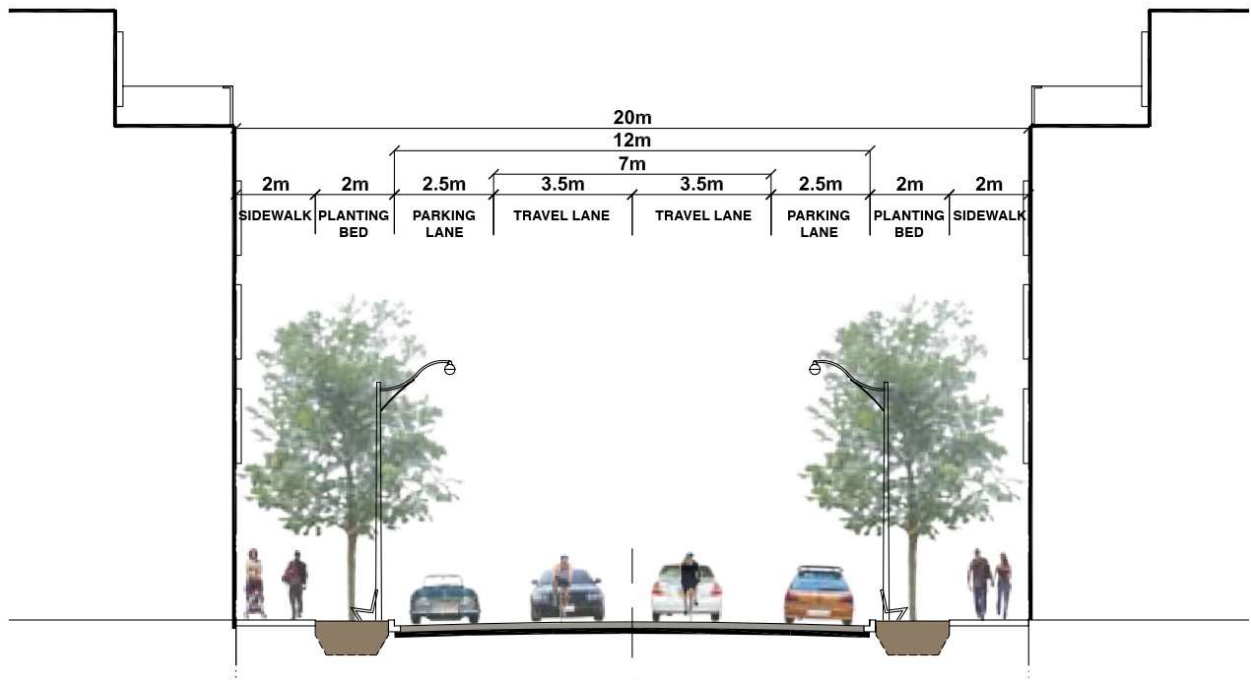

The proposed development will have nineteen interior intersections. However, only intersections with the future N/S arterial have been analyzed. All internal intersections are anticipated to operate at a LOS 'A' under the site generated traffic conditions for both the AM and the PM peak hours.

The school is located adjacent to an arterial and a collector roadway where on-street parking and loading/unloading will be limited. As well, the school site is located in close proximity to the existing signalized intersection where drop-offs are further discouraged as they can impact network circulation.

It is suggested that on-site facilities be provided to accommodate school bus and parent drop-offs, as well as required staff parking.

New residential roads will be designed for 30 km/h posted speed limits. Monitoring of speeds is suggested if concerns are raised.

4.2 Parking

Not applicable; exempted during screening and scoping.

4.3 Boundary Street Design

The planned development will be bound by the existing Huntmar Drive to the West, and Maple Grove Road to the South.

There are plans for the widening of Huntmar Drive to provide a four lane cross section with additional turning lanes and cycling and pedestrian facilities. The EA for widening of Huntmar drive will confirm the roadway elements and planned roadway design.

Maple Grove is currently a two lane roadway. The roadway is not currently planned for widening, but upgrades may be required to improve pedestrian and cycling facilities.

4.3.1 Design Concept

Multi-Modal Level of Service (MMLOS) was evaluated for the intersection at Huntmar Drive and Maple Grove Road to assist with developing a design concept that maximizes the achievement of the MMLOS objectives. Huntmar Drive, and Maple Grove Road are subject to MMLOS targets of school policy areas as the development will be within 300 metres of a school in the future.

Table 17 presents the minimum desirable LOS targets for each mode considering the policy area and road classification for each of the roads under review.

Table 17: Minimum Desirable MMLOS Targets

Policy Area	Road Segment	Road Class	Pedestrian LOS (PLOS)	Bicycle LOS (BLOS)	Transit LOS (TLOS)	Truck LOS (TkLOS)	Vehicle LOS (VLOS)
Within 300m of a School	Huntmar Drive	Arterial	A	C	C	No Target	E
	Maple Grove Road	Collector	A	C	C	No Target	E

Notes on the MMLOS analysis are as follows:

- The City's TMP identifies both Huntmar Drive as a cycling Spine Route therefore it has a BLOS target of "C".
- The transit LOS target for both Huntmar Drive and Maple Grove Road is a "C" as they are planned transit priority corridor with continuous lanes.
- Neither Huntmar Drive nor Maple Grove Road are designated truck routes therefore there is no Truck LOS target.

MMLOS analysis was undertaken for Maple Grove resulting in BLOS=D for the current roadway. The TIA suggests a target BLOS=C, however as a Local Route within 600m of a Rapid Transit station and 300m of a School a BLOS= B target should be adopted. To provide the target BLOS for a 50 km/h roadway, a minimum 1.5m cycle lane should be provided, and should the roadway be widened to 2 travel lanes in each direction a raised median would be required. Intersections would achieve a BLOS=B for a 50km/h roadway if no lanes were to be crossed to undertake a left turn which would not be the case if cycle lanes were provided on Maple Grove, or if the road is widened in the future. The intersections should therefore be designed with consideration for higher order cycling facilities.

The MMLOS analysis suggests that a 2 to 3-lane road would not require cycle facilities to achieve a BLOS B with posted speeds of 40km/h or less. Both roadways are envisioned as more than 1 lane per direction and are likely to operate with 50km/h vehicle speeds suggesting the need for Bike Lanes.

Table 18 provides the MMLOS conditions for the boundary road intersection at Maple Grove Road and Huntmar Drive with the planned near-term intersection modifications. The posted speeds were assumed to be 50 km/h on both roads.

The intersection does not achieve the PLOS target 'A' because the cycle length of the intersection and the effective walk time of the pedestrian provides a level of service 'E'. This may be remedied by reducing the cycle length of the intersection or by increasing the effective walk time available to pedestrians.

The intersection does not achieve the BLOS target 'C' because the intersection bikeway type is mixed traffic. This may be remedied through installing bike lanes along Maple Grove Road, which would

increase overall safety for bikers and increase the intersection LOS to 'B'. A future MUP will be constructed along Huntmar Drive connecting to the area active transportation network.

The intersection does not achieve the TLOS target 'C' because of the average signal delay on the eastbound movement. This may be remedied by installing a left turn lane on the eastbound movement, which would reduce the overall delay of the intersection. Note that the primary transit movement is via the North-South approaches. Also, the future Rapid Transit facility will significantly improve transit service with a station planned to accommodate the planned development.

It is noted that with the added capacity gained through the planned widening of Huntmar Drive, the future design will much better consider MMLOS impacts.

Table 18: MMLOS Conditions - Intersections

	Approach	Northbound	Southbound	Eastbound	Westbound
Pedestrian	Lanes to cross	4	4	3	3
	Median	No	No	No	No
	Island refuge	No	No	No	No
	Conflicting left turns	Prot+perm	Prot+perm	Prot+perm	Prot+perm
	Conflicting right turns	Prot+perm	Prot+perm	Prot+perm	Prot+perm
	RTOR?	Always	Always	Always	Always
	Pedestrian leading interval?	Yes	No	No	No
	Corner radius (largest)	10-15m	5-10m	5-10m	10-15m
	Crosswalk type	Std. transverse	Std. transverse	Std. transverse	Std. transverse
	PETSI points	55	54	71	70
	Cycle length	130	130	130	130
	Effective walk time	22	22	27	27
	Calculated pedestrian delay	45	45	41	41
	Level of service (PETSI points)	D	D	C	C
	Level of service (ped. delay)	E	E	E	E
Level of Service	E	E	E	E	
Level of Service (Select worst)	E				
Bicycle	Type of bikeway	Mixed Traffic	Mixed Traffic	Mixed Traffic	Mixed Traffic
	Bike lane shift	N/A	N/A	N/A	N/A
	Length of right-turn lane	N/A	N/A	N/A	N/A
	Right-turn vehicle turning speed (from int. geom.)	<=25 km/h	<=25 km/h	<=25 km/h	<=25 km/h
	Dual right-turn lane (shared or exclusive)	No	No	No	No
	Left-turn type / lanes crossed and turn speed	1 lane, 50km/h	None, <=50km/h	None, <=50km/h	None, <=50km/h
	Level of Service	D	B	B	B
Level of Service (Select worst)	D				
Transit	Average signal delay	20	20	50	40
	Level of Service	C	C	F	E
	Level of Service (Select worst)	F			
Truck	Effective turning radius (smallest)	10 to 15m	10 to 15m	10 to 15m	10 to 15m
	Number of Receiving Lanes	1	1	1	1
	Level of Service	E	E	E	E
	Level of Service (Select worst)	E			
Auto	Volume to capacity ratio	0.53 (0.51)	0.32 (0.84)	0.87 (0.65)	0.23 (0.87)
	Level of Service	A (A)	A (D)	D (A)	A (D)
	Level of Service (Select worst)	D			

4.4 Access Intersection Design

There are six locations where the adjacent roadway network will be connected to the planned development:

- Two full access intersections on Huntmar Drive (at Street 1 and Street 3). A third RIRO is provided (for the school driveway) but to ensure the results of the traffic analysis capture potential impacts, all site traffic was assigned to the full access intersections.
- Three full access intersections were assumed on Maple Grove Road (Street 2, Street 3 and Street 5).

4.4.1 Location and Design of Driveway

The roads that provide entry and the distance to boundary roads are presented in **Table 19**. Six full movement accesses were analyzed. It is not anticipated that they will be impacted by tapers. Street 5 is aligned with Rosehill Avenue on Maple Grove Road but is not signalized as part of this analysis.

To accommodate the school access, a driveway will be required within 100 metres of the intersection of Huntmar Drive and Maple Grove Road. School accesses are typically provided via the arterial and collector road network and do not rely on local roadways. School access is also controlled (particularly for elementary schools) limiting the number of locations for pedestrian site access. For the purposes of traffic analysis, this driveway was determined to be a RIRO configuration. There is limited ability to accommodate on-street school bus loading/ unloading and parent drop off. On-site facilities would be required with appropriate sidewalks and accessible connections to the building. Internal local access will also be facilitated within the development to promote active transportation and safe pedestrian and cycling to school.

Table 19: Proximity to Adjacent Driveways

Access Road	Access Intersection	Boundary Road 1	Boundary Road 1 Distance (m)	Boundary Road 2	Boundary Road 2 Distance (m)
Huntmar Drive	A1: School Access	Palladium Drive	720	Maple Grove Road	160
	A2: Street 1	Palladium Drive	580	Maple Grove Road	300
	A3: Street 3	Palladium Drive	370	Maple Grove Road	510
Maple Grove Road	A4: Street 5	Huntmar Drive	180	Terry Fox Drive	1510
	A5: Street 3	Huntmar Drive	300	Terry Fox Drive	1390
	A6: Street 2	Huntmar Drive	410	Terry Fox Drive	1280

4.4.2 Intersection Control

Six full access intersections were analyzed along Huntmar Drive and Maple Grove Road. The intersection of Street 2 at Street 1 (internal roadway) will be upgraded to a roundabout beyond the horizon year of this study. As well, Street 1 is to be extended West of Huntmar Drive while Street 2 will be extended South of Maple Grove Road and will require signalization to provide the N/S Arterial connection.

Within the timeframe of this analysis, signalization is not required at these accesses to accommodate 2024 vehicle traffic. The analysis for initial build-out (2024) includes stop control only but signalization has been assumed to be in place for 2029 at the intersections of Street 1 at Huntmar Drive, and Street 2 at Maple Grove Road to accommodate additional development, pedestrian volumes and pedestrian/cycling connectivity.

The remaining intersections will be two-way stop controlled:

- Street 3 at Huntmar Drive
- School Driveway
- Street 5 at Maple Grove
- Street 3 at Maple Grove Road

4.4.3 Intersection Design

The sections that follow present the analysis of access and internal intersection operations during the AM and PM peak hour for existing and future conditions.

4.4.3.1 Existing Access Intersection Operations

The proposed development is in a greenfield area and there are no existing access intersections.

4.4.3.2 Future Access Intersection Operations

The analysis confirms that vehicles will operate with satisfactory conditions at all access intersections with each movement operating at LOS A based on the volume to capacity ratio. It is noted that some intersections experience minor delays. **Table 20** and **Table 21** summarizes the Synchro results for the access intersections during the weekday AM and PM peak hours for the 2024 and 2029 horizon years. **Appendix B** provides full analyses results by movement for signalized intersections.

Table 20: Access Intersections – 2024 AM (PM) Peak Hour Operations

Main Road	Side Road	Overall			Worst Movement		
		Volume	Delay (s)	V/C	Movement	(V/C)	LOS
Huntmar Drive	Street 3 (unsignalized)	1475 (2035)	1.2 (1.3)	-	WBLR (WBLR)	0.28 (0.36)	A (A)
	Street 1 (unsignalized)	1515 (2100)	2.6 (12.9)	-	WBLTR (WBLTR)	0.35 (1.43)	A (F)
	School Access (RIRO)	1470 (1905)	1.1 (0.2)	-	WBR (WBR)	0.24 (0.05)	A (A)
Maple Grove Road	Rosehill Avenue / Street 5 (unsignalized)	775 (875)	3.4 (1.3)	-	WBLTR (NBLTR)	0.13 (0.1)	A (A)
	Street 3 (unsignalized)	715 (855)	0.3 (0.3)	-	SBLR (SBLR)	0.03 (0.04)	A (A)
	Street 2 (unsignalized)	810 (945)	3.0 (1.9)	-	SBLR (SBLR)	0.26 (0.21)	A (A)

Table 21: Access Intersections – 2029 AM (PM) Peak Hour Operations

Main Road	Side Road	Overall			Worst Movement		
		Volume	Delay (s)	V/C	Movement	(V/C)	LOS
Huntmar Drive	Street 3 (unsignalized)	1620 (2240)	1.4 (1.7)	-	WBLTR (WBLTR)	0.34 (0.48)	A (A)
	Street 1 (signalized)	1665 (2250)	16.2 (32.0)	0.66 (0.85)	NBTLR (SBTLR)	0.79 (1)	C (E)
	School Access (RIRO)	1640 (2110)	1.1 (0.1)	-	WBR (WBR)	0.28 (0.06)	A (A)
Maple Grove Road	Rosehill Avenue / Street 5 (unsignalized)	845 (950)	3.6 (1.3)	-	WBLTR (NBLTR)	0.15 (0.11)	A (A)
	Street 3 (unsignalized)	785 (935)	0.2 (0.3)	-	SBLR (SBLR)	0.03 (0.04)	A (A)
	Street 2 (signalized)	880 (1030)	8.0 (8.9)	0.41 (0.5)	EBTL (WBTR)	0.48 (0.56)	A (A)

In 2024 the unsignalized access at Huntmar Drive at Street 1 operates with an unsatisfactory LOS. It is anticipated that this intersection will be signalized shortly after development buildout, and the analysis shows that the signalized intersection operates well 5 years after in 2029.

A signal warrant analysis (based on OTM Book 12) was performed on the intersection of Huntmar Drive and Street 3. Total forecasted traffic for the horizon year 2029 was used for this analysis, shown in **Table 22**. If both conditions A and B for Justification 1, or both conditions A and B for Justification 2 were met, a signal would be warranted. It can be seen that signalization was not justified at this time for the intersection of Huntmar Drive and Street 3. **Appendix C** provides the full signal warrant analysis.

Table 22: Signal Warrant Analysis (Huntmar Drive and Street 1)

Justification		Compliance	Signal Justified?
1. Minimum Vehicular Volume	A Total Volume (all approaches)	100%	No
	B Crossing Volume (minor streets)	10%	
2. Delay to Cross Traffic	A Total Volume (major streets)	100%	No
	B Crossing Volume (minor streets vehicle volume)	13%	

While the signal warrant analysis was not met, the analysis include signalization by 2029.

4.4.3.3

Internal Intersections

Table 23 provides internal intersection results for both 2024 and 2029. There is no difference in results anticipated between 2024 and 2029. The internal intersections are forecast to operate well with LOS A at all movements, operating well below capacity and having no queue.

Table 23: AM (PM) Peak Hour Operations: Internal Intersections

Main Road	Side Road	Overall			Worst Movement		
		Volume	Delay (s)	V/C	Movement	(V/C)	LOS
Street 1	Street 5	125 (145)	1.8 (1.7)	-	WBLT (NBLR)	0.02 (0.02)	A (A)
	Street 3	115 (170)	6.1 (5.9)	-	SBLTR (SBLTR)	0.07 (0.05)	A (A)
	Street 2	75 (120)	6.9 (7.2)	-	EBLR (SBTR)	0.01 (0.05)	A (A)

4.5

Transportation Demand Management

TDM program measures can be adopted to complement the development's proposed design. These measure encourage sustainable transportation choices, benefit occupants and visitors, and increase marketability.

Appendix D contains the complete TDM checklists which help identify relevant TDM measures to be adopted in the future.

From the TDM residential checklists, some recommendations are:

- Display local area maps with walking/cycling access routes and key destinations at major entrances;
- Display relevant transit schedules and route maps at residential building entrances;
- Contract with provider to install on-site bike share station;
- Contract with provider to install on-site car share vehicles and promote their use by residents;
- Unbundle parking costs - condominium purchase price / monthly rent;
- Provide a multimodal travel option information package to new residents.

From the TDM non-residential checklist, some recommendations are:

- Conduct periodic surveys to identify travel-related behaviours, attitudes, challenges and solutions, and to track progress
- Display local area maps with walking/cycling access routes and key destinations at major entrances;
- Display relevant transit schedules and route maps at entrances;
- Provide online links to OC Transpo and STO information;
- Subsidize or reimburse monthly transit pass purchases by employees;

- Contract with provider to install on-site bikeshare station for use by commuters and visitors;
- Provide employees with bikeshare memberships for local business travel;
- Unbundle parking cost from lease rates at multi-tenant sites;
- Provide a multimodal travel option information package to new/relocating employees and students;
- Encourage flexible work hours;
- Encourage compressed workweeks;
- Encourage telework;
- Provide on-site amenities/services to minimize mid-day or mid-commute errands.

TDM-supportive design & infrastructure measures:

- Locate buildings close to the street, and do not locate parking areas between the street and building entrances
- Locate building entrances in order to minimize walking distances to sidewalks and transit stops/stations
- Locate building doors and windows to ensure visibility of pedestrians from the building, for their security and comfort
- Provide shower and lockers for retail employees.

4.6 Neighbourhood Traffic Management

Not applicable; exempted during screening and scoping.

4.7 Transit

In order to achieve target transit shares, transit facilities will need to be provided along Maple Grove road in advance of the new development. Transit stops are recommended to be built at the access intersections Street 1 at Huntmar Drive and Street 3 at Maple Grove road. Once these stops are built all residents will be within 400 metres of transit, therefore there is no need for transit to travel through the development.

The existing transit services that run along Huntmar Drive will need to be improved in the future to accommodate the increased transit demand. Standard and articulated buses have seated capacities of 40 and 55 people respectively. In order to be conservative, the average seated capacity was approximated to be 45. To serve the additional passengers related to the 130 Huntmar Drive development, an additional 1-2 bus trips would be required during the peak hours (to serve the peak 60 passengers per hour in the peak direction).

Ultimately, transit service will operate on Street 1 and 2 in order to provide coverage for the new development. Both of these streets include sidewalks and do not require specialized infrastructure for transit. Transit stops will be provided at Street 1 and Block 23 (Street 5 & 7). Which coincides with the

suggested PXO crossing Street 1. A second set of stops will be shown near Maple Grove Station. The ultimate design roundabout at the intersection of Street 1 and Street 2 (N/S Arterial) will be designed to accommodate both standard and articulated transit vehicles.

4.8 Review of Network Concept

Not applicable; exempted during screening and scoping.

4.9 Intersection Design

This section addresses the potential impacts to area intersections beyond the immediate access intersections presented in **Section 4.4**. Six existing intersections were identified during the project Scoping that are to be assessed for impacts due to the additional site-generated vehicles as follows:

1. Huntmar Drive and Hazeldean Road
2. Huntmar Drive and Rosehill Avenue
3. Huntmar Drive and Maple Grove Road
4. Huntmar Drive and Palladium Drive
5. Terry Fox Drive and Palladium Drive
6. Terry Fox Drive and Maple Grove Road

Refer to **Figure 9** for lane configurations of the study area. **Appendix A** contains the intersection performance worksheets.

4.9.1 Intersection Control

See **Section 4.4.2**.

4.9.2 Intersection Design

The identified network intersections are all signal controlled. The analysis of area intersections includes the planned improvement at the intersection of Huntmar Drive and Maple Grove Road as follows:

- Auxiliary left-turns on all approaches
- Auxiliary southbound right-turn lane
- Two through lanes on the northbound approach
- Single through lanes on southbound, westbound, and eastbound approaches

The other area intersections were assumed to be maintained as is.

It is noted that lost time reduction was included in the PM peak hour analyses for the following intersection approaches:

- Terry Fox Drive and Palladium Drive: EBL, WBL, SBT (2.0 seconds)
- Terry Fox Drive and Maple Grove Road: SBT

This lost time reduction is included to ensure that observed vehicles are being processed by the modelled network. It reflects vehicles using a portion of the amber phase for traversing the intersection. The same lost time reduction is applied to both future forecasts as it is expected that drivers' behavior will not change. Los time represents vehicles making use of the All-red clearance interval when there are longer delays and queues.

4.9.2.1 Existing Network Intersection Operations

Table 24 summarizes the Synchro results for the existing network intersections during the AM and PM peak hours. The overall intersections are operating acceptably with each movement at LOS E or better and below capacity. **Appendix B** provides full analyses results by movement for signalized intersections.

Table 24: AM (PM) Peak Hour Operations – Existing (2019) Network Intersections

Main Road	Side Road	Overall			Worst Movement		
		Volume	Delay (s)	V/C	Movement	(V/C)	LOS
Huntmar Drive	Hazeldean Road	2570 (3935)	32.9 (37.7)	0.47 (0.61)	NBT (SBT)	0.73 (0.8)	C (D)
	Rosehill Avenue	1000 (1575)	6.3 (9.9)	-	NB (SB)	0.42 (0.66)	A (B)
	Palladium Drive	1495 (2165)	34.0 (26.0)	0.4 (0.41)	NBL (SBT)	0.76 (0.79)	C (C)
	Maple Grove Road	1370 (2090)	35.6 (37.2)	0.54 (0.71)	EBTLR (WBTLR)	0.83 (0.93)	D (E)
Terry Fox Drive	Maple Grove Road	2615 (3640)	18.4 (21.5)	0.46 (0.62)	EBL (SBT)	0.81 (0.75)	D (C)
	Palladium Drive	3675 (5090)	30.3 (52.5)	0.54 (0.78)	NBL (SBT)	0.7 (0.99)	C (E)

4.9.2.2 2024 Network Intersection Operations

Table 25 summarizes the Synchro results for the 2024 forecast network intersections during the AM and PM peak hours. **Appendix B** provides full analyses results by movement for signalized intersections.

The majority of the intersections operate acceptably with each movement at LOS E or better and below capacity. The intersection at Terry Fox Drive at Palladium Drive is the most congested with a reported LOS F in the PM peak hour.

Traffic congestion at the intersections may be mitigated through higher transit mode shares from implementing isolated transit measures or bus rapid transit through the area. It is also noted that peak spreading may occur throughout the peak period as shown in **Table 15**.

Table 25: AM (PM) Peak Hour Operations – 2024 Network Intersections

Main Road	Side Road	Overall			Worst Movement		
		Volume	Delay (s)	V/C	Movement	(V/C)	LOS
Huntmar Drive	Hazeldean Road	3020 (4645)	35.5 (43.1)	0.53 (0.73)	NBT (WBT)	0.78 (0.89)	C (D)
	Rosehill Avenue	1240 (1910)	7.4 (15.4)	-	NB (SB)	0.51 (0.85)	A (D)
	Palladium Drive	1970 (2855)	32.2 (34.1)	0.48 (0.58)	NBL (NBL)	0.9 (0.9)	E (E)
	Maple Grove Road	1875 (2760)	29.4 (35.0)	0.47 (0.63)	EBL (SBT)	0.82 (0.87)	D (D)
Terry Fox Drive	Maple Grove Road	3155 (4395)	24.1 (36.0)	0.56 (0.77)	EBL (SBT)	0.88 (0.98)	D (E)
	Palladium Drive	4325 (5575)	36.6 (60.3)	0.66 (0.85)	EBL (SBT)	0.9 (1.04)	E (F)

4.9.2.3

2029 Network Intersection Operations

Table 26 summarizes the Synchro results for the 2029 forecast network intersections during the AM and PM peak hours. **Appendix B** provides full analyses results by movement for signalized intersections.

The majority of the intersections operate acceptably with each movement at LOS E or better. The intersections at Huntmar Drive and Hazeldean Road, Terry Fox Drive and Maple Grove Road, and at Terry Fox Drive and Palladium Drive are the most congested with a reported LOS F.

Traffic congestion at the intersections may be mitigated through higher transit mode shares from implementing isolated transit measures or bus rapid transit through the area. It is also noted that peak spreading may occur throughout the peak period as shown in **Table 15**.

Table 26: AM (PM) Peak Hour Operations – 2029 Network Intersections

Main Road	Side Road	Overall			Worst Movement		
		Volume	Delay (s)	V/C	Movement	(V/C)	LOS
Huntmar Drive	Hazeldean Road	3375 (5205)	37.6 (57.1)	0.59 (0.83)	NBT (WBT)	0.79 (1.08)	C (F)
	Rosehill Avenue	1370 (2070)	8.2 (23.9)	-	NB (SB)	0.57 (0.96)	A (E)
	Palladium Drive	2165 (3175)	33.7 (39.4)	0.51 (0.65)	NBL (WBL)	0.93 (0.96)	E (E)
	Maple Grove Road	2075 (3055)	31.0 (46.9)	0.52 (0.72)	EBL (SBT)	0.84 (1.01)	D (F)
Terry Fox Drive	Maple Grove Road	3510 (4905)	27.6 (55.9)	0.65 (0.86)	EBL (SBT)	0.9 (1.08)	E (F)
	Palladium Drive	4830 (5700)	41.1 (63.7)	0.74 (0.86)	SBR (EBL)	0.95 (1.05)	E (F)

Conclusions

This Transportation Impact Assessment for 130 Huntmar Drive was undertaken to identify potential pressures on the transportation network once the site is developed. The analysis addressed all modes of travel in and around the site with a MMLOS assessment of boundary roads and detailed intersection analysis at access intersections, network intersections beyond the immediate study area, as well as internal circulation on new streets within the site.

To accommodate the transportation demand for the site, the following measures have been identified:

- Increased Capacity at the intersection of Huntmar Drive and Maple Grove Road (by 2024)
- Signalization of access roads: Street 1 at Huntmar Drive, Street 2 at Maple Grove Road (by 2029)
- Provision of an additional unsignalized access roadway and a right-in right-out driveway for the identified school property on Huntmar Drive.
- Provision of two additional unsignalized access roadways via Maple Grove Road.
- Provision of sidewalks on all local roadways.
- Provision of additional active transportation facilities on Huntmar Drive via the planned roadway widening. Consider advancement of active transportation facilities in advance of roadway construction.
- Consider upgrading Maple Grove with increased cycling facilities, continuity with planned infrastructure east and west of the Study Area.

The analysis also indicates that a network intersection will operate at unsatisfactory levels. For this intersection, congestion may be mitigated through peak spreading, implementation of the N/S arterial, the Huntmar Drive widening, and increasing transit mode share in the surrounding development. The study intersection which is forecasted to experience deficiencies by 2024 is listed below:

- Terry Fox Drive and Palladium Drive

By 2029 additional intersections are expected to operate at or exceed the capacity. Planned capacity improvements will be required such as the widening of Huntmar Drive and construction of the new North-South Arterial. Study intersections which are forecasted to experience deficiencies by 2029 are listed below:

- **Huntmar Drive and Hazeldean Road:** This intersection operates at an unsatisfactory LOS along the westbound through movement for the PM peak period. Traffic congestion at this intersection may be mitigated through higher transit mode shares from implementing isolated transit measures or bus rapid transit through the area.
- **Huntmar Drive and Maple Grove Road:** This intersection operates at an unsatisfactory LOS along the southbound through movement only, due to the planned intersection modifications. Traffic congestion at this intersection may also be mitigated through higher transit mode shares

from implementing isolated transit measures or bus rapid transit in the area, or from the Huntmar Drive road widening from two lanes to four lanes.





























- **Terry Fox Drive and Maple Grove Road:** This intersection operates at an unsatisfactory LOS along the southbound through movement for the PM peak period. The proposed site is not expected to produce traffic along southbound through movement at this intersection hence the failure LOS is a byproduct of emergent developments in the area.
- **Terry Fox Drive and Palladium Drive:** This intersection operates at an unsatisfactory LOS along the eastbound left movement for the PM peak period. This is a pre-existing condition of the intersection and the site generated traffic of the proposed development is anticipated to be only 2.4% of the total traffic travelling along the movements that fail. The failure LOS is a pre-existing condition and traffic congestion at this intersection may be mitigated through higher transit mode shares from implementing isolated transit measures or bus rapid transit in the area.

Appendix A

Synchro Performance Worksheets

Lanes, Volumes, Timings
3: Iber/Huntmar & Hazeldean

09-04-2020

												
Lane Group	EBL	EBT	EBR	WBL	WBT	WBR	NBL	NBT	NBR	SBL	SBT	SBR
Lane Configurations	 	 		 	 		 		 	 		
Traffic Volume (vph)	200	665	110	160	395	80	45	235	245	115	210	110
Future Volume (vph)	200	665	110	160	395	80	45	235	245	115	210	110
Confl. Peds. (#/hr)	5		5	5		5	5		5	5		5
Confl. Bikes (#/hr)												
Peak Hour Factor	1.00	1.00	1.00	1.00	1.00	1.00	1.00	1.00	1.00	1.00	1.00	1.00
Growth Factor	100%	100%	100%	100%	100%	100%	100%	100%	100%	100%	100%	100%
Heavy Vehicles (%)	3%	3%	14%	4%	5%	2%	4%	0%	5%	3%	3%	0%
Bus Blockages (#/hr)	0	0	0	0	0	0	0	0	0	0	0	0
Parking (#/hr)												
Mid-Block Traffic (%)		0%			0%			0%			0%	
Shared Lane Traffic (%)												
Lane Group Flow (vph)	200	775	0	160	395	80	45	235	245	115	210	110
Turn Type	Prot	NA		Prot	NA	Perm	pm+pt	NA	Perm	pm+pt	NA	pm+ov
Protected Phases	5	2		1	6		3	8		7	4	5
Permitted Phases						6	8		8	4		4
Detector Phase	5	2		1	6	6	3	8	8	7	4	5
Switch Phase												
Minimum Initial (s)	5.0	10.0		5.0	10.0	10.0	5.0	10.0	10.0	5.0	10.0	5.0
Minimum Split (s)	12.5	38.6		12.5	38.6	38.6	12.5	58.0	58.0	12.5	41.3	12.5
Total Split (s)	18.2	44.8		14.6	41.2	41.2	12.5	58.0	58.0	12.6	58.1	18.2
Total Split (%)	14.0%	34.5%		11.2%	31.7%	31.7%	9.6%	44.6%	44.6%	9.7%	44.7%	14.0%
Yellow Time (s)	3.6	3.6		3.6	3.6	3.6	3.0	3.3	3.3	3.0	3.3	3.6
All-Red Time (s)	2.0	2.0		2.0	2.0	2.0	0.0	2.0	2.0	0.0	2.0	2.0
Lost Time Adjust (s)	0.0	0.0		0.0	0.0	0.0	0.0	0.0	0.0	0.0	0.0	0.0
Total Lost Time (s)	5.6	5.6		5.6	5.6	5.6	3.0	5.3	5.3	3.0	5.3	5.6
Lead/Lag	Lead	Lag		Lead	Lag	Lag	Lead	Lag	Lag	Lead	Lag	Lead
Lead-Lag Optimize?	Yes	Yes		Yes	Yes	Yes	Yes	Yes	Yes	Yes	Yes	Yes
Recall Mode	None	C-Max		None	C-Max	C-Max	None	None	None	None	None	None
Act Effct Green (s)	13.3	65.9		12.0	64.6	64.6	33.5	23.2	23.2	36.4	26.4	39.4
Actuated g/C Ratio	0.10	0.51		0.09	0.50	0.50	0.26	0.18	0.18	0.28	0.20	0.30
v/c Ratio	0.61	0.48		0.54	0.24	0.10	0.17	0.73	0.54	0.50	0.59	0.21
Control Delay	63.5	23.2		63.0	21.0	4.0	32.4	63.1	9.4	41.2	54.0	5.2
Queue Delay	0.0	0.0		0.0	0.0	0.0	0.0	0.0	0.0	0.0	0.0	0.0
Total Delay	63.5	23.2		63.0	21.0	4.0	32.4	63.1	9.4	41.2	54.0	5.2
LOS	E	C		E	C	A	C	E	A	D	D	A
Approach Delay		31.5			29.4			35.4			38.3	
Approach LOS		C			C			D			D	
Queue Length 50th (m)	27.0	67.8		21.5	31.0	0.0	8.9	60.9	0.0	23.7	53.0	0.0
Queue Length 95th (m)	39.0	104.8		32.6	51.6	8.4	16.7	82.1	21.5	35.7	73.8	11.4
Internal Link Dist (m)		871.0			1427.4			1305.6			301.9	
Turn Bay Length (m)	50.0			90.0		225.0	30.0		60.0	50.0		275.0
Base Capacity (vph)	349	1625		296	1617	777	280	729	725	232	709	543
Starvation Cap Reductn	0	0		0	0	0	0	0	0	0	0	0
Spillback Cap Reductn	0	0		0	0	0	0	0	0	0	0	0
Storage Cap Reductn	0	0		0	0	0	0	0	0	0	0	0
Reduced v/c Ratio	0.57	0.48		0.54	0.24	0.10	0.16	0.32	0.34	0.50	0.30	0.20









Intersection Summary

Lanes, Volumes, Timings
 3: Iber/Huntmar & Hazeldean

09-04-2020

























Cycle Length: 130	
Actuated Cycle Length: 130	
Offset: 0 (0%), Referenced to phase 2:EBT and 6:WBT, Start of Green	
Natural Cycle: 125	
Control Type: Actuated-Coordinated	
Maximum v/c Ratio: 0.73	
Intersection Signal Delay: 32.9	Intersection LOS: C
Intersection Capacity Utilization 70.9%	ICU Level of Service C
Analysis Period (min) 15	

Splits and Phases: 3: Iber/Huntmar & Hazeldean

 Ø1 14.6 s	 Ø2 (R) 44.8 s	 Ø3 12.5 s	 Ø4 58.1 s
 Ø5 18.2 s	 Ø6 (R) 41.2 s	 Ø7 12.6 s	 Ø8 58 s

Lanes, Volumes, Timings
6: Terry Fox & Palladium/Katimavik

09-04-2020

												
Lane Group	EBL	EBT	EBR	WBL	WBT	WBR	NBL	NBT	NBR	SBL	SBT	SBR
Lane Configurations												
Traffic Volume (vph)	225	55	95	55	95	140	290	1095	75	80	775	695
Future Volume (vph)	225	55	95	55	95	140	290	1095	75	80	775	695
Confl. Peds. (#/hr)	5		5	5		5	5		5	5		5
Confl. Bikes (#/hr)												
Peak Hour Factor	1.00	1.00	1.00	1.00	1.00	1.00	1.00	1.00	1.00	1.00	1.00	1.00
Growth Factor	100%	100%	100%	100%	100%	100%	100%	100%	100%	100%	100%	100%
Heavy Vehicles (%)	6%	6%	3%	12%	6%	4%	0%	3%	13%	3%	5%	1%
Bus Blockages (#/hr)	0	0	0	0	0	0	0	0	0	0	0	0
Parking (#/hr)												
Mid-Block Traffic (%)		0%			0%			0%			0%	
Shared Lane Traffic (%)												
Lane Group Flow (vph)	225	55	95	55	95	140	290	1095	75	80	775	695
Turn Type	Prot	NA	Perm	Prot	NA	Perm	Prot	NA	Perm	Prot	NA	Perm
Protected Phases	7	4		3	8		5	2		1	6	
Permitted Phases			4			8			2			6
Detector Phase	7	4	4	3	8	8	5	2	2	1	6	6
Switch Phase												
Minimum Initial (s)	5.0	10.0	10.0	5.0	10.0	10.0	5.0	10.0	10.0	5.0	10.0	10.0
Minimum Split (s)	12.0	40.6	40.6	12.0	40.3	40.3	12.0	42.5	42.5	30.0	41.0	41.0
Total Split (s)	17.0	44.3	44.3	30.7	58.0	58.0	22.0	45.0	45.0	30.0	53.0	53.0
Total Split (%)	11.3%	29.5%	29.5%	20.5%	38.7%	38.7%	14.7%	30.0%	30.0%	20.0%	35.3%	35.3%
Yellow Time (s)	3.6	3.6	3.6	3.3	3.3	3.3	4.0	4.0	4.0	4.0	4.0	4.0
All-Red Time (s)	2.0	2.0	2.0	2.0	2.0	2.0	2.0	2.0	2.0	2.0	2.0	2.0
Lost Time Adjust (s)	-2.0	0.0	0.0	-2.0	0.0	0.0	0.0	0.0	0.0	0.0	0.0	0.0
Total Lost Time (s)	3.6	5.6	5.6	3.3	5.3	5.3	6.0	6.0	6.0	6.0	6.0	6.0
Lead/Lag	Lag	Lead	Lead	Lag	Lead	Lead	Lead	Lag	Lag	Lead	Lag	Lag
Lead-Lag Optimize?	Yes	Yes	Yes	Yes	Yes	Yes	Yes	Yes	Yes	Yes	Yes	Yes
Recall Mode	None	None	None	None	None	None	None	C-Max	C-Max	None	C-Max	C-Max
Act Effct Green (s)	18.4	18.3	18.3	19.1	16.7	16.7	18.7	84.9	84.9	9.1	75.4	75.4
Actuated g/C Ratio	0.12	0.12	0.12	0.13	0.11	0.11	0.12	0.57	0.57	0.06	0.50	0.50
v/c Ratio	0.59	0.27	0.28	0.28	0.50	0.48	0.70	0.58	0.09	0.41	0.47	0.65
Control Delay	68.3	63.0	2.0	61.1	70.0	11.7	72.3	25.0	0.2	73.6	28.2	6.9
Queue Delay	0.0	0.0	0.0	0.0	0.0	0.0	0.0	0.0	0.0	0.0	0.0	0.0
Total Delay	68.3	63.0	2.0	61.1	70.0	11.7	72.3	25.0	0.2	73.6	28.2	6.9
LOS	E	E	A	E	E	B	E	C	A	E	C	A
Approach Delay		50.7			40.1			33.1			21.0	
Approach LOS		D			D			C			C	
Queue Length 50th (m)	34.8	16.9	0.0	15.5	29.1	0.0	45.5	107.6	0.0	12.6	78.4	7.9
Queue Length 95th (m)	48.1	27.6	0.0	30.2	43.1	16.1	60.2	183.8	0.0	21.7	133.7	59.6
Internal Link Dist (m)		1802.0			304.5			406.9			280.2	
Turn Bay Length (m)	100.0			115.0		115.0	240.0		115.0	70.0		190.0
Base Capacity (vph)	383	438	515	278	596	604	420	1879	831	515	1636	1066
Starvation Cap Reductn	0	0	0	0	0	0	0	0	0	0	0	0
Spillback Cap Reductn	0	0	0	0	0	0	0	0	0	0	0	0
Storage Cap Reductn	0	0	0	0	0	0	0	0	0	0	0	0
Reduced v/c Ratio	0.59	0.13	0.18	0.20	0.16	0.23	0.69	0.58	0.09	0.16	0.47	0.65

Intersection Summary

Cycle Length: 150

Actuated Cycle Length: 150

Offset: 0 (0%), Referenced to phase 2:NBT and 6:SBT, Start of Green, Master Intersection

Natural Cycle: 130

Control Type: Actuated-Coordinated

Maximum v/c Ratio: 0.70

Intersection Signal Delay: 30.3

Intersection LOS: C

Intersection Capacity Utilization 80.3%

ICU Level of Service D





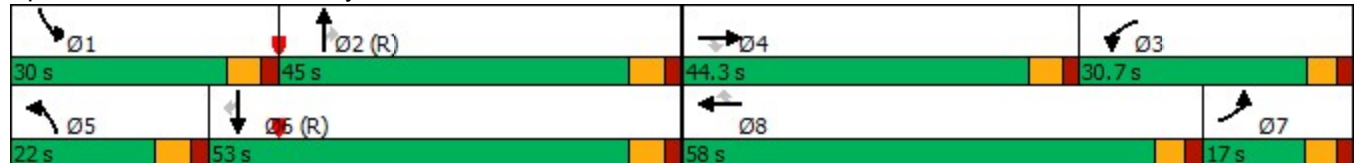

















Analysis Period (min) 15

Splits and Phases: 6: Terry Fox & Palladium/Katimavik



Lanes, Volumes, Timings
8: Huntmar & Palladium

09-04-2020

												
Lane Group	EBL	EBT	EBR	WBL	WBT	WBR	NBL	NBT	NBR	SBL	SBT	SBR
Lane Configurations												
Traffic Volume (vph)	30	155	165	40	80	35	325	260	130	85	145	45
Future Volume (vph)	30	155	165	40	80	35	325	260	130	85	145	45
Confl. Peds. (#/hr)	5		5	5		5	5		5	5		5
Confl. Bikes (#/hr)												
Peak Hour Factor	1.00	1.00	1.00	1.00	1.00	1.00	1.00	1.00	1.00	1.00	1.00	1.00
Growth Factor	100%	100%	100%	100%	100%	100%	100%	100%	100%	100%	100%	100%
Heavy Vehicles (%)	0%	4%	2%	11%	1%	0%	1%	1%	1%	2%	4%	2%
Bus Blockages (#/hr)	0	0	0	0	0	0	0	0	0	0	0	0
Parking (#/hr)												
Mid-Block Traffic (%)		0%			0%			0%			0%	
Shared Lane Traffic (%)												
Lane Group Flow (vph)	30	320	0	40	115	0	325	260	130	85	145	45
Turn Type	pm+pt	NA		pm+pt	NA		pm+pt	NA	Perm	Perm	NA	Perm
Protected Phases	5	2		1	6		3	8			4	
Permitted Phases	2			6			8		8	4		4
Detector Phase	5	2		1	6		3	8	8	4	4	4
Switch Phase												
Minimum Initial (s)	5.0	10.0		5.0	10.0		4.0	10.0	10.0	10.0	10.0	10.0
Minimum Split (s)	12.5	43.0		12.5	43.0		10.0	42.3	42.3	42.3	42.3	42.3
Total Split (s)	13.0	49.0		13.0	49.0		33.0	78.0	78.0	45.0	45.0	45.0
Total Split (%)	9.3%	35.0%		9.3%	35.0%		23.6%	55.7%	55.7%	32.1%	32.1%	32.1%
Yellow Time (s)	4.0	4.0		4.0	4.0		4.0	3.3	3.3	3.3	3.3	3.3
All-Red Time (s)	2.0	2.0		2.0	2.0		2.0	2.0	2.0	2.0	2.0	2.0
Lost Time Adjust (s)	0.0	0.0		0.0	0.0		0.0	0.0	0.0	0.0	0.0	0.0
Total Lost Time (s)	6.0	6.0		6.0	6.0		6.0	5.3	5.3	5.3	5.3	5.3
Lead/Lag	Lead	Lag		Lead	Lag		Lead			Lag	Lag	Lag
Lead-Lag Optimize?	Yes	Yes		Yes	Yes		Yes			Yes	Yes	Yes
Recall Mode	None	C-Max		None	C-Max		None	None	None	None	None	None
Act Effct Green (s)	72.0	66.3		74.2	69.2		50.7	51.4	51.4	19.9	19.9	19.9
Actuated g/C Ratio	0.51	0.47		0.53	0.49		0.36	0.37	0.37	0.14	0.14	0.14
v/c Ratio	0.05	0.21		0.08	0.07		0.76	0.40	0.21	0.57	0.59	0.15
Control Delay	18.8	13.0		18.9	17.3		50.4	39.2	11.7	68.4	64.3	1.0
Queue Delay	0.0	0.0		0.0	0.0		0.0	0.0	0.0	0.0	0.0	0.0
Total Delay	18.8	13.0		18.9	17.3		50.4	39.2	11.7	68.4	64.3	1.0
LOS	B	B		B	B		D	D	B	E	E	A
Approach Delay		13.5			17.7			39.3				55.2
Approach LOS		B			B			D				E
Queue Length 50th (m)	3.8	13.1		5.1	6.5		76.9	56.5	7.0	24.0	41.1	0.0
Queue Length 95th (m)	11.9	30.4		14.9	16.4		101.5	79.0	m20.4	36.5	54.6	0.0
Internal Link Dist (m)		535.2			1802.0			357.2			231.7	
Turn Bay Length (m)	95.0			75.0			120.0		45.0	50.0		
Base Capacity (vph)	653	1517		489	1611		439	925	835	298	490	501
Starvation Cap Reductn	0	0		0	0		0	0	0	0	0	0
Spillback Cap Reductn	0	0		0	0		0	0	0	0	0	0
Storage Cap Reductn	0	0		0	0		0	0	0	0	0	0
Reduced v/c Ratio	0.05	0.21		0.08	0.07		0.74	0.28	0.16	0.29	0.30	0.09

Intersection Summary

Lanes, Volumes, Timings
 8: Huntmar & Palladium

09-04-2020

Cycle Length: 140

Actuated Cycle Length: 140

Offset: 87 (62%), Referenced to phase 2:EBTL and 6:WBTL, Start of Green

Natural Cycle: 110

Control Type: Actuated-Coordinated

Maximum v/c Ratio: 0.76

Intersection Signal Delay: 34.0

Intersection LOS: C

Intersection Capacity Utilization 80.3%

ICU Level of Service D

Analysis Period (min) 15

m Volume for 95th percentile queue is metered by upstream signal.

Splits and Phases: 8: Huntmar & Palladium

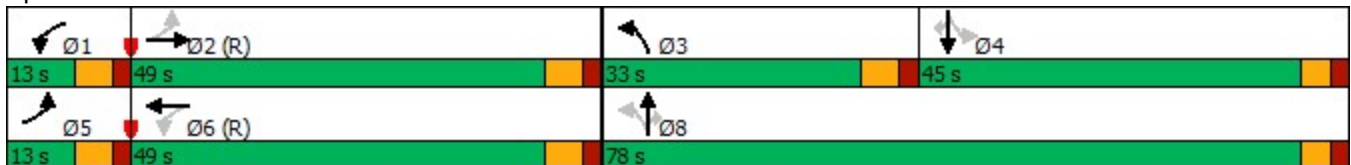

Lanes, Volumes, Timings
21: Huntmar & Maple Grove

09-04-2020



Lane Group	EBL	EBT	EBR	WBL	WBT	WBR	NBL	NBT	NBR	SBL	SBT	SBR
Lane Configurations		↕			↕		↕	↕			↕	
Traffic Volume (vph)	220	115	50	40	40	25	30	445	90	5	270	40
Future Volume (vph)	220	115	50	40	40	25	30	445	90	5	270	40
Confl. Peds. (#/hr)	5		5	5		5	5		5	5		5
Confl. Bikes (#/hr)												
Peak Hour Factor	1.00	1.00	1.00	1.00	1.00	1.00	1.00	1.00	1.00	1.00	1.00	1.00
Growth Factor	100%	100%	100%	100%	100%	100%	100%	100%	100%	100%	100%	100%
Heavy Vehicles (%)	1%	2%	6%	0%	10%	5%	23%	2%	4%	14%	3%	0%
Bus Blockages (#/hr)	0	0	0	0	0	0	0	0	0	0	0	0
Parking (#/hr)												
Mid-Block Traffic (%)		0%			0%			0%			0%	
Shared Lane Traffic (%)												
Lane Group Flow (vph)	0	385	0	0	105	0	30	535	0	0	315	0
Turn Type	pm+pt	NA		Perm	NA		Perm	NA		Perm	NA	
Protected Phases	7	4			8			2			6	
Permitted Phases	4			8			2			6		
Detector Phase	7	4		8	8		2	2		6	6	
Switch Phase												
Minimum Initial (s)	4.0	10.0		10.0	10.0		10.0	10.0		10.0	10.0	
Minimum Split (s)	10.0	33.0		33.0	33.0		29.0	29.0		49.0	49.0	
Total Split (s)	10.0	67.0		57.0	57.0		73.0	73.0		73.0	73.0	
Total Split (%)	7.1%	47.9%		40.7%	40.7%		52.1%	52.1%		52.1%	52.1%	
Yellow Time (s)	4.0	3.0		3.0	3.0		3.3	3.3		3.3	3.3	
All-Red Time (s)	2.0	2.0		2.0	2.0		2.0	2.0		2.0	2.0	
Lost Time Adjust (s)		0.0			0.0		0.0	0.0			0.0	
Total Lost Time (s)		5.0			5.0		5.3	5.3			5.3	
Lead/Lag	Lead			Lag	Lag							
Lead-Lag Optimize?	Yes											
Recall Mode	None	None		None	None		C-Max	C-Max		C-Max	C-Max	
Act Effct Green (s)		49.1			49.1		80.6	80.6			80.6	
Actuated g/C Ratio		0.35			0.35		0.58	0.58			0.58	
v/c Ratio		0.83			0.23		0.07	0.54			0.32	
Control Delay		55.8			26.8		17.1	22.5			21.5	
Queue Delay		0.0			0.0		0.0	0.0			0.0	
Total Delay		55.8			26.8		17.1	22.5			21.5	
LOS		E			C		B	C			C	
Approach Delay		55.8			26.8			22.2			21.5	
Approach LOS		E			C			C			C	
Queue Length 50th (m)		99.9			18.5		3.8	92.1			72.2	
Queue Length 95th (m)		126.0			29.1		10.9	153.1			77.6	
Internal Link Dist (m)		630.5			86.3			293.1			175.1	
Turn Bay Length (m)							20.0					
Base Capacity (vph)		583			513		448	985			982	
Starvation Cap Reductn		0			0		0	0			0	
Spillback Cap Reductn		0			0		0	0			0	
Storage Cap Reductn		0			0		0	0			0	
Reduced v/c Ratio		0.66			0.20		0.07	0.54			0.32	

Intersection Summary

Lanes, Volumes, Timings
 21: Huntmar & Maple Grove

09-04-2020





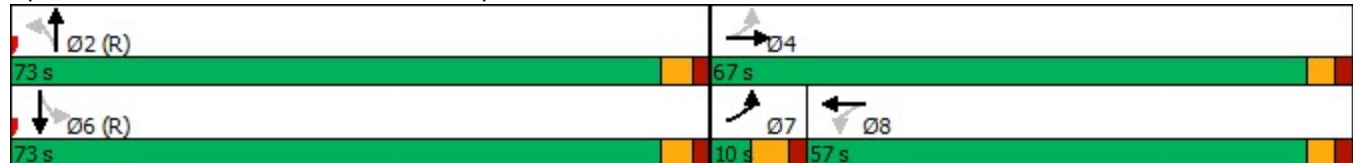

















Cycle Length: 140	
Actuated Cycle Length: 140	
Offset: 0 (0%), Referenced to phase 2:NBTL and 6:SBTL, Start of Green	
Natural Cycle: 95	
Control Type: Actuated-Coordinated	
Maximum v/c Ratio: 0.83	
Intersection Signal Delay: 31.8	Intersection LOS: C
Intersection Capacity Utilization 68.4%	ICU Level of Service C
Analysis Period (min) 15	

Splits and Phases: 21: Huntmar & Maple Grove



Lanes, Volumes, Timings
31: Terry Fox & Maple Grove

09-04-2020

												
Lane Group	EBL	EBT	EBR	WBL	WBT	WBR	NBL	NBT	NBR	SBL	SBT	SBR
Lane Configurations												
Traffic Volume (vph)	195	25	135	30	25	45	170	1150	35	10	710	85
Future Volume (vph)	195	25	135	30	25	45	170	1150	35	10	710	85
Confl. Peds. (#/hr)	5		5	5		5	5		5	5		5
Confl. Bikes (#/hr)												
Peak Hour Factor	1.00	1.00	1.00	1.00	1.00	1.00	1.00	1.00	1.00	1.00	1.00	1.00
Growth Factor	100%	100%	100%	100%	100%	100%	100%	100%	100%	100%	100%	100%
Heavy Vehicles (%)	10%	9%	12%	11%	9%	0%	8%	5%	7%	0%	8%	19%
Bus Blockages (#/hr)	0	0	0	0	0	0	0	0	0	0	0	0
Parking (#/hr)												
Mid-Block Traffic (%)		0%			0%			0%			0%	
Shared Lane Traffic (%)												
Lane Group Flow (vph)	195	25	135	30	70	0	170	1185	0	10	710	85
Turn Type	Perm	NA	Perm	Perm	NA		pm+pt	NA		pm+pt	NA	Perm
Protected Phases		4			8		5	2		1	6	
Permitted Phases	4		4	8			2			6		6
Detector Phase	4	4	4	8	8		5	2		1	6	6
Switch Phase												
Minimum Initial (s)	10.0	10.0	10.0	10.0	10.0		5.0	10.0		5.0	10.0	10.0
Minimum Split (s)	42.0	42.0	42.0	42.0	42.0		12.0	43.0		12.0	43.0	43.0
Total Split (s)	46.0	46.0	46.0	46.0	46.0		24.0	72.0		12.0	60.0	60.0
Total Split (%)	35.4%	35.4%	35.4%	35.4%	35.4%		18.5%	55.4%		9.2%	46.2%	46.2%
Yellow Time (s)	3.0	3.0	3.0	3.0	3.0		4.0	4.0		4.0	4.0	4.0
All-Red Time (s)	2.0	2.0	2.0	2.0	2.0		2.0	2.0		2.0	2.0	2.0
Lost Time Adjust (s)	0.0	0.0	0.0	0.0	0.0		0.0	0.0		0.0	0.0	0.0
Total Lost Time (s)	5.0	5.0	5.0	5.0	5.0		6.0	6.0		6.0	6.0	6.0
Lead/Lag							Lead	Lag		Lead	Lag	Lag
Lead-Lag Optimize?							Yes	Yes		Yes	Yes	Yes
Recall Mode	None	None	None	None	None		None	C-Max		None	C-Max	C-Max
Act Effct Green (s)	27.2	27.2	27.2	27.2	27.2		91.8	89.3		81.1	75.3	75.3
Actuated g/C Ratio	0.21	0.21	0.21	0.21	0.21		0.71	0.69		0.62	0.58	0.58
v/c Ratio	0.81	0.07	0.35	0.12	0.19		0.37	0.53		0.03	0.39	0.11
Control Delay	71.8	37.9	8.4	39.2	17.7		9.9	13.1		8.8	17.3	1.6
Queue Delay	0.0	0.0	0.0	0.0	0.0		0.0	0.0		0.0	0.0	0.0
Total Delay	71.8	37.9	8.4	39.2	17.7		9.9	13.1		8.8	17.3	1.6
LOS	E	D	A	D	B		A	B		A	B	A
Approach Delay		45.3			24.2			12.7			15.5	
Approach LOS		D			C			B			B	
Queue Length 50th (m)	50.3	5.4	0.0	6.6	5.5		13.7	70.6		0.7	51.9	0.0
Queue Length 95th (m)	72.6	12.2	15.8	14.1	16.9		28.5	144.4		3.2	85.1	4.6
Internal Link Dist (m)		1246.0			796.0			547.8			406.9	
Turn Bay Length (m)	65.0		60.0	40.0			145.0			125.0		70.0
Base Capacity (vph)	365	520	515	377	522		515	2226		297	1834	772
Starvation Cap Reductn	0	0	0	0	0		0	0		0	0	0
Spillback Cap Reductn	0	0	0	0	0		0	0		0	0	0
Storage Cap Reductn	0	0	0	0	0		0	0		0	0	0
Reduced v/c Ratio	0.53	0.05	0.26	0.08	0.13		0.33	0.53		0.03	0.39	0.11

Intersection Summary

Cycle Length: 130

Actuated Cycle Length: 130

Offset: 112 (86%), Referenced to phase 2:NBTL and 6:SBTL, Start of Green

Natural Cycle: 100

Control Type: Actuated-Coordinated

Maximum v/c Ratio: 0.81

Intersection Signal Delay: 18.4

Intersection LOS: B

Intersection Capacity Utilization 75.0%

ICU Level of Service D

Analysis Period (min) 15





























Splits and Phases: 31: Terry Fox & Maple Grove



Intersection				
Intersection Delay, s/veh	6.3			
Intersection LOS	A			
Approach	EB	WB	NB	SB
Entry Lanes	1	1	1	1
Conflicting Circle Lanes	1	1	1	1
Adj Approach Flow, veh/h	55	40	530	375
Demand Flow Rate, veh/h	61	43	557	393
Vehicles Circulating, veh/h	419	557	37	48
Vehicles Exiting, veh/h	22	37	443	552
Ped Vol Crossing Leg, #/h	5	5	5	5
Ped Cap Adj	0.999	0.999	0.999	0.999
Approach Delay, s/veh	5.1	5.5	7.0	5.6
Approach LOS	A	A	A	A
Lane	Left	Left	Left	Left
Designated Moves	LTR	LTR	LTR	LTR
Assumed Moves	LTR	LTR	LTR	LTR
RT Channelized				
Lane Util	1.000	1.000	1.000	1.000
Follow-Up Headway, s	2.609	2.609	2.609	2.609
Critical Headway, s	4.976	4.976	4.976	4.976
Entry Flow, veh/h	61	43	557	393
Cap Entry Lane, veh/h	900	782	1329	1314
Entry HV Adj Factor	0.902	0.936	0.952	0.954
Flow Entry, veh/h	55	40	530	375
Cap Entry, veh/h	811	732	1264	1252
V/C Ratio	0.068	0.055	0.419	0.299
Control Delay, s/veh	5.1	5.5	7.0	5.6
LOS	A	A	A	A
95th %tile Queue, veh	0	0	2	1

Lanes, Volumes, Timings
3: Iber/Huntmar & Hazeldean

09-04-2020

												
Lane Group	EBL	EBT	EBR	WBL	WBT	WBR	NBL	NBT	NBR	SBL	SBT	SBR
Lane Configurations	 	 		 	 					 	 	
Traffic Volume (vph)	195	630	120	315	985	205	135	270	235	135	330	380
Future Volume (vph)	195	630	120	315	985	205	135	270	235	135	330	380
Confl. Peds. (#/hr)	5		5	5		5	5		5	5		5
Confl. Bikes (#/hr)												
Peak Hour Factor	1.00	1.00	1.00	1.00	1.00	1.00	1.00	1.00	1.00	1.00	1.00	1.00
Growth Factor	100%	100%	100%	100%	100%	100%	100%	100%	100%	100%	100%	100%
Heavy Vehicles (%)	0%	2%	3%	1%	1%	0%	7%	2%	1%	1%	2%	1%
Bus Blockages (#/hr)	0	0	0	0	0	0	0	0	0	0	0	0
Parking (#/hr)												
Mid-Block Traffic (%)		0%			0%			0%			0%	
Shared Lane Traffic (%)												
Lane Group Flow (vph)	195	750	0	315	985	205	135	270	235	135	330	380
Turn Type	Prot	NA		Prot	NA	Perm	pm+pt	NA	Perm	pm+pt	NA	pm+ov
Protected Phases	5	2		1	6		3	8		7	4	5
Permitted Phases						6	8		8	4		4
Detector Phase	5	2		1	6	6	3	8	8	7	4	5
Switch Phase												
Minimum Initial (s)	5.0	10.0		5.0	10.0	10.0	5.0	10.0	10.0	5.0	10.0	5.0
Minimum Split (s)	12.5	38.6		12.5	38.6	38.6	12.5	58.0	58.0	12.5	41.3	12.5
Total Split (s)	18.2	44.8		14.6	41.2	41.2	12.5	58.0	58.0	12.6	58.1	18.2
Total Split (%)	14.0%	34.5%		11.2%	31.7%	31.7%	9.6%	44.6%	44.6%	9.7%	44.7%	14.0%
Yellow Time (s)	3.6	3.6		3.6	3.6	3.6	3.0	3.3	3.3	3.0	3.3	3.6
All-Red Time (s)	2.0	2.0		2.0	2.0	2.0	0.0	2.0	2.0	0.0	2.0	2.0
Lost Time Adjust (s)	0.0	0.0		0.0	0.0	0.0	0.0	0.0	0.0	0.0	0.0	0.0
Total Lost Time (s)	5.6	5.6		5.6	5.6	5.6	3.0	5.3	5.3	3.0	5.3	5.6
Lead/Lag	Lead	Lag		Lead	Lag	Lag	Lead	Lag	Lag	Lead	Lag	Lead
Lead-Lag Optimize?	Yes	Yes		Yes	Yes	Yes	Yes	Yes	Yes	Yes	Yes	Yes
Recall Mode	None	C-Max		None	C-Max	C-Max	None	None	None	None	None	None
Act Effct Green (s)	12.9	46.4		24.2	57.8	57.8	42.2	30.4	30.4	42.1	30.4	43.0
Actuated g/C Ratio	0.10	0.36		0.19	0.44	0.44	0.32	0.23	0.23	0.32	0.23	0.33
v/c Ratio	0.59	0.64		0.51	0.65	0.26	0.61	0.65	0.45	0.48	0.80	0.69
Control Delay	63.3	37.7		51.9	32.8	4.6	41.6	51.9	7.0	34.7	61.1	31.7
Queue Delay	0.0	0.0		0.0	0.0	0.0	0.0	0.0	0.0	0.0	0.0	0.0
Total Delay	63.3	37.7		51.9	32.8	4.6	41.6	51.9	7.0	34.7	61.1	31.7
LOS	E	D		D	C	A	D	D	A	C	E	C
Approach Delay		43.0			32.9			33.3			43.7	
Approach LOS		D			C			C			D	
Queue Length 50th (m)	26.3	83.7		40.7	107.7	0.0	25.8	66.4	0.0	25.7	84.5	65.7
Queue Length 95th (m)	38.2	118.6		56.5	157.4	17.1	37.7	88.0	19.2	37.4	109.0	83.6
Internal Link Dist (m)		871.0			1427.4			1305.6			301.9	
Turn Bay Length (m)	50.0			90.0		225.0	30.0		60.0	50.0		275.0
Base Capacity (vph)	352	1174		612	1504	781	220	715	742	283	716	558
Starvation Cap Reductn	0	0		0	0	0	0	0	0	0	0	0
Spillback Cap Reductn	0	0		0	0	0	0	0	0	0	0	0
Storage Cap Reductn	0	0		0	0	0	0	0	0	0	0	0
Reduced v/c Ratio	0.55	0.64		0.51	0.65	0.26	0.61	0.38	0.32	0.48	0.46	0.68









Intersection Summary

Lanes, Volumes, Timings
 3: Iber/Huntmar & Hazeldean

09-04-2020

































Cycle Length: 130	
Actuated Cycle Length: 130	
Offset: 0 (0%), Referenced to phase 2:EBT and 6:WBT, Start of Green	
Natural Cycle: 125	
Control Type: Actuated-Coordinated	
Maximum v/c Ratio: 0.80	
Intersection Signal Delay: 37.7	Intersection LOS: D
Intersection Capacity Utilization 80.0%	ICU Level of Service D
Analysis Period (min) 15	

Splits and Phases: 3: Iber/Huntmar & Hazeldean

 Ø1 14.6 s	 Ø2 (R) 44.8 s	 Ø3 12.5 s	 Ø4 58.1 s
 Ø5 18.2 s	 Ø6 (R) 41.2 s	 Ø7 12.6 s	 Ø8 58 s

Lanes, Volumes, Timings
6: Terry Fox & Palladium/Katimavik

09-04-2020

												
Lane Group	EBL	EBT	EBR	WBL	WBT	WBR	NBL	NBT	NBR	SBL	SBT	SBR
Lane Configurations	 		 	 		 	 	 		 	 	
Traffic Volume (vph)	680	245	315	130	175	145	215	1080	95	115	1270	625
Future Volume (vph)	680	245	315	130	175	145	215	1080	95	115	1270	625
Confl. Peds. (#/hr)	5		5	5		5	5		5	5		5
Confl. Bikes (#/hr)												
Peak Hour Factor	1.00	1.00	1.00	1.00	1.00	1.00	1.00	1.00	1.00	1.00	1.00	1.00
Growth Factor	100%	100%	100%	100%	100%	100%	100%	100%	100%	100%	100%	100%
Heavy Vehicles (%)	0%	0%	1%	5%	2%	0%	0%	2%	4%	0%	1%	0%
Bus Blockages (#/hr)	0	0	0	0	0	0	0	0	0	0	0	0
Parking (#/hr)												
Mid-Block Traffic (%)		0%			0%			0%			0%	
Shared Lane Traffic (%)												
Lane Group Flow (vph)	680	245	315	130	175	145	215	1080	95	115	1270	625
Turn Type	Prot	NA	Perm	Prot	NA	Perm	Prot	NA	Perm	Prot	NA	Perm
Protected Phases	7	4		3	8		5	2		1	6	
Permitted Phases			4			8			2			6
Detector Phase	7	4	4	3	8	8	5	2	2	1	6	6
Switch Phase												
Minimum Initial (s)	5.0	10.0	10.0	5.0	10.0	10.0	5.0	10.0	10.0	5.0	10.0	10.0
Minimum Split (s)	12.0	37.6	37.6	12.0	37.3	37.3	12.0	38.0	38.0	11.0	38.0	38.0
Total Split (s)	35.7	46.3	46.3	29.7	40.3	40.3	12.0	56.0	56.0	18.0	62.0	62.0
Total Split (%)	23.8%	30.9%	30.9%	19.8%	26.9%	26.9%	8.0%	37.3%	37.3%	12.0%	41.3%	41.3%
Yellow Time (s)	3.6	3.6	3.6	3.3	3.3	3.3	4.0	4.0	4.0	4.0	4.0	4.0
All-Red Time (s)	2.0	2.0	2.0	2.0	2.0	2.0	2.0	2.0	2.0	2.0	2.0	2.0
Lost Time Adjust (s)	-2.0	0.0	0.0	-2.0	0.0	0.0	0.0	0.0	0.0	0.0	0.0	0.0
Total Lost Time (s)	3.6	5.6	5.6	3.3	5.3	5.3	6.0	6.0	6.0	6.0	6.0	6.0
Lead/Lag	Lead	Lead	Lead	Lag	Lag	Lag	Lead	Lag	Lag	Lead	Lag	Lag
Lead-Lag Optimize?	Yes	Yes	Yes	Yes	Yes	Yes	Yes	Yes	Yes	Yes	Yes	Yes
Recall Mode	None	None	None	None	None	None	None	C-Max	C-Max	None	C-Max	C-Max
Act Effct Green (s)	32.1	25.9	25.9	27.3	21.2	21.2	19.2	65.3	65.3	10.5	56.7	56.7
Actuated g/C Ratio	0.21	0.17	0.17	0.18	0.14	0.14	0.13	0.44	0.44	0.07	0.38	0.38
v/c Ratio	0.96	0.79	0.74	0.44	0.71	0.48	0.51	0.74	0.13	0.49	0.99	0.65
Control Delay	83.0	76.6	30.2	59.7	75.7	22.6	65.8	40.3	1.4	74.1	69.6	5.9
Queue Delay	0.0	0.0	0.0	0.0	0.0	0.0	0.0	0.0	0.0	0.0	0.0	0.0
Total Delay	83.0	76.6	30.2	59.7	75.7	22.6	65.8	40.3	1.4	74.1	69.6	5.9
LOS	F	E	C	E	E	C	E	D	A	E	E	A
Approach Delay		68.3			54.0			41.6			50.1	
Approach LOS		E			D			D			D	
Queue Length 50th (m)	109.7	74.5	33.2	36.9	53.5	11.0	32.8	144.8	0.0	18.2	205.7	0.0
Queue Length 95th (m)	#149.2	99.7	65.9	58.0	73.9	31.0	#67.0	#217.1	3.1	28.6	#262.6	29.2
Internal Link Dist (m)		1802.0			304.5			406.9			280.2	
Turn Bay Length (m)	100.0			115.0		115.0	240.0		115.0	70.0		190.0
Base Capacity (vph)	709	488	552	297	411	431	424	1459	708	272	1279	956
Starvation Cap Reductn	0	0	0	0	0	0	0	0	0	0	0	0
Spillback Cap Reductn	0	0	0	0	0	0	0	0	0	0	0	0
Storage Cap Reductn	0	0	0	0	0	0	0	0	0	0	0	0
Reduced v/c Ratio	0.96	0.50	0.57	0.44	0.43	0.34	0.51	0.74	0.13	0.42	0.99	0.65

Intersection Summary

Cycle Length: 150

Actuated Cycle Length: 150

Offset: 0 (0%), Referenced to phase 2:NBT and 6:SBT, Start of Green, Master Intersection

Natural Cycle: 150

Control Type: Actuated-Coordinated

Maximum v/c Ratio: 0.99

Intersection Signal Delay: 52.5

Intersection LOS: D

Intersection Capacity Utilization 94.1%

ICU Level of Service F

Analysis Period (min) 15

95th percentile volume exceeds capacity, queue may be longer.





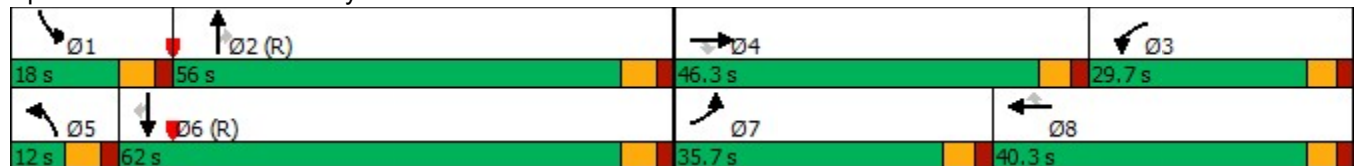

















Queue shown is maximum after two cycles.

Splits and Phases: 6: Terry Fox & Palladium/Katimavik



Lanes, Volumes, Timings
8: Huntmar & Palladium

09-04-2020

												
Lane Group	EBL	EBT	EBR	WBL	WBT	WBR	NBL	NBT	NBR	SBL	SBT	SBR
Lane Configurations												
Traffic Volume (vph)	25	140	420	155	395	110	215	190	70	80	280	85
Future Volume (vph)	25	140	420	155	395	110	215	190	70	80	280	85
Confl. Peds. (#/hr)	5		5	5		5	5		5	5		5
Confl. Bikes (#/hr)												
Peak Hour Factor	1.00	1.00	1.00	1.00	1.00	1.00	1.00	1.00	1.00	1.00	1.00	1.00
Growth Factor	100%	100%	100%	100%	100%	100%	100%	100%	100%	100%	100%	100%
Heavy Vehicles (%)	12%	0%	1%	1%	0%	0%	1%	1%	0%	1%	2%	1%
Bus Blockages (#/hr)	0	0	0	0	0	0	0	0	0	0	0	0
Parking (#/hr)												
Mid-Block Traffic (%)		0%			0%			0%			0%	
Shared Lane Traffic (%)												
Lane Group Flow (vph)	25	560	0	155	505	0	215	190	70	80	280	85
Turn Type	pm+pt	NA		pm+pt	NA		pm+pt	NA	Perm	Perm	NA	Perm
Protected Phases	5	2		1	6		3	8			4	
Permitted Phases	2			6			8		8	4		4
Detector Phase	5	2		1	6		3	8	8	4	4	4
Switch Phase												
Minimum Initial (s)	5.0	10.0		5.0	10.0		4.0	10.0	10.0	10.0	10.0	10.0
Minimum Split (s)	12.5	43.0		12.5	43.0		10.0	42.3	42.3	42.3	42.3	42.3
Total Split (s)	19.0	43.0		22.0	46.0		21.0	75.0	75.0	54.0	54.0	54.0
Total Split (%)	13.6%	30.7%		15.7%	32.9%		15.0%	53.6%	53.6%	38.6%	38.6%	38.6%
Yellow Time (s)	4.0	4.0		4.0	4.0		4.0	3.3	3.3	3.3	3.3	3.3
All-Red Time (s)	2.0	2.0		2.0	2.0		2.0	2.0	2.0	2.0	2.0	2.0
Lost Time Adjust (s)	0.0	0.0		0.0	0.0		0.0	0.0	0.0	0.0	0.0	0.0
Total Lost Time (s)	6.0	6.0		6.0	6.0		6.0	5.3	5.3	5.3	5.3	5.3
Lead/Lag	Lag	Lead		Lag	Lead		Lead			Lag	Lag	Lag
Lead-Lag Optimize?	Yes	Yes		Yes	Yes		Yes			Yes	Yes	Yes
Recall Mode	None	C-Max		None	C-Max		None	None	None	None	None	None
Act Effct Green (s)	68.0	62.4		74.0	68.8		52.2	52.9	52.9	28.0	28.0	28.0
Actuated g/C Ratio	0.49	0.45		0.53	0.49		0.37	0.38	0.38	0.20	0.20	0.20
v/c Ratio	0.07	0.36		0.38	0.31		0.67	0.28	0.11	0.35	0.79	0.22
Control Delay	20.0	7.9		25.8	23.5		34.7	22.2	1.5	50.8	69.1	3.8
Queue Delay	0.0	0.0		0.0	0.0		0.0	0.0	0.0	0.0	0.0	0.0
Total Delay	20.0	7.9		25.8	23.5		34.7	22.2	1.5	50.8	69.1	3.8
LOS	B	A		C	C		C	C	A	D	E	A
Approach Delay		8.4			24.1			24.8			53.3	
Approach LOS		A			C			C			D	
Queue Length 50th (m)	3.3	12.6		22.3	46.4		29.2	25.7	0.1	20.3	78.4	0.0
Queue Length 95th (m)	9.8	30.0		42.4	70.7		m40.7	m30.4	m2.1	34.5	103.7	6.4
Internal Link Dist (m)		535.2			1802.0			357.2			231.7	
Turn Bay Length (m)	95.0			75.0			120.0		45.0	50.0		
Base Capacity (vph)	437	1545		512	1631		322	887	783	393	613	593
Starvation Cap Reductn	0	0		0	0		0	0	0	0	0	0
Spillback Cap Reductn	0	0		0	0		0	0	0	0	0	0
Storage Cap Reductn	0	0		0	0		0	0	0	0	0	0
Reduced v/c Ratio	0.06	0.36		0.30	0.31		0.67	0.21	0.09	0.20	0.46	0.14

Intersection Summary

Lanes, Volumes, Timings
 8: Huntmar & Palladium

09-04-2020

Cycle Length: 140
 Actuated Cycle Length: 140
 Offset: 0 (0%), Referenced to phase 2:EBTL and 6:WBTL, Start of Green
 Natural Cycle: 110
 Control Type: Actuated-Coordinated
 Maximum v/c Ratio: 0.79
 Intersection Signal Delay: 26.0 Intersection LOS: C
 Intersection Capacity Utilization 89.8% ICU Level of Service E
 Analysis Period (min) 15
 m Volume for 95th percentile queue is metered by upstream signal.

Splits and Phases: 8: Huntmar & Palladium

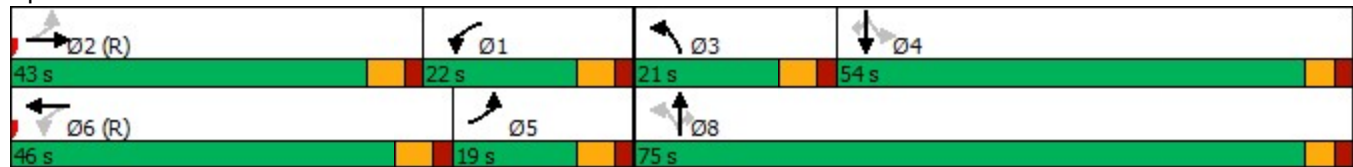

Lanes, Volumes, Timings
21: Huntmar & Maple Grove

09-04-2020



Lane Group	EBL	EBT	EBR	WBL	WBT	WBR	NBL	NBT	NBR	SBL	SBT	SBR
Lane Configurations		↕			↕		↕	↕			↕	
Traffic Volume (vph)	90	85	65	135	145	30	95	455	100	35	660	195
Future Volume (vph)	90	85	65	135	145	30	95	455	100	35	660	195
Confl. Peds. (#/hr)	5		5	5		5	5		5	5		5
Confl. Bikes (#/hr)												
Peak Hour Factor	1.00	1.00	1.00	1.00	1.00	1.00	1.00	1.00	1.00	1.00	1.00	1.00
Growth Factor	100%	100%	100%	100%	100%	100%	100%	100%	100%	100%	100%	100%
Heavy Vehicles (%)	0%	1%	0%	0%	0%	0%	2%	1%	0%	0%	1%	0%
Bus Blockages (#/hr)	0	0	0	0	0	0	0	0	0	0	0	0
Parking (#/hr)												
Mid-Block Traffic (%)		0%			0%			0%			0%	
Shared Lane Traffic (%)												
Lane Group Flow (vph)	0	240	0	0	310	0	95	555	0	0	890	0
Turn Type	pm+pt	NA		Perm	NA		Perm	NA		Perm	NA	
Protected Phases	7	4			8			2			6	
Permitted Phases	4			8			2			6		
Detector Phase	7	4		8	8		2	2		6	6	
Switch Phase												
Minimum Initial (s)	4.0	10.0		10.0	10.0		10.0	10.0		10.0	10.0	
Minimum Split (s)	10.0	33.0		33.0	33.0		29.0	29.0		49.0	49.0	
Total Split (s)	10.0	52.0		42.0	42.0		88.0	88.0		88.0	88.0	
Total Split (%)	7.1%	37.1%		30.0%	30.0%		62.9%	62.9%		62.9%	62.9%	
Yellow Time (s)	4.0	3.0		3.0	3.0		3.3	3.3		3.3	3.3	
All-Red Time (s)	2.0	2.0		2.0	2.0		2.0	2.0		2.0	2.0	
Lost Time Adjust (s)		0.0			0.0		0.0	0.0			0.0	
Total Lost Time (s)		5.0			5.0		5.3	5.3			5.3	
Lead/Lag	Lead			Lag	Lag							
Lead-Lag Optimize?	Yes											
Recall Mode	None	None		None	None		C-Max	C-Max		C-Max	C-Max	
Act Effct Green (s)		38.1			38.1		91.6	91.6			91.6	
Actuated g/C Ratio		0.27			0.27		0.65	0.65			0.65	
v/c Ratio		0.70			0.93		0.28	0.49			0.82	
Control Delay		53.1			82.1		14.7	14.9			17.7	
Queue Delay		0.0			0.0		0.0	0.0			0.0	
Total Delay		53.1			82.1		14.7	14.9			17.7	
LOS		D			F		B	B			B	
Approach Delay		53.1			82.1			14.9			17.7	
Approach LOS		D			F			B			B	
Queue Length 50th (m)		59.1			86.8		11.2	76.4			62.7	
Queue Length 95th (m)		84.0			118.8		26.0	124.1			#320.9	
Internal Link Dist (m)		630.5			86.3			293.1			175.1	
Turn Bay Length (m)							20.0					
Base Capacity (vph)		422			355		337	1133			1087	
Starvation Cap Reductn		0			0		0	0			0	
Spillback Cap Reductn		0			0		0	0			0	
Storage Cap Reductn		0			0		0	0			0	
Reduced v/c Ratio		0.57			0.87		0.28	0.49			0.82	

Intersection Summary

Lanes, Volumes, Timings
21: Huntmar & Maple Grove

09-04-2020

Cycle Length: 140

Actuated Cycle Length: 140

Offset: 0 (0%), Referenced to phase 2:NBTL and 6:SBTL, Start of Green

Natural Cycle: 95

Control Type: Actuated-Coordinated

Maximum v/c Ratio: 0.93

Intersection Signal Delay: 30.5

Intersection LOS: C

Intersection Capacity Utilization 113.5%

ICU Level of Service H

Analysis Period (min) 15

95th percentile volume exceeds capacity, queue may be longer.

Queue shown is maximum after two cycles.

Splits and Phases: 21: Huntmar & Maple Grove

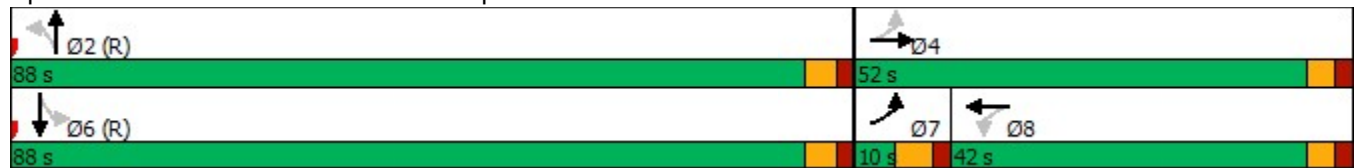

Lanes, Volumes, Timings
31: Terry Fox & Maple Grove

09-04-2020

































Lane Group	EBL	EBT	EBR	WBL	WBT	WBR	NBL	NBT	NBR	SBL	SBT	SBR
Lane Configurations	↖	↗	↘	↖	↗		↖	↗		↖	↗	↘
Traffic Volume (vph)	130	30	280	15	25	35	170	1190	40	55	1545	125
Future Volume (vph)	130	30	280	15	25	35	170	1190	40	55	1545	125
Confl. Peds. (#/hr)	5		5	5		5	5		5	5		5
Confl. Bikes (#/hr)												
Peak Hour Factor	1.00	1.00	1.00	1.00	1.00	1.00	1.00	1.00	1.00	1.00	1.00	1.00
Growth Factor	100%	100%	100%	100%	100%	100%	100%	100%	100%	100%	100%	100%
Heavy Vehicles (%)	3%	0%	1%	0%	0%	0%	3%	2%	0%	0%	1%	4%
Bus Blockages (#/hr)	0	0	0	0	0	0	0	0	0	0	0	0
Parking (#/hr)												
Mid-Block Traffic (%)		0%			0%			0%			0%	
Shared Lane Traffic (%)												
Lane Group Flow (vph)	130	30	280	15	60	0	170	1230	0	55	1545	125
Turn Type	Perm	NA	Perm	Perm	NA		pm+pt	NA		pm+pt	NA	Perm
Protected Phases		4			8		5	2		1	6	
Permitted Phases	4		4	8			2			6		6
Detector Phase	4	4	4	8	8		5	2		1	6	6
Switch Phase												
Minimum Initial (s)	10.0	10.0	10.0	10.0	10.0		5.0	10.0		5.0	10.0	10.0
Minimum Split (s)	42.0	42.0	42.0	42.0	42.0		12.0	43.0		12.0	43.0	43.0
Total Split (s)	46.0	46.0	46.0	46.0	46.0		24.0	72.0		12.0	60.0	60.0
Total Split (%)	35.4%	35.4%	35.4%	35.4%	35.4%		18.5%	55.4%		9.2%	46.2%	46.2%
Yellow Time (s)	3.0	3.0	3.0	3.0	3.0		4.0	4.0		4.0	4.0	4.0
All-Red Time (s)	2.0	2.0	2.0	2.0	2.0		2.0	2.0		2.0	2.0	2.0
Lost Time Adjust (s)	0.0	0.0	0.0	0.0	0.0		0.0	0.0		0.0	0.0	0.0
Total Lost Time (s)	5.0	5.0	5.0	5.0	5.0		6.0	6.0		6.0	6.0	6.0
Lead/Lag							Lead	Lag		Lead	Lag	Lag
Lead-Lag Optimize?							Yes	Yes		Yes	Yes	Yes
Recall Mode	None	None	None	None	None		None	C-Max		None	C-Max	C-Max
Act Effct Green (s)	21.0	21.0	21.0	21.0	21.0		97.4	87.6		86.0	79.3	79.3
Actuated g/C Ratio	0.16	0.16	0.16	0.16	0.16		0.75	0.67		0.66	0.61	0.61
v/c Ratio	0.65	0.10	0.68	0.07	0.21		0.66	0.55		0.18	0.75	0.14
Control Delay	64.0	42.6	22.5	41.5	22.3		28.7	14.5		8.4	23.8	4.2
Queue Delay	0.0	0.0	0.0	0.0	0.0		0.0	0.0		0.0	0.0	0.0
Total Delay	64.0	42.6	22.5	41.5	22.3		28.7	14.5		8.4	23.8	4.2
LOS	E	D	C	D	C		C	B		A	C	A
Approach Delay		36.1			26.1			16.2			21.9	
Approach LOS		D			C			B			C	
Queue Length 50th (m)	33.9	7.1	19.0	3.5	5.9		15.1	82.5		3.0	140.3	0.8
Queue Length 95th (m)	47.7	13.9	43.3	8.8	16.1		45.5	155.6		10.7	#288.0	13.5
Internal Link Dist (m)		1246.0			796.0			547.8			406.9	
Turn Bay Length (m)	65.0		60.0	40.0			145.0			125.0		70.0
Base Capacity (vph)	393	567	608	416	536		326	2249		303	2064	916
Starvation Cap Reductn	0	0	0	0	0		0	0		0	0	0
Spillback Cap Reductn	0	0	0	0	0		0	0		0	0	0
Storage Cap Reductn	0	0	0	0	0		0	0		0	0	0
Reduced v/c Ratio	0.33	0.05	0.46	0.04	0.11		0.52	0.55		0.18	0.75	0.14

Intersection Summary

Intersection				
Intersection Delay, s/veh	9.9			
Intersection LOS	A			
Approach	EB	WB	NB	SB
Entry Lanes	1	1	1	1
Conflicting Circle Lanes	1	1	1	1
Adj Approach Flow, veh/h	50	80	650	795
Demand Flow Rate, veh/h	54	81	656	804
Vehicles Circulating, veh/h	849	646	32	131
Vehicles Exiting, veh/h	86	42	870	596
Ped Vol Crossing Leg, #/h	5	5	5	5
Ped Cap Adj	0.999	0.999	0.999	0.999
Approach Delay, s/veh	7.8	6.3	7.8	12.2
Approach LOS	A	A	A	B
Lane	Left	Left	Left	Left
Designated Moves	LTR	LTR	LTR	LTR
Assumed Moves	LTR	LTR	LTR	LTR
RT Channelized				
Lane Util	1.000	1.000	1.000	1.000
Follow-Up Headway, s	2.609	2.609	2.609	2.609
Critical Headway, s	4.976	4.976	4.976	4.976
Entry Flow, veh/h	54	81	656	804
Cap Entry Lane, veh/h	580	714	1336	1207
Entry HV Adj Factor	0.932	0.988	0.991	0.989
Flow Entry, veh/h	50	80	650	795
Cap Entry, veh/h	541	705	1323	1193
V/C Ratio	0.093	0.114	0.492	0.666
Control Delay, s/veh	7.8	6.3	7.8	12.2
LOS	A	A	A	B
95th %tile Queue, veh	0	0	3	5

Lanes, Volumes, Timings
3: Iber/Huntmar & Hazeldean

09-04-2020

												
Lane Group	EBL	EBT	EBR	WBL	WBT	WBR	NBL	NBT	NBR	SBL	SBT	SBR
Lane Configurations	 	 		 	 		 			 	 	
Traffic Volume (vph)	225	750	120	180	445	120	55	295	275	140	290	125
Future Volume (vph)	225	750	120	180	445	120	55	295	275	140	290	125
Confl. Peds. (#/hr)	5		5	5		5	5		5	5		5
Confl. Bikes (#/hr)												
Peak Hour Factor	1.00	1.00	1.00	1.00	1.00	1.00	1.00	1.00	1.00	1.00	1.00	1.00
Growth Factor	100%	100%	100%	100%	100%	100%	100%	100%	100%	100%	100%	100%
Heavy Vehicles (%)	2%	2%	13%	3%	4%	2%	4%	0%	5%	3%	2%	0%
Bus Blockages (#/hr)	0	0	0	0	0	0	0	0	0	0	0	0
Parking (#/hr)												
Mid-Block Traffic (%)		0%			0%			0%			0%	
Shared Lane Traffic (%)												
Lane Group Flow (vph)	225	870	0	180	445	120	55	295	275	140	290	125
Turn Type	Prot	NA		Prot	NA	Perm	pm+pt	NA	Perm	pm+pt	NA	pm+ov
Protected Phases	5	2		1	6		3	8		7	4	5
Permitted Phases						6	8		8	4		4
Detector Phase	5	2		1	6	6	3	8	8	7	4	5
Switch Phase												
Minimum Initial (s)	5.0	10.0		5.0	10.0	10.0	5.0	10.0	10.0	5.0	10.0	5.0
Minimum Split (s)	12.5	38.6		12.5	38.6	38.6	12.5	58.0	58.0	12.5	41.3	12.5
Total Split (s)	18.2	44.8		14.6	41.2	41.2	12.5	58.0	58.0	12.6	58.1	18.2
Total Split (%)	14.0%	34.5%		11.2%	31.7%	31.7%	9.6%	44.6%	44.6%	9.7%	44.7%	14.0%
Yellow Time (s)	3.6	3.6		3.6	3.6	3.6	3.0	3.3	3.3	3.0	3.3	3.6
All-Red Time (s)	2.0	2.0		2.0	2.0	2.0	0.0	2.0	2.0	0.0	2.0	2.0
Lost Time Adjust (s)	0.0	0.0		0.0	0.0	0.0	0.0	0.0	0.0	0.0	0.0	0.0
Total Lost Time (s)	5.6	5.6		5.6	5.6	5.6	3.0	5.3	5.3	3.0	5.3	5.6
Lead/Lag	Lead	Lag		Lead	Lag	Lag	Lead	Lag	Lag	Lead	Lag	Lead
Lead-Lag Optimize?	Yes	Yes		Yes	Yes	Yes	Yes	Yes	Yes	Yes	Yes	Yes
Recall Mode	None	C-Max		None	C-Max	C-Max	None	None	None	None	None	None
Act Effct Green (s)	14.3	60.6		13.0	59.4	59.4	37.8	27.3	27.3	40.4	30.4	44.4
Actuated g/C Ratio	0.11	0.47		0.10	0.46	0.46	0.29	0.21	0.21	0.31	0.23	0.34
v/c Ratio	0.63	0.58		0.56	0.30	0.16	0.23	0.78	0.54	0.62	0.70	0.21
Control Delay	63.2	28.3		62.3	24.6	5.1	30.9	62.6	9.3	43.9	55.5	4.4
Queue Delay	0.0	0.0		0.0	0.0	0.0	0.0	0.0	0.0	0.0	0.0	0.0
Total Delay	63.2	28.3		62.3	24.6	5.1	30.9	62.6	9.3	43.9	55.5	4.4
LOS	E	C		E	C	A	C	E	A	D	E	A
Approach Delay		35.5			30.5			36.3			41.1	
Approach LOS		D			C			D			D	
Queue Length 50th (m)	30.3	86.9		24.2	38.9	0.0	10.4	75.8	1.9	27.8	73.9	0.0
Queue Length 95th (m)	43.0	127.8		35.8	61.5	13.4	18.6	100.7	24.8	40.8	98.9	11.3
Internal Link Dist (m)		871.0			1427.4			1305.6			301.9	
Turn Bay Length (m)	50.0			90.0		225.0	30.0		60.0	50.0		275.0
Base Capacity (vph)	368	1512		321	1501	738	255	729	738	226	716	603
Starvation Cap Reductn	0	0		0	0	0	0	0	0	0	0	0
Spillback Cap Reductn	0	0		0	0	0	0	0	0	0	0	0
Storage Cap Reductn	0	0		0	0	0	0	0	0	0	0	0
Reduced v/c Ratio	0.61	0.58		0.56	0.30	0.16	0.22	0.40	0.37	0.62	0.41	0.21









Intersection Summary

Lanes, Volumes, Timings
 3: Iber/Huntmar & Hazeldean

09-04-2020

























Cycle Length: 130	
Actuated Cycle Length: 130	
Offset: 0 (0%), Referenced to phase 2:EBT and 6:WBT, Start of Green	
Natural Cycle: 125	
Control Type: Actuated-Coordinated	
Maximum v/c Ratio: 0.78	
Intersection Signal Delay: 35.5	Intersection LOS: D
Intersection Capacity Utilization 76.0%	ICU Level of Service D
Analysis Period (min) 15	

Splits and Phases: 3: Iber/Huntmar & Hazeldean

 Ø1 14.6 s	 Ø2 (R) 44.8 s	 Ø3 12.5 s	 Ø4 58.1 s
 Ø5 18.2 s	 Ø6 (R) 41.2 s	 Ø7 12.6 s	 Ø8 58 s

Lanes, Volumes, Timings
6: Terry Fox & Palladium/Katimavik

09-04-2020

												
Lane Group	EBL	EBT	EBR	WBL	WBT	WBR	NBL	NBT	NBR	SBL	SBT	SBR
Lane Configurations												
Traffic Volume (vph)	285	60	125	60	105	155	380	1260	85	90	885	835
Future Volume (vph)	285	60	125	60	105	155	380	1260	85	90	885	835
Confl. Peds. (#/hr)	5		5	5		5	5		5	5		5
Confl. Bikes (#/hr)												
Peak Hour Factor	1.00	1.00	1.00	1.00	1.00	1.00	1.00	1.00	1.00	1.00	1.00	1.00
Growth Factor	100%	100%	100%	100%	100%	100%	100%	100%	100%	100%	100%	100%
Heavy Vehicles (%)	5%	5%	3%	11%	5%	3%	0%	2%	12%	2%	5%	1%
Bus Blockages (#/hr)	0	0	0	0	0	0	0	0	0	0	0	0
Parking (#/hr)												
Mid-Block Traffic (%)		0%			0%			0%			0%	
Shared Lane Traffic (%)												
Lane Group Flow (vph)	285	60	125	60	105	155	380	1260	85	90	885	835
Turn Type	Prot	NA	Perm	Prot	NA	Perm	Prot	NA	Perm	Prot	NA	Perm
Protected Phases	7	4		3	8		5	2		1	6	
Permitted Phases			4			8			2			6
Detector Phase	7	4	4	3	8	8	5	2	2	1	6	6
Switch Phase												
Minimum Initial (s)	5.0	10.0	10.0	5.0	10.0	10.0	5.0	10.0	10.0	5.0	10.0	10.0
Minimum Split (s)	12.0	40.6	40.6	12.0	40.3	40.3	12.0	42.5	42.5	30.0	41.0	41.0
Total Split (s)	20.7	47.0	47.0	14.0	40.3	40.3	24.0	59.0	59.0	30.0	65.0	65.0
Total Split (%)	13.8%	31.3%	31.3%	9.3%	26.9%	26.9%	16.0%	39.3%	39.3%	20.0%	43.3%	43.3%
Yellow Time (s)	3.6	3.6	3.6	3.3	3.3	3.3	4.0	4.0	4.0	4.0	4.0	4.0
All-Red Time (s)	2.0	2.0	2.0	2.0	2.0	2.0	2.0	2.0	2.0	2.0	2.0	2.0
Lost Time Adjust (s)	0.0	0.0	0.0	0.0	0.0	0.0	0.0	0.0	0.0	0.0	0.0	0.0
Total Lost Time (s)	5.6	5.6	5.6	5.3	5.3	5.3	6.0	6.0	6.0	6.0	6.0	6.0
Lead/Lag	Lead	Lead	Lead	Lag	Lag	Lag	Lead	Lag	Lag	Lead	Lag	Lag
Lead-Lag Optimize?	Yes	Yes	Yes	Yes	Yes	Yes	Yes	Yes	Yes	Yes	Yes	Yes
Recall Mode	None	None	None	None	None	None	None	C-Max	C-Max	None	C-Max	C-Max
Act Effct Green (s)	15.1	19.1	19.1	15.7	17.3	17.3	22.4	85.2	85.2	9.5	72.3	72.3
Actuated g/C Ratio	0.10	0.13	0.13	0.10	0.12	0.12	0.15	0.57	0.57	0.06	0.48	0.48
v/c Ratio	0.90	0.28	0.43	0.37	0.53	0.51	0.77	0.66	0.10	0.44	0.56	0.84
Control Delay	96.0	62.9	12.9	68.3	70.6	13.4	71.9	26.4	0.3	73.8	30.8	20.8
Queue Delay	0.0	0.0	0.0	0.0	0.0	0.0	0.0	0.0	0.0	0.0	0.0	0.0
Total Delay	96.0	62.9	12.9	68.3	70.6	13.4	71.9	26.4	0.3	73.8	30.8	20.8
LOS	F	E	B	E	E	B	E	C	A	E	C	C
Approach Delay		69.7			42.5			35.1			28.3	
Approach LOS		E			D			D			C	
Queue Length 50th (m)	46.2	18.5	0.0	17.4	32.2	0.0	58.8	132.2	0.0	14.2	100.5	89.5
Queue Length 95th (m)	#73.6	29.3	18.0	33.8	46.4	19.6	#86.4	214.2	0.2	23.5	146.1	#219.0
Internal Link Dist (m)		1802.0			304.5			406.9			280.2	
Turn Bay Length (m)	100.0			115.0		115.0	240.0		115.0	70.0		190.0
Base Capacity (vph)	318	473	492	165	399	458	496	1905	822	520	1569	996
Starvation Cap Reductn	0	0	0	0	0	0	0	0	0	0	0	0
Spillback Cap Reductn	0	0	0	0	0	0	0	0	0	0	0	0
Storage Cap Reductn	0	0	0	0	0	0	0	0	0	0	0	0
Reduced v/c Ratio	0.90	0.13	0.25	0.36	0.26	0.34	0.77	0.66	0.10	0.17	0.56	0.84

Intersection Summary

Lanes, Volumes, Timings
 6: Terry Fox & Palladium/Katimavik

09-04-2020

Cycle Length: 150

Actuated Cycle Length: 150

Offset: 0 (0%), Referenced to phase 2:NBT and 6:SBT, Start of Green, Master Intersection

Natural Cycle: 150

Control Type: Actuated-Coordinated

Maximum v/c Ratio: 0.90

Intersection Signal Delay: 36.6

Intersection LOS: D

Intersection Capacity Utilization 92.1%

ICU Level of Service F

Analysis Period (min) 15

95th percentile volume exceeds capacity, queue may be longer.

Queue shown is maximum after two cycles.

Splits and Phases: 6: Terry Fox & Palladium/Katimavik

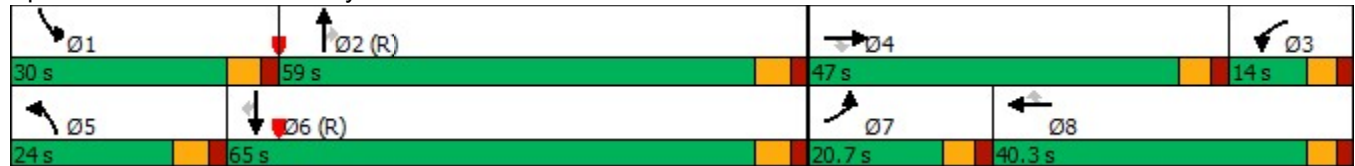

Lanes, Volumes, Timings
8: Huntmar & Palladium

09-04-2020

Lane Group	EBL	EBT	EBR	WBL	WBT	WBR	NBL	NBT	NBR	SBL	SBT	SBR
Lane Configurations												
Traffic Volume (vph)	35	185	250	60	90	40	455	330	205	95	175	50
Future Volume (vph)	35	185	250	60	90	40	455	330	205	95	175	50
Confl. Peds. (#/hr)	5		5	5		5	5		5	5		5
Confl. Bikes (#/hr)												
Peak Hour Factor	1.00	1.00	1.00	1.00	1.00	1.00	1.00	1.00	1.00	1.00	1.00	1.00
Growth Factor	100%	100%	100%	100%	100%	100%	100%	100%	100%	100%	100%	100%
Heavy Vehicles (%)	0%	3%	2%	7%	1%	0%	0%	1%	1%	2%	4%	2%
Bus Blockages (#/hr)	0	0	0	0	0	0	0	0	0	0	0	0
Parking (#/hr)												
Mid-Block Traffic (%)		0%			0%			0%			0%	
Shared Lane Traffic (%)												
Lane Group Flow (vph)	35	435	0	60	130	0	455	330	205	95	175	50
Turn Type	pm+pt	NA		pm+pt	NA		pm+pt	NA	Perm	Perm	NA	Perm
Protected Phases	5	2		1	6		3	8			4	
Permitted Phases	2			6			8		8	4		4
Detector Phase	5	2		1	6		3	8	8	4	4	4
Switch Phase												
Minimum Initial (s)	5.0	10.0		5.0	10.0		4.0	10.0	10.0	10.0	10.0	10.0
Minimum Split (s)	12.5	43.0		12.5	43.0		10.0	42.3	42.3	42.3	42.3	42.3
Total Split (s)	12.6	45.4		12.6	45.4		39.0	82.0	82.0	43.0	43.0	43.0
Total Split (%)	9.0%	32.4%		9.0%	32.4%		27.9%	58.6%	58.6%	30.7%	30.7%	30.7%
Yellow Time (s)	4.0	4.0		4.0	4.0		4.0	3.3	3.3	3.3	3.3	3.3
All-Red Time (s)	2.0	2.0		2.0	2.0		2.0	2.0	2.0	2.0	2.0	2.0
Lost Time Adjust (s)	0.0	0.0		0.0	0.0		0.0	0.0	0.0	0.0	0.0	0.0
Total Lost Time (s)	6.0	6.0		6.0	6.0		6.0	5.3	5.3	5.3	5.3	5.3
Lead/Lag	Lead	Lag		Lead	Lag		Lead			Lag	Lag	Lag
Lead-Lag Optimize?	Yes	Yes		Yes	Yes		Yes			Yes	Yes	Yes
Recall Mode	None	C-Max		None	C-Max		None	None	None	None	None	None
Act Effct Green (s)	63.3	57.7		64.8	58.4		59.2	59.9	59.9	21.7	21.7	21.7
Actuated g/C Ratio	0.45	0.41		0.46	0.42		0.42	0.43	0.43	0.16	0.16	0.16
v/c Ratio	0.06	0.32		0.16	0.10		0.90	0.43	0.27	0.62	0.65	0.15
Control Delay	22.9	14.6		23.2	20.8		52.2	28.9	3.2	71.1	65.8	1.0
Queue Delay	0.0	0.0		0.0	0.0		0.0	0.0	0.0	0.0	0.0	0.0
Total Delay	22.9	14.6		23.2	20.8		52.2	28.9	3.2	71.1	65.8	1.0
LOS	C	B		C	C		D	C	A	E	E	A
Approach Delay		15.2			21.6			34.3				57.2
Approach LOS		B			C			C				E
Queue Length 50th (m)	5.1	18.8		8.9	8.3		105.0	68.0	0.0	26.8	49.5	0.0
Queue Length 95th (m)	14.4	39.3		22.0	19.0		111.5	74.0	11.9	40.6	65.1	0.0
Internal Link Dist (m)		535.2			1802.0			357.2				231.7
Turn Bay Length (m)	95.0			75.0			120.0		45.0	50.0		
Base Capacity (vph)	568	1378		386	1368		514	976	907	265	466	482
Starvation Cap Reductn	0	0		0	0		0	0	0	0	0	0
Spillback Cap Reductn	0	0		0	0		0	0	0	0	0	0
Storage Cap Reductn	0	0		0	0		0	0	0	0	0	0
Reduced v/c Ratio	0.06	0.32		0.16	0.10		0.89	0.34	0.23	0.36	0.38	0.10

Intersection Summary

Cycle Length: 140

Actuated Cycle Length: 140

Offset: 87 (62%), Referenced to phase 2:EBTL and 6:WBTL, Start of Green

Natural Cycle: 110

Control Type: Actuated-Coordinated

Maximum v/c Ratio: 0.90

Intersection Signal Delay: 32.2

Intersection LOS: C

Intersection Capacity Utilization 94.0%

ICU Level of Service F

Analysis Period (min) 15

Splits and Phases: 8: Huntmar & Palladium

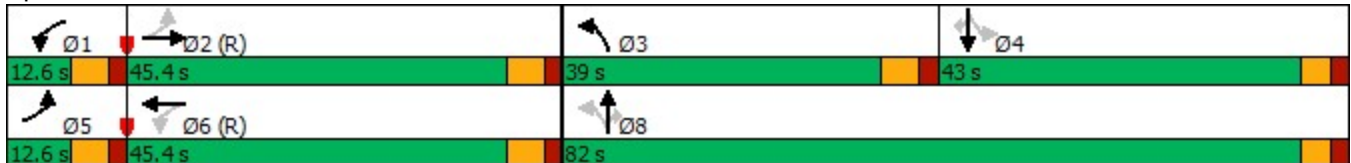

Lanes, Volumes, Timings
21: Huntmar & Maple Grove

09-04-2020



Lane Group	EBL	EBT	EBR	WBL	WBT	WBR	NBL	NBT	NBR	SBL	SBT	SBR
Lane Configurations	↖	↗		↖	↗		↖	↕		↖	↗	↖
Traffic Volume (vph)	280	155	60	75	65	105	35	550	110	45	335	60
Future Volume (vph)	280	155	60	75	65	105	35	550	110	45	335	60
Confl. Peds. (#/hr)	5		5	5		5	5		5	5		5
Confl. Bikes (#/hr)												
Peak Hour Factor	1.00	1.00	1.00	1.00	1.00	1.00	1.00	1.00	1.00	1.00	1.00	1.00
Growth Factor	100%	100%	100%	100%	100%	100%	100%	100%	100%	100%	100%	100%
Heavy Vehicles (%)	1%	1%	5%	0%	7%	1%	21%	2%	3%	2%	3%	0%
Bus Blockages (#/hr)	0	0	0	0	0	0	0	0	0	0	0	0
Parking (#/hr)												
Mid-Block Traffic (%)		0%			0%			0%			0%	
Shared Lane Traffic (%)												
Lane Group Flow (vph)	280	215	0	75	170	0	35	660	0	45	335	60
Turn Type	pm+pt	NA		pm+pt	NA		pm+pt	NA		pm+pt	NA	Perm
Protected Phases	7	4		3	8		5	2		1	6	
Permitted Phases	4			8			2			6		6
Detector Phase	7	4		3	8		5	2		1	6	6
Switch Phase												
Minimum Initial (s)	4.0	10.0		4.0	10.0		4.0	10.0		4.0	10.0	10.0
Minimum Split (s)	10.0	33.0		10.0	33.0		10.0	29.0		10.0	49.0	49.0
Total Split (s)	24.0	46.0		11.0	33.0		10.0	53.0		10.0	53.0	53.0
Total Split (%)	20.0%	38.3%		9.2%	27.5%		8.3%	44.2%		8.3%	44.2%	44.2%
Yellow Time (s)	4.0	3.0		4.0	3.0		4.0	3.3		4.0	3.3	3.3
All-Red Time (s)	2.0	2.0		2.0	2.0		2.0	2.0		2.0	2.0	2.0
Lost Time Adjust (s)	0.0	0.0		0.0	0.0		0.0	0.0		0.0	0.0	0.0
Total Lost Time (s)	6.0	5.0		6.0	5.0		6.0	5.3		6.0	5.3	5.3
Lead/Lag	Lead	Lag		Lead	Lag		Lead	Lag		Lead	Lag	Lag
Lead-Lag Optimize?	Yes	Yes		Yes			Yes	Yes		Yes	Yes	Yes
Recall Mode	None	None		None	None		None	C-Max		None	C-Max	C-Max
Act Effct Green (s)	38.0	30.2		19.2	15.2		65.1	60.2		66.4	62.7	62.7
Actuated g/C Ratio	0.32	0.25		0.16	0.13		0.54	0.50		0.55	0.52	0.52
v/c Ratio	0.82	0.50		0.37	0.68		0.08	0.40		0.12	0.37	0.07
Control Delay	52.6	39.1		35.6	44.0		13.2	20.6		13.4	21.2	0.1
Queue Delay	0.0	0.0		0.0	0.0		0.0	0.0		0.0	0.0	0.0
Total Delay	52.6	39.1		35.6	44.0		13.2	20.6		13.4	21.2	0.1
LOS	D	D		D	D		B	C		B	C	A
Approach Delay		46.7			41.4			20.3			17.5	
Approach LOS		D			D			C			B	
Queue Length 50th (m)	57.4	43.4		13.4	25.8		3.4	51.3		4.4	50.7	0.0
Queue Length 95th (m)	#75.9	61.5		22.4	45.8		9.9	80.1		11.9	89.3	0.0
Internal Link Dist (m)		630.5			86.3			293.1			175.1	
Turn Bay Length (m)							20.0					30.0
Base Capacity (vph)	344	583		202	409		429	1639		380	912	858
Starvation Cap Reductn	0	0		0	0		0	0		0	0	0
Spillback Cap Reductn	0	0		0	0		0	0		0	0	0
Storage Cap Reductn	0	0		0	0		0	0		0	0	0
Reduced v/c Ratio	0.81	0.37		0.37	0.42		0.08	0.40		0.12	0.37	0.07

Intersection Summary

Cycle Length: 120

Actuated Cycle Length: 120

Offset: 0 (0%), Referenced to phase 2:NBTL and 6:SBTL, Start of Green

Natural Cycle: 105

Control Type: Actuated-Coordinated

Maximum v/c Ratio: 0.82

Intersection Signal Delay: 29.4

Intersection LOS: C

Intersection Capacity Utilization 70.0%

ICU Level of Service C

Analysis Period (min) 15

95th percentile volume exceeds capacity, queue may be longer.

Queue shown is maximum after two cycles.

Splits and Phases: 21: Huntmar & Maple Grove



Lanes, Volumes, Timings
31: Terry Fox & Maple Grove

09-04-2020

Lane Group	EBL	EBT	EBR	WBL	WBT	WBR	NBL	NBT	NBR	SBL	SBT	SBR
Lane Configurations												
Traffic Volume (vph)	250	60	185	35	45	50	210	1350	35	15	810	110
Future Volume (vph)	250	60	185	35	45	50	210	1350	35	15	810	110
Confl. Peds. (#/hr)	5		5	5		5	5		5	5		5
Confl. Bikes (#/hr)												
Peak Hour Factor	1.00	1.00	1.00	1.00	1.00	1.00	1.00	1.00	1.00	1.00	1.00	1.00
Growth Factor	100%	100%	100%	100%	100%	100%	100%	100%	100%	100%	100%	100%
Heavy Vehicles (%)	8%	4%	9%	10%	5%	0%	7%	4%	6%	0%	7%	15%
Bus Blockages (#/hr)	0	0	0	0	0	0	0	0	0	0	0	0
Parking (#/hr)												
Mid-Block Traffic (%)		0%			0%			0%			0%	
Shared Lane Traffic (%)												
Lane Group Flow (vph)	250	60	185	35	95	0	210	1385	0	15	810	110
Turn Type	Perm	NA	Perm	Perm	NA		pm+pt	NA		pm+pt	NA	Perm
Protected Phases		4			8		5	2		1	6	
Permitted Phases	4		4	8			2			6		6
Detector Phase	4	4	4	8	8		5	2		1	6	6
Switch Phase												
Minimum Initial (s)	10.0	10.0	10.0	10.0	10.0		5.0	10.0		5.0	10.0	10.0
Minimum Split (s)	42.0	42.0	42.0	42.0	42.0		12.0	43.0		12.0	43.0	43.0
Total Split (s)	46.0	46.0	46.0	46.0	46.0		24.0	72.0		12.0	60.0	60.0
Total Split (%)	35.4%	35.4%	35.4%	35.4%	35.4%		18.5%	55.4%		9.2%	46.2%	46.2%
Yellow Time (s)	3.0	3.0	3.0	3.0	3.0		4.0	4.0		4.0	4.0	4.0
All-Red Time (s)	2.0	2.0	2.0	2.0	2.0		2.0	2.0		2.0	2.0	2.0
Lost Time Adjust (s)	0.0	0.0	0.0	0.0	0.0		0.0	0.0		0.0	0.0	0.0
Total Lost Time (s)	5.0	5.0	5.0	5.0	5.0		6.0	6.0		6.0	6.0	6.0
Lead/Lag							Lead	Lag		Lead	Lag	Lag
Lead-Lag Optimize?							Yes	Yes		Yes	Yes	Yes
Recall Mode	None	None	None	None	None		None	C-Max		None	C-Max	C-Max
Act Effct Green (s)	32.6	32.6	32.6	32.6	32.6		86.4	81.5		73.6	67.8	67.8
Actuated g/C Ratio	0.25	0.25	0.25	0.25	0.25		0.66	0.63		0.57	0.52	0.52
v/c Ratio	0.88	0.14	0.38	0.12	0.22		0.53	0.67		0.07	0.49	0.15
Control Delay	75.3	35.9	6.9	35.4	20.5		14.7	20.4		11.3	23.1	3.9
Queue Delay	0.0	0.0	0.0	0.0	0.0		0.0	0.0		0.0	0.0	0.0
Total Delay	75.3	35.9	6.9	35.4	20.5		14.7	20.4		11.3	23.1	3.9
LOS	E	D	A	D	C		B	C		B	C	A
Approach Delay		45.0			24.5			19.7			20.7	
Approach LOS		D			C			B			C	
Queue Length 50th (m)	64.4	12.5	0.0	7.3	10.4		20.8	108.3		1.3	72.1	0.0
Queue Length 95th (m)	92.5	22.5	17.3	15.2	23.1		38.1	196.0		4.6	110.6	10.5
Internal Link Dist (m)		1246.0			796.0			547.8			406.9	
Turn Bay Length (m)	65.0		60.0	40.0			145.0			125.0		70.0
Base Capacity (vph)	358	545	561	368	537		446	2052		210	1667	729
Starvation Cap Reductn	0	0	0	0	0		0	0		0	0	0
Spillback Cap Reductn	0	0	0	0	0		0	0		0	0	0
Storage Cap Reductn	0	0	0	0	0		0	0		0	0	0
Reduced v/c Ratio	0.70	0.11	0.33	0.10	0.18		0.47	0.67		0.07	0.49	0.15

Intersection Summary

Lanes, Volumes, Timings
 31: Terry Fox & Maple Grove

09-04-2020

Cycle Length: 130	
Actuated Cycle Length: 130	
Offset: 112 (86%), Referenced to phase 2:NBTL and 6:SBTL, Start of Green	
Natural Cycle: 100	
Control Type: Actuated-Coordinated	
Maximum v/c Ratio: 0.88	
Intersection Signal Delay: 24.1	Intersection LOS: C
Intersection Capacity Utilization 81.7%	ICU Level of Service D
Analysis Period (min) 15	

Splits and Phases: 31: Terry Fox & Maple Grove



Intersection

Int Delay, s/veh 2.6

Movement	EBL	EBT	EBR	WBL	WBT	WBR	NBL	NBT	NBR	SBL	SBT	SBR
Lane Configurations		↕			↕			↕			↕	
Traffic Vol, veh/h	25	0	20	5	0	45	30	870	10	40	445	25
Future Vol, veh/h	25	0	20	5	0	45	30	870	10	40	445	25
Conflicting Peds, #/hr	0	0	0	5	0	5	0	0	5	5	0	0
Sign Control	Stop	Stop	Stop	Stop	Stop	Stop	Free	Free	Free	Free	Free	Free
RT Channelized	-	-	None	-	-	None	-	-	None	-	-	None
Storage Length	-	-	-	-	-	-	-	-	-	-	-	-
Veh in Median Storage,-#	0	-	-	0	-	-	0	-	-	0	-	-
Grade, %	-	0	-	-	0	-	-	0	-	-	0	-
Peak Hour Factor	100	100	100	100	100	100	100	100	100	100	100	100
Heavy Vehicles, %	0	0	0	0	0	0	0	1	0	0	3	0
Mvmt Flow	25	0	20	5	0	45	30	870	10	40	445	25

Major/Minor	Minor2	Minor1		Major1		Major2						
Conflicting Flow All	1501	1483	463	1493	1490	885	470	0	0	885	0	0
Stage 1	538	538	-	940	940	-	-	-	-	-	-	-
Stage 2	963	945	-	553	550	-	-	-	-	-	-	-
Critical Hdwy	7.1	6.5	6.2	7.1	6.5	6.2	4.1	-	-	4.1	-	-
Critical Hdwy Stg 1	6.1	5.5	-	6.1	5.5	-	-	-	-	-	-	-
Critical Hdwy Stg 2	6.1	5.5	-	6.1	5.5	-	-	-	-	-	-	-
Follow-up Hdwy	3.5	4	3.3	3.5	4	3.3	2.2	-	-	2.2	-	-
Pot Cap-1 Maneuver	101	126	603	103	125	347	1102	-	-	773	-	-
Stage 1	531	526	-	319	345	-	-	-	-	-	-	-
Stage 2	310	343	-	521	519	-	-	-	-	-	-	-
Platoon blocked, %								-	-	-	-	-
Mov Cap-1 Maneuver	79	110	600	90	110	344	1102	-	-	770	-	-
Mov Cap-2 Maneuver	79	110	-	90	110	-	-	-	-	-	-	-
Stage 1	503	489	-	301	325	-	-	-	-	-	-	-
Stage 2	254	323	-	466	482	-	-	-	-	-	-	-

Approach	EB	WB	NB	SB
HCM Control Delay, s	47.2	21.5	0.3	0.8
HCM LOS	E	C		

Minor Lane/Major Mvmt	NBL	NBT	NBR	EBLn1	WBLn1	SBL	SBT	SBR
Capacity (veh/h)	1102	-	-	129	268	770	-	-
HCM Lane V/C Ratio	0.027	-	-	0.349	0.187	0.052	-	-
HCM Control Delay (s)	8.4	0	-	47.2	21.5	9.9	0	-
HCM Lane LOS	A	A	-	E	C	A	A	-
HCM 95th %tile Q(veh)	0.1	-	-	1.4	0.7	0.2	-	-

Intersection						
Int Delay, s/veh	1.2					
Movement	WBL	WBR	NBT	NBR	SBL	SBT
Lane Configurations	Y		B			A
Traffic Vol, veh/h	25	35	925	5	10	475
Future Vol, veh/h	25	35	925	5	10	475
Conflicting Peds, #/hr	5	5	0	5	5	0
Sign Control	Stop	Stop	Free	Free	Free	Free
RT Channelized	- None		- None		- None	
Storage Length	0	-	-	-	-	-
Veh in Median Storage#	-	0	-	-	-	0
Grade, %	0	-	0	-	-	0
Peak Hour Factor	100	100	100	100	100	100
Heavy Vehicles, %	0	0	1	0	0	3
Mvmt Flow	25	35	925	5	10	475

Major/Minor	Minor1	Major1	Major2			
Conflicting Flow All	1433	938	0	0	935	0
Stage 1	933	-	-	-	-	-
Stage 2	500	-	-	-	-	-
Critical Hdwy	6.4	6.2	-	-	4.1	-
Critical Hdwy Stg 1	5.4	-	-	-	-	-
Critical Hdwy Stg 2	5.4	-	-	-	-	-
Follow-up Hdwy	3.5	3.3	-	-	2.2	-
Pot Cap-1 Maneuver	149	323	-	-	741	-
Stage 1	386	-	-	-	-	-
Stage 2	613	-	-	-	-	-
Platoon blocked, %			-	-		-
Mov Cap-1 Maneuver	145	320	-	-	738	-
Mov Cap-2 Maneuver	145	-	-	-	-	-
Stage 1	384	-	-	-	-	-
Stage 2	600	-	-	-	-	-

Approach	WB	NB	SB
HCM Control Delay, s	28.4	0	0.2
HCM LOS	D		

Minor Lane/Major Mvmt	NBT	NBR	WBLn1	SBL	SBT
Capacity (veh/h)	-	-	213	738	-
HCM Lane V/C Ratio	-	-	0.282	0.014	-
HCM Control Delay (s)	-	-	28.4	9.9	0
HCM Lane LOS	-	-	D	A	A
HCM 95th %tile Q(veh)	-	-	1.1	0	-

Intersection

Int Delay, s/veh 3

Movement	EBL	EBT	WBT	WBR	SBL	SBR
Lane Configurations		↑	↑		↑	
Traffic Vol, veh/h	70	285	310	30	70	45
Future Vol, veh/h	70	285	310	30	70	45
Conflicting Peds, #/hr	5	0	0	5	5	5
Sign Control	Free	Free	Free	Free	Stop	Stop
RT Channelized	-	None	-	None	-	None
Storage Length	-	-	-	-	0	-
Veh in Median Storage,-#	0	0	0	-	0	-
Grade, %	-	0	0	-	0	-
Peak Hour Factor	100	100	100	100	100	100
Heavy Vehicles, %	0	2	2	0	0	0
Mvmt Flow	70	285	310	30	70	45

Major/Minor	Major1	Major2	Minor2
Conflicting Flow All	345	0	0
Stage 1	-	-	-
Stage 2	-	-	-
Critical Hdwy	4.1	-	-
Critical Hdwy Stg 1	-	-	-
Critical Hdwy Stg 2	-	-	-
Follow-up Hdwy	2.2	-	-
Pot Cap-1 Maneuver	225	-	-
Stage 1	-	-	-
Stage 2	-	-	-
Platoon blocked, %	-	-	-
Mov Cap-1 Maneuver	220	-	-
Mov Cap-2 Maneuver	-	-	-
Stage 1	-	-	-
Stage 2	-	-	-

Approach	EB	WB	SB
HCM Control Delay, s	6	0	16.2
HCM LOS			C

Minor Lane/Major Mvmt	EBL	EBT	WBT	WBR	SBLn1
Capacity (veh/h)	1220	-	-	-	435
HCM Lane V/C Ratio	0.057	-	-	-	-0.264
HCM Control Delay (s)	8.1	0	-	-	16.2
HCM Lane LOS	A	A	-	-	C
HCM 95th %tile Q(veh)	0.2	-	-	-	1.1

Intersection

Int Delay, s/veh 3.4

Movement	EBL	EBT	EBR	WBL	WBT	WBR	NBL	NBT	NBR	SBL	SBT	SBR
Lane Configurations		↕			↕			↕			↕	
Traffic Vol, veh/h	5	310	5	165	190	5	5	0	20	15	0	55
Future Vol, veh/h	5	310	5	165	190	5	5	0	20	15	0	55
Conflicting Peds, #/hr	5	0	0	0	0	5	0	0	0	5	0	5
Sign Control	Free	Free	Free	Free	Free	Free	Stop	Stop	Stop	Stop	Stop	Stop
RT Channelized	-	-	None	-	-	None	-	-	None	-	-	None
Storage Length	-	-	-	-	-	-	-	-	-	-	-	-
Veh in Median Storage, #	0	-	-	0	-	-	0	-	0	-	0	-
Grade, %	-	0	-	-	0	-	-	0	-	-	0	-
Peak Hour Factor	100	100	100	100	100	100	100	100	100	100	100	100
Heavy Vehicles, %	0	2	0	0	3	0	0	0	0	0	0	0
Mvmt Flow	5	310	5	165	190	5	5	0	20	15	0	55

Major/Minor	Major1	Major2	Minor1	Minor2
Conflicting Flow All	200	0	0	315
Stage 1	-	-	-	-
Stage 2	-	-	-	-
Critical Hdwy	4.1	-	-	4.1
Critical Hdwy Stg 1	-	-	-	-
Critical Hdwy Stg 2	-	-	-	-
Follow-up Hdwy	2.2	-	-	2.2
Pot Cap-1 Maneuver	384	-	-	1257
Stage 1	-	-	-	-
Stage 2	-	-	-	-
Platoon blocked, %	-	-	-	-
Mov Cap-1 Maneuver	378	-	-	1257
Mov Cap-2 Maneuver	-	-	-	-
Stage 1	-	-	-	-
Stage 2	-	-	-	-

Approach	EB	WB	NB	SB
HCM Control Delay, s	0.1	3.8	12.6	12.7
HCM LOS			B	B

Minor Lane/Major Mvm	NBLn1	EBL	EBT	EBR	WBL	WBT	WBR	SBLn1
Capacity (veh/h)		500	1378	-	-	1257	-	540
HCM Lane V/C Ratio		0.05	0.004	-	-	0.131	-	0.13
HCM Control Delay (s)		12.6	7.6	0	-	8.3	0	12.7
HCM Lane LOS		B	A	A	-	A	A	B
HCM 95th %tile Q(veh)		0.2	0	-	-	0.5	-	0.4

Intersection

Int Delay, s/veh 0.3

Movement	EBL	EBT	WBT	WBR	SBL	SBR
Lane Configurations		↑	↑		↑	
Traffic Vol, veh/h	0	345	350	5	10	5
Future Vol, veh/h	0	345	350	5	10	5
Conflicting Peds, #/hr	0	0	0	0	0	0
Sign Control	Free	Free	Free	Free	Stop	Stop
RT Channelized	- None		- None		- None	
Storage Length	-	-	-	-	0	-
Veh in Median Storage,-#	0	0	-	0	-	-
Grade, %	-	0	0	-	0	-
Peak Hour Factor	100	100	100	100	100	100
Heavy Vehicles, %	0	2	2	0	0	0
Mvmt Flow	0	345	350	5	10	5

Major/Minor	Major1	Major2	Minor2
Conflicting Flow All	355	0	0
Stage 1	-	-	-
Stage 2	-	-	-
Critical Hdwy	4.1	-	-
Critical Hdwy Stg 1	-	-	-
Critical Hdwy Stg 2	-	-	-
Follow-up Hdwy	2.2	-	-
Pot Cap-1 Maneuver	1215	-	-
Stage 1	-	-	-
Stage 2	-	-	-
Platoon blocked, %	-	-	-
Mov Cap-1 Maneuver	1215	-	-
Mov Cap-2 Maneuver	-	-	-
Stage 1	-	-	-
Stage 2	-	-	-

Approach	EB	WB	SB
HCM Control Delay, s	0	0	12.8
HCM LOS			B

Minor Lane/Major Mvmt	EBL	EBT	WBT	WBR	SBLn1
Capacity (veh/h)	1215	-	-	-	475
HCM Lane V/C Ratio	-	-	-	-	-0.032
HCM Control Delay (s)	0	-	-	-	12.8
HCM Lane LOS	A	-	-	-	B
HCM 95th %tile Q(veh)	0	-	-	-	0.1

Intersection

Int Delay, s/veh 6.1

Movement	EBL	EBT	EBR	WBL	WBT	WBR	NBL	NBT	NBR	SBL	SBT	SBR
Lane Configurations		↕			↕			↕			↕	
Traffic Vol, veh/h	15	5	0	0	30	0	0	5	0	0	25	35
Future Vol, veh/h	15	5	0	0	30	0	0	5	0	0	25	35
Conflicting Peds, #/hr	0	0	0	0	0	0	0	0	0	0	0	0
Sign Control	Free	Free	Free	Free	Free	Free	Stop	Stop	Stop	Stop	Stop	Stop
RT Channelized	-	-	None	-	-	None	-	-	None	-	-	None
Storage Length	-	-	-	-	-	-	-	-	-	-	-	-
Veh in Median Storage, #	0	-	-	0	-	-	0	-	-	0	-	-
Grade, %	-	0	-	-	0	-	-	0	-	-	0	-
Peak Hour Factor	100	100	100	100	100	100	100	100	100	100	100	100
Heavy Vehicles, %	0	0	0	0	0	0	0	0	0	0	0	0
Mvmt Flow	15	5	0	0	30	0	0	5	0	0	25	35

Major/Minor	Major1	Major2	Minor1	Minor2								
Conflicting Flow All	30	0	0	5	0	0	95	65	5	68	65	30
Stage 1	-	-	-	-	-	-	35	35	-	30	30	-
Stage 2	-	-	-	-	-	-	60	30	-	38	35	-
Critical Hdwy	4.1	-	-	4.1	-	-	7.1	6.5	6.2	7.1	6.5	6.2
Critical Hdwy Stg 1	-	-	-	-	-	-	6.1	5.5	-	6.1	5.5	-
Critical Hdwy Stg 2	-	-	-	-	-	-	6.1	5.5	-	6.1	5.5	-
Follow-up Hdwy	2.2	-	-	2.2	-	-	3.5	4	3.3	3.5	4	3.3
Pot Cap-1 Maneuver	596	-	-	1630	-	-	893	830	1084	930	830	1050
Stage 1	-	-	-	-	-	-	986	870	-	992	874	-
Stage 2	-	-	-	-	-	-	957	874	-	982	870	-
Platoon blocked, %	-	-	-	-	-	-	-	-	-	-	-	-
Mov Cap-1 Maneuver	596	-	-	1630	-	-	838	823	1084	920	823	1050
Mov Cap-2 Maneuver	-	-	-	-	-	-	838	823	-	920	823	-
Stage 1	-	-	-	-	-	-	977	862	-	983	874	-
Stage 2	-	-	-	-	-	-	899	874	-	968	862	-

Approach	EB	WB	NB	SB
HCM Control Delay, s	5	0	9.4	9.1
HCM LOS			A	A

Minor Lane/Major Mvm	NBLn1	EBL	EBT	EBR	WBL	WBT	WBR	SBLn1
Capacity (veh/h)		823	1596	-	-	1630	-	942
HCM Lane V/C Ratio		0.006	0.009	-	-	-	-	-0.064
HCM Control Delay (s)		9.4	7.3	0	-	0	-	9.1
HCM Lane LOS		A	A	A	-	A	-	A
HCM 95th %tile Q(veh)		0	0	-	-	0	-	0.2

Intersection

Int Delay, s/veh 1.1

Movement	WBL	WBR	NBT	NBR	SBL	SBT
Lane Configurations		↑	↑			↑
Traffic Vol, veh/h	0	85	825	110	0	470
Future Vol, veh/h	0	85	825	110	0	470
Conflicting Peds, #/hr	5	5	0	5	5	0
Sign Control	Stop	Stop	Free	Free	Free	Free
RT Channelized	-	None	-	None	-	None
Storage Length	-	0	-	-	-	-
Veh in Median Storage0#	-	0	-	-	-	0
Grade, %	0	-	0	-	-	0
Peak Hour Factor	100	100	100	100	100	100
Heavy Vehicles, %	0	0	1	0	0	3
Mvmt Flow	0	85	825	110	0	470

Major/Minor	Minor1	Major1	Major2			
Conflicting Flow All	-	890	0	0	-	-
Stage 1	-	-	-	-	-	-
Stage 2	-	-	-	-	-	-
Critical Hdwy	-	6.2	-	-	-	-
Critical Hdwy Stg 1	-	-	-	-	-	-
Critical Hdwy Stg 2	-	-	-	-	-	-
Follow-up Hdwy	-	3.3	-	-	-	-
Pot Cap-1 Maneuver	0	345	-	-	0	-
Stage 1	0	-	-	-	0	-
Stage 2	0	-	-	-	0	-
Platoon blocked, %			-	-		-
Mov Cap-1 Maneuver	-	342	-	-	-	-
Mov Cap-2 Maneuver	-	-	-	-	-	-
Stage 1	-	-	-	-	-	-
Stage 2	-	-	-	-	-	-

Approach	WB	NB	SB
HCM Control Delay, s19		0	0
HCM LOS	C		

Minor Lane/Major Mvmt	NBT	NB	BLn1	SBT
Capacity (veh/h)	-	-	342	-
HCM Lane V/C Ratio	-	-	0.249	-
HCM Control Delay (s)	-	-	19	-
HCM Lane LOS	-	-	C	-
HCM 95th %tile Q(veh)	-	-	1	-

Intersection

Int Delay, s/veh 1.8

Movement EBT EBR WBL WBT NBL NBR

Lane Configurations	↶			↷	↶	↷
Traffic Vol, veh/h	15	35	25	45	0	5
Future Vol, veh/h	15	35	25	45	0	5
Conflicting Peds, #/hr	0	5	5	0	5	5
Sign Control	Free	Free	Free	Free	Stop	Stop
RT Channelized	-	None	-	None	-	None
Storage Length	-	-	-	-	0	-
Veh in Median Storage0#	-	-	-	0	0	-
Grade, %	0	-	-	0	0	-
Peak Hour Factor	100	100	100	100	100	100
Heavy Vehicles, %	0	0	0	0	0	0
Mvmt Flow	15	35	25	45	0	5

Major/Minor Major1 Major2 Minor1

Conflicting Flow All	0	0	55	0	138	43
Stage 1	-	-	-	-	38	-
Stage 2	-	-	-	-	100	-
Critical Hdwy	-	-	4.1	-	6.4	6.2
Critical Hdwy Stg 1	-	-	-	-	5.4	-
Critical Hdwy Stg 2	-	-	-	-	5.4	-
Follow-up Hdwy	-	-	2.2	-	3.5	3.3
Pot Cap-1 Maneuver	-	-	1563	-	860	1033
Stage 1	-	-	-	-	990	-
Stage 2	-	-	-	-	929	-
Platoon blocked, %	-	-	-	-	-	-
Mov Cap-1 Maneuver	-	-	1556	-	839	1024
Mov Cap-2 Maneuver	-	-	-	-	839	-
Stage 1	-	-	-	-	986	-
Stage 2	-	-	-	-	910	-

Approach EB WB NB

HCM Control Delay, s	0	2.6	8.5
HCM LOS			A

Minor Lane/Major MvmNBLn1 EBT EBR WBL WBT

Capacity (veh/h)	1024	-	-	1556	-
HCM Lane V/C Ratio	0.005	-	-	0.016	-
HCM Control Delay (s)	8.5	-	-	7.4	0
HCM Lane LOS	A	-	-	A	A
HCM 95th %tile Q(veh)	0	-	-	0	-

Intersection				
Intersection Delay, s/veh	7.4			
Intersection LOS	A			
Approach	EB	WB	NB	SB
Entry Lanes	1	1	1	1
Conflicting Circle Lanes	1	1	1	1
Adj Approach Flow, veh/h	65	45	650	480
Demand Flow Rate, veh/h	71	48	677	499
Vehicles Circulating, veh/h	530	682	42	53
Vehicles Exiting, veh/h	22	37	560	677
Ped Vol Crossing Leg, #/h	5	5	5	5
Ped Cap Adj	0.999	0.999	0.999	0.999
Approach Delay, s/veh	5.8	6.3	8.3	6.5
Approach LOS	A	A	A	A
Lane	Left	Left	Left	Left
Designated Moves	LTR	LTR	LTR	LTR
Assumed Moves	LTR	LTR	LTR	LTR
RT Channelized				
Lane Util	1.000	1.000	1.000	1.000
Follow-Up Headway, s	2.609	2.609	2.609	2.609
Critical Headway, s	4.976	4.976	4.976	4.976
Entry Flow, veh/h	71	48	677	499
Cap Entry Lane, veh/h	804	688	1322	1307
Entry HV Adj Factor	0.915	0.945	0.961	0.962
Flow Entry, veh/h	65	45	650	480
Cap Entry, veh/h	735	650	1269	1257
V/C Ratio	0.088	0.070	0.512	0.382
Control Delay, s/veh	5.8	6.3	8.3	6.5
LOS	A	A	A	A
95th %tile Queue, veh	0	0	3	2

Intersection	
Intersection Delay, s/veh	6.9
Intersection LOS	A































Movement	EBL	EBR	NBL	NBT	SBT	SBR
Lane Configurations	W			↑	↑	
Traffic Vol, veh/h	5	0	0	10	30	30
Future Vol, veh/h	5	0	0	10	30	30
Peak Hour Factor	1.00	1.00	1.00	1.00	1.00	1.00
Heavy Vehicles, %	0	0	0	0	0	0
Mvmt Flow	5	0	0	10	30	30
Number of Lanes	1	0	0	1	1	0

Approach	EB	NB	SB
Opposing Approach		SB	NB
Opposing Lanes	0	1	1
Conflicting Approach Left	SB	EB	
Conflicting Lanes Left	1	1	0
Conflicting Approach Right			EB
Conflicting Lanes Right	1	0	1
HCM Control Delay	7.3	7	6.9
HCM LOS	A	A	A

Lane	NBLn1	EBLn1	SBLn1
Vol Left, %	0%	100%	0%
Vol Thru, %	100%	0%	50%
Vol Right, %	0%	0%	50%
Sign Control	Stop	Stop	Stop
Traffic Vol by Lane	10	5	60
LT Vol	0	5	0
Through Vol	10	0	30
RT Vol	0	0	30
Lane Flow Rate	10	5	60
Geometry Grp	1	1	1
Degree of Util (X)	0.011	0.006	0.06
Departure Headway (Hd)	3.952	4.221	3.615
Convergence, Y/N	Yes	Yes	Yes
Cap	909	850	995
Service Time	1.962	2.238	1.621
HCM Lane V/C Ratio	0.011	0.006	0.06
HCM Control Delay	7	7.3	6.9
HCM Lane LOS	A	A	A
HCM 95th-tile Q	0	0	0.2

Lanes, Volumes, Timings
3: Iber/Huntmar & Hazeldean

09-04-2020

												
Lane Group	EBL	EBT	EBR	WBL	WBT	WBR	NBL	NBT	NBR	SBL	SBT	SBR
Lane Configurations	 	 		 	 				 		 	 
Traffic Volume (vph)	220	710	135	355	1110	285	150	350	265	190	450	425
Future Volume (vph)	220	710	135	355	1110	285	150	350	265	190	450	425
Confl. Peds. (#/hr)	5		5	5		5	5		5	5		5
Confl. Bikes (#/hr)												
Peak Hour Factor	1.00	1.00	1.00	1.00	1.00	1.00	1.00	1.00	1.00	1.00	1.00	1.00
Growth Factor	100%	100%	100%	100%	100%	100%	100%	100%	100%	100%	100%	100%
Heavy Vehicles (%)	0%	2%	2%	1%	1%	0%	6%	1%	1%	1%	2%	1%
Bus Blockages (#/hr)	0	0	0	0	0	0	0	0	0	0	0	0
Parking (#/hr)												
Mid-Block Traffic (%)		0%			0%			0%			0%	
Shared Lane Traffic (%)												
Lane Group Flow (vph)	220	845	0	355	1110	285	150	350	265	190	450	425
Turn Type	Prot	NA		Prot	NA	Perm	pm+pt	NA	Perm	pm+pt	NA	pm+ov
Protected Phases	5	2		1	6		3	8		7	4	5
Permitted Phases						6	8		8	4		4
Detector Phase	5	2		1	6	6	3	8	8	7	4	5
Switch Phase												
Minimum Initial (s)	5.0	10.0		5.0	10.0	10.0	5.0	10.0	10.0	5.0	10.0	5.0
Minimum Split (s)	12.5	38.6		12.5	38.6	38.6	12.5	58.0	58.0	12.5	41.3	12.5
Total Split (s)	18.2	44.8		14.6	41.2	41.2	12.5	58.0	58.0	12.6	58.1	18.2
Total Split (%)	14.0%	34.5%		11.2%	31.7%	31.7%	9.6%	44.6%	44.6%	9.7%	44.7%	14.0%
Yellow Time (s)	3.6	3.6		3.6	3.6	3.6	3.0	3.3	3.3	3.0	3.3	3.6
All-Red Time (s)	2.0	2.0		2.0	2.0	2.0	0.0	2.0	2.0	0.0	2.0	2.0
Lost Time Adjust (s)	0.0	0.0		0.0	0.0	0.0	0.0	0.0	0.0	0.0	0.0	0.0
Total Lost Time (s)	5.6	5.6		5.6	5.6	5.6	3.0	5.3	5.3	3.0	5.3	5.6
Lead/Lag	Lead	Lag		Lead	Lag	Lag	Lead	Lag	Lag	Lead	Lag	Lead
Lead-Lag Optimize?	Yes	Yes		Yes	Yes	Yes	Yes	Yes	Yes	Yes	Yes	Yes
Recall Mode	None	C-Max		None	C-Max	C-Max	None	None	None	None	None	None
Act Effct Green (s)	13.5	39.2		22.5	48.1	48.1	51.0	39.2	39.2	51.2	39.3	52.6
Actuated g/C Ratio	0.10	0.30		0.17	0.37	0.37	0.39	0.30	0.30	0.39	0.30	0.40
v/c Ratio	0.64	0.85		0.63	0.89	0.39	0.69	0.65	0.42	0.62	0.84	0.67
Control Delay	64.3	51.1		56.6	49.1	5.6	40.3	44.5	5.6	33.8	56.6	27.7
Queue Delay	0.0	0.0		0.0	0.0	0.0	0.0	0.0	0.0	0.0	0.0	0.0
Total Delay	64.3	51.1		56.6	49.1	5.6	40.3	44.5	5.6	33.8	56.6	27.7
LOS	E	D		E	D	A	D	D	A	C	E	C
Approach Delay		53.8			43.5			30.2			41.0	
Approach LOS		D			D			C			D	
Queue Length 50th (m)	29.7	110.6		46.4	147.7	0.0	25.6	81.8	0.8	33.1	113.4	73.1
Queue Length 95th (m)	42.7	137.7		#88.9	#234.2	22.2	35.8	103.3	18.6	44.3	140.2	88.6
Internal Link Dist (m)		871.0			1427.4			1305.6			301.9	
Turn Bay Length (m)	50.0			90.0		225.0	30.0		60.0	50.0		275.0
Base Capacity (vph)	360	995		567	1253	735	217	722	758	305	716	644
Starvation Cap Reductn	0	0		0	0	0	0	0	0	0	0	0
Spillback Cap Reductn	0	0		0	0	0	0	0	0	0	0	0
Storage Cap Reductn	0	0		0	0	0	0	0	0	0	0	0
Reduced v/c Ratio	0.61	0.85		0.63	0.89	0.39	0.69	0.48	0.35	0.62	0.63	0.66

Intersection Summary

Lanes, Volumes, Timings
 3: Iber/Huntmar & Hazeldean

09-04-2020

Cycle Length: 130

Actuated Cycle Length: 130

Offset: 0 (0%), Referenced to phase 2:EBT and 6:WBT, Start of Green

Natural Cycle: 135

Control Type: Actuated-Coordinated

Maximum v/c Ratio: 0.89

Intersection Signal Delay: 43.1

Intersection LOS: D

Intersection Capacity Utilization 90.3%









ICU Level of Service E

Analysis Period (min) 15

95th percentile volume exceeds capacity, queue may be longer.

Queue shown is maximum after two cycles.

Splits and Phases: 3: Iber/Huntmar & Hazeldean

 Ø1	 Ø2 (R)	 Ø3	 Ø4
14.6 s	44.8 s	12.5 s	58.1 s
 Ø5	 Ø6 (R)	 Ø7	 Ø8
18.2 s	41.2 s	12.6 s	58 s

Lanes, Volumes, Timings
6: Terry Fox & Palladium/Katimavik

09-04-2020

Lane Group	EBL	EBT	EBR	WBL	WBT	WBR	NBL	NBT	NBR	SBL	SBT	SBR
Lane Configurations												
Traffic Volume (vph)	830	250	395	135	180	150	245	1135	100	120	1340	695
Future Volume (vph)	830	250	395	135	180	150	245	1135	100	120	1340	695
Confl. Peds. (#/hr)	5		5	5		5	5		5	5		5
Confl. Bikes (#/hr)												
Peak Hour Factor	1.00	1.00	1.00	1.00	1.00	1.00	1.00	1.00	1.00	1.00	1.00	1.00
Growth Factor	100%	100%	100%	100%	100%	100%	100%	100%	100%	100%	100%	100%
Heavy Vehicles (%)	0%	0%	1%	5%	2%	0%	0%	2%	4%	0%	1%	0%
Bus Blockages (#/hr)	0	0	0	0	0	0	0	0	0	0	0	0
Parking (#/hr)												
Mid-Block Traffic (%)		0%			0%			0%			0%	
Shared Lane Traffic (%)												
Lane Group Flow (vph)	830	250	395	135	180	150	245	1135	100	120	1340	695
Turn Type	Prot	NA	Perm	Prot	NA	Perm	Prot	NA	Perm	Prot	NA	Perm
Protected Phases	7	4		3	8		5	2		1	6	
Permitted Phases			4			8			2			6
Detector Phase	7	4	4	3	8	8	5	2	2	1	6	6
Switch Phase												
Minimum Initial (s)	5.0	10.0	10.0	5.0	10.0	10.0	5.0	10.0	10.0	5.0	10.0	10.0
Minimum Split (s)	10.6	37.6	37.6	10.3	37.3	37.3	11.0	38.0	38.0	11.0	38.0	38.0
Total Split (s)	40.0	58.0	58.0	20.0	38.0	38.0	11.0	47.0	47.0	25.0	61.0	61.0
Total Split (%)	26.7%	38.7%	38.7%	13.3%	25.3%	25.3%	7.3%	31.3%	31.3%	16.7%	40.7%	40.7%
Yellow Time (s)	3.6	3.6	3.6	3.3	3.3	3.3	4.0	4.0	4.0	4.0	4.0	4.0
All-Red Time (s)	2.0	2.0	2.0	2.0	2.0	2.0	2.0	2.0	2.0	2.0	2.0	2.0
Lost Time Adjust (s)	-2.0	0.0	0.0	0.0	0.0	0.0	0.0	0.0	0.0	0.0	-2.0	0.0
Total Lost Time (s)	3.6	5.6	5.6	5.3	5.3	5.3	6.0	6.0	6.0	6.0	4.0	6.0
Lead/Lag	Lead	Lead	Lead	Lag	Lag	Lag	Lead	Lag	Lag	Lead	Lag	Lag
Lead-Lag Optimize?	Yes	Yes	Yes	Yes	Yes	Yes	Yes	Yes	Yes	Yes	Yes	Yes
Recall Mode	None	None	None	None	None	None	None	C-Max	C-Max	None	C-Max	C-Max
Act Effct Green (s)	36.4	33.7	33.7	23.0	22.3	22.3	15.4	59.6	59.6	10.8	57.0	55.0
Actuated g/C Ratio	0.24	0.22	0.22	0.15	0.15	0.15	0.10	0.40	0.40	0.07	0.38	0.37
v/c Ratio	1.03	0.62	0.88	0.54	0.69	0.43	0.72	0.85	0.15	0.50	1.04	0.70
Control Delay	94.9	57.6	54.9	68.7	73.0	10.9	75.5	49.1	0.5	74.1	81.6	6.6
Queue Delay	0.0	0.0	0.0	0.0	0.0	0.0	0.0	0.0	0.0	0.0	0.0	0.0
Total Delay	94.9	57.6	54.9	68.7	73.0	10.9	75.5	49.1	0.5	74.1	81.6	6.6
LOS	F	E	D	E	E	B	E	D	A	E	F	A
Approach Delay		77.8			51.7			50.2			57.0	
Approach LOS		E			D			D			E	
Queue Length 50th (m)~	143.0	71.2	79.8	40.1	55.0	0.0	38.4	166.0	0.0	19.0	~238.0	0.0
Queue Length 95th (m)#	185.2	89.3	110.5	65.3	75.1	19.3	#93.2	#255.7	0.0	29.5	#283.1	32.4
Internal Link Dist (m)		1802.0			304.5			406.9			280.2	
Turn Bay Length (m)	100.0			115.0		115.0	240.0		115.0	70.0		190.0
Base Capacity (vph)	804	628	615	249	384	444	340	1333	685	420	1286	990
Starvation Cap Reductn	0	0	0	0	0	0	0	0	0	0	0	0
Spillback Cap Reductn	0	0	0	0	0	0	0	0	0	0	0	0
Storage Cap Reductn	0	0	0	0	0	0	0	0	0	0	0	0
Reduced v/c Ratio	1.03	0.40	0.64	0.54	0.47	0.34	0.72	0.85	0.15	0.29	1.04	0.70

Intersection Summary

Cycle Length: 150

Actuated Cycle Length: 150

Offset: 0 (0%), Referenced to phase 2:NBT and 6:SBT, Start of Green, Master Intersection

Natural Cycle: 150

Control Type: Actuated-Coordinated

Maximum v/c Ratio: 1.04

Intersection Signal Delay: 60.3

Intersection LOS: E

Intersection Capacity Utilization 100.1%

ICU Level of Service G

Analysis Period (min) 15

~ Volume exceeds capacity, queue is theoretically infinite.

Queue shown is maximum after two cycles.

95th percentile volume exceeds capacity, queue may be longer.





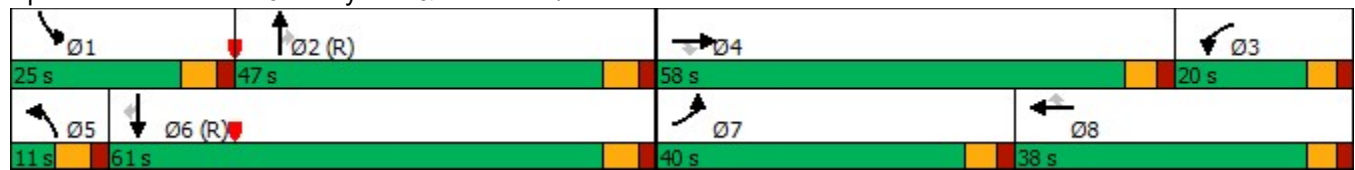

















Queue shown is maximum after two cycles.

Splits and Phases: 6: Terry Fox & Palladium/Katimavik



Lanes, Volumes, Timings
8: Huntmar & Palladium

09-04-2020

												
Lane Group	EBL	EBT	EBR	WBL	WBT	WBR	NBL	NBT	NBR	SBL	SBT	SBR
Lane Configurations												
Traffic Volume (vph)	25	165	605	225	470	125	335	250	125	90	345	95
Future Volume (vph)	25	165	605	225	470	125	335	250	125	90	345	95
Confl. Peds. (#/hr)	5		5	5		5	5		5	5		5
Confl. Bikes (#/hr)												
Peak Hour Factor	1.00	1.00	1.00	1.00	1.00	1.00	1.00	1.00	1.00	1.00	1.00	1.00
Growth Factor	100%	100%	100%	100%	100%	100%	100%	100%	100%	100%	100%	100%
Heavy Vehicles (%)	11%	0%	1%	0%	0%	0%	1%	1%	0%	1%	2%	1%
Bus Blockages (#/hr)	0	0	0	0	0	0	0	0	0	0	0	0
Parking (#/hr)												
Mid-Block Traffic (%)		0%			0%			0%			0%	
Shared Lane Traffic (%)												
Lane Group Flow (vph)	25	770	0	225	595	0	335	250	125	90	345	95
Turn Type	pm+pt	NA		pm+pt	NA		pm+pt	NA	Perm	Perm	NA	Perm
Protected Phases	5	2		1	6		3	8			4	
Permitted Phases	2			6			8		8	4		4
Detector Phase	5	2		1	6		3	8	8	4	4	4
Switch Phase												
Minimum Initial (s)	5.0	10.0		5.0	10.0		4.0	10.0	10.0	10.0	10.0	10.0
Minimum Split (s)	12.5	43.0		12.5	43.0		10.0	42.3	42.3	42.3	42.3	42.3
Total Split (s)	12.5	40.5		24.0	52.0		32.9	75.5	75.5	42.6	42.6	42.6
Total Split (%)	8.9%	28.9%		17.1%	37.1%		23.5%	53.9%	53.9%	30.4%	30.4%	30.4%
Yellow Time (s)	4.0	4.0		4.0	4.0		4.0	3.3	3.3	3.3	3.3	3.3
All-Red Time (s)	2.0	2.0		2.0	2.0		2.0	2.0	2.0	2.0	2.0	2.0
Lost Time Adjust (s)	0.0	0.0		0.0	0.0		0.0	0.0	0.0	0.0	0.0	0.0
Total Lost Time (s)	6.0	6.0		6.0	6.0		6.0	5.3	5.3	5.3	5.3	5.3
Lead/Lag	Lead	Lag		Lead	Lag		Lead			Lag	Lag	Lag
Lead-Lag Optimize?	Yes	Yes		Yes	Yes		Yes			Yes	Yes	Yes
Recall Mode	None	C-Max		None	C-Max		None	None	None	None	None	None
Act Effct Green (s)	49.8	43.4		66.6	58.8		61.4	62.1	62.1	31.6	31.6	31.6
Actuated g/C Ratio	0.36	0.31		0.48	0.42		0.44	0.44	0.44	0.23	0.23	0.23
v/c Ratio	0.09	0.61		0.73	0.42		0.90	0.32	0.17	0.37	0.87	0.21
Control Delay	24.7	16.8		39.7	31.1		59.2	25.3	3.5	49.1	73.4	1.0
Queue Delay	0.0	0.0		0.0	0.0		0.0	0.0	0.0	0.0	0.0	0.0
Total Delay	24.7	16.8		39.7	31.1		59.2	25.3	3.5	49.1	73.4	1.0
LOS	C	B		D	C		E	C	A	D	E	A
Approach Delay		17.0			33.5			37.4			56.3	
Approach LOS		B			C			D			E	
Queue Length 50th (m)	3.9	34.9		39.9	66.4		70.0	45.3	0.0	22.2	96.8	0.0
Queue Length 95th (m)	10.5	61.2		#74.8	90.9		#112.6	60.4	10.6	38.1	129.9	0.0
Internal Link Dist (m)		535.2			1802.0			357.2			231.7	
Turn Bay Length (m)	95.0			75.0			120.0		45.0	50.0		
Base Capacity (vph)	288	1255		322	1400		397	893	815	285	470	516
Starvation Cap Reductn	0	0		0	0		0	0	0	0	0	0
Spillback Cap Reductn	0	0		0	0		0	0	0	0	0	0
Storage Cap Reductn	0	0		0	0		0	0	0	0	0	0
Reduced v/c Ratio	0.09	0.61		0.70	0.42		0.84	0.28	0.15	0.32	0.73	0.18

Intersection Summary

Lanes, Volumes, Timings
 8: Huntmar & Palladium

09-04-2020

Cycle Length: 140

Actuated Cycle Length: 140

Offset: 87 (62%), Referenced to phase 2:EBTL and 6:WBTL, Start of Green

Natural Cycle: 110

Control Type: Actuated-Coordinated

Maximum v/c Ratio: 0.90

Intersection Signal Delay: 34.1

Intersection LOS: C

Intersection Capacity Utilization 104.0%

ICU Level of Service G

Analysis Period (min) 15

95th percentile volume exceeds capacity, queue may be longer.





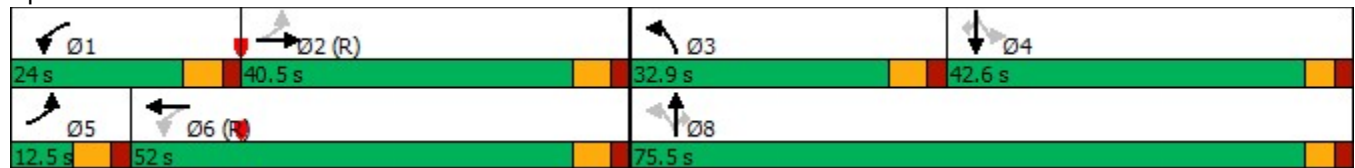

















Queue shown is maximum after two cycles.

Splits and Phases: 8: Huntmar & Palladium



Lanes, Volumes, Timings
21: Huntmar & Maple Grove

09-04-2020

												
Lane Group	EBL	EBT	EBR	WBL	WBT	WBR	NBL	NBT	NBR	SBL	SBT	SBR
Lane Configurations												
Traffic Volume (vph)	120	120	75	170	195	80	110	590	130	80	830	260
Future Volume (vph)	120	120	75	170	195	80	110	590	130	80	830	260
Confl. Peds. (#/hr)	5		5	5		5	5		5	5		5
Confl. Bikes (#/hr)												
Peak Hour Factor	1.00	1.00	1.00	1.00	1.00	1.00	1.00	1.00	1.00	1.00	1.00	1.00
Growth Factor	100%	100%	100%	100%	100%	100%	100%	100%	100%	100%	100%	100%
Heavy Vehicles (%)	0%	1%	0%	0%	0%	0%	2%	1%	0%	0%	1%	0%
Bus Blockages (#/hr)	0	0	0	0	0	0	0	0	0	0	0	0
Parking (#/hr)												
Mid-Block Traffic (%)		0%			0%			0%			0%	
Shared Lane Traffic (%)												
Lane Group Flow (vph)	120	195	0	170	275	0	110	720	0	80	830	260
Turn Type	pm+pt	NA		pm+pt	NA		pm+pt	NA		pm+pt	NA	Perm
Protected Phases	7	4		3	8		5	2		1	6	
Permitted Phases	4			8			2			6		6
Detector Phase	7	4		3	8		5	2		1	6	6
Switch Phase												
Minimum Initial (s)	4.0	10.0		4.0	10.0		4.0	10.0		4.0	10.0	10.0
Minimum Split (s)	10.0	33.0		10.0	33.0		10.0	29.0		10.0	49.0	49.0
Total Split (s)	10.0	33.0		10.0	33.0		10.0	66.0		11.0	67.0	67.0
Total Split (%)	8.3%	27.5%		8.3%	27.5%		8.3%	55.0%		9.2%	55.8%	55.8%
Yellow Time (s)	4.0	3.0		4.0	3.0		4.0	3.3		4.0	3.3	3.3
All-Red Time (s)	2.0	2.0		2.0	2.0		2.0	2.0		2.0	2.0	2.0
Lost Time Adjust (s)	0.0	0.0		0.0	0.0		0.0	0.0		0.0	0.0	0.0
Total Lost Time (s)	6.0	5.0		6.0	5.0		6.0	5.3		6.0	5.3	5.3
Lead/Lag	Lead	Lag		Lead	Lag		Lead	Lag		Lead	Lag	Lag
Lead-Lag Optimize?	Yes	Yes		Yes			Yes	Yes		Yes	Yes	Yes
Recall Mode	None	None		None	None		None	C-Max		None	C-Max	C-Max
Act Effct Green (s)	25.8	22.8		25.8	22.8		71.5	67.0		69.8	64.2	64.2
Actuated g/C Ratio	0.22	0.19		0.22	0.19		0.60	0.56		0.58	0.54	0.54
v/c Ratio	0.84	0.58		0.85	0.82		0.54	0.39		0.20	0.87	0.31
Control Delay	81.2	45.0		74.9	62.6		23.4	16.3		10.8	36.8	9.1
Queue Delay	0.0	0.0		0.0	0.0		0.0	0.0		0.0	0.0	0.0
Total Delay	81.2	45.0		74.9	62.6		23.4	16.3		10.8	36.8	9.1
LOS	F	D		E	E		C	B		B	D	A
Approach Delay		58.8			67.3			17.2			28.8	
Approach LOS		E			E			B			C	
Queue Length 50th (m)	23.4	38.6		34.2	61.9		10.1	52.7		7.2	180.7	17.0
Queue Length 95th (m)	#47.3	61.0		#58.5	89.9		#26.4	70.3		15.2	#269.7	34.4
Internal Link Dist (m)		630.5			86.3			293.1			175.1	
Turn Bay Length (m)							20.0					30.0
Base Capacity (vph)	143	406		201	410		204	1844		406	953	849
Starvation Cap Reductn	0	0		0	0		0	0		0	0	0
Spillback Cap Reductn	0	0		0	0		0	0		0	0	0
Storage Cap Reductn	0	0		0	0		0	0		0	0	0
Reduced v/c Ratio	0.84	0.48		0.85	0.67		0.54	0.39		0.20	0.87	0.31

Intersection Summary

Lanes, Volumes, Timings
 21: Huntmar & Maple Grove

09-04-2020

Cycle Length: 120
 Actuated Cycle Length: 120
 Offset: 0 (0%), Referenced to phase 2:NBTL and 6:SBTL, Start of Green
 Natural Cycle: 105
 Control Type: Actuated-Coordinated
 Maximum v/c Ratio: 0.87
 Intersection Signal Delay: 35.0 Intersection LOS: C
 Intersection Capacity Utilization 94.9% ICU Level of Service F
 Analysis Period (min) 15
 # 95th percentile volume exceeds capacity, queue may be longer.
 Queue shown is maximum after two cycles.

Splits and Phases: 21: Huntmar & Maple Grove

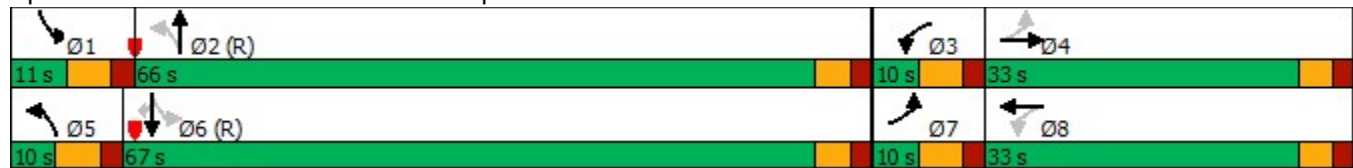

Lanes, Volumes, Timings
31: Terry Fox & Maple Grove

09-04-2020

Lane Group	EBL	EBT	EBR	WBL	WBT	WBR	NBL	NBT	NBR	SBL	SBT	SBR
Lane Configurations												
Traffic Volume (vph)	175	65	340	20	70	40	225	1365	45	60	1810	180
Future Volume (vph)	175	65	340	20	70	40	225	1365	45	60	1810	180
Confl. Peds. (#/hr)	5		5	5		5	5		5	5		5
Confl. Bikes (#/hr)												
Peak Hour Factor	1.00	1.00	1.00	1.00	1.00	1.00	1.00	1.00	1.00	1.00	1.00	1.00
Growth Factor	100%	100%	100%	100%	100%	100%	100%	100%	100%	100%	100%	100%
Heavy Vehicles (%)	2%	0%	1%	0%	0%	0%	2%	2%	0%	0%	1%	3%
Bus Blockages (#/hr)	0	0	0	0	0	0	0	0	0	0	0	0
Parking (#/hr)												
Mid-Block Traffic (%)		0%			0%			0%			0%	
Shared Lane Traffic (%)												
Lane Group Flow (vph)	175	65	340	20	110	0	225	1410	0	60	1810	180
Turn Type	Perm	NA	Perm	Perm	NA		pm+pt	NA		pm+pt	NA	Perm
Protected Phases		4			8		5	2		1	6	
Permitted Phases	4		4	8			2			6		6
Detector Phase	4	4	4	8	8		5	2		1	6	6
Switch Phase												
Minimum Initial (s)	10.0	10.0	10.0	10.0	10.0		5.0	10.0		5.0	10.0	10.0
Minimum Split (s)	42.0	42.0	42.0	42.0	42.0		12.0	43.0		12.0	43.0	43.0
Total Split (s)	46.0	46.0	46.0	46.0	46.0		24.0	72.0		12.0	60.0	60.0
Total Split (%)	35.4%	35.4%	35.4%	35.4%	35.4%		18.5%	55.4%		9.2%	46.2%	46.2%
Yellow Time (s)	3.0	3.0	3.0	3.0	3.0		4.0	4.0		4.0	4.0	4.0
All-Red Time (s)	2.0	2.0	2.0	2.0	2.0		2.0	2.0		2.0	2.0	2.0
Lost Time Adjust (s)	0.0	0.0	0.0	0.0	0.0		0.0	0.0		0.0	0.0	0.0
Total Lost Time (s)	5.0	5.0	5.0	5.0	5.0		6.0	6.0		6.0	6.0	6.0
Lead/Lag							Lead	Lag		Lead	Lag	Lag
Lead-Lag Optimize?							Yes	Yes		Yes	Yes	Yes
Recall Mode	None	None	None	None	None		None	C-Max		None	C-Max	C-Max
Act Effct Green (s)	25.4	25.4	25.4	25.4	25.4		93.6	82.9		77.9	70.9	70.9
Actuated g/C Ratio	0.20	0.20	0.20	0.20	0.20		0.72	0.64		0.60	0.55	0.55
v/c Ratio	0.80	0.19	0.75	0.08	0.32		0.83	0.66		0.26	0.98	0.21
Control Delay	74.4	41.9	29.7	39.1	35.3		60.0	19.2		11.5	47.1	8.3
Queue Delay	0.0	0.0	0.0	0.0	0.0		0.0	0.0		0.0	0.0	0.0
Total Delay	74.4	41.9	29.7	39.1	35.3		60.0	19.2		11.5	47.1	8.3
LOS	E	D	C	D	D		E	B		B	D	A
Approach Delay		44.5			35.9			24.8			42.6	
Approach LOS		D			D			C			D	
Queue Length 50th (m)	45.8	14.9	36.6	4.5	20.2		43.4	121.4		4.1	242.9	7.8
Queue Length 95th (m)	65.8	25.3	65.4	10.7	33.9		74.5	194.7		11.4	#370.5	26.6
Internal Link Dist (m)		1246.0			796.0			547.8			406.9	
Turn Bay Length (m)	65.0		60.0	40.0			145.0			125.0		70.0
Base Capacity (vph)	352	567	606	404	548		303	2129		234	1846	839
Starvation Cap Reductn	0	0	0	0	0		0	0		0	0	0
Spillback Cap Reductn	0	0	0	0	0		0	0		0	0	0
Storage Cap Reductn	0	0	0	0	0		0	0		0	0	0
Reduced v/c Ratio	0.50	0.11	0.56	0.05	0.20		0.74	0.66		0.26	0.98	0.21

Intersection Summary

Lanes, Volumes, Timings
 31: Terry Fox & Maple Grove

09-04-2020

Cycle Length: 130
 Actuated Cycle Length: 130
 Offset: 112 (86%), Referenced to phase 2:NBTL and 6:SBTL, Start of Green
 Natural Cycle: 140
 Control Type: Actuated-Coordinated
 Maximum v/c Ratio: 0.98
 Intersection Signal Delay: 36.0 Intersection LOS: D
 Intersection Capacity Utilization 99.2% ICU Level of Service F
 Analysis Period (min) 15
 # 95th percentile volume exceeds capacity, queue may be longer.
 Queue shown is maximum after two cycles.

Splits and Phases: 31: Terry Fox & Maple Grove

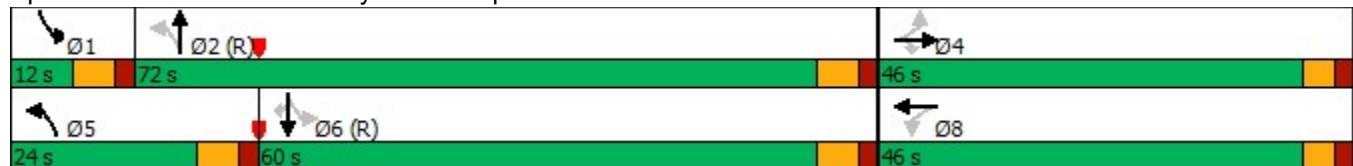

Intersection

Int Delay, s/veh 12.9

Movement	EBL	EBT	EBR	WBL	WBT	WBR	NBL	NBT	NBR	SBL	SBT	SBR
Lane Configurations		↕			↕			↕			↕	
Traffic Vol, veh/h	40	0	10	5	0	40	35	745	15	60	1085	10
Future Vol, veh/h	40	0	10	5	0	40	35	745	15	60	1085	10
Conflicting Peds, #/hr	0	0	0	5	0	5	0	0	5	5	0	0
Sign Control	Stop	Stop	Stop	Stop	Stop	Stop	Free	Free	Free	Free	Free	Free
RT Channelized	-	-	None	-	-	None	-	-	None	-	-	None
Storage Length	-	-	-	-	-	-	-	-	-	-	-	-
Veh in Median Storage, #	0	-	-	0	-	-	0	-	-	0	-	-
Grade, %	-	0	-	-	0	-	-	0	-	-	0	-
Peak Hour Factor	100	100	100	100	100	100	100	100	100	100	100	100
Heavy Vehicles, %	0	0	0	0	0	0	0	0	0	0	1	0
Mvmt Flow	40	0	10	5	0	40	35	745	15	60	1085	10

Major/Minor	Minor2	Minor1		Major1		Major2						
Conflicting Flow All	2058	2045	1095	2048	2043	763	1095	0	0	765	0	0
Stage 1	1210	1210	-	828	828	-	-	-	-	-	-	-
Stage 2	848	835	-	1220	1215	-	-	-	-	-	-	-
Critical Hdwy	7.1	6.5	6.2	7.1	6.5	6.2	4.1	-	-	4.1	-	-
Critical Hdwy Stg 1	6.1	5.5	-	6.1	5.5	-	-	-	-	-	-	-
Critical Hdwy Stg 2	6.1	5.5	-	6.1	5.5	-	-	-	-	-	-	-
Follow-up Hdwy	3.5	4	3.3	3.5	4	3.3	2.2	-	-	2.2	-	-
Pot Cap-1 Maneuver	41	57	262	42	57	408	645	-	-	857	-	-
Stage 1	225	258	-	368	389	-	-	-	-	-	-	-
Stage 2	359	386	-	222	256	-	-	-	-	-	-	-
Platoon blocked, %								-	-	-	-	-
Mov Cap-1 Maneuver	29	42	261	32	42	405	645	-	-	853	-	-
Mov Cap-2 Maneuver	29	42	-	32	42	-	-	-	-	-	-	-
Stage 1	204	212	-	332	351	-	-	-	-	-	-	-
Stage 2	292	348	-	174	210	-	-	-	-	-	-	-

Approach	EB	WB	NB	SB
HCM Control Delay, s	4.78.9	32.3	0.5	0.5
HCM LOS	F	D		

Minor Lane/Major Mvmt	NBL	NBT	NBR	EBLn1	WBLn1	SBL	SBT	SBR
Capacity (veh/h)	645	-	-	35	176	853	-	-
HCM Lane V/C Ratio	0.054	-	-	1.429	0.256	0.07	-	-
HCM Control Delay (s)	10.9	0	\$ 478.9	32.3	9.5	0	-	-
HCM Lane LOS	B	A	-	F	D	A	A	-
HCM 95th %tile Q(veh)	0.2	-	-	5.4	1	0.2	-	-

Notes
 ~: Volume exceeds capacity \$: Delay exceeds 300s +: Computation Not Defined *: All major volume in platoon

Intersection

Int Delay, s/veh 1.3

Movement WBL WBR NBT NBR SBL SBT

Lane Configurations	W	R	T	R	L	T
Traffic Vol, veh/h	15	30	790	25	45	1130
Future Vol, veh/h	15	30	790	25	45	1130
Conflicting Peds, #/hr	5	5	0	5	5	0
Sign Control	Stop	Stop	Free	Free	Free	Free
RT Channelized	-	None	-	None	-	None
Storage Length	0	-	-	-	-	-
Veh in Median Storage	0	-	0	-	-	0
Grade, %	0	-	0	-	-	0
Peak Hour Factor	100	100	100	100	100	100
Heavy Vehicles, %	0	0	0	0	0	1
Mvmt Flow	15	30	790	25	45	1130

Major/Minor Minor1 Major1 Major2

Conflicting Flow All	2033	813	0	0	820	0
Stage 1	808	-	-	-	-	-
Stage 2	1225	-	-	-	-	-
Critical Hdwy	6.4	6.2	-	-	4.1	-
Critical Hdwy Stg 1	5.4	-	-	-	-	-
Critical Hdwy Stg 2	5.4	-	-	-	-	-
Follow-up Hdwy	3.5	3.3	-	-	2.2	-
Pot Cap-1 Maneuver	64	382	-	-	818	-
Stage 1	442	-	-	-	-	-
Stage 2	280	-	-	-	-	-
Platoon blocked, %			-	-		-
Mov Cap-1 Maneuver	54	379	-	-	815	-
Mov Cap-2 Maneuver	54	-	-	-	-	-
Stage 1	440	-	-	-	-	-
Stage 2	237	-	-	-	-	-

Approach WB NB SB

HCM Control Delay, s 48.7 0 0.4
HCM LOS E

Minor Lane/Major Mvmt NBT NBR WBLn1 SBL SBT

Capacity (veh/h)	-	-	126	815	-
HCM Lane V/C Ratio	-	-	0.357	0.055	-
HCM Control Delay (s)	-	-	48.7	9.7	0
HCM Lane LOS	-	-	E	A	A
HCM 95th %tile Q(veh)	-	-	1.5	0.2	-

Intersection

Int Delay, s/veh 1.9

Movement	EBL	EBT	WBT	WBR	SBL	SBR
Lane Configurations		↑	↑		↑	
Traffic Vol, veh/h	40	340	405	65	35	60
Future Vol, veh/h	40	340	405	65	35	60
Conflicting Peds, #/hr	5	0	0	5	5	5
Sign Control	Free	Free	Free	Free	Stop	Stop
RT Channelized	-	None	-	None	-	None
Storage Length	-	-	-	-	0	-
Veh in Median Storage,-#	0	0	0	-	0	-
Grade, %	-	0	0	-	0	-
Peak Hour Factor	100	100	100	100	100	100
Heavy Vehicles, %	0	0	3	0	0	0
Mvmt Flow	40	340	405	65	35	60

Major/Minor	Major1	Major2	Minor2
Conflicting Flow All	475	0	0
Stage 1	-	-	-
Stage 2	-	-	-
Critical Hdwy	4.1	-	-
Critical Hdwy Stg 1	-	-	-
Critical Hdwy Stg 2	-	-	-
Follow-up Hdwy	2.2	-	-
Pot Cap-1 Maneuver	1098	-	-
Stage 1	-	-	-
Stage 2	-	-	-
Platoon blocked, %	-	-	-
Mov Cap-1 Maneuver	1093	-	-
Mov Cap-2 Maneuver	-	-	-
Stage 1	-	-	-
Stage 2	-	-	-

Approach	EB	WB	SB
HCM Control Delay, s	0.9	0	15.2
HCM LOS			C

Minor Lane/Major Mvmt	EBL	EBT	WBT	WBR	SBLn1
Capacity (veh/h)	1093	-	-	-	448
HCM Lane V/C Ratio	0.037	-	-	-	-0.212
HCM Control Delay (s)	8.4	0	-	-	15.2
HCM Lane LOS	A	A	-	-	C
HCM 95th %tile Q(veh)	0.1	-	-	-	0.8

Intersection

Int Delay, s/veh 1.3

Movement	EBL	EBT	EBR	WBL	WBT	WBR	NBL	NBT	NBR	SBL	SBT	SBR
Lane Configurations		↕			↕			↕			↕	
Traffic Vol, veh/h	5	325	15	25	420	15	10	0	40	10	0	10
Future Vol, veh/h	5	325	15	25	420	15	10	0	40	10	0	10
Conflicting Peds, #/hr	5	0	0	0	0	5	0	0	0	5	0	5
Sign Control	Free	Free	Free	Free	Free	Free	Stop	Stop	Stop	Stop	Stop	Stop
RT Channelized	-	-	None	-	-	None	-	-	None	-	-	None
Storage Length	-	-	-	-	-	-	-	-	-	-	-	-
Veh in Median Storage, #	0	-	-	0	-	-	0	-	-	0	-	-
Grade, %	-	0	-	-	0	-	-	0	-	-	0	-
Peak Hour Factor	100	100	100	100	100	100	100	100	100	100	100	100
Heavy Vehicles, %	0	0	7	4	3	0	0	0	3	0	0	0
Mvmt Flow	5	325	15	25	420	15	10	0	40	10	0	10

Major/Minor	Major1	Major2	Minor1	Minor2
Conflicting Flow All	440	0	0	340
Stage 1	-	-	-	-
Stage 2	-	-	-	-
Critical Hdwy	4.1	-	-	4.14
Critical Hdwy Stg 1	-	-	-	-
Critical Hdwy Stg 2	-	-	-	-
Follow-up Hdwy	2.2	-	-	2.236
Pot Cap-1 Maneuver	131	-	-	1208
Stage 1	-	-	-	-
Stage 2	-	-	-	-
Platoon blocked, %	-	-	-	-
Mov Cap-1 Maneuver	126	-	-	1208
Mov Cap-2 Maneuver	-	-	-	-
Stage 1	-	-	-	-
Stage 2	-	-	-	-

Approach	EB	WB	NB	SB
HCM Control Delay, s	0.1	0.4	12.4	15.5
HCM LOS			B	C

Minor Lane/Major Mvm	NBLn1	EBL	EBT	EBR	WBL	WBT	WBR	SBLn1
Capacity (veh/h)		537	1126	-	-	1208	-	363
HCM Lane V/C Ratio		0.093	0.004	-	-	0.021	-	0.055
HCM Control Delay (s)		12.4	8.2	0	-	8	0	15.5
HCM Lane LOS		B	A	A	-	A	A	C
HCM 95th %tile Q(veh)		0.3	0	-	-	0.1	-	0.2

Intersection

Int Delay, s/veh 0.3

Movement	EBL	EBT	WBT	WBR	SBL	SBR
Lane Configurations		↕	↕		↕	
Traffic Vol, veh/h	0	375	450	15	10	5
Future Vol, veh/h	0	375	450	15	10	5
Conflicting Peds, #/hr	0	0	0	0	0	0
Sign Control	Free	Free	Free	Free	Stop	Stop
RT Channelized	-	None	-	None	-	None
Storage Length	-	-	-	-	0	-
Veh in Median Storage,-#	0	0	0	0	0	0
Grade, %	-	0	0	0	0	0
Peak Hour Factor	100	100	100	100	100	100
Heavy Vehicles, %	0	0	2	0	0	0
Mvmt Flow	0	375	450	15	10	5

Major/Minor	Major1	Major2	Minor2
Conflicting Flow All	465	0	0
Stage 1	-	-	458
Stage 2	-	-	375
Critical Hdwy	4.1	-	6.4
Critical Hdwy Stg 1	-	-	5.4
Critical Hdwy Stg 2	-	-	5.4
Follow-up Hdwy	2.2	-	3.5
Pot Cap-1 Maneuvr	107	-	341
Stage 1	-	-	641
Stage 2	-	-	699
Platoon blocked, %	-	-	-
Mov Cap-1 Maneuvr	107	-	341
Mov Cap-2 Maneuver	-	-	341
Stage 1	-	-	641
Stage 2	-	-	699

Approach	EB	WB	SB
HCM Control Delay, s	0	0	14.4
HCM LOS			B

Minor Lane/Major Mvmt	EBL	EBT	WBT	WBR	SBLn1
Capacity (veh/h)	1107	-	-	-	399
HCM Lane V/C Ratio	-	-	-	-	-0.038
HCM Control Delay (s)	0	-	-	-	14.4
HCM Lane LOS	A	-	-	-	B
HCM 95th %tile Q(veh)	0	-	-	-	0.1

Intersection

Int Delay, s/veh 5.9

Movement	EBL	EBT	EBR	WBL	WBT	WBR	NBL	NBT	NBR	SBL	SBT	SBR
Lane Configurations		↕			↕			↕			↕	
Traffic Vol, veh/h	55	30	0	0	20	0	0	15	0	0	15	35
Future Vol, veh/h	55	30	0	0	20	0	0	15	0	0	15	35
Conflicting Peds, #/hr	0	0	0	0	0	0	0	0	0	0	0	0
Sign Control	Free	Free	Free	Free	Free	Free	Stop	Stop	Stop	Stop	Stop	Stop
RT Channelized	-	-	None	-	-	None	-	-	None	-	-	None
Storage Length	-	-	-	-	-	-	-	-	-	-	-	-
Veh in Median Storage, #	0	-	-	0	-	-	0	-	-	0	-	-
Grade, %	-	0	-	-	0	-	-	0	-	-	0	-
Peak Hour Factor	100	100	100	100	100	100	100	100	100	100	100	100
Heavy Vehicles, %	0	0	0	0	0	0	0	0	0	0	0	0
Mvmt Flow	55	30	0	0	20	0	0	15	0	0	15	35

Major/Minor	Major1	Major2	Minor1	Minor2
Conflicting Flow All	20	0	0	30
Stage 1	-	-	-	-
Stage 2	-	-	-	-
Critical Hdwy	4.1	-	-	4.1
Critical Hdwy Stg 1	-	-	-	-
Critical Hdwy Stg 2	-	-	-	-
Follow-up Hdwy	2.2	-	-	2.2
Pot Cap-1 Maneuver	609	-	-	1596
Stage 1	-	-	-	-
Stage 2	-	-	-	-
Platoon blocked, %	-	-	-	-
Mov Cap-1 Maneuver	609	-	-	1596
Mov Cap-2 Maneuver	-	-	-	-
Stage 1	-	-	-	-
Stage 2	-	-	-	-

Approach	EB	WB	NB	SB
HCM Control Delay, s	4.7	0	10.2	9.1
HCM LOS			B	A

Minor Lane/Major Mvm	NBLn1	EBL	EBT	EBR	WBL	WBT	WBR	SBLn1
Capacity (veh/h)	710	1609	-	-	1596	-	-	926
HCM Lane V/C Ratio	0.021	0.034	-	-	-	-	-	0.054
HCM Control Delay (s)	10.2	7.3	0	-	0	-	-	9.1
HCM Lane LOS	B	A	A	-	A	-	-	A
HCM 95th %tile Q(veh)	0.1	0.1	-	-	0	-	-	0.2

Intersection

Int Delay, s/veh 0.2

Movement	WBL	WBR	NBT	NBR	SBL	SBT
Lane Configurations		↑	↑			↑
Traffic Vol, veh/h	0	20	770	15	0	1100
Future Vol, veh/h	0	20	770	15	0	1100
Conflicting Peds, #/hr	5	5	0	5	5	0
Sign Control	Stop	Stop	Free	Free	Free	Free
RT Channelized	-	None	-	None	-	None
Storage Length	-	0	-	-	-	-
Veh in Median Storage#	-	0	-	-	-	0
Grade, %	0	-	0	-	-	0
Peak Hour Factor	100	100	100	100	100	100
Heavy Vehicles, %	0	0	0	0	0	1
Mvmt Flow	0	20	770	15	0	1100

Major/Minor	Minor1	Major1	Major2
Conflicting Flow All	-	788	0
Stage 1	-	-	-
Stage 2	-	-	-
Critical Hdwy	-	6.2	-
Critical Hdwy Stg 1	-	-	-
Critical Hdwy Stg 2	-	-	-
Follow-up Hdwy	-	3.3	-
Pot Cap-1 Maneuver	0	394	-
Stage 1	0	-	-
Stage 2	0	-	-
Platoon blocked, %		-	-
Mov Cap-1 Maneuver	-	391	-
Mov Cap-2 Maneuver	-	-	-
Stage 1	-	-	-
Stage 2	-	-	-

Approach	WB	NB	SB
HCM Control Delay, s	14.7	0	0
HCM LOS	B		

Minor Lane/Major Mvmt	NBT	NBR	WBLn1	SBT
Capacity (veh/h)	-	-	391	-
HCM Lane V/C Ratio	-	-	0.051	-
HCM Control Delay (s)	-	-	14.7	-
HCM Lane LOS	-	-	B	-
HCM 95th %tile Q(veh)	-	-	0.2	-

Intersection

Int Delay, s/veh 1.7

Movement	EBT	EBR	WBL	WBT	NBL	NBR
Lane Configurations						
Traffic Vol, veh/h	70	5	15	40	0	15
Future Vol, veh/h	70	5	15	40	0	15
Conflicting Peds, #/hr	0	5	5	0	5	5
Sign Control	Free	Free	Free	Free	Stop	Stop
RT Channelized	- None		- None		- None	
Storage Length	-	-	-	-	0	-
Veh in Median Storage0#	-	-	-	0	0	-
Grade, %	0	-	-	0	0	-
Peak Hour Factor	100	100	100	100	100	100
Heavy Vehicles, %	0	0	0	0	0	0
Mvmt Flow	70	5	15	40	0	15

Major/Minor	Major1	Major2	Minor1		
Conflicting Flow All	0	0	80	0	153 83
Stage 1	-	-	-	-	78 -
Stage 2	-	-	-	-	75 -
Critical Hdwy	-	-	4.1	-	6.4 6.2
Critical Hdwy Stg 1	-	-	-	-	5.4 -
Critical Hdwy Stg 2	-	-	-	-	5.4 -
Follow-up Hdwy	-	-	2.2	-	3.5 3.3
Pot Cap-1 Maneuver	-	-	1531	-	843 982
Stage 1	-	-	-	-	950 -
Stage 2	-	-	-	-	953 -
Platoon blocked, %	-	-	-	-	-
Mov Cap-1 Maneuver	-	-	1525	-	828 974
Mov Cap-2 Maneuver	-	-	-	-	828 -
Stage 1	-	-	-	-	946 -
Stage 2	-	-	-	-	940 -

Approach	EB	WB	NB
HCM Control Delay, s	0	2	8.8
HCM LOS			A

Minor Lane/Major MvmNBLn1	EBT	EBR	WBL	WBT
Capacity (veh/h)	974	-	-	1525 -
HCM Lane V/C Ratio	0.015	-	-	0.01 -
HCM Control Delay (s)	8.8	-	-	7.4 0
HCM Lane LOS	A	-	-	A A
HCM 95th %tile Q(veh)	0	-	-	0 -

Intersection				
Intersection Delay, s/veh	15.4			
Intersection LOS	C			
Approach	EB	WB	NB	SB
Entry Lanes	1	1	1	1
Conflicting Circle Lanes	1	1	1	1
Adj Approach Flow, veh/h	55	85	765	1005
Demand Flow Rate, veh/h	58	86	765	1016
Vehicles Circulating, veh/h	1061	755	32	136
Vehicles Exiting, veh/h	91	42	1087	705
Ped Vol Crossing Leg, #/h	5	5	5	5
Ped Cap Adj	1.000	0.999	0.999	0.999
Approach Delay, s/veh	9.9	7.3	9.1	21.2
Approach LOS	A	A	A	C
Lane	Left	Left	Left	Left
Designated Moves	LTR	LTR	LTR	LTR
Assumed Moves	LTR	LTR	LTR	LTR
RT Channelized				
Lane Util	1.000	1.000	1.000	1.000
Follow-Up Headway, s	2.609	2.609	2.609	2.609
Critical Headway, s	4.976	4.976	4.976	4.976
Entry Flow, veh/h	58	86	765	1016
Cap Entry Lane, veh/h	468	639	1336	1201
Entry HV Adj Factor	0.944	0.988	1.000	0.989
Flow Entry, veh/h	55	85	765	1005
Cap Entry, veh/h	441	631	1335	1188
V/C Ratio	0.124	0.135	0.573	0.846
Control Delay, s/veh	9.9	7.3	9.1	21.2
LOS	A	A	A	C
95th %tile Queue, veh	0	0	4	11

Intersection

Intersection Delay, s/veh	7.2
Intersection LOS	A































Movement	EBL	EBR	NBL	NBT	SBT	SBR
Lane Configurations	W			↑	↑	
Traffic Vol, veh/h	30	0	0	40	30	20
Future Vol, veh/h	30	0	0	40	30	20
Peak Hour Factor	1.00	1.00	1.00	1.00	1.00	1.00
Heavy Vehicles, %	0	0	0	0	0	0
Mvmt Flow	30	0	0	40	30	20
Number of Lanes	1	0	0	1	1	0

Approach	EB	NB	SB
Opposing Approach		SB	NB
Opposing Lanes	0	1	1
Conflicting Approach Left	SB	EB	
Conflicting Lanes Left	1	1	0
Conflicting Approach Right			EB
Conflicting Lanes Right	1	0	1
HCM Control Delay	7.4	7.2	7
HCM LOS	A	A	A

Lane	NBLn1	EBLn1	SBLn1
Vol Left, %	0%	100%	0%
Vol Thru, %	100%	0%	60%
Vol Right, %	0%	0%	40%
Sign Control	Stop	Stop	Stop
Traffic Vol by Lane	40	30	50
LT Vol	0	30	0
Through Vol	40	0	30
RT Vol	0	0	20
Lane Flow Rate	40	30	50
Geometry Grp	1	1	1
Degree of Util (X)	0.044	0.035	0.052
Departure Headway (Hd)	3.99	4.255	3.743
Convergence, Y/N	Yes	Yes	Yes
Cap	898	840	957
Service Time	2.013	2.286	1.766
HCM Lane V/C Ratio	0.045	0.036	0.052
HCM Control Delay	7.2	7.4	7
HCM Lane LOS	A	A	A
HCM 95th-tile Q	0.1	0.1	0.2

Lanes, Volumes, Timings
3: Iber/Huntmar & Hazeldean

09-04-2020

												
Lane Group	EBL	EBT	EBR	WBL	WBT	WBR	NBL	NBT	NBR	SBL	SBT	SBR
Lane Configurations	 	 		 	 					 	 	 
Traffic Volume (vph)	250	840	135	205	500	130	60	330	310	155	320	140
Future Volume (vph)	250	840	135	205	500	130	60	330	310	155	320	140
Confl. Peds. (#/hr)	5		5	5		5	5		5	5		5
Confl. Bikes (#/hr)												
Peak Hour Factor	1.00	1.00	1.00	1.00	1.00	1.00	1.00	1.00	1.00	1.00	1.00	1.00
Growth Factor	100%	100%	100%	100%	100%	100%	100%	100%	100%	100%	100%	100%
Heavy Vehicles (%)	2%	2%	12%	3%	4%	2%	4%	0%	4%	3%	2%	0%
Bus Blockages (#/hr)	0	0	0	0	0	0	0	0	0	0	0	0
Parking (#/hr)												
Mid-Block Traffic (%)		0%			0%			0%			0%	
Shared Lane Traffic (%)												
Lane Group Flow (vph)	250	975	0	205	500	130	60	330	310	155	320	140
Turn Type	Prot	NA		Prot	NA	Perm	pm+pt	NA	Perm	pm+pt	NA	pm+ov
Protected Phases	5	2		1	6		3	8		7	4	5
Permitted Phases						6	8		8	4		4
Detector Phase	5	2		1	6	6	3	8	8	7	4	5
Switch Phase												
Minimum Initial (s)	5.0	10.0		5.0	10.0	10.0	5.0	10.0	10.0	5.0	10.0	5.0
Minimum Split (s)	12.5	38.6		12.5	38.6	38.6	12.5	58.0	58.0	12.5	41.3	12.5
Total Split (s)	18.2	44.8		14.6	41.2	41.2	12.5	58.0	58.0	12.6	58.1	18.2
Total Split (%)	14.0%	34.5%		11.2%	31.7%	31.7%	9.6%	44.6%	44.6%	9.7%	44.7%	14.0%
Yellow Time (s)	3.6	3.6		3.6	3.6	3.6	3.0	3.3	3.3	3.0	3.3	3.6
All-Red Time (s)	2.0	2.0		2.0	2.0	2.0	0.0	2.0	2.0	0.0	2.0	2.0
Lost Time Adjust (s)	0.0	0.0		0.0	0.0	0.0	0.0	0.0	0.0	0.0	0.0	0.0
Total Lost Time (s)	5.6	5.6		5.6	5.6	5.6	3.0	5.3	5.3	3.0	5.3	5.6
Lead/Lag	Lead	Lag		Lead	Lag	Lag	Lead	Lag	Lag	Lead	Lag	Lead
Lead-Lag Optimize?	Yes	Yes		Yes	Yes	Yes	Yes	Yes	Yes	Yes	Yes	Yes
Recall Mode	None	C-Max		None	C-Max	C-Max	None	None	None	None	None	None
Act Effct Green (s)	15.5	56.1		14.6	55.2	55.2	40.8	30.2	30.2	43.2	33.2	48.5
Actuated g/C Ratio	0.12	0.43		0.11	0.42	0.42	0.31	0.23	0.23	0.33	0.26	0.37
v/c Ratio	0.64	0.70		0.57	0.36	0.19	0.24	0.79	0.59	0.68	0.71	0.22
Control Delay	62.3	34.6		60.7	28.2	5.6	29.0	60.1	13.9	45.7	53.2	3.8
Queue Delay	0.0	0.0		0.0	0.0	0.0	0.0	0.0	0.0	0.0	0.0	0.0
Total Delay	62.3	34.6		60.7	28.2	5.6	29.0	60.1	13.9	45.7	53.2	3.8
LOS	E	C		E	C	A	C	E	B	D	D	A
Approach Delay		40.2			32.7			37.0			40.1	
Approach LOS		D			C			D			D	
Queue Length 50th (m)	33.6	109.2		27.3	47.2	0.0	11.0	84.5	13.6	30.1	81.2	0.0
Queue Length 95th (m)	46.7	#167.4		39.8	74.2	14.7	18.9	108.4	39.6	42.6	105.6	10.9
Internal Link Dist (m)		871.0			1427.4			1305.6			301.9	
Turn Bay Length (m)	50.0			90.0		225.0	30.0		60.0	50.0		275.0
Base Capacity (vph)	393	1401		362	1396	700	259	729	733	227	716	653
Starvation Cap Reductn	0	0		0	0	0	0	0	0	0	0	0
Spillback Cap Reductn	0	0		0	0	0	0	0	0	0	0	0
Storage Cap Reductn	0	0		0	0	0	0	0	0	0	0	0
Reduced v/c Ratio	0.64	0.70		0.57	0.36	0.19	0.23	0.45	0.42	0.68	0.45	0.21

Intersection Summary

Lanes, Volumes, Timings
 3: Iber/Huntmar & Hazeldean

09-04-2020

Cycle Length: 130

Actuated Cycle Length: 130

Offset: 0 (0%), Referenced to phase 2:EBT and 6:WBT, Start of Green

Natural Cycle: 125

Control Type: Actuated-Coordinated

Maximum v/c Ratio: 0.79

Intersection Signal Delay: 37.6

Intersection LOS: D

Intersection Capacity Utilization 81.2%









ICU Level of Service D

Analysis Period (min) 15

95th percentile volume exceeds capacity, queue may be longer.

Queue shown is maximum after two cycles.

Splits and Phases: 3: Iber/Huntmar & Hazeldean

 Ø1	 Ø2 (R)	 Ø3	 Ø4
14.6 s	44.8 s	12.5 s	58.1 s
 Ø5	 Ø6 (R)	 Ø7	 Ø8
18.2 s	41.2 s	12.6 s	58 s

Lanes, Volumes, Timings
6: Terry Fox & Palladium/Katimavik

09-04-2020

Lane Group	EBL	EBT	EBR	WBL	WBT	WBR	NBL	NBT	NBR	SBL	SBT	SBR
Lane Configurations												
Traffic Volume (vph)	315	65	135	65	120	175	420	1415	95	100	990	935
Future Volume (vph)	315	65	135	65	120	175	420	1415	95	100	990	935
Confl. Peds. (#/hr)	5		5	5		5	5		5	5		5
Confl. Bikes (#/hr)												
Peak Hour Factor	1.00	1.00	1.00	1.00	1.00	1.00	1.00	1.00	1.00	1.00	1.00	1.00
Growth Factor	100%	100%	100%	100%	100%	100%	100%	100%	100%	100%	100%	100%
Heavy Vehicles (%)	5%	5%	2%	10%	5%	3%	0%	2%	11%	2%	4%	1%
Bus Blockages (#/hr)	0	0	0	0	0	0	0	0	0	0	0	0
Parking (#/hr)												
Mid-Block Traffic (%)		0%			0%			0%			0%	
Shared Lane Traffic (%)												
Lane Group Flow (vph)	315	65	135	65	120	175	420	1415	95	100	990	935
Turn Type	Prot	NA	Perm	Prot	NA	Perm	Prot	NA	Perm	Prot	NA	Perm
Protected Phases	7	4		3	8		5	2		1	6	
Permitted Phases			4			8			2			6
Detector Phase	7	4	4	3	8	8	5	2	2	1	6	6
Switch Phase												
Minimum Initial (s)	5.0	10.0	10.0	5.0	10.0	10.0	5.0	10.0	10.0	5.0	10.0	10.0
Minimum Split (s)	12.0	40.6	40.6	12.0	40.3	40.3	12.0	42.5	42.5	30.0	41.0	41.0
Total Split (s)	29.7	56.0	56.0	14.0	40.3	40.3	16.0	50.0	50.0	30.0	64.0	64.0
Total Split (%)	19.8%	37.3%	37.3%	9.3%	26.9%	26.9%	10.7%	33.3%	33.3%	20.0%	42.7%	42.7%
Yellow Time (s)	3.6	3.6	3.6	3.3	3.3	3.3	4.0	4.0	4.0	4.0	4.0	4.0
All-Red Time (s)	2.0	2.0	2.0	2.0	2.0	2.0	2.0	2.0	2.0	2.0	2.0	2.0
Lost Time Adjust (s)	-2.0	0.0	0.0	0.0	0.0	0.0	0.0	0.0	0.0	0.0	0.0	0.0
Total Lost Time (s)	3.6	5.6	5.6	5.3	5.3	5.3	6.0	6.0	6.0	6.0	6.0	6.0
Lead/Lag	Lead	Lead	Lead	Lag	Lag	Lag	Lead	Lag	Lag	Lead	Lag	Lag
Lead-Lag Optimize?	Yes	Yes	Yes	Yes	Yes	Yes	Yes	Yes	Yes	Yes	Yes	Yes
Recall Mode	None	None	None	None	None	None	None	C-Max	C-Max	None	C-Max	C-Max
Act Effct Green (s)	21.9	15.2	15.2	22.6	17.9	17.9	31.2	79.3	79.3	10.0	58.1	58.1
Actuated g/C Ratio	0.15	0.10	0.10	0.15	0.12	0.12	0.21	0.53	0.53	0.07	0.39	0.39
v/c Ratio	0.68	0.38	0.48	0.28	0.59	0.53	0.61	0.80	0.12	0.46	0.78	0.95
Control Delay	68.4	66.6	11.7	58.4	72.5	13.1	58.2	34.7	0.3	73.9	45.5	32.7
Queue Delay	0.0	0.0	0.0	0.0	0.0	0.0	0.0	0.0	0.0	0.0	0.0	0.0
Total Delay	68.4	66.6	11.7	58.4	72.5	13.1	58.2	34.7	0.3	73.9	45.5	32.7
LOS	E	E	B	E	E	B	E	C	A	E	D	C
Approach Delay		53.3			41.1			38.1			41.0	
Approach LOS		D			D			D			D	
Queue Length 50th (m)	48.8	20.0	0.0	17.9	36.7	0.0	61.4	180.3	0.0	15.8	141.6	116.9
Queue Length 95th (m)	63.9	31.3	15.0	33.7	52.3	21.0	#128.2	#306.3	0.0	25.7	170.8	#237.6
Internal Link Dist (m)		1802.0			304.5			406.9			280.2	
Turn Bay Length (m)	100.0			115.0		115.0	240.0		115.0	70.0		190.0
Base Capacity (vph)	549	575	592	234	399	474	689	1771	801	520	1273	980
Starvation Cap Reductn	0	0	0	0	0	0	0	0	0	0	0	0
Spillback Cap Reductn	0	0	0	0	0	0	0	0	0	0	0	0
Storage Cap Reductn	0	0	0	0	0	0	0	0	0	0	0	0
Reduced v/c Ratio	0.57	0.11	0.23	0.28	0.30	0.37	0.61	0.80	0.12	0.19	0.78	0.95

Intersection Summary

Cycle Length: 150

Actuated Cycle Length: 150

Offset: 0 (0%), Referenced to phase 2:NBT and 6:SBT, Start of Green, Master Intersection

Natural Cycle: 150

Control Type: Actuated-Coordinated

Maximum v/c Ratio: 0.95

Intersection Signal Delay: 41.1

Intersection LOS: D

Intersection Capacity Utilization 99.9%

ICU Level of Service F

Analysis Period (min) 15

95th percentile volume exceeds capacity, queue may be longer.

Queue shown is maximum after two cycles.

Splits and Phases: 6: Terry Fox & Palladium/Katimavik

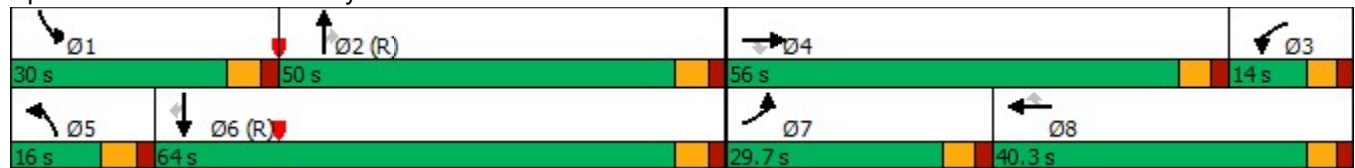

Lanes, Volumes, Timings
8: Huntmar & Palladium

09-04-2020

Lane Group	EBL	EBT	EBR	WBL	WBT	WBR	NBL	NBT	NBR	SBL	SBT	SBR
Lane Configurations												
Traffic Volume (vph)	35	205	275	65	100	45	500	365	220	105	195	55
Future Volume (vph)	35	205	275	65	100	45	500	365	220	105	195	55
Confl. Peds. (#/hr)	5		5	5		5	5		5	5		5
Confl. Bikes (#/hr)												
Peak Hour Factor	1.00	1.00	1.00	1.00	1.00	1.00	1.00	1.00	1.00	1.00	1.00	1.00
Growth Factor	100%	100%	100%	100%	100%	100%	100%	100%	100%	100%	100%	100%
Heavy Vehicles (%)	0%	3%	2%	7%	1%	0%	0%	1%	0%	2%	3%	2%
Bus Blockages (#/hr)	0	0	0	0	0	0	0	0	0	0	0	0
Parking (#/hr)												
Mid-Block Traffic (%)		0%			0%			0%			0%	
Shared Lane Traffic (%)												
Lane Group Flow (vph)	35	480	0	65	145	0	500	365	220	105	195	55
Turn Type	pm+pt	NA		pm+pt	NA		pm+pt	NA	Perm	Perm	NA	Perm
Protected Phases	5	2		1	6		3	8			4	
Permitted Phases	2			6			8		8	4		4
Detector Phase	5	2		1	6		3	8	8	4	4	4
Switch Phase												
Minimum Initial (s)	5.0	10.0		5.0	10.0		4.0	10.0	10.0	10.0	10.0	10.0
Minimum Split (s)	12.5	43.0		12.5	43.0		10.0	42.3	42.3	42.3	42.3	42.3
Total Split (s)	12.5	43.0		12.6	43.1		42.0	84.4	84.4	42.4	42.4	42.4
Total Split (%)	8.9%	30.7%		9.0%	30.8%		30.0%	60.3%	60.3%	30.3%	30.3%	30.3%
Yellow Time (s)	4.0	4.0		4.0	4.0		4.0	3.3	3.3	3.3	3.3	3.3
All-Red Time (s)	2.0	2.0		2.0	2.0		2.0	2.0	2.0	2.0	2.0	2.0
Lost Time Adjust (s)	0.0	0.0		0.0	0.0		0.0	0.0	0.0	0.0	0.0	0.0
Total Lost Time (s)	6.0	6.0		6.0	6.0		6.0	5.3	5.3	5.3	5.3	5.3
Lead/Lag	Lead	Lag		Lead	Lag		Lead			Lag	Lag	Lag
Lead-Lag Optimize?	Yes	Yes		Yes	Yes		Yes			Yes	Yes	Yes
Recall Mode	None	C-Max		None	C-Max		None	None	None	None	None	None
Act Effct Green (s)	58.8	53.3		60.8	54.3		63.4	64.1	64.1	22.9	22.9	22.9
Actuated g/C Ratio	0.42	0.38		0.43	0.39		0.45	0.46	0.46	0.16	0.16	0.16
v/c Ratio	0.07	0.37		0.19	0.11		0.93	0.45	0.27	0.67	0.68	0.16
Control Delay	25.2	18.4		26.0	22.4		54.2	26.7	2.8	74.1	66.2	1.0
Queue Delay	0.0	0.0		0.0	0.0		0.0	0.0	0.0	0.0	0.0	0.0
Total Delay	25.2	18.4		26.0	22.4		54.2	26.7	2.8	74.1	66.2	1.0
LOS	C	B		C	C		D	C	A	E	E	A
Approach Delay		18.9			23.5			34.5			58.4	
Approach LOS		B			C			C			E	
Queue Length 50th (m)	5.4	26.4		10.3	9.8		112.6	72.5	0.0	29.6	55.2	0.0
Queue Length 95th (m)	14.9	49.3		24.1	21.1		#138.7	78.5	11.7	44.9	71.9	0.0
Internal Link Dist (m)		535.2			1802.0			357.2			231.7	
Turn Bay Length (m)	95.0			75.0			120.0		45.0	50.0		
Base Capacity (vph)	523	1287		339	1275		547	1006	944	253	463	476
Starvation Cap Reductn	0	0		0	0		0	0	0	0	0	0
Spillback Cap Reductn	0	0		0	0		0	0	0	0	0	0
Storage Cap Reductn	0	0		0	0		0	0	0	0	0	0
Reduced v/c Ratio	0.07	0.37		0.19	0.11		0.91	0.36	0.23	0.42	0.42	0.12

Intersection Summary

Lanes, Volumes, Timings
 8: Huntmar & Palladium

09-04-2020

Cycle Length: 140

Actuated Cycle Length: 140

Offset: 87 (62%), Referenced to phase 2:EBTL and 6:WBTL, Start of Green

Natural Cycle: 110

Control Type: Actuated-Coordinated

Maximum v/c Ratio: 0.93

Intersection Signal Delay: 33.7

Intersection LOS: C

Intersection Capacity Utilization 97.2%

ICU Level of Service F

Analysis Period (min) 15

95th percentile volume exceeds capacity, queue may be longer.

Queue shown is maximum after two cycles.

Splits and Phases: 8: Huntmar & Palladium

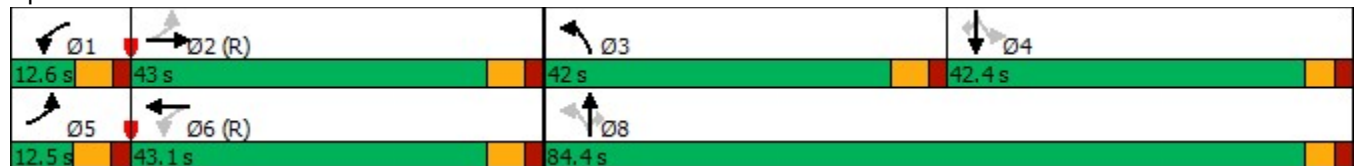

Lanes, Volumes, Timings
13: Huntmar & Street 1

09-04-2020



Lane Group	EBL	EBT	EBR	WBL	WBT	WBR	NBL	NBT	NBR	SBL	SBT	SBR
Lane Configurations		↕			↕			↕			↕	
Traffic Volume (vph)	25	0	20	5	0	45	30	970	10	40	495	25
Future Volume (vph)	25	0	20	5	0	45	30	970	10	40	495	25
Confl. Peds. (#/hr)				5		5			5	5		
Confl. Bikes (#/hr)												
Peak Hour Factor	1.00	1.00	1.00	1.00	1.00	1.00	1.00	1.00	1.00	1.00	1.00	1.00
Growth Factor	100%	100%	100%	100%	100%	100%	100%	100%	100%	100%	100%	100%
Heavy Vehicles (%)	0%	0%	0%	0%	0%	0%	0%	1%	0%	0%	3%	0%
Bus Blockages (#/hr)	0	0	0	0	0	0	0	0	0	0	0	0
Parking (#/hr)												
Mid-Block Traffic (%)		0%			0%			0%			0%	
Shared Lane Traffic (%)												
Lane Group Flow (vph)	0	45	0	0	50	0	0	1010	0	0	560	0
Turn Type	Perm	NA		Split	NA		Perm	NA		Perm	NA	
Protected Phases		4		8	8			2			6	
Permitted Phases	4						2			6		
Detector Phase	4	4		8	8		2	2		6	6	
Switch Phase												
Minimum Initial (s)	4.0	4.0		4.0	4.0		4.0	4.0		4.0	4.0	
Minimum Split (s)	24.0	24.0		24.0	24.0		24.0	24.0		24.0	24.0	
Total Split (s)	24.0	24.0		24.0	24.0		72.0	72.0		72.0	72.0	
Total Split (%)	20.0%	20.0%		20.0%	20.0%		60.0%	60.0%		60.0%	60.0%	
Yellow Time (s)	4.0	4.0		4.0	4.0		4.0	4.0		4.0	4.0	
All-Red Time (s)	2.0	2.0		2.0	2.0		2.0	2.0		2.0	2.0	
Lost Time Adjust (s)		0.0			0.0			0.0			0.0	
Total Lost Time (s)		6.0			6.0			6.0			6.0	
Lead/Lag												
Lead-Lag Optimize?												
Recall Mode	None	None		None	None		Max	Max		Max	Max	
Act Effct Green (s)		7.7			7.7			76.0			76.0	
Actuated g/C Ratio		0.07			0.07			0.74			0.74	
v/c Ratio		0.33			0.26			0.79			0.49	
Control Delay		8.1			6.5			19.6			11.4	
Queue Delay		0.0			0.0			0.0			0.0	
Total Delay		8.1			6.5			19.6			11.4	
LOS		A			A			B			B	
Approach Delay		8.1			6.5			19.6			11.4	
Approach LOS		A			A			B			B	
Queue Length 50th (m)		0.0			0.0			123.9			44.7	
Queue Length 95th (m)		2.8			4.5			#357.1			134.6	
Internal Link Dist (m)		13.2			122.1			53.9			0.1	
Turn Bay Length (m)												
Base Capacity (vph)		215			336			1282			1142	
Starvation Cap Reductn		0			0			0			0	
Spillback Cap Reductn		0			0			0			0	
Storage Cap Reductn		0			0			0			0	
Reduced v/c Ratio		0.21			0.15			0.79			0.49	

Intersection Summary

Lanes, Volumes, Timings
13: Huntmar & Street 1

09-04-2020

Cycle Length: 120

Actuated Cycle Length: 102.8

Natural Cycle: 120

Control Type: Actuated-Uncoordinated

Maximum v/c Ratio: 0.79

Intersection Signal Delay: 16.2

Intersection LOS: B

Intersection Capacity Utilization 82.3%

ICU Level of Service E

Analysis Period (min) 15

95th percentile volume exceeds capacity, queue may be longer.

Queue shown is maximum after two cycles.

Splits and Phases: 13: Huntmar & Street 1



Lanes, Volumes, Timings
21: Huntmar & Maple Grove

09-04-2020



Lane Group	EBL	EBT	EBR	WBL	WBT	WBR	NBL	NBT	NBR	SBL	SBT	SBR
Lane Configurations												
Traffic Volume (vph)	310	170	70	80	70	110	40	615	125	45	375	65
Future Volume (vph)	310	170	70	80	70	110	40	615	125	45	375	65
Confl. Peds. (#/hr)	5		5	5		5	5		5	5		5
Confl. Bikes (#/hr)												
Peak Hour Factor	1.00	1.00	1.00	1.00	1.00	1.00	1.00	1.00	1.00	1.00	1.00	1.00
Growth Factor	100%	100%	100%	100%	100%	100%	100%	100%	100%	100%	100%	100%
Heavy Vehicles (%)	1%	1%	5%	0%	6%	1%	20%	1%	3%	2%	2%	0%
Bus Blockages (#/hr)	0	0	0	0	0	0	0	0	0	0	0	0
Parking (#/hr)												
Mid-Block Traffic (%)		0%			0%			0%			0%	
Shared Lane Traffic (%)												
Lane Group Flow (vph)	310	240	0	80	180	0	40	740	0	45	375	65
Turn Type	pm+pt	NA		pm+pt	NA		pm+pt	NA		pm+pt	NA	Perm
Protected Phases	7	4		3	8		5	2		1	6	
Permitted Phases	4			8			2			6		6
Detector Phase	7	4		3	8		5	2		1	6	6
Switch Phase												
Minimum Initial (s)	4.0	10.0		4.0	10.0		4.0	10.0		4.0	10.0	10.0
Minimum Split (s)	10.0	33.0		10.0	33.0		10.0	29.0		10.0	49.0	49.0
Total Split (s)	26.0	48.0		11.0	33.0		10.0	51.0		10.0	51.0	51.0
Total Split (%)	21.7%	40.0%		9.2%	27.5%		8.3%	42.5%		8.3%	42.5%	42.5%
Yellow Time (s)	4.0	3.0		4.0	3.0		4.0	3.3		4.0	3.3	3.3
All-Red Time (s)	2.0	2.0		2.0	2.0		2.0	2.0		2.0	2.0	2.0
Lost Time Adjust (s)	0.0	0.0		0.0	0.0		0.0	0.0		0.0	0.0	0.0
Total Lost Time (s)	6.0	5.0		6.0	5.0		6.0	5.3		6.0	5.3	5.3
Lead/Lag	Lead	Lag		Lead	Lag		Lead	Lag		Lead	Lag	Lag
Lead-Lag Optimize?	Yes	Yes		Yes			Yes	Yes		Yes	Yes	Yes
Recall Mode	None	None		None	None		None	C-Max		None	C-Max	C-Max
Act Effct Green (s)	40.5	32.7		19.7	15.7		62.7	57.6		62.6	57.6	57.6
Actuated g/C Ratio	0.34	0.27		0.16	0.13		0.52	0.48		0.52	0.48	0.48
v/c Ratio	0.84	0.51		0.39	0.70		0.11	0.47		0.14	0.44	0.08
Control Delay	52.5	37.9		35.0	46.5		14.6	23.2		14.8	25.1	0.2
Queue Delay	0.0	0.0		0.0	0.0		0.0	0.0		0.0	0.0	0.0
Total Delay	52.5	37.9		35.0	46.5		14.6	23.2		14.8	25.1	0.2
LOS	D	D		C	D		B	C		B	C	A
Approach Delay		46.1			43.0			22.8			20.8	
Approach LOS		D			D			C			C	
Queue Length 50th (m)	62.5	48.0		13.8	28.7		4.2	62.7		4.7	61.5	0.0
Queue Length 95th (m)	#85.9	67.5		22.9	49.9		11.3	94.5		12.3	104.1	0.0
Internal Link Dist (m)		630.5			86.3			293.1			175.1	
Turn Bay Length (m)							20.0					30.0
Base Capacity (vph)	370	609		204	409		375	1583		330	847	803
Starvation Cap Reductn	0	0		0	0		0	0		0	0	0
Spillback Cap Reductn	0	0		0	0		0	0		0	0	0
Storage Cap Reductn	0	0		0	0		0	0		0	0	0
Reduced v/c Ratio	0.84	0.39		0.39	0.44		0.11	0.47		0.14	0.44	0.08

Intersection Summary

Lanes, Volumes, Timings
 21: Huntmar & Maple Grove

09-04-2020

Cycle Length: 120

Actuated Cycle Length: 120

Offset: 0 (0%), Referenced to phase 2:NBTL and 6:SBTL, Start of Green

Natural Cycle: 105

Control Type: Actuated-Coordinated

Maximum v/c Ratio: 0.84

Intersection Signal Delay: 31.0

Intersection LOS: C

Intersection Capacity Utilization 74.4%

ICU Level of Service D

Analysis Period (min) 15

95th percentile volume exceeds capacity, queue may be longer.

Queue shown is maximum after two cycles.

Splits and Phases: 21: Huntmar & Maple Grove



Lanes, Volumes, Timings
24: Maple Grove & Street 2

09-04-2020



Lane Group	EBL	EBT	WBT	WBR	SBL	SBR
Lane Configurations		↶	↷		↶	
Traffic Volume (vph)	70	320	345	30	70	45
Future Volume (vph)	70	320	345	30	70	45
Confl. Peds. (#/hr)	5			5	5	5
Confl. Bikes (#/hr)						
Peak Hour Factor	1.00	1.00	1.00	1.00	1.00	1.00
Growth Factor	100%	100%	100%	100%	100%	100%
Heavy Vehicles (%)	0%	2%	2%	0%	0%	0%
Bus Blockages (#/hr)	0	0	0	0	0	0
Parking (#/hr)						
Mid-Block Traffic (%)		0%	0%		0%	
Shared Lane Traffic (%)						
Lane Group Flow (vph)	0	390	375	0	115	0
Turn Type	Perm	NA	NA		Prot	
Protected Phases		4	8		1	
Permitted Phases	4					
Detector Phase	4	4	8		1	
Switch Phase						
Minimum Initial (s)	4.0	4.0	4.0		4.0	
Minimum Split (s)	24.0	24.0	24.0		10.0	
Total Split (s)	26.0	26.0	26.0		14.0	
Total Split (%)	65.0%	65.0%	65.0%		35.0%	
Yellow Time (s)	4.0	4.0	4.0		4.0	
All-Red Time (s)	2.0	2.0	2.0		2.0	
Lost Time Adjust (s)		0.0	0.0		0.0	
Total Lost Time (s)		6.0	6.0		6.0	
Lead/Lag						
Lead-Lag Optimize?						
Recall Mode	None	None	None		None	
Act Effct Green (s)		14.0	13.6		8.8	
Actuated g/C Ratio		0.55	0.53		0.34	
v/c Ratio		0.48	0.40		0.20	
Control Delay		8.5	7.0		9.4	
Queue Delay		0.0	0.0		0.0	
Total Delay		8.5	7.0		9.4	
LOS		A	A		A	
Approach Delay		8.5	7.0		9.4	
Approach LOS		A	A		A	
Queue Length 50th (m)		15.0	12.8		3.1	
Queue Length 95th (m)		33.9	28.1		13.9	
Internal Link Dist (m)		80.8	1246.0		278.2	
Turn Bay Length (m)						
Base Capacity (vph)		1104	1292		753	
Starvation Cap Reductn		0	0		0	
Spillback Cap Reductn		0	0		0	
Storage Cap Reductn		0	0		0	
Reduced v/c Ratio		0.35	0.29		0.15	

Intersection Summary

Lanes, Volumes, Timings
 24: Maple Grove & Street 2

09-04-2020























Cycle Length: 40	
Actuated Cycle Length: 25.6	
Natural Cycle: 40	
Control Type: Actuated-Uncoordinated	
Maximum v/c Ratio: 0.48	
Intersection Signal Delay: 8.0	Intersection LOS: A
Intersection Capacity Utilization 65.2%	ICU Level of Service C
Analysis Period (min) 15	

Splits and Phases: 24: Maple Grove & Street 2



Lanes, Volumes, Timings
31: Terry Fox & Maple Grove

09-04-2020

												
Lane Group	EBL	EBT	EBR	WBL	WBT	WBR	NBL	NBT	NBR	SBL	SBT	SBR
Lane Configurations												
Traffic Volume (vph)	275	65	205	35	50	55	235	1510	40	15	905	120
Future Volume (vph)	275	65	205	35	50	55	235	1510	40	15	905	120
Confl. Peds. (#/hr)	5		5	5		5	5		5	5		5
Confl. Bikes (#/hr)												
Peak Hour Factor	1.00	1.00	1.00	1.00	1.00	1.00	1.00	1.00	1.00	1.00	1.00	1.00
Growth Factor	100%	100%	100%	100%	100%	100%	100%	100%	100%	100%	100%	100%
Heavy Vehicles (%)	7%	4%	8%	9%	5%	0%	6%	4%	6%	0%	7%	14%
Bus Blockages (#/hr)	0	0	0	0	0	0	0	0	0	0	0	0
Parking (#/hr)												
Mid-Block Traffic (%)		0%			0%			0%			0%	
Shared Lane Traffic (%)												
Lane Group Flow (vph)	275	65	205	35	105	0	235	1550	0	15	905	120
Turn Type	Perm	NA	Perm	Perm	NA		pm+pt	NA		pm+pt	NA	Perm
Protected Phases		4			8		5	2		1	6	
Permitted Phases	4		4	8			2			6		6
Detector Phase	4	4	4	8	8		5	2		1	6	6
Switch Phase												
Minimum Initial (s)	10.0	10.0	10.0	10.0	10.0		5.0	10.0		5.0	10.0	10.0
Minimum Split (s)	42.0	42.0	42.0	42.0	42.0		12.0	43.0		12.0	43.0	43.0
Total Split (s)	46.0	46.0	46.0	46.0	46.0		24.0	72.0		12.0	60.0	60.0
Total Split (%)	35.4%	35.4%	35.4%	35.4%	35.4%		18.5%	55.4%		9.2%	46.2%	46.2%
Yellow Time (s)	3.0	3.0	3.0	3.0	3.0		4.0	4.0		4.0	4.0	4.0
All-Red Time (s)	2.0	2.0	2.0	2.0	2.0		2.0	2.0		2.0	2.0	2.0
Lost Time Adjust (s)	0.0	0.0	0.0	0.0	0.0		0.0	0.0		0.0	0.0	0.0
Total Lost Time (s)	5.0	5.0	5.0	5.0	5.0		6.0	6.0		6.0	6.0	6.0
Lead/Lag							Lead	Lag		Lead	Lag	Lag
Lead-Lag Optimize?							Yes	Yes		Yes	Yes	Yes
Recall Mode	None	None	None	None	None		None	C-Max		None	C-Max	C-Max
Act Effct Green (s)	35.3	35.3	35.3	35.3	35.3		83.7	78.9		69.9	64.1	64.1
Actuated g/C Ratio	0.27	0.27	0.27	0.27	0.27		0.64	0.61		0.54	0.49	0.49
v/c Ratio	0.90	0.14	0.39	0.11	0.22		0.66	0.78		0.09	0.57	0.17
Control Delay	76.7	34.4	6.5	33.8	21.2		19.9	25.1		12.7	26.9	4.9
Queue Delay	0.0	0.0	0.0	0.0	0.0		0.0	0.0		0.0	0.0	0.0
Total Delay	76.7	34.4	6.5	33.8	21.2		19.9	25.1		12.7	26.9	4.9
LOS	E	C	A	C	C		B	C		B	C	A
Approach Delay		45.3			24.3			24.4			24.2	
Approach LOS		D			C			C			C	
Queue Length 50th (m)	70.1	13.0	0.0	7.0	12.2		25.9	145.6		1.4	91.6	0.4
Queue Length 95th (m)#	111.8	24.2	18.0	15.2	26.5		42.6	#256.7		4.6	127.8	12.7
Internal Link Dist (m)		1246.0			796.0			547.8			406.9	
Turn Bay Length (m)	65.0		60.0	40.0			145.0			125.0		70.0
Base Capacity (vph)	354	545	579	370	536		401	1985		160	1576	702
Starvation Cap Reductn	0	0	0	0	0		0	0		0	0	0
Spillback Cap Reductn	0	0	0	0	0		0	0		0	0	0
Storage Cap Reductn	0	0	0	0	0		0	0		0	0	0
Reduced v/c Ratio	0.78	0.12	0.35	0.09	0.20		0.59	0.78		0.09	0.57	0.17

Intersection Summary

Cycle Length: 130
Actuated Cycle Length: 130
Offset: 112 (86%), Referenced to phase 2:NBTL and 6:SBTL, Start of Green
Natural Cycle: 110
Control Type: Actuated-Coordinated
Maximum v/c Ratio: 0.90
Intersection Signal Delay: 27.6 Intersection LOS: C
Intersection Capacity Utilization 87.7% ICU Level of Service E
Analysis Period (min) 15
95th percentile volume exceeds capacity, queue may be longer.
Queue shown is maximum after two cycles.

Splits and Phases: 31: Terry Fox & Maple Grove

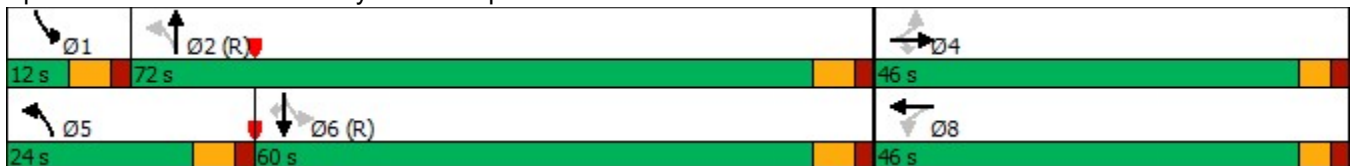

Intersection

Int Delay, s/veh 1.4

Movement WBL WBR NBT NBR SBL SBT

Lane Configurations	Y		B			A
Traffic Vol, veh/h	25	35	1025	5	10	520
Future Vol, veh/h	25	35	1025	5	10	520
Conflicting Peds, #/hr	5	5	0	5	5	0
Sign Control	Stop	Stop	Free	Free	Free	Free
RT Channelized	-	None	-	None	-	None
Storage Length	0	-	-	-	-	-
Veh in Median Storage#	-	0	-	-	-	0
Grade, %	0	-	0	-	-	0
Peak Hour Factor	100	100	100	100	100	100
Heavy Vehicles, %	0	0	1	0	0	3
Mvmt Flow	25	35	1025	5	10	520

Major/Minor Minor1 Major1 Major2

Conflicting Flow All	1578	1038	0	0	1035	0
Stage 1	1033	-	-	-	-	-
Stage 2	545	-	-	-	-	-
Critical Hdwy	6.4	6.2	-	-	4.1	-
Critical Hdwy Stg 1	5.4	-	-	-	-	-
Critical Hdwy Stg 2	5.4	-	-	-	-	-
Follow-up Hdwy	3.5	3.3	-	-	2.2	-
Pot Cap-1 Maneuver	122	283	-	-	679	-
Stage 1	346	-	-	-	-	-
Stage 2	585	-	-	-	-	-
Platoon blocked, %			-	-		-
Mov Cap-1 Maneuver	118	281	-	-	676	-
Mov Cap-2 Maneuver	118	-	-	-	-	-
Stage 1	345	-	-	-	-	-
Stage 2	570	-	-	-	-	-

Approach WB NB SB

HCM Control Delay, s 35.2 0 0.2
HCM LOS E

Minor Lane/Major Mvmt NBT NBR WBLn1 SBL SBT

Capacity (veh/h)	-	-	178	676	-
HCM Lane V/C Ratio	-	-	0.337	0.015	-
HCM Control Delay (s)	-	-	35.2	10.4	0
HCM Lane LOS	-	-	E	B	A
HCM 95th %tile Q(veh)	-	-	1.4	0	-

Intersection

Int Delay, s/veh 3.6

Movement	EBL	EBT	EBR	WBL	WBT	WBR	NBL	NBT	NBR	SBL	SBT	SBR
Lane Configurations		↕			↕			↕			↕	
Traffic Vol, veh/h	5	340	5	185	200	5	10	0	25	15	0	55
Future Vol, veh/h	5	340	5	185	200	5	10	0	25	15	0	55
Conflicting Peds, #/hr	5	0	0	0	0	5	0	0	0	5	0	5
Sign Control	Free	Free	Free	Free	Free	Free	Stop	Stop	Stop	Stop	Stop	Stop
RT Channelized	-	-	None	-	-	None	-	-	None	-	-	None
Storage Length	-	-	-	-	-	-	-	-	-	-	-	-
Veh in Median Storage, #	0	-	-	0	-	-	0	-	0	-	0	-
Grade, %	-	0	-	-	0	-	-	0	-	-	0	-
Peak Hour Factor	100	100	100	100	100	100	100	100	100	100	100	100
Heavy Vehicles, %	0	2	0	0	3	0	0	0	0	0	0	0
Mvmt Flow	5	340	5	185	200	5	10	0	25	15	0	55

Major/Minor	Major1	Major2	Minor1	Minor2
Conflicting Flow All	210	0	0	345
Stage 1	-	-	-	-
Stage 2	-	-	-	-
Critical Hdwy	4.1	-	-	4.1
Critical Hdwy Stg 1	-	-	-	-
Critical Hdwy Stg 2	-	-	-	-
Follow-up Hdwy	2.2	-	-	2.2
Pot Cap-1 Maneuver	373	-	-	1225
Stage 1	-	-	-	-
Stage 2	-	-	-	-
Platoon blocked, %	-	-	-	-
Mov Cap-1 Maneuver	367	-	-	1225
Mov Cap-2 Maneuver	-	-	-	-
Stage 1	-	-	-	-
Stage 2	-	-	-	-

Approach	EB	WB	NB	SB
HCM Control Delay, s	0.1	4	14.9	13.5
HCM LOS			B	B

Minor Lane/Major Mvm	NBLn1	EBL	EBT	EBR	WBL	WBT	WBR	SBLn1
Capacity (veh/h)		398	1367	-	-	1225	-	495
HCM Lane V/C Ratio		0.088	0.004	-	-	0.151	-	0.141
HCM Control Delay (s)		14.9	7.6	0	-	8.5	0	13.5
HCM Lane LOS		B	A	A	-	A	A	B
HCM 95th %tile Q(veh)		0.3	0	-	-	0.5	-	0.5

Intersection

Int Delay, s/veh 0.3

Movement	EBL	EBT	WBT	WBR	SBL	SBR
Lane Configurations		↑	↑		↑	
Traffic Vol, veh/h	0	380	385	5	10	5
Future Vol, veh/h	0	380	385	5	10	5
Conflicting Peds, #/hr	0	0	0	0	0	0
Sign Control	Free	Free	Free	Free	Stop	Stop
RT Channelized	- None		- None		- None	
Storage Length	-	-	-	-	0	-
Veh in Median Storage,-#	0	0	-	0	-	-
Grade, %	-	0	0	-	0	-
Peak Hour Factor	100	100	100	100	100	100
Heavy Vehicles, %	0	2	1	0	0	0
Mvmt Flow	0	380	385	5	10	5

Major/Minor	Major1	Major2	Minor2
Conflicting Flow All	390	0	0 768 388
Stage 1	-	-	- 388 -
Stage 2	-	-	- 380 -
Critical Hdwy	4.1	-	- 6.4 6.2
Critical Hdwy Stg 1	-	-	- 5.4 -
Critical Hdwy Stg 2	-	-	- 5.4 -
Follow-up Hdwy	2.2	-	- 3.5 3.3
Pot Cap-1 Maneuvr180	-	-	- 373 665
Stage 1	-	-	- 690 -
Stage 2	-	-	- 696 -
Platoon blocked, %	-	-	-
Mov Cap-1 Maneuvr180	-	-	- 373 665
Mov Cap-2 Maneuver	-	-	- 373 -
Stage 1	-	-	- 690 -
Stage 2	-	-	- 696 -

Approach	EB	WB	SB
HCM Control Delay, s	0	0	13.5
HCM LOS			B

Minor Lane/Major Mvmt	EBL	EBT	WBT	WBR	SBLn1
Capacity (veh/h)	1180	-	-	-	437
HCM Lane V/C Ratio	-	-	-	-	-0.034
HCM Control Delay (s)	0	-	-	-	13.5
HCM Lane LOS	A	-	-	-	B
HCM 95th %tile Q(veh)	0	-	-	-	0.1

Intersection

Int Delay, s/veh 6.1

Movement	EBL	EBT	EBR	WBL	WBT	WBR	NBL	NBT	NBR	SBL	SBT	SBR
Lane Configurations		↕			↕			↕			↕	
Traffic Vol, veh/h	15	5	0	0	30	0	0	5	0	0	25	35
Future Vol, veh/h	15	5	0	0	30	0	0	5	0	0	25	35
Conflicting Peds, #/hr	0	0	0	0	0	0	0	0	0	0	0	0
Sign Control	Free	Free	Free	Free	Free	Free	Stop	Stop	Stop	Stop	Stop	Stop
RT Channelized	-	-	None	-	-	None	-	-	None	-	-	None
Storage Length	-	-	-	-	-	-	-	-	-	-	-	-
Veh in Median Storage, #	0	-	-	0	-	-	0	-	-	0	-	-
Grade, %	-	0	-	-	0	-	-	0	-	-	0	-
Peak Hour Factor	100	100	100	100	100	100	100	100	100	100	100	100
Heavy Vehicles, %	0	0	0	0	0	0	0	0	0	0	0	0
Mvmt Flow	15	5	0	0	30	0	0	5	0	0	25	35

Major/Minor	Major1	Major2	Minor1	Minor2								
Conflicting Flow All	30	0	0	5	0	0	95	65	5	68	65	30
Stage 1	-	-	-	-	-	-	35	35	-	30	30	-
Stage 2	-	-	-	-	-	-	60	30	-	38	35	-
Critical Hdwy	4.1	-	-	4.1	-	-	7.1	6.5	6.2	7.1	6.5	6.2
Critical Hdwy Stg 1	-	-	-	-	-	-	6.1	5.5	-	6.1	5.5	-
Critical Hdwy Stg 2	-	-	-	-	-	-	6.1	5.5	-	6.1	5.5	-
Follow-up Hdwy	2.2	-	-	2.2	-	-	3.5	4	3.3	3.5	4	3.3
Pot Cap-1 Maneuver	596	-	-	1630	-	-	893	830	1084	930	830	1050
Stage 1	-	-	-	-	-	-	986	870	-	992	874	-
Stage 2	-	-	-	-	-	-	957	874	-	982	870	-
Platoon blocked, %	-	-	-	-	-	-	-	-	-	-	-	-
Mov Cap-1 Maneuver	596	-	-	1630	-	-	838	823	1084	920	823	1050
Mov Cap-2 Maneuver	-	-	-	-	-	-	838	823	-	920	823	-
Stage 1	-	-	-	-	-	-	977	862	-	983	874	-
Stage 2	-	-	-	-	-	-	899	874	-	968	862	-

Approach	EB	WB	NB	SB
HCM Control Delay, s	5.5	0	9.4	9.1
HCM LOS			A	A

Minor Lane/Major Mvm	NBLn1	EBL	EBT	EBR	WBL	WBT	WBR	SBLn1
Capacity (veh/h)		823	1596	-	-	1630	-	942
HCM Lane V/C Ratio		0.006	0.009	-	-	-	-	-0.064
HCM Control Delay (s)		9.4	7.3	0	-	0	-	9.1
HCM Lane LOS		A	A	A	-	A	-	A
HCM 95th %tile Q(veh)		0	0	-	-	0	-	0.2

Intersection

Int Delay, s/veh 1.1

Movement	WBL	WBR	NBT	NBR	SBL	SBT
Lane Configurations		↑	↑			↑
Traffic Vol, veh/h	0	85	925	110	0	520
Future Vol, veh/h	0	85	925	110	0	520
Conflicting Peds, #/hr	5	5	0	5	5	0
Sign Control	Stop	Stop	Free	Free	Free	Free
RT Channelized	-	None	-	None	-	None
Storage Length	-	0	-	-	-	-
Veh in Median Storage#	-	0	-	-	-	0
Grade, %	0	-	0	-	-	0
Peak Hour Factor	100	100	100	100	100	100
Heavy Vehicles, %	0	0	1	0	0	3
Mvmt Flow	0	85	925	110	0	520

Major/Minor	Minor1	Major1	Major2
Conflicting Flow All	-	990	0
Stage 1	-	-	-
Stage 2	-	-	-
Critical Hdwy	-	6.2	-
Critical Hdwy Stg 1	-	-	-
Critical Hdwy Stg 2	-	-	-
Follow-up Hdwy	-	3.3	-
Pot Cap-1 Maneuver	0	302	-
Stage 1	0	-	-
Stage 2	0	-	-
Platoon blocked, %		-	-
Mov Cap-1 Maneuver	-	299	-
Mov Cap-2 Maneuver	-	-	-
Stage 1	-	-	-
Stage 2	-	-	-

Approach	WB	NB	SB
HCM Control Delay, s	21.8	0	0
HCM LOS	C		

Minor Lane/Major Mvmt	NBT	NBR	WBLn1	SBT
Capacity (veh/h)	-	-	299	-
HCM Lane V/C Ratio	-	-	0.284	-
HCM Control Delay (s)	-	-	21.8	-
HCM Lane LOS	-	-	C	-
HCM 95th %tile Q(veh)	-	-	1.1	-

Intersection						
Int Delay, s/veh	1.8					
Movement	EBT	EBR	WBL	WBT	NBL	NBR
Lane Configurations	↔		↔		↔	
Traffic Vol, veh/h	15	35	25	45	0	5
Future Vol, veh/h	15	35	25	45	0	5
Conflicting Peds, #/hr	0	5	5	0	5	5
Sign Control	Free	Free	Free	Free	Stop	Stop
RT Channelized	- None		- None		- None	
Storage Length	-	-	-	-	0	-
Veh in Median Storage0#	-	-	-	0	0	-
Grade, %	0	-	-	0	0	-
Peak Hour Factor	100	100	100	100	100	100
Heavy Vehicles, %	0	0	0	0	0	0
Mvmt Flow	15	35	25	45	0	5

Major/Minor	Major1	Major2	Minor1	Minor2	Minor3
Conflicting Flow All	0	0	55	0	138
Stage 1	-	-	-	-	38
Stage 2	-	-	-	-	100
Critical Hdwy	-	-	4.1	-	6.4
Critical Hdwy Stg 1	-	-	-	-	5.4
Critical Hdwy Stg 2	-	-	-	-	5.4
Follow-up Hdwy	-	-	2.2	-	3.5
Pot Cap-1 Maneuver	-	-	1563	-	860
Stage 1	-	-	-	-	990
Stage 2	-	-	-	-	929
Platoon blocked, %	-	-	-	-	-
Mov Cap-1 Maneuver	-	-	1556	-	839
Mov Cap-2 Maneuver	-	-	-	-	839
Stage 1	-	-	-	-	986
Stage 2	-	-	-	-	910

Approach	EB	WB	NB
HCM Control Delay, s	0	2.6	8.5
HCM LOS			A

Minor Lane/Major Mvm	NBLn1	EBT	EBR	WBL	WBT
Capacity (veh/h)	1024	-	-	1556	-
HCM Lane V/C Ratio	0.005	-	-	0.016	-
HCM Control Delay (s)	8.5	-	-	7.4	0
HCM Lane LOS	A	-	-	A	A
HCM 95th %tile Q(veh)	0	-	-	0	-

Intersection				
Intersection Delay, s/veh	8.2			
Intersection LOS	A			
Approach	EB	WB	NB	SB
Entry Lanes	1	1	1	1
Conflicting Circle Lanes	1	1	1	1
Adj Approach Flow, veh/h	75	45	720	530
Demand Flow Rate, veh/h	82	47	749	546
Vehicles Circulating, veh/h	577	754	47	52
Vehicles Exiting, veh/h	21	42	612	749
Ped Vol Crossing Leg, #/h	5	5	5	5
Ped Cap Adj	0.999	0.999	0.999	0.999
Approach Delay, s/veh	6.3	6.8	9.4	6.9
Approach LOS	A	A	A	A
Lane	Left	Left	Left	Left
Designated Moves	LTR	LTR	LTR	LTR
Assumed Moves	LTR	LTR	LTR	LTR
RT Channelized				
Lane Util	1.000	1.000	1.000	1.000
Follow-Up Headway, s	2.609	2.609	2.609	2.609
Critical Headway, s	4.976	4.976	4.976	4.976
Entry Flow, veh/h	82	47	749	546
Cap Entry Lane, veh/h	766	640	1315	1309
Entry HV Adj Factor	0.915	0.950	0.961	0.971
Flow Entry, veh/h	75	45	720	530
Cap Entry, veh/h	700	607	1263	1270
V/C Ratio	0.107	0.074	0.570	0.418
Control Delay, s/veh	6.3	6.8	9.4	6.9
LOS	A	A	A	A
95th %tile Queue, veh	0	0	4	2

Intersection

Intersection Delay, s/veh	6.9
Intersection LOS	A



























Movement	EBL	EBR	NBL	NBT	SBT	SBR
Lane Configurations	W			↑	↑	
Traffic Vol, veh/h	5	0	0	10	30	30
Future Vol, veh/h	5	0	0	10	30	30
Peak Hour Factor	1.00	1.00	1.00	1.00	1.00	1.00
Heavy Vehicles, %	0	0	0	0	0	0
Mvmt Flow	5	0	0	10	30	30
Number of Lanes	1	0	0	1	1	0

Approach	EB	NB	SB
Opposing Approach		SB	NB
Opposing Lanes	0	1	1
Conflicting Approach Left	SB	EB	
Conflicting Lanes Left	1	1	0
Conflicting Approach Right			EB
Conflicting Lanes Right	1	0	1
HCM Control Delay	7.3	7	6.9
HCM LOS	A	A	A

Lane	NBLn1	EBLn1	SBLn1
Vol Left, %	0%	100%	0%
Vol Thru, %	100%	0%	50%
Vol Right, %	0%	0%	50%
Sign Control	Stop	Stop	Stop
Traffic Vol by Lane	10	5	60
LT Vol	0	5	0
Through Vol	10	0	30
RT Vol	0	0	30
Lane Flow Rate	10	5	60
Geometry Grp	1	1	1
Degree of Util (X)	0.011	0.006	0.06
Departure Headway (Hd)	3.952	4.221	3.615
Convergence, Y/N	Yes	Yes	Yes
Cap	909	850	995
Service Time	1.962	2.238	1.621
HCM Lane V/C Ratio	0.011	0.006	0.06
HCM Control Delay	7	7.3	6.9
HCM Lane LOS	A	A	A
HCM 95th-tile Q	0	0	0.2

Lanes, Volumes, Timings
3: Iber/Huntmar & Hazeldean

09-04-2020

												
Lane Group	EBL	EBT	EBR	WBL	WBT	WBR	NBL	NBT	NBR	SBL	SBT	SBR
Lane Configurations	 	 		 	 		 			 		
Traffic Volume (vph)	250	800	150	400	1250	310	170	390	300	210	495	480
Future Volume (vph)	250	800	150	400	1250	310	170	390	300	210	495	480
Confl. Peds. (#/hr)	5		5	5		5	5		5	5		5
Confl. Bikes (#/hr)												
Peak Hour Factor	1.00	1.00	1.00	1.00	1.00	1.00	1.00	1.00	1.00	1.00	1.00	1.00
Growth Factor	100%	100%	100%	100%	100%	100%	100%	100%	100%	100%	100%	100%
Heavy Vehicles (%)	0%	1%	2%	1%	1%	0%	6%	1%	1%	1%	2%	1%
Bus Blockages (#/hr)	0	0	0	0	0	0	0	0	0	0	0	0
Parking (#/hr)												
Mid-Block Traffic (%)		0%			0%			0%			0%	
Shared Lane Traffic (%)												
Lane Group Flow (vph)	250	950	0	400	1250	310	170	390	300	210	495	480
Turn Type	Prot	NA		Prot	NA	Perm	pm+pt	NA	Perm	pm+pt	NA	pm+ov
Protected Phases	5	2		1	6		3	8		7	4	5
Permitted Phases						6	8		8	4		4
Detector Phase	5	2		1	6	6	3	8	8	7	4	5
Switch Phase												
Minimum Initial (s)	5.0	10.0		5.0	10.0	10.0	5.0	10.0	10.0	5.0	10.0	5.0
Minimum Split (s)	12.5	38.6		12.5	38.6	38.6	12.5	58.0	58.0	12.5	41.3	12.5
Total Split (s)	18.2	44.8		14.6	41.2	41.2	12.5	58.0	58.0	12.6	58.1	18.2
Total Split (%)	14.0%	34.5%		11.2%	31.7%	31.7%	9.6%	44.6%	44.6%	9.7%	44.7%	14.0%
Yellow Time (s)	3.6	3.6		3.6	3.6	3.6	3.0	3.3	3.3	3.0	3.3	3.6
All-Red Time (s)	2.0	2.0		2.0	2.0	2.0	0.0	2.0	2.0	0.0	2.0	2.0
Lost Time Adjust (s)	0.0	0.0		0.0	0.0	0.0	0.0	0.0	0.0	0.0	0.0	0.0
Total Lost Time (s)	5.6	5.6		5.6	5.6	5.6	3.0	5.3	5.3	3.0	5.3	5.6
Lead/Lag	Lead	Lag		Lead	Lag	Lag	Lead	Lag	Lag	Lead	Lag	Lead
Lead-Lag Optimize?	Yes	Yes		Yes	Yes	Yes	Yes	Yes	Yes	Yes	Yes	Yes
Recall Mode	None	C-Max		None	C-Max	C-Max	None	None	None	None	None	None
Act Effct Green (s)	14.3	39.2		19.4	44.3	44.3	54.1	42.3	42.3	54.3	42.4	56.4
Actuated g/C Ratio	0.11	0.30		0.15	0.34	0.34	0.42	0.33	0.33	0.42	0.33	0.43
v/c Ratio	0.69	0.95		0.82	1.08	0.43	0.79	0.67	0.46	0.69	0.86	0.71
Control Delay	65.8	62.0		68.1	93.1	5.9	49.1	43.1	9.0	35.6	55.7	28.6
Queue Delay	0.0	0.0		0.0	0.0	0.0	0.0	0.0	0.0	0.0	0.0	0.0
Total Delay	65.8	62.0		68.1	93.1	5.9	49.1	43.1	9.0	35.6	55.7	28.6
LOS	E	E		E	F	A	D	D	A	D	E	C
Approach Delay		62.8			74.2			32.4			41.2	
Approach LOS		E			E			C			D	
Queue Length 50th (m)	33.6	130.0		54.8	~204.5	0.0	28.0	90.1	10.9	35.4	124.0	84.1
Queue Length 95th (m)	#51.8	#173.4		#113.9	#276.1	23.1	#43.1	112.6	31.4	46.6	152.2	108.5
Internal Link Dist (m)		871.0			1427.4			1305.6			301.9	
Turn Bay Length (m)	50.0			90.0		225.0	30.0		60.0	50.0		275.0
Base Capacity (vph)	371	1003		489	1153	716	214	722	747	304	716	678
Starvation Cap Reductn	0	0		0	0	0	0	0	0	0	0	0
Spillback Cap Reductn	0	0		0	0	0	0	0	0	0	0	0
Storage Cap Reductn	0	0		0	0	0	0	0	0	0	0	0
Reduced v/c Ratio	0.67	0.95		0.82	1.08	0.43	0.79	0.54	0.40	0.69	0.69	0.71

Intersection Summary

Lanes, Volumes, Timings
 3: Iber/Huntmar & Hazeldean

09-04-2020

Cycle Length: 130

Actuated Cycle Length: 130

Offset: 0 (0%), Referenced to phase 2:EBT and 6:WBT, Start of Green

Natural Cycle: 145

Control Type: Actuated-Coordinated

Maximum v/c Ratio: 1.08

Intersection Signal Delay: 57.1

Intersection LOS: E

Intersection Capacity Utilization 98.5%

ICU Level of Service F

Analysis Period (min) 15

~ Volume exceeds capacity, queue is theoretically infinite.

Queue shown is maximum after two cycles.

95th percentile volume exceeds capacity, queue may be longer.































Queue shown is maximum after two cycles.

Splits and Phases: 3: Iber/Huntmar & Hazeldean

Ø1 14.6 s	Ø2 (R) 44.8 s	Ø3 12.5 s	Ø4 58.1 s
Ø5 18.2 s	Ø6 (R) 41.2 s	Ø7 12.6 s	Ø8 58 s

Lanes, Volumes, Timings
6: Terry Fox & Palladium/Katimavik

09-04-2020

												
Lane Group	EBL	EBT	EBR	WBL	WBT	WBR	NBL	NBT	NBR	SBL	SBT	SBR
Lane Configurations	 		 	 	 	 	 	 	 			
Traffic Volume (vph)	845	260	405	135	185	150	250	1160	100	125	1375	710
Future Volume (vph)	845	260	405	135	185	150	250	1160	100	125	1375	710
Confl. Peds. (#/hr)	5		5	5		5	5		5	5		5
Confl. Bikes (#/hr)												
Peak Hour Factor	1.00	1.00	1.00	1.00	1.00	1.00	1.00	1.00	1.00	1.00	1.00	1.00
Growth Factor	100%	100%	100%	100%	100%	100%	100%	100%	100%	100%	100%	100%
Heavy Vehicles (%)	0%	0%	1%	5%	2%	0%	0%	2%	4%	0%	1%	0%
Bus Blockages (#/hr)	0	0	0	0	0	0	0	0	0	0	0	0
Parking (#/hr)												
Mid-Block Traffic (%)		0%			0%			0%			0%	
Shared Lane Traffic (%)												
Lane Group Flow (vph)	845	260	405	135	185	150	250	1160	100	125	1375	710
Turn Type	Prot	NA	Perm	Prot	NA	Perm	Prot	NA	Perm	Prot	NA	Perm
Protected Phases	7	4		3	8		5	2		1	6	
Permitted Phases			4			8			2			6
Detector Phase	7	4	4	3	8	8	5	2	2	1	6	6
Switch Phase												
Minimum Initial (s)	5.0	10.0	10.0	5.0	10.0	10.0	5.0	10.0	10.0	5.0	10.0	10.0
Minimum Split (s)	12.0	37.6	37.6	10.3	37.3	37.3	11.0	38.0	38.0	11.0	38.0	38.0
Total Split (s)	42.0	58.0	58.0	22.0	38.0	38.0	11.0	49.0	49.0	30.0	68.0	68.0
Total Split (%)	26.4%	36.5%	36.5%	13.8%	23.9%	23.9%	6.9%	30.8%	30.8%	18.9%	42.8%	42.8%
Yellow Time (s)	3.6	3.6	3.6	3.3	3.3	3.3	4.0	4.0	4.0	4.0	4.0	4.0
All-Red Time (s)	2.0	2.0	2.0	2.0	2.0	2.0	2.0	2.0	2.0	2.0	2.0	2.0
Lost Time Adjust (s)	-2.0	0.0	0.0	0.0	0.0	0.0	0.0	0.0	0.0	0.0	0.0	0.0
Total Lost Time (s)	3.6	5.6	5.6	5.3	5.3	5.3	6.0	6.0	6.0	6.0	6.0	6.0
Lead/Lag	Lead	Lead	Lead	Lag	Lag	Lag	Lead	Lag	Lag	Lead	Lag	Lag
Lead-Lag Optimize?	Yes	Yes	Yes	Yes	Yes	Yes	Yes	Yes	Yes	Yes	Yes	Yes
Recall Mode	None	None	None	None	None	None	None	C-Max	C-Max	None	C-Max	C-Max
Act Effct Green (s)	38.4	37.2	37.2	22.7	23.5	23.5	14.2	64.9	64.9	11.4	62.0	62.0
Actuated g/C Ratio	0.24	0.23	0.23	0.14	0.15	0.15	0.09	0.41	0.41	0.07	0.39	0.39
v/c Ratio	1.05	0.62	0.89	0.58	0.71	0.43	0.84	0.85	0.14	0.53	1.04	0.70
Control Delay	103.8	59.6	59.6	75.3	78.7	11.4	90.9	50.2	0.4	79.0	82.9	6.5
Queue Delay	0.0	0.0	0.0	0.0	0.0	0.0	0.0	0.0	0.0	0.0	0.0	0.0
Total Delay	103.8	59.6	59.6	75.3	78.7	11.4	90.9	50.2	0.4	79.0	82.9	6.5
LOS	F	E	E	E	E	B	F	D	A	E	F	A
Approach Delay		84.3			56.2			53.7			58.1	
Approach LOS		F			E			D			E	
Queue Length 50th (m)~	157.8	78.2	91.6	43.1	60.2	0.0	42.5	179.8	0.0	21.0	~259.2	0.8
Queue Length 95th (m)#	200.8	97.0	123.3	#77.4	82.3	20.0	#101.1	#265.3	0.0	32.3	#304.2	33.7
Internal Link Dist (m)		1802.0			304.5			406.9			280.2	
Turn Bay Length (m)	100.0			115.0		115.0	240.0		115.0	70.0		190.0
Base Capacity (vph)	801	593	582	232	362	427	297	1368	692	500	1320	1015
Starvation Cap Reductn	0	0	0	0	0	0	0	0	0	0	0	0
Spillback Cap Reductn	0	0	0	0	0	0	0	0	0	0	0	0
Storage Cap Reductn	0	0	0	0	0	0	0	0	0	0	0	0
Reduced v/c Ratio	1.05	0.44	0.70	0.58	0.51	0.35	0.84	0.85	0.14	0.25	1.04	0.70

Intersection Summary

Lanes, Volumes, Timings
8: Huntmar & Palladium

09-04-2020

Lane Group	EBL	EBT	EBR	WBL	WBT	WBR	NBL	NBT	NBR	SBL	SBT	SBR
Lane Configurations												
Traffic Volume (vph)	30	185	665	250	525	140	370	280	135	100	385	110
Future Volume (vph)	30	185	665	250	525	140	370	280	135	100	385	110
Confl. Peds. (#/hr)	5		5	5		5	5		5	5		5
Confl. Bikes (#/hr)												
Peak Hour Factor	1.00	1.00	1.00	1.00	1.00	1.00	1.00	1.00	1.00	1.00	1.00	1.00
Growth Factor	100%	100%	100%	100%	100%	100%	100%	100%	100%	100%	100%	100%
Heavy Vehicles (%)	11%	0%	0%	0%	0%	0%	1%	1%	0%	1%	2%	1%
Bus Blockages (#/hr)	0	0	0	0	0	0	0	0	0	0	0	0
Parking (#/hr)												
Mid-Block Traffic (%)		0%			0%			0%			0%	
Shared Lane Traffic (%)												
Lane Group Flow (vph)	30	850	0	250	665	0	370	280	135	100	385	110
Turn Type	pm+pt	NA		pm+pt	NA		pm+pt	NA	Perm	Perm	NA	Perm
Protected Phases	5	2		1	6		3	8			4	
Permitted Phases	2			6			8		8	4		4
Detector Phase	5	2		1	6		3	8	8	4	4	4
Switch Phase												
Minimum Initial (s)	5.0	10.0		5.0	10.0		4.0	10.0	10.0	10.0	10.0	10.0
Minimum Split (s)	12.5	43.0		12.5	43.0		10.0	42.3	42.3	42.3	42.3	42.3
Total Split (s)	12.5	43.0		14.0	44.5		40.4	83.0	83.0	42.6	42.6	42.6
Total Split (%)	8.9%	30.7%		10.0%	31.8%		28.9%	59.3%	59.3%	30.4%	30.4%	30.4%
Yellow Time (s)	4.0	4.0		4.0	4.0		4.0	3.3	3.3	3.3	3.3	3.3
All-Red Time (s)	2.0	2.0		2.0	2.0		2.0	2.0	2.0	2.0	2.0	2.0
Lost Time Adjust (s)	0.0	0.0		0.0	0.0		0.0	0.0	0.0	0.0	0.0	0.0
Total Lost Time (s)	6.0	6.0		6.0	6.0		6.0	5.3	5.3	5.3	5.3	5.3
Lead/Lag	Lead	Lag		Lead	Lag		Lead			Lag	Lag	Lag
Lead-Lag Optimize?	Yes	Yes		Yes	Yes		Yes			Yes	Yes	Yes
Recall Mode	None	C-Max		None	C-Max		None	None	None	None	None	None
Act Effct Green (s)	43.5	37.0		58.5	52.5		67.7	68.4	68.4	34.7	34.7	34.7
Actuated g/C Ratio	0.31	0.26		0.42	0.38		0.48	0.49	0.49	0.25	0.25	0.25
v/c Ratio	0.13	0.72		0.96	0.53		0.90	0.32	0.17	0.39	0.88	0.24
Control Delay	29.0	19.2		85.9	37.9		58.6	21.7	2.8	47.6	72.1	7.0
Queue Delay	0.0	0.0		0.0	0.0		0.0	0.0	0.0	0.0	0.0	0.0
Total Delay	29.0	19.2		85.9	37.9		58.6	21.7	2.8	47.6	72.1	7.0
LOS	C	B		F	D		E	C	A	D	E	A
Approach Delay		19.5			51.0			35.9			55.9	
Approach LOS		B			D			D			E	
Queue Length 50th (m)	5.1	41.5		~62.2	82.9		80.4	47.2	0.0	24.0	107.0	0.0
Queue Length 95th (m)	13.1	67.1		#152.1	112.7		112.1	60.0	9.8	42.1	#156.5	13.5
Internal Link Dist (m)		535.2			1802.0			357.2			231.7	
Turn Bay Length (m)	95.0			75.0			120.0		45.0	50.0		
Base Capacity (vph)	233	1188		260	1252		479	989	894	283	479	489
Starvation Cap Reductn	0	0		0	0		0	0	0	0	0	0
Spillback Cap Reductn	0	0		0	0		0	0	0	0	0	0
Storage Cap Reductn	0	0		0	0		0	0	0	0	0	0
Reduced v/c Ratio	0.13	0.72		0.96	0.53		0.77	0.28	0.15	0.35	0.80	0.22

Intersection Summary

Lanes, Volumes, Timings
 8: Huntmar & Palladium

09-04-2020

Cycle Length: 140

Actuated Cycle Length: 140

Offset: 87 (62%), Referenced to phase 2:EBTL and 6:WBTL, Start of Green

Natural Cycle: 130

Control Type: Actuated-Coordinated

Maximum v/c Ratio: 0.96

Intersection Signal Delay: 39.4

Intersection LOS: D

Intersection Capacity Utilization 109.3%

ICU Level of Service H

Analysis Period (min) 15

~ Volume exceeds capacity, queue is theoretically infinite.

Queue shown is maximum after two cycles.

95th percentile volume exceeds capacity, queue may be longer.

Queue shown is maximum after two cycles.

Splits and Phases: 8: Huntmar & Palladium

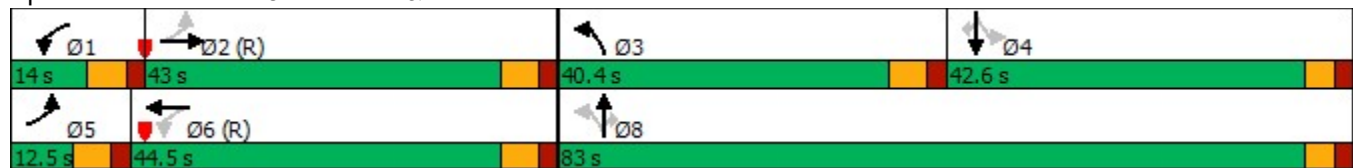

Lanes, Volumes, Timings

13: Huntmar & Street 1

09-04-2020

























Lane Group	EBL	EBT	EBR	WBL	WBT	WBR	NBL	NBT	NBR	SBL	SBT	SBR
Lane Configurations		↕			↕			↕			↕	
Traffic Volume (vph)	40	0	10	5	0	40	35	825	15	60	1210	10
Future Volume (vph)	40	0	10	5	0	40	35	825	15	60	1210	10
Confl. Peds. (#/hr)				5		5			5	5		
Confl. Bikes (#/hr)												
Peak Hour Factor	1.00	1.00	1.00	1.00	1.00	1.00	1.00	1.00	1.00	1.00	1.00	1.00
Growth Factor	100%	100%	100%	100%	100%	100%	100%	100%	100%	100%	100%	100%
Heavy Vehicles (%)	0%	0%	0%	0%	0%	0%	0%	0%	0%	0%	1%	0%
Bus Blockages (#/hr)	0	0	0	0	0	0	0	0	0	0	0	0
Parking (#/hr)												
Mid-Block Traffic (%)		0%			0%			0%			0%	
Shared Lane Traffic (%)												
Lane Group Flow (vph)	0	50	0	0	45	0	0	875	0	0	1280	0
Turn Type	Perm	NA		Split	NA		Perm	NA		Perm	NA	
Protected Phases		4		8	8			2			6	
Permitted Phases	4						2			6		
Detector Phase	4	4		8	8		2	2		6	6	
Switch Phase												
Minimum Initial (s)	4.0	4.0		4.0	4.0		4.0	4.0		4.0	4.0	
Minimum Split (s)	24.0	24.0		24.0	24.0		24.0	24.0		24.0	24.0	
Total Split (s)	13.0	13.0		24.0	24.0		93.0	93.0		93.0	93.0	
Total Split (%)	10.0%	10.0%		18.5%	18.5%		71.5%	71.5%		71.5%	71.5%	
Yellow Time (s)	4.0	4.0		4.0	4.0		4.0	4.0		4.0	4.0	
All-Red Time (s)	2.0	2.0		2.0	2.0		2.0	2.0		2.0	2.0	
Lost Time Adjust (s)		0.0			0.0			0.0			0.0	
Total Lost Time (s)		6.0			6.0			6.0			6.0	
Lead/Lag												
Lead-Lag Optimize?												
Recall Mode	None	None		None	None		Max	Max		Max	Max	
Act Effct Green (s)		7.7			7.7			94.0			94.0	
Actuated g/C Ratio		0.06			0.06			0.78			0.78	
v/c Ratio		0.38			0.27			0.69			1.00	
Control Delay		12.5			6.8			14.9			45.1	
Queue Delay		0.0			0.0			0.3			0.0	
Total Delay		12.5			6.8			15.2			45.1	
LOS		B			A			B			D	
Approach Delay		12.5			6.8			15.2			45.1	
Approach LOS		B			A			B			D	
Queue Length 50th (m)		0.0			0.0			96.5			~339.7	
Queue Length 95th (m)		5.9			3.9			#285.0			#559.5	
Internal Link Dist (m)		12.7			122.1			53.9			0.1	
Turn Bay Length (m)												
Base Capacity (vph)		142			292			1266			1274	
Starvation Cap Reductn		0			0			82			0	
Spillback Cap Reductn		0			0			0			0	
Storage Cap Reductn		0			0			0			0	
Reduced v/c Ratio		0.35			0.15			0.74			1.00	

Intersection Summary

Lanes, Volumes, Timings
21: Huntmar & Maple Grove

09-04-2020

												
Lane Group	EBL	EBT	EBR	WBL	WBT	WBR	NBL	NBT	NBR	SBL	SBT	SBR
Lane Configurations												
Traffic Volume (vph)	130	130	85	190	215	85	125	655	145	85	925	285
Future Volume (vph)	130	130	85	190	215	85	125	655	145	85	925	285
Confl. Peds. (#/hr)	5		5	5		5	5		5	5		5
Confl. Bikes (#/hr)												
Peak Hour Factor	1.00	1.00	1.00	1.00	1.00	1.00	1.00	1.00	1.00	1.00	1.00	1.00
Growth Factor	100%	100%	100%	100%	100%	100%	100%	100%	100%	100%	100%	100%
Heavy Vehicles (%)	0%	1%	0%	0%	0%	0%	2%	1%	0%	0%	1%	0%
Bus Blockages (#/hr)	0	0	0	0	0	0	0	0	0	0	0	0
Parking (#/hr)												
Mid-Block Traffic (%)		0%			0%			0%			0%	
Shared Lane Traffic (%)												
Lane Group Flow (vph)	130	215	0	190	300	0	125	800	0	85	925	285
Turn Type	pm+pt	NA		pm+pt	NA		pm+pt	NA		pm+pt	NA	Perm
Protected Phases	7	4		3	8		5	2		1	6	
Permitted Phases	4			8			2			6		6
Detector Phase	7	4		3	8		5	2		1	6	6
Switch Phase												
Minimum Initial (s)	4.0	10.0		4.0	10.0		4.0	10.0		4.0	10.0	10.0
Minimum Split (s)	10.0	33.0		10.0	33.0		10.0	29.0		10.0	49.0	49.0
Total Split (s)	10.0	33.0		10.0	33.0		11.0	65.0		12.0	66.0	66.0
Total Split (%)	8.3%	27.5%		8.3%	27.5%		9.2%	54.2%		10.0%	55.0%	55.0%
Yellow Time (s)	4.0	3.0		4.0	3.0		4.0	3.3		4.0	3.3	3.3
All-Red Time (s)	2.0	2.0		2.0	2.0		2.0	2.0		2.0	2.0	2.0
Lost Time Adjust (s)	0.0	0.0		0.0	0.0		0.0	0.0		0.0	0.0	0.0
Total Lost Time (s)	6.0	5.0		6.0	5.0		6.0	5.3		6.0	5.3	5.3
Lead/Lag	Lead	Lag		Lead	Lag		Lead	Lag		Lead	Lag	Lag
Lead-Lag Optimize?	Yes	Yes		Yes			Yes	Yes		Yes	Yes	Yes
Recall Mode	None	None		None	None		None	C-Max		None	C-Max	C-Max
Act Effct Green (s)	27.1	24.1		27.1	24.1		70.4	65.4		67.4	61.5	61.5
Actuated g/C Ratio	0.23	0.20		0.23	0.20		0.59	0.54		0.56	0.51	0.51
v/c Ratio	0.94	0.61		0.95	0.85		0.74	0.44		0.23	1.01	0.35
Control Delay	102.1	45.1		94.3	64.7		50.9	17.9		11.7	63.0	10.7
Queue Delay	0.0	0.0		0.0	0.0		0.0	0.0		0.0	0.0	0.0
Total Delay	102.1	45.1		94.3	64.7		50.9	17.9		11.7	63.0	10.7
LOS	F	D		F	E		D	B		B	E	B
Approach Delay		66.6			76.2			22.4			48.1	
Approach LOS		E			E			C			D	
Queue Length 50th (m)	24.9	42.3		37.8	67.8		16.4	63.6		8.1	~244.6	21.1
Queue Length 95th (m)	#57.1	66.8		#75.5	#99.3		#59.3	81.8		15.8	#324.1	40.6
Internal Link Dist (m)		630.5			86.3			293.1			175.1	
Turn Bay Length (m)							20.0					30.0
Base Capacity (vph)	138	407		200	409		168	1801		365	913	818
Starvation Cap Reductn	0	0		0	0		0	0		0	0	0
Spillback Cap Reductn	0	0		0	0		0	0		0	0	0
Storage Cap Reductn	0	0		0	0		0	0		0	0	0
Reduced v/c Ratio	0.94	0.53		0.95	0.73		0.74	0.44		0.23	1.01	0.35

Intersection Summary

Lanes, Volumes, Timings
24: Maple Grove & Street 2

09-04-2020



Lane Group	EBL	EBT	WBT	WBR	SBL	SBR
Lane Configurations		↕	↕		↕	
Traffic Volume (vph)	40	380	450	65	35	60
Future Volume (vph)	40	380	450	65	35	60
Confl. Peds. (#/hr)	5			5	5	5
Confl. Bikes (#/hr)						
Peak Hour Factor	1.00	1.00	1.00	1.00	1.00	1.00
Growth Factor	100%	100%	100%	100%	100%	100%
Heavy Vehicles (%)	0%	0%	3%	0%	0%	0%
Bus Blockages (#/hr)	0	0	0	0	0	0
Parking (#/hr)						
Mid-Block Traffic (%)		0%	0%		0%	
Shared Lane Traffic (%)						
Lane Group Flow (vph)	0	420	515	0	95	0
Turn Type	Perm	NA	NA		Prot	
Protected Phases		4	8		1	
Permitted Phases	4					
Detector Phase	4	4	8		1	
Switch Phase						
Minimum Initial (s)	4.0	4.0	4.0		4.0	
Minimum Split (s)	24.0	24.0	24.0		10.0	
Total Split (s)	27.0	27.0	27.0		13.0	
Total Split (%)	67.5%	67.5%	67.5%		32.5%	
Yellow Time (s)	4.0	4.0	4.0		4.0	
All-Red Time (s)	2.0	2.0	2.0		2.0	
Lost Time Adjust (s)		0.0	0.0		0.0	
Total Lost Time (s)		6.0	6.0		6.0	
Lead/Lag						
Lead-Lag Optimize?						
Recall Mode	Max	Max	Max		Max	
Act Effct Green (s)		21.0	21.0		7.0	
Actuated g/C Ratio		0.52	0.52		0.18	
v/c Ratio		0.48	0.56		0.29	
Control Delay		8.4	9.0		10.3	
Queue Delay		0.0	0.0		0.0	
Total Delay		8.4	9.0		10.3	
LOS		A	A		B	
Approach Delay		8.4	9.0		10.3	
Approach LOS		A	A		B	
Queue Length 50th (m)		16.3	19.8		2.2	
Queue Length 95th (m)		32.2	39.6		10.9	
Internal Link Dist (m)		80.8	1246.0		278.2	
Turn Bay Length (m)						
Base Capacity (vph)		870	915		326	
Starvation Cap Reductn		0	0		0	
Spillback Cap Reductn		0	0		0	
Storage Cap Reductn		0	0		0	
Reduced v/c Ratio		0.48	0.56		0.29	

Intersection Summary

Lanes, Volumes, Timings
 24: Maple Grove & Street 2

09-04-2020























Cycle Length: 40	
Actuated Cycle Length: 40	
Offset: 0 (0%), Referenced to phase 2: and 6:, Start of Green	
Natural Cycle: 40	
Control Type: Pretimed	
Maximum v/c Ratio: 0.56	
Intersection Signal Delay: 8.9	Intersection LOS: A
Intersection Capacity Utilization 72.6%	ICU Level of Service C
Analysis Period (min) 15	

Splits and Phases: 24: Maple Grove & Street 2



Lanes, Volumes, Timings
31: Terry Fox & Maple Grove

09-04-2020

												
Lane Group	EBL	EBT	EBR	WBL	WBT	WBR	NBL	NBT	NBR	SBL	SBT	SBR
Lane Configurations												
Traffic Volume (vph)	190	70	380	20	70	45	250	1535	50	70	2030	195
Future Volume (vph)	190	70	380	20	70	45	250	1535	50	70	2030	195
Confl. Peds. (#/hr)	5		5	5		5	5		5	5		5
Confl. Bikes (#/hr)												
Peak Hour Factor	1.00	1.00	1.00	1.00	1.00	1.00	1.00	1.00	1.00	1.00	1.00	1.00
Growth Factor	100%	100%	100%	100%	100%	100%	100%	100%	100%	100%	100%	100%
Heavy Vehicles (%)	2%	0%	1%	0%	0%	0%	2%	2%	0%	0%	1%	3%
Bus Blockages (#/hr)	0	0	0	0	0	0	0	0	0	0	0	0
Parking (#/hr)												
Mid-Block Traffic (%)		0%			0%			0%			0%	
Shared Lane Traffic (%)												
Lane Group Flow (vph)	190	70	380	20	115	0	250	1585	0	70	2030	195
Turn Type	Perm	NA	Perm	Perm	NA		pm+pt	NA		pm+pt	NA	Perm
Protected Phases		4			8		5	2		1	6	
Permitted Phases	4		4	8			2			6		6
Detector Phase	4	4	4	8	8		5	2		1	6	6
Switch Phase												
Minimum Initial (s)	10.0	10.0	10.0	10.0	10.0		5.0	10.0		5.0	10.0	10.0
Minimum Split (s)	42.0	42.0	42.0	42.0	42.0		11.0	43.0		11.0	43.0	43.0
Total Split (s)	42.0	42.0	42.0	42.0	42.0		21.0	95.0		13.0	87.0	87.0
Total Split (%)	28.0%	28.0%	28.0%	28.0%	28.0%		14.0%	63.3%		8.7%	58.0%	58.0%
Yellow Time (s)	3.0	3.0	3.0	3.0	3.0		4.0	4.0		4.0	4.0	4.0
All-Red Time (s)	2.0	2.0	2.0	2.0	2.0		2.0	2.0		2.0	2.0	2.0
Lost Time Adjust (s)	0.0	0.0	0.0	0.0	0.0		0.0	0.0		0.0	-2.0	0.0
Total Lost Time (s)	5.0	5.0	5.0	5.0	5.0		6.0	6.0		6.0	4.0	6.0
Lead/Lag							Lead	Lag		Lead	Lag	Lag
Lead-Lag Optimize?							Yes	Yes		Yes	Yes	Yes
Recall Mode	None	None	None	None	None		None	C-Max		None	C-Max	C-Max
Act Effct Green (s)	32.5	32.5	32.5	32.5	32.5		106.5	96.1		87.8	83.0	81.0
Actuated g/C Ratio	0.22	0.22	0.22	0.22	0.22		0.71	0.64		0.59	0.55	0.54
v/c Ratio	0.81	0.18	0.92	0.07	0.30		0.95	0.74		0.39	1.08	0.24
Control Delay	80.3	47.3	67.9	44.9	41.3		88.2	22.9		15.5	80.2	9.1
Queue Delay	0.0	0.0	0.0	0.0	0.0		0.0	0.0		0.0	0.0	0.0
Total Delay	80.3	47.3	67.9	44.9	41.3		88.2	22.9		15.5	80.2	9.1
LOS	F	D	E	D	D		F	C		B	F	A
Approach Delay		69.3			41.8			31.8			72.2	
Approach LOS		E			D			C			E	
Queue Length 50th (m)	55.3	17.5	83.4	4.9	24.2		~73.6	192.2		6.7	~373.4	13.9
Queue Length 95th (m)	#86.9	31.4	#137.7	12.4	42.6		#135.9	226.6		12.4	#415.8	28.7
Internal Link Dist (m)		1246.0			796.0			547.8			406.9	
Turn Bay Length (m)	65.0		60.0	40.0			145.0			125.0		70.0
Base Capacity (vph)	268	444	453	314	429		264	2138		182	1873	825
Starvation Cap Reductn	0	0	0	0	0		0	0		0	0	0
Spillback Cap Reductn	0	0	0	0	0		0	0		0	0	0
Storage Cap Reductn	0	0	0	0	0		0	0		0	0	0
Reduced v/c Ratio	0.71	0.16	0.84	0.06	0.27		0.95	0.74		0.38	1.08	0.24

Intersection Summary

Cycle Length: 150
 Actuated Cycle Length: 150
 Offset: 0 (0%), Referenced to phase 2:NBTL and 6:SBTL, Start of Green
 Natural Cycle: 150
 Control Type: Actuated-Coordinated
 Maximum v/c Ratio: 1.08
 Intersection Signal Delay: 55.9 Intersection LOS: E
 Intersection Capacity Utilization 106.1% ICU Level of Service G
 Analysis Period (min) 15
 ~ Volume exceeds capacity, queue is theoretically infinite.
 Queue shown is maximum after two cycles.
 # 95th percentile volume exceeds capacity, queue may be longer.
 Queue shown is maximum after two cycles.

Splits and Phases: 31: Terry Fox & Maple Grove

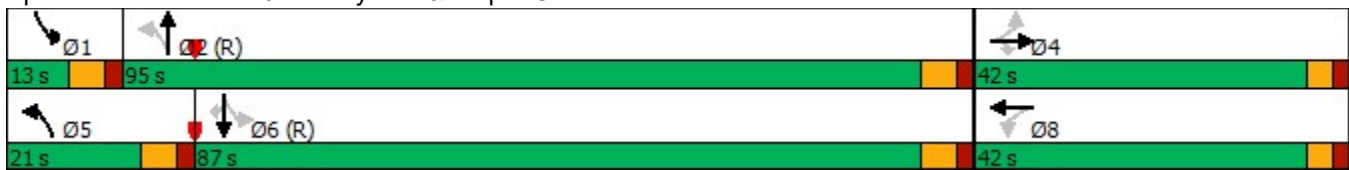

Intersection

Int Delay, s/veh 1.7

Movement	WBL	WBR	NBT	NBR	SBL	SBT
Lane Configurations	W	R	T	R	T	R
Traffic Vol, veh/h	15	30	870	25	45	1255
Future Vol, veh/h	15	30	870	25	45	1255
Conflicting Peds, #/hr	5	5	0	5	5	0
Sign Control	Stop	Stop	Free	Free	Free	Free
RT Channelized	-	None	-	None	-	None
Storage Length	0	-	-	-	-	-
Veh in Median Storage	0	-	0	-	-	0
Grade, %	0	-	0	-	-	0
Peak Hour Factor	100	100	100	100	100	100
Heavy Vehicles, %	0	0	0	0	0	1
Mvmt Flow	15	30	870	25	45	1255

Major/Minor	Minor1	Major1	Major2
Conflicting Flow All	2238	893	0
Stage 1	888	-	-
Stage 2	1350	-	-
Critical Hdwy	6.4	6.2	-
Critical Hdwy Stg 1	5.4	-	-
Critical Hdwy Stg 2	5.4	-	-
Follow-up Hdwy	3.5	3.3	-
Pot Cap-1 Maneuver	47	343	-
Stage 1	405	-	-
Stage 2	244	-	-
Platoon blocked, %		-	-
Mov Cap-1 Maneuver	38	340	-
Mov Cap-2 Maneuver	38	-	-
Stage 1	403	-	-
Stage 2	195	-	-

Approach	WB	NB	SB
HCM Control Delay, s	75.6	0	0.3
HCM LOS	F		

Minor Lane/Major Mvmt	NBT	NBR	SBL	SBT
Capacity (veh/h)	-	-	93	760
HCM Lane V/C Ratio	-	-	0.484	0.059
HCM Control Delay (s)	-	-	75.6	10
HCM Lane LOS	-	-	F	B
HCM 95th %tile Q(veh)	-	-	2.1	0.2

Intersection

Int Delay, s/veh 1.3

Movement	EBL	EBT	EBR	WBL	WBT	WBR	NBL	NBT	NBR	SBL	SBT	SBR
Lane Configurations		↕			↕			↕			↕	
Traffic Vol, veh/h	5	355	15	25	460	15	10	0	45	10	0	10
Future Vol, veh/h	5	355	15	25	460	15	10	0	45	10	0	10
Conflicting Peds, #/hr	5	0	0	0	0	5	0	0	0	5	0	5
Sign Control	Free	Free	Free	Free	Free	Free	Stop	Stop	Stop	Stop	Stop	Stop
RT Channelized	-	-	None	-	-	None	-	-	None	-	-	None
Storage Length	-	-	-	-	-	-	-	-	-	-	-	-
Veh in Median Storage, #	0	-	-	0	-	-	0	-	0	-	0	-
Grade, %	-	0	-	-	0	-	-	0	-	-	0	-
Peak Hour Factor	100	100	100	100	100	100	100	100	100	100	100	100
Heavy Vehicles, %	0	0	6	4	2	0	0	0	2	0	0	0
Mvmt Flow	5	355	15	25	460	15	10	0	45	10	0	10

Major/Minor	Major1	Major2	Minor1	Minor2
Conflicting Flow All	480	0	0	370
Stage 1	-	-	-	-
Stage 2	-	-	-	-
Critical Hdwy	4.1	-	-	4.14
Critical Hdwy Stg 1	-	-	-	-
Critical Hdwy Stg 2	-	-	-	-
Follow-up Hdwy	2.2	-	-	2.236
Pot Cap-1 Maneuver	1093	-	-	1178
Stage 1	-	-	-	-
Stage 2	-	-	-	-
Platoon blocked, %	-	-	-	-
Mov Cap-1 Maneuver	1088	-	-	1178
Mov Cap-2 Maneuver	-	-	-	-
Stage 1	-	-	-	-
Stage 2	-	-	-	-

Approach	EB	WB	NB	SB
HCM Control Delay, s	0.1	0.4	12.8	16.7
HCM LOS			B	C

Minor Lane/Major Mvm	NBLn1	EBL	EBT	EBR	WBL	WBT	WBR	SBLn1
Capacity (veh/h)		514	1088	-	-	1178	-	327
HCM Lane V/C Ratio		0.107	0.005	-	-	-0.021	-	-0.061
HCM Control Delay (s)		12.8	8.3	0	-	8.1	0	16.7
HCM Lane LOS		B	A	A	-	A	A	C
HCM 95th %tile Q(veh)		0.4	0	-	-	0.1	-	0.2

Intersection

Int Delay, s/veh 0.2

Movement	EBL	EBT	WBT	WBR	SBL	SBR
Lane Configurations		↕	↕		↕	
Traffic Vol, veh/h	0	410	495	15	10	5
Future Vol, veh/h	0	410	495	15	10	5
Conflicting Peds, #/hr	0	0	0	0	0	0
Sign Control	Free	Free	Free	Free	Stop	Stop
RT Channelized	-	None	-	None	-	None
Storage Length	-	-	-	-	0	-
Veh in Median Storage,-#	0	0	0	-	0	-
Grade, %	-	0	0	-	0	-
Peak Hour Factor	100	100	100	100	100	100
Heavy Vehicles, %	0	0	2	0	0	0
Mvmt Flow	0	410	495	15	10	5

Major/Minor	Major1	Major2	Minor2
Conflicting Flow All	510	0	0
Stage 1	-	-	503
Stage 2	-	-	410
Critical Hdwy	4.1	-	6.4
Critical Hdwy Stg 1	-	-	5.4
Critical Hdwy Stg 2	-	-	5.4
Follow-up Hdwy	2.2	-	3.5
Pot Cap-1 Maneuver	1065	-	306
Stage 1	-	-	612
Stage 2	-	-	674
Platoon blocked, %	-	-	-
Mov Cap-1 Maneuver	1065	-	306
Mov Cap-2 Maneuver	-	-	306
Stage 1	-	-	612
Stage 2	-	-	674

Approach	EB	WB	SB
HCM Control Delay, s	0	0	15.4
HCM LOS			C

Minor Lane/Major Mvmt	EBL	EBT	WBT	WBR	SBLn1
Capacity (veh/h)	1065	-	-	-	362
HCM Lane V/C Ratio	-	-	-	-	-0.041
HCM Control Delay (s)	0	-	-	-	15.4
HCM Lane LOS	A	-	-	-	C
HCM 95th %tile Q(veh)	0	-	-	-	0.1

Intersection

Int Delay, s/veh 5.9

Movement	EBL	EBT	EBR	WBL	WBT	WBR	NBL	NBT	NBR	SBL	SBT	SBR
Lane Configurations		↕			↕			↕			↕	
Traffic Vol, veh/h	55	30	0	0	20	0	0	15	0	0	15	35
Future Vol, veh/h	55	30	0	0	20	0	0	15	0	0	15	35
Conflicting Peds, #/hr	0	0	0	0	0	0	0	0	0	0	0	0
Sign Control	Free	Free	Free	Free	Free	Free	Stop	Stop	Stop	Stop	Stop	Stop
RT Channelized	-	-	None	-	-	None	-	-	None	-	-	None
Storage Length	-	-	-	-	-	-	-	-	-	-	-	-
Veh in Median Storage, #	0	-	-	0	-	-	0	-	-	0	-	-
Grade, %	-	0	-	-	0	-	-	0	-	-	0	-
Peak Hour Factor	100	100	100	100	100	100	100	100	100	100	100	100
Heavy Vehicles, %	0	0	0	0	0	0	0	0	0	0	0	0
Mvmt Flow	55	30	0	0	20	0	0	15	0	0	15	35

Major/Minor	Major1	Major2	Minor1	Minor2
Conflicting Flow All	20	0	0	30
Stage 1	-	-	-	-
Stage 2	-	-	-	-
Critical Hdwy	4.1	-	-	4.1
Critical Hdwy Stg 1	-	-	-	-
Critical Hdwy Stg 2	-	-	-	-
Follow-up Hdwy	2.2	-	-	2.2
Pot Cap-1 Maneuver	609	-	-	1596
Stage 1	-	-	-	-
Stage 2	-	-	-	-
Platoon blocked, %	-	-	-	-
Mov Cap-1 Maneuver	609	-	-	1596
Mov Cap-2 Maneuver	-	-	-	-
Stage 1	-	-	-	-
Stage 2	-	-	-	-

Approach	EB	WB	NB	SB
HCM Control Delay, s	4.7	0	10.2	9.1
HCM LOS			B	A

Minor Lane/Major Mvm	NBLn1	EBL	EBT	EBR	WBL	WBT	WBR	SBLn1
Capacity (veh/h)		710	1609	-	-	1596	-	926
HCM Lane V/C Ratio		0.021	0.034	-	-	-	-	-0.054
HCM Control Delay (s)		10.2	7.3	0	-	0	-	9.1
HCM Lane LOS		B	A	A	-	A	-	A
HCM 95th %tile Q(veh)		0.1	0.1	-	-	0	-	0.2

Intersection

Int Delay, s/veh 0.1

Movement	WBL	WBR	NBT	NBR	SBL	SBT
Lane Configurations		↑	↑			↑
Traffic Vol, veh/h	0	20	850	15	0	1225
Future Vol, veh/h	0	20	850	15	0	1225
Conflicting Peds, #/hr	5	5	0	5	5	0
Sign Control	Stop	Stop	Free	Free	Free	Free
RT Channelized	-	None	-	None	-	None
Storage Length	-	0	-	-	-	-
Veh in Median Storage#	-	0	-	-	-	0
Grade, %	0	-	0	-	-	0
Peak Hour Factor	100	100	100	100	100	100
Heavy Vehicles, %	0	0	0	0	0	1
Mvmt Flow	0	20	850	15	0	1225

Major/Minor	Minor1	Major1	Major2
Conflicting Flow All	-	868	0
Stage 1	-	-	-
Stage 2	-	-	-
Critical Hdwy	-	6.2	-
Critical Hdwy Stg 1	-	-	-
Critical Hdwy Stg 2	-	-	-
Follow-up Hdwy	-	3.3	-
Pot Cap-1 Maneuver	0	355	-
Stage 1	0	-	-
Stage 2	0	-	-
Platoon blocked, %		-	-
Mov Cap-1 Maneuver	-	352	-
Mov Cap-2 Maneuver	-	-	-
Stage 1	-	-	-
Stage 2	-	-	-

Approach	WB	NB	SB
HCM Control Delay, s	15.8	0	0
HCM LOS	C		

Minor Lane/Major Mvmt	NBT	NBR	WBLn1	SBT
Capacity (veh/h)	-	-	352	-
HCM Lane V/C Ratio	-	-	0.057	-
HCM Control Delay (s)	-	-	15.8	-
HCM Lane LOS	-	-	C	-
HCM 95th %tile Q(veh)	-	-	0.2	-

Intersection

Int Delay, s/veh 1.7

Movement	EBT	EBR	WBL	WBT	NBL	NBR
Lane Configurations						
Traffic Vol, veh/h	70	5	15	40	0	15
Future Vol, veh/h	70	5	15	40	0	15
Conflicting Peds, #/hr	0	5	5	0	5	5
Sign Control	Free	Free	Free	Free	Stop	Stop
RT Channelized	- None		- None		- None	
Storage Length	-	-	-	-	0	-
Veh in Median Storage0#	-	-	-	0	0	-
Grade, %	0	-	-	0	0	-
Peak Hour Factor	100	100	100	100	100	100
Heavy Vehicles, %	0	0	0	0	0	0
Mvmt Flow	70	5	15	40	0	15

Major/Minor	Major1	Major2	Minor1		
Conflicting Flow All	0	0	80	0	153 83
Stage 1	-	-	-	-	78 -
Stage 2	-	-	-	-	75 -
Critical Hdwy	-	-	4.1	-	6.4 6.2
Critical Hdwy Stg 1	-	-	-	-	5.4 -
Critical Hdwy Stg 2	-	-	-	-	5.4 -
Follow-up Hdwy	-	-	2.2	-	3.5 3.3
Pot Cap-1 Maneuver	-	-	1531	-	843 982
Stage 1	-	-	-	-	950 -
Stage 2	-	-	-	-	953 -
Platoon blocked, %	-	-	-	-	-
Mov Cap-1 Maneuver	-	-	1525	-	828 974
Mov Cap-2 Maneuver	-	-	-	-	828 -
Stage 1	-	-	-	-	946 -
Stage 2	-	-	-	-	940 -

Approach	EB	WB	NB
HCM Control Delay, s	0	2	8.8
HCM LOS			A

Minor Lane/Major MvmNBLn1	EBT	EBR	WBL	WBT
Capacity (veh/h)	974	-	-	1525 -
HCM Lane V/C Ratio	0.015	-	-	0.01 -
HCM Control Delay (s)	8.8	-	-	7.4 0
HCM Lane LOS	A	-	-	A A
HCM 95th %tile Q(veh)	0	-	-	0 -

Intersection				
Intersection Delay, s/veh	23.9			
Intersection LOS	C			
Approach	EB	WB	NB	SB
Entry Lanes	1	1	1	1
Conflicting Circle Lanes	1	1	1	1
Adj Approach Flow, veh/h	65	95	790	1120
Demand Flow Rate, veh/h	68	96	790	1132
Vehicles Circulating, veh/h	1182	780	42	151
Vehicles Exiting, veh/h	101	52	1208	725
Ped Vol Crossing Leg, #/h	5	5	5	5
Ped Cap Adj	1.000	0.999	0.999	0.999
Approach Delay, s/veh	11.7	7.7	9.7	36.0
Approach LOS	B	A	A	E
Lane	Left	Left	Left	Left
Designated Moves	LTR	LTR	LTR	LTR
Assumed Moves	LTR	LTR	LTR	LTR
RT Channelized				
Lane Util	1.000	1.000	1.000	1.000
Follow-Up Headway, s	2.609	2.609	2.609	2.609
Critical Headway, s	4.976	4.976	4.976	4.976
Entry Flow, veh/h	68	96	790	1132
Cap Entry Lane, veh/h	413	623	1322	1183
Entry HV Adj Factor	0.953	0.990	1.000	0.990
Flow Entry, veh/h	65	95	790	1120
Cap Entry, veh/h	394	616	1321	1170
V/C Ratio	0.165	0.154	0.598	0.958
Control Delay, s/veh	11.7	7.7	9.7	36.0
LOS	B	A	A	E
95th %tile Queue, veh	1	1	4	18

Intersection

Intersection Delay, s/veh	7.2
Intersection LOS	A

Movement	EBL	EBR	NBL	NBT	SBT	SBR
Lane Configurations	W			↑	↑	
Traffic Vol, veh/h	30	0	0	40	30	20
Future Vol, veh/h	30	0	0	40	30	20
Peak Hour Factor	1.00	1.00	1.00	1.00	1.00	1.00
Heavy Vehicles, %	0	0	0	0	0	0
Mvmt Flow	30	0	0	40	30	20
Number of Lanes	1	0	0	1	1	0

Approach	EB	NB	SB
Opposing Approach		SB	NB
Opposing Lanes	0	1	1
Conflicting Approach Left	SB	EB	
Conflicting Lanes Left	1	1	0
Conflicting Approach Right			EB
Conflicting Lanes Right	1	0	1
HCM Control Delay	7.4	7.2	7
HCM LOS	A	A	A

Lane	NBLn1	EBLn1	SBLn1
Vol Left, %	0%	100%	0%
Vol Thru, %	100%	0%	60%
Vol Right, %	0%	0%	40%
Sign Control	Stop	Stop	Stop
Traffic Vol by Lane	40	30	50
LT Vol	0	30	0
Through Vol	40	0	30
RT Vol	0	0	20
Lane Flow Rate	40	30	50
Geometry Grp	1	1	1
Degree of Util (X)	0.044	0.035	0.052
Departure Headway (Hd)	3.99	4.255	3.743
Convergence, Y/N	Yes	Yes	Yes
Cap	898	840	957
Service Time	2.013	2.286	1.766
HCM Lane V/C Ratio	0.045	0.036	0.052
HCM Control Delay	7.2	7.4	7
HCM Lane LOS	A	A	A
HCM 95th-tile Q	0.1	0.1	0.2

Appendix B

Signalized Intersection Traffic Operations Results

2019 Signalized Intersections

Notes:

- ~ Volume exceeds capacity, queue is theoretically infinite. Queue shown is maximum after two cycles.
- # 95th percentile volume exceeds capacity, queue may be longer. Queue shown is maximum after two cycles.
- m Volume for 95th percentile queue is metered by upstream signal.

N1: 2019 Existing Huntmar Drive at Hazeldean Road Traffic Operations

Movement	Volume	Delay (s)	LOS	V/C	Q50th	Q95th
EBL	200 (195)	63.5 (63.3)	B (A)	0.61 (0.59)	27 (26.3)	39 (38.2)
EBTR	775 (750)	23.2 (37.7)	A (B)	0.48 (0.64)	67.8 (83.7)	104.8 (118.6)
WBL	160 (315)	63 (51.9)	A (A)	0.54 (0.51)	21.5 (40.7)	32.6 (56.5)
WBT	395 (985)	21 (32.8)	A (B)	0.24 (0.65)	31 (107.7)	51.6 (157.4)
WBR	80 (205)	4 (4.6)	A (A)	0.1 (0.26)	0 (0)	8.4 (17.1)
NBL	45 (135)	32.4 (41.6)	A (B)	0.17 (0.61)	8.9 (25.8)	16.7 (37.7)
NBT	235 (270)	63.1 (51.9)	C (B)	0.73 (0.65)	60.9 (66.4)	82.1 (88)
NBR	245 (235)	9.4 (7)	A (A)	0.54 (0.45)	0 (0)	21.5 (19.2)
SBL	115 (135)	41.2 (34.7)	A (A)	0.5 (0.48)	23.7 (25.7)	35.7 (37.4)
SBT	210 (330)	54 (61.1)	A (D)	0.59 (0.8)	53 (84.5)	73.8 (109)
SBR	110 (380)	5.2 (31.7)	A (B)	0.21 (0.69)	0 (65.7)	11.4 (83.6)
OVERALL	2570 (3935)	32.9 (37.7)	A (B)	0.47 (0.61)	-	-
WORST MOVEMENT		NBT (SBT)	C (D)	0.73 (0.8)	-	-

N3: 2019 Existing Huntmar Drive at Maple Grove Road Traffic Operations

Movement	Volume	Delay (s)	LOS	V/C	Q50th	Q95th
EBTLR	385 (240)	55.8 (53.1)	D (C)	0.83 (0.7)	99.9 (59.1)	126 (84)
WBTLR	105 (310)	26.8 (82.1)	A (E)	0.23 (0.93)	18.5 (86.8)	29.1 (118.8)
NBL	30 (95)	17.1 (14.7)	A (A)	0.07 (0.28)	3.8 (11.2)	10.9 (26)
NBTR	535 (555)	22.5 (14.9)	A (A)	0.54 (0.49)	92.1 (76.4)	153.1 (124.1)
SBTLR	315 (890)	21.5 (17.7)	A (D)	0.32 (0.82)	72.2 (62.7)	77.6 (#320.9)
OVERALL	1370 (2090)	31.8 (30.5)	A (C)	0.54 (0.71)	-	-
WORST MOVEMENT		EBTLR (WBTLR)	D (E)	0.83 (0.93)	-	-

N4: 2019 Existing Huntmar Drive at Palladium Drive Traffic Operations

Movement	Volume	Delay (s)	LOS	V/C	Q50th	Q95th
EBL	30 (25)	18.8 (20)	A (A)	0.05 (0.07)	3.8 (3.3)	11.9 (9.8)
EBTR	320 (560)	13 (7.9)	A (A)	0.21 (0.36)	13.1 (12.6)	30.4 (30)
WBL	40 (155)	18.9 (25.8)	A (A)	0.08 (0.38)	5.1 (22.3)	14.9 (42.4)
WBTR	115 (505)	17.3 (23.5)	A (A)	0.07 (0.31)	6.5 (46.4)	16.4 (70.7)
NBL	325 (215)	50.4 (34.7)	C (B)	0.76 (0.67)	76.9 (29.2)	101.5 (m40.7)
NBT	260 (190)	39.2 (22.2)	A (A)	0.4 (0.28)	56.5 (25.7)	79 (m30.4)
NBR	130 (70)	11.7 (1.5)	A (A)	0.21 (0.11)	7 (0.1)	m20.4 (m2.1)
SBL	85 (80)	68.4 (50.8)	A (A)	0.57 (0.35)	24 (20.3)	36.5 (34.5)
SBT	145 (280)	64.3 (69.1)	A (C)	0.59 (0.79)	41.1 (78.4)	54.6 (103.7)
SBR	45 (85)	1 (3.8)	A (A)	0.15 (0.22)	0 (0)	0 (6.4)
OVERALL	1495 (2165)	34.0 (26.0)	A (A)	0.4 (0.41)	-	-
WORST MOVEMENT		NBL (SBT)	C (C)	0.76 (0.79)	-	-

N5: 2019 Existing Terry Fox Drive at Palladium Drive Traffic Operations

Movement	Volume	Delay (s)	LOS	V/C	Q50th	Q95th
EBL	225 (680)	68.3 (83)	A (E)	0.59 (0.96)	34.8 (109.7)	48.1 (#149.2)
EBT	55 (245)	63 (76.6)	A (C)	0.27 (0.79)	16.9 (74.5)	27.6 (99.7)
EBR	95 (315)	2 (30.2)	A (C)	0.28 (0.74)	0 (33.2)	0 (65.9)
WBL	55 (130)	61.1 (59.7)	A (A)	0.28 (0.44)	15.5 (36.9)	30.2 (58)
WBT	95 (175)	70 (75.7)	A (C)	0.5 (0.71)	29.1 (53.5)	43.1 (73.9)
WBR	140 (145)	11.7 (22.6)	A (A)	0.48 (0.48)	0 (11)	16.1 (31)
NBL	290 (215)	72.3 (65.8)	C (A)	0.7 (0.51)	45.5 (32.8)	60.2 (#67.0)
NBT	1095 (1080)	25 (40.3)	A (C)	0.58 (0.74)	107.6 (144.8)	183.8 (#217.1)
NBR	75 (95)	0.2 (1.4)	A (A)	0.09 (0.13)	0 (0)	0 (3.1)
SBL	80 (115)	73.6 (74.1)	A (A)	0.41 (0.49)	12.6 (18.2)	21.7 (28.6)
SBT	775 (1270)	28.2 (69.6)	A (E)	0.47 (0.99)	78.4 (205.7)	133.7 (#262.6)
SBR	695 (625)	6.9 (5.9)	B (B)	0.65 (0.65)	7.9 (0)	59.6 (29.2)
OVERALL	3675 (5090)	30.3 (52.5)	A (C)	0.54 (0.78)	-	-
WORST MOVEMENT		NBL (SBT)	C (E)	0.7 (0.99)	-	-

N6: 2019 Existing Terry Fox Drive at Maple Grove Traffic Operations

Movement	Volume	Delay (s)	LOS	V/C	Q50th	Q95th
EBL	195 (130)	73.3 (63.5)	D (B)	0.81 (0.65)	52.7 (34.4)	76 (m47.3)
EBT	25 (30)	39.8 (42.5)	A (A)	0.07 (0.1)	5.9 (7.2)	m10.1 (m12.6)
EBR	135 (280)	11.7 (22.4)	A (B)	0.35 (0.68)	5.4 (20.6)	m16.6 (m42.9)
WBL	30 (15)	39.2 (41.5)	A (A)	0.12 (0.07)	6.6 (3.5)	32.6 (8.8)
WBTR	70 (60)	17.7 (22.3)	A (A)	0.19 (0.21)	5.5 (5.9)	16.9 (16.1)
NBL	170 (170)	9.9 (28.7)	A (B)	0.37 (0.66)	13.7 (15.1)	28.5 (45.5)
NBTR	1185 (1230)	13.1 (14.5)	A (A)	0.53 (0.55)	70.6 (82.5)	144.4 (155.6)
SBL	10 (55)	8.8 (8.4)	A (A)	0.03 (0.18)	0.7 (3)	3.2 (10.7)
SBT	710 (1545)	17.3 (23.8)	A (C)	0.39 (0.75)	51.9 (140.3)	85.1 (#288.0)
SBR	85 (125)	1.6 (4.2)	A (A)	0.11 (0.14)	0 (0.8)	4.6 (13.5)
OVERALL	2615 (3640)	18.7 (21.5)	A (B)	0.46 (0.62)	-	-
WORST MOVEMENT		EBL (SBT)	D (C)	0.81 (0.75)	-	-

2024 Signalized Intersections

N1: 2024 Future Huntmar Drive at Hazeldean Road Traffic Operations

Movement	Volume	Delay (s)	LOS	V/C	Q50th	Q95th
EBL	225 (220)	63.2 (64.3)	B (B)	0.63 (0.64)	30.3 (29.7)	43 (42.7)
EBTR	870 (845)	28.3 (51.1)	A (D)	0.58 (0.85)	86.9 (110.6)	127.8 (137.7)
WBL	180 (355)	62.3 (56.6)	A (B)	0.56 (0.63)	24.2 (46.4)	35.8 (#88.9)
WBT	445 (1110)	24.6 (49.1)	A (D)	0.3 (0.89)	38.9 (147.7)	61.5 (#234.2)
WBR	120 (285)	5.1 (5.6)	A (A)	0.16 (0.39)	0 (0)	13.4 (22.2)
NBL	55 (150)	30.9 (40.3)	A (B)	0.23 (0.69)	10.4 (25.6)	18.6 (35.8)
NBT	295 (350)	62.6 (44.5)	C (B)	0.78 (0.65)	75.8 (81.8)	100.7 (103.3)
NBR	275 (265)	9.3 (5.6)	A (A)	0.54 (0.42)	1.9 (0.8)	24.8 (18.6)
SBL	140 (190)	43.9 (33.8)	B (B)	0.62 (0.62)	27.8 (33.1)	40.8 (44.3)
SBT	290 (450)	55.5 (56.6)	C (D)	0.7 (0.84)	73.9 (113.4)	98.9 (140.2)
SBR	125 (425)	4.4 (27.7)	A (B)	0.21 (0.67)	0 (73.1)	11.3 (88.6)
OVERALL	3020 (4645)	35.5 (43.1)	A (C)	0.53 (0.73)	-	-
WORST MOVEMENT		NBT (WBT)	C (D)	0.78 (0.89)	-	-

N3: 2024 Future Huntmar Drive at Maple Grove Road Traffic Operations

Movement	Volume	Delay (s)	LOS	V/C	Q50th	Q95th
EBL	280 (120)	52.6 (81.2)	D (D)	0.82 (0.84)	57.4 (23.4)	#75.9 (#47.3)
EBTR	215 (195)	39.1 (45)	A (A)	0.5 (0.58)	43.4 (38.6)	61.5 (61)
WBL	75 (170)	35.6 (74.9)	A (D)	0.37 (0.85)	13.4 (34.2)	22.4 (#58.5)
WBTR	170 (275)	44 (62.6)	B (D)	0.68 (0.82)	25.8 (61.9)	45.8 (89.9)
NBL	35 (110)	13.2 (23.4)	A (A)	0.08 (0.54)	3.4 (10.1)	9.9 (#26.4)
NBTR	660 (720)	20.6 (16.3)	A (A)	0.4 (0.39)	51.3 (52.7)	80.1 (70.3)
SBL	45 (80)	13.4 (10.8)	A (A)	0.12 (0.2)	4.4 (7.2)	11.9 (15.2)
SBT	335 (830)	21.2 (36.8)	A (D)	0.37 (0.87)	50.7 (180.7)	89.3 (#269.7)
SBR	60 (260)	0.1 (9.1)	A (A)	0.07 (0.31)	0 (17)	0 (34.4)
OVERALL	1875 (2760)	29.4 (35.0)	A (B)	0.47 (0.63)	-	-
WORST MOVEMENT		EBL (SBT)	D (D)	0.82 (0.87)	-	-

N4: 2024 Future Huntmar Drive at Palladium Drive Traffic Operations

Movement	Volume	Delay (s)	LOS	V/C	Q50th	Q95th
EBL	35 (25)	22.9 (24.7)	A (A)	0.06 (0.09)	5.1 (3.9)	14.4 (10.5)
EBTR	435 (770)	14.6 (16.8)	A (B)	0.32 (0.61)	18.8 (34.9)	39.3 (61.2)
WBL	60 (225)	23.2 (39.7)	A (C)	0.16 (0.73)	8.9 (39.9)	22 (#74.8)
WBTR	130 (595)	20.8 (31.1)	A (A)	0.1 (0.42)	8.3 (66.4)	19 (90.9)
NBL	455 (335)	52.2 (59.2)	E (E)	0.9 (0.9)	105 (70)	111.5 (#112.6)
NBT	330 (250)	28.9 (25.3)	A (A)	0.43 (0.32)	68 (45.3)	74 (60.4)
NBR	205 (125)	3.2 (3.5)	A (A)	0.27 (0.17)	0 (0)	11.9 (10.6)
SBL	95 (90)	71.1 (49.1)	B (A)	0.62 (0.37)	26.8 (22.2)	40.6 (38.1)
SBT	175 (345)	65.8 (73.4)	B (D)	0.65 (0.87)	49.5 (96.8)	65.1 (129.9)
SBR	50 (95)	1 (1)	A (A)	0.15 (0.21)	0 (0)	0 (0)
OVERALL	1970 (2855)	32.2 (34.1)	A (A)	0.48 (0.58)	-	-
WORST MOVEMENT	NBL (NBL)	E (E)	0.9 (0.9)	-	-	-

N5: 2024 Future Terry Fox Drive at Palladium Drive Traffic Operations

Movement	Volume	Delay (s)	LOS	V/C	Q50th	Q95th
EBL	285 (830)	96 (94.9)	E (F)	0.9 (1.03)	46.2 (~143.0)	#73.6 (#185.2)
EBT	60 (250)	62.9 (57.6)	A (B)	0.28 (0.62)	18.5 (71.2)	29.3 (89.3)
EBR	125 (395)	12.9 (54.9)	A (D)	0.43 (0.88)	0 (79.8)	18 (110.5)
WBL	60 (135)	68.3 (68.7)	A (A)	0.37 (0.54)	17.4 (40.1)	33.8 (65.3)
WBT	105 (180)	70.6 (73)	A (B)	0.53 (0.69)	32.2 (55)	46.4 (75.1)
WBR	155 (150)	13.4 (10.9)	A (A)	0.51 (0.43)	0 (0)	19.6 (19.3)
NBL	380 (245)	71.9 (75.5)	C (C)	0.77 (0.72)	58.8 (38.4)	#86.4 (#93.2)
NBT	1260 (1135)	26.4 (49.1)	B (D)	0.66 (0.85)	132.2 (166)	214.2 (#255.7)
NBR	85 (100)	0.3 (0.5)	A (A)	0.1 (0.15)	0 (0)	0.2 (0)
SBL	90 (120)	73.8 (74.1)	A (A)	0.44 (0.5)	14.2 (19)	23.5 (29.5)
SBT	885 (1340)	30.8 (81.6)	A (F)	0.56 (1.04)	100.5 (~238.0)	146.1 (#283.1)
SBR	835 (695)	20.8 (6.6)	D (C)	0.84 (0.7)	89.5 (0)	#219.0 (32.4)
OVERALL	4325 (5575)	36.6 (60.3)	B (D)	0.66 (0.85)	-	-
WORST MOVEMENT	EBL (SBT)	E (F)	0.9 (1.04)	-	-	-

N6: 2024 Future Terry Fox Drive at Maple Grove Traffic Operations

Movement	Volume	Delay (s)	LOS	V/C	Q50th	Q95th
EBL	250 (175)	75.3 (74.4)	D (D)	0.88 (0.8)	64.4 (45.8)	92.5 (65.8)
EBT	60 (65)	35.9 (41.9)	A (A)	0.14 (0.19)	12.5 (14.9)	22.5 (25.3)
EBR	185 (340)	6.9 (29.7)	A (C)	0.38 (0.75)	0 (36.6)	17.3 (65.4)
WBL	35 (20)	35.4 (39.1)	A (A)	0.12 (0.08)	7.3 (4.5)	15.2 (10.7)
WBTR	95 (110)	20.5 (35.3)	A (A)	0.22 (0.32)	10.4 (20.2)	23.1 (33.9)
NBL	210 (225)	14.7 (60)	A (D)	0.53 (0.83)	20.8 (43.4)	38.1 (74.5)
NBTR	1385 (1410)	20.4 (19.2)	B (B)	0.67 (0.66)	108.3 (121.4)	196 (194.7)
SBL	15 (60)	11.3 (11.5)	A (A)	0.07 (0.26)	1.3 (4.1)	4.6 (11.4)
SBT	810 (1810)	23.1 (47.1)	A (E)	0.49 (0.98)	72.1 (242.9)	110.6 (#370.5)
SBR	110 (180)	3.9 (8.3)	A (A)	0.15 (0.21)	0 (7.8)	10.5 (26.6)
OVERALL	3155 (4395)	24.1 (36.0)	A (C)	0.56 (0.77)	-	-
WORST MOVEMENT	EBL (SBT)		D (E)	0.88 (0.98)	-	-

2029 Signalized Intersections

N1: 2029 Future Huntmar Drive at Hazeldean Road Traffic Operations

Movement	Volume	Delay (s)	LOS	V/C	Q50th	Q95th
EBL	250 (250)	62.3 (65.8)	B (B)	0.64 (0.69)	33.6 (33.6)	46.7 (#51.8)
EBTR	975 (950)	34.6 (62)	C (E)	0.7 (0.95)	109.2 (130)	#167.4 (#173.4)
WBL	205 (400)	60.7 (68.1)	A (D)	0.57 (0.82)	27.3 (54.8)	39.8 (#113.9)
WBT	500 (1250)	28.2 (93.1)	A (F)	0.36 (1.08)	47.2 (~204.5)	74.2 (#276.1)
WBR	130 (310)	5.6 (5.9)	A (A)	0.19 (0.43)	0 (0)	14.7 (23.1)
NBL	60 (170)	29 (49.1)	A (C)	0.24 (0.79)	11 (28)	18.9 (#43.1)
NBT	330 (390)	60.1 (43.1)	C (B)	0.79 (0.67)	84.5 (90.1)	108.4 (112.6)
NBR	310 (300)	13.9 (9)	A (A)	0.59 (0.46)	13.6 (10.9)	39.6 (31.4)
SBL	155 (210)	45.7 (35.6)	B (B)	0.68 (0.69)	30.1 (35.4)	42.6 (46.6)
SBT	320 (495)	53.2 (55.7)	C (D)	0.71 (0.86)	81.2 (124)	105.6 (152.2)
SBR	140 (480)	3.8 (28.6)	A (C)	0.22 (0.71)	0 (84.1)	10.9 (108.5)
OVERALL	3375 (5205)	37.6 (57.1)	A (E)	0.59 (0.83)	-	-
WORST MOVEMENT		NBT (WBT)	C (F)	0.79 (1.08)	-	-

N3: 2029 Future Huntmar Drive at Maple Grove Road Traffic Operations

Movement	Volume	Delay (s)	LOS	V/C	Q50th	Q95th
EBL	310 (130)	52.5 (102.1)	D (E)	0.84 (0.94)	62.5 (24.9)	#85.9 (#57.1)
EBTR	240 (215)	37.9 (45.1)	A (B)	0.51 (0.61)	48 (42.3)	67.5 (66.8)
WBL	80 (190)	35 (94.3)	A (E)	0.39 (0.95)	13.8 (37.8)	22.9 (#75.5)
WBTR	180 (300)	46.5 (64.7)	C (D)	0.7 (0.85)	28.7 (67.8)	49.9 (#99.3)
NBL	40 (125)	14.6 (50.9)	A (C)	0.11 (0.74)	4.2 (16.4)	11.3 (#59.3)
NBTR	740 (800)	23.2 (17.9)	A (A)	0.47 (0.44)	62.7 (63.6)	94.5 (81.8)
SBL	45 (85)	14.8 (11.7)	A (A)	0.14 (0.23)	4.7 (8.1)	12.3 (15.8)
SBT	375 (925)	25.1 (63)	A (F)	0.44 (1.01)	61.5 (~244.6)	104.1 (#324.1)
SBR	65 (285)	0.2 (10.7)	A (A)	0.08 (0.35)	0 (21.1)	0 (40.6)
OVERALL	2075 (3055)	31.0 (46.9)	A (C)	0.52 (0.72)	-	-
WORST MOVEMENT		EBL (SBT)	D (F)	0.84 (1.01)	-	-

N4: 2029 Future Huntmar Drive at Palladium Drive Traffic Operations

Movement	Volume	Delay (s)	LOS	V/C	Q50th	Q95th
EBL	35 (30)	25.2 (29)	A (A)	0.07 (0.13)	5.4 (5.1)	14.9 (13.1)
EBTR	480 (850)	18.4 (19.2)	A (C)	0.37 (0.72)	26.4 (41.5)	49.3 (67.1)
WBL	65 (250)	26 (85.9)	A (E)	0.19 (0.96)	10.3 (~62.2)	24.1 (#152.1)
WBTR	145 (665)	22.4 (37.9)	A (A)	0.11 (0.53)	9.8 (82.9)	21.1 (112.7)
NBL	500 (370)	54.2 (58.6)	E (E)	0.93 (0.9)	112.6 (80.4)	#138.7 (112.1)
NBT	365 (280)	26.7 (21.7)	A (A)	0.45 (0.32)	72.5 (47.2)	78.5 (60)
NBR	220 (135)	2.8 (2.8)	A (A)	0.27 (0.17)	0 (0)	11.7 (9.8)
SBL	105 (100)	74.1 (47.6)	B (A)	0.67 (0.39)	29.6 (24)	44.9 (42.1)
SBT	195 (385)	66.2 (72.1)	B (D)	0.68 (0.88)	55.2 (107)	71.9 (#156.5)
SBR	55 (110)	1 (7)	A (A)	0.16 (0.24)	0 (0)	0 (13.5)
OVERALL	2165 (3175)	33.7 (39.4)	A (B)	0.51 (0.65)	-	-
WORST MOVEMENT	NBTLR (SBTLR)		C (E)	0.79 (1)	-	-

N5: 2029 Future Terry Fox Drive at Palladium Drive Traffic Operations

Movement	Volume	Delay (s)	LOS	V/C	Q50th	Q95th
EBL	315 (845)	68.4 (103.8)	B (F)	0.68 (1.05)	48.8 (~157.8)	63.9 (#200.8)
EBT	65 (260)	66.6 (59.6)	A (B)	0.38 (0.62)	20 (78.2)	31.3 (97)
EBR	135 (405)	11.7 (59.6)	A (D)	0.48 (0.89)	0 (91.6)	15 (123.3)
WBL	65 (135)	58.4 (75.3)	A (A)	0.28 (0.58)	17.9 (43.1)	33.7 (#77.4)
WBT	120 (185)	72.5 (78.7)	A (C)	0.59 (0.71)	36.7 (60.2)	52.3 (82.3)
WBR	175 (150)	13.1 (11.4)	A (A)	0.53 (0.43)	0 (0)	21 (20)
NBL	420 (250)	58.2 (90.9)	B (D)	0.61 (0.84)	61.4 (42.5)	#128.2 (#101.1)
NBT	1415 (1160)	34.7 (50.2)	D (D)	0.8 (0.85)	180.3 (179.8)	#306.3 (#265.3)
NBR	95 (100)	0.3 (0.4)	A (A)	0.12 (0.14)	0 (0)	0 (0)
SBL	100 (125)	73.9 (79)	A (A)	0.46 (0.53)	15.8 (21)	25.7 (32.3)
SBT	990 (1375)	45.5 (82.9)	C (F)	0.78 (1.04)	141.6 (~259.2)	170.8 (#304.2)
SBR	935 (710)	32.7 (6.5)	E (C)	0.95 (0.7)	116.9 (0.8)	#237.6 (33.7)
OVERALL	4830 (5700)	41.1 (63.7)	C (D)	0.74 (0.86)	-	-
WORST MOVEMENT	SBR (EBL)		E (F)	0.95 (1.05)	-	-

N6: 2029 Future Terry Fox Drive at Maple Grove Traffic Operations

Movement	Volume	Delay (s)	LOS	V/C	Q50th	Q95th
EBL	275 (190)	76.7 (80.3)	E (D)	0.9 (0.81)	70.1 (55.3)	#111.8 (#86.9)
EBT	65 (70)	34.4 (47.3)	A (A)	0.14 (0.18)	13 (17.5)	24.2 (31.4)
EBR	205 (380)	6.5 (67.9)	A (E)	0.39 (0.92)	0 (83.4)	18 (#137.7)
WBL	35 (20)	33.8 (44.9)	A (A)	0.11 (0.07)	7 (4.9)	15.2 (12.4)
WBTR	105 (115)	21.2 (41.3)	A (A)	0.22 (0.3)	12.2 (24.2)	26.5 (42.6)
NBL	235 (250)	19.9 (88.2)	B (E)	0.66 (0.95)	25.9 (~73.6)	42.6 (#135.9)
NBTR	1550 (1585)	25.1 (22.9)	C (C)	0.78 (0.74)	145.6 (192.2)	#256.7 (226.6)
SBL	15 (70)	12.7 (15.5)	A (A)	0.09 (0.39)	1.4 (6.7)	4.6 (12.4)
SBT	905 (2030)	26.9 (80.2)	A (F)	0.57 (1.08)	91.6 (~373.4)	127.8 (#415.8)
SBR	120 (195)	4.9 (9.1)	A (A)	0.17 (0.24)	0.4 (13.9)	12.7 (28.7)
OVERALL	3510 (4905)	27.6 (55.9)	B (D)	0.65 (0.86)	-	-
WORST MOVEMENT	EBL (SBT)		E (F)	0.9 (1.08)	-	-

A2: 2029 Future Huntmar Drive at Street 1 Traffic Operations

Movement	Volume	Delay (s)	LOS	V/C	Q50th	Q95th
EBLTR	45 (50)	8.1 (12.5)	A (A)	0.33 (0.38)	0 (0)	2.8 (5.9)
WBLTR	50 (45)	6.5 (6.8)	A (A)	0.26 (0.27)	0 (0)	4.5 (3.9)
NBLTR	1010 (875)	19.6 (15.2)	C (B)	0.79 (0.69)	123.9 (96.5)	#357.1 (#285.0)
SBLTR	560 (1280)	11.4 (45.1)	A (E)	0.49 (1)	44.7 (~339.7)	134.6 (#559.5)
OVERALL	1665 (2250)	41.1 (63.7)	B (D)	0.66 (0.85)	-	-
WORST MOVEMENT	NBLTR (SBLTR)		C (E)	0.79 (1)	-	-

A6: 2029 Future Maple Grove Road at Street 2 Traffic Operations

Movement	Volume	Delay (s)	LOS	V/C	Q50th	Q95th
EBLT	390 (420)	8.5 (8.4)	A (A)	0.48 (0.48)	15 (16.3)	33.9 (32.2)
WBTR	375 (515)	7 (9)	A (A)	0.4 (0.56)	12.8 (19.8)	28.1 (39.6)
SBLR	115 (95)	9.4 (10.3)	A (A)	0.2 (0.29)	3.1 (2.2)	13.9 (10.9)
OVERALL	880 (1030)	8.0 (8.9)	A (A)	0.41 (0.5)	-	-
WORST MOVEMENT	EBTL (WBTR)		A (A)	0.48 (0.56)	-	-

Appendix C

Signal Warrant Analysis

Input Data Sheet

Analysis Sheet

Results Sheet

Proposed Collision

GO TO Justification:

What are the intersecting roadways?

Huntmar Drive and EW Road 1

What is the direction of the Main Road street?

North-South

When was the data collected?

2029 Total Traffic

Justification 1 - 4: Volume Warrants

a.- Number of lanes on the Main Road?

1

b.- Number of lanes on the Minor Road?

1

c.- How many approaches?

3

d.- What is the operating environment?

Urban

Population >= 10,000

AND

Speed < 70 km/hr

e.- What is the eight hour vehicle volume at the intersection? (Please fill in table below)

Hour Ending	Main Northbound Approach			Minor Eastbound Approach			Main Southbound Approach			Minor Westbound Approach			Pedestrians Crossing Main Road
	LT	TH	RT	LT	TH	RT	LT	TH	RT	LT	TH	RT	
7:00		456	8				14	434		10		16	
8:00		456	8				14	434		10		16	
9:00		456	8				14	434		10		16	
10:00		456	8				14	434		10		16	
15:00		456	8				14	434		10		16	
16:00		456	8				14	434		10		16	
17:00		456	8				14	434		10		16	
18:00		456	8				14	434		10		16	
Total	0	3,648	61	0	0	0	112	3,472	0	80	0	128	0

Justification 5: Collision Experience

Preceding Months	Number of Collisions*
1-12	0
13-24	0
25-36	0

* Include only collisions that are susceptible to correction through the installation of traffic signal control

Justification 6: Pedestrian Volume

a.- Please fill in table below summarizing total pedestrians crossing major roadway at the intersection or in proximity to the intersection (zones). Please reference Section 4.8 of the Manual for further explanation and graphical representation.

	Zone 1		Zone 2		Zone 3 (if needed)		Zone 4 (if needed)		Total
	Assisted	Unassisted	Assisted	Unassisted	Assisted	Unassisted	Assisted	Unassisted	
Total 8 hour pedestrian volume	0	0	0	0	0	0	0	0	
Factored 8 hour pedestrian volume	0		0		0		0		
% Assigned to crossing rate	100%		50%		0%		0%		
Net 8 Hour Pedestrian Volume at Crossing									0
Net 8 Hour Vehicular Volume on Street Being Crossed									6,411

b.- Please fill in table below summarizing delay to pedestrians crossing major roadway at the intersection or in proximity to the intersection (zones). Please reference Section 4.8 of the Manual for further explanation and graphical representation.

	Zone 1		Zone 2		Zone 3 (if needed)		Zone 4 (if needed)		Total
	Assisted	Unassisted	Assisted	Unassisted	Assisted	Unassisted	Assisted	Unassisted	
Total 8 hour pedestrian volume	0	0	0	0	0	0	0	0	
Total 8 hour pedestrians delayed greater than 10 seconds	0	0	0	0	0	0	0	0	
Factored volume of total pedestrians	0		0		0		0		
Factored volume of delayed pedestrians	0		0		0		0		
% Assigned to Crossing Rate	100%		50%		0%		0%		
Net 8 Hour Volume of Total Pedestrians									0
Net 8 Hour Volume of Delayed Pedestrians									0

Justification 1: Minimum Vehicle Volumes

Restricted Flow Urban Conditions

Justification	Guidance Approach Lanes				Percentage Warrant								Total Across	Section Percent
	1 Lanes		2 or More Lanes		Hour Ending									
Flow Condition	FREE FLOW	RESTR. FLOW	FREE FLOW	RESTR. FLOW	7:00	8:00	9:00	10:00	15:00	16:00	17:00	18:00		
	<input type="checkbox"/>	<input checked="" type="checkbox"/>	<input type="checkbox"/>	<input type="checkbox"/>										
1A	480	720	600	900	938	938	938	938	938	938	938	938		
	COMPLIANCE %				100	100	100	100	100	100	100	100	800	100
1B	180	255	180	255	26	26	26	26	26	26	26	26		
	COMPLIANCE %				10	10	10	10	10	10	10	10	82	10
Restricted Flow					Both 1A and 1B 100% Fulfilled each of 8 hours								Yes <input type="checkbox"/>	No <input checked="" type="checkbox"/>
Signal Justification 1:					Lesser of 1A or 1B at least 80% fulfilled each of 8 hours								Yes <input type="checkbox"/>	No <input checked="" type="checkbox"/>

Justification 2: Delay to Cross Traffic

Restricted Flow Urban Conditions

Justification	Guidance Approach Lanes				Percentage Warrant								Total Across	Section Percent
	1 Lanes		2 or More lanes		Hour Ending									
Flow Condition	FREE FLOW	RESTR. FLOW	FREE FLOW	RESTR. FLOW	7:00	8:00	9:00	10:00	15:00	16:00	17:00	18:00		
	<input type="checkbox"/>	<input checked="" type="checkbox"/>	<input type="checkbox"/>	<input type="checkbox"/>										
2A	480	720	600	900	912	912	912	912	912	912	912	912		
	COMPLIANCE %				100	100	100	100	100	100	100	100	800	100
2B	50	75	50	75	10	10	10	10	10	10	10	10		
	COMPLIANCE %				13	13	13	13	13	13	13	13	107	13
Restricted Flow					Both 2A and 2B 100% fulfilled each of 8 hours								Yes <input type="checkbox"/>	No <input checked="" type="checkbox"/>
Signal Justification 2:					Lesser of 2A or 2B at least 80% fulfilled each of 8 hours								Yes <input type="checkbox"/>	No <input checked="" type="checkbox"/>

Justification 3: Combination

Combination Justification 1 and 2

Justification Satisfied 80% or More				Two Justifications Satisfied 80% or More	
Justification 1	Minimum Vehicle Volume	YES <input type="checkbox"/>	NO <input checked="" type="checkbox"/>	YES <input type="checkbox"/>	NO <input checked="" type="checkbox"/>
Justification 2	Delay Cross Traffic	YES <input type="checkbox"/>	NO <input checked="" type="checkbox"/>	NOT JUSTIFIED	

Justification 4: Four Hour Volume

Justification	Time Period	Total Volume of Both Approaches (Main)	Heaviest Minor Approach	Required Value	Average % Compliance	Overall % Compliance
		X	Y (actual)	Y (warrant threshold)		
Justification 4	7:00	912	26	121	21 %	21 %
	8:00	912	26	122	21 %	
	9:00	912	26	122	21 %	
	10:00	912	26	122	21 %	

Justification 5: Collision Experience

Justification	Preceding Months	% Fulfillment	Overall % Compliance
Justification 5	1-12	0 %	0 %
	13-24	0 %	
	25-36	0 %	

Justification 6: Pedestrian Volume

Pedestrian Volume Analysis

	8 Hour Vehicular Volume V_8	Net 8 Hour Pedestrian Volume				
		< 200	200 - 275	276 - 475	476 - 1000	>1000
Justification 6A	< 1440	Not Justified				
	1440 - 2600					
	2601 - 7000					
	> 7000					

Pedestrian Delay Analysis

	Net Total 8 Hour Volume of Total Pedestrians	Net Total 8 Hour Volume of Delayed Pedestrians		
		< 75	75 - 130	> 130
Justification 6B	< 200	Not Justified		
	200 - 300			
	> 300			

Results Sheet

[Input Sheet](#)

[Analysis Sheet](#)

[Proposed Collision](#)

[GO TO Justification:](#)

Intersection: Huntmar Drive and EW Road 1

Count Date: 2029 Total Traffic

Summary Results

	Justification	Compliance	Signal Justified?	
			YES	NO
1. Minimum Vehicular Volume	A Total Volume	100 %	<input type="checkbox"/>	<input checked="" type="checkbox"/>
	B Crossing Volume	10 %	<input type="checkbox"/>	<input checked="" type="checkbox"/>
2. Delay to Cross Traffic	A Main Road	100 %	<input type="checkbox"/>	<input checked="" type="checkbox"/>
	B Crossing Road	13 %	<input type="checkbox"/>	<input checked="" type="checkbox"/>
3. Combination	A Justificaton 1	10 %	<input type="checkbox"/>	<input checked="" type="checkbox"/>
	B Justification 2	13 %	<input type="checkbox"/>	<input checked="" type="checkbox"/>
4. 4-Hr Volume		21 %	<input type="checkbox"/>	<input checked="" type="checkbox"/>

5. Collision Experience		0 %	<input type="checkbox"/>	<input checked="" type="checkbox"/>
-------------------------	--	-----	--------------------------	-------------------------------------

6. Pedestrians	A Volume	Justification not met	<input type="checkbox"/>	<input checked="" type="checkbox"/>
	B Delay	Justification not met	<input type="checkbox"/>	<input checked="" type="checkbox"/>

Appendix D

TDM Checklists

Introduction

The City of Ottawa's *Transportation Impact Assessment (TIA) Guidelines* (specifically Module 4.3—Transportation Demand Management) requires proponents of qualifying developments to assess the context, need and opportunity for transportation demand management (TDM) measures at their development. The guidelines require that proponents complete the City's **TDM Measures Checklist**, at a minimum, to identify any TDM measures being proposed.

The remaining sections of this document are:

- Using the Checklist
- Glossary
- TDM Measures Checklist: Non-Residential Developments
- TDM Measures Checklist: Residential developments

Readers are encouraged to contact the City of Ottawa's TDM Officer for any guidance and assistance they require to complete this checklist.

Using the Checklist

The City's *TIA Guidelines* are designed so that *Module 3.1—Development-Generated Travel Demand*, *Module 4.1—Development Design*, and *Module 4.2—Parking* are complete before a proponent begins *Module 4.3—Transportation Demand Management*.

Within Module 4.3, *Element 4.3.1—Context for TDM* and *Element 4.3.2—Need and Opportunity* are intended to create an understanding of the need for any TDM measures, and of the results they are expected to achieve or support. Once those two elements are complete, proponents begin *Element 4.3.3—TDM Program* that requires proponents to identify proposed TDM measures using the **TDM Measures Checklist**, at a minimum. The *TIA Guidelines* note that the City may require additional analysis for large or complex development proposals, or those that represent a higher degree of performance risk; as well, proponents proposing TDM measures for a new development must also propose an implementation plan that addresses planning and coordination, funding and human resources, timelines for action, performance targets and monitoring requirements.

This **TDM Measures Checklist** document includes two actual checklists, one for non-residential developments (office, institutional, retail or industrial) and one for residential developments (multi-family, condominium or subdivision). Readers may download the applicable checklist in electronic format and complete it electronically, or print it out and complete it by hand. As an alternative, they may create a freestanding document that lists the TDM measures being proposed and provides additional detail on them, including an implementation plan as required by the City's *TIA Guidelines*.

Each measure in the checklist is numbered for easy reference. Each measure is also flagged as:

- **BASIC** —The measure is generally feasible and effective, and in most cases would benefit the development and its users.
- **BETTER** —The measure could maximize support for users of sustainable modes, and optimize development performance.
- **★** —The measure is one of the most dependably effective tools to encourage the use of sustainable modes.

Glossary

This glossary defines and describes the following measures that are identified in the **TDM Measures Checklist**:

TDM program management

- Program coordinator
- Travel surveys

Parking

- Priced parking

Walking & cycling

- Information on walking/cycling routes & destinations
- Bicycle skills training
- Valet bike parking

Transit

- Transit information
- Transit fare incentives
- Enhanced public transit service
- Private transit service

Ridesharing

- Ridematching service
- Carpool parking price incentives
- Vanpool service

Carsharing & bikesharing

- Bikeshare stations & memberships
- Carshare vehicles & memberships

TDM marketing & communications

- Multimodal travel information
- Personalized trip planning
- Promotions

Other incentives & amenities

- Emergency ride home
- Alternative work arrangements
- Local business travel options
- Commuter incentives
- On-site amenities

For further information on selecting and implementing TDM measures (particularly as they apply to non-residential developments, with a focus on workplaces), readers may find it helpful to consult Transport Canada's *Workplace Travel Plans: Guidance for Canadian Employers*, which can be downloaded in English and French from the ACT Canada website at www.actcanada.com/resources/act-resources.

► ***TDM program management***

While some TDM measures can be implemented with a minimum of effort through routine channels (e.g. parking or human resources), more complex measures or a larger development site may warrant assigning responsibility for TDM program coordination to a designated person either inside or outside the implementing organization. Similarly, some TDM measures are more effective if they are targeted or customized for specific audiences, and would benefit from the collection of related information.

Program coordinator. This person is charged with day-to-day TDM program development and implementation. Only in very large employers with thousands of workers is this likely to be a full-time, dedicated position. Usually, it is added to an existing role in parking, real estate, human resources or environmental management. In practice, this role may be called TDM coordinator, commute trip reduction coordinator or employee transportation coordinator. The City of Ottawa can identify external resources (e.g. non-profit organizations or consultants) that could provide these services.

Travel surveys. Travel surveys are most commonly conducted at workplaces, but can be helpful in other settings. They identify how and why people travel the way they do, and what barriers and opportunities exist for different behaviours. They usually capture the following information:

- *Personal data* including home address or postal code, destination, job type or function, employment status (full-time, part-time and/or teleworker), gender, age and hours of work
- *Commute information* including distance or time for the trip between home and work, usual methods of commuting, and reasons for choosing them
- *Barriers and opportunities* including why other commuting methods are unattractive, willingness to consider other options, and what improvements to other options could make them more attractive

► ***Parking***

Priced parking. Charging for parking is typically among the most effective ways of getting drivers to consider other travel options. While drivers may not support parking fees, they can be more accepting if the revenues are used to improve other travel options (e.g. new showers and change rooms, improved bicycle parking or subsidized transit passes). At workplaces or daytime destinations, parking discounts (e.g. early bird specials, daily passes that cost significantly less than the equivalent hourly charge, monthly passes that cost significantly less than the equivalent daily charge) encourage long-term parking and discourage the use of other travel options. For residential uses, unbundling parking costs from dwelling purchase, lease or rental costs provides an incentive for residents to own fewer cars, and can reduce car use and the costs of parking provision.

► **Walking & cycling**

Active transportation options like cycling and walking are particularly attractive for short trips (typically up to 5 km and 2 km, respectively). Other supportive factors include an active, health-conscious audience, and development proximity to high-quality walking and cycling networks. Common challenges to active transportation include rain, darkness, snowy or icy conditions, personal safety concerns, the potential for bicycle theft, and a lack of shower and change facilities for those making longer trips.

Information on walking/cycling routes & destinations. Ottawa, Gatineau and the National Capital Commission all publish maps to help people identify the most convenient and comfortable walking or cycling routes.

Bicycle skills training. Potential cyclists can be intimidated by the need to ride on roads shared with motor vehicles. This barrier can be reduced or eliminated by offering cycling skills training to interested cyclists (e.g. CAN-BIKE certification courses).

Valet bike parking. For large events, temporary “valet parking” areas can be easily set up to maximize convenience and security for cyclists. Experienced local non-profit groups can help.

► **Transit**

Transit information. Difficulty in finding or understanding basic information on transit fares, routes and schedules can prevent people from trying transit. Employers can help by providing online links to OC Transpo and STO websites. Transit users also appreciate visible maps and schedules of transit routes that serve the site; even better, a screen that shows real-time transit arrival information is particularly useful at sites with many transit users and an adjacent transit stop or station.

Transit fare incentives. Free or subsidized transit fares are an attractive incentive for non-transit riders to try transit. Many non-users are unsure of how to pay a fare, and providing tickets or a preloaded PRESTO card (or, for special events, pre-arranging with OC Transpo that transit fares are included with event tickets) overcome that barrier.

Enhanced public transit service. OC Transpo may adjust transit routes, stop locations, service hours or frequencies for an agreed fee under contract, or at no cost where warranted by the potential ridership increase. Information provided by a survey of people who travel to a given development can support these decisions.

Private transit service. At remote suburban or rural workplaces, a poor transit connection to the nearest rapid transit station can be an obstacle for potential transit users, and an employer in this situation could initiate a private shuttle service to make transit use more feasible or attractive. Other circumstances where a shuttle makes sense include large special events, or a residential development for people with limited independent mobility who still require regular access to shops and services.

► **Ridesharing**

Ridesharing's potential is greatest in situations where transit ridership is low, where parking costs are high, and/or where large numbers of car commuters (e.g. employees or full-time students) live reasonably far from the workplace.

Ridematching service. Potential carpoolers in Ottawa are served by www.OttawaRideMatch.com, an online service to help people find carpool partners. Employers can arrange for a dedicated portal where their employees can search for potential carpool partners only among their colleagues, if they desire. Some very large employers may establish internal ridematching services, to maximize employee uptake and corporate control. Ridematching service providers typically include a waiver to relieve employers of liability when their employees start carpooling through a ridematching service. Ridesharing with co-workers also tends to eliminate security concerns.

Carpool parking price incentives. Discounted parking fees for carpools can be an extra incentive to rideshare.

Vanpool service. Vanpools operate in the Toronto and Vancouver metropolitan areas, where vans that carry up to about ten occupants are driven by one of the vanpool members. Vanpools tend to operate on a cost-recovery basis, and are most practical for long-distance commutes where transit is not an option. Current legislation in Ontario does not permit third-party (i.e. private or non-profit) vanpool services, but does permit employers to operate internal vanpools.

► **Carsharing & bikesharing**

Bikeshare station & memberships. VeloGO Bike Share and Right Bike both operate bikesharing services in Ottawa. Developments that would benefit from having a bikeshare station installed at or near their development may negotiate directly with either service provider.

Carshare vehicles & memberships. VRTUCAR and Zipcar both operate carsharing services in Ottawa, for use by the general public or by businesses as an alternative to corporate fleets. Carsharing services offer 24-hour access, self-serve reservation systems, itemized monthly billings, and outsourcing of all financing, insurance, maintenance and administrative responsibilities.

► **TDM marketing & communications**

Multimodal travel information. Aside from mode-specific information discussed elsewhere in this document, multimodal information that identifies and explains the full range of travel options available to people can be very influential—especially when provided at times and locations where individuals are actively choosing among those options. Examples include: employees when their employer is relocating, or when they are joining a new employer; students when they are starting a program at a new institution; visitors or customers travelling to an unfamiliar destination, or when faced with new options (e.g. shuttle services or parking restrictions); and residents when they purchase or occupy a residence that is new to them.

Personalized trip planning. As an extension to the simple provision of information, this technique (also known as *individualized marketing*) is effective in helping people make more sustainable travel choices. The approach involves identifying who is most likely to change their travel choices (notably relocating employees, students or residents) giving them customized information, training and incentives to support them in making that change. It may be conducted with assistance from an external service provider with the necessary skills, and delivered in a variety of settings including workplaces and homes.

Promotions. Special events and incentives can raise awareness and encourage individuals to examine and try new travel options.

- *Special events* can help attract attention, build participation and celebrate successes. Events that have been held in Ottawa include Earth Day (in April) Bike to Work Month (in May), Environment Week (early June), International Car Free Day (September 22), and Canadian Ridesharing Week (October). At workplaces or educational institutions, similarly effective internal events could include workshops, lunch-and-learns, inter-departmental challenges, pancake breakfasts, and so on.
- *Incentives* can encourage trial of sustainable modes, and might include loyalty rewards for duration or consistency of activity (e.g. 1,000 km commuted by bicycle), participation prizes (e.g. for completing a survey or joining a special event), or personal recognition that highlights individual accomplishments.

► **Other incentives & amenities**

Emergency ride home. This measure assures non-driving commuters that they will be able to get home quickly and conveniently in case of family emergency (or in some workplaces, in case of unexpected overtime, severe weather conditions, or the early departure of a carpool driver) by offering a chit or reimbursement for taxi, carshare or rental car usage. Limits on annual usage or cost per employee may be set, although across North America the actual rates of usage are typically very low.

Alternative work arrangements. A number of alternatives to the standard 9-to-5, Monday-to-Friday workweek can support sustainable commuting (and work-life balance) at workplaces:

- *Flexible working hours* allow transit commuters to take advantage of the fastest and most convenient transit services, and allow potential carpoolers to include people who work slightly different schedules in their search for carpool partners. They also allow active commuters to travel at least one direction in daylight, either in the morning or the afternoon, during the winter.
- *Compressed workweeks* allow employees to work their required hours over fewer days (e.g. five days in four, or ten days in nine), eliminating the need to commute on certain days. For employees, this can promote work-life balance and gives flexibility for appointments. For employers, this can permit extended service hours as well as reduced parking demands if employees stagger their days off.
- *Telework* is a normal part of many workplaces. It helps reduce commuting activity, and can lead to significant cost savings through workspace sharing. Telework initiatives involve many stakeholders, and may face as much resistance as support within an organization. Consultation, education and training are helpful.

Local business travel options. A common obstacle for people who might prefer to not drive to work is that their employer requires them to bring a car to work so they can make business trips during the day. Giving employees convenient alternatives to private cars for local business travel during the workday makes walking, cycling, transit or carpooling in someone else's car more practical.

- *Walking and cycling*—Active transportation can be a convenient and enjoyable way to make short business trips. They can also reduce employer expenses, although they may require extra travel time. Providing a fleet of shared bikes, or reimbursing cyclists for the kilometres they ride, are inexpensive ways to validate their choice.
- *Public transit*—Transit can be convenient and inexpensive compared to driving. OC Transpo's PRESTO cards are transferable among employees and automatically reloadable, making them the perfect tool for enabling transit use during the day.
- *Ridesharing*—When multiple employees attend the same off-site meeting or event, they can be reminded to carpool whenever possible.
- *Taxis or ride-hailing*—Taxis and ride-hailing can eliminate parking costs, save time and eliminate collision liability concerns. Taxi chits eliminate cash transactions and minimize paperwork.
 - *Fleet vehicles or carsharing*—Fleet vehicles can be cost-effective for high travel volumes, while carsharing is a great option for less frequent trips.
 - *Interoffice shuttles*—Employers with multiple worksites in the region could use a shuttle service to move people as well as mail or supplies.
 - *Videoconferencing*—New technologies mean that staying in the office to hold meetings electronically is more viable, affordable and productive than ever.

Commuter incentives. Financial incentives can help create a level playing field and support commuting by sustainable modes. A "commuting allowance" given to all employees as a taxable benefit is one such incentive; employees who choose to drive could then be charged for parking, while other employees could use the allowance for transit fares or cycling equipment, or for spending or saving. (Note that in the United States this practice is known as "parking cash-out," and is popular because commuting allowances are not taxable up to a certain limit). Alternatively, a monthly commuting allowance for non-driving employees would give drivers an incentive to choose a different commuting mode. Another practical incentive for active commuters or transit users is to offer them discounted "rainy day" parking passes for a small number of days each month.

On-site amenities. Developments that offer services to limit employees' need for a car during their commute (e.g. to drop off clothing at the dry cleaners) or during their workday (e.g. to buy lunch) can free employees to make the commuting decision that otherwise works best for them.

TDM Measures Checklist:
Residential Developments (multi-family, condominium or subdivision)

TDM measures: <i>Residential developments</i>		Check if proposed & add descriptions
1. TDM PROGRAM MANAGEMENT		
1.1 Program coordinator		
BASIC ★	1.1.1 Designate an internal coordinator, or contract with an external coordinator	<input type="checkbox"/>
1.2 Travel surveys		
BETTER	1.2.1 Conduct periodic surveys to identify travel-related behaviours, attitudes, challenges and solutions, and to track progress	<input type="checkbox"/>
2. WALKING AND CYCLING		
2.1 Information on walking/cycling routes & destinations		
BASIC	2.1.1 Display local area maps with walking/cycling access routes and key destinations at major entrances (<i>multi-family, condominium</i>)	<input checked="" type="checkbox"/> Routes and maps will be displayed inside apartment buildings.
2.2 Bicycle skills training		
BETTER	2.2.1 Offer on-site cycling courses for residents, or subsidize off-site courses	<input type="checkbox"/>
3. TRANSIT		
3.1 Transit information		
BASIC	3.1.1 Display relevant transit schedules and route maps at entrances (<i>multi-family, condominium</i>)	<input checked="" type="checkbox"/> Routes and maps will be displayed inside apartment buildings.
BETTER	3.1.2 Provide real-time arrival information display at entrances (<i>multi-family, condominium</i>)	<input type="checkbox"/>
3.2 Transit fare incentives		
BASIC ★	3.2.1 Offer PRESTO cards preloaded with one monthly transit pass on residence purchase/move-in, to encourage residents to use transit	<input type="checkbox"/>
BETTER	3.2.2 Offer at least one year of free monthly transit passes on residence purchase/move-in	<input type="checkbox"/>
3.3 Enhanced public transit service		
BETTER ★	3.3.1 Contract with OC Transpo to provide early transit services until regular services are warranted by occupancy levels (<i>subdivision</i>)	<input checked="" type="checkbox"/> OC Transpo already has plans to run a route through the subdivision.
3.4 Private transit service		
BETTER	3.4.1 Provide shuttle service for seniors homes or lifestyle communities (e.g. scheduled mall or supermarket runs)	<input type="checkbox"/>

4. CARSHARING & BIKESHARING		
4.1 Bikeshare stations & memberships		
BETTER	4.1.1 Contract with provider to install on-site bikeshare station (<i>multi-family</i>)	<input checked="" type="checkbox"/> Client will contract with provider to install on-site bike share vehicles.
BETTER	4.1.2 Provide residents with bikeshare memberships, either free or subsidized (<i>multi-family</i>)	<input type="checkbox"/>
4.2 Carshare vehicles & memberships		
BETTER	4.2.1 Contract with provider to install on-site carshare vehicles and promote their use by residents	<input checked="" type="checkbox"/> Client will contract with provider to install on-site car share vehicles.
BETTER	4.2.2 Provide residents with carshare memberships, either free or subsidized	<input type="checkbox"/>
5. PARKING		
5.1 Priced parking		
BASIC	★ 5.1.1 Unbundle parking cost from purchase price (<i>condominium</i>)	<input checked="" type="checkbox"/> Parking cost will not be bundled.
BASIC	★ 5.1.2 Unbundle parking cost from monthly rent (<i>multi-family</i>)	<input checked="" type="checkbox"/> Parking cost will not be bundled.
6. TDM MARKETING & COMMUNICATIONS		
6.1 Multimodal travel information		
BASIC	★ 6.1.1 Provide a multimodal travel option information package to new residents	<input checked="" type="checkbox"/> Information package will be provided to new residents.
6.2 Personalized trip planning		
BETTER	★ 6.2.1 Offer personalized trip planning to new residents	<input type="checkbox"/>

TDM Measures Checklist:

Non-Residential Developments (office, institutional, retail or industrial)

Legend	
BASIC	The measure is generally feasible and effective, and in most cases would benefit the development and its users
BETTER	The measure could maximize support for users of sustainable modes, and optimize development performance
★	The measure is one of the most dependably effective tools to encourage the use of sustainable modes

TDM measures: <i>Non-residential developments</i>		Check if proposed & add descriptions
1. TDM PROGRAM MANAGEMENT		
1.1 Program coordinator		
BASIC	★	1.1.1 Designate an internal coordinator, or contract with an external coordinator <input type="checkbox"/>
1.2 Travel surveys		
BETTER		1.2.1 Conduct periodic surveys to identify travel-related behaviours, attitudes, challenges and solutions, and to track progress <input checked="" type="checkbox"/> Travel surveys will be undertaken annually.
2. WALKING AND CYCLING		
2.1 Information on walking/cycling routes & destinations		
BASIC		2.1.1 Display local area maps with walking/cycling access routes and key destinations at major entrances <input checked="" type="checkbox"/> Routes and maps will be displayed in workplaces
2.2 Bicycle skills training		
<i>Commuter travel</i>		
BETTER	★	2.2.1 Offer on-site cycling courses for commuters, or subsidize off-site courses <input type="checkbox"/>
2.3 Valet bike parking		
<i>Visitor travel</i>		
BETTER		2.3.1 Offer secure valet bike parking during public events when demand exceeds fixed supply (e.g. for festivals, concerts, games) <input type="checkbox"/>

TDM measures: <i>Non-residential developments</i>		Check if proposed & add descriptions
3. TRANSIT		
3.1 Transit information		
BASIC	3.1.1 Display relevant transit schedules and route maps at entrances	<input checked="" type="checkbox"/> Schedules will be displayed inside workplaces.
BASIC	3.1.2 Provide online links to OC Transpo and STO information	<input checked="" type="checkbox"/> Flyers will be available, pointing employees to links.
BETTER	3.1.3 Provide real-time arrival information display at entrances	<input type="checkbox"/>
3.2 Transit fare incentives		
<i>Commuter travel</i>		
BETTER	3.2.1 Offer preloaded PRESTO cards to encourage commuters to use transit	<input type="checkbox"/>
BETTER ★	3.2.2 Subsidize or reimburse monthly transit pass purchases by employees	<input checked="" type="checkbox"/> Transit ridership will be encouraged through subsidies.
<i>Visitor travel</i>		
BETTER	3.2.3 Arrange inclusion of same-day transit fare in price of tickets (e.g. for festivals, concerts, games)	<input type="checkbox"/>
3.3 Enhanced public transit service		
<i>Commuter travel</i>		
BETTER	3.3.1 Contract with OC Transpo to provide enhanced transit services (e.g. for shift changes, weekends)	<input type="checkbox"/>
<i>Visitor travel</i>		
BETTER	3.3.2 Contract with OC Transpo to provide enhanced transit services (e.g. for festivals, concerts, games)	<input type="checkbox"/>
3.4 Private transit service		
<i>Commuter travel</i>		
BETTER	3.4.1 Provide shuttle service when OC Transpo cannot offer sufficient quality or capacity to serve demand (e.g. for shift changes, weekends)	<input type="checkbox"/>
<i>Visitor travel</i>		
BETTER	3.4.2 Provide shuttle service when OC Transpo cannot offer sufficient quality or capacity to serve demand (e.g. for festivals, concerts, games)	<input type="checkbox"/>

TDM measures: <i>Non-residential developments</i>		Check if proposed & add descriptions
4. RIDESHARING		
4.1 Ridematching service		
<i>Commuter travel</i>		
BASIC ★	4.1.1 Provide a dedicated ridematching portal at OttawaRideMatch.com	<input type="checkbox"/>
4.2 Carpool parking price incentives		
<i>Commuter travel</i>		
BETTER	4.2.1 Provide discounts on parking costs for registered carpools	<input type="checkbox"/>
4.3 Vanpool service		
<i>Commuter travel</i>		
BETTER	4.3.1 Provide a vanpooling service for long-distance commuters	<input type="checkbox"/>
5. CARSHARING & BIKESHARING		
5.1 Bikeshare stations & memberships		
BETTER	5.1.1 Contract with provider to install on-site bikeshare station for use by commuters and visitors	<input checked="" type="checkbox"/> Cycling mode share will be increased by providing a bikeshare station on-site
<i>Commuter travel</i>		
BETTER	5.1.2 Provide employees with bikeshare memberships for local business travel	<input checked="" type="checkbox"/> Businesses can provide employees with memberships at a subsidized cost.
5.2 Carshare vehicles & memberships		
<i>Commuter travel</i>		
BETTER	5.2.1 Contract with provider to install on-site carshare vehicles and promote their use by tenants	<input type="checkbox"/>
BETTER	5.2.2 Provide employees with carshare memberships for local business travel	<input type="checkbox"/>
6. PARKING		
6.1 Priced parking		
<i>Commuter travel</i>		
BASIC ★	6.1.1 Charge for long-term parking (daily, weekly, monthly)	<input type="checkbox"/>
BASIC	6.1.2 Unbundle parking cost from lease rates at multi-tenant sites	<input checked="" type="checkbox"/> This will encourage lower car ownership while not discouraging visitors.
<i>Visitor travel</i>		
BETTER	6.1.3 Charge for short-term parking (hourly)	<input type="checkbox"/>

TDM measures: <i>Non-residential developments</i>		Check if proposed & add descriptions
7. TDM MARKETING & COMMUNICATIONS		
7.1 Multimodal travel information		
<i>Commuter travel</i>		
BASIC ★	7.1.1 Provide a multimodal travel option information package to new/relocating employees and students	<input checked="" type="checkbox"/> Package to be provided to new employees.
<i>Visitor travel</i>		
BETTER ★	7.1.2 Include multimodal travel option information in invitations or advertising that attract visitors or customers (e.g. for festivals, concerts, games)	<input type="checkbox"/>
7.2 Personalized trip planning		
<i>Commuter travel</i>		
BETTER ★	7.2.1 Offer personalized trip planning to new/relocating employees	<input type="checkbox"/>
7.3 Promotions		
<i>Commuter travel</i>		
BETTER	7.3.1 Deliver promotions and incentives to maintain awareness, build understanding, and encourage trial of sustainable modes	<input type="checkbox"/>
8. OTHER INCENTIVES & AMENITIES		
8.1 Emergency ride home		
<i>Commuter travel</i>		
BETTER ★	8.1.1 Provide emergency ride home service to non-driving commuters	<input type="checkbox"/>
8.2 Alternative work arrangements		
<i>Commuter travel</i>		
BASIC ★	8.2.1 Encourage flexible work hours	<input checked="" type="checkbox"/> Will assist with reducing vehicle trips.
BETTER	8.2.2 Encourage compressed workweeks	<input checked="" type="checkbox"/> Will assist with reducing vehicle trips.
BETTER ★	8.2.3 Encourage telework	<input checked="" type="checkbox"/> Will assist with reducing vehicle trips.
8.3 Local business travel options		
<i>Commuter travel</i>		
BASIC ★	8.3.1 Provide local business travel options that minimize the need for employees to bring a personal car to work	<input type="checkbox"/>
8.4 Commuter incentives		
<i>Commuter travel</i>		
BETTER	8.4.1 Offer employees a taxable, mode-neutral commuting allowance	<input type="checkbox"/>
8.5 On-site amenities		
<i>Commuter travel</i>		
BETTER	8.5.1 Provide on-site amenities/services to minimize mid-day or mid-commute errands	<input checked="" type="checkbox"/> On-site commercial facilities will be provided.