

# **APPENDICES**

## **Appendix A : POTABLE WATER SERVICING**

### **A.1 DOMESTIC WATER DEMAND CALCULATIONS**

**Trailsedge East Phase 4 - Domestic Water Demand Estimates**

| Densities as per City Guidelines: |     |     |
|-----------------------------------|-----|-----|
| Singles                           | 3.4 | ppu |
| Townhomes / Back-to-Back          | 2.7 | ppu |
| Block 193/194                     | 2.4 | ppu |
| Apartments                        | 1.8 | ppu |

**Trailsedge East Phase 4**

| Building ID                                 | Population  | Institutional Area (ha) | Daily Rate of Demand <sup>1</sup> (L/m <sup>2</sup> /day) | Daily Rate of Demand (L/ha/day) | Avg Day Demand |             | Max Day Demand <sup>1</sup> |             | Peak Hour Demand <sup>2</sup> |             |
|---|-------------|-------------------------|---|---------------------------------|----------------|-------------|-----------------------------|-------------|-------------------------------|-------------|
|   |             |                         |   |                                 | (L/min)        | (L/s)       | (L/min)                     | (L/s)       | (L/min)                       | (L/s)       |
| Back-to-Back Townhouses <sup>3</sup> (106)* | 286         |                         | 280   |                                 | 55.7           | 0.9         | 139.1                       | 2.3         | 306.1                         | 5.1         |
| Townhouses (154)*                           | 416         |                         | 280   |                                 | 80.9           | 1.3         | 202.1                       | 3.4         | 444.7                         | 7.4         |
| Single Family Homes (136)                   | 462         |                         | 280   |                                 | 89.9           | 1.5         | 224.8                       | 3.7         | 494.5                         | 8.2         |
| Commercial (Block 197)                      | 0           | 4.25                    |   | 28,000                          | 82.6           | 1.4         | 124.0                       | 2.1         | 223.1                         | 3.7         |
| Mid-High Density (Block 193/194)            | 446         |                         | 280   |                                 | 86.8           | 1.4         | 217.0                       | 3.6         | 477.4                         | 8.0         |
| Mixed-Use (Block 198/199)                   |             |                         |   |                                 |                |             |                             |             |                               |             |
| • Residential Portion                       | 1014        | 7.04                    | 280   |                                 | 197.1          | 3.3         | 492.8                       | 8.2         | 1084.2                        | 18.1        |
| • Commercial Portion                        |             | 7.04                    |   | 28,000                          | 136.9          | 2.3         | 205.3                       | 3.4         | 369.6                         | 6.2         |
| <b>Total Site :</b>                         | <b>2625</b> |                         |   |                                 | <b>729.9</b>   | <b>12.2</b> | <b>1605.1</b>               | <b>26.8</b> | <b>3399.5</b>                 | <b>56.7</b> |

Average day water demand for residential areas equal to 280 L/cap/d

The City water demand criteria used to estimate peak demand rates for residential areas are :

- 1 maximum day demand rate = 2.5 x average day demand rate for residential
- 2 peak hour demand rate = 2.2 x maximum day demand rate for residential

\* 6 Singles, 10 Back-to-Back units, 23 townhomes serviced through mains constructed as part of Phase 1, with demands included in prior designs.

Water demand criteria used to estimate peak demand rates for commercial/institutional areas

- 1 maximum day demand rate = 1.5 x average day demand rate
- 2 peak hour demand rate = 1.8 x maximum day demand rate

## **A.2 FUS CALCULATION SHEETS**



**FUS Fire Flow Calculation Sheet**

Stantec Project #: 160401250  
 Project Name: Trailledge East Phase 4  
 Date: 2/2/2021

Fire Flow Calculation #: 1  
 Description: Back-to-Back 10-Unit Townhouse Block (Block 151)

Notes: Case 1: 3-storey building with basement. Back-to-back townhouse units (on Street No. 23 and Street No.25). Building Classification C. 2-hour firewall provided vertically down the middle of the building, separating building into 5-unit sections.

| Step | Task  | Notes  | Value Used            | Req'd Fire Flow (L/min) |                          |                                    |                               |     |       |
|------|---|--|-----------------------|-------------------------|--------------------------|------------------------------------|-------------------------------|-----|-------|
| 1    | Determine Type of Construction              | Wood Frame   | 1.5                   | -                       |                          |                                    |                               |     |       |
| 2    | Determine Ground Floor Area of One Unit     | Approx. area of a single storey of a single unit                   | 54                    | -                       |                          |                                    |                               |     |       |
|      | Determine Number of Adjoining Units         | Includes adjacent wood frame structures separated by 3m or less    | 5                     | -                       |                          |                                    |                               |     |       |
| 3    | Determine Height in Storeys                 | Does not include floors >50% below grade or open attic space       | 3                     | -                       |                          |                                    |                               |     |       |
| 4    | Determine Required Fire Flow                | ( $F = 220 \times C \times A^{1/2}$ ). Round to nearest 1000 L/min | -                     | 9000                    |                          |                                    |                               |     |       |
| 5    | Determine Occupancy Charge                  | Limited Combustible  | -15%                  | 7650                    |                          |                                    |                               |     |       |
| 6    | Determine Sprinkler Reduction               | None   | 0%                    | 0                       |                          |                                    |                               |     |       |
|      |   | Non-Standard Water Supply or N/A                                   | 0%                    |                         |                          |                                    |                               |     |       |
|      |   | Not Fully Supervised or N/A  | 0%                    |                         |                          |                                    |                               |     |       |
|      |   | % Coverage of Sprinkler System                                     | 0%                    |                         |                          |                                    |                               |     |       |
| 7    | Determine Increase for Exposures (Max. 75%) | Direction  | Exposure Distance (m) | Exposed Length (m)      | Exposed Height (Stories) | Length-Height Factor (m x stories) | Construction of Adjacent Wall | -   | -     |
|      |   | North  | 0 to 3                | 8.5                     | 3                        | 0-30                               | Wood Frame or Non-Combustible | 22% | 4973  |
|      |   | East   | 0 to 3                | 31                      | 3                        | 91-120                             | Wood Frame or Non-Combustible | 25% |       |
|      |   | South  | 20.1 to 30            | 8.5                     | 3                        | 0-30                               | Wood Frame or Non-Combustible | 8%  |       |
|      |   | West   | 20.1 to 30            | 31                      | 3                        | 91-120                             | Wood Frame or Non-Combustible | 10% |       |
| 8    | Determine Final Required Fire Flow          | Total Required Fire Flow in L/min, Rounded to Nearest 1000L/min    |                       |                         |                          |                                    |                               |     | 13000 |
|      |   | Total Required Fire Flow in L/s                                    |                       |                         |                          |                                    |                               |     | 216.7 |
|      |   | Required Duration of Fire Flow (hrs)                               |                       |                         |                          |                                    |                               |     | 2.50  |
|      |   | Required Volume of Fire Flow (m <sup>3</sup> )                     |                       |                         |                          |                                    |                               |     | 1950  |



**FUS Fire Flow Calculation Sheet**

Stantec Project #: 160401250  
 Project Name: Trailledge East Phase 4  
 Date: 2/2/2021

Fire Flow Calculation #: 2

Description: Back-to-Back 10-Unit Townhouse Block (Block 171)

Notes: Case 2: 3-storey building with basement. Back-to-back townhouse units (on Street No. 27). Building Classification C. 2-hour firewall provided vertically down the middle of the building, separating building into 5-unit sections.

| Step | Task  | Notes  | Value Used            | Req'd Fire Flow (L/min) |                          |                                    |                               |     |       |
|------|---|--|-----------------------|-------------------------|--------------------------|------------------------------------|-------------------------------|-----|-------|
| 1    | Determine Type of Construction              | Wood Frame   | 1.5                   | -                       |                          |                                    |                               |     |       |
| 2    | Determine Ground Floor Area of One Unit     | Approx. area of a single storey of a single unit                   | 54                    | -                       |                          |                                    |                               |     |       |
|      | Determine Number of Adjoining Units         | Includes adjacent wood frame structures separated by 3m or less    | 5                     | -                       |                          |                                    |                               |     |       |
| 3    | Determine Height in Storeys                 | Does not include floors >50% below grade or open attic space       | 3                     | -                       |                          |                                    |                               |     |       |
| 4    | Determine Required Fire Flow                | ( $F = 220 \times C \times A^{1/2}$ ). Round to nearest 1000 L/min | -                     | 9000                    |                          |                                    |                               |     |       |
| 5    | Determine Occupancy Charge                  | Limited Combustible  | -15%                  | 7650                    |                          |                                    |                               |     |       |
| 6    | Determine Sprinkler Reduction               | None   | 0%                    | 0                       |                          |                                    |                               |     |       |
|      |   | Non-Standard Water Supply or N/A                                   | 0%                    |                         |                          |                                    |                               |     |       |
|      |   | Not Fully Supervised or N/A  | 0%                    |                         |                          |                                    |                               |     |       |
|      |   | % Coverage of Sprinkler System                                     | 0%                    |                         |                          |                                    |                               |     |       |
| 7    | Determine Increase for Exposures (Max. 75%) | Direction  | Exposure Distance (m) | Exposed Length (m)      | Exposed Height (Stories) | Length-Height Factor (m x stories) | Construction of Adjacent Wall | -   | -     |
|      |   | North  | 0 to 3                | 8.5                     | 3                        | 0-30                               | Wood Frame or Non-Combustible | 22% | 5738  |
|      |   | East   | 0 to 3                | 30.2                    | 3                        | 91-120                             | Wood Frame or Non-Combustible | 25% |       |
|      |   | South  | 0 to 3                | 8.5                     | 3                        | 0-30                               | Wood Frame or Non-Combustible | 22% |       |
|      |   | West   | 20.1 to 30            | 30.2                    | 3                        | 91-120                             | Wood Frame or Non-Combustible | 10% |       |
| 8    | Determine Final Required Fire Flow          | Total Required Fire Flow in L/min, Rounded to Nearest 1000L/min    |                       |                         |                          |                                    |                               |     | 13000 |
|      |   | Total Required Fire Flow in L/s                                    |                       |                         |                          |                                    |                               |     | 216.7 |
|      |   | Required Duration of Fire Flow (hrs)                               |                       |                         |                          |                                    |                               |     | 2.50  |
|      |   | Required Volume of Fire Flow (m <sup>3</sup> )                     |                       |                         |                          |                                    |                               |     | 1950  |

### **A.3 EXCERPTS FROM BACKGROUND REPORTS**

|  |   |                                       |   |
|--|---|---------------------------------------|---|
|  | Innes Road and 300 mm diameter watermain on Vanguard Drive. | diameter watermain on Vanguard Drive. | Innes Road and 300 mm diameter watermain on Vanguard Drive. |
|--|---|---------------------------------------|---|

The water supply servicing strategy for the North East quadrant is included in the *Hydraulic Capacity and Modelling Analysis East Urban Community Mixed-Use Centre Development* (GeoAdvice, July 2018). Results can be found in **Appendix B** and are summarized in **Section 9.6**.

### 9.3.3 Consideration of Alternative Implementation Details for Servicing Designs

Watermain sizing was reviewed as part of MSS-level design, to address all City of Ottawa and MECP requirements. Given the background infrastructure planning in this area, the modelled watermain performance, and the efficient looped network that is proposed, no other logical or efficient alternative designs were advanced for additional analysis and evaluation.

## 9.4 South West Quadrant Preferred Water Servicing Plan

### 9.4.1 South West Existing Water Supply Servicing

An existing 400 mm diameter watermain exists within the South West quadrant on the future extension of Fern Casey Street. The 400 mm diameter watermain is connected to a 600 mm diameter watermain along the Hydro Corridor north of the quadrant, and a 300 mm diameter watermain on Renaud Road to the south of the quadrant. A network of watermains servicing existing developments exists to the south west of the quadrant and a 400 mm diameter watermain exists on Mer Bleue Road. The surrounding existing watermain network is shown in **Drawing 7**.

### 9.4.2 South West Water Supply Servicing Design

The MSU (Stantec, July 2006) reviewed the required infrastructure to service the South West quadrant of the EUC Phase 3 Area study area, which, at the time of the MSU (Stantec, July 2006), was considered a mixed use centre. Per the MSU (Stantec, July 2006), the South West quadrant was to be serviced off of the trunk infrastructure surrounding the quadrant that was identified in the hydraulic model included within the MSU (Stantec, July 2006). See **Appendix C** for details of the hydraulic model included in the MSU (Stantec, July 2006). The model indicates 400 mm diameter watermains on Fern Casey Street and Mer Bleue Road and a 300 mm diameter east-west watermain to the south of the quadrant. Local watermains varying in size from 150 mm to 200 mm diameter are shown to service the South West quadrant off the mains identified above. Fire flows of 108 L/s (6,500 L/min) for residential areas and 217 L/s (13,000 L/min) for non-residential areas were assigned as part of the hydraulic analysis. Per the MSU (Stantec, July 2006), it was recommended that any future work on the water network in the area consider higher fire flows. The South West quadrant was deemed serviceable in the MSU (Stantec, July 2006).

More recently the water supply servicing for the South West quadrant has been considered within the *Servicing Report for Trails Edge and Orléans Business Park* (DSEL, July 2017). The watermain network was updated to reflect an updated road network and projected land uses. Consistent with the MSU (Stantec, July 2006), a network of 150 mm-300 mm diameter watermains was proposed to service the South West



quadrant off the 400 mm diameter watermains on Fern Casey Street and Mer Bleue Road. Per the *Servicing Report for Trails Edge and Orléans Business Park* (DSEL, July 2017), commercial fire flow requirements were consistent with the MSU (Stantec, July 2006) and residential fire flow requirements were refined and taken as 100 L/s (6,000 L/min) for detached single homes and 125 L/s (7,500 L/min) for townhomes. Excerpts from the *Servicing Report for Trails Edge and Orléans Business Park* (DSEL, July 2017) are provided in **Appendix C**.

As part of the approved development application bordering the South West quadrant, the overall water supply servicing strategy for the quadrant has been recently reconsidered. The *Trails Edge East – Functional Servicing Report* (Stantec, August 11, 2017) proposed the South West quadrant be serviced by existing watermains on Mer Bleue Road, Renaud Road and Fern Casey Street (formerly named Belcourt Boulevard), and a proposed 300 mm watermain running through the South West quadrant (consistent with the MSU (Stantec, July 2006)). The Trailsedge East lands are undergoing detailed design & construction per the *Trails Edge East Phase 1 Servicing and Stormwater Management Report* (Stantec, August, 2018) and subsequent reports associated with the development application. Based on the construction of certain lands within the MSU (Stantec, July 2006) hydraulic model, minor deviations from the MSU (Stantec, July 2006) have been proposed within the *Trails Edge East – Functional Servicing Report* (Stantec, August 11, 2017) and the *Trails Edge East Phase 1 Servicing and Stormwater Management Report* (Stantec, August, 2018).

The *Trails Edge East – Functional Servicing Report* (Stantec, August 11, 2017) proposes a network of 300 mm and 200 mm diameter watermains, deviating from the MSU (Stantec, July 2006) use of 150 mm diameter watermains. A minimum watermain diameter of 200 mm is expected to provide the entirety of the South West quadrant with a fire flow of 217 L/s (13,000 L/min), per the *Trails Edge East – Functional Servicing Report* (Stantec, August 11, 2017). See **Appendix C** for the proposed watermain system and excerpts from the *Trails Edge East – Functional Servicing Report* (Stantec, August 11, 2017). Note that while the watermain network is not shown extended into the South West quadrant, the quadrant was taken into consideration using the City of Ottawa's Water Supply Guidelines to estimate the quadrant's water demands.

Per the *Design Brief for the Trails Edge West Richcraft Group of Companies* (DSEL, January 26, 2015), servicing of the portion of the South West quadrant west of Fern Casey Street was considered in the design of the existing watermains in the area. It was considered to be serviced off the existing watermain network to the south, via a 200 mm diameter watermain stub bordering the block (Axis Way).

Respecting the development applications within the South West quadrant, the proposed water supply servicing strategy is to have 200 mm to 300 mm diameter watermain trunks run through the South West quadrant connecting to existing surrounding watermains. Connections are proposed to the existing 400 mm diameter watermains on Fern Casey Street and Mer Bleue Road via the future watermain network to the south. Note that certain watermains detailed within the *Trails Edge East – Functional Servicing Report* (Stantec, August 11, 2017) have been upsized to 300 mm diameter. The landowner to the south has been notified and the larger watermain is to be included in the future phases of Trailsedge East design. The portion of the South West quadrant west of Fern Casey Street is proposed to be serviced by the existing 200 mm diameter watermain stub bordering the block on Axis Way. A required fire flow of 250 L/s (15,000

L/min) was assumed throughout the quadrant, which is considered appropriate for the land uses being proposed.

The proposed watermain network is provided in **Drawing 6**. Note that at this stage of analysis, only the trunk watermain within the quadrant is shown. A network of local watermains is assumed to service the South West quadrant. The details of the local watermain network are subject to change and will be addressed as design of the parcels comprising the South West quadrant advance.

A summary of the Water Supply servicing for the South West quadrant is provided in **Table 10**.

**Table 10: Summary of Water Supply Servicing – South West Quadrant**

|                    | <b>Governing Servicing Study</b>   | <b>Additional Background Servicing Study</b>   | <b>Proposed MSS</b>   |
|--------------------|--|--|---|
| Study Name         | Gloucester and Cumberland East Urban Community Expansion Area and Bilberry Creek Industrial Park Master Servicing Update (Stantec, July 2006)  | Trails Edge East – Functional Servicing Report (Stantec, August 11, 2017) and Design Brief for the Trails Edge West Richcraft Group of Companies (DSEL, January 26, 2015)  | EUC Phase 3 Area CDP MSS (June 2020)  |
| Servicing Strategy | 150 mm to 200 mm diameter watermains connecting to the 400 mm diameter watermains on Fern Casey Street and Mer Bleue Road and a 300 mm diameter east-west watermain south of quadrant. | 200 mm and 300 mm diameter watermains connecting to the existing 400 mm diameter watermains on Fern Casey Street and Mer Bleue Road via the proposed watermain network to the south. Portion of quadrant west of Fern Casey street to be serviced by 200 mm diameter stub bordering block. | 200 mm and 300 mm diameter watermains connecting to the existing 400 mm diameter watermains on Fern Casey Street and Mer Bleue Road via the proposed watermain network to the south. Portion of quadrant west of Fern Casey street to be serviced by existing 200 mm diameter stub off of Axis Way. |

The water supply servicing strategy for the South West quadrant was included in the *Hydraulic Capacity and Modelling Analysis East Urban Community Mixed-Use Centre Development* (GeoAdvice, July 2018). Results are summarized in **Section 9.6** of this MSS and in **Appendix B**.

#### **9.4.3 Consideration of Alternative Implementation Details for Servicing Designs**

Watermain sizing was reviewed as part of MSS-level design, to address all City of Ottawa and MECP requirements. Given the background infrastructure planning in this area, the modelled watermain performance, and the efficient looped network that is proposed, no other logical or efficient alternative designs were advanced for additional analysis and evaluation. Additional connections to the existing 600mm dia watermain within the Hydro Corridor may be pursued as part of detailed design, depending on phasing – see **Section 9.2.3**.





N



**Legend**

- Junction
- Connection Point
- Water Main

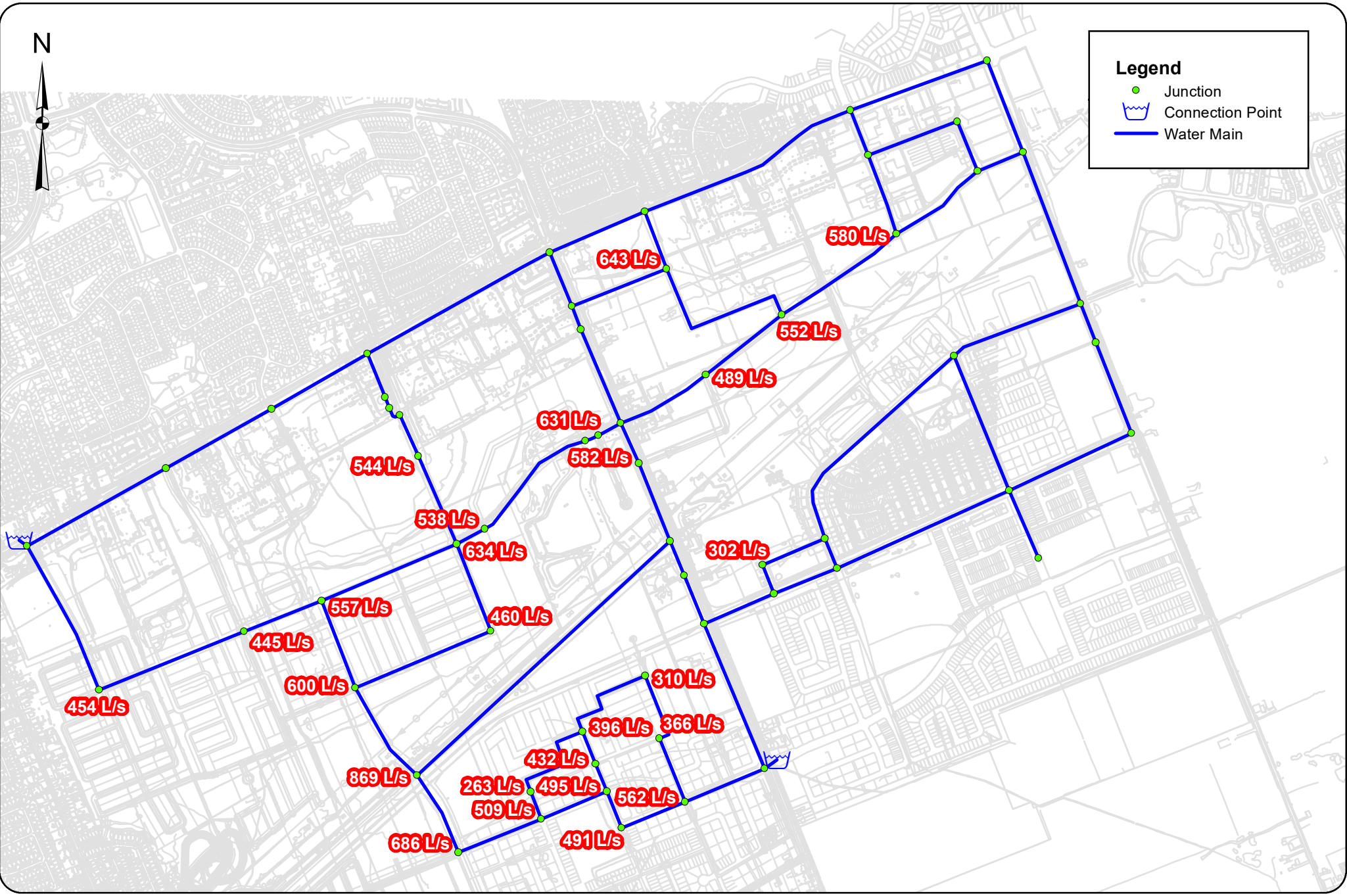

**GeoAdvice**  
Engineering Inc.

Project: **Hydraulic Capacity and Modeling Analysis East Urban Community Mixed-Use Centre Development**  
 Client: **David Schaeffer Engineering Ltd.**  
 Date: **July 2018**  
 Created by: **AM**  
 Reviewed by: **WdS**

DISCLAIMER: GeoAdvice does not warrant in any way the accuracy and completeness of the information shown on this map. Field verification of the accuracy and completeness of the information shown on this map is the sole responsibility of the user.

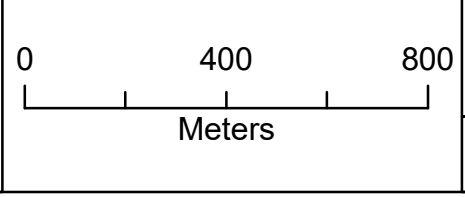

**Available Fire Flow @ 20 psi**

**Figure E.1**  
**B38**

N



**Legend**

- Junction
- Connection Point
- Water Main

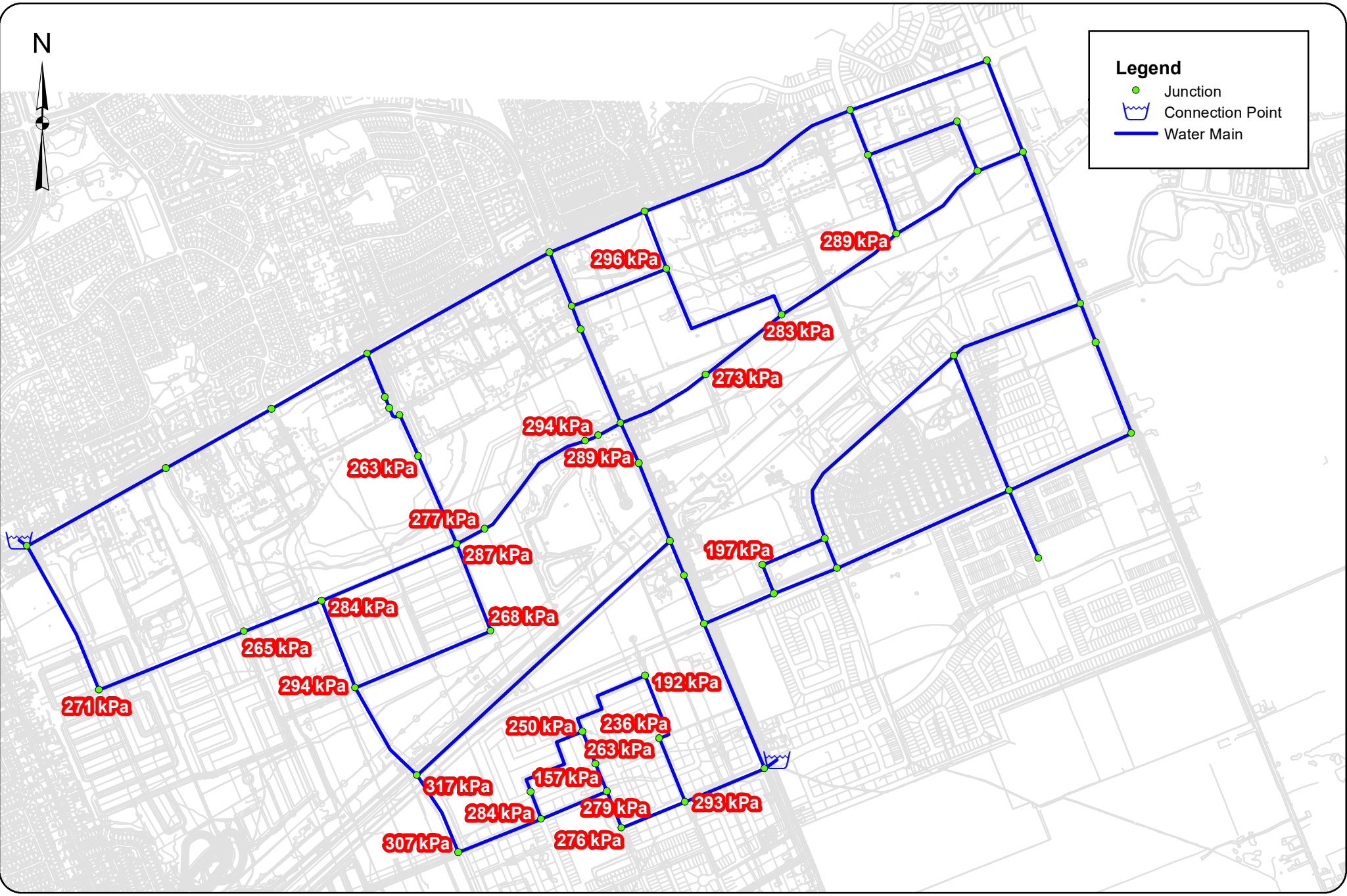

**GeoAdvice**  
Engineering Inc.

Project: **Hydraulic Capacity and Modeling Analysis East Urban Community Mixed-Use Centre Development**  
 Client: **David Schaeffer Engineering Ltd.**  
 Date: **July 2018**  
 Created by: **AM**  
 Reviewed by: **WdS**

DISCLAIMER: GeoAdvice does not warrant in any way the accuracy and completeness of the information shown on this map. Field verification of the accuracy and completeness of the information shown on this map is the sole responsibility of the user.

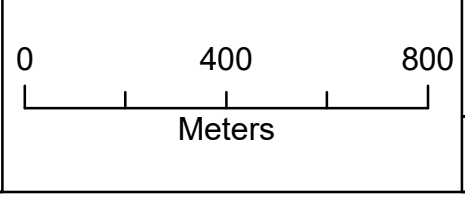

**Residual Pressure @ Required Fire Flow**

**Figure E.2**  
**B39**

## **Appendix B : WASTEWATER SERVICING**

### **B.1 SANITARY SEWER DESIGN SHEET**



SUBDIVISION:  
**Trailside East Phase 4**

DATE: 11/18/2021  
 REVISION: 1  
 DESIGNED BY: -  
 CHECKED BY: -

## SANITARY SEWER DESIGN SHEET (City of Ottawa)

FILE NUMBER: 160401250

| DESIGN PARAMETERS            |     |                          |                 |
|------------------------------|-----|--------------------------|-----------------|
| MAX PEAK FACTOR (RES.)=      | 4.0 | AVG. DAILY FLOW / PERSON | 280 l/p/day     |
| MIN PEAK FACTOR (RES.)=      | 2.0 | COMMERCIAL               | 28,000 l/ha/day |
| PEAKING FACTOR (INDUSTRIAL): | 2.4 | INDUSTRIAL (HEAVY)       | 55,000 l/ha/day |
| PEAKING FACTOR (ICI >20%):   | 1.5 | INDUSTRIAL (LIGHT)       | 35,000 l/ha/day |
| PERSONS / SINGLE             | 3.4 | INSTITUTIONAL            | 28,000 l/ha/day |
| PERSONS / TOWNHOME           | 2.7 | INFILTRATION             | 0.33 l/s/ha     |
| PERSONS / APARTMENT          | 1.8 |                          |                 |
|                              |     | MINIMUM VELOCITY         | 0.60 m/s        |
|                              |     | MAXIMUM VELOCITY         | 3.00 m/s        |
|                              |     | MANNINGS n               | 0.013           |
|                              |     | BEDDING CLASS            | B               |
|                              |     | MINIMUM COVER            | 2.50 m          |
|                              |     | HARMON CORRECTION FACTOR | 0.8             |

| LOCATION<br>AREA ID NUMBER | FROM M.H. | TO M.H. | RESIDENTIAL AREA AND POPULATION |        |            |     |      |                      |      |            | COMMERCIAL      |           | INDUSTRIAL (L)  |           | INDUSTRIAL (H)  |           | INSTITUTIONAL   |           | GREEN / UNUSED  |           | C+H<br>PEAK FLOW (l/s) | INFILTRATION    |           |                 | TOTAL FLOW (l/s) | PIPE            |                 |                    |            |          |          |        |           |                   |                      |
|----------------------------|-----------|---------|---------------------------------|--------|------------|-----|------|----------------------|------|------------|-----------------|-----------|-----------------|-----------|-----------------|-----------|-----------------|-----------|-----------------|-----------|------------------------|-----------------|-----------|-----------------|------------------|-----------------|-----------------|--------------------|------------|----------|----------|--------|-----------|-------------------|----------------------|
|                            |           |         | AREA (ha)                       | SINGLE | UNITS TOWN | APT | POP. | CUMULATIVE AREA (ha) | POP. | PEAK FACT. | PEAK FLOW (l/s) | AREA (ha) | ACCU. AREA (ha) | AREA (ha) | ACCU. AREA (ha) | AREA (ha) | ACCU. AREA (ha) | AREA (ha) | ACCU. AREA (ha) | AREA (ha) |                        | ACCU. AREA (ha) | AREA (ha) | ACCU. AREA (ha) |                  | TOTAL AREA (ha) | ACCU. AREA (ha) | INFILT. FLOW (l/s) | LENGTH (m) | DIA (mm) | MATERIAL | CLASS  | SLOPE (%) | CAP. (FULL) (l/s) | CAP. V PEAK FLOW (%) |
| R416A                      | 416       | 415     | 0.00                            | 0      | 0          | 0   | 1014 | 0.00                 | 1014 | 3.24       | 10.6            | 7.04      | 7.04            | 0.00      | 0.00            | 0.00      | 0.00            | 0.00      | 0.00            | 0.00      | 0.00                   | 3.4             | 7.04      | 7.04            | 2.3              | 16.4            | 43.4            | 375                | PVC        | SDR 35   | 0.15     | 62.9   | 26.06%    | 0.60              | 0.42                 |
| R415A                      | 415       | 409     | 1.01                            | 21     | 0          | 0   | 71   | 1.01                 | 1085 | 3.22       | 11.3            | 0.00      | 7.04            | 0.00      | 0.00            | 0.00      | 0.00            | 0.00      | 0.00            | 0.00      | 3.4                    | 1.01            | 8.05      | 2.7             | 17.4             | 120.9           | 375             | PVC                | SDR 35     | 0.15     | 62.9     | 27.69% | 0.60      | 0.42              |                      |
| R413A                      | 413       | 412     | 1.69                            | 5      | 57         | 0   | 171  | 1.69                 | 171  | 3.54       | 2.0             | 0.00      | 0.00            | 0.00      | 0.00            | 0.00      | 0.00            | 0.00      | 0.00            | 0.00      | 0.0                    | 1.69            | 1.69      | 0.6             | 2.5              | 113.7           | 200             | PVC                | SDR 35     | 0.50     | 23.6     | 10.65% | 0.74      | 0.40              |                      |
| C414A                      | 414       | 412     | 0.00                            | 0      | 0          | 0   | 0    | 0.00                 | 0    | 3.80       | 0.0             | 4.26      | 4.26            | 0.00      | 0.00            | 0.00      | 0.00            | 0.00      | 0.00            | 0.00      | 2.1                    | 4.26            | 4.26      | 1.4             | 3.5              | 41.5            | 250             | PVC                | SDR 35     | 0.30     | 33.2     | 10.46% | 0.67      | 0.36              |                      |
| R412A                      | 412       | 411     | 1.58                            | 10     | 13         | 0   | 69   | 3.27                 | 240  | 3.49       | 2.7             | 0.00      | 4.26            | 0.00      | 0.00            | 0.00      | 0.00            | 0.00      | 0.00            | 0.00      | 2.1                    | 1.58            | 7.53      | 2.5             | 7.3              | 79.5            | 250             | PVC                | SDR 35     | 0.30     | 33.2     | 21.89% | 0.67      | 0.45              |                      |
| R411A                      | 411       | 410     | 2.57                            | 34     | 23         | 0   | 178  | 5.84                 | 418  | 3.41       | 4.6             | 0.00      | 4.26            | 0.00      | 0.00            | 0.00      | 0.00            | 0.00      | 0.00            | 0.00      | 2.1                    | 2.57            | 10.10     | 3.3             | 10.0             | 243.0           | 250             | PVC                | SDR 35     | 0.30     | 33.2     | 30.17% | 0.67      | 0.49              |                      |
| R410A                      | 410       | 409     | 0.72                            | 13     | 0          | 0   | 44   | 6.57                 | 462  | 3.39       | 5.1             | 0.00      | 4.26            | 0.00      | 0.00            | 0.00      | 0.00            | 0.00      | 0.00            | 0.00      | 2.1                    | 0.72            | 10.82     | 3.6             | 10.7             | 73.8            | 250             | PVC                | SDR 35     | 0.30     | 33.2     | 32.28% | 0.67      | 0.50              |                      |
|                            | 409       | 405     | 0.00                            | 0      | 0          | 0   | 0    | 7.58                 | 1547 | 3.14       | 15.7            | 0.00      | 11.29           | 0.00      | 0.00            | 0.00      | 0.00            | 0.00      | 0.00            | 0.00      | 5.5                    | 0.00            | 18.87     | 6.2             | 27.4             | 84.0            | 375             | PVC                | SDR 35     | 0.15     | 62.9     | 43.65% | 0.60      | 0.49              |                      |
| R407A                      | 407       | 406     | 1.05                            | 6      | 22         | 0   | 80   | 1.05                 | 80   | 3.62       | 0.9             | 0.00      | 0.00            | 0.00      | 0.00            | 0.00      | 0.00            | 0.00      | 0.00            | 0.00      | 0.0                    | 1.05            | 1.05      | 0.3             | 1.3              | 97.7            | 200             | PVC                | SDR 35     | 0.50     | 23.6     | 5.43%  | 0.74      | 0.33              |                      |
| R406A                      | 406       | 405     | 1.37                            | 12     | 28         | 0   | 116  | 2.42                 | 196  | 3.52       | 2.2             | 0.00      | 0.00            | 0.00      | 0.00            | 0.00      | 0.00            | 0.00      | 0.00            | 0.00      | 0.0                    | 1.37            | 2.42      | 0.8             | 3.0              | 128.6           | 200             | PVC                | SDR 35     | 0.50     | 23.6     | 12.85% | 0.74      | 0.42              |                      |
| R408A                      | 408       | 405     | 0.73                            | 0      | 29         | 0   | 78   | 0.73                 | 78   | 3.62       | 0.9             | 0.00      | 0.00            | 0.00      | 0.00            | 0.00      | 0.00            | 0.00      | 0.00            | 0.00      | 0.0                    | 0.73            | 0.73      | 0.2             | 1.2              | 108.8           | 200             | PVC                | SDR 35     | 0.50     | 23.6     | 4.90%  | 0.74      | 0.32              |                      |
|                            | 405       | 404     | 0.00                            | 0      | 0          | 0   | 0    | 10.73                | 1822 | 3.09       | 18.3            | 0.00      | 11.29           | 0.00      | 0.00            | 0.00      | 0.00            | 0.00      | 0.00            | 0.00      | 5.5                    | 0.00            | 22.02     | 7.3             | 31.0             | 79.0            | 375             | PVC                | SDR 35     | 0.15     | 62.9     | 49.35% | 0.60      | 0.51              |                      |
| R404A                      | 404       | 403     | 1.80                            | 35     | 0          | 0   | 119  | 12.53                | 1941 | 3.08       | 19.4            | 0.00      | 11.29           | 0.00      | 0.00            | 0.00      | 0.00            | 0.00      | 0.00            | 0.00      | 5.5                    | 1.80            | 23.82     | 7.9             | 32.7             | 128.2           | 375             | PVC                | SDR 35     | 0.15     | 62.9     | 52.02% | 0.60      | 0.51              |                      |
|                            | 403       | 401     | 0.00                            | 0      | 0          | 0   | 0    | 12.53                | 1941 | 3.08       | 19.4            | 0.00      | 11.29           | 0.00      | 0.00            | 0.00      | 0.00            | 0.00      | 0.00            | 0.00      | 5.5                    | 0.00            | 23.82     | 7.9             | 32.7             | 48.5            | 375             | PVC                | SDR 35     | 0.15     | 62.9     | 52.02% | 0.60      | 0.51              |                      |
| R402A                      | 402       | 401     | 1.78                            | 0      | 63         | 0   | 170  | 1.78                 | 170  | 3.54       | 2.0             | 0.00      | 0.00            | 0.00      | 0.00            | 0.00      | 0.00            | 0.00      | 0.00            | 0.0       | 1.78                   | 1.78            | 0.6       | 2.5             | 113.3            | 200             | PVC             | SDR 35             | 0.50       | 23.6     | 10.73%   | 0.74   | 0.41      |                   |                      |
|                            | 401       | 104A    | 0.00                            | 0      | 0          | 0   | 0    | 14.31                | 2111 | 3.05       | 20.9            | 0.00      | 11.29           | 0.00      | 0.00            | 0.00      | 0.00            | 0.00      | 0.00            | 0.00      | 5.5                    | 0.00            | 25.60     | 8.4             | 34.8             | 14.9            | 375             | PVC                | SDR 35     | 0.30     | 88.9     | 39.18% | 0.84      | 0.67              |                      |
|                            | 104A      | 104     | 0.00                            | 0      | 0          | 0   | 0    | 14.31                | 2111 | 3.05       | 20.9            | 0.00      | 11.29           | 0.00      | 0.00            | 0.00      | 0.00            | 0.00      | 0.00            | 0.00      | 5.5                    | 0.00            | 25.60     | 8.4             | 34.8             | 23.0            | 375             | PVC                | SDR 35     | 0.30     | 88.9     | 39.18% | 0.84      | 0.67              |                      |
| R106B                      | 106       | 105     | 0.55                            | 0      | 25         | 0   | 68   | 0.55                 | 68   | 3.63       | 0.8             | 0.00      | 0.00            | 0.00      | 0.00            | 0.00      | 0.00            | 0.00      | 0.00            | 0.0       | 0.55                   | 0.55            | 0.2       | 1.0             | 85.6             | 200             | PVC             | SDR 35             | 0.10       | 10.6     | 9.21%    | 0.33   | 0.17      |                   |                      |
| R105A                      | 105       | 104     | 0.03                            | 0      | 0          | 0   | 0    | 0.58                 | 68   | 3.63       | 0.8             | 0.00      | 0.00            | 0.00      | 0.00            | 0.00      | 0.00            | 0.00      | 0.00            | 0.0       | 0.03                   | 0.58            | 0.2       | 1.0             | 10.5             | 200             | PVC             | SDR 35             | 0.10       | 10.6     | 9.31%    | 0.33   | 0.17      |                   |                      |
|                            | 104       | 103     | 0.00                            | 0      | 0          | 0   | 0    | 14.88                | 2178 | 3.05       | 21.5            | 0.00      | 11.29           | 0.00      | 0.00            | 0.00      | 0.00            | 0.00      | 0.00            | 0.00      | 5.5                    | 0.00            | 26.18     | 8.6             | 35.6             | 41.8            | 375             | PVC                | SDR 35     | 0.14     | 60.7     | 58.66% | 0.58      | 0.51              |                      |
| R107B                      | 107       | 103     | 0.41                            | 0      | 12         | 0   | 32   | 0.41                 | 32   | 3.68       | 0.4             | 0.00      | 0.00            | 0.00      | 0.00            | 0.00      | 0.00            | 0.00      | 0.00            | 0.0       | 0.41                   | 0.41            | 0.1       | 0.5             | 93.6             | 200             | PVC             | SDR 35             | 0.10       | 10.6     | 4.95%    | 0.33   | 0.14      |                   |                      |
| R103A                      | 103       | 102     | 0.51                            | 0      | 10         | 0   | 27   | 15.81                | 2238 | 3.04       | 22.0            | 0.00      | 11.29           | 0.00      | 0.00            | 0.00      | 0.00            | 0.00      | 0.00            | 0.00      | 5.5                    | 0.51            | 27.10     | 8.9             | 36.5             | 80.5            | 375             | PVC                | SDR 35     | 0.16     | 64.9     | 56.16% | 0.62      | 0.55              |                      |
| R102A                      | 102       | 101     | 0.23                            | 0      | 5          | 0   | 14   | 16.04                | 2251 | 3.04       | 22.2            | 0.00      | 11.29           | 0.00      | 0.00            | 0.00      | 0.00            | 0.00      | 0.00            | 0.00      | 5.5                    | 0.23            | 27.33     | 9.0             | 36.7             | 47.0            | 375             | PVC                | SDR 35     | 0.15     | 62.7     | 58.50% | 0.59      | 0.53              |                      |
| R400B, R400A               | 400       | 101A    | 3.30                            | 0      | 25         | 0   | 513  | 3.30                 | 513  | 3.37       | 5.6             | 0.00      | 0.00            | 0.00      | 0.00            | 0.00      | 0.00            | 0.00      | 0.00            | 0.0       | 3.30                   | 3.30            | 1.1       | 6.7             | 218.1            | 200             | PVC             | SDR 35             | 0.50       | 23.6     | 28.31%   | 0.74   | 0.54      |                   |                      |
|                            | 101A      | 101     | 0.00                            | 0      | 0          | 0   | 0    | 3.30                 | 513  | 3.37       | 5.6             | 0.00      | 0.00            | 0.00      | 0.00            | 0.00      | 0.00            | 0.00      | 0.00            | 0.0       | 0.00                   | 3.30            | 1.1       | 6.7             | 48.0             | 200             | PVC             | SDR 35             | 0.50       | 23.7     | 28.30%   | 0.74   | 0.54      |                   |                      |
| R101A                      | 101       | 100     | 0.46                            | 0      | 0          | 0   | 0    | 19.79                | 2764 | 2.98       | 26.7            | 0.00      | 11.29           | 0.00      | 0.00            | 0.00      | 0.00            | 0.00      | 0.00            | 0.00      | 5.5                    | 0.46            | 31.08     | 10.3            | 42.4             | 105.0           | 375             | PVC                | SDR 35     | 0.22     | 76.1     | 55.72% | 0.72      | 0.64              |                      |



## **B.2 EXCERPTS FROM BACKGROUND REPORTS**

sewer on Renaud Road. The Renaud Road sanitary sewer ultimately outlets to the Forest Valley Pump Station to the west. The existing sanitary sewer network is shown in **Drawing 7**.

#### **10.4.2 South West Wastewater Design**

The MSU (Stantec, July 2006) reviewed the required infrastructure to service the wastewater of the South West quadrant. The South West quadrant is tributary to the Forest Valley Pump Station. The MSU (Stantec, July 2006) considered the South West quadrant to be serviced by a 375 mm diameter trunk sanitary sewer to the south of the quadrant, running westward before ultimately draining into a 600 mm diameter sewer on Renaud Road (formerly named Fourth Line Road). The sanitary collector sewers considered in the MSU (Stantec, July 2006) can be seen in **Appendix D**. A peak sanitary flow of 29.40 L/s was considered within the MSU (Stantec, July 2006). Note that no commercial flows were applied to the quadrant within the MSU (Stantec, July 2006), although the area was contemplated as mixed-use.

More recently the wastewater servicing of the South West quadrant and its surrounding area has been considered within the *Servicing Report for Trails Edge and Orléans Business Park* (DSEL, July 2017). See **Appendix D** for excerpts from the *Servicing Report for Trails Edge and Orléans Business Park* (DSEL, July 2017).

Since the completion of the MSU (Stantec, July 2006), the wastewater servicing of the South West quadrant has been considered during the construction of downstream infrastructure. The *Design Brief – Minto Trailsedge Phase II* (IBI Group, May 2015) includes the wastewater drainage for the portion of the South West quadrant that is east of Fern Casey Street. Per the *Design Brief – Minto Trailsedge Phase II* (IBI Group, May 2015), the downstream wastewater infrastructure anticipated a total peak flow allowance of 45.97 L/s at the South West quadrant's outlet, MH35A. See **Appendix D**, for sanitary drainage information and flow allowance calculations. It can be concluded that the capacity in the constructed downstream infrastructure exceeds the capacity that was considered within the MSU (Stantec, July 2006).

The wastewater servicing for the South West quadrant has also been considered as part of an approved development application neighbouring the South West quadrant. Per the *Trails Edge East – Functional Servicing Report* (Stantec, August 11, 2017), an additional 2.96 ha area drains to the existing MH35A along with the portion of the South West quadrant east of Fern Casey Street. The Trailsedge East lands are undergoing detailed design and construction. Per the *Trails Edge East Phase 1 Servicing and Stormwater Management Report* (Stantec, August 2018) and subsequent reports associated with the development application, the additional area has been refined to a 1.92 ha area with a population of 105 persons draining to the existing MH35A along with the portion of the South West quadrant that is east of Fern Casey Street. Note that the *Trails Edge East Phase 1 Servicing and Stormwater Management Report* (Stantec, August 2018) proposes to accommodate the wastewater flows from the South West quadrant through 2 inlet locations. All wastewater flows from the South West quadrant east of Fern Casey Street are still proposed to be directed towards existing manhole MH35A, despite the multiple inlet locations. See **Appendix D** for details.

The *Design Brief for the Trails Edge West Richcraft Group of Companies* (DSEL, January 26, 2015) includes the wastewater drainage for the portion of the South West quadrant west of Fern Casey Street. A

peak flow allowance of 4.07 L/s at existing MH37A was considered in the constructed wastewater infrastructure for the portion of the South West quadrant that is west of Fern Casey Street. See **Appendix D** for sanitary drainage information and flow allowance calculations.

Respecting the MSU (Stantec, July 2006), existing wastewater infrastructure and development applications within the South East quadrant, the proposed sanitary servicing strategy is to have all flows from the quadrant drain to the Forest Valley Pump Station via the existing 600 mm diameter sanitary sewer on Renaud Road. The proposed sanitary sewer network is shown in **Drawing 5**. A sewer is proposed to cross Brian Coburn Boulevard at an existing gap in underground services – coordination will be required for work in the ROW, including utility coordination.

At this stage of analysis, only the trunk sanitary sewer within the quadrant is shown. To demonstrate servicing feasibility, the trunk sewer is carried back at minimum possible slopes while accounting for drops at manholes, existing infrastructure sizing, and possible conflicts with crossing other sewers. As the design of the South West quadrant advances, the sanitary sewer network details are subject to change; for example, to be raised where appropriate to offer construction cost savings, provided that the conditions in **Section 14** related to minor changes are met. Additional springline connections and/or reduced drops across maintenance holes may be proposed as part of detailed design, to assist in minimizing grade raise requirements, provided that the conditions in **Section 14** related to minor changes are met. These are currently considered deviations from City Standards, and will require review on a case-by-case basis.

As shown in the design sheet included in **Appendix D**, the anticipated peak sanitary flow from the portion of the quadrant east of Fern Casey Street is 38.08 L/s. Including the additional 1.92 ha and population of 105 as per *Trails Edge East Phase 1 Servicing and Stormwater Management Report* (Stantec, August 2018), the total peak sanitary flow to existing MH35A is 39.66 L/s. This represents roughly 86% of the 45.97 L/s allowance reported within the *Design Brief – Minto Trailsedge Phase II* (IBI Group, May 2015). Therefore, the existing downstream wastewater infrastructure is demonstrated to adequately service the portion of the South West quadrant east of Fern Casey Street.

Please note that consistent with the *Trails Edge East – Functional Servicing Report* (Stantec, August 11, 2017), the wastewater flows from the South West quadrant east of Fern Casey Street are shown directed towards one outlet in this MSS for the purpose of high-level serviceability review. Outlets and routing alternatives may be refined as the design process advances, based on the constructed downstream infrastructure (e.g. to direct flows to the constructed two outlets).

The anticipated peak sanitary flow from the portion of the South West quadrant that is west of Fern Casey Street is 7.03 L/s, which is larger than the 4.07 L/s allowance considered in the *Design Brief for the Trails Edge West Richcraft Group of Companies* (DSEL, January 26, 2015). The primary reason for the increase in wastewater flows is a proposed increase of the population from 184 to 532 based on the high-level demand estimate assumptions adopted in this MSS. A check of the downstream sanitary sewers considered in the *Design Brief for the Trails Edge West Richcraft Group of Companies* (DSEL, January 26, 2015) shows that the constraining segment (MH160A – MH17A) still has 22% residual capacity with the addition of the proposed population increase of 348 persons. See **Appendix D** for detailed calculations. Therefore it is concluded that the existing downstream wastewater infrastructure can adequately service

the portion of the South West quadrant that is west of Fern Casey Street. It is expected that capacity will be confirmed as part of detailed design and operational requirements for the downstream Forest Valley Pump Station and Forest Valley Trunk will be assessed by the City of Ottawa for the contributing flows described in this MSS, as part of their City-wide growth assessments, infrastructure management, etc.

A summary of the wastewater servicing for the South West quadrant is provided in **Table 17**.

**Table 17: Summary of Wastewater Servicing – South West Quadrant**

|                                   | <b>Governing Servicing Study</b>   | <b>Additional Background Servicing Study</b>   | <b>Proposed MSS</b>  |
|-----------------------------------|--|--|--|
| Study Name                        | Gloucester and Cumberland East Urban Community Expansion Area and Bilberry Creek Industrial Park Master Servicing Update (Stantec, July 2006)            | Design Brief for the Trails Edge West Richcraft Group of Companies (DSEL, January 26, 2015) and Design Brief – Minto Trailsedge Phase II (IBI Group, May 2015)             | EUC Phase 3 Area CDP MSS (June 2020)   |
| Servicing Strategy                | Quadrant to be serviced by the Forest Valley Pump Station and the 600 mm diameter sewer on Renaud Road via the sanitary sewer network to the south west. | Quadrant to be serviced by the Forest Valley Pump Station and the existing 600 mm diameter sewer on Renaud Road via the existing sanitary sewer network to the south west. | Quadrant to be serviced by the Forest Valley Pump Station and the existing 600 mm diameter sewer on Renaud Road via the existing sanitary sewer network to the south west. |
| Total Drainage Area to Ex MH37A   | N/A  | 3.84 ha.   | 3.69 ha.   |
| Residential Peak Flow to Ex MH37A | N/A  | 2.98 L/s   | 5.81 L/s.  |
| ICI Peak Flow to Ex MH37A         | N/A  | 0 L/s.   | 0 L/s.   |
| Peak Total Flow to Ex MH37A       | N/A  | 4.07 L/s.  | 7.03 L/s.  |
| Total Drainage Area to Ex MH35A   | N/A  | 42.80 ha.  | 29.54 ha. (31.46 ha including future area to the south).   |
| Residential Peak Flow to Ex MH35A | N/A  | 31.97 L/s  | 23.41 L/s. (24.36 L/s including future area to the south).   |
| ICI Peak Flow to Ex MH35A         | N/A  | 2.01 L/s.  | 4.92 L/s.  |
| Peak Total Flow to Ex MH35A       | N/A  | 45.97 L/s.   | 38.08 L/s. (39.66 L/s including future area to the south).   |





SUBDIVISION:  
**TrailsEdge East**

DATE: 24/7/2019  
REVISION: 2  
DESIGNED BY: MJS/SG  
CHECKED BY: DT

**SANITARY SEWER  
DESIGN SHEET**  
(City of Ottawa)

FILE NUMBER: 160401250

|                              |     | DESIGN PARAMETERS        |              |
|------------------------------|-----|--------------------------|--------------|
| MAX PEAK FACTOR (RES.)=      | 4.0 | AVG. DAILY FLOW / PERSON | 280 l/day    |
| MIN PEAK FACTOR (RES.)=      | 2.0 | COMMERCIAL               | 28,000 l/day |
| PEAKING FACTOR (INDUSTRIAL): | 2.4 | INDUSTRIAL (HEAVY)       | 55,000 l/day |
| PEAKING FACTOR (ICI >20%):   | 1.5 | INDUSTRIAL (LIGHT)       | 35,000 l/day |
| PERSONS / SINGLE             | 3.4 | INSTITUTIONAL            | 28,000 l/day |
| PERSONS / TOWNHOME           | 2.7 | INFILTRATION             | 0.33 l/s/ha  |
| PERSONS / APARTMENT          | 1.8 |                          |              |
|                              |     | MINIMUM VELOCITY         | 0.60 m/s     |
|                              |     | MAXIMUM VELOCITY         | 3.00 m/s     |
|                              |     | MANNINGS n               | 0.013        |
|                              |     | BEDDING CLASS            | B            |
|                              |     | MINIMUM COVER            | 2.50 m       |
|                              |     | HARMON CORRECTION FACTOR | 0.8          |

| LOCATION      | FROM           |      | RESIDENTIAL AREA AND POPULATION |           |        |            |     |      | COMMERCIAL           |      | INDUSTRIAL (L) |                 | INDUSTRIAL (H) |                 | INSTITUTIONAL |                 | GREEN / UNUSED |                 | C+H  | INFILTRATION |                 |                 | TOTAL FLOW (l/s) | PIPE            |                    |            |          |          |        |           |                   |                       |                   |                   |
|---------------|----------------|------|---------------------------------|-----------|--------|------------|-----|------|----------------------|------|----------------|-----------------|----------------|-----------------|---------------|-----------------|----------------|-----------------|------|--------------|-----------------|-----------------|------------------|-----------------|--------------------|------------|----------|----------|--------|-----------|-------------------|-----------------------|-------------------|-------------------|
|               | AREA ID NUMBER | M.H. | M.H.                            | AREA (ha) | SINGLE | UNITS TOWN | APT | POP. | CUMULATIVE AREA (ha) | POP. | PEAK FACT.     | PEAK FLOW (l/s) | AREA (ha)      | ACCU. AREA (ha) | AREA (ha)     | ACCU. AREA (ha) | AREA (ha)      | ACCU. AREA (ha) |      | AREA (ha)    | ACCU. AREA (ha) | TOTAL AREA (ha) |                  | ACCU. AREA (ha) | INFILT. FLOW (l/s) | LENGTH (m) | DIA (mm) | MATERIAL | CLASS  | SLOPE (%) | CAP. (FULL) (l/s) | CAP. V. PEAK FLOW (%) | VEL. (FULL) (m/s) | VEL. (ACT.) (m/s) |
| RENAUD, L237A | 237            | 236  |                                 | 5.19      | 4      | 0          | 0   | 245  | 5.19                 | 245  | 3.49           | 2.8             | 0.00           | 0.00            | 0.00          | 0.00            | 0.00           | 0.00            | 0.00 | 0.00         | 0.00            | 5.19            | 5.19             | 1.7             | 4.5                | 54.7       | 200      | PVC      | SDR 35 | 0.35      | 19.8              | 22.65%                | 0.62              | 0.42              |
| R236A         | 236            | 235  |                                 | 0.24      | 5      | 0          | 0   | 17   | 5.43                 | 262  | 3.48           | 3.0             | 0.00           | 0.00            | 0.00          | 0.00            | 0.00           | 0.00            | 0.00 | 0.00         | 0.00            | 0.24            | 5.43             | 1.8             | 4.7                | 26.9       | 200      | PVC      | SDR 35 | 0.35      | 19.8              | 23.98%                | 0.62              | 0.42              |
| R235A         | 235            | 206  |                                 | 0.86      | 17     | 0          | 0   | 58   | 6.29                 | 319  | 3.45           | 3.6             | 0.00           | 0.00            | 0.00          | 0.00            | 0.00           | 0.00            | 0.00 | 0.00         | 0.00            | 0.86            | 6.29             | 2.1             | 5.6                | 120.0      | 200      | PVC      | SDR 35 | 0.35      | 19.8              | 28.56%                | 0.62              | 0.45              |
| Phase 2       | Stub           | 218  |                                 | 3.84      | 38     | 47         | 0   | 256  | 3.84                 | 256  | 3.49           | 2.9             | 0.00           | 0.00            | 0.00          | 0.00            | 0.00           | 0.00            | 0.00 | 0.00         | 0.00            | 3.84            | 3.84             | 1.3             | 4.2                | 43.4       | 200      | PVC      | SDR 35 | 0.40      | 21.1              | 19.67%                | 0.67              | 0.43              |
| R107A         | 107            | 225  |                                 | 0.43      | 0      | 14         | 0   | 38   | 0.43                 | 38   | 3.67           | 0.4             | 0.00           | 0.00            | 0.00          | 0.00            | 0.00           | 0.00            | 0.00 | 0.00         | 0.00            | 0.43            | 0.43             | 0.1             | 0.6                | 120.0      | 200      | PVC      | SDR 35 | 0.50      | 23.6              | 2.50%                 | 0.74              | 0.27              |
| R227A         | 227            | 226  |                                 | 0.14      | 0      | 5          | 0   | 14   | 0.14                 | 14   | 3.72           | 0.2             | 0.00           | 0.00            | 0.00          | 0.00            | 0.00           | 0.00            | 0.00 | 0.00         | 0.00            | 0.14            | 0.14             | 0.0             | 0.2                | 18.5       | 200      | PVC      | SDR 35 | 1.00      | 33.4              | 0.62%                 | 1.05              | 0.26              |
| R106A         | 106            | 226  |                                 | 0.36      | 0      | 14         | 0   | 38   | 0.36                 | 38   | 3.67           | 0.4             | 0.00           | 0.00            | 0.00          | 0.00            | 0.00           | 0.00            | 0.00 | 0.00         | 0.00            | 0.36            | 0.36             | 0.1             | 0.6                | 120.0      | 200      | PVC      | SDR 35 | 0.50      | 23.6              | 2.41%                 | 0.74              | 0.26              |
| R226A         | 226            | 225  |                                 | 0.18      | 0      | 6          | 0   | 16   | 0.68                 | 68   | 3.63           | 0.8             | 0.00           | 0.00            | 0.00          | 0.00            | 0.00           | 0.00            | 0.00 | 0.00         | 0.00            | 0.18            | 0.68             | 0.2             | 1.0                | 49.3       | 200      | PVC      | SDR 35 | 0.50      | 23.6              | 4.31%                 | 0.74              | 0.31              |
| R225A         | 225            | 224  |                                 | 0.42      | 0      | 14         | 0   | 38   | 1.53                 | 143  | 3.56           | 1.7             | 0.00           | 0.00            | 0.00          | 0.00            | 0.00           | 0.00            | 0.00 | 0.00         | 0.00            | 0.42            | 1.53             | 0.5             | 2.2                | 110.5      | 200      | PVC      | SDR 35 | 0.75      | 29.0              | 7.44%                 | 0.91              | 0.44              |
| Phases 2, 3   | Stub           | 224  |                                 | 10.13     | 13     | 279        | 0   | 798  | 10.13                | 798  | 3.29           | 8.5             | 0.00           | 0.00            | 0.00          | 0.00            | 0.00           | 0.00            | 0.00 | 0.00         | 0.00            | 10.13           | 10.13            | 3.3             | 11.8               | 17.8       | 200      | PVC      | SDR 35 | 0.50      | 23.6              | 50.09%                | 0.74              | 0.64              |
| G224A         | Stub           | 224  |                                 | 0.00      | 0      | 0          | 0   | 0    | 0.00                 | 0    | 3.80           | 0.0             | 0.00           | 0.00            | 0.00          | 0.00            | 0.00           | 0.00            | 0.00 | 0.00         | 2.22            | 2.22            | 0.0              | 0.7             | 18.1               | 200        | PVC      | SDR 35   | 0.50   | 23.6      | 3.10%             | 0.74                  | 0.28              |                   |
| R224A         | 224            | 218  |                                 | 0.35      | 5      | 0          | 0   | 17   | 12.01                | 958  | 3.25           | 10.1            | 0.00           | 0.00            | 0.00          | 0.00            | 0.00           | 0.00            | 0.00 | 0.00         | 0.00            | 0.35            | 14.23            | 4.7             | 14.8               | 64.8       | 200      | PVC      | SDR 35 | 0.50      | 23.6              | 62.52%                | 0.74              | 0.68              |
| R218A         | 218            | 206  |                                 | 0.16      | 0      | 0          | 0   | 0    | 16.01                | 1214 | 3.20           | 12.6            | 0.00           | 0.00            | 0.00          | 0.00            | 0.00           | 0.00            | 0.00 | 0.00         | 0.00            | 0.16            | 18.23            | 6.0             | 18.6               | 79.0       | 250      | PVC      | SDR 35 | 0.50      | 42.9              | 43.35%                | 0.86              | 0.71              |
| Phase 2       | 207            | 206  |                                 | 7.16      | 0      | 0          | 0   | 429  | 7.16                 | 429  | 3.41           | 4.7             | 0.00           | 0.00            | 0.00          | 0.00            | 0.00           | 0.00            | 0.00 | 0.00         | 0.00            | 7.16            | 7.16             | 2.4             | 7.1                | 43.6       | 200      | PVC      | SDR 35 | 0.40      | 21.1              | 33.57%                | 0.67              | 0.51              |
| R206A         | 206            | 205  |                                 | 0.53      | 11     | 0          | 0   | 37   | 29.99                | 2000 | 3.07           | 19.9            | 0.00           | 0.00            | 0.00          | 0.00            | 0.00           | 0.00            | 0.00 | 0.00         | 0.00            | 0.53            | 32.21            | 10.6            | 30.5               | 81.0       | 300      | PVC      | SDR 35 | 0.30      | 52.6              | 58.02%                | 0.75              | 0.67              |
| R232B         | 232            | 233  |                                 | 0.17      | 1      | 0          | 0   | 3    | 0.17                 | 3    | 3.76           | 0.0             | 0.00           | 0.00            | 0.00          | 0.00            | 0.00           | 0.00            | 0.00 | 0.00         | 0.00            | 0.17            | 0.17             | 0.1             | 0.1                | 9.5        | 200      | PVC      | SDR 35 | 0.65      | 27.0              | 0.37%                 | 0.85              | 0.16              |
| R233A         | 233            | 234  |                                 | 0.49      | 9      | 0          | 0   | 31   | 0.67                 | 34   | 3.68           | 0.4             | 0.00           | 0.00            | 0.00          | 0.00            | 0.00           | 0.00            | 0.00 | 0.00         | 0.00            | 0.49            | 0.67             | 0.2             | 0.6                | 68.0       | 200      | PVC      | SDR 35 | 0.50      | 23.6              | 2.65%                 | 0.74              | 0.27              |
| R234A         | 234            | 205  |                                 | 0.25      | 4      | 0          | 0   | 14   | 0.92                 | 48   | 3.66           | 0.6             | 0.00           | 0.00            | 0.00          | 0.00            | 0.00           | 0.00            | 0.00 | 0.00         | 0.00            | 0.25            | 0.92             | 0.3             | 0.9                | 58.0       | 200      | PVC      | SDR 35 | 1.05      | 34.3              | 2.53%                 | 1.08              | 0.39              |
| R205A         | 205            | 204  |                                 | 0.55      | 11     | 0          | 0   | 37   | 31.46                | 2085 | 3.06           | 20.7            | 0.00           | 0.00            | 0.00          | 0.00            | 0.00           | 0.00            | 0.00 | 0.00         | 0.00            | 0.55            | 33.68            | 11.1            | 31.8               | 79.0       | 300      | PVC      | SDR 35 | 0.30      | 52.6              | 60.41%                | 0.75              | 0.68              |
| R232A         | 232            | 231  |                                 | 0.33      | 5      | 0          | 0   | 17   | 0.33                 | 17   | 3.71           | 0.2             | 0.00           | 0.00            | 0.00          | 0.00            | 0.00           | 0.00            | 0.00 | 0.00         | 0.00            | 0.33            | 0.33             | 0.1             | 0.3                | 64.4       | 200      | PVC      | SDR 35 | 0.65      | 27.0              | 1.17%                 | 0.85              | 0.24              |
| R231A         | 231            | 230  |                                 | 0.23      | 1      | 0          | 0   | 3    | 0.56                 | 20   | 3.70           | 0.2             | 0.00           | 0.00            | 0.00          | 0.00            | 0.00           | 0.00            | 0.00 | 0.00         | 0.00            | 0.23            | 0.56             | 0.2             | 0.4                | 11.8       | 200      | PVC      | SDR 35 | 0.65      | 27.0              | 1.60%                 | 0.85              | 0.26              |
| R230A         | 230            | 229  |                                 | 0.55      | 10     | 0          | 0   | 34   | 1.11                 | 54   | 3.65           | 0.6             | 0.00           | 0.00            | 0.00          | 0.00            | 0.00           | 0.00            | 0.00 | 0.00         | 0.00            | 0.55            | 1.11             | 0.4             | 1.0                | 67.3       | 200      | PVC      | SDR 35 | 0.50      | 23.6              | 4.27%                 | 0.74              | 0.31              |
| R229A         | 229            | 204  |                                 | 0.37      | 6      | 0          | 0   | 20   | 1.49                 | 75   | 3.62           | 0.9             | 0.00           | 0.00            | 0.00          | 0.00            | 0.00           | 0.00            | 0.00 | 0.00         | 0.00            | 0.37            | 1.49             | 0.5             | 1.4                | 67.3       | 200      | PVC      | SDR 35 | 1.90      | 46.1              | 2.97%                 | 1.45              | 0.55              |
| R204A         | 204            | 203  |                                 | 0.43      | 4      | 8          | 0   | 35   | 33.37                | 2195 | 3.04           | 21.6            | 0.00           | 0.00            | 0.00          | 0.00            | 0.00           | 0.00            | 0.00 | 0.00         | 0.00            | 0.43            | 35.59            | 11.7            | 33.4               | 68.9       | 300      | PVC      | SDR 35 | 0.30      | 52.6              | 63.49%                | 0.75              | 0.69              |
| R203A         | 203            | 202  |                                 | 0.40      | 6      | 4          | 0   | 31   | 33.77                | 2226 | 3.04           | 21.9            | 0.00           | 0.00            | 0.00          | 0.00            | 0.00           | 0.00            | 0.00 | 0.00         | 0.00            | 0.40            | 35.99            | 11.9            | 33.8               | 65.8       | 300      | PVC      | SDR 35 | 0.30      | 52.6              | 64.27%                | 0.75              | 0.69              |
| R213A         | 213            | 212  |                                 | 0.52      | 0      | 17         | 0   | 46   | 0.52                 | 46   | 3.66           | 0.5             | 0.00           | 0.00            | 0.00          | 0.00            | 0.00           | 0.00            | 0.00 | 0.00         | 0.00            | 0.52            | 0.52             | 0.2             | 0.7                | 114.3      | 200      | PVC      | SDR 35 | 0.50      | 23.6              | 3.03%                 | 0.74              | 0.28              |
| R212A         | 212            | 211  |                                 | 0.18      | 0      | 5          | 0   | 14   | 0.70                 | 59   | 3.64           | 0.7             | 0.00           | 0.00            | 0.00          | 0.00            | 0.00           | 0.00            | 0.00 | 0.00         | 0.00            | 0.18            | 0.70             | 0.2             | 0.9                | 34.1       | 200      | PVC      | SDR 35 | 0.50      | 23.6              | 3.94%                 | 0.74              | 0.31              |
| R211A         | 211            | 210  |                                 | 0.09      | 0      | 2          | 0   | 5    | 0.79                 | 65   | 3.63           | 0.8             | 0.00           | 0.00            | 0.00          | 0.00            | 0.00           | 0.00            | 0.00 | 0.00         | 0.00            | 0.09            | 0.79             | 0.3             | 1.0                | 12.6       | 200      | PVC      | SDR 35 | 0.40      | 21.1              | 4.84%                 | 0.67              | 0.28              |
| R210A         | 210            | 209  |                                 | 0.35      | 0      | 10         | 0   | 27   | 1.14                 | 92   | 3.60           | 1.1             | 0.00           | 0.00            | 0.00          | 0.00            | 0.00           | 0.00            | 0.00 | 0.00         | 0.00            | 0.35            | 1.14             | 0.4             | 1.4                | 71.5       | 200      | PVC      | SDR 35 | 0.40      | 21.1              | 6.85%                 | 0.67              | 0.31              |
| R215A         | 215A           | 215  |                                 | 0.00      | 0      | 0          | 0   | 0    | 0.00                 | 0    | 3.80           | 0.0             | 0.00           | 0.00            | 0.00          | 0.00            | 0.00           | 0.00            | 0.00 | 0.00         | 0.00            | 0.00            | 0.00             | 0.0             | 0.0                | 5.8        | 200      | PVC      | SDR 35 | 1.00      | 33.4              | 0.00%                 | 1.05              | 0.00              |
| R214A         | 215            | 214  |                                 | 0.69      | 0      | 24         | 0   | 65   | 0.69                 | 65   | 3.63           | 0.8             | 0.00           | 0.00            | 0.00          | 0.00            | 0.00           | 0.00            | 0.00 | 0.00         | 0.00            | 0.69            | 0.69             | 0.2             | 1.0                | 79.6       | 200      | PVC      | SDR 35 | 0.50      | 23.6              | 4.18%                 | 0.74              | 0.31              |
| R214A         | 214            | 209  |                                 | 0.59      | 0      | 22         | 0   | 59   | 1.28                 | 124  | 3.57           | 1.4             | 0.00           | 0.00            | 0.00          | 0.00            | 0.00           | 0.00            | 0.00 | 0.00         | 0.00            | 0.59            | 1.28             | 0.4             | 1.9                | 82.5       | 200      | PVC      | SDR 35 | 0.50      | 23.6              | 7.87%                 | 0.74              | 0.37              |
| R209A         | 209            | 208  |                                 | 0.27      | 0      | 6          | 0   | 16   | 2.69                 | 232  | 3.50           | 2.6             | 0.00           | 0.00            | 0.00          | 0.00            | 0.00           | 0.00            | 0.00 | 0.00         | 0.00            | 0.27            | 2.69             | 0.9             | 3.5                | 79.0       | 200      | PVC      | SDR    |           |                   |                       |                   |                   |

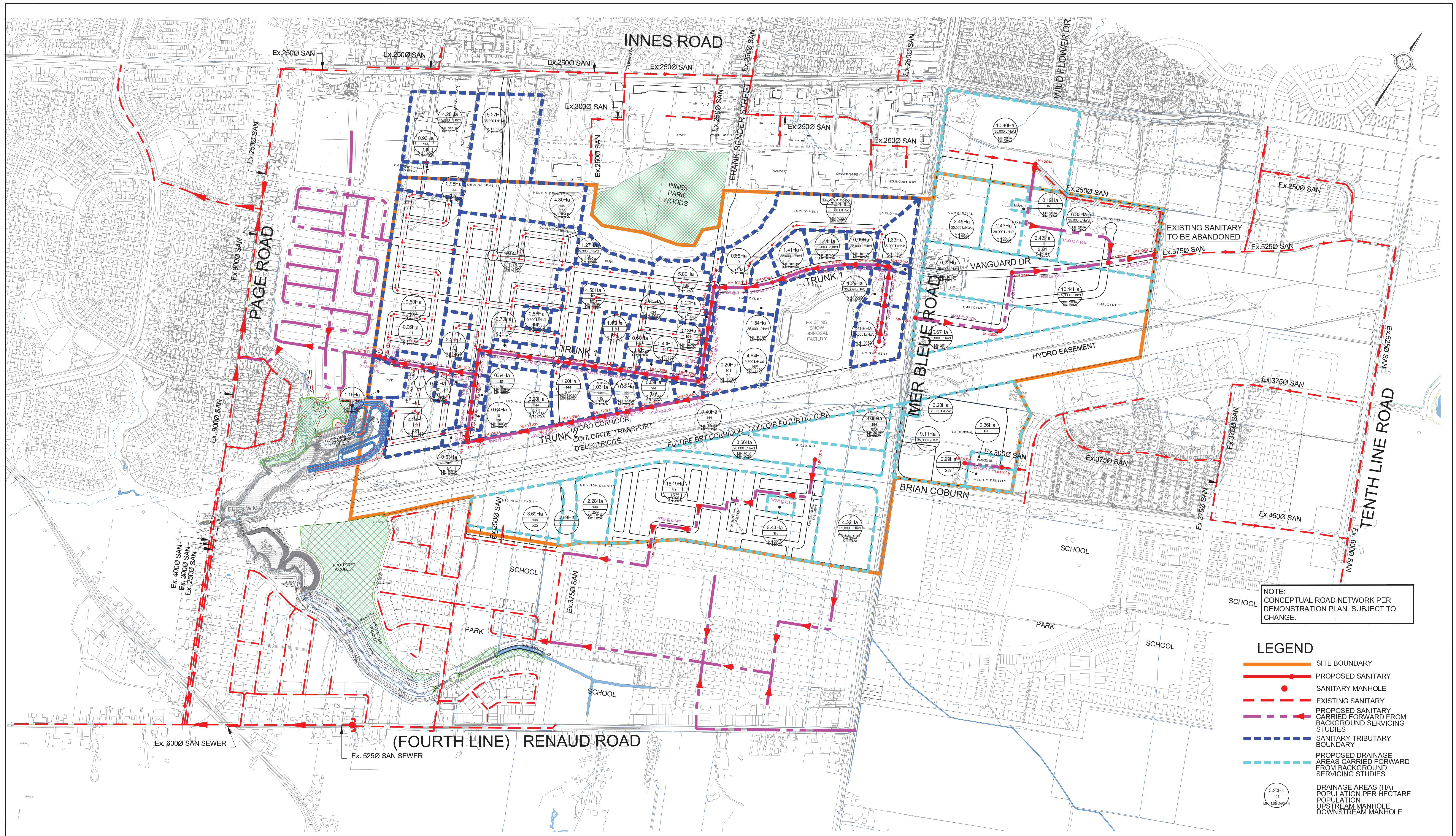

NOTE:  
CONCEPTUAL ROAD NETWORK PER  
DEMONSTRATION PLAN. SUBJECT TO  
CHANGE.

- LEGEND**
- SITE BOUNDARY
  - > PROPOSED SANITARY
  - - - EXISTING SANITARY
  - - -> PROPOSED SANITARY CARRIED FORWARD FROM BACKGROUND SERVICING STUDIES
  - - - SANITARY TRIBUTARY BOUNDARY
  - - - PROPOSED DRAINAGE AREAS CARRIED FORWARD FROM BACKGROUND SERVICING STUDIES
  - 0.20Ha  
MH 1000 DRAINAGE AREAS (HA)  
POPULATION PER HECTARE  
POPULATION  
UPSTREAM MANHOLE  
DOWNSTREAM MANHOLE



120 Iber Road, Unit 103  
Stittsville, ON K2S 1E9  
Tel. (613) 836-0856  
Fax. (613) 836-7183  
www.DSEL.ca

**EAST URBAN COMMUNITY PHASE 3 AREA COMMUNITY DESIGN PLAN  
CONCEPTUAL SANITARY SERVICING**

|               |              |
|---------------|--------------|
| PROJECT No. : | 14-733       |
| SCALE         | 1:5000       |
| DATE:         | OCTOBER 2019 |
| DRAWING No.   | 5            |





## **Appendix C : STORMWATER MANAGEMENT**

### **C.1 STORM SEWER DESIGN SHEET**



Trailsedge East Phase 4

**STORM SEWER  
DESIGN SHEET**  
(City of Ottawa)

DESIGN PARAMETERS

$I = a / (t+b)^5$  (As per City of Ottawa Guidelines, 2012)

|     |         |         |          |          |
|-----|---------|---------|----------|----------|
|     | 1:2 yr  | 1:5 yr  | 1:10 yr  | 1:100 yr |
| a = | 732.951 | 998.071 | 1174.184 | 1735.688 |
| b = | 6.199   | 6.053   | 6.014    | 6.014    |
| c = | 0.810   | 0.814   | 0.816    | 0.820    |

MANNING'S n = 0.013  
 MINIMUM COVER: 2.00 m  
 TIME OF ENTRY 10 min  
 BEDDING CLASS = B

DATE: 2021-02-02  
 REVISION: 1  
 DESIGNED BY: -  
 CHECKED BY: -  
 FILE NUMBER: 160401250

| LOCATION<br>AREA ID<br>NUMBER | FROM<br>M.H. | TO<br>M.H. | DRAINAGE AREA            |                          |                           |                            |                        |                      |                      |                       |                        |                           |                            |                           |                            |                            | PIPE SELECTION              |                             |                              |                 |                                |                                |                                 |                                  |                               |   |  |               |                                   |                        |                      |                 |              |            |                                     |               |                         |                        |                          |      |
|-------------------------------|--------------|------------|--------------------------|--------------------------|---------------------------|----------------------------|------------------------|----------------------|----------------------|-----------------------|------------------------|---------------------------|----------------------------|---------------------------|----------------------------|----------------------------|-----------------------------|-----------------------------|------------------------------|-----------------|--------------------------------|--------------------------------|---------------------------------|----------------------------------|-------------------------------|---|--|---------------|-----------------------------------|------------------------|----------------------|-----------------|--------------|------------|-------------------------------------|---------------|-------------------------|------------------------|--------------------------|------|
|                               |              |            | AREA<br>(2-YEAR)<br>(ha) | AREA<br>(5-YEAR)<br>(ha) | AREA<br>(10-YEAR)<br>(ha) | AREA<br>(100-YEAR)<br>(ha) | AREA<br>(ROOF)<br>(ha) | C<br>(2-YEAR)<br>(-) | C<br>(5-YEAR)<br>(-) | C<br>(10-YEAR)<br>(-) | C<br>(100-YEAR)<br>(-) | A x C<br>(2-YEAR)<br>(ha) | ACCUM<br>AxC (2YR)<br>(ha) | A x C<br>(5-YEAR)<br>(ha) | ACCUM<br>AxC (5YR)<br>(ha) | A x C<br>(10-YEAR)<br>(ha) | ACCUM<br>AxC (10YR)<br>(ha) | A x C<br>(100-YEAR)<br>(ha) | ACCUM<br>AxC (100YR)<br>(ha) | T of C<br>(min) | I <sub>2</sub> -YEAR<br>(mm/h) | I <sub>5</sub> -YEAR<br>(mm/h) | I <sub>10</sub> -YEAR<br>(mm/h) | I <sub>100</sub> -YEAR<br>(mm/h) | Q <sub>CONTROL</sub><br>(L/s) | ACCUM.<br>Q <sub>CONTROL</sub><br>(L/s) | Q <sub>ACT</sub><br>(CIA/360)<br>(L/s) | LENGTH<br>(m) | PIPE WIDTH<br>OR DIAMETER<br>(mm) | PIPE<br>HEIGHT<br>(mm) | PIPE<br>SHAPE<br>(-) | MATERIAL<br>(-) | CLASS<br>(-) | SLOPE<br>% | Q <sub>CAP</sub><br>(FULL)<br>(L/s) | % FULL<br>(-) | VEL.<br>(FULL)<br>(m/s) | VEL.<br>(ACT)<br>(m/s) | TIME OF<br>FLOW<br>(min) |      |
| L4007A                        | 4007         | 4006       | 1.16                     | 0.00                     | 0.00                      | 0.00                       | 0.00                   | 0.70                 | 0.00                 | 0.00                  | 0.00                   | 0.810                     | 0.810                      | 0.000                     | 0.000                      | 0.000                      | 0.000                       | 0.000                       | 0.000                        | 0.000           | 10.00                          | 76.81                          | 104.19                          | 122.14                           | 178.56                        | 0.0                                     | 0.0                                    | 172.8         | 92.1                              | 600                    | 600                  | CIRCULAR        | CONCRETE     | -          | 0.20                                | 286.5         | 60.33%                  | 0.98                   | 0.89                     | 1.72 |
| L4006A                        | 4006         | 4005       | 1.04                     | 0.00                     | 0.00                      | 0.00                       | 0.00                   | 0.70                 | 0.00                 | 0.00                  | 0.00                   | 0.730                     | 1.541                      | 0.000                     | 0.000                      | 0.000                      | 0.000                       | 0.000                       | 0.000                        | 0.000           | 11.72                          | 70.77                          | 95.90                           | 112.38                           | 164.22                        | 0.0                                     | 0.0                                    | 302.9         | 128.6                             | 750                    | 750                  | CIRCULAR        | CONCRETE     | -          | 0.15                                | 449.8         | 67.33%                  | 0.99                   | 0.92                     | 2.32 |
| L4013A                        | 4013         | 4012       | 1.62                     | 0.00                     | 0.00                      | 0.00                       | 0.00                   | 0.70                 | 0.00                 | 0.00                  | 0.00                   | 1.133                     | 1.133                      | 0.000                     | 0.000                      | 0.000                      | 0.000                       | 0.000                       | 0.000                        | 0.000           | 10.00                          | 76.81                          | 104.19                          | 122.14                           | 178.56                        | 0.0                                     | 0.0                                    | 241.7         | 113.7                             | 675                    | 675                  | CIRCULAR        | CONCRETE     | -          | 0.20                                | 392.2         | 61.64%                  | 1.06                   | 0.96                     | 1.96 |
| L4014A                        | 4014         | 4012       | 4.26                     | 0.00                     | 0.00                      | 0.00                       | 0.00                   | 0.90                 | 0.00                 | 0.00                  | 0.00                   | 3.831                     | 3.831                      | 0.000                     | 0.000                      | 0.000                      | 0.000                       | 0.000                       | 0.000                        | 0.000           | 10.00                          | 76.81                          | 104.19                          | 122.14                           | 178.56                        | 0.0                                     | 0.0                                    | 817.3         | 41.5                              | 1050                   | 1050                 | CIRCULAR        | CONCRETE     | -          | 0.15                                | 1103.3        | 74.07%                  | 1.23                   | 1.19                     | 0.58 |
| L4012A                        | 4012         | 4011       | 1.72                     | 0.00                     | 0.00                      | 0.00                       | 0.00                   | 0.65                 | 0.00                 | 0.00                  | 0.00                   | 1.120                     | 6.084                      | 0.000                     | 0.000                      | 0.000                      | 0.000                       | 0.000                       | 0.000                        | 0.000           | 11.96                          | 70.00                          | 94.85                           | 111.14                           | 162.39                        | 0.0                                     | 0.0                                    | 1183.1        | 79.5                              | 1200                   | 1200                 | CIRCULAR        | CONCRETE     | -          | 0.15                                | 1575.3        | 75.10%                  | 1.35                   | 1.31                     | 1.01 |
| L4011A                        | 4011         | 4010       | 1.80                     | 0.00                     | 0.00                      | 0.00                       | 0.00                   | 0.70                 | 0.00                 | 0.00                  | 0.00                   | 1.257                     | 7.342                      | 0.000                     | 0.000                      | 0.000                      | 0.000                       | 0.000                       | 0.000                        | 0.000           | 12.98                          | 66.99                          | 90.71                           | 106.27                           | 155.25                        | 0.0                                     | 0.0                                    | 1366.1        | 242.5                             | 1350                   | 1350                 | CIRCULAR        | CONCRETE     | -          | 0.15                                | 2156.5        | 63.35%                  | 1.46                   | 1.34                     | 3.02 |
| C4009A, L4015A                | 4010         | 4009       | 0.00                     | 0.00                     | 0.00                      | 0.00                       | 0.00                   | 0.00                 | 0.00                 | 0.00                  | 0.00                   | 0.000                     | 7.342                      | 0.000                     | 0.000                      | 0.000                      | 0.000                       | 0.000                       | 0.000                        | 0.000           | 16.00                          | 59.50                          | 80.45                           | 94.20                            | 137.53                        | 0.0                                     | 0.0                                    | 1213.3        | 73.8                              | 1350                   | 1350                 | CIRCULAR        | CONCRETE     | -          | 0.15                                | 2156.5        | 56.26%                  | 1.46                   | 1.29                     | 0.95 |
|                               | 4009         | 4005       | 7.04                     | 1.74                     | 0.00                      | 0.00                       | 0.00                   | 0.85                 | 0.70                 | 0.00                  | 0.00                   | 5.984                     | 13.326                     | 1.218                     | 1.218                      | 0.000                      | 0.000                       | 0.000                       | 0.000                        | 0.000           | 16.95                          | 57.51                          | 77.73                           | 91.00                            | 132.84                        | 0.0                                     | 0.0                                    | 2391.7        | 84.5                              | 1650                   | 1650                 | CIRCULAR        | CONCRETE     | -          | 0.15                                | 3682.6        | 64.95%                  | 1.67                   | 1.54                     | 0.92 |
| L4008A                        | 4008         | 4005       | 0.90                     | 0.00                     | 0.00                      | 0.00                       | 0.00                   | 0.70                 | 0.00                 | 0.00                  | 0.00                   | 0.630                     | 0.630                      | 0.000                     | 0.000                      | 0.000                      | 0.000                       | 0.000                       | 0.000                        | 0.000           | 10.00                          | 76.81                          | 104.19                          | 122.14                           | 178.56                        | 0.0                                     | 0.0                                    | 134.4         | 104.1                             | 600                    | 600                  | CIRCULAR        | CONCRETE     | -          | 0.20                                | 286.5         | 46.92%                  | 0.98                   | 0.82                     | 2.11 |
|                               | 4005         | 4004       | 0.00                     | 0.00                     | 0.00                      | 0.00                       | 0.00                   | 0.00                 | 0.00                 | 0.00                  | 0.00                   | 0.000                     | 15.496                     | 0.000                     | 1.218                      | 0.000                      | 0.000                       | 0.000                       | 0.000                        | 0.000           | 17.87                          | 55.73                          | 75.30                           | 88.15                            | 128.66                        | 0.0                                     | 0.0                                    | 2653.7        | 79.0                              | 1650                   | 1650                 | CIRCULAR        | CONCRETE     | -          | 0.15                                | 3682.6        | 72.06%                  | 1.67                   | 1.59                     | 0.83 |
| L4003A                        | 4004         | 4003       | 0.00                     | 0.00                     | 0.00                      | 0.00                       | 0.00                   | 0.00                 | 0.00                 | 0.00                  | 0.00                   | 0.000                     | 15.496                     | 0.000                     | 1.218                      | 0.000                      | 0.000                       | 0.000                       | 0.000                        | 0.000           | 18.70                          | 54.23                          | 73.25                           | 85.74                            | 125.12                        | 0.0                                     | 0.0                                    | 2582.1        | 127.8                             | 1650                   | 1650                 | CIRCULAR        | CONCRETE     | -          | 0.15                                | 3682.6        | 70.12%                  | 1.67                   | 1.58                     | 1.35 |
|                               | 4003         | 4001       | 2.68                     | 0.00                     | 0.00                      | 0.00                       | 0.00                   | 0.70                 | 0.00                 | 0.00                  | 0.00                   | 1.876                     | 17.372                     | 0.000                     | 1.218                      | 0.000                      | 0.000                       | 0.000                       | 0.000                        | 0.000           | 20.04                          | 51.97                          | 70.16                           | 82.11                            | 119.80                        | 0.0                                     | 0.0                                    | 2745.0        | 48.5                              | 1650                   | 1650                 | CIRCULAR        | CONCRETE     | -          | 0.15                                | 3682.6        | 74.54%                  | 1.67                   | 1.60                     | 0.50 |
| L4002A                        | 4002         | 4001       | 1.56                     | 0.00                     | 0.00                      | 0.00                       | 0.00                   | 0.70                 | 0.00                 | 0.00                  | 0.00                   | 1.089                     | 1.089                      | 0.000                     | 0.000                      | 0.000                      | 0.000                       | 0.000                       | 0.000                        | 0.000           | 10.00                          | 76.81                          | 104.19                          | 122.14                           | 178.56                        | 0.0                                     | 0.0                                    | 232.3         | 86.5                              | 600                    | 600                  | CIRCULAR        | CONCRETE     | -          | 0.20                                | 286.5         | 81.09%                  | 0.98                   | 0.97                     | 1.48 |
|                               | 4001         | 1005       | 0.00                     | 0.00                     | 0.00                      | 0.00                       | 0.00                   | 0.00                 | 0.00                 | 0.00                  | 0.00                   | 0.000                     | 18.461                     | 0.000                     | 1.218                      | 0.000                      | 0.000                       | 0.000                       | 0.000                        | 0.000           | 20.54                          | 51.17                          | 69.08                           | 80.83                            | 117.93                        | 0.0                                     | 0.0                                    | 2857.7        | 17.5                              | 2100                   | 2100                 | CIRCULAR        | CONCRETE     | -          | 0.15                                | 7005.7        | 40.79%                  | 1.96                   | 1.58                     | 0.19 |
| L4000A, L4000C, L4000B        | 4000         | 1002A      | 3.36                     | 0.00                     | 0.00                      | 0.00                       | 0.00                   | 0.78                 | 0.00                 | 0.00                  | 0.00                   | 2.615                     | 2.615                      | 0.000                     | 0.000                      | 0.000                      | 0.000                       | 0.000                       | 0.000                        | 0.000           | 10.00                          | 76.81                          | 104.19                          | 122.14                           | 178.56                        | 0.0                                     | 0.0                                    | 557.9         | 216.7                             | 900                    | 900                  | CIRCULAR        | CONCRETE     | -          | 0.10                                | 597.2         | 93.42%                  | 0.91                   | 0.94                     | 3.86 |

## **C.2 EXCERPTS FROM BACKGROUND REPORTS**

|   |  |  |   |
|---|--|--|---|
| Capture Rate – Development Lands  | 50 L/s/ha  | 50 L/s/ha  | 51.25 L/s/ha to account for future roads in development areas as road network is subject to change.*                            |
| Capture Rate – Roads  | 100 L/s/ha   | 100 L/s/ha   | 100 L/s/ha. Only Vanguard Drive (collector road) considered as road network is subject to change.*                              |
| Peak rational method total flow to Ex. 1350mm diameter stub   | 1666 L/s   | 1552.9 L/s   | 1666 L/s*   |
| Major System Stormwater Management Strategy   | On site storage and road sags proposed to meet the required release rates. Storage within quadrant up to 100 year storm event. | On site storage and road sags proposed to meet the required release rates. Storage within quadrant up to 100 year storm event. | On site storage and road sags proposed to meet the required release rates. Storage within quadrant up to 100 year storm event.* |
| *Reported values are based on background studies that contemplate the North East quadrant draining to Bilberry Creek. These values are subject to change based on a watershed analysis to be completed separate from this MSS, and is planned to be implemented through City of Ottawa review of development applications under the Planning Act. |  |  |   |

#### 11.3.4 Consideration of Alternative Implementation Details for Servicing Designs

Stormwater sewer sizing, minor and major flow routing, and preliminary grading were reviewed as part of MSS-level design, to address all City of Ottawa and MECP requirements. Given the background infrastructure planning in this area and the predicted performance, no other logical or efficient alternative designs were advanced for additional analysis and evaluation, except for consideration of future diversion from the Bilberry Creek watershed to the McKinnon's Creek watershed. This diversion is to be studied further in accordance with the recommendations of the Vanguard Drive Environmental Assessment (IBI, Jan 2020) and the Mer Bleue Urban Expansion Area McKinnons Creek Enhancement (IBI, Sept 30, 2019), to inform future development applications within the area, and is planned to be implemented via *Planning Act* approvals.

### 11.4 South West Quadrant Preferred Stormwater Management Plan

#### 11.4.1 South West Existing Stormwater Drainage Infrastructure

The quadrant was at one time tributary to the Mud Creek and McKinnon's Creek watersheds, which drain into Green's Creek (Ottawa River) and Bear Brook (South Nation River), respectively. Current earthworks programs associated with development have redirected drainage from existing conditions.

Existing developments to the southwest of the quadrant have brought a storm sewer network to the southern boundary of the South West quadrant. A 1050 mm diameter storm sewer stub borders the portion of the South West quadrant west of Fern Casey Street, and a 2700 mm diameter stub borders the portion of the quadrant east of Fern Casey Street. A 900 mm-1050 mm diameter storm sewer within Brian Coburn Boulevard is located within the South West quadrant. To the east, there is a 525 mm-900 mm diameter storm sewer on Mer Bleue Road. The existing storm sewer network is shown in **Drawing 7**.

#### **11.4.2 South West Minor System Design**

The MSU (Stantec, July 2006) reviewed the required infrastructure to service the South West quadrant of the EUC Phase 3 Area. The intended storm outlet for the quadrant is the existing South Forebay of EUC Pond 1.

The MSU (Stantec, July 2006) considered the South West quadrant to be serviced by trunk storm sewers ranging in diameter from 1250 mm to 2400 mm. The minor system generally drains east to west, through adjacent lands towards the EUC Pond 1 South Forebay. Five-year capture was used for all development lands and local roads, while 10-year capture was applied for arterial roads. The minor system did not consider flows from Brian Coburn Boulevard (then known as the Blackburn Hamlet By-Pass) as it was assumed that the drainage would be addressed through a separate sewer. The portion of the South West quadrant north of Brian Coburn was also assumed to drain separately from the rest of the quadrant. Details of the MSU (Stantec, July 2006) minor system can be found in **Appendix E**.

More recently, the South West quadrant was considered as part of the *Servicing Report for Trails Edge and Orléans Business Park* (DSEL, July 2017). Consistent with the MSU (Stantec, July 2006), the quadrant was to be serviced by a trunk sewer network draining towards the EUC Pond 1 South Forebay. A stormwater conveyance channel was detailed to direct outflows from the trunk storm sewers to the EUC Pond 1 South Forebay. The storm drainage plan can be seen in **Drawing 4**. Five-year capture was used for all development lands and local roads, while 10-year capture was applied for arterial roads. Deviating from the MSU (Stantec, July 2006), the portion of the South West quadrant north of Brian Coburn Boulevard and the segment of Brian Coburn Boulevard within the quadrant were assumed to drain through the quadrant's storm sewer network. The majority of the South West quadrant was considered as Mixed-Use and was assigned a runoff coefficient of 0.8. There were also Medium Density and Commercial land uses which were assigned runoff coefficients of 0.7 and 0.65, respectively.

Since the completion of the MSU (Stantec, July 2006), the stormwater management of the South West quadrant has been considered during the construction of downstream infrastructure. The *Design Brief – Minto Trailsedge Phase II* (IBI Group, May 2015) considers the stormwater drainage for the portion of the South West quadrant that is east of Fern Casey Street. Per the storm design information included in **Appendix E**, a 2700 mm diameter storm sewer stub exists south of the quadrant. Per the *Design Brief – Minto Trailsedge Phase II* (IBI Group, May 2015), this stretch of sewer anticipated a Rational Method peak flow of 5,424.84 L/s from undeveloped land to the east, which includes the portion of the South West quadrant that is east of Fern Casey Street. Five-year capture was assumed and an available Rational Method additional capacity of 5,040.86 L/s was reported available downstream in the constraining segment (MH55 - MH55B).

The *Design Brief – Minto Trailsedge Phase II* (IBI Group, May 2015) also considered the stormwater drainage for the portion of Fern Casey Street (formerly Belcourt Boulevard) within the South West quadrant. A portion of the street is to drain to Brian Coburn while a portion is being serviced by the storm sewers constructed as part of Trailsedge Phase II.

The stormwater servicing of the South West quadrant has also been considered as part of the approved *Trails Edge East – Functional Servicing Report* (Stantec, August 11, 2017). As shown in **Appendix E**, an additional 3.18 ha residential area drains to the existing 2700 mm diameter stub along with the stormwater flows from the portion of the South West quadrant east of Fern Casey Street. Per the *Trails Edge East – Functional Servicing Report* (Stantec, August 11, 2017), a rational method peak flow of 4,824.3 L/s was anticipated from the portion of the South West quadrant that is east of Fern Casey Street. 2-year capture was assumed for the portion of the South West quadrant that is east of Fern Casey Street, deviating from past studies, but consistent with current City of Ottawa and MECP standards. Brian Coburn Boulevard was expected to drain separately consistent with the MSU (Stantec, July 2006) and design information for Brian Coburn Boulevard.

The Trailsedge East lands are currently undergoing detailed design and construction. Per the *Trails Edge East Phase 1 Servicing and Stormwater Management Report* (Stantec, August, 2018), 5-year capture was assumed for the portion of the South West quadrant east of Fern Casey Street. Note that the *Trails Edge East Phase 1 Servicing and Stormwater Management Report* (Stantec, August, 2018) proposes to accommodate the stormwater flows from the portion of the South West quadrant east of Fern Casey Street through 2 inlet locations (MH1004 & MH1002). The anticipated Rational Method peak flow attributed to the portion of the South West quadrant east of Fern Casey Street to MH1004 and MH1002 are 4686.2 L/s and 741.52 L/s respectively. All stormwater flows from the South West quadrant east of Fern Casey Street are still proposed to ultimately be directed towards the existing 2700mm diameter stub. Brian Coburn Boulevard is reported to drain separately, which is consistent with the MSU (Stantec, July 2006) and with as-built information for Brian Coburn Boulevard. Details are provided in **Appendix E**. The total Rational Method peak flow anticipated to the existing 2700 mm diameter storm sewer stub is reported to be 6,154.9 L/s, which is above the 5,424.84 L/s allowance detailed in the *Design Brief – Minto Trailsedge Phase II* (IBI Group, May 2015). The anticipated increase in flows of 730.06 L/s is below the 5,040.86 L/s available Rational Method capacity downstream in the constraining segment (MH55 – MH55B).

The *Design Brief for the Trails Edge West Richcraft Group of Companies* (DSEL, January 26, 2015) includes the stormwater drainage for the portion of the South West quadrant west of Fern Casey Street. 5-year capture was assumed and a rational method peak flow of 845.8 L/s was determined to drain into existing Control MH2. See **Appendix E** for details.

Respecting the MSU (Stantec, July 2006), existing stormwater infrastructure, and ongoing development applications within the South West quadrant, the proposed stormwater servicing strategy is to have all flows from the quadrant drain to the EUC Pond 1 South Forebay via the existing stormwater conveyance channel and an extension of the existing trunk storm sewer network. The proposed storm sewer network is shown in **Drawing 4**. A trunk 2100 mm trunk storm sewer is shown servicing the majority of the quadrant by routing minor system stormwater flows to the proposed Trailsedge East storm sewer south of the quadrant. The remaining portions of the South West quadrant drain directly into existing infrastructure. A storm sewer

crosses Brian Coburn Boulevard at an existing gap in underground infrastructure – coordination will be required for work in the ROW, including utility coordination.

Note that at this stage of analysis, only the trunk storm sewer within the quadrant is shown. To demonstrate serviceability, the trunk sewer is carried back at minimum possible slopes accounting for drops at manholes, existing infrastructure sizing and possible conflicts with the sanitary sewer. As design of the South West quadrant advances, the storm sewer network details are subject to change for construction efficiencies, etc., provided that the conditions in Section 14 related to minor changes are met. Additional springline connections and/or reduced drops across maintenance holes may be proposed as part of detailed design, to assist in minimizing grade raise requirements, provided that the conditions in **Section 14** related to minor changes are met. These are currently considered deviations from City Standards, and will require review on a case-by-case basis.

2-year capture was assumed for all local roads and development lands in the South West quadrant. 5-year capture was used for collector roads in order to adhere to City Standards regarding allowable depth of flow on streets.

The rational method, with design criteria described in **Section 11.1**, was employed to size the storm sewer to accommodate all minor flows. Per the design sheet included in **Appendix E**, the anticipated rational method peak flow from the portion of the South West quadrant east of Fern Casey Street is 4,964 L/s. Please note that consistent with the *Trails Edge East – Functional Servicing Report* (Stantec, August 11, 2017), the stormwater flows from the North West quadrant east of Fern Casey Street are directed towards one outlet in this MSS for the purpose of high-level servicing review. Outlets and routing alternatives may be refined as the design and construction processes advance, based on constructed downstream infrastructure (e.g. direct flows to multiple constructed outlets, rather than a single outlet).

The proposed 4,964 L/s rational method peak flow to MH 302 is roughly 106% of the 4,686.2 L/s flow anticipated at this location within the *Trails Edge East Phase 1 Servicing and Stormwater Management Report* (Stantec, August, 2018). A flow of 741.5 L/s was also anticipated from the portion of the South West quadrant east of Fern Casey Street, to be collected further downstream per the *Trails Edge East Phase 1 Servicing and Stormwater Management Report* (Stantec, August, 2018). Per the *East Urban Community / Preliminary Hydraulic Gradeline Analysis and Pond Design* (JFSA, June 2019)(see **Appendix E**), the peak modelled flow to the existing stub is 5,800 L/s under the 100-year plus 20% storm event. The proposed design of the South West quadrant east of Fern Casey does not have a negative impact of the downstream stormwater management infrastructure. Therefore, it is concluded that the downstream infrastructure has adequate capacity to service the minor system stormwater flows from the portion of the South West quadrant, east of Fern Casey Street.

The portions of Brian Coburn Drive and Fern Casey Street within the South West quadrant are proposed to continue draining as they are at the time of this MSS, per asbuilt conditions.

The anticipated rational method peak flow from the portion of the South West quadrant west of Fern Casey Street is 853 L/s, roughly 101% of the 845.8 L/s flow anticipated in the in the *Design Brief for the Trails Edge West Richcraft Group of Companies* (DSEL, January 26, 2015). Seeing as the land is to provide 5-year capture consistent with the *Design Brief for the Trails Edge West Richcraft Group of Companies*

(DSEL, January 26, 2015), any discrepancy in anticipated rational method peak flow can be attributed to rounding. Per the *East Urban Community / Preliminary Hydraulic Gradeline Analysis and Pond Design* (JFSA, June 2019), see **Appendix E**, the proposed design of the South West quadrant west of Fern Casey is consistent with the design of the downstream stormwater management infrastructure. Therefore, it is concluded that the downstream infrastructure has adequate capacity to service the minor system stormwater flows from the portion of the South West quadrant, west of Fern Casey Street.

#### **11.4.3 South West Hydraulic Grade Line Analysis**

Given the preferred minor system design and land uses differ from background studies, a Hydraulic Grade Line analysis was completed for the South West quadrant, using downstream modelling information provided by Stantec from the *Trails Edge East Phase 1 Servicing and Stormwater Management Report* (Stantec, August, 2018). The suitability of the proposed trunk sewer network was analyzed in the *East Urban Community / Preliminary Hydraulic Gradeline Analysis and Pond Design* (JFSA, June 2019), provided in **Appendix E**. The simulated 100-year HGL results through the proposed trunk storm sewer network have been analyzed for suitability with the proposed road grades and anticipated underside of footing elevations, estimated to be 2.1 m below ground level.

The analysis was simulated with the 100-year 3-hour Chicago storm, 100-year 24-hour SCS Type II storm and July 1979, August 1988 and August 1996 historical events. The results indicated that the quadrant is serviceable per the preferred design as a freeboard of 0.3 m between the hydraulic gradeline and the estimated underside of footing is provided for the 100-year storms and a freeboard of 0 m has been provided for the historical events and the 100-year storm + 20% climate change stress test. As noted earlier, the storm sewer design is expected to change at detailed design (e.g. to include local sewers, to minimize earthworks costs, etc.), and an updated analysis will be required in conformance with all City of Ottawa and MECP guidelines.

#### **11.4.4 South West Major System & Grading Design**

The MSU (Stantec, July 2006) did not seem to include a detailed design of the major system for the South West quadrant. Based on the MSU (Stantec, July 2006) Macro Grading Plan, included in **Appendix E**, the major system flow is generally directed towards the EUC Pond 1 South Forebay. Grade raise restrictions for the South West quadrant are reported as 0-0.6 m and are respected in the grading plan.

Per the *Servicing Report for Trails Edge and Orléans Business Park* (DSEL, July 2017), the major flow servicing strategy was updated based on the proposed road network. Consistent with the MSU (Stantec, July 2006), the major flow was to be routed westward towards the EUC Pond 1 South Forebay. See **Appendix E** for details. The majority of the South West quadrant was reported to provide onsite storage up to the 100-year storm event as they were contemplated for Mixed-Use, High Density Residential and Commercial land uses. The *Servicing Report for Trails Edge and Orléans Business Park* (DSEL, July 2017) grading plan reports grade raises up to 3 m within the South West quadrant. This exceeds the grade raise restriction for the quadrant of 0.5 m to 1.5 m per the *Geotechnical – Existing Conditions Report East Urban Community Mixed Use CDP* (Paterson Group, June 28, 2018). As such, a surcharge program or lightweight fill was recommended to be considered as the design process continued.



---

Per the approved *Trails Edge East – Functional Servicing Report* (Stantec, August 11, 2017) and the *Trails Edge East Phase 1 Servicing Design Brief* (Stantec, August 2018), onsite storage up to the 100-year storm event was to be provided for the portion of the South West quadrant, east of Fern Casey Street. The *Design Brief for the Trails Edge West Richcraft Group of Companies* (DSEL, January 26, 2015) similarly states that onsite storage up to the 100-year storm event was to be provided for the portion of the South West quadrant, west of Fern Casey Street.

The proposed major system design is for commercial and mixed-use blocks within the South West quadrant to provide onsite storage up to the 100-year storm event, which is consistent with background servicing reports for the quadrant. The remaining areas are to have overland flow stored within the road network, then directed towards the EUC Pond 1 via the neighbouring lands to the south. The routing is to follow the proposed road network, as shown in **Drawing 2**. Note that the medium-high density block west of Fern Casey Street is to have major system flows directed towards Axis Way, while the other medium-high density block is to have major system flows directed towards Fern Casey Street.

Given that the updated preferred stormwater concept has not been detailed in background documents, a stormwater model has been prepared for the South West quadrant within the *East Urban Community / Preliminary Hydraulic Gradeline Analysis and Pond Design* (JFSA, June 2019) – see **Appendix E**. The modelling indicates that the main road network is expected to adequately convey major system flow per City of Ottawa and MECP standards.

As shown in the proposed grading plan, road grade elevations for the conceptual road network are anticipated to be greater than 1.5 m in some areas. The maximum permissible grade raise for the South West quadrant is 0.5 m - 1.5 m per the *Geotechnical – Existing Conditions Report East Urban Community Mixed Use CDP* (Paterson Group, June 28, 2018). Note that the conceptual road network is subject to change. The grading plan has been designed as low as possible to best respect the grade raise restrictions and was determined by providing minimum cover to the infrastructure (assuming basements for all land uses with gravity foundation drainage), facilitating major system flow to the EUC Pond 1, and respecting existing/proposed road grades surrounding the quadrant.

Since the proposed grading plan indicates portions of the South West quadrant to be above proposed grade raise restrictions, a surcharge program or lightweight fill program may be required to the satisfaction of a licensed Geotechnical Engineer in Ontario. As the design process advances for the quadrant, grading plans, grade raises, surcharge programs and fill specifications will be required from a Geotechnical Engineer.

A summary of the stormwater management strategy for the South West quadrant is provided in **Table 25**.

**Table 25: Summary of Stormwater Management Strategy – South West Quadrant**

|   | <b>Governing Servicing Study</b>  | <b>Additional Background Servicing Study</b>  | <b>Proposed MSS</b>   |
|---|---|---|---|
| Study Name  | Gloucester and Cumberland East Urban Community Expansion Area and Bilberry Creek Industrial Park Master Servicing Update (Stantec, July 2006) | Design Brief for the Trails Edge West Richcraft Group of Companies (DSEL, January 26, 2015) and the Trails Edge East Phase 1 Servicing and Stormwater Management Report (Stantec, August, 2018) | EUC Phase 3 Area CDP MSS (June 2020)  |
| Minor System Stormwater Management Strategy   | Quadrant to be serviced by trunk storm sewers running through southern adjacent lands to the South Forebay of the EUC Pond 1.                 | Quadrant to be serviced by trunk storm sewers running through southern adjacent lands and a stormwater conveyance channel to the South Forebay of the EUC Pond 1.                               | Quadrant to be serviced by trunk storm sewers running through southern adjacent lands and a stormwater conveyance channel to the South Forebay of the EUC Pond 1. |
| Total Area to Existing Control MH 2   | N/A   | 3.65 ha.  | 3.68 ha.  |
| Avg. C  | N/A   | 0.8   | 0.8   |
| Total Rational Method Peak Flow to Existing Control MH 2                                  | N/A   | 845.8 L/s.  | 853 L/s.  |
| 100-year, 3-Hour Chicago Storm + 20% modelled Peak Flow to proposed Existing Control MH 2 | N/A   | N/A   | 1,189 L/s.  |
| Total Area to Proposed MH STM 1004  | N/A   | 27.89 ha to MH 1004 & 3.20 ha to MH 1002 downstream   | 29.28 ha.   |
| Avg. C  | N/A   | 0.8   | 0.78  |
| Total Rational Method Peak Flow to Proposed STM MH 1004                                   | N/A   | 4,686.2 L/s to MH 1004 & 757.8 L/s to MH 1002 downstream  | 4,964 L/s   |
| 100-year, 3-Hour Chicago Storm + 20% modelled Peak Flow to existing                       | N/A   | N/A   | 5,800 L/s.  |

RICHCRAFT HOMES

JUNE 2020  
DSEL 14-733

|   |  |  |  |
|---|--|--|--|
| stub on Fern Casey Street                   |  |  |  |
| Major System Stormwater Management Strategy | Overland flow to be directed towards the EUC Pond 1. | Overland flow to be directed towards the EUC Pond 1. Onsite storage up to the 100-year storm event was to be provided. | Overland flow to be directed towards the EUC Pond 1. Onsite storage up to the 100-year storm event is to be provided for mixed use and commercial land uses. |

**11.4.5 Consideration of Alternative Implementation Details for Servicing Designs**

Stormwater sewer sizing, minor and major flow routing, and preliminary grading were reviewed as part of MSS-level servicing design, to address all City of Ottawa and MECP requirements. Given the background infrastructure planning in this area and the predicted performance, no other logical or efficient alternative designs were advanced for additional analysis and evaluation.

The use of sump pumps for foundation drainage is recommended to be advanced for consideration in detailed design as an alternative design for residential areas in the South West quadrant. Per City of Ottawa standards, sump pumps are only to be considered as drainage solutions under certain conditions per ISTB-2018-04 and subsequent Technical Bulletins. The area must be on full services, be underlain by clay soils subject to grade raise restrictions and have finished grades required to allow gravity drainage exceed the grade raise restriction. Finally, the HGL of the area cannot be able to be reasonably lowered any further due to outlet restrictions. Given the South West quadrant meets all of these requirements, sump pumps may be considered as an alternative for the South West as the design process advances. See Paterson Group (July 7, 2019) for additional details.

**11.5 South East Quadrant Preferred Stormwater Management Plan**

**11.5.1 South East Existing Stormwater Drainage Infrastructure**

Existing residential developments to the east of the South East quadrant have brought a 1350 mm diameter storm sewer stub to the eastern property boundary. This stub connects to the 1650 mm diameter storm sewer within Gerry Lalonde Drive, ultimately running to the existing Avalon West (Neighborhood 5) Stormwater Management Facility via an existing storm sewer network shown in **Drawing 7**.

A portion of the Hydro Corridor to the north of the quadrant is serviced by the existing 450 mm diameter storm sewer on Trigorina Crescent. The sewer then follows the existing storm sewer network to the existing Avalon West (Neighborhood 5) Stormwater Management Facility and ultimately McKinnon's Creek.

The portion of the South East quadrant designated as Medium Density has already been constructed and is being serviced by the 1350 mm diameter storm sewer stub mentioned above.

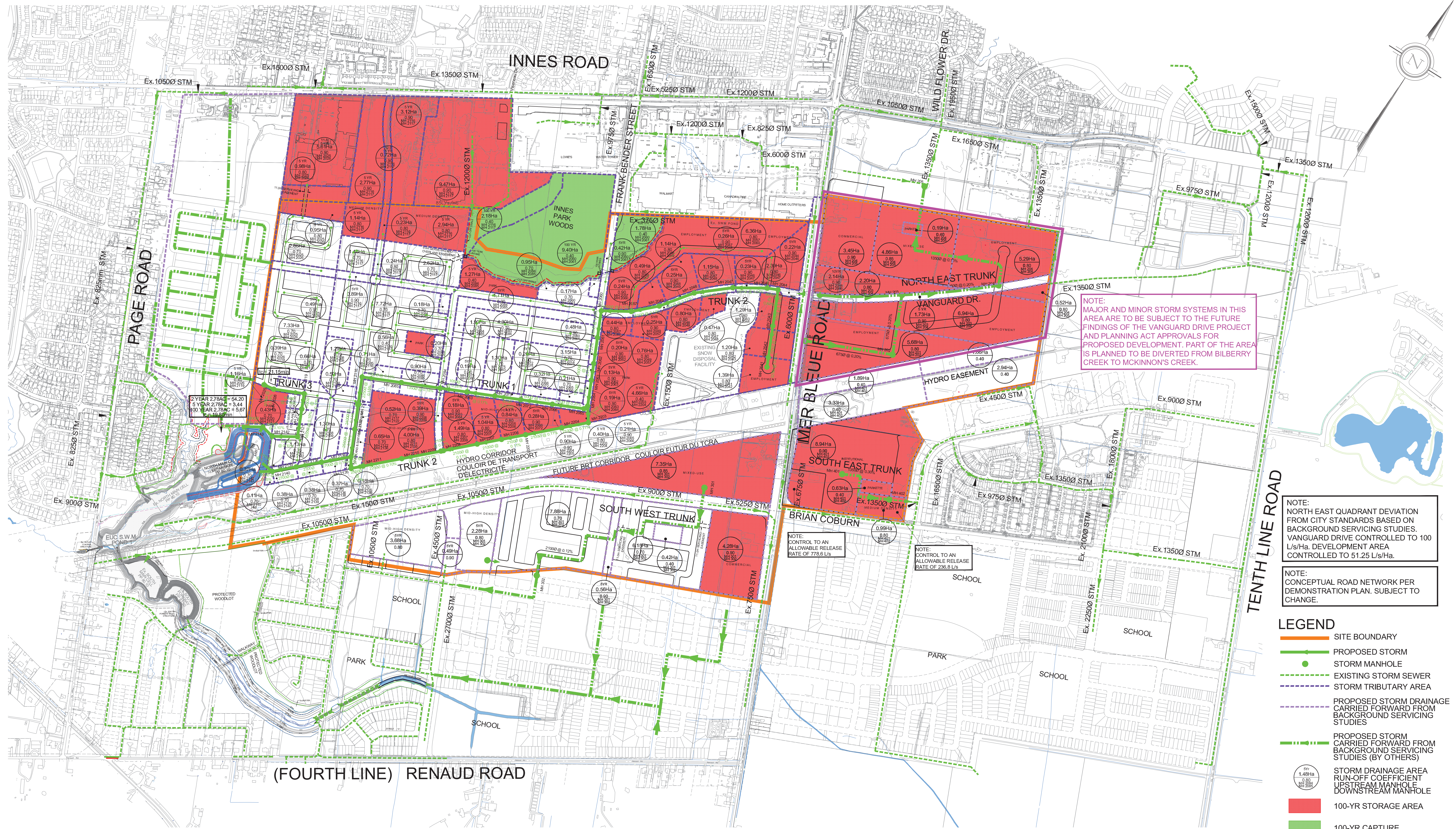

NOTE: MAJOR AND MINOR STORM SYSTEMS IN THIS AREA ARE TO BE SUBJECT TO THE FUTURE FINDINGS OF THE VANGUARD DRIVE PROJECT AND PLANNING ACT APPROVALS FOR PROPOSED DEVELOPMENT. PART OF THE AREA IS PLANNED TO BE DIVERTED FROM BILBERRY CREEK TO MCKINNON'S CREEK.

NOTE: NORTH EAST QUADRANT DEVIATION FROM CITY STANDARDS BASED ON BACKGROUND SERVICING STUDIES. VANGUARD DRIVE CONTROLLED TO 100 L/s/ha. DEVELOPMENT AREA CONTROLLED TO 51.25 L/s/ha.

NOTE: CONCEPTUAL ROAD NETWORK PER DEMONSTRATION PLAN. SUBJECT TO CHANGE.

- LEGEND**
- SITE BOUNDARY
  - PROPOSED STORM
  - STORM MANHOLE
  - EXISTING STORM SEWER
  - STORM TRIBUTARY AREA
  - PROPOSED STORM DRAINAGE CARRIED FORWARD FROM BACKGROUND SERVICING STUDIES
  - PROPOSED STORM CARRIED FORWARD FROM BACKGROUND SERVICING STUDIES (BY OTHERS)
  - 5YR  
1.48ha  
0.90  
MH 200 STORM DRAINAGE AREA RUN-OFF COEFFICIENT UPSTREAM MANHOLE DOWNSTREAM MANHOLE
  - 100-YR STORAGE AREA
  - 100-YR CAPTURE



120 Iber Road, Unit 103  
Stittsville, ON K2S 1E9  
Tel. (613) 836-0856  
Fax. (613) 836-7183  
www.DSEL.ca

**EAST URBAN COMMUNITY PHASE 3 AREA COMMUNITY DESIGN PLAN  
CONCEPTUAL STORM SERVICING**

|               |              |
|---------------|--------------|
| PROJECT No. : | 14-733       |
| SCALE         | 1:5000       |
| DATE:         | OCTOBER 2019 |
| DRAWING No.   | 4            |



Trails Edge East Phase 1

**STORM SEWER  
DESIGN SHEET**  
(City of Ottawa)

**DESIGN PARAMETERS**

$I = a / (t+b)^c$  (As per City of Ottawa Guidelines, 2012)

|     |         |         |          |          |                |        |
|-----|---------|---------|----------|----------|----------------|--------|
|     | 1:2 yr  | 1:5 yr  | 1:10 yr  | 1:100 yr |                |        |
| a = | 732.951 | 998.071 | 1174.184 | 1735.688 | MANNING'S n =  | 0.013  |
| b = | 6.199   | 6.053   | 6.014    | 6.014    | MINIMUM COVER: | 2.00 m |
| c = | 0.810   | 0.814   | 0.816    | 0.820    | TIME OF ENTRY  | 10 min |

FILE NUMBER: 160401250

DATE: 2019-07-24  
REVISION: 3  
DESIGNED BY: DT  
CHECKED BY: MJS

| LOCATION<br>AREA ID<br>NUMBER | FROM<br>M.H. | TO<br>M.H. | DRAINAGE AREA            |                          |                           |                            |                        |                      |                      |                       |                        |                           |                            | PIPE SELECTION            |                             |                            |                              |                             |                               |                 |                                |                                |                                 |                                  |                               |   |                           |               |                                   |                        |                      |                 |              |            |                                     |               |                         |                        |                          |
|-------------------------------|--------------|------------|--------------------------|--------------------------|---------------------------|----------------------------|------------------------|----------------------|----------------------|-----------------------|------------------------|---------------------------|----------------------------|---------------------------|-----------------------------|----------------------------|------------------------------|-----------------------------|-------------------------------|-----------------|--------------------------------|--------------------------------|---------------------------------|----------------------------------|-------------------------------|---|---------------------------|---------------|-----------------------------------|------------------------|----------------------|-----------------|--------------|------------|-------------------------------------|---------------|-------------------------|------------------------|--------------------------|
|                               |              |            | AREA<br>(2-YEAR)<br>(ha) | AREA<br>(5-YEAR)<br>(ha) | AREA<br>(10-YEAR)<br>(ha) | AREA<br>(100-YEAR)<br>(ha) | AREA<br>(ROOF)<br>(ha) | C<br>(2-YEAR)<br>(-) | C<br>(5-YEAR)<br>(-) | C<br>(10-YEAR)<br>(-) | C<br>(100-YEAR)<br>(-) | A x C<br>(2-YEAR)<br>(ha) | ACCUM<br>AxC (2YR)<br>(ha) | A x C<br>(5-YEAR)<br>(ha) | ACCUM.<br>AxC (5YR)<br>(ha) | A x C<br>(10-YEAR)<br>(ha) | ACCUM.<br>AxC (10YR)<br>(ha) | A x C<br>(100-YEAR)<br>(ha) | ACCUM.<br>AxC (100YR)<br>(ha) | T of C<br>(min) | I <sub>2</sub> -YEAR<br>(mm/h) | I <sub>5</sub> -YEAR<br>(mm/h) | I <sub>10</sub> -YEAR<br>(mm/h) | I <sub>100</sub> -YEAR<br>(mm/h) | Q <sub>CONTROL</sub><br>(L/s) | ACCUM.<br>Q <sub>CONTROL</sub><br>(L/s) | Q <sub>ACT</sub><br>(L/s) | LENGTH<br>(m) | PIPE WIDTH<br>OR DIAMETER<br>(mm) | PIPE<br>HEIGHT<br>(mm) | PIPE<br>SHAPE<br>(-) | MATERIAL<br>(-) | CLASS<br>(-) | SLOPE<br>% | Q <sub>CAP</sub><br>(FULL)<br>(L/s) | % FULL<br>(-) | VEL.<br>(FULL)<br>(m/s) | VEL.<br>(ACT)<br>(m/s) | TIME OF<br>FLOW<br>(min) |
| L1006W                        | 1006         | 1005       | 0.28                     | 0.00                     | 0.00                      | 0.00                       | 0.00                   | 0.69                 | 0.00                 | 0.00                  | 0.00                   | 0.194                     | 0.194                      | 0.000                     | 0.000                       | 0.000                      | 0.000                        | 0.000                       | 0.000                         | 10.00           | 76.81                          | 104.19                         | 122.14                          | 178.56                           | 0.0                           | 0.0                                     | 41.5                      | 86.4          | 300                               | 300                    | CIRCULAR             | PVC             | -            | 0.35       | 56.9                                | 72.91%        | 0.81                    | 0.77                   | 1.86                     |
|                               | 1005         | 1004       | 0.00                     | 0.00                     | 0.00                      | 0.00                       | 0.00                   | 0.00                 | 0.00                 | 0.00                  | 0.000                  | 0.194                     | 0.000                      | 0.000                     | 0.000                       | 0.000                      | 0.000                        | 0.000                       | 0.000                         | 11.86           | 70.32                          | 95.28                          | 111.65                          | 163.15                           | 0.0                           | 0.0                                     | 38.0                      | 9.4           | 300                               | 300                    | CIRCULAR             | PVC             | -            | 0.35       | 56.9                                | 66.76%        | 0.81                    | 0.76                   | 0.21                     |
|                               |              |            | 12.07                    |                          |                           |                            |                        |                      |                      |                       |                        |                           |                            |                           |                             |                            |                              |                             |                               |                 |                                |                                |                                 |                                  |                               |   |                           |               |                                   |                        |                      |                 |              |            |                                     |               |                         |                        |                          |
| L1008A                        | 1008         | 1004       | 0.00                     | 27.89                    | 0.00                      | 0.00                       | 0.00                   | 0.00                 | 0.80                 | 0.00                  | 0.000                  | 0.000                     | 22.312                     | 22.312                    | 0.000                       | 0.000                      | 0.000                        | 0.000                       | 0.000                         | 17.75           | 55.96                          | 75.61                          | 88.51                           | 129.19                           | 0.0                           | 0.0                                     | 4686.2                    | 17.7          | 2100                              | 2100                   | CIRCULAR             | CONCRETE        | -            | 0.10       | 5720.3                              | 81.92%        | 1.60                    | 1.59                   | 0.19                     |
|                               | 1004         | 1003       | 0.00                     | 0.00                     | 0.00                      | 0.00                       | 0.00                   | 0.00                 | 0.00                 | 0.00                  | 0.000                  | 0.194                     | 0.000                      | 22.312                    | 0.000                       | 0.000                      | 0.000                        | 0.000                       | 0.000                         | 17.94           | 55.61                          | 75.13                          | 87.95                           | 128.36                           | 0.0                           | 0.0                                     | 4686.7                    | 47.1          | 2100                              | 2100                   | CIRCULAR             | CONCRETE        | -            | 0.10       | 5720.1                              | 81.93%        | 1.60                    | 1.59                   | 0.50                     |
|                               |              |            | 18.43                    |                          |                           |                            |                        |                      |                      |                       |                        |                           |                            |                           |                             |                            |                              |                             |                               |                 |                                |                                |                                 |                                  |                               |   |                           |               |                                   |                        |                      |                 |              |            |                                     |               |                         |                        |                          |
| C1007W                        | 1007         | 1003       | 0.00                     | 0.32                     | 0.00                      | 0.00                       | 0.00                   | 0.00                 | 0.69                 | 0.00                  | 0.000                  | 0.000                     | 0.221                      | 0.221                     | 0.000                       | 0.000                      | 0.000                        | 0.000                       | 0.000                         | 10.00           | 76.81                          | 104.19                         | 122.14                          | 178.56                           | 0.0                           | 0.0                                     | 63.9                      | 94.2          | 450                               | 450                    | CIRCULAR             | CONCRETE        | -            | 0.25       | 148.7                               | 42.95%        | 0.91                    | 0.74                   | 2.13                     |
|                               |              |            | 12.13                    |                          |                           |                            |                        |                      |                      |                       |                        |                           |                            |                           |                             |                            |                              |                             |                               |                 |                                |                                |                                 |                                  |                               |   |                           |               |                                   |                        |                      |                 |              |            |                                     |               |                         |                        |                          |
| C1003A, C1003B                | 1003         | 1002       | 0.48                     | 0.00                     | 0.00                      | 0.00                       | 0.00                   | 0.69                 | 0.00                 | 0.00                  | 0.331                  | 0.526                     | 0.000                      | 22.533                    | 0.000                       | 0.000                      | 0.000                        | 0.000                       | 0.000                         | 18.43           | 54.70                          | 73.89                          | 86.49                           | 126.23                           | 0.0                           | 0.0                                     | 4705.0                    | 127.5         | 2100                              | 2100                   | CIRCULAR             | CONCRETE        | -            | 0.10       | 5719.9                              | 82.26%        | 1.60                    | 1.59                   | 1.34                     |
| L1002A, C1002AA, C1002AB      | 1002A        | 1002       | 0.25                     | 3.20                     | 0.00                      | 0.00                       | 0.00                   | 0.52                 | 0.80                 | 0.00                  | 0.130                  | 0.130                     | 2.560                      | 2.560                     | 0.000                       | 0.000                      | 0.000                        | 0.000                       | 0.000                         | 18.43           | 54.70                          | 73.89                          | 86.49                           | 126.23                           | 0.0                           | 0.0                                     | 545.3                     | 48.8          | 900                               | 900                    | CIRCULAR             | CONCRETE        | -            | 0.10       | 597.2                               | 91.30%        | 0.91                    | 0.93                   | 0.87                     |
| C1002A                        | 1002         | 1001       | 0.00                     | 0.13                     | 0.00                      | 0.00                       | 0.00                   | 0.69                 | 0.00                 | 0.00                  | 0.000                  | 0.526                     | 0.090                      | 22.622                    | 0.000                       | 0.000                      | 0.000                        | 0.000                       | 0.000                         | 19.77           | 52.40                          | 70.76                          | 82.80                           | 120.82                           | 0.0                           | 0.0                                     | 4522.9                    | 67.0          | 2100                              | 2100                   | CIRCULAR             | CONCRETE        | -            | 0.10       | 5720.2                              | 79.07%        | 1.60                    | 1.57                   | 0.71                     |
| C1001A                        | 1001         | 1000       | 0.00                     | 0.21                     | 0.00                      | 0.00                       | 0.00                   | 0.73                 | 0.00                 | 0.00                  | 0.000                  | 0.526                     | 0.153                      | 22.776                    | 0.000                       | 0.000                      | 0.000                        | 0.000                       | 0.000                         | 20.48           | 51.27                          | 69.21                          | 80.98                           | 118.15                           | 0.0                           | 0.0                                     | 4453.3                    | 33.1          | 2100                              | 2100                   | CIRCULAR             | CONCRETE        | -            | 0.10       | 5720.1                              | 77.85%        | 1.60                    | 1.57                   | 0.35                     |
|                               |              |            | 20.84                    |                          |                           |                            |                        |                      |                      |                       |                        |                           |                            |                           |                             |                            |                              |                             |                               |                 |                                |                                |                                 |                                  |                               |   |                           |               |                                   |                        |                      |                 |              |            |                                     |               |                         |                        |                          |



Trails Edge East Phase 1  
 DATE: 2019-07-24  
 REVISION: 3  
 DESIGNED BY: DT  
 CHECKED BY: MJS

**STORM SEWER  
 DESIGN SHEET  
 (City of Ottawa)**

FILE NUMBER: 160401250

**DESIGN PARAMETERS**  
 I = a / (t+b)<sup>c</sup> (As per City of Ottawa Guidelines, 2012)

|     |         |         |          |          |                |        |
|-----|---------|---------|----------|----------|----------------|--------|
|     | 1:2 yr  | 1:5 yr  | 1:10 yr  | 1:100 yr |                |        |
| a = | 732.951 | 998.071 | 1174.184 | 1735.688 | MANNING'S n =  | 0.013  |
| b = | 6.199   | 6.053   | 6.014    | 6.014    | MINIMUM COVER: | 2.00 m |
| c = | 0.810   | 0.814   | 0.816    | 0.820    | TIME OF ENTRY  | 10 min |

BEDDING CLASS = B

| LOCATION<br>AREA ID NUMBER | FROM M.H. | TO M.H. | DRAINAGE AREA |               |                |                 |             |            |            |             |              |                | PIPE SELECTION  |                |                 |                 |                  |                  |                   |              |                             |                             |                              |                               |                            |                                   |                                  |            |                             |                  |                |                   |                |           |                               |            |                   |                  |                    |      |
|----------------------------|-----------|---------|---------------|---------------|----------------|-----------------|-------------|------------|------------|-------------|--------------|----------------|-----------------|----------------|-----------------|-----------------|------------------|------------------|-------------------|--------------|-----------------------------|-----------------------------|------------------------------|-------------------------------|----------------------------|-----------------------------------|----------------------------------|------------|-----------------------------|------------------|----------------|-------------------|----------------|-----------|-------------------------------|------------|-------------------|------------------|--------------------|------|
|                            |           |         | AREA (2-YEAR) | AREA (5-YEAR) | AREA (10-YEAR) | AREA (100-YEAR) | AREA (ROOF) | C (2-YEAR) | C (5-YEAR) | C (10-YEAR) | C (100-YEAR) | A x C (2-YEAR) | ACCUM AxC (2YR) | A x C (5-YEAR) | ACCUM AxC (5YR) | A x C (10-YEAR) | ACCUM AxC (10YR) | A x C (100-YEAR) | ACCUM AxC (100YR) | T of C (min) | I <sub>2</sub> -YEAR (mm/h) | I <sub>5</sub> -YEAR (mm/h) | I <sub>10</sub> -YEAR (mm/h) | I <sub>100</sub> -YEAR (mm/h) | Q <sub>CONTROL</sub> (L/s) | ACCUM. Q <sub>CONTROL</sub> (L/s) | Q <sub>ACT</sub> (CIA/360) (L/s) | LENGTH (m) | PIPE WIDTH OR DIAMETER (mm) | PIPE HEIGHT (mm) | PIPE SHAPE (-) | PIPE MATERIAL (-) | PIPE CLASS (-) | SLOPE (%) | Q <sub>CAP</sub> (FULL) (L/s) | % FULL (-) | VEL. (FULL) (m/s) | VEL. (ACT) (m/s) | TIME OF FLOW (min) |      |
| L2007A, L2007B             | 2007      | 2006    | 9.20          | 0.00          | 0.00           | 0.00            | 0.00        | 0.65       | 0.00       | 0.00        | 0.00         | 5.972          | 5.972           | 0.000          | 0.000           | 0.000           | 0.000            | 0.000            | 0.000             | 0.000        | 14.08                       | 64.02                       | 86.64                        | 101.48                        | 148.22                     | 0.0                               | 0.0                              | 1061.9     | 45.6                        | 1200             | 1200           | CIRCULAR          | CONCRETE       | -         | 0.10                          | 1286.2     | 82.56%            | 1.10             | 1.10               | 0.69 |
|                            | 2028      | 2027    | 0.00          | 0.00          | 0.00           | 0.00            | 0.00        | 0.00       | 0.00       | 0.00        | 0.000        | 0.000          | 0.000           | 0.000          | 0.000           | 0.000           | 0.000            | 0.000            | 0.000             | 0.000        | 10.00                       | 76.81                       | 104.19                       | 122.14                        | 178.56                     | 0.0                               | 0.0                              | 0.0        | 16.9                        | 300              | 300            | CIRCULAR          | PVC            | -         | 0.35                          | 56.9       | 0.00%             | 0.81             | 0.00               | 0.00 |
| L1006B, L1006A             | 1006      | 2027    | 0.51          | 0.00          | 0.00           | 0.00            | 0.00        | 0.69       | 0.00       | 0.00        | 0.00         | 0.355          | 0.355           | 0.000          | 0.000           | 0.000           | 0.000            | 0.000            | 0.000             | 0.000        | 10.00                       | 76.81                       | 104.19                       | 122.14                        | 178.56                     | 0.0                               | 0.0                              | 75.7       | 120.0                       | 450              | 450            | CIRCULAR          | CONCRETE       | -         | 0.20                          | 133.0      | 56.95%            | 0.81             | 0.72               | 2.79 |
| L2027A                     | 2027      | 2026    | 0.31          | 0.00          | 0.00           | 0.00            | 0.00        | 0.69       | 0.00       | 0.00        | 0.00         | 0.210          | 0.565           | 0.000          | 0.000           | 0.000           | 0.000            | 0.000            | 0.000             | 0.000        | 12.79                       | 67.54                       | 91.47                        | 107.16                        | 156.56                     | 0.0                               | 0.0                              | 106.1      | 53.3                        | 525              | 525            | CIRCULAR          | CONCRETE       | -         | 0.20                          | 200.6      | 52.88%            | 0.90             | 0.78               | 1.13 |
| C1007A, C1007B             | 1007      | 2026    | 0.00          | 0.48          | 0.00           | 0.00            | 0.00        | 0.69       | 0.00       | 0.00        | 0.000        | 0.000          | 0.331           | 0.331          | 0.000           | 0.000           | 0.000            | 0.000            | 0.000             | 0.000        | 10.00                       | 76.81                       | 104.19                       | 122.14                        | 178.56                     | 0.0                               | 0.0                              | 95.8       | 120.0                       | 450              | 450            | CIRCULAR          | CONCRETE       | -         | 0.20                          | 133.0      | 72.01%            | 0.81             | 0.77               | 2.58 |
| C2026B, C2026A             | 2026      | 2025    | 0.00          | 0.42          | 0.00           | 0.00            | 0.00        | 0.69       | 0.00       | 0.00        | 0.000        | 0.565          | 0.291           | 0.622          | 0.000           | 0.000           | 0.000            | 0.000            | 0.000             | 0.000        | 13.92                       | 64.44                       | 87.22                        | 102.16                        | 149.21                     | 0.0                               | 0.0                              | 252.0      | 105.5                       | 825              | 825            | CIRCULAR          | CONCRETE       | -         | 0.10                          | 473.6      | 53.21%            | 0.86             | 0.75               | 2.35 |
| C2029A, L2029A             | 2029      | 2025    | 8.32          | 1.13          | 0.00           | 0.00            | 0.00        | 0.65       | 0.65       | 0.00        | 0.00         | 5.411          | 5.411           | 0.736          | 0.736           | 0.000           | 0.000            | 0.000            | 0.000             | 0.000        | 14.92                       | 61.96                       | 83.83                        | 98.17                         | 143.36                     | 0.0                               | 0.0                              | 1102.8     | 19.8                        | 1350             | 1350           | CIRCULAR          | CONCRETE       | -         | 0.10                          | 1760.6     | 62.64%            | 1.19             | 1.09               | 0.30 |
| L2025B, L2025A             | 2025      | 2022    | 0.46          | 0.00          | 0.00           | 0.00            | 0.00        | 0.66       | 0.00       | 0.00        | 0.00         | 0.304          | 6.281           | 0.000          | 1.359           | 0.000           | 0.000            | 0.000            | 0.000             | 0.000        | 16.27                       | 58.92                       | 79.66                        | 93.27                         | 136.17                     | 0.0                               | 0.0                              | 1328.6     | 80.3                        | 1350             | 1350           | CIRCULAR          | CONCRETE       | -         | 0.10                          | 1760.8     | 75.45%            | 1.19             | 1.15               | 1.16 |
| L2030B, L2030A             | 2030      | 2022    | 3.33          | 0.00          | 0.00           | 0.00            | 0.00        | 0.65       | 0.00       | 0.00        | 0.00         | 2.156          | 2.156           | 0.000          | 0.000           | 0.000           | 0.000            | 0.000            | 0.000             | 0.000        | 14.08                       | 64.02                       | 86.64                        | 101.48                        | 148.22                     | 0.0                               | 0.0                              | 383.4      | 45.4                        | 900              | 900            | CIRCULAR          | CONCRETE       | -         | 0.10                          | 597.2      | 64.19%            | 0.91             | 0.84               | 0.90 |
| L2022S                     | 2022      | 2006    | 0.16          | 0.00          | 0.00           | 0.00            | 0.00        | 0.69       | 0.00       | 0.00        | 0.00         | 0.111          | 8.548           | 0.000          | 1.359           | 0.000           | 0.000            | 0.000            | 0.000             | 0.000        | 17.43                       | 56.56                       | 76.44                        | 89.49                         | 130.62                     | 0.0                               | 0.0                              | 1631.5     | 83.5                        | 1650             | 1650           | CIRCULAR          | CONCRETE       | -         | 0.10                          | 3006.9     | 54.26%            | 1.36             | 1.20               | 1.16 |
| L2039A                     | 2039      | 2038    | 0.24          | 0.00          | 0.00           | 0.00            | 0.00        | 0.73       | 0.00       | 0.00        | 0.00         | 0.172          | 0.172           | 0.000          | 0.000           | 0.000           | 0.000            | 0.000            | 0.000             | 0.000        | 10.00                       | 76.81                       | 104.19                       | 122.14                        | 178.56                     | 0.0                               | 0.0                              | 36.7       | 39.8                        | 375              | 375            | CIRCULAR          | PVC            | -         | 0.25                          | 84.4       | 43.51%            | 0.80             | 0.66               | 1.01 |
|                            | 2038      | 2037    | 0.00          | 0.00          | 0.00           | 0.00            | 0.00        | 0.00       | 0.00       | 0.00        | 0.000        | 0.172          | 0.000           | 0.000          | 0.000           | 0.000           | 0.000            | 0.000            | 0.000             | 0.000        | 11.73                       | 73.14                       | 99.15                        | 116.21                        | 169.84                     | 0.0                               | 0.0                              | 35.0       | 26.3                        | 525              | 525            | CIRCULAR          | CONCRETE       | -         | 0.25                          | 224.3      | 15.58%            | 1.00             | 0.61               | 0.72 |
| L2040A                     | 2040      | 2037    | 0.10          | 0.00          | 0.00           | 0.00            | 0.00        | 0.58       | 0.00       | 0.00        | 0.00         | 0.060          | 0.060           | 0.000          | 0.000           | 0.000           | 0.000            | 0.000            | 0.000             | 0.000        | 10.00                       | 76.81                       | 104.19                       | 122.14                        | 178.56                     | 0.0                               | 0.0                              | 12.8       | 44.3                        | 450              | 450            | CIRCULAR          | CONCRETE       | -         | 0.25                          | 148.7      | 8.58%             | 0.91             | 0.46               | 1.60 |
| L2037A                     | 2037      | 2006    | 0.52          | 0.00          | 0.00           | 0.00            | 0.00        | 0.73       | 0.00       | 0.00        | 0.00         | 0.380          | 0.612           | 0.000          | 0.000           | 0.000           | 0.000            | 0.000            | 0.000             | 0.000        | 11.73                       | 70.75                       | 95.87                        | 112.34                        | 164.16                     | 0.0                               | 0.0                              | 120.3      | 119.2                       | 675              | 675            | CIRCULAR          | CONCRETE       | -         | 0.15                          | 339.6      | 35.41%            | 0.92             | 0.71               | 2.81 |
| L2006A                     | 2006      | 2005    | 0.29          | 0.00          | 0.00           | 0.00            | 0.00        | 0.73       | 0.00       | 0.00        | 0.00         | 0.208          | 15.339          | 0.000          | 1.359           | 0.000           | 0.000            | 0.000            | 0.000             | 0.000        | 18.60                       | 54.41                       | 73.49                        | 86.02                         | 125.54                     | 0.0                               | 0.0                              | 2595.6     | 77.1                        | 1950             | 1950           | CIRCULAR          | CONCRETE       | -         | 0.10                          | 4694.4     | 55.29%            | 1.52             | 1.34               | 0.96 |
| L2035A                     | 2034      | 2035    | 0.00          | 0.00          | 0.00           | 0.00            | 0.00        | 0.00       | 0.00       | 0.00        | 0.000        | 0.000          | 0.000           | 0.000          | 0.000           | 0.000           | 0.000            | 0.000            | 0.000             | 0.000        | 10.00                       | 76.81                       | 104.19                       | 122.14                        | 178.56                     | 0.0                               | 0.0                              | 0.0        | 9.5                         | 300              | 300            | CIRCULAR          | PVC            | -         | 0.35                          | 56.9       | 0.00%             | 0.81             | 0.00               | 0.00 |
| L2036B, L2036A             | 2035      | 2036    | 0.33          | 0.00          | 0.00           | 0.00            | 0.00        | 0.73       | 0.00       | 0.00        | 0.00         | 0.239          | 0.239           | 0.000          | 0.000           | 0.000           | 0.000            | 0.000            | 0.000             | 0.000        | 10.00                       | 76.81                       | 104.19                       | 122.14                        | 178.56                     | 0.0                               | 0.0                              | 50.9       | 68.2                        | 450              | 450            | CIRCULAR          | CONCRETE       | -         | 0.25                          | 148.7      | 34.23%            | 0.91             | 0.69               | 1.65 |
|                            | 2036      | 2005    | 0.86          | 0.00          | 0.00           | 0.00            | 0.00        | 0.61       | 0.00       | 0.00        | 0.00         | 0.525          | 0.763           | 0.000          | 0.000           | 0.000           | 0.000            | 0.000            | 0.000             | 0.000        | 11.65                       | 71.00                       | 96.21                        | 112.74                        | 164.75                     | 0.0                               | 0.0                              | 150.6      | 56.7                        | 525              | 525            | CIRCULAR          | CONCRETE       | -         | 0.20                          | 200.6      | 75.03%            | 0.90             | 0.87               | 1.09 |
| L2005A                     | 2005      | 2004    | 0.31          | 0.00          | 0.00           | 0.00            | 0.00        | 0.73       | 0.00       | 0.00        | 0.00         | 0.227          | 16.329          | 0.000          | 1.359           | 0.000           | 0.000            | 0.000            | 0.000             | 0.000        | 19.56                       | 52.76                       | 71.24                        | 83.38                         | 121.66                     | 0.0                               | 0.0                              | 2661.9     | 83.0                        | 1950             | 1950           | CIRCULAR          | CONCRETE       | -         | 0.10                          | 4694.5     | 56.70%            | 1.52             | 1.35               | 1.02 |
| L2034A, L2034B             | 2034      | 2033    | 0.86          | 0.00          | 0.00           | 0.00            | 0.00        | 0.63       | 0.00       | 0.00        | 0.00         | 0.540          | 0.540           | 0.000          | 0.000           | 0.000           | 0.000            | 0.000            | 0.000             | 0.000        | 10.00                       | 76.81                       | 104.19                       | 122.14                        | 178.56                     | 0.0                               | 0.0                              | 115.3      | 67.1                        | 525              | 525            | CIRCULAR          | CONCRETE       | -         | 0.20                          | 200.6      | 57.45%            | 0.90             | 0.80               | 1.39 |
| L2032A                     | 2033      | 2032    | 0.00          | 0.00          | 0.00           | 0.00            | 0.00        | 0.00       | 0.00       | 0.00        | 0.000        | 0.000          | 0.540           | 0.000          | 0.000           | 0.000           | 0.000            | 0.000            | 0.000             | 0.000        | 11.39                       | 71.84                       | 97.37                        | 114.10                        | 166.75                     | 0.0                               | 0.0                              | 107.8      | 12.3                        | 525              | 525            | CIRCULAR          | CONCRETE       | -         | 0.20                          | 200.6      | 53.74%            | 0.90             | 0.78               | 0.26 |
| L2031A, L2031B             | 2032      | 2031    | 0.23          | 0.00          | 0.00           | 0.00            | 0.00        | 0.73       | 0.00       | 0.00        | 0.00         | 0.168          | 0.709           | 0.000          | 0.000           | 0.000           | 0.000            | 0.000            | 0.000             | 0.000        | 11.66                       | 70.98                       | 96.19                        | 112.72                        | 164.72                     | 0.0                               | 0.0                              | 139.7      | 66.7                        | 600              | 600            | CIRCULAR          | CONCRETE       | -         | 0.20                          | 286.5      | 48.78%            | 0.98             | 0.83               | 1.34 |
|                            | 2031      | 2004    | 0.66          | 0.00          | 0.00           | 0.00            | 0.00        | 0.64       | 0.00       | 0.00        | 0.00         | 0.419          | 1.128           | 0.000          | 0.000           | 0.000           | 0.000            | 0.000            | 0.000             | 0.000        | 12.99                       | 66.95                       | 90.66                        | 106.21                        | 155.16                     | 0.0                               | 0.0                              | 209.7      | 66.7                        | 750              | 750            | CIRCULAR          | CONCRETE       | -         | 0.15                          | 449.8      | 46.62%            | 0.99             | 0.83               | 1.34 |
| L2004A, L2004B, L2004C     | 2004      | 2003    | 1.08          | 0.00          | 0.00           | 0.00            | 0.00        | 0.61       | 0.00       | 0.00        | 0.00         | 0.656          | 18.113          | 0.000          | 1.359           | 0.000           | 0.000            | 0.000            | 0.000             | 0.000        | 20.58                       | 51.12                       | 69.00                        | 80.75                         | 117.80                     | 0.0                               | 0.0                              | 2832.2     | 69.0                        | 1950             | 1950           | CIRCULAR          | CONCRETE       | -         | 0.10                          | 4694.4     | 60.33%            | 1.52             | 1.38               | 0.83 |
| L2003A, L2003B             | 2003      | 2002    | 0.70          | 0.00          | 0.00           | 0.00            | 0.00        | 0.64       | 0.00       | 0.00        | 0.00         | 0.447          | 18.559          | 0.000          | 1.359           | 0.000           | 0.000            | 0.000            | 0.000             | 0.000        | 22.22                       | 21.41                       | 49.87                        | 67.30                         | 78.74                      | 0.0                               | 0.0                              | 2824.7     | 66.2                        | 1950             | 1950           | CIRCULAR          | CONCRETE       | -         | 0.10                          | 4694.4     | 60.17%            | 1.52             | 1.37               | 0.80 |
| L2013B, L2013A             | 2013      | 2012    | 0.32          | 0.00          | 0.00           | 0.00            | 0.00        | 0.69       | 0.00       | 0.00        | 0.00         | 0.223          | 0.223           | 0.000          | 0.000           | 0.000           | 0.000            | 0.000            | 0.000             | 0.000        | 10.00                       | 76.81                       | 104.19                       | 122.14                        | 178.56                     | 0.0                               | 0.0                              | 47.6       | 113.3                       | 375              |                |                   |                |           |                               |            |                   |                  |                    |      |



Trails Edge East Phase 1

**STORM SEWER  
DESIGN SHEET**  
(City of Ottawa)

DESIGN PARAMETERS

$I = a / (t+b)^c$  (As per City of Ottawa Guidelines, 2012)

|     |         |         |          |          |                |        |
|-----|---------|---------|----------|----------|----------------|--------|
|     | 1:2 yr  | 1:5 yr  | 1:10 yr  | 1:100 yr |                |        |
| a = | 732.951 | 998.071 | 1174.184 | 1735.688 | MANNING'S n =  | 0.013  |
| b = | 6.199   | 6.053   | 6.014    | 6.014    | MINIMUM COVER: | 2.00 m |
| c = | 0.810   | 0.814   | 0.816    | 0.820    | TIME OF ENTRY  | 10 min |

BEDDING CLASS = B

DATE: 2019-07-24  
REVISION: 3  
DESIGNED BY: DT  
CHECKED BY: MJS

FILE NUMBER: 160401250

| LOCATION                       |           | DRAINAGE AREA |               |               |                |                 |             |            |            |             |              |                |                 |                |                  | PIPE SELECTION  |                   |                  |                    |              |                             |                             |                              |                               |                            |                                   |                                  |            |                             |                  |                |              |           |           |                               |            |                   |                  |                    |
|--------------------------------|-----------|---------------|---------------|---------------|----------------|-----------------|-------------|------------|------------|-------------|--------------|----------------|-----------------|----------------|------------------|-----------------|-------------------|------------------|--------------------|--------------|-----------------------------|-----------------------------|------------------------------|-------------------------------|----------------------------|-----------------------------------|----------------------------------|------------|-----------------------------|------------------|----------------|--------------|-----------|-----------|-------------------------------|------------|-------------------|------------------|--------------------|
| AREA ID NUMBER                 | FROM M.H. | TO M.H.       | AREA (2-YEAR) | AREA (5-YEAR) | AREA (10-YEAR) | AREA (100-YEAR) | AREA (ROOF) | C (2-YEAR) | C (5-YEAR) | C (10-YEAR) | C (100-YEAR) | A x C (2-YEAR) | ACCUM AxC (2YR) | A x C (5-YEAR) | ACCUM. AxC (5YR) | A x C (10-YEAR) | ACCUM. AxC (10YR) | A x C (100-YEAR) | ACCUM. AxC (100YR) | T of C (min) | I <sub>2</sub> -YEAR (mm/h) | I <sub>5</sub> -YEAR (mm/h) | I <sub>10</sub> -YEAR (mm/h) | I <sub>100</sub> -YEAR (mm/h) | Q <sub>CONTROL</sub> (L/s) | ACCUM. Q <sub>CONTROL</sub> (L/s) | Q <sub>ACT</sub> (CIA/360) (L/s) | LENGTH (m) | PIPE WIDTH OR DIAMETER (mm) | PIPE HEIGHT (mm) | PIPE SHAPE (-) | MATERIAL (-) | CLASS (-) | SLOPE (%) | Q <sub>CAP</sub> (FULL) (L/s) | % FULL (-) | VEL. (FULL) (m/s) | VEL. (ACT) (m/s) | TIME OF FLOW (min) |
| L2020A, L2020B                 | 2020      | 2008          | 0.77          | 0.00          | 0.00           | 0.00            | 0.00        | 0.52       | 0.00       | 0.00        | 0.00         | 0.399          | 2.153           | 0.000          | 0.000            | 0.000           | 0.000             | 0.000            | 0.000              | 14.41        | 63.20                       | 85.52                       | 100.16                       | 146.28                        | 0.0                        | 0.0                               | 378.1                            | 83.1       | 975                         | 975              | CIRCULAR       | CONCRETE     | -         | 0.10      | 739.4                         | 51.13%     | 0.96              | 0.83             | 1.67               |
| L2008A                         | 2008      | 2002          | 0.32          | 0.00          | 0.00           | 0.00            | 0.00        | 0.74       | 0.00       | 0.00        | 0.00         | 0.234          | 4.658           | 0.000          | 0.000            | 0.000           | 0.000             | 0.000            | 0.000              | 16.85        | 57.73                       | 78.03                       | 91.35                        | 133.36                        | 0.0                        | 0.0                               | 746.9                            | 87.8       | 1350                        | 1350             | CIRCULAR       | CONCRETE     | -         | 0.10      | 1760.8                        | 42.42%     | 1.19              | 0.97             | 1.51               |
| L2002A, L2002B, L2002C, L2001A | 2002      | 2001          | 1.52          | 0.00          | 0.00           | 0.00            | 0.00        | 0.56       | 0.00       | 0.00        | 0.00         | 0.858          | 24.075          | 0.000          | 1.359            | 0.000           | 0.000             | 0.000            | 0.000              | 22.22        | 48.72                       | 65.74                       | 76.91                        | 112.17                        | 0.0                        | 0.0                               | 3506.3                           | 120.0      | 2100                        | 2100             | CIRCULAR       | CONCRETE     | -         | 0.10      | 5720.1                        | 61.30%     | 1.60              | 1.45             | 1.38               |
|                                | 2001      | 2000          | 0.26          | 0.00          | 0.00           | 0.00            | 0.00        | 0.73       | 0.00       | 0.00        | 0.00         | 0.190          | 24.265          | 0.000          | 1.359            | 0.000           | 0.000             | 0.000            | 0.000              | 23.59        | 46.89                       | 63.24                       | 73.98                        | 107.88                        | 0.0                        | 0.0                               | 3399.1                           | 28.1       | 2100                        | 2100             | CIRCULAR       | CONCRETE     | -         | 0.10      | 5720.1                        | 59.42%     | 1.60              | 1.44             | 0.32               |

Copyright Reserved

The Contractor shall verify and be responsible for all dimensions. DO NOT scale the drawing - any errors or omissions shall be reported to Stantec without delay.  
The Copyrights to all designs and drawings are the property of Stantec. Reproduction or use for any purpose other than that authorized by Stantec is forbidden.

Legend

- AREA ID
- RUNOFF COEFFICIENT
- STORM DRAINAGE AREA ha.
- STORM DRAINAGE BOUNDARY
- EXISTING/FUTURE STORM DRAINAGE BOUNDARY
- EXISTING/FUTURE STORM DRAINAGE AREA
- TYPICAL SERVICE LATERAL LOCATION
- MAXIMUM PONDING LIMITS
- DIRECTION OF OVERLAND FLOW
- PROPOSED STORM SEWER
- PROPOSED CATCHBASIN MANHOLE
- PROPOSED DOUBLE CATCH BASIN
- PROPOSED SUB DRAIN CATCH BASIN AS PER CITY OF OTTAWA STANDARD DETAIL DRAWINGS L10 AND L11.
- PROPOSED PERFORATED SUBDRAIN
- EXISTING STORM SEWER
- EXISTING CATCHBASIN MANHOLE
- EXISTING CATCHBASIN
- EXISTING SUBDRAIN CATCHBASIN
- FUTURE STORM SEWER
- FUTURE CATCHBASIN MANHOLE
- FUTURE CATCHBASIN
- FUTURE SUBDRAIN CATCHBASIN
- CIRCULAR ORIFICE (SEE SEE ICD TABLE)
- MAJOR SYSTEM DIVIDE

Notes

|   |   |     |       |          |
|---|---|-----|-------|----------|
| 8 | ISSUED FOR APPROVAL                         | AJ  | DT    | 19.09.18 |
| 7 | REVISED ASCENDER OFFSITE SERVING            | AJ  | DT/SG | 19.05.17 |
| 6 | ISSUED FOR GRADING APPROVAL                 | AJ  | DT    | 19.03.11 |
| 5 | ISSUED FOR CONSTRUCTION                     | MJS | GR    | 18.10.25 |
| 4 | REVISED FIRE HYDRANT LOCATIONS              | MJS | DT    | 18.10.24 |
| 3 | REVISED AS PER CITY COMMENTS                | MJS | DT    | 18.09.28 |
| 2 | REVISED AS PER CITY COMMENTS AND DRAFT PLAN | MJS | DT    | 18.08.23 |
| 1 | REVISED AS PER CITY COMMENTS                | MJS | DT    | 18.05.30 |
| 0 | ISSUED TO CITY FOR REVIEW                   | MJS | DT    | 18.03.06 |

| Revision | By  | Appd. | YY.MM.DD |
|----------|-----|-------|----------|
| 8        | AJ  | DT    | 19.09.18 |
| 7        | AJ  | DT/SG | 19.05.17 |
| 6        | AJ  | DT    | 19.03.11 |
| 5        | MJS | GR    | 18.10.25 |
| 4        | MJS | DT    | 18.10.24 |
| 3        | MJS | DT    | 18.09.28 |
| 2        | MJS | DT    | 18.08.23 |
| 1        | MJS | DT    | 18.05.30 |
| 0        | MJS | DT    | 18.03.06 |

File Name: 16401250.DWG  
Dwn. Chkd. Dgn. YY.MM.DD

Permit-Seal

Client/Project

**RICHCRAFT GROUP OF COMPANIES**  
2280 ST. LAURENT BLVD  
OTTAWA, ON, K1G 4K1

**TRAILSEDGE EAST SUBDIVISION**  
OTTAWA, ON, CANADA

Title

**STORM DRAINAGE PLAN**

Project No. 16401250 Scale 0 7.5 22.5 37.5m

Drawing No. Sheet Revision

SD-1 40 of 46 8 DOT-1-16-0021 DWG# 17807

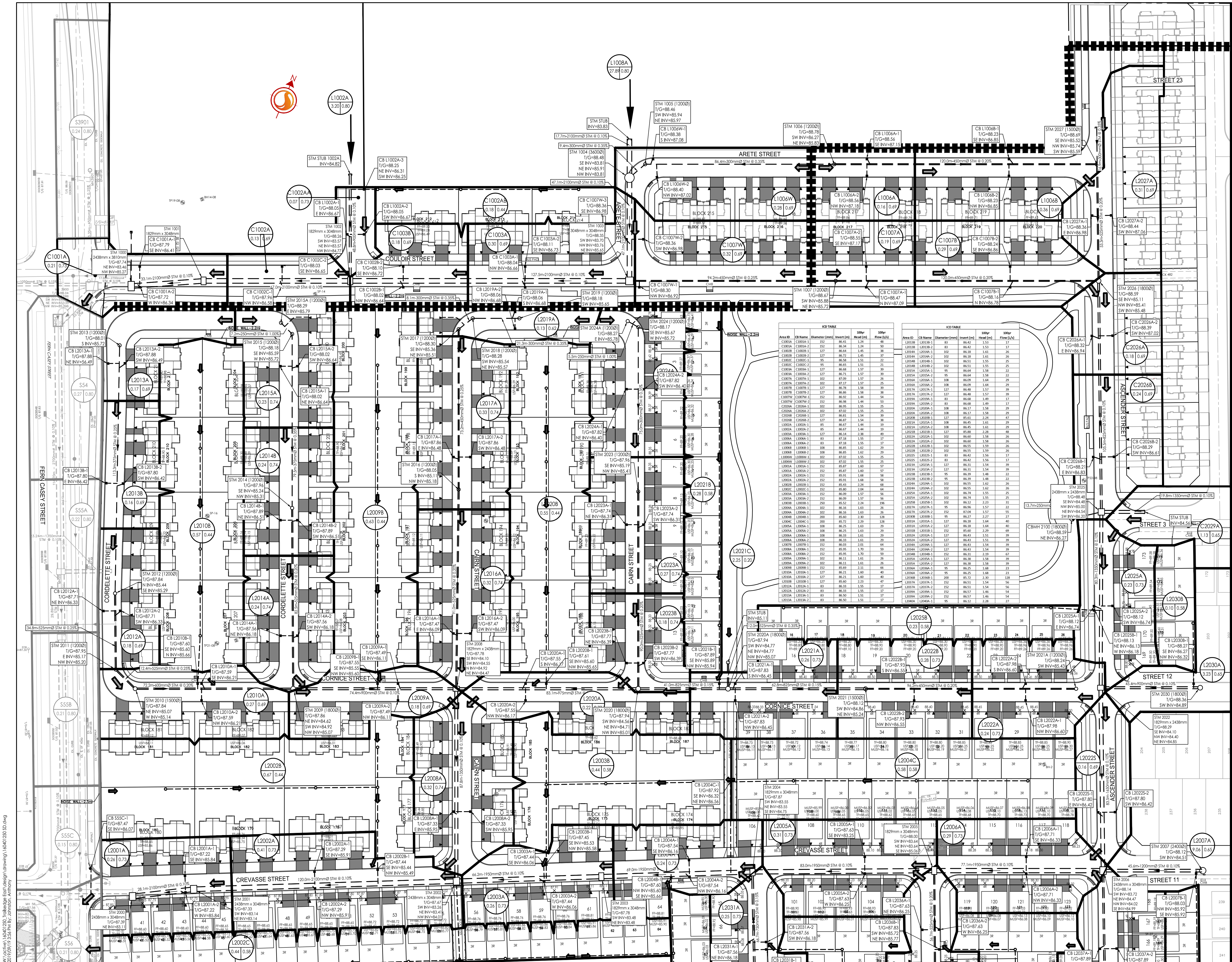

| Area ID | CB Name       | Diameter (mm) | Invert (m) | 500R | 500R | 500R | 500R | 500R |
|---------|---------------|---------------|------------|------|------|------|------|------|
| L2001A  | CB L2001A-1   | 150           | 86.41      | 1.34 | 88   |      |      |      |
| L2001A  | CB L2001A-2   | 150           | 86.41      | 1.34 | 88   |      |      |      |
| L2001A  | CB L2001A-3   | 150           | 86.41      | 1.34 | 88   |      |      |      |
| L2001A  | CB L2001A-4   | 150           | 86.41      | 1.34 | 88   |      |      |      |
| L2001A  | CB L2001A-5   | 150           | 86.41      | 1.34 | 88   |      |      |      |
| L2001A  | CB L2001A-6   | 150           | 86.41      | 1.34 | 88   |      |      |      |
| L2001A  | CB L2001A-7   | 150           | 86.41      | 1.34 | 88   |      |      |      |
| L2001A  | CB L2001A-8   | 150           | 86.41      | 1.34 | 88   |      |      |      |
| L2001A  | CB L2001A-9   | 150           | 86.41      | 1.34 | 88   |      |      |      |
| L2001A  | CB L2001A-10  | 150           | 86.41      | 1.34 | 88   |      |      |      |
| L2001A  | CB L2001A-11  | 150           | 86.41      | 1.34 | 88   |      |      |      |
| L2001A  | CB L2001A-12  | 150           | 86.41      | 1.34 | 88   |      |      |      |
| L2001A  | CB L2001A-13  | 150           | 86.41      | 1.34 | 88   |      |      |      |
| L2001A  | CB L2001A-14  | 150           | 86.41      | 1.34 | 88   |      |      |      |
| L2001A  | CB L2001A-15  | 150           | 86.41      | 1.34 | 88   |      |      |      |
| L2001A  | CB L2001A-16  | 150           | 86.41      | 1.34 | 88   |      |      |      |
| L2001A  | CB L2001A-17  | 150           | 86.41      | 1.34 | 88   |      |      |      |
| L2001A  | CB L2001A-18  | 150           | 86.41      | 1.34 | 88   |      |      |      |
| L2001A  | CB L2001A-19  | 150           | 86.41      | 1.34 | 88   |      |      |      |
| L2001A  | CB L2001A-20  | 150           | 86.41      | 1.34 | 88   |      |      |      |
| L2001A  | CB L2001A-21  | 150           | 86.41      | 1.34 | 88   |      |      |      |
| L2001A  | CB L2001A-22  | 150           | 86.41      | 1.34 | 88   |      |      |      |
| L2001A  | CB L2001A-23  | 150           | 86.41      | 1.34 | 88   |      |      |      |
| L2001A  | CB L2001A-24  | 150           | 86.41      | 1.34 | 88   |      |      |      |
| L2001A  | CB L2001A-25  | 150           | 86.41      | 1.34 | 88   |      |      |      |
| L2001A  | CB L2001A-26  | 150           | 86.41      | 1.34 | 88   |      |      |      |
| L2001A  | CB L2001A-27  | 150           | 86.41      | 1.34 | 88   |      |      |      |
| L2001A  | CB L2001A-28  | 150           | 86.41      | 1.34 | 88   |      |      |      |
| L2001A  | CB L2001A-29  | 150           | 86.41      | 1.34 | 88   |      |      |      |
| L2001A  | CB L2001A-30  | 150           | 86.41      | 1.34 | 88   |      |      |      |
| L2001A  | CB L2001A-31  | 150           | 86.41      | 1.34 | 88   |      |      |      |
| L2001A  | CB L2001A-32  | 150           | 86.41      | 1.34 | 88   |      |      |      |
| L2001A  | CB L2001A-33  | 150           | 86.41      | 1.34 | 88   |      |      |      |
| L2001A  | CB L2001A-34  | 150           | 86.41      | 1.34 | 88   |      |      |      |
| L2001A  | CB L2001A-35  | 150           | 86.41      | 1.34 | 88   |      |      |      |
| L2001A  | CB L2001A-36  | 150           | 86.41      | 1.34 | 88   |      |      |      |
| L2001A  | CB L2001A-37  | 150           | 86.41      | 1.34 | 88   |      |      |      |
| L2001A  | CB L2001A-38  | 150           | 86.41      | 1.34 | 88   |      |      |      |
| L2001A  | CB L2001A-39  | 150           | 86.41      | 1.34 | 88   |      |      |      |
| L2001A  | CB L2001A-40  | 150           | 86.41      | 1.34 | 88   |      |      |      |
| L2001A  | CB L2001A-41  | 150           | 86.41      | 1.34 | 88   |      |      |      |
| L2001A  | CB L2001A-42  | 150           | 86.41      | 1.34 | 88   |      |      |      |
| L2001A  | CB L2001A-43  | 150           | 86.41      | 1.34 | 88   |      |      |      |
| L2001A  | CB L2001A-44  | 150           | 86.41      | 1.34 | 88   |      |      |      |
| L2001A  | CB L2001A-45  | 150           | 86.41      | 1.34 | 88   |      |      |      |
| L2001A  | CB L2001A-46  | 150           | 86.41      | 1.34 | 88   |      |      |      |
| L2001A  | CB L2001A-47  | 150           | 86.41      | 1.34 | 88   |      |      |      |
| L2001A  | CB L2001A-48  | 150           | 86.41      | 1.34 | 88   |      |      |      |
| L2001A  | CB L2001A-49  | 150           | 86.41      | 1.34 | 88   |      |      |      |
| L2001A  | CB L2001A-50  | 150           | 86.41      | 1.34 | 88   |      |      |      |
| L2001A  | CB L2001A-51  | 150           | 86.41      | 1.34 | 88   |      |      |      |
| L2001A  | CB L2001A-52  | 150           | 86.41      | 1.34 | 88   |      |      |      |
| L2001A  | CB L2001A-53  | 150           | 86.41      | 1.34 | 88   |      |      |      |
| L2001A  | CB L2001A-54  | 150           | 86.41      | 1.34 | 88   |      |      |      |
| L2001A  | CB L2001A-55  | 150           | 86.41      | 1.34 | 88   |      |      |      |
| L2001A  | CB L2001A-56  | 150           | 86.41      | 1.34 | 88   |      |      |      |
| L2001A  | CB L2001A-57  | 150           | 86.41      | 1.34 | 88   |      |      |      |
| L2001A  | CB L2001A-58  | 150           | 86.41      | 1.34 | 88   |      |      |      |
| L2001A  | CB L2001A-59  | 150           | 86.41      | 1.34 | 88   |      |      |      |
| L2001A  | CB L2001A-60  | 150           | 86.41      | 1.34 | 88   |      |      |      |
| L2001A  | CB L2001A-61  | 150           | 86.41      | 1.34 | 88   |      |      |      |
| L2001A  | CB L2001A-62  | 150           | 86.41      | 1.34 | 88   |      |      |      |
| L2001A  | CB L2001A-63  | 150           | 86.41      | 1.34 | 88   |      |      |      |
| L2001A  | CB L2001A-64  | 150           | 86.41      | 1.34 | 88   |      |      |      |
| L2001A  | CB L2001A-65  | 150           | 86.41      | 1.34 | 88   |      |      |      |
| L2001A  | CB L2001A-66  | 150           | 86.41      | 1.34 | 88   |      |      |      |
| L2001A  | CB L2001A-67  | 150           | 86.41      | 1.34 | 88   |      |      |      |
| L2001A  | CB L2001A-68  | 150           | 86.41      | 1.34 | 88   |      |      |      |
| L2001A  | CB L2001A-69  | 150           | 86.41      | 1.34 | 88   |      |      |      |
| L2001A  | CB L2001A-70  | 150           | 86.41      | 1.34 | 88   |      |      |      |
| L2001A  | CB L2001A-71  | 150           | 86.41      | 1.34 | 88   |      |      |      |
| L2001A  | CB L2001A-72  | 150           | 86.41      | 1.34 | 88   |      |      |      |
| L2001A  | CB L2001A-73  | 150           | 86.41      | 1.34 | 88   |      |      |      |
| L2001A  | CB L2001A-74  | 150           | 86.41      | 1.34 | 88   |      |      |      |
| L2001A  | CB L2001A-75  | 150           | 86.41      | 1.34 | 88   |      |      |      |
| L2001A  | CB L2001A-76  | 150           | 86.41      | 1.34 | 88   |      |      |      |
| L2001A  | CB L2001A-77  | 150           | 86.41      | 1.34 | 88   |      |      |      |
| L2001A  | CB L2001A-78  | 150           | 86.41      | 1.34 | 88   |      |      |      |
| L2001A  | CB L2001A-79  | 150           | 86.41      | 1.34 | 88   |      |      |      |
| L2001A  | CB L2001A-80  | 150           | 86.41      | 1.34 | 88   |      |      |      |
| L2001A  | CB L2001A-81  | 150           | 86.41      | 1.34 | 88   |      |      |      |
| L2001A  | CB L2001A-82  | 150           | 86.41      | 1.34 | 88   |      |      |      |
| L2001A  | CB L2001A-83  | 150           | 86.41      | 1.34 | 88   |      |      |      |
| L2001A  | CB L2001A-84  | 150           | 86.41      | 1.34 | 88   |      |      |      |
| L2001A  | CB L2001A-85  | 150           | 86.41      | 1.34 | 88   |      |      |      |
| L2001A  | CB L2001A-86  | 150           | 86.41      | 1.34 | 88   |      |      |      |
| L2001A  | CB L2001A-87  | 150           | 86.41      | 1.34 | 88   |      |      |      |
| L2001A  | CB L2001A-88  | 150           | 86.41      | 1.34 | 88   |      |      |      |
| L2001A  | CB L2001A-89  | 150           | 86.41      | 1.34 | 88   |      |      |      |
| L2001A  | CB L2001A-90  | 150           | 86.41      | 1.34 | 88   |      |      |      |
| L2001A  | CB L2001A-91  | 150           | 86.41      | 1.34 | 88   |      |      |      |
| L2001A  | CB L2001A-92  | 150           | 86.41      | 1.34 | 88   |      |      |      |
| L2001A  | CB L2001A-93  | 150           | 86.41      | 1.34 | 88   |      |      |      |
| L2001A  | CB L2001A-94  | 150           | 86.41      | 1.34 | 88   |      |      |      |
| L2001A  | CB L2001A-95  | 150           | 86.41      | 1.34 | 88   |      |      |      |
| L2001A  | CB L2001A-96  | 150           | 86.41      | 1.34 | 88   |      |      |      |
| L2001A  | CB L2001A-97  | 150           | 86.41      | 1.34 | 88   |      |      |      |
| L2001A  | CB L2001A-98  | 150           | 86.41      | 1.34 | 88   |      |      |      |
| L2001A  | CB L2001A-99  | 150           | 86.41      | 1.34 | 88   |      |      |      |
| L2001A  | CB L2001A-100 | 150           | 86.41      | 1.34 | 88   |      |      |      |



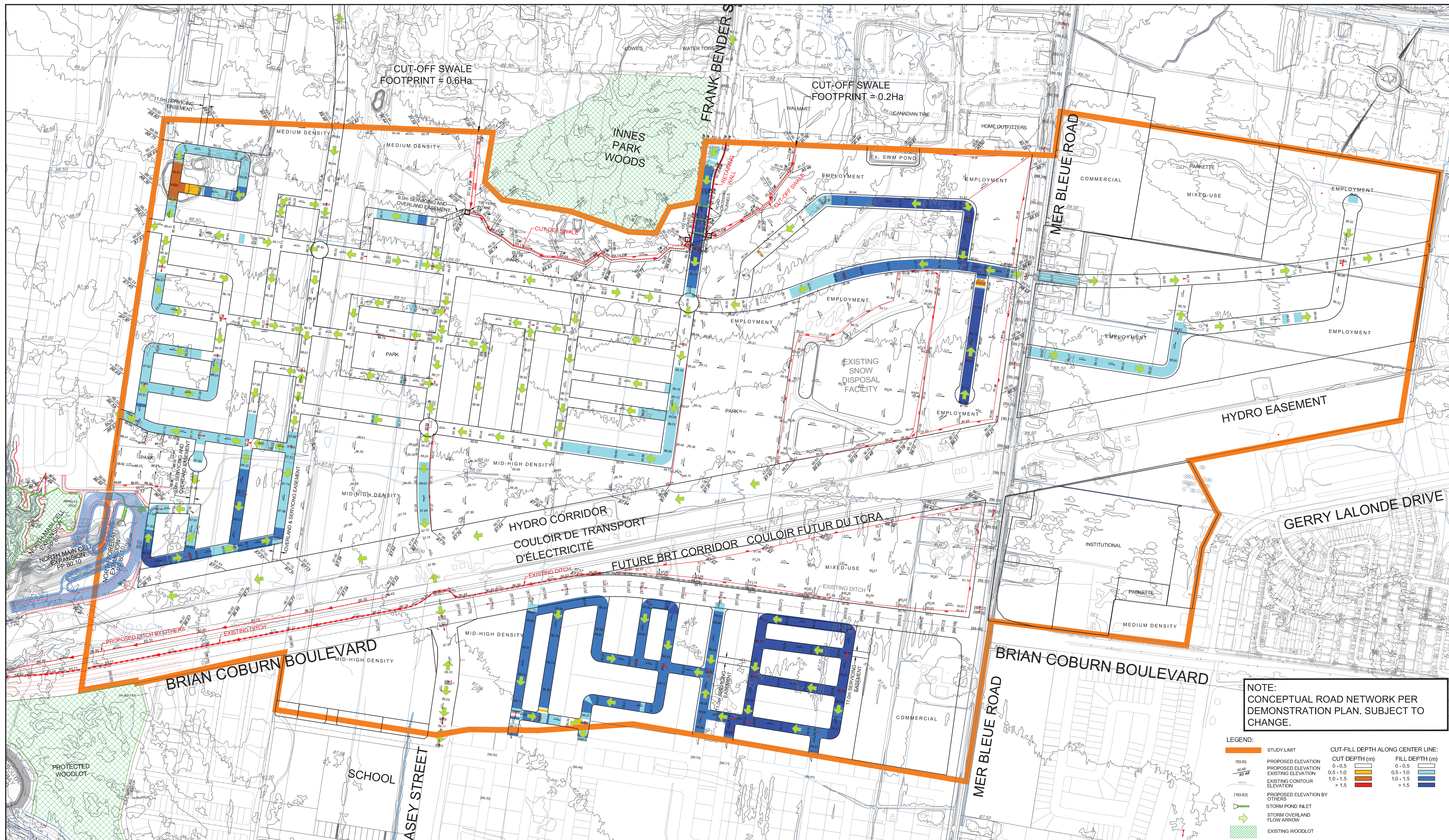

NOTE:  
CONCEPTUAL ROAD NETWORK PER  
DEMONSTRATION PLAN. SUBJECT TO  
CHANGE.

LEGEND:

|                      |                              |              |                                   |
|----------------------|------------------------------|--------------|-----------------------------------|
| [Orange line]        | STUDY LIMIT                  | [Color key]  | CUT-FILL DEPTH ALONG CENTER LINE: |
| [Elevation symbol]   | PROPOSED ELEVATION           | [Light blue] | CUT DEPTH (m)                     |
| [Elevation symbol]   | PROPOSED ELEVATION           | [Yellow]     | 0 - 0.5                           |
| [Elevation symbol]   | EXISTING ELEVATION           | [Orange]     | 0.5 - 1.0                         |
| [Elevation symbol]   | EXISTING CONTOUR ELEVATION   | [Red]        | 1.0 - 1.5                         |
| [Elevation symbol]   | EXISTING CONTOUR ELEVATION   | [Dark red]   | 1.5 - 2.0                         |
| [Elevation symbol]   | EXISTING CONTOUR ELEVATION   | [Blue]       | > 2.0                             |
| [Green arrow]        | PROPOSED ELEVATION BY OTHERS | [Light blue] | FILL DEPTH (m)                    |
| [Green arrow]        | STORM POND INLET             | [Yellow]     | 0 - 0.5                           |
| [Green arrow]        | STORM OVERLAND FLOW ARROW    | [Orange]     | 0.5 - 1.0                         |
| [Green arrow]        | STORM OVERLAND FLOW ARROW    | [Red]        | 1.0 - 1.5                         |
| [Green arrow]        | STORM OVERLAND FLOW ARROW    | [Dark red]   | 1.5 - 2.0                         |
| [Green arrow]        | STORM OVERLAND FLOW ARROW    | [Blue]       | > 2.0                             |
| [Green hatched area] | EXISTING WOODLOT             |              |                                   |



120 Iber Road, Unit 103  
Stittsville, ON K2S 1E9  
Tel. (613) 836-0856  
Fax. (613) 836-7183  
www.DSEL.ca

EAST URBAN COMMUNITY PHASE 3 AREA COMMUNITY DESIGN PLAN  
GRADING PLAN

|               |              |
|---------------|--------------|
| PROJECT No. : | 14-733       |
| SCALE         | 1:4000       |
| DATE:         | OCTOBER 2019 |
| DRAWING No.   | 2            |

## **Appendix D : GEOTECHNICAL INVESTIGATION**

Geotechnical  
Engineering

Environmental  
Engineering

Hydrogeology

Geological  
Engineering

Materials Testing

Building Science

Archaeological Services

## Geotechnical - Existing Conditions Report

East Urban Community Mixed Use CDP  
Mer Bleue Road  
Ottawa - Ontario

Prepared For

Richcraft Group of Companies

### Paterson Group Inc.

Consulting Engineers  
154 Colonnade Road South  
Ottawa (Nepean), Ontario  
Canada K2E 7J5

Tel: (613) 226-7381  
Fax: (613) 226-6344  
[www.patersongroup.ca](http://www.patersongroup.ca)

July 7, 2019

Report: PG3130-2 Revision 2

## Table of Contents

|            | <b>PAGE</b>                              |
|------------|--|
| <b>1.0</b> | <b>Intorductoin</b> ..... 1              |
| <b>2.0</b> | <b>Background Information</b> ..... 2    |
| <b>3.0</b> | <b>Existing Conditions</b>               |
| 3.1        | Surface Conditions ..... 4               |
| 3.2        | Subsurface Profile ..... 4               |
| <b>4.0</b> | <b>Geotechnical Assessment</b>           |
| 4.1        | Geotechnical Assessment ..... 5          |
| 4.2        | Foundation Design ..... 5                |
| 4.3        | Design of Earthquakes ..... 10           |
| 4.4        | Groundwater Control ..... 11             |
| 4.5        | Stormwater Management Facility ..... 11  |
| <b>5.0</b> | <b>Recommendations</b> ..... 12          |
| <b>6.0</b> | <b>Statement of Limitations</b> ..... 13 |

## Appendices

|            |  |
|------------|--|
| Appendix 1 | Soil Profile and Test Data Sheets<br>Boreholes by Others<br>Symbols and Terms<br>Consolidation Testing Results<br>Atterberg Limits Testing Results |
| Appendix 2 | Figure 1 - Key Plan<br>Drawing PG3130-6 - Test Hole Location Plan<br>Drawing PG3130-7 - Permissible Grade Raise Plan                               |
| Appendix 3 | Slope Stability Analysis Report - By Others  |

## 1.0 Introduction

Paterson Group (Paterson) was commissioned by Richcraft Group of Companies (Richcraft) to complete an existing conditions report from a geotechnical perspective for the proposed East Urban Community (EUC) development to be located along Mer Bleue Road, in the City of Ottawa (refer to Figure 1 - Key Plan presented in Appendix 2).

The objective of the study is:

- ❑ to determine the subsurface soil and groundwater conditions based on available subsoil information and supplemental borehole investigation.
- ❑ to provide preliminary geotechnical recommendations for the design of the proposed development including construction considerations which may affect the design.

The following report has been prepared specifically and solely for the aforementioned project which is described herein. Investigating the presence or potential presence of contamination on the proposed development was not part of the scope of work. Therefore, the present report does not address environmental issues.

## 2.0 Background Information

### Field Investigation

The subject site is located to the north of Renaud Road and to the south of Innes Road. Mer Bleue Road runs in a north-south direction through the east portion of the site and the existing Hydro corridor runs in roughly an east-west direction through the south portion of the site.

The current field program was completed on September 12 and 15, 2014. The historical geotechnical field investigations were completed by Paterson between March 2002 and February 2012. During that time, a total of fifty-four (54) test holes, consisting of boreholes, test pits and hand auger holes, were extended to a maximum depth of 22 m. Previous geotechnical investigations were also completed by others within the area of the subject site. The results of the previous investigations by others are discussed in the present report.

The locations of the test holes are shown on Drawing PG3130-6 - Test Hole Location Plan included in Appendix 2.

The boreholes were completed using a track-mounted auger drill rig operated by a two person crew. The test pits were completed using a rubber tire backhoe. All fieldwork was conducted under the full-time supervision of personnel from our geotechnical division under the direction of a senior engineer. The testing procedure consisted of augering to the required depths and at the selected locations sampling the overburden.

### Sampling and In Situ Testing

Soil samples were collected from the boreholes using a 50 mm diameter split-spoon (SS) sampler, using 73 mm diameter thin walled (TW) Shelby tubes in conjunction with a piston sampler, or from the auger flights.

Soil samples were recovered along the sidewalls of the test pits by hand during excavation.

All soil samples were visually inspected and initially classified on site. The split-spoon samples were placed in sealed plastic bags and the Shelby tubes were sealed at both ends on site. All samples were transported to the our laboratory for examination and classification. The depths at which the split-spoon, Shelby tube, auger and grab samples were recovered from the test holes are shown as SS, TW, AU and G, respectively, on the Soil Profile and Test Data sheets presented in Appendix 1.

The Standard Penetration Test (SPT) was conducted in conjunction with the recovery of the split-spoon samples. The SPT results are recorded as “N” values on the Soil Profile and Test Data sheets. The “N” value is the number of blows required to drive the split-spoon sampler 300 mm into the soil after a 150 mm initial penetration using a 63.5 kg hammer falling from a height of 760 mm.

Undrained shear strength testing was carried out at regular depth intervals in cohesive soils. Undrained shear strength testing in test pits was completed using a handheld, portable vane apparatus (field inspection vane tester Roctest Model H-60).

All soil samples were classified on site, placed in sealed plastic bags and were transported to our laboratory for visual inspection.

Overburden thickness was evaluated during the course of the site investigations by dynamic cone penetration testing (DCPT) at several of the borehole locations. The DCPT consists of driving a steel drill rod, equipped with a 50 mm diameter cone at the tip, using a 63.5 kg hammer falling from a height of 760 mm. The number of blows required to drive the cone into the soil is recorded for each 300 mm increment.

The subsurface conditions observed at the borehole and test pits were recorded in detail in the field. The soil profiles are presented on the Soil Profile and Test Data sheets and Borehole Logs by Others in Appendix 1.

## **Groundwater**

Flexible standpipes were installed in all boreholes to monitor the groundwater levels subsequent to the completion of the sampling program. Groundwater infiltration levels were noted at the time of excavation at the test pit locations.

## **Laboratory Testing**

The soil samples recovered from the subject site were visually examined in our laboratory to review the results of the field logging.

Ten (10) Shelby tube samples were submitted for unidimensional consolidation during the previous geotechnical investigations. The results of the consolidation and Atterberg testing are presented on the Consolidation Test sheets presented in Appendix 1 and are further discussed in Sections 4.

## **3.0 Existing Conditions**

### **3.1 Surface Conditions**

Currently, the subject site, consists of agricultural lands and lands formerly used for agricultural purposes. The site and regional topography is relatively flat and approximately at grade with neighboring properties and adjacent roadways.

### **3.2 Subsurface Profile**

#### **Overburden Profile**

Generally, the subsurface profile encountered at the test hole locations varies between shallow bedrock and a deep silty clay deposit across the subject site. Shallow bedrock was encountered below a cultivated organic zone/topsoil followed by a silty sand, and/or clayey silt layer within the north portion of the site. The remainder of the subject site was underlain by a sensitive silty clay deposit. Reference should be made to the Soil Profile and Test Data sheets in Appendix 1 for specific details of the soil profiles encountered at each test hole location.

Based on available geological mapping, the bedrock in this area mostly consists of interbedded limestone and dolomite of the Gull River formation with an overburden drift thickness of 0 to 30 m depth.

#### **Groundwater**

Generally, the groundwater levels recovered from the piezometers installed at the borehole locations varied between 0.2 and 6.3 m below existing ground surface. It is important to note that groundwater readings at piezometers can be influenced by surface water perched within the borehole backfill material. Groundwater conditions can also be estimated based on the observed colour and consistency of the recovered soil samples. Based on these observations, it is estimated that groundwater can be expected between 1.5 to 2.5 m depth. Groundwater levels are subject to seasonal fluctuations and therefore could vary during time of construction.

The groundwater conditions observed at the borehole and test pits were recorded in detail in the field. The soil profiles are presented on the Soil Profile and Test Data sheets in Appendix 1.



## **4.0 Geotechnical Assessment**

An existing slope stability analysis report was completed by others for Reaches 7 and 12 of the Stormwater Management Pond Block. The report also defines the limit of hazard lands limits along the west portion of the SWMP. Reference should be made to the attached report in Appendix 3.

### **4.1 Geotechnical Assessment**

From a geotechnical perspective, the subject site is adequate for the proposed development. Bedrock removal may require line drilling and blasting or hoe ramming depending on the depth of bedrock removal required. Due to the presence of the sensitive silty clay layer, residential buildings should be design in accordance with Part 4 of the current Ontario Building Code (OBC). Also, due to the sensitive silty clay deposit, the proposed development will be subjected to grade raise restrictions.

Preliminary permissible grade raise recommendations have been designed based on the existing soils information. The recommended permissible grade raise areas are presented in Drawing PG3130-7 - Permissible Grade Raise Plan in Appendix 2. If higher than permissible grade raises are required, preloading with or without a surcharge, lightweight fill and/or other measures should be investigated to reduce the risks of unacceptable long-term post construction total and differential settlements.

Municipal services are anticipated within the subject site and will be completed mostly through OHSA Type 2 and 3 soils.

The above and other considerations are further discussed in the following sections.

### **4.2 Foundation Design**

#### **Bearing Resistance Values**

For preliminary design purposes, a conventional style shallow footing for commercial or residential buildings can be designed using the bearing resistance values presented in Table 1. A geotechnical resistance factor of 0.5 was applied to the bearing resistance values at ULS.

| <b>Table 1 - Bearing Resistance Values</b> |  |   |
|--|--|---|
| <b>Bearing Surface</b>                     | <b>Bearing Resistance Value at SLS (kPa)</b> | <b>Factored Bearing Resistance Value at ULS (kPa)</b> |
| Compact Sandy Silt                         | 60   | 125   |
| Firm Clayey Silt/Silty Clay                | 60   | 125   |
| Stiff Silty Clay/Clayey Silt               | 100  | 150   |
| Glacial Till                               | 150  | 225   |
| Bedrock                                    | 500  | 1000  |

**Note:** Footings, up to 3 m wide, can be designed using the above noted bearing resistance values placed over a silty clay bearing surface.

The bearing resistance values are provided on the assumption that the footings will be placed on undisturbed soil bearing surfaces. An undisturbed soil bearing surface consists of one from which all topsoil and deleterious materials, such as loose, frozen or disturbed soil, whether in situ or not, have been removed, in the dry, prior to the placement of concrete for footings.

The bearing resistance values at SLS for shallow footing bearing on compact sandy silt, firm to stiff clayey silt/silty and/or glacial till will be subjected to potential post-construction total and differential settlements of 25 and 15 mm, respectively.

A clean, surface-sounded bedrock bearing surface should be free of loose materials, and have no near surface seams, voids, fissures or open joints which can be detected from surface sounding with a rock hammer.

Footings bearing on an acceptable bedrock bearing surface and designed using the bearing resistance values provided herein will be subjected to negligible potential post-construction total and differential settlements.

Where a building is founded partly on bedrock and partly on soil, it is recommended to decrease the soil bearing resistance value by 25% for the footings placed on soil bearing media to reduce the potential long term total and differential settlements. Also, at the soil/bedrock and bedrock/soil transitions, it is recommended that the upper 0.5 m of the bedrock be removed for a minimum length of 2 m (on the bedrock side) and replaced with nominally compacted OPSS Granular A or Granular B Type II material. The width of the subexcavation should be at least the proposed footing width plus 0.5 m. Steel reinforcement, extending at least 3 m on both sides of the 2 m long transition, should be placed in the top part of the footings and foundation walls.

### Settlement/Grade Raise

Ten (10) consolidation tests were conducted within the immediate area of the subject site. The results of the consolidation tests from the previous investigations are presented in Tables 2, 3 and 4 and in Appendix 1.

The value for  $p'_c$  is the preconsolidation pressure and  $p'_o$  is the effective overburden pressure of the test sample. The difference between these values is the available preconsolidation. The increase in stress on the soil due to the cumulative effects of the fill surcharge, the footing pressures, the slab loadings and the lowering of the groundwater should not exceed the available preconsolidation if unacceptable settlements are to be avoided.

The values for  $C_{cr}$  and  $C_c$  are the recompression and compression indices, respectively. These soil parameters are a measure of the compressibility due to stress increases below and above the preconsolidation pressures. The higher values for the  $C_c$ , as compared to the  $C_{cr}$ , illustrate the increased settlement potential above, as compared to below, the preconsolidation pressure.

| <b>Table 2 - Summary of Consolidation Test Results (Paterson Investigation PG2392)</b>     |        |       |        |        |          |       |   |
|--|--------|-------|--------|--------|----------|-------|---|
| Borehole   | Sample | Depth | $p'_c$ | $p'_o$ | $C_{cr}$ | $C_c$ | Q |
| BH 7   | TW 2   | 4.36  | 90     | 53     | 0.016    | 1.643 | A |
| BH 9   | TW 3   | 4.33  | 106    | 53     | 0.021    | 4.008 | A |
| BH 11  | TW 4   | 4.32  | 85     | 53     | 0.027    | 2.735 | P |
| * - Q - Quality assessment of sample - G: Good      A: Acceptable      P: Likely disturbed |        |       |        |        |          |       |   |

| <b>Table 3 - Summary of Consolidation Test Results (Paterson Investigation PG0861)</b>     |        |       |        |        |          |       |   |
|--|--------|-------|--------|--------|----------|-------|---|
| Borehole   | Sample | Depth | $p'_c$ | $p'_o$ | $C_{cr}$ | $C_c$ | Q |
| BH 9-08  | TW 2   | 4.8   | 126    | 55     | 0.026    | 3.260 | A |
| BH 12-08   | TW 4   | 9.4   | 109    | 68     | 0.031    | 3.080 | A |
| BH 13-08   | TW 2   | 3.42  | 142    | 43     | 0.025    | 1.334 | A |
| BH 15-08   | TW 2   | 4.91  | 87     | 50     | 0.029    | 1.890 | A |
| BH 19-08   | TW 3   | 4.9   | 99     | 43     | 0.025    | 3.100 | A |
| * - Q - Quality assessment of sample - G: Good      A: Acceptable      P: Likely disturbed |        |       |        |        |          |       |   |

| <b>Table 4 - Summary of Consolidation Test Results (Paterson Investigation G8533)</b>      |               |              |                       |                       |                       |                      |          |
|--|---------------|--------------|-----------------------|-----------------------|-----------------------|----------------------|----------|
| <b>Borehole</b>  | <b>Sample</b> | <b>Depth</b> | <b>p'<sub>c</sub></b> | <b>p'<sub>o</sub></b> | <b>C<sub>cr</sub></b> | <b>C<sub>c</sub></b> | <b>Q</b> |
| BH 3   | TW 5          | 6.53         | 103                   | 64                    | 0.043                 | 2.967                | A        |
| BH 3   | TW 7          | 9.6          | 175                   | 82                    | 0.028                 | 3.046                | A        |
| * - Q - Quality assessment of sample - G: Good      A: Acceptable      P: Likely disturbed |               |              |                       |                       |                       |                      |          |

The values of  $p'_c$ ,  $p'_o$ ,  $C_{cr}$  and  $C_c$  are determined using standard engineering testing procedures and are estimates only. Natural variations within the soil deposit will affect the results. The  $p'_o$  parameter is directly influenced by the groundwater level. Groundwater levels were measured during the site investigation. Groundwater levels vary seasonally which has an impact on the available preconsolidation. Lowering the groundwater level increases the  $p'_o$  and therefore reduces the available preconsolidation. Unacceptable settlements could be induced by a significant lowering of the groundwater level. The  $p'_o$  values for the consolidation tests during the investigation are based on the long term groundwater level being at 0.5 m below the existing groundwater table. The groundwater level is based on the colour and undrained shear strength profile of the silty clay.

The total and differential settlements will be dependent on characteristics of the proposed buildings. For design purposes, the total and differential settlements are estimated to be 25 and 20 mm, respectively. A post-development groundwater lowering of 0.5 m was assumed.

The potential post construction total and differential settlements are dependent on the position of the long term groundwater level when building are situated over deposits of compressible silty clay. Efforts can be made to reduce the impacts of the proposed development on the long term groundwater level by placing clay dykes in the service trenches, reducing the sizes of paved areas, leaving green spaces to allow for groundwater recharge or limiting planting of trees to areas away from the buildings. However, it is not economically possible to control the groundwater level.

To reduce potential long term liabilities, consideration should be given to accounting for a larger groundwater lowering and to provide means to reduce long term groundwater lowering (e.g. clay dykes, restriction on planting around the dwellings, etc). Buildings on silty clay deposits increases the likelihood of movements and therefore of cracking. The use of steel reinforcement in foundations placed at key structural locations will tend to reduce foundation cracking compared to unreinforced foundations.

The recommended permissible grade raise areas for buildings are defined in Drawing PG3130-7 - Permissible Grade Raise Plan in Appendix 2.

Where proposed grade raises exceed our permissible grade raise recommendations, several options could be considered for the foundation support of the proposed buildings:

### **Scenario A**

Where the grade raise is close to, but below, the maximum permissible grade raise, consideration should be given to using more reinforcement in the design of the foundation (footings and walls) to reduce the risks of cracking in the concrete foundation. The use of control joints within the brick work between the garage and basement area should also be considered.

### **Scenario B**

Where the grade raise cannot be accommodated with soil fill, the following options could be used alone or in combination.

#### **Option 1 - Use of Lightweight Fill**

Lightweight fill (LWF) can be used, consisting of EPS (expanded polystyrene) Type 19 or 22 blocks or other light weight materials which allow for raising the grade without adding a significant load to the underlying soils. However, these materials are expensive and, in the case of the EPS, are more difficult to use under the groundwater level, as they are buoyant, and must be protected against potential hydrocarbon spills. Use lightweight fill within the interior of the garage and porch areas to reduce the fill-related loads.

## Option 2 - Preloading or Surcharging

It is possible to preload or surcharge the proposed site in localized areas provided sufficient time is available to achieve the desired settlements based on theoretical values from the settlement analysis. If this option is considered, a monitoring program using settlement plates will have to be implemented. This program will determine the amount of settlement in the preloaded or surcharged areas. Obviously, preloading to proposed finished grades will allow for consolidation of the underlying clays over a longer time period. Surcharging the site with additional fill above the proposed finished grade will add additional load to the underlying clays accelerating the consolidation process and allowing for accelerated settlements. Once the desired settlements are achieved, the site can be unloaded and the fill can be used elsewhere on site.

Once the required grade raises are established, the above options could be further discussed along with further recommendations on specific requirements.

## 4.3 Design for Earthquakes

The site class for seismic site response can be taken as **Class C** for the foundations bearing on a compact to dense glacial till and/or bedrock within the north portion of the subject site. A higher site class, such as Class A or B, is applicable for footings bearing on the bedrock surface. However, a site specific seismic shear wave test will be required to confirm the Class A or B seismic site classification.

Based on existing subsoils information, a seismic site response **Class D or E** is applicable for design of the proposed buildings bearing over a stiff to firm silty clay deposit throughout the remainder of the site. The specific site classification is dependent on the bedrock depth, which should be more accurately delineated as part of a future geotechnical investigation program for the subject site.

Soils underlying the subject site are not susceptible to liquefaction. Reference should be made to the latest revision of the 2012 Ontario Building Code for a full discussion of the earthquake design requirements.

## 4.4 Groundwater Control

Due to the relatively impervious nature of the silty clay/clayey silt materials, it is anticipated that groundwater infiltration into the excavations should be low and controllable using open sumps. A perched groundwater condition may be encountered within the sandy silt deposit, where encountered, which may produce significant temporary groundwater infiltration levels. Pumping from open sumps should be sufficient to control the groundwater influx through the sides of shallow excavations.

A temporary MOE permit to take water (PTTW) will be required for this project if more than 50,000 L/day are to be pumped during the construction phase. At least 4 to 5 months should be allowed for completion of the application and issuance of the permit by the MOE.

The contractor should be prepared to direct water away from all bearing surfaces and subgrades, regardless of the source, to prevent disturbance to the founding medium.

## 4.5 Stormwater Management Facility

It is understood that a stormwater management facility is planned for the subject site. However, details of the SWMF have not been designed yet. From a geotechnical perspective, the construction of the proposed SWMF is possible. The main areas of concern will be:

- The groundwater infiltration rate within the excavation side slopes and along the bottom of the pond
- The permeability of the subsoil materials
- The stability of the excavation side slopes

From a geotechnical perspective, the construction of the proposed SWMF is possible and its long term performance will depend on the stability of its excavation side slopes. From a geotechnical perspective, sidewalls shaped to a 3H:1V slope are considered to be stable in the long term and are adequate for SWMF construction at the subject site.

## 5.0 Recommendations

This existing conditions report provides preliminary design information. A detailed geotechnical investigation will be required once the proposed design is finalized. It is recommended that the following be carried out once the design plans and site development are determined:

- Carry out a detailed geotechnical investigation for the final detailed design which will include boreholes at strategic locations to recover undisturbed soil samples of the sensitive underlying silty clay deposit for consolidation testing.
- Review detailed grading plan(s) from a geotechnical perspective.
- Review detailed foundation plan(s) from a geotechnical perspective.
- A MOE Permit to Take Water (PTTW) will be required for the subject site and should be applied for well in advance of building construction (4 to 5 months).



## 6.0 Statement Of Limitations

The recommendations made in this report are in accordance with Paterson's present understanding of the project. Paterson requests permission to review the grading plan once available. Paterson's recommendations should be reviewed when the drawings and specifications are complete.

The client should be aware that any information pertaining to soils and all test hole logs are furnished as a matter of general information only. Test hole descriptions or logs are not to be interpreted as descriptive of conditions at locations other than those of the test holes.

A soils investigation is a limited sampling of a site. Should any conditions at the site be encountered which differ from those at the test locations, Paterson requests to be notified immediately in order to permit reassessment of the recommendations.

The present report applies only to the project described in this document. Use of this report for purposes other than those described herein or by person(s) other than Richcraft Group of Companies or their agent(s) is not authorized without review by this firm for the applicability of our recommendations to the altered use of the report.

### Paterson Group Inc.



Faisal I. Abou-Seido, P.Eng.



David J. Gilbert, P.Eng.

### Report Distribution:

- Richcraft Group of Companies (3 copies)
- Paterson Group (1 copy)



**PERMISSIBLE GRADE RAISE:**

SHALLOW OVERBURDEN WITH BEDROCK RANGING FROM 1m TO 5m BELOW GRADE (<2m GRADE RAISE RESTRICTION)

SILTY CLAY DEPOSIT WITH BEDROCK RANGING FROM 5m TO 25m BELOW GRADE (0.5 TO 1.5m GRADE RAISE RESTRICTION)

- LEGEND:**
- BOREHOLE LOCATION, CURRENT INVESTIGATION
  - BOREHOLE LOCATION, PATERSON GROUP REPORT PG2392
  - HAND AUGER HOLE LOCATION, PATERSON GROUP REPORT PG1605
  - BOREHOLE LOCATION, PATERSON GROUP REPORT PG0861
  - TEST PIT LOCATION, PATERSON GROUP REPORT PG0861
  - BOREHOLE LOCATION, PATERSON GROUP REPORT G8533
  - BOREHOLE LOCATION, PATERSON GROUP REPORT PG0811
  - TEST PIT LOCATION, PATERSON GROUP REPORT PG0811
  - TEST PIT LOCATION, PATERSON GROUP REPORT PG0861
  - BOREHOLE LOCATION BY OTHERS
  - 86.93 GROUND SURFACE ELEVATION (m)
  - (62.93) PRACTICAL REFUSAL TO AUGERING / DCPT ELEVATION (m)

**patersongroup**  
consulting engineers

154 Colonnade Road South  
Ottawa, Ontario K2E 7J5  
Tel: (613) 226-7381 Fax: (613) 226-6344

| NO. | REVISIONS | DATE | INITIAL |
|-----|-----------|------|---------|
|     |           |      |         |
|     |           |      |         |
|     |           |      |         |

RICHCRAFT GROUP OF COMPANIES  
EXISTING CONDITIONS REPORT  
EAST URBAN COMMUNITY MIXED-USE DEVELOPMENT  
OTTAWA, ONTARIO  
**PERMISSIBLE GRADE RAISE PLAN**

|             |         |              |          |
|-------------|---------|--------------|----------|
| Drawn by:   | MPG     | Report No.:  | PG3130-2 |
| Checked by: | CDS     | Drawing No.: | PG3130-7 |
| Scale:      | 1:4000  |              |          |
| Date:       | 10/2014 |              |          |

p:\autoCAD\drawings\geotechnical\pg3130 - richcraft\forms - e\existing conditions east urban\pg3130-7.rvt

## Appendix E : DRAWINGS

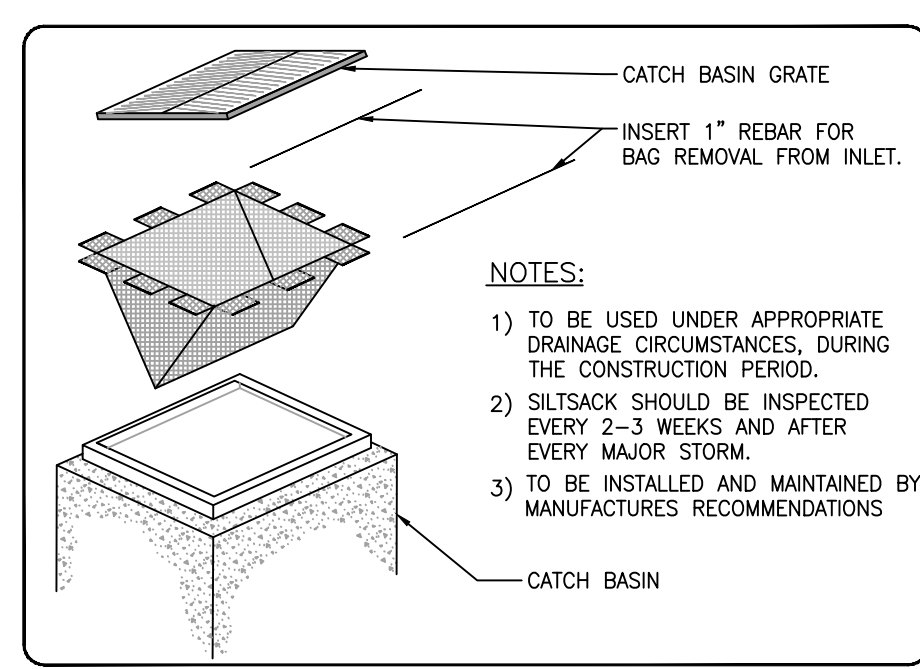
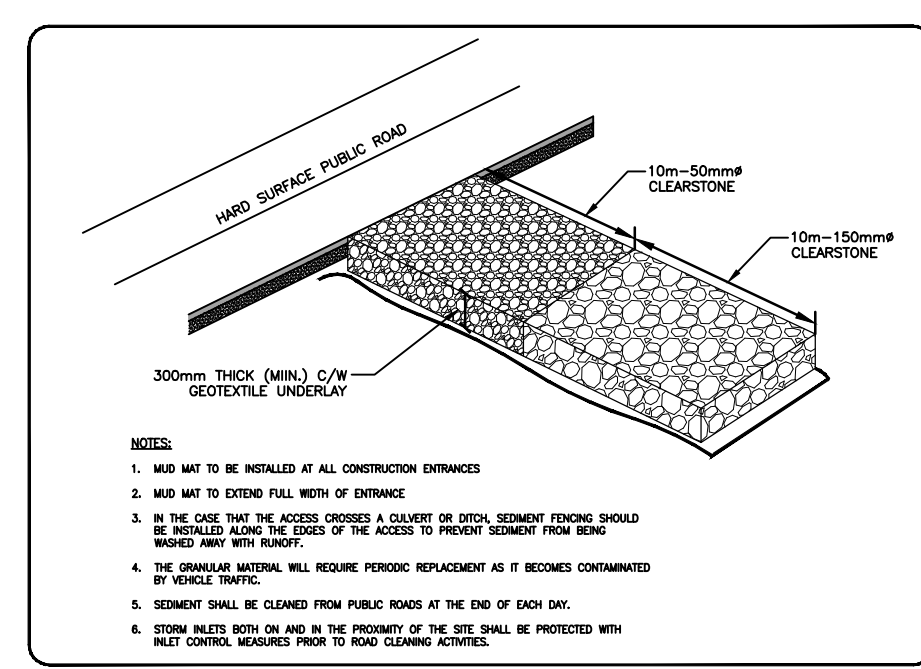

Copyright Reserved  
The Contractor shall verify and be responsible for all dimensions. DO NOT locate this drawing - any errors or omissions shall be reported to Stantec without delay.  
The Copyrights to all designs and drawings are the property of Stantec. Reproduction or use for any purpose other than that authorized by Stantec is forbidden.

**Legend**

- EXISTING TOPO ELEVATION
- 89.40 x PROPOSED ELEVATIONS
- 89.40 x EXISTING SUB-DIVISION ELEVATIONS
- PROPOSED MUD MAT LOCATION
- PROPOSED CATCH BASIN PROTECTION AS PER DETAIL (SILTSACK)
- PROPOSED SILT FENCE BOUNDARY AS PER OPSD 219.110
- PROPOSED STRAW BALE LOCATION AS PER OPSD 219.180

**Notes**

- BEST MANAGEMENT PRACTICES**  
EROSION AND SEDIMENT CONTROLS (BEST MANAGEMENT PRACTICES) SHALL BE PROVIDED DURING CONSTRUCTION OF THIS PROJECT.
- EROSION MUST BE MINIMIZED AND SEDIMENT MUST BE REMOVED FROM CONSTRUCTION SITE RUN-OFF IN ORDER TO PROTECT DOWNSTREAM AREAS. DURING ALL CONSTRUCTION, EROSION AND SEDIMENTATION SHALL BE CONTROLLED BY THE FOLLOWING PRACTICES:
- LIMIT THE EXTENT OF EXPOSED SOILS AT ANY GIVEN TIME.
  - REVEGETATE EXPOSED AREAS AND SLOPES AS SOON AS POSSIBLE.
  - MINIMIZE AREA TO BE CLEARED AND GRUBBED.
  - PROTECT EXPOSED SLOPES WITH PLASTIC OR SYNTHETIC MULCHES.
  - INSTALL FILTER CLOTH BETWEEN FRAME AND COVER ON ALL PROPOSED CATCH BASINS AND CATCH BASIN MANHOLES AND ON ALL EXISTING CATCH BASINS THAT WILL RECEIVE RUN-OFF FROM THE SITE.
  - A SILT FENCE SHALL BE REVEALED AROUND THE PERIMETER OF ALL AND ANY STOCKPILES OF MATERIAL TO BE USED OR REMOVED FROM SITE (LOCATION TO BE DETERMINED).
  - A VISUAL INSPECTION SHALL BE DONE DAILY ON SEDIMENT CONTROL MEASURES AND CLEANED OF ANY ACCUMULATED SILT AS REQUIRED. THE SEDIMENT SHALL BE EXPOSED OFF-SITE AS FOR THE REQUIREMENTS OF THE CONTRACT.
  - SEDIMENT CONTROL BARRIERS MAY ONLY BE REMOVED TEMPORARILY WITH APPROVAL OF CONTRACT ADMINISTRATOR TO ACCOMMODATE CONSTRUCTION OPERATIONS. ALL AFFECTED BARRIERS MUST BE REINSTATED AT NIGHT WHEN CONSTRUCTION IS COMPLETED. NO REMOVAL WILL OCCUR IF THERE IS A SIGNIFICANT RAINFALL EVENT ANTICIPATED (10mm) UNLESS A NEW DEVICE HAS BEEN INSTALLED TO PROTECT THE EXISTING STORM AND SANITARY SEWER SYSTEMS.
  - NO REFUELING OR CLEANING OF EQUIPMENT IS PERMITTED NEAR ANY EXISTING WATERWAY.
  - SEDIMENT CONTROL MEASURES SHALL BE REMOVED WHEN, IN THE OPINION OF THE CONTRACT ADMINISTRATOR, THE NEIGHBORHOOD IS NO LONGER REQUIRING SUCH CONTROL. MEASURES SHALL BE PERMANENTLY REMOVED WITHOUT WRITTEN AUTHORIZATION FROM THE CONTRACT ADMINISTRATOR.
  - THE CONTRACTOR SHALL IMMEDIATELY REPORT TO THE ENGINEER ANY ACCIDENTAL DISCHARGES OF SEDIMENT MATERIAL INTO THE WATERCOURSE. APPROPRIATE RESPONSE MEASURES, INCLUDING ANY REPAIRS TO EXISTING CONTROL MEASURES OR THE INSTALLATION OF ADDITIONAL CONTROL MEASURES, SHALL BE CARRIED OUT BY THE CONTRACTOR WITHOUT DELAY.

|                                    |      |       |              |
|------------------------------------|------|-------|--------------|
| DRAFT PLAN APPROVAL 1ST SUBMISSION | MJS  | SG    | 21.11.17     |
| DRAFT PLAN APPROVAL 1ST SUBMISSION | MJS  | SG    | 21.02.01     |
| Revision                           | By   | Appd. | YY.MM.DD     |
| File Name: 160401250 M55 PH 4      | MJS  | SG    | MJS 20.11.11 |
|                                    | Dwn. | Chkd. | Dgn.         |
|                                    |      |       | YY.MM.DD     |

Permit-Seal

Client/Project  
**RICHCRAFT GROUP OF COMPANIES**  
2280 ST. LAURENT BLVD  
OTTAWA, ON, K1G 4K1  
**TRAILSEDGE EAST SUBDIVISION**

Title  
**EROSION AND SEDIMENT CONTROL PLAN**

|                          |                 |                 |               |
|--------------------------|-----------------|-----------------|---------------|
| Project No.<br>160401250 | Scale<br>1:1500 | Sheet<br>5 of 5 | Revision<br>2 |
|--------------------------|-----------------|-----------------|---------------|

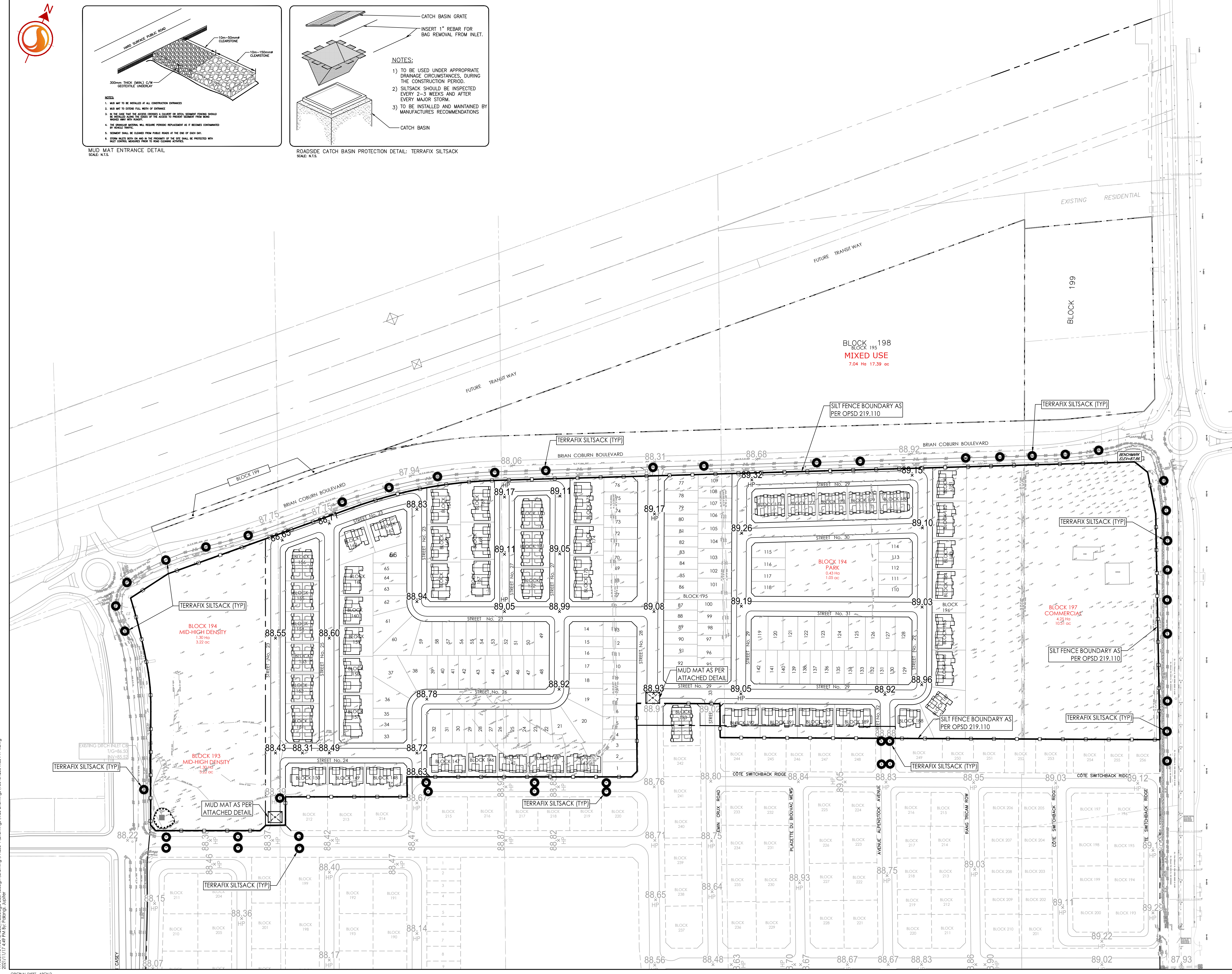

W:\projects\160401250 - Trailsedge East\design\Drawings\Phase 4\Drawings\M55 Drawings\160401250 M55 PH 4.dwg  
 2021/11/17 11:40 AM by: J. P. P. / J. P. P.  
 ORIGINAL SHEET - ARCH D

Copyright Reserved

The Contractor shall verify and be responsible for all dimensions. DO NOT scale the drawing - any errors or omissions shall be reported to Stantec without delay.  
The Copyrights to all designs and drawings are the property of Stantec. Reproduction or use for any purpose other than that authorized by Stantec is forbidden.

Legend

- EXISTING ELEVATION
- PROPOSED ELEVATION
- MAJOR OVERLAND FLOW ROUTE
- EXISTING MAJOR OVERLAND FLOW ROUTE
- GRADE RAISES FROM 0.5m UP TO 1.2m ARE PERMITTED.
- GRADE RAISES FROM 0.5m UP TO 1.5m ARE PERMITTED.

Notes

|          |                                    |     |       |          |
|----------|------------------------------------|-----|-------|----------|
| 2        | DRAFT PLAN APPROVAL 1ST SUBMISSION | MJS | SG    | 21.11.17 |
| 1        | DRAFT PLAN APPROVAL 1ST SUBMISSION | MJS | SG    | 21.02.01 |
| Revision |                                    | By  | Appd. | YY.MM.DD |

|            |                    |      |       |      |          |
|------------|--------------------|------|-------|------|----------|
| File Name: | 160401250 M55 PH 4 | MJS  | SG    | MJS  | 20.11.11 |
|            |                    | Dwn. | Chkd. | Dgn. | YY.MM.DD |

Permit-Seal

Client/Project  
**RICHCRAFT GROUP OF COMPANIES**  
 2280 ST. LAURENT BLVD  
 OTTAWA, ON, K1G 4K1  
**TRAILSEDGE EAST SUBDIVISION**

Title  
**OVERALL GRADE CONTROL PLAN**

|             |           |          |                       |
|-------------|-----------|----------|-----------------------|
| Project No. | 160401250 | Scale    | 0 15 45 75m<br>1:1500 |
| Drawing No. | GP-1      | Sheet    | 4 of 5                |
|             |           | Revision | 2                     |



W:\active\160401250\_Trailsedge East\design\Drawings\160401250 M55 PH 4.dwg  
 2021/11/17 4:49 PM By: P. Babin, J. Babin  
 ORIGINAL SHEET - ARCH D



Copyright Reserved

The Contractor shall verify and be responsible for all dimensions. DO NOT scale the drawing - any errors or omissions shall be reported to Stantec without delay.  
The Copyrights to all designs and drawings are the property of Stantec. Reproduction or use for any purpose other than that authorized by Stantec is forbidden.

Legend

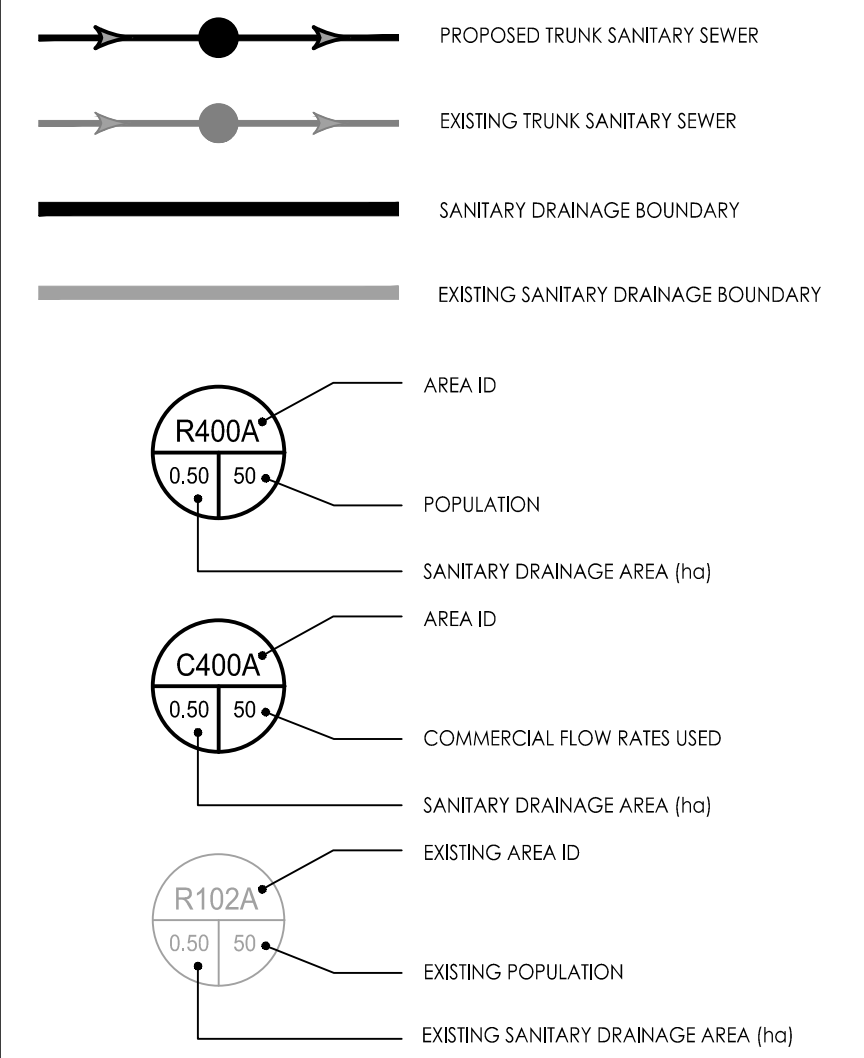

Notes

| Revision | By  | Appd. | YY.MM.DD |
|----------|-----|-------|----------|
| 2        | MJS | SG    | 21.11.17 |
| 1        | MJS | SG    | 21.02.01 |

| File Name:         | MJS  | SG    | MJS  | 20.11.11 |
|--------------------|------|-------|------|----------|
|                    | Dwn. | Chkd. | Dgn. | YY.MM.DD |
| 160401250 M55 PH 4 |      |       |      |          |

Permit-Seal

Client/Project  
**RICHCRAFT GROUP OF COMPANIES**  
2280 ST. LAURENT BLVD  
OTTAWA, ON, K1G 4K1  
**TRAILSEDGE EAST SUBDIVISION**

Title  
**OVERALL SANITARY SEWER SYSTEM**

|                          |                 |                |               |
|--------------------------|-----------------|----------------|---------------|
| Project No.<br>160401250 | Scale<br>1:1500 | Sheet<br>SAN-1 | Revision<br>2 |
|--------------------------|-----------------|----------------|---------------|

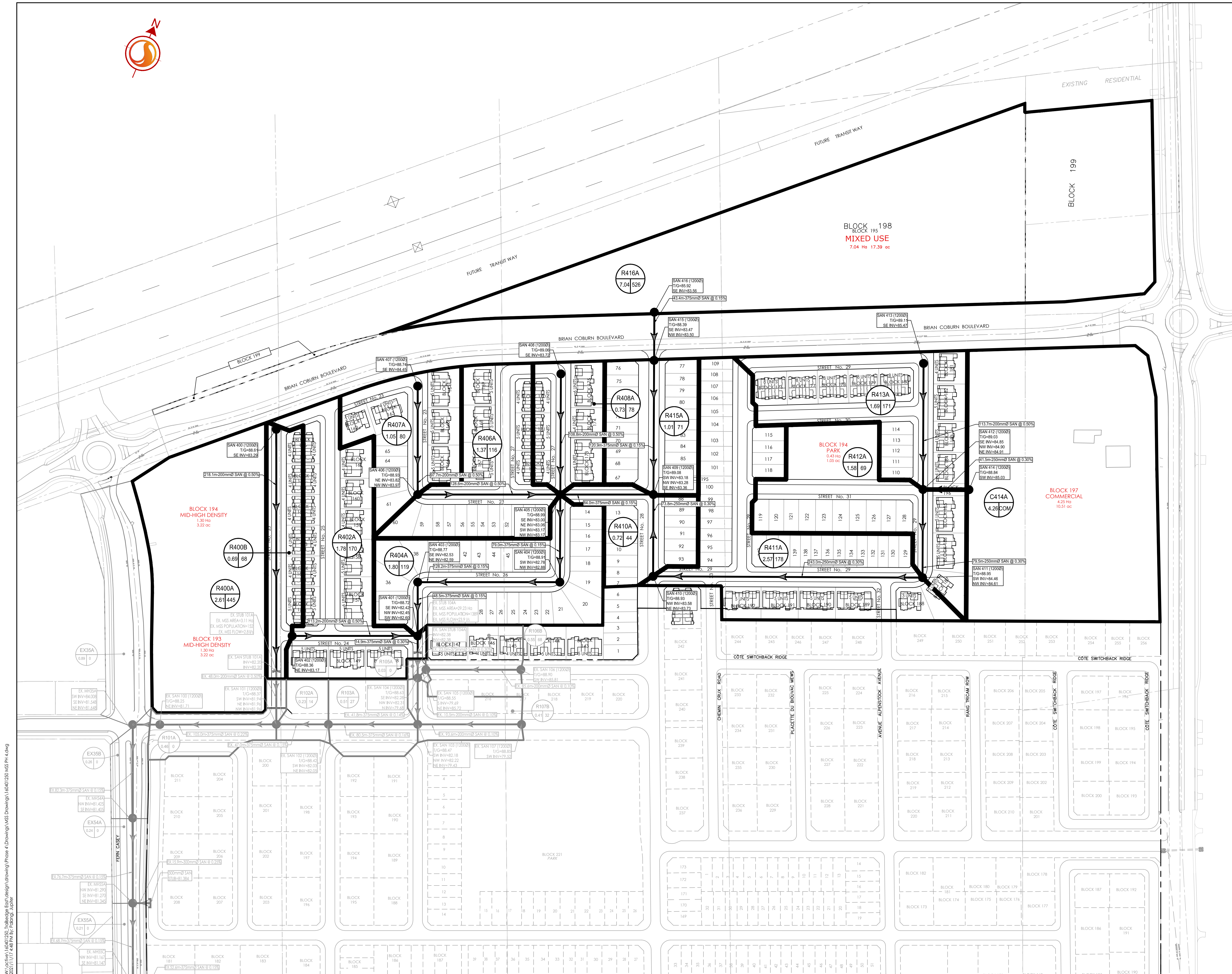

W:\projects\160401250\_TrailsEdge East\Design\Drawings\Phase 4\Drawings\M55 Drawings\160401250 M55 PH 4.dwg  
2021/11/17 4:48 PM by P. Roberge - Juper

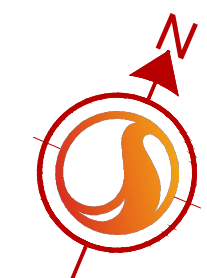

Copyright Reserved

The Contractor shall verify and be responsible for all dimensions. DO NOT scale the drawing - any errors or omissions shall be reported to Stantec without delay.  
The Copyrights to all designs and drawings are the property of Stantec. Reproduction or use for any purpose other than that authorized by Stantec is forbidden.

Legend

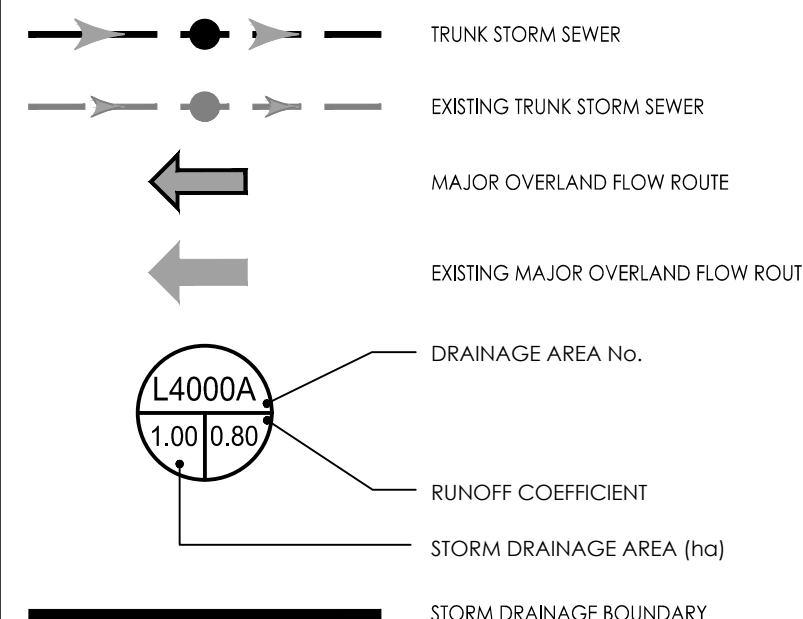

Notes

| Revision | By  | Appd. | YY.MM.DD |
|----------|-----|-------|----------|
| 2        | MJS | SG    | 21.11.17 |
| 1        | MJS | SG    | 21.02.01 |

| File Name:         | MJS  | SG    | MJS  | 20.11.11 |
|--------------------|------|-------|------|----------|
|                    | Dwn. | Chkd. | Dgn. | YY.MM.DD |
| 160401250 M55 PH 4 |      |       |      |          |

Permit-Seal

Client/Project  
**RICHCRAFT GROUP OF COMPANIES**  
2280 ST. LAURENT BLVD  
OTTAWA, ON, K1G 4K1  
**TRAILSEDGE EAST SUBDIVISION**

Title  
**OVERALL STORM SEWER SYSTEM**

|                          |                 |                 |               |
|--------------------------|-----------------|-----------------|---------------|
| Project No.<br>160401250 | Scale<br>1:1500 | Sheet<br>1 of 5 | Revision<br>2 |
|--------------------------|-----------------|-----------------|---------------|

STM-1

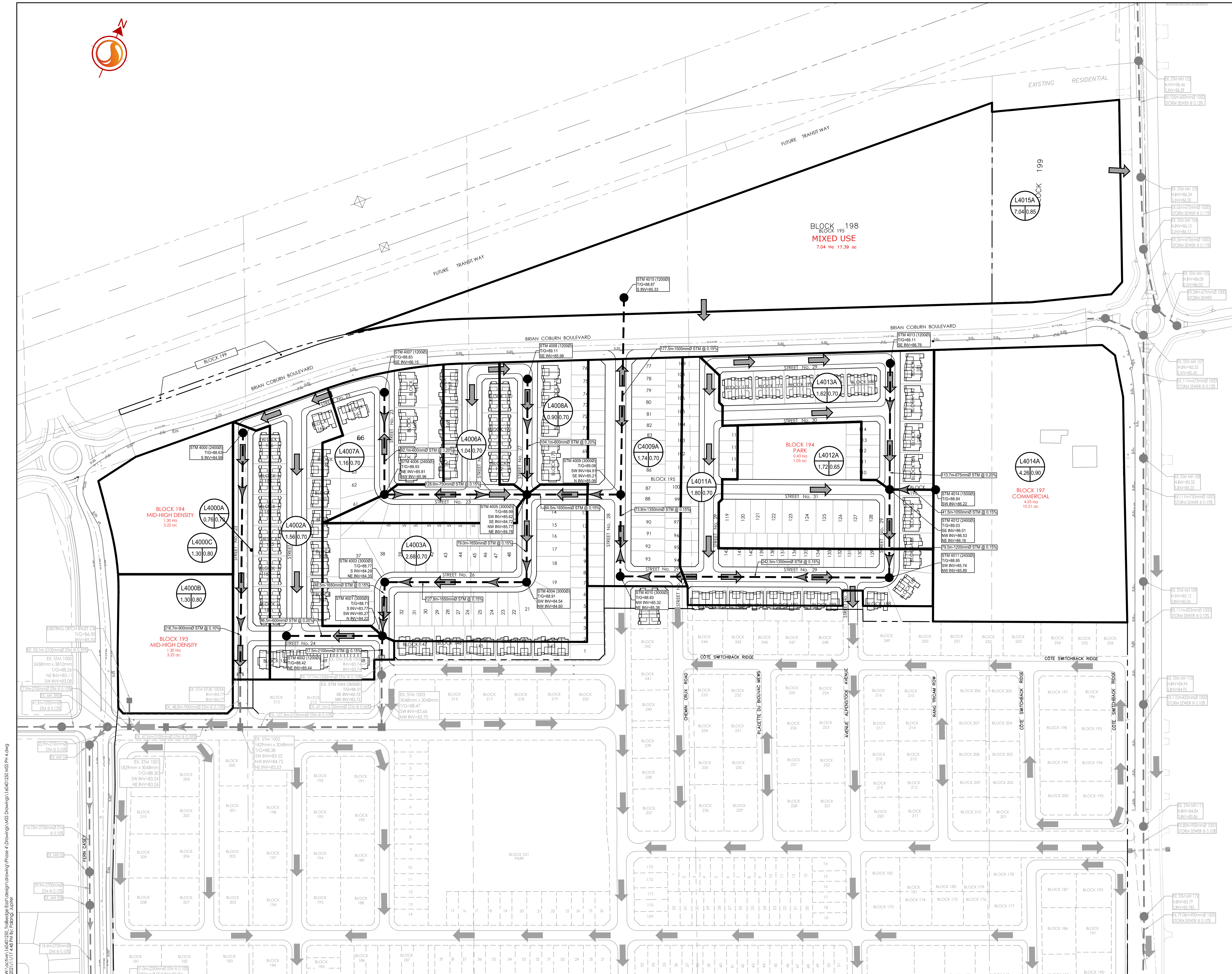

W:\01\160401250 - Trailsedge East\design\Drawings\160401250 M55 PH 4.dwg  
2021/11/17 4:48 PM by P. Poirier - Juper  
ORIGINAL SHEET - ARCH D

Copyright Reserved

The Contractor shall verify and be responsible for all dimensions. DO NOT scale the drawing - any errors or omissions shall be reported to Stantec without delay.  
The Copyrights to all designs and drawings are the property of Stantec. Reproduction or use for any purpose other than that authorized by Stantec is forbidden.

Legend

- 610mmØ WATERMAIN
- 406mmØ WATERMAIN
- 305mmØ WATERMAIN
- 203mmØ WATERMAIN
- 152mmØ WATERMAIN
- EX. 610mmØ WATERMAIN
- EX. 406mmØ WATERMAIN
- EX. 305mmØ WATERMAIN
- EX. 203mmØ WATERMAIN
- EX. 152mmØ WATERMAIN

Notes

| Revision | By  | Appd. | YY.MM.DD |
|----------|-----|-------|----------|
| 2        | MJS | SG    | 21.11.17 |
| 1        | MJS | SG    | 21.02.01 |

| File Name:         | MJS  | SG    | MJS  | 20.11.11 |
|--------------------|------|-------|------|----------|
| 160401250 WSS PH 4 | Dwn. | Chkd. | Dgn. | YY.MM.DD |

Permit-Seal

Client/Project  
**RICHCRAFT GROUP OF COMPANIES**  
2280 ST. LAURENT BLVD  
OTTAWA, ON, K1G 4K1  
**TRAILSEDGE EAST SUBDIVISION**

Title  
**OVERALL WATERMAIN SYSTEM**

|                          |                 |                 |               |
|--------------------------|-----------------|-----------------|---------------|
| Project No.<br>160401250 | Scale<br>1:1500 | Sheet<br>3 of 5 | Revision<br>2 |
|--------------------------|-----------------|-----------------|---------------|

WTR-1

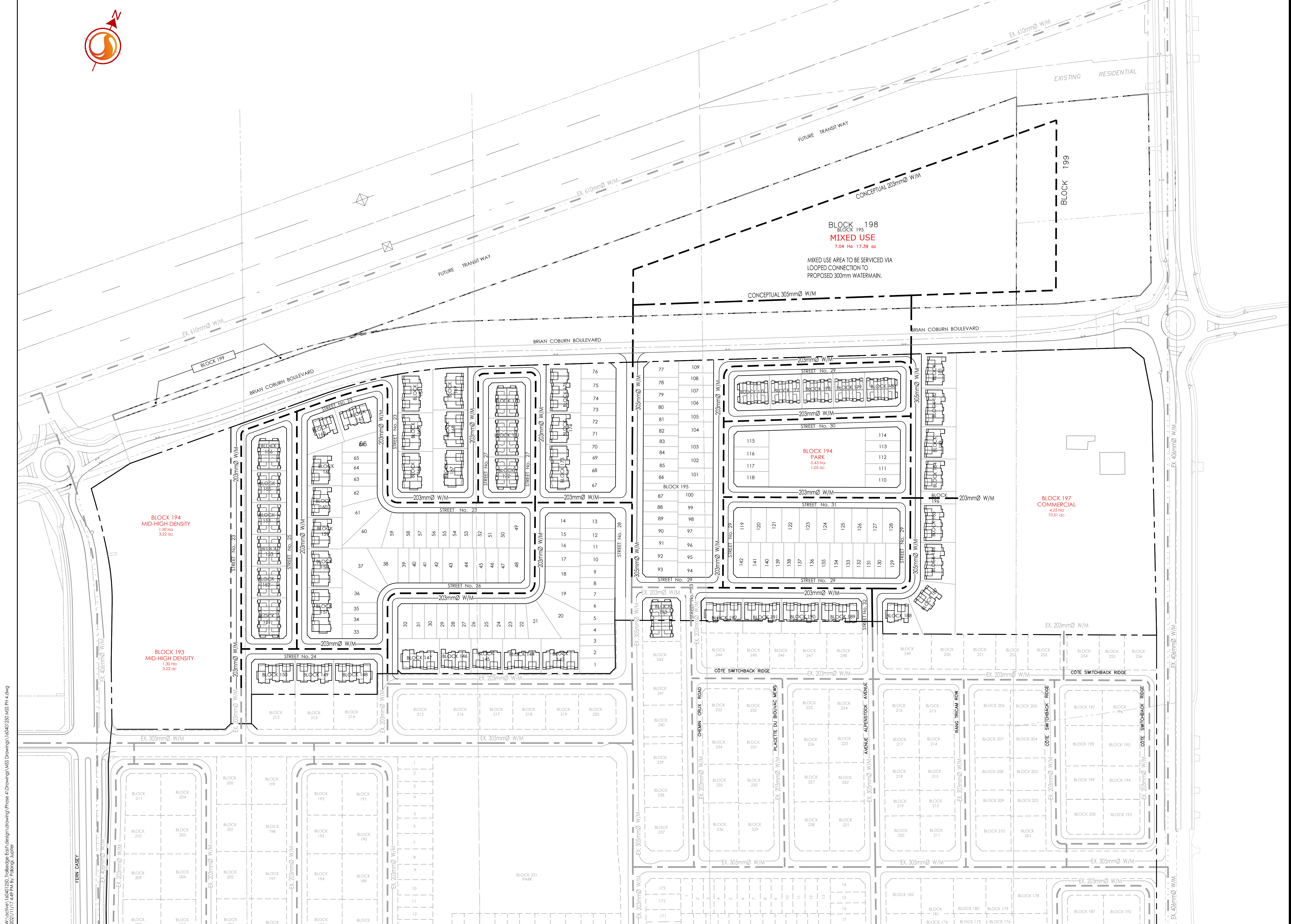

W:\active\160401250 - Trailsedge East\design\Drawings\Phase 4\Drawings\MSS Drawings\160401250 WSS PH 4.dwg  
 2021/11/17 4:07 PM by P. Babin, J. Babin