

Stormwater Management - Grading & Drainage - Storm & Sanitary Sewers - Watermains

700 Long Point Circle
Ottawa, Ontario K1T 4E9

613-425-8044
d.gray@dbgrayengineering.com

SITE SERVICING STUDY & STORMWATER MANAGEMENT REPORT

2009-2013 PRINCE OF WALES DRIVE
OTTAWA, ONTARIO

REPORT NO. 22055

JUNE 29, 2023

CONTENTS

- 1.0 INTRODUCTION
- 2.0 WATER SERVICING
 - 2.1 WATER SUPPLY FOR FIREFIGHTING
 - 2.2 DOMESTIC WATER SUPPLY
- 3.0 SANITARY SERVICING
- 4.0 STORMWATER MANAGEMENT
 - 4.1 QUANTITY CONTROL
 - 4.2 QUALITY CONTROL
 - 4.3 STORM SERVICING
- 5.0 CONCLUSIONS

LIST OF APPENDICES

- A PRE-APPLICATION CONSULTATION MEETING NOTES
- B WATER SERVICING
- C SANITARY SERVICING
- D STORMWATER MANAGEMENT
- E DEVELOPMENT SERVICING STUDY CHECKLIST

1.0 INTRODUCTION

This Site Servicing Study & Stormwater Management Report has been prepared in support of a rezoning application and an application for a seven residential lot subdivision on a private roadway located on a 1.13 hectare property at 2009-2013 Prince of Wales Drive in Ottawa, Ontario. The property backs onto the Rideau River to the east and is adjacent to a railway line to the south, and is currently occupied by two single residential dwellings. The dwelling at 2009 Prince of Wales Drive is to remain and the dwelling at 2013 will be demolished. Refer to Pre-Consultation Meeting notes in Appendix A.

This report forms part of the site servicing and stormwater management design for the proposed development. Also refer to drawings C-1 to C-10 prepared by D.B. Gray Engineering Inc.

2.0 WATER SERVICING

2.1 WATER SUPPLY FOR FIREFIGHTING

There is an existing municipal Class AA fire hydrant located in the Prince of Wales Drive ROW in front of the subject property. It is proposed to be relocated approximately 20 m north. Two private onsite hydrants are proposed. One fire hydrant (FH-1) is located at the far east end of the private road and the other (FH-2) is located near the entrance (west end) of the private road.

In accordance with City of Ottawa Technical Bulletin ISTB-2021-03, when calculating the required fire flow where pipe sizing is affected, the Fire Underwriters Survey Method (FUS) is to be used. However, as per City of Ottawa Technical Bulletins ISDB-2014-02 and ISTB-2018-02, the FUS calculated fire flows may be capped to 10,000 L/min for single detached dwellings and row houses (provided there is a minimum spatial separation of 10 m between the back of adjacent units); therefore, the fire flow is capped at 10,000 L/min (166.7 L/s).

The boundary conditions for the 166.7 L/s fire flow (based on the city's computer model of the municipal water distribution system) were received from the City. They include a HGL (hydraulic grade line) of 126.7 m for the above flow rate in the 400 mm Prince of Wales Drive municipal watermain in front of the subject property. This HGL calculates to be 426 kPa (61.9 psi). Since the pressure is above 138 kPa (20 psi) there is an adequate water supply for firefighting from the existing municipal water distribution system.

A 200 mm private watermain, connecting to the 400 mm municipal watermain, is proposed to serve the proposed residential development including the two private on-site fire hydrants. A model was created using EPANET software to analyze the hydraulics of the private watermain. Using the provided HGL boundary conditions, and a 95 L/s demand at each hydrant (plus the Max Day flow of 0.7 L/s – see Domestic Water Supply below), the pressure at fire hydrant FH-1 is calculated to be 302 kPa (43.7 psi); and 351 kPa (50.9 psi) at FH-2. Since the pressures are above 138 kPa (20 psi), the private watermain is adequately sized. Refer to Appendix B.

In accordance with City of Ottawa Technical Bulletin ISTB-2018-02, the aggregate flow of all contributing fire hydrants within 150 m of the building shall not be less than the required fire flow; and the contribution from a given hydrant shall be as per Table 1 in Appendix I (an excerpt is below):

Hydrant Class	Distance to Building (m)	Contribution to Fire Flow (L/min)
AA	≤ 75	5,700
	> 75 and ≤ 150	3,800

The front entrances of the four west dwelling units (closest to Prince of Wales Drive) will be less than 75 m from at least two fire hydrants (existing municipal and/or proposed private hydrant); as such, the aggregate flow of the two contributing fire hydrants is 11,400 L/min (190 L/s) ($= 2 \times 5,700 \text{ L/min}$ or $2 \times 95 \text{ L/s}$); which is greater than required fire flow of 10,000 L/min or 166.7 L/s. The front entrances of the three east dwelling units (furthest from Prince of Wales Drive) will be less than 75 m from one fire hydrant and less than 150 m from the other two; as such, the aggregate flow of the three contributing fire hydrants is 13,300 L/min or 221.7 L/s ($= 5,700 + 2 \times 3,800 \text{ L/min}$ or $95 + 2 \times 63.3 \text{ L/s}$); which is greater than required fire flow of 10,000 L/min (166.7 L/s). Therefore, the aggregate flow of all contributing fire hydrants within 150 m of each dwelling unit is greater than the required fire flow.

2.2 DOMESTIC WATER SUPPLY

In accordance with:

- i. the City of Ottawa Water Design Guidelines for the populations;
- ii. City of Ottawa Technical Bulletin ISTB-2021-03 for the consumption rate; and
- iii. the Ministry of the Environment Water Design Guidelines for the peaking factors.

Based on seven single family dwelling units, the average daily demand was calculated to be 0.1 L/s, the maximum daily demand was calculated to be 0.7 L/s and the maximum hourly demand was calculated to be 1.1 L/s. Refer to calculations in Appendix B.

To determine water pressure under these demands, boundary conditions, based on the City of Ottawa computer simulation of the water distribution system, at the subject location, are required. The boundary conditions received from the City stated that the minimum HGL (hydraulic grade line) is 124.3 m, and the maximum is 132.3 m. Based on these HGLs the water pressure at the water meters are calculated to vary from 410 kPa to 490 kPa (59 psi to 71 psi). This is an acceptable range of water pressures for the proposed development.

3.0 SANITARY SERVICING

In accordance with:

- i. the City of Ottawa Sewer Design Guidelines for the populations;
- ii. City of Ottawa Technical Bulletin ISTB-2018-01 for the average daily flow, Harmon Formula correction factor and infiltration allowance; and
- iii. the Harmon Formula for the peaking factor.

Based on seven single family dwelling units, the total sanitary flow rate was calculated to be 0.58 L/s. A proposed 200 mm private sanitary sewer at 0.65% slope (26.80 L/s capacity) is proposed to service the subdivision. At the design flow rate the private sanitary sewer service will only be at about 2% of its capacity. Refer to calculations in Appendix C.

The proposed 200 mm sanitary sewer will connect to the existing 250 mm Prince of Wales Drive municipal sanitary sewer, which at 0.85% slope has a capacity of 44.17 L/s. Refer to calculations in Appendix C. Given the capacity of the municipal sewer and the generated peak flow generated (0.58 L/s) the proposed development is expected to have an acceptable impact on the municipal sanitary sewer.

Backwater valves are proposed for each dwelling unit.

Since the proposed sanitary sewers services more than one property, it is expected that a Ministry of the Environment (MECP) Environmental Compliance Approval (ECA) will be required.

4.0 STORMWATER MANAGEMENT

4.1 QUANTITY CONTROL

City staff has stated: *“The City’s preferred stormwater arrangement is for the proposed subdivision to outlet to the Rideau River. If the RVCA requires quantity control, the City will not support oversized underground sewers to accommodate storage requirements. Catchbasin (CB) inlet-control devices (ICDs), with associated street ponding, per City guidelines, are acceptable to control storm events greater than the 2 year event. Quantity control to the Rideau River is within the RVCA’s jurisdiction.”* Refer to Appendix A. In response, Rideau Valley Conservation Authority (RVCA) staff has stated: *“The RVCA deferred quantity control requirements to the City, so we will provide comments based on the design parameters that is required by the City.”* Refer to Appendix D.

The stormwater management criteria for quantity control are to control the post development peak flows for the 5-year and 100-year storm events to peak flows during the 2-year storm event using a pre-development runoff coefficient, whichever is less; and a calculated time of concentration (but not less than 10 minutes). It is calculated that the pre-development conditions reflect a runoff coefficient of 0.34 and a time of concentration of 19 minutes; therefore, using the Rational Method; the maximum allowable release rate is 56.73 L/s for all storm events. The Modified Rational Method is used to calculate the required storage volume. The runoff coefficients for the 100-year event are increased by 25% to maximum 1.00.

Drainage Area I (Uncontrolled Flow Off Site – 1,905 m²)

Areas immediately adjacent to the Rideau River will drain uncontrolled off site. The flow rates are calculated at a time of concentration of 10 minutes.

	100-Year Event	5-Year Event
Maximum Flow Rate	29.11 L/s	14.02 L/s

Drainage Area III (excluding offsite the railway embankment – not required to be controlled – 9,394 m²)

An inlet control device (ICD) located in the outlet pipe of catch-basin / manhole CB/MH-8 will control the release of stormwater from the property by restricting the flow of stormwater and cause it to backup into the upstream infrastructure and pond in a ditch (required by the railway company) located adjacent to the railway embankment in the rear yards of the dwelling units. The ICD will discharge to the Rideau River via a 525 storm sewer near the southeast corner of the property. The ICD shall be a plug style with a round orifice design manufactured by Pedro Plastics (or approved equal) and each shall be sized by the manufacturer for a discharge rate of 27.62 L/s at 2.12 m head. It is calculated that an orifice area of 7,014 mm² (±95 mm diameter) and a discharge coefficient of 0.61 will restrict the outflow rate to 27.62 L/s at a head of 2.12 m. Based on this orifice the maximum outflow rate for the 5-year storm event is calculated to be 25.48 L/s at 1.81 m.

	100-Year Event	5-Year Event
Maximum Release Rate	27.62 L/s	25.48 L/s
Maximum Ponding Elevation	80.61 m	80.30 m
Maximum Volume Stored	178.19	69.39 m ³

Drainage Area III + III-A (including offsite the railway embankment – 12,093 m²)

The calculations used for Drainage Area III were used to calculate the required storage volume. However, the offsite railway embankment area (2,699 m²) does not need to be controlled but drains onto Drainage Area III. Including this offsite area in the calculations and assuming the excess water is allowed to overflow out the top of CB/MH-8 during the 100-year event (set at 80.61 – the 100-year ponding elevation) the release rate increases to 48.44 L/s. The ponding elevation and volume increases to 80.38 m and 87.64 m³, respectively, during the 5-year event.

	100-Year Event	5-Year Event
Maximum ICD Release Rate	27.62 L/s	26.04 L/s
Maximum Overflow Release Rate	20.82 L/s	0.00 L/s
Maximum Total Release Rate	48.44 L/s	26.04 L/s
Maximum Ponding Elevation	80.61 m	80.38 m
Maximum Volume Stored	178.19 m ³	87.64 m ³

Summary

The maximum post-development release rate during the 100-year event was calculated to be 56.73 L/s, which is 75% less than the pre-development flow rate and equal to the maximum allowable release rate. To achieve the maximum allowable release rate, a maximum storage volume of 178.19 m³ is required during the 100-year even and is provided. The maximum post-development release rate during the 5-year event was calculated to be 31.46 L/s, which is 48% less than the pre-development flow rate 30% less than the maximum allowable release rate. The restricted flow rate is expected to have a positive impact on the Rideau River.

	100-Year Event	5-Year Event
Pre-development Flow Rate	227.91 L/s	46.27 L/s
Maximum Allowable Release Rate	56.73 L/s	46.27 L/s
Maximum Release Rate	56.73 L/s	31.46 L/s
Maximum Volume Required	178.19 m ³	69.39 m ³
Maximum Volume Stored	178.19 m ³	69.39 m ³

4.2 QUALITY CONTROL

City staff has stated: *“If agreeable to the RVCA, the City of Ottawa would accept an oil-grit separator (OGS) prior to releasing drainage into the Rideau River. Quality control requirements are to be provided by the RVCA however, the City expects Enhanced Level protection will be the requirement (i.e. 80% TSS removal). In response, RVCA staff has stated: “Water Quality Control is required as detailed [above], a new outlet to the Rideau would also need to be designed to ensure that adequate erosion protection is provided as part of the design.”*

To meet the water quality target of 80% TSS (total suspended solids) removal an oil grit separator (OGS) is proposed to be located downstream of the inlet control device (ICD). A CDS Model PMSU2020-5-C was selected by the manufacturer based on the manufacturer’s software which calculated that it would remove about 83% of the TSS. The proposed OGS has an oil capacity of 376 L and a sediment capacity of 1.1 m³.

An erosion and sediment control plan has been developed to be implemented during construction, (see drawing C-4 and notes 2.1 to 2.7 on drawing C-8). In summary: to filter out construction sediment a silt fence barrier will be installed where runoff will drain off the site toward the river; sediment capture filter sock inserts are to be installed in all existing catch-basins adjacent to the site and in all new catch basins as they are installed; straw bale check dams will be installed at the proposed outlet to the river; and any material deposited on a public road will be removed.

4.3 STORM SERVICING

A private storm sewer system is proposed: However, since the system is flooded during extreme storm events (as part of the stormwater management quantity control design) storm sewers serving the

foundation drains for each building drain to the rear yard ditch. In addition, in the event these storm sewers are blocked due to ice, snow or debris, the foundation drains also connect to a sump and pump and, in an emergency, the foundation drainage can be pumped to grade. Backwater valves are proposed for each dwelling units.

The unrestricted 5-year flow rate in each pipe segment varies from 2% to 91% capacity, with the flow rate in the last segment being 117.20 L/s. However, at the 5-year restricted flow rate of 42.27 L/s (through the ICDs) flow rate in each pipe segment is significantly reduced. As previously mentioned, the private storm sewer system is proposed to outlet near the southeast corner of the property and to the Rideau River.

Since the proposed storm sewers services more than one property, it is expected that a Ministry of the Environment (MECP) Environmental Compliance Approval (ECA) will be required.

5.0 CONCLUSIONS

1. Two private onsite hydrants are required.
2. There is an adequate water supply for firefighting from the existing municipal water distribution system.
3. Since the pressures are above 138 kPa (20 psi) during fire flow conditions, the private watermain is adequately sized.
4. The aggregate flow of all contributing fire hydrants within 150 m of each dwelling unit is greater than the required fire flow.
5. There is an acceptable range of water pressures available for the proposed development.
6. The post-development sanitary flow rates will be adequately handled by the proposed private sanitary sewer system.
7. The proposed development is expected to have an acceptable impact on the existing municipal sanitary sewer.
8. Since the proposed sewers service more than one property, it is expected that a Ministry of the Environment (MECP) Environmental Compliance Approval (ECA) will be required.
9. The maximum post-development release rate during the 100-year event was calculated to be 75% less than the pre-development flow rate and equal to the maximum allowable release rate. The maximum post-development release rate during the 5-year event was calculated to be 48% less than the pre-development flow rate 30% less than the maximum allowable release rate.
10. The restricted flow rate is expected to have a positive impact on the Rideau River.
11. The proposed OGS will achieve 80% TSS removal.
12. An Erosion & Sediment Control Plan has been developed to be implemented during construction.
13. The peak restricted flow rates during the 5-year event will be adequately handled by the proposed private storm sewer system.

Prepared by D.B. Gray Engineering Inc.

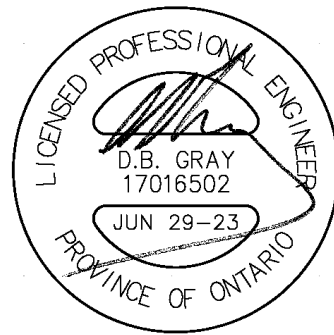

NOT VALID UNLESS
SIGNED & DATED

APPENDIX A

PRE-APPLICATION CONSULTATION MEETING NOTES

ADDRESS: 2009 & 2013 Prince Of Wales**Pre-Consultation Meeting Minutes****Meeting Date: April 8, 2022**

Attendee	Role	Organization
Lisa Stern	File Lead	City of Ottawa
Sami Rehman	Environmental Planner	
Louise Cerveney	Parks Planner	
Mark Richardson	Forester	
Gabrielle Shaeffer	Engineer	
Josiane Gervais	Transportation	
Eric Lalande	Planner	RVCA
Alex Sivasambu		Land Owner
Jane Thompson	Applicant	Jane Thompson Architect
Erin Duncan		

Comments from the Applicant:

1. Subdivision and rezoning to facilitate the creation of seven residential lots and a public roadway.
2. 1 storey brick dwelling at 2009 Prince of Wales to remain

Planning Comments:

1. A minor rezoning and subdivision application are required.
2. The site is located adjacent to the Rideau River and next to an elevated rail corridor.
3. The site is designated General Urban Area and Natural Heritage in the Existing Official Plan and is designated Neighbourhood Area within the Outer Urban Transect and Natural Area in the Council Adopted Official Plan. These designations support low rise infill development that is compatible with existing development.
4. The site is zoned Residential First Density subzone E (R1E). A rezoning is required to facilitate reduced lot areas, increased setbacks from the Watercourse and rail line.
5. A Planning Rationale prepared by a qualified professional is required to support the proposed application. The Planning Rationale should discuss compliance with Official Plan policy and guidelines and should address compatibility with adjacent residential uses, rail line and Rideau River.
6. A “no touch” setback to the Rideau River is required as per the environmental comments below. Parks Canada and the NCC will be circulated on the application and will provide comments on impacts to the River.
7. To improve compatibility, retention of existing mature vegetation should be considered.
8. Consideration for the interface between the roadway and the property to the north should be given. Minimizing retaining walls and lighting ,and the retention or provision of screening plantings should be thought-out.
9. As the site is adjacent to a rail line, the Guidelines for New Development in Proximity to Railway Operations which was prepared for the Federation of Canadian Municipalities and the Railway Association of Canada apply. These guidelines recommend a *minimum* 30m setback from the building face to the rail right of way. Additionally, noise walls and crash berms may be required to mitigate impacts. Please reach out to the railway to discuss requirements for safety setbacks and/or mitigation measures.

10. As this property is located adjacent to the Rideau Canal World Heritage Site, a Cultural Heritage Impact Statement *may* be required. Please reach out to the Heritage Planning branch via our general email: heritage@ottawa.ca prior to submission.

Parks:

1. Parks and Facilities Planning request that Cash-in-lieu of parkland be taken based on the total developable area of the site

Environment:

1. The subject property is situated next to the Rideau River, so according to the new Official Plan (OP) policies, the proposed development will require an Environmental Impact Study (EIS).
2. The EIS should address the setback requirements outlined in the OP Section 4.9.
3. The minimum required setbacks are to be kept in a naturally vegetated state. So, the EIS should provide recommendations for ecological enhancements in the setbacks, in addition to general tree retention throughout the property.
4. The EIS should focus on mitigating potential impacts on the Rideau River.
5. The EIS should also explore potential significant habitat for threatened or endangered species on or near the subject property.

Forestry:

1. a Tree Conservation Report (TCR) must be supplied for review along with the suite of other plans/reports required by the City
 - a. an approved TCR is a requirement of Site Plan approval.
 - b. The TCR may be combined with the EIS provided all information is supplied
2. Any removal of privately-owned trees 10cm or larger in diameter, or city-owned trees of any diameter requires a tree permit issued under the Tree Protection Bylaw (Bylaw 2020 – 340); the permit will be based on an approved TCR and made available at or near plan approval.
3. The Planning Forester from Planning and Growth Management as well as foresters from Forestry Services will review the submitted TCR
 - a. If tree removal is required, both municipal and privately-owned trees will be addressed in a single permit issued through the Planning Forester
 - b. Compensation may be required for city owned trees – if so, it will need to be paid prior to the release of the tree permit
4. the TCR must list all trees on site, as well as off-site trees if the CRZ extends into the developed area, by species, diameter and health condition
5. please identify trees by ownership – private onsite, private on adjoining site, city owned, co-owned (trees on a property line)
6. If trees are to be removed, the TCR must clearly show where they are, and document the reason they cannot be retained
7. All retained trees must be shown, and all retained trees within the area impacted by the development process must be protected as per City guidelines available at [Tree Protection Specification](#) or by searching Ottawa.ca
 - a. the location of tree protection fencing must be shown on the plan
 - b. show the critical root zone of the retained trees
 - c. if excavation will occur within the critical root zone, please show the limits of excavation
8. the City encourages the retention of healthy trees; if possible, please seek opportunities for retention of trees that will contribute to the design/function of the site.

9. For more information on the process or help with tree retention options, contact Mark Richardson mark.richardson@ottawa.ca or on City of Ottawa

LP tree planting requirements:

For additional information on the following please contact tracy.smith@Ottawa.ca

Minimum Setbacks

- Maintain 1.5m from sidewalk or MUP/cycle track.
- Maintain 2.5m from curb
- Coniferous species require a minimum 4.5m setback from curb, sidewalk or MUP/cycle track/pathway.
- Maintain 7.5m between large growing trees, and 4m between small growing trees. Park or open space planting should consider 10m spacing, except where otherwise approved in naturalization / afforestation areas. Adhere to Ottawa Hydro’s planting guidelines (species and setbacks) when planting around overhead primary conductors.

Tree specifications

- Minimum stock size: 50mm tree caliper for deciduous, 200cm height for coniferous.
- Maximize the use of large deciduous species wherever possible to maximize future canopy coverage
- Tree planting on city property shall be in accordance with the City of Ottawa’s Tree Planting Specification; and include watering and warranty as described in the specification (can be provided by Forestry Services).
- Plant native trees whenever possible
- No root barriers, dead-man anchor systems, or planters are permitted.
- No tree stakes unless necessary (and only 1 on the prevailing winds side of the tree)

Hard surface planting

- Curb style planter is highly recommended
- No grates are to be used and if guards are required, City of Ottawa standard (which can be provided) shall be used.
- Trees are to be planted at grade

Soil Volume

- Please ensure adequate soil volumes are met:

Tree Type/Size	Single Tree Soil Volume (m3)	Multiple Tree Soil Volume (m3/tree)
Ornamental	15	9
Columnar	15	9
Small	20	12
Medium	25	15
Large	30	18
Conifer	25	15

Please note that these soil volumes are not applicable in cases with Sensitive Marine Clay.

Sensitive Marine Clay

- Please follow the City’s 2017 Tree Planting in Sensitive Marine Clay guidelines

Tree Canopy Cover

- The landscape plan shall show how the proposed tree planting will replace and increase canopy cover on the site over time, to support the City's 40% urban forest canopy cover target.
- At a site level, efforts shall be made to provide as much canopy cover as possible, through tree planting and tree retention, with an aim of 40% canopy cover at 40 years, as appropriate.
- Indicate on the plan the projected future canopy cover at 40 years for the site.

Engineering:

1. The Servicing Study Guidelines for Development Applications are available at the following address: <https://ottawa.ca/en/planning-development-and-construction/developing-property/development-application-review-process/development-application-submission/guide-preparing-studies-and-plans#servicing-study-guidelines-development-applications>

2. Servicing and site works shall be in accordance with the following documents:

- ⇒ Ottawa Sewer Design Guidelines (October 2012)
- ⇒ Ottawa Design Guidelines – Water Distribution (2010)
- ⇒ Geotechnical Investigation and Reporting Guidelines for Development Applications in the City of Ottawa (2007)
- ⇒ City of Ottawa Slope Stability Guidelines for Development Applications (revised 2012)
- ⇒ City of Ottawa Environmental Noise Control Guidelines (January, 2016)
- ⇒ City of Ottawa Park and Pathway Development Manual (2012)
- ⇒ City of Ottawa Accessibility Design Standards (2012)
- ⇒ Ottawa Standard Tender Documents (latest version)
- ⇒ Ontario Provincial Standards for Roads & Public Works (2013)
- ⇒ Fire Underwriter's Survey (2020)

3. Record drawings and utility plans are also available for purchase from the City (Contact the City's Information Centre by email at geoinformation@ottawa.ca or by phone at (613) 580-2424 x.44455).

Stormwater

4. There is a 525mm diameter concrete storm sewer on Prince of Wales Drive built in 1975 fronting the site. The site also fronts the Rideau River.

5. There is an existing localized stormwater management system in place within the Prince of Wales roadside ditch fronting the site. The proposed cul-de-sac connection to Prince of Wales is through this system. Please incorporate into the design changes that would relocate the localized stormwater system.

6. The City's preferred stormwater arrangement is for the proposed subdivision to outlet to the Rideau River. To pursue this option, please confirm with the Rideau Valley Conservation Authority (RVCA) if this option is possible, as they have Rideau River jurisdiction.

a) If agreeable to the RVCA, the City of Ottawa would accept an oil-grit separator (OGS) prior to releasing drainage into the Rideau River. Quality control requirements are to be provided by the RVCA however, the City expects Enhanced Level protection will be the requirement (i.e. 80% TSS removal).

b) If the RVCA requires quantity control, the City will not support oversized underground sewers to accommodate storage requirements. Catchbasin (CB) inlet-control devices (ICDs), with associated street ponding, per City guidelines, are acceptable to control storm events greater than the 2 year event. Quantity control to the Rideau River is within the RVCA's jurisdiction.

c) If basements are proposed the storm sewer is to be for the 5 year minor storm event. All storm events greater than the minor storm event is to be controlled with CB ICDs and/or overland flow toward the Rideau River.

7. If the applicant wishes to explore connection to the Prince of Wales 525mm diameter concrete storm sewer (built in 1975):

- a. Please provide gabrielle.schaeffer@ottawa.ca the expected flow rate from the site to the Prince of Wales storm sewer to assess storm boundary conditions. Please note this is not the City's preferred option and is expected to be a more restrictive option with respect to stormwater release rates.
- b. Utilize the 5-yr storm event using the IDF information derived from the Meteorological Services of Canada rainfall data, taken from the MacDonal Cartier Airport, collected 1966 to 1997.
- c. Utilize the pre-development runoff coefficient or a maximum equivalent 'C' of 0.5, whichever is less (§ 8.3.7.3).
- d. A calculated time of concentration (Cannot be less than 10 minutes).
- e. Flows to the storm sewer in excess of the allowable release rate, up to and including the 100-year storm event, may need to be detained on site.
- f. This option may work best when only necessary flows (i.e. road and fronting half of houses) flow toward the Prince of Wales minor system, and the rest flows to the Rideau River.

Sanitary

8. There is an existing 250mm diameter sanitary ductile iron sewer on Prince of Wales built in 1975 fronting the site.

Water

9. There is an existing 406mm diameter ductile iron watermain on Prince of Wales built in +/-1975 fronting the site.

10. Water Boundary condition requests must include the location of the service (map or plan with connection location(s) indicated) and the expected loads required by the proposed development, including calculations. Please provide the following information:

- i. Location of service
- ii. Type of development and the amount of fire flow required (as per FUS, 1999).
- iii. Average daily demand: ___ l/s.
- iv. Maximum daily demand: ___ l/s.
- v. Maximum hourly daily demand: ___ l/s.

11. Fire trucks require access to each building entrance as per the Ontario Building Code. Please ensure that the fire route extends as much as needed. Also, a fire route does not need a turn around unless the road length is more than 90m. If a turn around is needed for fire services, please follow the City standard. Please note the City standard turn around may be needed for other reasons.

MECP ECA Requirements

12. An MECP Environmental Compliance Approval (Municipal Sewage Works), for SWM/STM/SAN, will be required for the proposed development. This application qualifies to be reviewed by Transfer of Review through the City.

Slope Stability / Geotechnical Report

13. A slope stability analysis will need to be completed as per City guidelines for the slope next to the river.

14. A geotechnical report is required as per City guidelines.

ESAs

15. Phase 1 ESAs and Phase 2 ESAs must conform to clause 4.8.4 of the Official Plan that requires that development applications conform to Ontario Regulation 153/04.

Transportation:

1. Follow Transportation Impact Assessment Guidelines:
 - a. A TIA is required. Submit a Scoping Report at your earliest convenience to josiane.gervais@ottawa.ca.
 - b. Correct the Screening Form:
 - i. The proposed roadway is within the area of influence of the Colonnade Rd traffic signal.
 - ii. The proposed roadway is within the auxiliary lanes of the intersection.
 - c. A review of auxiliary lane warrants and sightline analysis must be addressed with the TIA.
 - d. A turning lane on Prince of Wales may be required, which would trigger an RMA.
 - e. Start this process asap, the TIA process is iterative and the majority of the work must take place before submission. The application will not be deemed complete until the submission of the draft step 1-4, including the functional draft RMA package (if applicable) and/or monitoring report (if applicable).
 - f. Request base mapping asap if RMA is required. Contact Engineering Services (<https://ottawa.ca/en/city-hall/planning-and-development/engineering-services>)
 - g. An update to the *TRANS Trip Generation Manual* has been completed (October 2020). This manual is to be utilized for this TIA. A copy of this document can be provided upon request.
2. ROW protection on Prince of Wales between Colonnade and Rideau Heights Lane is 32-58m (varies and subject to unequal widening requirements of the Prince of Wales Dr Widening ESR). Future ROW line must be shown on the site plan, and all set-backs must be measured from this new property line.
3. Widening of Prince of Wales is on the TMP's Affordable Network. Note that ROW is required from these parcels, as described in the Prince of Wales Drive EA. I've included a plan depicting the ROW lines as per the EA, note that these are still subject to change during detailed design. As per the EA, a service road parallel to Prince of Wales is proposed along the frontage of the properties to provide access via the Colonnade signalized intersection.
4. The proposed local roadway design would need to consider both the existing condition of Prince of Wales, as well as the future horizon when Prince of Wales is widened.
5. Corner triangles as per OP Annex 1 - Road Classification and Rights-of-Way at the following locations on the final plan will be required (measure on the property line/ROW protected line; no structure above or below this triangle): Local Road to Arterial Road: 5 m x 5 m
6. The proposed local roadway would require a cul-de-sac at the end to allow vehicles to turn around. Refer to Ontario Provincial Standard Drawing (OPSD) 500.020.
7. While preparing the Draft Plan, note that all new local residential streets should be designed with a target operating speed of 30km/h per the new Strategic Road Safety Action Plan Update. Please follow the City's *Local Residential Streets 30 km/h Design Toolbox (2021)* document.
8. A sidewalk would be required along the new local road.
9. Corner clearances should follow minimum distances set out within TAC Figure 8.8.2.
10. Geometric Road Design Drawings (GRDD) will be required with the first submission of underground infrastructure and grading drawings. These drawings should include such items as, but are not limited to:
 - a. Road signage and pavement markings.
 - b. Location of depressed curbs and tactile walking surface indicators (TWSI).

- c. Traffic calming measures aimed at reducing vehicle speed and enhancing pedestrian safety. Measures may include either vertical or horizontal features, however such measures shall not interfere with stormwater management and overland flow routing. Traffic calming measures shall reference best management practices from the Canadian Guide to Neighbourhood Traffic Calming, published by the Transportation Association of Canada, and/or Ontario Traffic Manual, and/or the City of Ottawa's Traffic Calming Design Guidelines.

11. Noise Impact Studies required for the following:

- a. Road, as the site is within proximity to Prince of Wales
- b. Rail, Noise and Vibration study required. The Outdoor Living Area noise levels may be a concern and mitigation may be a challenge as a traditional noise wall would be less effective since the railway is raised.
- c. Aircraft, as the site falls within the Airport Vicinity Development Zone.

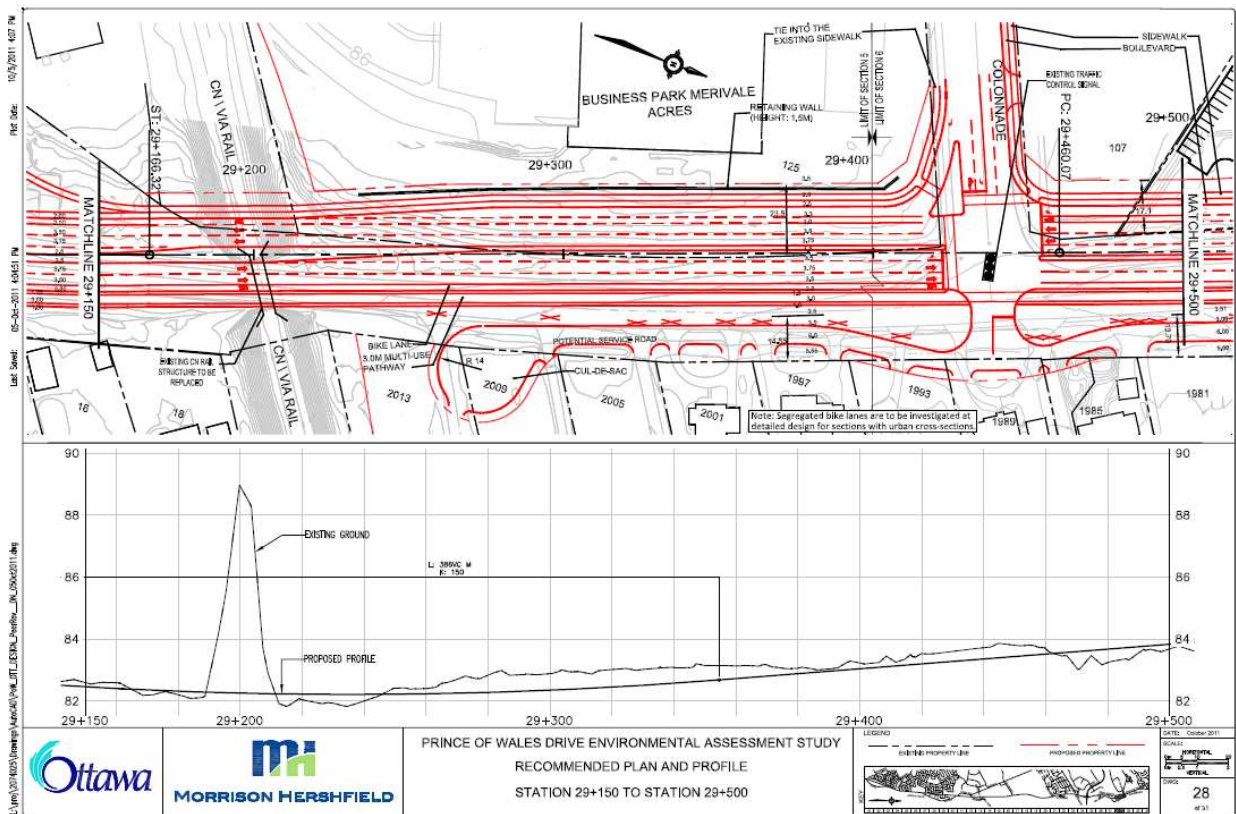

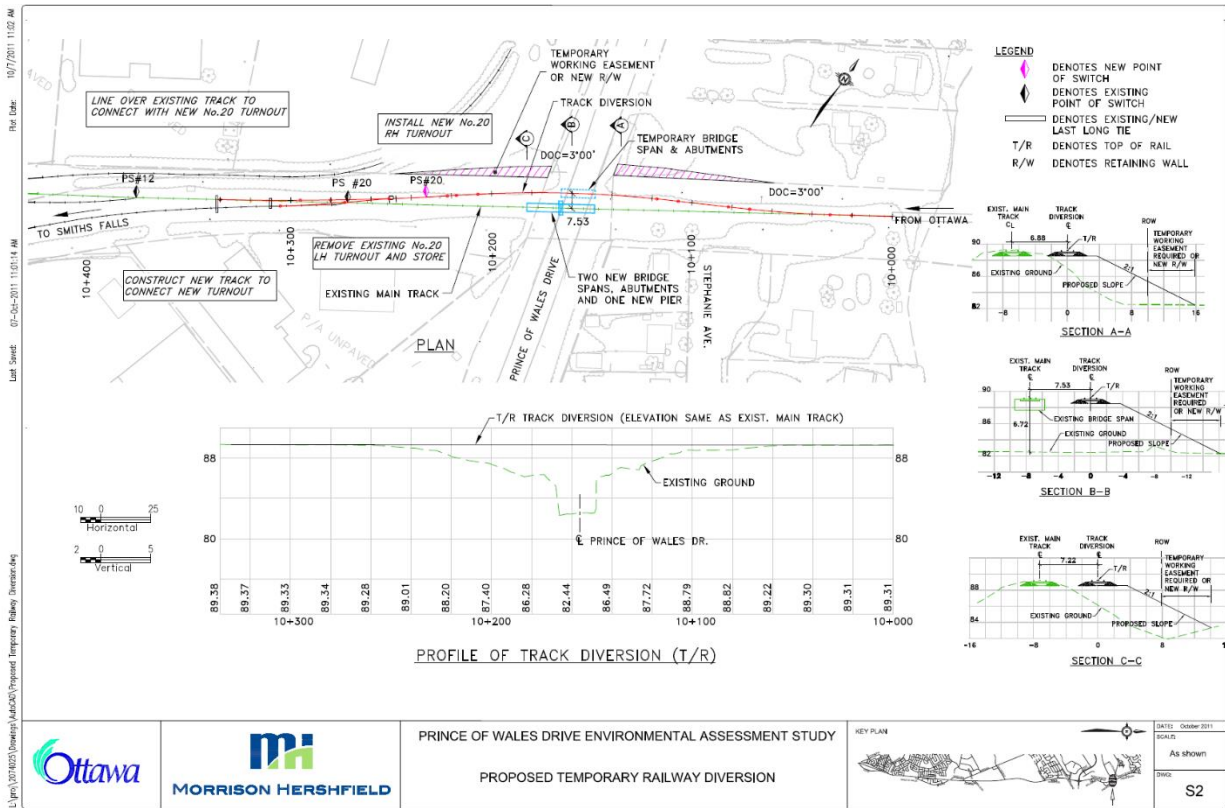

RVCA:

1. A RVCA permit is required for any works within the Regulated area of the property.
2. Please contact the RVCA to determine if any permits or approvals are required under their regulations.

Please refer to the links to [“Guide to preparing studies and plans”](#) and fees for general information. Additional information is available related to [building permits](#), [development charges](#), and the [Accessibility Design Standards](#). Be aware that other fees and permits may be required, outside of the development review process. You may obtain background drawings by contacting informationcentre@ottawa.ca.

These pre-con comments are valid for one year. If you submit a development application(s) after this time, you may be required to meet for another pre-consultation meeting and/or the submission requirements may change. You are as well encouraged to contact us for a follow-up meeting if the plan/concept will be further refined.

Please contact me at Lisa.Stern@ottawa.ca or at 613-580-2424 extension 21108 if you have any questions.

APPENDIX B

WATER SERVICING

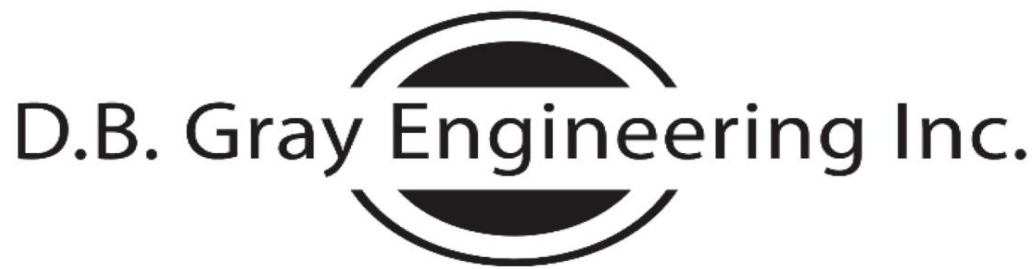

Stormwater Management - Grading & Drainage - Storm & Sanitary Sewers - Watermains

700 Long Point Circle
Ottawa, Ontario K1T 4E9

613-425-8044
d.gray@dbgrayengineering.com

February 28, 2023

REVISED June 28, 2023

2009-2013 Prince of Wales Dr
7-Lot Residential Development
Ottawa, Ontario

WATER DEMAND CALCULATIONS

	Number of Units	Persons per Unit	Population
Single Family:	7	3.4	23.8
Semi- detached:	0	2.7	0.0
Duplex:	0	2.3	0.0
Townhouse:	0	2.7	0.0
Total:	7		23.8

Average Daily Demand: 280 L/capita/day
4.6 L/min 0.1 L/s 1.2 USgpm

Maximum Daily Demand: 9.5 (Peaking factor for a population of 23.8 interpolated from MOE Design Guidelines for Drinking Water Systems Table 3-3)
44.0 L/min 0.7 L/s 11.6 USgpm

Maximum Hourly Demand: 14.3 (Peaking factor for a population of 23.8 interpolated from MOE Design Guidelines for Drinking Water Systems Table 3-3)
66.2 L/min 1.1 L/s 17.5 USgpm

Elevation of Water Meter:	82.53	m		
Basement Floor Elevation:	81.63	m		
(Varies - Highest):				
Minimum HGL:	124.3	m		
Static Pressure at Water Meter:	41.8	m	410	kPa 59 psi
Maximum HGL:	132.3	m		
Static Pressure at Water Meter:	49.8	m	488	kPa 71 psi
Elevation of Water Meter:	82.33	m		
Basement Floor Elevation:	81.43	m		
(Varies - Lowest):				
Minimum HGL:	124.3	m		
Static Pressure at Water Meter:	42.0	m	411	kPa 60 psi
Maximum HGL:	132.3	m		
Static Pressure at Water Meter:	50.0	m	490	kPa 71 psi



Laurent Brosseau <l.brosseau@dbgrayengineering.com>

Boundary Conditions Request - 2009-2013 Prince of Wales Dr

Schaeffer, Gabrielle <gabrielle.schaeffer@ottawa.ca>
To: Laurent Brosseau <l.brosseau@dbgrayengineering.com>
Cc: Douglas Gray <d.gray@dbgrayengineering.com>

Wed, Apr 19, 2023 at 11:17 AM

Hi Laurent,

The following are boundary conditions, HGL, for hydraulic analysis at [2009-2013 Prince of Wales Drive](#) (zone 2W2C) assumed to be connected to the 406 mm watermain on Prince of Wales Drive. (see attached PDF for location).

Minimum HGL: 124.3 m

Maximum HGL: 132.3 m

Max Day + Fire Flow (166.7 L/s): 126.7 m

These are for current conditions and are based on computer model simulation.

Disclaimer: The boundary condition information is based on current operation of the city water distribution system. The computer model simulation is based on the best information available at the time. The operation of the water distribution system can change on a regular basis, resulting in a variation in boundary conditions. The physical properties of watermains deteriorate over time, as such must be assumed in the absence of actual field test data. The variation in physical watermain properties can therefore alter the results of the computer model simulation.

Regards,

Gabrielle (Gabi) Schaeffer, P.Eng

Senior Engineer - Infrastructure Applications

City of Ottawa

Development Review - West Branch

Planning, Real Estate and Economic Development Department

[110 Laurier Ave West, 4th Floor](#) East;

Ottawa ON K1P 1J1

Cell: 613-227-7419

From: Laurent Brosseau <l.brosseau@dbgrayengineering.com>

Sent: March 21, 2023 9:33 AM

To: Schaeffer, Gabrielle <gabrielle.schaeffer@Ottawa.ca>
Cc: Douglas Gray <d.gray@dbgrayengineering.com>
Subject: Boundary Conditions Request - 2009-2013 Prince of Wales Dr

CAUTION: This email originated from an External Sender. Please do not click links or open attachments unless you recognize the source.

ATTENTION : Ce courriel provient d'un expéditeur externe. Ne cliquez sur aucun lien et n'ouvrez pas de pièce jointe, excepté si vous connaissez l'expéditeur.

Good morning,

We are working on a 7 lot development, each with a single family dwelling.

Please provide the boundary conditions at 2009-2013 Prince of Wales. We have calculated the following expected demands.

Average daily demand: 0.1 L/s.

Maximum daily demand: 0.7 L/s.

Maximum hourly daily demand: 1.1 L/s

Fire Flow demand: 166.7 L/s

Fire Flow + Max Day: 167.4 L/s

The fire flow demand was capped at 10 000L/min (166.7 L/s) as stated in the technical bulletin ISTB-2018-02, P. 25. Which states:

In the interim, the City of Ottawa Technical Bulletin ISDTB-2014-02 [12] that was issued in 2014 to qualify the application of the FUS method to single detached dwellings as well as traditional side-by-side town and row houses remains in effect. Accordingly, practitioners may cap FUS calculated fire flows to 10 000 L/min under the following conditions:

1. For single detached dwellings, provided that there is a minimum spatial separation of 10 m between the backs of adjacent units;

Calculations are attached. Also attached is a sketch showing the approximate location of the proposed service connection.

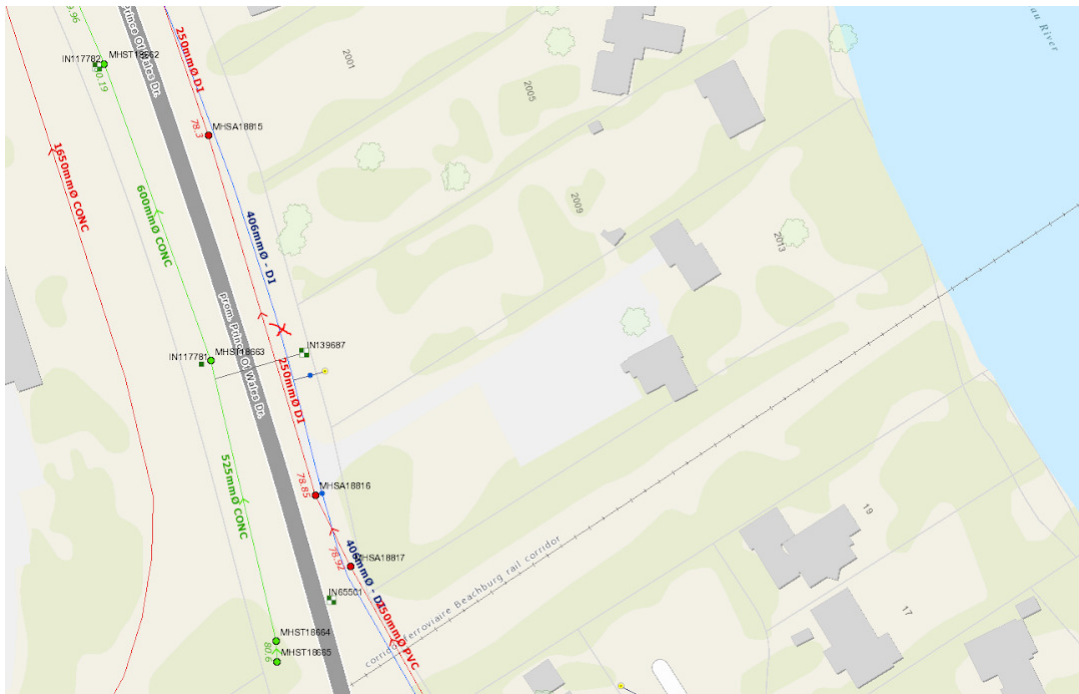

--

Laurent Brosseau

D. B. GRAY ENGINEERING INC.

Stormwater Management - Grading & Drainage - Storm & Sanitary Sewers - Watermains

700 Long Point Circle

Tel: 613-425-8044

Ottawa, Ontario K1T 4E9

l.brosseau@dbgrayengineering.com

[Quoted text hidden]

 **2009-2013 Prince of Wales Drive March 2023.pdf**
727K

Boundary Conditions for 2009-2013 Prince of Wales Drive



June 28, 2023

2009-2013 Prince of Wales Drive

Ottawa, Ontario

EPANET RESULTS

Node ID	Demand (L/s)	HGL (m)	Elevation (m)	Pressure		
				(m)	(kPa)	(psi)
1 - Reservoir	-190.7	126.7	83.20	43.5	426	61.9
2 - Fire Hydrant FH-2	95.0	118.92	83.15	35.8	351	50.9
3 - Fire Hydrant FH-1 (inc Max Day 0.7 L/s)	95.7	113.13	82.37	30.8	302	43.7

Link ID	Length (m)	Diameter (mm)	Roughness Coefficient	Minor Loss Coefficient	Flow	Velocity
					(L/s)	(m/s)
1 - Reservoir to Fire Hydrant FH-2	10.3	200	110	3.00	190.7	6.07
2 - Fire Hydrant FH-2 to FH-1	94.7	200	110	0.60	95.7	3.05

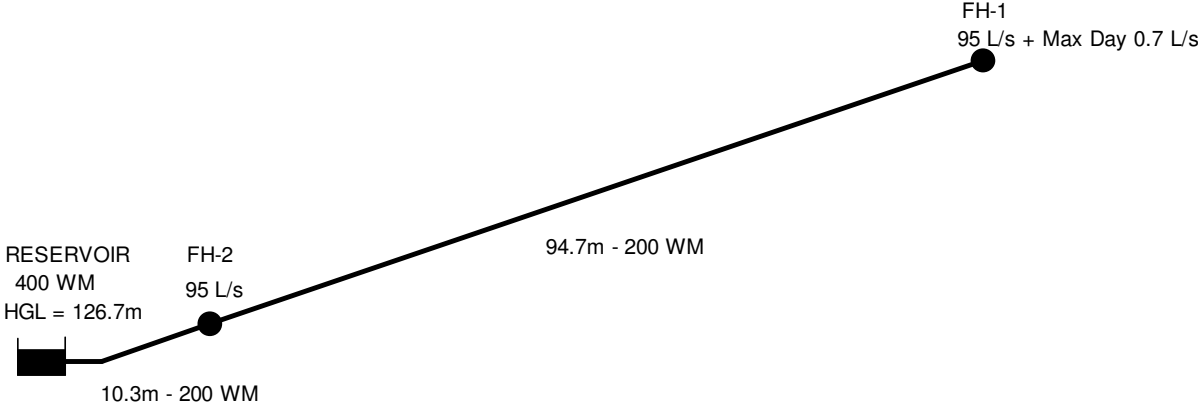

Network Table - Nodes

Node ID	Elevation m	Demand LPS	Head m	Pressure m
Junc 2	83.15	95.00	118.92	35.77
Junc 3	82.37	95.70	113.13	30.76
Resvr 1	126.7	-190.70	126.70	0.00

Network Table - Links

Link ID	Length m	Diameter mm	Roughness	Flow LPS	Velocity m/s
Pipe 1	10.3	200	110	190.70	6.07
Pipe 2	94.7	200	110	95.70	3.05

APPENDIX C

SANITARY SERVICING



SANITARY SEWER CALCULATIONS

Stormwater Management - Grading & Drainage - Storm & Sanitary Sewers - Watermains

700 Long Point Circle
Ottawa, Ontario K1T 4E9

613-425-8044
d.gray@dbgrayengineering.com

2009-2013 Prince of Wales
7 Lot Development
Ottawa, Ontario

June 28, 2023

Residential Average Daily Flow: 280 L/capita/day
Commercial Average Daily Flow: 28,000 L/ha/day
Institutional Average Daily Flow: 28,000 L/ha/day
Light Industrial Average Daily Flow: 35,000 L/ha/day
Heavy Industrial Average Daily Flow: 55,000 L/ha/day

Residential Peaking Factor: Harmon Formula
Harmon Formula Correction Factor: 0.8
Commercial Peaking Factor: 1.5
Institutional Peaking Factor: 1.5
Industrial Peaking Factor: Ministry of the Environment

Infiltration Allowance: 0.33 L/s/ha

Manning's Roughness Coefficient: 0.013

Location		Residential												Non-Residential				Infiltration			Q Total Flow Rate (L/s)	Sewer Data								
		Single Family	Semi Detached	Duplex	Apartment				Area (ha)	Population	Cumulative			Area (ha)	Daily Flow L/ha/day	Peaking Factor	Cumulative Flow Rate (L/s)	Area (ha)	Area (ha)	Flow Rate (L/s)		Length (m)	Nominal Diameter (mm)	Actual Diameter (mm)	Slope (%)	Velocity (m/s)	Q _{Full} Capacity (L/s)	Q / Q _{Full}		
					(1 Bed)	(2 Bed)	(3 Bed)	(Average)			Area (ha)	Population	Peaking Factor								Flow Rate (L/s)									
		ppu = 3.4	ppu = 2.7	ppu = 2.3	ppu = 1.4	ppu = 2.1	ppu = 3.1	ppu = 1.8																						
Lot 1	MH-SA.1	1							0.1114	3.4	0.1114	3.4	3.2	0.04					0.1114	0.1114	0.04	0.07	22.2	135	133	2.00	1.12	15.63	0.00	
Lot 2	MH-SA.1	1							0.2370	3.4	0.2370	3.4	3.2	0.04					0.2370	0.2370	0.08	0.11	15.4	135	133	2.00	1.12	15.63	0.01	
Lot 3	MH-SA.1	1							0.0750	3.4	0.0750	3.4	3.2	0.04					0.0750	0.0750	0.02	0.06	19.2	135	133	2.00	1.12	15.63	0.00	
Lot 4	MH-SA.1	1							0.0908	3.4	0.0908	3.4	3.2	0.04					0.0908	0.0908	0.03	0.07	11.9	135	133	2.00	1.12	15.63	0.00	
Lot 5	MH-SA.1	1							0.0917	3.4	0.1825	3.4	3.2	0.04					0.0917	0.1825	0.06	0.10	11.5	135	133	2.00	1.12	15.63	0.01	
Lot 6	MH-SA.1	1							0.0924	3.4	0.0924	3.4	3.2	0.04					0.0924	0.0924	0.03	0.07	11.5	135	133	2.00	1.12	15.63	0.00	
Lot 7	MH-SA.1	1							0.2122	3.4	0.2122	3.4	3.2	0.04					0.2122	0.2122	0.07	0.11	11.5	135	133	2.00	1.12	15.63	0.01	
MH-SA.1	MH-SA.2								0.0	1.0013	23.8	3.2	0.25						0.0000	1.0013	0.33	0.58	97.5	200	201	0.65	0.84	26.80	0.02	
MH-SA.2	Existing 250 SAN								0.0	1.5792	23.8	3.2	0.25						0.0000	1.0013	0.33	0.58	3.2	200	201	0.65	0.84	26.80	0.02	
250 mm Prince of Wales Drive Sanitary Sewer:																				250	251	0.54	0.89	44.17						

APPENDIX D

STORMWATER MANAGEMENT

STORMWATER MANAGEMENT CALCULATIONS

The orifice calculations are based on the following formula:

$$Q = C_d \times A_o \sqrt{2gh} \times 1000$$

where:

Q = flowrate in litres per second

C_d = coefficient of discharge

A_o = orifice area in sq.m.

g = 9.81 m/s²

h = head above orifice in meters

Storage calculations for the stormwater detention area are based on the following formula for volume of a prismatic shape (the formula is accurate if both length and width are changing proportionally):

$$V = (A_{\text{top}} + A_{\text{bottom}} + (A_{\text{top}} \times A_{\text{bottom}})^{0.5}) / 3 \times d$$

where:

V = volume in cu.m.

A_{top} = area of pond in sq.m.

A_{bottom} = area of bottom of depressed area

d = ponding depth in meters

SUMMARY TABLES

100-YEAR EVENT					
Drainage Area	Pre-Development Flow Rate (L/s)	Maximum Allowable Release Rate (L/s)	Maximum Release Rate (L/s)	Maximum Volume Required (cu.m)	Maximum Volume Stored (cu.m)
AREA I (Uncontrolled Flow Off Site)	-	-	29.11	-	-
AREA II	-	-	27.62	178.19	178.19
TOTAL	227.91	56.73	56.73	178.19	178.19

5-YEAR EVENT					
Drainage Area	Pre-Development Flow Rate (L/s)	Maximum Allowable Release Rate (L/s)	Maximum Release Rate (L/s)	Maximum Volume Required (cu.m)	Maximum Volume Stored (cu.m)
AREA I (Uncontrolled Flow Off Site)	-	-	14.02	-	-
AREA II	-	-	25.48	69.39	69.39
TOTAL	76.62	56.73	39.50	69.39	69.39

2009-2013 Prince of Wales Dr

Ottawa, Ontario

STORMWATER MANAGEMENT CALCULATIONS

Modified Rational Method

PRE-DEVELOPMENT CONDITIONS

100-YEAR EVENT

			C
Roof Area:	394	sq.m	1.00
Hard Area:	878	sq.m	1.00
Gravel Area:	1,300	sq.m	0.875
Soft Area:	<u>8,727</u>	<u>sq.m</u>	<u>0.25</u>

Total Catchment Area: 11,299 sq.m 0.41

Bransby Williams Formula (Used when $C \geq 0.40$)

$$T_c = \frac{0.057 \cdot L}{S_w^{0.2} \cdot A^{0.1}} \text{ min}$$

Sheet Flow Distance (L): 164 m

Slope of Land (Sw): 4.8 %

Area (A): 1.1299 ha

Time of Concentration (Tc) (Sheet Flow): 6.7 min

Time of Concentration: 10.0 min

Rainfall Intensity (i): 179 mm/hr

100-Year Pre-Development Flow Rate ($2.78AiC$): 227.91 L/s

5-YEAR EVENT

			C
Roof Area:	394	sq.m	0.90
Hard Area:	878	sq.m	0.90
Gravel Area:	1,300	sq.m	0.70
Soft Area:	<u>8,727</u>	<u>sq.m</u>	<u>0.20</u>

Total Catchment Area: 11,299 sq.m 0.34

Airport Formula (Used when C < 0.40)

$$T_c = \frac{3.26 \cdot (1.1 - C) \cdot L^{1/2}}{S_w^{0.33}} \text{ min}$$

Runoff Coefficient (C): 0.34

Sheet Flow Distance (L): 164 m

Slope of Land (Sw): 4.8 %

Time of Concentration (Tc) (Sheet Flow): 19.0 min

Time of Concentration: 19 min

Rainfall Intensity (i): 73 mm/hr

5-Year Pre-Development Flow Rate (2.78AiC): 76.62 L/s

2-YEAR EVENT

MAXIMUM ALLOWABLE RELEASE RATE

			C
Roof Area:	394	sq.m	0.90
Hard Area:	878	sq.m	0.90
Gravel Area:	1,300	sq.m	0.70
Soft Area:	<u>8,727</u>	<u>sq.m</u>	<u>0.20</u>

Total Catchment Area: 11,299 sq.m 0.34

Time of Concentration (Tc): 19 min

Rainfall Intensity (i): 54 mm/hr (2-Year Event)

Maximum Allowable Release Rate (2.78AiC): 56.73 L/s

100-YEAR EVENT

DRAINAGE AREA I (Uncontrolled Flow Off Site)

(100-YEAR EVENT)

			C
Roof Area:	82	sq.m	1.00
Hard Area:	65	sq.m	1.00
Gravel Area:	0	sq.m	1.00
Soft Area:	<u>1,758</u>	<u>sq.m</u>	<u>0.25</u>
Total Catchment Area:	1,905	sq.m	0.31
Time of Concentration:	10	min	
Rainfall Intensity (i):	179	mm/hr	
Flow Rate (2.78AiC):	29.11	L/s	

DRAINAGE AREA II

EXCLUDING OFF SITE DRAINAGE

(100-YEAR EVENT)

			C
Roof Area:	1,546	sq.m	1.00
Hard Area:	1,824	sq.m	1.00
Gravel Area:	0	sq.m	1.00
Soft Area:	<u>6,024</u>	sq.m	<u>0.25</u>

Total Catchment Area: 9,394 sq.m 0.52

Water Elevation: 80.61 m

Head: 2.12 m

Centroid of ICD Orifice: 78.49 m
(ICD in Outlet Pipe of CB/MH-8)

Invert of Outlet Pipe of CB/MH-8: 78.44 m

Orifice Diameter: 95 mm

Orifice Area: 7,014 sq.mm

Discharge Coefficient: 0.61

Maximum Release Rate: 27.62 L/s

Detention Area

	Bottom Area	Top Area	Ave. Depth		
	sq.m.	sq.m.	m		
Ditch:	81.5	217	0.38	54.05	cu.m.
Detention Area:	169.0	260	0.58	<u>124.14</u>	cu.m.

Maximum Volume Stored: 178.19 cu.m

Maximum Volume Required: 178.19 cu.m

DRAINAGE AREA II (Continued)

(100-YEAR EVENT)

Time (min)	i (mm/hr)	2.78AiC (L/s)	ICD Release Rate (L/s)	Stored Rate (L/s)	Required Storage Volume (cu.m)
10	179	242.04	27.62	214.42	128.65
15	143	193.70	27.62	166.08	149.47
20	120	162.60	27.62	134.98	161.97
25	104	140.77	27.62	113.15	169.73
30	92	124.53	27.62	96.91	174.44
35	83	111.94	27.62	84.32	177.07
40	75	101.86	27.62	74.24	178.19
45	69	93.60	27.62	65.98	178.15
50	64	86.69	27.62	59.07	177.22
55	60	80.82	27.62	53.20	175.58
60	56	75.77	27.62	48.15	173.34
65	53	71.36	27.62	43.75	170.61
70	50	67.49	27.62	39.87	167.47
75	47	64.06	27.62	36.44	163.98
80	45	60.99	27.62	33.37	160.17
85	43	58.23	27.62	30.61	156.10
90	41	55.73	27.62	28.11	151.79
95	39	53.45	27.62	25.84	147.28
100	38	51.38	27.62	23.76	142.57
105	36	49.47	27.62	21.86	137.69
110	35	47.72	27.62	20.10	132.67
115	34	46.10	27.62	18.48	127.50
120	33	44.59	27.62	16.97	122.20
125	32	43.19	27.62	15.57	116.79
130	31	41.88	27.62	14.27	111.28
135	30	40.66	27.62	13.04	105.66
140	29	39.52	27.62	11.90	99.95
145	28	38.44	27.62	10.82	94.16
150	28	37.43	27.62	9.81	88.29
155	27	36.47	27.62	8.85	82.35
160	26	35.57	27.62	7.95	76.33
165	26	34.71	27.62	7.10	70.25
170	25	33.90	27.62	6.29	64.11
175	24	33.13	27.62	5.52	57.91
180	24	32.40	27.62	4.78	51.66
195	22	30.40	27.62	2.79	32.61
210	21	28.66	27.62	1.04	13.17
225	20	27.13	27.13	0.00	0.00
240	19	25.76	25.76	0.00	0.00
255	18	24.54	24.54	0.00	0.00
270	17	23.44	23.44	0.00	0.00
285	17	22.45	22.45	0.00	0.00
300	16	21.54	21.54	0.00	0.00

DRAINAGE AREA II + II-A INCLUDING OFF SITE DRAINAGE

(100-YEAR EVENT)

			C
Roof Area:	1,546	sq.m	1.00
Hard Area:	2,120	sq.m	1.00
Gravel Area:	0	sq.m	0.875
Soft Area:	<u>8,427</u>	<u>sq.m</u>	<u>0.25</u>

Total Catchment Area: 12,093 sq.m 0.48

Water Elevation: 80.61 m

Head: 2.12 m

Centroid of ICD Orifice: 78.49 m
(ICD in Outlet Pipe of CB/MH-8)

Invert of Outlet Pipe of CB/MH-8: 78.44 m

Orifice Diameter: 95 mm

Orifice Area: 7,014 sq.mm

Discharge Coefficient: 0.61

Maximum Release Rate: 27.62 L/s

Maximum Overflow Release Rate: 20.82 L/s
(out the top of CB/MH-8)

Total Maximum Release Rate: 48.44 L/s

Detention Area

	Bottom Area sq.m.	Top Area sq.m.	Ave. Depth m		
Ditch:	81.5	217	0.38	54.05	cu.m.
Detention Area	169.0	260	0.58	<u>124.14</u>	cu.m.

Maximum Volume Stored: 178.19 cu.m

Maximum Volume Required: 178.19 cu.m

DRAINAGE AREA II-A (Continued)

INCLUDING OFF SITE DRAINAGE

(100-YEAR EVENT)

Time (min)	i (mm/hr)	2.78AiC (L/s)	ICD Release Rate (L/s)	Overflow Flow Rate Rate (L/s)	Total Release Rate (L/s)	Stored Rate (L/s)	Required Storage Volume (cu.m)
10	179	286.56	27.62	0.00	27.62	258.94	155.36
15	143	229.32	27.62	3.72	31.33	197.99	178.19
20	120	192.50	27.62	16.39	44.01	148.49	178.19
25	104	166.66	27.62	20.25	47.87	118.79	178.19
30	92	147.43	27.62	20.82	48.44	98.99	178.19
35	83	132.52	27.62	20.06	47.67	84.85	178.19
40	75	120.60	27.62	18.73	46.35	74.24	178.19
45	69	110.81	27.62	17.20	44.82	66.00	178.19
50	64	102.64	27.62	15.62	43.24	59.40	178.19
55	60	95.69	27.62	14.07	41.69	54.00	178.19
60	56	89.70	27.62	12.59	40.20	49.50	178.19
65	53	84.49	27.62	11.18	38.80	45.69	178.19
70	50	79.90	27.62	9.86	37.48	42.43	178.19
75	47	75.84	27.62	8.62	36.24	39.60	178.19
80	45	72.20	27.62	7.46	35.08	37.12	178.19
85	43	68.93	27.62	6.38	33.99	34.94	178.19
90	41	65.98	27.62	5.36	32.98	33.00	178.19
95	39	63.29	27.62	4.41	32.02	31.26	178.19
100	38	60.83	27.62	3.51	31.13	29.70	178.19
105	36	58.57	27.62	2.67	30.29	28.28	178.19
110	35	56.49	27.62	1.88	29.50	27.00	178.19
115	34	54.57	27.62	1.13	28.75	25.82	178.19
120	33	52.79	27.62	0.43	28.04	24.75	178.19
125	32	51.13	27.62	0.00	27.62	23.52	176.37
130	31	49.59	27.62	0.00	27.62	21.97	171.36
135	30	48.14	27.62	0.00	27.62	20.52	166.23
140	29	46.78	27.62	0.00	27.62	19.17	161.00
145	28	45.51	27.62	0.00	27.62	17.89	155.67
150	28	44.31	27.62	0.00	27.62	16.69	150.24
155	27	43.18	27.62	0.00	27.62	15.56	144.72
160	26	42.11	27.62	0.00	27.62	14.49	139.13
165	26	41.10	27.62	0.00	27.62	13.48	133.45
170	25	40.14	27.62	0.00	27.62	12.52	127.71
175	24	39.23	27.62	0.00	27.62	11.61	121.90
180	24	38.36	27.62	0.00	27.62	10.74	116.02
195	22	36.00	27.62	0.00	27.62	8.38	98.03
210	21	33.93	27.62	0.00	27.62	6.32	79.58
225	20	32.12	27.62	0.00	27.62	4.50	60.73
240	19	30.50	27.62	0.00	27.62	2.88	41.53
255	18	29.06	27.62	0.00	27.62	1.44	22.02
270	17	27.75	27.62	0.00	27.62	0.14	2.23
285	17	26.58	26.58	0.00	26.58	0.00	0.00
300	16	25.50	25.50	0.00	25.50	0.00	0.00

5-YEAR EVENT

DRAINAGE AREA I (Uncontrolled Flow Off Site)

(5-YEAR EVENT)

			C
Roof Area:	82	sq.m	0.90
Hard Area:	65	sq.m	0.90
Gravel Area:	0	sq.m	0.80
Soft Area:	<u>1,758</u>	<u>sq.m</u>	<u>0.20</u>
Total Catchment Area:	1,905	sq.m	0.25
Time of Concentration:	10	min	
Rainfall Intensity (i):	104	mm/hr	
Flow Rate (2.78AiC):	14.02	L/s	

DRAINAGE AREA II

EXCLUDING OFF SITE DRAINAGE

(5-YEAR EVENT)

		C
Roof Area:	1,546 sq.m	0.90
Hard Area:	1,824 sq.m	0.90
Gravel Area:	0 sq.m	0.80
Soft Area:	<u>6,024 sq.m</u>	<u>0.20</u>

Total Catchment Area: 9,394 sq.m 0.45

Water Elevation: 80.30 m

Head: 1.81 m

Centroid of ICD Orifice: 78.49 m
(ICD in Outlet Pipe of CB/MH-8)

Invert of Outlet Pipe of CB/MH-8: 78.44 m

Orifice Diameter: 95 mm

Orifice Area: 7,014 sq.mm

Discharge Coefficient: 0.61

Maximum Release Rate: 25.48 L/s

Detention Area

	Bottom Area sq.m.	Top Area sq.m.	Ave. Depth m		
Ditch:	48.0	103	0.26	18.91	cu.m.
Detention Area	169.0	208	0.27	<u>50.48</u>	cu.m.

Maximum Volume Stored: 69.39 cu.m

Maximum Volume Required: 69.39 cu.m

DRAINAGE AREA II (Continued)

(5-YEAR EVENT)

Time (min)	i (mm/hr)	2.78AiC (L/s)	ICD Release Rate (L/s)	Stored Rate (L/s)	Required Storage Volume (cu.m)
10	104	122.75	25.48	97.27	58.36
15	84	98.44	25.48	72.95	65.66
20	70	82.76	25.48	57.28	68.73
25	61	71.74	25.48	46.26	69.39
30	54	63.53	25.48	38.05	68.49
35	49	57.16	25.48	31.67	66.52
40	44	52.05	25.48	26.57	63.77
45	41	47.86	25.48	22.38	60.43
50	38	44.36	25.48	18.87	56.62
55	35	41.38	25.48	15.89	52.45
60	33	38.81	25.48	13.33	47.97
65	31	36.57	25.48	11.09	43.24
70	29	34.60	25.48	9.12	38.30
75	28	32.86	25.48	7.37	33.17
80	27	31.29	25.48	5.81	27.88
85	25	29.89	25.48	4.40	22.45
90	24	28.61	25.48	3.13	16.90
95	23	27.46	25.48	1.97	11.24
100	22	26.40	25.48	0.91	5.48
105	22	25.43	25.43	0.00	0.00
110	21	24.53	24.53	0.00	0.00
115	20	23.70	23.70	0.00	0.00
120	19	22.93	22.93	0.00	0.00
125	19	22.22	22.22	0.00	0.00
130	18	21.55	21.55	0.00	0.00
135	18	20.93	20.93	0.00	0.00
140	17	20.34	20.34	0.00	0.00
145	17	19.79	19.79	0.00	0.00
150	16	19.28	19.28	0.00	0.00
155	16	18.79	18.79	0.00	0.00
160	16	18.33	18.33	0.00	0.00
165	15	17.89	17.89	0.00	0.00
170	15	17.47	17.47	0.00	0.00
175	14	17.08	17.08	0.00	0.00
180	14	16.71	16.71	0.00	0.00
195	13	15.68	15.68	0.00	0.00
210	13	14.79	14.79	0.00	0.00
225	12	14.01	14.01	0.00	0.00
240	11	13.31	13.31	0.00	0.00
255	11	12.68	12.68	0.00	0.00
270	10	12.12	12.12	0.00	0.00
285	10	11.61	11.61	0.00	0.00
300	9	11.14	11.14	0.00	0.00

DRAINAGE AREA II + II-A INCLUDING OFF SITE DRAINAGE

(5-YEAR EVENT)

			C
Roof Area:	1,546	sq.m	0.90
Hard Area:	2,120	sq.m	0.90
Gravel Area:	0	sq.m	0.70
Soft Area:	<u>8,427</u>	<u>sq.m</u>	<u>0.20</u>

Total Catchment Area: 12,093 sq.m 0.41

Water Elevation: 80.38 m

Head: 1.89 m

Centroid of ICD Orifice: 78.49 m
(ICD in Outlet Pipe of CB/MH-8)

Invert of Outlet Pipe of CB/MH-8: 78.44 m

Orifice Diameter: 95 mm

Orifice Area: 7,014 sq.mm

Discharge Coefficient: 0.61

Maximum Release Rate: 26.04 L/s

Detention Area

	Bottom Area sq.m.	Top Area sq.m.	Ave. Depth m		
Ditch:	51.0	107	0.26	19.96	cu.m.
Detention Area	169.0	220	0.35	<u>67.67</u>	cu.m.

Maximum Volume Stored: 87.64 cu.m

Maximum Volume Required: 87.64 cu.m

DRAINAGE AREA II-A (Continued)

INCLUDING OFF SITE DRAINAGE

(5-YEAR EVENT)

Time (min)	i (mm/hr)	2.78AiC (L/s)	ICD Release Rate (L/s)	Stored Rate (L/s)	Required Storage Volume (cu.m)
10	104	144.39	26.04	118.34	71.01
15	84	115.79	26.04	89.75	80.77
20	70	97.35	26.04	71.31	85.57
25	61	84.39	26.04	58.34	87.52
30	54	74.73	26.04	48.69	87.64
35	49	67.23	26.04	41.19	86.50
40	44	61.23	26.04	35.18	84.44
45	41	56.30	26.04	30.26	81.69
50	38	52.18	26.04	26.13	78.40
55	35	48.67	26.04	22.63	74.67
60	33	45.65	26.04	19.61	70.59
65	31	43.02	26.04	16.97	66.20
70	29	40.70	26.04	14.66	61.56
75	28	38.65	26.04	12.60	56.71
80	27	36.81	26.04	10.76	51.67
85	25	35.16	26.04	9.11	46.46
90	24	33.66	26.04	7.61	41.11
95	23	32.30	26.04	6.25	35.63
100	22	31.05	26.04	5.01	30.04
105	22	29.91	26.04	3.86	24.34
110	21	28.86	26.04	2.81	18.55
115	20	27.88	26.04	1.84	12.67
120	19	26.98	26.04	0.93	6.72
125	19	26.14	26.04	0.09	0.69
130	18	25.35	25.35	0.00	0.00
135	18	24.62	24.62	0.00	0.00
140	17	23.93	23.93	0.00	0.00
145	17	23.28	23.28	0.00	0.00
150	16	22.67	22.67	0.00	0.00
155	16	22.10	22.10	0.00	0.00
160	16	21.56	21.56	0.00	0.00
165	15	21.04	21.04	0.00	0.00
170	15	20.55	20.55	0.00	0.00
175	14	20.09	20.09	0.00	0.00
180	14	19.65	19.65	0.00	0.00
195	13	18.45	18.45	0.00	0.00
210	13	17.40	17.40	0.00	0.00
225	12	16.47	16.47	0.00	0.00
240	11	15.65	15.65	0.00	0.00
255	11	14.92	14.92	0.00	0.00
270	10	14.25	14.25	0.00	0.00
285	10	13.65	13.65	0.00	0.00
300	9	13.10	13.10	0.00	0.00



Douglas Gray <d.gray@dbgrayengineering.com>

RE: 2009-2013 Prince of Wales Dr

1 message

Eric Lalande <eric.lalande@rvca.ca>
To: Douglas Gray <d.gray@dbgrayengineering.com>

Fri, Nov 4, 2022 at 9:35 AM

Hi Doug,

Water Quality Control is required as detailed below, a new outlet to the Rideau would also need to be designed to ensure that adequate erosion protection is provided as part of the design.

The RVCA deferred quantity control requirements to the City, so we will provide comments based on the design parameters that is required by the City.

Thank you,

Eric Lalande, MCIP, RPP

Planner, Rideau Valley Conservation Authority

613-692-3571 x1137

From: Douglas Gray <d.gray@dbgrayengineering.com>
Sent: Wednesday, November 02, 2022 9:53 AM
To: Eric Lalande <eric.lalande@rvca.ca>
Cc: Laurent Brosseau <l.brosseau@dbgrayengineering.com>
Subject: 2009-2013 Prince of Wales Dr

Hi Eric

We are working on a 7 lot subdivision at [2009-2013 Prince of Wales Dr](#) (see attached site plan and two topo survey plans).

The City has stated:

"The City's preferred stormwater arrangement is for the proposed subdivision to outlet to the Rideau River. To pursue this option, please confirm with the Rideau Valley Conservation Authority (RVCA) if this option is possible, as they have Rideau River jurisdiction.

a) If agreeable to the RVCA, the City of Ottawa would accept an oil-grit separator (OGS) prior to releasing drainage into the Rideau River. Quality control requirements are to be provided by the RVCA however, the City expects Enhanced Level protection will be the requirement (i.e. 80% TSS removal).

b) If the RVCA requires quantity control, the City will not support oversized underground sewers to accommodate storage requirements. Catchbasin (CB) inlet-control devices (ICDs), with associated street

ponding, per City guidelines, are acceptable to control storm events greater than the 2 year event. Quantity control to the Rideau River is within the RVCA's jurisdiction.

c) If basements are proposed the storm sewer is to be for the 5 year minor storm event. All storm events greater than the minor storm event is to be controlled with CB ICDs and/or overland flow toward the Rideau River."

Please comment on the above and any other issues that RVCA may have concerning this site.

Also, please identify any permits or approvals that are required

Regards, Doug

Stormwater Management - Grading & Drainage - Storm & Sanitary Sewers - Watermains

700 Long Point Circle

Tel: 613-425-8044

Ottawa, Ontario K1T 4E9

d.gray@dbgrayengineering.com



**CDS ESTIMATED NET ANNUAL SOLIDS LOAD REDUCTION
BASED ON THE RATIONAL RAINFALL METHOD
BASED ON A FINE PARTICLE SIZE DISTRIBUTION**



Project Name: 2009-2016 Prince of Wales Dr.	Engineer: D. B. Gray Engineering Inc.
Location: Ottawa, ON	Contact: Laurent Brosseau
OGS #: OGS	Report Date: 8-Jun-23
Area 1.21 ha	Rainfall Station # 215
Weighted C 0.48	Particle Size Distribution FINE
CDS Model 2020	CDS Treatment Capacity 31 l/s

<u>Rainfall Intensity¹</u> <u>(mm/hr)</u>	<u>Percent Rainfall Volume¹</u>	<u>Cumulative Rainfall Volume</u>	<u>Total Flowrate</u> <u>(l/s)</u>	<u>Treated Flowrate (l/s)</u>	<u>Operating Rate (%)</u>	<u>Removal Efficiency (%)</u>	<u>Incremental Removal (%)</u>
0.5	9.2%	9.2%	0.8	0.8	2.6	98.1	9.0
1.0	10.6%	19.8%	1.6	1.6	5.2	97.4	10.3
1.5	9.9%	29.7%	2.4	2.4	7.8	96.6	9.6
2.0	8.4%	38.1%	3.2	3.2	10.4	95.9	8.0
2.5	7.7%	45.8%	4.0	4.0	13.0	95.1	7.3
3.0	5.9%	51.7%	4.8	4.8	15.5	94.4	5.6
3.5	4.4%	56.1%	5.7	5.7	18.1	93.7	4.1
4.0	4.7%	60.7%	6.5	6.5	20.7	92.9	4.3
4.5	3.3%	64.0%	7.3	7.3	23.3	92.2	3.1
5.0	3.0%	67.1%	8.1	8.1	25.9	91.4	2.8
6.0	5.4%	72.4%	9.7	9.7	31.1	89.9	4.8
7.0	4.4%	76.8%	11.3	11.3	36.3	88.5	3.8
8.0	3.5%	80.3%	12.9	12.9	41.5	87.0	3.1
9.0	2.8%	83.2%	14.5	14.5	46.6	85.5	2.4
10.0	2.2%	85.3%	16.1	16.1	51.8	84.0	1.8
15.0	7.0%	92.3%	24.2	24.2	77.7	76.6	5.3
20.0	4.5%	96.9%	32.3	31.2	100.0	67.7	3.1
25.0	1.4%	98.3%	40.4	31.2	100.0	54.2	0.8
30.0	0.7%	99.0%	48.4	31.2	100.0	45.1	0.3
35.0	0.5%	99.5%	56.5	31.2	100.0	38.7	0.2
40.0	0.5%	100.0%	64.6	31.2	100.0	33.9	0.2
45.0	0.0%	100.0%	72.7	31.2	100.0	30.1	0.0
50.0	0.0%	100.0%	80.7	31.2	100.0	27.1	0.0
							90.0

Removal Efficiency Adjustment² = 6.5%
Predicted Net Annual Load Removal Efficiency = 83.5%
Predicted Annual Rainfall Treated = 98.8%

- 1 - Based on 42 years of hourly rainfall data from Canadian Station 6105976, Ottawa ON
- 2 - Reduction due to use of 60-minute data for a site that has a time of concentration less than 30-minutes.
- 3 - CDS efficiency based on testing conducted at the University of Central Florida.
- 4 - CDS design and scaling based on original manufacturer model and product specifications.

C:\USERS\HUDA.ECHELON\VIDEODOCUMENTS\START ITEMS\PMSU SAMPLE DRAWINGS\CDS2020-5-C-DTL.DWG 5/29/2022 11:50 PM

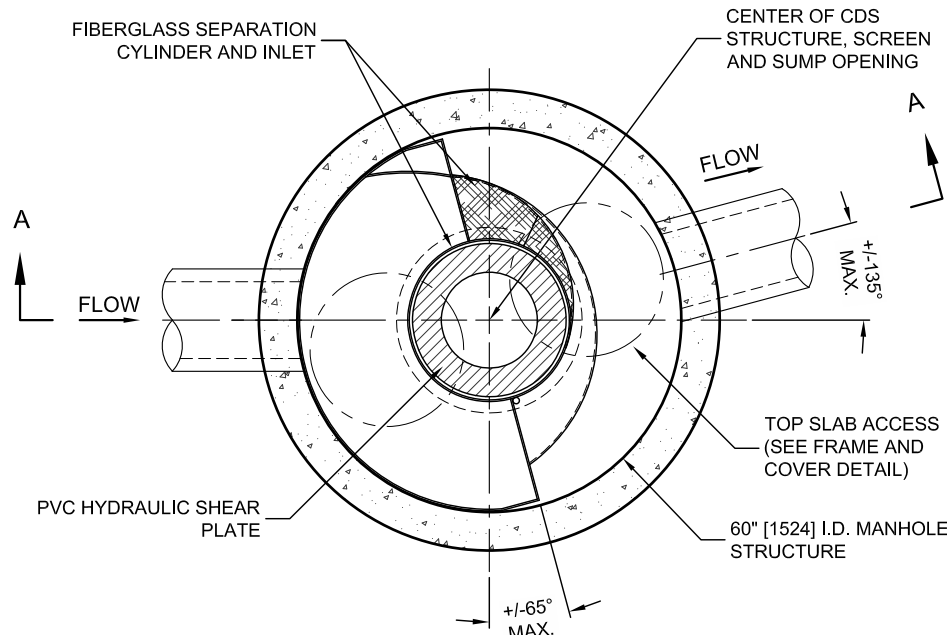

PLAN VIEW B-B
N.T.S.

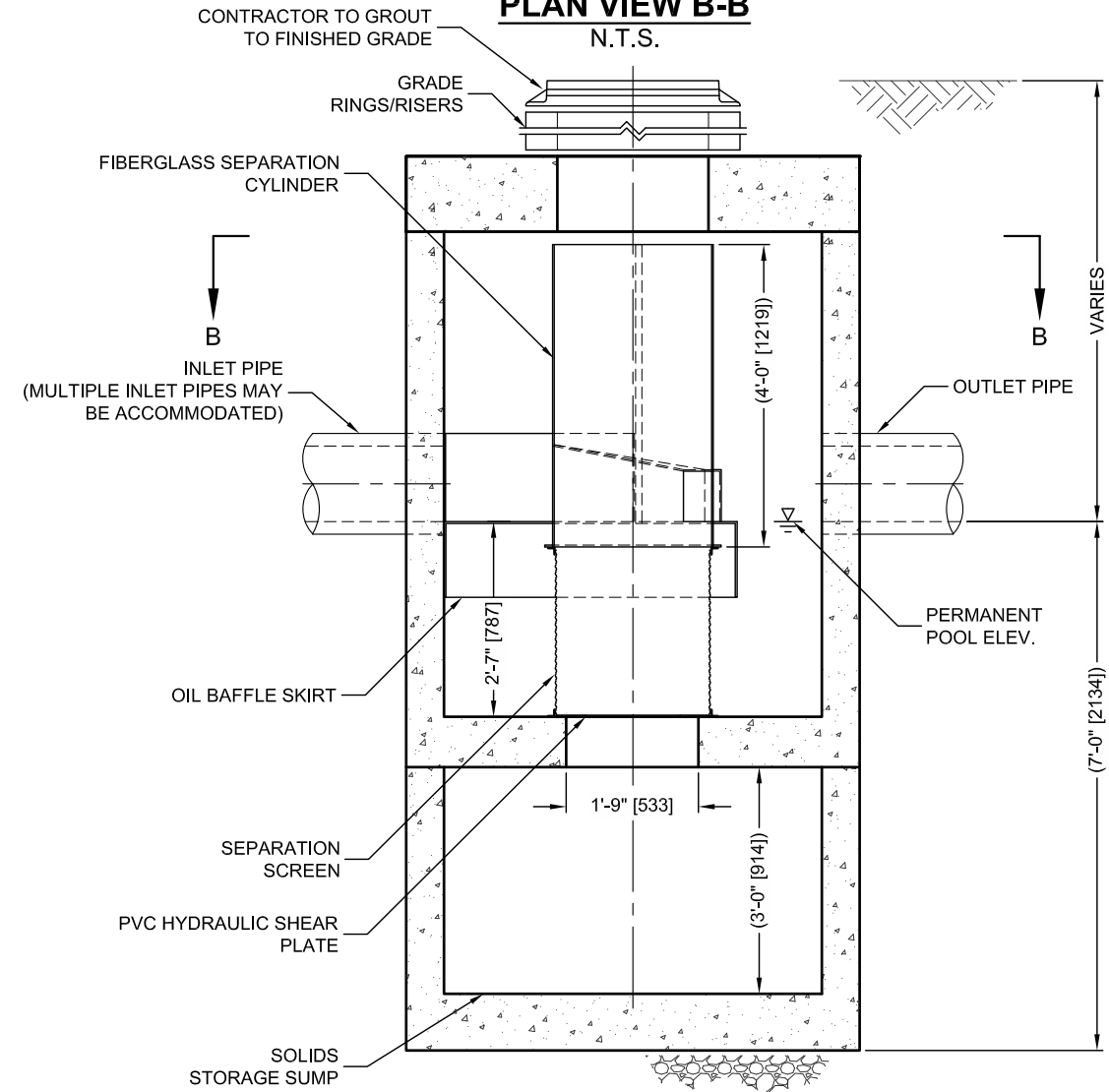

ELEVATION A-A
N.T.S.



THIS PRODUCT MAY BE PROTECTED BY ONE OR MORE OF THE FOLLOWING U.S. PATENTS: 6,788,848; 6,641,722; 6,911,502; 6,581,783; RELATED FOREIGN PATENTS, OR OTHER PATENTS PENDING.

CDS PMSU2020-5-C DESIGN NOTES

THE STANDARD CDS PMSU2020-5-C CONFIGURATION IS SHOWN. ALTERNATE CONFIGURATIONS ARE AVAILABLE AND ARE LISTED BELOW. SOME CONFIGURATIONS MAY BE COMBINED TO SUIT SITE REQUIREMENTS.

CONFIGURATION DESCRIPTION

- GRATED INLET ONLY (NO INLET PIPE)
- GRATED INLET WITH INLET PIPE OR PIPES
- CURB INLET ONLY (NO INLET PIPE)
- CURB INLET WITH INLET PIPE OR PIPES
- CUSTOMIZABLE SUMP DEPTH AVAILABLE
- ANTI-FLOTATION DESIGN AVAILABLE UPON REQUEST

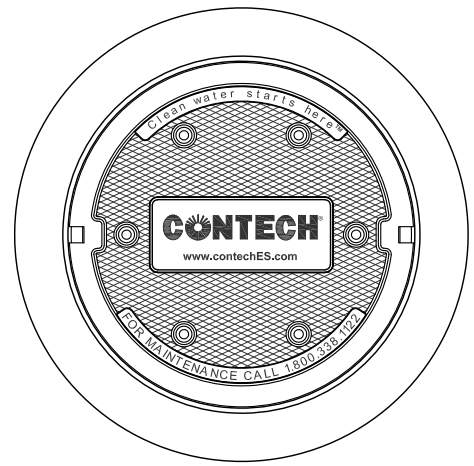

FRAME AND COVER
(DIAMETER VARIES)
N.T.S.

SITE SPECIFIC DATA REQUIREMENTS

STRUCTURE ID				
WATER QUALITY FLOW RATE (CFS OR L/s)				*
PEAK FLOW RATE (CFS OR L/s)				*
RETURN PERIOD OF PEAK FLOW (YRS)				*
SCREEN APERTURE (2400 OR 4700)				*
PIPE DATA:	I.E.	MATERIAL	DIAMETER	
INLET PIPE 1	*	*	*	
INLET PIPE 2	*	*	*	
OUTLET PIPE	*	*	*	
RIM ELEVATION				*
ANTI-FLOTATION BALLAST	WIDTH	HEIGHT		
	*	*		
NOTES/SPECIAL REQUIREMENTS:				
* PER ENGINEER OF RECORD				

GENERAL NOTES

1. CONTECH TO PROVIDE ALL MATERIALS UNLESS NOTED OTHERWISE.
2. DIMENSIONS MARKED WITH () ARE REFERENCE DIMENSIONS. ACTUAL DIMENSIONS MAY VARY.
3. FOR FABRICATION DRAWINGS WITH DETAILED STRUCTURE DIMENSIONS AND WEIGHTS, PLEASE CONTACT YOUR CONTECH ENGINEERED SOLUTIONS LLC REPRESENTATIVE. www.contechES.com
4. CDS WATER QUALITY STRUCTURE SHALL BE IN ACCORDANCE WITH ALL DESIGN DATA AND INFORMATION CONTAINED IN THIS DRAWING.
5. STRUCTURE SHALL MEET AASHTO HS20 AND CASTINGS SHALL MEET HS20 (AASHTO M 306) LOAD RATING, ASSUMING GROUNDWATER ELEVATION AT, OR BELOW, THE OUTLET PIPE INVERT ELEVATION. ENGINEER OF RECORD TO CONFIRM ACTUAL GROUNDWATER ELEVATION.
6. PVC HYDRAULIC SHEAR PLATE IS PLACED ON SHELF AT BOTTOM OF SCREEN CYLINDER. REMOVE AND REPLACE AS NECESSARY DURING MAINTENANCE CLEANING.

INSTALLATION NOTES

- A. ANY SUB-BASE, BACKFILL DEPTH, AND/OR ANTI-FLOTATION PROVISIONS ARE SITE-SPECIFIC DESIGN CONSIDERATIONS AND SHALL BE SPECIFIED BY ENGINEER OF RECORD.
- B. CONTRACTOR TO PROVIDE EQUIPMENT WITH SUFFICIENT LIFTING AND REACH CAPACITY TO LIFT AND SET THE CDS MANHOLE STRUCTURE (LIFTING CLUTCHES PROVIDED).
- C. CONTRACTOR TO ADD JOINT SEALANT BETWEEN ALL STRUCTURE SECTIONS, AND ASSEMBLE STRUCTURE.
- D. CONTRACTOR TO PROVIDE, INSTALL, AND GROUT PIPES. MATCH PIPE INVERTS WITH ELEVATIONS SHOWN.
- E. CONTRACTOR TO TAKE APPROPRIATE MEASURES TO ASSURE UNIT IS WATER TIGHT, HOLDING WATER TO FLOWLINE INVERT MINIMUM. IT IS SUGGESTED THAT ALL JOINTS BELOW PIPE INVERTS ARE GROUTED.

CONTECH[®]
ENGINEERED SOLUTIONS LLC
www.contechES.com
9025 Centre Pointe Dr., Suite 400, West Chester, OH 45069
800-338-1122 513-645-7000 513-645-7993 FAX

CDS PMSU2020-5-C
INLINE CDS
STANDARD DETAIL

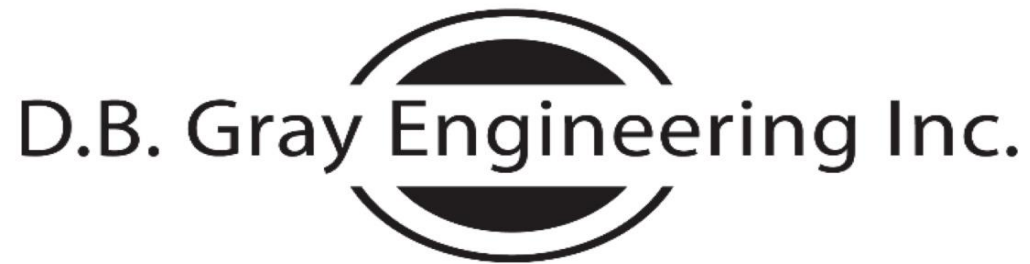

STORM SEWER CALCULATIONS

Rational Method

FIVE YEAR EVENT

Stormwater Management - Grading & Drainage - Storm & Sanitary Sewers - Watermains

700 Long Point Circle
Ottawa, Ontario K1T 4E9

613-425-8044
d.gray@dbgrayengineering.com

2009-2013 Prince of Wales
7 Lot development
Ottawa, Ontario

June 28, 2023

Manning's Roughness Coefficient: 0.013

Location		Individual				Cumulative				Sewer Data									
		Roof C = 0.90 (ha)	Hard C = 0.90 (ha)	Gravel C = 0.70 (ha)	Soft C = 0.20 (ha)	2.78AC	2.78AC	Time (min)	Rainfall Intensity (mm/hr)	Flow Rate (L/s)	Length (m)	Nominal Diameter (mm)	Actual Diameter (mm)	Slope (%)	Velocity (m/s)	Q _{Full} Capacity (L/s)	Time (min)	Q / Q _{Full}	
From	To																		
CB-1	CB-2				0.0555	0.0309	0.0309	10.00	104	3.22	5	250	251	0.43	0.80	39.41	0.10	0.08	
CB-2	CB/MH-3	0.1075	0.0764		0.0842	0.5069	0.5378	10.10	104	55.74	19.2	375	366	0.26	0.80	83.79	0.40	0.67	
CB/MH-3	CB/MH-4					0.0000	0.5378	10.51	102	54.64	34.7	375	366	0.26	0.80	83.79	0.73	0.65	
CB-4A	CB/MH-4				0.0364	0.0202	0.0202	10.00	104	2.11	5.8	250	251	2	1.72	85.00	0.06	0.02	
CB/MH-4	CB/MH-5	0.0379	0.0442		0.0257	0.2197	0.7777	11.23	98	76.30	17.7	375	366	0.26	0.80	83.79	0.37	0.91	
CB/MH-5	CB/MH-6					0.0000	0.7777	11.60	96	74.99	19.2	375	366	0.26	0.80	83.79	0.40	0.89	
CB/MH-6	CB/MH-7	0.0091	0.0908		0.0182	0.2601	1.0378	12.00	95	98.25	37.3	375	366	0.55	1.16	121.87	0.54	0.81	
CB/MH-7	CB/MH-8				0.4746	0.2639	1.3017	12.54	92	120.33	98.7	450	457	0.20	0.81	132.86	2.03	0.91	
CB/MH-8	MH-9				0.1442	0.0802	1.3819	14.57	85	117.41	3.1	525	533	0.34	1.17	261.09	0.04	0.45	
										Flow through inlet control device:	26.04	3.1	525	533	0.34	1.17	261.09	0.04	0.10
MH-9	Rideau					0.0000	1.3819	14.62	85	117.20	18.4	525	533	0.34	1.17	261.09	0.26	0.45	
	River									Restricted Flow:	26.04	18.4	525	533	0.34	1.17	261.09	0.26	0.10

APPENDIX E

DEVELOPMENT SERVICING STUDY CHECKLIST

GENERAL

Executive Summary: **N/A**

Date and revision number of report: **Included**

Location map and plan showing municipal address, boundary and layout of proposed development: **Included**

Plan showing site and location of all existing services: **Included**

Development statistics, land use, density, adherence to zoning and Official Plan and reference to applicable watershed and subwatershed plans: **N/A**

Summary of Pre-Application Consultation meetings with City of Ottawa and other approval agencies: **Included**

Confirmation of conformance with higher level studies: **N/A**

Statement of objectives and servicing criteria: **Included**

Identification of existing and proposed infrastructure available in the immediate area: **Included**

Identification of Environmentally Significant Areas, watercourses and Municipal Drains potentially impacted by the proposed development: **N/A**

Concept level master grading plan to confirm existing and proposed grades in the proposed development: **Included**

Identification of potential impacts of proposed piped services on private services on adjacent lands: **N/A**

Proposed phasing of proposed development: **N/A**

Reference to geotechnical studies: **Included**

All preliminary and formal site plan submissions should have the following information:

Metric scale: **Included**

North arrow: **Included**

Key plan: **Included**

Property limits: **Included**

Existing and proposed structures and parking areas: **Included**

Easements, road widenings and right-of-ways: **Included**

Street names: **Included**

WATER SERVICING

Confirmation of conformance with Master Servicing Study: **N/A**

Availability of public infrastructure to service proposed development: **Included**

Identification of system constraints: **Included**

Identification of boundary conditions: **Included**

Confirmation of adequate domestic supply: **Included**

Confirmation of adequate fire flow: **Included**

Check of high pressures: **Included**

Definition of phasing constraints: **N/A**

Address reliability requirements: **Included**

Check on necessity of a pressure zone boundary modification: **N/A**

Reference to water supply analysis to show that major infrastructure is capable of delivering sufficient water for proposed development: **Included**

Description of proposed water distribution network: **Included**

Description of required off-site infrastructure to service proposed development: **N/A**

Confirmation that water demands are calculated based on the City of Ottawa Water Design Guidelines: **Included**

Provision of a model schematic showing the boundary conditions locations, streets, parcels and building locations: **Included**

SANITARY SERVICING

Summary of proposed design criteria: **Included**

Confirmation of conformance with Master Servicing Study: **N/A**

Consideration of local conditions that may contribute to extraneous flows that are higher than the recommended flows in the City of Ottawa Sewer Design Guidelines: **N/A**

Description of existing sanitary sewer available for discharge of wastewater from proposed development: **Included**

Verification of available capacity in downstream sanitary sewer and/or identification of upgrades necessary to service proposed development: **N/A**

Calculations related to dry-weather and wet-weather flow rates: **Included**

Description of proposed sewer network: **Included**

Discussion of previously identified environmental constraints and impact on servicing: **N/A**

Impacts of proposed development on existing pumping stations or requirements for new pumping station: **N/A**

Forcemain capacity in terms of operational redundancy, surge pressure and maximum flow velocity: **N/A**

Identification and implementation of emergency overflow from sanitary pumping stations in relation to the hydraulic grade line to protect against basement flooding: **N/A**

Special considerations (e.g. contamination, corrosive environment): **N/A**

STORMWATER MANAGEMENT & STORM SERVICING

Description of drainage outlets and downstream constraints: **Included**

Analysis of available capacity in existing public infrastructure: **N/A**

Plan showing subject lands, its surroundings, receiving watercourse, existing drainage pattern and proposed drainage pattern: **Included**

Water quantity control objective: **Included**

Water quality control objective: **Included**

Description of the stormwater management concept: **Included**

Setback from private sewage disposal systems: **N/A**

Watercourse and hazard lands setbacks: **N/A**

Record of pre-consultation with the Ministry of the Environment, Conservation and Parks and the Conservation Authority having jurisdiction on the affected watershed: **Included**

Confirmation of conformance with Master Servicing Study: **N/A**

Storage requirements and conveyance capacity for minor events (5-year return period) and major events (100-year return period): **Included**

Identification of watercourses within the proposed development and how watercourses will be protected or if necessary altered by the proposed development: **N/A**

Calculation of pre-development and post-development peak flow rates: **N/A**

Any proposed diversion of drainage catchment areas from one outlet to another: **N/A**

Proposed minor and major systems: **N/A**

If quantity control is not proposed, demonstration that downstream system has adequate capacity for the post-development flows up to and including the 100-year return period storm event: **N/A**

Identification of potential impacts to receiving watercourses: **N/A**

Identification of municipal drains: **N/A**

Description of how the conveyance and storage capacity will be achieved for the proposed development: **Included**

100-year flood levels and major flow routing: **N/A**

Inclusion of hydraulic analysis including hydraulic grade line elevations: **N/A**

Description of erosion and sediment control during construction: **Included**

Obtain relevant floodplain information from Conservation Authority: **N/A**

Identification of fill constraints related to floodplain and geotechnical investigation: **N/A**

APPROVAL AND PERMIT REQUIREMENTS

Conservation Authority as the designated approval agency for modification of floodplain, potential impact on fish habitat, proposed works in or adjacent to a watercourse, cut/fill permits and Approval under Lakes and Rivers Improvement Act. The Conservation Authority is not the approval authority for the Lakes and Rivers Improvement Act. Where there are Conservation Authority regulations in place, approval under the Lakes and Rivers Improvement Act is not required, except in cases of dams as defined in the Act: **N/A**

Application for Certificate of Approval (CofA) under the Ontario Water Resources Act: **N/A**

Changes to Municipal Drains: **N/A**

Other permits (e.g. National Capital Commission, Parks Canada, Public Works and Government Services Canada, Ministry of Transportation): **N/A**

CONCLUSIONS

Clearly stated conclusions and recommendations: **Included**

Comments received from review agencies: **N/A**

Signed and stamped by a professional Engineer registered in Ontario: **Included**