

## Engineering

Land/Site  
Development

Municipal  
Infrastructure

Environmental/  
Water Resources

Traffic/  
Transportation

Recreational

## Planning

Land/Site  
Development

Planning Application  
Management

Municipal Planning

Urban Design

Expert Witness  
(LPAT)

Wireless Industry

## Landscape Architecture

Streetscapes &  
Public Amenities

Open Space, Parks &  
Recreation

Community &  
Residential

Commercial &  
Institutional

Environmental  
Restoration



## Proposed Mixed-Use Development 555, 591, 595, and 603 March Road, Ottawa Transportation Impact Assessment

**Proposed Mixed-Use Development  
555, 591, 595, and 603 March Road  
Transportation Impact Assessment**

Prepared For:

March & Main Developments Inc. and  
591-595 March Road Developments Inc.

Prepared By:

**NOVATECH**  
Suite 200, 240 Michael Cowpland Drive  
Ottawa, Ontario  
K2M 1P6

Dated: November 2022  
*Revised: April 2023*  
*Revised: December 2023*

Novatech File: 122125  
Ref: R-2022-145

December 18, 2023

City of Ottawa  
Planning, Real Estate, and Economic Development Department  
110 Laurier Ave. W., 4<sup>th</sup> Floor,  
Ottawa, Ontario K1P 1J1

**Attention: Mr. Mike Giampa**  
**Senior Engineer, Infrastructure Applications**

Dear Mr. Giampa:

**Reference: 555, 591, 595, and 603 March Road**  
**Revised Transportation Impact Assessment**  
**Novatech File No. 122125**

---

We are pleased to submit the following revised Transportation Impact Assessment (TIA) on behalf of March & Main Developments Inc. and 591-595 March Road Developments Inc., in support of a Draft Plan of Subdivision application at 555-603 March Road, for your review and signoff. The structure and format of this report is in accordance with the City of Ottawa's *Transportation Impact Assessment Guidelines* (June 2017).

The original TIA was submitted in November 2022 and revised in April 2023, in support of a Zoning By-Law Amendment application. This revised TIA reflects the proposed Draft Plan, includes the review on-site design modules that were previously exempt from analysis, and addresses City comments.

If you have any questions or comments regarding this report, please feel free to contact Brad Byvelds, or the undersigned.

Yours truly,

**NOVATECH**



Joshua Audia, P.Eng.  
Project Engineer | Transportation



## Certification Form for Transportation Impact Assessment (TIA) Study Program Manager

### TIA Plan Reports

On April 14, 2022, the Province's Bill 109 received Royal Assent providing legislative direction to implement the More Homes for Everyone Act, 2022 aiming to increase the supply of a range of housing options to make housing more affordable. Revisions have been made to the TIA guidelines to comply with Bill 109 and streamline the process for applicants and staff.

Individuals submitting TIA reports will be responsible for all aspects of development-related transportation assessment and reporting, and undertaking such work, in accordance and compliance with the City of Ottawa's Official Plan, the Transportation Master Plan and the Transportation Impact Assessment (2017) Guidelines.

By submitting the attached TIA report (and any associated documents) and signing this document, the individual acknowledges that they meet the four criteria listed below.

### Certification

- I have reviewed and have a sound understanding of the objectives, needs and requirements of the City of Ottawa's Official Plan, Transportation Master Plan and the Transportation Impact Assessment (2017) Guidelines (Update Effective July 2023);
- I have a sound knowledge of industry standard practice with respect to the preparation of transportation impact assessment reports, including multi modal level of service review;
- I have substantial experience (more than 5 years) in undertaking and delivering transportation impact studies (analysis, reporting and geometric design) with strong background knowledge in transportation planning, engineering or traffic operations; and

City of Ottawa  
Transportation Engineering Services  
Planning, Real Estate and Economic Development  
110 Laurier Avenue West, 4th fl.  
Ottawa, ON K1P 1J1  
Tel. : 613-580-2424  
Fax: 613-560-6006

**Revision Date: June, 2023**

## Transportation Impact Assessment Guidelines

I am either a licensed or registered<sup>1</sup> professional in good standing, whose field of expertise [check  appropriate field(s)]:

is either transportation engineering

or transportation planning.

Dated at  this  day of , 20.

(City)

Name:

Professional Title:

*B. Byvelds*

Signature of Individual certifier that they meet the above four criteria

### Office Contact Information (Please Print)

Address:

City / Postal Code:

Telephone / Extension:

E-Mail Address:

### Stamp

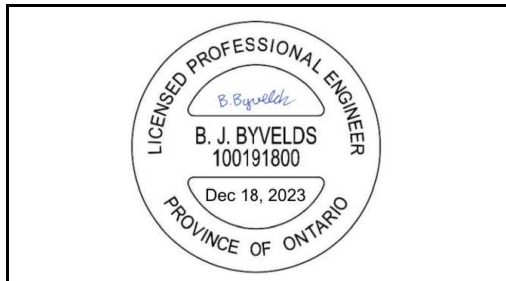

<sup>1</sup> License of registration body that oversees the profession is required to have a code of conduct and ethics guidelines that will ensure appropriate conduct and representation for transportation planning and/or transportation engineering works.

**TABLE OF CONTENTS**

**EXECUTIVE SUMMARY .....I**

**1.0 SCREENING.....1**

1.1 INTRODUCTION ..... 1

1.2 PROPOSED SUBDIVISION ..... 1

1.3 SCREENING FORM ..... 2

**2.0 SCOPING.....3**

2.1 EXISTING CONDITIONS ..... 3

2.1.1 Roadways.....3

2.1.2 Intersections .....5

2.1.3 Driveways.....7

2.1.4 Pedestrian and Cycling Facilities .....7

2.1.5 Transit .....8

2.1.6 Area Traffic Management .....10

2.1.7 Existing Traffic Volumes .....10

2.1.8 Collision Records.....12

2.2 PLANNED CONDITIONS ..... 15

2.2.1 Planned Transportation Projects.....15

2.2.2 Other Area Developments .....18

2.3 STUDY AREA AND TIME PERIODS ..... 19

2.4 EXEMPTIONS REVIEW..... 19

**3.0 FORECASTING .....20**

3.1 DEVELOPMENT-GENERATED TRAVEL DEMAND..... 20

3.1.1 Trip Generation.....20

3.1.2 Trip Distribution.....27

3.1.3 Trip Assignment.....28

3.2 BACKGROUND TRAFFIC ..... 29

3.2.1 Other Area Developments .....29

3.2.2 General Background Growth Rate .....31

3.2.3 March Road BRT Corridor .....31

3.2.4 Diverted/Cut-Through Traffic.....32

3.3 VOLUME FIGURES ..... 32

3.4 DEMAND RATIONALIZATION..... 32

3.4.1 Existing Traffic Conditions .....40

3.4.2 2037 Background Traffic Conditions .....40

**4.0 ANALYSIS.....43**

4.1 DEVELOPMENT DESIGN ..... 43

4.1.1 Design for Sustainable Modes .....43

4.1.2 Circulation and Access .....44

4.1.3 New Street Networks .....44

4.2 PARKING ..... 45

4.3 BOUNDARY STREETS ..... 45

4.4 ACCESS INTERSECTIONS..... 47

4.4.1 Proposed March Road Intersection.....47

4.4.2 Proposed Hines Road Intersection.....48

4.4.3 Proposed Terry Fox Drive Access.....48

4.4.4 Proposed Access to East-West Street .....49

4.5 TRANSPORTATION DEMAND MANAGEMENT ..... 49

|            |  |           |
|------------|--|-----------|
| 4.5.1      | Context for TDM .....                        | 49        |
| 4.5.2      | Need and Opportunity.....                    | 49        |
| 4.5.3      | TDM Program .....                            | 50        |
| 4.6        | NEIGHBOURHOOD TRAFFIC CALMING .....          | 51        |
| 4.7        | TRANSIT .....                                | 51        |
| 4.8        | NETWORK CONCEPT .....                        | 54        |
| 4.9        | INTERSECTION DESIGN.....                     | 55        |
| 4.9.1      | Existing Intersection MMLOS Review .....     | 55        |
| 4.9.2      | 2037 Total Intersection Operations .....     | 58        |
| <b>5.0</b> | <b>CONCLUSIONS AND RECOMMENDATIONS .....</b> | <b>62</b> |

**Figures**

|            |   |    |
|------------|---|----|
| Figure 1:  | View of the Subject Site .....                        | 2  |
| Figure 2:  | Roadway Network.....                                  | 5  |
| Figure 3:  | Pedestrian and Cycling Network .....                  | 8  |
| Figure 4:  | OC Transpo Bus Stop Locations .....                   | 9  |
| Figure 5:  | Existing Traffic Volumes.....                         | 11 |
| Figure 6:  | Excerpt of the 2031 Affordable RTTP Network.....      | 16 |
| Figure 7:  | Excerpt of the 2031 RTTP Network Concept.....         | 17 |
| Figure 8:  | Existing Site-Generated Volumes.....                  | 33 |
| Figure 9:  | Proposed Site-Generated Volumes.....                  | 34 |
| Figure 10: | Net Site-Generated Volumes.....                       | 35 |
| Figure 11: | Other Area Development-Generated Volumes .....        | 36 |
| Figure 12: | 2037 Background Volumes .....                         | 37 |
| Figure 13: | 2037 Diverted Volumes .....                           | 38 |
| Figure 14: | 2037 Total Volumes .....                              | 39 |
| Figure 15: | Planned Modifications to March Road/Solandt Road..... | 41 |

**Tables**

|           |  |    |
|-----------|--|----|
| Table 1:  | OC Transpo Transit Stops.....                                | 8  |
| Table 2:  | OC Transpo Route Information .....                           | 10 |
| Table 3:  | Reported Collisions .....                                    | 12 |
| Table 4:  | TIA Exemptions.....  | 19 |
| Table 5:  | Existing Development – Peak Hour Trip Generation.....        | 21 |
| Table 6:  | Surveyed Kanata/Stittsville Mode Shares – Existing Uses..... | 21 |
| Table 7:  | Existing Development – Peak Hour Trips by Mode Share .....   | 22 |
| Table 8:  | Existing Strip Retail – Primary and Pass-by Trips.....       | 23 |
| Table 9:  | Surveyed Kanata/Stittsville Mode Shares – Proposed Uses..... | 23 |
| Table 10: | Proposed Residential – Peak Period Trip Generation.....      | 24 |
| Table 11: | Proposed Residential – Peak Period Trips by Mode Share ..... | 24 |
| Table 12: | Proposed Residential – Peak Hour Trips by Mode Share.....    | 24 |
| Table 13: | Proposed Office/Retail – Peak Hour Trip Generation .....     | 25 |
| Table 14: | Proposed Office/Retail – Peak Hour Trips by Mode Share ..... | 25 |
| Table 15: | Conceptual Development – Total Peak Hour Trips.....          | 26 |
| Table 16: | Conceptual Development – Internally Captured Trips.....      | 26 |
| Table 17: | Proposed Retail – Primary and Pass-by Trips .....            | 27 |
| Table 18: | Existing Office – Trip Assignment.....                       | 28 |
| Table 19: | Conceptual Development – Trip Assignment.....                | 29 |

Table 20: Existing Traffic Operations ..... 40  
 Table 21: 2037 Background Traffic Operations ..... 42  
 Table 22: 2037 Background – Critical Queues ..... 42  
 Table 23: Comparison of Roadway Classifications..... 44  
 Table 24: Segment MMLOS Summary..... 46  
 Table 25: Transit Utilization..... 52  
 Table 26: Intersection MMLOS Summary..... 55  
 Table 27: 2037 Total Traffic Operations – Median BRT Terminates at Solandt Road..... 58  
 Table 28: 2037 Total – Critical Queues ..... 59  
 Table 29: 2037 Total Operations and Queues – Median BRT Terminates at Terry Fox Drive ..... 61

**Appendices**

Appendix A: Concept, Draft, and Phasing Plans  
 Appendix B: TIA Screening Form  
 Appendix C: OC Transpo Information  
 Appendix D: Traffic Count Data  
 Appendix E: Collision Records  
 Appendix F: Internal Capture Worksheets  
 Appendix G: Other Area Developments  
 Appendix H: Strategic Long-Range Model Snapshots  
 Appendix I: Future March Road Transitway Functional Design  
 Appendix J: Signal Timing Plans  
 Appendix K: Existing Synchro Analysis  
 Appendix L: Background Synchro Analysis  
 Appendix M: Proposed Cross-Sections  
 Appendix N: MMLOS Analysis  
 Appendix O: Left Turn Lane Warrants  
 Appendix P: Functional Design of Terry Fox Drive Access  
 Appendix Q: Transportation Demand Management  
 Appendix R: Total Synchro Analysis



## EXECUTIVE SUMMARY

This Transportation Impact Assessment (TIA) has been prepared on behalf of March & Main Developments Inc. and 591-595 March Road Developments Inc., in support of a Draft Plan of Subdivision application for the property located at 555, 591, 595, and 603 March Road ('Subject Site'). The Subject Site is approximately 13.6 acres in size, and currently includes a one-storey commercial use (recreational athletic facility) at 555 March Road, a one-storey retail plaza at 591 March Road, a vacant parcel at 595 March Road, and a two-storey office building at 603 March Road. The Subject Site is currently served by three right-in/right-out (RIRO) driveways to March Road and a full-movement driveway to Terry Fox Drive, which serve the separate parcels. Only the parcels at 555 and 591 March Road share access.

The Subject Site is surrounded by the following:

- Terry Fox Drive, followed by low-rise single-detached residences to the north,
- Commercial/office uses to the south,
- March Road, followed by the 'Nokia' office use to the east, and
- Hines Road and commercial/office uses to the west.

March & Main is proposing a subdivision of the Subject Site to include four residential, mixed-use, and office development blocks, a parkland block at the existing 90-degree curve of Hines Road, a north-south private street block, and an east-west public street block. The north-south street block is proposed to have a 18m right-of-way (ROW) and will accommodate a future private street. The east-west street block is proposed to have a 26m ROW and will accommodate a public street.

March & Main previously prepared a concept plan in support of the Zoning By-Law Amendment application, to illustrate the potential redevelopment of the Subject Site in conformity with the policies in the new City of Ottawa Official Plan (particularly for the 'Activity Centre' outlined in Section 6.6.3.2 – Kanata North Economic District). The Zoning By-Law Amendment application has since been approved. Conceptually, the ultimate development will include nine residential and mixed-use buildings between six and 30 storeys, and two office buildings with seven or eight storeys. Ground-floor retail is proposed in select buildings. The conceptual development will have the potential to include approximately 2,100 dwellings, 154,178 ft<sup>2</sup> gross floor area (GFA) of office space, and 31,482 ft<sup>2</sup> GFA of retail space. These unit statistics have been considered for the purposes of this study, but it is noted that they are subject to change as subsequent Site Plan applications are filed. Access to the proposed subdivision will be provided via new connections to March Road, Terry Fox Drive, and Hines Road.

It is anticipated that the proposed subdivision will be constructed in three phases, with an estimated ultimate buildout year of 2037. It is anticipated that initial phases of the subdivision may proceed with access solely on Hines Road. For the purposes of this Draft Plan application, analysis has been completed for the ultimate build-out of the subject development. Subsequent Site Plan Control applications for each phase will be completed, and will confirm the order in which the development blocks will be constructed, as well as any additional site-specific transportation needs.

The current zoning for the properties is the 'General Mixed-Use' zone (GM [2907]). Pursuant to the City of Ottawa's Official Plan, the Subject Site is located within the 'Kanata North Economic District,' 'Evolving Neighbourhood' overlay, and is designated as 'Corridor – Mainstreet' (March Road) and 'Corridor – Minor' (Terry Fox Drive) on Schedule B5.

The City's Official Plan includes proposed policies that will permit a higher density of development and greater degree of mixed uses, including residential within new 'activity centres' that are generally located within 600m of two planned transit stations in the Kanata North Economic District. The goal of the activity centres is to create a place to live, work, learn, play, and provide access to daily needs without the use of a car. The Subject Site is in the activity centre based around a planned transit station at the intersection of March Road/Terry Fox Drive, as part of a future Bus Rapid Transit (BRT) project.

The study area for this report includes the boundary roadways March Road, Terry Fox Drive, and Hines Road, as well as March Road/Morgan's Grant Way/Shirley's Brook Drive, March Road/Terry Fox Drive, March Road/Solandt Road, Terry Fox Drive/Flamborough Way/Innovation Drive, and Innovation Drive/Hines Road.

The selected time periods for the analysis are the weekday AM and PM peak hours, as they represent the 'worst case' combination of site generated traffic and adjacent street traffic. Analysis has been completed for the ultimate buildout year 2037.

The conclusions and recommendations of this TIA can be summarized as follows:

#### Forecasting

- The conceptual development as a whole is estimated to generate 1,232 person trips during the AM peak hour (including 611 external vehicle trips) and 1,382 person trips during the PM peak hour (including 662 external vehicle trips).

#### Existing Traffic Operations

- All study area intersections operate at an acceptable level of service during the AM and PM peak hours.

#### Background Traffic Operations

- Critical movements at the study area intersections generally operate at an acceptable level of service, with the exception of the westbound left turn movement at March Road/Solandt Road during the PM peak hour. Per the functional design of the March Road BRT, one of the westbound left turn lanes will be removed. It is anticipated that this is the primary driver for the failing vehicular level of service of this movement, and therefore it is recommended that the dual westbound left turn lanes are maintained at this intersection.
- To achieve the target vehicular level of service (Auto LOS) E at March Road/Solandt Road, a reduction of approximately 110 southbound through/right turning vehicles is required during the AM peak hour, and a reduction of approximately 45 northbound through/right turning vehicles are required during the PM peak hour.

#### Development Design

- Based on the proposed concept plan, it is anticipated that sidewalks will be provided on both sides of the proposed east-west public street (connecting March Road and Hines Road), and on both sides of the proposed north-south private street (connecting Terry Fox Drive and the east-west public street). Cycle tracks are proposed on both sides of the proposed east-west public street.

- OC Transpo's service design guideline for peak period service is to provide service within a five-minute (400m) walk of home, work, or school for 95% of urban residents. All proposed blocks on the Draft Plan are anticipated to be within a five-minute walk of one or more existing transit stops on March Road or Terry Fox Drive. It is anticipated that some blocks will be located beyond 400m walking distance to future median BRT stops at March Road/Terry Fox Drive.

### New Street Networks

- The proposed cross-section of the east-west public street will include a ROW width of 26m and a pavement width of 11.0m, which allows for a travel lane and a parking lane in each direction. Periodic bulbouts will narrow the street to reduce the operating speed and clearly identify where on-street parking is provided. A 2.0m-wide sidewalk and 2.0m-wide cycle track is proposed on both sides of the roadway.
- The proposed cross-section of the north-south private street will include a ROW width of 18m and a pavement width of 8.5m, which allows for a travel lane in each direction and a parking lane in one direction. The 18m ROW and 8.5m roadway platform are most consistent with local roadways throughout the City of Ottawa. A sidewalk with a 2.0m width is proposed on both sides of the roadway, with 2.75m-wide boulevards separating the sidewalk from the roadway on each side.

### Boundary Streets

- The results of the segment MMLOS analysis can be summarized as follows:
  - No boundary streets meet the target pedestrian level of service (PLOS) C;
  - No boundary streets meet the target bicycle level of service (BLOS) B or C;
  - March Road does not meet the target transit level of service (TLOS) B;
  - All boundary streets meet the target truck level of service (TkLOS) B or D.
- March Road achieves the best-possible PLOS D by providing sidewalks with a minimum width of 2.0m and minimum boulevard width of 2.0m. To achieve the target PLOS C, a reduced operating speed of 60 km/h is required.
- Terry Fox Drive achieves the best-possible PLOS D on the south side, where a 3.0m multi-use pathway (MUP) with boulevard widths greater than 2.0m is provided. The north side of Terry Fox Drive does not generally provide any pedestrian facilities, and a PLOS D can be achieved by implementing sidewalks with a minimum width of 2.0m and minimum boulevard width of 2.0m. This is identified for the City's consideration.
- No pedestrian facilities are provided on Hines Road at the subject site, and a 1.8m-wide sidewalk with no boulevard is provided on the west side of Hines Road (south of the subject site). The 1.8m-wide sidewalk south of the site achieves a PLOS C. Therefore, the extension of additional sidewalks with a minimum width of 1.8m on both sides of Hines Road adjacent to the site would achieve the area target. This is identified for the City's consideration.
- March Road can only achieve the target BLOS B through the implementation of physically separated bikeways (such as multi-use pathways or cycle tracks), due to the high operating speed. As part of the City's future conversion of March Road to median BRT north of Solandt Road, cycle tracks are anticipated to be provided.

- Terry Fox Drive achieves a BLOS A on the south side, where a 3.0m MUP is provided. The north side of Terry Fox Drive achieves a BLOS E with the existing on-street bike lane, due to the high operating speed. The target BLOS C can be achieved by implementing a physically separated bikeway, or reducing the operating speed to 60 km/h. This is identified for the City's consideration.
- Hines Road can achieve the target BLOS C by reducing the operating speed to 50 km/h.
- March Road can achieve the target TLOS B through the implementation of bus lanes with no/limited parking and driveway friction. Future conversion to median BRT along the entire March Road corridor, including at the subject site, is anticipated to meet the target TLOS.

#### Access Intersections

- The proposed signalized intersection at March Road/Nokia Access/E-W Street will have the following lane configuration for each approach:
  - Northbound Approach (March Road):  
one left turn lane, two through lanes, and one right turn lane;
  - Southbound Approach (March Road):  
one left turn lane, two through lanes, and one shared through/right turn lane;
  - Eastbound Approach (E-W Street):  
one left turn lane and one shared through/right turn lane;
  - Westbound Approach (Nokia Access):  
one left turn lane and one shared through/right turn lane.
- The proposed intersection at Hines Road will be unsignalized, with stop control on the proposed east-west public street. The intersection will have the following lane configuration for each approach:
  - Northbound Approach (Hines Road):  
one shared through/right turn lane;
  - Southbound Approach (Hines Road):  
one shared left turn/through lane;
  - Westbound Approach (E-W Street):  
one shared left turn/right turn lane.
- The proposed access to Terry Fox Drive is approximately 130m west of the March Road/Terry Fox Drive, measuring from the nearest edge of the north-south private street to the nearest edge of March Road. This meets the minimum corner clearance requirement.
- It is anticipated that an auxiliary westbound left turn lane with 30m of storage length will be required at the proposed access to Terry Fox Drive. This can be accommodated without impacting the eastbound left turn storage at March Road/Terry Fox Drive, by widening the existing median and shifting the alignment of the westbound lanes on Terry Fox Drive in front of the subject site.

- The proposed north-south private street will connect to the east-west public street east of Hines Road, with separation distances of approximately 55m (when measuring nearest edge to nearest edge) and approximately 70 (when measuring centre to centre). For access to an collector roadway, the Transportation Association of Canada (TAC)'s *Geometric Design Guide* identifies a minimum corner clearance of 25m between the nearest edge of a driveway and the nearest edge of an intersecting street, when the intersection is unsignalized. The *Geometric Design Guide* identifies a minimum intersection spacing of 60m on collector roadways, measuring centre to centre. Both requirements are met by the proposed access location.

#### Transportation Demand Management

- While the final list of TDM measures to be implemented by the proposed subdivision will be confirmed at the Site Plan Control application stage, the proponent has agreed to consider a suite of TDM measures for non-residential and residential developments at this time.

#### Transit

- The conceptual development is anticipated to generate the following number of external transit trips:
  - 287 transit trips during the AM peak hour (124 trips in, 163 trips out);
  - 279 transit trips during the PM peak hour (136 trips in, 143 trips out).
- The proposed subdivision is not anticipated to necessitate more frequent service for OC Routes 63, 64, 110, and 166.

#### Intersection MMLOS

- The results of the intersection MMLOS analysis can be summarized as follows:
  - No study area intersections meet the target PLOS;
  - No study area intersections meet the target BLOS;
  - No study area intersections along March Road meet the target TLOS;
  - All study area intersections meet the target TkLOS, except for Terry Fox Drive/Flamborough Way/Innovation Drive.
- There is limited opportunity in improving the PLOS at any approach without reducing the number of travel lanes, restricting turning movements, or removing right turn channels. There is also limited opportunity in improving the delay score at any intersection to the target PLOS.
- The north, south, and east approaches of March Road/Morgan's Grant Way/Shirley's Brook Drive do not meet the target BLOS. The target BLOS can be achieved at the east approach by reducing the operating speed to 40 km/h (which is the current speed limit on Shirley's Brook Drive). For left turns from the north and south approaches, the implementation of two-stage left-turn bike boxes at all approaches would not require a right turns on red (RTOR) restriction. This would require the stop bars at all approaches to be shifted away from the intersection. These measures are identified for the City's consideration.

- All approaches of March Road/Terry Fox Drive do not meet the target BLOS. Given that all right turn movements are channelized at this intersection, the implementation of two-stage left turn-bike boxes at all approaches would not require a RTOR restriction. This would require the stop bars at all approaches to be shifted away from the intersection. This is identified for the City's consideration. The target BLOS can be met by shortening the right turn lanes to 50m or shorter. Given the high traffic volumes at this intersection, this is not recommended.
- The east and west approaches of March Road/Solandt Road does not meet the target BLOS. Two-stage left-turn bike boxes have recently been implemented for northbound and southbound cyclists. Implementing this improvement for eastbound and westbound cyclists as well is identified for the City's consideration. For cyclists interacting with right turning vehicles, the right turn lanes at the north and west approaches are greater than 50m, and the bike lane shifts to the left of the right turn lane at the south approach. The target BLOS can be met by shortening the right turn lanes to 50m or shorter. Given the high traffic volumes at this intersection, this is not recommended.
- All approaches of Terry Fox Drive/Flamborough Way/Innovation Drive do not meet the target BLOS. The target BLOS requires the implementation of two-stage left-turn bike boxes on all approaches, which would require RTOR restrictions. This is identified for the City's consideration. For cyclists interacting with right turning vehicles, the right turn lanes at the east and west approaches are greater than 50m. The target BLOS can be met by shortening the right turn lanes to 50m or shorter. Given the magnitude of right-turning traffic volumes at this intersection, this is not recommended.
- The City's RTTP Affordable Network includes at-grade median bus rapid transit (BRT) on March Road south of Solandt Road, and transit signal priority and queue jump lanes north of Solandt Road. These initial measures are anticipated to improve the delays for transit vehicles to the target TLOS or better. Future conversion to median BRT along the entire March Road corridor is anticipated to further improve the delays for buses travelling along March Road.
- While the effective corner radii of each corner at Terry Fox Drive/Flamborough Way/Innovation Drive is greater than 15m, the target TkLOS can only be achieved by providing multiple receiving lanes. Since Flamborough Way and Innovation Drive are not classified as truck routes, no recommendations are identified.

#### Total Traffic Operations

- The maximum northbound queue lengths at March Road/Terry Fox Drive and maximum southbound queue lengths at March Road/Solandt Road are not anticipated to extend upstream and block the new proposed signal location. Similarly, the maximum northbound and southbound queue lengths at March Road/Nokia Access/E-W Street are not anticipated to block the upstream intersections.

- In the scenario where median bus rapid transit (BRT) is extended to Terry Fox Drive, the southbound through/right turn movement at the new proposed signal operates at a failing level of service during the AM peak hour, with a maximum queue length approaching Terry Fox Drive (265m, where the intersection spacing is approximately 280m). The southbound through movement is anticipated to only improve marginally from a level of service and queueing perspective. The marginal improvement is due to southbound right turn volumes being very low compared to the southbound through volumes (i.e. approximately 1,600 through vehicles versus 60 right turning vehicles during the AM peak hour). As this additional lane will increase the crossing distance for pedestrians in exchange for minor operational improvements, an auxiliary southbound right turn lane at the new proposed signal is not recommended.
- A storage length of 65m is recommended for an auxiliary northbound left turn lane at the new proposed signal to March Road, in both pre- and post-BRT conditions. The proposed signal location is over 300m north of the nearest upstream access at 500 March Road. Therefore, an auxiliary northbound left turn lane at the proposed signal can be provided.
- A storage length of 30m is recommended for an auxiliary eastbound left turn lane at the new proposed signal to March Road, in both pre- and post-BRT conditions. This can be accommodated within March & Main's site at 555-603 March Road.
- Based on low eastbound through volumes that are projected at the new proposed signal and since a right turn lane would increase the pedestrian crossing distance at the intersection, an auxiliary eastbound right turn lane is not recommended at the proposed signal.
- The proposed subdivision is recommended from a transportation perspective.

## 1.0 SCREENING

### 1.1 Introduction

This Transportation Impact Assessment (TIA) has been prepared on behalf of March & Main Developments Inc. and 591-595 March Road Developments Inc., in support of a Draft Plan of Subdivision application for the property located at 555, 591, 595, and 603 March Road ('Subject Site'). The Subject Site is approximately 13.6 acres in size, and currently includes a one-storey commercial use (recreational athletic facility) at 555 March Road, a one-storey retail plaza at 591 March Road, a vacant parcel at 595 March Road, and a two-storey office building at 603 March Road. The Subject Site is currently served by three right-in/right-out (RIRO) driveways to March Road and a full-movement driveway to Terry Fox Drive, which serve the separate parcels. Only the parcels at 555 and 591 March Road share access. The Subject Site is surrounded by the following:

- Terry Fox Drive, followed by low-rise single-detached residences to the north,
- Commercial/office uses to the south,
- March Road, followed by the 'Nokia' office use to the east, and
- Hines Road and commercial/office uses to the west.

An aerial of the vicinity around the Subject Site is provided in **Figure 1**.

### 1.2 Proposed Subdivision

March & Main is proposing a subdivision of the Subject Site to include four residential, mixed-use, and office development blocks, a parkland block at the existing 90-degree curve of Hines Road, a north-south private street block, and an east-west public street block. The north-south street block is proposed to have a 18m right-of-way (ROW) and will accommodate a future private street. The east-west street block is proposed to have a 26m ROW and will accommodate a public street.

March & Main previously prepared a concept plan in support of the Zoning By-Law Amendment application, to illustrate the potential redevelopment of the Subject Site in conformity with the policies in the new City of Ottawa Official Plan (particularly for the 'Activity Centre' outlined in Section 6.6.3.2 – Kanata North Economic District). The Zoning By-Law Amendment application has since been approved. Conceptually, the ultimate development will include nine residential and mixed-use buildings between six and 30 storeys, and two office buildings with seven or eight storeys. Ground-floor retail is proposed in select buildings. The conceptual development will have the potential to include approximately 2,100 dwellings, 154,178 ft<sup>2</sup> gross floor area (GFA) of office space, and 31,482 ft<sup>2</sup> GFA of retail space. These unit statistics have been considered for the purposes of this study, but it is noted that they are subject to change as subsequent Site Plan applications are filed. Access to the proposed subdivision will be provided via new connections to March Road, Terry Fox Drive, and Hines Road.

It is anticipated that the proposed subdivision will be constructed in three phases, with an estimated ultimate buildout year of 2037. It is anticipated that initial phases of the subdivision may proceed with access solely on Hines Road. For the purposes of this Draft Plan application, analysis has been completed for the ultimate build-out of the subject development. Subsequent Site Plan Control applications for each phase will be completed, and will confirm the order in which the development blocks will be constructed, as well as any additional site-specific transportation needs. A copy of the Concept Plan, Draft Plan, and Phasing Plan is included in **Appendix A**.



Figure 1: View of the Subject Site



The current zoning for the properties is the 'General Mixed-Use' zone (GM [2907]). Pursuant to the City of Ottawa's Official Plan, the Subject Site is located within the 'Kanata North Economic District,' 'Evolving Neighbourhood' overlay, and is designated as 'Corridor – Mainstreet' (March Road) and 'Corridor – Minor' (Terry Fox Drive) on Schedule B5.

The City's Official Plan includes proposed policies that will permit a higher density of development and greater degree of mixed uses, including residential within new 'activity centres' that are generally located within 600m of two planned transit stations in the Kanata North Economic District. The goal of the activity centres is to create a place to live, work, learn, play, and provide access to daily needs without the use of a car. The Subject Site is in the activity centre based around a planned transit station at the intersection of March Road/Terry Fox Drive, as part of a future Bus Rapid Transit (BRT) project.

### 1.3 Screening Form

The City's 2017 TIA Guidelines identify three triggers for completing a TIA report, including trip generation, location, and safety. The criteria for each trigger are outlined in the City's TIA Screening Form, which is included in **Appendix B**. The trigger results are as follows.

- Trip Generation Trigger – The development is anticipated to generate over 60 peak hour person trips; further assessment is **required** based on this trigger.
- Location Triggers – The development is located within a designated Design Priority Area (DPA), and proposes new connections to a designated Rapid Transit or Transit Priority (RTTP) corridor; further assessment is **required** based on this trigger.
- Safety Triggers – The development meets multiple safety triggers; further assessment is **required** based on this trigger.

## 2.0 SCOPING

### 2.1 Existing Conditions

#### 2.1.1 Roadways

All roadways within the study area fall under the jurisdiction of the City of Ottawa.

March Road is an arterial roadway that, for the purposes of this report, is considered to run on a north-south alignment within the study area, running between Dunrobin Road and Highway 417. West of Dunrobin Road, the roadway runs on an east-west alignment until Appleton Sideroad in the Town of Mississippi Mills, where it continues as Ottawa Street. South of Highway 417, the roadway continues on a north-south alignment as Eagleson Road. Within the study area, March Road has a four-lane divided urban cross-section, sidewalks on both sides of the roadway, on-street bike lanes, and a posted speed limit of 80 km/h. March Road is classified as a truck route, allowing full loads. Street parking is not permitted. The Official Plan reserves a 44.5m right-of-way (ROW) for March Road.

The *West Transitway Connection – Highway 417/Egleson Road to North of Maxwell Bridge Road* Environmental Project Report (EPR), prepared by Delcan in October 2013, identifies that further ROW widening within the vicinity of the intersection of March Road/Terry Fox Drive may be required. Per the approved functional design within the EPR, the ROW protection for March Road widens to approximately 51.5m along the Subject Site's frontage. The required road widening along the Subject Site's frontage is shown on the Draft Plan. Additional localized road widenings at the March Road intersection will be considered through review of the Road Modification Approval (RMA) functional design.

Terry Fox Drive travels between Eagleson Road and Herzberg Road, and is classified as an arterial roadway west of March Road and major collector roadway east of March Road. Within the study area, Terry Fox Drive generally runs on an east-west alignment, has on-street bike lanes and a multi-use pathway west of the Subject Site, and a posted speed limit of 50 or 60 km/h. Terry Fox Drive generally has a four-lane divided rural cross-section west of March Road, transitioning to an urban cross-section within 50m of March Road, and a two-lane divided urban cross-section with a grass median east of March Road. Sidewalks or pathways are provided on the north side of Terry Fox Drive west of Flamborough Way, on the south side of Terry Fox Drive west of Acklam Terrace and east of McKinley Drive, and on both sides of Terry Fox Drive between Acklam Terrace and McKinley Drive. West of March Road, Terry Fox Drive is classified as a truck route, allowing full loads. Between March Road and Herzberg Road, Terry Fox Drive is not classified as a truck route. Street parking is not permitted. The Official Plan reserves a 44.5m ROW for Terry Fox Drive. The required road widening along the Subject Site's frontage is shown on the Draft Plan.

Morgan's Grant Way is a collector roadway that generally runs on an east-west alignment within the study area, running between Flamborough Way and March Road. East of March Road, the roadway continues as Shirley's Brook Drive. Within the study area, Morgan's Grant Way has a two-lane undivided urban cross-section, sidewalk on the south side of the roadway, and a posted speed limit of 40 km/h. Morgan's Grant Way is not classified as a truck route. Street parking is not permitted on either side of the roadway for the 60m immediately west of March Road, and is not permitted on the north side of the roadway for an additional 50m.

Shirley's Brook Drive is a collector roadway that generally runs on an east-west alignment within the study area, running between March Road and Helmsdale Drive. The roadway intersects with Helmsdale Drive in two locations, as it forms a loop east of Helmsdale Drive. West of March Road, the roadway continues as Morgan's Grant Way. Within the study area, Shirley's Brook Drive has a two-lane undivided urban cross-section, sidewalk on the south side of the roadway, and a posted speed limit of 40 km/h. Shirley's Brook Drive is not classified as a truck route. Street parking is permitted.

Solandt Road is a collector roadway that generally runs on an east-west alignment, starting at Hines Road and terminating approximately 450m east of Legget Drive. Within the study area, Solandt Road has a two-lane urban cross-section and an unposted regulatory speed limit of 50 km/h. Sidewalks are provided along the north side for the entire distance of Solandt Road, as well as the south side between March Road and Legget Drive. Solandt Road is not classified as a truck route. Street parking is permitted.

Flamborough Way is a collector roadway that generally runs on a north-south alignment, running between Halton Terrace and Terry Fox Drive. South of Terry Fox Drive, the roadway continues as Innovation Drive. Flamborough Way has a two-lane undivided urban cross-section, sidewalks on both sides of the roadway, and a posted speed limit of 40 km/h. Flamborough Way is not classified as a truck route. Street parking is permitted.

Innovation Drive is a curvilinear collector roadway, running between Terry Fox Drive and Hines Road. North of Terry Fox Drive, the roadway continues as Flamborough Way. Innovation Drive has a two-lane cross-section that is divided in the vicinity of Terry Fox Drive and undivided elsewhere, sidewalks or pathways on both sides of the roadway, and an unposted speed limit of 50 km/h. Innovation Drive is not classified as a truck route. Street parking is generally permitted.

Hines Road is a collector roadway that generally runs on a north-south alignment between Solandt Road and approximately 320m north of Innovation Drive. The roadway then turns 90-degrees and becomes an east-west roadway for approximately 140m to the west. Within the study area, Hines Road has a two-lane undivided cross-section, no sidewalks, and an unposted speed limit of 50 km/h. Hines Road is not classified as a truck route. Street parking is permitted.

The roadway network of the greater area surrounding the Subject Site is illustrated in **Figure 2**.

Figure 2: Roadway Network

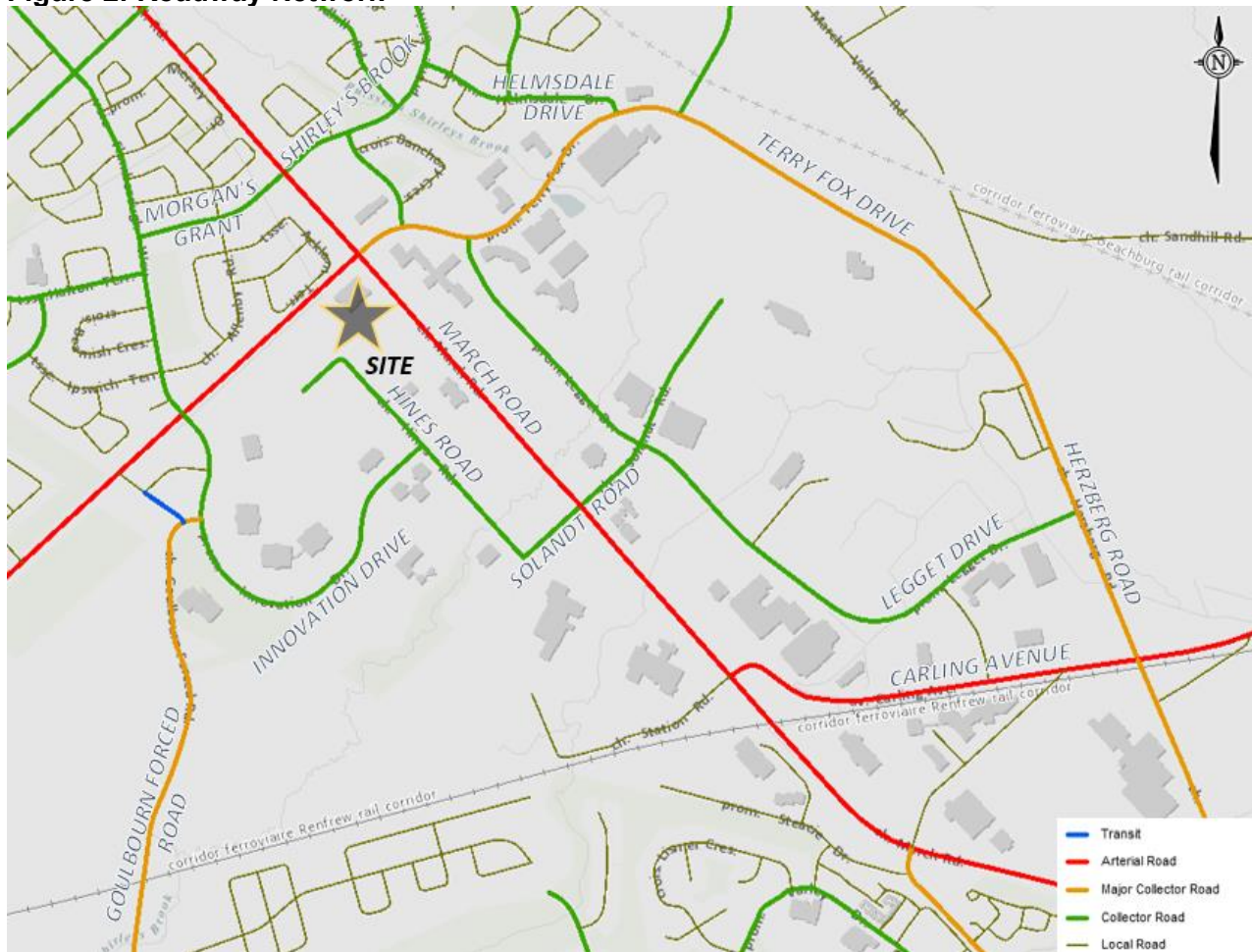

Source: GeoOttawa

### 2.1.2 Intersections

#### March Road/Morgan's Grant Way/ Shirley's Brook Drive

- Signalized four-legged intersection
- North/South Approaches (March Road): one left turn lane, three through lanes, one bike lane, and one channelized right turn lane
- East Approach (Shirley's Brook Drive): one left turn lane, one through lane, and one channelized right turn lane
- West Approach (Morgan's Grant Way): one shared left turn/through lane and one channelized right turn lane
- Standard crosswalks on all approaches



March Road/Terry Fox Drive

- Signalized four-legged intersection
- North Approach (March Road): one left turn lane, three through lanes, one bike lane, and one channelized right turn lane
- South Approach (March Road): two left turn lanes, three through lanes, one bike lane, and one channelized right turn lane
- East/West Approaches (Terry Fox Drive): two left turn lanes, two through lanes, one bike lane, and one channelized right turn lane
- Standard crosswalks on all approaches



March Road/Solandt Road

- Signalized four-legged intersection
- North/South Approaches (March Road): one left turn lane, two through lanes, one bike lane, and one channelized right turn lane
- East Approach (Solandt Road): two left turn lanes, and one shared through/channelized right turn lane
- West Approach (Solandt Road): one left turn lane, one through lane, and one channelized right turn lane
- Standard crosswalks on all approaches
- Two-stage, left-turn bike boxes for northbound and southbound cyclists

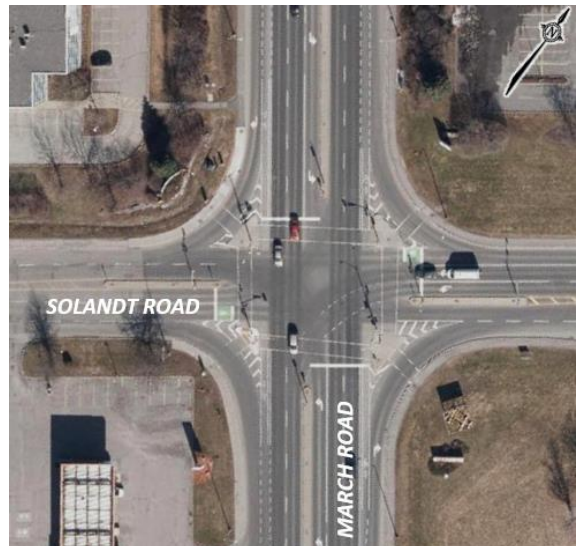

Terry Fox Drive/Flamborough Way/  
Innovation Drive

- Signalized four-legged intersection
- North Approach (Flamborough Way): one left turn lane and one shared through/right turn lane
- South Approach (Innovation Drive): one left turn lane and one shared through/right turn lane
- East/West Approaches (Terry Fox Drive): one left turn lane, one through lane, one bike lane, and one right turn lane
- Standard crosswalks on all approaches



Innovation Drive/Hines Road

- Unsignalized four-legged intersection
- Stop-controlled on Innovation Drive and access to 70 Hines Road (Royal Canadian Legion)
- Multiple accesses across from west approach
- North Approach (Hines Road): one shared left turn/through/right turn lane
- South Approach (Hines Road): one shared left turn/through/right turn lane
- East Approach (access to 70 Hines Road): one shared left turn/through/right turn lane
- West Approach (Innovation Drive): one shared left turn/through/right turn lane
- Standard crosswalks on west approach (not shown in aerial)

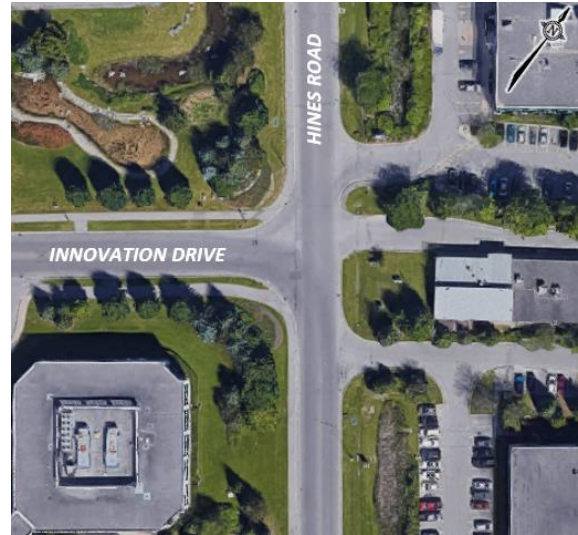

**2.1.3 Driveways**

A review of the existing adjacent driveways along the boundary roads are provided as follows:

**March Road, east side**

- One driveway to an office use at 600 March Road

**March Road, west side**

- One driveway to an office use at 525 March Road

**Terry Fox Drive, north side**

- No driveways within 200m of Subject Site

**Terry Fox Drive, south side**

- No driveways within 200m of Subject Site

**Hines Road, east side**

- Six driveways to commercial/office uses at 50, 70, 84, and 88 Hines Road

**Hines Road, west side**

- Five driveways to commercial/office uses at 93-99 Hines Road, 1000 Innovation Drive, and 385 Terry Fox Drive

**2.1.4 Pedestrian and Cycling Facilities**

As described in Section 2.1.1, sidewalks are provided on both sides of March Road, and on one or both sides of Terry Fox Drive, Morgan’s Grant Way, Shirley’s Brook Drive, Solandt Road, Flamborough Way, Innovation Drive, and Hines Road. Asphalt pathways with widths of 3.0m are provided on the south side of Terry Fox Drive west of the Subject Site, and on the outside of Innovation Drive.

In the City of Ottawa’s primary cycling network, the Spine Routes within the study area include March Road and Terry Fox Drive, which is also designated as a Crosstown Bikeway west of March Road. The Local Routes within the study area include Shirley’s Brook Drive west of Helmsdale Drive, Solandt Road west of Legget Drive, Flamborough Way south of Klondike Road, and the entire lengths of Morgan’s Grant Way, Innovation Drive, and Hines Road. Bike lanes are provided along March Road and Terry Fox Drive within the study area.

The pedestrian and cycling network of the greater area is illustrated in **Figure 3**.

Figure 3: Pedestrian and Cycling Network

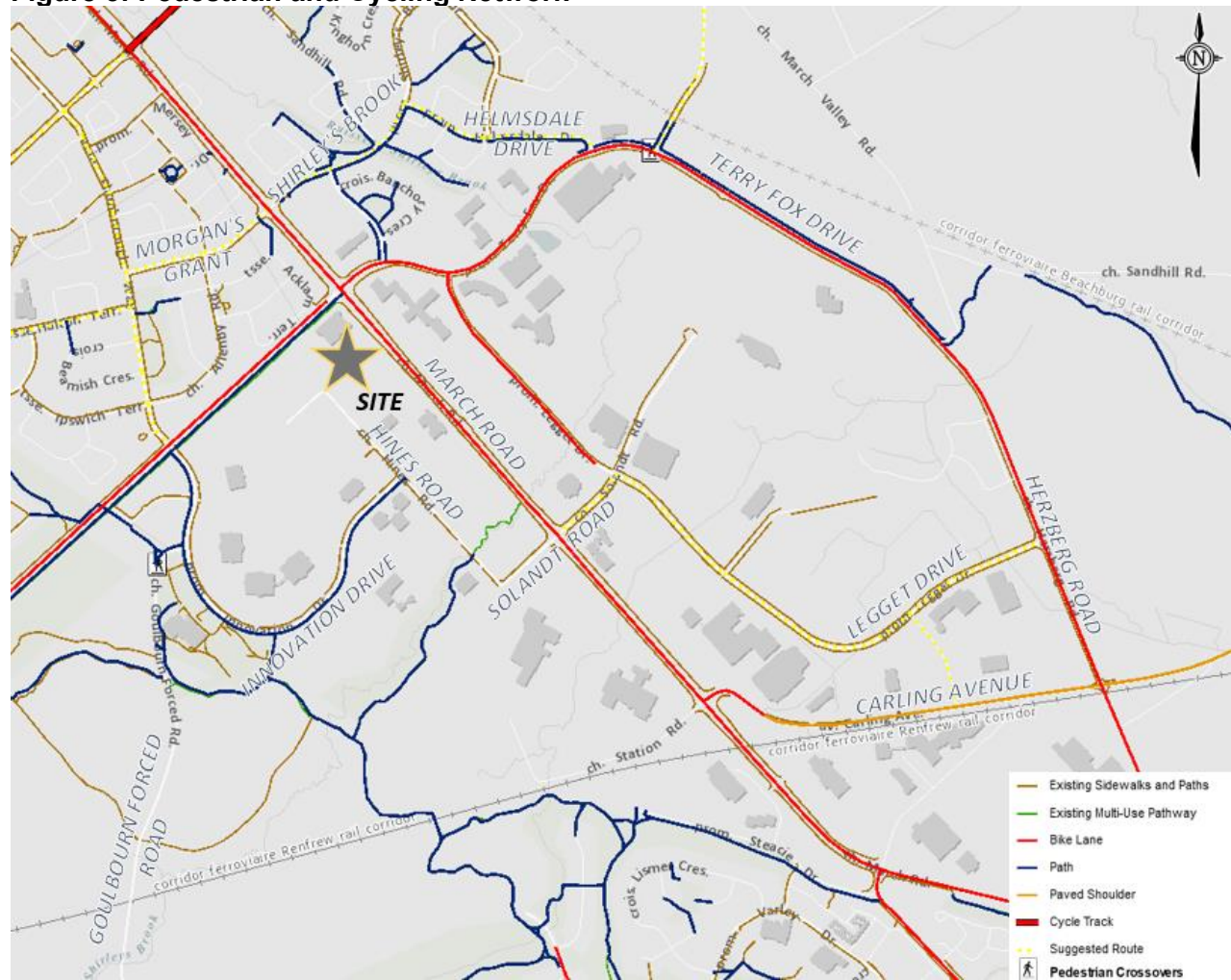

Source: GeoOttawa

### 2.1.5 Transit

The locations of OC Transpo bus stops in the vicinity of the Subject Site are described in **Table 1**, and are shown in **Figure 4**. A summary of the various routes which serve the study area is included in **Table 2**. Detailed route information and an excerpt from the OC Transpo System Map are included in **Appendix C**.

Table 1: OC Transpo Transit Stops

| Stop  | Location  | Routes Served |
|-------|---|---------------|
| #1174 | East side of Hines Road, south of Innovation Drive                | 64, 166       |
| #1175 | West side of Hines Road, south of Innovation Drive                | 64, 166       |
| #1176 | North side of Innovation Drive, west of Hines Road                | 64, 166       |
| #1177 | South side of Innovation Drive, west of Hines Road                | 64, 166       |
| #1515 | North side of Terry Fox Drive, east of Legget Drive               | 66, 166       |
| #1536 | East side of Innovation Drive, south of Terry Fox Drive           | 63, 165, 166  |
| #1819 | West side of Flamborough Way, south of Allenby Road               | 63, 64, 165   |
| #1820 | East side of March Road, between Terry Fox Drive and Solandt Road | 63            |

| Stop        | Location  | Routes Served         |
|-------------|---|-----------------------|
| #1821       | North side of Shirley's Brook Drive, west of Inverary Drive           | 63, 165               |
| #3057 (A/B) | Innovation Station, between Terry Fox Drive and Goulbourn Forced Road | 63, 64, 110, 165, 166 |
| #4875       | North side of Terry Fox Drive, west of March Road                     | 63, 110               |
| #4972       | West side of Legget Drive, south of Terry Fox Drive                   | 63, 66, 110, 166      |
| #6149       | East side of Legget Drive, south of Terry Fox Drive                   | 63, 66, 110, 166      |
| #6152       | North side of Morgan's Grant Way, west of March Road                  | 63, 165               |
| #6155       | South side of Terry Fox Drive, west of March Road                     | 63, 110               |
| #6159       | South side of Terry Fox Drive, east of Legget Drive                   | 66, 166               |
| #6578       | West side of Innovation Drive, south of Terry Fox Drive               | 63, 165, 166          |
| #7994       | West side of March Road, between Terry Fox Drive and Solandt Road     | 63                    |
| #7999       | East side of Flamborough Way, south of Allenby Road                   | 63, 64                |

Figure 4: OC Transpo Bus Stop Locations





**Table 2: OC Transpo Route Information**

| Route | From ↔ To  | Frequency   |
|-------|--|---|
| 63    | Innovation / Briarbrook ↔<br>Tunney's Pasture / Gatineau | 15- to 30-minute headways, seven days per week;<br>all day service  |
| 64    | Innovation / Morgan's Grant ↔<br>Tunney's Pasture        | 15- to 30-minute headways, Monday to Friday;<br>all day service     |
| 66    | Kanata ↔<br>Tunney's Pasture / Gatineau                  | 15- to 30-minute headways, Monday to Friday;<br>peak period service |
| 110   | Innovation ↔<br>Fallowfield                              | 30-minute headways, Monday to Friday;<br>no late evening service    |
| 165   | Innovation ↔<br>Terry Fox                                | 60-minute headways, Monday to Friday;<br>selected time periods      |
| 166   | Innovation ↔<br>Eagleson                                 | Single bus per peak period, Monday to Friday;<br>limited service    |

**2.1.6 Area Traffic Management**

There are no Area Traffic Management (ATM) studies within the study area that have been completed or are currently in progress. The following traffic calming measures have been implemented within the study area:

- Morgan's Grant Way: '40 KM/HR MAX' line painting and painted edge lines;
- Shirley's Brook Drive: '40 KM/HR MAX' line painting, centreline flex posts, and painted edge lines;
- Solandt Road: painted edge lines (west of March Road);
- Flamborough Way: '40 KM/HR MAX' line painting and centreline flex posts;
- Innovation Drive: 'SLOW' line painting.

**2.1.7 Existing Traffic Volumes**

Weekday traffic counts coordinated by Novatech were used to determine the existing pedestrian, cyclist, and vehicular traffic volumes at the study area intersections. These counts were completed on the following dates.

- March Road/Morgan's Grant Way/Shirley's Brook Drive August 4, 2022
- March Road/Terry Fox Drive August 4, 2022
- March Road/Solandt Road August 4, 2022
- Terry Fox Drive/Flamborough Way/Innovation Drive August 9, 2022
- Innovation Drive/Hines Road August 10, 2022

It is acknowledged that City traffic counts were conducted at the study area intersections between 2016 and 2018. City staff have concurred that these counts no longer reflect commuter patterns, with the increased prevalence of 'work from home' and 'hybrid work' arrangements arising from the COVID-19 pandemic, particularly among technology-based companies. Comparing pre-pandemic and post-pandemic data within the study area, traffic volumes are generally significantly lower in post-pandemic conditions.

Along the frontages to the Subject Site, the boundary streets March Road, Terry Fox Drive, and Hines Road approximately have the following average annual daily traffic (AADT) volumes, in vehicles per day (vpd):

- March Road: 21,580 vpd;
- Terry Fox Drive: 10,060 vpd;
- Hines Road: 950 vpd.

All traffic count data previously discussed are included in **Appendix D**. Traffic volumes within the study area are shown in **Figure 5**.

**Figure 5: Existing Traffic Volumes**

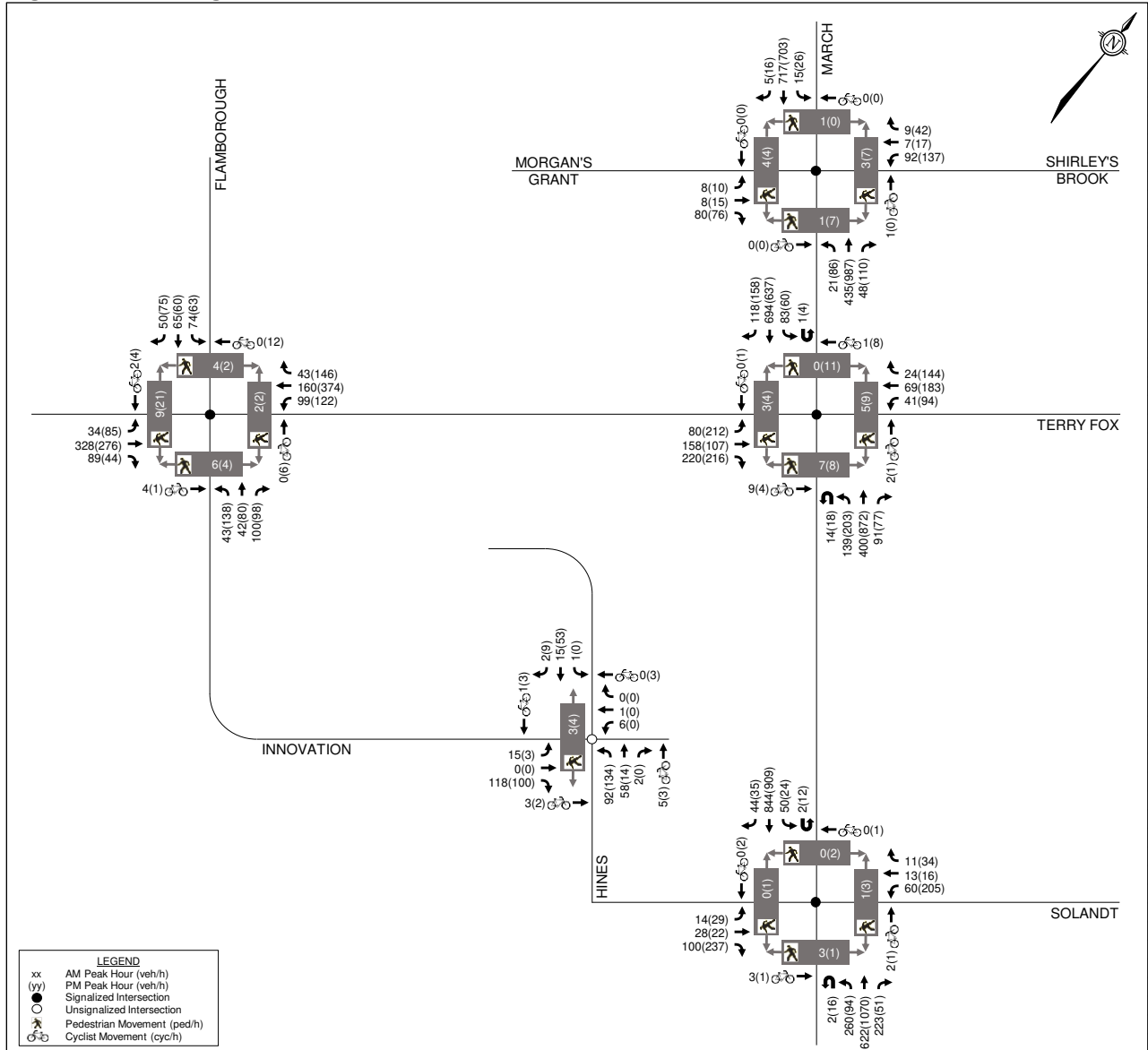

**2.1.8 Collision Records**

Historical collision data from the last five years was obtained from the City’s Public Works and Service Department for the study area intersections and midblock segments. Copies of the collision summary reports are included in **Appendix E**.

The collision data has been evaluated to determine if there are any identifiable collision patterns, which are defined in the *2017 TIA Guidelines* as ‘more than six collisions in five years’ for any one movement. The number of collisions at each intersection from January 1, 2016 to December 31, 2020 is summarized in **Table 3**.

**Table 3: Reported Collisions**

| Intersection/<br>Street Segment                        | Impact Types |       |          |           |                  |                               | Total     |
|--|--------------|-------|----------|-----------|------------------|-------------------------------|-----------|
|  | Approach     | Angle | Rear End | Sideswipe | Turning Movement | SMV <sup>(1)</sup> /<br>Other |           |
| March Road/Morgan’s Grant Way/Shirley’s Brook Drive    | -            | 4     | 12       | 4         | 17               | 1                             | <b>38</b> |
| March Road/Terry Fox Drive                             | 1            | 2     | 28       | 7         | 2                | 7                             | <b>47</b> |
| March Road/Solandt Road                                | -            | 1     | 21       | 1         | 20               | 1                             | <b>44</b> |
| Terry Fox Drive/Flamborough Way/Innovation Drive       | -            | 4     | 11       | 1         | 3                | 1                             | <b>20</b> |
| Innovation Drive/Hines Road                            | -            | -     | 1        | -         | -                | -                             | <b>1</b>  |
| March Road btwn Morgan’s Grant Way and Terry Fox Drive | -            | -     | 2        | 2         | -                | 2                             | <b>6</b>  |
| March Road btwn Terry Fox Drive and Solandt Road       | -            | 1     | 7        | 2         | -                | 6                             | <b>16</b> |
| Terry Fox Drive btwn March Road and Innovation Drive   | -            | -     | 3        | -         | 1                | 1                             | <b>5</b>  |
| Innovation Drive btwn Terry Fox Drive and Hines Road   | -            | 3     | -        | -         | -                | 2                             | <b>5</b>  |
| Hines Road north of Innovation Drive                   | -            | -     | -        | -         | -                | 1                             | <b>1</b>  |

1. SMV = Single Motor Vehicle

**March Road/Morgan’s Grant Way/Shirley’s Brook Drive**

A total of 38 collisions were reported at this intersection over the last five years, of which there were four angle impacts, 12 rear-end impacts, four sideswipe impacts, 17 turning movement impacts, and one single vehicle/other impact. Eleven of the collisions caused injuries, but none caused fatalities. Eleven of the 38 collisions occurred in poor driving conditions. No collisions involved cyclists or pedestrians.

Of the 12 rear-end impacts, four involved northbound vehicles (one left turn incident and three through incidents), two involved southbound vehicles (two through incidents), two involved eastbound vehicles (one through incident and one right turn incident), and four involved westbound vehicles (two through incidents and two right turn incidents).

Of the 17 turning movement impacts, six involved left turns from the northbound approach, one involved a U-turn from the northbound approach, and ten involved left turns from the southbound approach. Turning movement impacts from the southbound approach exceeds the threshold to be considered a collision pattern.

Fully protected left turn phasing for the northbound and southbound left turn movements at March Road/Morgan's Grant Way/Shirley's Brook Drive have recently been implemented. This is anticipated to reduce the frequency of these collisions.

#### *March Road/Terry Fox Drive*

A total of 47 collisions were reported at this intersection over the last five years, of which there was one approaching impact, two angle impacts, 28 rear-end impacts, seven sideswipe impacts, two turning movement impacts, and seven single vehicle/other impacts. Ten of the collisions caused injuries, but none caused fatalities. Twenty-four of the 47 collisions occurred in poor driving conditions. No collisions involved cyclists or pedestrians.

Of the 28 rear-end impacts, 16 occurred at the northbound approach (including one left turn incident, 14 through incidents, and one right turn incident), seven occurred at the southbound approach (six through incidents and one right turn incident), three occurred at the eastbound approach (one through incident and two right turn incidents), and two occurred at the westbound approach (one through incident and one right turn incident). Through rear-end impacts at the northbound approach exceeds the threshold to be considered a collision pattern. High traffic volumes on March Road, as well as a posted speed limit of 80 km/h, may have been factors in these collisions. There does not appear to be any apparent geometric factors that would make rear-end impacts more likely at this intersection.

Of the seven sideswipe impacts, three occurred at the northbound approach, two occurred at the eastbound approach, and two occurred at the westbound approach.

Of the seven single vehicle/other impacts, two occurred at the northbound approach, two occurred at the southbound approach, two occurred at the eastbound approach, and one occurred at the westbound approach.

#### *March Road/Solandt Road*

A total of 44 collisions were reported at this intersection over the last five years, of which there was one angle impact, 21 rear-end impacts, one sideswipe impact, 20 turning movement impacts, and one single vehicle/other impact. Six collisions resulted in injuries, but none caused fatalities. Twenty of the 44 collisions occurred in poor driving conditions. None of the collisions involved pedestrians or cyclists.

Of the 21 rear-end impacts, six occurred at the northbound approach (one left turn incident, four through incidents, and one right turn incident), eight occurred at the southbound approach (six through incidents and two right turn incidents), four occurred at the eastbound approach (two through incidents and two right turn incidents), and three occurred at the westbound approach (one through incident and one right turn incidents). Similar to the discussion of the previous intersection, high traffic volumes and operating speeds on March Road may have been factors in these collisions.

Of the 20 turning movement impacts, ten involved a left turning vehicle at the northbound approach, four involved a left turning vehicle at the southbound approach, four involved a U-turning vehicle at the southbound approach, one involved a U-turning vehicle at the eastbound approach, and one involved a left turning vehicle at the westbound approach. Turning movement impacts at the northbound approach exceed the threshold to be considered a collision pattern.

Six of the ten northbound impacts occurred in poor driving conditions, suggesting that environmental conditions may have been a factor in these collisions. Other likely factors include the posted 80 km/h speed limit on March Road, and the significant left turn/opposing through volumes on March Road during the peak hours, which may result in drivers misjudging gaps in traffic or taking more risks when attempting a left turn.

#### *Terry Fox Drive/Flamborough Way/Innovation Drive*

A total of 20 collisions were reported at this intersection over the last five years, of which there was four angle impacts, 11 rear-end impacts, one sideswipe impact, three turning movement impacts, and one single vehicle/other impact. Six collisions resulted in injuries, but none caused fatalities. Ten of the 20 collisions occurred in poor driving conditions. One collision involved a pedestrian, and none involved cyclists.

Of the 11 rear-end impacts, three occurred at the southbound approach (three through incidents), two occurred at the eastbound approach (two through incidents), and six occurred at the westbound approach (one left turn incident and five through incidents).

#### *Innovation Drive/Hines Road*

One collision was reported at this intersection over the last five years, which was a rear-end impact at the eastbound approach. This collision did not result in injury, and did not involve any pedestrians or cyclists.

#### *March Road between Morgan's Grant Way/Shirley's Brook Drive and Terry Fox Drive*

A total of six collisions were reported along this segment over the last five years, of which there were two rear-end impacts, two sideswipe impacts, and two single vehicle/other impacts. Two collisions resulted in injuries, but none caused fatalities. All six collisions occurred in poor driving conditions. None of the collisions involved pedestrians or cyclists.

#### *March Road between Terry Fox Drive and Solandt Road*

A total of 16 collisions were reported along this segment over the last five years, of which there was one angle impact, seven rear-end impacts, two sideswipe impacts, and six single vehicle/other impacts. Six collisions resulted in injuries, but none caused fatalities. Nine of the 16 collisions occurred in poor driving conditions. None of the collisions involved pedestrians or cyclists.

Of the seven rear-end impacts, five involved northbound vehicles and two involved southbound vehicles. Of the six single vehicle/other impacts, one involved a northbound vehicle and five involved a southbound vehicle.

#### *Terry Fox Drive between March Road and Innovation Drive*

A total of five collisions were reported along this segment over the last five years, of which there were three rear-end impacts, one turning movement impact, and one single vehicle/other impact. One collision resulted in injuries, but none caused fatalities. Two of the five collisions occurred in poor driving conditions. None of the collisions involved pedestrians or cyclists.

### Innovation Drive between Terry Fox Drive and Hines Road

A total of five collisions were reported along this segment over the last five years, of which there were three angle impacts and two single vehicle/other impacts. One collision resulted in injuries, but none caused fatalities. One of the five collisions occurred in poor driving conditions. None of the collisions involved pedestrians or cyclists.

### Hines Road north of Innovation Drive

One collision was reported along this segment over the last five years, which was a single vehicle/other impact involving a southbound vehicle. This collision did not result in injury, and did not involve any pedestrians or cyclists.

## **2.2 Planned Conditions**

### **2.2.1 Planned Transportation Projects**

The City's *2013 Transportation Master Plan (TMP)* does not identify any upcoming roadway projects within the study area in its 2031 Affordable Road Network.

The City's *2013 TMP* identifies transit improvements in its 2031 Affordable Network and 2031 Network Concept. In the Network Concept, at-grade bus rapid transit (BRT) will be provided on March Road between Highway 417 and the urban boundary. In the Affordable Network, at-grade BRT will be provided on March Road between Highway 417 and Solandt Road, and transit priority measures such as transit priority signals and queue jump lanes will be provided on March Road between Solandt Road and the urban boundary, which will allow for future conversion to BRT.

An excerpt of the Affordable Network and Network Concept maps from the City's *2013 TMP* are shown in **Figure 6** and **Figure 7**.

The City's *2013 Cycling Plan* identifies multiple Phase 2 (2020-2025) cycling infrastructure projects within the vicinity of the Kanata Research Park. Bike lanes will be implemented on Flamborough Way, Innovation Drive, Hines Road, Solandt Road, and Legget Drive, to improve connectivity between the residential and employment areas in northern Kanata. These projects are retained on the Active Transportation Project List in the City's Draft *2023 Transportation Master Plan*.

The City's *2013 Pedestrian Plan* does not identify any pedestrian infrastructure projects within the vicinity of the Kanata Research Park.

Figure 6: Excerpt of the 2031 Affordable RTTP Network

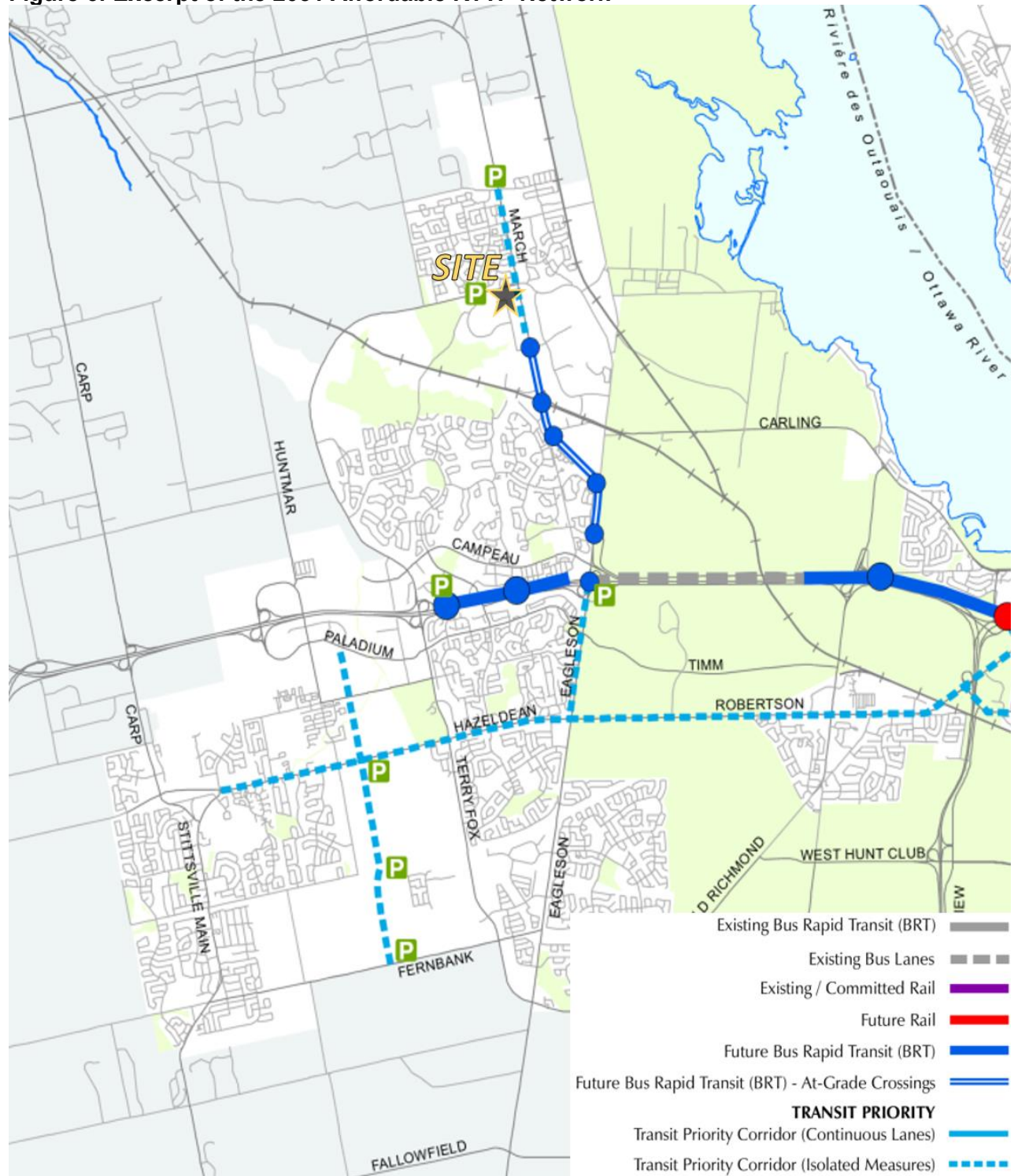

Source: City of Ottawa 2013 TMP

Figure 7: Excerpt of the 2031 RTP Network Concept

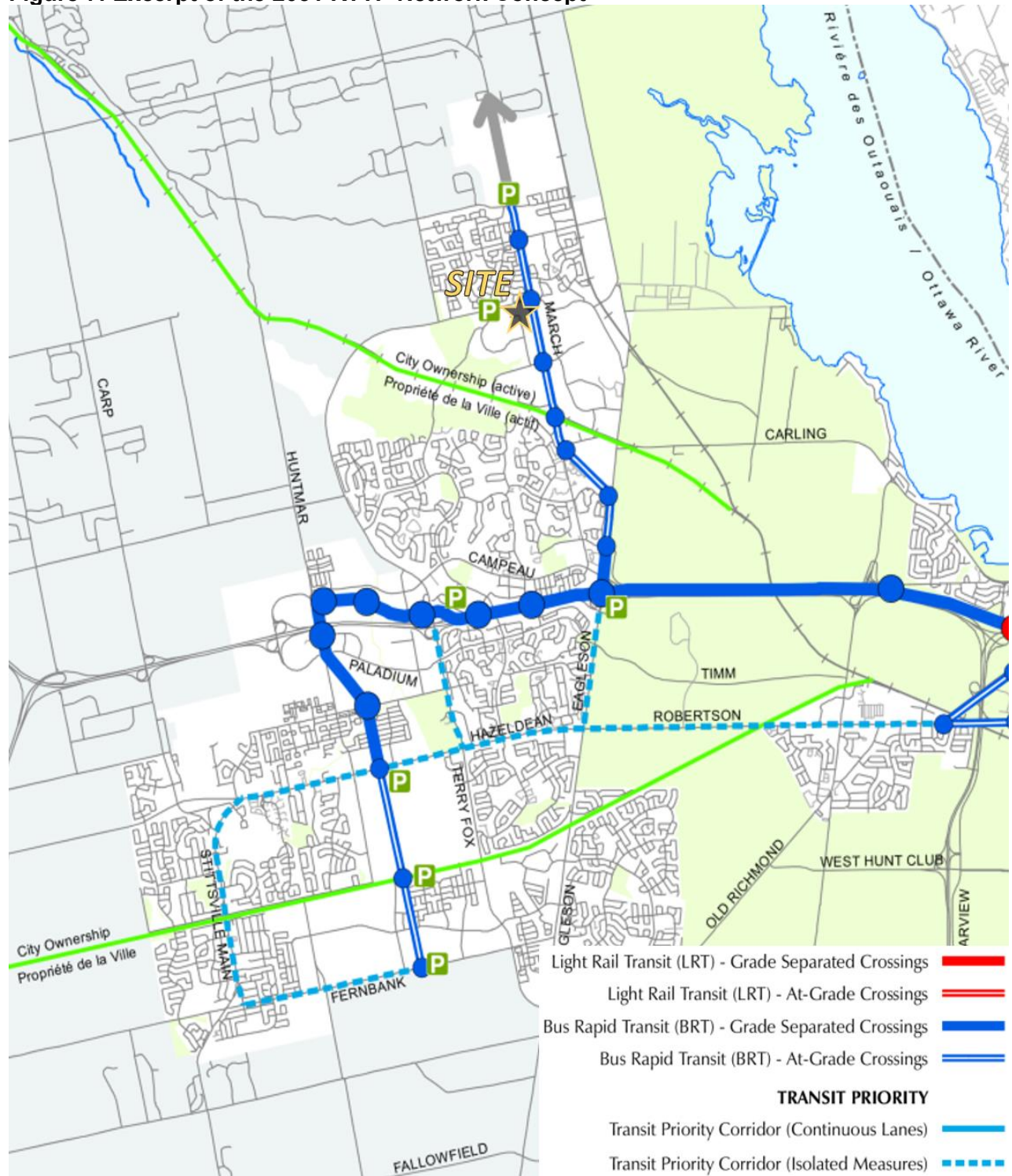

Source: City of Ottawa 2013 TMP



## 2.2.2 Other Area Developments

In proximity of the Subject Site, there are multiple other residential and mixed-use developments that are under construction, approved, or in the approval process. Other developments in the area include the following.

### 359 Terry Fox Drive and 525 Legget Drive

A TIA was prepared by Novatech in January 2022, in support of a development including a single 30-storey building with 253 apartment dwellings and a 3,877 ft<sup>2</sup> rooftop restaurant. The TIA identified a buildout year of 2024.

### 570-600 March Road

A TIA was prepared by Stantec in July 2022, in support of a development including 1,900 residential dwellings, 46,000 m<sup>2</sup> of office space, and 11,350 m<sup>2</sup> of retail space. The TIA identified a buildout year of 2032.

### 706-714 March Road

A TIA was prepared by CGH in December 2020, in support of a development including a 4,165 m<sup>2</sup> GFA supermarket, 350 m<sup>2</sup> GFA fast-food restaurant with drive-through, and 1,500 m<sup>2</sup> GFA of multi-unit commercial space. The TIA identified a buildout year of 2023.

### 788 March Road

A TIA and three subsequent addenda were prepared by Parsons (originally submitted in August 2018, with the addenda submitted in October 2018, December 2018, and March 2020), in support of a development including 92 apartment dwellings. The TIA identified a buildout year of 2023.

### 910 March Road

A TIA was prepared by CGH in January 2021, in support of a development including a 1,835 m<sup>2</sup> hardware store, a 234 m<sup>2</sup> restaurant with drive-through, a 191 m<sup>2</sup> coffee shop with drive-through, a 416 m<sup>2</sup> retail store, and a 249 m<sup>2</sup> gas bar. The TIA identified a buildout year of 2022.

### 1104 Halton Terrace

A TIA was prepared by Novatech in October 2021, in support of a development including a four-storey building with 86 apartment dwellings. The TIA identified a buildout year of 2024.

### 2700 Solandt Road and 415 Legget Drive

A TIA was prepared by WSP in March 2022, in support of a development application to convert an existing two-storey office building into a warehouse and construct two new warehouses. In total, the development will result in approximately 32,930 m<sup>2</sup> of new warehouse space. The TIA identified a buildout year of 2023.

### 2707 Solandt Road

A TIA was prepared by Novatech in January 2020, in support of a development that includes an eight-storey, 198,615 ft<sup>2</sup> office building. The TIA identified a buildout year of 2021.

### 3026 Solandt Road

A TIA was prepared by CIMA+ in March 2020, in support of a development that includes a five-storey, 100,000 ft<sup>2</sup> office building. The TIA identified a buildout year of 2021.

Kanata North Urban Expansion Area (KNUEA)

The KNUEA TMP was prepared by Novatech in June 2016, and estimated that the development of the Kanata North lands has the potential to consist of 960 single-detached homes, 950 street townhomes, 1,040 multi-unit residential dwellings, 400,000 ft<sup>2</sup> GFA of commercial space, three elementary schools, one high school, and a 500-space park and ride. The TMP identified a buildout year of 2026.

**2.3 Study Area and Time Periods**

The study area for this report includes the boundary roadways March Road, Terry Fox Drive, and Hines Road, as well as the following intersections:

- March Road/Morgan’s Grant Way/Shirley’s Brook Drive;
- March Road/Terry Fox Drive;
- March Road/Solandt Road;
- Terry Fox Drive/Flamborough Way/Innovation Drive;
- Innovation Drive/Hines Road.

The selected time periods for the analysis are the weekday AM and PM peak hours, as they represent the ‘worst case’ combination of site generated traffic and adjacent street traffic. Analysis will be completed for the ultimate buildout year 2037. Due to the extended buildout period, a five-year horizon will not be completed. A further review of traffic operations will be provided as each phase proceeds to the Site Plan Control application stage.

**2.4 Exemptions Review**

This module reviews possible exemptions from the final Transportation Impact Assessment, as outlined in the 2017 TIA Guidelines and 2023 Revisions to the TIA Guidelines. The applicable exemptions for this site are shown in **Table 4**.

**Table 4: TIA Exemptions**

| Module   | Element                         | Exemption Criteria  | Status     |
|--|---------------------------------|---|------------|
| <b>Design Review Component</b>                 |                                 |   |            |
| <b>4.1</b><br>Development Design               | 4.1.2<br>Circulation and Access | • Required for site plan control and zoning by-law amendment applications | Exempt     |
|  | 4.1.3<br>New Street Networks    | • Required for draft plan of subdivision applications                     | Not Exempt |
| <b>4.2</b><br>Parking                          | <i>All elements</i>             | • Required for site plan control and zoning by-law amendment applications | Exempt     |
| <b>Network Impact Component</b>                |                                 |   |            |
| <b>4.5</b><br>Transportation Demand Management | <i>All elements</i>             | • Required when proposed development generates more than 60 person trips  | Not Exempt |

| Module                                  | Element      | Exemption Criteria  | Status |
|---|--------------|---|--------|
| 4.6<br>Neighbourhood<br>Traffic Calming | All elements | <ul style="list-style-type: none"> <li>• If all of the following criteria are met:                             <ol style="list-style-type: none"> <li>1. Access is provided to a collector or local roadway</li> <li>2. Application is for zoning by-law amendment or draft plan of subdivision</li> <li>3. Proposed development generates more than 75 vehicle trips</li> <li>4. Site trip infiltration is expected, and site-generated traffic will increase peak hour volumes by 50% or more along the route between the site and an arterial roadway</li> <li>5. The subject street segment is adjacent to two or more of the following significant sensitive land uses:                                     <ul style="list-style-type: none"> <li>○ School (within 250m walking distance)</li> <li>○ Park</li> <li>○ Retirement/older adult facility</li> <li>○ Licensed child care centre</li> <li>○ Community centre</li> <li>○ 50+% of adjacent properties along the route(s) are occupied by residential lands and at least ten dwellings are occupied</li> </ul> </li> </ol> </li> </ul> | Exempt |
| 4.8<br>Network Concept                  | All elements | <ul style="list-style-type: none"> <li>• Only required when proposed development generates more than 200 person-trips during the peak hour in excess of the equivalent volume permitted by the established zoning</li> </ul>  | Exempt |

Based on the foregoing, the following modules will be included in the TIA report:

**Design Review Component**

- Module 4.1: Development Design
- Module 4.3: Boundary Streets
- Module 4.4: Access Design

**Network Impact Component**

- Module 4.5: Transportation Demand Management
- Module 4.7: Transit
- Module 4.9: Intersection Design

**3.0 FORECASTING**

**3.1 Development-Generated Travel Demand**

**3.1.1 Trip Generation**

Existing Trip Generation

The area of the existing buildings at 555, 591, and 603 March Road have been estimated using aerial photography. The existing one-storey athletic facility is estimated to include 18,500 ft<sup>2</sup> of gym space, the existing two-storey office building is estimated to include 78,400 ft<sup>2</sup> GFA of office space, and the existing one-storey retail plaza is estimated to include 15,400 ft<sup>2</sup> GFA of retail space.

The number of trips generated by the existing uses has been estimated using the trip generation rates outlined in the *ITE Trip Generation Manual, 11<sup>th</sup> Edition*, corresponding to the Health/Fitness Club (code 492), General Office Building (code 710), or Strip Retail Plaza (code 822) land uses. Trips estimated using the *ITE Trip Generation Manual* have been converted to person trips using an adjustment factor of 1.28, consistent with the City's *2017 TIA Guidelines*. To reflect the prevalence of 'work from home' or 'hybrid work' arrangements, the estimated vehicular volumes that are currently generated by the existing offices has been reduced by 40%. This assumption is based on the comparison of pre-pandemic and post-pandemic traffic counts on Solandt Road and Terry Fox Drive, which shows that 2022 volumes on these roadways have decreased by approximately 35% to 50%.

The estimated number of person trips generated by the existing land uses are shown in **Table 5**.

**Table 5: Existing Development – Peak Hour Trip Generation**

| Land Use            | ITE Code | GFA                    | AM Peak Hour (pph <sup>(1)</sup> ) |           |            | PM Peak Hour (pph) |            |            |
|---------------------|----------|------------------------|------------------------------------|-----------|------------|--------------------|------------|------------|
|                     |          |                        | IN                                 | OUT       | TOT        | IN                 | OUT        | TOT        |
| Health/Fitness Club | 492      | 18,500 ft <sup>2</sup> | 16                                 | 15        | 31         | 47                 | 35         | 82         |
| General Office Bldg | 710      | 78,400 ft <sup>2</sup> | 154                                | 20        | 174        | 29                 | 145        | 174        |
| 40% reduction       |          |                        | -61                                | -8        | -69        | -11                | -58        | -69        |
| Strip Retail Plaza  | 822      | 15,400 ft <sup>2</sup> | 29                                 | 20        | 49         | 68                 | 68         | 136        |
| <b>Total</b>        |          |                        | <b>138</b>                         | <b>47</b> | <b>185</b> | <b>133</b>         | <b>190</b> | <b>323</b> |

1. pph: Person Trips per Hour

From the previous table, the existing development is estimated to generate approximately 254 person trips during the AM peak hour and 323 person trips during the PM peak hour.

The *TRANS Trip Generation Manual Summary Report*, prepared in October 2020 by WSP, includes data to estimate the mode shares for employment trip generators and commercial trip generators, based on the district. The *TRANS Trip Generation Manual* identifies the Subject Site as being located within the Kanata/Stittsville district. The employment mode shares were only surveyed during the AM peak hour, as employees are assumed to use the same mode to arrive at and depart from work. All trips to/from the athletic facility are assumed to originate or terminate at other sites within Kanata/Stittsville. Therefore, the athletic facility mode shares have been estimated using the 'Within District' mode shares outlined in the *2011 TRANS O-D Survey Report*, for the Kanata/Stittsville district.

The surveyed peak hour mode shares for the existing land uses are summarized in **Table 6**.

**Table 6: Surveyed Kanata/Stittsville Mode Shares – Existing Uses**

| Mode           | Trips Within District |     | Employment |    | Commercial |     |
|----------------|-----------------------|-----|------------|----|------------|-----|
|                | AM                    | PM  | AM         | PM | AM         | PM  |
| Auto Driver    | 45%                   | 57% | 84%        | -  | 81%        | 73% |
| Auto Passenger | 17%                   | 23% | 4%         | -  | 12%        | 22% |
| Transit        | 4%                    | 2%  | 8%         | -  | 5%         | 1%  |
| Cyclist        | 1%                    | 1%  | 1%         | -  | 0%         | 0%  |
| Pedestrian     | 19%                   | 12% | 3%         | -  | 2%         | 4%  |
| Other          | 15%                   | 6%  | -          | -  | -          | -   |

For the purposes of this review, the employment mode shares have been applied directly to the trips generated by the existing office building. The commercial mode shares during the PM peak hour have been applied directly to the trips generated by the existing retail uses. The mode shares of the existing athletic facility are assumed to generally follow the surveyed mode shares within the Kanata/Stittsville district (i.e. 55% auto driver, 20% auto passenger, 5% transit, 5% cyclist, and 15% pedestrian). The estimated number of trips generated by the existing uses, broken down by mode share, are included in **Table 7**.

**Table 7: Existing Development – Peak Hour Trips by Mode Share**

| Travel Mode                      | Mode Share |     | AM Peak Hour |           |            | PM Peak Hour |            |            |
|----------------------------------|------------|-----|--------------|-----------|------------|--------------|------------|------------|
|                                  | AM         | PM  | IN           | OUT       | TOT        | IN           | OUT        | TOT        |
| <b>Fitness Person Trips</b>      |            |     | <b>16</b>    | <b>15</b> | <b>31</b>  | <b>47</b>    | <b>35</b>  | <b>82</b>  |
| Auto Driver                      | 55%        |     | 8            | 8         | 16         | 26           | 19         | 45         |
| Auto Passenger                   | 20%        |     | 3            | 3         | 6          | 10           | 7          | 17         |
| Transit                          | 5%         |     | 1            | 1         | 2          | 2            | 2          | 4          |
| Cyclist                          | 5%         |     | 1            | 1         | 2          | 2            | 2          | 4          |
| Pedestrian                       | 15%        |     | 3            | 2         | 5          | 7            | 5          | 12         |
| <b>Office Person Trips</b>       |            |     | <b>93</b>    | <b>12</b> | <b>105</b> | <b>18</b>    | <b>87</b>  | <b>105</b> |
| Auto Driver                      | 84%        |     | 78           | 10        | 88         | 15           | 73         | 88         |
| Auto Passenger                   | 4%         |     | 4            | 1         | 5          | 1            | 3          | 4          |
| Transit                          | 8%         |     | 7            | 1         | 8          | 2            | 7          | 9          |
| Cyclist                          | 1%         |     | 1            | -         | 1          | -            | 1          | 1          |
| Pedestrian                       | 3%         |     | 3            | -         | 3          | -            | 3          | 3          |
| <b>Strip Retail Person Trips</b> |            |     | <b>29</b>    | <b>20</b> | <b>49</b>  | <b>68</b>    | <b>68</b>  | <b>136</b> |
| Auto Driver                      | 81%        | 73% | 24           | 16        | 40         | 50           | 50         | 100        |
| Auto Passenger                   | 12%        | 22% | 3            | 2         | 5          | 15           | 15         | 30         |
| Transit                          | 5%         | 1%  | 1            | 1         | 2          | 1            | -          | 1          |
| Cyclist                          | 0%         | 0%  | -            | -         | -          | -            | -          | -          |
| Pedestrian                       | 2%         | 4%  | 1            | 1         | 2          | 2            | 3          | 5          |
| <b>Total Person Trips</b>        |            |     | <b>138</b>   | <b>47</b> | <b>185</b> | <b>133</b>   | <b>190</b> | <b>323</b> |
| Auto Driver                      |            |     | 110          | 34        | 144        | 91           | 142        | 233        |
| Auto Passenger                   |            |     | 10           | 6         | 16         | 26           | 25         | 51         |
| Transit                          |            |     | 9            | 3         | 12         | 5            | 9          | 14         |
| Cyclist                          |            |     | 2            | 1         | 3          | 2            | 3          | 5          |
| Pedestrian                       |            |     | 7            | 3         | 10         | 9            | 11         | 20         |

From the previous table, the existing development is anticipated to generate 144 vehicle trips during the AM peak hour and 233 vehicle trips during the PM peak hour.

The retail land uses is anticipated to generate two types of external peak hour trips: primary and pass-by trips. Primary trips are made for the specific purpose of visiting the site, while pass-by trips are made as intermediate stops on the way to another destination. Peak hour pass-by trips for the existing retail plaza are estimated to account for approximately 40% of all trips, based on the average rate identified in the *ITE Trip Generation Manual*.

The primary and pass-by trips generated by the existing retail plaza are summarized in **Table 8**.

**Table 8: Existing Strip Retail – Primary and Pass-by Trips**

| Trip Type                          | AM Peak Hour (vph <sup>(1)</sup> ) |          |           | PM Peak Hour (vph) |           |           |
|------------------------------------|------------------------------------|----------|-----------|--------------------|-----------|-----------|
|                                    | IN                                 | OUT      | TOT       | IN                 | OUT       | TOT       |
| Existing Strip Retail Trips        | 24                                 | 16       | 40        | 50                 | 50        | 100       |
| Adjustment for Pass-by Trips (40%) | -8                                 | -8       | -16       | -20                | -20       | -40       |
| <b>Primary Trips (60%)</b>         | <b>16</b>                          | <b>8</b> | <b>24</b> | <b>30</b>          | <b>30</b> | <b>60</b> |

1. vph: Vehicle Trips per Hour

It has been assumed that no existing trips generated by the Subject Site are internally captured, based on the general layout of the existing athletic facility, retail plaza, and office building. This assumption allows for a more conservative analysis.

Proposed Trip Generation

The conceptual development is assumed to include 2,100 high-rise dwellings, 154,178 ft<sup>2</sup> GFA of office space, and 31,482 ft<sup>2</sup> GFA of retail space.

The *TRANS Trip Generation Manual Summary Report* includes data to estimate the mode shares for residential trip generators in the Kanata/Stittsville district, in addition to the employment and commercial trip generators described previously. The surveyed mode shares for the proposed land uses are included in **Table 9**.

**Table 9: Surveyed Kanata/Stittsville Mode Shares – Proposed Uses**

| Mode           | Residential |     | Employment |    | Commercial |     |
|----------------|-------------|-----|------------|----|------------|-----|
|                | AM          | PM  | AM         | PM | AM         | PM  |
| Auto Driver    | 42%         | 55% | 84%        | -  | 81%        | 73% |
| Auto Passenger | 26%         | 19% | 4%         | -  | 12%        | 22% |
| Transit        | 28%         | 21% | 8%         | -  | 5%         | 1%  |
| Cyclist        | 0%          | 0%  | 1%         | -  | 0%         | 0%  |
| Pedestrian     | 4%          | 5%  | 3%         | -  | 2%         | 4%  |

The assumed residential mode shares for the proposed residences have been developed by taking the average of the surveyed mode shares for residences in the Kanata/Stittsville district. Since the 2031 Affordable Transit Network will only include bus rapid transit along March Road between Solandt Road and Highway 417, and the surveyed transit share is already notably high at 21% to 28% during the peak hours, the transit share for the proposed residential development has not been increased. The assumed employment mode shares for the proposed offices have been adjusted by increasing the transit share to 20% from 8% and decreasing the driver share accordingly from 84% to 72%, to account for planned bus rapid transit to Solandt Road. The assumed commercial mode shares for the proposed retail uses have been adjusted by considering the PM peak hour only, increasing the transit share to 10% from 1%, and decreasing the driver share accordingly from 73% to 64%. This can be summarized as follows.

**Residential Mode Shares**

- Auto Driver: 49%
- Auto Passenger: 22%
- Transit: 25%
- Cyclist: 0%
- Pedestrian: 4%

**Employment Mode Shares**

- Auto Driver: 72%
- Auto Passenger: 4%
- Transit: 20%
- Cyclist: 1%
- Pedestrian: 3%

**Commercial Mode Shares**

- Auto Driver: 64%
- Auto Passenger: 22%
- Transit: 10%
- Cyclist: 0%
- Pedestrian: 4%

Proposed Residential Trip Generation

The *TRANS Trip Generation Manual Summary Report*, prepared in October 2020 by WSP, includes data to estimate the trip generation for residential uses, divided into single-family detached housing, low-rise multifamily housing (one or two storeys), and high-rise multifamily housing (three or more storeys). For the High-Rise Multifamily Housing land use, the process of converting the trip generation estimates from peak period to peak hour is shown in the following tables. The estimated number of person trips generated by the proposed dwellings for the AM and PM peak periods are shown in **Table 10**. A breakdown of these trips by mode share is shown in **Table 11**.

**Table 10: Proposed Residential – Peak Period Trip Generation**

| Land Use                      | TRANS Rate           | Units | AM Peak Period (ppp <sup>(1)</sup> ) |       |       | PM Peak Period (ppp) |     |       |
|-------------------------------|----------------------|-------|--------------------------------------|-------|-------|----------------------|-----|-------|
|                               |                      |       | IN                                   | OUT   | TOT   | IN                   | OUT | TOT   |
| High-Rise Multifamily Housing | AM: 0.80<br>PM: 0.90 | 2,100 | 521                                  | 1,159 | 1,680 | 1,096                | 794 | 1,890 |

1. ppp: Person Trips per Peak Period

**Table 11: Proposed Residential – Peak Period Trips by Mode Share**

| Travel Mode              | Mode Share | AM Peak Period |              |              | PM Peak Period |            |              |
|--------------------------|------------|----------------|--------------|--------------|----------------|------------|--------------|
|                          |            | IN             | OUT          | TOT          | IN             | OUT        | TOT          |
| <b>Residential Trips</b> |            | <b>521</b>     | <b>1,159</b> | <b>1,680</b> | <b>1,096</b>   | <b>794</b> | <b>1,890</b> |
| Auto Driver              | 49%        | 255            | 568          | 823          | 537            | 389        | 926          |
| Auto Passenger           | 22%        | 115            | 255          | 370          | 241            | 175        | 416          |
| Transit                  | 25%        | 130            | 290          | 420          | 274            | 198        | 472          |
| Cyclist                  | 0%         | -              | -            | -            | -              | -          | -            |
| Pedestrian               | 4%         | 21             | 46           | 67           | 44             | 32         | 76           |

Table 4 of the *TRANS Trip Generation Manual* includes adjustment factors to convert the estimated number of trips generated for each mode from peak period to peak hour. A breakdown of the peak hour trips by mode is shown in **Table 12**.

**Table 12: Proposed Residential – Peak Hour Trips by Mode Share**

| Travel Mode                   | Adj. Factor |      | AM Peak Hour |            |            | PM Peak Hour |            |            |
|-------------------------------|-------------|------|--------------|------------|------------|--------------|------------|------------|
|                               | AM          | PM   | IN           | OUT        | TOT        | IN           | OUT        | TOT        |
| Auto Driver                   | 0.48        | 0.44 | 123          | 273        | 396        | 236          | 171        | 407        |
| Auto Passenger                | 0.48        | 0.44 | 55           | 122        | 177        | 106          | 76         | 182        |
| Transit                       | 0.55        | 0.47 | 71           | 160        | 231        | 129          | 94         | 223        |
| Cyclist                       | 0.58        | 0.48 | -            | -          | -          | -            | -          | -          |
| Pedestrian                    | 0.58        | 0.52 | 12           | 27         | 39         | 23           | 17         | 40         |
| <b>Peak Hour Person Trips</b> |             |      | <b>261</b>   | <b>582</b> | <b>843</b> | <b>494</b>   | <b>358</b> | <b>852</b> |

From the previous table, the proposed residential dwellings are estimated to generate 843 person trips during the AM peak hour (including 396 vehicle trips) and 852 person trips during the PM peak hour (including 407 vehicle trips).

Proposed Office and Retail Trip Generation

The number of trips generated by the proposed office and retail uses has been estimated using the trip generation rates outlined in the *ITE Trip Generation Manual, 11<sup>th</sup> Edition*, corresponding to the General Office Building (code 710) or Strip Retail Plaza (code 822) land uses. A 40% reduction has not been applied to the estimated number of office-generated trips, as this maintains a conservative analysis. The estimated number of person trips generated by the proposed office and retail uses are shown in **Table 13**, and are broken down by mode share in **Table 14**.

**Table 13: Proposed Office/Retail – Peak Hour Trip Generation**

| Land Use            | ITE Code | GFA                     | AM Peak Hour (pph) |           |            | PM Peak Hour (pph) |            |            |
|---------------------|----------|-------------------------|--------------------|-----------|------------|--------------------|------------|------------|
|                     |          |                         | IN                 | OUT       | TOT        | IN                 | OUT        | TOT        |
| General Office Bldg | 710      | 154,178 ft <sup>2</sup> | 274                | 37        | 311        | 52                 | 253        | 305        |
| Strip Retail Plaza  | 822      | 31,482 ft <sup>2</sup>  | 47                 | 31        | 78         | 113                | 112        | 225        |
| <b>Total</b>        |          |                         | <b>321</b>         | <b>68</b> | <b>389</b> | <b>165</b>         | <b>365</b> | <b>530</b> |

**Table 14: Proposed Office/Retail – Peak Hour Trips by Mode Share**

| Travel Mode                | Mode Share | AM Peak Hour |           |            | PM Peak Hour |            |            |
|----------------------------|------------|--------------|-----------|------------|--------------|------------|------------|
|                            |            | IN           | OUT       | TOT        | IN           | OUT        | TOT        |
| <b>Office Person Trips</b> |            | <b>274</b>   | <b>37</b> | <b>311</b> | <b>52</b>    | <b>253</b> | <b>305</b> |
| Auto Driver                | 72%        | 197          | 27        | 224        | 37           | 182        | 219        |
| Auto Passenger             | 4%         | 12           | 1         | 13         | 1            | 10         | 11         |
| Transit                    | 20%        | 55           | 7         | 62         | 11           | 51         | 62         |
| Cyclist                    | 1%         | 2            | 1         | 3          | 1            | 2          | 3          |
| Pedestrian                 | 3%         | 8            | 1         | 9          | 2            | 8          | 10         |
| <b>Retail Person Trips</b> |            | <b>47</b>    | <b>31</b> | <b>78</b>  | <b>113</b>   | <b>112</b> | <b>225</b> |
| Auto Driver                | 64%        | 30           | 20        | 50         | 72           | 72         | 144        |
| Auto Passenger             | 22%        | 10           | 6         | 16         | 25           | 25         | 50         |
| Transit                    | 10%        | 5            | 4         | 9          | 12           | 11         | 23         |
| Cyclist                    | 0%         | -            | -         | -          | -            | -          | -          |
| Pedestrian                 | 4%         | 2            | 1         | 3          | 4            | 4          | 8          |
| <b>Total Person Trips</b>  |            | <b>321</b>   | <b>68</b> | <b>389</b> | <b>165</b>   | <b>365</b> | <b>530</b> |
| Auto Driver                |            | 227          | 47        | 274        | 109          | 254        | 363        |
| Auto Passenger             |            | 22           | 7         | 29         | 26           | 35         | 61         |
| Transit                    |            | 60           | 11        | 71         | 23           | 62         | 85         |
| Cyclist                    |            | 2            | 1         | 3          | 1            | 2          | 3          |
| Pedestrian                 |            | 10           | 2         | 12         | 6            | 12         | 19         |

From the previous table, the proposed office and retail uses are estimated to generate 389 person trips during the AM peak hour (including 274 vehicle trips) and 530 person trips during the PM peak hour (including 363 vehicle trips).

The conceptual development as a whole is estimated to generate 1,232 person trips during the AM peak hour (including 670 vehicle trips) and 1,382 person trips during the PM peak hour (including 770 vehicle trips). A detailed breakdown of the estimated trip generation by mode share is included in **Table 15**.



**Table 15: Conceptual Development – Total Peak Hour Trips**

| Travel Mode               | AM Peak Hour |            |              | PM Peak Hour |            |              |
|---------------------------|--------------|------------|--------------|--------------|------------|--------------|
|                           | IN           | OUT        | TOT          | IN           | OUT        | TOT          |
| <b>Total Person Trips</b> | <b>582</b>   | <b>650</b> | <b>1,232</b> | <b>659</b>   | <b>723</b> | <b>1,382</b> |
| Auto Driver               | 350          | 320        | 670          | 345          | 425        | 770          |
| Auto Passenger            | 77           | 129        | 206          | 132          | 111        | 243          |
| Transit                   | 131          | 171        | 302          | 152          | 156        | 308          |
| Cyclist                   | 2            | 1          | 3            | 1            | 2          | 3            |
| Pedestrian                | 22           | 29         | 51           | 29           | 29         | 58           |

Subtracting the existing site-generated volumes shown in **Table 7** from the proposed site-generated volumes shown in **Table 15**, the conceptual development is estimated to generate a net additional 1,047 person trips (including 536 vehicle trips) during the AM peak hour, and a net additional 1,059 person trips (including 537 vehicle trips) during the PM peak hour.

Pass-by and Internally Captured Trips

Some trips are anticipated to be internally captured within the Subject Site, as people may both live and work within the Subject Site, and some resident/employee trips may involve travelling between home, work, and the proposed retail areas on-site. Additionally, the proposed retail uses are anticipated to generate both primary and pass-by trips. The results of adjusting for internally captured trips and pass-by trips is included below. Per the example included in the *TRANS Trip Generation Manual*, internally captured trips between the proposed land uses have been estimated using the methodology outlined in the *ITE Trip Generation Handbook* and the *NCHRP Report 684 Estimator* spreadsheet tool (developed by the Texas A&M Transportation Institute in 2010). The completed spreadsheets are included in **Appendix F**, and include internal trip adjustments for the driver, transit, and non-motorized modes.

A summary of the internally captured and external trips generated by the conceptual development are included in **Table 16**.

**Table 16: Conceptual Development – Internally Captured Trips**

| Trip Type           |          | AM Peak Hour |     |     | PM Peak Hour |     |     |
|---------------------|----------|--------------|-----|-----|--------------|-----|-----|
|                     |          | IN           | OUT | TOT | IN           | OUT | TOT |
| Residential Trips   | Vehicle  | 123          | 273 | 396 | 236          | 171 | 407 |
|                     | Transit  | 71           | 160 | 231 | 129          | 94  | 223 |
|                     | Non-Auto | 12           | 27  | 39  | 23           | 17  | 40  |
| Internal Adjustment | Vehicle  | -3           | -10 | -13 | -24          | -17 | -41 |
|                     | Transit  | -1           | -4  | -5  | -9           | -7  | -16 |
|                     | Non-Auto | -            | -1  | -1  | -2           | -1  | -3  |
| External Trips      | Vehicle  | 120          | 263 | 383 | 212          | 154 | 366 |
|                     | Transit  | 70           | 156 | 226 | 120          | 87  | 207 |
|                     | Non-Auto | 12           | 26  | 38  | 21           | 16  | 37  |
| Office Trips        | Vehicle  | 197          | 27  | 224 | 37           | 182 | 219 |
|                     | Transit  | 55           | 7   | 62  | 11           | 51  | 62  |
|                     | Non-Auto | 10           | 2   | 12  | 3            | 10  | 13  |
| Internal Adjustment | Vehicle  | -13          | -8  | -21 | -12          | -11 | -23 |
|                     | Transit  | -4           | -2  | -6  | -4           | -3  | -7  |
|                     | Non-Auto | -            | -1  | -1  | -2           | -   | -2  |
| External Trips      | Vehicle  | 184          | 19  | 203 | 25           | 171 | 196 |
|                     | Transit  | 51           | 5   | 56  | 7            | 48  | 55  |
|                     | Non-Auto | 10           | 1   | 11  | 1            | 10  | 11  |

| Trip Type           |          | AM Peak Hour |     |     | PM Peak Hour |     |     |
|---------------------|----------|--------------|-----|-----|--------------|-----|-----|
|                     |          | IN           | OUT | TOT | IN           | OUT | TOT |
| Retail Trips        | Vehicle  | 30           | 20  | 50  | 72           | 72  | 144 |
|                     | Transit  | 5            | 4   | 9   | 12           | 11  | 23  |
|                     | Non-Auto | 2            | 1   | 3   | 4            | 4   | 8   |
| Internal Adjustment | Vehicle  | -14          | -11 | -25 | -17          | -27 | -44 |
|                     | Transit  | -2           | -2  | -4  | -3           | -3  | -6  |
|                     | Non-Auto | -1           | -   | -1  | -            | -1  | -1  |
| External Trips      | Vehicle  | 16           | 9   | 25  | 55           | 45  | 100 |
|                     | Transit  | 3            | 2   | 5   | 9            | 8   | 17  |
|                     | Non-Auto | 1            | 1   | 2   | 4            | 3   | 7   |

Peak hour pass-by trips for the proposed retail areas are estimated to account for approximately 40% of all trips, matching the assumption for the existing strip retail uses. The primary and pass-by trips generated by the proposed retail uses are summarized in **Table 17**.

**Table 17: Proposed Retail – Primary and Pass-by Trips**

| Trip Type                          | AM Peak Hour (vph) |          |           | PM Peak Hour (vph) |           |           |
|------------------------------------|--------------------|----------|-----------|--------------------|-----------|-----------|
|                                    | IN                 | OUT      | TOT       | IN                 | OUT       | TOT       |
| Retail External Vehicle Trips      | 16                 | 9        | 25        | 55                 | 45        | 100       |
| Adjustment for Pass-by Trips (40%) | -5                 | -5       | -10       | -20                | -20       | -40       |
| <b>Primary Trips (60%)</b>         | <b>11</b>          | <b>4</b> | <b>15</b> | <b>35</b>          | <b>25</b> | <b>60</b> |

### 3.1.2 Trip Distribution

The assumed distribution of trips generated by the proposed residential and existing/proposed office uses have been estimated by considering the typical commuter patterns (based on AM peak outbound volumes and PM peak inbound volumes for residential trips, and vice versa for office trips) and logical trip routing. Additional trips have been distributed to/from the north for the proposed offices, to account for the extensive KNUEA developments north of the study area. As a result, the assumed trip distribution for the residential and office uses is summarized as follows:

Proposed Residential

- 20% to/from the north via March Road;
- 45% to/from the south via March Road;
- 10% to/from the east via Terry Fox Drive;
- 10% to/from the east via Solandt Road;
- 10% to/from the west via Terry Fox Drive;
- 5% to/from the west via Innovation Drive.

Existing Office

- 25% to/from the north via March Road;
- 5% to/from the north via Flamborough Way;
- 40% to/from the south via March Road;
- 5% to/from the east via Terry Fox Drive;
- 5% to/from the east via Shirley’s Brook Drive;
- 15% to/from the west via Terry Fox Drive;
- 5% to/from the west via Morgan’s Grant Way.

Proposed Office

- 35% to/from the north via March Road;
- 5% to/from the north via Flamborough Way;
- 35% to/from the south via March Road;
- 5% to/from the east via Terry Fox Drive;
- 5% to/from the east via Shirley’s Brook Drive;
- 10% to/from the west via Terry Fox Drive;
- 5% to/from the west via Morgan’s Grant Way.

The assumed distribution of trips generated by the existing athletic facility and existing/proposed retail uses have been estimated based on the two-way midday peak hour volumes, as these uses are anticipated to have a more regional draw. As a result, the assumed trip distribution for the athletic facility and retail uses can be summarized as follows:

Existing or Proposed Retail and Existing Athletic Facility

- 25% to/from the north via March Road;
- 5% to/from the north via Flamborough Way;
- 30% to/from the south via March Road;
- 5% to/from the east via Terry Fox Drive;
- 5% to/from the east via Shirley’s Brook Drive;
- 5% to/from the east via Solandt Road;
- 10% to/from the west via Terry Fox Drive;
- 5% to/from the west via Morgan’s Grant Way;
- 10% to/from the west via Innovation Drive.

All pass-by trips for the existing or proposed retail uses are assumed to occur on March Road, as it carries the majority of traffic volumes throughout the study area and acts as the primary arterial roadway through northern Kanata.

**3.1.3 Trip Assignment**

Existing Land Uses

The existing office building are accessed via one full-movement access to Terry Fox Drive and one RIRO access to March Road. The assumed trip assignment for the office use is summarized in **Table 18**.

**Table 18: Existing Office – Trip Assignment**

| Origin/Destination                    | March Road Access | Terry Fox Drive Access |
|---------------------------------------|-------------------|------------------------|
| to the north via March Road           | -                 | 100%                   |
| from the north via March Road         | 100%              | -                      |
| to the south via March Road           | 100%              | -                      |
| from the south via March Road         | -                 | 100%                   |
| to/from the north via Flamborough Way | -                 | 100%                   |
| to/from the east via Terry Fox Drive  | -                 | 100%                   |
| to/from the west via Terry Fox Drive  | -                 | 100%                   |

The existing retail plaza and athletic facility are accessed via the same two RIRO accesses to March Road. Based on the layout of these sites, all retail trips have been assigned to the northerly access (including all pass-by trips), and all athletic facility trips have been assigned to the southerly access. Based on the existing U-turn volumes at March Road/Terry Fox Drive and March Road/Solandt Road, it has been conservatively assumed that no trips travelling to/from the Subject Site perform a U-turn, and use other roadways within the Kanata Research Park. For example, inbound trips originating from the south via March Road or east via Solandt Road are assumed to travel on Legget Drive to Terry Fox Drive, and outbound trips destined to the north via Flamborough Way or west via Terry Fox Drive are assumed to travel on Solandt Road, Hines Road, and Innovation Drive.

Proposed Land Uses

The Subject Site is anticipated to include a full-movement access to March Road opposite the proposed signalized access to the Nokia development at 570-600 March Road (discussed further in Section 3.2.1), and full-movement accesses to Terry Fox Drive and Hines Road. In accordance with the previous section, all pass-by trips have been assigned to the proposed March Road access. All primary trips have been assigned to the proposed accesses as shown in **Table 19**.

**Table 19: Conceptual Development – Trip Assignment**

| Origin/Destination                         | March Road Access | Terry Fox Drive Access | Hines Road Access |
|--|-------------------|------------------------|-------------------|
| to/from the north via March Road           | 50%               | 50%                    | -                 |
| to/from the north via Flamborough Way      | -                 | 100%                   | -                 |
| to/from the south via March Road           | 100%              | -                      | -                 |
| to/from the east via Terry Fox Drive       | -                 | 100%                   | -                 |
| to/from the east via Shirley’s Brook Drive | 50%               | 50%                    | -                 |
| to/from the east via Solandt Road          | 100%              | -                      | -                 |
| to/from the west via Terry Fox Drive       | -                 | 100%                   | -                 |
| to/from the west via Morgan’s Grant Way    | 50%               | 50%                    | -                 |
| to/from the west via Innovation Drive      | -                 | -                      | 100%              |

**3.2 Background Traffic**

**3.2.1 Other Area Developments**

As first discussed in Section 2.2.2, there are multiple development applications for sites in proximity of the Subject Site that are under construction, approved, or in the approval process. Traffic generated by these developments have been accounted for as background traffic. Relevant excerpts for the transportation studies in support of each development listed below are included in **Appendix G**.

359 Terry Fox Drive and 525 Legget Drive

The proposed development includes 253 apartment dwellings and 3,877 ft<sup>2</sup> GFA of restaurant space, and the associated TIA identified a buildout year of 2024. Therefore, volumes generated by this development have been added to the 2037 background volumes.

570-600 March Road

The proposed redevelopment of the Nokia campus includes 1,900 residential dwellings, 46,000 m<sup>2</sup> of office space, and 11,350 m<sup>2</sup> of retail space. The TIA identified a buildout year of 2032. Therefore, the net additional volumes generated by this development have been added to the 2037 background volumes. To reflect the prevalence of ‘work from home’ or ‘hybrid work’ arrangements, the estimated vehicular volumes that are currently generated by the existing offices has been reduced by 40%. This assumption is based on the comparison of pre-pandemic and post-pandemic traffic counts on Solandt Road and Terry Fox Drive, which shows that 2022 volumes on these roadways have decreased by approximately 35% to 50%.

The development includes a signalized, full-movement access to March Road. While the exact location of this signalized access has not been determined, it has been assumed that this signal will be located at the southern limit of the Subject Site, so that both the Nokia redevelopment and this proposed development can use this signal.

*706-714 March Road*

The proposed development includes a 4,165 m<sup>2</sup> GFA supermarket, 350 m<sup>2</sup> GFA fast-food restaurant with drive-through, and 1,500 m<sup>2</sup> GFA of multi-unit commercial space. The associated TIA identified a buildout year of 2023. Therefore, volumes generated by this development have been added to the 2037 background volumes.

*788 March Road*

The proposed development includes 92 apartment dwellings, and the associated TIA identified a buildout year of 2023. Therefore, volumes generated by this development have been added to the 2037 background volumes.

*910 March Road*

The proposed development includes a 1,835 m<sup>2</sup> hardware store, a 234 m<sup>2</sup> restaurant with drive-through, a 191 m<sup>2</sup> coffee shop with drive-through, a 416 m<sup>2</sup> retail store, and a 249 m<sup>2</sup> gas bar. The associated TIA identified a buildout year of 2022. Therefore, volumes generated by this development have been added to the 2037 background volumes.

*1104 Halton Terrace*

The proposed development includes 86 apartment dwellings. As this did not meet the trip generation trigger, the TIA did not include a distribution of development-generated traffic to its study area. Therefore, volumes generated by this development have not been added to the 2037 background volumes.

*2700 Solandt Road and 415 Legget Drive*

The proposed development includes approximately 32,930 m<sup>2</sup> of new warehouse space. The associated TIA identified a buildout year of 2022. Therefore, volumes generated by this development have been added to the 2037 background volumes.

*2707 Solandt Road*

The proposed development includes an eight-storey, 198,615 ft<sup>2</sup> office building. While the associated TIA identified a buildout year of 2021, this development has not been built out. Therefore, volumes generated by this development have been added to the 2037 background volumes.

*3026 Solandt Road*

The proposed development includes a five-storey, 100,000 ft<sup>2</sup> office building. While the associated TIA identified a buildout year of 2021, this development has not been built out. Therefore, volumes generated by this development have been added to the 2037 background volumes.

*Kanata North Urban Expansion Area (KNUEA)*

The KNUEA TMP was prepared by Novatech in June 2016, and estimated that the development of the Kanata North lands has the potential to consist of 960 single-detached homes, 950 street townhomes, 1,040 multi-unit residential dwellings, 400,000 ft<sup>2</sup> GFA of commercial space, three elementary schools, one high school, and a 500-space park and ride. The TMP originally identified a buildout year of 2026. Therefore, volumes generated by this development have been added to the 2037 background volumes.

### 3.2.2 General Background Growth Rate

A review of the City's *Strategic Long-Range Model* (comparing snapshots of 2011 and 2031 AM peak hour volumes) and *2013 TMP* has been conducted. The snapshots are included in **Appendix H**. A review of the long-range snapshots estimate negligible growth in traffic volumes on March Road, and the magnitude of traffic volumes modelled on Terry Fox Drive and Innovation Drive are generally not large enough to estimate a consistent growth rate. Since background volumes from all of the other area developments listed above have been added to the study area volumes, an annual background growth rate has not been applied.

### 3.2.3 March Road BRT Corridor

The assumed existing transit modal shares within the study area follow the modal shares outlined in the Existing Conditions report of the *KNUEA TMP*. The TMP included a Transportation Area of Interest (TAI) screenline located immediately south of Terry Fox Drive between Second Line Road and March Valley Road, where person trips for vehicle and non-auto modes were estimated using observed traffic, transit rider, cyclist, and pedestrian volumes. Passenger volumes were estimated using a private vehicle occupancy of 1.2. This analysis was performed because the *KNUEA* is located at the boundary between the Kanata/Stittsville and Rural West regions as shown in the *2011 TRANS O-D Survey Report*.

The results of this exercise indicated that, at the TAI screenline, the existing transit share is 7% and 5% in the weekday AM and PM peak hours, respectively. Existing mode shares at the TAI screenline were not found to be reflective of the mode shares presented for the Kanata/Stittsville district, since the rapid transit stations within Kanata/Stittsville are centralized along Highway 417, which is approximately 4.5km south of the screenline. Conversely, the existing shares are more aligned with those presented for the Rural West district. As the TAI screenline was located immediately south of Terry Fox Drive, and is therefore located within the study area, the existing transit shares of 7% in the AM peak hour and 5% in the PM peak hour have been assumed for this study.

Exhibit 2.13 of the City's *2013 TMP* identifies a transit share target of 21% within the Kanata/Stittsville district by 2031. Within the study area, it is anticipated that the 21% transit share target will be achieved through the implementation of the planned RTTP projects on March Road, as described in Section 2.2.1. Consistent with the *KNUEA TMP*, a reduction in the background vehicular volumes has been made in the buildout year 2037, to reflect the 21% transit share target and the planned implementation of transit priority measures on March Road.

A functional design of median BRT lanes on March Road was included as part of the *West Transitway Connection EPR*, prepared by Delcan in October 2013. The relevant pages of the functional design are included in **Appendix I**.

### 3.2.4 Diverted/Cut-Through Traffic

It is assumed that the proposed subdivision will create the potential for diverted or cut-through traffic on the east-west public street, using the proposed signalized intersection to March Road. A proportion of background volumes on the following routes have been re-routed through the subject site for the 2037 total traffic scenario:

- 50% of the northbound and southbound through volumes at Hines Road/Innovation Drive have been re-routed to travel through the Subject Site rather than on Hines Road;
- 10% of the northbound right turn, southbound left turn, eastbound through, westbound left turn, westbound through, and westbound right turn volumes at March Road/Solandt Road have been re-routed to perform those movements at March Road/Nokia Access/E-W Street instead.

### 3.3 Volume Figures

The figures below present the following traffic conditions:

- Existing site-generated traffic volumes are shown in **Figure 8**;
- Proposed site-generated traffic volumes are shown in **Figure 9**;
- Net site-generated traffic volumes are shown in **Figure 10**;
- Other area development-generated traffic volumes in 2037 are shown in **Figure 11**;
- Background traffic volumes in 2037 are shown in **Figure 12**;
- Diverted traffic volumes in 2037 are shown in **Figure 13**;
- Total traffic volumes in 2037 are shown in **Figure 14**.

### 3.4 Demand Rationalization

A review of the existing and background intersection operations has been conducted to determine where traffic volumes exceed capacity within the study area. The intersection parameters used in the analysis are consistent with the *2017 TIA Guidelines* (Saturated Flow Rate: 1,800 vphpl, Peak Hour Factor: 0.9 in existing conditions and 1.0 in future conditions). Per Exhibit 22 of the *Multi-Modal Level of Service (MMLoS) Guidelines*, the target vehicular level of service (Auto LOS) at all study area intersections is an Auto LOS D in existing conditions. This equates to a vehicle-to-capacity (v/c) ratio of 0.90 at signalized intersections, and a maximum delay of 35 seconds at unsignalized intersections. In future conditions, the *MMLoS Guidelines* identify a target Auto LOS E for March Road/Solandt Road and March Road/Nokia Access, as the 2031 Affordable Network identifies a future transit station within 600m of these intersections. Signal timing plans have been obtained from the City, and are included in **Appendix J**.

Figure 8: Existing Site-Generated Volumes

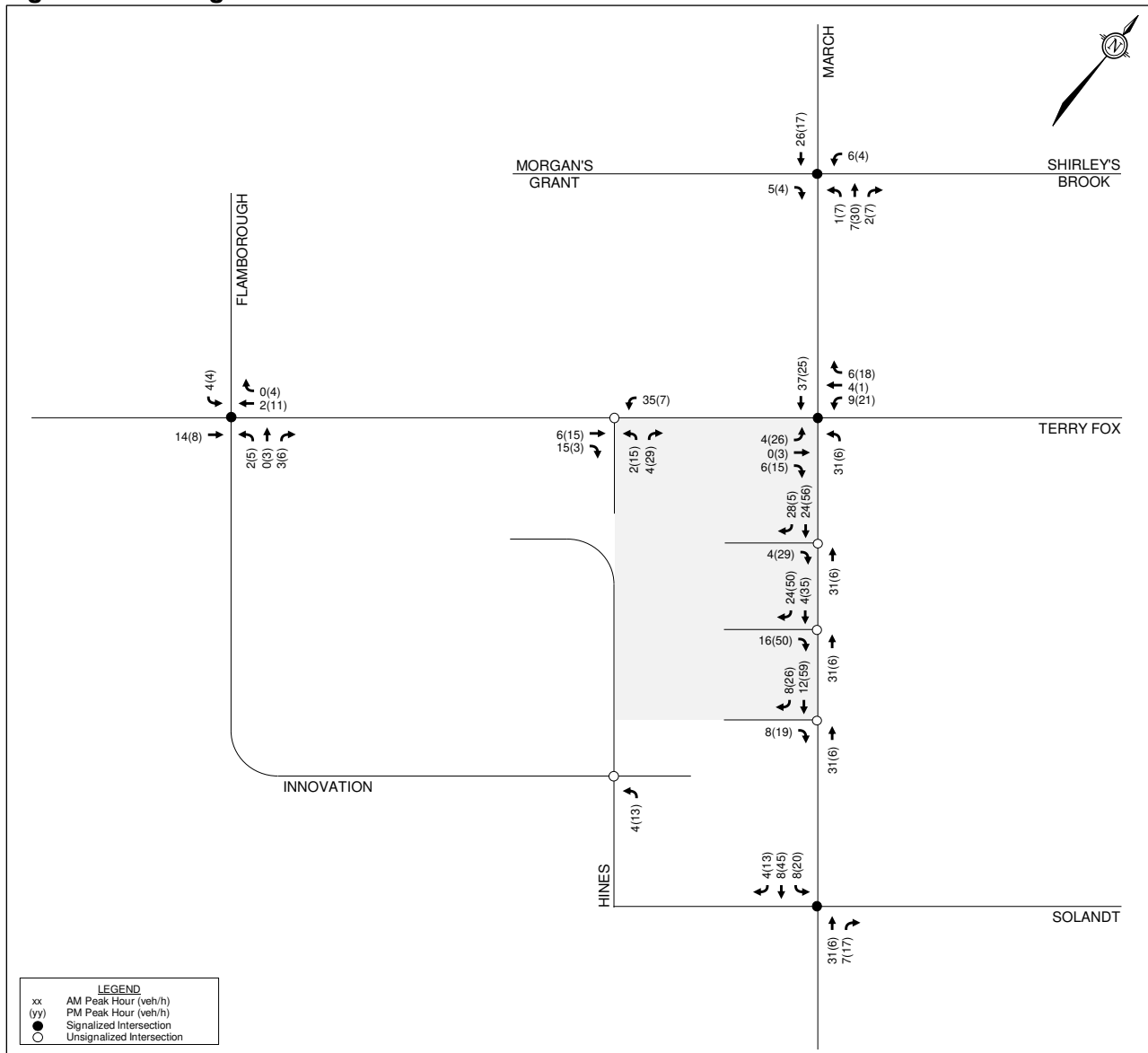



Figure 9: Proposed Site-Generated Volumes

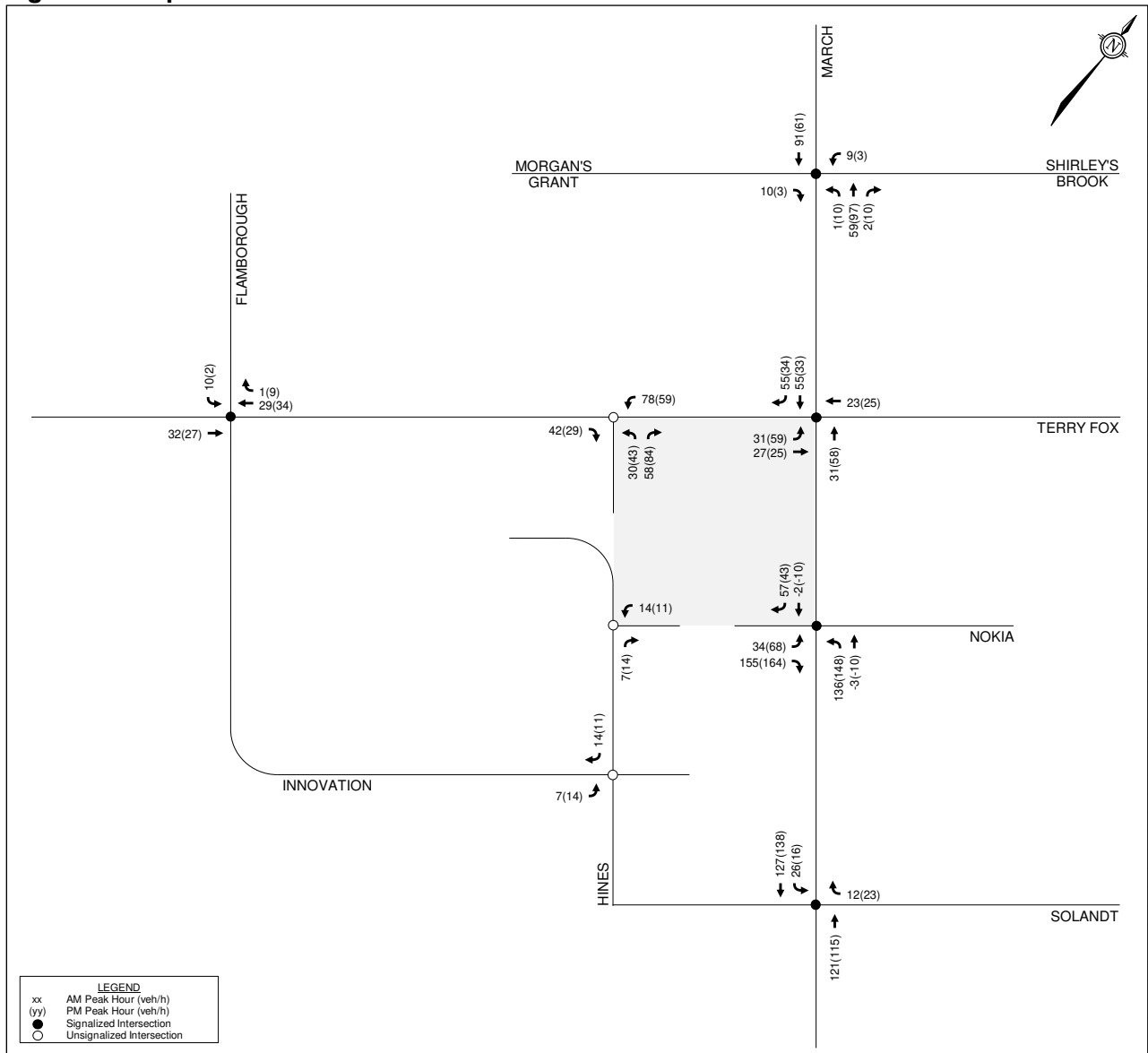

Figure 10: Net Site-Generated Volumes

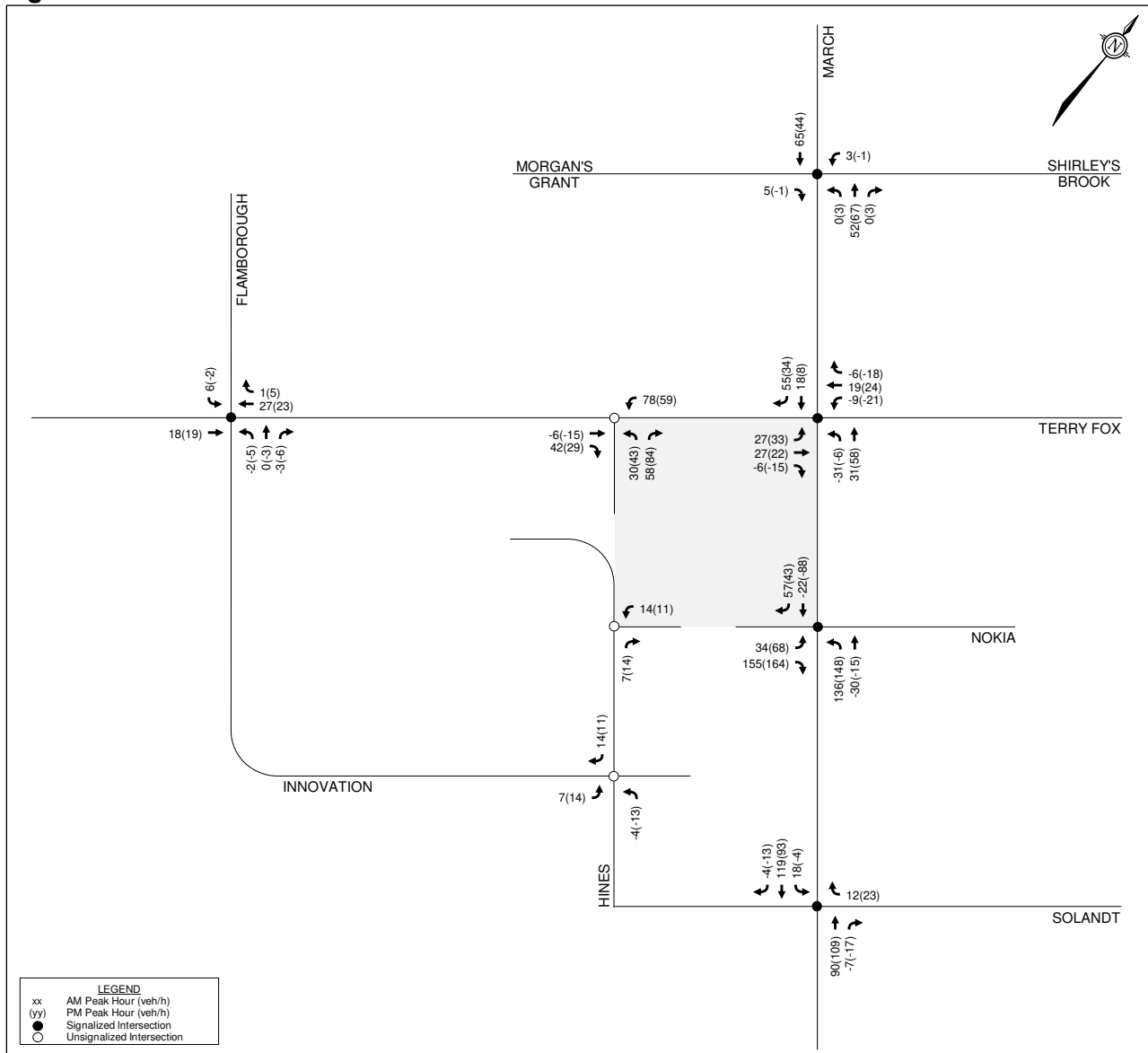

Figure 11: Other Area Development-Generated Volumes

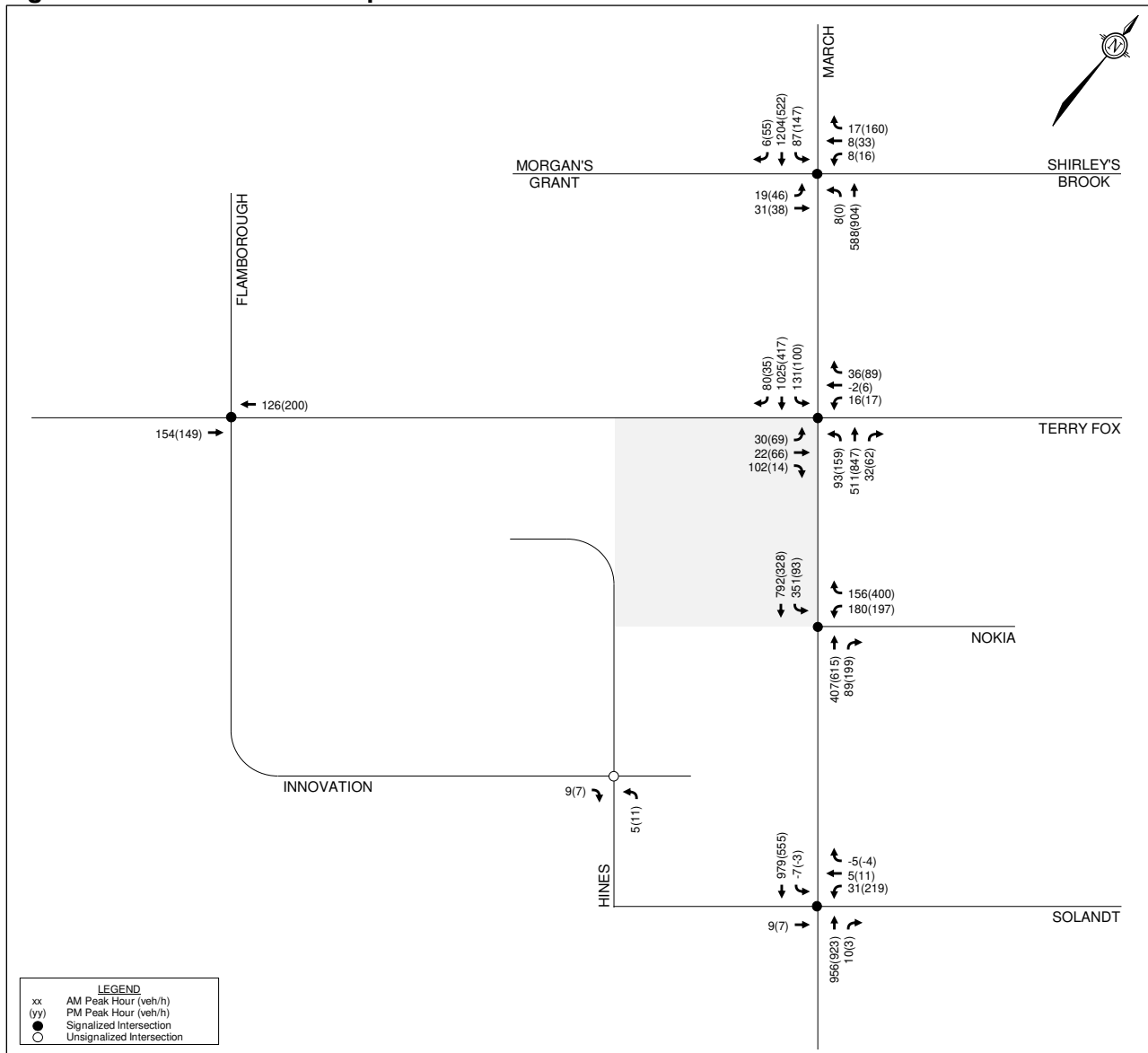

Figure 12: 2037 Background Volumes

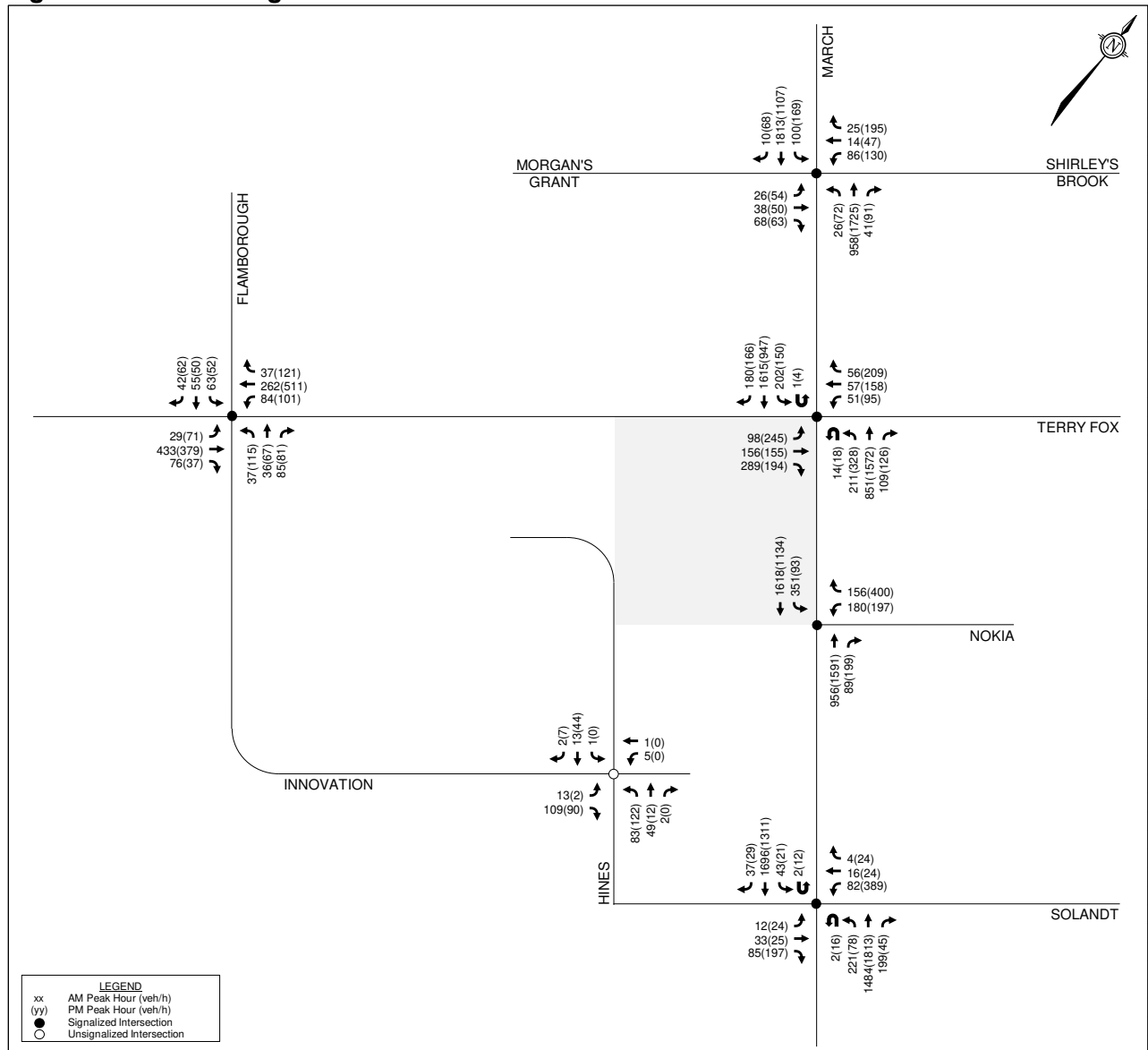

Figure 13: 2037 Diverted Volumes

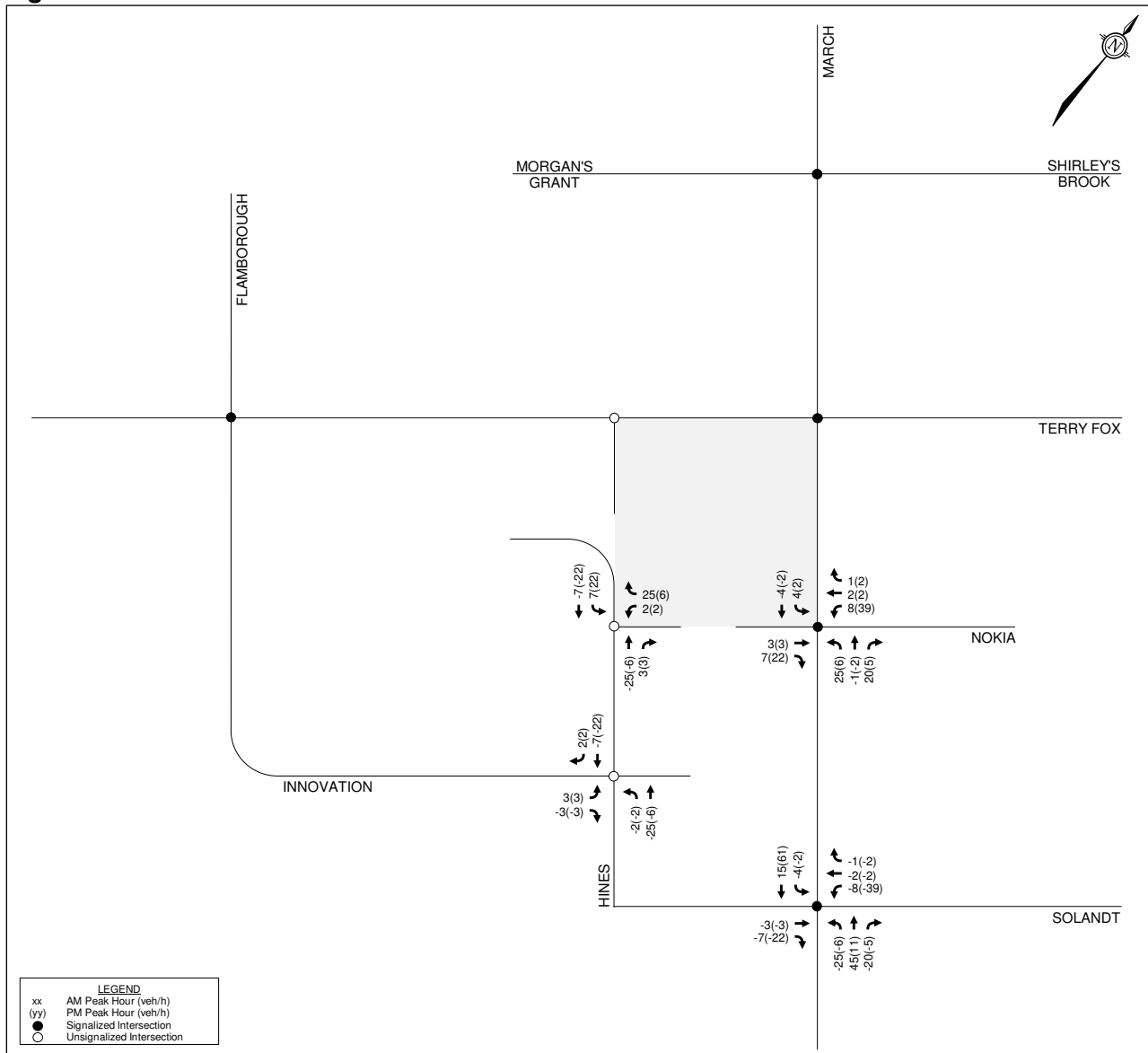
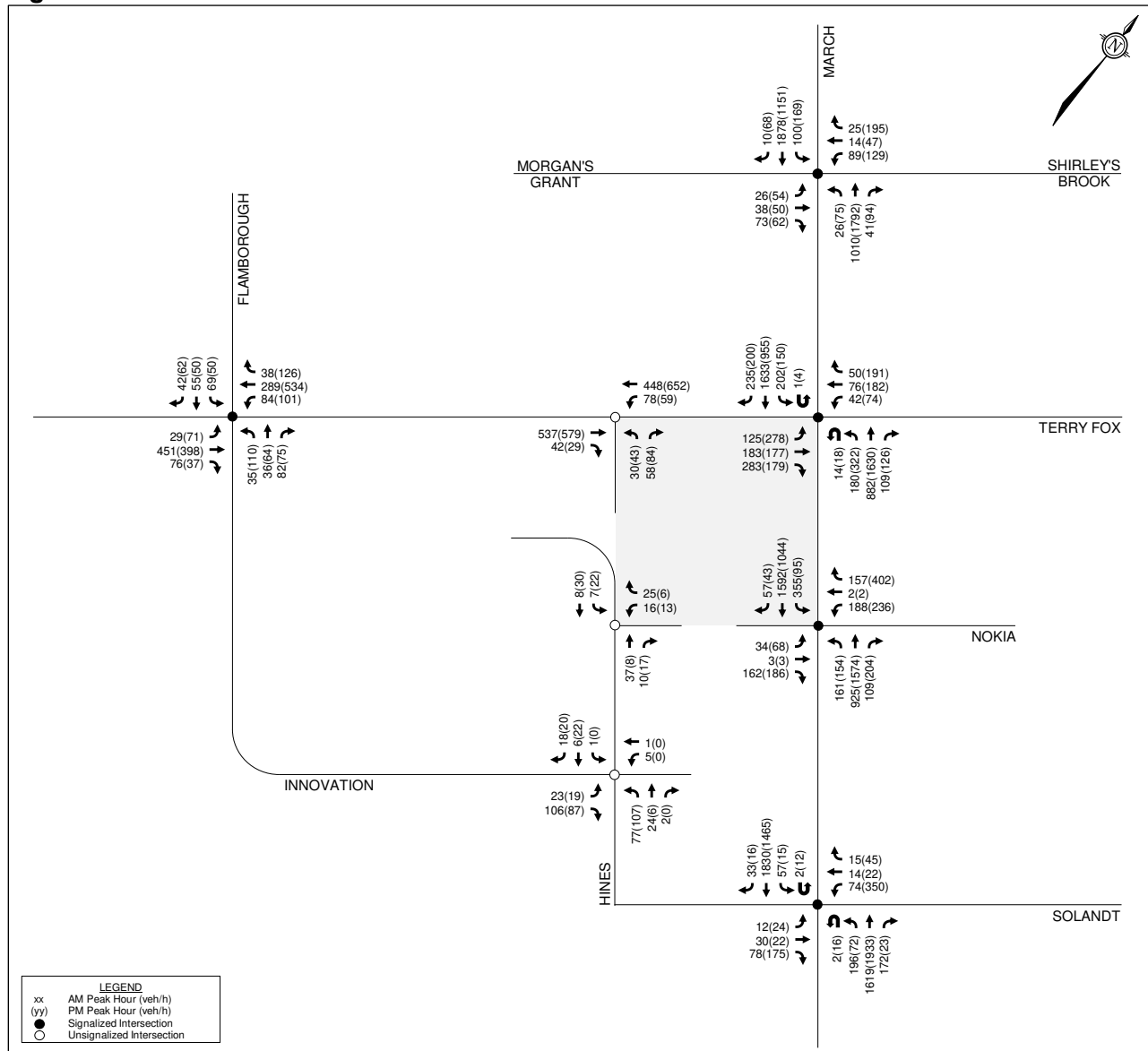

Figure 14: 2037 Total Volumes



### 3.4.1 Existing Traffic Conditions

Intersection capacity analysis has been conducted for the existing traffic conditions. The results of the analysis are summarized in **Table 20** for the weekday AM and PM peak hours. Detailed reports are included in **Appendix K**.

**Table 20: Existing Traffic Operations**

| Intersection   | Period | Critical Movements |     |      | Intersection |        |     |
|--|--------|--------------------|-----|------|--------------|--------|-----|
|  |        | Max v/c or Delay   | LOS | Mvmt | v/c          | Delay  | LOS |
| March Road/Morgan’s Grant Way/Shirley’s Brook Drive <sup>(1)</sup> | AM     | 0.60               | A   | WBL  | 0.28         | 14 sec | A   |
|  | PM     | 0.73               | C   | WBL  | 0.31         | 16 sec | A   |
| March Road/Terry Fox Drive <sup>(1)</sup>                          | AM     | 0.62               | B   | EBR  | 0.36         | 28 sec | A   |
|  | PM     | 0.69               | B   | NBL  | 0.48         | 32 sec | A   |
| March Road/Solandt Road <sup>(1)</sup>                             | AM     | 0.64               | B   | NBL  | 0.56         | 14 sec | A   |
|  | PM     | 0.80               | C   | EBR  | 0.64         | 24 sec | B   |
| Terry Fox Drive/Flamborough Way/Innovation Drive <sup>(1)</sup>    | AM     | 0.73               | C   | SBL  | 0.40         | 21 sec | A   |
|  | PM     | 0.86               | D   | NBL  | 0.46         | 23 sec | A   |
| Innovation Drive/Hines Road <sup>(2)</sup>                         | AM     | 13 sec             | B   | WB   | -            |        |     |
|  | PM     | 9 sec              | A   | EB   |              |        |     |

- 1. Signalized intersection
- 2. Unsignalized intersection

From the previous table, all study area intersections operate at an acceptable level of service during the AM and PM peak hours.

### 3.4.2 2037 Background Traffic Conditions

Intersection capacity analysis has been conducted for the 2037 background traffic conditions. A reduction in the background vehicular volumes has been applied to reflect a higher transit modal share as a result of rapid transit and transit priority measures that will be implemented on March Road. Within the study area and the City’s Affordable Network, median bus lanes are anticipated on March Road at Solandt Road, and transit priority measures are anticipated on March Road north of Solandt Road. Therefore, the intersection geometry at March Road/Solandt Road and the signal timings at March Road/Morgan’s Grant Way/Shirley’s Brook Drive, March Road/Terry Fox Drive, and March Road/Solandt Road have been adjusted to reflect these measures. Other parameters have also been adjusted, consistent with the transportation assessments conducted by Delcan as part of the *West Transitway Connection* EPR. It should be noted that the transportation assessments evaluated the transitway alternatives based on person travel time rather than vehicular level of service.

Adjustments to the March Road/Morgan’s Grant Way/Shirley’s Brook Drive and March Road/Terry Fox Drive intersections are summarized as follows:

- Reduction of speed limit on March Road from 80 km/h to 60 km/h;
- Amber plus all-red timings adjusted to reflect increased clearance requirements and changes in the speed limit on March Road;
- Cycle length maintained at 130 seconds, but with splits and offsets optimized.

Adjustments to the March Road/Solandt Road intersection are summarized as follows:

- Adjustments to all right turn curb radii and turn lane lengths as required;
- Removal of the existing northbound right turn lane, southbound right turn lane, and one of the westbound left turn lanes;
- Addition of one auxiliary westbound right turn lane;
- Reduction of speed limit on March Road from 80 km/h to 60 km/h;
- Minimum pedestrian crossing times for eastbound/westbound pedestrians consistent with a two-stage crossing;
- Northbound/southbound left turn phases adjusted to become fully protected;
- Eastbound left turn phase adjusted to become permitted (no fully protected phase);
- Westbound left turn phase adjusted to become permitted during AM peak hour and protected plus permitted during PM peak hour (no fully protected phase);
- Amber plus all-red timings adjusted to reflect increased clearance requirements and changes in the speed limit on March Road;
- Cycle length maintained at 130 seconds, but with splits and offsets optimized.

A screenshot of the geometric changes to March Road/Solandt Road is included in **Figure 15**.

**Figure 15: Planned Modifications to March Road/Solandt Road**

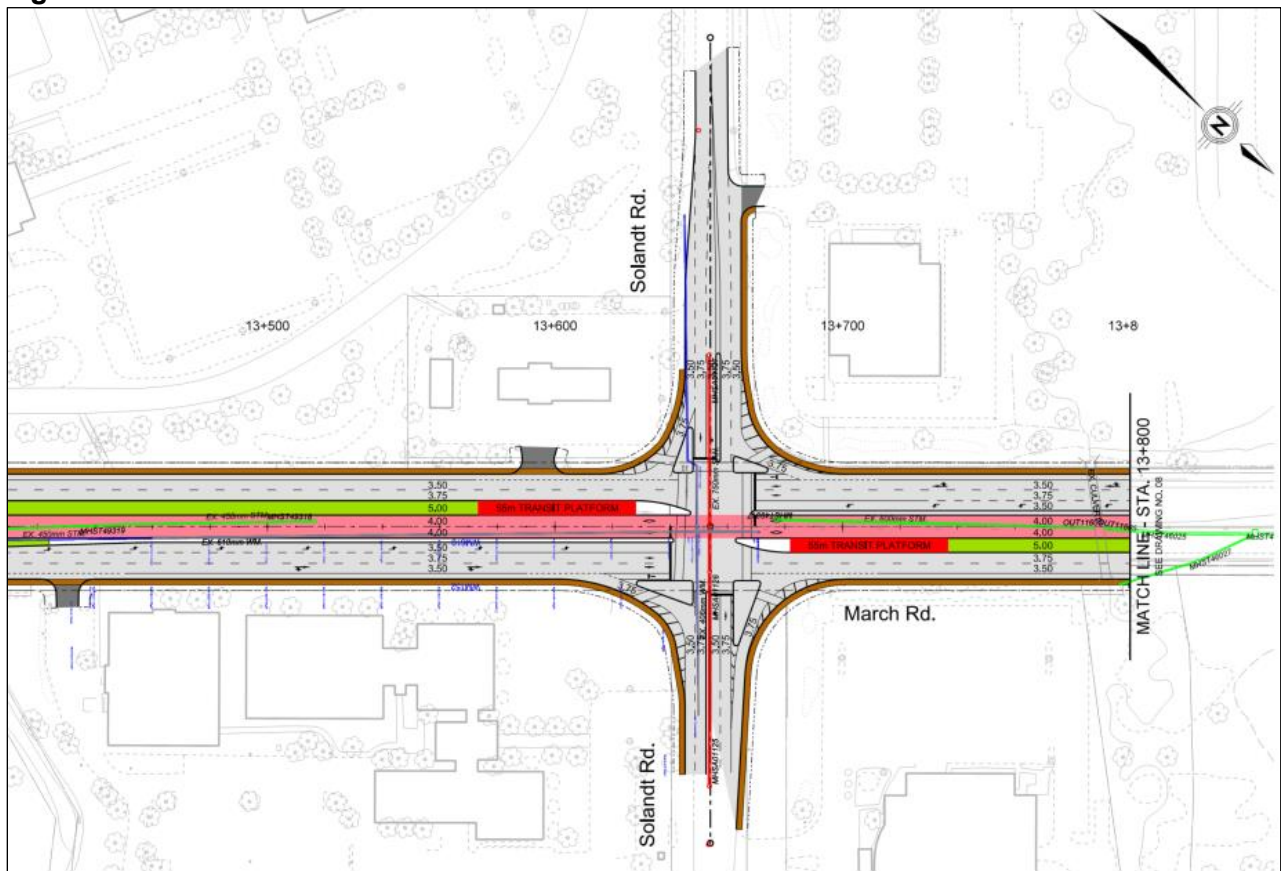



Analysis of the 2037 background volumes also includes the future signalized intersection at 570-600 March Road (referred to as March Road/Nokia Access). As the intersection is approximately located where three southbound lanes on March Road reduce to two, the location of this reduction has been shifted further south for the purposes of the Synchro analysis. This assumption is carried forward for the total traffic analysis as well (i.e. the southbound approach of this intersection will include one left turn lane into the Nokia development, two through lanes, and one shared through/right turn lane into the Subject Site).

The results of the analysis are summarized in **Table 21** and **Table 22** for the weekday AM and PM peak hours. Detailed reports are included in **Appendix L**.

**Table 21: 2037 Background Traffic Operations**

| Intersection   | Period | Critical Movements |          |            | Intersection |               |          |
|--|--------|--------------------|----------|------------|--------------|---------------|----------|
|  |        | Max v/c or Delay   | LOS      | Mvmt       | v/c          | Delay         | LOS      |
| March Road/Morgan's Grant Way/Shirley's Brook Drive <sup>(1)</sup> | AM     | 0.60               | A        | SBL        | 0.38         | 14 sec        | A        |
|  | PM     | 0.74               | C        | SBL        | 0.65         | 33 sec        | B        |
| March Road/Terry Fox Drive <sup>(1)</sup>                          | AM     | 0.78               | C        | SBL        | 0.64         | 35 sec        | B        |
|  | PM     | 0.85               | D        | EBL        | 0.74         | 38 sec        | C        |
| March Road/Solandt Road <sup>(1)</sup>                             | AM     | 1.00               | E        | SBT/R      | 0.93         | 30 sec        | E        |
|  | PM     | <b>1.65</b>        | <b>F</b> | <b>WBL</b> | <b>1.02</b>  | <b>61 sec</b> | <b>F</b> |
| Terry Fox Drive/Flamborough Way/Innovation Drive <sup>(1)</sup>    | AM     | 0.51               | A        | SBL        | 0.37         | 18 sec        | A        |
|  | PM     | 0.72               | C        | NBL        | 0.44         | 24 sec        | A        |
| Innovation Drive/Hines Road <sup>(2)</sup>                         | AM     | 12 sec             | B        | WB         | -            |               |          |
|  | PM     | 9 sec              | A        | EB         |              |               |          |
| March Road/Nokia Access <sup>(1)</sup>                             | AM     | 0.72               | C        | WBL        | 0.61         | 14 sec        | B        |
|  | PM     | 0.87               | D        | WBR        | 0.89         | 36 sec        | D        |

- 1. Signalized intersection
- 2. Unsignalized intersection

**Table 22: 2037 Background – Critical Queues**

| Intersection            | Mvmt  | Storage/ Spacing <sup>(1)</sup> | AM Peak   |                              |                              | PM Peak         |                              |                              |
|-------------------------|-------|---------------------------------|-----------|------------------------------|------------------------------|-----------------|------------------------------|------------------------------|
|                         |       |                                 | v/c [LOS] | 50 <sup>th</sup> % Queue (m) | 95 <sup>th</sup> % Queue (m) | v/c [LOS]       | 50 <sup>th</sup> % Queue (m) | 95 <sup>th</sup> % Queue (m) |
| March Road/Solandt Road | NBL   | 165m                            | 0.69 [B]  | 49                           | #105                         | 0.59 [A]        | 21                           | #52                          |
|                         | NBT/R | 200m                            | 0.76 [C]  | 129                          | 213                          | 0.91 [E]        | 199                          | #316                         |
|                         | SBT/R | 520m                            | 1.00 [E]  | 222                          | #268                         | 0.76 [C]        | 63                           | 137                          |
|                         | WBL   | 135m                            | 0.53 [A]  | 19                           | 30                           | <b>1.65 [F]</b> | <b>~140</b>                  | <b>#164</b>                  |
| March Road/Nokia Access | SBL   | TBC <sup>(2)</sup>              | 0.72 [B]  | 28                           | 24                           | 0.62 [B]        | 14                           | m#36                         |
|                         | WBL   |                                 | 0.69 [B]  | 41                           | 57                           | 0.47 [A]        | 39                           | 56                           |

- 1: Indicates the storage length for auxiliary lanes or the spacing to the nearest upstream intersection/access for through lanes
- 2. Storage requirements for SBL and WBL movements to be confirmed as part of the intersection design being undertaken by Nokia
- #: Volume for the 95<sup>th</sup> percentile cycle exceeds capacity
- m: Queue is metered by an upstream signal
- ~: Approach is above capacity

From the previous tables, critical movements at the study area intersections generally operate at an acceptable level of service, with the exception of the westbound left turn movement at March Road/Solandt Road during the PM peak hour. Per the functional design of the March Road BRT, one of the westbound left turn lanes will be removed. It is anticipated that this is the primary driver for the failing vehicular level of service of this movement.

Analysis of an alternate scenario has been conducted, where dual westbound left turn lanes at March Road/Solandt Road are maintained, with a fully protected left turn phase. Detailed Synchro reports of this scenario are included in **Appendix L**. A comparison of the northbound through/right turn, southbound through/right turn, and westbound left turn movements in both scenarios is provided below:

- AM Peak Hour
  - Northbound through/right turn: v/c downgrades from 0.76 to 0.85 (Auto LOS D);
  - Southbound through/right turn: v/c downgrades from 1.00 to 1.07 (Auto LOS F);
  - Westbound left turn: v/c downgrades from 0.53 to 0.68 (Auto LOS B).
- PM Peak Hour
  - Northbound through/right turn: v/c downgrades from 0.91 to 1.03 (Auto LOS F);
  - Southbound through/right turn: v/c downgrades from 0.76 to 0.87 (Auto LOS D);
  - Westbound left turn: v/c improves from 1.65 to 0.97 (Auto LOS E).

Given the level of improvement for the westbound left turn movement during the PM peak hour, it is recommended that the dual westbound left turns remain at March Road/Solandt Road after the median BRT is implemented. Therefore, this recommendation has been carried forward to the 2037 total traffic analysis.

The movements that are operating at an Auto LOS F above would require the following volume reductions to achieve the target Auto LOS E:

- AM Peak Hour
  - Southbound through/right turn (v/c: 1.07): approximately 110 vehicles required.
- PM Peak Hour
  - Northbound through/right turn (v/c: 1.03): approximately 45 vehicles required.

Detailed Synchro reports with these reductions applied is also included in **Appendix L**.

## 4.0 ANALYSIS

### 4.1 Development Design

#### 4.1.1 Design for Sustainable Modes

Based on the proposed concept plan, it is anticipated that sidewalks will be provided on both sides of the proposed east-west public street (connecting March Road and Hines Road), and on both sides of the proposed north-south private street (connecting Terry Fox Drive and the east-west public street). Cycle tracks are proposed on both sides of the proposed east-west public street. The cross-sections of these two roadways are described further in Section 4.1.3. Subsequent Site Plan Control applications will confirm the location of on-site pedestrian walkways leading to each proposed building and the location of future private roads/woonerfs. The Site Plan applications will also confirm the locations of surface and interior bicycle parking spaces at each phase.

OC Transpo's service design guideline for peak period service is to provide service within a five-minute (400m) walk of home, work, or school for 95% of urban residents. All proposed blocks on the Draft Plan are anticipated to be within a five-minute walk of one or more existing transit stops on March Road or Terry Fox Drive (shown in **Figure 4**). It is anticipated that some blocks will be located beyond 400m walking distance to future median BRT stops at March Road/Terry Fox Drive.

A review of the *Transportation Demand Management (TDM)-Supportive Development Design and Infrastructure Checklist* will be conducted in subsequent Site Plan Control applications.

**4.1.2 Circulation and Access**

The *2023 Revisions to the TIA Guidelines* identify that this element of the Development Design module is required for Site Plan Control and Zoning By-Law Amendment applications. Therefore, this element is exempt, as this TIA has been prepared in support of a Draft Plan of Subdivision application. This element will be reviewed as part of subsequent Site Plan Control applications, in support of each phase of the proposed subdivision.

**4.1.3 New Street Networks**

This section reviews the proposed east-west public street and north-south private street. All other internal private streets/woonerfs will be private approaches to the different phases, and will therefore be evaluated in subsequent Site Plan Control applications in support of each phase.

East-West Public Street (March Road to Hines Road)

Based on the 2037 total traffic volumes shown in **Figure 14**, the east-west public street will have a two-way AADT of approximately 4,560 vpd at ultimate buildout (estimated by multiplying the PM peak hour volumes by ten). The Transportation Association of Canada (TAC)’s *Geometric Design Guide for Canadian Roads* includes the Characteristics of Urban Roads table (Table 2.6.5), which identifies that the proposed east-west street will have characteristics that are most consistent with a residential collector roadway, rather than a residential local roadway. A comparison of the typical characteristics of residential local and collector roadways, along with the characteristics of the east-west street is included in **Table 23**.

**Table 23: Comparison of Roadway Classifications**

| Characteristic        | Residential Local         | Residential Collector         | East-West Street                              |
|-----------------------|---------------------------|-------------------------------|---|
| Daily Traffic Volume  | Less than 1,000 vpd       | 1,000 to 8,000 vpd            | Approx. 4,560 vpd                             |
| Desirable Connections | Lanes, locals, collectors | Locals, collectors, arterials | Collector (Hines Road), arterial (March Road) |

In the City’s Official Plan, Policy 5 of Section 4.1.3 identifies that, ‘An amendment to this Plan is required when an Arterial or City Highway is added to Schedules C4, C5, C7, and C8, but not when either is deleted. An amendment to this Plan shall not be required to add or delete Collectors or Major Collectors.’ Therefore, an Official Plan Amendment is not required to add the proposed east-west public street to the roadway network, and can be added as part of this Draft Plan of Subdivision application.

As the characteristics of the east-west public road are similar to a collector roadway, a 26m ROW is proposed in accordance with Table 1 of Schedule C16 in the City’s Official Plan. The proposed cross-section of the east-west public street has been developed based on the City’s *2019 Designing Neighbourhood Collector Streets* document, and is consistent with the Pre-Vetted Option 26D. The street will include a pavement width of 11.0m, which allows for a travel lane and a parking lane in each direction. Periodic bulbouts will narrow the street to reduce the operating speed and clearly identify where on-street parking is provided. Per the Pre-Vetted Option 26D, a 2.0m-wide sidewalk and 2.0m-wide cycle track is proposed on both sides of the roadway. The proposed cross-section of the east-west public street is included in **Appendix M**.

### North-South Private Street (Terry Fox Drive to East-West Street)

The proposed cross-section of the north-south private street will include a ROW width of 18m and a pavement width of 8.5m, which allows for a travel lane in each direction and a parking lane in one direction. The 18m ROW and 8.5m roadway platform are most consistent with local roadways throughout the City of Ottawa. A sidewalk with a 2.0m width is proposed on both sides of the roadway, with 2.75m-wide boulevards separating the sidewalk from the roadway on each side. These 2.75m-wide boulevards are anticipated to include planters or flex/patio spaces. Periodic bulbouts will narrow the street to reduce operating speed and clearly identify where on-street parking is provided. The proposed cross-section of the east-west public street is included in **Appendix M**.

The proposed subdivision, including the proposed streets, have been designed to meet the following strategic directions of the City's *Building Better and Smarter Suburbs (BBSS): Strategic Directions and Action Plan*, prepared in February 2015:

- Design the street network as an integral part and extension of the municipal grid, taking into consideration its future adjustments and evolution;
- Design the street network in conjunction with the land use and open space system to ensure direct pedestrian and cycling connectivity to key destination in the community (schools, shops, bus stops and stations, etc.);
- Ensure that a range of appropriately sized roadways complements the character and functional needs of each community area;
- Implement traffic calming measures at the outset of road design for local and collector streets;
- Provide flexibility in zoning to accommodate a mix of land uses within a community, such as areas that allow live-work units or local commercial land uses.

## 4.2 Parking

The *2023 Revisions to the TIA Guidelines* identify that this element of the Development Design module is required for Site Plan Control and Zoning By-Law Amendment applications. Therefore, this element is exempt, as this TIA has been prepared in support of a Draft Plan of Subdivision application. The Parking module will be reviewed as part of subsequent Site Plan Control applications.

## 4.3 Boundary Streets

This section provides a review of the boundary streets March Road, Terry Fox Drive, and Hines Road, using complete streets principles. The *MMLOS Guidelines*, produced by IBI Group in October 2015, were used to evaluate the levels of service for each alternative mode of transportation on the boundary streets. The boundary streets review has been conducted for March Road, Terry Fox Drive, and Hines Road, based on existing conditions.

March Road and Hines Road have been evaluated based on the targets for the Employment Area, per Exhibit 22 of the *MMLOS Guidelines*. Terry Fox Drive has been evaluated based on the targets for the General Urban Area or Employment Area, whichever target is stricter. A detailed MMLOS review of the boundary streets is **Appendix N**. A summary of the segment MMLOS results for March Road, Terry Fox Drive, and Hines Road is provided in **Table 24**.

**Table 24: Segment MMLOS Summary**

| Segment         | PLOS   |        | BLOS   |        | TLOS   |        | TkLOS  |        |
|-----------------|--------|--------|--------|--------|--------|--------|--------|--------|
|                 | Actual | Target | Actual | Target | Actual | Target | Actual | Target |
| March Road      | D      | C      | E      | C      | D      | B      | A      | B      |
| Terry Fox Drive | F      |        | E      | B      | D      | -      | B      |        |
| Hines Road      | F      |        | F      | C      | -      | -      | B      | D      |

The results of the segment MMLOS analysis can be summarized as follows:

- No boundary streets meet the target pedestrian level of service (PLOS) C;
- No boundary streets meet the target bicycle level of service (BLOS) B or C;
- March Road does not meet the target transit level of service (TLOS) B;
- All boundary streets meet the target truck level of service (TkLOS) B or D.

March Road, between Terry Fox Drive and Solandt Road

March Road does not achieve the target PLOS C, BLOS C, or TLOS B.

Per Exhibit 4 of the *MMLOS Guidelines*, March Road achieves the best-possible PLOS D by providing sidewalks with a minimum width of 2.0m and minimum boulevard width of 2.0m. To achieve the target PLOS C, a reduced operating speed of 60 km/h is required.

Per Exhibit 11 of the *MMLOS Guidelines*, March Road can only achieve the target BLOS B through the implementation of physically separated bikeways (such as multi-use pathways or cycle tracks), due to the high operating speed. As part of the City’s future conversion of March Road to median BRT north of Solandt Road, cycle tracks are anticipated to be provided.

Per Exhibit 15 of the *MMLOS Guidelines*, March Road can achieve the target TLOS B through the implementation of bus lanes with no/limited parking and driveway friction. The City’s RTTP Affordable Network includes at-grade median BRT on March Road south of Solandt Road, and transit signal priority and queue jump lanes north of Solandt Road. Future conversion to median BRT along the entire March Road corridor, including at the subject site, is anticipated to meet the target TLOS.

Terry Fox Drive, between March Road and Flamborough Way/Innovation Drive

Terry Fox Drive does not achieve the target PLOS C or BLOS B.

Per Exhibit 4 of the *MMLOS Guidelines*, Terry Fox Drive achieves the best-possible PLOS D on the south side, where a 3.0m multi-use pathway (MUP) with boulevard widths greater than 2.0m is provided. The north side of Terry Fox Drive does not generally provide any pedestrian facilities, and a PLOS D can be achieved by implementing sidewalks with a minimum width of 2.0m and minimum boulevard width of 2.0m. This is identified for the City’s consideration.

Per Exhibit 11 of the *MMLOS Guidelines*, Terry Fox Drive achieves a BLOS A on the south side, where a 3.0m MUP is provided. The north side of Terry Fox Drive achieves a BLOS E with the existing on-street bike lane, due to the high operating speed. The target BLOS C can be achieved by implementing a physically separated bikeway, or reducing the operating speed to 60 km/h. This is identified for the City’s consideration.

### Hines Road, north of Innovation Drive

Hines Road does not achieve the target PLOS C or BLOS C.

No pedestrian facilities are provided on Hines Road at the subject site, and a 1.8m-wide sidewalk with no boulevard is provided on the west side of Hines Road (south of the subject site). The 1.8m-wide sidewalk south of the site achieves a PLOS C. Therefore, the extension of additional sidewalks with a minimum width of 1.8m on both sides of Hines Road adjacent to the site would achieve the area target. This is identified for the City's consideration.

Per Exhibit 11 of the *MMLOS Guidelines*, Hines Road can achieve the target BLOS C by reducing the operating speed to 50 km/h.

## **4.4 Access Intersections**

This module evaluates the parameters of the proposed connections of the east-west public street to March Road and Hines Road, and the proposed connections of the north-south private street to Terry Fox Drive and the east-west street.

### **4.4.1 Proposed March Road Intersection**

The proposed signalized intersection at March Road/Nokia Access/E-W Street will have the following lane configuration for each approach:

- Northbound Approach (March Road):  
one left turn lane, two through lanes, and one right turn lane;
- Southbound Approach (March Road):  
one left turn lane, two through lanes, and one shared through/right turn lane;
- Eastbound Approach (E-W Street):  
one left turn lane and one shared through/right turn lane;
- Westbound Approach (Nokia Access):  
one left turn lane and one shared through/right turn lane.

Discussion of the northbound left turn lane and eastbound left turn lane storage length requirements are included in Section 4.9.2. These lanes represent the auxiliary lanes to accommodate left turns in and out of the subject site.

As of writing, a functional design of the new proposed signal at March Road/Nokia Access/E-W Street is being prepared by others, as part of the Nokia development application at 570-600 March Road. The functional design is being coordinated to properly address the requirements of both Nokia's site and March & Main's site. A Roadway Modification Approval (RMA) report for the proposed intersection will also be submitted by others, as part of the development application for the Nokia lands. The timing of when the E-W Street shall form the fourth leg of the March Road/Nokia Access intersection will be evaluated as each Site Plan application is submitted. It is not anticipated to be required as part of the first phase.

The new intersection is anticipated to be a fully protected intersection, constructed to City of Ottawa standards. As a fully-protected intersection, the new intersection is anticipated to achieve the following multi-modal levels of service.

- PLOS F, due to the crossing distance for pedestrians along March Road;
- BLOS A, as each approach will accommodate left and right turns for cyclists outside of the roadway platform;
- TLOS E, as the north and south approaches are anticipated to operate with approximately 15 to 40 seconds of delay during the peak hours;
- TkLOS A for trucks turning onto March Road, and TkLOS C for trucks turning onto the east-west street or Nokia access. Turning movements will be completed at all approaches to ensure the largest design vehicles can navigate the intersection safely.

The provision of isolated transit priority measures on March Road at the new intersection (such as queue jump lanes) can be considered as functional designs of the intersection are developed. Isolated measures like queue jump lanes could mitigate the delay for northbound and southbound transit vehicles, and would be consistent with the City's Affordable RTTP Network, which identifies isolated transit priority measures on March Road north of Solandt Road.

#### 4.4.2 Proposed Hines Road Intersection

The proposed intersection at Hines Road will be unsignalized, with stop control on the proposed east-west public street. The intersection will have the following lane configuration for each approach:

- Northbound Approach (Hines Road):  
one shared through/right turn lane;
- Southbound Approach (Hines Road):  
one shared left turn/through lane;
- Westbound Approach (E-W Street):  
one shared left turn/right turn lane.

Further details of the intersection configuration will be provided through the detailed subdivision engineering design.

#### 4.4.3 Proposed Terry Fox Drive Access

The proposed access to Terry Fox Drive is approximately 130m west of the March Road/Terry Fox Drive, measuring from the nearest edge of the north-south private street to the nearest edge of March Road. For access to an arterial roadway, TAC's *Geometric Design Guide* identifies a minimum corner clearance of 70m between the nearest edge of a driveway and the nearest edge of an intersecting street, when the intersection is signalized. Therefore, the minimum corner clearance requirement is met.

Based on the projected 2037 total traffic volumes shown in **Figure 14**, it is anticipated that an auxiliary westbound left turn lane will be required at the proposed access to Terry Fox Drive. A review of the most relevant left turn lane storage graphs included in the Ministry of Transportation of Ontario (MTO)'s *Design Supplement to TAC's Geometric Design Guide for Canadian Roads* has been conducted to determine the storage length required. For the proposed Terry Fox Drive access, the most relevant graphs are Exhibit 9A-10 and 9A-11, which are used for roadways with a design speed of 70km/h.

During the AM peak hour, the westbound left-turning volume is approximately 15% of the total advancing volume (corresponding to Exhibit 9A-11). During the PM peak hour, the westbound left-turning volume is approximately 10% of the total advancing volume (corresponding to Exhibit 9A-10). In both exhibits, a storage length of 30m is required. These exhibits are included in **Appendix O**.

A functional design has been prepared by Novatech for the proposed auxiliary westbound left turn lane at the Terry Fox Drive access. The functional design is included in **Appendix P**. A RMA report in support of this modification has been submitted under separate cover.

An auxiliary westbound left turn lane with 30m of storage can be accommodated without impacting the eastbound left turn storage at March Road/Terry Fox Drive, by widening the existing median and shifting the alignment of the westbound lanes on Terry Fox Drive in front of the subject site. Section 4.9.2 includes peak hour intersection analysis in 2037 total traffic conditions, and identifies that the maximum eastbound left turn queue lengths at March Road/Terry Fox Drive are not anticipated to extend through the proposed access to Terry Fox Drive.

#### **4.4.4 Proposed Access to East-West Street**

The proposed north-south private street will connect to the east-west public street east of Hines Road, with separation distances of approximately 55m (when measuring nearest edge to nearest edge) and approximately 70 (when measuring centre to centre). For access to a collector roadway, TAC's *Geometric Design Guide* identifies a minimum corner clearance of 25m between the nearest edge of a driveway and the nearest edge of an intersecting street, when the intersection is unsignalized. The *Geometric Design Guide* identifies a minimum intersection spacing of 60m on collector roadways, measuring centre to centre. Both requirements are met by the proposed access location.

### **4.5 Transportation Demand Management**

#### **4.5.1 Context for TDM**

The exact number of proposed residential dwellings and GFAs for the proposed office and retail uses will be determined as part of subsequent Site Plan Control application(s). For the purposes of this TIA, the unit statistics outlined in the concept plan have been considered, which can be described as follows:

- 2,100 residential dwellings, which will include a mix of studio, one-bedroom, two-bedroom, and three-bedroom units;
- 154,178 ft<sup>2</sup> GFA of office space;
- 31,482 ft<sup>2</sup> GFA of retail space.

#### **4.5.2 Need and Opportunity**

The Subject Site is located within the 'Kanata North Economic District,' 'Evolving Neighbourhood' overlay, and is designated as 'Corridor – Mainstreet' (March Road) and 'Corridor – Minor' (Terry Fox Drive) on Schedule B5 of the City of Ottawa's Official Plan. As first discussed in Section 3.1.1, the assumed mode shares for the proposed subdivision are generally consistent with the surveyed residential, employment, and commercial mode shares of the Kanata/Stittsville district (as outlined in the *TRANS Trip Generation Manual*), with increased transit shares for the proposed office and retail uses.



The purpose of the proposed subdivision is to become an 'activity centre,' designed for residents or employees to live, work, learn, play, and access daily needs without a car. Therefore, it is anticipated that the assumed driver share target will not be exceeded. Additionally, bus rapid transit along March Road is identified as a future improvement for commuters and residents of Kanata North.

### 4.5.3 TDM Program

A review of the City's *TDM Measures Checklist* has been conducted by the proponent (included in **Appendix P**). While the final list of TDM measures to be implemented by the proposed subdivision will be confirmed as part of the Site Plan Control applications, the proponent has agreed to consider the following measures at this time:

#### Non-Residential

- 1.1.1 – Designate an internal coordinator, or contract with an external coordinator;
- 2.1.1 – Display local area maps with walking/cycling access routes and key destinations at major entrances;
- 3.1.1 – Display relevant transit schedules and route maps at entrances;
- 3.1.2 – Provide online links to OC Transpo and STO information;
- 4.1.1 – Provide a dedicated ridematching portal at OttawaRideMatch.com;
- 5.1.1 – Contract with provider to install on-site bikeshare station for use by commuters and visitors;
- 5.2.1 – Contact with provider to install on-site carshare vehicles and promote their use by tenants;
- 6.1.1 – Charge for long-term parking (daily, weekly, monthly);
- 6.1.3 – Charge for short-term parking (hourly);
- 7.1.1 – Provide a multimodal travel option information package to new/relocating employees and students;
- 8.2.1 – Encourage flex work hours;
- 8.3.1 – Provide local business travel options that minimize the need for employees to bring a personal car to work;
- 8.5.1 – Provide on-site amenities/services to minimize mid-day or mid-commute errands.

#### Residential

- 1.1.1 – Designate an internal coordinator, or contract with an external coordinator;
- 2.1.1 – Display local area maps with walking/cycling access routes and key destinations at major entrances;
- 3.1.1 – Display relevant transit schedules and route maps at entrances;
- 4.1.1 – Contract with provider to install on-site bikeshare station;
- 4.2.1 – Contract with provider to install on-site carshare vehicles and promote their use by residents;
- 5.1.1 – Unbundle parking cost from purchase price;
- 5.1.2 – Unbundle parking cost from monthly rent;
- 6.1.1 – Provide a multimodal travel option information package to new residents.

#### 4.6 Neighbourhood Traffic Calming

The *2023 Revisions to the TIA Guidelines* identify that the Neighbourhood Traffic Calming shall be completed if all of the following criteria are met:

1. A proposed access is provided to a collector roadway or local roadway;
2. The development application is for Zoning By-Law Amendment or Draft Plan of Subdivision;
3. The proposed development is projected to generate more than 75 vehicle trips;
4. Site trip infiltration is expected, and site-generated traffic will increase peak hour volumes by 50% or more, along the route between the site and an arterial roadway;
5. 'Significant sensitive land use presence' exists, where there is at least two of the following land uses adjacent to the subject street segment:
  - School (within 250m walking distance);
  - Park;
  - Retirement or older adult facility (i.e. long-term care and retirement homes);
  - Licensed child care centre;
  - Community centre; or
  - 50% or greater of adjacent property along the route(s) are occupied by residential lands, and a minimum of ten occupied residential dwellings are present on the route.

The proposed subdivision meets the first three criteria above, but not the final two. Therefore, the Neighbourhood Traffic Calming module is exempt from further analysis.

#### 4.7 Transit

Based on the trip generation estimates presented in Section 3.1.1 and **Table 16**, the conceptual development is anticipated to generate the following number of external transit trips:

- 287 transit trips during the AM peak hour (124 trips in, 163 trips out);
- 279 transit trips during the PM peak hour (136 trips in, 143 trips out).

Per discussions with City staff, all site-generated transit trips are anticipated to arrive or depart the study area via OC Routes 63, 64, 110, or 166, and all trips will utilize stops at Innovation Drive/Hines Road (stops #1174, #1175, #1176, and #1177), March Road/Terry Fox Drive (stops #4875 and #6155), and at 501 March Road (stop #7994).

Since nearly all site-generated transit trips are anticipated to be generated by the residential component of the development, the assumed transit trip distribution is similar to the residential distribution outlined in Section 3.1.2. The assumed distribution of transit trips to/from the proposed subdivision can be summarized as follows:

- 25% to/from the north/west (i.e. Kanata North or Innovation) via OC Routes 63 and 64;
- 75% to/from the south/east (i.e. City of Ottawa) via OC Routes 63, 64, 110, and 166.

Transit utilization data from the Spring 2022 period (April 24 to June 25) has been obtained from OC Transpo, and is included in **Appendix C**. Average peak period (6:00am to 9:00am and 3:00pm to 6:00pm) boarding, alighting, and bus load at departure information was obtained for the stops previously listed in this section.

Existing and projected boarding and alighting information is summarized in **Table 25**. Any zero (0) values in the table indicate a measured average boarding and alighting value of zero, rather than an absence of data. Any dash (-) values in the table indicate that the route does not serve the stop in a given time period. Peak period boarding and alighting data have been converted to peak hour boardings and alightings, using factors of 0.55 for the AM peak hour and 0.47 for the PM peak hour (per the *TRANS Trip Generation Manual*).

**Table 25: Transit Utilization**

| Stop                | Location         | Route | Dir           | Boarding (tph) <sup>(1)</sup> |      |       | Alighting (tph) <sup>(1)</sup> |      |       |
|---------------------|------------------|-------|---------------|-------------------------------|------|-------|--------------------------------|------|-------|
|                     |                  |       |               | Existing                      | Site | Total | Existing                       | Site | Total |
| <b>AM Peak Hour</b> |                  |       |               |                               |      |       |                                |      |       |
| #1174               | 40 Hines         | 64    | WB            | 1                             | 0    | 1     | 3                              | 25   | 28    |
|                     |                  | 166   | EB            | 0                             | 0    | 0     | 0                              | 19   | 19    |
| #1175               | Hines/Innovation | 64    | EB            | 0                             | 41   | 41    | 0                              | 0    | 0     |
|                     |                  | 166   | WB            | -                             | -    | -     | -                              | -    | -     |
| #1176               | Innovation/Hines | 64    | WB            | 0                             | 21   | 21    | 4                              | 0    | 4     |
|                     |                  | 166   | EB            | 0                             | 0    | 0     | 0                              | 0    | 0     |
| #1177               | Innovation/Hines | 64    | EB            | 0                             | 0    | 0     | 0                              | 16   | 16    |
|                     |                  | 166   | WB            | -                             | -    | -     | -                              | -    | -     |
|                     |                  | 63    | WB            | 0                             | 20   | 22    | 1                              | 25   | 26    |
| #4875               | Terry Fox/March  | 110   | NB            | 0                             | 0    | 0     | 1                              | 0    | 1     |
|                     |                  | 63    | EB            | 2                             | 20   | 22    | 0                              | 7    | 7     |
| #6155               | Terry Fox/March  | 110   | SB            | 1                             | 41   | 42    | 0                              | 25   | 25    |
|                     |                  | #7994 | March/Ad. 501 | 63                            | EB   | 0     | 20                             | 20   | 0     |
| <b>PM Peak Hour</b> |                  |       |               |                               |      |       |                                |      |       |
| #1174               | 40 Hines         | 64    | WB            | 0                             | 0    | 0     | 1                              | 34   | 35    |
|                     |                  | 166   | EB            | -                             | -    | -     | -                              | -    | -     |
| #1175               | Hines/Innovation | 64    | EB            | 8                             | 29   | 37    | 0                              | 0    | 0     |
|                     |                  | 166   | WB            | 0                             | 21   | 21    | 0                              | 0    | 0     |
| #1176               | Innovation/Hines | 64    | WB            | 0                             | 18   | 18    | 1                              | 0    | 1     |
|                     |                  | 166   | EB            | -                             | -    | -     | -                              | -    | -     |
| #1177               | Innovation/Hines | 64    | EB            | 4                             | 0    | 4     | 0                              | 17   | 17    |
|                     |                  | 166   | WB            | 0                             | 0    | 0     | 0                              | 0    | 0     |
| #4875               | Terry Fox/March  | 63    | WB            | 0                             | 18   | 18    | 14                             | 34   | 48    |
|                     |                  | 110   | NB            | 1                             | 0    | 1     | 3                              | 0    | 3     |
| #6155               | Terry Fox/March  | 63    | EB            | 5                             | 14   | 19    | 0                              | 8    | 8     |
|                     |                  | 110   | SB            | 1                             | 29   | 30    | 0                              | 34   | 34    |
| #7994               | March/Ad. 501    | 63    | EB            | 0                             | 14   | 14    | 0                              | 9    | 9     |

1. tph: transit trips per hour

A discussion of the ultimate site-generated impacts to OC Routes 63, 64, 110, and 166 during the weekday peak hours is included below.

Route 63 (eastbound, to Tunney's Pasture / Gatineau)

At stops #6155 and #7994, the conceptual development is projected to generate an additional 20 AM boarding trips, seven AM alighting trips, 14 PM boarding trips, and eight PM alighting trips per stop. As route 63 runs on approximately 15-minute headways during the peak hours, this equates to approximately five AM boardings, two AM alightings, four PM boardings, and two PM alightings per bus at both stops.

The existing average bus loads at departure are five riders in the AM peak and three riders in the PM peak. Accounting for the above trips at both stops, the average bus loads when departing stop #7994 are anticipated to increase from five riders to 15 riders during the AM peak hour, and from three riders to 11 riders during the PM peak hour.

Route 63 (westbound, to Innovation / Briarbrook)

At stops #1820 and #4875, the conceptual development is projected to generate an additional ten AM boarding trips, 13 AM alighting trips, nine PM boarding trips, and 17 PM alighting trips per stop. As route 63 runs on approximately 15-minute headways during the peak hours, this equates to approximately three AM boardings, four AM alightings, three PM boardings, and five PM alightings per bus at both stops.

The existing average bus loads at departure are one rider in the AM peak and six riders in the PM peak. Accounting for the above trips, the average bus loads when departing stop #4875 are anticipated to increase from one rider to six riders during the AM peak hour, and from six riders to 11 riders during the PM peak hour.

Route 64 (eastbound, to Tunney's Pasture)

At stop #1175, the conceptual development is projected to generate an additional 41 AM boarding trips and 29 PM boarding trips. At stop #1177, the conceptual development is projected to generate an additional 16 AM alighting trips and 17 PM alighting trips. As route 64 runs on approximately 15-minute headways during the peak hours, this equates to approximately 11 AM boardings, four AM alightings, eight PM boardings, and five PM alightings per bus at these stops.

The existing average bus loads at departure are five riders in the AM peak at both stops, two riders in the PM peak at stop #1177, and four riders in the PM peak at stop #1175. Accounting for the above trips, the average bus loads when departing stop #1175 are anticipated to increase from five riders to 16 riders during the AM peak hour, and from four riders to 12 riders during the PM peak hour. The average bus loads when arriving at stop #1177 are anticipated to increase from five riders to nine riders during the AM peak hour, and from two riders to seven riders during the PM peak hour.

Route 64 (westbound, to Innovation / Morgan's Grant)

At stop #1176, the conceptual development is projected to generate an additional 21 AM boarding trips and 18 PM boarding trips. At stop #1174, the conceptual development is projected to generate an additional 25 AM alighting trips and 34 PM alighting trips. As route 64 runs on approximately 15-minute headways during the peak hours, this equates to approximately five AM boardings, seven AM alightings, five PM boardings, and nine PM alightings per bus at these stops.

The existing average bus loads at departure are two riders in the AM peak at both stops, six riders in the PM peak at stop #1176, and seven riders in the PM peak at stop #1174. Accounting for the above trips, the average bus loads when departing stop #1176 are anticipated to increase from two riders to seven riders during the AM peak hour, and from six riders to 11 riders during the PM peak hour. The average bus loads when arriving at stop #1174 are anticipated to increase from two riders to nine riders during the AM peak hour, and from seven riders to 17 riders during the PM peak hour.

Route 110 (northbound, to Innovation)

The conceptual development is not projected to generate any trips for this route and direction, as the route terminates at Innovation Station (i.e. within one kilometre of the Subject Site).

Route 110 (southbound, to Fallowfield)

At stop #6155, the conceptual development is projected to generate an additional 41 AM boarding trips, 25 AM alighting trips, 29 PM boarding trips, and 34 PM alighting trips. As route 110 runs on approximately 30-minute headways during the peak hours, this equates to approximately 21 AM boardings, 13 AM alightings, 15 PM boardings, and 17 PM alightings per bus.

The existing average bus load at departure is one rider during both the AM and PM peaks. Accounting for the above trips, the average bus loads when departing stop #6155 are anticipated to increase from one rider to 22 riders during the AM peak hour, and from one rider to 16 riders during the PM peak hour.

Route 166 (northbound, to Innovation)

At stop #1174, the conceptual development is projected to generate an additional 19 AM alighting trips. Route 166 runs once during the AM peak hour, in the northbound direction only.

The existing average bus load at departure is one rider during the AM peak. Accounting for the above trips, the average bus load when arriving at stop #1174 is anticipated to increase from one rider to 20 riders during the AM peak hour.

Route 166 (southbound, to Eagleson)

At stop #1175, the conceptual development is projected to generate an additional 21 PM boarding trips. Route 166 runs once during the PM peak hour, in the southbound direction only.

The existing average bus load at departure is one rider during the PM peak. Accounting for the above trips, the average bus load when departing stop #1175 is anticipated to increase from one rider to 22 riders during the PM peak hour.

Based on the above, the conceptual development is not anticipated to necessitate more frequent service for OC Routes 63, 64, 110, and 166.

As discussed in Section 2.2.1, the Affordable RTTP Network identifies at-grade BRT on March Road between Highway 417 and Solandt Road, along with transit priority signals and/or queue jump lanes on March Road between Solandt Road and the urban boundary. A future rapid transit station at Solandt Road will be located within 600m walking distance of the proposed subdivision. These improvements to the transit service in the area is anticipated to increase the transit share of those travelling to/from the proposed subdivision.

#### **4.8 Network Concept**

The current zoning of the Subject Site permits a total GFA of approximately 1,415,000 ft<sup>2</sup>. From a traffic generation perspective, the 'worst case' would be constructing an office of this size. Based on the General Office Building land use rates included in the *ITE Trip Generation Manual, 11<sup>th</sup> Edition*, this would result in approximately 2,093 person trips during the AM peak hour and 1,917 person trips during the PM peak hour.

Per the *2017 TIA Guidelines*, the Network Concept module is only required when a proposed development generates more than 200 person trips during the peak hour in excess of the equivalent volume permitted by the established zoning. Since the proposed subdivision will not generate more than the maximum development permitted by the established zoning, this module is exempt.

## 4.9 Intersection Design

### 4.9.1 Existing Intersection MMLOS Review

This section provides a review of the signalized study area intersections using complete streets principles. All intersections within the study area have been evaluated for PLOS, BLOS, TLOS, and TkLOS. Since the *MMLOS Guidelines* refer to the land use designations outlined in the City’s previously adopted Official Plan, those designations have been considered for the purposes of this review.

The MMLOS targets associated with the ‘General Urban Area’ designation have been used to evaluate March Road/Morgan’s Grant Way/Shirley’s Brook Drive, and the targets associated with the ‘Employment Area’ designation have been used to evaluate March Road/Solandt Road. Since March Road/Terry Fox Drive and Terry Fox Drive/Flamborough Way/Innovation Drive are located in both land use designations, whichever target is stricter has been used in evaluation of these intersections. The full intersection MMLOS analysis is included in **Appendix N**. A summary of the results is shown in **Table 26**.

**Table 26: Intersection MMLOS Summary**

| Intersection  | PLOS   |        | BLOS   |        | TLOS   |        | TkLOS  |        |
|---|--------|--------|--------|--------|--------|--------|--------|--------|
|   | Actual | Target | Actual | Target | Actual | Target | Actual | Target |
| March Road/<br>Morgan’s Grant Way/Shirley’s Brook Drive | F      | C      | F      | B      | F      | D      | C      | D      |
| March Road/<br>Terry Fox Drive                          | F      | C      | F      | B      | F      | D      | A      | B      |
| March Road/<br>Solandt Road                             | F      | C      | F      | C      | F      | B      | A      | B      |
| Terry Fox Drive/<br>Flamborough Way/Innovation Drive    | F      | C      | F      | B      | F      | -      | C      | B      |

The results of the intersection MMLOS analysis can be summarized as follows:

- No study area intersections meet the target PLOS;
- No study area intersections meet the target BLOS;
- No study area intersections along March Road meet the target TLOS;
- All study area intersections meet the target TkLOS, except for Terry Fox Drive/Flamborough Way/Innovation Drive.

#### March Road/Morgan’s Grant Way/Shirley’s Brook Drive

This intersection does not meet the target PLOS C, BLOS B, or TLOS D.

All approaches have a divided cross-section with a width equivalent to ten lanes crossed or more (assuming a lane width equals 3.5m, per the *MMLOS Guidelines*). There is limited opportunity in improving the PLOS at each approach without reducing the number of travel lanes or restricting turning movements. No approaches meet the City’s vehicle/pedestrian conflict threshold for zebra-striped crosswalks (greater than 400,000 vehicle/pedestrian conflicts over an eight-hour period). There is limited opportunity in improving the delay score for pedestrians without incurring major delays for vehicles.

The north, south, and east approaches do not meet the target BLOS based on left turn characteristics. Per Exhibit 12 of the *MMLOS Guidelines*, the target BLOS can be achieved at the east approach by reducing the operating speed to 40 km/h (which is the current speed limit on Shirley's Brook Drive). For left turns from the north and south approaches, cyclists are required to cross multiple lanes of traffic, on a roadway with a posted speed limit of 80 km/h. Given that all right turn movements are channelized at this intersection, the implementation of two-stage left-turn bike boxes at all approaches would not require a right turns on red (RTOR) restriction. This would require the stop bars at all approaches to be shifted away from the intersection. These measures are identified for the City's consideration.

The east approach does not meet the target TLOS. As Shirley's Brook Drive is not designated as a transit priority route, no modifications are recommended for the east approach.

#### March Road/Terry Fox Drive

This intersection does not meet the target PLOS C, BLOS B, or TLOS D.

All approaches have a divided cross-section with a width equivalent to ten lanes crossed or more. There is limited opportunity in improving the PLOS at each approach without reducing the number of travel lanes or restricting turning movements. The north and south approaches meet the City's vehicle/pedestrian conflict threshold for zebra-striped crosswalks. There is limited opportunity in improving the delay score for pedestrians without incurring major delays for vehicles.

All approaches do not meet the target BLOS, based on both left and right turn characteristics. Given that all right turn movements are channelized at this intersection, the implementation of two-stage left turn-bike boxes at all approaches would not require a RTOR restriction. This would require the stop bars at all approaches to be shifted away from the intersection. This is identified for the City's consideration. Exhibit 12 of the *MMLOS Guidelines* identifies that the target BLOS can be met by shortening the right turn lanes to 50m or shorter. Given the high traffic volumes at this intersection, this is not recommended.

The east and west approaches do not have a target TLOS, but the approach delays of approximately 35 to 45 seconds during the peak hours are noted. The City's RTTP Affordable Network includes transit priority signals and queue jump lanes on March Road north of Solandt Road, and would be expected to improve the delays for northbound/southbound transit vehicles. Future conversion to median BRT is anticipated to further improve the delays for buses travelling along March Road.

#### March Road/Solandt Road

This intersection does not meet the target PLOS C, BLOS C, or TLOS B.

All approaches have a divided cross-section with a width equivalent to ten lanes crossed or more. There is limited opportunity in improving the PLOS at each approach without reducing the number of travel lanes or restricting turning movements. No approaches meet the City's vehicle/pedestrian conflict threshold for zebra-striped crosswalks. There is limited opportunity in improving the delay score for pedestrians without incurring major delays for vehicles.

The east approach does not meet the target BLOS based on left turn characteristics, and the west approach does not meet the target BLOS based on both left and right turn characteristics. For left turning cyclists on all approaches, they are required to cross at least one lane of traffic on roads with an operating speed of 50 km/h or greater. Two-stage left-turn bike boxes have recently been implemented for northbound and southbound cyclists. Implementing this improvement for eastbound and westbound cyclists as well is identified for the City's consideration.

For cyclists interacting with right turning vehicles, the right turn lanes at the north and west approaches are greater than 50m, and the bike lane shifts to the left of the right turn lane at the south approach. Exhibit 12 of the *MMLOS Guidelines* identifies that the target BLOS can be met by shortening the right turn lanes to 50m or shorter. Given the high traffic volumes at this intersection, this is not recommended.

The north and south approaches do not meet the target TLOS. The east and west approaches do not have a target TLOS, however delays are significant. The City's RTTP Affordable Network includes at-grade median BRT on March Road south of Solandt Road, and transit signal priority and queue jump lanes north of Solandt Road. These initial measures are anticipated to improve the delays for transit vehicles to the target TLOS or better. Future conversion to median BRT along the entire March Road corridor is anticipated to further improve the delays for buses travelling along March Road.

#### Terry Fox Drive/Flamborough Way/Innovation Drive

This intersection does not meet the target PLOS C, BLOS B, or TkLOS B.

All approaches have a divided cross-section with a width equivalent to five to eight lanes crossed. There is limited opportunity in improving the PLOS at each approach without reducing the number of travel lanes or restricting turning movements. The west approach meets the City's vehicle/pedestrian conflict threshold for zebra-striped crosswalks. There is limited opportunity in improving the delay score for pedestrians without incurring major delays for vehicles.

All approaches do not meet the target BLOS based on left turn characteristics, and additionally, the east and west approaches do not meet the target BLOS based on right turn characteristics. For left turning cyclists on all approaches, they are required to cross one lane of traffic on roads with an operating speed of 50 or 60 km/h. Exhibit 12 of the *MMLOS Guidelines* identifies that the target BLOS requires the implementation of two-stage left-turn bike boxes on all approaches, which would require RTOR restrictions. This is identified for the City's consideration.

For cyclists interacting with right turning vehicles, the right turn lanes at the east and west approaches are greater than 50m. Exhibit 12 of the *MMLOS Guidelines* identifies that the target BLOS can be met by shortening the right turn lanes to 50m or shorter. Given the magnitude of right-turning traffic volumes at this intersection, this is not recommended.

All approaches do not meet the target TkLOS. While the effective corner radii of each corner is greater than 15m (i.e. the best possible, per Exhibit 21 of the *MMLOS Guidelines*), the target TkLOS can only be achieved by providing multiple receiving lanes. Since Flamborough Way and Innovation Drive are not classified as truck routes, no recommendations are identified.



### 4.9.2 2037 Total Intersection Operations

The previous submission of this TIA (prepared by Novatech in April 2023 in support of the initial Zoning By-Law Amendment application) included intersection capacity analysis for the 2037 total traffic conditions, assuming median BRT terminated at March Road/Solandt Road. As the only changes to this scenario involve updated amber, all-red, and pedestrian walk timings at March Road/Terry Fox Drive and Terry Fox Drive/Flamborough Way/Innovation Drive, the conclusions of the April 2023 analysis remain valid and are included below.

Per discussions with City staff, a subsequent technical memorandum was prepared by Novatech in June 2023 to include additional capacity analysis of the March Road/Terry Fox Drive and March Road/Nokia Access/E-W Street intersections, in the scenario where median BRT is extended to Terry Fox Drive by 2037. The results of this additional analysis have also been included in this TIA, for ease of reference.

#### 2037 Total Capacity Analysis – Median BRT Terminates at Solandt Road

Intersection capacity analysis has been conducted for the 2037 total traffic conditions. As identified in Section 3.4.2, it is assumed that dual westbound left turn lanes are maintained at the March Road/Solandt Road intersection following implementation of the BRT.

The results of the analysis are summarized in **Table 27** and **Table 28** for the weekday AM and PM peak hours. Detailed reports are included in **Appendix Q**.

**Table 27: 2037 Total Traffic Operations – Median BRT Terminates at Solandt Road**

| Intersection   | Period | Critical Movements |          |              | Intersection |               |          |
|--|--------|--------------------|----------|--------------|--------------|---------------|----------|
|  |        | Max v/c or Delay   | LOS      | Mvmt         | v/c          | Delay         | LOS      |
| March Road/Morgan’s Grant Way/Shirley’s Brook Drive <sup>(1)</sup> | AM     | 0.60               | A        | SBL          | 0.39         | 16 sec        | A        |
|  | PM     | 0.75               | C        | SBL          | 0.68         | 18 sec        | B        |
| March Road/Terry Fox Drive <sup>(1)</sup>                          | AM     | 0.78               | C        | SBL          | 0.67         | 31 sec        | B        |
|  | PM     | 0.85               | D        | EBL          | 0.79         | 35 sec        | C        |
| March Road/Solandt Road <sup>(1)</sup>                             | AM     | <b>1.15</b>        | <b>F</b> | <b>SBT/R</b> | <b>1.07</b>  | <b>62 sec</b> | <b>F</b> |
|  | PM     | <b>1.06</b>        | <b>F</b> | <b>NBT/R</b> | <b>1.02</b>  | <b>58 sec</b> | <b>F</b> |
| Terry Fox Drive/Flamborough Way/Innovation Drive <sup>(1)</sup>    | AM     | 0.53               | A        | SBL          | 0.38         | 17 sec        | A        |
|  | PM     | 0.70               | B        | NBL          | 0.45         | 22 sec        | A        |
| Innovation Drive/Hines Road <sup>(2)</sup>                         | AM     | 11 sec             | B        | WB           | -            |               |          |
|  | PM     | 9 sec              | A        | EB           |              |               |          |
| March Road/Nokia Access/E-W Street <sup>(1)</sup>                  | AM     | 0.90               | D        | WBL          | 0.65         | 32 sec        | B        |
|  | PM     | 0.95               | E        | NBT          | 0.92         | 28 sec        | E        |
| Terry Fox Drive/N-S Access <sup>(2)</sup>                          | AM     | 16 sec             | C        | NB           | -            |               |          |
|  | PM     | 18 sec             | C        | NB           |              |               |          |
| Hines Road/E-W Street <sup>(2)</sup>                               | AM     | 9 sec              | A        | WB           | -            |               |          |
|  | PM     | 9 sec              | A        | WB           |              |               |          |

- 1. Signalized intersection
- 2. Unsignalized intersection

**Table 28: 2037 Total – Critical Queues**

| Intersection                         | Mvmt  | Storage/ Spacing <sup>(1)</sup> | AM Peak         |                              |                              | PM Peak         |                              |                              |
|--------------------------------------|-------|---------------------------------|-----------------|------------------------------|------------------------------|-----------------|------------------------------|------------------------------|
|                                      |       |                                 | v/c [LOS]       | 50 <sup>th</sup> % Queue (m) | 95 <sup>th</sup> % Queue (m) | v/c [LOS]       | 50 <sup>th</sup> % Queue (m) | 95 <sup>th</sup> % Queue (m) |
| March Road/ Terry Fox Drive          | NBL   | 130m                            | 0.67 [B]        | 21                           | 34                           | 0.78 [C]        | 43                           | m45                          |
|                                      | NBT   | 280m                            | 0.42 [A]        | 74                           | 93                           | 0.85 [D]        | 68                           | m#166                        |
|                                      | EBL   | 95m                             | 0.74 [C]        | 16                           | #33                          | 0.85 [D]        | 31                           | #54                          |
| March Road/ Solandt Road             | NBL   | 165m                            | 0.59 [A]        | 43                           | #126                         | 0.59 [A]        | 20                           | #50                          |
|                                      | NBT/R | 200m                            | 0.88 [D]        | 189                          | #294                         | <b>1.06 [F]</b> | <b>~273</b>                  | <b>#371</b>                  |
|                                      | SBT/R | 520m                            | <b>1.15 [F]</b> | <b>~276</b>                  | <b>#304</b>                  | 0.94 [E]        | 178                          | #261                         |
|                                      | WBL   | 135m                            | 0.62 [B]        | 9                            | #18                          | 0.88 [D]        | ~42                          | #66                          |
| March Road/ Nokia Access/ E-W Street | NBL   | 65m                             | 0.69 [B]        | 28                           | m42                          | 0.53 [A]        | 1                            | m3                           |
|                                      | NBT   | 375m                            | 0.60 [A]        | 82                           | m117                         | 0.95 [E]        | ~211                         | m197                         |
|                                      | SBL   | TBC <sup>(2)</sup>              | 0.77 [C]        | 60                           | 46                           | 0.69 [B]        | 15                           | m#39                         |
|                                      | SBT   | 280m                            | 0.63 [B]        | 141                          | 158                          | 0.49 [A]        | 27                           | 74                           |
|                                      | WBL   | TBC <sup>(2)</sup>              | 0.90 [D]        | 43                           | #70                          | 0.90 [D]        | 43                           | #77                          |

1: Indicates the storage length for auxiliary lanes or the spacing to the nearest upstream intersection/access for through lanes  
 2: Storage requirements for SBL and WBL movements to be confirmed as part of the intersection design being undertaken by Nokia  
 #: Volume for the 95<sup>th</sup> percentile cycle exceeds capacity  
 m: Queue is metered by an upstream signal  
 ~: Approach is above capacity

From the previous tables, critical movements at the study area intersections generally operate at an acceptable level of service, with the exception of the southbound through/right turn movement at March Road/Solandt Road during the AM peak hour and the northbound through/right turn movement at March Road/Solandt Road during the PM peak hour.

The maximum northbound queue lengths at March Road/Terry Fox Drive and maximum southbound queue lengths at March Road/Solandt Road are not anticipated to extend upstream and block the new proposed signal location. Similarly, the maximum northbound and southbound queue lengths at March Road/Nokia Access/E-W Street are not anticipated to block the upstream intersections.

As identified in Section 4.4.1, an RMA for the March Road/Nokia Access/E-W Street intersection will be prepared by others. For the purposes of this report, auxiliary turn lane requirements for the subject property have been reviewed (i.e. northbound left turn and eastbound left turn lanes). Auxiliary lane requirements for the Nokia development will be confirmed by others through a separate TIA.

The maximum northbound left turn queue length at March Road/Nokia Access/E-W Street is approximately 45m during the peak hours. TAC’s *Geometric Design Guide* also includes a storage length equation for signalized intersections ( $S = 1.5 * N * L / [3600 / CL]$ , where S is storage length, N is number of vehicles during the peak hour, L is an assumed vehicle length of 7m, and CL is the cycle length in seconds). Using this equation, the recommended northbound left turn storage length at the proposed signal is 65m. The proposed signal location is over 300m north of the nearest upstream access at 500 March Road. Therefore, an auxiliary northbound left turn lane with 65m of storage length at the new signal can be provided.

The maximum eastbound left turn queue length at March Road/Nokia Access/E-W Street is approximately 15m during the AM peak hour and 20m during the PM peak hour. Using TAC's storage length equation, the recommended eastbound left turn storage length is 30m. This can be accommodated within March & Main's site at 555-603 March Road.

Based on the low eastbound through volumes that are projected at the new proposed signal and since a right turn lane would increase the pedestrian crossing distance at the intersection, an auxiliary eastbound right turn lane is not recommended.

#### 2037 Total Capacity Analysis – Median BRT Terminates at Terry Fox Drive

A separate scenario where the median BRT is extended to Terry Fox Drive has been analyzed, using the same 2037 total traffic volumes. The intersection geometry at March Road/Terry Fox Drive has generally been adjusted to reflect the functional design included in the *West Transitway Connection* EPR. While the EPR reduced the eastbound left turn movement at March Road/Terry Fox Drive to a single lane, dual eastbound left turn lanes have been maintained in this analysis, as a single lane results in a significantly over-capacity eastbound left turn movement. Maintaining dual left turn lanes for this approach is consistent with City staff's request to maintain dual westbound left turn lanes at March Road/Solandt Road.

The adjustments in Synchro to March Road/Terry Fox Drive and March Road/Nokia Access/E-W Street are summarized as follows:

- All-red timings adjusted where necessary to reflect increased clearance requirements;
- Adjustments to right turn curb radii and turn lane lengths as required;
- Removal of one northbound through lane and one southbound through lane at both intersections;
- Removal of the northbound right turn lane and converting the curbside through lane to a northbound through/right turn lane at March Road/Terry Fox Drive (a 20m northbound right turn lane is modelled in Synchro to represent the storage provided by the planned smart channel for this movement);
- Minimum pedestrian crossing times for eastbound/westbound pedestrians consistent with a two-stage crossing;
- Northbound/southbound left turn phases adjusted to become fully protected, if they weren't already;
- Cycle lengths maintained at 130 seconds, but with splits and offsets optimized.

Queueing and operations for the northbound movements at March Road/Terry Fox Drive, southbound movements at March Road/Solandt Road, and all movements at March Road/Nokia Access/E-W Street are included in **Table 29**. Detailed Synchro reports for these intersections are also included in **Appendix Q**.

**Table 29: 2037 Total Operations and Queues – Median BRT Terminates at Terry Fox Drive**

| Intersection                               | Mvmt  | Storage/<br>Spacing | AM Peak         |                                 |                                 | PM Peak         |                                 |                                 |
|--|-------|---------------------|-----------------|---------------------------------|---------------------------------|-----------------|---------------------------------|---------------------------------|
|  |       |                     | v/c<br>[LOS]    | 50 <sup>th</sup> %<br>Queue (m) | 95 <sup>th</sup> %<br>Queue (m) | v/c<br>[LOS]    | 50 <sup>th</sup> %<br>Queue (m) | 95 <sup>th</sup> %<br>Queue (m) |
| March Road/<br>Terry Fox Drive             | NBL   | 130m                | 0.58 [A]        | 25                              | m#47                            | 0.81 [D]        | 42                              | m#47                            |
|  | NBT   | 280m                | 0.53 [A]        | 66                              | 112                             | <b>1.01 [F]</b> | <b>81</b>                       | <b>m#250</b>                    |
|  | NBR   | 20m                 | 0.13 [A]        | 3                               | m11                             | 0.16 [A]        | 1                               | m1                              |
|  | EBL   | 95m                 | 0.85 [C]        | ~16                             | #37                             | <b>1.24 [F]</b> | ~41                             | <b>#67</b>                      |
|  | EBT   | 150m                | 0.35 [A]        | 21                              | 22                              | 0.27 [A]        | 23                              | 32                              |
|  | EBR   | 60m                 | 0.72 [C]        | 16                              | 30                              | 0.39 [A]        | 5                               | 27                              |
| March Road/<br>Solandt Road                | SBL   | 150m                | 0.48 [A]        | 15                              | m15                             | 0.32 [A]        | 6                               | m9                              |
|  | SBT/R | 520m                | <b>1.15 [F]</b> | ~270                            | <b>m#255</b>                    | 0.94 [E]        | 181                             | m#260                           |
| March Road/<br>Nokia Access/<br>E-W Street | NBL   | 65m                 | 0.74 [C]        | 31                              | m41                             | 0.72 [C]        | 31                              | m32                             |
|  | NBT   | 375m                | 0.81 [D]        | 114                             | m#140                           | 0.99 [E]        | ~214                            | m197                            |
|  | NBR   | TBC <sup>(1)</sup>  | 0.18 [A]        | 0                               | m6                              | 0.26 [A]        | 5                               | m0                              |
|  | SBL   | TBC <sup>(1)</sup>  | 0.80 [C]        | 81                              | m#103                           | 0.78 [C]        | ~25                             | m#52                            |
|  | SBT/R | 280m                | <b>1.05 [F]</b> | <b>40</b>                       | <b>m#265</b>                    | 0.78 [C]        | 43                              | #163                            |
|  | EBL   | 30m                 | 0.15 [A]        | 7                               | 13                              | 0.56 [A]        | 11                              | 21                              |
|  | EBT/R | 190m                | 0.48 [A]        | 1                               | 17                              | 0.43 [A]        | 1                               | 18                              |
|  | WBL   | TBC <sup>(1)</sup>  | 0.90 [D]        | ~42                             | #55                             | 0.92 [E]        | 43                              | #80                             |
| WBT/R                                      | 180m  | 0.41 [A]            | 1               | 16                              | 0.91 [E]                        | 60              | #111                            |                                 |

1. Storage lengths to be confirmed as part of the intersection design being undertaken by Nokia

#: Volume for the 95<sup>th</sup> percentile cycle exceeds capacity

m: Queue is metered by an upstream signal

~: Approach is above capacity

The maximum northbound queue lengths at March Road/Terry Fox Drive and southbound queue lengths at March Road/Solandt Road are not anticipated to extend upstream and block the new proposed signal location.

The maximum northbound and southbound queue lengths at March Road/Nokia Access/E-W Street are not anticipated to block the upstream intersections. It is noted that the southbound through/right turn movement at the new proposed signal operates at a failing level of service during the AM peak hour, with a maximum queue length approaching Terry Fox Drive (265m, where the intersection spacing is approximately 280m). Synchro analysis identifies that if an auxiliary southbound right turn lane is provided, the southbound through movement is anticipated to only improve marginally from a level of service and queueing perspective. The marginal improvement is due to southbound right turn volumes being very low compared to the southbound through volumes (i.e. approximately 1,600 through vehicles versus 60 right turning vehicles during the AM peak hour). As this additional lane will increase the crossing distance for pedestrians in exchange for minor operational improvements, an auxiliary southbound right turn lane at the new proposed signal is not recommended.

Similar to the previous scenario where median BRT is not extended to Terry Fox Drive, 65m of northbound left turn lane storage is required, based on the maximum queue lengths and TAC equation. The proposed signal location is over 300m north of the nearest upstream access at 500 March Road. Therefore, an auxiliary northbound left turn lane with 65m of storage at the new signal can be provided.

The maximum eastbound left turn queue length at March Road/Nokia Access/E-W Street is approximately 15m during the AM peak hour and 20m during the PM peak hour, and the storage length equation identifies a requirement of 30m. An auxiliary eastbound left turn lane with 30m of storage can be accommodated within March & Main's site at 555-603 March Road.

Based on the low eastbound through volumes that are projected at the new proposed signal and since a right turn lane would increase the pedestrian crossing distance at the intersection, an auxiliary eastbound right turn lane is not recommended.

## 5.0 CONCLUSIONS AND RECOMMENDATIONS

Based on the foregoing, the conclusions and recommendations of this TIA can be summarized as follows:

### Forecasting

- The conceptual development as a whole is estimated to generate 1,232 person trips during the AM peak hour (including 611 external vehicle trips) and 1,382 person trips during the PM peak hour (including 662 external vehicle trips).

### Existing Traffic Operations

- All study area intersections operate at an acceptable level of service during the AM and PM peak hours.

### Background Traffic Operations

- Critical movements at the study area intersections generally operate at an acceptable level of service, with the exception of the westbound left turn movement at March Road/Solandt Road during the PM peak hour. Per the functional design of the March Road BRT, one of the westbound left turn lanes will be removed. It is anticipated that this is the primary driver for the failing vehicular level of service of this movement, and therefore it is recommended that the dual westbound left turn lanes are maintained at this intersection.
- To achieve the target vehicular level of service (Auto LOS) E at March Road/Solandt Road, a reduction of approximately 110 southbound through/right turning vehicles is required during the AM peak hour, and a reduction of approximately 45 northbound through/right turning vehicles are required during the PM peak hour.

### Development Design

- Based on the proposed concept plan, it is anticipated that sidewalks will be provided on both sides of the proposed east-west public street (connecting March Road and Hines Road), and on both sides of the proposed north-south private street (connecting Terry Fox Drive and the east-west public street). Cycle tracks are proposed on both sides of the proposed east-west public street.
- OC Transpo's service design guideline for peak period service is to provide service within a five-minute (400m) walk of home, work, or school for 95% of urban residents. All proposed blocks on the Draft Plan are anticipated to be within a five-minute walk of one or more existing transit stops on March Road or Terry Fox Drive. It is anticipated that some blocks will be located beyond 400m walking distance to future median BRT stops at March Road/Terry Fox Drive.

### New Street Networks

- The proposed cross-section of the east-west public street will include a ROW width of 26m and a pavement width of 11.0m, which allows for a travel lane and a parking lane in each direction. Periodic bulbouts will narrow the street to reduce the operating speed and clearly identify where on-street parking is provided. A 2.0m-wide sidewalk and 2.0m-wide cycle track is proposed on both sides of the roadway.
- The proposed cross-section of the north-south private street will include a ROW width of 18m and a pavement width of 8.5m, which allows for a travel lane in each direction and a parking lane in one direction. The 18m ROW and 8.5m roadway platform are most consistent with local roadways throughout the City of Ottawa. A sidewalk with a 2.0m width is proposed on both sides of the roadway, with 2.75m-wide boulevards separating the sidewalk from the roadway on each side.

### Boundary Streets

- The results of the segment MMLOS analysis can be summarized as follows:
  - No boundary streets meet the target pedestrian level of service (PLOS) C;
  - No boundary streets meet the target bicycle level of service (BLOS) B or C;
  - March Road does not meet the target transit level of service (TLOS) B;
  - All boundary streets meet the target truck level of service (TkLOS) B or D.
- March Road achieves the best-possible PLOS D by providing sidewalks with a minimum width of 2.0m and minimum boulevard width of 2.0m. To achieve the target PLOS C, a reduced operating speed of 60 km/h is required.
- Terry Fox Drive achieves the best-possible PLOS D on the south side, where a 3.0m multi-use pathway (MUP) with boulevard widths greater than 2.0m is provided. The north side of Terry Fox Drive does not generally provide any pedestrian facilities, and a PLOS D can be achieved by implementing sidewalks with a minimum width of 2.0m and minimum boulevard width of 2.0m. This is identified for the City's consideration.
- No pedestrian facilities are provided on Hines Road at the subject site, and a 1.8m-wide sidewalk with no boulevard is provided on the west side of Hines Road (south of the subject site). The 1.8m-wide sidewalk south of the site achieves a PLOS C. Therefore, the extension of additional sidewalks with a minimum width of 1.8m on both sides of Hines Road adjacent to the site would achieve the area target. This is identified for the City's consideration.
- March Road can only achieve the target BLOS B through the implementation of physically separated bikeways (such as multi-use pathways or cycle tracks), due to the high operating speed. As part of the City's future conversion of March Road to median BRT north of Solandt Road, cycle tracks are anticipated to be provided.
- Terry Fox Drive achieves a BLOS A on the south side, where a 3.0m MUP is provided. The north side of Terry Fox Drive achieves a BLOS E with the existing on-street bike lane, due to the high operating speed. The target BLOS C can be achieved by implementing a physically separated bikeway, or reducing the operating speed to 60 km/h. This is identified for the City's consideration.
- Hines Road can achieve the target BLOS C by reducing the operating speed to 50 km/h.

- March Road can achieve the target TLOS B through the implementation of bus lanes with no/limited parking and driveway friction. Future conversion to median BRT along the entire March Road corridor, including at the subject site, is anticipated to meet the target TLOS.

#### Access Intersections

- The proposed signalized intersection at March Road/Nokia Access/E-W Street will have the following lane configuration for each approach:
  - Northbound Approach (March Road):  
one left turn lane, two through lanes, and one right turn lane;
  - Southbound Approach (March Road):  
one left turn lane, two through lanes, and one shared through/right turn lane;
  - Eastbound Approach (E-W Street):  
one left turn lane and one shared through/right turn lane;
  - Westbound Approach (Nokia Access):  
one left turn lane and one shared through/right turn lane.
- The proposed intersection at Hines Road will be unsignalized, with stop control on the proposed east-west public street. The intersection will have the following lane configuration for each approach:
  - Northbound Approach (Hines Road):  
one shared through/right turn lane;
  - Southbound Approach (Hines Road):  
one shared left turn/through lane;
  - Westbound Approach (E-W Street):  
one shared left turn/right turn lane.
- The proposed access to Terry Fox Drive is approximately 130m west of the March Road/Terry Fox Drive, measuring from the nearest edge of the north-south private street to the nearest edge of March Road. This meets the minimum corner clearance requirement.
- It is anticipated that an auxiliary westbound left turn lane with 30m of storage length will be required at the proposed access to Terry Fox Drive. This can be accommodated without impacting the eastbound left turn storage at March Road/Terry Fox Drive, by widening the existing median and shifting the alignment of the westbound lanes on Terry Fox Drive in front of the subject site.
- The proposed north-south private street will connect to the east-west public street east of Hines Road, with separation distances of approximately 55m (when measuring nearest edge to nearest edge) and approximately 70 (when measuring centre to centre). For access to an collector roadway, the Transportation Association of Canada (TAC)'s *Geometric Design Guide* identifies a minimum corner clearance of 25m between the nearest edge of a driveway and the nearest edge of an intersecting street, when the intersection is unsignalized. The *Geometric Design Guide* identifies a minimum intersection spacing of 60m on collector roadways, measuring centre to centre. Both requirements are met by the proposed access location.

Transportation Demand Management

- While the final list of TDM measures to be implemented by the proposed subdivision will be confirmed at the Site Plan Control application stage, the proponent has agreed to consider a suite of TDM measures for non-residential and residential developments at this time.

Transit

- The conceptual development is anticipated to generate the following number of external transit trips:
  - 287 transit trips during the AM peak hour (124 trips in, 163 trips out);
  - 279 transit trips during the PM peak hour (136 trips in, 143 trips out).
- The proposed subdivision is not anticipated to necessitate more frequent service for OC Routes 63, 64, 110, and 166.

Intersection MMLOS

- The results of the intersection MMLOS analysis can be summarized as follows:
  - No study area intersections meet the target PLOS;
  - No study area intersections meet the target BLOS;
  - No study area intersections along March Road meet the target TLOS;
  - All study area intersections meet the target TkLOS, except for Terry Fox Drive/Flamborough Way/Innovation Drive.
- There is limited opportunity in improving the PLOS at any approach without reducing the number of travel lanes, restricting turning movements, or removing right turn channels. There is also limited opportunity in improving the delay score at any intersection to the target PLOS.
- The north, south, and east approaches of March Road/Morgan's Grant Way/Shirley's Brook Drive do not meet the target BLOS. The target BLOS can be achieved at the east approach by reducing the operating speed to 40 km/h (which is the current speed limit on Shirley's Brook Drive). For left turns from the north and south approaches, the implementation of two-stage left-turn bike boxes at all approaches would not require a right turns on red (RTOR) restriction. This would require the stop bars at all approaches to be shifted away from the intersection. These measures are identified for the City's consideration.
- All approaches of March Road/Terry Fox Drive do not meet the target BLOS. Given that all right turn movements are channelized at this intersection, the implementation of two-stage left turn-bike boxes at all approaches would not require a RTOR restriction. This would require the stop bars at all approaches to be shifted away from the intersection. This is identified for the City's consideration. The target BLOS can be met by shortening the right turn lanes to 50m or shorter. Given the high traffic volumes at this intersection, this is not recommended.



- The east and west approaches of March Road/Solandt Road does not meet the target BLOS. Two-stage left-turn bike boxes have recently been implemented for northbound and southbound cyclists. Implementing this improvement for eastbound and westbound cyclists as well is identified for the City's consideration. For cyclists interacting with right turning vehicles, the right turn lanes at the north and west approaches are greater than 50m, and the bike lane shifts to the left of the right turn lane at the south approach. The target BLOS can be met by shortening the right turn lanes to 50m or shorter. Given the high traffic volumes at this intersection, this is not recommended.
- All approaches of Terry Fox Drive/Flamborough Way/Innovation Drive do not meet the target BLOS. The target BLOS requires the implementation of two-stage left-turn bike boxes on all approaches, which would require RTOR restrictions. This is identified for the City's consideration. For cyclists interacting with right turning vehicles, the right turn lanes at the east and west approaches are greater than 50m. The target BLOS can be met by shortening the right turn lanes to 50m or shorter. Given the magnitude of right-turning traffic volumes at this intersection, this is not recommended.
- The City's RTTP Affordable Network includes at-grade median bus rapid transit (BRT) on March Road south of Solandt Road, and transit signal priority and queue jump lanes north of Solandt Road. These initial measures are anticipated to improve the delays for transit vehicles to the target TLOS or better. Future conversion to median BRT along the entire March Road corridor is anticipated to further improve the delays for buses travelling along March Road.
- While the effective corner radii of each corner at Terry Fox Drive/Flamborough Way/Innovation Drive is greater than 15m, the target TkLOS can only be achieved by providing multiple receiving lanes. Since Flamborough Way and Innovation Drive are not classified as truck routes, no recommendations are identified.

#### Total Traffic Operations

- The maximum northbound queue lengths at March Road/Terry Fox Drive and maximum southbound queue lengths at March Road/Solandt Road are not anticipated to extend upstream and block the new proposed signal location. Similarly, the maximum northbound and southbound queue lengths at March Road/Nokia Access/E-W Street are not anticipated to block the upstream intersections.
- In the scenario where median bus rapid transit (BRT) is extended to Terry Fox Drive, the southbound through/right turn movement at the new proposed signal operates at a failing level of service during the AM peak hour, with a maximum queue length approaching Terry Fox Drive (265m, where the intersection spacing is approximately 280m). The southbound through movement is anticipated to only improve marginally from a level of service and queueing perspective. The marginal improvement is due to southbound right turn volumes being very low compared to the southbound through volumes (i.e. approximately 1,600 through vehicles versus 60 right turning vehicles during the AM peak hour). As this additional lane will increase the crossing distance for pedestrians in exchange for minor operational improvements, an auxiliary southbound right turn lane at the new proposed signal is not recommended.

- A storage length of 65m is recommended for an auxiliary northbound left turn lane at the new proposed signal to March Road, in both pre- and post-BRT conditions. The proposed signal location is over 300m north of the nearest upstream access at 500 March Road. Therefore, an auxiliary northbound left turn lane at the proposed signal can be provided.
- A storage length of 30m is recommended for an auxiliary eastbound left turn lane at the new proposed signal to March Road, in both pre- and post-BRT conditions. This can be accommodated within March & Main’s site at 555-603 March Road.
- Based on low eastbound through volumes that are projected at the new proposed signal and since a right turn lane would increase the pedestrian crossing distance at the intersection, an auxiliary eastbound right turn lane is not recommended at the proposed signal.

Based on the foregoing, the proposed subdivision is recommended from a transportation perspective.

**NOVATECH**

Prepared by:

Reviewed by:



Joshua Audia, P.Eng.  
Project Engineer | Transportation

Brad Byvelds, P.Eng.  
Project Manager | Transportation

## **APPENDIX A**

---

Concept, Draft, and Phasing Plans

# Concept Plan

- Residential
- Amenity
- Office
- Retail
- Parking
- Bike Lane
- Loading/Parking
- Park
- Retail Edge
- Amenity Edge
- Parking/Loading Entrance
- Easement

Proposed GCA: **192,305m<sup>2</sup>** (2,069,971ft<sup>2</sup>)

Total # Units: **2,100**

Site Area: **55,511m<sup>2</sup>**



MARCH ROAD (REGIONAL ROAD NO. 49)

ROAD ALLOWANCE BETWEEN CONCESSIONS 3 AND 4

TRANSFERRED BY ORDER IN COUNCIL 2446/82 INST. N5166501 (MTO PLAN P-1648-45)  
P.I.N. 04517 - 0348

SUBJECT TO THE CONDITIONS, IF ANY, SET FORTH IN OUR LETTER DATED

THIS DRAFT PLAN IS APPROVED BY THE CITY OF OTTAWA UNDER SECTION 51 OF THE PLANNING ACT.  
THIS DAY OF \_\_\_\_\_ 20\_\_

LILY XU, MCIP RPP, MANAGER  
DEVELOPMENT REVIEW-SOUTH  
PLANNING, REAL ESTATE AND ECONOMIC  
DEVELOPMENT DEPARTMENT, CITY OF OTTAWA

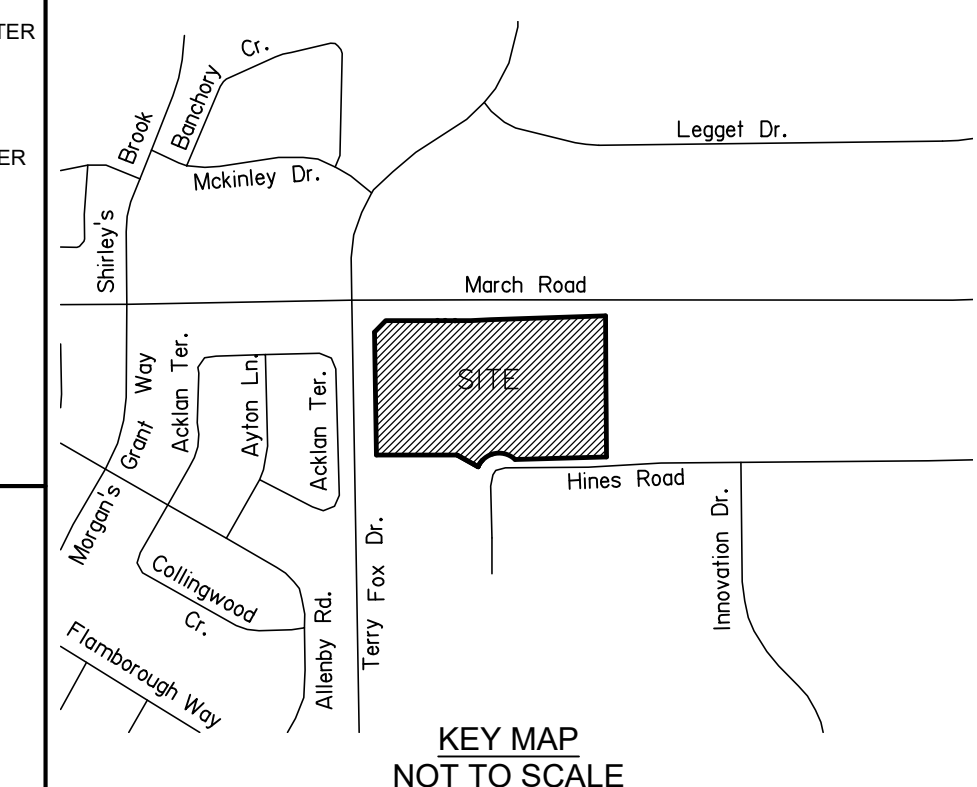

**DRAFT PLAN OF SUBDIVISION OF BLOCK 1 REGISTERED PLAN 4M-1104 AND PART OF LOT 9 CONCESSION 3 Geographic Township of March CITY OF OTTAWA**  
Prepared by Annis, O'Sullivan, Vollebakk Ltd.

Scale 1 : 500

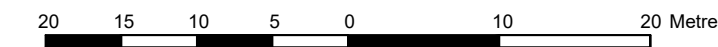

Metric  
DISTANCES SHOWN ON THIS PLAN ARE IN METRES AND CAN BE CONVERTED TO FEET BY DIVIDING BY 0.3048

**SURVEYOR'S CERTIFICATE**

I CERTIFY THAT:  
The boundaries of the lands to be subdivided and their relationship to adjoining lands have been accurately and correctly shown.

Date \_\_\_\_\_ E. H. Herweyer  
ONTARIO LAND SURVEYOR

**ADDITIONAL INFORMATION REQUIRED UNDER SECTION 51-17 OF THE PLANNING ACT**

- (a) see plan
- (b) see plan
- (c) see plan
- (d) (purpose for which lots are to be used)
- (e) see plan
- (f) see plan
- (g) see plan
- (h) City of Ottawa
- (i) see soils report
- (j) see plan
- (k) (municipal services available or to be available)
- (l) see plan

| REVISION SCHEDULE |   |              |    |
|-------------------|---|--------------|----|
| NO.               | REVISION  | DATE         | BY |
| D5                | Blocks 3 & 5 revised  | Dec 8, 2023  | lg |
| D4                | revised   | Nov 24, 2023 | lg |
| D3                | Block, sight triangle, reserve added, street changed to 18m | Nov 23, 2023 | lg |
| D2                |   |              |    |
| D1                | PLAN PREPARED   | 2023         | lg |

TERRY FOX DRIVE REGISTERED PLAN 4M-625 P.I.N. 04522 - 0257

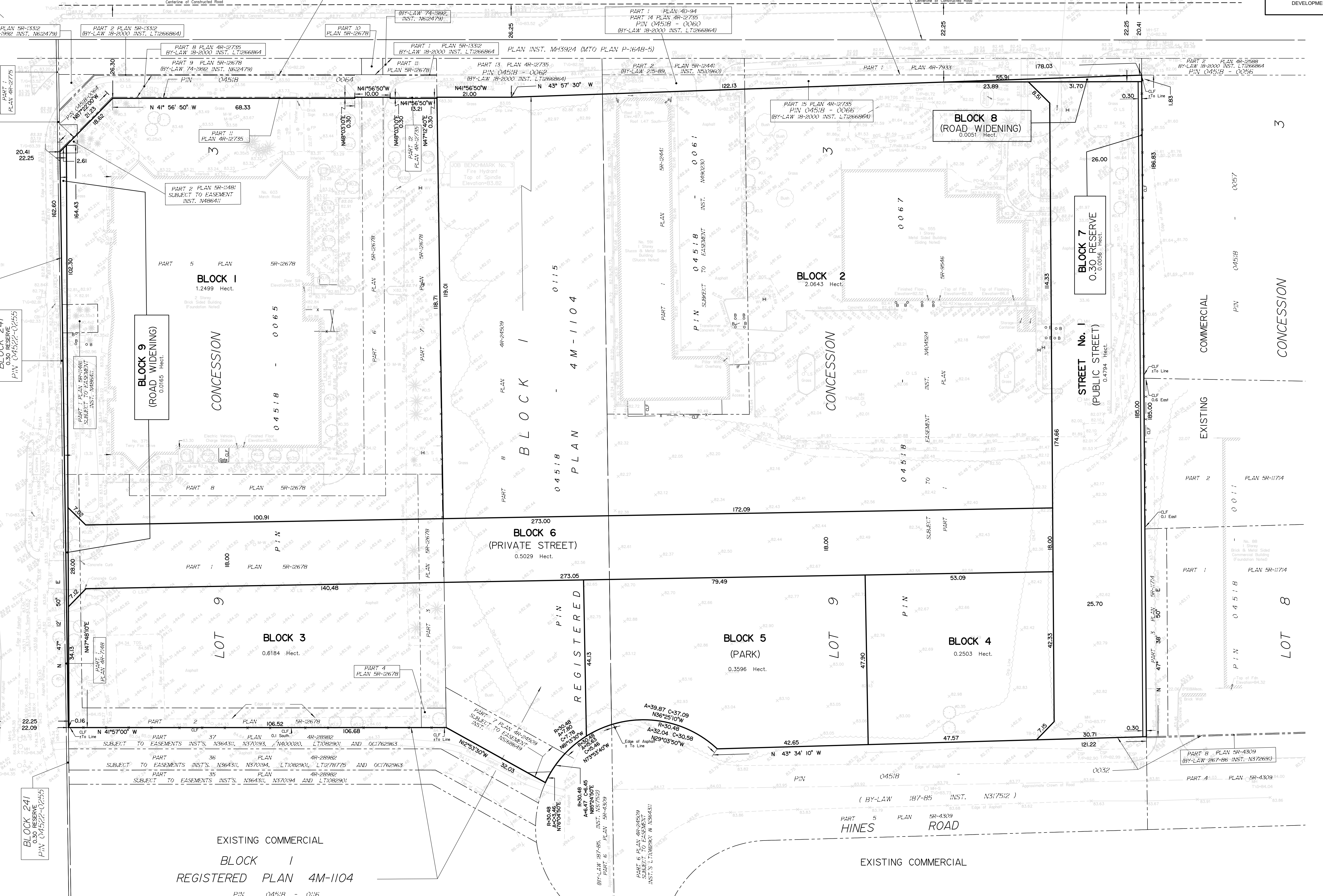

EXISTING COMMERCIAL  
BLOCK 1  
REGISTERED PLAN 4M-1104  
P.I.N. 04518 - 0016  
PART 34 PLAN 4R-28982

EXISTING COMMERCIAL

M:\2022\122125\CAD\Overall\Civil-Adequacy\122125-Phasing.dwg, 11x17 landscape, Apr 26, 2023 - 3:23pm, dmaratha

MARCH ROAD

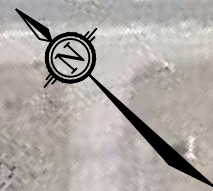

TERRY FOX DRIVE

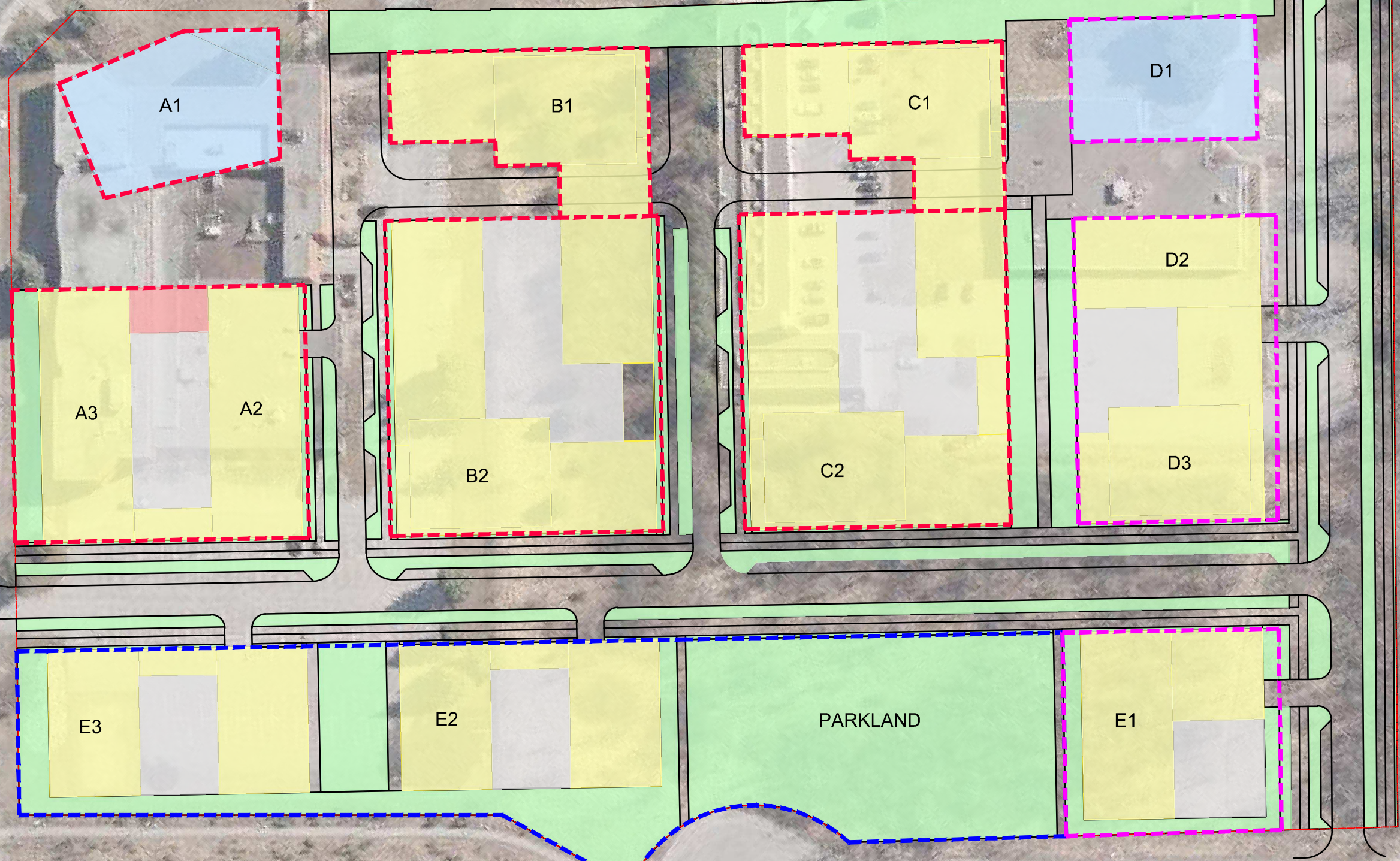

**LEGEND:**

- PHASE 1
- PHASE 2
- PHASE 3

HINES ROAD

**NOVATECH**  
 Engineers, Planners & Landscape Architects  
 Suite 200, 240 Michael Cowpland Drive  
 Ottawa, Ontario, Canada K2M 1P6

Telephone (613) 254-9643  
 Facsimile (613) 254-5867  
 Website www.novatech-eng.com

555, 591, 595 & 603  
 MARCH ROAD

**PRELIMINARY PHASING  
 PLAN**

SCALE 1 : 1000

|               |            |                  |
|---------------|------------|------------------|
| DATE JUN 2023 | JOB 122125 | FIGURE 122125-PH |
|---------------|------------|------------------|

## **APPENDIX B**

---

TIA Screening Form

City of Ottawa 2017 TIA Guidelines TIA Screening

1. Description of Proposed Development

|   |   |
|---|---|
| Municipal Address                               | 555, 591, 595, and 603 March Road                             |
| Description of Location                         | South of March Road, west of Terry Fox Drive                  |
| Land Use Classification                         | Residential, office, and retail                               |
| Development Size (units)                        | 2,100 dwellings   |
| Development Size square metre (m <sup>2</sup> ) | 14,324 m <sup>2</sup> office, 2,925 m <sup>2</sup> commercial |
| Number of Accesses and Locations                | 1 each to March Rd, Terry Fox Dr, and Hines Rd                |
| Phase of Development                            | 3   |
| Buildout Year                                   | 2037  |

If available, please attach a sketch of the development or site plan to this form.

2. Trip Generation Trigger

Considering the Development’s Land Use type and Size (as filled out in the previous section), please refer to the Trip Generation Trigger checks below.

Table notes:

1. Table 2, Table 3 & Table 4 TRANS Trip Generation Manual
2. Institute of Transportation Engineers (ITE) Trip Generation Manual 11.1 Ed.

| Land Use Type                                    | Minimum Development Size |
|--|--------------------------|
| Single-family homes                              | 60 units                 |
| Multi-Use Family (Low-Rise) <sup>1</sup>         | 90 units                 |
| Multi-Use Family (High-Rise) <sup>1</sup>        | 150 units                |
| Office <sup>2</sup>                              | 1,400 m <sup>2</sup>     |
| Industrial <sup>2</sup>                          | 7,000 m <sup>2</sup>     |
| Fast-food restaurant or coffee shop <sup>2</sup> | 110 m <sup>2</sup>       |
| Destination retail <sup>2</sup>                  | 1,800 m <sup>2</sup>     |
| Gas station or convenience market <sup>2</sup>   | 90 m <sup>2</sup>        |



If the proposed development size is equal to or greater than the sizes identified above, the Trip Generation Trigger is satisfied.

### 3. Location Triggers

|  | Yes                                 | No                       |
|--|-------------------------------------|--------------------------|
| Does the development propose a new driveway to a boundary street that is designated as part of the Transit Priority Network, Rapid Transit network or Cross-Town Bikeways? | <input checked="" type="checkbox"/> | <input type="checkbox"/> |
| Is the development in a Hub, a Protected Major Transit Station Area (PMTSA), or a Design Priority Area (DPA)? <sup>2</sup>   | <input checked="" type="checkbox"/> | <input type="checkbox"/> |

If any of the above questions were answered with ‘Yes,’ the Location Trigger is satisfied.

### 4. Safety Triggers

|   | Yes                                 | No                                  |
|---|-------------------------------------|-------------------------------------|
| Are posted speed limits on a boundary street are 80 kilometers per hour (km/h) or greater?  | <input checked="" type="checkbox"/> | <input type="checkbox"/>            |
| Are there any horizontal/vertical curvatures on a boundary street limits sight lines at a proposed driveway?  | <input type="checkbox"/>            | <input checked="" type="checkbox"/> |
| Is the proposed driveway within the area of influence of an adjacent traffic signal or roundabout (i.e. within 300 metre [m] of intersection in rural conditions, or within 150 m of intersection in urban/ suburban conditions)? | <input checked="" type="checkbox"/> | <input type="checkbox"/>            |
| Is the proposed driveway within auxiliary lanes of an intersection?   | <input checked="" type="checkbox"/> | <input type="checkbox"/>            |
| Does the proposed driveway make use of an existing median break that serves an existing site?   | <input checked="" type="checkbox"/> | <input type="checkbox"/>            |

<sup>2</sup> Hubs are identified in Schedules B1 to B8 of the City of Ottawa Official Plan. PMTSAs are identified in Schedule C1 of the Official Plan. DPAs are identified in Schedule C7A and C7B of the Official. See Chapter 4 for a list of City of Ottawa Planning and Engineering documents that support the completion of TIA.

## Transportation Impact Assessment Guidelines

|  | Yes                      | No                                  |
|--|--------------------------|-------------------------------------|
| Is there is a documented history of traffic operations or safety concerns on the boundary streets within 500 m of the development? | <input type="checkbox"/> | <input checked="" type="checkbox"/> |
| Does the development include a drive-thru facility?  | <input type="checkbox"/> | <input checked="" type="checkbox"/> |

**If any of the above questions were answered with 'Yes,' the Safety Trigger is satisfied.**

### 5. Summary

| Results of Screening                                      | Yes                                 | No                       |
|---|-------------------------------------|--------------------------|
| Does the development satisfy the Trip Generation Trigger? | <input checked="" type="checkbox"/> | <input type="checkbox"/> |
| Does the development satisfy the Location Trigger?        | <input checked="" type="checkbox"/> | <input type="checkbox"/> |
| Does the development satisfy the Safety Trigger?          | <input checked="" type="checkbox"/> | <input type="checkbox"/> |

**If none of the triggers are satisfied, the TIA Study is complete. If one or more of the triggers is satisfied, the TIA Study must continue into the next stage (Screening and Scoping).**

## **APPENDIX C**

---

OC Transpo Information



**INNOVATION  
BRIARBROOK  
TUNNEY'S PASTURE  
GATINEAU**

**7 days a week / 7 jours par semaine**  
All day service  
Service toute la journée

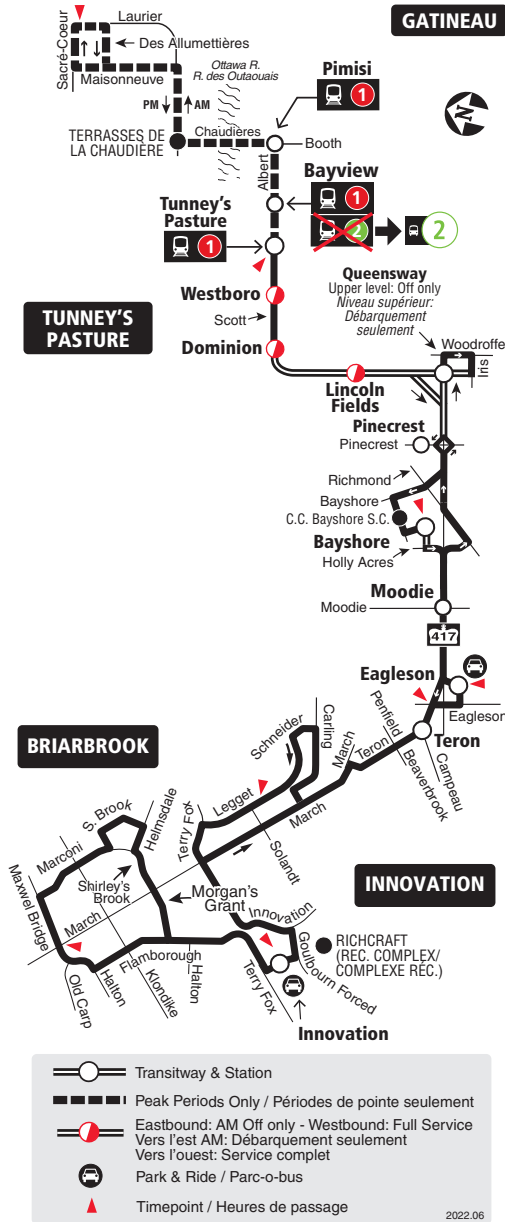

**Schedule / Horaire ..... 613-560-1000**  
**Text / Texto\* ..... 560560**  
plus your four digit bus stop number / plus votre numéro d'arrêt à quatre chiffres

Customer Service  
Service à la clientèle ..... **613-560-5000**  
Lost and Found / Objets perdus ..... **613-563-4011**  
Security / Sécurité ..... **613-741-2478**

**Effective June 26, 2022**  
**En vigueur 26 juin 2022**

**OC Transpo** INFO 613-560-5000  
octranspo.com



# 64

## MORGAN'S GRANT INNOVATION TUNNEY'S PASTURE

Local

Monday to Friday / Lundi au vendredi

All day service  
Service toute la journée

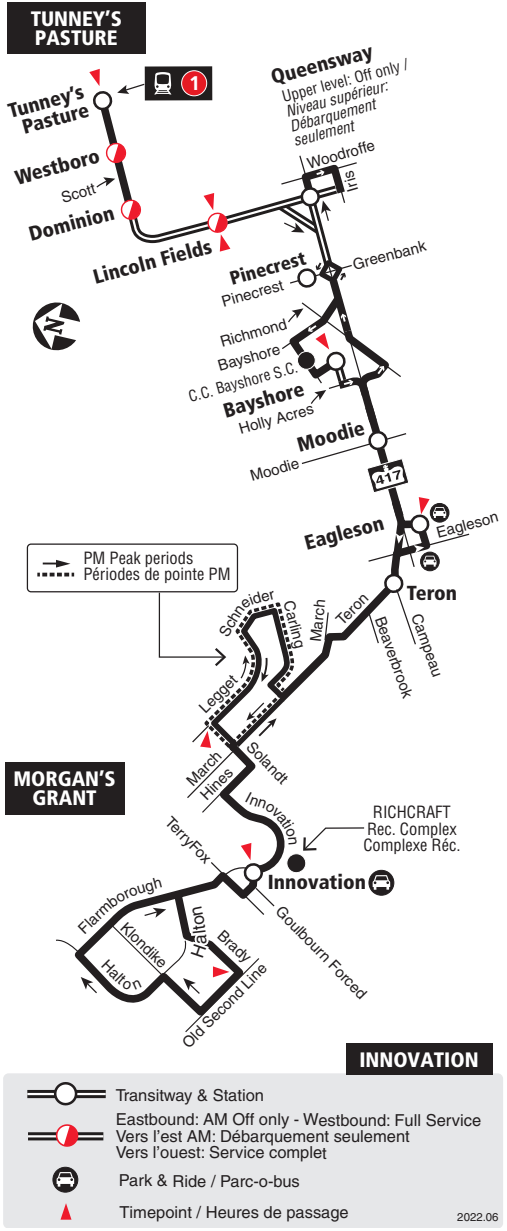

2022.06



Schedule / Horaire ..... 613-560-1000

Text / Texto\* ..... 560560

plus your four digit bus stop number / plus votre numéro d'arrêt à quatre chiffres

\*Standard message rates may apply / Les tarifs réguliers de messagerie texte peuvent s'appliquer

Customer Service  
Service à la clientèle ..... 613-560-5000

Lost and Found / Objets perdus ..... 613-563-4011

Security / Sécurité ..... 613-741-2478

Effective June 26, 2022

En vigueur 26 juin 2022



INFO 613-560-5000  
octranspo.com



# 66

## KANATA TUNNEY'S PASTURE GATINEAU

### Local

Monday to Friday / Lundi au vendredi

Peak periods only

Périodes de pointe seulement

PM  
↑  
GATINEAU

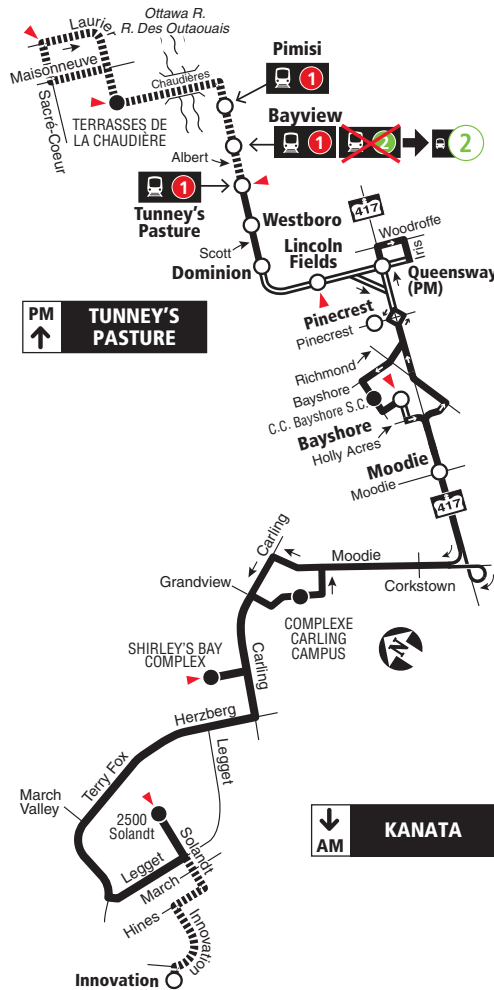

PM  
↑  
TUNNEY'S  
PASTURE

↓  
AM  
KANATA

- Transitway & Station
- Some trips / Quelques trajets
- Timepoint / Heures de passage

2022.06

2022.06

**Schedule / Horaire ..... 613-560-1000**  
**Text / Texto\* ..... 560560**  
*plus your four digit bus stop number / plus votre numéro d'arrêt à quatre chiffres*  
\*Standard message rates may apply / Les tarifs réguliers de messagerie texte peuvent s'appliquer

- Customer Service / Service à la clientèle ..... **613-560-5000**
- Lost and Found / Objets perdus ..... **613-563-4011**
- Security / Sécurité ..... **613-741-2478**

**Effective June 26, 2022**

**En vigueur 26 juin 2022**



# 110

## FALLOWFIELD INNOVATION

Local

Monday to Friday / Lundi au vendredi

No late evening service

Aucun service en fin de soirée

### INNOVATION

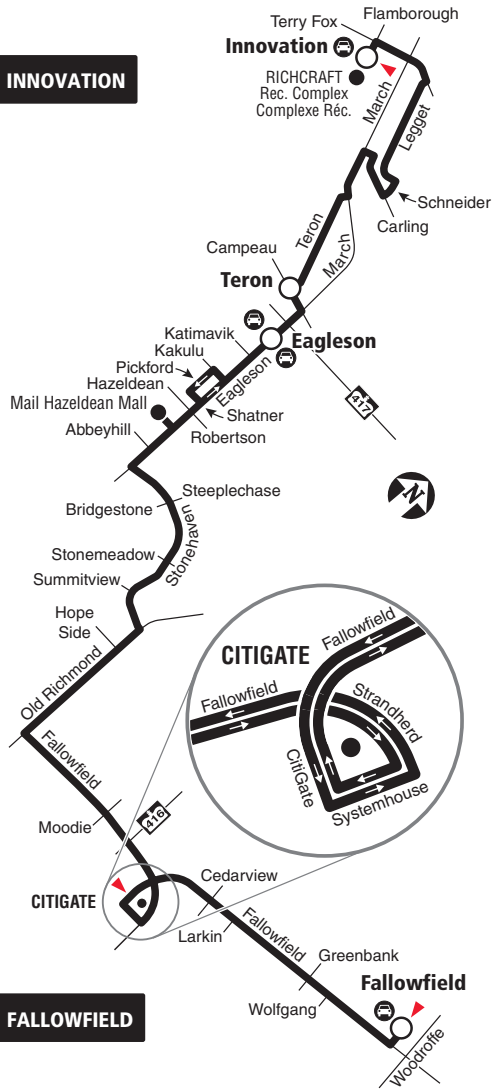

### FALLOWFIELD

- Stations
- Park & Ride / Parc-o-bus
- Timepoint / Heures de passage

2021.06

**Schedule / Horaire ..... 613-560-1000**  
**Text / Texto\* ..... 560560**  
*plus your four digit bus stop number / plus votre numéro d'arrêt à quatre chiffres*  
\*Standard message rates may apply / Les tarifs réguliers de messagerie texte peuvent s'appliquer

Customer Service  
 Service à la clientèle ..... **613-741-4390**  
 Lost and Found / Objets perdus ..... **613-563-4011**  
 Security / Sécurité ..... **613-741-2478**

**Effective June 20, 2021**  
**En vigueur 20 juin 2021**



# 165

## INNOVATION TERRY FOX

Local

Monday to Friday/ Lundi au vendredi

Selected time periods  
Périodes sélectionnées

### INNOVATION

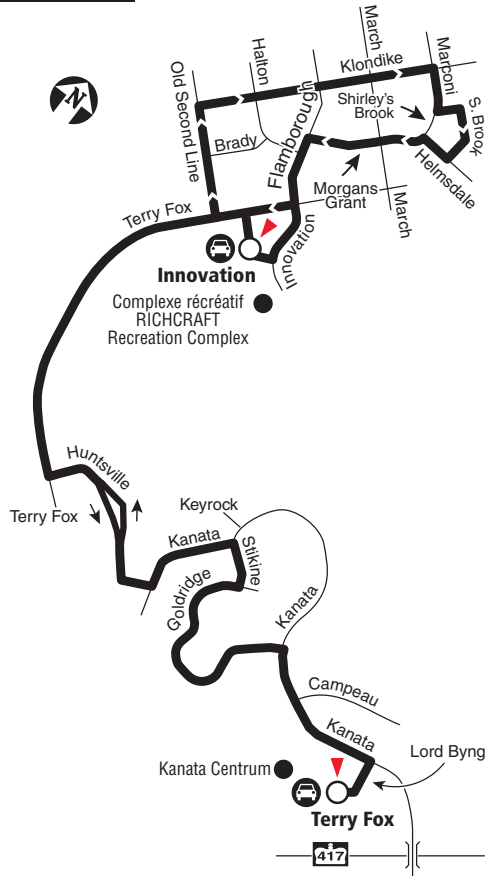

### TERRY FOX

- Station
- Park & Ride / Parc-o-bus
- Timepoint / Heures de passage

2019.06

**Schedule / Horaire.....613-560-1000**  
**Text / Texto .....560560**  
*plus your four digit bus stop number / plus votre numéro d'arrêt à quatre chiffres*

Customer Service  
 Service à la clientèle ..... **613-741-4390**  
 Lost and Found / Objets perdus..... **613-563-4011**  
 Security / Sécurité ..... **613-741-2478**

**Effective December 25, 2016**  
**En vigueur 25 décembre 2016**

**INFO 613-741-4390**  
 octranspo.com





# 166

## INNOVATION EAGLESON

Local

Monday to Friday/ Lundi au vendredi

Limited service / Service limité

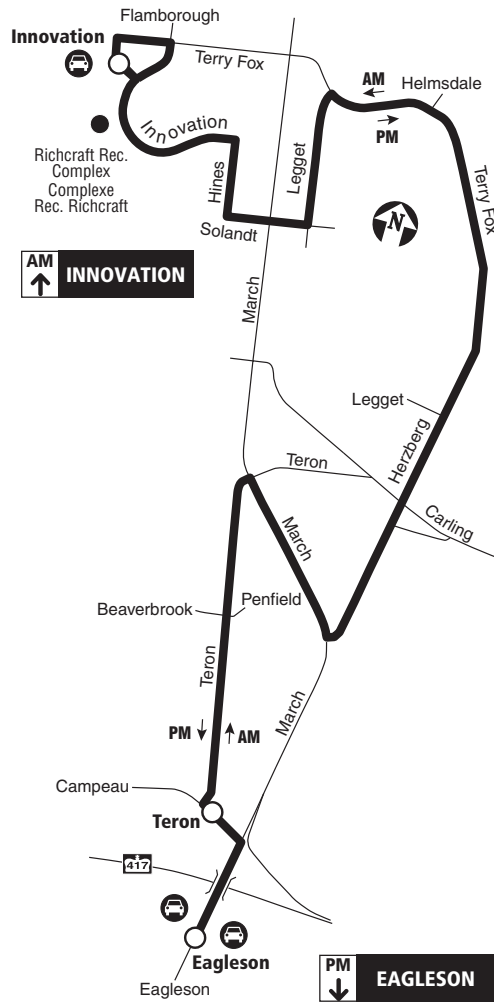

- Station
- 🚗 Park & Ride / Parc-o-bus

2019.06

 **Schedule / Horaire.....613-560-1000**  
**Text / Texto .....560560**  
*plus your four digit bus stop number / plus votre numéro d'arrêt à quatre chiffres*

Customer Service  
 Service à la clientèle ..... **613-741-4390**  
 Lost and Found / Objets perdus..... **613-563-4011**  
 Security / Sécurité ..... **613-741-2478**

**Effective December 25, 2016**  
**En vigueur 25 décembre 2016**

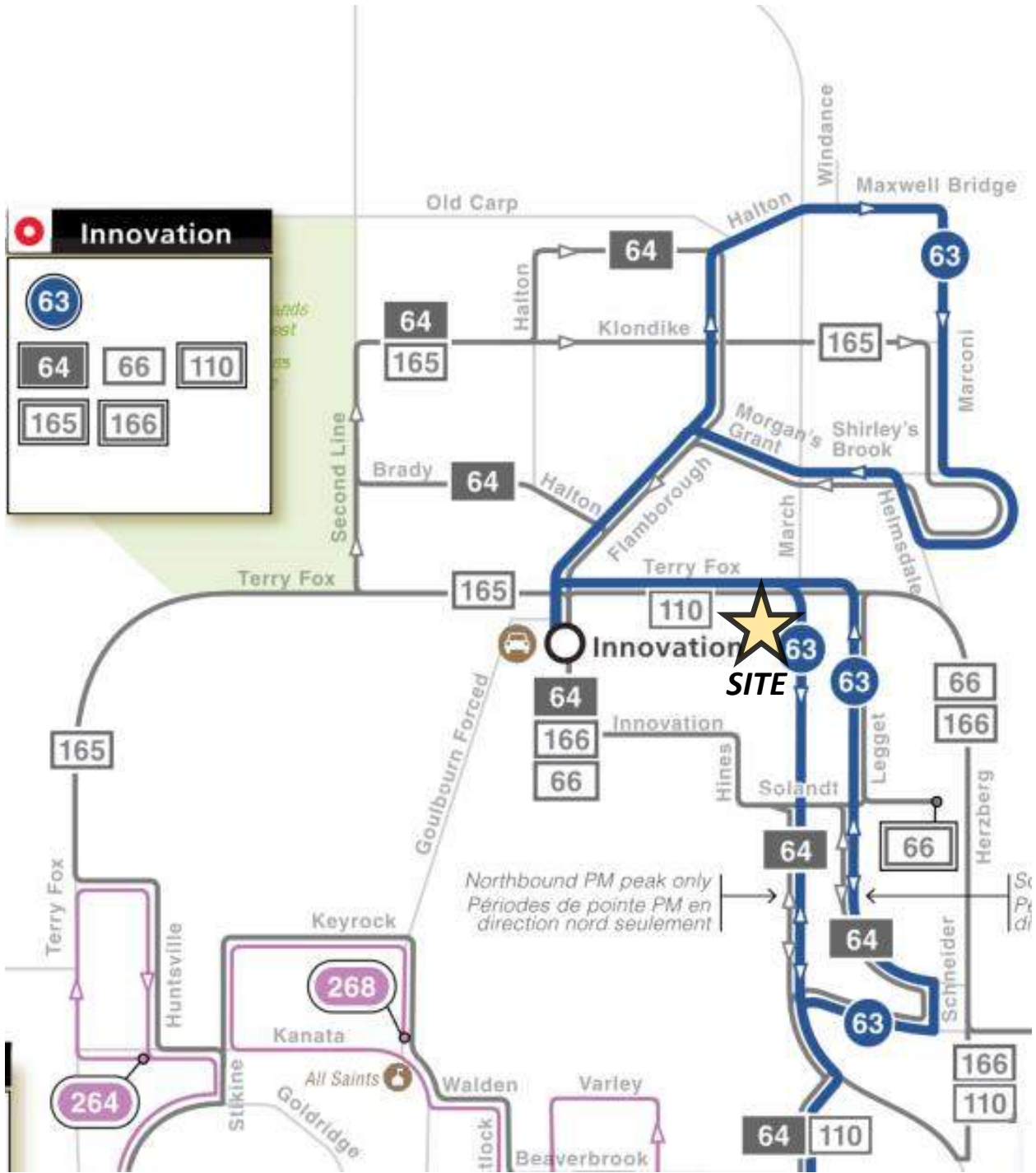

## Joshua Audia

---

**From:** Rathwell, Graham <graham.rathwell@ottawa.ca>  
**Sent:** Tuesday, September 13, 2022 8:34 AM  
**To:** Joshua Audia <j.audia@novatech-eng.com>  
**Subject:** RE: Transit Data Request - March/Terry Fox area

Hi again Josh,

My apologies again for the delay, the requested data is provided in the table below. This list of stops should be a sufficient representative sample, covering those closest to the site in question and all of the routes/directions available within a short walk distance.

Data is provided for the Spring 2022 schedule period which ran from April 24 to June 25. System wide, conventional bus ridership for this period was at 51% of the ridership for same period in 2019, pre-pandemic. A reminder that zero (0) values indicate a measured average value of zero rather than an absence of data, based on available APC data. Dashes (-) indicate that the route does not serve the stop in question in the given time period. In this case this applies only to Route 166, which is a special limited peak-direction service.

| Spring 2022 (April 24 - June 25) |                      |       |     | AM (06:00-09:00) |        |                    | PM (15:00-18:00) |        |                    | 24-hr |        |                    |
|----------------------------------|----------------------|-------|-----|------------------|--------|--------------------|------------------|--------|--------------------|-------|--------|--------------------|
| Stop                             | Location             | Route | Dir | Board            | Alight | Avg Load Departure | Board            | Alight | Avg Load Departure | Board | Alight | Avg Load Departure |
| 1174                             | 40 Hines             | 64    | WB  | 1                | 6      | 2                  | 0                | 1      | 7                  | 1     | 10     | 3                  |
|                                  |                      | 166   | EB  | 0                | 0      | 1                  | -                | -      | -                  | 0     | 0      | 1                  |
| 1175                             | Hines/<br>Innovation | 64    | EB  | 0                | 0      | 5                  | 17               | 0      | 4                  | 17    | 0      | 3                  |
|                                  |                      | 166   | WB  | -                | -      | -                  | 0                | 0      | 1                  | 0     | 0      | 1                  |
| 1176                             | Innovation/<br>Hines | 64    | WB  | 0                | 8      | 2                  | 0                | 1      | 6                  | 0     | 13     | 3                  |
|                                  |                      | 166   | EB  | 0                | 0      | 1                  | -                | -      | -                  | 0     | 0      | 1                  |
| 1177                             | Innovation/<br>Hines | 64    | EB  | 0                | 0      | 5                  | 9                | 0      | 2                  | 10    | 0      | 2                  |
|                                  |                      | 166   | WB  | -                | -      | -                  | 0                | 0      | 1                  | 0     | 0      | 1                  |
| 4875                             | Terry Fox/<br>March  | 63    | WB  | 0                | 1      | 1                  | 0                | 29     | 6                  | 1     | 51     | 3                  |
|                                  |                      | 110   | NB  | 0                | 1      | 0                  | 1                | 6      | 1                  | 1     | 11     | 1                  |
| 6155                             | Terry Fox/<br>March  | 63    | EB  | 3                | 0      | 5                  | 11               | 0      | 3                  | 29    | 0      | 3                  |
|                                  |                      | 110   | SB  | 2                | 0      | 1                  | 2                | 0      | 1                  | 5     | 0      | 1                  |
| 7994                             | March/<br>AD. 501    | 63    | EB  | 0                | 0      | 5                  | -                | -      | -                  | 1     | 0      | 4                  |

Please let me know if there are any questions, or if there is any additional data that you require.

Thank you,

**Graham Rathwell**

Transit Planner, Network Service Design  
Service Planning Branch  
Transit Services Department  
OC Transpo | City of Ottawa

## **APPENDIX D**

---

Traffic Count Data



# Turning Movement Count

## Summary Report Including Peak Hours, AADT and Expansion Factors

All Vehicles Except Bicycles



### March Road & Morgan's Grant Way/Shirley's Brook Drive Kanata, ON

**Survey Date:** Thursday, August 04, 2022      **Start Time:** 0700      **AADT Factor:** 0.9  
**Weather AM:** Overcast 20° C      **Survey Duration:** 8 Hrs.      **Survey Hours:** 0700-1000, 1130-1330 & 1500-1800  
**Weather PM:** Mostly Cloudy 28° C      **Surveyor(s):** T. Carmody

#### Morgan's Grant Way

#### Shirley's Brook Dr.

#### March Rd.

#### March Rd.

Eastbound

Westbound

Northbound

Southbound

| Time Period   | Morgan's Grant Way Eastbound |           |            |          |            | Shirley's Brook Dr. Westbound |           |            |          |             | Street Total | March Rd. Northbound |             |            |           |             | March Rd. Southbound |             |           |           |             | Street Total | Grand Total  |
|---------------|------------------------------|-----------|------------|----------|------------|-------------------------------|-----------|------------|----------|-------------|--------------|----------------------|-------------|------------|-----------|-------------|----------------------|-------------|-----------|-----------|-------------|--------------|--------------|
|               | LT                           | ST        | RT         | UT       | E/B Tot    | LT                            | ST        | RT         | UT       | W/B Tot     |              | LT                   | ST          | RT         | UT        | N/B Tot     | LT                   | ST          | RT        | UT        | S/B Tot     |              |              |
| 0700-0800     | 4                            | 8         | 82         | 0        | 94         | 74                            | 7         | 9          | 0        | 90          | 184          | 20                   | 267         | 26         | 1         | 314         | 5                    | 594         | 4         | 1         | 604         | 918          | 1102         |
| 0800-0900     | 6                            | 4         | 88         | 0        | 98         | 110                           | 5         | 9          | 0        | 124         | 222          | 29                   | 387         | 43         | 0         | 459         | 14                   | 741         | 3         | 0         | 758         | 1217         | 1439         |
| 0900-1000     | 6                            | 8         | 82         | 0        | 96         | 82                            | 14        | 12         | 0        | 108         | 204          | 29                   | 446         | 51         | 1         | 527         | 15                   | 617         | 10        | 1         | 643         | 1170         | 1374         |
| 1130-1230     | 11                           | 4         | 66         | 0        | 81         | 92                            | 7         | 14         | 0        | 113         | 194          | 47                   | 642         | 73         | 4         | 766         | 17                   | 610         | 12        | 1         | 640         | 1406         | 1600         |
| 1230-1330     | 12                           | 11        | 61         | 0        | 84         | 83                            | 8         | 22         | 0        | 113         | 197          | 44                   | 631         | 74         | 3         | 752         | 15                   | 613         | 11        | 3         | 642         | 1394         | 1591         |
| 1500-1600     | 8                            | 13        | 58         | 0        | 79         | 91                            | 14        | 29         | 0        | 134         | 213          | 70                   | 818         | 93         | 6         | 987         | 23                   | 600         | 12        | 6         | 641         | 1628         | 1841         |
| 1600-1700     | 12                           | 17        | 71         | 0        | 100        | 141                           | 17        | 43         | 0        | 201         | 301          | 77                   | 990         | 113        | 3         | 1183        | 31                   | 668         | 13        | 2         | 714         | 1897         | 2198         |
| 1700-1800     | 9                            | 14        | 79         | 0        | 102        | 98                            | 17        | 26         | 0        | 141         | 243          | 77                   | 992         | 115        | 1         | 1185        | 27                   | 620         | 16        | 1         | 664         | 1849         | 2092         |
| <b>Totals</b> | <b>68</b>                    | <b>79</b> | <b>587</b> | <b>0</b> | <b>734</b> | <b>771</b>                    | <b>89</b> | <b>164</b> | <b>0</b> | <b>1024</b> | <b>1758</b>  | <b>393</b>           | <b>5173</b> | <b>588</b> | <b>19</b> | <b>6173</b> | <b>147</b>           | <b>5063</b> | <b>81</b> | <b>15</b> | <b>5306</b> | <b>11479</b> | <b>13237</b> |

#### Equivalent 12 & 24-hour Vehicle Volumes Including the Annual Average Daily Traffic (AADT) Factor Applicable to the Day and Month of the Turning Movement Count

**Expansion factors are applied exclusively to standard weekday 8-hour turning movement counts conducted during the hours of 0700h - 1000h, 1130h - 1330h and 1500h - 1800h**

Equivalent 12-hour vehicle volumes. These volumes are calculated by multiplying the 8-hour totals by the 8 → 12 expansion factor of 1.39

|            |    |     |     |   |      |      |     |     |   |      |      |     |      |     |    |      |     |      |     |    |      |       |       |
|------------|----|-----|-----|---|------|------|-----|-----|---|------|------|-----|------|-----|----|------|-----|------|-----|----|------|-------|-------|
| Equ. 12 Hr | 95 | 110 | 816 | 0 | 1020 | 1072 | 124 | 228 | 0 | 1423 | 2444 | 546 | 7190 | 817 | 26 | 8580 | 204 | 7038 | 113 | 21 | 7375 | 15956 | 18399 |
|------------|----|-----|-----|---|------|------|-----|-----|---|------|------|-----|------|-----|----|------|-----|------|-----|----|------|-------|-------|

Average daily 12-hour vehicle volumes. These volumes are calculated by multiplying the equivalent 12-hour totals by the AADT factor of: 0.9

|            |    |    |     |   |     |     |     |     |   |      |      |     |      |     |    |      |     |      |     |    |      |       |       |
|------------|----|----|-----|---|-----|-----|-----|-----|---|------|------|-----|------|-----|----|------|-----|------|-----|----|------|-------|-------|
| AADT 12-hr | 85 | 99 | 734 | 0 | 918 | 965 | 111 | 205 | 0 | 1281 | 2199 | 492 | 6471 | 736 | 24 | 7722 | 184 | 6334 | 101 | 19 | 6638 | 14360 | 16559 |
|------------|----|----|-----|---|-----|-----|-----|-----|---|------|------|-----|------|-----|----|------|-----|------|-----|----|------|-------|-------|

24-Hour AADT. These volumes are calculated by multiplying the average daily 12-hour vehicle volumes by the 12 → 24 expansion factor of 1.31

|            |     |     |     |   |      |      |     |     |   |      |      |     |      |     |    |       |     |      |     |    |      |       |       |
|------------|-----|-----|-----|---|------|------|-----|-----|---|------|------|-----|------|-----|----|-------|-----|------|-----|----|------|-------|-------|
| AADT 24 Hr | 111 | 129 | 962 | 0 | 1203 | 1264 | 146 | 269 | 0 | 1678 | 2881 | 644 | 8478 | 964 | 31 | 10116 | 241 | 8297 | 133 | 25 | 8696 | 18812 | 21693 |
|------------|-----|-----|-----|---|------|------|-----|-----|---|------|------|-----|------|-----|----|-------|-----|------|-----|----|------|-------|-------|

#### AADT and expansion factors provided by the City of Ottawa

| AM Peak Hour Factor → 0.97  |    |    |    |    |       |     |    |    |    |       | Highest Hourly Vehicle Volume Between 0700h & 1000h |    |     |     |    |       |    |     |    |    |       |           |          |
|-----------------------------|----|----|----|----|-------|-----|----|----|----|-------|---|----|-----|-----|----|-------|----|-----|----|----|-------|-----------|----------|
| AM Peak Hr                  | LT | ST | RT | UT | Total | LT  | ST | RT | UT | Total | Str. Tot.   | LT | ST  | RT  | UT | Total | LT | ST  | RT | UT | Total | Str. Tot. | Gr. Tot. |
| 0815-0915                   | 8  | 8  | 80 | 0  | 96    | 92  | 7  | 9  | 0  | 108   | 204   | 21 | 435 | 48  | 0  | 504   | 15 | 717 | 5  | 0  | 737   | 1241      | 1445     |
| OFF Peak Hour Factor → 0.98 |    |    |    |    |       |     |    |    |    |       | Highest Hourly Vehicle Volume Between 1130h & 1330h |    |     |     |    |       |    |     |    |    |       |           |          |
| OFF Peak Hr                 | LT | ST | RT | UT | Total | LT  | ST | RT | UT | Total | Str. Tot.   | LT | ST  | RT  | UT | Total | LT | ST  | RT | UT | Total | Str. Tot. | Gr. Tot. |
| 1145-1245                   | 12 | 9  | 64 | 0  | 85    | 86  | 8  | 17 | 0  | 111   | 196   | 42 | 676 | 78  | 3  | 799   | 17 | 629 | 12 | 1  | 659   | 1458      | 1654     |
| PM Peak Hour Factor → 0.89  |    |    |    |    |       |     |    |    |    |       | Highest Hourly Vehicle Volume Between 1500h & 1800h |    |     |     |    |       |    |     |    |    |       |           |          |
| PM Peak Hr                  | LT | ST | RT | UT | Total | LT  | ST | RT | UT | Total | Str. Tot.   | LT | ST  | RT  | UT | Total | LT | ST  | RT | UT | Total | Str. Tot. | Gr. Tot. |
| 1545-1645                   | 10 | 15 | 76 | 0  | 101   | 137 | 17 | 42 | 0  | 196   | 297   | 82 | 987 | 110 | 4  | 1183  | 24 | 703 | 16 | 2  | 745   | 1928      | 2225     |

#### Comments:

OC Transpo and Para Transpo buses, together with a few school buses, comprise 10.19% of the heavy vehicle traffic. The bicycle totals include 2 E-Scooters (stand-up type). The pedestrian crossing totals include 1 with accessibility issues using an electric wheelchair.

#### Notes:

- Includes all vehicle types except bicycles, electric bicycles, and electric scooters.
- When expansion and AADT factors are applied, the results will differ slightly due to rounding.



# Turning Movement Count Summary, AM and PM Peak Hour Flow Diagrams



All Vehicles Except Bicycles

## March Road & Morgan's Grant Way/Shirley's Brook Drive Kanata, ON

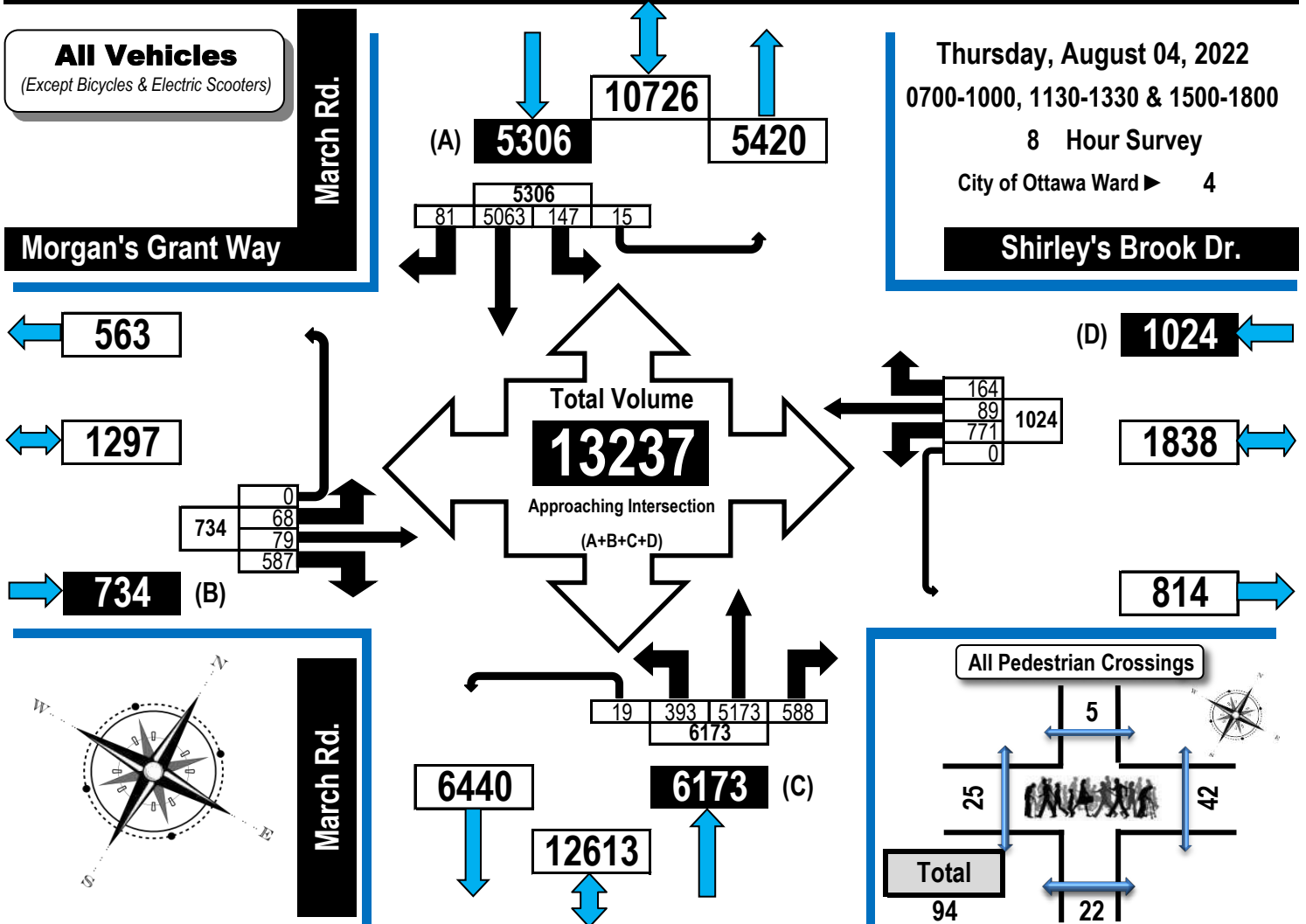

### AM Peak Hour Flow Diagram      PM Peak Hour Flow Diagram

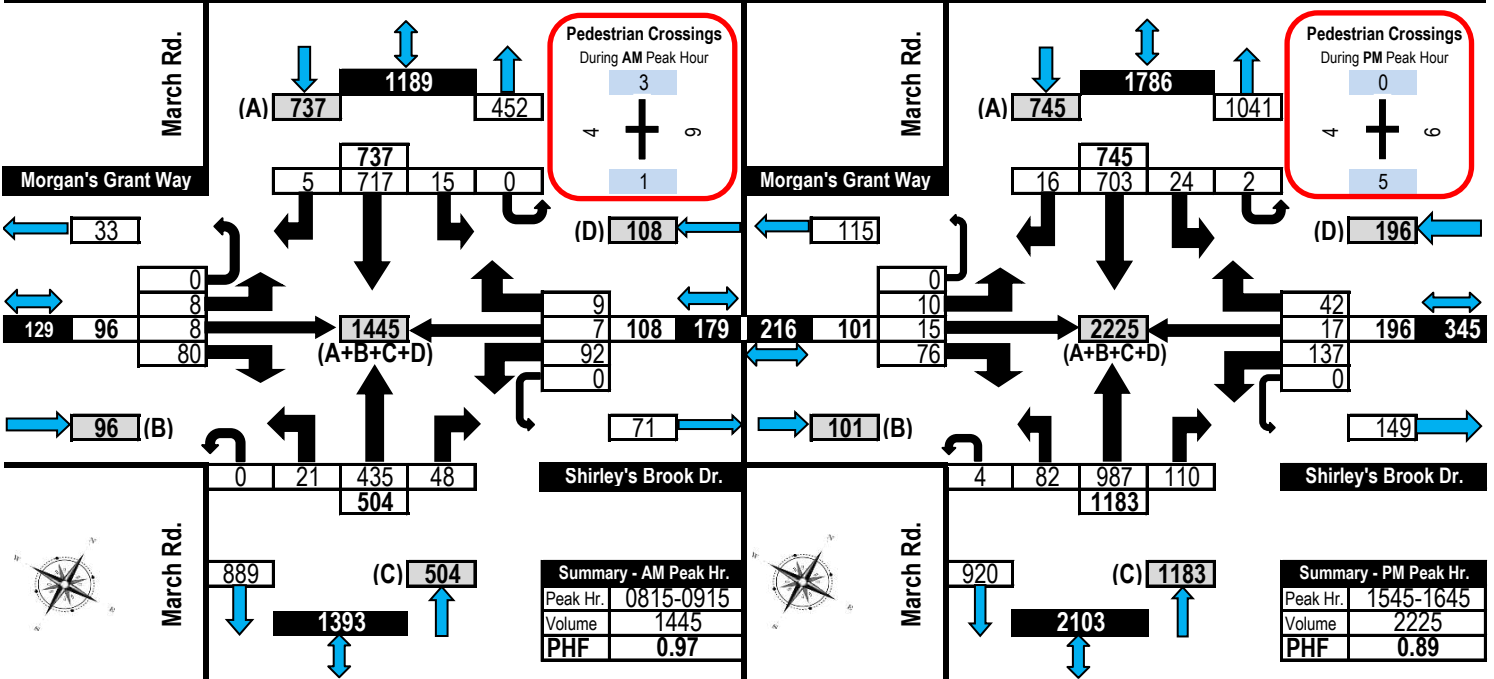



# Turning Movement Count

## Summary Report Including Peak Hours, AADT and Expansion Factors

All Vehicles Except Bicycles



### March Road & Terry Fox DriveKanata, ON

**Survey Date:** Thursday, August 04, 2022      **Start Time:** 0700      **AADT Factor:** 0.9  
**Weather AM:** Overcast 22° C      **Survey Duration:** 8 Hrs.      **Survey Hours:** 0700-1000, 1130-1330 & 1500-1800  
**Weather PM:** Mostly Cloudy 28° C      **Surveyor(s):** T. Carmody

| Time Period   | Terry Fox Dr. Eastbound |            |             |          |             | Terry Fox Dr. Westbound |            |            |          |             | March Rd. Northbound |             |             |            |            | March Rd. Southbound |            |             |            |           | Street Total | Grand Total  |              |
|---------------|-------------------------|------------|-------------|----------|-------------|-------------------------|------------|------------|----------|-------------|----------------------|-------------|-------------|------------|------------|----------------------|------------|-------------|------------|-----------|--------------|--------------|--------------|
|               | LT                      | ST         | RT          | UT       | E/B Tot     | LT                      | ST         | RT         | UT       | W/B Tot     | Street Total         | LT          | ST          | RT         | UT         | N/B Tot              | LT         | ST          | RT         | UT        |              |              | S/B Tot      |
| 0700-0800     | 35                      | 87         | 151         | 0        | 273         | 32                      | 37         | 11         | 0        | 80          | 353                  | 71          | 267         | 52         | 10         | 400                  | 50         | 630         | 59         | 1         | 740          | 1140         | 1493         |
| 0800-0900     | 67                      | 130        | 194         | 0        | 391         | 29                      | 50         | 19         | 1        | 99          | 490                  | 127         | 369         | 96         | 14         | 606                  | 85         | 743         | 111        | 0         | 939          | 1545         | 2035         |
| 0900-1000     | 87                      | 158        | 157         | 0        | 402         | 45                      | 74         | 36         | 0        | 155         | 557                  | 131         | 418         | 78         | 16         | 643                  | 71         | 589         | 113        | 2         | 775          | 1418         | 1975         |
| 1130-1230     | 129                     | 104        | 146         | 0        | 379         | 75                      | 111        | 82         | 0        | 268         | 647                  | 125         | 550         | 82         | 14         | 771                  | 85         | 583         | 112        | 0         | 780          | 1551         | 2198         |
| 1230-1330     | 141                     | 100        | 130         | 0        | 371         | 76                      | 84         | 70         | 1        | 231         | 602                  | 125         | 530         | 76         | 18         | 749                  | 75         | 554         | 121        | 3         | 753          | 1502         | 2104         |
| 1500-1600     | 146                     | 89         | 167         | 0        | 402         | 81                      | 118        | 93         | 0        | 292         | 694                  | 128         | 752         | 54         | 21         | 955                  | 63         | 567         | 127        | 2         | 759          | 1714         | 2408         |
| 1600-1700     | 214                     | 119        | 207         | 0        | 540         | 87                      | 194        | 137        | 0        | 418         | 958                  | 213         | 819         | 78         | 20         | 1130                 | 65         | 636         | 170        | 5         | 876          | 2006         | 2964         |
| 1700-1800     | 194                     | 91         | 194         | 0        | 479         | 101                     | 158        | 117        | 2        | 378         | 857                  | 206         | 874         | 71         | 8          | 1159                 | 60         | 582         | 137        | 4         | 783          | 1942         | 2799         |
| <b>Totals</b> | <b>1013</b>             | <b>878</b> | <b>1346</b> | <b>0</b> | <b>3237</b> | <b>526</b>              | <b>826</b> | <b>565</b> | <b>4</b> | <b>1921</b> | <b>5158</b>          | <b>1126</b> | <b>4579</b> | <b>587</b> | <b>121</b> | <b>6413</b>          | <b>554</b> | <b>4884</b> | <b>950</b> | <b>17</b> | <b>6405</b>  | <b>12818</b> | <b>17976</b> |

**Equivalent 12 & 24-hour Vehicle Volumes Including the Annual Average Daily Traffic (AADT) Factor**  
**Applicable to the Day and Month of the Turning Movement Count**

**Expansion factors are applied exclusively to standard weekday 8-hour turning movement counts conducted during the hours of 0700h - 1000h, 1130h - 1330h and 1500h - 1800h**

| Equivalent 12-hour vehicle volumes. These volumes are calculated by multiplying the 8-hour totals by the 8 → 12 expansion factor of 1.39    |      |      |      |   |      |     |      |     |   |      |      |      |      |     |     |       |     |      |      |    |       |       |       |
|---|------|------|------|---|------|-----|------|-----|---|------|------|------|------|-----|-----|-------|-----|------|------|----|-------|-------|-------|
| Equ. 12 Hr  | 1408 | 1220 | 1871 | 0 | 4499 | 731 | 1148 | 785 | 6 | 2670 | 7170 | 1565 | 6365 | 816 | 168 | 8914  | 770 | 6789 | 1321 | 24 | 8903  | 17817 | 24987 |
| Average daily 12-hour vehicle volumes. These volumes are calculated by multiplying the equivalent 12-hour totals by the AADT factor of: 0.9 |      |      |      |   |      |     |      |     |   |      |      |      |      |     |     |       |     |      |      |    |       |       |       |
| AADT 12-hr  | 1267 | 1098 | 1684 | 0 | 4049 | 658 | 1033 | 707 | 5 | 2403 | 6453 | 1409 | 5728 | 734 | 151 | 8023  | 693 | 6110 | 1188 | 21 | 8013  | 16035 | 22488 |
| 24-Hour AADT. These volumes are calculated by multiplying the average daily 12-hour vehicle volumes by the 12 → 24 expansion factor of 1.31 |      |      |      |   |      |     |      |     |   |      |      |      |      |     |     |       |     |      |      |    |       |       |       |
| AADT 24 Hr  | 1660 | 1439 | 2206 | 0 | 5305 | 862 | 1354 | 926 | 7 | 3148 | 8453 | 1845 | 7504 | 962 | 198 | 10510 | 908 | 8004 | 1557 | 28 | 10497 | 21006 | 29459 |

**AADT and expansion factors provided by the City of Ottawa**

| AM Peak Hour Factor → 0.94  |     |     |     |    |       |    |     |     |    |       | Highest Hourly Vehicle Volume Between 0700h & 1000h |     |     |     |    |       |      |    |     |     |       |           |          |      |
|-----------------------------|-----|-----|-----|----|-------|----|-----|-----|----|-------|---|-----|-----|-----|----|-------|------|----|-----|-----|-------|-----------|----------|------|
| AM Peak Hr                  | LT  | ST  | RT  | UT | Total | LT | ST  | RT  | UT | Total | Str. Tot.   | LT  | ST  | RT  | UT | Total | LT   | ST | RT  | UT  | Total | Str. Tot. | Gr. Tot. |      |
| 0815-0915                   | 80  | 158 | 220 | 0  | 458   | 40 | 69  | 24  | 1  | 134   | 592   | 134 | 139 | 400 | 91 | 14    | 644  | 83 | 694 | 118 | 1     | 896       | 1540     | 2132 |
| OFF Peak Hour Factor → 0.97 |     |     |     |    |       |    |     |     |    |       | Highest Hourly Vehicle Volume Between 1130h & 1330h |     |     |     |    |       |      |    |     |     |       |           |          |      |
| OFF Peak Hr                 | LT  | ST  | RT  | UT | Total | LT | ST  | RT  | UT | Total | Str. Tot.   | LT  | ST  | RT  | UT | Total | LT   | ST | RT  | UT  | Total | Str. Tot. | Gr. Tot. |      |
| 1145-1245                   | 144 | 114 | 135 | 0  | 393   | 83 | 110 | 95  | 1  | 289   | 682   | 289 | 143 | 577 | 86 | 14    | 820  | 85 | 588 | 117 | 0     | 790       | 1610     | 2292 |
| PM Peak Hour Factor → 0.92  |     |     |     |    |       |    |     |     |    |       | Highest Hourly Vehicle Volume Between 1500h & 1800h |     |     |     |    |       |      |    |     |     |       |           |          |      |
| PM Peak Hr                  | LT  | ST  | RT  | UT | Total | LT | ST  | RT  | UT | Total | Str. Tot.   | LT  | ST  | RT  | UT | Total | LT   | ST | RT  | UT  | Total | Str. Tot. | Gr. Tot. |      |
| 1615-1715                   | 212 | 107 | 216 | 0  | 535   | 93 | 183 | 144 | 1  | 421   | 956   | 421 | 203 | 872 | 77 | 18    | 1170 | 60 | 637 | 158 | 4     | 859       | 2029     | 2985 |

**Comments:**

OC Transpo and Para Transpo buses, together with a few school buses, comprise 18.97% of the heavy vehicle traffic. The bicycle totals include 3 E-Scooters (stand-up type). The pedestrian crossing totals include 1 with accessibility issues using an electric wheelchair.

**Notes:**

- Includes all vehicle types except bicycles, electric bicycles, and electric scooters.
- When expansion and AADT factors are applied, the results will differ slightly due to rounding.



# Turning Movement Count

## Summary, AM and PM Peak Hour

### Flow Diagrams

All Vehicles Except Bicycles



## March Road & Terry Fox Drive Kanata, ON

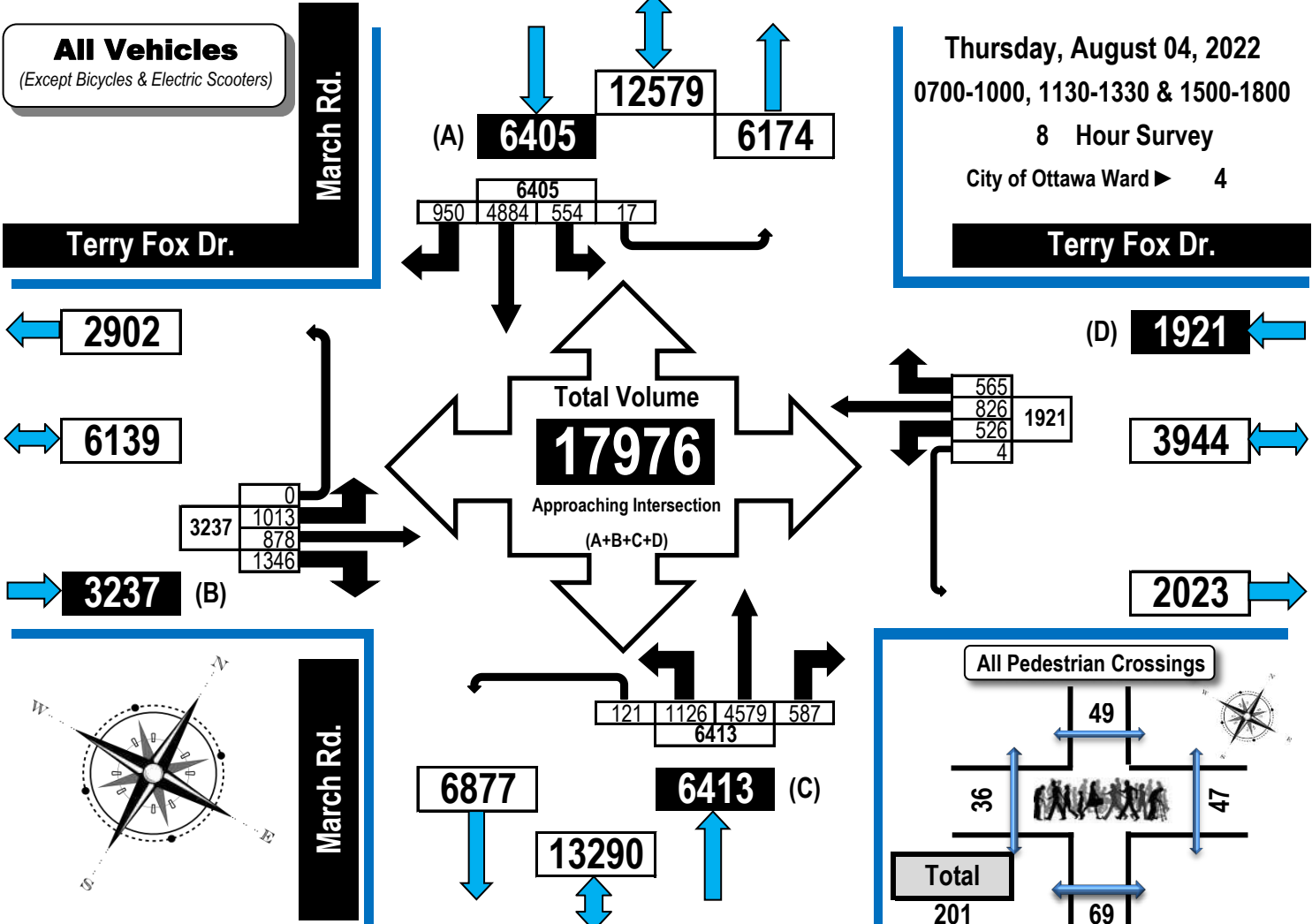

### AM Peak Hour Flow Diagram PM Peak Hour Flow Diagram

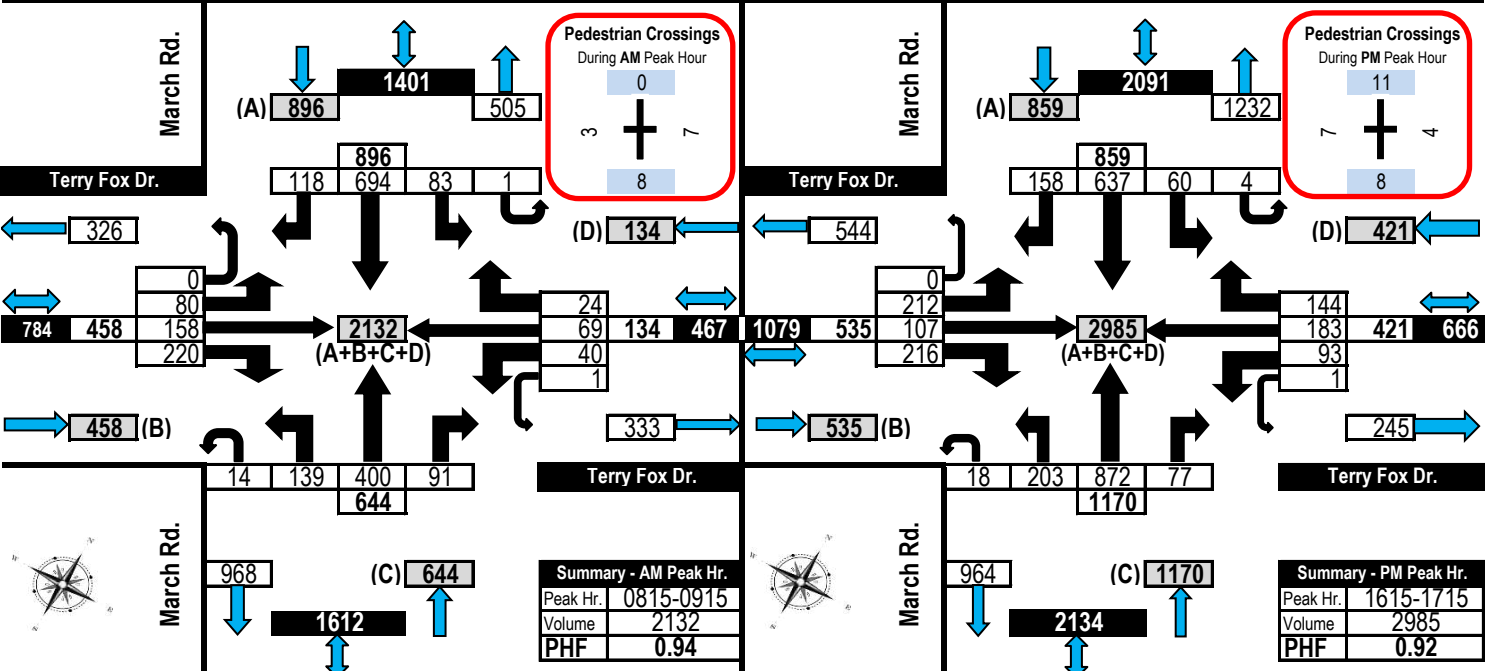





# Turning Movement Count

## Summary Report Including Peak Hours, AADT and Expansion Factors

All Vehicles Except Bicycles



### March Road & Solandt Road Kanata, ON

**Survey Date:** Thursday, August 04, 2022      **Start Time:** 0700      **AADT Factor:** 0.9  
**Weather AM:** Overcast 20° C      **Survey Duration:** 8 Hrs.      **Survey Hours:** 0700-1000, 1130-1330 & 1500-1800  
**Weather PM:** Mostly Cloudy 28° C      **Surveyor(s):** T. Carmody

| Time Period   | Solandt Rd. Eastbound |            |            |          |             | Solandt Rd. Westbound |            |            |          |             | March Rd. Northbound |             |             |            |           | March Rd. Southbound |            |             |            |           | Street Total | Grand Total  |              |
|---------------|-----------------------|------------|------------|----------|-------------|-----------------------|------------|------------|----------|-------------|----------------------|-------------|-------------|------------|-----------|----------------------|------------|-------------|------------|-----------|--------------|--------------|--------------|
|               | LT                    | ST         | RT         | UT       | E/B Tot     | LT                    | ST         | RT         | UT       | W/B Tot     | LT                   | ST          | RT          | UT         | N/B Tot   | LT                   | ST         | RT          | UT         | S/B Tot   |              |              |              |
| 0700-0800     | 4                     | 15         | 37         | 0        | 56          | 18                    | 8          | 4          | 0        | 30          | 86                   | 175         | 389         | 118        | 1         | 683                  | 25         | 753         | 34         | 0         | 812          | 1495         | 1581         |
| 0800-0900     | 17                    | 25         | 80         | 0        | 122         | 50                    | 13         | 10         | 0        | 73          | 195                  | 248         | 567         | 202        | 2         | 1019                 | 52         | 873         | 38         | 4         | 967          | 1986         | 2181         |
| 0900-1000     | 20                    | 15         | 86         | 0        | 121         | 69                    | 12         | 5          | 0        | 86          | 207                  | 219         | 636         | 194        | 3         | 1052                 | 35         | 742         | 47         | 0         | 824          | 1876         | 2083         |
| 1130-1230     | 42                    | 12         | 110        | 0        | 164         | 90                    | 12         | 18         | 0        | 120         | 284                  | 96          | 703         | 66         | 11        | 876                  | 36         | 726         | 41         | 3         | 806          | 1682         | 1966         |
| 1230-1330     | 22                    | 18         | 106        | 0        | 146         | 80                    | 13         | 10         | 0        | 103         | 249                  | 106         | 692         | 85         | 8         | 891                  | 24         | 705         | 46         | 12        | 787          | 1678         | 1927         |
| 1500-1600     | 20                    | 12         | 119        | 0        | 151         | 146                   | 16         | 15         | 0        | 177         | 328                  | 71          | 912         | 67         | 3         | 1053                 | 16         | 760         | 33         | 5         | 814          | 1867         | 2195         |
| 1600-1700     | 31                    | 14         | 228        | 0        | 273         | 198                   | 19         | 39         | 0        | 256         | 529                  | 80          | 1050        | 59         | 7         | 1196                 | 27         | 905         | 38         | 11        | 981          | 2177         | 2706         |
| 1700-1800     | 28                    | 16         | 193        | 0        | 237         | 193                   | 12         | 30         | 0        | 235         | 472                  | 104         | 1078        | 40         | 22        | 1244                 | 19         | 857         | 27         | 10        | 913          | 2157         | 2629         |
| <b>Totals</b> | <b>184</b>            | <b>127</b> | <b>959</b> | <b>0</b> | <b>1270</b> | <b>844</b>            | <b>105</b> | <b>131</b> | <b>0</b> | <b>1080</b> | <b>2350</b>          | <b>1099</b> | <b>6027</b> | <b>831</b> | <b>57</b> | <b>8014</b>          | <b>234</b> | <b>6321</b> | <b>304</b> | <b>45</b> | <b>6904</b>  | <b>14918</b> | <b>17268</b> |

#### Equivalent 12 & 24-hour Vehicle Volumes Including the Annual Average Daily Traffic (AADT) Factor Applicable to the Day and Month of the Turning Movement Count

**Expansion factors are applied exclusively to standard weekday 8-hour turning movement counts conducted during the hours of 0700h - 1000h, 1130h - 1330h and 1500h - 1800h**

Equivalent 12-hour vehicle volumes. These volumes are calculated by multiplying the 8-hour totals by the 8 → 12 expansion factor of 1.39

|            |     |     |      |   |      |      |     |     |   |      |      |      |      |      |    |       |     |      |     |    |      |       |       |
|------------|-----|-----|------|---|------|------|-----|-----|---|------|------|------|------|------|----|-------|-----|------|-----|----|------|-------|-------|
| Equ. 12 Hr | 256 | 177 | 1333 | 0 | 1765 | 1173 | 146 | 182 | 0 | 1501 | 3267 | 1528 | 8378 | 1155 | 79 | 11139 | 325 | 8786 | 423 | 63 | 9597 | 20736 | 24003 |
|------------|-----|-----|------|---|------|------|-----|-----|---|------|------|------|------|------|----|-------|-----|------|-----|----|------|-------|-------|

Average daily 12-hour vehicle volumes. These volumes are calculated by multiplying the equivalent 12-hour totals by the AADT factor of: 0.9

|            |     |     |      |   |      |      |     |     |   |      |      |      |      |      |    |       |     |      |     |    |      |       |       |
|------------|-----|-----|------|---|------|------|-----|-----|---|------|------|------|------|------|----|-------|-----|------|-----|----|------|-------|-------|
| AADT 12-hr | 230 | 159 | 1200 | 0 | 1589 | 1056 | 131 | 164 | 0 | 1351 | 2940 | 1375 | 7540 | 1040 | 71 | 10026 | 293 | 7908 | 380 | 56 | 8637 | 18662 | 21602 |
|------------|-----|-----|------|---|------|------|-----|-----|---|------|------|------|------|------|----|-------|-----|------|-----|----|------|-------|-------|

24-Hour AADT. These volumes are calculated by multiplying the average daily 12-hour vehicle volumes by the 12 → 24 expansion factor of 1.31

|            |     |     |      |   |      |      |     |     |   |      |      |      |      |      |    |       |     |       |     |    |       |       |       |
|------------|-----|-----|------|---|------|------|-----|-----|---|------|------|------|------|------|----|-------|-----|-------|-----|----|-------|-------|-------|
| AADT 24 Hr | 302 | 208 | 1572 | 0 | 2081 | 1383 | 172 | 215 | 0 | 1770 | 3851 | 1801 | 9877 | 1362 | 93 | 13133 | 383 | 10359 | 498 | 74 | 11314 | 24448 | 28299 |
|------------|-----|-----|------|---|------|------|-----|-----|---|------|------|------|------|------|----|-------|-----|-------|-----|----|-------|-------|-------|

#### AADT and expansion factors provided by the City of Ottawa

| AM Peak Hour Factor → 0.94  |    |    |     |    |       | Highest Hourly Vehicle Volume Between 0700h & 1000h |    |    |    |       |           |     |      |     |    |       |    |     |    |    |       |           |          |
|-----------------------------|----|----|-----|----|-------|---|----|----|----|-------|-----------|-----|------|-----|----|-------|----|-----|----|----|-------|-----------|----------|
| AM Peak Hr                  | LT | ST | RT  | UT | Total | LT  | ST | RT | UT | Total | Str. Tot. | LT  | ST   | RT  | UT | Total | LT | ST  | RT | UT | Total | Str. Tot. | Gr. Tot. |
| 0815-0915                   | 14 | 28 | 100 | 0  | 142   | 60  | 13 | 11 | 0  | 84    | 226       | 260 | 622  | 223 | 2  | 1107  | 50 | 844 | 44 | 2  | 940   | 2047      | 2273     |
| OFF Peak Hour Factor → 0.97 |    |    |     |    |       | Highest Hourly Vehicle Volume Between 1130h & 1330h |    |    |    |       |           |     |      |     |    |       |    |     |    |    |       |           |          |
| OFF Peak Hr                 | LT | ST | RT  | UT | Total | LT  | ST | RT | UT | Total | Str. Tot. | LT  | ST   | RT  | UT | Total | LT | ST  | RT | UT | Total | Str. Tot. | Gr. Tot. |
| 1145-1245                   | 39 | 16 | 116 | 0  | 171   | 99  | 12 | 18 | 0  | 129   | 300       | 105 | 722  | 71  | 12 | 910   | 40 | 719 | 45 | 7  | 811   | 1721      | 2021     |
| PM Peak Hour Factor → 0.97  |    |    |     |    |       | Highest Hourly Vehicle Volume Between 1500h & 1800h |    |    |    |       |           |     |      |     |    |       |    |     |    |    |       |           |          |
| PM Peak Hr                  | LT | ST | RT  | UT | Total | LT  | ST | RT | UT | Total | Str. Tot. | LT  | ST   | RT  | UT | Total | LT | ST  | RT | UT | Total | Str. Tot. | Gr. Tot. |
| 1630-1730                   | 29 | 22 | 237 | 0  | 288   | 205   | 16 | 34 | 0  | 255   | 543       | 94  | 1070 | 51  | 16 | 1231  | 24 | 909 | 35 | 12 | 980   | 2211      | 2754     |

#### Comments:

OC Transpo and Para Transpo buses, together with a few school buses, comprise 18.11% of the heavy vehicle traffic. The bicycle totals include 1 E-Scooter (Vespa style). There was one serious conflict between a N/B left-turning & a S/B straight vehicle at 0916h.

#### Notes:

- Includes all vehicle types except bicycles, electric bicycles, and electric scooters.
- When expansion and AADT factors are applied, the results will differ slightly due to rounding.



# Turning Movement Count

## Summary, AM and PM Peak Hour

### Flow Diagrams

All Vehicles Except Bicycles



## March Road & Solandt Road Kanata, ON

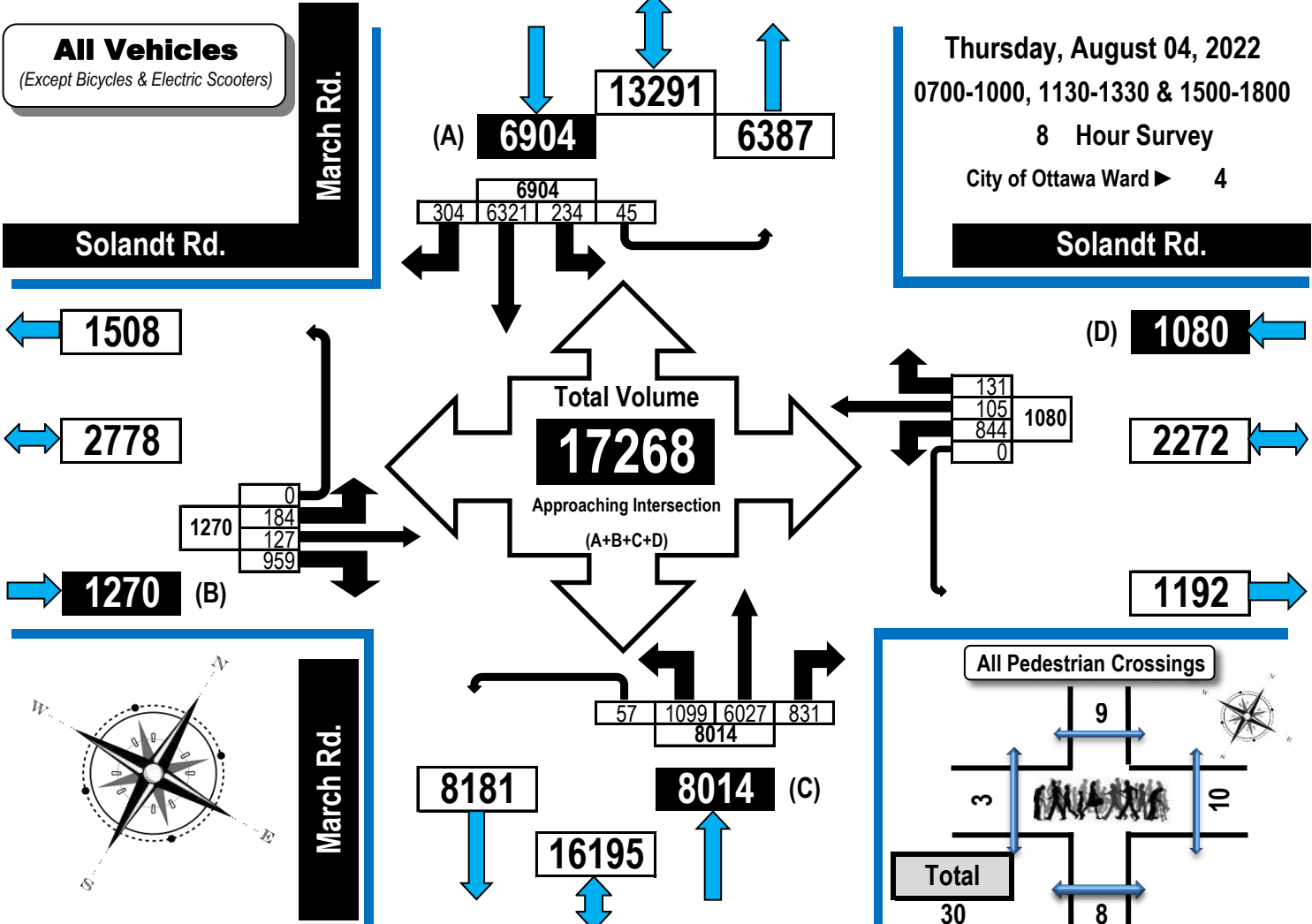

### AM Peak Hour Flow Diagram PM Peak Hour Flow Diagram

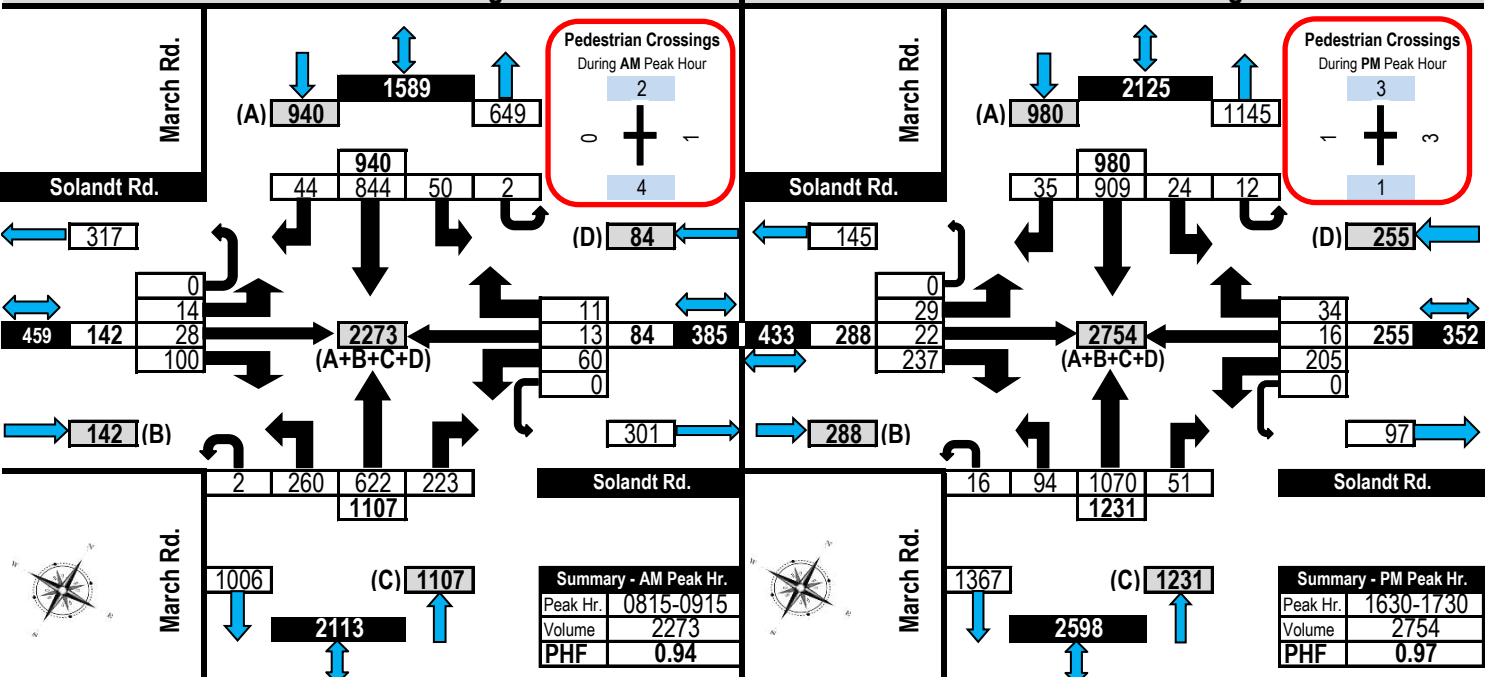



# Turning Movement Count

## Summary Report Including Peak Hours, AADT and Expansion Factors

All Vehicles Except Bicycles



### Flamborough Way/Innovation Drive & Terry Fox Drive Kanata, ON

**Survey Date:** Tuesday, August 09, 2022      **Start Time:** 0700      **AADT Factor:** 0.9  
**Weather AM:** Light Rain 15° C      **Survey Duration:** 8 Hrs.      **Survey Hours:** 0700-1000, 1130-1330 & 1500-1800  
**Weather PM:** Cloudy 19° C      **Surveyor(s):** J. Mousseau/S. Merrett

| Terry Fox Dr. | Terry Fox Dr. | Innovation Dr. | Flamborough Way |
|---------------|---------------|----------------|-----------------|
| Eastbound     | Westbound     | Northbound     | Southbound      |

| Time Period   | LT         | ST          | RT         | UT       | E/B Tot     | LT         | ST          | RT         | UT       | W/B Tot     | Street Total | LT         | ST         | RT         | UT       | N/B Tot     | LT         | ST         | RT         | UT       | S/B Tot     | Street Total | Grand Total |
|---------------|------------|-------------|------------|----------|-------------|------------|-------------|------------|----------|-------------|--------------|------------|------------|------------|----------|-------------|------------|------------|------------|----------|-------------|--------------|-------------|
| 0700-0800     | 21         | 165         | 55         | 0        | 241         | 35         | 96          | 26         | 0        | 157         | 398          | 25         | 12         | 40         | 0        | 77          | 73         | 40         | 32         | 0        | 145         | 222          | 620         |
| 0800-0900     | 40         | 269         | 96         | 0        | 405         | 75         | 140         | 41         | 0        | 256         | 661          | 31         | 40         | 85         | 0        | 156         | 98         | 64         | 49         | 0        | 211         | 367          | 1028        |
| 0900-1000     | 31         | 262         | 55         | 0        | 348         | 88         | 158         | 40         | 0        | 286         | 634          | 43         | 32         | 97         | 0        | 172         | 66         | 33         | 46         | 0        | 145         | 317          | 951         |
| 1130-1230     | 41         | 214         | 38         | 0        | 293         | 95         | 205         | 61         | 0        | 361         | 654          | 40         | 31         | 88         | 0        | 159         | 63         | 45         | 40         | 0        | 148         | 307          | 961         |
| 1230-1330     | 46         | 241         | 40         | 0        | 327         | 92         | 197         | 65         | 0        | 354         | 681          | 48         | 44         | 82         | 0        | 174         | 70         | 36         | 36         | 0        | 142         | 316          | 997         |
| 1500-1600     | 42         | 260         | 36         | 0        | 338         | 78         | 228         | 77         | 0        | 383         | 721          | 60         | 37         | 79         | 0        | 176         | 67         | 29         | 45         | 0        | 141         | 317          | 1038        |
| 1600-1700     | 85         | 276         | 44         | 0        | 405         | 122        | 374         | 146        | 0        | 642         | 1047         | 138        | 80         | 98         | 0        | 316         | 63         | 60         | 75         | 0        | 198         | 514          | 1561        |
| 1700-1800     | 85         | 253         | 47         | 0        | 385         | 119        | 321         | 113        | 0        | 553         | 938          | 89         | 52         | 97         | 0        | 238         | 76         | 40         | 66         | 0        | 182         | 420          | 1358        |
| <b>Totals</b> | <b>391</b> | <b>1940</b> | <b>411</b> | <b>0</b> | <b>2742</b> | <b>704</b> | <b>1719</b> | <b>569</b> | <b>0</b> | <b>2992</b> | <b>5734</b>  | <b>474</b> | <b>328</b> | <b>666</b> | <b>0</b> | <b>1468</b> | <b>576</b> | <b>347</b> | <b>389</b> | <b>0</b> | <b>1312</b> | <b>2780</b>  | <b>8514</b> |

**Equivalent 12 & 24-hour Vehicle Volumes Including the Annual Average Daily Traffic (AADT) Factor**  
**Applicable to the Day and Month of the Turning Movement Count**

**Expansion factors are applied exclusively to standard weekday 8-hour turning movement counts conducted during the hours of 0700h - 1000h, 1130h - 1330h and 1500h - 1800h**

Equivalent 12-hour vehicle volumes. These volumes are calculated by multiplying the 8-hour totals by the 8 → 12 expansion factor of 1.39

|            |     |      |     |   |      |     |      |     |   |      |      |     |     |     |   |      |     |     |     |   |      |      |       |
|------------|-----|------|-----|---|------|-----|------|-----|---|------|------|-----|-----|-----|---|------|-----|-----|-----|---|------|------|-------|
| Equ. 12 Hr | 543 | 2697 | 571 | 0 | 3811 | 979 | 2389 | 791 | 0 | 4159 | 7970 | 659 | 456 | 926 | 0 | 2041 | 801 | 482 | 541 | 0 | 1824 | 3864 | 11834 |
|------------|-----|------|-----|---|------|-----|------|-----|---|------|------|-----|-----|-----|---|------|-----|-----|-----|---|------|------|-------|

Average daily 12-hour vehicle volumes. These volumes are calculated by multiplying the equivalent 12-hour totals by the AADT factor of: 0.9

|            |     |      |     |   |      |     |      |     |   |      |      |     |     |     |   |      |     |     |     |   |      |      |       |
|------------|-----|------|-----|---|------|-----|------|-----|---|------|------|-----|-----|-----|---|------|-----|-----|-----|---|------|------|-------|
| AADT 12-hr | 489 | 2427 | 514 | 0 | 3430 | 881 | 2150 | 712 | 0 | 3743 | 7173 | 593 | 410 | 833 | 0 | 1836 | 721 | 434 | 487 | 0 | 1641 | 3478 | 10651 |
|------------|-----|------|-----|---|------|-----|------|-----|---|------|------|-----|-----|-----|---|------|-----|-----|-----|---|------|------|-------|

24-Hour AADT. These volumes are calculated by multiplying the average daily 12-hour vehicle volumes by the 12 → 24 expansion factor of 1.31

|            |     |      |     |   |      |      |      |     |   |      |      |     |     |      |   |      |     |     |     |   |      |      |       |
|------------|-----|------|-----|---|------|------|------|-----|---|------|------|-----|-----|------|---|------|-----|-----|-----|---|------|------|-------|
| AADT 24 Hr | 641 | 3179 | 674 | 0 | 4494 | 1154 | 2817 | 932 | 0 | 4903 | 9397 | 777 | 538 | 1091 | 0 | 2406 | 944 | 569 | 637 | 0 | 2150 | 4556 | 13953 |
|------------|-----|------|-----|---|------|------|------|-----|---|------|------|-----|-----|------|---|------|-----|-----|-----|---|------|------|-------|

**AADT and expansion factors provided by the City of Ottawa**

|                                    |    |     |    |    |       |     |     |     |    |       |  |     |    |     |    |       |    |    |    |    |       |           |          |
|------------------------------------|----|-----|----|----|-------|-----|-----|-----|----|-------|--|-----|----|-----|----|-------|----|----|----|----|-------|-----------|----------|
| <b>AM Peak Hour Factor → 0.88</b>  |    |     |    |    |       |     |     |     |    |       | <b>Highest Hourly Vehicle Volume Between 0700h &amp; 1000h</b> |     |    |     |    |       |    |    |    |    |       |           |          |
| AM Peak Hr                         | LT | ST  | RT | UT | Total | LT  | ST  | RT  | UT | Total | Str. Tot.  | LT  | ST | RT  | UT | Total | LT | ST | RT | UT | Total | Str. Tot. | Gr. Tot. |
| 0830-0930                          | 34 | 328 | 89 | 0  | 451   | 99  | 160 | 43  | 0  | 302   | 753  | 43  | 42 | 100 | 0  | 185   | 74 | 65 | 50 | 0  | 189   | 374       | 1127     |
| <b>OFF Peak Hour Factor → 0.95</b> |    |     |    |    |       |     |     |     |    |       | <b>Highest Hourly Vehicle Volume Between 1130h &amp; 1330h</b> |     |    |     |    |       |    |    |    |    |       |           |          |
| OFF Peak Hr                        | LT | ST  | RT | UT | Total | LT  | ST  | RT  | UT | Total | Str. Tot.  | LT  | ST | RT  | UT | Total | LT | ST | RT | UT | Total | Str. Tot. | Gr. Tot. |
| 1200-1300                          | 43 | 258 | 43 | 0  | 344   | 117 | 205 | 68  | 0  | 390   | 734  | 45  | 34 | 81  | 0  | 160   | 71 | 51 | 40 | 0  | 162   | 322       | 1056     |
| <b>PM Peak Hour Factor → 0.92</b>  |    |     |    |    |       |     |     |     |    |       | <b>Highest Hourly Vehicle Volume Between 1500h &amp; 1800h</b> |     |    |     |    |       |    |    |    |    |       |           |          |
| PM Peak Hr                         | LT | ST  | RT | UT | Total | LT  | ST  | RT  | UT | Total | Str. Tot.  | LT  | ST | RT  | UT | Total | LT | ST | RT | UT | Total | Str. Tot. | Gr. Tot. |
| 1600-1700                          | 85 | 276 | 44 | 0  | 405   | 122 | 374 | 146 | 0  | 642   | 1047   | 138 | 80 | 98  | 0  | 316   | 63 | 60 | 75 | 0  | 198   | 514       | 1561     |

**Comments:**

OC Transpo buses, together with a few school buses, comprise 55.36% of the heavy vehicle traffic.

**Notes:**

1. Includes all vehicle types except bicycles, electric bicycles, and electric scooters.
2. When expansion and AADT factors are applied, the results will differ slightly due to rounding.



# Turning Movement Count Summary, AM and PM Peak Hour Flow Diagrams



All Vehicles Except Bicycles

## Flamborough Way/Innovation Drive & Terry Fox Drive Kanata, ON

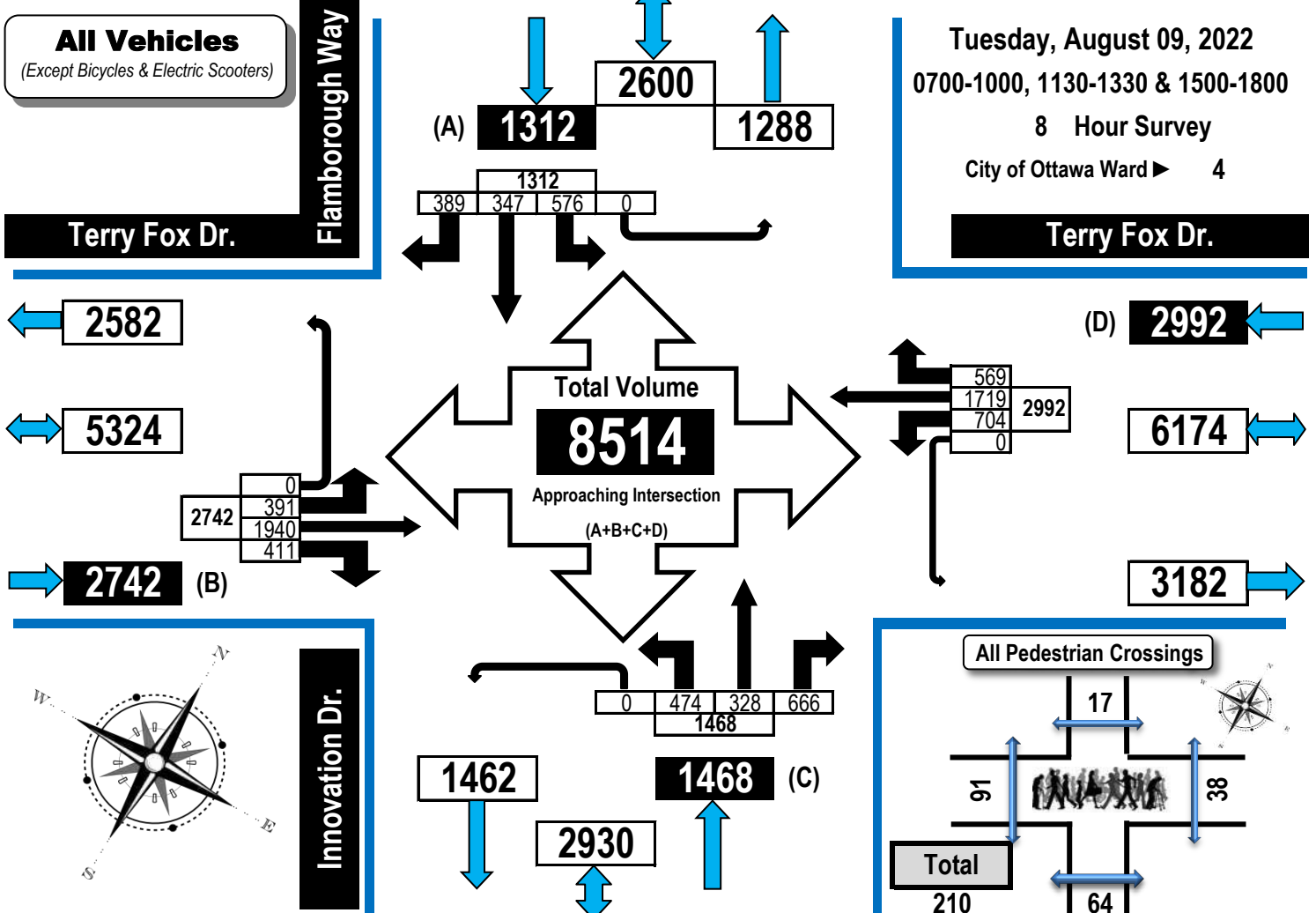

### AM Peak Hour Flow Diagram | PM Peak Hour Flow Diagram

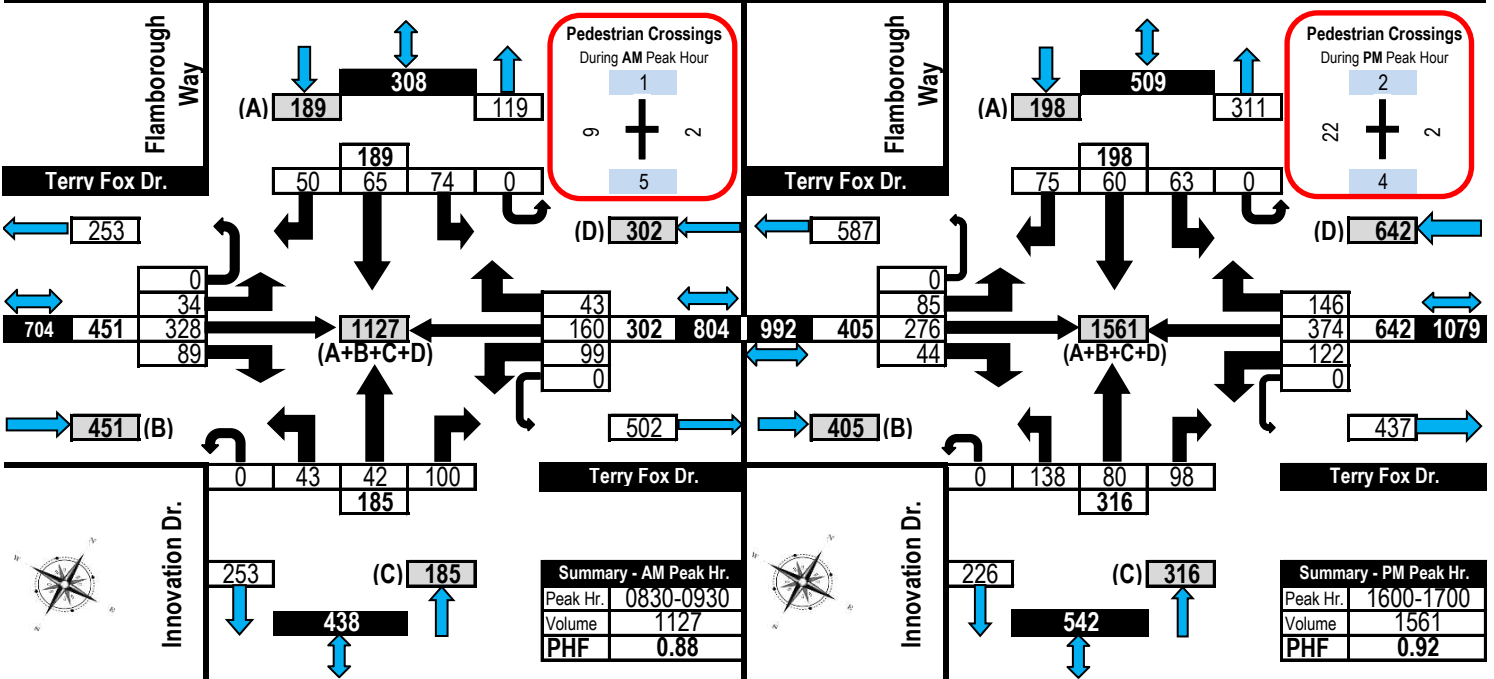



# Turning Movement Count

## Summary Report Including Peak Hours, AADT and Expansion Factors

All Vehicles Except Bicycles



### Hines Road & Innovation Drive

**Kanata, ON**

**Survey Date:** Wednesday, August 10, 2022      **Start Time:** 0700      **AADT Factor:** 0.9  
**Weather AM:** Clear & Sunny 12° C      **Survey Duration:** 8 Hrs.      **Survey Hours:** 0700-1000, 1130-1330 & 1500-1800  
**Weather PM:** Mostly Sunny 28° C      **Surveyor(s):** J. Mousseau, S. Merrett

| Innovation Dr. |  |  |  |  | Royal Cdn. Legion |  |  |  |  | Hines Rd.  |  |  |  |  | Hines Rd.  |  |  |  |  |
|----------------|--|--|--|--|-------------------|--|--|--|--|------------|--|--|--|--|------------|--|--|--|--|
| Eastbound      |  |  |  |  | Westbound         |  |  |  |  | Northbound |  |  |  |  | Southbound |  |  |  |  |

| Time Period   | LT        | ST       | RT         | UT       | E/B Tot    | LT        | ST       | RT       | UT       | W/B Tot   | Street Total | LT         | ST         | RT        | UT       | N/B Tot    | LT       | ST         | RT        | UT       | S/B Tot    | Street Total | Grand Total |
|---------------|-----------|----------|------------|----------|------------|-----------|----------|----------|----------|-----------|--------------|------------|------------|-----------|----------|------------|----------|------------|-----------|----------|------------|--------------|-------------|
| 0700-0800     | 12        | 0        | 69         | 1        | 82         | 1         | 0        | 0        | 0        | 1         | 83           | 44         | 40         | 4         | 0        | 88         | 0        | 12         | 2         | 0        | 14         | 102          | 185         |
| 0800-0900     | 9         | 0        | 113        | 0        | 122        | 5         | 1        | 0        | 0        | 6         | 128          | 91         | 56         | 1         | 0        | 148        | 2        | 11         | 1         | 0        | 14         | 162          | 290         |
| 0900-1000     | 12        | 2        | 93         | 0        | 107        | 4         | 0        | 0        | 0        | 4         | 111          | 75         | 41         | 12        | 0        | 128        | 1        | 15         | 6         | 0        | 22         | 150          | 261         |
| 1130-1230     | 6         | 1        | 75         | 0        | 82         | 6         | 5        | 0        | 0        | 11        | 93           | 73         | 27         | 2         | 0        | 102        | 0        | 26         | 12        | 0        | 38         | 140          | 233         |
| 1230-1330     | 8         | 0        | 80         | 0        | 88         | 2         | 0        | 0        | 0        | 2         | 90           | 53         | 34         | 0         | 0        | 87         | 0        | 21         | 14        | 0        | 35         | 122          | 212         |
| 1500-1600     | 4         | 0        | 71         | 0        | 75         | 3         | 1        | 0        | 0        | 4         | 79           | 69         | 18         | 2         | 0        | 89         | 1        | 49         | 15        | 0        | 65         | 154          | 233         |
| 1600-1700     | 2         | 0        | 100        | 1        | 103        | 0         | 0        | 0        | 0        | 0         | 103          | 134        | 14         | 0         | 0        | 148        | 0        | 53         | 9         | 0        | 62         | 210          | 313         |
| 1700-1800     | 2         | 1        | 68         | 0        | 71         | 0         | 0        | 0        | 0        | 0         | 71           | 113        | 4          | 0         | 0        | 117        | 0        | 33         | 9         | 0        | 42         | 159          | 230         |
| <b>Totals</b> | <b>55</b> | <b>4</b> | <b>669</b> | <b>2</b> | <b>730</b> | <b>21</b> | <b>7</b> | <b>0</b> | <b>0</b> | <b>28</b> | <b>758</b>   | <b>652</b> | <b>234</b> | <b>21</b> | <b>0</b> | <b>907</b> | <b>4</b> | <b>220</b> | <b>68</b> | <b>0</b> | <b>292</b> | <b>1199</b>  | <b>1957</b> |

**Equivalent 12 & 24-hour Vehicle Volumes Including the Annual Average Daily Traffic (AADT) Factor**  
**Applicable to the Day and Month of the Turning Movement Count**

**Expansion factors are applied exclusively to standard weekday 8-hour turning movement counts conducted during the hours of 0700h - 1000h, 1130h - 1330h and 1500h - 1800h**

|  |    |   |     |   |      |    |    |   |   |    |      |     |     |    |   |      |   |     |    |   |     |      |      |
|--|----|---|-----|---|------|----|----|---|---|----|------|-----|-----|----|---|------|---|-----|----|---|-----|------|------|
| Equivalent 12-hour vehicle volumes. These volumes are calculated by multiplying the 8-hour totals by the 8 → 12 expansion factor of 1.39 |    |   |     |   |      |    |    |   |   |    |      |     |     |    |   |      |   |     |    |   |     |      |      |
| Equ. 12 Hr   | 76 | 6 | 930 | 3 | 1015 | 29 | 10 | 0 | 0 | 39 | 1054 | 906 | 325 | 29 | 0 | 1261 | 6 | 306 | 95 | 0 | 406 | 1667 | 2720 |

|   |    |   |     |   |     |    |   |   |   |    |     |     |     |    |   |      |   |     |    |   |     |      |      |
|---|----|---|-----|---|-----|----|---|---|---|----|-----|-----|-----|----|---|------|---|-----|----|---|-----|------|------|
| Average daily 12-hour vehicle volumes. These volumes are calculated by multiplying the equivalent 12-hour totals by the AADT factor of: 0.9 |    |   |     |   |     |    |   |   |   |    |     |     |     |    |   |      |   |     |    |   |     |      |      |
| AADT 12-hr  | 69 | 5 | 837 | 3 | 913 | 26 | 9 | 0 | 0 | 35 | 948 | 816 | 293 | 26 | 0 | 1135 | 5 | 275 | 85 | 0 | 365 | 1500 | 2448 |

|   |    |   |      |   |      |    |    |   |   |    |      |      |     |    |   |      |   |     |     |   |     |      |      |
|---|----|---|------|---|------|----|----|---|---|----|------|------|-----|----|---|------|---|-----|-----|---|-----|------|------|
| 24-Hour AADT. These volumes are calculated by multiplying the average daily 12-hour vehicle volumes by the 12 → 24 expansion factor of 1.31 |    |   |      |   |      |    |    |   |   |    |      |      |     |    |   |      |   |     |     |   |     |      |      |
| AADT 24 Hr  | 90 | 7 | 1096 | 3 | 1196 | 34 | 11 | 0 | 0 | 46 | 1242 | 1069 | 383 | 34 | 0 | 1486 | 7 | 361 | 111 | 0 | 479 | 1965 | 3207 |

**AADT and expansion factors provided by the City of Ottawa**

|                                    |    |    |     |    |       |    |    |    |    |       |  |     |    |    |    |       |    |    |    |    |       |           |          |
|------------------------------------|----|----|-----|----|-------|----|----|----|----|-------|--|-----|----|----|----|-------|----|----|----|----|-------|-----------|----------|
| <b>AM Peak Hour Factor → 0.93</b>  |    |    |     |    |       |    |    |    |    |       | <b>Highest Hourly Vehicle Volume Between 0700h &amp; 1000h</b> |     |    |    |    |       |    |    |    |    |       |           |          |
| <b>AM Peak Hr</b>                  | LT | ST | RT  | UT | Total | LT | ST | RT | UT | Total | Str. Tot.  | LT  | ST | RT | UT | Total | LT | ST | RT | UT | Total | Str. Tot. | Gr. Tot. |
| 0815-0915                          | 15 | 0  | 118 | 0  | 133   | 6  | 1  | 0  | 0  | 7     | 140  | 92  | 58 | 2  | 0  | 152   | 1  | 15 | 2  | 0  | 18    | 170       | 310      |
| <b>OFF Peak Hour Factor → 0.94</b> |    |    |     |    |       |    |    |    |    |       | <b>Highest Hourly Vehicle Volume Between 1130h &amp; 1330h</b> |     |    |    |    |       |    |    |    |    |       |           |          |
| <b>OFF Peak Hr</b>                 | LT | ST | RT  | UT | Total | LT | ST | RT | UT | Total | Str. Tot.  | LT  | ST | RT | UT | Total | LT | ST | RT | UT | Total | Str. Tot. | Gr. Tot. |
| 1130-1230                          | 6  | 1  | 75  | 0  | 82    | 6  | 5  | 0  | 0  | 11    | 93   | 73  | 27 | 2  | 0  | 102   | 0  | 26 | 12 | 0  | 38    | 140       | 233      |
| <b>PM Peak Hour Factor → 0.89</b>  |    |    |     |    |       |    |    |    |    |       | <b>Highest Hourly Vehicle Volume Between 1500h &amp; 1800h</b> |     |    |    |    |       |    |    |    |    |       |           |          |
| <b>PM Peak Hr</b>                  | LT | ST | RT  | UT | Total | LT | ST | RT | UT | Total | Str. Tot.  | LT  | ST | RT | UT | Total | LT | ST | RT | UT | Total | Str. Tot. | Gr. Tot. |
| 1600-1700                          | 2  | 0  | 100 | 1  | 103   | 0  | 0  | 0  | 0  | 0     | 103  | 134 | 14 | 0  | 0  | 148   | 0  | 53 | 9  | 0  | 62    | 210       | 313      |

**Comments:**

OC Transpo buses comprise 32.46% of the heavy vehicle traffic.

**Notes:**

1. Includes all vehicle types except bicycles, electric bicycles, and electric scooters.
2. When expansion and AADT factors are applied, the results will differ slightly due to rounding.



# Turning Movement Count

## Summary, AM and PM Peak Hour

### Flow Diagrams

All Vehicles Except Bicycles



## Hines Road & Innovation Drive Kanata, ON

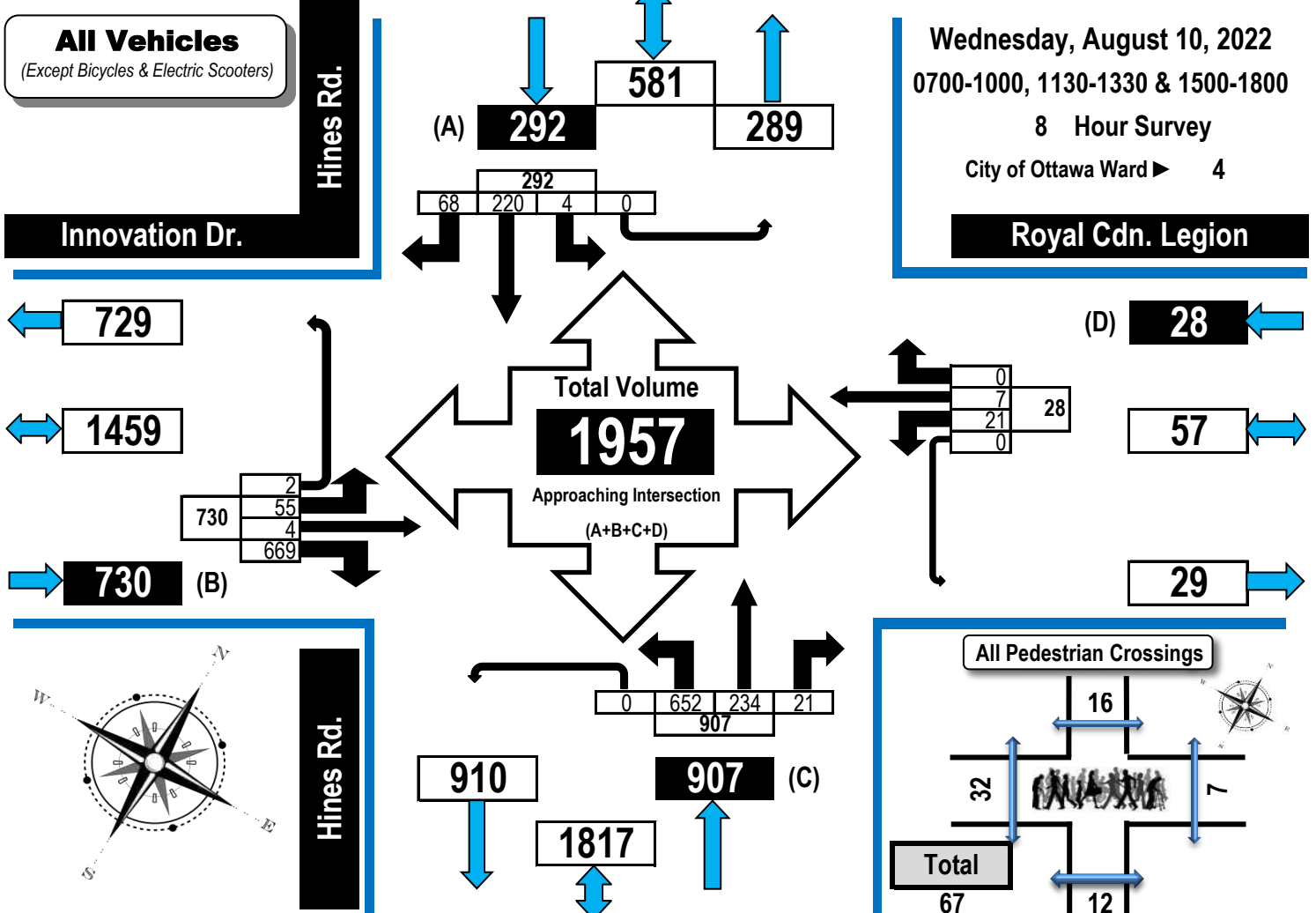

### AM Peak Hour Flow Diagram PM Peak Hour Flow Diagram

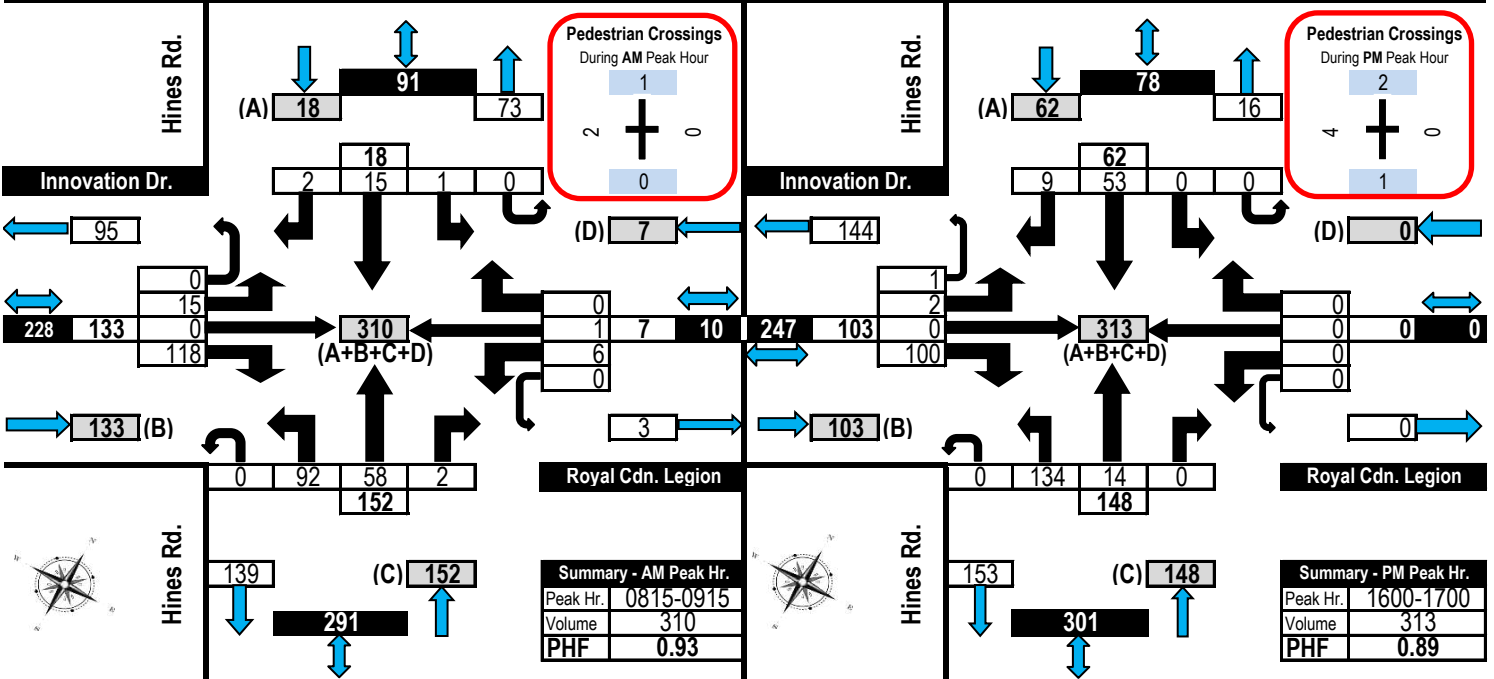

## **APPENDIX E**

---

Collision Records



# Transportation Services - Traffic Services

## Collision Details Report - Public Version

From: January 1, 2016 To: December 31, 2020

**Location:** HINES RD @ INNOVATION DR

**Traffic Control:** Stop sign

**Total Collisions:** 1

| Date/Day/Time          | Environment | Impact Type | Classification | Surface Cond'n | Veh. Dir | Vehicle Manoeuver | Vehicle type              | First Event         | No. Ped |
|------------------------|-------------|-------------|----------------|----------------|----------|-------------------|---------------------------|---------------------|---------|
| 2017-Mar-20, Mon,09:26 | Clear       | Rear end    | P.D. only      | Dry            | East     | Going ahead       | Automobile, station wagon | Other motor vehicle | 0       |
|                        |             |             |                |                | East     | Stopped           | Unknown                   | Other motor vehicle |         |

**Location:** INNOVATION DR @ ProposedNULL NAME

**Traffic Control:** Traffic signal

**Total Collisions:** 1

| Date/Day/Time          | Environment | Impact Type | Classification | Surface Cond'n | Veh. Dir | Vehicle Manoeuver | Vehicle type              | First Event         | No. Ped |
|------------------------|-------------|-------------|----------------|----------------|----------|-------------------|---------------------------|---------------------|---------|
| 2018-Sep-11, Tue,16:48 | Clear       | Angle       | P.D. only      | Dry            | North    | Going ahead       | Automobile, station wagon | Other motor vehicle | 0       |
|                        |             |             |                |                | West     | Going ahead       | Automobile, station wagon | Other motor vehicle |         |

**Location:** INNOVATION DR btwn FLAMBOROUGH WAY & FLAMBOROUGH WAY

**Traffic Control:** No control

**Total Collisions:** 4

| Date/Day/Time          | Environment | Impact Type | Classification   | Surface Cond'n | Veh. Dir | Vehicle Manoeuver   | Vehicle type              | First Event         | No. Ped |
|------------------------|-------------|-------------|------------------|----------------|----------|---------------------|---------------------------|---------------------|---------|
| 2016-Jun-20, Mon,13:10 | Clear       | SMV other   | Non-fatal injury | Dry            | North    | Going ahead         | Motorcycle                | Other               | 0       |
| 2018-Apr-04, Wed,16:24 | Clear       | SMV other   | P.D. only        | Wet            | South    | Slowing or stopping | Automobile, station wagon | Debris on road      | 0       |
| 2018-Sep-12, Wed,18:26 | Clear       | Angle       | P.D. only        | Dry            | East     | Turning left        | Automobile, station wagon | Other motor vehicle | 0       |
|                        |             |             |                  |                | North    | Going ahead         | Automobile, station wagon | Other motor vehicle |         |
| 2020-Feb-27, Thu,07:00 | Snow        | Angle       | P.D. only        | Loose snow     | South    | Unknown             | Truck - dump              | Other motor vehicle | 0       |
|                        |             |             |                  |                | East     | Turning left        | Automobile, station wagon | Other motor vehicle |         |

**Location:** MARCH RD @ MORGAN'S GRANT WAY/SHIRLEY'S BROOK

**Traffic Control:** Traffic signal

**Total Collisions:** 38

| Date/Day/Time          | Environment | Impact Type      | Classification   | Surface Cond'n | Veh. Dir | Vehicle Manoeuver | Vehicle type              | First Event         | No. Ped |
|------------------------|-------------|------------------|------------------|----------------|----------|-------------------|---------------------------|---------------------|---------|
| 2016-Mar-06, Sun,12:03 | Clear       | Turning movement | Non-fatal injury | Dry            | South    | Going ahead       | Pick-up truck             | Other motor vehicle | 0       |
|                        |             |                  |                  |                | North    | Turning left      | Passenger van             | Other motor vehicle |         |
| 2016-Jun-17, Fri,13:40 | Clear       | Rear end         | P.D. only        | Dry            | North    | Changing lanes    | Automobile, station wagon | Other motor vehicle | 0       |
|                        |             |                  |                  |                | North    | Going ahead       | Pick-up truck             | Other motor vehicle |         |





# Transportation Services - Traffic Services

## Collision Details Report - Public Version

From: January 1, 2016 To: December 31, 2020

**Location:** MARCH RD @ MORGAN'S GRANT WAY/SHIRLEY'S BROOK

**Traffic Control:** Traffic signal

**Total Collisions:** 38

| Date/Day/Time          | Environment | Impact Type      | Classification   | Surface Cond'n | Veh. Dir | Vehicle Manoeuver | Vehicle type              | First Event                | No. Ped |
|------------------------|-------------|------------------|------------------|----------------|----------|-------------------|---------------------------|----------------------------|---------|
| 2016-Aug-04, Thu,09:12 | Clear       | Angle            | P.D. only        | Dry            | South    | Going ahead       | Pick-up truck             | Other motor vehicle        | 0       |
|                        |             |                  |                  |                | West     | Going ahead       | Automobile, station wagon | Other motor vehicle        |         |
| 2016-Nov-16, Wed,17:43 | Clear       | Turning movement | Non-fatal injury | Dry            | North    | Turning left      | Delivery van              | Other motor vehicle        | 0       |
|                        |             |                  |                  |                | South    | Going ahead       | Automobile, station wagon | Other motor vehicle        |         |
|                        |             |                  |                  |                | East     | Stopped           | Automobile, station wagon | Debris falling off vehicle |         |
| 2017-Apr-18, Tue,09:31 | Clear       | Turning movement | P.D. only        | Dry            | South    | Turning left      | Passenger van             | Other motor vehicle        | 0       |
|                        |             |                  |                  |                | North    | Going ahead       | Automobile, station wagon | Other motor vehicle        |         |
| 2017-Apr-27, Thu,12:53 | Clear       | Rear end         | P.D. only        | Dry            | West     | Turning right     | Pick-up truck             | Other motor vehicle        | 0       |
|                        |             |                  |                  |                | West     | Turning right     | Automobile, station wagon | Other motor vehicle        |         |
| 2017-May-17, Wed,16:47 | Clear       | Turning movement | P.D. only        | Dry            | South    | Turning left      | Pick-up truck             | Other motor vehicle        | 0       |
|                        |             |                  |                  |                | North    | Going ahead       | Pick-up truck             | Other motor vehicle        |         |
| 2017-Jun-09, Fri,22:27 | Clear       | Turning movement | P.D. only        | Dry            | South    | Turning left      | Automobile, station wagon | Other motor vehicle        | 0       |
|                        |             |                  |                  |                | North    | Going ahead       | Automobile, station wagon | Other motor vehicle        |         |
| 2017-Jun-28, Wed,13:14 | Clear       | Rear end         | Non-fatal injury | Dry            | North    | Going ahead       | Automobile, station wagon | Other motor vehicle        | 0       |
|                        |             |                  |                  |                | North    | Stopped           | Automobile, station wagon | Other motor vehicle        |         |
| 2017-Sep-21, Thu,17:33 | Clear       | Turning movement | Non-fatal injury | Dry            | North    | Turning left      | Automobile, station wagon | Other motor vehicle        | 0       |
|                        |             |                  |                  |                | South    | Going ahead       | Automobile, station wagon | Other motor vehicle        |         |
| 2017-Sep-28, Thu,08:21 | Clear       | Sideswipe        | P.D. only        | Dry            | South    | Changing lanes    | Passenger van             | Other motor vehicle        | 0       |
|                        |             |                  |                  |                | South    | Going ahead       | Automobile, station wagon | Other motor vehicle        |         |
| 2017-Nov-28, Tue,17:07 | Clear       | Turning movement | P.D. only        | Dry            | North    | Turning left      | Truck and trailer         | Other motor vehicle        | 0       |
|                        |             |                  |                  |                | South    | Going ahead       | Pick-up truck             | Other motor vehicle        |         |
|                        |             |                  |                  |                | East     | Turning left      | Automobile, station wagon | Other motor vehicle        |         |
| 2017-Dec-26, Tue,14:33 | Clear       | Rear end         | P.D. only        | Dry            | West     | Stopped           | Automobile, station wagon | Other motor vehicle        | 0       |
|                        |             |                  |                  |                | West     | Turning left      | Delivery van              | Other motor vehicle        |         |



# Transportation Services - Traffic Services

## Collision Details Report - Public Version

**From:** January 1, 2016    **To:** December 31, 2020

**Location:** MARCH RD @ MORGAN'S GRANT WAY/SHIRLEY'S BROOK

**Traffic Control:** Traffic signal

**Total Collisions:** 38

| Date/Day/Time          | Environment | Impact Type      | Classification   | Surface Cond'n | Veh. Dir | Vehicle Manoeuvre   | Vehicle type              | First Event         | No. Ped |
|------------------------|-------------|------------------|------------------|----------------|----------|---------------------|---------------------------|---------------------|---------|
| 2018-Jan-30, Tue,15:35 | Clear       | Rear end         | P.D. only        | Dry            | South    | Going ahead         | Pick-up truck             | Other motor vehicle | 0       |
|                        |             |                  |                  |                | South    | Stopped             | Unknown                   | Other motor vehicle |         |
| 2018-Feb-28, Wed,09:47 | Clear       | Rear end         | P.D. only        | Dry            | East     | Going ahead         | Automobile, station wagon | Other motor vehicle | 0       |
|                        |             |                  |                  |                | East     | Merging             | Automobile, station wagon | Other motor vehicle |         |
| 2018-Apr-22, Sun,15:30 | Clear       | Rear end         | Non-fatal injury | Dry            | North    | Slowing or stopping | Motorcycle                | Skidding/sliding    | 0       |
|                        |             |                  |                  |                | North    | Stopped             | Automobile, station wagon | Other motor vehicle |         |
| 2018-May-17, Thu,07:35 | Clear       | Turning movement | P.D. only        | Dry            | South    | Turning left        | Passenger van             | Other motor vehicle | 0       |
|                        |             |                  |                  |                | South    | Going ahead         | Automobile, station wagon | Other motor vehicle |         |
| 2018-May-25, Fri,17:46 | Rain        | Sideswipe        | P.D. only        | Wet            | North    | Going ahead         | Automobile, station wagon | Other motor vehicle | 0       |
|                        |             |                  |                  |                | North    | Slowing or stopping | Automobile, station wagon | Other motor vehicle |         |
| 2018-Aug-15, Wed,22:13 | Clear       | Turning movement | Non-fatal injury | Dry            | South    | Turning left        | Automobile, station wagon | Other motor vehicle | 0       |
|                        |             |                  |                  |                | North    | Going ahead         | Automobile, station wagon | Other motor vehicle |         |
| 2018-Sep-22, Sat,12:00 | Clear       | Rear end         | P.D. only        | Dry            | West     | Merging             | Passenger van             | Other motor vehicle | 0       |
|                        |             |                  |                  |                | West     | Merging             | Automobile, station wagon | Other motor vehicle |         |
| 2018-Nov-23, Fri,07:54 | Clear       | Rear end         | P.D. only        | Ice            | South    | Going ahead         | Automobile, station wagon | Other motor vehicle | 0       |
|                        |             |                  |                  |                | South    | Stopped             | Pick-up truck             | Other motor vehicle |         |
| 2018-Dec-06, Thu,06:21 | Snow        | Angle            | P.D. only        | Wet            | South    | Going ahead         | Automobile, station wagon | Other motor vehicle | 0       |
|                        |             |                  |                  |                | West     | Going ahead         | Municipal transit bus     | Other motor vehicle |         |
| 2018-Dec-20, Thu,09:55 | Clear       | Turning movement | P.D. only        | Dry            | South    | Turning left        | Automobile, station wagon | Other motor vehicle | 0       |
|                        |             |                  |                  |                | North    | Going ahead         | Unknown                   | Other motor vehicle |         |
| 2019-Jan-02, Wed,12:42 | Clear       | Turning movement | P.D. only        | Dry            | South    | Turning left        | Automobile, station wagon | Other motor vehicle | 0       |
|                        |             |                  |                  |                | North    | Going ahead         | Passenger van             | Other motor vehicle |         |
| 2019-Jan-17, Thu,18:45 | Clear       | Angle            | P.D. only        | Dry            | North    | Going ahead         | Automobile, station wagon | Other motor vehicle | 0       |
|                        |             |                  |                  |                | East     | Going ahead         | Automobile, station wagon | Other motor vehicle |         |



# Transportation Services - Traffic Services

## Collision Details Report - Public Version

From: January 1, 2016 To: December 31, 2020

**Location:** MARCH RD @ MORGAN'S GRANT WAY/SHIRLEY'S BROOK

**Traffic Control:** Traffic signal

**Total Collisions:** 38

| Date/Day/Time          | Environment | Impact Type      | Classification   | Surface Cond'n | Veh. Dir | Vehicle Manoeuver | Vehicle type              | First Event         | No. Ped |
|------------------------|-------------|------------------|------------------|----------------|----------|-------------------|---------------------------|---------------------|---------|
| 2019-Mar-06, Wed,15:45 | Clear       | Rear end         | P.D. only        | Dry            | North    | Turning left      | Pick-up truck             | Other motor vehicle | 0       |
|                        |             |                  |                  |                | North    | Turning left      | Automobile, station wagon | Other motor vehicle |         |
| 2019-May-01, Wed,18:11 | Rain        | Sideswipe        | P.D. only        | Wet            | North    | Unknown           | Unknown                   | Other motor vehicle | 0       |
|                        |             |                  |                  |                | North    | Going ahead       | Automobile, station wagon | Other motor vehicle |         |
| 2019-Jul-30, Tue,17:36 | Clear       | Rear end         | P.D. only        | Dry            | West     | Turning right     | Automobile, station wagon | Other motor vehicle | 0       |
|                        |             |                  |                  |                | West     | Turning right     | Automobile, station wagon | Other motor vehicle |         |
| 2019-Sep-28, Sat,19:33 | Clear       | Turning movement | Non-fatal injury | Dry            | South    | Turning left      | Automobile, station wagon | Other motor vehicle | 0       |
|                        |             |                  |                  |                | North    | Going ahead       | Automobile, station wagon | Other motor vehicle |         |
| 2019-Dec-13, Fri,17:57 | Clear       | Turning movement | P.D. only        | Dry            | South    | Turning left      | Automobile, station wagon | Other motor vehicle | 0       |
|                        |             |                  |                  |                | North    | Going ahead       | Automobile, station wagon | Other motor vehicle |         |
| 2020-Jan-22, Wed,08:55 | Clear       | Rear end         | P.D. only        | Loose snow     | East     | Turning right     | Automobile, station wagon | Other motor vehicle | 0       |
|                        |             |                  |                  |                | East     | Turning right     | Pick-up truck             | Other motor vehicle |         |
| 2020-Feb-14, Fri,16:48 | Clear       | Turning movement | P.D. only        | Dry            | North    | Turning left      | Automobile, station wagon | Other motor vehicle | 0       |
|                        |             |                  |                  |                | South    | Going ahead       | Automobile, station wagon | Other motor vehicle |         |
| 2020-Apr-10, Fri,18:14 | Clear       | Turning movement | Non-fatal injury | Dry            | North    | Turning left      | Pick-up truck             | Other motor vehicle | 0       |
|                        |             |                  |                  |                | South    | Going ahead       | Automobile, station wagon | Other motor vehicle |         |
| 2020-May-23, Sat,12:21 | Clear       | Angle            | P.D. only        | Dry            | North    | Going ahead       | Unknown                   | Other motor vehicle | 0       |
|                        |             |                  |                  |                | West     | Going ahead       | Pick-up truck             | Other motor vehicle |         |
| 2020-Sep-26, Sat,15:23 | Clear       | Turning movement | Non-fatal injury | Dry            | South    | Turning left      | Automobile, station wagon | Other motor vehicle | 0       |
|                        |             |                  |                  |                | North    | Going ahead       | Automobile, station wagon | Other motor vehicle |         |
| 2020-Oct-20, Tue,17:28 | Clear       | SMV other        | Non-fatal injury | Dry            | North    | Going ahead       | Automobile, station wagon | Ran off road        | 0       |
| 2020-Nov-10, Tue,06:40 | Clear       | Turning movement | Non-fatal injury | Dry            | North    | Making "U" turn   | Automobile, station wagon | Other motor vehicle | 0       |
|                        |             |                  |                  |                | South    | Going ahead       | Automobile, station wagon | Other motor vehicle |         |



# Transportation Services - Traffic Services

## Collision Details Report - Public Version

From: January 1, 2016 To: December 31, 2020

**Location:** MARCH RD @ MORGAN'S GRANT WAY/SHIRLEY'S BROOK

**Traffic Control:** Traffic signal

**Total Collisions:** 38

| Date/Day/Time          | Environment | Impact Type | Classification | Surface Cond'n | Veh. Dir | Vehicle Manoeuver | Vehicle type              | First Event         | No. Ped |
|------------------------|-------------|-------------|----------------|----------------|----------|-------------------|---------------------------|---------------------|---------|
| 2020-Dec-10, Thu,15:15 | Clear       | Sideswipe   | P.D. only      | Dry            | North    | Changing lanes    | Automobile, station wagon | Other motor vehicle | 0       |
|                        |             |             |                |                | North    | Going ahead       | Automobile, station wagon | Other motor vehicle |         |

**Location:** MARCH RD @ SOLANDT RD

**Traffic Control:** Traffic signal

**Total Collisions:** 44

| Date/Day/Time          | Environment | Impact Type      | Classification   | Surface Cond'n | Veh. Dir | Vehicle Manoeuver   | Vehicle type              | First Event                | No. Ped |
|------------------------|-------------|------------------|------------------|----------------|----------|---------------------|---------------------------|----------------------------|---------|
| 2016-Feb-16, Tue,11:02 | Snow        | Turning movement | P.D. only        | Loose snow     | West     | Turning left        | Passenger van             | Other motor vehicle        | 0       |
|                        |             |                  |                  |                | East     | Going ahead         | Pick-up truck             | Other motor vehicle        |         |
| 2016-Feb-23, Tue,15:50 | Clear       | Rear end         | P.D. only        | Dry            | North    | Slowing or stopping | Automobile, station wagon | Other motor vehicle        | 0       |
|                        |             |                  |                  |                | North    | Stopped             | Pick-up truck             | Other motor vehicle        |         |
| 2016-Mar-02, Wed,19:35 | Clear       | Turning movement | P.D. only        | Wet            | North    | Turning left        | Automobile, station wagon | Other motor vehicle        | 0       |
|                        |             |                  |                  |                | South    | Going ahead         | Passenger van             | Other motor vehicle        |         |
| 2016-Mar-14, Mon,10:46 | Rain        | Turning movement | P.D. only        | Wet            | North    | Turning left        | Automobile, station wagon | Other motor vehicle        | 0       |
|                        |             |                  |                  |                | South    | Going ahead         | Automobile, station wagon | Other motor vehicle        |         |
| 2016-May-03, Tue,16:55 | Clear       | Rear end         | P.D. only        | Dry            | East     | Turning right       | Pick-up truck             | Other motor vehicle        | 0       |
|                        |             |                  |                  |                | East     | Turning right       | Automobile, station wagon | Other motor vehicle        |         |
| 2016-Aug-17, Wed,10:51 | Clear       | Rear end         | Non-fatal injury | Dry            | North    | Turning left        | Automobile, station wagon | Other motor vehicle        | 0       |
|                        |             |                  |                  |                | North    | Turning left        | Automobile, station wagon | Other motor vehicle        |         |
| 2016-Sep-16, Fri,11:14 | Clear       | Rear end         | P.D. only        | Dry            | South    | Turning right       | Automobile, station wagon | Other motor vehicle        | 0       |
|                        |             |                  |                  |                | South    | Going ahead         | Automobile, station wagon | Other motor vehicle        |         |
|                        |             |                  |                  |                | South    | Going ahead         | Passenger van             | Debris falling off vehicle |         |
| 2016-Oct-20, Thu,16:28 | Rain        | Rear end         | P.D. only        | Wet            | South    | Slowing or stopping | Automobile, station wagon | Other motor vehicle        | 0       |
|                        |             |                  |                  |                | South    | Stopped             | Passenger van             | Other motor vehicle        |         |



# Transportation Services - Traffic Services

## Collision Details Report - Public Version

From: January 1, 2016 To: December 31, 2020

**Location:** MARCH RD @ SOLANDT RD

**Traffic Control:** Traffic signal

**Total Collisions:** 44

| Date/Day/Time          | Environment   | Impact Type      | Classification   | Surface Cond'n | Veh. Dir | Vehicle Manoeuvre | Vehicle type              | First Event           | No. Ped |
|------------------------|---------------|------------------|------------------|----------------|----------|-------------------|---------------------------|-----------------------|---------|
| 2016-Oct-31, Mon,08:05 | Clear         | Rear end         | P.D. only        | Dry            | South    | Turning right     | Automobile, station wagon | Other motor vehicle   | 0       |
|                        |               |                  |                  |                | South    | Turning right     | Automobile, station wagon | Other motor vehicle   |         |
| 2016-Nov-20, Sun,20:27 | Drifting Snow | SMV other        | P.D. only        | Ice            | North    | Turning left      | Automobile, station wagon | Pole (utility, power) | 0       |
| 2016-Nov-28, Mon,12:27 | Clear         | Turning movement | P.D. only        | Dry            | East     | Making "U" turn   | Automobile, station wagon | Other motor vehicle   | 0       |
|                        |               |                  |                  |                | West     | Going ahead       | Automobile, station wagon | Other motor vehicle   |         |
| 2017-Feb-16, Thu,19:15 | Clear         | Turning movement | P.D. only        | Dry            | North    | Turning left      | Automobile, station wagon | Other motor vehicle   | 0       |
|                        |               |                  |                  |                | South    | Going ahead       | Pick-up truck             | Other motor vehicle   |         |
| 2017-Mar-22, Wed,09:35 | Clear         | Turning movement | Non-fatal injury | Dry            | South    | Going ahead       | Pick-up truck             | Other motor vehicle   | 0       |
|                        |               |                  |                  |                | North    | Turning left      | Automobile, station wagon | Other motor vehicle   |         |
| 2017-Apr-18, Tue,15:58 | Clear         | Rear end         | Non-fatal injury | Dry            | West     | Turning right     | Motorcycle                | Other motor vehicle   | 0       |
|                        |               |                  |                  |                | West     | Turning right     | Automobile, station wagon | Other motor vehicle   |         |
| 2017-May-09, Tue,09:30 | Clear         | Rear end         | P.D. only        | Dry            | North    | Turning right     | Automobile, station wagon | Other motor vehicle   | 0       |
|                        |               |                  |                  |                | North    | Turning right     | Pick-up truck             | Other motor vehicle   |         |
| 2017-Jun-02, Fri,07:58 | Clear         | Turning movement | P.D. only        | Dry            | North    | Going ahead       | Automobile, station wagon | Other motor vehicle   | 0       |
|                        |               |                  |                  |                | South    | Turning left      | Automobile, station wagon | Other motor vehicle   |         |
| 2017-Jun-13, Tue,17:30 | Clear         | Turning movement | P.D. only        | Dry            | South    | Making "U" turn   | Automobile, station wagon | Other motor vehicle   | 0       |
|                        |               |                  |                  |                | North    | Going ahead       | Pick-up truck             | Other motor vehicle   |         |
| 2017-Sep-12, Tue,07:13 | Clear         | Rear end         | P.D. only        | Dry            | East     | Going ahead       | Passenger van             | Other motor vehicle   | 0       |
|                        |               |                  |                  |                | East     | Stopped           | Automobile, station wagon | Other motor vehicle   |         |
| 2017-Oct-24, Tue,07:37 | Rain          | Turning movement | P.D. only        | Wet            | North    | Turning left      | Automobile, station wagon | Other motor vehicle   | 0       |
|                        |               |                  |                  |                | South    | Going ahead       | Automobile, station wagon | Other motor vehicle   |         |
| 2017-Oct-31, Tue,15:47 | Clear         | Turning movement | P.D. only        | Dry            | North    | Turning left      | Automobile, station wagon | Other motor vehicle   | 0       |
|                        |               |                  |                  |                | South    | Going ahead       | Automobile, station wagon | Other motor vehicle   |         |



# Transportation Services - Traffic Services

## Collision Details Report - Public Version

From: January 1, 2016 To: December 31, 2020

**Location:** MARCH RD @ SOLANDT RD

**Traffic Control:** Traffic signal

**Total Collisions:** 44

| Date/Day/Time          | Environment | Impact Type      | Classification   | Surface Cond'n | Veh. Dir | Vehicle Manoeuver   | Vehicle type              | First Event         | No. Ped |
|------------------------|-------------|------------------|------------------|----------------|----------|---------------------|---------------------------|---------------------|---------|
| 2017-Dec-20, Wed,15:51 | Clear       | Rear end         | P.D. only        | Dry            | West     | Going ahead         | Automobile, station wagon | Other motor vehicle | 0       |
|                        |             |                  |                  |                | West     | Turning left        | Automobile, station wagon | Other motor vehicle |         |
| 2017-Dec-21, Thu,10:30 | Clear       | Angle            | P.D. only        | Dry            | North    | Going ahead         | Automobile, station wagon | Other motor vehicle | 0       |
|                        |             |                  |                  |                | West     | Turning left        | Automobile, station wagon | Other motor vehicle |         |
| 2018-Jan-31, Wed,17:54 | Snow        | Rear end         | P.D. only        | Loose snow     | South    | Going ahead         | Automobile, station wagon | Skidding/sliding    | 0       |
|                        |             |                  |                  |                | South    | Stopped             | Automobile, station wagon | Other motor vehicle |         |
| 2018-Feb-26, Mon,19:50 | Clear       | Turning movement | P.D. only        | Dry            | South    | Changing lanes      | Automobile, station wagon | Other motor vehicle | 0       |
|                        |             |                  |                  |                | North    | Turning left        | Automobile, station wagon | Other motor vehicle |         |
| 2018-Mar-14, Wed,08:56 | Snow        | Turning movement | Non-fatal injury | Slush          | North    | Turning left        | Automobile, station wagon | Other motor vehicle | 0       |
|                        |             |                  |                  |                | South    | Going ahead         | Automobile, station wagon | Other motor vehicle |         |
| 2018-Apr-06, Fri,16:40 | Rain        | Rear end         | P.D. only        | Wet            | South    | Slowing or stopping | Automobile, station wagon | Other motor vehicle | 0       |
|                        |             |                  |                  |                | South    | Stopped             | Automobile, station wagon | Other motor vehicle |         |
| 2018-May-28, Mon,20:50 | Clear       | Rear end         | P.D. only        | Dry            | East     | Turning right       | Pick-up truck             | Other motor vehicle | 0       |
|                        |             |                  |                  |                | East     | Turning right       | Automobile, station wagon | Other motor vehicle |         |
| 2018-Jun-06, Wed,20:24 | Clear       | Turning movement | P.D. only        | Dry            | South    | Making "U" turn     | Automobile, station wagon | Other motor vehicle | 0       |
|                        |             |                  |                  |                | North    | Going ahead         | Automobile, station wagon | Other motor vehicle |         |
| 2018-Aug-09, Thu,09:19 | Clear       | Turning movement | Non-fatal injury | Dry            | South    | Turning left        | Automobile, station wagon | Other motor vehicle | 0       |
|                        |             |                  |                  |                | North    | Going ahead         | Automobile, station wagon | Other motor vehicle |         |
| 2018-Aug-24, Fri,15:53 | Clear       | Rear end         | P.D. only        | Dry            | South    | Slowing or stopping | Pick-up truck             | Other motor vehicle | 0       |
|                        |             |                  |                  |                | South    | Stopped             | Automobile, station wagon | Other motor vehicle |         |
| 2018-Oct-09, Tue,06:53 | Clear       | Rear end         | P.D. only        | Wet            | East     | Unknown             | Unknown                   | Other motor vehicle | 0       |
|                        |             |                  |                  |                | East     | Stopped             | Automobile, station wagon | Other motor vehicle |         |
| 2018-Oct-26, Fri,13:38 | Clear       | Rear end         | P.D. only        | Dry            | South    | Going ahead         | Automobile, station wagon | Other motor vehicle | 0       |
|                        |             |                  |                  |                | South    | Stopped             | Automobile, station wagon | Other motor vehicle |         |



# Transportation Services - Traffic Services

## Collision Details Report - Public Version

From: January 1, 2016 To: December 31, 2020

**Location:** MARCH RD @ SOLANDT RD

**Traffic Control:** Traffic signal

**Total Collisions:** 44

| Date/Day/Time          | Environment   | Impact Type      | Classification   | Surface Cond'n | Veh. Dir | Vehicle Manoeuvre   | Vehicle type              | First Event         | No. Ped |
|------------------------|---------------|------------------|------------------|----------------|----------|---------------------|---------------------------|---------------------|---------|
| 2018-Oct-31, Wed,15:43 | Rain          | Rear end         | P.D. only        | Wet            | North    | Going ahead         | Pick-up truck             | Other motor vehicle | 0       |
|                        |               |                  |                  |                | North    | Stopped             | Automobile, station wagon | Other motor vehicle |         |
|                        |               |                  |                  |                | North    | Stopped             | Passenger van             | Other motor vehicle |         |
| 2019-Jan-11, Fri,07:27 | Clear         | Turning movement | P.D. only        | Dry            | South    | Making "U" turn     | Automobile, station wagon | Other motor vehicle | 0       |
|                        |               |                  |                  |                | North    | Going ahead         | Automobile, station wagon | Other motor vehicle |         |
| 2019-Jan-28, Mon,17:24 | Clear         | Turning movement | Non-fatal injury | Packed snow    | South    | Turning left        | Automobile, station wagon | Other motor vehicle | 0       |
|                        |               |                  |                  |                | North    | Going ahead         | Automobile, station wagon | Other motor vehicle |         |
| 2019-Apr-01, Mon,12:40 | Clear         | Rear end         | P.D. only        | Dry            | West     | Turning right       | Automobile, station wagon | Other motor vehicle | 0       |
|                        |               |                  |                  |                | West     | Turning right       | Automobile, station wagon | Other motor vehicle |         |
| 2019-Jun-08, Sat,10:11 | Clear         | Rear end         | P.D. only        | Dry            | North    | Slowing or stopping | Automobile, station wagon | Other motor vehicle | 0       |
|                        |               |                  |                  |                | North    | Stopped             | Automobile, station wagon | Other motor vehicle |         |
| 2019-Jul-10, Wed,10:24 | Clear         | Turning movement | P.D. only        | Dry            | North    | Turning left        | Truck and trailer         | Other motor vehicle | 0       |
|                        |               |                  |                  |                | South    | Going ahead         | Automobile, station wagon | Other motor vehicle |         |
| 2019-Jul-27, Sat,21:52 | Clear         | Sideswipe        | P.D. only        | Dry            | North    | Changing lanes      | Automobile, station wagon | Other motor vehicle | 0       |
|                        |               |                  |                  |                | North    | Going ahead         | Automobile, station wagon | Other motor vehicle |         |
| 2019-Sep-24, Tue,08:59 | Clear         | Turning movement | P.D. only        | Dry            | North    | Turning left        | Automobile, station wagon | Other motor vehicle | 0       |
|                        |               |                  |                  |                | South    | Going ahead         | Automobile, station wagon | Other motor vehicle |         |
| 2019-Dec-19, Thu,10:15 | Clear         | Rear end         | P.D. only        | Dry            | South    | Slowing or stopping | Automobile, station wagon | Other motor vehicle | 0       |
|                        |               |                  |                  |                | South    | Stopped             | Automobile, station wagon | Other motor vehicle |         |
| 2019-Dec-30, Mon,20:00 | Freezing Rain | Rear end         | P.D. only        | Ice            | North    | Going ahead         | Automobile, station wagon | Skidding/sliding    | 0       |
|                        |               |                  |                  |                | North    | Stopped             | Automobile, station wagon | Other motor vehicle |         |
| 2020-Jan-05, Sun,10:55 | Clear         | Turning movement | P.D. only        | Wet            | South    | Turning left        | Automobile, station wagon | Other motor vehicle | 0       |
|                        |               |                  |                  |                | North    | Going ahead         | Automobile, station wagon | Other motor vehicle |         |



# Transportation Services - Traffic Services

## Collision Details Report - Public Version

From: January 1, 2016 To: December 31, 2020

**Location:** MARCH RD @ SOLANDT RD

**Traffic Control:** Traffic signal

**Total Collisions:** 44

| Date/Day/Time          | Environment | Impact Type      | Classification | Surface Cond'n | Veh. Dir | Vehicle Manoeuver | Vehicle type              | First Event         | No. Ped |
|------------------------|-------------|------------------|----------------|----------------|----------|-------------------|---------------------------|---------------------|---------|
| 2020-Jan-21, Tue,18:06 | Clear       | Turning movement | P.D. only      | Wet            | South    | Making "U" turn   | Automobile, station wagon | Other motor vehicle | 0       |
|                        |             |                  |                |                | North    | Going ahead       | Automobile, station wagon | Other motor vehicle |         |

**Location:** MARCH RD @ TERRY FOX DR

**Traffic Control:** Traffic signal

**Total Collisions:** 47

| Date/Day/Time          | Environment | Impact Type | Classification   | Surface Cond'n | Veh. Dir | Vehicle Manoeuver | Vehicle type              | First Event         | No. Ped |
|------------------------|-------------|-------------|------------------|----------------|----------|-------------------|---------------------------|---------------------|---------|
| 2016-Jan-12, Tue,17:18 | Clear       | Rear end    | P.D. only        | Wet            | North    | Going ahead       | Automobile, station wagon | Other motor vehicle | 0       |
|                        |             |             |                  |                | North    | Going ahead       | Automobile, station wagon | Other motor vehicle |         |
| 2016-Apr-05, Tue,08:26 | Clear       | Rear end    | P.D. only        | Dry            | East     | Turning right     | Pick-up truck             | Other motor vehicle | 0       |
|                        |             |             |                  |                | East     | Turning right     | Pick-up truck             | Other motor vehicle |         |
| 2016-Apr-14, Thu,07:40 | Clear       | Rear end    | Non-fatal injury | Dry            | East     | Turning right     | Pick-up truck             | Other motor vehicle | 0       |
|                        |             |             |                  |                | East     | Turning right     | Pick-up truck             | Other motor vehicle |         |
| 2016-Jul-26, Tue,16:23 | Clear       | Rear end    | P.D. only        | Dry            | North    | Going ahead       | Automobile, station wagon | Other motor vehicle | 0       |
|                        |             |             |                  |                | North    | Stopped           | Pick-up truck             | Other motor vehicle |         |
| 2016-Oct-02, Sun,13:23 | Rain        | Sideswipe   | P.D. only        | Wet            | West     | Turning left      | Pick-up truck             | Other motor vehicle | 0       |
|                        |             |             |                  |                | West     | Turning left      | Automobile, station wagon | Other motor vehicle |         |
| 2016-Dec-14, Wed,11:30 | Clear       | Angle       | P.D. only        | Dry            | South    | Turning left      | Automobile, station wagon | Other motor vehicle | 0       |
|                        |             |             |                  |                | East     | Going ahead       | Automobile, station wagon | Other motor vehicle |         |
| 2016-Dec-22, Thu,09:33 | Snow        | Sideswipe   | P.D. only        | Slush          | North    | Changing lanes    | Automobile, station wagon | Skidding/sliding    | 0       |
|                        |             |             |                  |                | North    | Going ahead       | Automobile, station wagon | Other motor vehicle |         |
|                        |             |             |                  |                | North    | Going ahead       | Automobile, station wagon | Other motor vehicle |         |
| 2017-Jan-08, Sun,14:48 | Clear       | Rear end    | P.D. only        | Wet            | South    | Turning right     | Automobile, station wagon | Other motor vehicle | 0       |
|                        |             |             |                  |                | South    | Turning right     | Pick-up truck             | Other motor vehicle |         |





# Transportation Services - Traffic Services

## Collision Details Report - Public Version

From: January 1, 2016 To: December 31, 2020

**Location:** MARCH RD @ TERRY FOX DR

**Traffic Control:** Traffic signal

**Total Collisions:** 47

| Date/Day/Time          | Environment | Impact Type | Classification   | Surface Cond'n | Veh. Dir | Vehicle Manoeuver   | Vehicle type              | First Event         | No. Ped |
|------------------------|-------------|-------------|------------------|----------------|----------|---------------------|---------------------------|---------------------|---------|
| 2017-Apr-24, Mon,14:47 | Clear       | Rear end    | P.D. only        | Dry            | West     | Going ahead         | Automobile, station wagon | Other motor vehicle | 0       |
|                        |             |             |                  |                | West     | Stopped             | Automobile, station wagon | Other motor vehicle |         |
| 2017-May-18, Thu,09:47 | Clear       | Rear end    | P.D. only        | Dry            | North    | Going ahead         | Passenger van             | Other motor vehicle | 0       |
|                        |             |             |                  |                | North    | Stopped             | Truck and trailer         | Other motor vehicle |         |
| 2017-Jun-13, Tue,20:15 | Clear       | Rear end    | P.D. only        | Dry            | North    | Changing lanes      | Pick-up truck             | Other motor vehicle | 0       |
|                        |             |             |                  |                | North    | Going ahead         | Pick-up truck             | Other motor vehicle |         |
| 2017-Jun-14, Wed,18:47 | Clear       | Rear end    | Non-fatal injury | Dry            | North    | Slowing or stopping | Automobile, station wagon | Other motor vehicle | 0       |
|                        |             |             |                  |                | North    | Stopped             | Pick-up truck             | Other motor vehicle |         |
| 2017-Jun-29, Thu,11:53 | Rain        | Rear end    | P.D. only        | Wet            | South    | Going ahead         | Automobile, station wagon | Other motor vehicle | 0       |
|                        |             |             |                  |                | South    | Stopped             | Automobile, station wagon | Other motor vehicle |         |
| 2017-Jul-24, Mon,15:37 | Rain        | Rear end    | P.D. only        | Wet            | South    | Going ahead         | Automobile, station wagon | Other motor vehicle | 0       |
|                        |             |             |                  |                | South    | Stopped             | Passenger van             | Other motor vehicle |         |
| 2017-Aug-24, Thu,17:49 | Clear       | Rear end    | P.D. only        | Dry            | North    | Going ahead         | Automobile, station wagon | Other motor vehicle | 0       |
|                        |             |             |                  |                | North    | Stopped             | Automobile, station wagon | Other motor vehicle |         |
| 2017-Sep-03, Sun,10:39 | Rain        | Sideswipe   | Non-fatal injury | Wet            | East     | Going ahead         | Automobile, station wagon | Other motor vehicle | 0       |
|                        |             |             |                  |                | East     | Turning left        | Automobile, station wagon | Other motor vehicle |         |
| 2017-Sep-20, Wed,16:15 | Clear       | Rear end    | P.D. only        | Dry            | North    | Changing lanes      | Automobile, station wagon | Other motor vehicle | 0       |
|                        |             |             |                  |                | North    | Going ahead         | Automobile, station wagon | Other motor vehicle |         |
| 2017-Sep-27, Wed,14:43 | Clear       | Rear end    | Non-fatal injury | Dry            | North    | Changing lanes      | Automobile, station wagon | Other motor vehicle | 0       |
|                        |             |             |                  |                | North    | Stopped             | Automobile, station wagon | Other motor vehicle |         |
| 2017-Oct-04, Wed,17:45 | Clear       | Sideswipe   | P.D. only        | Dry            | West     | Overtaking          | Automobile, station wagon | Other motor vehicle | 0       |
|                        |             |             |                  |                | West     | Going ahead         | Automobile, station wagon | Other motor vehicle |         |
| 2017-Oct-14, Sat,08:00 | Rain        | SMV other   | P.D. only        | Wet            | North    | Merging             | Automobile, station wagon | Curb                | 0       |



# Transportation Services - Traffic Services

## Collision Details Report - Public Version

From: January 1, 2016 To: December 31, 2020

**Location:** MARCH RD @ TERRY FOX DR

**Traffic Control:** Traffic signal

**Total Collisions:** 47

| Date/Day/Time          | Environment   | Impact Type      | Classification   | Surface Cond'n | Veh. Dir | Vehicle Manoeuvre   | Vehicle type              | First Event         | No. Ped |
|------------------------|---------------|------------------|------------------|----------------|----------|---------------------|---------------------------|---------------------|---------|
| 2017-Oct-20, Fri,19:04 | Clear         | Other            | P.D. only        | Dry            | West     | Reversing           | Automobile, station wagon | Other motor vehicle | 0       |
|                        |               |                  |                  |                | West     | Stopped             | Automobile, station wagon | Other motor vehicle |         |
| 2017-Dec-02, Sat,18:19 | Clear         | Sideswipe        | P.D. only        | Dry            | North    | Changing lanes      | Passenger van             | Other motor vehicle | 0       |
|                        |               |                  |                  |                | North    | Turning left        | Automobile, station wagon | Other motor vehicle |         |
| 2017-Dec-19, Tue,08:32 | Clear         | SMV other        | P.D. only        | Loose snow     | North    | Turning right       | Automobile, station wagon | Snowbank/drift      | 0       |
| 2017-Dec-27, Wed,14:55 | Clear         | SMV other        | P.D. only        | Ice            | South    | Going ahead         | Automobile, station wagon | Other               | 0       |
| 2018-Jan-14, Sun,12:37 | Clear         | Rear end         | P.D. only        | Ice            | North    | Going ahead         | Automobile, station wagon | Other motor vehicle | 0       |
|                        |               |                  |                  |                | North    | Stopped             | Automobile, station wagon | Other motor vehicle |         |
| 2018-Jan-21, Sun,21:32 | Clear         | Angle            | P.D. only        | Dry            | East     | Reversing           | Automobile, station wagon | Other motor vehicle | 0       |
|                        |               |                  |                  |                | South    | Going ahead         | Automobile, station wagon | Other motor vehicle |         |
| 2018-Feb-09, Fri,23:12 | Snow          | Turning movement | Non-fatal injury | Loose snow     | South    | Going ahead         | Automobile, station wagon | Other motor vehicle | 0       |
|                        |               |                  |                  |                | North    | Turning left        | Automobile, station wagon | Other motor vehicle |         |
| 2018-Feb-11, Sun,18:56 | Freezing Rain | SMV other        | P.D. only        | Ice            | East     | Turning right       | Automobile, station wagon | Skidding/sliding    | 0       |
| 2018-Feb-22, Thu,17:20 | Clear         | Rear end         | P.D. only        | Wet            | North    | Slowing or stopping | Automobile, station wagon | Other motor vehicle | 0       |
|                        |               |                  |                  |                | North    | Turning left        | Automobile, station wagon | Other motor vehicle |         |
| 2018-Feb-28, Wed,13:53 | Clear         | Rear end         | P.D. only        | Dry            | North    | Slowing or stopping | Pick-up truck             | Other motor vehicle | 0       |
|                        |               |                  |                  |                | North    | Stopped             | Automobile, station wagon | Other motor vehicle |         |
| 2018-Jun-06, Wed,17:35 | Clear         | Rear end         | P.D. only        | Dry            | North    | Unknown             | Motorcycle                | Other motor vehicle | 0       |
|                        |               |                  |                  |                | North    | Stopped             | Automobile, station wagon | Other motor vehicle |         |
| 2018-Jun-09, Sat,17:11 | Clear         | SMV other        | P.D. only        | Dry            | South    | Going ahead         | Automobile, station wagon | Curb                | 0       |
| 2018-Jun-22, Fri,15:38 | Clear         | Rear end         | P.D. only        | Dry            | North    | Turning right       | Pick-up truck             | Other motor vehicle | 0       |
|                        |               |                  |                  |                | North    | Turning right       | Automobile, station wagon | Other motor vehicle |         |
| 2018-Jul-14, Sat,11:41 | Clear         | Rear end         | P.D. only        | Dry            | West     | Turning right       | Automobile, station wagon | Other motor vehicle | 0       |
|                        |               |                  |                  |                | West     | Stopped             | Automobile, station wagon | Other motor vehicle |         |



# Transportation Services - Traffic Services

## Collision Details Report - Public Version

From: January 1, 2016 To: December 31, 2020

**Location:** MARCH RD @ TERRY FOX DR

**Traffic Control:** Traffic signal

**Total Collisions:** 47

| Date/Day/Time          | Environment | Impact Type | Classification   | Surface Cond'n | Veh. Dir | Vehicle Manoeuvre   | Vehicle type              | First Event         | No. Ped |
|------------------------|-------------|-------------|------------------|----------------|----------|---------------------|---------------------------|---------------------|---------|
| 2018-Jul-24, Tue,09:30 | Rain        | Rear end    | P.D. only        | Wet            | East     | Going ahead         | Automobile, station wagon | Other motor vehicle | 0       |
|                        |             |             |                  |                | East     | Going ahead         | Automobile, station wagon | Other motor vehicle |         |
| 2018-Nov-14, Wed,19:00 | Clear       | Rear end    | Non-fatal injury | Dry            | North    | Going ahead         | Automobile, station wagon | Other motor vehicle | 0       |
|                        |             |             |                  |                | North    | Stopped             | Automobile, station wagon | Other motor vehicle |         |
| 2018-Dec-18, Tue,08:59 | Clear       | Rear end    | Non-fatal injury | Dry            | South    | Going ahead         | Automobile, station wagon | Other motor vehicle | 0       |
|                        |             |             |                  |                | South    | Slowing or stopping | Automobile, station wagon | Other motor vehicle |         |
| 2018-Dec-21, Fri,16:20 | Rain        | Rear end    | Non-fatal injury | Wet            | South    | Going ahead         | Automobile, station wagon | Other motor vehicle | 0       |
|                        |             |             |                  |                | South    | Stopped             | Automobile, station wagon | Other motor vehicle |         |
| 2019-Feb-26, Tue,16:30 | Snow        | Sideswipe   | P.D. only        | Ice            | North    | Changing lanes      | Automobile, station wagon | Other motor vehicle | 0       |
|                        |             |             |                  |                | North    | Going ahead         | Automobile, station wagon | Other motor vehicle |         |
| 2019-Mar-10, Sun,14:45 | Snow        | Rear end    | P.D. only        | Slush          | South    | Slowing or stopping | Automobile, station wagon | Other motor vehicle | 0       |
|                        |             |             |                  |                | South    | Stopped             | Automobile, station wagon | Other motor vehicle |         |
| 2019-Jun-26, Wed,09:46 | Rain        | Approaching | Non-fatal injury | Wet            | South    | Going ahead         | Automobile, station wagon | Skidding/sliding    | 0       |
|                        |             |             |                  |                | North    | Stopped             | Automobile, station wagon | Other motor vehicle |         |
|                        |             |             |                  |                | North    | Stopped             | Automobile, station wagon | Other motor vehicle |         |
| 2019-Nov-05, Tue,18:17 | Clear       | Sideswipe   | P.D. only        | Dry            | East     | Turning right       | Automobile, station wagon | Other motor vehicle | 0       |
|                        |             |             |                  |                | East     | Turning right       | Truck and trailer         | Other motor vehicle |         |
| 2019-Dec-24, Tue,22:58 | Clear       | Rear end    | P.D. only        | Dry            | North    | Going ahead         | Automobile, station wagon | Other motor vehicle | 0       |
|                        |             |             |                  |                | North    | Stopped             | Automobile, station wagon | Other motor vehicle |         |
| 2020-May-24, Sun,14:00 | Clear       | Rear end    | P.D. only        | Dry            | North    | Slowing or stopping | Automobile, station wagon | Other motor vehicle | 0       |
|                        |             |             |                  |                | North    | Going ahead         | Automobile, station wagon | Other motor vehicle |         |
| 2020-Aug-13, Thu,14:30 | Clear       | Rear end    | P.D. only        | Dry            | South    | Unknown             | Unknown                   | Other motor vehicle | 0       |
|                        |             |             |                  |                | South    | Stopped             | Pick-up truck             | Other motor vehicle |         |



# Transportation Services - Traffic Services

## Collision Details Report - Public Version

From: January 1, 2016 To: December 31, 2020

**Location:** MARCH RD @ TERRY FOX DR

**Traffic Control:** Traffic signal

**Total Collisions:** 47

| Date/Day/Time          | Environment | Impact Type      | Classification   | Surface Cond'n | Veh. Dir | Vehicle Manoeuvre   | Vehicle type              | First Event         | No. Ped |
|------------------------|-------------|------------------|------------------|----------------|----------|---------------------|---------------------------|---------------------|---------|
| 2020-Oct-14, Wed,22:26 | Clear       | Turning movement | Non-fatal injury | Dry            | South    | Going ahead         | Automobile, station wagon | Other motor vehicle | 0       |
|                        |             |                  |                  |                | North    | Turning left        | Automobile, station wagon | Other motor vehicle |         |
| 2020-Nov-22, Sun,17:45 | Snow        | SMV other        | P.D. only        | Loose snow     | East     | Slowing or stopping | Automobile, station wagon | Skidding/sliding    | 0       |

**Location:** MARCH RD btwn MORGAN'S GRANT WAY & TERRY FOX DR

**Traffic Control:** No control

**Total Collisions:** 6

| Date/Day/Time          | Environment   | Impact Type | Classification   | Surface Cond'n | Veh. Dir | Vehicle Manoeuvre | Vehicle type              | First Event         | No. Ped |
|------------------------|---------------|-------------|------------------|----------------|----------|-------------------|---------------------------|---------------------|---------|
| 2018-Feb-23, Fri,13:12 | Freezing Rain | SMV other   | Non-fatal injury | Ice            | North    | Going ahead       | Automobile, station wagon | Ran off road        | 0       |
| 2018-Oct-29, Mon,07:27 | Rain          | Rear end    | P.D. only        | Wet            | South    | Going ahead       | Automobile, station wagon | Other motor vehicle | 0       |
|                        |               |             |                  |                | South    | Stopped           | Automobile, station wagon | Other motor vehicle |         |
|                        |               |             |                  |                | South    | Going ahead       | Delivery van              | Other motor vehicle |         |
|                        |               |             |                  |                | South    | Stopped           | Automobile, station wagon | Other motor vehicle |         |
| 2019-May-14, Tue,20:48 | Clear         | Sideswipe   | P.D. only        | Dry            | North    | Going ahead       | Automobile, station wagon | Other motor vehicle | 0       |
|                        |               |             |                  |                | North    | Going ahead       | Delivery van              | Other motor vehicle |         |
| 2019-May-28, Tue,10:39 | Rain          | SMV other   | P.D. only        | Wet            | North    | Going ahead       | Automobile, station wagon | Curb                | 0       |
| 2019-Nov-05, Tue,06:41 | Clear         | Rear end    | Non-fatal injury | Wet            | South    | Changing lanes    | Automobile, station wagon | Other motor vehicle | 0       |
|                        |               |             |                  |                | South    | Going ahead       | Automobile, station wagon | Other motor vehicle |         |
| 2020-Jan-04, Sat,19:54 | Clear         | Sideswipe   | P.D. only        | Wet            | North    | Changing lanes    | Automobile, station wagon | Other motor vehicle | 0       |
|                        |               |             |                  |                | North    | Going ahead       | Automobile, station wagon | Other motor vehicle |         |

**Location:** MARCH RD btwn SOLANDT RD & TERRY FOX DR

**Traffic Control:** No control

**Total Collisions:** 16

| Date/Day/Time | Environment | Impact Type | Classification | Surface Cond'n | Veh. Dir | Vehicle Manoeuvre | Vehicle type | First Event | No. Ped |
|---------------|-------------|-------------|----------------|----------------|----------|-------------------|--------------|-------------|---------|
|---------------|-------------|-------------|----------------|----------------|----------|-------------------|--------------|-------------|---------|



# Transportation Services - Traffic Services

## Collision Details Report - Public Version

**From:** January 1, 2016    **To:** December 31, 2020

**Location:** MARCH RD btwn SOLANDT RD & TERRY FOX DR

**Traffic Control:** No control

**Total Collisions:** 16

| Date/Day/Time          | Environment | Impact Type | Classification   | Surface Cond'n | Veh. Dir | Vehicle Manoeuver   | Vehicle type              | First Event         | No. Ped |
|------------------------|-------------|-------------|------------------|----------------|----------|---------------------|---------------------------|---------------------|---------|
| 2016-Jan-15, Fri,17:54 | Clear       | Rear end    | P.D. only        | Dry            | North    | Slowing or stopping | Automobile, station wagon | Other motor vehicle | 0       |
|                        |             |             |                  |                | North    | Stopped             | Automobile, station wagon | Other motor vehicle |         |
|                        |             |             |                  |                | North    | Stopped             | Automobile, station wagon | Other motor vehicle |         |
| 2016-Jun-17, Fri,06:36 | Clear       | SMV other   | Non-fatal injury | Dry            | South    | Going ahead         | Automobile, station wagon | Animal - wild       | 0       |
| 2016-Jun-30, Thu,16:46 | Clear       | Angle       | Non-fatal injury | Dry            | North    | Going ahead         | Bicycle                   | Other motor vehicle | 0       |
|                        |             |             |                  |                | East     | Turning right       | Pick-up truck             | Cyclist             |         |
| 2016-Dec-19, Mon,23:58 | Clear       | Sideswipe   | P.D. only        | Loose snow     | North    | Changing lanes      | Automobile, station wagon | Other motor vehicle | 0       |
|                        |             |             |                  |                | North    | Going ahead         | Pick-up truck             | Other motor vehicle |         |
| 2017-Feb-14, Tue,11:55 | Snow        | Rear end    | Non-fatal injury | Wet            | North    | Merging             | Automobile, station wagon | Other motor vehicle | 0       |
|                        |             |             |                  |                | North    | Stopped             | Automobile, station wagon | Other motor vehicle |         |
| 2017-May-20, Sat,07:57 | Clear       | Sideswipe   | P.D. only        | Dry            | South    | Changing lanes      | Automobile, station wagon | Other motor vehicle | 0       |
|                        |             |             |                  |                | South    | Going ahead         | Automobile, station wagon | Other motor vehicle |         |
| 2017-Jun-05, Mon,08:55 | Clear       | Rear end    | P.D. only        | Dry            | South    | Changing lanes      | Automobile, station wagon | Other motor vehicle | 0       |
|                        |             |             |                  |                | South    | Going ahead         | Automobile, station wagon | Other motor vehicle |         |
|                        |             |             |                  |                | South    | Going ahead         | Truck and trailer         | Other motor vehicle |         |
| 2018-Oct-30, Tue,17:12 | Clear       | Rear end    | P.D. only        | Dry            | North    | Going ahead         | Automobile, station wagon | Other motor vehicle | 0       |
|                        |             |             |                  |                | North    | Slowing or stopping | Automobile, station wagon | Other motor vehicle |         |
|                        |             |             |                  |                | North    | Stopped             | Automobile, station wagon | Other motor vehicle |         |
|                        |             |             |                  |                | North    | Stopped             | Automobile, station wagon | Other motor vehicle |         |
| 2019-Apr-18, Thu,03:22 | Clear       | Rear end    | Non-fatal injury | Dry            | North    | Going ahead         | Automobile, station wagon | Other motor vehicle | 0       |
|                        |             |             |                  |                | North    | Going ahead         | Pick-up truck             | Other motor vehicle |         |
| 2019-May-23, Thu,16:30 | Rain        | Rear end    | P.D. only        | Wet            | South    | Unknown             | Unknown                   | Other motor vehicle | 0       |
|                        |             |             |                  |                | South    | Stopped             | Automobile, station wagon | Other motor vehicle |         |
| 2019-Aug-04, Sun,11:40 | Clear       | SMV other   | Non-fatal injury | Dry            | North    | Going ahead         | Motorcycle                | Skidding/sliding    | 0       |



# Transportation Services - Traffic Services

## Collision Details Report - Public Version

From: January 1, 2016 To: December 31, 2020

**Location:** MARCH RD btwn SOLANDT RD & TERRY FOX DR

**Traffic Control:** No control

**Total Collisions:** 16

| Date/Day/Time          | Environment | Impact Type | Classification   | Surface Cond'n | Veh. Dir | Vehicle Manoeuver | Vehicle type              | First Event           | No. Ped |
|------------------------|-------------|-------------|------------------|----------------|----------|-------------------|---------------------------|-----------------------|---------|
| 2019-Nov-16, Sat,19:07 | Clear       | SMV other   | P.D. only        | Dry            | South    | Going ahead       | Automobile, station wagon | Debris on road        | 0       |
| 2019-Nov-26, Tue,07:00 | Clear       | SMV other   | P.D. only        | Dry            | South    | Going ahead       | Automobile, station wagon | Animal - wild         | 0       |
| 2019-Dec-31, Tue,07:57 | Snow        | Rear end    | P.D. only        | Slush          | North    | Going ahead       | Pick-up truck             | Other motor vehicle   | 0       |
|                        |             |             |                  |                | North    | Stopped           | Automobile, station wagon | Other motor vehicle   |         |
| 2020-Apr-03, Fri,09:29 | Rain        | SMV other   | Non-fatal injury | Wet            | South    | Going ahead       | Automobile, station wagon | Pole (utility, power) | 0       |
| 2020-Oct-29, Thu,07:10 | Clear       | SMV other   | P.D. only        | Dry            | South    | Going ahead       | Passenger van             | Animal - wild         | 0       |

**Location:** TERRY FOX DR btwn INNOVATION DR & MARCH RD

**Traffic Control:** No control

**Total Collisions:** 5

| Date/Day/Time          | Environment | Impact Type      | Classification   | Surface Cond'n | Veh. Dir | Vehicle Manoeuver   | Vehicle type              | First Event         | No. Ped |
|------------------------|-------------|------------------|------------------|----------------|----------|---------------------|---------------------------|---------------------|---------|
| 2016-May-20, Fri,15:14 | Clear       | Rear end         | Non-fatal injury | Dry            | West     | Going ahead         | Automobile, station wagon | Other motor vehicle | 0       |
|                        |             |                  |                  |                | West     | Slowing or stopping | Pick-up truck             | Other motor vehicle |         |
| 2018-Apr-22, Sun,15:43 | Clear       | SMV other        | P.D. only        | Dry            | West     | Going ahead         | Automobile, station wagon | Animal - wild       | 0       |
| 2018-Jun-14, Thu,17:32 | Rain        | Rear end         | P.D. only        | Wet            | West     | Slowing or stopping | Automobile, station wagon | Other motor vehicle | 0       |
|                        |             |                  |                  |                | West     | Stopped             | Automobile, station wagon | Other motor vehicle |         |
|                        |             |                  |                  |                | West     | Going ahead         | Automobile, station wagon | Other motor vehicle |         |
| 2018-Oct-22, Mon,11:30 | Clear       | Turning movement | P.D. only        | Dry            | West     | Turning right       | Automobile, station wagon | Other motor vehicle | 0       |
|                        |             |                  |                  |                | West     | Going ahead         | Automobile, station wagon | Other motor vehicle |         |
| 2018-Nov-29, Thu,17:09 | Clear       | Rear end         | P.D. only        | Dry            | West     | Slowing or stopping | Automobile, station wagon | Other motor vehicle | 0       |
|                        |             |                  |                  |                | West     | Stopped             | Automobile, station wagon | Other motor vehicle |         |

**Location:** TERRY FOX DR N @ FLAMBOROUGH WAY/INNOVATION DR

**Traffic Control:** Traffic signal

**Total Collisions:** 20

| Date/Day/Time | Environment | Impact Type | Classification | Surface Cond'n | Veh. Dir | Vehicle Manoeuver | Vehicle type | First Event | No. Ped |
|---------------|-------------|-------------|----------------|----------------|----------|-------------------|--------------|-------------|---------|
|---------------|-------------|-------------|----------------|----------------|----------|-------------------|--------------|-------------|---------|



# Transportation Services - Traffic Services

## Collision Details Report - Public Version

**From:** January 1, 2016    **To:** December 31, 2020

**Location:** TERRY FOX DR N @ FLAMBOROUGH WAY/INNOVATION DR

**Traffic Control:** Traffic signal

**Total Collisions:** 20

| Date/Day/Time          | Environment | Impact Type      | Classification   | Surface Cond'n | Veh. Dir | Vehicle Manoeuver   | Vehicle type              | First Event         | No. Ped |
|------------------------|-------------|------------------|------------------|----------------|----------|---------------------|---------------------------|---------------------|---------|
| 2016-Feb-19, Fri,06:43 | Clear       | Angle            | P.D. only        | Ice            | East     | Going ahead         | Pick-up truck             | Other motor vehicle | 0       |
|                        |             |                  |                  |                | North    | Turning left        | Pick-up truck             | Other motor vehicle |         |
| 2016-Jul-24, Sun,11:52 | Clear       | Rear end         | P.D. only        | Dry            | East     | Slowing or stopping | Passenger van             | Other motor vehicle | 0       |
|                        |             |                  |                  |                | East     | Stopped             | Automobile, station wagon | Other motor vehicle |         |
| 2016-Jul-26, Tue,19:34 | Clear       | Rear end         | P.D. only        | Dry            | West     | Turning left        | Pick-up truck             | Other motor vehicle | 0       |
|                        |             |                  |                  |                | West     | Turning left        | Automobile, station wagon | Other motor vehicle |         |
| 2016-Sep-08, Thu,17:36 | Clear       | Rear end         | P.D. only        | Dry            | West     | Going ahead         | Automobile, station wagon | Other motor vehicle | 0       |
|                        |             |                  |                  |                | West     | Going ahead         | Automobile, station wagon | Other motor vehicle |         |
| 2016-Oct-20, Thu,11:30 | Rain        | Sideswipe        | P.D. only        | Wet            | North    | Unknown             | Pick-up truck             | Other motor vehicle | 0       |
|                        |             |                  |                  |                | North    | Going ahead         | Pick-up truck             | Other motor vehicle |         |
| 2017-Apr-04, Tue,09:11 | Rain        | Turning movement | Non-fatal injury | Wet            | West     | Turning left        | Pick-up truck             | Other motor vehicle | 0       |
|                        |             |                  |                  |                | East     | Going ahead         | Automobile, station wagon | Other motor vehicle |         |
|                        |             |                  |                  |                | North    | Stopped             | Automobile, station wagon | Other motor vehicle |         |
|                        |             |                  |                  |                | North    | Stopped             | Passenger van             | Other motor vehicle |         |
|                        |             |                  |                  |                | North    | Stopped             | Pick-up truck             | Other motor vehicle |         |
| 2017-Jun-17, Sat,13:17 | Clear       | Angle            | P.D. only        | Dry            | West     | Slowing or stopping | Pick-up truck             | Other motor vehicle | 0       |
|                        |             |                  |                  |                | South    | Going ahead         | Passenger van             | Other motor vehicle |         |
| 2017-Aug-23, Wed,16:59 | Clear       | Rear end         | Non-fatal injury | Dry            | West     | Going ahead         | Delivery van              | Other motor vehicle | 0       |
|                        |             |                  |                  |                | West     | Stopped             | Automobile, station wagon | Other motor vehicle |         |
|                        |             |                  |                  |                | West     | Slowing or stopping | Automobile, station wagon | Other motor vehicle |         |
|                        |             |                  |                  |                | West     | Stopped             | Automobile, station wagon | Other motor vehicle |         |
| 2017-Dec-12, Tue,19:04 | Snow        | Rear end         | P.D. only        | Slush          | South    | Going ahead         | Automobile, station wagon | Other motor vehicle | 0       |
|                        |             |                  |                  |                | South    | Stopped             | Pick-up truck             | Other motor vehicle |         |



# Transportation Services - Traffic Services

## Collision Details Report - Public Version

From: January 1, 2016 To: December 31, 2020

**Location:** TERRY FOX DR N @ FLAMBOROUGH WAY/INNOVATION DR

**Traffic Control:** Traffic signal

**Total Collisions:** 20

| Date/Day/Time          | Environment | Impact Type      | Classification   | Surface Cond'n | Veh. Dir | Vehicle Manoeuver   | Vehicle type              | First Event         | No. Ped |
|------------------------|-------------|------------------|------------------|----------------|----------|---------------------|---------------------------|---------------------|---------|
| 2018-Jan-13, Sat,14:18 | Clear       | Turning movement | Non-fatal injury | Loose snow     | West     | Turning left        | Automobile, station wagon | Other motor vehicle | 0       |
|                        |             |                  |                  |                | East     | Going ahead         | Automobile, station wagon | Other motor vehicle |         |
| 2018-Jan-16, Tue,15:00 | Clear       | Rear end         | P.D. only        | Loose snow     | West     | Going ahead         | Automobile, station wagon | Other motor vehicle | 0       |
|                        |             |                  |                  |                | West     | Stopped             | Automobile, station wagon | Other motor vehicle |         |
| 2018-Apr-05, Thu,17:54 | Clear       | Turning movement | P.D. only        | Dry            | West     | Making "U" turn     | Automobile, station wagon | Other motor vehicle | 0       |
|                        |             |                  |                  |                | West     | Going ahead         | Automobile, station wagon | Other motor vehicle |         |
| 2018-May-24, Thu,13:46 | Clear       | Rear end         | P.D. only        | Dry            | South    | Going ahead         | Automobile, station wagon | Other motor vehicle | 0       |
|                        |             |                  |                  |                | South    | Stopped             | Automobile, station wagon | Other motor vehicle |         |
|                        |             |                  |                  |                | South    | Stopped             | Automobile, station wagon | Other motor vehicle |         |
| 2018-Jun-04, Mon,17:47 | Rain        | Rear end         | P.D. only        | Wet            | West     | Going ahead         | Automobile, station wagon | Other motor vehicle | 0       |
|                        |             |                  |                  |                | West     | Stopped             | Automobile, station wagon | Other motor vehicle |         |
| 2018-Sep-12, Wed,19:05 | Clear       | SMV other        | P.D. only        | Dry            | North    | Turning left        | Unknown                   | Pedestrian          | 1       |
| 2019-Oct-01, Tue,09:00 | Rain        | Rear end         | Non-fatal injury | Wet            | East     | Going ahead         | Pick-up truck             | Other motor vehicle | 0       |
|                        |             |                  |                  |                | East     | Slowing or stopping | Pick-up truck             | Other motor vehicle |         |
| 2019-Oct-28, Mon,17:48 | Clear       | Angle            | Non-fatal injury | Dry            | East     | Going ahead         | Passenger van             | Other motor vehicle | 0       |
|                        |             |                  |                  |                | North    | Going ahead         | Automobile, station wagon | Other motor vehicle |         |
| 2019-Nov-14, Thu,07:45 | Snow        | Rear end         | P.D. only        | Loose snow     | South    | Slowing or stopping | Automobile, station wagon | Other motor vehicle | 0       |
|                        |             |                  |                  |                | South    | Stopped             | Automobile, station wagon | Other motor vehicle |         |
| 2020-Feb-25, Tue,17:20 | Clear       | Rear end         | P.D. only        | Wet            | West     | Going ahead         | Automobile, station wagon | Other motor vehicle | 0       |
|                        |             |                  |                  |                | West     | Stopped             | Unknown                   | Other motor vehicle |         |
| 2020-Sep-21, Mon,18:51 | Clear       | Angle            | Non-fatal injury | Dry            | North    | Turning right       | Automobile, station wagon | Cyclist             | 0       |
|                        |             |                  |                  |                | East     | Going ahead         | Bicycle                   | Other motor vehicle |         |





# Transportation Services - Traffic Services

## Collision Details Report - Public Version

**From:** January 1, 2016 **To:** December 31, 2020

**Location:** HINES RD btwn END & INNOVATION DR

**Traffic Control:** No control

**Total Collisions:** 1

| Date/Day/Time          | Environment | Impact Type | Classification | Surface Cond'n | Veh. Dir | Vehicle Manoeuver | Vehicle type              | First Event  | No. Ped |
|------------------------|-------------|-------------|----------------|----------------|----------|-------------------|---------------------------|--------------|---------|
| 2017-Dec-07, Thu,07:40 | Snow        | SMV other   | P.D. only      | Ice            | South    | Stopped           | Automobile, station wagon | Ran off road | 0       |

## **APPENDIX F**

---

Internal Capture Worksheets

| NCHRP 684 Internal Trip Capture Estimation Tool |                       |               |            |
|---|-----------------------|---------------|------------|
| Project Name:                                   | 555-603 March Road    | Organization: | Novatech   |
| Project Location:                               | Ottawa, ON            | Performed By: | Josh Audia |
| Scenario Description:                           | Full Site Development | Date:         | 10/28/2022 |
| Analysis Year:                                  |                       | Checked By:   |            |
| Analysis Period:                                | AM Street Peak Hour   | Date:         |            |

| Table 1-A: Base Vehicle-Trip Generation Estimates (Single-Use Site Estimate) |   |          |       |                                      |          |         |
|--|---|----------|-------|--------------------------------------|----------|---------|
| Land Use   | Development Data (For Information Only) |          |       | Estimated Vehicle-Trips <sup>3</sup> |          |         |
|  | ITE LUCs <sup>1</sup>                   | Quantity | Units | Total                                | Entering | Exiting |
| Office   |   |          |       | 224                                  | 197      | 27      |
| Retail   |   |          |       | 50                                   | 30       | 20      |
| Restaurant   |   |          |       | 0                                    |          |         |
| Cinema/Entertainment   |   |          |       | 0                                    |          |         |
| Residential  |   |          |       | 396                                  | 123      | 273     |
| Hotel  |   |          |       | 0                                    |          |         |
| All Other Land Uses <sup>2</sup>   |   |          |       | 0                                    |          |         |
|  |   |          |       | 670                                  | 350      | 320     |

| Table 2-A: Mode Split and Vehicle Occupancy Estimates |                        |           |                 |                        |           |                 |
|---|------------------------|-----------|-----------------|------------------------|-----------|-----------------|
| Land Use  | Entering Trips         |           |                 | Exiting Trips          |           |                 |
|   | Veh. Occ. <sup>4</sup> | % Transit | % Non-Motorized | Veh. Occ. <sup>4</sup> | % Transit | % Non-Motorized |
| Office  |                        | 20%       | 4%              |                        | 20%       | 4%              |
| Retail  |                        | 10%       | 4%              |                        | 10%       | 4%              |
| Restaurant  |                        |           |                 |                        |           |                 |
| Cinema/Entertainment                                  |                        |           |                 |                        |           |                 |
| Residential   |                        | 27%       | 5%              |                        | 27%       | 5%              |
| Hotel   |                        |           |                 |                        |           |                 |
| All Other Land Uses <sup>2</sup>                      |                        |           |                 |                        |           |                 |

| Table 3-A: Average Land Use Interchange Distances (Feet Walking Distance) |                  |        |            |                      |             |       |
|---|------------------|--------|------------|----------------------|-------------|-------|
| Origin (From)   | Destination (To) |        |            |                      |             |       |
|   | Office           | Retail | Restaurant | Cinema/Entertainment | Residential | Hotel |
| Office  |                  |        |            |                      |             |       |
| Retail  |                  |        |            |                      |             |       |
| Restaurant  |                  |        |            |                      |             |       |
| Cinema/Entertainment  |                  |        |            |                      |             |       |
| Residential   |                  |        |            |                      |             |       |
| Hotel   |                  |        |            |                      |             |       |

| Table 4-A: Internal Person-Trip Origin-Destination Matrix* |                  |        |            |                      |             |       |
|--|------------------|--------|------------|----------------------|-------------|-------|
| Origin (From)  | Destination (To) |        |            |                      |             |       |
|  | Office           | Retail | Restaurant | Cinema/Entertainment | Residential | Hotel |
| Office   |                  | 10     | 0          | 0                    | 0           | 0     |
| Retail   | 9                |        | 0          | 0                    | 4           | 0     |
| Restaurant   | 0                | 0      |            | 0                    | 0           | 0     |
| Cinema/Entertainment                                       | 0                | 0      | 0          |                      | 0           | 0     |
| Residential  | 8                | 6      | 0          | 0                    |             | 0     |
| Hotel  | 0                | 0      | 0          | 0                    | 0           |       |

| Table 5-A: Computations Summary           |       |          |         |
|---|-------|----------|---------|
|   | Total | Entering | Exiting |
| All Person-Trips                          | 1,232 | 582      | 650     |
| Internal Capture Percentage               | 6%    | 6%       | 6%      |
| External Vehicle-Trips <sup>5</sup>       | 611   | 320      | 291     |
| External Transit-Trips <sup>6</sup>       | 287   | 124      | 163     |
| External Non-Motorized Trips <sup>8</sup> | 51    | 23       | 28      |

| Table 6-A: Internal Trip Capture Percentages by Land Use |                |               |
|--|----------------|---------------|
| Land Use   | Entering Trips | Exiting Trips |
| Office   | 6%             | 27%           |
| Retail   | 34%            | 42%           |
| Restaurant   | N/A            | N/A           |
| Cinema/Entertainment                                     | N/A            | N/A           |
| Residential  | 2%             | 2%            |
| Hotel  | N/A            | N/A           |

<sup>1</sup>Land Use Codes (LUCs) from *Trip Generation Manual*, published by the Institute of Transportation Engineers.

<sup>2</sup>Total estimate for all other land uses at mixed-use development site is not subject to internal trip capture computations in this estimator.

<sup>3</sup>Enter trips assuming no transit or non-motorized trips (as assumed in ITE *Trip Generation Manual*).

<sup>4</sup>Enter vehicle occupancy assumed in Table 1-A vehicle trips. If vehicle occupancy changes for proposed mixed-use project, manual adjustments must be made to Tables 5-A, 9-A (O and D). Enter transit, non-motorized percentages that will result with proposed mixed-use project complete.

<sup>5</sup>Vehicle-trips computed using the mode split and vehicle occupancy values provided in Table 2-A.

<sup>6</sup>Person-Trips

\*Indicates computation that has been rounded to the nearest whole number.

Estimation Tool Developed by the Texas A&M Transportation Institute - Version 2013.1

|                         |                     |
|-------------------------|---------------------|
| <b>Project Name:</b>    | 555-603 March Road  |
| <b>Analysis Period:</b> | AM Street Peak Hour |

| Land Use             | Table 7-A (D): Entering Trips |               | Table 7-A (O): Exiting Trips |               |
|----------------------|-------------------------------|---------------|------------------------------|---------------|
|                      | Vehicle-Trips                 | Person-Trips* | Vehicle-Trips                | Person-Trips* |
| Office               | 197                           | 274           | 27                           | 37            |
| Retail               | 30                            | 47            | 20                           | 31            |
| Restaurant           | 0                             | 0             | 0                            | 0             |
| Cinema/Entertainment | 0                             | 0             | 0                            | 0             |
| Residential          | 123                           | 261           | 273                          | 582           |
| Hotel                | 0                             | 0             | 0                            | 0             |

| Origin (From)        | Destination (To) |        |            |                      |             |       |
|----------------------|------------------|--------|------------|----------------------|-------------|-------|
|                      | Office           | Retail | Restaurant | Cinema/Entertainment | Residential | Hotel |
| Office               |                  | 10     | 23         | 0                    | 0           | 0     |
| Retail               | 9                |        | 4          | 0                    | 4           | 0     |
| Restaurant           | 0                | 0      |            | 0                    | 0           | 0     |
| Cinema/Entertainment | 0                | 0      | 0          |                      | 0           | 0     |
| Residential          | 12               | 6      | 116        | 0                    |             | 0     |
| Hotel                | 0                | 0      | 0          | 0                    | 0           |       |

| Origin (From)        | Destination (To) |        |            |                      |             |       |
|----------------------|------------------|--------|------------|----------------------|-------------|-------|
|                      | Office           | Retail | Restaurant | Cinema/Entertainment | Residential | Hotel |
| Office               |                  | 15     | 0          | 0                    | 0           | 0     |
| Retail               | 11               |        | 0          | 0                    | 5           | 0     |
| Restaurant           | 38               | 4      |            | 0                    | 13          | 0     |
| Cinema/Entertainment | 0                | 0      | 0          |                      | 0           | 0     |
| Residential          | 8                | 8      | 0          | 0                    |             | 0     |
| Hotel                | 8                | 2      | 0          | 0                    | 0           |       |

| Destination Land Use             | Person-Trip Estimates |          |       | External Trips by Mode* |                      |                            |
|----------------------------------|-----------------------|----------|-------|-------------------------|----------------------|----------------------------|
|                                  | Internal              | External | Total | Vehicles <sup>1</sup>   | Transit <sup>2</sup> | Non-Motorized <sup>2</sup> |
| Office                           | 17                    | 257      | 274   | 184                     | 51                   | 10                         |
| Retail                           | 16                    | 31       | 47    | 16                      | 3                    | 1                          |
| Restaurant                       | 0                     | 0        | 0     | 0                       | 0                    | 0                          |
| Cinema/Entertainment             | 0                     | 0        | 0     | 0                       | 0                    | 0                          |
| Residential                      | 4                     | 257      | 261   | 120                     | 70                   | 12                         |
| Hotel                            | 0                     | 0        | 0     | 0                       | 0                    | 0                          |
| All Other Land Uses <sup>3</sup> | 0                     | 0        | 0     | 0                       | 0                    | 0                          |

| Origin Land Use                  | Person-Trip Estimates |          |       | External Trips by Mode* |                      |                            |
|----------------------------------|-----------------------|----------|-------|-------------------------|----------------------|----------------------------|
|                                  | Internal              | External | Total | Vehicles <sup>1</sup>   | Transit <sup>2</sup> | Non-Motorized <sup>2</sup> |
| Office                           | 10                    | 27       | 37    | 19                      | 5                    | 1                          |
| Retail                           | 13                    | 18       | 31    | 9                       | 2                    | 1                          |
| Restaurant                       | 0                     | 0        | 0     | 0                       | 0                    | 0                          |
| Cinema/Entertainment             | 0                     | 0        | 0     | 0                       | 0                    | 0                          |
| Residential                      | 14                    | 568      | 582   | 263                     | 156                  | 26                         |
| Hotel                            | 0                     | 0        | 0     | 0                       | 0                    | 0                          |
| All Other Land Uses <sup>3</sup> | 0                     | 0        | 0     | 0                       | 0                    | 0                          |

<sup>1</sup>Vehicle-trips computed using the mode split and vehicle occupancy values provided in Table 2-A  
<sup>2</sup>Person-Trips  
<sup>3</sup>Total estimate for all other land uses at mixed-use development site is not subject to internal trip capture computations in this estimator  
\*Indicates computation that has been rounded to the nearest whole number.

| NCHRP 684 Internal Trip Capture Estimation Tool |                       |               |            |
|---|-----------------------|---------------|------------|
| Project Name:                                   | 555-603 March Road    | Organization: | Novatech   |
| Project Location:                               | Ottawa, ON            | Performed By: | Josh Audia |
| Scenario Description:                           | Full Site Development | Date:         | 10/28/2022 |
| Analysis Year:                                  |                       | Checked By:   |            |
| Analysis Period:                                | PM Street Peak Hour   | Date:         |            |

| Table 1-P: Base Vehicle-Trip Generation Estimates (Single-Use Site Estimate) |   |          |       |                                      |          |         |
|--|---|----------|-------|--------------------------------------|----------|---------|
| Land Use   | Development Data (For Information Only) |          |       | Estimated Vehicle-Trips <sup>3</sup> |          |         |
|  | ITE LUCs <sup>1</sup>                   | Quantity | Units | Total                                | Entering | Exiting |
| Office   |   |          |       | 219                                  | 37       | 182     |
| Retail   |   |          |       | 144                                  | 72       | 72      |
| Restaurant   |   |          |       | 0                                    |          |         |
| Cinema/Entertainment   |   |          |       | 0                                    |          |         |
| Residential  |   |          |       | 407                                  | 236      | 171     |
| Hotel  |   |          |       | 0                                    |          |         |
| All Other Land Uses <sup>2</sup>   |   |          |       | 0                                    |          |         |
|  |   |          |       | 770                                  | 345      | 425     |

| Table 2-P: Mode Split and Vehicle Occupancy Estimates |                        |           |                 |                        |           |                 |
|---|------------------------|-----------|-----------------|------------------------|-----------|-----------------|
| Land Use  | Entering Trips         |           |                 | Exiting Trips          |           |                 |
|   | Veh. Occ. <sup>4</sup> | % Transit | % Non-Motorized | Veh. Occ. <sup>4</sup> | % Transit | % Non-Motorized |
| Office  |                        | 20%       | 4%              |                        | 20%       | 4%              |
| Retail  |                        | 10%       | 4%              |                        | 10%       | 4%              |
| Restaurant  |                        |           |                 |                        |           |                 |
| Cinema/Entertainment                                  |                        |           |                 |                        |           |                 |
| Residential   |                        | 26%       | 5%              |                        | 26%       | 5%              |
| Hotel   |                        |           |                 |                        |           |                 |
| All Other Land Uses <sup>2</sup>                      |                        |           |                 |                        |           |                 |

| Table 3-P: Average Land Use Interchange Distances (Feet Walking Distance) |                  |        |            |                      |             |       |
|---|------------------|--------|------------|----------------------|-------------|-------|
| Origin (From)   | Destination (To) |        |            |                      |             |       |
|   | Office           | Retail | Restaurant | Cinema/Entertainment | Residential | Hotel |
| Office  |                  | 328    |            |                      | 328         |       |
| Retail  |                  |        |            |                      | 328         |       |
| Restaurant  |                  |        |            |                      |             |       |
| Cinema/Entertainment  |                  |        |            |                      |             |       |
| Residential   |                  | 328    |            |                      |             |       |
| Hotel   |                  |        |            |                      |             |       |

| Table 4-P: Internal Person-Trip Origin-Destination Matrix* |                  |        |            |                      |             |       |
|--|------------------|--------|------------|----------------------|-------------|-------|
| Origin (From)  | Destination (To) |        |            |                      |             |       |
|  | Office           | Retail | Restaurant | Cinema/Entertainment | Residential | Hotel |
| Office   |                  | 9      | 0          | 0                    | 5           | 0     |
| Retail   | 2                |        | 0          | 0                    | 29          | 0     |
| Restaurant   | 0                | 0      |            | 0                    | 0           | 0     |
| Cinema/Entertainment                                       | 0                | 0      | 0          |                      | 0           | 0     |
| Residential  | 14               | 11     | 0          | 0                    |             | 0     |
| Hotel  | 0                | 0      | 0          | 0                    | 0           |       |

| Table 5-P: Computations Summary           |       |          |         |
|---|-------|----------|---------|
|   | Total | Entering | Exiting |
| All Person-Trips                          | 1,382 | 659      | 723     |
| Internal Capture Percentage               | 10%   | 11%      | 10%     |
| External Vehicle-Trips <sup>5</sup>       | 662   | 292      | 370     |
| External Transit-Trips <sup>6</sup>       | 279   | 136      | 143     |
| External Non-Motorized Trips <sup>6</sup> | 55    | 26       | 29      |

| Table 6-P: Internal Trip Capture Percentages by Land Use |                |               |
|--|----------------|---------------|
| Land Use   | Entering Trips | Exiting Trips |
| Office   | 31%            | 6%            |
| Retail   | 18%            | 28%           |
| Restaurant   | N/A            | N/A           |
| Cinema/Entertainment                                     | N/A            | N/A           |
| Residential  | 7%             | 7%            |
| Hotel  | N/A            | N/A           |

<sup>1</sup>Land Use Codes (LUCs) from *Trip Generation Manual*, published by the Institute of Transportation Engineers.

<sup>2</sup>Total estimate for all other land uses at mixed-use development site is not subject to internal trip capture computations in this estimator.

<sup>3</sup>Enter trips assuming no transit or non-motorized trips (as assumed in *ITE Trip Generation Manual*).

<sup>4</sup>Enter vehicle occupancy assumed in Table 1-P vehicle trips. If vehicle occupancy changes for proposed mixed-use project, manual

<sup>5</sup>Vehicle-trips computed using the mode split and vehicle occupancy values provided in Table 2-P.

<sup>6</sup>Person-Trips

\*Indicates computation that has been rounded to the nearest whole number.

Estimation Tool Developed by the Texas A&M Transportation Institute - Version 2013.1

|                         |                     |
|-------------------------|---------------------|
| <b>Project Name:</b>    | 555-603 March Road  |
| <b>Analysis Period:</b> | PM Street Peak Hour |

| Land Use             | Table 7-P (D): Entering Trips |               | Table 7-P (O): Exiting Trips |               |
|----------------------|-------------------------------|---------------|------------------------------|---------------|
|                      | Vehicle-Trips                 | Person-Trips* | Vehicle-Trips                | Person-Trips* |
| Office               | 37                            | 52            | 182                          | 253           |
| Retail               | 72                            | 113           | 72                           | 112           |
| Restaurant           | 0                             | 0             | 0                            | 0             |
| Cinema/Entertainment | 0                             | 0             | 0                            | 0             |
| Residential          | 236                           | 494           | 171                          | 358           |
| Hotel                | 0                             | 0             | 0                            | 0             |

| Origin (From)        | Destination (To) |        |            |                      |             |       |
|----------------------|------------------|--------|------------|----------------------|-------------|-------|
|                      | Office           | Retail | Restaurant | Cinema/Entertainment | Residential | Hotel |
| Office               |                  | 49     | 10         | 0                    | 5           | 0     |
| Retail               | 2                |        | 32         | 4                    | 29          | 6     |
| Restaurant           | 0                | 0      |            | 0                    | 0           | 0     |
| Cinema/Entertainment | 0                | 0      | 0          |                      | 0           | 0     |
| Residential          | 14               | 145    | 75         | 0                    |             | 11    |
| Hotel                | 0                | 0      | 0          | 0                    | 0           |       |

| Origin (From)        | Destination (To) |        |            |                      |             |       |
|----------------------|------------------|--------|------------|----------------------|-------------|-------|
|                      | Office           | Retail | Restaurant | Cinema/Entertainment | Residential | Hotel |
| Office               |                  | 9      | 0          | 0                    | 20          | 0     |
| Retail               | 16               |        | 0          | 0                    | 227         | 0     |
| Restaurant           | 16               | 57     |            | 0                    | 79          | 0     |
| Cinema/Entertainment | 3                | 5      | 0          |                      | 20          | 0     |
| Residential          | 30               | 11     | 0          | 0                    |             | 0     |
| Hotel                | 0                | 2      | 0          | 0                    | 0           |       |

| Destination Land Use             | Person-Trip Estimates |          |       | External Trips by Mode* |                      |                            |
|----------------------------------|-----------------------|----------|-------|-------------------------|----------------------|----------------------------|
|                                  | Internal              | External | Total | Vehicles <sup>1</sup>   | Transit <sup>2</sup> | Non-Motorized <sup>2</sup> |
| Office                           | 16                    | 36       | 52    | 25                      | 7                    | 1                          |
| Retail                           | 20                    | 93       | 113   | 55                      | 9                    | 4                          |
| Restaurant                       | 0                     | 0        | 0     | 0                       | 0                    | 0                          |
| Cinema/Entertainment             | 0                     | 0        | 0     | 0                       | 0                    | 0                          |
| Residential                      | 34                    | 460      | 494   | 212                     | 120                  | 21                         |
| Hotel                            | 0                     | 0        | 0     | 0                       | 0                    | 0                          |
| All Other Land Uses <sup>3</sup> | 0                     | 0        | 0     | 0                       | 0                    | 0                          |

| Origin Land Use                  | Person-Trip Estimates |          |       | External Trips by Mode* |                      |                            |
|----------------------------------|-----------------------|----------|-------|-------------------------|----------------------|----------------------------|
|                                  | Internal              | External | Total | Vehicles <sup>1</sup>   | Transit <sup>2</sup> | Non-Motorized <sup>2</sup> |
| Office                           | 14                    | 239      | 253   | 171                     | 48                   | 10                         |
| Retail                           | 31                    | 81       | 112   | 45                      | 8                    | 3                          |
| Restaurant                       | 0                     | 0        | 0     | 0                       | 0                    | 0                          |
| Cinema/Entertainment             | 0                     | 0        | 0     | 0                       | 0                    | 0                          |
| Residential                      | 25                    | 333      | 358   | 154                     | 87                   | 16                         |
| Hotel                            | 0                     | 0        | 0     | 0                       | 0                    | 0                          |
| All Other Land Uses <sup>3</sup> | 0                     | 0        | 0     | 0                       | 0                    | 0                          |

<sup>1</sup>Vehicle-trips computed using the mode split and vehicle occupancy values provided in Table 2-P  
<sup>2</sup>Person-Trips  
<sup>3</sup>Total estimate for all other land uses at mixed-use development site is not subject to internal trip capture computations in this estimator  
\*Indicates computation that has been rounded to the nearest whole number.

## **APPENDIX G**

---

Other Area Developments

## 1.0 SCREENING

### 1.1 Introduction

This Transportation Impact Assessment (TIA) has been prepared for a proposed development at 359 Terry Fox Drive and 525 Legget Drive on behalf of Wesley Clover International (Brookstreet Hotel), in support of Zoning By-Law Amendment and Site Plan Control applications. The Subject Site is a redevelopment of portions of 359 Terry Fox Drive and 525 Legget Drive (Brookstreet Hotel). A new parcel will be created through a severance process that will consist of the existing easterly access to 359 Terry Fox Drive and a portion of the area of 525 Legget Drive between an existing parking garage and the stormwater pond to the east.

The existing uses at 359 Terry Fox Drive include light industrial and office uses, and the existing uses at 525 Legget Drive include the Brookstreet Hotel, and accessory small commercial and office uses. Based on the location of the existing driveways, the subject site could be accessed via a driveway to 525 Legget Drive, two driveways to 555 Legget Drive, and two driveways to 359 Terry Fox Drive. The easterly access to 359 Terry Fox Drive, which will become part of the proposed parcel, is proposed to be the primary access to the development.

The subject site is surrounded by the following:

- Office uses, followed by Terry Fox Drive to the north,
- The Marshes Golf Club, followed by office uses and Solandt Road to the south,
- The Marshes Golf Club, followed by office uses and Terry Fox Drive to the east, and
- Legget Drive, followed by office uses and March Road to the west.

An aerial of the vicinity around the subject site is provided in **Figure 1**. A copy of the site plan is included in **Appendix A**.

### 1.2 Proposed Development

The subject site is designated as 'Urban Employment Area' on Schedule B of the City of Ottawa's Official Plan. The implemented zoning for the property is 'Business Park Industrial Zone (Kanata North Business Park)' (IP6). The subject site is not within any Community Design Plan or Secondary Plan areas. A Zoning By-Law Amendment is required to permit the proposed use. The draft City of Ottawa Official Plan includes proposed policies that will permit a higher density of development and greater degree of mixed uses, including residential within new 'activity centres' that are generally located within 600 metres of planned transit stations. The goal of the activity centres is to create a place to live, work, learn and play and provide access daily needs without a car. The City of Ottawa Official Plan includes a transit station at the intersection of March Road and Terry Fox as part of the future Bus Rapid Transit.

The proposed development consists of a single 30-storey high-rise residential building with 253 rental dwellings and approximately 3,877 ft<sup>2</sup> gross floor area (GFA) of rooftop restaurant space. The proposed development will provide a unique residential rental accommodation within the Kanata North Economic District, a technology park which employs over 20,000 people. The rental units will offer apartments within short walking or cycling distance of major employers, and will act as the catalyst for one of the City's proposed activity centres within the district. The residential tower will also be directly connected to the Brookstreet Hotel and will provide a unique experience for residents, as tenants will have access to amenities such as restaurants, fitness facilities, a spa, and recreational facilities.

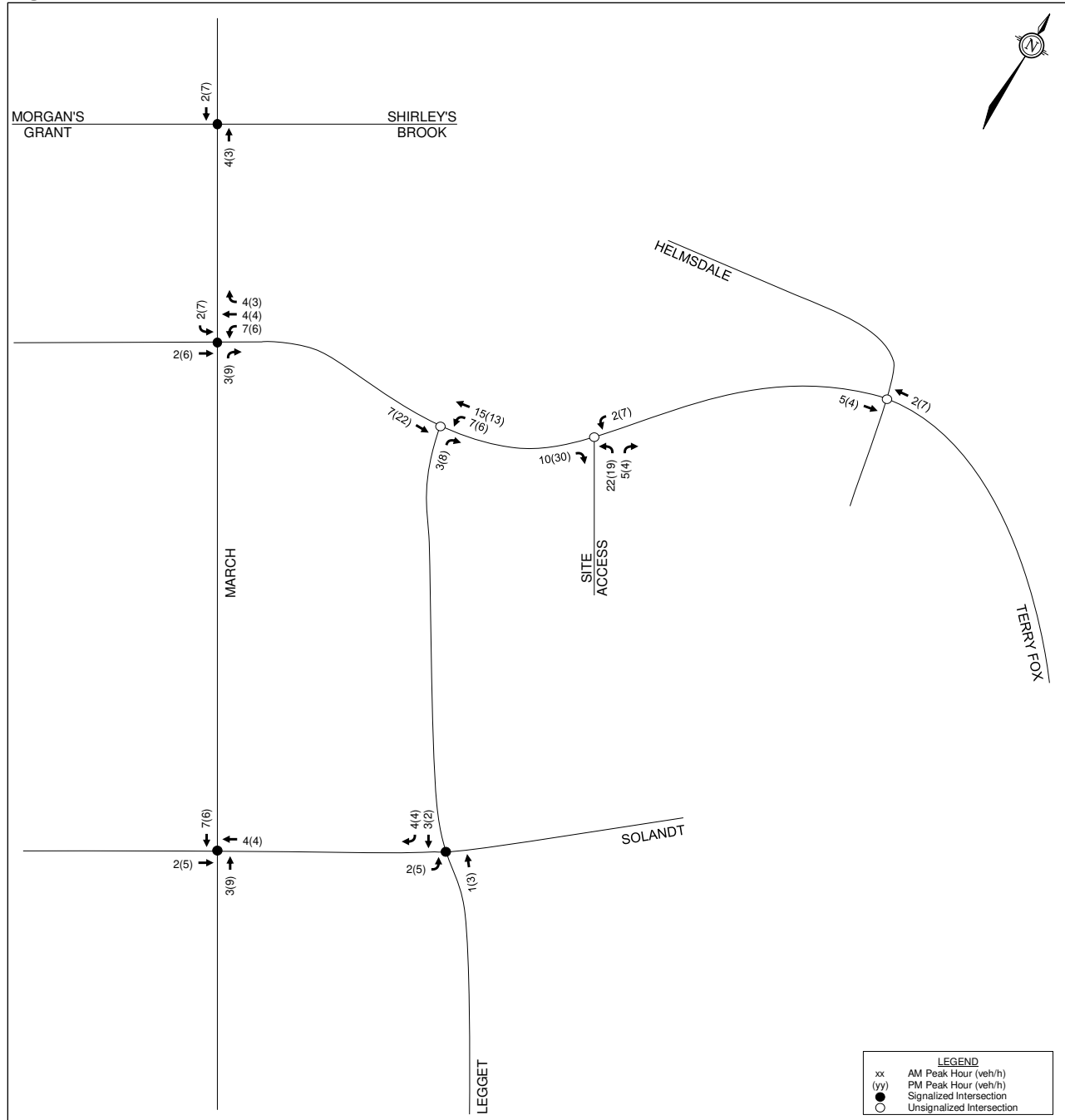

Figure 1: View of the Subject Site



- Other area development-generated traffic volumes in 2029 are shown in **Figure 12**;
- Background traffic volumes in 2024 are shown in **Figure 13**;
- Background traffic volumes in 2029 are shown in **Figure 14**;
- Total traffic volumes in 2024 are shown in **Figure 15**;
- Total traffic volumes in 2029 are shown in **Figure 16**.

**Figure 8: Proposed Site-Generated Volumes**



## 1.0 SCREENING

### 1.1 SUMMARY OF DEVELOPMENT

| Municipal Address                       | 600 March Road  |
|---|---|
| <b>Description of Location</b>          | Southeast quadrant of the March Road at Terry Fox Drive intersection  |
| <b>Land Use Classification</b>          | Mixed-Use Development (Residential High-Rise, Retail, Office)   |
| <b>Development Size (units)</b>         | Residential units = 1,900   |
| <b>Development Size (m<sup>2</sup>)</b> | Office/Lab: 46,000 m <sup>2</sup><br>Retail: 11,350 m <sup>2</sup>  |
| <b>Number of Accesses and Locations</b> | Four (4) accesses from March Road,<br>One (1) access from Terry Fox Drive,<br>Three (3) accesses from Legget Drive. |
| <b>Phase of Development</b>             | Nokia Campus: 2026<br>Residential: 1 tower (250 units/year) after 2026  |
| <b>Buildout Year</b>                    | 2032 (10 year build out)  |

If available, please attach a sketch of the development or site plan to this form.

### 1.2 TRIP GENERATION TRIGGER

Considering the Development's Land Use type and Size (as filled out in the previous section), please refer to the Trip Generation Trigger checks below.

| Land Use Type                       | Minimum Development Size | Triggered |
|-------------------------------------|--------------------------|-----------|
| Single-family homes                 | 40 units                 | ✘         |
| Townhomes or apartments             | 90 units                 | ✓         |
| Office                              | 3,500 m <sup>2</sup>     | ✓         |
| Industrial                          | 5,000 m <sup>2</sup>     | ✘         |
| Fast-food restaurant or coffee shop | 100 m <sup>2</sup>       | ✘         |
| Destination retail                  | 1,000 m <sup>2</sup>     | ✓         |
| Gas station or convenience market   | 75 m <sup>2</sup>        | ✘         |

*\* If the development has a land use type other than what is presented in the table above, estimates of person-trip generation may be made based on average trip generation characteristics represented in the current edition of the Institute of Transportation Engineers (ITE) Trip Generation Manual.*

**If the proposed development size is greater than the sizes identified above, the Trip Generation Trigger is satisfied.**



Figure 1 - Site Location

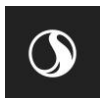

|     |                         |                | In  | Out | Total | In  | Out | Total |     |
|-----|-------------------------|----------------|-----|-----|-------|-----|-----|-------|-----|
| 710 | General Office Building | Auto Driver    | 48% | 694 | 94    | 788 | 107 | 523   | 631 |
|     |                         | Auto Passenger | 23% | 209 | 28    | 238 | 32  | 158   | 190 |
|     |                         | Transit        | 25% | 10  | 1     | 11  | 1   | 7     | 9   |
|     |                         | Cycling        | 0%  | 0   | 0     | 0   | 0   | 0     | 0   |
|     |                         | Walking        | 5%  | 38  | 5     | 43  | 6   | 29    | 35  |

Comparing the vehicle trips associated with the existing Nokia campus, as outlined in **Table 9** above, to the existing traffic volumes along Legget Drive, it is clear that the volumes outlined in **Table 9** are an overestimation of the actual volumes the existing Nokia campus is generating. As the main entrances to the existing Nokia campus are on Legget Drive, the vehicle trips outlined in **Table 9** above are not realistic and thus were decreased to more accurately match the existing volumes along Legget Drive. This reduction was done in conjunction with assessing the existing volumes on Legget Drive along with the surrounding land uses. **Table 10** below outlines the existing Nokia volumes after the reductions were applied, which are more in line with the turning movement counts collected in the area.

**Table 10 – Adjusted Existing Trips**

| LUC | Land Use                | Trip Conversion |     | Weekday AM Peak Hour |     |       | Weekday PM Peak Hour |     |       |
|-----|-------------------------|-----------------|-----|----------------------|-----|-------|----------------------|-----|-------|
|     |                         |                 |     | In                   | Out | Total | In                   | Out | Total |
| 710 | General Office Building | Reduction       | 30% | 486                  | 66  | 552   | 75                   | 366 | 442   |

### 3.1.2 Future Trip Generation and Mode Shares

The *Institute of Transportation (ITE) Trip Generation Manual (11<sup>th</sup> Edition)* was used to forecast the auto trip generation for the retail and office land uses and the *Trans Trip Generation Study* was used to forecast the auto trip generation for the residential land use. Land use codes 222 – Multi-Unit High Rise Building, 821 – Shopping Plaza, and 710 – General Office Building were thought to be the most representative of the proposed land uses.

**Table 11** outlines the assumed land uses and the trip generation rates for each land use.

**Table 11 – Future Land Uses and Trip Generation Rates**

| LUC | Land Use                 | Units/Employees/<br>GFA (1000's SF) | Weekday AM Peak Hour |     |       | Weekday PM Peak Hour |     |       |
|-----|--------------------------|-------------------------------------|----------------------|-----|-------|----------------------|-----|-------|
|     |                          |                                     | In                   | Out | Total | In                   | Out | Total |
| 222 | Multi - Unit (High-Rise) | 1900 Units                          | 31%                  | 69% | 0.80  | 58%                  | 42% | 0.90  |
| 710 | General Office Building  | 2400                                | 88%                  | 12% | 0.42  | 17%                  | 83% | 0.32  |
| 821 | Shopping Plaza           | 122 GFA                             | 62%                  | 38% | 1.73  | 48%                  | 52% | 5.19  |

It is noted that as per direction from Nokia, the office land use is anticipated to generate an additional 25 inbound and 25 outbound delivery trips during each of the AM and PM peak hours. Of the net 25 deliveries, 3 are anticipated to be tractor trailers (entering the site from Legget Drive), and 22 are anticipated to be box trucks / vans (entering the site from March Road). The delivery trips are not included in the trip generation tables and were accounted for as part of the total office land use trips shown in **Figure 12**.

**Table 12** outlines development-generated person trips for each land use.



**Table 12 – Future Person Trips Generated by Land Use**

| LUC                      | Land Use                 | Trip Conversion                                       | Weekday AM Peak Hour |            |             | Weekday PM Peak Hour |             |             |
|--------------------------|--------------------------|---|----------------------|------------|-------------|----------------------|-------------|-------------|
|                          |                          |   | In                   | Out        | Total       | In                   | Out         | Total       |
| 222                      | Multi - Unit (High-Rise) | Person Trips (Peak Period                             | 471                  | 1049       | 1520        | 992                  | 718         | 1710        |
|                          |                          | Person Trips (Peak Hour)<br>0.50 for AM & 0.40 for PM | 236                  | 525        | 761         | 436                  | 316         | 752         |
| 710                      | General Office           | Auto Trips  | 880                  | 120        | 1000        | 131                  | 641         | 772         |
|                          |                          | Person Trip Factor                                    | 1.28                 |            |             |                      |             |             |
|                          |                          | Person Trips  | 1126                 | 154        | 1280        | 168                  | 820         | 988         |
| 821                      | Shopping Plaza           | Auto Trips  | 131                  | 80         | 211         | 304                  | 330         | 634         |
|                          |                          | Person Trip Factor                                    | 1.28                 |            |             |                      |             |             |
|                          |                          | Person Trips  | 168                  | 102        | 270         | 389                  | 422         | 812         |
| <b>Total Development</b> |                          | <b>Total Person Trips</b>                             | <b>1530</b>          | <b>781</b> | <b>2311</b> | <b>993</b>           | <b>1558</b> | <b>2552</b> |

To reflect local travel characteristics, the person trips were assigned to the four primary modal shares (i.e., auto, passenger, transit, and active moves). As per the City of Ottawa’s TMP, the March Road Bus Rapid Transit (BRT) is scheduled to be implemented by 2031, between Solandt Road and Highway 417. The subject development is planned to be built and occupied by 2032. The office portion of the subject development is anticipated to be within 400m of the planned BRT station at Solandt Road. Per direction from the City of Ottawa, the March Road BRT, north of Solandt Road, is scheduled to occur beyond the horizons of this subject study (i.e., post 2037). The residential / retail portion of the subject development (north half) are not anticipated to be within 400m of a rapid transit station during the study horizons. As such, the modal shares for the northern and southern portions of the subject development will differ as a direct result of the implementation plan of the March Road BRT.

**Residential Trips – Mode Shares**

Section 4.2 (Table 8) of the *TRANS Trip Generation Summary Report* was utilized to determine the residential mode share for high rise multi-family housing for the Kanata / Stittsville district. The average mode shares for the district include a 49% auto mode share and a 25% transit mode share. As the existing transit mode share is notably high for the general area, it is not anticipated to see increase as a result of the planned March Road BRT (between Highway 417 and Solandt Road) as the distance between the transit station and the residential component of the proposed development is anticipated to be greater than 400m.

**Office Trips – Mode Shares**

Section 6.2 (Table 12) of the *TRANS Trip Generation Summary Report* was utilized to determine the employment generator mode share by district. The report exclusively cites AM mode shares, however, it is expected that the PM mode shares would be identical as the commute from employment generators during the PM peak hour is very unlikely to differ from the commute to employment generators during the AM peak hour. For the Kanata / Stittsville district, the aforementioned report cites an 8% transit mode share and an 84% auto mode share.

**Commercial Trips – Mode Shares**

Section 6.3 (Table 13) of the *TRANS Trip Generation Summary Report* was utilized to determine the commercial generator mode share for the Kanata / Stittsville district. The report exclusively cites that the sample size for shopping trips during the AM peak tends to be low. As such, more emphasis was placed on the mode shares during the PM peak period to better represent the activity in the district. During the PM peak, the mode shares for the district include a 73%



auto mode share and a 1% transit mode share. To account for the enhanced overall transit service as a result of the planned March Road BRT (between Highway 417 and Solandt Road), the transit mode share for the commercial land use was increased from 1% to 10% (a 9% net increase) while subsequently reducing the 73% auto mode share by 9% for a total of 64%.

Table 13 outlines the modal shares that were used for the proposed development.

**Table 13 – Future Trip Generation by Travel Mode**

| LUC               | Land Use                 | Trip Conversion       | Weekday AM Peak Hour |             |            | Weekday PM Peak Hour |            |             |             |
|-------------------|--------------------------|-----------------------|----------------------|-------------|------------|----------------------|------------|-------------|-------------|
|                   |                          |                       | In                   | Out         | Total      | In                   | Out        | Total       |             |
| 222               | Multi - Unit (High-Rise) | Auto Driver           | 49%                  | 116         | 257        | 373                  | 214        | 155         | 369         |
|                   |                          | Auto Passenger        | 22%                  | 52          | 116        | 168                  | 96         | 70          | 166         |
|                   |                          | Transit               | 25%                  | 58          | 129        | 187                  | 107        | 77          | 184         |
|                   |                          | Cycling               | 0%                   | 0           | 0          | 0                    | 0          | 0           | 0           |
|                   |                          | Walking               | 4%                   | 9           | 21         | 30                   | 17         | 13          | 30          |
| 710               | General Office Building  | Auto Driver           | 84%                  | 946         | 129        | 1075                 | 141        | 689         | 832         |
|                   |                          | Auto Passenger        | 4%                   | 45          | 6          | 51                   | 7          | 33          | 39          |
|                   |                          | Transit               | 8%                   | 90          | 12         | 102                  | 13         | 66          | 79          |
|                   |                          | Cycling               | 1%                   | 11          | 2          | 12                   | 2          | 8           | 11          |
|                   |                          | Walking               | 3%                   | 34          | 5          | 37                   | 5          | 25          | 31          |
| 821               | Shopping Plaza           | Auto Driver           | 64%                  | 108         | 65         | 173                  | 249        | 270         | 51          |
|                   |                          | Auto Passenger        | 22%                  | 37          | 22         | 59                   | 86         | 93          | 179         |
|                   |                          | Transit               | 10%                  | 17          | 10         | 27                   | 39         | 42          | 81          |
|                   |                          | Cycling               | 0%                   | 0           | 0          | 0                    | 0          | 0           | 0           |
|                   |                          | Walking               | 4%                   | 7           | 4          | 11                   | 16         | 17          | 33          |
| Total Development |                          | <b>Auto Driver</b>    |                      | <b>1170</b> | <b>451</b> | <b>1621</b>          | <b>604</b> | <b>1114</b> | <b>1719</b> |
|                   |                          | <b>Auto Passenger</b> |                      | <b>139</b>  | <b>144</b> | <b>278</b>           | <b>189</b> | <b>196</b>  | <b>384</b>  |
|                   |                          | <b>Transit</b>        |                      | <b>165</b>  | <b>151</b> | <b>316</b>           | <b>159</b> | <b>185</b>  | <b>344</b>  |
|                   |                          | <b>Cycling</b>        |                      | <b>11</b>   | <b>2</b>   | <b>12</b>            | <b>2</b>   | <b>8</b>    | <b>11</b>   |
|                   |                          | <b>Walking</b>        |                      | <b>50</b>   | <b>30</b>  | <b>78</b>            | <b>38</b>  | <b>55</b>   | <b>94</b>   |

### 3.1.3 Internal Capture and Pass-By

When predicting trips that are associated with different land use types the interaction between those land use types must be accounted for by applying the principals of internal capture adjustments. Internal capture trips are trips which are shared between two or more uses on the same site. A portion of the generated trips for each individual land use is therefore drawn from the adjacent land uses. Internal capture adjustments were made to account for vehicles that visit more than one land use within the subject development. Since these trips are contained within the subject site, accounting for each trip separately on the roadway network would result in “double-counting”. For this reason, land uses that may have associated internal capture trips between one another ultimately had their net new trips adjusted consistent with typical industry standards. In the subject development, the land uses that are subject to internal capture reductions are the retail and office land uses.

In addition, a portion of the auto trips generated by the proposed retail land uses will be ‘pass-by’ in nature. Pass-by trips are considered intermediate stops between an origin and a destination. They are site trips that are drawn from existing traffic volumes on the road network that are “passing-by” the site. While the total number of trips generated by a given development remains the same, the turning movements at study area intersections and site accesses require



adjustments to reflect pass-by traffic. The rate of pass-by traffic is based on the specific land use which was obtained from the *ITE Trip Generation Manual*. A pass-by rate of 34% was used for the retail land use.

**Table 14** outlines the pass-by, internal capture, and net new trips anticipated for the proposed development.

**Table 14 – Future Pass-By and Internal Capture Trips**

| LUC                          | Land Use                | Trip Conversion    |     |      | Weekday AM Peak Hour |      |       | Weekday PM Peak Hour |      |       |
|------------------------------|-------------------------|--------------------|-----|------|----------------------|------|-------|----------------------|------|-------|
|                              |                         |                    |     |      | In                   | Out  | Total | In                   | Out  | Total |
| 710                          | General Office Building | Auto Trips         |     |      | 946                  | 129  | 1075  | 141                  | 690  | 831   |
|                              |                         | Internal Capture   | AM  | PM   |                      |      |       |                      |      |       |
|                              |                         | Inbound            | 4%  | 10%  | -38                  | -36  | -74   | -14                  | -34  | -48   |
|                              |                         | Outbound           | 28% | 5%   |                      |      |       |                      |      |       |
|                              |                         | Net New Auto Trips |     |      | 908                  | 93   | 1001  | 127                  | 655  | 783   |
| 821                          | Shopping Plaza          | Auto Trips         |     |      | 108                  | 65   | 173   | 249                  | 270  | 519   |
|                              |                         | Internal Capture   | AM  | PM   |                      |      |       |                      |      |       |
|                              |                         | Inbound            | 24% | 16%  | -26                  | -21  | -47   | -40                  | -76  | -116  |
|                              |                         | Outbound           | 33% | 28%  |                      |      |       |                      |      |       |
|                              |                         | Net New Auto Trips |     |      | 82                   | 44   | 126   | 209                  | 194  | 403   |
| 821 – Shopping Plaza         | Auto Trips              |                    |     | 82   | 44                   | 126  | 209   | 194                  | 403  |       |
|                              | Pass-By                 |                    |     |      |                      |      | 71    | 66                   | 137  |       |
|                              | Net Auto Trips          |                    |     | 82   | 44                   | 126  | 138   | 128                  | 266  |       |
| <b>Net New Auto Trips</b>    |                         |                    |     |      |                      |      |       |                      |      |       |
| 222 – Multi Unit (High Rise) |                         |                    |     | 116  | 257                  | 373  | 214   | 155                  | 369  |       |
| 710 – Office Building/ Lab   |                         |                    |     | 908  | 93                   | 1001 | 127   | 655                  | 783  |       |
| 821 – Shopping Plaza         |                         |                    |     | 82   | 44                   | 126  | 138   | 128                  | 266  |       |
| <b>Total Development</b>     |                         |                    |     |      |                      |      |       |                      |      |       |
| Net New Auto Trips           |                         |                    |     | 1106 | 394                  | 1500 | 479   | 938                  | 1418 |       |

### 3.1.4 Trip Distribution

The distribution of traffic to / from the proposed development was developed using the relative traffic flows and volumes at the study area inlets / outlets. To account for the significant Kanata North Urban Expansion Area (KNU EA) development north of the study area (anticipated to be fully built by the 2032 horizon year and is projected to add 800 vehicles to / from the north during the peak hours), the 2032 future background horizon volumes were utilized for this exercise.

Overall, for the office land use, the following trip distribution is anticipated:

- 35% to / from the North (via March Road)
- 50% to / from the South (via March Road)
- 15% to / from the West (via Terry Fox Drive)
- Note: Terry Fox Road (E) and Legget Drive (S) are anticipated to carry negligible development traffic due to the limited connectivity to the adjacent transportation network. Traffic to / from the south of the proposed development is projected to be predominantly on March Road due to the higher speeds and superior connectivity to Highway 417 and the district to the south.





Figure 15 - Site Generated Traffic Volumes - All Land Uses & Pass-by Trips

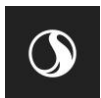
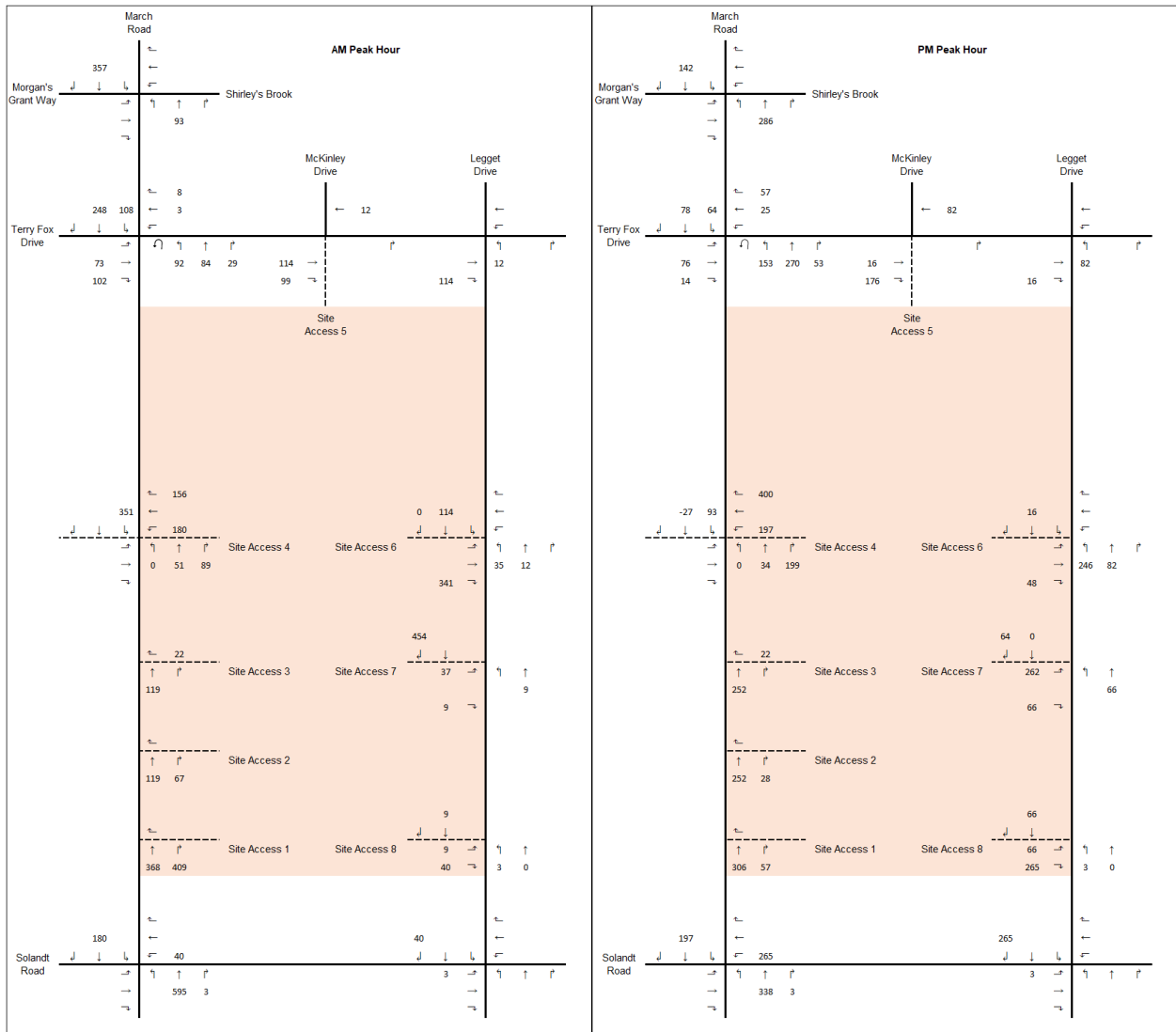

## 1 Screening

This study has been prepared according to the City of Ottawa's 2017 Transportation Impact Assessment (TIA) Guidelines. Accordingly, a Step 1 Screening Form has been prepared and is included as Appendix A, along with the Certification Form for TIA Study PM. As shown in the Screening Form, a TIA is required including the Design Review Component and the Network Impact Component.

## 2 Existing and Planned Conditions

### 2.1 Proposed Development

The subject property, located at 706, 710, and 714 March Road, is currently zoned as General Mixed Use [GM] and Local Commercial [LC] and is currently undeveloped.

The proposed development consists of a 4,165 square metre supermarket, a 350 square-metre fast-food restaurant with a drive-through, and a large multi-unit commercial space that is 1,500 square metres. A total of 225 parking stalls are shown on the site plan.

Access to the site will be accommodated via March Road (190 metres north of Terry Fox Drive), McKinley Drive (235 and 210 metres north of Terry Fox Drive), and Shirley's Brook Drive (100 metres east of March Road). As March road is divided by a median, this access would be restricted to a right in / right out only. The McKinley Drive access 235 metres north of Terry Fox Drive is anticipated to be a full movement access and will serve customers as well as small and medium trucks. Large heavy vehicles serving the supermarket loading docks will also exist the site via this access. The McKinley Drive Access 210 metres north of Terry Fox Drive will be a left-in only access and allow large trucks serving the supermarket to enter the site. The Shirley's Brook Drive access will be east of the end of the left turn lane that is provided for the intersection with March Road, therefore, a full movement access can be considered at this access. For the purposes of this TIA the projected full build-out and occupancy horizon is 2023, and the plus five-year horizon is 2028. Figure 1 illustrates the Study Area Context. Figure 2 illustrates the proposed concept plan.

Figure 1: Area Context Plan

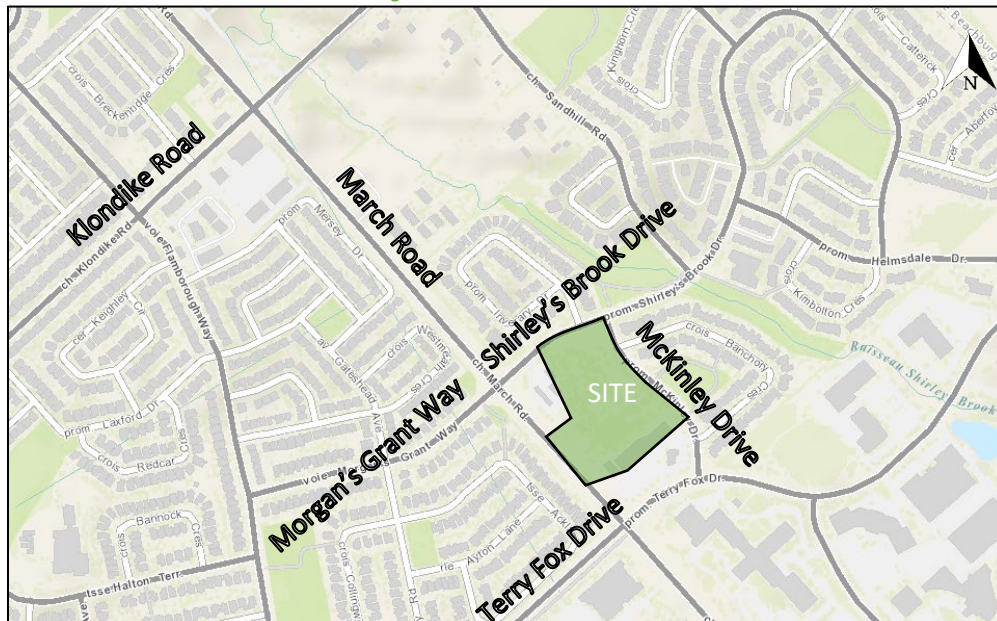

Source: <http://maps.ottawa.ca/geoOttawa/> Accessed: August 20, 2020

To assign the pass-by trips to the accesses, a ratio of southbound trips as a portion of all traffic on March Road, and northbound trips as a portion of all traffic on March Road was developed. It was determined that 75% of the total traffic is southbound and 25% is northbound in the 2023 AM peak period and 30% of the total traffic is southbound and 70% is northbound in both the 2023 PM and 2023 Saturday peak periods. It was also determined that 75% of the total traffic is southbound and 25% is northbound in the 2028 AM peak period and 30% of the total traffic is southbound and 70% is northbound in both the 2028 PM and 2028 Saturday peak periods. Using these percentages, the traffic volumes have been logically distributed to the access points. Figure 21 illustrates the site pass-by trip volumes.

Figure 22 illustrates the combined impact of the net new site trip generation and pass-by trips.

Figure 20: New Site Generation Auto Volumes

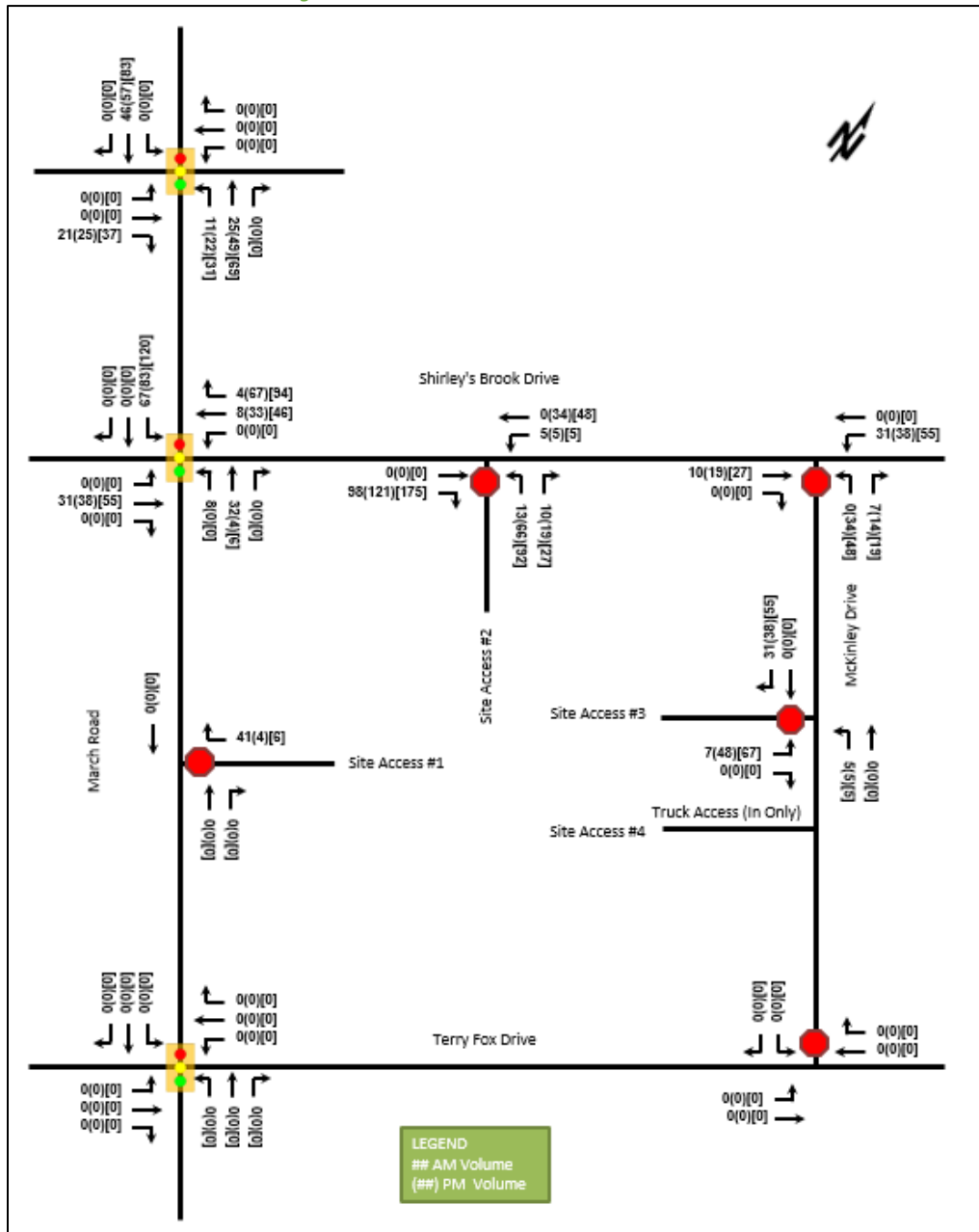

Figure 21: Forecasted Site Pass-by Trip Volumes

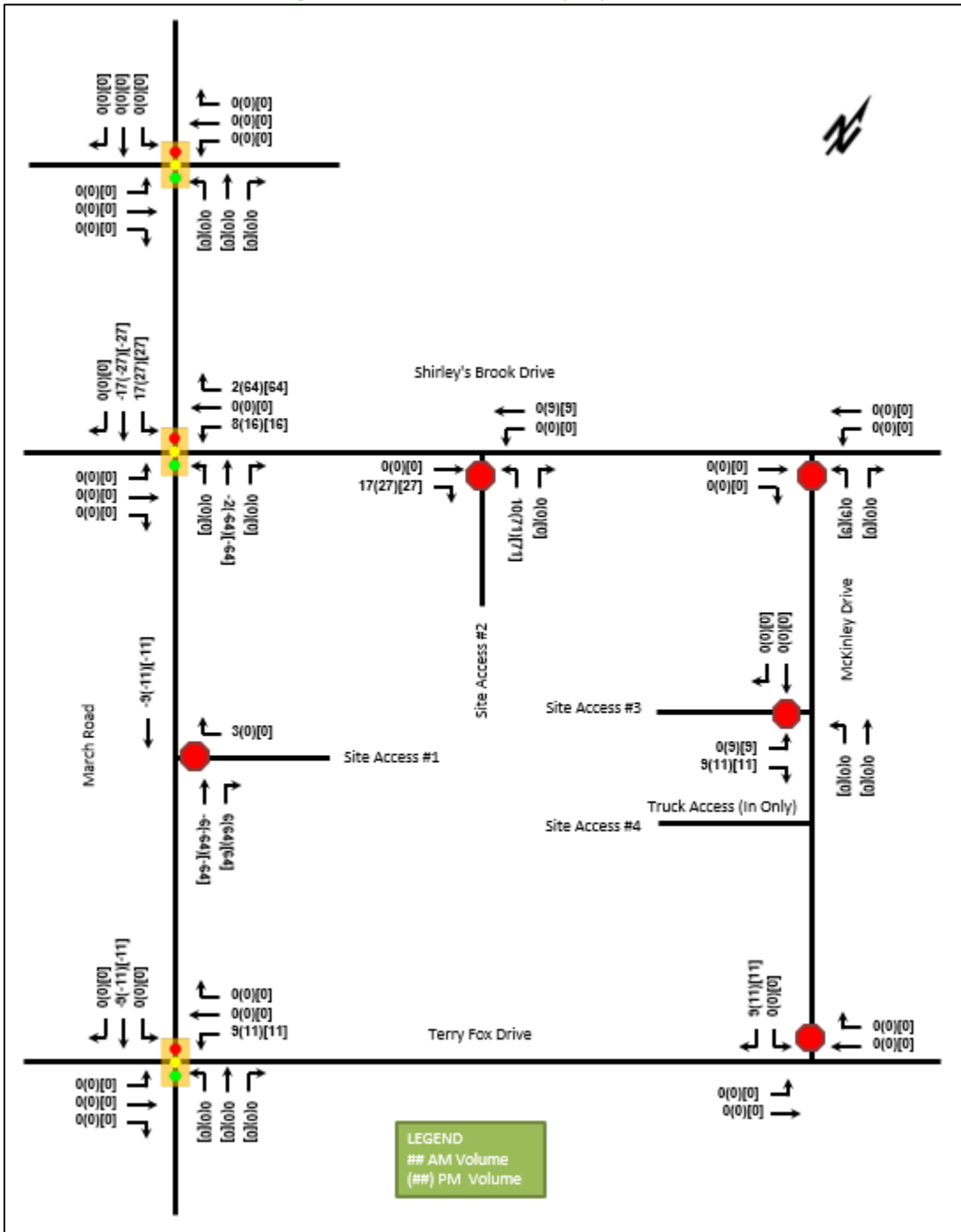
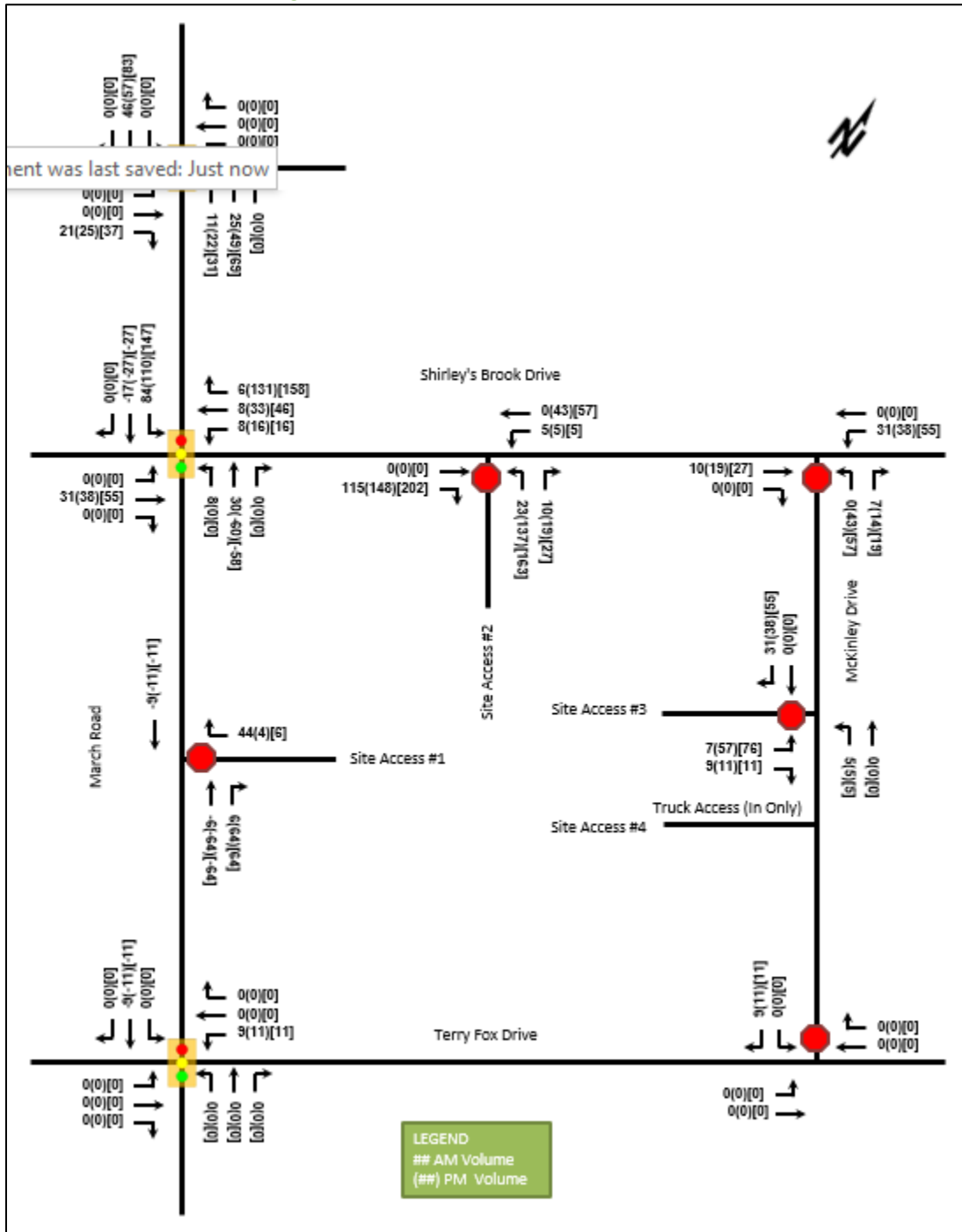

Figure 22: Net New Site Generation Auto Volumes



**March 19, 2020**

Ralph Esposito Jr.  
10731854 Canada Inc.  
555 Legget Drive, Suite 304, Tower A, Kanata, ON, K2K 2X3

**Subject: 788 March Road**

**Transportation Impact Assessment Study (October 2018) - Addendum 3**

## 1. Introduction

### 1.1. Context

Recent changes have been made to the original Site Plan (dated July 07, 2018) for this residential project that impact the proposed development’s peak hour traffic generation, and result in a different site configuration with respect to access location. This Addendum 3 represents an update to the original TIA and subsequent Addendum 1 to 2 with regard to these two items. The site is now anticipated to be developed in a single phase, and the updated Site Plan can be found in Appendix A.

## 2. Changes to Trip Generation

Site generated traffic is directly related to the number of proposed residential units. There is a proposed decrease in the number of units relative to the original study, and therefore the anticipated trips generated by the site is also expected to decrease. The following sections summarize the expected changes to the trip generation.

### 2.1. Trip Generation – Previous Study (2018)

The values shown in Table 1 below, were taken from the previous Site Plan for the Phase 2 (2023) horizon full buildout horizon where 196 residential units were proposed.

Table 1: Site Person Trip Generation Using OD-Survey Mode Share – Previous Study

| Travel Mode   | AM Mode Share | AM Peak (persons/h) |            |            | PM Peak (persons/h) |           |            |
|---|---------------|---------------------|------------|------------|---------------------|-----------|------------|
|   |               | In                  | Out        | Total      | In                  | Out       | Total      |
| Auto Driver   | 50%           | 20                  | 49         | 69         | 41                  | 28        | 69         |
| Auto Passenger                                      | 10%           | 3                   | 11         | 14         | 8                   | 6         | 14         |
| Transit   | 25%           | 7                   | 20         | 27         | 16                  | 12        | 28         |
| Non-motorized                                       | 15%           | 8                   | 20         | 28         | 15                  | 12        | 27         |
| <b>Total People Trips</b>                           | <b>100%</b>   | <b>38</b>           | <b>100</b> | <b>138</b> | <b>80</b>           | <b>58</b> | <b>138</b> |
| Total 'New' High-Rise Condominium (2023) Auto Trips |               | 20                  | 49         | 69         | 41                  | 28        | 69         |

The total two-way anticipated site generated person trips are 138 for the AM and PM peak hours, and the total two-way vehicle generated trips are 69 trips for the AM and PM peak hours.

### 2.2. Trip Generation – 2020 Updated Site Plan

Using the updated Site Plan with the total of 92 proposed residential units and applying the same modal shares and directional splits, the new anticipated person trips are shown in Table 2 below.

Table 2: Site Person Trip Generation Using OD-Survey Mode Share – Updated

| Travel Mode   | AM Mode Share | AM Peak (persons/h) |     |       | PM Peak (persons/h) |     |       |
|---|---------------|---------------------|-----|-------|---------------------|-----|-------|
|   |               | In                  | Out | Total | In                  | Out | Total |
| Auto Driver   | 50%           | 9                   | 23  | 32    | 19                  | 13  | 32    |
| Auto Passenger                                      | 10%           | 1                   | 5   | 6     | 4                   | 3   | 7     |
| Transit   | 25%           | 4                   | 13  | 17    | 9                   | 7   | 16    |
| Non-motorized                                       | 15%           | 3                   | 7   | 10    | 5                   | 5   | 10    |
| Total People Trips                                  | 100%          | 17                  | 48  | 65    | 37                  | 28  | 65    |
| Total 'New' High-Rise Condominium (2023) Auto Trips |               | 9                   | 23  | 32    | 19                  | 13  | 32    |

The total two-way anticipated site generated person trips are 65 for the AM and PM peak hours, and the total two-way vehicle generated trips are 32 trips for the AM and PM peak hours. Figure 1, below shows the updated vehicle volumes assigned to the local roadways within the study area.

Figure 1: Updated Total Site Generated Vehicle Trips

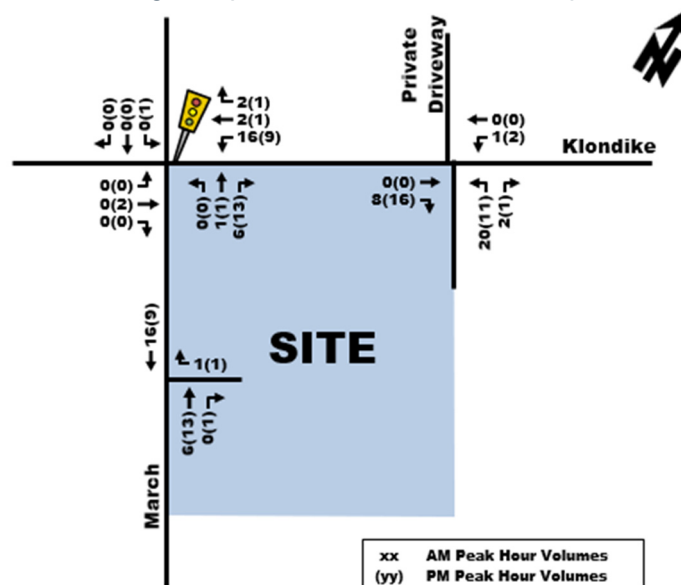

### 2.3. Difference in Forecasted Trips

To understand the difference between the previous Site Plan and the updated Site Plan with regard to trip generation, the forecasted volumes from the original TIA were compared to those associated with the updated Site Plan. Table 3 summarizes the difference (Table 2 - Table 1 values).

## 1 Screening

This study has been prepared according to the City of Ottawa's 2017 Transportation Impact Assessment (TIA) Guidelines. Accordingly, a Step 1 Screening Form has been prepared and is included as Appendix A, along with the Certification Form for TIA Study PM. As shown in the Screening Form, a TIA is required including the Design Review Component and the Network Impact Component.

As a result of the review process, additional comments and analysis have been produced for the City of Ottawa in the form of comment-response documents. The first round of responses to the City's comments have been included in Appendix B and the second round of responses to the City's comments have been included in Appendix C as supplements to the TIA.

Additionally, as the plan has evolved, the building areas have shifted slightly, however these changes are considered minor and have not been reflected in the analysis. Ambiguity surrounding the use of what is shown as Retail B in the most recent plan submitted with this report has required a conservative analysis approach to be adopted. It has been indicated that Retail B may in fact take the form of a restaurant. A previous version of the plan identified the building in question as a restaurant (Restaurant 2) instead of a retail building and as a result, the analysis sections of this TIA have considered this building to be a restaurant in order to produce a conservative analysis. The previous version of the plan is shown in Appendix D which shows the statistics used for Restaurant 2.

## 2 Existing and Planned Conditions

### 2.1 Proposed Development

The subject property, located at 910 March Road, is currently zoned as Rural [Ru] and Development Reserve [DR] and is undeveloped.

The proposed development consists of a 1,835 square metre hardware store, a 234 square metre restaurant with a drive through, a 416 square metre retail store, and a 249 square metre gas bar attached to a 191 square metre Tim Hortons with a drive-through. A total of 164 vehicle parking stalls and 16 bicycle parking spaces will be provided. The site is proposed to have two accesses. Both accesses are located along March Road; the first (Site Access #1) is a full-movement access located approximately 215 metres north of Maxwell Bridge Road, measured from intersection centreline to intersection centreline. Based on professional experience and the development design, signalization of this access is anticipated, however it will be confirmed within this report. The second (Site Access #2) is a right-in / right-out access located approximately 150 metres north of Maxwell Bridge Road, measured intersection centreline to intersection centreline. The anticipated full build-out and occupancy horizon is 2022. Figure 1 illustrates the Study Area Context. Figure 2 illustrates the proposed concept plan.



Figure 1: Area Context Plan

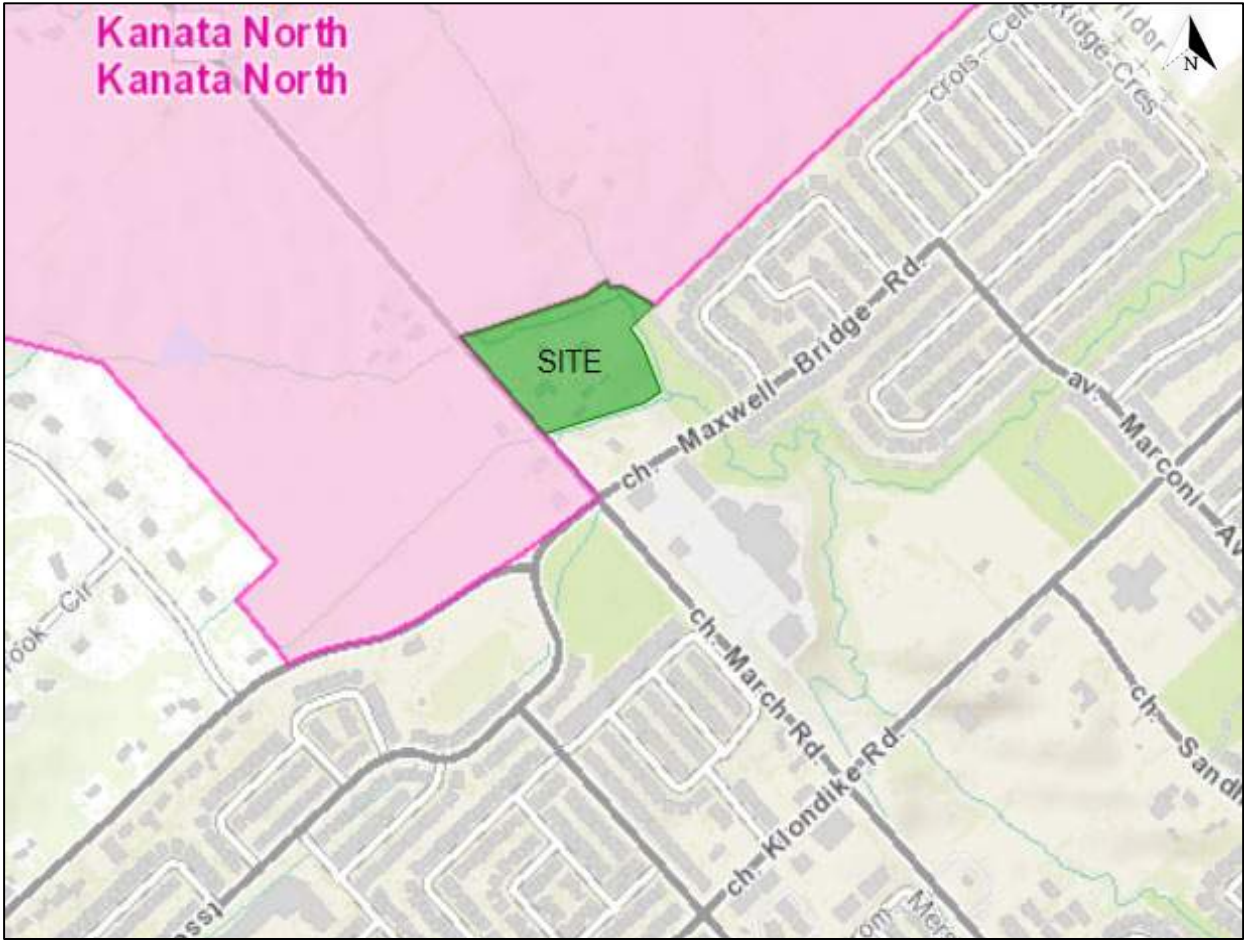
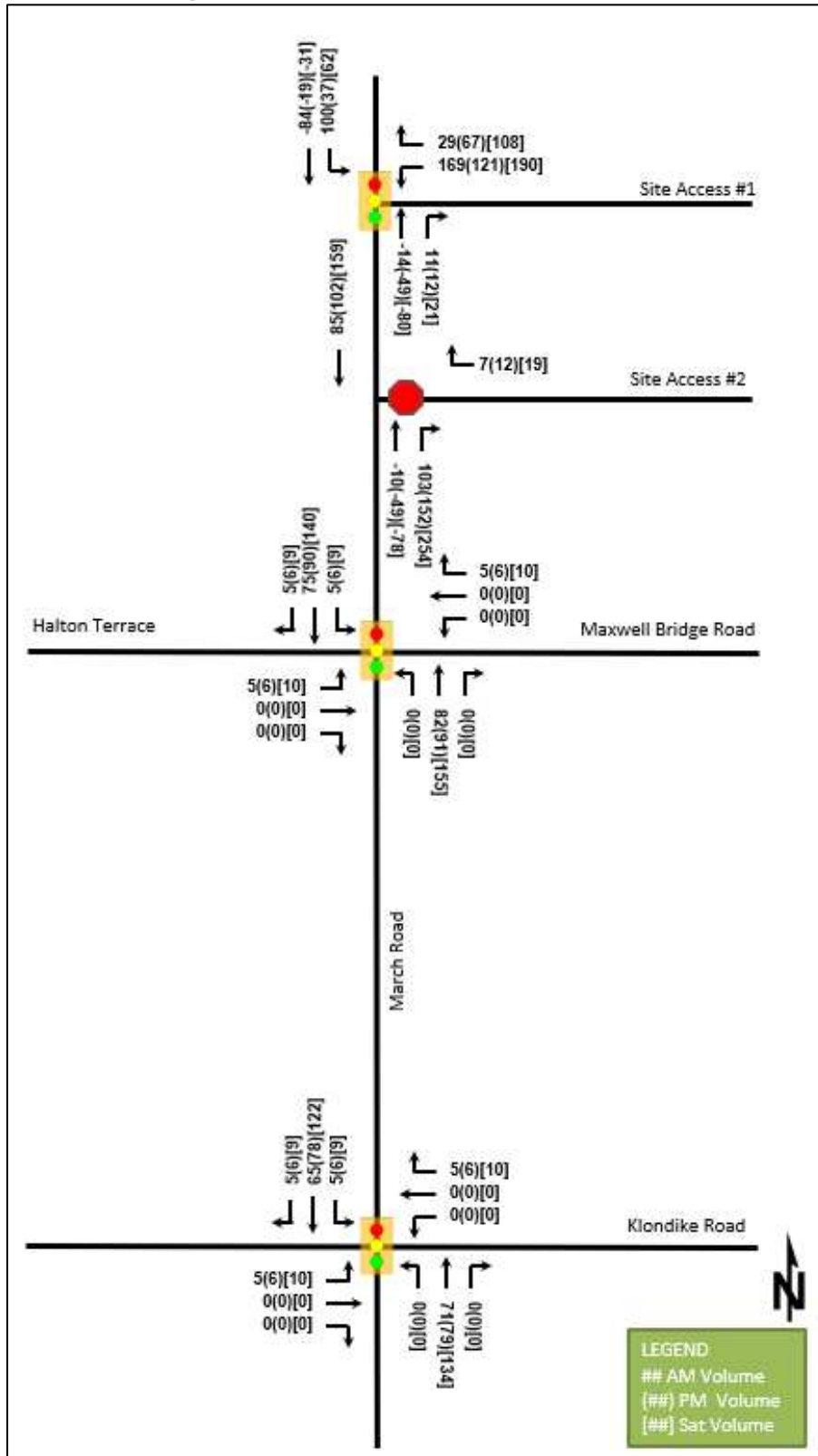

Figure 24: Net New Site Generation Auto Volumes 2022



## 1.0 INTRODUCTION

This TIA has been prepared in support of Site Plan Control and Zoning By-Law Amendment applications for the property located at 1104 Halton Terrace. The site is currently vacant and is surrounded by the following:

- Old Carp Road, followed by vacant land to the north;
- Halton Terrace, followed by a stormwater management pond to the east;
- Halton Terrace, followed by existing low-density residential development to the south; and
- Low-density residential development to the west.

A view of the subject site is provided in **Figure 1**.

**Figure 1: View of the Subject Site**



## 2.0 PROPOSED DEVELOPMENT

The proposed development is designated as 'General Urban Area' in Schedule B of the City of Ottawa's Official Plan. The implemented zoning for 1104 Halton Terrace is 'Residential Third Density' (R3).

The proposed development will feature 86 apartment dwellings. Five single detached dwellings with frontage on Halton Terrace are proposed at the southern limits of the site but are not part of the subject application. The proposed development will be accessed by two new driveways along Halton Terrace and Old Carp Road. The access along Halton Terrace will serve a surface parking lot containing 53 parking spaces. The access along Old Carp Road will serve an underground parking lot containing 68 parking spaces. The proposed development is expected to be constructed in a single phase, with full occupancy in 2024.

A copy of the proposed Site Plan is included in **Appendix A**.

## 3.0 SCREENING

### 3.1 Screening Form

The City's 2017 TIA Guidelines identify three triggers for completing a TIA report, including trip generation, location, and safety. The criteria for each trigger are outlined in the City's TIA Screening Form. The trigger results are as follows:

- Trip Generation Trigger – The development is not anticipated to generate over 60 peak hour person trips; further assessment is not required based on this trigger.
- Location Triggers – The development is not located within a Design Priority Area or Transit-Oriented Development zone, and does not propose a new driveway to a boundary street designated as part of the City's Rapid Transit, Transit Priority, or Spine Cycling networks; further assessment is not required based on this trigger.
- Safety Triggers – The horizontal curvature of Halton Terrace may limit sightlines at the proposed access to Halton Terrace; further assessment is required based on this trigger.

A copy of the TIA Screening Form is included in **Appendix B**.

## 4.0 SCOPING

### 4.1 Existing Conditions

#### 4.1.1 Roadways

All roadways within the study area fall under the jurisdiction of the City of Ottawa.

March Road is an arterial roadway that generally runs on a north-south alignment within the study area, running between Dunrobin Road and Highway 417. West of Dunrobin Road, the roadway runs on an east-west alignment until Appleton Sideroad in Almonte, where it continues as Ottawa Street. South of Highway 417, the roadway continues on a north-south alignment as Eagleson Road. Within

**Table 4: Proposed Residential – Peak Period Person Trips by Mode Share**

| Travel Mode                     | Mode Share | AM Peak Period |           |           | PM Peak Period |           |           |
|---------------------------------|------------|----------------|-----------|-----------|----------------|-----------|-----------|
|                                 |            | IN             | OUT       | TOT       | IN             | OUT       | TOT       |
| <b>Peak Period Person Trips</b> |            | <b>21</b>      | <b>48</b> | <b>69</b> | <b>45</b>      | <b>32</b> | <b>77</b> |
| Auto Driver                     | 50%        | 11             | 24        | 35        | 23             | 16        | 39        |
| Auto Passenger                  | 20%        | 4              | 10        | 14        | 9              | 6         | 15        |
| Transit                         | 25%        | 5              | 12        | 17        | 11             | 8         | 19        |
| Cyclist                         | 0%         | 0              | 0         | 0         | 0              | 0         | 0         |
| Pedestrian                      | 5%         | 1              | 2         | 3         | 2              | 2         | 4         |

Table 4 of the *TRANS Trip Generation Manual* includes adjustment factors to convert the estimated number of trips generated for each mode from peak period to peak hour. A breakdown of the peak hour person trips by mode is shown in the following table.

**Table 5: Proposed Residential – Peak Hour Person Trips by Mode Share**

| Travel Mode                   | Adj. Factor |      | AM Peak Hour |           |           | PM Peak Hour |           |           |
|-------------------------------|-------------|------|--------------|-----------|-----------|--------------|-----------|-----------|
|                               | AM          | PM   | IN           | OUT       | TOT       | IN           | OUT       | TOT       |
| Auto Driver                   | 0.48        | 0.44 | 5            | 12        | 17        | 10           | 7         | 17        |
| Auto Passenger                | 0.48        | 0.44 | 2            | 5         | 7         | 4            | 3         | 7         |
| Transit                       | 0.55        | 0.47 | 3            | 6         | 9         | 5            | 4         | 9         |
| Cyclist                       | 0.58        | 0.48 | 0            | 0         | 0         | 0            | 0         | 0         |
| Pedestrian                    | 0.58        | 0.52 | 1            | 1         | 2         | 1            | 1         | 2         |
| <b>Peak Hour Person Trips</b> |             |      | <b>11</b>    | <b>24</b> | <b>35</b> | <b>20</b>    | <b>15</b> | <b>35</b> |

From the previous table, the development is estimated to generate 35 person trips (including 17 vehicle trips) during the AM and PM peak hours.

## 5.2 Background Traffic

### 5.2.1 Other Area Developments

The City of Ottawa Development Application Search Tool identifies the following other area developments in proximity of the subject site. Relevant excerpts from other area development traffic reports are included in **Appendix F**.

#### 706-714 March Road

Development of a 4,165 m<sup>2</sup> GFA supermarket, 350 m<sup>2</sup> GFA fast-food restaurant with drive-through, and 1,500 m<sup>2</sup> GFA of multi-unit commercial space. The TIA identified a buildout year of 2023. Traffic generated by this development has been added to the 2024 background traffic volumes.

#### 788 March Road

Development of a 92 apartment dwellings. The TIA identified a buildout year of 2023. Traffic generated by this development has been added to the 2024 background traffic volumes.

#### 910 March Road

Development of a 1,835 m<sup>2</sup> hardware store, a 234 m<sup>2</sup> restaurant with drive-through, a 191 m<sup>2</sup> coffee shop with drive-through, a 416 m<sup>2</sup> retail store, and a 249 m<sup>2</sup> gas bar. The TIA identified a buildout year of 2022. Traffic generated by this development has been added to the 2024 background traffic volumes.

## 2 SCOPING

### 2.1 SCREENING FORM

The completed Screening Form is provided in **Appendix B**.

### 2.2 DESCRIPTION OF PROPOSED DEVELOPMENT

This Transportation Impact Assessment (TIA) has been prepared in support of the Site Plan Control Application for the proposed development at 415 Legget Drive and 2700 Solandt Road. The site is currently occupied by a two-storey general office building (9,600 m<sup>2</sup>) with a large parking lot. The site area is 72,860 m<sup>2</sup> and is located at the northeast corner of the Legget Drive and Solandt Road intersection.

The redevelopment of the site is split into two (2) phases. Phase 1 includes the change of use from existing office and building to 2-storey warehousing occupancy. A partial removal of the second storey is proposed which will reduce the overall GFA of the building to approximately 14,350 m<sup>2</sup>.

The proposed development of Phase 2 will include the construction of two warehouse buildings. Proposed building 'A' and Proposed Building 'B' (combined GFA of 18,580 m<sup>2</sup>) will be constructed within the existing parking lot.

The property contains two access points along Legget Drive, and a third along Solandt Road about 150 m north of the intersection of Legget Drive and Solandt Road. All existing site accesses will remain as the access/egress points to the proposed development.

The property is currently zoned as a Business Park Industrial Zone Subzone 6 (IP-6). **Figure 2-1** illustrates the Study Area Context. The development information, as stated in the draft site plan attached as **Appendix C**, states that 152 surface level parking spaces will be provided.

The new warehouse buildings will be built with an estimated date of completion in 2022 and full occupancy in mid 2023.



**Figure 2-1. Area Context Plan**



Figure 3-1. Vehicle Trips Generated by Development

## 1.0 INTRODUCTION

This Transportation Impact Assessment has been prepared in support of Site Plan Control and Zoning By-Law Amendment applications for the property located at 2707 Solandt Road. The site is currently vacant.

The subject site is surrounded by the following:

- The Marshes Golf Club to the north and east;
- Solandt Road, followed by offices to the south;
- Offices, followed by Legget Drive to the west.

A view of the subject site is provided in **Figure 1**.

## 2.0 PROPOSED DEVELOPMENT

The proposed development will include an 8-storey, 198,615 ft<sup>2</sup> office building at 2707 Solandt Road, and will connect to the existing parking lot located at 2505 Solandt Road. As the parking lot at 2505 Solandt Road was previously approved in 2009 (SP D07-12-06-007), the Site Plan and re-zoning applications relate to the 2707 Solandt Road property only. A total of 587 parking spaces will be provided on the two sites combined. Access to the proposed development will be provided via two existing driveways to the parking lot at 2505 Solandt Road and two new driveways to 2707 Solandt Road. It is anticipated that the proposed development may be constructed in a single phase, with full occupancy in 2021.

The proposed development is designated as 'Urban Employment Area' in Schedule B of the City of Ottawa's Official Plan. The implemented zoning for the subject site is 'Business Park Industrial Zone (Kanata North Business Park)' (IP6). The proposed development is permitted under the implemented zoning, however a Zoning By-Law Amendment is required to seek relief of the current height limit of 22m.

A copy of the concept plan is included in **Appendix A**.

## 3.0 SCREENING

The City's 2017 TIA Guidelines identify three triggers for completing a TIA report, including trip generation, location, and safety. The criteria for each trigger are outlined in the City's TIA Screening Form. A copy of the TIA Screening Form is included in **Appendix B**. The trigger results are as follows:

- Trip Generation Trigger – The development is anticipated to generate over 60 peak hour person trips; further assessment is required based on this trigger.
- Location Triggers – The development is not located within a Design Priority Area or Transit-Oriented Development zone, and does not propose a new driveway to a boundary street designated as part of the City's Rapid Transit, Transit Priority, or Spine Cycling networks; further assessment is not required based on this trigger.
- Safety Triggers – No safety triggers outlined in the TIA Screening Form are met; further assessment is not required based on this trigger.



Figure 1: View of the Subject Site

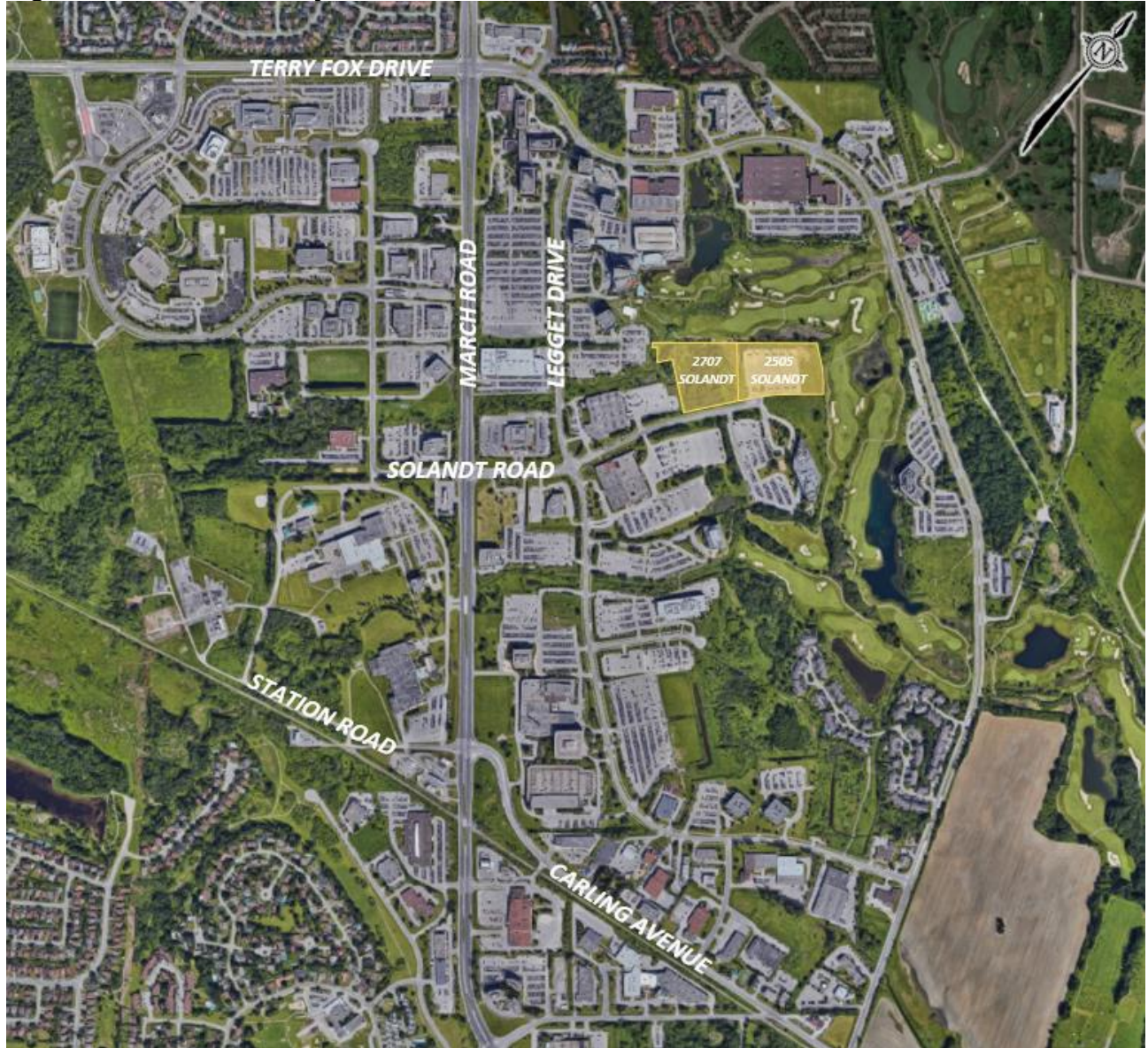
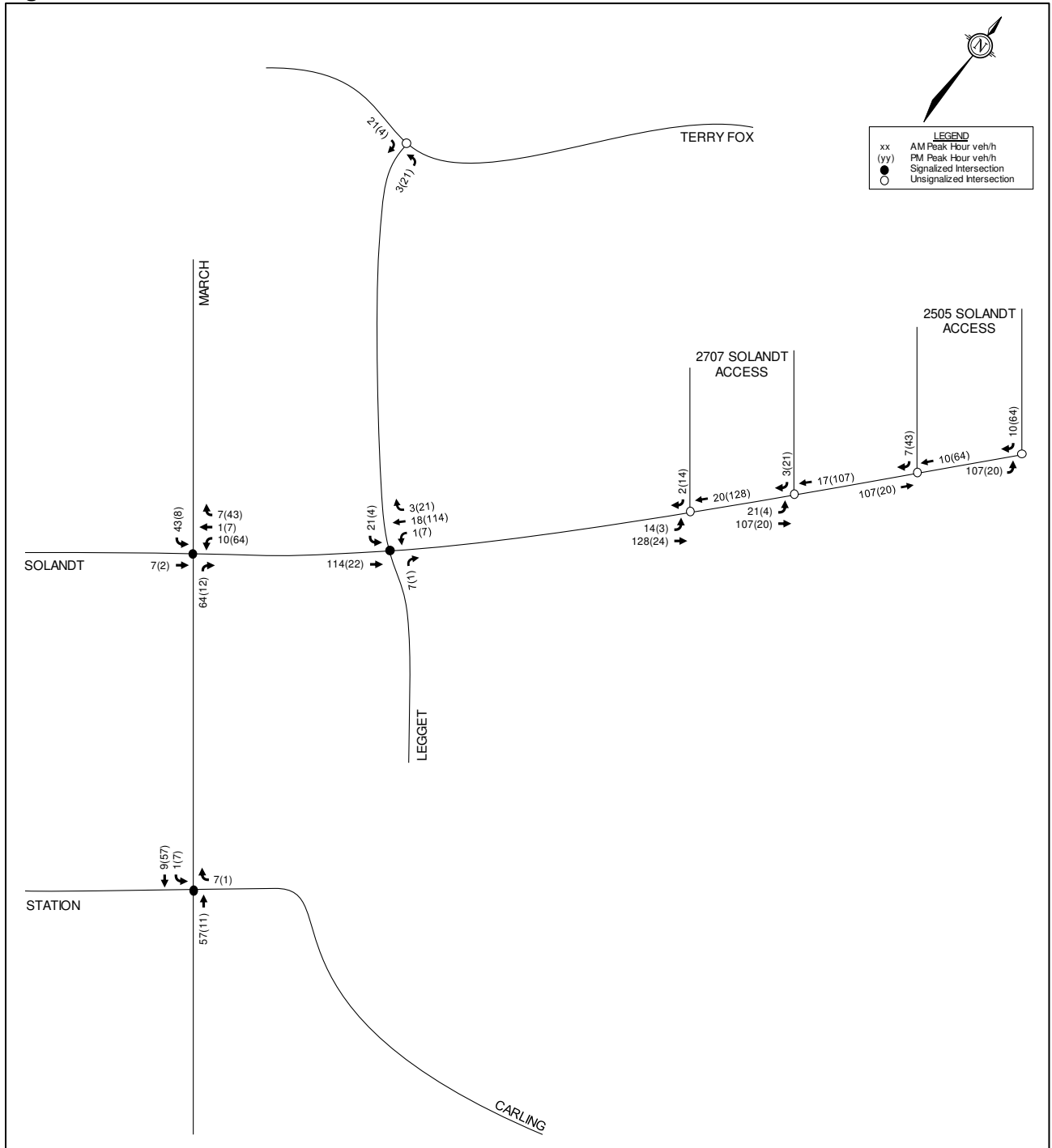

Figure 6: Site-Generated Traffic



## 1. Step 1 – Screening Form

With respect to the City of Ottawa's 2017 Transportation Impact Assessment (TIA) Guidelines, the proposed development (described below in Section 2.1) triggered the trip generation and the safety criteria outlined in the City's TIA Step 1 – Screening form. However, based on the location of the proposed development, the location trigger was not met. As only one of three triggers are required, a formal TIA (i.e. completed Steps 1-5) must accompany the subject development application.

## 2. Step 2 – Scoping

### 2.1 Description of Proposed Development

Based on the information provided, it is our understanding that the proponent is proposing a new office building located at 3026 Solandt Road, which is located on a vacant parcel of land that was previously occupied by a similar land use in 2014 (i.e. an office building existed on the subject parcel of land and has since been demolished). The new office building being proposed includes approximately 100,000 ft<sup>2</sup> of total floor area, accompanied by approximately 350 new parking spaces. The proposed development will be built in a single phase with an anticipated buildout year in 2021.

The latest Site Plan shows two direct vehicle driveway connections to Solandt Road, with inter-site connectivity between adjacent land uses to two other driveway connections (i.e. there will be a shared driveway connection to Legget Drive and March Road). All these driveways currently exist and are proposed to be maintained, with the exception of the west driveway connection to Solandt Road is proposed to be relocated towards the east and will function as one-way inbound only. It should be noted that the driveway connections to Solandt Road are currently barricaded.

In the event that inter-site connectivity between adjacent land uses is severed, it has been assumed that all site-generated traffic for the subject development will be assigned to the driveway connections to Solandt Road only. This is considered to be a conservative assumption as the available shared driveway connections to Legget Drive and March Road can provide additional capacity.

The local context of the subject site is provided as **Figure 1** and the proposed Concept Plan is provided as **Figure 2**.



Figure 1: Local Context

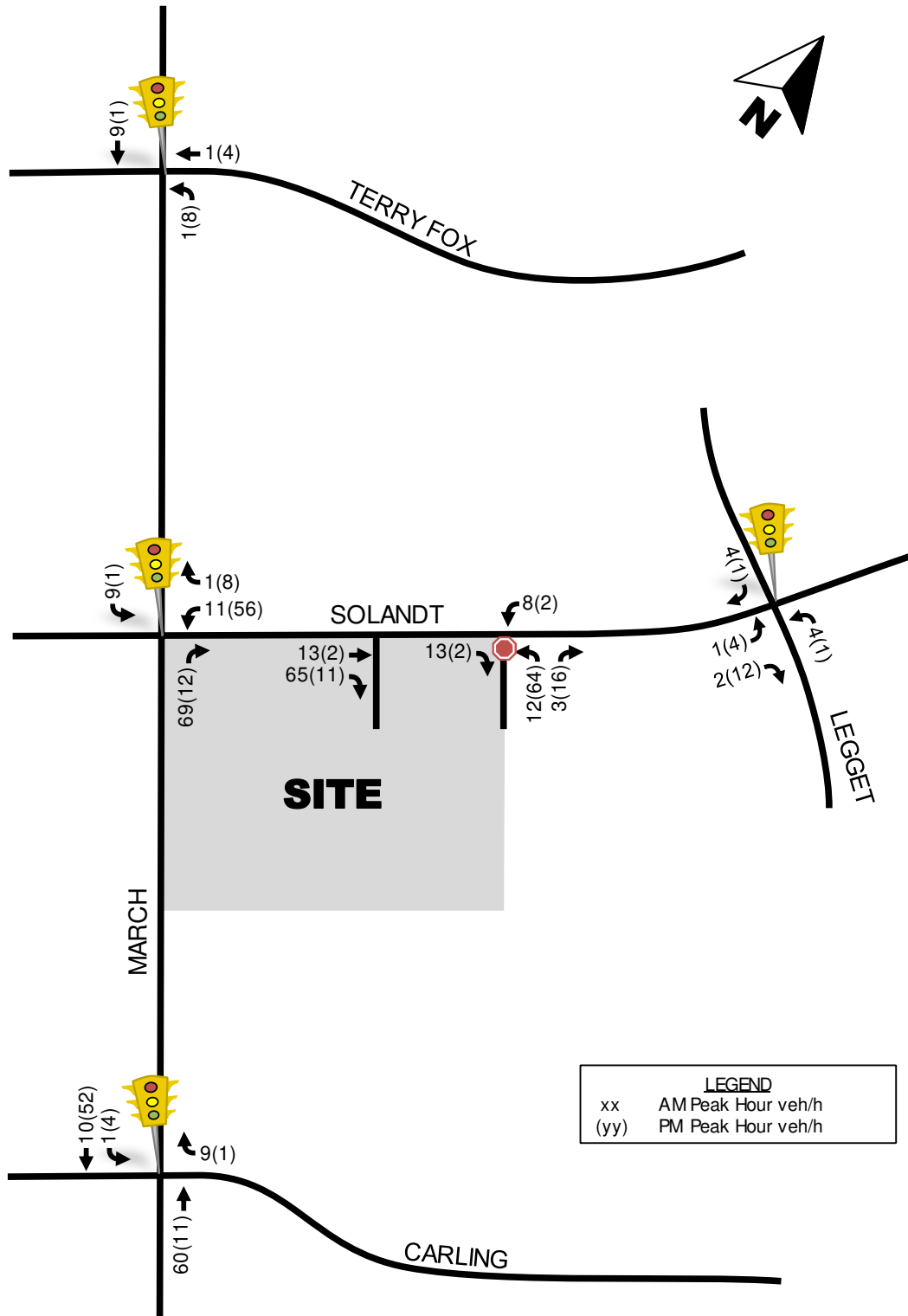
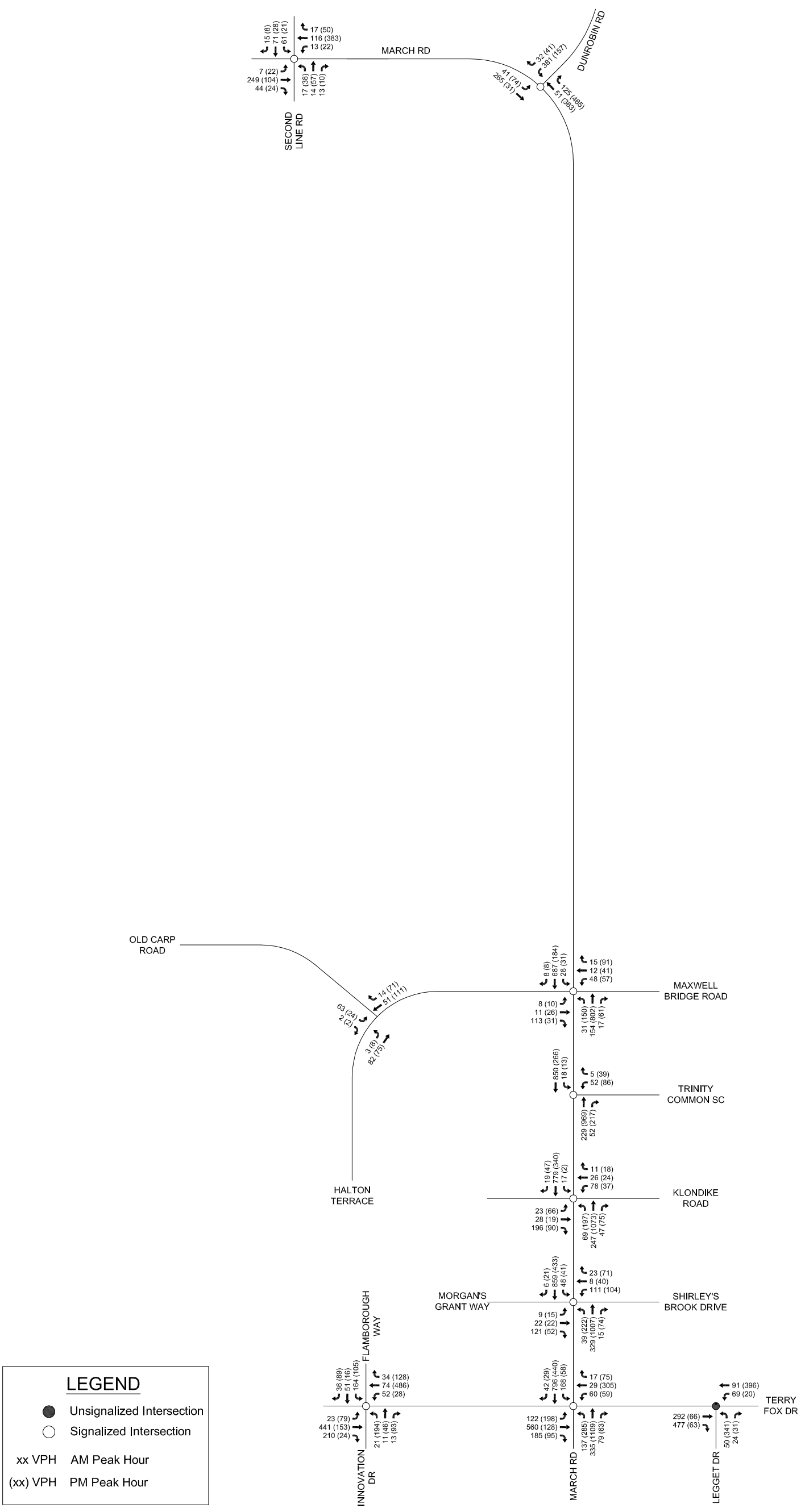

Figure 7: Projected Site-Generated Traffic

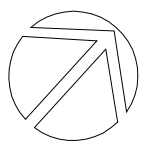

Figure 35 – Demonstration Plan

M:\2012\112117\CAD\Design\Figures\Traffic\FINAL\Traffic Figures.dwg, 2026 BACKGROUND, Mar 28, 2016 - 3:07pm, bbyvelds



**KANATA NORTH**  
COMMUNITY DESIGN PLAN



DATE JUN 2016 JOB 112117  
SCALE N.T.S.

**FIGURE NO. 11**  
2026 BACKGROUND TRAFFIC VOLUMES



Engineers, Planners & Landscape Architects

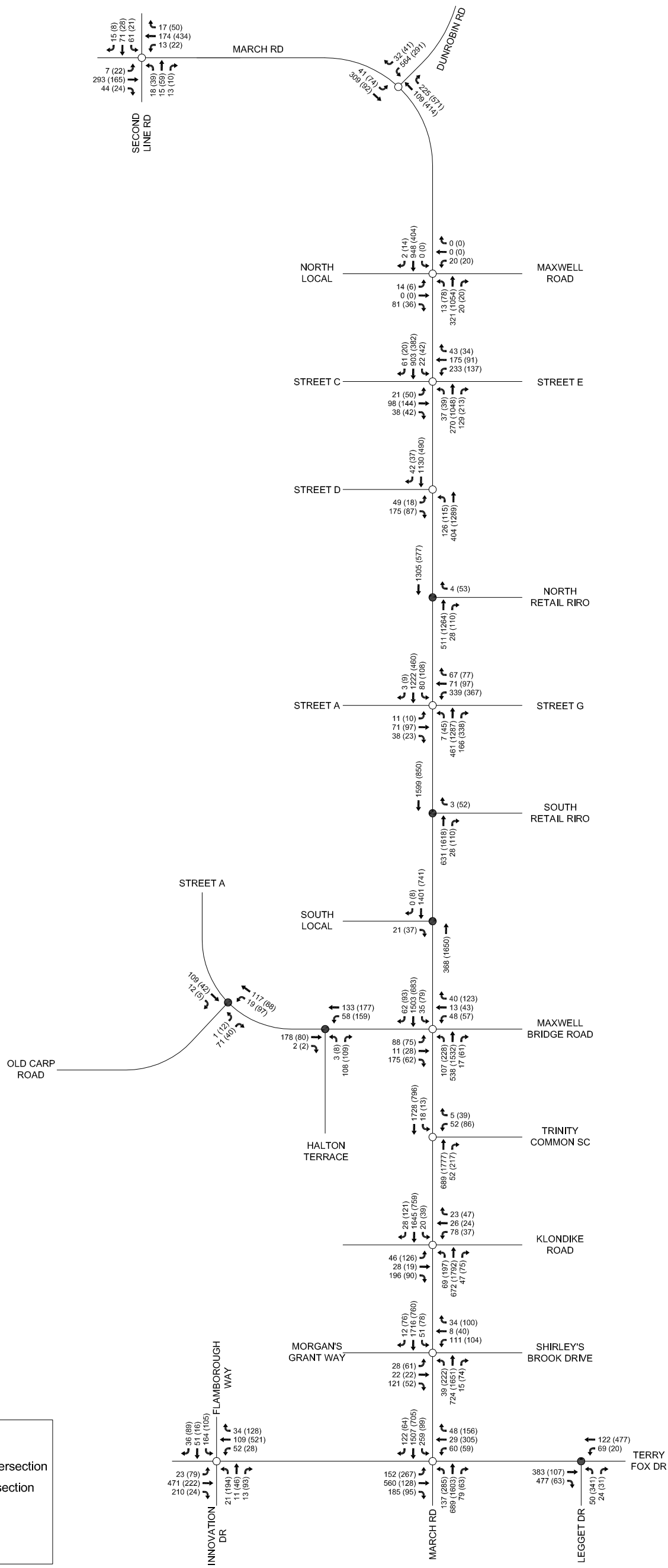

**KANATA NORTH**  
COMMUNITY DESIGN PLAN

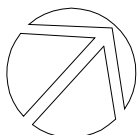

DATE JUN 2016 JOB 112117  
SCALE N.T.S.

**FIGURE NO. 36**  
2026 TOTAL TRAFFIC VOLUMES



Engineers, Planners & Landscape Architects



## **APPENDIX H**

---

### Strategic Long-Range Model Snapshots

# TRANS Regional Model

Version 2.15 - Assigned June 16, 2020

## AM Peak Hour Total Traffic Volume

### Shirley's Brook - Kanata

2011 Model - Basecase

N/A

User Initials: KN

Plot Prepared: Aug 5, 2022

EMME Scenario: 21713



## Legend

AM Peak Hour Total Traffic Volume

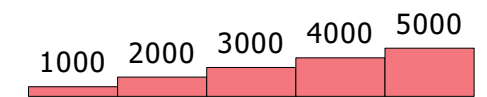

Distance (m)

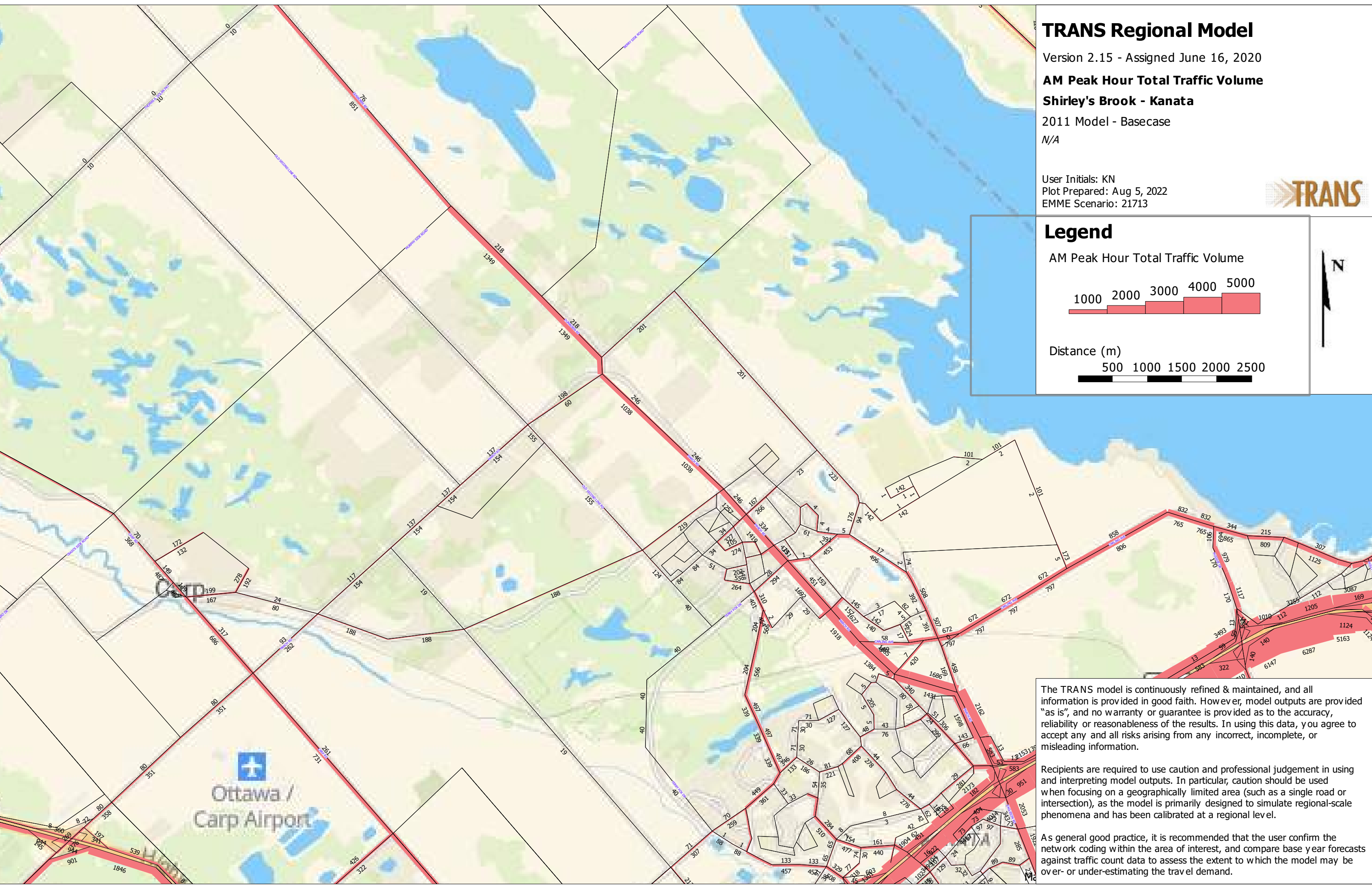
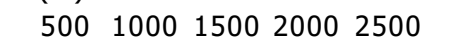

  
Ottawa /  
Carp Airport

The TRANS model is continuously refined & maintained, and all information is provided in good faith. However, model outputs are provided "as is", and no warranty or guarantee is provided as to the accuracy, reliability or reasonableness of the results. In using this data, you agree to accept any and all risks arising from any incorrect, incomplete, or misleading information.

Recipients are required to use caution and professional judgement in using and interpreting model outputs. In particular, caution should be used when focusing on a geographically limited area (such as a single road or intersection), as the model is primarily designed to simulate regional-scale phenomena and has been calibrated at a regional level.

As general good practice, it is recommended that the user confirm the network coding within the area of interest, and compare base year forecasts against traffic count data to assess the extent to which the model may be over- or under-estimating the travel demand.

# TRANS Regional Model

Version 2.15 - Assigned June 16, 2020

## AM Peak Hour Total Traffic Volume

### Shirley's Brook - Kanata

2031 Model - Basecase

N/A

User Initials: KN  
Plot Prepared: Aug 5, 2022  
EMME Scenario: 21715



## Legend

AM Peak Hour Total Traffic Volume

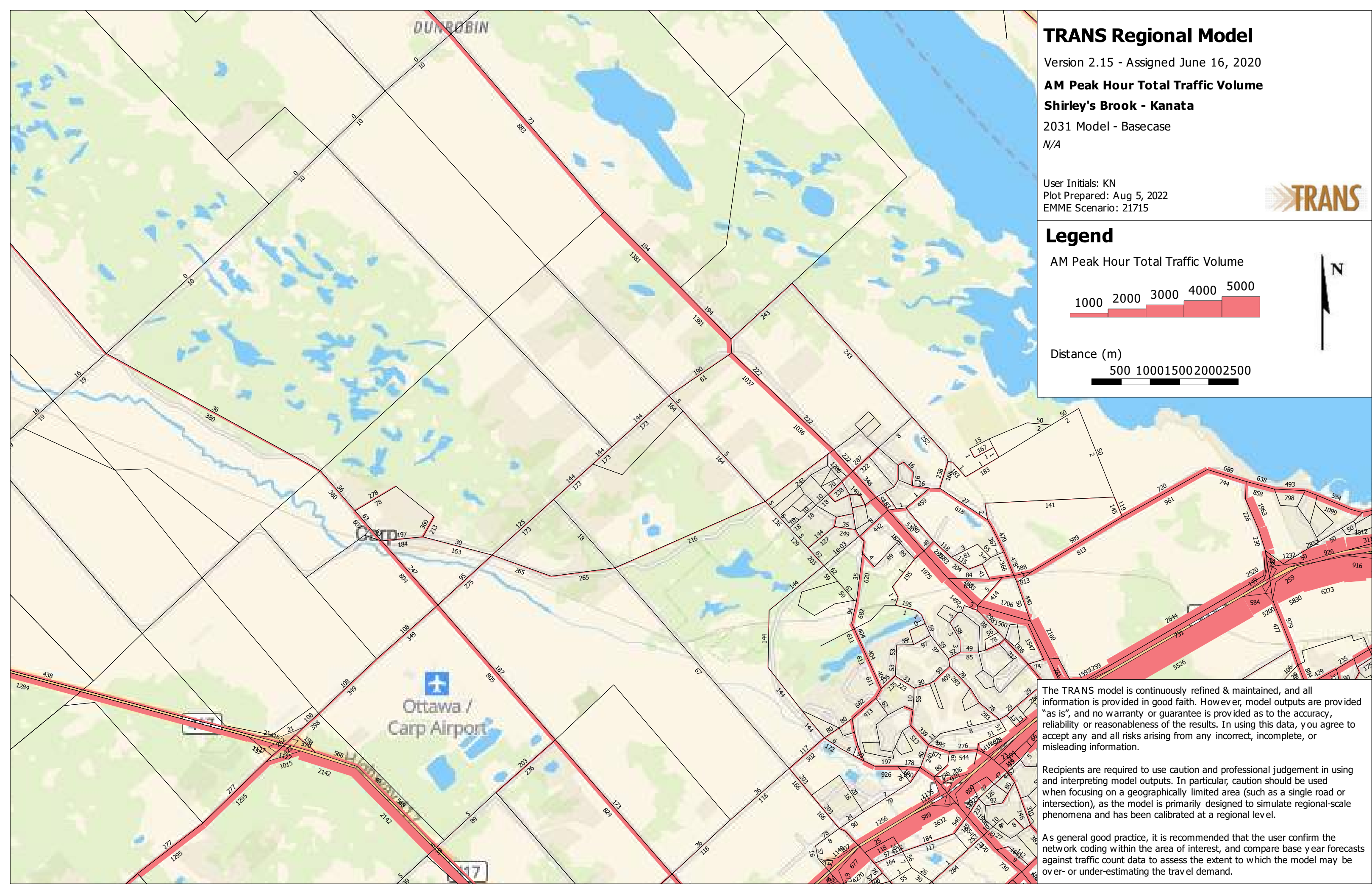
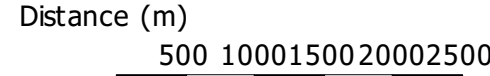
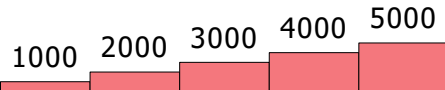

The TRANS model is continuously refined & maintained, and all information is provided in good faith. However, model outputs are provided "as is", and no warranty or guarantee is provided as to the accuracy, reliability or reasonableness of the results. In using this data, you agree to accept any and all risks arising from any incorrect, incomplete, or misleading information.

Recipients are required to use caution and professional judgement in using and interpreting model outputs. In particular, caution should be used when focusing on a geographically limited area (such as a single road or intersection), as the model is primarily designed to simulate regional-scale phenomena and has been calibrated at a regional level.

As general good practice, it is recommended that the user confirm the network coding within the area of interest, and compare base year forecasts against traffic count data to assess the extent to which the model may be over- or under-estimating the travel demand.

## **APPENDIX I**

---

### Future March Road Transitway Functional Design



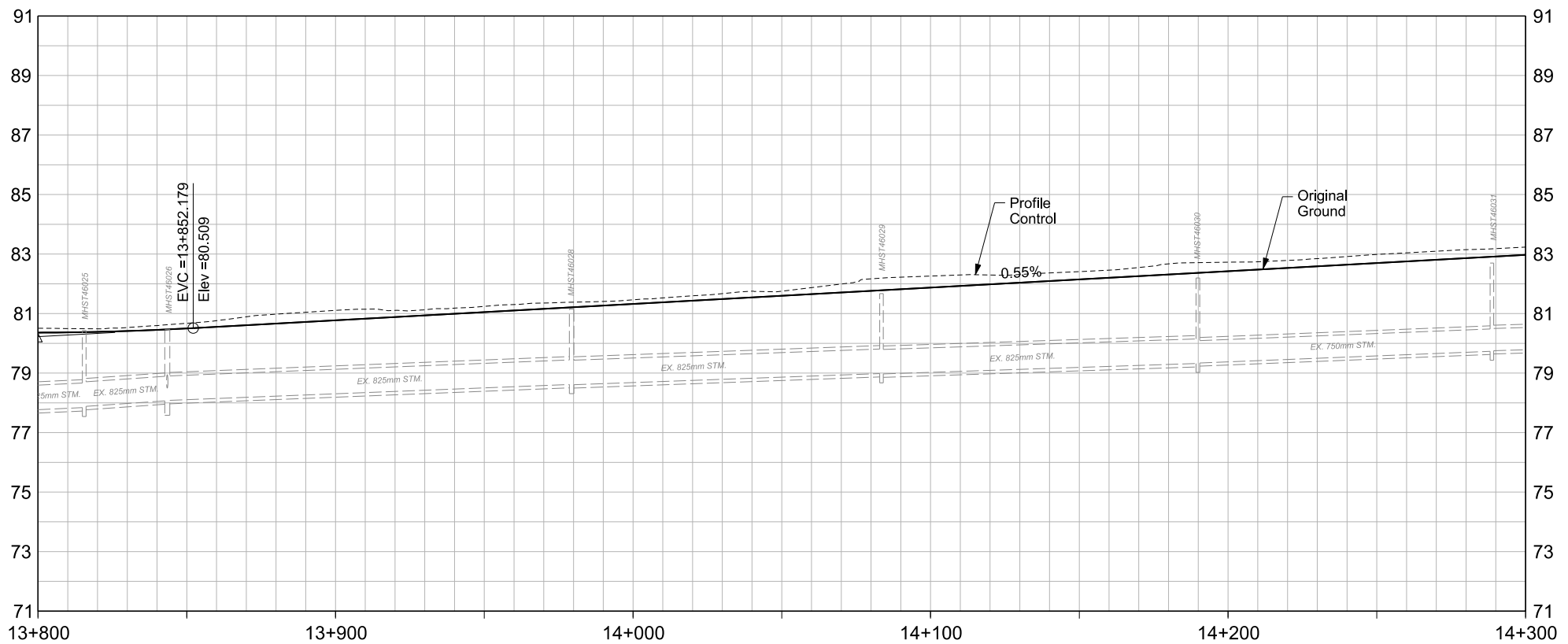
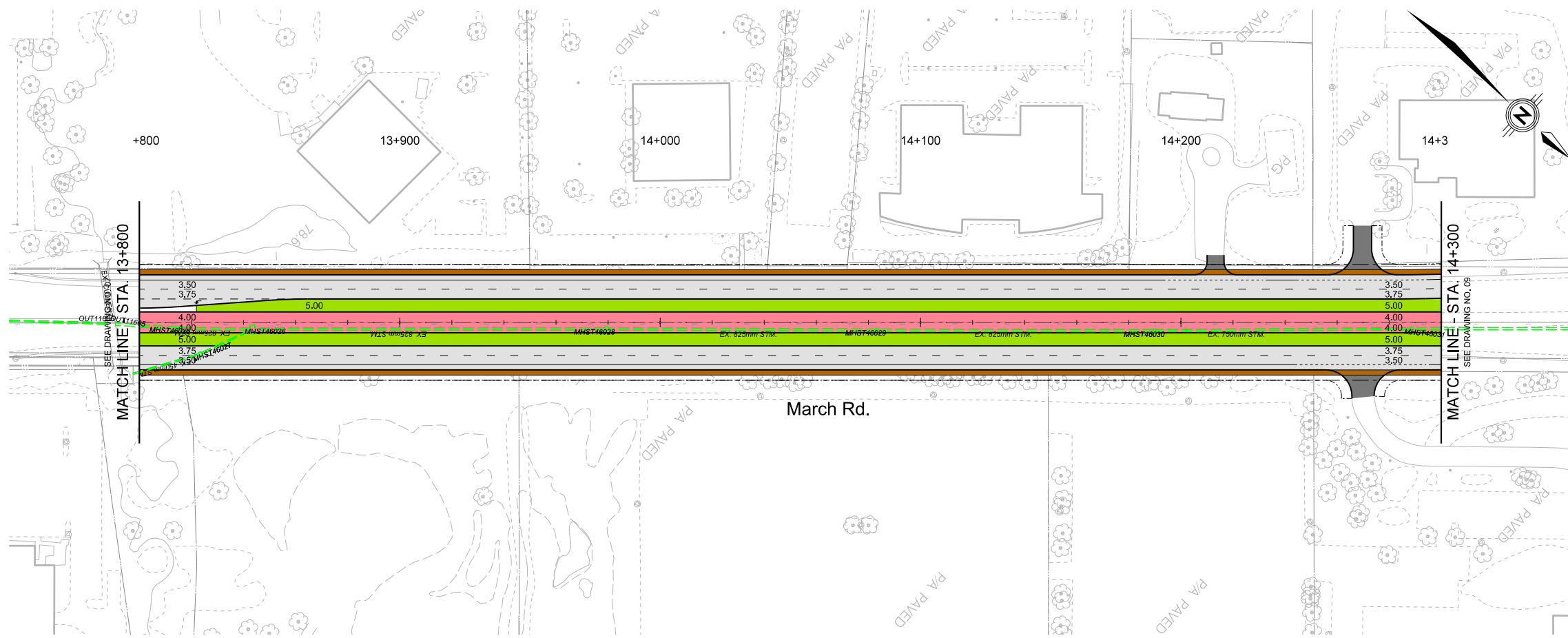

**NOTES:**  
 1. DURING DETAILED DESIGN STAGE SEGREGATED BICYCLE FACILITY WILL BE DESIGNED ALONG THE CORRIDOR AND THROUGH THE INTERSECTION.  
 2. METHODOLOGY FOR DETERMINING THE RIGHT OF WAY (ROW): MARCH ROAD - CORKSTOWN ROAD TO OLD CARP ROAD  
 -PROPERTY FOR THE TRANSITWAY FOR THE MOST PART IS INCLUDED WITHIN THE EXISTING MARCH ROAD ROW.  
 -PROPERTY ACQUISITION REQUIRED ON BOTH SIDES OF WIDENING.  
 -ROW SET TO FOOTPRINT OF TRANSITWAY PLUS 4.0m.  
 -THE EXACT OWNERSHIP WILL BE DETERMINED DURING DETAILED DESIGN.  
 SOUTH OF CORKSTOWN ROAD/MARCH ROAD STATION/WEST TRANSITWAY CONNECTION  
 -ROW SET TO FOOTPRINT OF TRANSITWAY PLUS 4.0m.  
 -THE EXACT OWNERSHIP WILL BE DETERMINED DURING DETAILED DESIGN.

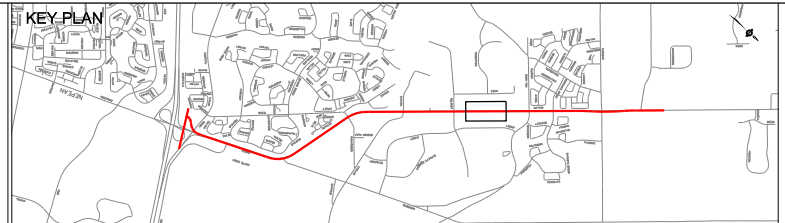

**LEGEND:**

|  |                  |  |                                  |
|--|------------------|--|----------------------------------|
|  | TRANSIT STATION  |  | TRANSIT CENTRELINE               |
|  | TRANSIT LANES    |  | PROPOSED RIGHT-OF-WAY            |
|  | TRAFFIC LANES    |  | STRUCTURE OUTLINE                |
|  | SIDEWALK         |  | PEDESTRIAN BRIDGE                |
|  | EDGE OF PAVEMENT |  | BRIDGE ACCESS POINT SEE SHEET 13 |

**Delcan**

|                                      |                          |                    |
|--------------------------------------|--------------------------|--------------------|
| Date: SEPTEMBER 26 2012              | Designed By: MDR / RRG   | Drawn By: MB / RRG |
| Project Manager: DAH                 | Discipline Engineer: DAH | Checked By: RRG    |
| Scale:                               |                          |                    |
| CAD File Name: T03065TOD-2-0-008.DGN | Plot Date: 30/09/2013    | Drawings No.2      |

**Ottawa**

**Kanata North Transitway**  
 (Hwy 417/Eagleson-March Road to North of Maxwell Bridge Road)

|             |              |
|-------------|--------------|
| Revision 01 | Sheet No. 08 |
|-------------|--------------|

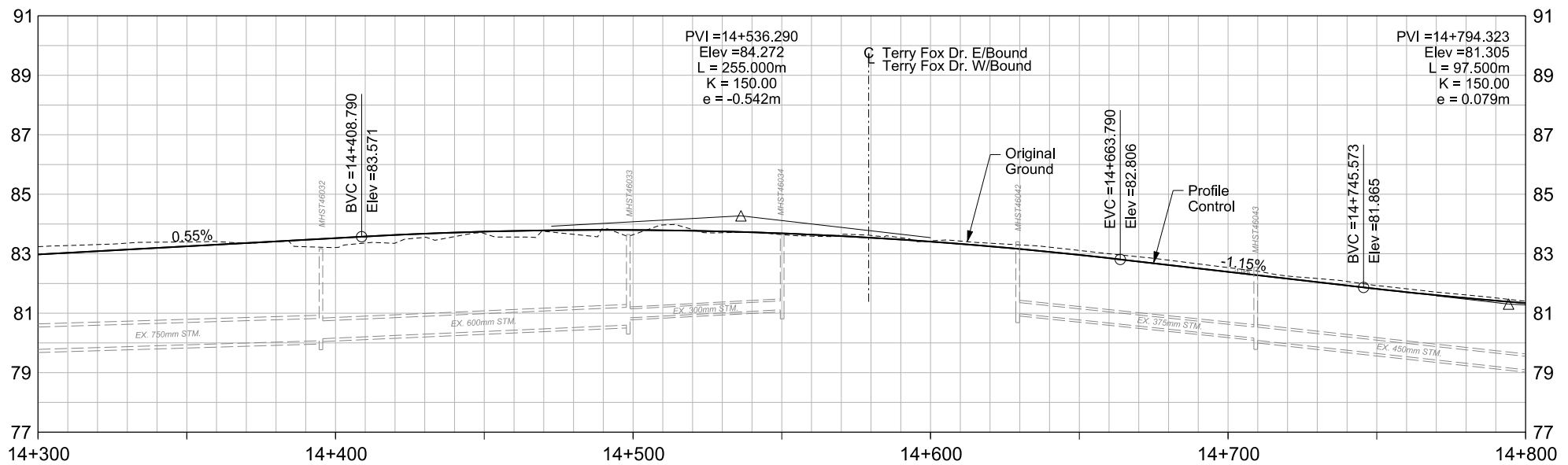
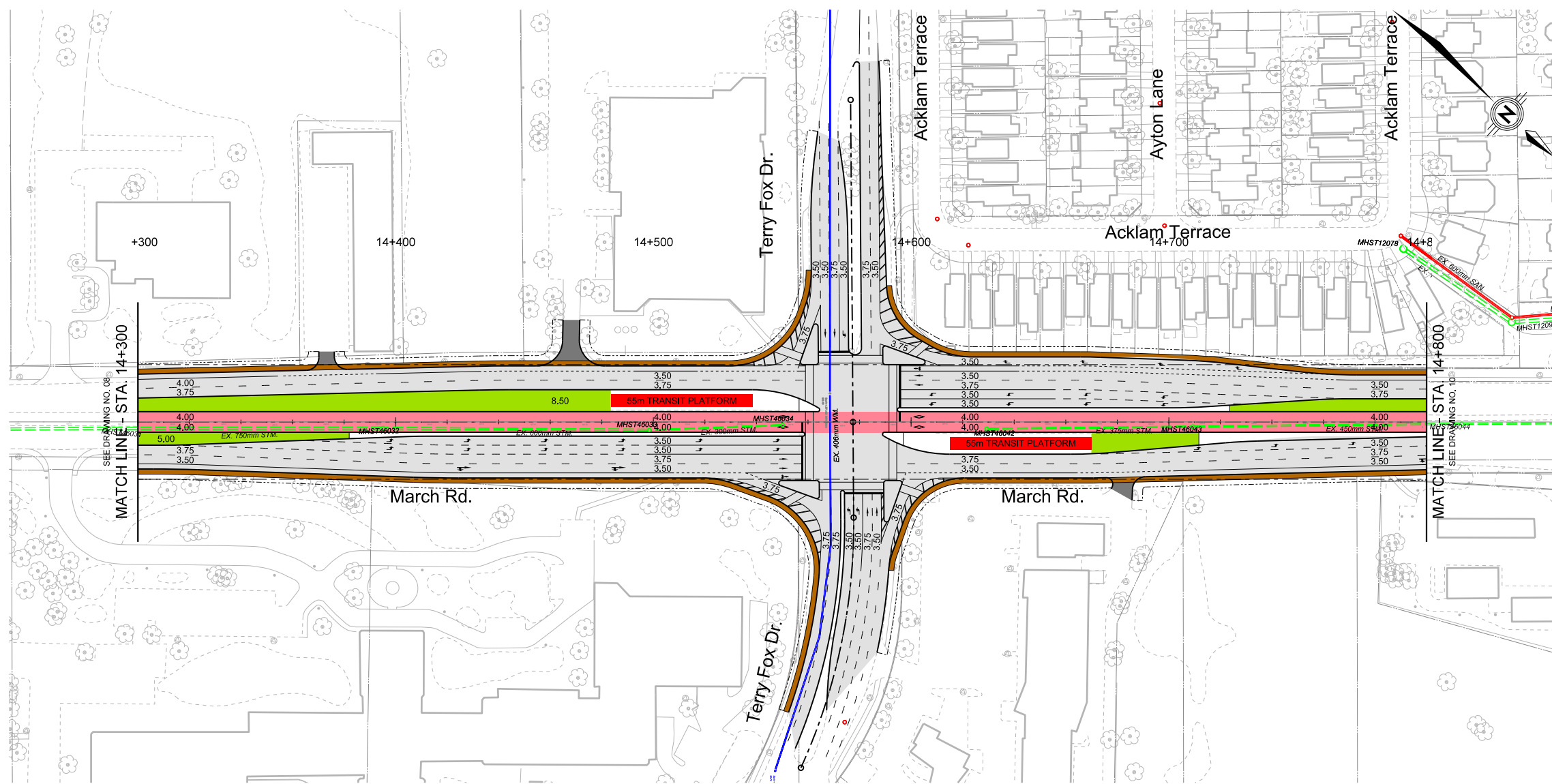

**NOTES:**  
 1. DURING DETAILED DESIGN STAGE SEGREGATED BICYCLE FACILITY WILL BE DESIGNED ALONG THE CORRIDOR AND THROUGH THE INTERSECTION.  
 2. METHODOLOGY FOR DETERMINING THE RIGHT OF WAY (ROW): MARCH ROAD - CORKSTOWN ROAD TO OLD CARP ROAD  
 -PROPERTY FOR THE TRANSITWAY FOR THE MOST PART IS INCLUDED WITHIN THE EXISTING MARCH ROAD ROW.  
 -PROPERTY ACQUISITION REQUIRED ON BOTH SIDES OF WIDENING.  
 -ROW SET TO FOOTPRINT OF TRANSITWAY PLUS 4.0m.  
 -THE EXACT OWNERSHIP WILL BE DETERMINED DURING DETAILED DESIGN.  
 SOUTH OF CORKSTOWN ROAD/MARCH ROAD STATION/WEST TRANSITWAY CONNECTION  
 -ROW SET TO FOOTPRINT OF TRANSITWAY PLUS 4.0m.  
 -THE EXACT OWNERSHIP WILL BE DETERMINED DURING DETAILED DESIGN.

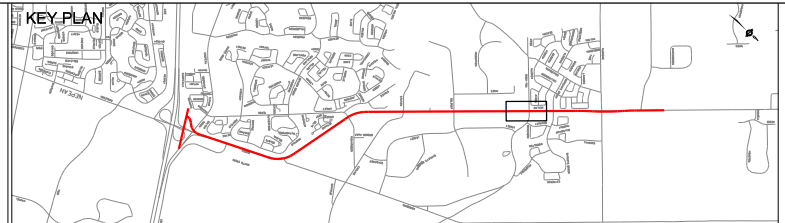

**LEGEND:**

|  |                  |  |                                  |
|--|------------------|--|----------------------------------|
|  | TRANSIT STATION  |  | TRANSIT CENTRELINE               |
|  | TRANSIT LANES    |  | PROPOSED RIGHT-OF-WAY            |
|  | TRAFFIC LANES    |  | STRUCTURE OUTLINE                |
|  | SIDEWALK         |  | PEDESTRIAN BRIDGE                |
|  | EDGE OF PAVEMENT |  | BRIDGE ACCESS POINT SEE SHEET 13 |

**Delcan**

|                         |                          |                    |
|-------------------------|--------------------------|--------------------|
| Date: SEPTEMBER 26 2012 | Designed By: MDR / RRG   | Drawn By: MB / RRG |
| Project Manager: DAH    | Discipline Engineer: DAH | Checked By: RRG    |

Scale: 0m 10 20 40 60  
 HORIZONTAL 1:1  
 VERTICAL 1:4

CAD File Name: T03065TOD-2.0-009.DGN  
 Plot Date: 30/09/2013

**Ottawa**

**Kanata North Transitway**  
 (Hwy 417/Egleson-March Road to North of Maxwell Bridge Road)

Drawings No. 2  
 Revision 01  
 Sheet No. 09

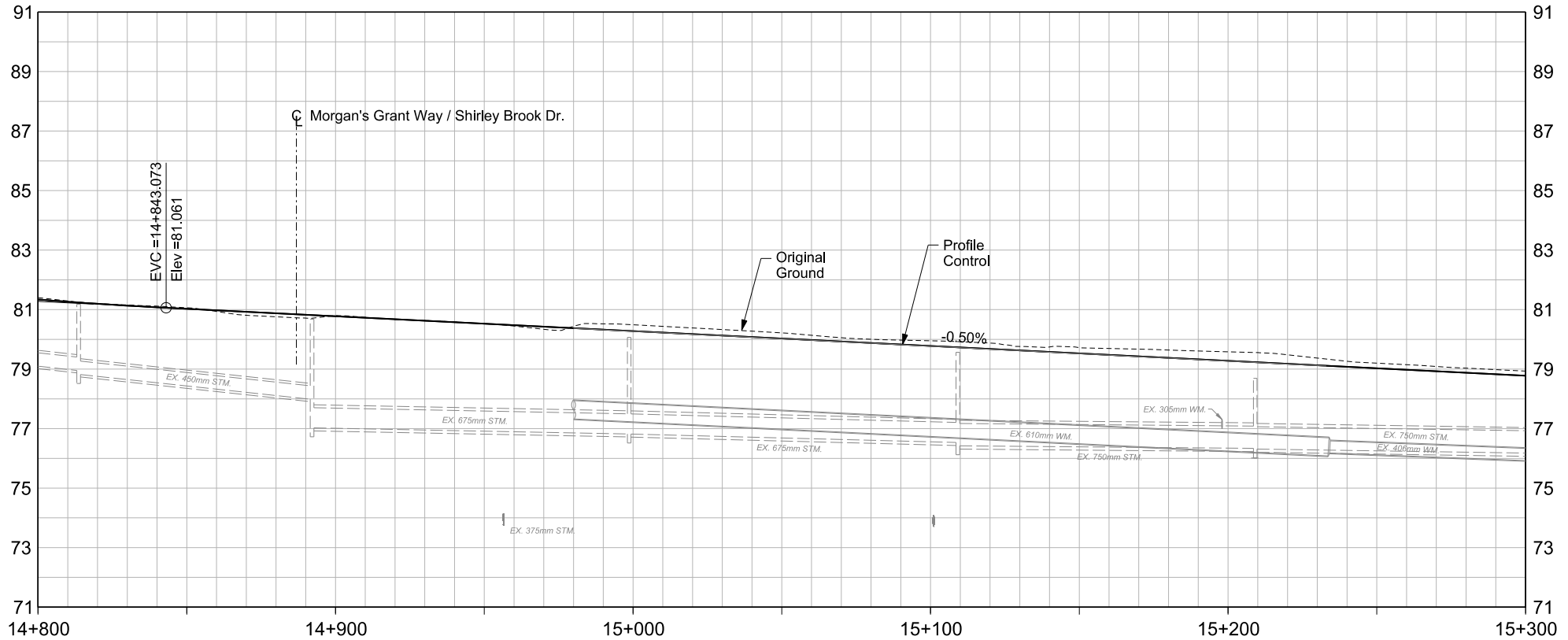
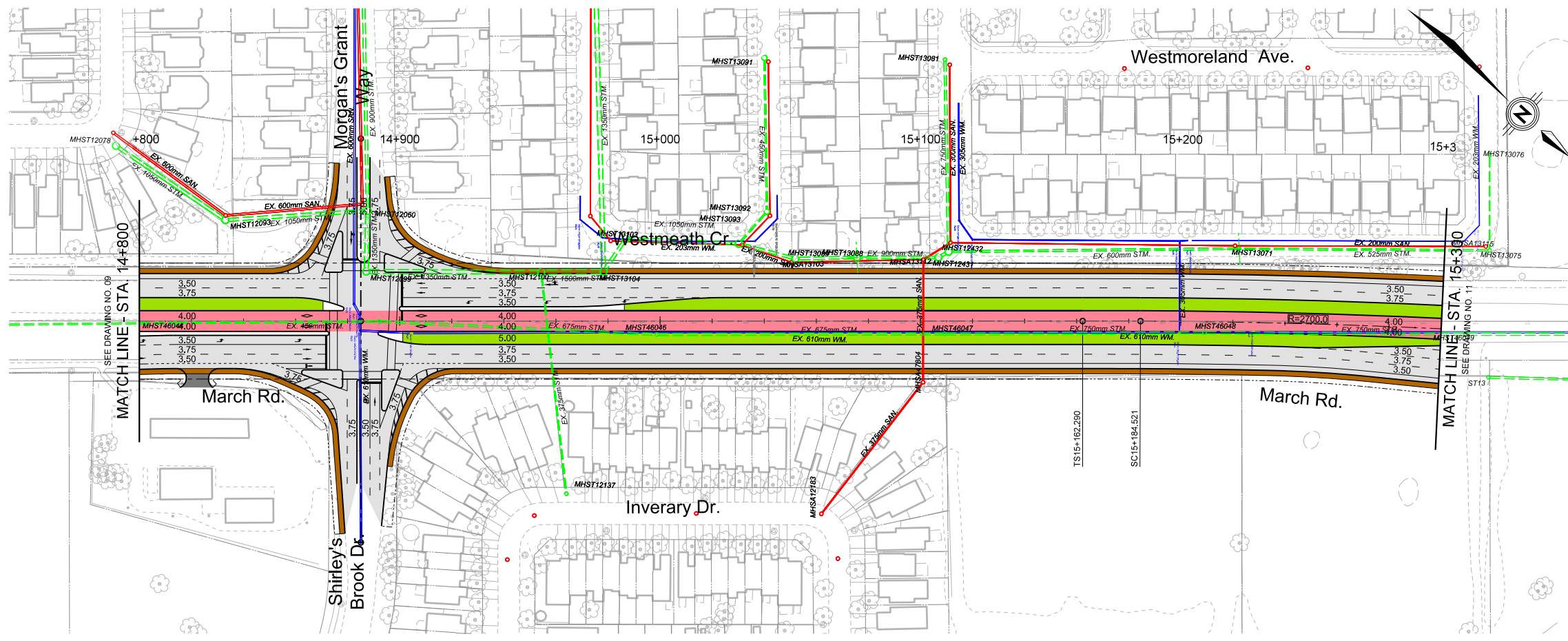

**NOTES:**  
 1. DURING DETAILED DESIGN STAGE SEGREGATED BICYCLE FACILITY WILL BE DESIGNED ALONG THE CORRIDOR AND THROUGH THE INTERSECTION.  
 2. METHODOLOGY FOR DETERMINING THE RIGHT OF WAY (ROW): MARCH ROAD - CORKSTOWN ROAD TO OLD CARP ROAD  
 -PROPERTY FOR THE TRANSITWAY FOR THE MOST PART IS INCLUDED WITHIN THE EXISTING MARCH ROAD ROW.  
 -PROPERTY ACQUISITION REQUIRED ON BOTH SIDES OF WIDENING.  
 -ROW SET TO FOOTPRINT OF TRANSITWAY PLUS 4.0m.  
 -THE EXACT OWNERSHIP WILL BE DETERMINED DURING DETAILED DESIGN.  
 SOUTH OF CORKSTOWN ROAD/MARCH ROAD STATION/WEST TRANSITWAY CONNECTION  
 -ROW SET TO FOOTPRINT OF TRANSITWAY PLUS 4.0m.  
 -THE EXACT OWNERSHIP WILL BE DETERMINED DURING DETAILED DESIGN.



**LEGEND:**

|  |                  |  |                                  |
|--|------------------|--|----------------------------------|
|  | TRANSIT STATION  |  | TRANSIT CENTRELINE               |
|  | TRANSIT LANES    |  | PROPOSED RIGHT-OF-WAY            |
|  | TRAFFIC LANES    |  | STRUCTURE OUTLINE                |
|  | SIDEWALK         |  | PEDESTRIAN BRIDGE                |
|  | EDGE OF PAVEMENT |  | BRIDGE ACCESS POINT SEE SHEET 13 |

**Delcan**

|                         |                          |                    |
|-------------------------|--------------------------|--------------------|
| Date: SEPTEMBER 26 2012 | Designed By: MDR / RRG   | Drawn By: MB / RRG |
| Project Manager: DAH    | Discipline Engineer: DAH | Checked By: RRG    |

Scale:

CAD File Name: T03065TOD-2.0-010.DGN | Plot Date: 30/09/2013

**Ottawa**

**Kanata North Transitway**  
 (Hwy 417/Egleson-March Road to North of Maxwell Bridge Road)

Drawings No. 2 | Revision 01 | Sheet No. 10



## **APPENDIX J**

---

### Signal Timing Plans

# Traffic Signal Timing

City of Ottawa, Public Works Department

Traffic Signal Operations Unit

|                      |                         |              |                                |
|----------------------|-------------------------|--------------|--------------------------------|
| <b>Intersection:</b> | <u>Main:</u> March      | <u>Side:</u> | Morgans Grant / Shirleys Brook |
| <b>Controller:</b>   | <u>ATC3</u>             | <b>TSD:</b>  | <u>5767</u>                    |
| <b>Author:</b>       | <u>Matthew Anderson</u> | <b>Date:</b> | <u>28-Jul-2022</u>             |

## Existing Timing Plans<sup>†</sup>

|               | Plan         |               |              |            |                | Ped Minimum Time |    |         |
|---------------|--------------|---------------|--------------|------------|----------------|------------------|----|---------|
|               | AM Peak<br>1 | Off Peak<br>2 | PM Peak<br>3 | Night<br>4 | PM Heavy<br>13 | Walk             | DW | A+R     |
| <b>Cycle</b>  | 130          | 110           | 120          | 95         | 130            |                  |    |         |
| <b>Offset</b> | 95           | 90            | 89           | X          | 105            |                  |    |         |
| NB Thru       | 70           | 51            | 61           | 41         | 70             | 7                | 11 | 4.6+1.5 |
| SB Thru       | 70           | 51            | 61           | 41         | 70             | 7                | 11 | 4.6+1.5 |
| EB Thru       | 39           | 39            | 39           | 39         | 39             | 7                | 24 | 3.0+4.5 |
| WB Thru       | 39           | 39            | 39           | 39         | 39             | 7                | 24 | 3.0+4.5 |
| NB Left (fp)  | 21           | 20            | 20           | 15         | 21             | -                | -  | 4.6+1.8 |
| SB Left (fp)  | 21           | 20            | 20           | 15         | 21             | -                | -  | 4.6+1.8 |

## Phasing Sequence<sup>‡</sup>

Plan: All

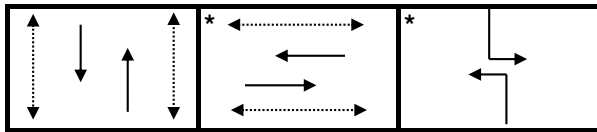

**Notes:** 1) If the EW pedestrian phase is not actuated, the EW phases will force off after 28s

## Schedule

| Weekday |      | Weekend |      | Sunday |      |
|---------|------|---------|------|--------|------|
| Time    | Plan | Time    | Plan | Time   | Plan |
| 0:10    | 4    | 0:10    | 4    | 0:10   | 4    |
| 6:30    | 1    | 8:00    | 2    | 8:00   | 2    |
| 9:30    | 2    | 22:00   | 4    | 22:00  | 4    |
| 15:00   | 3    |         |      |        |      |
| 16:30   | 13   |         |      |        |      |
| 18:00   | 3    |         |      |        |      |
| 18:30   | 2    |         |      |        |      |
| 23:00   | 4    |         |      |        |      |

## NOTES

†: Time for each direction includes amber and all red intervals  
 ‡: Start of first phase should be used as reference point for offset  
 Asterisk (\*) Indicates actuated phase  
 (fp): Fully Protected Left Turn  
 ◀.....▶ Pedestrian signal

Cost is \$61.16 (\$54.12 + HST)

# Traffic Signal Timing

City of Ottawa, Transportation Services Department

## Traffic Signal Operations Unit

|                      |                    |                          |
|----------------------|--------------------|--------------------------|
| <b>Intersection:</b> | <i>Main:</i> March | <i>Side:</i> Terry Fox   |
| <b>Controller:</b>   | <b>MS 3200</b>     | <b>TSD: 5920</b>         |
| <b>Author:</b>       | Matthew Anderson   | <b>Date:</b> 01-Sep-2023 |

### Existing Timing Plans<sup>†</sup>

|                     | Plan         |               |              |            |                | Ped Minimum Time |    |         |
|---------------------|--------------|---------------|--------------|------------|----------------|------------------|----|---------|
|                     | AM Peak<br>1 | Off Peak<br>2 | PM Peak<br>3 | Night<br>4 | PM Heavy<br>13 | Walk             | DW | A+R     |
| <b>Cycle</b>        | 130          | 110           | 120          | 105        | 130            |                  |    |         |
| <b>Offset</b>       | 114          | 80            | 72           | X          | 96             |                  |    |         |
| <b>NB Thru</b>      | 47           | 38            | 38           | 38         | 41             | 7                | 19 | 4.6+2.1 |
| <b>SB Thru</b>      | 47           | 38            | 38           | 38         | 41             | 7                | 19 | 4.6+2.1 |
| <i>EB Left (fp)</i> | 16           | 15            | 19           | 13         | 24             | -                | -  | 3.7+3.1 |
| <i>WB Left (fp)</i> | 16           | 15            | 19           | 13         | 24             | -                | -  | 3.7+3.1 |
| <b>EB Thru</b>      | 42           | 42            | 42           | 42         | 42             | 7                | 28 | 3.7+3.2 |
| <b>WB Thru</b>      | 42           | 42            | 42           | 42         | 42             | 7                | 28 | 3.7+3.2 |
| <i>NB Left (fp)</i> | 25           | 15            | 21           | 12         | 23             | -                | -  | 4.6+2.2 |
| <i>SB Left (fp)</i> | 25           | 15            | 21           | 12         | 23             | -                | -  | 4.6+2.2 |

### Phasing Sequence<sup>‡</sup>

Plan: All

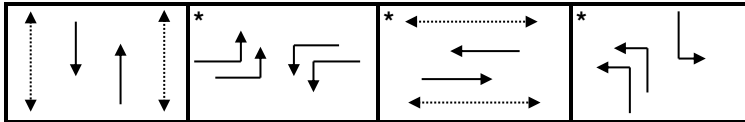

**Notes:** 1) If the EW Pedestrian phase is not actuated, the EW Thru phases will force off after 30s

### Schedule

#### Weekday

| Time  | Plan |
|-------|------|
| 0:10  | 4    |
| 6:30  | 1    |
| 9:30  | 2    |
| 15:00 | 3    |
| 16:30 | 13   |
| 18:00 | 3    |
| 18:30 | 2    |
| 22:00 | 4    |

#### Weekend

| Time  | Plan |
|-------|------|
| 0:10  | 4    |
| 8:00  | 2    |
| 22:00 | 4    |

### NOTES

- †: Time for each direction includes amber and all red intervals
- ‡: Start of first phase should be used as reference point for offset
- Asterisk (\*) Indicates actuated phase
- (fp): Fully Protected Left Turn
- ◄.....► Pedestrian signal

Cost is \$62.38 (\$55.20 + HST)

# Traffic Signal Timing

City of Ottawa, Transportation Services Department

## Traffic Signal Operations Unit

|                      |                     |              |                    |
|----------------------|---------------------|--------------|--------------------|
| <b>Intersection:</b> | <u>Main: March</u>  | <b>Side:</b> | <u>Solandt</u>     |
| <b>Controller:</b>   | <u>MS-3200</u>      | <b>TSD:</b>  | <u>5359</u>        |
| <b>Author:</b>       | <u>Jean Nabolle</u> | <b>Date:</b> | <u>08-Jul-2019</u> |

### Existing Timing Plans†

|               | Plan         |               |              |            |                | Ped Minimum Time |    |           |
|---------------|--------------|---------------|--------------|------------|----------------|------------------|----|-----------|
|               | AM Peak<br>1 | Off Peak<br>2 | PM Peak<br>3 | Night<br>4 | PM Heavy<br>13 | Walk             | DW | A+R       |
| <b>Cycle</b>  | 130          | 110           | 120          | 85         | 130            |                  |    |           |
| <b>Offset</b> | 15           | 16            | 21           | X          | 30             |                  |    |           |
| NB Thru       | 85           | 60            | 59           | 38         | 64             | 7                | 12 | 4.6 + 1.7 |
| SB Thru       | 46           | 47            | 47           | 38         | 52             | 7                | 12 | 4.6 + 1.7 |
| EB Left (fp)  | 13           | 18            | 29           | 16         | 34             | -                | -  | 3.3 + 2.6 |
| WB Left (fp)  | 13           | 18            | 29           | 16         | 34             | -                | -  | 3.3 + 2.6 |
| EB Thru       | 32           | 32            | 32           | 31         | 32             | 7                | 18 | 3.3 + 3.2 |
| WB Thru       | 32           | 32            | 32           | 31         | 32             | 7                | 18 | 3.3 + 3.2 |
| NB Left       | 39           | 13            | 12           | -          | 12             | -                | -  | 4.6 + 1.7 |

### Phasing Sequence‡

**Plan: 1, 2, 3, 13**

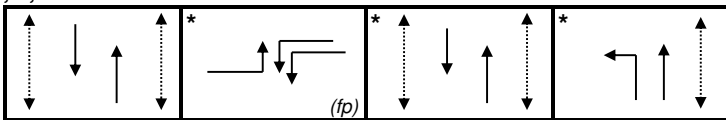

**Plan: 4**

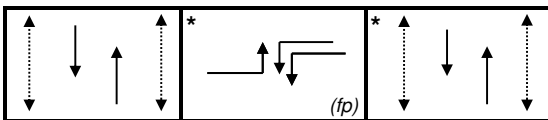

Notes: 1) For plan 1, if the pedestrian phase is not actuated then the EW thru movements will be forced off after 10 seconds green. In addition, all extra time for plan 1 will be added to the NS thru movements

#### Weekday

| Time  | Plan |
|-------|------|
| 0:10  | 4    |
| 6:30  | 1    |
| 9:30  | 2    |
| 15:00 | 3    |
| 16:30 | 13   |
| 18:00 | 3    |
| 18:30 | 2    |
| 23:00 | 4    |

#### Weekend

| Time  | Plan |
|-------|------|
| 0:10  | 4    |
| 8:00  | 2    |
| 22:30 | 4    |

### Notes

†: Time for each direction includes amber and all red intervals  
 ‡: Start of first phase should be used as reference point for offset

Asterisk (\*) Indicates actuated phase  
 (fp): Fully Protected Left Turn  
 ◀.....▶ Pedestrian signal

Cost is \$57.63 (\$51 + HST)

# Traffic Signal Timing

City of Ottawa, Public Works Department

Traffic Signal Operations Unit

|                      |                        |                                       |
|----------------------|------------------------|---------------------------------------|
| <b>Intersection:</b> | <i>Main:</i> Terry Fox | <i>Side:</i> Innovation / Flamborough |
| <b>Controller:</b>   | <b>ATC 3</b>           | <b>TSD: 6768</b>                      |
| <b>Author:</b>       | Matthew Anderson       | <b>Date:</b> 01-Sep-2023              |

## Existing Timing Plans<sup>†</sup>

|               | Plan         |               |              |            |                | Ped Minimum Time |    |         |
|---------------|--------------|---------------|--------------|------------|----------------|------------------|----|---------|
|               | AM Peak<br>1 | Off Peak<br>2 | PM Peak<br>3 | Night<br>4 | PM Heavy<br>13 | Walk             | DW | A+R     |
| <b>Cycle</b>  | 130          | 110           | 120          | 80         | 130            |                  |    |         |
| <b>Offset</b> | 124          | 41            | 47           | X          | 66             |                  |    |         |
| EB Thru       | 70           | 57            | 63           | 42         | 66             | 7                | 15 | 3.7+2.2 |
| WB Thru       | 70           | 57            | 63           | 42         | 66             | 7                | 15 | 3.7+2.2 |
| NB Thru       | 42           | 40            | 45           | 38         | 52             | 7                | 22 | 3.0+3.6 |
| SB Thru       | 42           | 40            | 45           | 38         | 52             | 7                | 22 | 3.0+3.6 |
| EB Left       | 18           | 13            | 12           | -          | 12             | -                | -  | 3.7+2.2 |
| WB Left       | 18           | 13            | 12           | -          | 12             | -                | -  | 3.7+2.2 |

## Phasing Sequence<sup>‡</sup>

Plan: 1,2,3,13

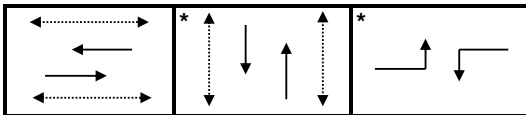

Plan: 4

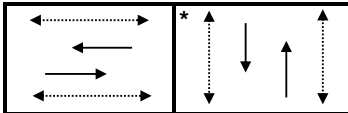

## Schedule

### Weekday

| Time  | Plan |
|-------|------|
| 0:15  | 4    |
| 6:30  | 1    |
| 9:30  | 2    |
| 15:00 | 3    |
| 16:30 | 13   |
| 18:00 | 3    |
| 18:30 | 2    |
| 22:00 | 4    |

### Weekend

| Time  | Plan |
|-------|------|
| 0:15  | 4    |
| 8:00  | 2    |
| 22:00 | 4    |

## Notes

- †: Time for each direction includes amber and all red intervals
- ‡: Start of first phase should be used as reference point for offset
- Asterisk (\*) Indicates actuated phase
- (fp): Fully Protected Left Turn
- ◄.....► Pedestrian signal

Cost is \$62.38 (\$55.20 + HST)

## **APPENDIX K**

---

Existing Synchro Analysis

1: March & Morgan's Grant/Shirley's Brook  
AM Peak Hour

555-603 March Road  
2022 Existing Traffic



| Lane Group                 | EBL   | EBT   | EBR   | WBL   | WBT   | WBR   | NBL   | NBT   | NBR   | SBL   | SBT   | SBR   |
|----------------------------|-------|-------|-------|-------|-------|-------|-------|-------|-------|-------|-------|-------|
| Lane Configurations        |       | ↕     | ↗     | ↖     | ↕     | ↗     | ↖     | ↕↕↕   | ↗     | ↖     | ↕↕↕   | ↗     |
| Traffic Volume (vph)       | 8     | 8     | 80    | 92    | 7     | 9     | 21    | 435   | 48    | 15    | 717   | 5     |
| Future Volume (vph)        | 8     | 8     | 80    | 92    | 7     | 9     | 21    | 435   | 48    | 15    | 717   | 5     |
| Ideal Flow (vphpl)         | 1800  | 1800  | 1800  | 1800  | 1800  | 1800  | 1800  | 1800  | 1800  | 1800  | 1800  | 1800  |
| Storage Length (m)         | 0.0   |       | 20.0  | 45.0  |       | 35.0  | 130.0 |       | 30.0  | 65.0  |       | 25.0  |
| Storage Lanes              | 0     |       | 1     | 1     |       | 1     | 1     |       | 1     | 1     |       | 1     |
| Taper Length (m)           | 10.0  |       |       | 30.0  |       |       | 40.0  |       |       | 35.0  |       |       |
| Lane Util. Factor          | 1.00  | 1.00  | 1.00  | 1.00  | 1.00  | 1.00  | 1.00  | 0.91  | 1.00  | 1.00  | 0.91  | 1.00  |
| Ped Bike Factor            |       | 1.00  | 0.99  | 1.00  |       | 0.99  | 1.00  |       | 0.97  | 0.99  |       | 0.97  |
| Frt                        |       |       | 0.850 |       |       | 0.850 |       |       | 0.850 |       |       | 0.850 |
| Flt Protected              |       | 0.976 |       | 0.950 |       |       | 0.950 |       |       | 0.950 |       |       |
| Satd. Flow (prot)          | 0     | 1720  | 1498  | 1580  | 1271  | 1498  | 1674  | 4628  | 1427  | 1674  | 4718  | 1498  |
| Flt Permitted              |       | 0.876 |       | 0.746 |       |       | 0.950 |       |       | 0.950 |       |       |
| Satd. Flow (perm)          | 0     | 1543  | 1478  | 1239  | 1271  | 1478  | 1666  | 4628  | 1383  | 1665  | 4718  | 1447  |
| Right Turn on Red          |       |       | Yes   |       |       | Yes   |       |       | Yes   |       |       | Yes   |
| Satd. Flow (RTOR)          |       |       | 89    |       |       | 80    |       |       | 91    |       |       | 91    |
| Link Speed (k/h)           |       | 40    |       |       | 40    |       |       | 80    |       |       | 80    |       |
| Link Distance (m)          |       | 465.2 |       |       | 359.5 |       |       | 318.9 |       |       | 462.6 |       |
| Travel Time (s)            |       | 41.9  |       |       | 32.4  |       |       | 14.4  |       |       | 20.8  |       |
| Confl. Peds. (#/hr)        | 1     |       | 1     | 1     |       | 1     | 4     |       | 3     | 3     |       | 4     |
| Confl. Bikes (#/hr)        |       |       |       |       |       |       |       |       | 1     |       |       |       |
| Peak Hour Factor           | 0.90  | 0.90  | 0.90  | 0.90  | 0.90  | 0.90  | 0.90  | 0.90  | 0.90  | 0.90  | 0.90  | 0.90  |
| Heavy Vehicles (%)         | 1%    | 1%    | 1%    | 7%    | 40%   | 1%    | 1%    | 5%    | 6%    | 1%    | 3%    | 1%    |
| Adj. Flow (vph)            | 9     | 9     | 89    | 102   | 8     | 10    | 23    | 483   | 53    | 17    | 797   | 6     |
| Shared Lane Traffic (%)    |       |       |       |       |       |       |       |       |       |       |       |       |
| Lane Group Flow (vph)      | 0     | 18    | 89    | 102   | 8     | 10    | 23    | 483   | 53    | 17    | 797   | 6     |
| Enter Blocked Intersection | No    | No    | No    | No    | No    | No    | No    | No    | No    | No    | No    | No    |
| Lane Alignment             | L NA  | Left  | R NA  | L NA  | Left  | R NA  | L NA  | Left  | R NA  | L NA  | Left  | R NA  |
| Median Width(m)            |       | 3.5   |       |       | 5.0   |       |       | 9.0   |       |       | 9.0   |       |
| Link Offset(m)             |       | 0.0   |       |       | 0.0   |       |       | 0.0   |       |       | 0.0   |       |
| Crosswalk Width(m)         |       | 5.0   |       |       | 5.0   |       |       | 5.0   |       |       | 5.0   |       |
| Two way Left Turn Lane     |       |       |       |       |       |       |       |       |       |       |       |       |
| Headway Factor             | 1.09  | 1.09  | 1.09  | 1.09  | 1.09  | 1.09  | 1.09  | 1.09  | 1.09  | 1.09  | 1.09  | 1.09  |
| Number of Detectors        | 1     | 2     | 1     | 1     | 2     | 1     | 1     | 2     | 1     | 1     | 2     | 1     |
| Detector Template          | Left  | Thru  | Right | Left  | Thru  | Right | Left  | Thru  | Right | Left  | Thru  | Right |
| Leading Detector (m)       | 2.0   | 10.0  | 2.0   | 2.0   | 10.0  | 2.0   | 2.0   | 10.0  | 2.0   | 2.0   | 10.0  | 2.0   |
| Trailing Detector (m)      | 0.0   | 0.0   | 0.0   | 0.0   | 0.0   | 0.0   | 0.0   | 0.0   | 0.0   | 0.0   | 0.0   | 0.0   |
| Detector 1 Position(m)     | 0.0   | 0.0   | 0.0   | 0.0   | 0.0   | 0.0   | 0.0   | 0.0   | 0.0   | 0.0   | 0.0   | 0.0   |
| Detector 1 Size(m)         | 2.0   | 0.6   | 2.0   | 2.0   | 0.6   | 2.0   | 2.0   | 0.6   | 2.0   | 2.0   | 0.6   | 2.0   |
| Detector 1 Type            | Cl+Ex | Cl+Ex | Cl+Ex | Cl+Ex | Cl+Ex | Cl+Ex | Cl+Ex | Cl+Ex | Cl+Ex | Cl+Ex | Cl+Ex | Cl+Ex |
| Detector 1 Channel         |       |       |       |       |       |       |       |       |       |       |       |       |
| Detector 1 Extend (s)      | 0.0   | 0.0   | 0.0   | 0.0   | 0.0   | 0.0   | 0.0   | 0.0   | 0.0   | 0.0   | 0.0   | 0.0   |
| Detector 1 Queue (s)       | 0.0   | 0.0   | 0.0   | 0.0   | 0.0   | 0.0   | 0.0   | 0.0   | 0.0   | 0.0   | 0.0   | 0.0   |
| Detector 1 Delay (s)       | 0.0   | 0.0   | 0.0   | 0.0   | 0.0   | 0.0   | 0.0   | 0.0   | 0.0   | 0.0   | 0.0   | 0.0   |
| Detector 2 Position(m)     |       | 9.4   |       |       | 9.4   |       |       | 9.4   |       |       | 9.4   |       |
| Detector 2 Size(m)         |       | 0.6   |       |       | 0.6   |       |       | 0.6   |       |       | 0.6   |       |
| Detector 2 Type            |       | Cl+Ex |       |       | Cl+Ex |       |       | Cl+Ex |       |       | Cl+Ex |       |
| Detector 2 Channel         |       |       |       |       |       |       |       |       |       |       |       |       |
| Detector 2 Extend (s)      |       | 0.0   |       |       | 0.0   |       |       | 0.0   |       |       | 0.0   |       |
| Turn Type                  | Perm  | NA    | Perm  | Perm  | NA    | Perm  | Prot  | NA    | Perm  | Prot  | NA    | Perm  |
| Protected Phases           |       | 4     |       |       | 8     |       | 5     | 2     |       | 1     | 6     |       |
| Permitted Phases           | 4     |       | 4     | 8     |       | 8     |       |       | 2     |       |       | 6     |
| Detector Phase             | 4     | 4     | 4     | 8     | 8     | 8     | 5     | 2     | 2     | 1     | 6     | 6     |
| Switch Phase               |       |       |       |       |       |       |       |       |       |       |       |       |



| Lane Group              | EBL   | EBT   | EBR   | WBL   | WBT   | WBR   | NBL   | NBT   | NBR   | SBL   | SBT   | SBR   |
|-------------------------|-------|-------|-------|-------|-------|-------|-------|-------|-------|-------|-------|-------|
| Minimum Initial (s)     | 10.0  | 10.0  | 10.0  | 10.0  | 10.0  | 10.0  | 5.0   | 20.0  | 20.0  | 5.0   | 20.0  | 20.0  |
| Minimum Split (s)       | 38.5  | 38.5  | 38.5  | 38.5  | 38.5  | 38.5  | 11.4  | 26.1  | 26.1  | 11.4  | 26.1  | 26.1  |
| Total Split (s)         | 39.0  | 39.0  | 39.0  | 39.0  | 39.0  | 39.0  | 21.0  | 70.0  | 70.0  | 21.0  | 70.0  | 70.0  |
| Total Split (%)         | 30.0% | 30.0% | 30.0% | 30.0% | 30.0% | 30.0% | 16.2% | 53.8% | 53.8% | 16.2% | 53.8% | 53.8% |
| Maximum Green (s)       | 31.5  | 31.5  | 31.5  | 31.5  | 31.5  | 31.5  | 14.6  | 63.9  | 63.9  | 14.6  | 63.9  | 63.9  |
| Yellow Time (s)         | 3.0   | 3.0   | 3.0   | 3.0   | 3.0   | 3.0   | 4.6   | 4.6   | 4.6   | 4.6   | 4.6   | 4.6   |
| All-Red Time (s)        | 4.5   | 4.5   | 4.5   | 4.5   | 4.5   | 4.5   | 1.8   | 1.5   | 1.5   | 1.8   | 1.5   | 1.5   |
| Lost Time Adjust (s)    |       | 0.0   | 0.0   | 0.0   | 0.0   | 0.0   | 0.0   | 0.0   | 0.0   | 0.0   | 0.0   | 0.0   |
| Total Lost Time (s)     |       | 7.5   | 7.5   | 7.5   | 7.5   | 7.5   | 6.4   | 6.1   | 6.1   | 6.4   | 6.1   | 6.1   |
| Lead/Lag                |       |       |       |       |       |       | Lead  | Lag   | Lag   | Lead  | Lag   | Lag   |
| Lead-Lag Optimize?      |       |       |       |       |       |       | Yes   | Yes   | Yes   | Yes   | Yes   | Yes   |
| Vehicle Extension (s)   | 3.0   | 3.0   | 3.0   | 3.0   | 3.0   | 3.0   | 3.0   | 3.0   | 3.0   | 3.0   | 3.0   | 3.0   |
| Recall Mode             | None  | None  | None  | None  | None  | None  | None  | C-Max | C-Max | None  | C-Max | C-Max |
| Walk Time (s)           | 7.0   | 7.0   | 7.0   | 7.0   | 7.0   | 7.0   |       | 7.0   | 7.0   |       | 7.0   | 7.0   |
| Flash Dont Walk (s)     | 24.0  | 24.0  | 24.0  | 24.0  | 24.0  | 24.0  |       | 11.0  | 11.0  |       | 11.0  | 11.0  |
| Pedestrian Calls (#/hr) | 1     | 1     | 1     | 1     | 1     | 1     |       | 4     | 4     |       | 3     | 3     |
| Act Effct Green (s)     |       | 17.8  | 17.8  | 17.8  | 17.8  | 17.8  | 7.3   | 92.7  | 92.7  | 6.9   | 89.7  | 89.7  |
| Actuated g/C Ratio      |       | 0.14  | 0.14  | 0.14  | 0.14  | 0.14  | 0.06  | 0.71  | 0.71  | 0.05  | 0.69  | 0.69  |
| v/c Ratio               |       | 0.09  | 0.32  | 0.60  | 0.05  | 0.04  | 0.24  | 0.15  | 0.05  | 0.19  | 0.24  | 0.01  |
| Control Delay           |       | 45.4  | 11.5  | 65.7  | 43.9  | 0.2   | 64.4  | 7.9   | 2.4   | 63.2  | 9.6   | 0.0   |
| Queue Delay             |       | 0.0   | 0.0   | 0.0   | 0.0   | 0.0   | 0.0   | 0.0   | 0.0   | 0.0   | 0.0   | 0.0   |
| Total Delay             |       | 45.4  | 11.5  | 65.7  | 43.9  | 0.2   | 64.4  | 7.9   | 2.4   | 63.2  | 9.6   | 0.0   |
| LOS                     |       | D     | B     | E     | D     | A     | E     | A     | A     | E     | A     | A     |
| Approach Delay          |       | 17.2  |       |       | 58.8  |       |       | 9.7   |       |       | 10.6  |       |
| Approach LOS            |       | B     |       |       | E     |       |       | A     |       |       | B     |       |
| Queue Length 50th (m)   |       | 3.8   | 0.0   | 23.4  | 1.7   | 0.0   | 5.8   | 10.2  | 0.0   | 3.9   | 25.4  | 0.0   |
| Queue Length 95th (m)   |       | 9.4   | 12.3  | 35.7  | 5.4   | 0.0   | 14.9  | 19.4  | 0.7   | 11.1  | 45.4  | 0.0   |
| Internal Link Dist (m)  |       | 441.2 |       |       | 335.5 |       |       | 294.9 |       |       | 438.6 |       |
| Turn Bay Length (m)     |       |       | 20.0  | 45.0  |       | 35.0  | 130.0 |       | 30.0  | 65.0  |       | 25.0  |
| Base Capacity (vph)     |       | 373   | 425   | 300   | 307   | 418   | 188   | 3300  | 1012  | 188   | 3256  | 1026  |
| Starvation Cap Reductn  |       | 0     | 0     | 0     | 0     | 0     | 0     | 0     | 0     | 0     | 0     | 0     |
| Spillback Cap Reductn   |       | 0     | 0     | 0     | 0     | 0     | 0     | 0     | 0     | 0     | 0     | 0     |
| Storage Cap Reductn     |       | 0     | 0     | 0     | 0     | 0     | 0     | 0     | 0     | 0     | 0     | 0     |
| Reduced v/c Ratio       |       | 0.05  | 0.21  | 0.34  | 0.03  | 0.02  | 0.12  | 0.15  | 0.05  | 0.09  | 0.24  | 0.01  |

**Intersection Summary**  
 Area Type: Other  
 Cycle Length: 130  
 Actuated Cycle Length: 130  
 Offset: 95 (73%), Referenced to phase 2:NBT and 6:SBT, Start of Green  
 Natural Cycle: 80  
 Control Type: Actuated-Coordinated  
 Maximum v/c Ratio: 0.60  
 Intersection Signal Delay: 14.3  
 Intersection Capacity Utilization 52.1%  
 Analysis Period (min) 15  
 Intersection LOS: B  
 ICU Level of Service A

Splits and Phases: 1: March & Morgan's Grant/Shirley's Brook





2: March & Terry Fox  
AM Peak Hour

555-603 March Road  
2022 Existing Traffic



| Lane Group                 | EBL   | EBT   | EBR   | WBL   | WBT   | WBR   | NBU   | NBL   | NBT   | NBR   | SBU   | SBL   |
|----------------------------|-------|-------|-------|-------|-------|-------|-------|-------|-------|-------|-------|-------|
| Lane Configurations        | ↖↖    | ↕↕    | ↗     | ↖↖    | ↕↕    | ↗     |       | ↖↖    | ↕↕↕   | ↗     |       | ↖     |
| Traffic Volume (vph)       | 80    | 158   | 220   | 41    | 69    | 24    | 14    | 139   | 400   | 91    | 1     | 83    |
| Future Volume (vph)        | 80    | 158   | 220   | 41    | 69    | 24    | 14    | 139   | 400   | 91    | 1     | 83    |
| Ideal Flow (vphpl)         | 1800  | 1800  | 1800  | 1800  | 1800  | 1800  | 1800  | 1800  | 1800  | 1800  | 1800  | 1800  |
| Storage Length (m)         | 95.0  |       | 60.0  | 75.0  |       | 75.0  |       | 130.0 |       | 85.0  |       | 110.0 |
| Storage Lanes              | 2     |       | 2     | 2     |       | 1     |       | 2     |       | 2     |       | 1     |
| Taper Length (m)           | 40.0  |       |       | 20.0  |       |       |       | 90.0  |       |       |       | 40.0  |
| Lane Util. Factor          | 0.97  | 0.95  | 1.00  | 0.97  | 0.95  | 1.00  | 0.91  | 0.97  | 0.91  | 1.00  | 0.91  | 1.00  |
| Ped Bike Factor            |       |       | 0.97  | 0.99  |       | 0.99  |       | 1.00  |       | 0.98  |       | 1.00  |
| Frt                        |       |       | 0.850 |       |       | 0.850 |       |       |       | 0.850 |       |       |
| Flt Protected              | 0.950 |       |       | 0.950 |       |       |       | 0.950 |       |       |       | 0.950 |
| Satd. Flow (prot)          | 3185  | 3316  | 1483  | 3248  | 3161  | 1498  | 0     | 3245  | 4628  | 1469  | 0     | 1674  |
| Flt Permitted              | 0.950 |       |       | 0.950 |       |       |       | 0.950 |       |       |       | 0.950 |
| Satd. Flow (perm)          | 3185  | 3316  | 1443  | 3228  | 3161  | 1479  | 0     | 3237  | 4628  | 1438  | 0     | 1667  |
| Right Turn on Red          |       |       | Yes   |       |       | Yes   |       |       |       | Yes   |       |       |
| Satd. Flow (RTOR)          |       |       | 244   |       |       | 145   |       |       |       | 147   |       |       |
| Link Speed (k/h)           |       | 60    |       |       | 60    |       |       |       | 80    |       |       |       |
| Link Distance (m)          |       | 165.4 |       |       | 149.1 |       |       |       | 308.9 |       |       |       |
| Travel Time (s)            |       | 9.9   |       |       | 8.9   |       |       |       | 13.9  |       |       |       |
| Confl. Peds. (#/hr)        |       |       | 7     | 7     |       |       |       | 3     |       | 5     |       | 5     |
| Confl. Bikes (#/hr)        |       |       | 9     |       |       | 1     |       |       |       | 2     |       |       |
| Peak Hour Factor           | 0.90  | 0.90  | 0.90  | 0.90  | 0.90  | 0.90  | 0.90  | 0.90  | 0.90  | 0.90  | 0.90  | 0.90  |
| Heavy Vehicles (%)         | 3%    | 2%    | 2%    | 1%    | 7%    | 1%    | 2%    | 1%    | 5%    | 3%    | 2%    | 1%    |
| Adj. Flow (vph)            | 89    | 176   | 244   | 46    | 77    | 27    | 16    | 154   | 444   | 101   | 1     | 92    |
| Shared Lane Traffic (%)    |       |       |       |       |       |       |       |       |       |       |       |       |
| Lane Group Flow (vph)      | 89    | 176   | 244   | 46    | 77    | 27    | 0     | 170   | 444   | 101   | 0     | 93    |
| Enter Blocked Intersection | No    | No    | No    | Yes   | Yes   | Yes   | No    | No    | No    | No    | No    | No    |
| Lane Alignment             | L NA  | Left  | R NA  | L NA  | Left  | R NA  | R NA  | L NA  | Left  | R NA  | R NA  | L NA  |
| Median Width(m)            |       | 10.5  |       |       | 10.5  |       |       |       | 10.5  |       |       |       |
| Link Offset(m)             |       | 0.0   |       |       | 0.0   |       |       |       | 0.0   |       |       |       |
| Crosswalk Width(m)         |       | 5.0   |       |       | 5.0   |       |       |       | 5.0   |       |       |       |
| Two way Left Turn Lane     |       |       |       |       |       |       |       |       |       |       |       |       |
| Headway Factor             | 1.09  | 1.09  | 1.09  | 1.09  | 1.09  | 1.09  | 1.09  | 1.09  | 1.09  | 1.09  | 1.09  | 1.09  |
| Number of Detectors        | 1     | 2     | 1     | 1     | 2     | 1     | 1     | 1     | 2     | 1     | 1     | 1     |
| Detector Template          | Left  | Thru  | Right | Left  | Thru  | Right | Left  | Left  | Thru  | Right | Left  | Left  |
| Leading Detector (m)       | 2.0   | 10.0  | 2.0   | 2.0   | 10.0  | 2.0   | 2.0   | 2.0   | 10.0  | 2.0   | 2.0   | 2.0   |
| Trailing Detector (m)      | 0.0   | 0.0   | 0.0   | 0.0   | 0.0   | 0.0   | 0.0   | 0.0   | 0.0   | 0.0   | 0.0   | 0.0   |
| Detector 1 Position(m)     | 0.0   | 0.0   | 0.0   | 0.0   | 0.0   | 0.0   | 0.0   | 0.0   | 0.0   | 0.0   | 0.0   | 0.0   |
| Detector 1 Size(m)         | 2.0   | 0.6   | 2.0   | 2.0   | 0.6   | 2.0   | 2.0   | 2.0   | 0.6   | 2.0   | 2.0   | 2.0   |
| Detector 1 Type            | Cl+Ex | Cl+Ex | Cl+Ex | Cl+Ex | Cl+Ex | Cl+Ex | Cl+Ex | Cl+Ex | Cl+Ex | Cl+Ex | Cl+Ex | Cl+Ex |
| Detector 1 Channel         |       |       |       |       |       |       |       |       |       |       |       |       |
| Detector 1 Extend (s)      | 0.0   | 0.0   | 0.0   | 0.0   | 0.0   | 0.0   | 0.0   | 0.0   | 0.0   | 0.0   | 0.0   | 0.0   |
| Detector 1 Queue (s)       | 0.0   | 0.0   | 0.0   | 0.0   | 0.0   | 0.0   | 0.0   | 0.0   | 0.0   | 0.0   | 0.0   | 0.0   |
| Detector 1 Delay (s)       | 0.0   | 0.0   | 0.0   | 0.0   | 0.0   | 0.0   | 0.0   | 0.0   | 0.0   | 0.0   | 0.0   | 0.0   |
| Detector 2 Position(m)     |       | 9.4   |       |       | 9.4   |       |       |       | 9.4   |       |       |       |
| Detector 2 Size(m)         |       | 0.6   |       |       | 0.6   |       |       |       | 0.6   |       |       |       |
| Detector 2 Type            |       | Cl+Ex |       |       | Cl+Ex |       |       |       | Cl+Ex |       |       |       |
| Detector 2 Channel         |       |       |       |       |       |       |       |       |       |       |       |       |
| Detector 2 Extend (s)      |       | 0.0   |       |       | 0.0   |       |       |       | 0.0   |       |       |       |
| Turn Type                  | Prot  | NA    | Perm  | Prot  | NA    | Perm  | Prot  | Prot  | NA    | Perm  | Prot  | Prot  |
| Protected Phases           | 7     | 4     |       | 3     | 8     |       | 5     | 5     | 2     |       | 1     | 1     |
| Permitted Phases           |       |       | 4     |       |       | 8     |       |       |       | 2     |       |       |
| Detector Phase             | 7     | 4     | 4     | 3     | 8     | 8     | 5     | 5     | 2     | 2     | 1     | 1     |
| Switch Phase               |       |       |       |       |       |       |       |       |       |       |       |       |

2: March & Terry Fox  
AM Peak Hour

555-603 March Road  
2022 Existing Traffic



| Lane Group                 | SBT   | SBR   |
|----------------------------|-------|-------|
| Lane Configurations        | ↑↑↑   | ↑     |
| Traffic Volume (vph)       | 694   | 118   |
| Future Volume (vph)        | 694   | 118   |
| Ideal Flow (vphpl)         | 1800  | 1800  |
| Storage Length (m)         |       | 100.0 |
| Storage Lanes              |       | 1     |
| Taper Length (m)           |       |       |
| Lane Util. Factor          | 0.91  | 1.00  |
| Ped Bike Factor            |       | 0.98  |
| Frt                        |       | 0.850 |
| Flt Protected              |       |       |
| Satd. Flow (prot)          | 4718  | 1469  |
| Flt Permitted              |       |       |
| Satd. Flow (perm)          | 4718  | 1445  |
| Right Turn on Red          |       | Yes   |
| Satd. Flow (RTOR)          |       | 147   |
| Link Speed (k/h)           | 80    |       |
| Link Distance (m)          | 318.9 |       |
| Travel Time (s)            | 14.4  |       |
| Confl. Peds. (#/hr)        |       | 3     |
| Confl. Bikes (#/hr)        |       |       |
| Peak Hour Factor           | 0.90  | 0.90  |
| Heavy Vehicles (%)         | 3%    | 3%    |
| Adj. Flow (vph)            | 771   | 131   |
| Shared Lane Traffic (%)    |       |       |
| Lane Group Flow (vph)      | 771   | 131   |
| Enter Blocked Intersection | No    | No    |
| Lane Alignment             | Left  | R NA  |
| Median Width(m)            | 7.0   |       |
| Link Offset(m)             | 0.0   |       |
| Crosswalk Width(m)         | 5.0   |       |
| Two way Left Turn Lane     |       |       |
| Headway Factor             | 1.09  | 1.09  |
| Number of Detectors        | 2     | 1     |
| Detector Template          | Thru  | Right |
| Leading Detector (m)       | 10.0  | 2.0   |
| Trailing Detector (m)      | 0.0   | 0.0   |
| Detector 1 Position(m)     | 0.0   | 0.0   |
| Detector 1 Size(m)         | 0.6   | 2.0   |
| Detector 1 Type            | CI+Ex | CI+Ex |
| Detector 1 Channel         |       |       |
| Detector 1 Extend (s)      | 0.0   | 0.0   |
| Detector 1 Queue (s)       | 0.0   | 0.0   |
| Detector 1 Delay (s)       | 0.0   | 0.0   |
| Detector 2 Position(m)     | 9.4   |       |
| Detector 2 Size(m)         | 0.6   |       |
| Detector 2 Type            | CI+Ex |       |
| Detector 2 Channel         |       |       |
| Detector 2 Extend (s)      | 0.0   |       |
| Turn Type                  | NA    | Perm  |
| Protected Phases           | 6     |       |
| Permitted Phases           |       | 6     |
| Detector Phase             | 6     | 6     |
| Switch Phase               |       |       |

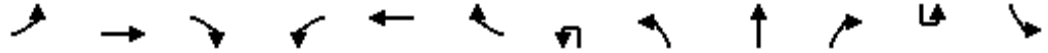

| Lane Group              | EBL   | EBT   | EBR   | WBL   | WBT   | WBR   | NBU   | NBL   | NBT   | NBR   | SBU   | SBL   |
|-------------------------|-------|-------|-------|-------|-------|-------|-------|-------|-------|-------|-------|-------|
| Minimum Initial (s)     | 5.0   | 10.0  | 10.0  | 5.0   | 10.0  | 10.0  | 5.0   | 5.0   | 20.0  | 20.0  | 5.0   | 5.0   |
| Minimum Split (s)       | 11.8  | 42.0  | 42.0  | 11.8  | 42.0  | 42.0  | 11.9  | 11.9  | 32.7  | 32.7  | 11.9  | 11.9  |
| Total Split (s)         | 16.0  | 42.0  | 42.0  | 16.0  | 42.0  | 42.0  | 25.0  | 25.0  | 47.0  | 47.0  | 25.0  | 25.0  |
| Total Split (%)         | 12.3% | 32.3% | 32.3% | 12.3% | 32.3% | 32.3% | 19.2% | 19.2% | 36.2% | 36.2% | 19.2% | 19.2% |
| Maximum Green (s)       | 9.2   | 35.1  | 35.1  | 9.2   | 35.1  | 35.1  | 18.2  | 18.2  | 40.3  | 40.3  | 18.2  | 18.2  |
| Yellow Time (s)         | 3.7   | 3.7   | 3.7   | 3.7   | 3.7   | 3.7   | 4.6   | 4.6   | 4.6   | 4.6   | 4.6   | 4.6   |
| All-Red Time (s)        | 3.1   | 3.2   | 3.2   | 3.1   | 3.2   | 3.2   | 2.2   | 2.2   | 2.1   | 2.1   | 2.2   | 2.2   |
| Lost Time Adjust (s)    | 0.0   | 0.0   | 0.0   | 0.0   | 0.0   | 0.0   |       | 0.0   | 0.0   | 0.0   |       | 0.0   |
| Total Lost Time (s)     | 6.8   | 6.9   | 6.9   | 6.8   | 6.9   | 6.9   |       | 6.8   | 6.7   | 6.7   |       | 6.8   |
| Lead/Lag                | Lead  | Lag   | Lag   | Lead  | Lag   | Lag   | Lead  | Lead  | Lag   | Lag   | Lead  | Lead  |
| Lead-Lag Optimize?      | Yes   | Yes   | Yes   | Yes   | Yes   | Yes   | Yes   | Yes   | Yes   | Yes   | Yes   | Yes   |
| Vehicle Extension (s)   | 3.0   | 3.0   | 3.0   | 3.0   | 3.0   | 3.0   | 3.0   | 3.0   | 3.0   | 3.0   | 3.0   | 3.0   |
| Recall Mode             | None  | None  | None  | None  | None  | None  | None  | None  | C-Max | C-Max | None  | None  |
| Walk Time (s)           |       | 7.0   | 7.0   |       | 7.0   | 7.0   |       |       | 7.0   | 7.0   |       |       |
| Flash Dont Walk (s)     |       | 28.0  | 28.0  |       | 28.0  | 28.0  |       |       | 19.0  | 19.0  |       |       |
| Pedestrian Calls (#/hr) |       | 7     | 7     |       | 1     | 1     |       |       | 5     | 5     |       |       |
| Act Effct Green (s)     | 9.1   | 16.5  | 16.5  | 7.3   | 15.6  | 15.6  |       | 12.1  | 69.0  | 69.0  |       | 12.5  |
| Actuated g/C Ratio      | 0.07  | 0.13  | 0.13  | 0.06  | 0.12  | 0.12  |       | 0.09  | 0.53  | 0.53  |       | 0.10  |
| v/c Ratio               | 0.40  | 0.42  | 0.62  | 0.25  | 0.20  | 0.09  |       | 0.56  | 0.18  | 0.12  |       | 0.58  |
| Control Delay           | 59.5  | 50.9  | 15.3  | 61.7  | 50.0  | 0.6   |       | 58.9  | 23.6  | 7.3   |       | 85.9  |
| Queue Delay             | 0.0   | 0.0   | 0.0   | 0.0   | 0.0   | 0.0   |       | 0.0   | 0.0   | 0.0   |       | 0.0   |
| Total Delay             | 59.5  | 50.9  | 15.3  | 61.7  | 50.0  | 0.6   |       | 58.9  | 23.6  | 7.3   |       | 85.9  |
| LOS                     | E     | D     | B     | E     | D     | A     |       | E     | C     | A     |       | F     |
| Approach Delay          |       | 35.3  |       |       | 44.7  |       |       |       | 29.7  |       |       |       |
| Approach LOS            |       | D     |       |       | D     |       |       |       | C     |       |       |       |
| Queue Length 50th (m)   | 10.7  | 21.7  | 8.4   | 5.4   | 9.1   | 0.0   |       | 20.1  | 18.0  | 0.0   |       | 23.4  |
| Queue Length 95th (m)   | 16.4  | 28.4  | 28.8  | 11.2  | 13.1  | 0.0   |       | 32.0  | 41.2  | 11.7  |       | 36.9  |
| Internal Link Dist (m)  |       | 141.4 |       |       | 125.1 |       |       |       | 284.9 |       |       |       |
| Turn Bay Length (m)     | 95.0  |       | 60.0  | 75.0  |       | 75.0  |       | 130.0 |       | 85.0  |       | 110.0 |
| Base Capacity (vph)     | 229   | 895   | 567   | 229   | 853   | 505   |       | 454   | 2455  | 831   |       | 234   |
| Starvation Cap Reductn  | 0     | 0     | 0     | 0     | 0     | 0     |       | 0     | 0     | 0     |       | 0     |
| Spillback Cap Reductn   | 0     | 0     | 0     | 0     | 0     | 0     |       | 0     | 0     | 0     |       | 0     |
| Storage Cap Reductn     | 0     | 0     | 0     | 0     | 0     | 0     |       | 0     | 0     | 0     |       | 0     |
| Reduced v/c Ratio       | 0.39  | 0.20  | 0.43  | 0.20  | 0.09  | 0.05  |       | 0.37  | 0.18  | 0.12  |       | 0.40  |

Intersection Summary

Area Type: Other  
 Cycle Length: 130  
 Actuated Cycle Length: 130  
 Offset: 114 (88%), Referenced to phase 2:NBT and 6:SBT, Start of Green  
 Natural Cycle: 100  
 Control Type: Actuated-Coordinated  
 Maximum v/c Ratio: 0.62  
 Intersection Signal Delay: 27.8  
 Intersection Capacity Utilization 71.1%  
 Analysis Period (min) 15  
 Intersection LOS: C  
 ICU Level of Service C

Splits and Phases: 2: March & Terry Fox

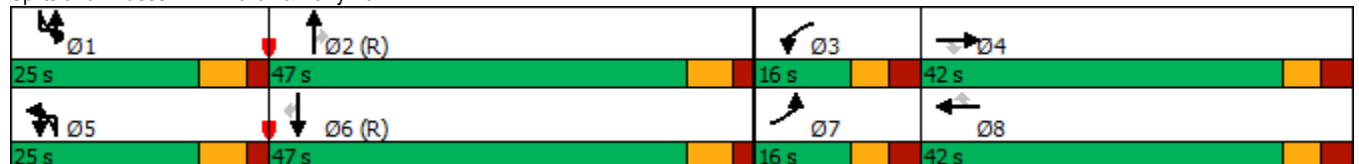



| Lane Group                  | SBT   | SBR   |
|-----------------------------|-------|-------|
| Minimum Initial (s)         | 20.0  | 20.0  |
| Minimum Split (s)           | 32.7  | 32.7  |
| Total Split (s)             | 47.0  | 47.0  |
| Total Split (%)             | 36.2% | 36.2% |
| Maximum Green (s)           | 40.3  | 40.3  |
| Yellow Time (s)             | 4.6   | 4.6   |
| All-Red Time (s)            | 2.1   | 2.1   |
| Lost Time Adjust (s)        | 0.0   | 0.0   |
| Total Lost Time (s)         | 6.7   | 6.7   |
| Lead/Lag                    | Lag   | Lag   |
| Lead-Lag Optimize?          | Yes   | Yes   |
| Vehicle Extension (s)       | 3.0   | 3.0   |
| Recall Mode                 | C-Max | C-Max |
| Walk Time (s)               | 7.0   | 7.0   |
| Flash Dont Walk (s)         | 19.0  | 19.0  |
| Pedestrian Calls (#/hr)     | 3     | 3     |
| Act Effct Green (s)         | 69.4  | 69.4  |
| Actuated g/C Ratio          | 0.53  | 0.53  |
| v/c Ratio                   | 0.31  | 0.16  |
| Control Delay               | 15.2  | 1.5   |
| Queue Delay                 | 0.0   | 0.0   |
| Total Delay                 | 15.2  | 1.5   |
| LOS                         | B     | A     |
| Approach Delay              | 20.0  |       |
| Approach LOS                | C     |       |
| Queue Length 50th (m)       | 18.8  | 0.3   |
| Queue Length 95th (m)       | 68.2  | 3.4   |
| Internal Link Dist (m)      | 294.9 |       |
| Turn Bay Length (m)         |       | 100.0 |
| Base Capacity (vph)         | 2517  | 839   |
| Starvation Cap Reductn      | 0     | 0     |
| Spillback Cap Reductn       | 0     | 0     |
| Storage Cap Reductn         | 0     | 0     |
| Reduced v/c Ratio           | 0.31  | 0.16  |
| <b>Intersection Summary</b> |       |       |

3: March & Solandt  
AM Peak Hour

555-603 March Road  
2022 Existing Traffic

| Lane Group                 | EBL   | EBT   | EBR   | WBL   | WBT   | WBR  | NBU   | NBL   | NBT   | NBR   | SBU   | SBL   |
|----------------------------|-------|-------|-------|-------|-------|------|-------|-------|-------|-------|-------|-------|
| Lane Configurations        |       |       |       |       |       |      |       |       |       |       |       |       |
| Traffic Volume (vph)       | 14    | 28    | 100   | 60    | 13    | 11   | 2     | 260   | 622   | 223   | 2     | 50    |
| Future Volume (vph)        | 14    | 28    | 100   | 60    | 13    | 11   | 2     | 260   | 622   | 223   | 2     | 50    |
| Ideal Flow (vphpl)         | 1800  | 1800  | 1800  | 1800  | 1800  | 1800 | 1800  | 1800  | 1800  | 1800  | 1800  | 1800  |
| Storage Length (m)         | 35.0  |       | 60.0  | 85.0  |       |      |       | 165.0 |       | 0.0   |       | 155.0 |
| Storage Lanes              | 1     |       | 1     | 2     |       | 0    |       | 1     |       | 1     |       | 1     |
| Taper Length (m)           | 50.0  |       |       | 95.0  |       |      |       | 40.0  |       |       |       | 25.0  |
| Lane Util. Factor          | 1.00  | 1.00  | 1.00  | 0.97  | 1.00  | 1.00 | 0.95  | 1.00  | 0.95  | 1.00  | 0.95  | 1.00  |
| Ped Bike Factor            |       |       | 0.98  | 0.99  |       |      |       |       |       | 0.98  |       | 1.00  |
| Fr <sub>t</sub>            |       |       | 0.850 |       | 0.931 |      |       |       |       | 0.850 |       |       |
| Fl <sub>t</sub> Protected  | 0.950 |       |       | 0.950 |       |      |       | 0.950 |       |       |       | 0.950 |
| Satd. Flow (prot)          | 1537  | 1728  | 1414  | 3124  | 1421  | 0    | 0     | 1658  | 3283  | 1498  | 0     | 1674  |
| Fl <sub>t</sub> Permitted  | 0.950 |       |       | 0.950 |       |      |       | 0.194 |       |       |       | 0.389 |
| Satd. Flow (perm)          | 1537  | 1728  | 1386  | 3101  | 1421  | 0    | 0     | 339   | 3283  | 1461  | 0     | 684   |
| Right Turn on Red          |       |       | Yes   |       |       | Yes  |       |       |       | Yes   |       |       |
| Satd. Flow (RTOR)          |       |       | 130   |       | 12    |      |       |       |       | 248   |       |       |
| Link Speed (k/h)           |       | 50    |       |       | 50    |      |       |       | 80    |       |       |       |
| Link Distance (m)          |       | 212.6 |       |       | 241.6 |      |       |       | 610.9 |       |       |       |
| Travel Time (s)            |       | 15.3  |       |       | 17.4  |      |       |       | 27.5  |       |       |       |
| Confl. Peds. (#/hr)        |       |       | 3     | 3     |       |      |       |       |       | 1     |       | 1     |
| Confl. Bikes (#/hr)        |       |       | 3     |       |       |      |       |       |       | 2     |       |       |
| Peak Hour Factor           | 0.90  | 0.90  | 0.90  | 0.90  | 0.90  | 0.90 | 0.90  | 0.90  | 0.90  | 0.90  | 0.90  | 0.90  |
| Heavy Vehicles (%)         | 10%   | 3%    | 7%    | 5%    | 30%   | 1%   | 2%    | 2%    | 3%    | 1%    | 2%    | 1%    |
| Adj. Flow (vph)            | 16    | 31    | 111   | 67    | 14    | 12   | 2     | 289   | 691   | 248   | 2     | 56    |
| Shared Lane Traffic (%)    |       |       |       |       |       |      |       |       |       |       |       |       |
| Lane Group Flow (vph)      | 16    | 31    | 111   | 67    | 26    | 0    | 0     | 291   | 691   | 248   | 0     | 58    |
| Enter Blocked Intersection | No    | No    | No    | No    | No    | No   | No    | No    | No    | No    | No    | No    |
| Lane Alignment             | L NA  | Left  | R NA  | L NA  | Left  | R NA | R NA  | L NA  | Left  | R NA  | R NA  | L NA  |
| Median Width(m)            |       | 7.0   |       |       | 10.5  |      |       |       | 3.5   |       |       |       |
| Link Offset(m)             |       | 0.0   |       |       | 0.0   |      |       |       | 0.0   |       |       |       |
| Crosswalk Width(m)         |       | 5.0   |       |       | 5.0   |      |       |       | 5.0   |       |       |       |
| Two way Left Turn Lane     |       |       |       |       |       |      |       |       |       |       |       |       |
| Headway Factor             | 1.09  | 1.09  | 1.09  | 1.09  | 1.09  | 1.09 | 1.09  | 1.09  | 1.09  | 1.09  | 1.09  | 1.09  |
| Number of Detectors        | 1     | 2     | 1     | 1     | 2     |      | 1     | 1     | 2     | 1     | 1     | 1     |
| Detector Template          | Left  | Thru  | Right | Left  | Thru  |      | Left  | Left  | Thru  | Right | Left  | Left  |
| Leading Detector (m)       | 2.0   | 10.0  | 2.0   | 2.0   | 10.0  |      | 2.0   | 2.0   | 10.0  | 2.0   | 2.0   | 2.0   |
| Trailing Detector (m)      | 0.0   | 0.0   | 0.0   | 0.0   | 0.0   |      | 0.0   | 0.0   | 0.0   | 0.0   | 0.0   | 0.0   |
| Detector 1 Position(m)     | 0.0   | 0.0   | 0.0   | 0.0   | 0.0   |      | 0.0   | 0.0   | 0.0   | 0.0   | 0.0   | 0.0   |
| Detector 1 Size(m)         | 2.0   | 0.6   | 2.0   | 2.0   | 0.6   |      | 2.0   | 2.0   | 0.6   | 2.0   | 2.0   | 2.0   |
| Detector 1 Type            | Cl+Ex | Cl+Ex | Cl+Ex | Cl+Ex | Cl+Ex |      | Cl+Ex | Cl+Ex | Cl+Ex | Cl+Ex | Cl+Ex | Cl+Ex |
| Detector 1 Channel         |       |       |       |       |       |      |       |       |       |       |       |       |
| Detector 1 Extend (s)      | 0.0   | 0.0   | 0.0   | 0.0   | 0.0   |      | 0.0   | 0.0   | 0.0   | 0.0   | 0.0   | 0.0   |
| Detector 1 Queue (s)       | 0.0   | 0.0   | 0.0   | 0.0   | 0.0   |      | 0.0   | 0.0   | 0.0   | 0.0   | 0.0   | 0.0   |
| Detector 1 Delay (s)       | 0.0   | 0.0   | 0.0   | 0.0   | 0.0   |      | 0.0   | 0.0   | 0.0   | 0.0   | 0.0   | 0.0   |
| Detector 2 Position(m)     |       | 9.4   |       |       | 9.4   |      |       |       | 9.4   |       |       |       |
| Detector 2 Size(m)         |       | 0.6   |       |       | 0.6   |      |       |       | 0.6   |       |       |       |
| Detector 2 Type            |       | Cl+Ex |       |       | Cl+Ex |      |       |       | Cl+Ex |       |       |       |
| Detector 2 Channel         |       |       |       |       |       |      |       |       |       |       |       |       |
| Detector 2 Extend (s)      |       | 0.0   |       |       | 0.0   |      |       |       | 0.0   |       |       |       |
| Turn Type                  | Prot  | NA    | Perm  | Prot  | NA    |      | pm+pt | pm+pt | NA    | Perm  | Perm  | Perm  |
| Protected Phases           | 7     | 4     |       | 3     | 8     |      | 5     | 5     | 2     |       |       |       |
| Permitted Phases           |       |       | 4     |       |       |      | 2     | 2     |       | 2     | 6     | 6     |
| Detector Phase             | 7     | 4     | 4     | 3     | 8     |      | 5     | 5     | 2     | 2     | 6     | 6     |
| Switch Phase               |       |       |       |       |       |      |       |       |       |       |       |       |

3: March & Solandt  
AM Peak Hour

555-603 March Road  
2022 Existing Traffic

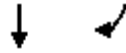

| Lane Group                 | SBT   | SBR   |
|----------------------------|-------|-------|
| Lane Configurations        | ↑↑    | ↑     |
| Traffic Volume (vph)       | 844   | 44    |
| Future Volume (vph)        | 844   | 44    |
| Ideal Flow (vphpl)         | 1800  | 1800  |
| Storage Length (m)         |       | 75.0  |
| Storage Lanes              |       | 1     |
| Taper Length (m)           |       |       |
| Lane Util. Factor          | 0.95  | 1.00  |
| Ped Bike Factor            |       |       |
| Frt                        |       | 0.850 |
| Flt Protected              |       |       |
| Satd. Flow (prot)          | 3283  | 1498  |
| Flt Permitted              |       |       |
| Satd. Flow (perm)          | 3283  | 1498  |
| Right Turn on Red          |       | Yes   |
| Satd. Flow (RTOR)          |       | 132   |
| Link Speed (k/h)           | 80    |       |
| Link Distance (m)          | 610.3 |       |
| Travel Time (s)            | 27.5  |       |
| Confl. Peds. (#/hr)        |       |       |
| Confl. Bikes (#/hr)        |       |       |
| Peak Hour Factor           | 0.90  | 0.90  |
| Heavy Vehicles (%)         | 3%    | 1%    |
| Adj. Flow (vph)            | 938   | 49    |
| Shared Lane Traffic (%)    |       |       |
| Lane Group Flow (vph)      | 938   | 49    |
| Enter Blocked Intersection | No    | No    |
| Lane Alignment             | Left  | R NA  |
| Median Width(m)            | 3.5   |       |
| Link Offset(m)             | 0.0   |       |
| Crosswalk Width(m)         | 5.0   |       |
| Two way Left Turn Lane     |       |       |
| Headway Factor             | 1.09  | 1.09  |
| Number of Detectors        | 2     | 1     |
| Detector Template          | Thru  | Right |
| Leading Detector (m)       | 10.0  | 2.0   |
| Trailing Detector (m)      | 0.0   | 0.0   |
| Detector 1 Position(m)     | 0.0   | 0.0   |
| Detector 1 Size(m)         | 0.6   | 2.0   |
| Detector 1 Type            | CI+Ex | CI+Ex |
| Detector 1 Channel         |       |       |
| Detector 1 Extend (s)      | 0.0   | 0.0   |
| Detector 1 Queue (s)       | 0.0   | 0.0   |
| Detector 1 Delay (s)       | 0.0   | 0.0   |
| Detector 2 Position(m)     | 9.4   |       |
| Detector 2 Size(m)         | 0.6   |       |
| Detector 2 Type            | CI+Ex |       |
| Detector 2 Channel         |       |       |
| Detector 2 Extend (s)      | 0.0   |       |
| Turn Type                  | NA    | Perm  |
| Protected Phases           | 6     |       |
| Permitted Phases           |       | 6     |
| Detector Phase             | 6     | 6     |
| Switch Phase               |       |       |



| Lane Group              | EBL   | EBT   | EBR   | WBL   | WBT   | WBR | NBU   | NBL   | NBT   | NBR   | SBU   | SBL   |
|-------------------------|-------|-------|-------|-------|-------|-----|-------|-------|-------|-------|-------|-------|
| Minimum Initial (s)     | 5.0   | 10.0  | 10.0  | 5.0   | 10.0  |     | 5.0   | 5.0   | 20.0  | 20.0  | 20.0  | 20.0  |
| Minimum Split (s)       | 10.9  | 31.5  | 31.5  | 10.9  | 31.5  |     | 11.3  | 11.3  | 26.3  | 26.3  | 26.3  | 26.3  |
| Total Split (s)         | 13.0  | 32.0  | 32.0  | 13.0  | 32.0  |     | 39.0  | 39.0  | 85.0  | 85.0  | 46.0  | 46.0  |
| Total Split (%)         | 10.0% | 24.6% | 24.6% | 10.0% | 24.6% |     | 30.0% | 30.0% | 65.4% | 65.4% | 35.4% | 35.4% |
| Maximum Green (s)       | 7.1   | 25.5  | 25.5  | 7.1   | 25.5  |     | 32.7  | 32.7  | 78.7  | 78.7  | 39.7  | 39.7  |
| Yellow Time (s)         | 3.3   | 3.3   | 3.3   | 3.3   | 3.3   |     | 4.6   | 4.6   | 4.6   | 4.6   | 4.6   | 4.6   |
| All-Red Time (s)        | 2.6   | 3.2   | 3.2   | 2.6   | 3.2   |     | 1.7   | 1.7   | 1.7   | 1.7   | 1.7   | 1.7   |
| Lost Time Adjust (s)    | 0.0   | 0.0   | 0.0   | 0.0   | 0.0   |     |       | 0.0   | 0.0   | 0.0   | 0.0   | 0.0   |
| Total Lost Time (s)     | 5.9   | 6.5   | 6.5   | 5.9   | 6.5   |     |       | 6.3   | 6.3   | 6.3   |       | 6.3   |
| Lead/Lag                | Lead  | Lag   | Lag   | Lead  | Lag   |     | Lead  | Lead  |       |       | Lag   | Lag   |
| Lead-Lag Optimize?      | Yes   | Yes   | Yes   | Yes   | Yes   |     | Yes   | Yes   |       |       | Yes   | Yes   |
| Vehicle Extension (s)   | 3.0   | 3.0   | 3.0   | 3.0   | 3.0   |     | 3.0   | 3.0   | 3.0   | 3.0   | 3.0   | 3.0   |
| Recall Mode             | None  | None  | None  | None  | None  |     | None  | None  | C-Max | C-Max | C-Max | C-Max |
| Walk Time (s)           |       | 7.0   | 7.0   |       | 7.0   |     |       |       | 7.0   | 7.0   | 7.0   | 7.0   |
| Flash Dont Walk (s)     |       | 18.0  | 18.0  |       | 18.0  |     |       |       | 12.0  | 12.0  | 12.0  | 12.0  |
| Pedestrian Calls (#/hr) |       | 3     | 3     |       | 1     |     |       |       | 1     | 1     | 1     | 1     |
| Act Effct Green (s)     | 6.5   | 13.0  | 13.0  | 6.9   | 18.2  |     |       | 93.8  | 93.8  | 93.8  |       | 66.6  |
| Actuated g/C Ratio      | 0.05  | 0.10  | 0.10  | 0.05  | 0.14  |     |       | 0.72  | 0.72  | 0.72  |       | 0.51  |
| v/c Ratio               | 0.21  | 0.18  | 0.44  | 0.41  | 0.12  |     |       | 0.64  | 0.29  | 0.22  |       | 0.17  |
| Control Delay           | 65.6  | 53.5  | 10.5  | 67.2  | 32.5  |     |       | 15.7  | 7.8   | 1.6   |       | 13.5  |
| Queue Delay             | 0.0   | 0.0   | 0.0   | 0.0   | 0.0   |     |       | 0.0   | 0.0   | 0.0   |       | 0.0   |
| Total Delay             | 65.6  | 53.5  | 10.5  | 67.2  | 32.5  |     |       | 15.7  | 7.8   | 1.6   |       | 13.5  |
| LOS                     | E     | D     | B     | E     | C     |     |       | B     | A     | A     |       | B     |
| Approach Delay          |       | 24.5  |       |       | 57.5  |     |       |       | 8.4   |       |       |       |
| Approach LOS            |       | C     |       |       | E     |     |       |       | A     |       |       |       |
| Queue Length 50th (m)   | 3.7   | 7.0   | 0.0   | 8.0   | 2.8   |     |       | 20.5  | 26.6  | 0.0   |       | 3.5   |
| Queue Length 95th (m)   | 10.8  | 14.3  | 10.4  | 15.1  | 10.2  |     |       | 51.9  | 50.7  | 9.2   |       | 8.2   |
| Internal Link Dist (m)  |       | 188.6 |       |       | 217.6 |     |       |       | 586.9 |       |       |       |
| Turn Bay Length (m)     | 35.0  |       | 60.0  | 85.0  |       |     |       | 165.0 |       |       |       | 155.0 |
| Base Capacity (vph)     | 83    | 338   | 376   | 170   | 288   |     |       | 576   | 2368  | 1122  |       | 350   |
| Starvation Cap Reductn  | 0     | 0     | 0     | 0     | 0     |     |       | 0     | 0     | 0     |       | 0     |
| Spillback Cap Reductn   | 0     | 0     | 0     | 0     | 0     |     |       | 0     | 0     | 0     |       | 0     |
| Storage Cap Reductn     | 0     | 0     | 0     | 0     | 0     |     |       | 0     | 0     | 0     |       | 0     |
| Reduced v/c Ratio       | 0.19  | 0.09  | 0.30  | 0.39  | 0.09  |     |       | 0.51  | 0.29  | 0.22  |       | 0.17  |

Intersection Summary

Area Type: Other  
 Cycle Length: 130  
 Actuated Cycle Length: 130  
 Offset: 15 (12%), Referenced to phase 2:NBTL and 6:SBTL, Start of Green  
 Natural Cycle: 90  
 Control Type: Actuated-Coordinated  
 Maximum v/c Ratio: 0.64  
 Intersection Signal Delay: 13.9 Intersection LOS: B  
 Intersection Capacity Utilization 74.5% ICU Level of Service D  
 Analysis Period (min) 15  
 # 95th percentile volume exceeds capacity, queue may be longer.  
 Queue shown is maximum after two cycles.

Splits and Phases: 3: March & Solandt





| Lane Group                  | SBT    | SBR   |
|-----------------------------|--------|-------|
| Minimum Initial (s)         | 20.0   | 20.0  |
| Minimum Split (s)           | 26.3   | 26.3  |
| Total Split (s)             | 46.0   | 46.0  |
| Total Split (%)             | 35.4%  | 35.4% |
| Maximum Green (s)           | 39.7   | 39.7  |
| Yellow Time (s)             | 4.6    | 4.6   |
| All-Red Time (s)            | 1.7    | 1.7   |
| Lost Time Adjust (s)        | 0.0    | 0.0   |
| Total Lost Time (s)         | 6.3    | 6.3   |
| Lead/Lag                    | Lag    | Lag   |
| Lead-Lag Optimize?          | Yes    | Yes   |
| Vehicle Extension (s)       | 3.0    | 3.0   |
| Recall Mode                 | C-Max  | C-Max |
| Walk Time (s)               | 7.0    | 7.0   |
| Flash Dont Walk (s)         | 12.0   | 12.0  |
| Pedestrian Calls (#/hr)     | 1      | 1     |
| Act Effct Green (s)         | 66.6   | 66.6  |
| Actuated g/C Ratio          | 0.51   | 0.51  |
| v/c Ratio                   | 0.56   | 0.06  |
| Control Delay               | 15.8   | 0.1   |
| Queue Delay                 | 0.0    | 0.0   |
| Total Delay                 | 15.8   | 0.1   |
| LOS                         | B      | A     |
| Approach Delay              | 15.0   |       |
| Approach LOS                | B      |       |
| Queue Length 50th (m)       | 86.7   | 0.1   |
| Queue Length 95th (m)       | #147.3 | 0.2   |
| Internal Link Dist (m)      | 586.3  |       |
| Turn Bay Length (m)         |        | 75.0  |
| Base Capacity (vph)         | 1681   | 831   |
| Starvation Cap Reductn      | 0      | 0     |
| Spillback Cap Reductn       | 0      | 0     |
| Storage Cap Reductn         | 0      | 0     |
| Reduced v/c Ratio           | 0.56   | 0.06  |
| <b>Intersection Summary</b> |        |       |



4: Innovation/Flamborough & Terry Fox  
AM Peak Hour

555-603 March Road  
2022 Existing Traffic



| Lane Group                 | EBL   | EBT   | EBR   | WBL   | WBT   | WBR   | NBL   | NBT   | NBR  | SBL   | SBT   | SBR   |
|----------------------------|-------|-------|-------|-------|-------|-------|-------|-------|------|-------|-------|-------|
| Lane Configurations        |       |       |       |       |       |       |       |       |      |       |       |       |
| Traffic Volume (vph)       | 34    | 328   | 89    | 99    | 160   | 43    | 43    | 42    | 100  | 74    | 65    | 50    |
| Future Volume (vph)        | 34    | 328   | 89    | 99    | 160   | 43    | 43    | 42    | 100  | 74    | 65    | 50    |
| Ideal Flow (vphpl)         | 1800  | 1800  | 1800  | 1800  | 1800  | 1800  | 1800  | 1800  | 1800 | 1800  | 1800  | 1800  |
| Storage Length (m)         | 75.0  |       | 120.0 | 110.0 |       | 130.0 | 220.0 |       | 0.0  | 30.0  |       | 0.0   |
| Storage Lanes              | 1     |       | 1     | 1     |       | 1     | 1     |       | 0    | 1     |       | 0     |
| Taper Length (m)           | 50.0  |       |       | 80.0  |       |       | 50.0  |       |      | 15.0  |       |       |
| Lane Util. Factor          | 1.00  | 1.00  | 1.00  | 1.00  | 1.00  | 1.00  | 1.00  | 1.00  | 1.00 | 1.00  | 1.00  | 1.00  |
| Ped Bike Factor            | 0.99  |       | 0.96  | 0.99  |       | 0.97  | 0.98  | 0.98  |      | 1.00  | 0.98  |       |
| Frt                        |       |       | 0.850 |       |       | 0.850 |       | 0.895 |      |       | 0.934 |       |
| Flt Protected              | 0.950 |       |       | 0.950 |       |       | 0.950 |       |      | 0.950 |       |       |
| Satd. Flow (prot)          | 1470  | 1728  | 1469  | 1626  | 1728  | 1498  | 1658  | 1525  | 0    | 1674  | 1555  | 0     |
| Flt Permitted              | 0.645 |       |       | 0.498 |       |       | 0.594 |       |      | 0.492 |       |       |
| Satd. Flow (perm)          | 989   | 1728  | 1410  | 845   | 1728  | 1451  | 1019  | 1525  | 0    | 864   | 1555  | 0     |
| Right Turn on Red          |       |       | Yes   |       |       | Yes   |       |       | Yes  |       |       | Yes   |
| Satd. Flow (RTOR)          |       |       | 99    |       |       | 80    |       | 90    |      |       |       | 30    |
| Link Speed (k/h)           |       | 60    |       |       | 60    |       |       | 50    |      |       |       | 50    |
| Link Distance (m)          |       | 508.2 |       |       | 485.8 |       |       | 547.1 |      |       |       | 313.7 |
| Travel Time (s)            |       | 30.5  |       |       | 29.1  |       |       | 39.4  |      |       |       | 22.6  |
| Confl. Peds. (#/hr)        | 4     |       | 6     | 6     |       | 4     | 9     |       | 2    | 2     |       | 9     |
| Confl. Bikes (#/hr)        |       |       | 4     |       |       |       |       |       |      |       |       | 2     |
| Peak Hour Factor           | 0.90  | 0.90  | 0.90  | 0.90  | 0.90  | 0.90  | 0.90  | 0.90  | 0.90 | 0.90  | 0.90  | 0.90  |
| Heavy Vehicles (%)         | 15%   | 3%    | 3%    | 4%    | 3%    | 1%    | 2%    | 2%    | 3%   | 1%    | 1%    | 10%   |
| Adj. Flow (vph)            | 38    | 364   | 99    | 110   | 178   | 48    | 48    | 47    | 111  | 82    | 72    | 56    |
| Shared Lane Traffic (%)    |       |       |       |       |       |       |       |       |      |       |       |       |
| Lane Group Flow (vph)      | 38    | 364   | 99    | 110   | 178   | 48    | 48    | 158   | 0    | 82    | 128   | 0     |
| Enter Blocked Intersection | No    | No    | No    | No    | No    | No    | No    | No    | No   | No    | No    | No    |
| Lane Alignment             | L NA  | Left  | R NA  | L NA  | Left  | R NA  | L NA  | Left  | R NA | L NA  | Left  | R NA  |
| Median Width(m)            |       | 3.5   |       |       | 3.5   |       |       | 3.5   |      |       |       | 3.5   |
| Link Offset(m)             |       | 0.0   |       |       | 0.0   |       |       | 0.0   |      |       |       | 0.0   |
| Crosswalk Width(m)         |       | 5.0   |       |       | 5.0   |       |       | 5.0   |      |       |       | 5.0   |
| Two way Left Turn Lane     |       |       |       |       |       |       |       |       |      |       |       |       |
| Headway Factor             | 1.09  | 1.09  | 1.09  | 1.09  | 1.09  | 1.09  | 1.09  | 1.09  | 1.09 | 1.09  | 1.09  | 1.09  |
| Number of Detectors        | 1     | 2     | 1     | 1     | 2     | 1     | 1     | 2     |      | 1     | 2     |       |
| Detector Template          | Left  | Thru  | Right | Left  | Thru  | Right | Left  | Thru  |      | Left  | Thru  |       |
| Leading Detector (m)       | 2.0   | 10.0  | 2.0   | 2.0   | 10.0  | 2.0   | 2.0   | 10.0  |      | 2.0   | 10.0  |       |
| Trailing Detector (m)      | 0.0   | 0.0   | 0.0   | 0.0   | 0.0   | 0.0   | 0.0   | 0.0   |      | 0.0   | 0.0   |       |
| Detector 1 Position(m)     | 0.0   | 0.0   | 0.0   | 0.0   | 0.0   | 0.0   | 0.0   | 0.0   |      | 0.0   | 0.0   |       |
| Detector 1 Size(m)         | 2.0   | 0.6   | 2.0   | 2.0   | 0.6   | 2.0   | 2.0   | 0.6   |      | 2.0   | 0.6   |       |
| Detector 1 Type            | CI+Ex | CI+Ex | CI+Ex | CI+Ex | CI+Ex | CI+Ex | CI+Ex | CI+Ex |      | CI+Ex | CI+Ex |       |
| Detector 1 Channel         |       |       |       |       |       |       |       |       |      |       |       |       |
| Detector 1 Extend (s)      | 0.0   | 0.0   | 0.0   | 0.0   | 0.0   | 0.0   | 0.0   | 0.0   |      | 0.0   | 0.0   |       |
| Detector 1 Queue (s)       | 0.0   | 0.0   | 0.0   | 0.0   | 0.0   | 0.0   | 0.0   | 0.0   |      | 0.0   | 0.0   |       |
| Detector 1 Delay (s)       | 0.0   | 0.0   | 0.0   | 0.0   | 0.0   | 0.0   | 0.0   | 0.0   |      | 0.0   | 0.0   |       |
| Detector 2 Position(m)     |       | 9.4   |       |       | 9.4   |       |       | 9.4   |      |       |       | 9.4   |
| Detector 2 Size(m)         |       | 0.6   |       |       | 0.6   |       |       | 0.6   |      |       |       | 0.6   |
| Detector 2 Type            |       | CI+Ex |       |       | CI+Ex |       |       | CI+Ex |      |       |       | CI+Ex |
| Detector 2 Channel         |       |       |       |       |       |       |       |       |      |       |       |       |
| Detector 2 Extend (s)      |       | 0.0   |       |       | 0.0   |       |       | 0.0   |      |       |       | 0.0   |
| Turn Type                  | pm+pt | NA    | Perm  | pm+pt | NA    | Perm  | Perm  | NA    |      | Perm  | NA    |       |
| Protected Phases           | 5     | 2     |       | 1     | 6     |       |       | 8     |      |       |       | 4     |
| Permitted Phases           | 2     |       | 2     | 6     |       | 6     | 8     |       |      | 4     |       |       |
| Detector Phase             | 5     | 2     | 2     | 1     | 6     | 6     | 8     | 8     |      | 4     |       | 4     |
| Switch Phase               |       |       |       |       |       |       |       |       |      |       |       |       |

4: Innovation/Flamborough & Terry Fox  
AM Peak Hour

555-603 March Road  
2022 Existing Traffic



| Lane Group              | EBL   | EBT   | EBR   | WBL   | WBT   | WBR   | NBL   | NBT   | NBR | SBL   | SBT   | SBR |
|-------------------------|-------|-------|-------|-------|-------|-------|-------|-------|-----|-------|-------|-----|
| Minimum Initial (s)     | 5.0   | 10.0  | 10.0  | 5.0   | 10.0  | 10.0  | 10.0  | 10.0  |     | 10.0  | 10.0  |     |
| Minimum Split (s)       | 10.9  | 27.9  | 27.9  | 10.9  | 27.9  | 27.9  | 35.6  | 35.6  |     | 35.6  | 35.6  |     |
| Total Split (s)         | 18.0  | 70.0  | 70.0  | 18.0  | 70.0  | 70.0  | 42.0  | 42.0  |     | 42.0  | 42.0  |     |
| Total Split (%)         | 13.8% | 53.8% | 53.8% | 13.8% | 53.8% | 53.8% | 32.3% | 32.3% |     | 32.3% | 32.3% |     |
| Maximum Green (s)       | 12.1  | 64.1  | 64.1  | 12.1  | 64.1  | 64.1  | 35.4  | 35.4  |     | 35.4  | 35.4  |     |
| Yellow Time (s)         | 3.7   | 3.7   | 3.7   | 3.7   | 3.7   | 3.7   | 3.0   | 3.0   |     | 3.0   | 3.0   |     |
| All-Red Time (s)        | 2.2   | 2.2   | 2.2   | 2.2   | 2.2   | 2.2   | 3.6   | 3.6   |     | 3.6   | 3.6   |     |
| Lost Time Adjust (s)    | 0.0   | 0.0   | 0.0   | 0.0   | 0.0   | 0.0   | 0.0   | 0.0   |     | 0.0   | 0.0   |     |
| Total Lost Time (s)     | 5.9   | 5.9   | 5.9   | 5.9   | 5.9   | 5.9   | 6.6   | 6.6   |     | 6.6   | 6.6   |     |
| Lead/Lag                | Lead  | Lag   | Lag   | Lead  | Lag   | Lag   |       |       |     |       |       |     |
| Lead-Lag Optimize?      | Yes   | Yes   | Yes   | Yes   | Yes   | Yes   |       |       |     |       |       |     |
| Vehicle Extension (s)   | 3.0   | 3.0   | 3.0   | 3.0   | 3.0   | 3.0   | 3.0   | 3.0   |     | 3.0   | 3.0   |     |
| Recall Mode             | None  | C-Max | C-Max | None  | C-Max | C-Max | None  | None  |     | None  | None  |     |
| Walk Time (s)           |       | 7.0   | 7.0   |       | 7.0   | 7.0   | 7.0   | 7.0   |     | 7.0   | 7.0   |     |
| Flash Dont Walk (s)     |       | 15.0  | 15.0  |       | 15.0  | 15.0  | 22.0  | 22.0  |     | 22.0  | 22.0  |     |
| Pedestrian Calls (#/hr) |       | 3     | 3     |       | 3     | 3     | 3     | 3     |     | 3     | 3     |     |
| Act Effct Green (s)     | 93.2  | 86.8  | 86.8  | 97.1  | 90.5  | 90.5  | 17.0  | 17.0  |     | 17.0  | 17.0  |     |
| Actuated g/C Ratio      | 0.72  | 0.67  | 0.67  | 0.75  | 0.70  | 0.70  | 0.13  | 0.13  |     | 0.13  | 0.13  |     |
| v/c Ratio               | 0.05  | 0.32  | 0.10  | 0.16  | 0.15  | 0.05  | 0.36  | 0.57  |     | 0.73  | 0.56  |     |
| Control Delay           | 5.2   | 11.4  | 2.5   | 2.9   | 5.9   | 2.1   | 56.4  | 30.3  |     | 86.5  | 48.1  |     |
| Queue Delay             | 0.0   | 0.0   | 0.0   | 0.0   | 0.0   | 0.0   | 0.0   | 0.0   |     | 0.0   | 0.0   |     |
| Total Delay             | 5.2   | 11.4  | 2.5   | 2.9   | 5.9   | 2.1   | 56.4  | 30.3  |     | 86.5  | 48.1  |     |
| LOS                     | A     | B     | A     | A     | A     | A     | E     | C     |     | F     | D     |     |
| Approach Delay          |       | 9.2   |       |       | 4.4   |       |       | 36.4  |     |       | 63.1  |     |
| Approach LOS            |       | A     |       |       | A     |       |       | D     |     |       | E     |     |
| Queue Length 50th (m)   | 1.7   | 31.5  | 0.0   | 1.6   | 13.4  | 0.0   | 10.7  | 15.1  |     | 19.2  | 22.2  |     |
| Queue Length 95th (m)   | 6.0   | 66.4  | 7.2   | 11.5  | 20.7  | 0.0   | 19.8  | 31.6  |     | 32.0  | 36.4  |     |
| Internal Link Dist (m)  |       | 484.2 |       |       | 461.8 |       |       | 523.1 |     |       | 289.7 |     |
| Turn Bay Length (m)     | 75.0  |       | 120.0 | 110.0 |       | 130.0 | 220.0 |       |     | 30.0  |       |     |
| Base Capacity (vph)     | 796   | 1153  | 974   | 723   | 1202  | 1034  | 277   | 480   |     | 235   | 445   |     |
| Starvation Cap Reductn  | 0     | 0     | 0     | 0     | 0     | 0     | 0     | 0     |     | 0     | 0     |     |
| Spillback Cap Reductn   | 0     | 0     | 0     | 0     | 0     | 0     | 0     | 0     |     | 0     | 0     |     |
| Storage Cap Reductn     | 0     | 0     | 0     | 0     | 0     | 0     | 0     | 0     |     | 0     | 0     |     |
| Reduced v/c Ratio       | 0.05  | 0.32  | 0.10  | 0.15  | 0.15  | 0.05  | 0.17  | 0.33  |     | 0.35  | 0.29  |     |

Intersection Summary

Area Type: Other  
 Cycle Length: 130  
 Actuated Cycle Length: 130  
 Offset: 124 (95%), Referenced to phase 2:EBTL and 6:WBTL, Start of Green  
 Natural Cycle: 75  
 Control Type: Actuated-Coordinated  
 Maximum v/c Ratio: 0.73  
 Intersection Signal Delay: 21.4  
 Intersection Capacity Utilization 65.7%  
 Analysis Period (min) 15  
 Intersection LOS: C  
 ICU Level of Service C

Splits and Phases: 4: Innovation/Flamborough & Terry Fox



5: Hines & Innovation  
AM Peak Hour

555-603 March Road  
2022 Existing Traffic



| Lane Group                 | EBL  | EBT   | EBR   | WBL  | WBT   | WBR   | NBL  | NBT   | NBR   | SBL  | SBT   | SBR   |
|----------------------------|------|-------|-------|------|-------|-------|------|-------|-------|------|-------|-------|
| Lane Configurations        |      |       |       |      |       |       |      |       |       |      |       |       |
| Traffic Volume (vph)       | 15   | 0     | 118   | 6    | 1     | 0     | 92   | 58    | 2     | 1    | 15    | 2     |
| Future Volume (vph)        | 15   | 0     | 118   | 6    | 1     | 0     | 92   | 58    | 2     | 1    | 15    | 2     |
| Ideal Flow (vphpl)         | 1800 | 1800  | 1800  | 1800 | 1800  | 1800  | 1800 | 1800  | 1800  | 1800 | 1800  | 1800  |
| Lane Util. Factor          | 1.00 | 1.00  | 1.00  | 1.00 | 1.00  | 1.00  | 1.00 | 1.00  | 1.00  | 1.00 | 1.00  | 1.00  |
| Ped Bike Factor            |      |       |       |      |       |       |      |       |       |      |       |       |
| Frt                        |      | 0.881 |       |      |       |       |      | 0.998 |       |      | 0.986 |       |
| Flt Protected              |      | 0.994 |       |      | 0.958 |       |      | 0.971 |       |      | 0.998 |       |
| Satd. Flow (prot)          | 0    | 1479  | 0     | 0    | 1688  | 0     | 0    | 1633  | 0     | 0    | 1677  | 0     |
| Flt Permitted              |      | 0.994 |       |      | 0.958 |       |      | 0.971 |       |      | 0.998 |       |
| Satd. Flow (perm)          | 0    | 1479  | 0     | 0    | 1688  | 0     | 0    | 1633  | 0     | 0    | 1677  | 0     |
| Link Speed (k/h)           |      | 50    |       |      | 50    |       |      | 50    |       |      | 50    |       |
| Link Distance (m)          |      | 438.6 |       |      | 104.0 |       |      | 421.8 |       |      | 319.0 |       |
| Travel Time (s)            |      | 31.6  |       |      | 7.5   |       |      | 30.4  |       |      | 23.0  |       |
| Confl. Peds. (#/hr)        | 3    |       |       |      |       | 3     | 3    |       |       |      |       | 3     |
| Confl. Bikes (#/hr)        |      |       | 3     |      |       |       |      |       | 5     |      |       | 1     |
| Peak Hour Factor           | 0.90 | 0.90  | 0.90  | 0.90 | 0.90  | 0.90  | 0.90 | 0.90  | 0.90  | 0.90 | 0.90  | 0.90  |
| Heavy Vehicles (%)         | 1%   | 2%    | 6%    | 1%   | 1%    | 1%    | 8%   | 2%    | 2%    | 2%   | 5%    | 1%    |
| Adj. Flow (vph)            | 17   | 0     | 131   | 7    | 1     | 0     | 102  | 64    | 2     | 1    | 17    | 2     |
| Shared Lane Traffic (%)    |      |       |       |      |       |       |      |       |       |      |       |       |
| Lane Group Flow (vph)      | 0    | 148   | 0     | 0    | 8     | 0     | 0    | 168   | 0     | 0    | 20    | 0     |
| Enter Blocked Intersection | No   | No    | No    | No   | No    | No    | No   | No    | No    | No   | No    | No    |
| Lane Alignment             | Left | Left  | Right | Left | Left  | Right | Left | Left  | Right | Left | Left  | Right |
| Median Width(m)            |      | 0.0   |       |      | 0.0   |       |      | 0.0   |       |      | 0.0   |       |
| Link Offset(m)             |      | 0.0   |       |      | 0.0   |       |      | 0.0   |       |      | 0.0   |       |
| Crosswalk Width(m)         |      | 5.0   |       |      | 5.0   |       |      | 5.0   |       |      | 5.0   |       |
| Two way Left Turn Lane     |      |       |       |      |       |       |      |       |       |      |       |       |
| Headway Factor             | 1.09 | 1.09  | 1.09  | 1.09 | 1.09  | 1.09  | 1.09 | 1.09  | 1.09  | 1.09 | 1.09  | 1.09  |
| Sign Control               |      | Stop  |       |      | Stop  |       |      | Free  |       |      | Free  |       |

| Intersection Summary              |              |
|-----------------------------------|--------------|
| Area Type:                        | Other        |
| Control Type:                     | Unsignalized |
| Intersection Capacity Utilization | 30.3%        |
| ICU Level of Service              | A            |
| Analysis Period (min)             | 15           |

1: March & Morgan's Grant/Shirley's Brook  
PM Peak Hour

555-603 March Road  
2022 Existing Traffic



| Lane Group                 | EBL   | EBT   | EBR   | WBL   | WBT   | WBR   | NBL   | NBT   | NBR   | SBL   | SBT   | SBR   |
|----------------------------|-------|-------|-------|-------|-------|-------|-------|-------|-------|-------|-------|-------|
| Lane Configurations        |       | ↕     | ↗     | ↖     | ↕     | ↗     | ↖     | ↕↕↕   | ↗     | ↖     | ↕↕↕   | ↗     |
| Traffic Volume (vph)       | 10    | 15    | 76    | 137   | 17    | 42    | 86    | 987   | 110   | 26    | 703   | 16    |
| Future Volume (vph)        | 10    | 15    | 76    | 137   | 17    | 42    | 86    | 987   | 110   | 26    | 703   | 16    |
| Ideal Flow (vphpl)         | 1800  | 1800  | 1800  | 1800  | 1800  | 1800  | 1800  | 1800  | 1800  | 1800  | 1800  | 1800  |
| Storage Length (m)         | 0.0   |       | 20.0  | 45.0  |       | 35.0  | 130.0 |       | 30.0  | 65.0  |       | 25.0  |
| Storage Lanes              | 0     |       | 1     | 1     |       | 1     | 1     |       | 1     | 1     |       | 1     |
| Taper Length (m)           | 10.0  |       |       | 30.0  |       |       | 40.0  |       |       | 35.0  |       |       |
| Lane Util. Factor          | 1.00  | 1.00  | 1.00  | 1.00  | 1.00  | 1.00  | 1.00  | 0.91  | 1.00  | 1.00  | 0.91  | 1.00  |
| Ped Bike Factor            |       |       | 0.98  | 0.99  |       |       | 1.00  |       | 0.95  | 0.99  |       | 0.97  |
| Frt                        |       |       | 0.850 |       |       | 0.850 |       |       | 0.850 |       |       | 0.850 |
| Flt Protected              |       | 0.981 |       | 0.950 |       |       | 0.950 |       |       | 0.950 |       |       |
| Satd. Flow (prot)          | 0     | 1670  | 1498  | 1674  | 1548  | 1498  | 1674  | 4764  | 1498  | 1674  | 4718  | 1498  |
| Flt Permitted              |       | 0.899 |       | 0.739 |       |       | 0.950 |       |       | 0.950 |       |       |
| Satd. Flow (perm)          | 0     | 1531  | 1467  | 1291  | 1548  | 1498  | 1666  | 4764  | 1428  | 1665  | 4718  | 1447  |
| Right Turn on Red          |       |       | Yes   |       |       | Yes   |       |       | Yes   |       |       | Yes   |
| Satd. Flow (RTOR)          |       |       | 84    |       |       | 80    |       |       | 91    |       |       | 91    |
| Link Speed (k/h)           |       | 40    |       |       | 40    |       |       | 80    |       |       | 80    |       |
| Link Distance (m)          |       | 465.2 |       |       | 359.5 |       |       | 318.9 |       |       | 462.6 |       |
| Travel Time (s)            |       | 41.9  |       |       | 32.4  |       |       | 14.4  |       |       | 20.8  |       |
| Confl. Peds. (#/hr)        |       |       | 7     | 7     |       |       | 4     |       | 7     | 7     |       | 4     |
| Confl. Bikes (#/hr)        |       |       |       |       |       |       |       |       | 3     |       |       |       |
| Peak Hour Factor           | 0.90  | 0.90  | 0.90  | 0.90  | 0.90  | 0.90  | 0.90  | 0.90  | 0.90  | 0.90  | 0.90  | 0.90  |
| Heavy Vehicles (%)         | 10%   | 1%    | 1%    | 1%    | 15%   | 1%    | 1%    | 2%    | 1%    | 1%    | 3%    | 1%    |
| Adj. Flow (vph)            | 11    | 17    | 84    | 152   | 19    | 47    | 96    | 1097  | 122   | 29    | 781   | 18    |
| Shared Lane Traffic (%)    |       |       |       |       |       |       |       |       |       |       |       |       |
| Lane Group Flow (vph)      | 0     | 28    | 84    | 152   | 19    | 47    | 96    | 1097  | 122   | 29    | 781   | 18    |
| Enter Blocked Intersection | No    | No    | No    | No    | No    | No    | No    | No    | No    | No    | No    | No    |
| Lane Alignment             | L NA  | Left  | R NA  | L NA  | Left  | R NA  | L NA  | Left  | R NA  | L NA  | Left  | R NA  |
| Median Width(m)            |       | 3.5   |       |       | 5.0   |       |       | 9.0   |       |       | 9.0   |       |
| Link Offset(m)             |       | 0.0   |       |       | 0.0   |       |       | 0.0   |       |       | 0.0   |       |
| Crosswalk Width(m)         |       | 5.0   |       |       | 5.0   |       |       | 5.0   |       |       | 5.0   |       |
| Two way Left Turn Lane     |       |       |       |       |       |       |       |       |       |       |       |       |
| Headway Factor             | 1.09  | 1.09  | 1.09  | 1.09  | 1.09  | 1.09  | 1.09  | 1.09  | 1.09  | 1.09  | 1.09  | 1.09  |
| Turning Speed (k/h)        | 24    |       | 14    | 24    |       | 14    | 24    |       | 14    | 24    |       | 14    |
| Number of Detectors        | 1     | 2     | 1     | 1     | 2     | 1     | 1     | 2     | 1     | 1     | 2     | 1     |
| Detector Template          | Left  | Thru  | Right | Left  | Thru  | Right | Left  | Thru  | Right | Left  | Thru  | Right |
| Leading Detector (m)       | 2.0   | 10.0  | 2.0   | 2.0   | 10.0  | 2.0   | 2.0   | 10.0  | 2.0   | 2.0   | 10.0  | 2.0   |
| Trailing Detector (m)      | 0.0   | 0.0   | 0.0   | 0.0   | 0.0   | 0.0   | 0.0   | 0.0   | 0.0   | 0.0   | 0.0   | 0.0   |
| Detector 1 Position(m)     | 0.0   | 0.0   | 0.0   | 0.0   | 0.0   | 0.0   | 0.0   | 0.0   | 0.0   | 0.0   | 0.0   | 0.0   |
| Detector 1 Size(m)         | 2.0   | 0.6   | 2.0   | 2.0   | 0.6   | 2.0   | 2.0   | 0.6   | 2.0   | 2.0   | 0.6   | 2.0   |
| Detector 1 Type            | Cl+Ex | Cl+Ex | Cl+Ex | Cl+Ex | Cl+Ex | Cl+Ex | Cl+Ex | Cl+Ex | Cl+Ex | Cl+Ex | Cl+Ex | Cl+Ex |
| Detector 1 Channel         |       |       |       |       |       |       |       |       |       |       |       |       |
| Detector 1 Extend (s)      | 0.0   | 0.0   | 0.0   | 0.0   | 0.0   | 0.0   | 0.0   | 0.0   | 0.0   | 0.0   | 0.0   | 0.0   |
| Detector 1 Queue (s)       | 0.0   | 0.0   | 0.0   | 0.0   | 0.0   | 0.0   | 0.0   | 0.0   | 0.0   | 0.0   | 0.0   | 0.0   |
| Detector 1 Delay (s)       | 0.0   | 0.0   | 0.0   | 0.0   | 0.0   | 0.0   | 0.0   | 0.0   | 0.0   | 0.0   | 0.0   | 0.0   |
| Detector 2 Position(m)     |       | 9.4   |       |       | 9.4   |       |       | 9.4   |       |       | 9.4   |       |
| Detector 2 Size(m)         |       | 0.6   |       |       | 0.6   |       |       | 0.6   |       |       | 0.6   |       |
| Detector 2 Type            |       | Cl+Ex |       |       | Cl+Ex |       |       | Cl+Ex |       |       | Cl+Ex |       |
| Detector 2 Channel         |       |       |       |       |       |       |       |       |       |       |       |       |
| Detector 2 Extend (s)      |       | 0.0   |       |       | 0.0   |       |       | 0.0   |       |       | 0.0   |       |
| Turn Type                  | Perm  | NA    | Perm  | Perm  | NA    | Perm  | Prot  | NA    | Perm  | Prot  | NA    | Perm  |
| Protected Phases           |       | 4     |       |       | 8     |       | 5     | 2     |       | 1     | 6     |       |
| Permitted Phases           | 4     |       | 4     | 8     |       | 8     |       |       | 2     |       |       | 6     |
| Detector Phase             | 4     | 4     | 4     | 8     | 8     | 8     | 5     | 2     | 2     | 1     | 6     | 6     |



| Lane Group              | EBL   | EBT   | EBR   | WBL   | WBT   | WBR   | NBL   | NBT   | NBR   | SBL   | SBT   | SBR   |
|-------------------------|-------|-------|-------|-------|-------|-------|-------|-------|-------|-------|-------|-------|
| Switch Phase            |       |       |       |       |       |       |       |       |       |       |       |       |
| Minimum Initial (s)     | 10.0  | 10.0  | 10.0  | 10.0  | 10.0  | 10.0  | 5.0   | 20.0  | 20.0  | 5.0   | 20.0  | 20.0  |
| Minimum Split (s)       | 38.5  | 38.5  | 38.5  | 38.5  | 38.5  | 38.5  | 11.4  | 26.1  | 26.1  | 11.4  | 26.1  | 26.1  |
| Total Split (s)         | 39.0  | 39.0  | 39.0  | 39.0  | 39.0  | 39.0  | 21.0  | 70.0  | 70.0  | 21.0  | 70.0  | 70.0  |
| Total Split (%)         | 30.0% | 30.0% | 30.0% | 30.0% | 30.0% | 30.0% | 16.2% | 53.8% | 53.8% | 16.2% | 53.8% | 53.8% |
| Maximum Green (s)       | 31.5  | 31.5  | 31.5  | 31.5  | 31.5  | 31.5  | 14.6  | 63.9  | 63.9  | 14.6  | 63.9  | 63.9  |
| Yellow Time (s)         | 3.0   | 3.0   | 3.0   | 3.0   | 3.0   | 3.0   | 4.6   | 4.6   | 4.6   | 4.6   | 4.6   | 4.6   |
| All-Red Time (s)        | 4.5   | 4.5   | 4.5   | 4.5   | 4.5   | 4.5   | 1.8   | 1.5   | 1.5   | 1.8   | 1.5   | 1.5   |
| Lost Time Adjust (s)    |       | 0.0   | 0.0   | 0.0   | 0.0   | 0.0   | 0.0   | 0.0   | 0.0   | 0.0   | 0.0   | 0.0   |
| Total Lost Time (s)     |       | 7.5   | 7.5   | 7.5   | 7.5   | 7.5   | 6.4   | 6.1   | 6.1   | 6.4   | 6.1   | 6.1   |
| Lead/Lag                |       |       |       |       |       |       | Lead  | Lag   | Lag   | Lead  | Lag   | Lag   |
| Lead-Lag Optimize?      |       |       |       |       |       |       | Yes   | Yes   | Yes   | Yes   | Yes   | Yes   |
| Vehicle Extension (s)   | 3.0   | 3.0   | 3.0   | 3.0   | 3.0   | 3.0   | 3.0   | 3.0   | 3.0   | 3.0   | 3.0   | 3.0   |
| Recall Mode             | None  | None  | None  | None  | None  | None  | None  | C-Max | C-Max | None  | C-Max | C-Max |
| Walk Time (s)           | 7.0   | 7.0   | 7.0   | 7.0   | 7.0   | 7.0   |       | 7.0   | 7.0   |       | 7.0   | 7.0   |
| Flash Dont Walk (s)     | 24.0  | 24.0  | 24.0  | 24.0  | 24.0  | 24.0  |       | 11.0  | 11.0  |       | 11.0  | 11.0  |
| Pedestrian Calls (#/hr) | 7     | 7     | 7     | 1     | 1     | 1     |       | 7     | 7     |       | 4     | 4     |
| Act Effct Green (s)     |       | 21.0  | 21.0  | 21.0  | 21.0  | 21.0  | 12.2  | 86.2  | 86.2  | 7.8   | 76.8  | 76.8  |
| Actuated g/C Ratio      |       | 0.16  | 0.16  | 0.16  | 0.16  | 0.16  | 0.09  | 0.66  | 0.66  | 0.06  | 0.59  | 0.59  |
| v/c Ratio               |       | 0.11  | 0.27  | 0.73  | 0.08  | 0.15  | 0.61  | 0.35  | 0.12  | 0.29  | 0.28  | 0.02  |
| Control Delay           |       | 44.0  | 10.6  | 70.6  | 43.1  | 3.1   | 93.1  | 3.0   | 0.5   | 65.1  | 14.6  | 0.1   |
| Queue Delay             |       | 0.0   | 0.0   | 0.0   | 0.0   | 0.0   | 0.0   | 0.0   | 0.0   | 0.0   | 0.0   | 0.0   |
| Total Delay             |       | 44.0  | 10.6  | 70.6  | 43.1  | 3.1   | 93.1  | 3.0   | 0.5   | 65.1  | 14.6  | 0.1   |
| LOS                     |       | D     | B     | E     | D     | A     | F     | A     | A     | E     | B     | A     |
| Approach Delay          |       | 19.0  |       |       | 53.6  |       |       | 9.3   |       |       | 16.1  |       |
| Approach LOS            |       | B     |       |       | D     |       |       | A     |       |       | B     |       |
| Queue Length 50th (m)   |       | 5.8   | 0.0   | 34.6  | 3.9   | 0.0   | 20.6  | 31.2  | 0.5   | 6.7   | 31.5  | 0.0   |
| Queue Length 95th (m)   |       | 12.7  | 11.9  | 51.5  | 9.5   | 2.7   | 40.6  | 8.7   | 0.1   | 15.7  | 49.0  | 0.0   |
| Internal Link Dist (m)  |       | 441.2 |       |       | 335.5 |       |       | 294.9 |       |       | 438.6 |       |
| Turn Bay Length (m)     |       |       | 20.0  | 45.0  |       | 35.0  | 130.0 |       | 30.0  | 65.0  |       | 25.0  |
| Base Capacity (vph)     |       | 370   | 419   | 312   | 375   | 423   | 190   | 3157  | 977   | 188   | 2786  | 891   |
| Starvation Cap Reductn  |       | 0     | 0     | 0     | 0     | 0     | 0     | 0     | 0     | 0     | 0     | 0     |
| Spillback Cap Reductn   |       | 0     | 0     | 0     | 0     | 0     | 0     | 0     | 0     | 0     | 0     | 0     |
| Storage Cap Reductn     |       | 0     | 0     | 0     | 0     | 0     | 0     | 0     | 0     | 0     | 0     | 0     |
| Reduced v/c Ratio       |       | 0.08  | 0.20  | 0.49  | 0.05  | 0.11  | 0.51  | 0.35  | 0.12  | 0.15  | 0.28  | 0.02  |

Intersection Summary

|                                    |  |
|------------------------------------|--|
| Area Type:                         | Other  |
| Cycle Length:                      | 130  |
| Actuated Cycle Length:             | 130  |
| Offset:                            | 105 (81%), Referenced to phase 2:NBT and 6:SBT, Start of Green |
| Natural Cycle:                     | 80   |
| Control Type:                      | Actuated-Coordinated   |
| Maximum v/c Ratio:                 | 0.73   |
| Intersection Signal Delay:         | 15.9   |
| Intersection LOS:                  | B  |
| Intersection Capacity Utilization: | 58.0%  |
| ICU Level of Service:              | B  |
| Analysis Period (min):             | 15   |

Splits and Phases: 1: March & Morgan's Grant/Shirley's Brook

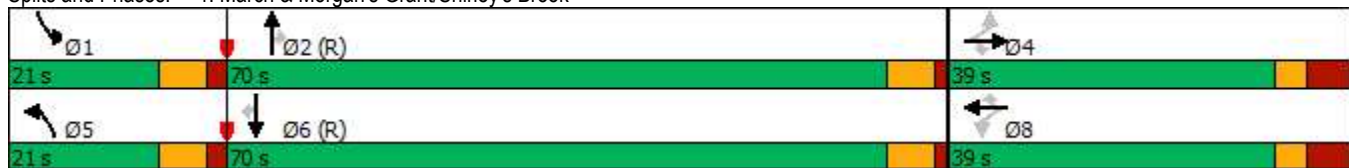

2: March & Terry Fox  
PM Peak Hour

555-603 March Road  
2022 Existing Traffic



| Lane Group                 | EBL   | EBT   | EBR   | WBL   | WBT   | WBR   | NBU   | NBL   | NBT   | NBR   | SBU   | SBL   |
|----------------------------|-------|-------|-------|-------|-------|-------|-------|-------|-------|-------|-------|-------|
| Lane Configurations        |       |       |       |       |       |       |       |       |       |       |       |       |
| Traffic Volume (vph)       | 212   | 107   | 216   | 94    | 183   | 144   | 18    | 203   | 872   | 77    | 4     | 60    |
| Future Volume (vph)        | 212   | 107   | 216   | 94    | 183   | 144   | 18    | 203   | 872   | 77    | 4     | 60    |
| Ideal Flow (vphpl)         | 1800  | 1800  | 1800  | 1800  | 1800  | 1800  | 1800  | 1800  | 1800  | 1800  | 1800  | 1800  |
| Storage Length (m)         | 95.0  |       | 60.0  | 75.0  |       | 75.0  |       | 130.0 |       | 85.0  |       | 110.0 |
| Storage Lanes              | 2     |       | 2     | 2     |       | 1     |       | 2     |       | 2     |       | 1     |
| Taper Length (m)           | 40.0  |       |       | 20.0  |       |       |       | 90.0  |       |       |       | 40.0  |
| Lane Util. Factor          | 0.97  | 0.95  | 1.00  | 0.97  | 0.95  | 1.00  | 0.91  | 0.97  | 0.91  | 1.00  | 0.91  | 1.00  |
| Ped Bike Factor            | 0.99  |       | 0.98  | 0.99  |       | 0.97  |       | 1.00  |       | 0.97  |       | 1.00  |
| Fr <sub>t</sub>            |       |       | 0.850 |       |       | 0.850 |       |       |       | 0.850 |       |       |
| Fl <sub>t</sub> Protected  | 0.950 |       |       | 0.950 |       |       |       | 0.950 |       |       |       | 0.950 |
| Satd. Flow (prot)          | 3248  | 3221  | 1498  | 3248  | 3349  | 1498  | 0     | 3188  | 4764  | 1469  | 0     | 1673  |
| Fl <sub>t</sub> Permitted  | 0.950 |       |       | 0.950 |       |       |       | 0.950 |       |       |       | 0.950 |
| Satd. Flow (perm)          | 3218  | 3221  | 1462  | 3224  | 3349  | 1452  | 0     | 3176  | 4764  | 1431  | 0     | 1667  |
| Right Turn on Red          |       |       | Yes   |       |       | Yes   |       |       |       | Yes   |       |       |
| Satd. Flow (RTOR)          |       |       | 240   |       |       | 160   |       |       |       | 147   |       |       |
| Link Speed (k/h)           |       | 60    |       |       | 60    |       |       |       | 80    |       |       |       |
| Link Distance (m)          |       | 165.4 |       |       | 149.1 |       |       |       | 308.9 |       |       |       |
| Travel Time (s)            |       | 9.9   |       |       | 8.9   |       |       |       | 13.9  |       |       |       |
| Confl. Peds. (#/hr)        | 11    |       | 8     | 8     |       | 11    |       | 4     |       | 9     |       | 9     |
| Confl. Bikes (#/hr)        |       |       | 4     |       |       | 8     |       |       |       | 1     |       |       |
| Peak Hour Factor           | 0.90  | 0.90  | 0.90  | 0.90  | 0.90  | 0.90  | 0.90  | 0.90  | 0.90  | 0.90  | 0.90  | 0.90  |
| Heavy Vehicles (%)         | 1%    | 5%    | 1%    | 1%    | 1%    | 1%    | 2%    | 3%    | 2%    | 3%    | 2%    | 1%    |
| Adj. Flow (vph)            | 236   | 119   | 240   | 104   | 203   | 160   | 20    | 226   | 969   | 86    | 4     | 67    |
| Shared Lane Traffic (%)    |       |       |       |       |       |       |       |       |       |       |       |       |
| Lane Group Flow (vph)      | 236   | 119   | 240   | 104   | 203   | 160   | 0     | 246   | 969   | 86    | 0     | 71    |
| Enter Blocked Intersection | No    | No    | No    | Yes   | Yes   | Yes   | No    | No    | No    | No    | No    | No    |
| Lane Alignment             | L NA  | Left  | R NA  | L NA  | Left  | R NA  | R NA  | L NA  | Left  | R NA  | R NA  | L NA  |
| Median Width(m)            |       | 10.5  |       |       | 10.5  |       |       |       | 10.5  |       |       |       |
| Link Offset(m)             |       | 0.0   |       |       | 0.0   |       |       |       | 0.0   |       |       |       |
| Crosswalk Width(m)         |       | 5.0   |       |       | 5.0   |       |       |       | 5.0   |       |       |       |
| Two way Left Turn Lane     |       |       |       |       |       |       |       |       |       |       |       |       |
| Headway Factor             | 1.09  | 1.09  | 1.09  | 1.09  | 1.09  | 1.09  | 1.09  | 1.09  | 1.09  | 1.09  | 1.09  | 1.09  |
| Turning Speed (k/h)        | 24    |       | 14    | 24    |       | 14    | 14    | 24    |       | 14    | 14    | 24    |
| Number of Detectors        | 1     | 2     | 1     | 1     | 2     | 1     | 1     | 1     | 2     | 1     | 1     | 1     |
| Detector Template          | Left  | Thru  | Right | Left  | Thru  | Right | Left  | Left  | Thru  | Right | Left  | Left  |
| Leading Detector (m)       | 2.0   | 10.0  | 2.0   | 2.0   | 10.0  | 2.0   | 2.0   | 2.0   | 10.0  | 2.0   | 2.0   | 2.0   |
| Trailing Detector (m)      | 0.0   | 0.0   | 0.0   | 0.0   | 0.0   | 0.0   | 0.0   | 0.0   | 0.0   | 0.0   | 0.0   | 0.0   |
| Detector 1 Position(m)     | 0.0   | 0.0   | 0.0   | 0.0   | 0.0   | 0.0   | 0.0   | 0.0   | 0.0   | 0.0   | 0.0   | 0.0   |
| Detector 1 Size(m)         | 2.0   | 0.6   | 2.0   | 2.0   | 0.6   | 2.0   | 2.0   | 2.0   | 0.6   | 2.0   | 2.0   | 2.0   |
| Detector 1 Type            | Cl+Ex | Cl+Ex | Cl+Ex | Cl+Ex | Cl+Ex | Cl+Ex | Cl+Ex | Cl+Ex | Cl+Ex | Cl+Ex | Cl+Ex | Cl+Ex |
| Detector 1 Channel         |       |       |       |       |       |       |       |       |       |       |       |       |
| Detector 1 Extend (s)      | 0.0   | 0.0   | 0.0   | 0.0   | 0.0   | 0.0   | 0.0   | 0.0   | 0.0   | 0.0   | 0.0   | 0.0   |
| Detector 1 Queue (s)       | 0.0   | 0.0   | 0.0   | 0.0   | 0.0   | 0.0   | 0.0   | 0.0   | 0.0   | 0.0   | 0.0   | 0.0   |
| Detector 1 Delay (s)       | 0.0   | 0.0   | 0.0   | 0.0   | 0.0   | 0.0   | 0.0   | 0.0   | 0.0   | 0.0   | 0.0   | 0.0   |
| Detector 2 Position(m)     |       | 9.4   |       |       | 9.4   |       |       |       | 9.4   |       |       |       |
| Detector 2 Size(m)         |       | 0.6   |       |       | 0.6   |       |       |       | 0.6   |       |       |       |
| Detector 2 Type            |       | Cl+Ex |       |       | Cl+Ex |       |       |       | Cl+Ex |       |       |       |
| Detector 2 Channel         |       |       |       |       |       |       |       |       |       |       |       |       |
| Detector 2 Extend (s)      |       | 0.0   |       |       | 0.0   |       |       |       | 0.0   |       |       |       |
| Turn Type                  | Prot  | NA    | Perm  | Prot  | NA    | Perm  | Prot  | Prot  | NA    | Perm  | Prot  | Prot  |
| Protected Phases           | 7     | 4     |       | 3     | 8     |       | 5     | 5     | 2     |       | 1     | 1     |
| Permitted Phases           |       |       | 4     |       |       | 8     |       |       |       | 2     |       |       |
| Detector Phase             | 7     | 4     | 4     | 3     | 8     | 8     | 5     | 5     | 2     | 2     | 1     | 1     |

2: March & Terry Fox  
PM Peak Hour

555-603 March Road  
2022 Existing Traffic



| Lane Group                 | SBT   | SBR   |
|----------------------------|-------|-------|
| Lane Configurations        | ↑↑↑   | ↗     |
| Traffic Volume (vph)       | 637   | 158   |
| Future Volume (vph)        | 637   | 158   |
| Ideal Flow (vphpl)         | 1800  | 1800  |
| Storage Length (m)         |       | 100.0 |
| Storage Lanes              |       | 1     |
| Taper Length (m)           |       |       |
| Lane Util. Factor          | 0.91  | 1.00  |
| Ped Bike Factor            |       | 0.98  |
| Frt                        |       | 0.850 |
| Flt Protected              |       |       |
| Satd. Flow (prot)          | 4718  | 1483  |
| Flt Permitted              |       |       |
| Satd. Flow (perm)          | 4718  | 1456  |
| Right Turn on Red          |       | Yes   |
| Satd. Flow (RTOR)          |       | 176   |
| Link Speed (k/h)           | 80    |       |
| Link Distance (m)          | 318.9 |       |
| Travel Time (s)            | 14.4  |       |
| Confl. Peds. (#/hr)        |       | 4     |
| Confl. Bikes (#/hr)        |       | 1     |
| Peak Hour Factor           | 0.90  | 0.90  |
| Heavy Vehicles (%)         | 3%    | 2%    |
| Adj. Flow (vph)            | 708   | 176   |
| Shared Lane Traffic (%)    |       |       |
| Lane Group Flow (vph)      | 708   | 176   |
| Enter Blocked Intersection | No    | No    |
| Lane Alignment             | Left  | R NA  |
| Median Width(m)            | 7.0   |       |
| Link Offset(m)             | 0.0   |       |
| Crosswalk Width(m)         | 5.0   |       |
| Two way Left Turn Lane     |       |       |
| Headway Factor             | 1.09  | 1.09  |
| Turning Speed (k/h)        |       | 14    |
| Number of Detectors        | 2     | 1     |
| Detector Template          | Thru  | Right |
| Leading Detector (m)       | 10.0  | 2.0   |
| Trailing Detector (m)      | 0.0   | 0.0   |
| Detector 1 Position(m)     | 0.0   | 0.0   |
| Detector 1 Size(m)         | 0.6   | 2.0   |
| Detector 1 Type            | Cl+Ex | Cl+Ex |
| Detector 1 Channel         |       |       |
| Detector 1 Extend (s)      | 0.0   | 0.0   |
| Detector 1 Queue (s)       | 0.0   | 0.0   |
| Detector 1 Delay (s)       | 0.0   | 0.0   |
| Detector 2 Position(m)     | 9.4   |       |
| Detector 2 Size(m)         | 0.6   |       |
| Detector 2 Type            | Cl+Ex |       |
| Detector 2 Channel         |       |       |
| Detector 2 Extend (s)      | 0.0   |       |
| Turn Type                  | NA    | Perm  |
| Protected Phases           | 6     |       |
| Permitted Phases           |       | 6     |
| Detector Phase             | 6     | 6     |



| Lane Group              | EBL   | EBT   | EBR   | WBL   | WBT   | WBR   | NBU   | NBL   | NBT   | NBR   | SBU   | SBL   |
|-------------------------|-------|-------|-------|-------|-------|-------|-------|-------|-------|-------|-------|-------|
| Switch Phase            |       |       |       |       |       |       |       |       |       |       |       |       |
| Minimum Initial (s)     | 5.0   | 10.0  | 10.0  | 5.0   | 10.0  | 10.0  | 5.0   | 5.0   | 20.0  | 20.0  | 5.0   | 5.0   |
| Minimum Split (s)       | 11.8  | 42.0  | 42.0  | 11.8  | 42.0  | 42.0  | 11.9  | 11.9  | 32.7  | 32.7  | 11.9  | 11.9  |
| Total Split (s)         | 24.0  | 42.0  | 42.0  | 24.0  | 42.0  | 42.0  | 23.0  | 23.0  | 41.0  | 41.0  | 23.0  | 23.0  |
| Total Split (%)         | 18.5% | 32.3% | 32.3% | 18.5% | 32.3% | 32.3% | 17.7% | 17.7% | 31.5% | 31.5% | 17.7% | 17.7% |
| Maximum Green (s)       | 17.2  | 35.1  | 35.1  | 17.2  | 35.1  | 35.1  | 16.2  | 16.2  | 34.3  | 34.3  | 16.2  | 16.2  |
| Yellow Time (s)         | 3.7   | 3.7   | 3.7   | 3.7   | 3.7   | 3.7   | 4.6   | 4.6   | 4.6   | 4.6   | 4.6   | 4.6   |
| All-Red Time (s)        | 3.1   | 3.2   | 3.2   | 3.1   | 3.2   | 3.2   | 2.2   | 2.2   | 2.1   | 2.1   | 2.2   | 2.2   |
| Lost Time Adjust (s)    | 0.0   | 0.0   | 0.0   | 0.0   | 0.0   | 0.0   |       |       | 0.0   | 0.0   |       | 0.0   |
| Total Lost Time (s)     | 6.8   | 6.9   | 6.9   | 6.8   | 6.9   | 6.9   |       |       | 6.8   | 6.7   |       | 6.8   |
| Lead/Lag                | Lead  | Lag   | Lag   | Lead  | Lag   | Lag   | Lead  | Lead  | Lag   | Lag   | Lead  | Lead  |
| Lead-Lag Optimize?      | Yes   | Yes   | Yes   | Yes   | Yes   | Yes   | Yes   | Yes   | Yes   | Yes   | Yes   | Yes   |
| Vehicle Extension (s)   | 3.0   | 3.0   | 3.0   | 3.0   | 3.0   | 3.0   | 3.0   | 3.0   | 3.0   | 3.0   | 3.0   | 3.0   |
| Recall Mode             | None  | None  | None  | None  | None  | None  | None  | None  | C-Max | C-Max | None  | None  |
| Walk Time (s)           |       | 7.0   | 7.0   |       | 7.0   | 7.0   |       |       | 7.0   | 7.0   |       |       |
| Flash Dont Walk (s)     |       | 28.0  | 28.0  |       | 28.0  | 28.0  |       |       | 19.0  | 19.0  |       |       |
| Pedestrian Calls (#/hr) |       | 8     | 8     |       | 11    | 11    |       |       | 9     | 9     |       |       |
| Act Effect Green (s)    | 14.4  | 25.9  | 25.9  | 9.5   | 21.0  | 21.0  |       | 14.6  | 59.2  | 59.2  |       | 10.9  |
| Actuated g/C Ratio      | 0.11  | 0.20  | 0.20  | 0.07  | 0.16  | 0.16  |       | 0.11  | 0.46  | 0.46  |       | 0.08  |
| v/c Ratio               | 0.66  | 0.19  | 0.50  | 0.44  | 0.38  | 0.43  |       | 0.69  | 0.45  | 0.12  |       | 0.51  |
| Control Delay           | 66.6  | 43.0  | 13.9  | 63.1  | 48.5  | 9.2   |       | 51.7  | 23.2  | 7.3   |       | 71.2  |
| Queue Delay             | 0.0   | 0.0   | 0.0   | 0.0   | 0.0   | 0.0   |       | 0.0   | 0.0   | 0.0   |       | 0.0   |
| Total Delay             | 66.6  | 43.0  | 13.9  | 63.1  | 48.5  | 9.2   |       | 51.7  | 23.2  | 7.3   |       | 71.2  |
| LOS                     | E     | D     | B     | E     | D     | A     |       | D     | C     | A     |       | E     |
| Approach Delay          |       | 40.6  |       |       | 38.3  |       |       |       | 27.5  |       |       |       |
| Approach LOS            |       | D     |       |       | D     |       |       |       | C     |       |       |       |
| Queue Length 50th (m)   | 28.6  | 14.2  | 7.6   | 12.3  | 24.5  | 0.0   |       | 24.0  | 61.2  | 3.4   |       | 17.3  |
| Queue Length 95th (m)   | 40.7  | 16.3  | 23.9  | 20.4  | 29.2  | 15.0  |       | 36.5  | 100.3 | m15.4 |       | 31.4  |
| Internal Link Dist (m)  |       | 141.4 |       |       | 125.1 |       |       |       | 284.9 |       |       |       |
| Turn Bay Length (m)     | 95.0  |       | 60.0  | 75.0  |       | 75.0  |       | 130.0 |       | 85.0  |       | 110.0 |
| Base Capacity (vph)     | 429   | 921   | 589   | 429   | 904   | 508   |       | 401   | 2170  | 732   |       | 208   |
| Starvation Cap Reductn  | 0     | 0     | 0     | 0     | 0     | 0     |       | 0     | 0     | 0     |       | 0     |
| Spillback Cap Reductn   | 0     | 0     | 0     | 0     | 0     | 0     |       | 0     | 0     | 0     |       | 0     |
| Storage Cap Reductn     | 0     | 0     | 0     | 0     | 0     | 0     |       | 0     | 0     | 0     |       | 0     |
| Reduced v/c Ratio       | 0.55  | 0.13  | 0.41  | 0.24  | 0.22  | 0.31  |       | 0.61  | 0.45  | 0.12  |       | 0.34  |

**Intersection Summary**

Area Type: Other  
 Cycle Length: 130  
 Actuated Cycle Length: 130  
 Offset: 96 (74%), Referenced to phase 2:NBT and 6:SBT, Start of Green  
 Natural Cycle: 100  
 Control Type: Actuated-Coordinated  
 Maximum v/c Ratio: 0.69  
 Intersection Signal Delay: 31.2 Intersection LOS: C  
 Intersection Capacity Utilization 73.4% ICU Level of Service D  
 Analysis Period (min) 15  
 m Volume for 95th percentile queue is metered by upstream signal.

Splits and Phases: 2: March & Terry Fox

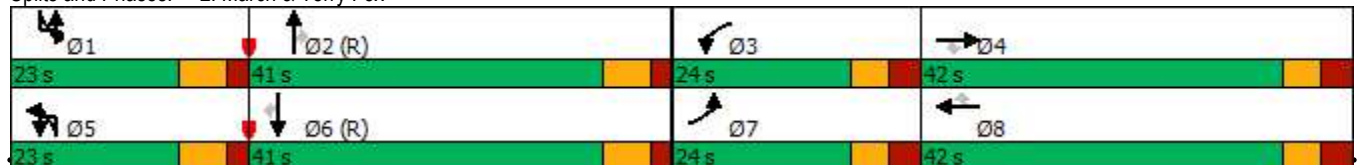





| Lane Group                  | SBT   | SBR   |
|-----------------------------|-------|-------|
| Switch Phase                |       |       |
| Minimum Initial (s)         | 20.0  | 20.0  |
| Minimum Split (s)           | 32.7  | 32.7  |
| Total Split (s)             | 41.0  | 41.0  |
| Total Split (%)             | 31.5% | 31.5% |
| Maximum Green (s)           | 34.3  | 34.3  |
| Yellow Time (s)             | 4.6   | 4.6   |
| All-Red Time (s)            | 2.1   | 2.1   |
| Lost Time Adjust (s)        | 0.0   | 0.0   |
| Total Lost Time (s)         | 6.7   | 6.7   |
| Lead/Lag                    | Lag   | Lag   |
| Lead-Lag Optimize?          | Yes   | Yes   |
| Vehicle Extension (s)       | 3.0   | 3.0   |
| Recall Mode                 | C-Max | C-Max |
| Walk Time (s)               | 7.0   | 7.0   |
| Flash Dont Walk (s)         | 19.0  | 19.0  |
| Pedestrian Calls (#/hr)     | 4     | 4     |
| Act Effct Green (s)         | 52.8  | 52.8  |
| Actuated g/C Ratio          | 0.41  | 0.41  |
| v/c Ratio                   | 0.37  | 0.25  |
| Control Delay               | 27.7  | 6.7   |
| Queue Delay                 | 0.0   | 0.0   |
| Total Delay                 | 27.7  | 6.7   |
| LOS                         | C     | A     |
| Approach Delay              | 27.0  |       |
| Approach LOS                | C     |       |
| Queue Length 50th (m)       | 33.0  | 0.7   |
| Queue Length 95th (m)       | 53.0  | 15.7  |
| Internal Link Dist (m)      | 294.9 |       |
| Turn Bay Length (m)         |       | 100.0 |
| Base Capacity (vph)         | 1917  | 696   |
| Starvation Cap Reductn      | 0     | 0     |
| Spillback Cap Reductn       | 0     | 0     |
| Storage Cap Reductn         | 0     | 0     |
| Reduced v/c Ratio           | 0.37  | 0.25  |
| <b>Intersection Summary</b> |       |       |

3: March & Solandt  
PM Peak Hour

555-603 March Road  
2022 Existing Traffic

| Lane Group                 | EBL   | EBT   | EBR   | WBL   | WBT   | WBR  | NBU   | NBL   | NBT   | NBR   | SBU   | SBL   |
|----------------------------|-------|-------|-------|-------|-------|------|-------|-------|-------|-------|-------|-------|
| Lane Configurations        |       |       |       |       |       |      |       |       |       |       |       |       |
| Traffic Volume (vph)       | 29    | 22    | 237   | 205   | 16    | 34   | 16    | 94    | 1070  | 51    | 12    | 24    |
| Future Volume (vph)        | 29    | 22    | 237   | 205   | 16    | 34   | 16    | 94    | 1070  | 51    | 12    | 24    |
| Ideal Flow (vphpl)         | 1800  | 1800  | 1800  | 1800  | 1800  | 1800 | 1800  | 1800  | 1800  | 1800  | 1800  | 1800  |
| Storage Length (m)         | 35.0  |       | 60.0  | 85.0  |       | 0.0  |       | 165.0 |       | 0.0   |       | 155.0 |
| Storage Lanes              | 1     |       | 1     | 2     |       | 0    |       | 1     |       | 1     |       | 1     |
| Taper Length (m)           | 50.0  |       |       | 95.0  |       |      |       | 40.0  |       |       |       | 25.0  |
| Lane Util. Factor          | 1.00  | 1.00  | 1.00  | 0.97  | 1.00  | 1.00 | 0.95  | 1.00  | 0.95  | 1.00  | 0.95  | 1.00  |
| Ped Bike Factor            | 1.00  |       | 0.99  | 1.00  | 0.99  |      |       |       |       | 0.97  |       |       |
| Fr <sub>t</sub>            |       |       | 0.850 |       | 0.898 |      |       |       |       | 0.850 |       |       |
| Fl <sub>t</sub> Protected  | 0.950 |       |       | 0.950 |       |      |       | 0.950 |       |       |       | 0.950 |
| Satd. Flow (prot)          | 1674  | 1695  | 1483  | 3248  | 1463  | 0    | 0     | 1644  | 3316  | 1427  | 0     | 1647  |
| Fl <sub>t</sub> Permitted  | 0.950 |       |       | 0.950 |       |      |       | 0.159 |       |       |       | 0.225 |
| Satd. Flow (perm)          | 1669  | 1695  | 1462  | 3240  | 1463  | 0    | 0     | 275   | 3316  | 1383  | 0     | 390   |
| Right Turn on Red          |       |       | Yes   |       |       | Yes  |       |       |       | Yes   |       |       |
| Satd. Flow (RTOR)          |       |       | 170   |       | 38    |      |       |       |       | 79    |       |       |
| Link Speed (k/h)           |       | 50    |       |       | 50    |      |       |       | 80    |       |       |       |
| Link Distance (m)          |       | 212.6 |       |       | 241.6 |      |       |       | 610.9 |       |       |       |
| Travel Time (s)            |       | 15.3  |       |       | 17.4  |      |       |       | 27.5  |       |       |       |
| Confl. Peds. (#/hr)        | 2     |       | 1     | 1     |       | 2    |       | 1     |       | 3     |       | 3     |
| Confl. Bikes (#/hr)        |       |       | 1     |       |       | 1    |       |       |       | 1     |       |       |
| Peak Hour Factor           | 0.90  | 0.90  | 0.90  | 0.90  | 0.90  | 0.90 | 0.90  | 0.90  | 0.90  | 0.90  | 0.90  | 0.90  |
| Heavy Vehicles (%)         | 1%    | 5%    | 2%    | 1%    | 6%    | 9%   | 2%    | 3%    | 2%    | 6%    | 2%    | 3%    |
| Adj. Flow (vph)            | 32    | 24    | 263   | 228   | 18    | 38   | 18    | 104   | 1189  | 57    | 13    | 27    |
| Shared Lane Traffic (%)    |       |       |       |       |       |      |       |       |       |       |       |       |
| Lane Group Flow (vph)      | 32    | 24    | 263   | 228   | 56    | 0    | 0     | 122   | 1189  | 57    | 0     | 40    |
| Enter Blocked Intersection | No    | No    | No    | No    | No    | No   | No    | No    | No    | No    | No    | No    |
| Lane Alignment             | L NA  | Left  | R NA  | L NA  | Left  | R NA | R NA  | L NA  | Left  | R NA  | R NA  | L NA  |
| Median Width(m)            |       | 7.0   |       |       | 10.5  |      |       |       | 3.5   |       |       |       |
| Link Offset(m)             |       | 0.0   |       |       | 0.0   |      |       |       | 0.0   |       |       |       |
| Crosswalk Width(m)         |       | 5.0   |       |       | 5.0   |      |       |       | 5.0   |       |       |       |
| Two way Left Turn Lane     |       |       |       |       |       |      |       |       |       |       |       |       |
| Headway Factor             | 1.09  | 1.09  | 1.09  | 1.09  | 1.09  | 1.09 | 1.09  | 1.09  | 1.09  | 1.09  | 1.09  | 1.09  |
| Turning Speed (k/h)        | 24    |       | 14    | 24    |       | 14   | 14    | 24    |       | 14    | 14    | 24    |
| Number of Detectors        | 1     | 2     | 1     | 1     | 2     |      | 1     | 1     | 2     | 1     | 1     | 1     |
| Detector Template          | Left  | Thru  | Right | Left  | Thru  |      | Left  | Left  | Thru  | Right | Left  | Left  |
| Leading Detector (m)       | 2.0   | 10.0  | 2.0   | 2.0   | 10.0  |      | 2.0   | 2.0   | 10.0  | 2.0   | 2.0   | 2.0   |
| Trailing Detector (m)      | 0.0   | 0.0   | 0.0   | 0.0   | 0.0   |      | 0.0   | 0.0   | 0.0   | 0.0   | 0.0   | 0.0   |
| Detector 1 Position(m)     | 0.0   | 0.0   | 0.0   | 0.0   | 0.0   |      | 0.0   | 0.0   | 0.0   | 0.0   | 0.0   | 0.0   |
| Detector 1 Size(m)         | 2.0   | 0.6   | 2.0   | 2.0   | 0.6   |      | 2.0   | 2.0   | 0.6   | 2.0   | 2.0   | 2.0   |
| Detector 1 Type            | Cl+Ex | Cl+Ex | Cl+Ex | Cl+Ex | Cl+Ex |      | Cl+Ex | Cl+Ex | Cl+Ex | Cl+Ex | Cl+Ex | Cl+Ex |
| Detector 1 Channel         |       |       |       |       |       |      |       |       |       |       |       |       |
| Detector 1 Extend (s)      | 0.0   | 0.0   | 0.0   | 0.0   | 0.0   |      | 0.0   | 0.0   | 0.0   | 0.0   | 0.0   | 0.0   |
| Detector 1 Queue (s)       | 0.0   | 0.0   | 0.0   | 0.0   | 0.0   |      | 0.0   | 0.0   | 0.0   | 0.0   | 0.0   | 0.0   |
| Detector 1 Delay (s)       | 0.0   | 0.0   | 0.0   | 0.0   | 0.0   |      | 0.0   | 0.0   | 0.0   | 0.0   | 0.0   | 0.0   |
| Detector 2 Position(m)     |       | 9.4   |       |       | 9.4   |      |       |       | 9.4   |       |       |       |
| Detector 2 Size(m)         |       | 0.6   |       |       | 0.6   |      |       |       | 0.6   |       |       |       |
| Detector 2 Type            |       | Cl+Ex |       |       | Cl+Ex |      |       |       | Cl+Ex |       |       |       |
| Detector 2 Channel         |       |       |       |       |       |      |       |       |       |       |       |       |
| Detector 2 Extend (s)      |       | 0.0   |       |       | 0.0   |      |       |       | 0.0   |       |       |       |
| Turn Type                  | Prot  | NA    | Perm  | Prot  | NA    |      | pm+pt | pm+pt | NA    | Perm  | Perm  | Perm  |
| Protected Phases           | 7     | 4     |       | 3     | 8     |      | 5     | 5     | 2     |       |       |       |
| Permitted Phases           |       |       | 4     |       |       |      | 2     | 2     |       | 2     | 6     | 6     |
| Detector Phase             | 7     | 4     | 4     | 3     | 8     |      | 5     | 5     | 2     | 2     | 6     | 6     |

3: March & Solandt  
PM Peak Hour

555-603 March Road  
2022 Existing Traffic



| Lane Group                 | SBT   | SBR   |
|----------------------------|-------|-------|
| Lane Configurations        | ↑↑    | ↑     |
| Traffic Volume (vph)       | 909   | 35    |
| Future Volume (vph)        | 909   | 35    |
| Ideal Flow (vphpl)         | 1800  | 1800  |
| Storage Length (m)         |       | 75.0  |
| Storage Lanes              |       | 1     |
| Taper Length (m)           |       |       |
| Lane Util. Factor          | 0.95  | 1.00  |
| Ped Bike Factor            |       | 0.97  |
| Frt                        |       | 0.850 |
| Flt Protected              |       |       |
| Satd. Flow (prot)          | 3316  | 1469  |
| Flt Permitted              |       |       |
| Satd. Flow (perm)          | 3316  | 1432  |
| Right Turn on Red          |       | Yes   |
| Satd. Flow (RTOR)          |       | 132   |
| Link Speed (k/h)           | 80    |       |
| Link Distance (m)          | 610.3 |       |
| Travel Time (s)            | 27.5  |       |
| Confl. Peds. (#/hr)        |       | 1     |
| Confl. Bikes (#/hr)        |       | 2     |
| Peak Hour Factor           | 0.90  | 0.90  |
| Heavy Vehicles (%)         | 2%    | 3%    |
| Adj. Flow (vph)            | 1010  | 39    |
| Shared Lane Traffic (%)    |       |       |
| Lane Group Flow (vph)      | 1010  | 39    |
| Enter Blocked Intersection | No    | No    |
| Lane Alignment             | Left  | R NA  |
| Median Width(m)            | 3.5   |       |
| Link Offset(m)             | 0.0   |       |
| Crosswalk Width(m)         | 5.0   |       |
| Two way Left Turn Lane     |       |       |
| Headway Factor             | 1.09  | 1.09  |
| Turning Speed (k/h)        |       | 14    |
| Number of Detectors        | 2     | 1     |
| Detector Template          | Thru  | Right |
| Leading Detector (m)       | 10.0  | 2.0   |
| Trailing Detector (m)      | 0.0   | 0.0   |
| Detector 1 Position(m)     | 0.0   | 0.0   |
| Detector 1 Size(m)         | 0.6   | 2.0   |
| Detector 1 Type            | Cl+Ex | Cl+Ex |
| Detector 1 Channel         |       |       |
| Detector 1 Extend (s)      | 0.0   | 0.0   |
| Detector 1 Queue (s)       | 0.0   | 0.0   |
| Detector 1 Delay (s)       | 0.0   | 0.0   |
| Detector 2 Position(m)     | 9.4   |       |
| Detector 2 Size(m)         | 0.6   |       |
| Detector 2 Type            | Cl+Ex |       |
| Detector 2 Channel         |       |       |
| Detector 2 Extend (s)      | 0.0   |       |
| Turn Type                  | NA    | Perm  |
| Protected Phases           | 6     |       |
| Permitted Phases           |       | 6     |
| Detector Phase             | 6     | 6     |

3: March & Solandt  
PM Peak Hour

555-603 March Road  
2022 Existing Traffic

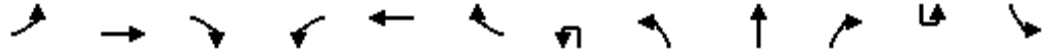

| Lane Group              | EBL   | EBT   | EBR   | WBL   | WBT   | WBR | NBU  | NBL   | NBT   | NBR   | SBU   | SBL   |
|-------------------------|-------|-------|-------|-------|-------|-----|------|-------|-------|-------|-------|-------|
| Switch Phase            |       |       |       |       |       |     |      |       |       |       |       |       |
| Minimum Initial (s)     | 5.0   | 10.0  | 10.0  | 5.0   | 10.0  |     | 5.0  | 5.0   | 20.0  | 20.0  | 20.0  | 20.0  |
| Minimum Split (s)       | 10.9  | 31.5  | 31.5  | 10.9  | 31.5  |     | 11.3 | 11.3  | 26.3  | 26.3  | 26.3  | 26.3  |
| Total Split (s)         | 34.0  | 32.0  | 32.0  | 34.0  | 32.0  |     | 12.0 | 12.0  | 64.0  | 64.0  | 52.0  | 52.0  |
| Total Split (%)         | 26.2% | 24.6% | 24.6% | 26.2% | 24.6% |     | 9.2% | 9.2%  | 49.2% | 49.2% | 40.0% | 40.0% |
| Maximum Green (s)       | 28.1  | 25.5  | 25.5  | 28.1  | 25.5  |     | 5.7  | 5.7   | 57.7  | 57.7  | 45.7  | 45.7  |
| Yellow Time (s)         | 3.3   | 3.3   | 3.3   | 3.3   | 3.3   |     | 4.6  | 4.6   | 4.6   | 4.6   | 4.6   | 4.6   |
| All-Red Time (s)        | 2.6   | 3.2   | 3.2   | 2.6   | 3.2   |     | 1.7  | 1.7   | 1.7   | 1.7   | 1.7   | 1.7   |
| Lost Time Adjust (s)    | 0.0   | 0.0   | 0.0   | 0.0   | 0.0   |     |      | 0.0   | 0.0   | 0.0   |       | 0.0   |
| Total Lost Time (s)     | 5.9   | 6.5   | 6.5   | 5.9   | 6.5   |     |      | 6.3   | 6.3   | 6.3   |       | 6.3   |
| Lead/Lag                | Lead  | Lag   | Lag   | Lead  | Lag   |     | Lead | Lead  |       |       | Lag   | Lag   |
| Lead-Lag Optimize?      | Yes   | Yes   | Yes   | Yes   | Yes   |     | Yes  | Yes   |       |       | Yes   | Yes   |
| Vehicle Extension (s)   | 3.0   | 3.0   | 3.0   | 3.0   | 3.0   |     | 3.0  | 3.0   | 3.0   | 3.0   | 3.0   | 3.0   |
| Recall Mode             | None  | None  | None  | None  | None  |     | None | None  | C-Max | C-Max | C-Max | C-Max |
| Walk Time (s)           |       | 7.0   | 7.0   |       | 7.0   |     |      |       | 7.0   | 7.0   | 7.0   | 7.0   |
| Flash Dont Walk (s)     |       | 18.0  | 18.0  |       | 18.0  |     |      |       | 12.0  | 12.0  | 12.0  | 12.0  |
| Pedestrian Calls (#/hr) |       | 3     | 3     |       | 1     |     |      |       | 1     | 1     | 1     | 1     |
| Act Effct Green (s)     | 8.0   | 16.1  | 16.1  | 14.4  | 27.4  |     |      | 80.7  | 80.7  | 80.7  |       | 62.5  |
| Actuated g/C Ratio      | 0.06  | 0.12  | 0.12  | 0.11  | 0.21  |     |      | 0.62  | 0.62  | 0.62  |       | 0.48  |
| v/c Ratio               | 0.31  | 0.11  | 0.80  | 0.63  | 0.17  |     |      | 0.41  | 0.58  | 0.06  |       | 0.21  |
| Control Delay           | 65.5  | 48.3  | 37.0  | 63.0  | 19.1  |     |      | 16.4  | 17.5  | 1.7   |       | 18.5  |
| Queue Delay             | 0.0   | 0.0   | 0.0   | 0.0   | 0.0   |     |      | 0.0   | 0.0   | 0.0   |       | 0.0   |
| Total Delay             | 65.5  | 48.3  | 37.0  | 63.0  | 19.1  |     |      | 16.4  | 17.5  | 1.7   |       | 18.5  |
| LOS                     | E     | D     | D     | E     | B     |     |      | B     | B     | A     |       | B     |
| Approach Delay          |       | 40.7  |       |       | 54.4  |     |      |       | 16.7  |       |       |       |
| Approach LOS            |       | D     |       |       | D     |     |      |       | B     |       |       |       |
| Queue Length 50th (m)   | 7.4   | 5.2   | 21.7  | 26.9  | 3.6   |     |      | 10.8  | 79.8  | 0.0   |       | 4.8   |
| Queue Length 95th (m)   | 16.8  | 11.7  | 46.6  | 37.9  | 13.2  |     |      | 24.6  | 130.4 | 3.5   |       | m17.5 |
| Internal Link Dist (m)  |       | 188.6 |       |       | 217.6 |     |      |       | 586.9 |       |       |       |
| Turn Bay Length (m)     | 35.0  |       | 60.0  | 85.0  |       |     |      | 165.0 |       |       |       | 155.0 |
| Base Capacity (vph)     | 361   | 332   | 423   | 702   | 347   |     |      | 295   | 2059  | 888   |       | 187   |
| Starvation Cap Reductn  | 0     | 0     | 0     | 0     | 0     |     |      | 0     | 0     | 0     |       | 0     |
| Spillback Cap Reductn   | 0     | 0     | 0     | 0     | 0     |     |      | 0     | 0     | 0     |       | 0     |
| Storage Cap Reductn     | 0     | 0     | 0     | 0     | 0     |     |      | 0     | 0     | 0     |       | 0     |
| Reduced v/c Ratio       | 0.09  | 0.07  | 0.62  | 0.32  | 0.16  |     |      | 0.41  | 0.58  | 0.06  |       | 0.21  |

Intersection Summary

Area Type: Other  
 Cycle Length: 130  
 Actuated Cycle Length: 130  
 Offset: 30 (23%), Referenced to phase 2:NBT and 6:SBTL, Start of Green  
 Natural Cycle: 90  
 Control Type: Actuated-Coordinated  
 Maximum v/c Ratio: 0.80  
 Intersection Signal Delay: 25.0 Intersection LOS: C  
 Intersection Capacity Utilization 77.2% ICU Level of Service D  
 Analysis Period (min) 15  
 m Volume for 95th percentile queue is metered by upstream signal.

Splits and Phases: 3: March & Solandt

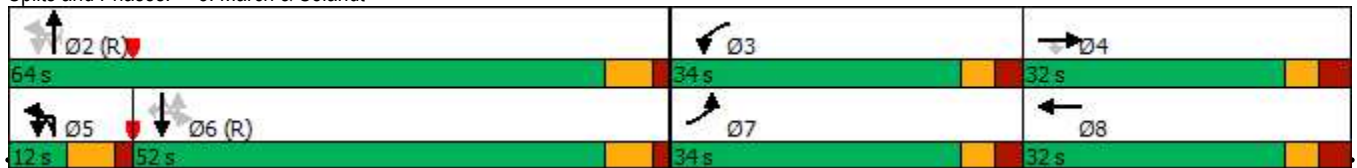



| Lane Group                  | SBT   | SBR   |
|-----------------------------|-------|-------|
| Switch Phase                |       |       |
| Minimum Initial (s)         | 20.0  | 20.0  |
| Minimum Split (s)           | 26.3  | 26.3  |
| Total Split (s)             | 52.0  | 52.0  |
| Total Split (%)             | 40.0% | 40.0% |
| Maximum Green (s)           | 45.7  | 45.7  |
| Yellow Time (s)             | 4.6   | 4.6   |
| All-Red Time (s)            | 1.7   | 1.7   |
| Lost Time Adjust (s)        | 0.0   | 0.0   |
| Total Lost Time (s)         | 6.3   | 6.3   |
| Lead/Lag                    | Lag   | Lag   |
| Lead-Lag Optimize?          | Yes   | Yes   |
| Vehicle Extension (s)       | 3.0   | 3.0   |
| Recall Mode                 | C-Max | C-Max |
| Walk Time (s)               | 7.0   | 7.0   |
| Flash Dont Walk (s)         | 12.0  | 12.0  |
| Pedestrian Calls (#/hr)     | 1     | 1     |
| Act Effct Green (s)         | 62.5  | 62.5  |
| Actuated g/C Ratio          | 0.48  | 0.48  |
| v/c Ratio                   | 0.63  | 0.05  |
| Control Delay               | 24.0  | 2.0   |
| Queue Delay                 | 0.0   | 0.0   |
| Total Delay                 | 24.0  | 2.0   |
| LOS                         | C     | A     |
| Approach Delay              | 23.0  |       |
| Approach LOS                | C     |       |
| Queue Length 50th (m)       | 108.7 | 0.4   |
| Queue Length 95th (m)       | 144.4 | m4.0  |
| Internal Link Dist (m)      | 586.3 |       |
| Turn Bay Length (m)         |       | 75.0  |
| Base Capacity (vph)         | 1595  | 757   |
| Starvation Cap Reductn      | 0     | 0     |
| Spillback Cap Reductn       | 0     | 0     |
| Storage Cap Reductn         | 0     | 0     |
| Reduced v/c Ratio           | 0.63  | 0.05  |
| <b>Intersection Summary</b> |       |       |

4: Innovation/Flamborough & Terry Fox  
PM Peak Hour

555-603 March Road  
2022 Existing Traffic

| Lane Group                 | EBL   | EBT   | EBR   | WBL   | WBT   | WBR   | NBL   | NBT   | NBR  | SBL   | SBT   | SBR  |
|----------------------------|-------|-------|-------|-------|-------|-------|-------|-------|------|-------|-------|------|
| Lane Configurations        |       |       |       |       |       |       |       |       |      |       |       |      |
| Traffic Volume (vph)       | 85    | 276   | 44    | 122   | 374   | 146   | 138   | 80    | 98   | 63    | 60    | 75   |
| Future Volume (vph)        | 85    | 276   | 44    | 122   | 374   | 146   | 138   | 80    | 98   | 63    | 60    | 75   |
| Ideal Flow (vphpl)         | 1800  | 1800  | 1800  | 1800  | 1800  | 1800  | 1800  | 1800  | 1800 | 1800  | 1800  | 1800 |
| Storage Length (m)         | 75.0  |       | 120.0 | 110.0 |       | 130.0 | 220.0 |       | 0.0  | 30.0  |       | 0.0  |
| Storage Lanes              | 1     |       | 1     | 1     |       | 1     | 1     |       | 0    | 1     |       | 0    |
| Taper Length (m)           | 50.0  |       |       | 80.0  |       |       | 50.0  |       |      | 15.0  |       |      |
| Lane Util. Factor          | 1.00  | 1.00  | 1.00  | 1.00  | 1.00  | 1.00  | 1.00  | 1.00  | 1.00 | 1.00  | 1.00  | 1.00 |
| Ped Bike Factor            | 1.00  |       | 0.97  | 0.99  |       | 0.96  | 0.96  | 0.98  |      | 1.00  | 0.96  |      |
| Fr <sub>t</sub>            |       |       | 0.850 |       |       | 0.850 |       | 0.917 |      |       | 0.917 |      |
| Flt Protected              | 0.950 |       |       | 0.950 |       |       | 0.950 |       |      | 0.950 |       |      |
| Satd. Flow (prot)          | 1566  | 1745  | 1498  | 1642  | 1762  | 1498  | 1674  | 1548  | 0    | 1674  | 1496  | 0    |
| Flt Permitted              | 0.465 |       |       | 0.533 |       |       | 0.576 |       |      | 0.459 |       |      |
| Satd. Flow (perm)          | 765   | 1745  | 1450  | 915   | 1762  | 1445  | 977   | 1548  | 0    | 806   | 1496  | 0    |
| Right Turn on Red          |       |       | Yes   |       |       | Yes   |       |       | Yes  |       |       | Yes  |
| Satd. Flow (RTOR)          |       |       | 80    |       |       | 162   |       | 52    |      |       | 53    |      |
| Link Speed (k/h)           |       | 60    |       |       | 60    |       |       | 50    |      |       | 50    |      |
| Link Distance (m)          |       | 508.2 |       |       | 485.8 |       |       | 547.1 |      |       | 313.7 |      |
| Travel Time (s)            |       | 30.5  |       |       | 29.1  |       |       | 39.4  |      |       | 22.6  |      |
| Confl. Peds. (#/hr)        | 2     |       | 4     | 4     |       | 2     | 21    |       | 2    | 2     |       | 21   |
| Confl. Bikes (#/hr)        |       |       | 1     |       |       | 12    |       |       | 6    |       |       | 4    |
| Peak Hour Factor           | 0.90  | 0.90  | 0.90  | 0.90  | 0.90  | 0.90  | 0.90  | 0.90  | 0.90 | 0.90  | 0.90  | 0.90 |
| Heavy Vehicles (%)         | 8%    | 2%    | 1%    | 3%    | 1%    | 1%    | 1%    | 2%    | 5%   | 1%    | 1%    | 8%   |
| Adj. Flow (vph)            | 94    | 307   | 49    | 136   | 416   | 162   | 153   | 89    | 109  | 70    | 67    | 83   |
| Shared Lane Traffic (%)    |       |       |       |       |       |       |       |       |      |       |       |      |
| Lane Group Flow (vph)      | 94    | 307   | 49    | 136   | 416   | 162   | 153   | 198   | 0    | 70    | 150   | 0    |
| Enter Blocked Intersection | No    | No    | No    | No    | No    | No    | No    | No    | No   | No    | No    | No   |
| Lane Alignment             | L NA  | Left  | R NA  | L NA  | Left  | R NA  | L NA  | Left  | R NA | L NA  | Left  | R NA |
| Median Width(m)            |       | 3.5   |       |       | 3.5   |       |       | 3.5   |      |       | 3.5   |      |
| Link Offset(m)             |       | 0.0   |       |       | 0.0   |       |       | 0.0   |      |       | 0.0   |      |
| Crosswalk Width(m)         |       | 5.0   |       |       | 5.0   |       |       | 5.0   |      |       | 5.0   |      |
| Two way Left Turn Lane     |       |       |       |       |       |       |       |       |      |       |       |      |
| Headway Factor             | 1.09  | 1.09  | 1.09  | 1.09  | 1.09  | 1.09  | 1.09  | 1.09  | 1.09 | 1.09  | 1.09  | 1.09 |
| Turning Speed (k/h)        | 24    |       | 14    | 24    |       | 14    | 24    |       | 14   | 24    |       | 14   |
| Number of Detectors        | 1     | 2     | 1     | 1     | 2     | 1     | 1     | 2     |      | 1     | 2     |      |
| Detector Template          | Left  | Thru  | Right | Left  | Thru  | Right | Left  | Thru  |      | Left  | Thru  |      |
| Leading Detector (m)       | 2.0   | 10.0  | 2.0   | 2.0   | 10.0  | 2.0   | 2.0   | 10.0  |      | 2.0   | 10.0  |      |
| Trailing Detector (m)      | 0.0   | 0.0   | 0.0   | 0.0   | 0.0   | 0.0   | 0.0   | 0.0   |      | 0.0   | 0.0   |      |
| Detector 1 Position(m)     | 0.0   | 0.0   | 0.0   | 0.0   | 0.0   | 0.0   | 0.0   | 0.0   |      | 0.0   | 0.0   |      |
| Detector 1 Size(m)         | 2.0   | 0.6   | 2.0   | 2.0   | 0.6   | 2.0   | 2.0   | 0.6   |      | 2.0   | 0.6   |      |
| Detector 1 Type            | Cl+Ex | Cl+Ex | Cl+Ex | Cl+Ex | Cl+Ex | Cl+Ex | Cl+Ex | Cl+Ex |      | Cl+Ex | Cl+Ex |      |
| Detector 1 Channel         |       |       |       |       |       |       |       |       |      |       |       |      |
| Detector 1 Extend (s)      | 0.0   | 0.0   | 0.0   | 0.0   | 0.0   | 0.0   | 0.0   | 0.0   |      | 0.0   | 0.0   |      |
| Detector 1 Queue (s)       | 0.0   | 0.0   | 0.0   | 0.0   | 0.0   | 0.0   | 0.0   | 0.0   |      | 0.0   | 0.0   |      |
| Detector 1 Delay (s)       | 0.0   | 0.0   | 0.0   | 0.0   | 0.0   | 0.0   | 0.0   | 0.0   |      | 0.0   | 0.0   |      |
| Detector 2 Position(m)     |       | 9.4   |       |       | 9.4   |       |       | 9.4   |      |       | 9.4   |      |
| Detector 2 Size(m)         |       | 0.6   |       |       | 0.6   |       |       | 0.6   |      |       | 0.6   |      |
| Detector 2 Type            |       | Cl+Ex |       |       | Cl+Ex |       |       | Cl+Ex |      |       | Cl+Ex |      |
| Detector 2 Channel         |       |       |       |       |       |       |       |       |      |       |       |      |
| Detector 2 Extend (s)      |       | 0.0   |       |       | 0.0   |       |       | 0.0   |      |       | 0.0   |      |
| Turn Type                  | pm+pt | NA    | Perm  | pm+pt | NA    | Perm  | Perm  | NA    |      | Perm  | NA    |      |
| Protected Phases           | 5     | 2     |       | 1     | 6     |       |       | 8     |      |       | 4     |      |
| Permitted Phases           | 2     |       | 2     | 6     |       | 6     | 8     |       |      | 4     |       |      |
| Detector Phase             | 5     | 2     | 2     | 1     | 6     | 6     | 8     | 8     |      | 4     | 4     |      |

4: Innovation/Flamborough & Terry Fox  
PM Peak Hour

555-603 March Road  
2022 Existing Traffic



| Lane Group              | EBL  | EBT   | EBR   | WBL   | WBT   | WBR   | NBL   | NBT   | NBR | SBL   | SBT   | SBR |
|-------------------------|------|-------|-------|-------|-------|-------|-------|-------|-----|-------|-------|-----|
| Switch Phase            |      |       |       |       |       |       |       |       |     |       |       |     |
| Minimum Initial (s)     | 5.0  | 10.0  | 10.0  | 5.0   | 10.0  | 10.0  | 10.0  | 10.0  |     | 10.0  | 10.0  |     |
| Minimum Split (s)       | 10.9 | 27.9  | 27.9  | 10.9  | 27.9  | 27.9  | 35.6  | 35.6  |     | 35.6  | 35.6  |     |
| Total Split (s)         | 12.0 | 66.0  | 66.0  | 12.0  | 66.0  | 66.0  | 52.0  | 52.0  |     | 52.0  | 52.0  |     |
| Total Split (%)         | 9.2% | 50.8% | 50.8% | 9.2%  | 50.8% | 50.8% | 40.0% | 40.0% |     | 40.0% | 40.0% |     |
| Maximum Green (s)       | 6.1  | 60.1  | 60.1  | 6.1   | 60.1  | 60.1  | 45.4  | 45.4  |     | 45.4  | 45.4  |     |
| Yellow Time (s)         | 3.7  | 3.7   | 3.7   | 3.7   | 3.7   | 3.7   | 3.0   | 3.0   |     | 3.0   | 3.0   |     |
| All-Red Time (s)        | 2.2  | 2.2   | 2.2   | 2.2   | 2.2   | 2.2   | 3.6   | 3.6   |     | 3.6   | 3.6   |     |
| Lost Time Adjust (s)    | 0.0  | 0.0   | 0.0   | 0.0   | 0.0   | 0.0   | 0.0   | 0.0   |     | 0.0   | 0.0   |     |
| Total Lost Time (s)     | 5.9  | 5.9   | 5.9   | 5.9   | 5.9   | 5.9   | 6.6   | 6.6   |     | 6.6   | 6.6   |     |
| Lead/Lag                | Lead | Lag   | Lag   | Lead  | Lag   | Lag   |       |       |     |       |       |     |
| Lead-Lag Optimize?      | Yes  | Yes   | Yes   | Yes   | Yes   | Yes   |       |       |     |       |       |     |
| Vehicle Extension (s)   | 3.0  | 3.0   | 3.0   | 3.0   | 3.0   | 3.0   | 3.0   | 3.0   |     | 3.0   | 3.0   |     |
| Recall Mode             | None | C-Max | C-Max | None  | C-Max | C-Max | None  | None  |     | None  | None  |     |
| Walk Time (s)           |      | 7.0   | 7.0   |       | 7.0   | 7.0   | 7.0   | 7.0   |     | 7.0   | 7.0   |     |
| Flash Dont Walk (s)     |      | 15.0  | 15.0  |       | 15.0  | 15.0  | 22.0  | 22.0  |     | 22.0  | 22.0  |     |
| Pedestrian Calls (#/hr) |      | 3     | 3     |       | 3     | 3     | 3     | 3     |     | 3     | 3     |     |
| Act Effct Green (s)     | 86.8 | 78.8  | 78.8  | 88.9  | 79.8  | 79.8  | 23.7  | 23.7  |     | 23.7  | 23.7  |     |
| Actuated g/C Ratio      | 0.67 | 0.61  | 0.61  | 0.68  | 0.61  | 0.61  | 0.18  | 0.18  |     | 0.18  | 0.18  |     |
| v/c Ratio               | 0.17 | 0.29  | 0.05  | 0.20  | 0.38  | 0.17  | 0.86  | 0.61  |     | 0.48  | 0.47  |     |
| Control Delay           | 7.6  | 14.9  | 1.2   | 3.7   | 7.4   | 0.7   | 89.0  | 42.5  |     | 56.3  | 33.6  |     |
| Queue Delay             | 0.0  | 0.0   | 0.0   | 0.0   | 0.0   | 0.0   | 0.0   | 0.0   |     | 0.0   | 0.0   |     |
| Total Delay             | 7.6  | 14.9  | 1.2   | 3.7   | 7.4   | 0.7   | 89.0  | 42.5  |     | 56.3  | 33.6  |     |
| LOS                     | A    | B     | A     | A     | A     | A     | F     | D     |     | E     | C     |     |
| Approach Delay          |      | 11.9  |       |       | 5.2   |       |       | 62.8  |     |       | 40.8  |     |
| Approach LOS            |      | B     |       |       | A     |       |       | E     |     |       | D     |     |
| Queue Length 50th (m)   | 5.9  | 32.5  | 0.0   | 4.8   | 19.9  | 0.5   | 35.4  | 31.9  |     | 15.0  | 20.3  |     |
| Queue Length 95th (m)   | 13.9 | 61.6  | 2.2   | 10.9  | 34.9  | 1.1   | 54.0  | 50.2  |     | 26.7  | 36.0  |     |
| Internal Link Dist (m)  |      | 484.2 |       |       | 461.8 |       |       | 523.1 |     |       | 289.7 |     |
| Turn Bay Length (m)     | 75.0 |       | 120.0 | 110.0 |       | 130.0 | 220.0 |       |     | 30.0  |       |     |
| Base Capacity (vph)     | 560  | 1057  | 910   | 675   | 1082  | 949   | 341   | 574   |     | 281   | 556   |     |
| Starvation Cap Reductn  | 0    | 0     | 0     | 0     | 0     | 0     | 0     | 0     |     | 0     | 0     |     |
| Spillback Cap Reductn   | 0    | 0     | 0     | 0     | 0     | 0     | 0     | 0     |     | 0     | 0     |     |
| Storage Cap Reductn     | 0    | 0     | 0     | 0     | 0     | 0     | 0     | 0     |     | 0     | 0     |     |
| Reduced v/c Ratio       | 0.17 | 0.29  | 0.05  | 0.20  | 0.38  | 0.17  | 0.45  | 0.34  |     | 0.25  | 0.27  |     |

Intersection Summary

|                                    |   |
|------------------------------------|---|
| Area Type:                         | Other   |
| Cycle Length:                      | 130   |
| Actuated Cycle Length:             | 130   |
| Offset:                            | 66 (51%), Referenced to phase 2:EBTL and 6:WBTL, Start of Green |
| Natural Cycle:                     | 75  |
| Control Type:                      | Actuated-Coordinated  |
| Maximum v/c Ratio:                 | 0.86  |
| Intersection Signal Delay:         | 23.1  |
| Intersection LOS:                  | C   |
| Intersection Capacity Utilization: | 71.7%   |
| ICU Level of Service:              | C   |
| Analysis Period (min):             | 15  |

Splits and Phases: 4: Innovation/Flamborough & Terry Fox

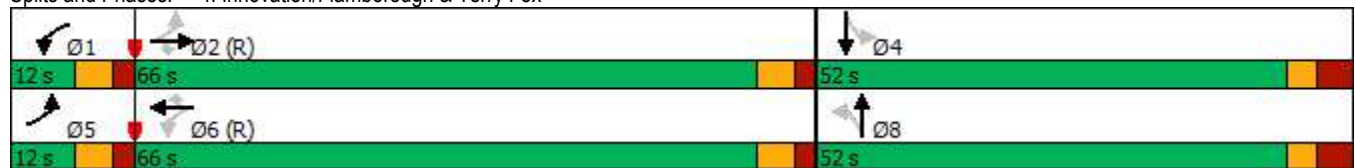

5: Hines & Innovation  
PM Peak Hour

555-603 March Road  
2022 Existing Traffic



| Lane Group                 | EBL  | EBT   | EBR   | WBL  | WBT   | WBR   | NBL  | NBT   | NBR   | SBL  | SBT   | SBR   |
|----------------------------|------|-------|-------|------|-------|-------|------|-------|-------|------|-------|-------|
| Lane Configurations        |      | ↕     |       |      | ↕     |       |      | ↕     |       |      | ↕     |       |
| Traffic Volume (vph)       | 3    | 0     | 100   | 0    | 0     | 0     | 134  | 14    | 0     | 0    | 53    | 9     |
| Future Volume (vph)        | 3    | 0     | 100   | 0    | 0     | 0     | 134  | 14    | 0     | 0    | 53    | 9     |
| Ideal Flow (vphpl)         | 1800 | 1800  | 1800  | 1800 | 1800  | 1800  | 1800 | 1800  | 1800  | 1800 | 1800  | 1800  |
| Lane Util. Factor          | 1.00 | 1.00  | 1.00  | 1.00 | 1.00  | 1.00  | 1.00 | 1.00  | 1.00  | 1.00 | 1.00  | 1.00  |
| Ped Bike Factor            |      |       |       |      |       |       |      |       |       |      |       |       |
| Frt                        |      | 0.869 |       |      |       |       |      |       |       |      | 0.980 |       |
| Flt Protected              |      | 0.999 |       |      |       |       |      | 0.957 |       |      |       |       |
| Satd. Flow (prot)          | 0    | 1515  | 0     | 0    | 1762  | 0     | 0    | 1649  | 0     | 0    | 1684  | 0     |
| Flt Permitted              |      | 0.999 |       |      |       |       |      | 0.957 |       |      |       |       |
| Satd. Flow (perm)          | 0    | 1515  | 0     | 0    | 1762  | 0     | 0    | 1649  | 0     | 0    | 1684  | 0     |
| Link Speed (k/h)           |      | 50    |       |      | 50    |       |      | 50    |       |      | 50    |       |
| Link Distance (m)          |      | 438.6 |       |      | 104.0 |       |      | 421.8 |       |      | 319.0 |       |
| Travel Time (s)            |      | 31.6  |       |      | 7.5   |       |      | 30.4  |       |      | 23.0  |       |
| Confl. Peds. (#/hr)        | 2    |       | 1     | 1    |       | 2     | 4    |       |       |      |       | 4     |
| Confl. Bikes (#/hr)        |      |       | 2     |      |       | 3     |      |       | 3     |      |       | 3     |
| Peak Hour Factor           | 0.90 | 0.90  | 0.90  | 0.90 | 0.90  | 0.90  | 0.90 | 0.90  | 0.90  | 0.90 | 0.90  | 0.90  |
| Heavy Vehicles (%)         | 1%   | 1%    | 2%    | 1%   | 1%    | 1%    | 3%   | 6%    | 1%    | 1%   | 4%    | 1%    |
| Adj. Flow (vph)            | 3    | 0     | 111   | 0    | 0     | 0     | 149  | 16    | 0     | 0    | 59    | 10    |
| Shared Lane Traffic (%)    |      |       |       |      |       |       |      |       |       |      |       |       |
| Lane Group Flow (vph)      | 0    | 114   | 0     | 0    | 0     | 0     | 0    | 165   | 0     | 0    | 69    | 0     |
| Enter Blocked Intersection | No   | No    | No    | No   | No    | No    | No   | No    | No    | No   | No    | No    |
| Lane Alignment             | Left | Left  | Right | Left | Left  | Right | Left | Left  | Right | Left | Left  | Right |
| Median Width(m)            |      | 0.0   |       |      | 0.0   |       |      | 0.0   |       |      | 0.0   |       |
| Link Offset(m)             |      | 0.0   |       |      | 0.0   |       |      | 0.0   |       |      | 0.0   |       |
| Crosswalk Width(m)         |      | 5.0   |       |      | 5.0   |       |      | 5.0   |       |      | 5.0   |       |
| Two way Left Turn Lane     |      |       |       |      |       |       |      |       |       |      |       |       |
| Headway Factor             | 1.09 | 1.09  | 1.09  | 1.09 | 1.09  | 1.09  | 1.09 | 1.09  | 1.09  | 1.09 | 1.09  | 1.09  |
| Turning Speed (k/h)        | 24   |       | 14    | 24   |       | 14    | 24   |       | 14    | 24   |       | 14    |
| Sign Control               |      | Stop  |       |      | Stop  |       |      | Free  |       |      | Free  |       |

Intersection Summary

Area Type: Other

Control Type: Unsignalized

Intersection Capacity Utilization 29.0% ICU Level of Service A

Analysis Period (min) 15



## **APPENDIX L**

---

### Background Synchro Analysis

1: March & Morgan's Grant/Shirley's Brook  
AM Peak Hour

555-603 March Road  
2037 Background Traffic



| Lane Group                 | EBL   | EBT   | EBR   | WBL   | WBT   | WBR   | NBL   | NBT   | NBR   | SBL   | SBT   | SBR   |
|----------------------------|-------|-------|-------|-------|-------|-------|-------|-------|-------|-------|-------|-------|
| Lane Configurations        |       | ↕     | ↗     | ↖     | ↕     | ↗     | ↖     | ↕↕↕   | ↗     | ↖     | ↕↕↕   | ↗     |
| Traffic Volume (vph)       | 26    | 38    | 68    | 86    | 14    | 25    | 26    | 958   | 41    | 100   | 1813  | 10    |
| Future Volume (vph)        | 26    | 38    | 68    | 86    | 14    | 25    | 26    | 958   | 41    | 100   | 1813  | 10    |
| Ideal Flow (vphpl)         | 1800  | 1800  | 1800  | 1800  | 1800  | 1800  | 1800  | 1800  | 1800  | 1800  | 1800  | 1800  |
| Storage Length (m)         | 0.0   |       | 20.0  | 45.0  |       | 35.0  | 130.0 |       | 30.0  | 65.0  |       | 25.0  |
| Storage Lanes              | 0     |       | 1     | 1     |       | 1     | 1     |       | 1     | 1     |       | 1     |
| Taper Length (m)           | 10.0  |       |       | 30.0  |       |       | 40.0  |       |       | 35.0  |       |       |
| Lane Util. Factor          | 1.00  | 1.00  | 1.00  | 1.00  | 1.00  | 1.00  | 1.00  | 0.91  | 1.00  | 1.00  | 0.91  | 1.00  |
| Ped Bike Factor            |       | 1.00  | 0.98  | 0.99  |       | 0.98  | 1.00  |       | 0.96  | 1.00  |       | 0.96  |
| Frt                        |       |       | 0.850 |       |       | 0.850 |       |       | 0.850 |       |       | 0.850 |
| Flt Protected              |       | 0.980 |       | 0.950 |       |       | 0.950 |       |       | 0.950 |       |       |
| Satd. Flow (prot)          | 0     | 1727  | 1498  | 1580  | 1271  | 1498  | 1674  | 4628  | 1427  | 1674  | 4718  | 1498  |
| Flt Permitted              |       | 0.861 |       | 0.715 |       |       | 0.950 |       |       | 0.950 |       |       |
| Satd. Flow (perm)          | 0     | 1514  | 1464  | 1183  | 1271  | 1464  | 1672  | 4628  | 1368  | 1666  | 4718  | 1436  |
| Right Turn on Red          |       |       | Yes   |       |       | Yes   |       |       | Yes   |       |       | Yes   |
| Satd. Flow (RTOR)          |       |       | 136   |       |       | 136   |       |       | 145   |       |       | 91    |
| Link Speed (k/h)           |       | 40    |       |       | 40    |       |       | 60    |       |       | 60    |       |
| Link Distance (m)          |       | 465.2 |       |       | 359.5 |       |       | 318.9 |       |       | 462.6 |       |
| Travel Time (s)            |       | 41.9  |       |       | 32.4  |       |       | 19.1  |       |       | 27.8  |       |
| Confl. Peds. (#/hr)        | 5     |       | 5     | 5     |       | 5     | 5     |       | 5     | 5     |       | 5     |
| Confl. Bikes (#/hr)        |       |       | 5     |       |       | 5     |       |       | 5     |       |       | 5     |
| Peak Hour Factor           | 1.00  | 1.00  | 1.00  | 1.00  | 1.00  | 1.00  | 1.00  | 1.00  | 1.00  | 1.00  | 1.00  | 1.00  |
| Heavy Vehicles (%)         | 1%    | 1%    | 1%    | 7%    | 40%   | 1%    | 1%    | 5%    | 6%    | 1%    | 3%    | 1%    |
| Adj. Flow (vph)            | 26    | 38    | 68    | 86    | 14    | 25    | 26    | 958   | 41    | 100   | 1813  | 10    |
| Shared Lane Traffic (%)    |       |       |       |       |       |       |       |       |       |       |       |       |
| Lane Group Flow (vph)      | 0     | 64    | 68    | 86    | 14    | 25    | 26    | 958   | 41    | 100   | 1813  | 10    |
| Enter Blocked Intersection | No    | No    | No    | No    | No    | No    | No    | No    | No    | No    | No    | No    |
| Lane Alignment             | L NA  | Left  | R NA  | L NA  | Left  | R NA  | L NA  | Left  | R NA  | L NA  | Left  | R NA  |
| Median Width(m)            |       | 3.5   |       |       | 5.0   |       |       | 9.0   |       |       | 9.0   |       |
| Link Offset(m)             |       | 0.0   |       |       | 0.0   |       |       | 0.0   |       |       | 0.0   |       |
| Crosswalk Width(m)         |       | 5.0   |       |       | 5.0   |       |       | 10.0  |       |       | 10.0  |       |
| Two way Left Turn Lane     |       |       |       |       |       |       |       |       |       |       |       |       |
| Headway Factor             | 1.09  | 1.09  | 1.09  | 1.09  | 1.09  | 1.09  | 1.09  | 1.09  | 1.09  | 1.09  | 1.09  | 1.09  |
| Turning Speed (k/h)        | 24    |       | 14    | 24    |       | 14    | 24    |       | 14    | 24    |       | 14    |
| Number of Detectors        | 1     | 2     | 1     | 1     | 2     | 1     | 1     | 2     | 1     | 1     | 2     | 1     |
| Detector Template          | Left  | Thru  | Right | Left  | Thru  | Right | Left  | Thru  | Right | Left  | Thru  | Right |
| Leading Detector (m)       | 2.0   | 10.0  | 2.0   | 2.0   | 10.0  | 2.0   | 2.0   | 10.0  | 2.0   | 2.0   | 10.0  | 2.0   |
| Trailing Detector (m)      | 0.0   | 0.0   | 0.0   | 0.0   | 0.0   | 0.0   | 0.0   | 0.0   | 0.0   | 0.0   | 0.0   | 0.0   |
| Detector 1 Position(m)     | 0.0   | 0.0   | 0.0   | 0.0   | 0.0   | 0.0   | 0.0   | 0.0   | 0.0   | 0.0   | 0.0   | 0.0   |
| Detector 1 Size(m)         | 2.0   | 0.6   | 2.0   | 2.0   | 0.6   | 2.0   | 2.0   | 0.6   | 2.0   | 2.0   | 0.6   | 2.0   |
| Detector 1 Type            | Cl+Ex | Cl+Ex | Cl+Ex | Cl+Ex | Cl+Ex | Cl+Ex | Cl+Ex | Cl+Ex | Cl+Ex | Cl+Ex | Cl+Ex | Cl+Ex |
| Detector 1 Channel         |       |       |       |       |       |       |       |       |       |       |       |       |
| Detector 1 Extend (s)      | 0.0   | 0.0   | 0.0   | 0.0   | 0.0   | 0.0   | 0.0   | 0.0   | 0.0   | 0.0   | 0.0   | 0.0   |
| Detector 1 Queue (s)       | 0.0   | 0.0   | 0.0   | 0.0   | 0.0   | 0.0   | 0.0   | 0.0   | 0.0   | 0.0   | 0.0   | 0.0   |
| Detector 1 Delay (s)       | 0.0   | 0.0   | 0.0   | 0.0   | 0.0   | 0.0   | 0.0   | 0.0   | 0.0   | 0.0   | 0.0   | 0.0   |
| Detector 2 Position(m)     |       | 9.4   |       |       | 9.4   |       |       | 9.4   |       |       | 9.4   |       |
| Detector 2 Size(m)         |       | 0.6   |       |       | 0.6   |       |       | 0.6   |       |       | 0.6   |       |
| Detector 2 Type            |       | Cl+Ex |       |       | Cl+Ex |       |       | Cl+Ex |       |       | Cl+Ex |       |
| Detector 2 Channel         |       |       |       |       |       |       |       |       |       |       |       |       |
| Detector 2 Extend (s)      |       | 0.0   |       |       | 0.0   |       |       | 0.0   |       |       | 0.0   |       |
| Turn Type                  | Perm  | NA    | Perm  | Perm  | NA    | Perm  | Prot  | NA    | Perm  | Prot  | NA    | Perm  |
| Protected Phases           |       | 4     |       |       | 8     |       | 5     | 2     |       | 1     | 6     |       |
| Permitted Phases           | 4     |       | 4     | 8     |       | 8     |       |       | 2     |       |       | 6     |
| Detector Phase             | 4     | 4     | 4     | 8     | 8     | 8     | 5     | 2     | 2     | 1     | 6     | 6     |



| Lane Group              | EBL   | EBT   | EBR   | WBL   | WBT   | WBR   | NBL   | NBT   | NBR   | SBL   | SBT   | SBR   |
|-------------------------|-------|-------|-------|-------|-------|-------|-------|-------|-------|-------|-------|-------|
| Switch Phase            |       |       |       |       |       |       |       |       |       |       |       |       |
| Minimum Initial (s)     | 10.0  | 10.0  | 10.0  | 10.0  | 10.0  | 10.0  | 5.0   | 10.0  | 10.0  | 5.0   | 10.0  | 10.0  |
| Minimum Split (s)       | 38.5  | 38.5  | 38.5  | 38.5  | 38.5  | 38.5  | 11.4  | 24.4  | 24.4  | 11.4  | 24.4  | 24.4  |
| Total Split (s)         | 40.0  | 40.0  | 40.0  | 40.0  | 40.0  | 40.0  | 14.0  | 65.0  | 65.0  | 25.0  | 76.0  | 76.0  |
| Total Split (%)         | 30.8% | 30.8% | 30.8% | 30.8% | 30.8% | 30.8% | 10.8% | 50.0% | 50.0% | 19.2% | 58.5% | 58.5% |
| Maximum Green (s)       | 32.5  | 32.5  | 32.5  | 32.5  | 32.5  | 32.5  | 7.6   | 58.6  | 58.6  | 18.6  | 69.6  | 69.6  |
| Yellow Time (s)         | 3.0   | 3.0   | 3.0   | 3.0   | 3.0   | 3.0   | 3.7   | 3.7   | 3.7   | 3.7   | 3.7   | 3.7   |
| All-Red Time (s)        | 4.5   | 4.5   | 4.5   | 4.5   | 4.5   | 4.5   | 2.7   | 2.7   | 2.7   | 2.7   | 2.7   | 2.7   |
| Lost Time Adjust (s)    |       | 0.0   | 0.0   | 0.0   | 0.0   | 0.0   | 0.0   | 0.0   | 0.0   | 0.0   | 0.0   | 0.0   |
| Total Lost Time (s)     |       | 7.5   | 7.5   | 7.5   | 7.5   | 7.5   | 6.4   | 6.4   | 6.4   | 6.4   | 6.4   | 6.4   |
| Lead/Lag                |       |       |       |       |       |       | Lead  | Lag   | Lag   | Lead  | Lag   | Lag   |
| Lead-Lag Optimize?      |       |       |       |       |       |       |       |       |       |       |       |       |
| Vehicle Extension (s)   | 3.0   | 3.0   | 3.0   | 3.0   | 3.0   | 3.0   | 3.0   | 3.0   | 3.0   | 3.0   | 3.0   | 3.0   |
| Recall Mode             | None  | None  | None  | None  | None  | None  | None  | C-Max | C-Max | None  | C-Max | C-Max |
| Walk Time (s)           | 7.0   | 7.0   | 7.0   | 7.0   | 7.0   | 7.0   |       | 7.0   | 7.0   |       | 7.0   | 7.0   |
| Flash Dont Walk (s)     | 24.0  | 24.0  | 24.0  | 24.0  | 24.0  | 24.0  |       | 11.0  | 11.0  |       | 11.0  | 11.0  |
| Pedestrian Calls (#/hr) | 5     | 5     | 5     | 5     | 5     | 5     |       | 5     | 5     |       | 5     | 5     |
| Act Effct Green (s)     |       | 17.1  | 17.1  | 17.1  | 17.1  | 17.1  | 7.4   | 79.6  | 79.6  | 13.1  | 90.2  | 90.2  |
| Actuated g/C Ratio      |       | 0.13  | 0.13  | 0.13  | 0.13  | 0.13  | 0.06  | 0.61  | 0.61  | 0.10  | 0.69  | 0.69  |
| v/c Ratio               |       | 0.32  | 0.22  | 0.55  | 0.08  | 0.08  | 0.27  | 0.34  | 0.05  | 0.60  | 0.55  | 0.01  |
| Control Delay           |       | 52.8  | 1.6   | 64.3  | 45.9  | 0.5   | 86.8  | 2.0   | 0.1   | 69.8  | 13.1  | 0.0   |
| Queue Delay             |       | 0.0   | 0.0   | 0.0   | 0.0   | 0.0   | 0.0   | 0.0   | 0.0   | 0.0   | 0.0   | 0.0   |
| Total Delay             |       | 52.8  | 1.6   | 64.3  | 45.9  | 0.5   | 86.8  | 2.0   | 0.1   | 69.8  | 13.1  | 0.0   |
| LOS                     |       | D     | A     | E     | D     | A     | F     | A     | A     | E     | B     | A     |
| Approach Delay          |       | 26.4  |       |       | 49.5  |       |       | 4.1   |       |       | 16.0  |       |
| Approach LOS            |       | C     |       |       | D     |       |       | A     |       |       | B     |       |
| Queue Length 50th (m)   |       | 14.2  | 0.0   | 19.7  | 3.0   | 0.0   | 6.5   | 2.1   | 0.0   | 22.9  | 76.6  | 0.0   |
| Queue Length 95th (m)   |       | 23.6  | 0.0   | 30.8  | 7.7   | 0.0   | m15.0 | 3.7   | m0.0  | 38.4  | 130.4 | 0.0   |
| Internal Link Dist (m)  |       | 441.2 |       |       | 335.5 |       |       | 294.9 |       |       | 438.6 |       |
| Turn Bay Length (m)     |       |       | 20.0  | 45.0  |       | 35.0  | 130.0 |       | 30.0  | 65.0  |       | 25.0  |
| Base Capacity (vph)     |       | 378   | 468   | 295   | 317   | 468   | 103   | 2832  | 893   | 239   | 3272  | 1024  |
| Starvation Cap Reductn  |       | 0     | 0     | 0     | 0     | 0     | 0     | 0     | 0     | 0     | 0     | 0     |
| Spillback Cap Reductn   |       | 0     | 0     | 0     | 0     | 0     | 0     | 0     | 0     | 0     | 0     | 0     |
| Storage Cap Reductn     |       | 0     | 0     | 0     | 0     | 0     | 0     | 0     | 0     | 0     | 0     | 0     |
| Reduced v/c Ratio       |       | 0.17  | 0.15  | 0.29  | 0.04  | 0.05  | 0.25  | 0.34  | 0.05  | 0.42  | 0.55  | 0.01  |

Intersection Summary

Area Type: Other  
 Cycle Length: 130  
 Actuated Cycle Length: 130  
 Offset: 94 (72%), Referenced to phase 2:NBT and 6:SBT, Start of Green  
 Natural Cycle: 90  
 Control Type: Actuated-Coordinated  
 Maximum v/c Ratio: 0.60  
 Intersection Signal Delay: 13.9 Intersection LOS: B  
 Intersection Capacity Utilization 76.8% ICU Level of Service D  
 Analysis Period (min) 15  
 m Volume for 95th percentile queue is metered by upstream signal.

Splits and Phases: 1: March & Morgan's Grant/Shirley's Brook

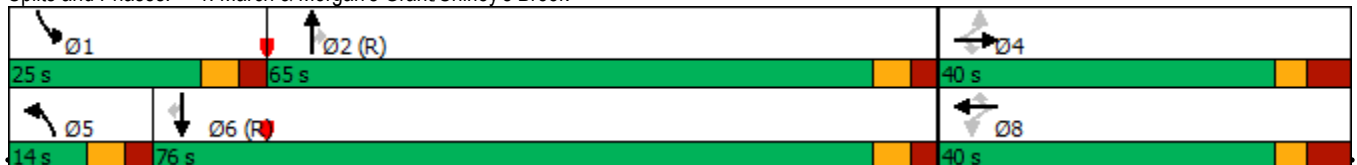

2: March & Terry Fox  
AM Peak Hour

555-603 March Road  
2037 Background Traffic

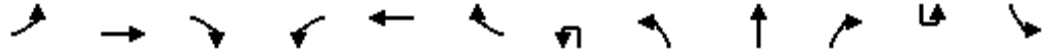

| Lane Group                 | EBL   | EBT   | EBR   | WBL   | WBT   | WBR   | NBU   | NBL   | NBT   | NBR   | SBU   | SBL   |
|----------------------------|-------|-------|-------|-------|-------|-------|-------|-------|-------|-------|-------|-------|
| Lane Configurations        | ↖↖    | ↕↕    | ↗     | ↖↖    | ↕↕    | ↗     |       | ↖↖    | ↕↕↕   | ↗     |       | ↖     |
| Traffic Volume (vph)       | 98    | 156   | 289   | 51    | 57    | 56    | 14    | 211   | 851   | 109   | 1     | 202   |
| Future Volume (vph)        | 98    | 156   | 289   | 51    | 57    | 56    | 14    | 211   | 851   | 109   | 1     | 202   |
| Ideal Flow (vphpl)         | 1800  | 1800  | 1800  | 1800  | 1800  | 1800  | 1800  | 1800  | 1800  | 1800  | 1800  | 1800  |
| Storage Length (m)         | 95.0  |       | 60.0  | 75.0  |       | 75.0  |       | 130.0 |       | 85.0  |       | 110.0 |
| Storage Lanes              | 2     |       | 2     | 2     |       | 1     |       | 2     |       | 2     |       | 1     |
| Taper Length (m)           | 40.0  |       |       | 20.0  |       |       |       | 90.0  |       |       |       | 40.0  |
| Lane Util. Factor          | 0.97  | 0.95  | 1.00  | 0.97  | 0.95  | 1.00  | 0.91  | 0.97  | 0.91  | 1.00  | 0.91  | 1.00  |
| Ped Bike Factor            | 0.99  |       | 0.97  | 0.99  |       | 0.98  |       | 1.00  |       | 0.97  |       | 1.00  |
| Fr t                       |       |       | 0.850 |       |       | 0.850 |       |       |       | 0.850 |       |       |
| Flt Protected              | 0.950 |       |       | 0.950 |       |       |       | 0.950 |       |       |       | 0.950 |
| Satd. Flow (prot)          | 3185  | 3316  | 1483  | 3248  | 3161  | 1498  | 0     | 3246  | 4628  | 1469  | 0     | 1674  |
| Flt Permitted              | 0.950 |       |       | 0.950 |       |       |       | 0.950 |       |       |       | 0.950 |
| Satd. Flow (perm)          | 3169  | 3316  | 1438  | 3219  | 3161  | 1466  | 0     | 3242  | 4628  | 1424  | 0     | 1666  |
| Right Turn on Red          |       |       | Yes   |       |       | Yes   |       |       |       | Yes   |       |       |
| Satd. Flow (RTOR)          |       |       | 202   |       |       | 202   |       |       |       | 204   |       |       |
| Link Speed (k/h)           |       | 60    |       |       | 60    |       |       |       | 60    |       |       |       |
| Link Distance (m)          |       | 165.4 |       |       | 149.1 |       |       |       | 308.9 |       |       |       |
| Travel Time (s)            |       | 9.9   |       |       | 8.9   |       |       |       | 18.5  |       |       |       |
| Confl. Peds. (#/hr)        | 5     |       | 10    | 10    |       | 5     |       | 5     |       | 10    |       | 10    |
| Confl. Bikes (#/hr)        |       |       | 10    |       |       | 5     |       |       |       | 5     |       |       |
| Peak Hour Factor           | 1.00  | 1.00  | 1.00  | 1.00  | 1.00  | 1.00  | 1.00  | 1.00  | 1.00  | 1.00  | 1.00  | 1.00  |
| Heavy Vehicles (%)         | 3%    | 2%    | 2%    | 1%    | 7%    | 1%    | 2%    | 1%    | 5%    | 3%    | 2%    | 1%    |
| Adj. Flow (vph)            | 98    | 156   | 289   | 51    | 57    | 56    | 14    | 211   | 851   | 109   | 1     | 202   |
| Shared Lane Traffic (%)    |       |       |       |       |       |       |       |       |       |       |       |       |
| Lane Group Flow (vph)      | 98    | 156   | 289   | 51    | 57    | 56    | 0     | 225   | 851   | 109   | 0     | 203   |
| Enter Blocked Intersection | No    | No    | No    | Yes   | Yes   | Yes   | No    | No    | No    | No    | No    | No    |
| Lane Alignment             | L NA  | Left  | R NA  | L NA  | Left  | R NA  | R NA  | L NA  | Left  | R NA  | R NA  | L NA  |
| Median Width(m)            |       | 10.5  |       |       | 10.5  |       |       |       | 10.5  |       |       |       |
| Link Offset(m)             |       | 0.0   |       |       | 0.0   |       |       |       | 0.0   |       |       |       |
| Crosswalk Width(m)         |       | 5.0   |       |       | 5.0   |       |       |       | 5.0   |       |       |       |
| Two way Left Turn Lane     |       |       |       |       |       |       |       |       |       |       |       |       |
| Headway Factor             | 1.09  | 1.09  | 1.09  | 1.09  | 1.09  | 1.09  | 1.09  | 1.09  | 1.09  | 1.09  | 1.09  | 1.09  |
| Turning Speed (k/h)        | 24    |       | 14    | 24    |       | 14    | 14    | 24    |       | 14    | 14    | 24    |
| Number of Detectors        | 1     | 2     | 1     | 1     | 2     | 1     | 1     | 1     | 2     | 1     | 1     | 1     |
| Detector Template          | Left  | Thru  | Right | Left  | Thru  | Right | Left  | Left  | Thru  | Right | Left  | Left  |
| Leading Detector (m)       | 2.0   | 10.0  | 2.0   | 2.0   | 10.0  | 2.0   | 2.0   | 2.0   | 10.0  | 2.0   | 2.0   | 2.0   |
| Trailing Detector (m)      | 0.0   | 0.0   | 0.0   | 0.0   | 0.0   | 0.0   | 0.0   | 0.0   | 0.0   | 0.0   | 0.0   | 0.0   |
| Detector 1 Position(m)     | 0.0   | 0.0   | 0.0   | 0.0   | 0.0   | 0.0   | 0.0   | 0.0   | 0.0   | 0.0   | 0.0   | 0.0   |
| Detector 1 Size(m)         | 2.0   | 0.6   | 2.0   | 2.0   | 0.6   | 2.0   | 2.0   | 2.0   | 0.6   | 2.0   | 2.0   | 2.0   |
| Detector 1 Type            | Cl+Ex | Cl+Ex | Cl+Ex | Cl+Ex | Cl+Ex | Cl+Ex | Cl+Ex | Cl+Ex | Cl+Ex | Cl+Ex | Cl+Ex | Cl+Ex |
| Detector 1 Channel         |       |       |       |       |       |       |       |       |       |       |       |       |
| Detector 1 Extend (s)      | 0.0   | 0.0   | 0.0   | 0.0   | 0.0   | 0.0   | 0.0   | 0.0   | 0.0   | 0.0   | 0.0   | 0.0   |
| Detector 1 Queue (s)       | 0.0   | 0.0   | 0.0   | 0.0   | 0.0   | 0.0   | 0.0   | 0.0   | 0.0   | 0.0   | 0.0   | 0.0   |
| Detector 1 Delay (s)       | 0.0   | 0.0   | 0.0   | 0.0   | 0.0   | 0.0   | 0.0   | 0.0   | 0.0   | 0.0   | 0.0   | 0.0   |
| Detector 2 Position(m)     |       | 9.4   |       |       | 9.4   |       |       |       | 9.4   |       |       |       |
| Detector 2 Size(m)         |       | 0.6   |       |       | 0.6   |       |       |       | 0.6   |       |       |       |
| Detector 2 Type            |       | Cl+Ex |       |       | Cl+Ex |       |       |       | Cl+Ex |       |       |       |
| Detector 2 Channel         |       |       |       |       |       |       |       |       |       |       |       |       |
| Detector 2 Extend (s)      |       | 0.0   |       |       | 0.0   |       |       |       | 0.0   |       |       |       |
| Turn Type                  | Prot  | NA    | Perm  | Prot  | NA    | Perm  | Prot  | Prot  | NA    | Perm  | Prot  | Prot  |
| Protected Phases           | 7     | 4     |       | 3     | 8     |       | 5     | 5     | 2     |       | 1     | 1     |
| Permitted Phases           |       |       | 4     |       |       | 8     |       |       |       | 2     |       |       |
| Detector Phase             | 7     | 4     | 4     | 3     | 8     | 8     | 5     | 5     | 2     | 2     | 1     | 1     |



| Lane Group                 | SBT   | SBR   |
|----------------------------|-------|-------|
| Lane Configurations        | ↑↑↑   | ↗     |
| Traffic Volume (vph)       | 1615  | 180   |
| Future Volume (vph)        | 1615  | 180   |
| Ideal Flow (vphpl)         | 1800  | 1800  |
| Storage Length (m)         |       | 100.0 |
| Storage Lanes              |       | 1     |
| Taper Length (m)           |       |       |
| Lane Util. Factor          | 0.91  | 1.00  |
| Ped Bike Factor            |       | 0.98  |
| Frt                        |       | 0.850 |
| Flt Protected              |       |       |
| Satd. Flow (prot)          | 4718  | 1469  |
| Flt Permitted              |       |       |
| Satd. Flow (perm)          | 4718  | 1436  |
| Right Turn on Red          |       | Yes   |
| Satd. Flow (RTOR)          |       | 180   |
| Link Speed (k/h)           | 60    |       |
| Link Distance (m)          | 318.9 |       |
| Travel Time (s)            | 19.1  |       |
| Confl. Peds. (#/hr)        |       | 5     |
| Confl. Bikes (#/hr)        |       | 5     |
| Peak Hour Factor           | 1.00  | 1.00  |
| Heavy Vehicles (%)         | 3%    | 3%    |
| Adj. Flow (vph)            | 1615  | 180   |
| Shared Lane Traffic (%)    |       |       |
| Lane Group Flow (vph)      | 1615  | 180   |
| Enter Blocked Intersection | No    | No    |
| Lane Alignment             | Left  | R NA  |
| Median Width(m)            | 7.0   |       |
| Link Offset(m)             | 0.0   |       |
| Crosswalk Width(m)         | 5.0   |       |
| Two way Left Turn Lane     |       |       |
| Headway Factor             | 1.09  | 1.09  |
| Turning Speed (k/h)        |       | 14    |
| Number of Detectors        | 2     | 1     |
| Detector Template          | Thru  | Right |
| Leading Detector (m)       | 10.0  | 2.0   |
| Trailing Detector (m)      | 0.0   | 0.0   |
| Detector 1 Position(m)     | 0.0   | 0.0   |
| Detector 1 Size(m)         | 0.6   | 2.0   |
| Detector 1 Type            | Cl+Ex | Cl+Ex |
| Detector 1 Channel         |       |       |
| Detector 1 Extend (s)      | 0.0   | 0.0   |
| Detector 1 Queue (s)       | 0.0   | 0.0   |
| Detector 1 Delay (s)       | 0.0   | 0.0   |
| Detector 2 Position(m)     | 9.4   |       |
| Detector 2 Size(m)         | 0.6   |       |
| Detector 2 Type            | Cl+Ex |       |
| Detector 2 Channel         |       |       |
| Detector 2 Extend (s)      | 0.0   |       |
| Turn Type                  | NA    | Perm  |
| Protected Phases           | 6     |       |
| Permitted Phases           |       | 6     |
| Detector Phase             | 6     | 6     |



| Lane Group              | EBL   | EBT   | EBR   | WBL  | WBT   | WBR   | NBU   | NBL   | NBT   | NBR   | SBU   | SBL   |
|-------------------------|-------|-------|-------|------|-------|-------|-------|-------|-------|-------|-------|-------|
| Switch Phase            |       |       |       |      |       |       |       |       |       |       |       |       |
| Minimum Initial (s)     | 5.0   | 10.0  | 10.0  | 5.0  | 10.0  | 10.0  | 5.0   | 5.0   | 10.0  | 10.0  | 5.0   | 5.0   |
| Minimum Split (s)       | 11.8  | 41.9  | 41.9  | 11.8 | 41.9  | 41.9  | 11.8  | 11.8  | 32.7  | 32.7  | 11.8  | 11.8  |
| Total Split (s)         | 13.0  | 43.0  | 43.0  | 12.0 | 42.0  | 42.0  | 18.0  | 18.0  | 44.0  | 44.0  | 31.0  | 31.0  |
| Total Split (%)         | 10.0% | 33.1% | 33.1% | 9.2% | 32.3% | 32.3% | 13.8% | 13.8% | 33.8% | 33.8% | 23.8% | 23.8% |
| Maximum Green (s)       | 6.2   | 36.1  | 36.1  | 5.2  | 35.1  | 35.1  | 11.2  | 11.2  | 37.3  | 37.3  | 24.2  | 24.2  |
| Yellow Time (s)         | 3.7   | 3.7   | 3.7   | 3.7  | 3.7   | 3.7   | 4.6   | 4.6   | 4.6   | 4.6   | 4.6   | 4.6   |
| All-Red Time (s)        | 3.1   | 3.2   | 3.2   | 3.1  | 3.2   | 3.2   | 2.2   | 2.2   | 2.1   | 2.1   | 2.2   | 2.2   |
| Lost Time Adjust (s)    | 0.0   | 0.0   | 0.0   | 0.0  | 0.0   | 0.0   |       |       | 0.0   | 0.0   |       | 0.0   |
| Total Lost Time (s)     | 6.8   | 6.9   | 6.9   | 6.8  | 6.9   | 6.9   |       |       | 6.8   | 6.7   |       | 6.8   |
| Lead/Lag                | Lead  | Lag   | Lag   | Lead | Lag   | Lag   | Lead  | Lead  | Lag   | Lag   | Lead  | Lead  |
| Lead-Lag Optimize?      |       |       |       |      |       |       |       |       |       |       |       |       |
| Vehicle Extension (s)   | 3.0   | 3.0   | 3.0   | 3.0  | 3.0   | 3.0   | 3.0   | 3.0   | 3.0   | 3.0   | 3.0   | 3.0   |
| Recall Mode             | None  | None  | None  | None | None  | None  | None  | None  | C-Max | C-Max | None  | None  |
| Walk Time (s)           |       | 7.0   | 7.0   |      | 7.0   | 7.0   |       |       | 7.0   | 7.0   |       |       |
| Flash Dont Walk (s)     |       | 28.0  | 28.0  |      | 28.0  | 28.0  |       |       | 19.0  | 19.0  |       |       |
| Pedestrian Calls (#/hr) |       | 10    | 10    |      | 5     | 5     |       |       | 5     | 5     |       |       |
| Act Effect Green (s)    | 7.0   | 21.3  | 21.3  | 5.2  | 20.5  | 20.5  |       | 12.4  | 58.6  | 58.6  |       | 20.1  |
| Actuated g/C Ratio      | 0.05  | 0.16  | 0.16  | 0.04 | 0.16  | 0.16  |       | 0.10  | 0.45  | 0.45  |       | 0.15  |
| v/c Ratio               | 0.58  | 0.29  | 0.72  | 0.40 | 0.11  | 0.14  |       | 0.73  | 0.41  | 0.14  |       | 0.78  |
| Control Delay           | 83.1  | 44.2  | 21.1  | 70.1 | 42.9  | 0.7   |       | 54.7  | 39.4  | 9.0   |       | 74.4  |
| Queue Delay             | 0.0   | 0.0   | 0.0   | 0.0  | 0.0   | 0.0   |       | 0.0   | 0.0   | 0.0   |       | 0.0   |
| Total Delay             | 83.1  | 44.2  | 21.1  | 70.1 | 42.9  | 0.7   |       | 54.7  | 39.4  | 9.0   |       | 74.4  |
| LOS                     | F     | D     | C     | E    | D     | A     |       | D     | D     | A     |       | E     |
| Approach Delay          |       | 38.9  |       |      | 37.0  |       |       |       | 39.5  |       |       |       |
| Approach LOS            |       | D     |       |      | D     |       |       |       | D     |       |       |       |
| Queue Length 50th (m)   | 12.6  | 14.2  | 11.5  | 6.1  | 6.5   | 0.0   |       | 24.2  | 73.4  | 1.1   |       | 49.2  |
| Queue Length 95th (m)   | #23.5 | 21.3  | 35.5  | 12.5 | 10.3  | 0.0   |       | #43.7 | 90.2  | 19.5  |       | 74.1  |
| Internal Link Dist (m)  |       | 141.4 |       |      | 125.1 |       |       |       | 284.9 |       |       |       |
| Turn Bay Length (m)     | 95.0  |       | 60.0  | 75.0 |       | 75.0  |       | 130.0 |       | 85.0  |       | 110.0 |
| Base Capacity (vph)     | 170   | 920   | 545   | 129  | 853   | 543   |       | 312   | 2085  | 753   |       | 311   |
| Starvation Cap Reductn  | 0     | 0     | 0     | 0    | 0     | 0     |       | 0     | 0     | 0     |       | 0     |
| Spillback Cap Reductn   | 0     | 0     | 0     | 0    | 0     | 0     |       | 0     | 0     | 0     |       | 0     |
| Storage Cap Reductn     | 0     | 0     | 0     | 0    | 0     | 0     |       | 0     | 0     | 0     |       | 0     |
| Reduced v/c Ratio       | 0.58  | 0.17  | 0.53  | 0.40 | 0.07  | 0.10  |       | 0.72  | 0.41  | 0.14  |       | 0.65  |

**Intersection Summary**

Area Type: Other

Cycle Length: 130

Actuated Cycle Length: 130

Offset: 80 (62%), Referenced to phase 2:NBT and 6:SBT, Start of Green

Natural Cycle: 110

Control Type: Actuated-Coordinated

Maximum v/c Ratio: 0.78

Intersection Signal Delay: 35.1      Intersection LOS: D

Intersection Capacity Utilization 89.1%      ICU Level of Service E

Analysis Period (min) 15

# 95th percentile volume exceeds capacity, queue may be longer.  
Queue shown is maximum after two cycles.

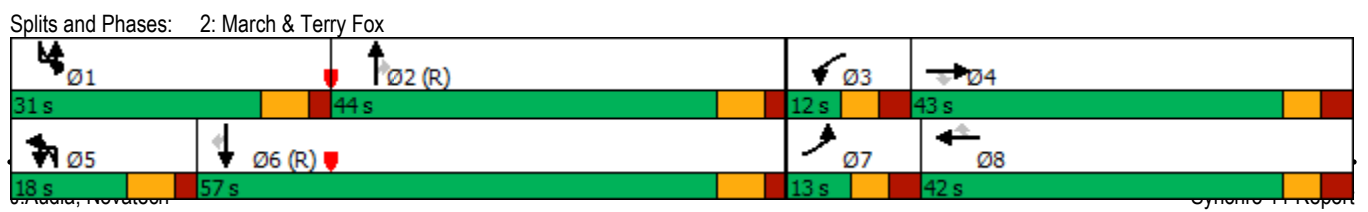



| Lane Group                  | SBT   | SBR   |
|-----------------------------|-------|-------|
| Switch Phase                |       |       |
| Minimum Initial (s)         | 10.0  | 10.0  |
| Minimum Split (s)           | 32.7  | 32.7  |
| Total Split (s)             | 57.0  | 57.0  |
| Total Split (%)             | 43.8% | 43.8% |
| Maximum Green (s)           | 50.3  | 50.3  |
| Yellow Time (s)             | 4.6   | 4.6   |
| All-Red Time (s)            | 2.1   | 2.1   |
| Lost Time Adjust (s)        | 0.0   | 0.0   |
| Total Lost Time (s)         | 6.7   | 6.7   |
| Lead/Lag                    | Lag   | Lag   |
| Lead-Lag Optimize?          |       |       |
| Vehicle Extension (s)       | 3.0   | 3.0   |
| Recall Mode                 | C-Max | C-Max |
| Walk Time (s)               | 7.0   | 7.0   |
| Flash Dont Walk (s)         | 19.0  | 19.0  |
| Pedestrian Calls (#/hr)     | 5     | 5     |
| Act Effct Green (s)         | 66.3  | 66.3  |
| Actuated g/C Ratio          | 0.51  | 0.51  |
| v/c Ratio                   | 0.67  | 0.22  |
| Control Delay               | 28.4  | 9.0   |
| Queue Delay                 | 0.0   | 0.0   |
| Total Delay                 | 28.4  | 9.0   |
| LOS                         | C     | A     |
| Approach Delay              | 31.3  |       |
| Approach LOS                | C     |       |
| Queue Length 50th (m)       | 67.6  | 0.0   |
| Queue Length 95th (m)       | 123.2 | 27.2  |
| Internal Link Dist (m)      | 294.9 |       |
| Turn Bay Length (m)         |       | 100.0 |
| Base Capacity (vph)         | 2404  | 819   |
| Starvation Cap Reductn      | 0     | 0     |
| Spillback Cap Reductn       | 0     | 0     |
| Storage Cap Reductn         | 0     | 0     |
| Reduced v/c Ratio           | 0.67  | 0.22  |
| <b>Intersection Summary</b> |       |       |

3: March & Solandt  
AM Peak Hour

555-603 March Road  
2037 Background Traffic



| Lane Group                 | EBL   | EBT   | EBR   | WBL   | WBT   | WBR   | NBU   | NBL   | NBT   | NBR  | SBU   | SBL   |
|----------------------------|-------|-------|-------|-------|-------|-------|-------|-------|-------|------|-------|-------|
| Lane Configurations        |       |       |       |       |       |       |       |       |       |      |       |       |
| Traffic Volume (vph)       | 12    | 33    | 85    | 82    | 16    | 4     | 2     | 221   | 1484  | 199  | 2     | 43    |
| Future Volume (vph)        | 12    | 33    | 85    | 82    | 16    | 4     | 2     | 221   | 1484  | 199  | 2     | 43    |
| Ideal Flow (vphpl)         | 1800  | 1800  | 1800  | 1800  | 1800  | 1800  | 1800  | 1800  | 1800  | 1800 | 1800  | 1800  |
| Storage Length (m)         | 35.0  |       | 60.0  | 135.0 |       | 55.0  |       | 165.0 |       | 0.0  |       | 155.0 |
| Storage Lanes              | 1     |       | 1     | 1     |       | 1     |       | 1     |       | 0    |       | 1     |
| Taper Length (m)           | 50.0  |       |       | 50.0  |       |       |       | 40.0  |       |      |       | 25.0  |
| Lane Util. Factor          | 1.00  | 1.00  | 1.00  | 1.00  | 1.00  | 1.00  | 0.95  | 1.00  | 0.95  | 0.95 | 0.95  | 1.00  |
| Ped Bike Factor            | 0.99  |       | 0.98  | 0.99  |       | 0.98  |       | 1.00  | 1.00  |      |       | 1.00  |
| Frt                        |       |       | 0.850 |       |       | 0.850 |       |       | 0.982 |      |       |       |
| Flt Protected              | 0.950 |       |       | 0.950 |       |       |       | 0.950 |       |      |       | 0.950 |
| Satd. Flow (prot)          | 1537  | 1728  | 1414  | 1610  | 1369  | 1498  | 0     | 1658  | 3223  | 0    | 0     | 1674  |
| Flt Permitted              | 0.747 |       |       | 0.736 |       |       |       | 0.950 |       |      |       | 0.950 |
| Satd. Flow (perm)          | 1201  | 1728  | 1381  | 1240  | 1369  | 1463  | 0     | 1656  | 3223  | 0    | 0     | 1672  |
| Right Turn on Red          |       |       | Yes   |       |       | Yes   |       |       |       | Yes  |       |       |
| Satd. Flow (RTOR)          |       |       | 141   |       |       | 141   |       |       | 19    |      |       |       |
| Link Speed (k/h)           |       | 50    |       |       | 50    |       |       |       | 60    |      |       |       |
| Link Distance (m)          |       | 212.6 |       |       | 241.6 |       |       |       | 610.9 |      |       |       |
| Travel Time (s)            |       | 15.3  |       |       | 17.4  |       |       |       | 36.7  |      |       |       |
| Confl. Peds. (#/hr)        | 5     |       | 5     | 5     |       | 5     |       | 5     |       | 5    |       | 5     |
| Confl. Bikes (#/hr)        |       |       | 5     |       |       | 5     |       |       |       | 5    |       |       |
| Peak Hour Factor           | 1.00  | 1.00  | 1.00  | 1.00  | 1.00  | 1.00  | 1.00  | 1.00  | 1.00  | 1.00 | 1.00  | 1.00  |
| Heavy Vehicles (%)         | 10%   | 3%    | 7%    | 5%    | 30%   | 1%    | 2%    | 2%    | 3%    | 1%   | 2%    | 1%    |
| Adj. Flow (vph)            | 12    | 33    | 85    | 82    | 16    | 4     | 2     | 221   | 1484  | 199  | 2     | 43    |
| Shared Lane Traffic (%)    |       |       |       |       |       |       |       |       |       |      |       |       |
| Lane Group Flow (vph)      | 12    | 33    | 85    | 82    | 16    | 4     | 0     | 223   | 1683  | 0    | 0     | 45    |
| Enter Blocked Intersection | No    | No    | No    | No    | No    | No    | No    | No    | No    | No   | No    | No    |
| Lane Alignment             | L NA  | Left  | R NA  | L NA  | Left  | R NA  | R NA  | L NA  | Left  | R NA | R NA  | L NA  |
| Median Width(m)            |       | 3.5   |       |       | 10.5  |       |       |       | 17.5  |      |       |       |
| Link Offset(m)             |       | 0.0   |       |       | 0.0   |       |       |       | 0.0   |      |       |       |
| Crosswalk Width(m)         |       | 5.0   |       |       | 5.0   |       |       |       | 5.0   |      |       |       |
| Two way Left Turn Lane     |       |       |       |       |       |       |       |       |       |      |       |       |
| Headway Factor             | 1.09  | 1.09  | 1.09  | 1.09  | 1.09  | 1.09  | 1.09  | 1.09  | 1.09  | 1.09 | 1.09  | 1.09  |
| Turning Speed (k/h)        | 24    |       | 14    | 24    |       | 14    | 14    | 24    |       | 14   | 14    | 24    |
| Number of Detectors        | 1     | 2     | 1     | 1     | 2     | 1     | 1     | 1     | 2     |      | 1     | 1     |
| Detector Template          | Left  | Thru  | Right | Left  | Thru  | Right | Left  | Left  | Thru  |      | Left  | Left  |
| Leading Detector (m)       | 2.0   | 10.0  | 2.0   | 2.0   | 10.0  | 2.0   | 2.0   | 2.0   | 10.0  |      | 2.0   | 2.0   |
| Trailing Detector (m)      | 0.0   | 0.0   | 0.0   | 0.0   | 0.0   | 0.0   | 0.0   | 0.0   | 0.0   |      | 0.0   | 0.0   |
| Detector 1 Position(m)     | 0.0   | 0.0   | 0.0   | 0.0   | 0.0   | 0.0   | 0.0   | 0.0   | 0.0   |      | 0.0   | 0.0   |
| Detector 1 Size(m)         | 2.0   | 0.6   | 2.0   | 2.0   | 0.6   | 2.0   | 2.0   | 2.0   | 0.6   |      | 2.0   | 2.0   |
| Detector 1 Type            | Cl+Ex | Cl+Ex | Cl+Ex | Cl+Ex | Cl+Ex | Cl+Ex | Cl+Ex | Cl+Ex | Cl+Ex |      | Cl+Ex | Cl+Ex |
| Detector 1 Channel         |       |       |       |       |       |       |       |       |       |      |       |       |
| Detector 1 Extend (s)      | 0.0   | 0.0   | 0.0   | 0.0   | 0.0   | 0.0   | 0.0   | 0.0   | 0.0   |      | 0.0   | 0.0   |
| Detector 1 Queue (s)       | 0.0   | 0.0   | 0.0   | 0.0   | 0.0   | 0.0   | 0.0   | 0.0   | 0.0   |      | 0.0   | 0.0   |
| Detector 1 Delay (s)       | 0.0   | 0.0   | 0.0   | 0.0   | 0.0   | 0.0   | 0.0   | 0.0   | 0.0   |      | 0.0   | 0.0   |
| Detector 2 Position(m)     |       | 9.4   |       |       | 9.4   |       |       |       | 9.4   |      |       |       |
| Detector 2 Size(m)         |       | 0.6   |       |       | 0.6   |       |       |       | 0.6   |      |       |       |
| Detector 2 Type            |       | Cl+Ex |       |       | Cl+Ex |       |       |       | Cl+Ex |      |       |       |
| Detector 2 Channel         |       |       |       |       |       |       |       |       |       |      |       |       |
| Detector 2 Extend (s)      |       | 0.0   |       |       | 0.0   |       |       |       | 0.0   |      |       |       |
| Turn Type                  | Perm  | NA    | Perm  | Perm  | NA    | Perm  | Prot  | Prot  | NA    |      | Prot  | Prot  |
| Protected Phases           |       | 4     |       |       | 8     |       | 5     | 5     | 2     |      | 1     | 1     |
| Permitted Phases           | 4     |       | 4     | 8     |       | 8     |       |       |       |      |       |       |
| Detector Phase             | 4     | 4     | 4     | 8     | 8     | 8     | 5     | 5     | 2     |      | 1     | 1     |



3: March & Solandt  
AM Peak Hour

555-603 March Road  
2037 Background Traffic



| Lane Group                 | SBT   | SBR  |
|----------------------------|-------|------|
| Lane Configurations        | ↑↑    |      |
| Traffic Volume (vph)       | 1696  | 37   |
| Future Volume (vph)        | 1696  | 37   |
| Ideal Flow (vphpl)         | 1800  | 1800 |
| Storage Length (m)         |       | 0.0  |
| Storage Lanes              |       | 0    |
| Taper Length (m)           |       |      |
| Lane Util. Factor          | 0.95  | 0.95 |
| Ped Bike Factor            | 1.00  |      |
| Frt                        | 0.997 |      |
| Flt Protected              |       |      |
| Satd. Flow (prot)          | 3272  | 0    |
| Flt Permitted              |       |      |
| Satd. Flow (perm)          | 3272  | 0    |
| Right Turn on Red          |       | Yes  |
| Satd. Flow (RTOR)          | 2     |      |
| Link Speed (k/h)           | 60    |      |
| Link Distance (m)          | 411.0 |      |
| Travel Time (s)            | 24.7  |      |
| Confl. Peds. (#/hr)        |       | 5    |
| Confl. Bikes (#/hr)        |       | 5    |
| Peak Hour Factor           | 1.00  | 1.00 |
| Heavy Vehicles (%)         | 3%    | 1%   |
| Adj. Flow (vph)            | 1696  | 37   |
| Shared Lane Traffic (%)    |       |      |
| Lane Group Flow (vph)      | 1733  | 0    |
| Enter Blocked Intersection | No    | No   |
| Lane Alignment             | Left  | R NA |
| Median Width(m)            | 17.5  |      |
| Link Offset(m)             | 0.0   |      |
| Crosswalk Width(m)         | 5.0   |      |
| Two way Left Turn Lane     |       |      |
| Headway Factor             | 1.09  | 1.09 |
| Turning Speed (k/h)        |       | 14   |
| Number of Detectors        | 2     |      |
| Detector Template          | Thru  |      |
| Leading Detector (m)       | 10.0  |      |
| Trailing Detector (m)      | 0.0   |      |
| Detector 1 Position(m)     | 0.0   |      |
| Detector 1 Size(m)         | 0.6   |      |
| Detector 1 Type            | Cl+Ex |      |
| Detector 1 Channel         |       |      |
| Detector 1 Extend (s)      | 0.0   |      |
| Detector 1 Queue (s)       | 0.0   |      |
| Detector 1 Delay (s)       | 0.0   |      |
| Detector 2 Position(m)     | 9.4   |      |
| Detector 2 Size(m)         | 0.6   |      |
| Detector 2 Type            | Cl+Ex |      |
| Detector 2 Channel         |       |      |
| Detector 2 Extend (s)      | 0.0   |      |
| Turn Type                  | NA    |      |
| Protected Phases           | 6     |      |
| Permitted Phases           |       |      |
| Detector Phase             | 6     |      |

3: March & Solandt  
AM Peak Hour

555-603 March Road  
2037 Background Traffic

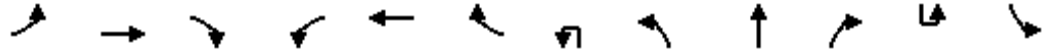

| Lane Group              | EBL   | EBT   | EBR   | WBL   | WBT   | WBR   | NBU   | NBL    | NBT   | NBR | SBU   | SBL   |
|-------------------------|-------|-------|-------|-------|-------|-------|-------|--------|-------|-----|-------|-------|
| Switch Phase            |       |       |       |       |       |       |       |        |       |     |       |       |
| Minimum Initial (s)     | 10.0  | 10.0  | 10.0  | 10.0  | 10.0  | 10.0  | 5.0   | 5.0    | 10.0  |     | 5.0   | 5.0   |
| Minimum Split (s)       | 36.5  | 36.5  | 36.5  | 36.5  | 36.5  | 36.5  | 12.0  | 12.0   | 26.8  |     | 12.0  | 12.0  |
| Total Split (s)         | 36.6  | 36.6  | 36.6  | 36.6  | 36.6  | 36.6  | 23.0  | 23.0   | 80.4  |     | 13.0  | 13.0  |
| Total Split (%)         | 28.2% | 28.2% | 28.2% | 28.2% | 28.2% | 28.2% | 17.7% | 17.7%  | 61.8% |     | 10.0% | 10.0% |
| Maximum Green (s)       | 30.1  | 30.1  | 30.1  | 30.1  | 30.1  | 30.1  | 16.0  | 16.0   | 74.6  |     | 6.0   | 6.0   |
| Yellow Time (s)         | 3.3   | 3.3   | 3.3   | 3.3   | 3.3   | 3.3   | 3.7   | 3.7    | 3.7   |     | 3.7   | 3.7   |
| All-Red Time (s)        | 3.2   | 3.2   | 3.2   | 3.2   | 3.2   | 3.2   | 3.3   | 3.3    | 2.1   |     | 3.3   | 3.3   |
| Lost Time Adjust (s)    | 0.0   | 0.0   | 0.0   | 0.0   | 0.0   | 0.0   |       | 0.0    | 0.0   |     |       | 0.0   |
| Total Lost Time (s)     | 6.5   | 6.5   | 6.5   | 6.5   | 6.5   | 6.5   |       | 7.0    | 5.8   |     |       | 7.0   |
| Lead/Lag                |       |       |       |       |       |       | Lead  | Lead   | Lag   |     | Lead  | Lead  |
| Lead-Lag Optimize?      |       |       |       |       |       |       |       |        |       |     |       |       |
| Vehicle Extension (s)   | 3.0   | 3.0   | 3.0   | 3.0   | 3.0   | 3.0   | 3.0   | 3.0    | 3.0   |     | 3.0   | 3.0   |
| Recall Mode             | None  | None  | None  | None  | None  | None  | None  | None   | C-Max |     | None  | None  |
| Walk Time (s)           | 7.0   | 7.0   | 7.0   | 7.0   | 7.0   | 7.0   |       |        | 7.0   |     |       |       |
| Flash Dont Walk (s)     | 23.0  | 23.0  | 23.0  | 23.0  | 23.0  | 23.0  |       |        | 14.0  |     |       |       |
| Pedestrian Calls (#/hr) | 5     | 5     | 5     | 5     | 5     | 5     |       |        | 5     |     |       |       |
| Act Effct Green (s)     | 16.3  | 16.3  | 16.3  | 16.3  | 16.3  | 16.3  |       | 25.3   | 89.1  |     |       | 7.8   |
| Actuated g/C Ratio      | 0.13  | 0.13  | 0.13  | 0.13  | 0.13  | 0.13  |       | 0.19   | 0.69  |     |       | 0.06  |
| v/c Ratio               | 0.08  | 0.15  | 0.29  | 0.53  | 0.09  | 0.01  |       | 0.69   | 0.76  |     |       | 0.45  |
| Control Delay           | 46.6  | 48.6  | 3.0   | 63.4  | 47.1  | 0.0   |       | 61.4   | 18.6  |     |       | 77.5  |
| Queue Delay             | 0.0   | 0.0   | 0.0   | 0.0   | 0.0   | 0.0   |       | 0.0    | 0.0   |     |       | 0.0   |
| Total Delay             | 46.6  | 48.6  | 3.0   | 63.4  | 47.1  | 0.0   |       | 61.4   | 18.6  |     |       | 77.5  |
| LOS                     | D     | D     | A     | E     | D     | A     |       | E      | B     |     |       | E     |
| Approach Delay          |       | 18.6  |       |       | 58.4  |       |       |        | 23.6  |     |       |       |
| Approach LOS            |       | B     |       |       | E     |       |       |        | C     |     |       |       |
| Queue Length 50th (m)   | 2.6   | 7.2   | 0.0   | 18.8  | 3.5   | 0.0   |       | 48.6   | 129.3 |     |       | 11.2  |
| Queue Length 95th (m)   | 7.2   | 14.3  | 1.5   | 29.8  | 8.7   | 0.0   |       | #105.1 | 212.6 |     |       | #26.8 |
| Internal Link Dist (m)  |       | 188.6 |       |       | 217.6 |       |       |        | 586.9 |     |       |       |
| Turn Bay Length (m)     | 35.0  |       | 60.0  | 135.0 |       | 55.0  |       | 165.0  |       |     |       | 155.0 |
| Base Capacity (vph)     | 278   | 400   | 428   | 287   | 316   | 447   |       | 322    | 2214  |     |       | 101   |
| Starvation Cap Reductn  | 0     | 0     | 0     | 0     | 0     | 0     |       | 0      | 0     |     |       | 0     |
| Spillback Cap Reductn   | 0     | 0     | 0     | 0     | 0     | 0     |       | 0      | 0     |     |       | 0     |
| Storage Cap Reductn     | 0     | 0     | 0     | 0     | 0     | 0     |       | 0      | 0     |     |       | 0     |
| Reduced v/c Ratio       | 0.04  | 0.08  | 0.20  | 0.29  | 0.05  | 0.01  |       | 0.69   | 0.76  |     |       | 0.45  |

Intersection Summary

Area Type: Other  
 Cycle Length: 130  
 Actuated Cycle Length: 130  
 Offset: 112 (86%), Referenced to phase 2:NBT and 6:SBT, Start of Green  
 Natural Cycle: 140  
 Control Type: Actuated-Coordinated  
 Maximum v/c Ratio: 1.00  
 Intersection Signal Delay: 30.0 Intersection LOS: C  
 Intersection Capacity Utilization 104.5% ICU Level of Service G  
 Analysis Period (min) 15  
 # 95th percentile volume exceeds capacity, queue may be longer.  
 Queue shown is maximum after two cycles.

Splits and Phases: 3: March & Solandt





| Lane Group                  | SBT    | SBR |
|-----------------------------|--------|-----|
| Switch Phase                |        |     |
| Minimum Initial (s)         | 10.0   |     |
| Minimum Split (s)           | 26.8   |     |
| Total Split (s)             | 70.4   |     |
| Total Split (%)             | 54.2%  |     |
| Maximum Green (s)           | 64.6   |     |
| Yellow Time (s)             | 3.7    |     |
| All-Red Time (s)            | 2.1    |     |
| Lost Time Adjust (s)        | 0.0    |     |
| Total Lost Time (s)         | 5.8    |     |
| Lead/Lag                    | Lag    |     |
| Lead-Lag Optimize?          |        |     |
| Vehicle Extension (s)       | 3.0    |     |
| Recall Mode                 | C-Max  |     |
| Walk Time (s)               | 7.0    |     |
| Flash Dont Walk (s)         | 14.0   |     |
| Pedestrian Calls (#/hr)     | 5      |     |
| Act Effct Green (s)         | 69.1   |     |
| Actuated g/C Ratio          | 0.53   |     |
| v/c Ratio                   | 1.00   |     |
| Control Delay               | 34.9   |     |
| Queue Delay                 | 0.0    |     |
| Total Delay                 | 34.9   |     |
| LOS                         | C      |     |
| Approach Delay              | 36.0   |     |
| Approach LOS                | D      |     |
| Queue Length 50th (m)       | 222.4  |     |
| Queue Length 95th (m)       | #267.7 |     |
| Internal Link Dist (m)      | 387.0  |     |
| Turn Bay Length (m)         |        |     |
| Base Capacity (vph)         | 1740   |     |
| Starvation Cap Reductn      | 0      |     |
| Spillback Cap Reductn       | 0      |     |
| Storage Cap Reductn         | 0      |     |
| Reduced v/c Ratio           | 1.00   |     |
| <b>Intersection Summary</b> |        |     |

4: Innovation/Flamborough & Terry Fox  
AM Peak Hour

555-603 March Road  
2037 Background Traffic



| Lane Group                 | EBL   | EBT   | EBR   | WBL   | WBT   | WBR   | NBL   | NBT   | NBR  | SBL   | SBT   | SBR   |
|----------------------------|-------|-------|-------|-------|-------|-------|-------|-------|------|-------|-------|-------|
| Lane Configurations        |       |       |       |       |       |       |       |       |      |       |       |       |
| Traffic Volume (vph)       | 29    | 433   | 76    | 84    | 262   | 37    | 37    | 36    | 85   | 63    | 55    | 42    |
| Future Volume (vph)        | 29    | 433   | 76    | 84    | 262   | 37    | 37    | 36    | 85   | 63    | 55    | 42    |
| Ideal Flow (vphpl)         | 1800  | 1800  | 1800  | 1800  | 1800  | 1800  | 1800  | 1800  | 1800 | 1800  | 1800  | 1800  |
| Storage Length (m)         | 75.0  |       | 120.0 | 110.0 |       | 130.0 | 220.0 |       | 0.0  | 30.0  |       | 0.0   |
| Storage Lanes              | 1     |       | 1     | 1     |       | 1     | 1     |       | 0    | 1     |       | 0     |
| Taper Length (m)           | 50.0  |       |       | 80.0  |       |       | 50.0  |       |      | 15.0  |       |       |
| Lane Util. Factor          | 1.00  | 1.00  | 1.00  | 1.00  | 1.00  | 1.00  | 1.00  | 1.00  | 1.00 | 1.00  | 1.00  | 1.00  |
| Ped Bike Factor            | 0.99  |       | 0.95  | 0.99  |       | 0.96  | 0.98  | 0.97  |      | 0.99  | 0.98  |       |
| Frt                        |       |       | 0.850 |       |       | 0.850 |       | 0.895 |      |       | 0.935 |       |
| Flt Protected              | 0.950 |       |       | 0.950 |       |       | 0.950 |       |      | 0.950 |       |       |
| Satd. Flow (prot)          | 1470  | 1728  | 1469  | 1626  | 1728  | 1498  | 1658  | 1510  | 0    | 1674  | 1553  | 0     |
| Flt Permitted              | 0.597 |       |       | 0.454 |       |       | 0.694 |       |      | 0.604 |       |       |
| Satd. Flow (perm)          | 916   | 1728  | 1392  | 769   | 1728  | 1441  | 1187  | 1510  | 0    | 1054  | 1553  | 0     |
| Right Turn on Red          |       |       | Yes   |       |       | Yes   |       |       | Yes  |       |       | Yes   |
| Satd. Flow (RTOR)          |       |       | 80    |       |       | 80    |       | 85    |      |       |       | 29    |
| Link Speed (k/h)           |       | 60    |       |       | 60    |       |       | 50    |      |       |       | 50    |
| Link Distance (m)          |       | 508.2 |       |       | 485.8 |       |       | 547.1 |      |       |       | 313.7 |
| Travel Time (s)            |       | 30.5  |       |       | 29.1  |       |       | 39.4  |      |       |       | 22.6  |
| Confl. Peds. (#/hr)        | 5     |       | 10    | 10    |       | 5     | 10    |       | 5    | 5     |       | 10    |
| Confl. Bikes (#/hr)        |       |       | 5     |       |       | 5     |       |       | 5    |       |       | 5     |
| Peak Hour Factor           | 1.00  | 1.00  | 1.00  | 1.00  | 1.00  | 1.00  | 1.00  | 1.00  | 1.00 | 1.00  | 1.00  | 1.00  |
| Heavy Vehicles (%)         | 15%   | 3%    | 3%    | 4%    | 3%    | 1%    | 2%    | 2%    | 3%   | 1%    | 1%    | 10%   |
| Adj. Flow (vph)            | 29    | 433   | 76    | 84    | 262   | 37    | 37    | 36    | 85   | 63    | 55    | 42    |
| Shared Lane Traffic (%)    |       |       |       |       |       |       |       |       |      |       |       |       |
| Lane Group Flow (vph)      | 29    | 433   | 76    | 84    | 262   | 37    | 37    | 121   | 0    | 63    | 97    | 0     |
| Enter Blocked Intersection | No    | No    | No    | No    | No    | No    | No    | No    | No   | No    | No    | No    |
| Lane Alignment             | L NA  | Left  | R NA  | L NA  | Left  | R NA  | L NA  | Left  | R NA | L NA  | Left  | R NA  |
| Median Width(m)            |       | 3.5   |       |       | 3.5   |       |       | 3.5   |      |       |       | 3.5   |
| Link Offset(m)             |       | 0.0   |       |       | 0.0   |       |       | 0.0   |      |       |       | 0.0   |
| Crosswalk Width(m)         |       | 5.0   |       |       | 5.0   |       |       | 5.0   |      |       |       | 5.0   |
| Two way Left Turn Lane     |       |       |       |       |       |       |       |       |      |       |       |       |
| Headway Factor             | 1.09  | 1.09  | 1.09  | 1.09  | 1.09  | 1.09  | 1.09  | 1.09  | 1.09 | 1.09  | 1.09  | 1.09  |
| Turning Speed (k/h)        | 24    |       | 14    | 24    |       | 14    | 24    |       | 14   | 24    |       | 14    |
| Number of Detectors        | 1     | 2     | 1     | 1     | 2     | 1     | 1     | 2     |      | 1     | 2     |       |
| Detector Template          | Left  | Thru  | Right | Left  | Thru  | Right | Left  | Thru  |      | Left  | Thru  |       |
| Leading Detector (m)       | 2.0   | 10.0  | 2.0   | 2.0   | 10.0  | 2.0   | 2.0   | 10.0  |      | 2.0   | 10.0  |       |
| Trailing Detector (m)      | 0.0   | 0.0   | 0.0   | 0.0   | 0.0   | 0.0   | 0.0   | 0.0   |      | 0.0   | 0.0   |       |
| Detector 1 Position(m)     | 0.0   | 0.0   | 0.0   | 0.0   | 0.0   | 0.0   | 0.0   | 0.0   |      | 0.0   | 0.0   |       |
| Detector 1 Size(m)         | 2.0   | 0.6   | 2.0   | 2.0   | 0.6   | 2.0   | 2.0   | 0.6   |      | 2.0   | 0.6   |       |
| Detector 1 Type            | Cl+Ex | Cl+Ex | Cl+Ex | Cl+Ex | Cl+Ex | Cl+Ex | Cl+Ex | Cl+Ex |      | Cl+Ex | Cl+Ex |       |
| Detector 1 Channel         |       |       |       |       |       |       |       |       |      |       |       |       |
| Detector 1 Extend (s)      | 0.0   | 0.0   | 0.0   | 0.0   | 0.0   | 0.0   | 0.0   | 0.0   |      | 0.0   | 0.0   |       |
| Detector 1 Queue (s)       | 0.0   | 0.0   | 0.0   | 0.0   | 0.0   | 0.0   | 0.0   | 0.0   |      | 0.0   | 0.0   |       |
| Detector 1 Delay (s)       | 0.0   | 0.0   | 0.0   | 0.0   | 0.0   | 0.0   | 0.0   | 0.0   |      | 0.0   | 0.0   |       |
| Detector 2 Position(m)     |       | 9.4   |       |       | 9.4   |       |       | 9.4   |      |       |       | 9.4   |
| Detector 2 Size(m)         |       | 0.6   |       |       | 0.6   |       |       | 0.6   |      |       |       | 0.6   |
| Detector 2 Type            |       | Cl+Ex |       |       | Cl+Ex |       |       | Cl+Ex |      |       |       | Cl+Ex |
| Detector 2 Channel         |       |       |       |       |       |       |       |       |      |       |       |       |
| Detector 2 Extend (s)      |       | 0.0   |       |       | 0.0   |       |       | 0.0   |      |       |       | 0.0   |
| Turn Type                  | pm+pt | NA    | Perm  | pm+pt | NA    | Perm  | Perm  | NA    |      | Perm  | NA    |       |
| Protected Phases           | 5     | 2     |       | 1     | 6     |       |       | 8     |      |       |       | 4     |
| Permitted Phases           | 2     |       | 2     | 6     |       | 6     | 8     |       |      | 4     |       |       |
| Detector Phase             | 5     | 2     | 2     | 1     | 6     | 6     | 8     | 8     |      | 4     |       | 4     |

4: Innovation/Flamborough & Terry Fox  
AM Peak Hour

555-603 March Road  
2037 Background Traffic



| Lane Group              | EBL   | EBT   | EBR   | WBL   | WBT   | WBR   | NBL   | NBT   | NBR | SBL   | SBT   | SBR |
|-------------------------|-------|-------|-------|-------|-------|-------|-------|-------|-----|-------|-------|-----|
| Switch Phase            |       |       |       |       |       |       |       |       |     |       |       |     |
| Minimum Initial (s)     | 5.0   | 10.0  | 10.0  | 5.0   | 10.0  | 10.0  | 10.0  | 10.0  |     | 10.0  | 10.0  |     |
| Minimum Split (s)       | 10.9  | 27.9  | 27.9  | 10.9  | 27.9  | 27.9  | 35.6  | 35.6  |     | 35.6  | 35.6  |     |
| Total Split (s)         | 18.0  | 70.0  | 70.0  | 18.0  | 70.0  | 70.0  | 42.0  | 42.0  |     | 42.0  | 42.0  |     |
| Total Split (%)         | 13.8% | 53.8% | 53.8% | 13.8% | 53.8% | 53.8% | 32.3% | 32.3% |     | 32.3% | 32.3% |     |
| Maximum Green (s)       | 12.1  | 64.1  | 64.1  | 12.1  | 64.1  | 64.1  | 35.4  | 35.4  |     | 35.4  | 35.4  |     |
| Yellow Time (s)         | 3.7   | 3.7   | 3.7   | 3.7   | 3.7   | 3.7   | 3.0   | 3.0   |     | 3.0   | 3.0   |     |
| All-Red Time (s)        | 2.2   | 2.2   | 2.2   | 2.2   | 2.2   | 2.2   | 3.6   | 3.6   |     | 3.6   | 3.6   |     |
| Lost Time Adjust (s)    | 0.0   | 0.0   | 0.0   | 0.0   | 0.0   | 0.0   | 0.0   | 0.0   |     | 0.0   | 0.0   |     |
| Total Lost Time (s)     | 5.9   | 5.9   | 5.9   | 5.9   | 5.9   | 5.9   | 6.6   | 6.6   |     | 6.6   | 6.6   |     |
| Lead/Lag                | Lead  | Lag   | Lag   | Lead  | Lag   | Lag   |       |       |     |       |       |     |
| Lead-Lag Optimize?      |       |       |       |       |       |       |       |       |     |       |       |     |
| Vehicle Extension (s)   | 3.0   | 3.0   | 3.0   | 3.0   | 3.0   | 3.0   | 3.0   | 3.0   |     | 3.0   | 3.0   |     |
| Recall Mode             | None  | C-Max | C-Max | None  | C-Max | C-Max | None  | None  |     | None  | None  |     |
| Walk Time (s)           |       | 7.0   | 7.0   |       | 7.0   | 7.0   | 7.0   | 7.0   |     | 7.0   | 7.0   |     |
| Flash Dont Walk (s)     |       | 15.0  | 15.0  |       | 15.0  | 15.0  | 22.0  | 22.0  |     | 22.0  | 22.0  |     |
| Pedestrian Calls (#/hr) |       | 5     | 5     |       | 5     | 5     | 5     | 5     |     | 5     | 5     |     |
| Act Effct Green (s)     | 95.4  | 89.2  | 89.2  | 99.6  | 94.8  | 94.8  | 15.2  | 15.2  |     | 15.2  | 15.2  |     |
| Actuated g/C Ratio      | 0.73  | 0.69  | 0.69  | 0.77  | 0.73  | 0.73  | 0.12  | 0.12  |     | 0.12  | 0.12  |     |
| v/c Ratio               | 0.04  | 0.37  | 0.08  | 0.13  | 0.21  | 0.03  | 0.27  | 0.48  |     | 0.51  | 0.47  |     |
| Control Delay           | 4.8   | 11.0  | 2.4   | 6.3   | 13.4  | 5.5   | 54.0  | 23.9  |     | 66.2  | 42.9  |     |
| Queue Delay             | 0.0   | 0.0   | 0.0   | 0.0   | 0.0   | 0.0   | 0.0   | 0.0   |     | 0.0   | 0.0   |     |
| Total Delay             | 4.8   | 11.0  | 2.4   | 6.3   | 13.4  | 5.5   | 54.0  | 23.9  |     | 66.2  | 42.9  |     |
| LOS                     | A     | B     | A     | A     | B     | A     | D     | C     |     | E     | D     |     |
| Approach Delay          |       | 9.4   |       |       | 11.1  |       |       | 30.9  |     |       | 52.1  |     |
| Approach LOS            |       | A     |       |       | B     |       |       | C     |     |       | D     |     |
| Queue Length 50th (m)   | 1.1   | 35.4  | 0.0   | 11.4  | 37.1  | 0.9   | 8.3   | 8.0   |     | 14.5  | 15.5  |     |
| Queue Length 95th (m)   | 4.9   | 80.4  | 5.8   | m19.5 | 66.8  | m4.0  | 16.1  | 22.0  |     | 24.8  | 27.5  |     |
| Internal Link Dist (m)  |       | 484.2 |       |       | 461.8 |       |       | 523.1 |     |       | 289.7 |     |
| Turn Bay Length (m)     | 75.0  |       | 120.0 | 110.0 |       | 130.0 | 220.0 |       |     | 30.0  |       |     |
| Base Capacity (vph)     | 765   | 1186  | 980   | 683   | 1260  | 1072  | 323   | 473   |     | 287   | 443   |     |
| Starvation Cap Reductn  | 0     | 0     | 0     | 0     | 0     | 0     | 0     | 0     |     | 0     | 0     |     |
| Spillback Cap Reductn   | 0     | 0     | 0     | 0     | 0     | 0     | 0     | 0     |     | 0     | 0     |     |
| Storage Cap Reductn     | 0     | 0     | 0     | 0     | 0     | 0     | 0     | 0     |     | 0     | 0     |     |
| Reduced v/c Ratio       | 0.04  | 0.37  | 0.08  | 0.12  | 0.21  | 0.03  | 0.11  | 0.26  |     | 0.22  | 0.22  |     |

Intersection Summary

Area Type: Other  
 Cycle Length: 130  
 Actuated Cycle Length: 130  
 Offset: 124 (95%), Referenced to phase 2:EBTL and 6:WBTL, Start of Green  
 Natural Cycle: 75  
 Control Type: Actuated-Coordinated  
 Maximum v/c Ratio: 0.51  
 Intersection Signal Delay: 18.2 Intersection LOS: B  
 Intersection Capacity Utilization 71.0% ICU Level of Service C  
 Analysis Period (min) 15  
 m Volume for 95th percentile queue is metered by upstream signal.

Splits and Phases: 4: Innovation/Flamborough & Terry Fox



5: Hines & Innovation  
AM Peak Hour

555-603 March Road  
2037 Background Traffic



| Lane Group                 | EBL  | EBT   | EBR   | WBL  | WBT   | WBR   | NBL  | NBT   | NBR   | SBL  | SBT   | SBR   |
|----------------------------|------|-------|-------|------|-------|-------|------|-------|-------|------|-------|-------|
| Lane Configurations        |      |       |       |      |       |       |      |       |       |      |       |       |
| Traffic Volume (vph)       | 15   | 0     | 118   | 6    | 1     | 0     | 92   | 58    | 2     | 1    | 15    | 2     |
| Future Volume (vph)        | 15   | 0     | 118   | 6    | 1     | 0     | 92   | 58    | 2     | 1    | 15    | 2     |
| Ideal Flow (vphpl)         | 1800 | 1800  | 1800  | 1800 | 1800  | 1800  | 1800 | 1800  | 1800  | 1800 | 1800  | 1800  |
| Lane Util. Factor          | 1.00 | 1.00  | 1.00  | 1.00 | 1.00  | 1.00  | 1.00 | 1.00  | 1.00  | 1.00 | 1.00  | 1.00  |
| Ped Bike Factor            |      |       |       |      |       |       |      |       |       |      |       |       |
| Frt                        |      | 0.880 |       |      |       |       |      | 0.998 |       |      | 0.985 |       |
| Flt Protected              |      | 0.994 |       |      | 0.959 |       |      | 0.971 |       |      | 0.997 |       |
| Satd. Flow (prot)          | 0    | 1477  | 0     | 0    | 1690  | 0     | 0    | 1633  | 0     | 0    | 1675  | 0     |
| Flt Permitted              |      | 0.994 |       |      | 0.959 |       |      | 0.971 |       |      | 0.997 |       |
| Satd. Flow (perm)          | 0    | 1477  | 0     | 0    | 1690  | 0     | 0    | 1633  | 0     | 0    | 1675  | 0     |
| Link Speed (k/h)           |      | 50    |       |      | 50    |       |      | 50    |       |      | 50    |       |
| Link Distance (m)          |      | 438.6 |       |      | 104.0 |       |      | 421.8 |       |      | 319.0 |       |
| Travel Time (s)            |      | 31.6  |       |      | 7.5   |       |      | 30.4  |       |      | 23.0  |       |
| Confl. Peds. (#/hr)        |      |       |       |      |       |       | 5    |       |       |      |       | 5     |
| Confl. Bikes (#/hr)        |      |       | 5     |      |       | 5     |      |       | 10    |      |       | 5     |
| Peak Hour Factor           | 1.00 | 1.00  | 1.00  | 1.00 | 1.00  | 1.00  | 1.00 | 1.00  | 1.00  | 1.00 | 1.00  | 1.00  |
| Heavy Vehicles (%)         | 1%   | 2%    | 6%    | 1%   | 1%    | 1%    | 8%   | 2%    | 2%    | 2%   | 5%    | 1%    |
| Adj. Flow (vph)            | 15   | 0     | 118   | 6    | 1     | 0     | 92   | 58    | 2     | 1    | 15    | 2     |
| Shared Lane Traffic (%)    |      |       |       |      |       |       |      |       |       |      |       |       |
| Lane Group Flow (vph)      | 0    | 133   | 0     | 0    | 7     | 0     | 0    | 152   | 0     | 0    | 18    | 0     |
| Enter Blocked Intersection | No   | No    | No    | No   | No    | No    | No   | No    | No    | No   | No    | No    |
| Lane Alignment             | Left | Left  | Right | Left | Left  | Right | Left | Left  | Right | Left | Left  | Right |
| Median Width(m)            |      | 0.0   |       |      | 0.0   |       |      | 0.0   |       |      | 0.0   |       |
| Link Offset(m)             |      | 0.0   |       |      | 0.0   |       |      | 0.0   |       |      | 0.0   |       |
| Crosswalk Width(m)         |      | 5.0   |       |      | 5.0   |       |      | 5.0   |       |      | 5.0   |       |
| Two way Left Turn Lane     |      |       |       |      |       |       |      |       |       |      |       |       |
| Headway Factor             | 1.09 | 1.09  | 1.09  | 1.09 | 1.09  | 1.09  | 1.09 | 1.09  | 1.09  | 1.09 | 1.09  | 1.09  |
| Turning Speed (k/h)        | 24   |       | 14    | 97   |       | 97    | 24   |       | 97    | 97   |       | 14    |
| Sign Control               |      | Stop  |       |      | Stop  |       |      | Free  |       |      | Free  |       |

Intersection Summary

Area Type: Other













Control Type: Unsignalized

Intersection Capacity Utilization 30.3% ICU Level of Service A

Analysis Period (min) 15

6: March & Nokia Access  
AM Peak Hour

555-603 March Road  
2037 Background Traffic

|                            |  |  |  |  |  |  |
|----------------------------|---|---|---|---|---|---|
| Lane Group                 | WBL   | WBR   | NBT   | NBR   | SBL   | SBT   |
| Lane Configurations        |  |  |  |  |  |  |
| Traffic Volume (vph)       | 180   | 156   | 956   | 89  | 351   | 1618  |
| Future Volume (vph)        | 180   | 156   | 956   | 89  | 351   | 1618  |
| Ideal Flow (vphpl)         | 1800  | 1800  | 1800  | 1800  | 1800  | 1800  |
| Storage Length (m)         | 65.0  | 0.0   |   | 100.0   | 75.0  |   |
| Storage Lanes              | 1   | 1   |   | 1   | 1   |   |
| Taper Length (m)           | 25.0  |   |   |   | 50.0  |   |
| Lane Util. Factor          | 1.00  | 1.00  | 0.95  | 1.00  | 1.00  | 0.91  |
| Ped Bike Factor            | 0.99  | 0.97  |   | 0.94  |   |   |
| Fr t                       |   | 0.850   |   | 0.850   |   |   |
| Flt Protected              | 0.950   |   |   |   | 0.950   |   |
| Satd. Flow (prot)          | 1674  | 1498  | 3283  | 1498  | 1674  | 4718  |
| Flt Permitted              | 0.950   |   |   |   | 0.202   |   |
| Satd. Flow (perm)          | 1654  | 1456  | 3283  | 1408  | 356   | 4718  |
| Right Turn on Red          |   | Yes   |   | Yes   |   |   |
| Satd. Flow (RTOR)          |   | 156   |   | 89  |   |   |
| Link Speed (k/h)           | 50  |   | 60  |   |   | 60  |
| Link Distance (m)          | 167.8   |   | 199.3   |   |   | 308.9   |
| Travel Time (s)            | 12.1  |   | 12.0  |   |   | 18.5  |
| Confl. Peds. (#/hr)        | 10  | 10  |   | 10  | 10  |   |
| Confl. Bikes (#/hr)        |   | 5   |   | 5   |   |   |
| Peak Hour Factor           | 1.00  | 1.00  | 1.00  | 1.00  | 1.00  | 1.00  |
| Heavy Vehicles (%)         | 1%  | 1%  | 3%  | 1%  | 1%  | 3%  |
| Adj. Flow (vph)            | 180   | 156   | 956   | 89  | 351   | 1618  |
| Shared Lane Traffic (%)    |   |   |   |   |   |   |
| Lane Group Flow (vph)      | 180   | 156   | 956   | 89  | 351   | 1618  |
| Enter Blocked Intersection | No  | No  | No  | No  | No  | No  |
| Lane Alignment             | L NA  | Right   | Left  | Right   | L NA  | Left  |
| Median Width(m)            | 3.5   |   | 7.0   |   |   | 7.0   |
| Link Offset(m)             | 0.0   |   | 0.0   |   |   | 0.0   |
| Crosswalk Width(m)         | 5.0   |   | 5.0   |   |   | 5.0   |
| Two way Left Turn Lane     |   |   |   |   |   |   |
| Headway Factor             | 1.09  | 1.09  | 1.09  | 1.09  | 1.09  | 1.09  |
| Turning Speed (k/h)        | 24  | 14  |   | 14  | 24  |   |
| Number of Detectors        | 1   | 1   | 2   | 1   | 1   | 2   |
| Detector Template          | Left  | Right   | Thru  | Right   | Left  | Thru  |
| Leading Detector (m)       | 2.0   | 2.0   | 10.0  | 2.0   | 2.0   | 10.0  |
| Trailing Detector (m)      | 0.0   | 0.0   | 0.0   | 0.0   | 0.0   | 0.0   |
| Detector 1 Position(m)     | 0.0   | 0.0   | 0.0   | 0.0   | 0.0   | 0.0   |
| Detector 1 Size(m)         | 2.0   | 2.0   | 0.6   | 2.0   | 2.0   | 0.6   |
| Detector 1 Type            | Cl+Ex   | Cl+Ex   | Cl+Ex   | Cl+Ex   | Cl+Ex   | Cl+Ex   |
| Detector 1 Channel         |   |   |   |   |   |   |
| Detector 1 Extend (s)      | 0.0   | 0.0   | 0.0   | 0.0   | 0.0   | 0.0   |
| Detector 1 Queue (s)       | 0.0   | 0.0   | 0.0   | 0.0   | 0.0   | 0.0   |
| Detector 1 Delay (s)       | 0.0   | 0.0   | 0.0   | 0.0   | 0.0   | 0.0   |
| Detector 2 Position(m)     |   |   | 9.4   |   |   | 9.4   |
| Detector 2 Size(m)         |   |   | 0.6   |   |   | 0.6   |
| Detector 2 Type            |   |   | Cl+Ex   |   |   | Cl+Ex   |
| Detector 2 Channel         |   |   |   |   |   |   |
| Detector 2 Extend (s)      |   |   | 0.0   |   |   | 0.0   |
| Turn Type                  | Perm  | Perm  | NA  | Perm  | pm+pt   | NA  |
| Protected Phases           |   |   | 2   |   | 1   | 6   |
| Permitted Phases           | 8   | 8   |   | 2   | 6   |   |
| Detector Phase             | 8   | 8   | 2   | 2   | 1   | 6   |



| Lane Group              | WBL   | WBR   | NBT   | NBR   | SBL   | SBT   |
|-------------------------|-------|-------|-------|-------|-------|-------|
| Switch Phase            |       |       |       |       |       |       |
| Minimum Initial (s)     | 10.0  | 10.0  | 10.0  | 10.0  | 5.0   | 10.0  |
| Minimum Split (s)       | 38.5  | 38.5  | 23.8  | 23.8  | 11.4  | 23.8  |
| Total Split (s)         | 42.0  | 42.0  | 55.0  | 55.0  | 33.0  | 88.0  |
| Total Split (%)         | 32.3% | 32.3% | 42.3% | 42.3% | 25.4% | 67.7% |
| Maximum Green (s)       | 35.5  | 35.5  | 49.2  | 49.2  | 26.6  | 82.2  |
| Yellow Time (s)         | 3.3   | 3.3   | 3.7   | 3.7   | 3.7   | 3.7   |
| All-Red Time (s)        | 3.2   | 3.2   | 2.1   | 2.1   | 2.7   | 2.1   |
| Lost Time Adjust (s)    | 0.0   | 0.0   | 0.0   | 0.0   | 0.0   | 0.0   |
| Total Lost Time (s)     | 6.5   | 6.5   | 5.8   | 5.8   | 6.4   | 5.8   |
| Lead/Lag                |       |       | Lag   | Lag   | Lead  |       |
| Lead-Lag Optimize?      |       |       |       |       |       |       |
| Vehicle Extension (s)   | 3.0   | 3.0   | 3.0   | 3.0   | 3.0   | 3.0   |
| Recall Mode             | None  | None  | C-Max | C-Max | None  | C-Max |
| Walk Time (s)           | 7.0   | 7.0   | 7.0   | 7.0   |       | 7.0   |
| Flash Dont Walk (s)     | 25.0  | 25.0  | 11.0  | 11.0  |       | 11.0  |
| Pedestrian Calls (#/hr) | 10    | 10    | 10    | 10    |       | 10    |
| Act Effct Green (s)     | 20.6  | 20.6  | 68.5  | 68.5  | 96.5  | 97.1  |
| Actuated g/C Ratio      | 0.16  | 0.16  | 0.53  | 0.53  | 0.74  | 0.75  |
| v/c Ratio               | 0.69  | 0.43  | 0.55  | 0.11  | 0.72  | 0.46  |
| Control Delay           | 64.2  | 10.0  | 19.7  | 6.1   | 15.8  | 6.3   |
| Queue Delay             | 0.0   | 0.0   | 0.0   | 0.0   | 0.0   | 0.0   |
| Total Delay             | 64.2  | 10.0  | 19.7  | 6.1   | 15.8  | 6.3   |
| LOS                     | E     | B     | B     | A     | B     | A     |
| Approach Delay          | 39.0  |       | 18.6  |       |       | 8.0   |
| Approach LOS            | D     |       | B     |       |       | A     |
| Queue Length 50th (m)   | 41.1  | 0.0   | 34.0  | 0.0   | 30.4  | 61.6  |
| Queue Length 95th (m)   | 56.7  | 15.5  | 93.2  | m6.8  | 24.2  | 76.2  |
| Internal Link Dist (m)  | 143.8 |       | 175.3 |       |       | 284.9 |
| Turn Bay Length (m)     | 65.0  |       |       | 100.0 | 75.0  |       |
| Base Capacity (vph)     | 451   | 511   | 1729  | 783   | 542   | 3524  |
| Starvation Cap Reductn  | 0     | 0     | 0     | 0     | 0     | 0     |
| Spillback Cap Reductn   | 0     | 0     | 0     | 0     | 0     | 0     |
| Storage Cap Reductn     | 0     | 0     | 0     | 0     | 0     | 0     |
| Reduced v/c Ratio       | 0.40  | 0.31  | 0.55  | 0.11  | 0.65  | 0.46  |

Intersection Summary

Area Type: Other  
 Cycle Length: 130  
 Actuated Cycle Length: 130  
 Offset: 0 (0%), Referenced to phase 2:NBT and 6:SBTL, Start of Green  
 Natural Cycle: 90  
 Control Type: Actuated-Coordinated  
 Maximum v/c Ratio: 0.72  
 Intersection Signal Delay: 14.4 Intersection LOS: B  
 Intersection Capacity Utilization 79.1% ICU Level of Service D  
 Analysis Period (min) 15  
 m Volume for 95th percentile queue is metered by upstream signal.

Splits and Phases: 6: March & Nokia Access

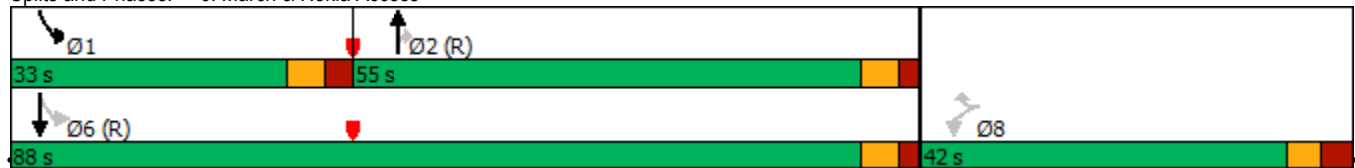



3: March & Solandt  
AM Peak Hour

555-603 March Road  
2037 Background Traffic (dual WBL on Solandt)



| Lane Group                 | EBL   | EBT   | EBR   | WBL   | WBT   | WBR  | NBU   | NBL   | NBT   | NBR  | SBU   | SBL   |
|----------------------------|-------|-------|-------|-------|-------|------|-------|-------|-------|------|-------|-------|
| Lane Configurations        |       |       |       |       |       |      |       |       |       |      |       |       |
| Traffic Volume (vph)       | 12    | 33    | 85    | 82    | 16    | 4    | 2     | 221   | 1484  | 199  | 2     | 43    |
| Future Volume (vph)        | 12    | 33    | 85    | 82    | 16    | 4    | 2     | 221   | 1484  | 199  | 2     | 43    |
| Ideal Flow (vphpl)         | 1800  | 1800  | 1800  | 1800  | 1800  | 1800 | 1800  | 1800  | 1800  | 1800 | 1800  | 1800  |
| Storage Length (m)         | 35.0  |       | 60.0  | 85.0  |       | 55.0 |       | 165.0 |       | 0.0  |       | 155.0 |
| Storage Lanes              | 1     |       | 1     | 2     |       | 0    |       | 1     |       | 0    |       | 1     |
| Taper Length (m)           | 50.0  |       |       | 95.0  |       |      |       | 40.0  |       |      |       | 25.0  |
| Lane Util. Factor          | 1.00  | 1.00  | 1.00  | 0.97  | 1.00  | 1.00 | 0.95  | 1.00  | 0.95  | 0.95 | 0.95  | 1.00  |
| Ped Bike Factor            | 0.99  |       | 0.98  | 0.99  | 1.00  |      |       | 1.00  | 1.00  |      |       | 1.00  |
| Fr <sub>t</sub>            |       |       | 0.850 |       | 0.970 |      |       |       | 0.982 |      |       |       |
| Fl <sub>t</sub> Protected  | 0.950 |       |       | 0.950 |       |      |       | 0.950 |       |      |       | 0.950 |
| Satd. Flow (prot)          | 1537  | 1728  | 1414  | 3124  | 1384  | 0    | 0     | 1658  | 3223  | 0    | 0     | 1674  |
| Fl <sub>t</sub> Permitted  | 0.950 |       |       | 0.950 |       |      |       | 0.950 |       |      |       | 0.950 |
| Satd. Flow (perm)          | 1528  | 1728  | 1381  | 3092  | 1384  | 0    | 0     | 1656  | 3223  | 0    | 0     | 1672  |
| Right Turn on Red          |       |       | Yes   |       |       | Yes  |       |       |       | Yes  |       |       |
| Satd. Flow (RTOR)          |       |       | 137   |       | 4     |      |       |       | 16    |      |       |       |
| Link Speed (k/h)           |       | 50    |       |       | 50    |      |       |       | 60    |      |       |       |
| Link Distance (m)          |       | 212.6 |       |       | 241.6 |      |       |       | 610.9 |      |       |       |
| Travel Time (s)            |       | 15.3  |       |       | 17.4  |      |       |       | 36.7  |      |       |       |
| Confl. Peds. (#/hr)        | 5     |       | 5     | 5     |       | 5    |       | 5     |       | 5    |       | 5     |
| Confl. Bikes (#/hr)        |       |       | 5     |       |       | 5    |       |       |       | 5    |       |       |
| Peak Hour Factor           | 1.00  | 1.00  | 1.00  | 1.00  | 1.00  | 1.00 | 1.00  | 1.00  | 1.00  | 1.00 | 1.00  | 1.00  |
| Heavy Vehicles (%)         | 10%   | 3%    | 7%    | 5%    | 30%   | 1%   | 2%    | 2%    | 3%    | 1%   | 2%    | 1%    |
| Adj. Flow (vph)            | 12    | 33    | 85    | 82    | 16    | 4    | 2     | 221   | 1484  | 199  | 2     | 43    |
| Shared Lane Traffic (%)    |       |       |       |       |       |      |       |       |       |      |       |       |
| Lane Group Flow (vph)      | 12    | 33    | 85    | 82    | 20    | 0    | 0     | 223   | 1683  | 0    | 0     | 45    |
| Enter Blocked Intersection | No    | No    | No    | No    | No    | No   | No    | No    | No    | No   | No    | No    |
| Lane Alignment             | L NA  | Left  | R NA  | L NA  | Left  | R NA | R NA  | L NA  | Left  | R NA | R NA  | L NA  |
| Median Width(m)            |       | 7.0   |       |       | 10.5  |      |       |       | 17.5  |      |       |       |
| Link Offset(m)             |       | 0.0   |       |       | 0.0   |      |       |       | 0.0   |      |       |       |
| Crosswalk Width(m)         |       | 5.0   |       |       | 5.0   |      |       |       | 5.0   |      |       |       |
| Two way Left Turn Lane     |       |       |       |       |       |      |       |       |       |      |       |       |
| Headway Factor             | 1.09  | 1.09  | 1.09  | 1.09  | 1.09  | 1.09 | 1.09  | 1.09  | 1.09  | 1.09 | 1.09  | 1.09  |
| Number of Detectors        | 1     | 2     | 1     | 1     | 2     |      | 1     | 1     | 2     |      | 1     | 1     |
| Detector Template          | Left  | Thru  | Right | Left  | Thru  |      | Left  | Left  | Thru  |      | Left  | Left  |
| Leading Detector (m)       | 2.0   | 10.0  | 2.0   | 2.0   | 10.0  |      | 2.0   | 2.0   | 10.0  |      | 2.0   | 2.0   |
| Trailing Detector (m)      | 0.0   | 0.0   | 0.0   | 0.0   | 0.0   |      | 0.0   | 0.0   | 0.0   |      | 0.0   | 0.0   |
| Detector 1 Position(m)     | 0.0   | 0.0   | 0.0   | 0.0   | 0.0   |      | 0.0   | 0.0   | 0.0   |      | 0.0   | 0.0   |
| Detector 1 Size(m)         | 2.0   | 0.6   | 2.0   | 2.0   | 0.6   |      | 2.0   | 2.0   | 0.6   |      | 2.0   | 2.0   |
| Detector 1 Type            | Cl+Ex | Cl+Ex | Cl+Ex | Cl+Ex | Cl+Ex |      | Cl+Ex | Cl+Ex | Cl+Ex |      | Cl+Ex | Cl+Ex |
| Detector 1 Channel         |       |       |       |       |       |      |       |       |       |      |       |       |
| Detector 1 Extend (s)      | 0.0   | 0.0   | 0.0   | 0.0   | 0.0   |      | 0.0   | 0.0   | 0.0   |      | 0.0   | 0.0   |
| Detector 1 Queue (s)       | 0.0   | 0.0   | 0.0   | 0.0   | 0.0   |      | 0.0   | 0.0   | 0.0   |      | 0.0   | 0.0   |
| Detector 1 Delay (s)       | 0.0   | 0.0   | 0.0   | 0.0   | 0.0   |      | 0.0   | 0.0   | 0.0   |      | 0.0   | 0.0   |
| Detector 2 Position(m)     |       | 9.4   |       |       | 9.4   |      |       |       | 9.4   |      |       |       |
| Detector 2 Size(m)         |       | 0.6   |       |       | 0.6   |      |       |       | 0.6   |      |       |       |
| Detector 2 Type            |       | Cl+Ex |       |       | Cl+Ex |      |       |       | Cl+Ex |      |       |       |
| Detector 2 Channel         |       |       |       |       |       |      |       |       |       |      |       |       |
| Detector 2 Extend (s)      |       | 0.0   |       |       | 0.0   |      |       |       | 0.0   |      |       |       |
| Turn Type                  | Prot  | NA    | Perm  | Prot  | NA    |      | Prot  | Prot  | NA    |      | Prot  | Prot  |
| Protected Phases           | 7     | 4     |       | 3     | 8     |      | 5     | 5     | 2     |      | 1     | 1     |
| Permitted Phases           |       |       | 4     |       |       |      |       |       |       |      |       |       |
| Detector Phase             | 7     | 4     | 4     | 3     | 8     |      | 5     | 5     | 2     |      | 1     | 1     |
| Switch Phase               |       |       |       |       |       |      |       |       |       |      |       |       |

3: March & Solandt  
AM Peak Hour

555-603 March Road  
2037 Background Traffic (dual WBL on Solandt)



| Lane Group                 | SBT   | SBR  |
|----------------------------|-------|------|
| Lane Configurations        | ↑↑    |      |
| Traffic Volume (vph)       | 1696  | 37   |
| Future Volume (vph)        | 1696  | 37   |
| Ideal Flow (vphpl)         | 1800  | 1800 |
| Storage Length (m)         |       | 0.0  |
| Storage Lanes              |       | 0    |
| Taper Length (m)           |       |      |
| Lane Util. Factor          | 0.95  | 0.95 |
| Ped Bike Factor            | 1.00  |      |
| Frt                        | 0.997 |      |
| Flt Protected              |       |      |
| Satd. Flow (prot)          | 3272  | 0    |
| Flt Permitted              |       |      |
| Satd. Flow (perm)          | 3272  | 0    |
| Right Turn on Red          |       | Yes  |
| Satd. Flow (RTOR)          | 2     |      |
| Link Speed (k/h)           | 60    |      |
| Link Distance (m)          | 411.0 |      |
| Travel Time (s)            | 24.7  |      |
| Confl. Peds. (#/hr)        |       | 5    |
| Confl. Bikes (#/hr)        |       | 5    |
| Peak Hour Factor           | 1.00  | 1.00 |
| Heavy Vehicles (%)         | 3%    | 1%   |
| Adj. Flow (vph)            | 1696  | 37   |
| Shared Lane Traffic (%)    |       |      |
| Lane Group Flow (vph)      | 1733  | 0    |
| Enter Blocked Intersection | No    | No   |
| Lane Alignment             | Left  | R NA |
| Median Width(m)            | 17.5  |      |
| Link Offset(m)             | 0.0   |      |
| Crosswalk Width(m)         | 5.0   |      |
| Two way Left Turn Lane     |       |      |
| Headway Factor             | 1.09  | 1.09 |
| Number of Detectors        | 2     |      |
| Detector Template          | Thru  |      |
| Leading Detector (m)       | 10.0  |      |
| Trailing Detector (m)      | 0.0   |      |
| Detector 1 Position(m)     | 0.0   |      |
| Detector 1 Size(m)         | 0.6   |      |
| Detector 1 Type            | Cl+Ex |      |
| Detector 1 Channel         |       |      |
| Detector 1 Extend (s)      | 0.0   |      |
| Detector 1 Queue (s)       | 0.0   |      |
| Detector 1 Delay (s)       | 0.0   |      |
| Detector 2 Position(m)     | 9.4   |      |
| Detector 2 Size(m)         | 0.6   |      |
| Detector 2 Type            | Cl+Ex |      |
| Detector 2 Channel         |       |      |
| Detector 2 Extend (s)      | 0.0   |      |
| Turn Type                  | NA    |      |
| Protected Phases           | 6     |      |
| Permitted Phases           |       |      |
| Detector Phase             | 6     |      |
| Switch Phase               |       |      |

3: March & Solandt  
AM Peak Hour

555-603 March Road  
2037 Background Traffic (dual WBL on Solandt)

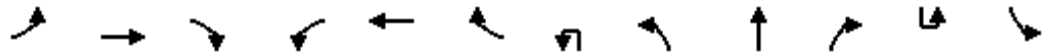

| Lane Group              | EBL  | EBT   | EBR   | WBL   | WBT   | WBR | NBU  | NBL    | NBT    | NBR | SBU  | SBL   |
|-------------------------|------|-------|-------|-------|-------|-----|------|--------|--------|-----|------|-------|
| Minimum Initial (s)     | 5.0  | 10.0  | 10.0  | 5.0   | 10.0  |     | 5.0  | 5.0    | 10.0   |     | 5.0  | 5.0   |
| Minimum Split (s)       | 11.5 | 36.5  | 36.5  | 11.5  | 36.5  |     | 12.0 | 12.0   | 26.8   |     | 12.0 | 12.0  |
| Total Split (s)         | 11.5 | 36.5  | 36.5  | 11.5  | 36.5  |     | 12.0 | 12.0   | 70.0   |     | 12.0 | 12.0  |
| Total Split (%)         | 8.8% | 28.1% | 28.1% | 8.8%  | 28.1% |     | 9.2% | 9.2%   | 53.8%  |     | 9.2% | 9.2%  |
| Maximum Green (s)       | 5.0  | 30.0  | 30.0  | 5.0   | 30.0  |     | 5.0  | 5.0    | 64.2   |     | 5.0  | 5.0   |
| Yellow Time (s)         | 3.3  | 3.3   | 3.3   | 3.3   | 3.3   |     | 3.7  | 3.7    | 3.7    |     | 3.7  | 3.7   |
| All-Red Time (s)        | 3.2  | 3.2   | 3.2   | 3.2   | 3.2   |     | 3.3  | 3.3    | 2.1    |     | 3.3  | 3.3   |
| Lost Time Adjust (s)    | 0.0  | 0.0   | 0.0   | 0.0   | 0.0   |     |      |        | 0.0    |     | 0.0  | 0.0   |
| Total Lost Time (s)     | 6.5  | 6.5   | 6.5   | 6.5   | 6.5   |     |      |        | 7.0    |     | 5.8  | 7.0   |
| Lead/Lag                | Lead | Lag   | Lag   | Lead  | Lag   |     | Lead | Lead   | Lag    |     | Lead | Lead  |
| Lead-Lag Optimize?      | Yes  |       |       |       | Yes   |     |      |        |        |     |      |       |
| Vehicle Extension (s)   | 3.0  | 3.0   | 3.0   | 3.0   | 3.0   |     | 3.0  | 3.0    | 3.0    |     | 3.0  | 3.0   |
| Recall Mode             | None | None  | None  | None  | None  |     | None | None   | C-Max  |     | None | None  |
| Walk Time (s)           |      | 7.0   | 7.0   |       | 7.0   |     |      |        | 7.0    |     |      |       |
| Flash Dont Walk (s)     |      | 23.0  | 23.0  |       | 23.0  |     |      |        | 14.0   |     |      |       |
| Pedestrian Calls (#/hr) |      | 5     | 5     |       | 5     |     |      |        | 5      |     |      |       |
| Act Effct Green (s)     | 5.0  | 14.0  | 14.0  | 5.0   | 20.9  |     |      | 21.0   | 79.9   |     |      | 7.9   |
| Actuated g/C Ratio      | 0.04 | 0.11  | 0.11  | 0.04  | 0.16  |     |      | 0.16   | 0.61   |     |      | 0.06  |
| v/c Ratio               | 0.20 | 0.18  | 0.31  | 0.68  | 0.09  |     |      | 0.84   | 0.85   |     |      | 0.45  |
| Control Delay           | 68.8 | 51.8  | 3.9   | 89.0  | 40.1  |     |      | 77.5   | 26.9   |     |      | 88.9  |
| Queue Delay             | 0.0  | 0.0   | 0.0   | 0.0   | 0.0   |     |      | 0.0    | 0.0    |     |      | 0.0   |
| Total Delay             | 68.8 | 51.8  | 3.9   | 89.0  | 40.1  |     |      | 77.5   | 26.9   |     |      | 88.9  |
| LOS                     | E    | D     | A     | F     | D     |     |      | E      | C      |     |      | F     |
| Approach Delay          |      | 22.1  |       |       | 79.4  |     |      |        | 32.8   |     |      |       |
| Approach LOS            |      | C     |       |       | E     |     |      |        | C      |     |      |       |
| Queue Length 50th (m)   | 2.8  | 7.5   | 0.0   | 10.0  | 3.2   |     |      | 49.6   | 158.0  |     |      | 10.6  |
| Queue Length 95th (m)   | 9.0  | 14.3  | 2.2   | #21.1 | 9.3   |     |      | #139.8 | #266.6 |     |      | #30.6 |
| Internal Link Dist (m)  |      | 188.6 |       |       | 217.6 |     |      |        | 586.9  |     |      |       |
| Turn Bay Length (m)     | 35.0 |       | 60.0  | 85.0  |       |     |      | 165.0  |        |     |      | 155.0 |
| Base Capacity (vph)     | 59   | 398   | 424   | 120   | 322   |     |      | 267    | 1987   |     |      | 101   |
| Starvation Cap Reductn  | 0    | 0     | 0     | 0     | 0     |     |      | 0      | 0      |     |      | 0     |
| Spillback Cap Reductn   | 0    | 0     | 0     | 0     | 0     |     |      | 0      | 0      |     |      | 0     |
| Storage Cap Reductn     | 0    | 0     | 0     | 0     | 0     |     |      | 0      | 0      |     |      | 0     |
| Reduced v/c Ratio       | 0.20 | 0.08  | 0.20  | 0.68  | 0.06  |     |      | 0.84   | 0.85   |     |      | 0.45  |

Intersection Summary

Area Type: Other  
 Cycle Length: 130  
 Actuated Cycle Length: 130  
 Offset: 0 (0%), Referenced to phase 2:NBT and 6:SBT, Start of Green  
 Natural Cycle: 150  
 Control Type: Actuated-Coordinated  
 Maximum v/c Ratio: 1.07  
 Intersection Signal Delay: 50.8  
 Intersection LOS: D  
 Intersection Capacity Utilization 100.3%  
 ICU Level of Service G  
 Analysis Period (min) 15  
 ~ Volume exceeds capacity, queue is theoretically infinite.  
 Queue shown is maximum after two cycles.  
 # 95th percentile volume exceeds capacity, queue may be longer.  
 Queue shown is maximum after two cycles.

Splits and Phases: 3: March & Solandt

|      |        |        |        |
|------|--------|--------|--------|
| Ø1   | Ø2 (R) | Ø3     | Ø4     |
| 12 s | 70 s   | 11.5 s | 36.5 s |
| Ø5   | Ø6 (R) | Ø7     | Ø8     |
| 12 s | 70 s   | 11.5 s | 36.5 s |



| Lane Group                  | SBT    | SBR |
|-----------------------------|--------|-----|
| Minimum Initial (s)         | 10.0   |     |
| Minimum Split (s)           | 26.8   |     |
| Total Split (s)             | 70.0   |     |
| Total Split (%)             | 53.8%  |     |
| Maximum Green (s)           | 64.2   |     |
| Yellow Time (s)             | 3.7    |     |
| All-Red Time (s)            | 2.1    |     |
| Lost Time Adjust (s)        | 0.0    |     |
| Total Lost Time (s)         | 5.8    |     |
| Lead/Lag                    | Lag    |     |
| Lead-Lag Optimize?          |        |     |
| Vehicle Extension (s)       | 3.0    |     |
| Recall Mode                 | C-Max  |     |
| Walk Time (s)               | 7.0    |     |
| Flash Dont Walk (s)         | 14.0   |     |
| Pedestrian Calls (#/hr)     | 5      |     |
| Act Effct Green (s)         | 64.2   |     |
| Actuated g/C Ratio          | 0.49   |     |
| v/c Ratio                   | 1.07   |     |
| Control Delay               | 70.0   |     |
| Queue Delay                 | 0.0    |     |
| Total Delay                 | 70.0   |     |
| LOS                         | E      |     |
| Approach Delay              | 70.5   |     |
| Approach LOS                | E      |     |
| Queue Length 50th (m)       | ~234.6 |     |
| Queue Length 95th (m)       | #283.4 |     |
| Internal Link Dist (m)      | 387.0  |     |
| Turn Bay Length (m)         |        |     |
| Base Capacity (vph)         | 1616   |     |
| Starvation Cap Reductn      | 0      |     |
| Spillback Cap Reductn       | 0      |     |
| Storage Cap Reductn         | 0      |     |
| Reduced v/c Ratio           | 1.07   |     |
| <b>Intersection Summary</b> |        |     |

3: March & Solandt  
AM Peak Hour

555-603 March Road  
2037 Background Traffic (demand rationalization)



| Lane Group                 | EBL   | EBT   | EBR   | WBL   | WBT   | WBR  | NBU   | NBL   | NBT   | NBR  | SBU   | SBL   |
|----------------------------|-------|-------|-------|-------|-------|------|-------|-------|-------|------|-------|-------|
| Lane Configurations        |       |       |       |       |       |      |       |       |       |      |       |       |
| Traffic Volume (vph)       | 12    | 33    | 85    | 82    | 16    | 4    | 2     | 221   | 1484  | 199  | 2     | 43    |
| Future Volume (vph)        | 12    | 33    | 85    | 82    | 16    | 4    | 2     | 221   | 1484  | 199  | 2     | 43    |
| Ideal Flow (vphpl)         | 1800  | 1800  | 1800  | 1800  | 1800  | 1800 | 1800  | 1800  | 1800  | 1800 | 1800  | 1800  |
| Storage Length (m)         | 35.0  |       | 60.0  | 85.0  |       | 55.0 |       | 165.0 |       | 0.0  |       | 155.0 |
| Storage Lanes              | 1     |       | 1     | 2     |       | 0    |       | 1     |       | 0    |       | 1     |
| Taper Length (m)           | 50.0  |       |       | 95.0  |       |      |       | 40.0  |       |      |       | 25.0  |
| Lane Util. Factor          | 1.00  | 1.00  | 1.00  | 0.97  | 1.00  | 1.00 | 0.95  | 1.00  | 0.95  | 0.95 | 0.95  | 1.00  |
| Ped Bike Factor            | 0.99  |       | 0.98  | 0.99  | 1.00  |      |       | 1.00  | 1.00  |      |       | 1.00  |
| Fr <sub>t</sub>            |       |       | 0.850 |       | 0.970 |      |       |       | 0.982 |      |       |       |
| Fl <sub>t</sub> Protected  | 0.950 |       |       | 0.950 |       |      |       | 0.950 |       |      |       | 0.950 |
| Satd. Flow (prot)          | 1537  | 1728  | 1414  | 3124  | 1384  | 0    | 0     | 1658  | 3223  | 0    | 0     | 1674  |
| Fl <sub>t</sub> Permitted  | 0.950 |       |       | 0.950 |       |      |       | 0.950 |       |      |       | 0.950 |
| Satd. Flow (perm)          | 1528  | 1728  | 1381  | 3092  | 1384  | 0    | 0     | 1655  | 3223  | 0    | 0     | 1672  |
| Right Turn on Red          |       |       | Yes   |       |       | Yes  |       |       |       | Yes  |       |       |
| Satd. Flow (RTOR)          |       |       | 137   |       | 4     |      |       |       | 16    |      |       |       |
| Link Speed (k/h)           |       | 50    |       |       | 50    |      |       |       | 60    |      |       |       |
| Link Distance (m)          |       | 212.6 |       |       | 241.6 |      |       |       | 610.9 |      |       |       |
| Travel Time (s)            |       | 15.3  |       |       | 17.4  |      |       |       | 36.7  |      |       |       |
| Confl. Peds. (#/hr)        | 5     |       | 5     | 5     |       | 5    |       | 5     |       | 5    |       | 5     |
| Confl. Bikes (#/hr)        |       |       | 5     |       |       | 5    |       |       |       | 5    |       |       |
| Peak Hour Factor           | 1.00  | 1.00  | 1.00  | 1.00  | 1.00  | 1.00 | 1.00  | 1.00  | 1.00  | 1.00 | 1.00  | 1.00  |
| Heavy Vehicles (%)         | 10%   | 3%    | 7%    | 5%    | 30%   | 1%   | 2%    | 2%    | 3%    | 1%   | 2%    | 1%    |
| Adj. Flow (vph)            | 12    | 33    | 85    | 82    | 16    | 4    | 2     | 221   | 1484  | 199  | 2     | 43    |
| Shared Lane Traffic (%)    |       |       |       |       |       |      |       |       |       |      |       |       |
| Lane Group Flow (vph)      | 12    | 33    | 85    | 82    | 20    | 0    | 0     | 223   | 1683  | 0    | 0     | 45    |
| Enter Blocked Intersection | No    | No    | No    | No    | No    | No   | No    | No    | No    | No   | No    | No    |
| Lane Alignment             | L NA  | Left  | R NA  | L NA  | Left  | R NA | R NA  | L NA  | Left  | R NA | R NA  | L NA  |
| Median Width(m)            |       | 7.0   |       |       | 10.5  |      |       |       | 17.5  |      |       |       |
| Link Offset(m)             |       | 0.0   |       |       | 0.0   |      |       |       | 0.0   |      |       |       |
| Crosswalk Width(m)         |       | 5.0   |       |       | 5.0   |      |       |       | 5.0   |      |       |       |
| Two way Left Turn Lane     |       |       |       |       |       |      |       |       |       |      |       |       |
| Headway Factor             | 1.09  | 1.09  | 1.09  | 1.09  | 1.09  | 1.09 | 1.09  | 1.09  | 1.09  | 1.09 | 1.09  | 1.09  |
| Number of Detectors        | 1     | 2     | 1     | 1     | 2     |      | 1     | 1     | 2     |      | 1     | 1     |
| Detector Template          | Left  | Thru  | Right | Left  | Thru  |      | Left  | Left  | Thru  |      | Left  | Left  |
| Leading Detector (m)       | 2.0   | 10.0  | 2.0   | 2.0   | 10.0  |      | 2.0   | 2.0   | 10.0  |      | 2.0   | 2.0   |
| Trailing Detector (m)      | 0.0   | 0.0   | 0.0   | 0.0   | 0.0   |      | 0.0   | 0.0   | 0.0   |      | 0.0   | 0.0   |
| Detector 1 Position(m)     | 0.0   | 0.0   | 0.0   | 0.0   | 0.0   |      | 0.0   | 0.0   | 0.0   |      | 0.0   | 0.0   |
| Detector 1 Size(m)         | 2.0   | 0.6   | 2.0   | 2.0   | 0.6   |      | 2.0   | 2.0   | 0.6   |      | 2.0   | 2.0   |
| Detector 1 Type            | Cl+Ex | Cl+Ex | Cl+Ex | Cl+Ex | Cl+Ex |      | Cl+Ex | Cl+Ex | Cl+Ex |      | Cl+Ex | Cl+Ex |
| Detector 1 Channel         |       |       |       |       |       |      |       |       |       |      |       |       |
| Detector 1 Extend (s)      | 0.0   | 0.0   | 0.0   | 0.0   | 0.0   |      | 0.0   | 0.0   | 0.0   |      | 0.0   | 0.0   |
| Detector 1 Queue (s)       | 0.0   | 0.0   | 0.0   | 0.0   | 0.0   |      | 0.0   | 0.0   | 0.0   |      | 0.0   | 0.0   |
| Detector 1 Delay (s)       | 0.0   | 0.0   | 0.0   | 0.0   | 0.0   |      | 0.0   | 0.0   | 0.0   |      | 0.0   | 0.0   |
| Detector 2 Position(m)     |       | 9.4   |       |       | 9.4   |      |       |       | 9.4   |      |       |       |
| Detector 2 Size(m)         |       | 0.6   |       |       | 0.6   |      |       |       | 0.6   |      |       |       |
| Detector 2 Type            |       | Cl+Ex |       |       | Cl+Ex |      |       |       | Cl+Ex |      |       |       |
| Detector 2 Channel         |       |       |       |       |       |      |       |       |       |      |       |       |
| Detector 2 Extend (s)      |       | 0.0   |       |       | 0.0   |      |       |       | 0.0   |      |       |       |
| Turn Type                  | Prot  | NA    | Perm  | Prot  | NA    |      | Prot  | Prot  | NA    |      | Prot  | Prot  |
| Protected Phases           | 7     | 4     |       | 3     | 8     |      | 5     | 5     | 2     |      | 1     | 1     |
| Permitted Phases           |       |       | 4     |       |       |      |       |       |       |      |       |       |
| Detector Phase             | 7     | 4     | 4     | 3     | 8     |      | 5     | 5     | 2     |      | 1     | 1     |
| Switch Phase               |       |       |       |       |       |      |       |       |       |      |       |       |

3: March & Solandt  
AM Peak Hour

555-603 March Road  
2037 Background Traffic (demand rationalization)

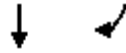

| Lane Group                 | SBT   | SBR  |
|----------------------------|-------|------|
| Lane Configurations        | ↑↑    |      |
| Traffic Volume (vph)       | 1586  | 37   |
| Future Volume (vph)        | 1586  | 37   |
| Ideal Flow (vphpl)         | 1800  | 1800 |
| Storage Length (m)         |       | 0.0  |
| Storage Lanes              |       | 0    |
| Taper Length (m)           |       |      |
| Lane Util. Factor          | 0.95  | 0.95 |
| Ped Bike Factor            | 1.00  |      |
| Frt                        | 0.997 |      |
| Flt Protected              |       |      |
| Satd. Flow (prot)          | 3272  | 0    |
| Flt Permitted              |       |      |
| Satd. Flow (perm)          | 3272  | 0    |
| Right Turn on Red          |       | Yes  |
| Satd. Flow (RTOR)          | 2     |      |
| Link Speed (k/h)           | 60    |      |
| Link Distance (m)          | 411.0 |      |
| Travel Time (s)            | 24.7  |      |
| Confl. Peds. (#/hr)        |       | 5    |
| Confl. Bikes (#/hr)        |       | 5    |
| Peak Hour Factor           | 1.00  | 1.00 |
| Heavy Vehicles (%)         | 3%    | 1%   |
| Adj. Flow (vph)            | 1586  | 37   |
| Shared Lane Traffic (%)    |       |      |
| Lane Group Flow (vph)      | 1623  | 0    |
| Enter Blocked Intersection | No    | No   |
| Lane Alignment             | Left  | R NA |
| Median Width(m)            | 17.5  |      |
| Link Offset(m)             | 0.0   |      |
| Crosswalk Width(m)         | 5.0   |      |
| Two way Left Turn Lane     |       |      |
| Headway Factor             | 1.09  | 1.09 |
| Number of Detectors        | 2     |      |
| Detector Template          | Thru  |      |
| Leading Detector (m)       | 10.0  |      |
| Trailing Detector (m)      | 0.0   |      |
| Detector 1 Position(m)     | 0.0   |      |
| Detector 1 Size(m)         | 0.6   |      |
| Detector 1 Type            | Cl+Ex |      |
| Detector 1 Channel         |       |      |
| Detector 1 Extend (s)      | 0.0   |      |
| Detector 1 Queue (s)       | 0.0   |      |
| Detector 1 Delay (s)       | 0.0   |      |
| Detector 2 Position(m)     | 9.4   |      |
| Detector 2 Size(m)         | 0.6   |      |
| Detector 2 Type            | Cl+Ex |      |
| Detector 2 Channel         |       |      |
| Detector 2 Extend (s)      | 0.0   |      |
| Turn Type                  | NA    |      |
| Protected Phases           | 6     |      |
| Permitted Phases           |       |      |
| Detector Phase             | 6     |      |
| Switch Phase               |       |      |

3: March & Solandt  
AM Peak Hour

555-603 March Road  
2037 Background Traffic (demand rationalization)



| Lane Group              | EBL  | EBT   | EBR   | WBL   | WBT   | WBR | NBU  | NBL    | NBT    | NBR | SBU  | SBL   |
|-------------------------|------|-------|-------|-------|-------|-----|------|--------|--------|-----|------|-------|
| Minimum Initial (s)     | 5.0  | 10.0  | 10.0  | 5.0   | 10.0  |     | 5.0  | 5.0    | 10.0   |     | 5.0  | 5.0   |
| Minimum Split (s)       | 11.5 | 36.5  | 36.5  | 11.5  | 36.5  |     | 12.0 | 12.0   | 26.8   |     | 12.0 | 12.0  |
| Total Split (s)         | 11.5 | 36.5  | 36.5  | 11.5  | 36.5  |     | 12.0 | 12.0   | 70.0   |     | 12.0 | 12.0  |
| Total Split (%)         | 8.8% | 28.1% | 28.1% | 8.8%  | 28.1% |     | 9.2% | 9.2%   | 53.8%  |     | 9.2% | 9.2%  |
| Maximum Green (s)       | 5.0  | 30.0  | 30.0  | 5.0   | 30.0  |     | 5.0  | 5.0    | 64.2   |     | 5.0  | 5.0   |
| Yellow Time (s)         | 3.3  | 3.3   | 3.3   | 3.3   | 3.3   |     | 3.7  | 3.7    | 3.7    |     | 3.7  | 3.7   |
| All-Red Time (s)        | 3.2  | 3.2   | 3.2   | 3.2   | 3.2   |     | 3.3  | 3.3    | 2.1    |     | 3.3  | 3.3   |
| Lost Time Adjust (s)    | 0.0  | 0.0   | 0.0   | 0.0   | 0.0   |     |      | 0.0    | 0.0    |     |      | 0.0   |
| Total Lost Time (s)     | 6.5  | 6.5   | 6.5   | 6.5   | 6.5   |     |      | 7.0    | 5.8    |     |      | 7.0   |
| Lead/Lag                | Lead | Lag   | Lag   | Lead  | Lag   |     | Lead | Lead   | Lag    |     | Lead | Lead  |
| Lead-Lag Optimize?      | Yes  |       |       |       | Yes   |     |      |        |        |     |      |       |
| Vehicle Extension (s)   | 3.0  | 3.0   | 3.0   | 3.0   | 3.0   |     | 3.0  | 3.0    | 3.0    |     | 3.0  | 3.0   |
| Recall Mode             | None | None  | None  | None  | None  |     | None | None   | C-Max  |     | None | None  |
| Walk Time (s)           |      | 7.0   | 7.0   |       | 7.0   |     |      |        | 7.0    |     |      |       |
| Flash Dont Walk (s)     |      | 23.0  | 23.0  |       | 23.0  |     |      |        | 14.0   |     |      |       |
| Pedestrian Calls (#/hr) |      | 5     | 5     |       | 5     |     |      |        | 5      |     |      |       |
| Act Effct Green (s)     | 5.0  | 14.0  | 14.0  | 5.0   | 20.9  |     |      | 21.0   | 79.9   |     |      | 7.9   |
| Actuated g/C Ratio      | 0.04 | 0.11  | 0.11  | 0.04  | 0.16  |     |      | 0.16   | 0.61   |     |      | 0.06  |
| v/c Ratio               | 0.20 | 0.18  | 0.31  | 0.68  | 0.09  |     |      | 0.84   | 0.85   |     |      | 0.45  |
| Control Delay           | 68.8 | 51.8  | 3.9   | 89.0  | 40.1  |     |      | 77.5   | 26.9   |     |      | 75.6  |
| Queue Delay             | 0.0  | 0.0   | 0.0   | 0.0   | 0.0   |     |      | 0.0    | 0.0    |     |      | 0.0   |
| Total Delay             | 68.8 | 51.8  | 3.9   | 89.0  | 40.1  |     |      | 77.5   | 26.9   |     |      | 75.6  |
| LOS                     | E    | D     | A     | F     | D     |     |      | E      | C      |     |      | E     |
| Approach Delay          |      | 22.1  |       |       | 79.4  |     |      |        | 32.8   |     |      |       |
| Approach LOS            |      | C     |       |       | E     |     |      |        | C      |     |      |       |
| Queue Length 50th (m)   | 2.8  | 7.5   | 0.0   | 10.0  | 3.2   |     |      | 49.6   | 158.0  |     |      | 11.2  |
| Queue Length 95th (m)   | 9.0  | 14.3  | 2.2   | #21.1 | 9.3   |     |      | #139.8 | #266.6 |     |      | #30.2 |
| Internal Link Dist (m)  |      | 188.6 |       |       | 217.6 |     |      |        | 586.9  |     |      |       |
| Turn Bay Length (m)     | 35.0 |       | 60.0  | 85.0  |       |     |      | 165.0  |        |     |      | 155.0 |
| Base Capacity (vph)     | 59   | 398   | 424   | 120   | 322   |     |      | 267    | 1987   |     |      | 101   |
| Starvation Cap Reductn  | 0    | 0     | 0     | 0     | 0     |     |      | 0      | 0      |     |      | 0     |
| Spillback Cap Reductn   | 0    | 0     | 0     | 0     | 0     |     |      | 0      | 0      |     |      | 0     |
| Storage Cap Reductn     | 0    | 0     | 0     | 0     | 0     |     |      | 0      | 0      |     |      | 0     |
| Reduced v/c Ratio       | 0.20 | 0.08  | 0.20  | 0.68  | 0.06  |     |      | 0.84   | 0.85   |     |      | 0.45  |

Intersection Summary

Area Type: Other  
 Cycle Length: 130  
 Actuated Cycle Length: 130  
 Offset: 103 (79%), Referenced to phase 2:NBT and 6:SBT, Start of Green  
 Natural Cycle: 150  
 Control Type: Actuated-Coordinated  
 Maximum v/c Ratio: 1.00  
 Intersection Signal Delay: 37.1  
 Intersection LOS: D  
 Intersection Capacity Utilization 97.1%  
 ICU Level of Service F  
 Analysis Period (min) 15  
 ~ Volume exceeds capacity, queue is theoretically infinite.  
 Queue shown is maximum after two cycles.  
 # 95th percentile volume exceeds capacity, queue may be longer.  
 Queue shown is maximum after two cycles.

Splits and Phases: 3: March & Solandt



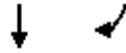

| Lane Group                  | SBT    | SBR |
|-----------------------------|--------|-----|
| Minimum Initial (s)         | 10.0   |     |
| Minimum Split (s)           | 26.8   |     |
| Total Split (s)             | 70.0   |     |
| Total Split (%)             | 53.8%  |     |
| Maximum Green (s)           | 64.2   |     |
| Yellow Time (s)             | 3.7    |     |
| All-Red Time (s)            | 2.1    |     |
| Lost Time Adjust (s)        | 0.0    |     |
| Total Lost Time (s)         | 5.8    |     |
| Lead/Lag                    | Lag    |     |
| Lead-Lag Optimize?          |        |     |
| Vehicle Extension (s)       | 3.0    |     |
| Recall Mode                 | C-Max  |     |
| Walk Time (s)               | 7.0    |     |
| Flash Dont Walk (s)         | 14.0   |     |
| Pedestrian Calls (#/hr)     | 5      |     |
| Act Effct Green (s)         | 64.2   |     |
| Actuated g/C Ratio          | 0.49   |     |
| v/c Ratio                   | 1.00   |     |
| Control Delay               | 39.5   |     |
| Queue Delay                 | 0.0    |     |
| Total Delay                 | 39.5   |     |
| LOS                         | D      |     |
| Approach Delay              | 40.5   |     |
| Approach LOS                | D      |     |
| Queue Length 50th (m)       | ~131.9 |     |
| Queue Length 95th (m)       | #103.7 |     |
| Internal Link Dist (m)      | 387.0  |     |
| Turn Bay Length (m)         |        |     |
| Base Capacity (vph)         | 1616   |     |
| Starvation Cap Reductn      | 0      |     |
| Spillback Cap Reductn       | 0      |     |
| Storage Cap Reductn         | 0      |     |
| Reduced v/c Ratio           | 1.00   |     |
| <b>Intersection Summary</b> |        |     |



1: March & Morgan's Grant/Shirley's Brook  
PM Peak Hour

555-603 March Road  
2037 Background Traffic



| Lane Group                 | EBL   | EBT   | EBR   | WBL   | WBT   | WBR   | NBL   | NBT   | NBR   | SBL   | SBT   | SBR   |
|----------------------------|-------|-------|-------|-------|-------|-------|-------|-------|-------|-------|-------|-------|
| Lane Configurations        |       | ↕     | ↗     | ↖     | ↕     | ↗     | ↖     | ↕↕↕   | ↗     | ↖     | ↕↕↕   | ↗     |
| Traffic Volume (vph)       | 54    | 50    | 63    | 130   | 47    | 195   | 72    | 1725  | 91    | 169   | 1107  | 68    |
| Future Volume (vph)        | 54    | 50    | 63    | 130   | 47    | 195   | 72    | 1725  | 91    | 169   | 1107  | 68    |
| Ideal Flow (vphpl)         | 1800  | 1800  | 1800  | 1800  | 1800  | 1800  | 1800  | 1800  | 1800  | 1800  | 1800  | 1800  |
| Storage Length (m)         | 0.0   |       | 20.0  | 45.0  |       | 35.0  | 130.0 |       | 30.0  | 65.0  |       | 25.0  |
| Storage Lanes              | 0     |       | 1     | 1     |       | 1     | 1     |       | 1     | 1     |       | 1     |
| Taper Length (m)           | 10.0  |       |       | 30.0  |       |       | 40.0  |       |       | 35.0  |       |       |
| Lane Util. Factor          | 1.00  | 1.00  | 1.00  | 1.00  | 1.00  | 1.00  | 1.00  | 0.91  | 1.00  | 1.00  | 0.91  | 1.00  |
| Ped Bike Factor            |       | 1.00  | 0.97  | 0.99  |       | 0.98  | 1.00  |       | 0.94  | 1.00  |       | 0.96  |
| Frt                        |       |       | 0.850 |       |       | 0.850 |       |       | 0.850 |       |       | 0.850 |
| Flt Protected              |       | 0.975 |       | 0.950 |       |       | 0.950 |       |       | 0.950 |       |       |
| Satd. Flow (prot)          | 0     | 1642  | 1498  | 1674  | 1548  | 1498  | 1674  | 4764  | 1498  | 1674  | 4718  | 1498  |
| Flt Permitted              |       | 0.812 |       | 0.690 |       |       | 0.950 |       |       | 0.950 |       |       |
| Satd. Flow (perm)          | 0     | 1364  | 1455  | 1203  | 1548  | 1464  | 1668  | 4764  | 1409  | 1669  | 4718  | 1436  |
| Right Turn on Red          |       |       | Yes   |       |       | Yes   |       |       | Yes   |       |       | Yes   |
| Satd. Flow (RTOR)          |       |       | 136   |       |       | 195   |       |       | 145   |       |       | 91    |
| Link Speed (k/h)           |       | 40    |       |       | 40    |       |       | 60    |       |       | 60    |       |
| Link Distance (m)          |       | 465.2 |       |       | 359.5 |       |       | 318.9 |       |       | 462.6 |       |
| Travel Time (s)            |       | 41.9  |       |       | 32.4  |       |       | 19.1  |       |       | 27.8  |       |
| Confl. Peds. (#/hr)        | 5     |       | 10    | 10    |       | 5     | 5     |       | 10    | 10    |       | 5     |
| Confl. Bikes (#/hr)        |       |       | 5     |       |       | 5     |       |       | 5     |       |       | 5     |
| Peak Hour Factor           | 1.00  | 1.00  | 1.00  | 1.00  | 1.00  | 1.00  | 1.00  | 1.00  | 1.00  | 1.00  | 1.00  | 1.00  |
| Heavy Vehicles (%)         | 10%   | 1%    | 1%    | 1%    | 15%   | 1%    | 1%    | 2%    | 1%    | 1%    | 3%    | 1%    |
| Adj. Flow (vph)            | 54    | 50    | 63    | 130   | 47    | 195   | 72    | 1725  | 91    | 169   | 1107  | 68    |
| Shared Lane Traffic (%)    |       |       |       |       |       |       |       |       |       |       |       |       |
| Lane Group Flow (vph)      | 0     | 104   | 63    | 130   | 47    | 195   | 72    | 1725  | 91    | 169   | 1107  | 68    |
| Enter Blocked Intersection | No    | No    | No    | No    | No    | No    | No    | No    | No    | No    | No    | No    |
| Lane Alignment             | L NA  | Left  | R NA  | L NA  | Left  | R NA  | L NA  | Left  | R NA  | L NA  | Left  | R NA  |
| Median Width(m)            |       | 3.5   |       |       | 5.0   |       |       | 9.0   |       |       | 9.0   |       |
| Link Offset(m)             |       | 0.0   |       |       | 0.0   |       |       | 0.0   |       |       | 0.0   |       |
| Crosswalk Width(m)         |       | 5.0   |       |       | 5.0   |       |       | 10.0  |       |       | 10.0  |       |
| Two way Left Turn Lane     |       |       |       |       |       |       |       |       |       |       |       |       |
| Headway Factor             | 1.09  | 1.09  | 1.09  | 1.09  | 1.09  | 1.09  | 1.09  | 1.09  | 1.09  | 1.09  | 1.09  | 1.09  |
| Turning Speed (k/h)        | 24    |       | 14    | 24    |       | 14    | 24    |       | 14    | 24    |       | 14    |
| Number of Detectors        | 1     | 2     | 1     | 1     | 2     | 1     | 1     | 2     | 1     | 1     | 2     | 1     |
| Detector Template          | Left  | Thru  | Right | Left  | Thru  | Right | Left  | Thru  | Right | Left  | Thru  | Right |
| Leading Detector (m)       | 2.0   | 10.0  | 2.0   | 2.0   | 10.0  | 2.0   | 2.0   | 10.0  | 2.0   | 2.0   | 10.0  | 2.0   |
| Trailing Detector (m)      | 0.0   | 0.0   | 0.0   | 0.0   | 0.0   | 0.0   | 0.0   | 0.0   | 0.0   | 0.0   | 0.0   | 0.0   |
| Detector 1 Position(m)     | 0.0   | 0.0   | 0.0   | 0.0   | 0.0   | 0.0   | 0.0   | 0.0   | 0.0   | 0.0   | 0.0   | 0.0   |
| Detector 1 Size(m)         | 2.0   | 0.6   | 2.0   | 2.0   | 0.6   | 2.0   | 2.0   | 0.6   | 2.0   | 2.0   | 0.6   | 2.0   |
| Detector 1 Type            | Cl+Ex | Cl+Ex | Cl+Ex | Cl+Ex | Cl+Ex | Cl+Ex | Cl+Ex | Cl+Ex | Cl+Ex | Cl+Ex | Cl+Ex | Cl+Ex |
| Detector 1 Channel         |       |       |       |       |       |       |       |       |       |       |       |       |
| Detector 1 Extend (s)      | 0.0   | 0.0   | 0.0   | 0.0   | 0.0   | 0.0   | 0.0   | 0.0   | 0.0   | 0.0   | 0.0   | 0.0   |
| Detector 1 Queue (s)       | 0.0   | 0.0   | 0.0   | 0.0   | 0.0   | 0.0   | 0.0   | 0.0   | 0.0   | 0.0   | 0.0   | 0.0   |
| Detector 1 Delay (s)       | 0.0   | 0.0   | 0.0   | 0.0   | 0.0   | 0.0   | 0.0   | 0.0   | 0.0   | 0.0   | 0.0   | 0.0   |
| Detector 2 Position(m)     |       | 9.4   |       |       | 9.4   |       |       | 9.4   |       |       | 9.4   |       |
| Detector 2 Size(m)         |       | 0.6   |       |       | 0.6   |       |       | 0.6   |       |       | 0.6   |       |
| Detector 2 Type            |       | Cl+Ex |       |       | Cl+Ex |       |       | Cl+Ex |       |       | Cl+Ex |       |
| Detector 2 Channel         |       |       |       |       |       |       |       |       |       |       |       |       |
| Detector 2 Extend (s)      |       | 0.0   |       |       | 0.0   |       |       | 0.0   |       |       | 0.0   |       |
| Turn Type                  | Perm  | NA    | Perm  | Perm  | NA    | Perm  | Prot  | NA    | Perm  | Prot  | NA    | Perm  |
| Protected Phases           |       | 4     |       |       | 8     |       | 5     | 2     |       | 1     | 6     |       |
| Permitted Phases           | 4     |       | 4     | 8     |       | 8     |       |       | 2     |       |       | 6     |
| Detector Phase             | 4     | 4     | 4     | 8     | 8     | 8     | 5     | 2     | 2     | 1     | 6     | 6     |



| Lane Group              | EBL   | EBT   | EBR   | WBL   | WBT   | WBR   | NBL   | NBT   | NBR   | SBL   | SBT   | SBR   |
|-------------------------|-------|-------|-------|-------|-------|-------|-------|-------|-------|-------|-------|-------|
| Switch Phase            |       |       |       |       |       |       |       |       |       |       |       |       |
| Minimum Initial (s)     | 10.0  | 10.0  | 10.0  | 10.0  | 10.0  | 10.0  | 5.0   | 10.0  | 10.0  | 5.0   | 10.0  | 10.0  |
| Minimum Split (s)       | 38.5  | 38.5  | 38.5  | 38.5  | 38.5  | 38.5  | 11.4  | 24.4  | 24.4  | 11.4  | 24.4  | 24.4  |
| Total Split (s)         | 39.0  | 39.0  | 39.0  | 39.0  | 39.0  | 39.0  | 19.0  | 63.0  | 63.0  | 28.0  | 72.0  | 72.0  |
| Total Split (%)         | 30.0% | 30.0% | 30.0% | 30.0% | 30.0% | 30.0% | 14.6% | 48.5% | 48.5% | 21.5% | 55.4% | 55.4% |
| Maximum Green (s)       | 31.5  | 31.5  | 31.5  | 31.5  | 31.5  | 31.5  | 12.6  | 56.6  | 56.6  | 21.6  | 65.6  | 65.6  |
| Yellow Time (s)         | 3.0   | 3.0   | 3.0   | 3.0   | 3.0   | 3.0   | 3.7   | 3.7   | 3.7   | 3.7   | 3.7   | 3.7   |
| All-Red Time (s)        | 4.5   | 4.5   | 4.5   | 4.5   | 4.5   | 4.5   | 2.7   | 2.7   | 2.7   | 2.7   | 2.7   | 2.7   |
| Lost Time Adjust (s)    |       | 0.0   | 0.0   | 0.0   | 0.0   | 0.0   | 0.0   | 0.0   | 0.0   | 0.0   | 0.0   | 0.0   |
| Total Lost Time (s)     |       | 7.5   | 7.5   | 7.5   | 7.5   | 7.5   | 6.4   | 6.4   | 6.4   | 6.4   | 6.4   | 6.4   |
| Lead/Lag                |       |       |       |       |       |       | Lead  | Lag   | Lag   | Lead  | Lag   | Lag   |
| Lead-Lag Optimize?      |       |       |       |       |       |       |       |       |       |       |       |       |
| Vehicle Extension (s)   | 3.0   | 3.0   | 3.0   | 3.0   | 3.0   | 3.0   | 3.0   | 3.0   | 3.0   | 3.0   | 3.0   | 3.0   |
| Recall Mode             | None  | None  | None  | None  | None  | None  | None  | C-Max | C-Max | None  | C-Max | C-Max |
| Walk Time (s)           | 7.0   | 7.0   | 7.0   | 7.0   | 7.0   | 7.0   |       | 7.0   | 7.0   |       | 7.0   | 7.0   |
| Flash Dont Walk (s)     | 24.0  | 24.0  | 24.0  | 24.0  | 24.0  | 24.0  |       | 11.0  | 11.0  |       | 11.0  | 11.0  |
| Pedestrian Calls (#/hr) | 10    | 10    | 10    | 5     | 5     | 5     |       | 10    | 10    |       | 5     | 5     |
| Act Effct Green (s)     |       | 20.0  | 20.0  | 20.0  | 20.0  | 20.0  | 10.5  | 71.9  | 71.9  | 17.7  | 81.8  | 81.8  |
| Actuated g/C Ratio      |       | 0.15  | 0.15  | 0.15  | 0.15  | 0.15  | 0.08  | 0.55  | 0.55  | 0.14  | 0.63  | 0.63  |
| v/c Ratio               |       | 0.50  | 0.19  | 0.70  | 0.20  | 0.50  | 0.53  | 0.65  | 0.11  | 0.74  | 0.37  | 0.07  |
| Control Delay           |       | 56.6  | 1.2   | 70.6  | 46.7  | 10.3  | 46.0  | 42.5  | 12.9  | 72.9  | 14.1  | 1.7   |
| Queue Delay             |       | 0.0   | 0.0   | 0.0   | 0.0   | 0.0   | 0.0   | 0.0   | 0.0   | 0.0   | 0.0   | 0.0   |
| Total Delay             |       | 56.6  | 1.2   | 70.6  | 46.7  | 10.3  | 46.0  | 42.5  | 12.9  | 72.9  | 14.1  | 1.7   |
| LOS                     |       | E     | A     | E     | D     | B     | D     | D     | B     | E     | B     | A     |
| Approach Delay          |       | 35.7  |       |       | 36.0  |       |       | 41.2  |       |       | 20.8  |       |
| Approach LOS            |       | D     |       |       | D     |       |       | D     |       |       | C     |       |
| Queue Length 50th (m)   |       | 22.9  | 0.0   | 29.6  | 9.9   | 0.0   | 15.8  | 112.6 | 0.3   | 38.6  | 46.0  | 0.0   |
| Queue Length 95th (m)   |       | 35.8  | 0.0   | 45.0  | 18.3  | 17.2  | m22.1 | 172.9 | m11.1 | 59.3  | 71.1  | 4.0   |
| Internal Link Dist (m)  |       | 441.2 |       |       | 335.5 |       |       | 294.9 |       |       | 438.6 |       |
| Turn Bay Length (m)     |       |       | 20.0  | 45.0  |       | 35.0  | 130.0 |       | 30.0  | 65.0  |       | 25.0  |
| Base Capacity (vph)     |       | 330   | 455   | 291   | 375   | 502   | 163   | 2636  | 844   | 279   | 2967  | 936   |
| Starvation Cap Reductn  |       | 0     | 0     | 0     | 0     | 0     | 0     | 0     | 0     | 0     | 0     | 0     |
| Spillback Cap Reductn   |       | 0     | 0     | 0     | 0     | 0     | 0     | 0     | 0     | 0     | 0     | 0     |
| Storage Cap Reductn     |       | 0     | 0     | 0     | 0     | 0     | 0     | 0     | 0     | 0     | 0     | 0     |
| Reduced v/c Ratio       |       | 0.32  | 0.14  | 0.45  | 0.13  | 0.39  | 0.44  | 0.65  | 0.11  | 0.61  | 0.37  | 0.07  |

Intersection Summary

Area Type: Other  
 Cycle Length: 130  
 Actuated Cycle Length: 130  
 Offset: 83 (64%), Referenced to phase 2:NBT and 6:SBT, Start of Green  
 Natural Cycle: 90  
 Control Type: Actuated-Coordinated  
 Maximum v/c Ratio: 0.74  
 Intersection Signal Delay: 33.2 Intersection LOS: C  
 Intersection Capacity Utilization 81.5% ICU Level of Service D  
 Analysis Period (min) 15  
 m Volume for 95th percentile queue is metered by upstream signal.

Splits and Phases: 1: March & Morgan's Grant/Shirley's Brook

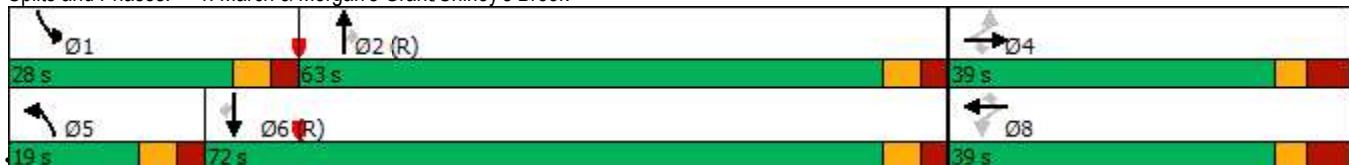

2: March & Terry Fox  
PM Peak Hour

555-603 March Road  
2037 Background Traffic

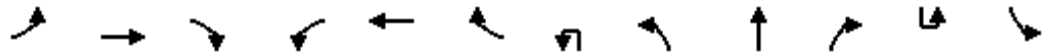

| Lane Group                 | EBL   | EBT   | EBR   | WBL   | WBT   | WBR   | NBU   | NBL   | NBT   | NBR   | SBU   | SBL   |
|----------------------------|-------|-------|-------|-------|-------|-------|-------|-------|-------|-------|-------|-------|
| Lane Configurations        | ↖↖    | ↕     | ↗     | ↖↖    | ↕     | ↗     |       | ↖↖    | ↕↕↕   | ↗     |       | ↖     |
| Traffic Volume (vph)       | 245   | 155   | 194   | 95    | 158   | 209   | 18    | 328   | 1572  | 126   | 4     | 150   |
| Future Volume (vph)        | 245   | 155   | 194   | 95    | 158   | 209   | 18    | 328   | 1572  | 126   | 4     | 150   |
| Ideal Flow (vphpl)         | 1800  | 1800  | 1800  | 1800  | 1800  | 1800  | 1800  | 1800  | 1800  | 1800  | 1800  | 1800  |
| Storage Length (m)         | 95.0  |       | 60.0  | 75.0  |       | 75.0  |       | 130.0 |       | 85.0  |       | 110.0 |
| Storage Lanes              | 2     |       | 2     | 2     |       | 1     |       | 2     |       | 2     |       | 1     |
| Taper Length (m)           | 40.0  |       |       | 20.0  |       |       |       | 90.0  |       |       |       | 40.0  |
| Lane Util. Factor          | 0.97  | 0.95  | 1.00  | 0.97  | 0.95  | 1.00  | 0.91  | 0.97  | 0.91  | 1.00  | 0.91  | 1.00  |
| Ped Bike Factor            | 0.99  |       | 0.97  | 0.99  |       | 0.96  |       | 1.00  |       | 0.97  |       | 1.00  |
| Fr                         |       |       | 0.850 |       |       | 0.850 |       |       |       | 0.850 |       |       |
| Flt Protected              | 0.950 |       |       | 0.950 |       |       |       | 0.950 |       |       |       | 0.950 |
| Satd. Flow (prot)          | 3248  | 3221  | 1498  | 3248  | 3349  | 1498  | 0     | 3187  | 4764  | 1469  | 0     | 1674  |
| Flt Permitted              | 0.950 |       |       | 0.950 |       |       |       | 0.950 |       |       |       | 0.950 |
| Satd. Flow (perm)          | 3204  | 3221  | 1458  | 3219  | 3349  | 1444  | 0     | 3176  | 4764  | 1425  | 0     | 1671  |
| Right Turn on Red          |       |       | Yes   |       |       | Yes   |       |       |       | Yes   |       |       |
| Satd. Flow (RTOR)          |       |       | 202   |       |       | 202   |       |       |       | 147   |       |       |
| Link Speed (k/h)           |       | 60    |       |       | 60    |       |       |       | 60    |       |       |       |
| Link Distance (m)          |       | 165.4 |       |       | 149.1 |       |       |       | 308.9 |       |       |       |
| Travel Time (s)            |       | 9.9   |       |       | 8.9   |       |       |       | 18.5  |       |       |       |
| Confl. Peds. (#/hr)        | 15    |       | 10    | 10    |       | 15    |       | 5     |       | 10    |       | 10    |
| Confl. Bikes (#/hr)        |       |       | 5     |       |       | 10    |       |       |       | 5     |       |       |
| Peak Hour Factor           | 1.00  | 1.00  | 1.00  | 1.00  | 1.00  | 1.00  | 1.00  | 1.00  | 1.00  | 1.00  | 1.00  | 1.00  |
| Heavy Vehicles (%)         | 1%    | 5%    | 1%    | 1%    | 1%    | 1%    | 2%    | 3%    | 2%    | 3%    | 2%    | 1%    |
| Adj. Flow (vph)            | 245   | 155   | 194   | 95    | 158   | 209   | 18    | 328   | 1572  | 126   | 4     | 150   |
| Shared Lane Traffic (%)    |       |       |       |       |       |       |       |       |       |       |       |       |
| Lane Group Flow (vph)      | 245   | 155   | 194   | 95    | 158   | 209   | 0     | 346   | 1572  | 126   | 0     | 154   |
| Enter Blocked Intersection | No    | No    | No    | Yes   | Yes   | Yes   | No    | No    | No    | No    | No    | No    |
| Lane Alignment             | L NA  | Left  | R NA  | L NA  | Left  | R NA  | R NA  | L NA  | Left  | R NA  | R NA  | L NA  |
| Median Width(m)            |       | 10.5  |       |       | 10.5  |       |       |       | 10.5  |       |       |       |
| Link Offset(m)             |       | 0.0   |       |       | 0.0   |       |       |       | 0.0   |       |       |       |
| Crosswalk Width(m)         |       | 5.0   |       |       | 5.0   |       |       |       | 5.0   |       |       |       |
| Two way Left Turn Lane     |       |       |       |       |       |       |       |       |       |       |       |       |
| Headway Factor             | 1.09  | 1.09  | 1.09  | 1.09  | 1.09  | 1.09  | 1.09  | 1.09  | 1.09  | 1.09  | 1.09  | 1.09  |
| Turning Speed (k/h)        | 24    |       | 14    | 24    |       | 14    | 14    | 24    |       | 14    | 14    | 24    |
| Number of Detectors        | 1     | 2     | 1     | 1     | 2     | 1     | 1     | 1     | 2     | 1     | 1     | 1     |
| Detector Template          | Left  | Thru  | Right | Left  | Thru  | Right | Left  | Left  | Thru  | Right | Left  | Left  |
| Leading Detector (m)       | 2.0   | 10.0  | 2.0   | 2.0   | 10.0  | 2.0   | 2.0   | 2.0   | 10.0  | 2.0   | 2.0   | 2.0   |
| Trailing Detector (m)      | 0.0   | 0.0   | 0.0   | 0.0   | 0.0   | 0.0   | 0.0   | 0.0   | 0.0   | 0.0   | 0.0   | 0.0   |
| Detector 1 Position(m)     | 0.0   | 0.0   | 0.0   | 0.0   | 0.0   | 0.0   | 0.0   | 0.0   | 0.0   | 0.0   | 0.0   | 0.0   |
| Detector 1 Size(m)         | 2.0   | 0.6   | 2.0   | 2.0   | 0.6   | 2.0   | 2.0   | 2.0   | 0.6   | 2.0   | 2.0   | 2.0   |
| Detector 1 Type            | Cl+Ex | Cl+Ex | Cl+Ex | Cl+Ex | Cl+Ex | Cl+Ex | Cl+Ex | Cl+Ex | Cl+Ex | Cl+Ex | Cl+Ex | Cl+Ex |
| Detector 1 Channel         |       |       |       |       |       |       |       |       |       |       |       |       |
| Detector 1 Extend (s)      | 0.0   | 0.0   | 0.0   | 0.0   | 0.0   | 0.0   | 0.0   | 0.0   | 0.0   | 0.0   | 0.0   | 0.0   |
| Detector 1 Queue (s)       | 0.0   | 0.0   | 0.0   | 0.0   | 0.0   | 0.0   | 0.0   | 0.0   | 0.0   | 0.0   | 0.0   | 0.0   |
| Detector 1 Delay (s)       | 0.0   | 0.0   | 0.0   | 0.0   | 0.0   | 0.0   | 0.0   | 0.0   | 0.0   | 0.0   | 0.0   | 0.0   |
| Detector 2 Position(m)     |       | 9.4   |       |       | 9.4   |       |       |       | 9.4   |       |       |       |
| Detector 2 Size(m)         |       | 0.6   |       |       | 0.6   |       |       |       | 0.6   |       |       |       |
| Detector 2 Type            |       | Cl+Ex |       |       | Cl+Ex |       |       |       | Cl+Ex |       |       |       |
| Detector 2 Channel         |       |       |       |       |       |       |       |       |       |       |       |       |
| Detector 2 Extend (s)      |       | 0.0   |       |       | 0.0   |       |       |       | 0.0   |       |       |       |
| Turn Type                  | Prot  | NA    | Perm  | Prot  | NA    | Perm  | Prot  | Prot  | NA    | Perm  | Prot  | Prot  |
| Protected Phases           | 7     | 4     |       | 3     | 8     |       | 5     | 5     | 2     |       | 1     | 1     |
| Permitted Phases           |       |       | 4     |       |       | 8     |       |       |       | 2     |       |       |
| Detector Phase             | 7     | 4     | 4     | 3     | 8     | 8     | 5     | 5     | 2     | 2     | 1     | 1     |



| Lane Group                 | SBT   | SBR   |
|----------------------------|-------|-------|
| Lane Configurations        | ↑↑↑   | ↗     |
| Traffic Volume (vph)       | 947   | 166   |
| Future Volume (vph)        | 947   | 166   |
| Ideal Flow (vphpl)         | 1800  | 1800  |
| Storage Length (m)         |       | 100.0 |
| Storage Lanes              |       | 1     |
| Taper Length (m)           |       |       |
| Lane Util. Factor          | 0.91  | 1.00  |
| Ped Bike Factor            |       | 0.98  |
| Frt                        |       | 0.850 |
| Flt Protected              |       |       |
| Satd. Flow (prot)          | 4718  | 1483  |
| Flt Permitted              |       |       |
| Satd. Flow (perm)          | 4718  | 1449  |
| Right Turn on Red          |       | Yes   |
| Satd. Flow (RTOR)          |       | 204   |
| Link Speed (k/h)           | 60    |       |
| Link Distance (m)          | 318.9 |       |
| Travel Time (s)            | 19.1  |       |
| Confl. Peds. (#/hr)        |       | 5     |
| Confl. Bikes (#/hr)        |       | 5     |
| Peak Hour Factor           | 1.00  | 1.00  |
| Heavy Vehicles (%)         | 3%    | 2%    |
| Adj. Flow (vph)            | 947   | 166   |
| Shared Lane Traffic (%)    |       |       |
| Lane Group Flow (vph)      | 947   | 166   |
| Enter Blocked Intersection | No    | No    |
| Lane Alignment             | Left  | R NA  |
| Median Width(m)            | 7.0   |       |
| Link Offset(m)             | 0.0   |       |
| Crosswalk Width(m)         | 5.0   |       |
| Two way Left Turn Lane     |       |       |
| Headway Factor             | 1.09  | 1.09  |
| Turning Speed (k/h)        |       | 14    |
| Number of Detectors        | 2     | 1     |
| Detector Template          | Thru  | Right |
| Leading Detector (m)       | 10.0  | 2.0   |
| Trailing Detector (m)      | 0.0   | 0.0   |
| Detector 1 Position(m)     | 0.0   | 0.0   |
| Detector 1 Size(m)         | 0.6   | 2.0   |
| Detector 1 Type            | Cl+Ex | Cl+Ex |
| Detector 1 Channel         |       |       |
| Detector 1 Extend (s)      | 0.0   | 0.0   |
| Detector 1 Queue (s)       | 0.0   | 0.0   |
| Detector 1 Delay (s)       | 0.0   | 0.0   |
| Detector 2 Position(m)     | 9.4   |       |
| Detector 2 Size(m)         | 0.6   |       |
| Detector 2 Type            | Cl+Ex |       |
| Detector 2 Channel         |       |       |
| Detector 2 Extend (s)      | 0.0   |       |
| Turn Type                  | NA    | Perm  |
| Protected Phases           | 6     |       |
| Permitted Phases           |       | 6     |
| Detector Phase             | 6     | 6     |



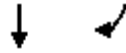

| Lane Group                  | SBT   | SBR   |
|-----------------------------|-------|-------|
| Switch Phase                |       |       |
| Minimum Initial (s)         | 10.0  | 10.0  |
| Minimum Split (s)           | 32.7  | 32.7  |
| Total Split (s)             | 42.5  | 42.5  |
| Total Split (%)             | 32.7% | 32.7% |
| Maximum Green (s)           | 35.8  | 35.8  |
| Yellow Time (s)             | 4.6   | 4.6   |
| All-Red Time (s)            | 2.1   | 2.1   |
| Lost Time Adjust (s)        | 0.0   | 0.0   |
| Total Lost Time (s)         | 6.7   | 6.7   |
| Lead/Lag                    | Lag   | Lag   |
| Lead-Lag Optimize?          |       |       |
| Vehicle Extension (s)       | 3.0   | 3.0   |
| Recall Mode                 | C-Max | C-Max |
| Walk Time (s)               | 7.0   | 7.0   |
| Flash Dont Walk (s)         | 19.0  | 19.0  |
| Pedestrian Calls (#/hr)     | 10    | 10    |
| Act Effct Green (s)         | 52.6  | 52.6  |
| Actuated g/C Ratio          | 0.40  | 0.40  |
| v/c Ratio                   | 0.50  | 0.23  |
| Control Delay               | 30.6  | 10.1  |
| Queue Delay                 | 0.0   | 0.0   |
| Total Delay                 | 30.6  | 10.1  |
| LOS                         | C     | B     |
| Approach Delay              | 32.4  |       |
| Approach LOS                | C     |       |
| Queue Length 50th (m)       | 62.3  | 10.5  |
| Queue Length 95th (m)       | 96.3  | 30.3  |
| Internal Link Dist (m)      | 294.9 |       |
| Turn Bay Length (m)         |       | 100.0 |
| Base Capacity (vph)         | 1907  | 707   |
| Starvation Cap Reductn      | 0     | 0     |
| Spillback Cap Reductn       | 0     | 0     |
| Storage Cap Reductn         | 0     | 0     |
| Reduced v/c Ratio           | 0.50  | 0.23  |
| <b>Intersection Summary</b> |       |       |

3: March & Solandt  
PM Peak Hour

555-603 March Road  
2037 Background Traffic

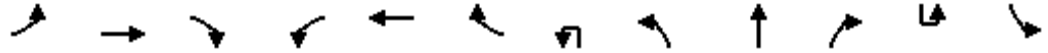

| Lane Group                 | EBL   | EBT   | EBR   | WBL   | WBT   | WBR   | NBU   | NBL   | NBT   | NBR  | SBU   | SBL   |
|----------------------------|-------|-------|-------|-------|-------|-------|-------|-------|-------|------|-------|-------|
| Lane Configurations        |       |       |       |       |       |       |       |       |       |      |       |       |
| Traffic Volume (vph)       | 24    | 25    | 197   | 389   | 24    | 24    | 16    | 78    | 1813  | 45   | 12    | 21    |
| Future Volume (vph)        | 24    | 25    | 197   | 389   | 24    | 24    | 16    | 78    | 1813  | 45   | 12    | 21    |
| Ideal Flow (vphpl)         | 1800  | 1800  | 1800  | 1800  | 1800  | 1800  | 1800  | 1800  | 1800  | 1800 | 1800  | 1800  |
| Storage Length (m)         | 35.0  |       | 60.0  | 135.0 |       | 55.0  |       | 165.0 |       | 0.0  |       | 155.0 |
| Storage Lanes              | 1     |       | 1     | 1     |       | 1     |       | 1     |       | 0    |       | 1     |
| Taper Length (m)           | 50.0  |       |       | 50.0  |       |       |       | 40.0  |       |      |       | 25.0  |
| Lane Util. Factor          | 1.00  | 1.00  | 1.00  | 1.00  | 1.00  | 1.00  | 0.95  | 1.00  | 0.95  | 0.95 | 0.95  | 1.00  |
| Ped Bike Factor            | 0.99  |       | 0.98  | 0.99  |       | 0.98  |       | 1.00  | 1.00  |      |       | 1.00  |
| Frt                        |       |       | 0.850 |       |       | 0.850 |       |       | 0.996 |      |       |       |
| Flt Protected              | 0.950 |       |       | 0.950 |       |       |       | 0.950 |       |      |       | 0.950 |
| Satd. Flow (prot)          | 1674  | 1695  | 1483  | 1674  | 1679  | 1388  | 0     | 1644  | 3297  | 0    | 0     | 1648  |
| Flt Permitted              | 0.742 |       |       | 0.520 |       |       |       | 0.950 |       |      |       | 0.950 |
| Satd. Flow (perm)          | 1299  | 1695  | 1449  | 911   | 1679  | 1358  | 0     | 1641  | 3297  | 0    | 0     | 1646  |
| Right Turn on Red          |       |       | Yes   |       |       | Yes   |       |       |       | Yes  |       |       |
| Satd. Flow (RTOR)          |       |       | 137   |       |       | 82    |       |       | 3     |      |       |       |
| Link Speed (k/h)           |       | 50    |       |       | 50    |       |       |       | 60    |      |       |       |
| Link Distance (m)          |       | 212.6 |       |       | 241.6 |       |       |       | 610.9 |      |       |       |
| Travel Time (s)            |       | 15.3  |       |       | 17.4  |       |       |       | 36.7  |      |       |       |
| Confl. Peds. (#/hr)        | 5     |       | 5     | 5     |       | 5     |       | 5     |       | 5    |       | 5     |
| Confl. Bikes (#/hr)        |       |       | 5     |       |       | 5     |       |       |       | 5    |       |       |
| Peak Hour Factor           | 1.00  | 1.00  | 1.00  | 1.00  | 1.00  | 1.00  | 1.00  | 1.00  | 1.00  | 1.00 | 1.00  | 1.00  |
| Heavy Vehicles (%)         | 1%    | 5%    | 2%    | 1%    | 6%    | 9%    | 2%    | 3%    | 2%    | 6%   | 2%    | 3%    |
| Adj. Flow (vph)            | 24    | 25    | 197   | 389   | 24    | 24    | 16    | 78    | 1813  | 45   | 12    | 21    |
| Shared Lane Traffic (%)    |       |       |       |       |       |       |       |       |       |      |       |       |
| Lane Group Flow (vph)      | 24    | 25    | 197   | 389   | 24    | 24    | 0     | 94    | 1858  | 0    | 0     | 33    |
| Enter Blocked Intersection | No    | No    | No    | No    | No    | No    | No    | No    | No    | No   | No    | No    |
| Lane Alignment             | L NA  | Left  | R NA  | L NA  | Left  | R NA  | R NA  | L NA  | Left  | R NA | R NA  | L NA  |
| Median Width(m)            |       | 3.5   |       |       | 10.5  |       |       |       | 17.5  |      |       |       |
| Link Offset(m)             |       | 0.0   |       |       | 0.0   |       |       |       | 0.0   |      |       |       |
| Crosswalk Width(m)         |       | 5.0   |       |       | 5.0   |       |       |       | 5.0   |      |       |       |
| Two way Left Turn Lane     |       |       |       |       |       |       |       |       |       |      |       |       |
| Headway Factor             | 1.09  | 1.09  | 1.09  | 1.09  | 1.09  | 1.09  | 1.09  | 1.09  | 1.09  | 1.09 | 1.09  | 1.09  |
| Turning Speed (k/h)        | 24    |       | 14    | 24    |       | 14    | 14    | 24    |       | 14   | 14    | 24    |
| Number of Detectors        | 1     | 2     | 1     | 1     | 2     | 1     | 1     | 1     | 2     |      | 1     | 1     |
| Detector Template          | Left  | Thru  | Right | Left  | Thru  | Right | Left  | Left  | Thru  |      | Left  | Left  |
| Leading Detector (m)       | 2.0   | 10.0  | 2.0   | 2.0   | 10.0  | 2.0   | 2.0   | 2.0   | 10.0  |      | 2.0   | 2.0   |
| Trailing Detector (m)      | 0.0   | 0.0   | 0.0   | 0.0   | 0.0   | 0.0   | 0.0   | 0.0   | 0.0   |      | 0.0   | 0.0   |
| Detector 1 Position(m)     | 0.0   | 0.0   | 0.0   | 0.0   | 0.0   | 0.0   | 0.0   | 0.0   | 0.0   |      | 0.0   | 0.0   |
| Detector 1 Size(m)         | 2.0   | 0.6   | 2.0   | 2.0   | 0.6   | 2.0   | 2.0   | 2.0   | 0.6   |      | 2.0   | 2.0   |
| Detector 1 Type            | Cl+Ex | Cl+Ex | Cl+Ex | Cl+Ex | Cl+Ex | Cl+Ex | Cl+Ex | Cl+Ex | Cl+Ex |      | Cl+Ex | Cl+Ex |
| Detector 1 Channel         |       |       |       |       |       |       |       |       |       |      |       |       |
| Detector 1 Extend (s)      | 0.0   | 0.0   | 0.0   | 0.0   | 0.0   | 0.0   | 0.0   | 0.0   | 0.0   |      | 0.0   | 0.0   |
| Detector 1 Queue (s)       | 0.0   | 0.0   | 0.0   | 0.0   | 0.0   | 0.0   | 0.0   | 0.0   | 0.0   |      | 0.0   | 0.0   |
| Detector 1 Delay (s)       | 0.0   | 0.0   | 0.0   | 0.0   | 0.0   | 0.0   | 0.0   | 0.0   | 0.0   |      | 0.0   | 0.0   |
| Detector 2 Position(m)     |       | 9.4   |       |       | 9.4   |       |       |       | 9.4   |      |       |       |
| Detector 2 Size(m)         |       | 0.6   |       |       | 0.6   |       |       |       | 0.6   |      |       |       |
| Detector 2 Type            |       | Cl+Ex |       |       | Cl+Ex |       |       |       | Cl+Ex |      |       |       |
| Detector 2 Channel         |       |       |       |       |       |       |       |       |       |      |       |       |
| Detector 2 Extend (s)      |       | 0.0   |       |       | 0.0   |       |       |       | 0.0   |      |       |       |
| Turn Type                  | Perm  | NA    | Perm  | pm+pt | NA    | Perm  | Prot  | Prot  | NA    |      | Prot  | Prot  |
| Protected Phases           |       | 4     |       | 3     | 8     |       | 5     | 5     | 2     |      | 1     | 1     |
| Permitted Phases           | 4     |       | 4     | 8     |       | 8     |       |       |       |      |       |       |
| Detector Phase             | 4     | 4     | 4     | 3     | 8     | 8     | 5     | 5     | 2     |      | 1     | 1     |

3: March & Solandt  
PM Peak Hour

555-603 March Road  
2037 Background Traffic

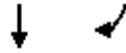

| Lane Group                 | SBT   | SBR  |
|----------------------------|-------|------|
| Lane Configurations        | ↑↑    |      |
| Traffic Volume (vph)       | 1311  | 29   |
| Future Volume (vph)        | 1311  | 29   |
| Ideal Flow (vphpl)         | 1800  | 1800 |
| Storage Length (m)         |       | 0.0  |
| Storage Lanes              |       | 0    |
| Taper Length (m)           |       |      |
| Lane Util. Factor          | 0.95  | 0.95 |
| Ped Bike Factor            | 1.00  |      |
| Frt                        | 0.997 |      |
| Flt Protected              |       |      |
| Satd. Flow (prot)          | 3302  | 0    |
| Flt Permitted              |       |      |
| Satd. Flow (perm)          | 3302  | 0    |
| Right Turn on Red          |       | Yes  |
| Satd. Flow (RTOR)          | 2     |      |
| Link Speed (k/h)           | 60    |      |
| Link Distance (m)          | 411.0 |      |
| Travel Time (s)            | 24.7  |      |
| Confl. Peds. (#/hr)        |       | 5    |
| Confl. Bikes (#/hr)        |       | 5    |
| Peak Hour Factor           | 1.00  | 1.00 |
| Heavy Vehicles (%)         | 2%    | 3%   |
| Adj. Flow (vph)            | 1311  | 29   |
| Shared Lane Traffic (%)    |       |      |
| Lane Group Flow (vph)      | 1340  | 0    |
| Enter Blocked Intersection | No    | No   |
| Lane Alignment             | Left  | R NA |
| Median Width(m)            | 17.5  |      |
| Link Offset(m)             | 0.0   |      |
| Crosswalk Width(m)         | 5.0   |      |
| Two way Left Turn Lane     |       |      |
| Headway Factor             | 1.09  | 1.09 |
| Turning Speed (k/h)        |       | 14   |
| Number of Detectors        | 2     |      |
| Detector Template          | Thru  |      |
| Leading Detector (m)       | 10.0  |      |
| Trailing Detector (m)      | 0.0   |      |
| Detector 1 Position(m)     | 0.0   |      |
| Detector 1 Size(m)         | 0.6   |      |
| Detector 1 Type            | CI+Ex |      |
| Detector 1 Channel         |       |      |
| Detector 1 Extend (s)      | 0.0   |      |
| Detector 1 Queue (s)       | 0.0   |      |
| Detector 1 Delay (s)       | 0.0   |      |
| Detector 2 Position(m)     | 9.4   |      |
| Detector 2 Size(m)         | 0.6   |      |
| Detector 2 Type            | CI+Ex |      |
| Detector 2 Channel         |       |      |
| Detector 2 Extend (s)      | 0.0   |      |
| Turn Type                  | NA    |      |
| Protected Phases           | 6     |      |
| Permitted Phases           |       |      |
| Detector Phase             | 6     |      |



3: March & Solandt  
PM Peak Hour

555-603 March Road  
2037 Background Traffic



| Lane Group              | EBL   | EBT   | EBR   | WBL    | WBT   | WBR   | NBU   | NBL   | NBT    | NBR | SBU  | SBL   |
|-------------------------|-------|-------|-------|--------|-------|-------|-------|-------|--------|-----|------|-------|
| Switch Phase            |       |       |       |        |       |       |       |       |        |     |      |       |
| Minimum Initial (s)     | 10.0  | 10.0  | 10.0  | 5.0    | 10.0  | 10.0  | 5.0   | 5.0   | 10.0   |     | 5.0  | 5.0   |
| Minimum Split (s)       | 36.5  | 36.5  | 36.5  | 11.5   | 36.5  | 36.5  | 12.0  | 12.0  | 26.8   |     | 12.0 | 12.0  |
| Total Split (s)         | 37.0  | 37.0  | 37.0  | 13.0   | 50.0  | 50.0  | 15.0  | 15.0  | 68.0   |     | 12.0 | 12.0  |
| Total Split (%)         | 28.5% | 28.5% | 28.5% | 10.0%  | 38.5% | 38.5% | 11.5% | 11.5% | 52.3%  |     | 9.2% | 9.2%  |
| Maximum Green (s)       | 30.5  | 30.5  | 30.5  | 6.5    | 43.5  | 43.5  | 8.0   | 8.0   | 62.2   |     | 5.0  | 5.0   |
| Yellow Time (s)         | 3.3   | 3.3   | 3.3   | 3.3    | 3.3   | 3.3   | 3.7   | 3.7   | 3.7    |     | 3.7  | 3.7   |
| All-Red Time (s)        | 3.2   | 3.2   | 3.2   | 3.2    | 3.2   | 3.2   | 3.3   | 3.3   | 2.1    |     | 3.3  | 3.3   |
| Lost Time Adjust (s)    | 0.0   | 0.0   | 0.0   | 0.0    | 0.0   | 0.0   |       | 0.0   | 0.0    |     |      | 0.0   |
| Total Lost Time (s)     | 6.5   | 6.5   | 6.5   | 6.5    | 6.5   | 6.5   |       | 7.0   | 5.8    |     |      | 7.0   |
| Lead/Lag                | Lag   | Lag   | Lag   | Lead   |       |       | Lead  | Lead  | Lag    |     | Lead | Lead  |
| Lead-Lag Optimize?      |       |       |       |        |       |       |       |       |        |     |      |       |
| Vehicle Extension (s)   | 3.0   | 3.0   | 3.0   | 3.0    | 3.0   | 3.0   | 3.0   | 3.0   | 3.0    |     | 3.0  | 3.0   |
| Recall Mode             | None  | None  | None  | None   | None  | None  | None  | None  | C-Max  |     | None | None  |
| Walk Time (s)           | 7.0   | 7.0   | 7.0   |        | 7.0   | 7.0   |       |       | 7.0    |     |      |       |
| Flash Dont Walk (s)     | 23.0  | 23.0  | 23.0  |        | 23.0  | 23.0  |       |       | 14.0   |     |      |       |
| Pedestrian Calls (#/hr) | 5     | 5     | 5     |        | 5     | 5     |       |       | 5      |     |      |       |
| Act Effct Green (s)     | 15.3  | 15.3  | 15.3  | 28.3   | 28.3  | 28.3  |       | 12.6  | 80.6   |     |      | 7.1   |
| Actuated g/C Ratio      | 0.12  | 0.12  | 0.12  | 0.22   | 0.22  | 0.22  |       | 0.10  | 0.62   |     |      | 0.05  |
| v/c Ratio               | 0.16  | 0.13  | 0.68  | 1.65   | 0.07  | 0.07  |       | 0.59  | 0.91   |     |      | 0.37  |
| Control Delay           | 50.0  | 48.8  | 29.1  | 342.0  | 37.2  | 0.4   |       | 71.5  | 31.4   |     |      | 80.0  |
| Queue Delay             | 0.0   | 0.0   | 0.0   | 0.0    | 0.0   | 0.0   |       | 0.0   | 0.0    |     |      | 0.0   |
| Total Delay             | 50.0  | 48.8  | 29.1  | 342.0  | 37.2  | 0.4   |       | 71.5  | 31.4   |     |      | 80.0  |
| LOS                     | D     | D     | C     | F      | D     | A     |       | E     | C      |     |      | F     |
| Approach Delay          |       | 33.1  |       |        | 306.5 |       |       |       | 33.4   |     |      |       |
| Approach LOS            |       | C     |       |        | F     |       |       |       | C      |     |      |       |
| Queue Length 50th (m)   | 5.4   | 5.6   | 13.7  | ~139.6 | 4.7   | 0.0   |       | 21.2  | 199.4  |     |      | 8.2   |
| Queue Length 95th (m)   | 11.3  | 11.6  | 32.2  | #163.9 | 9.6   | 0.0   |       | #52.1 | #315.8 |     |      | #19.8 |
| Internal Link Dist (m)  |       | 188.6 |       |        | 217.6 |       |       |       | 586.9  |     |      |       |
| Turn Bay Length (m)     | 35.0  |       | 60.0  | 135.0  |       | 55.0  |       | 165.0 |        |     |      | 155.0 |
| Base Capacity (vph)     | 304   | 397   | 444   | 236    | 561   | 508   |       | 159   | 2045   |     |      | 90    |
| Starvation Cap Reductn  | 0     | 0     | 0     | 0      | 0     | 0     |       | 0     | 0      |     |      | 0     |
| Spillback Cap Reductn   | 0     | 0     | 0     | 0      | 0     | 0     |       | 0     | 0      |     |      | 0     |
| Storage Cap Reductn     | 0     | 0     | 0     | 0      | 0     | 0     |       | 0     | 0      |     |      | 0     |
| Reduced v/c Ratio       | 0.08  | 0.06  | 0.44  | 1.65   | 0.04  | 0.05  |       | 0.59  | 0.91   |     |      | 0.37  |

Intersection Summary

Area Type: Other  
 Cycle Length: 130  
 Actuated Cycle Length: 130  
 Offset: 16 (12%), Referenced to phase 2:NBT and 6:SBT, Start of Green  
 Natural Cycle: 150  
 Control Type: Actuated-Coordinated  
 Maximum v/c Ratio: 1.65  
 Intersection Signal Delay: 60.9  
 Intersection LOS: E  
 Intersection Capacity Utilization 104.2%  
 ICU Level of Service G  
 Analysis Period (min) 15  
 ~ Volume exceeds capacity, queue is theoretically infinite.  
 Queue shown is maximum after two cycles.  
 # 95th percentile volume exceeds capacity, queue may be longer.  
 Queue shown is maximum after two cycles.

Splits and Phases: 3: March & Solandt





| Lane Group                  | SBT   | SBR |
|-----------------------------|-------|-----|
| Switch Phase                |       |     |
| Minimum Initial (s)         | 10.0  |     |
| Minimum Split (s)           | 26.8  |     |
| Total Split (s)             | 65.0  |     |
| Total Split (%)             | 50.0% |     |
| Maximum Green (s)           | 59.2  |     |
| Yellow Time (s)             | 3.7   |     |
| All-Red Time (s)            | 2.1   |     |
| Lost Time Adjust (s)        | 0.0   |     |
| Total Lost Time (s)         | 5.8   |     |
| Lead/Lag                    | Lag   |     |
| Lead-Lag Optimize?          |       |     |
| Vehicle Extension (s)       | 3.0   |     |
| Recall Mode                 | C-Max |     |
| Walk Time (s)               | 7.0   |     |
| Flash Dont Walk (s)         | 14.0  |     |
| Pedestrian Calls (#/hr)     | 5     |     |
| Act Effct Green (s)         | 69.8  |     |
| Actuated g/C Ratio          | 0.54  |     |
| v/c Ratio                   | 0.76  |     |
| Control Delay               | 25.6  |     |
| Queue Delay                 | 0.0   |     |
| Total Delay                 | 25.6  |     |
| LOS                         | C     |     |
| Approach Delay              | 26.9  |     |
| Approach LOS                | C     |     |
| Queue Length 50th (m)       | 62.3  |     |
| Queue Length 95th (m)       | 137.3 |     |
| Internal Link Dist (m)      | 387.0 |     |
| Turn Bay Length (m)         |       |     |
| Base Capacity (vph)         | 1774  |     |
| Starvation Cap Reductn      | 0     |     |
| Spillback Cap Reductn       | 0     |     |
| Storage Cap Reductn         | 0     |     |
| Reduced v/c Ratio           | 0.76  |     |
| <b>Intersection Summary</b> |       |     |

4: Innovation/Flamborough & Terry Fox  
PM Peak Hour

555-603 March Road  
2037 Background Traffic



| Lane Group                 | EBL   | EBT   | EBR   | WBL   | WBT   | WBR   | NBL   | NBT   | NBR  | SBL   | SBT   | SBR  |
|----------------------------|-------|-------|-------|-------|-------|-------|-------|-------|------|-------|-------|------|
| Lane Configurations        |       |       |       |       |       |       |       |       |      |       |       |      |
| Traffic Volume (vph)       | 71    | 379   | 37    | 101   | 511   | 121   | 115   | 67    | 81   | 52    | 50    | 62   |
| Future Volume (vph)        | 71    | 379   | 37    | 101   | 511   | 121   | 115   | 67    | 81   | 52    | 50    | 62   |
| Ideal Flow (vphpl)         | 1800  | 1800  | 1800  | 1800  | 1800  | 1800  | 1800  | 1800  | 1800 | 1800  | 1800  | 1800 |
| Storage Length (m)         | 75.0  |       | 120.0 | 110.0 |       | 130.0 | 220.0 |       | 0.0  | 30.0  |       | 0.0  |
| Storage Lanes              | 1     |       | 1     | 1     |       | 1     | 1     |       | 0    | 1     |       | 0    |
| Taper Length (m)           | 50.0  |       |       | 80.0  |       |       | 50.0  |       |      | 15.0  |       |      |
| Lane Util. Factor          | 1.00  | 1.00  | 1.00  | 1.00  | 1.00  | 1.00  | 1.00  | 1.00  | 1.00 | 1.00  | 1.00  | 1.00 |
| Ped Bike Factor            | 1.00  |       | 0.96  | 0.99  |       | 0.95  | 0.95  | 0.98  |      | 0.99  | 0.95  |      |
| Fr <sub>t</sub>            |       |       | 0.850 |       |       | 0.850 |       | 0.918 |      |       | 0.917 |      |
| Fl <sub>t</sub> Protected  | 0.950 |       |       | 0.950 |       |       | 0.950 |       |      | 0.950 |       |      |
| Satd. Flow (prot)          | 1566  | 1745  | 1498  | 1642  | 1762  | 1498  | 1674  | 1541  | 0    | 1674  | 1483  | 0    |
| Fl <sub>t</sub> Permitted  | 0.422 |       |       | 0.488 |       |       | 0.657 |       |      | 0.545 |       |      |
| Satd. Flow (perm)          | 693   | 1745  | 1440  | 838   | 1762  | 1429  | 1102  | 1541  | 0    | 952   | 1483  | 0    |
| Right Turn on Red          |       |       | Yes   |       |       | Yes   |       |       | Yes  |       |       | Yes  |
| Satd. Flow (RTOR)          |       |       | 80    |       |       | 121   |       | 51    |      |       | 53    |      |
| Link Speed (k/h)           |       | 60    |       |       | 60    |       |       | 50    |      |       | 50    |      |
| Link Distance (m)          |       | 508.2 |       |       | 485.8 |       |       | 547.1 |      |       | 313.7 |      |
| Travel Time (s)            |       | 30.5  |       |       | 29.1  |       |       | 39.4  |      |       | 22.6  |      |
| Confl. Peds. (#/hr)        | 5     |       | 5     | 5     |       | 5     | 25    |       | 5    | 5     |       | 25   |
| Confl. Bikes (#/hr)        |       |       | 5     |       |       | 15    |       |       | 10   |       |       | 10   |
| Peak Hour Factor           | 1.00  | 1.00  | 1.00  | 1.00  | 1.00  | 1.00  | 1.00  | 1.00  | 1.00 | 1.00  | 1.00  | 1.00 |
| Heavy Vehicles (%)         | 8%    | 2%    | 1%    | 3%    | 1%    | 1%    | 1%    | 2%    | 5%   | 1%    | 1%    | 8%   |
| Adj. Flow (vph)            | 71    | 379   | 37    | 101   | 511   | 121   | 115   | 67    | 81   | 52    | 50    | 62   |
| Shared Lane Traffic (%)    |       |       |       |       |       |       |       |       |      |       |       |      |
| Lane Group Flow (vph)      | 71    | 379   | 37    | 101   | 511   | 121   | 115   | 148   | 0    | 52    | 112   | 0    |
| Enter Blocked Intersection | No    | No    | No    | No    | No    | No    | No    | No    | No   | No    | No    | No   |
| Lane Alignment             | L NA  | Left  | R NA  | L NA  | Left  | R NA  | L NA  | Left  | R NA | L NA  | Left  | R NA |
| Median Width(m)            |       | 3.5   |       |       | 3.5   |       |       | 3.5   |      |       | 3.5   |      |
| Link Offset(m)             |       | 0.0   |       |       | 0.0   |       |       | 0.0   |      |       | 0.0   |      |
| Crosswalk Width(m)         |       | 5.0   |       |       | 5.0   |       |       | 5.0   |      |       | 5.0   |      |
| Two way Left Turn Lane     |       |       |       |       |       |       |       |       |      |       |       |      |
| Headway Factor             | 1.09  | 1.09  | 1.09  | 1.09  | 1.09  | 1.09  | 1.09  | 1.09  | 1.09 | 1.09  | 1.09  | 1.09 |
| Turning Speed (k/h)        | 24    |       | 14    | 24    |       | 14    | 24    |       | 14   | 24    |       | 14   |
| Number of Detectors        | 1     | 2     | 1     | 1     | 2     | 1     | 1     | 2     |      | 1     | 2     |      |
| Detector Template          | Left  | Thru  | Right | Left  | Thru  | Right | Left  | Thru  |      | Left  | Thru  |      |
| Leading Detector (m)       | 2.0   | 10.0  | 2.0   | 2.0   | 10.0  | 2.0   | 2.0   | 10.0  |      | 2.0   | 10.0  |      |
| Trailing Detector (m)      | 0.0   | 0.0   | 0.0   | 0.0   | 0.0   | 0.0   | 0.0   | 0.0   |      | 0.0   | 0.0   |      |
| Detector 1 Position(m)     | 0.0   | 0.0   | 0.0   | 0.0   | 0.0   | 0.0   | 0.0   | 0.0   |      | 0.0   | 0.0   |      |
| Detector 1 Size(m)         | 2.0   | 0.6   | 2.0   | 2.0   | 0.6   | 2.0   | 2.0   | 0.6   |      | 2.0   | 0.6   |      |
| Detector 1 Type            | Cl+Ex | Cl+Ex | Cl+Ex | Cl+Ex | Cl+Ex | Cl+Ex | Cl+Ex | Cl+Ex |      | Cl+Ex | Cl+Ex |      |
| Detector 1 Channel         |       |       |       |       |       |       |       |       |      |       |       |      |
| Detector 1 Extend (s)      | 0.0   | 0.0   | 0.0   | 0.0   | 0.0   | 0.0   | 0.0   | 0.0   |      | 0.0   | 0.0   |      |
| Detector 1 Queue (s)       | 0.0   | 0.0   | 0.0   | 0.0   | 0.0   | 0.0   | 0.0   | 0.0   |      | 0.0   | 0.0   |      |
| Detector 1 Delay (s)       | 0.0   | 0.0   | 0.0   | 0.0   | 0.0   | 0.0   | 0.0   | 0.0   |      | 0.0   | 0.0   |      |
| Detector 2 Position(m)     |       | 9.4   |       |       | 9.4   |       |       | 9.4   |      |       | 9.4   |      |
| Detector 2 Size(m)         |       | 0.6   |       |       | 0.6   |       |       | 0.6   |      |       | 0.6   |      |
| Detector 2 Type            |       | Cl+Ex |       |       | Cl+Ex |       |       | Cl+Ex |      |       | Cl+Ex |      |
| Detector 2 Channel         |       |       |       |       |       |       |       |       |      |       |       |      |
| Detector 2 Extend (s)      |       | 0.0   |       |       | 0.0   |       |       | 0.0   |      |       | 0.0   |      |
| Turn Type                  | pm+pt | NA    | Perm  | pm+pt | NA    | Perm  | Perm  | NA    |      | Perm  | NA    |      |
| Protected Phases           | 5     | 2     |       | 1     | 6     |       |       | 8     |      |       | 4     |      |
| Permitted Phases           | 2     |       | 2     | 6     |       | 6     | 8     |       |      | 4     |       |      |
| Detector Phase             | 5     | 2     | 2     | 1     | 6     | 6     | 8     | 8     |      | 4     | 4     |      |

4: Innovation/Flamborough & Terry Fox  
PM Peak Hour

555-603 March Road  
2037 Background Traffic



| Lane Group              | EBL  | EBT   | EBR   | WBL   | WBT   | WBR   | NBL   | NBT   | NBR | SBL   | SBT   | SBR |
|-------------------------|------|-------|-------|-------|-------|-------|-------|-------|-----|-------|-------|-----|
| Switch Phase            |      |       |       |       |       |       |       |       |     |       |       |     |
| Minimum Initial (s)     | 5.0  | 10.0  | 10.0  | 5.0   | 10.0  | 10.0  | 10.0  | 10.0  |     | 10.0  | 10.0  |     |
| Minimum Split (s)       | 10.9 | 27.9  | 27.9  | 10.9  | 27.9  | 27.9  | 35.6  | 35.6  |     | 35.6  | 35.6  |     |
| Total Split (s)         | 12.0 | 66.0  | 66.0  | 12.0  | 66.0  | 66.0  | 52.0  | 52.0  |     | 52.0  | 52.0  |     |
| Total Split (%)         | 9.2% | 50.8% | 50.8% | 9.2%  | 50.8% | 50.8% | 40.0% | 40.0% |     | 40.0% | 40.0% |     |
| Maximum Green (s)       | 6.1  | 60.1  | 60.1  | 6.1   | 60.1  | 60.1  | 45.4  | 45.4  |     | 45.4  | 45.4  |     |
| Yellow Time (s)         | 3.7  | 3.7   | 3.7   | 3.7   | 3.7   | 3.7   | 3.0   | 3.0   |     | 3.0   | 3.0   |     |
| All-Red Time (s)        | 2.2  | 2.2   | 2.2   | 2.2   | 2.2   | 2.2   | 3.6   | 3.6   |     | 3.6   | 3.6   |     |
| Lost Time Adjust (s)    | 0.0  | 0.0   | 0.0   | 0.0   | 0.0   | 0.0   | 0.0   | 0.0   |     | 0.0   | 0.0   |     |
| Total Lost Time (s)     | 5.9  | 5.9   | 5.9   | 5.9   | 5.9   | 5.9   | 6.6   | 6.6   |     | 6.6   | 6.6   |     |
| Lead/Lag                | Lead | Lag   | Lag   | Lead  | Lag   | Lag   |       |       |     |       |       |     |
| Lead-Lag Optimize?      |      |       |       |       |       |       |       |       |     |       |       |     |
| Vehicle Extension (s)   | 3.0  | 3.0   | 3.0   | 3.0   | 3.0   | 3.0   | 3.0   | 3.0   |     | 3.0   | 3.0   |     |
| Recall Mode             | None | C-Max | C-Max | None  | C-Max | C-Max | None  | None  |     | None  | None  |     |
| Walk Time (s)           |      | 7.0   | 7.0   |       | 7.0   | 7.0   | 7.0   | 7.0   |     | 7.0   | 7.0   |     |
| Flash Dont Walk (s)     |      | 15.0  | 15.0  |       | 15.0  | 15.0  | 22.0  | 22.0  |     | 22.0  | 22.0  |     |
| Pedestrian Calls (#/hr) |      | 3     | 3     |       | 3     | 3     | 3     | 3     |     | 3     | 3     |     |
| Act Effct Green (s)     | 92.1 | 84.9  | 84.9  | 94.4  | 87.8  | 87.8  | 18.9  | 18.9  |     | 18.9  | 18.9  |     |
| Actuated g/C Ratio      | 0.71 | 0.65  | 0.65  | 0.73  | 0.68  | 0.68  | 0.15  | 0.15  |     | 0.15  | 0.15  |     |
| v/c Ratio               | 0.13 | 0.33  | 0.04  | 0.15  | 0.43  | 0.12  | 0.72  | 0.55  |     | 0.38  | 0.43  |     |
| Control Delay           | 5.8  | 12.4  | 0.1   | 9.0   | 22.0  | 8.6   | 75.6  | 39.8  |     | 55.3  | 30.6  |     |
| Queue Delay             | 0.0  | 0.0   | 0.0   | 0.0   | 0.0   | 0.0   | 0.0   | 0.0   |     | 0.0   | 0.0   |     |
| Total Delay             | 5.8  | 12.4  | 0.1   | 9.0   | 22.0  | 8.6   | 75.6  | 39.8  |     | 55.3  | 30.6  |     |
| LOS                     | A    | B     | A     | A     | C     | A     | E     | D     |     | E     | C     |     |
| Approach Delay          |      | 10.5  |       |       | 18.0  |       |       | 55.5  |     |       | 38.5  |     |
| Approach LOS            |      | B     |       |       | B     |       |       | E     |     |       | D     |     |
| Queue Length 50th (m)   | 3.6  | 36.2  | 0.0   | 8.6   | 60.8  | 0.2   | 26.3  | 21.4  |     | 11.3  | 12.6  |     |
| Queue Length 95th (m)   | 9.8  | 69.0  | 0.1   | m21.9 | 119.4 | m20.9 | 41.6  | 37.7  |     | 21.3  | 26.9  |     |
| Internal Link Dist (m)  |      | 484.2 |       |       | 461.8 |       |       | 523.1 |     |       | 289.7 |     |
| Turn Bay Length (m)     | 75.0 |       | 120.0 | 110.0 |       | 130.0 | 220.0 |       |     | 30.0  |       |     |
| Base Capacity (vph)     | 539  | 1139  | 968   | 656   | 1190  | 1004  | 384   | 571   |     | 332   | 552   |     |
| Starvation Cap Reductn  | 0    | 0     | 0     | 0     | 0     | 0     | 0     | 0     |     | 0     | 0     |     |
| Spillback Cap Reductn   | 0    | 0     | 0     | 0     | 0     | 0     | 0     | 0     |     | 0     | 0     |     |
| Storage Cap Reductn     | 0    | 0     | 0     | 0     | 0     | 0     | 0     | 0     |     | 0     | 0     |     |
| Reduced v/c Ratio       | 0.13 | 0.33  | 0.04  | 0.15  | 0.43  | 0.12  | 0.30  | 0.26  |     | 0.16  | 0.20  |     |

Intersection Summary

Area Type: Other  
 Cycle Length: 130  
 Actuated Cycle Length: 130  
 Offset: 66 (51%), Referenced to phase 2:EBTL and 6:WBTL, Start of Green  
 Natural Cycle: 80  
 Control Type: Actuated-Coordinated  
 Maximum v/c Ratio: 0.72  
 Intersection Signal Delay: 23.8      Intersection LOS: C  
 Intersection Capacity Utilization 79.0%      ICU Level of Service D  
 Analysis Period (min) 15  
 m Volume for 95th percentile queue is metered by upstream signal.

Splits and Phases: 4: Innovation/Flamborough & Terry Fox

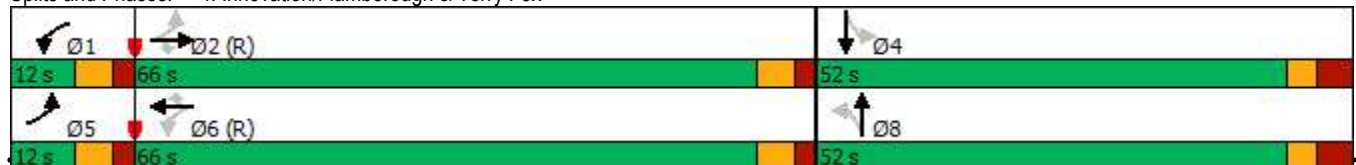

5: Hines & Innovation  
PM Peak Hour

555-603 March Road  
2037 Background Traffic



| Lane Group                 | EBL   | EBT  | EBR   | WBL  | WBT  | WBR   | NBL  | NBT  | NBR   | SBL  | SBT  | SBR   |
|----------------------------|-------|------|-------|------|------|-------|------|------|-------|------|------|-------|
| Lane Configurations        |       | ↕    |       |      | ↕    |       |      | ↕    |       |      | ↕    |       |
| Traffic Volume (vph)       | 3     | 0    | 100   | 0    | 0    | 0     | 134  | 14   | 0     | 0    | 53   | 9     |
| Future Volume (vph)        | 3     | 0    | 100   | 0    | 0    | 0     | 134  | 14   | 0     | 0    | 53   | 9     |
| Ideal Flow (vphpl)         | 1800  | 1800 | 1800  | 1800 | 1800 | 1800  | 1800 | 1800 | 1800  | 1800 | 1800 | 1800  |
| Lane Util. Factor          | 1.00  | 1.00 | 1.00  | 1.00 | 1.00 | 1.00  | 1.00 | 1.00 | 1.00  | 1.00 | 1.00 | 1.00  |
| Ped Bike Factor            |       |      |       |      |      |       |      |      |       |      |      |       |
| Frt                        | 0.869 |      |       |      |      |       |      |      |       |      |      | 0.980 |
| Flt Protected              | 0.999 |      |       |      |      |       |      |      |       |      |      | 0.957 |
| Satd. Flow (prot)          | 0     | 1515 | 0     | 0    | 1762 | 0     | 0    | 1649 | 0     | 0    | 1684 | 0     |
| Flt Permitted              | 0.999 |      |       |      |      |       |      |      |       |      |      | 0.957 |
| Satd. Flow (perm)          | 0     | 1515 | 0     | 0    | 1762 | 0     | 0    | 1649 | 0     | 0    | 1684 | 0     |
| Link Speed (k/h)           | 50    |      |       |      |      |       |      |      |       |      |      | 50    |
| Link Distance (m)          | 438.6 |      |       |      |      |       |      |      |       |      |      | 104.0 |
| Travel Time (s)            | 31.6  |      |       |      |      |       |      |      |       |      |      | 7.5   |
| Confl. Peds. (#/hr)        |       |      |       |      |      |       |      |      |       |      |      | 10    |
| Confl. Bikes (#/hr)        |       |      |       |      |      |       |      |      |       |      |      | 5     |
| Peak Hour Factor           | 1.00  | 1.00 | 1.00  | 1.00 | 1.00 | 1.00  | 1.00 | 1.00 | 1.00  | 1.00 | 1.00 | 1.00  |
| Heavy Vehicles (%)         | 1%    | 1%   | 2%    | 1%   | 1%   | 1%    | 3%   | 6%   | 1%    | 1%   | 4%   | 1%    |
| Adj. Flow (vph)            | 3     | 0    | 100   | 0    | 0    | 0     | 134  | 14   | 0     | 0    | 53   | 9     |
| Shared Lane Traffic (%)    |       |      |       |      |      |       |      |      |       |      |      |       |
| Lane Group Flow (vph)      | 0     | 103  | 0     | 0    | 0    | 0     | 0    | 148  | 0     | 0    | 62   | 0     |
| Enter Blocked Intersection | No    | No   | No    | No   | No   | No    | No   | No   | No    | No   | No   | No    |
| Lane Alignment             | Left  | Left | Right | Left | Left | Right | Left | Left | Right | Left | Left | Right |
| Median Width(m)            | 0.0   |      |       |      |      |       |      |      |       |      |      | 0.0   |
| Link Offset(m)             | 0.0   |      |       |      |      |       |      |      |       |      |      | 0.0   |
| Crosswalk Width(m)         | 5.0   |      |       |      |      |       |      |      |       |      |      | 5.0   |
| Two way Left Turn Lane     |       |      |       |      |      |       |      |      |       |      |      |       |
| Headway Factor             | 1.09  | 1.09 | 1.09  | 1.09 | 1.09 | 1.09  | 1.09 | 1.09 | 1.09  | 1.09 | 1.09 | 1.09  |
| Turning Speed (k/h)        | 24    |      | 14    | 24   |      | 14    | 24   |      | 14    | 24   |      | 14    |
| Sign Control               | Stop  |      |       |      |      |       |      |      |       |      |      | Stop  |
|                            |       |      |       |      |      |       |      |      |       |      |      | Free  |
|                            |       |      |       |      |      |       |      |      |       |      |      | Free  |

Intersection Summary

Area Type: Other

Control Type: Unsignalized















Intersection Capacity Utilization 28.6%

ICU Level of Service A

Analysis Period (min) 15

6: March & Nokia Access  
PM Peak Hour

555-603 March Road  
2037 Background Traffic

|                            |  |  |   |  |  |    |
|----------------------------|---|---|--|---|---|---|
| Lane Group                 | WBL   | WBR   | NBT  | NBR   | SBL   | SBT   |
| Lane Configurations        |  |  | <br> |  |  | <br><br> |
| Traffic Volume (vph)       | 197   | 400   | 1591   | 199   | 93  | 1134  |
| Future Volume (vph)        | 197   | 400   | 1591   | 199   | 93  | 1134  |
| Ideal Flow (vphpl)         | 1800  | 1800  | 1800   | 1800  | 1800  | 1800  |
| Storage Length (m)         | 65.0  | 0.0   |  | 100.0   | 75.0  |   |
| Storage Lanes              | 1   | 1   |  | 1   | 1   |   |
| Taper Length (m)           | 25.0  |   |  |   | 50.0  |   |
| Lane Util. Factor          | 1.00  | 1.00  | 0.95   | 1.00  | 1.00  | 0.91  |
| Ped Bike Factor            | 0.99  | 0.97  |  | 0.94  |   |   |
| Fr <sub>t</sub>            |   | 0.850   |  | 0.850   |   |   |
| Fl <sub>t</sub> Protected  | 0.950   |   |  |   | 0.950   |   |
| Satd. Flow (prot)          | 1674  | 1498  | 3283   | 1498  | 1674  | 4718  |
| Fl <sub>t</sub> Permitted  | 0.950   |   |  |   | 0.052   |   |
| Satd. Flow (perm)          | 1654  | 1457  | 3283   | 1410  | 92  | 4718  |
| Right Turn on Red          |   | Yes   |  | Yes   |   |   |
| Satd. Flow (RTOR)          |   | 99  |  | 199   |   |   |
| Link Speed (k/h)           | 50  |   | 60   |   |   | 60  |
| Link Distance (m)          | 167.8   |   | 199.3  |   |   | 308.9   |
| Travel Time (s)            | 12.1  |   | 12.0   |   |   | 18.5  |
| Confl. Peds. (#/hr)        | 10  | 10  |  | 10  | 10  |   |
| Confl. Bikes (#/hr)        |   | 5   |  | 5   |   |   |
| Peak Hour Factor           | 1.00  | 1.00  | 1.00   | 1.00  | 1.00  | 1.00  |
| Heavy Vehicles (%)         | 1%  | 1%  | 3%   | 1%  | 1%  | 3%  |
| Adj. Flow (vph)            | 197   | 400   | 1591   | 199   | 93  | 1134  |
| Shared Lane Traffic (%)    |   |   |  |   |   |   |
| Lane Group Flow (vph)      | 197   | 400   | 1591   | 199   | 93  | 1134  |
| Enter Blocked Intersection | No  | No  | No   | No  | No  | No  |
| Lane Alignment             | L NA  | Right   | Left   | Right   | L NA  | Left  |
| Median Width(m)            | 3.5   |   | 7.0  |   |   | 7.0   |
| Link Offset(m)             | 0.0   |   | 0.0  |   |   | 0.0   |
| Crosswalk Width(m)         | 5.0   |   | 5.0  |   |   | 5.0   |
| Two way Left Turn Lane     |   |   |  |   |   |   |
| Headway Factor             | 1.09  | 1.09  | 1.09   | 1.09  | 1.09  | 1.09  |
| Turning Speed (k/h)        | 97  | 97  |  | 97  | 97  |   |
| Number of Detectors        | 1   | 1   | 2  | 1   | 1   | 2   |
| Detector Template          | Left  | Right   | Thru   | Right   | Left  | Thru  |
| Leading Detector (m)       | 2.0   | 2.0   | 10.0   | 2.0   | 2.0   | 10.0  |
| Trailing Detector (m)      | 0.0   | 0.0   | 0.0  | 0.0   | 0.0   | 0.0   |
| Detector 1 Position(m)     | 0.0   | 0.0   | 0.0  | 0.0   | 0.0   | 0.0   |
| Detector 1 Size(m)         | 2.0   | 2.0   | 0.6  | 2.0   | 2.0   | 0.6   |
| Detector 1 Type            | Cl+Ex   | Cl+Ex   | Cl+Ex  | Cl+Ex   | Cl+Ex   | Cl+Ex   |
| Detector 1 Channel         |   |   |  |   |   |   |
| Detector 1 Extend (s)      | 0.0   | 0.0   | 0.0  | 0.0   | 0.0   | 0.0   |
| Detector 1 Queue (s)       | 0.0   | 0.0   | 0.0  | 0.0   | 0.0   | 0.0   |
| Detector 1 Delay (s)       | 0.0   | 0.0   | 0.0  | 0.0   | 0.0   | 0.0   |
| Detector 2 Position(m)     |   |   | 9.4  |   |   | 9.4   |
| Detector 2 Size(m)         |   |   | 0.6  |   |   | 0.6   |
| Detector 2 Type            |   |   | Cl+Ex  |   |   | Cl+Ex   |
| Detector 2 Channel         |   |   |  |   |   |   |
| Detector 2 Extend (s)      |   |   | 0.0  |   |   | 0.0   |
| Turn Type                  | Perm  | Perm  | NA   | Perm  | pm+pt   | NA  |
| Protected Phases           |   |   | 2  |   | 1   | 6   |
| Permitted Phases           | 8   | 8   |  | 2   | 6   |   |
| Detector Phase             | 8   | 8   | 2  | 2   | 1   | 6   |



| Lane Group              | WBL   | WBR   | NBT    | NBR   | SBL    | SBT   |
|-------------------------|-------|-------|--------|-------|--------|-------|
| Switch Phase            |       |       |        |       |        |       |
| Minimum Initial (s)     | 10.0  | 10.0  | 10.0   | 10.0  | 5.0    | 10.0  |
| Minimum Split (s)       | 38.5  | 38.5  | 23.8   | 23.8  | 11.4   | 23.8  |
| Total Split (s)         | 48.0  | 48.0  | 70.0   | 70.0  | 12.0   | 82.0  |
| Total Split (%)         | 36.9% | 36.9% | 53.8%  | 53.8% | 9.2%   | 63.1% |
| Maximum Green (s)       | 41.5  | 41.5  | 64.2   | 64.2  | 5.6    | 76.2  |
| Yellow Time (s)         | 3.3   | 3.3   | 3.7    | 3.7   | 3.7    | 3.7   |
| All-Red Time (s)        | 3.2   | 3.2   | 2.1    | 2.1   | 2.7    | 2.1   |
| Lost Time Adjust (s)    | 0.0   | 0.0   | 0.0    | 0.0   | 0.0    | 0.0   |
| Total Lost Time (s)     | 6.5   | 6.5   | 5.8    | 5.8   | 6.4    | 5.8   |
| Lead/Lag                |       |       | Lag    | Lag   | Lead   |       |
| Lead-Lag Optimize?      |       |       |        |       |        |       |
| Vehicle Extension (s)   | 3.0   | 3.0   | 3.0    | 3.0   | 3.0    | 3.0   |
| Recall Mode             | None  | None  | C-Max  | C-Max | None   | C-Max |
| Walk Time (s)           | 7.0   | 7.0   | 7.0    | 7.0   |        | 7.0   |
| Flash Dont Walk (s)     | 25.0  | 25.0  | 11.0   | 11.0  |        | 11.0  |
| Pedestrian Calls (#/hr) | 10    | 10    | 10     | 10    |        | 10    |
| Act Effct Green (s)     | 33.1  | 33.1  | 70.7   | 70.7  | 84.0   | 84.6  |
| Actuated g/C Ratio      | 0.25  | 0.25  | 0.54   | 0.54  | 0.65   | 0.65  |
| v/c Ratio               | 0.47  | 0.90  | 0.89   | 0.23  | 0.62   | 0.37  |
| Control Delay           | 43.3  | 58.1  | 48.5   | 13.6  | 58.8   | 8.9   |
| Queue Delay             | 0.0   | 0.0   | 0.0    | 0.0   | 0.0    | 0.0   |
| Total Delay             | 43.3  | 58.1  | 48.5   | 13.6  | 58.8   | 8.9   |
| LOS                     | D     | E     | D      | B     | E      | A     |
| Approach Delay          | 53.2  |       | 44.6   |       |        | 12.7  |
| Approach LOS            | D     |       | D      |       |        | B     |
| Queue Length 50th (m)   | 39.0  | 70.7  | 201.1  | 18.2  | 13.9   | 17.7  |
| Queue Length 95th (m)   | 55.7  | 101.8 | #247.4 | m31.1 | m#36.1 | 43.1  |
| Internal Link Dist (m)  | 143.8 |       | 175.3  |       |        | 284.9 |
| Turn Bay Length (m)     | 65.0  |       |        | 100.0 | 75.0   |       |
| Base Capacity (vph)     | 528   | 532   | 1786   | 858   | 150    | 3069  |
| Starvation Cap Reductn  | 0     | 0     | 0      | 0     | 0      | 0     |
| Spillback Cap Reductn   | 0     | 0     | 0      | 0     | 0      | 0     |
| Storage Cap Reductn     | 0     | 0     | 0      | 0     | 0      | 0     |
| Reduced v/c Ratio       | 0.37  | 0.75  | 0.89   | 0.23  | 0.62   | 0.37  |

Intersection Summary

Area Type: Other  
 Cycle Length: 130  
 Actuated Cycle Length: 130  
 Offset: 108 (83%), Referenced to phase 2:NBT and 6:SBTL, Start of Green  
 Natural Cycle: 100  
 Control Type: Actuated-Coordinated  
 Maximum v/c Ratio: 0.90  
 Intersection Signal Delay: 35.2 Intersection LOS: D  
 Intersection Capacity Utilization 83.9% ICU Level of Service E  
 Analysis Period (min) 15  
 # 95th percentile volume exceeds capacity, queue may be longer.  
 Queue shown is maximum after two cycles.  
 m Volume for 95th percentile queue is metered by upstream signal.

Splits and Phases: 6: March & Nokia Access



3: March & Solandt  
PM Peak Hour

555-603 March Road  
2037 Background Traffic (dual WBL on Solandt)

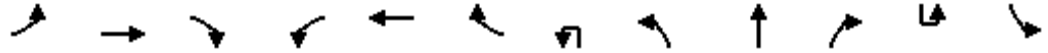

| Lane Group                 | EBL   | EBT   | EBR   | WBL   | WBT   | WBR  | NBU   | NBL   | NBT   | NBR  | SBU   | SBL   |
|----------------------------|-------|-------|-------|-------|-------|------|-------|-------|-------|------|-------|-------|
| Lane Configurations        |       |       |       |       |       |      |       |       |       |      |       |       |
| Traffic Volume (vph)       | 24    | 25    | 197   | 389   | 24    | 24   | 16    | 78    | 1813  | 45   | 12    | 21    |
| Future Volume (vph)        | 24    | 25    | 197   | 389   | 24    | 24   | 16    | 78    | 1813  | 45   | 12    | 21    |
| Ideal Flow (vphpl)         | 1800  | 1800  | 1800  | 1800  | 1800  | 1800 | 1800  | 1800  | 1800  | 1800 | 1800  | 1800  |
| Storage Length (m)         | 35.0  |       | 60.0  | 85.0  |       | 55.0 |       | 165.0 |       | 0.0  |       | 155.0 |
| Storage Lanes              | 1     |       | 1     | 2     |       | 0    |       | 1     |       | 0    |       | 1     |
| Taper Length (m)           | 50.0  |       |       | 95.0  |       |      |       | 40.0  |       |      |       | 25.0  |
| Lane Util. Factor          | 1.00  | 1.00  | 1.00  | 0.97  | 1.00  | 1.00 | 0.95  | 1.00  | 0.95  | 0.95 | 0.95  | 1.00  |
| Ped Bike Factor            | 0.99  |       | 0.98  | 0.99  | 0.99  |      |       | 1.00  | 1.00  |      |       | 1.00  |
| Fr <sub>t</sub>            |       |       | 0.850 |       | 0.925 |      |       |       | 0.996 |      |       |       |
| Fl <sub>t</sub> Protected  | 0.950 |       |       | 0.950 |       |      |       | 0.950 |       |      |       | 0.950 |
| Satd. Flow (prot)          | 1674  | 1695  | 1483  | 3248  | 1515  | 0    | 0     | 1644  | 3297  | 0    | 0     | 1648  |
| Fl <sub>t</sub> Permitted  | 0.950 |       |       | 0.950 |       |      |       | 0.950 |       |      |       | 0.950 |
| Satd. Flow (perm)          | 1664  | 1695  | 1449  | 3214  | 1515  | 0    | 0     | 1641  | 3297  | 0    | 0     | 1646  |
| Right Turn on Red          |       |       | Yes   |       |       | Yes  |       |       |       | Yes  |       |       |
| Satd. Flow (RTOR)          |       |       | 137   |       | 24    |      |       |       | 2     |      |       |       |
| Link Speed (k/h)           |       | 50    |       |       | 50    |      |       |       | 60    |      |       |       |
| Link Distance (m)          |       | 212.6 |       |       | 241.6 |      |       |       | 610.9 |      |       |       |
| Travel Time (s)            |       | 15.3  |       |       | 17.4  |      |       |       | 36.7  |      |       |       |
| Confl. Peds. (#/hr)        | 5     |       | 5     | 5     |       | 5    |       | 5     |       | 5    |       | 5     |
| Confl. Bikes (#/hr)        |       |       | 5     |       |       | 5    |       |       |       | 5    |       |       |
| Peak Hour Factor           | 1.00  | 1.00  | 1.00  | 1.00  | 1.00  | 1.00 | 1.00  | 1.00  | 1.00  | 1.00 | 1.00  | 1.00  |
| Heavy Vehicles (%)         | 1%    | 5%    | 2%    | 1%    | 6%    | 9%   | 2%    | 3%    | 2%    | 6%   | 2%    | 3%    |
| Adj. Flow (vph)            | 24    | 25    | 197   | 389   | 24    | 24   | 16    | 78    | 1813  | 45   | 12    | 21    |
| Shared Lane Traffic (%)    |       |       |       |       |       |      |       |       |       |      |       |       |
| Lane Group Flow (vph)      | 24    | 25    | 197   | 389   | 48    | 0    | 0     | 94    | 1858  | 0    | 0     | 33    |
| Enter Blocked Intersection | No    | No    | No    | No    | No    | No   | No    | No    | No    | No   | No    | No    |
| Lane Alignment             | L NA  | Left  | R NA  | L NA  | Left  | R NA | R NA  | L NA  | Left  | R NA | R NA  | L NA  |
| Median Width(m)            |       | 7.0   |       |       | 10.5  |      |       |       | 17.5  |      |       |       |
| Link Offset(m)             |       | 0.0   |       |       | 0.0   |      |       |       | 0.0   |      |       |       |
| Crosswalk Width(m)         |       | 5.0   |       |       | 5.0   |      |       |       | 5.0   |      |       |       |
| Two way Left Turn Lane     |       |       |       |       |       |      |       |       |       |      |       |       |
| Headway Factor             | 1.09  | 1.09  | 1.09  | 1.09  | 1.09  | 1.09 | 1.09  | 1.09  | 1.09  | 1.09 | 1.09  | 1.09  |
| Number of Detectors        | 1     | 2     | 1     | 1     | 2     |      | 1     | 1     | 2     |      | 1     | 1     |
| Detector Template          | Left  | Thru  | Right | Left  | Thru  |      | Left  | Left  | Thru  |      | Left  | Left  |
| Leading Detector (m)       | 2.0   | 10.0  | 2.0   | 2.0   | 10.0  |      | 2.0   | 2.0   | 10.0  |      | 2.0   | 2.0   |
| Trailing Detector (m)      | 0.0   | 0.0   | 0.0   | 0.0   | 0.0   |      | 0.0   | 0.0   | 0.0   |      | 0.0   | 0.0   |
| Detector 1 Position(m)     | 0.0   | 0.0   | 0.0   | 0.0   | 0.0   |      | 0.0   | 0.0   | 0.0   |      | 0.0   | 0.0   |
| Detector 1 Size(m)         | 2.0   | 0.6   | 2.0   | 2.0   | 0.6   |      | 2.0   | 2.0   | 0.6   |      | 2.0   | 2.0   |
| Detector 1 Type            | Cl+Ex | Cl+Ex | Cl+Ex | Cl+Ex | Cl+Ex |      | Cl+Ex | Cl+Ex | Cl+Ex |      | Cl+Ex | Cl+Ex |
| Detector 1 Channel         |       |       |       |       |       |      |       |       |       |      |       |       |
| Detector 1 Extend (s)      | 0.0   | 0.0   | 0.0   | 0.0   | 0.0   |      | 0.0   | 0.0   | 0.0   |      | 0.0   | 0.0   |
| Detector 1 Queue (s)       | 0.0   | 0.0   | 0.0   | 0.0   | 0.0   |      | 0.0   | 0.0   | 0.0   |      | 0.0   | 0.0   |
| Detector 1 Delay (s)       | 0.0   | 0.0   | 0.0   | 0.0   | 0.0   |      | 0.0   | 0.0   | 0.0   |      | 0.0   | 0.0   |
| Detector 2 Position(m)     |       | 9.4   |       |       | 9.4   |      |       |       | 9.4   |      |       |       |
| Detector 2 Size(m)         |       | 0.6   |       |       | 0.6   |      |       |       | 0.6   |      |       |       |
| Detector 2 Type            |       | Cl+Ex |       |       | Cl+Ex |      |       |       | Cl+Ex |      |       |       |
| Detector 2 Channel         |       |       |       |       |       |      |       |       |       |      |       |       |
| Detector 2 Extend (s)      |       | 0.0   |       |       | 0.0   |      |       |       | 0.0   |      |       |       |
| Turn Type                  | Prot  | NA    | Perm  | Prot  | NA    |      | Prot  | Prot  | NA    |      | Prot  | Prot  |
| Protected Phases           | 7     | 4     |       | 3     | 8     |      | 5     | 5     | 2     |      | 1     | 1     |
| Permitted Phases           |       |       | 4     |       |       |      |       |       |       |      |       |       |
| Detector Phase             | 7     | 4     | 4     | 3     | 8     |      | 5     | 5     | 2     |      | 1     | 1     |
| Switch Phase               |       |       |       |       |       |      |       |       |       |      |       |       |



3: March & Solandt  
PM Peak Hour

555-603 March Road  
2037 Background Traffic (dual WBL on Solandt)



| Lane Group                 | SBT   | SBR  |
|----------------------------|-------|------|
| Lane Configurations        | ↑↑    |      |
| Traffic Volume (vph)       | 1311  | 29   |
| Future Volume (vph)        | 1311  | 29   |
| Ideal Flow (vphpl)         | 1800  | 1800 |
| Storage Length (m)         |       | 0.0  |
| Storage Lanes              |       | 0    |
| Taper Length (m)           |       |      |
| Lane Util. Factor          | 0.95  | 0.95 |
| Ped Bike Factor            | 1.00  |      |
| Frt                        | 0.997 |      |
| Flt Protected              |       |      |
| Satd. Flow (prot)          | 3302  | 0    |
| Flt Permitted              |       |      |
| Satd. Flow (perm)          | 3302  | 0    |
| Right Turn on Red          |       | Yes  |
| Satd. Flow (RTOR)          | 2     |      |
| Link Speed (k/h)           | 60    |      |
| Link Distance (m)          | 411.0 |      |
| Travel Time (s)            | 24.7  |      |
| Confl. Peds. (#/hr)        |       | 5    |
| Confl. Bikes (#/hr)        |       | 5    |
| Peak Hour Factor           | 1.00  | 1.00 |
| Heavy Vehicles (%)         | 2%    | 3%   |
| Adj. Flow (vph)            | 1311  | 29   |
| Shared Lane Traffic (%)    |       |      |
| Lane Group Flow (vph)      | 1340  | 0    |
| Enter Blocked Intersection | No    | No   |
| Lane Alignment             | Left  | R NA |
| Median Width(m)            | 17.5  |      |
| Link Offset(m)             | 0.0   |      |
| Crosswalk Width(m)         | 5.0   |      |
| Two way Left Turn Lane     |       |      |
| Headway Factor             | 1.09  | 1.09 |
| Number of Detectors        | 2     |      |
| Detector Template          | Thru  |      |
| Leading Detector (m)       | 10.0  |      |
| Trailing Detector (m)      | 0.0   |      |
| Detector 1 Position(m)     | 0.0   |      |
| Detector 1 Size(m)         | 0.6   |      |
| Detector 1 Type            | CI+Ex |      |
| Detector 1 Channel         |       |      |
| Detector 1 Extend (s)      | 0.0   |      |
| Detector 1 Queue (s)       | 0.0   |      |
| Detector 1 Delay (s)       | 0.0   |      |
| Detector 2 Position(m)     | 9.4   |      |
| Detector 2 Size(m)         | 0.6   |      |
| Detector 2 Type            | CI+Ex |      |
| Detector 2 Channel         |       |      |
| Detector 2 Extend (s)      | 0.0   |      |
| Turn Type                  | NA    |      |
| Protected Phases           | 6     |      |
| Permitted Phases           |       |      |
| Detector Phase             | 6     |      |
| Switch Phase               |       |      |

3: March & Solandt  
PM Peak Hour

555-603 March Road  
2037 Background Traffic (dual WBL on Solandt)

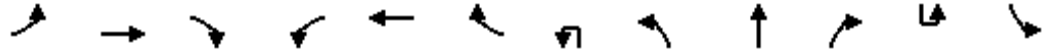

| Lane Group              | EBL   | EBT   | EBR   | WBL   | WBT   | WBR | NBU   | NBL   | NBT    | NBR | SBU  | SBL   |
|-------------------------|-------|-------|-------|-------|-------|-----|-------|-------|--------|-----|------|-------|
| Minimum Initial (s)     | 5.0   | 10.0  | 10.0  | 5.0   | 10.0  |     | 5.0   | 5.0   | 10.0   |     | 5.0  | 5.0   |
| Minimum Split (s)       | 11.5  | 36.5  | 36.5  | 11.5  | 36.5  |     | 12.0  | 12.0  | 26.8   |     | 12.0 | 12.0  |
| Total Split (s)         | 16.3  | 36.5  | 36.5  | 22.5  | 42.7  |     | 15.0  | 15.0  | 59.0   |     | 12.0 | 12.0  |
| Total Split (%)         | 12.5% | 28.1% | 28.1% | 17.3% | 32.8% |     | 11.5% | 11.5% | 45.4%  |     | 9.2% | 9.2%  |
| Maximum Green (s)       | 9.8   | 30.0  | 30.0  | 16.0  | 36.2  |     | 8.0   | 8.0   | 53.2   |     | 5.0  | 5.0   |
| Yellow Time (s)         | 3.3   | 3.3   | 3.3   | 3.3   | 3.3   |     | 3.7   | 3.7   | 3.7    |     | 3.7  | 3.7   |
| All-Red Time (s)        | 3.2   | 3.2   | 3.2   | 3.2   | 3.2   |     | 3.3   | 3.3   | 2.1    |     | 3.3  | 3.3   |
| Lost Time Adjust (s)    | 0.0   | 0.0   | 0.0   | 0.0   | 0.0   |     |       | 0.0   | 0.0    |     |      | 0.0   |
| Total Lost Time (s)     | 6.5   | 6.5   | 6.5   | 6.5   | 6.5   |     |       | 7.0   | 5.8    |     |      | 7.0   |
| Lead/Lag                | Lead  | Lag   | Lag   | Lead  | Lag   |     | Lead  | Lead  | Lag    |     | Lead | Lead  |
| Lead-Lag Optimize?      | Yes   |       |       |       | Yes   |     |       |       |        |     |      |       |
| Vehicle Extension (s)   | 3.0   | 3.0   | 3.0   | 3.0   | 3.0   |     | 3.0   | 3.0   | 3.0    |     | 3.0  | 3.0   |
| Recall Mode             | None  | None  | None  | None  | None  |     | None  | None  | C-Max  |     | None | None  |
| Walk Time (s)           |       | 7.0   | 7.0   |       | 7.0   |     |       |       | 7.0    |     |      |       |
| Flash Dont Walk (s)     |       | 23.0  | 23.0  |       | 23.0  |     |       |       | 14.0   |     |      |       |
| Pedestrian Calls (#/hr) |       | 5     | 5     |       | 5     |     |       |       | 5      |     |      |       |
| Act Effct Green (s)     | 7.4   | 15.3  | 15.3  | 16.0  | 28.8  |     |       | 12.5  | 71.2   |     |      | 7.0   |
| Actuated g/C Ratio      | 0.06  | 0.12  | 0.12  | 0.12  | 0.22  |     |       | 0.10  | 0.55   |     |      | 0.05  |
| v/c Ratio               | 0.25  | 0.13  | 0.68  | 0.97  | 0.14  |     |       | 0.59  | 1.03   |     |      | 0.38  |
| Control Delay           | 64.4  | 48.8  | 29.1  | 95.8  | 24.9  |     |       | 71.9  | 58.8   |     |      | 67.8  |
| Queue Delay             | 0.0   | 0.0   | 0.0   | 0.0   | 0.0   |     |       | 0.0   | 0.0    |     |      | 0.0   |
| Total Delay             | 64.4  | 48.8  | 29.1  | 95.8  | 24.9  |     |       | 71.9  | 58.8   |     |      | 67.8  |
| LOS                     | E     | D     | C     | F     | C     |     |       | E     | E      |     |      | E     |
| Approach Delay          |       | 34.5  |       |       | 88.0  |     |       |       | 59.5   |     |      |       |
| Approach LOS            |       | C     |       |       | F     |     |       |       | E      |     |      |       |
| Queue Length 50th (m)   | 5.5   | 5.6   | 13.7  | 47.8  | 4.9   |     |       | 21.2  | ~254.8 |     |      | 7.8   |
| Queue Length 95th (m)   | 13.6  | 11.6  | 32.2  | #76.8 | 13.1  |     |       | #53.6 | #346.3 |     |      | #21.6 |
| Internal Link Dist (m)  |       | 188.6 |       |       | 217.6 |     |       |       | 586.9  |     |      |       |
| Turn Bay Length (m)     | 35.0  |       | 60.0  | 85.0  |       |     |       | 165.0 |        |     |      | 155.0 |
| Base Capacity (vph)     | 126   | 391   | 439   | 399   | 439   |     |       | 158   | 1806   |     |      | 88    |
| Starvation Cap Reductn  | 0     | 0     | 0     | 0     | 0     |     |       | 0     | 0      |     |      | 0     |
| Spillback Cap Reductn   | 0     | 0     | 0     | 0     | 0     |     |       | 0     | 0      |     |      | 0     |
| Storage Cap Reductn     | 0     | 0     | 0     | 0     | 0     |     |       | 0     | 0      |     |      | 0     |
| Reduced v/c Ratio       | 0.19  | 0.06  | 0.45  | 0.97  | 0.11  |     |       | 0.59  | 1.03   |     |      | 0.38  |

Intersection Summary

Area Type: Other  
 Cycle Length: 130  
 Actuated Cycle Length: 130  
 Offset: 0 (0%), Referenced to phase 2:NBT and 6:SBT, Start of Green  
 Natural Cycle: 150  
 Control Type: Actuated-Coordinated  
 Maximum v/c Ratio: 1.03  
 Intersection Signal Delay: 56.4  
 Intersection LOS: E  
 Intersection Capacity Utilization 94.1%  
 ICU Level of Service F  
 Analysis Period (min) 15  
 ~ Volume exceeds capacity, queue is theoretically infinite.  
 Queue shown is maximum after two cycles.  
 # 95th percentile volume exceeds capacity, queue may be longer.  
 Queue shown is maximum after two cycles.

Splits and Phases: 3: March & Solandt

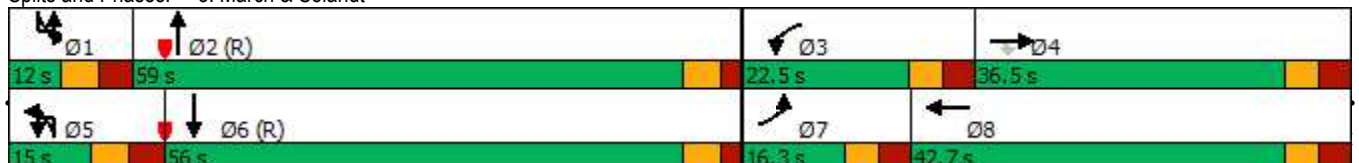



| Lane Group                  | SBT    | SBR |
|-----------------------------|--------|-----|
| Minimum Initial (s)         | 10.0   |     |
| Minimum Split (s)           | 26.8   |     |
| Total Split (s)             | 56.0   |     |
| Total Split (%)             | 43.1%  |     |
| Maximum Green (s)           | 50.2   |     |
| Yellow Time (s)             | 3.7    |     |
| All-Red Time (s)            | 2.1    |     |
| Lost Time Adjust (s)        | 0.0    |     |
| Total Lost Time (s)         | 5.8    |     |
| Lead/Lag                    | Lag    |     |
| Lead-Lag Optimize?          |        |     |
| Vehicle Extension (s)       | 3.0    |     |
| Recall Mode                 | C-Max  |     |
| Walk Time (s)               | 7.0    |     |
| Flash Dont Walk (s)         | 14.0   |     |
| Pedestrian Calls (#/hr)     | 5      |     |
| Act Effct Green (s)         | 60.4   |     |
| Actuated g/C Ratio          | 0.46   |     |
| v/c Ratio                   | 0.87   |     |
| Control Delay               | 45.2   |     |
| Queue Delay                 | 0.0    |     |
| Total Delay                 | 45.2   |     |
| LOS                         | D      |     |
| Approach Delay              | 45.8   |     |
| Approach LOS                | D      |     |
| Queue Length 50th (m)       | 114.4  |     |
| Queue Length 95th (m)       | #226.0 |     |
| Internal Link Dist (m)      | 387.0  |     |
| Turn Bay Length (m)         |        |     |
| Base Capacity (vph)         | 1535   |     |
| Starvation Cap Reductn      | 0      |     |
| Spillback Cap Reductn       | 0      |     |
| Storage Cap Reductn         | 0      |     |
| Reduced v/c Ratio           | 0.87   |     |
| <b>Intersection Summary</b> |        |     |

3: March & Solandt  
PM Peak Hour

555-603 March Road  
2037 Background Traffic (demand rationalization)

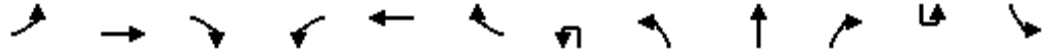

| Lane Group                 | EBL   | EBT   | EBR   | WBL   | WBT   | WBR  | NBU   | NBL   | NBT   | NBR  | SBU   | SBL   |
|----------------------------|-------|-------|-------|-------|-------|------|-------|-------|-------|------|-------|-------|
| Lane Configurations        |       |       |       |       |       |      |       |       |       |      |       |       |
| Traffic Volume (vph)       | 24    | 25    | 197   | 389   | 24    | 24   | 16    | 78    | 1768  | 45   | 12    | 21    |
| Future Volume (vph)        | 24    | 25    | 197   | 389   | 24    | 24   | 16    | 78    | 1768  | 45   | 12    | 21    |
| Ideal Flow (vphpl)         | 1800  | 1800  | 1800  | 1800  | 1800  | 1800 | 1800  | 1800  | 1800  | 1800 | 1800  | 1800  |
| Storage Length (m)         | 35.0  |       | 60.0  | 85.0  |       | 55.0 |       | 165.0 |       | 0.0  |       | 155.0 |
| Storage Lanes              | 1     |       | 1     | 2     |       | 0    |       | 1     |       | 0    |       | 1     |
| Taper Length (m)           | 50.0  |       |       | 95.0  |       |      |       | 40.0  |       |      |       | 25.0  |
| Lane Util. Factor          | 1.00  | 1.00  | 1.00  | 0.97  | 1.00  | 1.00 | 0.95  | 1.00  | 0.95  | 0.95 | 0.95  | 1.00  |
| Ped Bike Factor            | 0.99  |       | 0.98  | 0.99  | 0.99  |      |       | 1.00  | 1.00  |      |       | 1.00  |
| Fr <sub>t</sub>            |       |       | 0.850 |       | 0.925 |      |       |       | 0.996 |      |       |       |
| Fl <sub>t</sub> Protected  | 0.950 |       |       | 0.950 |       |      |       | 0.950 |       |      |       | 0.950 |
| Satd. Flow (prot)          | 1674  | 1695  | 1483  | 3248  | 1515  | 0    | 0     | 1644  | 3297  | 0    | 0     | 1648  |
| Fl <sub>t</sub> Permitted  | 0.950 |       |       | 0.950 |       |      |       | 0.950 |       |      |       | 0.950 |
| Satd. Flow (perm)          | 1664  | 1695  | 1449  | 3214  | 1515  | 0    | 0     | 1641  | 3297  | 0    | 0     | 1646  |
| Right Turn on Red          |       |       | Yes   |       |       | Yes  |       |       |       | Yes  |       |       |
| Satd. Flow (RTOR)          |       |       | 137   |       | 24    |      |       |       | 2     |      |       |       |
| Link Speed (k/h)           |       | 50    |       |       | 50    |      |       |       | 60    |      |       |       |
| Link Distance (m)          |       | 212.6 |       |       | 241.6 |      |       |       | 610.9 |      |       |       |
| Travel Time (s)            |       | 15.3  |       |       | 17.4  |      |       |       | 36.7  |      |       |       |
| Confl. Peds. (#/hr)        | 5     |       | 5     | 5     |       | 5    |       | 5     |       | 5    |       | 5     |
| Confl. Bikes (#/hr)        |       |       | 5     |       |       | 5    |       |       |       | 5    |       |       |
| Peak Hour Factor           | 1.00  | 1.00  | 1.00  | 1.00  | 1.00  | 1.00 | 1.00  | 1.00  | 1.00  | 1.00 | 1.00  | 1.00  |
| Heavy Vehicles (%)         | 1%    | 5%    | 2%    | 1%    | 6%    | 9%   | 2%    | 3%    | 2%    | 6%   | 2%    | 3%    |
| Adj. Flow (vph)            | 24    | 25    | 197   | 389   | 24    | 24   | 16    | 78    | 1768  | 45   | 12    | 21    |
| Shared Lane Traffic (%)    |       |       |       |       |       |      |       |       |       |      |       |       |
| Lane Group Flow (vph)      | 24    | 25    | 197   | 389   | 48    | 0    | 0     | 94    | 1813  | 0    | 0     | 33    |
| Enter Blocked Intersection | No    | No    | No    | No    | No    | No   | No    | No    | No    | No   | No    | No    |
| Lane Alignment             | L NA  | Left  | R NA  | L NA  | Left  | R NA | R NA  | L NA  | Left  | R NA | R NA  | L NA  |
| Median Width(m)            |       | 7.0   |       |       | 10.5  |      |       |       | 17.5  |      |       |       |
| Link Offset(m)             |       | 0.0   |       |       | 0.0   |      |       |       | 0.0   |      |       |       |
| Crosswalk Width(m)         |       | 5.0   |       |       | 5.0   |      |       |       | 5.0   |      |       |       |
| Two way Left Turn Lane     |       |       |       |       |       |      |       |       |       |      |       |       |
| Headway Factor             | 1.09  | 1.09  | 1.09  | 1.09  | 1.09  | 1.09 | 1.09  | 1.09  | 1.09  | 1.09 | 1.09  | 1.09  |
| Number of Detectors        | 1     | 2     | 1     | 1     | 2     |      | 1     | 1     | 2     |      | 1     | 1     |
| Detector Template          | Left  | Thru  | Right | Left  | Thru  |      | Left  | Left  | Thru  |      | Left  | Left  |
| Leading Detector (m)       | 2.0   | 10.0  | 2.0   | 2.0   | 10.0  |      | 2.0   | 2.0   | 10.0  |      | 2.0   | 2.0   |
| Trailing Detector (m)      | 0.0   | 0.0   | 0.0   | 0.0   | 0.0   |      | 0.0   | 0.0   | 0.0   |      | 0.0   | 0.0   |
| Detector 1 Position(m)     | 0.0   | 0.0   | 0.0   | 0.0   | 0.0   |      | 0.0   | 0.0   | 0.0   |      | 0.0   | 0.0   |
| Detector 1 Size(m)         | 2.0   | 0.6   | 2.0   | 2.0   | 0.6   |      | 2.0   | 2.0   | 0.6   |      | 2.0   | 2.0   |
| Detector 1 Type            | Cl+Ex | Cl+Ex | Cl+Ex | Cl+Ex | Cl+Ex |      | Cl+Ex | Cl+Ex | Cl+Ex |      | Cl+Ex | Cl+Ex |
| Detector 1 Channel         |       |       |       |       |       |      |       |       |       |      |       |       |
| Detector 1 Extend (s)      | 0.0   | 0.0   | 0.0   | 0.0   | 0.0   |      | 0.0   | 0.0   | 0.0   |      | 0.0   | 0.0   |
| Detector 1 Queue (s)       | 0.0   | 0.0   | 0.0   | 0.0   | 0.0   |      | 0.0   | 0.0   | 0.0   |      | 0.0   | 0.0   |
| Detector 1 Delay (s)       | 0.0   | 0.0   | 0.0   | 0.0   | 0.0   |      | 0.0   | 0.0   | 0.0   |      | 0.0   | 0.0   |
| Detector 2 Position(m)     |       | 9.4   |       |       | 9.4   |      |       |       | 9.4   |      |       |       |
| Detector 2 Size(m)         |       | 0.6   |       |       | 0.6   |      |       |       | 0.6   |      |       |       |
| Detector 2 Type            |       | Cl+Ex |       |       | Cl+Ex |      |       |       | Cl+Ex |      |       |       |
| Detector 2 Channel         |       |       |       |       |       |      |       |       |       |      |       |       |
| Detector 2 Extend (s)      |       | 0.0   |       |       | 0.0   |      |       |       | 0.0   |      |       |       |
| Turn Type                  | Prot  | NA    | Perm  | Prot  | NA    |      | Prot  | Prot  | NA    |      | Prot  | Prot  |
| Protected Phases           | 7     | 4     |       | 3     | 8     |      | 5     | 5     | 2     |      | 1     | 1     |
| Permitted Phases           |       |       | 4     |       |       |      |       |       |       |      |       |       |
| Detector Phase             | 7     | 4     | 4     | 3     | 8     |      | 5     | 5     | 2     |      | 1     | 1     |
| Switch Phase               |       |       |       |       |       |      |       |       |       |      |       |       |

3: March & Solandt  
PM Peak Hour

555-603 March Road  
2037 Background Traffic (demand rationalization)



| Lane Group                 | SBT   | SBR  |
|----------------------------|-------|------|
| Lane Configurations        | ↑↑    |      |
| Traffic Volume (vph)       | 1311  | 29   |
| Future Volume (vph)        | 1311  | 29   |
| Ideal Flow (vphpl)         | 1800  | 1800 |
| Storage Length (m)         |       | 0.0  |
| Storage Lanes              |       | 0    |
| Taper Length (m)           |       |      |
| Lane Util. Factor          | 0.95  | 0.95 |
| Ped Bike Factor            | 1.00  |      |
| Frt                        | 0.997 |      |
| Flt Protected              |       |      |
| Satd. Flow (prot)          | 3302  | 0    |
| Flt Permitted              |       |      |
| Satd. Flow (perm)          | 3302  | 0    |
| Right Turn on Red          |       | Yes  |
| Satd. Flow (RTOR)          | 2     |      |
| Link Speed (k/h)           | 60    |      |
| Link Distance (m)          | 411.0 |      |
| Travel Time (s)            | 24.7  |      |
| Confl. Peds. (#/hr)        |       | 5    |
| Confl. Bikes (#/hr)        |       | 5    |
| Peak Hour Factor           | 1.00  | 1.00 |
| Heavy Vehicles (%)         | 2%    | 3%   |
| Adj. Flow (vph)            | 1311  | 29   |
| Shared Lane Traffic (%)    |       |      |
| Lane Group Flow (vph)      | 1340  | 0    |
| Enter Blocked Intersection | No    | No   |
| Lane Alignment             | Left  | R NA |
| Median Width(m)            | 17.5  |      |
| Link Offset(m)             | 0.0   |      |
| Crosswalk Width(m)         | 5.0   |      |
| Two way Left Turn Lane     |       |      |
| Headway Factor             | 1.09  | 1.09 |
| Number of Detectors        | 2     |      |
| Detector Template          | Thru  |      |
| Leading Detector (m)       | 10.0  |      |
| Trailing Detector (m)      | 0.0   |      |
| Detector 1 Position(m)     | 0.0   |      |
| Detector 1 Size(m)         | 0.6   |      |
| Detector 1 Type            | CI+Ex |      |
| Detector 1 Channel         |       |      |
| Detector 1 Extend (s)      | 0.0   |      |
| Detector 1 Queue (s)       | 0.0   |      |
| Detector 1 Delay (s)       | 0.0   |      |
| Detector 2 Position(m)     | 9.4   |      |
| Detector 2 Size(m)         | 0.6   |      |
| Detector 2 Type            | CI+Ex |      |
| Detector 2 Channel         |       |      |
| Detector 2 Extend (s)      | 0.0   |      |
| Turn Type                  | NA    |      |
| Protected Phases           | 6     |      |
| Permitted Phases           |       |      |
| Detector Phase             | 6     |      |
| Switch Phase               |       |      |

3: March & Solandt  
PM Peak Hour

555-603 March Road  
2037 Background Traffic (demand rationalization)



| Lane Group              | EBL   | EBT   | EBR   | WBL   | WBT   | WBR | NBU   | NBL   | NBT    | NBR | SBU  | SBL   |
|-------------------------|-------|-------|-------|-------|-------|-----|-------|-------|--------|-----|------|-------|
| Minimum Initial (s)     | 5.0   | 10.0  | 10.0  | 5.0   | 10.0  |     | 5.0   | 5.0   | 10.0   |     | 5.0  | 5.0   |
| Minimum Split (s)       | 11.5  | 36.5  | 36.5  | 11.5  | 36.5  |     | 12.0  | 12.0  | 26.8   |     | 12.0 | 12.0  |
| Total Split (s)         | 16.3  | 36.5  | 36.5  | 22.5  | 42.7  |     | 15.0  | 15.0  | 59.0   |     | 12.0 | 12.0  |
| Total Split (%)         | 12.5% | 28.1% | 28.1% | 17.3% | 32.8% |     | 11.5% | 11.5% | 45.4%  |     | 9.2% | 9.2%  |
| Maximum Green (s)       | 9.8   | 30.0  | 30.0  | 16.0  | 36.2  |     | 8.0   | 8.0   | 53.2   |     | 5.0  | 5.0   |
| Yellow Time (s)         | 3.3   | 3.3   | 3.3   | 3.3   | 3.3   |     | 3.7   | 3.7   | 3.7    |     | 3.7  | 3.7   |
| All-Red Time (s)        | 3.2   | 3.2   | 3.2   | 3.2   | 3.2   |     | 3.3   | 3.3   | 2.1    |     | 3.3  | 3.3   |
| Lost Time Adjust (s)    | 0.0   | 0.0   | 0.0   | 0.0   | 0.0   |     |       | 0.0   | 0.0    |     |      | 0.0   |
| Total Lost Time (s)     | 6.5   | 6.5   | 6.5   | 6.5   | 6.5   |     |       | 7.0   | 5.8    |     |      | 7.0   |
| Lead/Lag                | Lead  | Lag   | Lag   | Lead  | Lag   |     | Lead  | Lead  | Lag    |     | Lead | Lead  |
| Lead-Lag Optimize?      | Yes   |       |       |       | Yes   |     |       |       |        |     |      |       |
| Vehicle Extension (s)   | 3.0   | 3.0   | 3.0   | 3.0   | 3.0   |     | 3.0   | 3.0   | 3.0    |     | 3.0  | 3.0   |
| Recall Mode             | None  | None  | None  | None  | None  |     | None  | None  | C-Max  |     | None | None  |
| Walk Time (s)           |       | 7.0   | 7.0   |       | 7.0   |     |       |       | 7.0    |     |      |       |
| Flash Dont Walk (s)     |       | 23.0  | 23.0  |       | 23.0  |     |       |       | 14.0   |     |      |       |
| Pedestrian Calls (#/hr) |       | 5     | 5     |       | 5     |     |       |       | 5      |     |      |       |
| Act Effct Green (s)     | 7.4   | 15.3  | 15.3  | 16.0  | 28.8  |     |       | 12.5  | 71.2   |     |      | 7.0   |
| Actuated g/C Ratio      | 0.06  | 0.12  | 0.12  | 0.12  | 0.22  |     |       | 0.10  | 0.55   |     |      | 0.05  |
| v/c Ratio               | 0.25  | 0.13  | 0.68  | 0.97  | 0.14  |     |       | 0.59  | 1.00   |     |      | 0.38  |
| Control Delay           | 64.4  | 48.8  | 29.1  | 95.8  | 24.9  |     |       | 71.9  | 52.3   |     |      | 84.7  |
| Queue Delay             | 0.0   | 0.0   | 0.0   | 0.0   | 0.0   |     |       | 0.0   | 0.0    |     |      | 0.0   |
| Total Delay             | 64.4  | 48.8  | 29.1  | 95.8  | 24.9  |     |       | 71.9  | 52.3   |     |      | 84.7  |
| LOS                     | E     | D     | C     | F     | C     |     |       | E     | D      |     |      | F     |
| Approach Delay          |       | 34.5  |       |       | 88.0  |     |       |       | 53.3   |     |      |       |
| Approach LOS            |       | C     |       |       | F     |     |       |       | D      |     |      |       |
| Queue Length 50th (m)   | 5.5   | 5.6   | 13.7  | 47.8  | 4.9   |     |       | 21.2  | ~243.0 |     |      | 6.3   |
| Queue Length 95th (m)   | 13.6  | 11.6  | 32.2  | #76.8 | 13.1  |     |       | #53.6 | #334.8 |     |      | #21.5 |
| Internal Link Dist (m)  |       | 188.6 |       |       | 217.6 |     |       |       | 586.9  |     |      |       |
| Turn Bay Length (m)     | 35.0  |       | 60.0  | 85.0  |       |     |       | 165.0 |        |     |      | 155.0 |
| Base Capacity (vph)     | 126   | 391   | 439   | 399   | 439   |     |       | 158   | 1806   |     |      | 88    |
| Starvation Cap Reductn  | 0     | 0     | 0     | 0     | 0     |     |       | 0     | 0      |     |      | 0     |
| Spillback Cap Reductn   | 0     | 0     | 0     | 0     | 0     |     |       | 0     | 0      |     |      | 0     |
| Storage Cap Reductn     | 0     | 0     | 0     | 0     | 0     |     |       | 0     | 0      |     |      | 0     |
| Reduced v/c Ratio       | 0.19  | 0.06  | 0.45  | 0.97  | 0.11  |     |       | 0.59  | 1.00   |     |      | 0.38  |

Intersection Summary

Area Type: Other  
 Cycle Length: 130  
 Actuated Cycle Length: 130  
 Offset: 68 (52%), Referenced to phase 2:NBT and 6:SBT, Start of Green  
 Natural Cycle: 150  
 Control Type: Actuated-Coordinated  
 Maximum v/c Ratio: 1.00  
 Intersection Signal Delay: 52.3  
 Intersection LOS: D  
 Intersection Capacity Utilization 93.1%  
 ICU Level of Service F  
 Analysis Period (min) 15  
 ~ Volume exceeds capacity, queue is theoretically infinite.  
 Queue shown is maximum after two cycles.  
 # 95th percentile volume exceeds capacity, queue may be longer.  
 Queue shown is maximum after two cycles.

Splits and Phases: 3: March & Solandt

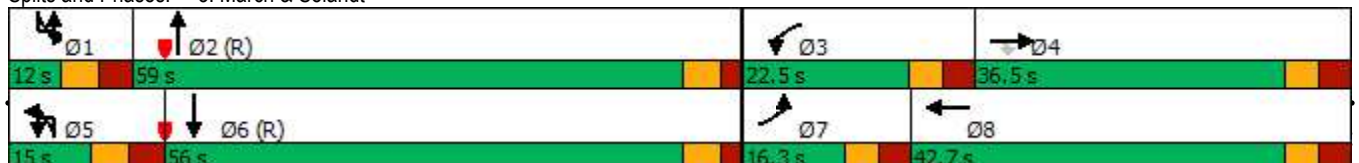



| Lane Group                  | SBT    | SBR |
|-----------------------------|--------|-----|
| Minimum Initial (s)         | 10.0   |     |
| Minimum Split (s)           | 26.8   |     |
| Total Split (s)             | 56.0   |     |
| Total Split (%)             | 43.1%  |     |
| Maximum Green (s)           | 50.2   |     |
| Yellow Time (s)             | 3.7    |     |
| All-Red Time (s)            | 2.1    |     |
| Lost Time Adjust (s)        | 0.0    |     |
| Total Lost Time (s)         | 5.8    |     |
| Lead/Lag                    | Lag    |     |
| Lead-Lag Optimize?          |        |     |
| Vehicle Extension (s)       | 3.0    |     |
| Recall Mode                 | C-Max  |     |
| Walk Time (s)               | 7.0    |     |
| Flash Dont Walk (s)         | 14.0   |     |
| Pedestrian Calls (#/hr)     | 5      |     |
| Act Effct Green (s)         | 60.4   |     |
| Actuated g/C Ratio          | 0.46   |     |
| v/c Ratio                   | 0.87   |     |
| Control Delay               | 41.7   |     |
| Queue Delay                 | 0.0    |     |
| Total Delay                 | 41.7   |     |
| LOS                         | D      |     |
| Approach Delay              | 42.8   |     |
| Approach LOS                | D      |     |
| Queue Length 50th (m)       | 174.3  |     |
| Queue Length 95th (m)       | #226.1 |     |
| Internal Link Dist (m)      | 387.0  |     |
| Turn Bay Length (m)         |        |     |
| Base Capacity (vph)         | 1535   |     |
| Starvation Cap Reductn      | 0      |     |
| Spillback Cap Reductn       | 0      |     |
| Storage Cap Reductn         | 0      |     |
| Reduced v/c Ratio           | 0.87   |     |
| <b>Intersection Summary</b> |        |     |

## **APPENDIX M**

---

### Proposed Cross-Sections



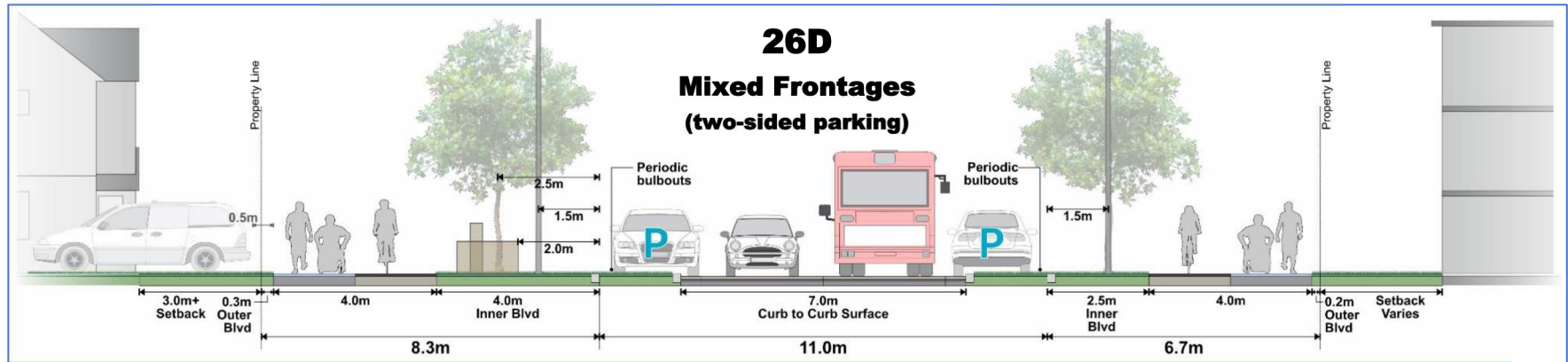

### Defining Features



- 27% of width (more with bulb-outs) is green, including large trees
- Tree-protected sidewalks and cycle tracks near the right-of-way edge
- Wide boulevard on one side with space for large trees, bus stops, utilities and snow storage
- Boulevard on other side with compressed space for trees, bus stops and snow storage
- Compatible for large trees in areas with sensitive marine clay soils



- Surface-mount hydroelectric transformer and grounding grid located within the right-of-way on one side only
- Sidewalks and cycle tracks narrow locally to provide 1.0m clearance from hydroelectric transformer



- Two-sided street parking (with potential seasonal restrictions on one side)
- Private driveway parking provided outside the right-of-way
- Narrow travel lanes may support low frequency transit service

### Applicability (all apply)

- Where land use on one side does not require surface-mount transformers in the right-of-way (e.g. parks, schools, mixed use, stacked townhomes, apartments)
- Where on-street parking on both sides of the street is a priority

Figure 7 Pre-Vetted Cross-Section 26D

# CROSS SECTION - 18m PRIVATE ROW

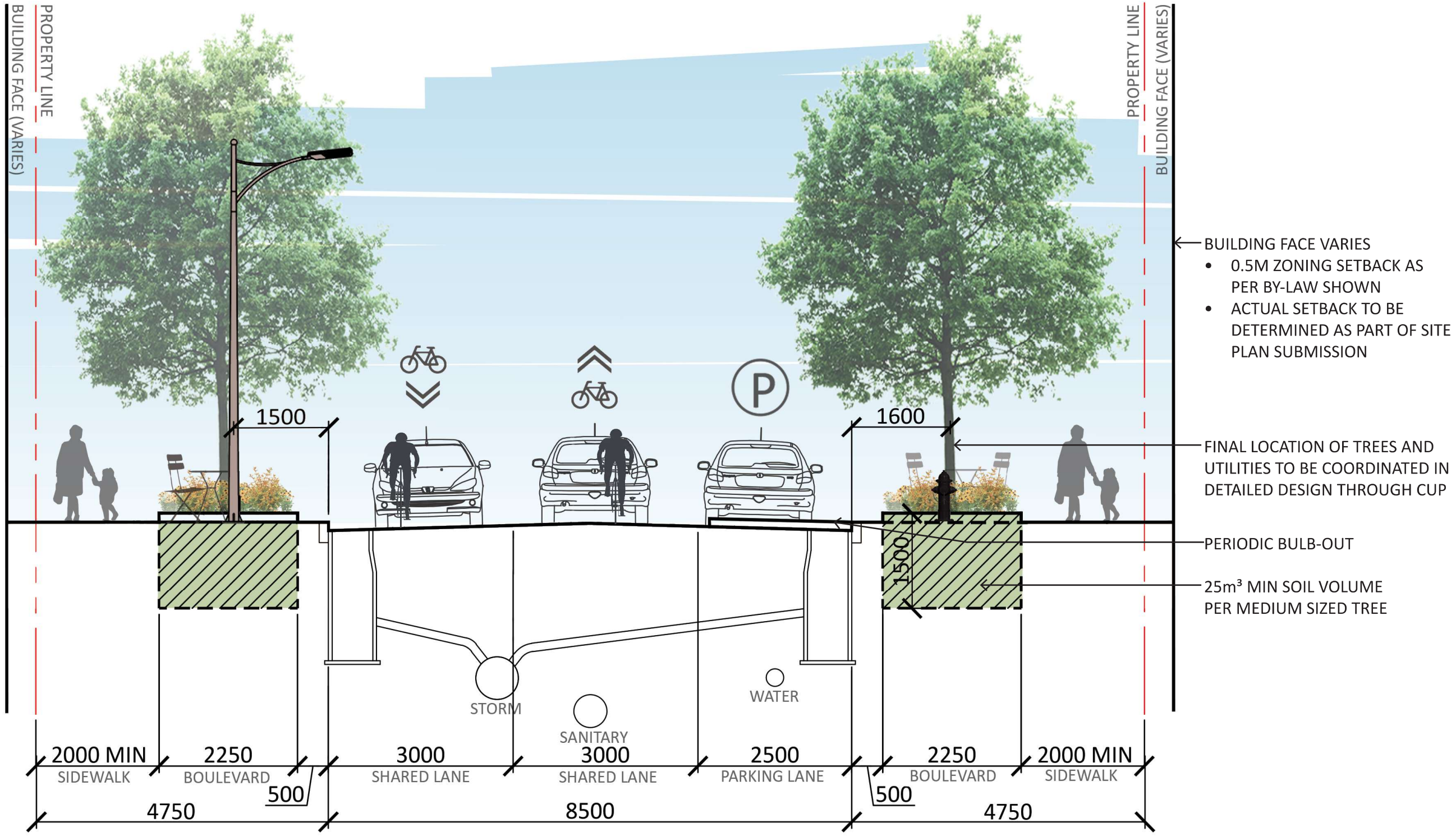

## **APPENDIX N**

---

MMLOS Analysis

## Segment MMLOS Analysis

This section provides a review of the boundary streets March Road, Terry Fox Drive, and Hines Road, using complete streets principles. The *Multi-Modal Level of Service (MMLOS) Guidelines*, produced by IBI Group in October 2015, were used to evaluate the levels of service for each alternative mode of transportation on the boundary streets. March Road and Hines Road have been evaluated based on the targets for the Employment Area. Terry Fox Drive has been evaluated based on the targets for the General Urban Area or Employment Area, whichever target is stricter.

Exhibit 4 of the *MMLOS Guidelines* has been used to evaluate the segment pedestrian level of service (PLOS) of the boundary streets. Exhibit 22 of the *MMLOS Guidelines* identifies a target PLOS C for all roadways in the General Urban Area or Employment Area. The results of the segment PLOS analysis are summarized in **Table 1**.

Exhibit 11 of the *MMLOS Guidelines* has been used to evaluate the segment bicycle level of service (BLOS) of the boundary streets. Exhibit 22 of the *MMLOS Guidelines* identifies a target BLOS B for roadways in the General Urban Area or Employment Area with a Crosstown Bikeway designation (Terry Fox Drive west of March Road), and a target BLOS C for roadways in the Employment Area with a Local Route designation (Hines Road) or Spine Route designation (March Road). The results of the segment BLOS analysis are summarized in **Table 2**.

Exhibit 15 of the *MMLOS Guidelines* has been used to evaluate the segment transit level of service (TLOS) of the boundary streets. Within the General Urban Area or Employment Area, Exhibit 22 of the *MMLOS Guidelines* identifies a target TLOS B for roadways with a Rapid Transit Corridor designation in the RTTP Network Concept (March Road south of Terry Fox Drive), and no target TLOS for roadways without a RTTP designation (Terry Fox Drive, Hines Road). The segment TLOS of Terry Fox Drive has still been evaluated, as it is currently used by transit, but Hines Road has not. The results of the segment TLOS analysis are summarized in **Table 3**.

Exhibit 20 of the *MMLOS Guidelines* has been used to evaluate the segment truck level of service (TkLOS) of the boundary streets. Within the Employment Area, Exhibit 22 of the *MMLOS Guidelines* identifies a target TkLOS B for arterial roadways with a truck route designation (March Road, Terry Fox Drive), and a target TkLOS D for collector roadways without a truck route designation (Hines Road). The results of the segment TkLOS analysis are summarized in **Table 4**.

Table 1: PLOS Segment Analysis

| Sidewalk Width  | Boulevard Width | Avg. Daily Curb Lane Traffic Volume | Presence of On-Street Parking | Operating Speed <sup>(1)</sup> | PLOS     |
|---|-----------------|-------------------------------------|-------------------------------|--------------------------------|----------|
| <b>March Road (east side, Terry Fox Drive to Solandt Road)</b>                    |                 |                                     |                               |                                |          |
| ≥ 2.0m  | ≥ 2.0m          | > 3,000 vpd                         | No                            | 90 km/h                        | <b>D</b> |
| <b>March Road (west side, Terry Fox Drive to Solandt Road)</b>                    |                 |                                     |                               |                                |          |
| ≥ 2.0m  | ≥ 2.0m          | > 3,000 vpd                         | No                            | 90 km/h                        | <b>D</b> |
| <b>Terry Fox Drive (north side, March Road to Flamborough Way)<sup>(2)</sup></b>  |                 |                                     |                               |                                |          |
| No sidewalk   |                 | > 3,000 vpd                         | No                            | 70 km/h                        | <b>F</b> |
| <b>Terry Fox Drive (south side, March Road to Innovation Drive)<sup>(2)</sup></b> |                 |                                     |                               |                                |          |
| ≥ 2.0m  | > 2.0m          | > 3,000 vpd                         | No                            | 70 km/h                        | <b>D</b> |
| <b>Hines Road (east side, north of Innovation Drive)</b>                          |                 |                                     |                               |                                |          |
| No sidewalk   |                 | ≤ 3,000 vpd                         | No                            | 60 km/h                        | <b>F</b> |
| <b>Hines Road (west side, north of Innovation Drive)<sup>(3)</sup></b>            |                 |                                     |                               |                                |          |
| No sidewalk   |                 | ≤ 3,000 vpd                         | No                            | 60 km/h                        | <b>F</b> |

1. Operating speed taken as the speed limit plus 10 km/h.

2. Primarily, this section of Terry Fox Drive does not include a sidewalk on the north side, and includes a MUP on the south side.

3. Hines Road does not include a sidewalk across from the subject site, and the worst-case has therefore been considered.

Table 2: BLOS Segment Analysis

| Road Class  | Route Type        | Bikeway Type       | Travel Lanes | Operating Speed | Bike Lane Width | Bike Lane Blockage | BLOS     |
|---|-------------------|--------------------|--------------|-----------------|-----------------|--------------------|----------|
| <b>March Road (Terry Fox Drive to Solandt Road)</b>                     |                   |                    |              |                 |                 |                    |          |
| Arterial  | Spine Route       | Curbside Bike Lane | 4 to 6       | 90 km/h         | ≥ 1.8m          | Rare               | <b>E</b> |
| <b>Terry Fox Drive (March Road to Flamborough Way/Innovation Drive)</b> |                   |                    |              |                 |                 |                    |          |
| Arterial  | Crosstown Bikeway | Curbside Bike Lane | 4 to 5       | 70 km/h         | 1.2-1.5m        | Rare               | <b>E</b> |
|   |                   | Mixed-Use Pathway  | -            | -               | -               | -                  | <b>A</b> |
| <b>Hines Road (north of Innovation Drive)</b>                           |                   |                    |              |                 |                 |                    |          |
| Collector   | Local Route       | Mixed Traffic      | 2            | 60 km/h         | -               | -                  | <b>F</b> |

Table 3: TLOS Segment Analysis

| Facility Type   | Exposure to Congestion Delay, Friction, and Incidents |          |                    | TLOS     |
|---|---|----------|--------------------|----------|
|   | Congestion  | Friction | Incident Potential |          |
| <b>March Road (Terry Fox Drive to Solandt Road)</b>                     |   |          |                    |          |
| Mixed Traffic – Limited Parking/Driveway Friction                       | Yes   | Low      | Medium             | <b>D</b> |
| <b>Terry Fox Drive (March Road to Flamborough Way/Innovation Drive)</b> |   |          |                    |          |
| Mixed Traffic – Limited Parking/Driveway Friction                       | Yes   | Low      | Medium             | <b>D</b> |

Table 4: TkLOS Segment Analysis

| Curb Lane Width   | Number of Travel Lanes Per Direction | TkLOS    |
|---|--------------------------------------|----------|
| <b>March Road (Terry Fox Drive to Solandt Road)</b>                     |                                      |          |
| 3.5m to 3.7m  | 2 to 3                               | <b>A</b> |
| <b>Terry Fox Drive (March Road to Flamborough Way/Innovation Drive)</b> |                                      |          |
| ≥ 3.7m  | 1                                    | <b>B</b> |
| <b>Hines Road (north of Innovation Drive)</b>                           |                                      |          |
| ≥ 3.7m  | 1                                    | <b>B</b> |

## Intersection MMLOS Analysis

The following is a review of the MMLOS of the signalized intersections within the study area, using complete streets principles. The MMLOS targets associated with the 'General Urban Area' designation have been used to evaluate March Road/Morgan's Grant Way/Shirley's Brook Drive, and the targets associated with the 'Employment Area' designation have been used to evaluate March Road/Solandt Road. Since March Road/Terry Fox Drive and Terry Fox Drive/Flamborough Way/Innovation Drive is located in both land use designations, whichever target is stricter has been considered for these intersections.

Exhibit 5 of the *Addendum to the MMLOS Guidelines* has been used to evaluate the existing PLOS at the intersections listed above. Exhibit 22 of the *MMLOS Guidelines* suggests a target PLOS C for all roadways within the General Urban or Employment Areas. The results of the intersection PLOS analysis are summarized in **Table 5** through **Table 8**.

Exhibit 12 of the *MMLOS Guidelines* has been used to evaluate the existing BLOS at the intersections listed above. Exhibit 22 of the *MMLOS Guidelines* suggests a target BLOS B for Local Routes in the General Urban Area (Morgan's Grant Way and Shirley's Brook Drive), and a target BLOS C for Spine Routes in the General Urban and Employment Areas (March Road and Terry Fox Drive) and Local Routes in the Employment Area (Solandt Road and Legget Drive). The results of the intersection BLOS analysis are summarized in **Table 9**.

Exhibit 16 of the *MMLOS Guidelines* has been used to evaluate the existing TLOS at the intersections listed above. Exhibit 22 of the *MMLOS Guidelines* identifies a target TLOS B for Rapid Transit Corridors (March Road south of Solandt Road), a target TLOS D for Transit Priority Corridors with Isolated Measures (March Road north of Solandt Road), and does not identify a target TLOS for roadways without a Rapid Transit or Transit Priority designation (Terry Fox Drive, Morgan's Grant Way/Shirley's Brook Drive, Solandt Road, Legget Drive). The TLOS has been evaluated for every approach that is currently used by transit. The results of the intersection TLOS analysis are summarized in **Table 10**.

Exhibit 21 of the *MMLOS Guidelines* has been used to evaluate the existing TkLOS at the intersections listed above. Exhibit 22 of the *MMLOS Guidelines* identifies a target TkLOS B for arterial truck routes in the Employment Area (March Road south of Terry Fox Drive, Terry Fox Drive west of March Road), and a target TkLOS D for arterial truck routes in the General Urban Area (March Road north of Terry Fox Drive) and collector roadways without a truck route designation in the Employment Area (Terry Fox Drive east of March Road, Legget Drive, and Solandt Road). No target is identified for collector roadways without a truck route designation in the General Urban Area (Morgan's Grant Way, Shirley's Brook Drive). The results of the intersection TkLOS analysis are summarized in **Table 11**.

**Table 5: PLOS Intersection Analysis – March Road/Morgan’s Grant Way/Shirley’s Brook Drive**

| CRITERIA                            | North Approach                 |             | South Approach                 |             | East Approach                  |             | West Approach                  |             |
|-------------------------------------|--------------------------------|-------------|--------------------------------|-------------|--------------------------------|-------------|--------------------------------|-------------|
| <b>PETSI SCORE</b>                  |                                |             |                                |             |                                |             |                                |             |
| <i>CROSSING DISTANCE CONDITIONS</i> |                                |             |                                |             |                                |             |                                |             |
| Median > 2.4m in Width              | No                             | -10         | No                             | -10         | No                             | -10         | No                             | -10         |
| Lanes Crossed (3.5m Lane Width)     | 10 +                           |             | 10 +                           |             | 10 +                           |             |                                |             |
| <i>SIGNAL PHASING AND TIMING</i>    |                                |             |                                |             |                                |             |                                |             |
| Left Turn Conflict                  | Permissive                     | -8          | Permissive                     | -8          | Perm + Prot                    | -8          | Perm + Prot                    | -8          |
| Right Turn Conflict                 | Permissive or Yield            | -5          | Permissive or Yield            | -5          | Permissive or Yield            | -5          | Permissive or Yield            | -5          |
| Right Turn on Red                   | N/A                            | 0           | N/A                            | 0           | N/A                            | 0           | N/A                            | 0           |
| Leading Pedestrian Interval         | No                             | -2          | No                             | -2          | No                             | -2          | No                             | -2          |
| <i>CORNER RADIUS</i>                |                                |             |                                |             |                                |             |                                |             |
| Parallel Radius                     | > 15m to 25m                   | -8          | > 15m to 25m                   | -8          | > 15m to 25m                   | -8          | > 15m to 25m                   | -8          |
| Parallel Right Turn Channel         | Conventional without Receiving | 0           | Conventional without Receiving | 0           | Conventional without Receiving | 0           | Conventional without Receiving | 0           |
| Perpendicular Radius                | > 15m to 25m                   | -8          | > 15m to 25m                   | -8          | > 15m to 25m                   | -8          | > 15m to 25m                   | -8          |
| Perpendicular Right Turn Channel    | Conventional without Receiving | 0           | Conventional without Receiving | 0           | Conventional without Receiving | 0           | Conventional without Receiving | 0           |
| <i>CROSSING TREATMENT</i>           |                                |             |                                |             |                                |             |                                |             |
| Treatment                           | Standard                       | -7          | Standard                       | -7          | Standard                       | -7          | Standard                       | -7          |
|                                     | <b>PETSI SCORE</b>             | <b>-48</b>  |                                | <b>-48</b>  |                                | <b>-48</b>  |                                | <b>-48</b>  |
|                                     | <b>LOS</b>                     | <b>F</b>    |                                | <b>F</b>    |                                | <b>F</b>    |                                | <b>F</b>    |
| <b>DELAY SCORE</b>                  |                                |             |                                |             |                                |             |                                |             |
| Cycle Length                        |                                | 130         |                                | 130         |                                | 130         |                                | 130         |
| Pedestrian Walk Time                |                                | 7.5         |                                | 7.5         |                                | 52.9        |                                | 52.9        |
|                                     | <b>DELAY SCORE</b>             | <b>57.7</b> |                                | <b>57.7</b> |                                | <b>22.9</b> |                                | <b>22.9</b> |
|                                     | <b>LOS</b>                     | <b>E</b>    |                                | <b>E</b>    |                                | <b>C</b>    |                                | <b>C</b>    |
| <b>OVERALL</b>                      |                                | <b>F</b>    | <b>F</b>                       |             | <b>F</b>                       |             | <b>F</b>                       |             |

**Table 6: PLOS Intersection Analysis – March Road/Terry Fox Drive**

| CRITERIA                            | North Approach                 |             | South Approach                 |             | East Approach                  |             | West Approach                  |             |
|-------------------------------------|--------------------------------|-------------|--------------------------------|-------------|--------------------------------|-------------|--------------------------------|-------------|
| <b>PETSI SCORE</b>                  |                                |             |                                |             |                                |             |                                |             |
| <i>CROSSING DISTANCE CONDITIONS</i> |                                |             |                                |             |                                |             |                                |             |
| Median > 2.4m in Width              | No                             | -10         | No                             | -10         | No                             | -10         | No                             | -10         |
| Lanes Crossed (3.5m Lane Width)     | 10 +                           |             | 10 +                           |             | 10 +                           |             |                                |             |
| <i>SIGNAL PHASING AND TIMING</i>    |                                |             |                                |             |                                |             |                                |             |
| Left Turn Conflict                  | Protected                      | 0           | Protected                      | 0           | Protected                      | 0           | Protected                      | 0           |
| Right Turn Conflict                 | Permissive or Yield            | -5          | Permissive or Yield            | -5          | Permissive or Yield            | -5          | Permissive or Yield            | -5          |
| Right Turn on Red                   | N/A                            | 0           | N/A                            | 0           | N/A                            | 0           | N/A                            | 0           |
| Leading Pedestrian Interval         | No                             | -2          | No                             | -2          | No                             | -2          | No                             | -2          |
| <i>CORNER RADIUS</i>                |                                |             |                                |             |                                |             |                                |             |
| Parallel Radius                     | > 15m to 25m                   | -8          | > 15m to 25m                   | -8          | > 15m to 25m                   | -8          | > 15m to 25m                   | -8          |
| Parallel Right Turn Channel         | Conventional without Receiving | 0           | Conventional without Receiving | 0           | Conventional without Receiving | 0           | Conventional without Receiving | 0           |
| Perpendicular Radius                | > 15m to 25m                   | -8          | > 15m to 25m                   | -8          | > 15m to 25m                   | -8          | > 15m to 25m                   | -8          |
| Perpendicular Right Turn Channel    | Conventional without Receiving | 0           | Conventional without Receiving | 0           | Conventional without Receiving | 0           | Conventional without Receiving | 0           |
| <i>CROSSING TREATMENT</i>           |                                |             |                                |             |                                |             |                                |             |
| Treatment                           | Standard                       | -7          | Standard                       | -7          | Standard                       | -7          | Standard                       | -7          |
|                                     | <b>PETSI SCORE</b>             | <b>-40</b>  |                                | <b>-40</b>  |                                | <b>-40</b>  |                                | <b>-40</b>  |
|                                     | <b>LOS</b>                     | <b>F</b>    |                                | <b>F</b>    |                                | <b>F</b>    |                                | <b>F</b>    |
| <b>DELAY SCORE</b>                  |                                |             |                                |             |                                |             |                                |             |
| Cycle Length                        |                                | 130         |                                | 130         |                                | 130         |                                | 130         |
| Pedestrian Walk Time                |                                | 7.1         |                                | 7.1         |                                | 15.3        |                                | 15.3        |
|                                     | <b>DELAY SCORE</b>             | <b>58.1</b> |                                | <b>58.1</b> |                                | <b>50.6</b> |                                | <b>50.6</b> |
|                                     | <b>LOS</b>                     | <b>E</b>    |                                | <b>E</b>    |                                | <b>E</b>    |                                | <b>E</b>    |
| <b>OVERALL</b>                      |                                | <b>F</b>    | <b>F</b>                       |             | <b>F</b>                       |             | <b>F</b>                       |             |

**Table 7: PLOS Intersection Analysis – March Road/Solandt Road**

| CRITERIA                            | North Approach                 |             | South Approach                 |             | East Approach                  |             | West Approach                  |             |
|-------------------------------------|--------------------------------|-------------|--------------------------------|-------------|--------------------------------|-------------|--------------------------------|-------------|
| <b>PETSI SCORE</b>                  |                                |             |                                |             |                                |             |                                |             |
| <i>CROSSING DISTANCE CONDITIONS</i> |                                |             |                                |             |                                |             |                                |             |
| Median > 2.4m in Width              | No                             | -10         | No                             | -10         | No                             | -10         | No                             | -10         |
| Lanes Crossed (3.5m Lane Width)     | 10 +                           |             | 10 +                           |             | 10 +                           |             |                                |             |
| <i>SIGNAL PHASING AND TIMING</i>    |                                |             |                                |             |                                |             |                                |             |
| Left Turn Conflict                  | Protected                      | 0           | Protected                      | 0           | Permissive                     | -8          | Perm + Prot                    | -8          |
| Right Turn Conflict                 | Permissive or Yield            | -5          | Permissive or Yield            | -5          | Permissive or Yield            | -5          | Permissive or Yield            | -5          |
| Right Turn on Red                   | N/A                            | 0           | N/A                            | 0           | N/A                            | 0           | N/A                            | 0           |
| Leading Pedestrian Interval         | No                             | -2          | No                             | -2          | No                             | -2          | No                             | -2          |
| <i>CORNER RADIUS</i>                |                                |             |                                |             |                                |             |                                |             |
| Parallel Radius                     | > 15m to 25m                   | -8          | > 15m to 25m                   | -8          | > 15m to 25m                   | -8          | > 15m to 25m                   | -8          |
| Parallel Right Turn Channel         | Conventional without Receiving | 0           | Conventional without Receiving | 0           | Conventional without Receiving | 0           | Conventional without Receiving | 0           |
| Perpendicular Radius                | > 15m to 25m                   | -8          | > 15m to 25m                   | -8          | > 15m to 25m                   | -8          | > 15m to 25m                   | -8          |
| Perpendicular Right Turn Channel    | Conventional without Receiving | 0           | Conventional without Receiving | 0           | Conventional without Receiving | 0           | Conventional without Receiving | 0           |
| <i>CROSSING TREATMENT</i>           |                                |             |                                |             |                                |             |                                |             |
| Treatment                           | Standard                       | -7          | Standard                       | -7          | Standard                       | -7          | Standard                       | -7          |
|                                     | <b>PETSI SCORE</b>             | <b>-40</b>  |                                | <b>-40</b>  |                                | <b>-48</b>  |                                | <b>-48</b>  |
|                                     | <b>LOS</b>                     | <b>F</b>    |                                | <b>F</b>    |                                | <b>F</b>    |                                | <b>F</b>    |
| <b>DELAY SCORE</b>                  |                                |             |                                |             |                                |             |                                |             |
| Cycle Length                        |                                | 130         |                                | 130         |                                | 130         |                                | 130         |
| Pedestrian Walk Time                |                                | 7.5         |                                | 7.5         |                                | 45.7        |                                | 27.7        |
|                                     | <b>DELAY SCORE</b>             | <b>57.7</b> |                                | <b>57.7</b> |                                | <b>27.3</b> |                                | <b>40.3</b> |
|                                     | <b>LOS</b>                     | <b>E</b>    |                                | <b>E</b>    |                                | <b>C</b>    |                                | <b>E</b>    |
|                                     | <b>OVERALL</b>                 | <b>F</b>    |                                | <b>F</b>    |                                | <b>F</b>    |                                | <b>F</b>    |

**Table 8: PLOS Intersection Analysis – Terry Fox Drive/Flamborough Way/Innovation Drive**

| CRITERIA                            | North Approach        |             | South Approach        |             | East Approach         |             | West Approach         |             |
|-------------------------------------|-----------------------|-------------|-----------------------|-------------|-----------------------|-------------|-----------------------|-------------|
| <b>PETSI SCORE</b>                  |                       |             |                       |             |                       |             |                       |             |
| <i>CROSSING DISTANCE CONDITIONS</i> |                       |             |                       |             |                       |             |                       |             |
| Median > 2.4m in Width              | No                    | 72          | No                    | 72          | No                    | 23          | No                    | 39          |
| Lanes Crossed (3.5m Lane Width)     | 5                     |             | 5                     |             | 8                     |             | 7                     |             |
| <i>SIGNAL PHASING AND TIMING</i>    |                       |             |                       |             |                       |             |                       |             |
| Left Turn Conflict                  | Perm + Prot           | -8          | Perm + Prot           | -8          | Permissive            | -8          | Perm + Prot           | -8          |
| Right Turn Conflict                 | Permissive or Yield   | -5          | Permissive or Yield   | -5          | Permissive or Yield   | -5          | Permissive or Yield   | -5          |
| Right Turn on Red                   | RTOR Allowed          | -3          | RTOR Allowed          | -3          | RTOR Allowed          | -3          | RTOR Allowed          | -3          |
| Leading Pedestrian Interval         | No                    | -2          | No                    | -2          | No                    | -2          | No                    | -2          |
| <i>CORNER RADIUS</i>                |                       |             |                       |             |                       |             |                       |             |
| Parallel Radius                     | > 10m to 15m          | -6          | > 10m to 15m          | -6          | > 10m to 15m          | -6          | > 10m to 15m          | -6          |
| Parallel Right Turn Channel         | No Right Turn Channel | -4          | No Right Turn Channel | -4          | No Right Turn Channel | -4          | No Right Turn Channel | -4          |
| Perpendicular Radius                | N/A                   | 0           | N/A                   | 0           | N/A                   | 0           | N/A                   | 0           |
| Perpendicular Right Turn Channel    | N/A                   | 0           | N/A                   | 0           | N/A                   | 0           | N/A                   | 0           |
| <i>CROSSING TREATMENT</i>           |                       |             |                       |             |                       |             |                       |             |
| Treatment                           | Standard              | -7          | Standard              | -7          | Standard              | -7          | Standard              | -7          |
|                                     | <b>PETSI SCORE</b>    | <b>37</b>   |                       | <b>37</b>   |                       | <b>-12</b>  |                       | <b>4</b>    |
|                                     | <b>LOS</b>            | <b>E</b>    |                       | <b>E</b>    |                       | <b>F</b>    |                       | <b>F</b>    |
| <b>DELAY SCORE</b>                  |                       |             |                       |             |                       |             |                       |             |
| Cycle Length                        |                       | 130         |                       | 130         |                       | 130         |                       | 130         |
| Pedestrian Walk Time                |                       | 45.1        |                       | 45.1        |                       | 13.4        |                       | 13.4        |
|                                     | <b>DELAY SCORE</b>    | <b>27.7</b> |                       | <b>27.7</b> |                       | <b>52.3</b> |                       | <b>52.3</b> |
|                                     | <b>LOS</b>            | <b>C</b>    |                       | <b>C</b>    |                       | <b>E</b>    |                       | <b>E</b>    |
|                                     | <b>OVERALL</b>        | <b>E</b>    |                       | <b>E</b>    |                       | <b>F</b>    |                       | <b>F</b>    |



Table 9: BLOS Intersection Analysis

| Approach   | Facility Type      | Criteria                        | Travel Lanes and/or Speed                              | BLOS     |
|--|--------------------|---------------------------------|--|----------|
| <b>March Road/Morgan's Grant Way/Shirley's Brook Drive</b> |                    |                                 |  |          |
| North Approach   | Pocket Bike Lane   | Right Turn Lane Characteristics | Right turn lane $\leq$ 50m and introduced to the right | <b>B</b> |
|  |                    | Left Turn Accommodation         | Three lanes crossed, $\geq$ 60 km/h                    | <b>F</b> |
| South Approach   | Pocket Bike Lane   | Right Turn Lane Characteristics | Right turn lane $\leq$ 50m and introduced to the right | <b>B</b> |
|  |                    | Left Turn Accommodation         | Three lanes crossed, $\geq$ 60 km/h                    | <b>F</b> |
| East Approach  | Pocket Bike Lane   | Right Turn Lane Characteristics | Right turn lane $\leq$ 50m and introduced to the right | <b>B</b> |
|  |                    | Left Turn Accommodation         | One lane crossed, 50 km/h                              | <b>C</b> |
| West Approach  | Curbside Bike Lane | Right Turn Lane Characteristics | No impact to level of traffic stress                   | <b>A</b> |
|  |                    | Left Turn Accommodation         | No lanes crossed, $\leq$ 50 km/h                       | <b>B</b> |
| <b>March Road/Terry Fox Drive</b>                          |                    |                                 |  |          |
| North Approach   | Pocket Bike Lane   | Right Turn Lane Characteristics | Right turn lane $>$ 50m and introduced to the right    | <b>D</b> |
|  |                    | Left Turn Accommodation         | Three lanes crossed, $\geq$ 50 km/h                    | <b>F</b> |
| South Approach   | Pocket Bike Lane   | Right Turn Lane Characteristics | Right turn lane $>$ 50m and introduced to the right    | <b>D</b> |
|  |                    | Left Turn Accommodation         | Dual left turn lanes                                   | <b>F</b> |
| East Approach  | Pocket Bike Lane   | Right Turn Lane Characteristics | Right turn lane $>$ 50m and introduced to the right    | <b>D</b> |
|  |                    | Left Turn Accommodation         | Dual left turn lanes                                   | <b>F</b> |
| West Approach  | Pocket Bike Lane   | Right Turn Lane Characteristics | Right turn lane $>$ 50m and introduced to the right    | <b>D</b> |
|  |                    | Left Turn Accommodation         | Dual left turn lanes                                   | <b>F</b> |
| <b>March Road/Solandt Road</b>                             |                    |                                 |  |          |
| North Approach   | Pocket Bike Lane   | Right Turn Lane Characteristics | Right turn lane $>$ 50m and introduced to the right    | <b>D</b> |
|  |                    | Left Turn Accommodation         | Two-stage left-turn bike box                           | <b>A</b> |
| South Approach   | Pocket Bike Lane   | Right Turn Lane Characteristics | Bike lane shifts to the left of the right turn lane    | <b>D</b> |
|  |                    | Left Turn Accommodation         | Two-stage left-turn bike box                           | <b>A</b> |
| East Approach  | Mixed Traffic      | Right Turn Lane Characteristics | Shared through/right turn lane                         | <b>A</b> |
|  |                    | Left Turn Accommodation         | Dual left turn lanes                                   | <b>F</b> |
| West Approach  | Mixed Traffic      | Right Turn Lane Characteristics | Right turn lane $>$ 50m                                | <b>F</b> |
|  |                    | Left Turn Accommodation         | One lane crossed, $\geq$ 60 km/h                       | <b>F</b> |

| Approach  | Facility Type    | Criteria                        | Travel Lanes and/or Speed                         | BLOS |
|---|------------------|---------------------------------|---|------|
| <b>Terry Fox Drive/Flamborough Way/Innovation Drive</b> |                  |                                 |   |      |
| North Approach  | Mixed Traffic    | Right Turn Lane Characteristics | Shared through/right turn lane                    | A    |
|   |                  | Left Turn Accommodation         | One lane crossed; 50 km/h                         | D    |
| South Approach  | Mixed Traffic    | Right Turn Lane Characteristics | Shared through/right turn lane                    | A    |
|   |                  | Left Turn Accommodation         | One lane crossed; 50 km/h                         | F    |
| East Approach   | Pocket Bike Lane | Right Turn Lane Characteristics | Right turn lane > 50m and introduced to the right | D    |
|   |                  | Left Turn Accommodation         | One lane crossed; 50 km/h                         | E    |
| West Approach   | Pocket Bike Lane | Right Turn Lane Characteristics | Right turn lane > 50m and introduced to the right | D    |
|   |                  | Left Turn Accommodation         | One lane crossed; 50 km/h                         | E    |

Table 10: TLOS Intersection Analysis

| Approach   | Delay <sup>(1)</sup> |         | TLOS |
|--|----------------------|---------|------|
|  | AM Peak              | PM Peak |      |
| <b>March Road/Morgan's Grant Way/Shirley's Brook Drive</b> |                      |         |      |
| North Approach   | 11 sec               | 16 sec  | C    |
| South Approach   | 10 sec               | 9 sec   | B    |
| East Approach  | 59 sec               | 54 sec  | F    |
| West Approach  | 17 sec               | 19 sec  | C    |
| <b>March Road/Terry Fox Drive</b>                          |                      |         |      |
| North Approach   | 20 sec               | 27 sec  | D    |
| South Approach   | 30 sec               | 28 sec  | D    |
| East Approach  | 45 sec               | 38 sec  | F    |
| West Approach  | 35 sec               | 41 sec  | F    |
| <b>March Road/Solandt Road</b>                             |                      |         |      |
| North Approach   | 15 sec               | 23 sec  | D    |
| South Approach   | 8 sec                | 17 sec  | C    |
| East Approach  | 58 sec               | 54 sec  | F    |
| West Approach  | 25 sec               | 41 sec  | F    |
| <b>Terry Fox Drive/Flamborough Way/Innovation Drive</b>    |                      |         |      |
| North Approach   | 63 sec               | 41 sec  | F    |
| South Approach   | 36 sec               | 63 sec  | F    |
| East Approach  | 4 sec                | 5 sec   | B    |
| West Approach  | 9 sec                | 12 sec  | C    |

1. Delay based on outputs from Synchro analysis of existing conditions

Table 11: TkLOS Intersection Analysis

| Approach   | Effective Corner Radius | Number of Receiving Lanes Departing Intersection | TkLOS |
|--|-------------------------|--|-------|
| <b>March Road/Morgan's Grant Way/Shirley's Brook Drive</b> |                         |  |       |
| North Approach   | > 15m                   | 1  | C     |
| South Approach   | > 15m                   | 1  | C     |
| East Approach  | > 15m                   | 3  | A     |
| West Approach  | > 15m                   | 3  | A     |
| <b>March Road/Terry Fox Drive</b>                          |                         |  |       |
| North Approach   | > 15m                   | 2  | A     |
| South Approach   | > 15m                   | 2  | A     |
| East Approach  | > 15m                   | 3  | A     |
| West Approach  | > 15m                   | 3  | A     |
| <b>March Road/Solandt Road</b>                             |                         |  |       |
| North Approach   | > 15m                   | 2  | A     |
| South Approach   | > 15m                   | 2  | A     |
| East Approach  | > 15m                   | 3  | A     |
| West Approach  | > 15m                   | 3  | A     |
| <b>Terry Fox Drive/Flamborough Way/Innovation Drive</b>    |                         |  |       |
| North Approach   | > 15m                   | 1  | C     |
| South Approach   | > 15m                   | 1  | C     |
| East Approach  | > 15m                   | 1  | C     |
| West Approach  | > 15m                   | 1  | C     |

## **APPENDIX O**

---

Left Turn Lane Warrants

**Exhibit 9A-10**

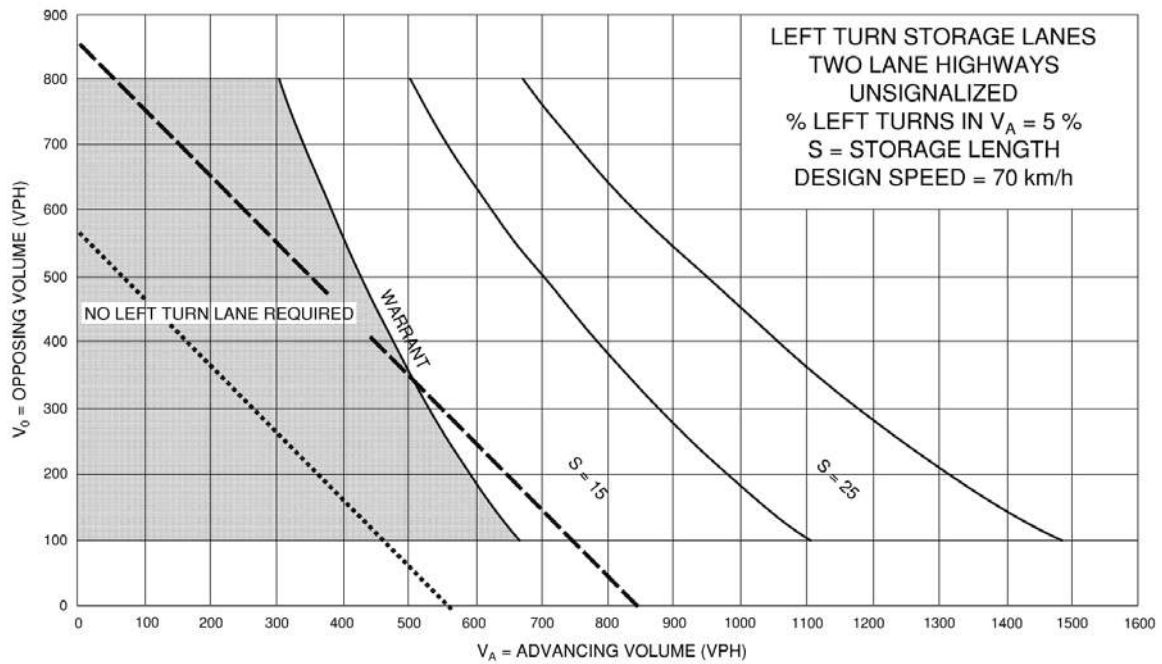

- TRAFFIC SIGNALS MAY BE WARRANTED IN RURAL AREAS OR URBAN AREAS WITH RESTRICTED FLOW
- ..... TRAFFIC SIGNALS MAY BE WARRANTED IN "FREE FLOW" URBAN AREAS

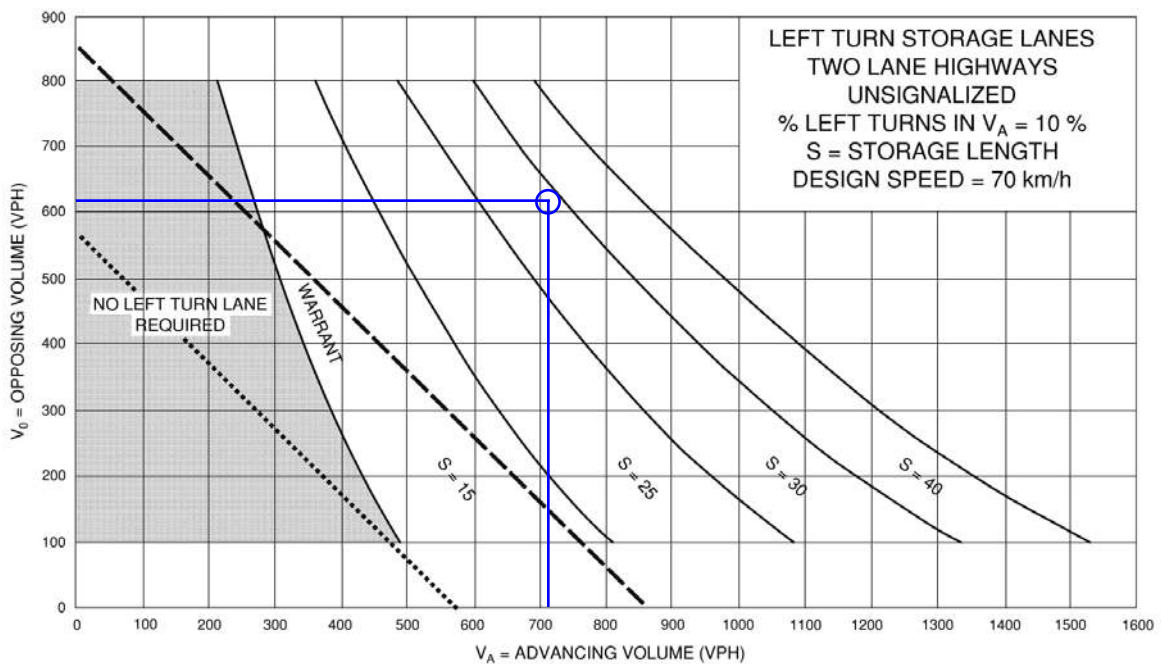

**Exhibit 9A-11**

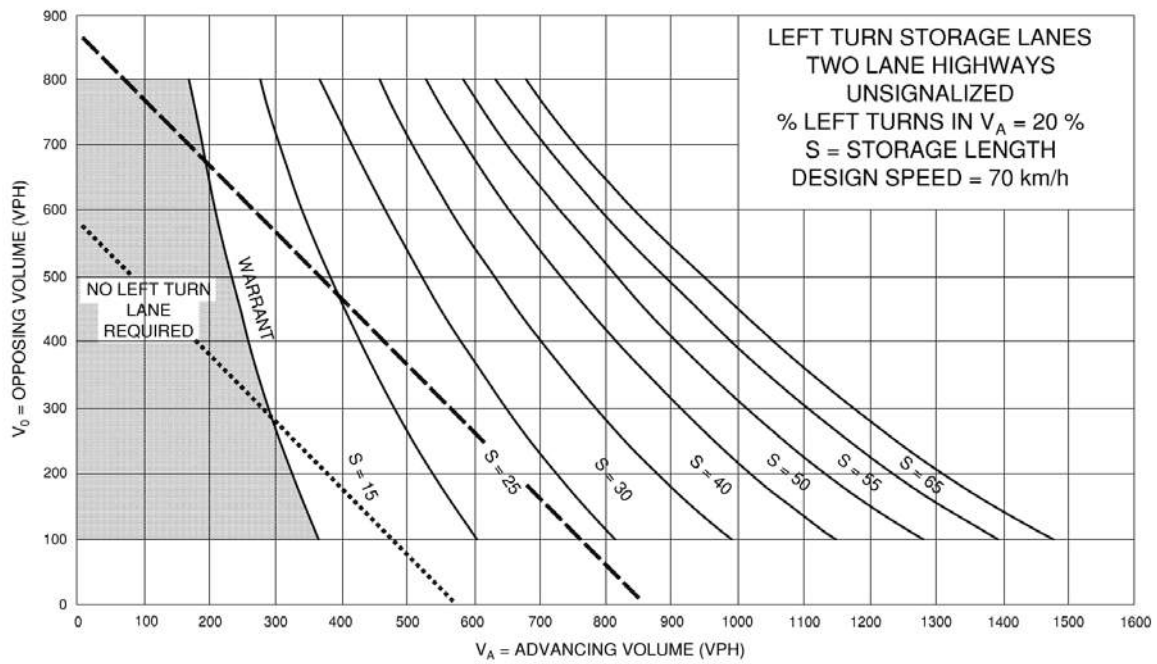
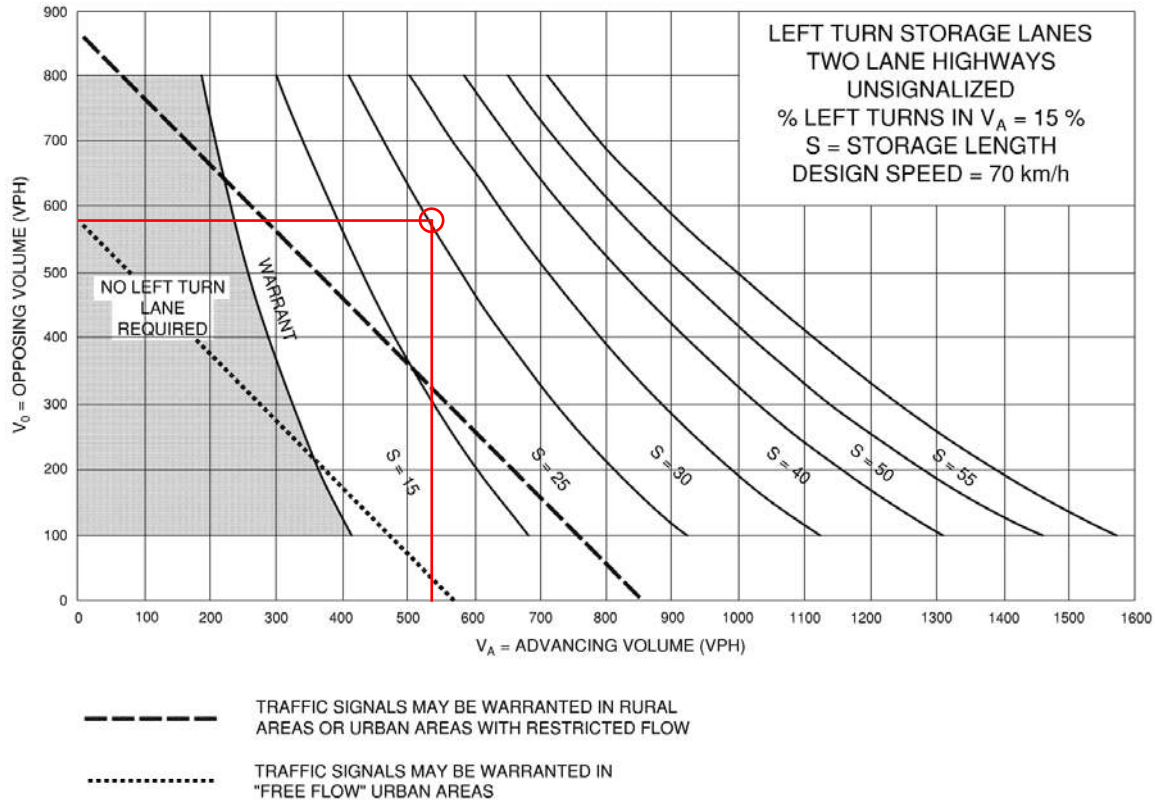

## **APPENDIX P**

---

### Functional Design of Terry Fox Drive Access

- LEGEND**
- ◻ EXISTING MANHOLE
  - ◻ EXISTING CATCHBASIN
  - ◻ EXISTING DITCH INLET CATCH BASIN
  - EXISTING VALVE CHAMBER
  - EXISTING VALVE BOX
  - EXISTING HYDRANT
  - ◻ EXISTING TRAFFIC MANHOLE
  - ⋆ EXISTING TRAFFIC POLE
  - ⋆ EXISTING TRAFFIC HANDHOLE

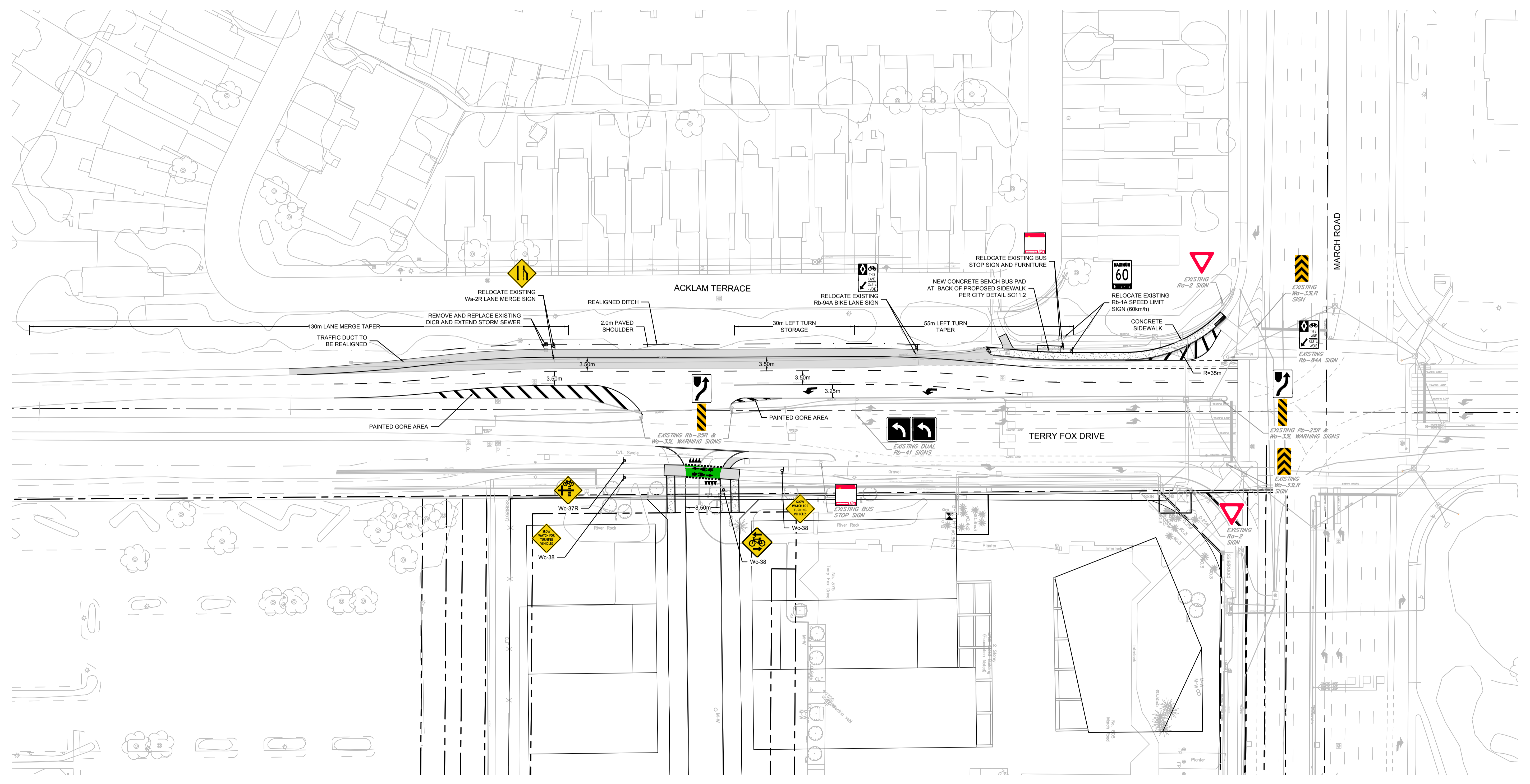
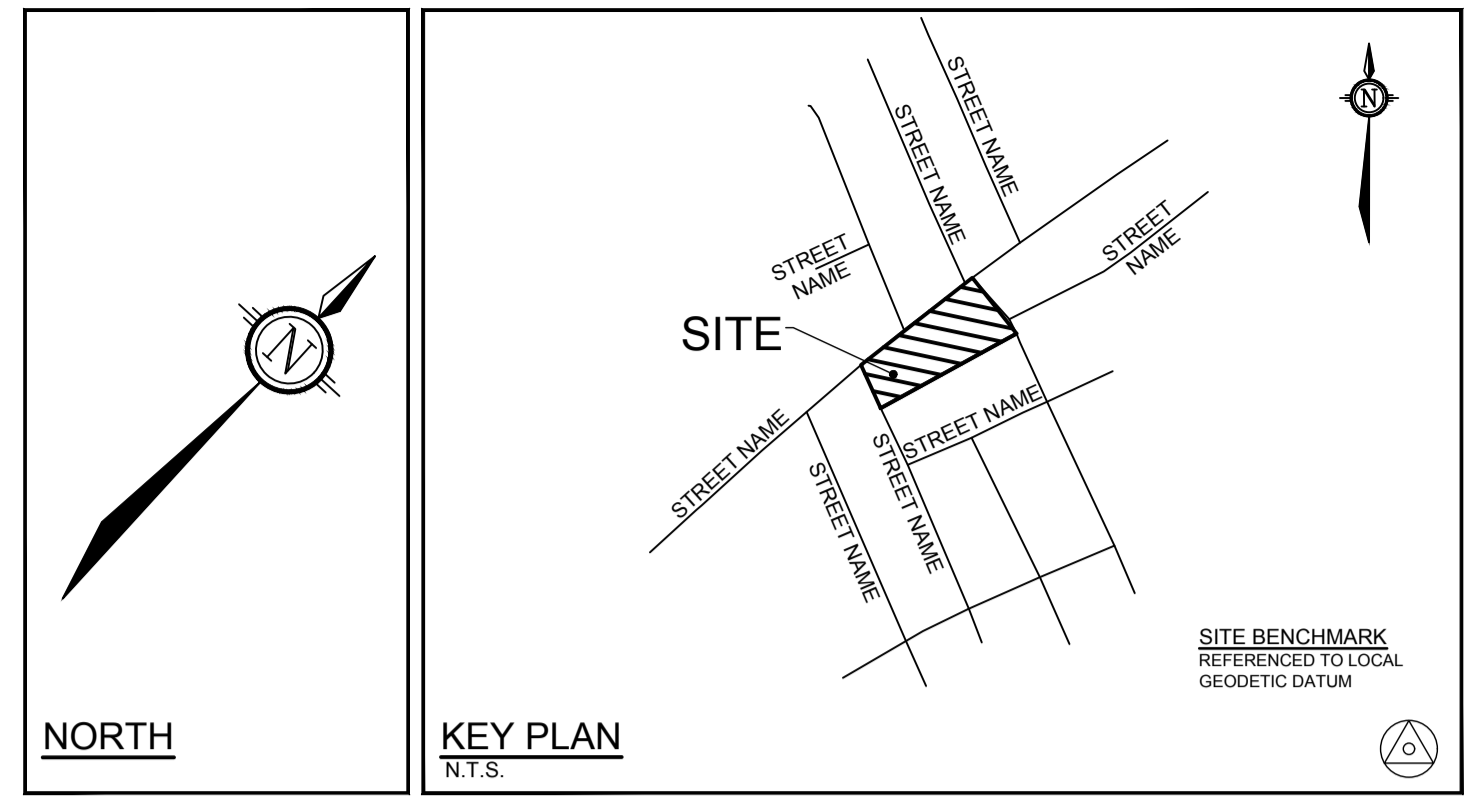

**NOTE:**  
THE POSITION OF ALL POLE LINES, CONDUITS, WATERMANS, SEWERS AND OTHER UNDERGROUND AND OVERGROUND UTILITIES AND STRUCTURES IS NOT NECESSARILY SHOWN ON THE CONTRACT DRAWINGS, AND WHERE SHOWN, THE ACCURACY OF THE POSITION OF SUCH UTILITIES AND STRUCTURES IS NOT GUARANTEED. BEFORE STARTING WORK, DETERMINE THE EXACT LOCATION OF ALL SUCH UTILITIES AND STRUCTURES AND ASSUME ALL LIABILITY FOR DAMAGE TO THEM.

| No. | REVISION               | DATE      | BY  |
|-----|------------------------|-----------|-----|
| 1.  | ISSUED FOR CITY REVIEW | DEC 18/23 | BJB |

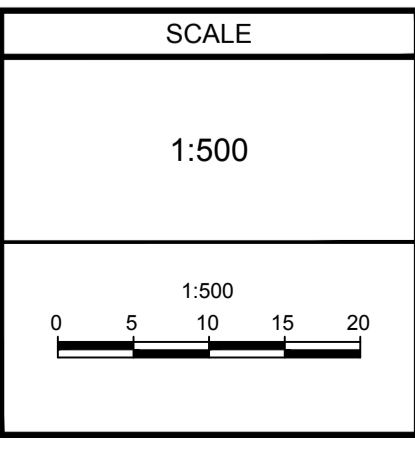

| DESIGN   | RCH |
|----------|-----|
| CHECKED  | JRA |
| DRAWN    | RCH |
| CHECKED  | JRA |
| APPROVED | BJB |

**FOR REVIEW ONLY**

**NOVATECH**  
Engineers, Planners & Landscape Architects  
Suite 200, 240 Michael Cowpland Drive  
Ottawa, Ontario, Canada K2M 1P6  
Telephone (613) 254-9643  
Facsimile (613) 254-5867  
Website www.novatech-eng.com

|  |                                 |
|--|---------------------------------|
| <b>LOCATION</b><br>CITY OF OTTAWA<br>TERRY FOX DRIVE ROADWAY MODIFICATIONS |                                 |
| <b>DRAWING NAME</b><br>FUNCTIONAL DESIGN                                   | <b>PROJECT No.</b><br>122125    |
|  | <b>REV</b><br>REV # 1           |
|  | <b>DRAWING No.</b><br>122125-FD |

C:\temp\p\publish\_1177611212125-FD.dwg, FD, Dec 18, 2023, 1:50pm, miller



## **APPENDIX Q**

---

### Transportation Demand Management

**TDM Measures Checklist:**  
*Residential Developments (multi-family, condominium or subdivision)*

| <b>Legend</b> |  |
|---------------|--|
| <b>BASIC</b>  | The measure is generally feasible and effective, and in most cases would benefit the development and its users |
| <b>BETTER</b> | The measure could maximize support for users of sustainable modes, and optimize development performance        |
| ★             | The measure is one of the most dependably effective tools to encourage the use of sustainable modes            |

| <b>TDM measures: Residential developments</b>                       |   | <b>Check if proposed &amp; add descriptions</b> |
|---|---|---|
| <b>1. TDM PROGRAM MANAGEMENT</b>                                    |   |   |
| <b>1.1 Program coordinator</b>                                      |   |   |
| <b>BASIC</b>  | ★ 1.1.1 Designate an internal coordinator, or contract with an external coordinator   | <input checked="" type="checkbox"/>             |
| <b>1.2 Travel surveys</b>   |   |   |
| <b>BETTER</b>   | 1.2.1 Conduct periodic surveys to identify travel-related behaviours, attitudes, challenges and solutions, and to track progress              | <input type="checkbox"/>                        |
| <b>2. WALKING AND CYCLING</b>                                       |   |   |
| <b>2.1 Information on walking/cycling routes &amp; destinations</b> |   |   |
| <b>BASIC</b>  | 2.1.1 Display local area maps with walking/cycling access routes and key destinations at major entrances ( <i>multi-family, condominium</i> ) | <input checked="" type="checkbox"/>             |
| <b>2.2 Bicycle skills training</b>                                  |   |   |
| <b>BETTER</b>   | 2.2.1 Offer on-site cycling courses for residents, or subsidize off-site courses  | <input type="checkbox"/>                        |

| TDM measures: <i>Residential developments</i>   |  | Check if proposed & add descriptions |
|---|--|--------------------------------------|
| <b>3. TRANSIT</b>                               |  |                                      |
| <b>3.1 Transit information</b>                  |  |                                      |
| BASIC   | 3.1.1 Display relevant transit schedules and route maps at entrances ( <i>multi-family, condominium</i> )  | <input checked="" type="checkbox"/>  |
| BETTER  | 3.1.2 Provide real-time arrival information display at entrances ( <i>multi-family, condominium</i> )  | <input type="checkbox"/>             |
| <b>3.2 Transit fare incentives</b>              |  |                                      |
| BASIC ★   | 3.2.1 Offer PRESTO cards preloaded with one monthly transit pass on residence purchase/move-in, to encourage residents to use transit            | <input type="checkbox"/>             |
| BETTER  | 3.2.2 Offer at least one year of free monthly transit passes on residence purchase/move-in   | <input type="checkbox"/>             |
| <b>3.3 Enhanced public transit service</b>      |  |                                      |
| BETTER ★  | 3.3.1 Contract with OC Transpo to provide early transit services until regular services are warranted by occupancy levels ( <i>subdivision</i> ) | <input type="checkbox"/>             |
| <b>3.4 Private transit service</b>              |  |                                      |
| BETTER  | 3.4.1 Provide shuttle service for seniors homes or lifestyle communities (e.g. scheduled mall or supermarket runs)                               | <input type="checkbox"/>             |
| <b>4. CARSHARING &amp; BIKESHARING</b>          |  |                                      |
| <b>4.1 Bikeshare stations &amp; memberships</b> |  |                                      |
| BETTER  | 4.1.1 Contract with provider to install on-site bikeshare station ( <i>multi-family</i> )  | <input checked="" type="checkbox"/>  |
| BETTER  | 4.1.2 Provide residents with bikeshare memberships, either free or subsidized ( <i>multi-family</i> )  | <input type="checkbox"/>             |
| <b>4.2 Carshare vehicles &amp; memberships</b>  |  |                                      |
| BETTER  | 4.2.1 Contract with provider to install on-site carshare vehicles and promote their use by residents   | <input checked="" type="checkbox"/>  |
| BETTER  | 4.2.2 Provide residents with carshare memberships, either free or subsidized   | <input type="checkbox"/>             |
| <b>5. PARKING</b>                               |  |                                      |
| <b>5.1 Priced parking</b>                       |  |                                      |
| BASIC ★   | 5.1.1 Unbundle parking cost from purchase price ( <i>condominium</i> )   | <input checked="" type="checkbox"/>  |
| BASIC ★   | 5.1.2 Unbundle parking cost from monthly rent ( <i>multi-family</i> )  | <input checked="" type="checkbox"/>  |

| TDM measures: <i>Residential developments</i> |   | Check if proposed & add descriptions |
|---|---|--------------------------------------|
| <b>6. TDM MARKETING &amp; COMMUNICATIONS</b>  |   |                                      |
| <b>6.1 Multimodal travel information</b>      |   |                                      |
| <b>BASIC</b> ★                                | 6.1.1 Provide a multimodal travel option information package to new residents | <input checked="" type="checkbox"/>  |
| <b>6.2 Personalized trip planning</b>         |   |                                      |
| <b>BETTER</b> ★                               | 6.2.1 Offer personalized trip planning to new residents                       | <input type="checkbox"/>             |

**TDM Measures Checklist:**  
*Non-Residential Developments (office, institutional, retail or industrial)*

| <b>Legend</b> |  |
|---------------|--|
| <b>BASIC</b>  | The measure is generally feasible and effective, and in most cases would benefit the development and its users |
| <b>BETTER</b> | The measure could maximize support for users of sustainable modes, and optimize development performance        |
| ★             | The measure is one of the most dependably effective tools to encourage the use of sustainable modes            |

| TDM measures: <i>Non-residential developments</i>                   |   | Check if proposed & add descriptions   |
|---|---|--|
| <b>1. TDM PROGRAM MANAGEMENT</b>                                    |   |  |
| <b>1.1 Program coordinator</b>                                      |   |  |
| BASIC   | ★ | 1.1.1 Designate an internal coordinator, or contract with an external coordinator <input checked="" type="checkbox"/>                                      |
| <b>1.2 Travel surveys</b>   |   |  |
| BETTER  |   | 1.2.1 Conduct periodic surveys to identify travel-related behaviours, attitudes, challenges and solutions, and to track progress <input type="checkbox"/>  |
| <b>2. WALKING AND CYCLING</b>                                       |   |  |
| <b>2.1 Information on walking/cycling routes &amp; destinations</b> |   |  |
| BASIC   |   | 2.1.1 Display local area maps with walking/cycling access routes and key destinations at major entrances <input checked="" type="checkbox"/>               |
| <b>2.2 Bicycle skills training</b>                                  |   |  |
| <i>Commuter travel</i>  |   |  |
| BETTER  | ★ | 2.2.1 Offer on-site cycling courses for commuters, or subsidize off-site courses <input type="checkbox"/>  |
| <b>2.3 Valet bike parking</b>                                       |   |  |
| <i>Visitor travel</i>   |   |  |
| BETTER  |   | 2.3.1 Offer secure valet bike parking during public events when demand exceeds fixed supply (e.g. for festivals, concerts, games) <input type="checkbox"/> |

| TDM measures: <i>Non-residential developments</i> |   | Check if proposed & add descriptions |
|---|---|--------------------------------------|
| <b>3. TRANSIT</b>                                 |   |                                      |
| <b>3.1 Transit information</b>                    |   |                                      |
| BASIC   | 3.1.1 Display relevant transit schedules and route maps at entrances  | <input checked="" type="checkbox"/>  |
| BASIC   | 3.1.2 Provide online links to OC Transpo and STO information  | <input checked="" type="checkbox"/>  |
| BETTER  | 3.1.3 Provide real-time arrival information display at entrances  | <input type="checkbox"/>             |
| <b>3.2 Transit fare incentives</b>                |   |                                      |
| <i>Commuter travel</i>                            |   |                                      |
| BETTER  | 3.2.1 Offer preloaded PRESTO cards to encourage commuters to use transit  | <input type="checkbox"/>             |
| BETTER ★  | 3.2.2 Subsidize or reimburse monthly transit pass purchases by employees  | <input type="checkbox"/>             |
| <i>Visitor travel</i>                             |   |                                      |
| BETTER  | 3.2.3 Arrange inclusion of same-day transit fare in price of tickets (e.g. for festivals, concerts, games)                                      | <input type="checkbox"/>             |
| <b>3.3 Enhanced public transit service</b>        |   |                                      |
| <i>Commuter travel</i>                            |   |                                      |
| BETTER  | 3.3.1 Contract with OC Transpo to provide enhanced transit services (e.g. for shift changes, weekends)  | <input type="checkbox"/>             |
| <i>Visitor travel</i>                             |   |                                      |
| BETTER  | 3.3.2 Contract with OC Transpo to provide enhanced transit services (e.g. for festivals, concerts, games)                                       | <input type="checkbox"/>             |
| <b>3.4 Private transit service</b>                |   |                                      |
| <i>Commuter travel</i>                            |   |                                      |
| BETTER  | 3.4.1 Provide shuttle service when OC Transpo cannot offer sufficient quality or capacity to serve demand (e.g. for shift changes, weekends)    | <input type="checkbox"/>             |
| <i>Visitor travel</i>                             |   |                                      |
| BETTER  | 3.4.2 Provide shuttle service when OC Transpo cannot offer sufficient quality or capacity to serve demand (e.g. for festivals, concerts, games) | <input type="checkbox"/>             |

| TDM measures: <i>Non-residential developments</i> |   | Check if proposed & add descriptions |
|---|---|--------------------------------------|
| <b>4. RIDESHARING</b>                             |   |                                      |
| <b>4.1 Ridematching service</b>                   |   |                                      |
| <i>Commuter travel</i>                            |   |                                      |
| <b>BASIC</b> ★                                    | 4.1.1 Provide a dedicated ridematching portal at OttawaRideMatch.com                                | <input checked="" type="checkbox"/>  |
| <b>4.2 Carpool parking price incentives</b>       |   |                                      |
| <i>Commuter travel</i>                            |   |                                      |
| <b>BETTER</b>                                     | 4.2.1 Provide discounts on parking costs for registered carpools                                    | <input type="checkbox"/>             |
| <b>4.3 Vanpool service</b>                        |   |                                      |
| <i>Commuter travel</i>                            |   |                                      |
| <b>BETTER</b>                                     | 4.3.1 Provide a vanpooling service for long-distance commuters                                      | <input type="checkbox"/>             |
| <b>5. CARSHARING &amp; BIKESHARING</b>            |   |                                      |
| <b>5.1 Bikeshare stations &amp; memberships</b>   |   |                                      |
| <b>BETTER</b>                                     | 5.1.1 Contract with provider to install on-site bikeshare station for use by commuters and visitors | <input checked="" type="checkbox"/>  |
| <i>Commuter travel</i>                            |   |                                      |
| <b>BETTER</b>                                     | 5.1.2 Provide employees with bikeshare memberships for local business travel                        | <input type="checkbox"/>             |
| <b>5.2 Carshare vehicles &amp; memberships</b>    |   |                                      |
| <i>Commuter travel</i>                            |   |                                      |
| <b>BETTER</b>                                     | 5.2.1 Contract with provider to install on-site carshare vehicles and promote their use by tenants  | <input checked="" type="checkbox"/>  |
| <b>BETTER</b>                                     | 5.2.2 Provide employees with carshare memberships for local business travel                         | <input type="checkbox"/>             |
| <b>6. PARKING</b>                                 |   |                                      |
| <b>6.1 Priced parking</b>                         |   |                                      |
| <i>Commuter travel</i>                            |   |                                      |
| <b>BASIC</b> ★                                    | 6.1.1 Charge for long-term parking (daily, weekly, monthly)   | <input checked="" type="checkbox"/>  |
| <b>BASIC</b>                                      | 6.1.2 Unbundle parking cost from lease rates at multi-tenant sites                                  | <input type="checkbox"/>             |
| <i>Visitor travel</i>                             |   |                                      |
| <b>BETTER</b>                                     | 6.1.3 Charge for short-term parking (hourly)  | <input checked="" type="checkbox"/>  |

| TDM measures: <i>Non-residential developments</i> |   | Check if proposed & add descriptions |
|---|---|--------------------------------------|
| <b>7. TDM MARKETING &amp; COMMUNICATIONS</b>      |   |                                      |
| <b>7.1 Multimodal travel information</b>          |   |                                      |
| <i>Commuter travel</i>                            |   |                                      |
| BASIC ★   | 7.1.1 Provide a multimodal travel option information package to new/relocating employees and students   | <input checked="" type="checkbox"/>  |
| <i>Visitor travel</i>                             |   |                                      |
| BETTER ★  | 7.1.2 Include multimodal travel option information in invitations or advertising that attract visitors or customers (e.g. for festivals, concerts, games) | <input type="checkbox"/>             |
| <b>7.2 Personalized trip planning</b>             |   |                                      |
| <i>Commuter travel</i>                            |   |                                      |
| BETTER ★  | 7.2.1 Offer personalized trip planning to new/relocating employees  | <input type="checkbox"/>             |
| <b>7.3 Promotions</b>                             |   |                                      |
| <i>Commuter travel</i>                            |   |                                      |
| BETTER  | 7.3.1 Deliver promotions and incentives to maintain awareness, build understanding, and encourage trial of sustainable modes                              | <input type="checkbox"/>             |
| <b>8. OTHER INCENTIVES &amp; AMENITIES</b>        |   |                                      |
| <b>8.1 Emergency ride home</b>                    |   |                                      |
| <i>Commuter travel</i>                            |   |                                      |
| BETTER ★  | 8.1.1 Provide emergency ride home service to non-driving commuters  | <input type="checkbox"/>             |
| <b>8.2 Alternative work arrangements</b>          |   |                                      |
| <i>Commuter travel</i>                            |   |                                      |
| BASIC ★   | 8.2.1 Encourage flexible work hours   | <input checked="" type="checkbox"/>  |
| BETTER  | 8.2.2 Encourage compressed workweeks  | <input type="checkbox"/>             |
| BETTER ★  | 8.2.3 Encourage telework  | <input type="checkbox"/>             |
| <b>8.3 Local business travel options</b>          |   |                                      |
| <i>Commuter travel</i>                            |   |                                      |
| BASIC ★   | 8.3.1 Provide local business travel options that minimize the need for employees to bring a personal car to work  | <input checked="" type="checkbox"/>  |
| <b>8.4 Commuter incentives</b>                    |   |                                      |
| <i>Commuter travel</i>                            |   |                                      |
| BETTER  | 8.4.1 Offer employees a taxable, mode-neutral commuting allowance   | <input type="checkbox"/>             |
| <b>8.5 On-site amenities</b>                      |   |                                      |
| <i>Commuter travel</i>                            |   |                                      |
| BETTER  | 8.5.1 Provide on-site amenities/services to minimize mid-day or mid-commute errands   | <input checked="" type="checkbox"/>  |



## **APPENDIX R**

---

Total Synchro Analysis

1: March & Morgan's Grant/Shirley's Brook  
AM Peak Hour

555-603 March Road  
2037 Total Traffic (pre-BRT)



| Lane Group                 | EBL   | EBT   | EBR   | WBL   | WBT   | WBR   | NBL   | NBT   | NBR   | SBL   | SBT   | SBR   |
|----------------------------|-------|-------|-------|-------|-------|-------|-------|-------|-------|-------|-------|-------|
| Lane Configurations        |       | ↕     | ↗     | ↖     | ↕     | ↗     | ↖     | ↕↕↕   | ↗     | ↖     | ↕↕↕   | ↗     |
| Traffic Volume (vph)       | 26    | 38    | 73    | 89    | 14    | 25    | 26    | 1010  | 41    | 100   | 1878  | 10    |
| Future Volume (vph)        | 26    | 38    | 73    | 89    | 14    | 25    | 26    | 1010  | 41    | 100   | 1878  | 10    |
| Ideal Flow (vphpl)         | 1800  | 1800  | 1800  | 1800  | 1800  | 1800  | 1800  | 1800  | 1800  | 1800  | 1800  | 1800  |
| Storage Length (m)         | 0.0   |       | 20.0  | 45.0  |       | 35.0  | 130.0 |       | 30.0  | 65.0  |       | 25.0  |
| Storage Lanes              | 0     |       | 1     | 1     |       | 1     | 1     |       | 1     | 1     |       | 1     |
| Taper Length (m)           | 10.0  |       |       | 30.0  |       |       | 40.0  |       |       | 35.0  |       |       |
| Lane Util. Factor          | 1.00  | 1.00  | 1.00  | 1.00  | 1.00  | 1.00  | 1.00  | 0.91  | 1.00  | 1.00  | 0.91  | 1.00  |
| Ped Bike Factor            |       | 1.00  | 0.98  | 0.99  |       | 0.98  | 1.00  |       | 0.96  | 1.00  |       | 0.96  |
| Frt                        |       |       | 0.850 |       |       | 0.850 |       |       | 0.850 |       |       | 0.850 |
| Flt Protected              |       | 0.980 |       | 0.950 |       |       | 0.950 |       |       | 0.950 |       |       |
| Satd. Flow (prot)          | 0     | 1727  | 1498  | 1580  | 1271  | 1498  | 1674  | 4628  | 1427  | 1674  | 4718  | 1498  |
| Flt Permitted              |       | 0.862 |       | 0.715 |       |       | 0.950 |       |       | 0.950 |       |       |
| Satd. Flow (perm)          | 0     | 1515  | 1464  | 1183  | 1271  | 1464  | 1672  | 4628  | 1368  | 1667  | 4718  | 1436  |
| Right Turn on Red          |       |       | Yes   |       |       | Yes   |       |       | Yes   |       |       | Yes   |
| Satd. Flow (RTOR)          |       |       | 136   |       |       | 136   |       |       | 145   |       |       | 91    |
| Link Speed (k/h)           |       | 40    |       |       | 40    |       |       | 60    |       |       | 60    |       |
| Link Distance (m)          |       | 465.2 |       |       | 359.5 |       |       | 318.9 |       |       | 462.6 |       |
| Travel Time (s)            |       | 41.9  |       |       | 32.4  |       |       | 19.1  |       |       | 27.8  |       |
| Confl. Peds. (#/hr)        | 5     |       | 5     | 5     |       | 5     | 5     |       | 5     | 5     |       | 5     |
| Confl. Bikes (#/hr)        |       |       | 5     |       |       | 5     |       |       | 5     |       |       | 5     |
| Peak Hour Factor           | 1.00  | 1.00  | 1.00  | 1.00  | 1.00  | 1.00  | 1.00  | 1.00  | 1.00  | 1.00  | 1.00  | 1.00  |
| Heavy Vehicles (%)         | 1%    | 1%    | 1%    | 7%    | 40%   | 1%    | 1%    | 5%    | 6%    | 1%    | 3%    | 1%    |
| Adj. Flow (vph)            | 26    | 38    | 73    | 89    | 14    | 25    | 26    | 1010  | 41    | 100   | 1878  | 10    |
| Shared Lane Traffic (%)    |       |       |       |       |       |       |       |       |       |       |       |       |
| Lane Group Flow (vph)      | 0     | 64    | 73    | 89    | 14    | 25    | 26    | 1010  | 41    | 100   | 1878  | 10    |
| Enter Blocked Intersection | No    | No    | No    | No    | No    | No    | No    | No    | No    | No    | No    | No    |
| Lane Alignment             | L NA  | Left  | R NA  | L NA  | Left  | R NA  | L NA  | Left  | R NA  | L NA  | Left  | R NA  |
| Median Width(m)            |       | 3.5   |       |       | 5.0   |       |       | 9.0   |       |       | 9.0   |       |
| Link Offset(m)             |       | 0.0   |       |       | 0.0   |       |       | 0.0   |       |       | 0.0   |       |
| Crosswalk Width(m)         |       | 5.0   |       |       | 5.0   |       |       | 5.0   |       |       | 5.0   |       |
| Two way Left Turn Lane     |       |       |       |       |       |       |       |       |       |       |       |       |
| Headway Factor             | 1.09  | 1.09  | 1.09  | 1.09  | 1.09  | 1.09  | 1.09  | 1.09  | 1.09  | 1.09  | 1.09  | 1.09  |
| Number of Detectors        | 1     | 2     | 1     | 1     | 2     | 1     | 1     | 2     | 1     | 1     | 2     | 1     |
| Detector Template          | Left  | Thru  | Right | Left  | Thru  | Right | Left  | Thru  | Right | Left  | Thru  | Right |
| Leading Detector (m)       | 2.0   | 10.0  | 2.0   | 2.0   | 10.0  | 2.0   | 2.0   | 10.0  | 2.0   | 2.0   | 10.0  | 2.0   |
| Trailing Detector (m)      | 0.0   | 0.0   | 0.0   | 0.0   | 0.0   | 0.0   | 0.0   | 0.0   | 0.0   | 0.0   | 0.0   | 0.0   |
| Detector 1 Position(m)     | 0.0   | 0.0   | 0.0   | 0.0   | 0.0   | 0.0   | 0.0   | 0.0   | 0.0   | 0.0   | 0.0   | 0.0   |
| Detector 1 Size(m)         | 2.0   | 0.6   | 2.0   | 2.0   | 0.6   | 2.0   | 2.0   | 0.6   | 2.0   | 2.0   | 0.6   | 2.0   |
| Detector 1 Type            | Cl+Ex | Cl+Ex | Cl+Ex | Cl+Ex | Cl+Ex | Cl+Ex | Cl+Ex | Cl+Ex | Cl+Ex | Cl+Ex | Cl+Ex | Cl+Ex |
| Detector 1 Channel         |       |       |       |       |       |       |       |       |       |       |       |       |
| Detector 1 Extend (s)      | 0.0   | 0.0   | 0.0   | 0.0   | 0.0   | 0.0   | 0.0   | 0.0   | 0.0   | 0.0   | 0.0   | 0.0   |
| Detector 1 Queue (s)       | 0.0   | 0.0   | 0.0   | 0.0   | 0.0   | 0.0   | 0.0   | 0.0   | 0.0   | 0.0   | 0.0   | 0.0   |
| Detector 1 Delay (s)       | 0.0   | 0.0   | 0.0   | 0.0   | 0.0   | 0.0   | 0.0   | 0.0   | 0.0   | 0.0   | 0.0   | 0.0   |
| Detector 2 Position(m)     |       | 9.4   |       |       | 9.4   |       |       | 9.4   |       |       | 9.4   |       |
| Detector 2 Size(m)         |       | 0.6   |       |       | 0.6   |       |       | 0.6   |       |       | 0.6   |       |
| Detector 2 Type            |       | Cl+Ex |       |       | Cl+Ex |       |       | Cl+Ex |       |       | Cl+Ex |       |
| Detector 2 Channel         |       |       |       |       |       |       |       |       |       |       |       |       |
| Detector 2 Extend (s)      |       | 0.0   |       |       | 0.0   |       |       | 0.0   |       |       | 0.0   |       |
| Turn Type                  | Perm  | NA    | Perm  | Perm  | NA    | Perm  | Prot  | NA    | Perm  | Prot  | NA    | Perm  |
| Protected Phases           |       | 4     |       |       | 8     |       | 5     | 2     |       | 1     | 6     |       |
| Permitted Phases           | 4     |       | 4     | 8     |       | 8     |       |       | 2     |       |       | 6     |
| Detector Phase             | 4     | 4     | 4     | 8     | 8     | 8     | 5     | 2     | 2     | 1     | 6     | 6     |
| Switch Phase               |       |       |       |       |       |       |       |       |       |       |       |       |



| Lane Group              | EBL   | EBT   | EBR   | WBL   | WBT   | WBR   | NBL   | NBT   | NBR   | SBL   | SBT   | SBR   |
|-------------------------|-------|-------|-------|-------|-------|-------|-------|-------|-------|-------|-------|-------|
| Minimum Initial (s)     | 10.0  | 10.0  | 10.0  | 10.0  | 10.0  | 10.0  | 5.0   | 10.0  | 10.0  | 5.0   | 10.0  | 10.0  |
| Minimum Split (s)       | 38.5  | 38.5  | 38.5  | 38.5  | 38.5  | 38.5  | 11.4  | 24.4  | 24.4  | 11.4  | 24.4  | 24.4  |
| Total Split (s)         | 40.0  | 40.0  | 40.0  | 40.0  | 40.0  | 40.0  | 14.0  | 65.0  | 65.0  | 25.0  | 76.0  | 76.0  |
| Total Split (%)         | 30.8% | 30.8% | 30.8% | 30.8% | 30.8% | 30.8% | 10.8% | 50.0% | 50.0% | 19.2% | 58.5% | 58.5% |
| Maximum Green (s)       | 32.5  | 32.5  | 32.5  | 32.5  | 32.5  | 32.5  | 7.6   | 58.6  | 58.6  | 18.6  | 69.6  | 69.6  |
| Yellow Time (s)         | 3.0   | 3.0   | 3.0   | 3.0   | 3.0   | 3.0   | 3.7   | 3.7   | 3.7   | 3.7   | 3.7   | 3.7   |
| All-Red Time (s)        | 4.5   | 4.5   | 4.5   | 4.5   | 4.5   | 4.5   | 2.7   | 2.7   | 2.7   | 2.7   | 2.7   | 2.7   |
| Lost Time Adjust (s)    |       | 0.0   | 0.0   | 0.0   | 0.0   | 0.0   | 0.0   | 0.0   | 0.0   | 0.0   | 0.0   | 0.0   |
| Total Lost Time (s)     |       | 7.5   | 7.5   | 7.5   | 7.5   | 7.5   | 6.4   | 6.4   | 6.4   | 6.4   | 6.4   | 6.4   |
| Lead/Lag                |       |       |       |       |       |       | Lead  | Lag   | Lag   | Lead  | Lag   | Lag   |
| Lead-Lag Optimize?      |       |       |       |       |       |       |       |       |       |       |       |       |
| Vehicle Extension (s)   | 3.0   | 3.0   | 3.0   | 3.0   | 3.0   | 3.0   | 3.0   | 3.0   | 3.0   | 3.0   | 3.0   | 3.0   |
| Recall Mode             | None  | None  | None  | None  | None  | None  | None  | C-Max | C-Max | None  | C-Max | C-Max |
| Walk Time (s)           | 7.0   | 7.0   | 7.0   | 7.0   | 7.0   | 7.0   |       | 7.0   | 7.0   |       | 7.0   | 7.0   |
| Flash Dont Walk (s)     | 24.0  | 24.0  | 24.0  | 24.0  | 24.0  | 24.0  |       | 11.0  | 11.0  |       | 11.0  | 11.0  |
| Pedestrian Calls (#/hr) | 5     | 5     | 5     | 5     | 5     | 5     |       | 5     | 5     |       | 5     | 5     |
| Act Effct Green (s)     |       | 17.3  | 17.3  | 17.3  | 17.3  | 17.3  | 7.4   | 79.4  | 79.4  | 13.1  | 90.0  | 90.0  |
| Actuated g/C Ratio      |       | 0.13  | 0.13  | 0.13  | 0.13  | 0.13  | 0.06  | 0.61  | 0.61  | 0.10  | 0.69  | 0.69  |
| v/c Ratio               |       | 0.32  | 0.23  | 0.57  | 0.08  | 0.08  | 0.27  | 0.36  | 0.05  | 0.60  | 0.58  | 0.01  |
| Control Delay           |       | 52.5  | 1.8   | 64.9  | 45.8  | 0.5   | 56.9  | 10.0  | 0.6   | 69.8  | 13.5  | 0.0   |
| Queue Delay             |       | 0.0   | 0.0   | 0.0   | 0.0   | 0.0   | 0.0   | 0.0   | 0.0   | 0.0   | 0.0   | 0.0   |
| Total Delay             |       | 52.5  | 1.8   | 64.9  | 45.8  | 0.5   | 56.9  | 10.0  | 0.6   | 69.8  | 13.5  | 0.0   |
| LOS                     |       | D     | A     | E     | D     | A     | E     | A     | A     | E     | B     | A     |
| Approach Delay          |       | 25.4  |       |       | 50.2  |       |       | 10.7  |       |       | 16.3  |       |
| Approach LOS            |       | C     |       |       | D     |       |       | B     |       |       | B     |       |
| Queue Length 50th (m)   |       | 14.2  | 0.0   | 20.4  | 3.0   | 0.0   | 6.1   | 14.7  | 0.0   | 22.9  | 81.9  | 0.0   |
| Queue Length 95th (m)   |       | 23.6  | 0.0   | 32.0  | 7.7   | 0.0   | m14.7 | 39.1  | m0.6  | 38.4  | 138.0 | 0.0   |
| Internal Link Dist (m)  |       | 441.2 |       |       | 335.5 |       |       | 294.9 |       |       | 438.6 |       |
| Turn Bay Length (m)     |       |       | 20.0  | 45.0  |       | 35.0  | 130.0 |       | 30.0  | 65.0  |       | 25.0  |
| Base Capacity (vph)     |       | 378   | 468   | 295   | 317   | 468   | 103   | 2825  | 891   | 239   | 3265  | 1021  |
| Starvation Cap Reductn  |       | 0     | 0     | 0     | 0     | 0     | 0     | 0     | 0     | 0     | 0     | 0     |
| Spillback Cap Reductn   |       | 0     | 0     | 0     | 0     | 0     | 0     | 0     | 0     | 0     | 0     | 0     |
| Storage Cap Reductn     |       | 0     | 0     | 0     | 0     | 0     | 0     | 0     | 0     | 0     | 0     | 0     |
| Reduced v/c Ratio       |       | 0.17  | 0.16  | 0.30  | 0.04  | 0.05  | 0.25  | 0.36  | 0.05  | 0.42  | 0.58  | 0.01  |

Intersection Summary

Area Type: Other  
 Cycle Length: 130  
 Actuated Cycle Length: 130  
 Offset: 63 (48%), Referenced to phase 2:NBT and 6:SBT, Start of Green  
 Natural Cycle: 90  
 Control Type: Actuated-Coordinated  
 Maximum v/c Ratio: 0.60  
 Intersection Signal Delay: 16.2  
 Intersection LOS: B  
 Intersection Capacity Utilization 78.2%  
 ICU Level of Service D  
 Analysis Period (min) 15  
 m Volume for 95th percentile queue is metered by upstream signal.

Splits and Phases: 1: March & Morgan's Grant/Shirley's Brook

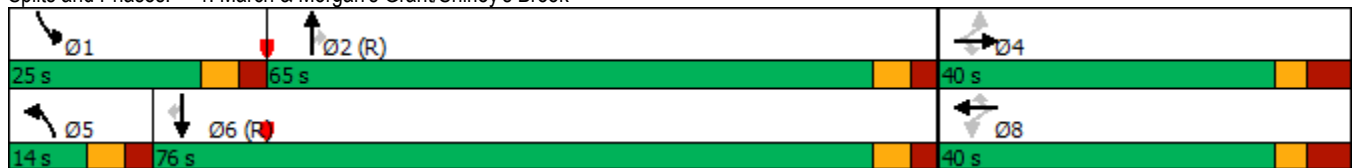

| Lane Group                 | EBL   | EBT   | EBR   | WBL   | WBT   | WBR   | NBU   | NBL   | NBT   | NBR   | SBU   | SBL   |
|----------------------------|-------|-------|-------|-------|-------|-------|-------|-------|-------|-------|-------|-------|
| Lane Configurations        |       |       |       |       |       |       |       |       |       |       |       |       |
| Traffic Volume (vph)       | 125   | 183   | 283   | 42    | 76    | 50    | 14    | 180   | 882   | 109   | 1     | 202   |
| Future Volume (vph)        | 125   | 183   | 283   | 42    | 76    | 50    | 14    | 180   | 882   | 109   | 1     | 202   |
| Ideal Flow (vphpl)         | 1800  | 1800  | 1800  | 1800  | 1800  | 1800  | 1800  | 1800  | 1800  | 1800  | 1800  | 1800  |
| Storage Length (m)         | 95.0  |       | 60.0  | 75.0  |       | 75.0  |       | 130.0 |       | 85.0  |       | 110.0 |
| Storage Lanes              | 2     |       | 2     | 2     |       | 1     |       | 2     |       | 2     |       | 1     |
| Taper Length (m)           | 40.0  |       |       | 20.0  |       |       |       | 90.0  |       |       |       | 40.0  |
| Lane Util. Factor          | 0.97  | 0.95  | 1.00  | 0.97  | 0.95  | 1.00  | 0.91  | 0.97  | 0.91  | 1.00  | 0.91  | 1.00  |
| Ped Bike Factor            | 0.99  |       | 0.97  | 0.99  |       | 0.98  |       | 1.00  |       | 0.97  |       | 1.00  |
| Frt                        |       |       | 0.850 |       |       | 0.850 |       |       |       | 0.850 |       |       |
| Flt Protected              | 0.950 |       |       | 0.950 |       |       |       | 0.950 |       |       |       | 0.950 |
| Satd. Flow (prot)          | 3185  | 3316  | 1483  | 3248  | 3161  | 1498  | 0     | 3246  | 4628  | 1469  | 0     | 1674  |
| Flt Permitted              | 0.950 |       |       | 0.950 |       |       |       | 0.950 |       |       |       | 0.950 |
| Satd. Flow (perm)          | 3169  | 3316  | 1438  | 3220  | 3161  | 1466  | 0     | 3242  | 4628  | 1424  | 0     | 1667  |
| Right Turn on Red          |       |       | Yes   |       |       | Yes   |       |       |       | Yes   |       |       |
| Satd. Flow (RTOR)          |       |       | 202   |       |       | 202   |       |       |       | 204   |       |       |
| Link Speed (k/h)           |       | 60    |       |       | 60    |       |       |       | 60    |       |       |       |
| Link Distance (m)          |       | 165.4 |       |       | 149.1 |       |       |       | 308.9 |       |       |       |
| Travel Time (s)            |       | 9.9   |       |       | 8.9   |       |       |       | 18.5  |       |       |       |
| Confl. Peds. (#/hr)        | 5     |       | 10    | 10    |       | 5     |       | 5     |       | 10    |       | 10    |
| Confl. Bikes (#/hr)        |       |       | 10    |       |       | 5     |       |       |       | 5     |       |       |
| Peak Hour Factor           | 1.00  | 1.00  | 1.00  | 1.00  | 1.00  | 1.00  | 1.00  | 1.00  | 1.00  | 1.00  | 1.00  | 1.00  |
| Heavy Vehicles (%)         | 3%    | 2%    | 2%    | 1%    | 7%    | 1%    | 2%    | 1%    | 5%    | 3%    | 2%    | 1%    |
| Adj. Flow (vph)            | 125   | 183   | 283   | 42    | 76    | 50    | 14    | 180   | 882   | 109   | 1     | 202   |
| Shared Lane Traffic (%)    |       |       |       |       |       |       |       |       |       |       |       |       |
| Lane Group Flow (vph)      | 125   | 183   | 283   | 42    | 76    | 50    | 0     | 194   | 882   | 109   | 0     | 203   |
| Enter Blocked Intersection | No    | No    | No    | Yes   | Yes   | Yes   | No    | No    | No    | No    | No    | No    |
| Lane Alignment             | L NA  | Left  | R NA  | L NA  | Left  | R NA  | R NA  | L NA  | Left  | R NA  | R NA  | L NA  |
| Median Width(m)            |       | 11.5  |       |       | 10.5  |       |       |       | 10.5  |       |       |       |
| Link Offset(m)             |       | 0.0   |       |       | 0.0   |       |       |       | 0.0   |       |       |       |
| Crosswalk Width(m)         |       | 5.0   |       |       | 5.0   |       |       |       | 5.0   |       |       |       |
| Two way Left Turn Lane     |       |       |       |       |       |       |       |       |       |       |       |       |
| Headway Factor             | 1.09  | 1.09  | 1.09  | 1.09  | 1.09  | 1.09  | 1.09  | 1.09  | 1.09  | 1.09  | 1.09  | 1.09  |
| Number of Detectors        | 1     | 2     | 1     | 1     | 2     | 1     | 1     | 1     | 2     | 1     | 1     | 1     |
| Detector Template          | Left  | Thru  | Right | Left  | Thru  | Right | Left  | Left  | Thru  | Right | Left  | Left  |
| Leading Detector (m)       | 2.0   | 10.0  | 2.0   | 2.0   | 10.0  | 2.0   | 2.0   | 2.0   | 10.0  | 2.0   | 2.0   | 2.0   |
| Trailing Detector (m)      | 0.0   | 0.0   | 0.0   | 0.0   | 0.0   | 0.0   | 0.0   | 0.0   | 0.0   | 0.0   | 0.0   | 0.0   |
| Detector 1 Position(m)     | 0.0   | 0.0   | 0.0   | 0.0   | 0.0   | 0.0   | 0.0   | 0.0   | 0.0   | 0.0   | 0.0   | 0.0   |
| Detector 1 Size(m)         | 2.0   | 0.6   | 2.0   | 2.0   | 0.6   | 2.0   | 2.0   | 2.0   | 0.6   | 2.0   | 2.0   | 2.0   |
| Detector 1 Type            | Cl+Ex | Cl+Ex | Cl+Ex | Cl+Ex | Cl+Ex | Cl+Ex | Cl+Ex | Cl+Ex | Cl+Ex | Cl+Ex | Cl+Ex | Cl+Ex |
| Detector 1 Channel         |       |       |       |       |       |       |       |       |       |       |       |       |
| Detector 1 Extend (s)      | 0.0   | 0.0   | 0.0   | 0.0   | 0.0   | 0.0   | 0.0   | 0.0   | 0.0   | 0.0   | 0.0   | 0.0   |
| Detector 1 Queue (s)       | 0.0   | 0.0   | 0.0   | 0.0   | 0.0   | 0.0   | 0.0   | 0.0   | 0.0   | 0.0   | 0.0   | 0.0   |
| Detector 1 Delay (s)       | 0.0   | 0.0   | 0.0   | 0.0   | 0.0   | 0.0   | 0.0   | 0.0   | 0.0   | 0.0   | 0.0   | 0.0   |
| Detector 2 Position(m)     |       | 9.4   |       |       | 9.4   |       |       |       | 9.4   |       |       |       |
| Detector 2 Size(m)         |       | 0.6   |       |       | 0.6   |       |       |       | 0.6   |       |       |       |
| Detector 2 Type            |       | Cl+Ex |       |       | Cl+Ex |       |       |       | Cl+Ex |       |       |       |
| Detector 2 Channel         |       |       |       |       |       |       |       |       |       |       |       |       |
| Detector 2 Extend (s)      |       | 0.0   |       |       | 0.0   |       |       |       | 0.0   |       |       |       |
| Turn Type                  | Prot  | NA    | Perm  | Prot  | NA    | Perm  | Prot  | Prot  | NA    | Perm  | Prot  | Prot  |
| Protected Phases           | 7     | 4     |       | 3     | 8     |       | 5     | 5     | 2     |       | 1     | 1     |
| Permitted Phases           |       |       | 4     |       |       | 8     |       |       |       | 2     |       |       |
| Detector Phase             | 7     | 4     | 4     | 3     | 8     | 8     | 5     | 5     | 2     | 2     | 1     | 1     |
| Switch Phase               |       |       |       |       |       |       |       |       |       |       |       |       |



| Lane Group                 | SBT   | SBR   |
|----------------------------|-------|-------|
| Lane Configurations        | ↑↑↑   | ↑     |
| Traffic Volume (vph)       | 1633  | 235   |
| Future Volume (vph)        | 1633  | 235   |
| Ideal Flow (vphpl)         | 1800  | 1800  |
| Storage Length (m)         |       | 100.0 |
| Storage Lanes              |       | 1     |
| Taper Length (m)           |       |       |
| Lane Util. Factor          | 0.91  | 1.00  |
| Ped Bike Factor            |       | 0.98  |
| Frt                        |       | 0.850 |
| Flt Protected              |       |       |
| Satd. Flow (prot)          | 4718  | 1469  |
| Flt Permitted              |       |       |
| Satd. Flow (perm)          | 4718  | 1436  |
| Right Turn on Red          |       | Yes   |
| Satd. Flow (RTOR)          |       | 235   |
| Link Speed (k/h)           | 60    |       |
| Link Distance (m)          | 318.9 |       |
| Travel Time (s)            | 19.1  |       |
| Confl. Peds. (#/hr)        |       | 5     |
| Confl. Bikes (#/hr)        |       | 5     |
| Peak Hour Factor           | 1.00  | 1.00  |
| Heavy Vehicles (%)         | 3%    | 3%    |
| Adj. Flow (vph)            | 1633  | 235   |
| Shared Lane Traffic (%)    |       |       |
| Lane Group Flow (vph)      | 1633  | 235   |
| Enter Blocked Intersection | No    | No    |
| Lane Alignment             | Left  | R NA  |
| Median Width(m)            | 7.0   |       |
| Link Offset(m)             | 0.0   |       |
| Crosswalk Width(m)         | 5.0   |       |
| Two way Left Turn Lane     |       |       |
| Headway Factor             | 1.09  | 1.09  |
| Number of Detectors        | 2     | 1     |
| Detector Template          | Thru  | Right |
| Leading Detector (m)       | 10.0  | 2.0   |
| Trailing Detector (m)      | 0.0   | 0.0   |
| Detector 1 Position(m)     | 0.0   | 0.0   |
| Detector 1 Size(m)         | 0.6   | 2.0   |
| Detector 1 Type            | CI+Ex | CI+Ex |
| Detector 1 Channel         |       |       |
| Detector 1 Extend (s)      | 0.0   | 0.0   |
| Detector 1 Queue (s)       | 0.0   | 0.0   |
| Detector 1 Delay (s)       | 0.0   | 0.0   |
| Detector 2 Position(m)     | 9.4   |       |
| Detector 2 Size(m)         | 0.6   |       |
| Detector 2 Type            | CI+Ex |       |
| Detector 2 Channel         |       |       |
| Detector 2 Extend (s)      | 0.0   |       |
| Turn Type                  | NA    | Perm  |
| Protected Phases           | 6     |       |
| Permitted Phases           |       | 6     |
| Detector Phase             | 6     | 6     |
| Switch Phase               |       |       |



| Lane Group              | EBL   | EBT   | EBR   | WBL  | WBT   | WBR   | NBU   | NBL   | NBT   | NBR   | SBU   | SBL   |
|-------------------------|-------|-------|-------|------|-------|-------|-------|-------|-------|-------|-------|-------|
| Minimum Initial (s)     | 5.0   | 10.0  | 10.0  | 5.0  | 10.0  | 10.0  | 5.0   | 5.0   | 10.0  | 10.0  | 5.0   | 5.0   |
| Minimum Split (s)       | 11.8  | 41.9  | 41.9  | 11.8 | 41.9  | 41.9  | 11.8  | 11.8  | 32.7  | 32.7  | 11.8  | 11.8  |
| Total Split (s)         | 13.0  | 43.0  | 43.0  | 12.0 | 42.0  | 42.0  | 18.0  | 18.0  | 44.0  | 44.0  | 31.0  | 31.0  |
| Total Split (%)         | 10.0% | 33.1% | 33.1% | 9.2% | 32.3% | 32.3% | 13.8% | 13.8% | 33.8% | 33.8% | 23.8% | 23.8% |
| Maximum Green (s)       | 6.2   | 36.1  | 36.1  | 5.2  | 35.1  | 35.1  | 11.2  | 11.2  | 37.3  | 37.3  | 24.2  | 24.2  |
| Yellow Time (s)         | 3.7   | 3.7   | 3.7   | 3.7  | 3.7   | 3.7   | 4.6   | 4.6   | 4.6   | 4.6   | 4.6   | 4.6   |
| All-Red Time (s)        | 3.1   | 3.2   | 3.2   | 3.1  | 3.2   | 3.2   | 2.2   | 2.2   | 2.1   | 2.1   | 2.2   | 2.2   |
| Lost Time Adjust (s)    | 0.0   | 0.0   | 0.0   | 0.0  | 0.0   | 0.0   |       | 0.0   | 0.0   | 0.0   |       | 0.0   |
| Total Lost Time (s)     | 6.8   | 6.9   | 6.9   | 6.8  | 6.9   | 6.9   |       | 6.8   | 6.7   | 6.7   |       | 6.8   |
| Lead/Lag                | Lead  | Lag   | Lag   | Lead | Lag   | Lag   | Lead  | Lead  | Lag   | Lag   | Lead  | Lead  |
| Lead-Lag Optimize?      |       |       |       |      |       |       |       |       |       |       |       |       |
| Vehicle Extension (s)   | 3.0   | 3.0   | 3.0   | 3.0  | 3.0   | 3.0   | 3.0   | 3.0   | 3.0   | 3.0   | 3.0   | 3.0   |
| Recall Mode             | None  | None  | None  | None | None  | None  | None  | None  | C-Max | C-Max | None  | None  |
| Walk Time (s)           |       | 7.0   | 7.0   |      | 7.0   | 7.0   |       |       | 7.0   | 7.0   |       |       |
| Flash Dont Walk (s)     |       | 28.0  | 28.0  |      | 28.0  | 28.0  |       |       | 19.0  | 19.0  |       |       |
| Pedestrian Calls (#/hr) |       | 10    | 10    |      | 5     | 5     |       |       | 5     | 5     |       |       |
| Act Effct Green (s)     | 7.0   | 21.2  | 21.2  | 5.2  | 20.4  | 20.4  |       | 11.6  | 58.7  | 58.7  |       | 20.1  |
| Actuated g/C Ratio      | 0.05  | 0.16  | 0.16  | 0.04 | 0.16  | 0.16  |       | 0.09  | 0.45  | 0.45  |       | 0.15  |
| v/c Ratio               | 0.74  | 0.34  | 0.70  | 0.33 | 0.15  | 0.12  |       | 0.67  | 0.42  | 0.14  |       | 0.78  |
| Control Delay           | 92.4  | 45.6  | 20.5  | 67.6 | 44.2  | 0.6   |       | 53.3  | 37.5  | 10.3  |       | 88.4  |
| Queue Delay             | 0.0   | 0.0   | 0.0   | 0.0  | 0.0   | 0.0   |       | 0.0   | 0.0   | 0.0   |       | 0.0   |
| Total Delay             | 92.4  | 45.6  | 20.5  | 67.6 | 44.2  | 0.6   |       | 53.3  | 37.5  | 10.3  |       | 88.4  |
| LOS                     | F     | D     | C     | E    | D     | A     |       | D     | D     | B     |       | F     |
| Approach Delay          |       | 43.5  |       |      | 37.1  |       |       |       | 37.6  |       |       |       |
| Approach LOS            |       | D     |       |      | D     |       |       |       | D     |       |       |       |
| Queue Length 50th (m)   | 16.1  | 17.2  | 10.6  | 5.0  | 8.8   | 0.0   |       | 21.4  | 73.6  | 4.6   |       | 51.1  |
| Queue Length 95th (m)   | #32.6 | 24.6  | 35.2  | 10.7 | 12.9  | 0.0   |       | #34.4 | 93.1  | 18.2  |       | 71.3  |
| Internal Link Dist (m)  |       | 141.4 |       |      | 125.1 |       |       |       | 284.9 |       |       |       |
| Turn Bay Length (m)     | 95.0  |       | 60.0  | 75.0 |       | 75.0  |       | 130.0 |       | 85.0  |       | 110.0 |
| Base Capacity (vph)     | 170   | 920   | 545   | 129  | 853   | 543   |       | 297   | 2089  | 755   |       | 311   |
| Starvation Cap Reductn  | 0     | 0     | 0     | 0    | 0     | 0     |       | 0     | 0     | 0     |       | 0     |
| Spillback Cap Reductn   | 0     | 0     | 0     | 0    | 0     | 0     |       | 0     | 0     | 0     |       | 0     |
| Storage Cap Reductn     | 0     | 0     | 0     | 0    | 0     | 0     |       | 0     | 0     | 0     |       | 0     |
| Reduced v/c Ratio       | 0.74  | 0.20  | 0.52  | 0.33 | 0.09  | 0.09  |       | 0.65  | 0.42  | 0.14  |       | 0.65  |

Intersection Summary

Area Type: Other  
 Cycle Length: 130  
 Actuated Cycle Length: 130  
 Offset: 80 (62%), Referenced to phase 2:NBT and 6:SBT, Start of Green  
 Natural Cycle: 110  
 Control Type: Actuated-Coordinated  
 Maximum v/c Ratio: 0.78  
 Intersection Signal Delay: 31.2  
 Intersection LOS: C  
 Intersection Capacity Utilization 88.2%  
 ICU Level of Service E  
 Analysis Period (min) 15  
 # 95th percentile volume exceeds capacity, queue may be longer.  
 Queue shown is maximum after two cycles.

Splits and Phases: 2: March & Terry Fox

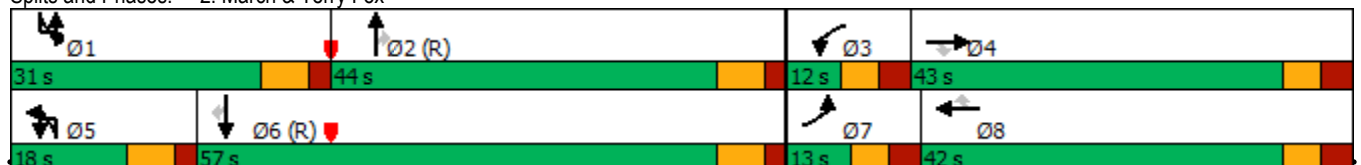



| Lane Group                  | SBT   | SBR   |
|-----------------------------|-------|-------|
| Minimum Initial (s)         | 10.0  | 10.0  |
| Minimum Split (s)           | 32.7  | 32.7  |
| Total Split (s)             | 57.0  | 57.0  |
| Total Split (%)             | 43.8% | 43.8% |
| Maximum Green (s)           | 50.3  | 50.3  |
| Yellow Time (s)             | 4.6   | 4.6   |
| All-Red Time (s)            | 2.1   | 2.1   |
| Lost Time Adjust (s)        | 0.0   | 0.0   |
| Total Lost Time (s)         | 6.7   | 6.7   |
| Lead/Lag                    | Lag   | Lag   |
| Lead-Lag Optimize?          |       |       |
| Vehicle Extension (s)       | 3.0   | 3.0   |
| Recall Mode                 | C-Max | C-Max |
| Walk Time (s)               | 7.0   | 7.0   |
| Flash Dont Walk (s)         | 19.0  | 19.0  |
| Pedestrian Calls (#/hr)     | 5     | 5     |
| Act Effct Green (s)         | 67.3  | 67.3  |
| Actuated g/C Ratio          | 0.52  | 0.52  |
| v/c Ratio                   | 0.67  | 0.27  |
| Control Delay               | 18.7  | 1.7   |
| Queue Delay                 | 0.0   | 0.0   |
| Total Delay                 | 18.7  | 1.7   |
| LOS                         | B     | A     |
| Approach Delay              | 23.6  |       |
| Approach LOS                | C     |       |
| Queue Length 50th (m)       | 34.9  | 0.0   |
| Queue Length 95th (m)       | 88.3  | 6.7   |
| Internal Link Dist (m)      | 294.9 |       |
| Turn Bay Length (m)         |       | 100.0 |
| Base Capacity (vph)         | 2440  | 856   |
| Starvation Cap Reductn      | 0     | 0     |
| Spillback Cap Reductn       | 0     | 0     |
| Storage Cap Reductn         | 0     | 0     |
| Reduced v/c Ratio           | 0.67  | 0.27  |
| <b>Intersection Summary</b> |       |       |

3: March & Solandt  
AM Peak Hour

555-603 March Road  
2037 Total Traffic (pre-BRT)

| Lane Group                 | EBL   | EBT   | EBR   | WBL   | WBT   | WBR  | NBU   | NBL   | NBT   | NBR  | SBU   | SBL   |
|----------------------------|-------|-------|-------|-------|-------|------|-------|-------|-------|------|-------|-------|
| Lane Configurations        |       |       |       |       |       |      |       |       |       |      |       |       |
| Traffic Volume (vph)       | 12    | 30    | 78    | 74    | 14    | 15   | 2     | 196   | 1619  | 172  | 2     | 57    |
| Future Volume (vph)        | 12    | 30    | 78    | 74    | 14    | 15   | 2     | 196   | 1619  | 172  | 2     | 57    |
| Ideal Flow (vphpl)         | 1800  | 1800  | 1800  | 1800  | 1800  | 1800 | 1800  | 1800  | 1800  | 1800 | 1800  | 1800  |
| Storage Length (m)         | 35.0  |       | 60.0  | 85.0  |       | 55.0 |       | 165.0 |       | 0.0  |       | 155.0 |
| Storage Lanes              | 1     |       | 1     | 2     |       | 0    |       | 1     |       | 0    |       | 1     |
| Taper Length (m)           | 50.0  |       |       | 95.0  |       |      |       | 40.0  |       |      |       | 25.0  |
| Lane Util. Factor          | 1.00  | 1.00  | 1.00  | 0.97  | 1.00  | 1.00 | 0.95  | 1.00  | 0.95  | 0.95 | 0.95  | 1.00  |
| Ped Bike Factor            | 0.99  |       | 0.98  | 0.99  | 0.99  |      |       | 1.00  | 1.00  |      |       | 1.00  |
| Fr <sub>t</sub>            |       |       | 0.850 |       | 0.922 |      |       |       | 0.986 |      |       |       |
| Fl <sub>t</sub> Protected  | 0.950 |       |       | 0.950 |       |      |       | 0.950 |       |      |       | 0.950 |
| Satd. Flow (prot)          | 1537  | 1728  | 1414  | 3124  | 1410  | 0    | 0     | 1658  | 3236  | 0    | 0     | 1674  |
| Fl <sub>t</sub> Permitted  | 0.950 |       |       | 0.950 |       |      |       | 0.950 |       |      |       | 0.950 |
| Satd. Flow (perm)          | 1528  | 1728  | 1381  | 3092  | 1410  | 0    | 0     | 1656  | 3236  | 0    | 0     | 1672  |
| Right Turn on Red          |       |       | Yes   |       |       | Yes  |       |       |       | Yes  |       |       |
| Satd. Flow (RTOR)          |       |       | 137   |       | 15    |      |       |       | 12    |      |       |       |
| Link Speed (k/h)           |       | 50    |       |       | 50    |      |       |       | 60    |      |       |       |
| Link Distance (m)          |       | 212.6 |       |       | 241.6 |      |       |       | 610.9 |      |       |       |
| Travel Time (s)            |       | 15.3  |       |       | 17.4  |      |       |       | 36.7  |      |       |       |
| Confl. Peds. (#/hr)        | 5     |       | 5     | 5     |       | 5    |       | 5     |       | 5    |       | 5     |
| Confl. Bikes (#/hr)        |       |       | 5     |       |       | 5    |       |       |       | 5    |       |       |
| Peak Hour Factor           | 1.00  | 1.00  | 1.00  | 1.00  | 1.00  | 1.00 | 1.00  | 1.00  | 1.00  | 1.00 | 1.00  | 1.00  |
| Heavy Vehicles (%)         | 10%   | 3%    | 7%    | 5%    | 30%   | 1%   | 2%    | 2%    | 3%    | 1%   | 2%    | 1%    |
| Adj. Flow (vph)            | 12    | 30    | 78    | 74    | 14    | 15   | 2     | 196   | 1619  | 172  | 2     | 57    |
| Shared Lane Traffic (%)    |       |       |       |       |       |      |       |       |       |      |       |       |
| Lane Group Flow (vph)      | 12    | 30    | 78    | 74    | 29    | 0    | 0     | 198   | 1791  | 0    | 0     | 59    |
| Enter Blocked Intersection | No    | No    | No    | No    | No    | No   | No    | No    | No    | No   | No    | No    |
| Lane Alignment             | L NA  | Left  | R NA  | L NA  | Left  | R NA | R NA  | L NA  | Left  | R NA | R NA  | L NA  |
| Median Width(m)            |       | 7.0   |       |       | 10.5  |      |       |       | 17.5  |      |       |       |
| Link Offset(m)             |       | 0.0   |       |       | 0.0   |      |       |       | 0.0   |      |       |       |
| Crosswalk Width(m)         |       | 5.0   |       |       | 5.0   |      |       |       | 5.0   |      |       |       |
| Two way Left Turn Lane     |       |       |       |       |       |      |       |       |       |      |       |       |
| Headway Factor             | 1.09  | 1.09  | 1.09  | 1.09  | 1.09  | 1.09 | 1.09  | 1.09  | 1.09  | 1.09 | 1.09  | 1.09  |
| Number of Detectors        | 1     | 2     | 1     | 1     | 2     |      | 1     | 1     | 2     |      | 1     | 1     |
| Detector Template          | Left  | Thru  | Right | Left  | Thru  |      | Left  | Left  | Thru  |      | Left  | Left  |
| Leading Detector (m)       | 2.0   | 10.0  | 2.0   | 2.0   | 10.0  |      | 2.0   | 2.0   | 10.0  |      | 2.0   | 2.0   |
| Trailing Detector (m)      | 0.0   | 0.0   | 0.0   | 0.0   | 0.0   |      | 0.0   | 0.0   | 0.0   |      | 0.0   | 0.0   |
| Detector 1 Position(m)     | 0.0   | 0.0   | 0.0   | 0.0   | 0.0   |      | 0.0   | 0.0   | 0.0   |      | 0.0   | 0.0   |
| Detector 1 Size(m)         | 2.0   | 0.6   | 2.0   | 2.0   | 0.6   |      | 2.0   | 2.0   | 0.6   |      | 2.0   | 2.0   |
| Detector 1 Type            | Cl+Ex | Cl+Ex | Cl+Ex | Cl+Ex | Cl+Ex |      | Cl+Ex | Cl+Ex | Cl+Ex |      | Cl+Ex | Cl+Ex |
| Detector 1 Channel         |       |       |       |       |       |      |       |       |       |      |       |       |
| Detector 1 Extend (s)      | 0.0   | 0.0   | 0.0   | 0.0   | 0.0   |      | 0.0   | 0.0   | 0.0   |      | 0.0   | 0.0   |
| Detector 1 Queue (s)       | 0.0   | 0.0   | 0.0   | 0.0   | 0.0   |      | 0.0   | 0.0   | 0.0   |      | 0.0   | 0.0   |
| Detector 1 Delay (s)       | 0.0   | 0.0   | 0.0   | 0.0   | 0.0   |      | 0.0   | 0.0   | 0.0   |      | 0.0   | 0.0   |
| Detector 2 Position(m)     |       | 9.4   |       |       | 9.4   |      |       |       | 9.4   |      |       |       |
| Detector 2 Size(m)         |       | 0.6   |       |       | 0.6   |      |       |       | 0.6   |      |       |       |
| Detector 2 Type            |       | Cl+Ex |       |       | Cl+Ex |      |       |       | Cl+Ex |      |       |       |
| Detector 2 Channel         |       |       |       |       |       |      |       |       |       |      |       |       |
| Detector 2 Extend (s)      |       | 0.0   |       |       | 0.0   |      |       |       | 0.0   |      |       |       |
| Turn Type                  | Prot  | NA    | Perm  | Prot  | NA    |      | Prot  | Prot  | NA    |      | Prot  | Prot  |
| Protected Phases           | 7     | 4     |       | 3     | 8     |      | 5     | 5     | 2     |      | 1     | 1     |
| Permitted Phases           |       |       | 4     |       |       |      |       |       |       |      |       |       |
| Detector Phase             | 7     | 4     | 4     | 3     | 8     |      | 5     | 5     | 2     |      | 1     | 1     |
| Switch Phase               |       |       |       |       |       |      |       |       |       |      |       |       |



3: March & Solandt  
AM Peak Hour

555-603 March Road  
2037 Total Traffic (pre-BRT)



| Lane Group                 | SBT   | SBR  |
|----------------------------|-------|------|
| Lane Configurations        | ↑↑    |      |
| Traffic Volume (vph)       | 1830  | 33   |
| Future Volume (vph)        | 1830  | 33   |
| Ideal Flow (vphpl)         | 1800  | 1800 |
| Storage Length (m)         |       | 0.0  |
| Storage Lanes              |       | 0    |
| Taper Length (m)           |       |      |
| Lane Util. Factor          | 0.95  | 0.95 |
| Ped Bike Factor            | 1.00  |      |
| Frt                        | 0.997 |      |
| Flt Protected              |       |      |
| Satd. Flow (prot)          | 3273  | 0    |
| Flt Permitted              |       |      |
| Satd. Flow (perm)          | 3273  | 0    |
| Right Turn on Red          |       | Yes  |
| Satd. Flow (RTOR)          | 2     |      |
| Link Speed (k/h)           | 60    |      |
| Link Distance (m)          | 382.6 |      |
| Travel Time (s)            | 23.0  |      |
| Confl. Peds. (#/hr)        |       | 5    |
| Confl. Bikes (#/hr)        |       | 5    |
| Peak Hour Factor           | 1.00  | 1.00 |
| Heavy Vehicles (%)         | 3%    | 1%   |
| Adj. Flow (vph)            | 1830  | 33   |
| Shared Lane Traffic (%)    |       |      |
| Lane Group Flow (vph)      | 1863  | 0    |
| Enter Blocked Intersection | No    | No   |
| Lane Alignment             | Left  | R NA |
| Median Width(m)            | 17.5  |      |
| Link Offset(m)             | 0.0   |      |
| Crosswalk Width(m)         | 5.0   |      |
| Two way Left Turn Lane     |       |      |
| Headway Factor             | 1.09  | 1.09 |
| Number of Detectors        | 2     |      |
| Detector Template          | Thru  |      |
| Leading Detector (m)       | 10.0  |      |
| Trailing Detector (m)      | 0.0   |      |
| Detector 1 Position(m)     | 0.0   |      |
| Detector 1 Size(m)         | 0.6   |      |
| Detector 1 Type            | Cl+Ex |      |
| Detector 1 Channel         |       |      |
| Detector 1 Extend (s)      | 0.0   |      |
| Detector 1 Queue (s)       | 0.0   |      |
| Detector 1 Delay (s)       | 0.0   |      |
| Detector 2 Position(m)     | 9.4   |      |
| Detector 2 Size(m)         | 0.6   |      |
| Detector 2 Type            | Cl+Ex |      |
| Detector 2 Channel         |       |      |
| Detector 2 Extend (s)      | 0.0   |      |
| Turn Type                  | NA    |      |
| Protected Phases           | 6     |      |
| Permitted Phases           |       |      |
| Detector Phase             | 6     |      |
| Switch Phase               |       |      |

3: March & Solandt  
AM Peak Hour

555-603 March Road  
2037 Total Traffic (pre-BRT)



| Lane Group              | EBL  | EBT   | EBR   | WBL   | WBT   | WBR | NBU  | NBL    | NBT    | NBR | SBU  | SBL    |
|-------------------------|------|-------|-------|-------|-------|-----|------|--------|--------|-----|------|--------|
| Minimum Initial (s)     | 5.0  | 10.0  | 10.0  | 5.0   | 10.0  |     | 5.0  | 5.0    | 10.0   |     | 5.0  | 5.0    |
| Minimum Split (s)       | 11.5 | 36.5  | 36.5  | 11.5  | 36.5  |     | 12.0 | 12.0   | 26.8   |     | 12.0 | 12.0   |
| Total Split (s)         | 11.5 | 36.5  | 36.5  | 11.5  | 36.5  |     | 12.0 | 12.0   | 70.0   |     | 12.0 | 12.0   |
| Total Split (%)         | 8.8% | 28.1% | 28.1% | 8.8%  | 28.1% |     | 9.2% | 9.2%   | 53.8%  |     | 9.2% | 9.2%   |
| Maximum Green (s)       | 5.0  | 30.0  | 30.0  | 5.0   | 30.0  |     | 5.0  | 5.0    | 64.2   |     | 5.0  | 5.0    |
| Yellow Time (s)         | 3.3  | 3.3   | 3.3   | 3.3   | 3.3   |     | 3.7  | 3.7    | 3.7    |     | 3.7  | 3.7    |
| All-Red Time (s)        | 3.2  | 3.2   | 3.2   | 3.2   | 3.2   |     | 3.3  | 3.3    | 2.1    |     | 3.3  | 3.3    |
| Lost Time Adjust (s)    | 0.0  | 0.0   | 0.0   | 0.0   | 0.0   |     |      |        | 0.0    |     | 0.0  | 0.0    |
| Total Lost Time (s)     | 6.5  | 6.5   | 6.5   | 6.5   | 6.5   |     |      |        | 7.0    |     | 5.8  | 7.0    |
| Lead/Lag                | Lead | Lag   | Lag   | Lead  | Lag   |     | Lead | Lead   | Lag    |     | Lead | Lead   |
| Lead-Lag Optimize?      | Yes  |       |       |       | Yes   |     |      |        |        |     |      |        |
| Vehicle Extension (s)   | 3.0  | 3.0   | 3.0   | 3.0   | 3.0   |     | 3.0  | 3.0    | 3.0    |     | 3.0  | 3.0    |
| Recall Mode             | None | None  | None  | None  | None  |     | None | None   | C-Max  |     | None | None   |
| Walk Time (s)           |      | 7.0   | 7.0   |       | 7.0   |     |      |        | 7.0    |     |      |        |
| Flash Dont Walk (s)     |      | 23.0  | 23.0  |       | 23.0  |     |      |        | 14.0   |     |      |        |
| Pedestrian Calls (#/hr) |      | 5     | 5     |       | 5     |     |      |        | 5      |     |      |        |
| Act Effct Green (s)     | 5.0  | 14.0  | 14.0  | 5.0   | 18.6  |     |      | 26.6   | 81.2   |     |      | 9.6    |
| Actuated g/C Ratio      | 0.04 | 0.11  | 0.11  | 0.04  | 0.14  |     |      | 0.20   | 0.62   |     |      | 0.07   |
| v/c Ratio               | 0.20 | 0.16  | 0.29  | 0.62  | 0.14  |     |      | 0.59   | 0.88   |     |      | 0.48   |
| Control Delay           | 68.8 | 51.3  | 2.8   | 83.3  | 29.4  |     |      | 56.7   | 29.8   |     |      | 70.3   |
| Queue Delay             | 0.0  | 0.0   | 0.0   | 0.0   | 0.0   |     |      | 0.0    | 0.0    |     |      | 0.0    |
| Total Delay             | 68.8 | 51.3  | 2.8   | 83.3  | 29.4  |     |      | 56.7   | 29.8   |     |      | 70.3   |
| LOS                     | E    | D     | A     | F     | C     |     |      | E      | C      |     |      | E      |
| Approach Delay          |      | 21.5  |       |       | 68.1  |     |      |        | 32.5   |     |      |        |
| Approach LOS            |      | C     |       |       | E     |     |      |        | C      |     |      |        |
| Queue Length 50th (m)   | 2.8  | 6.8   | 0.0   | 9.0   | 2.8   |     |      | 43.3   | 188.6  |     |      | 14.1   |
| Queue Length 95th (m)   | 9.0  | 13.1  | 0.4   | #18.4 | 10.1  |     |      | #125.6 | #294.4 |     |      | m#30.3 |
| Internal Link Dist (m)  |      | 188.6 |       |       | 217.6 |     |      |        | 586.9  |     |      |        |
| Turn Bay Length (m)     | 35.0 |       | 60.0  | 85.0  |       |     |      | 165.0  |        |     |      | 155.0  |
| Base Capacity (vph)     | 59   | 398   | 424   | 120   | 336   |     |      | 338    | 2025   |     |      | 123    |
| Starvation Cap Reductn  | 0    | 0     | 0     | 0     | 0     |     |      | 0      | 0      |     |      | 0      |
| Spillback Cap Reductn   | 0    | 0     | 0     | 0     | 0     |     |      | 0      | 0      |     |      | 0      |
| Storage Cap Reductn     | 0    | 0     | 0     | 0     | 0     |     |      | 0      | 0      |     |      | 0      |
| Reduced v/c Ratio       | 0.20 | 0.08  | 0.18  | 0.62  | 0.09  |     |      | 0.59   | 0.88   |     |      | 0.48   |

Intersection Summary

Area Type: Other  
 Cycle Length: 130  
 Actuated Cycle Length: 130  
 Offset: 2 (2%), Referenced to phase 2:NBT and 6:SBT, Start of Green  
 Natural Cycle: 150  
 Control Type: Actuated-Coordinated  
 Maximum v/c Ratio: 1.15  
 Intersection Signal Delay: 62.1  
 Intersection LOS: E  
 Intersection Capacity Utilization 102.7%  
 ICU Level of Service G  
 Analysis Period (min) 15  
 ~ Volume exceeds capacity, queue is theoretically infinite.  
 Queue shown is maximum after two cycles.  
 # 95th percentile volume exceeds capacity, queue may be longer.  
 Queue shown is maximum after two cycles.  
 m Volume for 95th percentile queue is metered by upstream signal.

Splits and Phases: 3: March & Solandt

|      |      |        |        |
|------|------|--------|--------|
|      |      |        |        |
| 12 s | 70 s | 11.5 s | 36.5 s |
|      |      |        |        |
| 12 s | 70 s | 11.5 s | 36.5 s |



| Lane Group                  | SBT    | SBR |
|-----------------------------|--------|-----|
| Minimum Initial (s)         | 10.0   |     |
| Minimum Split (s)           | 26.8   |     |
| Total Split (s)             | 70.0   |     |
| Total Split (%)             | 53.8%  |     |
| Maximum Green (s)           | 64.2   |     |
| Yellow Time (s)             | 3.7    |     |
| All-Red Time (s)            | 2.1    |     |
| Lost Time Adjust (s)        | 0.0    |     |
| Total Lost Time (s)         | 5.8    |     |
| Lead/Lag                    | Lag    |     |
| Lead-Lag Optimize?          |        |     |
| Vehicle Extension (s)       | 3.0    |     |
| Recall Mode                 | C-Max  |     |
| Walk Time (s)               | 7.0    |     |
| Flash Dont Walk (s)         | 14.0   |     |
| Pedestrian Calls (#/hr)     | 5      |     |
| Act Effct Green (s)         | 64.2   |     |
| Actuated g/C Ratio          | 0.49   |     |
| v/c Ratio                   | 1.15   |     |
| Control Delay               | 95.8   |     |
| Queue Delay                 | 0.0    |     |
| Total Delay                 | 95.8   |     |
| LOS                         | F      |     |
| Approach Delay              | 95.0   |     |
| Approach LOS                | F      |     |
| Queue Length 50th (m)       | ~275.7 |     |
| Queue Length 95th (m)       | #303.8 |     |
| Internal Link Dist (m)      | 358.6  |     |
| Turn Bay Length (m)         |        |     |
| Base Capacity (vph)         | 1617   |     |
| Starvation Cap Reductn      | 0      |     |
| Spillback Cap Reductn       | 0      |     |
| Storage Cap Reductn         | 0      |     |
| Reduced v/c Ratio           | 1.15   |     |
| <b>Intersection Summary</b> |        |     |

4: Innovation/Flamborough & Terry Fox  
AM Peak Hour

555-603 March Road  
2037 Total Traffic (pre-BRT)



| Lane Group                 | EBL   | EBT   | EBR   | WBL   | WBT   | WBR   | NBL   | NBT   | NBR  | SBL   | SBT   | SBR  |
|----------------------------|-------|-------|-------|-------|-------|-------|-------|-------|------|-------|-------|------|
| Lane Configurations        |       |       |       |       |       |       |       |       |      |       |       |      |
| Traffic Volume (vph)       | 29    | 451   | 76    | 84    | 289   | 38    | 35    | 36    | 82   | 69    | 55    | 42   |
| Future Volume (vph)        | 29    | 451   | 76    | 84    | 289   | 38    | 35    | 36    | 82   | 69    | 55    | 42   |
| Ideal Flow (vphpl)         | 1800  | 1800  | 1800  | 1800  | 1800  | 1800  | 1800  | 1800  | 1800 | 1800  | 1800  | 1800 |
| Storage Length (m)         | 75.0  |       | 120.0 | 110.0 |       | 130.0 | 220.0 |       | 0.0  | 30.0  |       | 0.0  |
| Storage Lanes              | 1     |       | 1     | 1     |       | 1     | 1     |       | 0    | 1     |       | 0    |
| Taper Length (m)           | 50.0  |       |       | 80.0  |       |       | 50.0  |       |      | 15.0  |       |      |
| Lane Util. Factor          | 1.00  | 1.00  | 1.00  | 1.00  | 1.00  | 1.00  | 1.00  | 1.00  | 1.00 | 1.00  | 1.00  | 1.00 |
| Ped Bike Factor            | 0.99  |       | 0.95  | 0.99  |       | 0.96  | 0.98  | 0.97  |      | 0.99  | 0.98  |      |
| Frt                        |       |       | 0.850 |       |       | 0.850 |       | 0.896 |      |       | 0.935 |      |
| Flt Protected              | 0.950 |       |       | 0.950 |       |       | 0.950 |       |      | 0.950 |       |      |
| Satd. Flow (prot)          | 1470  | 1728  | 1469  | 1626  | 1728  | 1498  | 1658  | 1512  | 0    | 1674  | 1553  | 0    |
| Flt Permitted              | 0.583 |       |       | 0.442 |       |       | 0.694 |       |      | 0.618 |       |      |
| Satd. Flow (perm)          | 895   | 1728  | 1392  | 749   | 1728  | 1441  | 1187  | 1512  | 0    | 1079  | 1553  | 0    |
| Right Turn on Red          |       |       | Yes   |       |       | Yes   |       |       | Yes  |       |       | Yes  |
| Satd. Flow (RTOR)          |       |       | 80    |       |       | 80    |       | 82    |      |       | 29    |      |
| Link Speed (k/h)           |       | 60    |       |       | 60    |       |       | 50    |      |       | 50    |      |
| Link Distance (m)          |       | 508.2 |       |       | 294.0 |       |       | 547.1 |      |       | 313.7 |      |
| Travel Time (s)            |       | 30.5  |       |       | 17.6  |       |       | 39.4  |      |       | 22.6  |      |
| Confl. Peds. (#/hr)        | 5     |       | 10    | 10    |       | 5     | 10    |       | 5    | 5     |       | 10   |
| Confl. Bikes (#/hr)        |       |       | 5     |       |       | 5     |       |       | 5    |       |       | 5    |
| Peak Hour Factor           | 1.00  | 1.00  | 1.00  | 1.00  | 1.00  | 1.00  | 1.00  | 1.00  | 1.00 | 1.00  | 1.00  | 1.00 |
| Heavy Vehicles (%)         | 15%   | 3%    | 3%    | 4%    | 3%    | 1%    | 2%    | 2%    | 3%   | 1%    | 1%    | 10%  |
| Adj. Flow (vph)            | 29    | 451   | 76    | 84    | 289   | 38    | 35    | 36    | 82   | 69    | 55    | 42   |
| Shared Lane Traffic (%)    |       |       |       |       |       |       |       |       |      |       |       |      |
| Lane Group Flow (vph)      | 29    | 451   | 76    | 84    | 289   | 38    | 35    | 118   | 0    | 69    | 97    | 0    |
| Enter Blocked Intersection | No    | No    | No    | No    | No    | No    | No    | No    | No   | No    | No    | No   |
| Lane Alignment             | L NA  | Left  | R NA  | L NA  | Left  | R NA  | L NA  | Left  | R NA | L NA  | Left  | R NA |
| Median Width(m)            |       | 3.5   |       |       | 3.5   |       |       | 3.5   |      |       | 3.5   |      |
| Link Offset(m)             |       | 0.0   |       |       | 0.0   |       |       | 0.0   |      |       | 0.0   |      |
| Crosswalk Width(m)         |       | 5.0   |       |       | 5.0   |       |       | 5.0   |      |       | 5.0   |      |
| Two way Left Turn Lane     |       |       |       |       |       |       |       |       |      |       |       |      |
| Headway Factor             | 1.09  | 1.09  | 1.09  | 1.09  | 1.09  | 1.09  | 1.09  | 1.09  | 1.09 | 1.09  | 1.09  | 1.09 |
| Number of Detectors        | 1     | 2     | 1     | 1     | 2     | 1     | 1     | 2     |      | 1     | 2     |      |
| Detector Template          | Left  | Thru  | Right | Left  | Thru  | Right | Left  | Thru  |      | Left  | Thru  |      |
| Leading Detector (m)       | 2.0   | 10.0  | 2.0   | 2.0   | 10.0  | 2.0   | 2.0   | 10.0  |      | 2.0   | 10.0  |      |
| Trailing Detector (m)      | 0.0   | 0.0   | 0.0   | 0.0   | 0.0   | 0.0   | 0.0   | 0.0   |      | 0.0   | 0.0   |      |
| Detector 1 Position(m)     | 0.0   | 0.0   | 0.0   | 0.0   | 0.0   | 0.0   | 0.0   | 0.0   |      | 0.0   | 0.0   |      |
| Detector 1 Size(m)         | 2.0   | 0.6   | 2.0   | 2.0   | 0.6   | 2.0   | 2.0   | 0.6   |      | 2.0   | 0.6   |      |
| Detector 1 Type            | Cl+Ex | Cl+Ex | Cl+Ex | Cl+Ex | Cl+Ex | Cl+Ex | Cl+Ex | Cl+Ex |      | Cl+Ex | Cl+Ex |      |
| Detector 1 Channel         |       |       |       |       |       |       |       |       |      |       |       |      |
| Detector 1 Extend (s)      | 0.0   | 0.0   | 0.0   | 0.0   | 0.0   | 0.0   | 0.0   | 0.0   |      | 0.0   | 0.0   |      |
| Detector 1 Queue (s)       | 0.0   | 0.0   | 0.0   | 0.0   | 0.0   | 0.0   | 0.0   | 0.0   |      | 0.0   | 0.0   |      |
| Detector 1 Delay (s)       | 0.0   | 0.0   | 0.0   | 0.0   | 0.0   | 0.0   | 0.0   | 0.0   |      | 0.0   | 0.0   |      |
| Detector 2 Position(m)     |       | 9.4   |       |       | 9.4   |       |       | 9.4   |      |       | 9.4   |      |
| Detector 2 Size(m)         |       | 0.6   |       |       | 0.6   |       |       | 0.6   |      |       | 0.6   |      |
| Detector 2 Type            |       | Cl+Ex |       |       | Cl+Ex |       |       | Cl+Ex |      |       | Cl+Ex |      |
| Detector 2 Channel         |       |       |       |       |       |       |       |       |      |       |       |      |
| Detector 2 Extend (s)      |       | 0.0   |       |       | 0.0   |       |       | 0.0   |      |       | 0.0   |      |
| Turn Type                  | pm+pt | NA    | Perm  | pm+pt | NA    | Perm  | Perm  | NA    |      | Perm  | NA    |      |
| Protected Phases           | 5     | 2     |       | 1     | 6     |       |       | 8     |      |       |       | 4    |
| Permitted Phases           | 2     |       | 2     | 6     |       | 6     | 8     |       |      | 4     |       |      |
| Detector Phase             | 5     | 2     | 2     | 1     | 6     | 6     | 8     | 8     |      | 4     | 4     |      |
| Switch Phase               |       |       |       |       |       |       |       |       |      |       |       |      |



| Lane Group              | EBL   | EBT   | EBR   | WBL   | WBT   | WBR   | NBL   | NBT   | NBR | SBL   | SBT   | SBR |
|-------------------------|-------|-------|-------|-------|-------|-------|-------|-------|-----|-------|-------|-----|
| Minimum Initial (s)     | 5.0   | 10.0  | 10.0  | 5.0   | 10.0  | 10.0  | 10.0  | 10.0  |     | 10.0  | 10.0  |     |
| Minimum Split (s)       | 10.9  | 27.9  | 27.9  | 10.9  | 27.9  | 27.9  | 35.6  | 35.6  |     | 35.6  | 35.6  |     |
| Total Split (s)         | 18.0  | 70.0  | 70.0  | 18.0  | 70.0  | 70.0  | 42.0  | 42.0  |     | 42.0  | 42.0  |     |
| Total Split (%)         | 13.8% | 53.8% | 53.8% | 13.8% | 53.8% | 53.8% | 32.3% | 32.3% |     | 32.3% | 32.3% |     |
| Maximum Green (s)       | 12.1  | 64.1  | 64.1  | 12.1  | 64.1  | 64.1  | 35.4  | 35.4  |     | 35.4  | 35.4  |     |
| Yellow Time (s)         | 3.7   | 3.7   | 3.7   | 3.7   | 3.7   | 3.7   | 3.0   | 3.0   |     | 3.0   | 3.0   |     |
| All-Red Time (s)        | 2.2   | 2.2   | 2.2   | 2.2   | 2.2   | 2.2   | 3.6   | 3.6   |     | 3.6   | 3.6   |     |
| Lost Time Adjust (s)    | 0.0   | 0.0   | 0.0   | 0.0   | 0.0   | 0.0   | 0.0   | 0.0   |     | 0.0   | 0.0   |     |
| Total Lost Time (s)     | 5.9   | 5.9   | 5.9   | 5.9   | 5.9   | 5.9   | 6.6   | 6.6   |     | 6.6   | 6.6   |     |
| Lead/Lag                | Lead  | Lag   | Lag   | Lead  | Lag   | Lag   |       |       |     |       |       |     |
| Lead-Lag Optimize?      |       |       |       |       |       |       |       |       |     |       |       |     |
| Vehicle Extension (s)   | 3.0   | 3.0   | 3.0   | 3.0   | 3.0   | 3.0   | 3.0   | 3.0   |     | 3.0   | 3.0   |     |
| Recall Mode             | None  | C-Max | C-Max | None  | C-Max | C-Max | None  | None  |     | None  | None  |     |
| Walk Time (s)           |       | 7.0   | 7.0   |       | 7.0   | 7.0   | 7.0   | 7.0   |     | 7.0   | 7.0   |     |
| Flash Dont Walk (s)     |       | 15.0  | 15.0  |       | 15.0  | 15.0  | 22.0  | 22.0  |     | 22.0  | 22.0  |     |
| Pedestrian Calls (#/hr) |       | 5     | 5     |       | 5     | 5     | 5     | 5     |     | 5     | 5     |     |
| Act Effct Green (s)     | 95.1  | 88.9  | 88.9  | 99.2  | 94.5  | 94.5  | 15.5  | 15.5  |     | 15.5  | 15.5  |     |
| Actuated g/C Ratio      | 0.73  | 0.68  | 0.68  | 0.76  | 0.73  | 0.73  | 0.12  | 0.12  |     | 0.12  | 0.12  |     |
| v/c Ratio               | 0.04  | 0.38  | 0.08  | 0.14  | 0.23  | 0.04  | 0.25  | 0.47  |     | 0.53  | 0.46  |     |
| Control Delay           | 4.9   | 11.4  | 2.4   | 4.9   | 9.8   | 2.8   | 53.0  | 23.7  |     | 66.9  | 42.3  |     |
| Queue Delay             | 0.0   | 0.0   | 0.0   | 0.0   | 0.0   | 0.0   | 0.0   | 0.0   |     | 0.0   | 0.0   |     |
| Total Delay             | 4.9   | 11.4  | 2.4   | 4.9   | 9.8   | 2.8   | 53.0  | 23.7  |     | 66.9  | 42.3  |     |
| LOS                     | A     | B     | A     | A     | A     | A     | D     | C     |     | E     | D     |     |
| Approach Delay          |       | 9.8   |       |       | 8.2   |       |       | 30.4  |     |       | 52.5  |     |
| Approach LOS            |       | A     |       |       | A     |       |       | C     |     |       | D     |     |
| Queue Length 50th (m)   | 1.1   | 38.1  | 0.0   | 7.7   | 31.3  | 0.5   | 7.8   | 8.0   |     | 15.9  | 15.4  |     |
| Queue Length 95th (m)   | 4.9   | 84.7  | 5.8   | m14.2 | 53.0  | m2.5  | 15.2  | 22.0  |     | 26.6  | 27.5  |     |
| Internal Link Dist (m)  |       | 484.2 |       |       | 270.0 |       |       | 523.1 |     |       | 289.7 |     |
| Turn Bay Length (m)     | 75.0  |       | 120.0 | 110.0 |       | 130.0 | 220.0 |       |     | 30.0  |       |     |
| Base Capacity (vph)     | 748   | 1181  | 976   | 667   | 1255  | 1069  | 323   | 471   |     | 293   | 443   |     |
| Starvation Cap Reductn  | 0     | 0     | 0     | 0     | 0     | 0     | 0     | 0     |     | 0     | 0     |     |
| Spillback Cap Reductn   | 0     | 0     | 0     | 0     | 0     | 0     | 0     | 0     |     | 0     | 0     |     |
| Storage Cap Reductn     | 0     | 0     | 0     | 0     | 0     | 0     | 0     | 0     |     | 0     | 0     |     |
| Reduced v/c Ratio       | 0.04  | 0.38  | 0.08  | 0.13  | 0.23  | 0.04  | 0.11  | 0.25  |     | 0.24  | 0.22  |     |

Intersection Summary

















Area Type: Other  
 Cycle Length: 130  
 Actuated Cycle Length: 130  
 Offset: 124 (95%), Referenced to phase 2:EBTL and 6:WBTL, Start of Green  
 Natural Cycle: 75  
 Control Type: Actuated-Coordinated  
 Maximum v/c Ratio: 0.53  
 Intersection Signal Delay: 17.2  
 Intersection Capacity Utilization 59.8%  
 Analysis Period (min) 15  
 m Volume for 95th percentile queue is metered by upstream signal.

Splits and Phases: 4: Innovation/Flamborough & Terry Fox



5: Hines & Innovation  
AM Peak Hour

555-603 March Road  
2037 Total Traffic (pre-BRT)

|   |  |  |  |  |  |  |  |  |  |  |  |  |
|---|---|---|---|---|---|---|--|---|---|---|---|---|
| Lane Group                              | EBL   | EBT   | EBR   | WBL   | WBT   | WBR   | NBL  | NBT   | NBR   | SBL   | SBT   | SBR   |
| Lane Configurations                     |   |  |   |   |  |   |  |  |   |   |  |   |
| Traffic Volume (vph)                    | 23  | 0   | 106   | 5   | 1   | 0   | 77   | 24  | 2   | 1   | 6   | 18  |
| Future Volume (vph)                     | 23  | 0   | 106   | 5   | 1   | 0   | 77   | 24  | 2   | 1   | 6   | 18  |
| Ideal Flow (vphpl)                      | 1800  | 1800  | 1800  | 1800  | 1800  | 1800  | 1800   | 1800  | 1800  | 1800  | 1800  | 1800  |
| Lane Util. Factor                       | 1.00  | 1.00  | 1.00  | 1.00  | 1.00  | 1.00  | 1.00   | 1.00  | 1.00  | 1.00  | 1.00  | 1.00  |
| Ped Bike Factor                         |   |   |   |   |   |   |  |   |   |   |   |   |
| Frt                                     |   | 0.889   |   |   |   |   |  | 0.997   |   |   | 0.903   |   |
| Flt Protected                           |   | 0.991   |   |   | 0.960   |   |  | 0.964   |   |   | 0.998   |   |
| Satd. Flow (prot)                       | 0   | 1492  | 0   | 0   | 1692  | 0   | 0  | 1607  | 0   | 0   | 1573  | 0   |
| Flt Permitted                           |   | 0.991   |   |   | 0.960   |   |  | 0.964   |   |   | 0.998   |   |
| Satd. Flow (perm)                       | 0   | 1492  | 0   | 0   | 1692  | 0   | 0  | 1607  | 0   | 0   | 1573  | 0   |
| Link Speed (k/h)                        |   | 50  |   |   | 50  |   |  | 50  |   |   | 50  |   |
| Link Distance (m)                       |   | 438.6   |   |   | 104.0   |   |  | 421.8   |   |   | 190.7   |   |
| Travel Time (s)                         |   | 31.6  |   |   | 7.5   |   |  | 30.4  |   |   | 13.7  |   |
| Confl. Peds. (#/hr)                     |   |   |   |   |   |   | 5  |   |   |   |   | 5   |
| Confl. Bikes (#/hr)                     |   |   | 5   |   |   | 5   |  |   | 10  |   |   | 5   |
| Peak Hour Factor                        | 1.00  | 1.00  | 1.00  | 1.00  | 1.00  | 1.00  | 1.00   | 1.00  | 1.00  | 1.00  | 1.00  | 1.00  |
| Heavy Vehicles (%)                      | 1%  | 2%  | 6%  | 1%  | 1%  | 1%  | 8%   | 2%  | 2%  | 2%  | 5%  | 1%  |
| Adj. Flow (vph)                         | 23  | 0   | 106   | 5   | 1   | 0   | 77   | 24  | 2   | 1   | 6   | 18  |
| Shared Lane Traffic (%)                 |   |   |   |   |   |   |  |   |   |   |   |   |
| Lane Group Flow (vph)                   | 0   | 129   | 0   | 0   | 6   | 0   | 0  | 103   | 0   | 0   | 25  | 0   |
| Enter Blocked Intersection              | No  | No  | No  | No  | No  | No  | No   | No  | No  | No  | No  | No  |
| Lane Alignment                          | Left  | Left  | Right   | Left  | Left  | Right   | Left   | Left  | Right   | Left  | Left  | Right   |
| Median Width(m)                         |   | 0.0   |   |   | 0.0   |   |  | 0.0   |   |   | 0.0   |   |
| Link Offset(m)                          |   | 0.0   |   |   | 0.0   |   |  | 0.0   |   |   | 0.0   |   |
| Crosswalk Width(m)                      |   | 5.0   |   |   | 5.0   |   |  | 5.0   |   |   | 5.0   |   |
| Two way Left Turn Lane                  |   |   |   |   |   |   |  |   |   |   |   |   |
| Headway Factor                          | 1.09  | 1.09  | 1.09  | 1.09  | 1.09  | 1.09  | 1.09   | 1.09  | 1.09  | 1.09  | 1.09  | 1.09  |
| Sign Control                            |   | Stop  |   |   | Stop  |   |  | Free  |   |   | Free  |   |
| <b>Intersection Summary</b>             |   |   |   |   |   |   |  |   |   |   |   |   |
| Area Type:                              | Other   |   |   |   |   |   |  |   |   |   |   |   |
| Control Type:                           | Unsignalized  |   |   |   |   |   |  |   |   |   |   |   |
| Intersection Capacity Utilization 27.1% | ICU Level of Service A  |   |   |   |   |   |  |   |   |   |   |   |
| Analysis Period (min) 15                |   |   |   |   |   |   |  |   |   |   |   |   |

6: March & Site Access/Nokia Access  
AM Peak Hour

555-603 March Road  
2037 Total Traffic (pre-BRT)

| Lane Group                 | EBL   | EBT   | EBR  | WBL   | WBT   | WBR  | NBL   | NBT   | NBR   | SBL   | SBT   | SBR   |
|----------------------------|-------|-------|------|-------|-------|------|-------|-------|-------|-------|-------|-------|
| Lane Configurations        |       |       |      |       |       |      |       |       |       |       |       |       |
| Traffic Volume (vph)       | 34    | 3     | 162  | 188   | 2     | 157  | 161   | 925   | 109   | 355   | 1592  | 57    |
| Future Volume (vph)        | 34    | 3     | 162  | 188   | 2     | 157  | 161   | 925   | 109   | 355   | 1592  | 57    |
| Ideal Flow (vphpl)         | 1800  | 1800  | 1800 | 1800  | 1800  | 1800 | 1800  | 1800  | 1800  | 1800  | 1800  | 1800  |
| Storage Length (m)         | 65.0  |       | 0.0  | 65.0  |       | 0.0  | 75.0  |       | 100.0 | 75.0  |       | 0.0   |
| Storage Lanes              | 1     |       | 0    | 1     |       | 0    | 1     |       | 1     | 1     |       | 0     |
| Taper Length (m)           | 20.0  |       |      | 25.0  |       |      | 50.0  |       |       | 50.0  |       |       |
| Lane Util. Factor          | 1.00  | 1.00  | 1.00 | 1.00  | 1.00  | 1.00 | 1.00  | 0.95  | 1.00  | 1.00  | 0.91  | 0.91  |
| Ped Bike Factor            |       |       |      | 0.99  | 0.97  |      |       |       | 0.94  |       |       |       |
| Fr t                       |       | 0.853 |      |       | 0.852 |      |       |       | 0.850 |       | 0.995 |       |
| Flt Protected              | 0.950 |       |      | 0.950 |       |      | 0.950 |       |       | 0.950 |       |       |
| Satd. Flow (prot)          | 1658  | 1489  | 0    | 1674  | 1460  | 0    | 1658  | 3283  | 1498  | 1674  | 4696  | 0     |
| Flt Permitted              | 0.575 |       |      | 0.563 |       |      | 0.111 |       |       | 0.188 |       |       |
| Satd. Flow (perm)          | 1003  | 1489  | 0    | 983   | 1460  | 0    | 194   | 3283  | 1408  | 331   | 4696  | 0     |
| Right Turn on Red          |       |       | Yes  |       |       | Yes  |       |       | Yes   |       |       | Yes   |
| Satd. Flow (RTOR)          |       | 162   |      |       | 157   |      |       |       | 137   |       |       | 6     |
| Link Speed (k/h)           |       | 50    |      |       | 50    |      |       | 60    |       |       |       | 60    |
| Link Distance (m)          |       | 126.2 |      |       | 167.8 |      |       | 227.7 |       |       |       | 308.9 |
| Travel Time (s)            |       | 9.1   |      |       | 12.1  |      |       | 13.7  |       |       |       | 18.5  |
| Confl. Peds. (#/hr)        |       |       |      | 10    |       | 10   |       |       | 10    | 10    |       |       |
| Confl. Bikes (#/hr)        |       |       |      |       |       | 5    |       |       | 5     |       |       |       |
| Peak Hour Factor           | 1.00  | 1.00  | 1.00 | 1.00  | 1.00  | 1.00 | 1.00  | 1.00  | 1.00  | 1.00  | 1.00  | 1.00  |
| Heavy Vehicles (%)         | 2%    | 2%    | 2%   | 1%    | 2%    | 1%   | 2%    | 3%    | 1%    | 1%    | 3%    | 2%    |
| Adj. Flow (vph)            | 34    | 3     | 162  | 188   | 2     | 157  | 161   | 925   | 109   | 355   | 1592  | 57    |
| Shared Lane Traffic (%)    |       |       |      |       |       |      |       |       |       |       |       |       |
| Lane Group Flow (vph)      | 34    | 165   | 0    | 188   | 159   | 0    | 161   | 925   | 109   | 355   | 1649  | 0     |
| Enter Blocked Intersection | No    | No    | No   | No    | No    | No   | No    | No    | No    | No    | No    | No    |
| Lane Alignment             | L NA  | Left  | R NA | L NA  | Left  | R NA | Left  | Left  | Right | Left  | Left  | Right |
| Median Width(m)            |       | 3.5   |      |       | 3.5   |      |       | 7.0   |       |       | 7.0   |       |
| Link Offset(m)             |       | 0.0   |      |       | 0.0   |      |       | 0.0   |       |       | 0.0   |       |
| Crosswalk Width(m)         |       | 5.0   |      |       | 5.0   |      |       | 5.0   |       |       | 5.0   |       |
| Two way Left Turn Lane     |       |       |      |       |       |      |       |       |       |       |       |       |
| Headway Factor             | 1.09  | 1.09  | 1.09 | 1.09  | 1.09  | 1.09 | 1.09  | 1.09  | 1.09  | 1.09  | 1.09  | 1.09  |
| Number of Detectors        | 1     | 2     |      | 1     | 2     |      | 1     | 2     | 1     | 1     | 2     |       |
| Detector Template          | Left  | Thru  |      | Left  | Thru  |      | Left  | Thru  | Right | Left  | Thru  |       |
| Leading Detector (m)       | 2.0   | 10.0  |      | 2.0   | 10.0  |      | 2.0   | 10.0  | 2.0   | 2.0   | 10.0  |       |
| Trailing Detector (m)      | 0.0   | 0.0   |      | 0.0   | 0.0   |      | 0.0   | 0.0   | 0.0   | 0.0   | 0.0   |       |
| Detector 1 Position(m)     | 0.0   | 0.0   |      | 0.0   | 0.0   |      | 0.0   | 0.0   | 0.0   | 0.0   | 0.0   |       |
| Detector 1 Size(m)         | 2.0   | 0.6   |      | 2.0   | 0.6   |      | 2.0   | 0.6   | 2.0   | 2.0   | 0.6   |       |
| Detector 1 Type            | Cl+Ex | Cl+Ex |      | Cl+Ex | Cl+Ex |      | Cl+Ex | Cl+Ex | Cl+Ex | Cl+Ex | Cl+Ex |       |
| Detector 1 Channel         |       |       |      |       |       |      |       |       |       |       |       |       |
| Detector 1 Extend (s)      | 0.0   | 0.0   |      | 0.0   | 0.0   |      | 0.0   | 0.0   | 0.0   | 0.0   | 0.0   |       |
| Detector 1 Queue (s)       | 0.0   | 0.0   |      | 0.0   | 0.0   |      | 0.0   | 0.0   | 0.0   | 0.0   | 0.0   |       |
| Detector 1 Delay (s)       | 0.0   | 0.0   |      | 0.0   | 0.0   |      | 0.0   | 0.0   | 0.0   | 0.0   | 0.0   |       |
| Detector 2 Position(m)     |       | 9.4   |      |       | 9.4   |      |       | 9.4   |       |       | 9.4   |       |
| Detector 2 Size(m)         |       | 0.6   |      |       | 0.6   |      |       | 0.6   |       |       | 0.6   |       |
| Detector 2 Type            |       | Cl+Ex |      |       | Cl+Ex |      |       | Cl+Ex |       |       | Cl+Ex |       |
| Detector 2 Channel         |       |       |      |       |       |      |       |       |       |       |       |       |
| Detector 2 Extend (s)      |       | 0.0   |      |       | 0.0   |      |       | 0.0   |       |       | 0.0   |       |
| Turn Type                  | Perm  | NA    |      | Perm  | NA    |      | pm+pt | NA    | Perm  | pm+pt | NA    |       |
| Protected Phases           |       | 4     |      |       | 8     |      | 5     | 2     |       | 1     | 6     |       |
| Permitted Phases           | 4     |       |      | 8     |       |      | 2     |       | 2     | 6     |       |       |
| Detector Phase             | 4     | 4     |      | 8     | 8     |      | 5     | 2     | 2     | 1     | 6     |       |
| Switch Phase               |       |       |      |       |       |      |       |       |       |       |       |       |



| Lane Group              | EBL   | EBT   | EBR | WBL   | WBT   | WBR | NBL   | NBT    | NBR   | SBL   | SBT   | SBR |
|-------------------------|-------|-------|-----|-------|-------|-----|-------|--------|-------|-------|-------|-----|
| Minimum Initial (s)     | 10.0  | 10.0  |     | 10.0  | 10.0  |     | 5.0   | 10.0   | 10.0  | 5.0   | 10.0  |     |
| Minimum Split (s)       | 38.5  | 38.5  |     | 38.5  | 38.5  |     | 11.4  | 23.8   | 23.8  | 11.4  | 23.8  |     |
| Total Split (s)         | 42.0  | 42.0  |     | 42.0  | 42.0  |     | 20.0  | 55.0   | 55.0  | 33.0  | 68.0  |     |
| Total Split (%)         | 32.3% | 32.3% |     | 32.3% | 32.3% |     | 15.4% | 42.3%  | 42.3% | 25.4% | 52.3% |     |
| Maximum Green (s)       | 35.5  | 35.5  |     | 35.5  | 35.5  |     | 13.6  | 49.2   | 49.2  | 26.6  | 62.2  |     |
| Yellow Time (s)         | 3.3   | 3.3   |     | 3.3   | 3.3   |     | 3.7   | 3.7    | 3.7   | 3.7   | 3.7   |     |
| All-Red Time (s)        | 3.2   | 3.2   |     | 3.2   | 3.2   |     | 2.7   | 2.1    | 2.1   | 2.7   | 2.1   |     |
| Lost Time Adjust (s)    | 0.0   | 0.0   |     | 0.0   | 0.0   |     | 0.0   | 0.0    | 0.0   | 0.0   | 0.0   |     |
| Total Lost Time (s)     | 6.5   | 6.5   |     | 6.5   | 6.5   |     | 6.4   | 5.8    | 5.8   | 6.4   | 5.8   |     |
| Lead/Lag                |       |       |     |       |       |     | Lead  | Lag    | Lag   | Lead  | Lag   |     |
| Lead-Lag Optimize?      |       |       |     |       |       |     |       |        |       |       |       |     |
| Vehicle Extension (s)   | 3.0   | 3.0   |     | 3.0   | 3.0   |     | 3.0   | 3.0    | 3.0   | 3.0   | 3.0   |     |
| Recall Mode             | None  | None  |     | None  | None  |     | None  | C-Max  | C-Max | None  | C-Max |     |
| Walk Time (s)           | 7.0   | 7.0   |     | 7.0   | 7.0   |     | 7.0   | 7.0    | 7.0   | 7.0   | 7.0   |     |
| Flash Dont Walk (s)     | 25.0  | 25.0  |     | 25.0  | 25.0  |     | 11.0  | 11.0   | 11.0  | 11.0  | 11.0  |     |
| Pedestrian Calls (#/hr) | 10    | 10    |     | 10    | 10    |     | 10    | 10     | 10    | 10    | 10    |     |
| Act Effct Green (s)     | 27.7  | 27.7  |     | 27.7  | 27.7  |     | 71.5  | 60.6   | 60.6  | 89.4  | 72.1  |     |
| Actuated g/C Ratio      | 0.21  | 0.21  |     | 0.21  | 0.21  |     | 0.55  | 0.47   | 0.47  | 0.69  | 0.55  |     |
| v/c Ratio               | 0.16  | 0.37  |     | 0.90  | 0.37  |     | 0.69  | 0.60   | 0.15  | 0.77  | 0.63  |     |
| Control Delay           | 40.3  | 8.2   |     | 89.0  | 8.2   |     | 32.9  | 41.4   | 13.6  | 19.2  | 29.9  |     |
| Queue Delay             | 0.0   | 0.0   |     | 0.0   | 0.0   |     | 0.0   | 0.0    | 0.0   | 0.0   | 0.0   |     |
| Total Delay             | 40.3  | 8.2   |     | 89.0  | 8.2   |     | 32.9  | 41.4   | 13.6  | 19.2  | 29.9  |     |
| LOS                     | D     | A     |     | F     | A     |     | C     | D      | B     | B     | C     |     |
| Approach Delay          |       | 13.7  |     |       | 52.0  |     |       | 37.7   |       |       | 28.0  |     |
| Approach LOS            |       | B     |     |       | D     |     |       | D      |       |       | C     |     |
| Queue Length 50th (m)   | 6.5   | 0.6   |     | 43.1  | 0.4   |     | 28.4  | 81.9   | 4.1   | 59.9  | 141.2 |     |
| Queue Length 95th (m)   | 14.1  | 15.7  |     | #69.5 | 15.3  |     | m41.9 | m116.5 | m11.1 | 46.2  | 157.7 |     |
| Internal Link Dist (m)  |       | 102.2 |     |       | 143.8 |     |       | 203.7  |       |       | 284.9 |     |
| Turn Bay Length (m)     | 65.0  |       |     | 65.0  |       |     | 75.0  |        | 100.0 | 75.0  |       |     |
| Base Capacity (vph)     | 273   | 524   |     | 268   | 512   |     | 268   | 1531   | 729   | 506   | 2606  |     |
| Starvation Cap Reductn  | 0     | 0     |     | 0     | 0     |     | 0     | 0      | 0     | 0     | 0     |     |
| Spillback Cap Reductn   | 0     | 0     |     | 0     | 0     |     | 0     | 0      | 0     | 0     | 0     |     |
| Storage Cap Reductn     | 0     | 0     |     | 0     | 0     |     | 0     | 0      | 0     | 0     | 0     |     |
| Reduced v/c Ratio       | 0.12  | 0.31  |     | 0.70  | 0.31  |     | 0.60  | 0.60   | 0.15  | 0.70  | 0.63  |     |

Intersection Summary

Area Type: Other  
 Cycle Length: 130  
 Actuated Cycle Length: 130  
 Offset: 0 (0%), Referenced to phase 2:NBT and 6:SBTL, Start of Green  
 Natural Cycle: 90  
 Control Type: Actuated-Coordinated  
 Maximum v/c Ratio: 0.90  
 Intersection Signal Delay: 32.6  
 Intersection LOS: C  
 Intersection Capacity Utilization 92.8%  
 ICU Level of Service F  
 Analysis Period (min) 15  
 # 95th percentile volume exceeds capacity, queue may be longer.  
 Queue shown is maximum after two cycles.  
 m Volume for 95th percentile queue is metered by upstream signal.

Splits and Phases: 6: March & Site Access/Nokia Access







| Lane Group                 | EBT   | EBR   | WBL   | WBT   | NBL   | NBR  |
|----------------------------|-------|-------|-------|-------|-------|------|
| Lane Configurations        |       |       |       |       |       |      |
| Traffic Volume (vph)       | 537   | 42    | 78    | 448   | 30    | 58   |
| Future Volume (vph)        | 537   | 42    | 78    | 448   | 30    | 58   |
| Ideal Flow (vphpl)         | 1800  | 1800  | 1800  | 1800  | 1800  | 1800 |
| Storage Length (m)         |       | 0.0   | 30.0  |       | 0.0   | 0.0  |
| Storage Lanes              |       | 0     | 1     |       | 1     | 0    |
| Taper Length (m)           |       |       | 40.0  |       | 10.0  |      |
| Lane Util. Factor          | 1.00  | 1.00  | 1.00  | 0.95  | 1.00  | 1.00 |
| Ped Bike Factor            |       |       |       |       |       |      |
| Frt                        | 0.990 |       |       |       | 0.911 |      |
| Flt Protected              |       |       | 0.950 |       | 0.983 |      |
| Satd. Flow (prot)          | 1713  | 0     | 1674  | 3283  | 1578  | 0    |
| Flt Permitted              |       |       | 0.950 |       | 0.983 |      |
| Satd. Flow (perm)          | 1713  | 0     | 1674  | 3283  | 1578  | 0    |
| Link Speed (k/h)           | 60    |       |       | 60    | 50    |      |
| Link Distance (m)          | 191.8 |       |       | 165.4 | 126.2 |      |
| Travel Time (s)            | 11.5  |       |       | 9.9   | 9.1   |      |
| Confl. Peds. (#/hr)        |       | 10    | 10    |       |       |      |
| Confl. Bikes (#/hr)        |       | 5     |       |       |       | 5    |
| Peak Hour Factor           | 1.00  | 1.00  | 1.00  | 1.00  | 1.00  | 1.00 |
| Heavy Vehicles (%)         | 3%    | 1%    | 1%    | 3%    | 1%    | 1%   |
| Adj. Flow (vph)            | 537   | 42    | 78    | 448   | 30    | 58   |
| Shared Lane Traffic (%)    |       |       |       |       |       |      |
| Lane Group Flow (vph)      | 579   | 0     | 78    | 448   | 88    | 0    |
| Enter Blocked Intersection | No    | No    | No    | No    | No    | No   |
| Lane Alignment             | Left  | Right | Left  | Left  | L NA  | R NA |
| Median Width(m)            | 7.0   |       |       | 9.0   | 3.5   |      |
| Link Offset(m)             | 0.0   |       |       | 0.0   | 0.0   |      |
| Crosswalk Width(m)         | 5.0   |       |       | 5.0   | 5.0   |      |
| Two way Left Turn Lane     |       |       |       |       |       |      |
| Headway Factor             | 1.09  | 1.09  | 1.09  | 1.09  | 1.09  | 1.09 |
| Sign Control               | Free  |       |       | Free  | Stop  |      |









**Intersection Summary**

Area Type: Other

Control Type: Unsignalized

Intersection Capacity Utilization 52.7% ICU Level of Service A

Analysis Period (min) 15

|                                   |  |  |  |  |  |  |
|-----------------------------------|---|---|---|---|---|---|
| Lane Group                        | WBL   | WBR   | NBT   | NBR   | SBL   | SBT   |
| Lane Configurations               |  |   |  |   |   |  |
| Traffic Volume (vph)              | 16  | 25  | 37  | 10  | 7   | 8   |
| Future Volume (vph)               | 16  | 25  | 37  | 10  | 7   | 8   |
| Ideal Flow (vphpl)                | 1800  | 1800  | 1800  | 1800  | 1800  | 1800  |
| Lane Util. Factor                 | 1.00  | 1.00  | 1.00  | 1.00  | 1.00  | 1.00  |
| <b>Ped Bike Factor</b>            |   |   |   |   |   |   |
| Frt                               | 0.918   |   | 0.971   |   |   |   |
| Flt Protected                     | 0.981   |   |   |   |   | 0.977   |
| Satd. Flow (prot)                 | 1587  | 0   | 1698  | 0   | 0   | 1713  |
| Flt Permitted                     | 0.981   |   |   |   |   | 0.977   |
| Satd. Flow (perm)                 | 1587  | 0   | 1698  | 0   | 0   | 1713  |
| Link Speed (k/h)                  | 50  |   | 50  |   |   | 50  |
| Link Distance (m)                 | 75.1  |   | 190.7   |   |   | 128.3   |
| Travel Time (s)                   | 5.4   |   | 13.7  |   |   | 9.2   |
| Confl. Peds. (#/hr)               |   |   |   | 10  | 10  |   |
| Confl. Bikes (#/hr)               |   | 5   |   | 5   |   |   |
| Peak Hour Factor                  | 1.00  | 1.00  | 1.00  | 1.00  | 1.00  | 1.00  |
| Heavy Vehicles (%)                | 1%  | 1%  | 2%  | 1%  | 1%  | 2%  |
| Adj. Flow (vph)                   | 16  | 25  | 37  | 10  | 7   | 8   |
| <b>Shared Lane Traffic (%)</b>    |   |   |   |   |   |   |
| Lane Group Flow (vph)             | 41  | 0   | 47  | 0   | 0   | 15  |
| Enter Blocked Intersection        | No  | No  | No  | No  | No  | No  |
| Lane Alignment                    | Left  | Right   | Left  | Right   | Left  | Left  |
| Median Width(m)                   | 3.5   |   | 0.0   |   |   | 0.0   |
| Link Offset(m)                    | 0.0   |   | 0.0   |   |   | 0.0   |
| Crosswalk Width(m)                | 5.0   |   | 5.0   |   |   | 5.0   |
| <b>Two way Left Turn Lane</b>     |   |   |   |   |   |   |
| Headway Factor                    | 1.09  | 1.09  | 1.09  | 1.09  | 1.09  | 1.09  |
| Sign Control                      | Stop  |   | Free  |   |   | Free  |
| <b>Intersection Summary</b>       |   |   |   |   |   |   |
| Area Type:                        | Other   |   |   |   |   |   |
| Control Type:                     | Unsignalized  |   |   |   |   |   |
| Intersection Capacity Utilization | 17.0%   |   |   | ICU Level of Service A  |   |   |
| Analysis Period (min)             | 15  |   |   |   |   |   |

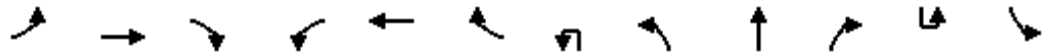

| Lane Group                 | EBL   | EBT   | EBR   | WBL   | WBT   | WBR   | NBU   | NBL   | NBT   | NBR   | SBU   | SBL   |
|----------------------------|-------|-------|-------|-------|-------|-------|-------|-------|-------|-------|-------|-------|
| Lane Configurations        | ↖↖    | ↕↕    | ↗     | ↖↖    | ↕↕    | ↗     |       | ↖↖    | ↕↕    | ↗     |       | ↖↖    |
| Traffic Volume (vph)       | 125   | 183   | 283   | 42    | 76    | 50    | 14    | 180   | 882   | 109   | 1     | 202   |
| Future Volume (vph)        | 125   | 183   | 283   | 42    | 76    | 50    | 14    | 180   | 882   | 109   | 1     | 202   |
| Ideal Flow (vphpl)         | 1800  | 1800  | 1800  | 1800  | 1800  | 1800  | 1800  | 1800  | 1800  | 1800  | 1800  | 1800  |
| Storage Length (m)         | 95.0  |       | 60.0  | 60.0  |       | 75.0  |       | 140.0 |       | 20.0  |       | 90.0  |
| Storage Lanes              | 2     |       | 1     | 2     |       | 1     |       | 2     |       | 1     |       | 2     |
| Taper Length (m)           | 40.0  |       |       | 25.0  |       |       |       | 90.0  |       |       |       | 75.0  |
| Lane Util. Factor          | 0.97  | 0.95  | 1.00  | 0.97  | 0.95  | 1.00  | 0.95  | 0.97  | 0.95  | 1.00  | 0.95  | 0.97  |
| Ped Bike Factor            | 0.99  |       | 0.97  | 0.99  |       | 0.98  |       | 1.00  |       | 0.97  |       | 0.99  |
| Fr                         |       |       | 0.850 |       |       | 0.850 |       |       |       | 0.850 |       |       |
| Flt Protected              | 0.950 |       |       | 0.950 |       |       |       | 0.950 |       |       |       | 0.950 |
| Satd. Flow (prot)          | 3185  | 3316  | 1483  | 3248  | 3161  | 1498  | 0     | 3246  | 3221  | 1469  | 0     | 3248  |
| Flt Permitted              | 0.950 |       |       | 0.950 |       |       |       | 0.950 |       |       |       | 0.950 |
| Satd. Flow (perm)          | 3158  | 3316  | 1436  | 3200  | 3161  | 1465  | 0     | 3242  | 3221  | 1426  | 0     | 3224  |
| Right Turn on Red          |       |       | Yes   |       |       | Yes   |       |       |       | Yes   |       |       |
| Satd. Flow (RTOR)          |       |       | 195   |       |       | 195   |       |       |       | 200   |       |       |
| Link Speed (k/h)           |       | 60    |       |       | 60    |       |       |       | 60    |       |       |       |
| Link Distance (m)          |       | 165.4 |       |       | 149.1 |       |       |       | 308.9 |       |       |       |
| Travel Time (s)            |       | 9.9   |       |       | 8.9   |       |       |       | 18.5  |       |       |       |
| Confl. Peds. (#/hr)        | 5     |       | 10    | 10    |       | 5     |       | 5     |       | 10    |       | 10    |
| Confl. Bikes (#/hr)        |       |       | 10    |       |       | 5     |       |       |       | 5     |       |       |
| Peak Hour Factor           | 1.00  | 1.00  | 1.00  | 1.00  | 1.00  | 1.00  | 1.00  | 1.00  | 1.00  | 1.00  | 1.00  | 1.00  |
| Heavy Vehicles (%)         | 3%    | 2%    | 2%    | 1%    | 7%    | 1%    | 2%    | 1%    | 5%    | 3%    | 2%    | 1%    |
| Adj. Flow (vph)            | 125   | 183   | 283   | 42    | 76    | 50    | 14    | 180   | 882   | 109   | 1     | 202   |
| Shared Lane Traffic (%)    |       |       |       |       |       |       |       |       |       |       |       |       |
| Lane Group Flow (vph)      | 125   | 183   | 283   | 42    | 76    | 50    | 0     | 194   | 882   | 109   | 0     | 203   |
| Enter Blocked Intersection | No    | No    | No    | Yes   | Yes   | Yes   | No    | No    | No    | No    | No    | No    |
| Lane Alignment             | L NA  | Left  | R NA  | L NA  | Left  | R NA  | R NA  | L NA  | Left  | R NA  | R NA  | L NA  |
| Median Width(m)            |       | 11.5  |       |       | 10.5  |       |       |       | 17.5  |       |       |       |
| Link Offset(m)             |       | 0.0   |       |       | 0.0   |       |       |       | 0.0   |       |       |       |
| Crosswalk Width(m)         |       | 5.0   |       |       | 5.0   |       |       |       | 5.0   |       |       |       |
| Two way Left Turn Lane     |       |       |       |       |       |       |       |       |       |       |       |       |
| Headway Factor             | 1.09  | 1.09  | 1.09  | 1.09  | 1.09  | 1.09  | 1.09  | 1.09  | 1.09  | 1.09  | 1.09  | 1.09  |
| Number of Detectors        | 1     | 2     | 1     | 1     | 2     | 1     | 1     | 1     | 2     | 1     | 1     | 1     |
| Detector Template          | Left  | Thru  | Right | Left  | Thru  | Right | Left  | Left  | Thru  | Right | Left  | Left  |
| Leading Detector (m)       | 2.0   | 10.0  | 2.0   | 2.0   | 10.0  | 2.0   | 2.0   | 2.0   | 10.0  | 2.0   | 2.0   | 2.0   |
| Trailing Detector (m)      | 0.0   | 0.0   | 0.0   | 0.0   | 0.0   | 0.0   | 0.0   | 0.0   | 0.0   | 0.0   | 0.0   | 0.0   |
| Detector 1 Position(m)     | 0.0   | 0.0   | 0.0   | 0.0   | 0.0   | 0.0   | 0.0   | 0.0   | 0.0   | 0.0   | 0.0   | 0.0   |
| Detector 1 Size(m)         | 2.0   | 0.6   | 2.0   | 2.0   | 0.6   | 2.0   | 2.0   | 2.0   | 0.6   | 2.0   | 2.0   | 2.0   |
| Detector 1 Type            | Cl+Ex | Cl+Ex | Cl+Ex | Cl+Ex | Cl+Ex | Cl+Ex | Cl+Ex | Cl+Ex | Cl+Ex | Cl+Ex | Cl+Ex | Cl+Ex |
| Detector 1 Channel         |       |       |       |       |       |       |       |       |       |       |       |       |
| Detector 1 Extend (s)      | 0.0   | 0.0   | 0.0   | 0.0   | 0.0   | 0.0   | 0.0   | 0.0   | 0.0   | 0.0   | 0.0   | 0.0   |
| Detector 1 Queue (s)       | 0.0   | 0.0   | 0.0   | 0.0   | 0.0   | 0.0   | 0.0   | 0.0   | 0.0   | 0.0   | 0.0   | 0.0   |
| Detector 1 Delay (s)       | 0.0   | 0.0   | 0.0   | 0.0   | 0.0   | 0.0   | 0.0   | 0.0   | 0.0   | 0.0   | 0.0   | 0.0   |
| Detector 2 Position(m)     |       | 9.4   |       |       | 9.4   |       |       |       | 9.4   |       |       |       |
| Detector 2 Size(m)         |       | 0.6   |       |       | 0.6   |       |       |       | 0.6   |       |       |       |
| Detector 2 Type            |       | Cl+Ex |       |       | Cl+Ex |       |       |       | Cl+Ex |       |       |       |
| Detector 2 Channel         |       |       |       |       |       |       |       |       |       |       |       |       |
| Detector 2 Extend (s)      |       | 0.0   |       |       | 0.0   |       |       |       | 0.0   |       |       |       |
| Turn Type                  | Prot  | NA    | Perm  | Prot  | NA    | Perm  | Prot  | Prot  | NA    | Perm  | Prot  | Prot  |
| Protected Phases           | 7     | 4     |       | 3     | 8     |       | 5     | 5     | 2     |       | 1     | 1     |
| Permitted Phases           |       |       | 4     |       |       | 8     |       |       |       | 2     |       |       |
| Detector Phase             | 7     | 4     | 4     | 3     | 8     | 8     | 5     | 5     | 2     | 2     | 1     | 1     |
| Switch Phase               |       |       |       |       |       |       |       |       |       |       |       |       |

2: March & Terry Fox  
AM Peak Hour

555-603 March Road  
2037 Total Traffic (post-BRT)



| Lane Group                 | SBT   | SBR   |
|----------------------------|-------|-------|
| Lane Configurations        | ↑↑    | ↑     |
| Traffic Volume (vph)       | 1633  | 235   |
| Future Volume (vph)        | 1633  | 235   |
| Ideal Flow (vphpl)         | 1800  | 1800  |
| Storage Length (m)         |       | 80.0  |
| Storage Lanes              |       | 1     |
| Taper Length (m)           |       |       |
| Lane Util. Factor          | 0.95  | 1.00  |
| Ped Bike Factor            |       | 0.98  |
| Frt                        |       | 0.850 |
| Flt Protected              |       |       |
| Satd. Flow (prot)          | 3283  | 1469  |
| Flt Permitted              |       |       |
| Satd. Flow (perm)          | 3283  | 1437  |
| Right Turn on Red          |       | Yes   |
| Satd. Flow (RTOR)          |       | 171   |
| Link Speed (k/h)           | 60    |       |
| Link Distance (m)          | 318.9 |       |
| Travel Time (s)            | 19.1  |       |
| Confl. Peds. (#/hr)        |       | 5     |
| Confl. Bikes (#/hr)        |       | 5     |
| Peak Hour Factor           | 1.00  | 1.00  |
| Heavy Vehicles (%)         | 3%    | 3%    |
| Adj. Flow (vph)            | 1633  | 235   |
| Shared Lane Traffic (%)    |       |       |
| Lane Group Flow (vph)      | 1633  | 235   |
| Enter Blocked Intersection | No    | No    |
| Lane Alignment             | Left  | R NA  |
| Median Width(m)            | 17.5  |       |
| Link Offset(m)             | 0.0   |       |
| Crosswalk Width(m)         | 5.0   |       |
| Two way Left Turn Lane     |       |       |
| Headway Factor             | 1.09  | 1.09  |
| Number of Detectors        | 2     | 1     |
| Detector Template          | Thru  | Right |
| Leading Detector (m)       | 10.0  | 2.0   |
| Trailing Detector (m)      | 0.0   | 0.0   |
| Detector 1 Position(m)     | 0.0   | 0.0   |
| Detector 1 Size(m)         | 0.6   | 2.0   |
| Detector 1 Type            | CI+Ex | CI+Ex |
| Detector 1 Channel         |       |       |
| Detector 1 Extend (s)      | 0.0   | 0.0   |
| Detector 1 Queue (s)       | 0.0   | 0.0   |
| Detector 1 Delay (s)       | 0.0   | 0.0   |
| Detector 2 Position(m)     | 9.4   |       |
| Detector 2 Size(m)         | 0.6   |       |
| Detector 2 Type            | CI+Ex |       |
| Detector 2 Channel         |       |       |
| Detector 2 Extend (s)      | 0.0   |       |
| Turn Type                  | NA    | Perm  |
| Protected Phases           | 6     |       |
| Permitted Phases           |       | 6     |
| Detector Phase             | 6     | 6     |
| Switch Phase               |       |       |



| Lane Group              | EBL   | EBT   | EBR   | WBL  | WBT   | WBR   | NBU  | NBL    | NBT   | NBR   | SBU   | SBL   |
|-------------------------|-------|-------|-------|------|-------|-------|------|--------|-------|-------|-------|-------|
| Minimum Initial (s)     | 5.0   | 10.0  | 10.0  | 5.0  | 10.0  | 10.0  | 5.0  | 5.0    | 10.0  | 10.0  | 5.0   | 5.0   |
| Minimum Split (s)       | 12.0  | 41.0  | 41.0  | 12.0 | 41.0  | 41.0  | 11.4 | 11.4   | 32.4  | 32.4  | 11.4  | 11.4  |
| Total Split (s)         | 12.0  | 41.0  | 41.0  | 12.0 | 41.0  | 41.0  | 12.0 | 12.0   | 57.0  | 57.0  | 20.0  | 20.0  |
| Total Split (%)         | 9.2%  | 31.5% | 31.5% | 9.2% | 31.5% | 31.5% | 9.2% | 9.2%   | 43.8% | 43.8% | 15.4% | 15.4% |
| Maximum Green (s)       | 5.0   | 34.0  | 34.0  | 5.0  | 34.0  | 34.0  | 5.6  | 5.6    | 50.6  | 50.6  | 13.6  | 13.6  |
| Yellow Time (s)         | 3.7   | 3.7   | 3.7   | 3.7  | 3.7   | 3.7   | 3.7  | 3.7    | 3.7   | 3.7   | 3.7   | 3.7   |
| All-Red Time (s)        | 3.3   | 3.3   | 3.3   | 3.3  | 3.3   | 3.3   | 2.7  | 2.7    | 2.7   | 2.7   | 2.7   | 2.7   |
| Lost Time Adjust (s)    | 0.0   | 0.0   | 0.0   | 0.0  | 0.0   | 0.0   |      | 0.0    | 0.0   | 0.0   |       | 0.0   |
| Total Lost Time (s)     | 7.0   | 7.0   | 7.0   | 7.0  | 7.0   | 7.0   |      | 6.4    | 6.4   | 6.4   |       | 6.4   |
| Lead/Lag                | Lead  | Lag   | Lag   | Lead | Lag   | Lag   | Lead | Lead   | Lag   | Lag   | Lead  | Lead  |
| Lead-Lag Optimize?      |       |       |       |      |       |       |      |        |       |       |       |       |
| Vehicle Extension (s)   | 3.0   | 3.0   | 3.0   | 3.0  | 3.0   | 3.0   | 3.0  | 3.0    | 3.0   | 3.0   | 3.0   | 3.0   |
| Recall Mode             | None  | None  | None  | None | None  | None  | None | None   | C-Max | C-Max | None  | None  |
| Walk Time (s)           |       | 7.0   | 7.0   |      | 7.0   | 7.0   |      |        | 7.0   | 7.0   |       |       |
| Flash Dont Walk (s)     |       | 27.0  | 27.0  |      | 27.0  | 27.0  |      |        | 19.0  | 19.0  |       |       |
| Pedestrian Calls (#/hr) |       | 10    | 10    |      | 5     | 5     |      |        | 5     | 5     |       |       |
| Act Effct Green (s)     | 6.0   | 20.7  | 20.7  | 5.0  | 20.7  | 20.7  |      | 13.4   | 67.4  | 67.4  |       | 12.4  |
| Actuated g/C Ratio      | 0.05  | 0.16  | 0.16  | 0.04 | 0.16  | 0.16  |      | 0.10   | 0.52  | 0.52  |       | 0.10  |
| v/c Ratio               | 0.85  | 0.35  | 0.72  | 0.34 | 0.15  | 0.13  |      | 0.58   | 0.53  | 0.13  |       | 0.65  |
| Control Delay           | 110.5 | 43.3  | 21.1  | 68.5 | 43.9  | 0.7   |      | 52.4   | 41.1  | 9.3   |       | 84.3  |
| Queue Delay             | 0.0   | 0.0   | 0.0   | 0.0  | 0.0   | 0.0   |      | 0.0    | 0.0   | 0.0   |       | 0.0   |
| Total Delay             | 110.5 | 43.3  | 21.1  | 68.5 | 43.9  | 0.7   |      | 52.4   | 41.1  | 9.3   |       | 84.3  |
| LOS                     | F     | D     | C     | E    | D     | A     |      | D      | D     | A     |       | F     |
| Approach Delay          |       | 46.9  |       |      | 37.2  |       |      |        | 40.0  |       |       |       |
| Approach LOS            |       | D     |       |      | D     |       |      |        | D     |       |       |       |
| Queue Length 50th (m)   | ~16.0 | 20.4  | 15.2  | 5.1  | 8.7   | 0.0   |      | 24.6   | 65.6  | 2.9   |       | 26.3  |
| Queue Length 95th (m)   | #36.5 | 21.4  | 28.4  | 10.7 | 13.1  | 0.0   |      | m#46.7 | 112.2 | m10.5 |       | 37.9  |
| Internal Link Dist (m)  |       | 141.4 |       |      | 125.1 |       |      |        | 284.9 |       |       |       |
| Turn Bay Length (m)     | 95.0  |       | 60.0  | 60.0 |       | 75.0  |      | 140.0  |       | 20.0  |       | 90.0  |
| Base Capacity (vph)     | 147   | 867   | 519   | 124  | 826   | 527   |      | 333    | 1670  | 836   |       | 339   |
| Starvation Cap Reductn  | 0     | 0     | 0     | 0    | 0     | 0     |      | 0      | 0     | 0     |       | 0     |
| Spillback Cap Reductn   | 0     | 0     | 0     | 0    | 0     | 0     |      | 0      | 0     | 0     |       | 0     |
| Storage Cap Reductn     | 0     | 0     | 0     | 0    | 0     | 0     |      | 0      | 0     | 0     |       | 0     |
| Reduced v/c Ratio       | 0.85  | 0.21  | 0.55  | 0.34 | 0.09  | 0.09  |      | 0.58   | 0.53  | 0.13  |       | 0.60  |

Intersection Summary

Area Type: Other  
 Cycle Length: 130  
 Actuated Cycle Length: 130  
 Offset: 75 (58%), Referenced to phase 2:NBT and 6:SBT, Start of Green  
 Natural Cycle: 150  
 Control Type: Actuated-Coordinated  
 Maximum v/c Ratio: 0.97  
 Intersection Signal Delay: 40.1  
 Intersection LOS: D  
 Intersection Capacity Utilization 102.0%  
 ICU Level of Service G  
 Analysis Period (min) 15  
 ~ Volume exceeds capacity, queue is theoretically infinite.  
 Queue shown is maximum after two cycles.  
 # 95th percentile volume exceeds capacity, queue may be longer.  
 Queue shown is maximum after two cycles.  
 m Volume for 95th percentile queue is metered by upstream signal.

Splits and Phases: 2: March & Terry Fox

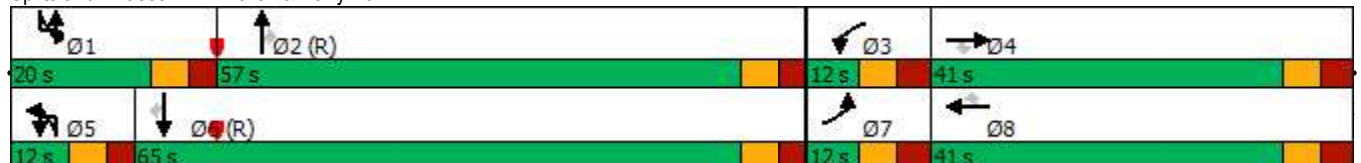























| Lane Group                  | SBT    | SBR   |
|-----------------------------|--------|-------|
| Minimum Initial (s)         | 10.0   | 10.0  |
| Minimum Split (s)           | 32.4   | 32.4  |
| Total Split (s)             | 65.0   | 65.0  |
| Total Split (%)             | 50.0%  | 50.0% |
| Maximum Green (s)           | 58.6   | 58.6  |
| Yellow Time (s)             | 3.7    | 3.7   |
| All-Red Time (s)            | 2.7    | 2.7   |
| Lost Time Adjust (s)        | 0.0    | 0.0   |
| Total Lost Time (s)         | 6.4    | 6.4   |
| Lead/Lag                    | Lag    | Lag   |
| Lead-Lag Optimize?          |        |       |
| Vehicle Extension (s)       | 3.0    | 3.0   |
| Recall Mode                 | C-Max  | C-Max |
| Walk Time (s)               | 7.0    | 7.0   |
| Flash Dont Walk (s)         | 19.0   | 19.0  |
| Pedestrian Calls (#/hr)     | 5      | 5     |
| Act Effct Green (s)         | 66.5   | 66.5  |
| Actuated g/C Ratio          | 0.51   | 0.51  |
| v/c Ratio                   | 0.97   | 0.29  |
| Control Delay               | 38.1   | 2.0   |
| Queue Delay                 | 0.0    | 0.0   |
| Total Delay                 | 38.1   | 2.0   |
| LOS                         | D      | A     |
| Approach Delay              | 38.5   |       |
| Approach LOS                | D      |       |
| Queue Length 50th (m)       | 190.8  | 1.0   |
| Queue Length 95th (m)       | #270.0 | 2.9   |
| Internal Link Dist (m)      | 294.9  |       |
| Turn Bay Length (m)         |        | 80.0  |
| Base Capacity (vph)         | 1679   | 818   |
| Starvation Cap Reductn      | 0      | 0     |
| Spillback Cap Reductn       | 0      | 0     |
| Storage Cap Reductn         | 0      | 0     |
| Reduced v/c Ratio           | 0.97   | 0.29  |
| <b>Intersection Summary</b> |        |       |

3: March & Solandt  
AM Peak Hour

555-603 March Road  
2037 Total Traffic (post-BRT)

|                            |  |  |  |  |  |  |  |  |  |  |  |  |
|----------------------------|---|---|---|---|---|---|--|---|---|---|---|---|
| Lane Group                 | EBL   | EBT   | EBR   | WBL   | WBT   | WBR   | NBU  | NBL   | NBT   | NBR   | SBU   | SBL   |
| Lane Configurations        |  |  |  |  |  |   |  |  |  |   |   |  |
| Traffic Volume (vph)       | 12  | 30  | 78  | 74  | 14  | 15  | 2  | 196   | 1619  | 172   | 2   | 57  |
| Future Volume (vph)        | 12  | 30  | 78  | 74  | 14  | 15  | 2  | 196   | 1619  | 172   | 2   | 57  |
| Ideal Flow (vphpl)         | 1800  | 1800  | 1800  | 1800  | 1800  | 1800  | 1800   | 1800  | 1800  | 1800  | 1800  | 1800  |
| Storage Length (m)         | 35.0  |   | 60.0  | 85.0  |   | 55.0  |  | 165.0   |   | 0.0   |   | 155.0   |
| Storage Lanes              | 1   |   | 1   | 2   |   | 0   |  | 1   |   | 0   |   | 1   |
| Taper Length (m)           | 50.0  |   |   | 95.0  |   |   |  | 40.0  |   |   |   | 25.0  |
| Lane Util. Factor          | 1.00  | 1.00  | 1.00  | 0.97  | 1.00  | 1.00  | 0.95   | 1.00  | 0.95  | 0.95  | 0.95  | 1.00  |
| Ped Bike Factor            | 0.99  |   | 0.98  | 0.99  | 0.99  |   |  | 1.00  | 1.00  |   |   | 1.00  |
| Fr <sub>t</sub>            |   |   | 0.850   |   | 0.922   |   |  |   | 0.986   |   |   |   |
| Fl <sub>t</sub> Protected  | 0.950   |   |   | 0.950   |   |   |  | 0.950   |   |   |   | 0.950   |
| Satd. Flow (prot)          | 1537  | 1728  | 1414  | 3124  | 1410  | 0   | 0  | 1658  | 3236  | 0   | 0   | 1674  |
| Fl <sub>t</sub> Permitted  | 0.950   |   |   | 0.950   |   |   |  | 0.950   |   |   |   | 0.950   |
| Satd. Flow (perm)          | 1528  | 1728  | 1381  | 3092  | 1410  | 0   | 0  | 1656  | 3236  | 0   | 0   | 1672  |
| Right Turn on Red          |   |   | Yes   |   |   | Yes   |  |   |   | Yes   |   |   |
| Satd. Flow (RTOR)          |   |   | 137   |   | 15  |   |  |   | 12  |   |   |   |
| Link Speed (k/h)           |   | 50  |   |   | 50  |   |  |   | 60  |   |   |   |
| Link Distance (m)          |   | 212.6   |   |   | 241.6   |   |  |   | 610.9   |   |   |   |
| Travel Time (s)            |   | 15.3  |   |   | 17.4  |   |  |   | 36.7  |   |   |   |
| Confl. Peds. (#/hr)        | 5   |   | 5   | 5   |   | 5   |  | 5   |   | 5   |   | 5   |
| Confl. Bikes (#/hr)        |   |   | 5   |   |   | 5   |  |   |   | 5   |   |   |
| Peak Hour Factor           | 1.00  | 1.00  | 1.00  | 1.00  | 1.00  | 1.00  | 1.00   | 1.00  | 1.00  | 1.00  | 1.00  | 1.00  |
| Heavy Vehicles (%)         | 10%   | 3%  | 7%  | 5%  | 30%   | 1%  | 2%   | 2%  | 3%  | 1%  | 2%  | 1%  |
| Adj. Flow (vph)            | 12  | 30  | 78  | 74  | 14  | 15  | 2  | 196   | 1619  | 172   | 2   | 57  |
| Shared Lane Traffic (%)    |   |   |   |   |   |   |  |   |   |   |   |   |
| Lane Group Flow (vph)      | 12  | 30  | 78  | 74  | 29  | 0   | 0  | 198   | 1791  | 0   | 0   | 59  |
| Enter Blocked Intersection | No  | No  | No  | No  | No  | No  | No   | No  | No  | No  | No  | No  |
| Lane Alignment             | L NA  | Left  | R NA  | L NA  | Left  | R NA  | R NA   | L NA  | Left  | R NA  | R NA  | L NA  |
| Median Width(m)            |   | 7.0   |   |   | 10.5  |   |  |   | 17.5  |   |   |   |
| Link Offset(m)             |   | 0.0   |   |   | 0.0   |   |  |   | 0.0   |   |   |   |
| Crosswalk Width(m)         |   | 5.0   |   |   | 5.0   |   |  |   | 5.0   |   |   |   |
| Two way Left Turn Lane     |   |   |   |   |   |   |  |   |   |   |   |   |
| Headway Factor             | 1.09  | 1.09  | 1.09  | 1.09  | 1.09  | 1.09  | 1.09   | 1.09  | 1.09  | 1.09  | 1.09  | 1.09  |
| Number of Detectors        | 1   | 2   | 1   | 1   | 2   |   | 1  | 1   | 2   |   | 1   | 1   |
| Detector Template          | Left  | Thru  | Right   | Left  | Thru  |   | Left   | Left  | Thru  |   | Left  | Left  |
| Leading Detector (m)       | 2.0   | 10.0  | 2.0   | 2.0   | 10.0  |   | 2.0  | 2.0   | 10.0  |   | 2.0   | 2.0   |
| Trailing Detector (m)      | 0.0   | 0.0   | 0.0   | 0.0   | 0.0   |   | 0.0  | 0.0   | 0.0   |   | 0.0   | 0.0   |
| Detector 1 Position(m)     | 0.0   | 0.0   | 0.0   | 0.0   | 0.0   |   | 0.0  | 0.0   | 0.0   |   | 0.0   | 0.0   |
| Detector 1 Size(m)         | 2.0   | 0.6   | 2.0   | 2.0   | 0.6   |   | 2.0  | 2.0   | 0.6   |   | 2.0   | 2.0   |
| Detector 1 Type            | Cl+Ex   | Cl+Ex   | Cl+Ex   | Cl+Ex   | Cl+Ex   |   | Cl+Ex  | Cl+Ex   | Cl+Ex   |   | Cl+Ex   | Cl+Ex   |
| Detector 1 Channel         |   |   |   |   |   |   |  |   |   |   |   |   |
| Detector 1 Extend (s)      | 0.0   | 0.0   | 0.0   | 0.0   | 0.0   |   | 0.0  | 0.0   | 0.0   |   | 0.0   | 0.0   |
| Detector 1 Queue (s)       | 0.0   | 0.0   | 0.0   | 0.0   | 0.0   |   | 0.0  | 0.0   | 0.0   |   | 0.0   | 0.0   |
| Detector 1 Delay (s)       | 0.0   | 0.0   | 0.0   | 0.0   | 0.0   |   | 0.0  | 0.0   | 0.0   |   | 0.0   | 0.0   |
| Detector 2 Position(m)     |   | 9.4   |   |   | 9.4   |   |  |   | 9.4   |   |   |   |
| Detector 2 Size(m)         |   | 0.6   |   |   | 0.6   |   |  |   | 0.6   |   |   |   |
| Detector 2 Type            |   | Cl+Ex   |   |   | Cl+Ex   |   |  |   | Cl+Ex   |   |   |   |
| Detector 2 Channel         |   |   |   |   |   |   |  |   |   |   |   |   |
| Detector 2 Extend (s)      |   | 0.0   |   |   | 0.0   |   |  |   | 0.0   |   |   |   |
| Turn Type                  | Prot  | NA  | Perm  | Prot  | NA  |   | Prot   | Prot  | NA  |   | Prot  | Prot  |
| Protected Phases           | 7   | 4   |   | 3   | 8   |   | 5  | 5   | 2   |   | 1   | 1   |
| Permitted Phases           |   |   | 4   |   |   |   |  |   |   |   |   |   |
| Detector Phase             | 7   | 4   | 4   | 3   | 8   |   | 5  | 5   | 2   |   | 1   | 1   |
| Switch Phase               |   |   |   |   |   |   |  |   |   |   |   |   |

3: March & Solandt  
AM Peak Hour

555-603 March Road  
2037 Total Traffic (post-BRT)



| Lane Group                 | SBT   | SBR  |
|----------------------------|-------|------|
| Lane Configurations        | ↑↑    |      |
| Traffic Volume (vph)       | 1830  | 33   |
| Future Volume (vph)        | 1830  | 33   |
| Ideal Flow (vphpl)         | 1800  | 1800 |
| Storage Length (m)         |       | 0.0  |
| Storage Lanes              |       | 0    |
| Taper Length (m)           |       |      |
| Lane Util. Factor          | 0.95  | 0.95 |
| Ped Bike Factor            | 1.00  |      |
| Frt                        | 0.997 |      |
| Flt Protected              |       |      |
| Satd. Flow (prot)          | 3273  | 0    |
| Flt Permitted              |       |      |
| Satd. Flow (perm)          | 3273  | 0    |
| Right Turn on Red          |       | Yes  |
| Satd. Flow (RTOR)          | 2     |      |
| Link Speed (k/h)           | 60    |      |
| Link Distance (m)          | 382.6 |      |
| Travel Time (s)            | 23.0  |      |
| Confl. Peds. (#/hr)        |       | 5    |
| Confl. Bikes (#/hr)        |       | 5    |
| Peak Hour Factor           | 1.00  | 1.00 |
| Heavy Vehicles (%)         | 3%    | 1%   |
| Adj. Flow (vph)            | 1830  | 33   |
| Shared Lane Traffic (%)    |       |      |
| Lane Group Flow (vph)      | 1863  | 0    |
| Enter Blocked Intersection | No    | No   |
| Lane Alignment             | Left  | R NA |
| Median Width(m)            | 17.5  |      |
| Link Offset(m)             | 0.0   |      |
| Crosswalk Width(m)         | 5.0   |      |
| Two way Left Turn Lane     |       |      |
| Headway Factor             | 1.09  | 1.09 |
| Number of Detectors        | 2     |      |
| Detector Template          | Thru  |      |
| Leading Detector (m)       | 10.0  |      |
| Trailing Detector (m)      | 0.0   |      |
| Detector 1 Position(m)     | 0.0   |      |
| Detector 1 Size(m)         | 0.6   |      |
| Detector 1 Type            | Cl+Ex |      |
| Detector 1 Channel         |       |      |
| Detector 1 Extend (s)      | 0.0   |      |
| Detector 1 Queue (s)       | 0.0   |      |
| Detector 1 Delay (s)       | 0.0   |      |
| Detector 2 Position(m)     | 9.4   |      |
| Detector 2 Size(m)         | 0.6   |      |
| Detector 2 Type            | Cl+Ex |      |
| Detector 2 Channel         |       |      |
| Detector 2 Extend (s)      | 0.0   |      |
| Turn Type                  | NA    |      |
| Protected Phases           | 6     |      |
| Permitted Phases           |       |      |
| Detector Phase             | 6     |      |
| Switch Phase               |       |      |



3: March & Solandt  
AM Peak Hour

555-603 March Road  
2037 Total Traffic (post-BRT)



| Lane Group              | EBL  | EBT   | EBR   | WBL   | WBT   | WBR | NBU  | NBL    | NBT    | NBR | SBU  | SBL   |
|-------------------------|------|-------|-------|-------|-------|-----|------|--------|--------|-----|------|-------|
| Minimum Initial (s)     | 5.0  | 10.0  | 10.0  | 5.0   | 10.0  |     | 5.0  | 5.0    | 10.0   |     | 5.0  | 5.0   |
| Minimum Split (s)       | 11.5 | 36.5  | 36.5  | 11.5  | 36.5  |     | 12.0 | 12.0   | 26.8   |     | 12.0 | 12.0  |
| Total Split (s)         | 11.5 | 36.5  | 36.5  | 11.5  | 36.5  |     | 12.0 | 12.0   | 70.0   |     | 12.0 | 12.0  |
| Total Split (%)         | 8.8% | 28.1% | 28.1% | 8.8%  | 28.1% |     | 9.2% | 9.2%   | 53.8%  |     | 9.2% | 9.2%  |
| Maximum Green (s)       | 5.0  | 30.0  | 30.0  | 5.0   | 30.0  |     | 5.0  | 5.0    | 64.2   |     | 5.0  | 5.0   |
| Yellow Time (s)         | 3.3  | 3.3   | 3.3   | 3.3   | 3.3   |     | 3.7  | 3.7    | 3.7    |     | 3.7  | 3.7   |
| All-Red Time (s)        | 3.2  | 3.2   | 3.2   | 3.2   | 3.2   |     | 3.3  | 3.3    | 2.1    |     | 3.3  | 3.3   |
| Lost Time Adjust (s)    | 0.0  | 0.0   | 0.0   | 0.0   | 0.0   |     |      | 0.0    | 0.0    |     |      | 0.0   |
| Total Lost Time (s)     | 6.5  | 6.5   | 6.5   | 6.5   | 6.5   |     |      | 7.0    | 5.8    |     |      | 7.0   |
| Lead/Lag                | Lead | Lag   | Lag   | Lead  | Lag   |     | Lead | Lead   | Lag    |     | Lead | Lead  |
| Lead-Lag Optimize?      | Yes  |       |       |       | Yes   |     |      |        |        |     |      |       |
| Vehicle Extension (s)   | 3.0  | 3.0   | 3.0   | 3.0   | 3.0   |     | 3.0  | 3.0    | 3.0    |     | 3.0  | 3.0   |
| Recall Mode             | None | None  | None  | None  | None  |     | None | None   | C-Max  |     | None | None  |
| Walk Time (s)           |      | 7.0   | 7.0   |       | 7.0   |     |      |        | 7.0    |     |      |       |
| Flash Dont Walk (s)     |      | 23.0  | 23.0  |       | 23.0  |     |      |        | 14.0   |     |      |       |
| Pedestrian Calls (#/hr) |      | 5     | 5     |       | 5     |     |      |        | 5      |     |      |       |
| Act Effct Green (s)     | 5.0  | 14.0  | 14.0  | 5.0   | 18.6  |     |      | 26.6   | 81.2   |     |      | 9.6   |
| Actuated g/C Ratio      | 0.04 | 0.11  | 0.11  | 0.04  | 0.14  |     |      | 0.20   | 0.62   |     |      | 0.07  |
| v/c Ratio               | 0.20 | 0.16  | 0.29  | 0.62  | 0.14  |     |      | 0.59   | 0.88   |     |      | 0.48  |
| Control Delay           | 68.8 | 51.3  | 2.8   | 83.3  | 29.4  |     |      | 56.7   | 29.8   |     |      | 67.7  |
| Queue Delay             | 0.0  | 0.0   | 0.0   | 0.0   | 0.0   |     |      | 0.0    | 0.0    |     |      | 0.0   |
| Total Delay             | 68.8 | 51.3  | 2.8   | 83.3  | 29.4  |     |      | 56.7   | 29.8   |     |      | 67.7  |
| LOS                     | E    | D     | A     | F     | C     |     |      | E      | C      |     |      | E     |
| Approach Delay          |      | 21.5  |       |       | 68.1  |     |      |        | 32.5   |     |      |       |
| Approach LOS            |      | C     |       |       | E     |     |      |        | C      |     |      |       |
| Queue Length 50th (m)   | 2.8  | 6.8   | 0.0   | 9.0   | 2.8   |     |      | 43.3   | 188.6  |     |      | 14.9  |
| Queue Length 95th (m)   | 9.0  | 13.1  | 0.4   | #18.4 | 10.1  |     |      | #125.6 | #294.4 |     |      | m15.3 |
| Internal Link Dist (m)  |      | 188.6 |       |       | 217.6 |     |      |        | 586.9  |     |      |       |
| Turn Bay Length (m)     | 35.0 |       | 60.0  | 85.0  |       |     |      | 165.0  |        |     |      | 155.0 |
| Base Capacity (vph)     | 59   | 398   | 424   | 120   | 336   |     |      | 338    | 2025   |     |      | 123   |
| Starvation Cap Reductn  | 0    | 0     | 0     | 0     | 0     |     |      | 0      | 0      |     |      | 0     |
| Spillback Cap Reductn   | 0    | 0     | 0     | 0     | 0     |     |      | 0      | 0      |     |      | 0     |
| Storage Cap Reductn     | 0    | 0     | 0     | 0     | 0     |     |      | 0      | 0      |     |      | 0     |
| Reduced v/c Ratio       | 0.20 | 0.08  | 0.18  | 0.62  | 0.09  |     |      | 0.59   | 0.88   |     |      | 0.48  |

Intersection Summary

Area Type: Other  
 Cycle Length: 130  
 Actuated Cycle Length: 130  
 Offset: 112 (86%), Referenced to phase 2:NBT and 6:SBT, Start of Green  
 Natural Cycle: 150  
 Control Type: Actuated-Coordinated  
 Maximum v/c Ratio: 1.15  
 Intersection Signal Delay: 58.3  
 Intersection LOS: E  
 Intersection Capacity Utilization 102.7%  
 ICU Level of Service G  
 Analysis Period (min) 15  
 ~ Volume exceeds capacity, queue is theoretically infinite.  
 Queue shown is maximum after two cycles.  
 # 95th percentile volume exceeds capacity, queue may be longer.  
 Queue shown is maximum after two cycles.  
 m Volume for 95th percentile queue is metered by upstream signal.

Splits and Phases: 3: March & Solandt





| Lane Group                  | SBT     | SBR |
|-----------------------------|---------|-----|
| Minimum Initial (s)         | 10.0    |     |
| Minimum Split (s)           | 26.8    |     |
| Total Split (s)             | 70.0    |     |
| Total Split (%)             | 53.8%   |     |
| Maximum Green (s)           | 64.2    |     |
| Yellow Time (s)             | 3.7     |     |
| All-Red Time (s)            | 2.1     |     |
| Lost Time Adjust (s)        | 0.0     |     |
| Total Lost Time (s)         | 5.8     |     |
| Lead/Lag                    | Lag     |     |
| Lead-Lag Optimize?          |         |     |
| Vehicle Extension (s)       | 3.0     |     |
| Recall Mode                 | C-Max   |     |
| Walk Time (s)               | 7.0     |     |
| Flash Dont Walk (s)         | 14.0    |     |
| Pedestrian Calls (#/hr)     | 5       |     |
| Act Effct Green (s)         | 64.2    |     |
| Actuated g/C Ratio          | 0.49    |     |
| v/c Ratio                   | 1.15    |     |
| Control Delay               | 87.5    |     |
| Queue Delay                 | 0.0     |     |
| Total Delay                 | 87.5    |     |
| LOS                         | F       |     |
| Approach Delay              | 86.9    |     |
| Approach LOS                | F       |     |
| Queue Length 50th (m)       | ~270.2  |     |
| Queue Length 95th (m)       | m#254.6 |     |
| Internal Link Dist (m)      | 358.6   |     |
| Turn Bay Length (m)         |         |     |
| Base Capacity (vph)         | 1617    |     |
| Starvation Cap Reductn      | 0       |     |
| Spillback Cap Reductn       | 0       |     |
| Storage Cap Reductn         | 0       |     |
| Reduced v/c Ratio           | 1.15    |     |
| <b>Intersection Summary</b> |         |     |

6: March & Site Access/Nokia Access  
AM Peak Hour

555-603 March Road  
2037 Total Traffic (post-BRT)



| Lane Group                 | EBL   | EBT   | EBR  | WBL   | WBT   | WBR  | NBL   | NBT   | NBR   | SBL   | SBT   | SBR   |
|----------------------------|-------|-------|------|-------|-------|------|-------|-------|-------|-------|-------|-------|
| Lane Configurations        |       |       |      |       |       |      |       |       |       |       |       |       |
| Traffic Volume (vph)       | 34    | 3     | 162  | 188   | 2     | 157  | 161   | 925   | 109   | 355   | 1592  | 57    |
| Future Volume (vph)        | 34    | 3     | 162  | 188   | 2     | 157  | 161   | 925   | 109   | 355   | 1592  | 57    |
| Ideal Flow (vphpl)         | 1800  | 1800  | 1800 | 1800  | 1800  | 1800 | 1800  | 1800  | 1800  | 1800  | 1800  | 1800  |
| Storage Length (m)         | 65.0  |       | 0.0  | 65.0  |       | 0.0  | 75.0  |       | 100.0 | 75.0  |       | 0.0   |
| Storage Lanes              | 1     |       | 0    | 1     |       | 0    | 1     |       | 1     | 1     |       | 0     |
| Taper Length (m)           | 20.0  |       |      | 25.0  |       |      | 50.0  |       |       | 50.0  |       |       |
| Lane Util. Factor          | 1.00  | 1.00  | 1.00 | 1.00  | 1.00  | 1.00 | 1.00  | 0.95  | 1.00  | 1.00  | 0.95  | 0.95  |
| Ped Bike Factor            |       |       |      | 0.99  | 0.97  |      |       |       | 0.94  | 0.99  |       |       |
| Fr t                       |       | 0.853 |      |       | 0.852 |      |       |       | 0.850 |       | 0.995 |       |
| Flt Protected              | 0.950 |       |      | 0.950 |       |      | 0.950 |       |       | 0.950 |       |       |
| Satd. Flow (prot)          | 1658  | 1489  | 0    | 1674  | 1458  | 0    | 1658  | 3283  | 1498  | 1674  | 3268  | 0     |
| Flt Permitted              | 0.616 |       |      | 0.452 |       |      | 0.950 |       |       | 0.950 |       |       |
| Satd. Flow (perm)          | 1075  | 1489  | 0    | 789   | 1458  | 0    | 1658  | 3283  | 1407  | 1658  | 3268  | 0     |
| Right Turn on Red          |       |       | Yes  |       |       | Yes  |       |       | Yes   |       |       | Yes   |
| Satd. Flow (RTOR)          |       | 162   |      |       | 157   |      |       |       | 201   |       |       | 3     |
| Link Speed (k/h)           |       | 50    |      |       | 50    |      |       | 60    |       |       |       | 60    |
| Link Distance (m)          |       | 126.2 |      |       | 167.8 |      |       | 227.7 |       |       |       | 308.9 |
| Travel Time (s)            |       | 9.1   |      |       | 12.1  |      |       | 13.7  |       |       |       | 18.5  |
| Confl. Peds. (#/hr)        |       |       |      | 10    |       | 10   |       |       | 10    | 10    |       |       |
| Confl. Bikes (#/hr)        |       |       |      |       |       | 5    |       |       | 5     |       |       |       |
| Peak Hour Factor           | 1.00  | 1.00  | 1.00 | 1.00  | 1.00  | 1.00 | 1.00  | 1.00  | 1.00  | 1.00  | 1.00  | 1.00  |
| Heavy Vehicles (%)         | 2%    | 2%    | 2%   | 1%    | 2%    | 1%   | 2%    | 3%    | 1%    | 1%    | 3%    | 2%    |
| Adj. Flow (vph)            | 34    | 3     | 162  | 188   | 2     | 157  | 161   | 925   | 109   | 355   | 1592  | 57    |
| Shared Lane Traffic (%)    |       |       |      |       |       |      |       |       |       |       |       |       |
| Lane Group Flow (vph)      | 34    | 165   | 0    | 188   | 159   | 0    | 161   | 925   | 109   | 355   | 1649  | 0     |
| Enter Blocked Intersection | No    | No    | No   | No    | No    | No   | No    | No    | No    | No    | No    | No    |
| Lane Alignment             | L NA  | Left  | R NA | L NA  | Left  | R NA | Left  | Left  | Right | Left  | Left  | Right |
| Median Width(m)            |       | 3.5   |      |       | 3.5   |      |       | 17.5  |       |       |       | 17.5  |
| Link Offset(m)             |       | 0.0   |      |       | 0.0   |      |       | 0.0   |       |       |       | 0.0   |
| Crosswalk Width(m)         |       | 5.0   |      |       | 5.0   |      |       | 5.0   |       |       |       | 5.0   |
| Two way Left Turn Lane     |       |       |      |       |       |      |       |       |       |       |       |       |
| Headway Factor             | 1.09  | 1.09  | 1.09 | 1.09  | 1.09  | 1.09 | 1.09  | 1.09  | 1.09  | 1.09  | 1.09  | 1.09  |
| Number of Detectors        | 1     | 2     |      | 1     | 2     |      | 1     | 2     | 1     | 1     | 2     |       |
| Detector Template          | Left  | Thru  |      | Left  | Thru  |      | Left  | Thru  | Right | Left  | Thru  |       |
| Leading Detector (m)       | 2.0   | 10.0  |      | 2.0   | 10.0  |      | 2.0   | 10.0  | 2.0   | 2.0   | 10.0  |       |
| Trailing Detector (m)      | 0.0   | 0.0   |      | 0.0   | 0.0   |      | 0.0   | 0.0   | 0.0   | 0.0   | 0.0   |       |
| Detector 1 Position(m)     | 0.0   | 0.0   |      | 0.0   | 0.0   |      | 0.0   | 0.0   | 0.0   | 0.0   | 0.0   |       |
| Detector 1 Size(m)         | 2.0   | 0.6   |      | 2.0   | 0.6   |      | 2.0   | 0.6   | 2.0   | 2.0   | 0.6   |       |
| Detector 1 Type            | Cl+Ex | Cl+Ex |      | Cl+Ex | Cl+Ex |      | Cl+Ex | Cl+Ex | Cl+Ex | Cl+Ex | Cl+Ex |       |
| Detector 1 Channel         |       |       |      |       |       |      |       |       |       |       |       |       |
| Detector 1 Extend (s)      | 0.0   | 0.0   |      | 0.0   | 0.0   |      | 0.0   | 0.0   | 0.0   | 0.0   | 0.0   |       |
| Detector 1 Queue (s)       | 0.0   | 0.0   |      | 0.0   | 0.0   |      | 0.0   | 0.0   | 0.0   | 0.0   | 0.0   |       |
| Detector 1 Delay (s)       | 0.0   | 0.0   |      | 0.0   | 0.0   |      | 0.0   | 0.0   | 0.0   | 0.0   | 0.0   |       |
| Detector 2 Position(m)     |       | 9.4   |      |       | 9.4   |      |       | 9.4   |       |       | 9.4   |       |
| Detector 2 Size(m)         |       | 0.6   |      |       | 0.6   |      |       | 0.6   |       |       | 0.6   |       |
| Detector 2 Type            |       | Cl+Ex |      |       | Cl+Ex |      |       | Cl+Ex |       |       | Cl+Ex |       |
| Detector 2 Channel         |       |       |      |       |       |      |       |       |       |       |       |       |
| Detector 2 Extend (s)      |       | 0.0   |      |       | 0.0   |      |       | 0.0   |       |       | 0.0   |       |
| Turn Type                  | pm+pt | NA    |      | pm+pt | NA    |      | Prot  | NA    | Perm  | Prot  | NA    |       |
| Protected Phases           | 7     | 4     |      | 3     | 8     |      | 5     | 2     |       | 1     | 6     |       |
| Permitted Phases           | 4     |       |      | 8     |       |      |       |       | 2     |       |       |       |
| Detector Phase             | 7     | 4     |      | 3     | 8     |      | 5     | 2     | 2     | 1     | 6     |       |
| Switch Phase               |       |       |      |       |       |      |       |       |       |       |       |       |

6: March & Site Access/Nokia Access  
AM Peak Hour

555-603 March Road  
2037 Total Traffic (post-BRT)



| Lane Group              | EBL   | EBT   | EBR | WBL   | WBT   | WBR | NBL   | NBT     | NBR   | SBL     | SBT     | SBR |
|-------------------------|-------|-------|-----|-------|-------|-----|-------|---------|-------|---------|---------|-----|
| Minimum Initial (s)     | 5.0   | 10.0  |     | 5.0   | 10.0  |     | 5.0   | 10.0    | 10.0  | 5.0     | 10.0    |     |
| Minimum Split (s)       | 11.5  | 36.5  |     | 11.5  | 36.5  |     | 12.0  | 23.8    | 23.8  | 12.0    | 23.8    |     |
| Total Split (s)         | 13.0  | 38.0  |     | 13.0  | 38.0  |     | 20.0  | 47.0    | 47.0  | 32.0    | 59.0    |     |
| Total Split (%)         | 10.0% | 29.2% |     | 10.0% | 29.2% |     | 15.4% | 36.2%   | 36.2% | 24.6%   | 45.4%   |     |
| Maximum Green (s)       | 6.5   | 31.5  |     | 6.5   | 31.5  |     | 13.0  | 41.2    | 41.2  | 25.0    | 53.2    |     |
| Yellow Time (s)         | 3.3   | 3.3   |     | 3.3   | 3.3   |     | 3.7   | 3.7     | 3.7   | 3.7     | 3.7     |     |
| All-Red Time (s)        | 3.2   | 3.2   |     | 3.2   | 3.2   |     | 3.3   | 2.1     | 2.1   | 3.3     | 2.1     |     |
| Lost Time Adjust (s)    | 0.0   | 0.0   |     | 0.0   | 0.0   |     | 0.0   | 0.0     | 0.0   | 0.0     | 0.0     |     |
| Total Lost Time (s)     | 6.5   | 6.5   |     | 6.5   | 6.5   |     | 7.0   | 5.8     | 5.8   | 7.0     | 5.8     |     |
| Lead/Lag                | Lead  | Lag   |     | Lead  | Lag   |     | Lead  | Lag     | Lag   | Lead    | Lag     |     |
| Lead-Lag Optimize?      |       |       |     |       |       |     |       |         |       |         |         |     |
| Vehicle Extension (s)   | 3.0   | 3.0   |     | 3.0   | 3.0   |     | 3.0   | 3.0     | 3.0   | 3.0     | 3.0     |     |
| Recall Mode             | None  | None  |     | None  | None  |     | None  | C-Max   | C-Max | None    | C-Max   |     |
| Walk Time (s)           |       | 7.0   |     |       | 7.0   |     |       | 7.0     | 7.0   |         | 7.0     |     |
| Flash Dont Walk (s)     |       | 23.0  |     |       | 23.0  |     |       | 11.0    | 11.0  |         | 11.0    |     |
| Pedestrian Calls (#/hr) |       | 10    |     |       | 10    |     |       | 10      | 10    |         | 10      |     |
| Act Effct Green (s)     | 24.3  | 18.0  |     | 27.1  | 23.2  |     | 17.1  | 45.3    | 45.3  | 34.4    | 62.6    |     |
| Actuated g/C Ratio      | 0.19  | 0.14  |     | 0.21  | 0.18  |     | 0.13  | 0.35    | 0.35  | 0.26    | 0.48    |     |
| v/c Ratio               | 0.15  | 0.48  |     | 0.90  | 0.41  |     | 0.74  | 0.81    | 0.18  | 0.80    | 1.05    |     |
| Control Delay           | 36.1  | 11.2  |     | 87.1  | 9.6   |     | 45.3  | 61.5    | 8.4   | 69.6    | 46.3    |     |
| Queue Delay             | 0.0   | 0.0   |     | 0.0   | 0.0   |     | 0.0   | 0.0     | 0.0   | 0.0     | 0.0     |     |
| Total Delay             | 36.1  | 11.2  |     | 87.1  | 9.6   |     | 45.3  | 61.5    | 8.4   | 69.6    | 46.3    |     |
| LOS                     | D     | B     |     | F     | A     |     | D     | E       | A     | E       | D       |     |
| Approach Delay          |       | 15.4  |     |       | 51.6  |     |       | 54.5    |       |         | 50.4    |     |
| Approach LOS            |       | B     |     |       | D     |     |       | D       |       |         | D       |     |
| Queue Length 50th (m)   | 6.8   | 0.7   |     | ~41.7 | 0.5   |     | 31.3  | 114.1   | 0.0   | 80.8    | 39.3    |     |
| Queue Length 95th (m)   | 12.5  | 16.7  |     | #55.0 | 16.3  |     | m40.5 | m#140.1 | m5.5  | m#102.6 | m#264.6 |     |
| Internal Link Dist (m)  |       | 102.2 |     |       | 143.8 |     |       | 203.7   |       |         | 284.9   |     |
| Turn Bay Length (m)     | 65.0  |       |     | 65.0  |       |     | 75.0  |         | 100.0 | 75.0    |         |     |
| Base Capacity (vph)     | 231   | 483   |     | 208   | 472   |     | 218   | 1143    | 620   | 443     | 1574    |     |
| Starvation Cap Reductn  | 0     | 0     |     | 0     | 0     |     | 0     | 0       | 0     | 0       | 0       |     |
| Spillback Cap Reductn   | 0     | 0     |     | 0     | 0     |     | 0     | 0       | 0     | 0       | 0       |     |
| Storage Cap Reductn     | 0     | 0     |     | 0     | 0     |     | 0     | 0       | 0     | 0       | 0       |     |
| Reduced v/c Ratio       | 0.15  | 0.34  |     | 0.90  | 0.34  |     | 0.74  | 0.81    | 0.18  | 0.80    | 1.05    |     |

Intersection Summary

Area Type: Other  
 Cycle Length: 130  
 Actuated Cycle Length: 130  
 Offset: 99 (76%), Referenced to phase 2:NBT and 6:SBT, Start of Green  
 Natural Cycle: 145  
 Control Type: Actuated-Coordinated  
 Maximum v/c Ratio: 1.05  
 Intersection Signal Delay: 50.0  
 Intersection LOS: D  
 Intersection Capacity Utilization 101.0%  
 ICU Level of Service G  
 Analysis Period (min) 15  
 ~ Volume exceeds capacity, queue is theoretically infinite.  
 Queue shown is maximum after two cycles.  
 # 95th percentile volume exceeds capacity, queue may be longer.  
 Queue shown is maximum after two cycles.  
 m Volume for 95th percentile queue is metered by upstream signal.

Splits and Phases: 6: March & Site Access/Nokia Access

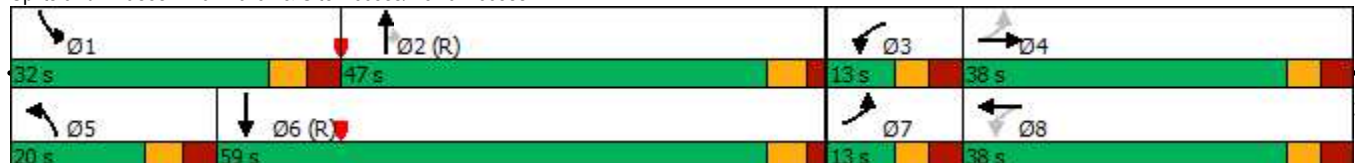

6: March & Site Access/Nokia Access  
AM Peak Hour

555-603 March Road  
2037 Total Traffic (post-BRT, SBR)



| Lane Group                 | EBL   | EBT   | EBR  | WBL   | WBT   | WBR  | NBL   | NBT   | NBR   | SBL   | SBT   | SBR   |
|----------------------------|-------|-------|------|-------|-------|------|-------|-------|-------|-------|-------|-------|
| Lane Configurations        |       |       |      |       |       |      |       |       |       |       |       |       |
| Traffic Volume (vph)       | 34    | 3     | 162  | 188   | 2     | 157  | 161   | 925   | 109   | 355   | 1592  | 57    |
| Future Volume (vph)        | 34    | 3     | 162  | 188   | 2     | 157  | 161   | 925   | 109   | 355   | 1592  | 57    |
| Ideal Flow (vphpl)         | 1800  | 1800  | 1800 | 1800  | 1800  | 1800 | 1800  | 1800  | 1800  | 1800  | 1800  | 1800  |
| Storage Length (m)         | 65.0  |       | 0.0  | 65.0  |       | 0.0  | 75.0  |       | 100.0 | 75.0  |       | 30.0  |
| Storage Lanes              | 1     |       | 0    | 1     |       | 0    | 1     |       | 1     | 1     |       | 1     |
| Taper Length (m)           | 20.0  |       |      | 25.0  |       |      | 50.0  |       |       | 50.0  |       |       |
| Lane Util. Factor          | 1.00  | 1.00  | 1.00 | 1.00  | 1.00  | 1.00 | 1.00  | 0.95  | 1.00  | 1.00  | 0.95  | 1.00  |
| Ped Bike Factor            |       |       |      | 0.99  | 0.97  |      |       |       | 0.94  | 0.99  |       |       |
| Fr t                       |       | 0.853 |      |       | 0.852 |      |       |       | 0.850 |       |       | 0.850 |
| Flt Protected              | 0.950 |       |      | 0.950 |       |      | 0.950 |       |       | 0.950 |       |       |
| Satd. Flow (prot)          | 1658  | 1489  | 0    | 1674  | 1458  | 0    | 1658  | 3283  | 1498  | 1674  | 3283  | 1483  |
| Flt Permitted              | 0.616 |       |      | 0.452 |       |      | 0.950 |       |       | 0.950 |       |       |
| Satd. Flow (perm)          | 1075  | 1489  | 0    | 789   | 1458  | 0    | 1658  | 3283  | 1407  | 1658  | 3283  | 1483  |
| Right Turn on Red          |       |       | Yes  |       |       | Yes  |       |       | Yes   |       |       | Yes   |
| Satd. Flow (RTOR)          |       | 162   |      |       | 157   |      |       |       | 201   |       |       | 143   |
| Link Speed (k/h)           |       | 50    |      |       | 50    |      |       | 60    |       |       |       | 60    |
| Link Distance (m)          |       | 126.2 |      |       | 167.8 |      |       | 227.7 |       |       |       | 308.9 |
| Travel Time (s)            |       | 9.1   |      |       | 12.1  |      |       | 13.7  |       |       |       | 18.5  |
| Confl. Peds. (#/hr)        |       |       |      | 10    |       | 10   |       |       | 10    | 10    |       |       |
| Confl. Bikes (#/hr)        |       |       |      |       |       | 5    |       |       | 5     |       |       |       |
| Peak Hour Factor           | 1.00  | 1.00  | 1.00 | 1.00  | 1.00  | 1.00 | 1.00  | 1.00  | 1.00  | 1.00  | 1.00  | 1.00  |
| Heavy Vehicles (%)         | 2%    | 2%    | 2%   | 1%    | 2%    | 1%   | 2%    | 3%    | 1%    | 1%    | 3%    | 2%    |
| Adj. Flow (vph)            | 34    | 3     | 162  | 188   | 2     | 157  | 161   | 925   | 109   | 355   | 1592  | 57    |
| Shared Lane Traffic (%)    |       |       |      |       |       |      |       |       |       |       |       |       |
| Lane Group Flow (vph)      | 34    | 165   | 0    | 188   | 159   | 0    | 161   | 925   | 109   | 355   | 1592  | 57    |
| Enter Blocked Intersection | No    | No    | No   | No    | No    | No   | No    | No    | No    | No    | No    | No    |
| Lane Alignment             | L NA  | Left  | R NA | L NA  | Left  | R NA | Left  | Left  | Right | Left  | Left  | Right |
| Median Width(m)            |       | 3.5   |      |       | 3.5   |      |       | 17.5  |       |       | 17.5  |       |
| Link Offset(m)             |       | 0.0   |      |       | 0.0   |      |       | 0.0   |       |       | 0.0   |       |
| Crosswalk Width(m)         |       | 5.0   |      |       | 5.0   |      |       | 5.0   |       |       | 5.0   |       |
| Two way Left Turn Lane     |       |       |      |       |       |      |       |       |       |       |       |       |
| Headway Factor             | 1.09  | 1.09  | 1.09 | 1.09  | 1.09  | 1.09 | 1.09  | 1.09  | 1.09  | 1.09  | 1.09  | 1.09  |
| Number of Detectors        | 1     | 2     |      | 1     | 2     |      | 1     | 2     | 1     | 1     | 2     | 1     |
| Detector Template          | Left  | Thru  |      | Left  | Thru  |      | Left  | Thru  | Right | Left  | Thru  | Right |
| Leading Detector (m)       | 2.0   | 10.0  |      | 2.0   | 10.0  |      | 2.0   | 10.0  | 2.0   | 2.0   | 10.0  | 2.0   |
| Trailing Detector (m)      | 0.0   | 0.0   |      | 0.0   | 0.0   |      | 0.0   | 0.0   | 0.0   | 0.0   | 0.0   | 0.0   |
| Detector 1 Position(m)     | 0.0   | 0.0   |      | 0.0   | 0.0   |      | 0.0   | 0.0   | 0.0   | 0.0   | 0.0   | 0.0   |
| Detector 1 Size(m)         | 2.0   | 0.6   |      | 2.0   | 0.6   |      | 2.0   | 0.6   | 2.0   | 2.0   | 0.6   | 2.0   |
| Detector 1 Type            | Cl+Ex | Cl+Ex |      | Cl+Ex | Cl+Ex |      | Cl+Ex | Cl+Ex | Cl+Ex | Cl+Ex | Cl+Ex | Cl+Ex |
| Detector 1 Channel         |       |       |      |       |       |      |       |       |       |       |       |       |
| Detector 1 Extend (s)      | 0.0   | 0.0   |      | 0.0   | 0.0   |      | 0.0   | 0.0   | 0.0   | 0.0   | 0.0   | 0.0   |
| Detector 1 Queue (s)       | 0.0   | 0.0   |      | 0.0   | 0.0   |      | 0.0   | 0.0   | 0.0   | 0.0   | 0.0   | 0.0   |
| Detector 1 Delay (s)       | 0.0   | 0.0   |      | 0.0   | 0.0   |      | 0.0   | 0.0   | 0.0   | 0.0   | 0.0   | 0.0   |
| Detector 2 Position(m)     |       | 9.4   |      |       | 9.4   |      |       | 9.4   |       |       | 9.4   |       |
| Detector 2 Size(m)         |       | 0.6   |      |       | 0.6   |      |       | 0.6   |       |       | 0.6   |       |
| Detector 2 Type            |       | Cl+Ex |      |       | Cl+Ex |      |       | Cl+Ex |       |       | Cl+Ex |       |
| Detector 2 Channel         |       |       |      |       |       |      |       |       |       |       |       |       |
| Detector 2 Extend (s)      |       | 0.0   |      |       | 0.0   |      |       | 0.0   |       |       | 0.0   |       |
| Turn Type                  | pm+pt | NA    |      | pm+pt | NA    |      | Prot  | NA    | Perm  | Prot  | NA    | Perm  |
| Protected Phases           | 7     | 4     |      | 3     | 8     |      | 5     | 2     |       | 1     | 6     |       |
| Permitted Phases           | 4     |       |      | 8     |       |      |       |       | 2     |       |       | 6     |
| Detector Phase             | 7     | 4     |      | 3     | 8     |      | 5     | 2     | 2     | 1     | 6     | 6     |
| Switch Phase               |       |       |      |       |       |      |       |       |       |       |       |       |

6: March & Site Access/Nokia Access  
AM Peak Hour

555-603 March Road  
2037 Total Traffic (post-BRT, SBR)



| Lane Group              | EBL   | EBT   | EBR | WBL   | WBT   | WBR | NBL   | NBT     | NBR   | SBL     | SBT     | SBR   |
|-------------------------|-------|-------|-----|-------|-------|-----|-------|---------|-------|---------|---------|-------|
| Minimum Initial (s)     | 5.0   | 10.0  |     | 5.0   | 10.0  |     | 5.0   | 10.0    | 10.0  | 5.0     | 10.0    | 10.0  |
| Minimum Split (s)       | 11.5  | 36.5  |     | 11.5  | 36.5  |     | 12.0  | 23.8    | 23.8  | 12.0    | 23.8    | 23.8  |
| Total Split (s)         | 13.0  | 38.0  |     | 13.0  | 38.0  |     | 20.0  | 47.0    | 47.0  | 32.0    | 59.0    | 59.0  |
| Total Split (%)         | 10.0% | 29.2% |     | 10.0% | 29.2% |     | 15.4% | 36.2%   | 36.2% | 24.6%   | 45.4%   | 45.4% |
| Maximum Green (s)       | 6.5   | 31.5  |     | 6.5   | 31.5  |     | 13.0  | 41.2    | 41.2  | 25.0    | 53.2    | 53.2  |
| Yellow Time (s)         | 3.3   | 3.3   |     | 3.3   | 3.3   |     | 3.7   | 3.7     | 3.7   | 3.7     | 3.7     | 3.7   |
| All-Red Time (s)        | 3.2   | 3.2   |     | 3.2   | 3.2   |     | 3.3   | 2.1     | 2.1   | 3.3     | 2.1     | 2.1   |
| Lost Time Adjust (s)    | 0.0   | 0.0   |     | 0.0   | 0.0   |     | 0.0   | 0.0     | 0.0   | 0.0     | 0.0     | 0.0   |
| Total Lost Time (s)     | 6.5   | 6.5   |     | 6.5   | 6.5   |     | 7.0   | 5.8     | 5.8   | 7.0     | 5.8     | 5.8   |
| Lead/Lag                | Lead  | Lag   |     | Lead  | Lag   |     | Lead  | Lag     | Lag   | Lead    | Lag     | Lag   |
| Lead-Lag Optimize?      |       |       |     |       |       |     |       |         |       |         |         |       |
| Vehicle Extension (s)   | 3.0   | 3.0   |     | 3.0   | 3.0   |     | 3.0   | 3.0     | 3.0   | 3.0     | 3.0     | 3.0   |
| Recall Mode             | None  | None  |     | None  | None  |     | None  | C-Max   | C-Max | None    | C-Max   | C-Max |
| Walk Time (s)           |       | 7.0   |     |       | 7.0   |     |       | 7.0     | 7.0   |         | 7.0     | 7.0   |
| Flash Dont Walk (s)     |       | 23.0  |     |       | 23.0  |     |       | 11.0    | 11.0  |         | 11.0    | 11.0  |
| Pedestrian Calls (#/hr) |       | 10    |     |       | 10    |     |       | 10      | 10    |         | 10      | 10    |
| Act Effct Green (s)     | 24.3  | 18.0  |     | 27.1  | 23.2  |     | 17.1  | 45.3    | 45.3  | 34.4    | 62.6    | 62.6  |
| Actuated g/C Ratio      | 0.19  | 0.14  |     | 0.21  | 0.18  |     | 0.13  | 0.35    | 0.35  | 0.26    | 0.48    | 0.48  |
| v/c Ratio               | 0.15  | 0.48  |     | 0.90  | 0.41  |     | 0.74  | 0.81    | 0.18  | 0.80    | 1.01    | 0.07  |
| Control Delay           | 36.1  | 11.2  |     | 87.1  | 9.6   |     | 45.3  | 61.5    | 8.4   | 69.6    | 33.6    | 0.1   |
| Queue Delay             | 0.0   | 0.0   |     | 0.0   | 0.0   |     | 0.0   | 0.0     | 0.0   | 0.0     | 0.0     | 0.0   |
| Total Delay             | 36.1  | 11.2  |     | 87.1  | 9.6   |     | 45.3  | 61.5    | 8.4   | 69.6    | 33.6    | 0.1   |
| LOS                     | D     | B     |     | F     | A     |     | D     | E       | A     | E       | C       | A     |
| Approach Delay          |       | 15.4  |     |       | 51.6  |     |       | 54.5    |       |         | 39.0    |       |
| Approach LOS            |       | B     |     |       | D     |     |       | D       |       |         | D       |       |
| Queue Length 50th (m)   | 6.8   | 0.7   |     | ~41.7 | 0.5   |     | 31.3  | 114.1   | 0.0   | 80.8    | 31.7    | 0.0   |
| Queue Length 95th (m)   | 12.5  | 16.7  |     | #55.0 | 16.3  |     | m40.5 | m#140.1 | m5.5  | m#102.6 | m#249.6 | m0.0  |
| Internal Link Dist (m)  |       | 102.2 |     |       | 143.8 |     |       | 203.7   |       |         | 284.9   |       |
| Turn Bay Length (m)     | 65.0  |       |     | 65.0  |       |     | 75.0  |         | 100.0 | 75.0    |         | 30.0  |
| Base Capacity (vph)     | 231   | 483   |     | 208   | 472   |     | 218   | 1143    | 620   | 443     | 1580    | 788   |
| Starvation Cap Reductn  | 0     | 0     |     | 0     | 0     |     | 0     | 0       | 0     | 0       | 0       | 0     |
| Spillback Cap Reductn   | 0     | 0     |     | 0     | 0     |     | 0     | 0       | 0     | 0       | 0       | 0     |
| Storage Cap Reductn     | 0     | 0     |     | 0     | 0     |     | 0     | 0       | 0     | 0       | 0       | 0     |
| Reduced v/c Ratio       | 0.15  | 0.34  |     | 0.90  | 0.34  |     | 0.74  | 0.81    | 0.18  | 0.80    | 1.01    | 0.07  |

Intersection Summary

Area Type: Other  
 Cycle Length: 130  
 Actuated Cycle Length: 130  
 Offset: 99 (76%), Referenced to phase 2:NBT and 6:SBT, Start of Green  
 Natural Cycle: 145  
 Control Type: Actuated-Coordinated  
 Maximum v/c Ratio: 1.01  
 Intersection Signal Delay: 43.9  
 Intersection LOS: D  
 Intersection Capacity Utilization 99.1%  
 ICU Level of Service F  
 Analysis Period (min) 15  
 ~ Volume exceeds capacity, queue is theoretically infinite.  
 Queue shown is maximum after two cycles.  
 # 95th percentile volume exceeds capacity, queue may be longer.  
 Queue shown is maximum after two cycles.  
 m Volume for 95th percentile queue is metered by upstream signal.

Splits and Phases: 6: March & Site Access/Nokia Access

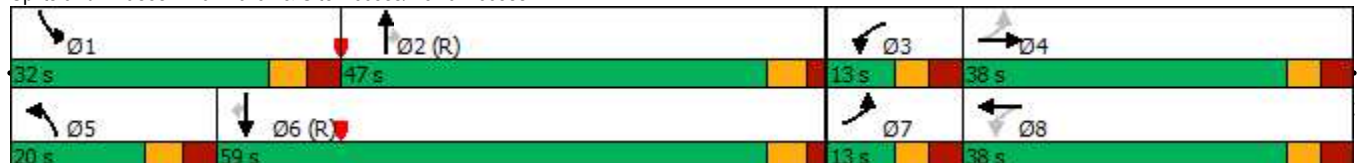

1: March & Morgan's Grant/Shirley's Brook  
PM Peak Hour

555-603 March Road  
2037 Total Traffic (pre-BRT)

| Lane Group                 | EBL   | EBT   | EBR   | WBL   | WBT   | WBR   | NBL   | NBT   | NBR   | SBL   | SBT   | SBR   |
|----------------------------|-------|-------|-------|-------|-------|-------|-------|-------|-------|-------|-------|-------|
| Lane Configurations        |       |       |       |       |       |       |       |       |       |       |       |       |
| Traffic Volume (vph)       | 54    | 50    | 62    | 129   | 47    | 195   | 75    | 1792  | 94    | 169   | 1151  | 68    |
| Future Volume (vph)        | 54    | 50    | 62    | 129   | 47    | 195   | 75    | 1792  | 94    | 169   | 1151  | 68    |
| Ideal Flow (vphpl)         | 1800  | 1800  | 1800  | 1800  | 1800  | 1800  | 1800  | 1800  | 1800  | 1800  | 1800  | 1800  |
| Storage Length (m)         | 0.0   |       | 20.0  | 45.0  |       | 35.0  | 130.0 |       | 30.0  | 65.0  |       | 25.0  |
| Storage Lanes              | 0     |       | 1     | 1     |       | 1     | 1     |       | 1     | 1     |       | 1     |
| Taper Length (m)           | 10.0  |       |       | 30.0  |       |       | 40.0  |       |       | 35.0  |       |       |
| Lane Util. Factor          | 1.00  | 1.00  | 1.00  | 1.00  | 1.00  | 1.00  | 1.00  | 0.91  | 1.00  | 1.00  | 0.91  | 1.00  |
| Ped Bike Factor            |       | 1.00  | 0.97  | 0.99  |       | 0.98  | 1.00  |       | 0.94  | 1.00  |       | 0.96  |
| Frt                        |       |       | 0.850 |       |       | 0.850 |       |       | 0.850 |       |       | 0.850 |
| Flt Protected              |       | 0.975 |       | 0.950 |       |       | 0.950 |       |       | 0.950 |       |       |
| Satd. Flow (prot)          | 0     | 1642  | 1498  | 1674  | 1548  | 1498  | 1674  | 4764  | 1498  | 1674  | 4718  | 1498  |
| Flt Permitted              |       | 0.812 |       | 0.690 |       |       | 0.950 |       |       | 0.950 |       |       |
| Satd. Flow (perm)          | 0     | 1364  | 1455  | 1203  | 1548  | 1464  | 1668  | 4764  | 1409  | 1669  | 4718  | 1436  |
| Right Turn on Red          |       |       | Yes   |       |       | Yes   |       |       | Yes   |       |       | Yes   |
| Satd. Flow (RTOR)          |       |       | 136   |       |       | 195   |       |       | 145   |       |       | 91    |
| Link Speed (k/h)           |       | 40    |       |       | 40    |       |       | 60    |       |       | 60    |       |
| Link Distance (m)          |       | 465.2 |       |       | 359.5 |       |       | 318.9 |       |       | 462.6 |       |
| Travel Time (s)            |       | 41.9  |       |       | 32.4  |       |       | 19.1  |       |       | 27.8  |       |
| Confl. Peds. (#/hr)        | 5     |       | 10    | 10    |       | 5     | 5     |       | 10    | 10    |       | 5     |
| Confl. Bikes (#/hr)        |       |       | 5     |       |       | 5     |       |       | 5     |       |       | 5     |
| Peak Hour Factor           | 1.00  | 1.00  | 1.00  | 1.00  | 1.00  | 1.00  | 1.00  | 1.00  | 1.00  | 1.00  | 1.00  | 1.00  |
| Heavy Vehicles (%)         | 10%   | 1%    | 1%    | 1%    | 15%   | 1%    | 1%    | 2%    | 1%    | 1%    | 3%    | 1%    |
| Adj. Flow (vph)            | 54    | 50    | 62    | 129   | 47    | 195   | 75    | 1792  | 94    | 169   | 1151  | 68    |
| Shared Lane Traffic (%)    |       |       |       |       |       |       |       |       |       |       |       |       |
| Lane Group Flow (vph)      | 0     | 104   | 62    | 129   | 47    | 195   | 75    | 1792  | 94    | 169   | 1151  | 68    |
| Enter Blocked Intersection | No    | No    | No    | No    | No    | No    | No    | No    | No    | No    | No    | No    |
| Lane Alignment             | L NA  | Left  | R NA  | L NA  | Left  | R NA  | L NA  | Left  | R NA  | L NA  | Left  | R NA  |
| Median Width(m)            |       | 3.5   |       |       | 5.0   |       |       | 9.0   |       |       | 9.0   |       |
| Link Offset(m)             |       | 0.0   |       |       | 0.0   |       |       | 0.0   |       |       | 0.0   |       |
| Crosswalk Width(m)         |       | 5.0   |       |       | 5.0   |       |       | 5.0   |       |       | 5.0   |       |
| Two way Left Turn Lane     |       |       |       |       |       |       |       |       |       |       |       |       |
| Headway Factor             | 1.09  | 1.09  | 1.09  | 1.09  | 1.09  | 1.09  | 1.09  | 1.09  | 1.09  | 1.09  | 1.09  | 1.09  |
| Number of Detectors        | 1     | 2     | 1     | 1     | 2     | 1     | 1     | 2     | 1     | 1     | 2     | 1     |
| Detector Template          | Left  | Thru  | Right | Left  | Thru  | Right | Left  | Thru  | Right | Left  | Thru  | Right |
| Leading Detector (m)       | 2.0   | 10.0  | 2.0   | 2.0   | 10.0  | 2.0   | 2.0   | 10.0  | 2.0   | 2.0   | 10.0  | 2.0   |
| Trailing Detector (m)      | 0.0   | 0.0   | 0.0   | 0.0   | 0.0   | 0.0   | 0.0   | 0.0   | 0.0   | 0.0   | 0.0   | 0.0   |
| Detector 1 Position(m)     | 0.0   | 0.0   | 0.0   | 0.0   | 0.0   | 0.0   | 0.0   | 0.0   | 0.0   | 0.0   | 0.0   | 0.0   |
| Detector 1 Size(m)         | 2.0   | 0.6   | 2.0   | 2.0   | 0.6   | 2.0   | 2.0   | 0.6   | 2.0   | 2.0   | 0.6   | 2.0   |
| Detector 1 Type            | Cl+Ex | Cl+Ex | Cl+Ex | Cl+Ex | Cl+Ex | Cl+Ex | Cl+Ex | Cl+Ex | Cl+Ex | Cl+Ex | Cl+Ex | Cl+Ex |
| Detector 1 Channel         |       |       |       |       |       |       |       |       |       |       |       |       |
| Detector 1 Extend (s)      | 0.0   | 0.0   | 0.0   | 0.0   | 0.0   | 0.0   | 0.0   | 0.0   | 0.0   | 0.0   | 0.0   | 0.0   |
| Detector 1 Queue (s)       | 0.0   | 0.0   | 0.0   | 0.0   | 0.0   | 0.0   | 0.0   | 0.0   | 0.0   | 0.0   | 0.0   | 0.0   |
| Detector 1 Delay (s)       | 0.0   | 0.0   | 0.0   | 0.0   | 0.0   | 0.0   | 0.0   | 0.0   | 0.0   | 0.0   | 0.0   | 0.0   |
| Detector 2 Position(m)     |       | 9.4   |       |       | 9.4   |       |       | 9.4   |       |       | 9.4   |       |
| Detector 2 Size(m)         |       | 0.6   |       |       | 0.6   |       |       | 0.6   |       |       | 0.6   |       |
| Detector 2 Type            |       | Cl+Ex |       |       | Cl+Ex |       |       | Cl+Ex |       |       | Cl+Ex |       |
| Detector 2 Channel         |       |       |       |       |       |       |       |       |       |       |       |       |
| Detector 2 Extend (s)      |       | 0.0   |       |       | 0.0   |       |       | 0.0   |       |       | 0.0   |       |
| Turn Type                  | Perm  | NA    | Perm  | Perm  | NA    | Perm  | Prot  | NA    | Perm  | Prot  | NA    | Perm  |
| Protected Phases           |       | 4     |       |       | 8     |       | 5     | 2     |       | 1     | 6     |       |
| Permitted Phases           | 4     |       | 4     | 8     |       | 8     |       |       | 2     |       |       | 6     |
| Detector Phase             | 4     | 4     | 4     | 8     | 8     | 8     | 5     | 2     | 2     | 1     | 6     | 6     |
| Switch Phase               |       |       |       |       |       |       |       |       |       |       |       |       |



| Lane Group              | EBL   | EBT   | EBR   | WBL   | WBT   | WBR   | NBL   | NBT   | NBR   | SBL   | SBT   | SBR   |
|-------------------------|-------|-------|-------|-------|-------|-------|-------|-------|-------|-------|-------|-------|
| Minimum Initial (s)     | 10.0  | 10.0  | 10.0  | 10.0  | 10.0  | 10.0  | 5.0   | 10.0  | 10.0  | 5.0   | 10.0  | 10.0  |
| Minimum Split (s)       | 38.5  | 38.5  | 38.5  | 38.5  | 38.5  | 38.5  | 11.4  | 24.4  | 24.4  | 11.4  | 24.4  | 24.4  |
| Total Split (s)         | 38.5  | 38.5  | 38.5  | 38.5  | 38.5  | 38.5  | 19.1  | 64.5  | 64.5  | 27.0  | 72.4  | 72.4  |
| Total Split (%)         | 29.6% | 29.6% | 29.6% | 29.6% | 29.6% | 29.6% | 14.7% | 49.6% | 49.6% | 20.8% | 55.7% | 55.7% |
| Maximum Green (s)       | 31.0  | 31.0  | 31.0  | 31.0  | 31.0  | 31.0  | 12.7  | 58.1  | 58.1  | 20.6  | 66.0  | 66.0  |
| Yellow Time (s)         | 3.0   | 3.0   | 3.0   | 3.0   | 3.0   | 3.0   | 3.7   | 3.7   | 3.7   | 3.7   | 3.7   | 3.7   |
| All-Red Time (s)        | 4.5   | 4.5   | 4.5   | 4.5   | 4.5   | 4.5   | 2.7   | 2.7   | 2.7   | 2.7   | 2.7   | 2.7   |
| Lost Time Adjust (s)    |       | 0.0   | 0.0   | 0.0   | 0.0   | 0.0   | 0.0   | 0.0   | 0.0   | 0.0   | 0.0   | 0.0   |
| Total Lost Time (s)     |       | 7.5   | 7.5   | 7.5   | 7.5   | 7.5   | 6.4   | 6.4   | 6.4   | 6.4   | 6.4   | 6.4   |
| Lead/Lag                |       |       |       |       |       |       | Lead  | Lag   | Lag   | Lead  | Lag   | Lag   |
| Lead-Lag Optimize?      |       |       |       |       |       |       |       |       |       |       |       |       |
| Vehicle Extension (s)   | 3.0   | 3.0   | 3.0   | 3.0   | 3.0   | 3.0   | 3.0   | 3.0   | 3.0   | 3.0   | 3.0   | 3.0   |
| Recall Mode             | None  | None  | None  | None  | None  | None  | None  | C-Max | C-Max | None  | C-Max | C-Max |
| Walk Time (s)           | 7.0   | 7.0   | 7.0   | 7.0   | 7.0   | 7.0   |       | 7.0   | 7.0   |       | 7.0   | 7.0   |
| Flash Dont Walk (s)     | 24.0  | 24.0  | 24.0  | 24.0  | 24.0  | 24.0  |       | 11.0  | 11.0  |       | 11.0  | 11.0  |
| Pedestrian Calls (#/hr) | 10    | 10    | 10    | 5     | 5     | 5     |       | 10    | 10    |       | 5     | 5     |
| Act Effct Green (s)     |       | 20.0  | 20.0  | 20.0  | 20.0  | 20.0  | 10.6  | 72.3  | 72.3  | 17.4  | 81.8  | 81.8  |
| Actuated g/C Ratio      |       | 0.15  | 0.15  | 0.15  | 0.15  | 0.15  | 0.08  | 0.56  | 0.56  | 0.13  | 0.63  | 0.63  |
| v/c Ratio               |       | 0.50  | 0.18  | 0.70  | 0.20  | 0.50  | 0.56  | 0.68  | 0.11  | 0.75  | 0.39  | 0.07  |
| Control Delay           |       | 56.8  | 1.2   | 70.5  | 46.8  | 10.3  | 71.3  | 9.7   | 0.4   | 74.7  | 14.2  | 1.7   |
| Queue Delay             |       | 0.0   | 0.0   | 0.0   | 0.0   | 0.0   | 0.0   | 0.0   | 0.0   | 0.0   | 0.0   | 0.0   |
| Total Delay             |       | 56.8  | 1.2   | 70.5  | 46.8  | 10.3  | 71.3  | 9.7   | 0.4   | 74.7  | 14.2  | 1.7   |
| LOS                     |       | E     | A     | E     | D     | B     | E     | A     | A     | E     | B     | A     |
| Approach Delay          |       | 36.0  |       |       | 35.9  |       |       | 11.6  |       |       | 21.0  |       |
| Approach LOS            |       | D     |       |       | D     |       |       | B     |       |       | C     |       |
| Queue Length 50th (m)   |       | 22.9  | 0.0   | 29.4  | 9.9   | 0.0   | 18.8  | 29.1  | 0.2   | 38.6  | 48.4  | 0.0   |
| Queue Length 95th (m)   |       | 35.8  | 0.0   | 44.5  | 18.3  | 17.2  | m23.0 | 35.6  | m0.2  | 60.2  | 74.1  | 3.9   |
| Internal Link Dist (m)  |       | 441.2 |       |       | 335.5 |       |       | 294.9 |       |       | 438.6 |       |
| Turn Bay Length (m)     |       |       | 20.0  | 45.0  |       | 35.0  | 130.0 |       | 30.0  | 65.0  |       | 25.0  |
| Base Capacity (vph)     |       | 325   | 450   | 286   | 369   | 497   | 164   | 2650  | 848   | 266   | 2968  | 937   |
| Starvation Cap Reductn  |       | 0     | 0     | 0     | 0     | 0     | 0     | 0     | 0     | 0     | 0     | 0     |
| Spillback Cap Reductn   |       | 0     | 0     | 0     | 0     | 0     | 0     | 0     | 0     | 0     | 0     | 0     |
| Storage Cap Reductn     |       | 0     | 0     | 0     | 0     | 0     | 0     | 0     | 0     | 0     | 0     | 0     |
| Reduced v/c Ratio       |       | 0.32  | 0.14  | 0.45  | 0.13  | 0.39  | 0.46  | 0.68  | 0.11  | 0.64  | 0.39  | 0.07  |

Intersection Summary

Area Type: Other  
 Cycle Length: 130  
 Actuated Cycle Length: 130  
 Offset: 128 (98%), Referenced to phase 2:NBT and 6:SBT, Start of Green  
 Natural Cycle: 100  
 Control Type: Actuated-Coordinated  
 Maximum v/c Ratio: 0.75  
 Intersection Signal Delay: 18.3  
 Intersection LOS: B  
 Intersection Capacity Utilization 82.9%  
 ICU Level of Service E  
 Analysis Period (min) 15  
 m Volume for 95th percentile queue is metered by upstream signal.

Splits and Phases: 1: March & Morgan's Grant/Shirley's Brook

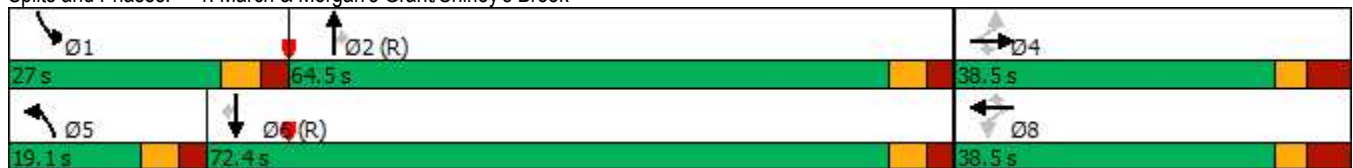





| Lane Group                 | EBL   | EBT   | EBR   | WBL   | WBT   | WBR   | NBU   | NBL   | NBT   | NBR   | SBU   | SBL   |
|----------------------------|-------|-------|-------|-------|-------|-------|-------|-------|-------|-------|-------|-------|
| Lane Configurations        |       |       |       |       |       |       |       |       |       |       |       |       |
| Traffic Volume (vph)       | 278   | 177   | 179   | 74    | 182   | 191   | 18    | 322   | 1630  | 126   | 4     | 150   |
| Future Volume (vph)        | 278   | 177   | 179   | 74    | 182   | 191   | 18    | 322   | 1630  | 126   | 4     | 150   |
| Ideal Flow (vphpl)         | 1800  | 1800  | 1800  | 1800  | 1800  | 1800  | 1800  | 1800  | 1800  | 1800  | 1800  | 1800  |
| Storage Length (m)         | 95.0  |       | 60.0  | 75.0  |       | 75.0  |       | 130.0 |       | 85.0  |       | 110.0 |
| Storage Lanes              | 2     |       | 2     | 2     |       | 1     |       | 2     |       | 2     |       | 1     |
| Taper Length (m)           | 40.0  |       |       | 20.0  |       |       |       | 90.0  |       |       |       | 40.0  |
| Lane Util. Factor          | 0.97  | 0.95  | 1.00  | 0.97  | 0.95  | 1.00  | 0.91  | 0.97  | 0.91  | 1.00  | 0.91  | 1.00  |
| Ped Bike Factor            | 0.99  |       | 0.97  | 0.99  |       | 0.96  |       | 1.00  |       | 0.97  |       | 1.00  |
| Fr                         |       |       | 0.850 |       |       | 0.850 |       |       |       | 0.850 |       |       |
| Flt Protected              | 0.950 |       |       | 0.950 |       |       |       | 0.950 |       |       |       | 0.950 |
| Satd. Flow (prot)          | 3248  | 3221  | 1498  | 3248  | 3349  | 1498  | 0     | 3187  | 4764  | 1469  | 0     | 1674  |
| Flt Permitted              | 0.950 |       |       | 0.950 |       |       |       | 0.950 |       |       |       | 0.950 |
| Satd. Flow (perm)          | 3206  | 3221  | 1459  | 3220  | 3349  | 1444  | 0     | 3176  | 4764  | 1425  | 0     | 1671  |
| Right Turn on Red          |       |       | Yes   |       |       | Yes   |       |       |       | Yes   |       |       |
| Satd. Flow (RTOR)          |       |       | 202   |       |       | 202   |       |       |       | 147   |       |       |
| Link Speed (k/h)           |       | 60    |       |       | 60    |       |       |       | 60    |       |       |       |
| Link Distance (m)          |       | 165.4 |       |       | 149.1 |       |       |       | 308.9 |       |       |       |
| Travel Time (s)            |       | 9.9   |       |       | 8.9   |       |       |       | 18.5  |       |       |       |
| Confl. Peds. (#/hr)        | 15    |       | 10    | 10    |       | 15    |       | 5     |       | 10    |       | 10    |
| Confl. Bikes (#/hr)        |       |       | 5     |       |       | 10    |       |       |       | 5     |       |       |
| Peak Hour Factor           | 1.00  | 1.00  | 1.00  | 1.00  | 1.00  | 1.00  | 1.00  | 1.00  | 1.00  | 1.00  | 1.00  | 1.00  |
| Heavy Vehicles (%)         | 1%    | 5%    | 1%    | 1%    | 1%    | 1%    | 2%    | 3%    | 2%    | 3%    | 2%    | 1%    |
| Adj. Flow (vph)            | 278   | 177   | 179   | 74    | 182   | 191   | 18    | 322   | 1630  | 126   | 4     | 150   |
| Shared Lane Traffic (%)    |       |       |       |       |       |       |       |       |       |       |       |       |
| Lane Group Flow (vph)      | 278   | 177   | 179   | 74    | 182   | 191   | 0     | 340   | 1630  | 126   | 0     | 154   |
| Enter Blocked Intersection | No    | No    | No    | Yes   | Yes   | Yes   | No    | No    | No    | No    | No    | No    |
| Lane Alignment             | L NA  | Left  | R NA  | L NA  | Left  | R NA  | R NA  | L NA  | Left  | R NA  | R NA  | L NA  |
| Median Width(m)            |       | 11.5  |       |       | 10.5  |       |       |       | 10.5  |       |       |       |
| Link Offset(m)             |       | 0.0   |       |       | 0.0   |       |       |       | 0.0   |       |       |       |
| Crosswalk Width(m)         |       | 5.0   |       |       | 5.0   |       |       |       | 5.0   |       |       |       |
| Two way Left Turn Lane     |       |       |       |       |       |       |       |       |       |       |       |       |
| Headway Factor             | 1.09  | 1.09  | 1.09  | 1.09  | 1.09  | 1.09  | 1.09  | 1.09  | 1.09  | 1.09  | 1.09  | 1.09  |
| Number of Detectors        | 1     | 2     | 1     | 1     | 2     | 1     | 1     | 1     | 2     | 1     | 1     | 1     |
| Detector Template          | Left  | Thru  | Right | Left  | Thru  | Right | Left  | Left  | Thru  | Right | Left  | Left  |
| Leading Detector (m)       | 2.0   | 10.0  | 2.0   | 2.0   | 10.0  | 2.0   | 2.0   | 2.0   | 10.0  | 2.0   | 2.0   | 2.0   |
| Trailing Detector (m)      | 0.0   | 0.0   | 0.0   | 0.0   | 0.0   | 0.0   | 0.0   | 0.0   | 0.0   | 0.0   | 0.0   | 0.0   |
| Detector 1 Position(m)     | 0.0   | 0.0   | 0.0   | 0.0   | 0.0   | 0.0   | 0.0   | 0.0   | 0.0   | 0.0   | 0.0   | 0.0   |
| Detector 1 Size(m)         | 2.0   | 0.6   | 2.0   | 2.0   | 0.6   | 2.0   | 2.0   | 2.0   | 0.6   | 2.0   | 2.0   | 2.0   |
| Detector 1 Type            | Cl+Ex | Cl+Ex | Cl+Ex | Cl+Ex | Cl+Ex | Cl+Ex | Cl+Ex | Cl+Ex | Cl+Ex | Cl+Ex | Cl+Ex | Cl+Ex |
| Detector 1 Channel         |       |       |       |       |       |       |       |       |       |       |       |       |
| Detector 1 Extend (s)      | 0.0   | 0.0   | 0.0   | 0.0   | 0.0   | 0.0   | 0.0   | 0.0   | 0.0   | 0.0   | 0.0   | 0.0   |
| Detector 1 Queue (s)       | 0.0   | 0.0   | 0.0   | 0.0   | 0.0   | 0.0   | 0.0   | 0.0   | 0.0   | 0.0   | 0.0   | 0.0   |
| Detector 1 Delay (s)       | 0.0   | 0.0   | 0.0   | 0.0   | 0.0   | 0.0   | 0.0   | 0.0   | 0.0   | 0.0   | 0.0   | 0.0   |
| Detector 2 Position(m)     |       | 9.4   |       |       | 9.4   |       |       |       | 9.4   |       |       |       |
| Detector 2 Size(m)         |       | 0.6   |       |       | 0.6   |       |       |       | 0.6   |       |       |       |
| Detector 2 Type            |       | Cl+Ex |       |       | Cl+Ex |       |       |       | Cl+Ex |       |       |       |
| Detector 2 Channel         |       |       |       |       |       |       |       |       |       |       |       |       |
| Detector 2 Extend (s)      |       | 0.0   |       |       | 0.0   |       |       |       | 0.0   |       |       |       |
| Turn Type                  | Prot  | NA    | Perm  | Prot  | NA    | Perm  | Prot  | Prot  | NA    | Perm  | Prot  | Prot  |
| Protected Phases           | 7     | 4     |       | 3     | 8     |       | 5     | 5     | 2     |       | 1     | 1     |
| Permitted Phases           |       |       | 4     |       |       | 8     |       |       |       | 2     |       |       |
| Detector Phase             | 7     | 4     | 4     | 3     | 8     | 8     | 5     | 5     | 2     | 2     | 1     | 1     |
| Switch Phase               |       |       |       |       |       |       |       |       |       |       |       |       |

2: March & Terry Fox  
PM Peak Hour

555-603 March Road  
2037 Total Traffic (pre-BRT)



| Lane Group                 | SBT   | SBR   |
|----------------------------|-------|-------|
| Lane Configurations        | ↑↑↑   | ↑     |
| Traffic Volume (vph)       | 955   | 200   |
| Future Volume (vph)        | 955   | 200   |
| Ideal Flow (vphpl)         | 1800  | 1800  |
| Storage Length (m)         |       | 100.0 |
| Storage Lanes              |       | 1     |
| Taper Length (m)           |       |       |
| Lane Util. Factor          | 0.91  | 1.00  |
| Ped Bike Factor            |       | 0.98  |
| Frt                        |       | 0.850 |
| Flt Protected              |       |       |
| Satd. Flow (prot)          | 4718  | 1483  |
| Flt Permitted              |       |       |
| Satd. Flow (perm)          | 4718  | 1449  |
| Right Turn on Red          |       | Yes   |
| Satd. Flow (RTOR)          |       | 204   |
| Link Speed (k/h)           | 60    |       |
| Link Distance (m)          | 318.9 |       |
| Travel Time (s)            | 19.1  |       |
| Confl. Peds. (#/hr)        |       | 5     |
| Confl. Bikes (#/hr)        |       | 5     |
| Peak Hour Factor           | 1.00  | 1.00  |
| Heavy Vehicles (%)         | 3%    | 2%    |
| Adj. Flow (vph)            | 955   | 200   |
| Shared Lane Traffic (%)    |       |       |
| Lane Group Flow (vph)      | 955   | 200   |
| Enter Blocked Intersection | No    | No    |
| Lane Alignment             | Left  | R NA  |
| Median Width(m)            | 7.0   |       |
| Link Offset(m)             | 0.0   |       |
| Crosswalk Width(m)         | 5.0   |       |
| Two way Left Turn Lane     |       |       |
| Headway Factor             | 1.09  | 1.09  |
| Number of Detectors        | 2     | 1     |
| Detector Template          | Thru  | Right |
| Leading Detector (m)       | 10.0  | 2.0   |
| Trailing Detector (m)      | 0.0   | 0.0   |
| Detector 1 Position(m)     | 0.0   | 0.0   |
| Detector 1 Size(m)         | 0.6   | 2.0   |
| Detector 1 Type            | CI+Ex | CI+Ex |
| Detector 1 Channel         |       |       |
| Detector 1 Extend (s)      | 0.0   | 0.0   |
| Detector 1 Queue (s)       | 0.0   | 0.0   |
| Detector 1 Delay (s)       | 0.0   | 0.0   |
| Detector 2 Position(m)     | 9.4   |       |
| Detector 2 Size(m)         | 0.6   |       |
| Detector 2 Type            | CI+Ex |       |
| Detector 2 Channel         |       |       |
| Detector 2 Extend (s)      | 0.0   |       |
| Turn Type                  | NA    | Perm  |
| Protected Phases           | 6     |       |
| Permitted Phases           |       | 6     |
| Detector Phase             | 6     | 6     |
| Switch Phase               |       |       |

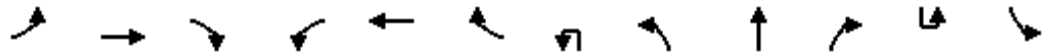

| Lane Group              | EBL   | EBT   | EBR   | WBL   | WBT   | WBR   | NBU   | NBL   | NBT     | NBR   | SBU   | SBL   |
|-------------------------|-------|-------|-------|-------|-------|-------|-------|-------|---------|-------|-------|-------|
| Minimum Initial (s)     | 5.0   | 10.0  | 10.0  | 5.0   | 10.0  | 10.0  | 5.0   | 5.0   | 10.0    | 10.0  | 5.0   | 5.0   |
| Minimum Split (s)       | 11.8  | 41.9  | 41.9  | 11.8  | 41.9  | 41.9  | 11.8  | 11.8  | 32.7    | 32.7  | 11.8  | 11.8  |
| Total Split (s)         | 20.0  | 48.0  | 48.0  | 14.0  | 42.0  | 42.0  | 26.0  | 26.0  | 50.0    | 50.0  | 18.0  | 18.0  |
| Total Split (%)         | 15.4% | 36.9% | 36.9% | 10.8% | 32.3% | 32.3% | 20.0% | 20.0% | 38.5%   | 38.5% | 13.8% | 13.8% |
| Maximum Green (s)       | 13.2  | 41.1  | 41.1  | 7.2   | 35.1  | 35.1  | 19.2  | 19.2  | 43.3    | 43.3  | 11.2  | 11.2  |
| Yellow Time (s)         | 3.7   | 3.7   | 3.7   | 3.7   | 3.7   | 3.7   | 4.6   | 4.6   | 4.6     | 4.6   | 4.6   | 4.6   |
| All-Red Time (s)        | 3.1   | 3.2   | 3.2   | 3.1   | 3.2   | 3.2   | 2.2   | 2.2   | 2.1     | 2.1   | 2.2   | 2.2   |
| Lost Time Adjust (s)    | 0.0   | 0.0   | 0.0   | 0.0   | 0.0   | 0.0   |       |       | 0.0     | 0.0   |       | 0.0   |
| Total Lost Time (s)     | 6.8   | 6.9   | 6.9   | 6.8   | 6.9   | 6.9   |       |       | 6.8     | 6.7   |       | 6.8   |
| Lead/Lag                | Lead  | Lag   | Lag   | Lead  | Lag   | Lag   | Lead  | Lead  | Lag     | Lag   | Lead  | Lead  |
| Lead-Lag Optimize?      |       |       |       |       |       |       |       |       |         |       |       |       |
| Vehicle Extension (s)   | 3.0   | 3.0   | 3.0   | 3.0   | 3.0   | 3.0   | 3.0   | 3.0   | 3.0     | 3.0   | 3.0   | 3.0   |
| Recall Mode             | None  | None  | None  | None  | None  | None  | None  | None  | C-Max   | C-Max | None  | None  |
| Walk Time (s)           |       | 7.0   | 7.0   |       | 7.0   | 7.0   |       |       | 7.0     | 7.0   |       |       |
| Flash Dont Walk (s)     |       | 28.0  | 28.0  |       | 28.0  | 28.0  |       |       | 19.0    | 19.0  |       |       |
| Pedestrian Calls (#/hr) |       | 15    | 15    |       | 15    | 15    |       |       | 10      | 10    |       |       |
| Act Effct Green (s)     | 13.1  | 29.4  | 29.4  | 7.0   | 20.7  | 20.7  |       | 17.7  | 52.2    | 52.2  |       | 16.8  |
| Actuated g/c Ratio      | 0.10  | 0.23  | 0.23  | 0.05  | 0.16  | 0.16  |       | 0.14  | 0.40    | 0.40  |       | 0.13  |
| v/c Ratio               | 0.85  | 0.24  | 0.37  | 0.43  | 0.34  | 0.48  |       | 0.78  | 0.85    | 0.19  |       | 0.71  |
| Control Delay           | 77.1  | 50.6  | 12.7  | 67.3  | 48.0  | 8.3   |       | 73.5  | 29.1    | 1.7   |       | 81.5  |
| Queue Delay             | 0.0   | 0.0   | 0.0   | 0.0   | 0.0   | 0.0   |       | 0.0   | 0.0     | 0.0   |       | 0.0   |
| Total Delay             | 77.1  | 50.6  | 12.7  | 67.3  | 48.0  | 8.3   |       | 73.5  | 29.1    | 1.7   |       | 81.5  |
| LOS                     | E     | D     | B     | E     | D     | A     |       | E     | C       | A     |       | F     |
| Approach Delay          |       | 51.5  |       |       | 34.2  |       |       |       | 34.7    |       |       |       |
| Approach LOS            |       | D     |       |       | C     |       |       |       | C       |       |       |       |
| Queue Length 50th (m)   | 31.4  | 22.5  | 5.1   | 8.8   | 22.0  | 0.0   |       | 42.5  | 67.5    | 1.1   |       | 36.2  |
| Queue Length 95th (m)   | #53.6 | 31.1  | 25.1  | 16.2  | 26.6  | 14.3  |       | m45.1 | m#165.9 | m1.5  |       | #82.5 |
| Internal Link Dist (m)  |       | 141.4 |       |       | 125.1 |       |       |       | 284.9   |       |       |       |
| Turn Bay Length (m)     | 95.0  |       | 60.0  | 75.0  |       | 75.0  |       | 130.0 |         | 85.0  |       | 110.0 |
| Base Capacity (vph)     | 329   | 1018  | 599   | 179   | 904   | 537   |       | 471   | 1914    | 660   |       | 216   |
| Starvation Cap Reductn  | 0     | 0     | 0     | 0     | 0     | 0     |       | 0     | 0       | 0     |       | 0     |
| Spillback Cap Reductn   | 0     | 0     | 0     | 0     | 0     | 0     |       | 0     | 0       | 0     |       | 0     |
| Storage Cap Reductn     | 0     | 0     | 0     | 0     | 0     | 0     |       | 0     | 0       | 0     |       | 0     |
| Reduced v/c Ratio       | 0.84  | 0.17  | 0.30  | 0.41  | 0.20  | 0.36  |       | 0.72  | 0.85    | 0.19  |       | 0.71  |

Intersection Summary

Area Type: Other  
 Cycle Length: 130  
 Actuated Cycle Length: 130  
 Offset: 0 (0%), Referenced to phase 2:NBT and 6:SBT, Start of Green  
 Natural Cycle: 130  
 Control Type: Actuated-Coordinated  
 Maximum v/c Ratio: 0.85  
 Intersection Signal Delay: 34.9  
 Intersection LOS: C  
 Intersection Capacity Utilization 93.2%  
 ICU Level of Service F  
 Analysis Period (min) 15  
 # 95th percentile volume exceeds capacity, queue may be longer.  
 Queue shown is maximum after two cycles.  
 m Volume for 95th percentile queue is metered by upstream signal.

Splits and Phases: 2: March & Terry Fox

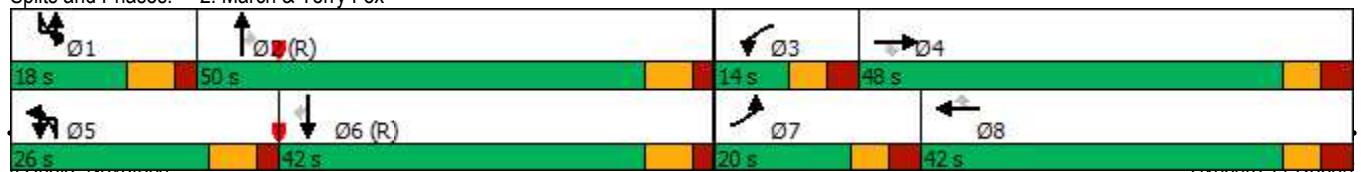



| Lane Group                  | SBT   | SBR   |
|-----------------------------|-------|-------|
| Minimum Initial (s)         | 10.0  | 10.0  |
| Minimum Split (s)           | 32.7  | 32.7  |
| Total Split (s)             | 42.0  | 42.0  |
| Total Split (%)             | 32.3% | 32.3% |
| Maximum Green (s)           | 35.3  | 35.3  |
| Yellow Time (s)             | 4.6   | 4.6   |
| All-Red Time (s)            | 2.1   | 2.1   |
| Lost Time Adjust (s)        | 0.0   | 0.0   |
| Total Lost Time (s)         | 6.7   | 6.7   |
| Lead/Lag                    | Lag   | Lag   |
| Lead-Lag Optimize?          |       |       |
| Vehicle Extension (s)       | 3.0   | 3.0   |
| Recall Mode                 | C-Max | C-Max |
| Walk Time (s)               | 7.0   | 7.0   |
| Flash Dont Walk (s)         | 19.0  | 19.0  |
| Pedestrian Calls (#/hr)     | 10    | 10    |
| Act Effct Green (s)         | 51.3  | 51.3  |
| Actuated g/C Ratio          | 0.39  | 0.39  |
| v/c Ratio                   | 0.51  | 0.29  |
| Control Delay               | 24.1  | 1.8   |
| Queue Delay                 | 0.0   | 0.0   |
| Total Delay                 | 24.1  | 1.8   |
| LOS                         | C     | A     |
| Approach Delay              | 27.4  |       |
| Approach LOS                | C     |       |
| Queue Length 50th (m)       | 34.2  | 0.0   |
| Queue Length 95th (m)       | 40.8  | 4.3   |
| Internal Link Dist (m)      | 294.9 |       |
| Turn Bay Length (m)         |       | 100.0 |
| Base Capacity (vph)         | 1861  | 695   |
| Starvation Cap Reductn      | 0     | 0     |
| Spillback Cap Reductn       | 0     | 0     |
| Storage Cap Reductn         | 0     | 0     |
| Reduced v/c Ratio           | 0.51  | 0.29  |
| <b>Intersection Summary</b> |       |       |

3: March & Solandt  
PM Peak Hour

555-603 March Road  
2037 Total Traffic (pre-BRT)

| Lane Group                 | EBL   | EBT   | EBR   | WBL   | WBT   | WBR  | NBU   | NBL   | NBT   | NBR  | SBU   | SBL   |
|----------------------------|-------|-------|-------|-------|-------|------|-------|-------|-------|------|-------|-------|
| Lane Configurations        |       |       |       |       |       |      |       |       |       |      |       |       |
| Traffic Volume (vph)       | 24    | 22    | 175   | 350   | 22    | 45   | 16    | 72    | 1933  | 23   | 12    | 15    |
| Future Volume (vph)        | 24    | 22    | 175   | 350   | 22    | 45   | 16    | 72    | 1933  | 23   | 12    | 15    |
| Ideal Flow (vphpl)         | 1800  | 1800  | 1800  | 1800  | 1800  | 1800 | 1800  | 1800  | 1800  | 1800 | 1800  | 1800  |
| Storage Length (m)         | 35.0  |       | 60.0  | 85.0  |       | 55.0 |       | 165.0 |       | 0.0  |       | 155.0 |
| Storage Lanes              | 1     |       | 1     | 2     |       | 0    |       | 1     |       | 0    |       | 1     |
| Taper Length (m)           | 50.0  |       |       | 95.0  |       |      |       | 40.0  |       |      |       | 25.0  |
| Lane Util. Factor          | 1.00  | 1.00  | 1.00  | 0.97  | 1.00  | 1.00 | 0.95  | 1.00  | 0.95  | 0.95 | 0.95  | 1.00  |
| Ped Bike Factor            | 0.99  |       | 0.98  | 0.99  | 0.99  |      |       | 1.00  | 1.00  |      |       | 1.00  |
| Fr <sub>t</sub>            |       |       | 0.850 |       | 0.899 |      |       |       | 0.998 |      |       |       |
| Flt Protected              | 0.950 |       |       | 0.950 |       |      |       | 0.950 |       |      |       | 0.950 |
| Satd. Flow (prot)          | 1674  | 1695  | 1483  | 3248  | 1459  | 0    | 0     | 1645  | 3307  | 0    | 0     | 1649  |
| Flt Permitted              | 0.950 |       |       | 0.950 |       |      |       | 0.950 |       |      |       | 0.950 |
| Satd. Flow (perm)          | 1664  | 1695  | 1449  | 3214  | 1459  | 0    | 0     | 1641  | 3307  | 0    | 0     | 1648  |
| Right Turn on Red          |       |       | Yes   |       |       | Yes  |       |       |       | Yes  |       |       |
| Satd. Flow (RTOR)          |       |       | 137   |       | 45    |      |       |       | 1     |      |       |       |
| Link Speed (k/h)           |       | 50    |       |       | 50    |      |       |       | 60    |      |       |       |
| Link Distance (m)          |       | 212.6 |       |       | 241.6 |      |       |       | 610.9 |      |       |       |
| Travel Time (s)            |       | 15.3  |       |       | 17.4  |      |       |       | 36.7  |      |       |       |
| Confl. Peds. (#/hr)        | 5     |       | 5     | 5     |       | 5    |       | 5     |       | 5    |       | 5     |
| Confl. Bikes (#/hr)        |       |       | 5     |       |       | 5    |       |       |       | 5    |       |       |
| Peak Hour Factor           | 1.00  | 1.00  | 1.00  | 1.00  | 1.00  | 1.00 | 1.00  | 1.00  | 1.00  | 1.00 | 1.00  | 1.00  |
| Heavy Vehicles (%)         | 1%    | 5%    | 2%    | 1%    | 6%    | 9%   | 2%    | 3%    | 2%    | 6%   | 2%    | 3%    |
| Adj. Flow (vph)            | 24    | 22    | 175   | 350   | 22    | 45   | 16    | 72    | 1933  | 23   | 12    | 15    |
| Shared Lane Traffic (%)    |       |       |       |       |       |      |       |       |       |      |       |       |
| Lane Group Flow (vph)      | 24    | 22    | 175   | 350   | 67    | 0    | 0     | 88    | 1956  | 0    | 0     | 27    |
| Enter Blocked Intersection | No    | No    | No    | No    | No    | No   | No    | No    | No    | No   | No    | No    |
| Lane Alignment             | L NA  | Left  | R NA  | L NA  | Left  | R NA | R NA  | L NA  | Left  | R NA | R NA  | L NA  |
| Median Width(m)            |       | 7.0   |       |       | 10.5  |      |       |       | 17.5  |      |       |       |
| Link Offset(m)             |       | 0.0   |       |       | 0.0   |      |       |       | 0.0   |      |       |       |
| Crosswalk Width(m)         |       | 5.0   |       |       | 5.0   |      |       |       | 5.0   |      |       |       |
| Two way Left Turn Lane     |       |       |       |       |       |      |       |       |       |      |       |       |
| Headway Factor             | 1.09  | 1.09  | 1.09  | 1.09  | 1.09  | 1.09 | 1.09  | 1.09  | 1.09  | 1.09 | 1.09  | 1.09  |
| Number of Detectors        | 1     | 2     | 1     | 1     | 2     |      | 1     | 1     | 2     |      | 1     | 1     |
| Detector Template          | Left  | Thru  | Right | Left  | Thru  |      | Left  | Left  | Thru  |      | Left  | Left  |
| Leading Detector (m)       | 2.0   | 10.0  | 2.0   | 2.0   | 10.0  |      | 2.0   | 2.0   | 10.0  |      | 2.0   | 2.0   |
| Trailing Detector (m)      | 0.0   | 0.0   | 0.0   | 0.0   | 0.0   |      | 0.0   | 0.0   | 0.0   |      | 0.0   | 0.0   |
| Detector 1 Position(m)     | 0.0   | 0.0   | 0.0   | 0.0   | 0.0   |      | 0.0   | 0.0   | 0.0   |      | 0.0   | 0.0   |
| Detector 1 Size(m)         | 2.0   | 0.6   | 2.0   | 2.0   | 0.6   |      | 2.0   | 2.0   | 0.6   |      | 2.0   | 2.0   |
| Detector 1 Type            | Cl+Ex | Cl+Ex | Cl+Ex | Cl+Ex | Cl+Ex |      | Cl+Ex | Cl+Ex | Cl+Ex |      | Cl+Ex | Cl+Ex |
| Detector 1 Channel         |       |       |       |       |       |      |       |       |       |      |       |       |
| Detector 1 Extend (s)      | 0.0   | 0.0   | 0.0   | 0.0   | 0.0   |      | 0.0   | 0.0   | 0.0   |      | 0.0   | 0.0   |
| Detector 1 Queue (s)       | 0.0   | 0.0   | 0.0   | 0.0   | 0.0   |      | 0.0   | 0.0   | 0.0   |      | 0.0   | 0.0   |
| Detector 1 Delay (s)       | 0.0   | 0.0   | 0.0   | 0.0   | 0.0   |      | 0.0   | 0.0   | 0.0   |      | 0.0   | 0.0   |
| Detector 2 Position(m)     |       | 9.4   |       |       | 9.4   |      |       |       | 9.4   |      |       |       |
| Detector 2 Size(m)         |       | 0.6   |       |       | 0.6   |      |       |       | 0.6   |      |       |       |
| Detector 2 Type            |       | Cl+Ex |       |       | Cl+Ex |      |       |       | Cl+Ex |      |       |       |
| Detector 2 Channel         |       |       |       |       |       |      |       |       |       |      |       |       |
| Detector 2 Extend (s)      |       | 0.0   |       |       | 0.0   |      |       |       | 0.0   |      |       |       |
| Turn Type                  | Prot  | NA    | Perm  | Prot  | NA    |      | Prot  | Prot  | NA    |      | Prot  | Prot  |
| Protected Phases           | 7     | 4     |       | 3     | 8     |      | 5     | 5     | 2     |      | 1     | 1     |
| Permitted Phases           |       |       | 4     |       |       |      |       |       |       |      |       |       |
| Detector Phase             | 7     | 4     | 4     | 3     | 8     |      | 5     | 5     | 2     |      | 1     | 1     |
| Switch Phase               |       |       |       |       |       |      |       |       |       |      |       |       |

3: March & Solandt  
PM Peak Hour

555-603 March Road  
2037 Total Traffic (pre-BRT)

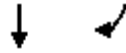

| Lane Group                 | SBT   | SBR  |
|----------------------------|-------|------|
| Lane Configurations        | ↑↑    |      |
| Traffic Volume (vph)       | 1465  | 16   |
| Future Volume (vph)        | 1465  | 16   |
| Ideal Flow (vphpl)         | 1800  | 1800 |
| Storage Length (m)         |       | 0.0  |
| Storage Lanes              |       | 0    |
| Taper Length (m)           |       |      |
| Lane Util. Factor          | 0.95  | 0.95 |
| Ped Bike Factor            | 1.00  |      |
| Frt                        | 0.998 |      |
| Flt Protected              |       |      |
| Satd. Flow (prot)          | 3307  | 0    |
| Flt Permitted              |       |      |
| Satd. Flow (perm)          | 3307  | 0    |
| Right Turn on Red          |       | Yes  |
| Satd. Flow (RTOR)          | 1     |      |
| Link Speed (k/h)           | 60    |      |
| Link Distance (m)          | 382.6 |      |
| Travel Time (s)            | 23.0  |      |
| Confl. Peds. (#/hr)        |       | 5    |
| Confl. Bikes (#/hr)        |       | 5    |
| Peak Hour Factor           | 1.00  | 1.00 |
| Heavy Vehicles (%)         | 2%    | 3%   |
| Adj. Flow (vph)            | 1465  | 16   |
| Shared Lane Traffic (%)    |       |      |
| Lane Group Flow (vph)      | 1481  | 0    |
| Enter Blocked Intersection | No    | No   |
| Lane Alignment             | Left  | R NA |
| Median Width(m)            | 17.5  |      |
| Link Offset(m)             | 0.0   |      |
| Crosswalk Width(m)         | 5.0   |      |
| Two way Left Turn Lane     |       |      |
| Headway Factor             | 1.09  | 1.09 |
| Number of Detectors        | 2     |      |
| Detector Template          | Thru  |      |
| Leading Detector (m)       | 10.0  |      |
| Trailing Detector (m)      | 0.0   |      |
| Detector 1 Position(m)     | 0.0   |      |
| Detector 1 Size(m)         | 0.6   |      |
| Detector 1 Type            | Cl+Ex |      |
| Detector 1 Channel         |       |      |
| Detector 1 Extend (s)      | 0.0   |      |
| Detector 1 Queue (s)       | 0.0   |      |
| Detector 1 Delay (s)       | 0.0   |      |
| Detector 2 Position(m)     | 9.4   |      |
| Detector 2 Size(m)         | 0.6   |      |
| Detector 2 Type            | Cl+Ex |      |
| Detector 2 Channel         |       |      |
| Detector 2 Extend (s)      | 0.0   |      |
| Turn Type                  | NA    |      |
| Protected Phases           | 6     |      |
| Permitted Phases           |       |      |
| Detector Phase             | 6     |      |
| Switch Phase               |       |      |

3: March & Solandt  
PM Peak Hour

555-603 March Road  
2037 Total Traffic (pre-BRT)

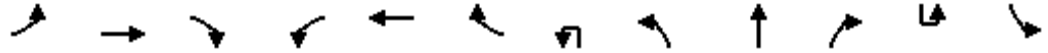

| Lane Group              | EBL   | EBT   | EBR   | WBL   | WBT   | WBR | NBU   | NBL   | NBT    | NBR | SBU  | SBL   |
|-------------------------|-------|-------|-------|-------|-------|-----|-------|-------|--------|-----|------|-------|
| Minimum Initial (s)     | 5.0   | 10.0  | 10.0  | 5.0   | 10.0  |     | 5.0   | 5.0   | 10.0   |     | 5.0  | 5.0   |
| Minimum Split (s)       | 11.5  | 36.5  | 36.5  | 11.5  | 36.5  |     | 12.0  | 12.0  | 26.8   |     | 12.0 | 12.0  |
| Total Split (s)         | 16.3  | 36.5  | 36.5  | 22.5  | 42.7  |     | 15.0  | 15.0  | 59.0   |     | 12.0 | 12.0  |
| Total Split (%)         | 12.5% | 28.1% | 28.1% | 17.3% | 32.8% |     | 11.5% | 11.5% | 45.4%  |     | 9.2% | 9.2%  |
| Maximum Green (s)       | 9.8   | 30.0  | 30.0  | 16.0  | 36.2  |     | 8.0   | 8.0   | 53.2   |     | 5.0  | 5.0   |
| Yellow Time (s)         | 3.3   | 3.3   | 3.3   | 3.3   | 3.3   |     | 3.7   | 3.7   | 3.7    |     | 3.7  | 3.7   |
| All-Red Time (s)        | 3.2   | 3.2   | 3.2   | 3.2   | 3.2   |     | 3.3   | 3.3   | 2.1    |     | 3.3  | 3.3   |
| Lost Time Adjust (s)    | 0.0   | 0.0   | 0.0   | 0.0   | 0.0   |     |       | 0.0   | 0.0    |     |      | 0.0   |
| Total Lost Time (s)     | 6.5   | 6.5   | 6.5   | 6.5   | 6.5   |     |       | 7.0   | 5.8    |     |      | 7.0   |
| Lead/Lag                | Lead  | Lag   | Lag   | Lead  | Lag   |     | Lead  | Lead  | Lag    |     | Lead | Lead  |
| Lead-Lag Optimize?      | Yes   |       |       |       | Yes   |     |       |       |        |     |      |       |
| Vehicle Extension (s)   | 3.0   | 3.0   | 3.0   | 3.0   | 3.0   |     | 3.0   | 3.0   | 3.0    |     | 3.0  | 3.0   |
| Recall Mode             | None  | None  | None  | None  | None  |     | None  | None  | C-Max  |     | None | None  |
| Walk Time (s)           |       | 7.0   | 7.0   |       | 7.0   |     |       |       | 7.0    |     |      |       |
| Flash Dont Walk (s)     |       | 23.0  | 23.0  |       | 23.0  |     |       |       | 14.0   |     |      |       |
| Pedestrian Calls (#/hr) |       | 5     | 5     |       | 5     |     |       |       | 5      |     |      |       |
| Act Effct Green (s)     | 7.4   | 14.6  | 14.6  | 15.9  | 27.9  |     |       | 11.7  | 72.4   |     |      | 6.6   |
| Actuated g/C Ratio      | 0.06  | 0.11  | 0.11  | 0.12  | 0.21  |     |       | 0.09  | 0.56   |     |      | 0.05  |
| v/c Ratio               | 0.25  | 0.12  | 0.62  | 0.88  | 0.19  |     |       | 0.59  | 1.06   |     |      | 0.32  |
| Control Delay           | 64.4  | 49.3  | 23.3  | 80.1  | 19.0  |     |       | 73.3  | 69.0   |     |      | 68.0  |
| Queue Delay             | 0.0   | 0.0   | 0.0   | 0.0   | 0.0   |     |       | 0.0   | 0.0    |     |      | 0.0   |
| Total Delay             | 64.4  | 49.3  | 23.3  | 80.1  | 19.0  |     |       | 73.3  | 69.0   |     |      | 68.0  |
| LOS                     | E     | D     | C     | F     | B     |     |       | E     | E      |     |      | E     |
| Approach Delay          |       | 30.3  |       |       | 70.3  |     |       |       | 69.2   |     |      |       |
| Approach LOS            |       | C     |       |       | E     |     |       |       | E      |     |      |       |
| Queue Length 50th (m)   | 5.5   | 4.9   | 8.7   | 42.4  | 4.6   |     |       | 19.9  | ~273.1 |     |      | 6.5   |
| Queue Length 95th (m)   | 13.6  | 10.8  | 25.7  | #65.9 | 14.3  |     |       | #49.7 | #371.3 |     |      | m13.1 |
| Internal Link Dist (m)  |       | 188.6 |       |       | 217.6 |     |       |       | 586.9  |     |      |       |
| Turn Bay Length (m)     | 35.0  |       | 60.0  | 85.0  |       |     |       | 165.0 |        |     |      | 155.0 |
| Base Capacity (vph)     | 126   | 391   | 439   | 399   | 438   |     |       | 148   | 1840   |     |      | 84    |
| Starvation Cap Reductn  | 0     | 0     | 0     | 0     | 0     |     |       | 0     | 0      |     |      | 0     |
| Spillback Cap Reductn   | 0     | 0     | 0     | 0     | 0     |     |       | 0     | 0      |     |      | 0     |
| Storage Cap Reductn     | 0     | 0     | 0     | 0     | 0     |     |       | 0     | 0      |     |      | 0     |
| Reduced v/c Ratio       | 0.19  | 0.06  | 0.40  | 0.88  | 0.15  |     |       | 0.59  | 1.06   |     |      | 0.32  |

Intersection Summary

Area Type: Other  
 Cycle Length: 130  
 Actuated Cycle Length: 130  
 Offset: 61 (47%), Referenced to phase 2:NBT and 6:SBT, Start of Green  
 Natural Cycle: 150  
 Control Type: Actuated-Coordinated  
 Maximum v/c Ratio: 1.06  
 Intersection Signal Delay: 58.0 Intersection LOS: E  
 Intersection Capacity Utilization 95.8% ICU Level of Service F  
 Analysis Period (min) 15  
 ~ Volume exceeds capacity, queue is theoretically infinite.  
 Queue shown is maximum after two cycles.  
 # 95th percentile volume exceeds capacity, queue may be longer.  
 Queue shown is maximum after two cycles.  
 m Volume for 95th percentile queue is metered by upstream signal.

Splits and Phases: 3: March & Solandt

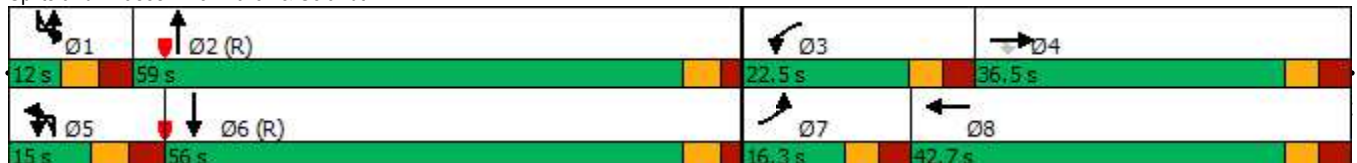

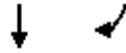

| Lane Group                  | SBT    | SBR |
|-----------------------------|--------|-----|
| Minimum Initial (s)         | 10.0   |     |
| Minimum Split (s)           | 26.8   |     |
| Total Split (s)             | 56.0   |     |
| Total Split (%)             | 43.1%  |     |
| Maximum Green (s)           | 50.2   |     |
| Yellow Time (s)             | 3.7    |     |
| All-Red Time (s)            | 2.1    |     |
| Lost Time Adjust (s)        | 0.0    |     |
| Total Lost Time (s)         | 5.8    |     |
| Lead/Lag                    | Lag    |     |
| Lead-Lag Optimize?          |        |     |
| Vehicle Extension (s)       | 3.0    |     |
| Recall Mode                 | C-Max  |     |
| Walk Time (s)               | 7.0    |     |
| Flash Dont Walk (s)         | 14.0   |     |
| Pedestrian Calls (#/hr)     | 5      |     |
| Act Effct Green (s)         | 62.0   |     |
| Actuated g/C Ratio          | 0.48   |     |
| v/c Ratio                   | 0.94   |     |
| Control Delay               | 43.0   |     |
| Queue Delay                 | 0.0    |     |
| Total Delay                 | 43.0   |     |
| LOS                         | D      |     |
| Approach Delay              | 43.4   |     |
| Approach LOS                | D      |     |
| Queue Length 50th (m)       | 178.1  |     |
| Queue Length 95th (m)       | #261.0 |     |
| Internal Link Dist (m)      | 358.6  |     |
| Turn Bay Length (m)         |        |     |
| Base Capacity (vph)         | 1578   |     |
| Starvation Cap Reductn      | 0      |     |
| Spillback Cap Reductn       | 0      |     |
| Storage Cap Reductn         | 0      |     |
| Reduced v/c Ratio           | 0.94   |     |
| <b>Intersection Summary</b> |        |     |



4: Innovation/Flamborough & Terry Fox  
PM Peak Hour

555-603 March Road  
2037 Total Traffic (pre-BRT)



| Lane Group                 | EBL   | EBT   | EBR   | WBL   | WBT   | WBR   | NBL   | NBT   | NBR  | SBL   | SBT   | SBR  |
|----------------------------|-------|-------|-------|-------|-------|-------|-------|-------|------|-------|-------|------|
| Lane Configurations        |       |       |       |       |       |       |       |       |      |       |       |      |
| Traffic Volume (vph)       | 71    | 398   | 37    | 101   | 534   | 126   | 110   | 64    | 75   | 50    | 50    | 62   |
| Future Volume (vph)        | 71    | 398   | 37    | 101   | 534   | 126   | 110   | 64    | 75   | 50    | 50    | 62   |
| Ideal Flow (vphpl)         | 1800  | 1800  | 1800  | 1800  | 1800  | 1800  | 1800  | 1800  | 1800 | 1800  | 1800  | 1800 |
| Storage Length (m)         | 75.0  |       | 120.0 | 110.0 |       | 130.0 | 220.0 |       | 0.0  | 30.0  |       | 0.0  |
| Storage Lanes              | 1     |       | 1     | 1     |       | 1     | 1     |       | 0    | 1     |       | 0    |
| Taper Length (m)           | 50.0  |       |       | 80.0  |       |       | 50.0  |       |      | 15.0  |       |      |
| Lane Util. Factor          | 1.00  | 1.00  | 1.00  | 1.00  | 1.00  | 1.00  | 1.00  | 1.00  | 1.00 | 1.00  | 1.00  | 1.00 |
| Ped Bike Factor            |       |       | 0.96  | 0.99  |       | 0.95  | 0.95  | 0.98  |      | 0.99  | 0.95  |      |
| Fr                         |       |       | 0.850 |       |       | 0.850 |       | 0.919 |      |       | 0.917 |      |
| Flt Protected              | 0.950 |       |       | 0.950 |       |       | 0.950 |       |      | 0.950 |       |      |
| Satd. Flow (prot)          | 1566  | 1745  | 1498  | 1642  | 1762  | 1498  | 1674  | 1543  | 0    | 1674  | 1483  | 0    |
| Flt Permitted              | 0.408 |       |       | 0.476 |       |       | 0.656 |       |      | 0.570 |       |      |
| Satd. Flow (perm)          | 672   | 1745  | 1440  | 818   | 1762  | 1429  | 1101  | 1543  | 0    | 995   | 1483  | 0    |
| Right Turn on Red          |       |       | Yes   |       |       | Yes   |       | Yes   |      |       |       | Yes  |
| Satd. Flow (RTOR)          |       |       | 80    |       |       | 126   |       | 50    |      |       | 53    |      |
| Link Speed (k/h)           |       | 60    |       |       | 60    |       |       | 50    |      |       | 50    |      |
| Link Distance (m)          |       | 508.2 |       |       | 294.0 |       |       | 547.1 |      |       | 313.7 |      |
| Travel Time (s)            |       | 30.5  |       |       | 17.6  |       |       | 39.4  |      |       | 22.6  |      |
| Confl. Peds. (#/hr)        | 5     |       | 5     | 5     |       | 5     | 25    |       | 5    | 5     |       | 25   |
| Confl. Bikes (#/hr)        |       |       | 5     |       |       | 15    |       |       | 10   |       |       | 10   |
| Peak Hour Factor           | 1.00  | 1.00  | 1.00  | 1.00  | 1.00  | 1.00  | 1.00  | 1.00  | 1.00 | 1.00  | 1.00  | 1.00 |
| Heavy Vehicles (%)         | 8%    | 2%    | 1%    | 3%    | 1%    | 1%    | 1%    | 2%    | 5%   | 1%    | 1%    | 8%   |
| Adj. Flow (vph)            | 71    | 398   | 37    | 101   | 534   | 126   | 110   | 64    | 75   | 50    | 50    | 62   |
| Shared Lane Traffic (%)    |       |       |       |       |       |       |       |       |      |       |       |      |
| Lane Group Flow (vph)      | 71    | 398   | 37    | 101   | 534   | 126   | 110   | 139   | 0    | 50    | 112   | 0    |
| Enter Blocked Intersection | No    | No    | No    | No    | No    | No    | No    | No    | No   | No    | No    | No   |
| Lane Alignment             | L NA  | Left  | R NA  | L NA  | Left  | R NA  | L NA  | Left  | R NA | L NA  | Left  | R NA |
| Median Width(m)            |       | 3.5   |       |       | 3.5   |       |       | 3.5   |      |       | 3.5   |      |
| Link Offset(m)             |       | 0.0   |       |       | 0.0   |       |       | 0.0   |      |       | 0.0   |      |
| Crosswalk Width(m)         |       | 5.0   |       |       | 5.0   |       |       | 5.0   |      |       | 5.0   |      |
| Two way Left Turn Lane     |       |       |       |       |       |       |       |       |      |       |       |      |
| Headway Factor             | 1.09  | 1.09  | 1.09  | 1.09  | 1.09  | 1.09  | 1.09  | 1.09  | 1.09 | 1.09  | 1.09  | 1.09 |
| Number of Detectors        | 1     | 2     | 1     | 1     | 2     | 1     | 1     | 2     |      | 1     | 2     |      |
| Detector Template          | Left  | Thru  | Right | Left  | Thru  | Right | Left  | Thru  |      | Left  | Thru  |      |
| Leading Detector (m)       | 2.0   | 10.0  | 2.0   | 2.0   | 10.0  | 2.0   | 2.0   | 10.0  |      | 2.0   | 10.0  |      |
| Trailing Detector (m)      | 0.0   | 0.0   | 0.0   | 0.0   | 0.0   | 0.0   | 0.0   | 0.0   |      | 0.0   | 0.0   |      |
| Detector 1 Position(m)     | 0.0   | 0.0   | 0.0   | 0.0   | 0.0   | 0.0   | 0.0   | 0.0   |      | 0.0   | 0.0   |      |
| Detector 1 Size(m)         | 2.0   | 0.6   | 2.0   | 2.0   | 0.6   | 2.0   | 2.0   | 0.6   |      | 2.0   | 0.6   |      |
| Detector 1 Type            | Cl+Ex | Cl+Ex | Cl+Ex | Cl+Ex | Cl+Ex | Cl+Ex | Cl+Ex | Cl+Ex |      | Cl+Ex | Cl+Ex |      |
| Detector 1 Channel         |       |       |       |       |       |       |       |       |      |       |       |      |
| Detector 1 Extend (s)      | 0.0   | 0.0   | 0.0   | 0.0   | 0.0   | 0.0   | 0.0   | 0.0   |      | 0.0   | 0.0   |      |
| Detector 1 Queue (s)       | 0.0   | 0.0   | 0.0   | 0.0   | 0.0   | 0.0   | 0.0   | 0.0   |      | 0.0   | 0.0   |      |
| Detector 1 Delay (s)       | 0.0   | 0.0   | 0.0   | 0.0   | 0.0   | 0.0   | 0.0   | 0.0   |      | 0.0   | 0.0   |      |
| Detector 2 Position(m)     |       | 9.4   |       |       | 9.4   |       |       | 9.4   |      |       | 9.4   |      |
| Detector 2 Size(m)         |       | 0.6   |       |       | 0.6   |       |       | 0.6   |      |       | 0.6   |      |
| Detector 2 Type            |       | Cl+Ex |       |       | Cl+Ex |       |       | Cl+Ex |      |       | Cl+Ex |      |
| Detector 2 Channel         |       |       |       |       |       |       |       |       |      |       |       |      |
| Detector 2 Extend (s)      |       | 0.0   |       |       | 0.0   |       |       | 0.0   |      |       | 0.0   |      |
| Turn Type                  | pm+pt | NA    | Perm  | pm+pt | NA    | Perm  | Perm  | NA    |      | Perm  | NA    |      |
| Protected Phases           | 5     | 2     |       | 1     | 6     |       |       | 8     |      |       |       | 4    |
| Permitted Phases           | 2     |       | 2     | 6     |       | 6     | 8     |       |      | 4     |       |      |
| Detector Phase             | 5     | 2     | 2     | 1     | 6     | 6     | 8     | 8     |      | 4     | 4     |      |
| Switch Phase               |       |       |       |       |       |       |       |       |      |       |       |      |



| Lane Group              | EBL  | EBT   | EBR   | WBL   | WBT   | WBR   | NBL   | NBT   | NBR | SBL   | SBT   | SBR |
|-------------------------|------|-------|-------|-------|-------|-------|-------|-------|-----|-------|-------|-----|
| Minimum Initial (s)     | 5.0  | 10.0  | 10.0  | 5.0   | 10.0  | 10.0  | 10.0  | 10.0  |     | 10.0  | 10.0  |     |
| Minimum Split (s)       | 10.9 | 27.9  | 27.9  | 10.9  | 27.9  | 27.9  | 35.6  | 35.6  |     | 35.6  | 35.6  |     |
| Total Split (s)         | 12.0 | 66.0  | 66.0  | 12.0  | 66.0  | 66.0  | 52.0  | 52.0  |     | 52.0  | 52.0  |     |
| Total Split (%)         | 9.2% | 50.8% | 50.8% | 9.2%  | 50.8% | 50.8% | 40.0% | 40.0% |     | 40.0% | 40.0% |     |
| Maximum Green (s)       | 6.1  | 60.1  | 60.1  | 6.1   | 60.1  | 60.1  | 45.4  | 45.4  |     | 45.4  | 45.4  |     |
| Yellow Time (s)         | 3.7  | 3.7   | 3.7   | 3.7   | 3.7   | 3.7   | 3.0   | 3.0   |     | 3.0   | 3.0   |     |
| All-Red Time (s)        | 2.2  | 2.2   | 2.2   | 2.2   | 2.2   | 2.2   | 3.6   | 3.6   |     | 3.6   | 3.6   |     |
| Lost Time Adjust (s)    | 0.0  | 0.0   | 0.0   | 0.0   | 0.0   | 0.0   | 0.0   | 0.0   |     | 0.0   | 0.0   |     |
| Total Lost Time (s)     | 5.9  | 5.9   | 5.9   | 5.9   | 5.9   | 5.9   | 6.6   | 6.6   |     | 6.6   | 6.6   |     |
| Lead/Lag                | Lead | Lag   | Lag   | Lead  | Lag   | Lag   |       |       |     |       |       |     |
| Lead-Lag Optimize?      |      |       |       |       |       |       |       |       |     |       |       |     |
| Vehicle Extension (s)   | 3.0  | 3.0   | 3.0   | 3.0   | 3.0   | 3.0   | 3.0   | 3.0   |     | 3.0   | 3.0   |     |
| Recall Mode             | None | C-Max | C-Max | None  | C-Max | C-Max | None  | None  |     | None  | None  |     |
| Walk Time (s)           |      | 7.0   | 7.0   |       | 7.0   | 7.0   | 7.0   | 7.0   |     | 7.0   | 7.0   |     |
| Flash Dont Walk (s)     |      | 15.0  | 15.0  |       | 15.0  | 15.0  | 22.0  | 22.0  |     | 22.0  | 22.0  |     |
| Pedestrian Calls (#/hr) |      | 3     | 3     |       | 3     | 3     | 3     | 3     |     | 3     | 3     |     |
| Act Effct Green (s)     | 92.5 | 85.3  | 85.3  | 94.8  | 88.2  | 88.2  | 18.6  | 18.6  |     | 18.6  | 18.6  |     |
| Actuated g/C Ratio      | 0.71 | 0.66  | 0.66  | 0.73  | 0.68  | 0.68  | 0.14  | 0.14  |     | 0.14  | 0.14  |     |
| v/c Ratio               | 0.13 | 0.35  | 0.04  | 0.16  | 0.45  | 0.12  | 0.70  | 0.53  |     | 0.35  | 0.44  |     |
| Control Delay           | 5.8  | 12.4  | 0.1   | 8.0   | 18.9  | 6.4   | 74.7  | 38.5  |     | 54.5  | 31.1  |     |
| Queue Delay             | 0.0  | 0.0   | 0.0   | 0.0   | 0.0   | 0.0   | 0.0   | 0.0   |     | 0.0   | 0.0   |     |
| Total Delay             | 5.8  | 12.4  | 0.1   | 8.0   | 18.9  | 6.4   | 74.7  | 38.5  |     | 54.5  | 31.1  |     |
| LOS                     | A    | B     | A     | A     | B     | A     | E     | D     |     | D     | C     |     |
| Approach Delay          |      | 10.6  |       |       | 15.4  |       |       | 54.5  |     |       | 38.3  |     |
| Approach LOS            |      | B     |       |       | B     |       |       | D     |     |       | D     |     |
| Queue Length 50th (m)   | 3.5  | 37.9  | 0.0   | 8.7   | 67.9  | 4.3   | 25.2  | 19.6  |     | 10.9  | 12.7  |     |
| Queue Length 95th (m)   | 9.8  | 73.1  | 0.1   | m19.6 | 115.1 | m15.4 | 40.0  | 35.2  |     | 20.5  | 26.9  |     |
| Internal Link Dist (m)  |      | 484.2 |       |       | 270.0 |       |       | 523.1 |     |       | 289.7 |     |
| Turn Bay Length (m)     | 75.0 |       | 120.0 | 110.0 |       | 130.0 | 220.0 |       |     | 30.0  |       |     |
| Base Capacity (vph)     | 527  | 1145  | 972   | 645   | 1196  | 1010  | 384   | 571   |     | 347   | 552   |     |
| Starvation Cap Reductn  | 0    | 0     | 0     | 0     | 0     | 0     | 0     | 0     |     | 0     | 0     |     |
| Spillback Cap Reductn   | 0    | 0     | 0     | 0     | 0     | 0     | 0     | 0     |     | 0     | 0     |     |
| Storage Cap Reductn     | 0    | 0     | 0     | 0     | 0     | 0     | 0     | 0     |     | 0     | 0     |     |
| Reduced v/c Ratio       | 0.13 | 0.35  | 0.04  | 0.16  | 0.45  | 0.12  | 0.29  | 0.24  |     | 0.14  | 0.20  |     |

**Intersection Summary**

Area Type: Other

Cycle Length: 130

Actuated Cycle Length: 130

Offset: 66 (51%), Referenced to phase 2:EBTL and 6:WBTL, Start of Green

Natural Cycle: 80

Control Type: Actuated-Coordinated

Maximum v/c Ratio: 0.70

Intersection Signal Delay: 21.9

Intersection Capacity Utilization 80.3%

Analysis Period (min) 15

Intersection LOS: C

ICU Level of Service D

















m Volume for 95th percentile queue is metered by upstream signal.

Splits and Phases: 4: Innovation/Flamborough & Terry Fox



5: Hines & Innovation  
PM Peak Hour

555-603 March Road  
2037 Total Traffic (pre-BRT)

|   |  |  |  |  |  |  |  |  |  |  |  |  |
|---|---|---|---|---|---|---|--|---|---|---|---|---|
| Lane Group                              | EBL   | EBT   | EBR   | WBL   | WBT   | WBR   | NBL  | NBT   | NBR   | SBL   | SBT   | SBR   |
| Lane Configurations                     |   |  |   |   |  |   |  |  |   |   |  |   |
| Traffic Volume (vph)                    | 19  | 0   | 87  | 0   | 0   | 0   | 107  | 6   | 0   | 0   | 22  | 20  |
| Future Volume (vph)                     | 19  | 0   | 87  | 0   | 0   | 0   | 107  | 6   | 0   | 0   | 22  | 20  |
| Ideal Flow (vphpl)                      | 1800  | 1800  | 1800  | 1800  | 1800  | 1800  | 1800   | 1800  | 1800  | 1800  | 1800  | 1800  |
| Lane Util. Factor                       | 1.00  | 1.00  | 1.00  | 1.00  | 1.00  | 1.00  | 1.00   | 1.00  | 1.00  | 1.00  | 1.00  | 1.00  |
| Ped Bike Factor                         |   |   |   |   |   |   |  |   |   |   |   |   |
| Frt                                     | 0.889   |   |   |   |   |   |  |   |   |   | 0.936   |   |
| Flt Protected                           | 0.991   |   |   |   |   |   |  |   |   |   | 0.955   |   |
| Satd. Flow (prot)                       | 0   | 1540  | 0   | 0   | 1762  | 0   | 0  | 1648  | 0   | 0   | 1624  | 0   |
| Flt Permitted                           | 0.991   |   |   |   |   |   |  |   |   |   | 0.955   |   |
| Satd. Flow (perm)                       | 0   | 1540  | 0   | 0   | 1762  | 0   | 0  | 1648  | 0   | 0   | 1624  | 0   |
| Link Speed (k/h)                        | 50  |   |   |   | 50  |   |  |   | 50  |   |   |   |
| Link Distance (m)                       | 438.6   |   |   |   | 104.0   |   |  |   | 421.8   |   |   |   |
| Travel Time (s)                         | 31.6  |   |   |   | 7.5   |   |  |   | 30.4  |   |   |   |
| Confl. Peds. (#/hr)                     |   |   |   |   |   |   | 10   |   |   |   |   |   |
| Confl. Bikes (#/hr)                     | 5   |   |   | 5   |   |   | 5  |   |   | 5   |   |   |
| Peak Hour Factor                        | 1.00  | 1.00  | 1.00  | 1.00  | 1.00  | 1.00  | 1.00   | 1.00  | 1.00  | 1.00  | 1.00  | 1.00  |
| Heavy Vehicles (%)                      | 1%  | 1%  | 2%  | 1%  | 1%  | 1%  | 3%   | 6%  | 1%  | 1%  | 4%  | 1%  |
| Adj. Flow (vph)                         | 19  | 0   | 87  | 0   | 0   | 0   | 107  | 6   | 0   | 0   | 22  | 20  |
| Shared Lane Traffic (%)                 |   |   |   |   |   |   |  |   |   |   |   |   |
| Lane Group Flow (vph)                   | 0   | 106   | 0   | 0   | 0   | 0   | 0  | 113   | 0   | 0   | 42  | 0   |
| Enter Blocked Intersection              | No  | No  | No  | No  | No  | No  | No   | No  | No  | No  | No  | No  |
| Lane Alignment                          | Left  | Left  | Right   | Left  | Left  | Right   | Left   | Left  | Right   | Left  | Left  | Right   |
| Median Width(m)                         | 0.0   |   |   |   | 0.0   |   |  |   | 0.0   |   |   |   |
| Link Offset(m)                          | 0.0   |   |   |   | 0.0   |   |  |   | 0.0   |   |   |   |
| Crosswalk Width(m)                      | 5.0   |   |   |   | 5.0   |   |  |   | 5.0   |   |   |   |
| Two way Left Turn Lane                  |   |   |   |   |   |   |  |   |   |   |   |   |
| Headway Factor                          | 1.09  | 1.09  | 1.09  | 1.09  | 1.09  | 1.09  | 1.09   | 1.09  | 1.09  | 1.09  | 1.09  | 1.09  |
| Sign Control                            | Stop  |   |   |   | Stop  |   |  |   | Free  |   |   |   |
| <b>Intersection Summary</b>             |   |   |   |   |   |   |  |   |   |   |   |   |
| Area Type:                              | Other   |   |   |   |   |   |  |   |   |   |   |   |
| Control Type:                           | Unsignalized  |   |   |   |   |   |  |   |   |   |   |   |
| Intersection Capacity Utilization 26.7% | ICU Level of Service A  |   |   |   |   |   |  |   |   |   |   |   |
| Analysis Period (min) 15                |   |   |   |   |   |   |  |   |   |   |   |   |

6: March & Site Access/Nokia Access  
PM Peak Hour

555-603 March Road  
2037 Total Traffic (pre-BRT)



| Lane Group                 | EBL   | EBT   | EBR  | WBL   | WBT   | WBR  | NBL   | NBT   | NBR   | SBL   | SBT   | SBR   |
|----------------------------|-------|-------|------|-------|-------|------|-------|-------|-------|-------|-------|-------|
| Lane Configurations        |       |       |      |       |       |      |       |       |       |       |       |       |
| Traffic Volume (vph)       | 68    | 3     | 186  | 236   | 2     | 402  | 154   | 1574  | 204   | 95    | 1044  | 43    |
| Future Volume (vph)        | 68    | 3     | 186  | 236   | 2     | 402  | 154   | 1574  | 204   | 95    | 1044  | 43    |
| Ideal Flow (vphpl)         | 1800  | 1800  | 1800 | 1800  | 1800  | 1800 | 1800  | 1800  | 1800  | 1800  | 1800  | 1800  |
| Storage Length (m)         | 65.0  |       | 0.0  | 65.0  |       | 0.0  | 75.0  |       | 100.0 | 75.0  |       | 0.0   |
| Storage Lanes              | 1     |       | 0    | 1     |       | 0    | 1     |       | 1     | 1     |       | 0     |
| Taper Length (m)           | 20.0  |       |      | 25.0  |       |      | 50.0  |       |       | 50.0  |       |       |
| Lane Util. Factor          | 1.00  | 1.00  | 1.00 | 1.00  | 1.00  | 1.00 | 1.00  | 0.95  | 1.00  | 1.00  | 0.91  | 0.91  |
| Ped Bike Factor            |       |       |      | 0.99  | 0.97  |      |       |       | 0.94  |       |       |       |
| Frt                        |       | 0.852 |      |       | 0.851 |      |       |       | 0.850 |       | 0.994 |       |
| Flt Protected              | 0.950 |       |      | 0.950 |       |      | 0.950 |       |       | 0.950 |       |       |
| Satd. Flow (prot)          | 1658  | 1487  | 0    | 1674  | 1457  | 0    | 1658  | 3283  | 1498  | 1674  | 4691  | 0     |
| Flt Permitted              | 0.140 |       |      | 0.498 |       |      | 0.178 |       |       | 0.067 |       |       |
| Satd. Flow (perm)          | 244   | 1487  | 0    | 870   | 1457  | 0    | 311   | 3283  | 1409  | 118   | 4691  | 0     |
| Right Turn on Red          |       |       | Yes  |       |       | Yes  |       |       | Yes   |       |       | Yes   |
| Satd. Flow (RTOR)          |       | 162   |      |       | 131   |      |       |       | 197   |       |       | 6     |
| Link Speed (k/h)           |       | 50    |      |       | 50    |      |       | 60    |       |       |       | 60    |
| Link Distance (m)          |       | 126.2 |      |       | 167.8 |      |       | 227.7 |       |       |       | 308.9 |
| Travel Time (s)            |       | 9.1   |      |       | 12.1  |      |       | 13.7  |       |       |       | 18.5  |
| Confl. Peds. (#/hr)        |       |       |      | 10    |       | 10   |       |       | 10    | 10    |       |       |
| Confl. Bikes (#/hr)        |       |       |      |       |       | 5    |       |       | 5     |       |       |       |
| Peak Hour Factor           | 1.00  | 1.00  | 1.00 | 1.00  | 1.00  | 1.00 | 1.00  | 1.00  | 1.00  | 1.00  | 1.00  | 1.00  |
| Heavy Vehicles (%)         | 2%    | 2%    | 2%   | 1%    | 2%    | 1%   | 2%    | 3%    | 1%    | 1%    | 3%    | 2%    |
| Adj. Flow (vph)            | 68    | 3     | 186  | 236   | 2     | 402  | 154   | 1574  | 204   | 95    | 1044  | 43    |
| Shared Lane Traffic (%)    |       |       |      |       |       |      |       |       |       |       |       |       |
| Lane Group Flow (vph)      | 68    | 189   | 0    | 236   | 404   | 0    | 154   | 1574  | 204   | 95    | 1087  | 0     |
| Enter Blocked Intersection | No    | No    | No   | No    | No    | No   | No    | No    | No    | No    | No    | No    |
| Lane Alignment             | L NA  | Left  | R NA | L NA  | Left  | R NA | Left  | Left  | Right | Left  | Left  | Right |
| Median Width(m)            |       | 3.5   |      |       | 3.5   |      |       | 7.0   |       |       | 7.0   |       |
| Link Offset(m)             |       | 0.0   |      |       | 0.0   |      |       | 0.0   |       |       | 0.0   |       |
| Crosswalk Width(m)         |       | 5.0   |      |       | 5.0   |      |       | 5.0   |       |       | 5.0   |       |
| Two way Left Turn Lane     |       |       |      |       |       |      |       |       |       |       |       |       |
| Headway Factor             | 1.09  | 1.09  | 1.09 | 1.09  | 1.09  | 1.09 | 1.09  | 1.09  | 1.09  | 1.09  | 1.09  | 1.09  |
| Number of Detectors        | 1     | 2     |      | 1     | 2     |      | 1     | 2     | 1     | 1     | 2     |       |
| Detector Template          | Left  | Thru  |      | Left  | Thru  |      | Left  | Thru  | Right | Left  | Thru  |       |
| Leading Detector (m)       | 2.0   | 10.0  |      | 2.0   | 10.0  |      | 2.0   | 10.0  | 2.0   | 2.0   | 10.0  |       |
| Trailing Detector (m)      | 0.0   | 0.0   |      | 0.0   | 0.0   |      | 0.0   | 0.0   | 0.0   | 0.0   | 0.0   |       |
| Detector 1 Position(m)     | 0.0   | 0.0   |      | 0.0   | 0.0   |      | 0.0   | 0.0   | 0.0   | 0.0   | 0.0   |       |
| Detector 1 Size(m)         | 2.0   | 0.6   |      | 2.0   | 0.6   |      | 2.0   | 0.6   | 2.0   | 2.0   | 0.6   |       |
| Detector 1 Type            | Cl+Ex | Cl+Ex |      | Cl+Ex | Cl+Ex |      | Cl+Ex | Cl+Ex | Cl+Ex | Cl+Ex | Cl+Ex |       |
| Detector 1 Channel         |       |       |      |       |       |      |       |       |       |       |       |       |
| Detector 1 Extend (s)      | 0.0   | 0.0   |      | 0.0   | 0.0   |      | 0.0   | 0.0   | 0.0   | 0.0   | 0.0   |       |
| Detector 1 Queue (s)       | 0.0   | 0.0   |      | 0.0   | 0.0   |      | 0.0   | 0.0   | 0.0   | 0.0   | 0.0   |       |
| Detector 1 Delay (s)       | 0.0   | 0.0   |      | 0.0   | 0.0   |      | 0.0   | 0.0   | 0.0   | 0.0   | 0.0   |       |
| Detector 2 Position(m)     |       | 9.4   |      |       | 9.4   |      |       | 9.4   |       |       | 9.4   |       |
| Detector 2 Size(m)         |       | 0.6   |      |       | 0.6   |      |       | 0.6   |       |       | 0.6   |       |
| Detector 2 Type            |       | Cl+Ex |      |       | Cl+Ex |      |       | Cl+Ex |       |       | Cl+Ex |       |
| Detector 2 Channel         |       |       |      |       |       |      |       |       |       |       |       |       |
| Detector 2 Extend (s)      |       | 0.0   |      |       | 0.0   |      |       | 0.0   |       |       | 0.0   |       |
| Turn Type                  | pm+pt | NA    |      | pm+pt | NA    |      | pm+pt | NA    | Perm  | pm+pt | NA    |       |
| Protected Phases           | 7     | 4     |      | 3     | 8     |      | 5     | 2     |       | 1     | 6     |       |
| Permitted Phases           | 4     |       |      | 8     |       |      | 2     |       | 2     | 6     |       |       |
| Detector Phase             | 7     | 4     |      | 3     | 8     |      | 5     | 2     | 2     | 1     | 6     |       |
| Switch Phase               |       |       |      |       |       |      |       |       |       |       |       |       |



| Lane Group              | EBL  | EBT   | EBR | WBL   | WBT    | WBR | NBL   | NBT    | NBR   | SBL    | SBT   | SBR |
|-------------------------|------|-------|-----|-------|--------|-----|-------|--------|-------|--------|-------|-----|
| Minimum Initial (s)     | 5.0  | 10.0  |     | 5.0   | 10.0   |     | 5.0   | 10.0   | 10.0  | 5.0    | 10.0  |     |
| Minimum Split (s)       | 11.5 | 38.5  |     | 11.5  | 38.5   |     | 11.4  | 23.8   | 23.8  | 11.4   | 23.8  |     |
| Total Split (s)         | 12.0 | 39.0  |     | 12.0  | 39.0   |     | 20.0  | 67.0   | 67.0  | 12.0   | 59.0  |     |
| Total Split (%)         | 9.2% | 30.0% |     | 9.2%  | 30.0%  |     | 15.4% | 51.5%  | 51.5% | 9.2%   | 45.4% |     |
| Maximum Green (s)       | 5.5  | 32.5  |     | 5.5   | 32.5   |     | 13.6  | 61.2   | 61.2  | 5.6    | 53.2  |     |
| Yellow Time (s)         | 3.3  | 3.3   |     | 3.3   | 3.3    |     | 3.7   | 3.7    | 3.7   | 3.7    | 3.7   |     |
| All-Red Time (s)        | 3.2  | 3.2   |     | 3.2   | 3.2    |     | 2.7   | 2.1    | 2.1   | 2.7    | 2.1   |     |
| Lost Time Adjust (s)    | 0.0  | 0.0   |     | 0.0   | 0.0    |     | 0.0   | 0.0    | 0.0   | 0.0    | 0.0   |     |
| Total Lost Time (s)     | 6.5  | 6.5   |     | 6.5   | 6.5    |     | 6.4   | 5.8    | 5.8   | 6.4    | 5.8   |     |
| Lead/Lag                | Lead | Lag   |     | Lead  | Lag    |     | Lead  | Lag    | Lag   | Lead   | Lag   |     |
| Lead-Lag Optimize?      | Yes  | Yes   |     | Yes   | Yes    |     |       |        |       |        |       |     |
| Vehicle Extension (s)   | 3.0  | 3.0   |     | 3.0   | 3.0    |     | 3.0   | 3.0    | 3.0   | 3.0    | 3.0   |     |
| Recall Mode             | None | None  |     | None  | None   |     | None  | C-Max  | C-Max | None   | C-Max |     |
| Walk Time (s)           |      | 7.0   |     |       | 7.0    |     |       | 7.0    | 7.0   |        | 7.0   |     |
| Flash Dont Walk (s)     |      | 25.0  |     |       | 25.0   |     |       | 11.0   | 11.0  |        | 11.0  |     |
| Pedestrian Calls (#/hr) |      | 10    |     |       | 10     |     |       | 10     | 10    |        | 10    |     |
| Act Effct Green (s)     | 32.7 | 27.2  |     | 34.0  | 29.6   |     | 75.4  | 65.7   | 65.7  | 67.1   | 61.3  |     |
| Actuated g/C Ratio      | 0.25 | 0.21  |     | 0.26  | 0.23   |     | 0.58  | 0.51   | 0.51  | 0.52   | 0.47  |     |
| v/c Ratio               | 0.56 | 0.43  |     | 0.90  | 0.94   |     | 0.53  | 0.95   | 0.25  | 0.69   | 0.49  |     |
| Control Delay           | 49.6 | 11.9  |     | 78.2  | 62.6   |     | 13.1  | 16.9   | 1.0   | 65.7   | 26.8  |     |
| Queue Delay             | 0.0  | 0.0   |     | 0.0   | 0.0    |     | 0.0   | 0.0    | 0.0   | 0.0    | 0.0   |     |
| Total Delay             | 49.6 | 11.9  |     | 78.2  | 62.6   |     | 13.1  | 16.9   | 1.0   | 65.7   | 26.8  |     |
| LOS                     | D    | B     |     | E     | E      |     | B     | B      | A     | E      | C     |     |
| Approach Delay          |      | 21.9  |     |       | 68.4   |     |       | 14.9   |       |        | 29.9  |     |
| Approach LOS            |      | C     |     |       | E      |     |       | B      |       |        | C     |     |
| Queue Length 50th (m)   | 11.0 | 4.9   |     | 42.5  | 65.1   |     | 1.0   | ~211.0 | 4.6   | 14.9   | 26.9  |     |
| Queue Length 95th (m)   | 20.9 | 22.9  |     | #76.8 | #117.2 |     | m3.4  | m196.7 | m0.0  | m#39.1 | 73.6  |     |
| Internal Link Dist (m)  |      | 102.2 |     |       | 143.8  |     |       | 203.7  |       |        | 284.9 |     |
| Turn Bay Length (m)     | 65.0 |       |     | 65.0  |        |     | 75.0  |        | 100.0 | 75.0   |       |     |
| Base Capacity (vph)     | 121  | 493   |     | 261   | 462    |     | 326   | 1658   | 809   | 138    | 2213  |     |
| Starvation Cap Reductn  | 0    | 0     |     | 0     | 0      |     | 0     | 0      | 0     | 0      | 0     |     |
| Spillback Cap Reductn   | 0    | 0     |     | 0     | 0      |     | 0     | 0      | 0     | 0      | 0     |     |
| Storage Cap Reductn     | 0    | 0     |     | 0     | 0      |     | 0     | 0      | 0     | 0      | 0     |     |
| Reduced v/c Ratio       | 0.56 | 0.38  |     | 0.90  | 0.87   |     | 0.47  | 0.95   | 0.25  | 0.69   | 0.49  |     |

Intersection Summary

Area Type: Other  
 Cycle Length: 130  
 Actuated Cycle Length: 130  
 Offset: 108 (83%), Referenced to phase 2:NBT and 6:SBTL, Start of Green  
 Natural Cycle: 130  
 Control Type: Actuated-Coordinated  
 Maximum v/c Ratio: 0.95  
 Intersection Signal Delay: 28.3      Intersection LOS: C  
 Intersection Capacity Utilization 104.1%      ICU Level of Service G  
 Analysis Period (min) 15  
 ~ Volume exceeds capacity, queue is theoretically infinite.  
 Queue shown is maximum after two cycles.  
 # 95th percentile volume exceeds capacity, queue may be longer.  
 Queue shown is maximum after two cycles.  
 m Volume for 95th percentile queue is metered by upstream signal.

Splits and Phases: 6: March & Site Access/Nokia Access

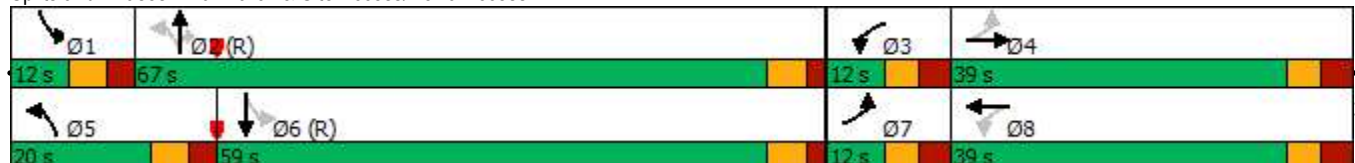



| Lane Group                 | EBT   | EBR   | WBL   | WBT   | NBL   | NBR  |
|----------------------------|-------|-------|-------|-------|-------|------|
| Lane Configurations        |       |       |       |       |       |      |
| Traffic Volume (vph)       | 579   | 29    | 59    | 652   | 43    | 84   |
| Future Volume (vph)        | 579   | 29    | 59    | 652   | 43    | 84   |
| Ideal Flow (vphpl)         | 1800  | 1800  | 1800  | 1800  | 1800  | 1800 |
| Storage Length (m)         |       | 0.0   | 30.0  |       | 0.0   | 0.0  |
| Storage Lanes              |       | 0     | 1     |       | 1     | 0    |
| Taper Length (m)           |       |       | 40.0  |       | 10.0  |      |
| Lane Util. Factor          | 1.00  | 1.00  | 1.00  | 0.95  | 1.00  | 1.00 |
| Ped Bike Factor            |       |       |       |       |       |      |
| Frt                        | 0.994 |       |       |       | 0.911 |      |
| Flt Protected              |       |       | 0.950 |       | 0.983 |      |
| Satd. Flow (prot)          | 1735  | 0     | 1674  | 3316  | 1578  | 0    |
| Flt Permitted              |       |       | 0.950 |       | 0.983 |      |
| Satd. Flow (perm)          | 1735  | 0     | 1674  | 3316  | 1578  | 0    |
| Link Speed (k/h)           | 60    |       |       | 60    | 50    |      |
| Link Distance (m)          | 191.8 |       |       | 165.4 | 126.2 |      |
| Travel Time (s)            | 11.5  |       |       | 9.9   | 9.1   |      |
| Confl. Peds. (#/hr)        |       | 10    | 10    |       |       |      |
| Confl. Bikes (#/hr)        |       | 5     |       |       |       | 5    |
| Peak Hour Factor           | 1.00  | 1.00  | 1.00  | 1.00  | 1.00  | 1.00 |
| Heavy Vehicles (%)         | 2%    | 1%    | 1%    | 2%    | 1%    | 1%   |
| Adj. Flow (vph)            | 579   | 29    | 59    | 652   | 43    | 84   |
| Shared Lane Traffic (%)    |       |       |       |       |       |      |
| Lane Group Flow (vph)      | 608   | 0     | 59    | 652   | 127   | 0    |
| Enter Blocked Intersection | No    | No    | No    | No    | No    | No   |
| Lane Alignment             | Left  | Right | Left  | Left  | L NA  | R NA |
| Median Width(m)            | 7.0   |       |       | 9.0   | 3.5   |      |
| Link Offset(m)             | 0.0   |       |       | 0.0   | 0.0   |      |
| Crosswalk Width(m)         | 5.0   |       |       | 5.0   | 5.0   |      |
| Two way Left Turn Lane     |       |       |       |       |       |      |
| Headway Factor             | 1.09  | 1.09  | 1.09  | 1.09  | 1.09  | 1.09 |
| Sign Control               | Free  |       |       | Free  | Stop  |      |

| Intersection Summary              |                        |
|-----------------------------------|------------------------|
| Area Type:                        | Other                  |
| Control Type:                     | Unsignalized           |
| Intersection Capacity Utilization | 55.5%                  |
| Analysis Period (min)             | 15                     |
|                                   | ICU Level of Service B |



| Lane Group                 | WBL   | WBR   | NBT   | NBR   | SBL  | SBT   |
|----------------------------|-------|-------|-------|-------|------|-------|
| Lane Configurations        |       |       |       |       |      |       |
| Traffic Volume (vph)       | 13    | 6     | 8     | 17    | 22   | 30    |
| Future Volume (vph)        | 13    | 6     | 8     | 17    | 22   | 30    |
| Ideal Flow (vphpl)         | 1800  | 1800  | 1800  | 1800  | 1800 | 1800  |
| Lane Util. Factor          | 1.00  | 1.00  | 1.00  | 1.00  | 1.00 | 1.00  |
| Ped Bike Factor            |       |       |       |       |      |       |
| Frt                        | 0.957 |       | 0.908 |       |      |       |
| Flt Protected              | 0.967 |       |       |       |      | 0.979 |
| Satd. Flow (prot)          | 1631  | 0     | 1595  | 0     | 0    | 1716  |
| Flt Permitted              | 0.967 |       |       |       |      | 0.979 |
| Satd. Flow (perm)          | 1631  | 0     | 1595  | 0     | 0    | 1716  |
| Link Speed (k/h)           | 50    |       | 50    |       |      | 50    |
| Link Distance (m)          | 75.1  |       | 190.7 |       |      | 128.3 |
| Travel Time (s)            | 5.4   |       | 13.7  |       |      | 9.2   |
| Confl. Peds. (#/hr)        |       |       |       | 10    | 10   |       |
| Confl. Bikes (#/hr)        |       | 5     |       | 5     |      |       |
| Peak Hour Factor           | 1.00  | 1.00  | 1.00  | 1.00  | 1.00 | 1.00  |
| Heavy Vehicles (%)         | 1%    | 1%    | 2%    | 1%    | 1%   | 2%    |
| Adj. Flow (vph)            | 13    | 6     | 8     | 17    | 22   | 30    |
| Shared Lane Traffic (%)    |       |       |       |       |      |       |
| Lane Group Flow (vph)      | 19    | 0     | 25    | 0     | 0    | 52    |
| Enter Blocked Intersection | No    | No    | No    | No    | No   | No    |
| Lane Alignment             | Left  | Right | Left  | Right | Left | Left  |
| Median Width(m)            | 3.5   |       | 0.0   |       |      | 0.0   |
| Link Offset(m)             | 0.0   |       | 0.0   |       |      | 0.0   |
| Crosswalk Width(m)         | 5.0   |       | 5.0   |       |      | 5.0   |
| Two way Left Turn Lane     |       |       |       |       |      |       |
| Headway Factor             | 1.09  | 1.09  | 1.09  | 1.09  | 1.09 | 1.09  |
| Sign Control               | Stop  |       | Free  |       |      | Free  |

**Intersection Summary**

|   |                        |
|---|------------------------|
| Area Type:                              | Other                  |
| Control Type:                           | Unsignalized           |
| Intersection Capacity Utilization 19.6% | ICU Level of Service A |
| Analysis Period (min)                   | 15                     |

2: March & Terry Fox  
PM Peak Hour

555-603 March Road  
2037 Total Traffic (post-BRT)



| Lane Group                 | EBL   | EBT   | EBR   | WBL   | WBT   | WBR   | NBU   | NBL   | NBT   | NBR   | SBU   | SBL   |
|----------------------------|-------|-------|-------|-------|-------|-------|-------|-------|-------|-------|-------|-------|
| Lane Configurations        | ↖↗    | ↕     | ↗     | ↖↗    | ↕     | ↗     |       | ↖↗    | ↕     | ↗     |       | ↖↗    |
| Traffic Volume (vph)       | 278   | 177   | 179   | 74    | 182   | 191   | 18    | 322   | 1630  | 126   | 4     | 150   |
| Future Volume (vph)        | 278   | 177   | 179   | 74    | 182   | 191   | 18    | 322   | 1630  | 126   | 4     | 150   |
| Ideal Flow (vphpl)         | 1800  | 1800  | 1800  | 1800  | 1800  | 1800  | 1800  | 1800  | 1800  | 1800  | 1800  | 1800  |
| Storage Length (m)         | 95.0  |       | 60.0  | 60.0  |       | 75.0  |       | 140.0 |       | 20.0  |       | 90.0  |
| Storage Lanes              | 2     |       | 1     | 2     |       | 1     |       | 2     |       | 1     |       | 2     |
| Taper Length (m)           | 40.0  |       |       | 25.0  |       |       |       | 90.0  |       |       |       | 75.0  |
| Lane Util. Factor          | 0.97  | 0.95  | 1.00  | 0.97  | 0.95  | 1.00  | 0.95  | 0.97  | 0.95  | 1.00  | 0.95  | 0.97  |
| Ped Bike Factor            | 0.98  |       | 0.97  | 0.99  |       | 0.96  |       | 1.00  |       | 0.97  |       | 1.00  |
| Fr                         |       |       | 0.850 |       |       | 0.850 |       |       |       | 0.850 |       |       |
| Flt Protected              | 0.950 |       |       | 0.950 |       |       |       | 0.950 |       |       |       | 0.950 |
| Satd. Flow (prot)          | 3248  | 3221  | 1498  | 3248  | 3349  | 1498  | 0     | 3187  | 3316  | 1469  | 0     | 3247  |
| Flt Permitted              | 0.950 |       |       | 0.950 |       |       |       | 0.950 |       |       |       | 0.950 |
| Satd. Flow (perm)          | 3176  | 3221  | 1458  | 3199  | 3349  | 1442  | 0     | 3176  | 3316  | 1426  | 0     | 3239  |
| Right Turn on Red          |       |       | Yes   |       |       | Yes   |       |       |       | Yes   |       |       |
| Satd. Flow (RTOR)          |       |       | 195   |       |       | 195   |       |       |       | 146   |       |       |
| Link Speed (k/h)           |       | 60    |       |       | 60    |       |       |       | 60    |       |       |       |
| Link Distance (m)          |       | 165.4 |       |       | 149.1 |       |       |       | 308.9 |       |       |       |
| Travel Time (s)            |       | 9.9   |       |       | 8.9   |       |       |       | 18.5  |       |       |       |
| Confl. Peds. (#/hr)        | 15    |       | 10    | 10    |       | 15    |       | 5     |       | 10    |       | 10    |
| Confl. Bikes (#/hr)        |       |       | 5     |       |       | 10    |       |       |       | 5     |       |       |
| Peak Hour Factor           | 1.00  | 1.00  | 1.00  | 1.00  | 1.00  | 1.00  | 1.00  | 1.00  | 1.00  | 1.00  | 1.00  | 1.00  |
| Heavy Vehicles (%)         | 1%    | 5%    | 1%    | 1%    | 1%    | 1%    | 2%    | 3%    | 2%    | 3%    | 2%    | 1%    |
| Adj. Flow (vph)            | 278   | 177   | 179   | 74    | 182   | 191   | 18    | 322   | 1630  | 126   | 4     | 150   |
| Shared Lane Traffic (%)    |       |       |       |       |       |       |       |       |       |       |       |       |
| Lane Group Flow (vph)      | 278   | 177   | 179   | 74    | 182   | 191   | 0     | 340   | 1630  | 126   | 0     | 154   |
| Enter Blocked Intersection | No    | No    | No    | Yes   | Yes   | Yes   | No    | No    | No    | No    | No    | No    |
| Lane Alignment             | L NA  | Left  | R NA  | L NA  | Left  | R NA  | R NA  | L NA  | Left  | R NA  | R NA  | L NA  |
| Median Width(m)            |       | 11.5  |       |       | 10.5  |       |       |       | 17.5  |       |       |       |
| Link Offset(m)             |       | 0.0   |       |       | 0.0   |       |       |       | 0.0   |       |       |       |
| Crosswalk Width(m)         |       | 5.0   |       |       | 5.0   |       |       |       | 5.0   |       |       |       |
| Two way Left Turn Lane     |       |       |       |       |       |       |       |       |       |       |       |       |
| Headway Factor             | 1.09  | 1.09  | 1.09  | 1.09  | 1.09  | 1.09  | 1.09  | 1.09  | 1.09  | 1.09  | 1.09  | 1.09  |
| Number of Detectors        | 1     | 2     | 1     | 1     | 2     | 1     | 1     | 1     | 2     | 1     | 1     | 1     |
| Detector Template          | Left  | Thru  | Right | Left  | Thru  | Right | Left  | Left  | Thru  | Right | Left  | Left  |
| Leading Detector (m)       | 2.0   | 10.0  | 2.0   | 2.0   | 10.0  | 2.0   | 2.0   | 2.0   | 10.0  | 2.0   | 2.0   | 2.0   |
| Trailing Detector (m)      | 0.0   | 0.0   | 0.0   | 0.0   | 0.0   | 0.0   | 0.0   | 0.0   | 0.0   | 0.0   | 0.0   | 0.0   |
| Detector 1 Position(m)     | 0.0   | 0.0   | 0.0   | 0.0   | 0.0   | 0.0   | 0.0   | 0.0   | 0.0   | 0.0   | 0.0   | 0.0   |
| Detector 1 Size(m)         | 2.0   | 0.6   | 2.0   | 2.0   | 0.6   | 2.0   | 2.0   | 2.0   | 0.6   | 2.0   | 2.0   | 2.0   |
| Detector 1 Type            | Cl+Ex | Cl+Ex | Cl+Ex | Cl+Ex | Cl+Ex | Cl+Ex | Cl+Ex | Cl+Ex | Cl+Ex | Cl+Ex | Cl+Ex | Cl+Ex |
| Detector 1 Channel         |       |       |       |       |       |       |       |       |       |       |       |       |
| Detector 1 Extend (s)      | 0.0   | 0.0   | 0.0   | 0.0   | 0.0   | 0.0   | 0.0   | 0.0   | 0.0   | 0.0   | 0.0   | 0.0   |
| Detector 1 Queue (s)       | 0.0   | 0.0   | 0.0   | 0.0   | 0.0   | 0.0   | 0.0   | 0.0   | 0.0   | 0.0   | 0.0   | 0.0   |
| Detector 1 Delay (s)       | 0.0   | 0.0   | 0.0   | 0.0   | 0.0   | 0.0   | 0.0   | 0.0   | 0.0   | 0.0   | 0.0   | 0.0   |
| Detector 2 Position(m)     |       | 9.4   |       |       | 9.4   |       |       |       | 9.4   |       |       |       |
| Detector 2 Size(m)         |       | 0.6   |       |       | 0.6   |       |       |       | 0.6   |       |       |       |
| Detector 2 Type            |       | Cl+Ex |       |       | Cl+Ex |       |       |       | Cl+Ex |       |       |       |
| Detector 2 Channel         |       |       |       |       |       |       |       |       |       |       |       |       |
| Detector 2 Extend (s)      |       | 0.0   |       |       | 0.0   |       |       |       | 0.0   |       |       |       |
| Turn Type                  | Prot  | NA    | Perm  | Prot  | NA    | Perm  | Prot  | Prot  | NA    | Perm  | Prot  | Prot  |
| Protected Phases           | 7     | 4     |       | 3     | 8     |       | 5     | 5     | 2     |       | 1     | 1     |
| Permitted Phases           |       |       | 4     |       |       | 8     |       |       |       | 2     |       |       |
| Detector Phase             | 7     | 4     | 4     | 3     | 8     | 8     | 5     | 5     | 2     | 2     | 1     | 1     |
| Switch Phase               |       |       |       |       |       |       |       |       |       |       |       |       |



2: March & Terry Fox  
PM Peak Hour

555-603 March Road  
2037 Total Traffic (post-BRT)



| Lane Group                 | SBT   | SBR   |
|----------------------------|-------|-------|
| Lane Configurations        | ↑↑    | ↑     |
| Traffic Volume (vph)       | 955   | 200   |
| Future Volume (vph)        | 955   | 200   |
| Ideal Flow (vphpl)         | 1800  | 1800  |
| Storage Length (m)         |       | 80.0  |
| Storage Lanes              |       | 1     |
| Taper Length (m)           |       |       |
| Lane Util. Factor          | 0.95  | 1.00  |
| Ped Bike Factor            |       | 0.98  |
| Frt                        |       | 0.850 |
| Flt Protected              |       |       |
| Satd. Flow (prot)          | 3283  | 1483  |
| Flt Permitted              |       |       |
| Satd. Flow (perm)          | 3283  | 1450  |
| Right Turn on Red          |       | Yes   |
| Satd. Flow (RTOR)          |       | 200   |
| Link Speed (k/h)           | 60    |       |
| Link Distance (m)          | 318.9 |       |
| Travel Time (s)            | 19.1  |       |
| Confl. Peds. (#/hr)        |       | 5     |
| Confl. Bikes (#/hr)        |       | 5     |
| Peak Hour Factor           | 1.00  | 1.00  |
| Heavy Vehicles (%)         | 3%    | 2%    |
| Adj. Flow (vph)            | 955   | 200   |
| Shared Lane Traffic (%)    |       |       |
| Lane Group Flow (vph)      | 955   | 200   |
| Enter Blocked Intersection | No    | No    |
| Lane Alignment             | Left  | R NA  |
| Median Width(m)            | 17.5  |       |
| Link Offset(m)             | 0.0   |       |
| Crosswalk Width(m)         | 5.0   |       |
| Two way Left Turn Lane     |       |       |
| Headway Factor             | 1.09  | 1.09  |
| Number of Detectors        | 2     | 1     |
| Detector Template          | Thru  | Right |
| Leading Detector (m)       | 10.0  | 2.0   |
| Trailing Detector (m)      | 0.0   | 0.0   |
| Detector 1 Position(m)     | 0.0   | 0.0   |
| Detector 1 Size(m)         | 0.6   | 2.0   |
| Detector 1 Type            | CI+Ex | CI+Ex |
| Detector 1 Channel         |       |       |
| Detector 1 Extend (s)      | 0.0   | 0.0   |
| Detector 1 Queue (s)       | 0.0   | 0.0   |
| Detector 1 Delay (s)       | 0.0   | 0.0   |
| Detector 2 Position(m)     | 9.4   |       |
| Detector 2 Size(m)         | 0.6   |       |
| Detector 2 Type            | CI+Ex |       |
| Detector 2 Channel         |       |       |
| Detector 2 Extend (s)      | 0.0   |       |
| Turn Type                  | NA    | Perm  |
| Protected Phases           | 6     |       |
| Permitted Phases           |       | 6     |
| Detector Phase             | 6     | 6     |
| Switch Phase               |       |       |

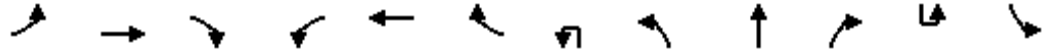

| Lane Group              | EBL   | EBT   | EBR   | WBL   | WBT   | WBR   | NBU   | NBL    | NBT     | NBR   | SBU  | SBL   |
|-------------------------|-------|-------|-------|-------|-------|-------|-------|--------|---------|-------|------|-------|
| Minimum Initial (s)     | 5.0   | 10.0  | 10.0  | 5.0   | 10.0  | 10.0  | 5.0   | 5.0    | 10.0    | 10.0  | 5.0  | 5.0   |
| Minimum Split (s)       | 12.0  | 41.0  | 41.0  | 12.0  | 41.0  | 41.0  | 11.4  | 11.4   | 32.4    | 32.4  | 11.4 | 11.4  |
| Total Split (s)         | 16.0  | 45.0  | 45.0  | 12.0  | 41.0  | 41.0  | 21.0  | 21.0   | 61.0    | 61.0  | 12.0 | 12.0  |
| Total Split (%)         | 12.3% | 34.6% | 34.6% | 9.2%  | 31.5% | 31.5% | 16.2% | 16.2%  | 46.9%   | 46.9% | 9.2% | 9.2%  |
| Maximum Green (s)       | 9.0   | 38.0  | 38.0  | 5.0   | 34.0  | 34.0  | 14.6  | 14.6   | 54.6    | 54.6  | 5.6  | 5.6   |
| Yellow Time (s)         | 3.7   | 3.7   | 3.7   | 3.7   | 3.7   | 3.7   | 3.7   | 3.7    | 3.7     | 3.7   | 3.7  | 3.7   |
| All-Red Time (s)        | 3.3   | 3.3   | 3.3   | 3.3   | 3.3   | 3.3   | 2.7   | 2.7    | 2.7     | 2.7   | 2.7  | 2.7   |
| Lost Time Adjust (s)    | 0.0   | 0.0   | 0.0   | 0.0   | 0.0   | 0.0   |       | 0.0    | 0.0     | 0.0   |      | 0.0   |
| Total Lost Time (s)     | 7.0   | 7.0   | 7.0   | 7.0   | 7.0   | 7.0   |       | 6.4    | 6.4     | 6.4   |      | 6.4   |
| Lead/Lag                | Lead  | Lag   | Lag   | Lead  | Lag   | Lag   | Lead  | Lead   | Lag     | Lag   | Lead | Lead  |
| Lead-Lag Optimize?      |       |       |       |       |       |       |       |        |         |       |      |       |
| Vehicle Extension (s)   | 3.0   | 3.0   | 3.0   | 3.0   | 3.0   | 3.0   | 3.0   | 3.0    | 3.0     | 3.0   | 3.0  | 3.0   |
| Recall Mode             | None  | None  | None  | None  | None  | None  | None  | None   | C-Max   | C-Max | None | None  |
| Walk Time (s)           |       | 7.0   | 7.0   |       | 7.0   | 7.0   |       |        | 7.0     | 7.0   |      |       |
| Flash Dont Walk (s)     |       | 27.0  | 27.0  |       | 27.0  | 27.0  |       |        | 19.0    | 19.0  |      |       |
| Pedestrian Calls (#/hr) |       | 15    | 15    |       | 15    | 15    |       |        | 10      | 10    |      |       |
| Act Effct Green (s)     | 9.0   | 26.7  | 26.7  | 5.0   | 20.3  | 20.3  |       | 17.2   | 63.5    | 63.5  |      | 10.4  |
| Actuated g/C Ratio      | 0.07  | 0.21  | 0.21  | 0.04  | 0.16  | 0.16  |       | 0.13   | 0.49    | 0.49  |      | 0.08  |
| v/c Ratio               | 1.24  | 0.27  | 0.39  | 0.60  | 0.35  | 0.49  |       | 0.81   | 1.01    | 0.16  |      | 0.59  |
| Control Delay           | 186.2 | 53.1  | 15.0  | 81.2  | 48.5  | 9.2   |       | 71.8   | 38.4    | 1.5   |      | 70.3  |
| Queue Delay             | 0.0   | 0.0   | 0.0   | 0.0   | 0.0   | 0.0   |       | 0.0    | 0.0     | 0.0   |      | 0.0   |
| Total Delay             | 186.2 | 53.1  | 15.0  | 81.2  | 48.5  | 9.2   |       | 71.8   | 38.4    | 1.5   |      | 70.3  |
| LOS                     | F     | D     | B     | F     | D     | A     |       | E      | D       | A     |      | E     |
| Approach Delay          |       | 100.7 |       |       | 37.1  |       |       |        | 41.6    |       |      |       |
| Approach LOS            |       | F     |       |       | D     |       |       |        | D       |       |      |       |
| Queue Length 50th (m)   | ~41.4 | 22.6  | 5.2   | 9.0   | 22.0  | 0.0   |       | 42.2   | 81.1    | 1.0   |      | 18.4  |
| Queue Length 95th (m)   | #67.3 | 31.7  | 27.0  | #17.8 | 26.9  | 15.8  |       | m#46.9 | m#250.0 | m1.3  |      | #43.2 |
| Internal Link Dist (m)  |       | 141.4 |       |       | 125.1 |       |       |        | 284.9   |       |      |       |
| Turn Bay Length (m)     | 95.0  |       | 60.0  | 60.0  |       | 75.0  |       | 140.0  |         | 20.0  |      | 90.0  |
| Base Capacity (vph)     | 224   | 941   | 564   | 124   | 875   | 521   |       | 421    | 1620    | 771   |      | 259   |
| Starvation Cap Reductn  | 0     | 0     | 0     | 0     | 0     | 0     |       | 0      | 0       | 0     |      | 0     |
| Spillback Cap Reductn   | 0     | 0     | 0     | 0     | 0     | 0     |       | 0      | 0       | 0     |      | 0     |
| Storage Cap Reductn     | 0     | 0     | 0     | 0     | 0     | 0     |       | 0      | 0       | 0     |      | 0     |
| Reduced v/c Ratio       | 1.24  | 0.19  | 0.32  | 0.60  | 0.21  | 0.37  |       | 0.81   | 1.01    | 0.16  |      | 0.59  |

Intersection Summary

Area Type: Other  
 Cycle Length: 130  
 Actuated Cycle Length: 130  
 Offset: 122 (94%), Referenced to phase 2:NBT and 6:SBT, Start of Green  
 Natural Cycle: 150  
 Control Type: Actuated-Coordinated  
 Maximum v/c Ratio: 1.24  
 Intersection Signal Delay: 44.9  
 Intersection LOS: D  
 Intersection Capacity Utilization 102.5%  
 ICU Level of Service G  
 Analysis Period (min) 15  
 ~ Volume exceeds capacity, queue is theoretically infinite.  
 Queue shown is maximum after two cycles.  
 # 95th percentile volume exceeds capacity, queue may be longer.  
 Queue shown is maximum after two cycles.  
 m Volume for 95th percentile queue is metered by upstream signal.

Splits and Phases: 2: March & Terry Fox

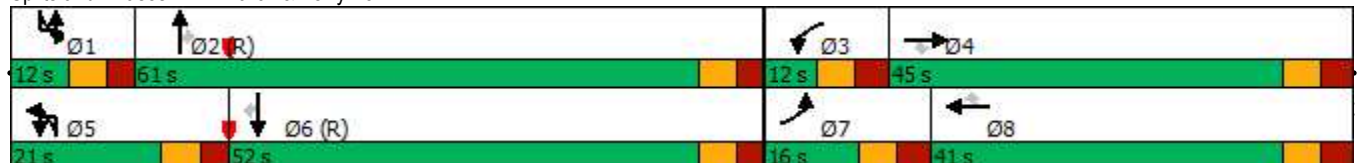



| Lane Group                  | SBT   | SBR   |
|-----------------------------|-------|-------|
| Minimum Initial (s)         | 10.0  | 10.0  |
| Minimum Split (s)           | 32.4  | 32.4  |
| Total Split (s)             | 52.0  | 52.0  |
| Total Split (%)             | 40.0% | 40.0% |
| Maximum Green (s)           | 45.6  | 45.6  |
| Yellow Time (s)             | 3.7   | 3.7   |
| All-Red Time (s)            | 2.7   | 2.7   |
| Lost Time Adjust (s)        | 0.0   | 0.0   |
| Total Lost Time (s)         | 6.4   | 6.4   |
| Lead/Lag                    | Lag   | Lag   |
| Lead-Lag Optimize?          |       |       |
| Vehicle Extension (s)       | 3.0   | 3.0   |
| Recall Mode                 | C-Max | C-Max |
| Walk Time (s)               | 7.0   | 7.0   |
| Flash Dont Walk (s)         | 19.0  | 19.0  |
| Pedestrian Calls (#/hr)     | 10    | 10    |
| Act Effct Green (s)         | 56.7  | 56.7  |
| Actuated g/C Ratio          | 0.44  | 0.44  |
| v/c Ratio                   | 0.67  | 0.27  |
| Control Delay               | 23.6  | 1.6   |
| Queue Delay                 | 0.0   | 0.0   |
| Total Delay                 | 23.6  | 1.6   |
| LOS                         | C     | A     |
| Approach Delay              | 25.7  |       |
| Approach LOS                | C     |       |
| Queue Length 50th (m)       | 47.3  | 0.0   |
| Queue Length 95th (m)       | 55.4  | 4.0   |
| Internal Link Dist (m)      | 294.9 |       |
| Turn Bay Length (m)         |       | 80.0  |
| Base Capacity (vph)         | 1431  | 745   |
| Starvation Cap Reductn      | 0     | 0     |
| Spillback Cap Reductn       | 0     | 0     |
| Storage Cap Reductn         | 0     | 0     |
| Reduced v/c Ratio           | 0.67  | 0.27  |
| <b>Intersection Summary</b> |       |       |

3: March & Solandt  
PM Peak Hour

555-603 March Road  
2037 Total Traffic (post-BRT)

| Lane Group                 | EBL   | EBT   | EBR   | WBL   | WBT   | WBR  | NBU   | NBL   | NBT   | NBR  | SBU   | SBL   |
|----------------------------|-------|-------|-------|-------|-------|------|-------|-------|-------|------|-------|-------|
| Lane Configurations        |       |       |       |       |       |      |       |       |       |      |       |       |
| Traffic Volume (vph)       | 24    | 22    | 175   | 350   | 22    | 45   | 16    | 72    | 1933  | 23   | 12    | 15    |
| Future Volume (vph)        | 24    | 22    | 175   | 350   | 22    | 45   | 16    | 72    | 1933  | 23   | 12    | 15    |
| Ideal Flow (vphpl)         | 1800  | 1800  | 1800  | 1800  | 1800  | 1800 | 1800  | 1800  | 1800  | 1800 | 1800  | 1800  |
| Storage Length (m)         | 35.0  |       | 60.0  | 85.0  |       | 55.0 |       | 165.0 |       | 0.0  |       | 155.0 |
| Storage Lanes              | 1     |       | 1     | 2     |       | 0    |       | 1     |       | 0    |       | 1     |
| Taper Length (m)           | 50.0  |       |       | 95.0  |       |      |       | 40.0  |       |      |       | 25.0  |
| Lane Util. Factor          | 1.00  | 1.00  | 1.00  | 0.97  | 1.00  | 1.00 | 0.95  | 1.00  | 0.95  | 0.95 | 0.95  | 1.00  |
| Ped Bike Factor            | 0.99  |       | 0.98  | 0.99  | 0.99  |      |       | 1.00  | 1.00  |      |       | 1.00  |
| Fr <sub>t</sub>            |       |       | 0.850 |       | 0.899 |      |       |       | 0.998 |      |       |       |
| Flt Protected              | 0.950 |       |       | 0.950 |       |      |       | 0.950 |       |      |       | 0.950 |
| Satd. Flow (prot)          | 1674  | 1695  | 1483  | 3248  | 1459  | 0    | 0     | 1645  | 3307  | 0    | 0     | 1649  |
| Flt Permitted              | 0.950 |       |       | 0.950 |       |      |       | 0.950 |       |      |       | 0.950 |
| Satd. Flow (perm)          | 1664  | 1695  | 1449  | 3214  | 1459  | 0    | 0     | 1641  | 3307  | 0    | 0     | 1648  |
| Right Turn on Red          |       |       | Yes   |       |       | Yes  |       |       |       | Yes  |       |       |
| Satd. Flow (RTOR)          |       |       | 137   |       | 45    |      |       |       | 1     |      |       |       |
| Link Speed (k/h)           |       | 50    |       |       | 50    |      |       |       | 60    |      |       |       |
| Link Distance (m)          |       | 212.6 |       |       | 241.6 |      |       |       | 610.9 |      |       |       |
| Travel Time (s)            |       | 15.3  |       |       | 17.4  |      |       |       | 36.7  |      |       |       |
| Confl. Peds. (#/hr)        | 5     |       | 5     | 5     |       | 5    |       | 5     |       | 5    |       | 5     |
| Confl. Bikes (#/hr)        |       |       | 5     |       |       | 5    |       |       |       | 5    |       |       |
| Peak Hour Factor           | 1.00  | 1.00  | 1.00  | 1.00  | 1.00  | 1.00 | 1.00  | 1.00  | 1.00  | 1.00 | 1.00  | 1.00  |
| Heavy Vehicles (%)         | 1%    | 5%    | 2%    | 1%    | 6%    | 9%   | 2%    | 3%    | 2%    | 6%   | 2%    | 3%    |
| Adj. Flow (vph)            | 24    | 22    | 175   | 350   | 22    | 45   | 16    | 72    | 1933  | 23   | 12    | 15    |
| Shared Lane Traffic (%)    |       |       |       |       |       |      |       |       |       |      |       |       |
| Lane Group Flow (vph)      | 24    | 22    | 175   | 350   | 67    | 0    | 0     | 88    | 1956  | 0    | 0     | 27    |
| Enter Blocked Intersection | No    | No    | No    | No    | No    | No   | No    | No    | No    | No   | No    | No    |
| Lane Alignment             | L NA  | Left  | R NA  | L NA  | Left  | R NA | R NA  | L NA  | Left  | R NA | R NA  | L NA  |
| Median Width(m)            |       | 7.0   |       |       | 10.5  |      |       |       | 17.5  |      |       |       |
| Link Offset(m)             |       | 0.0   |       |       | 0.0   |      |       |       | 0.0   |      |       |       |
| Crosswalk Width(m)         |       | 5.0   |       |       | 5.0   |      |       |       | 5.0   |      |       |       |
| Two way Left Turn Lane     |       |       |       |       |       |      |       |       |       |      |       |       |
| Headway Factor             | 1.09  | 1.09  | 1.09  | 1.09  | 1.09  | 1.09 | 1.09  | 1.09  | 1.09  | 1.09 | 1.09  | 1.09  |
| Number of Detectors        | 1     | 2     | 1     | 1     | 2     |      | 1     | 1     | 2     |      | 1     | 1     |
| Detector Template          | Left  | Thru  | Right | Left  | Thru  |      | Left  | Left  | Thru  |      | Left  | Left  |
| Leading Detector (m)       | 2.0   | 10.0  | 2.0   | 2.0   | 10.0  |      | 2.0   | 2.0   | 10.0  |      | 2.0   | 2.0   |
| Trailing Detector (m)      | 0.0   | 0.0   | 0.0   | 0.0   | 0.0   |      | 0.0   | 0.0   | 0.0   |      | 0.0   | 0.0   |
| Detector 1 Position(m)     | 0.0   | 0.0   | 0.0   | 0.0   | 0.0   |      | 0.0   | 0.0   | 0.0   |      | 0.0   | 0.0   |
| Detector 1 Size(m)         | 2.0   | 0.6   | 2.0   | 2.0   | 0.6   |      | 2.0   | 2.0   | 0.6   |      | 2.0   | 2.0   |
| Detector 1 Type            | Cl+Ex | Cl+Ex | Cl+Ex | Cl+Ex | Cl+Ex |      | Cl+Ex | Cl+Ex | Cl+Ex |      | Cl+Ex | Cl+Ex |
| Detector 1 Channel         |       |       |       |       |       |      |       |       |       |      |       |       |
| Detector 1 Extend (s)      | 0.0   | 0.0   | 0.0   | 0.0   | 0.0   |      | 0.0   | 0.0   | 0.0   |      | 0.0   | 0.0   |
| Detector 1 Queue (s)       | 0.0   | 0.0   | 0.0   | 0.0   | 0.0   |      | 0.0   | 0.0   | 0.0   |      | 0.0   | 0.0   |
| Detector 1 Delay (s)       | 0.0   | 0.0   | 0.0   | 0.0   | 0.0   |      | 0.0   | 0.0   | 0.0   |      | 0.0   | 0.0   |
| Detector 2 Position(m)     |       | 9.4   |       |       | 9.4   |      |       |       | 9.4   |      |       |       |
| Detector 2 Size(m)         |       | 0.6   |       |       | 0.6   |      |       |       | 0.6   |      |       |       |
| Detector 2 Type            |       | Cl+Ex |       |       | Cl+Ex |      |       |       | Cl+Ex |      |       |       |
| Detector 2 Channel         |       |       |       |       |       |      |       |       |       |      |       |       |
| Detector 2 Extend (s)      |       | 0.0   |       |       | 0.0   |      |       |       | 0.0   |      |       |       |
| Turn Type                  | Prot  | NA    | Perm  | Prot  | NA    |      | Prot  | Prot  | NA    |      | Prot  | Prot  |
| Protected Phases           | 7     | 4     |       | 3     | 8     |      | 5     | 5     | 2     |      | 1     | 1     |
| Permitted Phases           |       |       | 4     |       |       |      |       |       |       |      |       |       |
| Detector Phase             | 7     | 4     | 4     | 3     | 8     |      | 5     | 5     | 2     |      | 1     | 1     |
| Switch Phase               |       |       |       |       |       |      |       |       |       |      |       |       |

3: March & Solandt  
PM Peak Hour

555-603 March Road  
2037 Total Traffic (post-BRT)



| Lane Group                 | SBT   | SBR  |
|----------------------------|-------|------|
| Lane Configurations        | ↑↑    |      |
| Traffic Volume (vph)       | 1465  | 16   |
| Future Volume (vph)        | 1465  | 16   |
| Ideal Flow (vphpl)         | 1800  | 1800 |
| Storage Length (m)         |       | 0.0  |
| Storage Lanes              |       | 0    |
| Taper Length (m)           |       |      |
| Lane Util. Factor          | 0.95  | 0.95 |
| Ped Bike Factor            | 1.00  |      |
| Frt                        | 0.998 |      |
| Flt Protected              |       |      |
| Satd. Flow (prot)          | 3307  | 0    |
| Flt Permitted              |       |      |
| Satd. Flow (perm)          | 3307  | 0    |
| Right Turn on Red          |       | Yes  |
| Satd. Flow (RTOR)          | 1     |      |
| Link Speed (k/h)           | 60    |      |
| Link Distance (m)          | 382.6 |      |
| Travel Time (s)            | 23.0  |      |
| Confl. Peds. (#/hr)        |       | 5    |
| Confl. Bikes (#/hr)        |       | 5    |
| Peak Hour Factor           | 1.00  | 1.00 |
| Heavy Vehicles (%)         | 2%    | 3%   |
| Adj. Flow (vph)            | 1465  | 16   |
| Shared Lane Traffic (%)    |       |      |
| Lane Group Flow (vph)      | 1481  | 0    |
| Enter Blocked Intersection | No    | No   |
| Lane Alignment             | Left  | R NA |
| Median Width(m)            | 17.5  |      |
| Link Offset(m)             | 0.0   |      |
| Crosswalk Width(m)         | 5.0   |      |
| Two way Left Turn Lane     |       |      |
| Headway Factor             | 1.09  | 1.09 |
| Number of Detectors        | 2     |      |
| Detector Template          | Thru  |      |
| Leading Detector (m)       | 10.0  |      |
| Trailing Detector (m)      | 0.0   |      |
| Detector 1 Position(m)     | 0.0   |      |
| Detector 1 Size(m)         | 0.6   |      |
| Detector 1 Type            | Cl+Ex |      |
| Detector 1 Channel         |       |      |
| Detector 1 Extend (s)      | 0.0   |      |
| Detector 1 Queue (s)       | 0.0   |      |
| Detector 1 Delay (s)       | 0.0   |      |
| Detector 2 Position(m)     | 9.4   |      |
| Detector 2 Size(m)         | 0.6   |      |
| Detector 2 Type            | Cl+Ex |      |
| Detector 2 Channel         |       |      |
| Detector 2 Extend (s)      | 0.0   |      |
| Turn Type                  | NA    |      |
| Protected Phases           | 6     |      |
| Permitted Phases           |       |      |
| Detector Phase             | 6     |      |
| Switch Phase               |       |      |

3: March & Solandt  
PM Peak Hour

555-603 March Road  
2037 Total Traffic (post-BRT)



| Lane Group              | EBL   | EBT   | EBR   | WBL   | WBT   | WBR | NBU   | NBL   | NBT    | NBR | SBU  | SBL   |
|-------------------------|-------|-------|-------|-------|-------|-----|-------|-------|--------|-----|------|-------|
| Minimum Initial (s)     | 5.0   | 10.0  | 10.0  | 5.0   | 10.0  |     | 5.0   | 5.0   | 10.0   |     | 5.0  | 5.0   |
| Minimum Split (s)       | 11.5  | 36.5  | 36.5  | 11.5  | 36.5  |     | 12.0  | 12.0  | 26.8   |     | 12.0 | 12.0  |
| Total Split (s)         | 16.3  | 36.5  | 36.5  | 22.5  | 42.7  |     | 15.0  | 15.0  | 59.0   |     | 12.0 | 12.0  |
| Total Split (%)         | 12.5% | 28.1% | 28.1% | 17.3% | 32.8% |     | 11.5% | 11.5% | 45.4%  |     | 9.2% | 9.2%  |
| Maximum Green (s)       | 9.8   | 30.0  | 30.0  | 16.0  | 36.2  |     | 8.0   | 8.0   | 53.2   |     | 5.0  | 5.0   |
| Yellow Time (s)         | 3.3   | 3.3   | 3.3   | 3.3   | 3.3   |     | 3.7   | 3.7   | 3.7    |     | 3.7  | 3.7   |
| All-Red Time (s)        | 3.2   | 3.2   | 3.2   | 3.2   | 3.2   |     | 3.3   | 3.3   | 2.1    |     | 3.3  | 3.3   |
| Lost Time Adjust (s)    | 0.0   | 0.0   | 0.0   | 0.0   | 0.0   |     |       | 0.0   | 0.0    |     |      | 0.0   |
| Total Lost Time (s)     | 6.5   | 6.5   | 6.5   | 6.5   | 6.5   |     |       | 7.0   | 5.8    |     |      | 7.0   |
| Lead/Lag                | Lead  | Lag   | Lag   | Lead  | Lag   |     | Lead  | Lead  | Lag    |     | Lead | Lead  |
| Lead-Lag Optimize?      | Yes   |       |       |       | Yes   |     |       |       |        |     |      |       |
| Vehicle Extension (s)   | 3.0   | 3.0   | 3.0   | 3.0   | 3.0   |     | 3.0   | 3.0   | 3.0    |     | 3.0  | 3.0   |
| Recall Mode             | None  | None  | None  | None  | None  |     | None  | None  | C-Max  |     | None | None  |
| Walk Time (s)           |       | 7.0   | 7.0   |       | 7.0   |     |       |       | 7.0    |     |      |       |
| Flash Dont Walk (s)     |       | 23.0  | 23.0  |       | 23.0  |     |       |       | 14.0   |     |      |       |
| Pedestrian Calls (#/hr) |       | 5     | 5     |       | 5     |     |       |       | 5      |     |      |       |
| Act Effct Green (s)     | 7.4   | 14.6  | 14.6  | 15.9  | 27.9  |     |       | 11.7  | 72.4   |     |      | 6.6   |
| Actuated g/C Ratio      | 0.06  | 0.11  | 0.11  | 0.12  | 0.21  |     |       | 0.09  | 0.56   |     |      | 0.05  |
| v/c Ratio               | 0.25  | 0.12  | 0.62  | 0.88  | 0.19  |     |       | 0.59  | 1.06   |     |      | 0.32  |
| Control Delay           | 64.4  | 49.3  | 23.3  | 80.1  | 19.0  |     |       | 73.3  | 69.0   |     |      | 73.4  |
| Queue Delay             | 0.0   | 0.0   | 0.0   | 0.0   | 0.0   |     |       | 0.0   | 0.0    |     |      | 0.0   |
| Total Delay             | 64.4  | 49.3  | 23.3  | 80.1  | 19.0  |     |       | 73.3  | 69.0   |     |      | 73.4  |
| LOS                     | E     | D     | C     | F     | B     |     |       | E     | E      |     |      | E     |
| Approach Delay          |       | 30.3  |       |       | 70.3  |     |       |       | 69.2   |     |      |       |
| Approach LOS            |       | C     |       |       | E     |     |       |       | E      |     |      |       |
| Queue Length 50th (m)   | 5.5   | 4.9   | 8.7   | 42.4  | 4.6   |     |       | 19.9  | ~273.1 |     |      | 5.5   |
| Queue Length 95th (m)   | 13.6  | 10.8  | 25.7  | #65.9 | 14.3  |     |       | #49.7 | #371.3 |     |      | m8.5  |
| Internal Link Dist (m)  |       | 188.6 |       |       | 217.6 |     |       |       | 586.9  |     |      |       |
| Turn Bay Length (m)     | 35.0  |       | 60.0  | 85.0  |       |     |       | 165.0 |        |     |      | 155.0 |
| Base Capacity (vph)     | 126   | 391   | 439   | 399   | 438   |     |       | 148   | 1840   |     |      | 84    |
| Starvation Cap Reductn  | 0     | 0     | 0     | 0     | 0     |     |       | 0     | 0      |     |      | 0     |
| Spillback Cap Reductn   | 0     | 0     | 0     | 0     | 0     |     |       | 0     | 0      |     |      | 0     |
| Storage Cap Reductn     | 0     | 0     | 0     | 0     | 0     |     |       | 0     | 0      |     |      | 0     |
| Reduced v/c Ratio       | 0.19  | 0.06  | 0.40  | 0.88  | 0.15  |     |       | 0.59  | 1.06   |     |      | 0.32  |

Intersection Summary

Area Type: Other  
 Cycle Length: 130  
 Actuated Cycle Length: 130  
 Offset: 63 (48%), Referenced to phase 2:NBT and 6:SBT, Start of Green  
 Natural Cycle: 150  
 Control Type: Actuated-Coordinated  
 Maximum v/c Ratio: 1.06  
 Intersection Signal Delay: 56.7  
 Intersection LOS: E  
 Intersection Capacity Utilization 95.8%  
 ICU Level of Service F  
 Analysis Period (min) 15  
 ~ Volume exceeds capacity, queue is theoretically infinite.  
 Queue shown is maximum after two cycles.  
 # 95th percentile volume exceeds capacity, queue may be longer.  
 Queue shown is maximum after two cycles.  
 m Volume for 95th percentile queue is metered by upstream signal.

Splits and Phases: 3: March & Solandt

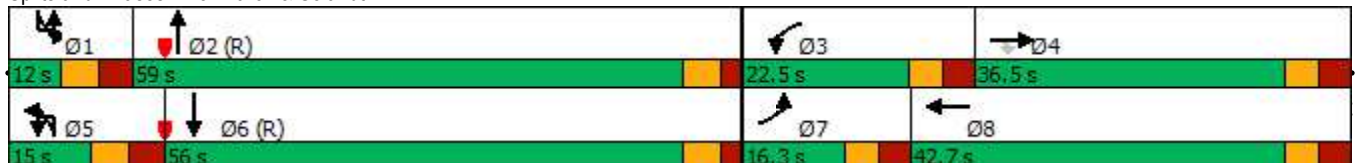



| Lane Group                  | SBT     | SBR |
|-----------------------------|---------|-----|
| Minimum Initial (s)         | 10.0    |     |
| Minimum Split (s)           | 26.8    |     |
| Total Split (s)             | 56.0    |     |
| Total Split (%)             | 43.1%   |     |
| Maximum Green (s)           | 50.2    |     |
| Yellow Time (s)             | 3.7     |     |
| All-Red Time (s)            | 2.1     |     |
| Lost Time Adjust (s)        | 0.0     |     |
| Total Lost Time (s)         | 5.8     |     |
| Lead/Lag                    | Lag     |     |
| Lead-Lag Optimize?          |         |     |
| Vehicle Extension (s)       | 3.0     |     |
| Recall Mode                 | C-Max   |     |
| Walk Time (s)               | 7.0     |     |
| Flash Dont Walk (s)         | 14.0    |     |
| Pedestrian Calls (#/hr)     | 5       |     |
| Act Effct Green (s)         | 62.0    |     |
| Actuated g/C Ratio          | 0.48    |     |
| v/c Ratio                   | 0.94    |     |
| Control Delay               | 39.3    |     |
| Queue Delay                 | 0.0     |     |
| Total Delay                 | 39.3    |     |
| LOS                         | D       |     |
| Approach Delay              | 39.9    |     |
| Approach LOS                | D       |     |
| Queue Length 50th (m)       | 181.0   |     |
| Queue Length 95th (m)       | m#259.8 |     |
| Internal Link Dist (m)      | 358.6   |     |
| Turn Bay Length (m)         |         |     |
| Base Capacity (vph)         | 1578    |     |
| Starvation Cap Reductn      | 0       |     |
| Spillback Cap Reductn       | 0       |     |
| Storage Cap Reductn         | 0       |     |
| Reduced v/c Ratio           | 0.94    |     |
| <b>Intersection Summary</b> |         |     |

6: March & Site Access/Nokia Access  
PM Peak Hour

555-603 March Road  
2037 Total Traffic (post-BRT)



| Lane Group                 | EBL   | EBT   | EBR  | WBL   | WBT   | WBR  | NBL   | NBT   | NBR   | SBL   | SBT   | SBR   |
|----------------------------|-------|-------|------|-------|-------|------|-------|-------|-------|-------|-------|-------|
| Lane Configurations        |       |       |      |       |       |      |       |       |       |       |       |       |
| Traffic Volume (vph)       | 68    | 3     | 186  | 236   | 2     | 402  | 154   | 1574  | 204   | 95    | 1044  | 43    |
| Future Volume (vph)        | 68    | 3     | 186  | 236   | 2     | 402  | 154   | 1574  | 204   | 95    | 1044  | 43    |
| Ideal Flow (vphpl)         | 1800  | 1800  | 1800 | 1800  | 1800  | 1800 | 1800  | 1800  | 1800  | 1800  | 1800  | 1800  |
| Storage Length (m)         | 65.0  |       | 0.0  | 65.0  |       | 0.0  | 75.0  |       | 100.0 | 75.0  |       | 0.0   |
| Storage Lanes              | 1     |       | 0    | 1     |       | 0    | 1     |       | 1     | 1     |       | 0     |
| Taper Length (m)           | 20.0  |       |      | 25.0  |       |      | 50.0  |       |       | 50.0  |       |       |
| Lane Util. Factor          | 1.00  | 1.00  | 1.00 | 1.00  | 1.00  | 1.00 | 1.00  | 0.95  | 1.00  | 1.00  | 0.95  | 0.95  |
| Ped Bike Factor            |       |       |      | 0.99  | 0.97  |      |       |       | 0.94  | 1.00  |       |       |
| Fr                         |       | 0.852 |      |       | 0.851 |      |       |       | 0.850 |       | 0.994 |       |
| Flt Protected              | 0.950 |       |      | 0.950 |       |      | 0.950 |       |       | 0.950 |       |       |
| Satd. Flow (prot)          | 1658  | 1487  | 0    | 1674  | 1456  | 0    | 1658  | 3283  | 1498  | 1674  | 3265  | 0     |
| Flt Permitted              | 0.150 |       |      | 0.467 |       |      | 0.950 |       |       | 0.950 |       |       |
| Satd. Flow (perm)          | 262   | 1487  | 0    | 816   | 1456  | 0    | 1658  | 3283  | 1409  | 1667  | 3265  | 0     |
| Right Turn on Red          |       |       | Yes  |       |       | Yes  |       |       | Yes   |       |       | Yes   |
| Satd. Flow (RTOR)          |       | 186   |      |       | 154   |      |       |       | 194   |       |       | 3     |
| Link Speed (k/h)           |       | 50    |      |       | 50    |      |       | 60    |       |       |       | 60    |
| Link Distance (m)          |       | 126.2 |      |       | 167.8 |      |       | 227.7 |       |       |       | 308.9 |
| Travel Time (s)            |       | 9.1   |      |       | 12.1  |      |       | 13.7  |       |       |       | 18.5  |
| Confl. Peds. (#/hr)        |       |       |      | 10    |       | 10   |       |       | 10    | 10    |       |       |
| Confl. Bikes (#/hr)        |       |       |      |       |       | 5    |       |       | 5     |       |       |       |
| Peak Hour Factor           | 1.00  | 1.00  | 1.00 | 1.00  | 1.00  | 1.00 | 1.00  | 1.00  | 1.00  | 1.00  | 1.00  | 1.00  |
| Heavy Vehicles (%)         | 2%    | 2%    | 2%   | 1%    | 2%    | 1%   | 2%    | 3%    | 1%    | 1%    | 3%    | 2%    |
| Adj. Flow (vph)            | 68    | 3     | 186  | 236   | 2     | 402  | 154   | 1574  | 204   | 95    | 1044  | 43    |
| Shared Lane Traffic (%)    |       |       |      |       |       |      |       |       |       |       |       |       |
| Lane Group Flow (vph)      | 68    | 189   | 0    | 236   | 404   | 0    | 154   | 1574  | 204   | 95    | 1087  | 0     |
| Enter Blocked Intersection | No    | No    | No   | No    | No    | No   | No    | No    | No    | No    | No    | No    |
| Lane Alignment             | L NA  | Left  | R NA | L NA  | Left  | R NA | Left  | Left  | Right | Left  | Left  | Right |
| Median Width(m)            |       | 3.5   |      |       | 3.5   |      |       | 17.5  |       |       |       | 17.5  |
| Link Offset(m)             |       | 0.0   |      |       | 0.0   |      |       | 0.0   |       |       |       | 0.0   |
| Crosswalk Width(m)         |       | 5.0   |      |       | 5.0   |      |       | 5.0   |       |       |       | 5.0   |
| Two way Left Turn Lane     |       |       |      |       |       |      |       |       |       |       |       |       |
| Headway Factor             | 1.09  | 1.09  | 1.09 | 1.09  | 1.09  | 1.09 | 1.09  | 1.09  | 1.09  | 1.09  | 1.09  | 1.09  |
| Number of Detectors        | 1     | 2     |      | 1     | 2     |      | 1     | 2     | 1     | 1     | 2     |       |
| Detector Template          | Left  | Thru  |      | Left  | Thru  |      | Left  | Thru  | Right | Left  | Thru  |       |
| Leading Detector (m)       | 2.0   | 10.0  |      | 2.0   | 10.0  |      | 2.0   | 10.0  | 2.0   | 2.0   | 10.0  |       |
| Trailing Detector (m)      | 0.0   | 0.0   |      | 0.0   | 0.0   |      | 0.0   | 0.0   | 0.0   | 0.0   | 0.0   |       |
| Detector 1 Position(m)     | 0.0   | 0.0   |      | 0.0   | 0.0   |      | 0.0   | 0.0   | 0.0   | 0.0   | 0.0   |       |
| Detector 1 Size(m)         | 2.0   | 0.6   |      | 2.0   | 0.6   |      | 2.0   | 0.6   | 2.0   | 2.0   | 0.6   |       |
| Detector 1 Type            | Cl+Ex | Cl+Ex |      | Cl+Ex | Cl+Ex |      | Cl+Ex | Cl+Ex | Cl+Ex | Cl+Ex | Cl+Ex |       |
| Detector 1 Channel         |       |       |      |       |       |      |       |       |       |       |       |       |
| Detector 1 Extend (s)      | 0.0   | 0.0   |      | 0.0   | 0.0   |      | 0.0   | 0.0   | 0.0   | 0.0   | 0.0   |       |
| Detector 1 Queue (s)       | 0.0   | 0.0   |      | 0.0   | 0.0   |      | 0.0   | 0.0   | 0.0   | 0.0   | 0.0   |       |
| Detector 1 Delay (s)       | 0.0   | 0.0   |      | 0.0   | 0.0   |      | 0.0   | 0.0   | 0.0   | 0.0   | 0.0   |       |
| Detector 2 Position(m)     |       | 9.4   |      |       | 9.4   |      |       | 9.4   |       |       | 9.4   |       |
| Detector 2 Size(m)         |       | 0.6   |      |       | 0.6   |      |       | 0.6   |       |       | 0.6   |       |
| Detector 2 Type            |       | Cl+Ex |      |       | Cl+Ex |      |       | Cl+Ex |       |       | Cl+Ex |       |
| Detector 2 Channel         |       |       |      |       |       |      |       |       |       |       |       |       |
| Detector 2 Extend (s)      |       | 0.0   |      |       | 0.0   |      |       | 0.0   |       |       | 0.0   |       |
| Turn Type                  | pm+pt | NA    |      | pm+pt | NA    |      | Prot  | NA    | Perm  | Prot  | NA    |       |
| Protected Phases           | 7     | 4     |      | 3     | 8     |      | 5     | 2     |       | 1     | 6     |       |
| Permitted Phases           | 4     |       |      | 8     |       |      |       |       | 2     |       |       |       |
| Detector Phase             | 7     | 4     |      | 3     | 8     |      | 5     | 2     | 2     | 1     | 6     |       |
| Switch Phase               |       |       |      |       |       |      |       |       |       |       |       |       |





| Lane Group              | EBL  | EBT   | EBR | WBL   | WBT    | WBR | NBL   | NBT    | NBR   | SBL    | SBT    | SBR |
|-------------------------|------|-------|-----|-------|--------|-----|-------|--------|-------|--------|--------|-----|
| Minimum Initial (s)     | 5.0  | 10.0  |     | 5.0   | 10.0   |     | 5.0   | 10.0   | 10.0  | 5.0    | 10.0   |     |
| Minimum Split (s)       | 11.5 | 36.5  |     | 11.5  | 36.5   |     | 12.0  | 23.8   | 23.8  | 12.0   | 23.8   |     |
| Total Split (s)         | 12.0 | 37.0  |     | 13.0  | 38.0   |     | 28.0  | 66.0   | 66.0  | 14.0   | 52.0   |     |
| Total Split (%)         | 9.2% | 28.5% |     | 10.0% | 29.2%  |     | 21.5% | 50.8%  | 50.8% | 10.8%  | 40.0%  |     |
| Maximum Green (s)       | 5.5  | 30.5  |     | 6.5   | 31.5   |     | 21.0  | 60.2   | 60.2  | 7.0    | 46.2   |     |
| Yellow Time (s)         | 3.3  | 3.3   |     | 3.3   | 3.3    |     | 3.7   | 3.7    | 3.7   | 3.7    | 3.7    |     |
| All-Red Time (s)        | 3.2  | 3.2   |     | 3.2   | 3.2    |     | 3.3   | 2.1    | 2.1   | 3.3    | 2.1    |     |
| Lost Time Adjust (s)    | 0.0  | 0.0   |     | 0.0   | 0.0    |     | 0.0   | 0.0    | 0.0   | 0.0    | 0.0    |     |
| Total Lost Time (s)     | 6.5  | 6.5   |     | 6.5   | 6.5    |     | 7.0   | 5.8    | 5.8   | 7.0    | 5.8    |     |
| Lead/Lag                | Lead | Lag   |     | Lead  | Lag    |     | Lead  | Lag    | Lag   | Lead   | Lag    |     |
| Lead-Lag Optimize?      |      |       |     |       |        |     |       |        |       |        |        |     |
| Vehicle Extension (s)   | 3.0  | 3.0   |     | 3.0   | 3.0    |     | 3.0   | 3.0    | 3.0   | 3.0    | 3.0    |     |
| Recall Mode             | None | None  |     | None  | None   |     | None  | C-Max  | C-Max | None   | C-Max  |     |
| Walk Time (s)           |      | 7.0   |     |       | 7.0    |     |       | 7.0    | 7.0   |        | 7.0    |     |
| Flash Dont Walk (s)     |      | 23.0  |     |       | 23.0   |     |       | 11.0   | 11.0  |        | 11.0   |     |
| Pedestrian Calls (#/hr) |      | 10    |     |       | 10     |     |       | 10     | 10    |        | 10     |     |
| Act Effct Green (s)     | 30.9 | 25.4  |     | 34.0  | 28.8   |     | 16.7  | 62.8   | 62.8  | 9.5    | 55.6   |     |
| Actuated g/C Ratio      | 0.24 | 0.20  |     | 0.26  | 0.22   |     | 0.13  | 0.48   | 0.48  | 0.07   | 0.43   |     |
| v/c Ratio               | 0.56 | 0.43  |     | 0.92  | 0.91   |     | 0.72  | 0.99   | 0.26  | 0.78   | 0.78   |     |
| Control Delay           | 50.5 | 9.0   |     | 81.7  | 56.2   |     | 71.8  | 22.0   | 1.0   | 93.2   | 31.4   |     |
| Queue Delay             | 0.0  | 0.0   |     | 0.0   | 0.0    |     | 0.0   | 0.0    | 0.0   | 0.0    | 0.0    |     |
| Total Delay             | 50.5 | 9.0   |     | 81.7  | 56.2   |     | 71.8  | 22.0   | 1.0   | 93.2   | 31.4   |     |
| LOS                     | D    | A     |     | F     | E      |     | E     | C      | A     | F      | C      |     |
| Approach Delay          |      | 20.0  |     |       | 65.6   |     |       | 23.7   |       |        | 36.3   |     |
| Approach LOS            |      | C     |     |       | E      |     |       | C      |       |        | D      |     |
| Queue Length 50th (m)   | 11.1 | 0.6   |     | 43.0  | 59.8   |     | 31.7  | ~214.3 | 4.7   | ~25.2  | 43.1   |     |
| Queue Length 95th (m)   | 21.2 | 17.7  |     | #79.7 | #110.7 |     | m32.1 | m197.2 | m0.0  | m#51.7 | #162.6 |     |
| Internal Link Dist (m)  |      | 102.2 |     |       | 143.8  |     |       | 203.7  |       |        | 284.9  |     |
| Turn Bay Length (m)     | 65.0 |       |     | 65.0  |        |     | 75.0  |        | 100.0 | 75.0   |        |     |
| Base Capacity (vph)     | 121  | 491   |     | 256   | 469    |     | 267   | 1587   | 781   | 122    | 1397   |     |
| Starvation Cap Reductn  | 0    | 0     |     | 0     | 0      |     | 0     | 0      | 0     | 0      | 0      |     |
| Spillback Cap Reductn   | 0    | 0     |     | 0     | 0      |     | 0     | 0      | 0     | 0      | 0      |     |
| Storage Cap Reductn     | 0    | 0     |     | 0     | 0      |     | 0     | 0      | 0     | 0      | 0      |     |
| Reduced v/c Ratio       | 0.56 | 0.38  |     | 0.92  | 0.86   |     | 0.58  | 0.99   | 0.26  | 0.78   | 0.78   |     |

Intersection Summary

Area Type: Other  
 Cycle Length: 130  
 Actuated Cycle Length: 130  
 Offset: 116 (89%), Referenced to phase 2:NBT and 6:SBT, Start of Green  
 Natural Cycle: 135  
 Control Type: Actuated-Coordinated  
 Maximum v/c Ratio: 0.99  
 Intersection Signal Delay: 33.9  
 Intersection LOS: C  
 Intersection Capacity Utilization 104.6%  
 ICU Level of Service G  
 Analysis Period (min) 15  
 ~ Volume exceeds capacity, queue is theoretically infinite.  
 Queue shown is maximum after two cycles.  
 # 95th percentile volume exceeds capacity, queue may be longer.  
 Queue shown is maximum after two cycles.  
 m Volume for 95th percentile queue is metered by upstream signal.

Splits and Phases: 6: March & Site Access/Nokia Access

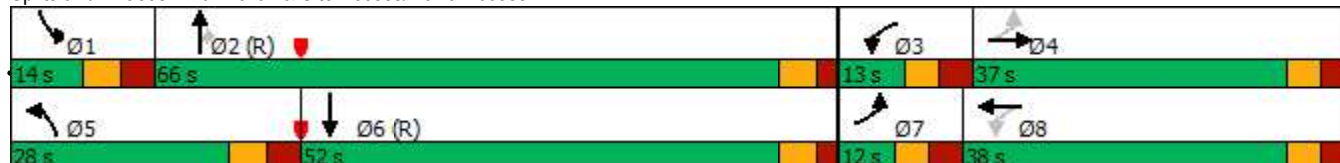

6: March & Site Access/Nokia Access  
PM Peak Hour

555-603 March Road  
2037 Total Traffic (post-BRT, SBR)



| Lane Group                 | EBL   | EBT   | EBR  | WBL   | WBT   | WBR  | NBL   | NBT   | NBR   | SBL   | SBT   | SBR   |
|----------------------------|-------|-------|------|-------|-------|------|-------|-------|-------|-------|-------|-------|
| Lane Configurations        |       |       |      |       |       |      |       |       |       |       |       |       |
| Traffic Volume (vph)       | 68    | 3     | 186  | 236   | 2     | 402  | 154   | 1574  | 204   | 95    | 1044  | 43    |
| Future Volume (vph)        | 68    | 3     | 186  | 236   | 2     | 402  | 154   | 1574  | 204   | 95    | 1044  | 43    |
| Ideal Flow (vphpl)         | 1800  | 1800  | 1800 | 1800  | 1800  | 1800 | 1800  | 1800  | 1800  | 1800  | 1800  | 1800  |
| Storage Length (m)         | 65.0  |       | 0.0  | 65.0  |       | 0.0  | 75.0  |       | 100.0 | 75.0  |       | 30.0  |
| Storage Lanes              | 1     |       | 0    | 1     |       | 0    | 1     |       | 1     | 1     |       | 1     |
| Taper Length (m)           | 20.0  |       |      | 25.0  |       |      | 50.0  |       |       | 50.0  |       |       |
| Lane Util. Factor          | 1.00  | 1.00  | 1.00 | 1.00  | 1.00  | 1.00 | 1.00  | 0.95  | 1.00  | 1.00  | 0.95  | 1.00  |
| Ped Bike Factor            |       |       |      | 0.99  | 0.97  |      |       |       | 0.94  | 1.00  |       |       |
| Frt                        |       | 0.852 |      |       | 0.851 |      |       |       | 0.850 |       |       | 0.850 |
| Flt Protected              | 0.950 |       |      | 0.950 |       |      | 0.950 |       |       | 0.950 |       |       |
| Satd. Flow (prot)          | 1658  | 1487  | 0    | 1674  | 1456  | 0    | 1658  | 3283  | 1498  | 1674  | 3283  | 1483  |
| Flt Permitted              | 0.150 |       |      | 0.467 |       |      | 0.950 |       |       | 0.950 |       |       |
| Satd. Flow (perm)          | 262   | 1487  | 0    | 816   | 1456  | 0    | 1658  | 3283  | 1409  | 1667  | 3283  | 1483  |
| Right Turn on Red          |       |       | Yes  |       |       | Yes  |       |       | Yes   |       |       | Yes   |
| Satd. Flow (RTOR)          |       | 186   |      |       | 154   |      |       |       | 194   |       |       | 201   |
| Link Speed (k/h)           |       | 50    |      |       | 50    |      |       | 60    |       |       | 60    |       |
| Link Distance (m)          |       | 126.2 |      |       | 167.8 |      |       | 227.7 |       |       | 308.9 |       |
| Travel Time (s)            |       | 9.1   |      |       | 12.1  |      |       | 13.7  |       |       | 18.5  |       |
| Confl. Peds. (#/hr)        |       |       |      | 10    |       | 10   |       |       | 10    | 10    |       |       |
| Confl. Bikes (#/hr)        |       |       |      |       |       | 5    |       |       | 5     |       |       |       |
| Peak Hour Factor           | 1.00  | 1.00  | 1.00 | 1.00  | 1.00  | 1.00 | 1.00  | 1.00  | 1.00  | 1.00  | 1.00  | 1.00  |
| Heavy Vehicles (%)         | 2%    | 2%    | 2%   | 1%    | 2%    | 1%   | 2%    | 3%    | 1%    | 1%    | 3%    | 2%    |
| Adj. Flow (vph)            | 68    | 3     | 186  | 236   | 2     | 402  | 154   | 1574  | 204   | 95    | 1044  | 43    |
| Shared Lane Traffic (%)    |       |       |      |       |       |      |       |       |       |       |       |       |
| Lane Group Flow (vph)      | 68    | 189   | 0    | 236   | 404   | 0    | 154   | 1574  | 204   | 95    | 1044  | 43    |
| Enter Blocked Intersection | No    | No    | No   | No    | No    | No   | No    | No    | No    | No    | No    | No    |
| Lane Alignment             | L NA  | Left  | R NA | L NA  | Left  | R NA | Left  | Left  | Right | Left  | Left  | Right |
| Median Width(m)            |       | 3.5   |      |       | 3.5   |      |       | 17.5  |       |       | 17.5  |       |
| Link Offset(m)             |       | 0.0   |      |       | 0.0   |      |       | 0.0   |       |       | 0.0   |       |
| Crosswalk Width(m)         |       | 5.0   |      |       | 5.0   |      |       | 5.0   |       |       | 5.0   |       |
| Two way Left Turn Lane     |       |       |      |       |       |      |       |       |       |       |       |       |
| Headway Factor             | 1.09  | 1.09  | 1.09 | 1.09  | 1.09  | 1.09 | 1.09  | 1.09  | 1.09  | 1.09  | 1.09  | 1.09  |
| Number of Detectors        | 1     | 2     |      | 1     | 2     |      | 1     | 2     | 1     | 1     | 2     | 1     |
| Detector Template          | Left  | Thru  |      | Left  | Thru  |      | Left  | Thru  | Right | Left  | Thru  | Right |
| Leading Detector (m)       | 2.0   | 10.0  |      | 2.0   | 10.0  |      | 2.0   | 10.0  | 2.0   | 2.0   | 10.0  | 2.0   |
| Trailing Detector (m)      | 0.0   | 0.0   |      | 0.0   | 0.0   |      | 0.0   | 0.0   | 0.0   | 0.0   | 0.0   | 0.0   |
| Detector 1 Position(m)     | 0.0   | 0.0   |      | 0.0   | 0.0   |      | 0.0   | 0.0   | 0.0   | 0.0   | 0.0   | 0.0   |
| Detector 1 Size(m)         | 2.0   | 0.6   |      | 2.0   | 0.6   |      | 2.0   | 0.6   | 2.0   | 2.0   | 0.6   | 2.0   |
| Detector 1 Type            | Cl+Ex | Cl+Ex |      | Cl+Ex | Cl+Ex |      | Cl+Ex | Cl+Ex | Cl+Ex | Cl+Ex | Cl+Ex | Cl+Ex |
| Detector 1 Channel         |       |       |      |       |       |      |       |       |       |       |       |       |
| Detector 1 Extend (s)      | 0.0   | 0.0   |      | 0.0   | 0.0   |      | 0.0   | 0.0   | 0.0   | 0.0   | 0.0   | 0.0   |
| Detector 1 Queue (s)       | 0.0   | 0.0   |      | 0.0   | 0.0   |      | 0.0   | 0.0   | 0.0   | 0.0   | 0.0   | 0.0   |
| Detector 1 Delay (s)       | 0.0   | 0.0   |      | 0.0   | 0.0   |      | 0.0   | 0.0   | 0.0   | 0.0   | 0.0   | 0.0   |
| Detector 2 Position(m)     |       | 9.4   |      |       | 9.4   |      |       | 9.4   |       |       | 9.4   |       |
| Detector 2 Size(m)         |       | 0.6   |      |       | 0.6   |      |       | 0.6   |       |       | 0.6   |       |
| Detector 2 Type            |       | Cl+Ex |      |       | Cl+Ex |      |       | Cl+Ex |       |       | Cl+Ex |       |
| Detector 2 Channel         |       |       |      |       |       |      |       |       |       |       |       |       |
| Detector 2 Extend (s)      |       | 0.0   |      |       | 0.0   |      |       | 0.0   |       |       | 0.0   |       |
| Turn Type                  | pm+pt | NA    |      | pm+pt | NA    |      | Prot  | NA    | Perm  | Prot  | NA    | Perm  |
| Protected Phases           | 7     | 4     |      | 3     | 8     |      | 5     | 2     |       | 1     | 6     |       |
| Permitted Phases           | 4     |       |      | 8     |       |      |       |       | 2     |       |       | 6     |
| Detector Phase             | 7     | 4     |      | 3     | 8     |      | 5     | 2     | 2     | 1     | 6     | 6     |
| Switch Phase               |       |       |      |       |       |      |       |       |       |       |       |       |

